

# AIRSEPT® 2018 CATALOG

OE-APPROVED, TECHNICIAN-FRIENDLY

ARE YOU  
R1234yf AND  
R134a  
READY?



PROTECT  
TRANSMISSIONS  
FROM DEBRIS  
page 40



STOP  
COMPRESSOR  
DEBRIS  
page 23



PROTECT  
A/C REPAIRS  
page 26

FASTER, SMARTER LINE REPAIR  
page 12



RESTORE  
HEADLIGHT LENS  
CLARITY  
page 45



DUAL-TANK  
TECHNOLOGY PROVIDES  
CLEAN SOLVENT FOR  
EVERY FLUSH  
page 37

INEXPENSIVE  
INSURANCE AGAINST  
REVENUE-KILLING  
EQUIPMENT  
DOWNTIME  
page 18



ADD A CABIN  
AIR FILTER  
page 34

CELEBRATING 27 YEARS OF SERVICE SOLUTIONS



# AIRSEPT®



## 27 YEARS OF SERVICE SOLUTIONS

### We Solve Repair Problems

In 1989, AirSept created the first product to effectively eliminate mold, mildew and odor in mobile air conditioning systems. AirSept's Cooling Coil Coating is used by 18 OE vehicle manufacturers worldwide because it is the only product that prevents the return of A/C odor for up to three years.

AirSept is the industry leader in developing OEM and aftermarket solutions to complex automotive repair problems. AirSept products are designed to save time, money and labor.



#### SMART SPLICE™

The ultimate OE-approved line repair solution. Installs on the vehicle in five minutes or less without special tools or adhesives. Durable and leak-proof to 2600 PSI

Page 4



#### RECYCLE GUARD™

The ONLY filter that traps all types of contaminants. Protects expensive A/C service equipment. Compatible with all equipment makes

Page 19



#### COMPRESSOR GUARD™

OE-approved filters protect replacement compressors from residual debris. Available as screens installed in the suction line or as plates mounted between suction hose and compressor

Page 25



#### BLEND DOOR REPAIR KITS

HVAC blend door repair often requires console/dash removal and up to ten hours labor. AirSept Blend Door Repair Kits reduce labor time by up to 80%

Page 35



#### R1234yf SERVICE TOOLS

A complete line of professional grade tools and equipment to service vehicles equipped with R1234yf refrigerant

Page 27 & 28



#### HIGH AND LOW SIDE PORT EXTENDER

A/C high and low side service ports can be obstructed and inaccessible with standard service couplers. High Side Extender solves the problem. Available for R134a & R1234yf systems

Page 27 & 28



#### EVC™ VARIABLE DISPLACEMENT COMPRESSOR TESTER

Our Award winning EVC tester sends commands to the compressor's electronic control solenoid valve without connecting to the vehicle's electrical system.

Page 30



#### GM CABIN AIR FILTER RETRO KIT

OE-approved design allows cabin air filter installation on millions of 2007-2014 GM trucks, vans and SUVs not factory-equipped with a CAF

Page 34



#### A/C CHARGE GUARD

Eliminates risk of electrical damage due to PAG oil entering Electric Compressors on Hybrid vehicles

Page 20

# AIRSEPT 2018 REPAIR SOLUTIONS CATALOG

## Table of Contents

### LINE REPAIR SOLUTIONS

Smart Splice™	4
Smart Splice Line Splice™	5
Smart Splice Line Splice™	6
Smart Splice Line Terminator™	7
Smart Splice™ Inline Service Port "T"	8
Smart Splice™ Line-To-Hose Connector	9
Smart Splice™ Hose-To-Hose Connector	10
Smart Splice™	
Barbed Line-To-Hose Connectors	10
Smart Splice™ Aluminum Tube Insert Kit	11
Smart Splice™ A/C Reduced Barrier Hose	11
Smart Splice Ultimate System™	12
<b>Tools Of The Trade</b>	16
Auto Stop Crimper	16
Deburrer	16
Tube Bender	16
Hose Cutter	16
Tube Cutter	16

### A/C SERVICE EQUIPMENT FILTRATION

Recycle Guard™	17
Dual Automatic Recycle Guard™	18
Recycle Guard™	19
A/C Charge Guard™	20
Recover-Only Recycle Guard™	21
Refrigerant Canister Filter™	21
Recycle Guard™ Service Fittings	22
Recycle Guard™ Adapters	22
A/C Charge Guard™ Filters	22

### A/C SYSTEM FILTRATION

Compressor Guard™	23
Compressor Guard™ Plates	24
Compressor Guard™ Screens	25
High Side Inline Filter™	26
Mio High Side Filter™	26

### A/C SYSTEM SECURITY

Click Lock™	26
-------------	----

### A/C SERVICE TOOLS

R134a Pro Grade Oil/Dye Injector With Unique Sight Glass Body	27
R134a Service Hoses	27
R134a High & Low Side Port Extender	27
R134a Service Couplers	27
R1234yf Pro Grade Oil/Dye Injector With Unique Sight Glass Body	28
R1234yf Service Hoses	28
R1234yf High And Low Side Port Extender	28
R1234yf Service Couplers	28
O Rings and Tools	28
R134a / R1234yf Pro Grade Oil/Dye Injector with Unique Sight Glass Body	29
Compressor Turner Tool™	29
EVC-1™, EVC-2™	30

### A/C SPRING LOCK TOOLS

A/C Spring Lock Tools™	31
------------------------	----

### THERMOMETERS

Dial Thermometer with 1 1/4" Face	32
Digital Thermometer with 1 1/4" Face	32

### SOLVENTS

Flush Solvent	32
---------------	----

### REFRIGERANT OILS

Refrigerant Oils	33
------------------	----

### LEAK DETECTION

Leak Detection Dyes	33
---------------------	----

### HVAC SERVICE KITS

GM Cabin Air Filter Retrofit Kit	34
Ford E-Series Return Air Debris Shield	34

### HVAC BLEND DOOR REPAIR KITS

Gm Equinox / Torrent Blend Door Repair Kit™	35
Ford F Series Blend Door Repair Kit	35
Ford Explorer / Mercury Mountaineer Blend Door Repair Kit	36
Jeep Grand Cherokee Blend Door Repair Kit	36

### A/C FLUSH MACHINE

A/C Flush Machine With Dual-Tank and Soundsilence™ Technology	37
---	----

### RADIATOR REPAIR

Permatube™	38
------------	----

### POWER STEERING FILTRATION

Steering Guard™	39
-----------------	----

### TRANSMISSION PRODUCTS

Transguard™	40
Barbed Inline Transmission Filter	41
Transmission Fill Adapter Tool	41

### A/C ODOR ABATEMENT PRODUCTS

Cooling Coil Coating™	42
A/C Odor Shield™	42
Oxyvap™	42
Cooling Coil Coating™ Starter Kit	43
A/C Odor Shield™ Starter Kit	43

### SPRAY APPLICATORS

Ulti-Flex Pressure Spray Tool™	44
Ms1 Spray Tool	44

### LIGHTING

See Brighter™	45
---------------	----

# SMART SPLICE™

5-MINUTE FIX: NO LINE REMOVAL

SMART SPLICE™ patented line repair products offer quick and durable repair for A/C, Coolant, Heater, Oil, Oil Cooler, Power Steering Return, Transmission and Trans Cooler lines.

**4X HIGHER BURST PRESSURE**  
THAN STANDARD COMPRESSION FITTINGS

## WHAT MAKES IT SMART

SMART SPLICE™ LINE REPAIR PRODUCTS ARE SUPERIOR TO TRADITIONAL COMPRESSION FITTINGS THANKS TO OUR PROPRIETARY SEALING TECHNOLOGY THAT CONTRIBUTES TO LONG SERVICE LIFE:

- UNIQUE HNBR SEAL SLEEVE DRAMATICALLY EXPANDS THE SEALING SURFACE AREA
- HIGH TECH ANTI-VIBRATION TENSION RING INSURES REPAIR DURABILITY IN HEAVY VIBRATION AUTOMOTIVE APPLICATIONS

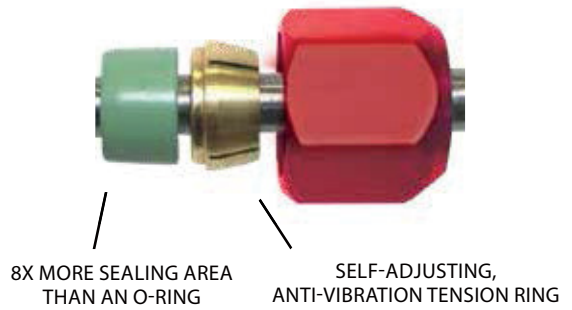

Patented

**AS EASY AS**

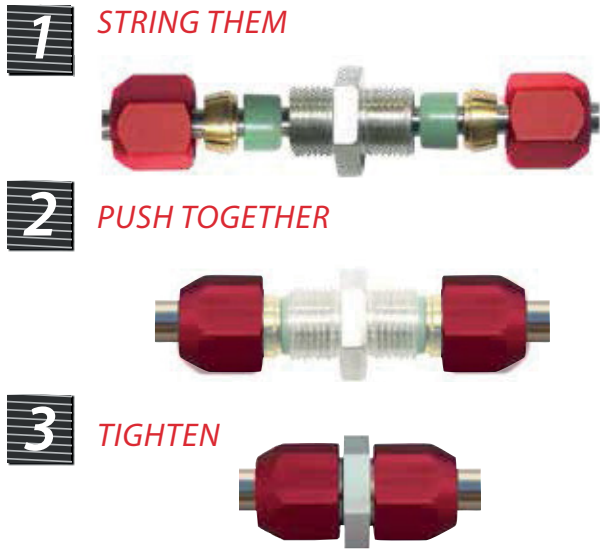

# SMART SPLICE LINE SPLICE™

OE-APPROVED

## 5-Minute Metal Line Repair Solution

Effective, Durable Leak Repair with No Line Removal

### PROBLEM:

Replacing damaged metal A/C, heater, oil, transmission, and power steering lines can be labor intensive and costly. Most replacement lines are "dealer only" items that can take days to source.

### SOLUTION:

AirSept's Line Splice is a fast, durable repair for metal lines.

### SUPERIOR TO TRADITIONAL COMPRESSION FITTINGS

- HNBR SEAL SLEEVE DRAMATICALLY EXPANDS THE SEALING SURFACE AREA
- HIGH-TECH ANTI-VIBRATION TENSION RING RESISTS VIBRATION LEAKS
- ENSURES DURABILITY IN TOUGH AUTOMOTIVE APPLICATIONS
- 5-MINUTE INSTALL - WITH A WRENCH (NO SPECIAL TOOLS, NO ADHESIVES REQUIRED)
- COMPENSATES FOR OUT-OF-ROUND TUBING
- BURST-TESTED TO 2600 PSI

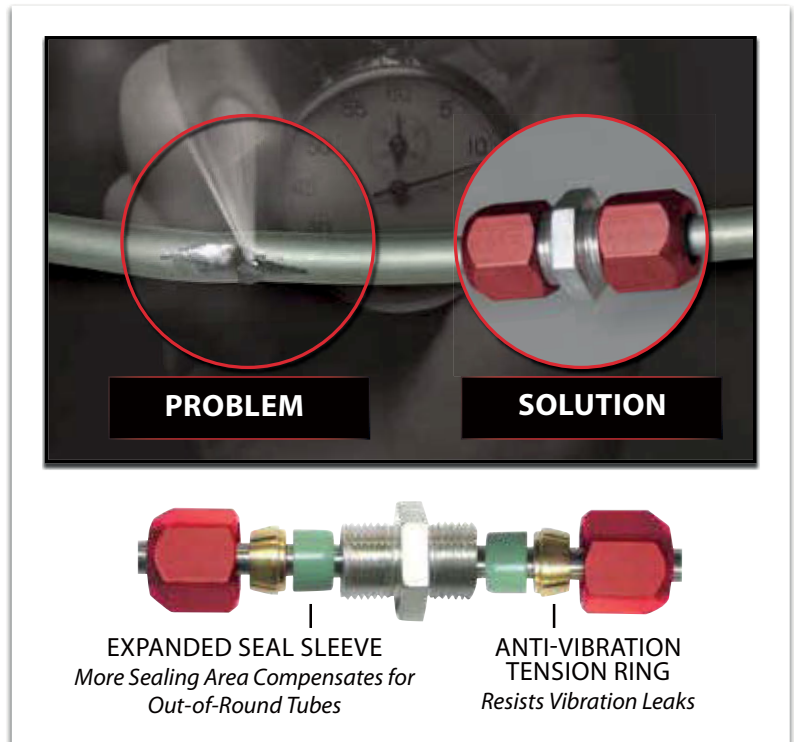

Patented

DESCRIPTION	PART NO.
<b>LINE SPLICE SAE – STRAIGHT FITTINGS</b>	
Line Splice Straight Kit - 1/2" OD Line	76001
Line Splice Straight Kit - 3/8" OD Line	76002
Line Splice Straight Kit - 5/16" OD Line	76003
Line Splice Straight Kit - 5/8" OD Line	76011
Line Splice Straight Kit - 3/4" OD Line	76012
Line Splice Straight Reducer - 3/8" to 5/16" OD	76004
Line Splice Straight Reducer - 1/2" to 5/16" OD	76005
Line Splice Straight Reducer - 1/2" to 3/8" OD	76006

DESCRIPTION	PART NO.
<b>LINE SPLICE METRIC – STRAIGHT FITTINGS</b>	
Line Splice Straight Kit - 8mm OD	77008
Line Splice Straight Kit - 10mm OD	77010
Line Splice Straight Kit - 12mm OD	77012
Line Splice Straight Kit - 15mm OD	77015
Line Splice Straight Kit - 16mm OD	77016
Line Splice Straight Reducer - 12mm to 10mm	77103
<b>LINE SPLICE ASSORTMENT PACKS – STRAIGHT FITTINGS</b>	
<b>Line Splice Straight SAE 5-Pack</b> ONE each: 5/16", 3/8", 1/2", 5/8" & 3/4" Line Splice Kits	76050
<b>Line Splice Straight SAE / Metric 10-Pack</b> ONE each: 5/16", 3/8", 1/2", 5/8" & 3/4" SAE Line Splice Kits, plus ONE each: 8mm, 10mm, 12mm, 15mm & 16mm Metric Line Splice Kits	76051

# SMART SPLICE LINE SPLICE™

45° AND 90° SAE FITTINGS & ASSORTMENT PACKS



*Quickly Replace Damaged Metal Line Bends or Reconfigure a Line*

**PROBLEM:**

*Need to repair a metal line at a bend, or replace a corroded angled fitting? Want to re-route a metal line around a component? Too sharp a bend can weaken a metal line and shorten its service life.*

**SOLUTION:**

*Keep SMART SPLICE™ 45° and 90° Line Splice fittings from AirSept on hand and you'll get repairs out the door faster than your competitors. Each product combines the superior sealing technology of AirSept's SMART SPLICE™ with durable cast aluminum angled fittings and OE-fit connector design. You get a reliable repair in 5 minutes with no special tools or adhesives required.*

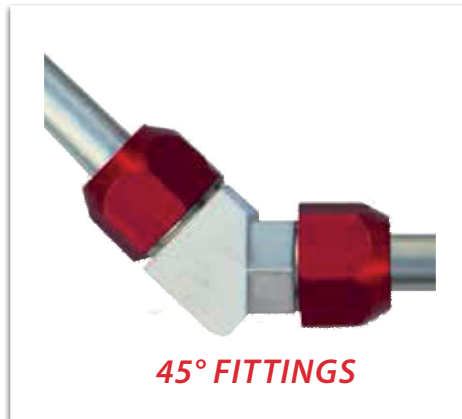

Patented



Patented

DESCRIPTION	PART NO.
<b>SMART SPLICE™ LINE SPLICE KITS - 45° FITTINGS</b>	
Line Splice 45° Kit - 1/2" OD	76061
Line Splice 45° Kit - 3/8" OD	76062
Line Splice 45° Kit - 5/16" OD	76063
Line Splice 45° Kit - 5/8" OD	76064
Line Splice 45° Kit - 3/4" OD	76065
<b>SMART SPLICE™ LINE SPLICE KITS - 90° FITTINGS</b>	
Line Splice 90° Kit - 1/2" OD	76071
Line Splice 90° Kit - 3/8" OD	76072
Line Splice 90° Kit - 5/16" OD	76073
Line Splice 90° Kit - 5/8" OD	76074
Line Splice 90° Kit - 3/4" OD	76075

DESCRIPTION	PART NO.
<b>LINE SPLICE ASSORTMENT PACKS - 45° FITTINGS</b>	
Line Splice 45° SAE 4-Pack ONE each: 5/16", 3/8", 1/2" and 5/8" Line Splice 45° Kits	76052
<b>LINE SPLICE ASSORTMENT PACKS - 90° FITTINGS</b>	
Line Splice 90° SAE 4-Pack ONE each: 5/16", 3/8", 1/2" and 5/8" Line Splice 90° Kits	76054

# SMART SPLICE LINE TERMINATOR™

OE-APPROVED REAR A/C BLOCK-OFF KITS

**Block Damaged or Unused A/C Lines – No Line R&R**



## PROBLEM:

Leaking rear A/C components or lines can reduce front A/C performance and require costly repairs.

## SOLUTION:

AirSept's Line Terminator maximizes front A/C cooling and installs under the hood in five minutes.

- QUICKLY AND EFFECTIVELY BLOCKS A/C LINES AT THE DAMAGE POINT OR AT THE FRONT SYSTEM "Y"
- BYPASSES LEAKING REAR EVAPORATORS AND FAILED SYSTEM COMPONENTS
- HELPS MAXIMIZE FRONT A/C PERFORMANCE
- ELIMINATES REFRIGERANT AND OIL POOLING IN REAR A/C LINES
- ALSO AVAILABLE IN TRAY TWO OF THE SMART SPLICE™ ULTIMATE SYSTEM

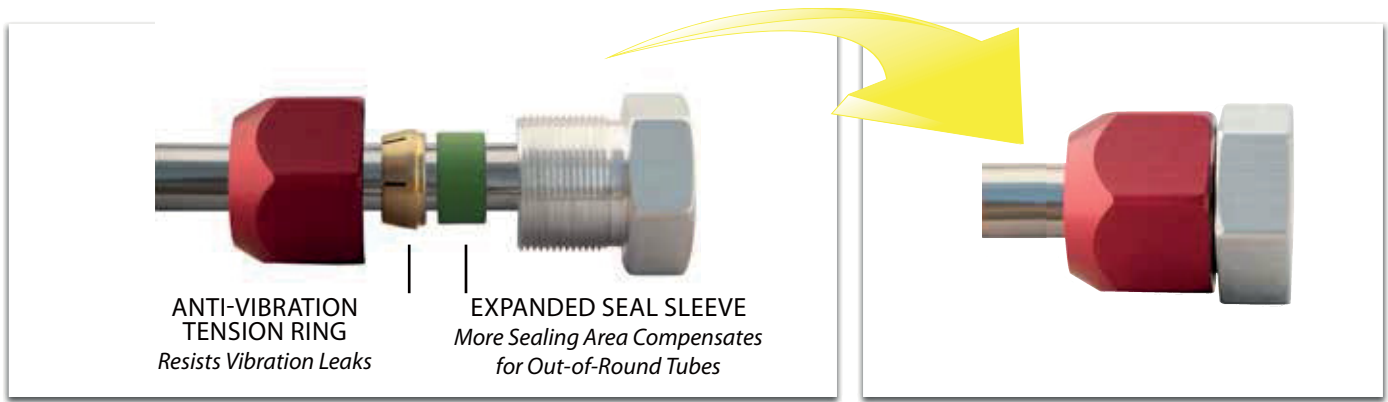

Patented

DESCRIPTION	PART NO.
<b>SAE BLOCKOFF KITS</b>	
Line Terminator A/C Blockoff Kit - 1/2" OD Line	76501
Line Terminator A/C Blockoff Kit - 3/8" OD Line	76502
Line Terminator A/C Blockoff Kit - 5/16" OD Line	76503
Line Terminator A/C Blockoff Kit - 5/8" OD Line	76504
Line Terminator A/C Blockoff Kit - 3/4" OD Line	76505

DESCRIPTION	PART NO.
<b>METRIC BLOCKOFF KITS</b>	
Line Terminator A/C Blockoff Kit - 8mm OD Line	77508
Line Terminator A/C Blockoff Kit - 10mm OD Line	77510
Line Terminator A/C Blockoff Kit - 12mm OD Line	77512
Line Terminator A/C Blockoff Kit - 15mm OD Line	77515
Line Terminator A/C Blockoff Kit - 16mm OD Line	77516

<b>BLOCKOFF KIT ASSORTMENTS</b>	
<b>Line Terminator SAE 5-Pack</b> ONE each: 5/16", 3/8", 1/2", 5/8" and 3/4" Kits	76526
<b>Line Terminator SAE / Metric 10-Pack</b> ONE each: 5/16", 3/8", 1/2", 5/8" and 3/4" SAE Kits, plus ONE each: 8mm, 10mm, 12mm, 15mm & 16mm Metric Kits	76530

# SMART SPLICE™ INLINE SERVICE PORT “T”

OE-APPROVED

## Replace Defective or Hard-to-Reach Service Ports

Quick and Profitable Port Repair Keeps You and Your Customer Happy

### PROBLEM:

Need to repair or relocate a damaged or inaccessible A/C service port?  
Want to relocate a service port for a custom mod or restoration?

### SOLUTION:

AirSept's Inline Service Port T™.

- DURABLE, LEAK-PROOF REPAIR
- INSTALLS IN MINUTES
- NO WELDING OR BRAZING REQUIRED
- ALSO AVAILABLE IN TRAY TWO OF THE SMART SPLICE™ ULTIMATE SYSTEM

**NO LINE R&R**



LOW SIDE SERVICE T™

Patented



HIGH SIDE SERVICE T™

Patented

## SMART SPLICE™ SEALING TECHNOLOGY ENSURES LEAK-FREE PERFORMANCE

DESCRIPTION	PART NO.
<b>LOW SIDE INLINE SERVICE PORT T™ SINGLES</b>	
Line Splice Low Side Service “T” for 1/2” OD line	76201
Line Splice Low Side Service “T” for 3/8” OD line	76202
Line Splice Low Side Service “T” for 5/8” OD line	76204
Line Splice Low Side Service “T” for 10mm OD line	77210
Line Splice Low Side Service “T” for 12mm OD line	77212
Line Splice Low Side Service “T” for 15mm OD line	77215
Line Splice Low Side Service “T” for 16mm OD line	77216

DESCRIPTION	PART NO.
<b>HIGH SIDE INLINE SERVICE PORT T™ SINGLES</b>	
Line Splice High Side Service “T” for 5/16” OD line	76212
Line Splice High Side Service “T” for 3/8” OD line	76213
Line Splice High Side Service “T” for 1/2” OD line	76214
Line Splice High Side Service “T” for 10mm OD line	77220
Line Splice High Side Service “T” for 12mm OD line	77222
Line Splice High Side Service “T” for 8mm OD line	77228



# SMART SPLICE™ LINE-TO-HOSE CONNECTOR

OE-APPROVED

*Quickly Connect Metal Line To A/C Reduced Barrier Hose*

SEALING TECHNOLOGY SUPERIOR TO TRADITIONAL COMPRESSION FITTINGS

**PROBLEM:**

When a metal-to-rubber A/C line is damaged, you often must replace the complete OE line. If the line is not in stock locally you inconvenience your customer by waiting for delivery.

**SOLUTION:**

Quickly and easily connect A/C reduced barrier hose to metal line using AirSept's SMART SPLICE™ Line-to-Hose Connector.

**MEETS OEM PERFORMANCE AND DURABILITY REQUIREMENTS**

- LEAK-PROOF LINE SPLICE™ TECHNOLOGY ON THE METAL SIDE OF THE CONNECTION
- SUPERIOR HOSE CRIMP TECHNOLOGY ON THE RUBBER SIDE
- INSTALLS IN 5 MINUTES
- ALSO AVAILABLE IN TRAY THREE OF THE SMART SPLICE™ ULTIMATE SYSTEM
- ULTIMATE SYSTEM TRAY FIVE INCLUDES ASSEMBLY TOOLS

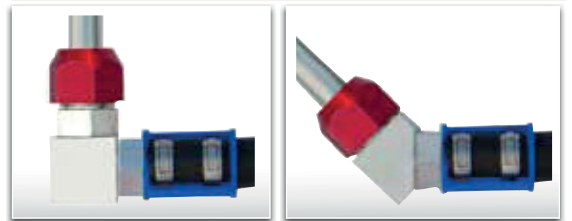

Patented

DESCRIPTION	PART NO.
<b>SMART SPLICE™ LINE-TO-HOSE CONNECTOR KITS - STRAIGHT FITTINGS</b>	
Straight Line-to-Hose Connector - 1/2" (#8 OD)	76701
Straight Line-to-Hose Connector - 3/8" (#6 OD)	76702
Straight Line-to-Hose Connector - 5/16" (#6 OD)	76703
Straight Line-to-Hose Connector - 5/8" (#10 OD)	76704
Straight Line-to-Hose Connector - 3/4" (#12 OD)	76705
<b>SMART SPLICE™ LINE-TO-HOSE CONNECTOR KITS - 45° FITTINGS</b>	
45° Line-to-Hose Connector - 1/2" (#8 OD)	76711
45° Line-to-Hose Connector - 3/8" (#6 OD)	76712
45° Line-to-Hose Connector - 5/16" (#6 OD)	76713
45° Line-to-Hose Connector - 5/8" (#10 OD)	76714
45° Line-to-Hose Connector - 3/4" (#12 OD)	76715

DESCRIPTION	PART NO.
<b>SMART SPLICE™ LINE-TO-HOSE CONNECTOR KITS - 90° FITTINGS</b>	
90° Line-to-Hose Connector - 1/2" (#8 OD)	76721
90° Line-to-Hose Connector - 3/8" (#6 OD)	76722
90° Line-to-Hose Connector - 5/16" (#6 OD)	76723
90° Line-to-Hose Connector - 5/8" (#10 OD)	76724
90° Line-to-Hose Connector - 3/4" (#12 OD)	76725
<b>SMART SPLICE™ LINE-TO-HOSE ASSORTMENTS / SMART SPLICE™ KITS</b>	
SMART SPLICE™ Four Pack - Straight ONE Each: 5/16", 3/8", 1/2" and 5/8"	76706
SMART SPLICE™ Five Pack - Straight ONE Each: 5/16", 3/8", 1/2", 5/8" and 3/4"	76707
SMART SPLICE™ Four Pack - 45° ONE Each: 5/16", 3/8", 1/2" and 5/8" 45°	76716
SMART SPLICE™ Four Pack - 90° ONE Each: 5/16", 3/8", 1/2" and 5/8" 90°	76726

## SMART SPLICE™ HOSE-TO-HOSE CONNECTOR

QUICKLY CONNECT A/C REDUCED BARRIER HOSE ENDS

PRECISION-DESIGNED HAND-HELD CRIMP SYSTEM PROVIDES SUPERIOR LEAK RESISTANCE

### PROBLEM:

Damaged A/C, Heater and Coolant hoses have traditionally required complete line replacement.

### SOLUTION:

Crimp-and-frame system offers field-proven reliability.

- ADVANCED CRIMP TECHNOLOGY WORKS WITH HAND-HELD CRIMPER
- MULTIPLE CRIMPS FOR LEAK-PROOF SEAL
- WORKS WITH ALL COOLANT, HEATER AND A/C REDUCED BARRIER HOSE
- ALSO AVAILABLE IN TRAY THREE OF THE SMART SPLICE™ ULTIMATE SYSTEM

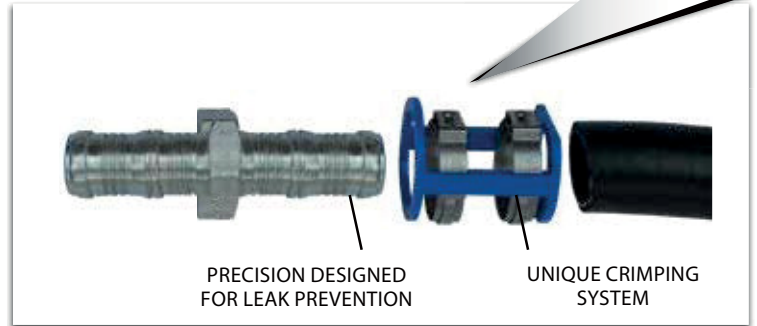

DESCRIPTION	PART NO.
<b>SMART SPLICE™ STRAIGHT SPLICER</b>	
# 6 A/C Hose to # 6 A/C Hose	76801
# 8 A/C Hose to # 8 A/C Hose	76802
# 10 A/C Hose to # 10 A/C Hose	76803
# 12 A/C Hose to # 12 A/C Hose	76804

## SMART SPLICE™ BARBED LINE-TO-HOSE CONNECTORS

QUICKLY CONNECT METAL LINE TO RUBBER HOSE

CONNECTORS SUITABLE FOR MULTIPLE FLUID CARRYING SYSTEMS

### PROBLEM:

Many automotive fluid lines are difficult to remove and replace.

### SOLUTION:

Smart Splice Barbed Connectors allow quick, durable on-vehicle repair.



### HOSE-TO-TUBE REPAIR FOR

- POWER STEERING RETURN LINES
- TRANSMISSION LINES
- TRANS OIL COOLER LINES
- ENGINE OIL LINES
- ENGINE OIL COOLER LINES
- COOLANT LINES
- HEATER LINES

DESCRIPTION	PART NO.
Smart Splice Barbed Connector - 1/2" OD Line to 1/2" ID Hose	76761
Smart Splice Barbed Connector - 3/8" OD Line to 3/8" ID Hose	76762
Smart Splice Barbed Connector - 5/16" OD Line to 5/16" ID Hose	76763
Smart Splice Barbed Connector - 5/8" OD Line to 5/8" ID Hose	76764

# SMART SPLICE™ ALUMINUM TUBE INSERT KIT

REPLACE DAMAGED OR LEAKING ALUMINUM TUBING

## PROBLEM:

Multiple leak points may require replacement of a length of tube.

## SOLUTION:

AirSept's Aluminum Tube Insert Kit.

- DURABLE TUBING IN STANDARD OD SIZES
- INSTALLS IN MINUTES
- NO WELDING OR BRAZING REQUIRED
- ALL TUBE SIZES AVAILABLE IN TRAY FOUR OF THE SMART SPLICE™ ULTIMATE SYSTEM



DESCRIPTION	PART NO.
<b>SAE ALUMINUM TUBE INSERT KITS</b>	
12" Tube Insert Kit for 5/16" OD line (4 tubes)	76603
12" Tube Insert Kit for 3/8" OD line (4 tubes)	76602
12" Tube Insert Kit for 1/2" OD line (4 tubes)	76601
12" Tube Insert Kit for 5/8" OD line (4 tubes)	76604
12" Tube Insert Kit for 3/4" OD line (4 tubes)	76605

DESCRIPTION	PART NO.
<b>METRIC ALUMINUM TUBE INSERT KITS</b>	
12" Tube Insert Kit for 8mm OD line (4 tubes)	77608
12" Tube Insert Kit for 10mm OD line (4 tubes)	77610
12" Tube Insert Kit for 12mm OD line (4 tubes)	77612
12" Tube Insert Kit for 15mm OD line (4 tubes)	77615
12" Tube Insert Kit for 16mm OD line (4 tubes)	77616

# SMART SPLICE™ A/C REDUCED BARRIER HOSE

QUICKLY REPLACE DAMAGED REDUCED BARRIER HOSE

BUILD YOUR OWN HOSES FOR MORE PROFIT,  
FASTER REPAIR COMPLETION

## PROBLEM:

One hard-to-find hose can hold up a repair.

## SOLUTION:

Don't put your customer on hold waiting for an OEM A/C hose delivery. Build your own with Reduced Barrier Hose from AirSept, and keep your customer satisfied.

- FLEXIBLE HOSE OFFERS HIGHER BEND RADIUS FOR EASY ROUTING
- DURABLE, LEAK-PROOF HOSE
- COMPATIBLE WITH R134a AND OTHER AUTOMOTIVE REFRIGERANTS



DESCRIPTION	PART NO.
<b>SAE REDUCED BARRIER HOSE KITS</b>	
15 ft. Reduced Barrier Hose for #6 (per foot)	76741
15 ft. Reduced Barrier Hose for #8 (per foot)	76742
15 ft. Reduced Barrier Hose for #10 (per foot)	76743
15 ft. Reduced Barrier Hose for #12 (per foot)	76744

# SMART SPLICE ULTIMATE SYSTEM™

FIXING A DAMAGED LINE? SMART SPLICE DOES IT ALL

THE ULTIMATE OE-APPROVED  
LINE REPAIR ASSORTMENT

## PROBLEM:

Line repair and hose building demands a versatile resource to handle any challenge a technician will encounter.

## SOLUTION:

AirSept's Smart Splice Ultimate System has got you covered.

- SAE AND METRIC
- STRAIGHT, 45° AND 90°
- LINE-TO-LINE
- HOSE-TO-LINE
- HOSE TO HOSE

## EVERYTHING NEEDED TO REPAIR:

Air Conditioning lines  
Power Steering Return lines  
Transmission lines  
Trans Oil Cooler lines  
Engine Oil lines  
Engine Oil Cooler lines  
Coolant lines  
Heater lines



WINNER OF FOUR AFTERMARKET  
INDUSTRY AWARDS

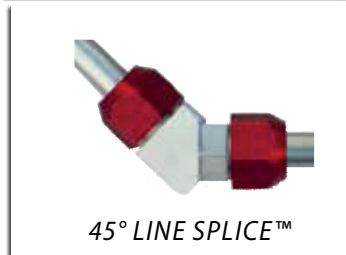
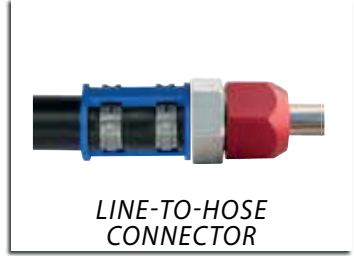

Not pictured: Tools, Reduced Barrier Hose, Aluminum Tube Inserts

**SMART SPLICE™**

**Ultimate System Master Cabinet- CONTAINS ALL 5 TRAYS**

DESCRIPTION	PART NO.
SMART SPLICE ULTIMATE LINE REPAIR SYSTEM MASTER CABINET	76057
Line Splice A/C, Coolant, Heater, Oil, Power Steering, Trans Hose to Tube Service Tray	76076
Line Splice A/C Service "T", Line Terminator Service Tray (for A/C, coolant and heater)	76077
Smart Splice A/C Barrier Hose to Tube, A/C Barrier Hose to Hose Service Tray	76078
Smart Splice Aluminum Tube Service Tray	76079
Smart Splice Tool Assortment	76080

**SMART SPLICE™**

**Ultimate System Master Cabinet Cart**

DESCRIPTION	PART NO.
Smart Splice Ultimate System Service Cart	76081



DESCRIPTION	PART NO.
<b>SMART SPLICE™ Straight   45°   90° Line Connectors (Tray 1)</b>	<b>76076</b>
<b>SMART SPLICE™ STRAIGHT SAE</b>	
Line Splice Straight Repair Kit - 1/2" OD line	76001
Line Splice Straight Repair Kit - 3/8" OD line	76002
Line Splice Straight Repair Kit - 5/16" OD line	76003
Line Splice Straight Repair Kit - 5/8" OD line	76011
Line Splice Straight Repair Kit - 3/4" OD line	76012
<b>SMART SPLICE™ STRAIGHT METRIC</b>	
Line Splice Straight Repair Kit - 8mm OD line	77008
Line Splice Straight Repair Kit - 10mm OD line	77010
Line Splice Straight Repair Kit - 12mm OD line	77012
Line Splice Straight Repair Kit - 15mm OD line	77015
Line Splice Straight Repair Kit - 16mm OD line	77016
<b>SMART SPLICE™ 45° SAE</b>	
Line Splice 45° Repair Kit - 1/2" OD line	76061
Line Splice 45° Repair Kit - 3/8" OD line	76062
Line Splice 45° Repair Kit - 5/16" OD line	76063
Line Splice 45° Repair Kit - 5/8" OD line	76064
<b>SMART SPLICE™ 90° SAE</b>	
Line Splice 90° Repair Kit - 1/2" OD line	76071
Line Splice 90° Repair Kit - 3/8" OD line	76072
Line Splice 90° Repair Kit - 5/16" OD line	76073
Line Splice 90° Repair Kit - 5/8" OD line	76074

**SMART SPLICE™**

**Straight | 45° | 90° Line Connectors (Tray 1)**

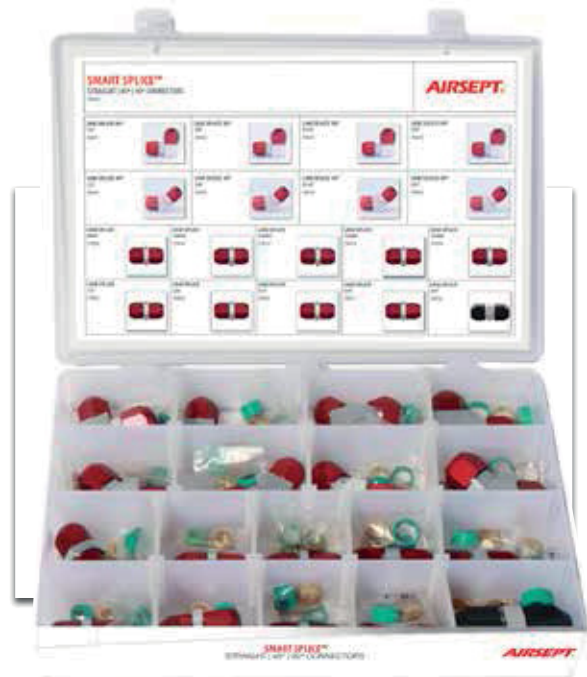

DESCRIPTION	PART NO.
<b>SMART SPLICE™ Line Terminator and Inline Service Port T (Tray 2)</b>	<b>76077</b>
<b>SMART SPLICE™ SAE BLOCKOFF KITS</b>	
Line Terminator Blockoff Kit - 1/2" OD line	76501
Line Terminator Blockoff Kit - 3/8" OD line	76502
Line Terminator Blockoff Kit - 5/16" OD line	76503
Line Terminator Blockoff Kit - 5/8" OD line	76504
Line Terminator Blockoff Kit - 3/4" OD line	76505
<b>SMART SPLICE™ METRIC BLOCKOFF KITS</b>	
Line Terminator Blockoff Kit - 8mm OD line	77508
Line Terminator Blockoff Kit - 10mm OD line	77510
Line Terminator Blockoff Kit - 12mm OD line	77512
Line Terminator Blockoff Kit - 15mm OD line	77515
Line Terminator Blockoff Kit - 16mm OD line	77516
<b>SMART SPLICE™ INLINE SERVICE PORT "T"s LOW SIDE</b>	
Line Splice Low Side Service "T" - 1/2" OD line	76201
Line Splice Low Side Service "T" - 5/8" OD line	76204
Line Splice Low Side Service "T" - 12mm OD line	77212
Line Splice Low Side Service "T" - 15mm OD line	77215
Line Splice Low Side Service "T" - 16mm OD line	77216
<b>SMART SPLICE™ INLINE SERVICE PORT "T"s HIGH SIDE</b>	
Line Splice High Side Service "T" - 5/16" OD line	76212
Line Splice High Side Service "T" - 3/8" OD line	76213
Line Splice High Side Service "T" - 1/2" OD line	76214
Line Splice High Side Service "T" - 10mm OD line	77220
Line Splice High Side Service "T" - 8mm OD line	77228

## SMART SPLICE™ Line Terminator and Inline Service Port T (Tray 2)

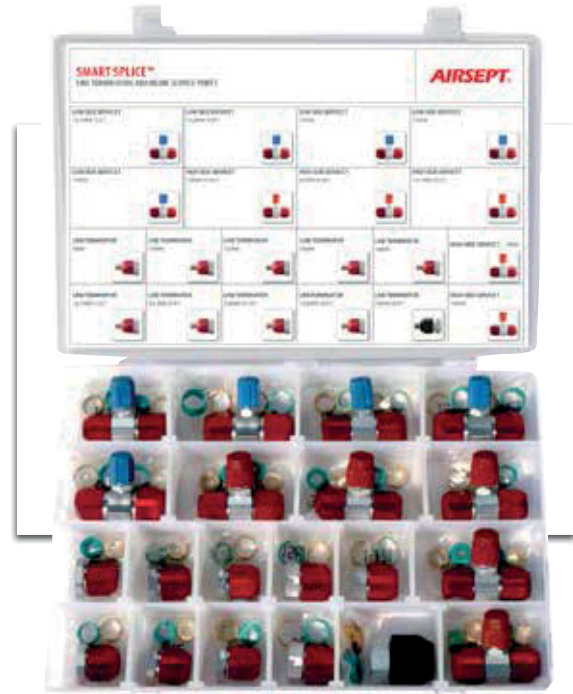

## SMART SPLICE™ SMART SPLICE™ Hose-to-Hose and Line-to-Hose Connectors (Tray 3)



DESCRIPTION	PART NO.
<b>SMART SPLICE™ Hose-to-Hose and Line-to-Hose Connectors (Tray 3)</b>	<b>76078</b>
<b>SMART SPLICE™ STRAIGHT SAE</b>	
A/C Splicer - # 6 Hose to # 6 Hose	76801
A/C Splicer - # 8 Hose to # 8 Hose	76802
A/C Splicer - # 10 Hose to # 10 Hose	76803
A/C Splicer - # 12 Hose to # 12 Hose	76804
<b>SMART SPLICE™ STRAIGHT SAE</b>	
A/C Connector - 1/2" Line to # 8 Hose	76701
A/C Connector - 3/8" Line to # 6 Hose	76702
A/C Connector - 5/16" Line to # 6 Hose	76703
A/C Connector - 5/8" Line to # 10 Hose	76704
A/C Connector - 3/4" Line to # 12 Hose	76705
<b>SMART SPLICE™ 45° SAE</b>	
A/C Connector - 1/2" Line to # 8 Hose	76711
A/C Connector - 3/8" Line to # 6 Hose	76712
A/C Connector - 5/16" Line to # 6 Hose	76713
A/C Connector - 5/8" Line to # 10 Hose	76714
<b>SMART SPLICE™ 90° SAE</b>	
A/C Connector - 1/2" Line to # 8 Hose	76721
A/C Connector - 3/8" Line to # 6 Hose	76722
A/C Connector - 5/16" Line to # 6 Hose	76723
A/C Connector - 5/8" Line to # 10 Hose	76724

DESCRIPTION	PART NO.
<b>SMART SPLICE™ Aluminum Tube Inserts (Tray 4)</b>	<b>76079</b>
<b>SMART SPLICE™ 12" SAE (4 tubes per kit)</b>	
Tube Insert Kit for 1/2" OD line	76601
Tube Insert Kit for 3/8" OD line	76602
Tube Insert Kit for 5/16" OD line	76603
Tube Insert Kit for 5/8" OD line	76604
Tube Insert Kit for 3/4" OD line	76605
<b>SMART SPLICE™ 12" METRIC (4 tubes per kit)</b>	
Tube Insert Kit for 8mm OD line	77608
Tube Insert Kit for 10mm OD line	77610
Tube Insert Kit for 12mm OD line	77612
Tube Insert Kit for 15mm OD line	77615
Tube Insert Kit for 16mm OD line	77616



### SMART SPLICE™

SMART SPLICE™ Aluminum Tube Inserts (Tray 4)



### SMART SPLICE™

SMART SPLICE™ Service Tools (Tray 5)

DESCRIPTION	PART NO.
<b>SMART SPLICE™ Service Tools (Tray 5)</b>	<b>76080</b>
Metal Line Deburrer	90041
Metal Tube Cutter	90043
Rubber Hose Cutter	90044
Pex Crimper	90045
Caliper	90049



## TOOLS OF THE TRADE

### PROFESSIONAL GRADE TOOLS FOR HOSE REPAIR AND ASSEMBLY

The Complete Solution. Build or Repair any A/C Hose or Line to OE Quality

#### AUTO STOP CRIMPER

USE TO INSTALL SMART SPLICE™ CRIMPS

90045



#### DEBURRER

REMOVE ROUGH METAL LINE EDGES

90041



#### TUBE BENDER

BEND TUBES TO BUILD A LINE

90046



#### HOSE CUTTER

PRECISION CUT RUBBER HOSE

90044



#### TUBE CUTTER

CUT LINES TO SIZE

90043



DESCRIPTION	PART NO.
Metal Line Deburrer	90041
Metal Tube Cutter	90043
Rubber Hose Cutter	90044
Pex Crimper	90045
Caliper	90049



# RECYCLE GUARD™

**PROTECT YOUR A/C SERVICE EQUIPMENT FROM DEBRIS, SEALANT, DYE, MOISTURE AND OTHER CONTAMINANTS**

The ONLY filter that traps all types of contaminants:

- METAL SHAVINGS
- DESSICANT PARTICLES
- SEALANT -- BOTH LIQUID (SEAL SWELLER TYPE) AND DRY (STOP LEAK TYPE)
- DYE, EXCESS OIL AND OTHER CONTAMINANTS



**INEXPENSIVE INSURANCE AGAINST REVENUE-KILLING EQUIPMENT DOWNTIME**



### PRODUCT CAPABILITIES

### RECYCLE GUARD

Connect between Vehicle & A/C Equipment

### IN-LINE / BUILT-IN FILTER

Splice into A/C Service Hose or Tubing

TRAPS LIQUID SEALANT (seal sweller type)	<b>YES</b>	<b>NO</b>
TRAPS HARDENED SEALANT (stop-leak type)	<b>YES</b>	<b>YES</b>
PREVENTS CONTAMINANT ENTRY TO EQUIPMENT VALVES, GAUGES AND TUBING	<b>YES</b>	Solid Contaminants Only
FILTER BYPASS CAPABILITY	<b>YES</b>	<b>NO</b>

# DUAL AUTOMATIC RECYCLE GUARD™

*HIGH AND LOW SIDE PROTECTION FROM DEBRIS, SEALANT, DYE, EXCESS LUBRICANT AND CONTAMINANTS, ALL IN ONE*



## COMPATIBLE WITH ALL AUTOMATIC A/C SERVICE EQUIPMENT

- HIGH A/C REPAIR COSTS WILL DRIVE MORE SEALANT INTO SERVICE BAYS
- BY THE TIME YOU NOTICE A PROBLEM, THE DAMAGE IS EXTENSIVE
- NO TECHNICIAN INPUT REQUIRED - SWITCHES AUTOMATICALLY FROM RECOVER TO RECHARGE
- ONE UNIT RECOVERS FROM BOTH HIGH AND LOW SIDES SIMULTANEOUSLY
- TRAPS METAL SHAVINGS, DESICCANT PARTICLES AND OTHER HARMFUL DEBRIS
- MAINTAINS REFRIGERANT FLOW



**USE WITH EVERY A/C SERVICE OR REPAIR AND YOU WON'T HAVE TO WORRY**



DESCRIPTION	PART NO.
Dual Automatic Recycle Guard for R134a with 1/2" ACME connections (includes 2 x 36" service hoses)	75000
Dual Automatic Recycle Guard for R134a with 1/4" Flare Connections (includes 2 x 36" service hoses)	75200
DARG Hose Assembly Kit - Includes 72" High Side and Low Side Charging Hoses with Quick Couplers and High and Low Side Quick Connect Service Adaptors	75100
DARG Replacement Filter - Two Pack	75112
DARG Replacement Filter - Four Pack	75114

See page 22 for Accessory Items

# RECYCLE GUARD™

**PROTECT YOUR RECOVERY EQUIPMENT FROM DEBRIS, SEALANT, DYE, EXCESS LUBRICANT AND OTHER CONTAMINANTS**

## SEALANT FROM AN A/C SYSTEM CAN BE DEADLY TO YOUR A/C SERVICE EQUIPMENT

- STOP-LEAK AND SEAL SWELLER TYPE SEALANTS PLUG TUBING, RESTRICT VALVE MOVEMENT AND ALTER SEAL SHAPE AND PERFORMANCE
- BUILT-IN FILTERS ON A/C SERVICE EQUIPMENT ARE OFTEN LOCATED TOO FAR INSIDE THE EQUIPMENT TO PROTECT SENSITIVE VALVES, SEALS AND FITTINGS



TRAPS METAL SHAVINGS / DESSICANT PARTICLES	✓
TRAPS BOTH STOP-LEAK AND SEAL SWELLER TYPE SEALANT	✓
MAINTAINS REFRIGERANT FLOW	✓
WORKS WITH ALL A/C SERVICE EQUIPMENT	✓
CAN BYPASS FILTER WITHOUT DISCONNECTING RECYCLE GUARD	✓
EASY DRAIN AND REPLACEABLE FILTERS FOR LONG SERVICE LIFE	✓

CONTAMINATED REFRIGERANT OUT OF CAR



SEALANT-FREE REFRIGERANT TO RECOVERY MACHINE

DESCRIPTION	PART NO.
Recycle Guard, 1/2" ACME fittings & 36" R134a Hose	72101
Recycle Guard, 1/4" Flare fittings & 36" R134a Hose	72102
Manual Recycle Guard Replacement Filter 2-Pack	72112
Manual Recycle Guard Replacement Filter 4-Pack	72114

See page 22 for Accessory Items

# A/C CHARGE GUARD™

*PROTECT ELECTRIC COMPRESSORS FROM CONTAMINANTS*



*PREVENTS ELECTRICAL DAMAGE DUE TO PAG OIL ENTERING ELECTRIC COMPRESSORS (Hybrid Vehicles)*

*ELIMINATES NEED FOR COSTLY DEDICATED HYBRID A/C SERVICE EQUIPMENT*

- ALLOWS NO MORE THAN 100 PPM LIQUID OR OTHER CONTAMINANT INTO VEHICLE A/C SYSTEM DURING RECHARGE
- 100 PPM SUBSTANTIALLY EXCEEDS THE STANDARD REQUIRED BY SAE J2788H
- ONE UNIT HANDLES BOTH HIGH AND LOW SIDE REFRIGERANT CHARGING SIMULTANEOUSLY



**NO HOSE FLUSH CYCLE NEEDED  
-- SAVE TIME AND LABOR!**

**A/C CHARGE GUARD CONNECT**  
- Low Side



72162



DESCRIPTION	PART NO.
A/C Charge Guard for Hybrid vehicles with 36" service hose	72161
A/C Charge Guard Replacement Filter – 2 Pack	72162

See page 22 for Accessory Items

## RECOVER-ONLY RECYCLE GUARD™

### PROTECT A/C SERVICE EQUIPMENT FROM CONTAMINANTS

- TRAP ALL DEBRIS, SEALANT, LUBRICANT, DYE, AND OTHER CONTAMINANTS AS THEY EXIT THE HVAC SYSTEM
- WORKS WITH ALL COMMERCIAL REFRIGERANT TYPES
- AVAILABLE WITH SAE 1/4" FLARE OR 1/2" ACME FITTINGS



DESCRIPTION	PART NO.
Recycle Guard - Recovery Only, 1/4" SAE fittings, w/36" hose	72104
Recycle Guard - Recovery Only, 1/2" ACME fittings, w/36" hose	72106

## REFRIGERANT CANISTER FILTER™

### PROTECT YOUR REFRIGERANT SUPPLY

- USE INLINE BETWEEN THE VIRGIN REFRIGERANT TANK AND THE TANK FILL HOSE
- HELPS STOP DEBRIS FROM ENTERING YOUR REFRIGERANT SUPPLY CANISTERS

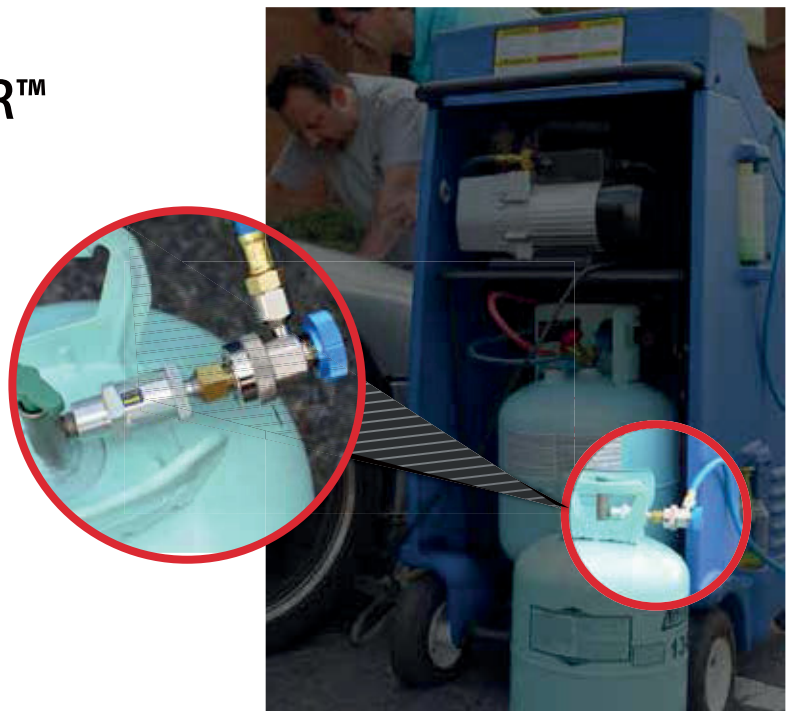

DESCRIPTION	PART NO.
Refrigerant Canister Filter, 1/2" ACME fittings	72900
Refrigerant Canister Filter, 1/4" SAE Flare Fittings	72901
Refrigerant Canister Filter Service Kit	76108

# RECYCLE GUARD™

REPLACEMENT FILTERS, FITTINGS & ACCESSORIES

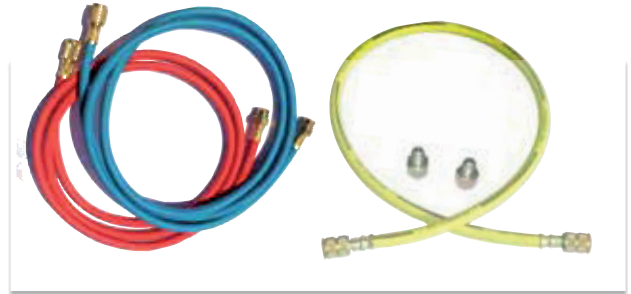

## RECYCLE GUARD™ ADAPTERS

DESCRIPTION	PART NO.
Adapter Kit for Recycling Equipment with 1/4" Flare fittings	72138
Dual Automatic Recycle Guard 1/4" Flare Adapter Kit (2 hoses and 4 fittings)	72139
Dual Automatic Recycle Guard 1/4" Flare to 1/2" ACME Adapter Kit (2 hoses and 4 fittings)	72127

## RECYCLE GUARD™ MOUNTING BRACKET

DESCRIPTION	PART NO.
Recycle Guard™ Mounting Bracket	72354



## DUAL AUTOMATIC RECYCLE GUARD™ FILTERS

REPLACEMENT FILTER KITS	PART NO.
Two Pack	75112
Four Pack	75114



## MANUAL RECYCLE GUARD™ FILTERS

REPLACEMENT FILTER KITS	PART NO.
Two Pack	72112
Four Pack	72114

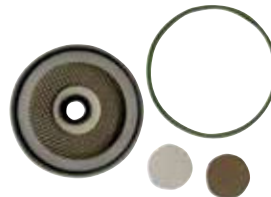

## A/C CHARGE GUARD™ FILTERS

FILTERS	PART NO.
Replacement Filter Pack	72162

## SERVICE FITTINGS



FITTINGS - 5 PACK	PART NO.
1/8" Male NPT x 1/4" SAE Male Flare fitting	72912
1/8" Male NPT x 1/2" Male ACME Fitting	72914
1/4" SAE Flare x 1/8" NPT 45° Fitting	72911
1/2" ACME Female x 1/4" Male Flare	72913
1/4" MPT T-Handle Drain Cock	72910
1/4" Female Flare x 1/2" ACME Male	72918



# COMPRESSOR GUARD™

REDUCE A/C COMPRESSOR COMEBACKS & WARRANTIES

Even in a flushed system, debris often remains, waiting to be drawn into your compressor installation at startup.

## An Exploding Compressor Leaves Metal Shavings in the Suction Line

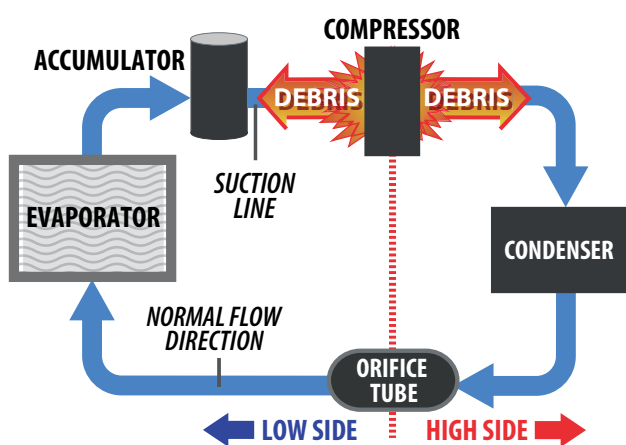

SCREEN PREVENTS DEBRIS FROM ENTERING THE COMPRESSOR

CLEAN REFRIGERANT ENTERS THE COMPRESSOR

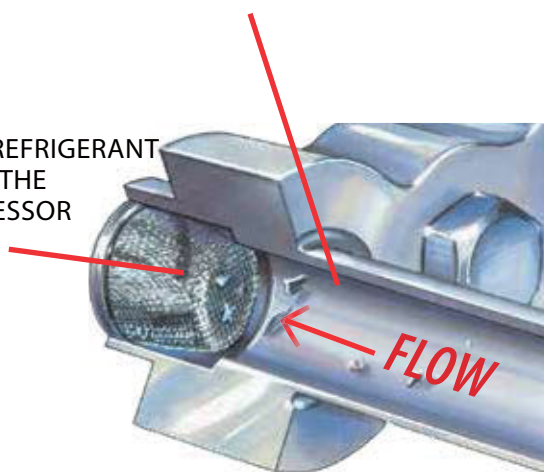

## COMPRESSOR GUARD REVIEWS

*"We have had not one comeback from any shop that purchased Compressor Guard™."*

*- Mark McDaniel, ATI Parts, Pensacola, FL*

*"I wouldn't install a compressor without it!"*

*- Alex Cole, ASAP Auto Electric, Las Vegas, NV*

*"I've had 100% success with suction screens. Never had one comeback."*

*- Kelly Yarbrough, Kelly's Auto Air, Panama City, FL*



## Compressor Guard™ Suction Filter – Don't Install a Compressor Without It!

PRODUCT CAPABILITIES	COMPRESSOR GUARD	TRADITIONAL IN LINE FILTERS
NO CUTTING REQUIRED	<b>YES</b>	NO
NO NEW LEAK POINTS	<b>YES</b>	NO
NO ALTERING FACTORY TUBING CONFIGURATION	<b>YES</b> (Fits in suction port)	NO
COSTS UNDER 4 PER FILTER	<b>YES</b>	NO
NOT VULNERABLE TO CLOGGING WITH SMALL PARTICLES	<b>YES</b>	NO

## COMPRESSOR GUARD™ PLATES

*FILTER PLATES AVAILABLE FOR OVER 9,000 POPULAR 1978-2016 COMPRESSOR APPLICATIONS*

*Compressors that fail soon after installation are just expensive filters that catch trash circulating in the A/C system. Compressor Guard suction filter plates catch the trash before it can cause a comeback*

### *Easy-Install Suction Filter Plates*

- OE-FIT COMPRESSOR GUARD FILTER PLATES MATCH THE FACTORY SUCTION LINE MANIFOLD, FOR EASY INSTALLATION
- PLATES FIT BETWEEN THE SUCTION HOSE MANIFOLD AND COMPRESSOR SUCTION PORT TO PREVENT DEBRIS ENTRY
- NORMAL PRESSURE AND FLOW RATES MAINTAINED
- INSTALL COMPRESSOR GUARD WITH EVERY A/C SYSTEM REPAIR



*NOW OFFERS MORE THAN 9,000 APPLICATIONS FOR 1978 - 2016 COMPRESSOR MODELS*



*FORD SCROLL FILTER PLATE*



*10PA15 / 17 / 20 (DENSO) FILTER PLATE*



*TRS090 & HS110 (HONDA) FILTER PLATE*

DESCRIPTION	PART NO.
Chrysler C171 / A590 Compressor Guard Plate	91001
Sanden TRS090 / HS110 Compressor Guard Plate	91003
Ford Scroll Compressor Guard Plate	91004
Sanden SD7V16 Compressor Guard Plate	91006
Denso 10PA15 / 17 / 20 Compressor Guard Plate	91007
Ford FS10 / FX15 Compressor Guard Plate	91008
GM H6 / HD6 / HT6 / V5 / V7 Compressor Guard Plate	91009
Sanden SD7H15 Compressor Guard Plate	91010
Denso 10S17 / 10S20 (GM Seal Washer) Compressor Guard Plate	91011
Denso 10S17 / 10S20 (O-ring seal) Compressor Guard Plate	91012
Mitsubishi MSC90C Compressor Guard Plate	91013

DESCRIPTION	PART NO.
Sanden 6SBU / 7SBU / 7SEU Compressor Guard Plate	91014
Sanden TRS105 Saab Scroll Compressor Guard Plate	91015
Sanden TRSA12 GM / Saab / Isuzu Scroll Compressor Guard Plate	91016
GM / Saturn Scroll, 3.5 Liter Compressor Guard Plate	91017
GM / Saturn Scroll, 2.2 Liter Small Port Compressor Guard Plate	91018
GM / Saturn Scroll, 2.2 Liter Large Port Compressor Guard Plate	91019
Mitsubishi MSC105CA Compressor Guard Plate	91020
Mitsubishi Scroll Compressor Guard Plate	91021
York Rotolock Filter Plate (HD Applications)	91022
York Tube O - 1" Filter Plate (HD Applications)	91023
VS16 Filter Plate (European Applications)	91024
Ford FS18 / FS20 / RS20 Filter Plate	91025



# COMPRESSOR GUARD™ SCREENS

## OE-APPROVED SUCTION SCREENS PROTECT YOUR COMPRESSOR REPAIRS

- MAINTAINS NORMAL PRESSURE AND FLOW
- NO ADDITIONAL FITTINGS REQUIRED
- CREATES NO ADDITIONAL LEAK POINTS
- SIZES FOR ANY OE SUCTION BLOCK / MANIFOLD

COMPRESSOR GUARD SCREEN  
PREVENTS DEBRIS ENTERING  
COMPRESSOR



Compressor Guard suction screen OE-fit sizes match any OE suction block / manifold

Install without cutting lines

Multi-size screen kits cover over 95% of all suction port IDs



CLEAN REFRIGERANT  
ENTERS COMPRESSOR

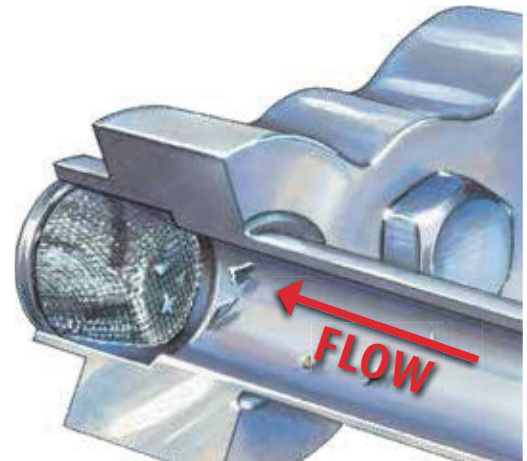

DESCRIPTION	PART NO.
Compressor Guard 24 Suction Screen Kit - contains 3 each of our 8 most popular sizes	67675
Compressor Guard Ultimate 72 Suction Screen Kit - contains 3 each of 24 sizes	67679

REPLACEMENT SCREENS (5 Pack)	PART NO.	FITS ID RANGE
0.395" (10.03 mm)	67518	.384" to .392"
0.404" (10.26 mm)	67520	.393" to .401"
0.436" (11.07 mm)	67522	.425" to .433"
0.463" (11.76 mm)	67524	.452" to .460"
0.471" (11.96 mm)	67502*	.460" to .468"
0.492" (12.50 mm)	67526	.481" to .489"
0.500" (12.70 mm)	67528	.489" to .497"
0.510" (12.95 mm)	67504*	.499" to .507"
0.521" (13.23 mm)	67506*	.510" to .518"
0.531" (13.49 mm)	67508*	.520" to .528"
0.538" (13.67 mm)	67510*	.527" to .538"
0.552" (14.02 mm)	67512*	.541" to .549"

REPLACEMENT SCREENS (5 Pack)	PART NO.	FITS ID RANGE
0.561" (14.25 mm)	67536	.550" to .558"
0.579" (14.70 mm)	67538	.568" to .576"
0.588" (14.93 mm)	67530	.577" to .585"
0.595" (15.11 mm)	67514*	.584" to .592"
0.600" (15.24 mm)	67532	.589" to .597"
0.618" (15.70 mm)	67516*	.607" to .615"
0.649" (16.48 mm)	67540	.638" to .646"
0.821" (20.85 mm)	67534	.811" to .819"
0.866" (22.00 mm)	67541	.856" to .864"
0.872" (22.15 mm)	67542	.862" to .870"
0.878" (23.00 mm)	67543	.868" to .876"
10PA17	67544	Denso 10PA17

\* = Screen Included in Compressor Guard 24 Screen Kit # 67675

## A/C SYSTEM FILTRATION

### HIGH SIDE INLINE FILTER™

**OE-APPROVED**

**PROTECT THE CONDENSER, OTHER NEW A/C COMPONENTS**

- TRAPS METAL SHAVINGS AND NON-METALLIC DEBRIS
- TAPERED DESIGN FORCES DEBRIS TO THE SIDE
- ALLOWS CONTINUAL REFRIGERANT FLOW, EVEN AFTER CATCHING DEBRIS
- WORKS WITH TXV OR CCOT SYSTEMS

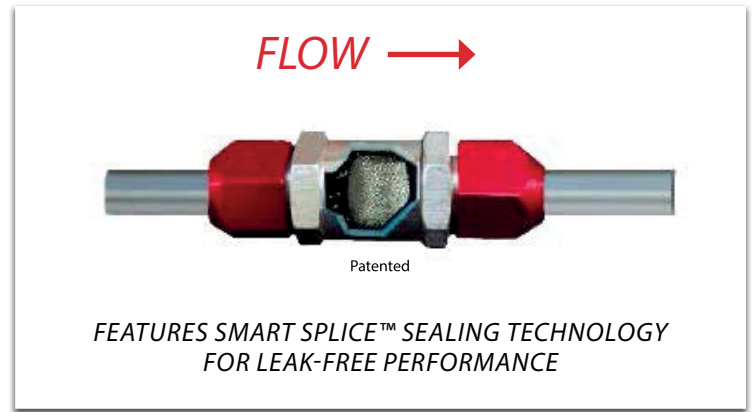

DESCRIPTION	PART NO.
In-Line SAE High Side Filter for 5/16", 3/8" or 1/2" Line	76100
In-Line Metric High Side Filter for 10mm or 12mm Line	77100

### MIO HIGH SIDE FILTER™

**WITH MALE INSERT O-RING FITTINGS  
A/C HIGH SIDE DEBRIS PROTECTION**

- FITS BETWEEN COMPRESSOR AND CONDENSER
- TRAPS HARMFUL METAL AND NON-METALLIC DEBRIS
- TAPERED SCREEN FORCES DEBRIS TO SIDE -- MAXIMIZES FLOW
- WORKS WITH TXV OR CCOT SYSTEMS



DESCRIPTION	PART NO.
MIO High Side Filter - #8 fitting	76107
MIO Filter Service Kit (contains new screen, 2 O rings)	76108

## A/C SYSTEM SECURITY

### CLICK LOCK™

**A/C SECURITY SYSTEM**

**PATENTED CAP SHOWS IF A/C SYSTEM HAS BEEN OPENED**

*Know if someone accessed the system since your last repair*

- ALERTS YOU TO CHECK FOR REFRIGERANT CROSS-CONTAMINATION
- PROOF THAT SYSTEM HAS BEEN OPENED ALLOWS EASIER CUSTOMER COMMUNICATION
- EASY REPAIR ORDER TRACKING - WITH UNIQUE SERIAL NUMBERS
- HELPS PREVENT UNWITTINGLY CAUSING SYSTEM PROBLEMS



DESCRIPTION	PART NO.
Click Lock 10 Pack for R134a A/C Systems	72921
Click Lock 10 Pack for R1234yf A/C Systems	72926

## R134a PRO GRADE OIL/DYE INJECTOR

*with unique sight glass body*

- EASY TO READ MEASURING SCALE
- DURABLE, ALL-STEEL BODY
- UP TO 230 PSI INJECTING PRESSURE

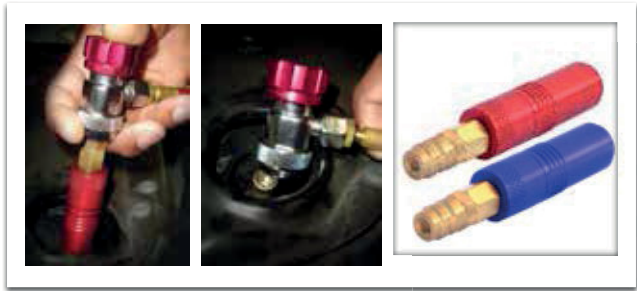

## R134a HIGH & LOW SIDE PORT EXTENDER

- FITS DEEP-SEATED OR STANDARD PORTS
- ELIMINATES RADIATOR SUPPORT R&R
- QUICK CONNECT, FITS IN TIGHT SPACES

DESCRIPTION	PART NO.
R134a A/C Oil Injector w/Sight Glass Body	90021

DESCRIPTION	PART NO.
R1234yf High Side Port Extender	90007
R1234yf Low Side Port Extender	90033



## R134a SERVICE COUPLERS

*Tough, durable quick connect design for years of service*

DESCRIPTION	PART NO.
R134a High Side Coupler	72130
R134a Low Side Coupler	72131
R134a Coupler Kit (1 High Side, 1 Low side)	72132

## R134a SERVICE HOSES

- HIGH QUALITY, OEM GRADE HOSE
- DESIGNED FOR ROUGH SERVICE
- AVAILABLE IN 36" AND 72"



DESCRIPTION	PART NO.
R134a 36" Yellow Jumper Hose, 1/2" ACME x 1/2" ACME	72136
R134a 36" Blue Low Side Hose, 1/2" ACME x 14mm	72137
1/2" ACME Can to Quick Coupler Charging Hose	72124

DESCRIPTION	PART NO.
R134a 72" Red High Side Hose, 1/2" ACME x 14mm	72134
R134a 72" Blue High Side Hose, 1/2" ACME x 14mm	72133
R134a 72" High/Low Side Hose Set, 1/2" ACME x 14mm	72125

## R1234yf PRO GRADE OIL/DYE INJECTOR

*with unique sight glass body*

- EASY TO READ MEASURING SCALE
- DURABLE, ALL-STEEL BODY
- UP TO 230 PSI INJECTING PRESSURE



DESCRIPTION	PART NO.
R1234yf A/C Oil Injector w/Sight Glass Body	90023

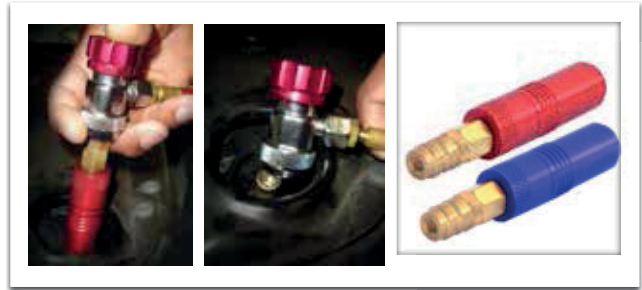

## R1234yf HIGH AND LOW SIDE PORT EXTENDER

- FITS DEEP-SEATED OR STANDARD PORTS
- ELIMINATES RADIATOR SUPPORT R&R
- QUICK CONNECT, FITS IN TIGHT SPACES

DESCRIPTION	PART NO.
R1234yf High Side Port Extender	90007
R1234yf Low Side Port Extender	90037



## R1234yf SERVICE COUPLERS

*Tough, durable quick connect design for years of service*

DESCRIPTION	PART NO.
R1234yf Low Side Coupler	72144
R1234yf High Side Coupler	72145
R1234yf Coupler Kit (1 High Side, 1 Low side)	72146
R1234yf Coupler to 1/4" Hose Adapter Fitting	72151
R1234yf Coupler to R134a Hose Adapter Fitting	72152

## O RINGS AND TOOLS

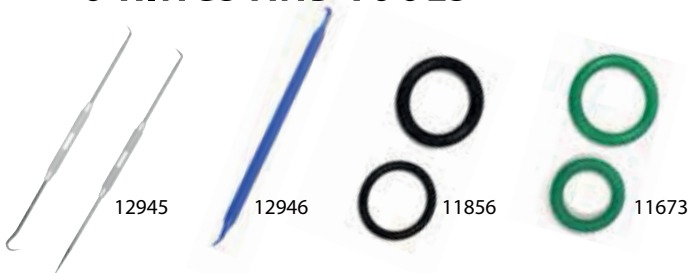

DESCRIPTION	PART NO.
O-Ring Hook and Scribble Set (Metal)	12945
O-Ring Pick (Plastic)	12946
O-Ring Repair Set for R134a Quick Coupler	11856
O-Ring Repair Set for R1234yf Quick Coupler Set	11673

## R1234yf SERVICE HOSES

- DESIGNED FOR ROUGH SERVICE
- AVAILABLE IN 36" AND 72"



DESCRIPTION	PART NO.
R1234yf 72" Red High Side Hose, 12mm-M x 12mm-M	72150
R1234yf 36" Yellow Jumper Hose, 12mm fitting x 1/2 x 16 ACME LH	72147
R1234yf 72" High/Low Side Hose, 12mm-M x 12mm-M	72148
R1234yf 72" Blue Low Side Hose, 12mm-M x 12mm-M	72149

## R134a / R1234yf PRO GRADE OIL/DYE INJECTOR

*with unique sight glass body*

- EASY TO READ MEASURING SCALE
- DURABLE, ALL-STEEL BODY
- UP TO 230 PSI INJECTING PRESSURE



*Compatible With Both R134a And R1234yf Systems*



DESCRIPTION	PART NO.
R134a/R1234yf A/C Oil Injector w/Sight Glass Body	90024

## SIGHT GLASS DIAGNOSTIC TOOL

*Compatible With Both R134a And R1234yf Systems*

- MONITOR SYSTEM FLUSHING
- CHECK CHARGING LEVEL
- VIEW OIL CHARGING
- DETECT CONTAMINANTS



DESCRIPTION	PART NO.
R134a/R1234yf Sight Glass Diagnostic Tool	90022

## R134a SMALL OIL / DYE INJECTOR

- LIGHT YET DURABLE
- MANUAL SHUT OFF, SIGHT GLASS
- 1/2" ACME, F X M



DESCRIPTION	PART NO.
R134a Small Oil/Dye Injector	90020

## COMPRESSOR TURNER TOOL™

**OEM-APPROVED COMPRESSOR STARTUP ASSISTANCE**  
**PREVENT NEW COMPRESSOR SEIZURE AT STARTUP**

### PROBLEM:

*Without proper internal lubrication, new compressors can seize during initial startup.*

### SOLUTION:

*Solution: AirSept's Compressor Turner Tool allows quick, easy circulation of lubricant for a trouble-free new compressor start.*

- RECOMMENDED BY COMPRESSOR MANUFACTURERS
- SPREAD LUBRICATION TO PREVENT COMPRESSOR DAMAGE AT STARTUP
- COMPRESSOR TURNER TOOL THREADS INTO CLUTCH, ALLOWS TURNING WITH A WRENCH



DESCRIPTION	PART NO.
Compressor Turner Tool	67700

# EVC-2™ VARIABLE DISPLACEMENT COMPRESSOR TESTER

**NEW!**

## TEST COMPRESSOR FUNCTION AT VARYING LEVELS

**PROBLEM:**

Technicians may easily misdiagnose an air conditioning system problem as a malfunctioning electronically-controlled variable displacement A/C compressor, when in fact the compressor is not at fault. Current diagnostic equipment is complex and can cost 600.00 or more. Technicians need an inexpensive, easy to use test tool.

**SOLUTION:**

High and Low Side Temperatures Tell a Story. Airsept's new EVC-1™ and EVC-2™ Variable Displacement Compressor Testers offer a quick, simple diagnostic process to help rule out an electronically-controlled compressor as a cause of air conditioning system performance problems. It is designed to activate the compressor's electronic control valve to test compressor operating efficiency. It works on all clutchless, direct drive, electronically-controlled air conditioning compressors.



READS HIGH AND LOW SIDE TEMPERATURES

SETS NO ERROR CODES IN OBD II

EASY TO USE



PART NO.	EVC
64500	EVC™-1 with temperature sensors
64501	EVC™-2 without temperature sensors

## SPRING-LOCK MASTER ASSORTMENT

### SPRING-LOCK TOOLS FOR MULTIPLE MAKES



- FOUR LOCK RELEASE TOOLS FOR MOST FORD AND CHRYSLER LH SERIES; SIZES 3/8", 1/2", 5/8" AND 3/4"
- TWO LOCK RELEASE TOOLS FOR NEWER VW MODELS
- TWO LOCK RELEASE TOOLS FOR NEWER GM MODELS
- FORD SPRING-LOCK TOOL KIT SOLD SEPARATELY

DESCRIPTION	PART NO.
Spring-Lock Master Assortment	90000
Ford Spring-Lock Tool Kit	90005

## GM SPRING-LOCK TOOL KIT

### DISCONNECTS GM SPRING-LOCK CONNECTORS



- OPENS SPRING-LOCK CONNECTORS ON A/C HIGH AND LOW SIDE HOSES
- TWO SIZES ACCOMMODATE SUCTION AND DISCHARGE LINES

DESCRIPTION	PART NO.
GM Spring-Lock Tool Set	90004

## VOLKSWAGEN SPRING-LOCK TOOL KIT

### OEM APPROVED TOOL EASILY OPENS SPRING-LOCK CONNECTORS DURING A/C SERVICE



- USE TO OPEN SPRING-LOCK CONNECTORS ON AIR CONDITIONING HIGH AND LOW SIDE HOSES FOR ACCESS DURING SERVICE OR REPAIR
- SPRING-LOADED CLAMP CLOSURES AROUND HOSE END TO MINIMIZE SPRAY WHEN LINE IS DISCONNECTED

DESCRIPTION	PART NO.
Volkswagen Spring-Lock Tool Kit	90001

## MERCEDES SPRING-LOCK RELEASE TOOL

### DISCONNECTS MERCEDES SPRING-LOCK CONNECTORS



- SPECIALLY DESIGNED TO DISCONNECT MERCEDES SPRING-LOCK CONNECTORS DURING A/C SERVICE
- SIMPLY CLAMP ONTO SPRING-LOCK CONNECTORS AND PRESS TO RELEASE SERVICE HOSES

DESCRIPTION	PART NO.
Mercedes Spring-Lock Release Tool	90002

## AUDI SPRING-LOCK TOOL KIT

- UNIQUE DESIGN FOR DISCONNECTING SPRING LOCK CONNECTORS ON NEWER AUDI, VOLKSWAGEN MODELS
- HIGH QUALITY TENSILE STEEL CONSTRUCTION



DESCRIPTION	PART NO.
Audi Spring-Lock Tool	90006

## REFRIGERANT OILS



### DIAL THERMOMETER WITH 1 ¼" FACE

- 1 1/4" FACE WITH MAGNIFYING LENS
- RANGE - 0° TO 220° F
- INCLUDES POCKET CLIP

DESCRIPTION	PART NO.
Dial Thermometer with 1¼" Face	90056



### DIGITAL THERMOMETER WITH 1 ¼" FACE

- AUTO SHUTOFF
- INCLUDES BATTERY
- FAHRENHEIT OR CELSIUS
- INCLUDES POCKET HOLDER WITH CLIP

DESCRIPTION	PART NO.
Digital Thermometer with 1¼" Face	90057

## LEAK DETECTION DYES



### FLUSH SOLVENT

- COMPLETE EVAPORATION - LEAVES NO RESIDUE
- REMOVES OIL AND CONTAMINANTS WITHIN THE A/C SYSTEM
- COMPATIBLE WITH ALL MOBILE A/C REFRIGERANTS AND OILS
- FOR USE WITH AIRSEPT A/C FLUSH MACHINE

DESCRIPTION	PART NO.
AirSept Flush Solvent (Quart)	40015
AirSept Flush Solvent (Gallon)	40016





## REFRIGERANT OILS

- COMPATIBLE WITH OEM SPECIFICATIONS
- TECHNOLOGICALLY ADVANCED CONTENT
- NON-CORROSIVE

DESCRIPTION	PART NO.
Hybrid A/C Oil – 8 Ounce	72603
PAG 46 Oil – 8 Ounce	72606
PAG 100 Oil – 8 Ounce	72608
PAG 150 Oil – 8 Ounce	72610

## LEAK DETECTION DYE

- EXPOSES LEAKS USING ANY UV OR BLUE LIGHT
- POE ESTER BASED
- SAFE FOR HYBRIDS



DESCRIPTION	PART NO.
R12/R134a Universal A/C Leak Dye – 1 Ounce	72621

## GM CABIN AIR FILTER RETROFIT KIT

**FOR 2007-2014 GM PICKUPS AND SUVs  
NOT FACTORY EQUIPPED WITH A CAF**

### PROBLEM:

Over 5 million 2007-2014 GM Pickups and SUVs are not factory equipped with a cabin air filter.

### SOLUTION:

AirSept's OEM-Approved GM Cabin Air Filter Retrofit kit installs a cabin air filter in minutes without special tools or equipment.

- OE-FIT, INSTALLS WITHIN VEHICLE HVAC SYSTEM
- EASY FOUR-STEP INSTALLATION - NO SPECIAL TOOLS REQUIRED
- GREATLY REDUCES DUST AND POLLUTANTS IN CABIN
- EXTENDS BLOWER MOTOR SERVICE LIFE
- OPTIONAL CARBON FILTER TRAPS SMALLER PARTICULATES



DESCRIPTION	PART NO.
GM Cabin Air Filter – Standard	90015
GM Cabin Air Filter – Carbon	90016
GM Cabin Air Filter Cover Plate	90017
GM Cabin Air Filter Retrofit Kit – Standard (ONE each Cabin Air Filter, Cover Plate, Install Screw)	90018
GM Cabin Air Filter Retrofit Kit – Carbon (ONE each Cabin Air Filter, Cover Plate, Install Screw)	90019

## FORD E-SERIES RETURN AIR DEBRIS SHIELD

**OPTIMIZES A/C SYSTEM PERFORMANCE**

### PROBLEM:

Millions of 2002 - 2015 Ford E-Series vans suffer A/C cooling problems due to debris blocking air flow over the evaporator.

### SOLUTION:

AirSept's patent pending Return Air Debris Shield (RADS) intercepts debris before it can reach the evaporator and optimizes A/C system performance.

- RADS INSTALLS IN THE PASSENGER CABIN - NO COMPONENT REMOVAL
- FOUR EASY STEPS, UNDER FIVE MINUTES
- NO SPECIAL TOOLS REQUIRED
- MERS RATED FILTER MEDIA
- STURDY FRAME PREVENTS WARPING



DESCRIPTION	PART NO.
Ford E Series (2002 - 2015) Return Air Debris Shield (RADS)	90025

# GM EQUINOX / TORRENT BLEND DOOR REPAIR KIT™

**OE-APPROVED**

**REPAIR GM A/C BLEND DOORS WITHOUT DASH OR HVAC CASE REMOVAL**



## PROBLEM:

On 2005-2009 Equinox / Torrent models, the blend door shaft can crack where it connects to the actuator control. Previous repair method required over 12 hours of labor time for dashboard removal, and blend door replacement.

## SOLUTION:

AirSept's new patent pending Equinox/Torrent Blend Door Repair Kit™ allows repair of broken blend doors with no dash removal or opening of HVAC case.

- REPAIR ONLY THE DAMAGED SECTION, INSTEAD OF REPLACING THE ENTIRE DOOR
- REDUCES LABOR TIME BY UP TO 80%

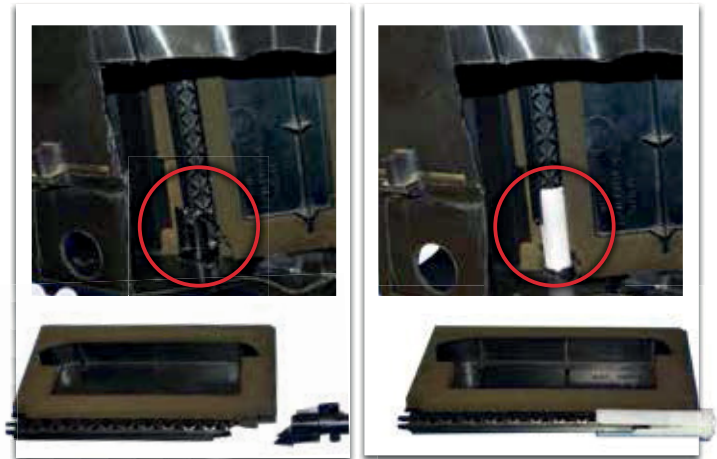

DESCRIPTION	PART NO.
Equinox/Torrent Blend Door Repair Kit with Sleeve	68001
Equinox/Torrent Blend Door Sleeve Refill Kit	68002

# FORD F SERIES BLEND DOOR REPAIR KIT

## PROBLEM:

On 1997-2004 Ford F-Series pickups, the HVAC blend door frequently fails at two different breakage points inside the case. Failure means loss of heated air flow into the cabin. Blend door replacement is a 7 to 9 hour job.

## SOLUTION:

AirSept's new patent pending F Series Blend Door Repair Kit allows repair of the blend door without dash or HVAC case removal.

R & R time is reduced to under two hours.

- NO DASH OR HVAC CASE REMOVAL NECESSARY
- TWO DIFFERENT SIZE REPAIR SLEEVES PROVIDED TO MAKE THE FIX AT EITHER BREAKAGE POINT
- NO SPECIAL TOOLS - JUST A RATCHET AND SCREWDRIVER
- REDUCES LABOR TIME BY 5 TO 7 HOURS



DESCRIPTION	PART NO.
Ford F Series (1997-2004) Blend Door Repair Kit With Sleeve	68003
Ford F Series (1997-2004) Blend Door Repair Sleeve	68013

## FORD EXPLORER / MERCURY MOUNTAINEER BLEND DOOR REPAIR KIT

### PROBLEM:

On 2002-2007 Ford Explorer SUVs, the HVAC driver's side blend door often breaks at the actuator motor port. Failure means loss of heated air flow into the cabin. Blend door replacement requires center console, dash and instrument cluster removal, then dropping the steering column.

### SOLUTION:

AirSept's new patent pending Explorer/Mountaineer Blend Door Repair Kit allows repair of the blend door without dash, cluster or steering column relocation. R & R time is reduced by 80 percent.

- NO DASH OR INSTRUMENT CLUSTER REMOVAL NECESSARY
- ACCESS THE ACTUATOR MOTOR BEHIND CENTER CONSOLE PANEL TO COMPLETE REPAIR
- REDUCES LABOR TIME BY 5 TO 7 HOURS

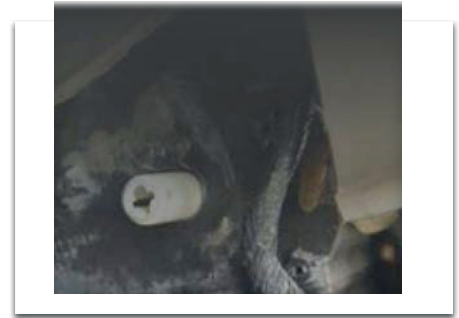

DESCRIPTION	PART NO.
Ford Explorer/Mercury Mountaineer (2002-2007) Blend Door Repair Kit With Sleeve	68004
Ford Explorer/Mercury Mountaineer (2002-2007) Blend Door Repair Sleeve	68014

## JEEP GRAND CHEROKEE BLEND DOOR REPAIR KIT

### PROBLEM:

On 1999-2004 Jeep Grand Cherokees, the HVAC driver's side blend door often breaks at the actuator motor port. Failure means loss of heated air flow into the cabin. Blend door replacement is difficult and time consuming due to the blend door design.

### SOLUTION:

AirSept's new patent pending Grand Cherokee Blend Door Repair Kit allows repair of the driver's side blend door.

Labor time is reduced by up to 75 percent.

- NO DASH OR HVAC CASE REMOVAL NECESSARY
- TWO DIFFERENT LENGTH REPAIR SLEEVES PROVIDED TO MAKE THE FIX FOR DRIVER'S SIDE OR BOTH BLEND DOORS AT ONCE
- NO SPECIAL TOOLS - JUST A RATCHET AND SCREWDRIVER
- REDUCES LABOR TIME BY 5 TO 6 HOURS



DESCRIPTION	PART NO.
Jeep Grand Cherokee (1997-2004) Blend Door Repair Kit - Driver Side With Sleeve	68006
Jeep Grand Cherokee (1997-2004) Blend Door Repair Sleeve - Driver Side	68017



# A/C FLUSH MACHINE WITH DUAL-TANK AND SOUNDSILENCE™ TECHNOLOGY

**QUIET AND ODOR-FREE – GREAT IN LARGE SHOPS OR SMALL WORK AREAS**

- DUAL-TANK TECHNOLOGY PROVIDES CLEAN SOLVENT FOR EACH VEHICLE FLUSH
- PERFORMS FULL FLUSH AND DRY CYCLES
- UNIQUE DRYING SYSTEM ENSURES MAX DRY AIR PURGE CYCLE

**PROPRIETARY ANTI-MISTING FLUID FLOW SYSTEM WITH CHARCOAL FILTRATION REDUCES SOLVENT FUMES**

- SOUNDSILENCE™ TECHNOLOGY SIGNIFICANTLY REDUCES NOISE
- OUR AIR FLOW MANAGEMENT SYSTEM PREVENTS FLUSHING UNLESS FLUSH/PURGE SETTINGS ARE IN THE CORRECT POSITION

**EASY, LOW COST MAINTENANCE R1234yf AND R134a COMPATIBLE**

- USE WITH AIRSEPT FLUSH SOLVENT
- REPLACEMENT FILTERS AVAILABLE FROM AIRSEPT

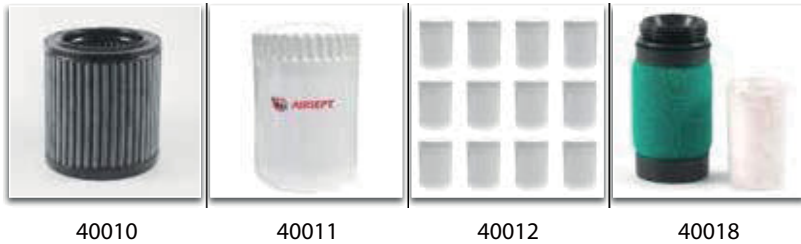

DESCRIPTION	PART NO.
AirSept A/C Flush Machine with Dual-Tank, SoundSilence Technology	40001
AirSept Charcoal Exhaust Filter for A/C Flush Machine - Two Pack	40010
AirSept Spin-on Filter for A/C Flush Machine - Single	40011
AirSept Spin-on Filter for A/C Flush Machine - Case (12 each)	40012
AirSept A/C Flush Solvent - Quart Bottle	40015
AirSept A/C Flush Solvent - One Gallon Bottle	40016
AirSept A/C Flush Solvent - Case (FOUR each, One Gallon Bottle)	40017
AirSept Air Inlet Filtration Cartridge Set for A/C Flush Machine	40018
AirSept Air Outlet Filtration Cartridge for A/C Flush Machine	40019
AirSept 100 Flush Cycle Filter Replacement Kit for A/C Flush Machine	40020
AirSept Flush Adaptor Set	40029





## PERMATUBE™

**RADIATOR OVERFLOW TUBE REPLACEMENT KITS**  
**REPAIR BROKEN RADIATOR TUBES IN LESS THEN 5 MINUTES**

### PROBLEM:

Radiator coolant overflow tubes are easily broken, often requiring replacement of the entire radiator.

### SOLUTION:

AirSept's patented PermaTube replacement kit allows overflow tube replacement on the vehicle, eliminating radiator replacement or repair.

- OEM-APPROVED
- COSTS LESS THAN RADIATOR R&R
- FACTORY APPEARANCE AND PERFORMANCE
- NO RADIATOR OR COOLANT REMOVAL



DESCRIPTION	PART NO.
PermaTube Replacement Kit	65605
PermaTube Relocation Tools	65607
PermaTube 2 Pack Refills	65602
PermaTube 5 Pack Refills	65608

# STEERING GUARD™

## IN-LINE POWER STEERING FILTER

### PROBLEM:

Debris left behind by a failed power steering pump can damage or disable the replacement pump.

### SOLUTION:

AirSept's Steering Guard in-line filter protect power steering repairs from debris.

### Protect your Power Steering Repairs from Debris

- DUAL FILTRATION TECHNOLOGY TRAPS METAL SHAVINGS AND NON-METALLIC DEBRIS
- BUILT-IN BYPASS MAINTAINS FLOW NO MATTER HOW MUCH TRASH THE FILTER CATCHES
- EASY TO CLEAN AND REINSTALL
- ADDED VALUE FOR INSTALLERS
- PEACE OF MIND FOR CUSTOMERS

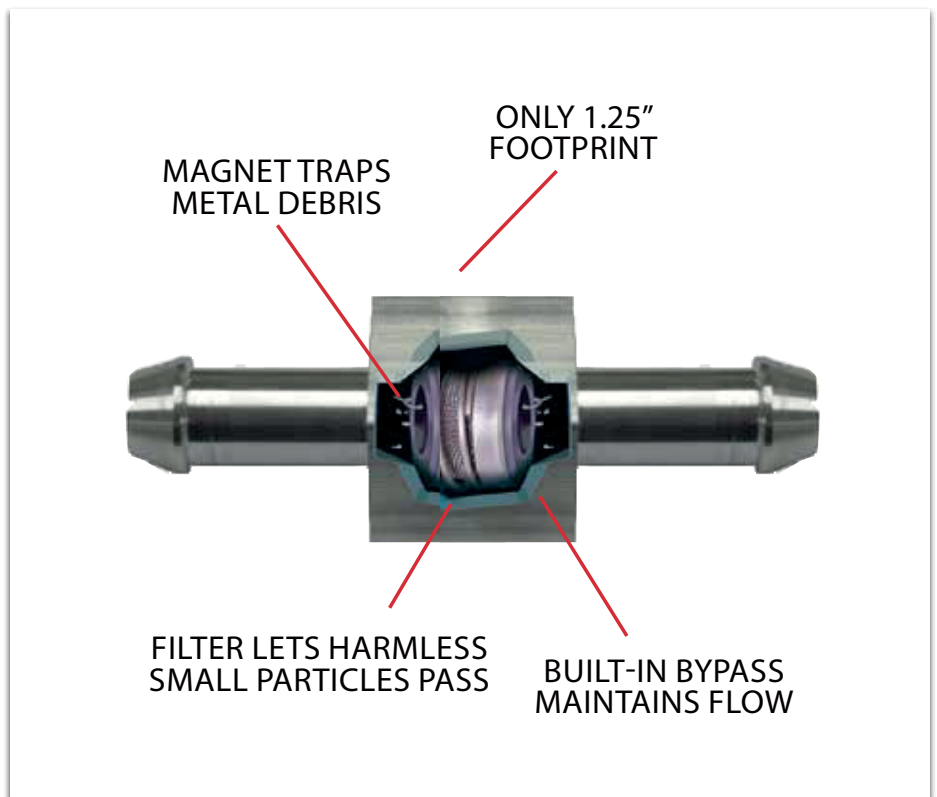

DESCRIPTION	PART NO.
Steering Guard 3/8" Double Barb	74010
Steering Guard 3/8" Barb Snap Connector	74011
Steering Guard 5/16" Double Barb	74012

# TRANSGUARD™

## IN-LINE TRANSMISSION FILTER

PROTECTS TRANSMISSIONS FROM OIL COOLER DEBRIS

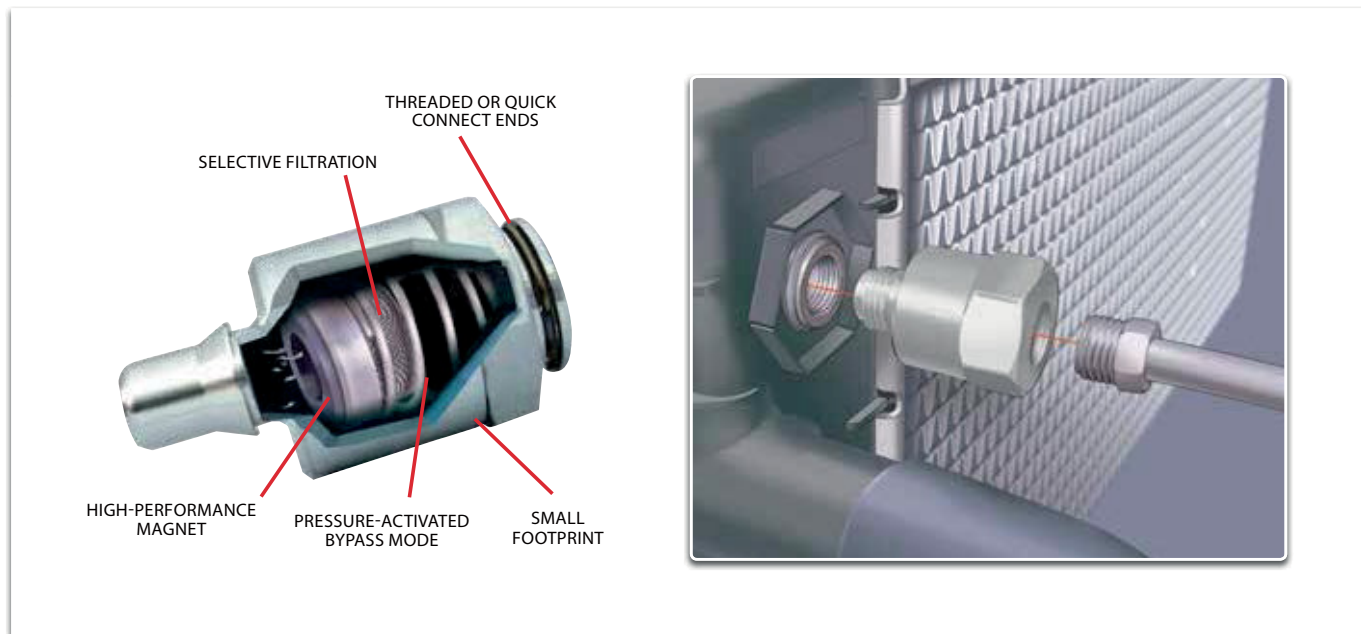

### PROBLEM:

80% of transmission repair comebacks are caused by metal and debris left behind in the system, usually in the radiator oil cooler.

### SOLUTION:

AirSept's TransGuard in-line filter protects transmission repairs from leftover debris.

- INSTALLS AT THE OIL COOLER OUTLET TO TRAP LEFTOVER SYSTEM METAL AND DEBRIS BEFORE IT ENTERS THE TRANSMISSION INLET
- INSTALLATION COMPLETE IN UNDER FIVE MINUTES
- FITS MOST APPLICATIONS WITHOUT ALTERING FACTORY CONFIGURATIONS
- UNIQUE BYPASS SYSTEM - NO MATTER HOW MUCH TRASH THE FILTER CATCHES, FLUID FLOW IS CONSTANT
- PROVIDES A GREAT OPPORTUNITY TO BOOST YOUR PROFITS AND INCREASE CUSTOMER SATISFACTION

TRANSGUARD CHRYSLER FILTER	PART NO.
Late Models with Quick Connect Fittings	71002
3/8" Male Inverted Flare x 3/8" Female Inverted Flare	71006
3/8" Male Flare x 3/8" Female Flare	71012

TRANSGUARD FORD FILTER	PART NO.
3/8" Male Long Shaft x 3/8" Female Long Shaft	71034
5/16" Male Long Shaft x 5/16" Female Long Shaft	71032

TRANSGUARD GM FILTER	PART NO.
All Models with Quick Connect Fittings	71002
5/16" Male Inverted Flare x 5/16" Female Inverted Flare	71004
3/8" Male Inverted Flare x 3/8" Female Inverted Flare	71006

TRANSGUARD IN LINE FILTER	PART NO.
3/8" Double Barb	71001
5/16" Double Barb	71008
3/8" Snap Connect	71022



## BARBED INLINE TRANSMISSION FILTER

**EXTEND THE LIFE OF YOUR TRANSMISSION REPAIRS**  
**FLUSHING DOESN'T CATCH 100% OF HARMFUL DEBRIS**

- TRAPS METAL SHAVINGS AND NON-METALLIC DEBRIS
- PRESSURE TESTED TO 750 PSI
- BUILT-IN BYPASS FOR CONSTANT FLUID FLOW EVEN AFTER FILTER IS FULL
- 60% SMALLER THAN TRADITIONAL TRANSMISSION FILTERS



DESCRIPTION	PART NO.
TransGuard - 3/8" Barbed In Line Filter - Metal	71015
TransGuard - 1/2" Barbed In Line Filter - Metal	71016
TransGuard - 5/8" Barbed In Line Filter - Metal	71017
TransGuard - 3/8" Barbed In Line Filter - Plastic	71115
TransGuard - 1/2" Barbed In Line Filter - Plastic	71116

## TRANSMISSION FILL ADAPTER TOOL

**ALLOWS FLUID INSTALLATION ON TRANSMISSIONS WITHOUT DIPSTICKS**

- STANDARD QUICK-CONNECT FITTING
- SLIM DESIGN FITS IN TIGHT SPACES
- 23.5" FLEXIBLE TUBE REACHES AROUND OBSTACLES

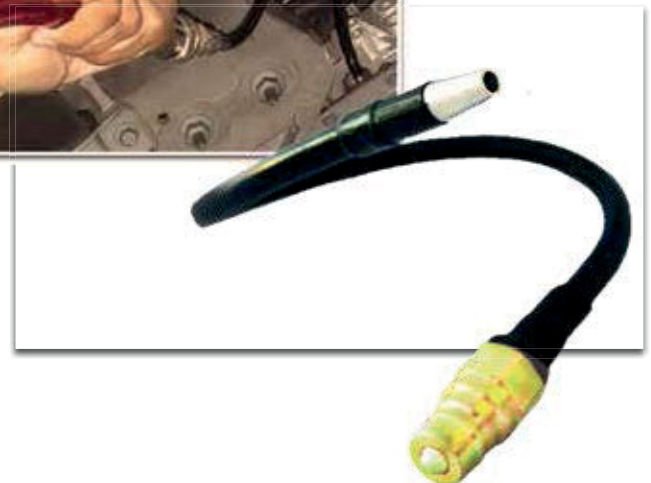

DESCRIPTION	PART NO.
Transmission Fill Adapter Tool	62640

## COOLING COIL COATING™

**OEM-APPROVED**

**ELIMINATE A/C ODOR FOR UP TO THREE YEARS**

*Cooling Coil Coating Combines a Powerful Antimicrobial with a Long-Lasting Acrylic Coating*

- COATED SURFACES RESIST RE-GROWTH OF ODOR-CAUSING MICROORGANISMS
- EFFECTIVELY REDUCES ODOR FOR THE LONG TERM
- ACRYLIC COATING HELPS SHED MOISTURE

DESCRIPTION	PART NO.
Cooling Coil Coating™ 4-oz. Non-Aerosol Bottle	60602
Cooling Coil Coating/CleanEvap Starter Kit*	60611

\* KIT CONTAINS (2) COOLING COIL COATING 4-OZ. BOTTLES, (2) CLEAN EVAP 8-OZ. BOTTLES, AND (1) ULTI-FLEX PRESSURE SPRAY TOOL



TREAT HARD-TO-REACH UNDERHOOD AREAS USING THE ULTI-FLEX PRESSURE SPRAY TOOL. WORKS WITH ALL AUTOMOTIVE FLUIDS.

## A/C ODOR SHIELD™

**ELIMINATE A/C ODOR UP TO 1 YEAR**

- SAME POWERFUL OE-APPROVED ANTIMICROBIAL AND ACRYLIC COATING AS COOLING COIL COATING
- FORMULATED TO LAST APPROXIMATELY ONE YEAR

DESCRIPTION	PART NO.
A/C Odor Shield™ 4-oz. Non-Aerosol Bottle	60641
A/C Odor Shield/CleanEvap Starter Kit*	62650

\* KIT CONTAINS (2) A/C ODOR SHIELD 4-OZ. BOTTLES, (2) CLEAN EVAP 8-OZ. BOTTLES, AND (1) ULTI-FLEX PRESSURE SPRAY TOOL

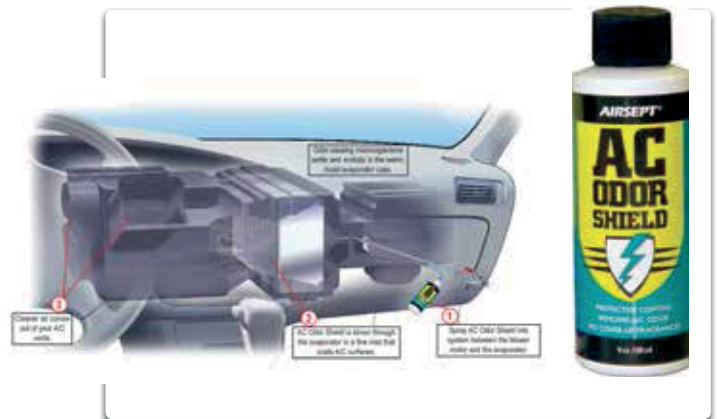

## OXYVAP™

**AUTOMOTIVE EVAPORATOR CLEANER**

- ELIMINATES ODOR RIGHT FROM THE SOURCE
- REMOVES DIRT AND CONTAMINANTS
- LEAVES NO RESIDUE
- SAFE FOR USE ON METALS

DESCRIPTION	PART NO.
OxyVap™ Evaporator Cleaner 4oz	60645
OxyVap™ Evaporator Cleaner Gallon	60645 GAL



## COOLING COIL COATING™ STARTER KIT

**OEM-APPROVED**

**THREE YEARS OF A/C ODOR ABATEMENT - FOR TWO VEHICLES**

Cooling Coil Coating Starter Kit Includes:

- (2) COOLING COIL COATING™ 4 OZ. BOTTLES
- (2) OXYVAP™ 4 OZ. BOTTLES
- (1) ULTI-FLEX PRESSURE SPRAY TOOL



DESCRIPTION	PART NO.
Cooling Coil Coating™ / OxyVap™ 4oz Starter Kit with Ulti-Flex delivery tool	60628

## A/C ODOR SHIELD™ STARTER KIT

**OEM-APPROVED**

**ONE YEAR OF A/C ODOR ABATEMENT - FOR TWO VEHICLES**

A/C Odor Shield Starter Kit Includes:

- (2) A/C ODOR SHIELD 4 OZ. BOTTLES
- (2) OXYVAP™ 4 OZ. BOTTLES
- (1) ULTI-FLEX PRESSURE SPRAY TOOL



DESCRIPTION	PART NO.
A/C Odor Shield™ / OxyVap™ 4oz Starter Kit with Ulti-Flex delivery tool	60629

## ULTI-FLEX PRESSURE SPRAY TOOL™

**OEM-APPROVED**

**PRECISION ATOMIZING TIP ASSURES OPTIMAL PRODUCT DIFFUSION**

*The best way to apply Cooling Coil Coating, A/C Odor Shield, CleanEvap or any automotive fluid*

- BEND TO FIT ANY UNDERHOOD OR UNDERCAR CONFIGURATION
- USE WITH SHOP AIR FOR FAST APPLICATION OR POWERFUL CLEANING ACTION
- DURABLE METAL CONSTRUCTION, PROTECTIVE SHEATHING

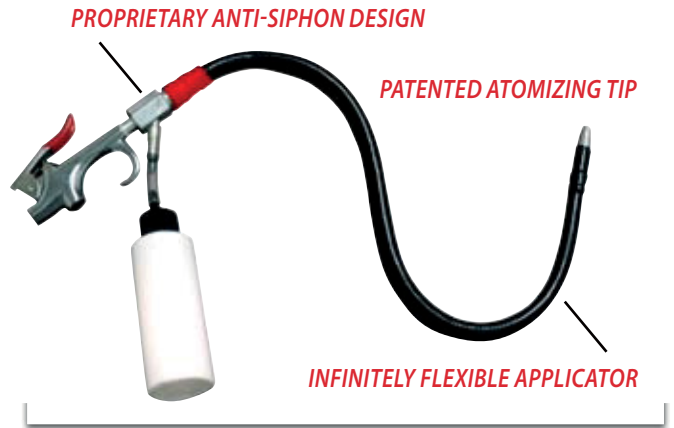

DESCRIPTION	PART NO.
Ulti-Flex Pressure Spray Tool	62644

## MS1 SPRAY TOOL

**EFFECTIVE, PENETRATING SPRAY APPLICATOR**

- PATENTED PRECISION ATOMIZING TIP PROVIDES OPTIMUM LIQUID DIFFUSION
- CREATES UNIFORM SPRAY COVERAGE
- SHOP AIR MAXIMIZES PENETRATION, CLEANING POWER



DESCRIPTION	PART NO.
MS1 Spray Tool	62602

# SEE BRIGHTER™

## NON-ABRASIVE HEADLIGHT RESTORATION KIT

*See Brighter™ removes clouding from polycarbonate lenses and restores light projection.*

- APPLY IN UNDER 5 MINUTES
- TWO EASY STEPS: CLEAN, APPLY -- DONE!
- NO CLEANUP OR DRY TIME
- LONG LASTING UV PROTECTION

**NO SANDING! NO POLISHING!  
BUILT-IN UV PROTECTION**



**SEE BRIGHTER™ 12-PACK DISPLAY**

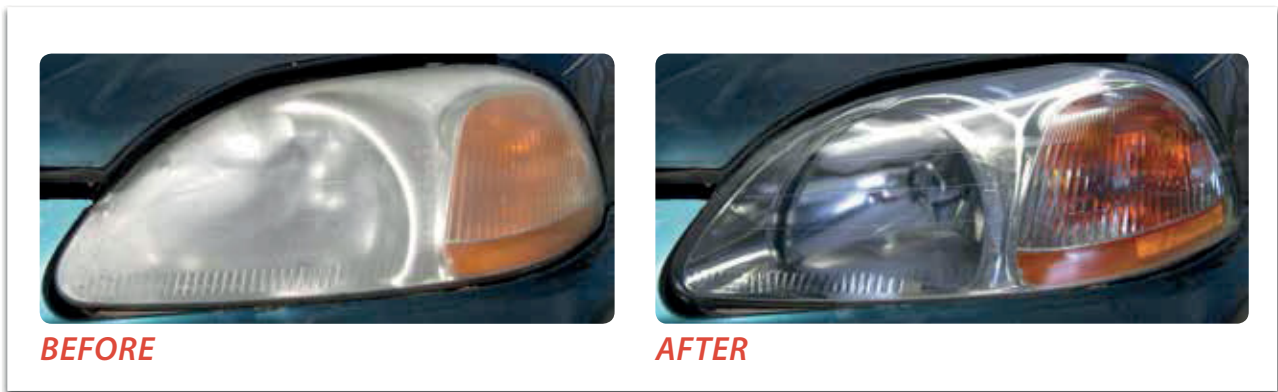

**BEFORE**

**AFTER**

DESCRIPTION	PART NO.
See Brighter™ Headlight Restoration Kit Counter Display 12-pack	60650
SeeBrighter Headlight Restoration Kit - Single	60652