









HEAVY DUTY®

Heavy Duty Exhaust Catalog

TRUCK • SCHOOL BUS • AGRICULTURAL



CONTENTS

	GENERAL INFORMATION	2
	ACCESSORIES, MUFFLERS & PIPES	16
	MEDIUM & H.D. APPLICATIONS	74
	SCHOOL BUS APPLICATIONS	128
	TRACTOR MUFFLERS	188
	CROSS REFERENCE	210

HOW-TO FIND GUIDE



VERTICAL SYSTEM COMPONENTS

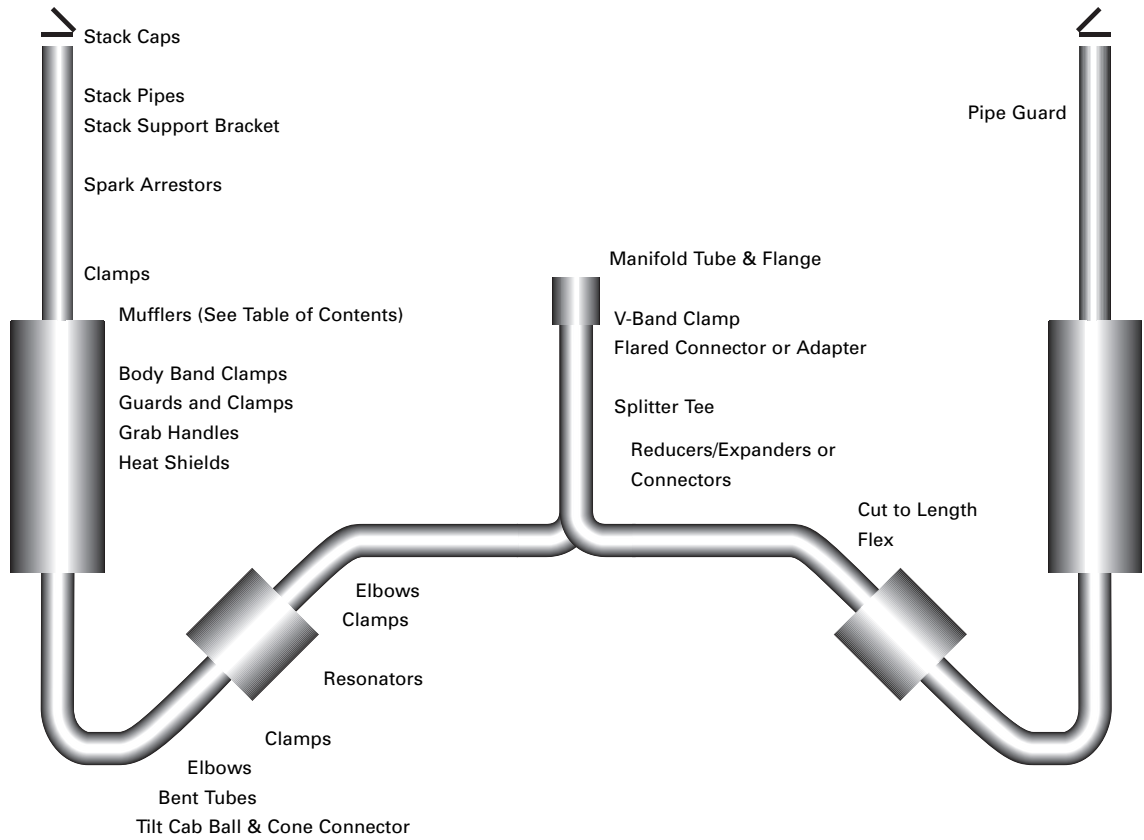

HORIZONTAL SYSTEM COMPONENTS

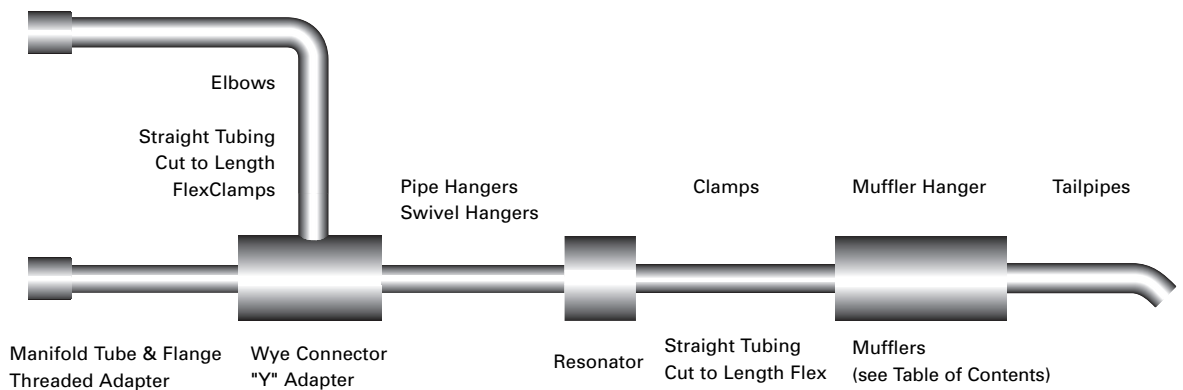

HOW-TO USE THIS CATALOG

① SERIES P30/3500

CHEV./GMC TRUCK 6 CYL.

91-95 6 Cyl. ② P30/P3500; 133", 157", 178" W.B., 262(4.3L) Engine; 1 Ton

③ (21412)

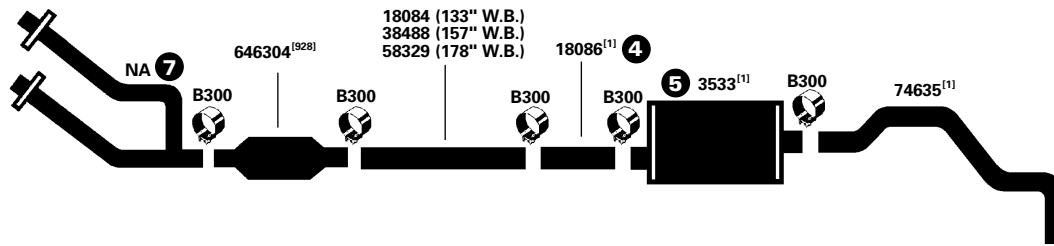

⑥ DIRECT FIT MAXIMUM MUFFLER...700141 UNIVERSAL FIT MAXIMUM MUFFLER...6577
UNIVERSAL CONVERTER...606007

- ① Basic Listing is provided to show make and model for easy reference.
- ② Within model, additional information is provided to distinguish year and engine options.
- ③ Every listing is numbered for quick reference
- ④ Footnotes are printed at the end of each truck model section.
- ⑤ Part numbers appear adjacent to each part for ease of use.
- ⑥ Options for additional muffler, converter and specialty parts are listed.
- ⑦ The appearance of this symbol indicates we do not carry this part.

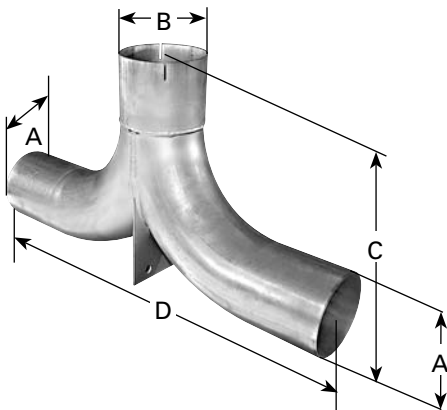

SPLITTER "T" ADAPTER PIPE

P/N WITHOUT BRACKET	P/N WITH BRACKET	A	B	C	D
92695	—	4" OD	4" ID	12"	20"
—	92673	4" OD	4" ID	11¼"	16"
—	92674	5" OD	5" ID	14"	25"
92696	—	5" OD	5" ID	11"	19"
92697	—	5" OD	5" ID	13½"	22"

All dimensional sizes are clearly referenced by letters within the chart.



HD EXHAUST GENERAL INFORMATION

GENERAL
INFORMATION

TRUCK CLASSIFICATION GUIDE

Based on Gross Vehicle Weight of Truck (GVW)

CATEGORY	GVW CLASS	GROSS VEHICLE WEIGHT RANGE-
Light	1	Up to 6,000 lbs GVW
Light	2	6,001 – 10,000 lbs GVW
Medium	3	10,001 – 14,000 lbs GVW
Medium	4	14,001 – 16,000 lbs GVW
Medium	5	16,001 – 19,500 lbs GVW
Medium	6	19,501 – 26,000 lbs GVW
Heavy	7	26,001 – 33,000 lbs GVW
Heavy	8	33,001 lbs and up GVW

ENGINE SIZE CONVERSION CHART

C.I.D.	C.C.	LITER	C.I.D.	C.C.	LITER	C.I.D.	C.C.	LITER
61	1000	1.0	255	4179	4.2	466	7638	7.6
92	1500	1.5	258	4229	4.2	475	7785	7.8
98	1606	1.6	260	4261	4.3	495	8113	8.1
105	1721	1.7	265	4343	4.3	500	8195	8.2
112	1836	1.8	267	4376	4.4	504	8261	8.3
121	1983	2.0	292	4786	4.8	525	8605	8.6
122	2000	2.0	300	4917	4.9	551	9031	9.0
134	2196	2.2	301	4933	4.9	552	9047	9.0
135	2213	2.2	302	4949	5.0	555	9096	9.1
140	2295	2.3	304	4983	5.0	568	9310	9.3
151	2475	2.5	305	4999	5.0	611	10014	10.0
156	2557	2.6	307	5032	5.0	636	10424	10.4
159	2606	2.6	318	5212	5.2	638	10457	10.5
170	2786	2.8	350	5736	5.7	672	11014	11.0
171	2803	2.8	351	5753	5.8	673	11030	11.0
173	2835	2.8	359	5884	5.9	707	11588	11.6
181	2967	3.0	360	5900	5.9	736	12036	12.0
196	3212	3.2	368	6032	6.0	743	12178	12.2
200	3278	3.3	378	6195	6.2	852	13964	13.9
212	3475	3.5	379	6212	6.2	855	14013	14.0
225	3688	3.7	400	6556	6.6	864	14161	14.2
229	3753	3.8	403	6605	6.6	866	14194	14.2
231	3786	3.8	420	6884	6.9	893	14636	14.6
232	3802	3.8	425	6966	7.0	903	14800	14.8
238	3901	3.9	426	6982	7.0	927	15193	15.2
250	4097	4.1	454	7447	7.4	1099	18013	18.0
252	4130	4.1	460	7539	7.5	1151	18848	18.8

FOR ENGINES NOT LISTED ABOVE, USE FOLLOWING CONVERSION TABLE

TO CONVERT	INTO	MULTIPLY BY-
C.I.D.	cc	16.39
C.I.D.	LITER	.01639
cc	C.I.D.	.06101
LITER	C.I.D.	61.01

WELDING TIPS

① OXYACETYLENE WELDING

Filler Metal: Use a mild steel filler, 3/32" diameter, free of rust. (American Welding Society classification A5.2) **DO NOT** use copper coated filler metal.

Welding Equipment: Use a number 3 or 4 tip. Observe instructions of the equipment manufacturer when adjusting the operating pressures at the gas regulators.

Procedure: Clean the parts to be welded thoroughly. Incline the torch at a 45° angle away from the direction of travel. Use the forehand welding technique. Keep the torch flame on the tip of the filler rod, not in the center of the puddle.

② SHIELDED METAL-ARC

(STICK ELECTRODE)

Any one of the following rods are recommended: Raco Fer-Al (Reid-Avery Co.), E-6011 (P. & H.), Fleetwood 47 (Lincoln), W-52 (General Electric), Flex-Arc LOH-2 (Westinghouse), Stainless Steel Rods Type 309 or 310 and Low Hydrogen Rods E-7015, E-7016 or E-7018.

③ GAS METAL-ARC (MIG)

Carbon dioxide shielding gas is used with A-675 Aircro Wire.

PRODUCT WARRANTY

HEAVY DUTY EXHAUST PRODUCTS	LENGTH OF WARRANTY
Diesel Mufflers, Vertical Installations	4 Years or 500,000 miles
Diesel Mufflers, Horizontal Installations	3 Years or 500,000 miles
Gas Mufflers	1 Year
Accessories	1 Year
Chrome Parts (Peeling & Blistering Only)	90 Days

TERMS & CONDITIONS

Warranty coverage begins on the date and mileage the part is purchased by the user and expires when the specified number of years or miles has passed, whichever occurs first.

The Length of Warranty for replacement parts provided under Warranty coverage is the balance of the Warranty period remaining on the part being replaced.

WARRANTY STATEMENT

TruckEx™ warrants its products against failure due to defects in materials and workmanship for the period specified under Terms and Conditions for the particular part. TruckEx's obligation under this warranty covers replacement of the failed part including transportation charges. If the TruckEx product failure is the sole and direct cause of damage to the equipment on which the product was installed, TruckEx will reimburse reasonable costs to restore the equipment to the condition it was in immediately before the failure.

This warranty does not cover failure due to misapplication, misuse, abuse, neglect, rust through and corrosion (muffler), improper service practices or non-approved modification. This warranty gives you specific legal rights. You may have other rights which may vary from state to state. Engine and Equipment Manufacturers warranties remain in effect when TruckEx products are used. TruckEx must be notified of any claims covered by this warranty within one year of the date of failure.

5 MAJOR SOURCES OF NOISE IN TRUCKS

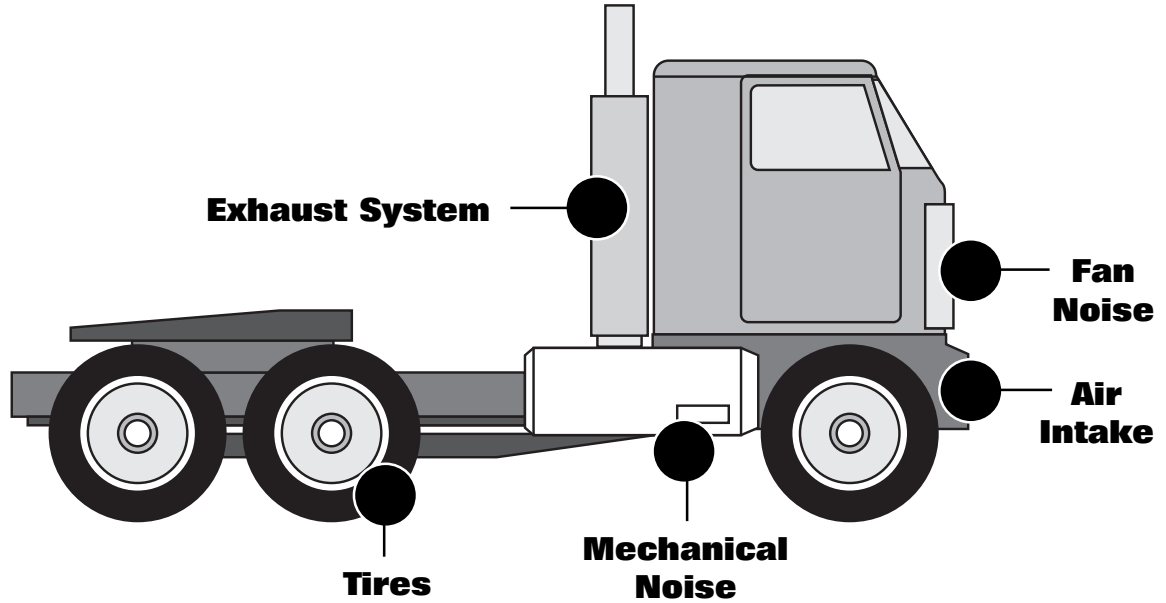

U.S. EPA NOISE REGULATIONS FOR ON ROAD TRUCKS

The first nationwide regulation of truck noise was established with the Noise Control Act of 1972 (P.L. 92-574.86 STAT. 1234). Regulations apply to trucks greater than 10,000 lbs GVW. Noise regulations apply to total truck noise, not just exhaust noise. The five major sources of noise in trucks are:

- 1. Fan Noise
- 2. Air Intake
- 3. Mechanical Noise (Engine & Drive Train)
- 4. Tires
- 5. Exhaust

TWICE THE LOUDNESS IS 10dB INCREASE

The increases are not linear! Increasing noise by 10dB sounds twice as loud.



NOISE REDUCTION TIPS

- 1 Make sure your muffler is recommended by the muffler manufacturer for the particular engine in your vehicle. To meet most new noise laws, the "universal" muffler must be replaced by a muffler designed specifically for the engine.
- 2 Tail pipes on horizontal exhaust systems should be tipped toward the center of the vehicle to avoid noise reflection off the road.
- 3 If you have curved stacks, replace them with straight stacks. Noise coming from a pipe outlet is directional and straight stacks will throw noise up, not to the side. Rain stacks and 45° cut stacks do not appreciably affect noise levels.
- 4 The length of stack installed on the muffler can be critical. If an irritating "rap" is heard at certain engine speeds, try stacks with different lengths.
- 5 In an exhaust system with piping exceeding 10 feet in length, the muffler is suggested to be installed where the exhaust pipe to the muffler is either one-half or four times the length of the tail pipe.
- 6 A resonator can be used in-line with the recommended muffler for additional noise reduction.
- 7 If you have increased the size of the exhaust piping or made a dual out of a single system, check recommendations for piping size. Over-sized systems are exceedingly noisy!
- 8 The vehicle operator, to a certain extent can control his vehicle noise. The greater the engine load the louder the noise. Certain engine speeds may be more noisy than others. High vehicle speed causes more tire noise. Operating an engine brake when it's not needed may cause extra noise.
- 9 If the above-mentioned techniques do not solve your problem, contact TruckEx for specific recommendations.

MAINTENANCE TIPS

- 1 Check flex tubing regularly. Repair worn or leaking tubing.
- 2 Make sure the exhaust system is properly supported with required brackets, clamps and braces.
- 3 Check strap seal band clamps to ensure properly tightened to avoid leaks.
- 4 Consider accoustic compound when repairing OD-ID connections.

AFTER MARKET REGULATIONS FOR TOTAL TRUCK NOISE

US EPA regulations stipulate maximum noise levels for both new (first-fit) and in-use trucks. Vehicle manufacturers are responsible for compliance of new trucks, and owners are responsible for in-use trucks. New trucks must be no louder than 80 dB at 50 feet. In-use trucks,

if manufactured 1986 or later, must be less than 83 dB. If they were manufactured before 1986, they must be no louder than 86 dB. EPA regulations also stipulate that a replacement muffler be no louder than the original equipment (first-fit) muffler.

EXHAUST PRODUCT MATERIALS

There are a number of materials used in heavy duty exhaust applications. Some of the materials are appropriate for heavy duty applications. Other choices are not durable at the temperatures generated by gas and diesel engines and should be avoided if acceptable service life is desired. Materials selected must not only survive high temperatures, but also severe vibration, corrosive exhaust gasses, and external corroding agents such as salt and water.

The materials generally considered for exhaust parts are as follows:

- Aluminized Steel
- 400 Series Stainless Steel
- 400 Series Aluminized Stainless Steel
- 300 Series Stainless Steel
- Galvanized Steel
- Low Carbon Cold Rolled Steel (CRS)

Aluminized Steel is the preferred material for most heavy duty diesel applications. Aluminized Steel is a low carbon steel with a thin layer of aluminum alloyed to the surface. The aluminum provides galvanic protection for the base material. Aluminized Steel parts have an ultimate service temperature of 1250° F with a continuous duty temperature of 1100° F. This material has excellent corrosion resistance to acidic diesel exhaust gasses. Aluminized Steel parts provide excellent field life at a reasonable cost.

400 Series Steels are used for extended service life in diesel applications, and often in gas applications due to their higher operating temperatures. This material family provides slightly better strength at exhaust system temperatures than aluminized steel.

The most common 400 Series Steel used in exhaust applications is Type 409. It is stronger than aluminized but has cosmetic problems at exhaust system temperature. At first exposure to high temperature it discolors. Over time it develops a nondestructive coating of surface rust. After an extended time in the field a 409 product will display external discoloration and look worse than a similar aluminized part. Parts made with type 409 generally require some type of paint or other coating to slightly delay the onset of external discoloration, and the parts will hold a magnet due to higher iron content.

Another choice is 409 Stainless Steel with an aluminum coating. Aluminized 409 is used on Diesel Catalytic Converter mufflers due to its excellent high temperature resistance and the corrosion protection of the aluminized coating. This is a premium material found

primarily on emission products or high temperature gas applications.

300 Series Stainless Steels are also applied in exhaust systems. The most common material is Type 304. This material has excellent corrosion resistance and very good high temperature strength and is used in some muffler applications where very high stresses occur. It is also used as a premium material for gas applications. The most prevalent use of the material in diesel heavy duty applications is for flex pipe. Flex pipe produced from light gauge 304 Stainless Steel is an excellent choice considering all the factors of cost, durability, and service life. In general field service life with stainless steel flex pipe is very good if the flex tubing is installed properly.

Often **Chrome Plated Cold Rolled Steel** parts are found on exhaust system parts. This material is a reasonable choice when a bright mirror finish is desired. Corrosion from the inside of the product can still occur, Chrome parts are very challenging to produce. It is important to produce the parts with a high level of quality because surface irregularities (and field damage to the surface) will lead to external rust. An alternate choice for chrome parts is **Bright Annealed Stainless Steel**. This material provides a bright mirror like finish with excellent exhaust service life. The material is costly, but part of the cost increase is offset by using lighter gauges.

Galvanized Steel parts are sometimes used in the exhaust market. Galvanized Steel has very poor field performance. This material has an upper temperature limit of approximately 600° F. At temperatures greater than 600° F the material rapidly corrodes with a resulting degradation in appearance and probable failure. Galvanized Steel is often used for flex pipe as a low cost replacement part. The initial low cost is offset by the limited field life of the product.

Cold Rolled Steel (CRS) is a very poor choice for any exhaust system part. This material is extremely susceptible to corrosion. These parts are only used when the lowest possible cost is desired. It is rare to find mufflers made of cold rolled steel, but there are stacks offered in some markets in Cold Rolled Steel. Clamps are another product commonly produced out of Cold Rolled Steel. Clamps are not exposed to the corrosive acids found in exhaust gasses but the high temperatures cause clamps to degrade rapidly in appearance and in function. Cold Rolled Steel clamps can be very difficult to remove after a short time in the field.

ABBREVIATIONS

A.I.R.	Air Injection Reactor	INCL.	Including
ALT.	Altitude	INJ.	Injection
A.T.	Automatic Transmission	INSL.	Insulator
AUTO.	Automatic	L.C.F.	Low Cab Forward
AUX.	Auxillary	L.H.	Left Hand
A.W.D.	All Wheel Drive	MAN.	Manual
B.B.C.	Bumper to Back Cab	M.F.I.	Multipoint Fuel Injection
BBL.	Barrel	M.H.C.	Motor Home Chassis
BRKT.	Bracket	M.T.	Manual Transmission
CALIF.	California	N.A.	Not Available
CARB.	Carburetor	N.F.	Not Furnished-Reuse Old Flange
cc.	Cubic Centimeters	NO.	Number
C.C.	Commercial Chassis	N.R.	Not Required
C.F.I.	Central Fuel Injection	N.R.A.	Noise Restricted Areas
C.I.D.	Cubic Inch Displacement	O.D.	Outside Diameter
CLMP.	Clamp	O.E.	Original Equipment
C.O.E.	Cab Over Engine	O.H.V.	Overhead Valve
CONV.	Converter	PASS.	Passenger
CU. IN.	Cubic Inch	PKG.	Package
CYL.	Cylinder	P.T.O.	Power Take Off
DIA.	Diameter	REG.	Regular
DOHC.	Dual Overhead Camshaft	REQ.	Required
DR.	Door	R.H.	Right Hand
E.F.E.	Early Fuel Evaporation	R.W.D.	Rear Wheel Drive
E.F.I.	Electronic Fuel Injection	S.C.	Supercharged
E.G.R.	Exhaust Gas Recirculation	S.B.C.	School Bus Chassis
ENG.	Engine	S.D.	Super Duty
EXC.	Except	SER.	Serial
EXH.	Exhaust	S.M.P.I.	Sequential Multipoint Fuel Injection
FED.	Federal	SOHC.	Single Overhead Camshaft
F.I.	Fuel Injection	SPEC.	Special
FLNG.	Flange	S.P.I.	Single Point Injection
F.W.D.	Front Wheel Drive	S.T.	Super Turbine
GMC.	General Motors Corporation	STD.	Standard
GSKT.	Gasket	STRP.	Strap
G.V.W.	Gross Vehicle Weight	SUB.	Suburban
H.D.	Heavy Duty	T.B.I.	Throttle Body Injection
HI PERF.	High Performance	T.P.I.	Tuned Port Injection
HNGR.	Hanger	TRANS.	Transmission
H.O.	High Output	TURBO.	Turbocharger
H.P.	Horse Power	w/.....	With
HYD.	Hydramatic	w/o.....	Without
H5D.	GM Heavy Duty Emissions	W.B.	Wheel Base
I.D.	Inside Diameter	W.D.	Wheel Drive



HD EXHAUST
GENERAL INFORMATION

GENERAL INFORMATION

TRUCK EXHAUST – FLEET SURVEY FORM

Fleet Name _____
 Street _____ City/State _____
 Owner/Manager _____ Buyer _____
 Maint. Supervisor _____ Pts. Mgr. _____
 Phone _____
 Exhaust Brands _____ Suppliers _____

TRUCK CLASS	VEHICLE				ENGINE		EXHAUST SYSTEM*			
	YEAR	MAKE	MODEL	#	MAKE	MODEL/SIZE	DIA.	H/V	S/D	VARIATIONS
1-3										
4-6										
7-8										

*H=Horizontal V=Vertical S=Single D=Dual Variations may be Wye Connectors, Tilt Cab, Chrome Stacks, Etc.

General Comments _____

Call Made By _____ (Sales Person) Date _____

HEAVY DUTY – EXHAUST SYSTEM CHECKLIST

ENGINE			EXHAUST DESIGN	
	MAKE	MUFFLERS	STYLE*	
	MODEL		VERTICAL	
TURBOCHARGED	NATURALLY ASPIRATED		HORIZONTAL	
			INLET SIZE	
MANIFOLD OR TURBO OUTLET DIAMETER	EXHAUST SYSTEM OR STACKS	OUTLET SIZE		
		SINGLE		
		DUAL		
		VERTICAL		
		HORIZONTAL		

*Refer to Data Section of Catalog

System Needs:

Manifold Tube/Flange _____	"Y" Pipe _____	Stack Pipe _____
Lipped Flange _____	Tail Spout _____	Muffler Guard _____
V-band Clamp _____	Rain Cap _____	Pipe Guard _____
15° Elbow _____	Straight Tubing _____	Hanger/Bracket _____
45° Elbow _____	Flex Connector _____	Resonator _____
90° Elbow _____	Clamps _____	Wye Connector _____
Reducer/Connector _____	Pipe _____	Muffler _____
Splitter T Adapter _____	Flex Tubing _____	Spark Arrestor _____

TRUCK MODEL IDENTIFICATION INDEX

Medium Duty trucks are 1-2½ ton load capacity vehicles with a GVW rating of 10,001 to 26,000 pounds.
Examples: school buses, delivery trucks, motor homes.

Heavy Duty trucks are 2½ ton and over load capacity vehicles with a GVW rating of 26,001 pounds and over.
Example: semi tractors, cement trucks, fire trucks.

CHEVROLET/GMC LIGHT DUTY (See Automotive Exhaust Catalog)

HOW TO IDENTIFY "H5D" EMISSIONS

On "C", "R" and "K", "V" Models, this identification sticker is attached to the inner surface of the glove compartment door OR on the left front inner fender skirt. On "P" Models, the sticker is mailed separately to the dealer. On "G" Models, the sticker is located on the inner hood panel surface.

CHEVROLET/GMC MEDIUM DUTY

SERIES	TYPE	CATALOGED UNDER
P	Forward Control	Series 40
C	Conventional, TopKick/Kodiak	Series 40, 50, 60, 65, 70, 80
M	Tandem	Series 50, 60, 65, 70, 80
S	School Bus	School Bus Catalog
T	Tilt Cab	Series 40, 50, 60, 65, 70, 80
W	Tilt Cab	W4N, W5N, W6N, W7N

CHRYSLER/DODGE/PLYMOUTH LIGHT DUTY SERIES (See Automotive Exhaust Catalog)

DODGE MEDIUM DUTY

SERIES	TYPE	CATALOGED UNDER
A, B, PB	Van, Wagon	B-Series/A-Series
CB, MB	Compact Front Section	B-Series/A-Series
D	Pickup - 2 W.D.	D-Series
M	Motor Home	M-Series
P	Forward Control	P-Series, Series 400, 450, 500, 600
W	Pickup - 4 W.D.	W-Series
C	Low Cab Forward	Series 500, 600, 700-1000
CB, MB	Compact Front Section	Series 400, 450
D	Conventional - 2 W.D.	Series 400, 450, 500, 600, 700-1000
L	Tilt Cab	Series 500, 600, 700-1000
M	Motor Home	Series 400, 450, 500, 600
S	School Bus	School Bus Catalog (Available summer, 2002)
W	Conventional - 4 W.D.	Series 400, 450, 500, 600

FORD LIGHT DUTY (See Automotive Exhaust Catalog)

TRUCK MODEL IDENTIFICATION INDEX

FORD MEDIUM DUTY

SERIES	TYPE	CATALOGED UNDER
B	School Bus	School Bus Catalog
C	Tilt Cab	Series 500, 550, 600, 700, 750, 800, 850, 900, 950, 1000, 1100
CT	Tilt Cab Tandem	Series 700, 750, 800, 850, 900, 950
F, N	Conventional	Series 500, 550, 600, 700, 750, 800, 850, 900, 950, 1000, 1100
L	Hi-Tilt Cab	Series 800, 850, 900, 950
LN	Short Tilt Cab	Series 500, 550, 600, 700, 750, 800, 850, 900, 950
P	Forward Control, Parcel Delivery	Series 500, 550, 600

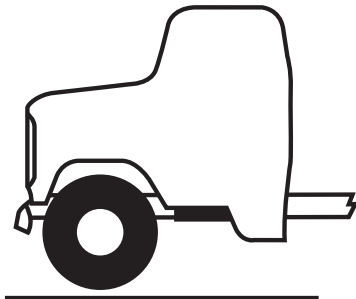

Model 81 Cab

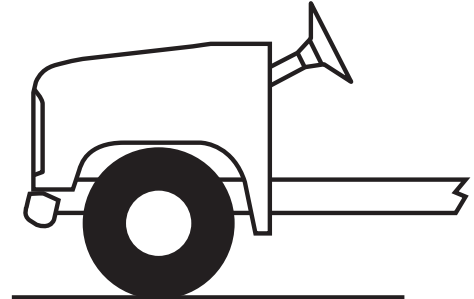

Model 84 Cowl

FORD SERIES "B" (See School Bus Catalog. Soon to be available.)

FREIGHTLINER MEDIUM DUTY

SERIES	TYPE	CATALOGED UNDER
FL Series	Commercial Truck	FL50-60-70

FREIGHTLINER HEAVY DUTY

SERIES	TYPE	CATALOGED UNDER
FLC120, FLD120	Commercial Truck	FLC, FLD

IH/INTERNATIONAL LIGHT DUTY (See Automotive Exhaust Catalog)

IH/INTERNATIONAL MEDIUM DUTY

SERIES	TYPE	CATALOGED UNDER
400, 500, 1000, 1100, 1200, 1300	Pickup, Travelall	Pickup, Terra, Traveler, Travelall
Fleetstar, Loadstar, S, 2600, 4000	Conventional, School Bus	Fleetstar, Cargostar, Loadstar, Series S, School Bus, 4000
Cargostar	Tilt Cab	Fleetstar, Cargostar, Loadstar, Series S
Metro	Step Van	Metro Series

IH/INTERNATIONAL HEAVY DUTY

SERIES	TYPE	CATALOGED UNDER
7100, 8000, 8100, 8200, 9300, 9600, 9700	Commercial Truck	7100, 8000, 8100, 8200, 9300, 9600, 9700

ISUZU MEDIUM DUTY

SERIES	TYPE	CATALOGED UNDER
NPR	Conventional	Isuzu

KENWORTH HEAVY DUTY

SERIES	TYPE	CATALOGED UNDER
C500B, K100E, T4B, T6, T8, T400A, T450, T450B, T600, T800, W9B, W9L, W900, W900L	Commercial Truck	C500B, K100E, T4B, T6, T8, T400A, T450, T450B, T600, T800, W9B, W9L, W900, W900L

MERCEDES BENZ

SERIES	TYPE	CATALOGED UNDER
1013, 1113, 1116, 1316, 1418	Medium Duty Truck	Mercedes Benz

MITSUBISHI LIGHT DUTY (See Automotive Exhaust Catalog)

NISSAN/DATSUN LIGHT DUTY (See Automotive Exhaust Catalog)

INSTALLATION GUIDE

INSTALLING WYE CONNECTOR

Wye connectors provide an easy and economical way to join the left and right hand exhaust pipes of V-6 and V-8 diesel engines to form a single exhaust. A wye connector system will have an exhaust noise level 3 to 7 dB lower than a conventional Y-pipe system. Wye connectors are pictured and described in the accessory section of the catalog.

Wye connectors are installed as original equipment on some trucks, and they can be custom installed on many V-6 and V-8 trucks with conventional Y-pipes, as shown below:

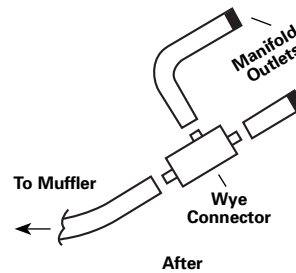
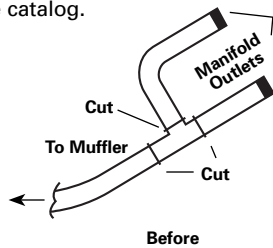

INSTALLING UNIVERSAL RESONATOR

The universal resonators are shown in the accessory section of the catalog. When properly installed in the center of the exhaust pipe, resonators can generally reduce the exhaust noise level 2 to 3 dB.

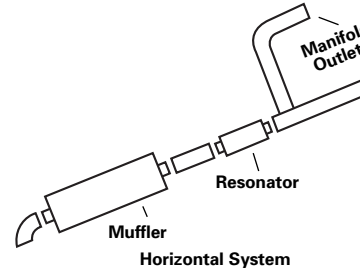
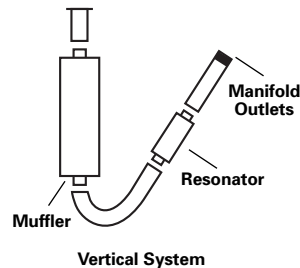

TYPICAL INSTALLATIONS ON DIESEL ENGINES

GENERAL POINTS

- 1) Length and diameter of straight tubing and flex tubing are dependent upon: cab size, wheel base, configuration and muffler placement.
- 2) Exhaust system parts are stated by name rather than by part number, because selection of the correct part depends upon variations in system configuration.

CATERPILLAR 1673T

TURBOCHARGED
SPLIT TO DUALS

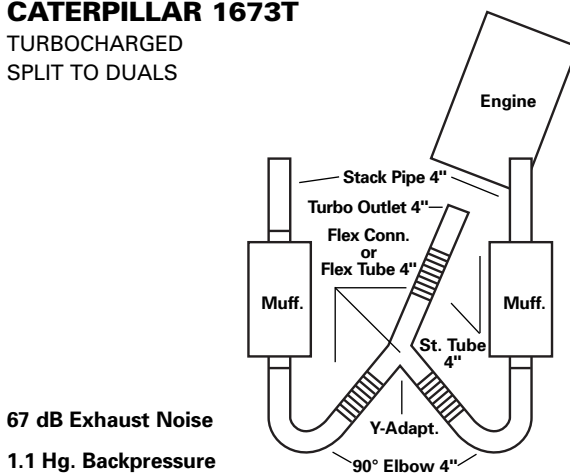

CUMMINS NH-250 SINGLE VERTICAL MOUNT

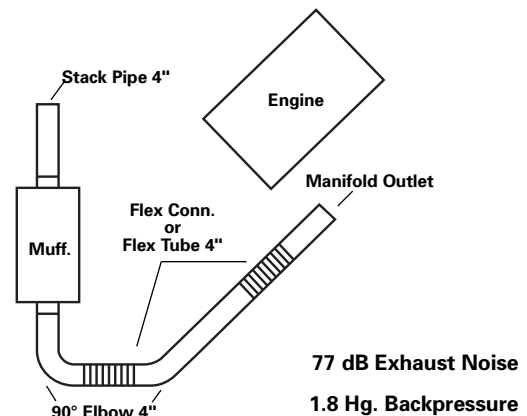

INSTALLATION GUIDE

DETROIT DIESEL 6V-53N

WYE CONNECTOR WITH HORIZONTAL
MUFFLER-VERTICAL STACK

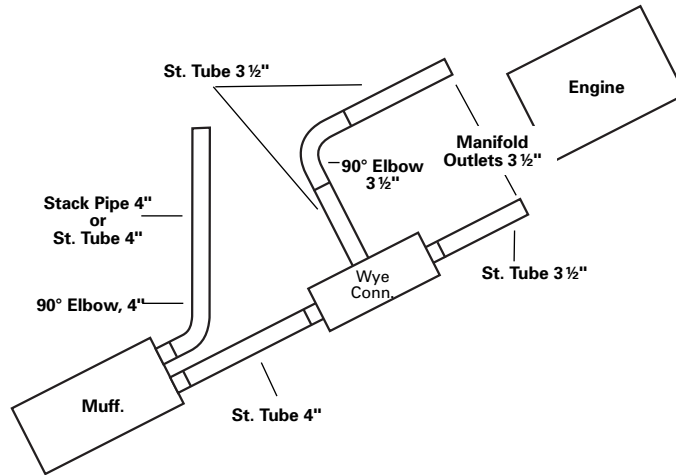

81 dB Exhaust Noise
2.8 Hg. Backpressure

DETROIT DIESEL 8V-71N

DUALS VERTICAL MOUNT

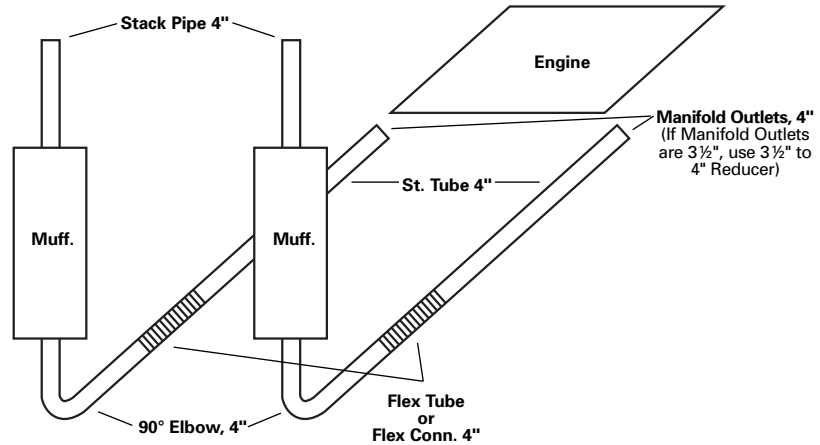

78 dB Exhaust Noise
3.8 Hg. Backpressure

MACK END - 672 OR 673

SINGLE HORIZONTAL MOUNT

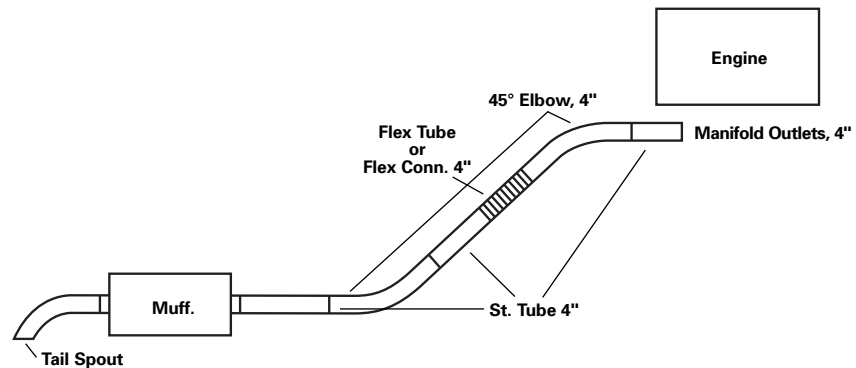

79 dB Exhaust Noise
1.3 Hg. Backpressure



CLAMPS

HEAVY DUTY 3/8" U-BOLT TRUCK CLAMPS



P/N	P/N ZINC	SIZE	BOX QTY
H234P	—	2 3/4"	1
H300P	H300PZ	3"	1
H312P	H312PZ	3 1/2"	1
H400P	H400PZ	4"	1
H412P	H412PZ	4 1/2"	1
H500P	H500PZ	5"	1

HEAVY DUTY GUILLOTINE CLAMPS



P/N	P/N ZINC	P/N CHROME	SIZE	BOX QTY
T234	—	—	2 3/4"	1
T300	T300Z	—	3"	1
T314	—	—	3 1/4"	1
T312	T312Z	—	3 1/2"	1
T400	T400Z	9486	4"	1
—	T412Z	—	4 1/2"	1
T500	T500Z	9487	5"	1
—	T512Z	—	5 1/2"	1
T600	T600Z	9734	6"	1

EXTRA HEAVY DUTY CLAMPS 3/8" U-BOLT 11 GAUGE SADDLE

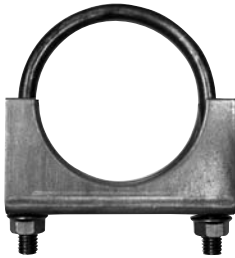

P/N	P/N ZINC	SIZE	BOX QTY
H200	—	2"	1
H218	—	2 1/8"	1
H214	—	2 1/4"	1
H238	—	2 3/8"	1
H212	—	2 1/2"	1
H258*	—	2 5/8"	1
H234*	—	2 3/4"	1

P/N	P/N ZINC	SIZE	BOX QTY
H300*	H300Z	3"	1
H314*	—	3 1/4"	1
H312*	—	3 1/2"	1
H400*	H400Z	4"	1
H412*	—	4 1/2"	1
H500*	H500Z	5"	1
H600*	H600Z	6"	1

*Welded Saddle

FLAT BAND CLAMPS



P/N ZINC	P/N CHROME	SIZE	BOX QTY
9501	9490	3"	1
9502	—	3 1/2"	1
9503	9492	4"	1
9504	9493	5"	1
9736	—	5 1/2"	1
9506	9495	6"	1



BAND CLAMPS



**PREFORMED CLAMP
W/ GASKET - LAP JOINT**

P/N	SIZE	MATERIAL
9700	3"	ALUMINIZED STEEL
9701	3 ½"	ALUMINIZED STEEL
9702	4"	ALUMINIZED STEEL
9703	5"	ALUMINIZED STEEL
9730	3"	BRIGHT 304 STAINLESS STEEL
9731	3 ½"	BRIGHT 304 STAINLESS STEEL
9732	4"	BRIGHT 304 STAINLESS STEEL
9733	5"	BRIGHT 304 STAINLESS STEEL



PREFORMED CLAMP - LAP JOINT

P/N	SIZE	MATERIAL
9660	2"	ALUMINIZED STEEL
9661	2 ¼"	ALUMINIZED STEEL
9662	2 ½"	ALUMINIZED STEEL
9663	2 ¾"	ALUMINIZED STEEL
9604	3"	ALUMINIZED STEEL
9605	3 ½"	ALUMINIZED STEEL
9606	4"	ALUMINIZED STEEL
9607	5"	ALUMINIZED STEEL

P/N	SIZE	MATERIAL
9664	2"	BRIGHT 304 STAINLESS STEEL
9665	2 ¼"	BRIGHT 304 STAINLESS STEEL
9666	2 ½"	BRIGHT 304 STAINLESS STEEL
9667	2 ¾"	BRIGHT 304 STAINLESS STEEL
9668	3"	BRIGHT 304 STAINLESS STEEL
9669	3 ½"	BRIGHT 304 STAINLESS STEEL
9623	4"	BRIGHT 304 STAINLESS STEEL
9670	4 ½"	BRIGHT 304 STAINLESS STEEL
9624	5"	BRIGHT 304 STAINLESS STEEL
9671	6"	BRIGHT 304 STAINLESS STEEL



BAND CLAMPS



PREFORMED CLAMP - BUTT JOINT

P/N	SIZE	MATERIAL
9672	2"	ALUMINIZED STEEL
9673	2 ¼"	ALUMINIZED STEEL
9674	2 ½"	ALUMINIZED STEEL
9675	2¾"	ALUMINIZED STEEL
9676	3"	ALUMINIZED STEEL
9677	3 ¼"	ALUMINIZED STEEL
9678	3 ½"	ALUMINIZED STEEL
9679	3¾"	ALUMINIZED STEEL
9680	4"	ALUMINIZED STEEL
9681	4 ½"	ALUMINIZED STEEL
9682	5"	ALUMINIZED STEEL
9683	6"	ALUMINIZED STEEL

P/N	SIZE	MATERIAL
9684	2"	BRIGHT 304 STAINLESS STEEL
9685	2 ¼"	BRIGHT 304 STAINLESS STEEL
9686	2 ½"	BRIGHT 304 STAINLESS STEEL
9687	2¾"	BRIGHT 304 STAINLESS STEEL
9688	3"	BRIGHT 304 STAINLESS STEEL
9689	3 ¼"	BRIGHT 304 STAINLESS STEEL
9690	3 ½"	BRIGHT 304 STAINLESS STEEL
9691	3¾"	BRIGHT 304 STAINLESS STEEL
9692	4"	BRIGHT 304 STAINLESS STEEL
9693	4 ½"	BRIGHT 304 STAINLESS STEEL
9694	5"	BRIGHT 304 STAINLESS STEEL
9695	6"	BRIGHT 304 STAINLESS STEEL



BAND CLAMPS



FLATBAND EXHAUST CLAMPS

P/N	SIZE	MATERIAL
AS200	2"	ALUMINIZED STEEL
AS214	2 ¼"	ALUMINIZED STEEL
AS212	2 ½"	ALUMINIZED STEEL
AS234	2 ¾"	ALUMINIZED STEEL
AS300	3"	ALUMINIZED STEEL
AS312	3 ½"	ALUMINIZED STEEL
AS400	4"	ALUMINIZED STEEL
AS500	5"	ALUMINIZED STEEL

P/N	SIZE	MATERIAL
SAS200	2"	BRIGHT 430 STAINLESS STEEL
SAS214	2 ¼"	BRIGHT 430 STAINLESS STEEL
SAS212	2 ½"	BRIGHT 430 STAINLESS STEEL
SAS234	2 ¾"	BRIGHT 430 STAINLESS STEEL
SAS300	3"	BRIGHT 430 STAINLESS STEEL
SAS312	3 ½"	BRIGHT 430 STAINLESS STEEL
SAS400	4"	BRIGHT 430 STAINLESS STEEL
SAS500	5"	BRIGHT 430 STAINLESS STEEL
SAS600	6"	BRIGHT 430 STAINLESS STEEL



FLATBAND EXHAUST CLAMPS

P/N	SIZE	MATERIAL
B200	2"	BRIGHT 304 STAINLESS STEEL
B214	2 ¼"	BRIGHT 304 STAINLESS STEEL
B212	2 ½"	BRIGHT 304 STAINLESS STEEL
B234	2 ¾"	BRIGHT 304 STAINLESS STEEL
B300	3"	BRIGHT 304 STAINLESS STEEL
B314	3 ¼"	BRIGHT 304 STAINLESS STEEL
B312	3 ½"	BRIGHT 304 STAINLESS STEEL
B400	4"	BRIGHT 304 STAINLESS STEEL
B412	4 ½"	BRIGHT 304 STAINLESS STEEL
B500	5"	BRIGHT 304 STAINLESS STEEL
B600	6"	BRIGHT 304 STAINLESS STEEL
B800	8"	BRIGHT 304 STAINLESS STEEL
B1000	10"	BRIGHT 304 STAINLESS STEEL



V-BAND CLAMPS



Cross Section

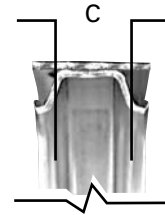
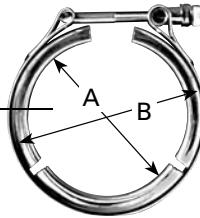

View of Cross Section

Manufacturer	P/N	TUBE DIA.	A	B	C	APPLICATION
UNIVERSAL						
	9398	3.00"	3.26"	4.06"	0.21"	Fits - OEM MUFFLERS.
	9399	4.00"	4.25"	4.81"	0.21"	Fits - FLARED CONNECTORS
	9616	5.00"	4.97"	5.25"	0.26"	Fits - FLARED CONNECTORS
AIRESEARCH						
	9614	4.00"	4.17"	4.61"	0.16"	TEO-699
	9616	5.00"	5.97"	5.25"	0.21"	T-1899, TH08A64
BLUE BIRD						
	9618	2.75"	2.80"	3.20"	0.26"	REPLACES BLUEBIRD #1334226
	9618	2.75"	2.80"	3.20"	0.26"	94-98 BLUEBIRD TC2000 SCHOOL BUS W/5.9L
	9651	4.00"	4.13"	4.69"	0.40"	REPLACES BLUEBIRD #125046
	9651	4.00"	4.13"	4.69"	0.40"	BLUEBIRD ALL AMERICAN W/CAT3116 /TURBO
	9399	4.00"	4.25"	4.81"	0.21"	REPLACES BLUEBIRD #0997791
	9399	4.00"	4.25"	4.81"	0.21"	1980-90 BLUEBIRD SCHOOL BUS W/8.2LT
CATERPILLAR						
	9622	3.50"	3.63"	4.19"	0.40"	3208T
	9396	3.50"	3.94"	4.50"	0.21"	3208T
	9651	4.00"	4.13"	4.69"	0.40"	3208T
	9652	4.00"	4.12"	4.81"	0.40"	3176T
	9653	4.00"	4.19"	4.75"	0.40"	3176T
	9615	5.00"	5.32"	5.88"	0.40"	3406, 3406B, 3176
CUMMINS						
	9618	2.75"	2.80"	3.20"	0.26"	6BT5.9L, 6BTA5.9L
	9612	3.00"	3.32"	3.88"	0.40"	V555, V902, V903
	9627	3.50"	3.69"	4.25"	0.40"	VT555, VT-555 MANIFOLD
	9396	3.50"	3.94"	4.50"	0.21"	VT555, VT-555 MANIFOLD
	9652	4.00"	4.12"	4.81"	0.40"	L10
	9653	4.00"	4.19"	4.75"	0.40"	L10
	9615	5.00"	5.32"	5.88"	0.40"	750, N, 88NT, NTC, VT
DETROIT DIESEL						
	9395	3.00"	3.26"	3.82"	0.21"	6V53, 6V71
	9656	3.50"	3.76"	4.04"	0.26"	
	9613	3.50"	3.77"	4.33"	0.21"	
	9396	3.50"	3.94"	4.50"	0.21"	4-53, 8V71, 8V92
	9617	4.00"	4.13"	4.75"	0.16"	8.2LT
	9399	4.00"	4.25"	4.81"	0.21"	6-71T, 8.2N, 8.2T, 12V71
	9647	4.00"	4.32"	4.91"	0.29"	6-71N
	9735	4.00"	4.97"	5.25"	0.26"	8V-71T, 16V-71, 6V-92T, 8V-92, 8V-92T, 16V-92T
	9616	5.00"	4.97"	5.25"	0.26"	8V-71T
	9654	5.00"	5.32"	5.92"	0.28"	6V-92
	9655	5.00"	5.32"	5.92"	0.28"	8V-71T (END AWAY FROM TURBO)
	9397	5.00"	5.32"	5.92"	0.28"	
	9615	5.00"	5.32"	5.88"	0.40"	SERIES 60, 6-71T

MUFFLERS, PIPES & ACCESSORIES



BAND CLAMPS

Manufacturer	P/N	TUBE DIA.	A	B	C	APPLICATION
FORD						
	9610	3.00"	3.25"	3.87"	0.43"	FORD #E5HZ5A231B
	9618	2.75"	2.80"	3.20"	0.26"	93-95 B600/700 W/5.9LT
	9618	2.75"	2.80"	3.20"	0.26"	REPLACES FORD #F3HZ5A281A
	9656	2.50"	3.76"	4.04"	0.26"	FORD #E0HZ5A231B
	9625	3.00"	3.05"	3.62"	0.28"	REPLACES FORD #F1HZ5C210A, E9HZ5A231B
	9625	3.00"	3.05"	3.62"	0.28"	89-95 MED/TRUCK,BUS W/370, 429 GAS
	9395	3.00"	3.26"	3.82"	0.21"	ALL MODELS W/DD 6V53, 6V71
	9395	3.00"	3.26"	3.82"	0.21"	ALL MODELS W/CUMMINS V555, V902
	9626	3.00"	3.17"	3.88"	0.40"	FORD D9HT-51210-DA
	9626	3.00"	3.17"	3.88"	0.40"	79-88 FORD MED TRUCK/BUS W/370, 429 GAS
	9611	3.00"	3.47"	4.06"	0.24"	8.2L NA
	9622	3.50"	3.50"	4.19"	0.40"	REPLACES FORD #E2HZ5A231A
	9622	3.50"	3.63"	4.19"	0.40"	87-90 B600/700 SCHOOL BUS CF600/800 W/6.6LT
	9622	3.50"	3.63"	4.19"	0.40"	REPLACES FORD #E8HZ5A231E
	9627	3.50"	3.69"	4.25"	0.40"	87-94 CF600/800, F600/800 W/7.8LT
	9627	3.50"	3.69"	4.25"	0.40"	REPLACES FORD #E7HZ5A231C
	9617	4.00"	4.13"	4.75"	0.16"	REPLACES FORD #E0HZ5A231C
	9399	4.00"	4.25"	4.81"	0.21"	ALL MODELS W/DD 6-71T, 8.2N, 8.2T, 12V71
FREIGHTLINER						
	9601	3.50"	3.38"	3.75"	0.75"	02-06 FREIGHTLINER BUS W/MERCEDES ENG. OE#A04-19184-000
	9609	4.00"	4.19"	4.75"	0.40"	FREIGHTLINER BUS W/MERCEDES 6 CYL. ENG.
	9615	5.00"	5.32"	5.88"	0.40"	FLD MODELS W/DD SERIES 60, CAT 3406
	9615	5.00"	5.32"	5.88"	0.40"	FLD MODELS W/CUMMINS NTC, VT DIESEL
	9615	5.00"	5.32"	5.88"	0.40"	REPLACES FREIGHTLINER #0114596000
GM						
	9656	3.50"	3.76"	4.04"	0.26"	
	9611	3.00"	3.50"	4.06"	0.24"	80-90-GM MED TRUCK/BUS W/8.2L NA
	9611	3.00"	3.50"	4.06"	0.24"	REPLACES GM #2069773
	9652	4.00"	4.12"	4.81"	0.40"	TOPKICK/KODIAK W/6.6L
	9652	4.00"	4.12"	4.81"	0.40"	REPLACES GM #15647159
	9399	4.00"	4.25"	4.81"	0.21"	ALL MODELS W/DD6-71T, 8.2N, 8.2T, 12V71
INTERNATIONAL						
	9627	3.50"	3.69"	4.25"	0.40"	86-89 SERIES S TRUCK/BUS W/DT360
	9627	3.50"	3.69"	4.25"	0.40"	REPLACES INTERNATIONAL #893944R92
	9613	3.50"	3.77"	4.33"	0.21"	REPLACES INTERNATIONAL #338614C1
	9613	3.50"	3.77"	4.33"	0.21"	88-94 SERIES S TRUCK BUS W/DT466
	9396	3.50"	3.94"	4.50"	0.21"	REPLACES INTERNATIONAL #434252R91
	9396	3.50"	3.94"	4.50"	0.21"	ALL MODELS W/DD 4-53, 8V71, 8V92, CAT 3208T
	9396	3.50"	3.94"	4.50"	0.21"	ALL MODELS W/CUMMINS VT-555
	9737	3.00"	3.28"	3.84"	0.40"	T444E 1994-2000 INTERNATIONAL BUS
	9653	4.00"	4.19"	4.75"	0.40"	REPLACES INTERNATIONAL #893945R92
	9653	4.00"	4.19"	4.75"	0.40"	7.3L, DT-DTA 360, DT-DTA 466
	9647	4.00"	4.32"	4.91"	0.29"	REPLACES INTERNATIONAL #433192R91
	9647	4.00"	4.32"	4.91"	0.29"	ALL MODELS W/6-71N
	9658	4.00"	4.30"	5.00"	0.40"	INTERNATIONAL #41667161
	9735	4.00"	4.97"	5.25"	0.26"	9300 SERIES W/DD 8V71, 8V92
	9735	4.00"	4.97"	5.25"	0.26"	REPLACES INTERNATIONAL #5132650
	9735	4.00"	4.97"	5.25"	0.26"	REPLACES INTERNATIONAL # 780067C91
	9615	5.00"	5.32"	5.88"	0.40"	REPLACES INTERNATIONAL #390226C91
	9615	5.00"	5.32"	5.88"	0.40"	INTERNATIONAL #1672105C91

MUFFLERS, PIPES & ACCESSORIES



V-BAND CLAMPS (CONT.)

Manufacturer	P/N	TUBE DIA.	A	B	C	APPLICATION
MACK						
	9396	3.50"	3.94"	4.50"	0.21"	ALL MODELS W/DD 4-53, 8V71, 8V92, CAT 3208T
	9396	3.50"	3.94"	4.50"	0.21"	ALL MODELS W/CUMMINS VT-555
	9614	4.00"	4.17"	4.61"	0.16"	REPLACES MACK #48RU2341
	9614	4.00"	4.17"	4.61"	0.16"	DM/MR MODELS
	9399	4.00"	4.25"	4.81"	0.21"	ALL MODELS W/DD6-71T, 8.2N, 8.2T, 12V71
	9619	4.00"	4.38"	4.94"	0.18"	REPLACES MACK #11ME29
	9615	5.00"	5.32"	5.88"	0.40"	REPLACES MACK #11ME241
PETERBILT						
	9616	5.00"	4.97"	5.25"	0.26"	PETERBILT #14-11039
THOMAS						
	9622	3.50"	3.63"	4.19"	0.40"	84-90 SAF-T-LINER MODELS W/3208T
	9622	3.50"	3.63"	4.19"	0.40"	REPLACES THOMAS #61240207
	9651	4.00"	4.13"	4.69"	0.40"	84-89 THOMAS SCHOOL BUS W/ 3208T
	9651	4.00"	4.13"	4.69"	0.40"	REPLACES THOMAS #61240208
	9659	4.00"	4.19"	4.75"	0.21"	89-93 THOMAS SCHOOL BUS W/8.2LT
	9659	4.00"	4.19"	4.75"	0.21"	REPLACES THOMAS #61240209
	9654	5.00"	5.32"	5.92"	0.28"	90-93 THOMAS SCHOOL BUS W/6V92
	9654	5.00"	5.32"	5.92"	0.28"	REPLACES THOMAS #61240715



FLEX TUBING

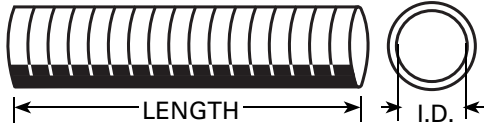

HOW TO ORDER

Determine your usage needs. Flex pipe is sold in a variety of lengths including precut lengths. All lengths range from 1" to 6" in diameter. Refer to the chart on the pages 24 - 25 to determine your desired part number.

Order by the part number, not by the foot.

HOW TO MEASURE

When you are ready to put Flex Pipe to use, follow these instructions for determining length to cut the Flex pipe.

Note: All flexible metal tubing is measured fully extended.

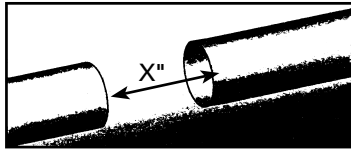

Determine the length (x") of pipe needed for your application by measuring the gap between the two pipes you wish to connect.

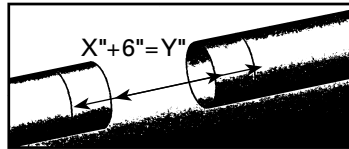

Allow a 3" overlap for each end (add 6" to the original measurement) This is the length (y") of Flex Pipe needed.

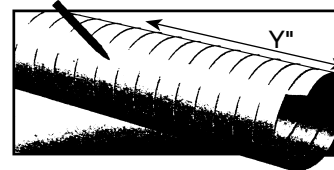

Measure distance needed from the far right side inward. Wrap area to be cut with duct tape. Use a marker to draw a cut guide on the tape. Flex Pipe is now ready to be cut. Cut through the tape. Remove tape from Flex Pipe before using.

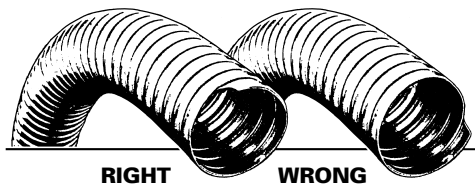

IMPORTANT: When **Measuring & Cutting**, keep the open side of the Flex Pipe to your right. To determine the open end, turn the end of the pipe toward you and look for the rings to wrap **ON TOP** of each other.

HOW TO CUT

There are three ways to cut Flex Pipe. Select one that suits your equipment.



CHOP SAW: For best results use 1/16" wide blade. Make sure Flex Pipe has the open side to the right. Align and secure pipe so cut guide lines up with Chop Saw blade, and cut.

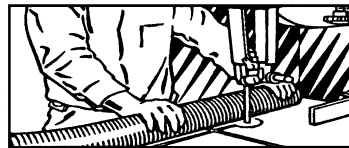

BAND SAW: For best results use a no-set blade with 24-32 teeth/inch. Make sure Flex Pipe has the open side to the right. Align and secure pipe so cut guide lines up with band saw blade, and cut.

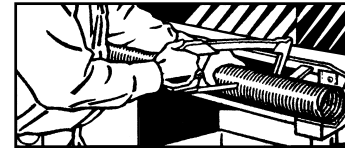

HACK SAW: For best results use a no-set blade with 24-32 teeth/inch. Make sure Flex Pipe has the open side to the right. Align and secure pipe and cut on guide line.



FLEX TUBING

FLEX TUBING 10 FOOT LENGTHS



P/N STAINLESS STANDARD THICKNESS	P/N ALUMINIZED HEAVY DUTY THICKNESS	P/N GALVANIZED HEAVY DUTY THICKNESS	ID
8883	—	8984	2"
8855	—	—	2 ¼"
8884	8858	8985	2 ½"
8885	8859	8986	3"
8886	8876	8987	3 ½"
8887	8856	8988	4"
8888	8857	8989	5"
8895	—	8990	6"
—	—	8893	8"
—	—	8894	10"

FLEX TUBING 25 FOOT LENGTHS



P/N STAINLESS STANDARD THICKNESS	P/N GALVANIZED STANDARD THICKNESS	P/N GALVANIZED HEAVY DUTY THICKNESS	ID
—	8860	—	1"
—	8861	—	1 ⅛"
—	8862	—	1 ¼"
—	8863	—	1 ⅜"
—	8864	—	1 ½"
—	8865	—	1 ⅝"
—	8866	—	1 ¾"
—	8867	—	1 ⅞"
—	8868	—	2"
—	8869	—	2 ⅛"
—	8870	—	2 ¼"
—	8872	—	2 ½"
8982	8875	8880	3"
8983	—	8881	3 ½"
8878	—	8882	4"
8879	—	8877	5"
8899	—	8898	6"

PRE-CUT FLEX HOSE STYLE ID-OD



P/N STAINLESS	P/N GALVANIZED	LGTH.
3" DIA		
—	24674	18"
3 ½" DIA		
—	24935	18"
4" DIA		
—	24654	18"
5" DIA		
—	24936	18"



FLEX TUBING

PRE-CUT FLEX HOSE STYLE ID-ID

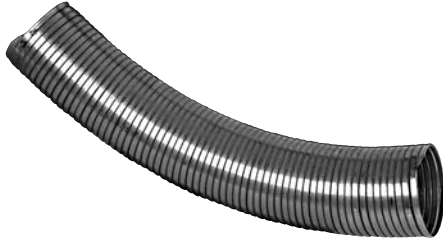

P/N STAINLESS	P/N ALUMINIZED	P/N GALVANIZED	LGTH.
3" DIA			
24675	—	24752	18"
—	—	24930	24"
—	—	34826	36"
3½" DIA			
24676	—	24753	18"
—	—	24849	24"
—	—	34785	36"
4" DIA			
14739	—	14738	12"
24677	24931	24754	18"
24836	—	24835	24"
34673	—	34743	36"
—	—	44786	48"
64791	64812	64793	72"
5" DIA			
14737	—	14740	12"
24678	24933	24755	18"
24838	—	24837	24"
34674	—	34744	36"
44867	—	54831	48"
64792	64813	64794	72"
6" DIA			
—	—	44915	48"

STAINLESS STEEL BELLOWS PIPE



WITH MESH

P/N	DIA	LGTH.
9726	3"	12"
9727	3½"	12"
9728	4"	12"
*28819	4"	14½"
9729	5"	12"

* WITH S.S. OUTER MESH

FLEX CONNECTORS

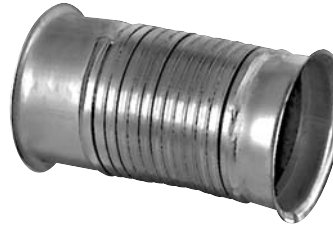

P/N	OAL	DIA INLET/OUTLET	USE CLAMP #
8981	8¼"	4¾" OD x 20 DEG FLARE	9399(2)
18106	8"	4" ID	B400(2)

STAINLESS STEEL O. E. REPLACEMENT BELLOWS



P/N	APPLICATION	O.E.#	INLET/OUTLET/LENGTH
28801	2007 & Up; Bluebird All-American School Bus, C7 Caterpillar w/ PDF	0109851	Flared x 4" ID x 13¼"
18191	2007 & Up; Bluebird All-American School Bus, C7 Caterpillar w/ PDF	0118999	Flared x 2½" ID x 12¾"

MUFFLERS, PIPES & ACCESSORIES

CONNECTORS & ADAPTERS

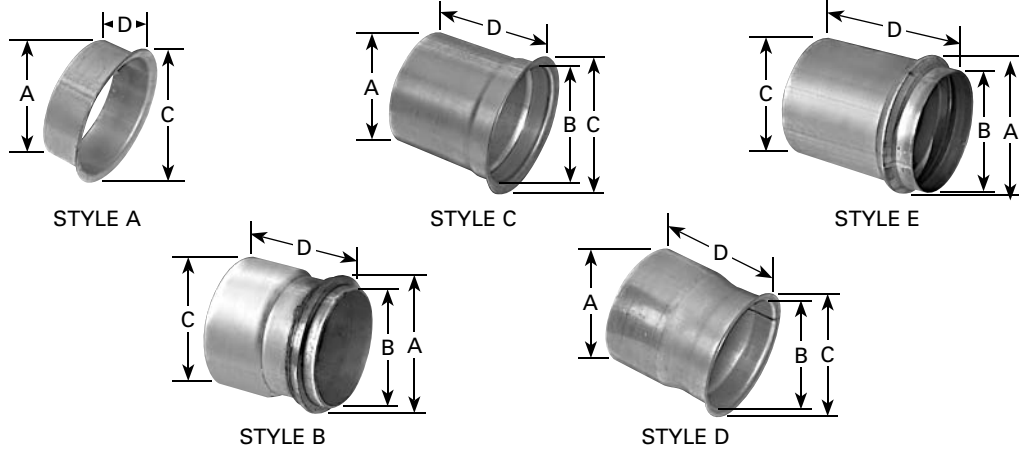

FLARED ADAPTERS

P/N	STYLE	A (O.D.)	B (I.D.)	C (O.D.)	D (LGTH.)	FLARE IN DEG.	APPLICATION	USE W/ V-BAND CLAMP
9705	D	3.970	2.850	3.780	3.867	20		9395
9706	D	3.977	2.836	3.970	3.482	20		9398
9707	A	2.500	3.345	3.695	1.532	20		9395
9390	A	NA	NA	NA	NA	20	FORD MOTOR CO, DETROIT DIESEL 6V71, 7V73, CUMMINS V555, V902	NA
9470	C	3.005	3.028	3.618	4.181	22	DETROIT DIESEL 6V71	9395
9708	A	3.005	2.869	3.541	3.568	45		NA
9471	C	3.005	3.040	3.775	4.522	45		9395
9479	A	3.183	3.015	3.915	2.200	20	GMC TRUCK/BUS W/ 8.2N	9611
9709	A	3.512	3.385	4.071	4.176	22	CAT 3208T	9611
9710	A	3.350	3.373	4.025	5.018	45	DETROIT DIESEL 6V71	9622
9392	C	3.525	3.505	4.320	6.095	45		9396
9473	C	3.490	3.630	4.165	4.035	22	DETROIT DIESEL 8V-71	9613
9711	C	3.520	3.620	4.270	4.100	22	DETROIT DIESEL 8V-72	9396
9712	C	3.480	3.670	4.212	4.140	22	DETROIT DIESEL 8V-73	9613
9391	A	3.010	2.865	3.905	1.310	20	DETROIT DIESEL 8V92, 4-53	9611
9713	D	3.990	3.605	4.260	4.050	22	DETROIT DIESEL 8V-71	9613
9476	C	NA	NA	NA	NA	22	DETROIT DIESEL 12V71	NA
9472	D	3.960	3.550	4.305	3.868	22	DETROIT DIESEL 8.2N, CUMMINS VT225	9396
9714	C	4.005	3.975	4.500	5.922	45		NA
9474	A	3.950	3.850	4.535	1.810	22	DETROIT DIESEL 6-71, 8.2N, 8.2T, MACK	NA
9475	C	3.985	3.875	4.540	5.170	45	CUMMINS	NA
▲9715	B	5.13	4.250	4.800	1.940	20	DETROIT DIESEL 8V-71T, 16V-71T, 6V-92T, 8V-92T	NA
9393	A	5.005	4.880	5.475	6.275	45	CUMMINS	NA
9478	A	5.035	4.870	5.720	3.025	22	CATERPILLAR TURBO, CUMMINS TURBO, INTERNATIONAL	9615
9716	A	4.990	4.825	5.572	5.608	20	INTERNATIONAL	NA
9717	A	5.010	4.885	5.845	6.287	20	T-50 TURBO CHARGER	9616
9394	C	NA	NA	NA	NA	45	T-50 TURBO CHARGER	NA
9718	B	5.150	4.215	4.780	2.045	20	DETROIT DIESEL 8V-71T, 16V-71, 6V-92T, 8B-92T, 16V-92T	NA
9719	E	5.658	4.825	4.998	6.168	NA	CUMMINS ENGINES	9615

▲ WITH MACHINED RING



REDUCERS

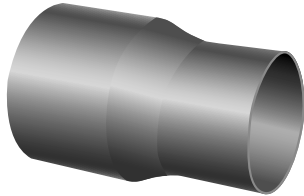

ALUMINIZED OD - ID REDUCER

Reduces larger I.D. pipe to smaller O.D. pipe.

P/N	OD - ID	LENGTH
8663	1 5/8" - 1 1/2"	4"
8661	1 7/8" - 1 3/4"	4 1/2"
8650	2" - 1 1/2"	4 1/2"
8651	2" - 1 5/8"	4"
8902	2" - 1 3/4"	5 3/4"
8652	2" - 1 7/8"	5 1/8"
8653	2 1/4" - 1 3/4"	5"
8938	2 1/4" - 2"	4"
8941	2 1/2" - 2"	4"
8654	2 1/2" - 2"	9 1/2"
8942	2 1/2" - 2 1/4"	4"
8655	2 1/2" - 2 1/4"	9 1/2"
9600	3" - 2 1/2"	6 1/4"
9334	3" - 2 3/4"	6"
9333	3 1/2" - 3"	6"
9722	4" - 3"	6"
9332	4" - 3 1/2"	6"
9331	5" - 4"	6"
9723	5" - 4 1/2"	6"
8969	6" - 5"	6"

ALUMINIZED ID - ID REDUCER

Reduces O.D. pipes of different sizes.

P/N	ID - ID	LENGTH
8920	1 5/8" - 1 1/2"	4"
8921	1 1/4" - 1 1/2"	4"
8922	2" - 1 1/2"	4"
8923	2" - 1 5/8"	4"
8944	2" - 1 3/4"	4 1/2"
8945	2" - 1 7/8"	4 1/2"
8924	2 1/8" - 2"	4"
8946	2 1/4" - 2"	4 1/2"
8947	2 1/2" - 2"	4 1/2"
8948	2 1/2" - 2 1/4"	4 1/2"
8952	2 3/4" - 2 1/2"	6"
8953	3" - 2 1/2"	6"
8954	3" - 2 3/4"	6"
8955	3 1/2" - 3"	6"
8956	4" - 3"	6"
8957	4" - 3 1/2"	8"
8958	5" - 4"	8"
9721	5" - 4 1/2"	6"
9335	6" - 5"	8"

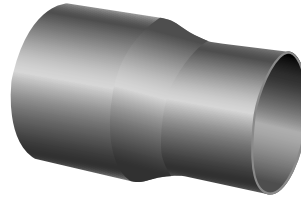

ALUMINIZED ID - OD REDUCER

Reduces larger O.D. pipe to smaller I.D. pipe.

P/N	ID - OD	LENGTH
8925	1 1/2" - 1 3/8"	4"
8926	1 5/8" - 1 1/2"	4"
8927	1 3/4" - 1 1/2"	4"
8928	1 3/4" - 1 5/8"	4"
8929	1 7/8" - 1 1/2"	4"
8935	1 7/8" - 1 3/4"	4 1/2"
8936	2" - 1 3/4"	4 1/2"
8930	2" - 1 13/16"	4"
8660	2" - 1 7/8"	4"
8909	2 1/8" - 2"	5 3/4"
8931	2 1/4" - 1 7/8"	4"
8911	2 1/4" - 2"	5 3/4"
8932	2 1/4" - 2 1/8"	4"
8913	2 1/2" - 2"	5 3/4"
8940	2 1/2" - 2 1/4"	4 1/2"
8959	2 3/4" - 2 1/2"	6"
8960	3" - 2 1/2"	6"
8961	3" - 2 3/4"	6"
8962	3 1/2" - 3"	6"
8963	4" - 3"	6"
8964	4" - 3 1/2"	6"
8965	5" - 4"	6"
9336	6" - 5"	6"

ALUMINIZED OD - OD REDUCER

Reduces larger O.D. pipe to smaller I.D. pipe.

P/N	OD - OD	LENGTH
8904	2" - 1 13/16"	5 3/4"
8908	2 1/8" - 2"	7 1/4"
8657	2 1/4" - 2"	4"
8912	2 1/4" - 2"	5 3/4"
8658	2 1/2" - 2"	9 1/2"
8659	2 1/2" - 2 1/4"	9 1/2"
9648	4" - 3"	8"
9649	5" - 4"	8"
9720	6" - 4"	6"
9650	6" - 5"	8"

MUFFLERS, PIPES
& ACCESSORIES



CONNECTORS

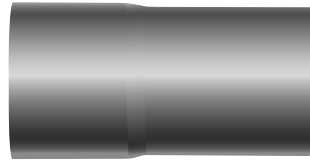

ALUMINIZED ID - OD CONNECTOR

Connects I.D. and O.D. pipes of the same size.

P/N	ID - OD	LENGTH
8662	1 1/2" - 1 1/2"	4 7/8"
13001	1 1/2" - 1 1/2"	12"
23001	1 1/2" - 1 1/2"	18"
23051	1 1/2" - 1 1/2"	24"
33001	1 1/2" - 1 1/2"	36"
13002	1 5/8" - 1 5/8"	12"
23002	1 5/8" - 1 5/8"	18"
8934	1 3/4" - 1 3/4"	4 1/2"
13003	1 3/4" - 1 3/4"	12"
23003	1 3/4" - 1 3/4"	18"
23052	1 3/4" - 1 3/4"	24"
33002	1 3/4" - 1 3/4"	36"
8937	1 7/8" - 1 7/8"	4 1/2"
13004	1 7/8" - 1 7/8"	12"
23004	1 7/8" - 1 7/8"	18"
23053	1 7/8" - 1 7/8"	24"
33003	1 7/8" - 1 7/8"	36"
8933	2" - 2"	5 3/4"
8906	2" - 2"	7 1/4"
13005	2" - 2"	12"
23005	2" - 2"	18"
23054	2" - 2"	24"
33004	2" - 2"	36"
8914	2 1/8" - 2 1/8"	4"
13006	2 1/8" - 2 1/8"	12"
23006	2 1/8" - 2 1/8"	18"
23055	2 1/8" - 2 1/8"	24"
33005	2 1/8" - 2 1/8"	36"

P/N	ID - OD	LENGTH
8939	2 1/4" - 2 1/4"	4 1/2"
8915	2 1/4" - 2 1/4"	9 1/2"
13007	2 1/4" - 2 1/4"	12"
23007	2 1/4" - 2 1/4"	18"
23056	2 1/4" - 2 1/4"	24"
33006	2 1/4" - 2 1/4"	36"
8943	2 1/2" - 2 1/2"	4 1/2"
13008	2 1/2" - 2 1/2"	12"
23008	2 1/2" - 2 1/2"	18"
23057	2 1/2" - 2 1/2"	24"
33007	2 1/2" - 2 1/2"	36"
8975	3" - 3"	6"
13009	3" - 3"	12"
23009	3" - 3"	18"
23058	3" - 3"	24"
33008	3" - 3"	36"
8976	3 1/2" - 3 1/2"	6"
13010	3 1/2" - 3 1/2"	12"
9599	3 1/2" - 3 1/2"	18"
8991	4" - 4"	6"
13011	4" - 4"	12"
23010	4" - 4"	18"
23059	4" - 4"	24"
8978	5" - 5"	6"
13012	5" - 5"	12"
24712	5" - 5"	18"
23060	5" - 5"	24"
8979	6" - 6"	6"



ALUMINIZED OD - OD CONNECTOR

Connects I.D. pipes of the same size.

P/N	OD - OD	LENGTH
8907	2" - 2"	5 3/4"
8918	2 1/4" - 2 1/4"	6"
8919	2 1/2" - 2 1/2"	4 1/2"
8970	3" - 3"	6"
8971	3 1/2" - 3 1/2"	6"
8972	4" - 4"	8"
8973	5" - 5"	8"



CONNECTORS



ALUMINIZED ID - ID CONNECTOR

Connects O.D. pipes of the same size.

P/N	ID - ID	LENGTH
8916	1 1/2" - 1 1/2"	4"
23075	1 1/2" - 1 1/2"	18"
8949	1 3/4" - 1 3/4"	4 1/2"
23076	1 3/4" - 1 3/4"	18"
8917	1 7/8" - 1 7/8"	4"
23077	1 7/8" - 1 7/8"	18"
14337	2" - 2"	4"
23078	2" - 2"	18"
8950	2 1/8" - 2 1/8"	4 1/2"
8951	2 1/4" - 2 1/4"	4 1/2"
23079	2 1/4" - 2 1/4"	18"
14338	2 1/2" - 2 1/2"	4"
23080	2 1/2" - 2 1/2"	18"
8980	2 3/4" - 2 3/4"	4"
13025	2 3/4" - 2 3/4"	12"
14339	3" - 3"	4"
14601	3" - 3"	6"
13026	3" - 3"	12"
14340	3 1/2" - 3 1/2"	4"
14602	3 1/2" - 3 1/2"	6"
13027	3 1/2" - 3 1/2"	12"
14603	4" - 4"	6"
14341	4" - 4"	4"
13028	4" - 4"	12"
14605	5" - 5"	6"
8974	6" - 6"	6"

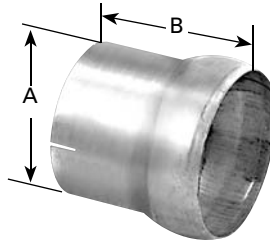

ALUMINIZED TILT CAB CONNECTORS BOTTOM

P/N	A	B
9343	4" ID	4 1/2"
9344	5" ID	5 3/8"

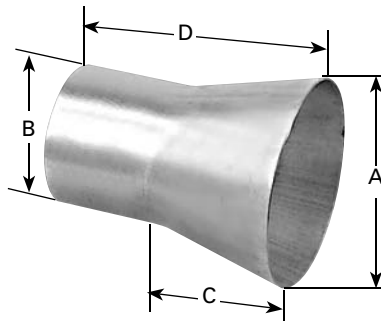

ALUMINIZED TILT CAB CONNECTORS TOP

P/N	A	B	C	D
9341	5 3/4" OD	4" OD	2 1/2"	7"
9342	6 3/4" OD	5" OD	2 1/2"	7 1/2"



THREADED ADAPTERS

P/N	OD SIZE	THREAD(NPT)	LENGTH
9514	3"	3"	6"
9516	3 1/2"	3 1/2"	6"
9518	4"	4"	6"

NPT - National Pipe Thread

MUFFLERS, PIPES & ACCESSORIES



ELBOWS, SPLITTER T, Y PIPES

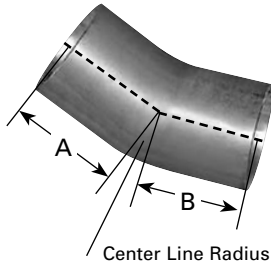

ALUMINIZED 15° ELBOWS

P/N	DIAMETER	LENGTH A-B	CENTERLINE RADIUS
10684	4"	2"-2"	4 ½"
10685	5"	4"-4"	8"

ALUMINIZED & CHROME 45° ELBOWS

One end is I.D., the other end is O.D.

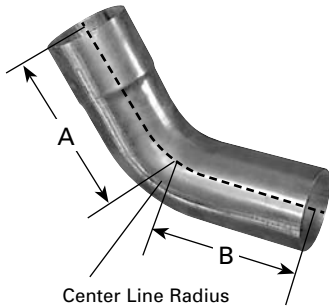

P/N ALUMINIZED	P/N CHROME	DIAMETER	STYLE	LENGTH A-B	CENTERLINE RADIUS
10311	—	2"	ID-OD	6"-6"	5"
10320	—	2 ¼"	ID-OD	6"-6"	4 ½"
10312	—	2 ½"	ID-OD	6"-6"	4"
10725	—	2 ½"	ID-OD	6"-6"	5"
10318	—	2 ¾"	ID-OD	6"-6"	5"
10313	—	3"	ID-OD	7"-7"	6"
10314	—	3 ½"	ID-OD	8"-8"	7"
10736	—	4"	ID-OD	5"-5"	4"
10726	—	4"	ID-OD	6"-6"	6"
10315	—	4"	ID-OD	9 ¼"-9 ¼"	8"
10727	—	4"	ID-OD	12"-12"	6"
10729	—	5"	ID-OD	7"-7"	8"
10730	809738	5"	ID-OD	8"-8"	10"
10317	809417	5"	ID-OD	12"-12"	8"
10731	—	5"	ID-OD	12"-12"	10"
10732	—	5"	ID-OD	15"-15"	8"

Both ends are O.D.

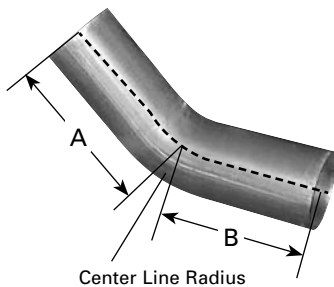

P/N ALUMINIZED	P/N CHROME	DIAMETER	STYLE	LENGTH A-B	CENTERLINE RADIUS
10562	—	2 ½"	OD-OD	6"-6"	5"
10742	—	3"	OD-OD	4"-4"	3"
10564	—	3"	OD-OD	7"-7"	6"
10565	—	3 ½"	OD-OD	8"-8"	7"
10743	—	4"	OD-OD	6"-6"	6"
10566	—	4"	OD-OD	8"-8"	4 ½"
10745	—	4"	OD-OD	12"-12"	6"
10567	—	5"	OD-OD	8"-8"	5 ½"
10746	809752	5"	OD-OD	8"-8"	8"
10747	809753	5"	OD-OD	15"-15"	8"
10748	—	6"	OD-OD	7"-7"	10"



ELBOWS, SPLITTER T, Y PIPES

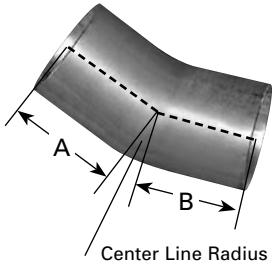
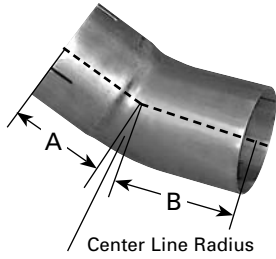

ALUMINIZED 30° ELBOWS

One end is I.D., the other end is O.D.

P/N	DIAMETER	STYLE	LENGTH A-B	CENTERLINE RADIUS
10631	3½"	ID-OD	4"-4"	5"
10632	4"	ID-OD	4"-4"	5"
10633	5"	ID-OD	4"-4"	6"

Both ends are O.D.

P/N	DIAMETER	STYLE	LENGTH A-B	CENTERLINE RADIUS
10636	4"	OD-OD	4"-4"	5"
10637	5"	OD-OD	4"-4"	6"

MUFFLERS, PIPES & ACCESSORIES

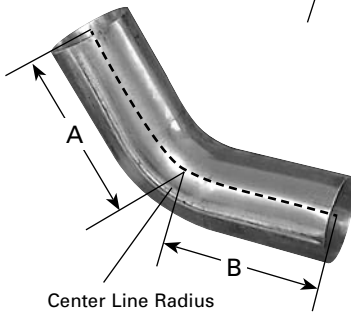
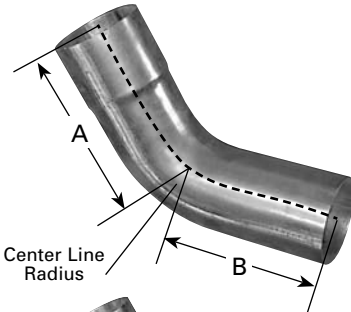

ALUMINIZED 60° ELBOWS

One end is I.D., the other end is O.D.

P/N	DIAMETER	STYLE	LENGTH A-B	CENTERLINE RADIUS
10639	3½"	ID-OD	8"-8"	5"
10640	4"	ID-OD	8"-8"	5"
10641	5"	ID-OD	8"-8"	6"

Both ends are O.D.

P/N	DIAMETER	STYLE	LENGTH A-B	CENTERLINE RADIUS
10644	4"	OD-OD	8"-8"	5"
10645	5"	OD-OD	8"-8"	6"

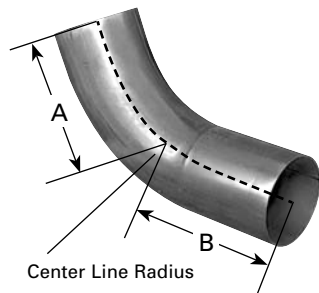

ALUMINIZED & CHROME 67° ELBOWS

Both ends are O.D.

P/N ALUMINIZED	P/N CHROME	DIAMETER	STYLE	LENGTH A-B	CENTERLINE RADIUS
10560	809530	5"	OD-OD	7½"-11"	8"



ELBOWS, SPLITTER T, Y PIPES

ALUMINIZED & CHROME 90° ELBOWS

One end is I.D., the other end is O.D.

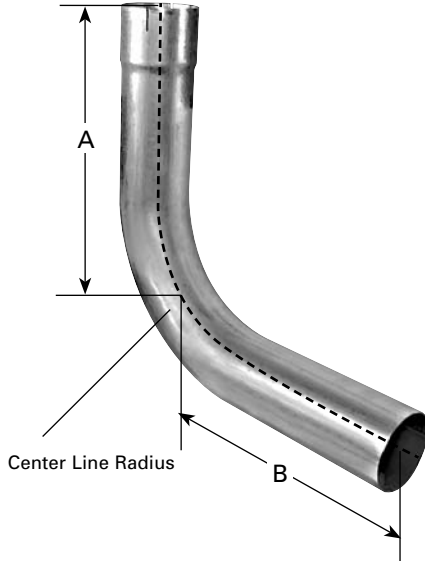

P/N ALUMINIZED	P/N CHROME	DIAMETER	LENGTH A-B	CENTERLINE RADIUS
10922	—	1 ½"	6 ½"-6 ½"	4"
10670	—	1 ¾"	6 ¼"-6 ¼"	4"
10301	—	2"	11"-11"	5"
10671	—	2"	6 ⅝"-6 ⅝"	4"
10673	—	2 ¼"	6 ⅝"-6 ⅝"	4 ½"
10302	—	2 ¼"	10 ⅞"-10 ⅞"	5"
10672	—	2 ½"	6 ⅝"-6 ⅝"	4 ½"
10303	—	2 ½"	12"-12"	5"
10674	—	2 ¾"	6 ⅝"-6 ⅝"	5"
10675	—	3"	8"-8 ¼"	6"
10756	—	3"	8 ½"-8 ½"	5"
10757	—	3"	10"-12"	5"
10758	—	3"	12"-12"	5"
10304	—	3"	14"-14"	6"
10795	—	3 ½"	6 ¼"-6 ¼"	3 ½"
10759	—	3 ½"	9 ½"-9 ¾"	5"
10676	—	3 ½"	9"-9"	4 ½"
10305	—	3 ½"	16"-16"	7"
10681	—	4"	8"-8"	4 ½"
—	809621	4"	10"-10"	5"
10678	—	4"	10"-10"	4 ½"
10761	809770	4"	12"-12"	6"
10762	—	4"	16"-16"	8"
10306	809406	4"	18"-18"	8"
10764	—	5"	8 ½"-8 ½"	6"
10557	809771	5"	11"-11"	5 ½"
10680	809547	5"	11"-11"	7 ½"
10765	—	5"	15"-15"	8"
10554	809546	5"	15"-15"	10"
10766	—	5"	16 ½"-16 ½"	10"
10308	809408	5"	18"-18"	10"
10556	—	6"	15"-15"	10"

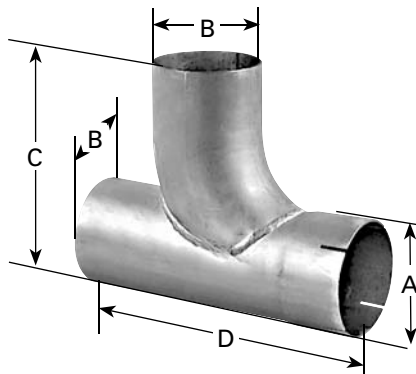

CONVENTIONAL "Y" PIPE

P/N	A	B	C	D
92698	4" ID	3" OD	8 ½"	14"
92678	4" ID	3 ½" OD	11"	15"
92679	4" ID	4" OD	9"	11"
92689	5" ID	5" OD	10 ½"	15"



ELBOWS, SPLITTER T, Y PIPES

ALUMINIZED & CHROME 90° ELBOWS

Both ends are O.D.

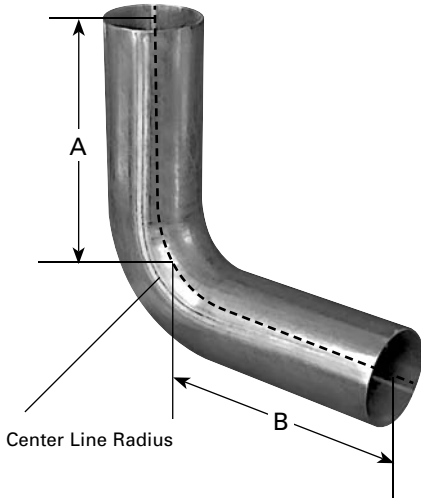

Center Line Radius

P/N ALUMINIZED	P/N CHROME	DIAMETER	LENGTH A-B	CENTERLINE RADIUS
10773	—	2"	9"-9"	5"
10774	—	2 ½"	12"-12"	5"
10337	—	3"	3"-3"	3 ½"
10776	—	3"	6"-6"	3"
10777	—	3"	7"-7"	3"
10534	—	3"	10"-10"	6"
10778	—	3"	14"-14"	8"
10794	—	3 ½"	6"-6"	3 ½"
10338	—	3 ½"	4"-4"	4"
10329	—	3 ½"	8"-8"	4"
10535	—	3 ½"	12"-12"	7"
10536	—	3 ½"	16"-16"	7"
10339	—	4"	4 ½"-4 ½"	4 ½"
10780	—	4"	7"-7"	5"
10781	—	4"	8"-8"	4"
10538	—	4"	9"-15"	4 ½"
10783	—	4"	10"-10"	6"
10539	—	4"	12"-12"	5 ½"
10797	—	4"	16"-16"	8"
10537	—	4"	18"-18"	8"
10340	—	5"	5 ½"-5 ½"	5 ½"
10784	—	5"	7 ½"-7 ½"	6"
10785	809795	5"	8 ½"-8 ½"	6"
10786	—	5"	9"-11 ½"	5 ½"
10787	—	5"	8 ½"-12 ½"	6"
10788	—	5"	8 ¾"-14 ¼"	5 ½"
10789	—	5"	9 ½"-9 ½"	6"
10541	—	5"	11"-16"	5 ½"
10791	—	5"	12"-12"	6"
—	809796	5"	12"-12"	8"
10796	—	5"	15"-15"	5 ½"
10540	—	5"	15"-15"	8"
10309	—	5"	20"-20"	8"

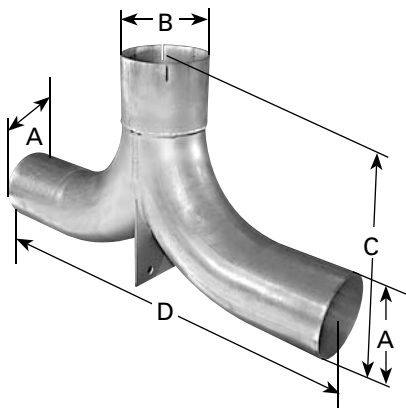

SPLITTER "T" ADAPTER PIPE

P/N WITHOUT BRACKET	P/N WITH BRACKET	A	B	C	D
92695	—	4" OD	4" ID	12"	20"
—	92673	4" OD	4" ID	11 ¼"	16"
—	92674	5" OD	5" ID	14"	25"
92696	—	5" OD	5" OD	11"	19"
92697	—	5" OD	5" ID	10 ¾"	15"

MUFFLERS, PIPES & ACCESSORIES



STRAIGHT TUBING

- **Manufactured from Aluminum Killed Deep Drawing Quality Steel - Prevents Splits and Wrinkles**
- **Re-aluminized Weld Seam - Better Appearance and Helps Prevent Corrosion**
- **All the Necessary Diameters, Lengths and Gauges For Your Bending Needs**



MUFFLERS, PIPES & ACCESSORIES

STRAIGHT TUBING

PART NO.	O.D.	GAUGE	LENGTH
BENDABLE ALUMINIZED TUBING			
112A1016	1 ½"	16	10'
112A7516	1 ½"	16	7.5'
134A1016	1 ¾"	16	10'
134A7516	1 ¾"	16	7.5'
178A1016	1 ⅞"	16	10'
200A1014	2"	14	10'
200A1016	2"	16	10'
200A7514	2"	14	7.5'
200A7516	2"	16	7.5'
212A1014	2 ½"	14	10'
212A7514	2 ½"	14	7.5'
214A1014	2 ¼"	14	10'
214A7514	2 ¼"	14	7.5'
234A1014	2 ¾"	14	10'
234A1414	2 ¾"	14	14'
300A1014	3"	14	10'

PART NO.	O.D.	GAUGE	LENGTH
BENDABLE ALUMINIZED TUBING			
300A1414#	3"	14	14'
300A7514	3"	14	7.5'
312A1014	3 ½"	14	10'
312A1016	3 ½"	16	10'
312A7516	3 ½"	16	7.5'
400A1014	4"	14	10'
400A1016	4"	16	10'
400A7516	4"	16	7.5'
400A1414	4"	14	14'
412A1016	4 ½"	16	10'
500A1016	5"	16	10'
512A1016	5 ½"	16	10'
600A1016	6"	16	10'
800A1016	8"	16	10'
1000A1016	10"	16	10'
BENDABLE 409 STAINLESS TUBING			
200S1016	2"	16	10'
214S1014	2 ¼"	14	10'
212S1014	2 ½"	14	10'
300S1014	3"	14	10'
600S1016	6"	16	10'

PART NO.	O.D.	GAUGE	LENGTH
304 STAINLESS STEEL TUBING (NON-BENDABLE)			
312S1016	3 ½"	16	10'
400S1016	4"	16	10'
500S1016	5"	16	10'

PART NO.	O.D.	GAUGE	LENGTH
COLD ROLLED STEEL			
400C1016	4"	16	10'
500C1016	5"	16	10'
600C1016	6"	16	10'

PART NO.	SIZE	LENGTH
ALUMINIZED STEEL TUBING (ONE END SWAGED & SLOTTED, OTHER END-O.D.)		
923120	3"	10'
924120	4"	10'
925120	5"	10'

- No Longer Available When Inventory is Sold Out.



STACK PIPES

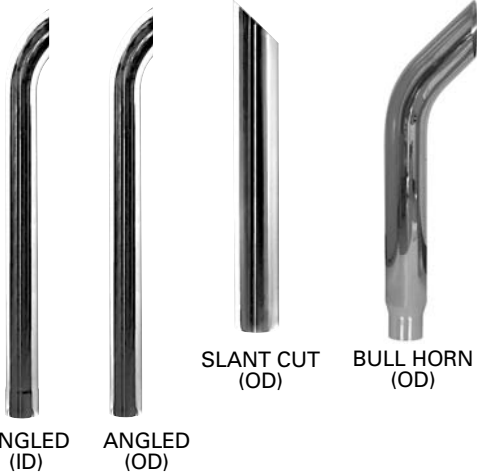

ANGLED (ID)

P/N ALUMINIZED	P/N CHROME	INLET DIA	LENGTH
—	824000	3" ID	18"
24744	—	3" ID	24"
—	844733*	3" ID	48"
—	854000	3" ID	60"
24938	824001	3½" ID	18"
34827	834000	3½" ID	36"
—	814620*	4" ID	12"
24713	824718*	4" ID	18"
24746	824756*	4" ID	24"
34719	834749*	4" ID	36"
44664	844667*	4" ID	48"
54721	854722*	4" ID	60"
—	864670*	4" ID	72"
—	874607*	4" ID	84"
—	884547*	4" ID	96"
—	824717*	5" ID	18"
24672	824673	5" ID	20"
24747	824759*	5" ID	24"
34720	834748*	5" ID	36"
44666	844672*	5" ID	48"
54722	854725*	5" ID	60"
—	864673*	5" ID	72"
—	874610*	5" ID	84"
—	884551*	5" ID	96"
—	883001*	5" ID	108"
—	883012*	6"-5" ID*	108"
—	864650*	6"-5" ID*	72"
—	884564*	6"-5" ID*	96"

* 6" Reduced to 5" ID

* New Item

SLANT CUT (OD)

P/N ALUMINIZED	P/N CHROME	INLET DIA	LENGTH
—	834780*	5" OD	36"
—	844005*	5" OD	48"
—	854008*	5" OD	60"
—	844601*	6"-5" OD*	48"
—	854501*	6"-5" OD*	60"

* 6" Reduced to 5" OD

* New Item

SLANT CUT (ID)

P/N ALUMINIZED	P/N CHROME	INLET DIA	LENGTH
—	864550*	5" ID	72"
—	884501*	5" ID	96"
—	884521*	6"-5" ID	96"
—	883021*	6"-5" ID	108"

* 6" Reduced to 5" OD

* New Item

BULL HORN (OD)

P/N ALUMINIZED	P/N CHROME	INLET DIA	LENGTH
—	834897*	6"-5"OD*	36"
—	844887*	6"-5"OD*	48"
—	854152*	6"-5"OD*	60"

* 6" Reduced to 5" OD

* New Item

ANGLED (OD)

P/N ALUMINIZED	P/N CHROME	INLET DIA	LENGTH
—	834724*	3" OD	36"
34828	—	3" OD	48"
24346	—	4" OD	12"
24717	824720*	4" OD	18"
24748	824748*	4" OD	24"
34723	834726*	4" OD	36"
44665	844674*	4" OD	48"
54725	854730*	4" OD	60"
—	864003*	4" OD	72"
—	884003*	4" OD	96"
24718	824723*	5" OD	18"
24347	—	5" OD	20"
24750	824752*	5" OD	24"
34724	834729*	5" OD	36"
44667	844673*	5" OD	48"
54726	854729*	5" OD	60"
—	864002*	5" OD	72"
—	884401*	5" OD	96"
—	844501*	6"-5" OD*	48"
—	854601*	6"-5" OD*	60"

* 6" Reduced to 5" OD

* New Item

MUFFLERS, PIPES
& ACCESSORIES



STACK PIPES



PIG EAR STACK (ID)

P/N ALUMINIZED	P/N CHROME	INLET DIA	LENGTH
—	824510*	5"ID*	24"
—	854510*	5"ID*	60"
—	883510*	6"-5"ID*	108"

* 6" Reduced to 5" OD

* New Item

PIG EAR STACK (OD)

P/N ALUMINIZED	P/N CHROME	INLET DIA	LENGTH
—	824501*	5"OD*	24"
—	854701*	5"OD*	60"
—	844701*	6"-5"OD*	48"

* 6" Reduced to 5" OD

* New Item



SQUARE CUT (ID)

P/N ALUMINIZED	P/N CHROME	INLET DIA	LGTH.
24731	—	3" ID	18"
24941	—	3" ID	24"
34713	—	3" ID	36"
44854	—	3" ID	48"
24735	—	3½" ID	24"
34714	—	3½" ID	36"
44656	—	4" ID	48"
54991	—	4" ID	60"
—	834008*	5" ID	36"
44658	—	5" ID	48"
54720	854009*	5" ID	60"

* New Item

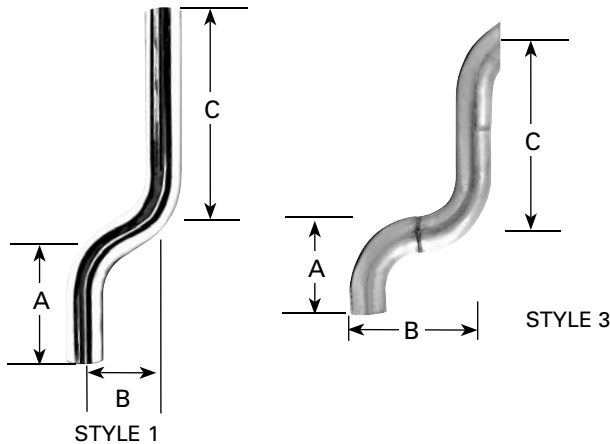

SQUARE CUT (OD)

P/N ALUMINIZED	P/N CHROME	INLET DIA	LGTH.
44657	—	4" OD	48"
54984	—	4" OD	60"
—	834709*	5" OD	36"
44659	844664*	5" OD	48"
54985	854717*	5" OD	60"

* New Item

SPECIALTY STACK PIPES

P/N ALUMINIZED	P/N CHROME	INLET DIA	LGTH.	STYLE	A	B	C
34830	834006	4" OD	30½"	3	8½"	12"	22"
44855	—	4" ID	48½"	1	6⅞"	1½"	30½"
54827	—	4" OD	51"	1	11"	10"	29"
34831	834007	5" OD	29½"	3	8"	11"	21½"



STACK PIPES

SQUARE CUT (OD)



P/N ALUMINIZED	P/N CHROME	INLET DIA	LGTH.
24706	—	4" OD	18"
—	834003	4" OD	36"
—	844661	4" OD	48"
—	854715	4" OD	60"
34829	834708	5" OD	36"
—	844663	5" OD	48"
—	854716	5" OD	60"

SQUARE CUT (ID)

P/N ALUMINIZED	P/N CHROME	INLET DIA	LGTH.
—	844002	3" ID	48"
—	834004	4" ID	36"
—	844003	4" ID	48"
—	854002	4" ID	60"
—	824701	5" ID	18"
—	824006	5" ID	24"
—	834005	5" ID	36"
—	844004	5" ID	48"
—	854003	5" ID	60"

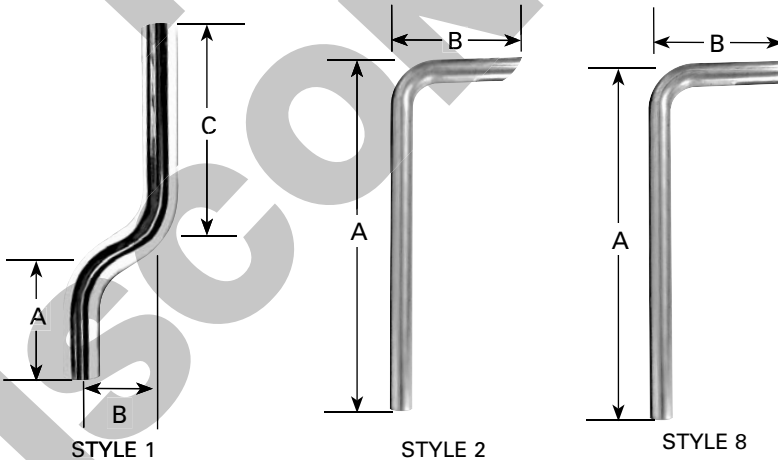
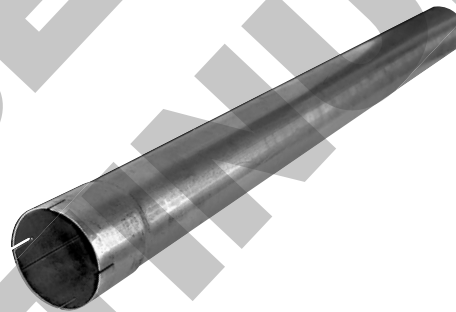

SPECIALTY STACK PIPES

P/N ALUMINIZED	P/N CHROME	INLET DIA	LGTH.	STYLE	A	B	C
—	854004	4" OD	51"	1	11"	10"	29"
54118	—	4" OD	60"	8	60"	23"	—
54993	854006	4" ID	60"	2	60"	27"	—
—	854830	5" OD	51"	1	20"	4"	19 ¼"
—	854005	5" OD	55"	1	20"	4"	19 ¼"
54992	—	5" OD	60"	1	11"	10"	30"
54128	—	5" OD	60"	2	60"	27"	—

MUFFLERS, PIPES & ACCESSORIES



STACK PIPES



ANGLED (ID) ANGLED (OD)

SLANT CUT (OD)

BULL HORN (OD)

ANGLED (ID)

P/N ALUMINIZED	P/N CHROME	INLET DIA	LENGTH
24937	824000	3" ID	18"
—	844734	3" ID	48"
24745	824002	3½" ID	24"
—	844735	3½" ID	48"
—	814623	4" ID	12"
—	824715	4" ID	18"
—	824757	4" ID	24"
—	834746	4" ID	36"
—	844668	4" ID	48"
—	854723	4" ID	60"
—	864671	4" ID	72"
—	874608	4" ID	84"
—	884548	4" ID	96"
14758	814624	5" ID	12"
—	824716	5" ID	18"
—	824758	5" ID	24"
—	834747	5" ID	36"
—	844670	5" ID	48"
—	854724	5" ID	60"
—	864672	5" ID	72"
—	874609	5" ID	84"
—	884550	5" ID	96"
—	884001	5" ID	108"
—	864746	6"-5" ID*	60"
—	874638	6"-5" ID*	72"
—	884563	6"-5" ID*	96"
—	894902	6"-5" ID*	108"
—	894903	6"-5" ID*	120"

* 6" Diameter Reduced to 5" ID

SLANT CUT (OD)

P/N CHROME	INLET DIA	LENGTH
834002	4" OD	36"
834779	5" OD	36"
844001	5" OD	48"
854001	5" OD	60"
884002	6"-5" OD*	120"

* 6" Diameter Reduced to 5" OD

BULL HORN (OD)

P/N CHROME	INLET DIA	LENGTH
834896	6"-5" OD*	36"
844886	6"-5" OD*	48"
854151	6"-5" OD*	60"

* 6" Diameter Reduced to 5" OD

ANGLED (OD)

P/N ALUMINIZED	P/N CHROME	INLET DIA	LENGTH
—	834725	3" OD	36"
—	844737	3" OD	48"
24939	824004	3½" OD	24"
—	834001	3½" OD	36"
44853	844000	3½" OD	48"
—	824721	4" OD	18"
—	824749	4" OD	24"
—	834727	4" OD	36"
—	844669	4" OD	48"
—	854727	4" OD	60"
—	864000	4" OD	72"
—	874000	4" OD	84"
—	884000	4" OD	96"
14759	814625	5" OD	12"
—	824722	5" OD	18"
—	824751	5" OD	24"
—	834728	5" OD	36"
—	844671	5" OD	48"
—	854728	5" OD	60"
—	864001	5" OD	72"
—	874002	5" OD	84"
—	874001	5" OD	96"
24697	824005	6" OD	18"
—	854881	6"-5" OD*	48"
—	864745	6"-5" OD*	60"

* 6" Diameter Reduced to 5" OD



BRACKETS & TAIL SPOUTS



AC4124



PT4124

CHROME TIPS

P/N	INLET ID	DIMENSIONS	BOX QTY.
SAC4124	4"	4"x12"	1
SAC4184	4"	4"x18"	1
SPT4124	4"	4"x12"	1
SPT4184	4"	4"x18"	1
AC4124	4"	4"x12"	6
AC4184	4"	4"x18"	6
PT4124	4"	4"x12"	6
PT4184	4"	4"x18"	6

MUFFLERS, PIPES & ACCESSORIES



STYLE A



STYLE B

TAIL PIPE SPOUTS

P/N		CHROME	DIA	LENGTH
ALUMINIZED STYLE A(OD)	STYLE B(ID)			
—	14748	—	1 ½"	12"
10921	—	—	2"	7 ⅞"
20824	—	—	2"	15"
14342	—	—	2 ¼"	12 ⅛"
14343	—	—	2 ½"	10"
—	24205	—	2 ½"	23 ¼"
14634	—	—	2 ¾"	12"
24344	14618	814621	3"	12"
—	24937	824000	3"	18"
24345	14619	814622	3 ½"	12"
—	24938	824001	3 ½"	18"
24346	14620	814623	4"	12"
24717	24713	824715	4"	18"
14759	14758	814624	5"	12"
24718	24714	824716	5"	18"
24347	24672	824673	5"	20"
—	24696	—	6"	20"



CHROME HEAVY DUTY EXHAUST STACK MOUNTING BRACKET

P/N	SIZE
SB400	4"
SB500	5"
SB600	6"

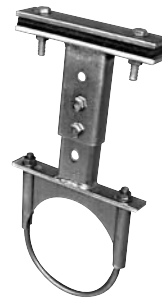

UNIVERSAL STACK BRACKETS FLAT BOTTOM CHROME

P/N	SIZE
SBF 400	4"
SBF 500	5"
SBF 600	6"

STAINLESS STEEL DIFFUSER TIP



P/N	INLET DIA	LGTH.
TK6014	4" ID	14 ½"

O.E. FLARED DIFFUSER TIP



Freightliner O.E. #04-24971-000
Thomas O.E. #135779

P/N	DIA	LGTH.
24011	4" ID	14 ½"

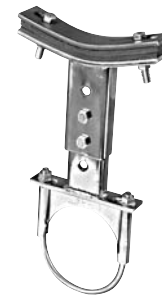

UNIVERSAL STACK BRACKETS CURVED BOTTOM CHROME

P/N	SIZE
SBC 400	4"
SBC 500	5"
SBC 600	6"



PIPE SHIELDS, CLAMP KITS & RAIN CAPS



180 DEG. PIPE SHIELD CLAMP KITS

P/N	SPECIFICATIONS
9456*	CHROME PLATED CLAMP KIT FOR 4" DIAMETER PIPE
9457*	CHROME PLATED CLAMP KIT FOR 5" DIAMETER PIPE
9801*	ZINC PLATED CLAMP KIT FOR 4" DIAMETER PIPE
9803*	ZINC PLATED CLAMP KIT FOR 5" DIAMETER PIPE
9810*	CHROME PLATED CLAMP KIT FOR 6" DIAMETER PIPE

* Box Quantity 2

180 DEG. MUFFLER SHIELD CLAMP KIT

P/N	SPECIFICATIONS
9804*	CHROME PLATED CLAMP KIT FOR 8" DIAMETER MUFFLER
9451*	CHROME PLATED CLAMP KIT FOR 8 1/2" DIAMETER MUFFLER
9805*	ZINC PLATED CLAMP KIT FOR 8 1/2" DIAMETER MUFFLER
9452*	CHROME CLAMP KIT FOR 9" DIAMETER MUFFLER
9806*	ZINC PLATED CLAMP KIT FOR 9" DIAMETER MUFFLER
9453*	CHROME CLAMP KIT FOR 10" DIAMETER MUFFLER
9807*	ZINC PLATED CLAMP KIT FOR 10" DIAMETER MUFFLER

* Box Quantity 2



RAIN CAPS

P/N	MATERIAL FINISH	MIN. O.D. SIZE	MAX. O.D. SIZE
9367	POWDER COATING	1 1/4"	1 7/16"
9896	POWDER COATING	1 1/2"	1 11/16"
9897	POWDER COATING	1 3/4"	1 15/16"
9371	POWDER COATING	2"	2 3/16"
9370	POWDER COATING	2 1/4"	2 7/8"
9372	POWDER COATING	2 1/2"	2 11/16"
9378	POWDER COATING	2 3/4"	2 15/16"
9373	POWDER COATING	3"	3 3/16"
9374	POWDER COATING	3 1/2"	3 11/16"
9375	POWDER COATING	4"	4 3/16"
9376	POWDER COATING	4 1/2"	4 11/16"
9377	POWDER COATING	5"	5 3/16"
9704	POWDER COATING	5 1/2"	5 11/16"
9369	POWDER COATING	6"	6 1/8"
9571	CHROME	3"	3 3/16"
9573	CHROME	4"	4 3/16"
9575	CHROME	5"	5 3/16"

FORD MUFFLER HANGERS ORIGINAL EQUIPMENT FIT



9758
Fits All Diesel
Mufflers 83-UP
11" Round

9759
Fits All Diesel
Mufflers 79-82
Oval



CHROME GRAB HANDLE

P/N	SPECIFICATIONS
9430	18" LENGTH
9811	24" LENGTH



MUFFLER, PIPE SHIELDS AND CLAMP KITS



180 DEG. PIPE SHIELDS

P/N	SPECIFICATIONS
809458	STAINLESS STEEL 4"- 5"x48" PIPE SHIELD W/O MTNG. CLAMPS, ROUND HOLES
809307	STAINLESS STEEL 6"x48" PIPE SHIELD W/O MTNG. CLAMPS, ROUND HOLES
809308	ALUMINIZED 4"- 5"x48" PIPE SHIELD W/O MTNG. CLAMPS, ROUND HOLES
809312	STAINLESS STEEL 4"x48" PIPE SHIELD WITH 4" CLAMP KIT
809313	STAINLESS STEEL 5"x48" PIPE SHIELD WITH 5" CLAMP KIT

270 DEG. PIPE SHIELD AND CLAMP KIT

P/N	SPECIFICATIONS
809301	ALUMINIZED 4"- 5"x36" PIPE SHIELD ROUND HOLES
9456*	CHROME PLATED CLAMP KIT FOR 4" DIAMETER PIPE
9801*	ZINC PLATED CLAMP KIT FOR 4" DIAMETER PIPE
9457*	CHROME PLATED CLAMP KIT FOR 5" DIAMETER PIPE
9803*	ZINC PLATED CLAMP KIT FOR 5" DIAMETER PIPE

* Box Quantity 2

MUFFLERS, PIPES
& ACCESSORIES

180 DEG. MUFFLER SHIELDS

P/N	SPECIFICATIONS
809302	STAINLESS STEEL 8"- 10"x42" MUFF. SHIELD W/O MTNG. CLAMPS, ROUND HOLES
809429	STAINLESS STEEL 8½"- 10"x51" MUFF. SHIELD W/O MTNG. CLAMPS, ROUND HOLES
809303	ALUMINIZED 8"- 10"x42" MUFF. SHIELD W/O MTNG. CLAMPS, ROUND HOLES
809304	ALUMINIZED 8"- 10"x51" MUFF. SHIELD W/O MTNG. CLAMPS, ROUND HOLES

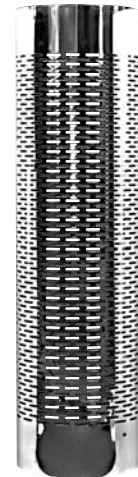

270 DEG. MUFFLER SHIELD AND CLAMP KIT

P/N	SPECIFICATIONS
809310	ALUMINIZED 9"- 10"x32" MUFF. SHIELD W/O MTNG. CLAMPS, ROUND HOLES
809298	ALUMINUM 6"- 9"x48" MUFF. SHIELD W/O MTNG. CLAMPS, ROUND HOLES
809299	ALUMINIZED 8½"- 10½"x48" MUFF. SHIELD W/O MTNG. CLAMPS, ROUND HOLES
809300	STAINLESS STEEL 8½"- 10½"x48" MUFF. SHIELD W/O MTNG. CLAMPS, ROUND HOLES
809500	STAINLESS STEEL 9"- 10"x51" MUFF. SHIELD W/O MTNG. CLAMPS, ROUND HOLES
9798*	CHROME CLAMP KIT FOR 9" DIAMETER MUFFLER
9799*	CHROME CLAMP KIT FOR 10" DIAMETER MUFFLER
9724*	ZINC PLATED CLAMP KIT FOR 10" DIAMETER MUFFLER
9725*	ZINC PLATED CLAMP KIT FOR 9" DIAMETER MUFFLER

* Box Quantity 2



BRACKETS

**4" FORD DIESEL
TAIL PIPE HANGER**



9130

FREIGHTLINER HANGERS



9348
Muffler Hanger
04 & Newer
OE# A04-20919-000



8323
Rubber Mount
04 & Newer
OE# 04-19919

MUFFLER HANGERS

P/N	STYLE	FITS BODY DIAMETER
8445	B	7"-8¾"
9354	A	6"
9355	A	7"
9580	A	8"
9356	A	8½"
9357	A	9"
9358	A	10"
9360	A	8¼"x11½"
9359	A	10"x15"
9628	C	11⅞"



STYLE A



STYLE B



STYLE C

PIPE HANGERS

P/N	FITS BODY DIAMETER
9582	2"
9361	2½"
9362	2¾"
9363	3"
9364	3½"
9365	4"
9366	5"





BRACKETS

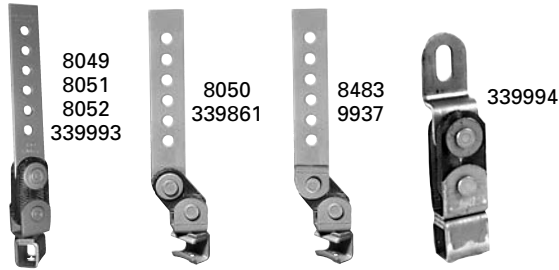

SWIVEL HANGERS

P/N	TYPE	LENGTH	BOX QTY
8049	REG. CLOSED	9 ½"	1
8050	REG. OPEN	9 ¾"	1
8052	MED. CLOSED	13 ¼"	1
8051	LONG CLOSED	17 ¼"	1
8483	REG. OPEN	9 ½"	1
9937	REG. OPEN	9 ½"	50
339861	REG. OPEN	9 ¾"	50
339993	REG. CLOSED	9 ½"	50
339994	SHORT CLOSED	5 ⅝"	50

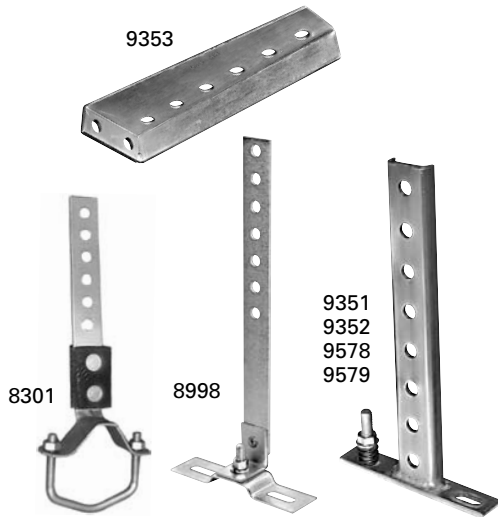

**UNIVERSAL HEAVY DUTY
HANGER AND BRACKET**

P/N	LENGTH	PIPE DIA
9578	9 ¼"	
9351	10"	2"-2 ¾"
9352	10"	3"-4"
9579	14"	
9353	10"	
8301	9"	
8998	12"	

BLUEBIRD TAILPIPE HANGERS

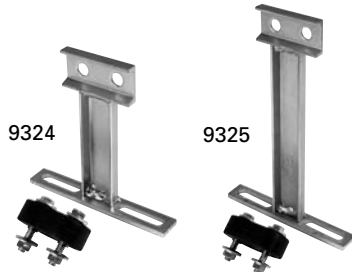

P/N	LENGTH	U-BOLT
9324	5 ⅝"	4" & 5"
9325	9 ¼"	4" & 5"

CHEVROLET/GMC FRAME BRACKET



9328
1989 & NEWER 366 GAS ENG.

MUFFLERS, PIPES
& ACCESSORIES



BRACKETS

MUFFLERS, PIPES
& ACCESSORIES

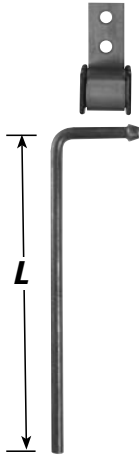

UNIVERSAL HANGER

BULK P/N	BOX QTY	SINGLE PACK P/N	LGTH.	ROD DIA
339820	25	339820S	10"	½"

**CHEVROLET/GMC DIESEL
MUFFLER STRAP**

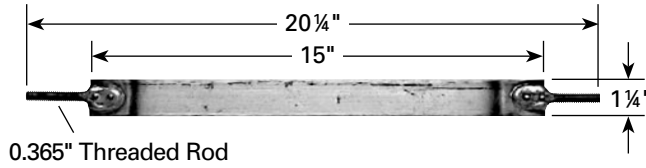

9762

**CHEVROLET/GMC
OVERAXLE HANGER ASSEMBLY**



9132
FRAME BRACKET



9761
U-SHAPED HANGER

**CHEVROLET/GMC
MANIFOLD PIPE ACCESSORIES**



8038



BRACKETS

INTERNATIONAL BRACKETS (EXTRA HEAVY DUTY REINFORCED)



9776
OVERAXLE BRACKET
(not included in complete set)

RUBBING BUSHING

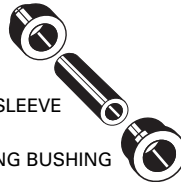

IH SLEEVE

RUBBING BUSHING



9779
COMPLETE SET
(tailpipe bracket, bushings, IH sleeve)



9738 (3")
9740 (4")
PIPE HANGERS



9753 (7.3L)
9755 (Forward Control)
MUFFLER HANGERS (88-UP)



9321 (96-UP)
T444E ENG. (FORWARD)
REAR MUFFLER HANGER



9322 (96-UP)
T444E ENG. (FORWARD)
FRONT MUFFLER HANGER



FLANGES AND GASKETS



9524 Tube
9569 Flange (Sold Separately)



9587



9586

CONVERSION FLANGE AND TUBE

P/N	SIZE	DESCRIPTION
9587	4"	TUBE 4" NH CUMMINS
9524	2¾"	TUBE
9569	3"	FLANGE
9586	4"	FLANGE 4" NH CUMMINS

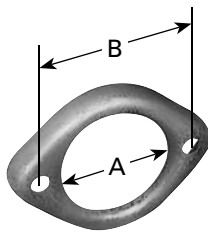

8791
FIG 1

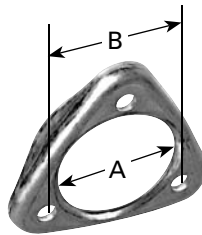

9146
FIG 2

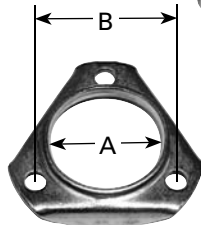

8780
FIG 3

FLANGE IDENTIFICATION CHARTS

P/N	FIG	A	B
8775	2	2 3/8"	3 3/8"
8780	3	2 5/32"	3 1/8"
8784	1	2 11/32"	3 3/4"
8791	1	2 3/8"	3 3/8"
8792	1	2 11/16"	3 3/4"
9569	1	2 29/32"	4 3/32"
8775	2	2 5/16"	2 7/8"
9146	2	2 5/8"	3 1/2"
9148	1	2 3/8"	3 3/8"
9149	2	2 9/16"	4 1/2"



9588



8699



9259

SINGLE PIECE INSERTS WITH GASKET

P/N	DESCRIPTION
9588	CHEVY/GMC TILTMASER, ISUZU NPR SERIES w/4BD1-T TURBO DIESEL ENGINE
9260	CHEV/GMC MED TRUCK/BUS w/366, 427 ENGINE
8698	INTERNATIONAL MED TRUCK/BUS w/V392 ENGINE
8699	INTERNATIONAL MED TRUCK/BUS w/V304, V345 ENGINE
9259	CHEV/GMC MED TRUCK BUS w/350 ENGINE



RUBBER GOODS / AIR INTAKE



90 DEG. ELBOWS

P/N	ID SIZE (EACH END)	OD SIZE (EACH END)	DIMENSIONS					
			A	B	C	D	R	T
924003	3.00	3.50	5.25	5.25	1.50	2.00	2.00	0.25
924004	4.00	4.50	5.75	5.75	1.50	1.50	2.00	0.25
924005	5.00	5.50	6.00	6.00	1.62	1.62	1.75	0.25
925506	5.50	6.00	6.50	6.50	1.75	1.75	1.75	0.25
926006*	6.00	6.50	7.00	7.00	2.25	2.25	1.75	0.25
927006*	7.00	7.62	7.56	7.56	2.25	2.25	1.75	0.31
928006*	8.00	8.75	8.50	8.50	2.00	2.25	2.12	0.37
926101*	6.00	6.50	5.00	5.00	1.50	1.50	1.00	0.25

*RIBBED ELBOW

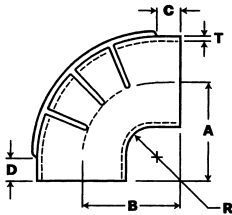

90 DEG. REDUCER ELBOWS

P/N	ID SIZE	ID SIZE	DIMENSIONS					
			A	B	C	D	R	T
926557*	5.50 (ID1)	6.00 (ID2)	6.75	6.75	1.75	2.00	1.75	0.25
927557*	5.50 (ID1)	7.00 (ID2)	5.75	6.25	1.50	1.50	0.62	0.31

*RIBBED ELBOW

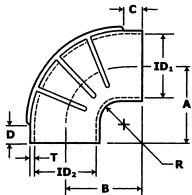

45 DEG. ELBOWS

P/N	ID SIZE (EACH END)	OD SIZE (EACH END)	DIMENSIONS					
			A	B	C	R	T	
924105	4.00	4.50	1.50	1.50	5.50	2.00	0.25	
925005	5.00	5.50	1.62	1.62	5.25	1.75	0.25	
925505	5.50	6.00	1.75	1.75	6.25	1.75	0.25	
926005*	6.00	6.50	2.00	2.00	6.50	1.75	0.25	
927005	7.00	7.62	2.00	2.00	8.00	1.75	0.31	
928005*	8.00	8.75	2.25	2.25	8.25	2.12	0.37	

*RIBBED ELBOW

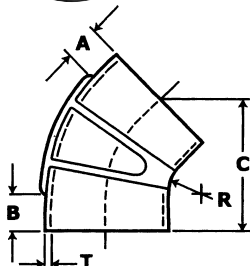

RUBBER GOODS / AIR INTAKE

MUFFLERS, PIPES
& ACCESSORIES

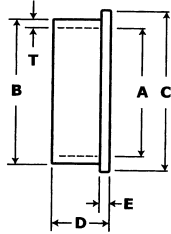

REDUCER INSERTS

P/N	DIMENSIONS					
	A	B	C	D	E	T
925458	4.50	5.00	5.50	1.50	0.25	0.25
925558	5.00	5.50	6.00	1.50	0.25	0.25
926508	5.00	6.00	6.50	1.75	0.25	0.50
926658	5.50	6.00	6.50	1.75	0.25	0.25



REDUCER HUMP HOSES

P/N	ID1 SIZE	ID2 SIZE	DIMENSIONS				
			A	B	C	D	T
925543	5.50	4.00	6.00	7.00	1.87	2.00	0.25
925553	5.50	5.00	6.00	7.00	1.87	2.00	0.25
926503	6.00	5.00	6.00	7.50	2.12	2.12	0.25
926553	6.00	5.50	6.00	7.50	2.00	2.00	0.25
928603	8.00	6.00	6.00	9.50	1.38	1.50	0.25
928703	8.00	7.00	6.00	9.50	2.00	2.00	0.27

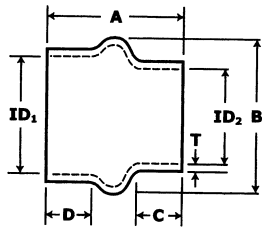

HUMP HOSES

P/N	ID SIZE	DIMENSIONS				
		A	B	C	T	
924104	4.00	5.25	5.50	2.00	0.25	
925105	5.00	6.00	6.50	2.25	0.25	
925504	5.50	6.00	7.00	2.25	0.25	
926004	6.00	7.00	7.50	2.75	0.25	
927004	7.00	7.00	8.50	2.50	0.31	
928004	8.00	5.00	9.50	1.50	0.25	

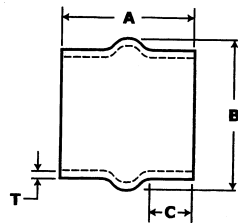

**AIR INTAKE
ALUMINUM TUBING**
(O.D. BOTH ENDS)

P/N	SIZE	LENGTH
923002	3"	10'
924002	4"	10'
925002	5"	10'
925502	5½"	10'
926002	6"	10'
927002	7"	10'
928002	8"	10'



AIR LINE CLAMPS

P/N	SIZE
9589	3"
9590	3½"
9591	4"
9592	5"
9593	5½"
9594	6"
9595	7"
9596	8"



EXHAUST BACK PRESSURE TESTER

Part No. B1

(Dial-Type Gauge)

Testers offer a quick and easy way to diagnose plugged or restricted exhaust systems without cutting or disconnecting pipes.



Part No. B1A

(100 Count)

Hole plugs for B1 Tester
(Shown with B1 image)



MUFFLER CEMENT

Part No. T26-6oz.

Part No. T27-16oz.

This high-performance muffler cement applies like putty but dries metal hard. Available in cases of 12 only.



PIPE EXPANDERS/SHAPERS

Part No.

CLV257 - (1 3/8" to 2 7/16" Dia.)

CLV258 - (to 2 1/8" to 3 7/8" Dia.)

CLV350 - (to 3 1/2" Dia.)

CLV400 - (to 4" Dia.)

CLV500 - (to 5" Dia.)

CLV657 - (1 1/8" to 1 3/4" Dia.)





MINI-SAW CUTTING BLADES

Part No. UP1150
(Three replacement cutting wheels)

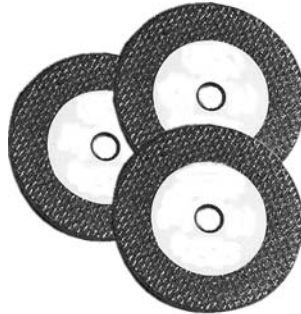

PIPE END SHAPER TOOLS

Part No. L32000 – (1 ½" to 2 ½" Dia.)
Part No. 9741 – (2 ¾" to 4 ½" Dia.)



PIPE CUTTER

Part No. L31500
This proven pipe cutter handles 1 ¾" to 3 ½" pipes. A one-third revolution cuts a full 360 degrees.

Part No. L31530
Replacement blades for L31500 Pipe Cutter.

Part No. 9742 – (3 ½" to 6" Dia.)
Chain type pipe cutter handles the big diameters.

Part No. 9780 – (2 ½" to 5" Dia.)
Part No. 9781 – (4" to 6 ¾" Dia.)
Standard tube cutter & wheel style.

Part No. 9784 – (Wheel)
Replacement components for tube style cutters.





PIPE HOOKS

Part No.

FPH51 – (1½" to 2½" Dia.)
Foreign car pipe hooks.

PH450 – (2¾" to 4" Dia.)
H.D. pipe hooks.

PH50 – (1½" to 2½" Dia.)
Pipe hooks.

PH550 – (5" to 6" Dia.)
H.D. pipe hooks.

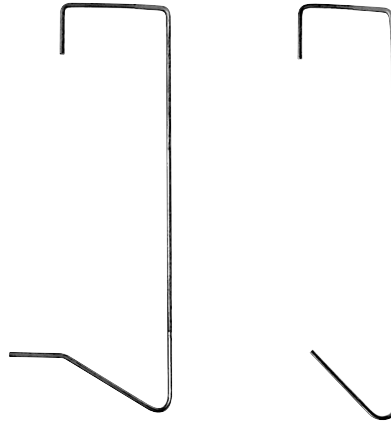



GENERAL SERVICE MUFFLER SPECIFICATIONS

STYLE 1 - CENTER TO CENTER



* NPT: National Pipe Thread;
1 Engine Brake Silencer Single

2 Engine Brake Silencer Duals
Engine Brake Silencers perform by using a combination of absorptive and reactive silencing techniques that are used to produce a more pleasant sound to the human ear. Using sound analysis, TruckEx has been able to reduce medium and high frequency noise levels and smooth out the sound spectrum eliminating the harsh staccato "bark" of an engine break.

MUFFLER P/N	INLET ID	OUTLET ID	CROSS SECTION	SHELL LENGTH	OVERALL LENGTH
4223	1½"	1½" OD	4 ¼"	3 ½"	5 29/32"
45	2"	2"	5"	10"	13 ½"
3690	2"	2" OD	5 5/8"	6 13/32"	11"
3878	2"*NPT	2"*NPT	6"	14 ½"	20"
3881	FLANGE	2 ¼"	9"	22"	28"
3879	2½"*NPT	2½"*NPT	6"	16 29/32"	18 1/8"
3651	2½"	2½"	6"	29"	36"
3691	2½"	2½"	6 39/64"	6 ¼"	13"
3880	2½"	2½"	6"	20"	26"
3882	2¾"	2¾"	7"	30"	36"
3721	3"	3"	6"	21"	30"
3692	3"	3"	7"	7 7/16"	14 5/8"
3683	3"*NPT	3"*NPT	7"	14"	19 3/4"
3883	3"	3"	7"	30"	36"
3652	3"	3"	7 1/8"	30"	36"
3875	3"	3"	9"	11 ½"	16"
3687	3"	3 1/8" OD	8"	12 3/16"	17"
3884	3"	3 1/8" OD	8 1/8"	12 ½"	17"
4252	3"	4"	11"	36"	41 3/4"
3726	3 3/8"	3 3/8"	10 1/8"	23 ½"	28 5/8"
3885	3 ½"	3 ½"	11 1/8"	22 ¾"	28 ¾"
3720	3 ½"	3 ½"	7 1/8"	30"	38"
3693	3 ½"	3 ½"	7"	9"	16 ½"
3618	3 ½"	3 ½"	7"	14"	19 ¾"
3685	3 ½"*NPT	3 ½"*NPT	7"	15"	20"
3679	3 ½"	3 ½"	9"	44 ½"	51"
4233	3 ½"	4"	8 ½"	29 ½"	36"
4253	3 ½"	4"	11"	36"	42 ½"
3871	4"	4"	7"	22"	28"
4251	4"	4"	11"	36"	43"
4227	4"	4"	10"	36"	43"
3653	4"	4"	7"	38"	44"
3887	4"	4"	7 1/8"	28"	36"
3694	4"	4"	8"	10 5/8"	18 3/16"
3625	4"	4"	8 ½"	34 ½"	40 ¼"
3891	4"	4"	8 ½"	44"	51"
3894	4"	4"	7"	17 ½"	22"
3684	4"*NPT	4"*NPT	9"	20"	26"
3888	4"	4"	9"	20"	26 1/2"
3889	4"	4"	9"	24"	34"
3666	4"	4"	9"	43 ½"	51"
3681	4"	4"	9"	10 ½"	16"
3714	4"	4"	10"	43 ½"	51"
4218	4"	4"	10 ¼"	34"	41 ½"
3890	4"	5"	9"	43 ½"	51"
3712	4"	5"	9"	44 ½"	51"
3893	4"	5"	10"	44"	51"
3715	4"	5"	10"	44 7/16"	51"
3682	5"	5"	9"	10"	16 ½"
3695	5"	5"	9"	11 ¾"	20 ¾"
3895	5"	5"	9"	20"	26 ½"
3872	5"	5"	9"	33"	40"
3897	5"	5"	9"	43 ½"	51"
3699	5"	5"	10 1/8"	44"	51"
3667	5"	5"	9"	44 ½"	51"
4206 ¹	5"	5"	10"	44 7/16"	51"
4207 ²	5"	5"	10"	44 7/16"	51"
3640	5"	5"	10"	44 ½"	51"
3699	5"	5"	10"	44"	51"
3873	5"	5"	10"	59 15/16"	66 ½"
3722	5"	5"	10 1/8"	44 ½"	51"



TRUCK MUFFLER SPECIFICATIONS

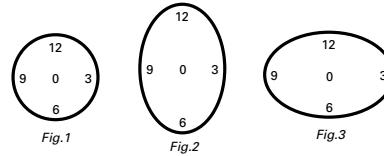

INLET/OUTLET POSITION

NOTE: Muffler Offsets and Positions should be measured and viewed from the Inlet end.

STYLE 2 - OFFSET TO OFFSET

P/N	INLET ID	OUTLET ID	INLET POSITION	OUTLET POSITION	FIG.	INLET OFFSET	OUTLET OFFSET	CROSS SECTION	SHELL LENGTH	OVERALL LENGTH
4221	Flange	2"	12	6	1	1 1/2"	1 1/4"	6 1/8"	29 5/16"	36 1/8"
3901	2"	2"	12	6	1	1 13/32"	1 13/32"	6"	24"	30"
3902	2 1/4"	2 1/4"	6	12	1	1 3/8"	1 3/8"	6"	26 1/2"	34"
4241	2 1/4"	2"	12	6	1	1 3/8"	1 3/8"	6"	25"	31"
3907	2 1/2"	2 1/4"	12	6	1	1 1/2"	1 1/2"	6 1/2"	26"	33"
3906	2 1/2"	2 1/4"	12	6	1	1 3/8"	1 3/8"	6"	26 1/2"	34"
3624	2 1/2"	2 1/2"	6	12	1	1 5/8"	1 5/8"	6 1/2"	18 13/16"	23"
3654	2 1/2"	2 1/2"	12	6	1	1 13/32"	1 13/32"	6 5/8"	28"	35"
3908	2 1/2"	2 1/2"	6	12	1	2 1/2"	2 1/2"	8 1/2"	26 1/2"	33 1/4"
687	2 1/2"	2"	12	6	1	1 3/8"	1 3/8"	6"	29"	34"
609	2 3/4"	2 1/4"	12	6	1	1 5/8"	1 5/8"	7"	31 1/4"	36 1/4"
3728	Flange	2 3/4"	12	6	1	1 13/16"	1 13/16"	7 5/16"	35"	45"
3613	2 3/4"	2 3/4" OD	12	6	1	1 1/2"	1 1/2"	7 1/8"	35"	40"
2958	2 3/4"	2 1/2" OD	11	7	1	1 3/4"	1 3/4"	7"	26"	33"
3607	2 3/4"	SPOUT	12	6	1	2"	2"	7"	35"	44 3/4"
3701	2 3/4"@	2 3/4"<	12	6	1	1 5/8"	1 5/8"	7 1/8"	35"	44"
4243	2 3/4"	3"	12	6	1	3"	2 3/4"	8 1/2"	30 1/4"	36 1/4"
3943	3"	2 3/4" OD	12	6	3	1 5/8"	1 5/8"	8 1/4" x 11 1/2"	21 1/4"	26 1/4"
2704	3"	3"	12	6	1	2"	2"	8 1/2"	31 1/4"	36 1/4"
3627	3"	3"	6	12	1	3 1/4"	2"	8 1/2"	20 1/2"	25"
3655	3"	3"	6	6	1	2"	2"	8 1/2"	31 1/2"	36"
4228	3"	3" OD	6	12	1	2"	2"	8 1/2"	24 1/2"	36"
4224	3"	4"	6	12	1	3"	4"	11"	36"	42"
2645	3 1/4"	2 1/2"	12	6	1	1 7/16"	1 3/16"	7"	27"	32"
3689	3 1/2"	3 1/2"	6	12	2	2 1/2"	2 1/2"	8 1/4" x 11 1/2"	26"	33"
3662	3 1/2"	3"	6	12	1	1 3/4"	2"	8 1/2"	37 3/4"	43"
3611	3 1/2"	4"	6	12	2	2 1/2"	2 1/2"	8 1/4" x 11 1/2"	26"	32 1/4"
4242	3 1/2"	4"	12	6	2	2 3/4"	2 3/4"	8 1/4" x 11 1/2"	26 1/2"	33"
3716	3 1/2"	4"	12	6	2	2 1/2"	2 1/2"	8 1/2" x 11"	30"	36 3/8"
3668	4"	3 1/2"	6	12	2	2 1/2"	2 1/2"	8 1/4" x 11 1/2"	26"	32 1/4"
3675#	4"	4"	6	12	2	4 1/4"	1/2"	10 5/16" x 15 5/16"	36"	42"
3669	4"	4"	6	12	1	2 7/16"	2 7/16"	10"	27 1/8"	33 1/2"
3614	4"	4"	12	6	2	4 1/4"	4 1/4"	10" x 15"	26"	33"
3911	4"	4"	12	6	1	2 1/2"	2 1/2"	10 1/8"	36"	43"
3713	4"	4"	12	6	1	2 1/2"	2 1/2"	11 1/8"	36"	42 1/4"
3700	4"	4"	6	12	1	2 1/2"	2 1/2"	11"	36"	41 1/4"
3711	4"	4"	6	12	1	2 1/2"	2 1/2"	11"	30"	36"
4225	4"	4"	12	6	1	2 1/2"	2 1/2"	11"	36"	43"
3710	4"	4"	6	12	2	2 3/4"	2 3/4"	8 1/4" x 11 1/2"	32"	39 1/2"
3632	4"	4"	12	6	2	2 1/2"	2 1/2"	8 5/16" x 11 1/2"	27"	32 1/4"
4240	4"	5"	12	6	2	3 1/8"	3 1/8"	10" x 15"	44"	50 1/2"
3647	5"	5"	6	12	2	3 1/8"	3 1/8"	10" x 15"	26"	32 29/32"
3676	5"	5"	6	12	2	3 1/8"	3 1/8"	10" x 15"	36"	42 1/2"
3912	5"	5"	12	3	2	3 19/32"	3 19/32"	10" x 15"	44"	50"
3913	6"	6"	12	6	2	3 19/32"	3 19/32"	10" x 15"	31 1/2"	42 1/2"

TRUCK MUFFLER SPECIFICATIONS

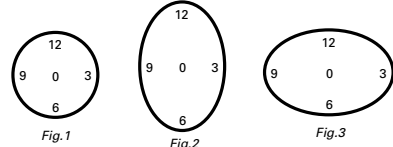
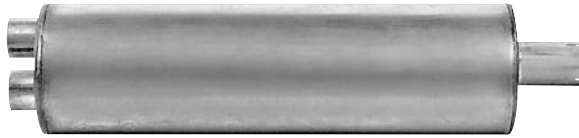

INLET/OUTLET POSITION

NOTE: Muffler Offsets and Positions should be measured and viewed from the Inlet end.

STYLE 2A - DUAL INLET TO SINGLE OUTLET

P/N	INLET ID	OUTLET ID	INLET POSITION	OUTLET POSITION	FIG.	INLET OFFSET	OUTLET OFFSET	CROSS SECTION	SHELL LENGTH	OVERALL LENGTH
3612	2 1/2"-2 1/2"	2 1/2"	9-3	9	1	1 3/4"-1 3/4"	2"	7"	32 1/4"	38 1/4"
3697	2 1/2"-2 1/2"	2 3/4"	6-6	6	1	1 3/4"-1 3/4"	2"	8 1/2"	30"	39"
3725#	2 1/2"-2 1/2"	2 3/4"	1:30-10:30	12	1	1 3/4"-1 3/4"	2"	8 1/2"	30"	39"
3150	2 1/2"-2 1/2"	3"	6-6	12	1	1 5/8"-1 5/8"	2"	8 1/2"	31 1/4"	36 1/4"
3663	2 1/2"-2 1/2"	3"	5-7	12	1	1 1/4"	2 1/8"	8 1/2"	37"	44 1/2"
3719#	2 1/2"-2 1/2" (@-@)	3"OD	6-6	12	1	1 5/8"-1 5/8"	2"	8 3/4"	30"	38 7/8"
4237	2 1/2"-2 1/2"	3"	6-12	0	1	3"-3"	0"	10"	28"	38 1/2"
3914	2 1/2"-2 1/2"	3 1/2"	5-7	6	1	1 1/4"	2 1/2"	8 1/2"	29 1/2"	39"
3708	2 1/2"-2 1/2" FLANGE	4"	1:30-10:30	6	1	1 3/4"-1 3/4"	2"	9 ²⁹ / ₃₂ "	40"	50"
3610	2 3/4"-2 3/4"	4"	12-6	6	2	5 ³² / ₃₂ " - 4"	2 1/2"	8 1/4"x11 1/2"	27"	32 3/4"

@ Spherical Flare # Wrapped Muffler Center Inlet

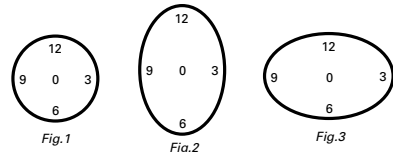
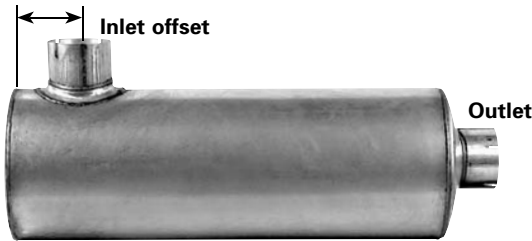

INLET/OUTLET POSITION

NOTE: Muffler Offsets and Positions should be measured and viewed from the Inlet end.

STYLE 3 - SIDE INLET, END OULET

P/N	INLET ID	OUTLET ID	INLET POSITION	OUTLET POSITION	FIG.	INLET OFFSET	OUTLET OFFSET	CROSS SECTION	SHELL LENGTH	OVERALL LENGTH
3617	1 5/8"	1 5/8"	12	0	1	2 3/4"	0	4 3/8"	13 ²⁵ / ₃₂ "	15 ²⁵ / ₃₂ "
3925	2 1/2"	2 1/2"	6	9	1	3 1/2"	1 5/8"	6 5/8"	20 ¹³ / ₁₆ "	23 1/2"
3636	3 1/2"	3 1/2"	6	3	3	3 1/2"	2 1/2"	8 ⁵ / ₁₆ "x11 1/2"	26 1/8"	29 1/4"
3626	3"	3"	6	9	1	4 1/2"	2"	8 1/2"	27"	29 1/2"
3678	4"	3 ¹³ / ₁₆ " OD	12	12	2	3 1/8"	4 ¹³ / ₃₂ "	10"x15"	16"	20 1/8"
3637	4"	4"	6	3	1	4 1/2"	2 ⁷ / ₁₆ "	10 1/8"	28"	32 1/4"
3927	4"	4"	6	9	1	4 1/4"	2 1/2"	11"	36"	39"
3928	4"	4"	3	12	1	4 1/2"	2 1/2"	11"	36"	40"
3930	4"	4"	5:30	12	2	24 1/4"	2 1/2"	8 1/4"x11 1/2"	28 1/2"	31 1/8"
3929	4"	4"	12	6	2	3 1/2"	2 ¹³ / ₃₂ "	8 ¹⁵ / ₁₆ "x11 1/2"	16 1/4"	21 3/4"
4246	4"	4"	12	0	1	3 3/4"	0	11"	33 1/2"	36 1/2"
4244	4"	4"	12	0	1	4"	0	11"	42"	45"
3931	4"	5"	6	6	2	2 ⁷ / ₈ "	4 1/4"	10"x15"	21"	25 1/4"
3926	4"	5"	6	0	1	3 ⁵ / ₁₆ "	0	9"	44 1/2"	48"
3702	5"	5"	12	0	1	5 1/2"	0	10"	44"	48"
3645	5"	5"	9	12	3	5 ⁷ / ₈ "	3 1/8"	10"x15"	35 ⁷ / ₈ "	39 ⁷ / ₈ "
3932	5"	5"	6	12	2	4"	3 1/2"	10"x15"	16 1/2"	20 1/2"
3933	5"	5"	1	6	2	21 1/4"	4"	10"x15"	26"	30"



TRUCK MUFFLER SPECIFICATIONS

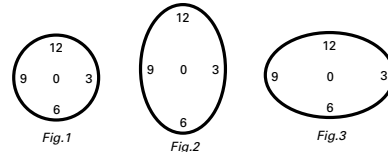
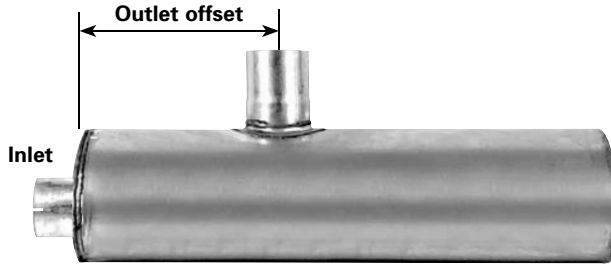

INLET/OUTLET POSITION

NOTE: Muffler Offsets and Positions should be measured and viewed from the Inlet end.

STYLE 4 - END INLET, SIDE OUTLET

P/N	INLET ID	OUTLET ID	INLET POSITION	OUTLET POSITION	FIG.	INLET OFFSET	OUTLET OFFSET	CROSS SECTION	SHELL LENGTH	OVERALL LENGTH
3915	3½"	4"	6	3	2	2¼"	11½"	8¼" x 11½"	26½"	30¼"
3703	3½"	4"	3	11:30	2	2½"	12 ⁹ / ₁₆ "	8¼" x 11½"	32 ⁹ / ₁₆ "	35 ⁵ / ₃₂ "
3704	3½"	4" OD	9	11:30	2	2½"	12 ⁹ / ₁₆ "	8¼" x 11½"	32 ⁹ / ₁₆ "	35 ⁵ / ₃₂ "
3916	3½"	4" OD	6	3	2	2½"	12"	8¼" x 11½"	32"	35"
3917	3½"	4" OD	12	3:30	2	2½"	21"	8¼" x 11½"	26½"	30"
3707	4"	4"	12	6	1	2 ¹³ / ₃₂ "	5½"	10 ¹ / ₈ "	36"	38 ²⁹ / ₃₂ "
3677	4"	4"	10	6	1	2 ⁷ / ₁₆ "	4"	10"	28"	31"
3918	4"	4"	6	11	1	3"	19½"	10"	26½"	30½"
3706	4"	4"	6	12	2	3¾"	7"	10" x 15"	36"	40½"
3921	4"	4"	6	12	2	4¼"	7 ³ / ₈ "	10" x 15"	30 ³ / ₈ "	34"
3730	4"	4"	10	12	1	2½"	3 ⁷ / ₈ "	11 ¹ / ₈ "	36"	39"
3920	4"	4"	2	12	1	2½"	3 ⁷ / ₈ "	11 ¹ / ₈ "	36"	39"
3919	4"	4"	6	12	1	1½"	4"	11"	36"	39½"
3705	4"	4"	12	8	2	4 ¹ / ₈ "	11½"	8¼" x 11½"	26"	31"
3698	5"	5"	6	12	2	3 ¹ / ₈ "	7 ³ / ₄ "	10" x 15"	36"	39¼"
3923	5"	5"	6	12	1	2¼"	7½"	11"	36"	39½"
3922	5"	5"	12	6	2	3 ⁷ / ₈ "	14½"	9" x 14"	18½"	22"
3924	5" OD	5" OD	0	12	1	0"	14½"	12 ¹ / ₈ "	36"	40"

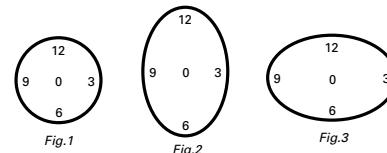

INLET/OUTLET POSITION

NOTE: Muffler Offsets and Positions should be measured and viewed from the Inlet end.

STYLE 5 - INLET/OUTLET SAME END

P/N	INLET ID	OUTLET ID	INLET POSITION	OUTLET POSITION	FIG.	INLET OFFSET	OUTLET OFFSET	CROSS SECTION	SHELL LENGTH	OVERALL LENGTH
3851	3½"	4"	12	6	2	2 ⁵ / ₈ "	2 ⁵ / ₈ "	8¼" x 11½"	30½"	34"
3670	4"	4"	12	6	1	2 ⁷ / ₁₆ "	2 ⁷ / ₁₆ "	10"	27¾"	30 ⁷ / ₈ "
4211	4"	4"	6	12	1	3"	3"	10"	26½"	31"
3898	4"	4"	12	6	2	4¼"	4¼"	10" x 15"	26"	28 ³ / ₈ "
3899	4"	4"	6	12	2	4½"	1½"	10" x 15"	36"	39½"
4232	4"	5"	0	12	2	2	4	12" x 15"	30"	34½"
3900	5"	5"	12	6	2	3 ¹ / ₈ "	3 ¹ / ₈ "	10" x 15"	26"	29 ²³ / ₆₄ "
4205	5"	5"	12	6	2	3 ¹⁹ / ₃₂ "	3 ¹⁹ / ₃₂ "	10" x 15"	44"	47 ³ / ₈ "

MUFFLERS, PIPES & ACCESSORIES



TRUCK MUFFLER SPECIFICATIONS

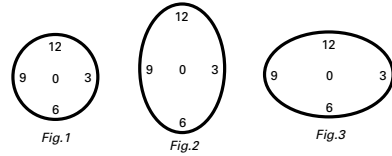

INLET/OUTLET POSITION

NOTE: Style 6 Inlet and Outlet Offsets are measured from each end. Style 6 Inlet and Outlet Positions are viewed from the Inlet end. On all other style mufflers, the Offsets and Positions should be measured and viewed from the Inlet end.

STYLE 6 - SIDE INLET, SIDE OUTLET

P/N	INLET ID	OUTLET ID	INLET POSITION	OUTLET POSITION	FIG.	INLET OFFSET	OUTLET OFFSET	CROSS SECTION	SHELL LENGTH	OVERALL LENGTH
3937	4"	4"	6	12	1	4 ½"	4 ½"	10 ¼"	28"	30 ½"
3938	4"	4"	12	9	1	4 ¼"	6 ¾"	11 ⅞"	36"	36"
3939	4"	4"	12	10:30	1	4 ½"	17 ½"	11"	36"	36"
3940	4"	4"OD	12	2	1	4"	13 ½"	11"	36"	36"
3941	5"	5"	6	12	3	5"	5"	10" X 15"	28"	28 ¼"

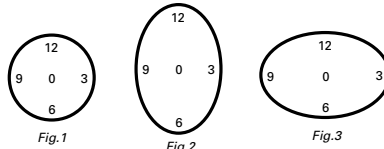

INLET/OUTLET POSITION

NOTE: Muffler Offsets and Positions should be measured and viewed from the Inlet end.

STYLE 8 - SINGLE INLET, DUAL OUTLET

P/N	INLET ID	OUTLET ID	INLET POSITION	OUTLET POSITION	FIG.	INLET OFFSET	OUTLET OFFSET	CROSS SECTION	SHELL LENGTH	OVERALL LENGTH
2057	2 ½"	2" OD-2" OD	6	12	2	2 ¾"	0-2 ¾"	4 ⅛" x 10 ½"	29"	32 ½"
4245	Flange	2 ½"	12	3-3	1	2 ½"	2 ½"	8 ½"	29 ½"	37 ½"
2328	3"	2"-2"	3	9	1	1 ¾"	7/8"-7/8"	7"	26"	32 ¾"

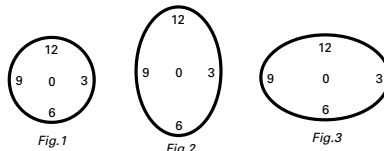

INLET/OUTLET POSITION

NOTE: Muffler Offsets and Positions should be measured and viewed from the Inlet end.

STYLE 9 - OFFSET TO CENTER

P/N	INLET ID	OUTLET ID	INLET POSITION	OUTLET POSITION	FIG.	INLET OFFSET	OUTLET OFFSET	CROSS SECTION	SHELL LENGTH	OVERALL LENGTH
3609	2 ½"	2 ¼"	12	0	2	2 ¾"	0	4 ⅛" x 8 ¾"	25"	29"

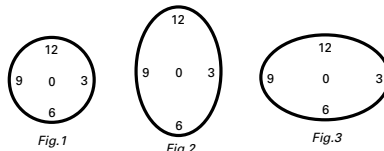

INLET/OUTLET POSITION

NOTE: Muffler Offsets and Positions should be measured and viewed from the Inlet end.

STYLE 10 - OFFSET TO OFFSET

P/N	INLET ID	OUTLET ID	INLET POSITION	OUTLET POSITION	FIG.	INLET OFFSET	OUTLET OFFSET	CROSS SECTION	SHELL LENGTH	OVERALL LENGTH
3616	3"	3"	6	6	2	2 ½"	2 ½"	8 ⅞" x 11 ½"	26"	33 ¾"



GENERAL SERVICE MUFFLER & SPARK ARRESTOR



GENERAL SERVICE MUFFLER SPECIFICATIONS

MUFFLER P/N	INLET ID	OUTLET ID	SHELL DIAMETER	SHELL LENGTH	OVERALL LENGTH
3651	2 1/2"	2 1/2"	6"	29"	36"
3721	3"	3"	6"	21"	30"
3720	3 1/2"	3 1/2"	7 1/8"	30"	38"
3871	4"	4"	7"	22"	28"
3887	4"	4"	7 1/8"	28"	36"
3712	4"	5"	9"	44 1/2"	51"
3872	5"	5"	9"	33"	40"
3873	5"	5"	10"	59 15/16"	66 1/2"
3699	5"	5"	10"	44"	51"



UNIVERSAL TYPE RESONATORS

MUFFLER P/N	INLET ID	OUTLET ID	SHELL DIAMETER	SHELL LENGTH	OVERALL LENGTH
3875	3"	3"	9"	11 1/2"	16"
3884	3"	3 1/8" OD	3 1/8"	12 1/4"	17"
3618	3 1/2"	3 1/2"	7"	14"	19 3/4"
3681	4"	4"	9"	10 1/2"	16"
3682	5"	5"	10"	10"	16 1/2"

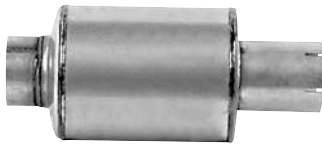

SPARK ARRESTORS

MUFFLER P/N	INLET ID	OUTLET ID	CROSS SECTION	SHELL LENGTH	OVERALL LENGTH
4223	1 1/2"	2 1/2" OD	4 1/4"	3 1/8"	5 29/32"
3690	2"	2" OD	5 5/8"	6 13/32"	11"
3691	2 1/2"	2 1/2"	6 39/64"	6 1/4"	13"
3692	3"	3"	7"	7 9/16"	14 5/8"
3693	3 1/2"	3 1/2"	7"	9"	16 1/2"
3694	4"	4"	8"	10 5/8"	18 3/16"
3695	5"	5"	9"	11 3/4"	20 3/4"

Over 90% effective. Can be used on all internal combustion engines. Qualified and rated by U.S. Dept. of Agriculture - Forestry Service.

MUFFLERS, PIPES & ACCESSORIES



GENERAL SERVICE MUFFLER & SPARK ARRESTOR



SPLITTER TEE MUFFLER

MUFFLER P/N	INLET ID	OUTLET ID	INLET POSITION	INLET OFFSET	CROSS SECTION	SHELL LENGTH	OVERALL LENGTH
3661	3 ½"-3 ½"	5"	0-SIDE	0-7"	7"	15"	18 ½"
3876	5"	5"-5"	12	5"	10"	10"	21"



MUFFLER SPARK ARRESTOR

MUFFLER P/N	INLET ID	OUTLET ID	INLET POSITION	INLET OFFSET	CROSS SECTION	SHELL LENGTH	OVERALL LENGTH
4222#	1 ½" OD	1 ¾" OD	12	2"	4 ¼"	18 ½"	21"
4238*	2"	2 ½" OD	6	2"	4 ¾"	13 ¼"	18 ½"

Onan Generator Motor Home

* 230 IH Tractor

ORIGINAL EQUIPMENT vs ECONOMY

MUFFLER OPTIONS

O.E.

ECONOMY

Original Equipment mufflers reduce exhaust noise to level required to meet EPA truck noise limits.

Original Equipment mufflers can be quieter (Up to 3 dba) than economy versions, depending on make of engine.

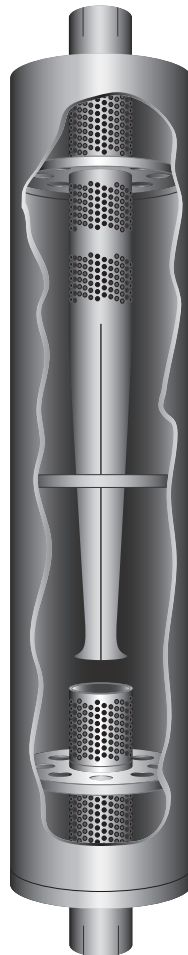

16 Gauge End Flange
(Some competitors are lighter).

Local noise laws should be checked before using Economy version.

Internal support flange
(Some competitors do not).

MUFFLERS, PIPES & ACCESSORIES

ALL ALUMINIZED STEEL CONSTRUCTION

TRUCKEX	O.E. NO.	ECONOMY NO.
4" INLET & OUTLET VERTICAL 9" BODY	3666	3891
5" INLET & OUTLET VERTICAL 10 $\frac{1}{8}$ " BODY	3640	3699
5" INLET & OUTLET VERTICAL 9" BODY	3897	3667
4" INLET & 5" OUTLET VERTICAL 9" BODY	3890	3712
4" INLET & 5" OUTLET VERTICAL 10" BODY	3715	3893



CATALYTIC CONVERTER MUFFLERS

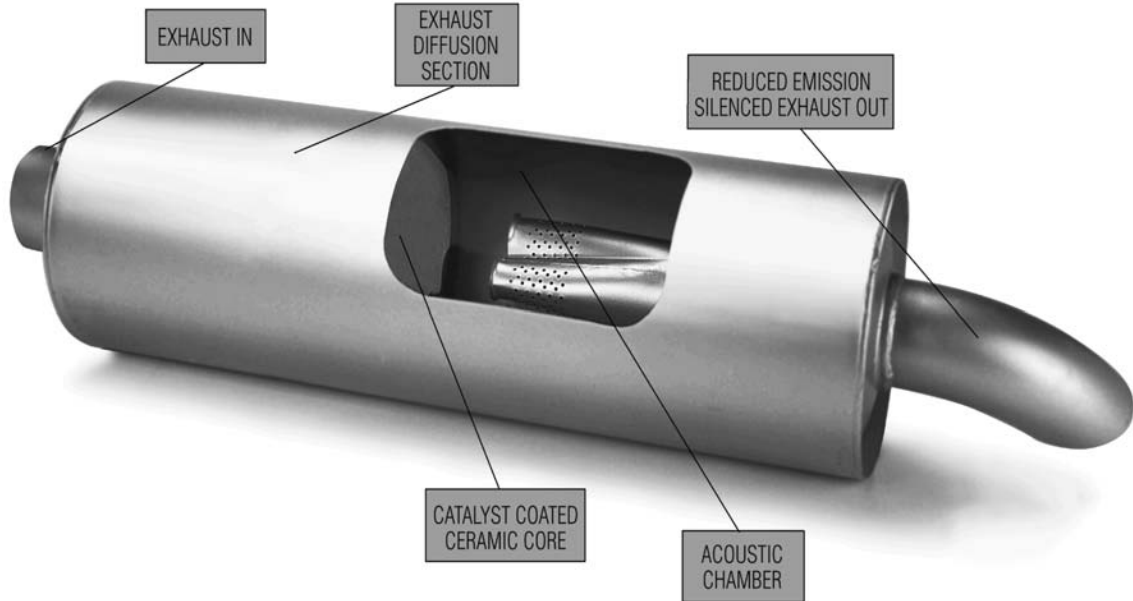

Certified to Meet EPA Requirements

TruckEx converter mufflers are engineered to enable mid-range engines to meet emission requirements of the EPA's Diesel Emissions Standards. The catalytic core within the muffler reduces gaseous hydrocarbons, carbon monoxide, and particulates, while at the same time reducing exhaust noise to 67-72 dBA at 50 feet per the EPA drive-by noise test (levels will vary depending on system configuration).

- Same package size as equivalent mufflers
- Only 10 to 15 pounds heavier than equivalent mufflers
- 409 Stainless steel
- Internal design for even exhaust flow distribution

P/N	STYLE▲	INLET ID	OUTLET ID	INLET POSITION	OUTLET POSITION	INLET OFFSET	OUTLET OFFSET	CROSS SECTION	SHELL LENGTH	OVERALL LENGTH
4208	1	4"	4"	0	0	0	0	10"	43"	50 ½"
STYLE/TYPE DESCRIPTION - CENTER TO CENTER										
APPLICATION / DESCRIPTION - Bluebird 97-00 6 Cyl. TC1000, 5.9L B-Series Cummins Engine; 132" Wheel Base										
Bluebird 95-98 6 Cyl. TC2000 w/ 6BTA; 5.9L Turbo Diesel; Rear Exit Tail Pipe; Side Mounted Fuel Tank; w/ Converter; 132", 146"-195", 216"-237" W.B.										
Bluebird 94-98 6 Cyl. TC2000, 5.9L B-Series Cummins Engine; w/ Air Ride Suspension; 174"-216" W.B., 237" W.B.										
4209	1	4"	4"	0	0	0	0	11"	36"	41"
STYLE/TYPE DESCRIPTION - CENTER TO CENTER										
APPLICATION / DESCRIPTION - Chevrolet/GMC 98-01 6 Cyl. 3126 Cat., CV200; GMC B7 Conventional Chassis										
Chevrolet/GMC 94-98 6 Cyl. 3116 Cat., CV200; GMC B7 Conventional Chassis										
Ford 95-99 6 Cyl. B800, FD1060 w/ 5.9L Cummins Diesel; w/ Converter; Air Suspension; 151"-275" W.B.										
Freightliner 02-04 4-6 Cyl. Freightliner Mercedes Engine										
4239	3	4"	4"	12	6	3 ¾"	2 ½"	11"	33 9/16"	37 3/8"
STYLE/TYPE DESCRIPTION - SIDE INLET, END OUTLET										
APPLICATION / DESCRIPTION - Bluebird 94-98 6 Cyl. TC2000 Rear Engine w/ Caterpillar 3116(6.6L) Diesel; (To Chassis No. 991136)										



CATALYTIC CONVERTER MUFFLERS

P/N	STYLE▲	INLET ID	OUTLET ID	INLET POSITION	OUTLET POSITION	INLET OFFSET	OUTLET OFFSET	CROSS SECTION	SHELL LENGTH	OVERALL LENGTH
4254	2	3 1/2"	4"	6	12	2 3/4"	2 3/4"	8 1/4 X 11 1/2"	29 1/2"	36 1/2"
STYLE/TYPE DESCRIPTION - OFFSET TO OFFSET										
APPLICATION / DESCRIPTION - International 05-06 6 Cyl. CE international w/ DT 466 Engine & VT 365 Engine										
International 94-00 6 Cyl. Series 3800; w/ DT408, DT466E Turbo Diesel; w/ Code 07AAW; w/ Allison MTB643, MTB653DR Auto. Trans.; LH Exit Tail Pipe; w/o Air Suspension; 152", 170"-276" W.B.										
International 94-00 6 Cyl. Series 3600, 3800; w/ DT408, DT466E, T444E Diesel; w/ Mor-Ryde Suspension (exc. RH Rear Exit Tail Pipe); 152", 170"-276" W.B.										
4255	1	3"	4"	0	0	0	0	8"	28"	34"
STYLE/TYPE DESCRIPTION - CENTER TO CENTER										
APPLICATION / DESCRIPTION - Freightliner 02-04 6 Cyl. Freightliner B-Series Cummins Engine w/ World Trans.										
Freightliner 98-01 6 Cyl. Freightliner B-Series Cummins Engine										
Freightliner 98-01 6 Cyl. Freightliner 3126 Caterpillar Engine										
4256	1	4"	4"	0	0	0	0	10"	43"	50 1/2"
STYLE/TYPE DESCRIPTION - CENTER TO CENTER										
APPLICATION / DESCRIPTION - Bluebird 04-06 6 Cyl. Vision w/ 3126-C7 Caterpillar Engine										
4258	2	3 1/2"	4"	6	12	2 3/4"	2 3/4"	8 1/4 X 11 1/2"	29 1/2"	36 1/2"
STYLE/TYPE DESCRIPTION - OFFSET TO OFFSET										
APPLICATION / DESCRIPTION - 89 & Newer International School Bus with DT360										
4259	2	3 1/2"	4"	6	12	2 3/4"	2 3/4"	8 1/4 X 11 1/2"	28"	34"
STYLE/TYPE DESCRIPTION - OFFSET TO OFFSET										
APPLICATION / DESCRIPTION - 88 & Older International School Bus with DT466 & T444E Engines										
4260	2	4"	4"	12	6	2 1/2"	2 1/2"	11"	32"	38"
STYLE/TYPE DESCRIPTION - OFFSET TO OFFSET										
APPLICATION / DESCRIPTION - 92 & Newer Ford School Bus with Cummins C Series Engine, International School Bus with 3126 Caterpillar Engine										
4261	3	4"	4"	12	0	4"	0	11"	42"	45"
STYLE/TYPE DESCRIPTION - SIDE INLET, END OUTLET										
APPLICATION / DESCRIPTION - Bluebird 94-98 6 Cyl. All-American w/ 3116 Caterpillar Rear Engine										
4262	2	4"	4"	12	6	2 1/2"	2 1/2"	11"	36"	44"
STYLE/TYPE DESCRIPTION - OFFSET TO OFFSET										
APPLICATION / DESCRIPTION - Freightliner 02-04 4-6 Cyl. Freightliner Mercedes Engine										
Freightliner 98-01 6 Cyl. Freightliner 3126 Caterpillar Engine										
4263	3	3"	4"	9	3	1 1/2"	4"	9" x 14"	30"	33 1/2"
STYLE/TYPE DESCRIPTION - SIDE INLET, END OUTLET										
APPLICATION / DESCRIPTION - Bluebird 94-98 6 Cyl. TC2000 Pusher B-Series Cummins (From Chassis No. 991136)										
4264	5	4"	5"	9	3	1 1/2"	5"	12" x 15"	26"	29"
STYLE/TYPE DESCRIPTION - INLET AND OUTLET SAME END										
APPLICATION / DESCRIPTION - Bluebird 94-98 6 Cyl. All-American 8.3 Cummins Rear Engine; Catalytic Muffler; (From Chassis No. 991136)										
Bluebird 94-98 6 Cyl. 8.3 Cummins TC2000 Rear Engine Catalytic Muffler; (From Chassis No. 991275)										
4265	3	4"	5"	12	0	4"	0"	11"	42"	45"
STYLE/TYPE DESCRIPTION - INLET, END OUTLET										
APPLICATION / DESCRIPTION - Bluebird 04-07 All-American w/ 3126 and C-7 Caterpillar Pusher										
4266	3	3 1/2"	4"	12	0	4"	0	11"	36"	36"
STYLE/TYPE DESCRIPTION - SIDE INLET, END OUTLET										
APPLICATION / DESCRIPTION - International 04-07 IC, VT-365 and DT466, Rear Engine										

MUFFLERS, PIPES & ACCESSORIES

▲ Refer to charts on following pages to determine muffler style.

606000 SERIES SUPER DUTY UNIVERSAL CONVERTERS

The **606*** Series Universal Converter** is an extra large capacity, without air tube, 2-way or 3-way converter.

Easy to read emissions ratings for both the EPA and CARB. The **606*** SERIES** is designed to fit light and medium duty trucks to 12,000 lbs., G.V.W.-EPA Rating, 11,620 lbs., CARB Rating.

High quality, stainless steel shell and end bushings will provide years of worry free service.

Insure maximum engine capacities and maximum test weight capacities for both the EPA and CARB standards and dimensional information for the **606*** Series Universal Converters**.



606000 SERIES HEAVY DUTY - WITHOUT AIR

Can be used as a 2-way converter on vehicles where the engine size is 7.5L or smaller and with a test weight of 9,000 lbs. or less or as a 3-way where the engine size is 7.5L or smaller and a test weight of 9,000 lbs. or less. G.V.W. of 12,500 lbs. approx., or less.

In California, can be used as a 2-way converter on vehicles where the engine size is 7.4L or smaller and with a test weight of 9,000 lbs. or less or a 3-way where the engine size is 7.4L or smaller and a test weight of 9,000 lbs. or less. G.V.W. of 11,620 lbs., or less.



2-WAY OR 3-WAY CONVERTER



SUPER DUTY CONFIGURATION

Converter Type	EPA Engine Size	EPA Test Weight	CARB Engine Size	CARB Test Weight
2-Way	460/7.5L	9,000 lbs.	454/7.4L	9,000 lbs.
3-Way	460/7.5L	9,000 lbs.	454/7.4L	9,000 lbs.

2-WAY OR 3-WAY

P/N	INLET I.D.	OUTLET I.D.
606005	2 ¼"	2 ¼"
606006	2 ½"	2 ½"
606007	3"	3"

607000 SERIES SUPER DUTY UNIVERSAL CONVERTERS

The **607*** Series Universal Converter** is an extra large capacity, with air tube, 2-way, 3-way or 3-way with air converter.

Easy to read emissions ratings for both the EPA and CARB. The **607*** Series** is designed to fit light and medium duty trucks to 12,000 lbs., G.V.W.-EPA Rating, 11,620 lbs., CARB RATING.

High quality, stainless steel shell and end bushings will provide years of worry free service.

Insure maximum engine capacities and maximum test weight capacities for both the EPA and CARB standards and dimensional information for the **607*** Series Universal Converters**.



MUFFLERS, PIPES & ACCESSORIES

607000 SERIES HEAVY DUTY - WITH AIR

Can be used as a 2-way converter on vehicles where the engine size is 7.5L or smaller and with a test weight of 9,000 lbs. or less or as a 3-way w/air where the engine size is 7.5L or smaller and a test weight of 9,000 lbs. or less G.V.W. of 12,500 lbs. approx., or less.

In California, can be used as a 2-way converter on vehicles where the engine size is 7.4L or smaller and with a test weight of 9,000 lbs. or less or a 3-way where the engine size is 7.4L or smaller and a test weight of 9,000 lbs. or less B.V.W. of 11,620 lbs. or less.

3-way w/air - NA. Please see below for details.



2-WAY, 3-WAY AND 3-WAY WITH AIR TUBE CONVERTER

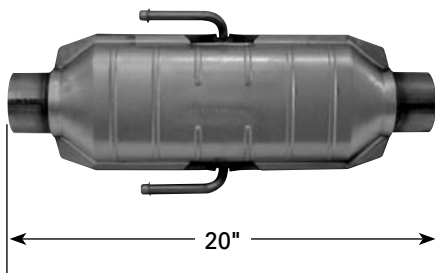

SUPER DUTY CONFIGURATION				
Converter Type	EPA Engine Size	EPA Test Weight	CARB Engine Size	CARB Test Weight
2-WAY	460/7.5L	9,000 lbs.	454/7.4L	9,000 lbs.
3-WAY	460/7.5L	9,000 lbs.	454/7.4L	9,000 lbs.
3-WAY w/air	460/7.5L	9,000 lbs.	NA	NA

2-WAY, 3-WAY AND 3-WAY WITH AIR TUBE

P/N	INLET I.D.	OUTLET I.D.
607005	2 ¼"	2 ¼"
607006	2 ½"	2 ½"
607007	3"	3"

REAR CONVERTER CUT-OFF INSTRUCTIONS

88-89 8 Cyl., C3500, K3500

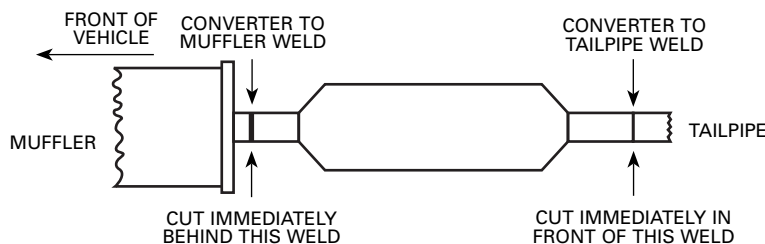



ALUMINIZED EXHAUST COMPONENTS - FORD

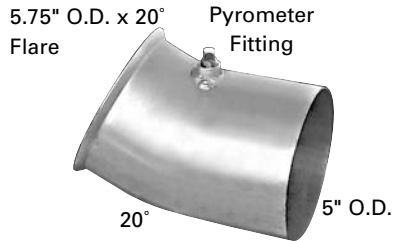

18109
Replaces FORD
Part No. **D8HZ-5246AC**
Inlet Pipe RH
L, LN, LNT, LT, LTS 9000 Series with
Cummins NTC Engines.

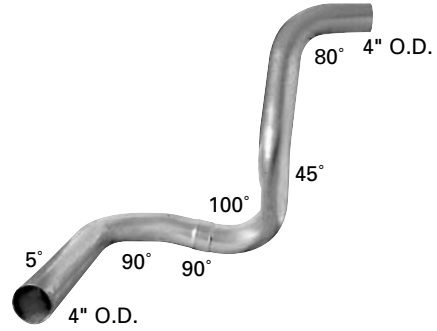

58372
Replaces FORD
Part No. **E2HZ-5A212F**
Exhaust Pipe
L, LT, LTS 8000 Series with Caterpillar
3208T Engines.

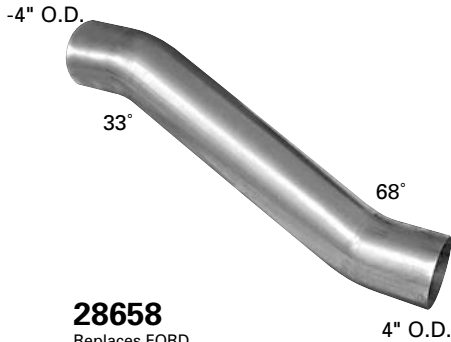

28658
Replaces FORD
Part No. **E7HZ-5255D**
Extension Pipe
Requires 14739 Flex on
outlet End to replace OE



ALUMINIZED EXHAUST COMPONENTS - FREIGHTLINER

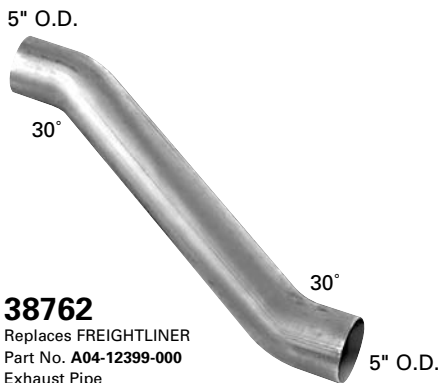

38762
Replaces FREIGHTLINER
Part No. **A04-12399-000**
Exhaust Pipe

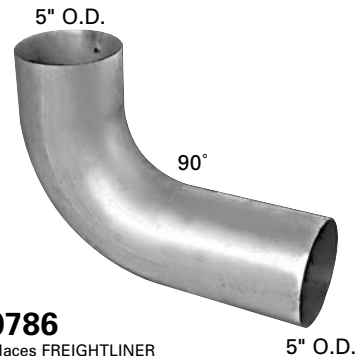

10786
Replaces FREIGHTLINER
Part No. **A04-09586-013**
Elbow



ALUMINIZED EXHAUST COMPONENTS - FREIGHTLINER

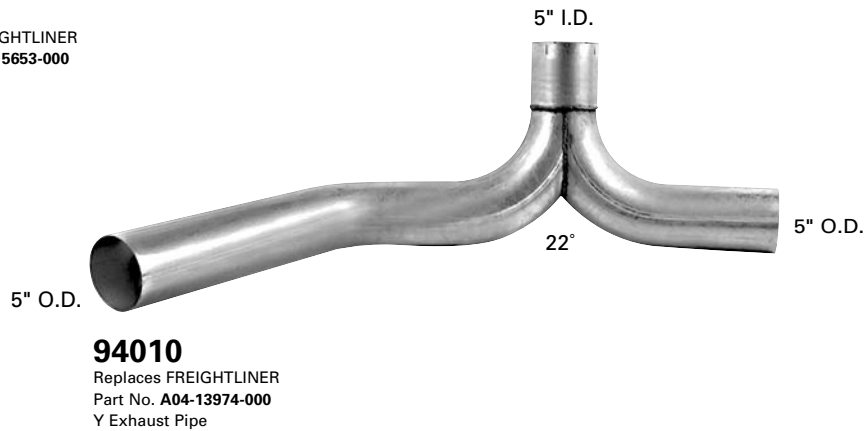
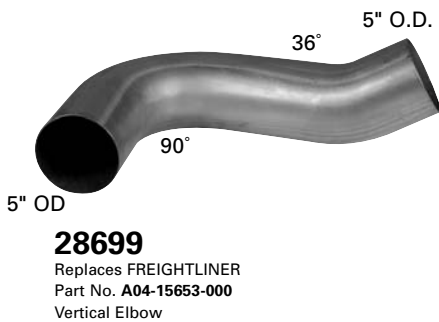
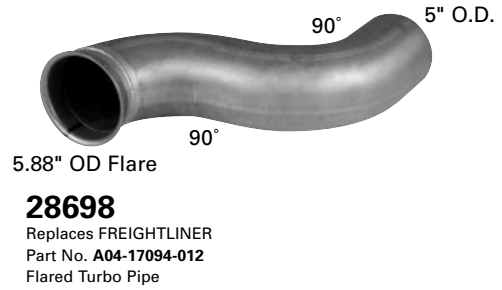

MUFFLERS, PIPES
& ACCESSORIES



ALUMINIZED EXHAUST COMPONENTS - GMC



4" O.D.

24346
Replaces GMC
Part No.2353719
Tail Pipe

3" I.D.



4" O.D.
x 90° Flare

9479
Replaces GMC
Part No.2046594
Extension
Requires 9611 V-Clamp

4" O.D.

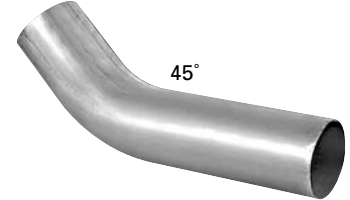

45°

4" O.D.

28310
Replaces GMC
Part No.2064499
Elbow



ALUMINIZED EXHAUST COMPONENTS - INTERNATIONAL

4" O.D.

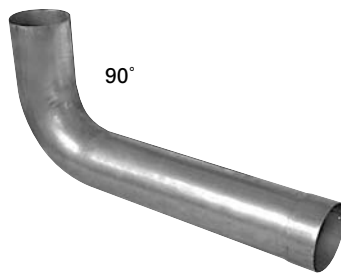

90°

4" O.D.

28661
Replaces INTERNATIONAL
Exhaust Pipe

5" O.D.



90°

5" O.D.

28534
Replaces INTERNATIONAL
Part No. 503-841-C1
Intermediate Pipe



ALUMINIZED EXHAUST COMPONENTS - INTERNATIONAL

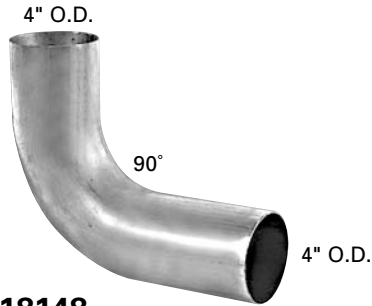

18148
Replaces INTERNATIONAL
Part No. 598-276-C1
Elbow



18149
Replaces INTERNATIONAL
Part No. 165-293-7C1
Turbo Elbow



38608
Replaces INTERNATIONAL
Part No. 582-167-C1

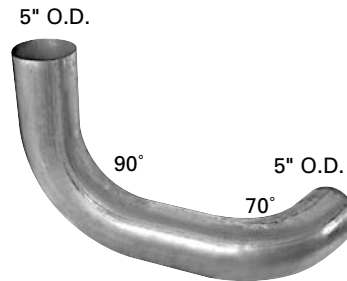

38607
Replaces INTERNATIONAL
Part No. 503-845-C1
89" Cab

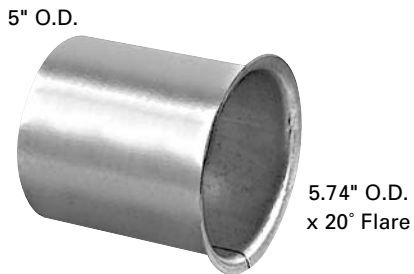

9716
Replaces INTERNATIONAL
Part No. 449-814-C1
Turbo Connector

MUFFLERS, PIPES
& ACCESSORIES

ALUMINIZED EXHAUST COMPONENTS - KENWORTH

MUFFLERS, PIPES
& ACCESSORIES

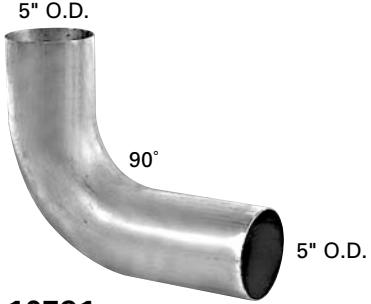

10791
Replaces KENWORTH
Part No. K180-15593
Elbow



68185
Replaces KENWORTH
Part No. K180B-10742-R
Right Side Elbow with Offset
868186 - Chrome

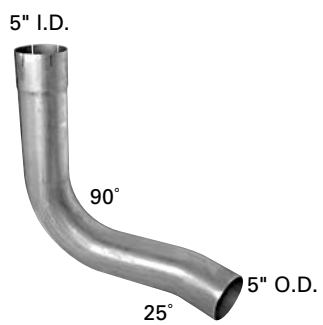

68183
Replaces KENWORTH
Part No. 180B-10742-L
Left Side Elbow with Offset
868184 - Chrome

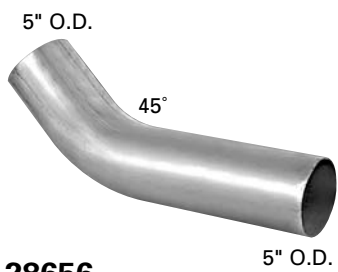

28656
Replaces KENWORTH
Part No. K180-14765
Extension Pipe

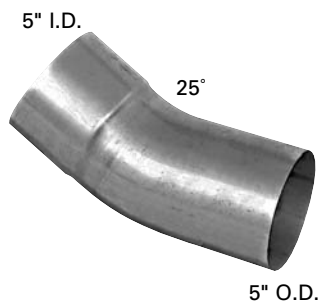

18110
Replaces KENWORTH
Part No. K180-5419



38612
Replaces KENWORTH
Part No. K180-14764R
RH Extension Pipe



ALUMINIZED EXHAUST COMPONENTS - KENWORTH

MUFFLERS, PIPES
& ACCESSORIES

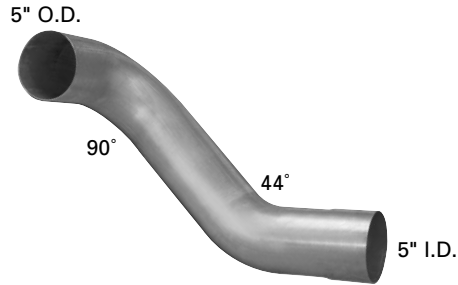

38611
Replaces KENWORTH
Part No. **K180-14764L**
(See Kmex)

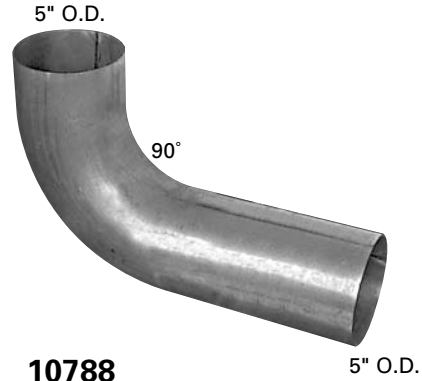

10788
Replaces KENWORTH
Part No. **K16948-012**

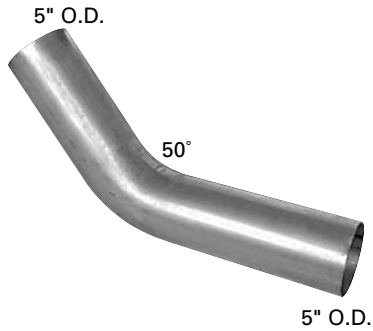

38614
Replaces KENWORTH
Part No. **K180-8049**

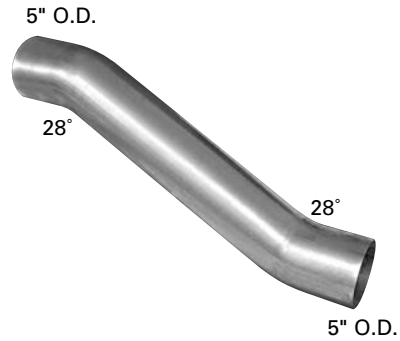

38610
Replaces KENWORTH
Part No. **K180-14122, K180-14967**
Fits Model T-800
Exhaust Pipe

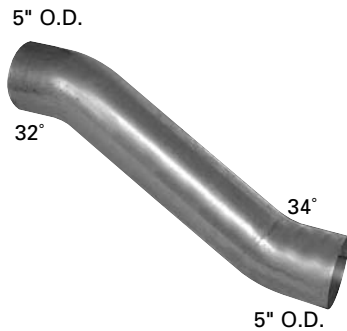

38613
Replaces KENWORTH
Part No. **K180-6326**
Extension Pipe



9629
Replaces KENWORTH
Flared Adapter w/ Thermo Coupler



ALUMINIZED EXHAUST COMPONENTS - KENWORTH

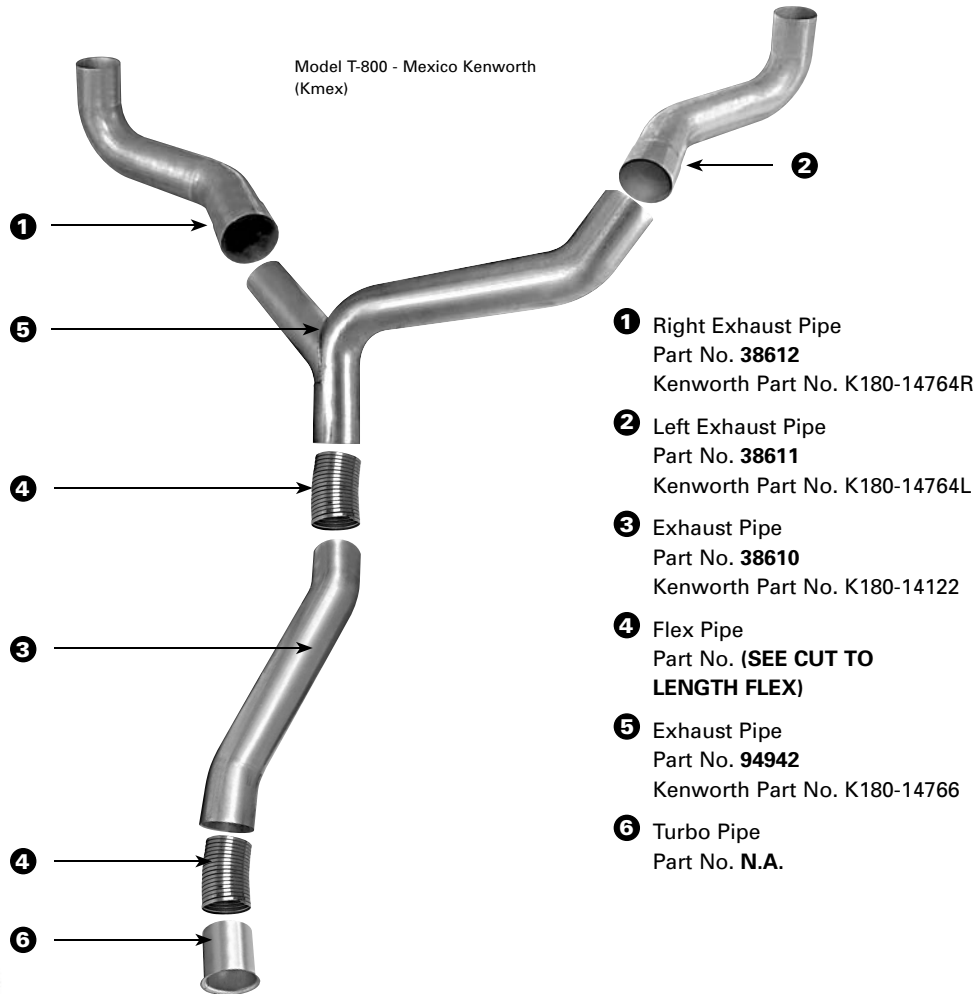

ALUMINIZED EXHAUST COMPONENTS - MACK

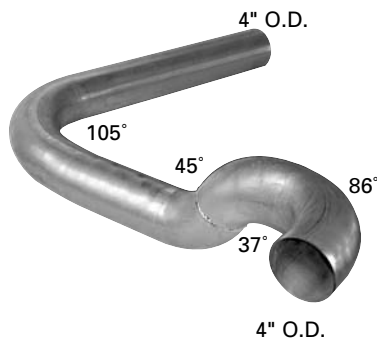

48476
Replaces MACK
Part No. **4ME32444**
Cruiser Liner



8981
Replaces MACK
Part No. **4ME21408**
Stainless Steel Flexible Tubing



ALUMINIZED EXHAUST COMPONENTS - MACK

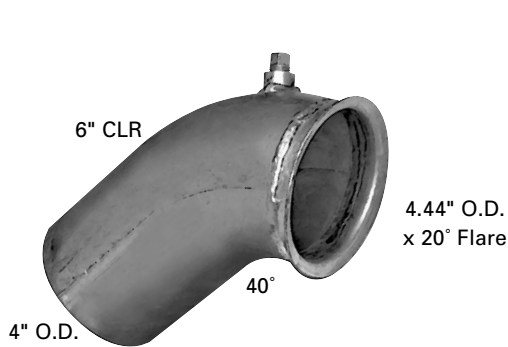

18108
Replaces MACK
Part No. **4ME21783P4**
Exhaust Pipe

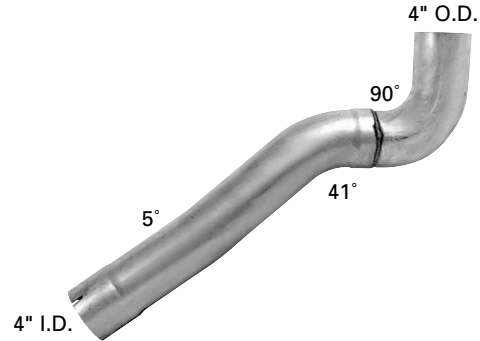

38761
Replaces MACK
Part No. **4ME32618**
Exhaust Pipe

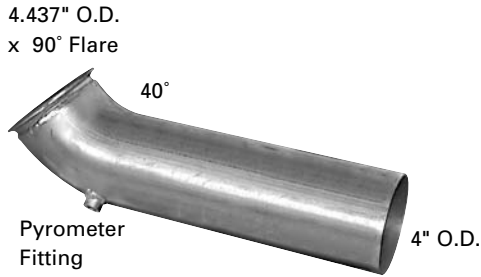

28528
Replaces MACK
Part No. **4ME21698**
R Model - Front Pipe

R & RD models EM6-237, EM6-237R, ENDT675, END864
Engines with Frame mounted Muffler

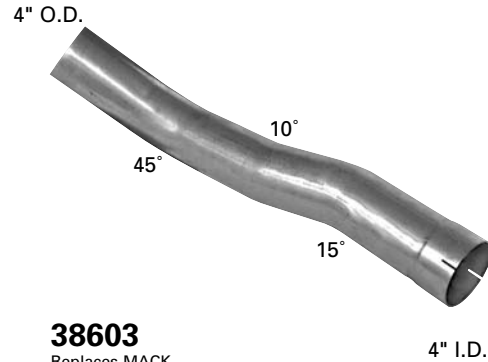

38603
Replaces MACK
Part No. **4ME32603**
R Model - Intermediate Pipe

R & RD models EM6-237, EM6-237R, ENDT675, END864
Engines with Frame mounted Muffler

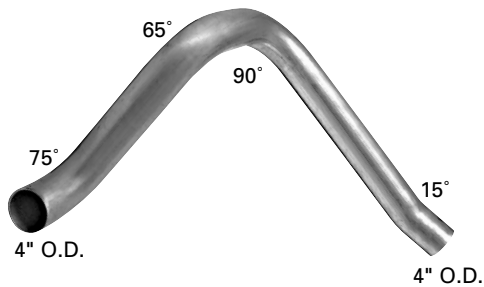

68182
Replaces MACK
Part No. **4ME32612**
R Model - Round Fuel Tanks

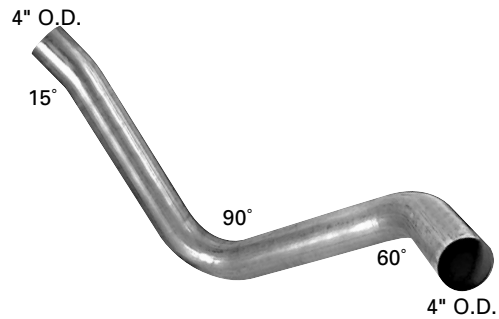

68181
Replaces MACK
Part No. **4ME32611**
R Model - Front Pipe

R & RD models EM6-237, EM6-237R, ENDT675, END864
Engines with Frame mounted Muffler

MUFFLERS, PIPES
& ACCESSORIES

ALUMINIZED EXHAUST COMPONENTS - MACK

MUFFLERS, PIPES
& ACCESSORIES

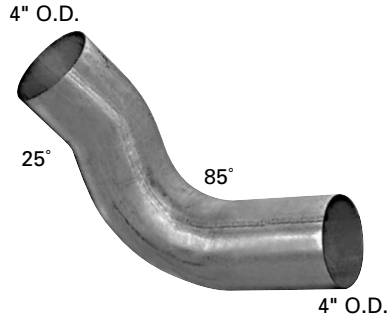

28529
Replaces MACK
Part No. 4ME32825
DM Model - Rear Pipe

ALUMINIZED EXHAUST COMPONENTS - PETERBILT

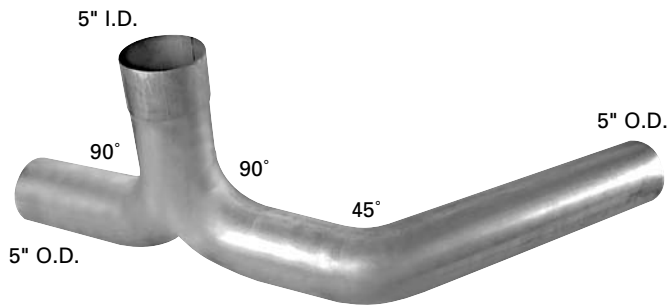

94941
Replaces PETERBILT
Part No. 14-04055



10560
Replaces PETERBILT
Part No. 14-10726
809530 - Chrome



ALUMINIZED EXHAUST COMPONENTS - MACK

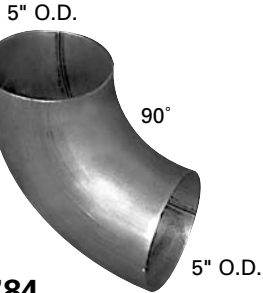

10784
Replaces PETERBILT
Part No. 14-08525

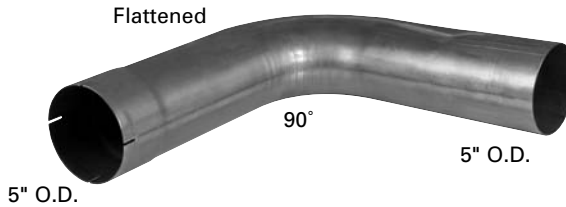

10799
Replaces PETERBILT
Part No. 14-13394-202
Lower Elbow

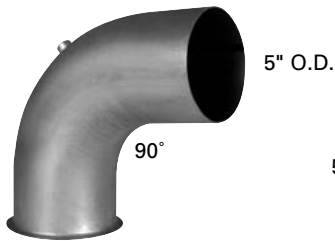

18166
Replaces PETERBILT
Part No. 14-13022
Turbo Elbow

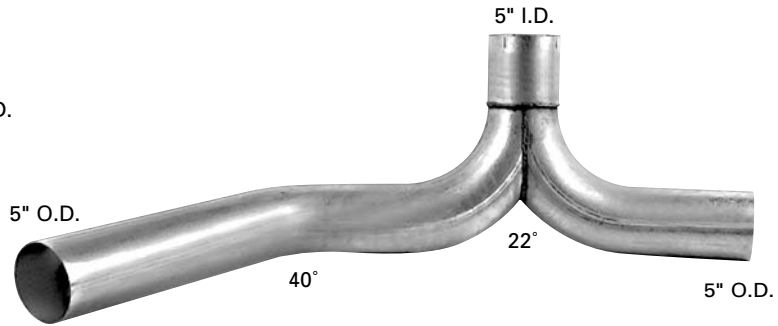

94011
Replaces PETERBILT
Part No. 14-13055
Y-Pipe

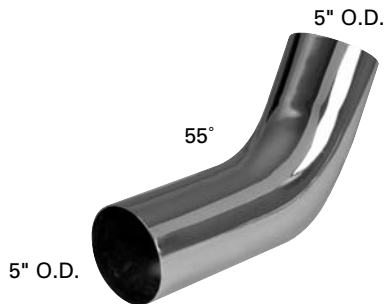

809519 - Chrome
Replaces PETERBILT
Part No. 14-13056CP
Muffler Inlet Elbow

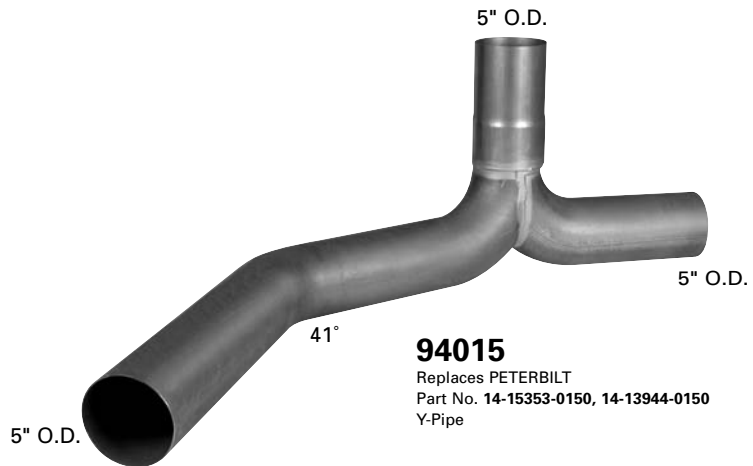

94015
Replaces PETERBILT
Part No. 14-15353-0150, 14-13944-0150
Y-Pipe

MUFFLERS, PIPES
& ACCESSORIES

G30/G3500

CHEV./GMC TRUCK 6 CYL.

1991 6 Cyl. G30/G3500; 125" W.B., 262(4.3L) Engine; Over 8500 lbs. G.V.W.; 1 Ton **(200100)**

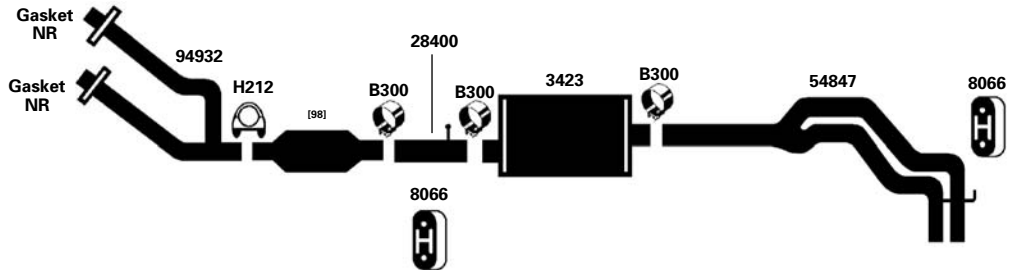

* ADAPTER MAY BE REQUIRED FOR INLET.
UNIVERSAL CONVERTER...606006

SERIES C30/C3500 (2 W.D.)

CHEV./GMC TRUCK 6 CYL.

80-85 6 Cyl. C30/C3500; 131.5", 135.5", 159.5" W.B., 292(4.8L) Engine; **(200101)**
2 W.D.; 1 Ton; (Built before Jan.1, 1985)
DO NOT USE w/FED. EMISSION CONTROL OR (H5D) EMISSIONS

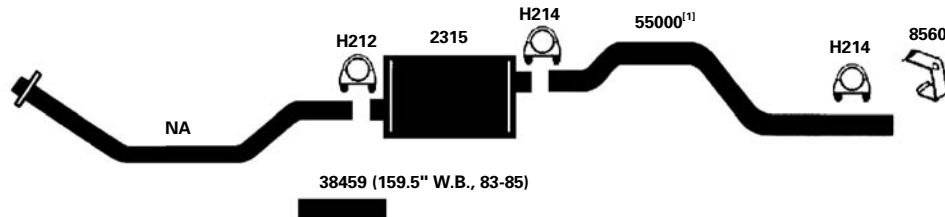

SERIES P20/P2500

CHEV./GMC TRUCK 6 CYL.

1990 6 Cyl. All models w/262 C.I.D. (4.3L) Engine; 125", 133" W.B. w/ Converter **(200102)**

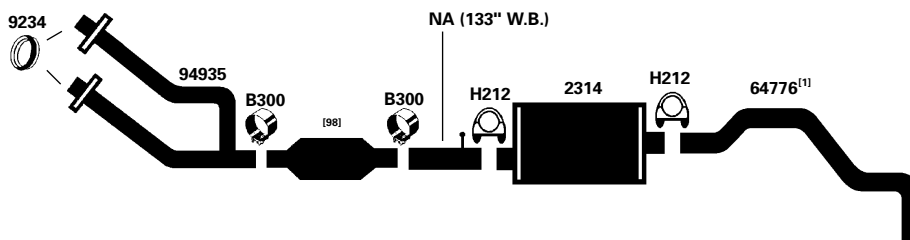

SERIES P30/3500

CHEV./GMC TRUCK 4-6 CYL.

89-91 4 Cyl. All models w/239 C.I.D. (3.9L); Diesel Engine (200103)

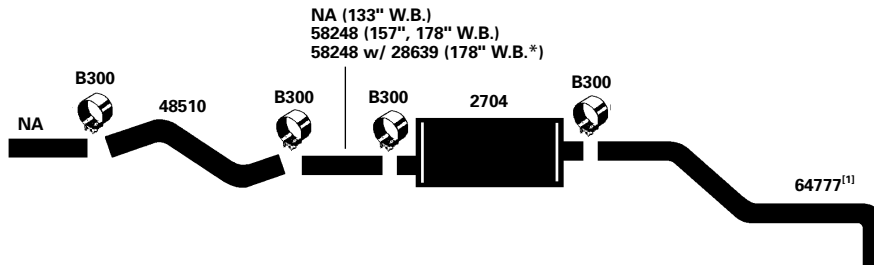

* Cut to length

SERIES G30/G3500 VANS

CHEV./GMC TRUCK 8 CYL.

98-00 8 Cyl. G30/G3500 Series Van; 350 C.I.D.; Muffler sits cross-ways (200104)

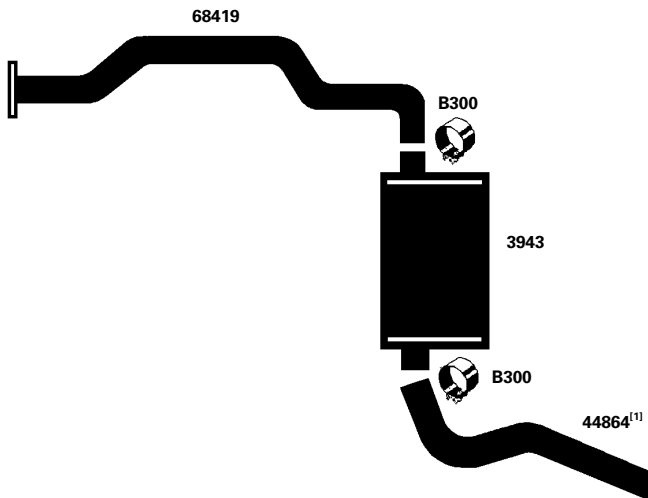

91-96 8 Cyl. All models w/454 C.I.D. (7.4L) Engine; 125", 146" W.B.; With Converter (200107)

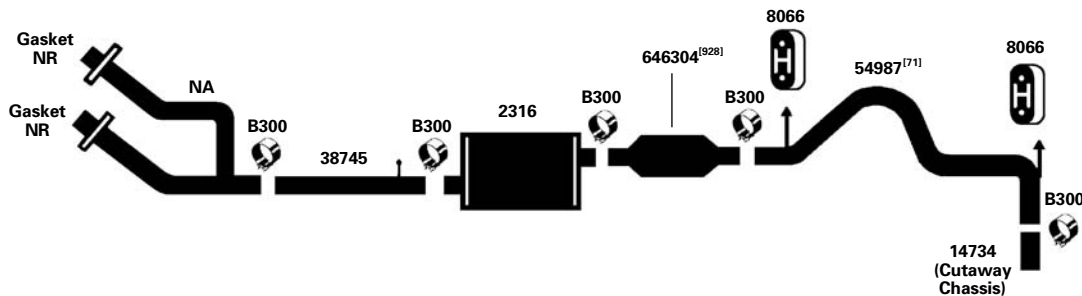

UNIVERSAL CONVERTER...606007⁽⁹²⁸⁾

See page 85 for footnote explanations

MEDIUM & H.D. APPLICATIONS

SERIES G30/3500

CHEV./GMC TRUCK 8 CYL.

1990 8 Cyl. All models w/ 454 C.I.D.(7.4L) Engine; 125", 146" W.B.; With Converter **(200108)**

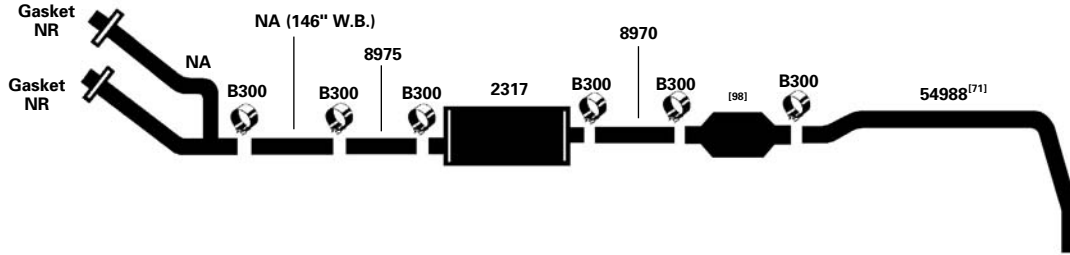

SERIES P20/2500

CHEV./GMC TRUCK 8 CYL.

89-90 8 Cyl. All models w/ 350 C.I.D.; 125", 133" W.B.; With Converter **(200109)**

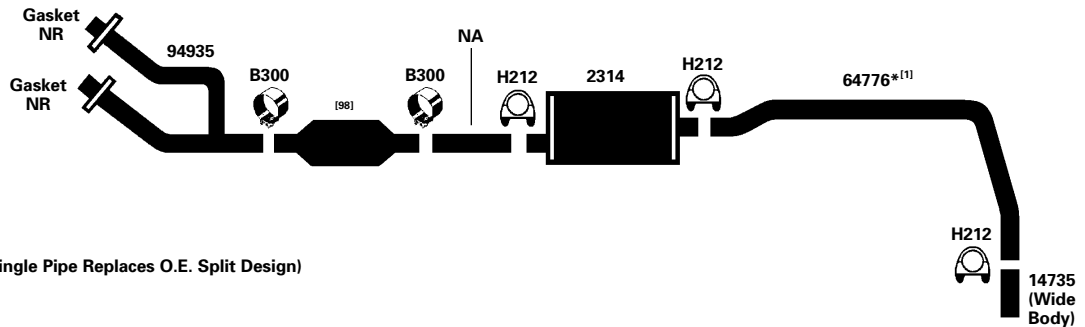

*(Single Pipe Replaces O.E. Split Design)

87-88 8 Cyl. All models w/ 350 C.I.D.; 133", 157", 178" W.B.; With two Converter system **(200110)**

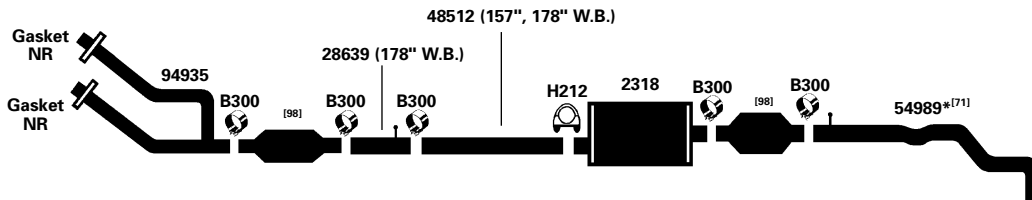

*(Single Pipe Replaces O.E. Split Design)

SERIES C20/2500, C30/3500 CHEV./GMC TRUCK 8 CYL.

01-04 8 Cyl. Silverado/Sierra 2500 HD/3500 6.6L Diesel Engine; 133" W.B.; 2 WD/4 WD **(200111)**

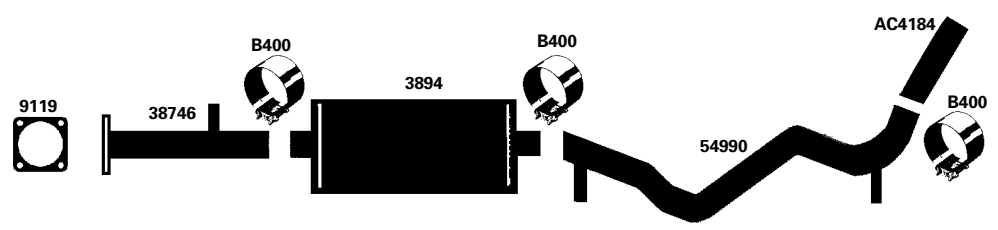

01-04 8 Cyl. Silverado/Sierra 2500 HD/3500 6.6L Diesel Engine; 143.5" W.B.; 2 WD/4 WD **(200112)**

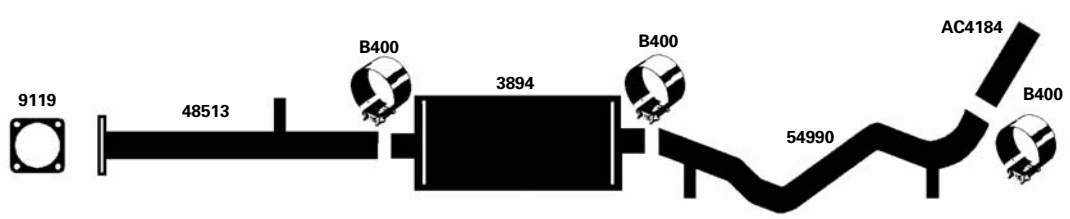

01-04 8 Cyl. Silverado/Sierra 2500 HD/3500 6.6L Diesel Engine; 157.5" W.B.; 2 WD/4 WD **(200113)**

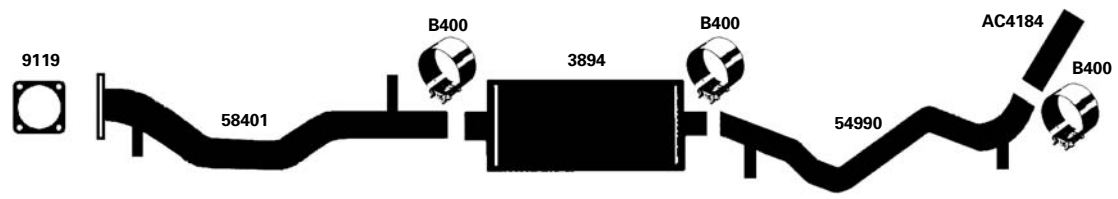

MEDIUM & H.D.
APPLICATIONS

SERIES C30/3500, R30/3500 CHEV./GMC TRUCK 8 CYL.

94-95 8 Cyl. All models w/ 6.5L Turbo Diesel Engine; 155.5", 168.5" W.B. **(200114)**

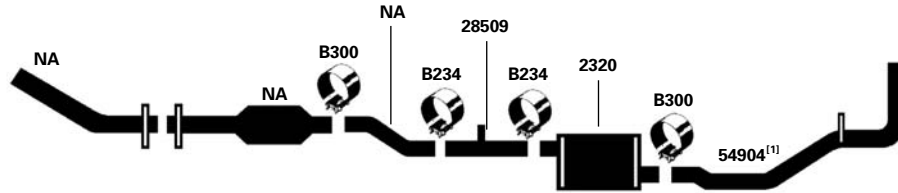

1993 8 Cyl. All models w/ 6.5L Turbo Diesel Engine; 155.5", 168.5" W.B. **(200115)**

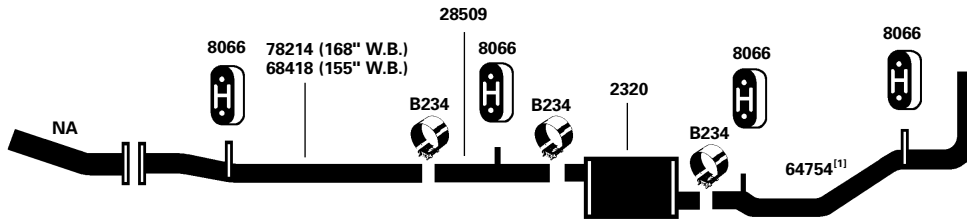

1991 8 Cyl. All models w/ 350 C.I.D. (5.7L) Engine; 164.5" W.B. **(200117)**

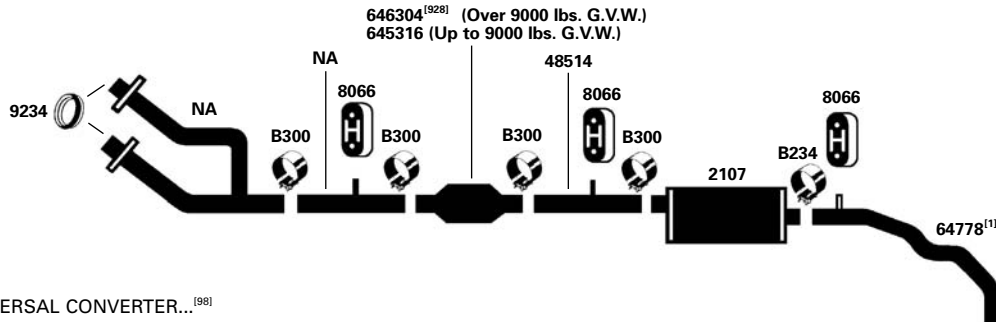

UNIVERSAL CONVERTER...^[98]

90-91 8 Cyl. Crew cab models w/ 454 C.I.D. (7.4L) Engine; 164.5" W.B.; With Converter **(200118)**

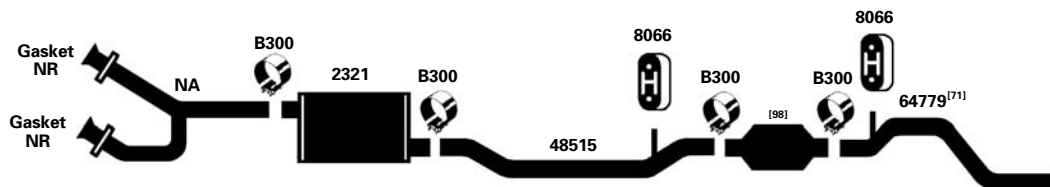

SERIES C30/3500, R30/3500 CHEV./GMC TRUCK 8 CYL.

88-89 8 Cyl. All models w/ 350, 454 C.I.D.; 135.5" W.B.; With two Converter system (200119)

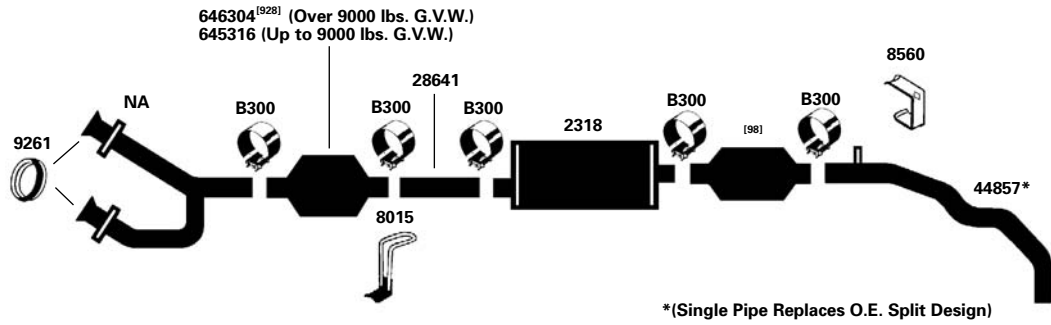

DIRECT FIT MAXIMUM MUFFLER...700141
 UNIVERSAL CONVERTER - Front...604007 (Up to 9000 lbs. G.V.W.) PIPE KIT (Up to 9000 lbs. G.V.W., exc. Calif.)...651086
 UNIVERSAL CONVERTER - Rear...[98]
 UNIVERSAL CONVERTER - Front...606007^[928] (Over 9000 lbs. G.V.W.)

82-86 8 Cyl. All models w/ 350 C.I.D.; DO NOT USE W/ FED. EMISSION CONTROL OR H5D EMISSIONS (200120)

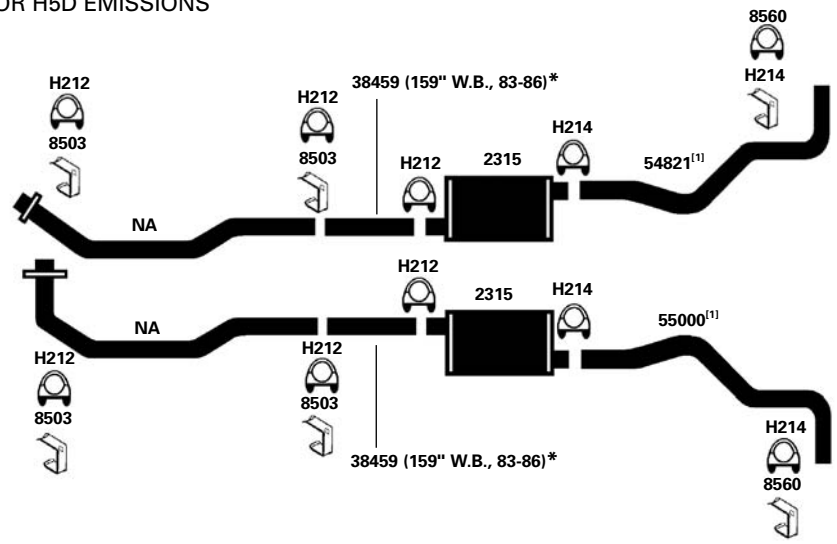

*Cut to length

SERIES K20/2500, K30/3500 CHEV./GMC TRUCK 8 CYL.

01-04 8 Cyl. Silverado/Sierra 2500 HD/3500 6.6L Diesel Engine; 133" W.B.; 2 WD/4 WD (200122)

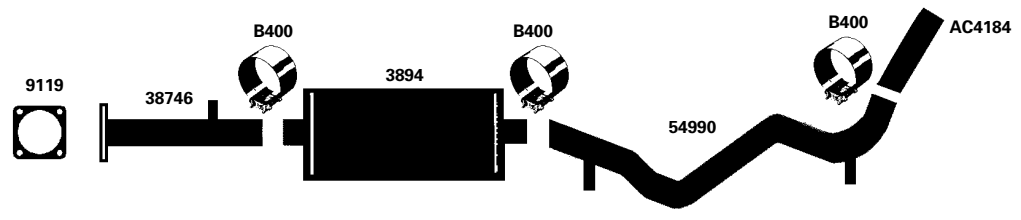

MEDIUM & H.D. APPLICATIONS

SERIES K20/2500, K30/3500 CHEV./GMC TRUCK 8 CYL.

01-04 8 Cyl. Silverado/Sierra 2500 HD/3500 6.6L Diesel Engine; 143.5" W.B.; 2 WD/4 WD **(200123)**

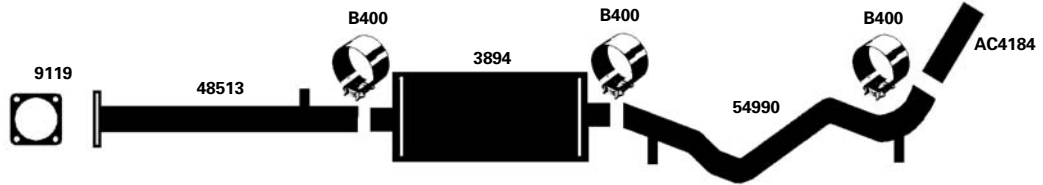

01-04 8 Cyl. Silverado/Sierra 2500 HD/3500 6.6L Diesel Engine; 157.5" W.B.; 2 WD/4 WD **(200124)**



SERIES K30/3500, V30/3500 CHEV./GMC TRUCK 8 CYL.

1994 8 Cyl. All models w/ 6.5L Turbo Diesel Engine; 155.5", 168.5" W.B. **(200125)**

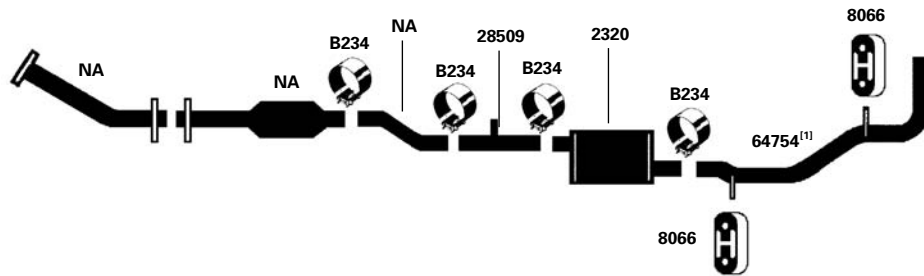

1993 8 Cyl. All models w/ 6.5L Turbo Diesel Engine; 155.5", 168.5" W.B. **(200126)**

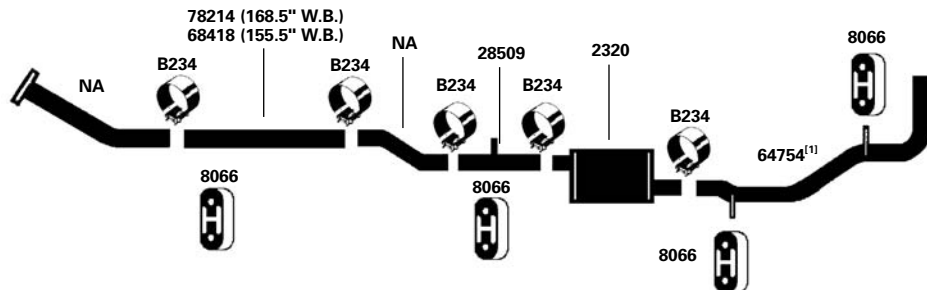

SERIES K30/3500, V30/3500 CHEV./GMC TRUCK 8 CYL.

92-93 8 Cyl. All models w/ 6.5L Turbo Diesel Engine; 135.5", 159.5" W.B (200127)
(Exc. 15,000 G.V.W.)

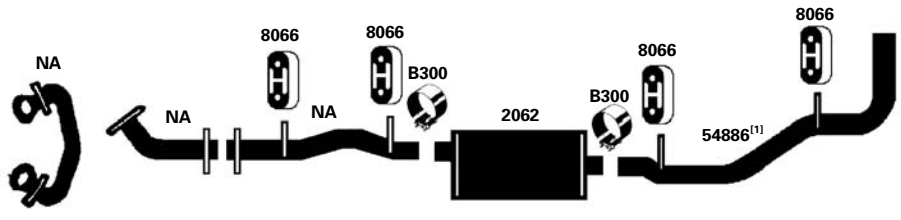

90-91 8 Cyl. Crew Cab models w/ 454 C.I.D. (7.4L) Engine; 164.5" W.B.; With Converter (200128)

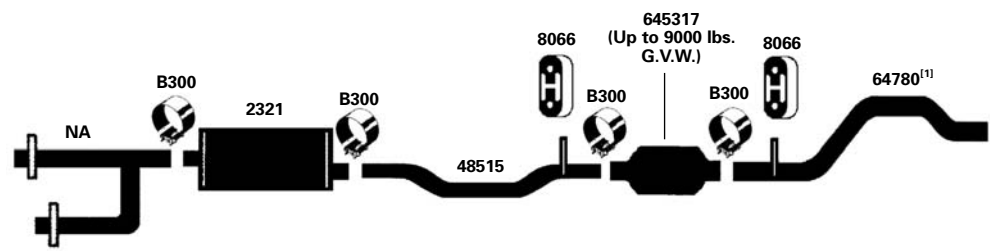

1991 8 Cyl. All models w/ 350 C.I.D. (5.7L) Engine; 164.5" W.B. (200129)

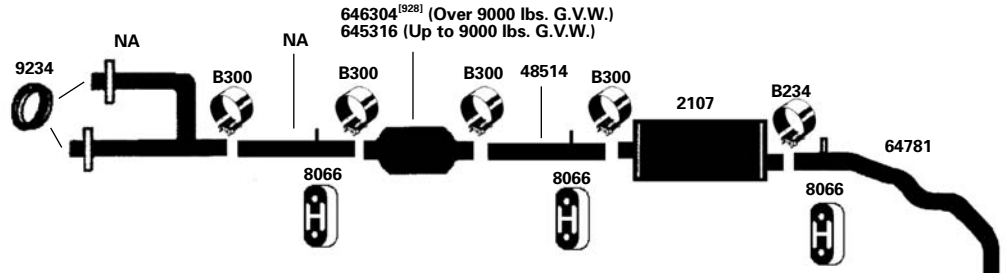

UNIVERSAL CONVERTER...604007 (Up to 9000 lbs. G.V.W.) PIPE KIT (Up to 9000 lbs. G.V.W.)...651086
UNIVERSAL CONVERTER...606007 (Over 9000 lbs. G.V.W.)

88-89 8 Cyl. All models w/ 350, 454 C.I.D.; 135.5" W.B.; With two Converter system (200131)

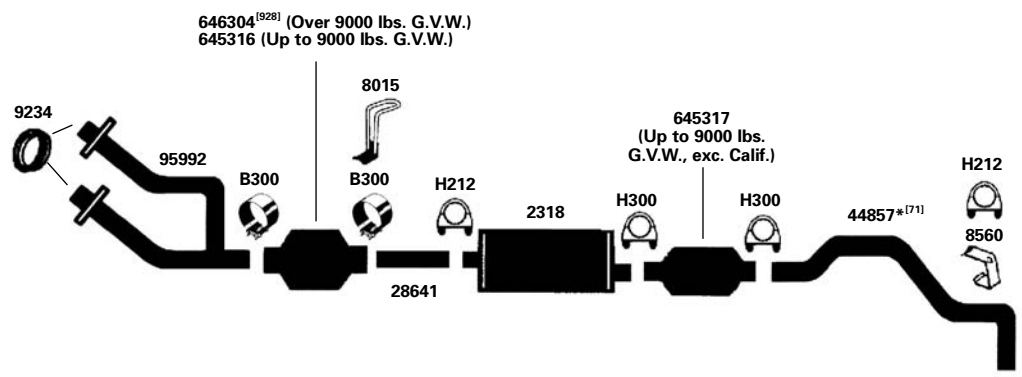

UNIVERSAL CONVERTER...^[98]

*(Single Pipe Replaces O.E. Split Design)

MEDIUM & H.D. APPLICATIONS

T-SERIES TILT CAB

CHEV./GMC TRUCK

97-98 6 Cyl. T-Series Tilt Cab w/3116 CAT(6.6L), 3126 CAT(7.2L) Turbo Diesel Engine **(200132)**

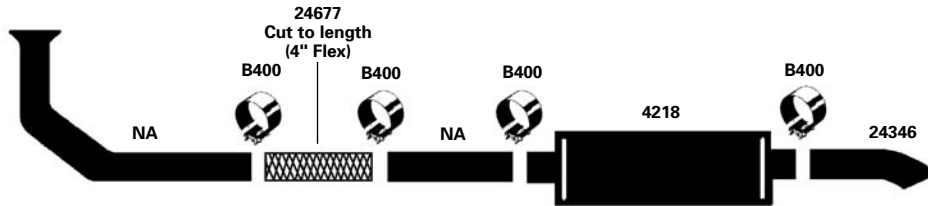

97-98 8 Cyl. T-Series Tilt Cab w/366 C.I.D.(6.0L) Gas Engine **(200133)**

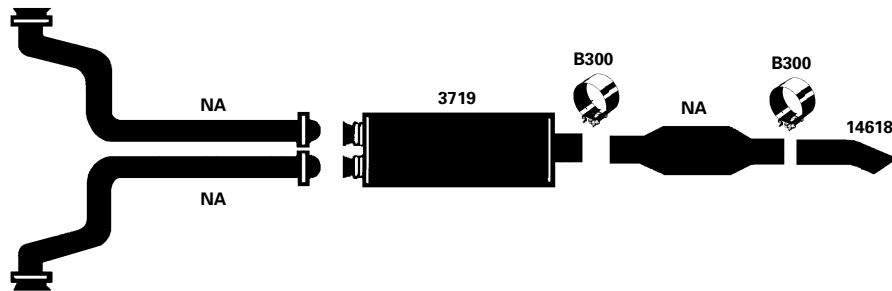

SERIES W5 TILTMASTER FORWARD CONTROL CHEV./GMC TRUCK

1993 6 Cyl. W5 Tiltmaster (Forward Control); All models; 6.5L Turbo diesel Engine; 113", 177" W.B. **(200134)**

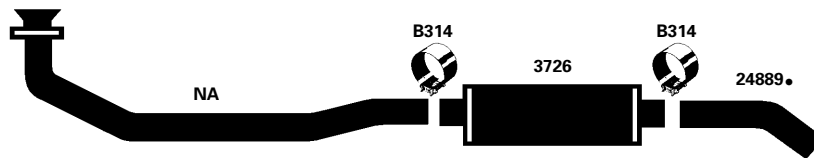

SERIES 50, 60, 70, 5000, 6000, 7000

CHEV./GMC TRUCK

90-00 6 Cyl. C7H, C6H w/ 3116 CAT.(6.6L) Turbo Diesel Engine **(200135)**

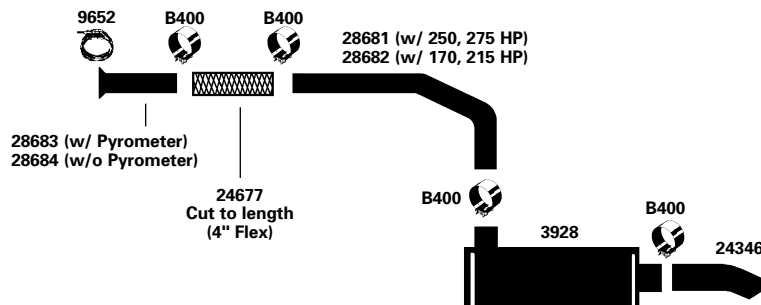

See page 85 for footnote explanations

SERIES 50, 60, 70, 5000, 6000, 7000

CHEV./GMC TRUCK

90-98 6 Cyl. C7H, C6H w/ 3116 CAT. 403 C.I.D.(6.6L) Turbo Diesel Engine; With Vertical Cab Mounted Tailpipe **(200136)**

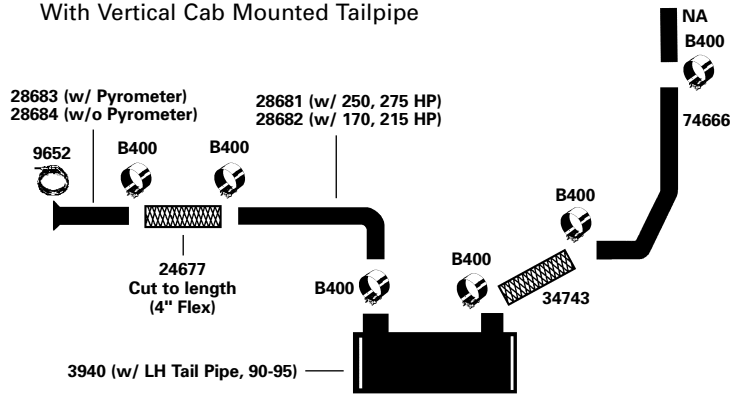

88-98 8 Cyl. C6D, C6H, C7D, C7H w/ 366 C.I.D.(6.0L), 427 C.I.D.(7.0L) T.B.I. Engine; Ball & Socket Joint without Converter **(200137)**

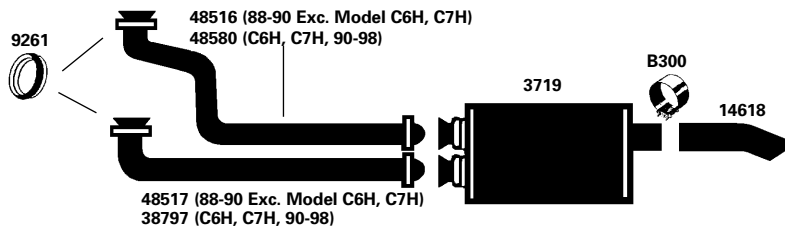

88-90 8 Cyl. C6D, C7D; 8.2N Detroit Diesel Engine; With Vertical Tailpipe **(200138)**

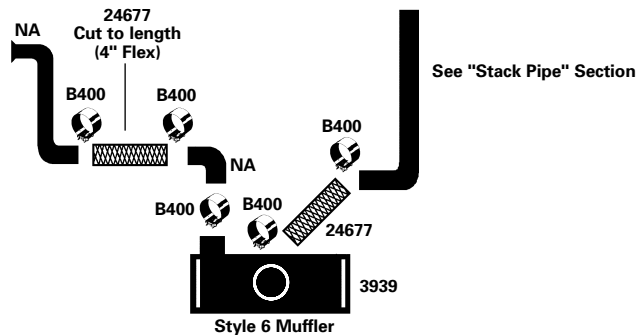

83-84 8 Cyl. C6D w/ Caterpillar 3208N Diesel Engine (Non-Turbo) **(200139)**

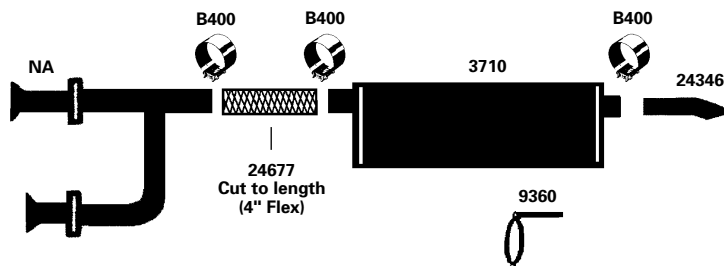

MEDIUM & H.D. APPLICATIONS

SERIES 50, 60, 70, 5000, 6000, 7000

CHEV./GMC TRUCK

79-87 6 Cyl. C5D, C6D; 292 C.I.D. Engine; Ball & Socket Joint (Exc. H5D) **(200140)**



79-87 8 Cyl. C5D, C6D, C7D; 366, 427 C.I.D., 4BBL Engine; Ball and Socket Joint (Exc. H5D) **(200141)**

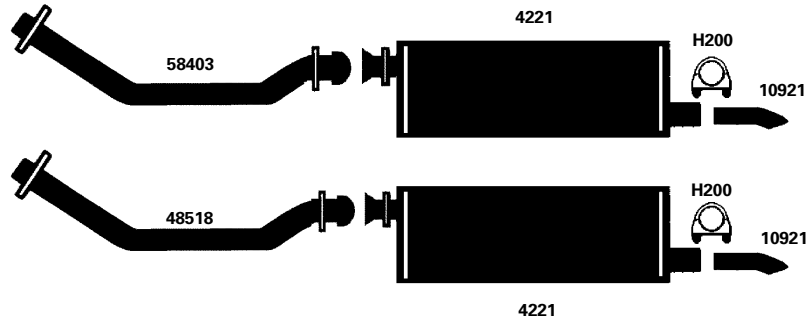

1978 4 Cyl. C55, C60, C65 w/ 4-53T Diesel Engine; Conv. Cab **(200143)**

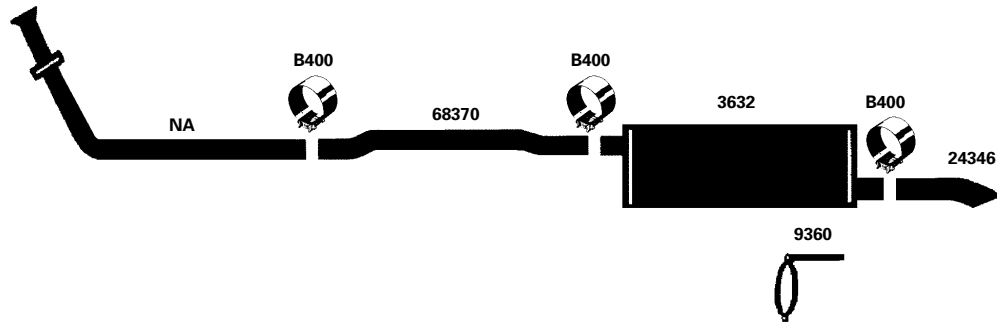

75-78 8 Cyl. C50, C60 w/ 350 C.I.D. **(200145)**

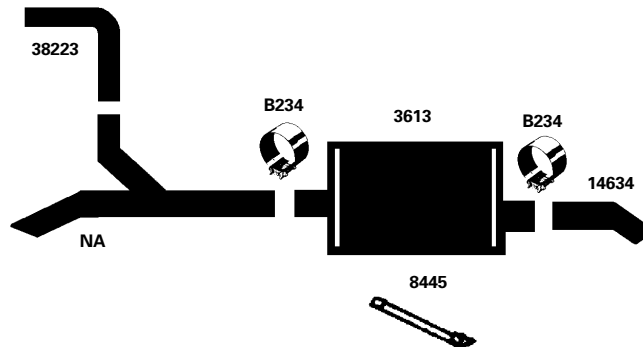

SERIES 50, 60, 70, 5000, 6000, 7000

CHEV./GMC TRUCK

75-78 8 Cyl. Series 65 w/ 366, 427 C.I.D. (Except Stainless Steel Exhaust) **(200146)**

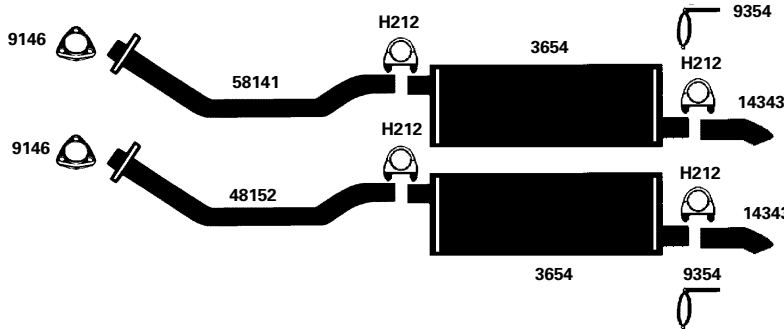

1978 8 Cyl. T60 w/ 366 C.I.D. **(200147)**
69-78 8 Cyl. C50, C60, C65, M50, M60 w/ 366, 427 C.I.D.
1969 8 Cyl. Series 6500 Tandem w/ 366, 427 C.I.D.

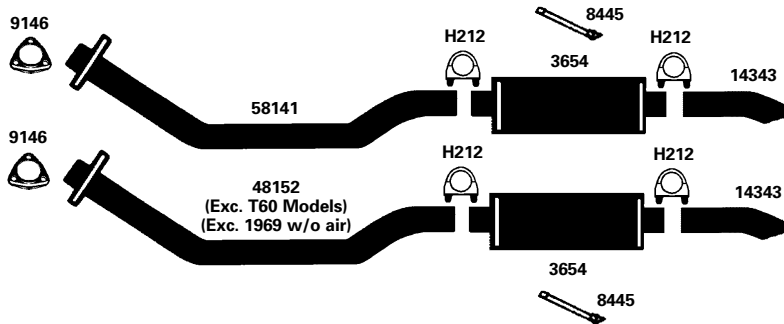

FOOTNOTES:

- [1] Original equipment system was welded assembly. It is recommended that all noted parts [1] to be replaced.
- [3] Required for installation.
- [5] Cut at inlet to match O.E. pipe.
- [22] O.E. exhaust pipe was one piece. Replacement is two pieces.
- [26] It is necessary to replace all parts together on models with spherical ball connections.
- [27] Use muffler with adapter 9524 and flange 9569 when mating with an exhaust pipe having spherical ball connections.
- [65] Heat Shield 9206 is required for installation.
- [67] Can also use combination 2923 muffler (H212 inlet) with 480930 exhaust pipe.
- [71] If replacing O.E. exhaust system, first cut tail pipe on vehicle immediately behind converter to tail pipe weld. Cut through outer pipe only, leaving converter nipple intact.
- [93] Locating clip must be knocked off converter outlet for proper installation.
- [98] Refer to Current Converter Catalog.
- [240] See page 63.
- [928] To 12,500 lbs. GVW-EPA; 11,620 lbs. GVW-CARB.
- Golden warehouse item.
- # Air Tube Attachment Kit 4948 may be required to complete installation.

MEDIUM & H.D. APPLICATIONS



HD EXHAUST
MEDIUM & H.D. APPLICATIONS

CHEVROLET

YEAR	CYL.	TONS	MAKE & MODEL	EXH. PIPE	MUFFLER	TAIL PIPE
CHEV/GMC Series 40-66						
67-81	8		C50, C5D, C60, C6d w/ 292 C.I.D.; Clamp Joint		3654	14343
1978	8		C50, C60, M60 w/ 366 C.I.D.		3613	14634
75-77	8		T60 w/ 350, 366 C.I.D.		3613	14634
1975	6		C50, C60 w/ COWL w/ 292 C.I.D.		3654	14343
73-74	8		Series 50, 60 w/ 350 C.I.D.		3613	14634
73-74	8		C65 (3 Ton), T65 (3 Ton), M65 (6 Ton) w/ 366, 427 C.I.D.		3654	14343
73-74	6		C50 w/ 250 C.I.D.		3901	10921
1972	6		CM5500, CM6500 w/ 351 C.I.D. Gas Engine		609	14342
1972	8		CE4500, CE5500 w/ 350 C.I.D. Gas Engine		609	14342
70-72	6		CS4500, CS5500 w/ 250 C.I.D. Gas Engine		3901	10921
70-72	6		CS4500, CS5500 w/ 292 C.I.D. Gas Engine		3654	14343
70-71	6		CM5500, TM5500 w/ 305 C.I.D. Gas Engine		3654	14343
70-71	6		CM5500, TM5500 w/ 351, 401 C.I.D. Gas Engine		2704	24344
69-74	8		T50, T60 w/366. 427 C.I.D.		3654	14343
69-72	8		Series 40, 50 w/ 350 C.I.D.		609	14342
67-72	6		Series 40 w/ 250 C.I.D.		3901	10921
67-72	6		Series 40 w/ 292 C.I.D.		3654	14343
67-68	6	1.5	PS4500 Series Step Van w/250 CID		3901	10921
67-68	6	1.5	PS4500 Series step Van w/292 CID		3654	14343
67-68	8		Series 50, 60 w/307, 366, 427 CID; 125"-218" W.B.		3654	14343
67-68	8		Series 40 w/307, 327 CID 125"-175" W.B.		3654	14343
1967	8		Series 50, 60 (EXC. Conv. Cab w/Sngl. Rear Axle, 288L ES6500; 127"-217" W.B.		3654	14343
67-69	6		EG4500, EM4500, ES4500, EG5500, EM5500, ES5500, EG6500, EM6500, ES6500; 127"-217" W.B.		3654	14343
1967	8		C50, C60; 2BBL. Carb. Sngl. Rear Axle w/366 CID		609	14343
60-68	6		Series 50, 60		3654	14343
63-66	6		Series 50, 60; w/ 292 CID		3654	14343
63-66	6		Series 50 w/ 230 C.I.D.		3901	10921
60-66	6		Series 3500, 4000, 5000, 6000, 6500		3654	14343
63-65	6		B3500, L3500, B4000, BH4000, H4000, KV4000, L4000, LH4000, S4000, B5000, H5000, L5000		3654	14343
60-62	6		C-41, C43; 133"-157" WB		3901	10921
58-59	8	2-2.5	ALL		3901	10921
1957	8	1.5	1.5 Ton (exc. Series 5); 132 1/2"-156 1/2" WB		3901	10921
56-57	8	2.5	2.5 Ton		3901	10921
1956	8	1.5	1.5 Ton (exc. Series 5); 130"-172" WB			
1956	8	2-2.5	2-2.5 Ton			
1955	8	2	2 Ton (2nd Series) 5100, 5400, 5700		3901	10921
56-59	8		500-600 Models		2704	24344
50-53	8		520, 600, 620, 630, 650; w/318, 360 CID		2704	24344
55-59	6		300-500 Models		3654	14343
55-56	8		300-500 Models		3654	14343

MEDIUM & H.D. APPLICATIONS

CHEVROLET

YEAR	CYL.	TONS	MAKE & MODEL	EXH. PIPE	MUFFLER	TAIL PIPE
CHEV/GMC Series 40-66 (Cont.)						
1954	6		300-24, 350-24, 350-27, M350-24, M350-27, F350-24, F350-27, 400-24, 400-27, M400-27, 450-30, F450-30, M450-30, W450-30, 470-30, F470-30, M470-30		3654	14343
55-59	6		W620-W670 Models		3662	24344
50-53	6		620, 630, 640; w/426 503 CID		3662	24344
60-61	6	2-2.5	2-2.5 Ton		3901	10921
55-59	6	2	2 Ton		3901	10921
55-56	6	1.5	1.5 Ton; 130"-172" WB		3901	10921
50-55	6	1.5	1.5 Ton; 110", 134", 158" WB		3901	10921
57-59	6	1.5	1.5 Ton; 132.5"-156.5" WB		3901	10921
50-55	6	2	2 Ton		3901	10921
50-53	6	1.5	1.5 Ton; (exc. 110", 134", 158" WB)		3901	10921
39-50	6		EC300, ECS300, EF300, FC300, w/228 CID		3901	10921

YEAR	CYL.	TONS	MAKE & MODEL	EXH. PIPE	MUFFLER	TAIL PIPE
CHEV/GMC Series 70-95						
1973	6		Series 70, 80 w/ 432, 478 C.I.D.		2704	24344
1973	6		HM7000, JM7000, TM7000, WM7000 HM8000, Jm8000, TM8000, WM8000 w/ 432, 478 C.I.D. Gas Engine		2704	24344
1972	6		Series 80; w/ 401, 478 CID		2704	24344
1972	8		HE9500, JE9500, TE9500 w/ 637 C.I.D. Gas Engine; With horizontal muffler and tailpipe		2704	24344
1972	6		HM7500, TM7500, JM7500, WM7500 w/ 401, 478 C.I.D. Gas Engine		3654	14343
1972	6		HM7500, TM7500, JM7500, WM7500 w/ 401, 478 C.I.D. Gas Engine		2704	24344
1971	6		Series 80 (Exc. Tilt Tandem) w/ 401, 478 C.I.D.		2704	24344
70-71	6		TS5500 w/ 292 C.I.D. Gas Engine		3654	14343
70-71	6		HM7500, TM7500, JM7500, WM7500 w/ 351, 401 C.I.D. Gas Engine		2704	24344
70-71	8		HJ7500, HJ7500A, JJ7500, JJ7500A, HE9500A, JE9500, JE9500A, TE9500 w/ 637 C.I.D. Gas Engine; With horizontal exhaust and tailpipe		2704	24344
1968	8		Series 80; w/ 366, 427 CID		3654	14343
66-69	6		Series 70, 80; (Muffler w/2-1/2" ID Outlet) w/ 401, 478 CID		3654	14343
67-68	6		Series 40 Dubl. Duty w/ 292 C.I.D.; 149", 175" W.B.		3654	14343
66-67	8		HJ7500, JE7500, JJ7500, TJ7500, CE9500, CJ9500, HE9500, HJ9500, TJ9500, WE9500, WJ9500, w/637 CID Gas Engine; With horizontal Exhaust & Tail Pipe		2704	28344
60-65	V12		7000 Series (exc. D)		2704	28344
63-66	8		Series 80		3654	14343
60-62	8		Series 70, 80"		3654	14343
50-53	6		700, 770; w/318, 360 CID		2704	28344
50-53	6		720, 740, 750, 760, 850, 870, 890; w/426, 503 CID		3662	28344

MEDIUM & H.D.
APPLICATIONS



HD EXHAUST
MEDIUM & H.D. APPLICATIONS

DIVCO

YEAR	CYL.	TONS	MAKE & MODEL	EXH. PIPE	MUFFLER	TAIL PIPE
DIVCO						
68-71	6		200, 206, 300, 306"		3901	10921
66-67	4		100B, 100BX"		3901	10921
66-67	6		40C, 50C, 70B, 100CX, 200B, 300B, 300C, 300D, 300E, 306E		3901	10921
66-67	6		40D, 40E, 50E, 50F, 70C, 70D, 200C, 206C, 206D, 306F; w/300 CID Gas Eng.		3901	10921
62-64	6		40D, 40E, 43, 50E, 50F, 53, 70C, 70D, 73, 75, 76, 200C		2704	24344
61-71	8		D400; w/318 CID		3901	10921
61-69	8		W400; w/318 CID		3901	10921
61-71	6		D400; w/170, 225 CID		3901	10921
1960	6		D400, W400		3901	10921
1960	8		W400		3901	10921

MEDIUM & H.D.
APPLICATIONS

RAM PICKUP - 2 WD/4 WD

DODGE/PLYM. TRUCK 6 CYL.

94-02 6 Cyl. Ram 2500/ 3500 w/ 5.9L Cummins Turbo Diesel Engine; All wheel bases **(200165)**

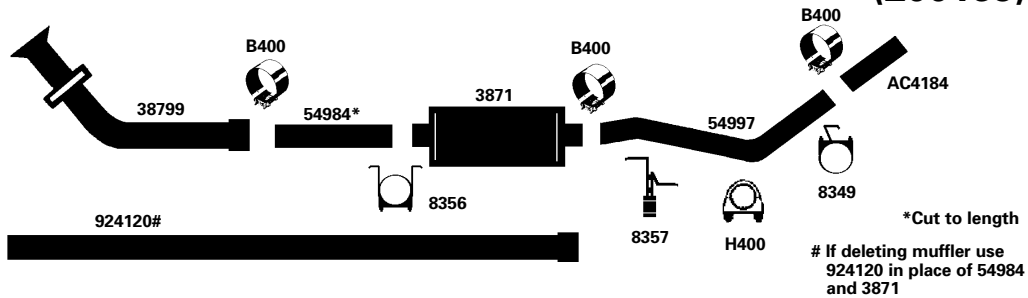

SERIES R3500

DODGE/PLYM. TRUCK 6 CYL.

1994 6 Cyl. R3500; 360 C.I.D.(5.9L) Cummins Turbo Diesel Engine; Built before 01-03-94; Without Converter **(200163)**

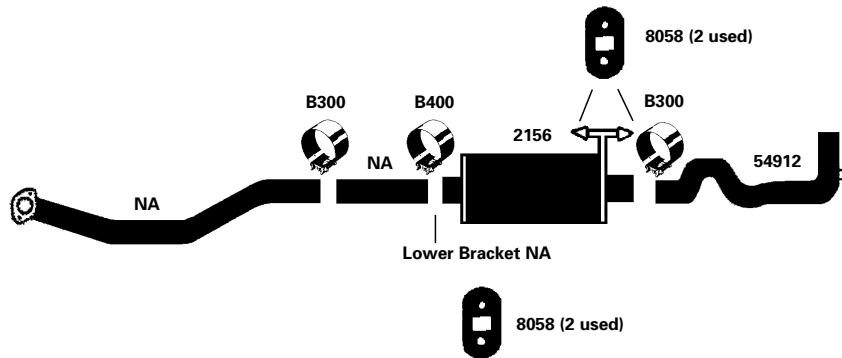

FOOTNOTES:

- [1] Original equipment system was welded assembly. It is recommended that all noted parts [1] to be replaced.
 - [12] Optional Heavy Duty Muffler.
 - [22] O.E. exhaust pipe was one piece. Replacement is two pieces.
 - [93] Locating clip must be knocked off converter outlet for proper installation.
 - [98] Refer to Current Converter Catalog.
 - [918] Models with one mini-Ox converter in Y-pipe.
 - [928] To 12,500 lbs. GVW-EPA; 11,620 lbs. GVW-CARB.
 - Golden warehouse item.
- # Airtube kit 4948 may be required to complete installation.

DODGE

YEAR	CYL.	TONS	MAKE & MODEL	EXH. PIPE	MUFFLER	TAIL PIPE
DODGE-Series 400, 450						1.5 TON
48-60	6		P400, Route Vans		3901	

E SERIES, ECONOLINE

FORD TRUCK 6 CYL.

92-96 6 Cyl. E350; 300 C.I.D. (4.9L) Engine;-138", 158" W.B.

(200167)

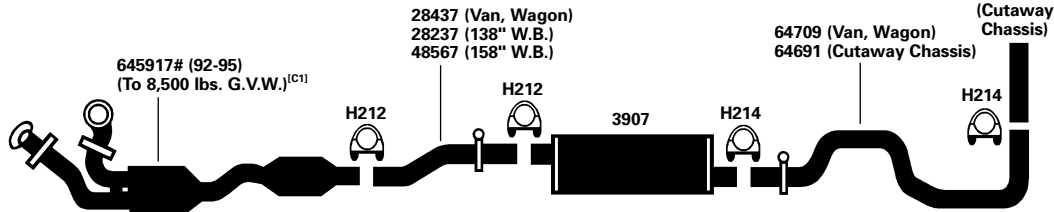

^[C1] Exc. Calif., over 7200 lbs. G.V.W. Combination Front and Rear Converter, 2 To 1 Replacement. Only Defective Converters May Be Legally Replaced.

UNIVERSAL CONVERTER...^[98]

88-91 6 Cyl. E350; 138" W.B.; 300 C.I.D. (4.9L) Engine; 138", 158" W.B.; With Converter

(200168)

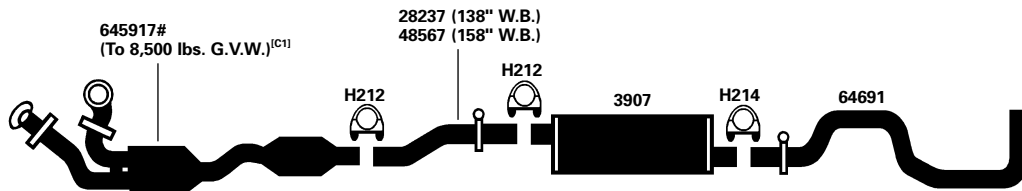

^[C1] Exc. Calif., over 7200 lbs. G.V.W. Combination Front and Rear Converter, 2 To 1 Replacement. Only Defective Converters May Be Legally Replaced.

UNIVERSAL CONVERTER...^[98]

1987 6 Cyl. E350; 300 C.I.D (4.9L) Engine; 138" W.B.; With Converter

(200169)

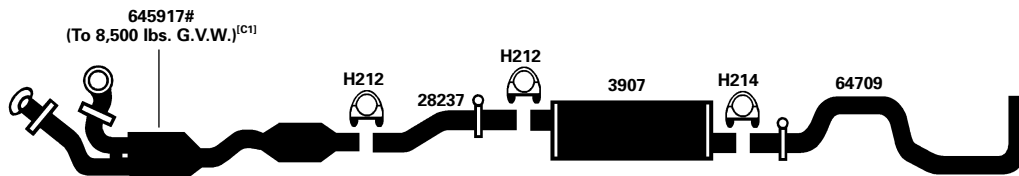

^[C1] Exc. Calif., over 7200 lbs. G.V.W. Combination Front and Rear Converter, 2 To 1 Replacement. Only Defective Converters May Be Legally Replaced.

UNIVERSAL CONVERTER...^[98]

F350 SERIES

FORD TRUCK 6 CYL.

1996 6 Cyl. F350 w/ 300 C.I.D.; 133" W.B.; 4.9L Engine

(200170)

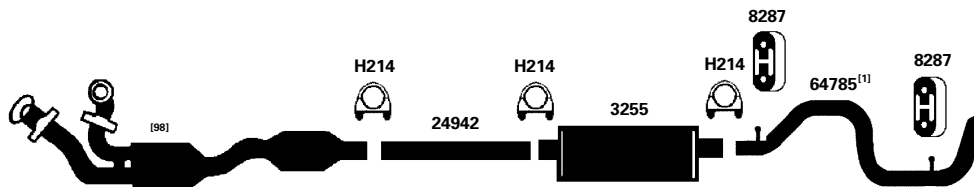

F350 SERIES

FORD TRUCK 6 CYL.

88-95 6 Cyl. F350 w/ 300 C.I.D.; 133" W.B.; 4.9L Engine

(200171)

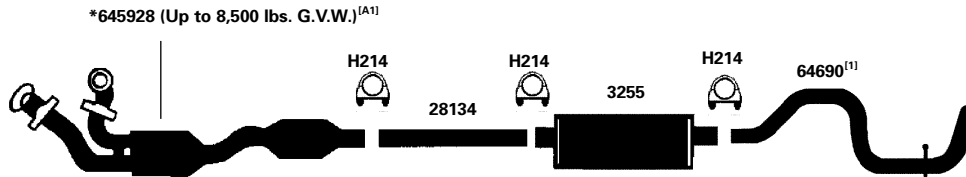

^(A1) Combination Front and Rear Converter, 2 To 1 Replacement
Only Defective Converters May Legally Be Replaced.

UNIVERSAL CONVERTER...^[98]

F SERIES - SUPER DUTY PICK-UP - DIESEL

FORD TRUCK 8 CYL.

99-03 8 Cyl. F250/350 Super Duty; 7.3L Power Stroke Turbo Diesel Engine;
Exits on Passenger Side; 4" Single Inlet/4" Single Tail Pipe

(200172)

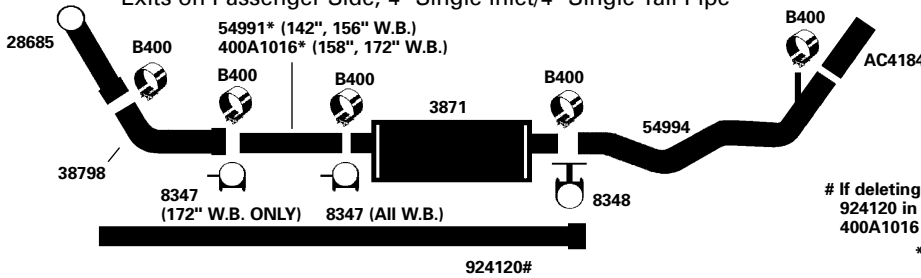

If deleting muffler use
924120 in place of 54991,
400A1016 and 3871

* Cut to length

F350 SERIES

FORD TRUCK 8 CYL.

96-97 8 Cyl. F350 Series; 351 C.I.D.(5.8L) Engine; 133" W.B.; 4 WD; 1 Ton

(200173)

96-97 8 Cyl. F350 Series; 351 C.I.D.(5.8L) Engine; 133", 155" W.B.; 2 WD; 1 Ton

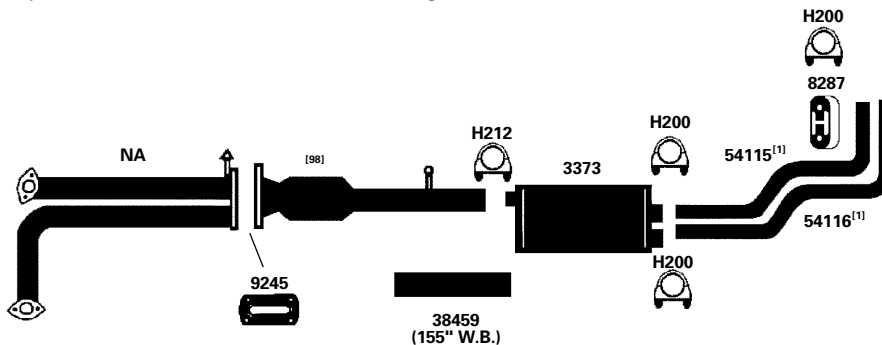

95-96 8 Cyl. F350 Series; 7.3L Turbo Diesel Engine; 168" W.B.; 1 Ton; w/ Converter

(200174)

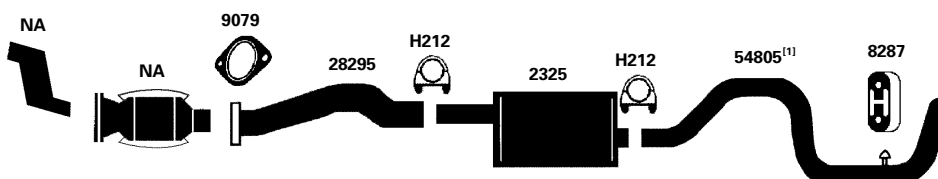

F350 SERIES

FORD TRUCK 8 CYL.

93-95 8 Cyl. F350 Series; 460 C.I.D.(7.5L) EFI Engine; 136", 160" W.B.

(200289)

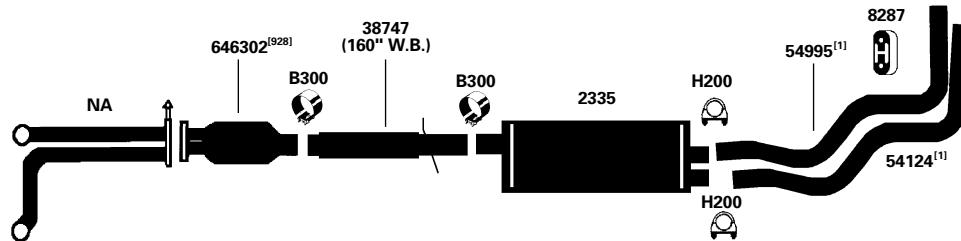

88-95 8 Cyl. F350 Series; 136", 160" W.B.; 351, 460 C.I.D. EFI Engine; Electronic 4 Speed Automatic Overdrive Transmission (E4OD) (Exc. 93-95 460 C.I.D.)

(200176)

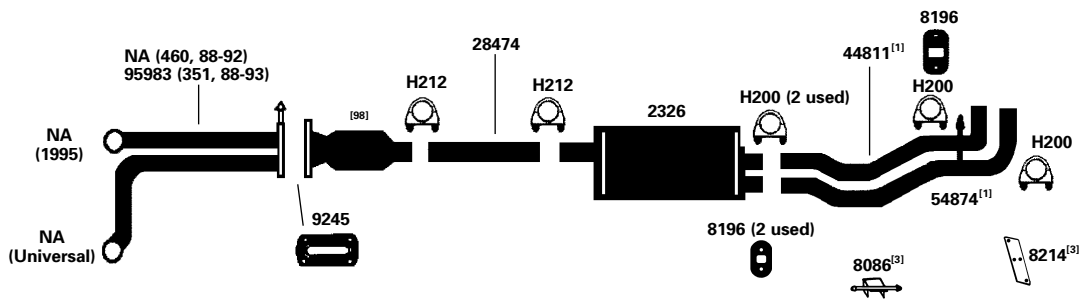

88-95 8 Cyl. F350 Series; 133", 168" W.B.; 351 C.I.D.(5.8L) Engine; (After 2-88)

88-92 8 Cyl. F350 Series; 133", 168" W.B.; 460 C.I.D.(7.5L) Engine; (After 2-88)

(200177)

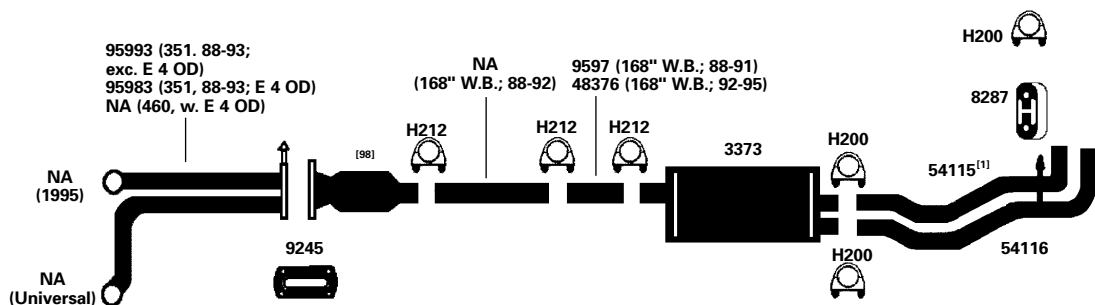

F450 SERIES

FORD TRUCK 8 CYL.

1997 8 Cyl. F450 Series; 137", 161", 178", 185" W.B.; Regular Cab; Pickup; (200180)
7.3L Turbo Diesel Engine

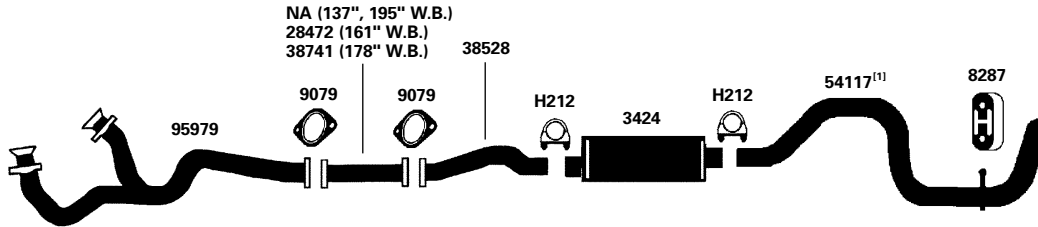

1997 8 Cyl. F450 Series; 178", 190", 208", 228" W.B.; Stripped Pickup; (200181)
7.3L Turbo Diesel Engine

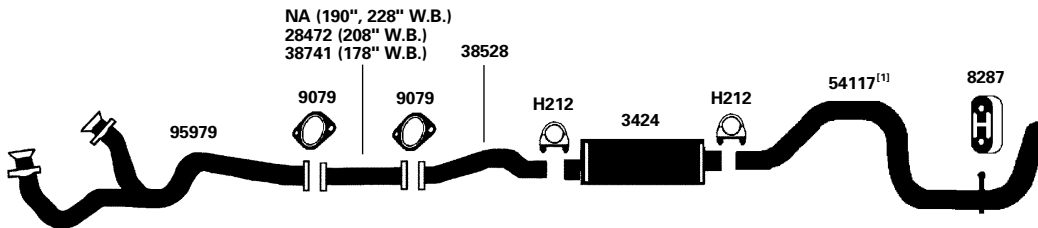

96-97 8 Cyl. F450 Series; 137", 161", 185" W.B.; Super Duty; Chassis Cab; (200182)
460 C.I.D.(7.5L) Engine

1997 8 Cyl. F450 Series Motorhome; 178", 190", 208" W.B.

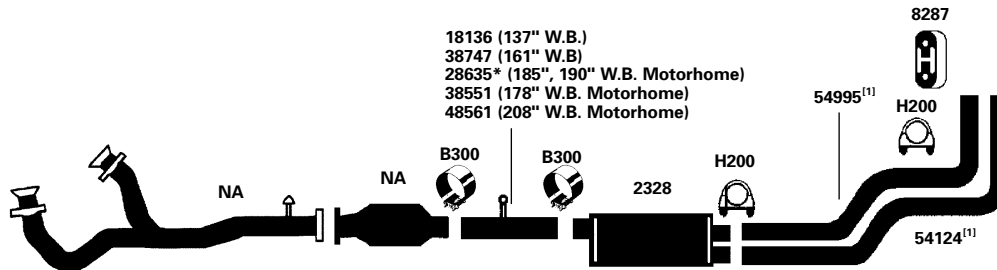

* Cut to length

NOTE: FRONT BRACKET ON MUFFLER NOT REQUIRED ON ALL MODELS – CUT OFF IF IT INTERFERES.

93-95 8 Cyl. F450; 460 C.I.D.(7.5L) Engine; 136", 160", 185" W.B.; With Converter (200294)

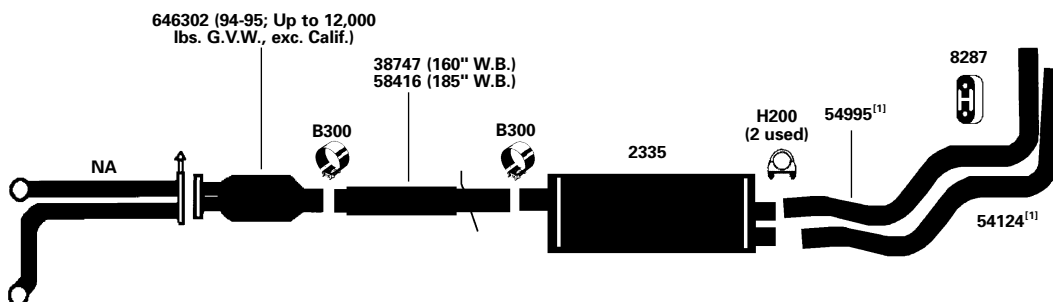

UNIVERSAL CONVERTER (94-95; Up to 12,000 lbs. G.V.W., exc. Calif.)...607007

F450 SERIES

FORD TRUCK 8 CYL.

93-95 8 Cyl. F450; 460 C.I.D.(7.5L) Engine; 136", 160" W.B.; Without Converter **(200295)**

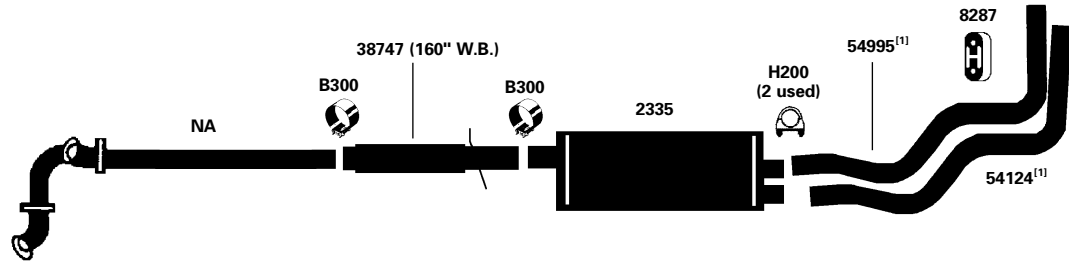

88-92 8 Cyl. F450 Series; 136", 160", 185" W.B.; 460 C.I.D.(7.5L) Engine; With Converter **(200183)**

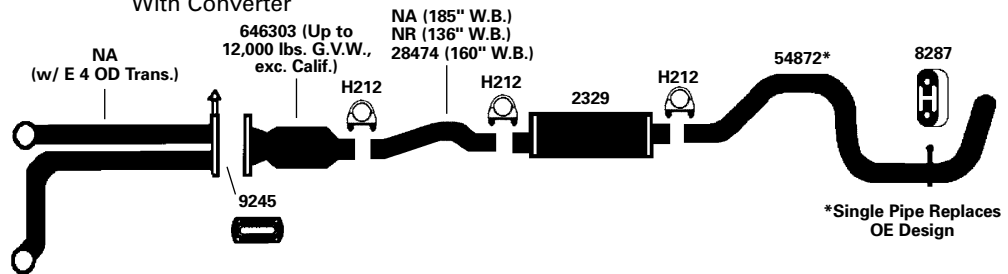

UNIVERSAL CONVERTER (Up to 12,000 lbs. G.V.W., exc. Calif.)...607007

C600, C700, C750, C800 SERIES

FORD TRUCK 6-8 CYL.

93-94 6 Cyl. CF700; Cummins FD1060(5.9L) Diesel Engine; Without Converter; (Before 11-93) **(200184)**

93-94 6 Cyl. CF800; Cummins FD1060(5.9L) Diesel Engine; Without Converter; (Before 11-93)

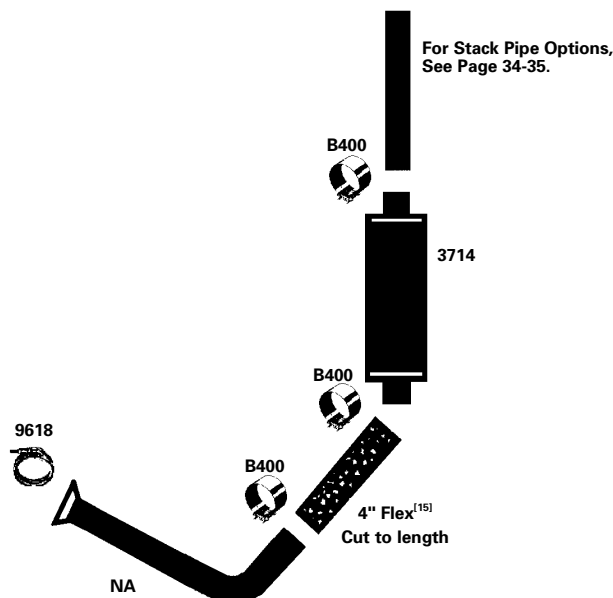

See page 99 for footnote explanations

C600, C700, C750, C800 SERIES

FORD TRUCK 6-8 CYL.

- | | | | |
|-------|--------|--|-----------------|
| 93-94 | 6 Cyl. | CF700; Cummins FD1460(8.3L) Diesel Engine; Without Converter; | (200185) |
| | | (Before 11-93) | |
| 93-94 | 6 Cyl. | CF800; Cummins FD1460(8.3L) Diesel Engine; Without Converter; (Before 11-93) | |

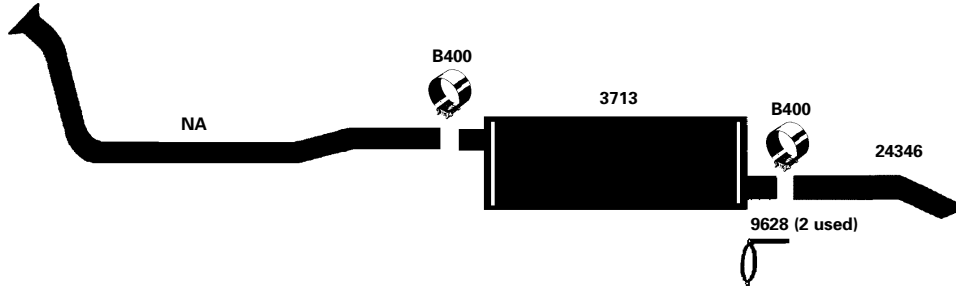

C900, CT900 SERIES

FORD TRUCK 6-8 CYL.

- | | | | |
|-------|--------|------------------------|-----------------|
| 79-80 | 8 Cyl. | CT900; 370, 429 C.I.D. | (200202) |
|-------|--------|------------------------|-----------------|

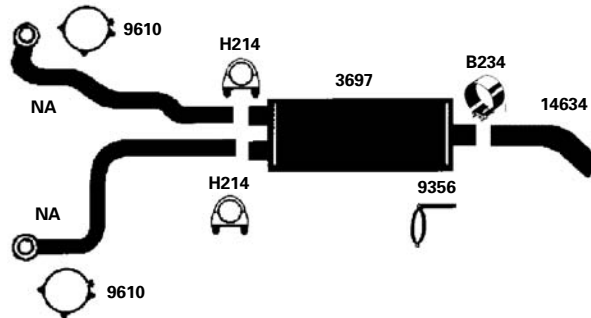

F500, F600, F700, F800 SERIES

FORD TRUCK 6-8 CYL.

- | | | | |
|-------|--------|---|-----------------|
| 90-98 | 8 Cyl. | F600; 370 C.I.D.(6.1L), 429 C.I.D.(7.0L) Engine; Dual Exhaust | (200203) |
| 90-98 | 8 Cyl. | F700; 429 C.I.D.(7.0L) EFI Engine; Dual Exhaust | |
| 90-98 | 8 Cyl. | F800, FT800; 429 C.I.D.(7.0L) EFI Engine; Dual Exhaust | |
| 90-93 | 8 Cyl. | FT900; 370, 429 C.I.D.; Gas Engine; Dual Exhaust | |

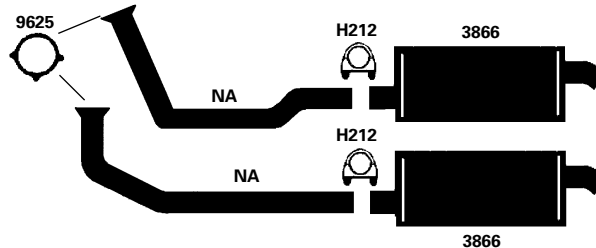

F500, F600, F700, F800 SERIES

FORD TRUCK 6-8 CYL.

- | | | | |
|-------|--------|---|-----------------|
| 92-98 | 6 Cyl. | F600; Cummins FD1060(5.9L) Diesel Engine; Without Converter | (200204) |
| 92-98 | 6 Cyl. | F700; Cummins FD1060(5.9L) Diesel Engine; Without Converter; (Before 11-93) | |

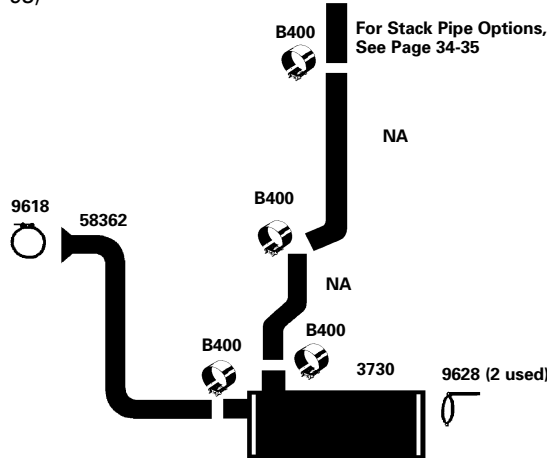

- | | | | |
|-------|--------|---|-----------------|
| 92-98 | 6 Cyl. | F600; Cummins FD1060(5.9L) Diesel Engine; Exc. Low Profile; (Before 11-93) | (200205) |
| 92-98 | 6 Cyl. | F700; Cummins FD1060(5.9L) Diesel Engine; Exc. Low Profile; (Before 11-93); Without Converter | |
| 92-98 | 6 Cyl. | F, FT800; Cummins FD1060(5.9L) Diesel Engine; Without Converter | |

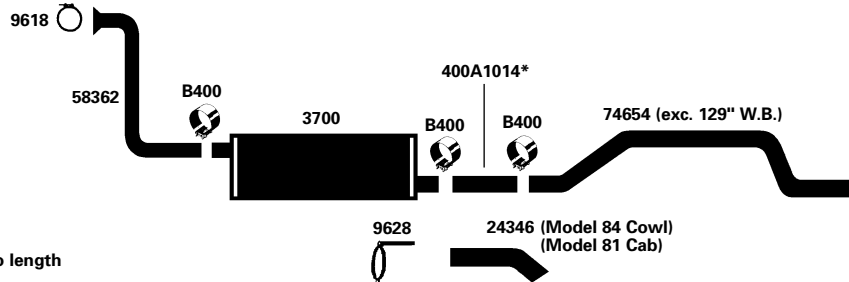

* Cut to length

- | | | | |
|-------|--------|--|-----------------|
| 90-92 | 6 Cyl. | F700; 401(6.6L) Diesel Engine; Model 81(Cab); Left Side Exhaust; Low Profile | (200206) |
| 90-92 | 6 Cyl. | F600; 401(6.6L) Diesel Engine; Model 81(Cab); Left Side Exhaust; Low Profile | |

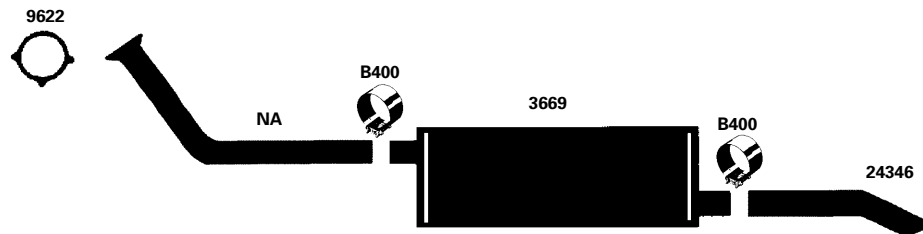

F500, F600, F700, F800 SERIES

FORD TRUCK 6-8 CYL.

1987	6 Cyl.	F600; 401(6.6L), 476(7.8L) Diesel Engine; Model 81(Cab); Left Side Mounted Vertical Tail Pipe	(200207)
1987	6 Cyl.	F700; 401(6.6L), 476(7.8L) Diesel Engine; Model 81(Cab); Left Side Mounted Vertical Tail Pipe	
1987	6 Cyl.	F800, FT800; 401(6.6L), 476(7.8L) Diesel Engine; Model 81(Cab); Left Side Mounted Vertical Tail Pipe	

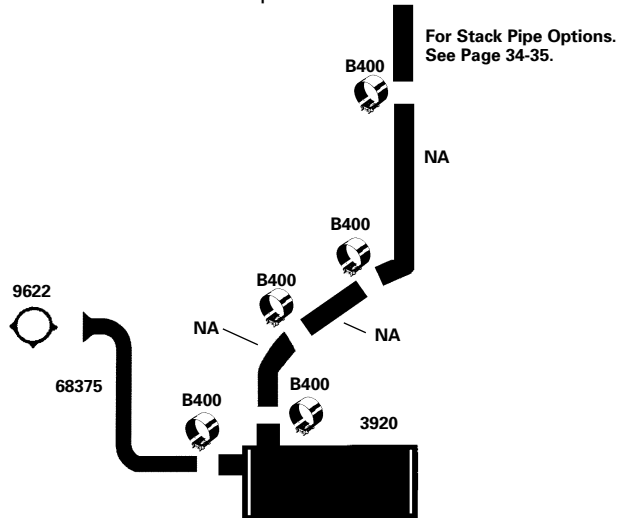

MEDIUM & H.D.
APPLICATIONS

80-83	8 Cyl.	F600; 501(8.2L) C.I.D. Turbo Diesel Engine; All Wheel Bases	(200209)
80-83	8 Cyl.	F700; 501(8.2L) C.I.D. Turbo Diesel Engine; All Wheel Bases	
80-83	8 Cyl.	F800, FT800; 501(8.2L) C.I.D. Turbo Diesel Engine; All Wheel Bases	

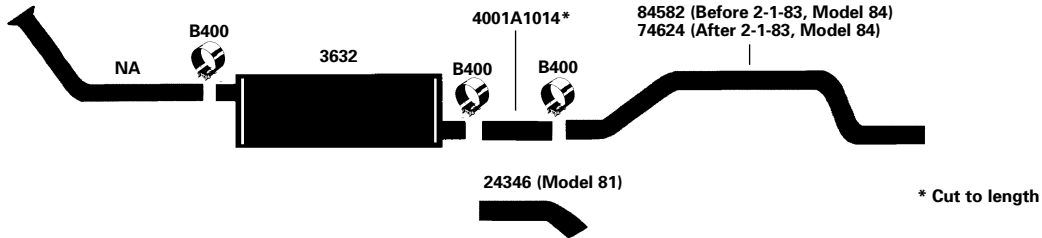

SERIES LN700, LN750

FORD TRUCK 6-8 CYL.

- | | | | |
|--------------|--------|--|-----------------|
| 93-94 | 6 Cyl. | All models w/ Cummins FD1060 (5.9L) Diesel Engine; (Before 11-93); Without Converter | (200231) |
| 93-94 | 6 Cyl. | All models w/ Cummins FD1460 (8.3L) Diesel Engine; (Before 11-93); Without Converter | |

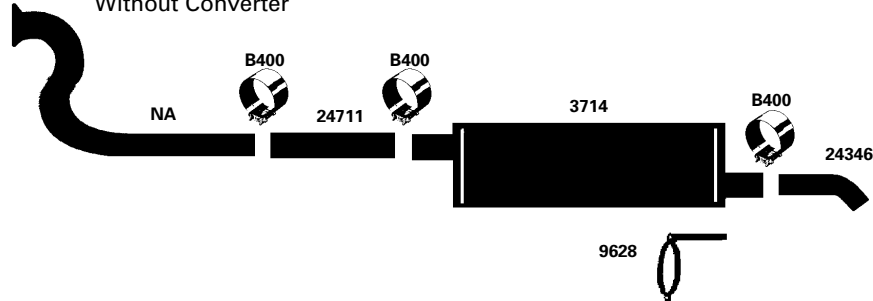

- | | | | |
|--------------|--------|--|-----------------|
| 93-94 | 6 Cyl. | All models w/ Cummins FD1460 (8.3L) Diesel Engine; (Before 11-93); Vertical Muffler; Without Converter | (200232) |
| 93-94 | 6 Cyl. | LN700 w/ Cummins FD1060 (5.9L) Diesel Engine; (Before 11-93); Vertical Muffler; Without Converter | |

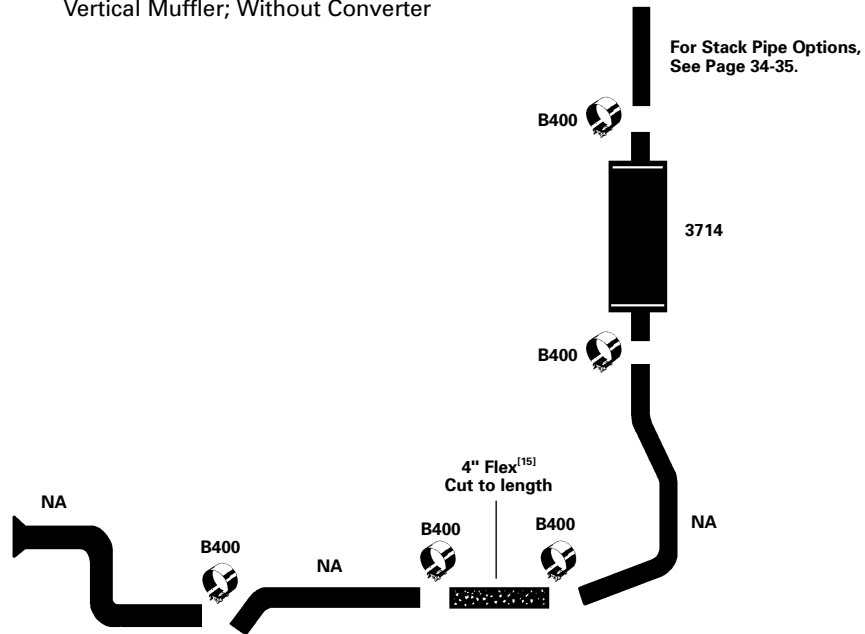

MEDIUM & H.D.
APPLICATIONS

MOTOR HOME

FORD

93-96 8 Cyl. F450 Motor Home Stripped Chassis (F53) w/ 460 C.I.D. (7.5L) Engine; (Tail Pipe Exit Front of LH Axle) **(200292)**

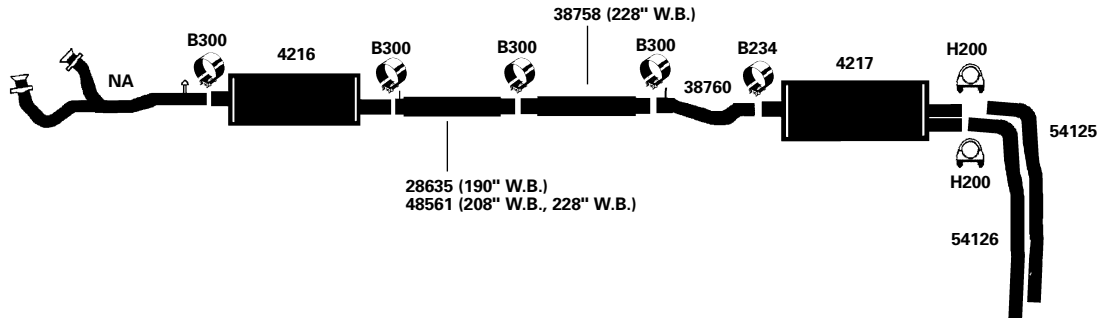

93-96 8 Cyl. F450 Motor Home Stripped Chassis (F53) w/ 460 C.I.D. (7.5L) Engine; (Tail Pipe Exit Rear of RH Axle) **(200293)**

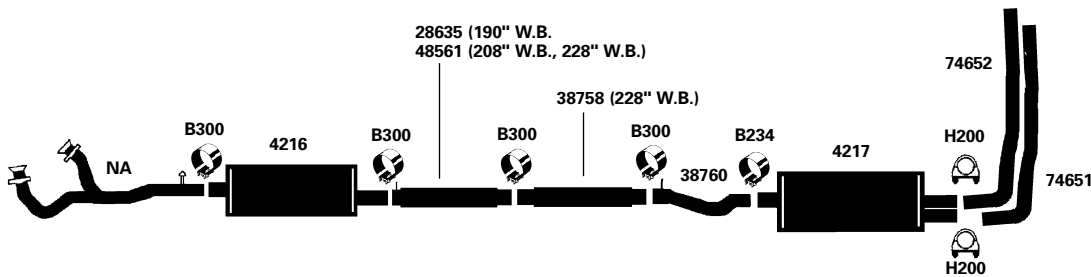

FOOTNOTES:

- [1] Original equipment system was welded assembly. It is recommended that all noted parts [1] to be replaced.
- [3] Required for installation.
- [12] Optional Heavy Duty Muffler.
- [15] See page 25 for flex options.
- [17] Separate tail pipe is included in carton with muffler.
- [18] Without windshield.
- [32] Remove and reuse O.E. heat shield, If required.
- [98] Refer to Current Converter Catalog.
- [346] For an explanation on model 81 Cab see page 12.
- [914] Direct fit converter includes front (exhaust) pipe, (1) piece assembly.
- [928] To 12,500 lbs. GVW-EPA; 11,620 lbs. GVW-CARB.
- Golden warehouse item.
- * New items

MEDIUM & H.D. APPLICATIONS



HD EXHAUST
MEDIUM & H.D. APPLICATIONS

FORD

YEAR	CYL.	TONS	MAKE & MODEL	EXH. PIPE	MUFFLER	TAIL PIPE
FORD-Series C500, C550						1-1.5 TON
65-72	6		C500, C550		3654	14343
61-72	8		C500, C550	94008	3654	14634
1969	8		C500, C550		3654	14343
61-64	6		C500, C550		3901	14634
61-64	8		C500, C550; w/ 2" Muffler Connections		3901	14343
1956	8		C500		3654	10921
54-55	8		C500; COE (exc. 256 CID)		3901	14342
48-53	8		1.5 Ton		3901	14342
47-53	6		1.5 Ton		3901	10921
FORD-Series F500, F550						1-1.5 TON
59-77	6		F500		3901	10921
69-75	8		F500; (Model 84, 85 Cowl Only)		3654	14343
67-75	8		F500; (Model 81 Cab Only) Before Ser. Q80,001		3654	14343
1969	8		F500	44698	3654	14343
65-69	6		F500; w/2-1/2" Muffler Connections		3654	14343
64-69	8		F500		3654	14343
61-64	8		F500; (exc. 292 CID, 4BBL Carb.) w/ 2" Muffler Inlet		3901	10921
54-60	8		F500; (exc. Heavy Duty Eng.)		3901	10921
54-58	8		F500		3901	10921
48-53	8	1.5	1.5 Ton		3901	10921
47-53	6		F500		3901	10921
FORD-Series L500, L550						1-1.5 TON
65-72	6		LN500		3901	10921
70-72	8		LN500	37764 & 48113	3654	14343
47-53	6	1.5	1.5 Ton		3901	10921
48-53	8	1.5	1.5 Ton		3901	10921
FORD-Series N500, N550						1-1.5 TON
61-72	6		N500		3901	10921
67-69	8		N500	37764 & 48113	3654	14343
65-66	6		N500; w/2-1/2" Muffler Connections		3654	14343
65-66	6		N500		3654	14343
47-53	6	1.5	1.5 Ton		3901	10921
48-53	8	1.5	1.5 Ton		3901	10921
FORD-Series P500, P550						1-1.5 TON
57-77	6		P500		3901	10921
67-71	4		P500D		3901	10921
1964	8		P500		3901	10921
57-60	8		P500		3901	10921
54-56	6		P500		3901	10921
48-53	8	1.5	1.5 Ton		3901	10921
47-53	6	1.5	1.5 Ton		3901	10921
FORD-Series C600						1.5-2.5 TON
75-78	6		C600; (From SER. V20,001)		2958	24344
75-78	8		C600; 330, 361 C.I.D. (From V20,001 to SER. BC5,001)		2958	24344
74-78	8		C600 Diesel Engine (p to SER. BC5,001)		3611	24346
69-78	8		C600		3654	14343
65-75	6		C600; (Up to SER. V20,001)		3654	14343
65-73	8		C600; 330, 361 C.I.D. (Before SER. V20,001)		3654	14343
1973	8		C600 Diesel Engine (After SER. Q80,001)		3611	24345
1970	6		C600; 363 C.I.D. Diesel Engine		3654	14343
1964	8		C600 w/2" Muffler Connections		3901	10921

MEDIUM & H.D.
APPLICATIONS

FORD

YEAR	CYL.	TONS	MAKE & MODEL	EXH. PIPE	MUFFLER	TAIL PIPE
FORD-Series C600 (Cont.)						1.5-2.5 TON
1964	8		C600; w/330 CID, 2-1/2" Muffler Connections	94008	3654	14343
61-64	6		C600		3901	10921
61-63	8		C600 w/2" Muffler Connections		3901	10921
55-56	8		C600		3654	14343
54-55	8		C600; C.O.E. (exc. 256 CID)		3901	10921
1953	8		C600 COE		3901	10921
FORD-Series F600						1.5-2.5 TON
74-79	8		F600 Diesel Engine; (Up to SER. V20,001) Exc. Models equipped w/ PTO (Power Take Off)		3611	24345
76-78			F600; Gas Engine; 4 WD; (Up to SER. BC5,001)		2958	14343
75-78	6		F600; (Up to SER. BC5,001)		2958	14343
75-78	8		F600; 330, 361 C.I.D. Model 81 ³⁴⁶ CAB		3868	14342
75-78	8		F600; Gas Engine; 2 WD		2958	14343
1978	8		F600; 330, 361 C.I.D. (From SER. BC0,001); 2 WD		3909	14343
73-75	8		F600 (Up to SER. V20,001)		3654	14343
73-75	8		F600; 330, 361 C.I.D. (Before SER. V80,001)		3654	14343
69-75	8		F600; Model 81 ³⁴⁶ CAB (Before SER. V80,001)		3654	14343
1975	8		F600; (From SER. W40,001)		2958	14343
1974	8		F600; 330 C.I.D. Model 81 ³⁴⁶ CAB		3654	14343
73-74	8		F600 Diesel Engine; (After SER. Q80,001)		3611	24346
71-73	8		F600; (Before SER. Q80,001); 4 WD		3654	14343
70-72	6		F600; 300 C.I.D.		3654	14343
1970	6		F600with 363 C.I.D. Diesel Engine		3654	14343
67-73	8		F600; Model 84(Cowl) Only; 2 WD		3654	14343
67-73	8		F600; Model 81(Cab); 2 WD		3654	14343
65-69	6		F600; w/2" Muffler Connections		3901	10921
65-69	6		F600; w/2-1/2" Muffler Connections		3654	14343
64-66	8		F600, F650	38273 & 48335	3654	14343
61-64	8		F600; (exc. 292 CID, 4BBL Carb.) w/2" Muffler Inlet		3901	10921
59-64	6		F600		3901	10921
57-60	8		F600; (exc. Heavy Duty Eng.)		3901	10921
57-58	6		F600		3901	10921
1956	8		F600		3654	14343
FORD-Series LN600						1.5-2.5 TON
75-78	6		LN600 (From SER. V20,001)		2958	14343
75-78	8		LN600 (From SER. V20,001 to BC5,001)		2958	14343
75-78	8		LN600; 330, 361 C.I.D. (From SER. V20,001 to BC0,001)		3868	14342
70-75	6		LN600		3654	14343
70-75	8		LN600		3654	14343
73-75	8		LN600; 330, 361 C.I.D. (From SER. V20,001)		3654	14343
70-73	8		LN600		3654	14343
FORD-Series N600						1.5-2.5 TON
1969	8		N600		3654	14343
67-69	8		N600	37764 & 48113	3654	14343
65-69	8		N600; w/2-1/2" Muffler Connections		3654	14343
64-66	8		N600; w/2-1/2" Muffler Inlet	38273 & 48335	3654	14343
61-66	6		N600; w/2" Muffler Connections		3901	10921
FORD-Series C700, C750						2-3.5 TON
73-79	8		C700 Diesel Engine (Up to SER. BC5,001)		3611	24346

MEDIUM & H.D.
APPLICATIONS



HD EXHAUST
MEDIUM & H.D. APPLICATIONS

FORD

YEAR	CYL.	TONS	MAKE & MODEL	EXH. PIPE	MUFFLER	TAIL PIPE
FORD-Series C700, C750 (Cont.)						2.5-3.5 TON
69-78	8		C700, C750		3654	14343
75-78	8		C700, C750; 361, 389, 391 C.I.D. (From SER. V20,001 to BC5,001)		2958	14343
1978	8		C700; 361, 389, 391 C.I.D. (From SER. BC5,001)		2958	24344
64-75	8		C700, C750; 361, 389, 391 C.I.D. (Before SER. V20,001)		3654	14343
1970	6		C700; 363(5.9L) C.I.D. Diesel Engine		3654	14343
61-69	8		C700, C750, CT750	94008	3654	14343
61-64	8		C700; w/2" Muffler Connections		3901	10921
56-60	8		Series C700, C750		3654	14343
FORD-Series F700, F750						2-3.5 TON
73-79	8		F700 Diesel Engine; (UP to SER. BC5,001)		3611	24345
75-78	8		F700; 360 C.I.D. Model 81 ³⁴⁶ CAB (From SER. V20,001 to BC5,001)		3868	14342
1978	8		F700; 361 C.I.D. Cowl Models (From SER. BC5,001)		3909	14343
75-77	8		C750; 361, 389, 391 C.I.D.; With Muffler Strap (From SER. V20,001)		2958	14343
73-75	8		C750; 361, 389, 391 C.I.D.; Without Muffler Strap (Before SER. V20,001)		3654	14343
73-75	8		F700, F750 (Up to SER. V20,001); F750 (Up to SER. V80,001)		3654	14343
67-73	8		F700, F750; Model 81(Cab) Only		3654	14343
1973	8		F700; 361 C.I.D.; Model 84(Cowl) Only		3654	14343
69-72	8		F700, F750		3654	14343
69-72	8		F700, F750; Model 84 (Cowl) Only		3654	14343
1970	6		F700 with 363 C.I.D. Diesel Engine		3654	14343
61-66	8		F700, F750		3654	14343
61-64	8		F700; (exc. 292 CID, 4 BBL) w/ 2" Muffler Inlet	94008	3901	10921
57-60	8		F750; w/2-1/2" Muffler Inlet		3654	14343
1956	8		Series F700, F750		3654	14343
FORD-Series LN700, LN750						2-3.5 TON
75-78	8		LN700; 361, 389, 391 C.I.D. (From SER. V20,001 to BC5,001)		2958	14343
75-78	8		LN700, LN750; 361, 389, 391 C.I.D. (From SER. V80,001 to BC5,001)		3868	14342
73-78	8		LN700; Diesel Engine		3611	24345
1978	8		LN700; 361, 389, 391 C.I.D.; Cab Models (From SER. BC0,001)		3909	14343
73-75	8		LN700; 361, 389, 391 C.I.D. (Before SER. V20,001)		3654	14343
70-75	8		LN700, LN750		3654	14343
70-73	8		LN700, LN750		3654	14343
FORD-Series N700, N750						2-3.5 TON
1969	8		N700, N750		3654	14343
67-69	8		N700, N750	37764 & 48113	3654	14343
61-66	8		N700, N750	37764 & 48113	3654	14343
1959	8		Series N700, N750		3654	14343
1956	8		Series N700, N750		3654	14343
FORD-Series P700, P750						2-3.5 TON
1956	8		Series P700, P750		3654	14343

MEDIUM & H.D.
APPLICATIONS

FORD

YEAR	CYL.	TONS	MAKE & MODEL	EXH. PIPE	MUFFLER	TAIL PIPE
FORD-Series T700, T750			2-3.5 TON			
61-66	8		T700, T750	94008	3654	14343
57-60	8		T700 w/302 CID, T750 w/2-1/2" Muffler Inlet		3654	14343
58-59	8		T700 w/401 CID w/3 1/4" Muffler Inlet		2645	14343
1956	8		Series T700, T750		3654	14343
FORD-Series C800, C850			2.5-3.5 TON			
78-82	8		C800, CT800; 573, 636 C.I.D.; Diesel Engine (Up to 12-01-81); (Exc. Turbo)		3611	24346
1980	8		C800; 475 C.I.D. (From SER. BC5,001)		3611	24346
75-79	8		C800, CT800; 475 C.I.D.; Gas		3611	24346
70-78	8		C800, CT800		3654	14343
75-78	8		C800, CT800; 361, 389, 391 C.I.D. (Up to SER. BC5,001)		2958	24344
1978	8		C800, CT800; 361, 389, 391 C.I.D. (From SER. BC5,001)		2958	24344
64-74	8		C800, C850, CT800		3654	14343
63-72	8		C850, CT850		2645	14343
1969	8		C800, CT800, C850; w/361, 391 CID		3654	14343
61-69	8		C800, CT800, C850		3654	14343
58-62	8		C850; w/401, 477 CID w/3-1/4" Muffler Inlet		2645	14343
58-60	8		C850		2645	14343
58-60	8		C800, C850; w/2-1/2" Muffler Inlet		3654	14343
1956	8		Series C800, C850		3654	14343
FORD-Series F800, F850, F880			2.5-3.5 TON			
75-79	8		F800, F880; 475 C.I.D.; Gas Engine		3611	24345
1969	8		F850; w/401, 477, 534 CID		2645	14343
63-68	8		F850		2645	14343
61-69	8		F800		3654	14343
56-60	8		F800, F850		3654	14343
FORD-Series L800, L850			2.5-3.5 TON			
75-78	8		L800, LN800, LNT800, LTS800; 361, 389, 391 C.I.D.		2958	14343
75-78	8		L800, LN800, LNT800, LTS800; 361, 389, 391 C.I.D. (From SER.vV80,001 to BC5,001)		3868	14342
70-74	8		L800, LN800, LT800, LNT800, LTS800		3654	14343
1956	8		Series L800, L850		3654	14343
FORD-Series N800, N850			2.5-3.5 TON			
63-69	8		N850, NT850		2645	14343
1956	8		Series N800, N850		3654	14343
FORD-Series P800, P850			2.5-3.5 TON			
1956	8		Series P800, P850		3654	14343
FORD-Series T800, T850			2.5-3.5 TON			
63-69	8		T850		2645	14343
61-69	8		T800		3654	14343
58-60	8		T850		2645	14343
56-57	8		Series T800, T850		3654	14343
FORD-Series C900, C950			2.5-5 TON			
73-78	8		C900, CT900; (From SER. V20,001 to BC5,001); 401, 477, 534 C.I.D.; Single Exhaust		3611	24345
63-73	8		C900, CT900 (Before SER. Q80,001)		2645	14343
58-62	8		C950		2645	14343
58-60	8		C900, C950		2645	14343
56-60	8		Series C900		3654	14343



HD EXHAUST
MEDIUM & H.D. APPLICATIONS

FORD

YEAR	CYL.	TONS	MAKE & MODEL	EXH. PIPE	MUFFLER	TAIL PIPE
FORD-Series F900, F950						2.5-5 TON
58-63	8		F950		2645	14343
58-60	8		F900, F950		2645	14343
56-60	8		F900		3654	14343
FORD-Series L900, L950						2.5-5 TON
1956	8		Series L900		3654	14343
FORD-Series N900, N950						2.5-5 TON
63-69	8		N950, NT950		2645	14343
1956	8		N900		3654	14343
FORD-Series P900, P950						2.5-5 TON
1956	8		Series P900		3654	14343
FORD-Series T900, T950						2.5-5 TON
1963	8		T950 (exc. 10, 12 Spd. Trans., Aux. Trans., Timken H.D. Axle)		2645	14343
1956	8		Series T900		3654	14343
FORD-Series 1000, 1100						4-6 TON
70-72	8		C1000		2645	14343
64-69	8		F1000, C1000, H1000, N1000, F1100, N1100		2645	14343
1963	8		F1000, C1000, N1000, F1100, N1100 (exc. 10, 12 Spd. Trans., Aux. Trans. Timken H.D. Axle)		2645	14343
58-62	8		F1000, C1000, H1000, F1100		2645	14343
58-60	8		F1000, C1000, F1100, C1100		2645	14343

MEDIUM & H.D.
APPLICATIONS

FREIGHTLINER

1998-01 Freightliner B-Series Cummins Engine (200339)

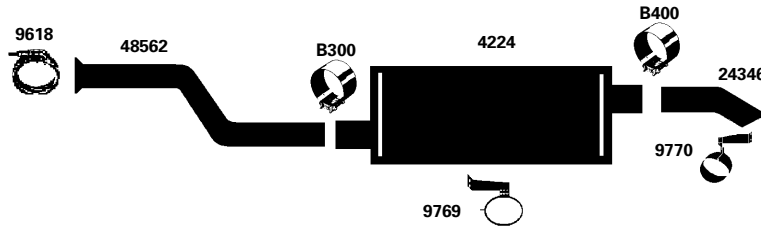

1998-01 Freightliner 3126 Caterpillar Engine (200340)

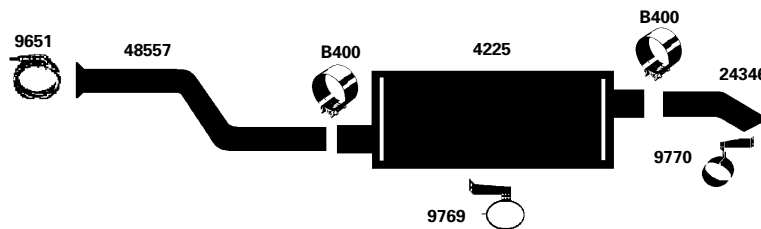

1 000 SERIES CHASSIS - 1 1/2 TON & OVER INTERNATIONAL

91-93 6 Cyl. 1652SC, DT360 Diesel Engine; Stripped Chassis; Long Tail Pipe; RH Mounting Front of Rear Wheel (200248)

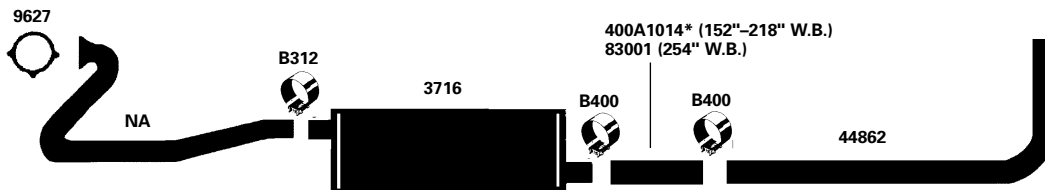

* Cut to length

91-93 8 Cyl. 1452SC, 1652SC, 7.3L Diesel Engine; Stripped Chassis; Long Tail Pipe; Exits Front of Rear Wheel; Right Hand Mounting (200355)

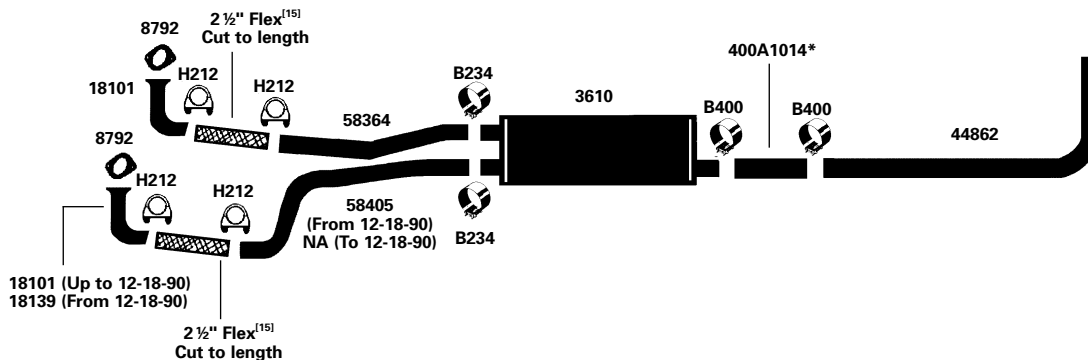

* Cut to length

1000 SERIES CHASSIS - 1 1/2 TON & OVER

INTERNATIONAL

91-93 8 Cyl. 1652SC, 7.3L Diesel Engine; Stripped Chassis; Long Tail Pipe; Left Hand Mounting **(200249)**

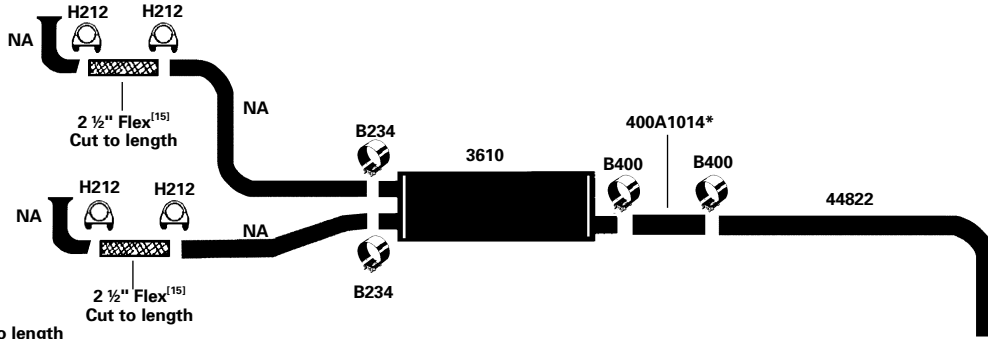

91-93 8 Cyl. 1652SC, 7.3L Diesel Engine; Left Hand Mounting; Tail Pipe Exits Front of Rear Wheel **(200250)**

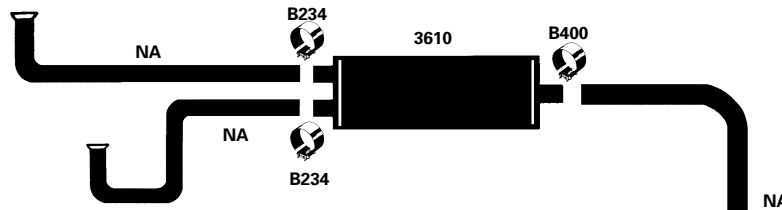

4000 SERIES CHASSIS - 1 1/2 TON & OVER

INTERNATIONAL

94-99 8 Cyl. 4500, 4700, T444E Diesel Engine; L.H. Frame Mounted Short Tail Pipe; Code 07AAZ **(200251)**

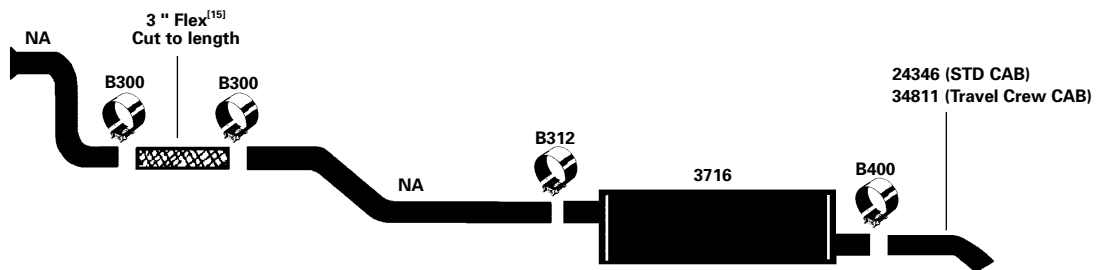

94-99 8 Cyl. 4700, T444E Diesel Engine; R.H. Mounted Muffler Long Tail Pipe; Code 07AAX **(200252)**

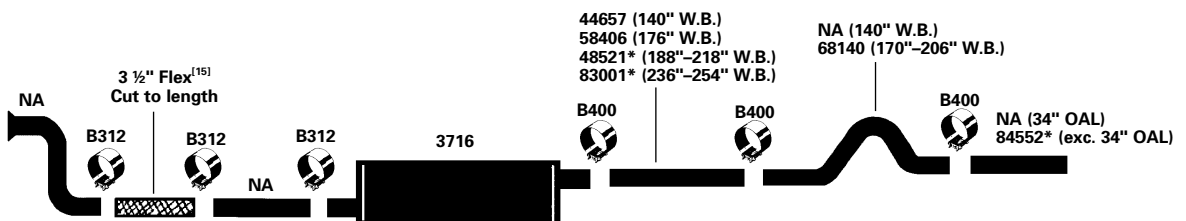

* Cut to length

See page 127 for footnote explanations

4000 SERIES CHASSIS - 1 1/2 TON & OVER

INTERNATIONAL

94-99 6 Cyl. 4700, 4900, DT408, DT466 NGD, 530 Diesel Engine; R.H. Muffler & Vertical Tail Pipe; Codes 07ABG, 07BGB **(200253)**

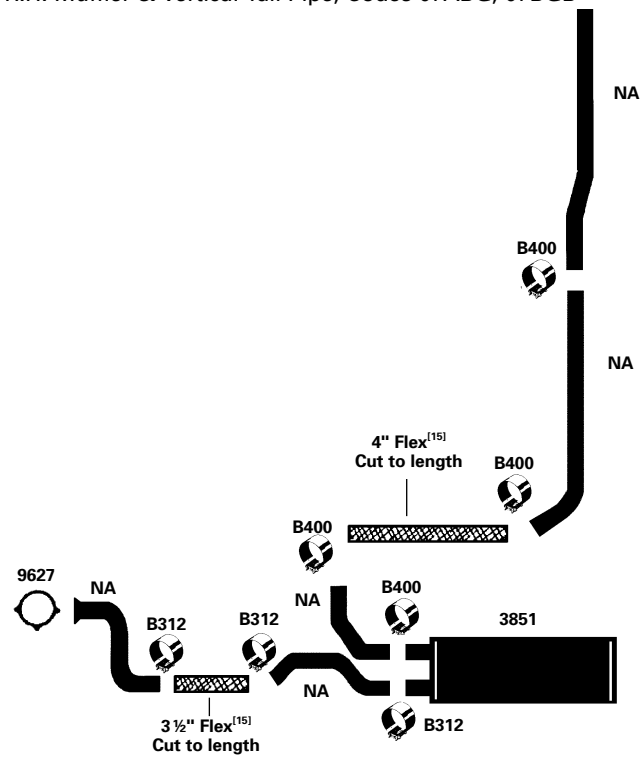

94-99 6 Cyl. 4000, DT408, DT466 NGD, 530 Diesel Engine; RH Cab Mounted, Vertical Tail Pipe; Codes 07ACS, 07ACT **(200254)**

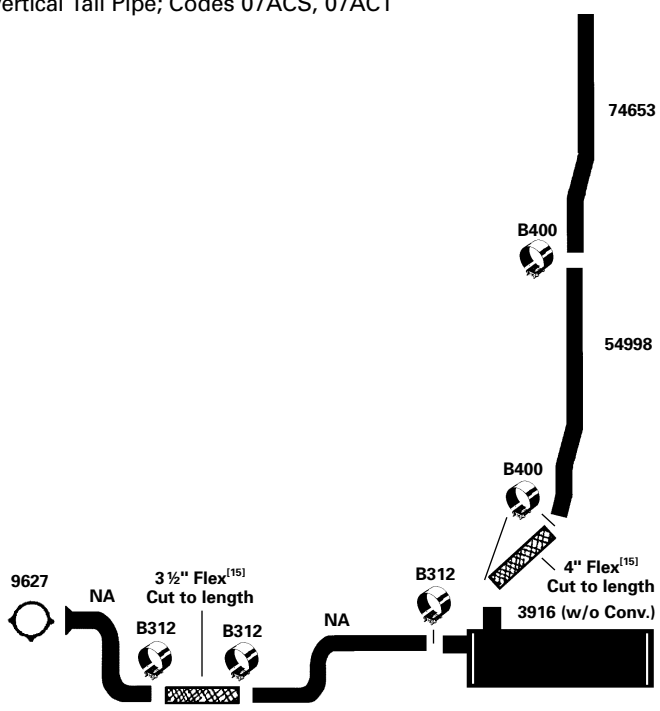

MEDIUM & H.D. APPLICATIONS

4000 SERIES CHASSIS - 1 1/2 TON & OVER

INTERNATIONAL

94-99 6 Cyl. 4000, DT408, DT466E, 530 Diesel Engine; RH Mounted Muffler Vertical Tail Pipe; Codes 07ACX, 07ACY; Beverage & Utility Body (200255)

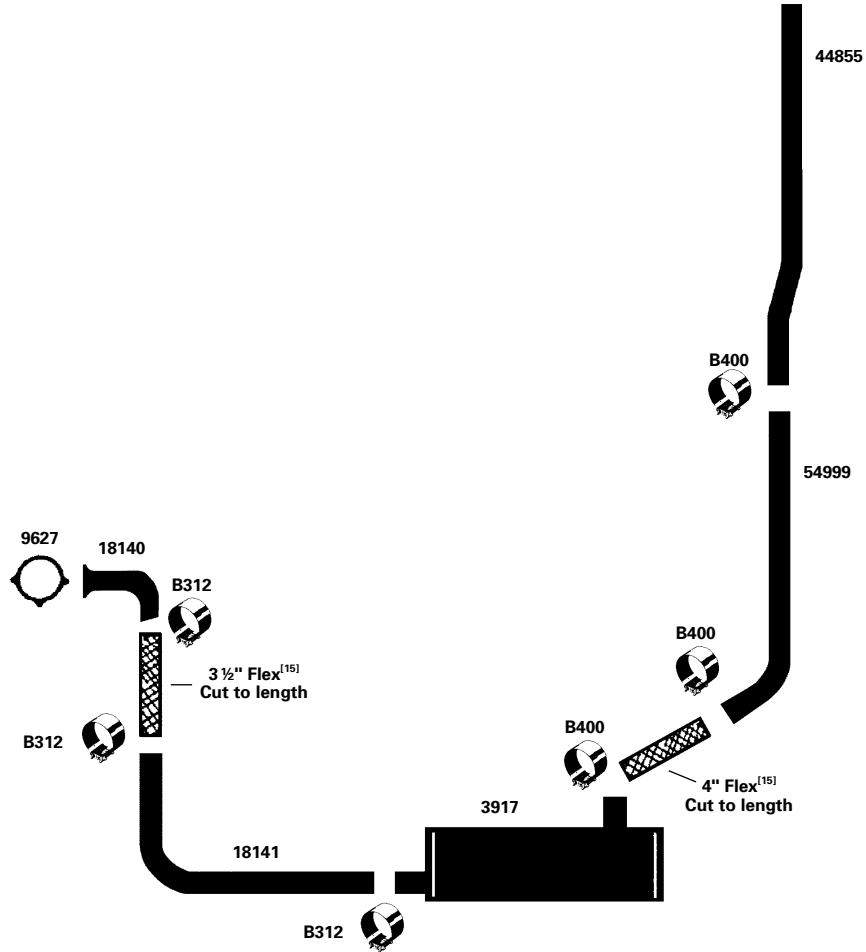

94-99 6 Cyl. 4000, DT408, DT466 NGD, 530 Diesel Engine; RH Frame Mounted without Beverage & Utility Body; Code 07AAY (200256)

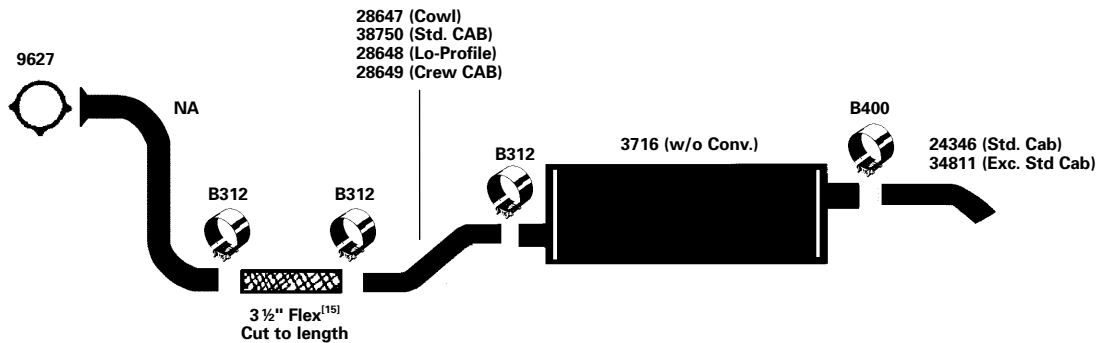

4000 SERIES CHASSIS - 1 1/2 TON & OVER

INTERNATIONAL

94-99 6 Cyl. 4000, DT408, DT466E, 530 Diesel Engine; RH Frame Mounted Muffler; Cab Mounted Vertical Tail Pipe; Code 07BAG (Exc. Beverage Body) **(200257)**

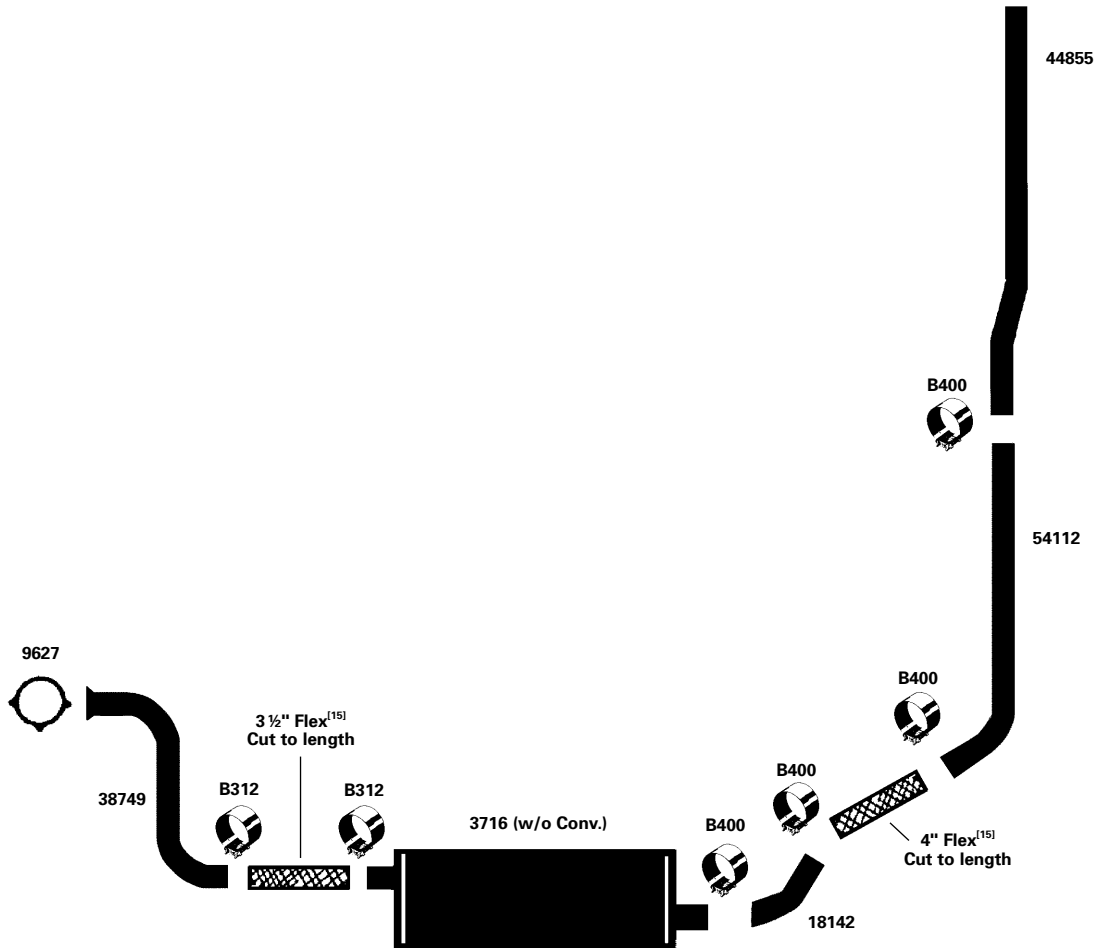

94-99 6 Cyl. 4000, DT408, DT466E, 530 Diesel Engine; L.H. Frame Mounted Muffler; With Short Tail Pipe **(200258)**

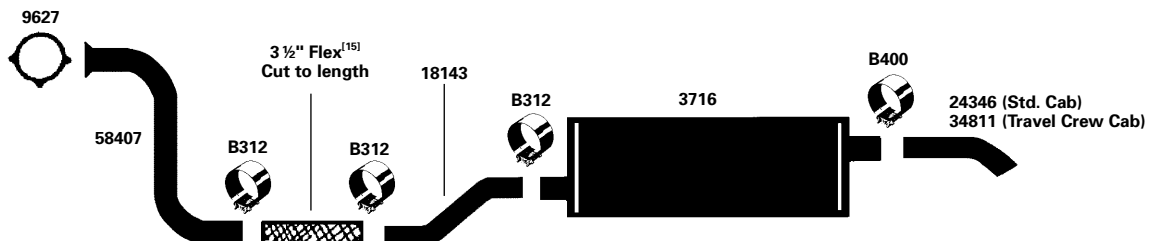

4000 SERIES CHASSIS - 1 1/2 TON & OVER

INTERNATIONAL

94-99 6 Cyl. 4000, DT408, DT466E, 530 Diesel Engine; R.H. Vertical Muffler & Tail Pipe; **(200259)**
Code 07AWB

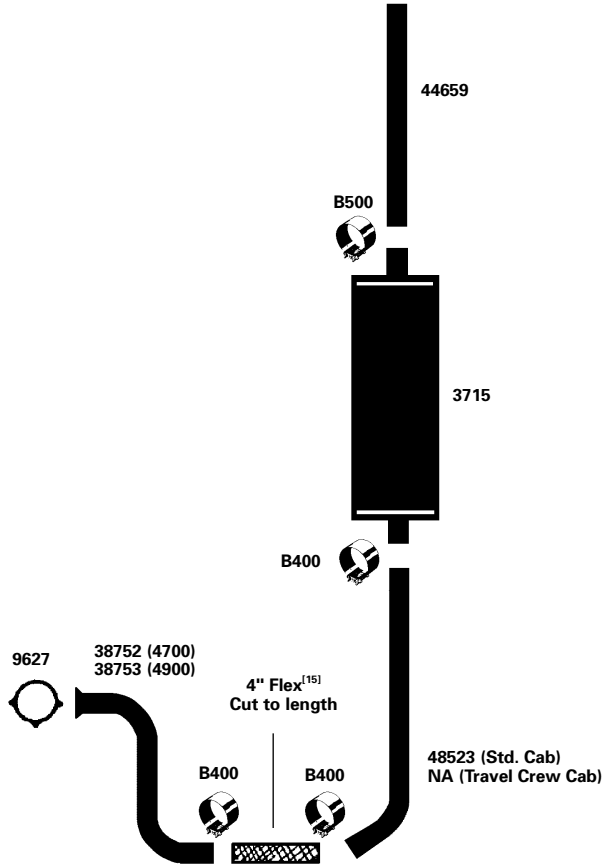

94-99 6 Cyl. 4000, DT408, DT466E, 530 Diesel Engine; R.H. Mounted Muffler; Short Tail Pipe; Codes 07BAG, 07AAY with Beverage Body **(200260)**

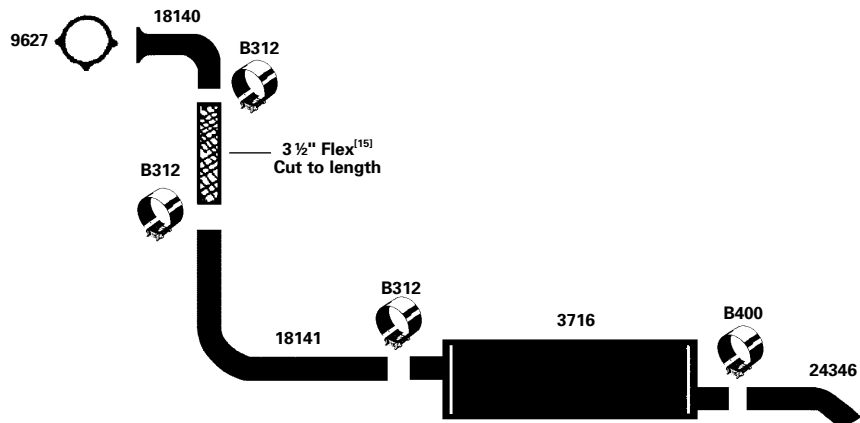

4000 SERIES CHASSIS - 1 1/2 TON & OVER

INTERNATIONAL

94-99 6 Cyl. 4000, DT408, DT466E, 530 Diesel Engine; R.H. Mounted Muffler; Short Tail Pipe; Code 07AAL with Beverage Body **(200261)**

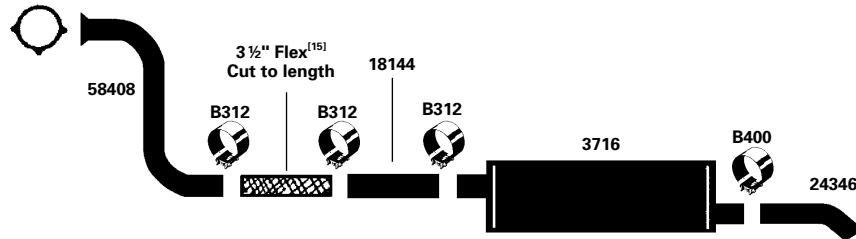

94-99 6 Cyl. 4000, DT408, DT466E, 530 Diesel Engine; R.H. Cab Mounted Vertical Tail Pipe; (Exc. Allison MT653DR & MT643 Auto. Trans.); Codes 07ACX, 07ACY **(200262)**

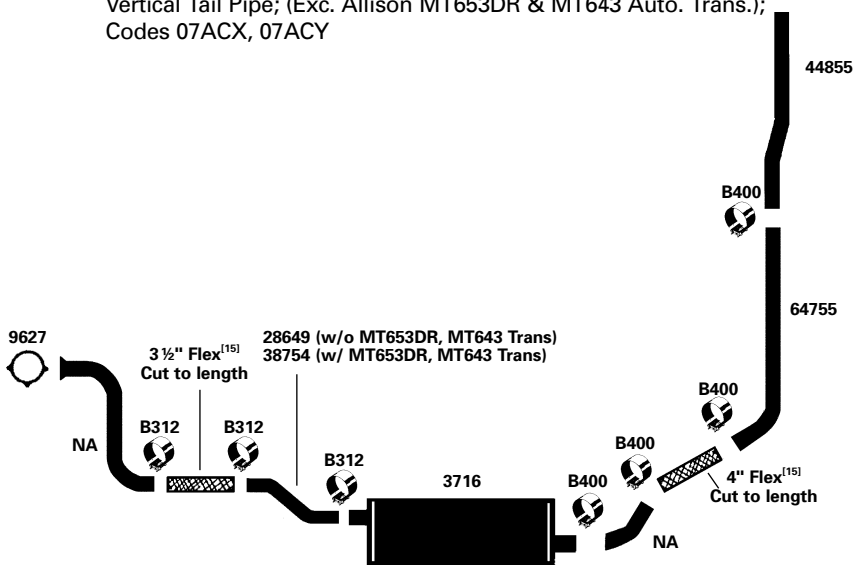

94-99 6 Cyl. 4000, DT408, DT466E, 530 Diesel Engine; Travelcrew Cab with L.H. Frame Mounted Muffler; Vertical Tail Pipe **(200263)**

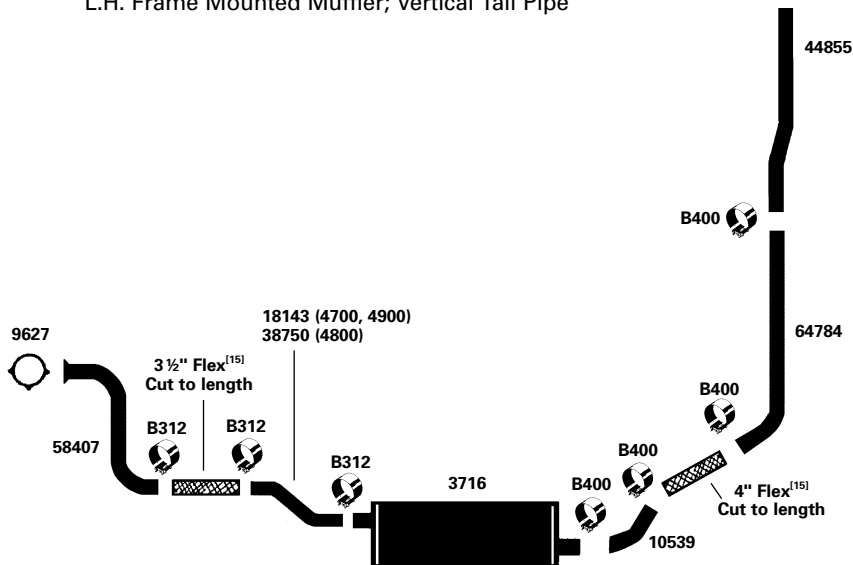

4000 SERIES CHASSIS - 1 1/2 TON & OVER

INTERNATIONAL

94-99 6 Cyl. 4000, DT408, DT466E, 530 Diesel Engine; R.H. Muffler Mounted 8" Back of Cab; Codes 07AMA, 07AAE w/ Short Tail Pipe **(200264)**

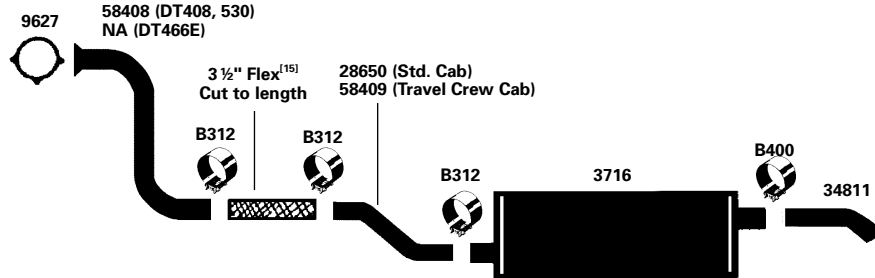

94-99 6 Cyl. 4000, DT408, DT466E, 530 Diesel Engine; R.H. Muffler Mounted 30" Back of Cab; Codes 07AMB, 07AAK w/ Short Tail Pipe **(200265)**



94-99 8 Cyl. 4000, T444E Diesel Engine; R.H. Muffler & Vertical Tail Pipe; Code 07BAC **(200266)**

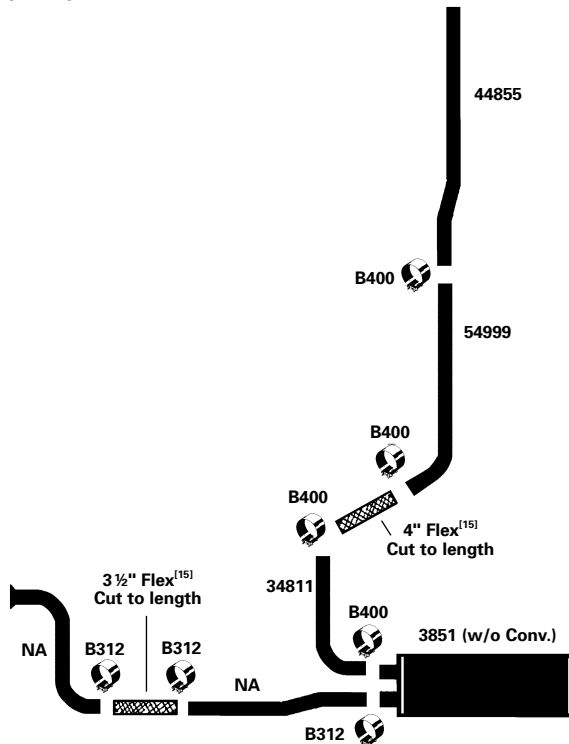

4000 SERIES CHASSIS - 1 1/2 TON & OVER

INTERNATIONAL

94-99 8 Cyl. 4000, T444E Diesel Engine; L.H. Frame Mounted Muffler; Vertical Tail Pipe; (200267)
Codes 07ACU, 07ACW

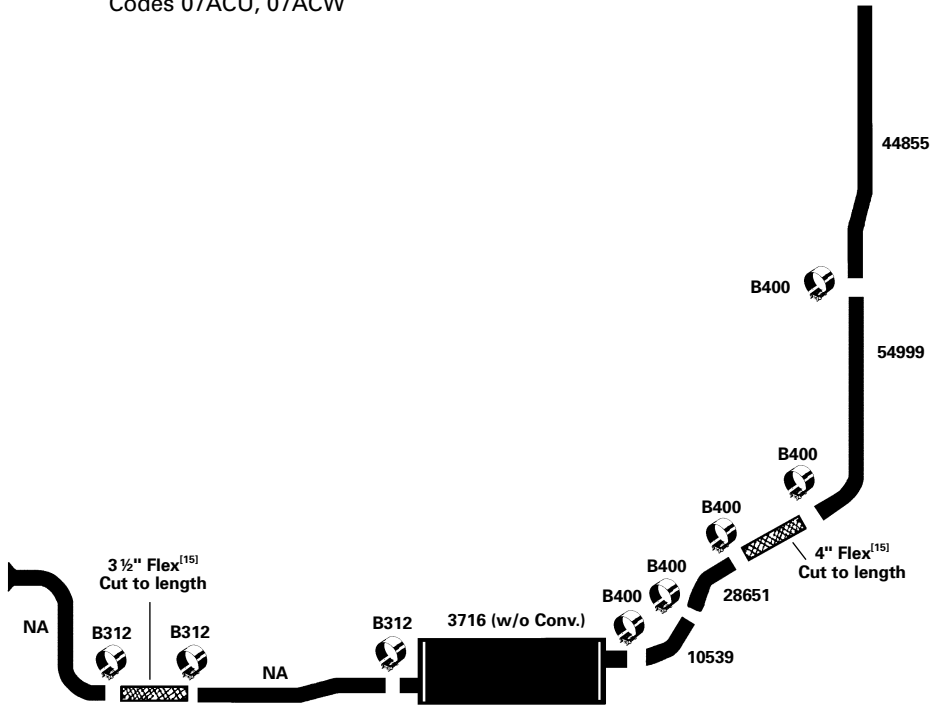

94-99 8 Cyl. 4000 Travelcrew Cab, T444E Diesel Engine; R.H. Frame Mounted Muffler; Cab Mounted Vertical Tail Pipe; Code 07ACY (200268)

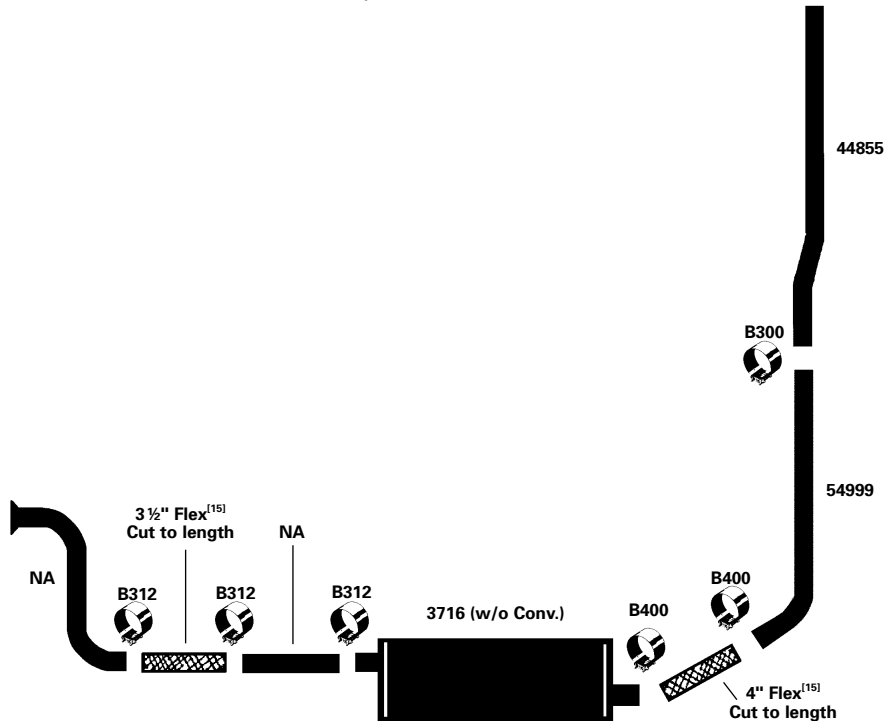

4000 SERIES CHASSIS - 1 1/2 TON & OVER

INTERNATIONAL

94-99 8 Cyl. 4000, T444E Diesel Engine; L.H. Mounted with Long Tail Pipe; Codes 07AAS, 07AAV, 07AAX **(200269)**

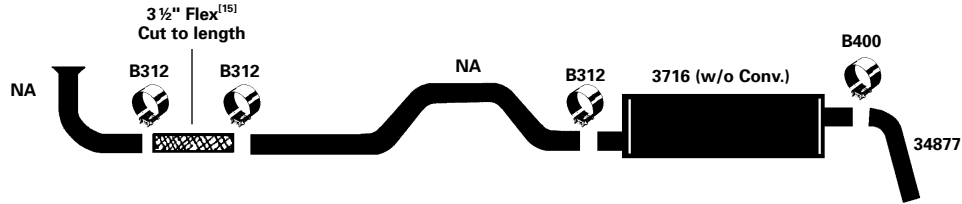

88-99 6 Cyl. 4000, DT408, 530, DT466 Diesel Engine; L.H. Mounted Muffler; Canada & Export Only; Code 07AAP **(200270)**

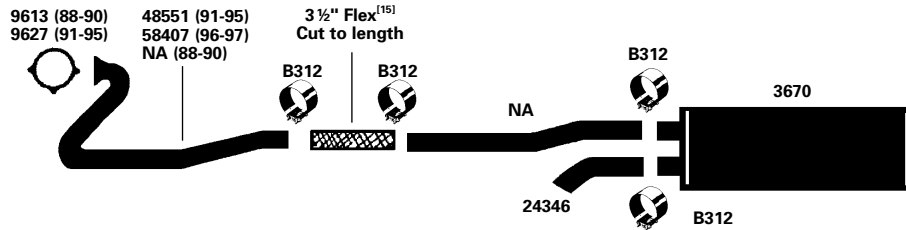

91-99 6 Cyl. 4700, 4900; DT360, DT408, DT/DTA466 Diesel Engine; R.H. Mounted Muffler; Long Tail Pipe; Code 07AAX **(200271)**

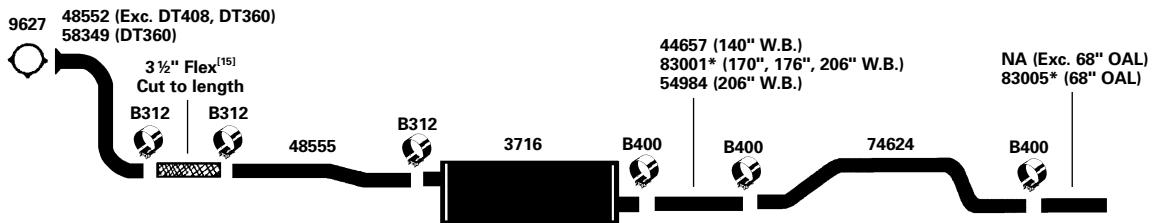

* Cut to length

93-99 6 Cyl. 4000, DT408/DT/DTA466 Diesel Engine; Temporarily Mounted R.H. Side Muffler; Code 07AAH **(200272)**

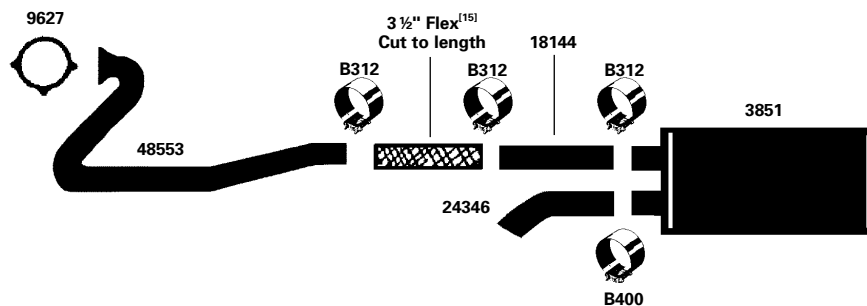

4000 SERIES CHASSIS - 1 1/2 TON & OVER

INTERNATIONAL

1993 6 Cyl. 4000, DT/DTA360; L.H. Frame Mounted; Long Tail Pipe; Side Exit; **(200273)**
Code 07AAV

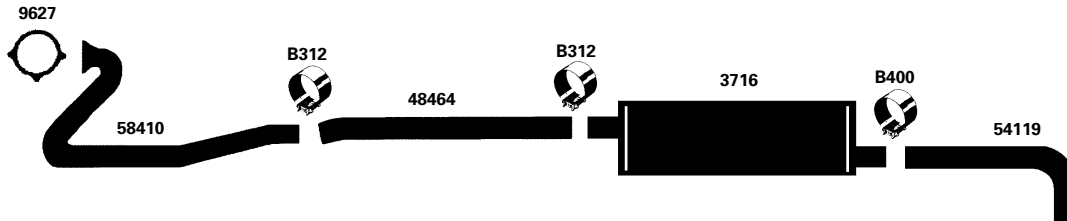

1993 8 Cyl. 4000, 7.3L Diesel Engine; R.H. Cab Mounted Vertical Tail Pipe **(200274)**

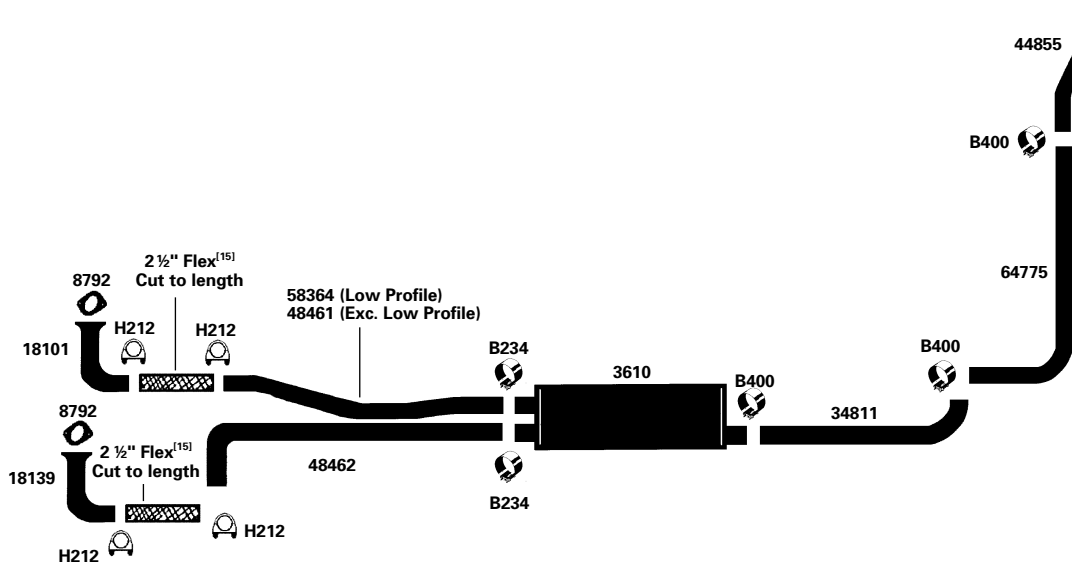

1993 6 Cyl. 4000, DT/DTA466 Diesel Engine; L.H. Cab Mounted Vertical Tail Pipe; **(200275)**
Codes 07ACW. 2004 & 2006

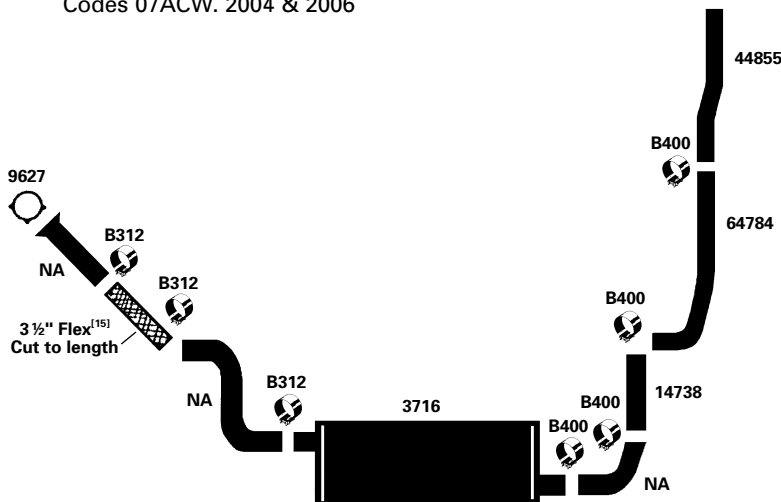

4000 SERIES CHASSIS - 1 1/2 TON & OVER

INTERNATIONAL

1993 6 Cyl. 4700 w/ DT 360 Diesel Engine; R.H. Side Mounting (Exc. Beverage Body) **(200276)**
90-92 6 Cyl. 4700 w/ DT/DTA 360 Diesel Engine; R.H. Side Mounting (Exc. Beverage Body)

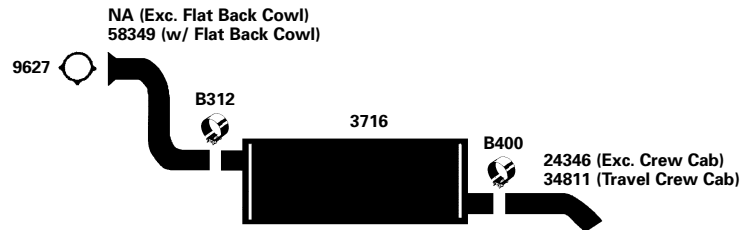

91-93 8 Cyl. 4000, 7.3L Diesel Engine; Long Tail Pipe; R.H. Mounting (Exc. Low profile) **(200277)**
 Code 07AAX

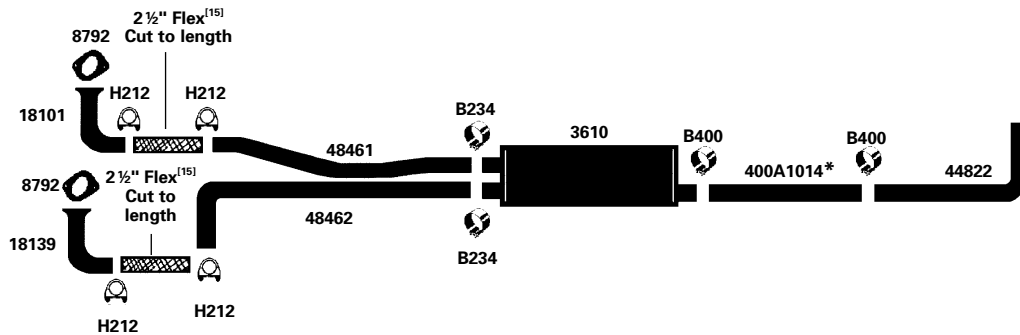

* Cut to length

91-93 8 Cyl. 4600LP, 4600UH, 7.3L Diesel Engine; Long Tail Pipe; R.H. Mounting; Low Profile **(200278)**

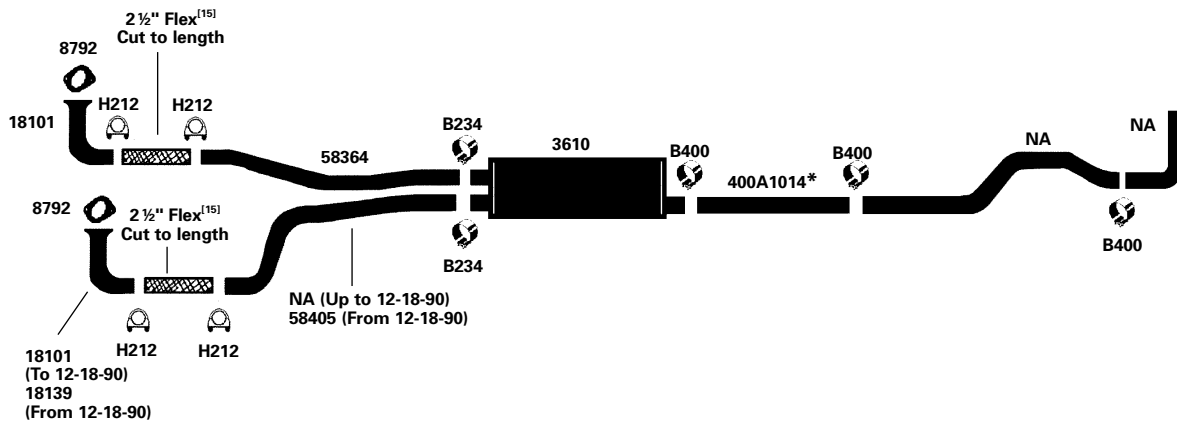

* Cut to length

See page 127 for footnote explanations

MEDIUM & H.D.
APPLICATIONS

4000 SERIES CHASSIS - 1 1/2 TON & OVER

INTERNATIONAL

91-93 6 Cyl. 4000, DT/DTA360 Diesel Engine; Travelcrew Cab; R.H. Cab Mounted Tail Pipe; Code 07ACY **(200351)**

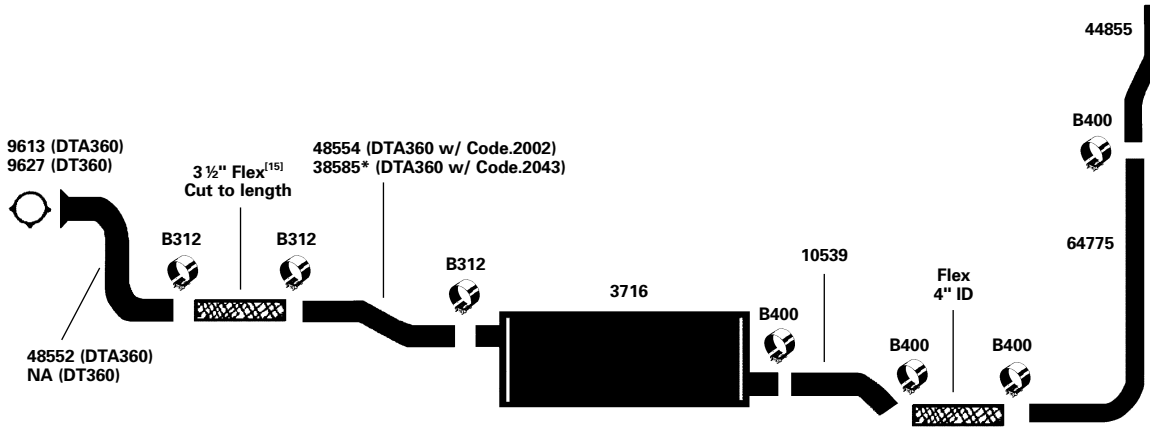

1993 6 Cyl. 4000, DTA360 Diesel Engine; R.H. Frame Mount (Exc. Beverage Body) **(200279)**

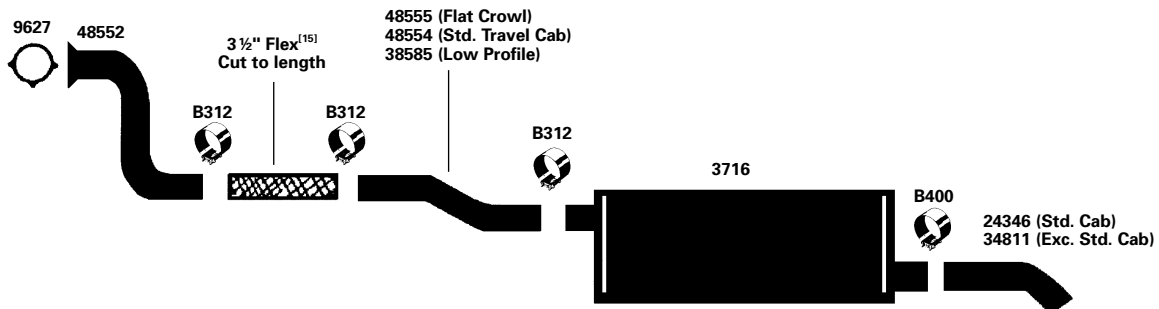

91-93 6 Cyl. 4000, DT/DTA466 Diesel Engine; R.H. Muffler Mounted 30" Back of Cab; Code 07AAK **(200280)**

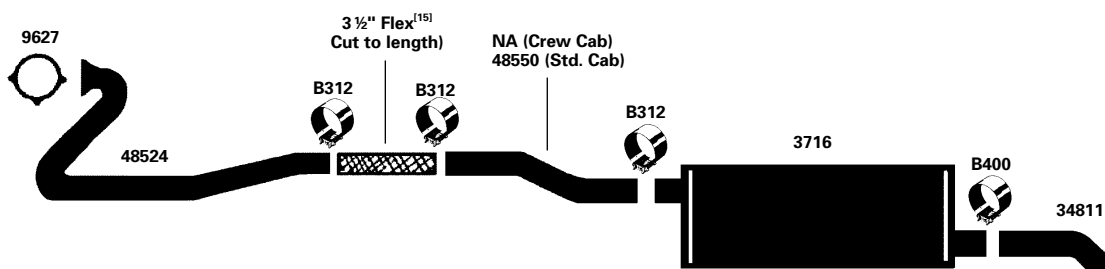

4000 SERIES CHASSIS - 1 1/2 TON & OVER

INTERNATIONAL

91-93 6 Cyl. 4000, DT/DTA466 Diesel Engine; R.H. Muffler Mounted 8" Back of Cab; Code 07AAE **(200281)**

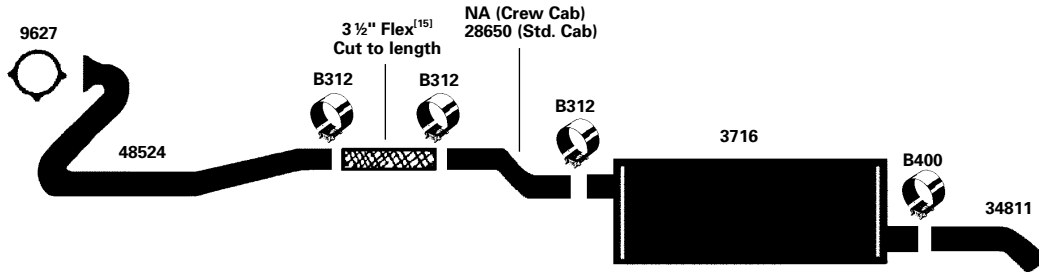

91-93 6 Cyl. 4000, DT/DTA466 Diesel Engine; Std. Cab; L.H. Cab Mounted Vertical Tail Pipe **(200282)**

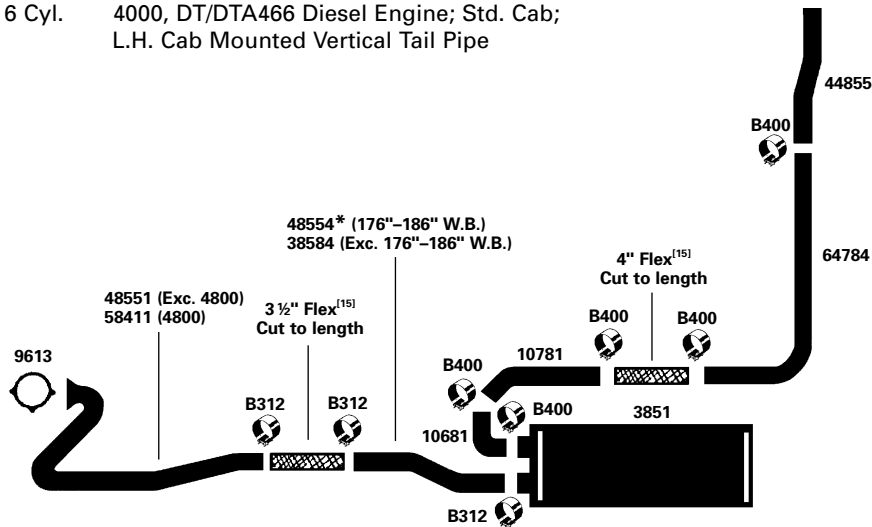

* Cut to length

91-93 8 Cyl. 4900, DT/DTA466 Diesel Engine; R.H. Cab Mount Tail Pipe; Codes 07ACY.2003, 2019, 2022, 2030, 2052, 2054 **(200283)**

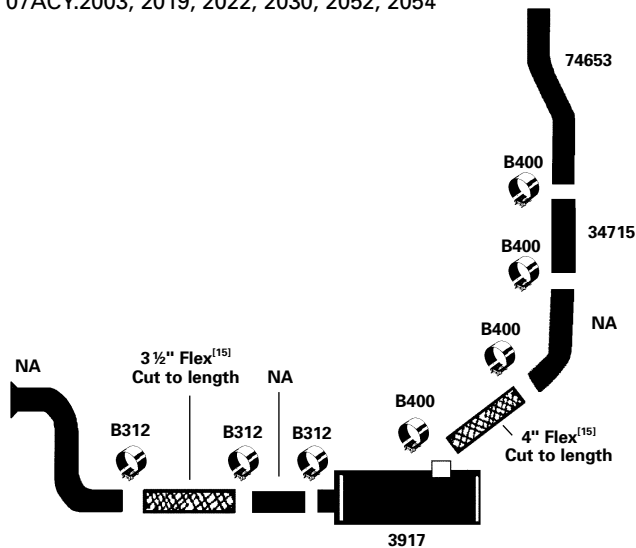

4000 SERIES CHASSIS - 1 1/2 TON & OVER

INTERNATIONAL

91-93 6 Cyl. 4000, DT/DTA466 Diesel Engine; Travelcrew Cab; L.H. Cab Mount Tail Pipe **(200284)**

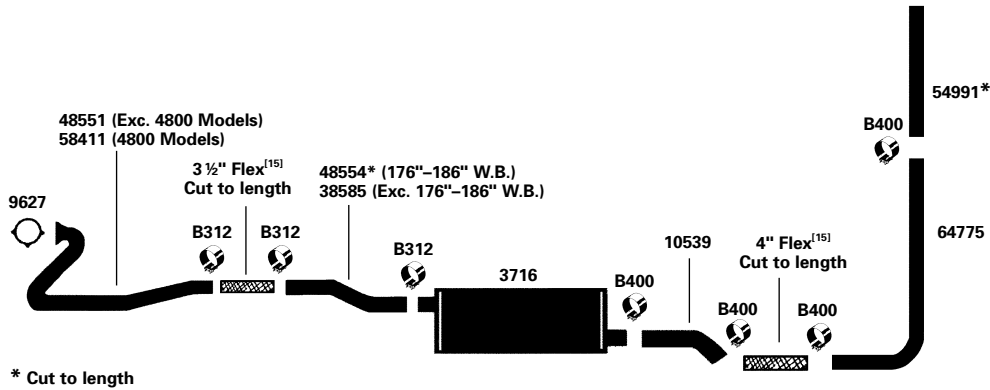

88-93 8 Cyl. 4600; 7.3L Diesel Engine; L.H. Side Mounting **(200285)**

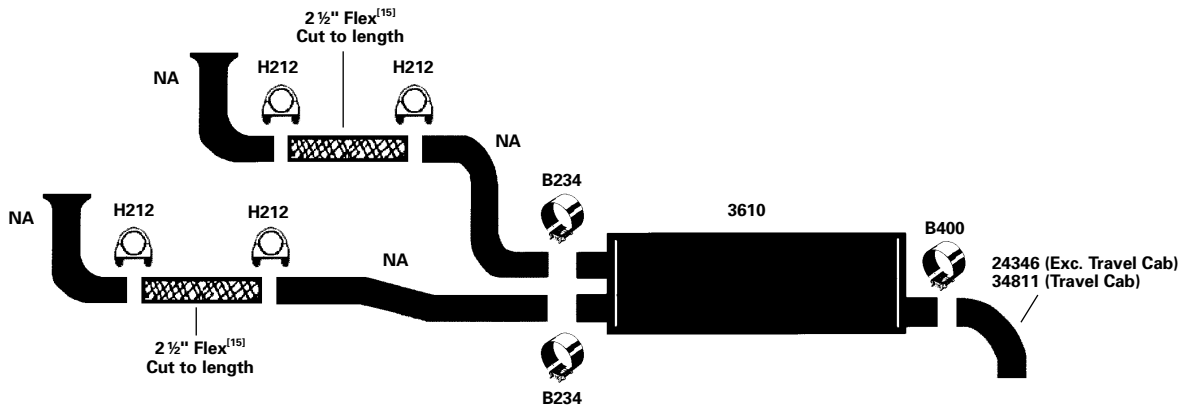

88-93 6 Cyl. 4000, DT/DTA360 Diesel Engine; L.H. Frame Mount; Codes 07AAZ.2003, .2003, .2010, .2011, .2012 **(200286)**

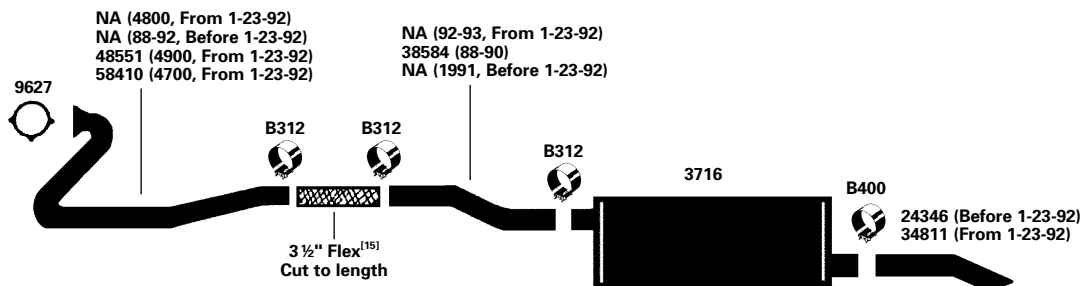

MEDIUM & H.D.
APPLICATIONS

4000 SERIES CHASSIS - 1 1/2 TON & OVER

INTERNATIONAL

88-93 6 Cyl. 4700, 4900, DT/DTA360, DT/DTA466 Diesel Engine; R.H. Cab Mount Tail Pipe; Codes 07ACR, 07ACY.2001, 2016, 2053, (1991 and later) **(200287)**

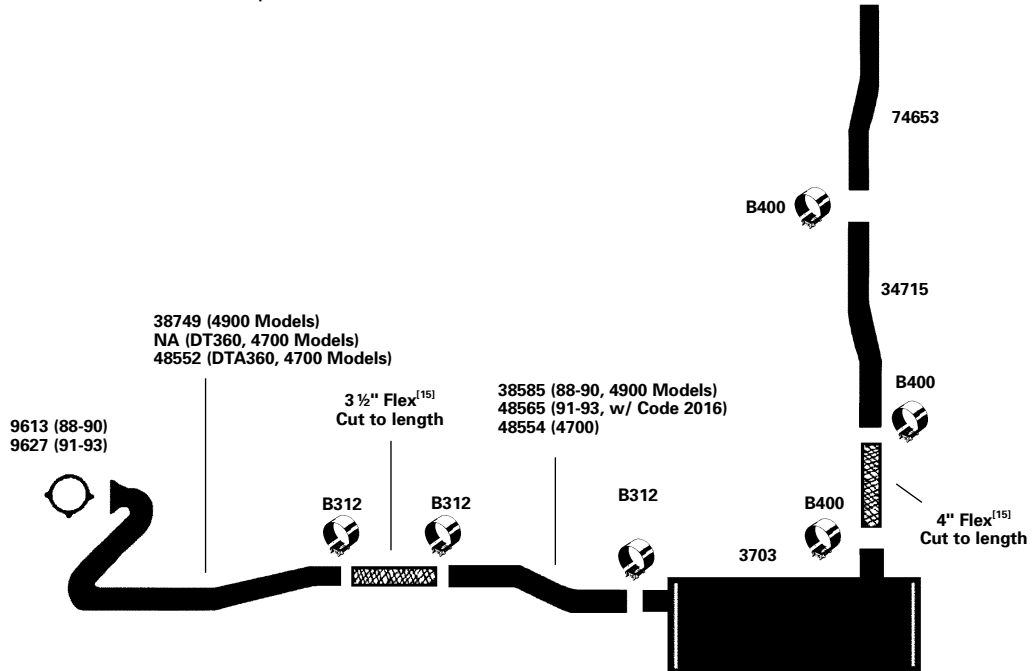

88-93 6 Cyl. 4000; DT/DTA360 Diesel Engine; STD. Cab; L.H. Cab Mounted Vertical Pipe **(200288)**

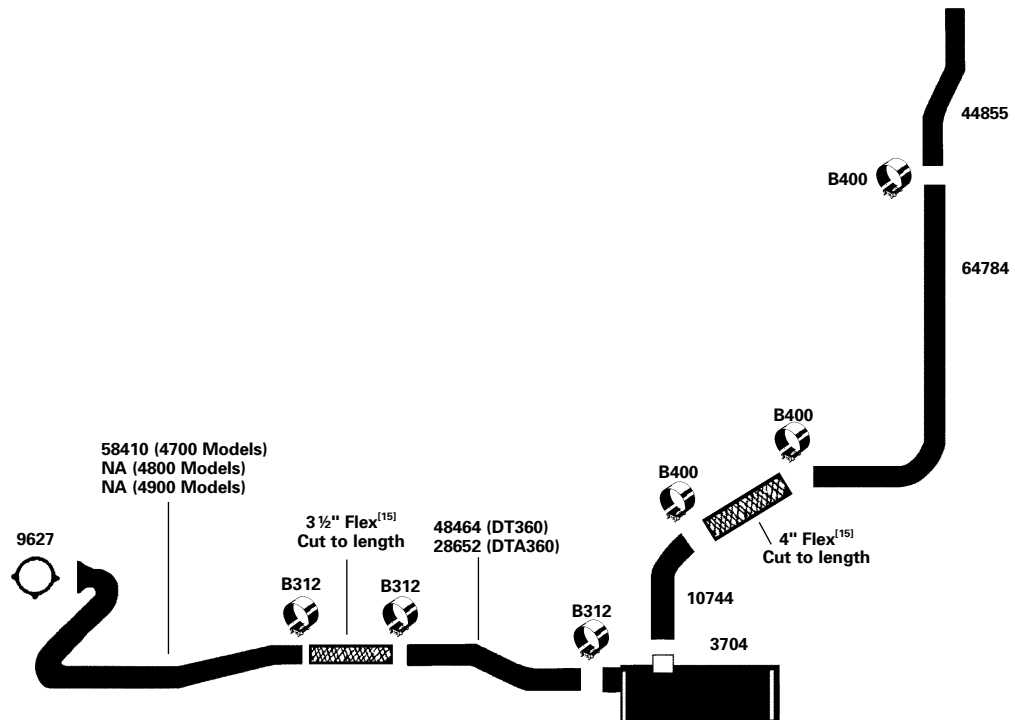

4000 SERIES CHASSIS - 1 1/2 TON & OVER

INTERNATIONAL

88-93 6 Cyl. 4700, 4900, DT/DTA360, DT/DTA466 Diesel Engine; R.H. Cab Mount Tail Pipe; Codes 07ACS, 07ACT, 07ACX, 07ACY.2014, 2025, 2026, 2038, 2041, 2048, 2050, 2051, 2056, 2057 **(200296)**

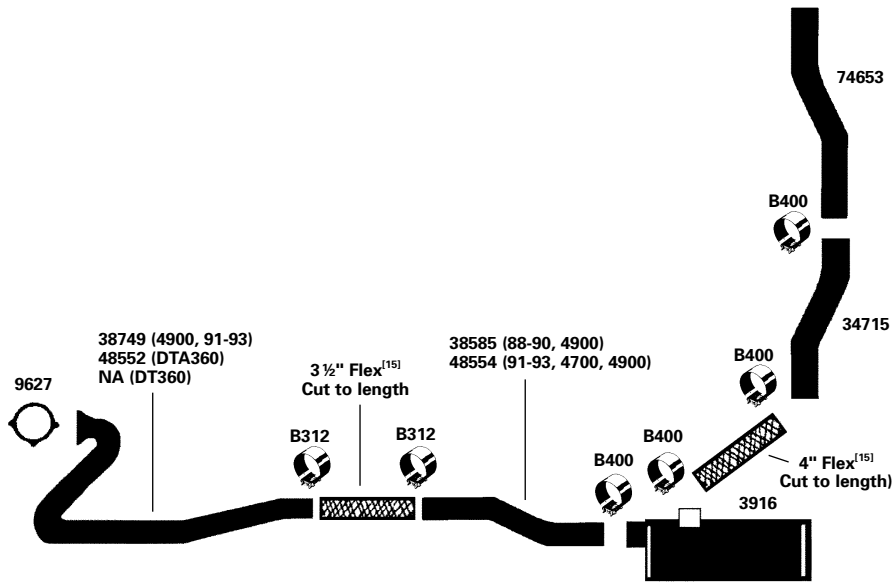

88-93 6 Cyl. 4000 Series; DT/DTA 466 Diesel Engine; L.H. Side Mount; Codes 07AAZ.2006, .2007 **(200297)**

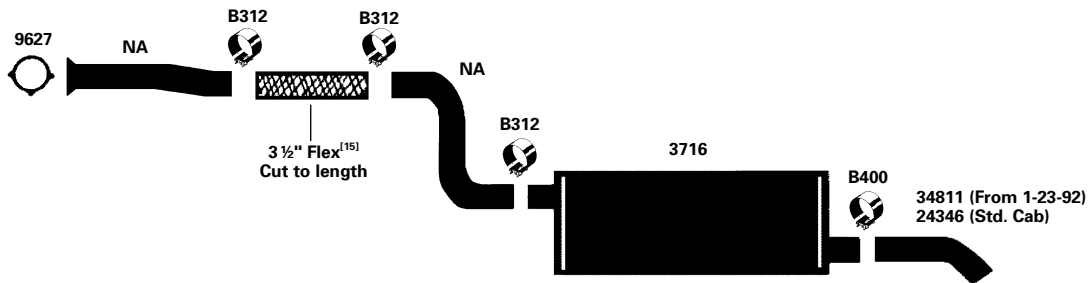

DIRECT FIT MAXIMUM MUFFLER...6585

88-93 6 Cyl. 4000 Series; DT/DTA 466 Diesel Engine; L.H. Side Mount; Codes 07AAZ.2002, .2003, .2010, .2011, .2012 **(200298)**

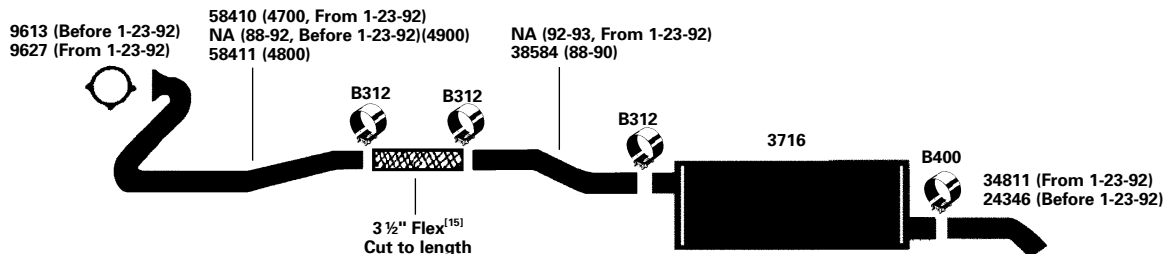

4000 SERIES CHASSIS - 1 1/2 TON & OVER

INTERNATIONAL

88-93 6 Cyl. 4000 Series; DT/DTA 466 Diesel Engine; (After 01-01-1988);
L.H. Side Mount; Codes 07AAZ.2001, .2008, .2009

(200299)

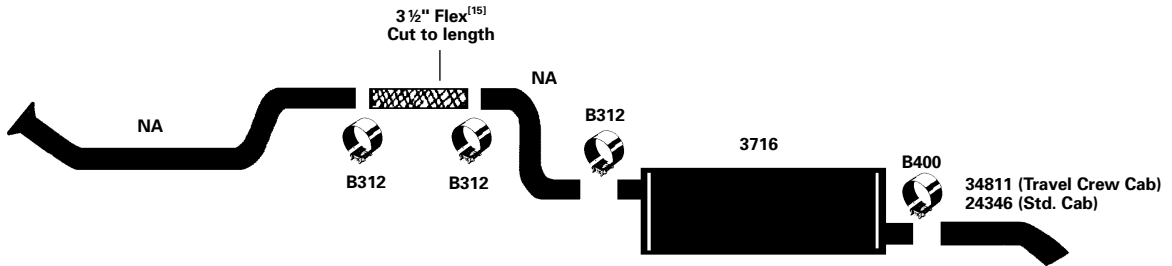

7000 SERIES CHASSIS - 1 1/2 TON & OVER

INTERNATIONAL

88-93 6 Cyl. 4700, 4900; DT360, DT/DTA466 Diesel Engine; R.H. Frame Mount
Vertical Muffler; Codes 07AWB, 07AWC.07554

(200300)

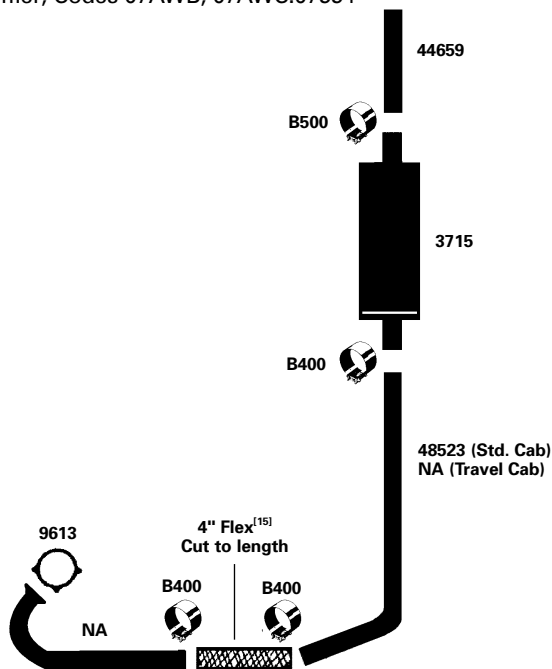

7000 SERIES CHASSIS - 1 1/2 TON & OVER

INTERNATIONAL

89-92 6 Cyl. 7100, DT/DTA466 Diesel Engine; R.H. Mount; Code 07AAY **(200301)**

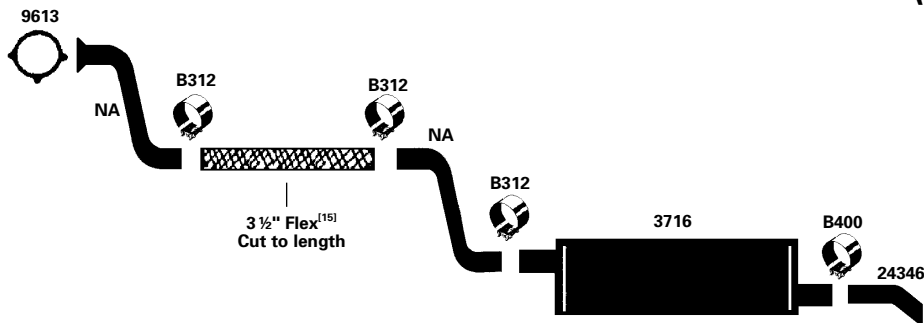

FLEETSTAR, CARGOSTAR, LOADSTAR, SERIES "S"

INTERNATIONAL

86-88 6 Cyl. Series "S"; DT/DTA466 Diesel Engine; (Before 01-01-1988); STD. Cab; R.H. Cab Mount Vertical Tail Pipe **(200302)**

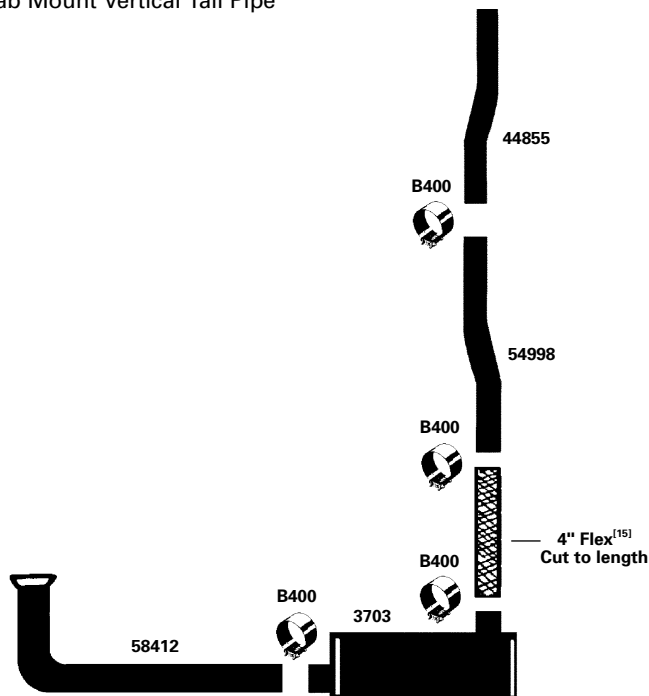

MEDIUM & H.D.
APPLICATIONS



HD EXHAUST
MEDIUM & H.D. APPLICATIONS

INTERNATIONAL HARVESTER

YEAR	CYL.	TONS	MAKE & MODEL	EXH. PIPE	MUFFLER	TAIL PIPE
IH Metro Series (Step Van)					1.5 TON & OVER	
65-72	6		M1600, M1700, MC1600, MC1700; Metro		2704	24344
65-72	8		M1600, M1700, MC1600, MC1700; Metro		2704	24344
59-64	6		AM160, AMC160		3654	14343
59-64	8		AM160, AMC160		3654	14343
57-59	6		A160, A160 - 4X4, AC160; (exc. Low Frame)		2704	24644
IH-Fleetstar, Cargostar, Loadstar, Series "S"					1.5 TON & OVER	
83-88	8		Series "S"; 6.9L Diesel Engine; All W.B.; Flex Tubing		3610	24346
81-88	6-8		Series "S"; 2500, 2600 Models; 3406 CAT, 6V-92 & 8V71T Detroit Diesel, Turbo Diesel Engines		3933	
79-86	6		Series "S"; DT466 Diesel Engine; Vertical Tail Pipe		3703	
79-86	8		Series "S"; 3208 Turbo Diesel Engine; Vertical Tail Pipe		3703	
79-86	8		Series "S"; DT466, 466B Diesel Engine; 4x2, 6x4 (Exc. Aux. Trans. Code 13552)		3704	24346
79-83	8		Cargostar; V555 Diesel Engine; Vertical Tail Pipe		3670	
72-83	6		Cargostar; RD406, RD450, RD502 Engine		3663	24344
71-83	8		Cargostar; MV404 C.I.D.; Gas Engine		2704	24344
1981	8		Series "S"; D150, 170, 190 Diesel Engine; 4x2, 4x4, 6x4, 6x6 Models for Aux. Trans.; Code 13552		3610	24346
73-80	8		CO1610, CO1710, CO1810 C Cab over Cargostar Models; Tilt with 266, V304, V345, V392 C.I.D.; Gas Engine		609	14342
77-78	8		Fleetstar 2050 Vertical Tail pipe; 3208 Diesel Engine		3705	
77-78	8		Fleetstar 2050, 2070; 3208 Diesel Engine; Horizontal Tailpipe		3632	24346
75-78	8		Loadstar; MV404, 466 C.I.D., Single		2704	24344
75-78	8		Loadstar; MV404, 466 C.I.D., Dual		3908	14343
73-78	8		1600, 1700, 1800, F1800, 1890 Loadstar; V345, V392 Gas Engine (Exc. 4 W.D. & Tilt)		2704	24344
73-78	8		1600, 1700 Loadstar; 4 W.D.		2704	14342
73-78	8		CO190, COF190, CO200, CO220, VCO190, VCO200, VCO220, VCOF190, COF1910A, CO1910A; Dual Inlet & Single Outlet; 401, 478, 549 C.I.D. Gas Engine		3663	24344
73-78	8		2110A, 1910A, 2010A, F2010A, CO190, CO200, COF190, CO220, CO1910A, COF1910A; 401, 478, 549 C.I.D. Gas Engine		609	14342
73-78	8		1600, 1700, F1700, F1800; Loadstar; V304 Gas Engine (Exc. 4 W.D. Tilt)		609	14342
71-78	8		Cargostar/Loadstar; 304, 345 C.I.D.		3906	14342
75-76	8		Fleetstar 2050; Vertical Tail Pipe; 3208 Diesel Engine (Caterpillar Engine); (After 02-24-75)		3705	
75-76	8		Fleetstar 2050, 2070; Horizontal Tail Pipe; 3208 Diesel Engine; (After 02-24-75)		3632	24346
72-76	8		Loadstar; VS401, 478 C.I.D.		3614	24346
72-76	6		Loadstar; RD406, RD450 C.I.D.		3663	24344
1975	8		Fleetstar 2050; Vertical Tail Pipe; 1160 Diesel Engine; (Before 02-24-75)		3705	
1975	8		Fleetstar Cab 2050, 2070; Horizontal Tail Pipe; 1160 Diesel Engine; (Before 02-24-75)		3632	24346

MEDIUM & H.D. APPLICATIONS

INTERNATIONAL HARVESTER

YEAR	CYL.	TONS	MAKE & MODEL	EXH. PIPE	MUFFLER	TAIL PIPE
IH-Fleetstar, Cargostar, Loadstar, Series "S" (Cont.)			1.5 TON & OVER			
73-75	6		CO190, COF190, CO200, 210, F210, CO220, F230, M-412-10, M-623-10, 1910A, F1910A, 2010A, F2010A, 2070A, F2070A, 2110A, M-6123-10; 406, 450, 501 C.I.D. Gas Engine		3663	24344
72-73	8		2050A, F2050A, COF1950, M412-50, M623-50, M6123-50; 549 C.I.D.; (DV-550) Diesel Engine		3614	24346
70-73	8		M623-10, M6123-10, 210, F210, F230, M412-10; 401, 478, 549 C.I.D.; Gas Engine		3662	24344
71-72	8		CO190, COF190, CO200, 210, F210, CO220, VC190, VCO200, F230, M-412-10, M-623-10, VC220, VCOF190, 1910A, F1910A, 2010A, F2010A, 2070A, F2070A, 2110A, M-6123-10; 406, 450, 501 C.I.D. Gas Engine		3663	24344
71-72	8		2110A, 1910A, 2010A, F2010A, CO190, COF190, CO200, 210, F210, CO220, VCO190, VCOF190, VCO200, VCO220, CO1910A, M623-10, M6123-10, 210, F210, F230, M412-10, COF1910A; 401, 549, 478 C.I.D.; Gas Engine		609	14342
70-72	6		1700, F1700, 1800, F1800, 1890; Loadstar; BD282, BD308 Gas Engine		609	14342
70-72	8		1600, 1700, 1800, F1800, 1890; Loadstar; V345, V392 Gas Engine (Exc. 4 WD & Tilt)		2704	24344
70-72	8		1600, 1700 Loadstar; 4 WD		2704	24344
70-72	8		CO1610, CO1710, CO1810; Cab over Cargostar Models; Tilt; V266, V304, V345, V392 Gas Engine		609	14342
1970	6		M412, M623, M6123, M8234; 406, 450 C.I.D. Gas Engine		3662	24344
1970	8		Cargostar; 550B Diesel Engine; Vertical Tail Pipe		3670	
68-69	6		R185, R190, RF190, CO190, COT195, R200, RF200, CO200, R210, RF210, R220, RF220, CO220		3662	24344
68-69	8		2010A, F2010A, 2110A; w/104, 478, 549 CID		609(2)	14342(2)
66-69	8		1900, 2000, COF4000, COT4000, F1900, M623 CBE, T1900; w/401, 478, 549 CID		3663	24344
66-69	6		1900, 2000, F1900, T1900, 2010A, F2010A, 2110A, M263 CBE; w/406, 450 or 501 CID		3663	24344
66-69	8		V-190, VF-190, V-200, VF210, V-220, VF-230, VT-195, VCO-190, VCOF-190, VCOT-195, VCO-200, VCO-220, CO8190; w/401, 478 or 549 CID		3662	24344
63-69	6		1600, 1700, CO1600 Loadstar w/BD264, BG265 Gas Eng.		3906	14342
63-69	6		1700, F1700, 1800, F1800, 1890 Loadstar w/BD282, BD308 Gas Eng.		609	14342
63-69	8		1600, 1700, F1700, F1800 Loadstar w/V266, V304 Gas Eng. (exc. 4WD & Tilt)	28169	609	14342
63-69	8		1700, 1800, F1800, 1890 Loadstar w/V345, V392 Gas Eng., (exc. 4WD & Tilt)	28169	2704	24344
63-69	8		CO1600, CO1700, CO1800, Loadstar-Tilt w/V266, V304, V345, V392 Gas Eng.		2704	24344
63-69	8		1600, 1700 Loadstar w/V266, V304, V345 Gas Eng.-4WD	28169	2704	24344
66-67	6		R185, R190, RF190, CO190, COT195, R200, RF200, CO200, R210, RF210, R220, RF230, CO220; After Chassis No. 32953		3662	24344

MEDIUM & H.D. APPLICATIONS



HD EXHAUST
MEDIUM & H.D. APPLICATIONS

INTERNATIONAL HARVESTER

YEAR	CYL.	TONS	MAKE & MODEL	EXH. PIPE	MUFFLER	TAIL PIPE
			IH-Fleetstar, Cargostar, Loadstar, Series "S" (Cont.)	1.5 TON & OVER		
63-69	8		1600 Loadstar w/V266 Gas Eng. (exc. 4WD & Tilt)	28169	609	14342
1965	6-8		CO-4000D, COF-4000D, COT-4000D		3897	24750
1965	8		CO-4000, COF-4000, COT-4000		3662(2)	24344(2)
62-65	6		1900, 2000, F1900, T1900		3663	24344
62-65	8		1900, 2000, F1900, T1900		3662	24344
61-65	8		210D, F-210-D, F-230-D, D-400, DF-400, DT-400, D-405, DF-405, DT-405, DC-400, DCF-400, DCT-400, DC-405, DCF-405, DCT-405		3891	24346
58-65	8		ACO-220, ACOF-190, ACOF-200, CO-190, CO-200, 210, F-210, F-230, CO-220, COF-190, COF-200, R-190 (4x4), R-210 (4x4), VF-190, VF-200, VF-210, VCOF-190, VCOF-200, VCO-190, VCO-200, VCO-220, VCO-400, VCO-405		3662	24344
56-65	6		R185, R190, RF190, CO190, COF190, RT195, R200, RF200, CO200, COF200, R210, RF210, R220, CO220; After Chassis No. 32953		3662	24344
56-65	6		DCO-190, RD-190, RDF-190, RDT-190, DCO-195-H, RD-195, RDF-195, RDT-195, DCO-200, RD-200, RDF-200, RDT-200, DCO-205-HRD-205, RDF-205, RDT-205, RD-210, RDF-210, RDT-210, DCO-220, RD-220, RDF-220, RDT-220, RD-400, RDT-405		3662	24344
55-65	6		DCO-405, DCOF-405, DCOT-405		3891	24346
59-61	6		B140 (4x4), B150, B160, B160 (4x4), BC150, BC160, B170, B-180, BC-170, BC-180, BC-1890, BC-170 (4x4), BC-180 (4x4), BC-170, BCF-180, BCF-170 (6x6), BCF-180 (6x6)		609	14342
59-61	8		BC150, BC160 (4x4), BC160, B-170, BC-170, B-180, BC-180, BC-1890, BC-170 (4x4), BC-180 (4x4), BCF-170, BCF-180, BCF-170 (6x6) x/V266, V-304 Eng.		609	14342
57-59	6		AC160 w/Low Frame, A170, AC170, ACF170, AC170 (4x4), ACF170 (6x6), A180, AC180, ACF180, AC1890, AC180 (4x4), ACF180 (6x6)		609	14342
1956	6		R185, R190, RF190, CO190, COF190, R200, RF200, CO200, COF200, R210, RF210, R220, CO220; up to Serial 32953		3662	24344
53-55	6		R150, RM150, R160, R165, RC160 w/SC220 Eng.		3901	10921
53-55	6		R185, R190, RF190, RC190, R195, R200, RC200, R205, R210, RF210, R212, R220, R225, R230, CO190, CO200, CO220; All 3-1/2" Exh. Pipes w/RD372 Eng. After Ser. No. 24669, RD406 Eng. After Ser. No. 42781, RD450 Eng. After Ser. No. 36607		3662	24344
50-52	6		LM150, L160, L165, LC160		3654	
47-49	6		KB6, KBS6, KBS6T, KB6F, KBS6B, KB7, KBS7 Also COE Models		609	14342
41-46	6		K6, KS6, K7, KS7, K6T, KS6T, K6F, K6B, KS6B, K7 COE, KS7 COE w/FAC259A Eng. After Ser. No. 751; All BLD-269A Eng.		609	14342
38-49	6		D.K. SERIES; 1.5 Ton & Over		3901	10921

MEDIUM & H.D. APPLICATIONS

MERCEDES-BENZ

YEAR	CYL.	TONS	MAKE & MODEL	EXH. PIPE	MUFFLER	TAIL PIPE
1993	6		NPR; 6.5L Turbo Diesel Engine; 113", 177" W.B.		3726	24889
79-84	6		Models L1013, L1113; OM352NA Diesel Engine (Exc. Turbo)		2704	24344
78-84	6		Models L1116, L1316; OM352A Turbo Diesel Engine		2704	24344
78-84	5		Models L1418, LS1418; OM355/5 Diesel Engine		2704	24344

FOOTNOTES:

- [1] Original equipment system was welded assembly. It is recommended that all noted parts [1] to be replaced.
- [3] Required for installation.
- [12] Optional Heavy Duty Muffler.
- [15] See page 25 for flex options.
- [17] Separate tail pipe is included in carton with muffler.
- [18] Without windshield.
- [32] Remove and reuse O.E. heat shield, If required.
- [98] Refer to Current Converter Catalog.
- [346] For an explanation on model 81 Cab see page 12.
- [914] Direct fit converter includes front (exhaust) pipe, (1) piece assembly.
- [928] To 12,500 lbs. GVW-EPA; 11,620 lbs. GVW-CARB.
- Golden warehouse item.
- * New items



HD EXHAUST
SCHOOL BUS APPLICATIONS

SCHOOL BUS CONVERSION CHART

WHEEL BASE TO PASSENGER SEATING CAPACITY*

BLUEBIRD

WHEEL BASES	PASSENGER CAPACITIES
125"	19, 20, 21
149"	54
179", 186.5"	60
194", 201.5"	66
209", 216.5"	72
224", 231.5"	78
239", 246.5"	84
254"	90

CHEVROLET/GMC

WHEEL BASES	PASSENGER CAPACITIES
125"	17, 18, 19
149.5"	36
189", 189.5"	42, 48
218"	54
235", 235.5"	60
254"	66
274"	72

FORD

WHEEL BASES	PASSENGER CAPACITIES
151", 156"	36
192", 198"	48
216", 222"	54
237", 242"	60
255", 260"	66
275", 280"	72

INTERNATIONAL

WHEEL BASES	PASSENGER CAPACITIES
151", 152"	36, 39
168", 169", 170"	42, 45
187", 193"	48, 51
205", 217", 218"	54, 57, 63
236"	60
254"	66
275", 276"	72

* Excluding State of Texas.

Referring to and measurement of wheel base is the most reliable method of specifying exhaust system requirements.

BLUEBIRD SCHOOL BUS

05-07 6 Cyl. All-American Puller, CAT. 3126 & C7, w/o Pac Brake

(200500)

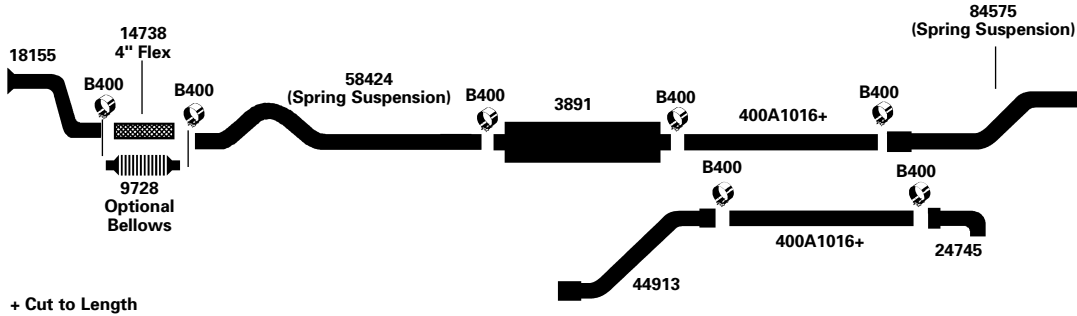

04-07 6 Cyl. All-American Pusher 3126 & C7 Caterpillar Pusher

(200501)

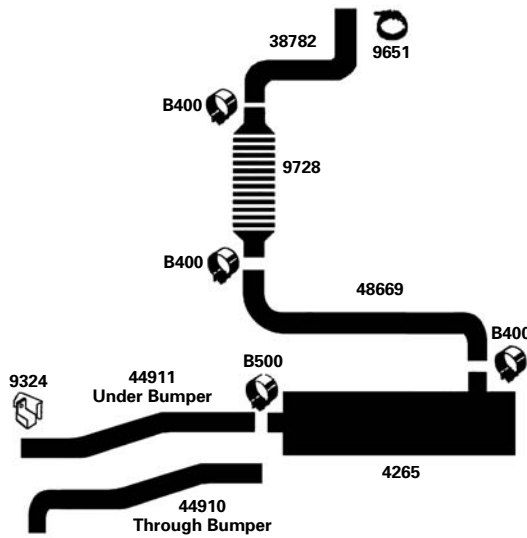

04-06 6 Cyl. Vision w/ 3126-C7 Caterpillar Engine

(200479)

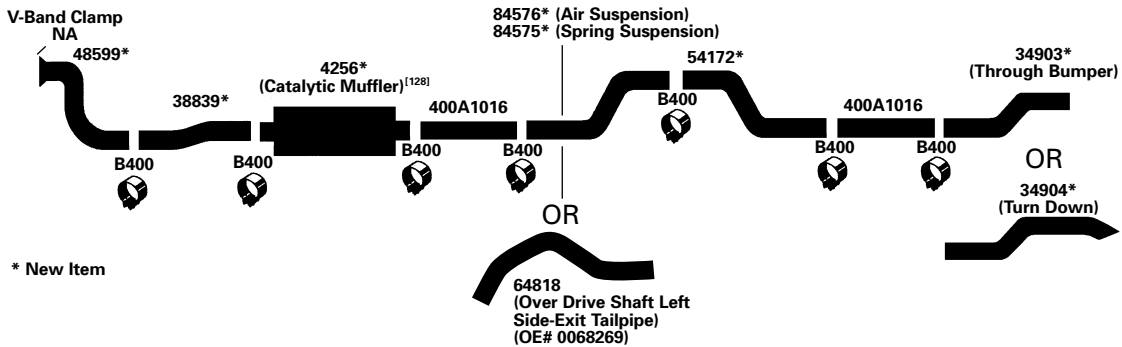

BLUEBIRD SCHOOL BUS

00-02 6 Cyl. B-Series All-American Pusher w/ 5.9L ISB Rear Engine

(200482)

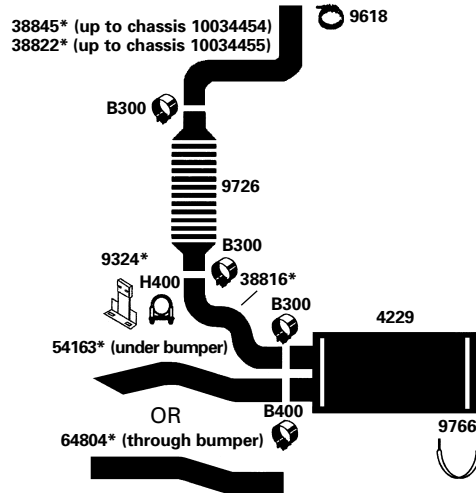

* New Item

99-02 6 Cyl. TC2000 Pusher w/ 3126 Caterpillar Engine

(200480)

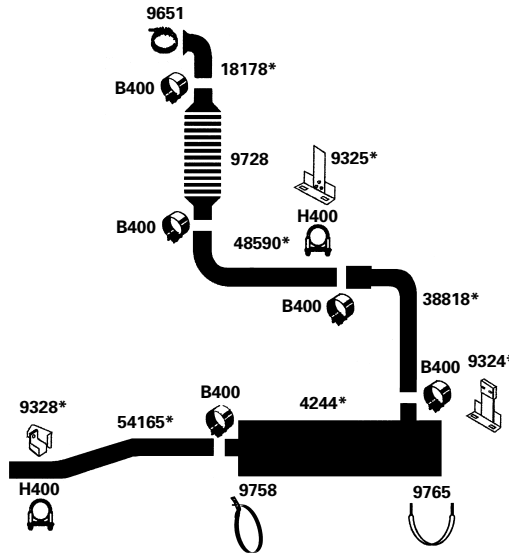

* New Item

98-02 8 Cyl. CV200 GMC B7 Conventional Chassis w/ 454-502 Engine

(200485)

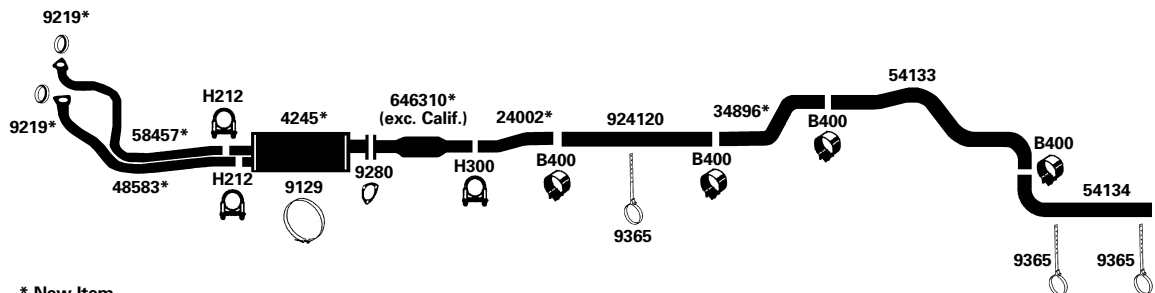

* New Item

See Page 152 for footnote explanations.

BLUEBIRD SCHOOL BUS

99-01 6 Cyl. All-American & TC2000 8.3 Cummins ISC

(200345)

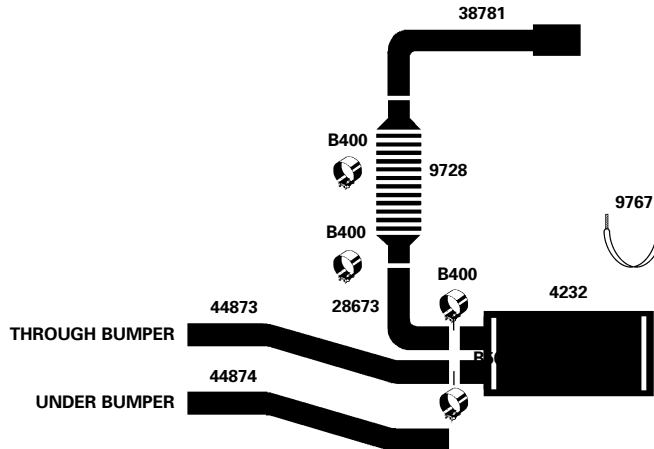

99-01 6 Cyl. All-American & 8.3 Cummins ISC w/ Left Hand 4" Tailpipe

(200502)

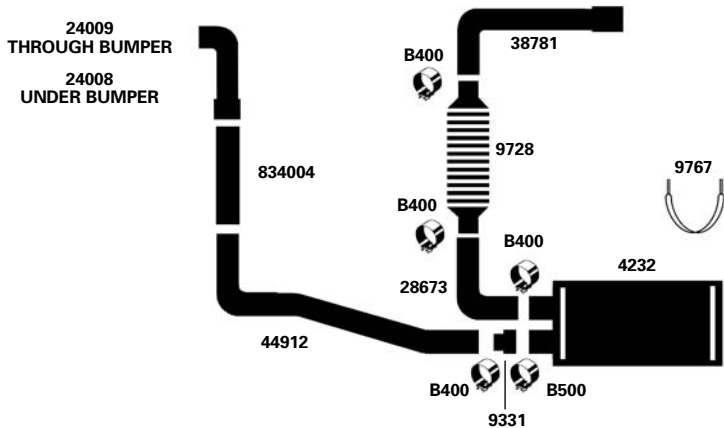

99-01 6 Cyl. All-American 3126 Caterpillar Pusher

(200346)

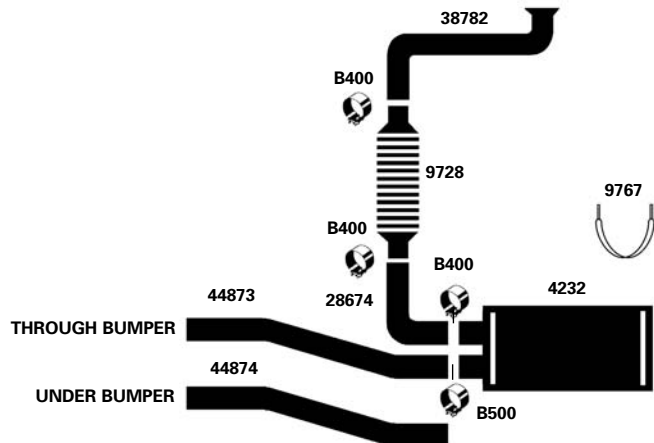

BLUEBIRD SCHOOL BUS

99-00 6 Cyl. All-American B-Series w/ Cummins Engine; 4" System

(200481)

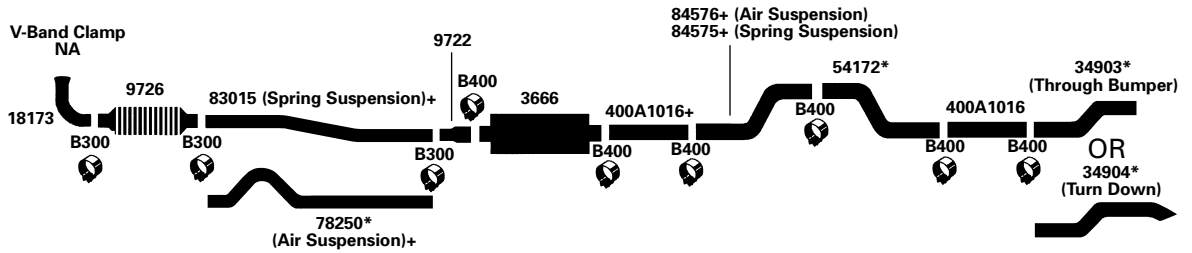

* New Item
+ Cut to Length

98-01 6 Cyl. All-American Puller, Cat. 3126 & Cummins 8.3 ISC Engines

(200347)

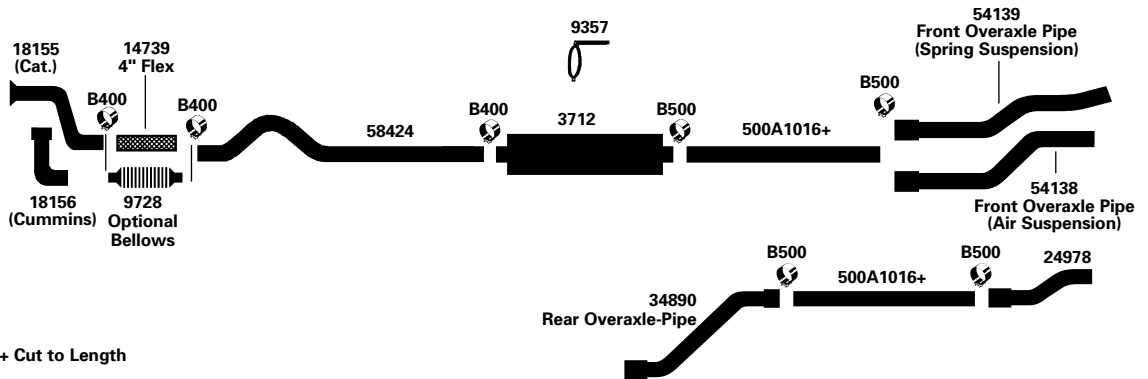

+ Cut to Length

98-01 6 Cyl. 3126 Cat Bluebird CV200; GMC B7 Conventional Chassis

(200348)

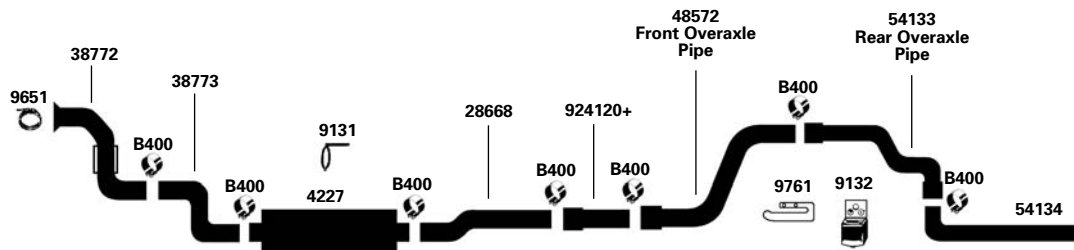

+ Cut to Length

BLUEBIRD SCHOOL BUS

97-00 6 Cyl. TC1000, 5.9L B-Series Cummins Engine; 132" Wheel Base **(200349)**

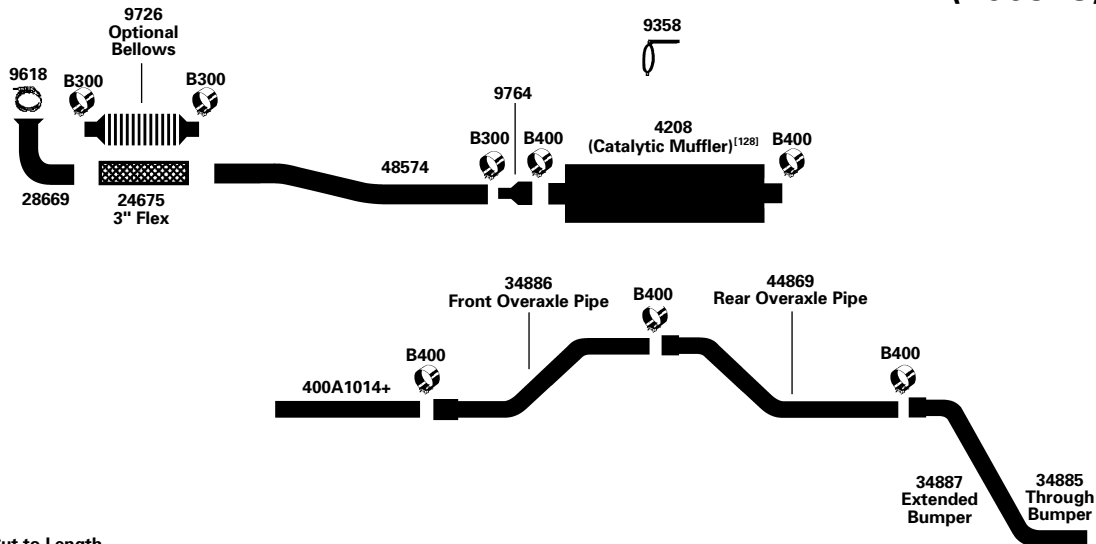

+ Cut to Length

95-98 6 Cyl. TC2000 w/ 6BTA; 5.9L Turbo Diesel; Rear Exit Tail Pipe; Side Mounted Fuel Tank; w/ Converter; 132", 146"-195", 216"-237" W.B. **(200353)**

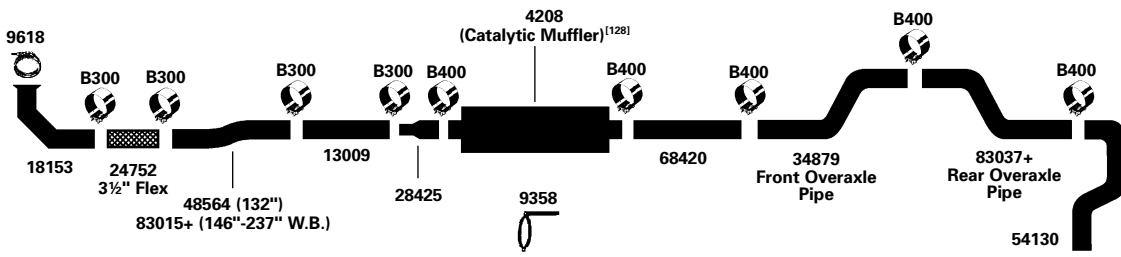

+ Cut to Length

94-98 6 Cyl. 3116 Cat Bluebird CV200; GMC B7 Conventional Chassis **(200350)**

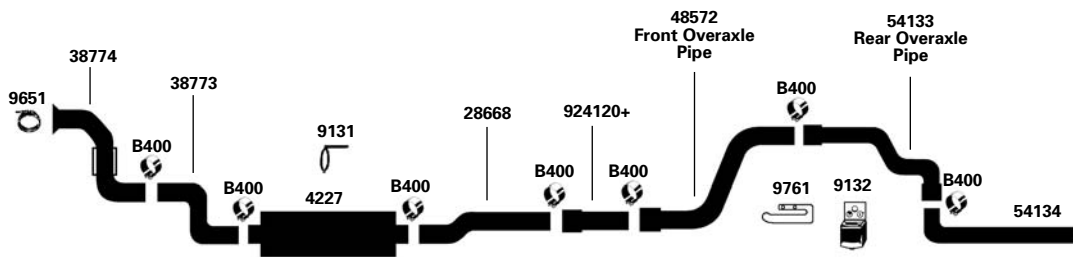

+ Cut to Length

See Page 152 for footnote explanations.

SCHOOL BUS APPLICATIONS

BLUEBIRD SCHOOL BUS

94-98 6 Cyl. TC2000 Rear Engine w/ Caterpillar 3116(6.6L) Diesel;
(To Chassis No. 991136)

(200357)

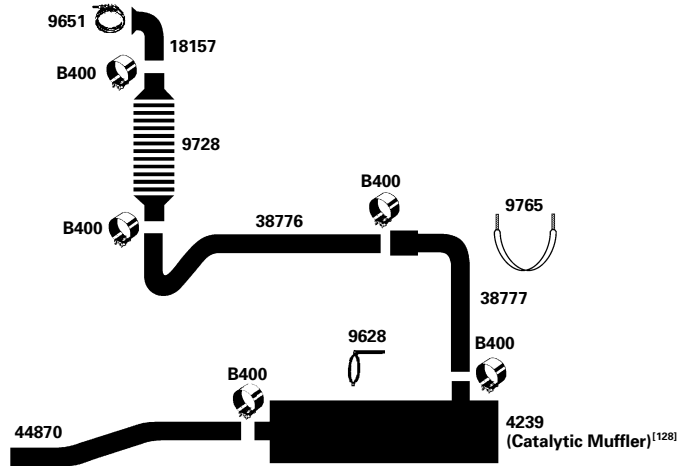

94-98 6 Cyl. TC2000 Pusher B-Series Cummins (From Chassis No. 991136)

(200358)

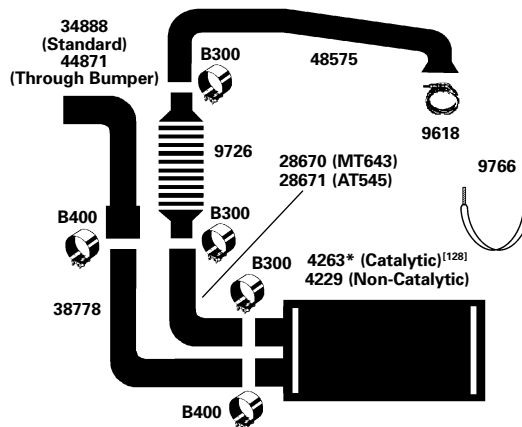

* New Item

94-98 6 Cyl. All-American 8.3 Cummins Rear Engine (To Chassis No. 991135)

(200359)

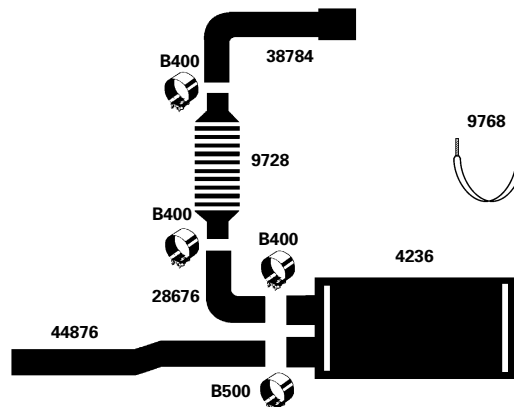

BLUEBIRD SCHOOL BUS

94-98 6 Cyl. All-American 8.3 Cummins Rear Engine; Catalytic Muffler; (From Chassis No. 991136) **(200360)**

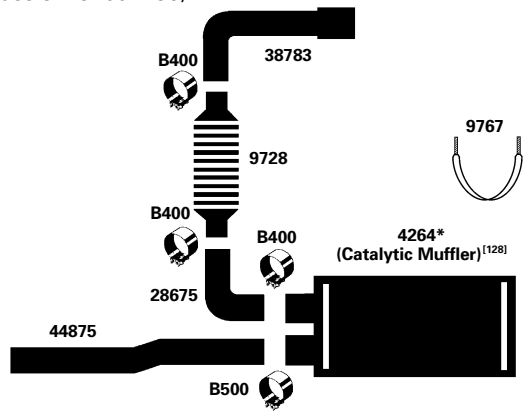

* New Item

94-98 6 Cyl. 8.3 Cummins TC2000 Rear Engine Catalytic Muffler; (From Chassis No. 991275) **(200361)**

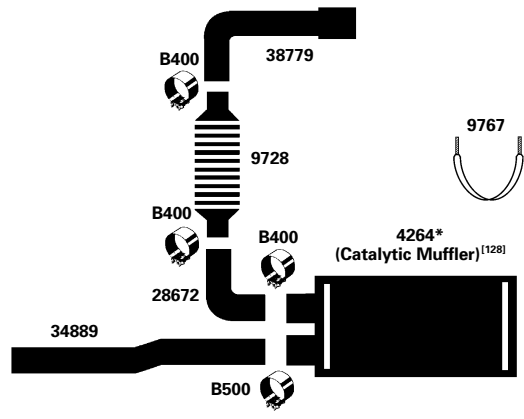

* New Item

94-98 6 Cyl. All-American w/ 3116 Caterpillar Rear Engine **(200483)**

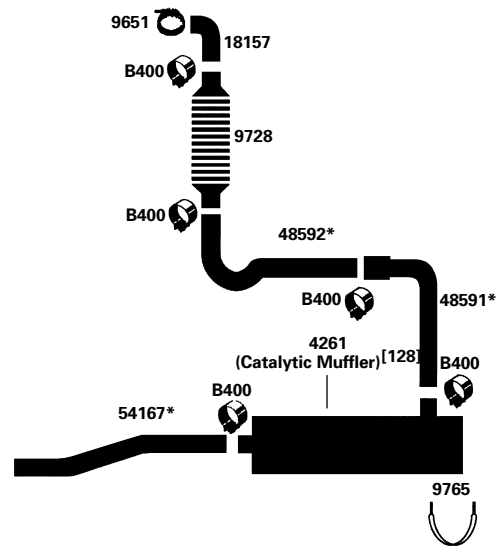

* New Item

See Page 152 for footnote explanations.

SCHOOL BUS APPLICATIONS

BLUEBIRD SCHOOL BUS

94-98 6 Cyl. TC2000, 5.9L B-Series Cummins Engine; w/ Air Ride Suspension; 174"-216" W.B., 237" W.B. **(200352)**

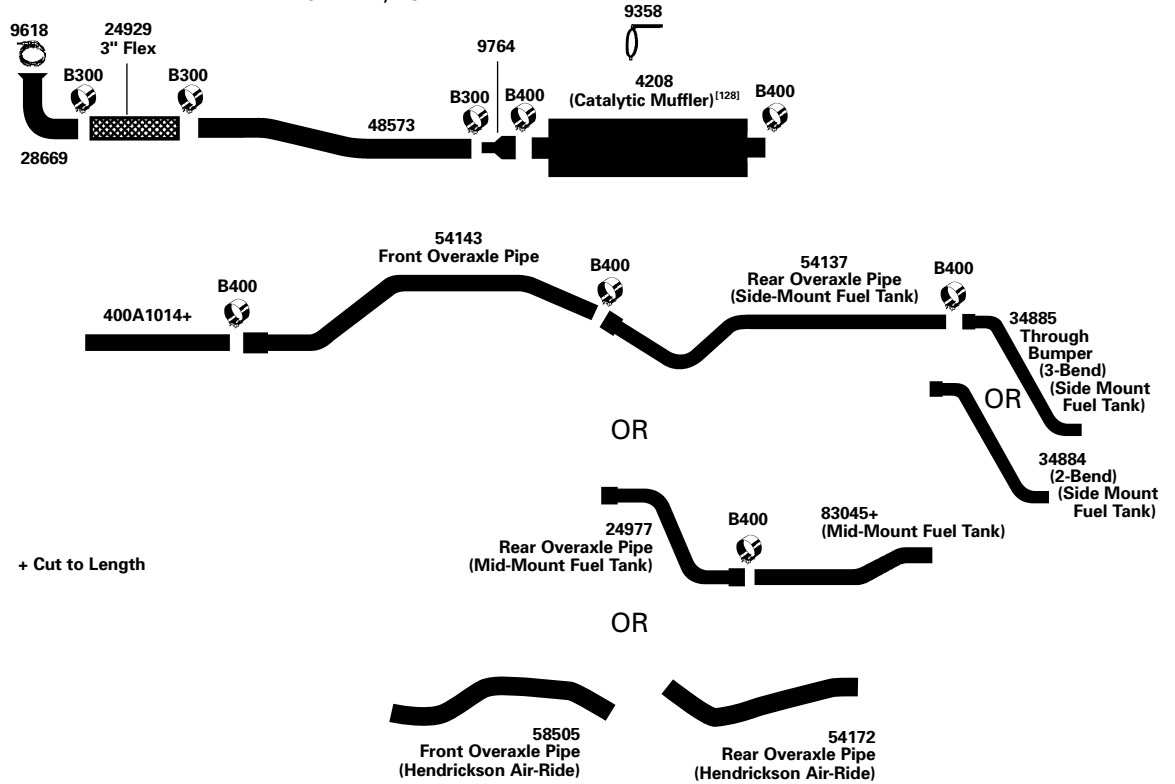

92-98 6 Cyl. All American w/ Cummins 8.3L Turbo Diesel; Spring Front Suspension; Mid Mounted Fuel Tank (From Chassis No. 977611); 5" Tail Pipe Through Rear Bumper; 175"-190", 197 1/2"-227 1/2", 235"-242 1/2" W.B. **(200354)**

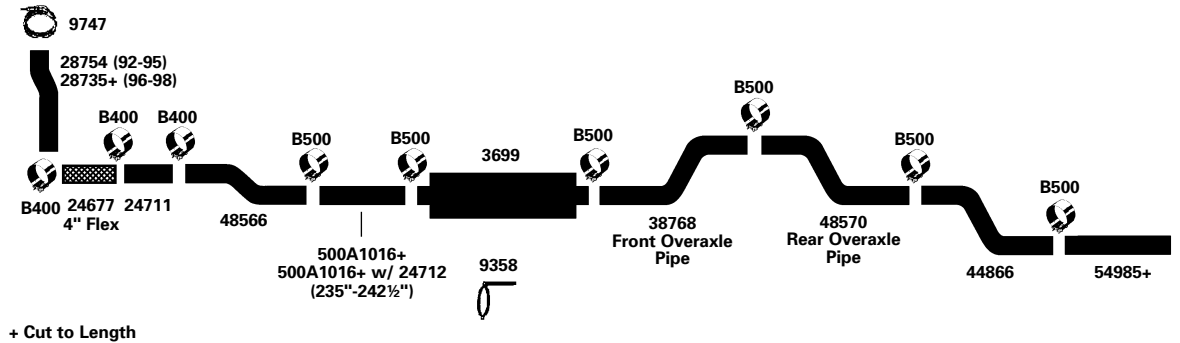

See Page 152 for footnote explanations.

BLUEBIRD SCHOOL BUS

92-98 6 Cyl. All American w/ Cummins 8.3L Turbo Diesel; **(200355)**
Spring Front Suspension; Side Mounted Fuel Tank
(From Chassis No. 977611); 5" Tail Pipe; 175", 190", 197 ½"-227 ½", 235"-242 ½" W.B.

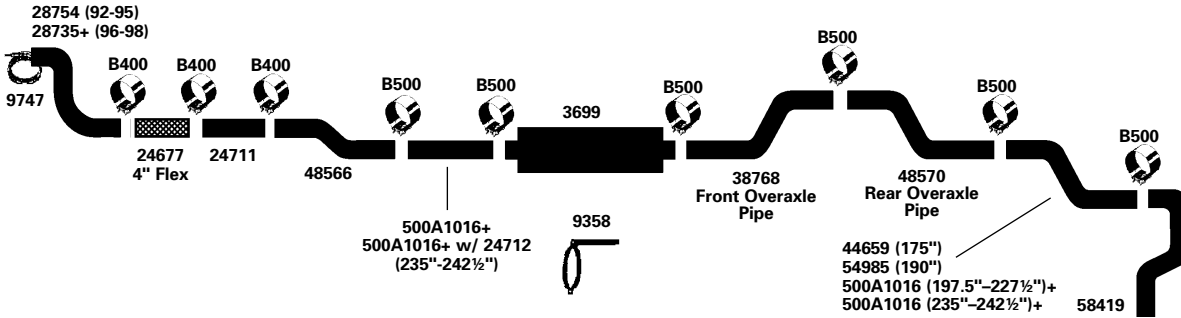

+ Cut to Length

92-98 6 Cyl. All American w/ Caterpillar 3116 (6.6L) Diesel; **(200356)**
Mid-Mounted Fuel Tank (From Chassis No. 977303);
5" Tail Pipe Through Rear Bumper; 175", 190"-227 ½", 235"-242 ½" W.B.

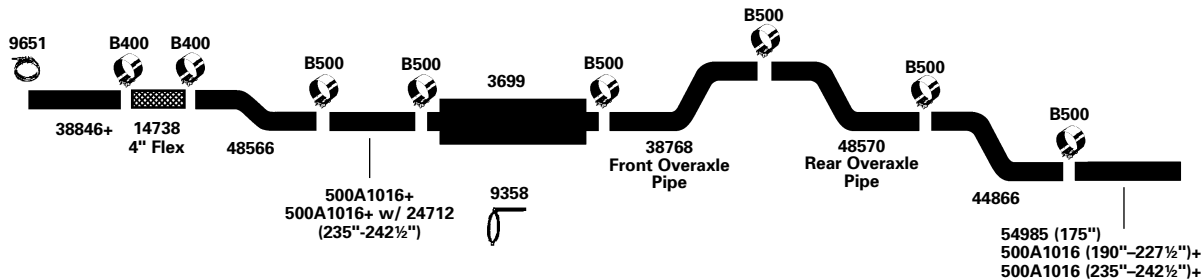

+ Cut to Length

92-98 6 Cyl. All American w/ Caterpillar 3116 (6.6L) Diesel; **(200496)**
Side-Mounted Fuel Tank (From Chassis No. 977303);
5" Tailpipe; 175", 190", 197 ½"-227 ½", 235"-242 ½" W.B.

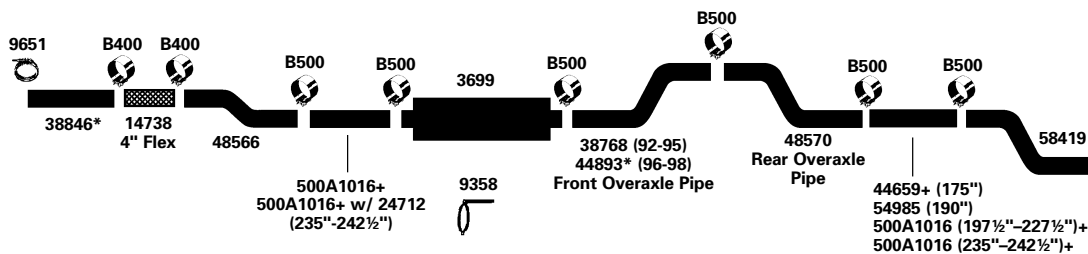

* New Item
+ Cut to Length

SCHOOL BUS
APPLICATIONS

BLUEBIRD SCHOOL BUS

92-98 6 Cyl. All American w/ Caterpillar 3116 (6.6L) Diesel; **(200373)**
Side Mounted Fuel Tank; 5" Tail Pipe (From Chassis No. 977303);
175", 190", 197 ½"-227 ½", 235"-242 ½" W.B.

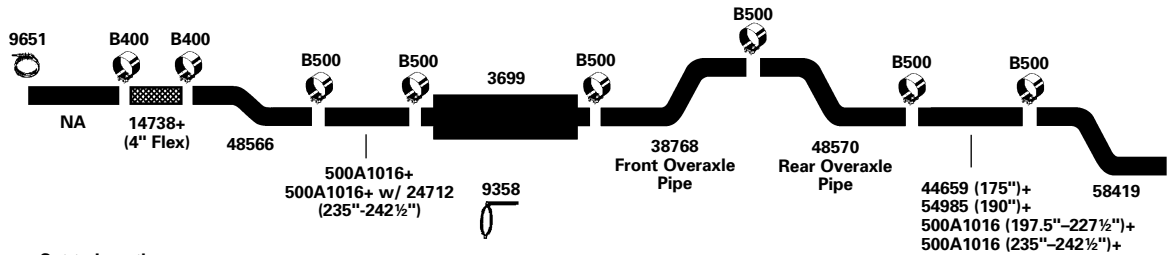

+ Cut to Length

88-97 6 Cyl. TC2000 w/ 6BTA; 5.9L Turbo Diesel; Rear Exit Tail Pipe; **(200367)**
Mid-Mounted Fuel Tank; w/ Codes 4452, 4453, 4513, 4514;
132", 146"-174", 195"-216", 237" W.B.

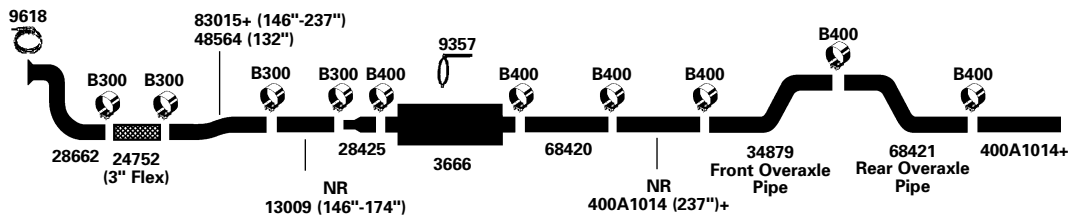

+ Cut to Length

92-95 8 Cyl. CV200 w/ 366, 427 C.I.D. gas Engine w/ Converter; **(200366)**
Tail Pipe Exits at the Rear of Bus; 145", 157"-193", 209"-261" W.B.

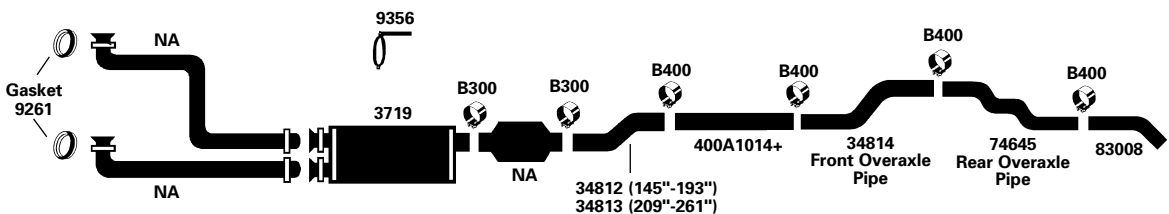

+ Cut to Length

92-95 8 Cyl. CV200; 366, 427 (6.0, 7.0) TBI Eng.; With Converter; **(200369)**
Tail Pipe Exits Side of Bus in Front of Rear Wheel; 145", 209", 261" W.B.

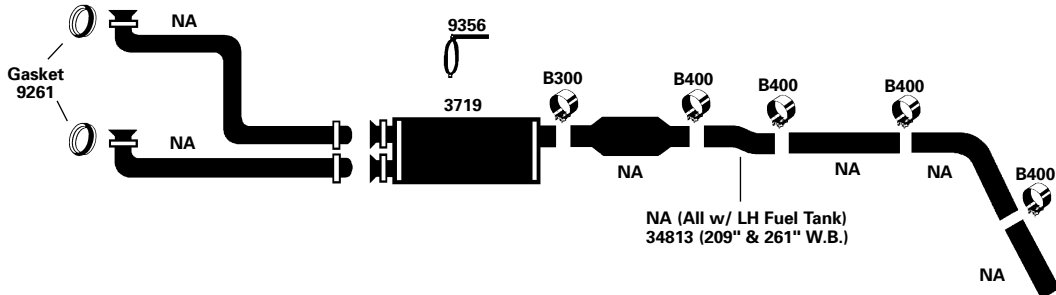

See Page 152 for footnote explanations.

BLUEBIRD SCHOOL BUS

92-95 8 Cyl. CV200; 366, 427 (6.0, 7.0) TBI Eng.; With Converter; **(200370)**
Tail Pipe Exits Side of Bus Behind Rear Wheel; 145", 209", 261" W.B.

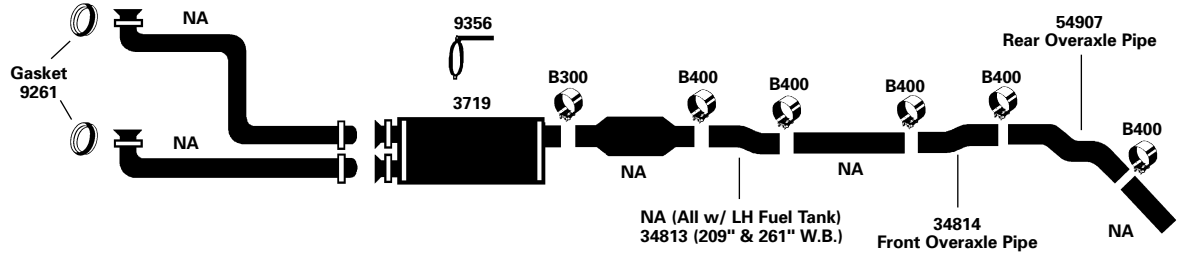

92-95 8 Cyl. CV200; 366, 427 (6.0, 7.0) TBI Eng.; With Converter; **(200371)**
Tail Pipe Exits at Rear of Bus; 145", 209", 261" W.B.

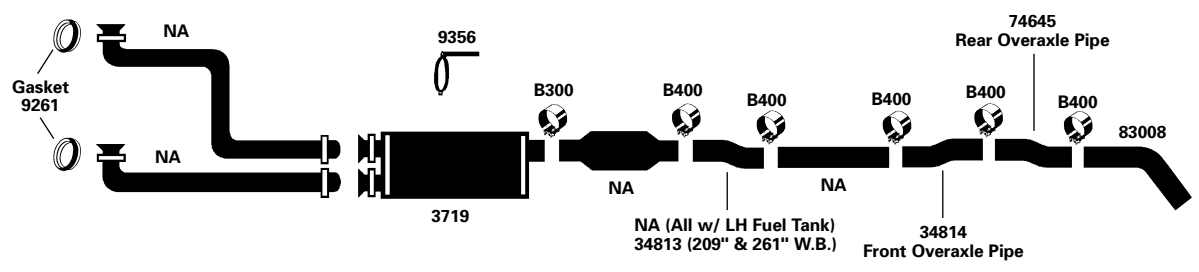

88-95 6 Cyl. TC2000 Rear Engine 5.9L B-Series Cummins **(200362)**

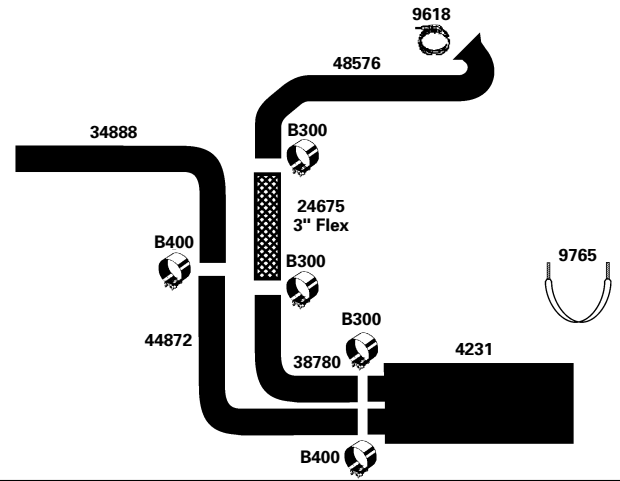

87-95 6 Cyl. Models with standard exhaust (Side Exit in Front of Rear Tire) **(200363)**
TC2000; 5.9L Cummins Diesel Engine

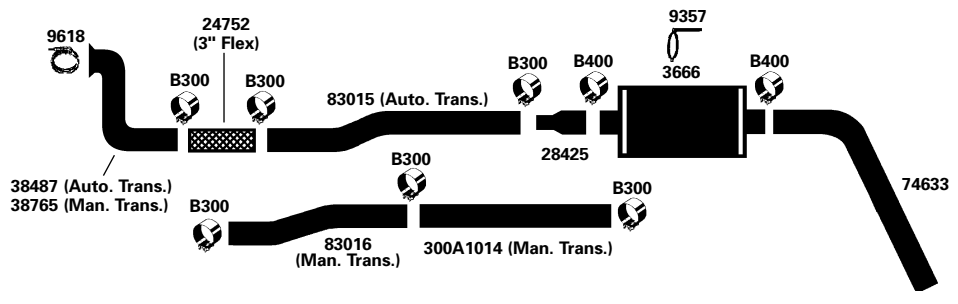

See Page 152 for footnote explanations.

SCHOOL BUS APPLICATIONS

BLUEBIRD SCHOOL BUS

87-95 6 Cyl. Models with Extended Tailpipe (Rear Outlet) **(200364)**
TC2000; 5.9L Cummins Diesel Engine; 132", 160"-216" W.B.

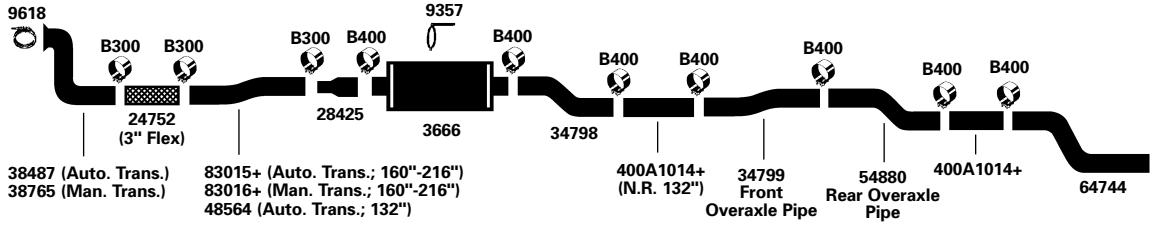

+ Cut to Length

88-94 6 Cyl. TC2000 w/ 6BTA; 5.9L Turbo Diesel; Rear Exit Tail Pipe; Side Mounted Fuel Tank; 132", 146"-195", 216"-237" W.B. **(200365)**

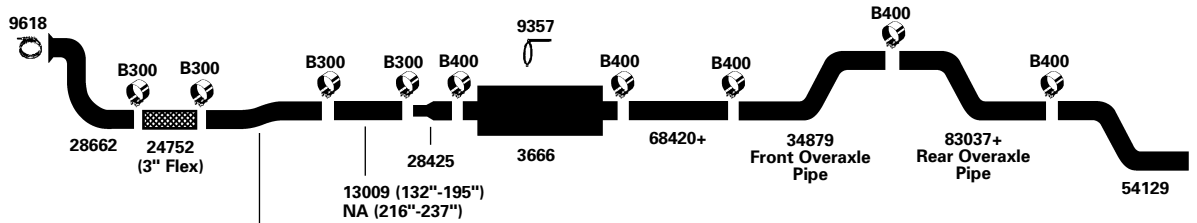

+ Cut to Length

92-93 6 Cyl. GMC-Bluebird 3116 Caterpillar Engine **(200351)**

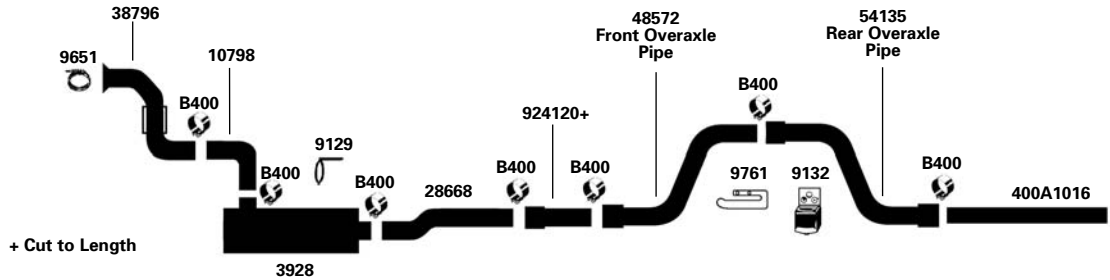

+ Cut to Length

91-92 6 Cyl. All American w/ Caterpillar 3116 Turbo Diesel; 4" Rear Exit Tail Pipe; (Before Chassis No. 977303); 175"-197 1/2", 205"-242 1/2" W.B. **(200374)**

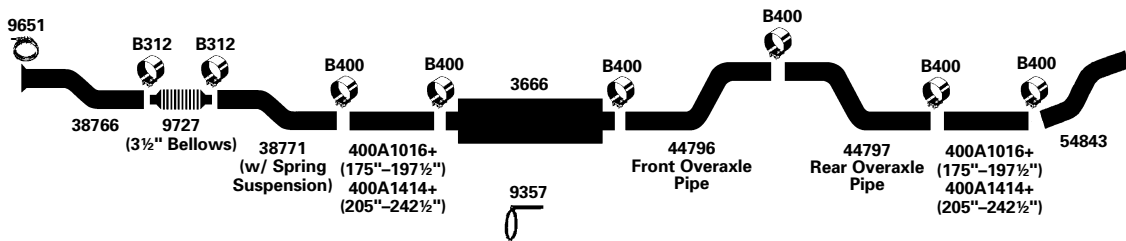

+ Cut to Length

BLUEBIRD SCHOOL BUS

88-92 8 Cyl. All American w/ 8.2LT, 8.2LTA Front Engine Models; Rear Exit Tail Pipe; **(200474)**
175"-242 1/2" W.B.

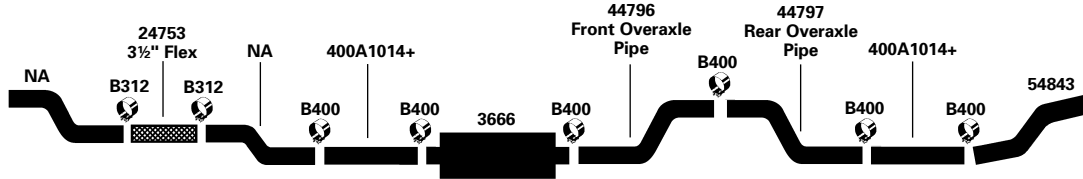

+ Cut to Length

88-92 8 Cyl. All American w/ Cummins 8.3L Front Engine Models; w/ 4" Exhaust **(200475)**
(Before Chassis No. 977611); 175"-242 1/2" W.B.

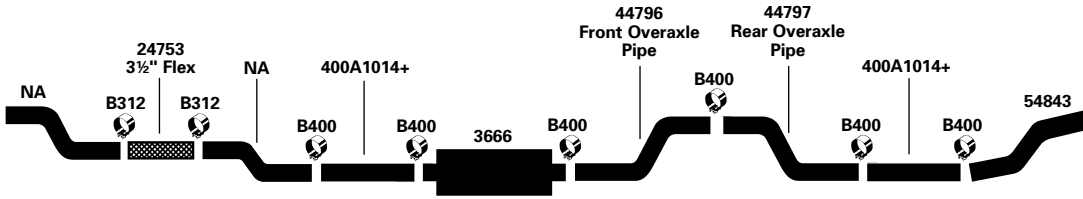

+ Cut to Length

89-91 8 Cyl. All models w/366 C.I.D. Engine w/ Converter; 254", 274" W.B. **(200476)**

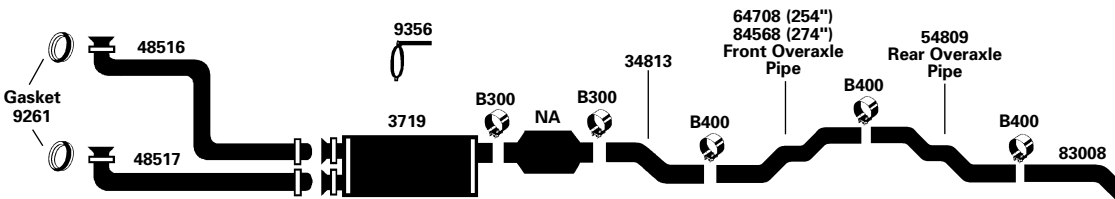

87-88 8 Cyl. High Temperature Exhaust System; Micro-Bird; G30/G3500; **(200372)**
125", 146" W.B.; 350M Eng. (5.7L); 1 Ton;
With H5D emissions, exc. Calif.

85-86 8 Cyl. High Temperature Exhaust System; Micro-Bird; G30/G3500;
125", 146" W.B.; 350M Eng. (5.7L); 1 Ton; Built after 01-01-85;
With H5D emissions

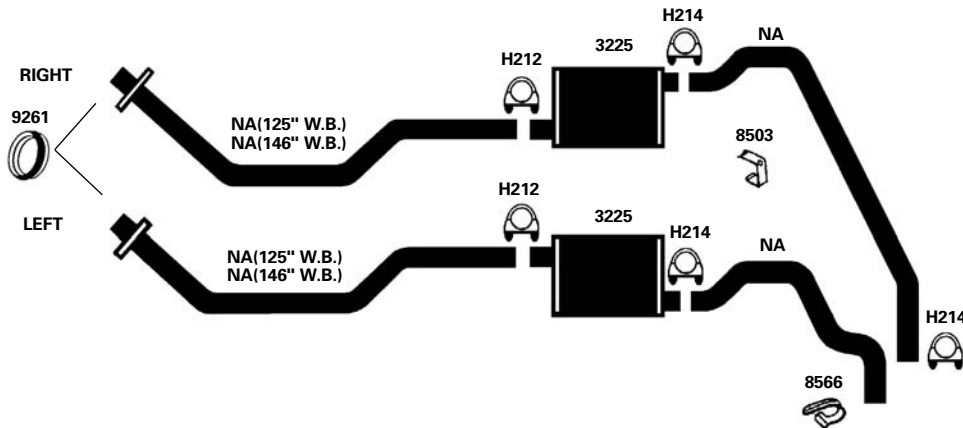

See Page 152 for footnote explanations.

BLUEBIRD SCHOOL BUS

82-87 8 Cyl. All American; Caterpillar 3208 Diesel Eng.; All W.B.

(200376)

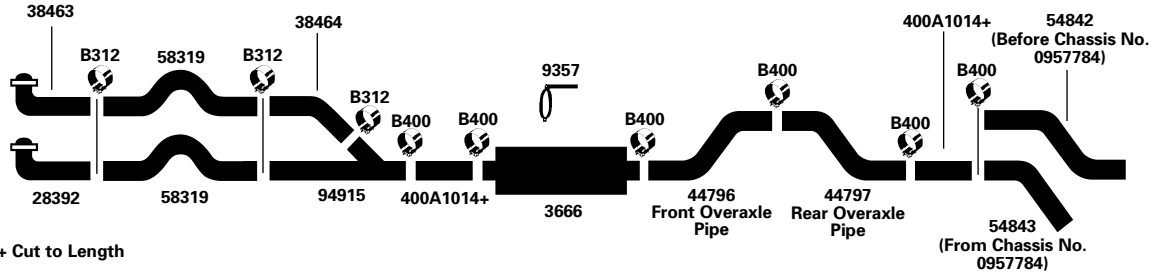

80-87 8 Cyl. All American w/ 8.2L Turbo Diesel Front Engine Models; Rear Exit Tail Pipe; 175"-242 1/2" W.B.

(200477)

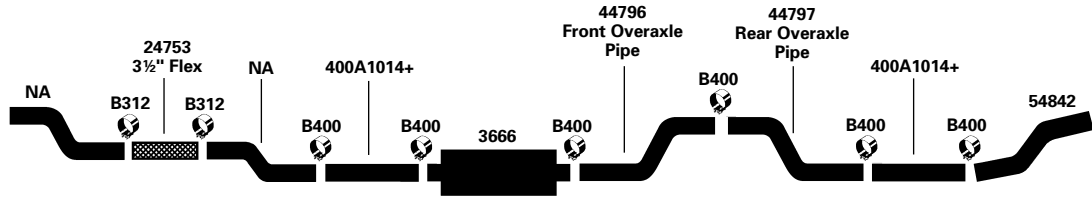

80-87 8 Cyl. All American; Cummins 504, 555 Diesel Eng.; All W.B.

(200375)

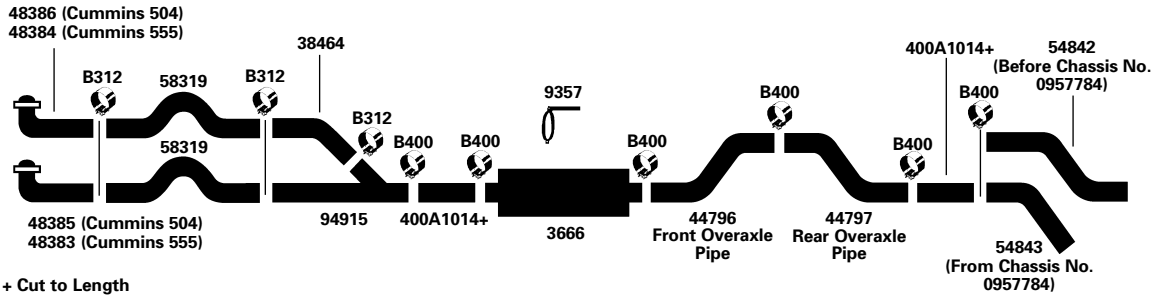

6 Cyl. All American 8.3 Cummins; Turbo Rear Engine Pusher

(200377)

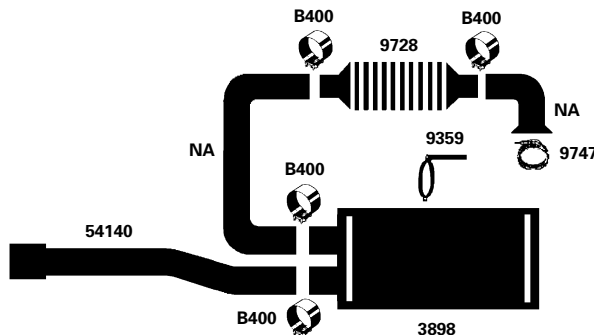

BLUEBIRD SCHOOL BUS

6 Cyl. 3208-3116 Caterpillar; Turbo Rear Engine Pusher

(200378)

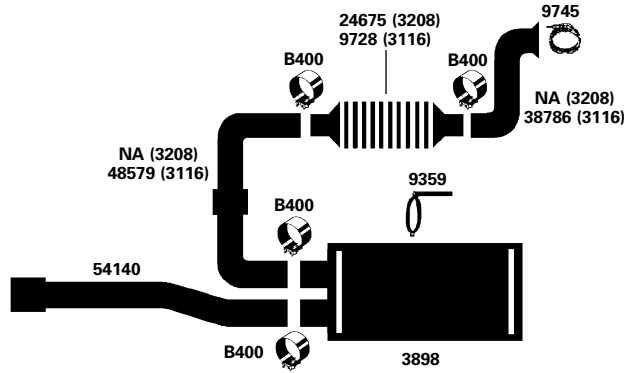

**CHEVROLET/GMC
G10, G20, G30/G1500, G2500, G3500 SERIES VANS**

98-00 8 Cyl. G30/G3500 Series Van; 350 C.I.D.; Transverse Muffler

(200104)

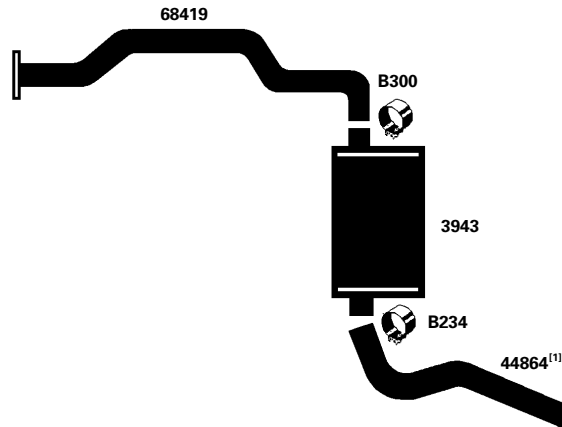

1991 6 Cyl. G30/G3500; 125" W.B., 262(4.3L) Engine; Over 8500 lbs. G.V.W.; 1 Ton

(200100)

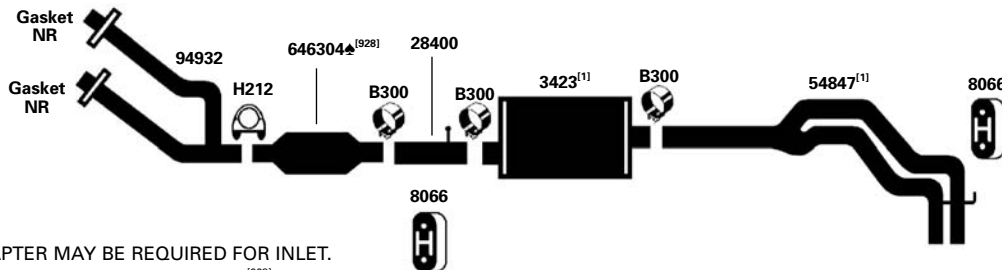

▲ ADAPTER MAY BE REQUIRED FOR INLET.
UNIVERSAL CONVERTER...606007⁽⁹²⁸⁾

SCHOOL BUS
APPLICATIONS

**CHEVROLET/GMC
G10, G20, G30/G1500, G2500, G3500 SERIES VANS**

1990 8 Cyl. All models w/ 454 C.I.D.(7.4L) Engine; 125", 146" W.B.; With Converter **(200108)**

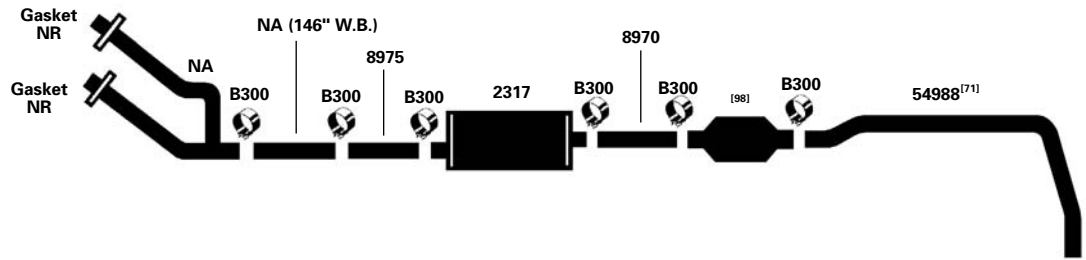

**CHEVROLET/GMC SCHOOL BUS
P10, P20, P30/P1500, P2500, P3500**

91-96 8 Cyl. P30/P3500 w/454 C.I.D. (7.4L) Engine; 125", 146" W.B.; With Converter **(200107)**

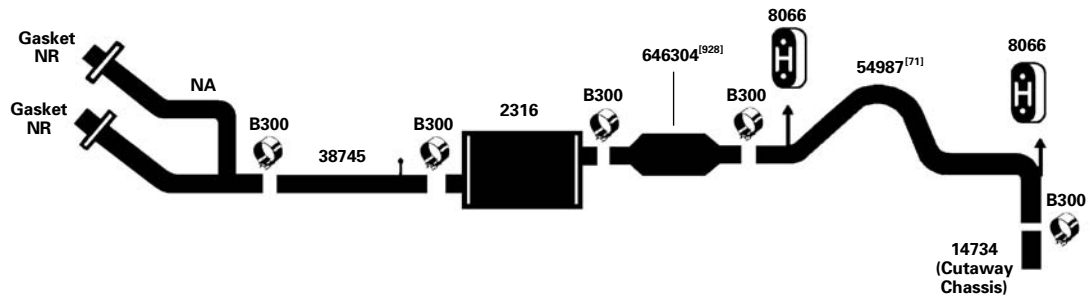

89-91 4 Cyl. P30/P3500 w/239 C.I.D. (3.9L); Diesel Engine **(200103)**

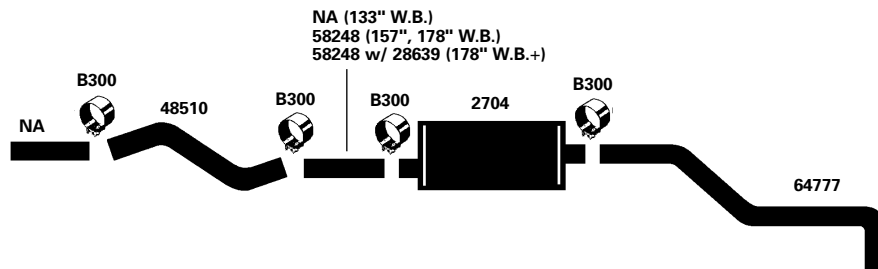

+ Cut to length

**CHEVROLET/GMC SCHOOL BUS
P10, P20, P30/P1500, P2500, P3500**

1990 6 Cyl. P30/P3500 w/ 262 C.I.D. (4.3L) Engine; 125", 133" W.B. w/ Converter **(200102)**

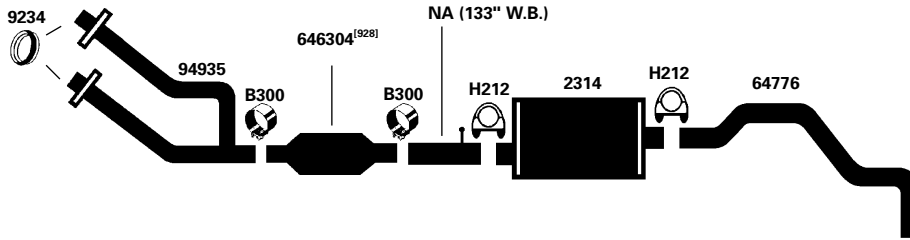

89-90 8 Cyl. P20/P2500 w/ 350 C.I.D.; 125", 133" W.B.; With Converter **(200109)**

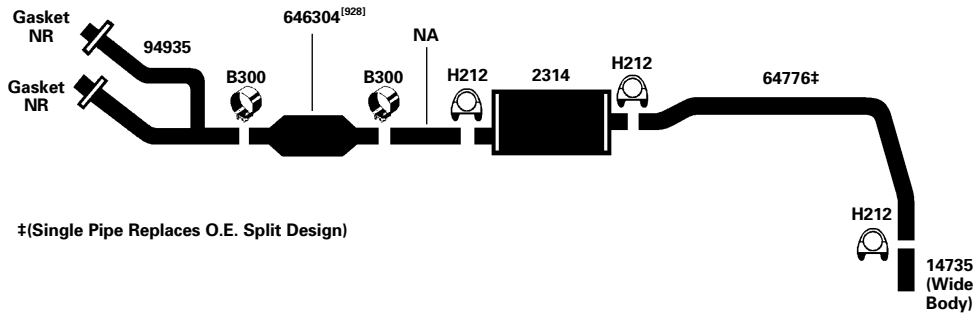

87-88 8 Cyl. P20/P2500 w/ 350 C.I.D.; 133", 157", 178" W.B.; With two Converter system **(200110)**

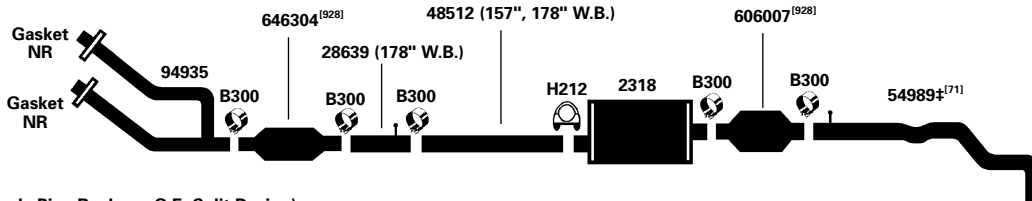

CHEVROLET/GMC SCHOOL BUS

98-02 8 Cyl. CV200 GMC B7 Conventional Chassis w/ 454-502 Engine **(200485)**

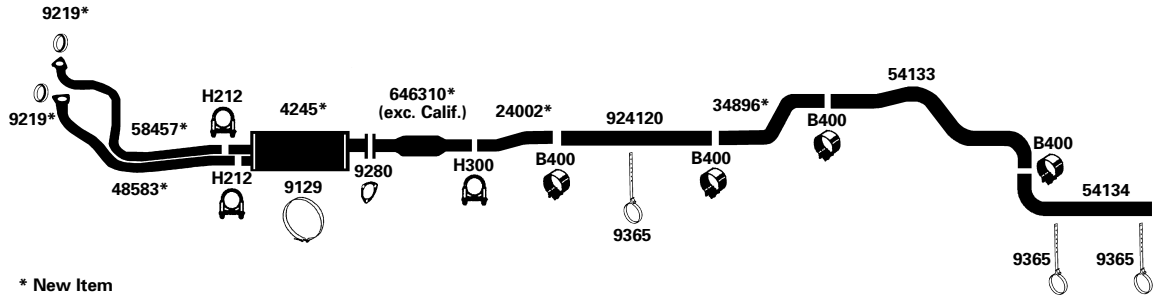

* New Item

97-02 8 Cyl. GMC Kodiak Topkick Chassis w/ 6.5L Turbo Diesel Engine **(200487)**

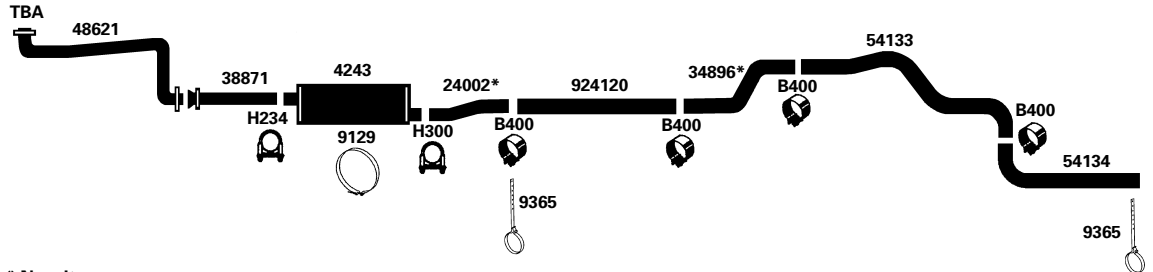

* New Item

98-01 6 Cyl. 3126 Cat., CV200; GMC B7 Conventional Chassis **(200379)**

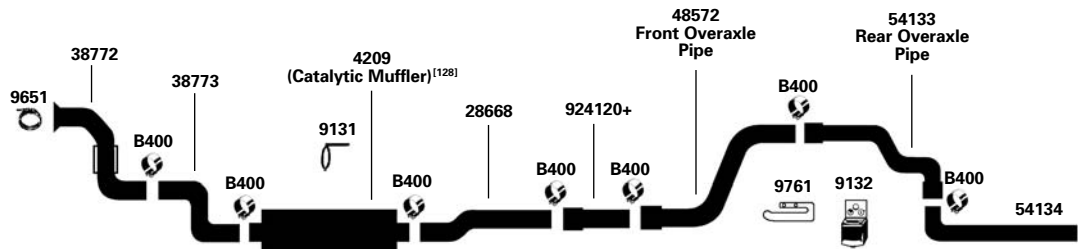

+ Cut to Length

94-98 6 Cyl. 3116 Cat., CV200; GMC B7 Conventional Chassis **(200380)**

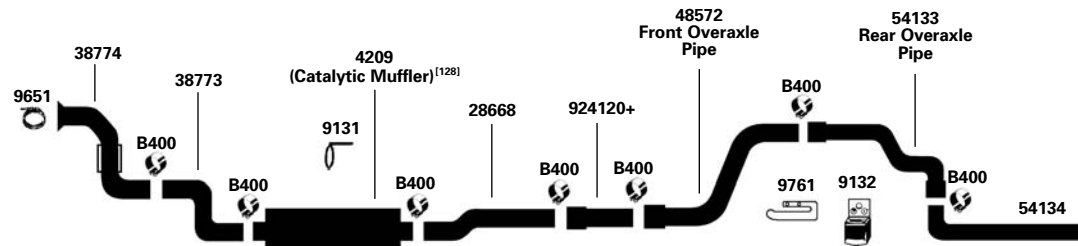

+ Cut to Length

See Page 152 for footnote explanations.

CHEVROLET/GMC SCHOOL BUS

92-95 8 Cyl. B7; 366, 427 (6.0, 7.0) TBI Eng.; With Converter; Tail Pipe Exits Side of Bus Behind Rear Wheel; 145", 209" & 261" W.B. **(200382)**

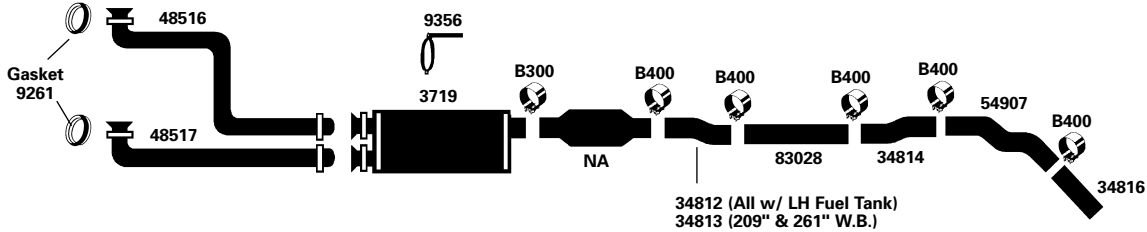

92-95 8 Cyl. B7; 366, 427 (6.0, 7.0) TBI Eng.; With Converter; Tail Pipe Exits Side of Bus in Front of Rear Wheel; 145", 209" & 261" W.B. **(200383)**

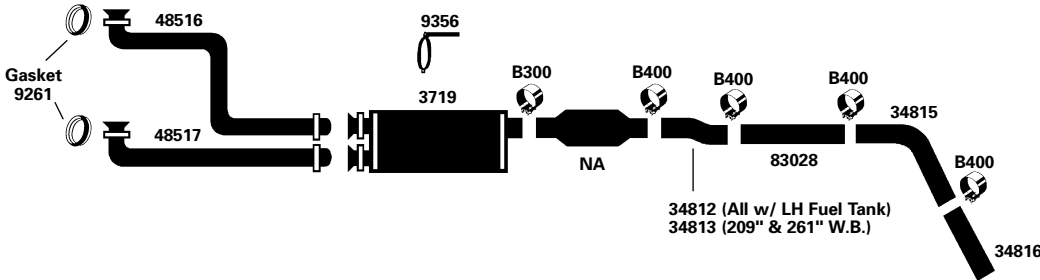

92-95 8 Cyl. B7; 366, 427 (6.0, 7.0) TBI Eng.; With Converter; All W.B.; Tail Pipe Exits at Rear of Bus; 145", 209" & 261" W.B. **(200384)**

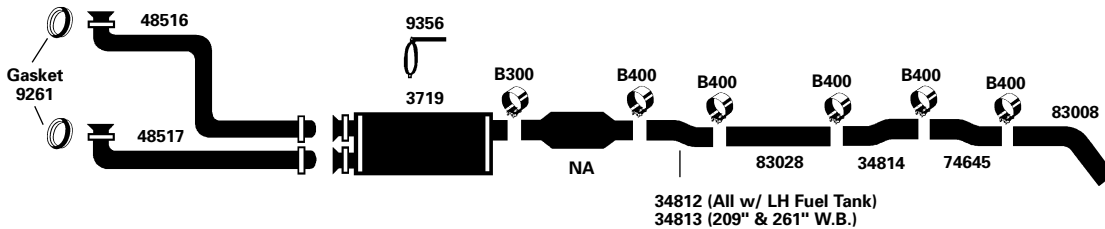

92-93 6 Cyl. GMC 3116 Caterpillar Engine **(200381)**

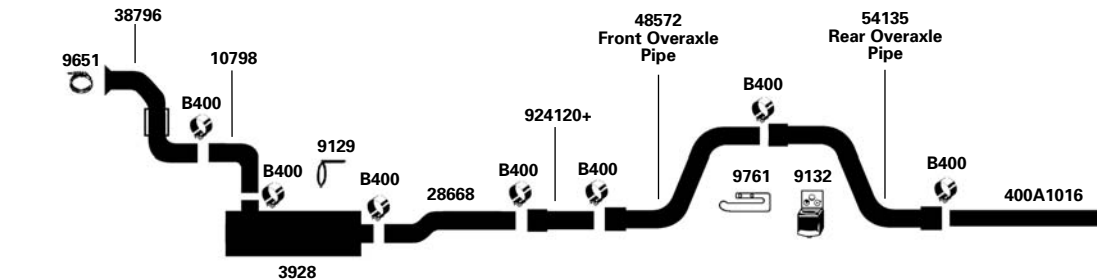

+ Cut to Length

CHEVROLET/GMC SCHOOL BUS

85-91 8 Cyl. High Temperature Exhaust System B6PO42; 366 TBI Engine; 254", 274" W.B. **(200385)**

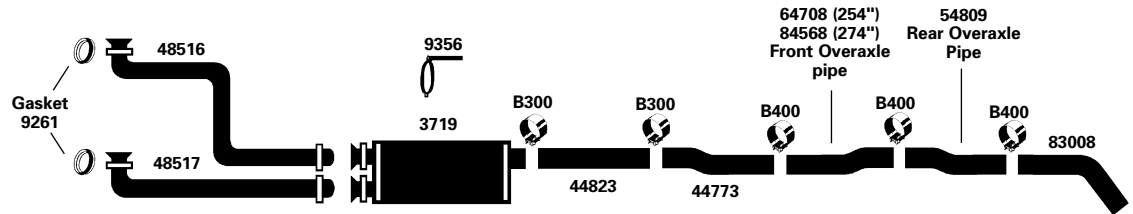

80-91 8 Cyl. B6, S7; 8.2N Eng.; Auto Trans; 189", 218", 235", 254" & 274" W.B. **(200386)**

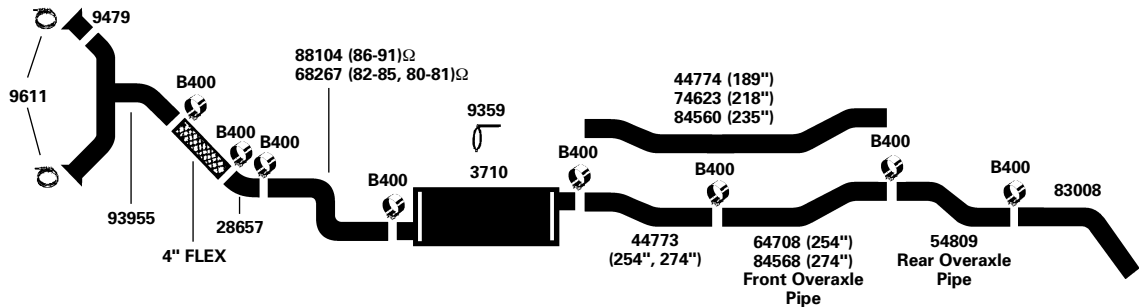

Ω Trim 3" Off Outlet End

80-91 8 Cyl. B6, S7; 8.2T Eng. (Turbocharged); Auto Trans; 189", 218", 235", 254" & 274" W.B. **(200387)**

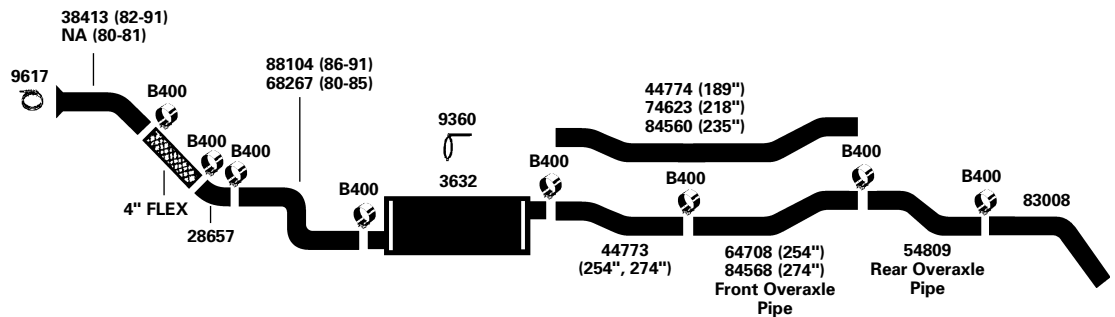

89-91 8 Cyl. All models w/366 C.I.D. Engine w/ Converter; 254", 274" W.B. **(200478)**

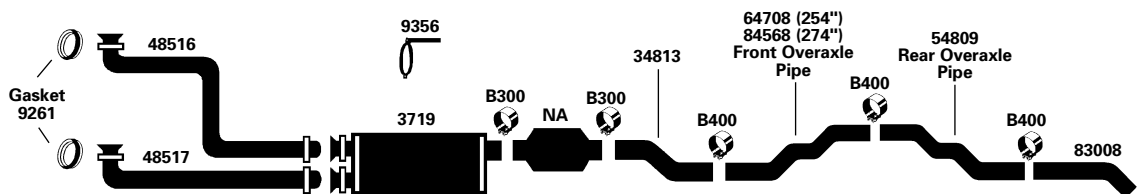

CHEVROLET/GMC SCHOOL BUS

85-90 8 Cyl. High Temperature Exhaust System B6PO42; 350 Eng. with Federal Emissions with Ball and Socket (Stainless Steel Exhaust) 189", 218", 235", 254" & 274" W.B. **(200388)**

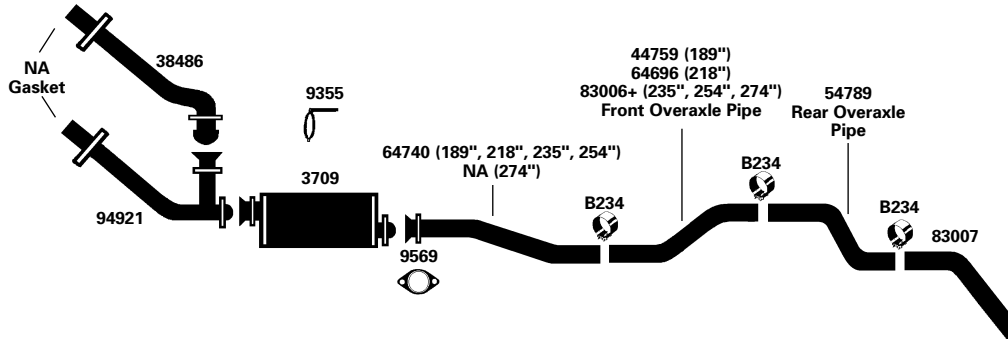

+ Cut to Length

85-90 8 Cyl. High Temperature Exhaust System B6PO42; 366 Eng.; Man. Trans.; Single Muffler; 189", 218", 235", 254" & 274" W.B. **(200389)**

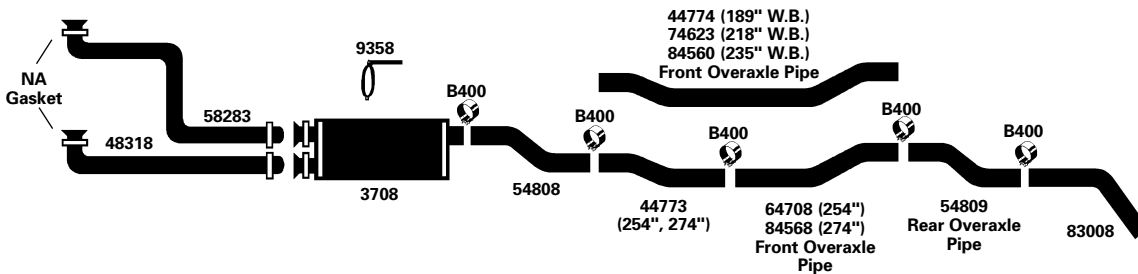

79-90 8 Cyl. Series 50, 60; 350 Eng.; w/o FEO; w/ Ball and Socket (exc. 1985 & Later Models with H5D Emissions-Stainless Steel Exhaust) 189", 218", 235", 254" & 274" W.B. **(200396)**

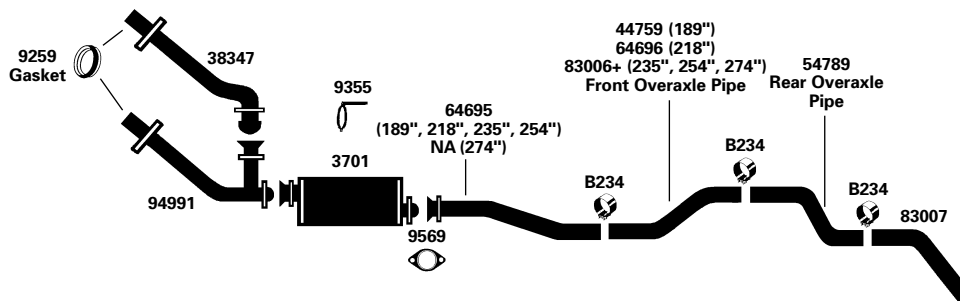

+ Cut to Length

CHEVROLET/GMC SCHOOL BUS

79-90 8 Cyl. Series 50, 60; 366, 427 Eng.; Auto Trans.; w/o FEO; w/ Ball and Socket (200397)
(exc. 1985 & Later Models with H5D Emissions-Stainless Steel Exhaust);
189", 218", 235", 254" & 274" W.B.

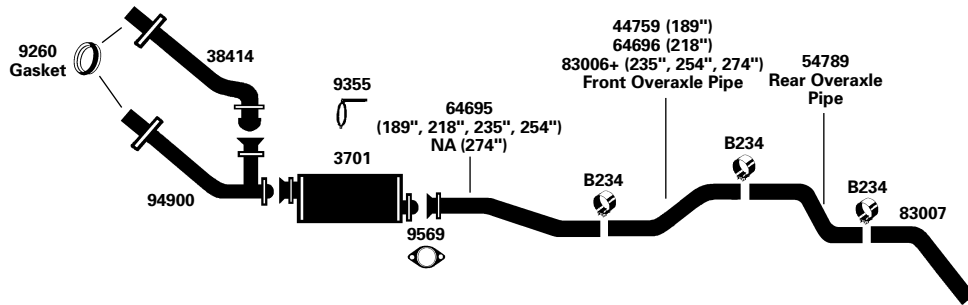

+ Cut to Length

75-90 8 Cyl. Series 50, 60; 350 Eng.; Std. Trans. and FEO; (200391)
189", 218", 235", 254" & 274" W.B.

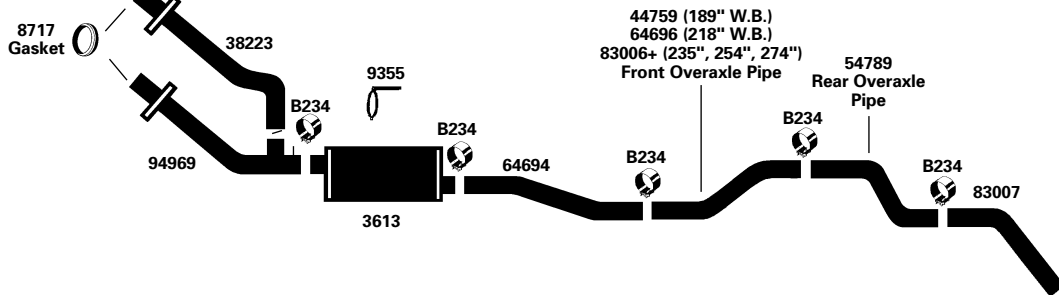

+ Cut to Length

75-90 8 Cyl. Series 50, 60; 366, 427 Eng.; AT540 Auto. Trans. and FEO; (200392)
189", 218", 235", 254" & 274" W.B.

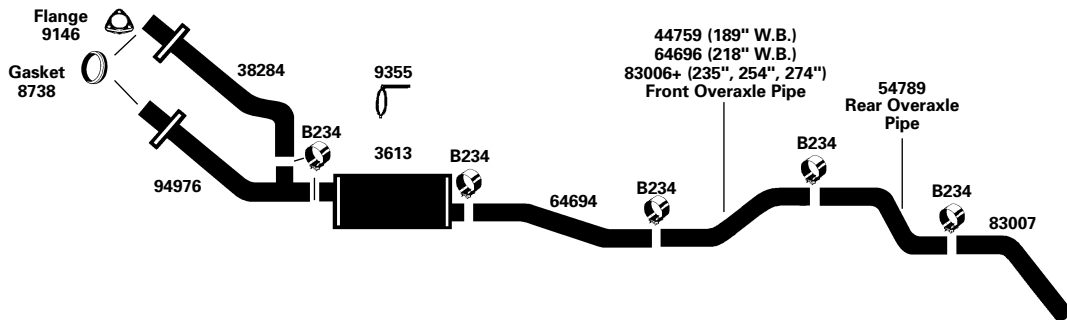

+ Cut to Length

SCHOOL BUS
APPLICATIONS

CHEVROLET/GMC SCHOOL BUS

79-88 8 Cyl. Series 50, 60; 366, 427 Eng.; Std. Trans.; w/o FEO; w/ Ball and Socket (exc. 1985 & Later Models with H5D Emissions-Stainless Steel Exhaust) **(200398)**
189", 218", 235", 254" & 274" W.B.

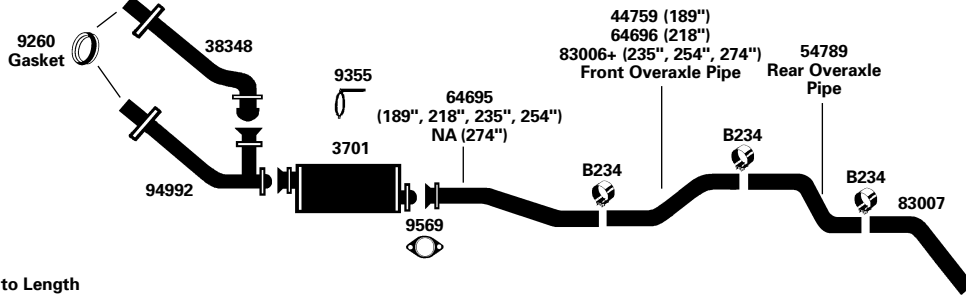

+ Cut to Length

85-87 8 Cyl. High Temperature Exhaust System B6PO42; 366 Eng.; Man. Trans.; Dual Mufflers; 189", 218", 235", 254" & 274" W.B. **(200390)**

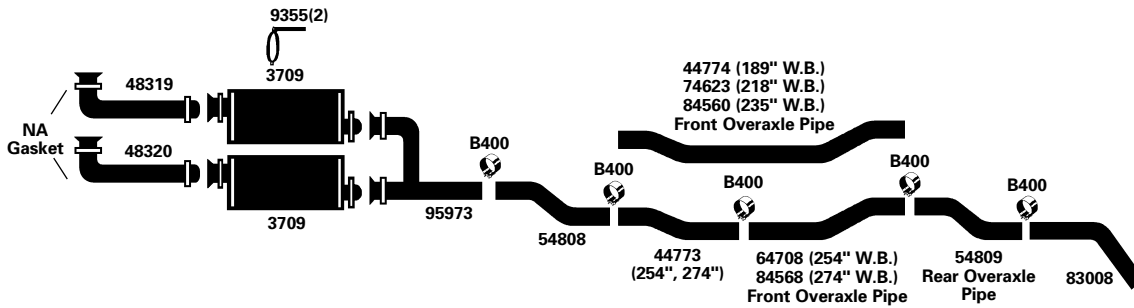

73-85 8 Cyl. Series 50, 60; 366 Eng.; Std. Trans.; 189", 218", 235", 254" & 274" W.B. **(200393)**

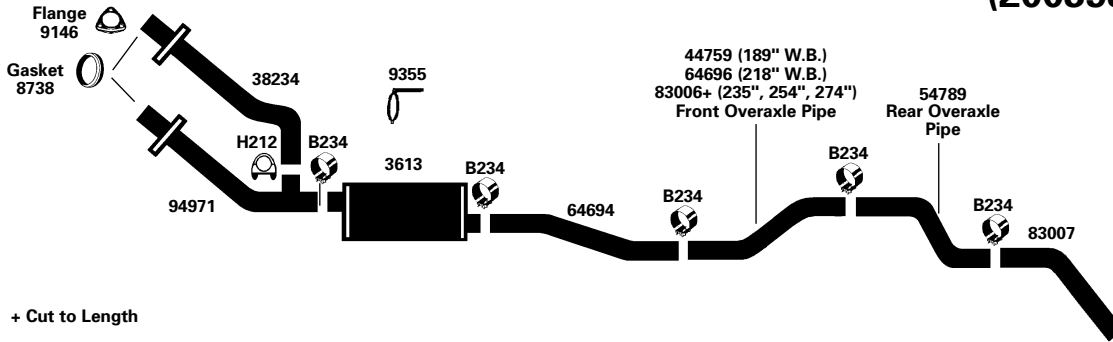

+ Cut to Length

73-78 8 Cyl. Series 50, 60; 366 Eng.; AT475 Auto. Trans.; 189", 218", 235", 254" & 274" W.B. **(200394)**

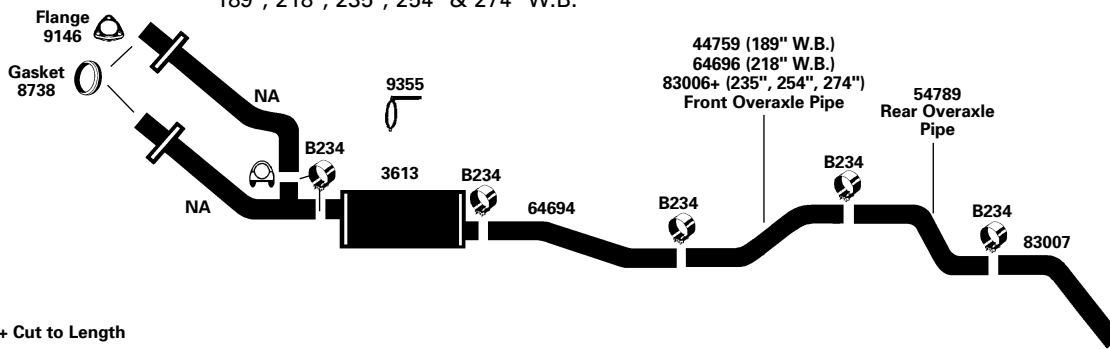

+ Cut to Length

See Page 152 for footnote explanations.

SCHOOL BUS
APPLICATIONS

CHEVROLET/GMC SCHOOL BUS

67-74 6 Cyl. Series 40, 50, 60 All Models w/ 292 C.I.D. – Gas Eng.;
149", 189", 218", 235" & 254" W.B.

(200399)

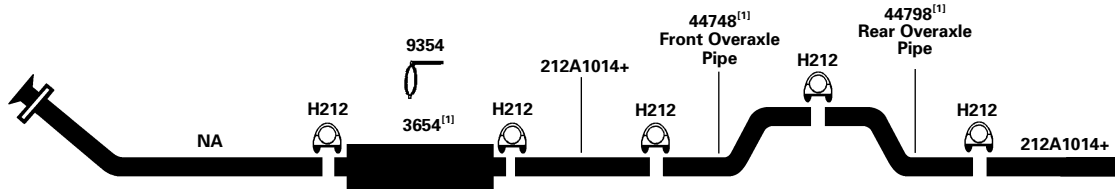

+ Cut to Length

FOOTNOTES:

- [1] Original equipment system was welded assembly. It is recommended that all noted parts [1] to be replaced.
- [71] If replacing O.E. exhaust system, first cut tail pipe on vehicle immediately behind converter to tail pipe weld. Cut through outer pipe only, leaving converter nipple intact.
- [93] Locating clip must be knocked off converter outlet for proper installation.
- [98] Refer to Current Catalog Converter.
- [128] Adapter(s) may be required to complete installation.
- [928] To 12,500 lbs. GVW-EPA; 11,620 lbs. GVW-CARB.
- Golden warehouse item.

FORD SCHOOL BUS E-SERIES

93-96 8 Cyl. E350 Series; 460 C.I.D. (7.5L) Engine; 138", 158", 176" W.B.

(200291)

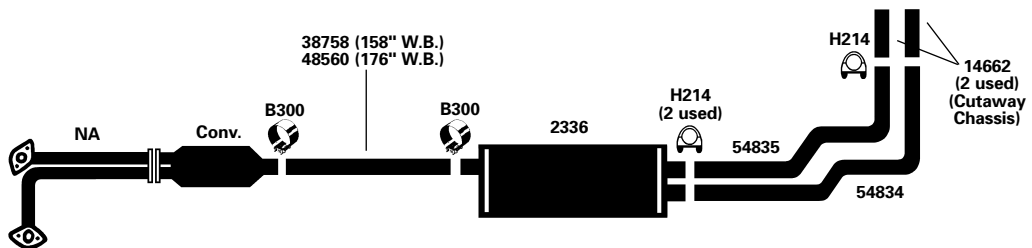

92-96 6 Cyl. E350; 300 C.I.D. (4.9L) Engine;-138", 158" W.B.

(200167)

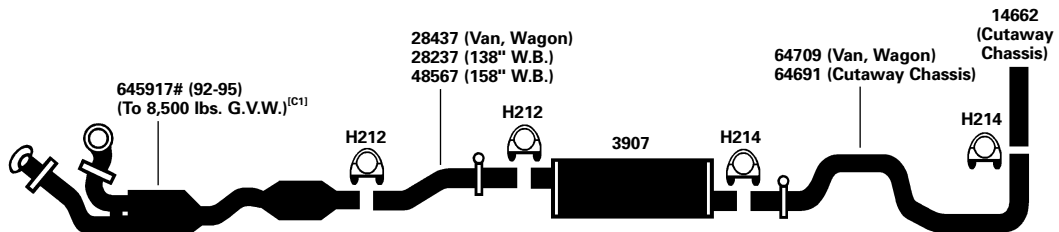

^(C1) Exc. Calif., over 7200 lbs. G.V.W. Combination Front and Rear Converter, 2 To 1 Replacement. Only Defective Converters May Be Legally Replaced.

FORD SCHOOL BUS E-SERIES

87-95 8 Cyl. Cut Away Van E350 7.3L Diesel; 138", 158", 176" W.B. **(200401)**

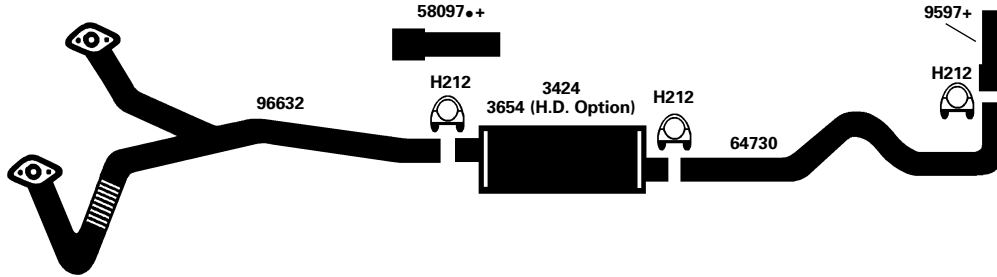

+ Cut to Length

88-91 6 Cyl. E350; 138" W.B.; 300 C.I.D. (4.9L) Engine; 138", 158" W.B.; With Converter **(200168)**

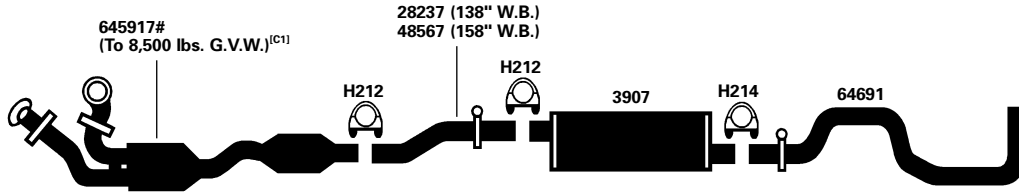

^(C1) Exc. Calif., over 7200 lbs. G.V.W. Combination Front and Rear Converter, 2 To 1 Replacement. Only Defective Converters May Be Legally Replaced.

1987 6 Cyl. E350; 300 C.I.D. (4.9L) Engine; 138" W.B.; With Converter **(200169)**

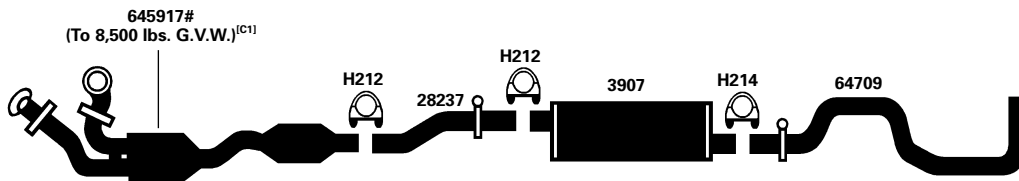

^(C1) Exc. Calif., over 7200 lbs. G.V.W. Combination Front and Rear Converter, 2 To 1 Replacement. Only Defective Converters May Be Legally Replaced.

95-99 6 Cyl. B800, FD1060 w/ 5.9L Cummins Diesel; w/ Converter; Air Suspension; 151"-275" W.B. **(200402)**

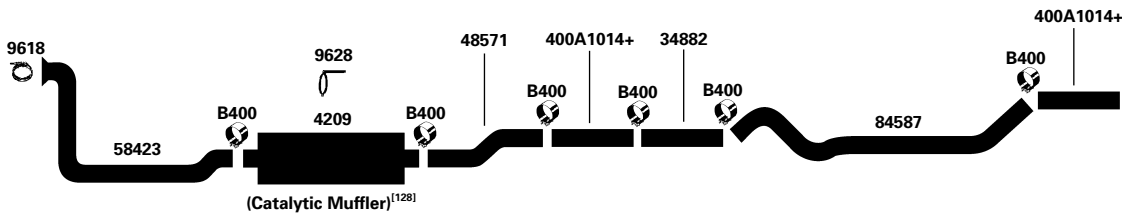

+ Cut to Length

FORD SCHOOL BUS

92-98 6 Cyl. B600, B700, FD1060 Diesel Eng.; 5.9L; 216" W.B. and Shorter; 237" W.B. and Longer **(200403)**

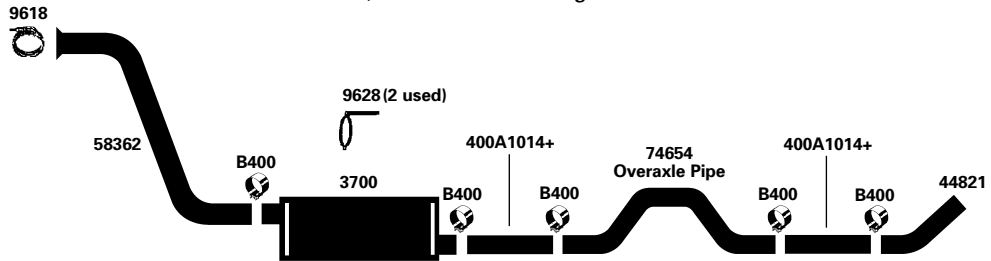

+ Cut to Length

87-94 6 Cyl. B600, B700; 6.6L Diesel Eng.; Models Built Before 11-93 **(200404)**
87-94 6 Cyl. B600, B700; 7.8L Diesel Eng.; Models Built Before 11-93

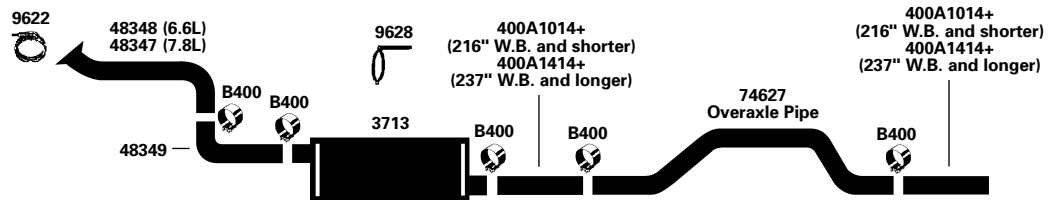

+ Cut to Length

85-94 8 Cyl. B600, B700; 370, 429 Eng. **(200405)**

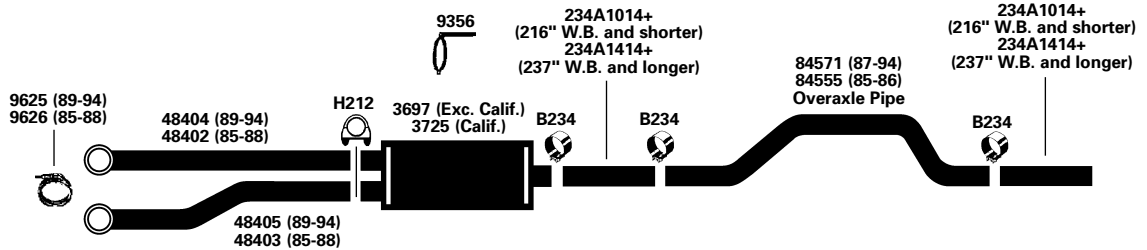

+ Cut to Length

86-87 8 Cyl. B600, B700; 8.2L Diesel Eng. (Turbo) **(200407)**
86-87 8 Cyl. B600, B700; 636 Diesel Eng. (3208 Caterpillar) (Turbo)

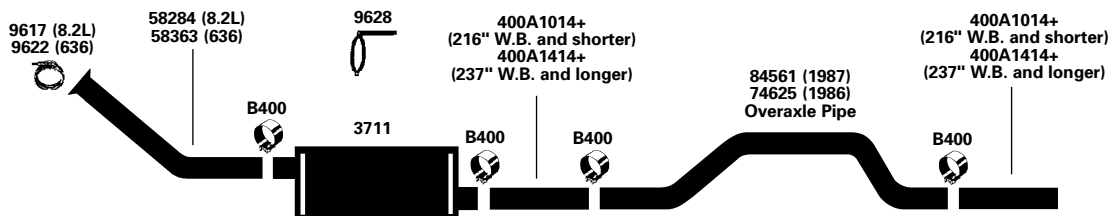

+ Cut to Length

See Page 158 for footnote explanations.

FORD SCHOOL BUS

86-87 8 Cyl. B600, B700; 8.2L Diesel Eng. (exc. Turbo) **(200410)**
86-87 8 Cyl. B600, B700; 636 Diesel Eng. (3208 Caterpillar) (exc. Turbo)



+ Cut to Length

83-85 8 Cyl. B600, B700; 8.2L Diesel Eng. (Turbo); From 2-1-83 **(200408)**
83-85 8 Cyl. B600, B700; 636 Diesel Eng. (3208 Caterpillar) (Turbo); From 2-1-83

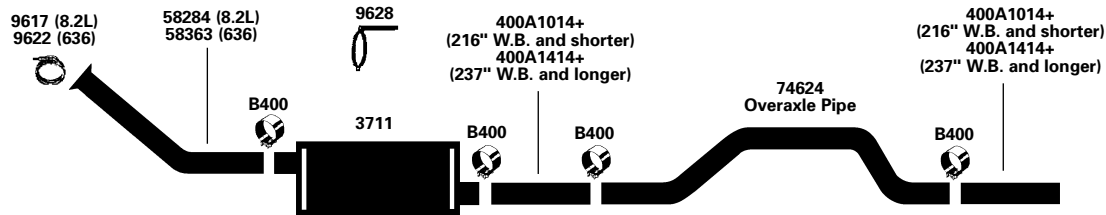

+ Cut to Length

83-85 8 Cyl. B600, B700; 8.2L Diesel Eng. (exc. Turbo); From 2-1-83 **(200411)**
83-85 8 Cyl. B600, B700; 636 Diesel Eng. (3208 Caterpillar) (exc. Turbo); From 2-1-83
80-83 8 Cyl. B600, B700; 8.2L Diesel Eng. (exc. Turbo); Before 2-1-83



+ Cut to Length

79-84 8 Cyl. B600, B700; 370, 429 Eng. **(200406)**

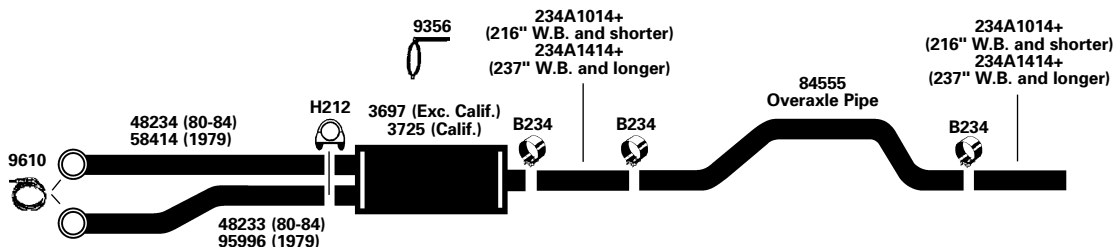

+ Cut to Length

FORD SCHOOL BUS

80-83 8 Cyl. B600, B700; 8.2L Diesel Eng. (Turbo); Before 2-1-83

(200409)

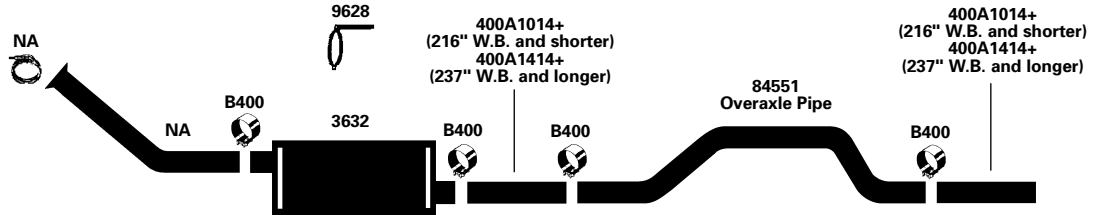

+ Cut to Length

75-82 8 Cyl. B700; 522, 636 Diesel Eng. (3208 Caterpillar); All Wheel Bases

(200412)

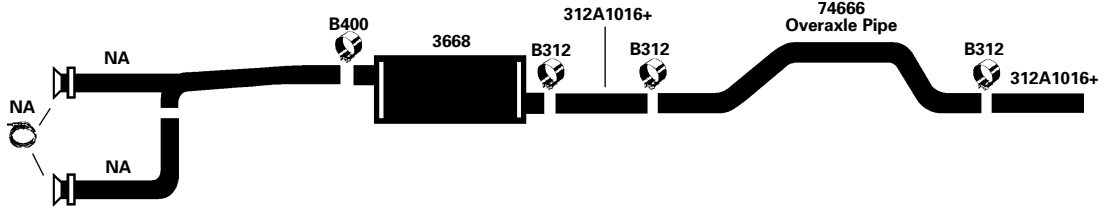

+ Cut to Length

1978 8 Cyl. B600; 330, 361 Eng. 198", 222" W.B. (From BC5,001)

(200413)

75-78 8 Cyl. B600; 330, 361 Eng. 198", 222" W.B. (From V20,001 to BC5,001)

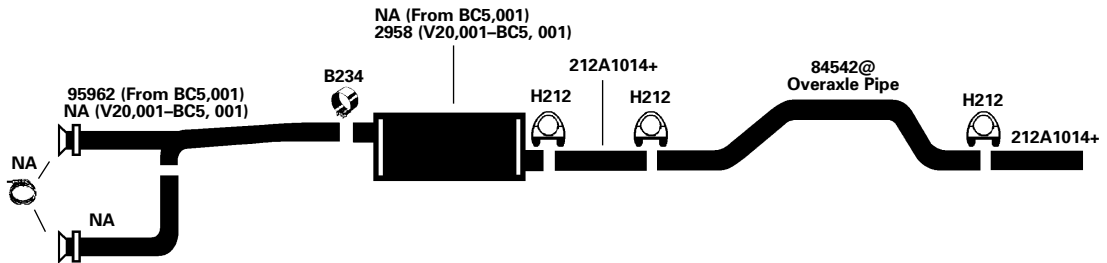

+ Cut to Length

1978 8 Cyl. B600, B700; 330, 361, 389 Eng.; 242", 260", 280" W.B. (From BC5,001)

(200417)

73-78 8 Cyl. B600, B700; 330, 361, 389 Eng.; 242", 260", 280" W.B. (From Q80,001 to BC5,001)

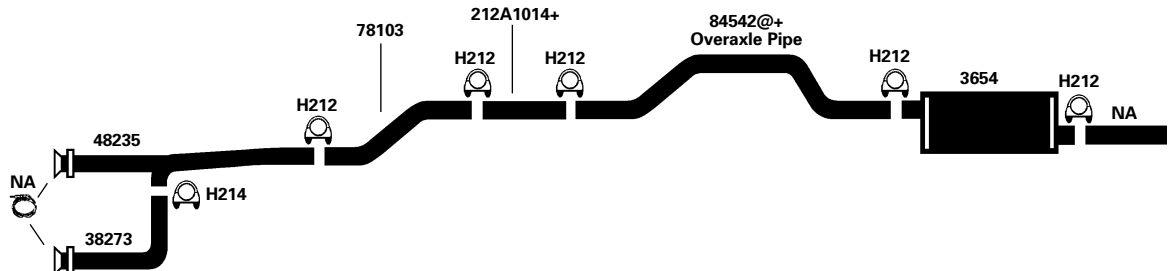

+ Cut to Length

FORD SCHOOL BUS

73-77 8 Cyl. B500; 330 Eng.; 156" W.B. (From V20,001) **(200416)**

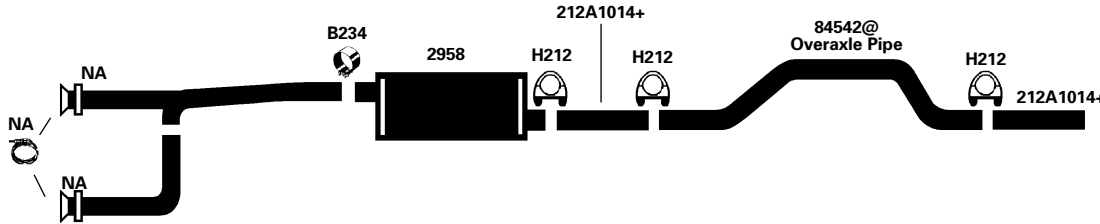

+ Cut to Length

73-77 8 Cyl. B600; 361 Eng.; 242", 260" W.B. (Q80,001 to V20,001) **(200419)**

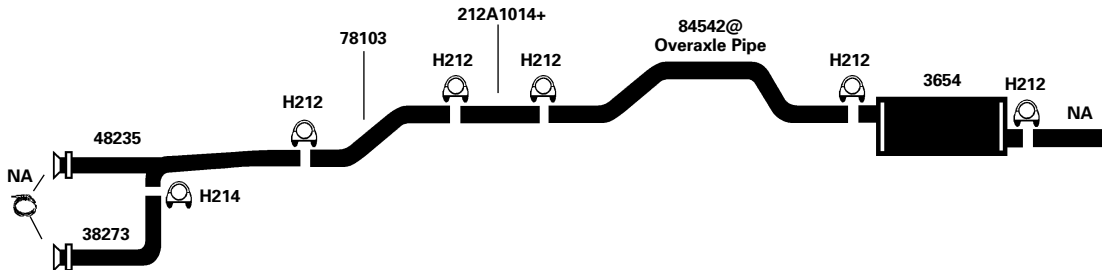

+ Cut to Length

73-77 8 Cyl. B500; 330 Eng.; 156" W.B. (Q80,001 to V20,001) **(200415)**
73-77 8 Cyl. B600; 330 Eng.; 198", 222" W.B. (Q80,001 to V20,001)

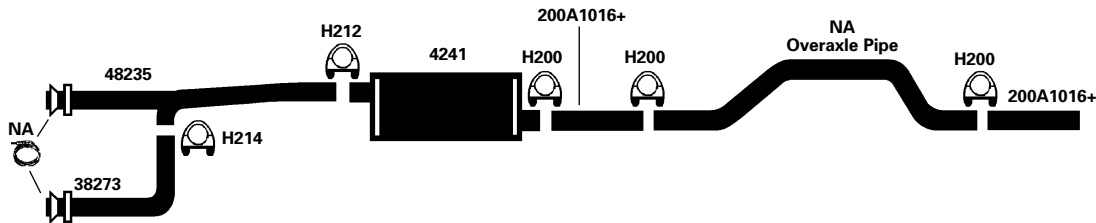

+ Cut to Length

70-73 8 Cyl. B600; 330, 361 Eng.; 198", 222" W.B. (Before Q80,001) **(200414)**
70-77 8 Cyl. B500; 330 Eng.; 156" W.B. (Before Q80,001)
73-77 8 Cyl. B600; 361 Eng.; 198", 222" W.B. (Q80,001 to V20,001)

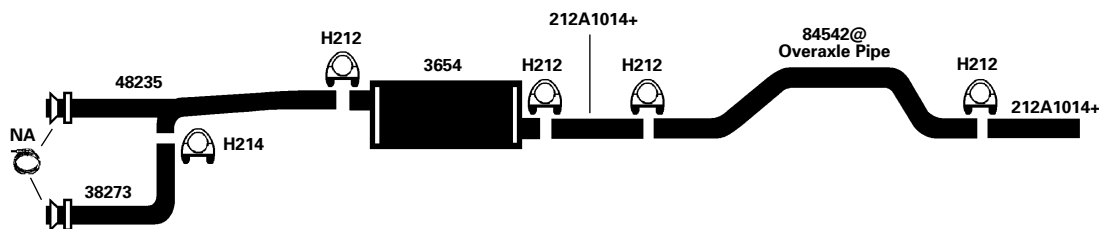

+ Cut to Length

FORD SCHOOL BUS

73-77 8 Cyl. B750; 361, 391 Eng.; 242", 260", 280" W.B. (From Q80,001)
70-73 8 Cyl. B600, B700, B750; 330, 361, 389, 391 Eng.; 242", 260" W.B. (Before Q80,001)

(200418)

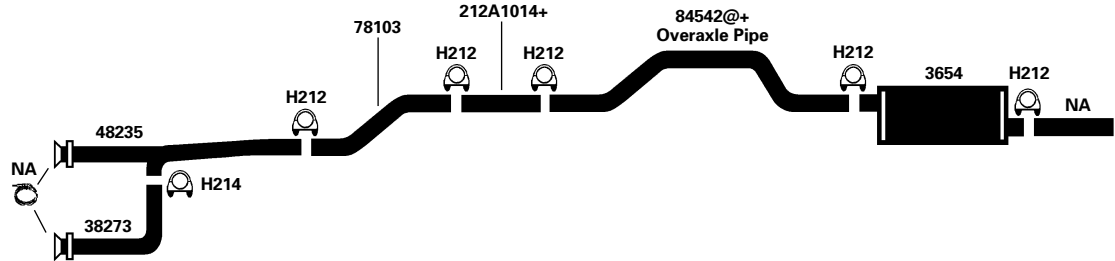

+ Cut to Length

FOOTNOTES:

- [1] Original equipment system was welded assembly. It is recommended that all noted parts [1] to be replaced.
- [12] Optional Heavy Duty Muffler.
- [32] Remove and reuse O.E. heat shield, If required.
- [128] Adapter(s) may be required to complete installation.
- [928] To 12,500 lbs. GVW-EPA; 11,620 lbs. GVW-CARB.
- Golden warehouse item.
- # Air Tube Kit 4948 may be required to complete installation.
- @ One (1) required. For two (2) piece replacement or to route away from obstacles, use 44748.

FREIGHTLINER SCHOOL BUS

05-06 4-6 Cyl. Freightliner Mercedes Engine

(200503)

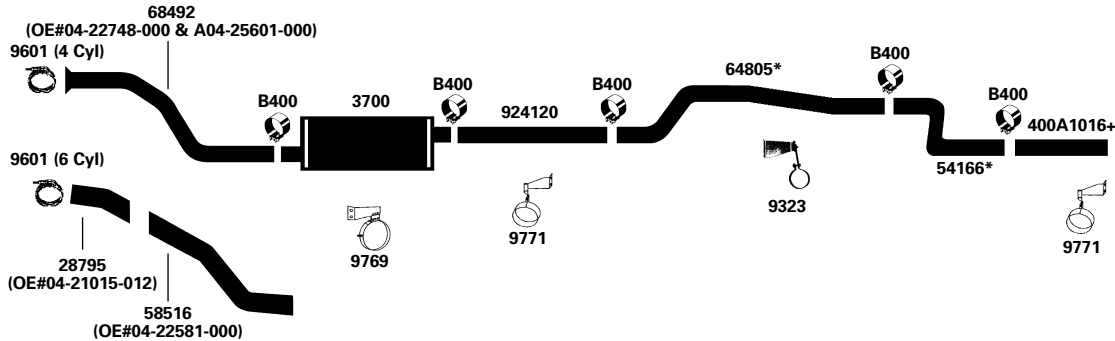

* New Item
+ Cut to Length

02-04 4-6 Cyl. Freightliner Mercedes Engine

(200484)

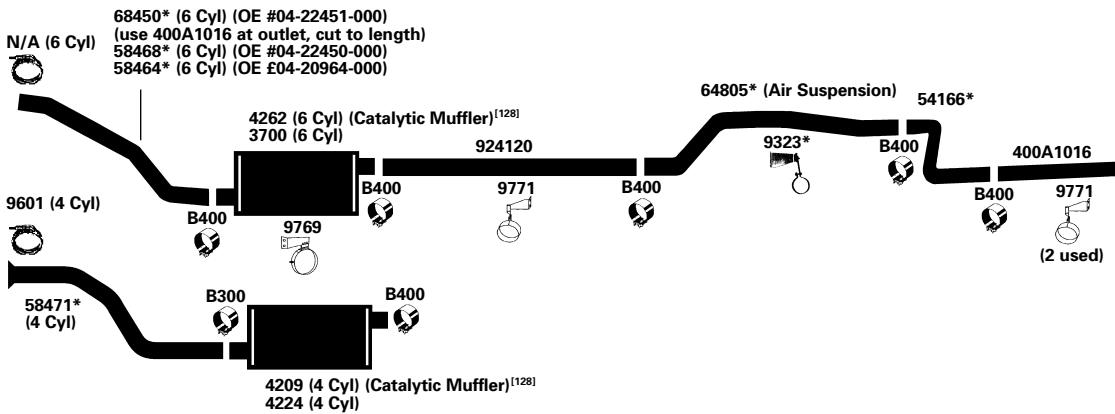

* New Item

02-04 6 Cyl. Freightliner B-Series Cummins Engine w/ World Trans.

(200486)

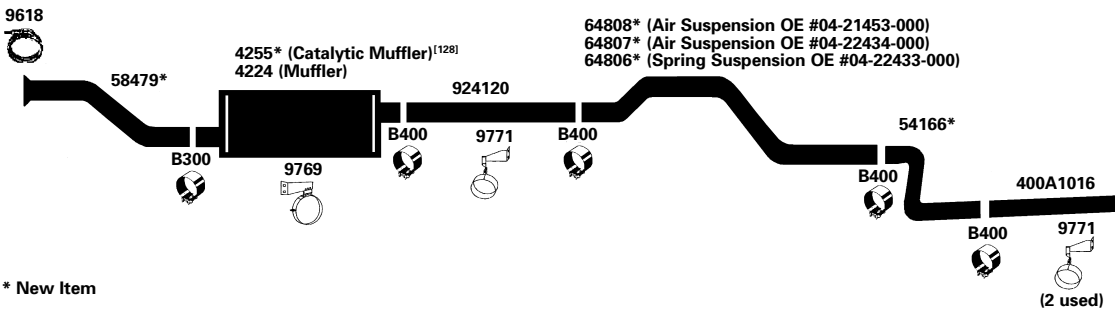

* New Item

FREIGHTLINER SCHOOL BUS

02-04 6 Cyl. Freightliner 3126 Caterpillar Engine

(200495)

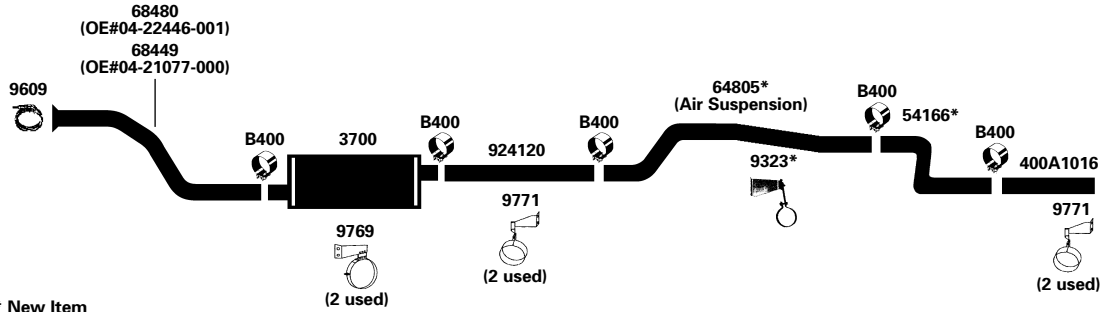

98-01 6 Cyl. Freightliner B-Series Cummins Engine

(200420)

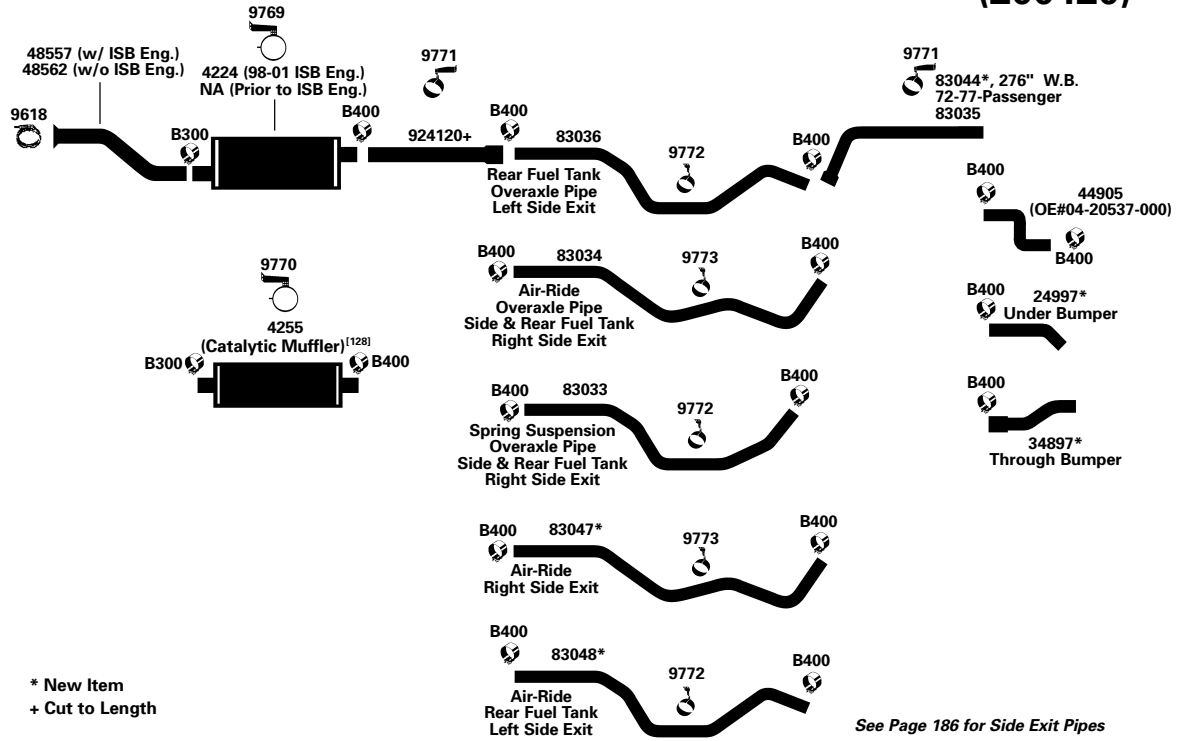

FREIGHTLINER SCHOOL BUS

98-01 6 Cyl. Freightliner 3126 Caterpillar Engine

(200421)

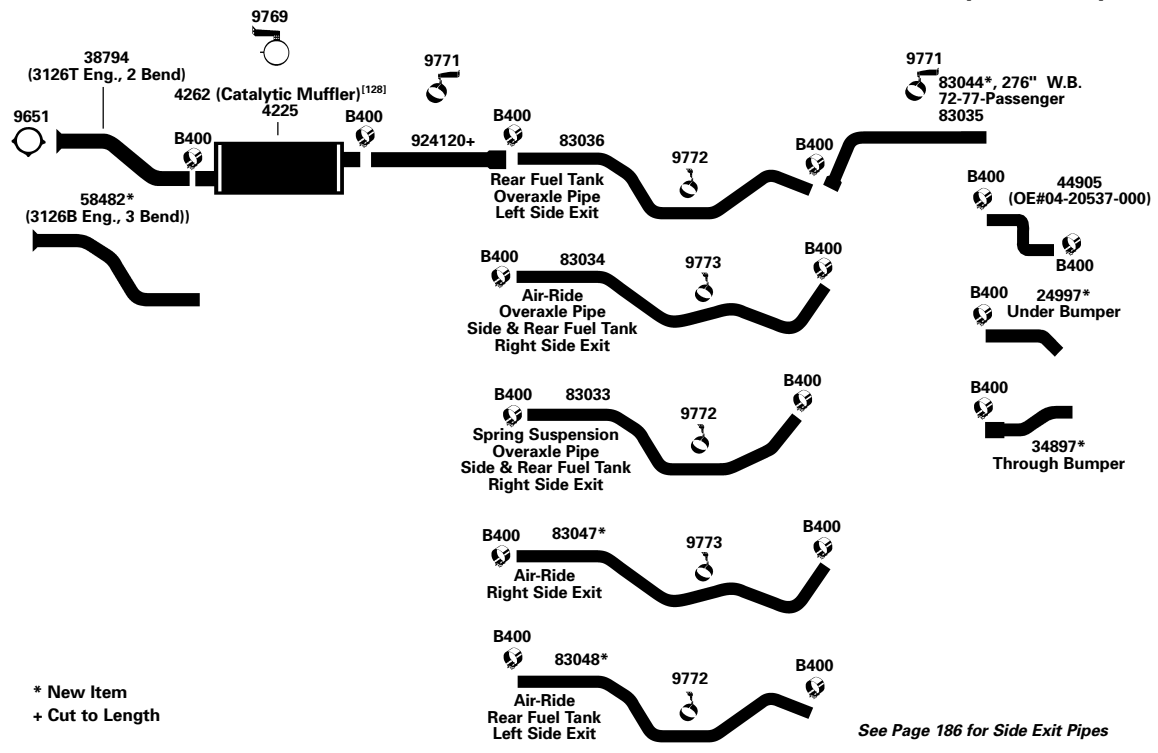

SCHOOL BUS APPLICATIONS

See Page 183 for footnote explanations.

GENESIS SCHOOL BUS

94-98 6 Cyl. Model 3900 Front Engine Chassis w/ DT466 Diesel; RH Tail Pipe; w/ Air Suspension; 152"-276" W.B. **(200422)**

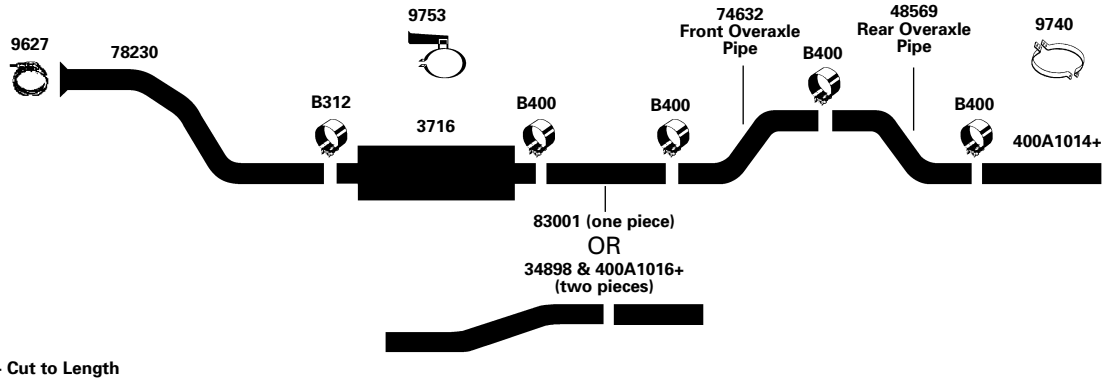

94-98 6 Cyl. Model 3900 Front Engine Chassis w/ DT466 NGD Diesel; w/o Air Suspension; 152"-276" W.B. **(200423)**

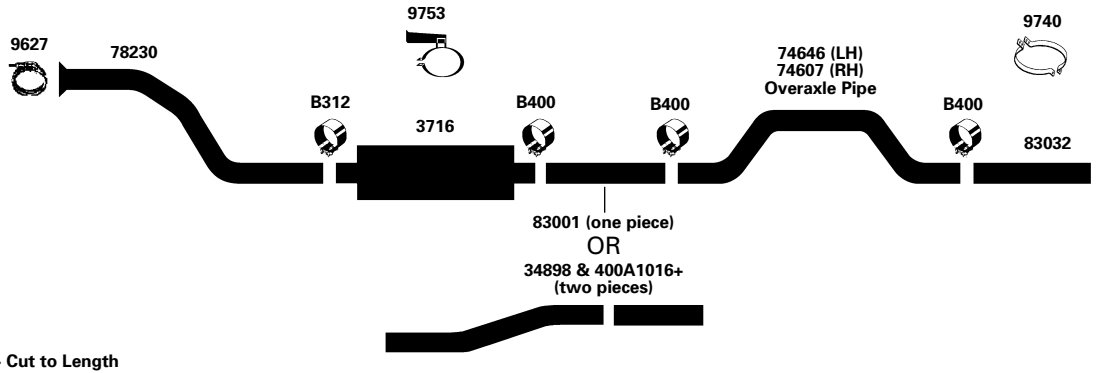

92-94 6 Cyl. Model 3900 Front Engine Chassis w/ DT360 Diesel; RH Tail Pipe; w/ Air Suspension; 152"-276" W.B. **(200424)**

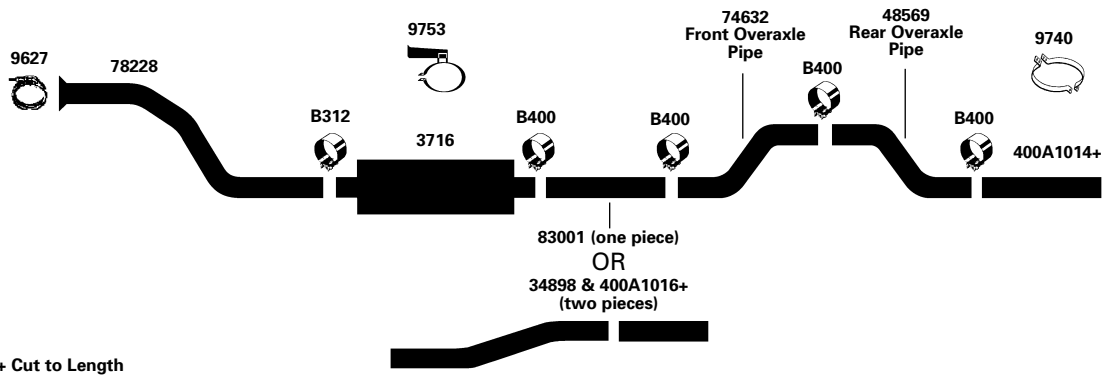

INTERNATIONAL SCHOOL BUS

07-08 6 Cyl. FE international DT 466 Engine, Right Side Exit Max Force DT **(200504)**

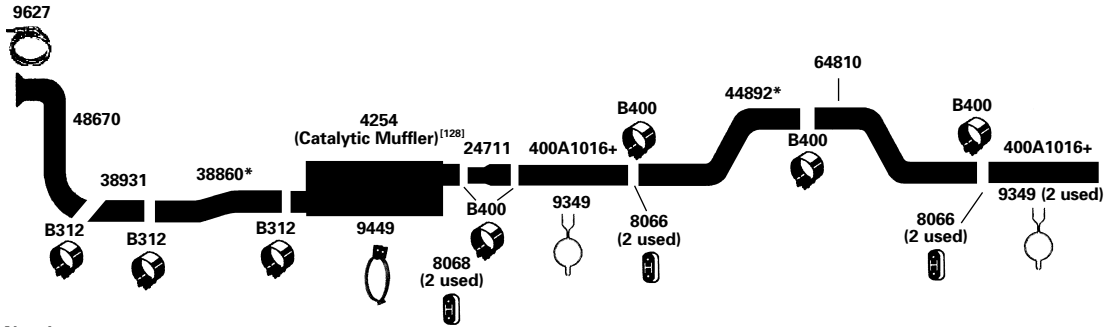

* New Item
+ Cut to Length

05-08 6 Cyl. CE international w/ DT 466 Engine & VT 365 Engine **(200488)**

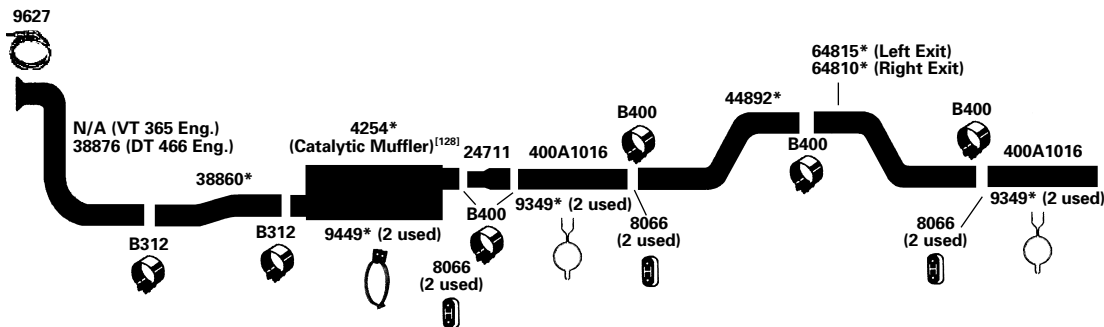

* New Item

04-07 8 Cyl. IC Rear Engine VT-365 & DT466 **(200506)**

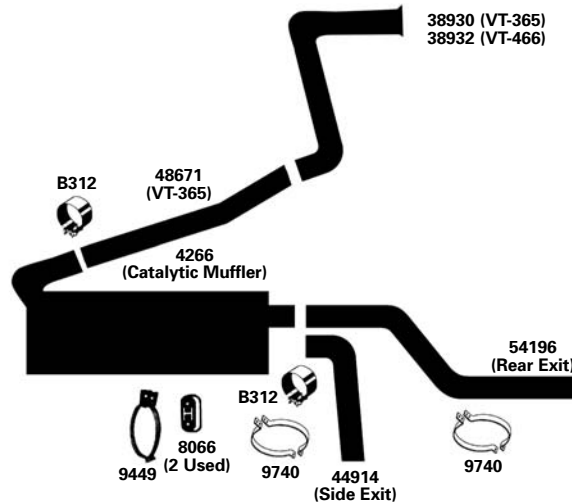

INTERNATIONAL SCHOOL BUS

04-05 8 Cyl. Model IC w/VT365 Diesel (200505)

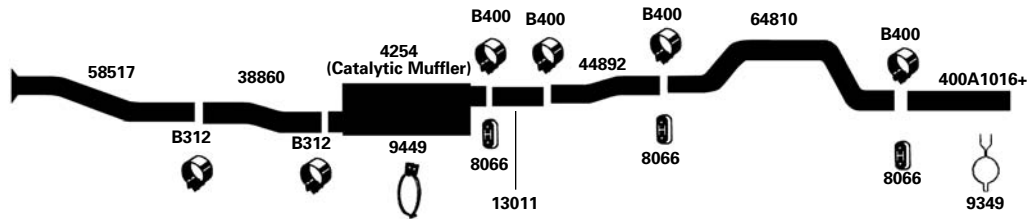

+ Cut to Length

00-03 6 Cyl. International DT 466 Engine, Left Side Exhaust System (200489)

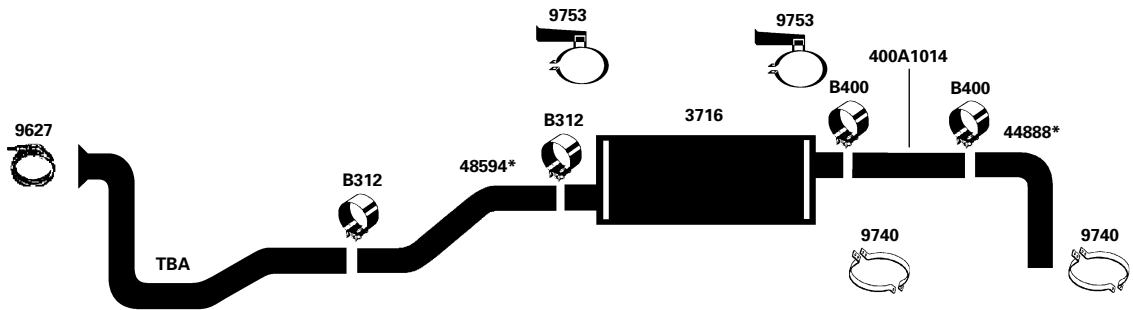

* New Item

01-04 6 Cyl. Series 3800 w/ T444 Turbo Diesel, w/ Air Ride Suspension (200497)

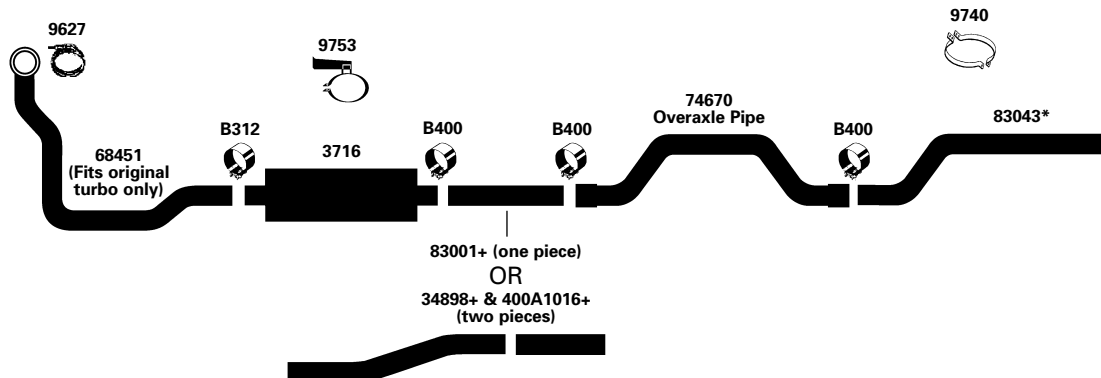

* New Item
+ Cut to Length

See Page183 for footnote explanations.

INTERNATIONAL SCHOOL BUS

2001 6 Cyl. Series 3800 w/ 444 Turbo Diesel, w/ Spring Suspension (200498)
(Vari-Rate Suspension)

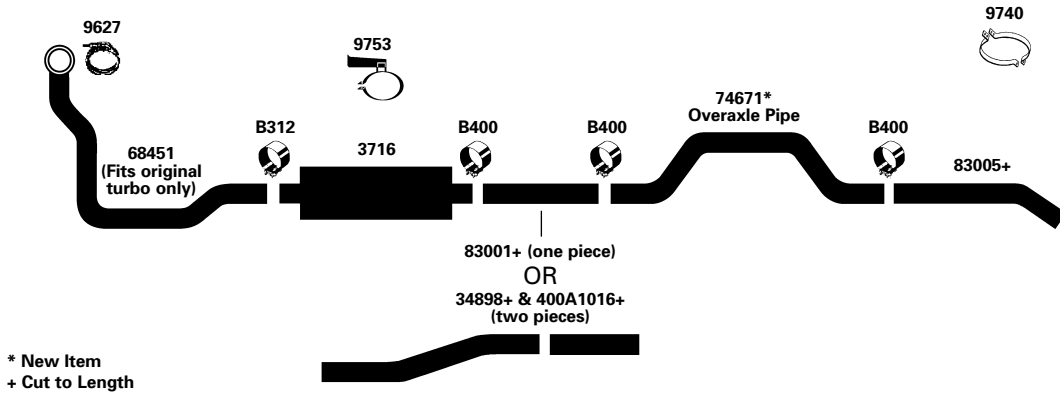

00-01 6 Cyl. Series 3800 w/ 466 Turbo Diesel, w/ Air Ride Suspension (200499)

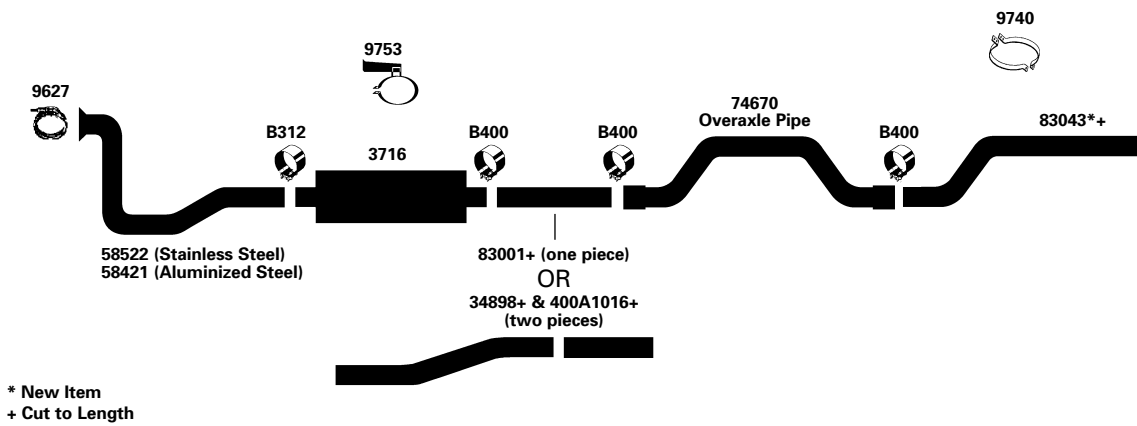

96-00 6 Cyl. Series 3800 w/ DT408, DT466 NGD Diesel; w/ Code 07ABC; RH Exhaust; 152" W.B. (200425)

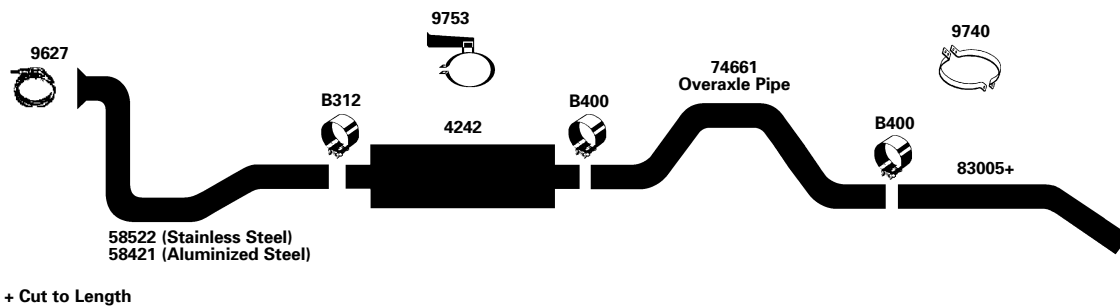

INTERNATIONAL SCHOOL BUS

94-02 8 Cyl. International; Amtran – T444E Rear Engine; Forward Control

(200426)

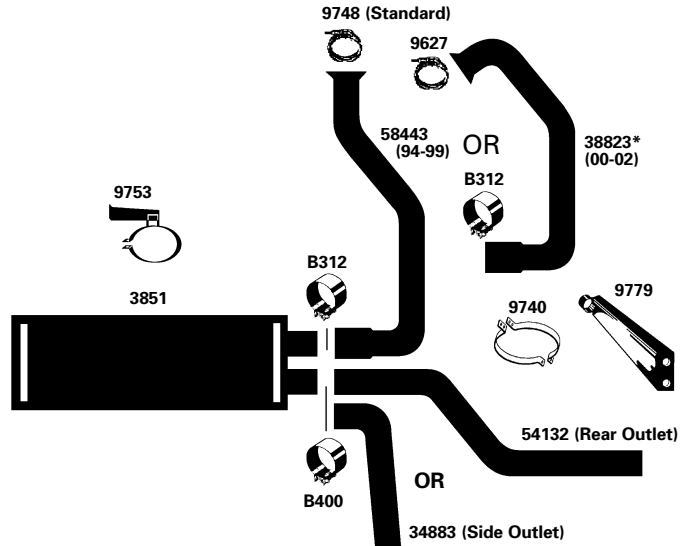

* New Item

94-00 8 Cyl. Series 3600; w/ T444E Diesel; w/ Code 10NXW-Handicap Pkg.; RH Rear Exit Tail Pipe; 152"-276" W.B.

(200427)

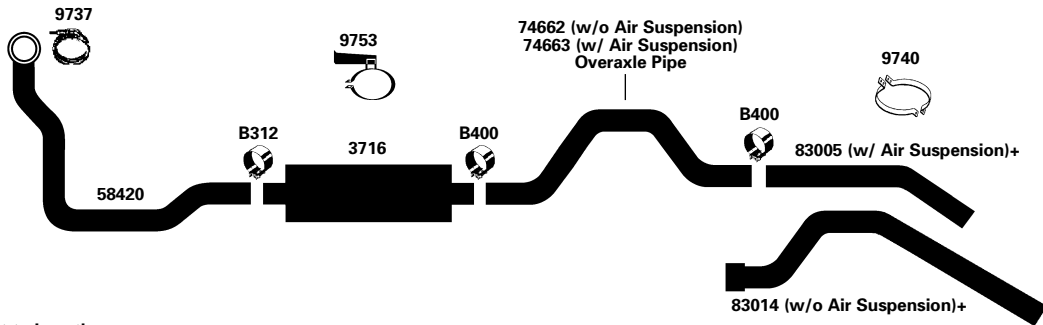

+ Cut to Length

94-00 6-8 Cyl. Series 3600, 3800; 6 Cyl. DT408, DT466E, 8 Cyl. T444E Diesel; w/ Air Suspension; 152"-276" W.B.

(200428)

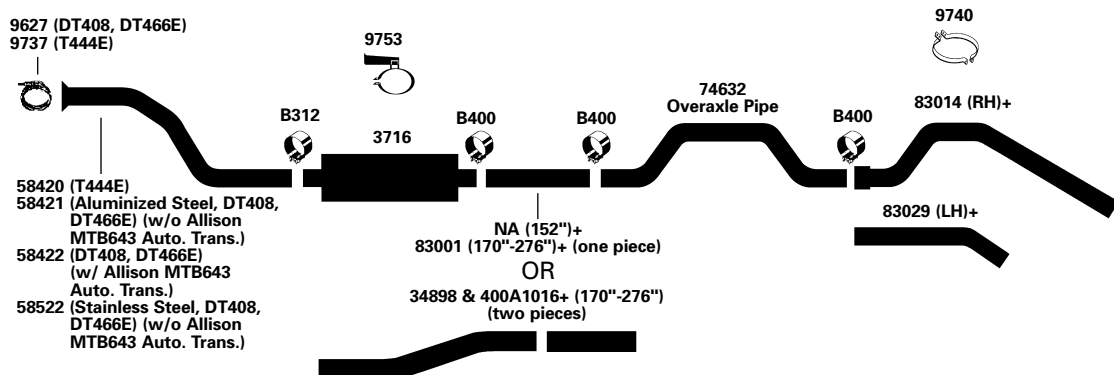

+ Cut to Length

See Page 183 for footnote explanations.

INTERNATIONAL SCHOOL BUS

94-00 6-8 Cyl. Series 3600, 3800; 6 Cyl. DT408, DT466E, 8 Cyl. T444E Turbo Diesel; w/ Vari-Rate Suspension; 152"-276" W.B. **(200429)**

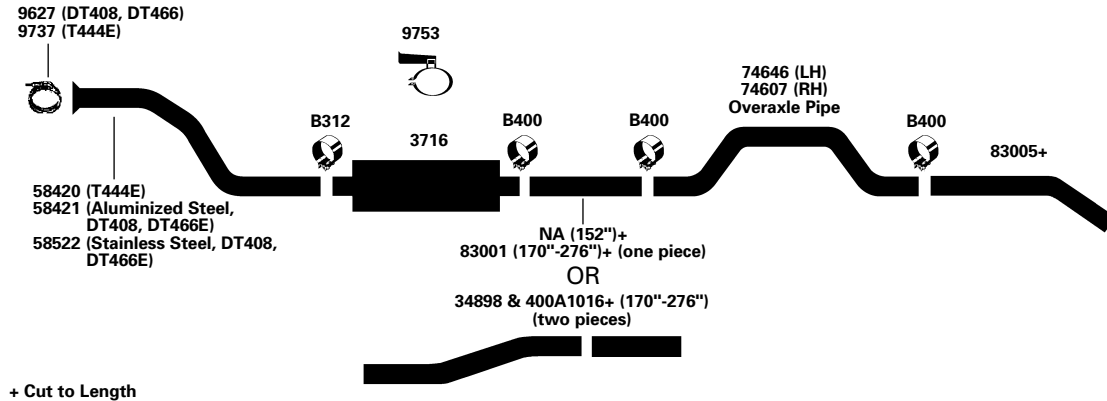

94-00 6 Cyl. Series 3800; w/ DT408, DT466E Turbo Diesel; Code 07AAS; Tail Pipe Exits Front of LH Rear Wheel; 152"-276" W.B. **(200430)**

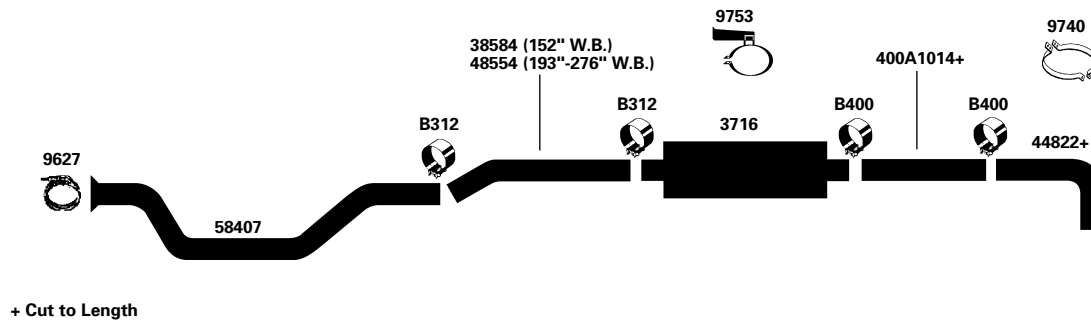

94-00 6 Cyl. Series 3800; w/ DT408, DT466E Turbo Diesel; w/ Code 07AAN; LH Exit Tail Pipe; w/o Air Suspension; 152"-276" W.B. **(200431)**

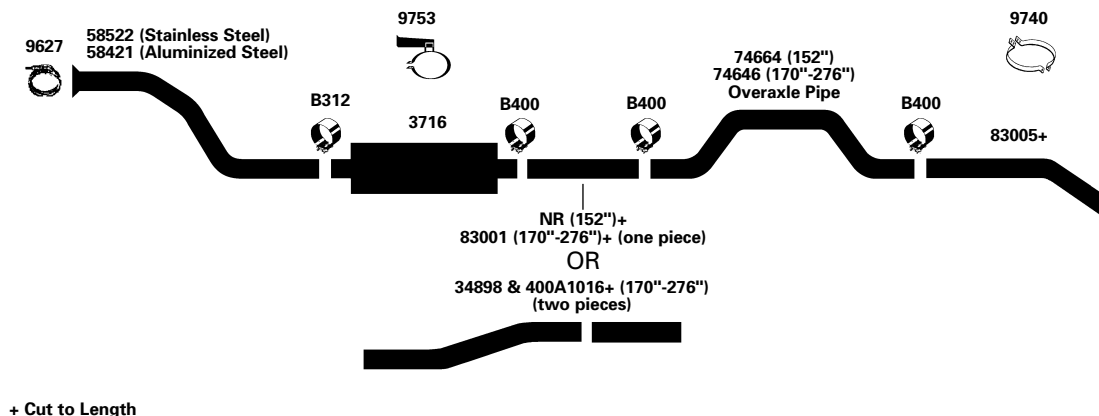

See Page 183 for footnote explanations.

INTERNATIONAL SCHOOL BUS

94-00 6 Cyl. Series 3800; w/ DT408, DT466E Turbo Diesel; w/ Code 07AAW; **(200432)**
w/ Allison MTB643, MTB653DR Auto. Trans.; LH Exit Tail Pipe;
w/o Air Suspension; 152", 170"-276" W.B.

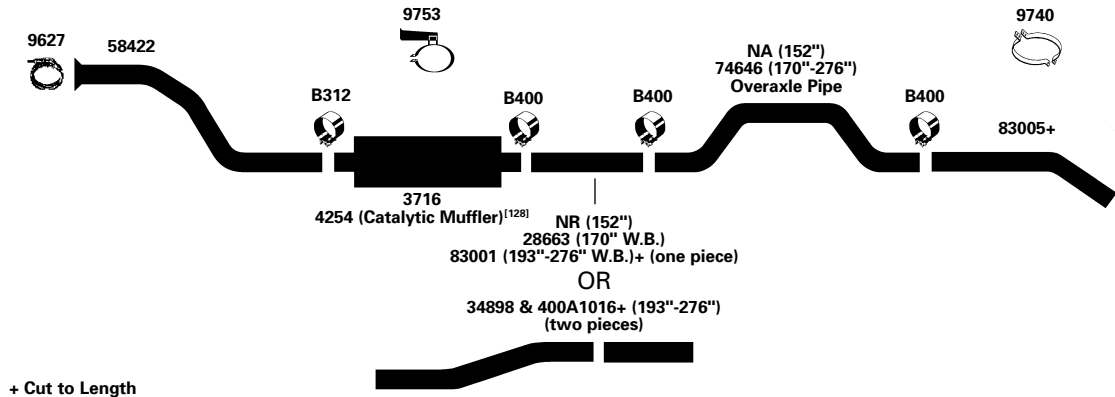

94-00 6 Cyl. Series 3600, 3800; w/ DT408, DT466E, T444E Diesel; **(200433)**
w/ Mor-Ryde Suspension (exc. RH Rear Exit Tail Pipe);
152", 170"-276" W.B.

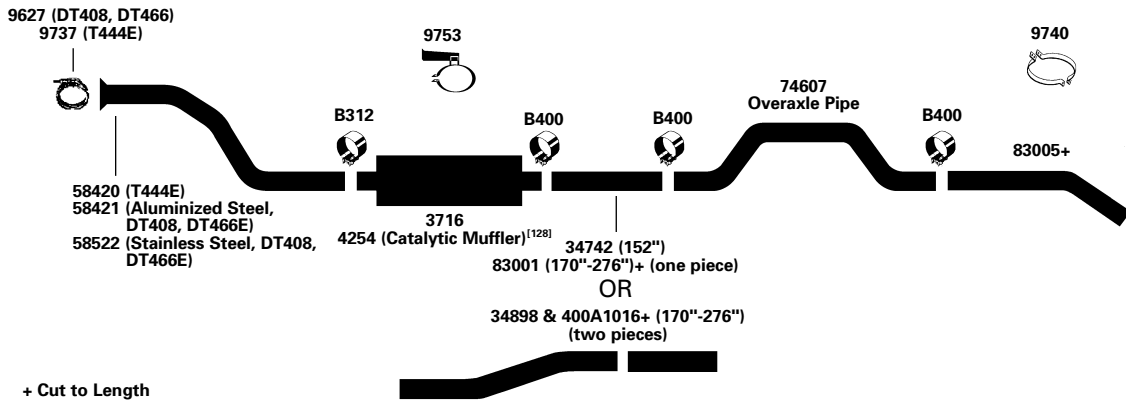

94-00 6 Cyl. International; Amtran – DT 466 Rear Engine; Forward Control **(200490)**

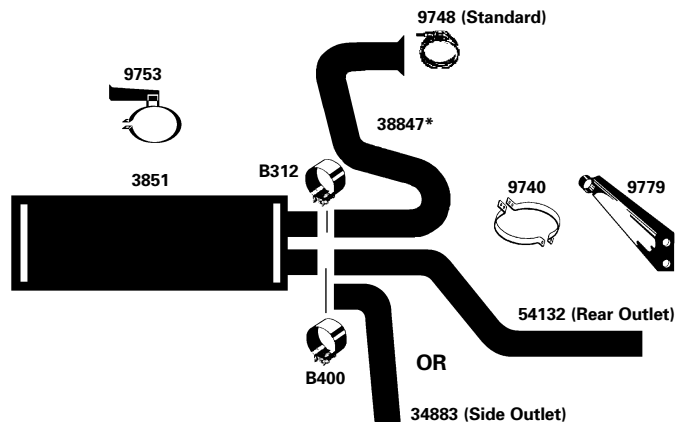

* New Item

See Page183 for footnote explanations.

INTERNATIONAL SCHOOL BUS

91-93 6 Cyl. Series "S"; 3700, 3800; w/ DT466, DTA466 Diesel Eng.; Allison MTB643 Auto. Trans; w/ Mor-Ryde or Vari-Rate Suspension; w/o Air Suspension; Long Tail Pipe-Left Side Exit **(200434)**

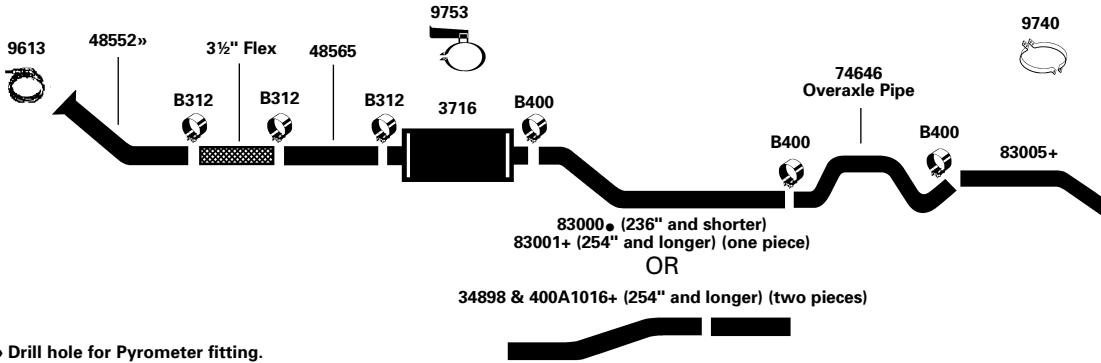

» Drill hole for Pyrometer fitting.
+ Cut to Length

91-93 6 Cyl. Series "S"; 3700, 3800; w/ DT466, DTA466 Diesel Eng.; Allison MTB643 Auto. Trans; w/ Air Suspension; Long Tail Pipe-Left Side Exit **(200435)**

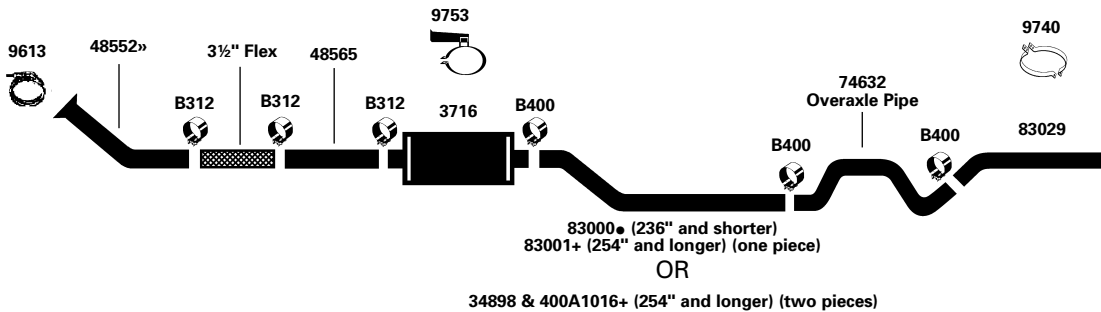

» Drill hole for Pyrometer fitting.
+ Cut to Length

91-93 6 Cyl. Series "S"; 3700, 3800; w/ DT466, DTA466 Diesel Eng.; Allison MTB643 Auto. Trans; w/ Air Suspension; Long Tail Pipe - Right Side Exit **(200436)**

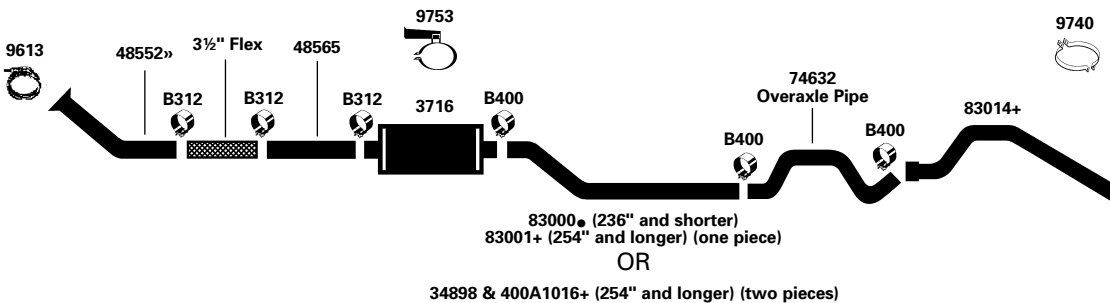

» Drill hole for Pyrometer fitting.
+ Cut to Length

INTERNATIONAL SCHOOL BUS

91-93 6 Cyl. Series "S"; 3700, 3800; w/ DT360, DTA360 Diesel Eng.;
Short Tail Pipe-Left Side Exit in Front of Rear Wheel

(200437)

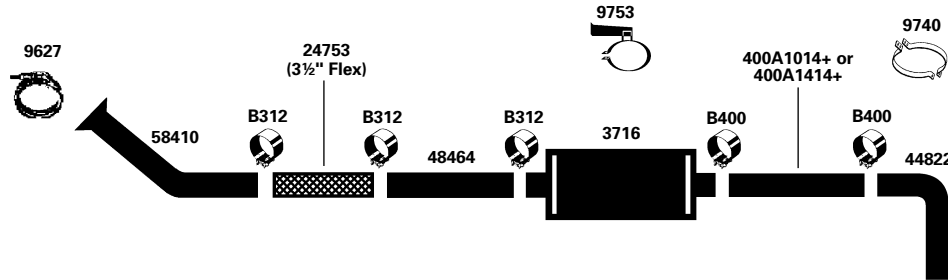

+ Cut to Length

91-93 6 Cyl. Series "S"; 3700, 3800; w/ DT466, DTA466 Diesel Eng.;
Short Tail Pipe-Left Side Exit in Front of Rear Wheel

(200438)

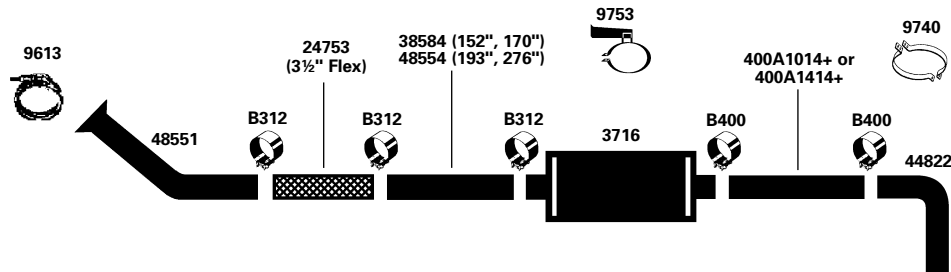

+ Cut to Length

91-93 6 Cyl. 3900 FC Series; w/ DT360, DTA360 Diesel Eng.;
Short Tail Pipe-Left Side Exit in Front of Rear Wheel

(200439)

91-93 6 Cyl. 3900 FC Series; w/ DT466, DTA466 Diesel Eng.;
Short Tail Pipe-Left Side Exit in Front of Rear Wheel

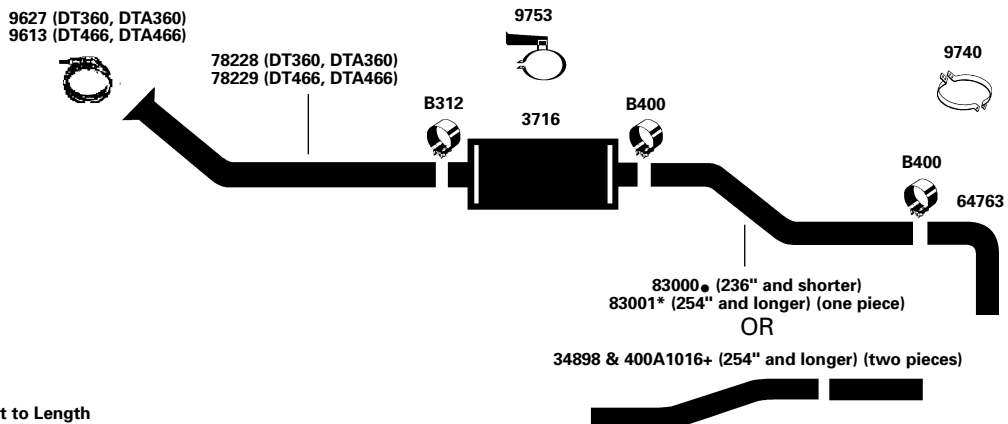

+ Cut to Length

See Page183 for footnote explanations.

INTERNATIONAL SCHOOL BUS

91-93 6 Cyl. 3900 FC Series; DT/DTA360, DT/DTA466 Diesel Eng.; w/o Air Suspension; Long Tail Pipe **(200441)**

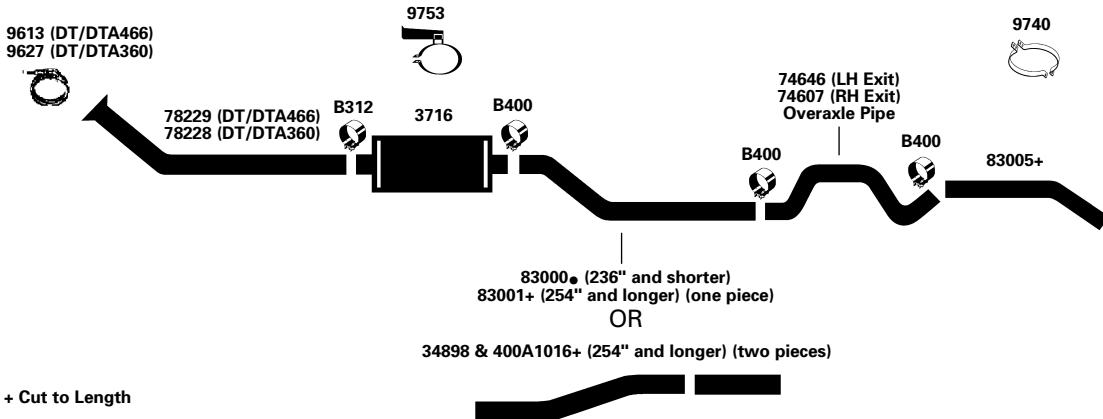

91-93 6 Cyl. 3900 FC Series; DT/DTA360, DT/DTA466 Diesel Eng.; w/ Air Suspension; Long Tail Pipe **(200442)**

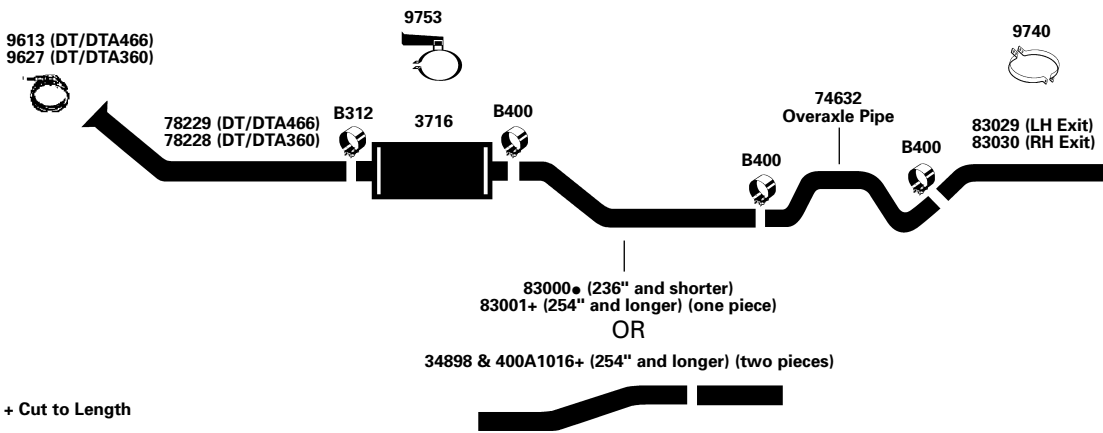

88-93 6 Cyl. Series 3700, 3800; w/ 7.3L Diesel; LH Side Exit in Front of Rear Wheel; 152"-276" W.B. **(200447)**

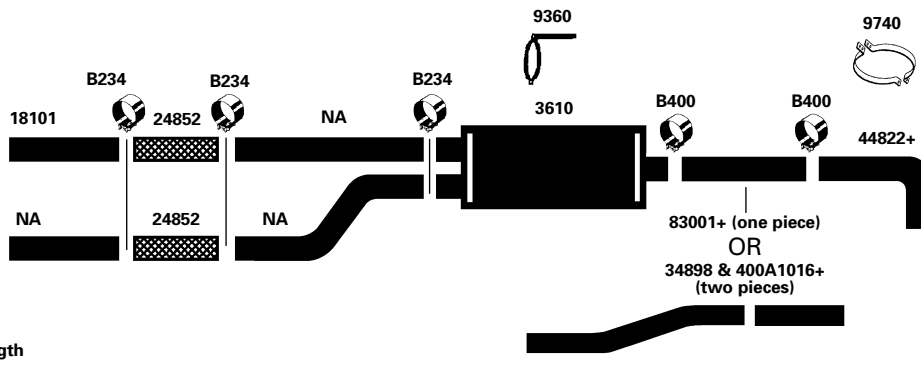

INTERNATIONAL SCHOOL BUS

- 88-93** 8 Cyl. Series "S"; 3600, 3700; 7.3L Diesel Eng.; w/o Air Susp.; **(200448)**
RH Mounted Tail Pipe
- 88-93** 8 Cyl. Series "S"; 3600, 3700; 7.3L Diesel Eng.; w Air Susp.; RH Mounted Tail Pipe

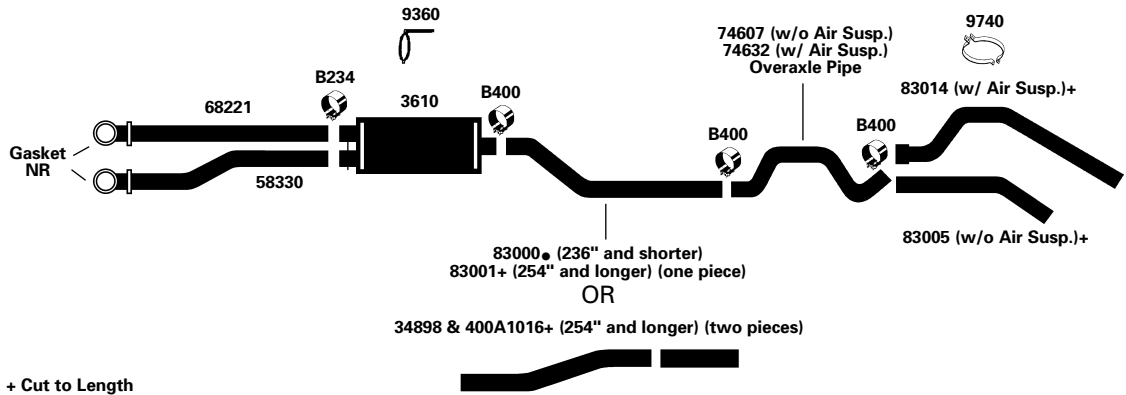

- 88-93** 8 Cyl. Series "S"; 3600, 3700; 7.3L Diesel Eng.; w/o Air Susp.; **(200449)**
LH Mounted Tail Pipe
- 88-93** 8 Cyl. Series "S"; 3600, 3700; 7.3L Diesel Eng.; w Air Susp.; LH Mounted Tail Pipe

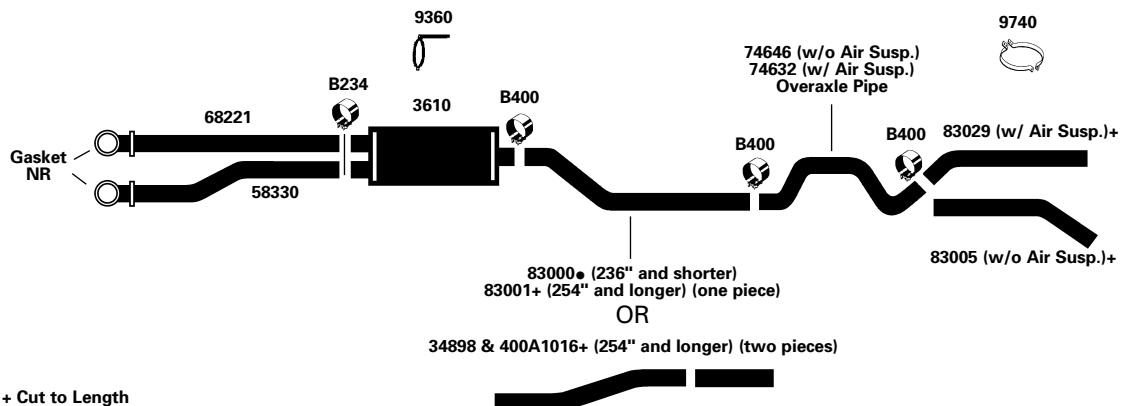

- 87-93** 6 Cyl. Series "S"; 3600, 3700, 3800; DT/DTA360 Diesel Eng.; w/o Air Susp. w/ Mor-Ryde or Vari-Rate Susp.; Long Tail Pipe - Left Side Exit **(200443)**
- 87-93** 6 Cyl. Series "S"; 3600, 3700, 3800; DT/DTA360 Diesel Eng.; w/o Air Susp.; Long Tail Pipe - Right Side Exit

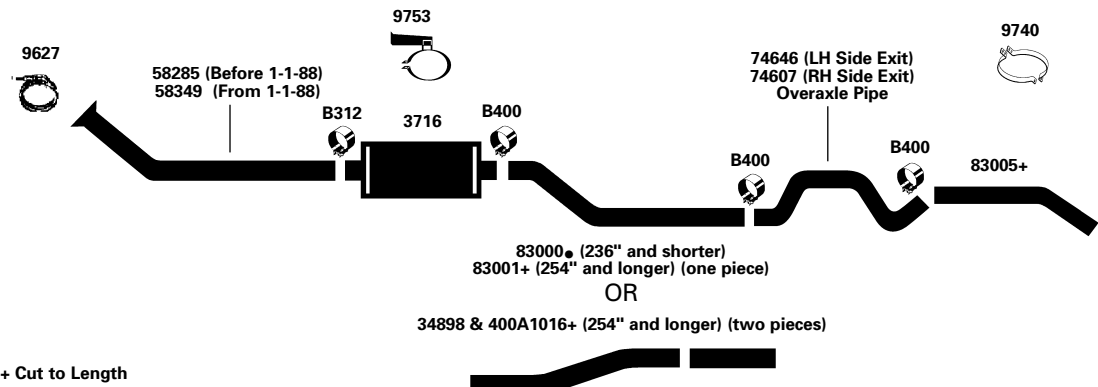

See Page183 for footnote explanations.

INTERNATIONAL SCHOOL BUS

- 87-93 6 Cyl. Series "S"; 3700, 3800; DT/DTA360 Diesel Eng.; w/ Air Susp.; **(200444)**
Long Tail Pipe - Left Side Exit
- 87-93 6 Cyl. Series "S"; 3600, 3700, 3800; DT/DTA360 Diesel Eng.; w/ Air Susp.;
Long Tail Pipe - Right Side Exit

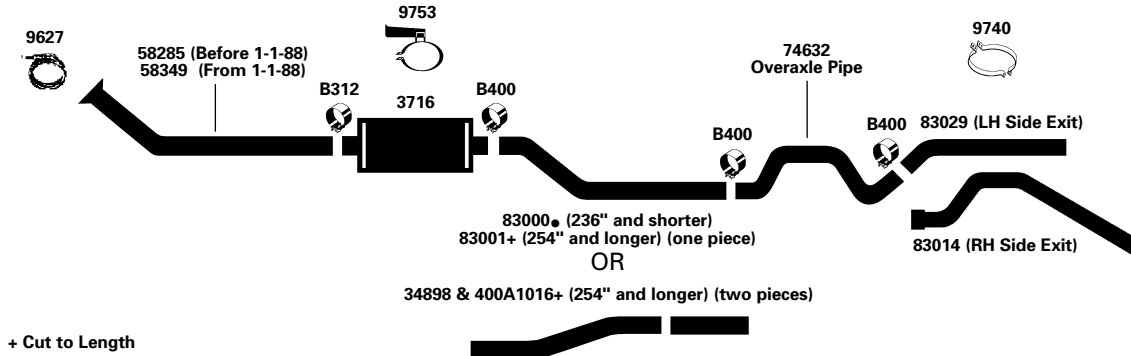

- 87-93 6 Cyl. Series "S"; 3700, 3800; DT/DTA466 Diesel Eng.; **(200445)**
w/ Mor-Ryde or Vari-Rate Susp.; exc. Allison MTB643 Auto. Trans.;
Long Tail Pipe - Left Side Exit
- 87-93 6 Cyl. Series "S"; 3700, 3800; DT/DTA466 Diesel Eng.; w/o Air Susp.;
exc. Allison MTB643 Auto. Trans.; Long Tail Pipe - Right Side Exit

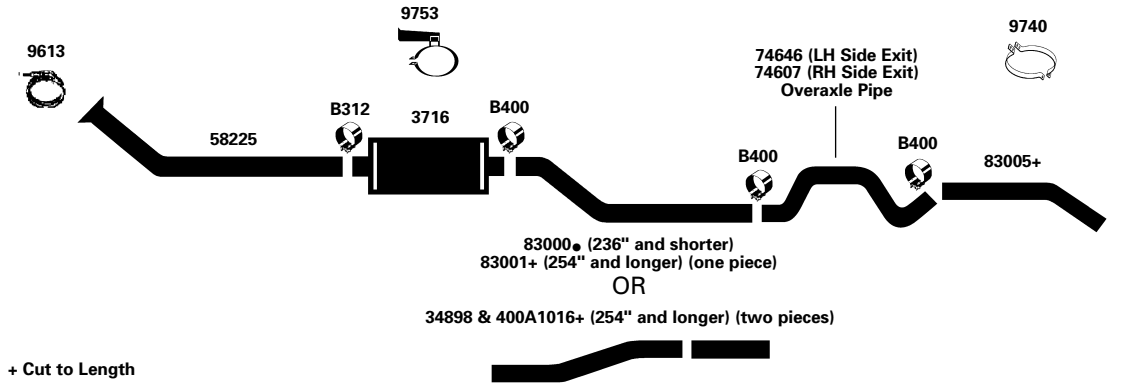

- 87-93 6 Cyl. Series "S"; 3700, 3800; DT/DTA466 Diesel Eng.; w. Air Susp.; **(200446)**
exc. Allison MTB643 Auto. Trans.; Long Tail Pipe - Right Side Exit
- 87-93 6 Cyl. Series "S"; 3700, 3800; DT/DTA466 Diesel Eng.; w. Air Susp.;
Long Tail Pipe - Left Side Exit

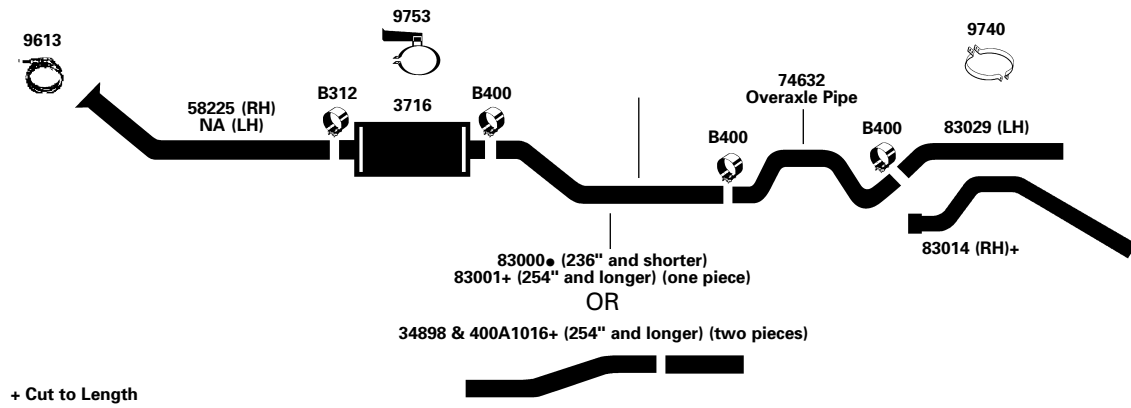

See Page 183 for footnote explanations.

SCHOOL BUS
APPLICATIONS

INTERNATIONAL SCHOOL BUS

80-89 8 Cyl. Model 1853; 9.0L Diesel Eng. **(200452)**
79-85 8 Cyl. Model 1723, 1823; MV404 Eng.

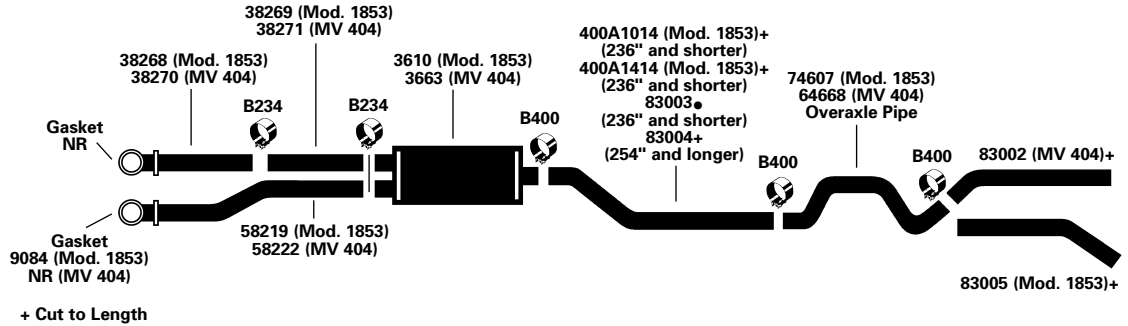

83-88 8 Cyl. Series "S"; 6.9L Diesel Eng.; w/o Air Susp.; RH Mounted Tail Pipe **(200450)**
83-88 8 Cyl. Series "S"; 6.9L Diesel Eng.; w Air Susp.; RH Mounted Tail Pipe

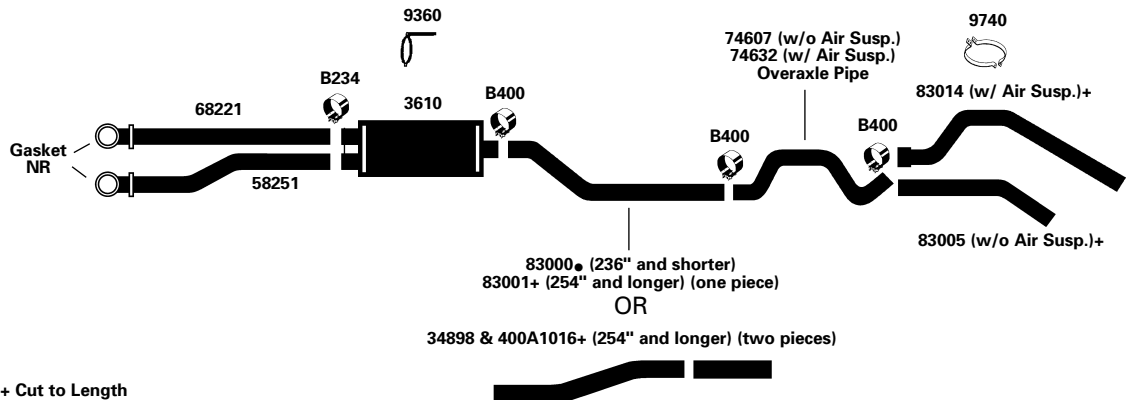

83-88 8 Cyl. Series "S"; 6.9L Diesel Eng.; w/o Air Susp.; LH Mounted Tail Pipe **(200451)**
83-88 8 Cyl. Series "S"; 6.9L Diesel Eng.; w Air Susp.; LH Mounted Tail Pipe

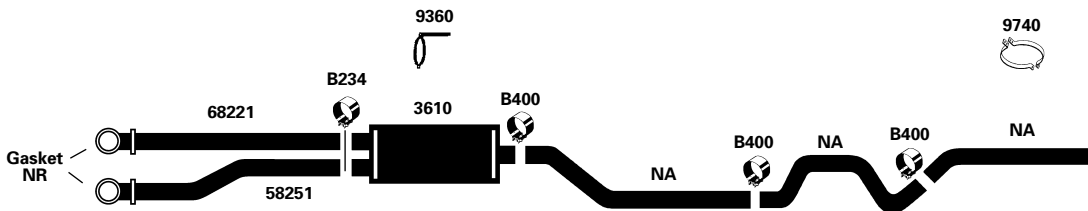

80-87 8 Cyl. Model 1853; w/ 3208 Eng. **(200454)**

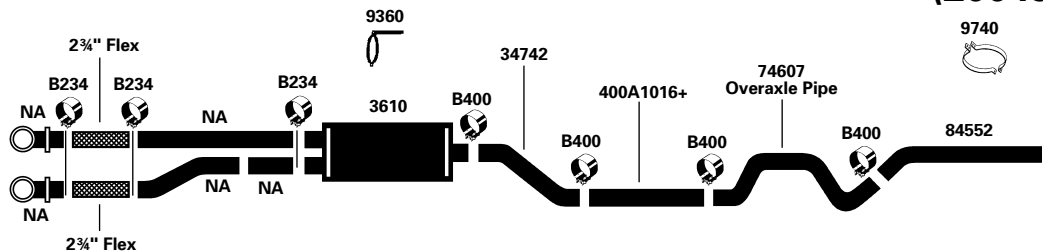

+ Cut to Length

See Page183 for footnote explanations.

INTERNATIONAL SCHOOL BUS

79-87 6 Cyl. Model 1853; DT466 Diesel Eng.

(200440)

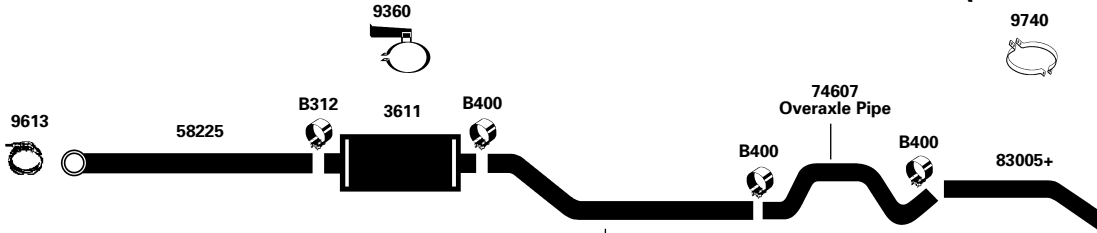

83000+ (236" and shorter)
83001+ (254" and longer) (one piece)
OR
34898 & 400A1016+ (254" and longer) (two pieces)

+ Cut to Length

79-85 8 Cyl. Series "S"; 345, 392 Eng.

(200453)

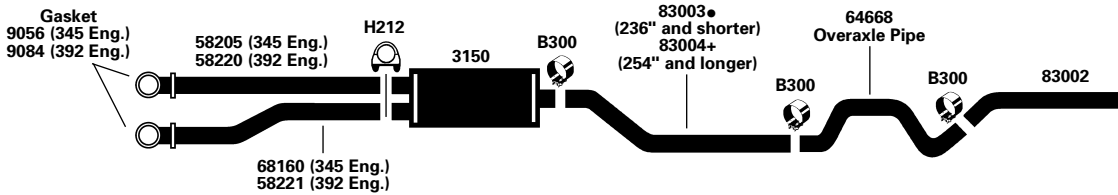

+ Cut to Length

76-78 8 Cyl. Model 1853; w/ D170, D190 Eng.

(200455)

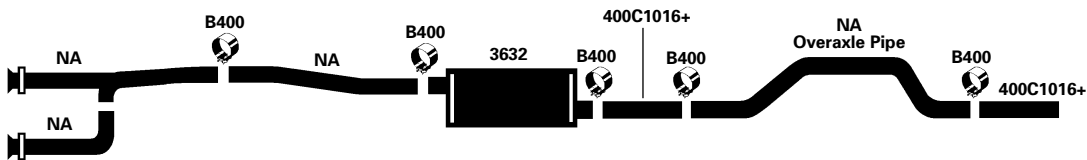

+ Cut to Length

INTERNATIONAL SCHOOL BUS

72-78 8 Cyl. All models w/ 406, 450, 501 C.I.D. Eng.; 151"-276" W.B.

(200457)

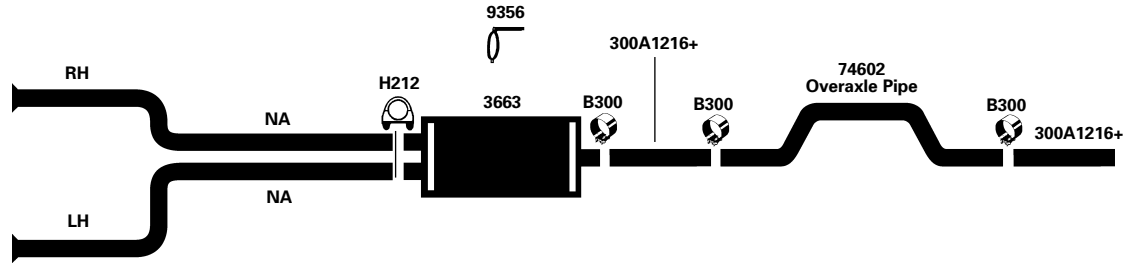

+ Cut to Length

71-78 8 Cyl. Loadstar; 304(62-78), 345, 392 Eng.

(200456)

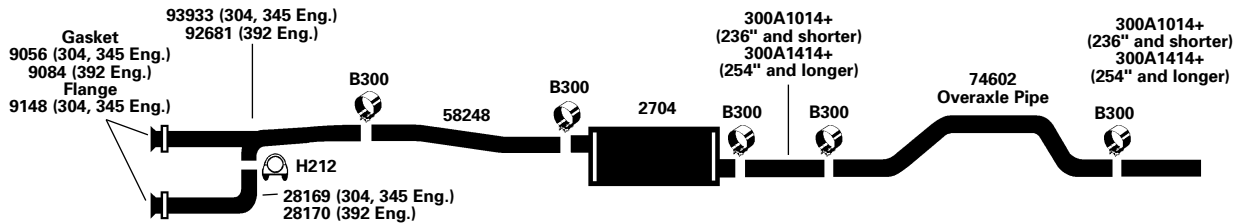

+ Cut to Length

THOMAS SCHOOL BUS

98-02 6 Cyl. Thomas MVP E-F, B-Series Cummins Engine Forward

(200491)

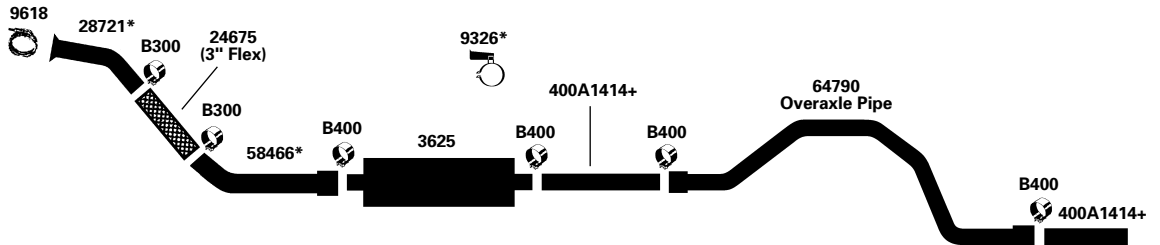

* New Item
+ Cut to Length

See Page 185 for Air Ride Overaxles and Side Exit Tailpipe
(100 gallon fuel tank use 2 piece Overaxle Pipes on page 187 for easy installation)

THOMAS SCHOOL BUS

98-01 6 Cyl. Thomas Pusher 3126 Cat. Eng.

(200458)

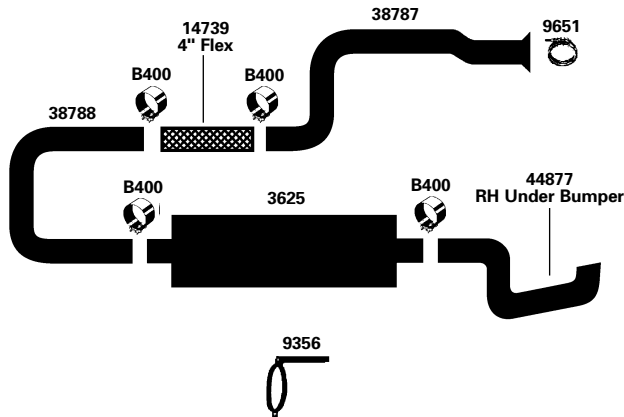

98-01 6 Cyl. Saf-T-Liner w/ 3126 Caterpillar Engine, 8.3L Cummins Engine

(200493)

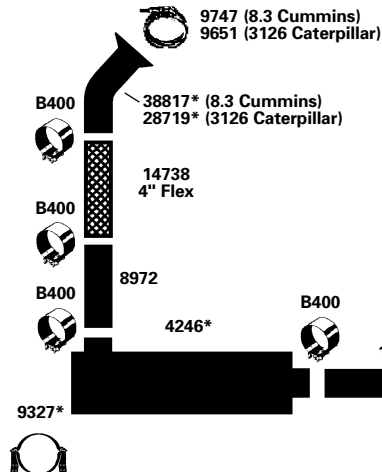

* New Item

94-01 6 Cyl. Thomas MVP E-F, B-Series Cummins (Non-Catalytic Muffler)

(200461)

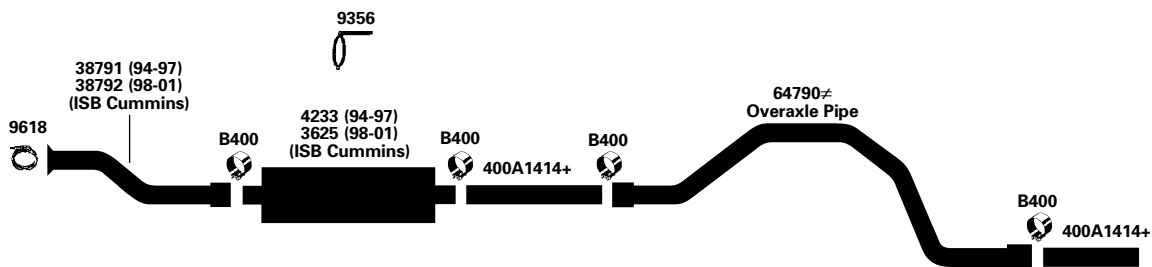

+ Cut to Length

See Page 185 for Air Ride Overaxles and Side Exit Tailpipe
≠(100 gallon fuel tank use 2 piece Overaxle Pipes on page 187 for easy installation)

See Page 183 for footnote explanations.

SCHOOL BUS
APPLICATIONS

THOMAS SCHOOL BUS

97-00 6 Cyl. Thomas MVP E-F, 3126 & C7, Caterpillar Engine Forward

(200492)

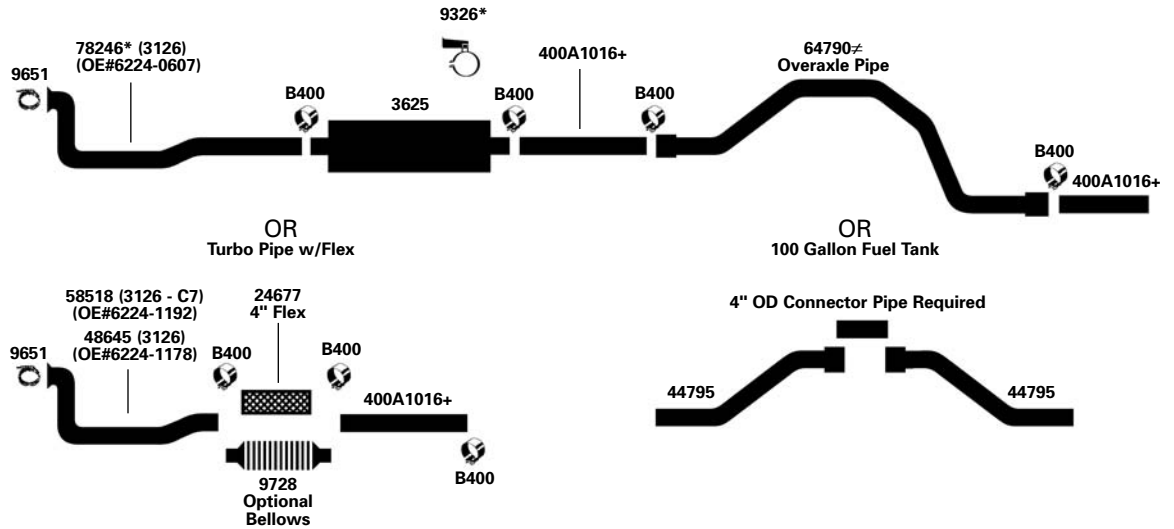

* New Item
+ Cut to Length

See Page 185 for Air Ride Overaxles and Side Exit Tailpipe
≠ (100 gallon fuel tank use 2 piece Overaxle Pipes on page 187 for easy installation)

96-00 6 Cyl. Thomas Pusher 8.3 Cummins

(200459)

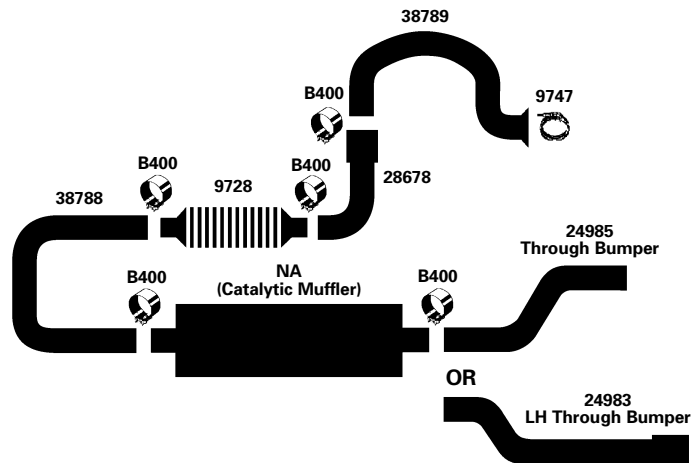

See Page 183 for footnote explanations.

THOMAS SCHOOL BUS

97-98 6 Cyl. MVP-ER Model; w/ 5.9L Cummins Turbo Diesel; Rear Eng.;
RH Rear Exit Tail Pipe

(200462)

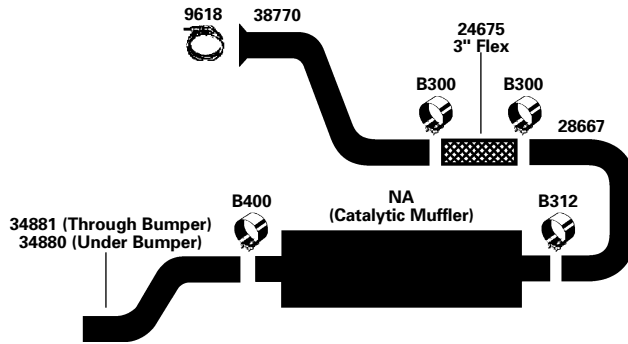

96-98 6 Cyl. MVP-ER Model w/ Cat. 3116 Turbo Diesel; Rear Eng.;
RH Below Bumper Exit

(200463)

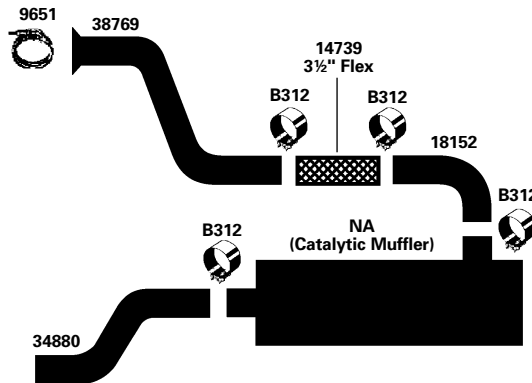

96-98 6 Cyl. Rear Engine Models w/ B-Series Cummins Engine w/ Standard Muffler

(200494)

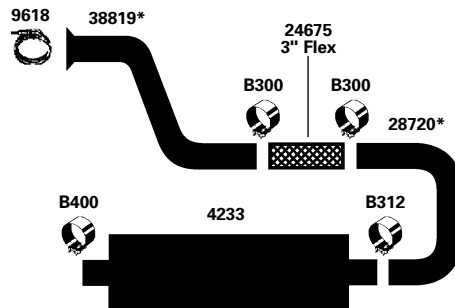

* New Item

See Page 185 for Tailpipe Options

THOMAS SCHOOL BUS

95-96 6 Cyl. MVP-ER Model w/ Cummins 5.9L Turbo Diesel; LH Rear Exit Tail Pipe **(200464)**

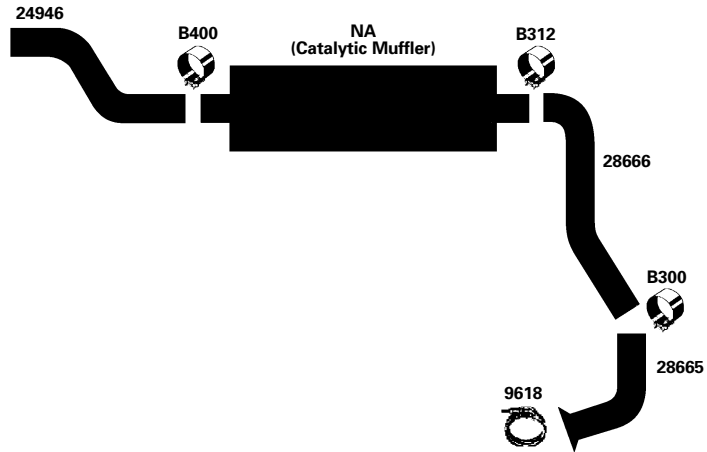

94-96 6 Cyl. Thomas Pusher 8.3 Cummins **(200460)**

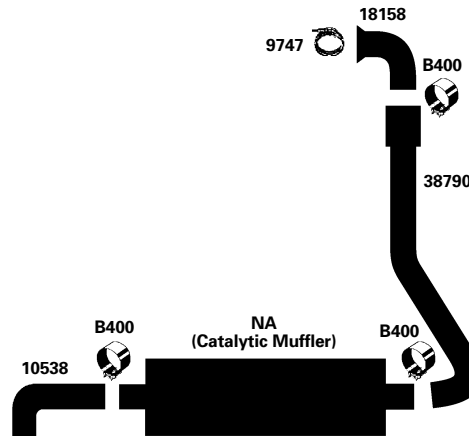

92-95 6 Cyl. MVP Model w/ Cat. 3116 Turbo Diesel; Rear Eng. **(200465)**

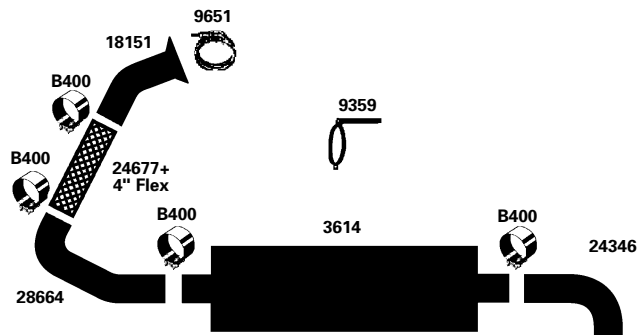

+ Cut to Length

THOMAS SCHOOL BUS

90-93 6 Cyl. Saf-T-Liner w/ 6V92 Rear Engine Model; Rear Exit Tail Pipe

(200466)

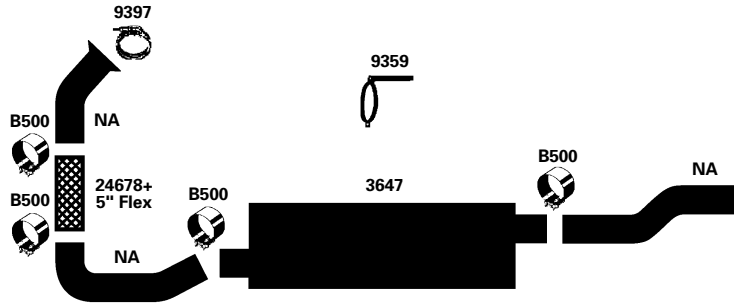

+ Cut to Length

89-93 6 Cyl. All models w/ Cummins 6BTA, 6CTA; Rear Eng.; Rear Exit Tail Pipe

(200467)

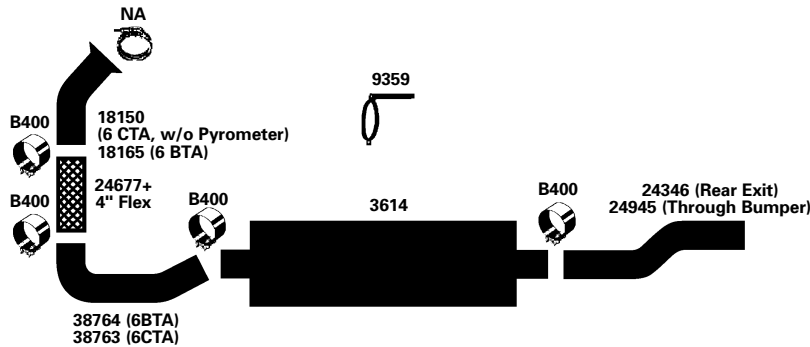

+ Cut to Length

89-93 8 Cyl. Saf-T-Liner w/ 8.2L Turbo Diesel; Rear Eng. Model; Left Side Exit-

(200469)

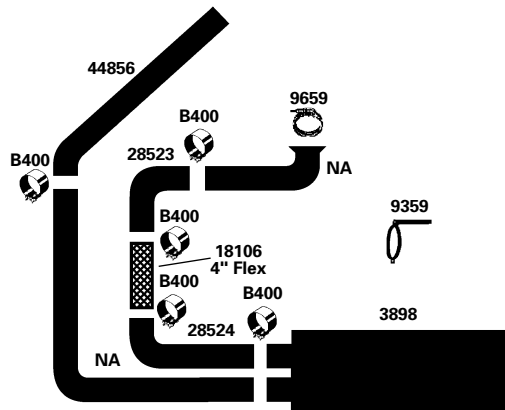

THOMAS SCHOOL BUS

89-93 8 Cyl. Saf-T-Liner w/ 8.2L Turbo Diesel; Rear Eng. Model; Rear Exit Tail Pipe **(200468)**

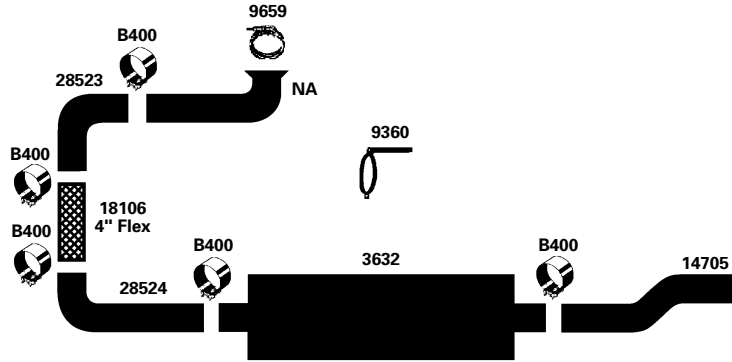

84-91 8 Cyl. Rear Engine Models w/ Caterpillar 3208 Turbo Diesel Engine; Left Side Exit **(200471)**

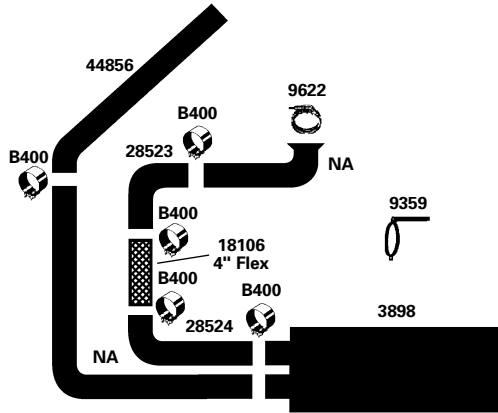

84-91 8 Cyl. Rear Engine Models w/ Caterpillar 3208 Naturally Aspirated Diesel Engine; Left Side Exit **(200470)**

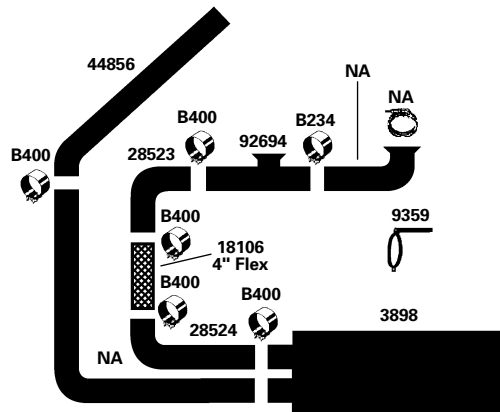

See Page 183 for footnote explanations.

THOMAS SCHOOL BUS

84-88 8 Cyl. Saf-T-Liner; 3208 Caterpillar Diesel Eng. (exc. Turbo); Rear Eng.; Rear Exhaust

(200473)

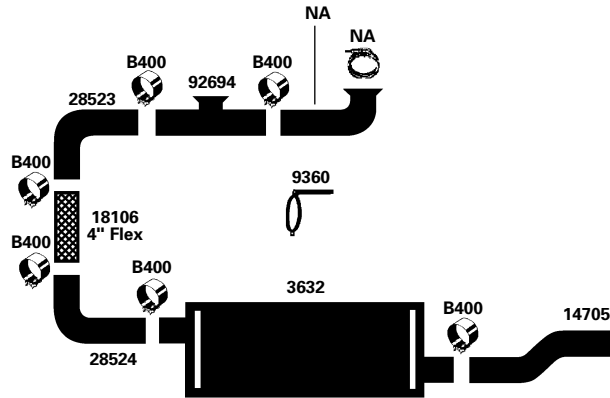

84-91 8 Cyl. Saf-T-Liner; 3208 Caterpillar Turbo Diesel Eng.; Rear Eng.; Rear Exhaust

(200472)

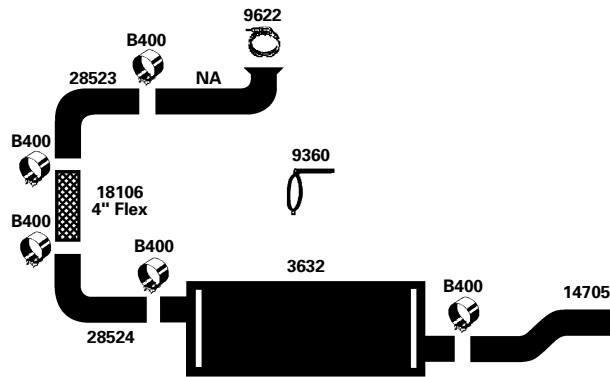

FOOTNOTES:
[128] Adapter(s) may be required to complete installation.
● Golden warehouse item.

SCHOOL BUS
APPLICATIONS



SCHOOL BUS ADAPTERS

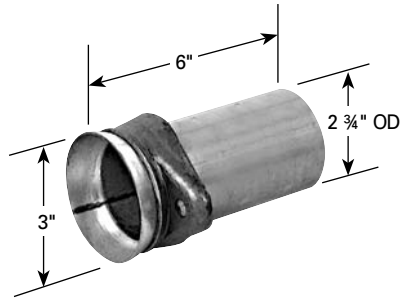

ADAPTER 9524 (TUBE)
(FLANGE 9569 IS SEPARATE)

Socket used to mate GM Y pipes with Ball Connections to 3613 GM muffler.

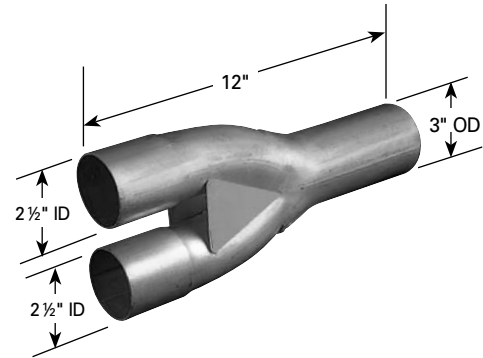

"Y" ADAPTER 92682

Y Adapter to convert I.H.C. 2 1/2" dual inlet muffler applications to a single inlet muffler. Use in conjunction with muffler **2704**. Can also be used with ID/OD straight tubing to relocate muffler behind rear wheels.

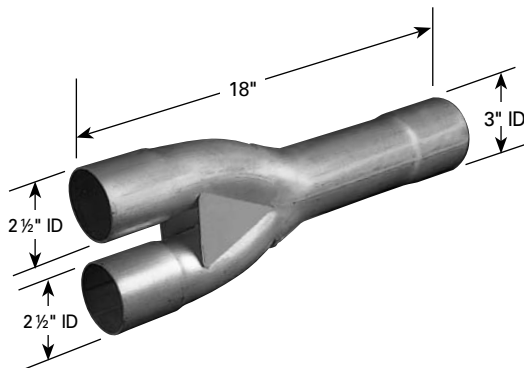

"Y" ADAPTER 92683

Used to convert "S" Series International trucks equipped with gasoline engines and dual inlet mufflers to a single inlet muffler. Single inlet muffler **2704** may be used with 345 & 392 applications (cut off expanded end of "Y" adapter).

Also used to relocate the muffler to a cooler position further back in the exhaust system. Single inlet muffler **2704** may be used with 345 & 392 applications.

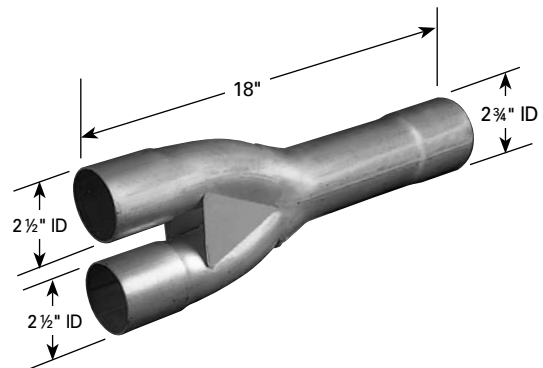

"Y" ADAPTER 92684

Used to convert late model, dual inlet muffler equipped Ford gasoline engine school buses to single inlet muffler. Single inlet muffler **3613** may be used (cut off expanded outlet end of "Y" adapter).

Also used to relocate the muffler to a cooler position further back in the exhaust system. Single inlet muffler **3613** may be used.



THOMAS PIPES

PULLER OVERAXLE PIPES

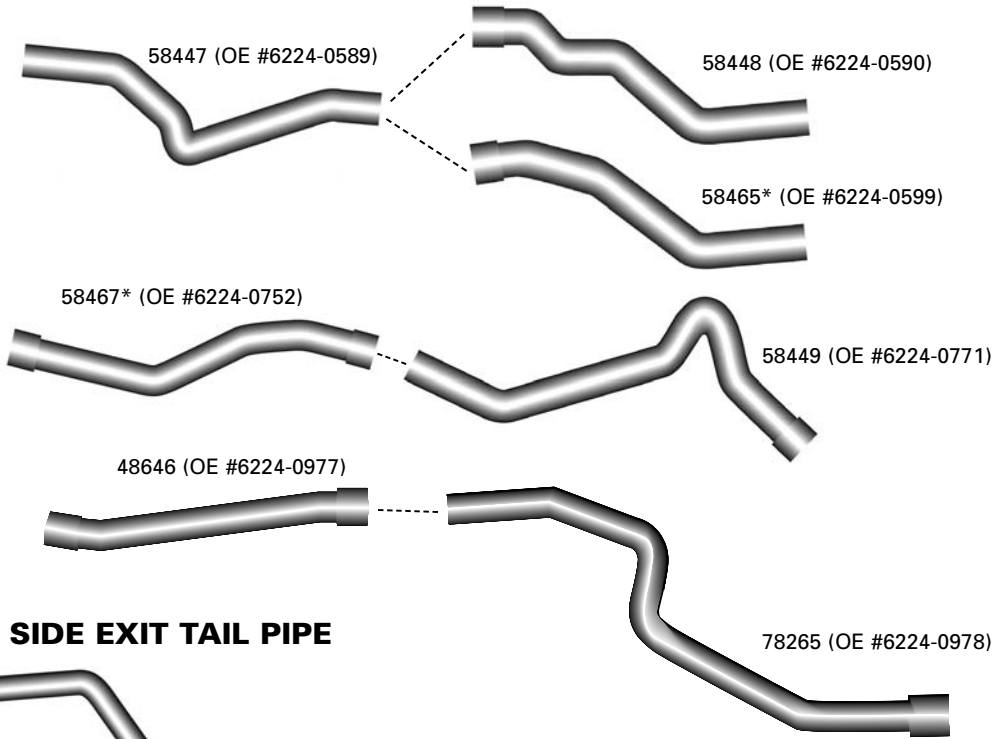

MVP 4" SIDE EXIT TAIL PIPE

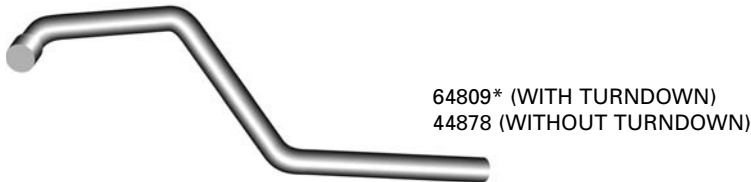

MVP PUSHER - TAIL PIPE OPTIONS

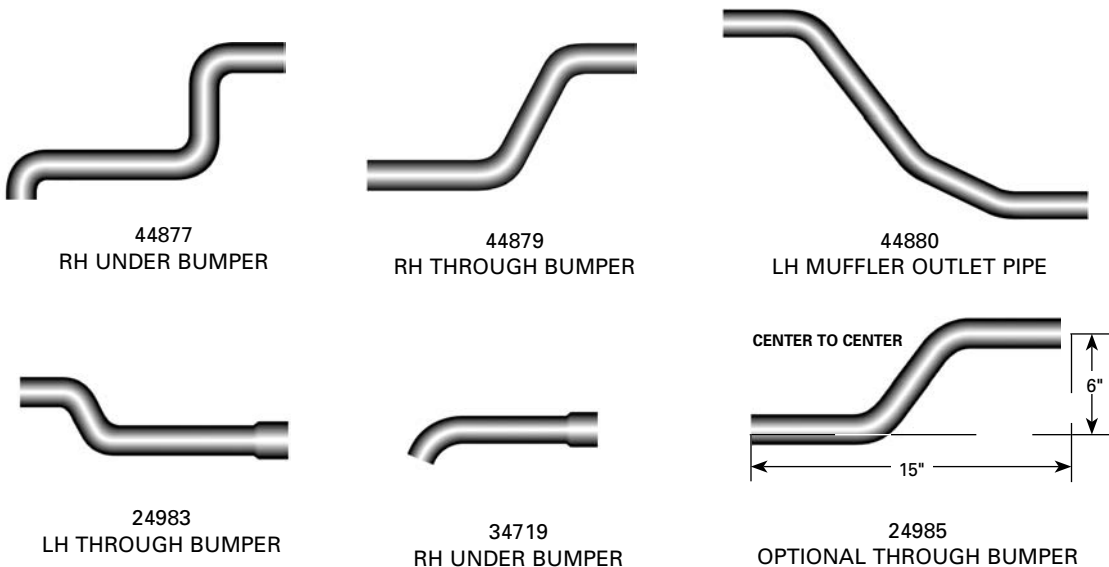

* New Item

SCHOOL BUS
APPLICATIONS



INTERNATIONAL PIPES

ALL MODELS – CONVENTIONAL & FLATNOSE TAIL PIPE OPTIONS

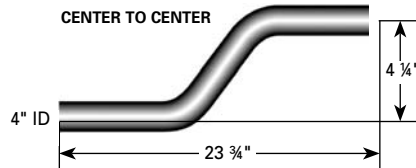

34901*
OPTIONAL THROUGH BUMPER



SIDE EXIT PIPES

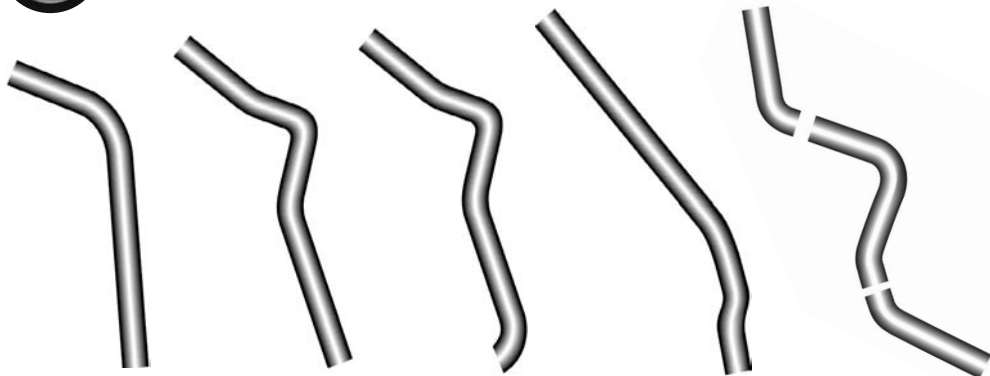

STYLE B

STYLE C

STYLE D

STYLE E

STYLE F

LEFT SIDE EXIT APPLICATIONS

O.E./MAKE ENG. DESCRIPTION	OUTLET TYPE	PIPE O.D.				STYLE
		2 3/4"	3"	4"	5"	
3700 & 3800 Series S	w/o Turndown	—	84583	44822	—	B
45° LEFT SIDE EXIT APPLICATION						
GMC & Chevy, 268 C.I.D.	w/o Turndown	84554♣	—	84586	—	E
International	w/o Turndown	—	84553♣	84559	—	C♣
	w/ Turndown	—	—	84584	—	D♣
65° LEFT SIDE EXIT APPLICATION						
Bluebird TC-2000, Cummins 5.9	w/o Turndown	—	—	74633	—	C♣
98-02 Bluebird All-American	Angle Cut	—	—	—	74669*	C♣
Ford B600/700 370, 429 Gas Eng.	w/o Turndown	84564♣	—	—	—	B
Freightliner	w/o Turndown	—	—	(1) 34899* (2) 24998* (3) 34900* One Piece Pipe 83052	—	F♣

♣ Installs over the drive train.
 ♣ Golden warehouse item.
 * New Item



UNIVERSAL OVER AXLE PIPES

TWO-PIECE UNIVERSAL OVER AXLE PIPES

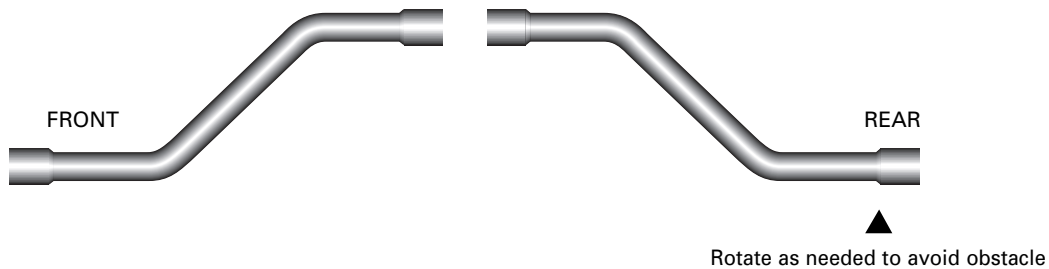

Cut rear pipe to proper length, insert into flared front pipe and clamp.

NOTE: on some installations a section of straight pipe may be required for proper clearance.

FOLLOW THESE INSTALLATION TIPS:

- A. Use two pipes of the same part number.
- B. Cut inlet end of rear pipe to give needed clearance and fit (See diagram).
- C. Join pipes together and secure with clamp.

The over axle pipe is best for school bus fleets. Four part numbers provide excellent coverage for most buses in operation.

One installation takes two over axle pipes of the same number. Less storage space.

By angling or rotating pipes (before you draw down clamps) you can avoid many under body obstacles (shocks, etc.). Easier installation. Also applicable to vans and other long wheel base trucks.

P/N	I.D.	LENGTH
44748	2 ½"	40"
44749	3"	40"
44795	4"	44 ½"

ALLIS CHALMERS

P/N	APPLICATION	INLET LENGTH (A)	INLET I.D. (B)	SHELL LENGTH (C)	OUTLET LENGTH (D)	OUTLET O.D. (E)	O/A LENGTH (F)	WEIGHT LBS.
3946	B, C, & CA (exc. low octane engine) (1938-1957) – long muffler (vertical-round body. Shell dia. 3 ¼")	7"	1 ⅝"	12 ¾"	9 ¼"	1 ½"	29"	5
9896 U112	Rain Cap Inlet Clamp Replaces OEM: 70210081							
3947	WD (Gas) (1948-1953) (vertical-round body. Shell dia. 3 ¼")	2 ¼"	1 ⅝"	16 ½"	10 ¼"	1 ¾"	29"	5
9897 U158	Rain Cap Inlet Clamp Replaces OEM: 70219534							
3948	7000 (s/n 8553 & up), 7010, 7020, 7030, 7040, 7050 & 7060 (all Diesel) – (1979-1981) (vertical-oval body. Shell 6" x 10")	4"	3"	32 ¼"	11 ¾"	3"	48"	17
9373 H300	Rain Cap Inlet Clamp Replaces OEM: 70268785, 70261975							
3949	200 (late), 7000 (to s/n 8553) (Diesel) 190 Diesel Turbo (vertical-round body. Shell Dia. 5 ¼")	3 ½"	3"	32 ½"	12"	3"	48"	16
9373 H300	Rain Cap Inlet Clamp Replaces OEM: 70271755							

ALLIS CHALMERS

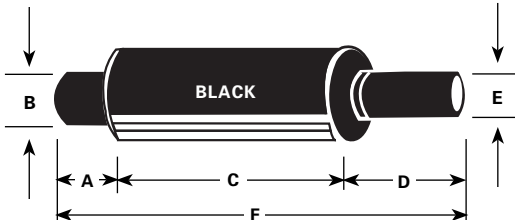
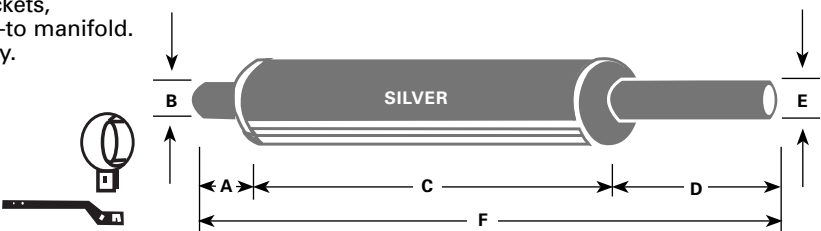
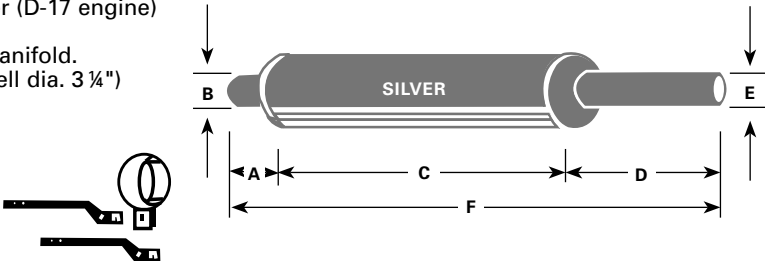
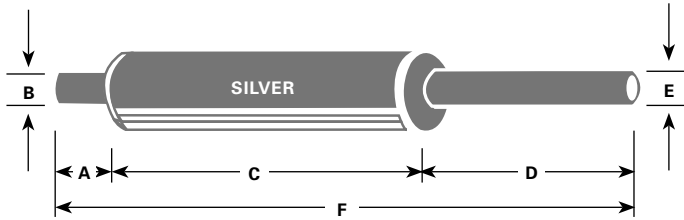
P/N	APPLICATION	INLET LENGTH (A)	INLET I.D. (B)	SHELL LENGTH (C)	OUTLET LENGTH (D)	OUTLET O.D. (E)	O/A LENGTH (F)	WEIGHT LBS.
3950		3"	2 1/4"	13"	2"	2 1/8"	18 3/4"	4
	 <p>(vertical-round body. Shell 3 1/4") Replaces OEM: 701444</p>							
3951	B, C & CA (1938-1957) – thru hood D10, D12, D14 & D15 (Gas) – (to s/n 9001) Note: Includes brackets, (1)-to head bolt, (1)-to manifold. (vertical-round body. Shell dia. 3 1/4")	2 1/4"	1 3/8"	16 1/2"	10"	1 1/2"	29"	5
								
9896	Rain Cap Replaces OEM: 70233450, 70227240							
3952	WD45 (Gas) (1953-1957), W226 & G226, D17 (Gas & LP) – (to s/n 32000) Model CP 2 Cotton Picker (D-17 engine) Note: Includes brackets, (1)-to head bolt, (1)-to manifold. (vertical-round body. Shell dia. 3 1/4")	2 1/2"	1 5/8"	16 1/2"	10"	1 3/4"	29"	7
								
9897	Rain Cap Replaces OEM: 70229531							
3953	D17 (Gas & LP) – (to s/n 32001-42000) D (Gas) combine Model CP 2 Cotton Picker (has different engine than D-17 engine) (vertical-round body. Shell dia. 4 1/4")	2 1/2"	1 5/8"	16 1/2"	10"	1 3/4"	29"	7
								
9371 H200	Rain Cap Inlet Clamp Replaces OEM: 70234494							

ALLIS CHALMERS

P/N	APPLICATION	INLET LENGTH (A)	INLET I.D. (B)	SHELL LENGTH (C)	OUTLET LENGTH (D)	OUTLET O.D. (E)	O/A LENGTH (F)	WEIGHT LBS.
4210	7000, 7020 w/ 301 Turbocharged Engine	4"	3 1/2"	28"	10"	3 5/8"	42"	

The diagram shows a side view of a cylindrical muffler with a flange on the left and a pipe on the right. Dimension lines indicate: A (inlet length), B (inlet inner diameter), C (shell length), D (outlet length), E (outlet outer diameter), and F (overall length). The word "SILVER" is printed on the shell.

H312	Inlet Clamp (vertical-round body. Shell dia. 5 5/8")							
------	---	--	--	--	--	--	--	--

CASE

P/N	APPLICATION	INLET LENGTH (A)	INLET I.D. (B)	SHELL LENGTH (C)	OUTLET LENGTH (D)	OUTLET O.D. (E)	O/A LENGTH (F)	WEIGHT LBS.
3954	C, CC, CL, D, DC, DE, DL, DIM, DS & "-4" (to 1954) (all Gas engine) 400 (Gas & Diesel) (1955-1957) 700 & 800 (Gas & Diesel) (1958-1959) (vertical-round body. Shell dia. 4 1/4")	3"	2 1/4"	17"	6"	2 1/4"	26"	6

The diagram shows a side view of a cylindrical muffler with a flange on the left and a pipe on the right. Dimension lines indicate: A (inlet length), B (inlet inner diameter), C (shell length), D (outlet length), E (outlet outer diameter), and F (overall length). The word "SILVER" is printed on the shell.

9370 H214	Rain Cap Inlet Clamp Replaces OEM: A20494							
--------------	---	--	--	--	--	--	--	--

3955	730, 740, 830 & 840 (1960-1969) (Gas & Diesel) Note: Short muffler (vertical-round body. Shell dia. 5 1/2")	5 1/2"	2 1/2"	17 1/4"	3 3/4"	2 1/2"	26"	6
------	--	--------	--------	---------	--------	--------	-----	---

The diagram shows a side view of a cylindrical muffler with a flange on the left and a pipe on the right. Dimension lines indicate: A (inlet length), B (inlet inner diameter), C (shell length), D (outlet length), E (outlet outer diameter), and F (overall length). The word "BLACK" is printed on the shell.

9372 H212	Rain Cap Inlet Clamp Replaces OEM: A24314							
--------------	---	--	--	--	--	--	--	--

CASE

P/N	APPLICATION	INLET LENGTH (A)	INLET I.D. (B)	SHELL LENGTH (C)	OUTLET LENGTH (D)	OUTLET O.D. (E)	O/A LENGTH (F)	WEIGHT LBS.
3956	930 & 940 (Gas & Diesel) – (1960-1969), 930 CK (Diesel) & 1030 (Diesel) – (1960-1969) (vertical-round body. Shell dia. 5 ½")	3"	2 ¾"	17"	12"	2 ¾"	32"	9
9378 H234	Rain Cap Inlet Clamp Replaces OEM: T42286, A24103, A27105							
3957	470 & 570 – (1970-1973) 480 & 580 Industrial (1970 & up) (all above – Gas & Diesel) (vertical-oval body. Shell dia. 4 ½" x 9")	5 ½"	2 ½"	19"	8 ½"	2"	33"	13
9371 H212	Rain Cap Inlet Clamp Replaces OEM: A39561							
3958	V, VA, VAC & VC (Gas) (1953-1955) 200B, 300B, 400B & 500B (1957-1959), 300, 400, 500 & 600 (1953-1957) 310 & 350 (1954-1959) (vertical-round body. Shell dia. 3 ¼")	2 ¾"	1 15/16"	16 ¾"	9 ½"	2"	29"	5
9371 H200	Rain Cap Inlet Clamp Replaces OEM: VTA 2811, VTA 1135							
3959	200B, 210B, 211B (Gas) – (1957-1959), 300 (53-57), 300B, 310B, 311B (1957-1959), 410B (1957-1959) – (Gas & Diesel) 430 (Gas) (to s/n 8191147) – (1960-1962) (horizontal-round body. Shell dia. 3 ¼")	2 ¾"	1 5/8"	16 ¾"	3"	1 ¾"	22 ½"	4
9897 U158	Rain Cap Inlet Clamp Replaces OEM: G13032							

CASE

P/N	APPLICATION	INLET LENGTH (A)	INLET I.D. (B)	SHELL LENGTH (C)	OUTLET LENGTH (D)	OUTLET O.D. (E)	O/A LENGTH (F)	WEIGHT LBS.
3961	530, 630, 640 & 641 (Gas & Diesel) (1960-1969) (vertical-round body. Shell dia. 4 ¼")	7 ½"	2 ½"	17"	4 ½"	2 ½"	29"	7
9372 H212	Rain Cap Inlet Clamp Replaces OEM: G45239							
4210	1170, 1175, 1270, 1370 w/ 451 C.I.D. w/ Turbocharger (V)	4"	3 ½"	28"	10"	3 5/8"	42"	
H312	Inlet Clamp (vertical-round body. Shell dia. 5 5/8") Replaces OEM: A64990							

COCKSHUTT

P/N	APPLICATION	INLET LENGTH (A)	INLET I.D. (B)	SHELL LENGTH (C)	OUTLET LENGTH (D)	OUTLET O.D. (E)	O/A LENGTH (F)	WEIGHT LBS.
3962	770 (Gas & Diesel), 1600 (Gas & Diesel), 1550 (Gas & Diesel) & 1650 (Gas) (vertical-round body. Shell dia. 4 1/4")	2 1/2"	2 3/8"	20"	7"	2 1/2"	29"	8
9372 H212	Rain Cap Inlet Clamp Replaces OEM: 164079A, 166486A							

DEERE COMBINES

P/N	APPLICATION	INLET LENGTH (A)	INLET I.D. (B)	SHELL LENGTH (C)	OUTLET LENGTH (D)	OUTLET O.D. (E)	O/A LENGTH (F)	WEIGHT LBS.
3963	55 Diesel – HA232 – (s/n 46801-60000) 95 Gas – HB317, HD217 or HG217 (s/n 9000 & up) 105 Gas – HA248 – (all s/n) (horizontal-round body. Shell dia. 5 1/2")	2 1/2"	3 1/8"	15"	7"	2 1/2"	22 1/2"	7
H314	Inlet Clamp Replaces OEM: AH11014H							

DEERE

P/N	APPLICATION	INLET LENGTH (A)	INLET I.D. (B)	SHELL LENGTH (C)	OUTLET LENGTH (D)	OUTLET O.D. (E)	O/A LENGTH (F)	WEIGHT LBS.
3964	1020, 1520, 1530, 2030, 2630, 2040, 2640 (s/n 341000 & up) (all Gas & Diesel) Note: Inlet is flared; uses special clamp not available at TruckEx. (OEM clamp is T19978) (vertical-oval body. Shell dia. 4 1/4" x 9")	3 1/2"	Flared	19 1/2"	7 3/4"	2"	30"	12
9371	Rain Cap Replaces OEM: AT21689, AT64102							

DEERE

P/N	APPLICATION	INLET LENGTH (A)	INLET I.D. (B)	SHELL LENGTH (C)	OUTLET LENGTH (D)	OUTLET O.D. (E)	O/A LENGTH (F)	WEIGHT LBS.
3965	3010 (Gas & LP) – (Diesel – to s/n 1T 6643) 3020 (Gas & LP), 4010 (Gas & LP) – (Diesel – to s/n 2T 7026) 4020 & 4000 (Gas & LP) Note: See 3966 for round body muffler with flared inlet (vertical-round body. Shell dia. 6")	3"	2 15/16"	20"	3"	2 5/8"	26"	10
9378 H300	Rain Cap Inlet Clamp Replaces OEM: AR26640, AR26786							
3966	3020 (Diesel) – (to s/n 122999) 4010 (Diesel) – (to s/n 2T 7027 & up) 4020 (Diesel) – (to s/n 200999) Note: Inlet is flared, uses special clamp 9890. Available from TruckEx; (OEM R32235 & AR46323) (vertical-round body. Shell dia. 6")	3"	2 15/16"	20"	3"	2 5/8"	26"	11
9378 9890	Rain Cap Inlet Clamp Replaces OEM: AR30189, AR30190							
3967	Model A, AR, AN, AW & AWH (33-52) Model G, GN, GH & GW (38-53) (Gas & all fuel) - (to s/n 410000 & up) Model 60, 620, 70, 720 (Gas & all fuel) Original equipment standard muffler. Note: 3967 has a 4-bolt mounting plate. 3967 can sub for #'s AA300R, AA4371R and AA5096R (vertical-round body. Shell dia. 3 3/4")	N/A	B-Plate	23"	1"	2 1/2"	24 1/2"	5
Replaces OEM: AF3770R & AA2214R								
3968	Model B, BN & BW (Gas & all fuel) – (to s/n B96000 & up) Model 50, 520 (standard muffler) & 530 (optional muffler) (1953-1959) Application note: 3968 has a 4-bolt mounting plate (vertical-round body. Shell dia. 3 3/4")	4 1/2"	B-Plate	14 1/2"	5"	2 1/4"	24 1/2"	5
9371	Rain Cap Replaces OEM: R21827R, AB2700R							

DEERE

P/N	APPLICATION	INLET LENGTH (A)	INLET I.D. (B)	SHELL LENGTH (C)	OUTLET LENGTH (D)	OUTLET O.D. (E)	O/A LENGTH (F)	WEIGHT LBS.
3969	M, MT, MC & MI (1947-1952) 40 (all 53-56), 320 & 330 (57-59) Application note: 2 bolt-flange mount; 1 7/8" OD (vertical & horizontal round body. Shell dia. 3 1/4")	3 1/4"	1 3/4"	14 1/2"	3 1/4"	2"	21"	5
9371	Rain Cap Replaces OEM: AM364T, AM625T							
3970	320, 330 & 420 (Gas) – (to s/n 135025 & up) 430 & 440 (Gas), 435 (Diesel) – (to s/n 442886 & up) (1957-1959) 1010 (Gas) (all types with vertical exhaust) (vertical-round body. Shell dia. 4 1/4")	2 1/4"	2"	12 1/4"	3"	2"	17 1/2"	4
9371 H200	Rain Cap Inlet Clamp Replaces OEM: AT10646T, AM3101T							
18146	Used with 3970 listed above Note: Adapter has 2 bolt flange mounting.	N/A	1 7/8"	N/A	N/A	2"	7 1/2"	1
H200	Outlet Clamp Replaces OEM: AT10523							
3996	770 Grader 8440, 8640, 4 W.D. Tractor (vertical-oval body. Shell dia. 8 1/4" x 11 1/2") Note: "G" curved aspirator Tube 1 1/2" O.D.	2 1/2"	3 7/8" ^	30"	5"	5 1/8"	37 3/4"	
	Replaces OEM: AR86604, AR89594, AT75038							

^ 83 Degree flare x 4.35" OD

DEERE

P/N	APPLICATION	INLET LENGTH (A)	INLET I.D. (B)	SHELL LENGTH (C)	OUTLET LENGTH (D)	OUTLET O.D. (E)	O/A LENGTH (F)	WEIGHT LBS.
4200	John Deere Tractor 4030, 4040, 4050, 4250, 4320, 4440, 4450, 4520, 4620, 4630, 4640, 4840, 7020 (vertical-oval body. Shell dia. 4 5/8" x 8 3/8") Replaces OEM: RE20224	7/8"	4 3/8">	33"	4 1/8"	3 5/8"	38"	

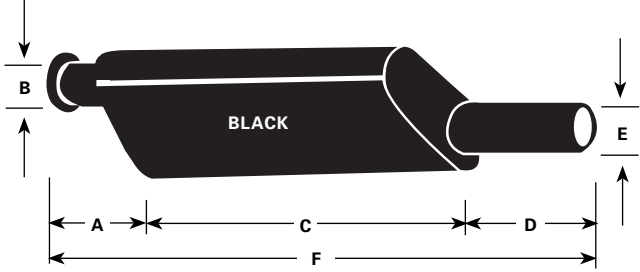

> Flared

FORD/NEW HOLLAND

P/N	APPLICATION	INLET LENGTH (A)	INLET I.D. (B)	SHELL LENGTH (C)	OUTLET LENGTH (D)	OUTLET O.D. (E)	O/A LENGTH (F)	WEIGHT LBS.
3971	801-901 (58-62), 4000 series (61-64), & 1801 (58-60) with 172 cid Gas & Diesel. 501, 601, 701 (58-62), 2000 series (63-64) with 144 cid Diesel 4000 (65-75), 3600 & 4600 (75-81) 3 cyl. Diesel All Orchard & Narrow (horizontal-round body. Shell dia. 3 1/2")	2"	2"	13 1/2"	2"	1 7/8"	17 1/2"	3
H200 U178	Inlet Clamp Outlet Clamp Replaces OEM: 310079							
3972	2000, 3000, 4000 & 5000 (68 & up) 3 cyl & 4 cyl Gas & Diesel (vertical-round body. Shell dia. 5 1/2")	4 1/2"	1 7/8"	17"	7 1/2"	2"	29"	7
9371 U178	Rain Cap Inlet Clamp Replaces OEM: C7NN 5230Z, C7NN 5230AB, C7NN 5230AC							

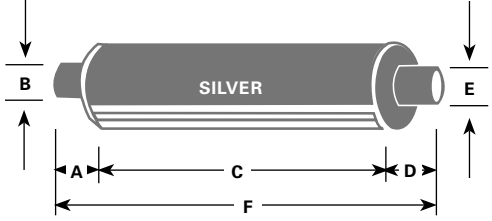
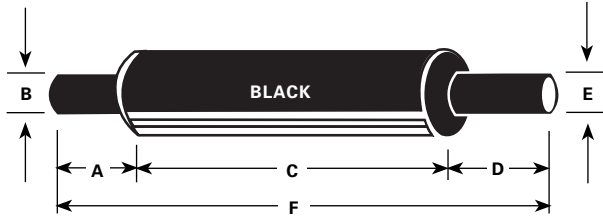
FORD/NEW HOLLAND

P/N	APPLICATION	INLET LENGTH (A)	INLET I.D. (B)	SHELL LENGTH (C)	OUTLET LENGTH (D)	OUTLET O.D. (E)	O/A LENGTH (F)	WEIGHT LBS.
7660	550, 555, 555A, 555B & 655 (75-78) Industrial Tractor/Loader/Backhoe Note: In some special applications can replace 3972 also. (horizontal-round body. Shell dia. 5 1/2")	3 3/4"	1 7/8"	27"	23 1/4"	Bent Pipe	55"	16

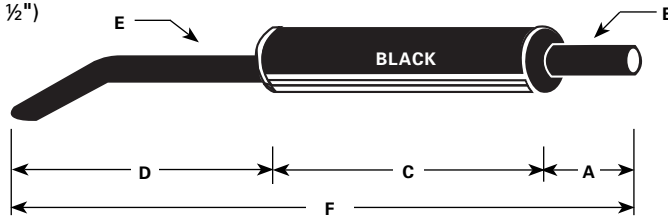

U178 Inlet Clamp
Replaces OEM: D6NN 5230F

P/N	APPLICATION	ASSEMBLY SPECIFICATIONS				WEIGHT LBS.
		INLET I.D.	VERT. LENGTH	OVERALL LENGTH	OUTLET O.D.	
7661	9N, 2N & 8N (1939-1952) – (Gas) Note: Welded one piece assembly, with flared inlet. See separate listing for details on inlet clamp.	Flared	15 1/2"	56"	1 1/2"	6

Special Inlet Clamp

9894



Replaces OEM: 8N5230 Muffler & Pipe



P/N	APPLICATION	INLET LENGTH (A)	INLET I.D. (B)	SHELL LENGTH (C)	OUTLET LENGTH (D)	OUTLET O.D. (E)	O/A LENGTH (F)	WEIGHT LBS.
3973	NAA (53-54), 600 & 700 (55-57), 501, 601 & 701 (58-62), 2000 series (63-64) with 134 cid (Gas) 800 & 900 (55-57) with 172 cid (Gas) (horizontal-round body. Shell dia. 3 1/4")	2 1/4"	1 5/8"	13"	2 1/4"	1 5/8"	17 1/2"	4

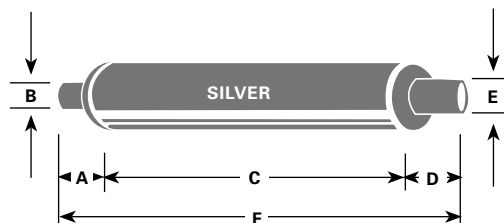

U158 Inlet Clamp
U158 Outlet Clamp
Replaces OEM: NAA 5230E

FORD/NEW HOLLAND

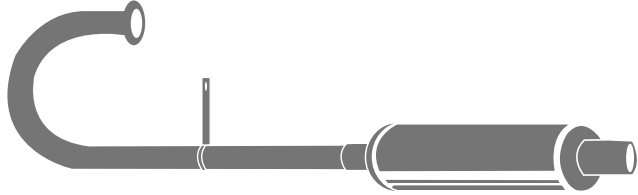
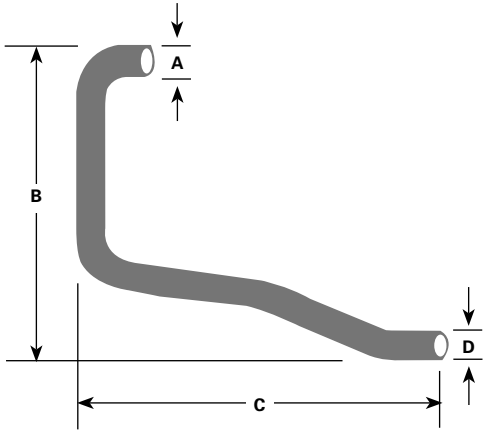
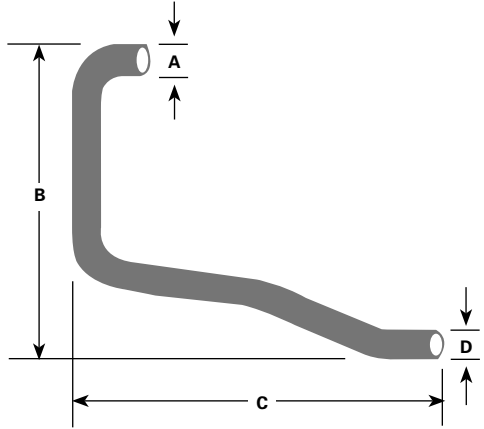
P/N	APPLICATION	ASSEMBLY SPECIFICATIONS				WEIGHT
		INLET I.D.	VERT. LENGTH	OVERALL LENGTH	OUTLET O.D.	LBS.
7662	9N, 2N & 8N (1939-1952) – (Gas) Note: Welded one piece assembly, with flared inlet, requires special inlet clamp 9894, see clamps page 279.	Flared	29"	30 ½"	1 ½"	7
Special Inlet Clamp						
9894	No OEM number					
38756	600 (55-57), 601 (58-62), 2000 series (63-64); 134 cid (Gas) 800 & 900 (55-57); 172 cid (Gas) (All models except row crop) Note: Used with 3973 muffler and 54121 tail pipe. (horizontal outlet pipe) – from muffler to tail pipe	1 ½"	17"	32"	1 ½"	3
U112	Inlet Clamp Replaces OEM: NCA 5255B					
38757	801 (58-62), 4000 series (61-64), 1801 (58-60); 172 cid (Gas) All transmissions, not for row crop Note: Used with 3971 muffler (horizontal outlet pipe) – from muffler to tail pipe	1 ¾"	24"	29"	1 ¾"	3
U134	Inlet Clamp Replaces OEM: 311051					

FORD/NEW HOLLAND

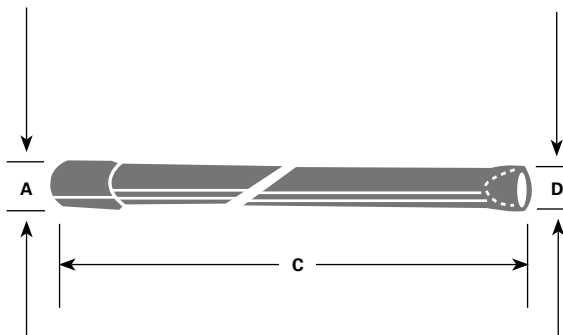
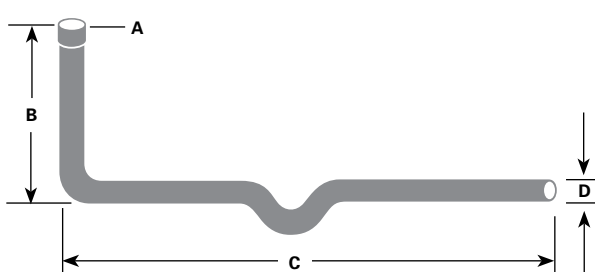
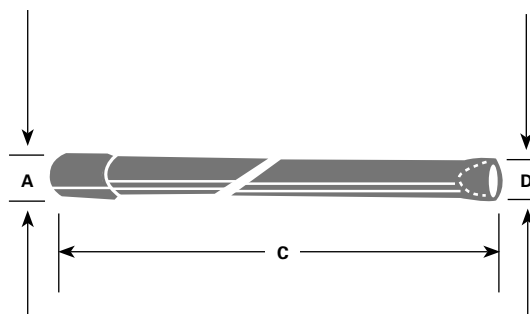
P/N	APPLICATION	ASSEMBLY SPECIFICATIONS				WEIGHT LBS.
		INLET I.D. (A)	VERT. LENGTH (B)	OVERALL LENGTH (C)	OUTLET O.D. (D)	
64786	901 (58-62), 4000 series (61-64) Row Crop w/ 172 cid (gas) 4 & 5 speed transmission. Note: Used with 3971 muffler. (horizontal tail pipe)	1 3/4"	N/A	60"	1 3/4"	2
U134	Inlet Clamp Replaces OEM: 311466					
44865	2000, 3000 (69 up), 2100, 2110, 3100, 4110, 2600, 3600, Ag. 231 & 531 Industrial (65 & up). (horizontal tail pipe) – from outlet pipe to rear.	2"	24"	47"	1 3/4"	5
H200	Inlet Clamp Replaces OEM: C7NN 5245B					
54121	NAA (53-54), 600 & 700 (55-57), 501 (59-62), 601 & 701 (58-62), 2000 series (63-64) w/ 134 cid (Gas) (all transmissions except Select-0-speed) Note: Used with 38756, above (horizontal tail pipe) – from outlet pipe to rear.	1 1/2"	N/A	54"	1 1/2"	3
U112	Inlet Clamp Replaces OEM: NCA 5263B					

TRACTOR
MUFFLERS

FORD/NEW HOLLAND

P/N	APPLICATION	INLET LENGTH (A)	INLET I.D. (B)	SHELL LENGTH (C)	OUTLET LENGTH (D)	OUTLET O.D. (E)	O/A LENGTH (F)	WEIGHT LBS.
3997	501, 600, 700, 800 1801 (58-64) (horizontal-round body. Shell dia. 3 1/4")	1 1/8"	2"	15"	2 1/4"	1 7/8"	17 1/4"	
H200 9371	Inlet Clamp Rain Cap Replaces OEM: 310079							
4203	7000, 7100, 7200, 7600, 7610, 7700, 7710 (vertical-oval body. Shell dia. 4 1/8" x 9")	3 3/4"	2 3/8"	26 1/4"	19"	2 1/2"	49"	
H212 9372	Inlet Clamp Rain Cap Replaces OEM: D5NN 5230F							
4204	2910, 3910, 4110 (81-85), 531, 4610 (81-82), 548 (78-82), 515, 531, 535, 4000, 4100, 4600, 5600, 5700, 6600, 6700 w/ Cab 67 (vertical-round body. Shell dia. 4 1/8")	6"	1 7/8"	26"	8 1/4"	2"	40 3/4"	
U178	Inlet Clamp Replaces OEM: E4NN5230GB17M							

TRACTOR
MUFFLERS

INTERNATIONAL

P/N	APPLICATION	INLET LENGTH (A)	INLET I.D. (B)	SHELL LENGTH (C)	OUTLET LENGTH (D)	OUTLET O.D. (E)	O/A LENGTH (F)	WEIGHT LBS.
3974	Farmall Cub – Standard (not Lo-Boy) (vertical-round body. Shell dia. 3 1/4")	2 3/4"	1 5/8"	12 1/2"	6 3/4"	1 1/2"	22"	5
9896 U112	Rain Cap Inlet Clamp Replaces OEM: 351436R92							
3975	Farmall H, Super H, M, Super M, MD, Super MD, Super MTA. Also International W-4, S-W4, W6, S-W6, WD6 & S-WD6. (Gas & Diesel) Farmall 300 & 350 (C-175 Gas) Farmall 400 & 450 (C-281 Gas & D281 Diesel), Farmall 460 & International 606 (C-221 Gas & D-236 Diesel), Farmall 560 (C-263 Gas & D-282 Diesel) (vertical-round body. Shell dia. 6")	2 1/2"	2 3/8"	13"	14"	2 1/2"	29"	8
9372 H200	Rain Cap Inlet Clamp Replaces OEM: 350601R95, 370773R91, 403551R1 (universal OEM muffler)							
3976	706 (D-310 Diesel) Note: This is original style muffler (vertical-round body. Shell dia. 5 1/2")	3"	2 3/8"	17"	14"	2 1/2"	34"	8
9372 H212	Rain Cap Inlet Clamp Replaces OEM: 384346R91							
3977	706 (C-263 Gas) & 806 (C-301 Gas & D-361 Diesel) (vertical-round body. Shell dia. 5 1/2")	3 1/2"	2 15/16"	17"	14"	3"	34"	8
9373 H300	Rain Cap Inlet Clamp Replaces OEM: 384345R1, 384345R91							

INTERNATIONAL

P/N	APPLICATION	INLET LENGTH (A)	INLET I.D. (B)	SHELL LENGTH (C)	OUTLET LENGTH (D)	OUTLET O.D. (E)	O/A LENGTH (F)	WEIGHT LBS.
3978	Farmall 544 (C-200 Gas & D-239 Diesel) (vertical-round body. Shell dia. 5 1/2")	2 1/2"	2 3/8"	14 1/2"	11 3/4"	2 1/2"	29"	5
9372 H212	Rain Cap Inlet Clamp Replaces OEM: 370664R1							
3979	706 (C-263 & C-29 Gas/LP), 756 & (C-291 Gas/LP), 856 (C-301 Gas/LP) (vertical-round body. Shell dia. 6")	4"	2 15/16"	19 1/2"	10 1/2"	3"	34"	10
9373 H300	Rain Cap Inlet Clamp Replaces OEM: 398511R1							
3980	Tractor models: 102, 104, 105, 106, 107, 122, 123, 125, 126 & 127 (using Kohler 10 & 12 hp 1 cyl. Engines) (horizontal-round body. Shell dia. 3 1/4")	1 3/4"	1 5/16"	12 1/2"	2 1/2"	1 5/16"	15"	2.5
	Replaces Case-IHC OEM: 393840R91							
3981	Farmall A, Super A, B, BN, C & Super C (1939-1954) Farmall 100, 130, 140, 200, 230 & 240 (C-123 Gas) Farmall 330 & 340 (C-135 Gas) International 330 & 340 (Utility C-135 Gas). Also T-340 Crawler (C-135 Gas) (vertical-round body. Shell dia. 4 1/4")	2 3/4"	1 15/16"	17"	9 1/4"	2"	29"	6
9371 H200	Rain Cap Inlet Clamp Replaces OEM: 360720R91, 360720R92							

INTERNATIONAL

P/N	APPLICATION	INLET LENGTH (A)	INLET I.D. (B)	SHELL LENGTH (C)	OUTLET LENGTH (D)	OUTLET O.D. (E)	O/A LENGTH (F)	WEIGHT LBS.
3982	Farmall H & International W-4 (with C-152 Gas) Super H & Super W-4 (with C-164 Gas) Farmall 300 & 350 (C-169 & C-175 Gas) Note: This is original style muffler, OEM style subs to 3975. (vertical-round body. Shell dia. 5 1/2")	2 1/2"	2 3/8"	14 1/2"	11 3/4"	2 1/2"	29"	6
9372 H212	Rain Cap Inlet Clamp Replaces OEM: 350600R95, 350660R95							
3998	Cub Cadet Tractor 1000, 1200, 1250, 1450, 1650 (horizontal-round body. Shell dia. 5")	1 1/4"	1 3/8"	12 3/8"	1 1/4"	1 3/8"	12 3/8"	
9896 U158	Rain Cap Inlet Clamp Replaces OEM: 106337C4							
4201	340, 540 Diesel Underslung 460, 540, 544, 560, 606, 656, 660, 664 Underslung (horizontal-round body. Shell dia. 4 1/4")	2 1/2"	1 7/8"	17 1/2"	2 1/2"	1 7/8" I.D.	22 1/2"	
H200	Inlet Clamp Replaces OEM: 371039R91							

INTERNATIONAL HARVESTER COMBINE

4202	1460 S.P., 1470 Hillside, 1480 S.P. (vertical-round body. Shell dia. 6 5/8")	2 1/2"	3 3/4"	27 1/2"	2 1/2"	4"	27 1/2"	
9375 H312	Rain Cap Inlet Clamp Replaces OEM: 131086C91							

MASSEY FERGUSON

P/N	APPLICATION	ASSEMBLY SPECIFICATIONS				WEIGHT
		INLET I.D.	VERT. LENGTH	OVERALL LENGTH	OUTLET O.D.	LBS.
7663	MF-35 MH-35 & TO-35 Ag. MF-202, 203, 204 & 205 (Gas & Diesel) Utility Tractors Note: Complete assembly includes muffler, inlet pipe, and clamp.	3-bolt	20"	54"	1 ½"	9

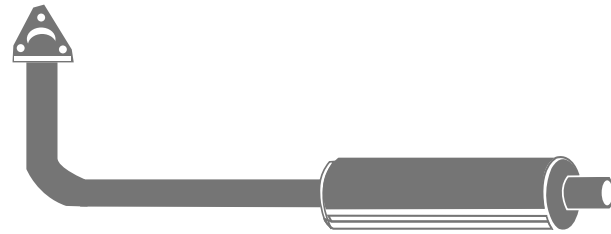

Replaces OEM:
505545M91 (muffler)
181600M91 (pipe)

7442	TO-20 & TO-30 Gas (1948-1957) Note: Pipe has flared inlet. Requires special inlet clamp 9895, see clamps Page 279.	Flared	18"	57"	1 ½"		7
------	--	--------	-----	-----	------	--	---



Replaces OEM:
505545M91 (muffler)
181860M91 (pipe)

P/N	APPLICATION	INLET LENGTH (A)	INLET I.D. (B)	SHELL LENGTH (C)	OUTLET LENGTH (D)	OUTLET O.D. (E)	O/A LENGTH (F)	WEIGHT LBS.
3983	MF-35 (1960-1964) (Gas & Diesel) MF-35 (1964-1974) (Gas & Diesel) MF-202, 203, 204, 205 (Gas & Diesel) Utility tractors. Note: 3983 is used as both vertical & horizontal for these tractor applications. (round body. Shell dia. 4 ¼")	3"	1 ⅞"	17"	14 ½"	2"	34"	6

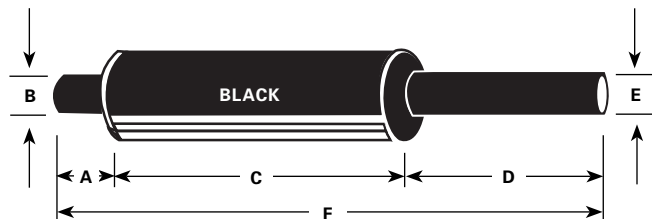

9371
U178
Rain Cap
Inlet Clamp
Replaces OEM: 181867M91

MASSEY FERGUSON

P/N	APPLICATION	INLET LENGTH (A)	INLET I.D. (B)	SHELL LENGTH (C)	OUTLET LENGTH (D)	OUTLET O.D. (E)	O/A LENGTH (F)	WEIGHT LBS.
3984	Ferguson F-40 & MF-50 (57-64) (Gas & LP) Note: Use for both horizontal & vertical applications (round body. Shell dia. 3 1/4")	2 1/2"	1 15/16"	15 1/2"	2"	1 3/8"	18 1/2"	4
H200 U112	Inlet Clamp Outlet Clamp Replaces OEM: 182609M91							
3985	Massey Harris (1942-1957) (Gas & Diesel). 20, 20K, 22, 22K (exc. 1948), 30, 30K, 33, 333, 44, 44SPL, 44D, 44K, 446, 444, 81, 82, 101Jr., 101Sr. & 102Sr. (horizontal-round body. Shell dia. 4 1/4")	2"	2 3/8"	14"	5"	2 1/2"	21"	4
9372 H212	Rain Cap Inlet Clamp Replaces OEM: 32289A & 767994M91							
3986	TE-20, TO-20 & TO-30 (1948-1954) TO-35 & MF-35 (1955-1963) (Gas & Diesel) MF-135 (1964-1974) (Gas & Diesel) (horizontal-round body. Shell dia. 3 1/4")	2 1/2"	1 1/2"	23"	8 1/2"	1 1/2" I.D.	34"	4
U112 U112	Inlet Clamp Outlet Clamp Replaces OEM: 180364M91, 505545M92							
3987	MF-165, MF-175 & MF-180 (Gas & Diesel) (Perkins 4-236 & 4-248 cid) Note: This muffler is for tractors with loaders. See also 3988. (vertical-round body. Shell dia. 4 1/4")	10"	2 1/8"	16 1/2"	13"	Bent Pipe	40"	7
H214	Inlet Clamp Replaces OEM: 194431M91							

TRACTOR MUFFLERS

MASSEY FERGUSON

P/N	APPLICATION	INLET LENGTH (A)	INLET I.D. (B)	SHELL LENGTH (C)	OUTLET LENGTH (D)	OUTLET O.D. (E)	O/A LENGTH (F)	WEIGHT LBS.
H214	Inlet Clamp Replaces OEM: 523394M95							
3989	MF-135 (U.K.) & MF-150 (Gas & Diesel). (Using Perkins) MF-230, 240, 250 (Gas & Diesel), MF-245, 255, 265, 275 (Diesel) (horizontal-round body. Shell dia. 4 1/4")	8"	1 3/4"	24"	7"	1 3/4"	39"	5
U134	Inlet Clamp Replaces OEM: 522589M91 & 539523M92 539525M91 & 890476M92							
P/N	APPLICATION	ASSEMBLY SPECIFICATIONS				WEIGHT LBS.		
		INLET I.D.	VERT. LENGTH	OVERALL LENGTH	OUTLET O.D.			
7664	MF-135 (Perkins Gas & Diesel)	3-bolt	12"	60 1/2"	1 3/4"	9		
Replaces OEM: 522589M91 (muffler) 522584M91 (pipe)								

MASSEY FERGUSON

P/N	APPLICATION	INLET LENGTH (A)	INLET I.D. (B)	SHELL LENGTH (C)	OUTLET LENGTH (D)	OUTLET O.D. (E)	O/A LENGTH (F)	WEIGHT LBS.
3990	MF-230, MF-235, MF-245, MF-255, MF-265 & MF-275 (Gas & Diesel) Note: 3990 has straight outlet pipe. To use as replacement for 535389M91 & 998669M91. (vertical-oval body. Shell dia. 4" x 8")	2 3/4"	2 1/8"	23"	8 1/2"	2"	34"	11
H214	Inlet Clamp Replaces OEM: 578090M92 Can sub for 535389M91 & 998669M91							

MINNEAPOLIS MOLINE

P/N	APPLICATION	INLET LENGTH (A)	INLET I.D. (B)	SHELL LENGTH (C)	OUTLET LENGTH (D)	OUTLET O.D. (E)	O/A LENGTH (F)	WEIGHT LBS.
3999	Minnneapolis Moline Tractor 335 Universal & Utility, 445 Universal & Utility (vertical-round body. Shell dia. 4 1/4")	1 1/2"	2 1/4"	13 1/2"	1 1/2"	2 3/8"	17"	
9372 H212	Rain Cap Inlet Clamp Replaces OEM: 10A7889, 10A8693							

OLIVER

P/N	APPLICATION	INLET LENGTH (A)	INLET I.D. (B)	SHELL LENGTH (C)	OUTLET LENGTH (D)	OUTLET O.D. (E)	O/A LENGTH (F)	WEIGHT LBS.
3991	Super 66, 77 & 88 (Gas & Diesel) (vertical-round body. Shell dia. 3 1/4")	4"	2 3/8"	20"	5"	2 1/2"	29"	4
9372 H212	Rain Cap Inlet Clamp Replaces OEM: K-452B							

OLIVER

P/N	APPLICATION	INLET LENGTH (A)	INLET I.D. (B)	SHELL LENGTH (C)	OUTLET LENGTH (D)	OUTLET O.D. (E)	O/A LENGTH (F)	WEIGHT LBS.
3992	770, 880, 1600 (Gas & Diesel) (vertical-round body. Shell dia. 4 1/4")	4 1/4"	2 3/8"	20"	4 1/2"	2 1/2"	29"	7
9372 H212	Rain Cap Inlet Clamp Replaces OEM: 100694A, 155623A, 164079A							
3993	1650 (Diesel), 1750, 1800 & 1850 (Gas, LP-Gas & Diesel) (vertical-round body - w/ heat shield) (Shell dia. 6")	4 1/2"	2 15/16"	23"	6"	2 1/2"	34"	9
H300	Inlet Clamp Replaces OEM: 104764A, 155980A, 164080A							
4248	77 & 78 (Diesel) Note: Underhood Muffler (vertical-round body. Shell dia. 9")	2 1/4"	2 3/8"	6 1/2"	1 1/4"	1 3/4"	10"	6
H212	Inlet Clamp							
U134	Outlet Clamp Replaces OEM: K-452							

VERSATILE

3663	118, 145 4WD articulated tractor (Diesel) both 6 cyl. & 8 cyl. Note: Muffler has double inlet tubes (vertical-round body. Shell dia. 9")	3 ½"	2 ½"	36"	5"	3 7/8"	43"	26"
9375 H212	Rain Cap Inlet Clamp Replaces OEM: 606T123-A							
3995	400 Swather (1981 & up) (Gas) & 4400 (Gas) Note: Muffler has side inlet. (horizontal-round body. Shell dia. 5 ½")	2"	2"	23 ½"	2 ¾"	2"	26"	10"
H200	Inlet Clamp Replaces OEM: 36460							

CLAMP STYLES	PART NUMBER	REPLACES OEM PART NUMBER	TRACTOR MODEL APPLICATION	WEIGHT LBS.
	9890	R2235 & also AR46323	to fit John Deere Tractors 3020, 4010, 4020, 4000, 4030 & 4230 with flared inlet mufflers	1
	9894	CAPN 5200A	to fit Ford Tractors 9N, 2N & 8N with flared inlet pipe	1
	9895	181461M1	to fit Massey Ferguson Tractors. TO-20 & TO-30 with flared inlet pipe	1

RAIN CAPS



P/N	MATERIAL FINISH	MIN. O.D. SIZE	MAX. O.D. SIZE
9367	POWDER COATING	1 ¼"	1 7/16"
9896	POWDER COATING	1 ½"	1 11/16"
9897	POWDER COATING	1 ¾"	1 15/16"
9371	POWDER COATING	2"	2 3/16"
9370	POWDER COATING	2 ¼"	2 7/8"
9372	POWDER COATING	2 ½"	2 11/16"
9378	POWDER COATING	2 ¾"	2 15/16"
9373	POWDER COATING	3"	3 3/16"
9374	POWDER COATING	3 ½"	3 11/16"
9375	POWDER COATING	4"	4 3/16"
9376	POWDER COATING	4 ½"	4 11/16"
9377	POWDER COATING	5"	5 3/16"
9704	POWDER COATING	5 ½"	5 11/16"
9369	POWDER COATING	6"	6 1/8"
9571	CHROME	3"	3 3/16"
9573	CHROME	4"	4 3/16"
9575	CHROME	5"	5 3/16"

OE INTERCHANGE

BLUEBIRD	TRUCKEX
707	18155
708	58424
3165	74669
3166	54138
3167	54139
3168	34890
3175	24978
3428	28674
3429	38782
4518	38822
4659	18173
174078	4261
1340926	9325
1340934	9324
1522325	9325
1530963	9324
1620566	9324
1664168	4256
1705482	4229
1705599	4232
1728062	44875
1740778	4239
1746676	24977
1746684	34886
1749894	18157
1753177	38776
1753185	38777
1758093	4229
1759182	4232
1777531	54165
1777556	4239
1777556	4261
1805241	54137
1851468	28673
1864677	34885
1864685	34887
1873447	44869
1874635	83045
1935238	18156
1935550	38845
1935758	38781
1949411	9324
1972793	9767
1977131	9324
1997212	44873
1999036	44874
2118149	400A1014
2119378	400A1014
3580115	3679
4303137	44659
4303152	54985
4303178	500A1016
4303194	500A1016
4303210	500A1016

BLUEBIRD	TRUCKEX
4303232	500A1016
4303244	500A1016
4303269	500A1016
4312955	312A1016
14051204	14662
15522175	78115
15522177	88098
15529620	3225
15537680	74613
15537681	54773
15595932	58240
15595934	78116
15651242	74645
15651243	34814
15653138	34815
15681043	34812
15684601	34813
15691575	54907
15691576	34816
15696039	83028
15953138	34815
2200993915	H500
2201005560	9605
2201033588	3911

CHEV./GMC	TRUCKEX
61997	4211
236730	2704
326453	37838
326472	57842
327255	8560
328166	8793
328647	77848
328649	77848
330913	64591
330914	64592
334623	54548
334628	54525
334629	54548
334633	74527
334985	77813
334986	67814
335219	2538
335219	18003
335220	64410
335220	64528
337509	74529
337510	64556
337511	74529
337949	93860
337951	94836
338014	93819
338251	2702

CHEV./GMC	TRUCKEX
340890	64592
341168	94981
341217	47925
341217	58094
341222	58091
341222	58097
341224	68093
341228	38083
341228	68099
341230	58091
341230	58097
341232	93860
343194	2773
343196	54548
343291	93526
344701	64619
344703	74527
344704	2774
344775	54525
344776	74527
345150	67809
345187	2757
346853	3906
346865	58313
346867	38744
348826	68093
348828	38083
348828	68099
348891	38099
348892	88082
348892	88083
348897	38099
348898	48117
348898	68108
348901	38099
348902	58120
348902	68108
348915	38099
348915	58106
348916	78077
348934	93934
348955	58106
349489	94981
350065	38105
350085	28080
351208	2757
351526	44535
352717	2641
352717	18004
352726	856
352732	8503
352733	8566
355024	37854
355485	38106

CHEV./GMC	TRUCKEX
355485	38172
355485	68099
355485	68093
355489	58091
355489	58097
356725	95951
356808	8503
356811	64556
356812	64556
356822	17853
356822	28326
356828	38092
356847	64556
356896	2757
357319	64409
357319	64451
357400	54650
358180	44641
358183	44641
358197	28077
358888	2941
358888	2757
359093	64640
359094	2538
359094	28083
359802	68114
359806	68114
359834	93860
359837	94953
359905	54650
359910	54672
362266	93934
362281	38093
363864	94981
363866	95952
363977	93934
365365	38099
365365	58091
365367	58091
367929	44535
367930	44535
367931	54499
367932	54499
368753	58118
368765	48116
368777	38109
368784	58121
368797	48109
369176	38114
369177	2538
369177	28082
369178	2943
369178	28082
370001	58108

CHEV./GMC	TRUCKEX
372489	2538
372491	54660
372492	74594
372493	54660
372494	44647
372498	2538
372498	18005
372499	74593
374689	2941
375285	58164
377424	3666
378370	38133
378370	68093
411328	856
411329	856
419416	38092
458295	24660
458462	2538
458462	3906
461521	6815
461982	64630
462954	8580
464012	2538
464012	28083
464015	2538
464015	18003
464738	38156
464742	93934
465373	64640
465374	54673
465375	54650
466411	93926
466468	78098
467545	38133
467545	68093
467548	38083
467548	38172
467548	68093
467548	68099
467556	93912
467567	38157
467570	38083
467570	68093
467570	68099
468419	38083
468419	38099
468419	68093
468419	68099
468422	6814
468424	88083
468426	88082
468428	48117
468428	68108
468776	38744

CHEV./GMC	TRUCKEX
468869	38147
468869	68143
468873	3006
468873	34684
471895	2944
471895	18004
472699	94987
474002	28154
474005	18004
474062	3015
474077	74593
474078	74594
474079	44641
474206	2943
474215	3036
474216	3020
474216	28102
474219	2538
474226	54686
474227	64640
474228	54673
474229	64640
474236	54686
474237	64640
474239	64634
474242	54712
474926	58119
475999	44687
476004	54686
476005	2538
476008	3015
476010	54686
476012	3020
476012	28114
488955	2769
497990	2941
525766	2941
525776	38092
551127	2757
554846	2941
559042	3006
559042	34684
563054	3005
563054	34684
593606	8719
626736	8566
644133	9395
651996	4211
661998	4211
666800	3911
679399	3713
691825	94959
691825	94978
691829	94971

CHEV./GMC	TRUCKEX
692944	54789
693299	3613
693604	44759
693606	54789
693606	64696
693607	84558
693609	54789
693609	83006
693610	83007
693611	83007
693612	64694
695424	3911
700106	38234
700106	38264
720386	94976
720387	38284
720390	94971
720723	58141
724859	3607
791988	38223
791989	9666
791989	94969
793928	9667
796790	3607
944511	28513
1240460	54499
1240534	2757
1240638	44535
1240744	T200
1241056	856
1242698	77823
1242700	2769
1243532	8557
1247115	38092
1249607	2757
1252075	54499
1252152	2941
1257749	8598
1258164	8599
1259323	3004
1259323	34684
1259324	3005
1259324	34684
1259481	8598
1261466	3006
1261466	34684
1261467	3005
1261467	34684
1276031	8780
2004199	9606
2006721	3614
2008782	687
2011503	9663
2013118	38235

CHEV./GMC	TRUCKEX
2023481	9662
2023483	9607
2023492	T300
2030130	9624
2030132	9669
2037190	38348
2037191	94992
2037196	58403
2037258	3740
2037788	3701
2037790	94991
2037791	38347
2037791	94992
2038233	64695
2041519	9399
2046594	9479
2046609	3710
2049060	83008
2055454	38414
2055456	94900
2056039	3740
2057214	3632
2061470	3632
2064499	28310
2069199	44773
2069773	9611
2079554	3710
2082228	68267
2082251	68267
2082251	88104
2082252	44774
2082253	74623
2082431	84560
2082432	64705
2082432	64708
2082829	54809
2083403	24836
2088280	93955
2094625	84568
2098817	38413
2199800	3654
2306634	3654
2306635	3654
2306636	2704
2344284	3625
2357630	3883
2373981	3651
2374639	3625
2378615	T134
2383254	4211
2393290	3654
2405604	9657
2407605	3901
2423714	2704



HD EXHAUST
CROSS REFERENCE

OE INTERCHANGE (Continued)

CHEV./GMC	TRUCKEX
2427177	3654
2428242	3654
2444889	3654
2453809	3901
2456787	4211
2482972	3911
2488074	3654
3633128	T212
3692831	8716
3693710	3901
3730022	3651
3731062	8717
3741413	3651
3746524	8318
3752900	92544
3754882	T178
3756559	3901
3768711	9118
3795640	11051
3816360	3901
3816538	3654
3820975	51230
3823885	17853
3831060	3901
3842793	8445
3842795	8445
3848522	3901
3848553	76107
3848554	85991
3848567	85992
3850420	3654
3850422	3654
3850424	3654
3852117	34164
3873128	3654
3890259	881
3895366	609
3904057	881
3906384	48150
3907220	2704
3915520	93140
3930268	3901
3930284	34164
3930770	57412
3930772	57416
3931370	93273
3931376	77141
3931392	3654
3933291	44328
3941438	881
3941444	38149
3941444	38288
3941446	3901
3941448	3654

CHEV./GMC	TRUCKEX
3946828	8720
3948601	93140
3948605	77360
3948609	87361
3948619	77370
3948629	87361
3948637	93273
3948652	68150
3954003	94978
3954005	48152
3954006	58141
3954008	48150
3954016	3901
3954018	3654
3954019	687
3954020	3654
3959674	3654
3963837	687
3963837	3654
3963837	11051
3977205	2642
3977973	44291
3977974	44278
3981940	421
3981941	687
3981942	749
3981945	615
3981946	792
3981947	829
3981948	3901
3983309	2642
3983310	57413
3983320	2641
3983321	57415
3983322	57416
3986274	67474
3986276	77475
3988612	379608
3988662	54085
3988668	44094
3996381	2677
3996417	2697
3996426	2698
3996435	44414
3996436	54415
3996441	64420
3996444	54413
3998323	2545
6258623	44422
6262202	77357
6262508	96600
6262765	93609
6262766	93607
6271611	8717

CHEV./GMC	TRUCKEX
6271612	8738
6272396	74416
6272398	64420
6272415	8560
6272431	47925
6272431	57856
6272433	57857
6274114	54413
6274115	44422
10007215	3006
10007215	34684
10112097	9087
10147977	44783
10148001	3404
10148001	44783
10170227	3554
10170227	17853
10170227	54859
10170234	44783
10213647	3553
10213647	18097
10213647	54858
12541351	54868
12541384	3599
12541384	9206
12541384	28470
14000137	3005
14000137	34684
14000203	38172
14000203	58091
14000203	58097
14000220	58091
14000220	58097
14000263	58091
14000263	58097
14000263	38099
14000264	58120
14000264	68108
14000517	95957
14002817	3006
14002817	34684
14004505	78097
14004509	94990
14004543	48116
14004548	94956
14004548	94964
14004552	88083
14004556	88082
14004559	93928
14004560	48117
14004560	52120
14004560	68108
14005180	96628
14005903	3005

CHEV./GMC	TRUCKEX
14005903	34684
14005978	38147
14005978	68143
14007696	48156
14008893	2538
14008893	28114
14008894	44697
14008903	2538
14008904	44697
14008906	2538
14008907	54660
14008908	2538
14008908	18013
14008909	54660
14008911	2538
14008911	38171
14008912	2538
14008912	38171
14008913	2943
14008913	18013
14008914	3020
14008914	38171
14008915	54689
14008917	3020
14008917	38170
14008918	2538
14008918	38170
14008919	44698
14008921	44688
14009390	38203
14010028	54699
14010029	54700
14010032	24684
14010047	94981
14013055	94011
14014746	38204
14014760	38205
14016364	54650
14016367	44687
14016370	54650
14016371	2943
14016371	28114
14016432	3108
14016432	28146
14016433	3108
14016433	28354
14016434	3108
14016434	28148
14016435	3105
14016439	44721
14016440	44722
14016467	44713
14016468	44715
14016469	54705

CROSS
REFERENCE

CHEV./GMC	TRUCKEX
14016470	54706
14016473	54707
14018680	38194
14019838	44688
14019839	4698
14019846	64631
14019857	64631
14019858	64631
14019860	3123
14019860	38193
14019861	3123
14019861	28145
14019873	64650
14019874	64650
14022511	38099
14022511	88089
14022515	38099
14022515	68156
14022520	38172
14022520	88089
14022522	38172
14022522	68156
14022533	88089
14022535	68156
14022563	88089
14022592	68156
14022593	58164
14024138	93962
14029173	94905
14029956	3822
14029956	93953
14029959	54650
14029960	55000
14032634	64640
14032686	54673
14032689	54700
14032689	68280
14032690	54760
14032691	68280
14032692	48329
14033537	68280
14033543	28326
14033544	54650
14033585	64640
14033588	54673
14033589	54650
14033591	54650
14034514	8212
14034516	8212
14034520	8212
14034801	44687
14034803	44687
14034805	54732
14034815	54732

CHEV./GMC	TRUCKEX
14034817	44698
14034823	54705
14034824	54706
14034825	44713
14034826	44715
14034829	54701
14034830	54702
14034831	44721
14034832	44722
14034833	54707
14034834	44712
14034891	54650
14034892	54712
14034896	54712
14034897	54650
14034905	2538
14034906	2538
14034911	54818
14034912	54819
14034934	54712
14034935	54650
14037802	68278
14038834	54747
14040224	74629
14040225	74630
14040259	93928
14040259	96634
14040260	96635
14040668	78145
14040674	78145
14040688	78143
14040702	78146
14040706	78146
14041279	94904
14044987	3388
14044988	3388
14044989	3387
14044989	28327
14044990	3387
14044990	28327
14044995	44767
14044996	44768
14044997	3387
14044998	3387
14045001	3387
14045002	3387
14045003	64712
14045004	64713
14045005	55000
14045006	54821
14045008	54821
14045049	74637
14045050	74636
14045062	38226

CHEV./GMC	TRUCKEX
14045064	38231
14045067	54746
14045068	2872
14045541	38429
14045545	68290
14045546	38093
14045546	38114
14045553	38290
14045561	48326
14045565	48326
14045568	38204
14045569	58291
14045573	48325
14045577	48327
14045581	48439
14045585	48440
14045597	68279
14049598	93954
14049602	94916
14049660	8113
14051204	14662
14051245	94981
14051246	8107
14051250	54749
14051251	54700
14051251	54750
14053564	38222
14054138	38205
14054726	54699
14058909	54746
14061322	93962
14061324	94904
14061335	38428
14061338	48144
14061339	48328
14063610	54673
14063659	2944
14063659	28174
14063659	54760
14063660	2944
14063660	28174
14063661	64716
14063662	84562
14063665	3123
14063665	28336
14063666	3123
14063666	38249
14063666	54749
14063666	54750
14063795	2315
14063795	2943
14063796	3020
14063796	28102
14063829	2943

CHEV./GMC	TRUCKEX
14063854	2538
14063875	3388
14063876	3388
14063877	3387
14063877	28327
14063878	3387
14063878	28327
14063927	38035
14063927	68172
14063929	38265
14063929	68172
14064642	94905
14067425	3387
14067425	38328
14067428	3387
14067429	3331
14067429	28272
14067430	3331
14067430	18045
14069527	28166
14069530	28173
14069533	38248
14069534	48242
14069535	38277
14069536	38289
14069592	2872
14069592	9206
14069592	28172
14069595	54758
14071760	3906
14071809	54759
14071813	54758
14072686	9220
14079371	3388
14079372	3388
14079373	64714
14079374	64715
14079376	64711
14079385	3387
14079386	3387
14079387	54816
14079388	84817
14079675	64710
14089132	2943
14089135	3108
14089135	28146
14095528	2538
14095603	3020
14095603	18013
14095660	2925
14095660	18004
14095661	2925
14095661	28154
14095661	54747

OE INTERCHANGE (Continued)

CHEV./GMC	TRUCKEX	CHEV./GMC	TRUCKEX	CHEV./GMC	TRUCKEX	CHEV./GMC	TRUCKEX
14098952	3553	15537605	64683	15567709	54785	15577864	2314
14098952	17853	15537606	64684	15567709	54786	15577864	3399
14098952	54858	15537607	54771	15567711	3269	15577864	18053
14098960	3554	15537608	54772	15567711	28240	15577865	64722
14098960	18097	15537610	64682	15567711	54785	15577868	3319
14098960	54859	15537617	2872	15567711	54786	15577868	28268
15327105	38432	15537617	9206	15567724	54811	15577999	64725
15507925	24677	15537617	28172	15567728	28245	15578000	54825
15516364	64740	15537618	2872	15567730	48300	15578266	3225
15516400	38486	15537680	74613	15567734	8109	15582808	3533
15516401	94921	15537681	54773	15567736	8111	15582808	18086
15522175	9160	15544288	3701	15569650	88104	15582809	54989
15522175	78115	15544289	3728	15569651	88104	15582853	2872
15522177	78116	15544299	95973	15570014	14618	15582853	9206
15522177	88098	15544300	95973	15572439	94919	15582853	28172
15522434	9234	15544570	94928	15572776	84568	15582856	54758
15522462	93976	15546623	48318	15576674	2943	15584678	2318
15522471	78111	15548421	28312	15576674	28241	15584678	3533
15522475	88095	15548523	93986	15576675	54787	15584678	9206
15522483	78109	15548776	38386	15576676	2943	15584678	48442
15522487	78114	15548783	48300	15576676	38345	15584681	54884
15522501	78113	15548958	93974	15576677	54788	15584690	3318
15529165	48320	15548980	94930	15576678	3369	15584690	28493
15529166	48319	15548982	94929	15576678	28313	15584691	54883
15529620	3225	15549058	94931	15576680	2943	15584692	3318
15530304	68308	15549136	93978	15576680	38387	15584692	24832
15530311	68310	15549327	3318	15576882	14735	15584692	28349
15530487	18053	15549327	28265	15577067	3533	15584693	54826
15530487	18084	15549327	2314	15577067	18053	15584698	3318
15530489	38488	15549327	54800	15577067	18086	15584698	24833
15530491	28639	15549622	48318	15577068	28424	15584698	28348
15530491	58329	15549622	58283	15577068	74634	15584700	2314
15531892	93973	15549623	58283	15577577	3319	15584700	3369
15531893	94916	15549631	54808	15577579	38367	15584700	28346
15531894	94999	15550726	94935	15577581	38368	15584702	3318
15535118	54760	15550755	8503	15577583	38369	15584702	24832
15535218	64679	15550775	18126	15577585	28266	15584702	28347
15535366	3123	15550775	28424	15577586	54802	15584703	54824
15535652	3388	15555594	3708	15577587	54803	15584802	3548
15535653	3388	15556734	84568	15577588	44766	15584803	54856
15535654	3387	15556740	64708	15577589	28267	15589909	3387
15535655	3387	15557001	93982	15577589	33190	15589927	3123
15535667	44758	15560703	93983	15577590	3319	15589927	28336
15535668	3387	15560705	93984	15577590	28268	15589928	3123
15535673	3387	15562593	94918	15577652	48291	15589928	38249
15535673	3534	15567084	54817	15577806	2318	15589929	2315
15535674	3387	15567706	3263	15577841	3319	15589929	2944
15535684	2872	15567706	8170	15577842	3319	15589929	28174
15535871	38289	15567706	28239	15577842	9162	15589930	2315
15537083	54816	15567706	54785	15577842	28267	15589930	2944
15537601	64680	15567706	54786	15577862	3533	15589930	28174
15537602	64681	15567709	3269	15577862	8975	15590286	38439
15537603	64686	15567709	8170	15577862	18085	15590290	48409
15537604	64685	15567709	28240	15577863	54853	15590705	94932

CHEV./GMC	TRUCKEX
15590793	3226
15590793	8111
15590793	28233
15592091	8223
15592436	68200
15592438	78110
15592440	88094
15592441	88097
15592442	88096
15592451	9261
15592462	78112
15593303	84562
15593365	54759
15594198	9206
15594198	28172
15595212	68278
15595216	58262
15595232	68281
15595236	78146
15595244	78146
15595249	68279
15595253	58263
15595256	93962
15595258	94904
15595262	78144
15595263	94905
15595266	78187
15595287	68290
15595292	38203
15595295	68290
15595305	38428
15595309	48328
15595313	48441
15595366	68201
15595595	68310
15595600	68308
15595607	9597
15595607	27875
15595609	18086
15595609	38744
15595610	58313
15595621	14662
15595625	18077
15595634	78116
15595679	2538
15595932	58240
15595932	78116
15595934	78116
15596401	8112
15596681	2872
15596681	9206
15596681	28172
15597492	94917
15597853	68266

CHEV./GMC	TRUCKEX
15597905	58414
15597915	18037
15597915	28309
15597916	28309
15597917	28309
15597917	38412
15597923	38412
15597926	58282
15597929	58282
15598205	8111
15598211	2893
15598211	3226
15598211	18038
15598217	44758
15598249	94914
15603976	3269
15603976	28240
15603976	54785
15603976	54786
15604893	94935
15607673	93972
15610504	94934
15610798	94930
15610799	94929
15611402	3123
15611402	8170
15611405	3269
15611405	38239
15611405	54785
15611405	54786
15613631	24731
15613631	28495
15613633	38558
15615515	54803
15615596	54989
15615596	64742
15615666	3533
15615666	9206
15615666	48442
15616241	2314
15616421	3400
15616421	18053
15616422	28344
15616422	64723
15616425	3400
15616425	28345
15616426	64724
15616765	2107
15616765	48456
15616768	64761
15617160	44766
15618161	2943
15618161	18078
15618162	54787

CHEV./GMC	TRUCKEX
15618163	2872
15618164	2944
15618164	28174
15618165	54760
15618166	2943
15618166	2944
15618166	28174
15618880	2063
15618881	64750
15618882	2059
15618883	54885
15619630	54988
15620225	93971
15623923	3422
15623923	18079
15623923	54846
15623923	64723
15624686	3400
15624686	28335
15624686	44778
15625872	48434
15625872	58339
15625873	48434
15627107	3123
15627107	3269
15627107	28334
15627107	54785
15627107	54786
15627111	38469
15627126	3123
15627126	3269
15627126	8170
15627126	28334
15627126	54785
15627126	54786
15627190	38573
15627445	96985
15627446	93984
15629014	58344
15629016	38555
15631327	8975
15631342	94933
15634746	3319
15634746	28267
15634747	54838
15635526	2111
15635528	64762
15635908	2111
15635908	18104
15635910	64759
15635911	2105
15635912	54904
15635938	2315
15635938	2944

CHEV./GMC	TRUCKEX
15635938	28401
15635940	2315
15635940	2944
15635940	28401
15635941	54848
15635942	38571
15635945	54903
15636093	74635
15637249	3534
15637250	3534
15638767	3719
15638973	38557
15638980	2062
15638980	64749
15639084	13009
15639084	95984
15639088	8975
15639088	94938
15639544	38570
15640098	94933
15640262	94937
15640263	64751
15640280	2704
15640311	93986
15640346	58345
15640482	58361
15640484	78193
15640485	38572
15640487	48453
15640489	68368
15641364	8066
15641375	3123
15641375	8140
15641375	28460
15641375	54699
15641375	54836
15641375	54837
15641685	2316
15642373	3123
15642373	8140
15642373	28387
15642373	54699
15642373	54836
15642373	54837
15643234	64777
15644152	68370
15644154	58347
15644642	3579
15644642	18092
15644642	44806
15651242	74645
15651243	34814
15651734	3423
15651734	28400



HD EXHAUST
CROSS REFERENCE

OE INTERCHANGE (Continued)

CHEV./GMC	TRUCKEX	CHEV./GMC	TRUCKEX	CHEV./GMC	TRUCKEX	CHEV./GMC	TRUCKEX
15651734	54847	15661675	28426	15671890	94938	15973812	28509
15651799	28391	15661676	54857	15671891	93986	15973820	64754
15651837	2944	15662508	38525	15671914	48454	15976974	28268
15651837	28401	15662509	38524	15671916	68369	15976980	54893
15651837	54848	15662510	28268	15671918	88118	15976981	3539
15651857	2944	15662511	48429	15671920	48457	15976981	38562
15651857	28401	15662512	28266	15676983	3539	15976982	3539
15651857	54848	15662513	38523	15676983	48448	15976982	48447
15654304	2064	15662514	48406	15677739	93983	15976984	54891
15654338	48510	15662515	38490	15679777	83008	15976984	54892
15654847	2062	15662516	28166	15681043	34812	15976993	54895
15654847	54886	15662517	3599	15681044	34812	15976993	54896
15658202	3595	15662518	3599	15682576	2016	15978269	54894
15658202	28444	15662519	3599	15682576	18095	15980181	2016
15658202	54864	15662520	3599	15682576	44813	15980181	38563
15659507	2058	15662521	3599	15683950	38504	15980181	54897
15659507	8170	15662522	3599	15683951	3269	15981463	2115
15659507	8214	15662523	3599	15683951	8170	15981463	38596
15659507	9206	15662524	3599	15683951	28438	15981463	54909
15659507	28494	15662525	3599	15683951	54785	15981464	2114
15659507	54758	15662525	28267	15683951	54786	15981464	38595
15659507	54786	15662526	3599	15684179	93985	15981464	54908
15659509	38554	15662526	28470	15684601	34813	16540345	38556
15659510	2058	15662527	3539	15687112	2062	22500899	3004
15659510	8170	15662528	3539	15687112	64749	22500899	34684
15659510	8214	15662529	54868	15687225	9234	45549072	94934
15659510	9206	15662530	44810	15691575	54907	52003985	3364
15659510	38553	15662530	54866	15691576	34816	52003985	44772
15659510	54785	15662530	54867	15696039	83028	52004422	3355
15659510	54786	15662531	54869	15696039	400A1014	52004422	44760
15659512	2058	15662532	54810	15697865	48454	52017921	3389
15659512	8170	15662533	54854	15697866	68369	52017921	64717
15659512	8214	15662533	54855	15697867	88118	94020431	8774
15659512	9206	15662795	54987	15697868	45457	94020492	44633
15659512	38553	15662796	38571	15697941	58347	94020500	2901
15659512	54785	15662797	54902	15725934	9328	94021915	8740
15659512	54786	15662798	2178	15953138	34815	94023386	7529
15659513	2058	15662798	3598	15957259	3549	94023909	54663
15659513	8170	15662798	28400	15957259	28426	94024717	8717
15659513	8214	15662799	44809	15967769	18098	94025153	68121
15659513	38553	15665181	3599	15967769	48451	94025154	44675
15659513	54785	15665182	3599	15967770	38567	94025155	44677
15659513	54786	15665700	2105	15967771	48452	94025156	28126
15659514	2058	15666316	2064	15973803	2100	94025159	8281
15659514	8170	15667757	14734	15973803	28508	94025166	2960
15659514	8214	15670818	3719	15973804	2099	94027000	68121
15659514	28494	15671561	2943	15973804	28508	94027002	24687
15659514	54785	15671712	2058	15973805	2100	94027002	44675
15659514	54786	15671712	38569	15973805	18098	94027666	68135
15661558	2106	15671712	54785	15973806	2099	94028791	8280
15661559	64760	15671712	54901	15973806	18098	94028792	8585
15661560	2061	15671884	93971	15973811	2099	94028793	8584
15661663	2105	15671887	93971	15973811	28509	94037873	24889
15661675	3549	15671889	95984	15973812	2100	94044319	3726

CROSS
REFERENCE

CHEV./GMC	TRUCKEX
94047627	3726
94139278	54906
94164431	48344
94206497	9058
94207180	8511
94222485	68158
94222494	2960
94222496	44738
94222497	24727
94222497	44738
94222502	8515
94222509	28153
94222510	18019
94236345	9233
94237689	78130
94246177	48352
94246178	48353
94316881	48460
94318786	54905
94318795	54906
94319279	54906
94400290	3727
94401135	48390
94407278	54906
94413923	48344
94449961	28514
94457763	8233
96051782	8172
96051783	8172
96053530	3232
96053530	58243

DODGE/PLY.	TRUCKEX
1636570	8724
1636570	8722
2228076	55870
2229617	735
2239535	8563
2460824	836
2506865	2537
2825226	734
2826822	93364
2828443	95949
2898472	34637
2898472	34643
2907887	93364
2914614	785
2961308	95535
2961309	34399
2961310	54401

DODGE/PLY.	TRUCKEX
2961311	74404
3466957	2690
3466958	2690
3466966	22690
3469868	74445
3491957	34530
3496843	47638
3496852	94639
3496854	27641
3496861	2715
3496863	64442
3496864	74443
3497152	37644
3497154	94640
3497242	67534
3497439	95621
3497444	8571
3633000	37642
3633332	47703
3638135	698
3638140	2715
3640433	34399
3640434	34530
3641271	8567
3726836	2690
3726837	2690
3732756	14532
3732756	20824
3733681	37644
3733683	47703
3733688	24619
3733688	64533
3733691	24619
3733691	64533
3733806	836
3733814	54438
3733815	74439
3735056	44632
3735056	54643
3735298	8567
3735308	2873
3820811	8571
3821039	8567
3822558	8563
3823783	94951
3823790	3807
3823791	48105
3823840	48263
3823885	18015
3827418	2922
3828445	2930
3828907	94951
3828908	93911
3828949	24659

DODGE/PLY.	TRUCKEX
3828949	64643
3893205	34637
3893205	74591
3893206	24629
3893206	74591
3893207	24629
3893207	74591
3893208	34637
3893208	74591
3893401	8571
3894085	2923
3894358	698
3898277	8563
3898282	1434
3898336	2664
3898338	64643
3898459	54654
3898466	34643
3898470	54655
3898478	34624
3898482	44645
3898746	24646
3898903	48263
4004093	223
4004371	2690
4004392	2923
4030210	24659
4030572	58110
4030574	58111
4030575	34637
4030575	58111
4031380	58131
4032891	54401
4032892	74404
4032895	54438
4032896	74439
4032897	44632
4032897	54643
4032952	64643
4036879	2924
4036881	2950
4036882	2873
4112523	3068
4112524	2923
4112525	2923
4112863	14342
4112933	44703
4112934	64652
4115381	3068
4115382	2930
4115409	34643
4115409	24646
4115409	T212
4115410	24646

DODGE/PLY.	TRUCKEX
4115410	54655
4115410	T212
4115411	24646
4115411	54655
4115411	T212
4115414	34643
4115415	54655
4115416	54655
4115417	34637
4115417	34643
4116874	2930
4117114	2874
4117403	93946
4117406	95949
4117407	48372
4117410	94911
4117411	94909
4117438	18015
4117446	54438
4117447	74439
4117450	44703
4117451	64652
4117455	24646
4117455	34643
4117455	T212
4117456	24646
4117456	54655
4117456	T212
4117457	24646
4117457	54655
4117457	T212
4117460	34643
4117461	54655
4117462	54655
4117463	34637
4117463	34643
4117581	54438
4117582	74439
4117585	44703
4117586	64652
4117684	24659
4131333	8094
4150693	34735
4164134	24646
4164135	24646
4164136	24646
4164138	14342
4167334	54438
4167335	74439
4167427	8563
4212523	3068
4213062	2925
4213125	2930
4218021	2925

OE INTERCHANGE (Continued)

DODGE/PLY.	TRUCKEX	DODGE/PLY.	TRUCKEX	DODGE/PLY.	TRUCKEX	DODGE/PLY.	TRUCKEX
4218032	8096	4218618	64699	4427799	54876	52006556	8093
4218036	2930	4218619	64699	4428526	38416	52006648	28311
4218084	14342	4218620	14642	4428532	3366	52006748	8093
4218124	38516	4218622	64699	4428532	28311	52006839	3436
4218166	8093	4218623	64699	4428538	58286	52006841	54790
4218183	94909	4218624	64699	4428542	54810	52006842	54840
4218199	8095	4218625	8095	4428550	9618	52006914	8093
4218200	8070	4218627	8093	4495283	3429	52007170	84567
4218208	28242	4218628	3268	4495284	74631	52007171	84567
4218243	8093	4218629	54790	4495290	54841	52007173	54863
4218249	18015	4218635	54810	4495291	3427	52007193	28433
4218250	2923	4218640	92688	4495291	24847	52007194	28434
4218297	14342	4301195	8069	4495296	3428	52007195	28435
4218298	2925	4301221	74620	4495296	24847	52007201	54862
4218299	3068	4301259	74612	4495301	3430	52017517	18077
4218307	74621	4301318	74612	4495305	64732	52017519	8093
4218308	74621	4301689	74612	4495306	8067	52017520	8093
4218310	74621	4301709	3264	4495307	8067	52017523	54810
4218311	74621	4301711	74619	4495308	2004	52017525	8093
4218328	8093	4301712	3265	4495314	2004	52017526	8093
4218329	8093	4301714	74620	4495314	18094	52017527	8093
4218339	64699	4301756	3264	4495324	54876	52017528	8093
4218341	64699	4301843	3264	4495360	3430	52017529	8093
4218343	64699	4301944	74619	4495377	24847	52018001	58286
4218344	64699	4301951	74620	4495377	44812	52018002	58340
4218346	64699	4301960	8068	4495680	58337	52018003	3395
4218347	64699	4318717	8094	4495681	2005	52018004	28391
4218350	74621	4425075	74619	4495681	34771	52018007	38415
4218353	3268	4427010	3265	4495701	2005	52018106	2078
4218355	54790	4427075	3265	4495701	34771	52018109	27434
4218365	2923	4427092	8070	4495703	58337	52018160	2070
4218396	3304	4427102	3265	4601520	74612	52018160	54900
4218441	3268	4427121	3264	7218604	74621	52018312	54865
4218459	54790	4427234	8069	52004065	24685	52018316	28433
4218469	74621	4427348	74620	52004171	3394	52018317	28434
4218470	74621	4427393	74619	52004174	3395	52018355	2070
4218472	74621	4427395	3429	52004176	3391	52018355	54890
4218473	74621	4427625	58337	52004178	3394	52018466	58340
4218493	3304	4427708	84565	52004197	8093	52018513	28434
4218494	3304	4427728	84570	52004208	8093	52018514	28433
4218495	2923	4427751	3430	52004210	8093	52018515	28434
4218496	2923	4427754	74631	52004225	27875	52018859	74641
4218497	2923	4427757	3430	52004229	3319	52018903	54898
4218532	92688	4427758	84565	52004232	64718	52019003	28242
4218534	54810	4427760	2004	52004245	3415	52019004	3391
4218536	8975	4427761	44812	52004462	8093	52019005	3394
4218537	38415	4427762	54876	52004701	58340	52019006	8975
4218541	3367	4427784	48431	52005760	38533	52019048	54810
4218541	3368	4427793	2004	52006460	8093	52019108	38415
4218541	3415	4427794	84570	52006463	94909	52019114	3571
4218603	74621	4427796	3430	52006539	2078	52019117	3570
4218607	74621	4427797	74643	52006540	2078	52019118	3570
4218608	74621	4427798	2004	52006554	54839	52019121	3570
4218610	74621	4427798	18004	52006556	3366	52019184	3571

DODGE/PLY.	TRUCKEX	DODGE/PLY.	TRUCKEX	DODGE/PLY.	TRUCKEX	FORD	TRUCKEX
52019185	3571	MB431820	48391	MB611877	38449	C7TZ5230E	3901
52019186	3571	MB431821	9240	MB611877	38451	C7TZ5230J	3654
52019187	3268	MB431822	28248	MB612176	28372	C7TZ5230K	736
52019188	3570	MB431913	3482	MB612220	14680	C7TZ5230L	880
52019189	3570	MB431914	9206	MB612221	24844	C7TZ5230M	881
52019190	84567	MB431915	44769	MB612304	8139	C7TZ5246C	48113
52019191	84567	MB431916	7802	MB612305	3482	C7TZ5255AA	74317
52019192	54790	MB431917	9206	MB612305	9206	C7TZ5255Z	20824
52019193	54862	MB431918	44769	MB612305	44769	C7TZ5255Z	64362
52019200	54899	MB514104	28247			C8TA5230M	3632
52019322	2070	MB514246	3347			C8TZ5230B	3654
52019322	54900	MB514246	9240			C8TZ5246F	95243
52019341	74642	MB514247	28283			C8TZ5246H	67085
52019342	74642	MB514248	44770			C8TZ5246M	95243
52019423	2080	MB514615	8287			C8TZ5267K	37244
52019424	2080	MB514708	8697			C8TZ5267L	37244
52019425	2080	MB548707	8139			C8UZ5230B	3901
52019426	2079	MB548708	3347			C8UZ5246A	47374
52019427	2079	MB548954	28283			C8UZ5246B	47373
52020003	28502	MB548954	48391			C8UZ5255B	64257
52020012	74644	MB548955	44770			C8UZ5255D	74251
52020115	3571	MB548956	9240			C9TZ5230A	3901
MB009240	8308	MB549140	9240			C9TZ5246C	96762
MB111601	78095	MB549145	28248			C1TT5230AT	4211
MB111721	78095	MB549146	38356			CO555230A	3901
MB111725	3098	MB549154	3482			CODD5230A	3901
MB111726	44708	MB549154	7802			DOHA5269D	9165
MB149083	8308	MB549155	9206			D0TZ5246A	95420
MB156140	78095	MB549156	44769			D0TZ5267A	27421
MB156141	78095	MB577056	28247			D0UZ5246A	47373
MB156180	8697	MB577058	3365			D1AZ5A231A	38273
MB179130	8729	MB577059	18051			D1TZ5230E	3521
MB179135	38374	MB577060	44775			D1TZ5230E	28420
MB179138	38321	MB577083	3482			D1TZ5230E	54851
MB179362	58238	MB577083	7802			D1TZ5255A	44148
MB179364	58238	MB577084	9206			D27Z5B266A	9033
MB179948	3365	MB577085	44769			D27Z9450A	9032
MB179949	18051	MB577116	48274			D37Z5230A	3089
MB179950	44775	MB577117	38357			D37Z5230A	34686
MB252005	48256	MB577361	3365			D3HA5230GA	3911
MB252246	3098	MB577362	18051			D3TZ5230A	3177
MB252247	44708	MB577363	44775			D3TZ5230A	38275
MB252441	3098	MB577515	28376			D3TZ5230A	54757
MB252442	44708	MB577832	3444			D3TZ5230D	2903
MB252617	38374	MB577833	3444			D3TZ5230E	3906
MB252619	48256	MB577833	18051			D3TZ5246F	97831
MB376490	3365	MB577834	18073			D3TZ5255AB	74587
MB376491	18051	MB577834	34790			D3TZ5255D	54507
MB376492	44775	MB577835	34790			D3TZ5255E	74508
MB376954	8172	MB611606	28389			D3TZ5255J	54511
MB431171	48274	MB611776	3445			D3TZ5A212B	2903
MB431174	38357	MB611777	9206			D3TZ5A212B	78103
MB431175	8136	MB611778	44790			D3TZ5A212C	2903
MB431699	38356	MB611876	28373			D3TZ5A212C	78103

CROSS REFERENCE



HD EXHAUST
CROSS REFERENCE

OE INTERCHANGE (Continued)

FORD	TRUCKEX
D47Z5230A	3090
D47Z5230A	44705
D47Z5260A	8257
D47Z5277A	8256
D47Z5277B	8513
D47Z5277C	8512
D47Z5A289A	7578
D47Z9450A	9047
D4TZ5230B	30810
D4TZ5230J	3081
D4TZ5230L	609
D4TZ5230L	2958
D4TZ5246H	95959
D4TZ5255D	64663
D4TZ5255N	64663
D4TZ5260B	8491
D4TZ5260E	8491
D50Z5260F	8491
D5HZ5246AC	28517
D5HZ5A231C	9667
D5TA5225BDA	3611
D5TZ5230A	2952
D5TZ5230AC	881
D5TZ5230AC	3654
D5TZ5230AF	881
D5TZ5230AH	3611
D5TZ5230AH	3668
D5TZ5230BM	3129
D5TZ5230BM	58188
D5TZ5230CC	881
D5TZ5230CC	3463
D5TZ5230CC	95953
D5TZ5230CD	2952
D5TZ5230CD	34635
D5TZ5230CD	95953
D5TZ5230CE	2952
D5TZ5230CE	34635
D5TZ5230CE	95953
D5TZ5230CG	2952
D5TZ5230CG	34635
D5TZ5230CG	95953
D5TZ5230CH	736
D5TZ5230CH	68106
D5TZ5230CK	881
D5TZ5230CK	34635
D5TZ5230CK	95953
D5TZ5230CL	2958
D5TZ5230CL	3607
D5TZ5230CM	3654
D5TZ5230CS	881
D5TZ5230CS	34635
D5TZ5230CU	2952
D5TZ5230CU	34635
D5TZ5230CU	95953

FORD	TRUCKEX
D5TZ5230J	881
D5TZ5230L	2771
D5TZ5230R	2771
D5TZ5246K	38453
D5TZ5255AJ	74606
D5TZ5255AN	64638
D5TZ5255AN	312A1016
D5TZ5255AR	54662
D5TZ5255BE	64627
D5TZ5255BF	64638
D5TZ5255BJ	54662
D5TZ5255BJ	64638
D5TZ5255H	54657
D5TZ5255H	64627
D5TZ5255R	64627
D5TZ5255R	64638
D5TZ5255S	54657
D5TZ5255T	54511
D5TZ5255U	54511
D5TZ5260E	8572
D5TZ5260L	8572
D5TZ5260M	8572
D5TZ5267N	37764
D5TZ5A246G	8572
D5TZ5A246K	8491
D5UZ5230AB	2930
D5UZ5230AJ	2930
D5UZ5230AJ	64633
D5UZ5230E	2930
D5UZ5230E	24644
D5UZ5230E	64633
D5UZ5230F	2930
D5UZ5230F	64632
D5UZ5230F	64633
D5UZ5230R	2930
D5UZ5230R	64632
D5UZ5230S	2930
D5UZ5230S	64633
D5UZ5246F	68104
D5UZ5246L	58107
D5UZ5255A	64633
D5UZ5255B	64633
D5UZ5260D	8572
D5UZ5A246A	8572
D5UZ5A246B	8491
D5UZ5A246F	8572
D6TZ5B266A	9075
D6TZ5230F	2771
D6TZ5230F	9202
D7TZ5260D	8289
D7TZ5277B	8534
D7TZ5A289A	68136
D7TZ5A289C	7587
D7HT5225BTA	3611

FORD	TRUCKEX
D7HT5270UA	9624
D7TZ5230C	97832
D7TZ5230D	2952
D7TZ5230D	96615
D7TZ5230H	2952
D7TZ5230H	48128
D7TZ5230H	93916
D7TZ5230J	2952
D7TZ5230J	58130
D7TZ5230J	93916
D7TZ5230L	2952
D7TZ5230L	96615
D7TZ5230N	2983
D7TZ5246C	58130
D7TZ5246C	93916
D7TZ5255A	54668
D7TZ5255B	64638
D7TZ5255J	54662
D7TZ5255K	64642
D7TZ5255N	54662
D7TZ5255R	64642
D7TZ5255W	44640
D7TZ5255Y	44640
D7TZ5255Z	64638
D7TZ5260D	8572
D7TZ5260F	8572
D8TZ5260A	3099
D8TZ5260A	44709
D8TZ5260B	8187
D8TZ5277A	8289
D8GZ5246AT	28161
D8HT5270BA	9669
D8HZ5230AC	3611
D8HZ5230AL	3698
D8HZ5230R	95962
D8HZ5230S	3607
D8HZ5230S	95962
D8HZ5246AT	28161
D8HZ5246M	18109
D8HZ5255AG	44659
D8HZ5A212BT	58317
D8HZ5A212DA	28518
D8HZ5A231J	3613
D8NN5A281AA	9663
D8TZ5230AJ	2952
D8TZ5230AJ	48128
D8TZ5230AJ	93916
D8TZ5230AT	736
D8TZ5230AT	96626
D8TZ5230B	3017
D8TZ5230B	54687
D8TZ5230BD	3023
D8TZ5230BH	2952
D8TZ5230BH	58130

FORD	TRUCKEX
D8TZ5230BH	93916
D8TZ5230BJ	736
D8TZ5230BJ	9202
D8TZ5230BK	736
D8TZ5230BK	67085
D8TZ5230BT	2930
D8TZ5230BT	64633
D8TZ5230BV	2983
D8TZ5230CB	736
D8TZ5230CS	2952
D8TZ5230CS	96627
D8TZ5230J	688
D8TZ5230J	9203
D8TZ5230J	74592
D8TZ5230N	688
D8TZ5230N	9203
D8TZ5230N	74592
D8TZ5246AA	93916
D8TZ5246AB	93916
D8TZ5246BS	38453
D8TZ5246G	94912
D8TZ5246N	58107
D8TZ5255AJ	74606
D8TZD230A	3017
D8TZD230A	54687
D9TZ5246D	48265
D9TZ5255A	28160
D9TZ5255A	28405
D9TZ5255B	38236
D9TZ5255B	38472
D9TZ5255D	38371
D9HZ5230A	3697
D9HZ5230A	9202
D9HZ5230B	3697
D9HZ5246AD	48470
D9HZ5246AG	58370
D9HZ5246AJ	94009
D9HZ5255A	234A1414
D9HZ5255J	234A1414
D9HZ5263F	234A1414
D9HZ5263K	234A1414
D9HZ5A231J	9610
D9HZ5A231J	9626
D9TZ5230AG	736
D9TZ5230AG	54657
D9TZ5230AH	736
D9TZ5230AH	54657
D9TZ5230AL	9202
D9TZ5230AL	64633
D9TZ5230AM	2930
D9TZ5230AM	64633
D9TZ5230AN	2930
D9TZ5230AN	24644
D9TZ5230AN	64633

CROSS
REFERENCE

FORD	TRUCKEX
D9TZ5230AR	2930
D9TZ5230AR	24644
D9TZ5230AR	64633
D9TZ5230AT	3157
D9TZ5230AT	64638
D9TZ5230AV	3157
D9TZ5230AV	64638
D9TZ5230AW	688
D9TZ5230AW	74592
D9TZ5230AW	9203
D9TZ5230AZ	2930
D9TZ5230AZ	9204
D9TZ5230AZ	64632
D9TZ5230BA	2930
D9TZ5230BA	9204
D9TZ5230BA	64632
D9TZ5230BC	2930
D9TZ5230BC	64632
D9TZ5230BC	9204
D9TZ5230BD	3157
D9TZ5230BD	64638
D9TZ5230BE	3157
D9TZ5230BE	64651
D9TZ5230BF	3157
D9TZ5230BF	64651
D9TZ5230BG	3157
D9TZ5230BG	64638
D9TZ5230BH	3157
D9TZ5230BH	64651
D9TZ5230BJ	3157
D9TZ5230BJ	64651
D9TZ5230BM	3155
D9TZ5230BR	3157
D9TZ5230BR	64651
D9TZ5230CC	3063
D9TZ5230CC	9202
D9TZ5230CC	64651
D9TZ5230CD	3063
D9TZ5230CD	9202
D9TZ5230CD	64651
D9TZ5230CE	2952
D9TZ5230CE	9202
D9TZ5230CE	24629
D9TZ5230CE	54668
D9TZ5230CF	2952
D9TZ5230CF	9202
D9TZ5230CF	24629
D9TZ5230CF	54668
D9TZ5230CJ	2952
D9TZ5230CJ	64642
D9TZ5230CK	2952
D9TZ5230CK	64642
D9TZ5230E	2930
D9TZ5230E	9204

FORD	TRUCKEX
D9TZ5230E	64633
D9TZ5230F	688
D9TZ5230F	9203
D9TZ5230F	74592
D9TZ5230G	2930
D9TZ5230G	9204
D9TZ5230G	64633
D9TZ5230J	2930
D9TZ5230J	9204
D9TZ5230J	64633
D9TZ5230K	6062
D9TZ5230K	9202
D9TZ5230K	54657
D9TZ5230L	3063
D9TZ5230L	9202
D9TZ5230L	54662
D9TZ5230M	3062
D9TZ5230M	9202
D9TZ5230M	54657
D9TZ5230N	3062
D9TZ5230N	9202
D9TZ5230N	54657
D9TZ5230R	3063
D9TZ5230R	9202
D9TZ5230R	54662
D9TZ5230S	3062
D9TZ5230S	9202
D9TZ5230S	54657
D9TZ5230V	3157
D9TZ5230V	64651
D9TZ5230W	3157
D9TZ5230W	64651
D9TZ5246AR	48128
D9TZ5246AR	93916
D9TZ5246AZ	96633
D9TZ5246AZ	96637
D9TZ5246L	38453
D9TZ5246M	38452
D9TZ5246N	94912
D9TZ5260E	8572
DOHA5225AE	3899
DOHA5225L	3632
DOHZ5230J	3611
DOHZ5230R	3614
DTZ5260A	8572
EOGZ5255V	84551
E0HT5225AB	3632
E0HZ246F	48233
E0HZ5225L	400A1014
E0HZ5230A	3632
E0HZ5230B	3632
E0HZ5246A	58228
E0HZ5246B	58229
E0HZ5246C	28515

FORD	TRUCKEX
E0HZ5246D	95986
E0HZ5246E	48234
E0HZ5246F	48233
E0HZ5246G	48466
E0HZ5246H	94973
E0HZ5246H	94993
E0HZ5246J	38266
E0HZ5246U	38266
E0HZ5255A	84555
E0HZ5255AD	234A1414
E0HZ5255C	234A1414
E0HZ5255E	234A1414
E0HZ5255F	234A1414
E0HZ5255G	400A1414
E0HZ5255J	400A1414
E0HZ5255V	84551
E0HZ5255V	84582
E0HZ5263B	234A1414
E0HZ5263D	234A1414
E0HZ5263F	234A1414
E0HZ5263H	400A1014
E0HZ5263K	400A1014
E0HZ5263M	400A1014
E0HZ5276J	38266
E0HZ5A212B	58372
E0HZ5A212F	48477
E0HZ5A212G	58318
E0HZ5A231A	9611
E0HZ5A231B	9611
E0HZ5A231C	9617
E0HZ5A231C	9735
E0NN5A281AA	9605
E0TZ5246B	94913
E0TZ5246C	38440
E0TZ5246D	93963
E0TZ5246W	38452
E0TZ5A212A	28134
E0TZ5A212A	34637
E0TZ5A212B	28134
E0TZ5B266A	9079
E17Z5255A	28405
E17Z5255A	28160
E17Z5255B	38236
E17Z5255B	38472
E1HT5270BA	9607
E1HT5270EA	9605
E1HT5270HA	9662
E1HZ5255N	T400Z
E1HZ5A231A	9611
E1HZ5A231C	T400Z
E1TZ5230AF	3424
E1TZ5230AF	28308
E1TZ5230AF	64728
E1TZ5230AG	2930

FORD	TRUCKEX
E1TZ5230AG	64632
E1TZ5230AH	2930
E1TZ5230AH	64633
E1TZ5230E	3112
E1TZ5230E	54704
E1TZ5230G	3155
E1TZ5230G	3424
E1TZ5230G	64728
E1TZ5230H	688
E1TZ5230H	74592
E1TZ5230J	3112
E1TZ5230J	54704
E1TZ5230N	3112
E1TZ5230N	9200
E1TZ5230N	24629
E1TZ5230N	54704
E1TZ5230S	3112
E1TZ5230S	38210
E1TZ5230S	54704
E1TZ5230Z	2930
E1TZ5230Z	64633
E1TZ5246A	48345
E1TZ5246B	96630
E1TZ5A212A	28134
E2HS5225GA	3700
E2HT5225AFB	3711
E2HT5225AG2A	3700
E2HT5230ANA	3697
E2HZ5230G	3697
E2HZ5230S	3697
E2HZ5230Z	3711
E2HZ5246C	48467
E2HZ5246D	48468
E2HZ5246E	48469
E2HZ5246F	28516
E2HZ5246H	95988
E2HZ5246J	94973
E2HZ5A212C	48478
E2HZ5A212D	18103
E2HZ5A212F	58372
E2HZ5A215C	9628
E2HZ5A231A	9622
E2TZ5230A	3112
E2TZ5230A	54704
E2TZ5230B	3112
E2TZ5230B	24629
E2TZ5230B	54704
E2TZ5230G	3112
E2TZ5230G	24629
E2TZ5230G	54704
E2TZ5230J	3112
E2TZ5230J	54704
E2TZ5230K	3112
E2TZ5230K	38210

OE INTERCHANGE (Continued)

FORD	TRUCKEX	FORD	TRUCKEX	FORD	TRUCKEX	FORD	TRUCKEX
E2TZ5230K	54704	E3TZ5230AD	54755	E3TZ5230N	38527	E4TZ5230J	3112
E2TZ5230L	3112	E3TZ5230AE	3112	E3TZ5230N	54870	E4TZ5230J	54775
E2TZ5230L	54703	E3TZ5230AE	54756	E3TZ5230R	3112	E4TZ5230K	3112
E2TZ5230L	54704	E3TZ5230AF	3177	E3TZ5230R	54755	E4TZ5230K	24629
E2TZ5230M	3112	E3TZ5230AF	38276	E3TZ5230S	3112	E4TZ5230K	54775
E2TZ5230M	54704	E3TZ5230AF	54757	E3TZ5230S	24629	E4TZ5230L	3257
E2TZ5230N	3112	E3TZ5230AG	3177	E3TZ5230S	54755	E4TZ5230L	54783
E2TZ5230N	24629	E3TZ5230AG	38276	E3TZ5230T	3112	E4TZ5230L	54784
E2TZ5230N	54704	E3TZ5230AG	54757	E3TZ5230T	54755	E4TZ5230M	3205
E2TZ5230R	688	E3TZ5230AH	3177	E3TZ5230U	3112	E4TZ5230M	8213
E2TZ5230R	74592	E3TZ5230AH	38276	E3TZ5230U	24629	E4TZ5230M	8214
E2TZ5230T	2930	E3TZ5230AH	54757	E3TZ5230U	54755	E4TZ5230M	54767
E2TZ5230T	64632	E3TZ5230AJ	3177	E3TZ5230W	3112	E4TZ5230M	54768
E2TZ5230U	2930	E3TZ5230AJ	38276	E3TZ5230W	54755	E4TZ5230R	3357
E2TZ5230U	64633	E3TZ5230AJ	54757	E3TZ5230Y	3112	E4TZ5230R	27875
E2TZ5230V	2930	E3TZ5230AK	3177	E3TZ5230Y	24629	E4TZ5230R	54755
E2TZ5230V	24644	E3TZ5230AK	54757	E3TZ5230Y	54755	E4TZ5230S	3357
E2TZ5230V	64633	E3TZ5230AK	38290	E3TZ5246B	95972	E4TZ5230S	27875
E2TZ5230W	3112	E3TZ5230AL	3177	E3TZ5246C	93964	E4TZ5230S	54755
E2TZ5230W	54703	E3TZ5230AL	54757	E3TZ5320V	3112	E4TZ5230T	2000
E2TZ5230Y	3112	E3TZ5230AL	38290	E3TZ5320V	54759	E4TZ5230T	38529
E2TZ5230Y	54703	E3TZ5230AM	3424	E3TZ5A212C	28308	E4TZ5230T	54870
E2TZ5246A	95970	E3TZ5230AM	58097	E3TZ5A212D	28471	E4TZ5230U	2000
E2TZ5246C	96630	E3TZ5230AM	64728	E3TZ5A212G	28297	E4TZ5230U	38529
E2TZ5246E	95975	E3TZ5230B	3177	E3TZ5A212H	28471	E4TZ5230U	54870
E2TZ5246G	95980	E3TZ5230B	38275	E3TZ5A246A	8196	E4TZ5230V	3185
E2TZ5246H	95971	E3TZ5230B	54757	E3TZ5A262A	8196	E4TZ5230V	8216
E3HZ5230B	3700	E3TZ5230E	2000	E3UZ5230A	688	E4TZ5246A	28362
E3HZ5230D	3698	E3TZ5230E	38529	E3UZ5230A	24644	E4TZ5246A	92690
E3HZ5230S	3697	E3TZ5230E	54870	E3UZ5230A	74592	E4TZ5260A	8197
E3HZ5246AA	2851	E3TZ5230F	2000	E3UZ5230B	2930	E4TZ5A212A	48375
E3HZ5246AA	28517	E3TZ5230F	3112	E3UZ5230B	64632	E4UZ5230	3258
E3HZ5246H	68372	E3TZ5230F	38529	E3UZ5230C	2930	E4UZ5230A	3193
E3HZ5246K	68371	E3TZ5230F	54755	E3UZ5230C	64633	E4UZ5230A	18024
E3HZ5246R	58284	E3TZ5230F	54870	E3UZ5230F	3424	E4UZ5230A	64675
E3HZ5246U	94993	E3TZ5230G	3177	E3UZ5230F	64728	E4UZ5230B	3112
E3HZ5246V	58363	E3TZ5230G	38276	E3UZ5230H	3424	E4UZ5230B	3193
E3HZ5246W	95987	E3TZ5230G	54757	E3UZ5230H	64728	E4UZ5230B	64675
E3HZ5246Y	52369	E3TZ5230H	3177	E3UZ5230J	3424	E4UZ5230C	3256
E3HZ5246Z	58368	E3TZ5230H	38276	E3UZ5230J	28308	E4UZ5230D	3181
E3HZ5255B	400A1014	E3TZ5230H	54757	E3UZ5230J	64728	E4UZ5230D	18025
E3HZ5255D	400A1014	E3TZ5230J	3112	E3UZ5246D	96631	E4UZ5230D	64675
E3HZ5255F	400A1014	E3TZ5230J	38210	E4HZ5230A	3697	E4UZ5230E	3181
E3HZ5255H	400A1014	E3TZ5230J	54755	E4TZ5230A	3182	E4UZ5230E	64675
E3HZ5255K	400A1014	E3TZ5230J	2000	E4TZ5230A	64676	E4UZ5230F	3181
E3HZ5255M	400A1014	E3TZ5230J	38529	E4TZ5230C	3185	E4UZ5230F	18025
E3HZ5255N	74624	E3TZ5230J	54870	E4TZ5230C	8216	E4UZ5230F	64675
E3HZ5255R	400A1014	E3TZ5230K	3112	E4TZ5230D	3185	E4UZ5230G	3258
E3TZ5230AA	3112	E3TZ5230K	38210	E4TZ5230D	54766	E4UZ5230G	64698
E3TZ5230AA	54756	E3TZ5230K	54755	E4TZ5230G	3122	E4UZ5230G	74617
E3TZ5230AC	3112	E3TZ5230M	3357	E4TZ5230G	54755	E4UZ5230H	3258
E3TZ5230AC	54755	E3TZ5230M	28294	E4TZ5230H	3112	E4UZ5230H	18025
E3TZ5230AD	3112	E3TZ5230M	54755	E4TZ5230H	24629	E4UZ5230H	64698
E3TZ5230AD	24629	E3TZ5230N	2000	E4TZ5230H	54755	E4UZ5230H	74617

FORD	TRUCKEX	FORD	TRUCKEX	FORD	TRUCKEX	FORD	TRUCKEX
E4UZ5320C	3181	E5TZ5230E	54804	E5UZ5230L	18025	E7HZ5246K	48347
E4UZ5320C	64675	E5TZ5230K	3112	E5UZ5230L	64698	E7HZ5246N	48349
E5HZ5246J	68371	E5TZ5230K	54755	E5UZ5230L	74617	E7HZ5255A	74627
E5HZ5246K	68372	E5TZ5230L	2048	E5UZ5230M	3424	E7HZ5255B	84561
E5HZ5246L	48234	E5TZ5230L	3112	E5UZ5230M	58097	E7HZ5255E	400A1014
E5HZ5246L	48402	E5TZ5230L	8080	E5UZ5230M	64728	E7HZ5255G	400A1014
E5HZ5246M	48403	E5TZ5230L	24629	E69Z5230A	3222	E7HZ5255J	400A1014
E5HZ5246Z	48402	E5TZ5230L	28295	E69Z5230A	28215	E7HZ5255L	400A1014
E5HZ5A231B	9626	E5TZ5230L	28296	E69Z5230A	44756	E7HZ5255N	400A1014
E5TZ5230A	3177	E5TZ5230L	54755	E69Z5230B	3222	E7HZ5255R	400A1414
E5TZ5230A	38290	E5TZ5230L	54805	E69Z5230B	28215	E7HZ5A231C	9627
E5TZ5230A	54757	E5TZ5230M	3185	E69Z5230B	44756	E7TZ5230A	3255
E5TZ5230AA	3205	E5TZ5230M	54756	E69Z5230D	3222	E7TZ5230A	64690
E5TZ5230AA	8213	E5TZ5230N	3201	E69Z5230D	28215	E7TZ5230B	3255
E5TZ5230AA	8214	E5TZ5230N	28202	E69Z5230D	44756	E7TZ5230B	24629
E5TZ5230AA	54767	E5TZ5230N	54757	E69Z5230D	8692	E7TZ5230B	64690
E5TZ5230AA	54768	E5TZ5230R	3201	E69Z5C226A	8768	E7TZ5230C	3374
E5TZ5230AB	3205	E5TZ5230R	28202	E69Z5C226A	9258	E7TZ5230C	24629
E5TZ5230AB	8213	E5TZ5230R	54757	E69Z5E257A	28458	E7TZ5230C	54782
E5TZ5230AB	24629	E5TZ5230S	3258	E6DZ5E241A	9095	E7TZ5230C	64692
E5TZ5230AB	54767	E5TZ5230S	18025	E6HZ5246F	94939	E7TZ5230D	3255
E5TZ5230AB	54768	E5TZ5230S	64698	E6HZ5255A	74625	E7TZ5230D	64690
E5TZ5230AL	7645	E5TZ5230S	74617	E6HZ5255A	74627	E7TZ5230E	3255
E5TZ5230AL	7647	E5TZ5230T	3201	E6TZ5230D	3201	E7TZ5230E	24629
E5TZ5230AL	8080	E5TZ5230T	28203	E6TZ5230D	28216	E7TZ5230E	64690
E5TZ5230AL	8177	E5TZ5230T	54757	E6TZ5230D	54757	E7TZ5230F	3257
E5TZ5230AL	54806	E5TZ5230U	3201	E6TZ5230E	3201	E7TZ5230F	54782
E5TZ5230AM	2000	E5TZ5230U	28203	E6TZ5230E	28216	E7TZ5230F	64692
E5TZ5230AM	7359	E5TZ5230U	54757	E6TZ5230E	54757	E7TZ5230G	3257
E5TZ5230AM	38529	E5TZ5230V	3177	E6TZ5230F	3223	E7TZ5230G	24629
E5TZ5230AM	54872	E5TZ5230V	38290	E6TZ5230F	54764	E7TZ5230G	54782
E5TZ5230AN	3205	E5TZ5230V	54757	E6TZ5230F	54804	E7TZ5230G	64692
E5TZ5230AN	8213	E5TZ5230W	3177	E6TZ5230M	3201	E7TZ5230H	2048
E5TZ5230AN	24629	E5TZ5230W	38290	E6TZ5230M	28203	E7TZ5230H	3358
E5TZ5230AN	54767	E5TZ5230W	54757	E6TZ5230M	54757	E7TZ5230H	8080
E5TZ5230AN	54768	E5TZ5230Y	3257	E6TZ5230N	3201	E7TZ5230H	8179
E5TZ5230AR	2048	E5TZ5230Y	54783	E6TZ5230N	28203	E7TZ5230H	28296
E5TZ5230AR	3358	E5TZ5230Y	54784	E6TZ5230N	54757	E7TZ5230H	54805
E5TZ5230AR	7645	E5TZ5246C	28362	E6TZ5230R	3309	E7TZ5230J	2048
E5TZ5230AR	7647	E5TZ5246C	92690	E6TZ5230R	48289	E7TZ5230J	8085
E5TZ5230AR	8080	E5TZ5246E	95974	E6TZ5230R	54799	E7TZ5230J	38528
E5TZ5230AR	8177	E5TZ5246J	95981	E6TZ5246A	93977	E7TZ5230J	44861
E5TZ5230AR	28295	E5TZ5A212F	28386	E6TZ5246C	95981	E7TZ5230K	3255
E5TZ5230AR	54805	E5TZ5A212J	28385	E6TZ5A212D	28230	E7TZ5230K	8168
E5TZ5230AR	54806	E5TZ5A212K	28472	E6TZ5A212E	28231	E7TZ5230K	54781
E5TZ5230AT	2048	E5UZ5230A	3426	E6TZ5B266A	9235	E7TZ5230L	3255
E5TZ5230AT	8085	E5UZ5230A	64731	E6UZ5A212A	28326	E7TZ5230L	38552
E5TZ5230AT	38528	E5UZ5230A	74628	E6UZ5A212A	28383	E7TZ5230L	54755
E5TZ5230AT	44861	E5UZ5230C	3426	E7HZ5230A	3713	E7TZ5230M	2001
E5TZ5230B	3177	E5UZ5230C	44793	E7HZ5230A	3725	E7TZ5230M	7359
E5TZ5230B	38290	E5UZ5230C	64731	E7HZ5230C	3730	E7TZ5230M	54872
E5TZ5230B	54757	E5UZ5230C	74628	E7HZ5246A	68375	E7TZ5230N	3257
E5TZ5230E	3200	E5UZ5230L	3258	E7HZ5246B	38587	E7TZ5230N	8168
E5TZ5230E	54764	E5UZ5230L	14672	E7HZ5246G	48348	E7TZ5230N	54783

OE INTERCHANGE (Continued)

FORD	TRUCKEX	FORD	TRUCKEX	FORD	TRUCKEX	FORD	TRUCKEX
E7TZ5230N	54784	E7UZ5230T	3531	E8TZ5230M	54872	E8UZ5246B	96632
E7TZ5230S	3001	E7UZ5230T	44793	E8TZ5230N	3373	E97A5K214YD	48322
E7TZ5230S	54872	E7UZ5230T	64731	E8TZ5230N	54812	E97Z5255C	28269
E7TZ5230T	3255	E7UZ5230T	74628	E8TZ5230N	54815	E9HZ5230A	3725
E7TZ5230T	8168	E7UZ5230T	84566	E8TZ5230R	2002	E9HZ5246A	68373
E7TZ5230T	54781	E7UZ5230W	3426	E8TZ5230R	44811	E9HZ5246B	68374
E7TZ5230U	3309	E7UZ5230W	64731	E8TZ5230R	54874	E9HZ5246C	48405
E7TZ5230U	48289	E7UZ5230W	74628	E8TZ5230W	3713	E9HZ5246D	48404
E7TZ5230U	48290	E7UZ5230X	3426	E8TZ5246A	93981	E9HZ5A231B	9625
E7TZ5230U	54799	E7UZ5230X	44793	E8TZ5246B	95982	E9HZ8560A	3632
E7TZ5246A	95974	E7UZ5230X	64731	E8TZ5246D	95982	E9TZ5230A	2057
E7TZ5A212A	28383	E7UZ5230X	74628	E8TZ5B266A	9263	E9TZ5230A	38551
E7TZ5A212B	28474	E7UZ5246A	95977	E8UZ5230A	3424	E9TZ5230A	74667
E7TZ5A212C	28231	E7UZ5246B	96632	E8UZ5230A	18076	E9TZ5230A	74668
E7TZ5A212C	38458	E8HA5246L	58367	E8UZ5230A	64729	E9TZ5230AY	3112
E7TZ5A212D	48519	E8HT5225A2A	3700	E8UZ5230AA	3926	E9TZ5230AY	9200
E7TZ5B266A	9245	E8HT5225AEA	3926	E8UZ5230AE	3873	E9TZ5230AY	24629
E7UA5230A	64709	E8HT5225G2A	3919	E8UZ5230B	3424	E9TZ5230AY	54704
E7UZ5230A	3256	E8HT5225LA	3873	E8UZ5230B	28382	E9TZ5230B	2048
E7UZ5230A	28237	E8HZ5230B	3722	E8UZ5230B	64730	E9TZ5230B	48443
E7UZ5230A	64691	E8HZ5230E	3920	E8UZ5230C	3256	E9TZ5230B	64752
E7UZ5230B	3256	E8HZ5230R	3713	E8UZ5230C	28297	E9TZ5230C	2048
E7UZ5230B	3258	E8HZ5246J	58366	E8UZ5230C	64691	E9TZ5230C	3223
E7UZ5230B	28237	E8HZ5255A	44659	E8UZ5230D	3256	E9TZ5230C	48443
E7UZ5230B	64691	E8HZ5A212B	18102	E8UZ5230D	64691	E9TZ5230C	54804
E7UZ5230E	3258	E8HZ5A231E	9622	E8UZ5230G	3425	E9TZ5230C	64752
E7UZ5230E	28238	E8TZ5230A	2048	E8UZ5230G	54834	E9TZ5230F	3112
E7UZ5230E	29238	E8TZ5230A	3358	E8UZ5230G	54835	E9TZ5230F	3309
E7UZ5230E	64693	E8TZ5230A	8179	E8UZ5230H	2323	E9TZ5230F	48299
E7UZ5230E	74617	E8TZ5230A	8080	E8UZ5230H	18083	E9TZ5230F	54703
E7UZ5230F	29238	E8TZ5230A	28296	E8UZ5230H	64741	E9TZ5230F	54799
E7UZ5230F	64693	E8TZ5230A	54805	E8UZ5230J	2319	E9TZ5230G	3112
E7UZ5230F	74617	E8TZ5230B	3257	E8UZ5230J	3425	E9TZ5230G	38210
E7UZ5230G	3256	E8TZ5230B	54782	E8UZ5230J	54834	E9TZ5230G	54704
E7UZ5230G	28237	E8TZ5230B	64692	E8UZ5230J	54875	E9TZ5230K	2002
E7UZ5230G	64691	E8TZ5230C	3257	E8UZ5230J	84835	E9TZ5230K	44811
E7UZ5230H	3425	E8TZ5230C	24629	E8UZ5230K	2319	E9TZ5230K	54874
E7UZ5230H	54834	E8TZ5230C	54782	E8UZ5230K	54875	E9TZ5230L	2002
E7UZ5230J	18083	E8TZ5230C	64692	E8UZ5230L	2319	E9TZ5230L	44811
E7UZ5230K	3424	E8TZ5230D	3257	E8UZ5230L	3424	E9TZ5230L	54874
E7UZ5230K	18076	E8TZ5230D	54783	E8UZ5230L	28382	E9TZ5230R	3373
E7UZ5230K	64729	E8TZ5230D	54784	E8UZ5230L	54875	E9TZ5230R	54812
E7UZ5230L	3424	E8TZ5230E	2001	E8UZ5230L	64730	E9TZ5230R	54815
E7UZ5230L	28382	E8TZ5230E	54872	E8UZ5230M	3425	E9TZ5230S	2002
E7UZ5230L	64730	E8TZ5230F	2048	E8UZ5230M	54834	E9TZ5230S	44811
E7UZ5230N	3256	E8TZ5230F	3424	E8UZ5230M	54835	E9TZ5230S	54874
E7UZ5230N	28237	E8TZ5230F	3730	E8UZ5230N	2323	E9TZ5230T	3373
E7UZ5230N	64691	E8TZ5230F	8086	E8UZ5230N	18083	E9TZ5230T	54812
E7UZ5230N	64709	E8TZ5230F	38529	E8UZ5230N	64741	E9TZ5230T	54815
E7UZ5230R	3256	E8TZ5230F	44861	E8UZ5230P	1807	E9TZ5230U	3113
E7UZ5230R	28237	E8TZ5230G	3373	E8UZ5230P	3424	E9TZ5230U	54704
E7UZ5230R	64691	E8TZ5230G	54812	E8UZ5230P	18076	E9TZ5230V	3112
E7UZ5230S	44567	E8TZ5230G	54815	E8UZ5230P	64730	E9TZ5230V	54704
E7UZ5230T	3426	E8TZ5230M	2001	E8UZ5246A	94012	E9TZ5230W	3112

FORD	TRUCKEX	FORD	TRUCKEX	FORD	TRUCKEX	FORD	TRUCKEX
E9TZ5230W	9200	F0TZ5230L	28339	F1TZ5230G	3521	F2TZ5230G	3255
E9TZ5230W	24629	F0TZ5230L	54823	F1TZ5230G	28420	F2TZ5230G	64690
E9TZ5230W	54704	F0TZ5230M	3201	F1TZ5230G	54852	F2TZ5230H	3521
E9TZ5230Z	3112	F0TZ5230M	28338	F1TZ5230H	3521	F2TZ5230H	28419
E9TZ5230Z	54704	F0TZ5230M	54822	F1TZ5230H	28419	F2TZ5230H	54851
E9TZ5246A	95979	F0TZ5230S	3309	F1TZ5230H	54852	F2TZ5230J	3521
E9TZ5246D	95983	F0TZ5230S	48336	F1TZ5230J	3521	F2TZ5230J	28419
E9TZ5260AA	3212	F0TZ5230S	54822	F1TZ5230J	28419	F2TZ5230J	54852
E9TZ5260AA	9200	F0TZ5230T	3373	F1TZ5230J	54851	F2TZ5230K	3522
E9TZ5260AA	24629	F0TZ5230T	54812	F1TZ5230K	3522	F2TZ5230K	48400
E9TZ5260AA	54704	F0TZ5230T	54815	F1TZ5230K	48400	F2TZ5230K	54851
E9TZ5A212A	38800	F0TZ5230V	3377	F1TZ5230K	54851	F2UZ5230A	3256
E9TZ5A212B	28474	F0TZ5230V	54804	F1TZ5230N	3521	F2UZ5230A	28437
E9UZ5230A	2319	F0TZ5230W	3257	F1TZ5230N	28338	F2UZ5230A	64691
E9UZ5230A	54875	F0TZ5230W	54782	F1TZ5230N	54851	F2UZ5230B	3424
E9UZ5230B	2323	F0TZ5230W	64692	F1TZ5230T	3414	F2UZ5230B	18091
E9UZ5230B	64741	F0TZ5230X	3257	F1TZ5230T	38364	F2UZ5230B	64729
E9UZ5230C	3425	F0TZ5230X	24629	F1TZ5230T	54833	F2UZ5230C	3425
E9UZ5230C	54834	F0TZ5230X	54782	F1TZ5230V	3414	F2UZ5230C	54834
E9UZ5230C	54835	F0TZ5230X	64692	F1TZ5230V	18071	F2UZ5230C	54835
E9UZ5230D	2319	F0TZ5A212A	48519	F1TZ5230V	54833	F2UZ5230D	3578
E9UZ5230D	54875	F0UZ5230A	3425	F1TZ5246D	95983	F2UZ5230D	28436
E9UZ5230E	18083	F0UZ5230A	54834	F1UZ5230B	3424	F2UZ5230D	38436
E9UZ5230E	35232	F0UZ5230B	54875	F1UZ5230B	18076	F2UZ5230D	64743
E9UZ5230E	64741	F0UZ5230C	54122	F1UZ5230B	64730	F2UZ5230E	3256
E9UZ5230F	3425	F0UZ5230D	2323	F1UZ5230D	2323	F2UZ5230E	28437
E9UZ5230F	54834	F0UZ5230D	18083	F1UZ5230D	18083	F2UZ5230E	64691
E9UZ5230F	54835	F0UZ5230D	64741	F1UZ5230D	64741	F2UZ5230F	3425
E9UZ5230G	3256	F0UZ5230E	2319	F1UZ5230H	2319	F2UZ5230F	54122
E9UZ5230G	64691	F0UZ5230E	3425	F1UZ5230H	54875	F2UZ5230F	54834
E9UZ5246A	95977	F0UZ5230E	54834	F1UZ5230J	2323	F2UZ5230F	54835
E9UZ5A212A	28383	F0UZ5230E	54835	F1UZ5230J	18083	F2UZ5230G	3256
EC27PLA	B234	F0UZ5230E	54875	F1UZ5230J	64741	F2UZ5230G	64691
EC35PLA	B312	F0UZ5230F	2323	F1UZ5230K	3424	F2UZ5230H	44567
EC40PLA	B400	F0UZ5230F	18083	F1UZ5230K	28382	F34Z5246N	58362
EOHZ5246E	48234	F0UZ5230F	64741	F1UZ5230K	64730	F37Z5230A	2007
F09Z5230A	3409	F0UZ5230H	2323	F1UZ5230L	2319	F37Z5230A	38530
F09Z5230A	28363	F0UZ5230H	18083	F1UZ5230L	54875	F37Z5230A	54877
F09Z5230A	44785	F0UZ5230H	64741	F1UZ5246A	95977	F37Z5230B	2007
F09Z5230B	3409	F0UZ5230J	2319	F2HZ5A212B	48477	F37Z5230B	38530
F09Z5230B	28363	F0UZ5230K	2323	F2SZ5230C	3573	F37Z5230B	54877
F09Z5230B	44785	F0UZ5230K	18083	F2TZ5230A	3255	F37Z5230C	2007
F0HZ5230B	3866	F0UZ5230K	64741	F2TZ5230A	3574	F37Z5230C	48432
F0OZ5230J	2319	F0UZ5230L	54122	F2TZ5230A	64690	F37Z5230C	54877
F0OZ5230J	54875	F1TZ5230C	3414	F2TZ5230B	3255	F37Z5230D	2008
F0TZ5230B	3201	F1TZ5230C	18071	F2TZ5230B	24629	F37Z5230D	28477
F0TZ5230B	28340	F1TZ5230C	54833	F2TZ5230B	64690	F37Z5230D	54877
F0TZ5230B	54823	F1TZ5230D	3414	F2TZ5230D	2011	F37Z5230E	2008
F0TZ5230C	3309	F1TZ5230D	28364	F2TZ5230D	54879	F37Z5230E	38531
F0TZ5230C	48337	F1TZ5230D	54833	F2TZ5230E	3257	F37Z5230E	54877
F0TZ5230C	54822	F1TZ5230E	3521	F2TZ5230E	54782	F37Z5230F	2008
F0TZ5230G	3255	F1TZ5230F	3522	F2TZ5230E	64692	F37Z5230F	48433
F0TZ5230G	54781	F1TZ5230F	48401	F2TZ5230F	3255	F37Z5230F	54877
F0TZ5230L	3201	F1TZ5230F	54851	F2TZ5230F	64690	F3HZ5230B	3700

OE INTERCHANGE (Continued)

FORD		TRUCKEX		FREIGHTLINER		TRUCKEX		INTERNATIONAL		TRUCKEX		INTERNATIONAL		TRUCKEX	
F3HZ5230B	9628	04-21453-000	64808	360486C1	400A1014	475761C91	9605								
F3HZ5230F	3713	04-21455-108	54166	360488C1	400A1014	475761C91	B234								
F3HZ5230G	3700	04-21455-114	54166	360490C1	400A1014	475762C91	9606								
F3HZ5230R	3700	04-22433-000	64806	360492C1	400A1014	476339C91	9624								
F3HZ5230S	3713	04-22434-000	64807	360494C1	44659	476349C91	9606								
F3HZ5246N	58362	04-22450-000	58468	360720R91	63	477562C1	28198								
F3HZ5255C	44821	04-22451-000	68450	373272C1	93680	481727C2	3915								
F3HZ5263B	400A1014	A0409586015	10787	391814C1	14740	482167C1	3611								
F3HZ5263D	400A1014	A0409586017	10788	394347C3	2956	482168C4	74607								
F3HZ5263F	400A1014	A0409833006	38606	394348C5	2957	482174C1	58225								
F3HZ5A281A	9618	A0413974000	94010	408790C2	54661	482611C2	83001								
F3TZ5230A	2009	A04156653000	28699	411707C2	54694	482612C2	83001								
F3TZ5230A	54878	A0417094012	28698	425624R91	9395	482613C2	83001								
F3TZ5230B	2010	A0417926001	83033	429025C2	18011	482614C2	83001								
F3TZ5230B	28478	A0417927008	83035	433192R91	9657	482616C1	83005								
F3TZ5230B	54878	A0417997000	9770	434252R91	9396	482618C1	83005								
F3UZ5230C	54122	A0417998001	9769	437790C1	3611	482618C2	83005								
F3UZ5263A	24684	A0418007000	9771	437953C1	9056	482620C1	83005								
F3XY5230A	2025	A0418007001	9772	437953C1	9613	482622C1	83005								
F3XY5230A	44814	A0418157000	48562	437954C1	9148	482624C1	83005								
F3XY5G226A	8196	A0418158000	38794	437960C2	58138	482626C1	83005								
F3XY5G226B	8196	A0418363001	83034	437963C2	92676	482626C1	84552								
F4TZ5230C	2329	A0418364000	9773	437967C3	18012	482726C1	38269								
F4TZ5230W	74652	A0418556000	48557	437968C2	58139	482728C1	58219								
F4TZ5230Z	3255	A01417926000	83036	439797C1	3677	482730C1	38268								
F4TZ5230Z	24629	A04-21076-000	58471	441335C1	9151	482739C91	9383								
F4TZ5230Z	64753	A04-20919-000	9348	441336C1	9084	483055C91	9662								
F4UZ2530F	64729			441337C1	9056	483082C1	38271								
F4UZ5230A	3256			441337C2	9056	483083C1	58222								
F4UZ5230A	64691			441583C1	28169	483083C2	58222								
F4UZ5230C	3425	INTERNATIONAL	TRUCKEX	441586C1	28170	483084C2	38270								
F4UZ5230C	54834	10148HA	609	441590C1	93933	484886C2	8300								
F4UZ5230E	44567	21194R2	48143	441590C1	93949	484886C2	34742								
F4UZ5230F	3424	72093R1	9086	441594C1	92681	484895C2	34742								
F4UZ5230G	18076	72095R91	3654	441894C11	92681	484895C2	83001								
F4UZ5230H	3424	119144H	2704	447662C1	3677	484895C2	400A1014								
F4UZ5230J	54875	138534R91	3651	447832C1	38560	484896C2	34742								
F4UZ5230K	18083	142414R91	3654	449814C1	9716	484896C2	83001								
F4UZ5230L	54834	172699R1	214A1014	459457C1	8784	484896C2	400A1014								
F4UZ5230M	28437	207524R2	48144	460096C1	93949	485123C91	9384								
F4UZ5A212B	38758	207524R2	48568	460096C11	93933	485124C91	9604								
F7T5246BA	97843	211914R2	58248	460938C1	834728	485489C1	38287								
		214463R91	4211	465953C1	24685	485490C1	38286								
		231488R91	3651	465953C2	54661	485491C2	48239								
		239331R1	27679	465954C1	74601	486926C1	83003								
		320218C1	8884	465969C1	609	486926C1	84544								
		320230C1	24676	465971C1	2704	486928C1	83003								
		320233C1	14738	466540C2	3632	486928C2	84544								
		321575R91	9373	466984C91	2704	486930C1	83003								
		321577R91	9377	470836C91	9389	486930C2	84544								
		323545R1	3899	470837C91	9384	486932C2	83004								
		338614C1	9613	470838C91	9385	486932C2	84544								
		360473C1	214A1014	471382C1	2704	486933C1	83003								
		360481C1	300A1014	475214C1	74602	486935C1	83003								
		360484C1	400A1014												

INTERNATIONAL	TRUCKEX
486937C1	83003
486939C1	83004
486948C1	83002
486950C1	83002
486951C1	83002
486952C4	64668
488710C1	3697
488710C2	3150
489397C2	48240
489398C1	48241
489737C61	9383
489737C61	B212
489737C91	9383
489737C91	B212
489790C91	9382
489790C91	9383
489790C91	B214
497843C91	9624
499528C1	2704
499550C1	8884
500210C1	28195
501471C91	9606
501721C1	38306
501722C1	28197
503841C1	28534
503845C1	38607
504542C1	58221
504589C1	58220
504816C2	68160
504818C2	58205
504926C1	3610
504959C91	9604
504960C91	9605
504960C91	9669
508887C91	9386
508903C91	9385
519513C3	400A1014
520541C1	3632
537757C2	18036
547446C2	44822
549464C1	3901
549466C1	3607
549469C1	2704
549564C91	8951
549904C91	T212
554319C1	T500Z
554430C1	9575
572479C1	3697
575323C1	54998
577265C1	8452
577265C1	83005
577265C1	84552
578068C1	3610
579231C91	T500Z

INTERNATIONAL	TRUCKEX
582167C1	38608
582175C1	28535
582177C1	28536
582181C1	38609
583964C91	9382
583965C91	9383
583966C91	9389
583967C91	9384
583968C91	9385
583969C91	9386
583970C91	B500
583975C91	9604
583975C91	T300
583977C91	9605
583978C91	9606
584965C91	9383
587521C2	38585
591593C91	58251
591595C1	68221
591595C92	68221
593781R2	18101
593783C2	48461
593784C2	18139
594054C1	8884
598276C1	10783
598281C1	34901
683191R1	36147
690420R91	3614
744829R91	609
758539C1	400A1014
762783C91	3713
764471C1	34811
865034C91	4211
868829C2	8975
870036R2	58248
870336R91	609
873578R91	3906
873695R91	739
874580C1	8960
893944R92	9627
910748R1	9149
976488R91	3614
978099R1	34811
987177R91	3625
989443R91	3614
998025C1	3625
1608381C1	74646
1610293C3	74632
1610299C3	83014
1613069C1	83001
1614956C1	58225
1616314C2	58410
1616315C1	48464
1616690C1	38584

INTERNATIONAL	TRUCKEX
1617608C1	9359
1618487C2	83029
1618490C2	83029
1618526C1	34742
1618527C2	83001
1618528C1	83001
1618529C2	83001
1618530C1	83001
1618531C1	83001
1618532C2	83001
1619352C1	44822
1619388C2	400A1014
1619389C2	400A1014
1619390C2	400A1014
1619391C2	400A1014
1619392C2	400A1014
1619482C1	400A1014
1619487C1	83001
1619642C1	83001
1619644C1	83001
1619646C1	83001
1620106C1	83001
1621341C1	48565
1622228C1	64784
1647244C1	48465
1647828C1	809299
1647829C1	809300
1647960C1	3610
1647998C1	3716
1648101C1	38586
1648101C2	38586
1653532C1	58285
1659768C1	38523
1659768C1	38583
1660460C1	18101
1660462C2	48463
1660463C2	58364
1660463C3	58364
1666045C1	48462
1666966C2	58330
1668838C1	58285
1668838C1	58349
1668843C1	83001
1669295C1	34811
1672105C1	9615
1672818C1	400A1014
1678067C1	83030
1678068C1	83030
1678069C1	83030
1678070C1	83030
1678074C1	83005
1680060C2	83001
1680062C2	83001
1680285C1	64763

INTERNATIONAL	TRUCKEX
1680287C2	83001
1680289C2	83001
1684275C1	78228
1684397C1	48552
1684404C1	44555
1686801C1	48554
1688108C1	83029
1688109C1	83029
1688111C1	83029
2000225C1	9799
2000976C1	44822
2003581C1	48554
2005724C2	28649
200827R91	4211
201761R91	609
2036193C2	68451
242148R91	3654
243658R91	609
244005R93	610
244007R91	2704
246017R91	3899
256017C91	3677
277839R91	3883
305122C91	3888
312137C91	3887
3358614C1	9613
336649R91	9375
3506665C1	38823
3544459C3	68451
61240193	18106
62240303	28523
62240304	28524
62240307	14705
62240309	92694
62240310	28522
62240318	28521
D86928C1	83003

JEEP	TRUCKEX
536091	64656
536094	3065
536254	2664
634814	8735
641856	25193
641872	20269
641878	393
906127	20824
916319	65194
934639	61328
942732	54467

OE INTERCHANGE (Continued)

JEEP	TRUCKEX
990265	44699
990457	3064
991879	2728
999713	2726
3226666	9226
5232724	3102
5232724	34665
5261842	2878
5351061	57832
5351912	2771
5351986	2799
5352478	38078
5352481	48090
5354074	8429
5354534	54648
5354541	2997
5355032	54653
5355207	54648
5355464	57832
5355541	2878
5355981	58112
5355985	58113
5355987	24648
5356440	54670
5357043	8593
5357985	54670
5357987	54653
5358640	54670
5358786	28113
5358841	3102
5358841	34665
5358842	3102
5358842	34665
5358861	38078
5358861	48090
5358914	57832
5358987	64656
5359456	3021
5359831	3102
5359831	34665
5360080	64662
5360106	2664
5360196	2878
5360929	54692
5361132	2664
5361132	64662
5361254	3021
5361399	2799
5361820	3065
5361821	3021
5361838	2771
5361952	54692
5361954	64666
5362150	3102

JEEP	TRUCKEX
5362150	447477
5362284	3326
5362494	2664
5362494	64662
5362517	3161
5362517	44744
5362691	2799
5362723	3102
5362725	3102
5362804	3161
5362804	34665
5363080	3102
5363080	44744
5363087	8593
5363113	64662
5363115	54801
5363566	3161
5363566	44744
5363569	3102
5363569	44744
5363571	3102
5363571	44744
5364312	48369
5364858	54776
8126303	896
8126631	3102
8126632	34665
8126641	38078
8126641	48090
8126654	54653
8126656	2726
52001759	8098
52002400	8097
52002989	48438
52003025	9264
52003934	3262
52003934	9206
52003934	44760
52003982	3364
52003982	44775
52003985	3364
52003985	44772
52004422	3355
52004422	44760
52004656	3389
52004656	74626
52004658	3389
52004658	64717
52007220	3364
52007220	44772
52007221	3389
52007221	64717
52007222	3389
52007222	74626

JEEP	TRUCKEX
52017690	2015
52017690	54882
52017921	3389
52017921	64717
52018162	2015
52018162	54882
52018163	2015
52018163	54882
52019133	2015
52019133	44750
52019134	2015
52019134	44750
52019135	2006
52019135	44760
52019136	2006
52019136	44760
52019137	2015
52019137	44750
52019138	2015
52019138	44750
52040278	48418
83300063	3326
83502645	54774
83502655	74622
83502978	3355
83502978	9206
83502979	3262
83502979	9206
83503452	3236
83503453	64700
83503980	44760

KENWORTH	TRUCKEX
K1805419	18110
K1806326	38613
K1806599	28537
K1807422	28538
K1808048	10317
K1808049	38614
K1809052	28539
K18014122	38610
K18014764L	38611
K18014764R	38612
K18014766	94942
K18015764R	38612
K180B10742L	68183
K180B10742L	868184
K180B10742R	68185
K180B10742R	868186

MACK	TRUCKEX
4ME3209M	28530
4ME4658	38435
4ME4762	38436
4ME4769ME	38605
4ME4786	38434
4ME21408	8981
4ME21698	28528
4ME21781	18107
4ME21783P4	18108
4ME32066P5	48563
4ME32444	48476
4ME32603	38603
4ME32611	68181
4ME32612	68182
4ME32825	28529
4ME32826	38604
4ME322825	58529

PETERBILT	TRUCKEX
1401726	10560
1401726C	809530
1404055	94941
1408525	10784
1408527	10782
1413002	18166
1413022	18166
1413055	94011
1413056CP	809519
61240007	3899
61240037	3632
61240207	9622
61240209	9659
62240301	NA
62240307	14705
62240310	28522
62240328	28660
62240355	24678
62240380	14739
62240386	18150
1413394202	10799
14139440150	94015
14153530150	94015

THOMAS	TRUCKEX
61240030	4261
61240193	18106
62240303	28523
62240304	28524
62240307	14705
62240309	92694
62240310	28522
62240318	28521
62240405	18165
62240464	64790
62240498	44878
62240530	38790
62240531	18158
62240553	44880
62240554	24983
62240558	24984
62240565	44877
62240579	44877
62240587	38791
62240589	58447
62240589	58448
62240590	58447
62240590	58448
62240599	58465
62240608	38789
62240609	28678
62240610	38788
62240683	28719
62240752	58467
62240771	58449
62240788	24985
62240808	38787
62246607	78246



HD EXHAUST
CROSS REFERENCE

SUPERCEDED PART NUMBERS

CURRENT NO.	NEW NO.
610	3906
2003	2319
2333	4241
3532	2323
3608	3613
3729	3704
3942	3941
3994	3663
7136	7661
8108	8503
8310	8166
8670	10670
8671	10671
8672	10672
8673	10673
8674	10674
8675	10675
8676	10676
8678	10678
8679	10679
8680	10680
8681	10681
8683	10683
8684	10684
8685	10685
9298	809298
9300	809300
9301	10301
9302	10302
9303	10303
9304	10304
9305	10305
9306	10306
9308	10308
9309	10309
9310	10310
9311	10311
9312	10312
9313	10313
9314	10314
9315	10315
9317	10317
9318	10318
9319	10319
9320	10320
9329	10329
9330	10330
9337	10337
9338	10338
9339	10339
9340	10340
9350	SBF500
9404	809404

CURRENT NO.	NEW NO.
9406	809406
9408	809408
9415	809415
9417	809417
9427	809427
9428	809428
9429	809429
9458	809458
9498	809498
9499	809499
9500	809500
9530	809530
9534	10534
9535	10535
9536	10536
9537	10537
9538	10538
9539	10539
9540	10540
9541	10541
9542	10542
9544	809544
9545	809545
9546	809546
9547	809547
9552	10760
9553	10553
9554	10554
9555	10555
9556	10556
9557	10557
9559	10559
9560	10560
9562	10562
9564	10564
9565	10565
9566	10566
9567	10567
9581	9359
9620	10620
9621	809621
9631	10631
9632	10632
9633	10633
9634	10634
9635	10635
9636	10636
9637	10637
9638	10638
9639	10639
9640	10640
9641	10641
9642	10724

CURRENT NO.	NEW NO.
9643	10643
9644	10644
9645	10645
9646	10646
9756	9618
9757	9618
9760	9651
10319	10733
14621	814621
14622	814622
14623	814623
18104	8975
24673	824673
24701	824701
24715	824715
24716	824716
24721	824721
24722	824722
24738	824738
24749	824749
24751	824751
24757	824757
24758	824758
28531	10787
28532	10788
34708	834708
34725	834725
34727	834727
34728	834728
34746	834746
34747	834747
34779	834779
38550	38800
38744	38459
38775	28668
38795	48562
44661	844661
44663	844663
44668	844668
44669	844669
44670	844670
44671	844671
44734	844734
44735	844735
44737	844737
48434	48517
48519	48376
54123	54834
54144	54835
54715	854715
54716	854716
54717	54984
54723	854723

CROSS
REFERENCE

HD EXHAUST
CROSS REFERENCE



CURRENT NO.	NEW NO.
54724	854724
54727	854727
54728	854728
54830	854830
54881	854881
58339	48516
64671	864671
64672	864672
64745	864745

CURRENT NO.	NEW NO.
64746	864746
68184	868184
68186	868186
74608	874608
74609	874609
74638	874638
74658	44809
84548	884548
84550	884550

CURRENT NO.	NEW NO.
84558	83006
84563	884563
94902	894902
809305	809302
809306	809429
809309	809458
809427	809312
809428	809313
809498	809302

HD MASTER INTERCHANGE

AUTOJET	TRUCKEX	AUTOJET	TRUCKEX	AUTOJET	TRUCKEX	AUTOJET	TRUCKEX
4"OUT-DODRP85	3871	275CON	8980	392Y	92681	40090	10761
6.2EXT	38459	275FORKL	92684	400CAT44	4256	48235	48235
6.9MPL	58251	275SAD	9524	400CATOFF	4262	50045E	10317
6.9MPR	68221	275SCPF	9667	400CATSI	4261	50090E	10308
7.3MPL	58330	275STPA	234A1014	400CON	14603	50090ETR	10765
9"SWHGR	8049	300CON	14601	400EXT	24737	60045E	10733
9.0LMP	58219	300EXT	24941	400FDA	3700	60090E	10310
9.0MP	38268	300PH2PC	9738	400FDCAT	4209	250250	3654
9.0RRMP	38269	300SC	9384	400PH2PC	9740	275275	3613
11-0025	4251	300SCPF	9668	400PHCE	9349	275275BS	3701
11-0060	4252	300STPA	300A1014	400SC	9386	300300	2704
17"SWHGR	8051	300STPID	923120	400SCPF	9623	350400CAT	4254
62GLM	68280	312STPA	312A1016	400SHAPER	9741	350400CAT	4258
62GRM	48329	345CO	28169	400STPA	400A1014	350400L	3716
62PRM	68308	345ER	9056	400STPID	924120	400400	3632
65G275TPOR	74657	345FL	9148	450STPA	412A1016	400400L	3710
65G275TPRH	74656	345HI	8699	454ER304	9219	2250275	3697
65G300FL	3944	345SL	68160	466DTFC	78230	2250300BS	3719
65GEXTFL	38755	345SR	58205	466DTLE	48551	2250300L	3150
65GYSS	93996	345Y	93949	466DTLEXT	48554	2250400BS	3708
65PYSS	95997	350CON	14340	466TURBO93	58421	2275400	3610
66FTURBO	48348	350EXT	24735	466TURBO93ST	58225	2502250V	2943
73MANFE	96632	350G30Y	94919	500CON	14605	2502250VL	3534
78FTURBO	48347	350LCO	38347	500EXT	24739	B83ELT99	18156
82CFP	44773	350LCOSS	38486	500SC	9387	B504LM	48385
82CNAEL	28310	350LY	94991	500SCPF	9624	B504RM	48386
82CNAT	93955	350LYSS	94921	500STPA	500A1016	B555LM	48383
82COA	54809	350PY	94935	500STPID	925120	B555RM	48384
82COFF	68267	350SC	9385	600MH	9354	B3116EPRE	48579
82CTP	83008	350SCPF	9669	600SC	9388	B3116OA	38771
82CTURBO	38413	360DT90	48552	600SCPF	9671	B3116T4	38766
82FFOA	84568	360DT90EXT	48565	600STPA	600A1016	B3116TRE	38786
82FLAIR	9479	360DTFC	78228	700MH	9355	B3126T99	18155
82FTURBO83	58284	360DTLE	58410	800MH	9580	B3208LM	28392
82FVCLNA	9611	360DTLEXT	48464	850MH	9356	B3208RM	38463
82FVCLT	9617	360DTURBO	58349	1000MH	9358	B400400	3666
82FY	94973	366LCOF	38348	1100MH	9628	B500500	3699
82FY83	94993	366LYF	94992	3116VCL	9651	BBFOA94	84576
83VCLT	9747	366SR5	48319	3208ER	9743	BBFOA95	84575
85-0016	4243	366SS7L	48318	3208VCLT	9745	BBFOAIR	78250
200SC	9381	366SS7R	58283	5003	3533	BBHGR5.62	9324
200SCPF	9664	366SSL5	48320	25045E	10725	BBHGR9.25	9325
200STPA	200A1014	370L83	48233	25090E	10303	BBROA675	54172
225CON	8951	370L85SS	48403	27545E	10318	BBTP6440	34904
225SC	9382	370R79	58414	27590E	10793	BBTPRE	54140
225SCPF	9665	370R83	48234	30045E	10313	BDCO	38464
234SC	9389	370R85SS	48402	30090E	10758	BDFOA	44796
250CON	14338	370VCLHD	9610	35045E	10314	BDFOA5	38768
250SC	9383	392CO	28170	35090E	10305	BDOA	58319
250SCPF	9666	392ER	9084	35090ETR	10759	BDOFFTP4	54843
250STP409	214S1014	392HI	8698	40045ETR	10315	BDROA	44797
250STPA	212A1014	392SL	58221	40082	3713	BDROA5	48570
275BAD	9814	392SR	58220	40082F	4225	BDTP5MM	44866

AUTOJET	TRUCKEX	AUTOJET	TRUCKEX	AUTOJET	TRUCKEX	AUTOJET	TRUCKEX
BDY	94915	CVOA94	54133	FORDOVMH	9759	GM6.2ER	9220
BFOA99	58424	CVTP93	54136	FRL0AAS149	83047	GM65300P	4228
BOD5	48566	CVTP94	54134	FRL11MH	9769	GM875BR	9328
BP3116EXT194	48592	DODTP95	54997	FRL300400	4224	GM900MH	9129
BP3126MIN	28674	DT360VCL	9627	FRL300CAT	4255	GMCONV	646304
BP3126T	38782	DT466TRE	38847	FRL3126BT	58482	GMCONV454	646310
BP400500RV	4236	DT466VCL	9613	FRL3126T	38794	GMCONVR	645317
BP400500RV99	4232	DTFP	34898	FRL8MH	9770	GMCS3HOLE	9280
BP400SI99	4244	DTFP	83001	FRLBTSS	48562	GMFRAMBR	9132
BP500PTB	44873	E350350	3685	FRLISBT	48557	GMHGR275	9763
BP500TPUB	44874	E6000A	84542	FRLISBTL	58479	GMHGR0A	9761
BP59MIN	38816	EXPANDER 35	CLV350	FRLMERC450	58468	GMMANKIT	8038
BP59T	38845	EXPANDER4	CLV400	FRLMERC451	68450	GMOVSTRAP	9762
BP59TPSTD	64804	EXPANDER5	CLV500	FRLMERCCT	58464	GMP30TP96	74659
BP59TPTD	54163	F60A	74627	FRLMERCYL4	58471	GMPTP89	74634
BP83MIN4	28676	F60A91	74654	FRLMH919	9348	GMPTP91ID	74660
BP83MIN4S	28675	F60A91	84587	FRLMHRUB	8323	HDFORDCO	38273
BP83MIN99	28673	F6TMP	48349	FRLOA	83033	HGRBR	9353
BP83T4	38784	F6TP91	44821	FRLOA433	64806	IDOA	74607
BP83T4S	38783	F820A86+S1847	74625	FRLOAAS	83034	IDOAAS	74632
BP83T99	38781	F820A	84551	FRLOAAS02	64805	IDOAAS98	74670
BPEL94	48591	F820A83	74624	FRLOARFT	83036	IDTP	83005
BPMH29	9768	F820A87	84561	FRLOARFTAS	83048	IDTPAS	83029
BPMH31	9767	FD1060T	58362	FRLOAS02	64808	IDTPAS98	83043
BPMOU5	44875	FD1060T96A	58423	FRLOAS434	64807	LCFP	64695
BPMOU5NC	44876	FDVCL96	9618	FRLPH	9771	LOA	74602
BPTP94	54167	FLD400TP	54994	FRLPHOA	9772	LYM	58248
BROAFP99AIR	54138	FLEX200SS	8883	FRLPHOAR	9773	M5325	3424
BROAFP99SP	54139	FLEX250SS	8884	FRLPHOAR02	9323	MERCVCL	9609
BROANAV	9776	FLEX27518	24852	FRLSDTP1	34899	NAVBRCOMP & BRTPNVAV	9779
BSD5ODS	74669	FLEX30018	24675	FRLSDTP1PC	83052	NAVCE427	44892
BTP995	24978	FLEX30024	24929	FRLSDTP2	24998	NAVCE445	64815
BV3126T143	48599	FLEX30036	34825	FRLSDTP3	34900	NAVCE451	64810
BVTM626	38839	FLEX300SS	8885	FRLT1077	68449	NAVCE939	38860
BVTP2614	34903	FLEX35018	24676	FRLTP	83035	NAVEXT20	48594
CFOA	83006	FLEX35024	24850	FRLTP02	54166	NAVTPEXT	34901
COA	54789	FLEX35036	34786	FRLTP77	83044	OVALMH1	9360
CONVBM1	646303	FLEX350SS	8886	FRLTPTB	34897	OVALMH2	9359
CSOFF	54808	FLEX40012	14739	FRLTPUB	24997	OVMHCE	9449
CTP	83007	FLEX40018	24677	G30300TP	54853	OVMHIH73	9753
CUS-071-04	4253	FLEX40024	24836	G3062TPL	64716	OVMHIHDT	9753
CV366FP	34812	FLEX40036	34673	G3062TPR	84562	OVMHIHDTAJ	9321
CV400CNTR	4227	FLEX400SS	8887	G30SAV300	3943	OVMHIHDTBH	9322
CV3116EL	10798	FLEX50012	14737	G30SAVEXT	68419	OVMHIHFC	9755
CV3116FP	28668	FLEX50018	24678	G30SAVTTP	44864	OVMHIHRE	9753
CV3116OFF	38773	FLEX50024	24838	G62TPL91	54903	P302250300	4237
CV3116T	38796	FLEX50036	34674	G62TPR	54902	P30EXT96	58446
CV3116T94	38774	FLEX500SS	8888	GM10MH	9131	P30LYPD	74637
CV3126T	38772	FLEX600SS	8899	GM30TP92	74658	P30RTPD	74636
CVFOA	34814	FLOA	84555	GM454FP	24002	PIPECUT1	9780
CVFOA	48572	FLOA85	84571	GM454L	48583	PIPECUT2	9781
CVFOA97	34896	FORD11MH	9758	GM454MUFFLER	4245	REOARP99	34890
CVOA93	54135	FORD400PH	9130	GM454R	58457	RUBHGR	8050

HD MASTER INTERCHANGE (Continued)

AUTOJET	TRUCKEX
S7OFF	88104
SD14FC	44822
SD190	44888
SDC275PL	84554
SDC4PL	84586
SDC4TD	84584
SDI123	84583
SDI13PL	84553
SDI14PL	84559
SFP	83004
SOA	64668
SSB30012	9726
SSB35012	9727
SSB40012	9728
SSB50010	9729
STP	83003
T444RETP	54132
T444RETPSD	34883
T444REV	3851
T444REVHDA	3851
T444TRE	58443
T444TRE99	38823
T444TURBO	58420
T444TURBO20	68451
T444VCL	9737
T444VCL	9748
T85171	3625
T85301	4233
TBILM	48434
TBIRM	58339
TC300400REV	4231
TC300400RV94	4229
TC400400CAT	4208
TCADAPTSS	9764
TCEXTRE	38780
TCFOASS	48573
TCFOASS132	48574
TCMAN20	18173
TCMAN94	28669
TCMANRE	48576
TCP3116T94	18157
TCP3126EXT	48590
TCP3126T	18178
TCP400SICAT	4239
TCP83MIN4S	28672
TCP83T4S	38779
TCPBMIN545	28671
TCPBMIN643	28670
TCPBMOUT	38778
TCPBT94	48575
TCPBTP94TB	44871
TCPEL94	38777
TCPEXT194	38776

AUTOJET	TRUCKEX
TCPMH26	9766
TCPMH27	9765
TCPMIN3126	38818
TCPMOU5	34889
TCPT98	38822
TCPTP94	44870
TCPTP94	54165
TCRAFSAS	54143
TCREROAMM	68421
TCRETP	34884
TCROAFS	34886
TCROARS	44869
TCROARSAS	54137
TCROARSASMM	24977
TCSDTP4	74633
TCTPEB	34887
TCTPMAS	83045
TCTPRE1	44872
TCTPRE2	34888
TCTPTB	34885
TCVCL	9756
TD275	14634
TD300ID	24344
TD350	14619
TD350ID	24345
TD400	14620
TD400ID	24346
TD500ID	24347
TD600ID	24696
THGR	9352
TMVP3126T	78246
TMVP85MH	9326
TMVPBT	38791
TMVPBT01A	28721
TMVPBT01B	58466
TMVPBT99	38792
TMVPFOAAS	58447
TMVPFOAD200	58467
TMVPOA	64790
TMVPROA0771	58449
TMVPROAAS	58448
TMVPROAS99	58465
TMVPSDT4	44878
TMVPSDT4TD	64809
TP11MH	9327
TP3116MIN94	18152
TP3116T94	38769
TP3126T	38787
TP3126T98	28719
TP32081	78166
TP32082	44856
TP320890	28523
TP3208CO	28521

AUTOJET	TRUCKEX
TP3208T	28522
TP3208Y	92694
TP400400SI	4246
TP400REV	3898
TP6BFM97	28720
TP6BT	18165
TP6BT97	38819
TP73FE	64730
TP83MIN94	38790
TP83MIN96	38788
TP83T	18150
TP83T94	18158
TP83T96	38789
TP83T98	38817
TP83TB96	28678
TP9090	28524
TPBELL	18106
TPMOU94LH	44880
TPTP	14705
TPTP94TBLH	24983
TPTP94TBRH	44879
TPTP94UBLH	24984
TPTP94UBRH	44877
TPTP96TB	24985
U200	U200
U225	U214
U250	U212
U300	H300P
U400	H400P
U450	H412
U500	H500P
U600	H600
WBEXT92	24981
WHEEL	9784
YOKESS	95973

DONALDSON	TRUCKEX
J000103	134A1016
J000107	178A1016
J000121	214A1014
J000127	234A1016
J000139	500C1016
J000140	600C1016
J000202	AS400
J000203	AS500
J000210	B200
J000211	B212
J000212	B214
J000213	B234
J000214	B300
J000215	B312
J000216	B400

DONALDSON	TRUCKEX
J000217	B500
J000218	B600
J000219	B412
J000220	H200
J000221	H212
J000222	H214
J000224	H234
J000227	H300
J000228	H312
J000230	H400
J000231	H412
J000232	H500
J000233	H600
J008167	8052
J008681	10681
J008868	8868
J008870	8870
J008872	8872
J008942	8942
J009391	9391
J009393	9393
J009427	809427
J009428	809428
J009429	809429
J009479	9479
J009486	9486
J009487	9487
J009500	809500
J009514	9514
J009516	9516
J009518	9518
J009530	809530
J009539	28661
J009547	809547
J009559	10559
J009560	10560
J009604	9604
J009605	9605
J009606	9606
J009607	9607
J009611	9611
J009612	9610
J009613	9613
J009614	9614
J009618	9618
J009623	9623
J009624	9624
J009629	9629
J009631	10631
J009632	10632
J009633	10633
J009634	10634
J009635	10635
J009636	10636

DONALDSON	TRUCKEX	DONALDSON	TRUCKEX	DONALDSON	TRUCKEX	DONALDSON	TRUCKEX
J009637	10637	J190002	10763	M070068	3692	M100796	4208
J009639	10639	J190003	10764	M070069	3693	M100807	3873
J009640	10640	J190004	809771	M070185	4241	M100845	4218
J009641	10641	J190009	10782	M070228	2645	M101181	4206
J009643	10643	J190013	10778	M080018	3687	M101182	4207
J009644	10644	J190014	10329	M080024	3694	M101355	4261
J009645	10645	J190019	809796	M085008	3662	M101362	4256
J009648	9648	J190023	10727	M085023	2704	M110012	3711
J009649	9649	J190025	10729	M085056	3627	M110014	3923
J009650	9650	J190027	10732	M085090	3626	M110028	3713
J014621	814621	J190050	9660	M085171	3625	M110189	3700
J014622	814622	J190051	9661	M085172	3697	M110311	3919
J014623	814623	J190052	9662	M085182	3663	M110364	4209
J018110	18110	J190053	9663	M085189	3150	M110479	3927
J024658	24658	J190056	9664	M085267	3719	M110728	4224
J024731	28495	J190057	9665	M090009	3684	M111189	4254
J024735	24735	J190058	9666	M090072	3682	M111189	4259
J024737	24737	J190059	9667	M090074	3667	M111211	4262
J024739	24739	J190060	9668	M090074	3897	M120100	3614
J024746	24746	J190061	9669	M090091	3695	M120108	3647
J024747	24747	J190062	9670	M090146	3679	M120131	3900
J024748	24748	J190063	9671	M090158	3689	M120154	3898
J024749	824749	J240006	14739	M090170	3616	M120189	3899
J024750	24750	J240007	14737	M090280	3632	M120197	3675
J024751	824751	J240024	824006	M090301	3636	M120235	3645
J024752	24752	J280002	28657	M090362	3681	M120365	3676
J024753	24753	J280003	18149	M090520	3611	M120366	3698
J024754	24754	J280006	10307	M090534	3710	M120367	3921
J024755	24755	J340023	834005	M090535	3667	M120382	3678
J024757	824757	J380004	48563	M090535	3897	M120418	3941
J024758	824758	J380007	38761	M090538	3668	M120448	3912
J024835	24835	J380008	38762	M090544	3666	M120450	4205
J024836	24836	J480001	44855	M090547	3704	M120566	3931
J024837	24837	J540008	854001	M090548	3703	M120592	4240
J024838	24838	J640005	864000	M090563	3610	M122300	3913
J024849	24849	JO44786	44786	M090594	3888	P101294	926553
J024850	24850	M001865	FB500	M090595	3895	P101891	925543
J024851	24851	M002164	FB400	M090680	3716	P103516	925553
J024852	24852	M045123	4223	M090781	3712	P105532	924003
J028528	28528	M045193	3617	M090823	3926	P105533	924004
J034673	34673	M045237	3970	M100043	3911	P105534	925506
J034674	34674	M060005	3879	M100048	3669	P105535	926006
J034743	34743	M060037	3690	M100049	3670	P105536	927006
J034744	34744	M060232	3901	M100052	3677	P105545	924105
J034746	834746	M060247	3878	M100058	3876	P105546	925505
J034785	34785	M060307	3721	M100146	3637	P105547	926005
J038603	38603	M065030	3691	M100213	3702	P105609	924104
J038611	38611	M065034	3624	M100463	3640	P105610	925105
J038612	38612	M065044	3925	M100464	3714	P105611	925504
J038613	38613	M065065	3654	M100465	3699	P105612	926004
J038614	38614	M070008	3683	M100466	3714	P105613	927004
J054831	54831	M070028	3618	M100572	3937	P107844	924005
J092679	92679	M070043	609	M100582	3722	P109021	925005
J092689	92689	M070050	3685	M100695	3715	P112611	926503

CROSS REFERENCE



HD EXHAUST CROSS REFERENCE

HD MASTER INTERCHANGE (Continued)

DONALDSON	TRUCKEX	DONALDSON	TRUCKEX	DONALDSON	TRUCKEX	DONALDSON	TRUCKEX
P117724	926557	P206336	400A1016	P206406	T234	P206614	9474
P148341	9589	P206337	500A1016	P206407	T300	P206615	9394
P148342	9590	P206338	600A1016	P206408	T314	P206616	9586
P148343	9591	P206339	10672	P206409	T312	P206617	9587
P148345	9592	P206340	10675	P206410	T400	P206641	9430
P148346	9593	P206341	10304	P206411	T500	P206849	925002
P148347	9594	P206342	10676	P206507	8483	P206850	926002
P148348	9595	P206343	10305	P206508	9456	P206851	927002
P148349	9596	P206344	10678	P206509	9457	P207281	9599
P159820	927557	P206345	10306	P206510	9451	P207282	24711
P205834	9811	P206346	10539	P206511	9452	P207283	24712
P205976	9343	P206347	10554	P206512	9453	P207285	44854
P205979	9341	P206348	10308	P206513	9453	P207286	44731
P206279	10312	P206349	10542	P206514	9453	P207287	44656
P206280	10313	P206350	10310	P206515	9354	P207288	54991
P206281	10314	P206353	809406	P206516	9355	P207289	54720
P206282	10315	P206354	809408	P206517	9356	P207290	54721
P206283	10731	P206362	8970	P206518	9357	P207291	54722
P206284	10733	P206363	8971	P206519	9358	P207292	44658
P206285	809736	P206364	8972	P206520	9360	P207295	44664
P206286	809738	P206365	8973	P206521	9359	P207296	44666
P206297	92673	P206366	18077	P206522	9361	P207297	24713
P206298	92674	P206367	8975	P206523	9363	P207298	24714
P206299	9342	P206368	8976	P206524	9364	P207299	854002
P206300	9344	P206369	8991	P206525	9365	P207300	854003
P206302	14618	P206370	8978	P206526	9366	P207301	854723
P206303	14619	P206371	14338	P206543	809458	P207302	854724
P206304	14620	P206372	14601	P206544	24674	P207306	824701
P206306	10921	P206373	14602	P206545	24935	P207308	824715
P206308	14343	P206374	14341	P206546	24654	P207309	824716
P206309	24344	P206375	14605	P206547	24936	P207312	844737
P206310	24345	P206378	44657	P206552	24675	P207314	844002
P206311	24346	P206379	44659	P206553	24676	P207317	844004
P206312	24347	P206380	34828	P206554	24677	P207318	844734
P206313	8953	P206381	44853	P206555	24678	P207319	844735
P206314	8955	P206382	44665	P206560	8986	P207320	844668
P206315	8956	P206383	44667	P206561	8987	P207321	844670
P206316	8957	P206384	824721	P206562	8988	P207322	10773
P206317	8958	P206385	824722	P206563	8989	P207324	10774
P206318	9335	P206386	844669	P206567	8888	P207325	10775
P206319	8960	P206387	844671	P206600	9501	P207326	10534
P206320	8962	P206388	844661	P206601	9502	P207327	10535
P206321	8963	P206389	844663	P206602	9503	P207328	10536
P206322	8964	P206390	854715	P206603	9504	P207329	10537
P206323	8965	P206391	854716	P206604	9395	P207330	10538
P206324	9600	P206395	10684	P206604	9612	P207331	10540
P206325	9333	P206396	10685	P206605	9396	P207332	10541
P206326	9722	P206397	10337	P206606	9399	P207333	10301
P206327	9332	P206398	10338	P206607	9615	P207335	10303
P206328	9331	P206399	10339	P206608	9490	P207337	10760
P206331	200A1014	P206400	10340	P206610	9492	P207338	10553
P206333	212A1016	P206403	U200	P206611	9493	P207339	10557
P206334	300A1016	P206404	U214	P206612	9390	P207340	10555
P206335	312A1016	P206405	U212	P206613	9709	P207341	10556

CROSS
REFERENCE

DONALDSON	TRUCKEX	DONALDSON	TRUCKEX	DONALDSON	TRUCKEX	DONALDSON	TRUCKEX
P207345	809545	P208348	34714	P224481	14740	P226156	8878
P207346	809546	P208350	34827	P224487	SBC500	P226157	8877
P207349	10562	P208357	834003	P224488	SBC600	P226158	8879
P207350	10741	P208358	34723	P224489	8899	P226166	8859
P207351	10564	P208359	834727	P224598	874000	P226167	8876
P207352	10565	P208364	34715	P224600	864001	P270530	9896
P207353	10566	P208366	34719	P224601	874002	P270531	9897
P207354	10567	P208372	34829	P224617	14758	P270532	9371
P207356	10311	P208373	834708	P224618	814624	P270533	9370
P207361	10330	P208374	34724	P224627	824738	P270534	9372
P207362	10776	P208375	834728	P224633	24745	P270535	9378
P207363	10329	P208380	34716	P224635	874608	P270536	9373
P207364	10781	P208386	24717	P224638	874609	P270538	9374
P207365	10789	P208387	54984	P224641	854006	P270539	9375
P207366	10792	P208388	54725	P224648	884002	P270540	9376
P207367	924002	P208389	854727	P224655	894903	P270541	9377
P207368	925502	P208392	24718	P224673	10646	P270542	9704
P207369	928002	P208393	54985	P224674	10747	P270543	9369
P207374	8990	P208394	54726	P224676	10638	P270837	9573
P207375	8883	P208395	854728	P224685	300S1014	P270838	9575
P207382	8947	P209910	884550	P224686	400S1016	P271507	9571
P207385	8952	P209911	884548	P224687	500S1016	X004476	9383
P207386	8954	P209912	874001	P224689	92678	X004478	9384
P207389	8941	P209913	884000	P224690	864745	X004480	9385
P207392	8959	P210110	9616	P224692	834006	X004482	9386
P207393	9334	P213191	9397	P224693	854830	X004484	9387
P207394	8969	P216164	10318	P224694	34830	X004536	9381
P207397	8913	P216169	809752	P224695	34831	X004537	9382
P207401	8961	P216171	10302	P224698	834002	X004538	9389
P207402	9336	P216172	10793	P224710	54993	X004539	9388
P207408	8974	P216191	24941	P224841	9628	X005190	B314
P207411	8933	P216197	44863	P225639	884001	X005265	9666
P207414	8979	P216200	834000	P226129	8880	X005921	9668
P207417	14634	P216202	864671	P226132	8982	X005985	9670
P207419	24697	P216204	834747	P226133	8983	X006202	A500
P207559	24696	P216205	864672	P226135	8855	X006203	A400
P207566	9478	P216212	894902	P226137	8856	X006204	A312
P207567	9475	P216214	54118	P226138	8857	X006211	9604
P207568	9392	P216227	834779	P226140	8986	X006463	A300
P207569	9471	P216228	844001	P226141	8987	X007057	9671
P207581	9473	P216240	54827	P226142	8988	X007784	9696
P207582	9713	P216241	54992	P226143	8989	X007785	9697
P207584	9715	P222018	9653	P226144	8885	X007805	9699
P207596	9506	P222745	9675	P226145	8886	X007824	9698
P207598	9495	P222747	9678	P226146	8887		
P207619	9470	P222753	9686	P226147	8888		
P207620	9476	P222755	9688	P226148	8984		
P207667	T600	P222757	9692	P226149	8985		
P207707	9398	P222758	9693	P226150	8990		
P207784	9350	P222759	9694	P226151	8883		
P208315	8881	P224473	44867	P226152	8884		
P208316	8882	P224475	24929	P226153	8895		
P208324	34713	P224477	34826	P226154	8881		
P208338	24939	P224479	14738	P226155	8882		



HD EXHAUST CROSS REFERENCE

HD MASTER INTERCHANGE (Continued)

DYNAFLEX	TRUCKEX
10-200	10671
10-225	10673
10-250	10672
10-275	10793
10-300	10756
10-350	10676
10-350CP	809544
10-400	10761
10-400CP	809770
10-450	10763
10-500	10554
10-500CP	809546
10-600	10556
10L-200	10301
10L-225	10302
10L-250	10303
10L-300	10758
10L-300CP	809404
10L-350	10305
10L-350CP	809769
10L-400	10762
10L-400CP	809406
10L-500	10308
10L-500CP	809408
10L-600	10310
10P-200	10773
10P-250	10774
10P-275	10775
10P-300	10534
10P-350	10329
10P-400	10539
10P-500	10540
10P-500CP	809796
10PL-300	10778
10PL-350	10536
10PL-400	10797
10PL-500	10542
10T-250-45	10562
10T-275-45	10741
10T-300-45	10564
10T-350-30	10635
10T-350-45	10565
10T-350-60	10643
10T-400-15	10684
10T-400-30	10636
10T-400-45	10743
10T-400-60	10644
10T-500-15	10685
10T-500-30	10637
10T-500-45	10567
10T-500-60	10645
10T-500-90	10309
10T-600-30	10638
10T-600-45	10748

DYNAFLEX	TRUCKEX
10T-600-60	10646
11-275	10674
11-300	10675
11-350	10795
11-400	10681
11-400CP	809621
11-500	10557
11-500CP	809771
11-600	10767
11L-400	10681
11L-500	10765
11P-300	10776
11P-350	10329
11P-350	10794
11P-400	10781
11P-500	10789
11P-600	10330
11PL-300	10777
11PL-400	18148
11PL-500	10796
11T-300-45	10742
11T-300-90	10337
11T-350-15	10683
11T-350-90	10338
11T-400-45	10566
11T-400-90	10339
11T-500-90	10340
12-200	10311
12-225	10320
12-250	10725
12-275	10318
12-300	10313
12-350	10314
12-400	10315
12-400CP	809736
12-500	10732
12-500CP	809738
12-600	10733
12L-250	10312
12L300CP	809734
12L350CP	809735
12L400CP	809415
12L-500	10317
12L-500	10731
12L-500CP	809739
12P-400	10744
12P-400CP	809750
12P-500	10559
12P-500CP	809752
12P-600	10749
12PL-400	10745
12PL-500	10747
12PL500CP	809753
13-400	10736

DYNAFLEX	TRUCKEX
13-500	10729
14FD-L5246	94939
14FD-R5246	28517
14FL-3006	38606
14FL-3974	94010
14FL-6015	10788
14GM-4099	28657
14GM-4099	48383
14GM-6594	9479
14IH-2167	38608
14KW-4122	38610
14KW-4765	28656
14KW-4766	94942
14KW-5419	18110
14KWL-0742	68183
14KWL-0742CP	868184
14KWL-4764	38611
14KWR-0742	68185
14KWR-0742CP	868186
14KWR-4764	38612
14MK-1408	8981
14MK-2603	38603
14MK-2611	68181
14MK-2612	68182
14MK-4658	38435
14PB-1726	10560
14PB-1726CP	809530
14PB-3055	94011
16-250	44748
16-250-1200	24205
16-300	44749
16-300-1256	24344
16-300-1256CP	814621
16-350-1406CP	814622
16-400-1450CP	814623
16P-300-1256	14618
22-150AZ	112A1016
22-162	158K1016
22-175AZ	134A1016
22-200AZ	200A1014
22-200AZ	200A1016
22-200S	200S1016
22-225AZ	214A1014
22-225AZ	214A1016
22-225S	214S1014
22-250	212K1014
22-250AZ	212A1014
22-250AZ	212A1016
22-250S	212S1014
22-275AZ	234A1014
22-275AZ	234A1016
22-300	300A1016
22-300AZ	300A1014
22-300S	300S1014

DYNAFLEX	TRUCKEX
22-350	312A1016
22-350AZ	312A1016
22-350S	312S1016
22-400	400C1016
22-400AZ	400A1014
22-400AZ	400A1016
22-400S	400S1016
22-450AZ	412A1016
22-500	500C1016
22-500AZ	500A1016
22-500S	500S1016
22-550AZ	512A1016
22-600	600C1016
22-600AZ	600A1016
24-25024	9597
24-30018	28495
24-30024	24941
24-30036	34713
24-30048	44854
24-30048CP	844002
24-35018	9599
24-35024	24735
24-35036	34714
24-35048	44731
24-40018	24711
24-40024	24737
24-40036	34715
24-40036CP	834004
24-40048	44656
24-40048CP	844003
24-40060	54991
24-40060CP	854002
24-50018	24712
24-50018CP	824701
24-50024	24739
24-50024CP	824006
24-50036	34716
24-50036CP	834005
24-50048	44658
24-50048CP	844004
24-50060	54720
24-50060CP	854003
24-60048	44863
24-950060CP	854716
24M-6050120CP	884002
24MP-40036CP	834002
24MP-50036CP	834779
24MP-50048CP	844001
24MP-50060CP	854001
24MP-DT40051	54827
24MP-DT50060	54992
24MP-DT50060CP	854830
24P-40018	24706
24P-40048	44657

CROSS
REFERENCE

DYNAFLEX	TRUCKEX
24P-40048CP	844661
24P-40060	54984
24P-40060CP	854715
24P-50036	34829
24P-50036CP	834708
24P-50048	44659
24P-50048CP	844663
24P-50060	54985
25-25036CP	834000
25-30018	24937
25-30018CP	824000
25-30048CP	844734
25-30060CP	854000
25-35012	14619
25-35018	24938
25-35018CP	824001
25-35024	24745
25-35024CP	824002
25-35036	34827
25-35048CP	844735
25-40012	14620
25-40018	24713
25-40018CP	824715
25-40024	24746
25-40024CP	824757
25-40036	34719
25-40036CP	834727
25-40036CP	834746
25-40048	44664
25-40048CP	844668
25-40060	54721
25-40060CP	854723
25-40072	64673
25-40072CP	864671
25-40084CP	874608
25-40096CP	884548
25-50010CP	884001
25-50018	24714
25-50018CP	824716
25-50024	24747
25-50024CP	824758
25-50036	34720
25-50036CP	834747
25-50048	44666
25-50048CP	844670
25-50060	54722
25-50060CP	854724
25-50072CP	864672
25-50084CP	874609
25-50096CP	884550
25-60018	24696
25-6050108CP	894902
25-6050120CP	894903
25-605096CP	884563

DYNAFLEX	TRUCKEX
25P-20012	20824
25P-22512	14342
25P-25012	14343
25P-27512	14634
25P-30036CP	834725
25P-30048	34828
25P-30048CP	844737
25P-35012	24345
25P-35024	24939
25P-35024CP	824004
25P-35036CP	834001
25P-35048	44853
25P-35048CP	844000
25P-40012	24346
25P-40018	24717
25P40018CP	824721
25P-40024	24748
25P-40024CP	824749
25P-40036	34723
25P-40048	44665
25P-40048CP	844669
25P-40060	54725
25P40060CP	854727
25P-40072CP	864000
25P-40084CP	874000
25P-40096CP	884000
25P-50018	24718
25P-50018CP	824722
25P-50024	24750
25P-50024CP	824751
25P-50036	34724
25P-50036CP	834728
25P-50048	44667
25P-50048CP	844671
25P-50060	54726
25P50060CP	854728
25P-50072CP	864001
25P-50096CP	874001
25P-60018	24697
25P-60018CP	824005
25PL-40060	54118
25PXL-40060	54993
27-125Z	9367
27-150Z	9896
27-175Z	9897
27-200Z	9371
27-225Z	9370
27-250Z	9372
27-275Z	9378
27-300CP	9571
27-300Z	9373
27-350Z	9374
27-400CP	9573
27-400Z	9375

DYNAFLEX	TRUCKEX
27-450Z	9376
27-500CP	9575
27-500Z	9377
27-550Z	9704
27-600Z	9369
31-200	8933
31-250	8943
31-300	8975
31-350	8976
31-400	18103
31-500	8978
31-600	8979
31L-500	8991
32-200	14337
32-250	14338
32-300	14601
32-350	14602
32-400	14603
32-500	14605
32-600	8974
33-500	92697
33BL-400	92673
33L-400	92695
33P-500	92696
34-3040	92698
34-3540	92678
34-400	92679
34-500	92689
35-2022	8946
35-2025	8947
35-2530	8953
35-3035	8955
35-3040	8956
35-3540	8957
35-4050	8958
35-5060	9335
35P-2022	8912
35P-3040	9648
35P-4050	9649
35P-5060	9650
36-2022	8911
36-2025	8913
36-2530	8960
36-3035	8962
36-3040	8963
36-3540	8964
36-4050	8965
36-5060	9336
37-2220	8938
37-2520	8941
37-3025	9600
37-3530	9333
37-4030	9722
37-4035	9332

DYNAFLEX	TRUCKEX
37-5040	9331
37-5045	9723
37-6050	8969
38P-401	9341
38P-500	9812
38P-501	9342
39-401	9343
39-501	9344
39P-500	9813
335L-500	92674
40-300-1S	9610
40-300S	9395
40-350-1S	9622
40-350-2S	9627
40-350S	9396
40-400-1S	9617
40-400-2S	9653
40-400S	9399
40-450S	9616
40-500-1S	9397
40-500S	9615
41-300-1S	9612
41-338S	9611
41-400S	9614
41-450S	9735
42-300	9390
42-350	9709
42B-500	9719
42E-4029	9705
42E-4036	9713
42EL-4029	9706
42F-400	9586
42HP-300	9708
42P-300	9392
42P-350	9391
42P-400	9474
42P-4050	9717
42P-500	9478
42P-500-1	9716
42P-500-45	9393
42R-300	9470
42R-3031-45	9471
42R-350	9711
42R-350-45	9392
42R-400	9476
42R-400-45	9475
42R-500-45	9394
42T-400	9587
43EL-487	9715
43EL-500	9718
45-312Z	FB300
45-362Z	FB350
45-412CP	FB400C
45-412Z	AS400



HD EXHAUST CROSS REFERENCE

HD MASTER INTERCHANGE (Continued)

DYNAFLEX	TRUCKEX
45-412Z	FB400
45-512CP	FB500C
45-512Z	AS500
45-512Z	FB500
45-562Z	FB550
45-600Z	FB600
45BC-800-3CP	9804
45PB-500CP	SB500
45PB-600CP	SB600
46-300	9501
46-300CP	9490
46-350	9502
46-400	9503
46-400CP	9492
46-500	9504
46-500CP	9493
46-600	9506
46-600CP	9495
47-150	U112
47-175	U134
47-200	U200
47-225	U214
47-250	U212
47-275	H234
47-300	H300
47-350	H312
47-400	H400
47-450	H412
47-500	H500PZ
47-600	H600
47G-200	U200
47G-225	U214
47G-250	U212
47G-300	T300
47G-350	T312
47G-350	T312Z
47G-400	T400Z
47G-400CP	9486
47G-450	T412Z
47G-500	T500Z
47G-500CP	9487
47G-550	T512Z
47G-600	T600
47G-600CP	9734
47HC-400CP	SBC400
47HC-500CP	SBC500
47HC-600CP	SBC600
47HF-400CP	SBF400
47HF-500CP	SBF500
47HF-600CP	SBF600
48CH-200	9582
48CH-250	9361
48CH-300	9363
48CH-350	9364

DYNAFLEX	TRUCKEX
48CH-400	9365
48-CH-500	9366
50EZ-300S	B300
50EZ-350S	B312
50EZ-400S	B400
50EZ-450S	B412
50EZ-500S	B500
50EZ-600S	B600
50TQ-200AZ	9660
50TQ-250AZ	9662
50TQ-275AZ	9663
50TQ-300AZ	9604
50TQ-350AZ	9605
50TQ-400AZ	9606
50TQ-400S	9623
50TQ-400S	9696
50TQ-500AZ	9699
50TQ-500S	9624
50TQ-500S	9697
50TS-200	9381
50TS-225	9382
50TS-250	9383
50TS-275	9389
50TS-300	9384
50TS-350	9385
50TS-400	9386
50TS-500	9387
50TS-600	9388
51-175	8866
51-225	8870
51-250	8872
51-300	8880
51-30018	24752
51-30024	24930
51-30036	34826
51-350	8881
51-35018	24753
51-35036	34785
51-400	8882
51-400-12-6	14738
51-400-18-6	24754
51-400-24-6	24835
51-400-36-6	34743
51-500	8877
51-500-12-6	14740
51-500-18-6	24755
51-500-24-6	24837
51-500-36-6	34744
51-600	8898
51F-125	8862
51F-150	8864
51F-200	8868
51F-250	8872
51F-300	8875

DYNAFLEX	TRUCKEX
51F-350	8881
51F-400	8882
51F-500	8877
51F-50048	54831
53-200	8883
53-225	8855
53-250	8884
53-300	8982
53-30018	24675
53-350	8983
53-35018	24676
53-400	8878
53-400-12-6	14739
53-400-18-6	24677
53-400-24-6	24836
53-400-36-6	34673
53-500	8879
53-500-12-6	14737
53-500-18-6	24678
53-500-24-6	24838
53-50036	34674
53-600	8899
54-50018S	24658
60L-400S	18106
66D-30012S	9726
66D-350-12S	9727
66D-400-12S	9728
66D-500-12S	9729
81R-40048C	809308
81R-40048CP	809309
81R-40048SP	809458
81R-60048SP	809307
83-1012S	9453
83-900S	9452
83F-90048CP	809498
83R-101248CP	809305
83R-90048C	809304
83R-90048CP	809306
84R-1012048CP	809500
84R-90048C	809299
84R-90048CP	809499
85-101233CP	9453
85GH-12SP	809793
85GH-18SP	9430
85GH-24SP	9811
85SC-10123CP	9799
85SC-10123Z	9807
85SC-4003CP	9456
85SC-4003Z	9801
85SC-5003CP	9457
85SC-5003Z	9803
85SC-6003CP	9810
85SC-9003CP	9724
85SC-9003Z	9725

DYNAFLEX	TRUCKEX
86-200	3690
86-250	3691
86-300	3692
86-350	3693
86-400	3694
86-500	3695
87Q-250-186	3880
87Q-300-119	3652
87Q-300-187	3721
87Q-350-113	3679
87Q-400-108	3666
87Q-400-127	3625
87Q-400-131	3891
87Q-400-189	3887
87Q-4050-205	3893
87Q-4050-514	3712
87Q-500-102	3667
87Q-500-130	3699
87Q-500-132	3667
87Q-500-145	3682
87Q-500-674	3895
88HQ-400-148	3918
88Q-400-115	3898
88Q-400-133	4211
88Q-500-121	3900
88TQ-500305	3876
89Q-250-137	3654
89Q-300-139	2704
89Q-350-106	3689
89Q-350-134	3662
89Q-400-054	3632
89Q-400-125	3614
89Q-500-117	3676
90-400	924002
90-500	925002
90-550	925502
90-600	926002
90-700	927002
90-800	928002
91-300	9589
91-350	9590
91-400	9591
91-500	9592
91-550	9593
91-600	9594
91-700	9595
91-800	9596
92-300	924003
92-400	924004
92-500	924005
92-550	925506
92-600	926006
92-700	927006
92-800	928006

CROSS
REFERENCE

DYNAFLEX	TRUCKEX
93-400	924105
93-500	925005
93-550	925505
93-600	926005
93-700	927005
94-400	924104
94-500	925105
94-550	925504
94-600	926004
94-700	927004
94-800	928004
95-5540	925543
95-5550	925553
95-6050	926503
95-6055	926553
95-8060	928603
96-6055	926557
96-7050	927557
97-5040	925458
97-5550	925558
97-6050	926508
97-6055	926658
D13-0034	3928

ECS	TRUCKEX
1-200	10671
1-250	10672
1-300	10675
1-300PE	10778
1-350	10305
1-400	10678
1-416PE	10797
1-617	10767
1-617PE	10309
2-245	10311
2-345	10313
2-445	10315
2-645PE	10749
2-5458	10728
2-5458-14	10731
4-352	10795
4-402	10681
4-402PE	10775
4-4313PE	10786
4-4315PE	10787
4-509	10557
4-515PE	10796
6-230	9501
6-235	9502
6-240	9503
6-250	9504
6-260	9506
6-330	H300P

ECS	TRUCKEX
6-335	H312PZ
6-530	T300
6-535	T312
6-3275	H234P
7-390	924003
7-445	924105
7-490	924004
7-524	925458
7-524	925558
7-545	925005
7-554	925543
7-555	925553
7-590	924005
7-645	926005
7-650	926503
7-690	926006
7-790	927006
7-840	924104
7-850	925105
7-855	925504
7-860	926004
7-870	927004
7-5545	925505
7-5590	925506
7-65590	926557
7-75590	927557
8-40	9591
8-50	9592
8-60	9594
8-70	9595
8-80	9596
8-275	9589
8-325	9590
8-525	9593
9-150	9896
9-175	9897
9-200	9371
9-225	9370
9-250	9372
9-275	9378
9-300	9373
9-350	9374
9-400	9375
9-450	9376
9-500	9377
9-550	9704
9-600	9369
10-20	200K1014
10-20SSHD	200S1016
10-25	212K1014
10-25SSHS	212S1014
10-30	300K1014
10-30SSHD	300S1014
10-40	400C1016

ECS	TRUCKEX
10-50	500C1016
10-60	600C1016
10-225	214K1016
13-902	14337
13-903	14339
13-904	14341
13-905	14605
13-935	14340
14-020	8933
14-025	8939
14-030	13009
14-035	9599
14-040	8991
14-050	8978
15-450	8958
25-1026-120	8894
25-2020	8868
25-2520	8872
25-3020	8875
25-3020-120	8986
25-3026	8880
25-3026-120	8986
25-3520-120	8987
25-3520-18	24753
25-3526	8881
25-3526-120	8987
25-4020	8882
25-4020-12	14738
25-4020-120	8988
25-4020-18	24754
25-4020-24	24835
25-4020-36	34743
25-4026	8882
25-4026-120	8988
25-5020	8877
25-5020-12	14740
25-5020-120	8989
25-5020-18	24755
25-5020-24	24837
25-5020-36	34744
25-5020-48	54831
25-5026	8877
25-5026-120	8989
25-6020-120	8990
25-6026	8898
25-6026-120	8990
25-8026-120	8893
25-22520	8870
26-3020-120	8859
26-3520-120	8876
26-4020-120	8856
26-4020-18	24931
26-4020-24	24835
26-5020-120	8857

ECS	TRUCKEX
26-5020-24	24934
27-040	924002
27-050	925002
27-055	925502
27-060	926002
27-070	927002
27-080	928002
40-436	834003
40-448	844661
40-460	854715
40-537	834708
40-548	844663
40-561	854716
56-9511	809499
56-9514-4	9456
56-9514-5	9457
56-9515-10	9453
56-9515-9	9452
56-9818	9430
56-9824	9811
57-5481	809458
57-6480	809307
57-9513-10	809429
57-9713-10	809500
58-51-4	SBC400
58-51-5	SBC500
58-51-6	SBC600
58-52-4	SBF400
58-52-5	SBF500
58-52-6	SBF600
66-1000	9307
66-200	9381
66-225	9382
66-250	9383
66-275	9389
66-300	9384
66-300AL	A300
66-350	9385
66-350AL	A312
66-400	9386
66-400AL	A400
66-500	9387
66-500AL	A500
66-600	9388
66-800	9380
67-200	9664
67-225	9665
67-250	9666
67-275	9667
67-300	9668
67-350	9669
67-400	9623
67-450	9670
67-500	9624

HD MASTER INTERCHANGE (Continued)

ECS	TRUCKEX
67-600	9671
68-350	B312
68-600	B600
88-306	9395
88-313	9618
88-350	9473
88-365	9626
88-384	9398
88-400	9474
88-401	9611
88-407	9622
88-414	9627
88-415	9476
88-419	9613
88-449	9614
88-462	9617
88-463	9653
88-469	9399
88-479	9647
88-479	9657
88-482	9619
88-487	9718
88-506	9615
88-511	9655
88-569	9616
89-481	9587
90-410	9341
90-510	9342
90-520	9344
302-2020	8883
302-2520	8884
302-3020	8982
302-3020-120	8885
302-3520	8983
302-3520-120	8886
302-4020	8878
302-4020-12	14739
302-4020-120	8887
302-4020-18	24677
302-4020-24	24836
302-4020-36	34673
302-5020	8879
302-5020-12	14737
302-5020-120	8888
302-5020-18	24678
302-5020-24	24838
302-5020-36	34674
302-6020	8899
350-047	9354
350-048	9355
350-049	8445
350-050	9356
350-051	9357
350-056	9360

ECS	TRUCKEX
401-300	809768
401-400PE	809794
401-410	809770
401-416	809406
401-508PE	809796
401-509	809547
401-512	809546
401-568PE	809530
401-5822L	868186
401-5822R	868184
402-345	809734
402-3545	809735
402-445	809415
402-445PE	809750
402-5458	809738
402-5458-14	809739
402-5458PE	809752
404-402	809793
404-445-10	809736
404-509	809771
406-230	9490
406-240	9492
406-250	9493
406-260	9495
406-540	9486
406-550	9487
409-400	9573
409-500	9575
420-436	834002
420-537	834779
420-548	844001
420-560	854001
426-255	T512Z
426-260	H600
426-330	H300PZ
426-340	H400PZ
426-350	H500PZ
426-530	T300Z
426-535	T312Z
426-540	T400Z
426-550	H500
431-200	10301
431-200PE	10773
431-250-10	10303
431-250-12PE	10774
431-300	10675
431-300PE	10534
431-350	10676
431-350PE	10535
431-400	10678
431-410	10620
431-410PE	10783
431-416	10762
431-416PE	10537

ECS	TRUCKEX
431-42922	10553
431-42922PE	10679
431-508	10764
431-512	10554
431-515	10765
431-515PE	10540
431-518	10308
431-518PE	10542
431-568PE	10560
431-5822L	68183
431-5822R	68185
431-589045Y	94942
431-5904026Y	94011
431-59044Y	94941
431-617	10556
431-617PE	10792
432-2545	10312
432-2545	10725
432-2545PE	10562
432-345	10313
432-345PE	10564
432-3530PE	10635
432-3545	10314
432-3545PE	10565
432-4015PE	10684
432-4030PE	10636
432-445-12	10727
432-445-12PE	10745
432-445-8	10726
432-445-8PE	10566
432-445PE	10744
432-5015PE	10685
432-5030PE	10637
432-5458	10729
432-5458-14	10732
432-5458-14PE	10747
432-5458PE	10746
432-5508PE	38614
432-6030PE	10638
432-645-15	10733
433-300	10337
433-350	10338
433-400	10339
433-500	10340
433-600	10330
434-1022E	38606
434-302PE	10776
434-345-7PE	10742
434-352PE	10794
434-402	10681
434-402PE	10781
434-4317PE	10788
434-446PE	10782
434-45545L	38611

ECS	TRUCKEX
434-45545R	38612
434-503PE	10784
434-509	10557
434-509PE	10789
434-545-12PE	10567
434-548PE	10788
4011-348	844002
4011-436	834004
4011-448	844003
4011-460	854002
4011-524	824006
4011-536	834005
4011-548	844004
4011-560	854003
4012-318	824000
4012-360	854000
4012-396	884548
4012-418	824715
4012-424	824757
4012-437	834746
4012-449	844668
4012-461	854723
4012-473	864671
4012-485	874608
4012-512	14758
4012-512	814624
4012-518	824716
4012-524	824758
4012-537	834747
4012-549	844670
4012-561	854724
4012-573	864672
4012-585	874609
4012-597	884550
4012-3518	824001
4012-3524	824002
4012-3536	834000
4012-3549	844735
4012-5108	884001
4012-5696	884563
4012-56108	894902
4012-56120	894903
4017-348	844000
4017-418	824721
4017-424	824749
4017-437	834727
4017-448	874000
4017-449	844669
4017-461	854727
4017-472	864000
4017-496	884000
4017-518	824722
4017-524	824751
4017-537	834728

ECS	TRUCKEX
4017-549	844671
4017-561	854728
4017-572	864001
4017-596	874001
4017-624	824005
4017-684	874002
4017-3524	824004
4017-3536	834001
4211-56120	884002
4310-20	200A1014
4310-25	212A1014
4310-30	300A1016
4310-35	312A1016
4310-40	400A1014
4310-50	500A1016
4310-60	600A1016
4310-448	44657
4310-460	54984
4310-536	34829
4310-548	44659
4310-560	54985
4311-324	28495
4311-336	34713
4311-348	44854
4311-418	24711
4311-424	24737
4311-436	34715
4311-448	44656
4311-460	54991
4311-518	24712
4311-524	24739
4311-536	34716
4311-548	44658
4311-560	54720
4311-648	44863
4311-3536	34714
4311-3548	44731
4312-318	24937
4312-3518	24938
4312-3536	34827
4312-418	24713
4312-424	24746
4312-436	34719
4312-448	44664
4312-460	54721
4312-472	64673
4312-518	24714
4312-524	24747
4312-536	34720
4312-548	44666
4312-560	54722
4313-903	14601
4313-904	14603
4313-905	14605

ECS	TRUCKEX
4313-906	8974
4313-935	14602
4314-030	8975
4314-035	8976
4314-040	18103
4314-050	8978
4314-060	8979
4315-253	8953
4315-253-1	9600
4315-253-2	8960
4315-335	8955
4315-335-1	9333
4315-335-2	8962
4315-340	8956
4315-340-1	9722
4315-340-2	8963
4315-340-3	9648
4315-354	8957
4315-354-1	9332
4315-354-2	8964
4315-450	8958
4315-450-1	9331
4315-450-2	8965
4315-450-3	9649
4315-560	9335
4315-560-1	8969
4315-560-2	9336
4315-560-3	9650
4316-400	92695
4316-404	92673
4316-449011	92679
4316-500	92697
4316-5530	92674
4316-559016	92689
4317-318	24344
4317-348	34828
4317-3518	24345
4317-3524	24939
4317-3548	44853
4317-418	24717
4317-424	24748
4317-436	34723
4317-448	44665
4317-460	54725
4317-518	24718
4317-524	24750
4317-536	34724
4317-548	44667
4317-560	54726
4367-200	9660
4367-225	9661
4367-250	9662
4367-300	9604
4367-350	9605

ECS	TRUCKEX
4367-400	9606
4367-500	9699
4368-350	9678
4368-400	9680
4368-500	9682
4368-600	9683
4369-400	AS400
4369-500	AS500
4388-302	9708
4388-353	9710
4388-413	9475
4388-503	9478
4388-504	9393
A17-0167	4264
A17-0213	4256
A17-0290	4263
A17-0355	4209
A17-0356	4239
A17-0395	4208
A17-0578	4258
A17-0580	4254
A17-0581	4262
A17-0647	4260
A17-0648	4259
A17-0657	4261
A17-0675	4255
D10-0902	45
D12-2002	2156
D12-2225	4241
D12-2230	3902
D12-2270	698
D12-2275	3697
D12-2276	3914
D12-2350	3613
D12-2575	3654
D12-2580	3908
D12-3030	3627
D12-3047	609
D12-3255	3663
D12-3260	3719
D12-3430	2704
D12-3437	2645
D12-4000	3651
D12-4002	3652
D12-5022	4213
D13-0005	3933
D13-0036	3939
D13-0079	4227
D13-0099	3640
D13-0103	3970
D13-0110	4233
D13-0114	4228
D13-0117	3917
D13-0123	3895

ECS	TRUCKEX
D13-0124	4232
D13-0196	3891
D13-1092	3899
D13-1095	3916
D13-1134	3920
D13-1147	4225
D13-1156	3704
D13-1161	3851
D13-1179	3653
D13-1188	3871
D13-1529	4229
D13-1585	3617
D13-1622	4245
D13-1624	4243
D13-1625	4244
D13-1626	4246
D13-2006	3898
D13-2008	3676
D13-2011	3900
D13-2012	3614
D13-2017	3670
D13-2018	3662
D13-2025	3647
D13-2032	3684
D13-2034	3150
D13-2036	3720
D13-2039	3714
D13-2040	3675
D13-2041	3689
D13-2045	3711
D13-2070	3931
D13-2074	3912
D13-2076	3923
D13-3590	3679
D13-4022	3713
D13-4023	3919
D13-4060	3625
D13-4070	4224
D13-4095	3712
D13-4104	3707
D13-4284	3677
D13-4285	3918
D13-4288	4211
D13-4289	4231
D13-4510	3714
D13-4515	3715
D13-4515	3893
D13-4525	4218
D13-4590	3666
D13-4595	3890
D13-5010	3699
D13-5090	3667
D13-5510	3640
D13-5520	3873

HD MASTER INTERCHANGE (Continued)

ECS	TRUCKEX
D13-5550	3702
D13-5590	3897
D13-6001	3610
D13-6035	3668
D13-6040	3632
D13-6045	3710
D13-6289	3703
D13-6290	3915
D13-6291	3611
D13-6295	3716
D13-6295	4242
D13-7550	3932
D13-7593	3879
D13-7594	3683
D13-7595	3685
D13-7599	3913
D13-7601	3880
D13-7602	3721
D13-7604	3995
D13-7605	3925
D13-7606	3626
D13-7613	3876
D13-7628	3699
D13-7635	3875
D13-7636	3708
D13-7637	3888
D13-7643	3705
D13-7650	3872
D13-7667	3225
D13-7674	3924
D13-7679	3669
D13-7689	3728
D13-7878	4252
D13-7879	4253
D14-0021	3884
D14-0123	3706
D14-0159	3698
D14-0244	3878
D14-0528	3887
D14-0533	3889
D14-0597	3645
D15-0002	4223
D15-0003	3690
D15-0004	3691
D15-0005	3692
D15-0006	3693
D15-0007	3694
D15-0008	3695
D16-0001	3681
D16-0002	3682
D16-0003	3618
D99-0087	4251
D99-1116	3612
Q-118-02	3894

ECS	TRUCKEX
Q-122-02	3943
Q-126-02	3944
Q-136-02	3907
Q-163-02	3883
Q-164-02	3882
Q-165-02	3892
Q-166-02	3911
Q-167-02	4216
Q-168-02	3881
Q-180-02	3910
Q-185-02	3901

Eil-Con	TRUCKEX
A-200A	10670
A-250A	10672
A-300A	10756
A-350A	10676
A-402A	10681
A-402K	809621
A-503A	10620
A-503K	809771
A-510A	10554
A-512A	10766
A-555A	10557
A-610	10310
A-615	809772
A-31414A	10304
A-31414K	809404
A-41212A	10761
A-41212K	809770
A-41818A	10306
A-41818K	809406
A-42532A	10553
A-51515A	10765
A-51515K	809546
A-52020A	10308
A-52020K	809408
A-52532A	10555
A-61515K	809737
A-351616A	10305
A-351616K	809769
A-451919A	10763
AA-324	24941
AA-336	34713
AA-348	44854
AA-418A	24711
AA-424A	24737
AA-424K	824738
AA-436A	34715
AA-436K	834004
AA-448A	44656
AA-448K	844003
AA-460A	54991

Eil-Con	TRUCKEX
AA-460K	854002
AA-518A	24712
AA-518K	824701
AA-524A	24739
AA-524K	824006
AA-536A	34716
AA-536K	834005
AA-548A	44658
AA-548K	844004
AA-560A	54720
AA-560K	854003
AA-648	44863
AA-3524	24735
AA-3536	34714
AA-3548	44731
AB-336	24744
AB-348K	844734
AB-360K	854000
AB-412K	814623
AB-418A	24713
AB-418K	824715
AB-424A	24746
AB-424K	824757
AB-436A	34719
AB-436K	834746
AB-448A	44664
AB-448K	844668
AB-460A	54721
AB-460K	854723
AB-472A	64673
AB-472K	864671
AB-484K	874608
AB-496K	884548
AB-518A	24714
AB-518K	824716
AB-524A	24747
AB-524K	824758
AB-536A	34720
AB-536K	834747
AB-548A	44666
AB-548K	844670
AB-560A	54722
AB-560K	854724
AB-572K	864672
AB-584K	874609
AB-596K	884550
AB-624	24696
AB-3516	24938
AB-3516K	824001
AB-3524	24745
AB-3524K	824002
AB-3536	34827
AB-3536K	834000
AB-3548K	844735

Eil-Con	TRUCKEX
AB-5108K	884001
AC-304	14339
AC-308	14601
AC-354	14340
AC-358	14602
AC-404	14341
AC-408	14603
AC-508	14605
AC-604	8974
AD-306	8975
AD-356	8976
AD-406	8991
AD-506	8978
AD-604	8979
AE-335	8955
AE-340	8956
AE-354	8957
AE-450	8958
AE-560	9335
AF-400	92679
AF-404L	92695
AF-500	92689
AF-510	94941
AF-512A	94011
AF-520	94942
AF-555L	92697
A-FL1013	10786
A-FL1015	10787
A-FL5100	28655
A-FL13974	94010
A-FL52916	38606
AG-336K	834725
AG-348	34828
AG-348K	844737
AG-418A	24717
AG-418K	824721
AG-424A	24748
AG-424K	824749
AG-436A	34723
AG-436K	834727
AG-448A	44665
AG-448K	844669
AG-460A	54725
AG-460K	854727
AG-472K	864000
AG-484K	874000
AG-496K	884000
AG-518A	24718
AG-518K	824722
AG-524A	24750
AG-524K	824751
AG-536A	34724
AG-536K	834728
AG-548A	44667

EII-Con	TRUCKEX
AG-548K	844671
AG-560A	54726
AG-560K	854728
AG-572K	864001
AG-596K	874001
AG-624	24697
AG-624K	824005
AG-3524	24939
AG-3524K	824004
AG-3536K	834001
AG-3548	44853
AG-3548K	844000
AH-318	24674
AH-418	24654
AH-436	34647
AH-518	24936
AH-3518	24935
AI-200	9582
AI-250	9361
AI-275	9362
AI-300	9363
AI-350	9364
AI-400	9365
AI-500	9366
AI-600	9354
AI-700	9355
AI-800	9580
AI-850	9356
AI-900	9357
AI-1000	9358
AI-1180	9360
AI-1500	9359
AJ-20	200K1016
AJ-30A	300A1014
AJ-35	300K1014
AJ-35A	312A1016
AJ-40	400C1016
AJ-40A	400A1016
AJ-45	412A1016
AJ-50	500C1016
AJ-50A	500A1016
AJ-60	600C1016
AJ-225	214K1016
AJ-436K	834003
AJ-436MCA	834002
AJ-448K	844661
AJ-460A	54984
AJ-460K	854715
AJ-536A	34829
AJ-536K	834708
AJ-536MCA	834779
AJ-548A	44659
AJ-548K	844663
AJ-548MCA	844001

EII-Con	TRUCKEX
AJ-560A	54985
AJ-560K	854716
AJ-560MCA	854001
AJ-4128A	24706
A-KW5242LA	68183
A-KW5242RA	68185
A-KW6599R	28537
A-KW7422L	28538
A-KW14122A	38610
A-KW52424LK	868184
A-KW52424RK	868186
A-KW54764L	38611
A-KW54764R	38612
AL-530A	10633
AL-P530A	10637
AL-560A	10641
AL-P560A	10645
A-P300A	10534
A-P508K	809796
A-P512A	10542
A-P555A	10791
A-P41818A	10537
A-P44915A	10538
A-P51515A	10540
A-P51616A	10796
A-P52020A	10309
A-P351212A	10535
A-PB5710	10560
A-PB5710K	809530
B-345A	10313
B-345K	809734
B-445A	10726
B-445LA	10315
B-445LK	809736
B-545A	10729
B-645	10733
B-645K	809740
B-3545A	10313
B-3545LK	809735
B-51212A	10317
B-51212K	809417
B-5458LK	809738
BA-430	8963
BA-435	8964
BA-540	8965
BA-650	9336
BB-648KOD	854881
BB-660K	864746
BB-660KOD	864745
BB-672K	874638
BB-696K	884563
BB-6108K	894902
BB-6120K	894903
BD-434A	34830

EII-Con	TRUCKEX
BD-434K	834006
BD-451EK	44855
BD-451K	854004
BD-534A	34831
BD-534K	834007
BD-551K	854005
BE-318	24752
BE-324	24930
BE-336	34826
BE-412	14738
BE-418	24754
BE-424	24835
BE-436	34743
BE-448	44786
BE-512	14740
BE-518	24755
BE-524	24837
BE-536	34744
BE-548	54831
BE-2010	8984
BE-2026	8868
BE-2510	8985
BE-2526	8872
BE-3010	8986
BE-3026	8875
BE-3510	8987
BE-3518	24753
BE-3524	24849
BE-3526	8881
BE-3536	34785
BE-4010	8988
BE-4026	8882
BE-5010	8989
BE-5026	8877
BE-6010	8990
BE-6026	8898
BE-22526	8869
BF-318	24675
BF-336	34825
BF-412	14739
BF-418	24677
BF-424	24836
BF-436	34673
BF-512	14737
BF-518	24678
BF-524	24838
BF-536	34674
BF-548	44867
BF-2010	8883
BF-2510	8884
BF-3010	8885
BF-3020	8982
BF-3510	8886
BF-3518	24676

EII-Con	TRUCKEX
BF-3520	8983
BF-3524	24850
BF-3536	34786
BF-4010	8887
BF-4020	8878
BF-4825	8981
BF-5010	8888
BF-5020	8879
BF-6010	8895
BF-6020	8899
BF-22510	8855
BG-040	924002
BG-050	925002
BG-055	925502
BG-060	926002
BG-070	927002
BG-080	928002
BG-303	923002
BH-450	9649
BH-560	9650
BJ-335	9333
BJ-340	9722
BJ-354	9332
BJ-450	9331
BJ-560	8969
B-P445A	10743
B-P445LA	10745
B-P445LK	809751
B-P645K	809754
B-P3545LA	10565
B-P51212A	10747
B-P51212K	809753
B-P5458LA	10746
B-P5458LK	809752
C-300	10337
C-350	10776
C-350	10794
C-400	10780
C-600	10330
D-302	10777
D-352	10329
D-399A	10778
D-402A	10781
D-402K	809793
D-446A	10782
D-503A	10784
D-503K	809795
D-548A	10541
D-S1506	10683
D-S1507	10684
D-S1508	10685
E-102	3891
E-103	3667
E-104	3897

HD MASTER INTERCHANGE (Continued)

EII-Con	TRUCKEX
E-106	3682
E-107	3666
E-108	3679
E-109	3681
E-110	3625
E-111	3714
E-112	3699
E-113	3890
E-114	3873
E-123	3683
E-130	3721
E-131	3875
E-135	3720
E-140	3887
E-203	3654
E-204	3906
E-205	2645
E-206	3669
E-208	3662
E-209	3901
E-210	3663
E-301	3668
E-302	3614
E-303	3677
E-401	3670
E-502	3900
E-704	3678
E-705	3931
E-707	3702
E-720	3690
E-725	3691
E-730	3692
E-735	3693
E-740	3694
E-750	3695
E-1351	3618
E-1413	3889
E-13039	3652
E-31505	3647
EE-4481K	809309
EE-5482K	809458
EF-8510	9804
EF-8551	9451
EF-8551	9805
EF-9270	9725
EF-9421K	809305
EF-9515	9806
EF-9516	9801
EF-9517	9803
EF-9518	9430
EF-9519	9810
EF-9520	9807
EF-9524	9811
EF-10270	9724

EII-Con	TRUCKEX
EG-6483S	809307
EG-9421S	809302
EG-9501K	809306
EG-9502S	809429
EI-10270S	809499
EI-10481S	809498
F-240K	9492
F-240Z	9503
F-250K	9504
F-250Z	9493
F-260K	9495
F-260Z	9506
F-320	H200
F-325	H214
F-330	H300
F-330Z	H300Z
F-335	H312
F-335Z	H312PZ
F-340	H400
F-340Z	H400Z
F-345	H412
F-345Z	H412PZ
F-350	H500
F-350Z	H500Z
F-360	H600
F-360Z	H600Z
F-640K	SBC400
F-650K	SBC500
F-660K	SBC600
F-1200	9381
F-1225	9382
F-1250	9383
F-1300	9384
F-1350	9385
F-1400	9386
F-1600	9388
F-2350	B312
F-2350APF	9605
F-2350PF	9669
F-2400	B400
F-2400APF	9606
F-2400PF	9623
F-2500	B500
F-2500APF	9699
F-2500PF	9624
F-2600	B600
F-2600PF	9671
F-3275	H234
F-3325	H314
F-5275	T234
F-5300	T300
F-5300Z	T300Z
F-5325	T314
F-5350	T312

EII-Con	TRUCKEX
F-5350Z	T312Z
F-5400	T400
F-5400K	9486
F-5400Z	T400Z
F-5450Z	T412Z
F-5500	T500
F-5500K	9487
F-5500Z	T500Z
F-5550Z	T512Z
F-5600	T600
F-5600K	9734
F-5600Z	T600Z
F-14500	9387
G-390	924003
G-445	924105
G-490	924004
G-545	925005
G-555	925553
G-590	924005
G-625	926508
G-645	926005
G-650	926503
G-655	926553
G-680	928603
G-690	926006
G-745	927005
G-780	928703
G-790	927006
G-840	924104
G-845	928005
G-850	925105
G-855	925504
G-860	926004
G-870	927004
G-880	928004
G-890	928006
G-5245	925458
G-5525	925558
G-5545	925505
G-5545	925543
G-5590	925506
G-6255	926658
G-65590	926557
G-75590	927557
GC-690	926101
H-30	9589
H-35	9590
H-40	9591
H-50	9592
H-55	9593
H-60	9594
H-70	9595
H-81	9596
HH-300	9470

EII-Con	TRUCKEX
HH-306	9395
HH-316	9612
HH-326	9611
HH-350	9391
HH-356	9396
HH-400	9474
HH-401	9617
HH-406	9399
HH-416	9614
HH-436	9619
HH-456	9616
HH-503	9476
HH-506	9615
HH-507	9652
HH-511	9397
HI-480	9586
HI-481	9587
HI-484	9518
HI-568	9719
I-150	9896
I-175	9897
I-200	9371
I-225	9370
I-250	9372
I-275	9378
I-300	9373
I-300K	9571
I-350	9374
I-400	9375
I-400K	9573
I-450	9376
I-500	9377
I-500K	9575
I-550	9704
I-600	9369
IJ-401	9341
IJ-402	9343
IJ-501	9342
IJ-502	9344
IJ-510	9812
IJ-520	9813
MT-21698P1	28528
MT-21781	18107
MT-21783P4	18108
MT-32066P5	48563
MT-32612	68182

FlexaTube	TRUCKEX
01300	8875
02300	T300Z
02312	T312Z
02400	T400Z
02500	T500Z

FlexaTube	TRUCKEX
04312	H312
04400	H400
04500	H500
04600	9354
06200	9381
06212	9383
06214	9382
06234	9389
06300	9384
06312	9385
06400	9386
06500	9387
06600	9388
10300	8880
10350	8881
10400	8882
10500	8877
16312	A312
16400	A400
16500	A500
17220	B200
17225	B214
17250	B212
17275	B234
17330	B300
17350	B312
17400	9623
17440	B400
17500	9624
17550	B500
17660	B600
20300	8986
20350	8987
20400	8882
20500	8877
33300	24752
33350	24753
33400	24754
33500	24755
35300	24930
35350	24849
35400	24835
35500	24837
39300	34826
39350	34785
39400	34743
39500	34744
40300	8885
40350	8886
40400	8887
40500	8888
44300	24929
44350	24850
44400	24836

FlexaTube	TRUCKEX
44500	24838
46300	34825
46350	34786
46400	34673
46500	34674
48300	24675
48350	24676
48400	24677
48500	24678
50300	8982
50350	8983
50400	8878
50500	8879
54400	9503
54500	9504
54600	9506
69400	10306
69401	10537
69403	809406
69500	10308
69501	10542
70300	9373
70350	9374
70400	9375
70500	9377
71400	10681
71401	10539
71500	10557
71501	10540
71503	854723
72400	10315
72401	10566
72500	10317
72503	809739
73400	92673
73402	92679
73500	92674
77416	824715
77472	864671
77484	874608
77496	884548
77518	824716
77572	864672
77584	874609
77596	884550
78424	824749
78436	834727
78448	844669
78460	854727
78518	824722
78524	824751
78536	834728
78548	844671
78560	854728

FlexaTube	TRUCKEX
80013	14338
91150	112A1016
91175	134A1016
91200	200A1016
91225	214A1016
91250	212A1016
91275	234A1016
91300	300A1016
91350	312A1016
91400	400A1016
91500	500A1016
93300	14618
93301	24344
93400	24713
93401	24346
93500	24714
93501	24718
94436	34719
94448	44664
94460	54721
94472	64673
94536	34720
94548	44666
94560	54722
95436	34723
95448	44665
95536	34724
95548	44667
95560	54726
96300	9334
96301	8954
96400	9332
96401	8957
96500	9331
96501	8958
96550	8978
99300	14601
99400	14603
99500	14605
50500X4	44867
78448SC	844661
78536AC	834779
78536SC	834708
78548SC	844663
78560SC	854716
94436SC	34715
94448SC	44656
94536SC	34716
94548SC	44658
94560SC	54720
95448SC	44657
95460SC	54984
95548SC	44659
FLX-459M	3712

FlexaTube	TRUCKEX
FLX-5510M	3699

GRAND ROCK	TRUCKEX
CN-36A	8975
CN-46	8991
CN-46A	18103
CN-56A	8978
CN-66	8979
CN-356A	8976
CP-38	14339
CP-38A	14601
CP-48	14341
CP-48A	14603
CP-58A	14605
CP-66A	8974
CP-358	14340
CP-358A	14602
CSP-460EX	54993
CSP-460EXC	854006
DISPLAY	HD3050
ED-4LA	34830
ED-4LC	834006
ED-5LA	34831
ED-5LC	834007
EZ-2	B200
EZ-3	B300
EZ-4	B400
EZ-5	B500
EZ-25	B212
EZ-35	B312
EZ-35A	9678
EZ-225	B214
EZ-275	B234
FB-3	9501
FB-4C	9492
FB-4ZN	9503
FB-5C	9493
FB-5ZN	9504
FB-6C	9495
FB-6ZN	9506
FB-35	9502
FL-4	9386
FL-4A	A400
FL-5	9387
FL-5A	A500
FL-6	9388
FL-25	9383
FL-30	9384
FL-35	9385
FL-15653-0	28699
FL-17094-012	28698
FL-98333-06	38606
GF-318	24752

HD MASTER INTERCHANGE (Continued)

GRAND ROCK	TRUCKEX	GRAND ROCK	TRUCKEX	GRAND ROCK	TRUCKEX	GRAND ROCK	TRUCKEX
GF-324	24929	K4-60EXC	854723	KW-14764L	38611	L515-0404SA	10685
GF-336	34826	K4-60SBA	54725	KW-14764R	38612	L530-0404A	10633
GF-412	14738	K4-60SBC	854727	KW-14766	94942	L530-0404SA	10637
GF-418	24754	K4-72EXA	64673	KW-10742LC	68183	L545-0808A	10729
GF-424	24835	K4-72EXC	864671	KW-10742RC	68185	L545-0808C	809738
GF-436	34743	K4-72SBC	864000	L345-0707C	809734	L545-0808SA	10567
GF-448	44786	K4-84EXC	874608	L345-0808A	10313	L545-0808SC	809752
GF-512	14740	K4-84SBC	874000	L345-0808SA	10564	L545-1212A	10317
GF-518	24755	K4-96EXC	884548	L390-0505SA	10337	L545-1212SA	10747
GF-524	24837	K4-96SBC	884000	L390-0707A	10675	L545-1515A	10732
GF-536	34744	K5-12EXA	14758	L390-0707SA	10777	L545-1515SC	809753
GF-548	54831	K5-12EXC	814624	L390-0808A	10675	L560-1010A	10641
GF-3120	8986	K5-12SBA	14759	L390-1010A	10757	L560-1010SA	10645
GF-3300	8880	K5-12SBC	814625	L390-1010SA	10534	L590	10541
GF-3518	24753	K5-18EXA	24714	L390-1414	10304	L590-0808SA	809795
GF-3524	24849	K5-18EXC	824716	L390-1414A	10758	L590-1010A	10764
GF-3536	34785	K5-18SBA	24718	L390-1414SA	10778	L590-1010C	809547
GF-4120	8988	K5-18SBC	824722	L415-0404A	10684	L590-1010SA	10784
GF-4300	8882	K5-24EXA	24747	L422-9405SA	84574	L590-10120SA	10782
GF-5120	8989	K5-24EXC	824758	L430-0404A	10632	L590-1212	10557
GF-5300	8877	K5-24SBA	24750	L430-0404SA	10636	L590-1212A	10557
GF-6300	8898	K5-24SBC	824751	L445-0606A	10726	L590-1212C	809771
GF-35120	8987	K5-36EXA	34720	L445-0606SA	10743	L590-1212SA	10789
GF-35300	8881	K5-36EXC	834747	L445-0808SA	10566	L590-1215SA	10787
GH-24S	9811	K5-36SBA	34724	L445-0909	10315	L590-1515C	809408
GH-18S	9430	K5-36SBC	834728	L445-0909A	10315	L590-1515S	10791
H-10	8483	K5-48EXA	44666	L445-0909SA	10744	L590-1515SA	10540
IH-167C1	38608	K5-48EXC	844670	L445-0909SC	809750	L590-1515SC	809796
IH-845C1	38607	K5-48SBA	44667	L445-1212A	10727	L590-1818	10765
JDS-4A	54827	K5-48SBC	844671	L445-1212SA	10745	L590-1818C	809546
K3-12EXA	14618	K5-60EXA	54722	L456-9806SA	84573	L590-1818S	10309
K3-12SBA	24344	K5-60EXC	854724	L460-1010A	10640	L590-520	10308
K3-24EX	24937	K5-60SBA	54726	L460-1010SA	10644	L645-1515A	10733
K3-48SBA	34828	K5-60SBC	854728	L476-5919SA	64775	L690-1313	10767
K4-12EXA	14620	K5-72EXC	864672	L490-0808A	10681	L690-1313A	10556
K4-12EXC	814623	K5-72SBC	864001	L490-0808S	10780	L690-1313S	10792
K4-12SBA	24346	K5-84EXC	874609	L490-0808SC	809793	L690-2424	10310
K4-18EXA	24713	K5-84SBC	874002	L490-1010	10620	L3530-0404	10631
K4-18EXC	824715	K5-96EXC	884550	L490-1010SA	10781	L3530-0404SA	10635
K4-18SBA	24717	K5-96SBC	874001	L490-1010SC	809794	L3545-0909	10314
K4-18SBC	824721	K5-108EXC	884001	L490-1212A	10620	L3545-0909A	10314
K4-24EXA	24746	K6-18SBC	824005	L490-1212A	10761	L3545-0909C	809735
K4-24EXC	824757	K35-12EXA	14619	L490-1212C	809770	L3545-0909SA	10565
K4-24SBA	24748	K35-12SB	24345	L490-1212SA	10539	L3560-0808A	10639
K4-24SBC	824749	K35-18EXA	24938	L490-1212SA	10783	L3560-0808SA	10643
K4-36EXA	34719	K35-18EXC	824001	L490-1515A	10761	L3590	10338
K4-36EXC	834746	K35-24EX	824002	L490-1515A	10762	L3590-0808SA	10329
K4-36SBA	34723	K35-24SB	824004	L490-1515SA	18148	L3590-1212A	10676
K4-36SBC	834727	K35-24SBC	24939	L490-1818	10306	L3590-1212A	10759
K4-48EXA	44664	K35-36EXA	34827	L490-1818A	10306	L3590-1212S	10329
K4-48EXC	844668	K35-36EXC	834000	L490-1818C	809406	L3590-1212SA	10535
K4-48SBA	44665	K35-48EXC	844735	L490-1818SA	10797	L3590-1616A	10305
K4-48SBC	844669	KW-6326	38613	L490-2734A	10553	L3590-1616C	809769
K4-60EXA	54721	KW-8049	38614	L490-52225SA	10679	L3590-1616SA	10536

GRAND ROCK	TRUCKEX
M-106	3611
M-115	3898
M-121	3900
M-127	3625
M-130-4	3893
M-131	3891
M-132	3667
M-144	3681
M-145	3682
M-147	3647
M-149	3678
M-153	3632
M-187	3721
M-188	3720
M-220	3706
M-444	3714
M-465	3699
M-511	3703
M-512	3716
M-514	3712
M-526	3702
M-530	3919
M-537	3704
M-542	3931
M-557	3872
M-595	3895
M-672	3698
MB-5PBS	SB500
MB-6PBS	SB600
MG-9CBRKT	9806
MG-85CBRKT	9451
MG-948C	809306
MG-1042RA	809303
MG-1048RA	809304
MG-9270S	809500
MG-10270BRKT	9799
MG-S	809429
MK-4762	38436
MK-21408	8981
MK-21698	28528
MK-21781	18107
MK-21783P4	18108
MK-32603	38603
MK-32612	68182
OMH-1015	9359
OMH-8511	9360
P5-36SBC	834779
P5-48SBC	844001
P5-54SBC	854830
P5-60SBC	854001
PB-01726	10560
PB-0455Y	94941
PB-13002	18166
PB-13055Y	94011

GRAND ROCK	TRUCKEX
PB-13056C	809519
PB-13394	10799
PB-15353Y	94015
PF-3	9668
PF-3A	9604
PF-4	9623
PF-4	9696
PF-4A	9606
PF-5	9624
PF-5	9697
PF-5A	9699
PF-6P	9671
PF-25A	9662
PF-275	9667
PF-35	9669
PF-35A	9605
PG 4CBRKT	9456
PG 5CBRKT	9803
PG-5CBRKT	9457
PG-6CBRKT	9810
PG 9CBRKT	9452
PG10CBRKT	9453
PG-548	809308
PG-648C	809307
PG-S	809458
PG VS	809499
R35I-30A	8962
R35I-3IA	8955
R35O-3IA	9333
R4I-30A	8963
R4I-35IA	8957
R4I-35OA	8964
R4I-3IA	8956
R4O-3IA	9722
R4O-30A	9648
R4O-35IA	9332
R5I-4IA	8958
R5I-4OA	8965
R5I-45IA	9721
R5O-4OA	9649
R5O-4IA	9331
R6I-5IA	9335
R6I-5OA	9336
R6O-4OA	9720
R6O-5IA	8969
R6O-5OA	9650
RB-2ZN	U200
RB-3ZN	T300Z
RB-4C	9486
RB-4ZN	T400Z
RB-5C	9487
RB-5ZN	T500Z
RB-6C	9734
RB-6ZN	T600Z

GRAND ROCK	TRUCKEX
RB-25ZN	U212
RB-35ZN	T312Z
RB45ZN	T412Z
RB-225ZN	U214
RB-275ZN	T234
RB-325	T314
RC-200	9371
RC-225	9370
RC-250	9372
RC-300	9373
RC-350	9374
RC-400	9375
RC-400C	9573
RC-450	9376
RC-500	9377
RC-500C	9575
RC-600	9369
RMH-9	9357
RMH-10	9358
RMH-11	9628
RMH-85	9580
S3-6SBA	8970
S3-18EXA	28495
S3-24EXA	24941
S3-48EXA	44854
S3-120EXA	923120
S3-120SB	300A1016
S3-120SBA	300A1014
S4-6SBA	8972
S4-120SB	400C1016
S4-120SBA	400A1016
S4-18EXA	24711
S4-24EXA	24737
S4-36EXA	34715
S4-36EXC	834004
S4-48EXA	44656
S4-48EXC	844003
S4-48SBA	44657
S4-48SBC	844661
S4-60EXA	54991
S4-60SBA	54984
S4-72SBC	854007
S5-6SBA	8973
S5-120EXA	924120
S5-120SB	500C1016
S5-120SBA	500A1016
S5-18EXA	24712
S5-24EXA	24739
S5-24EXC	824006
S5-36EXA	34716
S5-36EXC	834005
S5-36SBA	34829
S5-48EXA	44658
S5-48SBA	44659

GRAND ROCK	TRUCKEX
S5-60EXA	54720
S5-60EXC	854003
S5-60SBA	54985
S5-60SBC	854716
S6-120SB	600C1016
S6-120SBA	600A1016
S6-48EXA	44863
S8-120SBA	800A1016
S10-120SBA	1000A1016
S35-6SBA	8971
S35-18EXA	9599
S35-24EXA	24735
S35-36EXA	34714
S35-48EXA	44731
S35-120SB	312A1016
S35-120SBA	312A1016
SBH6-36SBC	834896
SBH6-48SBC	844886
SBH6-60SBC	854151
SF-3120	8885
SF-35120	8886
SF-418	24677
SF-424	24836
SF-436	34673
SF-518	24678
SF-524	24838
SF-536	34674
SF-4120	8887
SF-4300	8878
SF-5120	8888
SF-5300	8879
SK6-96EXC	884563
SP6-120EXC	884002
T362-6ID	9470
T375-6	9390
T400-6	9710
T407-4	9709
T425-6ID	9473
T450-6	9475
T450-6	9714
T475-4	9474
T475-4ID	9476
T525-4	9718
T550-6	9393
T588-6	9478
T588-6PYRO	9629
T6-433A	92698
T6BT	18165
TBA-4	9343
TBE-4	9341
TBE-5	9342
VB-419C	9622
VB-461M	9614
VB-475C	9653



HD EXHAUST CROSS REFERENCE

HD MASTER INTERCHANGE (Continued)

GRAND ROCK	TRUCKEX
VB-475D	9617
VB-525D	9652
VB-588C	9615
Y-400A	92673
Y-401NPA	92695
Y-500A	92674
Y-500NPA	92697
Y-501NPA	92696
YB500A	92689

HD MFG	TRUCKEX
1-300-18A	28495
1-300-24A	24941
1-300-36A	34713
1-300-48	44854
1-300-48CP	844002
1-300-120A	923120
1-350-18A	9599
1-350-24A	24735
1-350-36A	34714
1-350-48A	44731
1-400-18A	24711
1-400-24A	24737
1-400-24CP	824738
1-400-36A	34715
1-400-36CP	834004
1-400-48A	44656
1-400-48CP	844003
1-400-60A	54991
1-400-60CP	854002
1-500-18A	24712
1-500-18CP	824701
1-500-24A	24739
1-500-24CP	824006
1-500-36A	34716
1-500-36CP	834005
1-500-48A	44658
1-500-48CP	844004
1-500-60A	54720
1-500-60CP	854003
1-500-120A	924120
1-605-120CP	884002
2-400-18A	24706
2-400-36CP	834003
2-400-48A	44657
2-400-48CP	844661
2-400-60A	54984
2-400-60CP	854715
2-401-36CP	834002
2-401-51DA	54827

HD MFG	TRUCKEX
2-401-51DCP	854004
2-500-36A	34829
2-500-36CP	834708
2-500-48A	44659
2-500-48CP	844663
2-500-60A	54985
2-500-60CP	854716
2-501-36CP	834779
2-501-48CP	844001
2-501-55DA	54829
2-501-55DCP	854005
2-501-60CP	854001
2-501-60DA	54992
3-150-18	14748
3-300-12CP	814621
3-300-18A	24937
3-300-18CP	824000
3-300-24A	24744
3-300-48CP	844734
3-300-60CP	854000
3-300A	14618
3-301-36CP	834725
3-301-48A	34828
3-301-48CP	844737
3-301A	24344
3-350-12CP	814622
3-350-18A	24938
3-350-18CP	824001
3-350-24CP	824002
3-350-36A	34827
3-350-36CP	834000
3-350-48CP	844735
3-350A	14619
3-351-24A	24939
3-351-24CP	824004
3-351-36CP	834001
3-351-48	44853
3-351-48CP	844000
3-351A	24345
3-400-12CP	814623
3-400-18A	24713
3-400-18CP	824715
3-400-24A	24746
3-400-24CP	824757
3-400-36A	34719
3-400-36CP	834746
3-400-48A	44664
3-400-48CP	844668
3-400-60A	54721
3-400-60CP	854723
3-400-60LA	54993
3-400-60LCP	854006
3-400-60LCP	854007
3-400-72A	64673

HD MFG	TRUCKEX
3-400-72CP	864671
3-400-84CP	874608
3-400-96CP	884548
3-400A	24674
3-401-12A	24346
3-401-18A	24717
3-401-18CP	824721
3-401-24A	24748
3-401-24CP	824749
3-401-36A	34723
3-401-36CP	834727
3-401-48A	44665
3-401-48CP	844669
3-401-48LA	54117
3-401-60A	54725
3-401-60CP	854727
3-401-72CP	864000
3-401-84CP	874000
3-401-96CP	884000
3-500-084CP	874609
3-500-108CP	884001
3-500-18A	24714
3-500-18CP	824716
3-500-20A	24672
3-500-24A	24747
3-500-24CP	824758
3-500-36A	34720
3-500-36CP	834747
3-500-48A	44666
3-500-48CP	844670
3-500-60A	54722
3-500-60CP	854724
3-500-72CP	864672
3-500-96CP	884550
3-501-18A	24718
3-501-18CP	824722
3-501-20A	24347
3-501-24A	24750
3-501-24CP	824751
3-501-36A	34724
3-501-36CP	834728
3-501-48A	44667
3-501-48CP	844671
3-501-50DCP	854830
3-501-60A	54726
3-501-60CP	854728
3-501-72CP	864001
3-501-84CP	874002
3-501-96CP	874001
3-600A	24696
3-601A	24697
3-601CP	824005
3-605-108CP	894902
3-605-120CP	894903

CROSS
REFERENCE

HD EXHAUST CROSS REFERENCE



HD MFG	TRUCKEX
3-605-60CP	864746
3-605-96CP	884563
3-615-48CP	854881
3-615-60CP	864745
4-42	809298
4-42CP	809302
4-48-4CP	809309
4-51-1075SS	809500
4-51-10CP	809306
4-51-10P	809304
4-51-6SCSS	809307
4-51-85SS	809498
4-51-9075SS	809500
4-51-90SS	809429
4-364P	809301
4-484	809427
4-484SS	809458
4-485CP	809428
4-485P	809308
4-4285	809303
4-4285CP	809305
5-4CP	9456
5-5CP	9457
5-6CP	9810
5-10CP	9453
5-85CP	9451
5-85CP	9805
5-90CP	9452
5-1075CP	9724
5-9075CP	9725
6C-400CP	SBC400
6C-500CP	SBC500
6C-600CP	SBC600
6F-400	9350
6F-400CP	SBF400
6F-500CP	SBF500
6F-600CP	SBF600
7-18CP	9430
9-200	9371
9-225	9370
9-250	9372
9-275	9378
9-300	9373
9-300CP	9571
9-350	9374
9-400	9375
9-400CP	9573
9-450	9376
9-500	9377
9-500CP	9575
9-550	9704
9-600	9369
10-200	200K1014
10-200A	200A1016

HD MFG	TRUCKEX
10-250	212K1014
10-250A	212A1016
10-275A	234A1016
10-300	300K1014
10-300A	300A1016
10-350A	312A1016
10-400	400C1016
10-400A	400A1016
10-450	412A1016
10-500	500C1016
10-500A	500A1016
10-550A	512A1016
10-600	600C1016
10-600A	600A1016
11-300-45A	10313
11-300-45CP	809734
11-350-30A	10631
11-350-45A	10314
11-350-45CP	809735
11-350-60A	10639
11-400-30A	10632
11-400-45A	10315
11-400-45CP	809415
11-400-45CP	809736
11-400-60A	10640
11-500-30A	10633
11-500-45	10732
11-500-45A	10317
11-500-45CP	809417
11-500-60A	10641
11-600-45	10733
11-600-45CP	809740
11A-300-45	10564
11A-350-30A	10635
11A-350-45	10565
11A-350-60A	10643
11A-400-15A	10684
11A-400-30A	10636
11A-400-45A	10566
11A-400-45A	10745
11A-400-45CP	809750
11A-400-60A	10644
11A-500-15A	10685
11A-500-30A	10637
11A-500-45A	10747
11A-500-45CP	809753
11A-500-60A	10645
11B-400-45A	10736
11S-400-45	10728
11S-500-45A	10729
11S-500-45CP	809738
12-107L	68183
12-107R	68185
12-300A	10304

HD MFG	TRUCKEX
12-300CP	809768
12-300F	10675
12-300FA	10758
12-300FS	10756
12-350A	10305
12-350CP	809769
12-350FA	10759
12-350FS	10795
12-350FSA	10676
12-350LA	10760
12-400A	10306
12-400CP	809406
12-400FCP	809770
12-400FS	10761
12-410A	10620
12-410CP	809621
12-488A	10681
12-488CP	809793
12-500A	10308
12-500CP	809408
12-500F	10765
12-500FA	10554
12-500FCP	809546
12-510A	10557
12-510CP	809771
12-512A	10680
12-512CP	809547
12-600A	10310
12A-300A	10777
12A-350A	10794
12A-350FA	10329
12A-400A	10783
12A-440A	10781
12A-550	10785
12A-550A	10789
12A-550CP	809795
12A-555A	10541
12B-300A	10778
12B-300FA	10534
12B-350A	10536
12B-350FA	10535
12B-400A	10537
12B-400F	18148
12B-400FA	10539
12B-400FCP	809794
12B-400LA	10679
12B-410A	10538
12B-500	10309
12B-500FA	10796
12B-500LA	10542
12B-512	10791
12B-512CP	809796
12F-5006A	38606
12F-5013A	10786

HD MASTER INTERCHANGE (Continued)

HD MFG	TRUCKEX
12K-107LCP	868184
12K-107RCP	868186
12K-14122A	38610
12K-14764LA	38611
12K-14764RA	38612
12K-6326A	38613
12K-8049A	38614
12L-400A	10553
12L-500A	10555
12M-21698A	28528
12M-21781	18107
12M-21783P4	18108
12M-32603A	38603
12M-32611SA	68181
12M-32612RA	68182
12M-32618A	38761
12M-32825A	28529
12M-32826A	38604
12M-4762A	38436
12N-503841A	28534
12N-503845A	38607
12N-582167A	38608
12P-1726A	10560
12P-1726CP	809530
13-300	9363
13-350	9364
13-400	9365
13-500	9366
13-FMB-1	9352
13-FMB-2	9353
13P-500CP	SB500
13P-600CP	SB600
14-400A	92673
14-500A	92674
14B-400	92679
14B-500	92689
14F-5974A	94010
14K-14766A	94942
14P-04055A	94941
14P-13055A	94011
15-600	9354
15-700	9355
15-800	9580
15-850	9356
15-900	9357
15-1000	9358
15-1015	9359
15-8511	9360
16-200M	8868
16-250M	8872
16-300-10M	8986
16-300-10S	8885
16-300M	8880
16-300S	8982

HD MFG	TRUCKEX
16-350-10M	8987
16-350-10S	8886
16-350M	8881
16-350S	8983
16-400-10M	8988
16-400-10S	8887
16-400M	8882
16-400S	8878
16-500-10M	8989
16-500-10S	8888
16-500M	8877
16-500S	8879
16-600-10M	8990
16-600-10S	8895
16-600M	8898
16-600S	8899
17-350-18A	24935
17-400-18	24654
17-400-36SS	34647
17-500-18A	24936
17B-300-18	24752
17B-300-18SS	24675
17B-300-24	24929
17B-300-24SS	24850
17B-300-36	34826
17B-300-36SS	34825
17B-350-18	24753
17B-350-18SS	24676
17B-350-24	24849
17B-350-36	34785
17B-350-36SS	34786
17B-400-12	14738
17B-400-12SS	14739
17B-400-18	24754
17B-400-18SS	24677
17B-400-24	24835
17B-400-24SS	24836
17B-400-36	34743
17B-400-36SS	34673
17B-400-48	44786
17B-500-12	14740
17B-500-12SS	14737
17B-500-18	24755
17B-500-18SS	24678
17B-500-24	24837
17B-500-24SS	24838
17B-500-36	34744
17B-500-36SS	34674
17B-500-48A	54831
17B-500-48SS	44867
18-200	U200
18-225	U214
18-250	U212
18-275	H234P

HD MFG	TRUCKEX
18-275	T234
18-300	T300
18-300Z	T300Z
18-325	T314
18-350	T312
18-350Z	T312Z
18-400	T400
18-400CP	9486
18-400Z	T400Z
18-450	H412
18-450Z	T412Z
18-476Z	H412
18-500	T500
18-500CP	9487
18-500Z	T500Z
18-550	T512Z
18-600	T600
18-600Z	T600Z
18A-400	AS400
18A-500	AS500
19-300	9501
19-300CP	9490
19-350	9502
19-400CP	9492
19-400Z	9503
19-500	9504
19-500CP	9493
19-600CP	9495
19-600Z	9506
19A-200	H200
19A-225	H214
19A-250	H212
19A-300	H300
19A-300Z	H300Z
19A-350	H312
19A-350	H312P
19A-400	H400
19A-400Z	H400Z
19A-450	H412P
19A-450Z	H412PZ
19A-500	H500
19A-500Z	H500Z
19A-600	H600
19A-600Z	H600Z
20-200	9381
20-200-ES	B200
20-225	9382
20-225-ES	B214
20-250	9383
20-250-ES	B212
20-275	9389
20-275-ES	B234
20-300	9384
20-300A	A300

HD MFG	TRUCKEX
20-300-ES	B300
20-350	9385
20-350A	A312
20-350-ES	B312
20-400	9386
20-400A	A400
20-400-ES	B400
20-500	9387
20-500A	A500
20-500-ES	B500
20-600	9388
20-600-ES	B600
20A-200	9660
20A-225	9661
20A-250	9662
20A-275	9663
20A-300	9604
20A-350	9605
20A-400	9606
20A-400	9698
20A-500	9607
20A-500	9699
20B-225	9673
20B-250	9674
20B-275	9675
20B-300	9676
20B-300	9678
20B-350	9678
20B-400	9680
20B-500	9682
20S-200	9664
20S-225	9665
20S-250	9666
20S-275	9667
20S-300	9668
20S-350	9669
20S-400	9623
20S-500	9624
21-113	9395
21-113-1/2	9396
21-114	9399
21-192	9616
21-213	9610
21-215	9615
21-233	9622
21-243 1/2	9613
21-314	9614
21-344	9619
21-364	9617
21-374	9653
23-400A	9341
23-500A	9342
24-400A	9343
24-500A	9344

HD MFG	TRUCKEX
25-404	9587
26-300A	9470
26-305A	9708
26-350A	9391
26-355A	9392
26-400A	9474
26-405A	9475
26-500A	9478
26-505A	9393
26-506A	9717
26K-166A	9629
26M-21408	8981
27-404	9586
28-350A	8953
28-353A	8955
28-430A	8956
28-430A	8958
28-435A	8957
28-540A	8958
28-650A	9335
29-350	9600
29-353A	9333
29-375A	9334
29-430A	9722
29-435A	9332
29-540A	9331
29-650A	8969
29A-430A	8963
29A-435A	8964
29A-540A	8965
29A-650A	9336
30-300	8975
30-300A	13009
30-350A	8976
30-400	8991
30-400A	18103
30-500A	8972
30-500A	8978
30-600A	8979
31-300	14339
31-300A	14601
31-350	14340
31-350A	14602
31-400	14341
31-400A	14603
31-500A	14605
31-600A	8974
31A-300A	8970
31A-350A	8971
31A-500A	8973
32-390	924003
32-490	924004
32-590	924005
32-690	926006

HD MFG	TRUCKEX
32-790	927006
32-890	928006
32-5590	925506
32A-690	926101
33-445	924105
33-545	925005
33-645	926005
33-745	927005
33-845	928005
33-5545	925505
34-4	924104
34-5	925105
34-6	926004
34-7	927004
34-8	928004
34-55	925504
35-65	926503
35-86	928603
35-87	928703
35-554	925543
35-555	925553
35-655	926553
36-3	9589
36-4	9591
36-5	9592
36-6	9594
36-7	9595
36-8	9596
36-35	9590
36-55	9593
37-65	926508
37-545	925458
37-555	925558
37-655	926658
38-655	926557
38-7590	927557
40-5	925002
40-6	926002
40-7	927002
40-8	928002
40-55	925502
30566	3931
31001	3607
31002	3901
31004	3654
31008	609
31009	2645
31015	2704
31018	3662
31020	3891
31021	3667
31021	3897
31022	3891
31023	3897

HD MFG	TRUCKEX
31024	3682
31025	3679
31026	3689
31031	3669
31032	3670
31035	3676
31036	3614
31037	3647
31038	3687
31045	3893
31063	3640
31074	3970
31076	3955
31081	3925
31084	3683
31085	3618
31096	3625
31102	3626
31104	3627
31109	3681
31119	3666
31123	3632
31127	3611
31129	3716
31133	3705
31136	3636
31139	3677
31142	3637
31150	3702
31163	3873
31164	3714
31165	3699
31179	3898
31200	3900
31202	3678
31214	3704
31218	3698
31219	687
31226	3610
31230	3711
31233	3707
31249	3938
31252	3888
31253	3895
31388	3930
31479	3928
31514	3712
HD-225	3902
HD-250	3880
HD300	3721
HD-300-39	3652
HD350	3720
HD-400	3887
HD-6017	3889

HD MFG	TRUCKEX
HD-15011	3941
HD-94014	3913
SA300	3692
SA350	3693
SA400	3694
SA500	3695

JONES	TRUCKEX
MH150	4222
TM293	3901
TM294	3904
TM295	3902
TM296	687
TM297	3907
TM298	3651
TM299	3654
TM789	3225
TM790	2080
TM792	3906
TM794	698
TM795	3150
TM797	3652
TM798	609
TM799	3607
TM801	2704
TM804	3697

NELSON	TRUCKEX
6292T	3965
012825	4222
02366T	4248
02454T	3969
03154T	3947
03938T	3985
04269T	3956
04566T	3951
04648T	3984
04839T	3950
04859T	3999
05388T	3952
05757T	3963
05908T	3953
06292T	3966
06375T	3954
08045T	3960
09166T	3981
09167T	3959
09178T	3986
09707T	3964
09947T	3991
10156T	3977
10315T	3972

HD MASTER INTERCHANGE (Continued)

NELSON	TRUCKEX
11026T	4210
11669T	3957
11675T	3967
13994T	4238
14245T	3976
14472T	3980
14490T	3998
14944T	4203
15287T	7661
15288T	3973
15289T	3997
15510T	3995
15906T	4202
16487T	3974
17205T	3996
17257T	3949
18202T	3948
18901T	4200
201557N	3624
22708T	4201
22724A	2156
22724C	3225
24691T	4204
49115U	4223
49120B	3690
49125A	3691
49130A	3692
49135A	3693
49140A	3694
49150A	3695
86102M	3897
86106M	3689
86108M	3666
86111M	3666
86113M	3679
86115M	3898
86117M	3676
86118M	3911
86119M	3627
86121M	3900
86125M	3614
86127M	3625
86130M	3640
86131M	3666
86132M	3667
86133M	3670
86134M	3662
86135M	3663
86136M	3901
86137M	3654
86138M	3906
86139M	2704
86139M	3655
86140M	609

NELSON	TRUCKEX
86141M	2645
86142M	687
86144M	3681
86145M	3682
86147M	3647
86148M	3918
86149M	3678
86150M	3618
86151M	3677
86152M	3707
86153M	3632
86163M	3654
86164M	2958
86168M	3669
86172M	3879
86173M	3683
86174M	3685
86175M	3684
86177M	3970
86178M	3955
86180M	3913
86183M	3697
86184M	3150
86185M	3610
86186M	3880
86187M	3721
86188M	3720
86189M	3887
86191M	3925
86192M	3626
86193M	3636
86194M	3645
86196M	3722
86200M	3714
86203M	3675
86213M	3668
86220M	3706
86301M	3661
86305M	3876
86502M	3700
86503M	3698
86505M	3710
86509M	3701
86510M	3915
86511M	3703
86512M	3611
86514M	3890
86515M	4221
86519M	3613
86522M	3725
86526M	3702
86529M	3713
86530M	3919
86536M	3716

NELSON	TRUCKEX
86536M	4242
86537M	3704
86539M	3624
86542M	3931
86543M	4236
86544M	3714
86547M	3715
86548M	3916
86550M	3112
86556M	3875
86557M	3708
86560M	3888
86561M	3889
86562M	3929
86563M	3637
86570M	3933
86594M	3908
86597M	3705
86606M	3912
86607M	3930
86624M	3872
86626M	3873
86632M	2318
86635M	3387
86636M	4213
86639M	2314
86640M	2323
86641M	3425
86642M	3256
86646M	3909
86648M	3225
86649M	3701
86651M	3609
86653M	3711
86654M	3905
86655M	3924
86657M	3616
86672M	3923
86675M	3424
86682M	3699
86684M	3728
86685M	3932
86686M	3921
86690M	3726
86694M	3866
86695M	3914
86697M	3920
86698M	3730
86699M	3619
86713M	3891
86722M	3719
86723M	3939
86725M	3938
86739M	3667

NELSON	TRUCKEX
86740M	3712
86744M	3885
86753M	4240
86754M	3917
86755M	3851
86756M	3940
86771M	3926
86773M	3893
86774M	3851
89014C	834003
89015A	44657
89015C	844661
89017A	34829
89017C	834708
89018A	44659
89018C	844663
89019A	54985
89019C	854716
89020A	34713
89021A	44854
89021C	844002
89022A	24735
89023A	34714
89024A	44731
89025A	24737
89025C	824738
89026A	34715
89026C	834004
89027A	44656
89027C	844003
89028A	24739
89028C	824006
89029A	34716
89029C	834005
89030A	44658
89030C	844004
89031A	54720
89031C	854003
89036C	834725
89037A	34828
89037C	844737
89040A	24939
89040C	824004
89041C	834001
89042A	44853
89042C	844000
89043A	24748
89043C	824749
89044A	34723
89044C	834727
89045A	44665
89045C	844669
89046A	24750
89046C	824751

NELSON	TRUCKEX
89047A	34724
89047C	834728
89048A	44667
89048C	844671
89049A	54726
89049C	854728
89051C	844734
89052A	24745
89052C	824002
89053A	34827
89053C	834000
89054C	844735
89055A	24746
89055C	824757
89056A	34719
89056C	834746
89057A	44664
89057C	844668
89058A	24747
89058C	824758
89059A	34720
89059C	834747
89060A	44666
89060C	844670
89071A	10311
89072A	10312
89073A	10313
89073C	809734
89074A	10727
89074C	809737
89075A	10732
89075C	809739
89076A	10733
89077A	10314
89077C	809735
89082A	10562
89083A	10564
89084A	10745
89085A	10747
89087A	10565
89090A	10776
89091A	10337
89092A	10794
89093A	10338
89094A	10781
89095A	10339
89096A	10789
89097A	10340
89098A	10301
89099A	10303
89101A	10675
89102A	10304
89102C	809404
89103A	10759

NELSON	TRUCKEX
89104A	10305
89104C	809769
89105A	10620
89105C	809770
89106A	10306
89106C	809406
89107A	10765
89107C	809546
89108A	10308
89108C	809408
89109A	10556
89110A	10773
89111A	10774
89113A	10534
89114A	10536
89115A	10537
89116A	10539
89117A	10540
89117C	809796
89118A	10309
89119A	10792
89123A	10790
89124A	10783
89126A	10785
89131A	10683
89132A	10684
89133A	10685
89143A	14618
89143C	814621
89144A	14619
89144C	814622
89145A	24713
89145C	824715
89146A	24714
89146C	824716
89147A	24696
89150A	10921
89151A	14343
89152A	14634
89153A	24344
89154A	24345
89155A	24717
89155C	824721
89156A	24718
89156C	824722
89157A	24697
89157C	824005
89160A	14601
89161A	14602
89162A	14603
89163A	14605
89164A	8975
89165A	8976
89166A	8991

NELSON	TRUCKEX
89167A	8978
89168A	8960
89169A	8961
89170A	8962
89171A	8963
89172A	8964
89173A	8965
89180A	8941
89182A	9600
89183A	9334
89184A	9333
89185A	9722
89186A	9332
89187A	9331
89205A	54984
89205C	854715
89207A	24205
89211A	28495
89212A	24941
89214A	9599
89216A	24711
89217A	54991
89217C	854002
89218A	24712
89218C	824701
89220A	44863
89222A	54725
89222C	854727
89226A	54721
89226C	854723
89227A	54722
89227C	854724
89230A	10302
89232A	10793
89233A	10775
89234A	10778
89235A	10535
89236A	10330
89239A	10755
89241A	10320
89242A	10741
89243A	10318
89245A	8970
89247A	8972
89248A	8973
89249A	8933
89250A	8943
89252A	8979
89256A	9649
89258A	8971
89261A	14337
89262A	8951
89263A	14338
89264A	8980

NELSON	TRUCKEX
89266A	8974
89267A	8946
89268A	8947
89269A	8948
89270A	8952
89271A	8953
89273A	8954
89274A	8955
89275A	8956
89276A	8957
89277A	8958
89278A	9335
89279A	8942
89283A	9336
89284A	14342
89293C	864000
89294C	874000
89295C	884000
89296C	864001
89297C	874002
89298C	874001
89415A	9896
89417A	9897
89420A	9371
89422A	9370
89425A	9372
89427A	9378
89430A	9373
89430C	9571
89435A	9374
89440A	9375
89440C	9573
89445A	9376
89450A	9377
89450C	9575
89455A	9704
89460A	9369
89500K	9612
89501K	9627
89503K	9615
89505K	9395
89506K	9396
89507K	9647
89507K	9657
89508K	9479
89509K	9617
89510K	9616
89511K	9398
89512K	9613
89513K	9399
89518K	9350
89519K	8483
89520K	9653
89521K	B200

HD MASTER INTERCHANGE (Continued)

NELSON	TRUCKEX
89521W	9381
89522K	B214
89522W	9382
89523B	B234
89523K	B212
89523W	9383
89524K	B234
89524W	9389
89525B	B300
89525K	B300
89525W	9384
89526B	B312
89526K	B312
89526W	9385
89527B	B400
89527K	B400
89527W	9386
89528B	B500
89528K	B500
89528W	9387
89529B	B600
89529K	B600
89529W	9388
89530K	9626
89531K	9622
89532K	9619
89533K	9614
89534K	9354
89535K	9355
89536K	9580
89537K	9360
89538K	9356
89539K	9357
89540K	9358
89541K	U200
89542K	U214
89543K	U212
89544K	T234
89545K	T300Z
89546K	T314
89547K	T312Z
89548B	H400PZ
89548C	9486
89548K	T400Z
89549C	9487
89549K	T500Z
89550C	9734
89550K	T600Z
89551K	9359
89556K	9501
89557K	9502
89558K	9503
89559K	9504
89560K	9506

NELSON	TRUCKEX
89566K	9490
89568K	9492
89569K	9493
89570K	9495
89571K	9618
89580K	9589
89581K	9590
89582K	9591
89584K	9592
89585K	9593
89586K	9594
89587K	9595
89588K	9596
89600K	24752
89601K	24930
89602K	34826
89603K	24753
89604K	24849
89605K	34785
89606K	24754
89607K	24835
89608K	34743
89609K	24755
89610K	24837
89611K	34744
89613K	24675
89614K	24929
89615K	34825
89617K	24676
89618K	24850
89619K	34786
89620K	8883
89621K	8884
89622K	8885
89623K	8886
89624K	8887
89625K	8888
89626K	8895
89639K	8981
89640K	8984
89641K	8985
89642K	8986
89643K	8987
89644K	8988
89645K	8989
89646K	8990
89657K	8855
89661K	924002
89662K	925002
89663K	925502
89664K	926002
89665K	927002
89666K	928002
89666K	800A1016

NELSON	TRUCKEX
89670K	200K1016
89672K	300A1016
89673K	312A1016
89675K	500C1016
89676K	600C1016
89678K	412A1016
89679K	512A1016
89685K	300A1014
89686K	312A1014
89687K	400A1016
89688K	500A1016
89697K	214K1016
89698K	600A1016
89708K	8868
89709K	8870
89710K	8872
89712K	8875
89713K	8881
89714K	8882
89715K	8877
89716K	8898
89721K	8982
89722K	8983
89723K	8878
89724K	8879
89726A	8957
89726K	14739
89727K	24677
89728K	24836
89729K	34673
89730K	14737
89731K	24678
89732K	24838
89733K	34674
89740K	24931
89741K	34647
89744C	809428
89747C	809429
89748A	809298
89749C	809299
89749C	809300
89759K	8856
89761K	9451
89762K	9452
89763K	9453
89764K	9453
89766K	9798
89767K	9799
89770K	9456
89771K	9457
89772K	8857
89774C	809458
89775K	9811
89780A	10315

NELSON	TRUCKEX
89780C	809736
89781A	10730
89781C	809738
89782A	10566
89783A	10746
89784A	10680
89784C	809547
89786K	9726
89787K	9727
89788K	9728
89789K	9729
89805K	924105
89807K	925005
89808K	925505
89809K	926005
89810K	927005
89811K	928005
89818K	924003
89820K	924004
89821K	924005
89822K	925506
89824K	926006
89825K	927006
89827K	928006
89831K	926557
89835K	924104
89837K	925105
89838K	925504
89839K	926004
89840K	927004
89841K	928004
89846K	925543
89847K	925553
89848K	926503
89849K	926553
89851K	928603
89852K	928703
89858K	926508
89866K	927557
89880A	58412
89881A	9648
89883A	9650
89884A	48563
89885A	38607
89887A	68182
89893A	44855
89896A	10307
89897A	28528
89899A	34830
89901A	68185
89901C	868186
89902A	68183
89902C	868184
89915A	24706

NELSON	TRUCKEX
89924A	10764
89924C	809771
89925A	10538
89926A	10788
89940A	92673
89941A	92679
89942A	92698
89943A	92678
89950A	92674
89951A	92689
89955K	9470
89956K	9471
89957K	9392
89958A	9473
89958K	9711
89960K	9476
89961K	9394
89962K	9391
89963K	9710
89964K	9474
89965A	9475
89965K	9714
89966K	9393
89967K	9478
89968K	9706
89969K	9713
89971K	9718
89973K	9586
89974K	9587
89979K	9813
89980K	9812
89985A	64673
89985C	864671
89986C	874608
89987C	884548
89988C	864672
89989C	874609
89990C	884550
89991C	834002
89993C	834779
89994C	844001
89995C	809499
89996C	809498
90006A	9245
90013A	9261
90051A	8660
90054A	8911
90056A	8940
90057A	8959
90059A	8937
90066A	8939
90071A	9582
90072A	9361
90074A	9362

NELSON	TRUCKEX
90076A	9363
90077A	9364
90079A	9365
90080A	9366
90092A	T412Z
90161K	9736
90168K	8858
90191K	8859
90206K	8876
90266A	9927
90350A	9660
90351A	9661
90352A	9662
90353A	9663
90354A	9604
90355A	9605
90356A	9606
90358A	9699
90360A	9664
90361A	9665
90362A	9666
90363A	9667
90364A	9668
90365A	9669
90366A	9623
90367A	9670
90368A	9624
90369A	9671
90370A	9672
90371A	9673
90372A	9674
90373A	9675
90374A	9676
90375A	9678
90376A	9680
90377A	9681
90378A	9682
90379A	9683
90380A	9684
90381A	9685
90382A	9686
90383A	9687
90384A	9688
90385A	9690
90386A	9692
90387A	9693
90388A	9694
90389A	9695
90419A	8784
90438C	854001
90444A	54993
90444C	854006
90446A	54128
90447C	874638

NELSON	TRUCKEX
90449C	884563
90450C	894902
90451A	54827
90451C	834006
90452A	54829
90452C	854830
90459A	10553
90460A	10555
90463A	10763
90464K	B412
90465A	10560
90465C	809530
90468K	9514
90469K	9516
90470K	9518
90526C	884001
90527K	9610
90528K	9611
90530K	9397
90531K	9654
90532A	9341
90533A	9342
90536A	9343
90539A	9344
90555C	809500
90562A	10620
90566A	923120
90567A	9708
90568C	854881
90570C	864745
90578C	884002
90579C	894903
90823A	38608
90843K	8052
90855A	38604
90856C	809307
90857K	9810
90866A	H300
90867A	H400
90868A	H500
90875A	AS400
90877A	AS500
90902K	14740
90903K	14738
90905C	864746
90906A	924120
90907K	CLV400
90908K	CLV500
90909A	14620
90909C	814623
90910A	14758
90910C	814624
90913A	24346
90914K	U178

NELSON	TRUCKEX
90915K	U214
90916K	U212
90921A	58317
90922A	38603
90923A	68181
90924A	38436
90925A	38435
90927K	U112
90928K	U134
90929K	U200
90930K	H218
90931A	38761
90936A	9716
90938A	18109
90939A	28657
90951K	B314
90954A	11051
90955A	38613
90956A	9629
90957A	38610
90958A	28661
90958C	SB600
90961A	28534
90965A	38609
90967A	38585
90969A	48476
90971A	28529
90973A	28530
90974A	38605
90977A	38614
90979A	38612
90980A	38611
90981A	94942
90982A	10787
90984A	38606
90987A	28699
90989A	48478
90990A	58372
90991A	58318
90992A	48477
90993A	94941
900005A	9628
900022C	SB500
900025A	18108
900040K	H234P
900041K	H300P
900042K	H312P
900043K	H400P
900044K	H500P
900045K	H600
900050A	10674
900052A	10758
900054A	10760
900055A	10681

HD MASTER INTERCHANGE (Continued)

NELSON	TRUCKEX	NELSON	TRUCKEX	NELSON	TRUCKEX	NELSON	TRUCKEX
900056A	10678	913008A	93955	922034A	28645	924010S	48405
900059A	18148	913009A	94939	922038A	28237	924014A	44748
900060A	10679	914001A	94993	922041A	28662	924015A	44749
900062A	10791	914002A	94915	922044A	28523	924016A	48568
900064A	10315	914003A	48235	922045A	28524	924017A	48150
900065A	10317	914004A	94978	922046A	28522	924018A	58248
900069A	10567	914005A	94969	922047A	28521	924020A	83002
900070A	10559	914006A	94991	922049A	28660	924021A	48234
900071A	10748	914007A	94976	922051A	24945	924023A	48461
900072A	10631	914008A	94971	922053A	28659	924025S	48402
900073A	10632	914009A	94973	922070A	28655	924026A	44759
900074A	10633	914010A	94919	923003A	48386	924027A	44773
900075A	10634	914012A	95988	923004A	48385	924028A	44774
900076A	10635	914014A	58363	923005A	38464	924029A	54853
900077A	10636	914015A	95977	923006A	48383	924030A	48512
900078A	10637	914016A	95981	923007A	44796	924031A	48329
900079A	10638	915001A	95962	923008A	48348	924032S	54773
900080A	10639	915002A	48233	923010A	38463	924036A	34798
900081A	10640	915003S	48403	923011S	38486	924037A	34799
900082A	10641	915004S	94921	923014A	38288	924037A	54880
900083A	10724	915007A	96632	923015A	38223	924038A	58418
900084A	10643	915008A	95996	923016A	38268	924045A	84564
900085A	10644	915013A	95957	923017A	38269	924055A	44795
900086A	10645	915016A	95986	923018A	38270	924056A	48463
900087A	10646	915017A	95995	923019A	38271	924057A	54117
900091A	34831	918001A	84562	923020A	38348	924058S	48319
900095A	9721	921003A	18139	923021A	38347	924059S	48320
900096A	9723	921007A	28392	923022A	34742	924061A	48466
900103A	94010	921010A	18076	923023A	38234	924062A	48516
900105A	28656	921011A	24684	923024A	38266	924063A	48517
900121A	94011	921012A	18077	923025A	28174	924063A	58339
900190A	9479	921016A	18101	923026A	28382	924064A	48347
900243A	9149	921019A	18102	923028A	38193	924065A	48469
900248A	9165	921023A	18101	923034A	28326	924066A	48468
900249A	9146	921024A	18106	923034A	38459	924068A	48152
900253A	9569	921025A	14705	923037A	38528	924070A	48462
900268A	9353	921026A	18150	923040A	38413	924075A	83015
900269A	9578	922001A	38273	923042A	34879	924077A	34812
900270A	9579	922002A	37764	923043A	34814	924078A	34813
900304A	8566	922003A	28169	923044A	34816	924079A	54907
900306A	9220	922005A	38743	923045A	34815	924081A	44821
900307A	8717	922006A	38284	923049A	38763	924082A	44822
900308A	9260	922007S	38414	923050A	38764	924083A	48551
900309A	8698	922008A	38487	923059A	34882	924084A	48565
900310A	8699	922009A	28425	923063A	10786	924085A	48554
900311A	9118	922012A	9597	924001A	54843	924086A	48552
900315A	9259	922013A	28639	924002A	48384	924087A	48555
912003A	93933	922016A	28134	924003A	44797	924088A	44856
912004A	92681	922018S	28309	924004A	48349	924098A	48571
912005A	93928	922020A	18083	924005A	83016	925001A	58205
912006A	92694	922023A	28516	924006S	58283	925002A	54809
913001S	94900	922031A	28517	924007S	48318	925003A	54808
913005A	95973	922032A	34812	924008A	58330	925004A	58319
913007A	94992	922033A	28515	924009S	48404	925005A	58349

NELSON	TRUCKEX
925008A	54789
925009A	58414
925010A	58219
925011A	58220
925012A	58222
925013A	68421
925014A	58251
925015A	58284
925018A	64729
925019A	54989
925020A	54749
925021A	54750
925022A	54760
925023A	38222
925026A	64631
925030A	84553
925032A	64722
925033A	84559
925034A	84584
925035A	54835
925036A	54834
925041A	58364
925042A	58366
925043A	58369
925045A	68374
925046A	58367
925047A	54998
925048A	58225
925049A	58141
925050A	58368
925051C	854000
925052A	64763
925055A	54129
925056A	58362
925058A	48569
925059A	58410
925067A	58407
925068A	58421
925070A	58420
925072A	58423
926001A	68160
926002A	64694
926003A	64668
926004A	58221
926005A	74607
926006A	64695
926007A	74624
926008A	68221
926009A	88104
926010A	64708
926011A	74627
926014A	64716
926019A	64730
926020A	68280

NELSON	TRUCKEX
926021A	68308
926023A	68310
926029A	74634
926032A	64691
926036A	64741
926044A	74602
926060A	84583
926062A	58225
926068A	68371
926069A	68375
926070A	68420
926072A	74646
926074A	78166
927004A	78103
927005A	84555
927006A	84571
927007A	84561
927008A	74623
927010A	74632
927011A	74629
927012A	74630
927013A	74636
927014A	74637
927018A	64744
927019A	64650
927023A	74633
927024A	74645
927025A	74654
927026A	78228
927027A	78229
928001A	84551
928002A	84560
928008A	83003
928010A	84568
929001A	83014
929002A	200A1014
929003A	214A1014
929004A	212A1014
929005A	234A1414
929006A	300A1414
929007A	400A1414
929008A	212A1014
929009A	83007
929010A	83006
929011A	83005
929012A	83008
929013K	200K1014
929014K	212K1014
929015K	300K1014
929016A	83000
929023K	400C1016
929024A	234A1014
929025A	300A1014
929026A	312A1016

NELSON	TRUCKEX
929027A	400A1014
929032A	83004
929034S	300S1014
929035S	400S1016
929036S	500S1016
929037A	83037
929038A	83029
Q78465	8893

PDC	TRUCKEX
55X50	925558
00290-12A	10773
00345-9A	10564
00390-7A	10777
00390-14A	10778
00415-4A	10684
00430-4A	10636
00445-12A	10745
00445-9A	10566
00445-9C	809750
00460-8A	10644
00490-10A	10783
00490-10C	809794
00490-12A	10539
00490-15A	10797
00490-18A	10537
00490-8A	10781
00490-8C	809793
00515-4A	10685
00530-4A	10637
00545-12A	10567
00545-15A	10747
00560-10A	10645
00590-10A	10789
00590-10C	809795
00590-12A	10791
00590-12C	809796
00590-16A	10796
00590-20A	10309
00645-8A	10748
00690-13A	10792
00690-13C	809797
002590-12A	10774
003515-4A	10683
003530-4A	10635
003545-9A	10565
003590-8A	10329
003590-12A	10535
003590-16A	10536
10245-6A	10311
10290-12A	10301
10345-6A	10313
10345-6C	809734

PDC	TRUCKEX
10345-9A	10313
10390-12A	10758
10390-12C	809768
10390-14A	10304
10430-4A	10632
10445-12A	10727
10445-12C	809737
10445-6A	10726
10445-6A	10736
10445-9A	10315
10445-9C	809736
10460-8A	10640
10490-10A	10620
10490-10C	809621
10490-12A	10761
10490-12C	809770
10490-18A	10306
10490-18C	809406
10490-25A	10553
10490-8A	10681
10530-4A	10633
10545-7A	10729
10545-7C	809738
10545-12A	10317
10545-12C	809417
10545-12C	809739
10545-15A	10732
10545-15C	809740
10560-10A	10641
10590-8A	10764
10590-8C	809544
10590-10A	10557
10590-10C	809771
10590-12A	10680
10590-12C	809547
10590-16A	10765
10590-16A	10766
10590-16C	809546
10590-20A	10308
10590-20C	809408
10590-25A	10555
10645-16A	10733
10690-13A	10767
10690-13C	809772
10690-26A	10310
31207A	24344
31217	814621
31217A	14618
31810A	24731
31817	824000
31817A	24937
32410A	24941
32417A	24744
33607	834725

HD MASTER INTERCHANGE (Continued)

PDC	TRUCKEX
33610A	34713
34807	844737
34810	844002
34810A	44854
34817	844734
34817A	34828
36017	854000
41207A	24346
41217	814623
41217A	14620
41807	824721
41807A	24717
41810	PT4184
41810A	24706
41817	824715
41817A	24713
42407	824749
42407A	24748
42410	824738
42417	824757
42417A	24746
43507	834727
43600	834003
43601	834002
43607A	34723
43610	834004
43610A	34715
43617	834746
43617A	34719
44800	844661
44800A	44657
44807	844669
44807A	44665
44810	844003
44810A	44656
44817	844668
44817A	44664
45105	854004
46000	854715
46000A	54984
46007	854727
46007A	54725
46010	854002
46017	854723
46017A	54721
46019	854006
46019A	54993
47207	864000
47217	864671
47217A	64673
48407	874000
48417	874608
49607	884000
49617	884548

PDC	TRUCKEX
51207	814625
51207A	14759
51217	814624
51217A	14758
51807	824722
51807A	24718
51810	824701
51810A	24712
51817	824716
51817A	24714
52407	824751
52407A	24750
52410	824006
52410A	24739
52417	824758
52417A	24747
53600	834708
53600A	34829
53601	834779
53607	834728
53607A	34724
53610	834005
53610A	34716
53617	834747
53617A	34720
54800	844663
54800A	44659
54801	844001
54807	844671
54807A	44667
54810	844004
54810A	44658
54817A	44666
56000A	54985
56005A	54992
56007A	54726
56010A	54720
54817	844670
56000	854716
56001	854001
56007	854728
56010	854003
56017	854724
56017A	54722
56019A	54128
57207	864001
57217	864672
58407	874002
58417	874609
59607	874001
59617	884550
61807	824005
61807A	24697
64810A	44863

PDC	TRUCKEX
102245-6A	10320
102290-12A	10302
102545-6A	10312
102590-12A	10303
102745-6A	10318
102790-13A	10793
103530-4A	10631
103545-9C	809735
103590-16A	10305
103590-16C	809769
351207A	24345
351217	814622
351217A	14619
351817	824001
351817A	24938
352407	824004
352407A	24939
352410A	24735
352417	824002
352417A	24745
353607	834001
353610A	34714
353617	834000
353617A	34827
354807	844000
354810A	44731
354817	844735
354817A	44853
510817	884001
653604	834896
654804	844886
654807	854881
656004	854151
656007	864745
656017	864746
657217	874638
659617	884563
6510817	894902
6512011	884002
6512017	894903
AMC113	U118
AMC125	U114
AMC150	U112
AMC162	U158
AMC175	U134
AMC188	U178
AMC200	U200
AMC213	U218
AMC225	U214
AMC250	U212
AT300	923002
AT400	924002
AT500	925002
AT550	925502

PDC	TRUCKEX
AT600	926002
AT700	927002
AT800	928002
BA500	9719
CMB400C	SBC400
CMB500C	SBC500
CMB600C	SBC600
CN2120	8933
CN2121	14337
CN251250	9597
CN251251	14338
CN271271	8980
CN3030	8970
CN3130	8975
CN3131	14339
CN350350	8971
CN351350	8976
CN351351	14340
CN4040	8972
CN4140	8991
CN4141	14603
CN5050	8973
CN5150	8978
CN5151	14605
CN6160	8979
CN6161	8974
CNCN5150	8978
CR40	9801
CR50	9803
CR60	9810
CR80	9804
CR85	9805
CR90	9806
CR100	9807
CR270-10	9799
CRH100	9453
CRH270-10	9724
CRH270-9	9725
FBC200	9381
FBC225	9382
FBC234	9389
FBC250	9383
FBC300	9384
FBC350	9385
FBC400	9386
FBC400A	A400
FBC450	9630
FBC500	9387
FBC500A	A500
FBC600	9388
FC300-18	24674
FC350-18	24935
FC400-18	24654
FC500-18	24936

PDC	TRUCKEX
FL9586A	10787
FL9833A	38606
FL13974A	94010
FL15653-0	28699
FL17094-012	28698
FLX200	8984
FLX200BULK	8868
FLX200S	8883
FLX225BULK	8870
FLX225S	8855
FLX250	8985
FLX250A	8858
FLX250BULK	8872
FLX250S	8884
FLX300	8986
FLX300-18	24752
FLX300-24	24930
FLX300-36	34826
FLX300A	8859
FLX300BULK	8875
FLX300S	8885
FLX300S-18	24675
FLX300S-24	24929
FLX300S-36	34825
FLX300SBULK	8982
FLX350	8987
FLX350-18	24753
FLX350-24	24849
FLX350-36	34785
FLX350A	8876
FLX350S	8886
FLX350S-18	24676
FLX350S-24	24850
FLX350S-36	34786
FLX350SBULK	8983
FLX400	8988
FLX400-12	14738
FLX400-12	14740
FLX400-18	24754
FLX400-24	24835
FLX400-36	34743
FLX400-48	44786
FLX400A	8856
FLX400-BULK	8882
FLX400S	8887
FLX400S-12	14739
FLX400S-18	24677
FLX400S-24	24836
FLX400S-36	34673
FLX400SBULK	8878
FLX500	8989
FLX500-18	24755
FLX500-24	24837
FLX500-36	34744

PDC	TRUCKEX
FLX500-48	54831
FLX500-72	64794
FLX500A	8857
FLX500S	8888
FLX500S-12	14737
FLX500S-18	24678
FLX500S-24	24838
FLX500S-36	34674
FLX500S-48	44867
FLX500SBULK	8879
FLX600	8990
FLX600S	8895
FLX600SBULK	8899
FLX800	8893
FMB400C	SBF400
FMB500C	SBF500
FMB600C	SBF600
GH18C	9430
GH24C	9811
GR234	T234
GR300	T300
GR300	T300Z
GR325	T314
GR350	T312
GR350	T312Z
GR400	T400
GR400	T400Z
GR400C	9486
GR450	T412Z
GR500	T500
GR500	T500Z
GR500C	9487
GR550	T512Z
GR600	T600
GR600	T600Z
GR600C	9734
HD200	H200
HD225	H214
HD250	H212
HDF300	8880
HDF350	8881
HDF400	8882
HDF500	8877
HDF600	8898
HH40	924104
HH50	925105
HH55	925504
HH55X40	925543
HH55X5	925553
HH60	926004
HH60X55	926553
HH70	927004
HH80	928004
HH80X60	928603

PDC	TRUCKEX
HH80X70	928703
HP3	9589
HP4	9591
HP5	9594
IH845C1	38607
KW8049	38614
KW10742LA	68183
KW10742LC	868184
KW10742RA	68185
KW10742RC	868186
KW14122	38610
KW14764LA	38611
KW14764RA	38612
KW14766A	94942
LBP5510	3640
LDF100BULK	8860
LDF150BULK	8864
LDF175BULK	8866
LF18-500	9717
LF20-400	9474
LF20-525	9715
LF22-350	9709
LF22-500	9478
LF22-3031	9470
LF22-4041	9476
LF22-350351	9473
LF300	9708
LF301	9471
LF350	9710
LF351	9392
LF401	9475
LF500	9393
LF501	9394
LN5590	3897
LND5510	3722
LNS5510	3640
M2244	3970
M2-2525662	3654
M2-272270	609
M2-3385	2704
M2-3385X32	3627
M2-35358X11	3689
M2-3548X11	3611
M2-4358X11	3668
M2-4410	3669
M2-4410X15	3614
M2-4411	3711
M2-448X11	3632
M2-448X11	3710
M2-5510X15	3647
M2-5510X36	3676
M2A-2748X11	3610
M2A-25385	3150
M2A-252785	3697

PDC	TRUCKEX
M3-380	3687
M3-4410X15	3678
M3-4411X36	3928
M3-4411X6X3	3927
M3-4510X15	3931
M3-4590	3926
M3-5510	3702
M3-53570	3618
M3-53590	3679
M4-35408X11	3703
M4-35418X11	3704
M4410	3714
M4-4410	3677
M4-4410X15	3921
M4485	3625
M4490	3891
M4510	3715
M4510	3893
M4-5510X15	3698
M4-5511	3923
M4590	3712
M5-4410	3670
M5-4410X15	3898
M5510	3699
M5510X67	3873
M5-5510X15	3900
M5590	3667
MA400	9587
MC42-9SS	809302
MC51-9	809304
MC51-10SS	809429
MC51-10SS	809500
MC51-9SS	809500
MC5110SS	809306
MCH270-10SS	809300
MF400	9586
MH0811	9360
MH600	9354
MH700	9355
MH800	9580
MH850	9356
MH900	9357
MH1000	9358
MH1015	9359
MK21698A	28528
MK21783P4A	18108
MK32611A	68181
MK32612A	68182
MK42-10	809303
MPT20	3878
MPT25	3879
MPT30	3683
MPT35	3685
MPT40	3684

HD MASTER INTERCHANGE (Continued)

PDC	TRUCKEX
MR40	3681
MR50	3682
N50X45	925458
N60X50	926508
N60X55	926658
NPT300	9514
NPT350	9516
NPT400	9518
NS225	9370
NS275	9378
NS550	9704
NV582167A	38608
NV1652937A	18149
PB13002	18166
PB13055A	94011
PB13056C	809519
PB1726A	10560
PB1726C	809530
PB400C	SB400
PB4055A	94941
PB500C	SB500
PB600C	SB600
PH200	9582
PH250	9361
PH275	9362
PH300	9363
PH350	9364
PH400	9365
PH500	9366
RC125	9367
RC150	9896
RC175	9897
RC200	9371
RC250	9372
RC300	9373
RC300C	9571
RC350	9374
RC400	9375
RC400C	9573
RC450	9376
RC500	9377
RC500C	9575
RC600	9369
RD4030	9648
RD4031	9722
RD4130	8963
RD4131	8956
RD5040	9649
RD5041	9331
RD5140	8965
RD5141	8958
RD6040	9720
RD6050	9650
RD6051	8969

PDC	TRUCKEX
RD6150	9336
RD6151	9335
RD22021	8938
RD22120	8911
RD22121	8946
RD25021	8941
RD25120	8913
RD25121	8947
RD30251	9600
RD30271	9334
RD31250	8960
RD31251	8953
RD31271	8954
RD35031	9333
RD35130	8962
RD35131	8955
RD40351	9332
RD41350	8964
RD41351	8957
RD250221	8942
RD251220	8940
RD251221	8948
RE30	924003
RE40	924004
RE40-45	924105
RE50	924005
RE50-45	925005
RE55	925506
RE55-45	925505
RE60	926006
RE60-45	926005
RE60X50	926503
RE60x55	926557
RE70	927006
RE70-45	927005
RE70X55	927557
RE80	928006
RE80-45	928005
SA200	3690
SA250	3691
SA300	3692
SA350	3693
SA400	3694
SA500	3695
SC48SS	809458
SC485SS	809307
SF300	9501
SF300C	9490
SF350	9502
SF400	9503
SF400C	9492
SF500	9504
SF500C	9493
SF550	9736

PDC	TRUCKEX
SF600	9506
SF600C	9495
SM4490	3888
SM5590	3895
SP200A	200A1014
SP225A	214A1014
SP250A	212A1016
SP275A	234A1016
SP300	300K1014
SP300A	300A1016
SP350	312K1014
SP350A	312A1016
SP400	400C1016
SP400A	400A1016
SP450	412A1016
SP500	500C1016
SP500A	500A1016
SP550	512A1016
SP600	600C1016
SP600A	600A1016
SR300	H300
SR300	H300Z
SR350	H312
SR400	H400
SR400	H400Z
SR450	H412
SR500	H500
SR500	H500Z
SR600	H600
SRE390-4A	10337
SRE390-7A	10776
SRE490-4A	10339
SRE590-5A	10340
SRE590-16A	10541
SRE3590-4A	10338
SRE3590-7A	10329
STM50	3876
T401A	92679
T4130	92698
T41350	92678
T501A	92689
TAS400A	AS400
TAS500A	AS500
TBC200A	9672
TBC200S	9684
TBC225A	9673
TBC225S	9685
TBC250A	9674
TBC250S	9686
TBC275A	9675
TBC275S	9687
TBC300A	9676
TBC300S	9688
TBC350A	9678

PDC	TRUCKEX
TBC400A	9680
TBC400S	9692
TBC450A	9681
TBC450S	9693
TBC500A	9682
TBC500S	9694
TBC600A	9683
TBC600S	9695
TCB401	9343
TCB501	9344
TCT400	9341
TCT500	9342
TES200	B200
TES225	B214
TES250	B212
TES275	B234
TES300	B300
TES350	B312
TES400	B400
TES450	B412
TES500	B500
TES600	B600
TLC200A	9660
TLC200S	9664
TLC225A	9661
TLC225S	9665
TLC250A	9662
TLC250S	9666
TLC275A	9663
TLC275S	9667
TLC300A	9604
TLC300S	9668
TLC350A	9605
TLC350S	9669
TLC400A	9606
TLC400A	9698
TLC400S	9623
TLC400S	9696
TLC450S	9670
TLC500A	9607
TLC500A	9699
TLC500S	9624
TLC500S	9697
TLC600S	9671
UH100	8483
VBC250F	9610
VBC275C	9618
VBC275F	9656
VBC300C	9612
VBC300DD	9395
VBC300F	9626
VBC350CAT	9622
VBC350DD	9396
VBC350IHC	9613

PDC	TRUCKEX
VBC350NAV	9627
VBC400C	9653
VBC400DD	9647
VBC400M	9619
VBC400SW	9614
VBC400T	9399
VBC500C	9615
VBC500D	9655
VBC978DD	9735
Y401A	92673
Y501A	92674

RIKER	TRUCKEX
9XD403	3666
9XD503	3897
9XD508	3897
10019W	3714
10026W	3699
10915	3669
10922	3873
10928	3722
10931	3670
10945	3715
10961	3702
11901	3700
11917	3919
15007	3678
15901	3898
15903	3614
15904W	3675
15905	3647
15906	3676
15909	3645
15913	3913
60901	3901
65901	3654
81005	3616
81006	3689
81010	3915
81021	3703
81908	3632
81922	3668
85901	3625
85903	3662
85904	2704
85924	3150
90045	3712
90501	3872
90910	3888
90915	3679
90945	3890
A275	14634
A300	14618

RIKER	TRUCKEX
A300PL	824000
A350	14619
A350PL	824001
A400	14620
A400PL	824715
A500	24672
A500PL	824716
A600	24696
A30024	24744
A30060PL	854000
A35024PL	824002
A35036PL	834000
A35048PL	844735
A40024	24746
A40024PL	824757
A40036	34719
A40036PL	834746
A40048	44664
A40048PL	844668
A40060	54721
A40060PL	854723
A40072	64673
A40072PL	864671
A40084PL	874608
A40096PL	884548
A50024	24747
A50024PL	824758
A50036	34720
A50036PL	834747
A50048	44666
A50048PL	844670
A50060	54722
A50060PL	854724
A50072PL	864672
A50084PL	874609
A50096PL	884550
A60560PL	864746
A60596PL	884563
A500108PL	884001
A605108PL	894902
A605120PL	894903
AA200	10921
AA225	14342
AA250	14343
AA300	24344
AA350	24345
AA400	24717
AA400PL	824721
AA500	24347
AA500PL	824722
AA600	24697
AA600PL	824005
AA30048	34828
AA35024	24939

RIKER	TRUCKEX
AA35024PL	824004
AA35036PL	834001
AA35048	44853
AA35048PL	844000
AA40024	24748
AA40024PL	824749
AA40036	34723
AA40036PL	834727
AA40048	44665
AA40048PL	844669
AA40060	54725
AA40060PL	854727
AA40072PL	864000
AA40084PL	874000
AA40096PL	884000
AA50024	24750
AA50024PL	824751
AA50036	34724
AA50036PL	834728
AA50048	44667
AA50048PL	844671
AA50060	54726
AA50060PL	854728
AA50072PL	864001
AA50096PL	874001
AC300	9589
AC350	9590
AC400	9591
AC500	9592
AC550	9593
AC600	9594
AC700	9595
AC800	9596
AD302	9390
AD305	9708
AD308	9471
AD350	9473
AD352	9391
AD354	9473
AD355	9392
AD358	9392
AD400	9474
AD402	9476
AD404	9587
AD405	9475
AD408	9472
AD455	9718
AD502	9478
AD505	9393
AD506	9717
AD508	9394
AD5091	9719
ADN501	9716
AT300	923002

RIKER	TRUCKEX
AT400	924002
AT500	925002
AT550	925502
AT600	926002
AT700	927002
AT800	928002
B400	9343
B500	9344
C300	24674
C350	24935
C400	24654
C401SS	24677
C500	24936
C501SS	24678
CE200	8933
CE225	8939
CE250	8943
CE300	8975
CE350	8976
CE400	8991
CE500	8978
CE600	8979
CF477SS	8981
CO200	14337
CO225	8951
CO250	14338
CO275	8980
CO300	14601
CO350	14602
CO400	14603
CO500	14605
CO600	8974
CSP41960PL	854006
CT200	8907
CT300	8970
CT350	8971
CT400	8972
CT500	8973
DPS501PL	854830
DPS505	54992
FG40024	24835
FG40036	34743
FG40048	44786
FG50024	24837
FG50036	34744
FG50048	54831
FG3001918	24752
FG3501918	24753
FG4001912	14738
FG4001918	24754
FG5001912	14740
FG5001918	24755
FL275	9149
FL404	9586

HD MASTER INTERCHANGE (Continued)

RIKER	TRUCKEX
FS40024	24836
FS40036	34673
FS50024	24838
FS50036	34674
FS50048	44867
FS3001918	24675
FS3501918	24676
FS4001912	14739
FS5001912	14737
FTG20015	8868
FTG22515	8870
FTG25015	8872
FTG25019	8872
FTG30015	8875
FTG30019	8880
FTG35015	8881
FTG35019	8881
FTG40015	8882
FTG40019	8882
FTG50015	8877
FTG50019	8877
FTG60024	8898
FTG2001910	8984
FTG2501910	8985
FTG3001910	8986
FTG3501910	8987
FTG4001910	8988
FTG5001910	8989
FTG6001910	8990
FTS200SS	8883
FTS22519	8855
FTS250SS	8884
FTS30019	8982
FTS35019	8983
FTS40019	8878
FTS50019	8879
FTS60019	8899
FTS3001910	8885
FTS3501910	8886
FTS4001910	8887
FTS5001910	8888
GH115PL	9430
GH121PL	9811
H1000	9358
H1015	9359
H200	9582
H250	9361
H275	9362
H300	9363
H350	9364
H400	9365
H500	9366
H600	9354
H700	9355

RIKER	TRUCKEX
H800	8445
H811	9360
H850	9356
H900	9357
HD225	3954
HD275	4241
HD278	2958
HD2505	3651
HD2755	3882
HD3005	3721
HD3055	3652
HD3505	3720
HD4005	3887
HD6060	3677
HD6697	698
HD7429	3698
HD7713	3610
KB1001	48403
KB1002	48402
KB1003	95996
KB1004	58414
KB1005	58284
KB1008	38266
KB1009	94993
KB1010	94973
KB1012	95962
KB1013	38743
KB1101	234A1414
KB1102	84555
KB1110	400A1414
KB1113	84582
KB1115	74624
KB1116	84561
KB2001	9479
KB2002	93955
KB2003	28657
KB2007	58283
KB2008	48318
KB2009	48320
KB2010	48319
KB2011	38223
KB2012	94969
KB2014	94976
KB2016	94971
KB2017	38347
KB2018	94991
KB2019	38348
KB2020	94992
KB2021	38414
KB2022	94900
KB2101	44774
KB2102	74623
KB2103	84560
KB2104	44773

RIKER	TRUCKEX
KB2106	54809
KB2107	83008
KB2108	54808
KB2109	95973
KB2110	64694
KB2111	44759
KB2112	64693
KB2115	54789
KB2116	83007
KB3001	58285
KB3003	68160
KB3004	58205
KB3005	58221
KB3006	58220
KB3007	58251
KB3008	68221
KB3009	58219
KB3010	38268
KB3011	38269
KB3014	38271
KB3102	74607
KB3103	83005
KB3106	64668
KB3107	83002
KB3108	83003
KM1101	3697
KM1111	3911
KM2101	3613
KM2201	3710
KM2202	3708
KM2204	3701
KS3001	9056
L200	10301
L200NE	10773
L225	10302
L250	10303
L250NE	10774
L275	10793
L300	10304
L20045	10311
L22545	10320
L25045	10312
L25045NE	10562
L27545	10318
L30045	10313
L30045F	10313
L30045NE	10564
L30045PL	809734
L300F	10758
L300FNE	10534
L300FPL	809768
L300FS	10757
L300NE	10778
L300SB	10337

RIKER	TRUCKEX
L300SR	10777
L350	10305
L35030	10631
L35030NE	10635
L35045	10314
L35045NE	10565
L35045PL	809735
L35060	10639
L35060NE	10643
L350F	10676
L350FNE	10535
L350NE	10536
L350PL	809769
L350SB	10338
L350SR	10329
L400	10306
L40015	10684
L40030	10632
L40030NE	10636
L40045	10315
L40045F	10726
L40045F	10728
L40045NE	10743
L40045PL	809736
L40045SR	10744
L40045SRPL	809750
L40060	10640
L40060NE	10644
L400CR	10306
L400F	10761
L400FCR	10620
L400FNE	10539
L400FPL	809770
L400FS	10620
L400NE	10537
L400NECR	10797
L400PL	809406
L400SB	10780
L400SR	10781
L400SRPL	809793
L450F	10763
L488	10681
L488CR	10681
L500	10308
L50015	10685
L50030	10633
L50030NE	10637
L50045	10317
L50045F	10729
L50045FPL	809739
L50045NECR	10747
L50045PL	809417
L50045SR	10746
L50045SRPL	809752

RIKER	TRUCKEX
L50060	10641
L50060NE	10645
L500F	10765
L500FCR	10766
L500FNE	10540
L500FPL	809546
L500NE	10309
L500SB	10785
L500SR	10791
L510	10557
L510PL	809771
L512	10557
L512NEPL	809796
L600	10310
L600F	10556
L600SB	10792
L60030	10634
L60030NE	10638
L60045	10733
L60045SR	10749
L60060	10724
L60060NE	10646
LF501	10786
LF502	10787
LF503	10788
LF504	38606
LK501	68185
LK501PL	868186
LK502	68183
LK502PL	868184
LK503	38612
LK504	38611
LK505	18110
LL350	10760
LL400	10553
LL500	10555
LM401	28528
LM403	48476
LM405	38603
LM406	68182
LM407	68181
LM408	38435
LM409	38436
LM412	28529
LM413	38604
LM414	28530
LNN501	38607
LNN502	38608
LP402	10782
LP501	10560
LP501PL	809530
LP502	10784
LT300	3875
LT359	3618

RIKER	TRUCKEX
LT3540	3661
LT409	3681
M4010	3714
M4090	3891
M5010	3699
M5090	3667
MR200	45
MR500	3682
OR220	8938
OR250	8913
OR252	8942
OR275	8959
OR350	9600
OR353	9333
OR375	9334
OR430	9722
OR435	9332
OR540	9331
OR650	8969
OV516	3922
OV50032	3647
PB500PL	SB500
PB600PL	SB600
RCG200	9371
RCG225	9370
RCG250	9372
RCG275	9378
RCG300	9373
RCG300PL	9571
RCG350	9374
RCG400	9375
RCG400PL	9573
RCG450	9376
RCG500	9377
RCG500PL	9575
RCG550	9704
RCG600	9369
RE300	924003
RE400	924004
RE500	924005
RE550	925506
RE600	926006
RE655	926557
RE700	927006
RE750	927557
RE800	928006
RE40045	924105
RE50045	925005
RE55045	925505
RE60045	926005
RE70045	927005
RE80045	928005
RH400	924104
RH500	925105

RIKER	TRUCKEX
RH554	925543
RH555	925553
RH600	925504
RH650	926503
RH655	926553
RH700	927004
RH800	928004
RH860	928603
RH870	928703
RI220	8946
RI250	8947
RI252	8948
RI350	8953
RI353	8955
RI375	8954
RI430	8956
RI435	8957
RI540	8958
RI650	9335
RO430	8963
RO435	8964
RO540	8965
RS540	925458
RS555	925558
RS650	926508
RS655	926658
SA2009	3690
SA2509	3691
SA3009	3692
SA3509	3693
SA4009	3694
SA5009	3695
SK6-60SBC	854881
SKA1710	9724
SKA1740	9801
SKA1750	9803
SKA1760	9810
SKA1780	9804
SKA1785	9805
SKA1790	9725
SP14	809299
SP14PL	809499
SP14SS	809300
SP18PL	809428
SP214	809298
SP214SS	809500
SP1836	809301
SP5400PL	SBC400
SP5500PL	SBC500
SP5600PL	SBC600
SP1836040	809427
SPF5400PL	SBF400
SPF5500PL	SBF500
SPF5600PL	SBF600

RIKER	TRUCKEX
SPI40136PL	834002
SPI50136PL	834779
SPI50148PL	844001
SPI50160PL	854001
SPI605120PL	884002
SPO30024	24941
SPO30036	34713
SPO30048	44854
SPO30048PL	844002
SPO35036	34714
SPO40024	24737
SPO40036	34715
SPO40036PL	834004
SPO40048	44656
SPO40048PL	844003
SPO40060	54991
SPO40060PL	854002
SPO40836PL	834003
SPO40848	44657
SPO40848PL	844661
SPO40860	54984
SPO40860PL	854715
SPO50024	24739
SPO50024PL	824006
SPO50036	34716
SPO50036PL	834005
SPO50048	44658
SPO50048PL	844004
SPO50060	54720
SPO50060PL	854003
SPO50836	34829
SPO50836PL	834708
SPO50848	44659
SPO50848PL	844663
SPO50860	54985
SPO50860PL	854716
SPO60048	44863
T400	9341
T500	9342
TAA400	AS400
TAA500	AS500
TBA350	9678
TBA400	9680
TBA500	9682
TBS350	9690
TBS400	9692
TBS500	9694
TEC200	B200
TEC225	B214
TEC250	B212
TEC25050	B234
TEC275	B234
TEC300	B300
TEC350	B312

HD MASTER INTERCHANGE (Continued)

RIKER	TRUCKEX
TEC400	B400
TEC450	B412
TEC500	B500
TEC600	B600
TEC30050	B300
TEC35050	B312
TEC40050	B400
TEC50050	B500
TEC60050	B600
TFC200	9381
TFC225	9382
TFC250	9383
TFC275	9389
TFC300	9384
TFC350	9385
TFC400	9386
TFC500	9387
TFC600	9388
TTA200	9660
TTA225	9661
TTA250	9662
TTA275	9663
TTA300	9604
TTA350	9605
TTA400	9606
TTA500	9699
TTA600	9683
TTS200	9664
TTS225	9665
TTS250	9666
TTS275	9667
TTS300	9668
TTS350	9669
TTS400	9623
TTS500	9624
TTS600	9671
TTS22550	9665
U200	U200
U225	U214
U250	U212
U275	T234
U300	T300
U300Z	T300Z
U325	T314
U350	T312
U350Z	T312Z
U400	T400
U400PL	9486
U400Z	T400Z
U476Z	T412Z
U500	T500
U500PL	9487
U500Z	T500Z
U550	T512Z

RIKER	TRUCKEX
U600	T600
U600PL	9734
U600Z	T600Z
UA300	H300
UA350	H312
UA400	H400
UA500	H500
UA600	H600
UAF300	9501
UAF300PL	9490
UAF300Z	H300Z
UAF350	9502
UAF400	9503
UAF400PL	9492
UAF400Z	H400Z
UAF500	9504
UAF500PL	9493
UAF500Z	H500Z
UAF600	9506
UAF600PL	9495
UC300Z	FB300
UC350Z	FB350
UC400Z	FB400
UC450Z	FB450
UC500Z	FB500
UC550Z	FB550
UC600Z	FB600
UD300	H200
UD1501	U112
UD1751	U134
UD1781	U178
UD2001	U200
UD225	H214
UD2251	U214
UD250	H212
UD2501	U212
UD2751	H234
UD2751	H234P
UD3001	H300PZ
UD3501	H312P
UD4001	H400PZ
UD5001	H500PZ
UH100	8483
UH117	8051
UH227	9351
UH340	9352
UH380	9353
UH450	9579
UV227	9578
UV251	9610
UV300	9395
UV301	9612
UV352	9396
UV375	9613

RIKER	TRUCKEX
UV377	9622
UV379	9627
UV400	9399
UV401	9619
UV407	9611
UV408	9617
UV409	9647
UV409	9657
UV411	9614
UV478	9735
UV500	9616
UV501	9615
WT200	200A1014
WT200CR	200K1016
WT225	214A1014
WT225CR	214K1016
WT250	212A1014
WT300	300A1014
WT300CR	300K1014
WT350	312A1016
WT350CR	312A1016
WT400	400A1014
WT400CR	400C1016
WT450CR	412A1016
WT500	500A1016
WT500CR	500C1016
WT550CR	512A1016
WT600	600A1016
WT600CR	600C1016
WT2755	234A1014
WT3005	300A1014
WT30010	923120
WT35010	212A1014
WT40010	924120
X1220	3878
X12309	3683
X1235	3685
X12409	3684
XD4019	4211
XD413	3889
Y400	92673
Y500	92674
YP5011	94941
YS400	92679
YS500	92689

SCHOOL BUS PARTS	TRUCKEX
XB4-102	400A1014
XB4-105	400A1414
XB4AXF	44796
XB4AXF2	34799
XB4AXR	44797

SCHOOL BUS PARTS	TRUCKEX
XB4AXR2	58418
XB4TF	34798
XB4TR1	54843
XB7R2	64744
XC10M	3225
XC1SP	9597
XC1T	64650
XC212UAL	58141
XC214UAL	58225
XC234AXF1	83006
XC234AXR	54789
XC234TF1	64694
XC234TF7	64695
XC234TR1	83007
XC350CS-1	38288
XC350T1	74629
XC350T2	74630
XC350YS	94978
XC366CS1	38234
XC366L6	48318
XC366R6	58283
XC366R7	48319
XC366R8	48320
XC366Y4	38348
XC366YS1	94971
XC4AXF6	84568
XC4AXF7	64708
XC4AXR6	54809
XC4AXR8	74623
XC4M1	3710
XC4MD6	3708
XC4TF11	44773
XC4TF13	84560
XC4TF15	44774
XC4TFR6	54808
XC4TR1	83008
XC4Y7	95973
XC6.2RT2	74636
XC8.2C1	9479
XC802FL234	9569
XC80M5	3701
XC82XR5	88104
XC82Y2	93955
XC8SP	28326
XCG6.2L2	68280
XCG6.2LT2	64716
XCG6.2R2	48329
XCG6.2RT2	84562
XCG30M2	4213
XCG30RT4	54749
XCG30RT5	54750
XCG30T	64631
XCG30Y	95957
XCG350LT	54773

SCHOOL BUS PARTS	TRUCKEX
XCP4Y	93928
XCP6.2L2	68310
XF3M	3609
XF3SP	38459
XF4AX	84551
XF4AX2	74624
XF4MT2	3711
XF8.2C	38266
XF8.2Y	94973
XF8.2Y2	94993
XF8T	54835
XF15P	28134
XF361F4A	78103
XF361F4B	212A1014
XF361FL	9165
XF370AX2	84555
XF370F2	234A1414
XF370L1	95996
XF370M	3697
XF370M	3725
XF370R1	58414
XF3208C2	28516
XF3208XT	58363
XF3208Y2	95988
XH3AX2	64668
XH3TR13	83002
XH4AX	74632
XH4TF8	83000
XH4TR3	83005
XH9L	58219
XH9L	58251
XH9R	38268
XH9RX	38269
XH45SE	84553
XH45SE-1	84583
XH45SE4	84559
XH45SE4TD	84584
XH345LS	58221
XH345MD	3150
XH345R	58205
XH345RS	58220
XH360XT	58349
XH392FLHD	9149
XH404L	58222
XH404R	38270
XH69R	68221
XH404RH	38271
XH466EX	58225
XH466EXF	68421
XH466TF2	34742
XQ1	9578
XQ1-14	9579
XQ1MP	9353
XU4A3	74602

STANLEY	TRUCKEX
AC-1	3946
AC-2	3947
AC-3	3951
AC-4	3952
AC-5	3953
AC-20	3948
AC-22	3949
CA-1	3954
CA-2	3958
CA-4	3959
CA-6	3960
CA-7	3961
CA-12	3955
CA-14	3956
CA-18	3957
CO-3	3962
DR-3	3967
DR-4	3968
DR-5	3969
DR-8	3970
DR-8A	18146
DR-14	3964
DR-21	3965
DR-22	3966
DR-23	24737
DR-31	3996
DR-103	3963
DR-300	9890
DR-300A	9892
DR-400	9891
DR-400A	9893
FO-3	7661
FO-4	3973
FO-9	7662
FO-14	3971
FO-17	3972
FO-30	7660
FO-300	9894
FOE-1	38756
FOE-3	54121
FOE-10	38757
FOE-12	64786
FOE-21	44865
IH-1	3974
IH-3	3981
IH-4	3982
IH-10	3975
IH-13	3976
IH-14	3977
IH-18	3978
IH-19	3979
IH-20	3980
MF-7	7663
MF-10	3983

STANLEY	TRUCKEX
MF-11	3984
MF-15	3985
MF-16	7442
MF-17	3986
MF-23	3987
MF-30	3988
MF-31	3989
MF-36	7664
MF-38	3990
MF-300	9895
MM-2	3950
OL-3	3991
OL-6	3992
OL-7	3993
RC-0	9896
RC-1	9897
VT-1	3663
VT-4	3995

STEMCO	TRUCKEX
190-0205	2958
190-0406	3883
190-0408	3653
190-0414	3880
190-1107	3699
190-1125	3678
190-1126	3700
190-1134	3941
190-1135	3225
190-1138	3708
190-1141	3924
190-1150	3711
190-1160	3689
190-1173	3912
190-1187	3714
190-1204	3702
190-1205	3893
190-1208	3713
190-1220	3931
190-1221	3916
190-1223	3715
190-1231	3873
190-1234	3926
190-1235	3927
190-1265	3940
190-1266	3933
190-1267	3930
190-1268	3851
190-1269	3917
190-1277	3885
190-1286	3661
190-1289	3677
190-1290	3705

STEMCO	TRUCKEX
190-1292	3703
190-1293	3225
190-1294	3728
190-1296	3881
190-1297	3619
190-1298	4241
190-1299	3906
190-1300	3922
190-1302	3624
190-1303	3616
190-1304	3627
190-1306	3938
190-1310	3932
190-1312	3919
190-1314	3939
190-1315	3730
190-1316	3920
190-1322	3726
190-1324	3669
190-1330	3879
190-1331	3878
190-1332	3626
190-1333	3636
190-1334	3617
190-1335	3925
190-1336	3895
190-1337	3937
190-1343	3662
190-1347	3675
190-1348	3913
190-1349	4221
190-1350	3872
190-1351	3645
190-1354	3914
190-1355	3866
190-1358	3891
190-1359	3725
190-1360	3667
190-1361	3712
190-1364	3637
190-1365	3900
190-1366	3706
190-1367	3704
190-1368	3928
190-1369	3676
190-1371	3707
190-1372	3687
190-1372	3875
190-1373	3670
190-1374	3898
190-1375	3698
190-1379	3941
190-1380	3714
190-1381	3887

HD MASTER INTERCHANGE (Continued)

STEMCO	TRUCKEX
190-1384	3666
190-9013	3721
190-9103	3652
190-9105	3720
190-9121	3884
190-9122	3618
190-9123	3681
190-9124	3701
190-9127	2645
190-9129	3892
190-9135	3683
190-9146	3685
190-9159	3607
190-9208	2704
190-9234	3625
190-9241	3150
190-9303	3894
190-9305	3889
190-9310	3682
190-9316	3888
190-9333	3684
190-9341	3679
190-9344	3910
190-9377	3890
190-9400	3614
190-9401	3647
190-9416	3899
190-9451	3921
190-9515	3929
190-9532	3611
190-9538	3632
190-9542	3668
190-9550	3710
190-9553	3716
190-9608	3663
190-9855	4211
190-9858	3923
190-9860	3918
190-9872	3640
190-9887	3911
190-9931	3719
201-0014	14601
201-0041	14602
201-0061	14603
201-0069	14605
201-0114	8974
201-1272	14339
201-1274	14340
201-1275	14341
201-1276	14605
202-0200	9371
202-0225	9370
202-0250	9372
202-0300	9373

STEMCO	TRUCKEX
202-0350	9374
202-0400	9375
202-0450	9376
202-0500	9377
202-0550	9704
202-0600	9369
202-1300	9571
202-1400	9573
202-1500	9575
203-0208	8955
203-0212	8957
203-0213	8958
203-0214	9335
203-0401	8956
203-1275	8957
203-1276	8958
203-1280	9721
205-0010	92673
205-0032	92674
205-0655	92679
205-0657	92689
205-0933	92698
205-0947	92678
205-1148	92696
205-1149	92695
205-1151	92697
206-0001	T600
206-0001	T600Z
206-0030	T300
206-0030	T300Z
206-0036	T314
206-0042	T312
206-0042	T312Z
206-0063	T400
206-0063	T400Z
206-0072	T500
206-0072	T500Z
206-0078	T512Z
206-0350	T412Z
206-1040	9486
206-1050	9487
206-1060	9734
207-0196	9503
207-0201	9504
207-0209	9736
207-0215	9506
207-1276	9492
207-1277	9493
207-1283	9495
207-1284	9490
207-1285	9501
207-1286	9502
208-0103	H300P
208-0103	H300PZ

STEMCO	TRUCKEX
208-0105	H312P
208-0107	H400PZ
208-0108	H412
208-0109	H500PZ
208-0124	H412
208-0125	H314
209-0008	9350
209-0976	9578
209-0977	8998
209-0987	8052
210-0002	9360
210-0003	9359
210-0004	9628
210-0010	9810
210-0011	9799
210-0014	9801
210-0015	9803
210-0017	9363
210-0019	9366
210-0020	8445
210-0021	9453
210-0022	9364
210-0023	9365
210-0025	9453
210-0026	9806
210-0027	9807
210-0146	9354
210-0153	9355
210-0161	9580
210-0167	9356
210-0180	9357
210-0338	9358
210-0988	9456
210-0989	9457
210-0990	9804
210-0991	9451
210-0992	9452
210-0993	9453
211-0221	9586
211-1195	9084
211-1211	9056
211-1214	9118
211-1232	8784
211-1234	8699
211-1235	8698
211-1237	9260
211-1238	9259
211-1244	9146
211-1246	9588
212-0825	809499
212-0979	809306
212-0980	809429
212-0981	809304
212-0982	809305

STEMCO	TRUCKEX
212-0983	809302
212-0984	809303
212-0985	809309
212-0986	809458
212-0987	809308
212-0995	809500
212-0997	809301
212-0998	809310
212-1000	809498
212-1001	809300
212-1002	809307
212-1003	809299
212-1004	809427
212-1005	809298
212-1006	809500
212-1008	809428
213-0030	8986
213-0035	8987
213-0040	8988
213-0050	8989
213-0060	8990
213-0530	8875
213-0535	8881
213-0540	8882
213-0550	8877
213-1030	8986
213-1035	8987
213-1040	8988
213-1050	8989
213-1060	8990
213-1240	14738
213-1250	14740
213-1830	24752
213-1835	24753
213-1840	24754
213-1850	24755
213-2430	24929
213-2435	24849
213-2440	24835
213-2450	24837
213-2520	8868
213-2530	8880
213-2535	8881
213-2540	8882
213-2550	8877
213-2560	8898
213-3630	34826
213-3635	34785
213-3640	34743
213-3650	34744
213-4840	44786
213-4850	54831
214-1030	8859
214-1035	8876

STEMCO	TRUCKEX
214-1040	8856
214-1050	8857
214-1840	24931
214-1850	24933
214-2440	24835
214-2450	24934
215-1030	8885
215-1035	8886
215-1040	8887
215-1050	8888
215-1240	14739
215-1250	14737
215-1830	24675
215-1835	24676
215-1840	24677
215-1850	24678
215-1873	24674
215-1874	24654
215-1875	24936
215-1878	24935
215-2440	24836
215-2450	24838
215-2530	8982
215-2535	8983
215-2540	8878
215-2550	8879
215-2560	8899
215-3640	34673
215-3650	34674
215-4850	44867
216-0056	10313
216-0065	10314
216-0070	10315
216-0074	10730
216-1010	809415
216-1012	809738
216-1126	10313
216-1127	10314
216-1128	10315
216-1129	10730
216-1147	10732
216-1151	10728
216-1152	10726
216-1153	10727
216-1154	10729
216-1155	10733
216-1156	809736
216-1157	809734
216-1158	10731
216-1159	809739
216-1160	809735
217-0166	10778
217-0171	10536
217-0174	10537

STEMCO	TRUCKEX
217-0179	10542
217-0182	10534
217-0188	10535
217-0194	10783
217-0203	10791
217-0380	10538
217-0495	10540
217-0663	10788
217-0971	10797
217-0972	10309
217-0973	10329
217-0992	10789
217-0996	10792
217-1003	809794
217-1004	809796
217-1006	10781
217-1009	10777
217-1013	18148
217-1014	10776
217-1015	10541
217-1017	10796
217-1019	809793
217-1020	10539
217-1022	28661
217-1024	10780
217-1027	10790
217-1179	10679
217-1188	10794
217-8016	10785
218-0062	10305
218-0064	10762
218-0067	10554
218-0075	10757
218-0079	10759
218-0084	10680
218-0090	10760
218-0096	10553
218-0381	10764
218-0488	10681
218-0508	10767
218-0999	809769
218-1002	809770
218-1003	809406
218-1006	809408
218-1007	809546
218-1124	10555
218-1125	10304
218-1126	10305
218-1127	10762
218-1128	10766
218-1129	10756
218-1130	10676
218-1136	68185
218-1137	68183

STEMCO	TRUCKEX
218-1153	10556
218-1182	10620
218-1183	10675
218-1184	10676
218-1185	10678
218-1186	10620
218-1187	10758
218-1190	10795
218-1191	10765
218-1192	10763
218-1193	10557
218-1194	10557
218-1195	10310
218-1196	809771
218-1197	809768
218-1199	809547
218-1201	10675
218-1202	10329
218-1203	10678
218-1204	10761
218-1205	10761
218-1206	10308
218-1207	10306
218-1208	10306
218-8030	10681
219-0113	300A1016
219-0118	312A1016
219-0125	400C1016
219-0128	500C1016
219-0132	512A1016
219-0143	600C1016
219-0345	412A1016
220-0086	924002
220-0087	925002
220-0092	925502
220-0098	926002
220-1032	927002
220-1080	928002
221-0131	14618
221-0141	14619
221-0148	10745
221-0148	14620
221-0154	24714
221-0155	24672
221-8000	24696
222-0124	24344
222-0130	24345
222-0133	24346
222-0136	24347
222-0136	24718
222-0144	24889
222-0146	24945
222-8000	24697
224-0002	24939

STEMCO	TRUCKEX
224-0158	44853
224-0164	44665
224-0176	34723
224-0463	34724
224-0470	44667
224-0878	54725
224-0880	54726
224-0882	24748
224-0883	24750
224-4018	24717
224-8004	34828
225-0006	9390
225-0008	9708
225-0009	9715
225-0010	9717
225-0011	9719
225-0016	9479
225-0185	9471
225-0205	9714
225-0207	9394
225-0943	9478
225-0944	9474
225-1093	9706
225-1094	9718
225-1095	9470
225-1096	9711
225-1097	9476
225-1098	9713
225-1099	9705
225-1254	9475
225-1259	9393
225-1260	9710
225-1261	9392
225-1264	9712
225-1265	9709
225-1274	9707
225-1275	9473
225-1276	9391
225-1277	9392
225-1279	9473
225-1280	9472
227-0253	28495
227-0257	9599
227-0260	24711
227-0271	24712
227-0542	24737
227-0544	24941
227-0551	24739
227-0565	34713
227-0566	34715
227-0573	34714
227-0574	34716
227-0577	44854
227-0578	44656



HD EXHAUST CROSS REFERENCE

HD MASTER INTERCHANGE (Continued)

STEMCO	TRUCKEX
227-0579	44863
227-0585	44731
227-0586	44658
227-0590	54991
227-0598	54720
227-0958	44657
227-0959	54984
227-0960	34829
227-0961	44659
227-0962	54985
228-0003	44855
228-0764	44749
228-0779	74602
228-0780	64668
228-0783	64695
228-0783	64740
228-0794	83007
228-0803	84582
228-0901	83006
228-0901	84558
228-0942	83003
228-0942	83004
228-0950	34742
228-0960	74607
228-0961	83002
228-0997	84553
228-1056	84554
228-1061	44796
228-1062	44797
228-1063	54842
228-1065	64708
228-1066	54809
228-1069	83008
228-1071	44774
228-1072	74623
228-1073	84560
228-1086	54808
228-1101	74624
228-1107	95973
228-1117	44795
228-1150	84584
228-1152	14705
228-1158	74633
228-1159	34799
228-1160	54880
228-1162	34798
228-1172	38767
228-1173	58418
228-1174	64744
228-1177	74627
228-1183	83005
228-1183	84552
228-1191	84571
228-1192	84568

STEMCO	TRUCKEX
228-1193	74632
228-1194	83014
228-1195	44822
228-1198	83001
228-1201	84586
228-1230	18102
228-1233	34812
228-1234	34816
228-1235	34814
228-1236	34815
228-1237	38764
228-1239	34879
228-1240	38586
228-1241	34811
228-1242	38584
228-1244	54906
228-1246	38583
228-1254	48476
228-1255	48460
228-1257	54843
228-1260	10553
228-1261	48523
228-1263	44821
228-1264	34812
228-1265	34813
228-1266	54907
228-1268	84559
228-1270	54789
228-1271	74646
228-1273	64694
228-1277	44759
228-1278	54905
228-1279	54998
228-1282	54129
228-1283	68267
228-1287	54119
228-1291	78166
228-1292	64763
228-1294	64775
228-1296	68420
228-1297	64784
228-1303	84555
228-1305	74625
228-1306	74645
228-1307	74654
228-1308	74653
228-1310	83029
228-1312	38771
228-1313	48570
228-1325	44866
228-1326	48566
228-1327	38768
228-1328	58419
228-1332	84583

STEMCO	TRUCKEX
229-0220	10337
229-0224	10338
229-0227	10339
229-0229	10340
229-0233	10638
229-0234	10634
229-0236	10724
229-0660	10330
231-0255	9727
231-1253	8981
231-1300	18106
232-0002	9344
232-0003	9815
232-0482	9812
232-0779	9813
232-0939	9341
232-0940	9343
232-0941	9342
233-0001	9814
234-0327	924105
234-0328	925005
234-0331	925505
234-0333	926005
235-0326	924004
235-0329	924005
235-0332	925506
235-0335	926006
235-0474	924003
235-0475	927006
235-8000	926557
235-8002	927557
236-0315	924104
236-0317	925105
236-0325	925504
236-0330	926004
236-0478	927004
237-0450	925458
237-0555	925558
237-0886	925553
237-0887	926503
237-0924	925543
238-0904	844002
238-0906	834004
238-0907	844003
238-0908	854002
238-0909	834005
238-0910	844004
238-0911	854003
238-0912	824006
239-0713	H300
239-0714	H312
239-0715	H400
239-0716	H500
239-0728	H600

STEMCO	TRUCKEX
240-0285	9720
240-0749	9649
240-0860	9648
240-0865	9650
241-0307	9591
241-0309	9592
241-0312	9593
241-0321	9594
241-0603	9589
241-0604	9590
241-0605	9595
241-1270	9596
242-0982	894902
242-1144	824716
242-1280	824001
242-1281	824721
242-1282	824715
242-1283	824722
242-1284	834001
242-1285	834000
242-1286	834727
242-1287	834746
242-1288	834728
242-1289	834747
242-1290	844000
242-1291	844735
242-1292	844669
242-1293	844668
242-1294	844671
242-1295	844670
242-1296	854727
242-1297	854723
242-1298	854728
242-1299	854724
242-1300	864000
242-1301	864671
242-1302	864001
242-1303	864672
242-1304	874000
242-1305	874608
242-1307	874609
242-1308	884000
242-1309	884548
242-1310	874001
242-1311	884550
242-1312	824000
242-1313	824004
242-1314	824002
242-1315	854000
242-1318	884001
242-1319	894903
242-1321	54993
242-1402	824749
242-1403	824757

CROSS
REFERENCE

STEMCO	TRUCKEX
242-1404	824751
242-1405	824758
242-6019	824005
242-6596	884563
243-0278	10564
243-0283	10565
243-0286	10744
243-0299	10567
243-0301	10559
243-0492	10743
243-0600	10749
243-0613	809753
243-0615	10747
243-0617	10748
243-0618	10746
243-0619	10742
243-0620	809750
243-0621	809752
244-0191	8975
244-0192	8976
244-0200	18103
244-0204	8978
244-0602	8979
244-0755	8991
244-0756	8978
244-0762	13009
244-0763	18144
244-0763	24710
245-0726	300A1014
245-0727	300A1216
245-0727	300A1414
245-0728	312A1016
245-0729	400A1014
245-0729	400A1016
245-0730	400A1414
245-0732	500A1016
245-0735	300K1014
245-0736	500A1016
245-1282	600A1016
248-0648	9359
250-0001	9611
250-0002	9617
250-0004	9622
250-0006	9656
250-0013	9619
250-0016	9613
250-0017	9652
250-0018	9626
250-0020	9618
250-0021	9610
250-0023	9653
250-0024	9651
250-0025	9659
250-0026	9658

STEMCO	TRUCKEX
250-0028	9654
250-0031	9625
250-0638	9398
250-0640	9399
250-0900	9395
250-0901	9396
250-0902	9647
250-0902	9657
250-0930	9612
250-0931	9615
250-0970	9616
250-1017	9735
250-1278	9627
250-1280	9397
250-1280	9655
250-8001	9614
252-0843	834003
252-0844	844661
252-0845	854715
252-0846	834708
252-0847	844663
252-0848	854716
253-0189	44664
253-0193	34827
253-0198	34719
253-0466	34720
253-0468	44666
253-0894	54721
253-0896	54722
253-0976	24746
253-0977	24747
253-3018	24937
253-3018	24938
253-4018	24713
253-4072	64673
255-0001	8969
255-0002	8963
255-0003	9336
255-0157	9333
255-0162	9332
255-0168	9331
255-0904	9723
255-4030	9722
255-8157	8962
255-8162	8964
255-8168	8965
256-0635	8970
256-0636	8971
256-0637	8972
256-0637	28310
256-0752	8973
257-0199	9587
258-0681	923120
258-0684	924120

STEMCO	TRUCKEX
258-0686	925120
258-0994	9430
258-0996	9811
258-1371	94941
262-1058	4223
262-1059	3690
262-1060	3691
262-1061	3692
262-1062	3693
262-1063	3694
262-1064	3695
268-0001	9381
268-0002	9382
268-0003	9383
268-0004	9389
268-0005	9384
268-0006	9385
268-0007	9386
268-0008	9387
268-0009	9388
268-1130	A300
268-1135	A312
268-1140	A400
268-1140	A500
268-1420	9660
268-1422	9661
268-1425	9662
268-1427	9663
268-1430	9604
268-1435	9605
268-1440	9606
268-1450	9699
268-1520	9664
268-1522	9665
268-1525	9666
268-1527	9667
268-1530	9668
268-1535	9669
268-1540	9696
268-1545	9670
268-1550	9697
268-1560	9671
268-1820	9660
268-1825	9662
268-1827	9663
268-1830	9604
268-1835	9605
268-1840	9698
268-1850	9607
268-1922	9665
268-1925	9666
268-1927	9667
268-1930	9668
268-1935	9669

STEMCO	TRUCKEX
268-1940	9623
268-1945	9670
268-1950	9624
268-1960	9671
268-2420	9672
268-2422	9673
268-2425	9674
268-2427	9675
268-2430	9676
268-2435	9678
268-2440	9680
268-2450	9682
268-2460	9683
268-2827	9675
268-2830	9676
268-2835	9678
268-2840	A400
268-2845	9681
268-2850	A500
268-2920	9684
268-2922	9685
268-2925	9686
268-2927	9687
268-2930	9688
268-2935	9690
268-2940	9692
268-2945	9693
268-2950	9694
268-2960	9695
268-3532	B314
268-3537	9691
268-3545	B412
268-3630	B300
268-3635	B312
268-3640	B400
268-3650	B500
268-3660	B600
268-4040	AS400
268-4050	AS500
268-6940	9692
269-0040	10684
269-0044	10685
270-0005	834002
270-5036	834779
270-5048	844001
270-5060	854001
271-6120	884002
272-0001	809530
272-0002	10560
272-0068	10755
272-0350	10635
272-0400	10636
272-0500	10637
272-1350	10631

HD MASTER INTERCHANGE (Continued)

STEMCO	TRUCKEX
272-1400	10632
272-1500	10633
272-2350	10639
272-2400	10640
272-2500	10641
272-3350	10643
272-3400	10644
272-3500	10645
273-0001	48568
273-0003	58222
273-0004	38271
273-0006	38270
273-0025	28645
273-0027	48234
273-0029	48235
273-0033	58414
273-0034	95995
273-0037	48233
273-0038	38266
273-0039	38273
273-0040	38743
273-0041	95996
273-0064	38288
273-0067	94969
273-0068	38223
273-0078	94971
273-0084	94976
273-0085	38284
273-0087	94991
273-0088	38348
273-0089	94992
273-0127	93933
273-0128	92681
273-0129	58205
273-0131	38268
273-0135	28169
273-0135	28170
273-0136	68160
273-0138	58219
273-0155	38269
273-0162	58220
273-0165	58221
273-0174	95962
273-0176	94973
273-0204	58412
273-0242	28653
273-0243	94008
273-0267	95986
273-0268	28515
273-0269	68371
273-0270	58372
273-0279	58141
273-0280	48152
273-0281	58403

STEMCO	TRUCKEX
273-0282	48518
273-0285	48113
273-0288	93955
273-0310	38463
273-0311	48386
273-0315	58319
273-0318	28392
273-0320	94915
273-0324	10566
273-0326	38413
273-0329	44773
273-0337	94900
273-0338	38414
273-0341	94993
273-0344	92684
273-0345	48318
273-0346	58283
273-0347	92682
273-0350	58363
273-0357	48319
273-0358	48320
273-0359	38486
273-0360	94921
273-0362	88104
273-0363	58251
273-0364	68221
273-0365	58284
273-0370	28523
273-0371	92694
273-0373	28524
273-0374	28522
273-0397	28521
273-0399	83015
273-0409	58225
273-0410	38487
273-0412	28425
273-0415	48348
273-0416	48347
273-0417	48349
273-0418	58285
273-0418	58349
273-0420	58410
273-0421	48464
273-0423	58330
273-0427	48565
273-0428	38464
273-0433	48555
273-0434	48552
273-0466	94939
273-0467	48239
273-0469	95987
273-0471	95988
273-0473	18101
273-0474	18150

STEMCO	TRUCKEX
273-0477	28650
273-0479	28516
273-0484	28660
273-0487	28662
273-0489	28514
273-0490	28513
273-0491	38587
273-0493	38763
273-0498	38585
273-0500	38765
273-0505	38347
273-0506	38234
273-0507	48465
273-0508	48463
273-0509	48461
273-0510	48462
273-0512	48466
273-0513	48404
273-0514	48405
273-0516	48434
273-0517	58339
273-0518	48554
273-0520	48550
273-0521	48467
273-0522	48469
273-0523	48150
273-0529	18151
273-0534	94009
273-0535	48470
273-0536	58366
273-0537	58364
273-0540	68374
273-0541	58367
273-0542	58225
273-0543	58362
273-0548	58405
273-0551	58409
273-0554	68421
273-0555	68375
273-0557	78228
273-0558	78229
273-0561	28656
273-0562	28664
273-0563	38766
273-0565	48402
273-0566	48403
273-0567	37764
273-0569	38749
273-0570	48524
273-0572	94978
273-0584	58370
273-0585	58368
273-0586	84561
273-0587	212A1014

STEMCO	TRUCKEX
274-0011	28534
274-0016	38608
274-0017	38609
274-0019	38607
274-0020	28528
274-0021	38603
274-0022	68182
274-0023	68181
274-0024	38604
274-0025	28529
274-0033	28657
274-0033	48383
274-0055	28517
274-0061	48468
274-0064	18109
274-0065	58318
274-0066	48477
274-0067	9716
274-0070	10786
274-0071	10787
274-0072	10788
274-0073	38606
274-0075	38436
274-0076	10307
274-0109	28530
274-0110	38605
274-0115	48563
274-0118	38435
274-0121	18110
274-0122	54827
274-0123	854004
274-0124	54992
274-0126	54118
274-0127	854007
274-0148	38612
274-0150	38611
274-0161	38614
274-0165	10317
274-0171	10782
274-0172	10784
274-0175	38610
274-0176	94942
274-0180	94010
274-0190	94011
274-0191	18108
274-0193	18107
274-0244	28658
274-0250	34830
274-0251	34831
274-0252	834006
274-0253	834007
274-0254	854830
274-0256	854005
274-0257	854006

STEMCO	TRUCKEX
274-0260	54829
274-0270	28655
274-0272	38761
274-0277	38613

UNITED MUFFLER	TRUCKEX
6-0010	3902
6-0015	3901
6-0020	3907
6-0025	3654
6-0035	687
6-0040	4241
6-0045	3651
7-0005	3225
7-0015	3906
7-0020	698
7-0025	609
7-0030	3607
7-0035	3652
7-0040	3618
7-0045	3888
10-0005	3677
10-0010	3911
10-0015	3670
10-0020	3918
10-0030	3707
10-0035	3702
11-0005	3700
11-0010	3919
11-0020	3923
11-0035	3927
11-0040	4224
12-0005	3924
85-0005	3697
85-0006	3914
85-0015	2704
85-0025	3720
85-0030	3627
85-0035	3625
85-0045	4233
275275BS	3701
2250300BS	3150
2250400BS	3708
C-0005	3915
C-0010	3632
C-0015	3611
C-0020	3710
C-0025	3716
C-0030	3703
C-0040	3610
D-0005	3678
D-0010	3614
D-0015	3932

UNITED MUFFLER	TRUCKEX
D-0020	3647
D-0025	3898
D-0030	3900
D-0035	4205
NAV-0005	3916
NAV-0020	3851
NAV-0030	3917
V9-0005	3679
V9-0010	3891
V9-0015	3712
V9-0020	3890
V9-0025	3667
V9-0030	3897
V9-0035	3872
V10-0005	3714
V10-0010	3893
V10-0015	3699
V10-0020	3640
V10-0025	3873

WALKER	TRUCKEX
15146	604006
15147	604007
15556	645301
15684	645341
15693	645316
17190	700120
17197	700046
17197	700164
17806	6510
17807	6539
17809	700141
17809	709997
17824	6595
17827	700050
17831	6505
17832	6576
17840	700062
17842	700076
17843	700052
17849	700065
17849	700104
17855	700051
17868	700001
21033	3954
21035	3986
21036	3967
21039	3981
21040	3974
21041	3985
21046	2320
21050	4216
21051	3533
21054	3423

WALKER	TRUCKEX
21060	3976
21063	2325
21068	4217
21069	3940
21070	3933
21071	3930
21073	3917
21074	3916
21075	2328
21076	2335
21079	2336
21088	3885
21092	2080
21097	3654
21099	3609
21131	2156
21137	4211
21138	3883
21146	3884
21151	3906
21152	609
21154	3668
21161	3931
21164	3892
21165	3923
21167	3941
21169	3901
21172	3681
21174	3614
21175	3899
21188	3970
21259	687
21260	698
21300	3851
21309	4237
21464	3894
21466	2645
21467	3618
21468	3721
21470	3720
21471	3887
21473	3955
21473	3961
21475	3654
21476	2704
21578	3690
21579	3691
21580	3692
21581	3693
21582	3694
21584	3695
21585	4222
21751	3661
21784	2538
21832	3611

WALKER	TRUCKEX
21833	3911
21835	3682
21837	3670
21838	3625
21848	3304
21860	2923
21860	2930
21894	3868
21910	2315
21923	3898
21925	2958
21968	3677
21969	3918
21971	3678
22000	2952
22003	3908
22004	3632
22006	3705
22018	3969
22020	3998
22021	3963
22022	3980
22023	3953
22024	3984
22027	3965
22028	3951
22032	3950
22033	3977
22037	3956
22038	3999
22039	4248
22040	3964
22041	4200
22042	3947
22043	3952
22046	3973
22047	3971
22100	3424
22101	3909
22109	3960
22110	3959
22129	3068
22153	2925
22155	3112
22171	3123
22177	3904
22214	3915
22231	3610
22234	45
22315	3357
22329	3387
22337	3698
22355	3882
22356	3651
22381	3900



HD EXHAUST CROSS REFERENCE

HD MASTER INTERCHANGE (Continued)

WALKER	TRUCKEX
22382	3902
22389	3652
22390	3957
22391	3703
22398	3258
22402	3205
22438	4201
22444	3972
22449	3710
22452	3941
22460	3255
22467	3225
22499	2314
22504	3369
22509	2318
22512	2943
22538	3875
22547	3728
22551	3716
22552	3647
22555	3706
22564	3394
22566	3719
22570	3929
22571	3889
22572	3888
22575	2329
22576	2323
22577	3881
22581	3619
22582	2333
22582	4241
22583	3907
22584	3395
22596	3922
22604	3704
22604	3729
22628	3624
22630	3683
22631	3684
22632	3689
22634	3637
22635	3880
22636	3627
22642	3938
22643	3928
22644	3534
22648	2048
22658	3995
22664	3919
22665	3921
22668	3730
22669	3920
22672	2062
22674	2059

WALKER	TRUCKEX
22674	2061
22675	2063
22675	2111
22678	2178
22678	3598
22679	2064
22715	3726
22719	2058
22730	3905
22732	4213
22741	3571
22764	3685
22765	3879
22766	3878
22767	3626
22768	3636
22769	3617
22770	3925
22771	3895
22775	3937
22776	2105
22777	2106
22778	2107
22789	3711
22808	3662
22810	3653
22822	3663
22833	3676
22835	3714
22836	3699
22843	3675
22844	3679
22852	3607
22861	4210
22865	3150
22866	3697
22877	3613
22888	3700
22890	4203
22897	3708
22899	3713
22904	3948
22906	3701
22907	3913
22910	4221
22914	3872
22915	3702
22916	3714
22917	3645
22920	3699
22921	3949
22922	4204
22932	3914
22934	2316
22936	3891

WALKER	TRUCKEX
22938	3873
22940	3667
22941	3712
22948	3926
22950	3924
22951	3912
22952	3715
22958	3927
22960	3910
22962	3893
22963	3640
22964	3897
22965	3666
22966	3715
22967	4218
22971	4205
22980	4206
22981	4207
22991	4224
29029	809303
29031	809427
29032	809500
29033	809301
29034	809310
29036	809302
29039	809308
29041	809458
29042	809429
29044	809498
29046	809300
29047	809307
29048	809299
29051	809500
29052	809304
29100	824001
29101	824721
29102	824722
29103	809793
29105	809752
29108	809771
29109	809770
29110	9430
29111	824715
29112	824716
29113	809736
29116	809768
29120	824000
29121	809796
29126	809415
29127	809794
29129	809546
29140	814623
29146	809621
29200	809739
29201	824749

WALKER	TRUCKEX
29202	824751
29204	824004
29205	824002
29206	824757
29207	824758
29208	834006
29209	809530
29210	809408
29211	809406
29212	809547
29213	824006
29214	834007
29218	809753
29219	9811
29220	809738
29300	834002
29301	834779
29302	834001
29304	834000
29305	834746
29306	834747
29307	834727
29308	834728
29309	834003
29310	834708
29314	834004
29315	834005
29401	844663
29402	844669
29403	844671
29405	844001
29406	844000
29408	844668
29409	844670
29410	844002
29414	844003
29415	844004
29416	844735
29500	854715
29501	854716
29502	854727
29503	854728
29505	854000
29506	854002
29507	854003
29508	854723
29509	854724
29511	854001
29515	854007
29600	864671
29603	864672
29604	864001
29605	864000
29701	874609
29702	874608

CROSS
REFERENCE

WALKER	TRUCKEX
29704	874000
29705	874002
29800	884548
29801	884550
29804	884563
29806	884000
29807	874001
29901	884001
29902	894902
31307	8724
31337	8771
31358	9240
31370	9086
31394	9261
31398	9234
31400	8717
31405	8773
31416	9083
31417	9056
31500	8738
31508	9118
31510	9084
31512	9079
31520	9220
31530	9245
31543	9244
31591	9119
31801	8791
31802	8781
31803	8780
31806	8789
31850	8775
31850	9165
31851	8776
31853	8779
31855	8784
31865	8792
31873	8784
31875	9149
31883	9146
31887	8792
31952	9160
33220	9666
33222	9668
33223	9669
33224	9623
33225	9624
33226	9666
33227	9667
33229	9685
33231	9666
33240	9686
33271	9671
33272	9668
33272	9790

WALKER	TRUCKEX
33273	9669
33273	9791
33274	9792
33275	9670
33276	9793
33277	9671
33278	9688
33280	9692
33281	9693
33282	9694
33284	9604
33285	9605
33286	9698
33288	9607
33310	9676
33311	9678
33312	A400
33314	9682
33967	9604
33968	9605
33969	9606
33970	9699
33974	9660
33976	9662
33977	9663
33981	9731
33983	9732
35021	8555
35027	8236
35029	8137
35029	8536
35036	9652
35103	8483
35114	8581
35119	8531
35123	8518
35125	8503
35125	8592
35126	8519
35131	9651
35143	8515
35143	8516
35143	8545
35144	8176
35145	8554
35146	8308
35149	8061
35150	8148
35151	8077
35158	8074
35158	8078
35164	9704
35165	PH450
35172	8120
35175	8509

WALKER	TRUCKEX
35181	8494
35182	8493
35183	8580
35186	8067
35187	PH550
35206	8149
35209	8484
35212	8075
35216	9798
35225	9896
35226	9897
35227	AS400
35228	AS500
35229	8066
35229	8106
35243	8128
35243	8129
35244	8118
35247	8121
35258	CLV257
35261	8204
35265	8506
35268	8478
35270	8573
35273	CLV258
35274	8179
35276	8085
35277	8171
35283	8114
35284	8071
35285	8124
35286	8092
35290	9653
35291	A312
35292	A400
35293	A500
35304	U212
35319	8089
35322	U118
35323	U114
35325	U112
35334	U218
35335	H200
35336	H214
35337	H212
35338	9580
35339	8060
35348	9810
35351	8553
35352	8166
35353	8511
35357	9353
35358	8215
35358	8566
35362	8112

WALKER	TRUCKEX
35362	8560
35364	H218
35366	9588
35370	9799
35373	T412Z
35380	8238
35385	8537
35393	9369
35401	9610
35405	U158
35406	U134
35407	U178
35408	U200
35409	T600
35409	T600Z
35413	U214
35414	U212
35415	B314
35416	9691
35423	B412
35424	H412
35441	9801
35442	9803
35444	9490
35445	T314
35446	9736
35447	T512Z
35449	9398
35456	9486
35457	9487
35458	8389
35460	8196
35462	8223
35463	8245
35464	8246
35466	8197
35467	8234
35473	8233
35474	8267
35475	8165
35490	9260
35491	8698
35492	8699
35494	9613
35495	9611
35496	9627
35497	9734
35498	9614
35499	9617
35500	9616
35501	8169
35502	8216
35503	8123
35510	H258
35511	8158

HD MASTER INTERCHANGE (Continued)

WALKER	TRUCKEX
35512	9371
35513	9370
35514	9372
35520	9622
35525	8438
35527	8487
35530	9578
35542	9742
35544	8225
35546	8247
35549	8220
35551	8226
35552	8520
35556	9579
35562	8227
35566	8212
35568	8248
35597	9259
35600	8301
35604	9361
35605	9362
35606	9363
35608	9367
35616	L31500
35617	9378
35618	9373
35619	9374
35620	B200
35621	B214
35622	B234
35624	9501
35636	9618
35639	8115
35641	9647
35641	9657
35661	8557
35662	8119
35662	8498
35670	8588
35674	8510
35690	9612
35692	9495
35693	9506
35695	9395
35696	9502
35702	8181
35702	8182
35703	8081
35704	8116
35706	8195
35715	8111
35717	8079
35719	8122
35719	8161
35720	8200

WALKER	TRUCKEX
35723	H238
35724	8062
35725	8180
35726	8221
35728	8151
35729	PH50
35733	9360
35734	9366
35741	8219
35745	8445
35746	9735
35747	9718
35749	8202
35750	8068
35750	8098
35752	H400PZ
35753	H312P
35757	H500
35758	H412
35760	H314
35766	8080
35772	H300
35773	H312
35774	H400
35775	H500PZ
35776	9492
35777	9493
35786	T300Z
35787	T312Z
35788	T400Z
35789	T500Z
35790	9806
35791	9807
35792	9453
35793	H234P
35794	H300P
35795	H600
35796	9350
35799	9503
35800	9504
35801	8170
35804	9396
35805	9399
35806	9615
35807	4223
35811	8133
35812	8154
35819	8572
35819	8593
35852	9364
35853	9365
35854	9354
35855	9355
35856	9356
35870	8390

WALKER	TRUCKEX
35871	8391
35880	8429
35884	9456
35885	9457
35886	9451
35887	9452
35891	9741
35898	8052
35899	9628
35907	9375
35909	9376
35910	9377
35920	8152
35920	8153
35931	9573
35932	9575
35933	9453
35934	9384
35935	9453
35936	9385
35937	9386
35938	9387
35939	9388
35940	8113
35941	8568
35944	9937
35950	9625
35951	8139
35958	T27
35959	T26
35961	L32000
35966	8998
35972	9357
35975	B500
35976	B400
35977	B312
35978	B300
35979	B212
35980	B600
35983	9358
35984	9359
36119	8356
36125	8056
36145	U200
36147	T234
36149	9675
36164	924105
36166	926005
36168	925505
36171	924004
36172	924005
36173	925506
36175	926006
36177	926557
36178	927006

WALKER	TRUCKEX
36183	924104
36185	925504
36186	926004
36187	927004
36190	925458
36193	925558
36201	9593
36202	9590
36203	9589
36204	9591
36205	9592
36206	9594
36207	9595
36208	9596
36209	9359
36210	9626
36212	9737
36213	9397
36213	9655
36224	9804
36225	9656
36234	8055
36249	H300Z
36253	8208
36262	AC4184
36263	8348
36269	8357
36270	8349
36393	9753
40000	8860
40001	8862
40002	8864
40003	8866
40004	8867
40005	8868
40006	8870
40007	8872
40008	8875
40009	8880
40010	8881
40011	8882
40012	8877
40013	8865
40014	8869
40020	8982
40021	8983
40022	8878
40023	8879
40024	8881
40025	8882
40026	8877
40030	8872
40036	8883
40211	93986
40219	92698

WALKER	TRUCKEX
40220	92696
40221	92695
40223	92697
40247	92673
40253	93933
40255	92682
40256	92679
40257	92689
40258	92681
40259	93928
40295	93972
40295	94938
40318	94900
40342	94933
40343	94932
40358	93955
40364	92674
40366	94939
40400	94993
40405	94909
40419	94915
40424	94919
40425	95981
40426	95977
40428	48235
40440	48113
40441	94008
40453	94978
40468	94969
40479	94976
40484	94971
40491	94911
40540	95949
40545	95962
40548	95957
40551	95996
40553	48233
40554	96630
40555	95975
40556	95970
40558	95986
40559	95995
40563	48403
40564	95987
40565	95978
40566	96632
40571	95992
40572	95993
40573	95979
40577	94941
40582	95984
40584	95994
40585	95983
40587	94012
40588	94013

WALKER	TRUCKEX
40590	94011
40626	54902
40746	54902
40812	84562
41000	10670
41001	10671
41002	10672
41013	10921
41062	11051
41094	14343
41095	24344
41096	24345
41097	24346
41098	10673
41099	10674
41134	20824
41187	10311
41188	10320
41189	10725
41204	10684
41217	10685
41221	10337
41222	10338
41223	10339
41224	10340
41231	10922
41233	14634
41245	14342
41256	10780
41296	14643
41337	18025
41338	18139
41365	10675
41366	10676
41367	10678
41378	10620
41422	10921
41428	10564
41429	10565
41430	10566
41431	10746
41432	10774
41433	10775
41434	10534
41435	10535
41436	10791
41437	10312
41438	10562
41439	10318
41440	10741
41441	10303
41442	10793
41448	28238
41450	18076
41472	10761

WALKER	TRUCKEX
41473	10539
41474	10781
41475	10744
41476	10559
41477	10730
41479	9341
41480	9343
41493	18101
41514	8969
41515	9650
41532	10680
41534	10758
41535	10757
41536	10777
41537	10794
41538	10785
41539	9342
41540	9344
41544	14705
41545	18106
41557	8974
41558	10301
41560	10792
41563	8963
41583	10330
41590	18091
41603	18109
41604	17853
41612	10567
41614	10635
41615	10636
41616	10637
41618	10631
41619	10632
41620	10633
41622	10643
41623	10644
41624	10645
41626	10639
41627	10640
41628	10641
41630	10681
41631	10773
41632	10743
41633	10795
41638	18148
41640	10728
41641	10742
41645	9390
41646	9470
41647	9473
41648	9391
41649	9392
41650	9476
41651	9472

WALKER	TRUCKEX
41652	9474
41653	9475
41654	9393
41655	9478
41656	9471
41657	9392
41658	9394
41659	9708
41660	24981
41662	9479
41685	10776
41686	10726
41687	8954
41688	9715
41689	9717
41690	9719
41691	14739
41692	14738
41693	14737
41694	14740
41696	9716
41700	8912
41712	14734
41754	18151
41756	9727
41768	10759
41769	10764
41778	18152
41782	18141
41783	18143
41784	14748
41786	9723
41829	18136
41832	10789
41844	9720
41860	9713
41862	9710
41864	9712
41865	9709
41872	9711
41873	9706
41879	9721
41882	8934
41889	8979
41890	9648
41891	9649
41892	14601
41893	14602
41894	8957
41895	14603
41896	18103
41897	8978
41898	8958
41899	14605
41909	8965

HD MASTER INTERCHANGE (Continued)

WALKER	TRUCKEX
41920	8662
41924	8663
41926	8949
41932	8935
41935	8661
41937	8904
41939	8936
41940	14337
41941	8944
41942	8660
41943	8945
41944	8933
41945	8907
41946	8902
41947	24684
41948	8950
41949	8909
41951	8951
41952	8946
41953	8938
41954	8939
41955	8911
41956	14662
41957	14338
41958	8947
41959	8913
41960	8941
41961	8948
41962	8940
41963	8942
41965	8943
41966	18077
41967	8980
41970	8975
41971	8970
41972	9600
41973	8953
41974	8960
41975	9334
41976	13009
41978	8976
41979	8971
41980	9333
41981	8955
41982	8962
41983	18144
41983	24710
41984	8964
41987	8972
41988	9722
41989	8956
41991	9332
41992	8973
41994	9331
41997	9336

WALKER	TRUCKEX
41998	9335
41999	8959
42065	24752
42066	24753
42067	24754
42068	24755
42069	24835
42070	24837
42071	24746
42072	24747
42081	10787
42085	28523
42125	10541
42126	24712
42127	9599
42128	24696
42129	24717
42130	14759
42130	24718
42132	24939
42147	10790
42175	24674
42176	24935
42177	24654
42178	24941
42185	10305
42186	10788
42211	28517
42220	28400
42228	24889
42233	28502
42246	10727
42247	10745
42249	10747
42252	10755
42253	10788
42262	24937
42263	24938
42272	10765
42274	10796
42288	10536
42305	34798
42317	24936
42338	24836
42339	24838
42344	10778
42354	38273
42355	10729
42356	10763
42364	28344
42369	28658
42377	24672
42388	37764
42393	28169
42393	28170

WALKER	TRUCKEX
42407	28661
42423	24677
42424	24678
42444	28509
42445	10304
42447	14620
42448	14618
42449	14619
42453	10731
42455	24676
42477	24629
42477	24942
42492	24675
42499	24646
42528	28662
42530	24739
42531	24737
42535	38743
42543	24750
42544	24748
42594	24697
42596	9597
42596	27875
42606	24731
42606	28495
42648	38284
42690	28294
42715	24713
42716	14758
42716	24714
42758	10315
42760	10313
42761	10314
42763	10557
42781	28515
42782	28645
42846	28237
42855	10317
42856	10560
42857	10537
42858	10554
42891	24711
42901	28383
42924	28639
42926	28641
42936	10538
42937	10306
42938	10308
42939	10540
42940	10542
42944	10556
42955	38487
42956	28425
42978	28528
42984	18083

WALKER	TRUCKEX
43031	38587
43063	28174
43156	28385
43156	38503
43157	28472
43159	28295
43159	28296
43162	38249
43168	10553
43191	34814
43196	34799
43202	34673
43203	34674
43207	38758
43208	28635
43210	38747
43229	38763
43230	38760
43236	38741
43242	28382
43245	38528
43249	38764
43267	28437
43277	48348
43295	28240
43297	38345
43299	3373
43319	34715
43320	34719
43321	34720
43324	34879
43348	10766
43362	38603
43366	34714
43367	54906
43381	34743
43382	34744
43425	38553
43438	10555
43440	38570
43442	38571
43477	28424
43486	28401
43507	28474
43518	38572
43582	34716
43587	34830
43588	34831
43604	38555
43605	38557
43606	34713
43613	38606
43627	38413
43648	28326
43651	38288

WALKER	TRUCKEX
43698	10797
43699	10309
43718	34723
43719	34724
43729	28308
43729	38459
43729	38529
43729&42596	58097
43752	38223
43782	28134
43793	38745
43794	28494
43811	38268
43812	38269
43817	38270
43818	38271
43957	38234
43958	38266
43995	38440
44002	48564
44055	44795
44059	54117
44059	54806
44084	48560
44095	48349
44098	54811
44112	10679
44113	44857
44114	54853
44119	48512
44120	48456
44126	44656
44127	44658
44132	83015
44137	58283
44138	48318
44141	48319
44142	48320
44143	48518
44147	48329
44149	48463
44151	48461
44152	48462
44154	58330
44158	48404
44161	54871
44161	54872
44165	48460
44169	3425
44203	68182
44206	54833
44215	48516
44215	58339
44224	48434
44224	48517

WALKER	TRUCKEX
44240	38469w18078
44250	48554
44258	2002
44258	2326
44263	2319
44264	54875
44265	54874
44266	44811
44299	44664
44300	44666
44301	44854
44302	34828
44303	44863
44305	38435
44308	44731
44315	48347
44335	48468
44347	48552
44348	48568
44353	38415
44353	58248
44400	38556
44405	38552
44426	44809
44430	54755
44449	44822
44456	44657
44457	44659
44486	48453
44498	48514
44499	48456
44511	48152
44513	48457
44538	44821
44545	34813
44557	54880
44569	10310
44593	28504
44620	54116
44620	54815
44622	54115
44622	54767
44634	44853
44637	44665
44638	44667
44679	94009
44786	48234
44800	48519
44924	48470
44927	54768
44927	54815
44928	54812
44964	48402
44982	44773
45006	64690

WALKER	TRUCKEX
45007	54809
45029	54808
45031	64729
45050	54989
45052	48300
45066	54991
45074	58403
45076	58349
45077	38386w38387
45080	58364
45104	68374
45105	54810
45115	7647
45160	54835
45161	54834
45185	58340
45205	54835
45206	54834
45233	54721
45246	54722
45248	7661
45258	58344
45259	54885
45260	38436
45263	58318
45266	48443
45267	64752
45268	64730
45294	58345
45295	54886
45295	64749
45307	54786
45308	54785
45315	54998
45320	44855
45327	58225
45338	48569
45339	54984
45340	54985
45352	54903
45354	54848
45364	54904
45375	58362
45381	54863
45423	54847
45427	64722
45454	64785
45462	54125
45465	64754
45467	54124
45468	54995
45509	54129
45512	68267
45532	58141
45656	34643

WALKER	TRUCKEX
45656	54655
45656&42499	64699
45672	54912
45698	58419
45726	54725
45727	54726
45737	54438
45746	54704
45751	54699
45751	54749
45752	54700
45752	54750
45758	54827
45768	58414
45776	58205
45779	58412
45794	58219
45800	54992
45805	58220
45812	58222
45820	54747
45823	54821
45824	55000
45859	54870
45946	58251
45959	54760
45961	58370
45984	38222
45993	44861
45993	54805
46424	64631
46425	54650
46466	64633
46521	64728
46527	64694
46551	64650
46576	58221
46588	74607
46630	64716
46670	68221
46672	68372
46673	68371
46704	64691
46713	64708
46729	64730
46736	74627
46749	68375
46752	68280
46753	68308
46754	68309
46755	68310
46757	64776
46763	7359
46774	64691
46776	64741

HD MASTER INTERCHANGE (Continued)

WALKER	TRUCKEX
46778	54720
46793	64750
46802	68352
46812	38554
46820	64763
46821	74646
46828	68368
46831	64760
46832	68370
46833	64761
46844	64744
46854	68418
46867	64781
46874	68420
46887	68421
46896	64673
46913	64793
46914	64794
46915	64812
46916	64813
46917	64791
46918	64792
47552	64652
47552	74439
47570	84555
47586	74629
47587	74630
47607	74636
47608	74637
47617	74621
47620	84571
47621	84561
47625	74623
47643	74633
47645	74632
47653	74635
47659	64751
47669	84567
47674	74645
47684	78214
47694	74651
47698	74642
47700	74654
47704	78228
47706	78229
47726	74662
47729	74664
47735	74666
47744	78230
47766	74670
47767	64774
47960	200A7514
47968	112A7516
47969	178A7516
47971	134A7516

WALKER	TRUCKEX
47972	200A7516
47973	214A7514
47974	212A7514
48210	68093
48220	68099
48237	68156
48245	83004
48277	84559
48278	84568
48280	88104
48296	84584
48318	84587
49010	300A1016
49011	312A1016
49012	400C1016
49015	500C1016
49027	600C1016
49028	8986
49029	8987
49030	8988
49031	8989
49032	8885
49033	8886
49034	8887
49035	8888
49036	8990
49044	8884
49045	112A1016
49046	134A1016
49047	200A1014
49048	214A1014
49049	212A1014
49050	234A1414
49051	300A1414
49052	400A1414
49056	412A1016
49057	178A1016
49060	8883
49061	8855
49062	600A1016
49063	8895
49064	500A1016
49065	300A1014
49070	8856
49071	8857
49077	8984
49078	8985
49081	8858
49089	8986
49090	8987
49091	8988
49092	8989
49105	8859
49106	8876
49151	83005

WALKER	TRUCKEX
49158	83008
49159	300A1014
49160	312A1016
49161	400A1014
49162	500A1016
49165	83001
49166	83014
49177	83029
49194	83037
49195	234A1014
49200	924002
49202	925502
49203	926002
49204	927002
49214	924120
49215	925120
49232	83032
49234	83034
49235	83035
49238	83043
50005	8868
50008	8898
50015	8899
50505	64937
51000	18142
52032	28655
52034	28664
52058	10767
52089	28735
52097	28557
52119	10783
52123	24931
52124	24933
52128	24835
52129	24934
52130	28682
52134	10749
52135	10784
52138	10782
52150	28651
52152	28647
52156	28648
52157	28649
52160	28665
52161	28666
52162	24946
52163	28667
53017	38612
53018	38611
53031	38768
53042	10732
53049	34829
53053	34827
53089	24929
53090	24849

WALKER	TRUCKEX
53094	10762
53095	10786
53107	44893
53108	38846
53127	38797
53128	28684
53130	38769
53131	34880
53153	34877
53160	34881
53161	38770
53192	34882
53197	58443
53198	38823
53199	34883
53203	38746
54018	48570
54019	44866
54044	94942
54046	94010
54047	34826
54048	34785
54050	44867
54089	38631
54114	48580
54136	38627
54150	54997
54164	48513
54168	48557
54175	48571
55006	44786
55007	54831
55055	58407
55056	54130
55057	58420
55063	58421
55084	54112
55092	58423
55102	54994
55115	54132
55116	54990
55117	58401
55159	68451
55175	54953
55203	54954