

ARIES[®]

2022 CATALOG & APPLICATION GUIDES



BE BOLD.

TEAM **ARIES**



BULL BARS

BE BOLD

AdvantEDGE™ bull bar on Ford F-250 Super Duty

FOREFRONT™ BULL BAR

NEW



Product Details

- Carbon steel frame provides durable, high-quality front-end protection
- Four-point frame mount system for exceptional stability
- One-piece, welded build to maximize strength and durability
- Form-fitting, sleek design complements the lines of the vehicle
- Integrated tow hooks for towing and hauling capabilities (excluding Sport model)
- Built-in light mounts for aftermarket LED lights
- Highly corrosion-resistant zinc primer and textured black powder coat finish



2165200

Designed exclusively for Ford Bronco models.



Assembled as one fully welded piece, it is built with a four-point frame-mount system that maximizes stability and durability



Built-in light mounts for aftermarket LED lights come standard on the ForeFront for added convenience



ForeFront features a form-fitting design and strong carbon steel frame to provide sturdy, superior front-end protection

Finish & Material

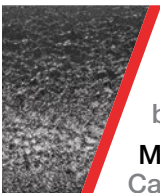

Finish:
Textured
black

Material:
Carbon steel

Make / Model	Years	Part #	Fits Light Bar #	Max Light Height
Ford				
Bronco*	21 - 21	2165200	1501264 (30")	9"
Bronco Sport	21 - 21	2165201	1501262 (20")	8"

* With heavy-duty modular bumper



5 1/2"

ADVANTEDGE™ BULL BAR

See page 106 for application information

Product Details

- Extruded, all-aluminum construction to be strong, lightweight and rust-free
- Stamped aluminum, octagonal grid cover plate for a distinct look
- Track mounting system for easy, secure installation
- No-drill, vehicle-specific application for a custom fit
- Bull bars with crossbar lights include wiring harnesses
- Made to complement AdvantEDGE side bars and headache rack (see pages 34 and 54)
- See page 15 for AdvantEDGE accessories
- Base-mount brackets (#1110312) available to mount LED light bars; see page 96 (drilling required on flush-mount LED models)
- Limited lifetime warranty (see last page for details)
- Patent# 9,637,178



Bold, edgy and aggressive



Unique, eight-sided tube profile to complement the style of modern trucks



Optional flush-mount LED work lights built into the crossbar add function and style



Crossbar without LEDs can be flipped to mount LED lights (see page 96 for lights)

Finishes & Materials

Bull bar



Bull bar

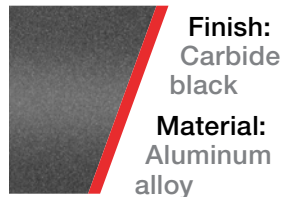

Cover plate

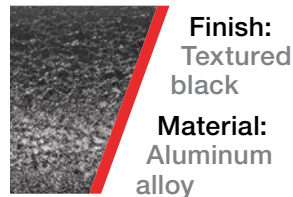



Toyota Tundra



Ford F-250

4"

BIG HORN™ BULL BAR

See page 107 for application information

Product Details

- Hardened aluminum alloy construction to be strong, lightweight and rust-free (also available in polished 304 stainless)
- Removable, brushed 304 stainless steel skid plate deflects small road debris
- Replacement tow hooks available for certain Ram 2500 / 3500 trucks
- Made to complement ARIES Big Step™ side bars (see page 44)
- See page 14 for 4" bull bar accessories
- No-drill, vehicle-specific application for a custom fit
- Limited lifetime warranty (see last page for details)



AL45-3014

45-3014

A bold look for large, lifted trucks



Bold, 4" diameter is designed to show well on larger, lifted vehicles



Textured black powder coat easily hides minor scratches and grime (select models)



Two pre-drilled holes in the crossbar for mounting LED lights (see page 96 for lights)

Finishes & Materials

Bull bar

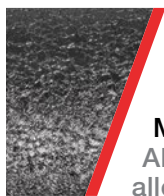

Finish:
Textured black

Material:
Aluminum alloy

Bull bar



Finish:
Polished stainless

Material:
304 stainless steel

Skid plate



Finish:
Brushed stainless

Material:
304 stainless steel



Ford F-350 Super Duty



Toyota Tundra

3"

BULL BARS

See page 107 for application information

Product Details

- 3" diameter, heavy-wall tubing (select models have 2-1/2" diameter tubing, see application guide for part numbers)
- Two pre-drilled holes in the crossbar for mounting LED lights (see page 96 for LED work lights and light bars)
- Removable, brushed 304 stainless steel skid plate deflects small road debris
- Replacement tow hooks available for certain Ram 2500 / 3500 trucks
- See page 14 for 3" bull bar accessories
- No-drill, vehicle-specific application for a custom fit
- Limited lifetime warranty (see last page for details)

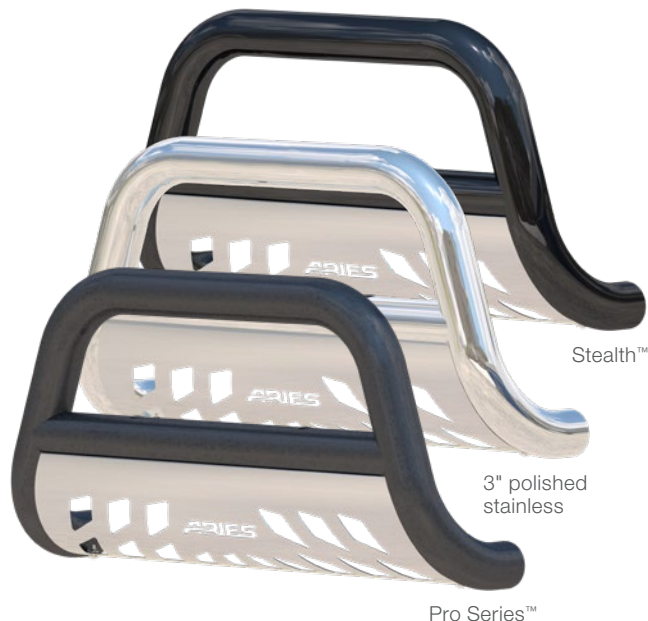

Stealth™ bull bar



Rigorously tested, powder-coated stainless steel resists moisture, road salt and rust

Pro Series™ bull bar



Textured black, powder-coated steel easily hides minor scratches and grime

3" bull bar



Wide range of applications, including some vans and many older trucks

Finishes & Materials

Stealth™ bull bar



Pro Series™ bull bar



3" bull bar



3" bull bar

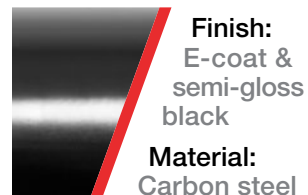

All skid plates

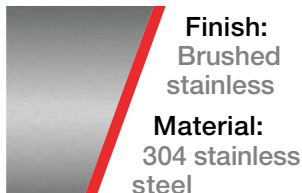



Jeep Grand Cherokee



Ford F-350 Super Duty



BULL BAR ACCESSORIES

/ Base-Mount Light Bar Brackets

- Provides a solid, adjustable mounting point for ARIES LED light bars (see page 96 for LED lights)
- Perfect for adding light bars to bull bars, grille guards and headache racks
- Equipped with an 8mm stud (light bar mounting hardware not included)
- Die-cast aluminum construction to be strong, lightweight and rust-free
- Some drilling and additional hardware may be required for installation



1110312



Part #	Fits	Includes	Finish
1110312	All ARIES bull bars	Two brackets	Aluminum with black powder coat

/ Tow Hooks

- Fits 4" and 3" round bull bars
- Perfect for recovery towing applications
- Up to 10,000 lbs. load capacity
- Durable semi-gloss black powder coat finish
- Includes hardware for a solid installation



35-5TOW



Make / Model	Years	Part #
Ram		
2500	10 - 19	35-5TOW
3500	10 - 19	35-5TOW

BULL BAR ACCESSORIES

/ AdvantEDGE™ Paintable Cover Plates

- Raw finish can be painted for easy customization
- Two styles to fit the AdvantEDGE bull bar with LEDs (#2055193) or without (#2055192)
- Stamped octagonal grid design for a distinct look
- Aluminum build is strong, lightweight and rust-free
- Includes one cover plate and mounting hardware

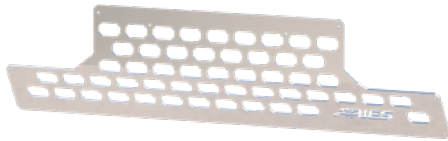

2055193
with LED

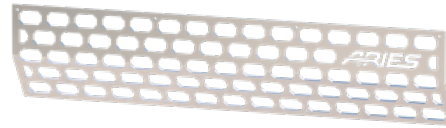

2055192
without LED

Part #	Fits	Finish
2055193	AdvantEDGE bull bar with LED lights	Raw aluminum
2055192	AdvantEDGE bull bar without LED lights	Raw aluminum

/ License Plate Brackets

- Easily bolts onto crossbar, using existing cover plate / skid plate hardware
- Provides a solid mounting location to keep license plate visible
- Includes license plate mounting bolts

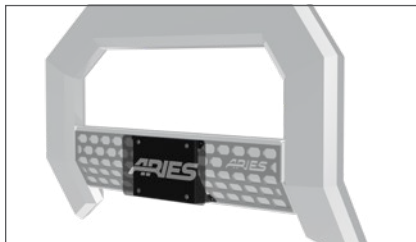

2169000



35-0000



45-0000

Part #	Fits	Finish
2169000	AdvantEDGE bull bar	Aluminum with black powder coat
35-0000	3" bull bars	Steel with black powder coat
45-0000	Big Horn 4" bull bar	Steel with black powder coat



GRILLE GUARDS

BE BOLD

Grille guard on Toyota 4Runner

FEATURED PRODUCTS



/ Pro Series™ grille guard

The Pro Series grille guard features a patented LED light bar housing and an interchangeable cover plate for easy customization.



/ Standard grille guard

ARIES standard grille guards offer a no-drill, custom fit and are available for a wide variety of applications, including many older trucks.



/ Light bar brackets

These universal brackets bolt onto the crossbar of ARIES grille guards and provide a solid mounting point for our single-row LED light bars.

PRODUCT INDEX



18

**Pro Series
Grille Guard**

**Applications
on page 111**



20

**Pro Series
Accessories**

**Universal
fit**



22

**Grille
Guards**

**Applications
on page 112**



22

**Light Bar
Brackets**

**Universal
fit**

PRO SERIES™ GRILLE GUARD

See page 111 for
application information

Product Details

- Patented crossbar houses a single-row LED light bar
- Interchangeable cover plate protects light bar and offers easy customization (see page 20)
- Black mesh cover plate #PC30MB included (#PJ20MB for Jeep)
- Channel-style bracket accepts one or multiple light bars
- Articulating bracket allows light to be mounted at a custom angle
- Textured black powder coat easily hides minor scratches and grime
- One-piece, 1-1/2" diameter, heavy-wall tubing in high-strength steel
- Vertical rubber stripping along the risers to help maintain a clean finish
- No-drill, vehicle-specific application for a custom fit
- Patent# 9,108,581
- Limited lifetime warranty (see last page for details)



#2170014 kit includes grille guard and light bar

Uniquely made for LED light bar customization



Patented crossbar houses a single-row LED light bar



Interchangeable cover plate protects light bar and offers easy customization (see page 20)



Black mesh cover plate #PC30MB included (#PJ20MB for Jeep)

Finishes & Materials

Grille guard

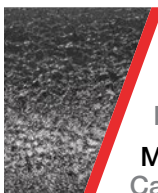

Finish:
E-coat & textured black

Material:
Carbon steel

Cover plate (included)

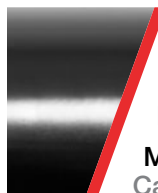

Finish:
Semi-gloss black

Material:
Carbon steel



Chevrolet Silverado 1500



Jeep Renegade



Ford F-150

PRO SERIES™ GRILLE GUARD ACCESSORIES

/ Cover Plates

- Interchangeable design for easy customization
- Helps protect lights bars from theft and road debris
- Securely bolts onto the patented center crossbar



PC30MB - black



PC20OS - brushed



PC30OS - brushed

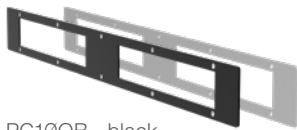

PC10OB - black
PC10OS - brushed



PC20OB - black
PC20OS - brushed

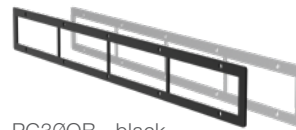

PC30OB - black
PC30OS - brushed



PC30MB - black
PC30MS - polished

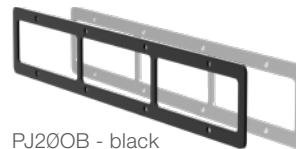

PJ20OB - black
PJ20OS - brushed

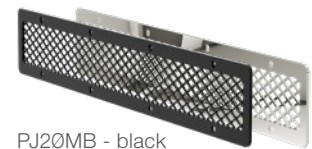

PJ20MB - black
PJ20MS - polished

Light Bar Length	Style	Black #	Polished #	Brushed #
Universal (excluding Jeep)				
10"	Open-face	PC10OB*	--	PC10OS*
20"	Open-face	PC20OB*	--	PC20OS*
30"	Mesh-face	PC30MB*	PC30MS*	--
30"	Open-face	PC30OB*	--	PC30OS*
Jeep Only				
20"	Mesh-face	PJ20MB*	PJ20MS*	--
20"	Open-face	PJ20OB*	--	PJ20OS*

* Continued while supplies last

/ License Plate Bracket

- Easily bolts onto the crossbar, using included hardware
- Provides a solid mounting location to keep license plate visible
- Strong steel construction with a durable black powder coat finish
- Includes license plate mounting bolts



85-0000



Part #	Includes	Finish
85-0000	Bracket and mounting hardware	Steel with black powder coat



Jeep Gladiator JT

GRILLE GUARDS

See page 112 for application information

Product Details

- One-piece, 1-1/2" diameter, heavy-wall tubing in rust-free stainless or strong, black carbon steel
- Two pre-drilled holes in the crossbar for mounting LED lights (see page 96 for LED work lights and light bars)
- Removable headlight cages for extra protection and a customizable look
- Vertical rubber stripping along the risers to help maintain a clean finish
- No-drill, vehicle-specific application for a custom fit
- Limited lifetime warranty (see last page for details)

Finishes & Materials

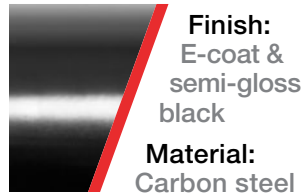
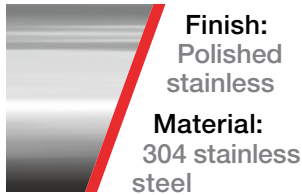

/ Base-Mount Light Bar Brackets

- Provides a solid, adjustable mounting point for ARIES LED light bars
- Perfect for adding light bars to bull bars, grille guards and headache racks
- Equipped with an 8mm stud (light bar mounting hardware not included)
- Die-cast aluminum construction to be strong, lightweight and rust-free
- Some drilling and additional hardware may be required for installation



See page 96 for our full line of LED lights



Part #	Includes	Finish
1110312	Two brackets	Aluminum with black powder coat



Ram 1500



Ford F-350 Super Duty



Ford F-150

Scan for current applications
or visit ariesautomotive.com



TEAM **ARIES**



RUNNING BOARDS & SIDE BARS

BE BOLD

ActionTrac™ boards and Switchback® headache rack on Ford F-150

FEATURED PRODUCTS



/ ActionTrac™ boards

With a patented step-within-a-step™ design, these powered boards provide easier, two-step access, especially on larger, lifted vehicles.



/ ActionTrac™ universal brackets

These brackets allow ActionTrac boards to be mounted with custom-fabricated brackets. Each kit also comes with a universal wiring kit.



/ AscentStep® boards

Our high-end running boards offer elevated style and feature unique step pads that combine raised poly treads and a sleek metal overlay.

PRODUCT INDEX



26
ActionTrac™
Running Boards

Applications
on page 116



30
VersaTrac®
Bracket System

Applications
on page 118



32
6-1/2"
RidgeStep®

Applications
on page 118



34
5-1/2"
AdvantEDGE™

Applications
on page 118



36
5-1/2"
AscentStep®

Applications
on page 118



38
6" Oval
Side Bars

Applications
on page 124



40
5" AeroTread®
Running Boards

Applications
on page 128



42
4" Oval
Side Bars

Applications
on page 130



44
4" Big Step™
Round Side Bars

Applications
on page 132



46
Rocker
Steps

Applications
on page 133



48
3" Round
Side Bars

Applications
on page 134

ACTIONTRAC™ POWERED BOARDS

See page 116 for
application information

Product Details

- Patented step-within-a-step™ design for easier access, especially on lifted vehicles
- Lightweight, non-corrosive aluminum
- Single, rotary motor for fast, quiet, reliable operation
- Integrated LED lights activate on deployment for added visibility and safety
- Rated for 650 lbs. static weight capacity (limited to mounting structure)
- Limited lifetime warranty (see last page for details)
- Patent# 9,771,024; 8,833,781; D718,195; D751,953; 10,059,268



Key Features



3" powered step automatically drops 8" when door opens, up to 15" below doorsill



Simple-2-install™ system with no-splice wiring and no-drill brackets (excl. some Ram models)



Integrated control module detects obstructions and eliminates pinch hazards

Step-Within-A-Step™ Benefits



Easier, two-step entry and 4" top step provides convenient access to the roof



Housing shields retractable step, pivot points and electronics from the elements



Contoured design helps protect the rocker panels from road debris and door dings

Finish & Material

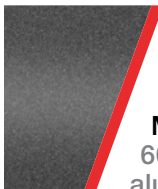

Finish:
Carbide
black

Material:
6061 T6
aluminum

Did you know?

ActionTrac boards can be mounted with custom-fabricated brackets using our universal mount kit. Each kit comes with universal brackets and wiring.



TEAM **ARIES**



Chevrolet Silverado 1500

ACTIONTRAC™ ACCESSORIES

/ ActionTrac Universal Brackets

- Provides board attachment points for custom-fabricated brackets (not included)
- Designed for custom installation if vehicle-specific brackets are not available
- Universal wiring kit included
- Steel brackets with black powder coat finish
- Custom vehicle brackets and boards not included

Part #	Qty	Includes
3025176	6	Wiring and board attachment brackets
3025177	8	Wiring and board attachment brackets

Requires fabricated vehicle brackets to install



/ Door Delete Kit

- Deploys and retracts the powered steps at the push of a button
- For Jeep applications with the factory doors removed or replaced with tube doors

Part #	Includes
3020000	Two wiring harnesses, two switches, four connectors

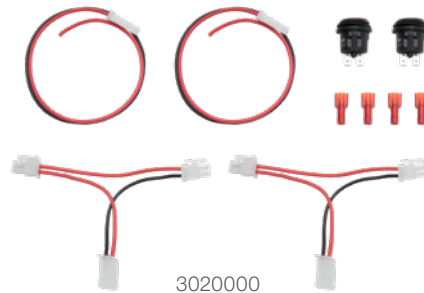

/ Replacement Door Magnets

- Replaces the magnet on the inside doorsill
- Works with control module to activate powered steps

Part #	Includes
2090206	Four magnets and four permanent VHB tape pads

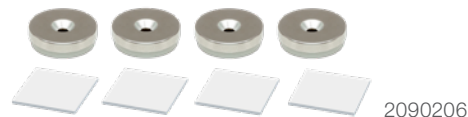

/ Replacement LED light and bracket

- Compatible with all ActionTrac running boards
- Constructed with LED components for bright, long-lasting light
- Quick plug connector for easy installation

Part #	Includes
2090204	One light and bracket included per package





Ford F-250 Super Duty

VERSATRAC® MOUNTING SYSTEM

See page 118 for
application information

/ Key Features

- Each bracket set fits VersaTrac compatible boards to save time, money and inventory space
- No-drill, vehicle-specific application for a custom fit



Compatible Running Boards

- RidgeStep® running boards (page 32)
- AdvantEDGE™ side bars (page 34)
- AscentStep® running boards (page 36)
- SlimGrip™ running boards (luvernetruck.com)

Mounting Brackets

- Heavy-duty steel construction with a durable black powder coat finish
- Co-cured in an E-coat finish for superior rust resistance

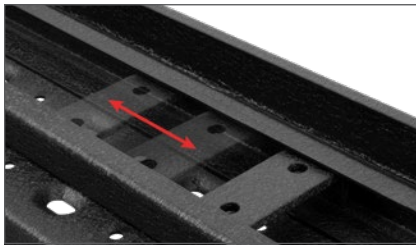

RidgeStep track system

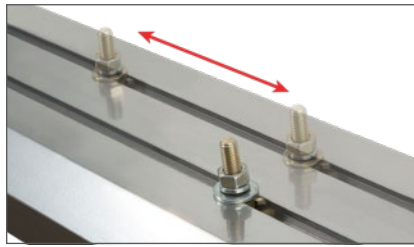

AdvantEDGE track system



AscentStep track system

/ VersaTrac Bracket Covers

- Covers brackets for an enhanced look and added protection
- Tough, rust-free thermoplastic rubber construction
- Slotted holes for easy adjustment
- Easy to trim for a custom fit on any application

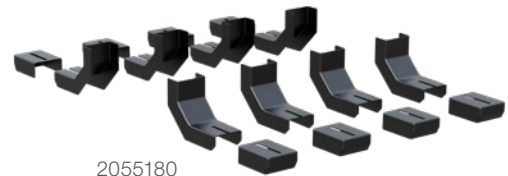

Part #	Covers	Cab Size
2055140	Four brackets	Regular
2055160	Six brackets	Extended
2055180	Eight brackets	Crew



**RidgeStep on
Ram ProMaster 2500**



**AdvantEDGE on
Chevrolet Colorado**



AscentStep on GMC Sierra 1500

6 1/2"

RIDGESTEP® RUNNING BOARDS

See page 118 for application information

Product Details

- Angular design for a tough, no-nonsense look on hardworking trucks
- Flat profile and 6-1/2" width provide a comfortable step
- Textured black powder coat easily hides minor scratches and grime
- Welded steel end caps for a durable accent
- **Compatible with the VersaTrac® mounting system for easy installation and vehicle customization (see page 30)**
- Four base lengths allow for fewer inventory requirements (53", 75", 85" and 91")
- Also available in a unique short-long configuration for cargo vans (36" and 96")
- No-drill, vehicle-specific application for a custom fit
- Heavy-duty, powder-coated steel mounting brackets for a solid step
- Limited lifetime warranty (see last page for details)

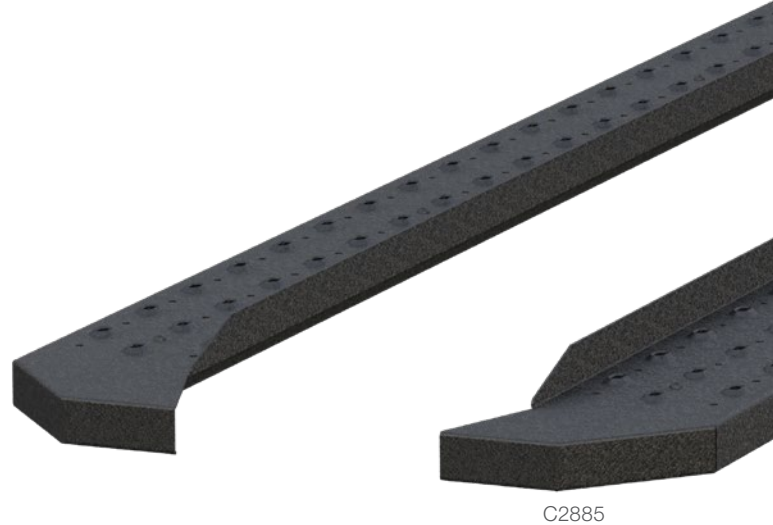

Truck steps built for hard work



High-strength, all-steel construction with no plastic parts



Stamped steel treads for a non-skid step that will never wear or crack

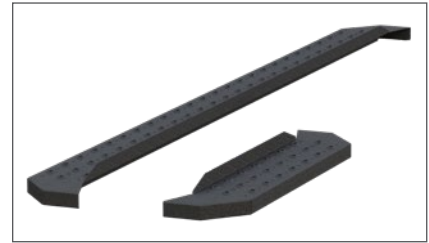

Also available in a unique short-long configuration for cargo vans

Finish & Material

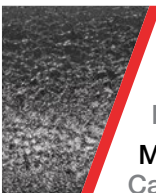

Finish:
E-coat & textured black

Material:
Carbon steel



5 1/2"

ADVANTEDGE™ SIDE BARS

See page 118 for application information

Product Details

- Extruded, all-aluminum construction to be strong, lightweight and rust-free
- Die-cast aluminum end caps for a durable accent
- Complements AdvantEDGE bull bar and headache rack (see pages 8 and 54)
- Four base lengths allow for fewer inventory requirements (53", 75", 85" and 91")
- **Compatible with the VersaTrac® mounting system for easy installation and vehicle customization (see page 30)**
- No-drill, vehicle-specific application for a custom fit
- Heavy-duty, powder-coated steel mounting brackets for a solid step
- Limited lifetime warranty (see last page for details)
- Patent# 9,637,178



2055853



2055953

Unique, octagonal profile for an aggressive look



Unique, eight-sided tube profile to complement the style of modern trucks



Stamped aluminum treads for a non-skid step that will never crack or fade



VersaTrac mounting system for easy installation and vehicle customization

Finishes & Materials

Side bar



Side bar

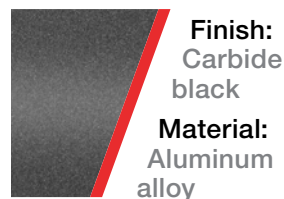

Step pad

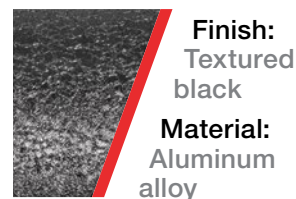



Toyota Tundra



Ford F-350 Super Duty



ADVANTEDGE™ ACCESSORIES

/ Paintable Step Pads

- Raw finish can be painted for easy customization
- Stamped octagonal grid design for a distinct look
- Aluminum build is lightweight and rust-free
- Mounting hardware finished in durable, fade-resistant black chromite
- Includes one step pad and mounting hardware



2055153

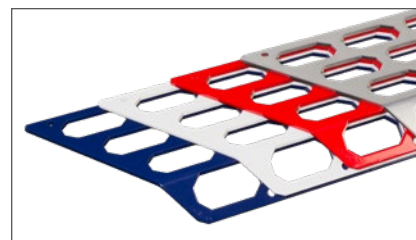

Part #	Fits	Finish
2055153	53" AdvantEDGE side bars	Raw aluminum
2055175	75" AdvantEDGE side bars	Raw aluminum
2055185	85" AdvantEDGE side bars	Raw aluminum
2055191	91" AdvantEDGE side bars	Raw aluminum

5 1/2"

ASCENTSTEP® RUNNING BOARDS

See page 118 for
application information

Product Details

- Polyethylene tread raised through stainless overlay for maximum traction
- Stainless steel tread plates resist corrosion in spite of heavy foot traffic
- Rigid steel construction with sleek, durable carbide black powder coat finish
- **Compatible with the VersaTrac® mounting system for easy installation and vehicle customization (see page 30)**
- No-drill, vehicle-specific application for a custom fit
- Available in three base lengths for fewer inventory requirements (75", 85" and 91")
- Limited lifetime warranty (see last page for details)



2057975

High-end boards for the modern truck



Stylish and modern teardrop design for a unique look



Aggressive, integrated step pads blend steel with non-skid, poly tread



VersaTrac mounting system for easy installation and vehicle customization

Finish & Material



Finish:
Carbide
black

Material:
Carbon steel

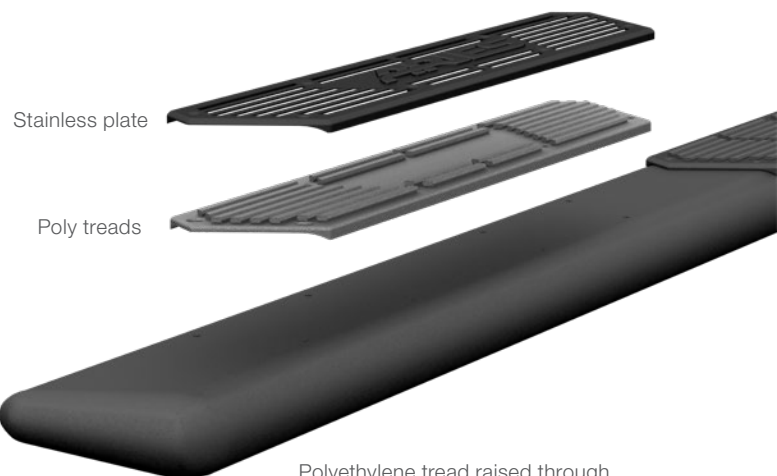

Polyethylene tread raised through stainless overlay for maximum traction and durability



Chevrolet Silverado 1500

6"

OVAL SIDE BARS

See page 124 for application information

Product Details

- Available in lightweight, rust-free aluminum alloy or polished stainless steel
- Four base lengths allow for fewer inventory requirements (53", 75", 85" and 91")
- No-drill, vehicle-specific application for a custom fit
- Heavy-duty, powder-coated steel mounting brackets for a solid step
- Limited lifetime warranty (see last page for details)



B2885

S2885

Classic boards for any truck or SUV



6" wide, OE-style tube with hard ABS plastic end caps



Extra-wide, non-skid step pads for safe, comfortable entry and exit

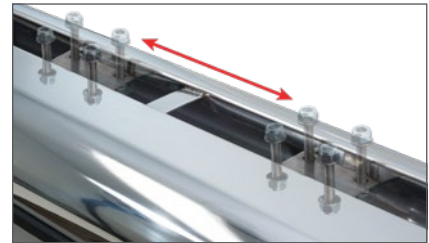

Universal track mounting system for easy, secure installation

Finishes & Materials

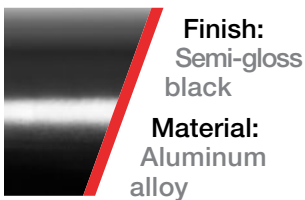



Chevrolet Silverado 1500



Chevrolet Tahoe

5"

AEROTREAD® RUNNING BOARDS

See page 128 for application information

Product Details

- Front trim available in bright rust-free polished or black powder-coated stainless steel
- Flat profile and 5" width provide a comfortable step
- Universal track mounting system for easy, secure installation
- Four base lengths allow for fewer inventory requirements (67", 70", 73" and 76")
- No-drill, vehicle-specific application for a custom fit
- Heavy-duty steel mounting brackets for a solid step
- Limited lifetime warranty (see last page for details)



2051867

2051967

SUV running boards engineered for style



Sleek, contoured design to complement the look of modern SUVs and CUVs



Extruded aluminum base to be lightweight and rust-free



Full-length, tough plastic treads offer a reliable, non-skid surface

Finishes & Materials



Front trim finish:
Polished stainless

Front trim material:
304 stainless steel

Base material:
Aluminum alloy



Front trim finish:
Carbide black

Front trim material:
201 stainless steel

Base material:
Aluminum alloy



Chevrolet Tahoe



4"

OVAL SIDE BARS

See page 130 for
application information

Product Details

- Elliptical, 4" wide, heavy-wall tubing in rust-free stainless or strong carbon steel
- No-drill, vehicle-specific application for a custom fit
- Heavy-duty steel mounting brackets for a solid step
- Sold in pairs with installation hardware included
- Limited lifetime warranty (see last page for details)



S224051-2

S224051

Elevated style and functionality



20° bends contour to the body of the vehicle



Seamless, welded end caps for a superior, finished look



Raised, custom, non-skid step pads for safe, comfortable entry and exit

Finishes & Materials

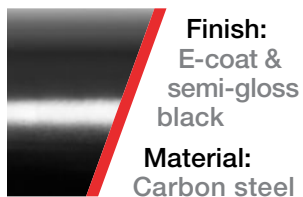



Chevrolet Silverado 1500

4"

BIG STEP™ ROUND SIDE BARS

See page 132 for
application information

Product Details

- Hardened T6 aluminum construction to be strong, lightweight and rust-free
- Textured black powder coat easily hides minor scratches and grime
- Brushed stainless steel ARIES insignia on each step for a distinguished look
- Made to complement ARIES Big Horn™ bull bars (see page 10)
- No-drill, vehicle-specific application for a custom fit
- Heavy-duty steel mounting brackets for a solid step
- Sold in pairs with installation hardware included
- Limited lifetime warranty (see last page for details)



AL233006

Bold style for larger, lifted trucks and Jeeps



Bold, 4" diameter is designed to show well on larger, lifted vehicles



Raised, custom, non-skid step pads for safe, comfortable entry and exit



Unique bends to contour to the body of the vehicle

Finish & Material

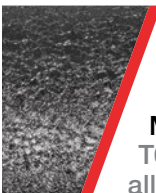

Finish:
Textured
black

Material:
T6 aluminum
alloy



Toyota Tacoma



ROCKER STEPS

See page 133 for application information

Product Details

- Heavy-duty design offers extra protection for the sides of the vehicle
- Textured black powder coat easily hides minor scratches and grime
- High-strength, all-steel construction with no plastic parts
- No-drill, vehicle-specific application for a custom fit
- Sold in pairs with mounting hardware included
- Limited lifetime warranty (see last page for details)



2074106

Rocker guard meets running board



Double-tube layout and 3" wide top plate provide a solid step



Flat profile increases ground clearance to be off-road ready



Pre-welded mounting brackets for increased rigidity and simpler installation

Finish & Material

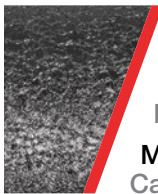

Finish:
E-coat & textured black

Material:
Carbon steel



Jeep JK Unlimited



Ford F-150

3"

ROUND SIDE BARS

See page 134 for
application information

Product Details

- 3" diameter, heavy-wall tubing in rust-free stainless or strong carbon steel
- Unique bends to contour to the body of the vehicle
- Custom, non-skid step pads for safe entry and exit
- No-drill, vehicle-specific application for a custom fit
- Heavy-duty steel mounting brackets for a solid step
- Sold in pairs with installation hardware included
- Limited lifetime warranty (see last page for details)

Fits a wide variety of vehicle applications



Unique bends to contour to the body of the vehicle



Custom, non-skid step pads for safe entry and exit



205040-2



205040 (carbon steel) & 2155040 (stainless steel)

Finishes & Materials

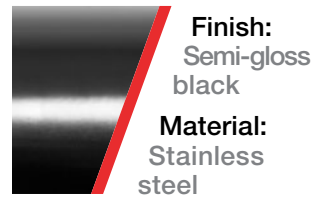
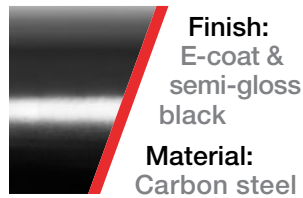



Ford Bronco



Chevrolet Silverado 1500





HEADACHE RACKS

BE BOLD

Switchback® headache rack on Ford F-150

FEATURED PRODUCTS



/ Switchback®

This off-road-style, aluminum headache rack adds an aggressive look and has an innovative three-piece design for easy shipping.



/ AdvantEDGE™

Made for modern trucks, this unique, all-aluminum headache rack is easy to install with its patented stake pocket anchoring system.



/ Classic

The ARIES classic headache rack is built from heavy-duty steel tubing and is available in three universal sizes to fit most full-size pickups.

PRODUCT INDEX

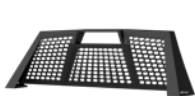

52

Switchback

**Applications
on page 139**



54

AdvantEDGE

**Applications
on page 140**



56

Classic

**Applications
on page 141**



57

Accessories

**Universal
fit**

SWITCHBACK® HEADACHE RACKS

See page 139 for
application information

Product Details

- All-aluminum construction to be strong, lightweight and rust-free
- Light mounting brackets available to mount LED lights (see page 96)
- Full-width slotted edge along the top allows for easy adjustment of the lights
- Three-piece design bolts together with strong stainless steel hardware
- Knockdown assembly ships in three pieces for reduced shipping requirements
- Stamped aluminum, octagonal grid center section for a distinct look
- Center section can be removed for convenient access to the rear window
- Highly durable carbide powder coat finish for maximum corrosion resistance
- Limited lifetime warranty (see last page for details)
- Patent# 10,023,247; 10,414,369; D840,905; D840,906; D840,907



1110109



1110109 showing
three-piece assembly



1110109 shown
without center mesh

Aggressive, angular design in all-aluminum



Slotted top edge accepts various LED lights (three 10" light bars recommended)



Angular profile contours to the lines of the truck cab for a professional look



Patented stake pocket mounting system for simple, secure installation (excl. #1110114)

Finish & Material



Finish:
Carbide
black

Material:
Aluminum
alloy



ADVANTEDGE™ HEADACHE RACKS

See page 140 for
application information

Product Details

- Extruded, all-aluminum construction to be strong, lightweight and rust-free
- Stamped aluminum, octagonal grid center section for a distinct look
- Complements AdvantEDGE bull bars and side bars (see pages 8 and 34)
- Limited lifetime warranty (see last page for details)
- Patent# 9,637,178 and 10,023,247

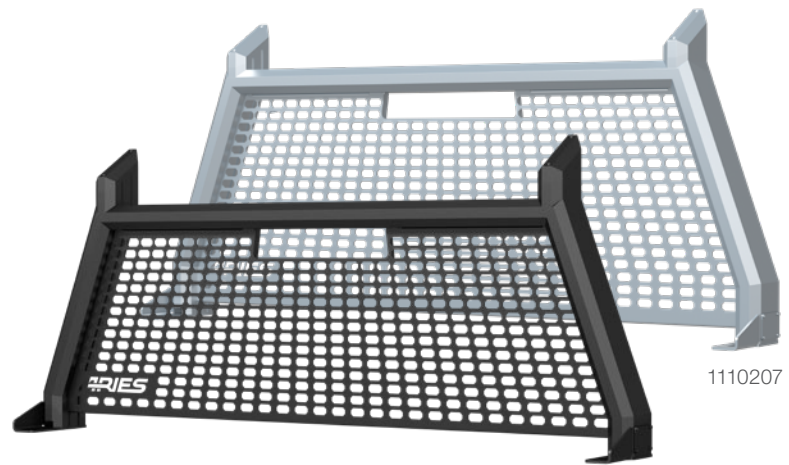

An aggressive look for modern pickups



Unique, eight-sided tube profile to complement the style of modern trucks



Topside track accepts LED lights and tie-down anchors (see pages 96 and 57)



Patented stake pocket mounting system for simple, secure installation

Finishes & Materials

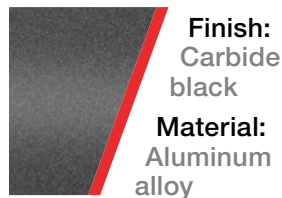

/ Replacement stake pocket anchors

- Compatible with AdvantEDGE or Switchback® headache rack
- Rust-resistant stainless steel and aluminum construction
- Not compatible with Toyota Tacoma
- Patent# 10,023,247



2090613



Patented design for no-drill installation

Part #	Includes
2090613	Two stake pocket anchors

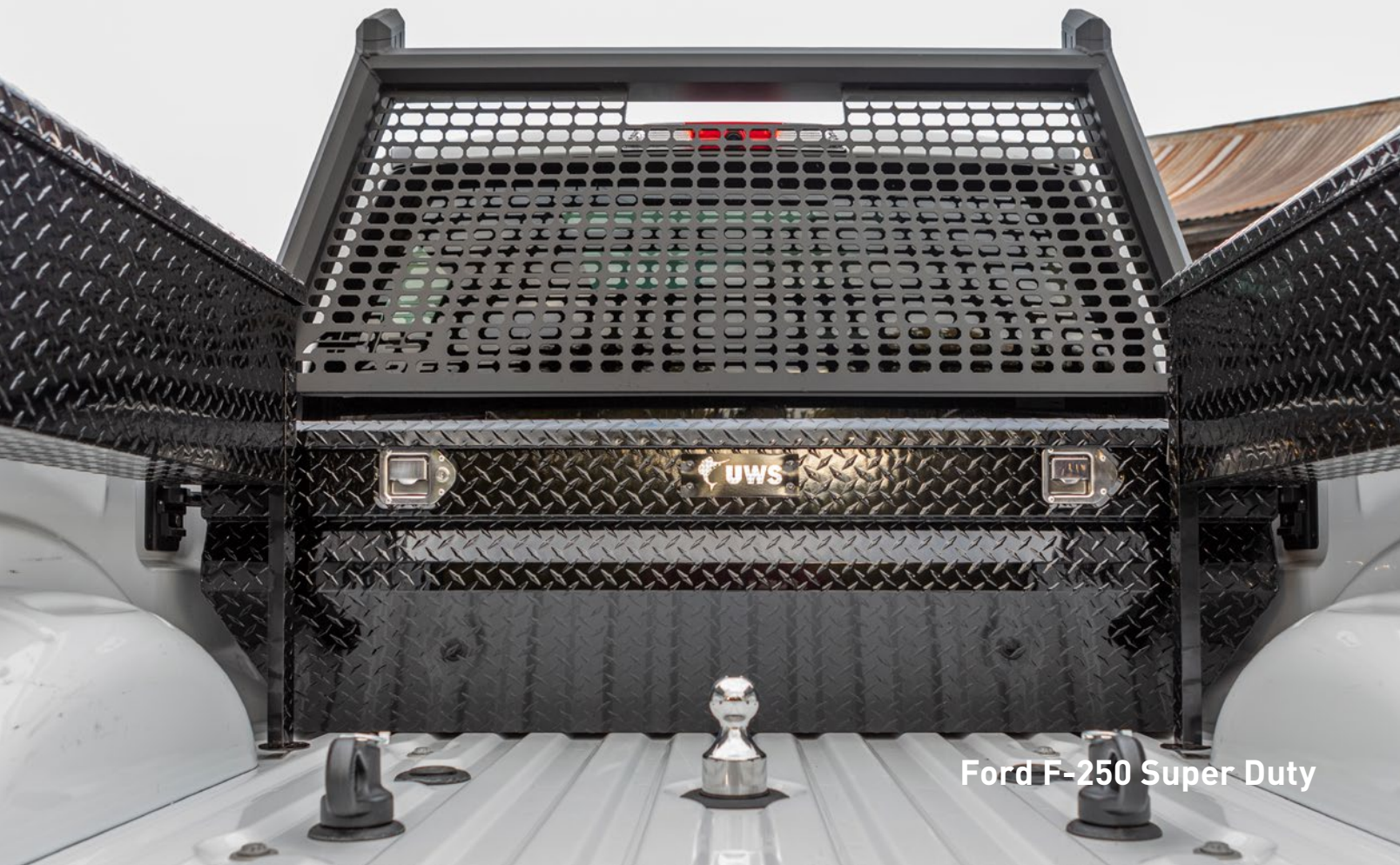

Ford F-250 Super Duty

CLASSIC HEADACHE RACKS

See page 141 for application information

Product Details

- Durable semi-gloss black powder coat finish for rust and chip resistance
- Louvers help keep the cab cooler by blocking direct sunlight
- Flat steel brackets bolt onto the truck bed walls (drilling may be required)
- Compatible with most crossover truck tool boxes
- Base-mount brackets available to mount LED light bars (drilling required)
- Limited lifetime warranty (see last page for details)

Finish & Material

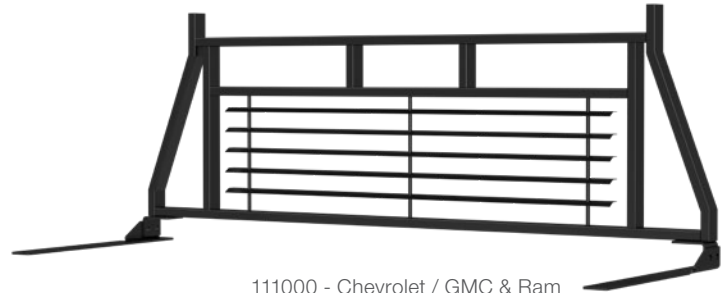
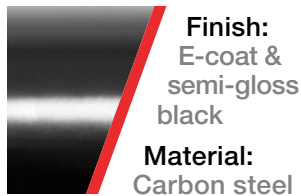

111000 - Chevrolet / GMC & Ram

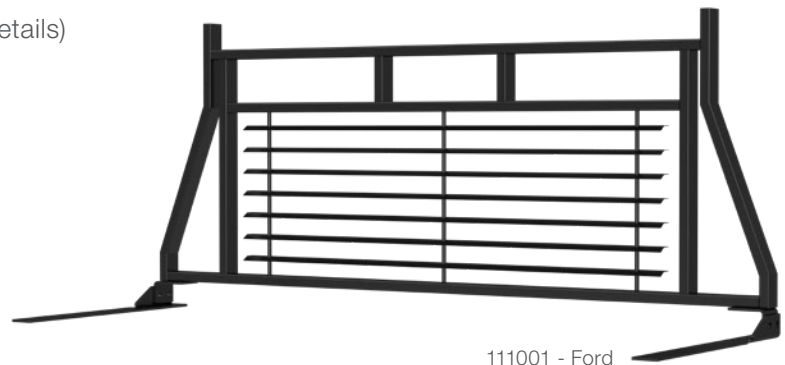

111001 - Ford

A classic look with dependable strength



Three universal sizes fit most full-size pickup trucks



Heavy-duty 1" x 2" steel tube construction for a solid frame



Fully louvered center section to protect the cab and passengers

HEADACHE RACK ACCESSORIES

/ Base-Mount Light Bar Brackets

- Provides a solid, adjustable mounting point for ARIES LED light bars (see page 96 for LED lights)
- Perfect for adding light bars to bull bars, grille guards and headache racks
- Equipped with an 8mm stud (light bar mounting hardware not included)
- Die-cast aluminum construction to be strong, lightweight and rust-free
- Some drilling and additional hardware may be required for installation



1110312

For LED work lights and light bars go to page 96



Part #	Fits	Includes	Finish
1110312	Headache racks, bull bars and grille guards	Two mounting brackets with 8mm stud	Aluminum with black powder coat

/ Mesh-Mount Brackets

- Securely mounts lights onto the AdvantEDGE™ or Switchback® mesh center section (see page 96 for LED lights)
- Allows for additional lighting without using the top channel of the headache rack
- Accepts light mounting hardware up to 8mm in diameter
- Adds LED work lights over the truck bed



1110311



Part #	Fits	Includes	Finish
1110311	Switchback and AdvantEDGE headache racks	Two mounting brackets and hardware (light mounting hardware not included)	304 stainless steel with black powder coat

/ Tie-Down Anchors

- Securely mounts onto the AdvantEDGE headache rack track system
- Multiple holes accept a variety of cargo straps, ropes or bungee cords
- Threaded knobs and track system allow for fast, simple adjustment as needed
- One-piece cast aluminum construction to be strong, lightweight and rust-free
- Rated at 150 lbs. straight line tension force



1110310



Part #	Fits	Includes	Finish
1110310	AdvantEDGE headache racks	Two tie-down anchors	Aluminum with carbide black powder coat

DELLS MILL
AUGUSTA WISCONSIN



JEEP PRODUCTS

BE BOLD

TrailChaser® bumper on Gladiator JT

FEATURED PRODUCTS



/ Gladiator accessories

To fully customize the Jeep Gladiator pickup, we have a complete line of bumpers, LED lights, tube doors and more, ready to order.



/ Tube door mirrors

For our popular Jeep tube doors, these offroad mirrors easily bolt into place and provide a rock-solid view, resisting vibration on the trail.



/ JL TrailChaser® corners

These bumper corner end caps for the TrailChaser are an industry-first, allowing the OE turn signals on the Jeep JL to be fully integrated.

PRODUCT INDEX



60

TrailChaser®
Bumpers



70

TrailCrusher®
Bumpers



74

ActionTrac™
Powered
Running Boards



76

Side Bars
& Steps



79

Pro Series™
Grille Guards



80

LED Lights
& Brackets



82

Tube
Doors



84

Fender
Flares



86

Inner Fender
Liners



88

Spare Tire
Carriers



90

Security
Cargo Lids



92

Roof Rack
Crossbars

TRAILCHASER® JEEP BUMPERS

See all applications and configurations on page 62

Product Details

- Multiple, unique bumper configurations available with or without LED lights for front and rear (page 62)
- Modular pieces can be added or removed as desired to change the look any time
- Optional corner end caps available with integrated flush-mount LED lights
- Cutouts and mounting tabs for OE lights and aftermarket LEDs (see page 96 for LED work lights and light bars)
- Choose between lightweight hardened T6 aluminum or high-strength carbon steel
- Textured black powder coat easily hides minor scratches and grime
- Compatible with tow hooks and a winch (#2072100 adapter required for winches wider than 22-1/2")
- Winch reinforcement bracket required for aluminum bumper configurations if installing a winch
- Uses pre-existing factory mounting points for no-drill installation
- Allows relocation of OE fog lights (Mopar #68081399AB) from factory steel front bumpers
- Limited lifetime warranty (see back page for details)

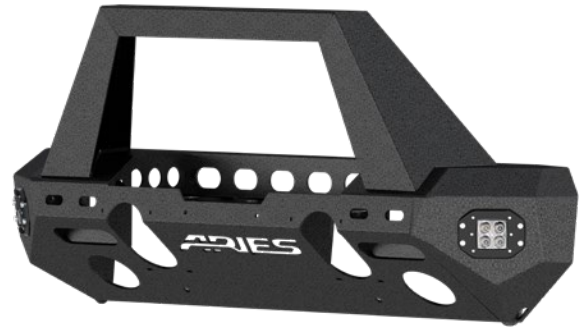

2082046 aluminum front with flush-mount LED corners

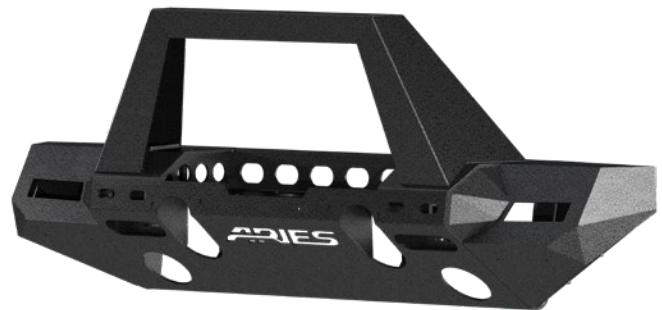

2082097 aluminum front with integrated turn signal corners

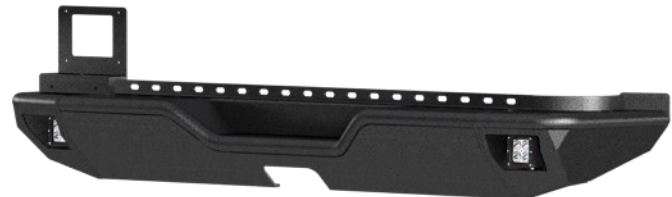

2082083 aluminum rear with integrated LED work light corners

Finishes & Materials

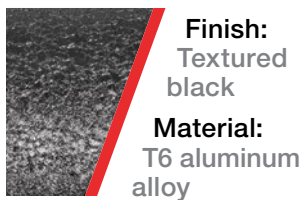

Finish:
Textured
black

Material:
T6 aluminum
alloy



Finish:
E-coat &
textured
black

Material:
Carbon steel



Wrangler JL



Gladiator JT



Wrangler JL

TRAILCHASER® JEEP BUMPERS



2082058 (JK) / 2082094 (JL / JT) alum.
2082056 (JK) / 2082084 (JL / JT) steel



2082054 (JK) / 2082092 (JL / JT) alum.
2082050 (JK) / 2082078 (JL / JT) steel



2082098 (JL) / 2082096* (JL) aluminum
2082088 (JL) / 2082086* (JL) steel
* Includes front fender flares (not pictured)



2082044 (JK) / 2082075 (JL / JT) alum.
2082057 (JK) / 2082071 (JL / JT) steel



2082052 (JK) / 2082074 (JL / JT) alum.
2082048 (JK) / 2082070 (JL / JT) steel



2082076 (JL) / 2082077* (JL) aluminum
2082072 (JL) / 2082073* (JL) steel
* Includes front fender flares (not pictured)

Model	Years	Kit #	Center #	Corner #	Corner Lights	Guard #	Guard Style
Aluminum Front							
Gladiator JT	20 - 21	2082075	2081004	2081205	Included	--	--
		2082094	2081004	2081205	Included	2081255	Round
		2082095	2081004	2081205	Included	2081101	Angular
		2082074	2081004	2081207	Not compatible	--	--
		2082092	2081004	2081207	Not compatible	2081255	Round
Wrangler JL	18 - 21	2082093	2081004	2081207	Not compatible	2081101	Angular
		2082076	2081004	2081209	Accepts OE turn signal lamps	--	--
		2082098	2081004	2081209	Accepts OE turn signal lamps	2081255	Round
		2082099	2081004	2081209	Accepts OE turn signal lamps	2081101	Angular
		2082077*	2081004	2081209	Accepts OE turn signal lamps	--	--
		2082096*	2081004	2081209	Accepts OE turn signal lamps	2081255	Round
		2082097*	2081004	2081209	Accepts OE turn signal lamps	2081101	Angular
		2082075	2081004	2081205	Included	--	--
		2082094	2081004	2081205	Included	2081255	Round
		2082095	2081004	2081205	Included	2081101	Angular
		2082074	2081004	2081207	Not compatible	--	--
Wrangler JK	07 - 18	2082092	2081004	2081207	Not compatible	2081255	Round
		2082093	2081004	2081207	Not compatible	2081101	Angular
		2082046	2081001	2081205	Included	2081101	Angular
		2082058	2081001	2081205	Included	2081255	Round
		2082044	2081001	2081205	Included	--	--
		2082055	2081001	2081207	Not compatible	2081101	Angular
Aluminum Rear							
Wrangler JL	18 - 21	2082054	2081001	2081207	Not compatible	2081255	Round
		2082052	2081001	2081207	Not compatible	--	--
Wrangler JK	07 - 18	2082082	2081025	2081221	Not included	--	--
		2082083	2081025	2081223	Included	--	--
Wrangler JK	07 - 18	2082036	2081021	2081221	Not included	--	--
		2082061	2081021	2081223	Included	--	--

* Includes front fender flares #1500203, see page 84 (OE turn signal lamps must be relocated to the new bumper corners #2081209)



2082046 (JK) / 2082095 (JL / JT) alum.
2082043 (JK) / 2082085 (JL / JT) steel



2082055 (JK) / 2082093 (JL / JT) alum.
2082051 (JK) / 2082079 (JL / JT) steel

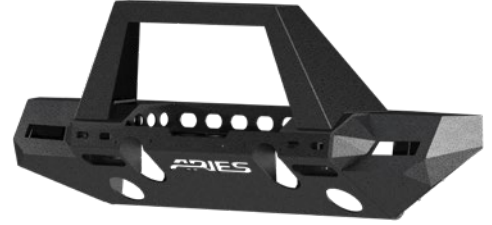

2082099 (JL) / 2082097* (JL) aluminum
2082089 (JL) / 2082087* (JL) steel
* Includes front fender flares (not pictured)



2082036 (JK) / 2082082 (JL) aluminum
2082038 (JK) / 2082080 (JL) steel



2082061 (JK) / 2082083 (JL) aluminum
2082060 (JK) / 2082081 (JL) steel

Model	Years	Kit #	Center #	Corner #	Corner Lights	Guard #	Guard Style
Steel Front							
Gladiator JT	20 - 21	2082071	2081003	2081200	Included	--	--
		2082084	2081003	2081200	Included	2081252	Round
		2082085	2081003	2081200	Included	2081100	Angular
		2082070	2081003	2081206	Not compatible	--	--
		2082078	2081003	2081206	Not compatible	2081252	Round
		2082079	2081003	2081206	Not compatible	2081100	Angular
Wrangler JL	18 - 21	2082072	2081003	2081208	Accepts OE turn signal lamps	--	--
		2082088	2081003	2081208	Accepts OE turn signal lamps	2081252	Round
		2082089	2081003	2081208	Accepts OE turn signal lamps	2081100	Angular
		2082073*	2081003	2081208	Accepts OE turn signal lamps	--	--
		2082086*	2081003	2081208	Accepts OE turn signal lamps	2081252	Round
		2082087*	2081003	2081208	Accepts OE turn signal lamps	2081100	Angular
		2082071	2081003	2081200	Included	--	--
		2082084	2081003	2081200	Included	2081252	Round
		2082085	2081003	2081200	Included	2081100	Angular
		2082070	2081003	2081206	Not compatible	--	--
		2082078	2081003	2081206	Not compatible	2081252	Round
2082079	2081003	2081206	Not compatible	2081100	Angular		
Wrangler JK	07 - 18	2082043	2081000	2081200	Included	2081100	Angular
		2082056	2081000	2081200	Included	2081252	Round
		2082057	2081000	2081200	Included	--	--
		2082051	2081000	2081206	Not compatible	2081100	Angular
		2082050	2081000	2081206	Not compatible	2081252	Round
		2082048	2081000	2081206	Not compatible	--	--
Steel Rear							
Wrangler JL	18 - 21	2082080	2081024	2081220	Not included	--	--
		2082081	2081024	2081222	Included	--	--
Wrangler JK	07 - 18	2082038	2081020	2081220	Not included	--	--
		2082060	2081020	2081222	Included	--	--

* Includes front fender flares #1500203, see page 84 (OE turn signal lamps must be relocated to the new bumper corners #2081208)

TRAILCHASER® BUMPER COMPONENTS

/ Bumper Center Sections

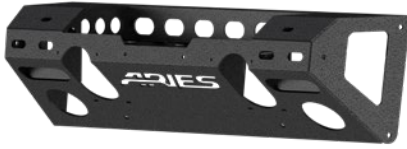

2081001 aluminum
2081000 steel



2081021 aluminum
2081020 steel

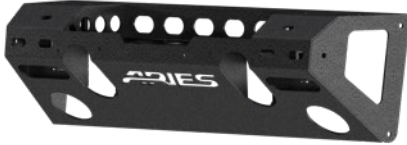

2081004 aluminum
2081003 steel



2081025 aluminum
2081024 steel



Model	Years	Location	Aluminum #	Steel #
Gladiator JT	20 - 21	Front	2081004	2081003
Wrangler JL	18 - 21	Front	2081004	2081003
		Rear	2081025	2081024
Wrangler JK	07 - 18	Front	2081001	2081000
		Rear	2081021	2081020

All TrailChaser bumper components are finished with a textured black powder coat

/ Bumper Corners

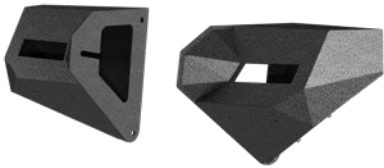

2081209 aluminum
2081208 steel



2081205 aluminum
2081200 steel

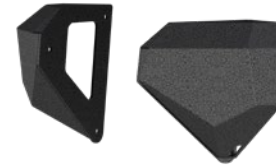

2081207 aluminum
2081206 steel

Model	Years	Location	Lights	Aluminum #	Steel #
Gladiator JT	20 - 21	Front	Included	2081205	2081200
			Not compatible	2081207	2081206
Wrangler JL	18 - 21	Front	Accepts OE turn signal lamps	2081209	2081208
			Included	2081205	2081200
		Rear	Included	2081223	2081222
			Not included	2081221	2081220
Wrangler JK	07 - 18	Front	Included	2081205	2081200
			Not compatible	2081207	2081206
		Rear	Included	2081223	2081222
			Not included	2081221	2081220



2081223 aluminum
2081222 steel



2081221 aluminum
2081220 steel

All TrailChaser bumper components are finished with a textured black powder coat

TRAILCHASER® BRUSH GUARDS

/ Angular Brush Guards

- Mounts onto TrailChaser center section only
- Adds extra protection for the winch housing and an aggressive, customized look
- Pre-formed slots readily accept LED lights on top or underneath (see page 96 for LED lights)
- Welded construction in high-strength steel or rust-free aluminum
- Textured black powder coat easily hides minor scratches and grime
- Quickly and securely bolts onto the bumper for a no-drill installation
- Includes all necessary mounting hardware
- Limited lifetime warranty (see back page for details)



2081101 aluminum
2081100 steel



Model	Years	Aluminum #	Steel #
Gladiator JT	20 - 21	2081101	2081100
Wrangler JL	18 - 21	2081101	2081100
Wrangler JK	07 - 18	2081101	2081100

/ Round Brush Guards

- Mounts onto TrailChaser center section only
- Modular design allows brush guards to be easily installed or removed as desired
- Two welded tabs along the top to mount aftermarket LED lights (see page 96 for LED lights)
- Adds extra protection for the winch housing and the front end
- Welded construction in high-strength steel or rust-free aluminum
- Textured black powder coat easily hides minor scratches and grime
- Quickly and securely bolts onto the bumper for a no-drill installation
- Includes all necessary mounting hardware
- Limited lifetime warranty (see back page for details)



2081255 aluminum
2081252 steel



Model	Years	Aluminum #	Steel #
Gladiator JT	20 - 21	2081255	2081252
Wrangler JL	18 - 21	2081255	2081252
Wrangler JK	07 - 18	2081255	2081252

TRAILCHASER® WINCH ACCESSORIES

/ Winch Reinforcement Brackets

- Required for mounting a winch on TrailChaser aluminum front bumpers
- Rated for 9,500 lbs. weight capacity
- 10" x 4-1/2" slotted hole pattern to accept most winches
- Heavy-duty steel construction with durable textured black powder coat finish
- Includes mounting hardware for attaching to the bumper



2072102

Model	Years	Part #	Finish
Gladiator JT	20 - 21	2072102	Steel with textured black powder coat
Wrangler JL	18 - 21	2072102	Steel with textured black powder coat
Wrangler JK	07 - 18	2072101	Steel with textured black powder coat

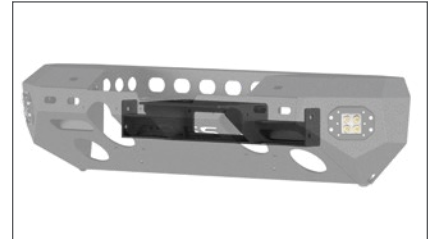

/ Winch Adapter Plate

- Allows oversize winches to be mounted onto the ARIES TrailChaser® Jeep bumper
- Slotted, standard mounting holes to accept most types of winches
- One-piece design with built-in bracket for securely mounting a fairlead
- Heavy-duty steel construction with durable textured black powder coat finish

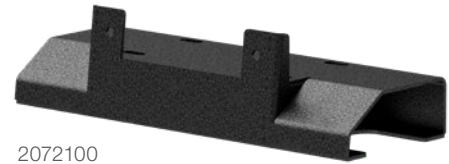

2072100

Part #	Includes	Finish
2072100	Adapter and mounting hardware	Steel with textured black powder coat

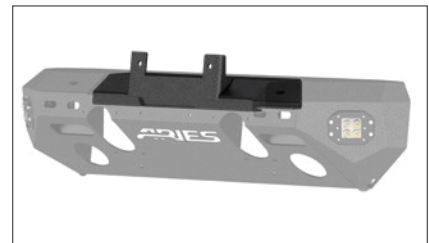

/ Winch Fairlead Mount

- Easily and securely mounts on ARIES TrailChaser® Jeep bumper winch housing
- Two holes, spaced 10" center-to-center, accept most types of fairleads
- Solid, 1/4" thick carbon steel construction with a durable powder coat finish
- Fits both steel and aluminum bumpers
- Uses winch and fairlead mounting hardware



15600FB

Part #	Includes	Finish
15600FB	Fairlead mount (uses existing hardware)	Steel with black powder coat

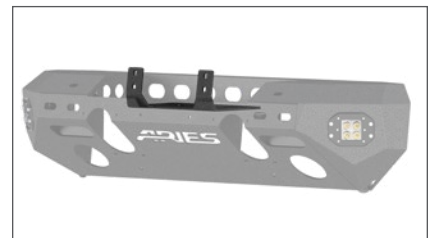

/ Hawse Fairlead

- Constructed from lightweight, rust-free, machined aluminum billet
- Black anodized aluminum finish for long-lasting corrosion resistance
- Compatible with braided nylon rope (not to be used with cable)
- Industry-standard mounting holes are set 10" on-center
- Compatible with both ARIES TrailCrusher® and TrailChaser bumpers (#15600FB or #2072100 required for fairlead install on TrailChaser bumpers, see page 66 for more information)
- Includes 10mm, class 8.8 metric mounting hardware



2156070

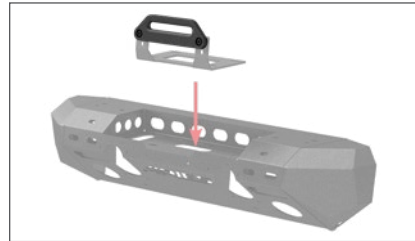

Part #	Includes	Finish
2156070	Fairlead and 10mm, class 8.8 metric mounting hardware	Black anodized aluminum

/ Roller Fairlead

- Provides a guide for steel winch cable for smooth operation with heavy loads
- Industry-standard mounting holes are set 10" on-center
- Main body built from high-strength steel with durable carbide powder coat
- Rollers constructed from galvanized steel to resist rust and last longer
- Compatible with both ARIES TrailCrusher® and TrailChaser bumpers (#15600FB or #2072100 required for winch install on TrailChaser bumpers, see page 66 for more information)
- Includes 10mm, class 8.8 metric mounting hardware



2156071

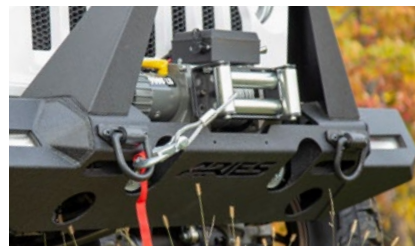

Part #	Includes	Finish
2156071	Fairlead and 10mm, class 8.8 metric mounting hardware	Steel with carbide black powder coat

TRAILCHASER® BUMPER ACCESSORIES

/ Anti-Rattle D-Rings

- Anti-rattle grommet installs tightly against the D-ring to stop vibration
- Rubber grommet also holds the D-ring in the horizontal position as needed
- Work load limit of 9,000 lbs. (limited to mounting structure capacity)
- Forged steel construction with a welded backing plate for maximum strength
- Highly durable carbide black powder coat finish for excellent rust resistance



2081300



Part #	Includes	Finish
2081300	Two D-rings and mounting hardware	Steel with carbide black powder coat

/ Tow Hook

- Work load limit of 9,000 lbs. (limited to mounting structure capacity)
- Utilizes existing factory bolts on Jeep YJ and TJ models
- Strong steel construction with a durable black powder coat finish
- Not compatible with angular brush guard



15600TW



Part #	Includes	Finish
15600TW	One tow hook and mounting hardware	Steel with black powder coat

/ License Plate Relocation Bracket

- Easily mounts on any ARIES TrailChaser® bumper
- Provides a solid mounting location to keep license plate visible
- Strong steel construction with a durable black powder coat finish



55-0000



Part #	Includes	Finish
55-0000	Bracket and mounting hardware	Steel with black powder coat



Wrangler JK



TEAM **ARIES**

Wrangler JL

TRAILCRUSHER® JEEP BUMPERS

For shackles and other accessories see page 72

Product Details

- Winch and shackle ratings of 12,500 lbs. (9,500 lbs. for Wrangler TJ)
- Standard winch mounting platform accepts most types of winches
- Angular brush guard helps protect the winch and adds an aggressive look (also available without brush guard)
- Welded shackle mounts and 1/4" thick shoulder sleeves provide reliable anchoring points
- Shackle mounts accept pins up to 7/8" in diameter (#2166071 recommended)
- No-drill install uses factory mounting points with no pump relocation required
- One-piece construction with 3/16" thick, all-steel plates for maximum strength
- Narrow width and high ground clearance for an improved off-road-style design
- Highly durable carbide black powder coat with rust-resistant E-coat finish
- Center round cutouts accept OE bumper lights
- Includes mounting hardware and 3/8" thick brackets for solid installation
- Models with factory steel front bumpers will require the purchase of aftermarket fog lights (not included)
- Limited lifetime warranty (see back page for details)



2186002
JL front kit



2157002
JL rear

Finish & Material

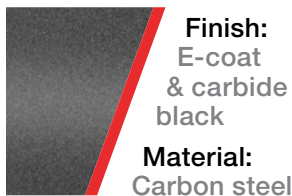

Model	Years	Capacity	Front Kit # (Center and Guard)	Front Center # Only	Guard # Only	Rear Center # Only
Gladiator JT	20 - 21	12,500 lbs.	2186002	2156002	2156050	--
Wrangler JL	18 - 21	12,500 lbs.	2186002	2156002	2156050	2157002
Wrangler JK	07 - 18	12,500 lbs.	2186000	2156000	2156050	2157000
Wrangler TJ	97 - 06	9,500 lbs.	2186001	2156001	2156050	2157001



Wrangler JK



Wrangler JK

TRAILCRUSHER® BUMPER ACCESSORIES

/ Angular Brush Guard

- Provides added protection for the winch and an aggressive, customized look
- One-piece, all-steel build for maximum strength
- Highly durable carbide black powder coat with rust-resistant E-coat finish
- Quickly and securely bolts onto the bumper for a no-drill installation
- Includes mounting hardware

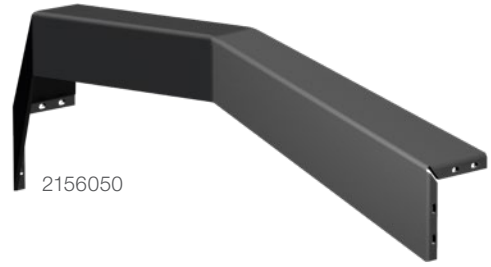

2156050



Part #	Includes	Finish
2156050	Brush guard and mounting hardware	Steel with carbide black powder coat

/ Shackles

- Work load limit of 12,500 lbs. (limited to mounting structure capacity)
- Solid, forged steel construction for maximum strength
- Highly durable carbide black powder coat finish for excellent rust resistance
- 7/8" hot-dipped galvanized pin for solid attachment to the bumper



2166071



Part #	Inside Diameter	Includes	Finish
2166071	2"	Two shackles	Steel with carbide black powder coat

/ Winch Fairlead Mount

- May be required for some winches on TrailCrusher bumper
- Two holes, spaced 10" center-to-center, accept most types of fairleads
- Solid, 1/4" thick carbon steel construction with a durable powder coat finish
- Uses winch and fairlead mounting hardware



15600FB

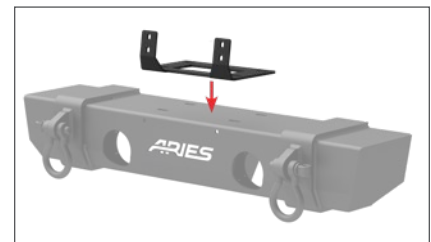

Part #	Includes	Finish
15600FB	Fairlead mount (uses existing bumper hardware)	Steel with black powder coat

/ Hawse Fairlead

- Constructed from lightweight, rust-free, machined aluminum billet
- Black anodized aluminum finish for long-lasting corrosion resistance
- Compatible with braided nylon rope (not to be used with cable)
- Industry-standard mounting holes are set 10" on-center
- Compatible with both ARIES TrailCrusher and TrailChaser® bumpers
- Includes 10mm, class 8.8 metric mounting hardware



2156070



Part #	Includes	Finish
2156070	Fairlead and 10mm, class 8.8 metric mounting hardware	Black anodized aluminum

/ Roller Fairlead

- Provides a guide for steel winch cable for smooth operation with heavy loads
- Industry-standard mounting holes are set 10" on-center
- Main body built from high-strength steel with durable carbide powder coat
- Rollers constructed from galvanized steel to resist rust and last longer
- Compatible with both ARIES TrailCrusher and TrailChaser® bumpers (#15600FB may be required for some winch installations on TrailCrusher bumpers, see page 72 for more information)
- Includes 10mm, class 8.8 metric mounting hardware



2156071



Part #	Includes	Finish
2156071	Fairlead and 10mm, class 8.8 metric mounting hardware	Steel with carbide black powder coat

ACTIONTRAC™ POWERED RUNNING BOARDS



Product Details

- Patented step-within-a-step™ design for easier access, especially on lifted Jeeps
- Single, rotary motor for fast, quiet, maintenance-free operation
- Integrated LED lights activate on deployment for added visibility and safety
- Rated for 650 lbs. static weight capacity (limited to mounting structure)
- Limited lifetime warranty (see last page for details)
- Patent# 9,771,024; 8,833,781; D718,195; D751,953; 10,059,268
- **For replacement LED lights, see page 28**



Key Features

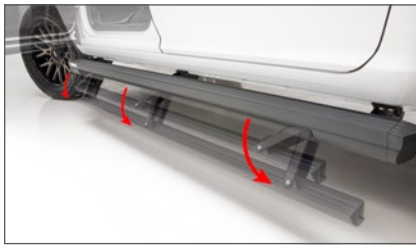

3" powered step automatically drops 8" when door opens, up to 15" below doorsill



Simple-2-install™ system with no-splice wiring and no-drill brackets



Integrated control module detects obstructions and eliminates pinch hazards

Step-Within-A-Step™ Benefits



Easier, two-step entry and 4" top step provides convenient access to the roof



Housing shields retractable step, pivot points and electronics from the elements



Contoured design helps protect the rocker panels from road debris and door dings

Finish & Material

Finish:
Carbide black

Material:
6061 T6 aluminum

Model	Style	Years	Kit # (Boards and Brackets)	Boards Only #	Brackets Only #
Gladiator JT	--	20 - 21	3047975	3025179	3025175
Wrangler JL	Unlimited (4-door)	18 - 21	3036571	3025165	3025171
Wrangler JK	Unlimited (4-door)	07 - 18	3036570	3025165	3025170



Gladiator JT

ACTIONTRAC™ ACCESSORIES

/ Door Delete Kit

- Deploys and retracts the powered steps at the push of a button
- For Jeep applications with the factory doors removed or replaced with tube doors

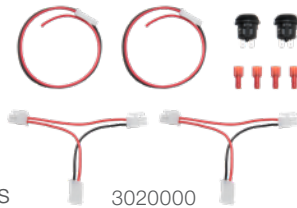

Part #	Includes
3020000	Two wiring harnesses, two switches, four connectors

/ Replacement Door Magnets

- Replaces the magnet on the inside doorsill
- Works with control module to activate powered steps

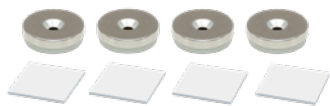

Part #	Includes
2090206	Four magnets and four permanent VHB tape pads

/ ActionTrac™ Universal Brackets

- Provides board attachment points for custom-fabricated brackets (not included)
- Designed for custom installation if vehicle-specific brackets are not available
- Universal wiring kit included
- Steel brackets with black powder coat finish
- Custom vehicle brackets and boards not included



Part #	Qty	Includes
3025176	6	Wiring and board attachment brackets
3025177	8	Wiring and board attachment brackets

Requires fabricated vehicle brackets to install



Wrangler JK

ROCKER STEPS

See page 133 for application information

Product Details

- Heavy-duty design offers extra protection for the sides of the Jeep
- Textured black powder coat easily hides minor scratches and grime
- High-strength, all-steel construction with no plastic parts
- No-drill, vehicle-specific application for a custom fit
- Sold in pairs with mounting hardware included
- Limited lifetime warranty (see last page for details)



2074102

Rocker guard meets running board



Double-tube layout and 3" wide top plate provide a solid step



Flat profile increases ground clearance to be off-road ready



Pre-welded mounting brackets for increased rigidity and simpler installation



Wrangler JK

4"

BIG STEP™ ROUND SIDE BARS

See page 132 for
application information

Product Details

- Hardened T6 aluminum construction to be strong, lightweight and rust-free
- Textured black powder coat easily hides minor scratches and grime
- Brushed stainless steel ARIES insignia on each step for a distinguished look
- No-drill, vehicle-specific application for a custom fit
- Heavy-duty steel mounting brackets for a solid step
- Sold in pairs with installation hardware included
- Limited lifetime warranty (see last page for details)



AL231008

Bold style for larger, lifted Jeeps



Bold, 4" diameter is designed to show well on larger, lifted vehicles



Raised, custom, non-skid step pads for safe, comfortable entry and exit



Unique bends to contour to the body of the vehicle



Wrangler TJ

3"

ROUND SIDE BARS

See page 134 for
application information

Product Details

- 3" diameter, heavy-wall tubing in rust-free polished stainless or semi-gloss black strong carbon steel
- Unique bends to contour to the body of the vehicle
- Custom, non-skid step pads for safe entry and exit
- No-drill, vehicle-specific application for a custom fit
- Heavy-duty steel mounting brackets for a solid step
- Sold in pairs with installation hardware included
- Limited lifetime warranty (see last page for details)

Fits a wide variety of vehicle applications



Unique bends to contour
to the body of the vehicle



Custom, non-skid step pads
for safe entry and exit



35600-2



35600



Gladiator JT

PRO SERIES™ GRILLE GUARDS

See page 111 for
application information

Product Details

- Channel-style bracket accepts one or multiple light bars
- Articulating bracket allows light to be mounted at a custom angle
- Textured black powder coat easily hides minor scratches and grime
- One-piece, 1-1/2" diameter, heavy-wall steel tubing
- Vertical rubber stripping along the risers to help maintain a clean finish
- No-drill, vehicle-specific application
- Patent# 9,108,581
- Limited lifetime warranty (see last page for details)
- **See page 96 for our full line of LED lights**



Uniquely made for LED light bar customization



Patented crossbar houses a single-row LED light bar



Interchangeable cover plate protects light bar and offers easy customization (see page 20)



Black mesh cover plate #PJ20MB included

LED LIGHTS & BRACKETS

For LED work lights and light bars go to page 96

Product Details

- Available to mount LED work lights or light bars over the roof or on the hood or windshield (see table)
- No-drill, vehicle-specific installation for a custom fit
- Limited lifetime warranty (see back page for details)



1501303 TJ roof brackets shown with 50" LED light bar

15914 JK roof brackets shown with crossbar

Hood light (JK & TJ)

- Mounts a 20" LED light bar on the hood
- Will not interfere with factory windshield washer sprayers
- Removable brushed stainless steel cover plates for added style

Hood lights (JL & JT)

- Mounts 2" LED work lights and / or a 50" LED light bar on the hood
- Slotted holes for easy light adjustment

Roof lights (JK & TJ)

- Mounts a 50" LED light bar above the windshield
- Slotted crossbar accepts multiple LED lights
- Contours to the windshield for an integrated look
- Bolt-on, brushed stainless steel cover plates for added style and light bar security

Windshield lights (JK)

- Mounts 2" LED work lights on the windshield hinges
- Securely mounts with pre-existing windshield bolts

Finishes & Materials

Hood (JK & TJ)

Finish:
Carbide black

Material:
Stainless steel

Hood (JL & JT)

Finish:
Carbide black

Material:
Carbon steel

Roof

Finish:
Carbide black

Material:
Stainless steel

Windshield

Finish:
Carbide black

Material:
Carbon steel



1501305 kit - JL & JT hood brackets shown with LED work lights



1501300 kit - JK hood brackets shown with 20" LED light bar



1501304 kit - JK windshield brackets shown with LED work lights

Model	Years	Kit # (Lights & Brackets)	Bracket #	Bracket Includes	Bracket Accepts	Light # in Kit
Hood						
Gladiator JT	20 - 21	1501305*	1110313*	Brackets and hardware	2" square	1501252
		1501306*	1110313*	Brackets and hardware	50" bar	1501278
Wrangler JL	18 - 21	1501305*	1110313*	Brackets and hardware	2" square	1501252
		1501306*	1110313*	Brackets and hardware	50" bar	1501278
Wrangler JK	07 - 18	1501300	15912	Brackets and hardware	20" bar	1501262
Wrangler TJ	97 - 06	1501302	15913	Brackets and hardware	20" bar	1501262
Roof (over windshield)						
Wrangler JK	07 - 18	--	15914*	Brackets, crossbar, hardware	Up to 50"	--
	07 - 18	1501301	15911	Brackets and hardware	50" bar	1501278
Wrangler TJ	97 - 06	--	15916*	Brackets, crossbar, hardware	Up to 50"	--
	97 - 06	1501303	15915	Brackets and hardware	50" bar	1501278
Windshield Hinges						
Wrangler JK	07 - 18	1501304	AR15800	Brackets only	2" square	1501252

* Accepts LED work lights or light bars up to 50" in total width

TUBE DOORS

Product Details

- Open design and aggressive cutout for ultimate offroad look and feel
- Hardened T6 aluminum construction to be strong, lightweight and rust-free
- Textured black powder coat easily hides minor scratches and grime
- 100% TIG welds for a precise fit
- Simple installation using existing hinge points
- Key-operated locking latch to help deter theft (excluding TJ)
- Accepts factory mirrors (not compatible with power mirrors)
- Sold in pairs with swing-out straps included
- Limited lifetime warranty (see back page for details)
- Check with local and state laws before installing tube doors

Finishes & Materials

JT, JL & JK doors

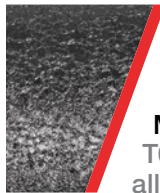

Finish:
Textured black

Material:
T6 aluminum alloy

TJ doors



Finish:
Carbide black

Material:
T6 aluminum alloy

Model	Years	Front #	Rear #
Gladiator JT	20 - 21	1500200	2500200
Wrangler JL	18 - 21	1500200	2500200
Wrangler JK	07 - 18	AR15009	25009
Wrangler TJ	97 - 06	1500100	--

Tube doors may be illegal in some states. Check with the local and state laws before installing.

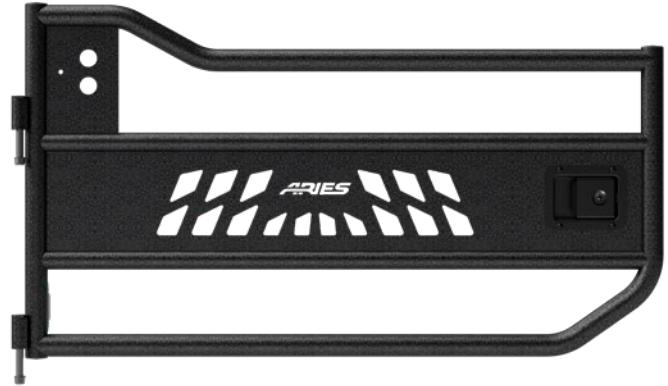

1500200 JL front
(sold in pairs)

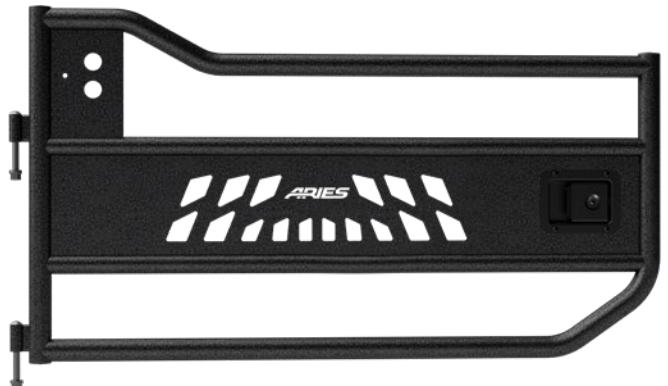

AR15009 JK front
(sold in pairs)



1500100
(sold in pairs)



Wrangler JK



Gladiator JT



Wrangler TJ

TUBE DOOR MIRRORS

- Rugged build provides a stable view on offroad Jeeps
- High-strength carbon steel construction with durable black powder coat
- Rock-solid 11-gauge steel brackets with 16-gauge steel mounting plate
- Easy, no-drill installation and quick, as-needed removal
- Fits all ARIES tube door bolt configurations (will not fit original equipment doors)
- Compatible with most other aftermarket tube doors (drilling may be required)
- 5" diameter convex glass helps eliminate blind spots for safe maneuvering
- 5/16" center-mount ball stud for added stability and easy tilt adjustment



3500300



Part #	Includes
3500300	Two mirrors, brackets and mounting hardware

FENDER FLARES

Product Details

- Hardened T6 aluminum construction to be strong, lightweight and rust-free
- Textured black powder coat easily hides minor scratches and grime (also available in a raw, paintable aluminum)
- Flat profile allows for greater clearance with larger, off-road tires
- Solid, bolt-on installation and vehicle-specific fit (drilling may be required)
- Accepts LED fender flare side markers #1500240 (not included)
- Available for front and rear wheels
- Compatible with ARIES Jeep inner fender liners (see page 86)
- Includes mounting hardware
- Limited lifetime warranty (see back page for details)



1500201 JK front
(sold in pairs)



1500204 JL front
(sold in pairs)



2500203 JL rear
(sold in pairs)

Finishes & Materials

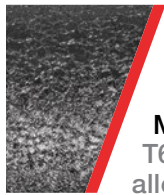

Finish:
Textured
black

Material:
T6 aluminum
alloy

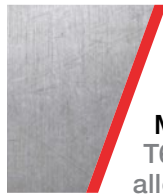

Finish:
Raw
aluminum

Material:
T6 aluminum
alloy

Model	Years	Front			Rear		
		Black #	Raw #	Width	Black #	Raw #	Width
Wrangler JL	18 - 21	1500203	1500204	12"	2500203	2500204	5-3/4"
Wrangler JK	07 - 18	1500201	1500202	9-1/4"	2500201	2500202	5-1/2"



Wrangler JK



Wrangler JL

FENDER FLARE SIDE MARKERS

- LED components for a bright, long-lasting light
- Splices into existing factory wiring harness
- Wires route through fender frame to keep them well protected
- DOT-approved for safety



Part #	Includes
1500240	Two lights and mounting hardware

INNER FENDER LINERS

Product Details

- Helps protect engine compartment against mud, water and other debris
- Replaces plastic factory fender liners on the front and rear
- Welded aluminum construction to be strong, lightweight and rust-free
- Highly durable carbide black powder coat finish for maximum corrosion resistance
- Designed for installation with ARIES fender flares (see page 84)
- Some drilling and rivet nut installation required
- Includes mounting hardware
- Limited lifetime warranty (see back page for details)



1500350
JK driver side
(sold in pairs)

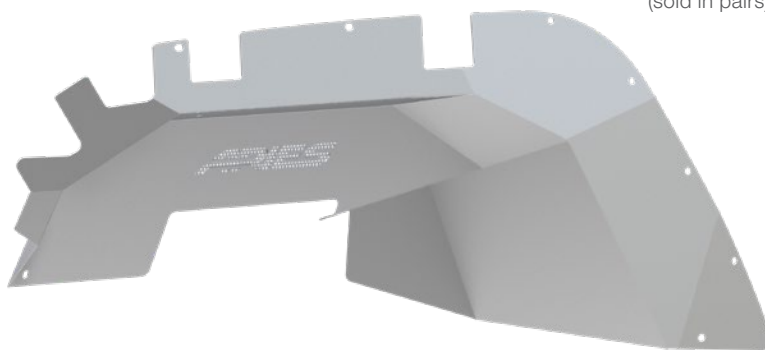

1500551
JL driver side
(sold in pairs)

Finishes & Materials

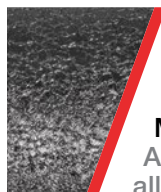

Finish:
Textured
black

Material:
Aluminum
alloy

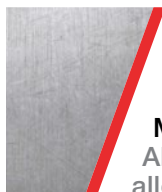

Finish:
Raw
aluminum

Material:
Aluminum
alloy

Model	Years	Black Kit # (Front and Rear)	Front #	Rear #	Raw Kit # (Front and Rear)	Front #	Rear #
Wrangler JL	18 - 21	2500650	1500550	2500550	2500651	1500551	2500551
Wrangler JK	07 - 18	2500450	1500350	2500350	2500451	1500351	2500351



Wrangler JK

TEAM **ARIES**



Wrangler JK

HEAVY-DUTY SPARE TIRE CARRIERS

Product Details

- Accepts oversized, off-road-style spare tires up to 37" in diameter
- Vertically and horizontally adjustable to avoid oversize tire interference
- Third brake light bracket can be raised or lowered to maintain visibility
- Integrated bracket for relocating the rear backup camera (#2563001)
- Replaces factory door hinges with heavy-duty hinges for a secure mount (#2563000)
- Constructed from welded steel for reliable strength
- Durable carbide black powder coat finish for maximum rust resistance
- No-drill, vehicle-specific installation for a custom fit
- Compatible with Wrangler rear factory bumper
- Includes mounting hardware
- Patent pending (#2563001)
- Limited lifetime warranty (see back page for details)



2563001
JL



2563000
JK

Finish & Material

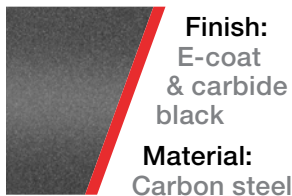

Model	Years	Part#	Description
Wrangler JL	18 - 21	2563001	HD spare tire carrier
Wrangler JK	07 - 18	2563000	HD spare tire carrier
		25630AB*	Tire relocation carrier
		256TBL*	Third brake light bracket

* See adjacent page for product details



Wrangler JL

LIGHT-DUTY SPARE TIRE CARRIER

/ Tire Relocation Carrier

- Allows for a larger spare tire up to 35" in diameter
- Securely bolts onto existing rear door tire carrier
- Maintains easy access to the rear cargo area
- Brackets fortify tire relocation carrier to accept larger tires
- Strong steel construction with a durable black powder coat finish
- Includes mounting hardware
- Limited lifetime warranty (see back page for details)



25630AB

/ Third Brake Light Extension Bracket

- Allows brake light to be seen over a spare tire up to 35" in diameter
- Improves safety on and off the road
- Compatible with tire relocation carrier #25630AB (above)
- Strong steel construction with a durable black powder coat finish
- Includes mounting hardware (some cutting required)
- Limited lifetime warranty (see back page for details)



256TBL

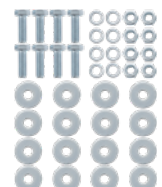

SECURITY CARGO LIDS

Product Details

- Six-panel, bolt-on design integrates with the Jeep layout (4-door models only)
- Key-operated enclosure provides a generous and more secure storage area
- Hardened T6 aluminum construction to be strong, lightweight and rust-free
- Works independently of the rear door for maximum functionality
- Textured black powder coat easily hides minor scratches and grime
- Lid can be flipped up and converted into a workbench or table area
- 1/2" diameter tie-down anchors on top for securing additional cargo
- Weight capacity up to 75 lbs.
- Compatible with hardtop (on or off), soft top and subwoofer
- Limited lifetime warranty (see back page for details)



2070465



2070475

Finish & Material

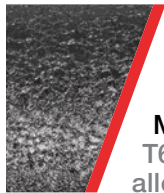

Finish:
Textured
black

Material:
T6 aluminum
alloy

Model	Years	Kit # (Center and Side Panels)	Center #	Side Panels#
Wrangler JK Unlimited	07 - 10	2070465*	ALC25000-00	ALC25000-01
	11 - 18	2070475*	ALC25000-00	ALC25001-01

* Kit numbers ship in two boxes



KEY-OPERATED LOCKING LATCH



The ARIES security cargo lid not only works with the rear door of the Jeep, but it also functions independently, meaning it can be opened without requiring the rear door to be opened first. It features a key-operated, quarter-turn latch for quick, convenient access to the cargo area.

Simply insert the key, turn the latch and lift the lid. The locking latch mechanism is made with durable metal components and is covered in a chrome finish for lasting rust resistance.



ROOF RACK CROSSBARS

Product Details

- Allows mounting of roof accessories for added storage and functionality on the Wrangler JK
- Full-width slotted channels for adjustable positioning of straps, hooks or bolts
- Quick-release, gutter clamps allow for no-drill, as-needed installation (compatible with hardtop only)
- Constructed from welded steel for reliable strength
- Carbide black powder coat finish for max rust resistance
- Limited lifetime warranty (see back page for details)



Finish & Material

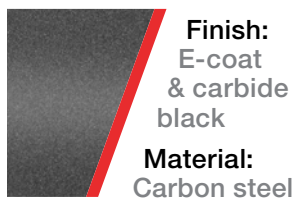

Finish:
E-coat
& carbide
black

Material:
Carbon steel

Model	Years	Part#	Capacity
Wrangler JK	07 - 18	2070450	150 lbs.



Gladiator JT



ACCESSORIES

BE BOLD

LED lights, D-rings and tow hooks on Jeep Wrangler JK

FEATURED PRODUCTS



/ Clamp-on hood brackets

Add LED lights to virtually any vehicle hood with no drilling required. These hood light brackets are slip- and weather-resistant.



/ LED light bars & work lights

Each ARIES LED light boasts grade-A LED chips, an IP68 breather, a waterproof aluminum build and a 50,000+ hour lifespan.



/ Seat Defender™

Rather than just covering it up, Seat Defender stops damage before it happens. They're easy to install, remove, clean and store.

PRODUCT INDEX



96
LED Light Bars
& Work Lights



97
LED
Light Covers



98
Light Mounting
Brackets



99
Fender Flare
Side Markers



99
VersaTrac®
Bracket Covers



100
D-Rings, Hooks
& Shackles



101
License Plate
Brackets



102
Seat
Defender

LED LIGHT BARS & WORK LIGHTS

See pages 97 & 98 for LED Light Accessories

Product Details

- Constructed with grade-A LED chips for superior quality
- IP68 and IP69K waterproof and dustproof ratings to keep water and air from getting trapped inside
- Rust-free aluminum housing with rugged, crack-resistant lexan lens
- Durable, painted, UV-resistant and mar-resistant finish
- Advanced optics system reduces wasted light for 96% reflector efficiency
- Dual, oversize heat sinks maintain low, efficient running temperatures
- Instant on-off requires no warmup time
- 50,000+ hours average lifespan for five years of continuous use
- Passes CE, RoHS, UV, extreme temperature, vibration, dust and salt testing
- Operates in temperatures from -40°F up to 145°F for extreme conditions
- Fitted with a strong, waterproof wiring harness for a reliable connection
- Includes stainless steel screws and a pivoting bracket for custom angling
- Limited lifetime warranty (see last page for details)



1501278



1501264



1501260



1501262



1501250



1501252

Part #	Light Type	Configuration	Light Size	Beam	Lumens
1501250	Work light	Square, flush-mount (set of two)	2"	Flood	2,200
1501252	Work light	Square (set of two)	2"	Spot	2,200
1501260	Light bar	Single-row	10"	Combo	4,900
1501262	Light bar	Single-row	20"	Combo	9,800
1501264	Light bar	Single-row	30"	Combo	14,800
1501278	Light bar	Double-row	50"	Combo	24,000



LED LIGHT ACCESSORIES

/ LED Light Covers

- Covers LED lights for legal operation on the road (not required in all states)
- Durable black plastic lens cover adds protection against scratches and grime
- Easy, secure snap-on installation requires no tools or hardware



1501253 shown on 1501252 work light



1501261 shown on 1501260 light bar



1501253



1501261



1501263



1501265



1501279

Part #	Fits	Pieces
1501253	LED work lights	1
1501261	10" LED light bars	1
1501263	20" LED light bars	2
1501265	30" LED light bars	3
1501279	50" LED light bars	5

LED LIGHT ACCESSORIES

/ Base-Mount Light Bar Brackets

- Provides a solid, adjustable mounting point for ARIES LED light bars (see page 96 for LED lights)
- Perfect for adding light bars to bull bars, grille guards and headache racks
- Equipped with an 8mm stud (light bar mounting hardware not included)
- Die-cast aluminum construction to be strong, lightweight and rust-free
- Some drilling and additional hardware may be required for installation



/ Mesh-Mount Brackets

- Securely mounts lights onto AdvantEDGE™ or Switchback® headache racks (see page 96 for LED lights)
- Allows for additional lighting without using the top channel of the headache rack
- Accepts light mounting hardware up to 8mm in diameter
- Adds LED work lights over the truck bed



/ Universal Clamp-On Hood Light Brackets

- Universal design clamps onto virtually any vehicle hood to mount lights
- Compatible with square LED lights #1501252 and other LED lights and light bars
- Easy to install with no drilling necessary
- Rubber protectors help prevent slipping and scratching the hood
- Constructed from strong, highly weather-resistant 304 stainless steel



Part #	Fits	Includes	Finish
1110312	Headache racks, bull bars and grille guards	Two mounting brackets with 8mm stud	Aluminum with black powder coat
1110311	Switchback and AdvantEDGE headache racks	Two mounting brackets and hardware (light mounting hardware not included)	304 stainless steel with black powder coat
1110315	Most vehicle hoods	Two mounting brackets and hardware (wrenches also included)	304 stainless steel with black powder coat



FENDER FLARE SIDE MARKERS

- LED components for a bright, long-lasting light
- Splices into existing factory wiring harness
- Wires route through fender frame to keep them well protected
- DOT-approved for safety



Part #	Includes
1500240	Two lights and mounting hardware

VERSATRAC® BRACKET COVERS

- Covers brackets for an enhanced look and added protection
- Tough, rust-free thermoplastic rubber construction
- Slotted holes for easy adjustment
- Easy to trim for a custom fit on any application



Part #	Covers	Cab Size
2055140	Four brackets	Regular
2055160	Six brackets	Extended
2055180	Eight brackets	Crew

D-RINGS, SHACKLES & HOOKS

/ Anti-Rattle D-Rings

- Work load limit of 9,000 lbs. (limited to mounting structure capacity)
- Anti-rattle grommet installs tightly against the D-ring to stop vibration
- Rubber grommet also holds the D-ring in the horizontal position as needed
- Forged steel construction with a welded backing plate for maximum strength
- Highly durable carbide black powder coat finish for excellent rust resistance



Part #	Includes	Finish
2081300	Two D-rings and mounting hardware	Steel with carbide black powder coat

/ Shackles

- Work load limit of 12,500 lbs. (limited to mounting structure capacity)
- Solid, forged steel construction for maximum strength
- Highly durable carbide black powder coat finish for excellent rust resistance
- 7/8" hot-dipped galvanized pin for solid attachment to the bumper



Part #	Inside Diameter	Includes	Finish
2166071	2"	Two shackles	Steel with carbide black powder coat

/ Tow Hook

- Work load limit of 9,000 lbs. (limited to mounting structure capacity)
- Utilizes existing factory bolts on Jeep YJ and TJ models
- Strong steel construction with a durable black powder coat finish
- Not compatible with TrailChaser® angular brush guard



Part #	Includes	Finish
15600TW	One tow hook and mounting hardware	Steel with black powder coat

LICENSE PLATE BRACKETS

/ License Plate Relocation Brackets

- Provides a solid mounting location to keep license plate visible



2169000

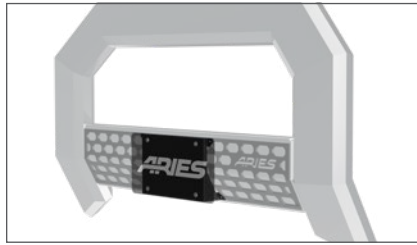

85-0000



35-0000



45-0000



55-0000



Part #	Fits	License Plate Hardware	Mounting Location	Mounting Hardware	Finish
2169000	AdvantEDGE™ bull bars	Four bolts	Crossbar	Uses existing cover plate hardware	Aluminum with black powder coat
85-0000	Pro Series™ grille guards	Four bolts	Crossbar	Hardware included (two bolts)	Steel with black powder coat
35-0000	3" bull bars	Two bolts	Crossbar	Uses existing skid plate hardware	Steel with black powder coat
45-0000	4" Big Horn™ bull bars	Two bolts	Crossbar	Uses existing skid plate hardware	Steel with black powder coat
55-0000	TrailChaser Jeep bumper or Jeep tube bumper	Four bolts	Universal	Hardware included (nut plate and two bolts)	Steel with black powder coat

SEAT DEFENDER™

Product Details

- Use-as-needed, universal design with dual-sided, non-skid protection
- Fast and easy to install, remove, clean and store
- Thermoplastic rubber grips the seat, providing added comfort and safety
- 100% waterproof and machine washable (air dry only)
- Allows for side airbag deployment
- Maintains seat belt access (bench seat units may interfere with center shoulder strap)
- XL bench seat model is designed to fit larger bench seats in full-size trucks and SUVs
- Cargo area blanket for picnics, sporting events, work under the car and more
- Limited lifetime warranty (see last page for details)



Bucket seat

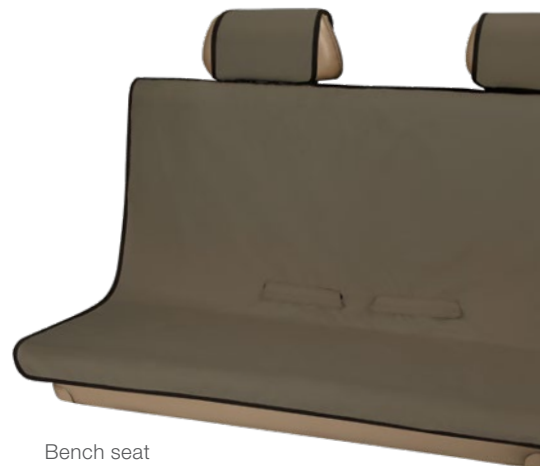

Bench seat



Cargo area

Two layers of protection



The top layer is a durable, woven 600-denier terylene fabric that keeps spills and dirt out and cleans up easily in the washing machine



The underside is waterproof thermoplastic rubber that not only protects against spills but also grips the seat for added safety

Colors & Materials

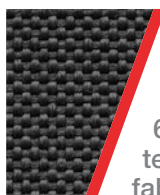

Color:
Black

Material:
600-denier
terylene
fabric

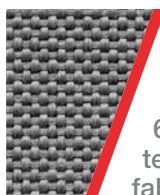

Color:
Grey

Material:
600-denier
terylene
fabric

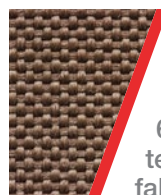

Color:
Brown

Material:
600-denier
terylene
fabric

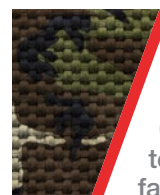

Color:
Camo

Material:
600-denier
terylene
fabric

Location	Width	Height	Black #	Grey #	Brown #	Camo #
Bucket	23"	58"	3142-09	3142-01	3142-18	3142-20
Bench	55"	58"	3146-09	3146-01	3146-18	3146-20
XL bench	63"	58"	3147-09	3147-01	3147-18	3147-20
Cargo area	60"	60"	3149-09	--	--	--





APPLICATION GUIDES

BE BOLD

AdvantEDGE™ side bars and headache rack on Ford F-250 Super Duty

APPLICATION GUIDE INDEX



06
ForeFront
Bull Bar



106
AdvantEDGE™
Bull Bar



107
4" Big Horn™
Bull Bar



107
3"
Bull Bars



111
Pro Series™
Grille Guard



112
Grille
Guards



116
ActionTrac™
Powered
Running Boards



118
VersaTrac®
Mounting
System



118
6-1/2"
RidgeStep®
Running Boards



118
5-1/2"
AdvantEDGE™
Side Bars



118
5-1/2"
AscentStep®
Running Boards



124
6" Oval
Side Bars



128
5" AeroTread®
Running Boards



130
4" Oval
Side Bars



132
4" Big Step™
Round Side Bars



133
Rocker
Steps



134
3" Round
Side Bars

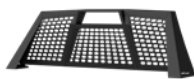

139
Switchback®
Headache Rack

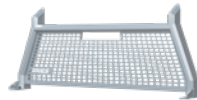

140
AdvantEDGE™
Headache Rack



141
Classic
Headache Rack



ADVANTEDGE™ BULL BAR APPLICATION GUIDE

AdvantEDGE 5-1/2" Bull Bars

Make / Model	Style / Notes	Years	Without Crossbar Lights		With Crossbar Lights	
			Chrome Powder Coat#	Carbide Black Powder Coat#	Chrome Powder Coat#	Carbide Black Powder Coat#
Chevrolet						
Silverado 1500	--	07 - 18	2154000*	2164000	2154100*	2164100
Silverado 1500 LD	--	19 - 19	2154000*	2164000	2154100*	2164100
Silverado 2500 HD / 3500 HD	--	20 - 22	--	2164003	--	2164103
		09 - 19	2154001*	2164001*	2154101*	2164101*
Dodge						
Ram 1500	--	09 - 10	2155000*	2165000	2155100*	2165100
Ram 2500 / 3500	--	09 - 10	2155001	2165001*	2155101*	2165101*
Ford						
F-150	Excluding Raptor	04 - 20	2153000*	2163000	--	2163100
F-250 / F-350 Super Duty	--	17 - 22	2153003*	--	2153103*	2163103
		11 - 16	2153002*	2163002*	2153102*	2163102*
F-450 / F-550 Super Duty	--	17 - 22	2153003*	--	2153103*	2163103
		11 - 16	2153002*	2163002*	2153102*	2163102*
GMC						
Sierra 1500	--	07 - 18	2154000*	2164000	2154100*	2164100
Sierra 1500 Limited	--	19 - 19	2154000*	2164000	2154100*	2164100
Sierra 2500 HD / 3500 HD	--	20 - 22	--	2164003	--	2164103
		09 - 19	2154001*	2164001*	2154101*	2164101*
Ram						
1500	Excluding Rebel or diesel	19 - 21	--	2165002	--	2165102
	Excluding Rebel	11 - 18	2155000*	2165000	2155100*	2165100
1500 Classic	Excluding Warlock	19 - 21	2155000*	2165000	2155100*	2165100
2500 / 3500	--	11 - 18	2155001	2165001*	2155101*	2165101*
Toyota						
Tacoma	--	16 - 21	--	--	--	2162101*
Tundra	--	07 - 21	2152000*	2162000	2152100*	2162100

* Continued while supplies last



3" & 4" BULL BAR APPLICATION GUIDE

Big Horn 4" & All 3" Bull Bars

Make / Model	Style	Years	4" Big Horn		3" Stealth	3" Pro Series	3" Bull Bars		
			Textured Black #	Polished Stainless #	High-Gloss Black #	Textured Black #	Polished Stainless #	Semi-Gloss Black #	
Cadillac									
Escalade	--	07 - 14	--	--	--	--	35-4016	B35-4016	
			--	--	--	--	35-4014*	--	
Escalade ESV	--	07 - 14	--	--	--	--	35-4016	B35-4016	
			--	--	--	--	35-4014*	--	
Escalade EXT	--	07 - 13	--	--	--	--	35-4016	B35-4016	
			--	--	--	--	35-4014*	--	
Chevrolet									
Avalanche	--	07 - 13	--	--	--	--	35-4016	B35-4016	
			--	--	--	--	35-4014*	--	
Avalanche 1500	--	02 - 06	--	45-4001*	--	--	35-4001	B35-4001	
Avalanche 2500	--	02 - 06	--	--	B35-4002-3*	P35-4002*	35-4002	B35-4002	
Blazer	--	92 - 94	--	--	--	--	35-4009	B35-4009	
C1500	--	88 - 99	--	--	--	--	35-4009	B35-4009	
C2500	--	88 - 00	--	--	--	--	35-4009	B35-4009	
C3500	--	88 - 00	--	--	--	--	35-4009	B35-4009	
Colorado	--	15 - 21	--	--	--	--	35-4015	B35-4015	
		04 - 12	--	--	--	--	35-4010†	B35-4010†	
K1500	--	88 - 98	--	--	--	--	35-4009	B35-4009	
K2500	--	88 - 98	--	--	--	--	35-4009	B35-4009	
K3500	--	88 - 98	--	--	--	--	35-4009	B35-4009	
Silverado 1500	Excl. Diesel	19 - 21	--	--	--	--	35-4017	B35-4017	
	--	14 - 15	--	45-4012*	--	--	--	--	
		07 - 18	--	--	--	--	--	35-4016	B35-4016
		07 - 15	--	--	--	--	--	35-4014*	--
		07 - 13	--	--	--	--	--	35-4005*	B35-4005*
99 - 06	--	--	45-4001*	--	--	35-4001	B35-4001		
Silverado 1500 Classic	--	07 - 07	--	45-4001*	--	--	35-4001	B35-4001	
			--	--	--	--	--	B35-4005*	

* Continued while supplies last

† Denotes 2-1/2" diameter tubing

Applications continued on the following page

Big Horn 4" & All 3" Bull Bars

Make / Model	Style	Years	4" Big Horn		3" Stealth	3" Pro Series	3" Bull Bars	
			Textured Black #	Polished Stainless #	High-Gloss Black #	Textured Black #	Polished Stainless #	Semi-Gloss Black #
Chevrolet (continued)								
Silver. 1500 HD	--	01 - 06	--	--	B35-4002-3*	P35-4002*	35-4002	B35-4002
Silverado 1500 HD Classic	--	07 - 07	--	--	B35-4002-3*	P35-4002*	35-4002	B35-4002
			--	--	--	--	--	B35-4005*
Silver. 1500 LD	--	19 - 19	--	--	--	--	35-4016	B35-4016
Silverado 2500	--	99 - 04	--	--	B35-4002-3*	P35-4002*	35-4002	B35-4002
Silverado 2500 HD	--	09 - 19	--	--	--	--	35-4013	B35-4013
		07 - 10	AL45-4006*	45-4006*	B35-4006-3*	P35-4006*	35-4006*	--
		01 - 06	--	--	B35-4002-3*	P35-4002*	35-4002	B35-4002
Silverado 2500 HD Classic	--	07 - 07	--	--	B35-4002-3*	P35-4002*	35-4002	B35-4002
Silverado 3500	--	01 - 06	--	--	B35-4002-3*	P35-4002*	35-4002	B35-4002
Silverado 3500 Classic	--	07 - 07	--	--	B35-4002-3*	P35-4002*	35-4002	B35-4002
Silverado 3500 HD	--	09 - 19	--	--	--	--	35-4013	B35-4013
		07 - 10	AL45-4006*	45-4006*	B35-4006-3*	P35-4006*	35-4006*	--
Suburban	--	15 - 20	--	--	--	--	35-4016	B35-4016
		15 - 15	--	--	--	--	35-4014*	--
Suburban 1500	--	07 - 14	--	--	--	--	35-4016	B35-4016
			--	--	--	--	35-4014*	--
		00 - 06	--	45-4001*	--	--	35-4001	B35-4001
Suburban 2500	--	00 - 06	--	--	B35-4002-3*	P35-4002*	35-4002	B35-4002
Tahoe	--	07 - 20	--	--	--	--	35-4016	B35-4016
		07 - 15	--	--	--	--	35-4014*	--
		00 - 06	--	45-4001*	B35-4002-3*	P35-4002*	35-4002	B35-4002
			--	--	--	--	35-4001	B35-4001
Dodge								
Dakota	--	05 - 10	--	--	--	--	--	B35-5003
Ram 1500	Excl. Rebel	09 - 10	AL45-5005*	45-5005*	--	--	35-5005	B35-5005
	--	02 - 05	--	--	B35-5006-3*	--	35-5006	B35-5006
		94 - 02	--	--	--	--	35-5000	--
Ram 2500 / 3500	--	03 - 10	--	--	B35-5006-3*	--	35-5006	B35-5006
		94 - 02	--	--	--	--	35-5000	--
Ford								
Excursion	--	00 - 05	--	--	B35-3001-3*	P35-3001*	35-3001	--
Expedition	--	03 - 17	--	--	--	--	35-3007	B35-3007
		4WD	97 - 02	--	--	--	--	35-3004
Explorer	--	11 - 19	--	--	--	--	--	B35-3013
F-150	Excl. EcoBoost, Diesel, FX4, and SVT Raptor	04 - 20	--	--	--	--	35-3007	B35-3007
	--	99 - 03	--	--	--	--	35-3004	B35-3004
		4WD	97 - 98	--	--	--	--	35-3004
F-250	--	99 - 99	--	--	--	--	35-3001	--
F-250 Super Duty	--	17 - 22	--	--	--	--	35-3014	B35-3014
		11 - 16	--	--	B35-3012-3*	P35-3012*	35-3012	B35-3012*
		08 - 10	--	--	B35-3006-3*	P35-3006*	35-3006	B35-3006*
		99 - 07	--	--	B35-3001-3*	P35-3001*	35-3001	--

* Continued while supplies last

† Denotes 2-1/2" diameter tubing

Applications continued on the following page

Big Horn 4" & All 3" Bull Bars

Make / Model	Style	Years	4" Big Horn		3" Stealth	3" Pro Series	3" Bull Bars	
			Textured Black #	Polished Stainless #	High-Gloss Black #	Textured Black #	Polished Stainless #	Semi-Gloss Black #
Ford (continued)								
F-350 Super Duty	--	17 - 22	--	--	--	--	35-3014	B35-3014
		11 - 16	--	--	B35-3012-3*	P35-3012*	35-3012	B35-3012*
		08 - 10	--	--	B35-3006-3*	P35-3006*	35-3006	B35-3006*
		99 - 07	--	--	B35-3001-3*	P35-3001*	35-3001	--
F-450 / F-550 Super Duty	--	11 - 16	--	--	B35-3012-3*	P35-3012*	35-3012	B35-3012*
		08 - 10	--	--	--	--	35-3006	--
Ranger	--	08 - 11	--	--	--	--	35-3011*†	--
	Edge or XLT	98 - 07	--	--	--	--	--	B35-3009
Freightliner								
Sprinter 2500	--	14 - 18	--	--	--	--	35-8000	B35-8000
Sprinter 3500	--	14 - 18	--	--	--	--	35-8000	B35-8000
GMC								
C1500	--	88 - 98	--	--	--	--	35-4009	B35-4009
C2500	--	88 - 98	--	--	--	--	35-4009	B35-4009
C3500	--	88 - 98	--	--	--	--	35-4009	B35-4009
Canyon	--	15 - 21	--	--	--	--	35-4015	B35-4015
		04 - 12	--	--	--	--	35-4010†	B35-4010†
K1500	--	88 - 99	--	--	--	--	35-4009	B35-4009
K2500	--	88 - 00	--	--	--	--	35-4009	B35-4009
K3500	--	88 - 00	--	--	--	--	35-4009	B35-4009
Sierra 1500	Excluding Diesel	19 - 21	--	--	--	--	35-4017	B35-4017
	--	14 - 15	--	45-4012*	--	--	--	--
	--	07 - 18	--	--	--	--	35-4016	B35-4016
	Excluding Denali	07 - 15	--	--	--	--	35-4014*	--
	--	99 - 06	--	45-4001*	--	--	35-4001	B35-4001
Sierra 1500 Classic	--	07 - 07	--	45-4001*	--	--	35-4001	B35-4001
Sierra 1500 HD	--	01 - 06	--	--	B35-4002-3*	P35-4002*	35-4002	B35-4002
Sierra 1500 HD Classic	--	07 - 07	--	--	B35-4002-3*	P35-4002*	35-4002	B35-4002
Sierra 1500 Ltd	--	19 - 19	--	--	--	--	35-4016	B35-4016
Sierra 2500	--	99 - 04	--	--	B35-4002-3*	P35-4002*	35-4002	B35-4002
Sierra 2500 HD	--	09 - 19	--	--	--	--	35-4013	B35-4013
		07 - 10	AL45-4006*	45-4006*	B35-4006-3*	P35-4006*	35-4006*	--
		01 - 06	--	--	B35-4002-3*	P35-4002*	35-4002	B35-4002
Sierra 2500 HD Classic	--	07 - 07	--	--	B35-4002-3*	P35-4002*	35-4002	B35-4002
Sierra 3500	--	01 - 06	--	--	B35-4002-3*	P35-4002*	35-4002	B35-4002
Sierra 3500 Classic	--	07 - 07	--	--	B35-4002-3*	P35-4002*	35-4002	B35-4002
Sierra 3500 HD	--	09 - 19	--	--	--	--	35-4013	B35-4013
		07 - 10	AL45-4006*	45-4006*	B35-4006-3*	P35-4006*	35-4006*	--
Yukon	--	07 - 20	--	--	--	--	35-4016	B35-4016
		00 - 06	--	45-4001*	--	--	35-4001	B35-4001
Yukon XL	--	15 - 20	--	--	--	--	35-4016	B35-4016
Yukon XL 1500	--	07 - 14	--	--	--	--	35-4014*	--
		00 - 06	--	45-4001*	--	--	35-4001	B35-4001
Yukon XL 2500	--	00 - 06	--	--	B35-4002-3*	P35-4002*	35-4002	B35-4002

* Continued while supplies last

† Denotes 2-1/2" diameter tubing

Applications continued on the following page

Big Horn 4" & All 3" Bull Bars

Make / Model	Style	Years	4" Big Horn		3" Stealth	3" Pro Series	3" Bull Bars	
			Textured Black #	Polished Stainless #	High-Gloss Black #	Textured Black #	Polished Stainless #	Semi-Gloss Black #
Honda								
Pilot	--	03 - 08	--	--	--	--	--	B35-6001
Ridgeline	--	06 - 14	--	--	--	--	--	B35-6001
Jeep								
Commander	--	06 - 10	--	--	--	--	--	B35-1001
Grand Cherokee	Excluding SRT, Summit, Trail Hawk, Track Hawk and models with active cruise control	11 - 20	--	--	--	--	35-1003 [†]	B35-1003 [†]
	--	05 - 07	--	--	--	--	--	B35-1001
Lincoln								
Mark LT	--	06 - 08	--	--	--	--	35-3007	B35-3007
Mercedes-Benz								
Sprinter 2500	--	14 - 18	--	--	--	--	35-8000	B35-8000
Sprinter 3500	--	14 - 18	--	--	--	--	35-8000	B35-8000
Nissan								
Armada	--	05 - 15	--	--	--	--	35-9001	B35-9001
Frontier	--	05 - 20	--	--	--	--	35-9002	B35-9002
NV1500	--	12 - 20	AL45-9004*	--	--	--	35-9004*	--
NV2500	--	12 - 20	AL45-9004*	--	--	--	35-9004*	--
NV3500	--	12 - 20	AL45-9004*	--	--	--	35-9004*	--
Pathfinder	--	05 - 07	--	--	--	--	35-9002	B35-9002
Titan	--	04 - 15	--	--	--	--	35-9001	B35-9001
Titan XD	--	16 - 21	AL45-9004*	--	--	--	35-9004*	--
Xterra	--	05 - 15	--	--	--	--	35-9002	B35-9002
Ram								
1500	Excluding Rebel or diesel	19 - 21	--	--	--	--	35-5008	B35-5008
	Excluding Rebel	11 - 18	AL45-5005*	45-5005*	--	--	35-5005	B35-5005
1500 Classic	Excluding Warlock	19 - 21	--	--	--	--	35-5005	B35-5005
2500	--	11 - 18	--	--	B35-5006-3*	--	35-5006	B35-5006
3500	--	11 - 18	--	--	B35-5006-3*	--	35-5006	B35-5006
Dakota	--	11 - 11	--	--	--	--	--	B35-5003
Toyota								
4Runner	--	10 - 18	--	--	--	--	35-2006	B35-2006
	--	03 - 09	--	--	--	--	--	B35-2005
FJ Cruiser	--	07 - 14	--	--	--	--	35-2003*	B35-2003
Sequoia	--	08 - 21	AL45-2004	45-2004	--	--	35-2004	B35-2004
	--	01 - 07	--	--	--	--	35-2001	B35-2001
Tacoma	--	16 - 21	--	--	--	--	35-2010	B35-2010
	--	05 - 15	--	--	--	--	35-2002	B35-2002
	--	98 - 04	--	--	--	--	35-2000	B35-2000
Tundra	--	07 - 21	AL45-2004	45-2004	--	--	35-2004	B35-2004
	--	00 - 06	--	--	--	--	35-2001	B35-2001

* Continued while supplies last

† Denotes 2-1/2" diameter tubing

PRO SERIES™ GRILLE GUARD APPLICATION GUIDE

Pro Series Grille Guards

Make / Model	Style / Notes	Years	Kit # (Guard and Light Bar)	Guard Only #	Light Bar Only #
Chevrolet					
Colorado	Excluding ZR2	15 - 21	2170022	P4088	1501264
Silverado 1500	Excluding Diesel	19 - 21	2170035	P4092	1501264
	--	14 - 18	2170030	P4091	1501264
	--	14 - 16	2170024*	P4090*	1501264
Silverado 1500 LD	--	19 - 19	2170030	P4091	1501264
Silverado 2500 HD / 3500 HD	--	15 - 19	2170020*	P4085*	1501264
Dodge					
Ram 1500	--	09 - 10	2170028	P5058	1501264
Ram 2500 / 3500	--	10 - 10	2170026	P5056	1501264
Ford					
F-150	Excluding Diesel	15 - 20	2170012	P3066	1501264
F-250 / F-350 / F-450 Super Duty	--	17 - 22	2170014	P3067	1501264
F-550 Super Duty	--	17 - 22	2170014	P3067	1501264
Ranger	--	19 - 21	2170037	P3069	1501264
GMC					
Canyon	--	15 - 20	2170022	P4088	1501264
Jeep					
Gladiator	--	20 - 21	2170032	P1053	1501262
Renegade	Excluding Trailhawk or tow hooks	15 - 18	2170031	P1055	1501262
Wrangler	JK	07 - 18	2170000	P1050	1501262
	JL, Excluding diesel and hybrid	18 - 21	2170032	P1053	1501262
Nissan					
Titan XD	--	16 - 21	2170029*	P9052*	1501264
Ram					
1500	Excluding Rebel	11 - 18	2170028	P5058	1501264
1500 Classic	Excluding Warlock	19 - 21	2170028	P5058	1501264
2500 / 3500	--	11 - 18	2170026	P5056	1501264
Toyota					
4Runner	Excluding Limited	14 - 18	2170034	P2066	1501264
Sequoia	--	08 - 20	2170004	P2067	1501264
Tacoma	--	16 - 21	2170006	P2068	1501264
		05 - 15	2170001	P2054	1501264
Tundra	--	07 - 20	2170004	P2067	1501264

Note: Grille guard may interfere with forward-facing cameras or sensors

* Continued while supplies last



Scan for current applications
or visit ariesautomotive.com

GRILLE GUARD APPLICATION GUIDE

Grille Guards

Make / Model	Style / Notes	Years	Polished #	Black #
Chevrolet				
Avalanche	--	07 - 13	--	4065
Avalanche 1500	With plastic cladding	02 - 06	4052-2*	--
	Without plastic cladding	03 - 06	--	4059
Blazer	4WD	98 - 04	--	4044
C1500	--	88 - 99	--	4042
C2500	--	88 - 98	--	4042
C3500	--	88 - 98	--	4042
Colorado	Excluding ZR2	15 - 21	4088-2	4088
	Front cross bar removal required	04 - 14	--	4080
K1500	--	88 - 99	--	4042
K2500	--	88 - 98	--	4042
K3500	--	88 - 98	--	4042
S10	4WD	98 - 04	--	4044
Silverado 1500	Excluding Diesel	19 - 21	4092-2	4092
	--	14 - 18	4091-2	4091
	--	14 - 16	4090-2	--
	--	07 - 13	4068-2	4068
	--	03 - 06	--	4059
	--	99 - 02	--	4043
Silverado 1500 Classic	--	07 - 07	--	4059
Silverado 1500 HD	--	01 - 02	--	4043
Silverado 1500 LD	--	19 - 19	4091-2	4091
Silverado 2500	--	99 - 02	--	4050
Silverado 2500 HD	--	15 - 19	--	4085
	--	11 - 14	4081-2	4081
	--	01 - 02	--	4050
Silverado 3500	--	01 - 02	--	4050
Silverado 3500 HD	--	15 - 19	--	4085
	--	11 - 14	4081-2	4081

Note: Grille guard may interfere with forward-facing cameras or sensors

* Continued while supplies last

Applications continued on the following page

Grille Guards

Make / Model	Style / Notes	Years	Polished #	Black #
Chevrolet (continued)				
Suburban	Without Adaptive Cruise Control	15 - 20	4087-2	--
	--	92 - 99	--	4042
Suburban 1500	--	07 - 14	--	4065
		00 - 06	--	4043
Tahoe	Without Adaptive Cruise Control	15 - 20	4087-2	--
	--	07 - 14	--	4065
	--	00 - 06	--	4043
	--	95 - 99	--	4042
Dodge				
Dakota	--	05 - 10	--	5055
		97 - 04	--	5041
Durango	--	98 - 04	--	5041
Nitro	--	07 - 11	--	5051
Ram 1500	--	09 - 10	5058-2	5058
		02 - 05	5045-2	--
		Excluding Sport	94 - 01	5042-2
Ram 2500	--	10 - 10	5056-2	5056
		94 - 02	5042-2	5042
Ram 3500	--	10 - 10	5056-2	5056
		94 - 02	5042-2	5042
Ford				
Escape	--	08 - 12	--	3062
Excursion	--	00 - 04	3045-2	3045
Expedition	--	07 - 14	--	3060
		03 - 06	--	3054
	4WD	99 - 03	--	3046F
	2WD	99 - 02	--	3046
	--	97 - 98	--	3046F
Explorer	--	16 - 19	--	3068
		11 - 15	--	3065
		06 - 10	--	3059
	Excluding Sport	02 - 05	--	3052
Explorer Sport	--	01 - 03	--	3048
Explorer Sport Trac	--	01 - 05	--	3048
F-150	Excluding Diesel	15 - 20	3066-2	3066
	--	09 - 14	3063-2	3063
	--	04 - 08	3056-2	3056
	2WD	99 - 03	--	3046
	4WD	99 - 03	--	3046F
F-150 Heritage	2WD	04 - 04	--	3046
	4WD	04 - 04	--	3046F
F-250 Super Duty	--	17 - 22	3067-2	3067
		11 - 16	3064-2	3064
		08 - 10	--	3061
		99 - 04	3045-2	3045
F-350 Super Duty	--	17 - 22	3067-2	3067
		11 - 16	3064-2	3064
		08 - 10	--	3061
		99 - 04	3045-2	3045

Note: Grille guard may interfere with forward-facing cameras or sensors
 * Continued while supplies last

Applications continued on the following page

Grille Guards

Make / Model	Style / Notes	Years	Polished #	Black #
Ford (continued)				
F-450 Super Duty	--	17 - 22	3067-2	3067
		11 - 16	3064-2	3064
		08 - 10	--	3061
F-550 Super Duty	--	17 - 22	3067-2	3067
		11 - 16	3064-2	3064
		08 - 10	--	3061
Ranger	--	19 - 21	--	3069
	EDGE or XLT	01 - 11	--	3053
	--	98 - 00	--	3044
GMC				
C1500	--	88 - 99	--	4042
C2500	--	88 - 98	--	4042
C3500	--	88 - 98	--	4042
Canyon	--	15 - 20	4088-2	4088
	Front cross bar removal required	04 - 14	--	4080
K1500	--	88 - 99	--	4042
K2500	--	88 - 98	--	4042
K3500	--	88 - 98	--	4042
Sierra 1500	--	07 - 13	--	4070
Sierra 2500 HD	--	15 - 19	4086-2	--
Sierra 3500 HD	--	15 - 19	4086-2	--
Yukon	--	95 - 99	--	4042
Honda				
Ridgeline	--	17 - 18	--	6057
		06 - 14	--	6055
Hummer				
H2	--	03 - 09	4076-2	4076
H3	--	06 - 10	4077-2	4078
H3T	--	09 - 10	4077-2	4078
Jeep				
Cherokee	Excluding Limited	84 - 01	--	1043
Gladiator	--	20 - 21	--	1053
Grand Cherokee	Excluding SRT, Summit, Trail Hawk, Track Hawk, and models with active cruise control	11 - 20	--	1052
	--	05 - 10	--	1046
	With factory tow hook	99 - 04	--	1044
Liberty	Without headlight cage	08 - 12	--	1051
	Excluding Renegade	02 - 04	--	1045
Wrangler	JK, excluding Rubicon Hard Rock, without headlight cage	07 - 18	--	1050
	JL, Excluding diesel and hybrid	18 - 21	--	1053
Lincoln				
Mark LT	--	05 - 08	3056-2	3056
Mazda				
Tribute	--	08 - 11	--	3062

Note: Grille guard may interfere with forward-facing cameras or sensors

* Continued while supplies last

Applications continued on the following page

Grille Guards

Make / Model	Style / Notes	Years	Polished #	Black #
Nissan				
Armada	Excluding XE	05 - 15	--	9046
Frontier	Excluding Desert Runner, Nismo, PRO-4X, SV	05 - 20	--	9047
	--	01 - 04	--	9044
	--	98 - 00	--	9043
Pathfinder	--	05 - 07	--	9047
Titan	Excluding XE	04 - 15	--	9046
Titan XD	--	16 - 21	9052-2	--
Xterra	--	05 - 15	--	9048
		00 - 01	--	9043
Ram				
1500	Excluding Rebel or diesel	19 - 21	--	5060
	Excluding Rebel	11 - 18	5058-2	5058
1500 Classic	Excluding Warlock	19 - 21	5058-2	5058
2500	--	11 - 18	5056-2	5056
3500	--	11 - 18	5056-2	5056
Dakota	--	11 - 11	--	5055
Toyota				
4Runner	Excluding Limited	14 - 18	2066-2	2066
	--	10 - 13	2066-2	2066
		03 - 09	--	2058
		99 - 02	--	2044
		96 - 98	--	2042
FJ Cruiser	--	07 - 14	--	2059
Land Cruiser	--	98 - 03	--	2043
RAV4	--	06 - 17	--	2065
Sequoia	--	08 - 21	2069-2	2069
Tacoma	--	16 - 21	2068-2	2068
		05 - 15	2054-2	2054
		01 - 04	2049-2	2049
		98 - 00	--	2042
Tundra	--	07 - 21	2069-2	2069
	Crew cab	04 - 06	--	2053
	Extended cab	03 - 06	--	2052
	--	99 - 02	2045-2	2045

Note: Grille guard may interfere with forward-facing cameras or sensors

* Continued while supplies last



ACTIONTRAC™ APPLICATION GUIDE

ActionTrac Powered Running Boards

Make / Model	Style	Years	Kit # (Boards and Brackets)	Boards Only #	Brackets Only #
Chevrolet					
Colorado	Crew cab	15 - 21	3047904	3025179	3025104
	Extended cab	15 - 21	3046504	3025165	3025104
Silverado 1500	Crew cab	19 - 21	3048315	3025183	3025103
		14 - 18	3047902	3025179	3025101
Silverado 2500 HD / 3500 HD	Crew cab	20 - 22	3048315	3025183	3025103
		15 - 19	3047902	3025179	3025101
Tahoe	All	21 - 21	3048103	3025165	3025103
Dodge					
Ram 1500	Crew cab	09 - 10	3047912	3025179	3025111
Ram 2500 / 3500	Crew cab	09 - 10	3047912	3025179	3025111
	Extended crew cab	10 - 10	3047913	3025183	3025111
Ford					
Bronco	4-door	21 - 21	3048923	3025165	3025123
F-150	Crew cab	15 - 21	3048321	3025183	3025121
		04 - 14	3048326	3025183	3025125
F-250 Super Duty	Crew cab	17 - 22	3048321	3025183	3025121
		99 - 16	3048324	3025183	3025124
F-350 Super Duty	Crew cab	17 - 22	3048321	3025183	3025121
		99 - 16	3048324	3025183	3025124
F-450 Super Duty	Crew cab	17 - 22	3048321	3025183	3025121
		08 - 16	3048324	3025183	3025124
	Crew cab, Cab & Chassis	17 - 22	3048321	3025183	3025121
F-550 Super Duty	Crew cab, Cab & Chassis	17 - 22	3048321	3025183	3025121
Ranger	Crew cab	19 - 21	3047923	3025179	3025123
GMC					
Canyon	Crew cab	15 - 21	3047904	3025179	3025104
	Extended cab	15 - 21	3046504	3025165	3025104
Sierra 1500	Crew cab	19 - 21	3048315	3025183	3025103
		14 - 18	3047902	3025179	3025101
Sierra 2500 HD / 3500 HD	Crew cab	20 - 22	3048315	3025183	3025103
		15 - 19	3047902	3025179	3025101



ActionTrac Powered Running Boards

Make / Model	Style	Years	Kit # (Boards and Brackets)	Boards Only #	Brackets Only #
Jeep					
Gladiator	All	20 - 21	3047975	3025179	3025175
Wrangler	JK, Unlimited (4-door)	07 - 18	3036570	3025165	3025170
	JL, Unlimited (4-door)	18 - 21	3036571	3025165	3025171
Nissan					
Titan	Crew cab	04 - 21	3047960	3025183	3025160
Titan XD	Crew cab	16 - 21	3047960	3025183	3025160
Ram					
1500	Crew cab	19 - 21	3048314	3025183	3025117
		11 - 18	3047912	3025179	3025111
1500 Classic	Crew cab	19 - 21	3047912	3025179	3025111
2500 / 3500	Crew cab	11 - 21	3047912	3025179	3025111
	Extended crew cab	11 - 21	3047913	3025183	3025111
Toyota					
4Runner	SR5	03 - 21	3047954	3025165	3025152
	Trail	15 - 16	3047954	3025165	3025152
	TRD Off-Road	17 - 21	3047954	3025165	3025152
	TRD Pro	15 - 21	3047954	3025165	3025152
Tacoma	Crew cab	05 - 21	3047953	3025179	3025152
	Extended cab	05 - 21	3047954	3025165	3025152
Tundra	Crew cab	07 - 21	3047952	3025179	3025151
	Extended crew cab	07 - 21	3048351	3025183	3025151



VERSATRAC® BRACKETS APPLICATION GUIDE

VersaTrac Brackets and Compatible Boards

Make / Model	Style / Notes	Years	VersaTrac Brackets	Bracket #
			Brackets Only	
Chevrolet				
Avalanche 1500 / 2500	--	02 - 06	2055101	
Colorado	Crew cab	15 - 21	2055104	
	Extended cab	15 - 21	2055104	
Silverado 1500	Crew cab	19 - 21	2055105	
		07 - 18	2055101	
	Extended cab	19 - 21	2055105	
		07 - 18	2055101	
	Standard cab	07 - 18	2055100	
Silverado 1500 LD	Extended cab	19 - 19	2055101	
Silverado 2500 HD	Crew cab	20 - 22	2055105	
	Crew cab (diesel)	07 - 19	2055102	
	Crew cab (gas)	07 - 19	2055101	
	Extended cab	20 - 22	2055105	
	Extended cab (diesel)	07 - 19	2055102	
	Extended cab (gas)	07 - 19	2055101	
	Standard cab (diesel)	07 - 19	2055102	
	Standard cab (gas)	07 - 19	2055100	
Silverado 3500 HD	Crew cab	20 - 22	2055105	
	Crew cab (diesel)	07 - 19	2055102	
	Crew cab (gas)	07 - 19	2055101	
	Extended cab	20 - 22	2055105	
	Extended cab (diesel)	07 - 18	2055102	
	Extended cab (gas)	07 - 18	2055101	
	Standard cab (diesel)	07 - 18	2055102	
	Standard cab (gas)	07 - 18	2055100	
Suburban	--	15 - 20	2055101	
Tahoe	--	05 - 20	2055101	

* Continued while supplies last



AdvantEDGE Side Bars				RidgeStep Running Boards		AscentStep Running Boards	
Kit (Bars & Brackets)		Bars Only		Kit (Brds, Brkts)	Boards Only	Kit (Brds, Brkts)	Boards Only
Chrome Powder Coat#	Carbide Black Powder Coat#	Chrome Powder Coat#	Carbide Black Powder Coat#	Textured Black#	Textured Black#	Carbide Black#	Carbide Black#
Chevrolet							
2555047	2556047	2055891	2055991	2055512	C2891	--	--
2555044	2556044	2055885	2055985	2055533	C2885	2558044	2057985
2555043	2556043	2055875	2055975	2055532	C2875	2558043	2057975
2555015	2556015	2055891	2055991	2055541	C2891	2558011	2057991
2555047	2556047	2055891	2055991	2055512	C2891	2558047	2057991
2555051	2556051	2055875	2055975	2055551	C2875	2558051	2057975
2555002	2556002	2055875	2055975	2055511	C2875	2558002	2057975
2555001	2556001	2055853	2055953	2055510	C2853	--	--
2555002	2556002	2055875	2055975	2055511	C2875	2558002	2057975
2555015	2556015	2055891	2055991	2055541	C2891	2558011	2057991
2555046	2556046	2055891	2055991	2055531	C2891	2558046	2057991
2555047	2556047	2055891	2055991	2055512	C2891	2558047	2057991
2555051	2556051	2055875	2055975	2055551	C2875	2558051	2057975
2555021	2556021	2055875	2055975	2055530	C2875	2558021	2057975
2555002	2556002	2055875	2055975	2055511	C2875	2558002	2057975
2555020	2556020	2055853	2055953	2055529	C2853	--	--
2555001	2556001	2055853	2055953	2055510	C2853	--	--
2555015	2556015	2055891	2055991	2055541	C2891	2558011	2057991
2555046	2556046	2055891	2055991	2055531	C2891	2558046	2057991
2555047	2556047	2055891	2055991	2055512	C2891	2558047	2057991
2555051	2556051	2055875	2055975	2055551	C2875	2558051	2057975
2555021	2556021	2055875	2055975	2055530	C2875	2558021	2057975
2555002	2556002	2055875	2055975	2055511	C2875	2558002	2057975
2555020	2556020	2055853	2055953	2055529	C2853	--	--
2555001	2556001	2055853	2055953	2055510	C2853	--	--
2555047	2556047	2055891	2055991	2055512	C2891	2558047	2057991
2555002	2556002	2055875	2055975	2055511	C2875	2558002	2057975

Applications continued on the following page

VersaTrac Brackets and Compatible Boards

Make / Model	Style / Notes	Years	VersaTrac Brackets	Bracket #
			Brackets Only	
Dodge				
Durango	--	11 - 21		2055181
Ram 1500	Extended cab	09 - 10		2055111
Ram 1500 / 2500 / 3500	Crew cab	09 - 10		2055111
	Standard cab	09 - 10		2055110
Ram 2500 / 3500	Extended crew cab	09 - 10		2055111
Ram 4500 / 5500	Crew cab, Cab & Chassis	09 - 10		2055111
Sprinter 2500 / 3500	Excluding models with rear air conditioning	07 - 09		2055113
Ford				
E-150 / E-250	--	03 - 14		2055126
E-150 / E-250 Econoline	--	99 - 02		2055126
E-350 Super Duty	--	99 - 14		2055126
Explorer	--	20 - 21		2055128
F-150	Crew cab	15 - 21		2055121
		04 - 14		2055120
	Extended cab	15 - 21		2055122
		04 - 14		2055120
	Standard cab	15 - 21		2055122
		04 - 14		2055120
F-250	Extended cab	99 - 99		2055123
	Standard cab	99 - 99		2055123
F-250 / F-350 Super Duty	Crew cab	17 - 22		2055121
		99 - 16		2055124
	Extended cab	17 - 22		2055122
		99 - 16		2055123
	Standard cab	17 - 22		2055122
		99 - 16		2055123
F-450 Super Duty	Crew cab	17 - 22		2055121
		99 - 16		2055124
	Extended cab, Cab & Chassis	17 - 22		2055122
	Standard cab	19 - 22		2055122
	Standard cab, Cab & Chassis	17 - 22		2055122
F-550 Super Duty	Crew cab, Cab & Chassis	17 - 22		2055121
	Extended cab, Cab & Chassis	17 - 22		2055122
	Standard cab, Cab & Chassis	17 - 22		2055122
Ranger	Crew cab	19 - 21		2055103
Transit-150 / 250 / 350	--	15 - 21		2055127
		15 - 18		2055125*
Freightliner				
Sprinter 2500 / 3500	Excluding models with rear air conditioning	07 - 21		2055113
GMC				
Canyon	Crew cab	15 - 21		2055104
	Extended cab	15 - 21		2055104
Sierra 1500	Crew cab	19 - 21		2055105
		07 - 18		2055101
	Extended cab	19 - 21		2055105
		07 - 18		2055101
	Standard cab	07 - 18		2055100

* Continued while supplies last

AdvantEDGE Side Bars				RidgeStep Running Boards		AscentStep Running Boards	
Kit (Bars & Brackets)		Bars Only		Kit (Brds, Brkts)	Boards Only	Kit (Brds, Brkts)	Boards Only
Chrome Powder Coat#	Carbide Black Powder Coat#	Chrome Powder Coat#	Carbide Black Powder Coat#	Textured Black#	Textured Black#	Carbide Black#	Carbide Black#
Dodge							
2555053	2556053	2055875	2055975	2055553	C2875	2558053	2057975
2555005	2556005	2055875	2055975	2055514	C2875	2558005	2057975
2555006	2556006	2055885	2055985	2055536	C2891	2558006	2057985
2555004	2556004	2055853	2055953	2055513	C2853	--	--
2555026	2556026	2055891	2055991	2055536	C2891	--	--
2555006	2556006	2055885	2055985	2055515	C2885	--	--
--	--	--	--	2055534	C3696	--	--
Ford							
--	--	--	--	2055537	C3696	--	--
--	--	--	--	2055537	C3696	--	--
--	--	--	--	2055537	C3696	--	--
2555054	2556054	2055875	2055875	2055554	C2875	2558054	2057975
2555048	2556048	2055891	2055991	2055519	C2891	2558048	2057991
2555009	2556009	2055885	2055985	2055518	C2891	2558009	2057985
2555012	2556012	2055875	2055975	2055521	C2885	2558012	2057975
2555008	2556008	2055875	2055975	2055517	C2875	2558008	2057975
2555011	2556011	2055853	2055953	2055520	C2853	--	--
2555007	2556007	2055853	2055953	2055516	C2853	--	--
2555014	2556014	2055875	2055975	2055523	C2875	2558014	2057975
2555013	2556013	2055853	2055953	2055522	C2853	--	--
2555048	2556048	2055891	2055991	2055519	C2891	2558048	2057991
2555024	2556024	2055891	2055991	2055524	C2891	2558024	2057991
2555012	2556012	2055875	2055975	2055521	C2885	2558012	2057975
2555014	2556014	2055875	2055975	2055523	C2875	2558014	2057975
2555011	2556011	2055853	2055953	2055520	C2853	--	--
2555013	2556013	2055853	2055953	2055522	C2853	--	--
2555048	2556048	2055891	2055991	2055519	C2891	2558048	2057991
2555024	2556024	2055891	2055991	2055524	C2891	2558024	2057991
2555012	2556012	2055875	2055975	2055521	C2885	2558012	2057975
2555011	2556011	2055853	2055953	2055520	C2853	--	--
2555011	2556011	2055853	2055953	2055520	C2853	--	--
2555048	2556048	2055891	2055991	2055519	C2891	2558048	2057991
2555012	2556012	2055875	2055975	2055521	C2885	2558012	2057975
2555011	2556011	2055853	2055953	2055520	C2853	--	--
2555052	2556052	2055885	2055985	2055552	C2885	2558052	2057985
--	--	--	--	2055545	C3696	--	--
--	--	--	--	2055535*	C3696	--	--
Freightliner							
--	--	--	--	2055534	C3696	--	--
GMC							
2555044	2556044	2055885	2055985	2055533	C2885	2558044	2057985
2555043	2556043	2055875	2055975	2055532	C2875	2558043	2057975
2555015	2556015	2055891	2055991	2055541	C2891	2558011	2057991
2555047	2556047	2055891	2055991	2055512	C2891	2558047	2057991
2555051	2556051	2055875	2055975	2055551	C2875	2558051	2057975
2555002	2556002	2055875	2055975	2055511	C2875	2558002	2057975
2555001	2556001	2055853	2055953	2055510	C2853	--	--

Applications continued on the following page

VersaTrac Brackets and Compatible Boards

Make / Model	Style / Notes	Years	VersaTrac Brackets	Bracket #
			Brackets Only	
GMC (continued)				
Sierra 1500 Limited	Extended cab	19 - 19	2055101	
Sierra 2500 HD	Crew cab	20 - 22	2055105	
	Crew cab (diesel)	07 - 19	2055102	
	Crew cab (gas)	07 - 19	2055101	
	Extended cab	20 - 22	2055105	
	Extended cab (diesel)	07 - 19	2055102	
	Extended cab (gas)	07 - 19	2055101	
	Standard cab (diesel)	07 - 19	2055102	
	Standard cab (gas)	07 - 19	2055100	
Sierra 3500 HD	Crew cab	20 - 22	2055105	
	Crew cab (diesel)	07 - 19	2055102	
	Crew cab (gas)	07 - 19	2055101	
	Extended cab	20 - 22	2055105	
	Extended cab (diesel)	07 - 18	2055102	
	Extended cab (gas)	07 - 18	2055101	
	Standard cab (diesel)	07 - 18	2055102	
	Standard cab (gas)	07 - 18	2055100	
Yukon	--	05 - 20	2055101	
Yukon XL	--	15 - 20	2055101	
Honda				
Ridgeline	--	17 - 18	2055130	
Mercedes-Benz				
Sprinter 2500 / 3500	Excluding models with rear air conditioning	10 - 21	2055113	
Nissan				
Titan	Crew cab	04 - 21	2055142	
	Extended cab	04 - 18	2055142	
Titan XD	Crew cab	16 - 21	2055142	
Ram				
1500	Crew cab	19 - 21	2055117	
		11 - 18	2055111	
	Extended cab	19 - 21	2055117	
		11 - 18	2055111	
1500 Classic	Standard cab	11 - 18	2055110	
	Crew cab	19 - 21	2055111	
	Extended cab	19 - 21	2055111	
2500 / 3500	Standard cab	19 - 21	2055110	
	Crew cab	11 - 21	2055111	
	Extended crew cab	11 - 21	2055111	
4500 / 5500	Standard cab	11 - 21	2055110	
	Crew cab, Cab & Chassis	11 - 17	2055111	
ProMaster 2500 / 3500	159 In. Wheel Base	14 - 21	2055115	
Toyota				
Tacoma	Crew cab	05 - 21	2055152	
Tundra	Crew cab	07 - 21	2055151	
	Extended crew cab	07 - 21	2055151	
	Standard cab	07 - 17	2055151	

* Continued while supplies last

AdvantEDGE Side Bars		RidgeStep Running Boards		AscentStep Running Boards			
Kit (Bars & Brackets)		Bars Only		Kit (Brds, Brkts)	Boards Only	Kit (Brds, Brkts)	Boards Only
Chrome Powder Coat#	Carbide Black Powder Coat#	Chrome Powder Coat#	Carbide Black Powder Coat#	Textured Black#	Textured Black#	Carbide Black#	Carbide Black#
GMC (continued)							
2555002	2556002	2055875	2055975	2055511	C2875	2558002	2057975
2555015	2556015	2055891	2055991	2055541	C2891	2558011	2057991
2555046	2556046	2055891	2055991	2055531	C2891	2558046	2057991
2555047	2556047	2055891	2055991	2055512	C2891	2558047	2057991
2555051	2556051	2055875	2055975	2055551	C2875	2558051	2057975
2555021	2556021	2055875	2055975	2055530	C2875	2558021	2057975
2555002	2556002	2055875	2055975	2055511	C2875	2558002	2057975
2555020	2556020	2055853	2055953	2055529	C2853	--	--
2555001	2556001	2055853	2055953	2055510	C2853	--	--
2555015	2556015	2055891	2055991	2055541	C2891	2558011	2057991
2555046	2556046	2055891	2055991	2055531	C2891	2558046	2057991
2555047	2556047	2055891	2055991	2055512	C2891	2558047	2057991
2555051	2556051	2055875	2055975	2055551	C2875	2558051	2057975
2555021	2556021	2055875	2055975	2055530	C2875	2558021	2057975
2555002	2556002	2055875	2055975	2055511	C2875	2558002	2057975
2555020	2556020	2055853	2055953	2055529	C2853	--	--
2555001	2556001	2055853	2055953	2055510	C2853	--	--
2555002	2556002	2055875	2055975	2055511	C2875	2558002	2057975
2555047	2556047	2055891	2055991	2055512	C2891	2558047	2057991
Honda							
2555030	2556030	2055885	2055985	2055538	C2885	2558030	2057985
Mercedes-Benz							
--	--	--	--	2055534	C3696	--	--
Nissan							
2555042	2556042	2055885	2055985	2055542	C2885	2558042	2057985
2555045	2556045	2055875	2055975	2055543	C2875	2558045	2057975
2555042	2556042	2055885	2055985	2055542	C2885	2558042	2057985
Ram							
2555049	2556049	2055891	2055991	2055549	C2891	2558007	2057991
2555006	2556006	2055885	2055985	2055515	C2885	2558006	2057985
2555050	2556050	2055875	2055975	2055550	C2875	2558004	2057975
2555005	2556005	2055875	2055975	2055514	C2875	2558005	2057975
2555004	2556004	2055853	2055953	2055513	C2853	--	--
2555006	2556006	2055885	2055985	2055515	C2885	2558006	2057985
2555005	2556005	2055875	2055975	2055514	C2875	2558005	2057975
2555004	2556004	2055853	2055953	2055513	C2853	--	--
2555006	2556006	2055885	2055985	2055515	C2885	2558006	2057985
2555026	2556026	2055891	2055991	2055536	C2891	--	--
2555004	2556004	2055853	2055953	2055513	C2853	--	--
2555006	2556006	2055885	2055985	2055515	C2885	--	--
--	--	--	--	2055539	C3696	--	--
Toyota							
2555023	2556023	2055885	2055985	--	--	2558023	2057985
2555019	2556019	2055885	2055985	2055528	C2885	2558019	2057985
2555019	2556019	2055885	2055985	2055528	C2885	2558019	2057985
2555018	2556018	2055853	2055953	2055527	C2853	--	--



6" OVAL SIDE BAR APPLICATION GUIDE

6" Oval Side Bars and Mounting Brackets

Make / Model	Style	Years	Mount Type	Kits (Bars and Brackets)		Bars Only		Brkts Only
				Polished #	Black #	Polished #	Black #	Bracket #
Chevrolet								
Avalanche	--	07 - 13	Rocker	4444003	4445003	S2891	B2891	4490
Avalanche 1500	--	02 - 06	Rocker	4444003	4445003	S2891	B2891	4490
Avalanche 2500	--	02 - 06	Rocker	4444003	4445003	S2891	B2891	4490
C1500	Extended cab	88 - 99	Frame	4444004	4445004	S2875	B2875	4491
C2500	Extended cab	88 - 00	Frame	4444004	4445004	S2875	B2875	4491
C3500	Extended cab	88 - 00	Frame	4444004	4445004	S2875	B2875	4491
K1500	Extended cab	88 - 99	Frame	4444004	4445004	S2875	B2875	4491
K2500	Extended cab	88 - 00	Frame	4444004	4445004	S2875	B2875	4491
K3500	Extended cab	88 - 00	Frame	4444004	4445004	S2875	B2875	4491
Silverado 1500	Crew cab	19 - 21	Rocker	4444049	4445049	S2891	B2891	4499
		07 - 18	Rocker	4444003	4445003	S2891	B2891	4490
	Extended cab	07 - 18	Rocker	4444002	4445002	S2875	B2875	4490
		99 - 13	Frame	4444007	4445007	S2875	B2875	4493
	Standard cab	07 - 18	Rocker	4444040	4445040	S2853	B2853	4495
99 - 13		Frame	4444006	4445006	S2853	B2853	4492	
Silverado 1500 Classic	Extended cab	07 - 07	Frame	4444007	4445007	S2875	B2875	4493
	Standard cab	07 - 07	Frame	4444006	4445006	S2853	B2853	4492
Silverado 1500 LD	Extended cab	19 - 19	Rocker	4444002	4445002	S2875	B2875	4490
Silverado 2500 HD	Crew cab	20 - 22	Rocker	4444049	4445049	S2891	B2891	4499
	Crew cab (diesel)	07 - 19	Rocker	4444045	4445045	S2891	B2891	4407
	Crew cab (gas)	07 - 19	Rocker	4444003	4445003	S2891	B2891	4490
	Extended cab (diesel)	07 - 19	Rocker	4444001	4445001	S2875	B2875	4407
	Extended cab (gas)	07 - 19	Rocker	4444002	4445002	S2875	B2875	4490
	Extended cab	01 - 13	Frame	4444007	4445007	S2875	B2875	4493
	Standard cab (gas)	07 - 19	Rocker	4444040	4445040	S2853	B2853	4495
	Standard cab	01 - 14	Frame	4444006	4445006	S2853	B2853	4492
Silverado 2500 HD Classic	Extended cab	07 - 07	Frame	4444007	4445007	S2875	B2875	4493
	Standard cab	07 - 07	Frame	4444006	4445006	S2853	B2853	4492
Silverado 3500	Extended cab	01 - 06	Frame	4444007	4445007	S2875	B2875	4493
	Standard cab	01 - 06	Frame	4444006	4445006	S2853	B2853	4492

Applications continued on the following page

6" Oval Side Bars and Mounting Brackets

Make / Model	Style	Years	Mount Type	Kits (Bars and Brackets)		Bars Only		Brkts Only
				Polished #	Black #	Polished #	Black #	Bracket #
Chevrolet (continued)								
Silverado 3500 Classic	Extended cab	07 - 07	Frame	4444007	4445007	S2875	B2875	4493
	Standard cab	07 - 07	Frame	4444006	4445006	S2853	B2853	4492
Silverado 3500 HD	Crew cab	20 - 22	Rocker	4444049	4445049	S2891	B2891	4499
	Crew cab (diesel)	07 - 19	Rocker	4444045	4445045	S2891	B2891	4407
	Crew cab (gas)	07 - 19	Rocker	4444003	4445003	S2891	B2891	4490
	Extended cab (diesel)	07 - 19	Rocker	4444001	4445001	S2875	B2875	4407
	Extended cab (gas)	07 - 19	Rocker	4444002	4445002	S2875	B2875	4490
	Extended cab	07 - 13	Frame	4444007	4445007	S2875	B2875	4493
	Standard cab (gas)	07 - 18	Rocker	4444040	4445040	S2853	B2853	4495
	Standard cab	07 - 14	Frame	4444006	4445006	S2853	B2853	4492
Suburban	--	15 - 20	Rocker	4444003	4445003	S2891	B2891	4490
Suburban 1500	Excluding Z71	05 - 14	Rocker	4444003	4445003	S2891	B2891	4490
Suburban 2500	--	05 - 14	Rocker	4444003	4445003	S2891	B2891	4490
Tahoe	--	05 - 20	Rocker	4444002	4445002	S2875	B2875	4490
Dodge								
Ram 1500	Crew cab	09 - 10	Rocker	4444044	4445044	S2885	B2885	4523
	Crew cab, excluding Daytona, Rumble Bee, and SRT-10	02 - 09	Frame	4444013	4445013	S2885	B2885	4501
	Extended cab	09 - 10	Rocker	4444044	4445044	S2885	B2885	4523
		98 - 01	Frame	4444014	4445014	S2875	B2875	4502
Ram 2500	Crew cab	09 - 10	Rocker	4444044	4445044	S2885	B2885	4523
	Extended crew cab	09 - 10	Rocker	4444046	4445046	S2891	B2891	4523
	Extended cab	98 - 01	Frame	4444015	4445015	S2885	B2885	4502
Ram 3500	Crew cab	09 - 10	Rocker	4444044	4445044	S2885	B2885	4523
	Extended crew cab	09 - 10	Rocker	4444046	4445046	S2891	B2891	4523
	Extended cab	98 - 01	Frame	4444015	4445015	S2885	B2885	4502
Ford								
Expedition	Excluding models with power retracting boards	97 - 15	Rocker	4444016	4445016	S2875	B2875	4503
F-150	Crew cab	15 - 21	Rocker	4444027	4445027	S2891	B2891	4508
		04 - 14	Rocker	4444020	4445020	S2891	B2891	4504
	Extended cab	15 - 21	Rocker	4444042	4445042	S2875	B2875	4509
		04 - 14	Rocker	4444018	4445018	S2875	B2875	4504
		97 - 03	Rocker	4444023	4445023	S2875	B2875	4506
	Standard cab	15 - 21	Rocker	4444028	4445028	S2853	B2853	4509
		04 - 14	Rocker	4444017	4445017	S2853	B2853	4504
97 - 03		Rocker	4444022	4445022	S2853	B2853	4506	
F-150 Heritage	Extended cab	04 - 04	Rocker	4444023	4445023	S2875	B2875	4506
	Standard cab	04 - 04	Rocker	4444022	4445022	S2853	B2853	4506
F-250	Extended cab	97 - 99	Rocker	4444023	4445023	S2875	B2875	4506
F-250 Super Duty	Crew cab	17 - 22	Rocker	4444027	4445027	S2891	B2891	4508
		99 - 16	Rocker	4444026	4445026	S2891	B2891	4507
	Extended cab	17 - 22	Rocker	4444042	4445042	S2875	B2875	4509
		99 - 16	Rocker	4444025	4445025	S2885	B2885	4507
	Standard cab	17 - 22	Rocker	4444028	4445028	S2853	B2853	4509
		99 - 16	Rocker	4444024	4445024	S2853	B2853	4507

Applications continued on the following page

6" Oval Side Bars and Mounting Brackets

Make / Model	Style	Years	Mount Type	Kits (Bars and Brackets)		Bars Only		Brkts Only
				Polished #	Black #	Polished #	Black #	Bracket #
Ford (continued)								
F-350 Super Duty	Crew cab	17 - 22	Rocker	4444027	4445027	S2891	B2891	4508
		99 - 16	Rocker	4444026	4445026	S2891	B2891	4507
	Extended cab	17 - 22	Rocker	4444042	4445042	S2875	B2875	4509
		99 - 16	Rocker	4444025	4445025	S2885	B2885	4507
	Standard cab	17 - 22	Rocker	4444028	4445028	S2853	B2853	4509
		99 - 16	Rocker	4444024	4445024	S2853	B2853	4507
F-450 Super Duty	Crew cab	17 - 22	Rocker	4444027	4445027	S2891	B2891	4508
		99 - 16	Rocker	4444026	4445026	S2891	B2891	4507
	Extended cab, Cab & Chassis	17 - 22	Rocker	4444042	4445042	S2875	B2875	4509
		02 - 16	Rocker	4444025	4445025	S2885	B2885	4507
	Standard cab	19 - 22	Rocker	4444028	4445028	S2853	B2853	4509
	Standard cab, Cab & Chassis	17 - 22	Rocker	4444028	4445028	S2853	B2853	4509
99 - 16	Rocker	4444024	4445024	S2853	B2853	4507		
F-550 Super Duty	Crew cab, Cab & Chassis	17 - 22	Rocker	4444027	4445027	S2891	B2891	4508
		99 - 16	Rocker	4444026	4445026	S2891	B2891	4507
	Extended cab, Cab & Chassis	02 - 16	Rocker	4444025	4445025	S2885	B2885	4507
		17 - 22	Rocker	4444042	4445042	S2875	B2875	4509
	Standard cab, Cab & Chassis	17 - 22	Rocker	4444028	4445028	S2853	B2853	4509
		99 - 16	Rocker	4444024	4445024	S2853	B2853	4507
GMC								
C1500	Extended cab	88 - 99	Frame	4444004	4445004	S2875	B2875	4491
C2500	Extended cab	88 - 00	Frame	4444004	4445004	S2875	B2875	4491
C3500	Extended cab	88 - 00	Frame	4444004	4445004	S2875	B2875	4491
K1500	Extended cab	88 - 99	Frame	4444004	4445004	S2875	B2875	4491
K2500	Extended cab	88 - 00	Frame	4444004	4445004	S2875	B2875	4491
K3500	Extended cab	88 - 00	Frame	4444004	4445004	S2875	B2875	4491
Sierra 1500	Crew cab	19 - 21	Rocker	4444049	4445049	S2891	B2891	4499
		07 - 18	Rocker	4444003	4445003	S2891	B2891	4490
	Extended cab	07 - 18	Rocker	4444002	4445002	S2875	B2875	4490
		99 - 13	Frame	4444007	4445007	S2875	B2875	4493
	Standard cab	07 - 18	Rocker	4444040	4445040	S2853	B2853	4495
		99 - 13	Frame	4444006	4445006	S2853	B2853	4492
Sierra 1500 Classic	Extended cab	07 - 07	Frame	4444007	4445007	S2875	B2875	4493
	Standard cab	07 - 07	Frame	4444006	4445006	S2853	B2853	4492
Sierra 1500 LD	Extended cab	19 - 19	Rocker	4444002	4445002	S2875	B2875	4490
Sierra 2500 HD	Crew cab	20 - 22	Rocker	4444049	4445049	S2891	B2891	4499
	Crew cab (diesel)	07 - 19	Rocker	4444045	4445045	S2891	B2891	4407
	Crew cab (gas)	07 - 19	Rocker	4444003	4445003	S2891	B2891	4490
	Extended cab (diesel)	07 - 19	Rocker	4444001	4445001	S2875	B2875	4407
	Extended cab (gas)	07 - 19	Rocker	4444002	4445002	S2875	B2875	4490
	Extended cab	01 - 13	Frame	4444007	4445007	S2875	B2875	4493
	Standard cab (gas)	07 - 19	Rocker	4444040	4445040	S2853	B2853	4495
	Standard cab	01 - 14	Frame	4444006	4445006	S2853	B2853	4492
Sierra 2500 HD Classic	Extended cab	07 - 07	Frame	4444007	4445007	S2875	B2875	4493
	Standard cab	07 - 07	Frame	4444006	4445006	S2853	B2853	4492
Sierra 3500	Extended cab	01 - 06	Frame	4444007	4445007	S2875	B2875	4493
	Standard cab	01 - 06	Frame	4444006	4445006	S2853	B2853	4492
Sierra 3500 Classic	Extended cab	07 - 07	Frame	4444007	4445007	S2875	B2875	4493
	Standard cab	07 - 07	Frame	4444006	4445006	S2853	B2853	4492

Applications continued on the following page

6" Oval Side Bars and Mounting Brackets

Make / Model	Style	Years	Mount Type	Kits (Bars and Brackets)		Bars Only		Brkts Only
				Polished #	Black #	Polished #	Black #	Bracket #
GMC (continued)								
Sierra 3500 HD	Crew cab	20 - 22	Rocker	4444049	4445049	S2891	B2891	4499
	Crew cab (diesel)	07 - 19	Rocker	4444045	4445045	S2891	B2891	4407
	Crew cab (gas)	07 - 19	Rocker	4444003	4445003	S2891	B2891	4490
	Extended cab (diesel)	07 - 19	Rocker	4444001	4445001	S2875	B2875	4407
	Extended cab (gas)	07 - 19	Rocker	4444002	4445002	S2875	B2875	4490
	Extended cab	07 - 13	Frame	4444007	4445007	S2875	B2875	4493
	Standard cab (gas)	07 - 18	Rocker	4444040	4445040	S2853	B2853	4495
	Standard cab	07 - 14	Frame	4444006	4445006	S2853	B2853	4492
Yukon	--	05 - 20	Rocker	4444002	4445002	S2875	B2875	4490
Yukon XL	--	15 - 20	Rocker	4444003	4445003	S2891	B2891	4490
Yukon XL 1500	--	05 - 14	Rocker	4444003	4445003	S2891	B2891	4490
Yukon XL 2500	--	05 - 14	Rocker	4444003	4445003	S2891	B2891	4490
Nissan								
Armada	--	05 - 15	Rocker	4444041	4445041	S2885	B2885	4542
Titan	Crew cab	04 - 21	Rocker	4444041	4445041	S2885	B2885	4542
	Extended cab	04 - 15	Rocker	4444034	4445034	S2875	B2875	4542
Titan XD	Crew cab	16 - 21	Rocker	4444041	4445041	S2885	B2885	4542
Ram								
1500	Crew cab	19 - 21	Rocker	4444047	4445047	S2891	B2891	4524
		11 - 18	Rocker	4444044	4445044	S2885	B2885	4523
	Extended cab	19 - 21	Rocker	4444048	4445048	S2875	B2875	4524
		11 - 18	Rocker	4444044	4445044	S2885	B2885	4523
Standard cab	16 - 18	Rocker	4444043	4445043	S2853	B2853	4520	
1500 Classic	Crew cab	19 - 21	Rocker	4444044	4445044	S2885	B2885	4523
	Extended cab	19 - 21	Rocker	4444044	4445044	S2885	B2885	4523
	Standard cab	19 - 21	Rocker	4444043	4445043	S2853	B2853	4520
2500	Crew cab	11 - 21	Rocker	4444044	4445044	S2885	B2885	4523
	Extended crew cab	11 - 21	Rocker	4444046	4445046	S2891	B2891	4523
	Standard cab	16 - 21	Rocker	4444043	4445043	S2853	B2853	4520
3500	Crew cab	11 - 21	Rocker	4444044	4445044	S2885	B2885	4523
	Extended crew cab	11 - 21	Rocker	4444046	4445046	S2891	B2891	4523
	Standard cab	16 - 21	Rocker	4444043	4445043	S2853	B2853	4520
Toyota								
Tacoma	Crew cab	05 - 21	Rocker	4444038	4445038	S2885	B2885	4521
	Extended cab	05 - 21	Rocker	4444037	4445037	S2875	B2875	4521
	Standard cab	05 - 14	Rocker	4444036	4445036	S2853	B2853	4521
Tundra	Crew cab	07 - 21	Rocker	4444031	4445031	S2885	B2885	4515
	Extended cab	00 - 06	Frame	4444033	4445033	S2875	B2875	4516
	Extended crew cab	07 - 21	Rocker	4444032	4445032	S2891	B2891	4515
	Standard cab	07 - 17	Rocker	4444030	4445030	S2853	B2853	4515



AEROTREAD® APPLICATION GUIDE

AeroTread 5" Running Boards and Mounting Brackets

Make / Model	Style / Notes	Years	Kit (Boards and Brackets)		Boards Only		Brackets Only
			Polished #	Black #	Polished #	Black #	Bracket #
Acura							
MDX	--	14 - 20	2051001	2061001	2051870	2051970	2051101
Buick							
Enclave	--	18 - 20	2051030	2061030	2051876	2051976	2051110
Cadillac							
Escalade	--	07 - 18	2051004	2061004	2051876	2051976	2051120
XT5	--	17 - 20	2051035	2061035	2051873	2051973	2051180
Chevrolet							
Blazer	--	19 - 20	2051041	2061041	2051873	2051973	2051182
Equinox	--	18 - 21	2051033	2061033	2051867	2051967	2051178
		10 - 17	2051022	2061022	2051873	2051973	2051122
Tahoe	--	07 - 20	2051004	2061004	2051876	2051976	2051120
Traverse	--	18 - 21	2051030	2061030	2051876	2051976	2051110
		09 - 17	2051020	2061020	2051876	2051976	2051106
Dodge							
Durango	Without OE side skirting	11 - 18	2051031	2061031	2051873	2051973	2051105
Ford							
Bronco Sport	--	21 - 21	2051042	2061042	2051867	2051967	2051183
Edge	--	15 - 20	2051002	2061002	2051870	2051970	2051107
Escape	--	13 - 19	2051021	2061021	2051870	2051970	2051108
Explorer	--	20 - 21	2051040	2061040	2051873	2051973	2051140
		11 - 19	2051003	2061003	2051876	2051976	2051109
GMC							
Acadia	--	17 - 21	2051035	2061035	2051873	2051973	2051180
		09 - 16	2051020	2061020	2051876	2051976	2051106
Acadia Limited	--	17 - 17	2051020	2061020	2051876	2051976	2051106
Terrain	--	18 - 21	2051033	2061033	2051867	2051967	2051178
		10 - 17	2051022	2061022	2051873	2051973	2051122
Yukon	--	07 - 20	2051004	2061004	2051876	2051976	2051120

* Continued while supplies last

AeroTread 5" Running Boards and Mounting Brackets

Make / Model	Style / Notes	Years	Kit (Boards and Brackets)		Boards Only		Brackets Only
			Polished #	Black #	Polished #	Black #	Bracket #
Honda							
CR-V	--	17 - 21	2051034	2061034	2051867	2051967	2051176
Pilot	--	16 - 19	2051029	2061029	2051870	2051970	2051129
		09 - 15	2051006	2061006	2051867	2051967	2051128
Hyundai							
Santa Fe	--	13 - 18	2051026*	2061026*	2051870	2051970	2051161*
Tucson	--	16 - 17	2051019	2061019	2051870	2051970	2051162
Jeep							
Cherokee	Excluding Trailhawk	14 - 20	2051032	2061032	2051870	2051970	2051132
Compass	--	11 - 16	2051008	2061008	2051867	2051967	2051134
Grand Cherokee	Excluding SRT, Summit, Trailhawk and Trackhawk	11 - 21	2051009	2061009	2051867	2051967	2051139
Patriot	--	07 - 17	2051008	2061008	2051867	2051967	2051134
Renegade	--	15 - 20	2051023	2061023	2051867	2051967	2051138
Kia							
Sorento	--	14 - 20	2051028	2061028	2051867	2051967	2051177
Sportage	--	17 - 19	2051039	2061039	2051867	2051967	2051179
Nissan							
Murano	--	15 - 20	2051010	2061010	2051870	2051970	2051144
Pathfinder	--	17 - 20	2051038	2061038	2051873	2051973	2051181
		13 - 16	2051011	2061011	2051870	2051970	2051146
Rogue	--	08 - 20	2051037	2061037	2051870	2051970	2051148
Rogue Select	--	14 - 15	2051037	2061037	2051870	2051970	2051148
Rogue Sport	--	17 - 20	2051037	2061037	2051870	2051970	2051148
Toyota							
4Runner	Excluding Limited	14 - 21	2051027	2061027	2051867	2051967	2051156
	Limited	14 - 20	2051025	2061025	2051870	2051970	2051104
Highlander	--	14 - 20	2051015	2061015	2051870	2051970	2051154
		07 - 13	2051014	2061014	2051870	2051970	2051153
RAV4	--	13 - 18	2051018	2061018	2051867	2051967	2051159
		09 - 12	2051017*	2061017*	2051867	2051967	2051158*

* Continued while supplies last

4" OVAL SIDE BAR APPLICATION GUIDE

4" Oval Side Bars

Make / Model	Style / Notes	Years	Polished #	Black #	
Chevrolet / GMC					
Acadia	Without cladding	09 - 16	S224031-2*	--	
Colorado / Canyon	Crew cab	15 - 21	S224051-2	S224051	
	Extended cab	15 - 21	S224052-2	S224052	
Silverado / Sierra 1500	Crew cab	19 - 21		S224053	
		07 - 18	S224045-2	S224045	
		04 - 13	S224013-2	S224013	
	Extended cab	19 - 21	S224054-2	S224054	
		07 - 18	S224046-2	S224046	
		99 - 13	S224009-2	S224009	
	Standard cab	07 - 18	S224048-2	S224048	
		99 - 13	S224017-2*	S224017*	
Silverado / Sierra 1500 / 2500 HD / 3500 Classic	Crew cab	07 - 07	S224013-2	S224013	
	Extended cab	07 - 07	S224009-2	S224009	
	Standard cab	07 - 07	S224017-2*	S224017*	
Silverado / Sierra 1500 HD	Crew cab	01 - 06	S224013-2	S224013	
Silverado / Sierra 1500 HD Classic	Crew cab	07 - 07	S224013-2	S224013	
Silverado / Sierra 1500 LD / Limited	Extended cab	19 - 19	S224046-2	S224046	
Silverado / Sierra 2500	Extended cab	01 - 04	S224009-2	S224009	
	Standard cab	99 - 04	S224017-2*	S224017*	
Silverado / Sierra 2500 HD	Crew cab	20 - 22	S224053-2	S224053	
		Crew cab (gas)	17 - 19	S224045-2	S224045
		Crew cab	07 - 16	S224045-2	S224045
	Extended cab	01 - 14	S224013-2	S224013	
		20 - 22	S224054-2	S224054	
		07 - 19	S224046-2	S224046	
	Standard cab	01 - 13	S224009-2	S224009	
		07 - 18	S224048-2	S224048	
		01 - 14	S224017-2*	S224017*	
Silverado / Sierra 3500	Crew cab	01 - 06	S224013-2	S224013	
	Extended cab	01 - 06	S224009-2	S224009	
	Standard cab	01 - 06	S224017-2*	S224017*	
Silverado / Sierra 3500 HD	Crew cab	20 - 22	S224053-2	S224053	
		Crew cab (gas)	17 - 19	S224045-2	S224045
		Crew cab	07 - 16	S224045-2	S224045
	Extended cab	07 - 14	S224013-2	S224013	
		20 - 22	S224054-2	S224054	
		07 - 19	S224046-2	S224046	
	Standard cab	07 - 13	S224009-2	S224009	
		07 - 18	S224048-2	S224048	
		07 - 14	S224017-2*	S224017*	
Traverse	--	09 - 16	S224031-2*	--	

* Continued while supplies last

4" Oval Side Bars

Make / Model	Style / Notes	Years	Polished #	Black #
Dodge				
Ram 1500	Crew cab	09 - 10	S225041-2	S225041
		02 - 08	S225008-2	S225008
	Extended cab	09 - 10	S225040-2	S225040
	Standard cab	09 - 10	S225039-2	S225039
Ram 2500 / 3500	Crew cab	10 - 10	S225019-2*	--
		09 - 10	S225041-2	S225041
		03 - 09	S225008-2	S225008
	Standard cab	09 - 10	S225039-2	S225039
Ford				
Excursion	--	01 - 05	S223006-2	S223006
Explorer	--	11 - 19	S223041-2	S223041
F-150	Crew cab	15 - 21	S223043-2	S223043
		09 - 14	S223039-2	S223039
		04 - 08	S223015-2	S223015
	Extended cab	15 - 21	S223044-2	S223044
		04 - 14	S223016-2	S223016
		F-150 Heritage	04 - 04	S223016-2
F-250 / F-350 Super Duty	Crew cab	17 - 22	S223043-2	S223043
		99 - 16	S223006-2	S223006
	Extended cab	17 - 22	S223044-2	S223044
F-450 / F-550 Super Duty	Crew cab	17 - 22	S223043-2	S223043
	Extended cab, Cab & Chassis	17 - 22	S223044-2	S223044
Ranger	Crew cab	19 - 21	S223046-2	S223046
Jeep				
Grand Cherokee	75th Anniversary, Laredo, Limited and Overland	11 - 19	S221008-2	S221008
Lexus				
RX350 / RX450h	--	10 - 13	S222016-2*	--
Lincoln				
Mark LT	--	06 - 08	S223015-2	S223015
Nissan				
Titan	Crew cab	04 - 21	S229042-2	S229042
		04 - 15	S229006-2*	--
Titan XD	Crew cab	16 - 21	S229042-2	S229042
		16 - 16	S229006-2*	--
Ram				
1500	Crew cab	19 - 21	S225045-2	S225045
		11 - 18	S225041-2	S225041
	Extended cab	19 - 21	S225044-2	S225044
		11 - 18	S225040-2	S225040
	Standard cab	11 - 18	S225039-2	S225039
		1500 Classic	Crew cab	19 - 21
Extended cab	19 - 21	S225040-2	S225040	
	Standard cab	19 - 21	S225039-2	S225039
2500 / 3500	Crew cab	11 - 21	S225041-2	S225041
		11 - 16	S225019-2*	--
	Standard cab	11 - 21	S225039-2	S225039
Toyota				
FJ Cruiser	--	07 - 14	--	S222011
Tacoma	Crew cab	05 - 21	S222009-2	S222009
	Extended cab	05 - 21	S222008-2	S222008
Tundra	Crew cab	07 - 21	S222012-2	S222012
		04 - 06	S222006-2*	--
	Extended crew cab	07 - 21	S222013-2	S222013

* Continued while supplies last



BIG STEP™ SIDE BAR APPLICATION GUIDE

Big Step 4" Round Side Bars

Make / Model	Style / Notes	Years	Part #
Chevrolet / GMC			
Colorado / Canyon	Crew cab	15 - 21	AL234051
Silverado / Sierra 1500	Crew cab	19 - 21	AL234053
		07 - 18	AL234045
Silverado 1500 LD / Sierra 1500 Limited	Extended cab	07 - 18	AL234046
	Extended cab	19 - 19	AL234046
Silverado / Sierra 2500 HD	Crew cab	20 - 22	AL234053
		07 - 19	AL234045
		01 - 14	AL234013
Silverado / Sierra 2500 HD Classic	Extended cab	07 - 19	AL234046
	Crew cab	07 - 07	AL234013
Silverado / Sierra 3500	Crew cab	01 - 06	AL234013
Silverado / Sierra 3500 Classic	Crew cab	07 - 07	AL234013
Silverado / Sierra 3500 HD	Crew cab	20 - 22	AL234053
		07 - 19	AL234045
		07 - 14	AL234013
	Extended cab	07 - 18	AL234046
Dodge			
Ram 1500	Crew cab	09 - 10	AL235041
	Extended cab	09 - 10	AL235040
Ram 2500 / 3500	Crew cab	09 - 10	AL235041
Ford			
Excursion	--	00 - 05	AL233006
F-150	Crew cab	15 - 21	AL233043
F-250 / F-350 Super Duty	Crew cab	17 - 22	AL233043
		99 - 16	AL233006

* Continued while supplies last

Big Step 4" Round Side Bars

Make / Model	Style / Notes	Years	Part #
Ford (continued)			
F-450 Super Duty	Crew cab	17 - 22	AL233043
F-550 Super Duty	Crew cab, cab & Chassis	17 - 22	AL233043
Jeep			
Wrangler	JL, Unlimited, 4-door	18 - 21	AL231009
	JK, excluding Unlimited, 2-door	07 - 18	AL231008
	JK, Unlimited, 4-door	07 - 18	AL231007
Nissan			
Titan	Crew cab	04 - 21	AL239042
		04 - 15	AL239006*
Titan XD	Crew cab	16 - 21	AL239042
		16 - 16	AL239006*
Ram			
1500	Crew cab	19 - 21	AL235045
		11 - 18	AL235041
	Extended cab	11 - 18	AL235040
1500 Classic	Crew cab	19 - 21	AL235041
	Extended cab	19 - 21	AL235040
2500 / 3500	Crew cab	11 - 21	AL235041
Toyota			
Tacoma	Crew cab	05 - 21	AL232009
Tundra	Crew cab	07 - 21	AL232012
	Ext. crew cab	07 - 21	AL232013

* Continued while supplies last



ROCKER STEP APPLICATION GUIDE

Rocker Steps			
Make / Model	Style / Notes	Years	Part #
Chevrolet			
Colorado	Crew cab	15 - 21	2074106
Silverado 1500	Crew cab	19 - 21	2074113
		07 - 18	2074109
	Extended cab	07 - 18	2074108
Silverado 1500 LD	Extended cab	19 - 19	2074108
Silverado 2500 HD	Crew cab	20 - 22	2074113
		07 - 19	2074109
	Extended cab	07 - 19	2074108
Silverado 3500 HD	Crew cab	20 - 22	2074113
		07 - 19	2074109
		07 - 18	2074108
Dodge			
Ram 1500	Crew cab	09 - 10	2074110
	Extended cab	09 - 10	2074111
Ram 2500 / 3500	Crew cab	09 - 10	2074110
Ford			
F-150	Crew cab	15 - 21	2074120
F-250 / F-350 / F-450 Super Duty	Crew cab	17 - 22	2074120
F-550 Super Duty	Crew cab, Cab & Chas.	17 - 22	2074120
GMC			
Canyon	Crew cab	15 - 21	2074106
Sierra 1500	Crew cab	19 - 21	2074113
		07 - 18	2074109
		07 - 18	2074108
Sierra 1500 Limited	Extended cab	19 - 19	2074108
Sierra 2500 HD	Crew cab	20 - 22	2074113
		07 - 19	2074109
	Extended cab	07 - 19	2074108
Sierra 3500 HD	Crew cab	20 - 22	2074113
		07 - 19	2074109
		07 - 18	2074108

Rocker Steps			
Make / Model	Style / Notes	Years	Part #
Jeep			
Grand Cherokee	75th Anniversary, Laredo, Limited, Overland	11 - 19	2074103
Wrangler	JL, excluding Unlimited (2-dr)	18 - 21	2074119
	JL, Unlimited (4-dr)	18 - 21	2074118
	JK, excluding Unlimited (2-dr)	07 - 18	2074100
	JK, Unlimited (4-dr)	07 - 18	2074101
	--	97 - 06	2074102
Nissan			
Frontier	Crew cab	05 - 20	2074140
Titan	Crew cab	04 - 21	2074141
Titan XD	Crew cab	16 - 21	2074141
Xterra	--	05 - 15	2074142
Ram			
1500	Crew cab	19 - 21	2074112
		11 - 18	2074110
		11 - 18	2074111
1500 Classic	Crew cab	19 - 21	2074110
	Extended cab	19 - 21	2074111
2500 / 3500	Crew cab	11 - 21	2074110
Toyota			
4Runner	SR5	10 - 21	2074150
	Trail	10 - 16	2074150
	TRD Pro	15 - 21	2074150
	TRD Off-Road	17 - 21	2074150
Tacoma	Crew cab	05 - 21	2074151
Tundra	Crew cab	07 - 21	2074152
	Extended Crew cab	07 - 16	2074153



3" ROUND SIDE BAR APPLICATION GUIDE

3" Round Side Bars

Make / Model	Style / Notes	Years	Stainless Steel		Carbon Steel
			Polished #	Semi-Gloss Black #	Semi-Gloss Black #
Acura					
MDX	--	02 - 06	--	--	206003
Chevrolet / GMC					
Acadia	Excluding cladding or Denali	09 - 16	204031-2*	--	204031
Avalanche	--	07 - 13	204004-2	--	204004
Avalanche 1500	--	02 - 06	204004-2	--	204004
Blazer K5	--	76 - 91	204044-2	--	204044
C1500	Extended cab	88 - 99	204001-2	--	204001
	Standard cab	88 - 99	204018-2	--	204018
	Standard cab, short bed	73 - 87	--	--	204037*
C2500 / C3500	Extended cab	88 - 00	204001-2	--	204001
	Standard cab	88 - 00	204018-2	--	204018
Colorado / Canyon	Crew cab	15 - 21	204051-2	214051	204051
	Extended cab	15 - 21	204052-2	--	204052
Equinox	--	10 - 17	204032-2	--	204032
K1500	Extended cab	88 - 99	204001-2	--	204001
	Standard cab	88 - 99	204018-2	--	204018
		67 - 72	204036-2	--	204036
K2500 / K3500	Extended cab	88 - 00	204001-2	--	204001
	Standard cab	88 - 00	204018-2	--	204018
	Standard cab, long bed	73 - 86	204041-2	--	204041
	Standard cab, short bed	73 - 86	204040-2	--	204040
	Standard cab	67 - 72	204036-2	--	204036
Silverado / Sierra 1500	Crew cab	19 - 21	204053-2	214053	204053
		07 - 18	204045-2	214045	204045
		04 - 13	204013-2	214013	204013
	Extended cab	19 - 21	204054-2	--	204054
		07 - 18	204046-2	214046	204046
		99 - 06	204009-2	214009	204009
	Standard cab	07 - 18	204048-2	214048	204048
		99 - 15	204017-2	--	204017

* Continued while supplies last

Applications continued on the following page

3" Round Side Bars

Make / Model	Style / Notes	Years	Stainless Steel		Carbon Steel
			Polished #	Semi-Gloss Black #	Semi-Gloss Black #
Chevrolet (continued)					
Silverado / Sierra 1500 Classic	Crew cab	07 - 07	204013-2	214013	204013
	Extended cab	07 - 07	204009-2	214009	204009
	Standard cab	07 - 07	204017-2	--	204017
Silverado / Sierra 1500 HD	Crew cab	01 - 06	204013-2	214013	204013
Silverado / Sierra 1500 HD Classic	Crew cab	07 - 07	204013-2	214013	204013
Silverado 1500 LD	Extended cab	19 - 19	204046-2	214046	204046
Sierra 1500 Limited	Extended cab	19 - 19	204046-2	214046	204046
Silverado / Sierra 2500	Crew cab	04 - 04	204013-2	214013	204013
	Extended cab	99 - 04	204009-2	214009	204009
	Standard cab	99 - 04	204017-2	--	204017
Silverado / Sierra 2500 HD	Crew cab	20 - 22	204053-2	214053	204053
		07 - 19	204045-2	214045	204045
		01 - 14	204013-2	214013	204013
	Extended cab	20 - 22	204054-2	--	204054
		07 - 19	204046-2	214046	204046
		01 - 06	204009-2	214009	204009
	Standard cab	07 - 18	204048-2	214048	204048
		01 - 15	204017-2	--	204017
Silverado / Sierra 2500 HD / 3500 Classic	Crew cab	07 - 07	204013-2	214013	204013
	Extended cab	07 - 07	204009-2	214009	204009
	Standard cab	07 - 07	204017-2	--	204017
Silverado / Sierra 3500	Crew cab	01 - 06	204013-2	214013	204013
	Extended cab	01 - 06	204009-2	214009	204009
	Standard cab	01 - 06	204017-2	--	204017
Silverado / Sierra 3500 HD	Crew cab	20 - 22	204053-2	214053	204053
		07 - 19	204045-2	214045	204045
		07 - 14	204013-2	214013	204013
	Extended cab	20 - 22	204054-2	--	204054
		07 - 19	204046-2	214046	204046
	Standard cab	07 - 18	204048-2	214048	204048
Suburban	--	15 - 20	204004-2	--	204004
		73 - 91	204039-2	--	204039
		9 / 3500	204014-2	--	204014
Suburban 1500	--	00 - 14	204004-2	--	204004
Tahoe	2-door	95 - 99	204018-2	--	204018
	4-door	95 - 99	--	--	204012
Terrain	--	10 - 17	204032-2	--	204032
Traverse	--	09 - 16	204031-2*	--	204031
Yukon	2-door	92 - 99	204018-2	--	204018
	4-door	95 - 99	--	--	204012
Yukon XL	--	15 - 20	204004-2	--	204004
Yukon XL 1500	--	00 - 14	204004-2	--	204004
Dodge					
Dakota	Crew cab	06 - 12	205010-2	--	205010
	Extended cab	97 - 04	205000-2	--	205000
Durango	Excluding OE side skirting	11 - 21	205031-2	--	205031
Nitro	--	07 - 11	205015-2	--	205015

* Continued while supplies last

Applications continued on the following page

3" Round Side Bars

Make / Model	Style / Notes	Years	Stainless Steel		Carbon Steel
			Polished #	Semi-Gloss Black #	Semi-Gloss Black #
Dodge (continued)					
Ram 1500	Crew cab	09 - 10	205041-2	215041	205041
		02 - 08	205008-2	--	205008
		98 - 01	205003-2	--	205003
	Extended cab	09 - 10	205040-2	215040	205040
	Standard cab	09 - 10	205039-2	215039	205039
		02 - 08	--	--	205013
94 - 01		205002-2	--	205002	
Ram 2500 / 3500	Crew cab	09 - 10	205041-2	215041	205041
		03 - 09	205008-2	--	205008
	Extended crew cab	06 - 10	205030-2	--	205030
	Standard cab	09 - 10	205039-2	215039	205039
		03 - 08	--	--	205013
		94 - 01	205002-2	--	205002
Ford					
Bronco	4-door	21 - 21	--	--	209045
	--	66 - 72	203038-2	--	203038
Bronco Sport	--	21 - 21	--	--	209043
Escape	--	08 - 12	--	--	203031
		01 - 07	--	--	203012
Excursion	--	00 - 05	203006-2	213006	203006
Expedition	Excluding EL, Max or Funkmaster Flex Edition	07 - 18	--	--	203030
	--	03 - 06	203004-2	--	203004
Explorer	--	11 - 19	203041-2	--	203041
	4-door	02 - 10	--	--	203018
		95 - 01	--	--	203036
Explorer Sport Trac	--	07 - 10	203019-2	--	203019
		01 - 05	203010-2	--	203010
F-150	Crew cab	15 - 21	203043-2	213043	203043
		09 - 14	203039-2	--	203039
		04 - 08	203015-2	--	203015
		01 - 03	203009-2	--	203009
	Extended cab	15 - 21	203044-2	213044	203044
		04 - 14	203016-2	--	203016
		97 - 03	203008-2	--	203008
	Standard cab	15 - 21	203045-2	213045	203045
		09 - 14	--	--	203040
		04 - 08	--	--	203017
97 - 03		203007-2	--	203007	
80 - 96	203001-2	--	203001		
F-150 Heritage	Extended cab	04 - 04	203008-2	--	203008
	Standard cab	04 - 04	203007-2	--	203007
F-250	Extended cab	99 - 99	203025-2	213025	203025
F-250 / F350 Super Duty	Crew cab	17 - 22	203043-2	213043	203043
		99 - 16	203006-2	213006	203006
	Extended cab	17 - 22	203044-2	213044	203044
		99 - 16	203025-2	213025	203025
	Standard cab	17 - 22	203045-2	213045	203045
99 - 16	203014-2	213014	203014		

* Continued while supplies last

Applications continued on the following page

3" Round Side Bars

Make / Model	Style / Notes	Years	Stainless Steel		Carbon Steel
			Polished #	Semi-Gloss Black #	Semi-Gloss Black #
Ford (continued)					
F-450 Super Duty	Crew cab	17 - 22	203043-2	213043	203043
		08 - 16	203006-2	213006	203006
	Standard cab	19 - 22	203045-2	213045	203045
F-450 / F-550 Super Duty	Crew cab, Cab & Chassis	17 - 22	203043-2	213043	203043
	Extended cab, Cab & Chassis	17 - 22	203044-2	213044	203044
	Standard cab, Cab & Chassis	17 - 22	203045-2	213045	203045
Ranger	Crew cab	19 - 21	203046-2	--	203046
	Extended cab, 2-door	98 - 10	203035-2	--	203035
		86 - 97	--	--	203003
	Extended cab, 4-door	98 - 09	203033-2	--	203033
	Standard cab	98 - 09	--	--	203034
Honda					
CR-V	--	12 - 16	206010-2*	--	--
Pilot	--	09 - 15	206008-2	--	206008
		03 - 08	--	--	206003
Ridgeline	--	06 - 14	--	--	206005
Hummer					
H2	With factory rocker bar	03 - 09	204075-2	--	204075
H3	Excluding factory rocker bar	06 - 10	204076-2	--	204076
Hyundai					
Santa Fe	--	07 - 12	207003-2	--	207003
Jeep					
Cherokee	--	84 - 00	201000-2*	--	201000
Grand Cherokee	75th Anniversary, Laredo, Limited, Overland, Overland Summit	11 - 19	201008-2	--	201008
	--	99 - 04	--	--	201001
Liberty	--	08 - 12	201005-2	--	201005
	Excluding mud flaps and cladding	02 - 07	--	--	201002
Wrangler	JL, Unlimited (4-door)	18 - 21	--	--	35701
	JK, 2-door excluding Unlimited and factory rocker	07 - 17	35800-2*	--	35800
	JK, Unlimited (4-door)	07 - 18	--	--	35700
	--	87 - 06	35600-2	--	35600
Kia					
Sportage	--	11 - 15	200104-2	--	--
Land Rover					
LR3	--	05 - 09	--	--	200112
Mazda					
B2300	Extended cab	03 - 04	203033-2	--	203033
B2500	Extended cab	98 - 01	203033-2	--	203033
B3000	Extended cab	98 - 07	203033-2	--	203033
B4000	Extended cab	98 - 09	203033-2	--	203033
Tribute	--	08 - 10	--	--	203031
		01 - 06	--	--	203012
Mitsubishi					
Outlander	Excluding sport	14 - 15	208007-2*	--	208007*
	--	11 - 13	208005-2*	--	--
RVR	--	14 - 15	208007-2*	--	208007*
		11 - 13	208005-2*	--	--

* Continued while supplies last

Applications continued on the following page

3" Round Side Bars

Make / Model	Style / Notes	Years	Stainless Steel		Carbon Steel
			Polished #	Semi-Gloss Black #	Semi-Gloss Black #
Nissan					
Frontier	Crew cab	05 - 20	209018-2	--	209018
	Extended cab	05 - 20	209019-2	--	209019
Titan	Crew cab	04 - 21	209042-2	--	209042
Titan XD	Crew cab	16 - 21	209042-2	--	209042
Ram					
1500	Crew cab	19 - 21	205045-2	215045	205045
		11 - 18	205041-2	215041	205041
	Extended cab	19 - 21	205044-2	--	205044
		11 - 18	205040-2	215040	205040
Standard cab	11 - 18	205039-2	215039	205039	
1500 Classic	Crew cab	19 - 21	205041-2	215041	205041
	Extended cab	19 - 21	205040-2	215040	205040
	Standard cab	19 - 21	205039-2	215039	205039
2500 / 3500	Crew cab	11 - 21	205041-2	215041	205041
	Extended crew cab, excluding 3-link front suspension	13 - 21	205030-2	--	205030
	Extended Crew cab	11 - 12	205030-2	--	205030
	Standard cab	11 - 21	205039-2	215039	205039
Saturn					
Outlook	--	08 - 09	204031-2*	--	204031
Subaru					
Forester	--	09 - 12	200801-2*	--	--
Suzuki					
Equator	Crew cab	09 - 12	209018-2	--	209018
	Extended cab	09 - 12	209019-2	--	209019
Toyota					
4Runner	Base	10 - 13	202000-2*	--	--
	SR5	14 - 18	202022-2	--	202022
	Trail	14 - 16	202022-2	--	202022
	--	03 - 09	202000-2*	--	202000
FJ Cruiser	--	07 - 14	--	--	202011
Highlander	--	14 - 21	202019-2	--	--
Tacoma	Crew cab	05 - 21	202009-2	--	202009
		01 - 04	--	--	202004
	Extended cab	05 - 21	202008-2	--	202008
		97 - 04	202001-2	--	202001
Tundra	Crew cab	07 - 21	202012-2	--	202012
		04 - 06	202006-2	--	202006
	Extended cab	00 - 06	202003-2	--	202003
	Extended crew cab	07 - 21	202013-2	--	202013

* Continued while supplies last



SWITCHBACK® APPLICATION GUIDE

Switchback Headache Racks

Make / Model	Style / Notes	Years	Part #
Chevrolet			
Colorado	--	15 - 21	1110109
Silverado 1500	--	15 - 18	1110110
Silverado 1500 LD	--	19 - 19	1110110
Silverado 2500 HD	--	15 - 19	1110110
Silverado 3500 HD	--	15 - 19	1110110
Dodge			
Ram 1500	Crew cab, excluding RamBox	09 - 10	1110111
Ram 2500	Crew cab, excluding RamBox	09 - 10	1110111
Ram 3500	Crew cab, excluding RamBox	09 - 10	1110111
Ford			
F-150	Excluding Police Responder	09 - 20	1110112
GMC			
Canyon	--	15 - 21	1110109
Sierra 1500	--	15 - 18	1110110
Sierra 1500 Limited	--	19 - 19	1110110
Sierra 2500 HD	--	15 - 19	1110110
Sierra 3500 HD	--	15 - 19	1110110
Ram			
1500	Crew cab, excluding RamBox	11 - 18	1110111
1500 Classic	Crew cab, excluding RamBox	19 - 21	1110111
2500	Crew cab, excluding RamBox	11 - 19	1110111
3500	Crew cab, excluding RamBox	11 - 19	1110111
Toyota			
Tacoma	--	05 - 21	1110114
Tundra	--	07 - 21	1110115
	Crew cab	07 - 21	1110117



ADVANTEDGE™ APPLICATION GUIDE

AdvantEDGE Headache Racks

Make / Model	Style / Notes	Years	Chrome Powder Coat#	Carbide Black #
Chevrolet				
Silverado 1500	--	07 - 18	1110204	1110104
Silverado 1500 LD	--	19 - 19	1110204	1110104
Silverado 2500 / 3500 HD	6' bed	07 - 19	1110204	1110104
	8' bed, dual rear wheels	07 - 19	1110204	1110104
	8' bed, single rear wheels	07 - 19	1110205*	1110105
Dodge				
Ram 1500	Excluding Ram Box	09 - 10	1110201	1110101
Ram 2500 / 3500	Excluding Ram Box	09 - 10	1110201	1110101
Ford				
F-150	Excluding Police Responder	09 - 20	1110202	1110102
F-250	--	99 - 99	1110203*	1110103
F-250 Super Duty	--	17 - 22	1110207	1110107
		99 - 16	1110203*	1110103
F-350 Super Duty	Excluding Cab & Chassis	17 - 22	1110207	1110107
		99 - 16	1110203*	1110103
F-450 Super Duty	Excluding Cab & Chassis	17 - 22	1110207	1110107
GMC				
Sierra 1500	--	07 - 18	1110204	1110104
Sierra 1500 Limited	--	19 - 19	1110204	1110104
Sierra 2500 / 3500 HD	6' bed	07 - 19	1110204	1110104
	8' bed, dual rear wheels	07 - 19	1110204	1110104
	8' bed, single rear wheels	07 - 19	1110205*	1110105
Ram				
1500	Excluding Ram Box	19 - 21	1110204	1110104
		11 - 18	1110201	1110101
1500 Classic	Excluding Ram Box	19 - 21	1110201	1110101
2500 / 3500	Excluding Ram Box	11 - 19	1110201	1110101
Toyota				
Tundra	--	07 - 21	1110206*	1110106*

Headache rack may interfere with 3rd brake light cargo camera

* Continued while supplies last

CLASSIC HEADACHE RACK APPLICATION GUIDE

Classic Headache Racks

Make / Model	Style / Notes	Years	Part #
Chevrolet / GMC			
C/K 1500	--	88 - 99	111000
C/K 2500 / 3500	Excluding Cab & Chassis	88 - 00	111000
Silverado / Sierra 1500	--	99 - 18	111000
Silverado / Sierra 1500 Classic	--	07 - 07	111000
Silverado / Sierra 1500 HD	--	01 - 06	111000
Silverado / Sierra 1500 HD Classic	--	07 - 07	111000
Silverado / Sierra 1500 LD / Limited	--	19 - 19	111000
Silverado / Sierra 2500	Excluding Cab & Chassis	99 - 04	111000
Silverado / Sierra 2500 HD	Excluding Cab & Chassis	01 - 19	111000
Silverado / Sierra 2500 HD Classic	Excluding Cab & Chassis	07 - 07	111000
Silverado / Sierra 3500	Excluding Cab & Chassis	01 - 06	111000
Silverado / Sierra 3500 Classic	Excluding Cab & Chassis	07 - 07	111000
Silverado / Sierra 3500 HD	Excluding Cab & Chassis	07 - 19	111000
Dodge			
Ram 1500	Excluding Ram Box	09 - 10	111000
	--	94 - 08	111000
Ram 2500 / 3500	Excluding Cab & Chassis or Ram Box	09 - 10	111000
	Excluding Cab & Chassis	94 - 08	111000
Ford			
F-150	Excluding Police Responder	15 - 20	111002
	--	97 - 14	111000
F-250	--	99 - 99	111001
F-250 Super Duty	--	99 - 16	111001
F-350 Super Duty	Excluding Cab & Chassis	99 - 16	111001
F-450 Super Duty	Crew Cab Pickup	08 - 16	111001
Ram			
1500	Excluding Ram Box	11 - 21	111000
1500 Classic	Excluding Ram Box	19 - 21	111000
2500	Excluding Ram Box	11 - 19	111000
3500	Excluding Cab & Chassis or Ram Box	11 - 19	111000



ARJES

ARJES

ARJES

ARJES

MARKETING SUPPORT

ADVANCE YOUR BUSINESS

Displays and point-of-purchase signage

Learn more about running boards on our website.