

ARIES™



**2016 EXTERIOR CATALOG
& APPLICATION GUIDES**

INTENTIONALLY BLANK



ARIES DEALER PORTAL

Access free marketing resources and order from our easy, new online ordering system!

At ARIES, we want to give you the tools you need to successfully market the ARIES brand and further your business. As such, we are proud to introduce our Dealer Portal. This online dealer-exclusive site is a one-stop shop for ordering ARIES parts and downloading all our latest marketing resources.

The ARIES Dealer Portal allows you to:

- Look up parts by vehicle and order them using a single username and password
- Access product content, photography, videos and more
- Download up-to-date vehicle application data

2015 Chevrolet Silverado 1500

CHANGE BODY STYLE

CHANGE COLOR

START OVER



Select part to display on vehicle

17 Results Show all



ARIES AUTOMOTIVE
4" Big Horn Bull Bar

[Details](#)



ARIES AUTOMOTIVE
3" Bull Bar

[Details](#)



ARIES AUTOMOTIVE
4" Big Horn Bull Bar

[Details](#)



ARIES AUTOMOTIVE
Grille Guard

[Details](#)



ARIES AUTOMOTIVE
3" Bull Bar

[Details](#)

envision™ ARIES CONFIGURATOR

Let your customers 'try on' ARIES with the most advanced online vehicle customizer!

Envision™ ARIES is an interactive, digital vehicle customization tool that lets your customers view any ARIES accessory, fully installed, on any vehicle, from the comfort and convenience of their own computer or device. They simply select the year, make and model, specify the style and color, and then select one or more ARIES accessories to preview.

This powerful, new tool features:

- Over 5,000 vehicles with years ranging from 1915 to 2016
- A spectrum of vehicle colors, styles and lifts
- A connection to our dealers through Where to Buy

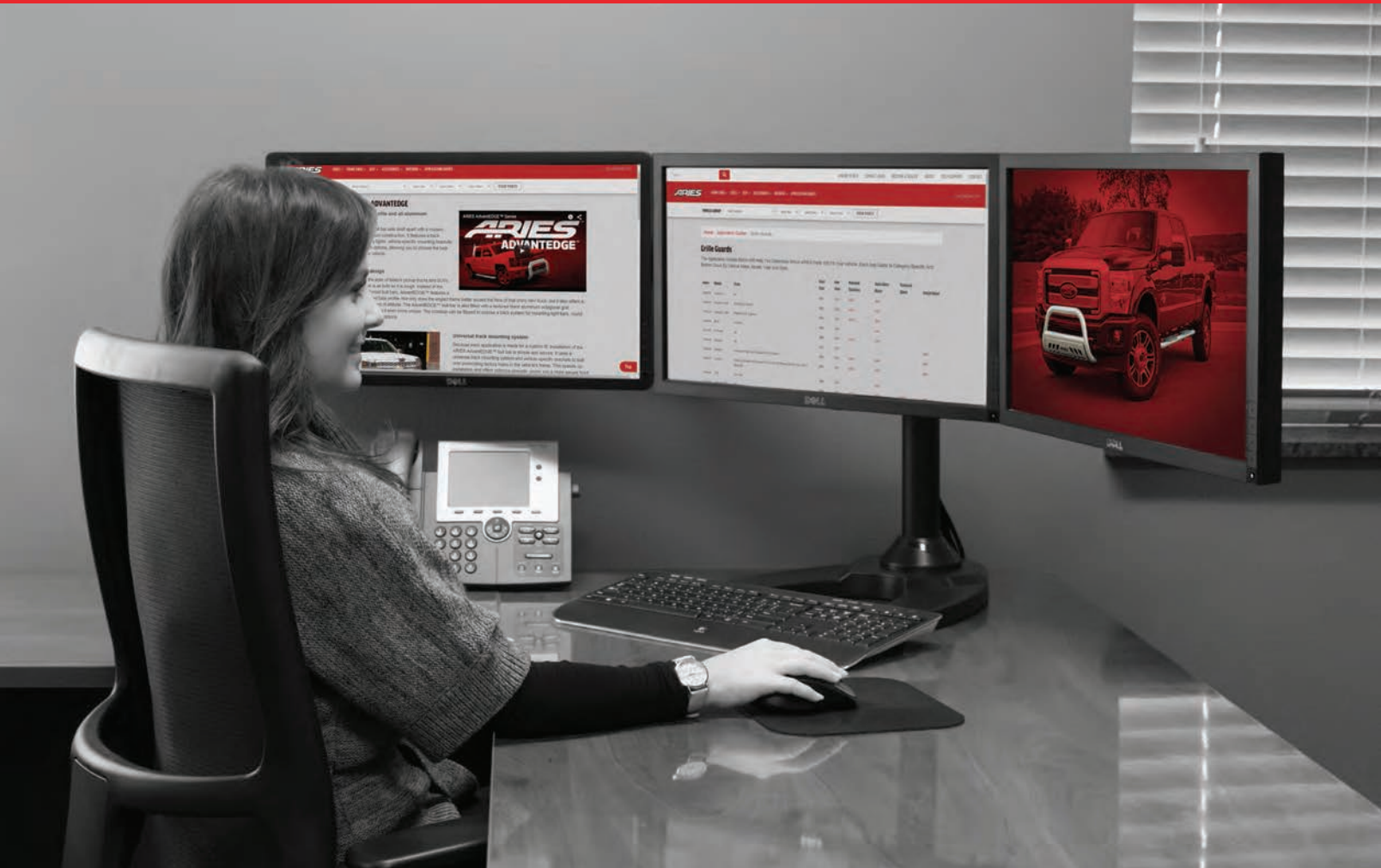

NEW IMAGERY, CONTENT & DATA

Implement our growing content resources in your store and on your website!

ARIES has undergone some major changes recently, refocusing our marketing strategies and customer support efforts. In addition to video, we have refined and expanded our photo library, written content and vehicle application data.

We have built an extensive photo library, consisting of professional product images, in-use images and lifestyle shots. We have expanded our written content offering,

including rich product descriptions, bullet points and more. We have also refined our application data to make it easy for our customers to find the products they are looking for.

All of these resources are available for you to use on your website and in printed materials. They can be accessed through the ARIES Dealer Portal at ariesautomotive.com, using our FTP server and Reporting tool.



UNMATCHED VIDEO LIBRARY

Show your customers the ARIES difference with our expanding video resources!

With a new, professional video team at our headquarters, ARIES is in the process of building a library of videos to support our dealers, installers and consumers. We offer installation videos, product feature videos and more, to show our customers the benefits of ARIES products. We now have over 50 videos, with new ones added every week.

NEW PRODUCTS



NEW PRODUCTS

At ARIES, we pride ourselves on offering something different – something that no one else in our industry has and that will keep our customers coming back for more. We are always working toward new innovations by listening to our customers and focusing on their passion.

For 2016, we are pleased to present several new products that will further set ARIES apart. Our new AdvantEDGE™ series features a unique, eight-sided tube profile and all-aluminum construction to specifically accent the style of modern trucks and SUVs. The series includes a bull bar, side bars and headache rack, all with the same angular, extruded aluminum design.

AeroTread™ Running Boards



Also for 2016, ARIES has added an entirely new product category: running boards. We are offering two running board options: fast, lightweight AeroTread™ to complement today's crossover or SUV, and tough, ready-to-work RidgeStep™ for hardworking commercial trucks.

We have also added new Jeep® products, including our Jeep® rocker steps, as well as many new applications within our existing product lines. We continue to offer grille guards, side bars, bull bars and more to provide a custom fit for a wide variety of vehicles.

AeroTread™ running boards are sleek and lightweight to accent the latest crossover or SUV. They feature an extruded aluminum base and full-length, non-skid treads. They mount using vehicle-specific brackets and come in two front trim finish options: polished stainless or black carbide. **Page 100**



Carbide black powder coat finish option

RidgeStep™ Commercial Running Boards



Powerful, defined and uncompromising as a mountain ridge, ARIES RidgeStep™ commercial running boards are made from solid steel with zero plastic parts. They come in four base lengths for reduced inventory and feature a tough, textured black powder coat finish. **Page 104**



Carbide black powder coat finish

AdvantEDGE™ Bull Bar

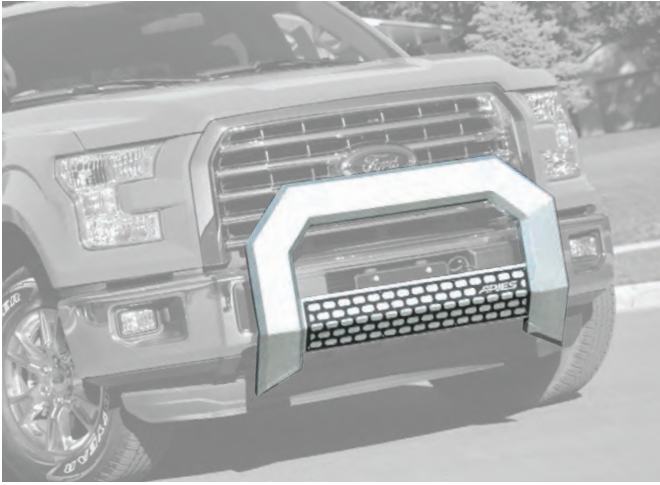

The AdvantEDGE™ bull bar boasts all-aluminum construction and a unique look to accent the style of today's trucks and SUVs. It mounts with a track system and custom brackets and has a reversible crossbar for auxiliary lights. It is available in a black carbide or chrome powder coat finish. **Page 28**



Carbide black powder coat finish option

AdvantEDGE™ Side Bars



AdvantEDGE™ side bars offer a fresh look for the modern truck. They are made with all-aluminum construction, including the end caps, and a stamped aluminum tread to be lightweight and rust-free. They come in four lengths and two finishes: black carbide and chrome powder coat. **Page 64**



Carbide black powder coat finish option

AdvantEDGE™ Headache Rack

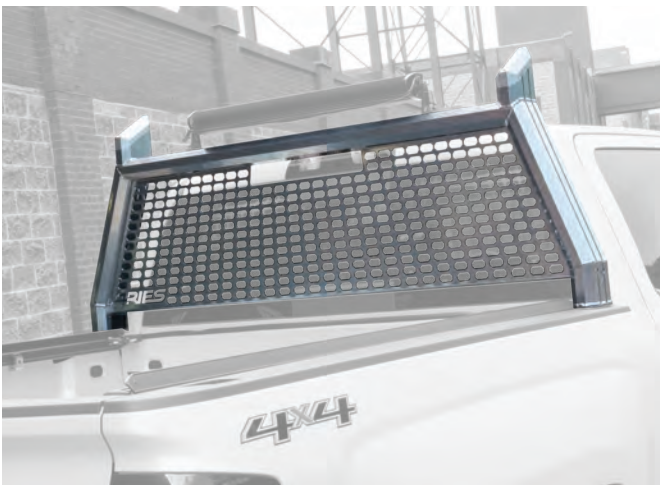

The AdvantEDGE™ headache rack is designed to protect and add style to the modern pickup truck. It features all-aluminum construction and uses a stake pocket anchor system. It also has a top track for auxiliary lights and is available in black carbide or chrome powder coat. **Page 110**

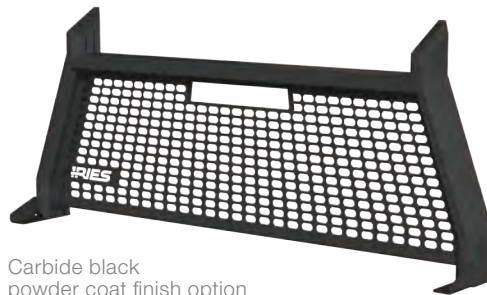

Carbide black powder coat finish option

Jeep® Rocker Steps



Jeep® rocker steps offer more than extra side protection. With their wide, flat profile and heavy-duty design, they offer a solid step, plenty of ground clearance and added protection on the trail. They are constructed with high-strength steel and shielded in a textured black powder coat finish. **Page 126**



Jeep® Fender Flare Side Markers



Jeep® side markers easily mount onto the side of our Jeep® fender flares and provide bright, DOT-approved, LED lights. The LED components are long-lasting and are able to be spliced directly into the existing factory harness for a seamless installation. **Page 131**



Winch Fairlead Mount



The winch fairlead mount easily and securely mounts onto our modular Jeep® bumper winch housing and offers two sets of mounting holes to accept most types of fairleads. It is made with 1/4" thick steel and protected with a durable carbide powder coat finish. **Page 137**





PRODUCT INDEX

When it comes to automotive accessories, ARIES has the variety and quality your customers are looking for. We offer custom-fit, vehicle-specific bull bars, grille guards side bars and running boards, as well as a full line of custom Jeep® products.

Our specialty liners are packed with ARIES-exclusive features and patented designs to give you the aftermarket edge. So whether they will be ruling the road or charging off it, get your customers ready for the drive with ARIES Automotive.

3" Bull Bars	42	Jeep® Modular Bumper, Accessories	124
3" Bull Bar Accessories	35	Jeep® Modular Bumpers, Front	118
3" Pro Series™ Bull Bars	38	Jeep® Modular Bumpers, Rear	122
3" Pro Series™ Round Side Bars	86	Jeep® Modular Bumper Replacement Parts	122
3" Round Side Bars	90	Jeep® Rocker Steps	126
3" Stealth Bull Bars	34	Jeep® Roof Light Bar	136
4" Big Horn™ Bull Bars	30	Jeep® Security Cargo Lid	132
4" Big Step™ Round Side Bars	82	Jeep® Third Brake Light Extension Bracket	139
4" Bull Bar Accessories	31	Jeep® Tire Relocation Carrier and Brackets	139
4" Oval Side Bars	74	Jeep® Tow Hook	137
4" Oval Wheel-to-Wheel Side Bars	78	Jeep® Tube Bumpers	134
5" AeroTread™ Running Boards	104	Jeep® Tube Doors	128
5 1/2" AdvantEDGE™ Bull Bars	28	Jeep® Winch Fairlead Mount	137
5 1/2" AdvantEDGE™ Side Bars	64	Jeep® Winch Receiver Plate Bracket	137
6" Oval Side Bars	68	Jeep® Windshield Light Brackets	139
6 1/2" RidgeStep™ Commercial Running Boards	100	Literature	146
AdvantEDGE™ Headache Rack	110	Marketing Materials	144
Grille Guards	54	Pro Series™ Grille Guards	50
Headache Racks	112	Pro Series™ Grille Guard Cover Plates	52
Jeep® Accessories	136	Pro Series™ Grille Guard Light Bar Brackets	53
Jeep® Fender Flares	130	Removable Universal Mud Flaps	114
Jeep® Fender Flare Side Markers	131	Seat Defender™	142
Jeep® License Plate Bracket	138	StyleGuard™ Floor Liners	143

TABLE OF CONTENTS

AUTO ACCESSORIES GUIDE **10 - 21**

SPECIALTY LINES **22 - 25**

BULL BARS **26 - 47**

GRILLE GUARDS **48 - 61**

SIDE BARS **62 - 97**

RUNNING BOARDS **98 - 107**

REARWARD PROTECTION **108 - 115**

JEEP PRODUCTS **116 - 139**

INTERIOR PROTECTION **140 - 143**

MARKETING MATERIALS **144 - 152**

AUTO ACCESSORIES GUIDE

The automotive accessories industry is ever changing and expanding with new designs, tech and terminology. As the ARIES product line continues to expand, we want our customers to stay fully informed and knowledgeable about our products.

The ARIES Auto Accessories Guide is a basic guide to our products and offers helpful information associated with the industry. It lays out the differences between our various products, what advantages they offer you and your customers, and it provides details about various terms used in our application guide.

In addition to the following sections, we have arranged a list of terms and definitions that are used in this catalog, on our website and throughout our other marketing materials. While these terms are used consistently within ARIES and widely across the industry, they may not reflect those used by other brands and manufacturers.

MATERIALS AND FINISHES

ARIES Automotive offers products that come in a wide variety of materials and finishes. There is no single finish to satisfy every need, taste and preference, and without knowing the differences, it can be difficult to help your customers make a purchasing decision.

The following guide describes some of the key characteristics and advantages of each material and finish we use in our products. It also lists some of the products associated with each to help you determine which products will best suit your customers.

MATERIALS

/ 201 stainless steel

This type of stainless steel is relatively harder than other types of stainless and offers good overall rust resistance, especially when properly coated. As an alternative to the polished stainless steel look, 201 stainless is used in ARIES 3" Stealth™ bull bars and covered in a high-gloss black powder coat finish. It provides a solid black finish option that can withstand moisture and road salt, making it a preferred choice for cold-weather climates.

/ Carbon steel

Perhaps the most common type of steel, carbon steel is preferred for its high strength, and ARIES carbon steel is cold rolled to add even more strength and hardness. Though it is not highly rust-resistant, carbon steel can easily be preserved with the right powder coat finish. Carbon steel is used for a variety of ARIES products, including our new RidgeStep™ commercial running boards, Pro Series™ accessories and removable mud flaps. It is the all-around steel of choice for adding extra strength and durability.

/ 304 stainless steel

This variation of stainless steel is higher in nickel content, allowing it to be very resilient to rust and corrosion. It is used in a number of ARIES products, from grille guards to side bars, and typically comes with a mirror-like polished finish. We also use 304 stainless in our bull bar skid plates to keep them free from rust despite frequent exposure to moisture, dirt and debris. 304 stainless steel is the ideal choice for anyone who prefers the look of polished stainless over black.

/ T6 aluminum alloy

Aluminum is commonly known to be lightweight and rust-free, making it an ideal material for truck accessories. T6 aluminum, however, provides an additional advantage by going through a heat treatment process to increase its overall hardness. We use T6 aluminum in many of our Jeep®-specific accessories, as well as in our Big Step™ side bars. It is the ideal material for off-roading, being completely free of rust and keeping excessive weight off the vehicle.

FINISHES

/ Polished stainless

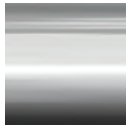

With a mirror-like finish, polished stainless steel adds a bright accent to any truck accessory.

Though not all polished stainless finishes are necessarily highly rust-resistant, the polished stainless steel offered by ARIES is a 304 stainless, meaning it has a large percentage of nickel content to be truly rust-resistant. This allows the polished finish to maintain its flawless, mirror-like appearance despite the elements and changing seasons. Polished stainless steel is available on a number of ARIES products, including many of our grille guards, bull bars and side bars.

/ Brushed stainless



A brushed finish is created by treating a metal surface with an abrasive. It has a somewhat grainy appearance compared to a polished finish and offers a unique texture, helping to

hide minor scratches and imperfections. All ARIES bull bar skid plates are made with brushed 304 stainless steel to maintain a consistent finish in spite of nicks, scratches and scuffs from road debris. Brushed stainless is an excellent choice on and off the road, helping to protect and preserve the vehicle's front end.

/ High-gloss black powder coat



Smooth and reflective like dark glass, this polyester-based finish offers excellent rust resistance and a sleek alternative to the flatter finishes. We put our high-gloss black through

a salt spray test to ensure long-lasting protection. It is applied to ARIES 3" Stealth™ bull bars to further protect the stainless steel construction from corrosion and provide a black finish option made specifically for cold climates to resist extreme temperatures, moisture and road salt.

/ Semi-gloss black powder coat



Similar to our high-gloss black finish, semi-gloss black powder coat is polyester-based to be durable and rust-resistant. It is typically applied to carbon steel products and is

designed to withstand moisture, scratches, chipping and peeling over time. Our semi-gloss black is also UV-resistant to help prevent fading. Like polished stainless, we offer this finish on several of our products, from grille guards and side bars to Jeep®-specific accessories.

/ Chrome powder coat



This polyester-based finish is designed to have the shine of chrome with the durability of a powder coat. Though it is not an actual chrome finish, it offers a reflective, polished appearance

and is very resistant to scratches, chipping and peeling. Chrome powder coat is applied to our new AdvantEDGE™ products, including the bull bar, side bars and headache rack.

/ Silver powder coat



Similar to our chrome powder coat, this finish offers a bright metallic look without being overly lustrous. It is also designed to be very durable, resisting scratches, peeling and rust.

The silver powder coat finish is specifically offered as an option for our aluminum modular bumpers and it is intended to work well alongside our textured black powder coat finish.

/ Textured black powder coat

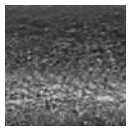

Textured black has a wrinkled-like appearance that is specially designed to hide scratches, grime and dirt. Because of this characteristic, textured black is an ideal choice for off-road

and work vehicles. We also put our textured black powder coat through an extensive salt spray test to ensure the best possible corrosion resistance in any season. Textured black is used on our Pro Series™ products, Big Horn™ bull bars, Big Step™ side bars and several of our Jeep® accessories.

/ Carbide black powder coat



Carbide powder coat is a gritty, flat finish compared to a high-gloss or semi-gloss black. However, it is also typically more durable.

Our carbide black is polyester-based and very resistant to rust, wear, chipping and scratches. It is offered as an option for our new AdvantEDGE™ series products, including the AdvantEDGE™ bull bar, side bars and headache rack.

TRUCK CAB GUIDE

Automotive manufacturers use different names for their various truck cab sizes. While Ford may call its largest cab the SuperCrew, Toyota calls it the CrewMax. However, all truck cabs generally fit into one of three categories: regular cab, extended cab or crew cab.



/ Regular cab

This type of truck cab has two full-size, front-hinging doors and provides seating for two or three people. Unlike the other cab types, it has no extra space or seating behind the first row.



/ Extended cab

This type of truck cab has at least two full-size, front-hinging doors and extra seating behind the first row. The back seats are accessed either by tilting and sliding the main seats forward or by opening a set of smaller, rearward doors. The rear doors are usually suicide doors but can also be standard front-hinging doors.

/ Crew cab

This type of truck cab is the largest and has four full-size, front-hinging doors. It offers the most room with two full rows and seating for up to five or six people.

TRUCK CAB NAMES BY MANUFACTURER

The table below lists each truck cab name by manufacturer and size. This categorization is only intended to promote a better understanding of the three basic types of truck cabs and does not imply certain design similarities across the various makes and models.

In the ARIES Application Guide, the names will reflect those actually used by each manufacturer.

Truck Cab Names By Manufacturer			
	Regular Cab	Extended Cab	Crew Cab
Chevrolet / GMC	Regular Cab	Double Cab	Crew Cab
Honda Ridgeline	--	--	Crew Cab
Ford	Regular Cab	Super Cab	SuperCrew
Dodge & Ram	Regular Cab	Quad Cab	Crew Cab & Mega Cab
Nissan Titan	--	King Cab	Crew Cab
Toyota Tacoma	Regular Cab	Access Cab	Double Cab
Toyota Tundra	Regular Cab	Double Cab	CrewMax

BULL BARS VS GRILLE GUARDS

The ARIES line includes both bull bars and grille guards, including our new AdvantEDGE™ bull bar and Pro Series™ grille guard. When helping your customers decide which accessory to select for their vehicle, it is important to know some of the differences.



/ Bull bars

A bull bar is generally designed with an A-shaped frame, consisting of a main outer tube and a center, horizontal tube or crossbar. The main tube extends up from the underside of the vehicle to cover a portion of the bumper and even the grille on certain models. Typically, a bull bar bolts onto the vehicle's frame and covers just the center portion of the vehicle's bumper and grille.

Bull bars are mainly found on pickup trucks, Jeep® and SUVs. Many come with a crossbar that can accept aftermarket lights, as well as a skid plate that attaches to the lower portion of the frame to deflect stones and other small road debris.

Bull bars are different from grille guards in that they:

- Generally cover less area than grille guards
- Do not have side brush guards to cover the headlights
- Usually come with a skid plate

/ Grille guards

If bull bars have an A-shaped frame, grille guards could be said to have an H-shaped frame. A grille guard (sometimes referred to as a brush guard) is essentially made up of two vertical members, called risers, and a center, horizontal member, called a crossbar or center flange. The risers are usually equipped with mounting holes to attach the grille guard to the frame.

Most grille guards also have a pair of side brush guards attached to the risers that extend outward to wrap around the vehicle's headlights, as well as a top tube and bottom tube spanning between the risers.

Like on a bull bar, the grille guard crossbar is typically designed to accept aftermarket lights, whether using pre-drilled holes or an LED light bar housing such as on the ARIES Pro Series™ grille guard.

Grille guards are different from bull bars in that they:

- Generally cover a large portion of the front end
- Have brush guards to protect the headlights
- Do not have a skid plate

SIDE BARS VS RUNNING BOARDS

For 2016, ARIES has introduced several new side accessories including an entirely new category of 'Running Boards', made up of our AeroTread™ and RidgeStep™ running boards. With this new product category, it is important to understand the differences between side bars and running boards to better serve your customers.

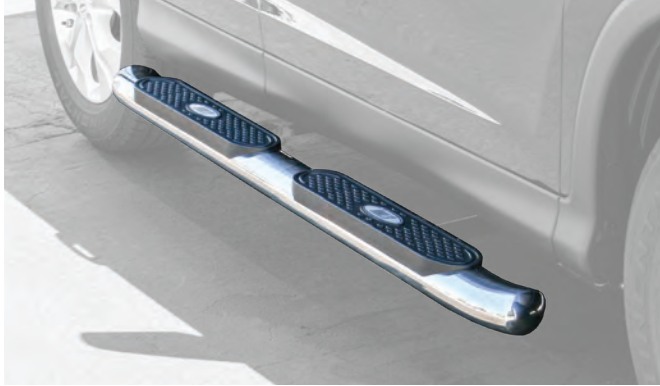

/ Side bars

Side bars are referred to by many names, including nerf bars, step bars and side steps, to name a few. A side bar's primary function is to provide a stepping surface into the vehicle. For this reason, they are generally used on vehicles that ride high off the ground, such as pickup trucks and SUVs. However, for aesthetic value, they are also found on smaller vehicles, such as compact SUVs and crossovers.

Side bars are typically designed to mount with a certain amount of space between the step and the body of the vehicle. This amount of space can vary, depending on the model, but in general, it is a few inches. They are also designed to mount low on the vehicle, allowing for less ground clearance, compared to running boards, but providing a more functional step for lifted vehicles. Side bars also usually have individual, custom step pads to correspond to each door on the vehicle, and they are generally narrower than running boards.

Side bars are different from running boards in that they:

- Leave extra space between the bar and the vehicle
- Offer reduced ground clearance for an easier step on lifted vehicles
- Feature individual, custom-placed step pads
- Typically have a narrower width than running boards

/ Running boards

Like a side bar, a running board provides a stepping surface into the vehicle. However, it generally mounts flush against the vehicle's rocker panel, instead of leaving a gap. Running boards are also typically wider than side bars and have an overall flat top surface. Instead of individually placed step pads, the flat stepping surface usually has a tread that spans the length of the board.

Running boards are found on everything from larger pickup trucks and SUVs to smaller crossovers, providing a convenient step and additional aesthetic value. Unlike side bars that mount down and away from the vehicle, running boards typically offer more ground clearance, making them an excellent choice for lower vehicles.

Running boards are different from side bars in that they:

- Mount relatively flush against the rocker panel
- Offer more ground clearance for lower vehicles
- Feature a single, full-length tread
- Typically have a wider, flatter profile

ADVANTAGES OF THE TRACK MOUNTING SYSTEM

/ 6" ovals

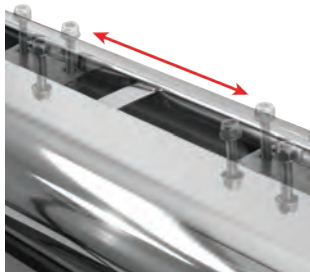

/ AdvantEDGE™

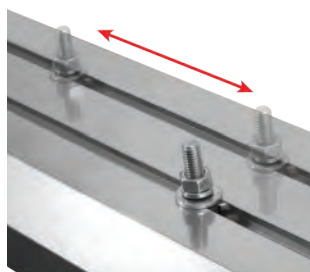

/ AeroTread™



/ RidgeStep™

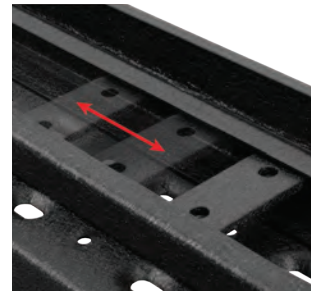

The number of ARIES side accessories that use a track mounting system continues to grow. It is used on our 6" oval side bars, new AdvantEDGE™ side bars, new AeroTread™ running boards and new RidgeStep™ running boards.

A track mounting system uses two key components: a channel or pair of channels and sliding bolts or C-shaped brackets. The channel allows the bolts to slide along the accessory and typically spans much of its length to allow for flexible positioning. The side bars or running boards can then be bolted onto vehicle-specific mounting brackets already attached to the vehicle.

This mounting system provides a few key advantages. Unlike side bars with fixed mounting locations, the track mounting system allows one side bar or running board to be used on multiple vehicle. This reduces inventory requirements, allowing room for more product. The track mounting system also makes installation easier. Because the bolts can slide along the channel, they can be precisely positioned and can easily accept nuts for a secure attachment.

ROCKER MOUNT VS BUSHING MOUNT

/ Rocker mount



All ARIES side bars and running boards mount using vehicle-specific brackets. This allows for easier and more secure installation. In addition to a vehicle-specific fit, there are two types of side bar / running board installations: rocker mount and bushing mount.

A rocker mount, also called a rocker panel mount, uses the vehicle's rocker panel to attach the mounting brackets. This may be done using pre-existing welded bolts on the vehicle, clip nuts or other fasteners. In general, side bars with 45° bent ends install using the rocker mount method.

/ Bushing mount



A bushing mount, on the other hand, attaches the mounting brackets to the vehicle using a set of pre-existing bolts on the vehicle, called bushing bolts. These bolts are installed on the vehicle by the manufacturer, and serve to anchor the body to the chassis. When installing side bars or running boards, these bushing bolts can be removed and reinstalled to hold the mounting brackets. A bushing mount is typically used for side bars with 90° bent ends.

HEADACHE RACKS

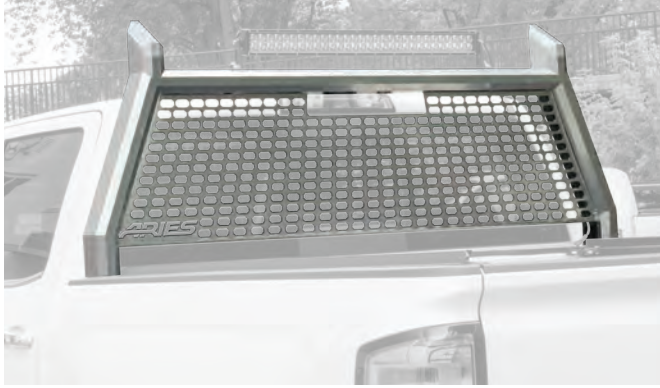

A headache rack is an accessory designed exclusively for pickup trucks. It consists of a main, outer frame that follows the outline of the truck cab, as well as some type of center section, such as a mesh grid or louvers.

The headache rack mounts at the front of the truck bed, just rearward of the cab, and is designed to provide some level of protection for the rear window, cab and passengers from loose cargo in the bed. Headache racks can also offer aesthetic value and protection from UV damage to the interior of the truck, making them a choice accessory for work trucks.

MUD FLAPS



A mud flap is an accessory typically found on trucks, SUVs or Jeeps® used for off-roading. It is essentially a thick rubber flap that mounts behind each rear tire and is intended to keep mud, stones and other debris from being projected into the wheel wells and behind the vehicle.

Because mud flaps may be illegal on main roads in some states, certain mud flaps, such as ARIES universal removable mud flaps, are designed for quick attachment and detachment as needed. To learn about the laws concerning mud flaps in your state, the State Patrol is a good resource.

A GUIDE TO JEEP® CUSTOMIZATION

Building (that is, customizing a vehicle with aftermarket accessories) has almost become an art form for today's Jeep® owner. The Jeep® Wrangler has particularly been a choice model for this hobby. The key to a great build is having the flexibility to add more and more accessories, and that is why the ARIES Jeep® line is diverse and innovative, giving your customers a wide selection to keep building and fueling their passion.



/ Customized look

For building a customized look, modular bumpers feature a six-piece, interchangeable design with up to 16 different configurations. Our modular bumpers, tube bumpers and roof light bar are also excellent choices for adding aftermarket lights. We also provide vehicle-specific grille guards and bull bars for various Jeep® models.



/ Ultimate off-roader

For building the ultimate off-roader, we carry tube doors, fender flares and our removable mud flaps with no drilling needed on the Jeep® JK. Our modular bumper accepts tow hooks and a winch for functionality on the trail. To keep your customers' items secure, our security cargo lid offers a fully lockable enclosure that integrates with the layout of the Jeep®.



/ Modular bumper design

Modular is simply a term used to describe accessories that have interchangeable pieces to allow for different combinations. For example, the ARIES Jeep® modular bumper is made up of a center section, two side extensions, a center brush guard and two side brush guards. Each piece individually attaches to the center section, meaning it can be added, left off or replaced with a different piece or finish to suit individual preference.

The modular design of the ARIES Jeep® bumper allows your customers to create different looks for their Jeep®, without needing to buy an entirely new accessory. They can start with one of 16 different base configurations, and then add, remove or swap out pieces as desired. See page 118 for a full listing of ARIES Jeep® modular bumpers.



/ Security cargo lid

The ARIES Jeep® security cargo lid is the perfect line of defense for your customer's items. This integrated security system turns the rear cargo area of the off-roading Jeep® Wrangler (4-door models only) into a fully lockable, key-operated storage enclosure. It not only allows your customers to keep items under lock and key while they're away, but it also helps protect them from the elements. The lid works with the layout of the Jeep® and with the rear door. It also features tie-down anchors and a 75-lb. weight capacity to accept additional cargo on top. The ARIES Jeep® security cargo lid is made from strong aluminum alloy and has a highly durable textured powder coat finish to easily resist the elements.



/ Rocker steps

New for 2016, ARIES Jeep® rocker steps offer extra side protection and a convenient step up. While many rocker panel protectors are simple steel panels or tubes, ARIES Jeep® rocker steps have a wide, flat profile that provides two key advantages. First, it offers a convenient, comfortable step up into the Jeep®. The double-tube layout and welded top plate create a sturdy, 3" wide stepping surface. Second, the flat design offers added ground clearance. Unlike some side bars that are mounted down and away from the vehicle, ARIES rocker steps are set high enough to clear brush, boulders and other off-road debris. They also feature a durable textured black powder coat finish to resist rust and hide scratches and grime. See page 126 for more.



/ Tube doors and fender flares

For stylizing the off-road machine, we offer tube doors and fender flares. ARIES tube doors feature an open design with an aggressive cutout pattern. They use the existing factory hinge brackets for easy mounting and are available for both the front and rear. The doors are made with hardened T6 aluminum construction and have a textured black powder coat finish to easily resist scratches and grime. Likewise, ARIES Jeep® fender flares add style and off-road readiness to your customer's Wrangler. They feature a 4" width and custom contours to show well with larger, off-road tires. With hardened T6 aluminum construction and a textured powder coat finish, these fender flares are made to go off road.

AUTO ACCESSORIES GLOSSARY

A

Access Cab

see 'Extended Cab'

Aftermarket

a term used to refer to automotive parts and accessories that fit a particular vehicle but are made by a manufacturer different than the original equipment manufacturer or OEM

All-Wheel Drive (AWD)

a drivetrain system that powers all four wheels simultaneously, all of the time; provides more traction when needed but generally will not activate until the vehicle requires it, making some automatic all-wheel drive vehicles essentially smart 2WD systems; different from four-wheel drive in that 4WD can be switched off by the driver

Application Guide

a complete index of current part numbers and associated vehicle applications for all ARIES parts; available online or in the ARIES catalog

B

Bench Seat

a type of vehicle seat that spans the width of the vehicle and provides seating for three or more persons; can be in the first row, but is commonly found in the rear passenger rows

Body

the external structure of a vehicle that gives it its recognizable shape; may be bolted to the chassis or combined as a single molded piece

Brush Guard

see 'Grille Guard'; may refer to the tubular attachment or extension of other front end accessories, such as the ARIES Jeep® modular bumper

Bucket Seat

a type of vehicle seat designed to hold only one person; typically used for the first row and sometimes second row

Bull Bar

a type of front end accessory, usually with an A-shaped frame, that bolts directly onto the vehicle and covers a center portion of the vehicle's bumper and grille

Bushing Bolt

a heavy-duty fastener used to anchor a vehicle's body to its chassis; can sometimes be used as an attachment point for side bars, running boards or other side accessories

Bushing Mount

a mounting style of side bars and running boards that uses the vehicle's bushing bolts to attach the mounting brackets; typically used for side bars with 90° bends and commonly used on aftermarket side bars as opposed to OEM

C

Cab & Chassis

also known as a 'cab and chassis truck' or 'chassis cab'; a type of heavy-duty truck comprised only of a cab and chassis, without a truck bed; typically used for heavy towing and commercial purposes

Chassis

the main framework of a vehicle, consisting of the frame and essential parts needed for operation (excludes the body); can be a unibody design, with the chassis and bodywork as a single piece, or with a C-frame construction

Clip Nut

a type of nut with an attached spring clip that allows it to be clipped onto the edge of an opening and held in place while a bolt is threaded through; frequently used for mounting points that are difficult to reach

Club Cab

see 'Extended Cab'

Crew Cab

also known as a 'quad cab', 'double cab', 'dual cab' and others; a truck cab with four full-size, front-hinging doors and seating for five or six people; larger than a regular cab and extended cab; see the 'Truck Cab Guide' on page 10 for more information

Crossbar

the main center section of a front end accessory, such as a bull bar or grille guard, to which aftermarket lights and other accessories may be attached

Cross-Linked Polyethylene (XPE) Foam

a fine-celled material comprised of linked polymer chains that provide increased hardness and rigidity, and offer characteristics of thermal insulation, waterproofing, shock absorption and sound insulation

Crossover Utility Vehicle (CUV)

also known simply as a 'crossover'; a vehicle that is built on a car platform using features and styling common on sport utility vehicles (SUV)

CUV

see 'Crossover Utility Vehicle'

D

Denier

a measurement of fabric weight, based on the fineness or thickness of the threads

Drivetrain

the set of parts in an automobile that allows the engine to channel its power to the axles; typically includes the driveshaft, CV joints, differential, axle shafts and U-joints

Dual Cab

see 'Crew Cab'

Dual Post

a floor liner attachment method that uses two knobs or posts, usually positioned on the driver's side near the seat, to help keep the floor liner held in place; also see 'Single Post'

Dually

a pickup truck with four tires on its rear axle, two on each side; usually able to carry heavier loads compared to a regular pickup truck

E

Extended Cab

also known as a 'king cab', 'super cab' and others; a truck cab with extra seating behind the front seats, usually accessed by tilting and sliding the main seats forward or using suicide doors; may also be referred to as a 'quad cab' on some older Dodge / Ram models; see the Truck Cab Guide on page 10 for more information

F

Four-Wheel Drive (4WD)

a drivetrain system in which all four wheels of the vehicle are powered by the engine simultaneously; different from all-wheel drive in that it can be disengaged by the driver so that the vehicle operates on a two-wheel drive system only

Frame

the part of a vehicle that serves as the base to which all other parts attach

G

Grille Guard

also called a 'brush guard'; a type of front end accessory that bolts directly onto the vehicle and usually covers a large portion of the vehicle's profile, including the grille and headlights; typically has a center section, consisting of a crossbar and two risers, as well as two side brush guards to cover the headlights

H

Headache Rack

a type of pickup truck accessory that mounts at the front of the truck bed, just rearward of the cab, and protects the cab and rear window from loose cargo in the bed

K

King Cab

see 'Extended Cab'

L

LED (Light-Emitting Diode)

a semiconducting light source that requires less amperage for illumination than a traditional light bulb

Long Bed (LB)

also called a 'long box'; a truck bed that is typically one or two feet longer than a short bed (compact long beds are generally 7' long and full size are 8' long)

M

Modular

a term applied to accessories that are able to be constructed with various, interchangeable pieces to produce different combinations; applies to ARIES Jeep® modular bumpers, see page 118

N

Nerf Bar

see 'Side Bar'

O

Original Equipment Manufacturer (OEM)

a term used to designate parts that are made by the original manufacturer as opposed to an aftermarket manufacturer

Q

Quad Cab

see 'Crew Cab'

R

Regular Cab

also known as a 'standard cab'; a truck cab with two full-size, front-hinging doors and seating for two or three people; has no extra space or seating behind the main seats, unlike an extended cab or crew cab; see the Truck Cab Guide on page 10 for more information

Risers

also known as 'uprights'; the vertical members of a grille guard that make up the main frame, together with the crossbar, and which provide mounting points to attach the grille guard to the vehicle; typically protected with rubber stripping on the front edges

Rocker Mount

also called a 'rocker panel mount'; a mounting style of side bars and running boards that uses the vehicle's rocker panel to attach the mounting brackets; may use welded bolts on the vehicle, clip nuts or other fasteners; typically used for side bars with 45° bends and commonly used on OEM side bars as opposed to aftermarket options

Rocker Panel

the side body panel on a vehicle, below the doors, spanning from wheel to wheel; can sometimes be used as an attachment point for side bars, running boards or other side accessories

Rocker Panel Mount

see 'Rocker Mount'

Running Board

a type of vehicle side accessory that provides a stepping surface into the vehicle and is generally mounted flush against the body; typically wider than a side bar and equipped with a tread that spans almost the full length of the board

S

Short Bed (SB)

a pickup truck bed that is usually a foot or two shorter than a long bed; typically 5.5' to 6.5' long

Side Bar

sometimes referred to as a 'nerf bar', 'step bar' or 'side step'; a type of vehicle side accessory that provides a stepping surface into the vehicle and is mounted with a certain amount of space between the step and the body; typically has individual step pads to correspond to each vehicle door

Side Marker

a small light mounted on either side of a vehicle to make it more visible to other drivers on the road; required by law; typically wired to illuminate with the vehicle's taillights and parking lights

Side Step

see 'Side Bar'

Single Hook

a floor liner attachment method, similar to 'Single Post', but using a hook instead of a knob, to help keep the floor liner held in place

Single Post

a floor liner attachment method that uses one knob or post, usually positioned on the driver's side near the seat, to help keep the floor liner held in place; also see 'Dual Post'

Sport Utility Vehicle (SUV)

a type of automotive vehicle with a station-wagon-like body built on a light truck chassis; usually equipped with four-wheel drive for on- or off-road capability

Stake Pocket

a rectangular recessed socket, accessible from the top surface of a truck's bed rail, designed to accept a stake or other aftermarket accessories such as tiedown anchors, ladder racks or headache racks, etc. (see the new AdvantEDGE™ headache rack on page 10)

Standard Cab

see 'Regular Cab'

Step Bar

see 'Side Bar'

Sub Frame

the part of a vehicle that supports the engine and front suspension on a unibody frame

Suicide Door

a type of vehicle door that has rearward hinges and that opens toward the front, opposite a standard vehicle door; typically requires the forward door to be opened first; commonly used on extended cab pickup trucks

Super Cab

see 'Extended Cab'

SUV

see 'Sport Utility Vehicle'

T

Terylene

a highly durable fabric that is made of synthetic polyester and characterized by its light weight and resistance to creasing

Thermoplastic rubber (TPR)

a material consisting of a combination of plastic and rubber and having properties of both, being flexible, moldable, durable, waterproof and resilient to extreme temperatures

Torque

a measurement of the turning force on an object such as a bolt or a flywheel (e.g. pushing or pulling the handle of a wrench when tightening a bolt)

Torque Wrench

a type of wrench that indicates to the user how much torque is being applied when turning the ratchet; used when a specific amount of torque must be applied to a fastener

Tow Hook

a large metal hook designed to be mounted on the front or rear of a vehicle, usually on the bumper, for straight-line towing purposes; typically used in combination with a tow strap

Track Mounting System

a type of mounting system for side bars and running boards that uses a channel and sliding bolts or brackets to attach to vehicle-specific mounting brackets; the channel typically spans the length of the accessory to allow for flexible positioning; helps reduce inventory requirements by allowing one accessory to fit multiple vehicles; may also refer to a system for mounting lights or other attachments to an automotive accessory, such as the AdvantEDGE™ bull bar (page 28) or AdvantEDGE™ headache rack (page 110)

Truck Bed

also called a 'truck box' or simply a 'box'; the rear portion of a truck, designed for holding cargo; usually equipped with sides and a tailgate; also see 'Short Bed' and 'Long Bed'

Truck Cab

also known as a 'cabin' or simply a 'cab'; the enclosed compartment of a pickup truck where the driver and passengers sit; see the Truck Cab Guide on page 10 for more information

Two-Wheel Drive (2WD)

a drivetrain system in which the engine powers only two of the vehicle's wheels; common on most non-commercial vehicles without four-wheel drive

U

Unibody Frame

a type of vehicle frame in which the bodywork and chassis are made up of a single molded piece; usually has a sub-frame on the front end to hold the engine and suspension

Uprights

see 'Risers'

V

Vehicle Identification Number (VIN)

a unique serial number used by the automotive industry to identify individual motor vehicles

VIN Tag

a metal plate or sticker on a vehicle or trailer that provides vital information about the vehicle, including the make, model, year, weight ratings and the VIN

W

Weld Nut

a type of nut that is welded to a metal surface on a vehicle and allows a bolt to be fastened directly to the surface without an additional nut

Wheel-to-Wheel

a term applied to side bars that extend from the front wheel of the vehicle to the rear wheel, and typically provide an additional step pad for accessing the truck bed

Wheelbase (WB)

the horizontal distance between the center of the front wheel and the center of the rear wheel on a vehicle

X

XPE Foam

see 'Cross-Linked Polyethylene (XPE) Foam'

ADVANTEDGE SERIES™



LET YOUR TRUCK DO THE TALKING

There are a lot of trucks out there, and giving your customers what they need to stand out means going outside the lines, thinking outside the box and living life on the edge. The patent pending ARIES AdvantEDGE™ series offers a unique look to complement the modern truck,

featuring a 5 1/2" wide, angular, eight-sided tube profile and all-aluminum construction. AdvantEDGE™ products are available in two finish options, including black carbide powder coat and chrome powder coat, and all are backed by a five-year warranty.

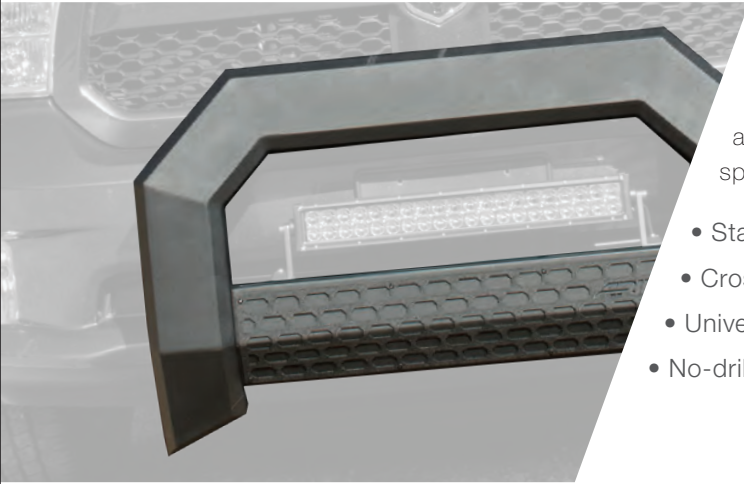

AdvantEDGE™ bull bar

The ARIES AdvantEDGE™ bull bar is made with eight-sided, extruded aluminum tubing to be strong, lightweight and rust-free. It features an angular design to mimic the front ends of today's trucks and uses vehicle-specific brackets for each make and model. See page 28 for more.

- Stamped aluminum, octagonal grid crossbar for a distinct look
- Crossbar can be flipped to mount auxiliary lights
- Universal track mounting system for easy, secure installation
- No-drill, vehicle-specific application for a custom fit



AdvantEDGE™ side bars

ARIES AdvantEDGE™ side bars are completely free of plastic parts, featuring die-cast aluminum end caps and a stamped aluminum tread that will never crack or fade. They come in four base lengths and install using a universal track mounting system. See page 64 for more.

- Stamped aluminum tread for a non-skid step that will never crack or fade
- Die-cast aluminum end caps for a durable accent
- Four base lengths use vehicle-specific brackets to fit all applications
- Universal 8mm track mounting system for easy, secure installation

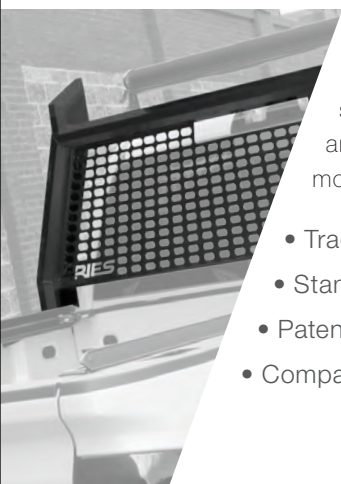

AdvantEDGE™ headache rack

The ARIES AdvantEDGE™ headache rack is designed to protect and add style to the modern pickup truck. It offers excellent protection for the cab and uses a patent pending stake pocket anchoring system to securely mount on multiple makes and models. See page 110 for more.

- Track on the top edge accepts lights, tie-down anchors or other accessories
- Stamped aluminum, octagonal grid center section for a distinct look
- Patent pending stake pocket mounting system for simple, secure installation
- Compatible with a variety of pickup makes and models

PRO SERIES™



FIND OUT WHAT IT MEANS TO BE A PRO

The ARIES Pro Series™ represents a higher class of truck accessories, reserved for those who see their ride as more than just four wheels and a cab. It includes our patented Pro Series™ grille guard with a single-row LED light bar housing, as well as the Pro Series™ bull bar and Pro Series™

side bars to allow your customers to completely upgrade the look of their truck. All Pro Series™ products feature high-strength carbon steel construction, a tested, textured black powder coat finish and a three-year warranty.



Pro Series™ bull bar

The Pro Series™ bull bar adds class to the front end of any truck or SUV. This vehicle-specific bull bar installs using preexisting factory holes to quickly transform the vehicle from stock to stylish. See page 38 for more.

- 3" diameter, heavy-wall tube design
- Pre-drilled crossbar for mounting auxiliary lights
- Removable brushed stainless steel skid plate deflects small road debris
- Tow hooks available for 2010-2016 Ram 2500 / 3500 trucks



Pro Series™ grille guard

The ARIES Pro Series™ grille guard is unlike any other grille guard or brush guard on the road today because of its patented center crossbar. The unique crossbar is able to house a single-row LED light bar, allowing your customers to truly set their truck or SUV apart. See page 50 for more.

- Patented crossbar houses a single-row LED light bar (light bar not included)
- Interchangeable cover plates offer quick and easy customization
- Tested, textured black powder coat easily hides scratches and dirt
- One-piece, 1 1/2" diameter, heavy-wall tube design



Pro Series™ side bars

ARIES Pro Series™ side bars are a step above the rest, featuring 3" diameter, heavy-wall construction and custom, raised, non-skid step pads. Each set of side bars is designed with vehicle-specific contours and mounts with heavy-duty steel brackets. See page 86 for more.

- 3" diameter, heavy-wall tube design
- Raised, custom, non-skid step pads
- Brushed stainless steel ARIES insignia
- No-drill, vehicle-specific application for a custom fit

BULL BARS

ARIE

ARIE





KEEP THAT STIFF UPPER LIP

From the cattle rancher on the open range, to the industrial man of the asphalt jungle, to the jaw-clenching off-roader of the backwoods, ARIES bull bars are made for those who face the uncertain road without fear.

New to our lineup is the AdvantEDGE™ bull bar, featuring an angular, eight-sided tube profile and all-aluminum construction. It is available in a black carbide or chrome powder coat finish and comes with a five-year warranty.

We also offer 3" and 4" bull bars in a variety of finishes, including our cold-climate high-gloss black stainless, polished 304 stainless and textured black aluminum and carbon steel. All ARIES bull bars are made for no-drill, vehicle-specific installation and can accept aftermarket lights for easy customization.



NEW AdvantEDGE™ series

The new AdvantEDGE™ bull bar boasts an all-aluminum construction and a unique, eight-sided tube profile in two finish options to complement the style of today's trucks



Auxiliary light mounts

With a pre-drilled crossbar or crossbar track system, each ARIES bull bar can easily be customized with auxiliary lights, including round lights up to 5 1/2" in diameter and LED light bars



Multiple finishes available

ARIES bull bars come in an array of finishes, including textured black carbon and high-gloss black stainless. See page 11 to learn more about our available finishes

CATEGORY INDEX

28 | 5 1/2" AdvantEDGE™

30 | 4" Big Horn™

34 | 3" Stealth™

38 | 3" Pro Series™

42 | 3" Bull Bars

5 1/2"

ADVANTEDGE™ BULL BARS

NEW

with a unique, octagonal tube and all-aluminum construction

/ Unique design

The 5 1/2" angular, eight-sided tube profile and octagonal grid crossbar offer a fresh look to complement the style of today's vehicles

/ All-aluminum build

The aluminum construction is strong, lightweight, rust-free and has no plastic parts, meaning it will never crack or fade

/ Reversible crossbar

The crossbar can be flipped to expose a 28" track mounting system for LED light bars, off-road lights or other auxiliary light options

Features and benefits

- Unique, eight-sided tube profile to complement the style of modern trucks
- Extruded, all-aluminum construction to be strong, lightweight and rust-free
- Stamped aluminum, octagonal grid crossbar for a distinct look
- Crossbar can be flipped to mount auxiliary lights
- Universal track mounting system for easy, secure installation
- No-drill, vehicle-specific application for a custom fit
- Complements other ARIES AdvantEDGE™ accessories
- Patent pending
- Five-year warranty



Material and finish options

Bull bar



Material:
Aluminum alloy

Finish:
Chrome
powder coat



Material:
Aluminum alloy

Finish:
Carbide black
powder coat

Octagonal grid

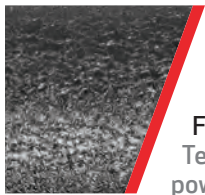

Material:
Aluminum alloy

Finish:
Textured black
powder coat



ACCESSORY

License plate bracket



2169000

- Easily bolts onto AdvantEDGE™ crossbar, using existing octagonal grid hardware
- Provides a solid mounting location to keep license plate visible
- Lightweight aluminum construction with black powder coat finish
- Includes four license plate mounting bolts

APPLICATION GUIDE

5 1/2" AdvantEDGE™ Bull Bars

Make / Model	Style	Years	Chrome#	Black#
Chevrolet				
Silverado 1500	All	07 - 16	2154000	2164000
Silverado 2500	All	09 - 16	2154001	2164001
Silverado 3500	All	09 - 16	2154001	2164001
Dodge & Ram				
1500	All	09 - 16	2155000	2165000
2500	All	09 - 16	2155001	2165001
3500	All	09 - 16	2155001	2165001
Ford				
F-150	All	04 - 16	2153000	2163000
F-250, F-350, F-450, F-550	All	11 - 16	2153002	2163002
GMC				
Sierra 1500	All	07 - 16	2154000	2164000
Sierra 2500	All	09 - 16	2154001	2164001
Sierra 3500	All	09 - 16	2154001	2164001
Toyota				
Tundra	All	07 - 16	2152000	2162000

4"

BIG HORN™ BULL BARS

for even more attitude on that oversized truck

/ Bold design

The 4" diameter and 1/8" thick walls are made to accent larger, lifted trucks and are best complemented with Big Step™ side bars

/ Lightweight aluminum build

Aluminum construction is strong, rust-free and 40% lighter than carbon steel, making it ideal for both off-roading and hard work

/ Pre-drilled crossbar

The crossbar has two pre-drilled holes to securely mount auxiliary lights, including round lights up to 5 1/2" in diameter and LED light bars

Features and benefits

- Bold, 4" diameter is designed to show well on larger trucks
- Hardened aluminum construction to be lightweight and rust-free (also available in polished 304 stainless)
- Textured black powder coat easily hides scratches and dirt
- Pre-drilled crossbar for mounting auxiliary lights
- Removable, brushed stainless steel deflects small road debris
- Complements ARIES Big Step™ side bars, see page 82
- Tow hooks available for 2010-2016 Ram 2500 / 3500 trucks. See page 31 for details
- No-drill, vehicle-specific application for a custom fit
- See page 32 for application information
- Three-year warranty on black finish and limited lifetime warranty on polished stainless



AL45-4006

Material and finish options

Bull bar



Material:
304 stainless steel
Finish:
Polished stainless

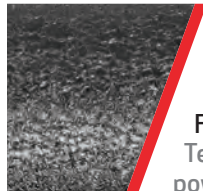

Material:
Aluminum alloy
Finish:
Textured black powder coat

Skid plate

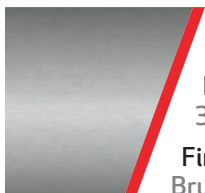

Material:
304 stainless steel
Finish:
Brushed stainless



4" BULL BAR ACCESSORIES

License plate bracket



45-0000

- Easily bolts onto 4" crossbar, using existing skid plate hardware
- Provides a solid mounting location to keep license plate visible
- Steel construction with black powder coat finish
- Includes two license plate mounting bolts

Bull bar tow hooks for Ram trucks



45-5TOW

- Perfect for recovery towing applications
- Up to 10,000 lbs. load capacity
- Durable semi-gloss black powder coat finish
- Includes hardware for a solid installation
- Fits bull bars #45-5006 and AL45-5006 for 2010-2016 Ram 2500 / 3500 trucks

APPLICATION GUIDE

4" Big Horn™ Bull Bars

Make / Model	Style / Notes	Years	Stainless#	Black#
Chevrolet				
Avalanche 1500	All	01 - 06	45-4001	AL45-4001
Avalanche 2500	All	01 - 06	45-4002	AL45-4002
Silverado 1500	All	99 - 06	45-4001	AL45-4001
	All	07 - 13	45-4005	AL45-4005
	All	14 - 16	45-4012	AL45-4012
	Classic only	07 - 07	45-4001	AL45-4001
Silverado 1500HD	All	01 - 06	45-4002	AL45-4002
	Classic only	2007	45-4002	AL45-4002
Silverado 2500HD	All	01 - 06	45-4002	AL45-4002
	All	07 - 10	45-4006	AL45-4006
	All	11 - 16	45-4013	AL45-4013
	Classic only	2007	45-4002	AL45-4002
Silverado 2500LD	All	99 - 06	45-4002	AL45-4002
Silverado 3500HD	All	01 - 06	45-4002	AL45-4002
	All	07 - 10	45-4006	AL45-4006
	All	11 - 16	45-4013	AL45-4013
	Classic only	2007	45-4002	AL45-4002
Suburban	All	00 - 06	45-4001	AL45-4001
Suburban 2500	All	00 - 06	45-4002	AL45-4002
Tahoe	All	00 - 06	45-4001	AL45-4001
	All	00 - 06	45-4002	AL45-4002
Dodge				
Ram 1500	Club Cab	09 - 16	45-5005	AL45-5005
	Crew Cab (excl. rebel package)	09 - 16	45-5005	AL45-5005
	Mega Cab	06 - 08	45-5006	AL45-5006
	Quad Cab	09 - 16	45-5005	AL45-5005
	Quad Cab	02 - 05	45-5006	AL45-5006
	Regular Cab	09 - 16	45-5005	AL45-5005
Ram 2500	Crew Cab	10 - 16	45-5006	AL45-5006
	Mega Cab	10 - 16	45-5006	AL45-5006
	Standard Cab	10 - 16	45-5006	AL45-5006
	Quad Cab	03 - 09	45-5006	AL45-5006
Ram 3500	Crew Cab	10 - 16	45-5006	AL45-5006
	Mega Cab	10 - 16	45-5006	AL45-5006
	Standard Cab	10 - 16	45-5006	AL45-5006
	Quad Cab	03 - 09	45-5006	AL45-5006
Ford				
Excursion	All	00 - 06	45-3001	AL45-3001
Expedition	4WD only	97 - 02	--	AL45-3007
	All	03 - 16	45-3007	--

4" Big Horn™ Bull Bars

Make / Model	Style / Notes	Years	Stainless#	Black#
Ford (continued)				
F-150	Excl. Raptor and EcoBoost models	04 - 16	45-3007	AL45-3007
F-250	Super Duty	99 - 07	45-3001	AL45-3001
	Super Duty	08 - 10	45-3006	AL45-3006
F-350	Super Duty	99 - 07	45-3001	AL45-3001
	Super Duty	08 - 10	45-3006	AL45-3006
	Super Duty	11 - 16	45-3012	AL45-3012
F-450	Super Duty	11 - 16	45-3012	AL45-3012
F-550	Super Duty	11 - 16	45-3012	AL45-3012
GMC				
Sierra 1500	All	99 - 06	45-4001	AL45-4001
	All	14 - 16	45-4012	AL45-4012
	All (excl. Denali)	07 - 16	45-4005	AL45-4005
	Classic only	2007	45-4001	AL45-4001
	Denali	07 - 13	45-4005	AL45-4005
Sierra 1500HD	All	01 - 06	45-4002	AL45-4002
	Classic only	2007	45-4002	AL45-4002
Sierra 2500HD	All	01 - 06	45-4002	AL45-4002
	All	07 - 10	45-4006	AL45-4006
	All	11 - 16	45-4013	AL45-4013
	Classic only	2007	45-4002	AL45-4002
Sierra 2500LD	All	99 - 06	45-4002	AL45-4002
Sierra 3500HD	All	01 - 06	45-4002	AL45-4002
	All	07 - 10	45-4006	AL45-4006
	All	11 - 16	45-4013	AL45-4013
	Classic only	2007	45-4002	AL45-4002
Yukon	All	00 - 06	45-4001	AL45-4001
Yukon XL	All	00 - 06	45-4001	AL45-4001
Yukon XL 2500	All	00 - 06	45-4002	AL45-4002
Nissan				
Titan	All	04 - 16	45-9001	AL45-9001
Ram				
1500	Club Cab	10 - 16	45-5005	AL45-5005
	Crew Cab (excl. rebel package)	10 - 16	45-5005	AL45-5005
	Quad Cab	10 - 16	45-5005	AL45-5005
	Regular Cab	10 - 16	45-5005	AL45-5005
2500	Crew Cab	10 - 16	45-5006	AL45-5006
	Mega Cab	10 - 16	45-5006	AL45-5006
3500	Crew Cab	10 - 16	45-5006	AL45-5006
	Mega Cab	10 - 16	45-5006	AL45-5006
Toyota				
Sequoia	All	08 - 16	45-2004	AL45-2004
Tundra	All	07 - 16	45-2004	AL45-2004

3"

STEALTH™ BULL BARS

a black finish made specifically for cold-weather climates

/ Cold-weather-resistant

201 stainless steel construction gives the Stealth™ bull bar strength and rust resistance to withstand extreme temperatures, moisture and salt

/ Rigorously tested

To prove the Stealth™ bull bar can face whatever the frozen tundra has in store, it is put through the most rigorous salt spray test in the industry

/ Black finish alternative

A high resilience to salt and cold temperatures provides a reliable black finish option for those who don't want the polished stainless steel look

Features and benefits

- Stainless steel construction to withstand rust and moisture
- Rigorously tested powder coat finish to easily outlast road salt
- Durable finish offers a high-gloss black alternative to polished stainless
- 3" diameter, heavy-wall tube design
- Pre-drilled crossbar for mounting auxiliary lights
- Removable, brushed stainless steel skid plate deflects small road debris
- Tow hooks available for 2010-2016 Ram 2500 / 3500 trucks. See page 35 for details
- No-drill, vehicle-specific application for a custom fit
- See page 36 for application information
- Three-year warranty



B35-4006-3

Material and finish

Bull bar

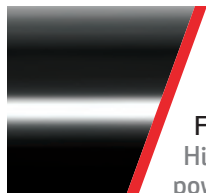

Material:
201 stainless steel

Finish:
High-gloss black
powder coat

Skid plate

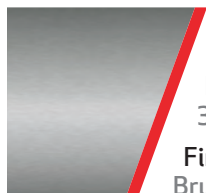

Material:
304 stainless steel

Finish:
Brushed stainless



3" BULL BAR ACCESSORIES

License plate bracket



35-0000

- Easily bolts onto 3" crossbar, using existing skid plate hardware
- Provides a solid mounting location to keep license plate visible
- Steel construction with black powder coat finish
- Includes two license plate mounting bolts

Bull bar tow hooks for Ram trucks



35-5TOW

- Perfect for recovery towing applications
- Up to 10,000 lbs. load capacity
- Durable semi-gloss black powder coat finish
- Includes hardware for a solid installation
- Fits bull bars #35-5006, #B35-5006, #B35-5006-3, #P35-5006 for 2010-2016 Ram 2500 / 3500 trucks

APPLICATION GUIDE

3" Stealth™ Bull Bars

Make / Model	Style / Notes	Years	Black#
Cadillac			
Escalade	All	07 - 14	B35-4014-3
Escalade EXT	All	07 - 14	B35-4014-3
Chevrolet			
Avalanche	All	07 - 14	B35-4014-3
Avalanche 1500	All	01 - 06	B35-4001-3
Avalanche 2500	All	01 - 06	B35-4002-3
Silverado 1500	All	99 - 06	B35-4001-3
	All	07 - 16	B35-4014-3
	Classic only	2007	B35-4001-3
Silverado 1500HD	All	01 - 06	B35-4002-3
Silverado 2500HD	All	01 - 06	B35-4002-3
	All	07 - 10	B35-4006-3
	All	11 - 16	B35-4013-3
	Classic only	2007	B35-4002-3
Silverado 2500LD	All	99 - 06	B35-4002-3
Silverado 3500HD	All	01 - 06	B35-4002-3
	All	07 - 10	B35-4006-3
	All	11 - 16	B35-4013-3
	Classic only	2007	B35-4002-3
Suburban	All	00 - 06	B35-4001-3
Suburban 1500	All	07 - 16	B35-4014-3
Suburban 2500	All	00 - 06	B35-4002-3
Tahoe	All	00 - 06	B35-4001-3
	All	00 - 06	B35-4002-3
	All	07 - 16	B35-4014-3
Dodge			
Ram 1500	Club Cab	09 - 16	B35-5005-3
	Crew Cab (excl. rebel package)	09 - 16	B35-5005-3
	Crew Cab	06 - 08	B35-5004-3
	Mega Cab	06 - 08	B35-5004-3
	Mega Cab	06 - 08	B35-5006-3
	Quad Cab	09 - 16	B35-5005-3
	Quad Cab	06 - 08	B35-5004-3
	Quad Cab	02 - 05	B35-5006-3
	Regular Cab	09 - 16	B35-5005-3
	Regular Cab	06 - 08	B35-5004-3
Ram 2500	Crew Cab	10 - 16	B35-5006-3
	Mega Cab	10 - 16	B35-5006-3
	Standard Cab	10 - 16	B35-5006-3
	Quad Cab	03 - 09	B35-5006-3
Ram 3500	Crew Cab	10 - 16	B35-5006-3
	Mega Cab	10 - 16	B35-5006-3
	Standard Cab	10 - 16	B35-5006-3
	Quad Cab	03 - 09	B35-5006-3

3" Stealth™ Bull Bars

Make / Model	Style / Notes	Years	Black#
Ford			
Excursion	All	00 - 06	B35-3001-3
Expedition	All	03 - 16	B35-3007-3
F-150	Excl. Raptor and EcoBoost models	04 - 16	B35-3007-3
F-250	Super Duty	08 - 10	B35-3006-3
	Super Duty	99 - 07	B35-3001-3
F-350	Super Duty	11 - 16	B35-3012-3
	Super Duty	08 - 10	B35-3006-3
	Super Duty	99 - 07	B35-3001-3
F-450	Super Duty	11 - 16	B35-3012-3
F-550	Super Duty	11 - 16	B35-3012-3
GMC			
Sierra 1500	All	99 - 06	B35-4001-3
	All (Excl. Denali)	07 - 16	B35-4014-3
	Classic only	2007	B35-4001-3
	Denali	07 - 13	B35-4014-3
Sierra 1500HD	All	01 - 06	B35-4002-3
	Classic only	2007	B35-4002-3
Sierra 2500HD	All	01 - 06	B35-4002-3
	All	07 - 10	B35-4006-3
	All	11 - 16	B35-4013-3
	Classic only	2007	B35-4002-3
Sierra 2500LD	All	99 - 06	B35-4002-3
Sierra 3500HD	All	01 - 06	B35-4002-3
	All	07 - 10	B35-4006-3
	All	11 - 16	B35-4013-3
	Classic only	2007	B35-4002-3
Yukon	All	00 - 06	B35-4001-3
Yukon Denali XL	All	07 - 16	B35-4014-3
Yukon XL	All	00 - 06	B35-4001-3
	All	07 - 16	B35-4014-3
Yukon XL 2500	All	00 - 06	B35-4002-3
Lincoln			
Mark LT	All	05 - 09	B35-3007-3
Ram			
1500	Club Cab	10 - 16	B35-5005-3
	Crew Cab (excl. rebel package)	10 - 16	B35-5005-3
	Quad Cab	10 - 16	B35-5005-3
	Regular Cab	10 - 16	B35-5005-3
2500	Crew Cab	10 - 16	B35-5006-3
	Mega Cab	10 - 16	B35-5006-3
3500	Crew Cab	10 - 16	B35-5006-3
	Mega Cab	10 - 16	B35-5006-3
Toyota			
Sequoia	All	08 - 16	B35-2004-3
Tacoma	All	2016	B35-2010-3
	All	05 - 15	B35-2002-3
Tundra	All	07 - 16	B35-2004-3

3"

PRO SERIES™ BULL BARS

with a durable finish that was born to go off-road

/ Tested finish

The textured powder coat easily hides scratches and is put through an extensive salt spray test to ensure durability in any season

/ Pre-drilled crossbar

The crossbar has two pre-drilled holes to securely mount auxiliary lights, including round lights up to 5 1/2" in diameter and LED light bars

/ Vehicle-specific fit

Each application uses unique mounting brackets and pre-existing factory holes to eliminate drilling and reduce installation time

Features and benefits

- Tested, textured black powder coat easily hides scratches and dirt
- 3" diameter, heavy-wall tube design
- High-strength carbon steel construction
- Pre-drilled crossbar for mounting auxiliary lights
- Removable, brushed stainless steel skid plate deflects small road debris
- Tow hooks available for 2010-2016 Ram 2500 / 3500 trucks. See page 39 for details
- Complements other ARIES Pro Series™ accessories
- No-drill, vehicle-specific application for a custom fit
- See page 40 for application information
- Three-year warranty



P35-4006

Material and finish

Bull bar



Material:
Carbon steel

Finish:
Textured black powder coat

Skid plate

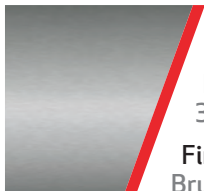

Material:
304 stainless steel

Finish:
Brushed stainless



3" BULL BAR ACCESSORIES

License plate bracket



35-0000

- Easily bolts onto 3" crossbar, using existing skid plate hardware
- Provides a solid mounting location to keep license plate visible
- Steel construction with black powder coat finish
- Includes two license plate mounting bolts

Bull bar tow hooks for Ram trucks



35-5TOW

- Perfect for recovery towing applications
- Up to 10,000 lbs. load capacity
- Durable semi-gloss black powder coat finish
- Includes hardware for a solid installation
- Fits bull bars #35-5006, #B35-5006, #B35-5006-3, #P35-5006 for 2010-2016 Ram 2500 / 3500 trucks

APPLICATION GUIDE

3" Pro Series™ Bull Bars

Make / Model	Style / Notes	Years	Black#
Cadillac			
Escalade	All	07 - 14	P35-4014
Chevrolet			
Avalanche	All	07 - 14	P35-4014
Avalanche 1500	All	01 - 06	P35-4001
Avalanche 2500	All	01 - 06	P35-4002
Silverado 1500	All	99 - 06	P35-4001
	All	07 - 16	P35-4014
Silverado 1500HD	All	01 - 06	P35-4002
	All	01 - 06	P35-4002
	All	07 - 10	P35-4006
	All	11 - 16	P35-4013
	Classic only	2007	P35-4002
Silverado 2500LD	All	99 - 06	P35-4002
Silverado 3500HD	All	01 - 06	P35-4002
	All	07 - 10	P35-4006
	All	11 - 16	P35-4013
	Classic only	2007	P35-4002
Suburban	All	00 - 06	P35-4001
Suburban 1500	All	07 - 16	P35-4014
Suburban 2500	All	00 - 06	P35-4002
Tahoe	All	00 - 06	P35-4001
	All	00 - 06	P35-4002
	All	07 - 16	P35-4014
Dodge			
Ram 1500	Club Cab	09 - 16	P35-5005
	Crew Cab (excl. rebel package)	09 - 16	P35-5005
	Mega Cab	06 - 08	P35-5006
	Quad Cab	09 - 16	P35-5005
	Quad Cab	02 - 05	P35-5006
	Regular Cab	09 - 16	P35-5005
Ram 2500	Crew Cab	10 - 16	P35-5006
	Mega Cab	10 - 16	P35-5006
	Standard Cab	10 - 16	P35-5006
	Quad Cab	03 - 09	P35-5006
Ram 3500	Crew Cab	10 - 16	P35-5006
	Mega Cab	10 - 16	P35-5006
	Standard Cab	10 - 16	P35-5006
	Quad Cab	03 - 09	P35-5006
Ford			
Excursion	All	00 - 06	P35-3001
Expedition	All	03 - 16	P35-3007
F-150	Excl. Raptor and EcoBoost models	04 - 16	P35-3007

3" Pro Series™ Bull Bars

Make / Model	Style / Notes	Years	Black#
Ford (continued)			
F-250	Super Duty	99 - 07	P35-3001
	Super Duty	08 - 10	P35-3006
	Super Duty	11 - 16	P35-3012
F-350	Super Duty	99 - 07	P35-3001
	Super Duty	08 - 10	P35-3006
	Super Duty	11 - 16	P35-3012
GMC			
Sierra 1500	All	99 - 06	P35-4001
	All (excl. Denali)	07 - 16	P35-4014
	Classic only	2007	P35-4001
	Denali	07 - 13	P35-4014
Sierra 1500HD	All	01 - 06	P35-4002
	Classic only	2007	P35-4002
Sierra 2500HD	All	01 - 06	P35-4002
	All	07 - 10	P35-4006
	All	11 - 16	P35-4013
	Classic only	2007	P35-4002
Sierra 2500LD	All	99 - 06	P35-4002
Sierra 3500HD	All	01 - 06	P35-4002
	All	07 - 10	P35-4006
	All	11 - 16	P35-4013
	Classic only	2007	P35-4002
Yukon	All	00 - 06	P35-4001
Yukon Denali XL	All	07 - 16	P35-4014
Yukon XL	All	00 - 06	P35-4001
	All	07 - 16	P35-4014
Yukon XL 2500	All	00 - 06	P35-4002
Lincoln			
Mark LT	All	05 - 09	P35-3007
Nissan			
Titan XD	All	2016	P35-9004
Titan	All	04 - 15	P35-9001
Ram			
1500	Club Cab	10 - 16	P35-5005
	Crew Cab (excl. rebel package)	10 - 16	P35-5005
	Quad Cab	10 - 16	P35-5005
	Regular Cab	10 - 16	P35-5005
2500	Crew Cab	10 - 16	P35-5006
	Mega Cab	10 - 16	P35-5006
3500	Crew Cab	10 - 16	P35-5006
	Mega Cab	10 - 16	P35-5006
Toyota			
Sequoia	All	08 - 16	P35-2004
Tacoma	All	2016	P35-2010
	All	05 - 15	P35-2002
Tundra	All	07 - 16	P35-2004

3"

BULL BARS

with a vehicle-specific fit for hundreds of applications

/ Pre-drilled crossbar

The crossbar has two pre-drilled holes to securely mount auxiliary lights, including round lights up to 5 1/2" in diameter and LED light bars

/ Removable skid plate

The brushed stainless steel skid plate protects the front and underside of the vehicle and can be removed for a custom look

/ Vehicle-specific fit

Each application uses unique mounting brackets and pre-existing factory holes to eliminate drilling and reduce installation time

Features and benefits

- 3" diameter, heavy-wall tube design
- Pre-drilled crossbar for mounting auxiliary lights
- Removable, brushed stainless steel skid plate deflects small road debris
- Tow hooks available for 2010-2016 Ram 2500 / 3500 trucks. See page 42 for details
- No-drill, vehicle-specific application for a custom fit
- See page 44 for application information
- Three-year warranty on black finish and limited lifetime warranty on polished stainless



B35-9003

Material and finish options

Bull bar

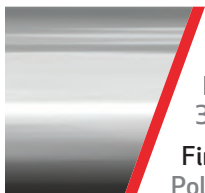

Material:
304 stainless steel
Finish:
Polished stainless

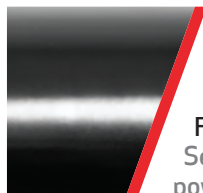

Material:
Carbon steel
Finish:
Semi-gloss black powder coat

Skid plate



Material:
304 stainless steel
Finish:
Brushed stainless



3" BULL BAR ACCESSORIES

License plate bracket



35-0000

- Easily bolts onto 3" crossbar, using existing skid plate hardware
- Provides a solid mounting location to keep license plate visible
- Steel construction with black powder coat finish
- Includes two license plate mounting bolts

Bull bar tow hooks for Ram trucks



35-5TOW

- Perfect for recovery towing applications
- Up to 10,000 lbs. load capacity
- Durable semi-gloss black powder coat finish
- Includes hardware for a solid installation
- Fits bull bars #35-5006, #B35-5006, #B35-5006-3, #P35-5006 for 2010-2016 Ram 2500 / 3500 trucks

APPLICATION GUIDE

3" Bull Bars				
Make / Model	Style / Notes	Years	Stainless#	Black#
Cadillac				
Escalade	All	07 - 14	35-4014	B35-4014
Escalade EXT	All	07 - 14	35-4014	B35-4014
Chevrolet				
Avalanche	All	07 - 14	35-4014	B35-4014
	All	2015	35-4015	--
Avalanche 1500	All	01 - 06	35-4001	B35-4001
Avalanche 2500	All	01 - 06	35-4002	B35-4002
Blazer	All	92 - 94	35-4009	B35-4009
CK Series Pickup	All	88 - 98	35-4009	B35-4009
Colorado	All	04 - 14	35-4010	B35-4010
	All	15 - 16	35-4015	B35-4015
Silverado 1500	All	99 - 06	35-4001	B35-4001
	All	07 - 16	35-4014	B35-4014
	Classic only	2007	35-4001	B35-4001
Silverado 1500HD	All	01 - 06	35-4002	B35-4002
	Classic only	2007	35-4002	--
Silverado 2500HD	All	01 - 06	35-4002	B35-4002
	All	07 - 10	35-4006	B35-4006
	All	11 - 16	35-4013	B35-4013
	Classic only	2007	35-4002	B35-4002
Silverado 2500LD	All	99 - 06	35-4002	B35-4002
Silverado 3500HD	All	01 - 06	35-4002	B35-4002
	All	07 - 10	35-4006	B35-4006
	All	11 - 16	35-4013	B35-4013
	Classic only	2007	35-4002	B35-4002
Suburban	All	92 - 94	35-4009	B35-4009
	All	00 - 06	35-4001	B35-4001
Suburban 1500	All	07 - 16	35-4014	B35-4014
	All	00 - 06	35-4002	B35-4002
	All	07 - 14	35-4007	--
Tahoe	All	92 - 94	35-4009	B35-4009
	All	00 - 06	35-4001	B35-4001
	All	00 - 06	35-4002	B35-4002
	All	07 - 16	35-4014	B35-4014

Applications continued on the following page

3" Bull Bars

Make / Model	Style / Notes	Years	Stainless#	Black#
Dodge				
Dakota	All	05 - 12	35-5003	B35-5003
Ram 1500	Club Cab	09 - 16	35-5005	B35-5005
	Crew Cab	06 - 08	35-5004	B35-5004
	Crew Cab (excl. rebel package)	09 - 16	35-5005	B35-5005
	Mega Cab	06 - 08	35-5004	B35-5004
	Mega Cab	06 - 08	35-5006	B35-5006
	Quad Cab	94 - 01	35-5000	B35-5000
	Quad Cab	06 - 08	35-5004	B35-5004
	Quad Cab	09 - 16	35-5005	B35-5005
	Quad Cab	02 - 05	35-5006	B35-5006
	Regular Cab	06 - 08	35-5004	B35-5004
	Regular Cab	09 - 16	35-5005	B35-5005
Ram 2500	All	94 - 02	35-5000	B35-5000
	Crew Cab	10 - 16	35-5006	B35-5006
	Mega Cab	10 - 16	35-5006	B35-5006
	Standard Cab	10 - 16	35-5006	B35-5006
	Quad Cab	94 - 01	35-5000	B35-5000
	Quad Cab	03 - 09	35-5006	B35-5006
Ram 3500	All	94 - 02	35-5000	B35-5000
	Crew Cab	10 - 16	35-5006	B35-5006
	Mega Cab	10 - 16	35-5006	B35-5006
	Standard Cab	10 - 16	35-5006	B35-5006
	Quad Cab	94 - 01	35-5000	B35-5000
	Quad Cab	03 - 09	35-5006	B35-5006
Ford				
Excursion	All	00 - 06	35-3001	B35-3001
Expedition	4WD only	97 - 02	35-3004	B35-3004
	All	03 - 16	35-3007	B35-3007
Explorer	All	06 - 10	35-3005	B35-3005
	All	11 - 16	35-3013	B35-3013
	Sport Trac	07 - 11	35-3005	B35-3005
F-150	2WD only	99 - 03	35-3004	B35-3004
	4WD only	97 - 03	35-3004	B35-3004
	Excl. Raptor and EcoBoost models	04 - 16	35-3007	B35-3007
F-250	Super Duty	99 - 07	35-3001	B35-3001
	Super Duty	08 - 10	35-3006	B35-3006
F-350	Super Duty	99 - 07	35-3001	B35-3001
	Super Duty	08 - 10	35-3006	B35-3006
	Super Duty	11 - 16	35-3012	B35-3012
F-450	Super Duty	11 - 16	35-3012	B35-3012
F-550	Super Duty	11 - 16	35-3012	B35-3012

Applications continued on the following page

APPLICATION GUIDE (CONTINUED)

3" Bull Bars				
Make / Model	Style / Notes	Years	Stainless#	Black#
Ford (continued)				
Ranger	All	08 - 12	35-3011	B35-3011
	Edge	98 - 07	35-3009	B35-3009
	XLT	98 - 07	35-3009	B35-3009
GMC				
Canyon	All	04 - 14	35-4010	B35-4010
CK Series Pickup	All	88 - 98	35-4009	B35-4009
Sierra 1500	All	99 - 06	35-4001	B35-4001
	All (Excl. Denali)	07 - 16	35-4014	B35-4014
	Classic only	2007	35-4001	B35-4001
	Denali	07 - 13	--	B35-4014
Sierra 1500HD	All	01 - 06	35-4002	B35-4002
	Classic only	2007	35-4002	B35-4002
Sierra 2500HD	All	01 - 06	35-4002	B35-4002
	All	07 - 10	35-4006	B35-4006
	All	11 - 16	35-4013	B35-4013
	Classic only	2007	35-4002	B35-4002
Sierra 2500LD	All	99 - 06	35-4002	B35-4002
Sierra 3500HD	All	01 - 06	35-4002	B35-4002
	All	07 - 10	35-4006	B35-4006
	All	11 - 16	35-4013	B35-4013
	Classic only	2007	35-4002	B35-4002
Yukon	All	00 - 06	35-4001	B35-4001
Yukon Denali XL	All	07 - 16	35-4014	B35-4014
Yukon XL	All	00 - 06	35-4001	B35-4001
	All	07 - 16	35-4014	B35-4014
Yukon XL 2500	All	00 - 06	35-4002	B35-4002
	All	07 - 14	35-4007	--
Honda				
Pilot	All	03 - 08	35-6001	B35-6001
Ridgeline	All	06 - 14	35-6001	B35-6001
Jeep				
Commander	All	06 - 11	35-1001	B35-1001
Grand Cherokee	All	05 - 07	35-1001	B35-1001
	All	11 - 16	35-1003	B35-1003
Lincoln				
Mark LT	All	05 - 09	35-3007	B35-3007

Applications continued on the following page

3" Bull Bars

Make / Model	Style / Notes	Years	Stainless#	Black#
Nissan				
Armada	All	04 - 15	35-9001	B35-9001
Frontier	All	05 - 15	35-9002	B35-9002
Pathfinder	All	05 - 07	35-9002	B35-9002
	All	08 - 12	35-9003	B35-9003
Titan XD	All	2016	35-9004	B35-9004
Titan	All	04 - 15	35-9001	B35-9001
Xterra	All	05 - 15	35-9002	B35-9002
Ram				
1500	Club Cab	10 - 16	35-5005	B35-5005
	Crew Cab (excl. rebel package)	10 - 16	35-5005	B35-5005
	Quad Cab	10 - 16	35-5005	B35-5005
	Regular Cab	10 - 16	35-5005	B35-5005
2500	Crew Cab	10 - 16	35-5006	B35-5006
	Mega Cab	10 - 16	35-5006	B35-5006
3500	Crew Cab	10 - 16	35-5006	B35-5006
	Mega Cab	10 - 16	35-5006	B35-5006
Toyota				
4Runner	All	03 - 09	35-2005	B35-2005
	All	10 - 13	35-2006	B35-2006
	SR5 only (excl. Limited)	14 - 16	35-2006	B35-2006
FJ Cruiser	All	07 - 14	35-2003	B35-2003
Highlander	All	14 - 16	35-2009	B35-2009
Sequoia	All	01 - 07	35-2001	B35-2001
	All	08 - 16	35-2004	B35-2004
Tacoma	All	2016	35-2010	B35-2010
	All	05 - 15	35-2002	B35-2002
	All	98 - 04	35-2000	B35-2000
Tundra	All	99 - 06	35-2001	B35-2001
	All	07 - 16	35-2004	B35-2004

GRILLE GUARDS





DARE TO CONQUER NEW TERRAIN

It wasn't the easy road that made your customers choose their truck. They chose it because there was new territory to be explored, wilderness to be tamed and terrain to be conquered.

For the conqueror in every truck owner, ARIES grille guards are available for a wide variety of applications. Each one is built vehicle-specific, not just to eliminate drilling and speed up installation, but because your customers expect a custom fit.

For those who dare to go even further, the Pro Series™ grille guard is unlike any other. Its patented crossbar is able to house an LED light bar and features an interchangeable cover plate to protect and add a custom look.

Don't make them settle. Give your customers confidence by giving them ARIES.



Pro Series™ grille guard

The Pro Series™ grille guard can accept one or more single-row LED light bars up to 20 or 30" long, using the patented crossbar housing and channel-style bracket



Patented light mounts

With a patented LED light bar housing on our Pro Series™ grille guards and a pre-drilled crossbar on our standard models, these grille guards make customization easy



Vehicle-specific fit

All ARIES grille guards use pre-existing holes on the vehicle to cut down on installation time, and many use a four-point mounting system for increased rigidity

CATEGORY INDEX

50 | **Pro Series™ Grille Guards**

52 | **Pro Series™ Cover Plates**

54 | **Grille Guards**

PRO SERIES™ GRILLE GUARDS

with a patented, customizable LED light bar housing

/ Patented crossbar

One or more single-row LED light bars, up to 20 or 30" in total length, can be mounted using the articulating, channel-style bracket

/ Customizable cover plate

The included black mesh cover plate keeps the light bar protected from theft and damage and can be swapped out for a custom look

/ Vehicle-specific fit

The 1/4" thick risers and 1 1/2" mandrel-bent steel tubing contour to the profile of each specific vehicle for seamless integration

Features and benefits

- Patented crossbar houses a single-row LED light bar (light bar not included)
- Interchangeable cover plate protects the light bar and offers easy customization
- Channel-style bracket accepts one or multiple light bars
- Articulating bracket allows light to be mounted at a custom angle
- Tested, textured black powder coat easily hides scratches and dirt
- One-piece, 1 1/2" diameter, heavy-wall tube design
- High-strength carbon steel construction
- Protective rubber stripping along the risers
- Complements other ARIES Pro Series™ accessories
- No-drill, vehicle-specific application for a custom fit
- Pro Series™ grille guard patent# US9108581B2
- All Pro Series™ grille guards come standard with the black mesh cover plate #PC30MB (#PJ20MB for Jeep)
- See application guide on page 53
- Three-year warranty



Material and finish

Grille guard

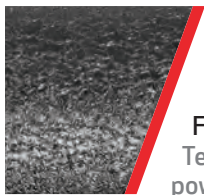

Material:
Carbon steel
Finish:
Textured black powder coat

Cover plate (included)

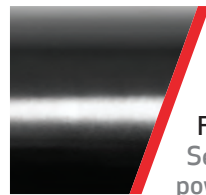

Material:
Carbon steel
Finish:
Semi-gloss black powder coat



PRO SERIES™ GRILLE GUARD ACCESSORIES

License plate bracket



85-0000

- Easily bolts onto the crossbar, using included hardware
- Provides a solid mounting location to keep license plate visible
- Steel construction with black powder coat finish
- Includes license plate mounting bolts

Interchangeable cover plates

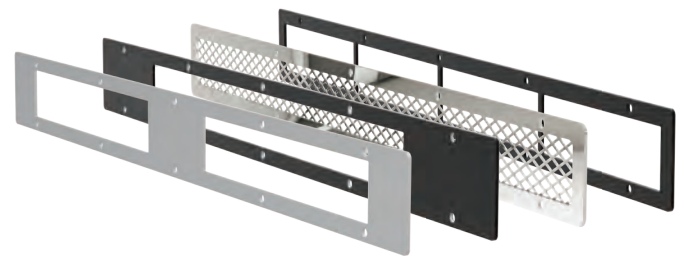

See page 52 for options

- Easily swapped out for instant customization
- Available in multiple styles and finishes
- Protects light bars from theft and the elements
- Securely bolts onto the patented center crossbar
- All cover plate part numbers listed on page 52

PRO SERIES™ GRILLE GUARD COVER PLATES

with an interchangeable design for easy customization

A key feature of the patented Pro Series™ grille guard is its unique light bar housing and mounting bracket. The channel-style bracket accepts one or more single-row light bars, up to 30" in total length (20" for Jeep®). This means multiple combinations can be used, such as one 30", two 10" or three 7". The crossbar housing keeps the light bars well protected from theft and damage.

To take customization even further, the Pro Series™ grille guard can also accept different crossbar cover plates. While each Pro Series™ grille guard comes standard with a black mesh cover plate, we offer replacements in three finishes and multiple styles to let your customers choose the look that best suits their vehicle.

Material and finish options

Cover plate

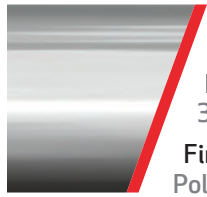

Material:
304 stainless steel
Finish:
Polished stainless



Material:
304 stainless steel
Finish:
Brushed stainless

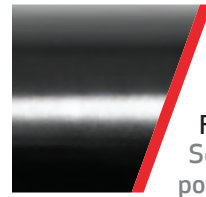

Material:
Carbon steel
Finish:
Semi-gloss black powder coat



PC10OB



PC10OS



PC20OB



PC20OS



PC30MB



PC30MS



PC30OB



PC30OS



PJ20MB



PJ20MS



PJ20OB

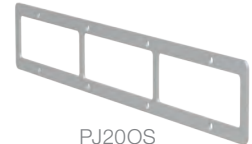

PJ20OS

Pro Series™ Cover Plates				
Light Bar Length	Style	Black#	Polished#	Brushed#
Universal (excluding Jeep JK)				
10"	Open-face	PC10OB	--	PC10OS
20"	Open-face	PC20OB	--	PC20OS
30"	Mesh-face	PC30MB	PC30MS	--
30"	Open-face	PC30OB	--	PC30OS
Jeep JK Only				
20"	Open-face	PJ20MB	PJ20MS	--
20"	Mesh-face	PJ20OB	--	PJ20OS



APPLICATION GUIDE

Pro Series™ Grille Guards			
Make / Model	Style / Notes	Years	Part#
Chevrolet			
Silverado 1500	All	07 - 13	P4068
	All	14 - 16	P4083
Dodge			
Ram 1500	Mega Cab	09 - 10	P5058
	Quad Cab	09 - 10	P5058
	Regular Cab	09 - 10	P5058
Ram 2500	Crew Cab	10 - 16	P5056
	Mega Cab	10 - 16	P5056
	Standard Cab	10 - 16	P5056
Ram 3500	Crew Cab	10 - 16	P5056
	Mega Cab	10 - 16	P5056
	Standard Cab	10 - 16	P5056
Ford			
F-150	Quick release tilt (allows for original tow hooks)	09 - 14	P3063
F-250	Super Duty (allows for original tow hooks)	11 - 14	P3064
F-350	Super Duty (allows for original tow hooks)	11 - 14	P3064
F-450	Super Duty (allows for original tow hooks)	11 - 14	P3064
F-550	Super Duty (allows for original tow hooks)	11 - 14	P3064
GMC			
Sierra 1500	All	14 - 15	P4084
Jeep			
Wrangler	All	07 - 15	P1050
Ram			
1500	All	09 - 15	P5058
2500	Crew Cab	10 - 15	P5056
	Mega Cab	10 - 15	P5056
3500	Crew Cab	10 - 15	P5056
	Mega Cab	10 - 15	P5056
Toyota			
Tacoma	All	2016	P2068
	All	05 - 15	P2054
Tundra	All	07 - 15	P2067

REPLACEMENT LIGHT BAR MOUNTING BRACKETS

- Accepts most single-row LED light bars up to 20" or 30" long
- Channel-style mounting system for flexible installation options
- Articulating design allows light to be mounted at a custom angle
- Included with all Pro Series™ grille guards
- Light bar not included



Available parts:
PR20 - 20" / PR30 - 30"

GRILLE GUARDS

with a vehicle-specific fit for hundreds of applications

/ Customizable design

The crossbar has two pre-drilled holes to accept auxiliary lights, and the headlight cages can be removed for a custom look

/ Vehicle-specific fit

The 1/4" thick risers and 1 1/2" mandrel-bent steel tubing contour to the profile of each specific vehicle for seamless integration

/ Simple, secure mounting

The risers bolt onto pre-existing factory holes in the vehicle's frame to eliminate the need for drilling and ensure a solid mount

Features and benefits

- One-piece, 1 1/2" diameter, heavy-wall tube design
- Pre-drilled crossbar for mounting auxiliary lights
- Removable headlight cages for a custom look
- Protective rubber stripping along the risers
- No-drill, vehicle-specific application for a custom fit
- See application guide on page 56
- Three-year warranty on black finish and limited lifetime warranty on polished stainless

Material and finish options

Grille guard

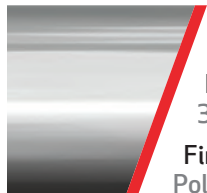

Material:
304 stainless steel
Finish:
Polished stainless

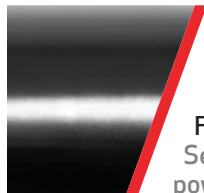

Material:
Carbon steel
Finish:
Semi-gloss black powder coat

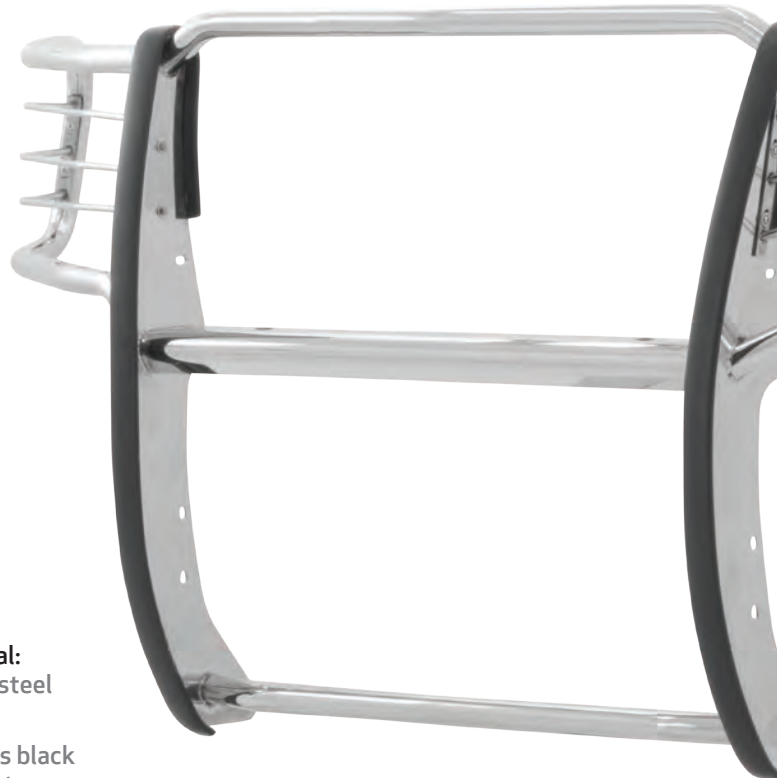



ARIES

ODYEA

LER

APPLICATION GUIDE

Grille Guards				
Make / Model	Style / Notes	Years	Stainless#	Black#
Chevrolet				
Avalanche	All	07 - 13	4065-2	4065
Avalanche 1500	With plastic clad only	02 - 06	4052-2	4052
	Without plastic clad only	03 - 06	4059-2	4059
Blazer	4WD only	98 - 04	--	4044
CK Pickup	All	88 - 98	4042-2	4042
Colorado	All	2015	4088-2	4088
	Incl. off-road 4WD packages for Z71 submodels	04 - 14	4080-2	4080
	Incl. off-road 4WD packages for Z71 submodels (removal of front crossbar is required)	09 - 10	4080-2	4080
S-10	4WD only	98 - 04	--	4044
Silverado 1500	All	99 - 02	4043-2	4043
	All	03 - 06	4059-2	4059
	All	07 - 13	4068-2	4068
	All	14 - 16	4083-2	4083
	Classic only	2007	4059-2	4059
Silverado 2500HD	All	00 - 02	--	4050
	All	03 - 06	4061-2	4061
	All	07 - 10	4069-2	4069
	All	11 - 14	4081-2	4081
	All	15 - 16	4085-2	4085
	Classic only	2007	4061-2	4061
Silverado 3500HD	All	00 - 02	--	4050
	All	03 - 06	4061-2	4061
	All	07 - 10	4069-2	4069
	All	11 - 14	4081-2	4081
	All	15 - 16	4085-2	4085
	Classic only	2007	4061-2	4061
Suburban	All	92 - 99	4042-2	4042
Suburban 1500	All	00 - 06	4043-2	4043
	All	07 - 14	4065-2	4065
	All	15 - 16	4087-2	4087
Tahoe	All	95 - 99	4042-2	4042
	All	00 - 06	4043-2	4043
	All	07 - 14	4065-2	4065
Dodge				
Dakota	All	97 - 04	--	5041
	All	05 - 13	5055-2	5055
Durango	All	98 - 03	--	5041
Nitro	All	07 - 13	--	5051

Applications continued on the following page

Grille Guards

Make / Model	Style / Notes	Years	Stainless#	Black#
Dodge (continued)				
Ram 1500	All	94 - 01	5042-2	5042
	All	02 - 05	5045-2	5045
	Mega Cab	06 - 08	--	5050
	Mega Cab	09 - 10	5058-2	5058
	Quad Cab	06 - 08	--	5050
	Quad Cab	09 - 10	5058-2	5058
	Regular Cab	06 - 08	--	5050
	Regular Cab	09 - 10	5058-2	5058
Ram 2500	All	94 - 02	5042-2	5042
	All	03 - 05	5046-2	5046
	Crew Cab	10 - 16	5056-2	5056
	Mega Cab	06 - 09	5049-2	5049
	Mega Cab	10 - 16	5056-2	5056
	Standard Cab	10 - 16	5056-2	5056
	Quad Cab	06 - 09	5049-2	5049
	Regular Cab	06 - 09	5049-2	5049
Ram 3500	All	94 - 02	5042-2	5042
	All	03 - 05	5046-2	5046
	Crew Cab	06 - 09	5049-2	5049
	Crew Cab	10 - 16	5056-2	5056
	Mega Cab	06 - 09	5049-2	5049
	Mega Cab	10 - 16	5056-2	5056
	Standard Cab	10 - 16	5056-2	5056
	Regular Cab	06 - 09	5049-2	5049
Ford				
Escape	All	02 - 04	--	3049
	All	05 - 07	--	3058
	All	08 - 12	3062-2	3062
Excursion	All	00 - 04	3045-2	3045
	All	05 - 06	3057-2	3057
Expedition	2WD only	99 - 02	3046-2	3046
	All	97 - 98	3046-2	3046
	All	03 - 06	--	3054
	All	07 - 14	3060-2	3060

Applications continued on the following page

APPLICATION GUIDE (CONTINUED)

Grille Guards				
Make / Model	Style / Notes	Years	Stainless#	Black#
Ford (continued)				
Explorer	All	2005	--	3052
	All	06 - 10	3059-2	3059
	All	11 - 15	3065-2	3065
	Eddie Bauer	02 - 04	--	3052
	Limited	02 - 04	--	3052
	NBX	2004	--	3052
	Sport	01 - 02	--	3048
	Sport XLS	03 - 04	--	3048
	Sport XLT	03 - 04	--	3048
	XLS	02 - 04	--	3052
	XLT	02 - 04	--	3052
Explorer Sport Trac	All	01 - 06	--	3048
	All	07 - 10	3059-2	3059
F-150	All	15 - 16	3066-2	3066
	All	04 - 08	3056-2	3056
	Incl. flareside (2WD only)	99 - 03	3046-2	3046
	Incl. flareside (4WD only)	99 - 03	3046F-2	--
	Quick release tilt (allows for original tow hooks)	09 - 14	3063-2	3063
F-250	Super Duty	99 - 04	3045-2	3045
	Super Duty	05 - 07	3057-2	3057
	Super Duty	08 - 10	3061-2	3061
	Super Duty (allows for original tow hooks)	11 - 14	3064-2	3064
	Super Duty (allows for original tow hooks)	15 - 16	3064-2	3064
F-350	Super Duty	99 - 04	3045-2	3045
	Super Duty	05 - 07	3057-2	3057
	Super Duty	08 - 10	3061-2	3061
	Super Duty (allows for original tow hooks)	11 - 14	3064-2	3064
	Super Duty (allows for original tow hooks)	15 - 16	3064-2	3064
F-450	Super Duty	08 - 10	3061-2	3061
	Super Duty (allows for original tow hooks)	11 - 14	3064-2	3064
	Super Duty (allows for original tow hooks)	15 - 16	3064-2	3064
F-550	Super Duty (allows for original tow hooks)	11 - 14	3064-2	3064
	Super Duty (allows for original tow hooks)	15 - 16	3064-2	3064
	Super Duty (without fender flares)	08 - 10	3061-2	3061
Ranger	All	98 - 00	--	3044
	Edge	01 - 12	3053-2	3053
	XLT	01 - 12	3053-2	3053

Applications continued on the following page

Grille Guards				
Make / Model	Style / Notes	Years	Stainless#	Black#
GMC				
Canyon	All	2015	4088-2	4088
	Incl. off-road 4WD packages for Z71 submodels	04 - 14	4080-2	4080
	Incl. off-road 4WD packages for Z71 submodels (removal of front crossbar is required)	09 - 10	4080-2	4080
CK Series Pickup	All	1998	4042-2	4042
	All	88 - 97	4042-2	--
Sierra 1500	All	99 - 02	4045-2	4045
	All	03 - 06	4062-2	4062
	All	07 - 13	4070-2	4070
	Classic only	2007	4062-2	4062
	Excl. Denali	14 - 16	4084-2	4084
Sierra 2500	All	11 - 14	4082-2	4082
	Excl. Denali	15 - 16	4086-2	4086
Sierra 2500HD	All	03 - 06	4063-2	4063
	All	07 - 10	4071-2	4071
	Classic only (All)	2007	4063-2	4063
Sierra 3500	All	11 - 14	4082-2	4082
	Excl. Denali	15 - 16	4086-2	4086
Sierra 3500HD	All	03 - 06	4063-2	4063
	All	07 - 10	4071-2	4071
	Classic only (All)	2007	4063-2	4063
Yukon	All	95 - 99	4042-2	4042
	All	00 - 06	4045-2	4045
Yukon XL 1500	All	07 - 14	4067-2	4067
	All	07 - 14	4067-2	4067
Honda				
Element	All	03 - 07	--	6048
	Excl. SC	08 - 10	--	6048
Pilot	All	09 - 11	6053-2	6053
	All	12 - 14	6056-2	6056
Ridgeline	All	06 - 12	6055-2	6055
Hummer				
H2	Incl. SUT deluxe	03 - 09	4076-2	4076
H3	4WD only	06 - 11	4077-2	4078
H3T	4WD only	09 - 10	4077-2	4078
Jeep				
Cherokee	Excl. Limited	86 - 00	--	1043
Commander	All	06 - 11	--	1048
Grand Cherokee	All	05 - 10	--	1046
	Excl. SRT and Trail Hawk	11 - 15	--	1052
	Tow hook only	99 - 04	--	1044
	Tow hook only (4WD only)	95 - 98	--	1042

Applications continued on the following page

APPLICATION GUIDE (CONTINUED)

Grille Guards				
Make / Model	Style / Notes	Years	Stainless#	Black#
Jeep (continued)				
Liberty	No headlight cage	08 - 12	--	1051
	All	05 - 07	--	1047
	Excl. Renegade	02 - 04	--	1045
Sport	Excl. Limited	86 - 00	--	1043
Wrangler	No headlight cage	07 - 16	--	1050
Lincoln				
Mark LT	All	05 - 08	3056-2	3056
Mazda				
Tribute	All	08 - 12	3062-2	3062
Nissan				
Armada	Excl. XE model	04 - 14	9046-2	9046
Frontier	All	98 - 00	--	9043
	All	01 - 04	--	9044
	All	05 - 15	9047-2	9047
Pathfinder	All	99 - 04	--	9042
	All	05 - 07	9047-2	9047
	All	08 - 12	9049-2	9049
Titan	Excl. XE model, Incl. Pro 4X	04 - 15	9046-2	9046
Xterra	All	99 - 01	--	9043
	All	02 - 04	--	9045
	All	05 - 15	--	9048
Ram				
1500	All	09 - 16	5058-2	5058
2500	Crew Cab	10 - 16	5056-2	5056
	Mega Cab	10 - 16	5056-2	5056
3500	Crew Cab	10 - 16	5056-2	5056
	Mega Cab	10 - 16	5056-2	5056
Toyota				
4Runner	SR5	14 - 15	2066-2	2066
	All	96 - 98	--	2042
	All	99 - 02	2044-2	2044
	All	03 - 09	2058-2	2058
	All	10 - 13	2063-2	2063
FJ Cruiser	All	07 - 14	--	2059
Highlander	Excl. Hybrid models	11 - 13	--	2064
	Gas and Hybrid models	01 - 07	--	2056
	Gas and Hybrid models	08 - 10	--	2061
Landcruiser	All	98 - 03	--	2043
Rav4	All	06 - 15	2065-2	2065

Applications continued on the following page

Grille Guards

Make / Model	Style / Notes	Years	Stainless#	Black#
Toyota (continued)				
Sequoia	All	08 - 15	2067-2	2067
	Trimming required	10 - 11	2067-2	2067
Tacoma	All	2016	2068-2	2068
	All	05 - 15	2054-2	2054
	All	01 - 04	2049-2	2049
	All	98 - 00	--	2042
Tundra	All	99 - 02	2045-2	2045
	All	07 - 15	2067-2	2067
	Double Cab	04 - 06	--	2053
	Extended Cab	03 - 06	2052-2	2052



SIDE BARS





STEP UP AND STAND OUT

When your customers start and end their day turning the ignition of their truck, unreliable footing isn't an option. For the serious truck owner, side bars aren't there just to look pretty. They're there to take a boot to the face every single day, and look pretty doing it.

New for 2016, AdvantEDGE™ side bars give your customers a fresh look, with an angular, eight-sided tube profile and all-aluminum construction. They feature a stamped aluminum tread, die-cast aluminum end caps and a track mounting system to fit multiple makes and models.

ARIES side bars are also available in three different diameters, two tube profiles and multiple finishes, including lightweight aluminum options.

Don't pull the footing out from under your customers. Give them a solid step up with ARIES.



NEW AdvantEDGE™ series

The new AdvantEDGE™ side bars have an all-aluminum construction and a unique, eight-sided tube profile in two finish options to complement the style of today's trucks



More applications

ARIES side bars are available for hundreds of applications, and each is designed for vehicle-specific installation to give your customers the right fit for their ride

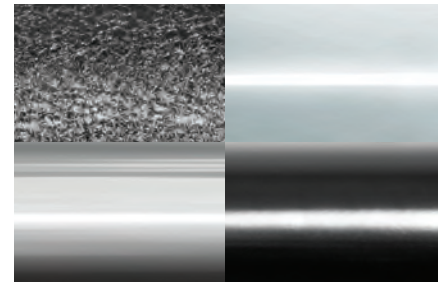

Variety of finishes

ARIES side bars come in an array of finishes, including textured black carbon and semi-gloss black aluminum. See page 11 to learn more about our finishes

CATEGORY INDEX

64 | 5 ½" AdvantEDGE™

68 | 6" Ovals

74 | 4" Ovals

78 | 4" Oval WTW

82 | 4" Big Step™ Round

86 | 3" Pro Series™ Round

90 | 3" Round

5 1/2"

ADVANTEDGE™ SIDE BARS

NEW

with a unique, octagonal tube and all-aluminum construction

/ Unique design

The 5 1/2" angular, eight-sided tube profile and octagonal grid tread offer a fresh look to complement the style of today's vehicles

/ All-aluminum build

The aluminum construction is strong, lightweight, rust-free and has no plastic parts, meaning it will never crack or fade

/ Easier inventory

Four base lengths fit all applications to allow additional space for inventory, while vehicle-specific brackets provide a custom fit

Features and benefits

- Unique, eight-sided tube profile to complement the style of modern trucks
- Extruded, all-aluminum construction to be strong, lightweight and rust-free
- Stamped aluminum tread for a non-skid step that will never crack or fade
- Die-cast aluminum end caps for a durable accent
- Complements other ARIES AdvantEDGE™ accessories
- Universal 8mm track mounting system for easy, secure installation
- Four base lengths for easier inventory (53", 75", 85" and 91")
- USA-made, vehicle-specific mounting brackets for a precise fit
- Sold in pairs with mounting brackets sold separately. See page 66 for application information
- Patent pending
- Five-year warranty



Material and finish options

Side bars



Material:
Aluminum alloy

Finish:
Chrome
powder coat



Material:
Aluminum alloy

Finish:
Carbide black
powder coat

Octagonal grid



Material:
Aluminum alloy

Finish:
Textured black
powder coat



UNIVERSAL TRACK MOUNTING SYSTEM

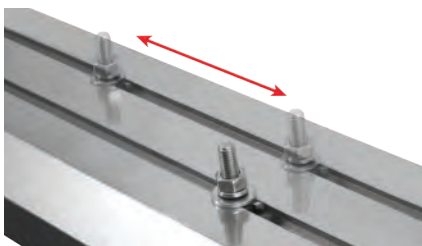

AdvantEDGE™ side bars come in four base lengths, including 53", 75", 85" and 91", to take up less inventory space and allow for easier ordering. To ensure a custom fit for every application, the side bars install using a track

mounting system and vehicle-specific mounting brackets. Using the application guide, determine the side bar length and bracket part number that will fit your customer's specific vehicle. All brackets will accommodate both finish options.

APPLICATION GUIDE

5 1/2" AdvantEDGE™ Side Bars & Mounting Brackets				Brackets Only	Side Bars Only		Side Bar Kits (Brackets Included)	
Make / Model	Style	Notes	Years	Bracket#	Chrome#	Black#	Chrome#	Black#
Chevrolet								
Colorado	Crew Cab	--	15 - 16	2055104	2055885	2055985	2555044	2556044
	Extended Cab	--	15 - 16	2055104	2055875	2055975	2555043	2556043
Silverado 1500	Standard Cab	Gas only	07 - 16	2055100	2055853	2055953	2555001	2556001
	Double Cab	Gas only	07 - 16	2055101	2055875	2055975	2555002	2556002
	Crew Cab	Gas only	07 - 16	2055101	2055885	2055985	2555003	2556003
Silverado 2500	Standard Cab	Gas only	07 - 16	2055100	2055853	2055953	2555001	2556001
	Double Cab	Gas only	07 - 16	2055101	2055875	2055975	2555002	2556002
	Crew Cab	Gas only	07 - 16	2055101	2055885	2055985	2555003	2556003
	Standard Cab	Diesel only	07 - 16	2055102	2055853	2055953	2555020	2556020
	Double Cab	Diesel only	07 - 16	2055102	2055875	2055975	2555021	2556021
	Crew Cab	Diesel only	07 - 16	2055102	2055885	2055985	2555022	2556022
Silverado 3500	Standard Cab	Gas only	07 - 16	2055100	2055853	2055953	2555001	2556001
	Double Cab	Gas only	07 - 16	2055101	2055875	2055975	2555002	2556002
	Crew Cab	Gas only	07 - 16	2055101	2055885	2055985	2555003	2556003
	Standard Cab	Diesel only	07 - 16	2055102	2055853	2055953	2555020	2556020
	Double Cab	Diesel only	07 - 16	2055102	2055875	2055975	2555021	2556021
	Crew Cab	Diesel only	07 - 16	2055102	2055885	2055985	2555022	2556022
Dodge								
Ram 1500	Regular Cab	Gas and diesel	09 - 10	2055110	2055853	2055953	2555004	2556004
	Quad Cab	Gas and diesel	09 - 10	2055111	2055875	2055975	2555005	2556005
	Crew Cab	Gas and diesel	09 - 10	2055111	2055885	2055985	2555006	2556006
Ram 2500	Regular Cab	Gas and diesel	2010	2055110	2055853	2055953	2555004	2556004
	Crew Cab	Gas and diesel	2010	2055111	2055885	2055985	2555006	2556006
Ram 3500	Regular Cab	Gas and diesel	2010	2055110	2055853	2055953	2555004	2556004
	Crew Cab	Gas and diesel	2010	2055111	2055885	2055985	2555006	2556006
Ford								
F-150	Regular Cab	Gas only	15 - 16	2055122	2055853	2055953	2555011	2556011
	Regular Cab	Gas only	04 - 14	2055120	2055853	2055953	2555007	2556007
	SuperCab	Gas only	15 - 16	2055122	2055875	2055975	2555012	2556012
	SuperCab	Gas only	04 - 14	2055120	2055875	2055975	2555008	2556008
	SuperCrew	Gas only	15 - 16	2055121	2055885	2055985	2555010	2556010
	SuperCrew	Gas only	09 - 14	2055120	2055885	2055985	2555009	2556009
F-250	Regular Cab	Gas and diesel	1999	2055123	2055853	2055953	2555013	2556013
	Crew Cab	Gas and diesel	1999	2055124	2055891	2055991	2555015	2556015
	SuperCab	Gas and diesel	1999	2055123	2055875	2055975	2555014	2556014
F-250 Super Duty	Regular Cab	Gas and diesel	99 - 16	2055123	2055853	2055953	2555013	2556013
	Crew Cab	Gas and diesel	99 - 16	2055124	2055891	2055991	2555015	2556015
	SuperCab	Gas and diesel	99 - 16	2055123	2055875	2055975	2555014	2556014

5 1/2" AdvantEDGE™ Side Bars & Mounting Brackets				Brackets Only	Side Bars Only		Side Bar Kits (Brackets Included)	
Make / Model	Style	Notes	Years	Bracket#	Chrome#	Black#	Chrome#	Black#
Ford (continued)								
F-350 Super Duty	Regular Cab	Gas and diesel	99 - 16	2055123	2055853	2055953	2555013	2556013
	Crew Cab	Gas and diesel	99 - 16	2055124	2055891	2055991	2555015	2556015
	SuperCab	Gas and diesel	99 - 16	2055123	2055875	2055975	2555014	2556014
F-450 Super Duty	Regular Cab	Gas and diesel	99 - 16	2055123	2055853	2055953	2555013	2556013
	Crew Cab	Gas and diesel	99 - 16	2055124	2055891	2055991	2555015	2556015
	SuperCab	Gas and diesel	99 - 16	2055123	2055875	2055975	2555014	2556014
GMC								
Canyon	Crew Cab	--	15 - 16	2055104	2055885	2055985	2555044	2556044
	Extended Cab	--	15 - 16	2055104	2055875	2055975	2555043	2556043
Sierra 1500	Standard Cab	Gas only	07 - 16	2055100	2055853	2055953	2555001	2556001
	Double Cab	Gas only	07 - 16	2055101	2055875	2055975	2555002	2556002
	Crew Cab	Gas only	07 - 16	2055101	2055885	2055985	2555003	2556003
Sierra 2500	Standard Cab	Gas only	07 - 16	2055100	2055853	2055953	2555001	2556001
	Double Cab	Gas only	07 - 16	2055101	2055875	2055975	2555002	2556002
	Crew Cab	Gas only	07 - 16	2055101	2055885	2055985	2555003	2556003
	Standard Cab	Diesel only	07 - 16	2055102	2055853	2055953	2555020	2556020
	Double Cab	Diesel only	07 - 16	2055102	2055875	2055975	2555021	2556021
	Crew Cab	Diesel only	07 - 16	2055102	2055885	2055985	2555022	2556022
Sierra 3500	Standard Cab	Gas only	07 - 16	2055100	2055853	2055953	2555001	2556001
	Double Cab	Gas only	07 - 16	2055101	2055875	2055975	2555002	2556002
	Crew Cab	Gas only	07 - 16	2055101	2055885	2055985	2555003	2556003
	Standard Cab	Diesel only	07 - 16	2055102	2055853	2055953	2555020	2556020
	Double Cab	Diesel only	07 - 16	2055102	2055875	2055975	2555021	2556021
	Crew Cab	Diesel only	07 - 16	2055102	2055885	2055985	2555022	2556022
Nissan								
Titan	King Cab	Gas only	04 - 15	2055141	2055875	2055975	2555016	2556016
	Crew Cab	Gas only	04 - 15	2055141	2055885	2055985	2555017	2556017
Titan XD	Crew Cab	--	2016	2055142	2055855	2055985	2555042	2556042
Ram								
1500	Regular Cab	Gas and diesel	11 - 16	2055110	2055853	2055953	2555004	2556004
	Quad Cab	Gas and diesel	11 - 16	2055111	2055875	2055975	2555005	2556005
	Crew Cab	Gas and diesel	11 - 16	2055111	2055885	2055985	2555006	2556006
2500	Regular Cab	Gas and diesel	11 - 16	2055110	2055853	2055953	2555004	2556004
	Crew Cab	Gas and diesel	11 - 16	2055111	2055885	2055985	2555006	2556006
3500	Regular Cab	Gas and diesel	11 - 16	2055110	2055853	2055953	2555004	2556004
	Crew Cab	Gas and diesel	11 - 16	2055111	2055885	2055985	2555006	2556006
Toyota								
Tacoma	Crew Cab	--	15 - 16	2055152	2055885	2055985	2555023	2556023
Tundra	Regular Cab	Gas only	07 - 16	2055151	2055853	2055953	2555018	2556018
	Double Cab	Gas only	07 - 16	2055151	2055885	2055985	2555019	2556019
	CrewMax	Gas only	07 - 16	2055151	2055885	2055985	2555019	2556019

6"

OVAL SIDE BARS

for an OE look in a lightweight aluminum option

/ OE styling

The 6" oval tube profile, large step pads and hard black plastic end caps are designed to mimic popular original-equipment side bars

/ Reliable footing

The tough polypropylene step pads provide a comfortable, 5" wide, non-skid surface and are UV-stable to outlast sun damage

/ Lightweight aluminum build

Aluminum construction is strong, rust-free and 40% lighter than carbon steel, making it ideal for both off-roading and hard work (also available in stainless)

Features and benefits

- 6" wide, OE-style tube with hard ABS plastic end caps
- Available in semi-gloss black aluminum for a lightweight, rust-free option
- Extra-wide, non-skid step pads for a safe, comfortable step
- Universal track mounting system for easy, secure installation
- Four base lengths for easy inventory (53", 75", 85" and 91")
- Vehicle-specific, heavy-duty steel mounting brackets for a custom fit
- Sold in pairs with mounting brackets sold separately. See page 70 for application information
- Five-year warranty on black finish and limited lifetime warranty on polished stainless



Material and finish options

Side bars



Material:
304 stainless steel
Finish:
Polished stainless

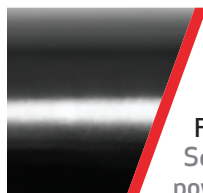

Material:
Aluminum alloy
Finish:
Semi-gloss black powder coat



UNIVERSAL TRACK MOUNTING SYSTEM

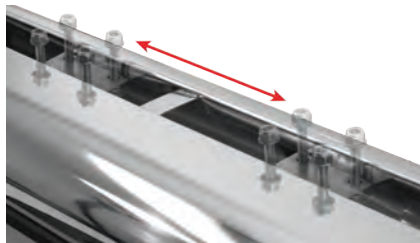

6" oval side bars come in four base lengths, including 53", 75", 85" and 91", to take up less inventory space and allow for easier ordering. To ensure a custom fit for every application, the side bars install using a track mounting

system and vehicle-specific mounting brackets. Using the application guide, determine the side bar length and bracket part number that will fit your customer's specific vehicle. All brackets will accommodate both finish options.

APPLICATION GUIDE

6" Oval Side Bars & Mounting Brackets

Make / Model	Style / Notes	Years	Bracket#	Stainless#	Black#	Footnote
Chevrolet						
Avalanche	With cladding	02 - 06	4490	S2891	B2891	1
	Without cladding	03 - 13	4491	S2891	B2891	1
CK Series Pickup	Extended Cab	88 - 98	4491	S2875	B2875	--
Silverado 1500	Crew Cab	04 - 07	4494	S2891	B2891	2
	Crew Cab	07 - 16	4490	S2891	B2891	1, 4
	Crew Cab	07 - 16	4407	S2891	B2891	1, 5
	Double Cab	14 - 16	4490	S2875	B2875	1, 3
	Crew Cab	14 - 16	4490	S2875	B2875	1, 5
	Extended Cab	07 - 13	4490	S2875	B2875	1, 4
	Extended Cab (3-door)	00 - 13	4493	S2875	B2875	2
	Extended Cab (4-door)	01 - 13	4493	S2875	B2875	2
	Standard Cab	99 - 13	4492	S2853	B2853	2
Silverado 1500HD	Crew Cab	01 - 03	4494	S2891	B2891	2
Silverado 2500	Crew Cab	07 - 16	4490	S2891	B2891	1, 4
	Crew Cab	07 - 16	4407	S2891	B2891	1, 5
	Crew Cab	07 - 16	4407	S2891	B2891	1, 5
	Double Cab	14 - 16	4490	S2875	B2875	1, 3
	Extended Cab	07 - 13	4490	S2875	B2875	1, 4
Silverado 2500HD	Crew Cab	01 - 07	4494	S2891	B2891	2
	Extended Cab	01 - 13	4493	S2875	B2875	2
	Standard Cab	99 - 14	4492	S2853	B2853	2
Silverado 2500LD	Extended Cab (3-door)	00 - 13	4493	S2875	B2875	2
	Extended Cab (4-door)	01 - 13	4493	S2875	B2875	2
	Standard Cab	99 - 13	4492	S2853	B2853	2
Silverado 3500	Crew Cab	07 - 16	4494	S2891	B2891	2
	Crew Cab	07 - 16	4490	S2891	B2891	1, 4
	Crew Cab	07 - 16	4407	S2891	B2891	1, 5
	Double Cab	14 - 16	4490	S2875	B2875	1, 3
	Extended Cab	07 - 13	4490	S2875	B2875	1, 4
Silverado 3500HD	Crew Cab	01 - 07	4494	S2891	B2891	2
	Extended Cab	01 - 13	4493	S2875	B2875	2
	Standard Cab	99 - 14	4492	S2853	B2853	2
Suburban XL	Excl. Z71 and Hybrid models	05 - 16	4490	S2891	B2891	1
Suburban XL 1500	All	00 - 05	4494	S2891	B2891	--
Tahoe	4-door	00 - 01	4497	S2875	B2875	--
	4-door, excl. Z71	02 - 04	4497	S2875	B2875	--
	4-door, excl. Z71 and Hybrid models	05 - 16	4490	S2875	B2875	--

1. Rocker mount

2. Bushing mount

3. Excluding diesel with DEF tank models

4. Excluding diesel with DEF tank models 2012 and up

5. Fits diesel models with DEF tank

6. Excluding Daytona, Rumble Bee and SRT-10 models

Applications continued on the following page

6" Oval Side Bars & Mounting Brackets

Make / Model	Style / Notes	Years	Bracket#	Stainless#	Black#	Footnote
Dodge & Ram						
Ram 1500	Crew Cab (models built during or after June 2015 require retrofit kit #4510)	09 - 16	4500	S2885	B2885	1
	Quad Cab	98 - 01	4502	S2875	B2875	--
	Quad Cab	02 - 08	4501	S2885	B2885	6
	Quad Cab (models built during or after June 2015 require retrofit kit #4510)	09 - 16	4500	S2875	B2875	1
	Regular Cab (models built during or after June 2015 require retrofit kit #4510)	09 - 16	4498	S2853	B2853	--
Ram 2500	Crew Cab	10 - 16	4500	S2885	B2885	1
	Quad Cab	98 - 01	4502	S2885	B2885	
	Quad Cab	02 - 09	4501	S2885	B2885	6
	Regular Cab	10 - 16	4498	S2853	B2853	--
Ram 3500	Crew Cab	10 - 16	4500	S2885	B2885	1
	Quad Cab	98 - 01	4502	S2885	B2885	--
	Quad Cab	02 - 09	4501	S2885	B2885	6
	Regular Cab	10 - 16	4498	S2853	B2853	--
Ram 4500	Quad Cab	08 - 09	4501	S2885	B2885	6
Ram 5500	Quad Cab	08 - 09	4501	S2885	B2885	6
Ford						
Expedition	Will not work on vehicles equipped with power retracting boards	97 - 15	4503	S2875	B2875	--
F-150	SuperCrew (2004 Heritage Ed. only)	01 - 04	4505	S2885	B2885	--
	SuperCrew	09 - 14	4504	S2891	B2891	1
	SuperCrew	15 - 16	4508	S2891	B2891	1
	SuperCrew (excl. Heritage Ed.)	04 - 08	4504	S2885	B2885	1
	SuperCab (Heritage Ed. only)	97 - 04	4506	S2875	B2875	--
	Regular Cab	15 - 16	4509	S2885	B2885	1
	SuperCab (excl. Heritage Ed.)	04 - 14	4504	S2875	B2875	1
	Regular Cab	97 - 03	4506	S2853	B2853	--
	Regular Cab	15 - 16	4509	S2853	B2853	1
	Regular Cab (excl. Heritage Ed.)	04 - 14	4504	S2853	B2853	1
F-250	SuperCrew	99 - 16	4507	S2891	B2891	1
	SuperCab	99 - 16	4507	S2885	B2885	1
	Regular Cab	99 - 16	4507	S2853	B2853	1
F-250LD	SuperCab (Heritage Ed. only)	97 - 04	4506	S2875	B2875	--
F-350	SuperCrew	99 - 16	4507	S2891	B2891	1
	SuperCab	99 - 16	4507	S2885	B2885	1
	Regular Cab	99 - 16	4507	S2853	B2853	1

1. Rocker mount

2. Bushing mount

3. Excluding diesel with DEF tank models

4. Excluding diesel with DEF tank models 2012 and up

5. Fits diesel models with DEF tank

6. Excluding Daytona, Rumble Bee and SRT-10 models

Applications continued on the following page

APPLICATION GUIDE (CONTINUED)

6" Oval Side Bars & Mounting Brackets						
Make / Model	Style / Notes	Years	Bracket#	Stainless#	Black#	Footnote
Ford (continued)						
F-450	SuperCrew	99 - 16	4507	S2891	B2891	1
	SuperCab	99 - 16	4507	S2885	B2885	1
	Regular Cab	99 - 16	4507	S2853	B2853	1
F-550HD	SuperCrew	99 - 16	4507	S2891	B2891	1
	SuperCab	99 - 16	4507	S2885	B2885	1
	Regular Cab	99 - 16	4507	S2853	B2853	1
GMC						
CK Series Pickup	Extended Cab	88 - 98	4491	S2875	B2875	--
Sierra 1500	Crew Cab	04 - 07	4494	S2891	B2891	2
	Crew Cab	07 - 16	4490	S2891	B2891	1, 4
	Crew Cab	07 - 16	4407	S2891	B2891	1, 5
	Double Cab	14 - 16	4490	S2875	B2875	1, 3
	Double Cab	07 - 16	4407	S2891	B2891	1, 5
	Extended Cab	07 - 13	4490	S2875	B2875	1, 4
	Extended Cab (3-door)	99 - 00	4493	S2875	B2875	2
	Extended Cab (4-door)	00 - 13	4493	S2875	B2875	2
	Standard Cab	99 - 13	4492	S2853	B2853	2
Sierra 1500HD	Crew Cab	01 - 03	4494	S2891	B2891	2
Sierra 2500	Crew Cab	07 - 16	4490	S2891	B2891	1, 4
	Crew Cab	07 - 16	4407	S2891	B2891	1, 5
	Double Cab	14 - 16	4490	S2875	B2875	1, 3
	Extended Cab	07 - 13	4490	S2875	B2875	1, 4
Sierra 2500HD	Crew Cab	01 - 07	4494	S2891	B2891	2
	Extended Cab	01 - 13	4493	S2875	B2875	2
	Standard Cab	01 - 14	4492	S2853	B2853	2
Sierra 2500LD	Extended Cab (3-door)	99 - 00	4493	S2875	B2875	2
	Extended Cab (4-door)	00 - 13	4493	S2875	B2875	2
	Standard Cab	99 - 13	4492	S2853	B2853	2
Sierra 3500	Crew Cab	07 - 16	4490	S2891	B2891	1, 4
	Crew Cab	07 - 16	4407	S2891	B2891	1, 5
	Double Cab	14 - 16	4490	S2875	B2875	1, 3
	Extended Cab	07 - 13	4490	S2875	B2875	1, 4
Sierra 3500HD	Crew Cab	01 - 07	4494	S2891	B2891	2
	Extended Cab	01 - 13	4493	S2875	B2875	2
	Standard Cab	01 - 14	4492	S2853	B2853	2

1. Rocker mount

2. Bushing mount

3. Excluding diesel with DEF tank models

4. Excluding diesel with DEF tank models 2012 and up

5. Fits diesel models with DEF tank

6. Excluding Daytona, Rumble Bee and SRT-10 models

Applications continued on the following page

6" Oval Side Bars & Mounting Brackets

Make / Model	Style / Notes	Years	Bracket#	Stainless#	Black#	Footnote
GMC (continued)						
Yukon	4-door	00 - 01	4497	S2875	B2875	--
	4-door, excl. Z71	02 - 04	4497	S2875	B2875	--
	4-door	05 - 16	4490	S2875	B2875	1, 4
Yukon XL	All	00 - 05	4494	S2891	B2891	--
	Excl. Z71 and Hybrid models	05 - 16	4490	S2891	B2891	1
Nissan						
Armada	--	04 - 13	4519	S2875	B2875	1
Titan	Crew Cab	04 - 16	4519	S2885	B2885	1
	King Cab	04 - 16	4519	S2875	B2875	1
Toyota						
Tacoma	Access Cab	05 - 16	4521	S2875	B2875	1
	Double Cab	01 - 04	4522	S2885	B2885	--
	Double Cab	05 - 16	4521	S2885	B2885	1
	Regular Cab	05 - 16	4521	S2853	B2853	1
Tundra	CrewMax	07 - 16	4515	S2891	B2891	1
	Double Cab	07 - 16	4515	S2885	B2885	1
	Double Cab (4-door)	99 - 06	4516	S2875	B2875	--
	Standard Cab	07 - 16	4515	S2853	B2853	1

1. Rocker mount

2. Bushing mount

3. Excluding diesel with DEF tank models

4. Excluding diesel with DEF tank models 2012 and up

5. Fits diesel models with DEF tank

6. Excluding Daytona, Rumble Bee and SRT-10 models

4"

OVAL SIDE BARS

with seamlessly blended ends for a unique, finished look

/ Unique finished look

The 30° bends and seamlessly blended end caps offer a superior, finished look to competitive straight tubes and plastic end caps

/ Raised step pads

The tough polypropylene step pads provide an extra-wide, non-skid surface and are custom-positioned to match the vehicle layout

/ Vehicle-specific fit

Each side bar has vehicle-specific bends and mounting brackets to contour to the vehicle and install quickly with no drilling required

Features and benefits

- 30° bends to contour to the body of the vehicle
- Seamless, welded end caps for a superior, finished look
- Wheel-to-wheel on select models for regular cab and others. See page 78 for more information
- Raised, custom, non-skid step pads
- Brushed stainless steel ARIES insignia on each step
- Elliptical, 4" wide, heavy-wall tube design
- No-drill, vehicle-specific application for a custom fit
- Sold in pairs with installation hardware included
- Heavy-duty steel mounting brackets
- See page 76 for application information
- Three-year warranty on black finish and limited lifetime warranty on polished stainless



Material and finish options

Side bars

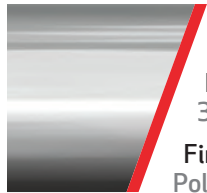

Material:
304 stainless steel
Finish:
Polished stainless

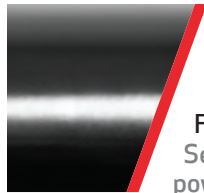

Material:
Carbon steel
Finish:
Semi-gloss black powder coat

WHEEL-TO-WHEEL

To give your customers a unique option for their ride, the ARIES 4" oval lineup includes wheel-to-wheel side bars. Wheel-to-wheel 4" ovals add utility and an enhanced appearance, featuring 30° bent ends and extra step pads in the rear for convenient truck bed access.

We offer wheel-to-wheel 4" oval side bars on select models for regular cab pickup trucks and others. They are available in both finishes of polished stainless and semi-gloss black powder coat (regular cab only available in black). See page 78 for more information.



APPLICATION GUIDE

4" Oval Side Bars					
Make / Model	Style	Notes	Years	Stainless#	Black#
Chevrolet					
Silverado 1500	Crew Cab	Bushing mount	01 - 13	S224013-2	S224013
	Crew Cab	Rocker mount	07 - 16	S224045-2	S224045
	Double Cab	Rocker mount	14 - 16	S224046-2	S224046
	Extended Cab	Bushing mount	99 - 13	S224009-2	S224009
	Extended Cab	Rocker mount	07 - 13	S224046-2	S224046
	Standard Cab	Bushing mount	99 - 13	S224017-2	S224017
	Standard Cab	Rocker mount	07 - 16	S224048-2	S224048
Silverado 2500	Crew Cab	Rocker mount	07 - 16	S224045-2	S224045
	Double Cab	Rocker mount	14 - 16	S224046-2	S224046
	Extended Cab	Rocker mount	07 - 13	S224046-2	S224046
	Standard Cab	Rocker mount	07 - 16	S224048-2	S224048
Silverado 2500HD	Crew Cab	Including diesel	01 - 14	S224013-2	S224013
	Extended Cab	Including diesel	01 - 14	S224009-2	S224009
	Standard Cab	Including diesel	99 - 14	S224017-2	S224017
Silverado 3500	Crew Cab	Rocker mount	07 - 16	S224045-2	S224045
	Double Cab	Rocker mount	14 - 16	S224046-2	S224046
	Extended Cab	Rocker mount	07 - 13	S224046-2	S224046
	Standard Cab	Rocker mount	07 - 16	S224048-2	S224048
Silverado 3500HD	Crew Cab	Including diesel	01 - 14	S224013-2	S224013
	Extended Cab	Including diesel	01 - 14	S224009-2	S224009
	Standard Cab	Including diesel	99 - 14	S224017-2	S224017
Traverse	All	--	07 - 16	S224031-2	S224031
Dodge & Ram					
Ram 1500	Crew Cab	--	09 - 16	S225016-2	S225016
	Quad Cab	--	02 - 08	S225008-2	S225008
	Quad Cab	--	09 - 16	S225017-2	S225017
	Standard Cab	--	15 - 16	--	S225018
	Standard Cab	--	09 - 14	S225018-2	S225018
Ram 2500	Crew Cab	--	15 - 16	--	S225019
	Crew Cab	--	10 - 14	S225019-2	S225019
	Quad Cab	--	03 - 09	S225008-2	S225008
	Standard Cab	--	15 - 16	--	S225018
	Standard Cab	--	09 - 14	S225018-2	S225018
Ram 3500	Crew Cab	--	15 - 16	--	S225019
	Crew Cab	--	10 - 14	S225019-2	S225019
	Quad Cab	--	03 - 09	S225008-2	S225008
	Standard Cab	--	09 - 14	S225018-2	S225018
Ford					
Excursion	All	--	01 - 06	S223006-2	S223006
Explorer	All	--	11 - 15	S223041-2	S223041
F-150	Crew Cab	--	04 - 08	S223015-2	S223015
	Crew Cab	--	09 - 14	S223039-2	S223039
	Extended Cab	--	04 - 14	S223016-2	S223016
	Standard Cab	--	04 - 14	S223017-2	S223017
	Super Crew	--	15 - 16	S223043-2	S223043
	Super Cab	--	15 - 16	S223044-2	S223044

4" Oval Side Bars

Make / Model	Style	Notes	Years	Stainless#	Black#
Ford (continued)					
F-250	Super Duty, Crew Cab	--	99 - 16	S223006-2	S223006
	Super Duty, Extended Cab	--	99 - 16	S223005-2	S223005
F-350	Super Duty, Crew Cab	--	99 - 16	S223006-2	S223006
	Super Duty, Extended Cab	--	99 - 16	S223005-2	S223005
GMC					
Acadia	All	--	08 - 15	S224031-2	S224031
Sierra 1500	Crew Cab	Bushing mount	01 - 13	S224013-2	S224013
	Crew Cab	Rocker mount	07 - 16	S224045-2	S224045
	Double Cab	Rocker mount	14 - 16	S224046-2	S224046
	Extended Cab	Bushing mount	99 - 13	S224009-2	S224009
	Extended Cab	Rocker mount	07 - 13	S224046-2	S224046
	Standard Cab	Bushing mount	99 - 13	S224017-2	S224017
	Standard Cab	Rocker mount	07 - 16	S224048-2	S224048
Sierra 2500	Crew Cab	Rocker mount	07 - 16	S224045-2	S224045
	Double Cab	Rocker mount	14 - 16	S224046-2	S224046
	Extended Cab	Rocker mount	07 - 13	S224046-2	S224046
	Standard Cab	Rocker mount	07 - 16	S224048-2	S224048
Sierra 2500HD	Crew Cab	Including diesel	01 - 14	S224013-2	S224013
	Extended Cab	Including diesel	01 - 14	S224009-2	S224009
	Standard Cab	Including diesel	99 - 14	S224017-2	S224017
Sierra 3500	Crew Cab	Rocker mount	07 - 16	S224045-2	S224045
	Double Cab	Rocker mount	14 - 16	S224046-2	S224046
	Extended Cab	Rocker mount	07 - 13	S224046-2	S224046
	Standard Cab	Rocker mount	07 - 16	S224048-2	S224048
Sierra 3500HD	Crew Cab	Including diesel	01 - 14	S224013-2	S224013
	Extended Cab	Including diesel	01 - 14	S224009-2	S224009
	Standard Cab	Including diesel	99 - 14	S224017-2	S224017
Honda					
Pilot	All	--	09 - 15	S226008-2	S226008
Jeep					
Grand Cherokee	All	--	11 - 15	S221008-2	S221008
Lexus					
RX350	All	--	10 - 13	S222016-2	--
RX400	All	--	10 - 13	S222016-2	--
RX400H	All	--	10 - 13	S222016-2	--
Lincoln					
Mark LT	All	--	05 - 08	S223015-2	S223015
Nissan					
Titan	Crew Cab	--	04 - 16	S229006-2	S229006
Xterra	All	--	05 - 16	--	S229008
Toyota					
FJ Cruiser	All	--	07 - 14	--	S222011
Tacoma	Access Cab	--	05 - 16	S222008-2	S222008
Tacoma	Double Cab	--	05 - 16	S222009-2	S222009
Tundra	CrewMax	--	07 - 16	S222013-2	S222013
	Double Cab	--	04 - 06	S222006-2	--
	Double Cab	--	07 - 16	S222012-2	S222012

4"

WHEEL-TO-WHEEL OVAL SIDE BARS

for a finished look from wheel to wheel

/ Regular cab options

We offer wheel-to-wheel 4" oval side bars on select models for regular cab pickup trucks and others (regular cab available in black finish only)

/ Extra step pads

Each wheel-to-wheel side bar features an extra step pad in the rear to allow for easy access to the truck bed or truck bed tool box

/ Unique finished look

The 30° bends and seamlessly blended end caps offer a superior, finished look to competitive straight tubes and plastic end caps

Features and benefits

- Extra rear step pad for convenient truck bed access
- Available for certain regular cab pickups. See page 80 for application information
- 30° bends to contour to the body of the vehicle
- Seamless, welded end caps for a superior, finished look
- Raised, custom, non-skid step pads
- Brushed stainless steel ARIES insignia on each step
- Elliptical, 4" wide, heavy-wall tube design
- No-drill, vehicle-specific application for a custom fit
- Sold in pairs with installation hardware included
- Heavy-duty steel mounting brackets
- Three-year warranty on black finish and limited lifetime warranty on polished stainless



Material and finish

Side bars

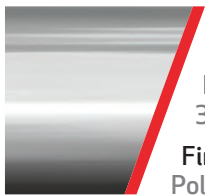

Material:
304 stainless steel
Finish:
Polished stainless

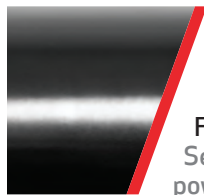

Material:
Carbon steel
Finish:
Semi-gloss black powder coat



Extra rear step pad
for convenient truck bed access



APPLICATION GUIDE

4" Wheel-to-Wheel Oval Side Bars

Make / Model	Style	Notes	Years	Stainless#	Black#	Footnote
Chevrolet						
Silverado 1500	Crew Cab	Rocker mount, Excluding 5.8 ft beds	07 - 16	364045-2	364045	--
	Double Cab	Rocker mount	14 - 16	364046-2	364046	--
	Extended Cab	Rocker mount	07 - 13	364046-2	364046	--
	Extended Cab	Excluding 5.5 ft beds	99 - 13	364009-2	364009	1
	Regular Cab	Rocker mount	07 - 16	--	364048	--
	Regular Cab	Short bed	99 - 13	--	364020	--
Silverado 2500	Crew Cab	Rocker mount, Excluding 5.8 ft beds	07 - 16	364045-2	364045	--
	Double Cab	Rocker mount	14 - 16	364046-2	364046	--
	Extended Cab	Rocker mount	07 - 13	364046-2	364046	--
	Extended Cab	Excluding 5.5 ft beds	99 - 13	364009-2	364009	1
	Regular Cab	Rocker mount	07 - 16	--	364048	--
Silverado 2500HD	Crew Cab	Excluding 5.5 or 5.8 ft beds	01 - 14	364013-2	364013	1
	Regular Cab	Long bed	01 - 13	--	364017	--
Silverado 3500	Crew Cab	Rocker mount, Excluding 5.8 ft beds	07 - 16	364045-2	364045	--
	Double Cab	Rocker mount	14 - 16	364046-2	364046	--
	Extended Cab	Rocker mount	07 - 13	364046-2	364046	--
	Extended Cab	Excluding 5.5 ft beds	99 - 13	364009-2	364009	1
	Regular Cab	Rocker mount	07 - 16	--	364048	--
Silverado 3500HD	Crew Cab	Excluding 5.5 or 5.8 ft beds	01 - 14	364013-2	364013	1
	Regular Cab	Long bed	01 - 13	--	364017	--
Dodge & Ram						
Ram 1500	Crew Cab	Fits 6.5 ft beds	09 - 16	365016-2	365016	1
	Mega Cab	Fits 6.5 ft beds	10 - 16	365030-2	365030	1
	Quad Cab	Fits 6.5 ft beds	02 - 08	365008-2	365008	1
	Quad Cab	Fits 6.5 ft beds	09 - 16	365017-2	365017	1
	Regular Cab	Long bed	10 - 14	--	365018	--
	Regular Cab	Short bed	09 - 14	--	365031	--
Ram 2500	Crew Cab	Fits 6.5 ft beds	10 - 16	365019-2	365019	1
	Mega Cab	Fits 6.5 ft beds	10 - 16	365030-2	365030	1
	Quad Cab	Fits 6.5 ft beds	03 - 09	365008-2	365008	1
	Regular Cab	Long bed	10 - 14	--	365018	--
	Regular Cab	Short bed	09 - 14	--	365031	--
Ram 3500	Crew Cab	Fits 6.5 ft beds	10 - 16	365019-2	365019	1
	Mega Cab	Fits 6.5 ft beds	10 - 16	365030-2	365030	1
	Quad Cab	Fits 6.5 ft beds	03 - 09	365008-2	365008	1
	Regular Cab	Long bed	10 - 14	--	365018	--
	Regular Cab	Short bed	09 - 14	--	365031	--

1. May leave extra space between the end of the side bar and the rear wheel

4" Wheel-to-Wheel Oval Side Bars

Make / Model	Style	Notes	Years	Stainless#	Black#	Footnote
Ford						
F-150	Regular Cab	Long bed	09 - 14	--	363017	--
F-250	Super Duty, Crew Cab	Fits 6.5 ft beds	14 - 16	--	363006	1
	Super Duty, Crew Cab	Fits 6.5 ft beds	99 - 13	363006-2	363006	1
F-350	Super Duty, Crew Cab	Fits 6.5 ft beds	14 - 16	--	363006	1
	Super Duty, Crew Cab	Fits 6.5 ft beds	99 - 13	363006-2	363006	1
GMC						
Sierra 1500	Crew Cab	Rocker mount, Excluding 5.8 ft beds	07 - 16	364045-2	364045	--
	Double Cab	Rocker mount	14 - 16	364046-2	364046	--
	Extended Cab	Rocker mount	07 - 13	364046-2	364046	--
	Extended Cab	Excluding 5.5 ft beds	99 - 13	364009-2	364009	1
	Regular Cab	Rocker mount	07 - 16	--	364048	--
	Regular Cab	Short bed	99 - 13	--	364020	--
Sierra 2500	Crew Cab	Rocker mount, Excluding 5.8 ft beds	07 - 16	364045-2	364045	--
	Double Cab	Rocker mount	14 - 16	364046-2	364046	--
	Extended Cab	Rocker mount	07 - 13	364046-2	364046	--
	Extended Cab	Excluding 5.5 ft beds	99 - 13	364009-2	364009	1
	Regular Cab	Rocker mount	07 - 16	--	364048	--
Sierra 2500HD	Crew Cab	Excluding 5.5 or 5.8 ft beds	01 - 14	364013-2	364013	1
	Regular Cab	Long bed	01 - 13	--	364017	--
Sierra 3500	Crew Cab	Rocker mount, Excluding 5.8 ft beds	07 - 16	364045-2	364045	--
	Double Cab	Rocker mount	14 - 16	364046-2	364046	--
	Extended Cab	Rocker mount	07 - 13	364046-2	364046	--
	Extended Cab	Excluding 5.5 ft beds	99 - 13	364009-2	364009	1
	Regular Cab	Rocker mount	07 - 16	--	364048	--
Sierra 3500HD	Crew Cab	Excluding 5.5 or 5.8 ft beds	01 - 14	364013-2	364013	1
	Regular Cab	Long bed	01 - 13	--	364017	--

1. May leave extra space between the end of the side bar and the rear wheel

4"

BIG STEP™ ROUND SIDE BARS

to give that oversized truck a real riding partner

/ Bold design

The 4" diameter and 1/8" thick walls are made to accent larger, lifted trucks and are best complemented with a Big Horn™ bull bar

/ Lightweight aluminum build

Aluminum construction is strong, rust-free and 40% lighter than carbon steel, making it ideal for both off-roading and hard work

/ Raised step pads

The tough polypropylene step pads provide an extra-wide, non-skid surface and are custom-positioned to match the vehicle layout

Features and benefits

- Bold, 4" diameter is designed to show well on larger trucks
- Hardened T6 aluminum construction to be lightweight and rust-free
- Textured black powder coat easily hides scratches and dirt
- Raised, custom, non-skid step pads
- Brushed stainless steel ARIES insignia on each step
- Unique bends to contour to the body of the vehicle
- Made to complement ARIES Big Horn™ bull bars
- No-drill, vehicle-specific application for a custom fit
- Sold in pairs with installation hardware included
- Heavy-duty steel mounting brackets
- Five-year warranty



Material and finish

Side bars

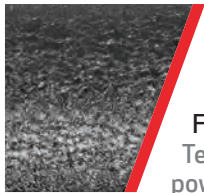

Material:
T6 aluminum alloy

Finish:
Textured black
powder coat



APPLICATION GUIDE

4" Big Step™ Round Side Bars

Make / Model	Style	Notes	Years	Black#
Chevrolet				
Silverado 1500	Crew Cab	--	07 - 16	AL234045
	Double Cab	Rocker mount	14 - 16	AL234046
	Extended Cab	Bushing mount	99 - 13	AL234009
	Extended Cab	Rocker mount	07 - 13	AL234046
Silverado 1500HD	Extended Cab	Bushing mount	01 - 14	AL234009
Silverado 2500	Crew Cab	--	01 - 14	AL234013
	Crew Cab	--	15 - 16	AL234045
	Double Cab	Rocker mount	14 - 16	AL234046
	Extended Cab	Rocker mount	07 - 13	AL234046
Silverado 2500HD	Extended Cab	Bushing mount	01 - 14	AL234009
Silverado 3500	Crew Cab	--	01 - 14	AL234013
	Crew Cab	--	15 - 16	AL234045
	Double Cab	Rocker mount	14 - 16	AL234046
	Extended Cab	Rocker mount	07 - 13	AL234046

Applications continued on the following page

4" Big Step™ Round Side Bars

Make / Model	Style	Notes	Years	Black#
Dodge & Ram				
Ram 1500	Crew Cab	Rocker mount	09 - 16	AL235033
	Quad Cab	Rocker mount	09 - 16	AL235017
Ram 2500	Crew Cab	Rocker mount	10 - 16	AL235033
Ram 3500	Crew Cab	Rocker mount	10 - 16	AL235033
Ford				
Excursion	All	--	01 - 06	AL233006
F-150	Crew Cab	--	09 - 14	AL233039
	SuperCrew Cab	--	15 - 16	AL233043
F-250	Super Duty, Crew Cab	--	99 - 16	AL233006
F-350	Super Duty, Crew Cab	--	99 - 16	AL233006
GMC				
Sierra 1500	Crew Cab	--	07 - 16	AL234045
	Double Cab	Rocker mount	14 - 16	AL234046
	Extended Cab	Bushing mount	99 - 16	AL234009
	Extended Cab	Rocker mount	07 - 13	AL234046
Sierra 1500HD	Extended Cab	Bushing mount	01 - 14	AL234009
Sierra 2500	Crew Cab	--	01 - 14	AL234013
	Crew Cab	--	15 - 16	AL234045
	Double Cab	Rocker mount	14 - 16	AL234046
	Extended Cab	Rocker mount	07 - 13	AL234046
Sierra 2500HD	Extended Cab	Bushing mount	01 - 14	AL234009
Sierra 3500	Crew Cab	--	01 - 14	AL234013
	Crew Cab	--	15 - 16	AL234045
	Double Cab	Rocker mount	14 - 16	AL234046
	Extended Cab	Rocker mount	07 - 13	AL234046
Jeep				
Wrangler	2-door	--	07 - 16	AL231008
	4-door	--	07 - 16	AL231007
Nissan				
Titan	Crew Cab	--	04 - 16	AL239006
Toyota				
Tacoma	Crew Cab	--	05 - 16	AL232009
Tundra	CrewMax	--	07 - 16	AL232013
	Double Cab	--	07 - 16	AL232012



3"

PRO SERIES™ ROUND SIDE BARS

with a textured black finish that won't back down

/ Tested finish

The textured powder coat easily hides scratches and is put through an extensive salt spray test to ensure durability in any season

/ Raised step pads

The tough polypropylene step pads provide an extra-wide, non-skid surface and are custom-positioned to match the vehicle layout

/ Vehicle-specific fit

Each side bar has vehicle-specific bends and mounting brackets to contour to the vehicle and install quickly with no drilling required

Features and benefits

- Tested, textured black powder coat easily hides scratches and dirt
- Raised, custom, non-skid step pads
- 3" diameter, heavy-wall tube design
- High-strength carbon steel construction
- Brushed stainless steel ARIES insignia on each step
- Unique bends to contour to the body of the vehicle
- Complements other ARIES Pro Series™ accessories
- No-drill, vehicle-specific application for a custom fit
- Heavy-duty steel mounting brackets
- Sold in pairs with installation hardware included
- See page 88 for application information
- Three-year warranty



Material and finish

Side bars

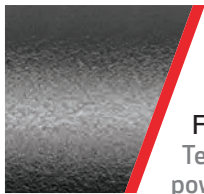

Material:
Carbon steel

Finish:
Textured black
powder coat



APPLICATION GUIDE

3" Pro Series™ Round Side Bars				
Make / Model	Style	Notes	Years	Part#
Chevrolet				
Silverado 1500	Crew Cab	--	01 - 13	P204013
	Crew Cab	Rocker mount	07 - 16	P204045
	Double Cab	Rocker mount	14 - 16	P204046
	Extended Cab	Bushing mount	99 - 13	P204009
	Extended Cab	Rocker mount	07 - 16	P204046
	Regular Cab	--	99 - 13	P204017
Silverado 1500HD	Crew Cab	Rocker mount	07 - 16	P204045
	Crew Cab	Bushing mount	01 - 13	P204013
	Extended Cab	Bushing mount	01 - 14	P204009
	Regular Cab	Bushing mount	01 - 14	P204017
Silverado 2500	Crew Cab	Bushing mount	01 - 14	P204013
	Crew Cab	Rocker mount	07 - 16	P204045
	Double Cab	Rocker mount	14 - 16	P204046
	Extended Cab	Rocker mount	07 - 16	P204046
Silverado 2500HD	Extended Cab	Bushing mount	01 - 14	P204009
	Regular Cab	Bushing mount	01 - 14	P204017
Silverado 3500	Crew Cab	Bushing mount	01 - 14	P204013
	Crew Cab	Rocker mount	07 - 16	P204045
	Double Cab	Rocker mount	14 - 16	P204046
	Extended Cab	Rocker mount	07 - 16t	P204046
Silverado 3500HD	Extended Cab	Bushing mount	01 - 14	P204009
	Regular Cab	Bushing mount	01 - 14	P204017
Dodge & Ram				
Ram 1500	Crew Cab	Rocker mount	09 - 16	P205033
	Regular Cab	--	09 - 16	P205018
	Quad Cab	Rocker mount	09 - 16	P205032
	Quad Cab	--	02 - 08	P205008
Ram 2500	Crew Cab	Rocker mount	09 - 16	P205033
	Quad Cab	--	03 - 09	P205008
Ram 3500	Crew Cab	Rocker mount	09 - 16	P205033
	Quad Cab	--	03 - 09	P205008
Ford				
Excursion	All	--	00 - 06	P203006
F-150	Regular Cab	--	09 - 14	P203040
	Super Cab	--	04 - 14	P203016
	Super Crew Cab	--	09 - 14	P203039
F-250	Super Duty, Crew Cab	--	99 - 16	P203006
	Super Duty, Regular Cab	--	99 - 16	P203014
F-350	Super Duty, Crew Cab	--	99 - 16	P203006
	Super Duty, Regular Cab	--	99 - 16	P203014

3" Pro Series™ Round Side Bars

Make / Model	Style	Notes	Years	Part#
GMC				
Sierra 1500	Crew Cab	--	01 - 13	P204013
	Crew Cab	Rocker mount	07 - 16	P204045
	Double Cab	Rocker mount	14 - 16	P204046
	Extended Cab	--	99 - 13	P204009
	Extended Cab	Rocker mount	07 - 16	P204046
	Regular Cab	--	99 - 13	P204017
Sierra 1500HD	Crew Cab	--	01 - 13	P204013
	Crew Cab	Rocker mount	07 - 16	P204045
	Extended Cab	--	01 - 14	P204009
	Regular Cab	--	01 - 13	P204017
Sierra 2500	Crew Cab	--	01 - 14	P204013
	Crew Cab	Rocker mount	07 - 16	P204045
	Double Cab	Rocker mount	14 - 16	P204046
	Extended Cab	Rocker mount	07 - 16	P204046
Sierra 2500HD	Extended Cab	--	01 - 14	P204009
	Regular Cab	--	01 - 13	P204017
Sierra 3500	Crew Cab	--	01 - 14	P204013
	Crew Cab	Rocker mount	07 - 16	P204045
	Double Cab	Rocker mount	14 - 16	P204046
	Extended Cab	Rocker mount	07 - 16	P204046
Sierra 3500HD	Extended Cab	--	01 - 14	P204009
	Regular Cab	--	01 - 13	P204017
Jeep				
Wrangler	2-door	--	07 - 16	P35800
	4-door	--	07 - 16	P35700
Toyota				
Tacoma	Access Cab	--	05 - 16	P202008
	Double Cab	--	05 - 16	P202009
Tundra	CrewMax	--	07 - 16	P202013
	Double Cab	--	07 - 16	P202012

3"

ROUND SIDE BARS

with a vehicle-specific fit for hundreds of applications

/ E-coat finish

In addition to a durable powder coat, our carbon steel side bars get an E-coat finish for added chip, scratch and peel resistance

/ Custom step pads

The tough polypropylene step pads provide a textured, non-skid surface and are custom-positioned to match the vehicle layout

/ Vehicle-specific fit

Each side bar has vehicle-specific bends and mounting brackets to contour to the vehicle and install quickly with no drilling required

Features and benefits

- No-drill, vehicle-specific application for a custom fit
- Unique bends to contour to the body of the vehicle
- Custom, non-skid step pads
- 3" diameter, heavy-wall tube design
- Heavy-duty steel mounting brackets
- Sold in pairs with installation hardware included
- See page 92 for application information
- Three-year warranty on black finish and limited lifetime warranty on polished stainless



Material and finish options

Side bars

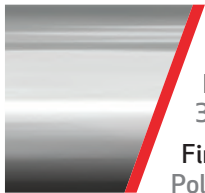

Material:
304 stainless steel
Finish:
Polished stainless

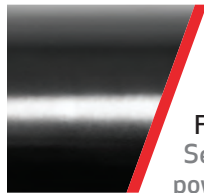

Material:
Carbon steel
Finish:
Semi-gloss black powder coat



APPLICATION GUIDE

3" Round Side Bars				
Make / Model	Style / Notes	Years	Stainless#	Black#
Acura				
MDX	All	02 - 06	206003-2	206003
Chevrolet				
Avalanche 1500	All	01 - 13	204004-2	--
Blazer FS	2-door	92 - 94	204018-2	204018
Blazer K5	All	76 - 91	204044-2	204044
CK 1500	Regular Cab (long bed and 2WD only)	73 - 87	204038-2	204038
	Regular Cab (short bed and 2WD only)	73 - 87	204037-2	204037
CK 2500	Regular Cab (long bed and 4WD only)	73 - 87	204041-2	204041
	Regular Cab (short bed and 4WD only)	73 - 87	204040-2	204040
CK 3500	Regular Cab (long bed and 4WD only)	73 - 87	204041-2	204041
	Regular Cab (short bed and 4WD only)	73 - 87	204040-2	204040
CK Series Pickup	Extended Cab (including Z71)	88 - 98	204001-2	204001
	Regular Cab (4WD only)	67 - 72	204036-2	204036
	Regular Cab (including Z71)	88 - 98	204018-2	204018
Colorado	Crew Cab	04 - 14	204016-2	204016
	Crew Cab	15 - 16	204051-2	204051
	Extended Cab	04 - 14	204051-2	204051
	Extended Cab	15 - 16	204052-2	204052
Equinox	All	10 - 16	204032-2	204032
Silverado 1500	Crew Cab	01 - 13	204013-2	204013
	Crew Cab (rocker mount)	07 - 16	204045-2	204045
	Double Cab (rocker mount)	14 - 16	204046-2	204046
	Extended Cab	99 - 13	204009-2	204009
	Extended Cab (rocker mount)	07 - 16	204046-2	204046
	Regular Cab (bushing mount)	99 - 13	204017-2	204017
	Regular Cab	07 - 16	204048-2	204048
Silverado 1500HD	Crew Cab	01 - 13	204013-2	204013
	Crew Cab (rocker mount)	07 - 16	204045-2	204045
	Extended Cab	99 - 13	204009-2	204009
	Regular Cab (bushing mount)	01 - 13	204017-2	204017
Silverado 2500	Crew Cab	01 - 14	204013-2	204013
	Crew Cab (rocker mount)	07 - 16	204045-2	204045
	Double Cab (rocker mount)	14 - 16	204046-2	204046
	Extended Cab (rocker mount)	07 - 16	204046-2	204046
	Regular Cab	07 - 16	204048-2	204048
Silverado 2500HD	Extended Cab	00 - 14	204009-2	204009
	Regular Cab (bushing mount)	01 - 13	204017-2	204017

Applications continued on the following page

3" Round Side Bars

Make / Model	Style / Notes	Years	Stainless#	Black#
Chevrolet (continued)				
Silverado 3500	Crew Cab	01 - 14	204013-2	204013
	Crew Cab (rocker mount)	07 - 16	204045-2	204045
	Double Cab (rocker mount)	14 - 16	204046-2	204046
	Extended Cab (rocker mount)	07 - 16	204046-2	204046
	Regular Cab	07 - 16	204048-2	204048
Silverado 3500HD	Extended Cab	00 - 14	204009-2	204009
	Regular Cab (bushing mount)	01 - 13	204017-2	204017
Suburban	All	92 - 99	204014-2	204014
	All	73 - 91	204039-2	204039
Suburban 1500	All	00 - 14	204004-2	--
Tahoe	2-door	95 - 99	204018-2	204018
	4-door	95 - 99	204012-2	204012
	All	00 - 16	204050-2	204050
Traverse	All	07 - 16	204031-2	204031
Dodge & Ram				
Dakota	Club Cab	97 - 04	205000-2	205000
	Quad Cab	05 - 12	205010-2	205010
	Regular Cab	97 - 04	205001-2	205001
Durango	4-door	04 - 10	205009-2	205009
	All	11 - 14	205031-2	205031
Nitro	All	07 - 13	205015-2	205015
Ram	Extended Cab (two-pad bar)	94 - 96	205003-2	205003
	Quad Cab	97 - 01	205003-2	205003
Ram 1500	Quad Cab	02 - 08	205008-2	205008
	Quad Cab	09 - 16	205032-2	205032
	Regular Cab	94 - 01	205002-2	205002
	Regular Cab	02 - 08	205013-2	205013
	Regular Cab	09 - 16	205018-2	205018
	Crew Cab	09 - 16	205033-2	205033
Ram 2500	Crew Cab	10 - 16	205033-2	205033
	Mega Cab	06 - 16	205030-2	205030
	Quad Cab	03 - 09	205008-2	205008
	Regular Cab	94 - 01	205002-2	205002
	Regular Cab	03 - 08	205013-2	205013
	Regular Cab	09 - 16	205013-2	205013
Ram 3500	Crew Cab	10 - 16	205033-2	205033
	Mega Cab	06 - 16	205030-2	205030
	Quad Cab	03 - 09	205008-2	205008
	Regular Cab	03 - 08	205013-2	205013
	Regular Cab	09 - 16	205018-2	205018

Applications continued on the following page

APPLICATION GUIDE (CONTINUED)

3" Round Side Bars				
Make / Model	Style / Notes	Years	Stainless#	Black#
Ford				
Bronco	All	80 - 96	203001-2	203001
	All	66 - 72	203038-2	203038
Edge	Excl. Sport	08 - 13	203032-2	203032
Escape	All	01 - 07	203012-2	203012
	All	08 - 12	203031-2	203031
	All (Incl. Hybrid)	13 - 15	203042-2	203042
Excursion	All	00 - 06	203006-2	203006
Expedition	All	03 - 06	203004-2	203004
	Excl. EX, EL and EXT models	07 - 15	203030-2	203030
	All	97 - 02	203037-2	203037
Explorer	4-door	02 - 10	203018-2	203018
	4-door	95 - 01	203036-2	203036
	All	11 - 15	203041-2	203041
Explorer Sport Trac	All	01 - 06	203010-2	203010
	All	07 - 11	203019-2	203019
F-150	Regular Cab	80 - 96	203001-2	203001
	Regular Cab	97 - 03	203007-2	203007
	Regular Cab	04 - 08	203017-2	203017
	Regular Cab	09 - 14	203040-2	203040
	Regular Cab	15 - 16	203045-2	203045
	Super Cab	97 - 03	203008-2	203008
	Super Cab	04 - 14	203016-2	203016
	Super Cab	15 - 16	203044-2	203044
	Super Crew	01 - 03	203009-2	203009
	Super Crew	04 - 08	203015-2	203015
	Super Crew	09 - 14	203039-2	203039
	Super Crew	15 - 16	203043-2	203043
	F-250	Super Duty (Regular Cab)	99 - 16	203014-2
Super Duty (Super Cab)		99 - 16	203005-2	203005
Super Duty (Super Crew)		99 - 16	203006-2	203006
F-350	Super Duty (Regular Cab)	99 - 16	203014-2	203014
	Super Duty (Super Cab)	99 - 16	203005-2	203005
	Super Duty (Super Crew)	99 - 16	203006-2	203006
Ranger	Edge (4-door Super Cab)	98 - 12	203033-2	203033
	Regular Cab	98 - 10	203034-2	203034
	Super Cab	83 - 97	203003-2	203003
	Super Cab (2-door)	98 - 10	203035-2	203035
	Super Cab (4-door)	98 - 12	203033-2	203033

Applications continued on the following page

3" Round Side Bars

Make / Model	Style / Notes	Years	Stainless#	Black#
GMC				
Acadia	All	07 - 15	204031-2	204031
Blazer K5	All	76 - 91	204044-2	204044
Canyon	Crew Cab	15 - 16	204051-2	204051
	Crew Cab	04 - 14	204016-2	204016
	Extended Cab	15 - 16	204052-2	204052
CK 1500	Regular Cab (long bed and 2WD only)	73 - 87	204038-2	204038
	Regular Cab (short bed and 2WD only)	73 - 87	204037-2	204037
CK 2500	Regular Cab (long bed and 4WD only)	73 - 87	204041-2	204041
	Regular Cab (short bed and 4WD only)	73 - 87	204040-2	204040
CK 3500	Regular Cab (long bed and 4WD only)	73 - 87	204041-2	204041
	Regular Cab (short bed and 4WD only)	73 - 87	204040-2	204040
CK Series Pickup	Extended Cab (including Z71)	88 - 98	204001-2	204001
	Regular Cab (4WD only)	67 - 72	204036-2	204036
	Regular Cab (including Z71)	88 - 99	204018-2	204018
Sierra	Regular Cab	99 - 13	204017-2	204017
Sierra 1500	Crew Cab	01 - 13	204013-2	204013
	Crew Cab (rocker mount)	07 - 16	204045-2	204045
	Double Cab (rocker mount)	14 - 16	204046-2	204046
	Extended Cab (bushing mount)	99 - 13	204009-2	204009
	Extended Cab (rocker mount)	07 - 16	204046-2	204046
	Regular Cab	07 - 16	204048-2	204048
Sierra 1500HD	Crew Cab (bushing mount)	01 - 13	204013-2	204013
	Extended Cab	00 - 14	204009-2	204009
	Regular Cab (bushing mount)	01 - 13	204017-2	204017
	Crew Cab (rocker mount)	07 - 16	204045-2	204045
Sierra 2500	Crew Cab (bushing mount)	01 - 14	204013-2	204013
	Crew Cab (rocker mount)	07 - 16	204045-2	204045
	Double Cab (rocker mount)	14 - 16	204046-2	204046
	Extended Cab (rocker mount)	07 - 16	204046-2	204046
	Regular Cab	07 - 16	204048-2	204048
Sierra 2500HD	Extended Cab (bushing mount)	00 - 14	204009-2	204009
	Regular Cab (bushing mount)	01 - 13	204017-2	204017
Sierra 3500	Crew Cab (bushing mount)	01 - 14	204013-2	204013
	Crew Cab (rocker mount)	07 - 16	204045-2	204045
	Double Cab (rocker mount)	14 - 16	204046-2	204046
	Extended Cab (rocker mount)	07 - 16	204046-2	204046
	Regular Cab	07 - 16	204048-2	204048
Sierra 3500HD	Extended Cab	00 - 14	204009-2	204009
	Regular Cab (bushing mount)	01 - 13	204017-2	204017
Suburban	All	92 - 99	204014-2	204014
	All	73 - 91	204039-2	204039

Applications continued on the following page

APPLICATION GUIDE (CONTINUED)

3" Round Side Bars				
Make / Model	Style / Notes	Years	Stainless#	Black#
GMC (continued)				
Terrain	All	10 - 15	204032-2	204032
Yukon	2-door	92 - 99	204018-2	204018
	4-door	95 - 99	204012-2	204012
	All	00 - 15	204050-2	204050
Yukon XL	All	00 - 14	204004-2	--
Honda				
CRV	All	12 - 15	206010-2	206010
Pilot	All	02 - 08	206003-2	206003
	All	09 - 15	206008-2	206008
Ridgeline	All	05 - 12	206005-2	206005
Hummer				
H2	Required factory rocker bar and incl. SUT	03 - 10	204075-2	204075
H3	Excl. with rocker bar (4WD only)	06 - 11	204076-2	204076
Hyundai				
Santa Fe	All	07 - 12	207003-2	207003
Santa Fe Sport	5 passenger only (Excl. models with HID auto-leveling headlights)	13 - 15	207005-2	207005
Tucson	All	10 - 14	207004-2	207004
Jeep				
Cherokee	All	84 - 00	201000-2	201000
Grand Cherokee	All	99 - 04	201001-2	201001
	All	05 - 10	201003-2	201003
	All	11 - 15	201008-2	201008
	All	02 - 06	201002-2	201002
Liberty	Without mud flaps	02 - 06	201002-2	201002
	All	08 - 12	201005-2	201005
	Excl. Sport (without mud flaps)	05 - 07	201002-2	201002
Patriot	All	07 - 15	201009-2	201009
Unlimited	All	87 - 06	35600-2	35600
Wrangler	2-door (will not work with factory rocker)	07 - 16	35800-2	35800
	4-door (will not work with factory rocker)	07 - 16	35700-2	35700
YJ Wrangler	All	87 - 06	35600-2	35600
Kia				
Sorento	All	03 - 09	200100-2	200100
	All	10 - 13	200103-2	200103
	All	14 - 15	200105-2	200105
Sportage	All	11 - 15	200104-2	200104
Land Rover				
LR3	All	05 - 09	200112-2	200112
Lexus				
RX350	All	10 - 13	202016-2	--
RX400	All	10 - 13	202016-2	--
RX400H	All	10 - 13	202016-2	--

Applications continued on the following page

3" Round Side Bars

Make / Model	Style / Notes	Years	Stainless#	Black#
Lincoln				
Mark LT	All	05 - 08	203015-2	203015
MKX	All	07 - 10	203032-2	203032
Mazda				
B Series Pickup	Regular Cab	98 - 12	203034-2	203034
	Super Cab	82 - 97	203003-2	203003
	Super Cab (2-door)	98 - 12	203033-2	203033
Tribute	All	01 - 07	203012-2	203012
	All	08 - 10	203031-2	203031
Mercedes				
ML 320-500	All	98 - 05	200001-2	--
Mitsubishi				
Outlander	All	11 - 13	208005-2	208005
	Excl. Sport	14 - 15	208007-2	208007
RVR	All	11 - 13	208005-2	208005
	Excl. Sport	14 - 15	208007-2	208007
Nissan				
Frontier	Crew Cab	05 - 15	209008-2	209008
	King Cab	05 - 15	209009-2	209009
Pathfinder	All	05 - 12	209011-2	209011
	All	13 - 15	209013-2	209013
Rogue	Excl. Select	14 - 15	209014-2	209014
Titan	Crew Cab	04 - 15	209006-2	209006
Saturn				
Outlook	All	08 - 09	204031-2	204031
Toyota				
4Runner	All	03 - 09	202000-2	202000
	Base model only	10 - 14	202000-2	202000
	With rocker covers SR5 and LTD models	10 - 15	202017-2	202017
FJ Cruiser	All	07 - 14	202011-2	202011
Highlander	All	14 - 15	202019-2	202019
	Both gas and hybrid models	08 - 13	202015-2	202015
Rav4	All	06 - 12	202010-2	202010
	All	13 - 15	202018-2	202018
Tacoma	Access Cab	05 - 16	202008-2	202008
	Crew Cab	01 - 04	202004-2	202004
	Double Cab	05 - 16	202009-2	202009
	Extended Cab	97 - 04	202001-2	202001
Tundra	CrewMax	07 - 16	202013-2	202013
	Double Cab	04 - 06	202006-2	202006
	Double Cab	07 - 16	202012-2	202012
	Extended Cab	00 - 06	202003-2	202003
	Regular Cab	07 - 16	202014-2	202014

RUNNING BOARDS





RISE TO THE CHALLENGE

For some, it's more than just a drive – more than a simple matter of A to B. It's about rising to the challenge. For 2016, ARIES introduces a new line of running boards, including fast, lightweight AeroTread™ and tough, ready-to-work RidgeStep™.

AeroTread™ running boards are sleek and lightweight, providing an aerodynamic accent for the modern CUV or SUV. They feature full-length treads, an aluminum base and two finish options. RidgeStep™ commercial running boards boast an all-steel construction. They perfectly complement the hard-working truck and are equipped with non-skid, stamped steel treads and a tough powder coat finish.

When the challenges arise, give your customers what they need to meet them head-on with ARIES.



NEW RidgeStep™

New RidgeStep™ commercial running boards are made to get the job done, featuring textured black, all-steel construction with a stamped tread that will not crack, fade or wear



NEW AeroTread™

Made with an aluminum base, new AeroTread™ running boards feature a front trim piece in two finish options: polished stainless steel or black carbide powder coat



Track mounting system

Using vehicle-specific mounting brackets and a track-type mounting system, ARIES running boards are made for easy, no-drill installation and a custom fit

CATEGORY INDEX

100 | 6 ½" RidgeStep™

104 | 5" AeroTread™

6 1/2"

RIDGESTEP™ COMMERCIAL BOARDS

NEW

with no plastic parts and no nonsense

/ Heavy-duty build

With all-steel construction and a durable textured black powder coat finish, the boards are designed to face tough jobs, day after day

/ Reliable footing

High-strength steel mounting brackets provide a solid step, while the non-skid, stamped steel tread will never crack or fade

/ Easier inventory

Four base lengths fit all applications to allow additional space for inventory, while vehicle-specific brackets provide a custom fit

Features and benefits

- High-strength, all-steel construction with no plastic parts
- Angular design for a tough, no-nonsense look
- Non-skid, all-steel tread will not wear or crack
- Flat profile and 6 1/2" width provide a comfortable step
- Textured black powder coat easily hides scratches and dirt
- Welded end caps complement the contours of the truck
- Universal track mounting system for easy, secure installation
- Four base lengths for easier inventory (53", 75", 85" and 91")
- USA-made, vehicle-specific mounting brackets for a precise fit
- Sold separately in pairs with mounting brackets
- See page 102 for application information
- Three-year warranty



Material and finish

Running boards

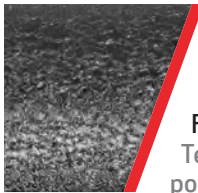

Material:
Carbon steel

Finish:
Textured black powder coat



UNIVERSAL TRACK MOUNTING SYSTEM

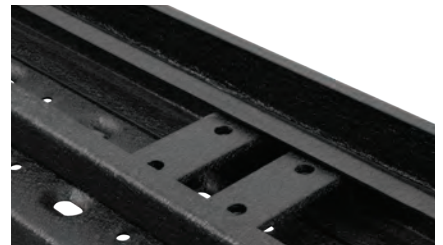
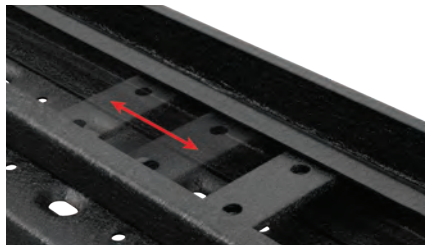

RidgeStep™ commercial running boards come in four base lengths, including 53", 75", 85" and 91", to take up less inventory space and allow for easier ordering. To ensure a custom fit for every application, the running

boards install using a track mounting system and vehicle-specific mounting brackets. Using the application guide, determine the board length and bracket part number that will fit your customer's specific vehicle.

APPLICATION GUIDE

6 1/2" RidgeStep™ Running Boards & Mounting Brackets

Make / Model	Style	Notes	Years	Bracket#	Board#
Chevrolet					
Silverado 1500	Standard Cab	Gas	07 - 16	2055100	C2853
	Double Cab	Gas	07 - 16	2055101	C2875
	Crew Cab	Gas	07 - 16	2055101	C2891
Silverado 2500 & 3500	Standard Cab	Gas and diesel	07 - 16	2055100	C2853
	Double Cab	Gas and diesel	07 - 16	2055101	C2875
	Crew Cab	Gas and diesel	07 - 16	2055101	C2891
Dodge & Ram					
1500	Regular Cab	Gas and diesel	09 - 16	2055110	C2853
	Quad Cab	Gas and diesel	09 - 16	2055111	C2875
	Crew Cab	Gas and diesel	09 - 16	2055111	C2885
2500	Regular Cab	Gas and diesel	10 - 16	2055110	C2853
	Crew Cab	Gas and diesel	10 - 16	2055111	C2885
3500	Regular Cab	Gas and diesel	10 - 16	2055110	C2853
	Crew Cab	Gas and diesel	10 - 16	2055111	C2885
Ford					
F-150	Regular Cab	Gas	15 - 16	2055122	C2853
	Regular Cab	Gas	04 - 14	2055120	C2853
	SuperCab	Gas	15 - 16	2055122	C2885
	SuperCab	Gas	04 - 14	2055120	C2875
	SuperCrew	Gas	15 - 16	2055121	C2891
	SuperCrew	Gas	04 - 14	2055120	C2891
F-250, F-350, F-450	Regular Cab	Gas and diesel	99 - 16	2055123	C2853
	Crew Cab	Gas and diesel	99 - 16	2055124	C2891
	SuperCab	Gas and diesel	99 - 16	2055123	C2875
GMC					
Sierra 1500	Standard Cab	Gas	07 - 16	2055100	C2853
	Double Cab	Gas	07 - 16	2055101	C2875
	Crew Cab	Gas	07 - 16	2055101	C2891
Sierra 2500 & 3500	Standard Cab	Gas and diesel	07 - 16	2055100	C2853
	Double Cab	Gas and diesel	07 - 16	2055101	C2875
	Crew Cab	Gas and diesel	07 - 16	2055101	C2891
Nissan					
Titan	King Cab	Gas	04 - 16	2055141	C2875
	Crew Cab	Gas	04 - 16	2055141	C2885
Toyota					
Tundra	Regular Cab	Gas	07 - 16	2055151	C2853
	Double Cab	Gas	07 - 16	2055151	C2885
	CrewMax	Gas	07 - 16	2055151	C2885



5"

AEROTREAD™ RUNNING BOARDS

NEW

for a sleek, fast, lightweight accent on the modern crossover or SUV

/ Sleek design

The vehicle-specific fit, curved edges, tapered ends and aero-dynamic tread pattern add a sleek accent to modern crossovers and SUVs

/ Lightweight build

The aluminum base provides a solid, lightweight, rust-free step and is covered in a front trim piece, available in two finishes

/ Full-length tread

The hard plastic step pad runs the entire length of the board, providing a non-skid surface no matter where you place your foot

Features and benefits

- Sleek design with rounded ends to complement the look of modern CUVs and SUVs
- Extruded aluminum base to be lightweight and rust-free
- Flat profile and 5" width provide a comfortable step
- Full-length, tough plastic tread offers a reliable, non-skid surface
- Universal track mounting system for easy, secure installation
- Four base lengths for easier inventory (67", 70", 73" and 76")
- Vehicle-specific mounting brackets for a precise fit
- Sold in pairs with mounting brackets sold separately
- See page 106 for application information
- Three-year warranty



Material and finish options

Running boards



Base material:
Aluminum alloy
Front trim material:
304 stainless steel
Front trim finish:
Polished stainless

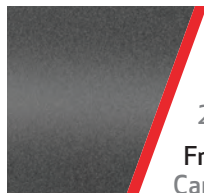

Base material:
Aluminum alloy
Front trim material:
201 stainless steel
Front trim finish:
Carbide black powder coat



UNIVERSAL TRACK MOUNTING SYSTEM

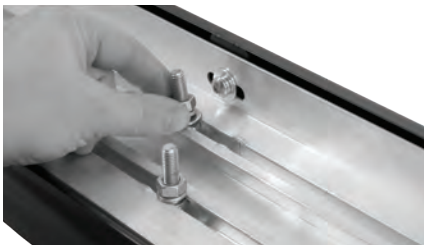

AeroTread™ running boards come in four base lengths, including 67", 70", 73" and 76", to take up less inventory space and allow for easier ordering. To ensure a custom fit for every application, the running boards install using

a track mounting system and vehicle-specific mounting brackets. Using the application guide, determine the board length and bracket part number that will fit your customer's specific vehicle.

APPLICATION GUIDE

5" AeroTread™ Running Board & Mounting Brackets			Brackets Only	Running Boards Only		Running Board Kits (Brackets Included)	
Make / Model	Style / Notes	Years	Bracket#	Stainless#	Black#	Stainless#	Black#
Chevrolet							
Equinox	--	10 - 16	2051122	2051873	2051973	2051022	2061022
Tahoe	--	07 - 16	2051120	2051876	2051976	2051004	2061004
Traverse	--	09 - 16	2051106	2051876	2051976	2051020	2061020
Dodge							
Durango	--	11 - 16	2051105	2051873	2051973	2051031	2061031
Ford							
Edge	--	15 - 16	2051107	2051870	2051970	2051002	2061002
Escape	--	13 - 16	2051108	2051870	2051970	2051021	2061022
Explorer	--	11 - 16	2051109	2051876	2051976	2051003	2061003
GMC							
Acadia	--	07 - 16	2051106	2051876	2051976	2051020	2061020
Terrain	--	10 - 16	2051122	2051873	2051973	2051022	2061022
Yukon	--	15 - 16	2051120	2051876	2051976	2051004	2061004
Honda							
CRV	--	12 - 16	2051125	2051867	2051967	2051005	2061005
Pilot	--	09 - 15	2051128	2051867	2051967	2051006	2061006
Hyundai							
Santa Fe	GLS	13 - 16	2051161	2051870	2051970	2051026	2061026
	Limited	13 - 16	2051161	2051870	2051970	2051026	2061026
	SE	13 - 16	2051161	2051870	2051970	2051026	2061026
Tucson	--	2016	2051162	2051870	2051970	2051019	2061019
Jeep							
Cherokee	--	14 - 16	2051132	2051870	2051970	2051032	2061032
Compass	--	11 - 16	2051134	2051867	2051967	2051008	2061008
Patriot	--	07 - 16	2051134	2051867	2051967	2051008	2061008
Renegade	--	15 - 16	2051138	2051867	2051967	2051023	2061023
Kia							
Sorento	EX	14 - 15	2051175	2051867	2051967	2051024	2061024
	Limited	14 - 15	2051175	2051867	2051967	2051024	2061024
	LX	14 - 15	2051175	2051867	2051967	2051024	2061024
Sportage	--	11 - 16	2051136	2051967	2051867	2051036	2061036
Nissan							
Murano	--	15 - 16	2051144	2051870	2051970	2051010	2061010
Toyota							
Rav4	--	13 - 15	2051159	2051867	2051967	2051018	2061018
Rav4	--	09 - 12	2051158	2051867	2051967	2051017	2061017
Highlander	--	14 - 16	2051154	2051870	2051970	2051015	2061015
Highlander	--	07 - 13	2051153	2051870	2051970	2051014	2061014



REARWARD PROTECTION





COVER YOUR SIX

At ARIES, we have your back, and that means giving you tough accessories to have your customer's back. Our new AdvantEDGE™ headache rack features a unique, octagonal tube profile and grid center section. It offers easy customization with a track-style light mounting system. We also continue to offer our universal headache racks with 1" x 2" steel tube construction and a fully louvered center section.

Our removable mud flaps are a must-have off-road accessory, featuring a quick-release removal system to easily be attached or detached whenever needed. They are available in two flap sizes and can be trimmed to fit virtually any tire offset. Whether hauling heavy loads to the job site or braving uncharted trails, prepare your customers for whatever lies ahead with ARIES.

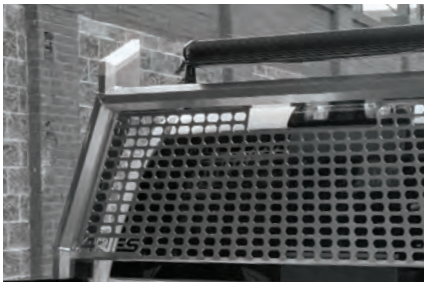

NEW AdvantEDGE™ series

The new AdvantEDGE™ headache rack features a unique look and lightweight design. It allows for easy customization with a top track for mounting lights or other accessories



Prepared to work

ARIES headache racks offer tough cab protection no matter what the job. Our universal racks come with full louvers, while AdvantEDGE™ features a stamped aluminum grid



Off-road ready

Our removable mud flaps are made for fast, easy, pull-pin removal for as-needed use. They quickly convert any truck, Jeep® or SUV into the ultimate off-roading machine

CATEGORY INDEX

110 | **AdvantEDGE™ Headache Rack**

112 | **Headache Racks**

114 | **Removable Universal Mud Flaps**

ADVANTEDGE™ HEADACHE RACKS

NEW

for a unique look and easy customization

/ Unique design

The angular, eight-sided tube profile and octagonal grid center section offer a fresh look to complement the style of today's pickups

/ Top track system

The top edge features a versatile track system to accept LED light bars, off-road lights, tie-down anchors or other accessories

/ All-aluminum build

The aluminum construction is strong, lightweight, rust-free and has no plastic parts, meaning it will never crack or fade

Features and benefits

- Unique, eight-sided tube profile to complement the style of modern trucks
- Track on the top edge accepts lights, tie-down anchors or other accessories
- Extruded, all-aluminum construction to be strong, lightweight and rust-free
- Stamped aluminum, octagonal grid center section for a distinct look
- Stake pocket mounting system for simple, secure installation
- Complements other ARIES AdvantEDGE™ accessories
- Patent pending
- Five-year warranty

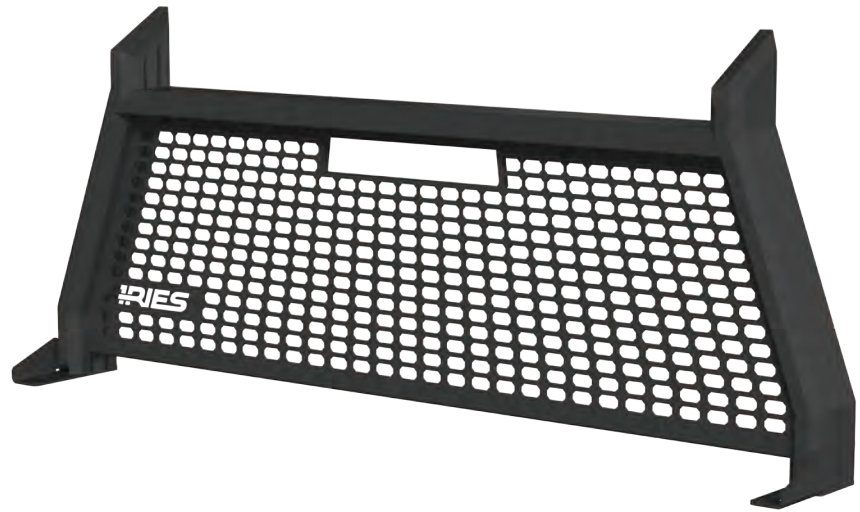

Material and finish options

Headache rack



Material:
Aluminum alloy

Finish:
Chrome
powder coat



Material:
Aluminum alloy

Finish:
Carbide black
powder coat

CUSTOMIZABLE TOP TRACK

In addition to an all-aluminum construction, a stake pocket anchor system and a unique, eight-sided tube profile, the AdvantEDGE™ headache rack also has a unique top track system. The tube running along the top edge of the rack

features an 8mm channel to accept mounting brackets for an LED light bar, round lights, tie-down anchors or other accessories. The channel design allows for a flexible number of accessories and flexible positioning.



APPLICATION GUIDE

AdvantEDGE™ Headache Racks					
Make / Model	Style / Notes	Years	Chrome#	Black#	
Chevrolet					
Silverado 1500	All	07 - 16	1110204	1110104	
Silverado 2500	Excl. 8' box, single axle	07 - 16	1110204	1110104	
	8' box, single axle	07 - 16	1110205	1110105	
Silverado 3500	Excl. 8' box, single axle	07 - 16	1110204	1110104	
	8' box, single axle	07 - 16	1110205	1110105	
Dodge & Ram					
1500	All, excl. Ram box	09 - 16	1110201	1110101	
2500	All, excl. Ram box	09 - 16	1110201	1110101	
3500	All, excl. Ram box	09 - 16	1110201	1110101	
Ford					
F-150	All	09 - 16	1110202	1110102	
F-250	All	99 - 16	1110203	1110103	
F-350	All	99 - 16	1110203	1110103	
GMC					
Sierra 1500	All	07 - 16	1110204	1110104	
Sierra 2500	Excl. 8' box, single axle	07 - 16	1110204	1110104	
	8' box, single axle	07 - 16	1110205	1110105	
Sierra 3500	Excl. 8' box, single axle	07 - 16	1110204	1110104	
	8' box, single axle	07 - 16	1110205	1110105	
Toyota					
Tundra	All	07 - 16	1110206	1110106	

HEADACHE RACKS

with a universal design to fit most full-size pickups

/ Universal design

The versatile mounting system allows for a solid fit on most full-size pickup trucks and is compatible with cross-bed tool boxes

/ Heavy-duty construction

High-strength steel tubing and a fully louvered center section provide a strong frame to keep the truck cab well protected

/ Tough finish

The durable, semi-gloss black powder coat finish easily resists scratches, rust, UV damage and other threats on the jobsite

Features and benefits

- Two universal sizes fit most full-size pickup trucks (see table below)
- Heavy-duty 1" x 2" steel tube construction
- Fully louvered to protect cab and passengers
- Compatible with cross-bed tool boxes
- Durable semi-gloss black powder coat finish
- Three-year warranty



111000

Material and finish

Headache rack

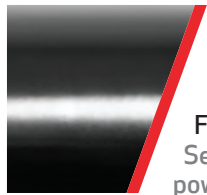

Material:
Carbon steel

Finish:
Semi-gloss black powder coat



111001

Applications

Headache Racks		
Make / Model	Years	Part#
Chevrolet / GMC full-size pickups	88 - 16	111000
Dodge & Ram 1500 / 2500 / 3500	94 - 16	111000
Ford F-150	97 - 14	111000
Ford Super Duty	99 - 16	111001



REMOVABLE UNIVERSAL MUD FLAPS

easily attached or detached with the pull of a pin

/ Use as needed

The mounting bracket features a quick-release pull-pin to allow the mud flaps to be attached or detached whenever necessary

/ Universal design

The 22" hanger can be cut to virtually any length needed to perfectly match the unique tire offset of each truck, Jeep® or SUV

/ Solid construction

The hangers and mounting brackets are made from high-strength steel and have a durable powder coat finish to withstand corrosion

Features and benefits

- Quick-release, pull-pin removal system for a use-as-needed design
- No drilling required on Jeep® Wrangler JK
- Universal brackets with multiple mounting holes fit a variety of vehicles
- 22" hanger can be cut to match different tire offsets
- Thick rubber flaps withstand heavy abrasions and shed water with ease
- High-strength steel brackets with durable powder coat finish
- Sold in pairs with installation hardware included
- One-year warranty

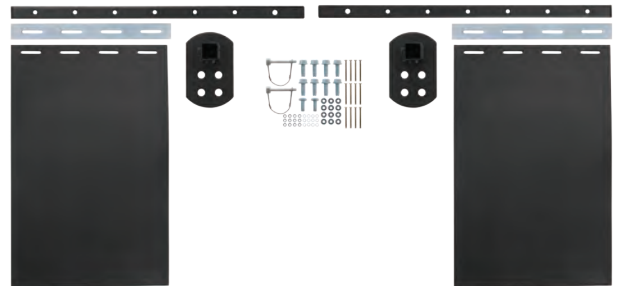

AR111900

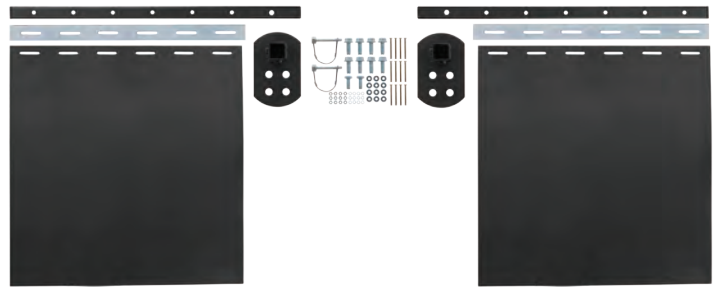

AR111950

Available finish

Mud flaps

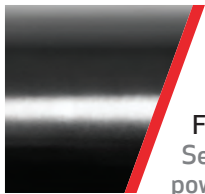

Material:
Carbon steel

Finish:
Semi-gloss black
powder coat

Applications

Removable Universal Mud Flaps

Size	Part#
12" x 18"	AR111900
18" x 18"	AR111950



MADE FOR VERSATILITY

The two key advantages of ARIES mud flaps are that they're removable and universal. The adjustable brackets mount on the vehicle, using four bolts. They can be positioned horizontally or vertically.

The quick-release pull-pin then allows the flaps to be attached to the brackets in mere seconds, and detached whenever necessary.

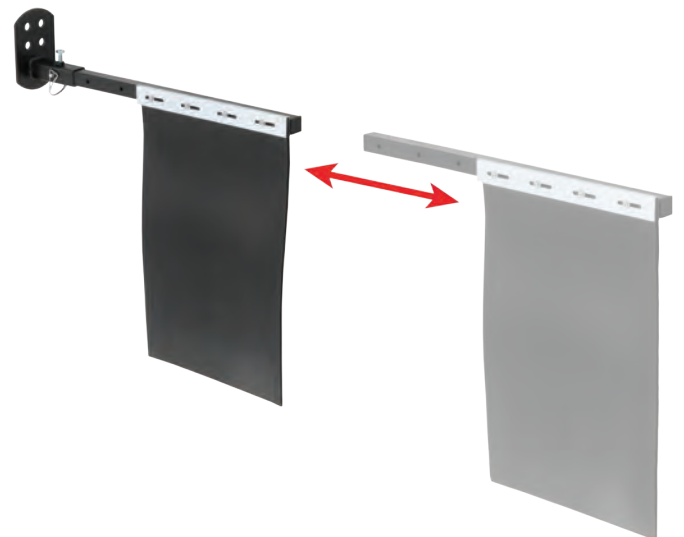
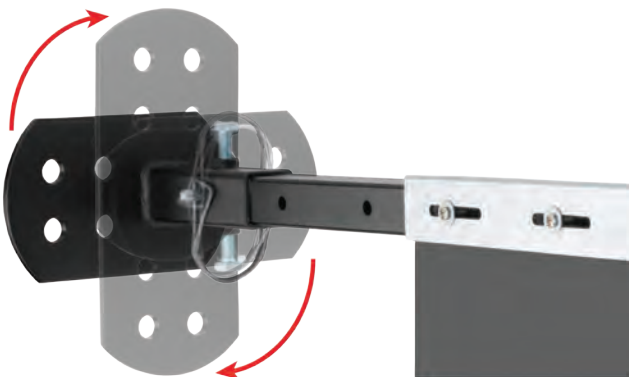

JEEP® PRODUCTS





TAKE THINGS OFF THE BEATEN PATH

At ARIES, we know what it means to be a Jeep® owner. From our modular bumpers and tube doors to our security cargo lid and fender flares, our complete line of Jeep® products reflects the same passion your customers have for going off the beaten path.

New for 2016, ARIES Jeep® rocker steps offer more than extra side protection. With their wide, flat profile and heavy-duty design, they offer a solid step up, plenty of ground clearance and protection from scratches and dents.

Never let your customers settle for Jeep® accessories that are unworthy to bear the name. Give them freedom on the trail with Jeep® products from ARIES.



NEW Jeep® rocker steps

Unlike side bars, new ARIES Jeep® rocker steps are designed to offer more ground clearance to be off-road ready. They not only offer extra protection but also a solid step up



Easy customization

ARIES Jeep® products make it easy for your customers to achieve that customized look, whether they want the entire package right away or prefer to build one piece at a time



Solid construction

Most of our Jeep® products are made from hardened T6 aluminum with a textured black finish to be strong, rust-free and keep your customer's Jeep® light on its feet

CATEGORY INDEX

118 | **Modular Bumpers**

126 | **Rocker Steps**

128 | **Tube Doors**

130 | **Fender Flares**

132 | **Security Cargo Lid**

134 | **Tube Bumpers**

136 | **Jeep Accessories**

JEEP[®] MODULAR BUMPERS

with a mix-and-match design for ultimate customization

/ Customizable configuration

The modular design allows pieces to be added to the center section as desired, making it easy to find the right look and change it any time

/ Lightweight build

Constructed with 3/16" T6 aluminum and 100% TIG welds, the aluminum option is strong, lightweight and rust-free for ready off-roading

/ Multiple accessory options

With light mounting tabs and cutouts, tow hook attachment points and a 22 1/2" x 7 3/4" winch housing, adding accessories is easy

Features and benefits

- Six-piece customizable design with 16 different configurations (see page 120 for more information)
- Modular pieces can be added or removed as desired
- Hardened T6 aluminum construction to be lightweight and rust-free (also available in carbon steel)
- Cutouts and light mounting tabs for OE bumper lights and auxiliary lighting
- Accepts tow hooks and a winch (aluminum requires winch bracket #15600WRB)
- Mid configuration with side caps available for larger tires or wheel wells
- Fits 2007 - 2016 Jeep[®] Wrangler JK
- Uses pre-existing factory mounting points for easy installation
- Front and rear bumpers available
- Five-year warranty on aluminum bumpers and three-year warranty on steel

Material and finish options

Center section

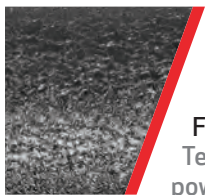

Material:
Carbon steel
Finish:
Textured black powder coat

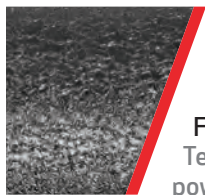

Material:
T6 aluminum alloy
Finish:
Textured black powder coat



Material:
T6 aluminum alloy
Finish:
Silver powder coat

Side extensions

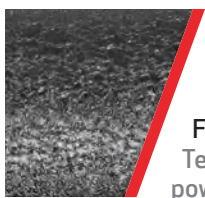

Material:
Carbon steel
Finish:
Textured black powder coat

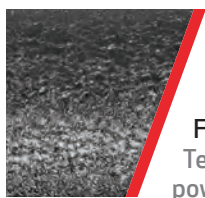

Material:
T6 aluminum alloy
Finish:
Textured black powder coat

Brush guards

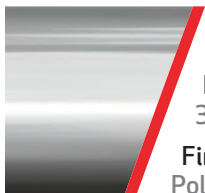

Material:
304 stainless steel
Finish:
Polished stainless



Material:
Carbon steel
Finish:
Textured black powder coat

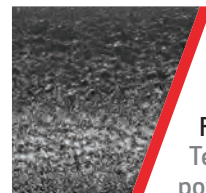

Material:
T6 aluminum alloy
Finish:
Textured black powder coat

Protective brush guards easily bolt onto sides and center section

Light mounting tabs for off-road lights

Side extensions can be swapped out for side caps

Universal winch housing
22 1/2" x 7 3/4"

Cutouts and mounting tabs for additional lights

Front and rear center sections use existing mounting points

Light mount cutouts for OE fog lights

2071051

Left and right bumper side extensions

Rear cutouts allow for dual exhaust

Light mount cutouts for OE lights

Center cutout allows for rear mount trailer hitch

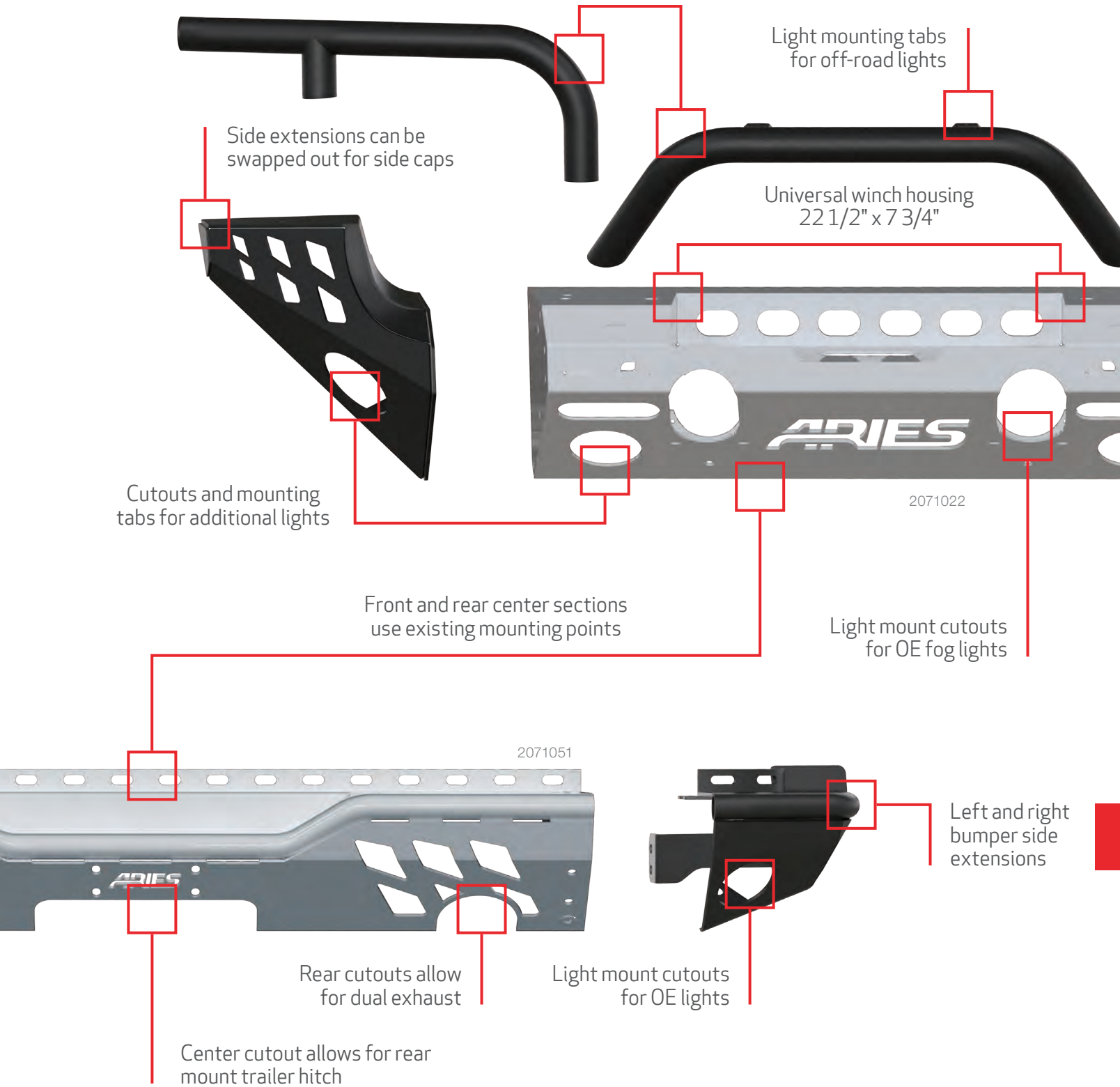

FULL-CONFIG FRONT MODULAR BUMPER KITS

/ Steel construction



2071030



2071031



2071032

/ Aluminum construction



2071023



2071024



2071020



2071021



2071022

Full-Config Front Modular Bumper Kits

Kit Part#	Center Section	Side Extensions	Brush Guards	Center and Side Material	Center Finish	Side Finish	Brush Guard Material	Brush Guard Finish
2071030	15600-0	15600-1	15600-4	Steel	2	2	Steel	2
2071031	15600-0	15600-1	15600-4-2	Steel	2	2	Stainless steel	1
2071032	15600-0	15600-1	--	Steel	2	2	--	--
2071023	AL15600-0	AL15600-1	--	Aluminum	2	2	--	--
2071024	AL15600-0-3	AL15600-1	--	Aluminum	3	2	--	--
2071020	AL15600-0	AL15600-1	AL15600-4	Aluminum	2	2	Aluminum	2
2071021	AL15600-0	AL15600-1	15600-4-2	Aluminum	2	2	Stainless steel	1
2071022	AL15600-0-3	AL15600-1	AL15600-4	Aluminum	3	2	Aluminum	2

1. Polished stainless steel

2. Textured black powder coat

3. Silver powder coat

MID-CONFIG FRONT MODULAR BUMPER KITS

/ Steel construction



2071033



2071034



2071035

/ Aluminum construction



2071028



2071029



2071025



2071026



2071027

Mid-Config Front Modular Bumper Kits

Kit Part#	Center Section	Side Caps	Brush Guard	Center and Side Material	Center Finish	Side Finish	Brush Guard Material	Brush Guard Finish
2071033	15600-0	C15600-1	15600-5	Steel	2	2	Steel	2
2071034	15600-0	C15600-1	15600-5-2	Steel	2	2	Stainless steel	1
2071035	15600-0	C15600-1	--	Steel	2	2	--	--
2071028	AL15600-0	ALC15600-1	--	Aluminum	2	2	--	--
2071029	AL15600-0-3	ALC15600-1	--	Aluminum	3	2	--	--
2071025	AL15600-0	ALC15600-1	AL15600-5	Aluminum	2	2	Aluminum	2
2071026	AL15600-0	ALC15600-1	15600-5-2	Aluminum	2	2	Stainless steel	1
2071027	AL15600-0-3	ALC15600-1	AL15600-5	Aluminum	3	2	Aluminum	2

1. Polished stainless steel

2. Textured black powder coat

3. Silver powder coat

REAR MODULAR BUMPER KITS



2071052



2071050



2071051

Rear Modular Bumper Kits

Kit Part#	Center Section	Side Extensions	Center Material	Center Finish	Side Finish
2071052	25600-0	25600-1	Steel	2	2
2071050	AL25600-0	AL25600-1	Aluminum	2	2
2071051	AL25600-0-3	AL25600-1	Aluminum	3	2

2. Textured black powder coat 3. Silver powder coat

MODULAR BUMPER REPLACEMENT PIECES

/ Brush guards



15600-4 & AL15600-4



15600-4-2



15600-5



15600-5-2

Front Modular Bumper Replacement Brush Guards

Part#	Material	Finish
Full Configuration - Center and Side Brush Guards		
15600-4	Steel	Textured black
15600-4-2	Stainless steel	Stainless steel
AL15600-4	Aluminum	Textured black
RA15600-4*	Aluminum	Raw aluminum
Mid Configuration - Center Brush Guards		
15600-5	Steel	Textured black
15600-5-2	Stainless steel	Stainless steel

* Raw aluminum (available by special order)

/ Side extensions and side caps

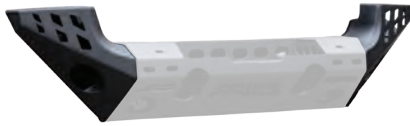

15600-1 & AL15600-1



C15600-1 & ALC15600-1



25600-1 & AL25600-1

Modular Bumper Replacement Side Extensions and Side Caps

Part#	Material	Side Extension Finish	Side Cap Finish
Front Bumper			
15600-1	Steel	Textured black	--
C15600-1	Steel	--	Textured black
AL15600-1	Aluminum	Textured black	--
ALC15600-1	Aluminum	--	Textured black
RA15600-1*	Aluminum	Raw aluminum	--
RAC15600-1*	Aluminum	--	Raw aluminum
Rear Bumper			
25600-1	Steel	Textured black	--
AL25600-1	Aluminum	Textured black	--
RA25600-1*	Aluminum	Raw aluminum	--

* Raw aluminum (available by special order)

/ Center sections



15600-0 & AL15600-0



AL15600-0-3



25600-0 & AL25600-0



AL25600-0-3

Modular Bumper Replacement Center Sections

Part#	Material	Finish
Front Bumper		
15600-0	Steel	Textured black
AL15600-0	Aluminum	Textured black
AL15600-0-3	Aluminum	Silver powder coat
RA15600-0*	Aluminum	Raw aluminum
Rear Bumper		
25600-0	Steel	Textured black
AL25600-0	Aluminum	Textured black
AL25600-0-3	Aluminum	Silver powder coat
RA25600-0*	Aluminum	Raw aluminum

* Raw aluminum (available by special order)

JEEP® MODULAR BUMPER ACCESSORIES

NEW Winch fairlead mount

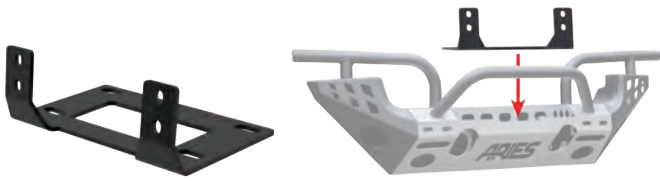

15600FB

- Easily and securely mounts on ARIES modular bumper winch housing
- Two holes, spaced 10" center-to-center, accept most types of fairleads
- See page 137 for more information

Tow hook



15600TW

- Perfect for recovery towing applications
- Up to 9,000 lbs. capacity
- Fits both steel and aluminum modular bumpers (aluminum requires winch receiver plate bracket)
- See page 137 for more information

Winch receiver plate bracket

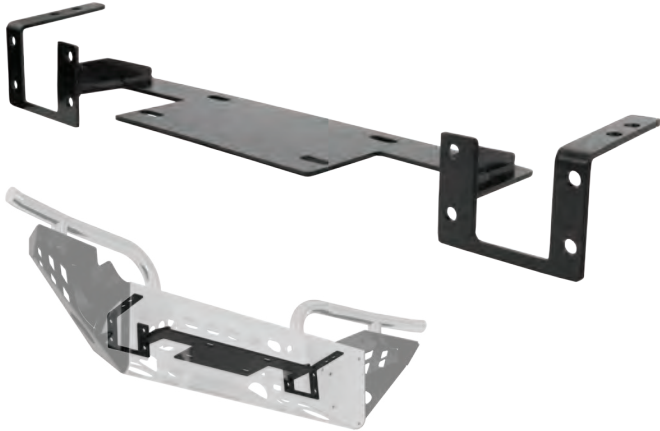

15600WRB

- Required to reinforce an aluminum front modular bumper when using a winch or tow hooks
- See page 137 for more information

License plate bracket



55-0000

- Provides a solid mounting location to keep license plate visible
- See page 138 for more information



JEEP® ROCKER STEPS

NEW

for added protection and a solid foothold on any off-roader

/ Wide, flat profile

Unlike side bars that have low ground clearance, rocker steps are set high enough to clear brush, boulders and other off-road debris

/ Reliable footing

While most rocker bars only serve to protect, the welded top plate provides a convenient, comfortable, 3" wide step up into the Jeep®

/ Off-road ready

The all-steel construction, double-tube layout and tough, textured black powder coat finish offer the durability needed to conquer the trail

Features and benefits

- Double-tube layout and 3" wide top plate provide a solid step
- Heavy-duty design offers extra protection for the sides of the Jeep®
- Flat profile increases ground clearance for ready off-roading
- Textured black powder coat easily hides scratches and dirt
- All-steel construction for reliable strength
- Pre-welded mounting brackets increase rigidity and simplify installation
- No-drill, vehicle-specific application for a custom fit
- Sold in pairs with mounting hardware included
- Three-year warranty

Available finish

Rocker steps



Material:
Carbon steel

Finish:
Textured black powder coat



2074101



2074101

Applications

Rocker Steps			
Model	Notes	Years	Part#
Wrangler	2-door	07 - 16	2074100
	4-door	07 - 16	2074101



JEEP® TUBE DOORS

for a taste of freedom with every drive

/ Off-road ready

The open design, aggressive cutout pattern and lightweight aluminum construction are geared for the ultimate off-roading experience

/ Solid construction

Hardened T6 aluminum provides high structural integrity, while the tungsten insert gas (TIG) welds allow for clean weld lines and a precise fit

/ Strong finish

The textured black powder coat finish resists UV damage and easily hides scratches and dirt to stand up to the off-road elements

Features and benefits

- Open design and aggressive cutout for the ultimate off-roading experience
- Hardened T6 aluminum construction to be lightweight and rust-free
- Textured black powder coat easily hides scratches and dirt
- 100% TIG welds for a precise fit
- Simple installation using existing hinge points
- Accepts factory mirrors (not compatible with power mirrors)
- Sold in pairs with swing-out straps included
- Five-year warranty

Available finish

Tube doors

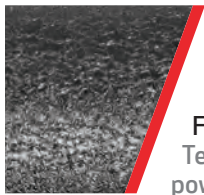

Material:
T6 aluminum alloy

Finish:
Textured black powder coat



AR15009
front door



25009
rear door

Applications

Tube Doors			
Model	Years	Location	Black#
Wrangler	07 - 16	Front	AR15009
	07 - 16	Rear	25009

Tube doors may be illegal in some states.
Check with the local and state laws before installing



KEY-OPERATED LOCKING LATCH



While ARIES tube doors are built to open up the Jeep® Wrangler for ultimate off-roading, they are also designed to be functional and maintain a certain level of vehicle security. The doors operate using the factory hinges and

existing striker plates, and they feature a locking latch mechanism to help deter unwelcomed access into the Jeep® while it is parked and left unattended.

JEEP® FENDER FLARES

give those off-road tires the recognition they deserve

/ Lightweight aluminum build

Aluminum construction allows the flares to be strong and lightweight, while the durable, textured black finish easily hides scratches and dirt

/ Custom fit

The 4" width and vehicle-specific contours offer a precise fit for the Jeep® Wrangler, adding style, utility and accommodating the off-road ride

/ Solid installation

The flares bolt directly onto the body, replacing the factory flares, and they can accept LED side markers for maximum safety on and off the road

Features and benefits

- Hardened T6 aluminum construction to be lightweight and rust-free
- Textured black powder coat easily hides scratches and dirt (also available in a raw, paintable finish)
- 4" wide design with vehicle-specific contours
- Solid, bolt-on installation
- Accepts LED fender flare side markers ARIES #1500240 (some drilling required)
- Available for front and rear wheels
- Sold in pairs, including passenger and driver side
- Mounting hardware included (some drilling may be required)
- Three-year warranty



1500201



2500201

Available finishes

Fender flares

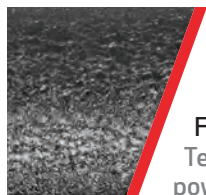

Material:
T6 aluminum alloy
Finish:
Textured black powder coat



Material:
T6 aluminum alloy
Special order finish:
Raw aluminum

Applications

Fender Flares				
Model	Location	Years	Black#	Raw#
Wrangler	Front	07 - 16	1500201	1500202
	Rear	07 - 16	2500201	2500202



NEW FENDER FLARE SIDE MARKERS

- LED components for a bright, long-lasting light
- Splices into existing factory wiring harness
- Wires route through fender frame to keep them well protected
- DOT-approved for safety
- Includes all necessary installation hardware
- One-year warranty



JEEP® SECURITY CARGO LID

for ultimate off-road security and storage

/ Integrated security

The six-panel enclosure bolts directly into the bed of the Jeep® and creates a spacious, key-operated storage area that works with the rear door

/ Versatile design

Tie-down anchors and a weight capacity of 75 lbs. allow items to be stored on top, and the lid can be flipped and converted into a usable surface

/ Lightweight aluminum build

The hardened T6 aluminum construction is strong, rust-free and lightweight to keep valuables safe and protect them from the elements

Features and benefits

- Six-panel, bolt-on design integrates with the layout of the Jeep® (4-door models only)
- Key-operated, water-resistant enclosure provides a generous storage area
- Hardened T6 aluminum construction to be lightweight and rust-free
- Textured black powder coat easily hides scratches and dirt
- Works in conjunction with the rear door
- Convertible to a workbench or table area
- 1/2" diameter tie-down anchors on top for securing additional cargo
- Weight capacity up to 75 lbs.
- Compatible with hardtop on or off, soft top and subwoofer
- Complete kit part number ships in two boxes
- Three-year warranty



Available finish

Cargo lid



Material:
T6 aluminum alloy

Finish:
Textured black
powder coat

Applications

Security Cargo Lid				
Model	Years	Complete Kit#	Component 1	Component 2
Wrangler Unlimited	07 - 10	2070465	ALC25000-01	ALC25000-00
	11 - 16	2070475	ALC25001-01	ALC25000-00



KEY-OPERATED LOCKING LATCH



The ARIES security cargo lid not only works with the rear door of the Jeep®, but it also functions independently, meaning it can be opened without requiring the rear door to be opened first. It features a key-operated, quarter-turn latch for quick, convenient access to the cargo area.

Simply insert the key, turn the latch and lift the lid. The locking latch mechanism is made with durable metal components and is covered in a chrome finish for lasting rust resistance.

JEEP® TUBE BUMPERS

for a classic look that never goes out of style

/ Solid construction

3" diameter tubing is welded together in a double-stacked design for increased strength and a classic appearance

/ Strong finish

Both the polished stainless and black powder coat finishes are highly resistant to rust, scratches and other damage

/ Simple installation

Bumper installs using the vehicle's original factory bumper mounting points for quick, secure, no-drill attachment

Features and benefits

- Double-stacked layout for a classic appearance
- 3" diameter, heavy-wall tube design
- Front bumper features protective welded brush guard
- Cutout on rear bumper allows for spare tire
- Uses pre-existing factory mounting points for easy installation
- Front and rear bumpers available
- Three-year warranty

Available finishes

Tube bumper

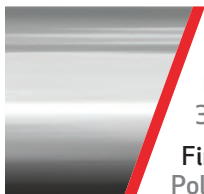

Material:
304 stainless steel
Finish:
Polished stainless

Tube bumper

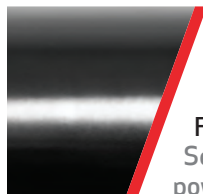

Material:
Carbon steel
Finish:
Semi-gloss black powder coat



15200-2
front bumper



25201-2
rear bumper

Applications

Tube Bumpers

Model / Location	Years	Black#	Stainless#
CJ, YJ, Wrangler - Front	76 - 06	15200	15200-2
CJ, YJ, Wrangler - Rear	76 - 06	25201	25201-2



LICENSE PLATE BRACKET



55-0000

- Easily bolts onto any ARIES tube bumper
- Provides a solid mounting location to keep license plate visible
- Steel construction with black powder coat finish
- Includes two license plate mounting bolts

JEEP® ACCESSORIES

go from roadworthy to trail-ready

When it comes to Jeep® accessories, ARIES gets revved up about charging off road. Our products reflect our passion because we know that it is the same passion that drives your customers.

With everything from our bumper tow hooks to our Jeep® roof light bar, we offer the variety you expect and the quality your customers demand.

Accessories parts list

Jeep® Accessories		
Part#	Description	Page#
AR111900	Removable universal mud flaps	138
AR15800	Windshield light brackets	139
15600WRB	Winch receiver plate bracket	137
15600TW	Tow hook	137
1500240	Fender flare side marker	138
15600FB	Winch fairlead mount	137

Jeep® Accessories		
Part#	Description	Page#
15910	Roof light bar	136
25630AB	Tire relocation carrier and reinforcement brackets	139
55-0000	License plate relocation bracket for Jeep® modular and tube bumpers	138
256TBL	Third brake light extension bracket	139

ROOF LIGHT BAR

- Accommodates most LED light bar sizes and round lights up to 9" in diameter
- Designed to contour to the windshield
- Fits 2007 - 2016 Jeep® Wrangler JK
- Hardened T6 aluminum construction to be lightweight and rust-free
- Textured black powder coat easily hides scratches and dirt
- Will not whistle like competitive models
- Compatible with hardtops and soft tops
- Three-year warranty



NEW WINCH FAIRLEAD MOUNT

- Easily and securely mounts on ARIES modular bumper winch housing
- Two holes, spaced 10" center-to-center, accept most types of fairleads
- Solid, 1/4" thick steel construction
- Durable carbide black powder coat finish
- Fits both steel and aluminum modular bumpers (aluminum requires winch receiver plate bracket)
- Uses winch and fairlead mounting hardware

15600FB

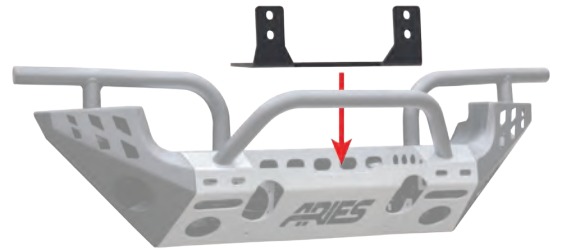

WINCH RECEIVER PLATE BRACKET

- Required to reinforce an aluminum front modular bumper when using a winch or tow hooks
- Solid, 1/4" thick carbon steel construction
- Durable black powder coat finish
- Includes mounting hardware



15600WRB

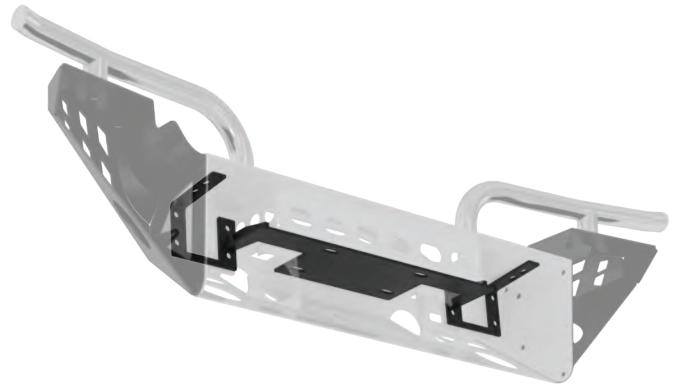

TOW HOOK

- Perfect for recovery towing applications
- Up to 9,000 lbs. capacity
- Fits both steel and aluminum modular bumpers (aluminum requires winch receiver plate bracket)
- Utilizes existing factory bolts on YJ and TJ models
- Steel construction with black powder coat finish
- Three-year warranty



15600TW

NEW FENDER FLARE SIDE MARKERS

- LED components for a bright, long-lasting light
- Splices into existing factory wiring harness
- Wires route through fender frame to keep them well protected
- DOT-approved for safety
- Includes all necessary installation hardware
- One-year warranty



REMOVABLE UNIVERSAL MUD FLAPS

- Quick-release, pull-pin removal system for a use-as-needed design
- No drilling required on Jeep® Wrangler JK
- Universal brackets with multiple mounting holes fit a variety of vehicles
- 22" hanger can be cut to match different tire offsets
- One-year warranty

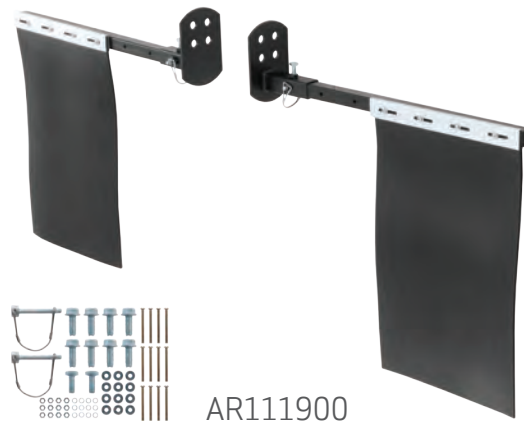
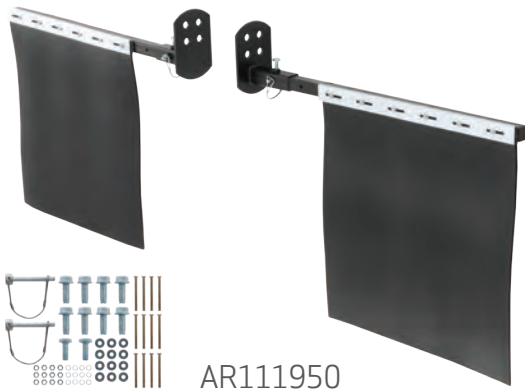

LICENSE PLATE RELOCATION BRACKETS

- Easily bolts onto any ARIES® tube bumper or modular bumper
- Provides a solid mounting location to keep license plate visible
- Steel construction with black powder coat finish
- Includes two license plate mounting bolts



TIRE RELOCATION CARRIER & REINFORCEMENT BRACKETS

- Allows for a larger spare tire up to 35" in diameter
- Fits 2007 - 2016 Jeep® Wrangler JK
- Securely bolts onto existing tire carrier
- Maintains easy access to the rear cargo area
- Steel construction with black powder coat finish
- Includes installation hardware

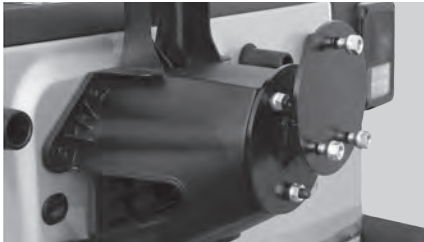

25630AB

WINDSHIELD LIGHT BRACKETS

- Accepts off-road lights, fog lights, driving lights and more
- Securely bolts on at the windshield hinge
- Easy, no-drill installation
- Durable black powder coat finish
- Includes driver-side and passenger-side brackets



AR15800



THIRD BRAKE LIGHT EXTENSION BRACKET

- Allows brake light to be seen over a spare tire up to 35" in diameter
- Improves safety on and off the road
- Compatible with tire relocation carrier
- Steel construction with black powder coat finish
- Includes installation hardware (some cutting required)

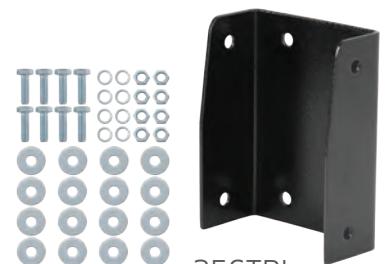

256TBL

INTERIOR PROTECTION



ARIES



WORK HARD TO PLAY EVEN HARDER

ARIES is aimed at complete protection of your customer's vehicle interior – not just for the floor but for every row and every seat. We offer Seat Defender™ and StyleGuard™ floor liners for interior protection unlike any other.

Seat Defender™ is an innovative, universal and use-as-needed seat protection system that stops damage before it happens, instead of just covering it up. It is easy to install, remove, clean and store.

StyleGuard™ floor liners feature a triple-layer defense, a custom-molded fit and a refined appearance. They break away from the industrial look and offer superior slip resistance using patented OmniGrip™ fibers.



Complete vehicle coverage

Instead of only protecting the vehicle's floor, StyleGuard™ and Seat Defender™ work together to offer a complete, waterproof protection system



Multiple applications

Seat Defender™ comes in two universal sizes, while StyleGuard™ liners are available for a variety of vehicles for individual rows or in complete kits



Durable construction

Seat Defender™ is made with a tough, dual-sided construction, and StyleGuard™ features a triple-layer design with industrial-strength materials

CATEGORY INDEX

142 | **Seat Defender™**

143 | **StyleGuard™ Floor Liners**

SEAT DEFENDER™

with a universal, dual-sided design to protect any seat

/ As-needed protection

The fast, simple design allows it to be used as needed to stop damage instead of just covering it up. It then removes and cleans quickly to be ready for use again

/ Dual-action defense

The bottom layer of thermoplastic rubber grips the seat, while the top layer of 600-denier terylene fabric defends against spills, dirt, pet dander and more

/ Universal design

Seat Defender™ is available in two universal sizes and four different color options. It easily installs on front or rear seats and fits virtually any bucket or bench seat

Features and benefits

- Use-as-needed, universal design with dual-layer, non-skid protection
- Fast and easy to remove, clean and store
- Thermoplastic rubber grips the seat, providing added comfort and safety
- Woven 600-denier terylene fabric blocks spills, dirt and more
- 100% waterproof and machine washable
- Allows for side airbag deployment
- Bucket and bench size options fit virtually all vehicles



Color options

Seat Defender™

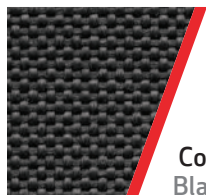

Color:
Black

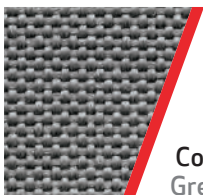

Color:
Grey



Color:
Brown

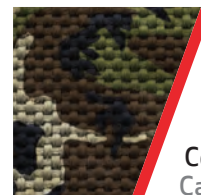

Color:
Camo

Applications

Seat Defender™				
Location	Black#	Grey#	Brown#	Camo#
Bucket	3142-09	3142-01	3142-18	3142-20
Bench	3146-09	3146-01	3146-18	3146-20

STYLEGUARD™ FLOOR LINERS

with patented OmniGrip™ fibers

/ Thermoplastic rubber

The top layer of finely-textured thermoplastic rubber (TPR) is strong, durable, wear-resistant and waterproof to stand up to scuffs, dings, spills, drips and more

/ Layered XPE foam

The middle layers of semi-rigid cross-linked polyethylene foam are waterproof, shock-absorbent, sound-insulating and thermostatic for a more comfortable ride

/ OmniGrip™ fibers

Instead of having two points of contact, the bottom layer of patented OmniGrip™ fibers has thousands. The fibers grip all carpet, preventing shift and providing safety

Features and benefits

- Durable, textured surface for a refined appearance and ultimate interior protection
- Triple-layer construction using industrial-strength materials
- Thousands of patented OmniGrip™ fibers resist slipping on all types of carpet
- Laser-measured for perfect, vehicle-specific contour
- Flexible, breathable rubber will not become brittle over time
- Raised edges contain all liquids and debris
- Resists moisture and reduces engine and road noise
- Simple, instantaneous installation; no extra grip discs required
- Offered in complete kits or individually for the first row, second row or cargo area
- Available for trucks, vans, SUVs, crossovers and passenger cars
- For application guide, see ariesautomotive.com
- Limited lifetime warranty

Color options

StyleGuard™ Floor Liners

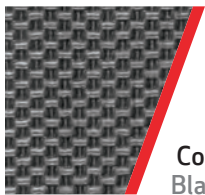

Color:
Black



Color:
Grey



Color:
Beige



MARKETING MATERIALS





SHOW THEM THE ARIES DIFFERENCE

At ARIES, we believe that creating a successful business means more than designing and delivering an innovative product line. We believe that supporting our customers is just as important.

Our marketing materials include brochures, signage, displays, crops and more to give you the tools you need to successfully market and sell ARIES products. With our recent rebranding, these materials feature our new logo and style and offer a professional look for the aftermarket dealer.

For both in-store and online use, we also offer extensive image, video and written content resources to inform your customers and increase sales. These assets are available to all ARIES dealers, free of charge. More information is available in the Dealer Portal Media Kit at ariesautomotive.com.



Detailed literature

Our catalogs and brochures present our products with high-res, professional photography and offer detailed information about our products, highlighting our unique selling points



Informative signage

With everything from banners and display boards to header cards and countertop signs, our signage features full-color images and graphics to draw in and educate your customers



Attractive displays

We offer crops and minis for a variety of our products, as well as retail-friendly wall displays and display stands to show off ARIES products, in the best light, to your customers

CATEGORY INDEX

146 | **Catalogs and Literature**

147 | **Display Boards**

147 | **Promotional Banner**

148 | **Side Bar Crops**

148 | **Vinyl Logo Decals**

149 | **StyleGuard™ Minis**

149 | **Countertop Display**

150 | **Wall Displays**

151 | **Display Stands**

PRODUCT CATALOGS

- Complete listings of ARIES products and applications
- Downloadable versions available at ariesautomotive.com



9900007



9900008



9900051

Product Catalogs

Part#	Description
9900007	2016 interior catalog and application guide
9900008	2016 exterior catalog and application guides
9900051	2016 Jeep® products catalog and application guides

PRODUCT LITERATURE

- Highlights key features of specific products for improved business-to-business sales



9900011



9900052



9900053



9900054



9900055

Product Literature

Part#	Description
9900011	StyleGuard™ floor liners
9900052	AdvantEDGE™ series
9900053	RidgeStep™ running boards
9900054	AeroTread™ running boards
9900055	Jeep® rocker steps

DISPLAY BOARDS

- Show off ARIES product offerings in your store
- Constructed of rigid styrene board



ADVANTEDGE™ SERIES



9900057



JEEP® PRODUCTS



9900058



STYLEGUARD™ FLOOR LINERS



9900059

Display Boards

Part#	Description	Dimensions
9900057	AdvantEDGE™ series	23 1/2" x 18"
9900058	Jeep® products	23 1/2" x 18"
9900059	StyleGuard™ floor liners	23 1/2" x 18"
9900060	AeroTread™ and RidgeStep™ running boards	23 1/2" x 18"



RIDGESTEP™ & AEROTREAD™ RUNNING BOARDS



9900060

PROMOTIONAL BANNER

- Show off ARIES brand name to draw in traffic



9900056

Promotional Banner

Part#	Description	Dimensions
9900056	ARIES logo banner	5' x 2'

SIDE BAR & RUNNING BOARD CROPS

- Fits on ARIES display stands WDP0002, 9910001 and 9910115
- Allows customers to handle and experience products with ease



9910102

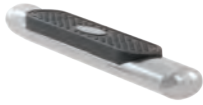

9910103



9910104



9910106

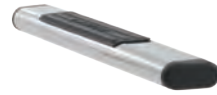

9910107



9910108



9910109



9910110



9910113



9910111

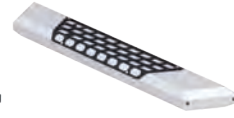

9910112

Side Bar & Running Board Crops

Part#	Description
9910102	4" oval, black
9910103	4" oval, stainless
9910104	4" round, black
9910106	6" oval, black
9910107	6" oval, stainless
9910108	RidgeStep™, black

Side Bar & Running Board Crops

Part#	Description
9910109	AeroTread™, black
9910110	AeroTread™, stainless
9910111	AdvantEDGE™, black
9910112	AdvantEDGE™, chrome powder coat
9910113	Jeep® rocker step

VINYL LOGO DECALS

- Accessory stickers to promote ARIES brand awareness
- Great for customer give-aways and to stick on vehicles



9900049



9900050



Vinyl Logo Decals

Part#	Description	Dimensions
9900049	Vinyl logo decal, red	5" x 1"
9900050	Vinyl logo decal, white	5" x 1"

STYLEGUARD™ FLOOR LINER MINIS

- Fits on ARIES display stand 3505-A, see page 151
- Great for ARIES countertop display 9900061, see below
- Allows customers to handle and experience products with ease



DP60-001



DP60-002



DP60-009

StyleGuard™ Floor Liner Minis

Part#	Description
DP60-001	StyleGuard™ floor liner mini, grey
DP60-002	StyleGuard™ floor liner mini, beige
DP60-009	StyleGuard™ floor liner mini, black



3505-A

STYLEGUARD™ COUNTER DISPLAY

- Attractive countertop display to help your staff promote ARIES StyleGuard™ floor liners



9900061

StyleGuard™ Counter Display

Part#	Description
9900061	StyleGuard™ floor liner countertop display

WALL DISPLAYS

- Educates customers and allows for hands-on experience
- Convenient, wall-mounted design utilizes wall space
- Product not included with the display stand



WDP0001



WDP0002



9910115

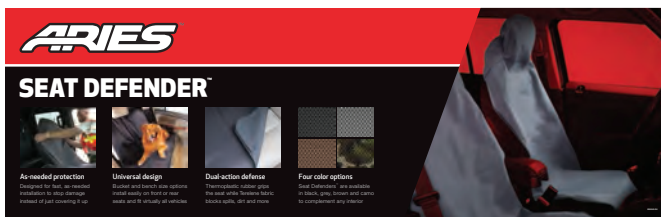

9900040



9900042

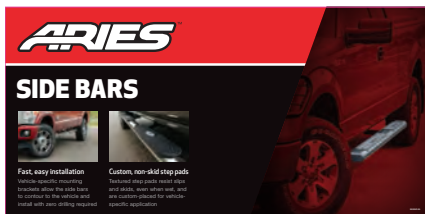

9900041 Side A



9900041 Side B

Wall Displays and Header Cards

Part#	Description	Dimensions
WDP0001	Seat Defender™, holds up to eight	--
9900040	Seat Defender™ header card for WDP0001 display	22" x 7"
WDP0002	Side bar and bull bar display, holds one each	--
9900042	Side bar and bull bar header card for WDP0002 display	22" x 7 1/2"
9910115	Slat board display, holds one side bar or one bull bar	--
9900041	Reversible side bar and bull bar header card for 9910115 display	12" x 6"

DISPLAY STANDS

- Educates customers and allows for hands-on experience
- Free-standing displays can easily be set up anywhere in your store

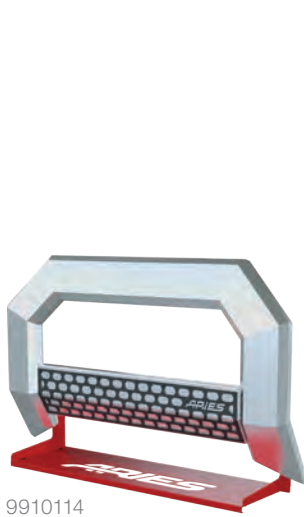

9910114



9910000



9910001



3505-A

JEOP® MODULAR BUMPERS

with a mix-and-match design for ultimate customization

- Customizable configuration**
With up to 16 different configurations for the front and three for the rear, the modular design allows pieces to be added as desired, making it easy to find the right look and change it any time.
- Available in aluminum or steel**
ARIES bumpers are available in aluminum or steel, with various finish options. Our aluminum bumpers are constructed with handcast T6 aluminum alloy to be strong, lightweight and rust-free.
- Multiple accessory options**
With mounting tabs and cutouts for LED lights, pre-drilled holes for mounting tow hooks, and a 22-1/2" x 2" DRP housing to accept most types of winches, wiring accessories is easy.

9900038

SIDE BARS

step up and stand out

- AdvantEDGE™ Series**
AdvantEDGE™ side bars have an all-aluminum construction to be lightweight and rust-free, and they feature a unique, eight-sided tube profile to complement the style of today's trucks.
- More applications**
ARIES side bars come in various tube diameters, from 2" up to 4". We offer hundreds of applications, and each of our side bars mounts using vehicle-specific brackets for a custom fit.
- Variety of finishes**
With material options like aluminum, stainless, and custom steel, and optional finishes like brushed black, and polished stainless, you can choose the side bar that best suits your ride.

9900039

STYLEGUARD™ FLOOR LINERS

- Triple-layer construction**
Three distinct materials provide enough material to absorb impact and prevent damage to the vehicle's floor.
- OmniGrip fibers**
These fibers provide superior traction and prevent slipping.
- Custom-modified fit**
Each liner is custom-molded to perfectly conform to its vehicle-specific application.
- Refined, textured surface**
The most durable and custom-molded design comes with a soft, yet textured surface.

9900043

Display Stands and Header Cards

Part#	Description	Dimensions
9910000	Jeep modular bumper display stand, holds one front and one rear bumper (bumpers and header car not included)	--
9900038	Jeep modular bumper display stand header card for 9910000	42 1/8" x 14 1/8"
9910001	Side bar display stand, holds five crops (crops and header car not included)	--
9900039	Side bar display stand header card for 991001	42 1/8" x 14 1/8"
3505-A	StyleGuard™ display stand tree (includes DP60-001, DP60-002 and DP60-009 floor liner minis and 9900043 header card)	--
9900043	Replacement StyleGuard™ display stand header card, two-sided	22" x 7"
9910114	AdvantEDGE™ bull bar display stand (bull bar not included)	--

BULL BAR DISPLAY INSERTS

- Easily fits into bull bar frame
- Educates customers and allows for hands-on experience



9900046, bull bar not included

Product Catalogs

Part#	Description	Fits
9900045	3" bull bar display sign	Bull bar #35-3007
9900046	4" Big Horn™ display sign	Bull bar #AL45-4013

