

2013



AUDIOPIPE MIAMI DEALER
Complete Custom Shop, Audio and Performance



10th Anniversary Audiopipe®

HIGH PERFORMANCE CAR AUDIO PRODUCTS

Hwy 836, U.S.A.

APDL SERIES

1 Dealer Line
AMPLIFIERS



APMB-6910T
Line-Up
6x9" LOUDSPEAKER

10th Anniversary
AUDIOPIPE

NEW YORK CITY
Dealers & Distributors
NEW PEOPLE / NEW SOUND



INSTALLER
TUNER / BUILDER



TRIPLE Stack
TXX-BD3 15
SUBWOOFERS



COLOMBIA
DISTRIBUTORS

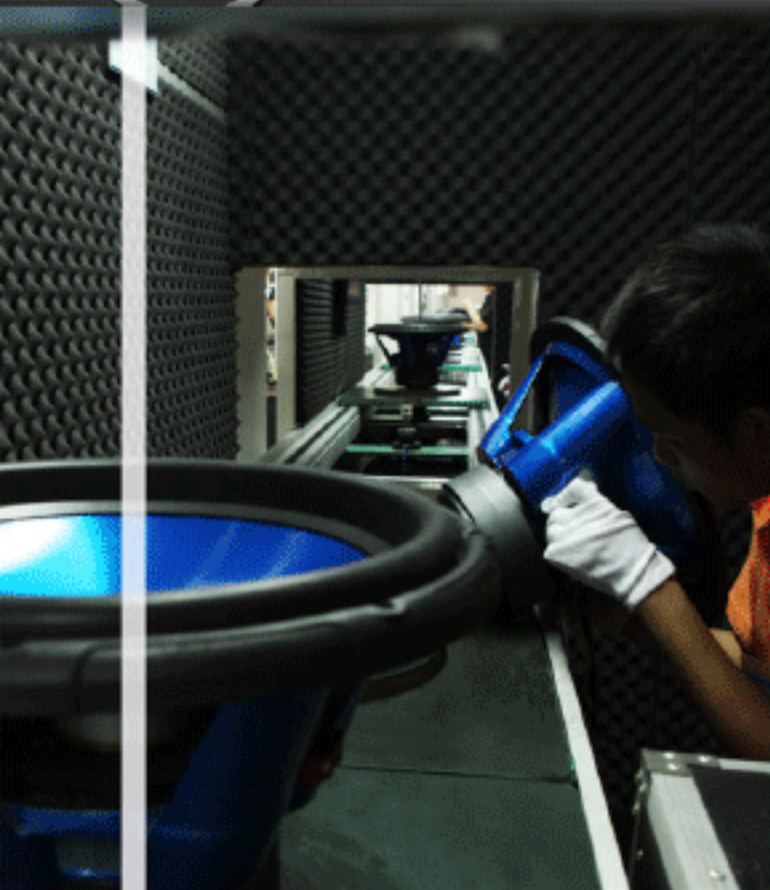

Audiopipe[®]



As we celebrate our 10 year Anniversary I reflect back on the incredible growth Audiopipe has accomplished in the last decade.

With incredible progress in the components of our speakers, the use of modern manufacturing techniques and the implementation of advanced testing equipment combined with good old fashioned live testing, we have been able to make our speakers Louder and Clearer than ever. Such techniques helped us implement Mid-Bass and revolutionize car audio along the way. Just in the last two years alone we have opened a brand new state-of-the-art factory in Haining China and just last year implemented new production lines for pro-audio tweeters and speakers. We have gone from Orange Crush to our new 10th Anniversary AP logo!

2013 also looks to be the Slim year for Audiopipe as we have created a wide variety of products designed for installations where space restrictions are a problem. We have our new TS-FA Slim line of subwoofers, the thinnest subwoofers ever developed by Audiopipe, slim line of APMB-FLT midbass models, and the new APSL-6 with a thinner frame designed to perfectly fit into the doors of smaller cars without interfering with the windows.

But not all is skinny at Audiopipe as we are finalizing the development and production of Edge Extension Technology with a butyl rubber solution and our latest SQ & SPL subwoofer both due out in the second quarter of 2013.

I hope you enjoy the new Audiopipe 10th Anniversary AP look and whether you are looking for a skinny body or a fat sound Audiopipe 2013 will deliver an exciting array of products that are Loud and Clear!

Gonzalo "Gonzi" Palenzuela

AUDIOPIPE



2013 Catalog



10th

ANNIVERSARY



2013 / New Products

TXX-BD3



TXX-BD3 Subs

August of this year marked Audiopipe's 10th anniversary, to celebrate this milestone we will be launching some new products and offering some changes on some current models at the upcoming CES in January 2013. First off, will be the brand new TXX-BD3 series subwoofers. These will be powerful, dual 4Ω triple-stacked magnet subwoofers available in 10", 12", and 15". Power ratings will be an impressive 2,400W Max/1,200W RMS for the 15", 1,800W Max/900W RMS for the 12" and 1,400W Max/700W RMS for the 10". Each model will use a 4 layer aluminum TIL voice coil with the 15" model using a 3.3", a 3" for the 12" and lastly, 2.5" for the 10" model. The entire line will also utilize Audiopipe's patent Pipe Multi-connect terminal design as well as a powdered black aluminum basket. Also to help commemorate the anniversary, a great new dust cap has been designed which will feature our new black and silver "Ap" style logo on the front which helps give the sub a clean, professional look.

10TH ANNIVERSARY

AUDIOPIPE



2400
WATTS





SUBWOOFERS

SPEAKER SIZE
15
INCHES



TXX-BD2 15

New Products for 2013



2000Watts

SPECIFICATIONS

Woofer Size
 Power (P.M.P.O)
 Power (R.M.S)
 Frequency Response
 Sensitivity
 Voice Coil
 Mounting Depth
 Impedance
 Magnet

TXX-BD2 10

10"
 1200 Watts
 600 Watts
 26-1000Hz
 88dB
 2.5" BASV
 158mm (6 1/14")
 2x4 Ohms 4 Layer
 100 Oz

TXX-BD2 12

12"
 1600 Watts
 800 Watts
 22-900Hz
 92dB
 2.5" BASV
 188mm (7 5/8")
 2x4 Ohms 4 Layer
 150 Oz

TXX-BD2 15

15"
 2000 Watts
 1000 Watts
 20-800Hz
 96dB
 3" BASV
 209mm (8 1/4")
 2x4 Ohms 4 Layer
 160 Oz



APPLICATION



SEALED



VENTED

SPEAKER SIZE
15
INCHES



TXX-BD3 15



2400Watts

SPECIFICATIONS

Woofer Size
Power (P.M.P.O)
Power (R.M.S)
Frequency Response
Sensitivity
Voice Coil
Mounting Depth
Impedance
Magnet

TXX-BD3 10

10"
1400 Watts
700 Watts
20-1000Hz
89dB
2.5" TIL
173mm (6 3/16")
2x4 Ohms 4 Layer
132 Oz

TXX-BD3 12

12"
1800 Watts
900 Watts
20-900Hz
93dB
3" TIL
193mm (7 5/8")
2x4 Ohms 4 Layer
204 Oz

TXX-BD3 15

15"
2400 Watts
1200 Watts
18-800Hz
97dB
4" TIL
209mm (8 5/8")
2x4 Ohms 4 Layer
220 Oz



APPLICATION

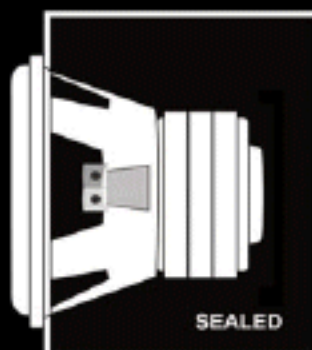



SUBWOOFERS

15
SPEAKER SIZE
INCHES



Application

BEALER

VENTER



TS-AR15



1000Watts

SPECIFICATIONS

Woofer Size
 Power (P.M.P.O)
 Power (R.M.S)
 Frequency Response
 Sensitivity
 Voice Coil
 Mounting Depth
 Impedance
 Magnet

TS-AR6

6"
 150 Watts
 75 Watts
 60-3000Hz
 85dB
 1.5" 4 Layer
 177mm (3.03")
 4 Ohms
 25 Oz

TS-AR8

8"
 300 Watts
 150 Watts
 30-2000Hz
 85dB
 1.5" 4 Layer
 116mm (4.56")
 4 Ohms
 30 Oz

TS-AR10

10"
 600 Watts
 300 Watts
 28-1500Hz
 87dB
 2" 4 Layer
 173mm (6.81")
 4 Ohms
 50 Oz

TS-AR12

12"
 750 Watts
 375 Watts
 25-1200Hz
 89dB
 2.5" 4 Layer
 153mm (6")
 4 Ohms
 60 Oz

• 4 Layer BASV single voice coil • Powdered Black Paint Steel Basket • Patent Pipe Multi-Connect Terminal

SPECIFICATIONS

Woofer Size
 Power (P.M.P.O)
 Power (R.M.S)
 Frequency Response
 Sensitivity
 Voice Coil
 Mounting Depth
 Impedance
 Magnet

TS-AR15

15"
 1000 Watts
 500 Watts
 20-1000Hz
 91dB
 2.5" 4 Layer
 180mm (7.07")
 4 Ohms
 73 Oz

replacement Kits

Factory spec'd these Woofer replacement kits can be a life saver repairing burn coils and accidental rashes



RK-TS-AR 6

6" TS-AR Car Subwoofer Replacement Kits

RK-TS-AR 8

8" TS-AR Car Subwoofer Replacement Kits

RK-TS-AR 10

10" TS-AR Car Subwoofer Replacement Kits

RK-TS-AR 12

12" TS-AR Car Subwoofer Replacement Kits

RK-TS-AR 15

15" TS-AR Car Subwoofer Replacement Kits

10TH ANNIVERSARY

WOOFER SIZE
15
INCHES



Application

SEALER

VENTER



TS-VR15

EXT
Edge of Excitement™ For Auto™



1000Watts

SPECIFICATIONS

Woofer Size
Power (P.M.P.O)
Power (R.M.S)
Frequency Response
Sensitivity
Voice Coil
Mounting Depth
Impedance
Magnet

TS-VR6

6"
150 Watts
75 Watts
60-3000Hz
85dB
1.5" 4 Layer
177mm (3.03")
2x4 Ohms
25 Oz

TS-VR8

8"
300 Watts
150 Watts
30-2000Hz
85dB
1.5" 4 Layer
116mm (4.56")
2x4 Ohms
30 Oz

TS-VR10

10"
600 Watts
300 Watts
28-1500Hz
87dB
2" 4 Layer
173mm (6³/₁₆")
2x4 Ohms
50 Oz

TS-VR12

12"
750 Watts
375 Watts
25-1200Hz
89dB
2.5" 4 Layer
153mm (6")
2x4 Ohms
60 Oz

• 4 Layer BASV dual voice coil • Powdered Black Paint Steel Basket • Patent Pipe Multi-Connect Terminal

SPECIFICATIONS

Woofer Size
Power (P.M.P.O)
Power (R.M.S)
Frequency Response
Sensitivity
Voice Coil
Mounting Depth
Impedance
Magnet

TS-VR15

15"
1000 Watts
500 Watts
20-1000Hz
91dB
2.5" 4 Layer
180mm (7.07")
2x4 Ohms
73 Oz

**replacement
kits**

Factory spec'd these Woofer replacement kits can be a life saver repairing burn coils and accidental mishaps



RK-TS-VR 6

6" TS-VR Car Subwoofer Replacement Kits

RK-TS-VR 8

8" TS-VR Car Subwoofer Replacement Kits

RK-TS-VR 10

10" TS-VR Car Subwoofer Replacement Kits

RK-TS-VR 12

12" TS-VR Car Subwoofer Replacement Kits

RK-TS-VR 15

15" TS-VR Car Subwoofer Replacement Kits



SUBWOOFERS

SPEAKER SIZE
15
INCHES



*New Products
for 2013*

TXX-APA15 BL



2000Watts

SPECIFICATIONS

Woofer Size
Power (P.M.P.O)
Power (R.M.S)
Frequency Response
Sensitivity
Voice Coil
Mounting Depth
Impedance
Magnet

TXX-APA10 BL

10"
1200 Watts
600 Watts
28-1200Hz
90dB
2.5" 4 Layer
173mm (6.81")
2x4 Ohms
120 Oz

TXX-APA12 BL

12"
1600 Watts
800 Watts
23-1000Hz
96dB
3" 4 Layer
186mm (7.32")
2x4 Ohms
120 Oz

TXX-APA15 BL

15"
2000 Watts
1000 Watts
18-900Hz
98.6dB
3" 4 Layer
228mm (9")
2x4 Ohms
150 Oz

*New Products
for 2013*



APPLICATION



SEALED

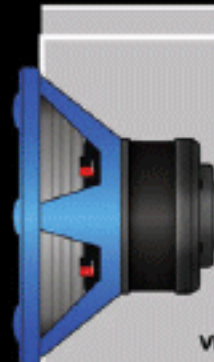

VENTED

SPEAKER SIZE
15
INCHES



*New Products
for 2013*

TXX-APA15 RD



2000Watts

SPECIFICATIONS

Woofer Size
Power (P.M.P.O)
Power (R.M.S)
Frequency Response
Sensitivity
Voice Coil
Mounting Depth
Impedance
Magnet

TXX-APA10 RD

10"
1200 Watts
600 Watts
28-1200Hz
90dB
2.5" 4 Layer
173mm (6.81")
2x4 Ohms
120 Oz

TXX-APA12 RD

12"
1600 Watts
800 Watts
23-1000Hz
96dB
3" 4 Layer
186mm (7.32")
2x4 Ohms
120 Oz

TXX-APA15 RD

15"
2000 Watts
1000 Watts
18-900Hz
98.6dB
3" 4 Layer
228mm (9")
2x4 Ohms
150 Oz

*New Products
for 2013*



APPLICATION





SUBWOOFERS

15 INCHES SPEAKER SIZE



New Products for 2013

TXX-SQ1555



2500Watts

SPECIFICATIONS

Woofer Size
Power (P.M.P.O)
Power (R.M.S)
Frequency Response
Sensitivity
Voice Coil
Mounting Depth
Impedance
Magnet

TXX-SQ1222

12"
2000 Watts
1000 Watts
25-700Hz
98dB
3" 2x2 Ω 4- Layer
215mm (8.46")
2x2 Ohms
240 Oz

TXX-SQ1555

15"
2500 Watts
1250 Watts
25-700Hz
98dB
3" 2x2 Ω 4- Layer
240mm (9.45")
2x2 Ohms
240 Oz

• SQ Competition Subwoofer • Reinforced COC PP Cone
• Precision Cast & Vented Aluminum Alloy Basket • Dual Nomex Spider

Replacement Kits

Factory spec'd these Woofer replacement kits can be a life saver repairing burn coils and occasional mishaps



RK-TXXSQ1222

Audiopipe repair kit for RK-TXX-SQ1222

RK-TXX-SQ1555

Audiopipe repair kit for RK-TXX-SQ1555



New Products for 2013

HIGH END CAR SUBWOOFERS

10TH ANNIVERSARY

SPEAKER SIZE
15
INCHES



TS-QR 15



1150Watts

SPECIFICATIONS

Woofer Size
Power (P.M.P.O)
Power (R.M.S)
Frequency Response
Sensitivity
Voice Coil
Mounting Depth
Impedance
Magnet

TS-QR 10

10"
750 Watts
375 Watts
28-1200Hz
89dB
2.5" KSV
143mm (5.63")
2x4 Ohms 4 Layers
68 Oz

TS-QR 12

12"
900 Watts
450 Watts
22-1000Hz
95dB
2.5" KSV
153mm (6.03")
2x4 Ohms 4 Layers
82 Oz

TS-QR 15

15"
1150 Watts
575 Watts
22-900Hz
96dB
3" KSV
175mm (6.9")
2x4 Ohms 4 Layers
100 Oz

- 4 Layer BASV dual voice coil • Powdered Black painted steel basket
- Rubber Butyl surround • Anti Flex grooved PP cone

Replacement Kits

Factory spec'd these Woofer replacement kits can be a life saver repairing burn coils and accidental mishaps



RK-TS-QR 10

10" TS-QR Car Subwoofer Replacement Kits

RK-TS-QR 12

12" TS-QR Car Subwoofer Replacement Kits

RK-TS-QR 15

15" TS-QR Car Subwoofer Replacement Kits

Application

SEALER

VENTER





TS-FA120
12" Shallow Mount Subwoofer

- 500 Watts Power (P.M.P.O.)
- 250 Watts Power (R.M.S.)
- Mounting Depth: 73mm (2-7/8")
- Frequency Response: 91 dB
- VC Size: 2"
- Impedance: 2x4 Ohms
- Magnet: 50 Oz
- Powdered Black Paint Aluminum Basket
- Piano Black IMPP Cone



Brand new to our TS series subwoofers, is the TS-FA shallow mount sub. Available in three sizes; 8", 10" and 12", they all feature a powdered black paint aluminum basket and piano black IMPP cone for superior performance and a sleek look. All three models also use a 2" 4-layer dual 4Ω voice coil (1.5" on 8") and a specially designed basket and magnet for a slim fit. The 12" model uses a 50oz. magnet and offers a power handling of 500W max, the 10" will be slightly less powerful at 400W max with a 40oz. magnet and lastly, the 8" will be the smallest at 300W max along with a 32oz. magnet. Mounting depth will range from only 2-7/8" (12" model) to just under 2" on the 8" model! With their thin mounting capabilities, great looks and high performance; these new TS-FA series subwoofer will be great for anyone in need of bass in a tight spot.

TS-FA100
10" Shallow Mount Subwoofer

- 400 Watts Power (P.M.P.O.)
- 200 Watts Power (R.M.S.)
- Mounting Depth: 71mm (2-3/4")
- Frequency Response: 90 dB
- VC Size: 2"
- Impedance: 2x4 Ohms
- Magnet: 40 Oz
- Powdered Black Paint Aluminum Basket
- Piano Black IMPP Cone



TS-FA80
8" Shallow Mount Subwoofer

- 300 Watts Power (P.M.P.O.)
- 150 Watts Power (R.M.S.)
- Mounting Depth: 65mm (2-9/16")
- Frequency Response: 89 dB
- VC Size: 1.5"
- Impedance: 2x4 Ohms
- Magnet: 32 Oz
- Powdered Black Paint Aluminum Basket
- Piano Black IMPP Cone



SPEAKER SIZE
15
INCHES



TS-PC 15

New Products
for 2013



600Watts

SPECIFICATIONS

| | | | |
|--------------------|------------------------|------------------------|-------------------------|
| Woofer Size | TS-PC 10 10" | TS-PC 12 12" | TS-PC 15 15" |
| Power (P.M.P.O) | 400 Watts | 500 Watts | 600 Watts |
| Power (R.M.S) | 200 Watts | 250 Watts | 300 Watts |
| Frequency Response | 30-2000Hz | 30-2000Hz | 26-1800Hz |
| Sensitivity | 86dB | 88dB | 89dB |
| Voice Coil | 2" 4-Layer Single VCK | 2" 4-Layer Single VCK | 2.5" 4-Layer Single VCK |
| Mounting Depth | 140mm (5 1/2") | 141mm (5-9/16") | 170mm (6 11/16") |
| Impedance | 4 Ohms | 4 Ohms | 4 Ohms |
| Magnet | 34 Oz | 34 Oz | 44 Oz |

New Products
for 2013

SPEAKER SIZE
10
INCHES



TS-PC 10

New Products
for 2013

SPEAKER SIZE
12
INCHES



TS-PC 12



SUBWOOFERS

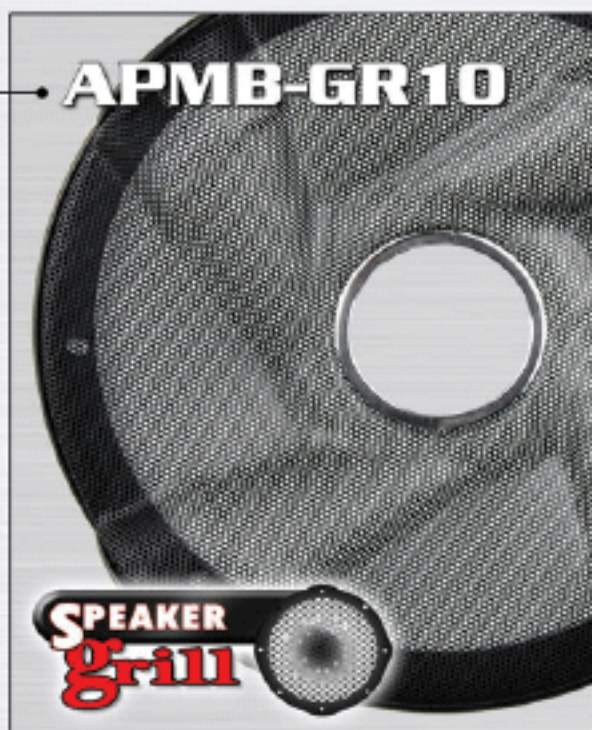

SPEAKER GRILLS



- APMB-GR6**
- 6"
 - Metal Grill
 - Rigid and Durable
 - Custom Pipe Stamped
 - Perfect Fit

- APMB-GR8**
- 8"
 - Metal Grill
 - Rigid and Durable
 - Custom Pipe Stamped
 - Perfect Fit

- APMB-GR10**
- 10"
 - Metal Grill
 - Rigid and Durable
 - Custom Pipe Stamped
 - Perfect Fit



APMB-GR6



APMB-GR8

10TH ANNIVERSARY

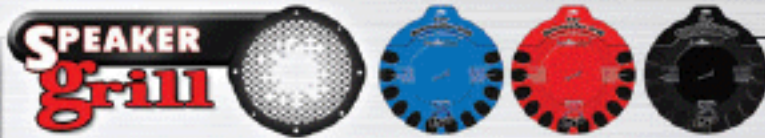

FOR LOW OR TALL SURROUNDS



- APG-12BL / APG-15BL**
- Car subwoofer grill
 - Color: Candy Blue
 - Shiny Metallic Color
 - Rigid and Durable
 - Fitting Easily

- APG-12BK / APG-15BK**
- Car subwoofer grill
 - Color: Candy Black
 - Shiny Metallic Color
 - Rigid and Durable
 - Fitting Easily

- APG-12RD / APG-15RD**
- Car subwoofer grill
 - Color: Candy Red
 - Shiny Metallic Color
 - Rigid and Durable
 - Fitting Easily





NEW YORK CITY

Audiopipe took a trip to NYC for the East Coast Distributor's show. There, dealers stopped by to speak with us and various other manufacturers and companies in the 12V industry regarding new and upcoming products as well as place a few orders. East Coast put on a great show; they provided food, drinks and also raffled off some nice prizes! The show started in the early evening and lasted till around midnight and the turnout was great.



NEW YORK

10TH ANNIVERSARY

AUDIOPIPE



The following day we stopped by several local dealers to check out their stores, take some photos and speak with the owners and employees in person regarding future ideas, new products, etc. We feel the show and overall trip was a great success and very beneficial to both us and everyone that showed up.





ENCLOSURES



Specifications

| | |
|-----------------|-------------------------------------|
| Power (P.M.P.O) | VOZ-5000 300 Watts |
| Power (R.M.S) | 150 Watts |
| Freq. Response | 100-20,000Hz |
| Sensitivity | 93dB |
| Driver | 1" Titanium Bullet Tweeter |
| Voice Coil | 5 1/4" Low Mid Freq. Loudspeaker |
| Magnet | 10 Oz |

ENCLOSURE³
IMPROVED TECHNOLOGY

HIGH PERFORMANCE VENTED ENCLOSURE

5 1/4" Low Mid Frequency

Loudspeaker

- High Fidelity Acoustic MDF Construction
- High Performance Vented Enclosure

VOZ-5000



This is a high performance vented speaker enclosure with tweeters. Built using high fidelity acoustic MDF constructions, this piece offers a unique look and design that sounds great too! Total power is rated at 300 Watts (P.M.P.O.) and 150 Watts (R.M.S.). The enclosure houses two 5-1/4" low mid frequency loudspeakers on the top and two 1" titanium bullet tweeters as well as two round ports on the side of the unit. Frequency response is 100 – 20KHz while sensitivity is rated at 93 dB. And with its compact, unique design and great sound output, this brand new enclosure from Audiopipe is sure to bring your vehicle's music to life!

10TH ANNIVERSARY

Super Bass *Combo Package* **APSB-PC1200K**

APSB-PC1200AMP

- RMS Power @ 4 Ohm, THD 1%: 250x1
- Frequency Response: 20Hz-20 KHz
- Input Sensitivity: 200mV-6.0V
- Variable low pass crossover: 50Hz-550Hz
- Variable high pass crossover: 50Hz-1 KHz
- Bass Boost: 0dB-18dB
- X-OVER switch: HPF/FULL/LPF
- Three way protection: Thermal, short circuit and overload

BMS-750

- Power: 750 Watts
- Primary Wire I: 17" 10 AWG Red
- Primary Wire II: 3" 10 AWG Silver
- Speaker Wire: 25" 16 AWG
- Fuse: 40AMP AGU
- Fuse Holder: N5-C
- Loom Tubing: 3" Split Loom Tubing
- Cable Ties: 10 Assorted

APSB-120PC

- High Performance Sealed Enclosure
- Frequency Response: 23 - 900Hz
- Single 4 Ohm Impedance
- Constructed of High Grade MDF
- 328mm(H) x 430mm (D) x 696mm (L)
- 12.9"(H) x 16.9"(D) x 27.4"(L)



New Products
for 2013

1800Watts



ENCLOSURE 3
IMPROVED TECHNOLOGY



APPB-12ET



New Products to 2013

Single Ported Bass Enclosure

APPB-12AMP-ET



New Products to 2013

750Watts

Specifications

- Output Power (PMPO)
- Output Power (RMS)
- Impedance
- Input Sensitivity
- Frequency Response
- Subwoofer
- Strontium Magnet
- Dimension (HxWxL)

APPB-12ET

- 750 Watts
- 375 Watts
- 4 Ohm mono
- 101dB
- 30-500Hz
- 12" Single
- 60 Oz
- 478x417x380mm
- 18.8x16.4x14.9"

APPB-12AMP-ET

- 750 Watts
- 375 Watts
- 4 Ohm mono
- 101dB
- 30-500Hz
- 12" Single
- 60 Oz
- 478x417x380mm
- 18.8x16.4x14.9"

AMPLIFIED



- High Quality MDF Construction
- Covered with Durable High Density Carpet
- Single 12" Edge Extension Technology PP Cone Woofer
- 2" 4-layer Single Voice Coil BASV



Flow Master-Vented



Remote Volume Control



Built-In Amplifier



AP5B-10SLM

- 10" Shallow Mount Subwoofer
- 400 Watts Power (P.M.P.O.)
- 200 Watts Power (R.M.S.)
- Mounting Depth: 71mm
- Frequency Response: 90 dB
- VC Size: 2"
- Impedance: 2x4 Ohms
- Magnet: 40 Oz

**extra
SLIM**

FLAT WOOFER

**MDF
CONSTRUCTION**

**12
INCHES**

AP5B-125LM



**ENCLOSURE
IMPROVED TECHNOLOGY**

**New Products
to 2013**

500Watts

Specifications

- Output Power (PMPO)
- Output Power (RMS)
- Impedance
- Input Sensitivity
- Frequency Response
- Subwoofer
- Strontium Magnet
- Dimension (HxWxL)

APBP-1000ET

- 500 Watts
- 250 Watts
- 4 Ohms mono
- 105dB
- 32-400Hz
- 10" TS-AR10
- 536x211x371mm
- 21.1x8.3x14.6"

APBP-1200ET

- 750 Watts
- 375 Watts
- 4 Ohms mono
- 108dB
- 28-400Hz
- 12" TS-AR12
- 600x211x396mm
- 23.6x8.3x15.6"



**SLIM
ENCLOSURE
IMPROVED TECHNOLOGY**

APBP-1000ET

**10
INCHES**



**SLIM
ENCLOSURE
IMPROVED TECHNOLOGY**

APBP-1200ET

**12
INCHES**



ENCLOSURES

EXT
Edge Extension Technology



ENCLOSURE
IMPROVED TECHNOLOGY

APSB-12ET

GREATER SIZE
12
INCHES

SEALED

- High Performance Vented Bass Enclosure
- Constructed of High Grade MDF
- Gray Automotive Grade Carpet
- One Piece PP Cone Woofer
- EXT Technology

750Watts

Specifications

Output Power (PMPO)
Output Power (RMS)
Impedance
Input Sensitivity
Frequency Response
Subwoofer
Dimension (HxWxL)

APSB-10ET APVB-10ET

500 Watts
250 Watts
4 Ohms mono
101dB
32-400Hz
10" TS-AR10
335x391x278mm
13.2x15.4x10.9"

APSB-12ET APVB-12ET

750 Watts
375 Watts
4 Ohms mono
103dB
28-400Hz
12" TS-AR12
350x430x328mm
13.8x16.9x12.9"



APSB-10ET (10")
APSB-12ET (12")



APVB-10ET (10")
APVB-12ET (12")

10TH ANNIVERSARY



APSB-120ET

12 INCHES SPEAKER SIZE

SEALED

1500Watts

EXT
Edge eXtension Technology

ENCLOSURE
IMPROVED TECHNOLOGY

- High Performance Vented Bass Enclosure
- Terminals for Multi Wiring Applications
- Constructed of High Grade MDF
- Gray Automotive Grade Carpet
- One Piece PP Cone Woofer
- EXT Technology

| Specifications | APSB-110ET APVB-100BET | APSB-120ET APVB-120BET |
|---------------------|----------------------------------|----------------------------------|
| Output Power (PMPO) | 1000 Watts | 1500 Watts |
| Output Power (RMS) | 500 Watts | 750 Watts |
| Impedance | Dual 2 Ω | Dual 2 Ω |
| Input Sensitivity | 102dB | 103dB |
| Frequency Response | 26-400Hz | 28-400Hz |
| Subwoofer | 10" TS-VR10 | 12" TS-VR12 |
| Dimension (HxWxL) | 278x391x658mm 10.9x15.4x25.9" | 328x430x696mm 12.9x16.9x27.4" |





1 Year Extended Warranty

APDL

AMPLIFIER SERIES



APDL-16001D • APDL-20001D • APDL-2504 • APDL-3502

DEALER
Audiopipe *Line*

Introducing the new **APDL Audiopipe** amplifiers! Expected to arrive by December of this year, this brand new line, consisting of one 4 channel, one 2 channel and two mono block class D amps, will be available to Authorized Audiopipe Dealers Only.

These will be Dealer exclusive and will carry a 2-year manufacturer's warranty (instead of the standard one year). This will be confirmed by validating the purchase receipt from a local

Exclusive features:

- Double dipped transformers
- Reinforced and silicone layered transformers
- Heavy duty, tiffany RCA inputs on the two class D models.

10TH ANNIVERSARY



AMPLIFIERS

2000 watts

New Products for 2013

PREMIUM CHOICE

1 YEAR Extended Warranty

1 year warranty extension is available when the unit is purchased, installed and registered by an Audioipe authorized dealer

DEALER Line

- Class-D Power Amplifier • Overload Protection • Overheat Protection.
- Variable Low Pass Electronic Crossover, • Variable Subsonic Filter.
- Built-in Variable Phase Shift • Remote Sub-Woofer Volume Control

| MODEL | APDL-16001D | | APDL-20001D |
|-----------------------|---|---|---|
| Power Amplifier | 1600 Watts | | 2000 Watts |
| Channel | 1 Channel Class D | <small>1 year warranty extension is available when the unit is purchased, installed and registered by an Audioipe authorized dealer</small> | 1 Channel Class D |
| Frequency Response | 80Hz - 180KHz | | 80Hz - 180KHz |
| Signal to Noise Ratio | 70dB | | 70dB |
| Bass Boost | 30-80Hz | | 30-80Hz |
| Input Sensitivity | 0.2-5V | | 0.2-5V |
| Speaker Impedance | 5-50Hz | | 5-50Hz |
| Total Harmonic Dist | <0.05% | | <0.05% |
| Output Power (RMS) | 1 Channel @ 4Ω - 650W 1 Channel @ 2Ω - 1000W 1 Channel @ 1Ω - 1600W | | 1 Channel @ 4Ω - 800W 1 Channel @ 2Ω - 1200W 1 Channel @ 1Ω - 2000W |
| Dimension (LxWxH) | 357x176x55mm 14.05x6.92x2.16" | | 433x176x55mm 17.04x6.92x2.16" |



10TH ANNIVERSARY

1600 watts

New Products for 2013

PREMIUM CHOICE

1 YEAR Extended Warranty

1 year warranty extension is available when the unit is purchased, installed and registered by an AudioPipe authorized dealer

DEALER Line

For the benefit of all our customers, our new dealer-exclusive amplifier line will carry a 1-year extended manufacturer's warranty (giving you a total of 2 years from the date of purchase). This will be validated by the dealer logging into <http://www.audiopipe.com/> and creating an account and registering the product. In addition, the product will need to be purchased and installed by the dealer in order for this extended warranty to be valid. We feel that this added incentive will prove to be beneficial to both dealers and consumers alike.

| MODEL | APDL-2504 | APDL-3502 |
|-----------------------|---|---|
| Power Amplifier | 2100 Watts | 1600 Watts |
| Channel | 4 Channel Class AB | 2 Channel Class AB |
| Frequency Response | 20Hz - 20KHz | 20Hz - 20KHz |
| Signal to Noise Ratio | 95dB | 100dB |
| Bass Boost | 0-18dB @ 45Hz | 0-18dB @ 45Hz |
| Input Sensitivity | 0.25V - 5V | 0.25V - 5V |
| Speaker Impedance | 2Ω to 4Ω | 2Ω to 4Ω |
| Total Harmonic Dist | <0.05% | <0.05% |
| Output Power (RMS) | Stereo 4 Ch-110W x 4@4Ω Stereo 4 Ch-160W x 4@2Ω Bridge 1 Ch-250W x 2@4Ω | Stereo 2 Ch-160W x 2@4Ω Stereo 2 Ch-325W x 2@2Ω Bridge 1 Ch-650W x 1@4Ω |
| Dimension (LxWxH) | 384x176x55mm 15.11x6.92x2.16" | 382x176x55mm 15.03x6.92x2.16" |







MODEL
Power Amplifier
Channel
Frequency Response
Signals to Noise Ratio
Bass Boost
Input Sensitivity
Subsonic Filter
Low Pass Filter
Phase
Damping Factor
Working Voltage
Dimension (LxWxH)

APK-5500
5500 Watts
1Ω Stable Digital Monoblock
10Hz - 270Hz
95dB
0-9dB @ 45 Hz
6V-0.2V
10Hz-50Hz@24dB/Oct
35Hz-250Hz@24dB/Oct
0-180 Degree
200<
8.5V-18V
650x230x64mm
26x9x2.5"

We are thrilled to introduce the much anticipated APK Series Amplifiers. These one ohm stable digital mono block powerhouses are manufactured in Korea, include 0 gauge power/ground terminals, hand-wound high grade power supplies and high purity copper trace circuit boards. These class D MOSFET power amplifiers also include a remote knob for conveniently adjusting bass levels, offer a 24dB Low pass and subsonic filter and an input capability of 16V. With 4 models ranging from 2,500 Watts all the way up to 5,500 Watts a piece and the ability to strap two together for double the power, the possibilities are endless. Plus, with their newly designed look they are sure to intimidate all competition!

| MODEL | APK-2500 | APK-3500 | APK-4500 |
|-----------------------|-----------------------------|-----------------------------|-----------------------------|
| Power Amplifier | 2500 Watts | 3500 Watts | 4500 Watts |
| Channel | 1Ω Stable Digital Monoblock | 1Ω Stable Digital Monoblock | 1Ω Stable Digital Monoblock |
| Frequency Response | 10Hz - 270Hz | 10Hz - 270Hz | 10Hz - 270Hz |
| Signal to Noise Ratio | 95dB | 95dB | 95dB |
| Bass Boost | 0-9dB @ 45 Hz | 0-9dB @ 45 Hz | 0-9dB @ 45 Hz |
| Input Sensitivity | 6V-0.2V | 6V-0.2V | 6V-0.2V |
| Subsonic Filter | 10Hz-50Hz@24dB/Oct | 10Hz-50Hz@24dB/Oct | 10Hz-50Hz@24dB/Oct |
| Low Pass Filter | 35Hz-250Hz@24dB/Oct | 35Hz-250Hz@24dB/Oct | 35Hz-250Hz@24dB/Oct |
| Phase | 0-180 Degree | 0-180 Degree | 0-180 Degree |
| Damping Factor | 200< | 200< | 200< |
| Working Voltage | 8.5V-16V | 8.5V-18V | 8.5V-18V |
| Dimension (LxWxH) | 400x230x64mm 16x9x2.5" | 540x230x64mm 21x9x2.5" | 620x230x64mm 25x9x2.5" |



3000 watts



APK-250.2

Power @ 4ohm 300W x 2
 Power @ 2ohm 470W x 2
 Power @ 4ohm 930W x 1 (mono)

APK-400.4

Power @ 4ohm 115W x 4
 Power @ 2ohm 170W x 4
 Power @ 4ohm 375W x 2 (mono)

APK-700.5

Power @ 4ohm 60Wx4+247Wx1
 Power @ 2ohm 85Wx4+375Wx1
 Power @ 4ohm 170Wx2+247Wx1 mono

POWER INFORMATION

Class "D" Mosfet Power Amplifier INPUT CAPABILITY **16V**

| MODEL | APK-250.2 | APK-400.4 | APK-700.5 |
|-----------------------|---------------------------|---------------------------|--|
| Power Amplifier | 3000 Watts | 2500 Watts | 3500 Watts |
| Channel | 2Ω Stable Class D | 2Ω Stable Class D | 2Ω Stable Class D |
| Frequency Response | 20Hz - 20KHz | 20Hz - 20KHz | 20Hz - 20KHz |
| Signal to Noise Ratio | 105dB | 100dB | 100dB |
| Bass Boost | 0-18dB @ 45 Hz | 0-18dB @ 45 Hz | 0-18dB @ 45 Hz CH5 |
| Input Sensitivity | 6V-0.2V | 6V-0.2V | 6V-0.2V |
| Subsonic Filter | 20Hz-5KHz@12dB/Oct | 20Hz-5KHz@12dB/Oct | 10Hz-4KHz for CH1/2 10Hz-10KHz for CH3/4 |
| Low Pass Filter | 50Hz-5KHz@12dB/Oct | 50Hz-5KHz@12dB/Oct | 100Hz-4KHz for CH3/4 50Hz-10KHz for CH5 |
| Phase | 0-180 Degree | 0-180 Degree | 0-180 Degree |
| Damping Factor | 300< | 200< | 200< |
| Working Voltage | 8.5V-16V | 8.5V-16V | 8.5V-16V |
| Dimension (LxWxH) | 450x230x64mm 18x9x2.5" | 400x230x64mm 16x9x2.5" | 400x230x64mm 16x9x2.5" |

3000 watts



APK-250.2

2500 watts



APK-400.4

3500 watts



APK-700.5



MODEL **APCL-6004**

Power Amplifier 2500 Watts

Channel 4 Channel Class AB

Frequency Response 20Hz - 20KHz

Signal to Noise Ratio 95dB

Bass Boost 0-18dB @ 45Hz

Input Sensitivity 0.25V - 5V

Speaker Impedance 2Ω to 4Ω

Total Harmonic Dist <0.05%

Output Power (RMS) Stereo 4 Ch-150W x 4@4Ω
Stereo 4 Ch-200W x 4@2Ω
Bridge 1 Ch-300W x 2@4Ω

Dimension (LxWxH) 384x176x55mm
15.1x7x2.2"

- Class AB Power Amplifier • Built-in Variable High Pass & Low Pass Crossover. • RCA Line Input/Output Jacks.
- Electronic Protection Circuitry to Protect The Amplifier from Short Circuit, DC Offset & Thermal Overload.
- Remote Sub-Woofer Volume Control



| MODEL | APCL-1004 | APCL-1504 | APCL-2004 |
|-----------------------|--|--|---|
| Power Amplifier | 1000 Watts | 1500 Watts | 2000 Watts |
| Channel | 4 Channel Class AB | 4 Channel Class AB | 4 Channel Class AB |
| Frequency Response | 20Hz - 20KHz | 20Hz - 20KHz | 20Hz - 20KHz |
| Signal to Noise Ratio | 95dB | 95dB | 95dB |
| Bass Boost | 0-18dB @ 45Hz | 0-18dB @ 45Hz | 0-18dB @ 45Hz |
| Input Sensitivity | 0.25V - 5V | 0.25V - 5V | 0.25V - 5V |
| Speaker Impedance | 2Ω to 4Ω | 2Ω to 4Ω | 2Ω to 4Ω |
| Total Harmonic Dist | <0.05% | <0.05% | <0.05% |
| Output Power (RMS) | Stereo 4 Ch-50W x 4@4Ω Stereo 4 Ch-100W x 2@2Ω Bridge 2 Ch-200W x 2@4Ω | Stereo 4 Ch-75W x 4@4Ω Stereo 4 Ch-150W x 4@2Ω Bridge 2 Ch-300W x 2@4Ω | Stereo 4 Ch-100W x 4@4Ω Stereo 4 Ch-150W x 4@2Ω Bridge 1 Ch-225W x 2@4Ω |
| Dimension (LxWxH) | 333x176x55mm 13.1x7x2.2" | 382x176x55mm 15x7x2.2" | 384x176x55mm 15.1x7x2.2" |

1000 watts

CONSUMER Line

New Products for 2013

APCL-1004

1500 watts

CONSUMER Line

New Products for 2013

APCL-1504

2000 watts

CONSUMER Line

New Products for 2013

APCL-2004

2000 watts

New Products for 2013



CONSUMER Line

| | |
|-----------------------|--|
| MODEL | APCL-6002 |
| Power Amplifier | 2000 Watts |
| Channel | 2 Channel Class AB |
| Frequency Response | 20Hz - 20KHz |
| Signal to Noise Ratio | 100dB |
| Bass Boost | 0-18dB @ 45Hz |
| Input Sensitivity | 0.25V - 5V |
| Speaker Impedance | 2Ω to 4Ω |
| Total Harmonic Dist | <0.05% |
| Output Power (RMS) | Stereo 2 Ch-300W x 2@4Ω Stereo 2 Ch-600W x 2@2Ω Bridge 1 Ch-1200W x 1@4Ω |
| Dimension (LxWxH) | 698x176x55mm 27.4x7x2.2" |

- Class AB Power Amplifier • Built-in Variable High Pass & Low Pass Crossover • RCA Line Input/Output Jacks
- Electronic Protection Circuitry to Protect The Amplifier from Short Circuit, DC Offset & Thermal Overload
- Remote Sub-Woofler Volume Control



MODEL

Power Amplifier
Channel
Frequency Response
Signal to Noise Ratio
Bass Boost
Input Sensitivity
Speaker Impedance
Total Harmonic Dist
Output Power (RMS)

Dimension (LxWxH)

APCL-1002

500 Watts
2 Channel Class AB
20Hz - 20KHz
100dB
0-18dB @ 45Hz
0.25V - 5V
2Ω to 4Ω
<0.05%
Stereo 2 Ch-50W x 2@4Ω
Stereo 2 Ch-100W x 2@2Ω
Bridge 1 Ch-200W x 1@4Ω
224x176x55mm
8.8x7x2.2"

APCL-2002

1000 Watts
2 Channel Class AB
20Hz - 20KHz
100dB
0-18dB @ 45Hz
0.25V - 5V
2Ω to 4Ω
<0.05%
Stereo 2 Ch-100W x 2@4Ω
Stereo 2 Ch-125W x 2@2Ω
Bridge 1 Ch-300W x 1@4Ω
260x176x55mm
10.2x7x2.2"

APCL-3002

1500 Watts
2 Channel Class AB
20Hz - 20KHz
100dB
0-18dB @ 45Hz
0.25V - 5V
2Ω to 4Ω
<0.05%
Stereo 2 Ch-150W x 2@4Ω
Stereo 2 Ch-300W x 2@2Ω
Bridge 1 Ch-600W x 1@4Ω
382x176x55mm
15x7x2.2"

500 watts

CONSUMER Line



APCL-1002

1000 watts

CONSUMER Line



APCL-2002

1500 watts

CONSUMER Line



APCL-3002



AMPLIFIERS

1500 watts

New Products for 2013



Oversized Toroid stabilizes voltage



Angled terminal allows for wires to easily conceal



Compatible with 16V systems

CONSUMER Line

- Class-D Power Amplifier • Overload Protection • Overheat Protection.
- Variable Low Pass Electronic Crossover. • Variable Subsonic Filter.
- Remote Sub-Woofer Volume Control • Built-in Variable Phase Shift.



| MODEL | APCL-10001D | APCL-15001D | APCL-18001D |
|-----------------------|--|--|---|
| Power Amplifier | 1000 Watts | 1500 Watts | 1800 Watts |
| Channel | 1 Channel Class D | 1 Channel Class D | 1 Channel Class D |
| Frequency Response | 80Hz - 180KHz | 80Hz - 180KHz | 80Hz - 180KHz |
| Signal to Noise Ratio | 70dB | 70dB | 70dB |
| Bass Boost | 30-80Hz | 30-80Hz | 30-80Hz |
| Input Sensitivity | 0.2-5V | 0.2-5V | 0.2-5V |
| Speaker Impedance | 5-50Hz | 5-50Hz | 5-50Hz |
| Total Harmonic Dist | <0.05% | <0.05% | <0.05% |
| Output Power (RMS) | 1 Channel @ 4Ω - 400W 1 Channel @ 2Ω - 600W 1 Channel @ 1Ω - 1000W | 1 Channel @ 4Ω - 600W 1 Channel @ 2Ω - 950W 1 Channel @ 1Ω - 1500W | 1 Channel @ 4Ω - 750W 1 Channel @ 2Ω - 1100W 1 Channel @ 1Ω - 1800W |
| Dimension (LxWxH) | 288x176x55mm 11.3x7x2.2" | 357x176x55mm 14x7x2.2" | 433x176x55mm 17x7x2.2" |

1000 watts

CONSUMER Line



AP-10001D

1500 watts

CONSUMER Line



AP-15001D

1800 watts

CONSUMER Line



AP-18001D

10TH ANNIVERSARY



| MODEL | APCL-30001D |
|-----------------------|-----------------------------|
| Power Amplifier | 3000 Watts |
| Channel | 1 Channel Class D |
| Frequency Response | 80Hz - 180KHz |
| Signal to Noise Ratio | 70dB |
| Bass Boost | 30-80Hz |
| Input Sensitivity | 0.2-5V |
| Subsonic Filter | 5-50Hz |
| Low Pass Filter | 40-180Hz |
| Dimension (LxWxH) | 710x176x55mm 27.9x7x2.2" |



1 Channel
3000Watts x 1 @ 2 Ohm



Remote Sub-Woofer Volume Control.

- Class-D Power Amplifier.
- Overload Protection.
- Overheat Protection.
- Variable Subsonic Filter.
- Variable Low Pass Electronic Crossover.
- Built-in Variable Phase Shift.



AMPLIFIERS

2000 watts



MINI amplifiers MINI



Mini Design MOSFET Car Amplifiers
Remote Subwoofer Volume Control



Mini-design for compact installs



Low pass/HI pass x-over, thermal controlled fan

MODEL

Power Amplifier
Channel
Outpower (RMS)
Outpower (RMS)
Outpower (RMS)
Freq. Response
S/N Ratio
Input Sensitivity
THD
LPF
SUBSONIC Filter
Dimension (LxWxH)

APSM-1300

1000 Watts Power
1 Channel
300W @ 4 Ohm
600W @ 2 Ohm
1000W @ 1 Ohm
50Hz - 180Hz
>70dB
0.2V - 5V
<0.15%
40Hz - 180Hz
0Hz - 50Hz
267x154x49mm
10½x6x2"

APSM-1500

1500 Watts Power
1 Channel
500W @ 4 Ohm
1000W @ 2 Ohm
1500W @ 1 Ohm
50Hz - 180Hz
>70dB
0.2V - 5V
<0.15%
40Hz - 180Hz
0Hz - 50Hz
342x154x49mm
13½x6x2"

APSM-2000

2000 Watts Power
1 Channel
900W @ 4 Ohm
1400W @ 2 Ohm
2000W @ 1 Ohm
50Hz - 180Hz
>70dB
0.2V - 5V
<0.2%
40Hz - 180Hz
0Hz - 50Hz
420x154x49mm
16½x6x2"

1000 watts



APSM-1300

1500 watts



APSM-1500

2000 watts



APSM-2000

10TH ANNIVERSARY

1600 watts



New Products for 2013

Mini Design MOSFET Car Amplifiers
Remote Subwoofer Volume Control

| MODEL | APSM-55100 |
|-------------------|----------------------------|
| Power Amplifier | 1600 Watts Power |
| Channel | 5 Channel |
| RMS @ 4 Ohm | 4 x 75+500W |
| RMS @ 2 Ohm | 4 x 120+350W |
| Freq. Response | 50Hz - 180Hz |
| S/N Ratio | >80dB |
| Input Sensitivity | 0.2V - 5V |
| THD | <0.05% |
| HPF | 50Hz - 250kHz |
| SUBSONIC Filter | 0Hz - 50Hz |
| Dimension (LxWxH) | 201.5x154x49mm 7.9x6x2" |

APSM-55100: Brand new from our APSM series amps is the APSM-55100. This 5 channel MOSFET 1600W max mini design car amplifier is capable of 75W x4 + 350W x1 (RMS@4ohms) or 120W x4 + 500W x1 (RMS@2ohms). Subsonic filter is adjustable from 50Hz to 250Hz while the HPF is adjustable from 50Hz to 1.2kHz. Frequency response on the amplifier is 20Hz to 30kHz. Plus, with its small footprint, high power output and 5 channel design, you can power your whole system with just this one amp.

| MODEL | APSM-2075 | APSM-2125 | APSM-4080 |
|-------------------|------------------------|--------------------------|-------------------------|
| Power Amplifier | 1000 Watts Power | 1200 Watts Power | 1200 Watts Power |
| Channel | 2 Channel | 2 Channel | 4 Channel |
| Outpower (RMS) | 2x75W @ 4 Ohm | 2x125W @ 4 Ohm | 4x80W @ 4 Ohm |
| Outpower (RMS) | 2x110W @ 2 Ohm | 2x200W @ 2 Ohm | 4x115W @ 2 Ohm |
| Outpower (RMS) | N / A | 1x250W @ 2 Ohm | 2x160W @ 4 Ohm |
| Freq. Response | 50Hz - 180Hz | 50Hz - 180Hz | 10Hz - 30kHz |
| S/N Ratio | >80dB | >80dB | >80dB |
| Input Sensitivity | 0.2V - 6V | 0.2V - 6V | 0.2V - 6V |
| THD | <0.05% | <0.05% | <0.05% |
| LPF | 50Hz - 500kHz | 50Hz - 500kHz | 50Hz - 1.2kHz |
| SUBSONIC Filter | 0Hz - 50Hz | 0Hz - 50Hz | 50Hz - 50Hz |
| Dimension (LxWxH) | 176x154x49mm 7x6x2" | 201x154x49mm 7.9x6x2" | 211x154x49mm 8½x6x2" |

1000 watts



APSM-2075

1200 watts



APSM-2125

1200 watts



APSM-4080



EQUALIZERS & CROSSOVERS

EQ-707X



7 Bands
EQUALIZER

EQ-707X

EQ-707X

7 Bands Parametric EQ with Subwoofer Output

- 7 Band Parametric: 50Hz, 315Hz, 750Hz, 2.2KHz, 6KHz, 16KHz, 12.8KHz
- In-Dash Equalizer & Pre-Amp.
- Adjustable Subwoofer Frequency: 60Hz-90Hz
- Adjustable Gain with up to 7V Output
- Input Sensitivity: Adjustable 200mV - 3.5V RMS
- T.H.D.: 0.05%
- Operating Voltage: 11~15V Negative Ground
- Universal Half-din Chassis for Easy of Installation
- Active Gain Pre-amplifiers with Adjustable Input Sensitivity
- Low noise Bi-Fet Op-amp Design Yields Minimum Distortion
- On-Board 30V Bi-Polar Switching Power Supply
- Subwoofer output and Level Control
- Gold-plated RCA Input Connectors

EQ-908X

9 Band Graphic Equalizer with Subwoofer Output

- 9 Band Parametric: 50Hz, 125Hz, 250Hz, 500Hz, 1KHz, 2KHz, 4KHz, 8KHz, 16KHz
- In-Dash Equalizer & Pre-Amp.
- Adjustable Subwoofer Frequency: 60Hz-90Hz
- Adjustable Gain with up to 9V Output
- Input Sensitivity: Adjustable 200mV - 3.5V RMS
- T.H.D.: 0.05%
- Operating Voltage: 11~15V Negative Ground
- Universal Half-din Chassis for Easy of Installation
- Active Gain Pre-amplifiers with Adjustable Input Sensitivity
- Low noise Bi-Fet Op-amp Design Yields Minimum Distortion
- On-Board 30V Bi-Polar Switching Power Supply
- Subwoofer output and Level Control
- Gold-plated RCA Input Connectors



9 Bands
EQUALIZER

EQ-908X

XV-3

- 3 Way Crossover
- 3 Way Crossover with Line Driver
- Remote Turn-on Input Terminal
- Dual Input Switch
- Front/Rear Channel high-Pass Frequency Selector
- Front/Rear Channel Output Gain Control
- Subwoofer Output Level Remote Control
- High Pass: 32Hz-800Hz(x10)
- Mid Pass: 32Hz-800Hz
- Low Pass: 50Hz-160Hz



XV-3 REMOTE



XV-4BXP

- 3 Way Crossover
- 3 Way Crossover with Line Driver
- Remote Turn-on Input Terminal
- Dual Input Switch
- Front/Rear Channel high-Pass Frequency Selector
- Front/Rear Channel Output Gain Control
- Subwoofer Output Level Remote Control
- High Pass: 32Hz-800Hz(x10)
72Hz-410Hz(x1), 500Hz-3.5KHz(x10)
- Mid Pass: 32Hz-800Hz
70Hz-400Hz, 420Hz-3.3Hz
- Low Pass: 50Hz-160Hz



SPLIT-3003

Multi-Audio Amplifier

- Input Impedance: 47 KOhms
- Input Sensitivity: 260mV
- S/N Ratio: > 95dB
- Output Level (10KHz): > 1V(1KHz)
- Output Impedance: 1 KOhms
- Channel Resolution: > 60dB
- Harmonics Distortion: 0.009%
- Frequency Response: 20-20000Hz
- Output Gain: 12 dB



This unit accepts 3 RCA inputs from a head unit "Front, Rear, and Subwoofer" and provides 3 amplified outputs for each input "3" front outputs, 3 rear outputs, 3 subwoofer outputs".

Install a SPLIT-3003 in a multi amplifier system

In more complex systems where multiple amplifiers are being used, it is important that the signal reaches the amplifier in its purest form to achieve maximum performance with the least amount of distortion. We can achieve this with the SPLIT-3003 as it can split the signal and maintain a 4V signal equally to multiple amplifiers. Depending on the input you feed into the SPLIT-3003, you can have up to 9 outputs.



Colombia



Quando comenzaste a escuchar sobre Audiopipe?

Hace 10 años en el 2003, comencé a trabajar con la marca.

Porque TU elección por Audiopipe?

Es una marca completa en todas sus líneas.

Siempre innovando nuevos productos, brindando calidad y entretenimiento.

Qué tiempo llevas usando Audiopipe?

10 años distribuyendo la marca en Colombia

Que equipos Audiopipe tienen mayor demanda?

En Colombia, su comercialización ha sido exitosa

Líderes en cables y accesorios

Líderes en amplificadores

Líderes en Subwoofers

Pioneros en la línea Pro Audio

10

10TH ANNIVERSARY

Que tipo información se puede conseguir de sus clientes, en lo que respecta a la marca?

Los instaladores y clientes finales ven un producto de alta calidad, durabilidad, excelente servicio de garantía y sobre todo el precio

Quien es su cliente objetivo? Rango de edad, uso y aplicaciones?

Nuestros clientes están en un rango de 18 a 40 años, la mayoría comienzan como uso personal y de los cuales un 60% decide participar en las competencias y se convierten en verdaderos aficionados de la industria llevando un desarrollo en los carros hasta obtener ranking #1 y poniendo la marca en los más altos estándares.

Explica tu experiencia con Audiopipe:

Comenzamos a trabajar desde el 2003 en Colombia pensando en un desarrollo completo de la marca.

Como estrategia decidimos vincularnos en todos los eventos de Car audio, promocionando nuestros productos a nivel de expositores y de competencia en las distintas modalidades.

Al poco tiempo la marca fue ganando terreno dentro de la industria, posicionando nuestros productos como #1 en ventas dentro del país.

Desde ese entonces nos mantenemos en constante capacitación a nuestros instaladores con seminarios técnicos, lanzamientos de nuevos productos y publicidad.

Andres Quintero
Xsite Car Audio - Medellin



Team Audiopipe Colombia

- Aicardo Gomez / Bogota
- Warrior Car Audio / Bogotá
- Pacho Car Audio / Bogotá
- Xsite Car Audio / Medellin
- Taro Audiopipe / Cali
- Aristech Car Audio / Cali
- Audio Xtreme / Cartagena
- JJ Audio / Barranquilla

COLOMBIA



COAXIALS

6.5
BIGGER SIZE
INCHES



Swivel Tweeter

APHE-650CMP



120Watts

- Titanium Dome Diaphragm High Performance Tweeter
- Separated Cross over (4.8KHz) 3 Level Settings • Impedance: 4 Ohms

SPECIFICATIONS

Power (P.M.P.O)

Power (R.M.S)

Size:

Frequency Response

Sensilivity

Voice Coil

Mounting Depth

Impedance

Magnet

APHE-650CMP

120 Watts

60 Watts

6.5"

60-20.000Hz

92 dB

1" KSV Voice Coil

61mm (2")

4 Ohms

15 Oz



APHE-650CMP

This premium 6.5" component speaker set offers a 1" KSV voice coil and a fiberglass woven cone. Power rating is 120 watts (P.M.P.O.) and 60 watts (R.M.S.).

Frequency response range is 60-20KHz and they are driven with 15 Oz. magnets. They include titanium dome diaphragm high performance tweeters as well as separated crossovers (4.8KHz) with 3 level settings. The tweeters offer two mounting options; angle and surface mount, and have a swivel-type design so you can adjust the tweeter even after mounting. With their various features and relatively thin design (2.5" mounting depth) they are a great choice for virtually any application!



10TH ANNIVERSARY

SPEAKER SIZE
6x9
INCHES



AMPLIFIER
compatible

• APC-6904

New Products
for 2013



250Watts

SPECIFICATIONS

Power (P.M.P.O)

Power (R.M.S)

Size:

Frequency Response

Sensitivity

Voice Coil

Mounting Depth

Impedance

Magnet

APC-6503

120 Watts

60 Watts

6.5"

50-20,000Hz

88dB

1.2" TIL

63mm (2 1/2")

4 Ohms

10 Oz

APC-6904

250 Watts

125 Watts

6x9"

44-20,000Hz

89dB

1.5" High Temperature CCAR

81mm (3-3/16")

4 Ohms

16 Oz

SPEAKER SIZE
6.5
INCHES



New Products
for 2013



APC-6503



COAXIALS

6.5
SPEAKER SIZE
INCHES



APT-1611 **3 WAY**

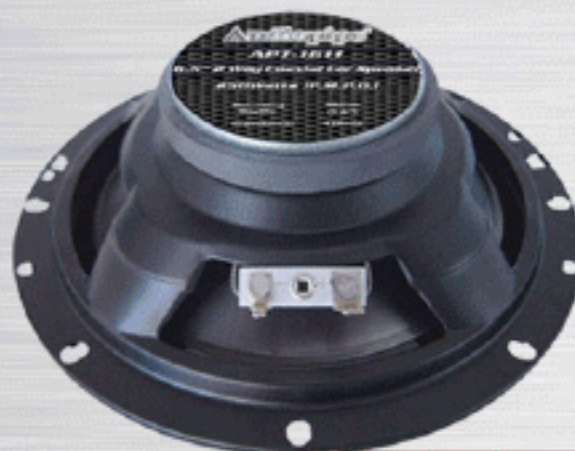

250Watts

- Electroplated PP Cone Coaxial Car Speaker
- Chrome Plated Tweeter Cover

| SPECIFICATIONS | APT-1611 | APT-1630 | APT-1631 | APT-1640 |
|--------------------|--------------|-------------|-------------|--------------|
| Size | 6.5" 3-Way | 6.5" 2-Way | 6.5" 3-Way | 6.5" 3-Way |
| Power (P.M.P.O) | 250 Watts | 250 Watts | 330 Watts | 330 Watts |
| Power (R.M.S) | 125 Watts | 125 Watts | 165 Watts | 165 Watts |
| Frequency Response | 50-20,000Hz | 50-20,000Hz | 50-20,000Hz | 50-21,000Hz |
| Sensitivity | 88dB | 91dB | 91dB | 88dB |
| Mounting Depth | 44mm (1.75") | 63mm (2.5") | 63mm (2.5") | 44mm (1.75") |
| Magnet | 10 Oz | 15 Oz | 15 Oz | 15 Oz |



APT-1630



APT-1631



APT-1640

SPEAKER SIZE
6x9
INCHES



APT-6930 **3 WAY**



200Watts

Coaxial Car Speakers

The least expensive and most common type of car speaker is the coaxial. The coaxial consists of a midrange/woofer with a tweeter placed over the cone, either on a bridge or on a pole that extends from the middle of the cone. These speakers are made in sizes that will exactly fit most brands of vehicles. Advantages of this design include low cost, ease of installation, and a speaker that more closely approaches the one loudspeaker ideal, also called a point source. This is where all frequencies appear to originate from the same location.

SPECIFICATIONS

| | APT-4107 | APT-6930 | APT-6940 |
|--------------------|-----------------|-----------------|-----------------|
| Size | 4x10" 2-Way | 6x9" 3-Way | 6x9" 4-Way |
| Power (P.M.P.O) | 200 Watts | 500 Watts | 500 Watts |
| Power (R.M.S) | 100 Watts | 250 Watts | 250 Watts |
| Frequency Response | 40-20,000Hz | 35-21,000Hz | 35-25,000Hz |
| Sensitivity | 88dB | 93dB | 93dB |
| Mounting Depth | 74mm (2.91") | 89mm (3.5") | 89mm (3.5") |
| Magnet | 10 Oz | 20 Oz | 20 Oz |



APT-4107



APT-6940



COAXIALS

SPEAKER SIZE
4x6
INCHES

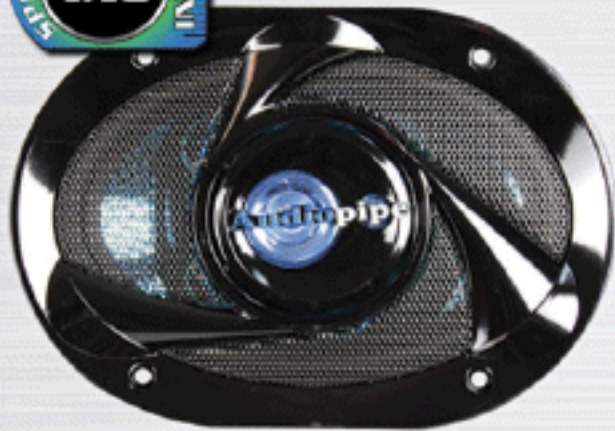

- Electroplated PP Cone Coaxial Car Speaker
- Chrome Plated Tweeter Cover

APT-469 **2WAY**



150Watts

SPECIFICATIONS

Size
Power (P.M.P.O)
Power (R.M.S)
Frequency Response
Sensitivity
Mounting Depth
Magnet

APT-469
4x6" 2-Way
150 Watts
75 Watts
50-20,000Hz
91dB
61mm (2.4")
10 Oz

APT-573
5x7" 3-Way
500 Watts
250 Watts
50-21,000Hz
91dB
59mm (2.32")
10 Oz

APT-683
6x8" 3-Way
400 Watts
200 Watts
50-21,000Hz
91dB
62mm (2.44")
10 Oz

SPEAKER SIZE
5x7
INCHES



APT-573

SPEAKER SIZE
6x8
INCHES



APT-683

10TH ANNIVERSARY



- Electroplated PP Cone Coaxial Car Speaker
- Chrome Plated Tweeter Cover



| SPECIFICATIONS | APT-879 | APT-1087 | APT-1525 |
|--------------------|--------------|---------------|--------------|
| Size | 3.5" 2-Way | 4" 2-Way | 5-25" 2-Way |
| Power (P.M.P.O) | 90 Watts | 150 Watts | 180 Watts |
| Power (R.M.S) | 45 Watts | 75 Watts | 90 Watts |
| Frequency Response | 100-20.000Hz | 65-20.000Hz | 55-20.000Hz |
| Sensitivity | 85dB | 90dB | 90dB |
| Mounting Depth | 41mm (1.61") | 50mm (1.974") | 68mm (2.78") |
| Magnet | 8 Oz | 10 Oz | 10 Oz |



APT-1087



APT-1525



2013 / New Products

APMB-6910T

Full Range Loudspeaker



6x9

300WATTS

10TH ANNIVERSARY

LOUDSPEAKER

New to our ever growing popular APMB loudspeaker line-up this year is the APMB-6910T. These 300 Watts 6x9" full range loudspeakers offer a 1.5" Til voice coil and a 30 oz. high powered magnet for out-performing even the highest quality coaxial speakers handling higher levels of RMS power with minimal distortion. Tweeters are included with the set for further improved sound quality and frequency range (70-22.000Hz) to maximize your listening experience. And with a mounting depth of just 3.78", these speakers are great for a wide range of applications.



- 300 Watts Power (P.M.P.O.)
- 150 Watts power (R.M.S.)
- Frequency Response: 70-22000 Hz
- Sensitivity: 94dB
- 1" Silk Dome Tweeter
- 1.5" Voice Coil
- Mounting Depth: 88mm (3 1/2")
- Impedance: 8 Ohms
- 30 Oz Magnet



Tweeters Included



Loudspeakers

"HEAR THE MUSIC, NOT JUST BASS"

SPEAKER SIZE
10
INCHES



SLIM
LOUDSPEAKERS

APSLM-10G



450Watts

SPECIFICATIONS

Loudspeaker Size
Power (P.M.P.O)
Power (R.M.S)
Frequency Response
Sensitivity
Voice Coil

Mounting Depth
Impedance
Magnet

APSL-6

6"
200 Watts
100 Watts
70-9.000Hz
91dB
2.5" Aluminium,
Rigid Steel Basket
78mm (3-5/64")
8 Ohms
22 Oz

APSL-10

10"
700 Watts
350 Watts
65-4.000Hz
96dB
2.5" Aluminium,
Rigid Steel Basket
102mm (4")
8 Ohms
56 Oz

APSLM-10G

10"
450 Watts
225 Watts
70-9.000Hz
91dB
2" High Temperature
CCAR
78mm (3-5/64")
4 Ohms
65 Oz

SPEAKER SIZE
6
INCHES



APSL-6

SPEAKER SIZE
10
INCHES



APSL-10

PERFECT FIT TO TOYOTA • HONDA • NISSAN

10TH ANNIVERSARY

SPEAKER SIZE
6x9
INCHES



• APMB-6910T



300Watts

SPECIFICATIONS

| | |
|--------------------|---------------------------|
| Loudspeaker Size | APMB-6910T 6x9" |
| Power (P.M.P.O) | 300 Watts |
| Power (R.M.S) | 150 Watts |
| Frequency Response | 70-22.000Hz |
| Sensitivity | 94dB |
| Voice Coil | 1.5" Tl |
| Mounting Depth | 88mm (3-1/2") |
| Impedance | 8 Ohms |
| Magnet | 30 Oz |

New to our ever growing popular APMB loudspeaker line-up this year is the APMB-6910T. These 300 Watts 6x9" full range loudspeakers offer a 1.5" Tl voice coil and a 30 oz. high powered magnet for out-performing even the highest quality coaxial speakers handling higher levels of RMS power with minimal distortion. Tweeters are included with the set for further improved sound quality and frequency range (70-22.000Hz) to maximize your listening experience. And with a mounting depth of just 3.78", these speakers are great for a wide range of applications.



Tweeters Included



Loudspeakers

"HEAR THE MUSIC, NOT JUST BASS"

SPEAKER SIZE
8
INCHES



for
InDoor OutDoor

• **APMB-8CF**

New Products
to 2013



300Watts

SPECIFICATIONS

Loudspeaker Size
Power (P.M.P.O)
Power (R.M.S)
Frequency Response
Sensitivity
Voice Coil
Mounting Depth
Impedance
Magnet

APMB-6CF

6"
200W
100W
46Hz-18KHz
89.6dB
1.3" KSV
80mm/3"
8 Ohms
21 Oz.



APMB-8CF

8"
300W
150W
60Hz-15KHz
92.6dB
1.5" KSV
100mm/4"
8 Ohms
38 Oz.



• Loudspeaker Low Mid Bass

for
InDoor OutDoor



APMB-6CF

for
InDoor OutDoor



APMB-8CF

10TH ANNIVERSARY

8
SPEAKER SIZE
INCHES



NEODYNIUM
magnet

• APMB-8SND

*New Products
to 2013*



500Watts

SPECIFICATIONS

Loudspeaker Size
Power (P.M.P.O)
Power (R.M.S)
Frequency Response
Sensitivity
Voice Coil
Mounting Depth
Impedance
Magnet

APMB-4SND

4"
100W
50W
120-13,000Hz
94dB
1" Ttl
46mm (1 3/4")
8 Ohms
1.3 Oz.

APMB-514SND

5 1/4"
100W
50W
100-13,000Hz
93dB
1" Ttl
48mm (2")
8 Ohms
1.3 Oz.

APMB-6SND

6"
200W
100W
100-8,000Hz
96dB
1.5" Ttl
63mm (2 1/2")
8 Ohms
3.1 Oz.

APMB-8SND

8"
500W
250W
66-6,000Hz
95dB
2" Ttl
85mm (3 11/32")
8 Ohms
5.5 Oz.

• Low Mid Frequency • Die-Cast Aluminum Basket • Neodymium Magnet





Loudspeakers

"HEAR THE MUSIC, NOT JUST BASS"

SPEAKER SIZE
6.5
INCHES

APMB-1611DL

New Products for 2013

SOLD
by
PAIRS



SLIM
LOUDSPEAKERS

120Watts

SPECIFICATIONS

Loudspeaker Size
Power (P.M.P.O)
Power (R.M.S)
Frequency Response
Sensitivity
Voice Coil
Mounting Depth
Impedance
Magnet

APMB-1611DL

6.5"
120 Watts
60 Watts
60Hz-17KHz
88dB
1" NSV
43mm (1.7")
8 Ohms
6 Oz



Mylar Crossover
Capacitor Included



FACTORY REPLACEMENT UPGRADE

APMB-6911DL

6X9"
200 Watts
100 Watts
60Hz-17KHz
89dB
1" NSV
88mm (3-1/2")
8 Ohms
18 Oz

SOLD
by
PAIRS



New Products for 2013

SLIM
LOUDSPEAKERS

APMB-6911DL

10TH ANNIVERSARY

SPEAKER SIZE
6.5
INCHES



APMB-65FLT

*New Products
for 2013*

FLAT
HOUSING DESIGN

250Watts

SPECIFICATIONS

Loudspeaker Size
Power (P.M.P.O)
Power (R.M.S)
Frequency Response
Sensitivity
Voice Coil
Mounting Depth
Impedance
Magnet

APMB-65FLT

6.5"
250 Watts
125 Watts
80-9000Hz
94dB
1.5" TIL
49mm(1.93")
8 Ohms
18 Oz

APMB-8FLT

8"
300 Watts
150 Watts
70-8000Hz
93dB
1.5" TIL
58mm(2.3")
8 Ohms
34 Oz

SPEAKER SIZE
8
INCHES



*New Products
for 2013*

FLAT
HOUSING DESIGN

APMB-8FLT



6 INCHES SPEAKER SIZE



APMB-6385B

SEALED BACK



300Watts

SPECIFICATIONS

Woofer Size
 Power (P.M.P.O)
 Power (R.M.S)
 Frequency Response
 Sensitivity
 Voice Coil
 Mounting Depth
 Impedance
 Magnet

APMB-6SB

6"
 250 Watts
 125 Watts
 350-5.000Hz
 99dB
 1.5" Til
 60mm (2-3/8")
 8 Ohms
 20 Oz

APMB-638SB

6"
 300 Watts
 150 Watts
 500-5.400Hz
 98dB
 1.5" Til
 68mm (2-3/4")
 8 Ohms
 38 Oz



APMB-6SB



APMB-638SB

SPEAKER SIZE
6
INCHES



• APMB-6ND

bullet



250Watts

SPECIFICATIONS

Woofer Size
Power (P.M.P.O)
Power (R.M.S)
Frequency Response
Sensitivity
Voice Coil
Mounting Depth
Impedance
Magnet

APMB-6

6"
250 Watts
125 Watts
100-8000Hz
95dB
1.5" Til
78mm (3.07")
8 Ohms
30 Oz

APMB-6DC

6"
250 Watts
125 Watts
100-8000Hz
95dB
1.5" Til
78mm (3.07")
8 Ohms
30 Oz

APMB-6ND

6"
250 Watts
125 Watts
100-8000Hz
96dB
1.5" Til
63mm (2.48")
8 Ohms
8.5 Oz Neodymium

• Out performs even the highest quality coaxial speakers, handling higher levels of RMS power with minimal distortion • Loud Mid Frequency Loudspeaker

DUST
cap



APMB-6DC

bullet



APMB-6ND



APMB-8385B



300Watts

SPECIFICATIONS

Loudspeaker Size
Power (P.M.P.O)
Power (R.M.S)
Frequency Response
Sensitivity
Voice Coil
Mounting Depth
Impedance
Magnet

APMB-8

8"
500 Watts
250 Watts
65-6.000Hz
95dB
2" Til
93mm (3.66")
8 Ohms
30 Oz

APMB-8BT

8"
500 Watts
250 Watts
65-6.000Hz
95dB
2" Til
93mm (3.66")
8 Ohms
35 Oz

APMB-8SB

8"
250 Watts
125 Watts
100-8000Hz
95dB
1.5" Til
70mm (2.76")
8 Ohms
20 Oz

APMB-8385B

8"
300 Watts
150 Watts
350-5.000Hz
99dB
1.5" Til
76mm (3")
8 Ohms
38 Oz



APMB-8



APMB-8BT



APMB-8SB



• APMB-6800

bullet



250Watts

SPECIFICATIONS

Loudspeaker Size
Power (P.M.P.O)
Power (R.M.S)
Frequency Response
Sensitivity
Voice Coil
Mounting Depth
Impedance
Magnet

APMB-6800

6x8"
250 Watts
125 Watts
120Hz-20,000Hz
94dB
1" Til
94mm (3.78")
8 Ohms
30 Oz

APMB-6900

6x9"
250 Watts
125 Watts
120Hz-20,000Hz
94dB
1" Til
94mm (3.78")
8 Ohms
30 Oz

• Loud Mid Frequency Loudspeakers • Out performs even the highest quality coaxial speakers, handling higher levels of RMS power with minimal distortion

OEM Replacements Sizes



APMB-6800



APMB-6900



Loudspeakers

"HEAR THE MUSIC, NOT JUST BASS"



*Elegance... Performance... Craftmanship,
Audiopipe*

10TH ANNIVERSARY

APMB-C6ND

*Elegance... Performance... Craftmanship,
Audiopipe*



**NEODYMIUM
Magnet**

SPECIFICATIONS

Loudspeaker Size

6"

APMB-C8RND

8"

APMB-C10RND

10"

Power (P.M.P.O)

250 Watts

500 Watts

700 Watts

Power (R.M.S)

125 Watts

250 Watts

350 Watts

Frequency Response

100-8000Hz

70-7000Hz

65-6500Hz

Sensitivity

96dB

95dB

95dB

Voice Coil

1.5" T11

2.5" T11

2.5" T11

Mounting Depth

74mm (2.91")

90mm (3.54")

111mm (4.37")

Impedance

8 Ohms

8 Ohms

8 Ohms

Magnet

8 Oz

9 Oz

12 Oz



SPEAKER SIZE
18
INCHES



PROAUDIO
SUBWOOFER

AP5BW-18136



2000Watts

SPECIFICATIONS

Woofer Size
Power (P.M.P.O)
Power (R.M.S)
Frequency Response
Sensitivity
Voice Coil
Mounting Depth
Impedance
Magnet

AP5BW-12076

12"
1200 Watts
600 Watts
35Hz-3.000Hz
98dB
3" Til
156mm (6.14")
8 Ohms
76 Oz

AP5BW-15136

15"
1600 Watts
800 Watts
31Hz-4.000Hz
98dB
4" Til
163mm (6.5")
8 Ohms
136 Oz

AP5BW-18136

18"
2000 Watts
1000 Watts
28Hz-3.000Hz
98dB
4" Til
192mm (6.5")
8 Ohms
136 Oz

• Extended Low Frequency Woofer • Die-Cast Aluminum Basket



AP5BW-12075



AP5BW-15136



AP5BW-18136

SPEAKER SIZE
10
INCHES



PROAUDIO
SUBWOOFER

• APLB-10



600Watts

SPECIFICATIONS

Woofer Size
Power (P.M.P.O)
Power (R.M.S)
Frequency Response
Sensitivity
Voice Coil
Mounting Depth
Impedance
Magnet

APLB-10

10"
600 Watts
300 Watts
50Hz-4.000Hz
96dB
3" Til
111mm (4.37")
8 Ohms
80 Oz

APLB-12

12"
800 Watts
400 Watts
40Hz-4.000Hz
98dB
3" Til
125mm (4.92")
8 Ohms
80 Oz

APLB-15

15"
1000 Watts
500 Watts
35Hz-3.000Hz
98dB
3" Til
156mm (6.14")
8 Ohms
80 Oz

• Loud Mid Frequency Loudspeaker • Aluminum Basket



APLB-10

APLB-12

APLB-15



Speakers

SPEAKER SIZE
15
INCHES



PROAUDIO
SUBWOOFER

NWA-1590



1200Watts

SPECIFICATIONS

Woofer Size
Power (P.M.P.O)
Power (R.M.S)
Frequency Response
Sensitivity
Voice Coil
Mounting Depth
Impedance
Magnet

NWA-1260

12"
800 Watts
400 Watts
33-4,000Hz
94dB
2.5" 2-Layer
128mm (5.04")
8 Ohms
56 Oz

NWA-1290

12"
1000 Watts
500 Watts
30-4,000Hz
96.6dB
2.5" 2-Layer
129mm (5.08")
8 Ohms
90 Oz

NWA-1560

15"
1000 Watts
500 Watts
30-3,500Hz
95dB
2.5" 2-Layer
144mm (5.67")
8 Ohms
56 Oz

NWA-1590

15"
1200 Watts
600 Watts
30-3,500Hz
96.3dB
2.5" 2-Layer
153mm (6.02")
8 Ohms
90 Oz



NWA-1260



NWA-1290



NWA-1560

10TH ANNIVERSARY

SPEAKER SIZE
15
INCHES



PROAUDIO
SUBWOOFER

NWA-15001D

DIE-CAST
BASKET



1400Watts

SPECIFICATIONS

Woofer Size
Power (P.M.P.O)
Power (R.M.S)
Frequency Response
Sensitivity
Voice Coil
Mounting Depth
Impedance
Magnet

NWA-15100

15"
1400 Watts
700 Watts
28-2.500Hz
98.3dB
3" 2-Layer
147mm (5.79")
8 Ohms
100 Oz

NWA-15100D

15"
1400 Watts
700 Watts
28-2.500Hz
98.3dB
3" 2-Layer
147mm (5.79")
8 Ohms
100 Oz

NWA-18100

18"
1400 Watts
700 Watts
24-2.500Hz
98.8dB
3" 2-Layer
181mm (7.13")
8 Ohms
100 Oz

Heavy Duty Reinforced Die Cast Basket



NWA-15100



NWA-18100



J.R. Electronics



When did you first hear about Audiopipe?

A little over 3 years ago, our distributor had first mentioned the brand Audiopipe, saying that the prices were competitive and the product line was solid, so we decided to take a closer look to see if it would be something we would be interested in carrying.

Why did you choose Audiopipe?

We closely examined the full product line and quickly realized the quality behind it, finding the products to be well designed and well built. We then decided to bring in the line and try it out.

How long have you been working with Audiopipe?

Since first bringing in their products, we have been working with Audiopipe for about 3 years now and have had, and continue to have, great success with them throughout.

10TH ANNIVERSARY

Which Audiopipe products have you the highest demand?

I would have to say that the class D mono block amplifiers and the TXX series subwoofers are our most in demand products from Audiopipe, we have many customers asking about and requesting them. The marine products have also been a great success for us as well.

What kind of feedback do you get from your customers in regards to the brand?

Our customers whom we've sold Audiopipe to, always have good things to say about the product. They cannot believe the power that comes from the class D amps and the sound from the subwoofers.

Who is your target customer?... age range?... and what kind of applications is the product used in? (personal, professional, competition...)

Our target customers are mostly the "Bass Fans" or guys who just like really "loud" music! Their ages range from around 18 to 35 years or so. We find that many of our customers are using the product in competition vehicles, just as I do. Of course, with the full range of products Audiopipe has to offer, many of our customers also use the products in their personal daily driver vehicles as well.

Tell us your general experience with Audiopipe?

Overall, Audiopipe has been a great company to work with. The quality that goes into designing and building their car audio line is great and we love the marine product as well; good stuff Audiopipe!

Juan Gonzalez
Sales Manager



J. R. Electronics & Accessories Team



3000Watts

Audiopipe

3000Watts

Audiopipe

100



TWEETERS



NTC-2727



Originally developed in Brazil and still manufactured in Brazil this tweeter utilizes a 100% Niobium coil. Audiopipe designed this series to reproduce high frequencies in the purest form possible with minimal distortion.

| MODEL | NTC-1515 | NTC-1525 | NTC-2727 |
|---------------------|------------|--------------|--------------|
| Output Power (PMPO) | 275 Watts | 300 Watts | 275 Watts |
| Output Power (RMS) | 135 Watts | 150 Watts | 50 Watts |
| Impedance | 4 1/2 Ohm | 4 1/2 Ohm | 4 Ohm/8 Ohm |
| Input Sensitivity | 97dB | 92dB | 92dB |
| Frequency Response | 4kHz-20kHz | 4.5kHz-30KHz | 2.5kHz-20KHz |



NTC-1515



Surface Mount



NTC-1525



Surface Mount

Flush Mount

APH-4545-CD

3.5" Titanium Driver

- Max. Input Power: 70W
- Frequency Range: 1K-20KHz
- Sound Pressure: 110dB±2dB
- Voice Coil: 1.3" KSV Voice Coil
- Impedance: 8 Ohms
- Magnet: 12 OZ.



APH-4545-H

High Frequency Horn

- Plastic Horn
- Throat size: 1.375"
- Overall Dimensions:
4.5"(H) x 4.5"(W) x 2.5"(D)



APH-5757

High Frequency Horn

- Plastic Horn
- Throat size: 1.375"
- Overall Dimensions:
5.5"(H) x 6.2"(W) x 4.3"(D)

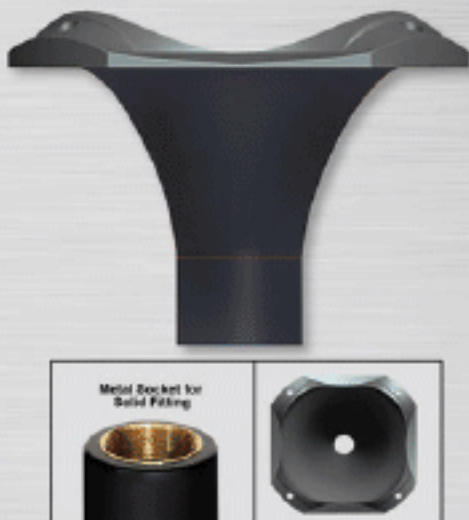

APHL-8634

1.4" Line Array System Horn

- Plastic Covered Steel
- Throat Diameter: 1.4 in (35.5mm)
- Mounting Diameter: 101mm & 75mm





TWEETERS



ATQ-3725

350 watts



250 watts

ATQ-1250



400 watts

ATQ-3240



600 watts

ATQ-4070

| MODEL | ATQ-1250 | ATQ-3240 | ATQ-3725 | ATQ-4070 |
|---------------------|------------|-----------|-----------|-----------|
| Output Power (PMPO) | 250 Watts | 400 Watts | 350 Watts | 600 Watts |
| Output Power (RMS) | 125 Watts | 200 Watts | 175 Watts | 300 Watts |
| Magnet Structure | 30*8 NdFeb | 35 Oz | 25 Oz | 65 Oz |
| Impedance | 8 Ohm | 8 Ohm | 8 Ohm | 8 Ohm |
| Input Sensitivity | 105dB | 104dB | 99dB | 105dB |
| Frequency Response | 2K-20KHz | 2K-20KHz | 2K-25KHz | 2K-25KHz |

ATQVC-1250

Replacement Voice Coil for ATQ-1250

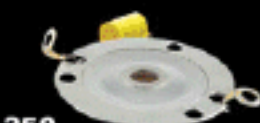

ATQVC-3240

Replacement Voice Coil for ATQ-3240



ATQVC-3725

Replacement Voice Coil for ATQ-3725

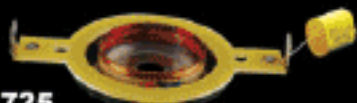

ATQVC-4070

Replacement Voice Coil for ATQ-4070

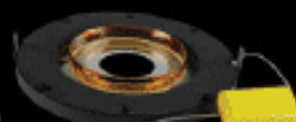

AUDIOPIPE

ATQ-4070

600 watts

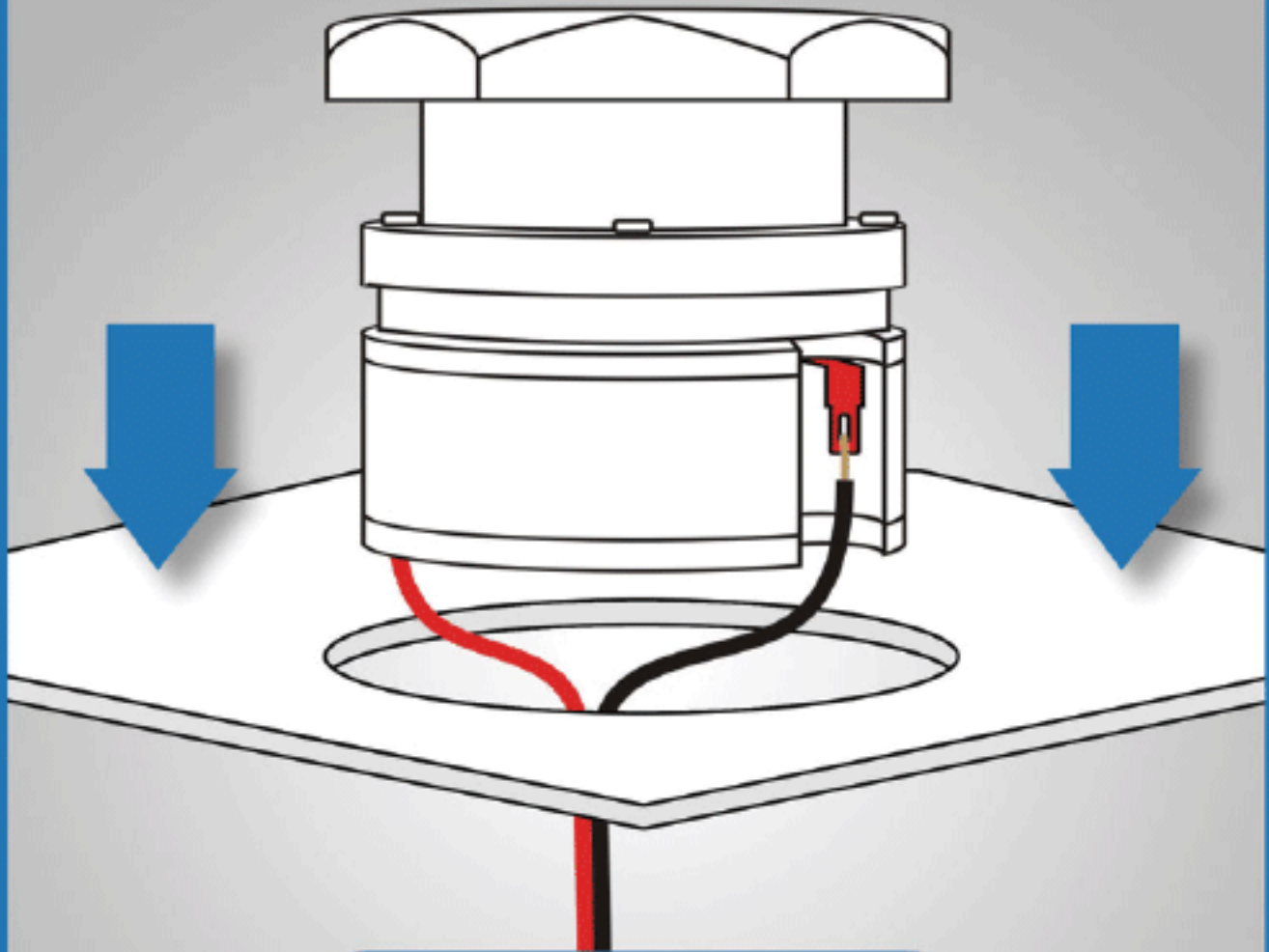

PATENT PENDING

With our Design the terminals are inside of the magnet so when installing all you have to do is open a round circle



TWEETERS



- Heavy Duty Titanium Super Tweeter
- Titanium Super Bullet Tweeter
- Diamond Chrome Cutting Finish
- High Temperature Kapton Voice Coil
- Ferro Fluid Enhanced Voice Coil



ATR-3231



ATR-3721



ATR-4061



ATR-4421

| MODEL | ATR-3231 | ATR-3721 | ATR-4061 | ATR-4421 |
|---------------------|-----------|-----------|-----------|-----------|
| Output Power (PMPO) | 300 Watts | 300 Watts | 500 Watts | 600 Watts |
| Output Power (RMS) | 150 Watts | 150 Watts | 250 Watts | 300 Watts |
| Magnet Structure | 30 Oz | 20 Oz | 60 Oz | 80 Oz |
| Impedance | 4-8 Ohm | 4-8 Ohm | 4-8 Ohm | 4-8 Ohm |
| Input Sensitivity | 104dB | 99dB | 105dB | 105dB |
| Frequency Response | 2K-20KHz | 2K-25KHz | 2K-25KHz | 2K-25KHz |



ATV-3231
Replacement Voice Coil for ATR-3231



ATV-3721
Replacement Voice Coil for ATR-3721

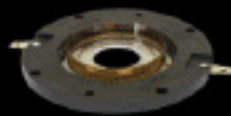

ATV-4061
Replacement Voice Coil for ATR-4061

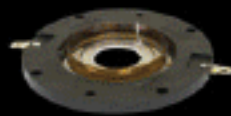

ATV-4421
Replacement Voice Coil for ATR-4421

AUDIOPIPE

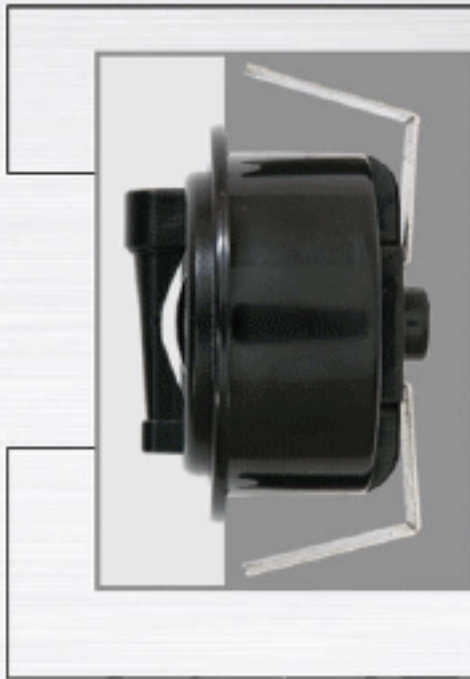

• **APHE-T100**



300Watts



Old school certified crispy clean high RMS power handling

| MODEL | APHE-T100 | APHE-S200 |
|---------------------|--------------|--------------|
| Output Power (PMPO) | 100 Watts | 300 Watts |
| Output Power (RMS) | 50 Watts | 150 Watts |
| Impedance | 4 1/2 Ohm | 4 1/2 Ohm |
| Input Sensitivity | 90dB | 92dB |
| Frequency Response | 2.5kHz-25kHz | 4.5kHz-30KHz |



APHE-S200



TWEETERS



ATX-115

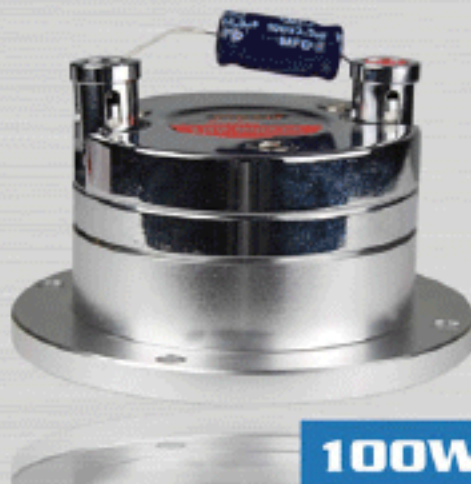

100Watts

- 1" Aluminum Titanium Tweeter • Diamond Chrome Cut Finish • 1" High Temperature kapton voice coil
- 25x8mm NdFeb Magnet structure • 50 Watts RSM/100 Watts peak power • 4 Ohm impedance
- Ferro fluid enhanced voice coil • Sensitivity: 102dB • Frequency response: 2K-20KHz

| MODEL | ATX-38 | ATX-100 | ATX-115 |
|---------------------|--------------|--------------|--------------|
| Output Power (PMPO) | 100 Watts | 200 Watts | 100 Watts |
| Output Power (RMS) | 50 Watts | 100 Watts | 50 Watts |
| Magnet Structure | 25x7mm NdFeb | 25x7mm NdFeb | 25x8mm NdFeb |
| Impedance | 4 Ohm | 4 Ohm | 4 Ohm |
| Input Sensitivity | 100dB | 100dB | 102dB |
| Frequency Response | 2K-20KHz | 2K-20KHz | 2K-20KHz |

100 watts



ATX-38

200 watts



ATX-100

SOLD by PAIRS

SOLD by PAIRS



| MODEL | ATX-125 | ATX-150 | ATX-250 |
|---------------------|--------------|--------------|-----------|
| Output Power (PMPO) | 200 Watts | 200 Watts | 300 Watts |
| Output Power (RMS) | 1000 Watts | 100 Watts | 150 Watts |
| Magnet Structure | 25x8mm NdFeb | 25x8mm NdFeb | 20 Oz |
| Impedance | 4 Ohm | 4 Ohm | 4 Ohm |
| Input Sensitivity | 105dB | 105dB | 102dB |
| Frequency Response | 2K-20KHz | 2K-20KHz | 3K-18KHz |



ATV-125

Replacement Voice Coil for ATX-125
• 1" High Temperature Kapton Voice Coil



ATV-150

Replacement Voice Coil for ATX-150
• 1" High Temperature Kapton Voice Coil



ATV-250

Replacement Voice Coil for ATX-250
1" High Temperature Kapton Voice Coil



COMPRESSION DRIVERS

NSDV-4000USA

Titanium Diaphragm

- Impedance: 8 Ohms
- 500W Max.

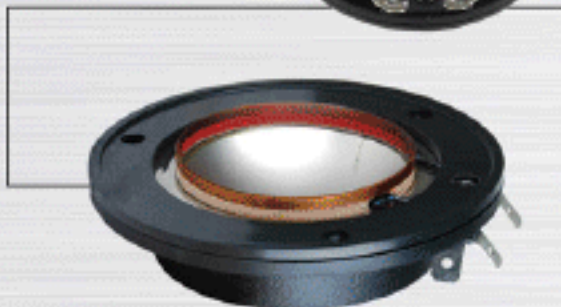

NTX-4000USA

High-Grade Dynamic Driver

- 2" Kapton Voice Coil
- High-grade Titanium Diaphragm
- Freq. Response: 1KHz - 20KHz
- SPL: 100dB
- Fs: 1KHz
- Max Power: 500W



500Watts

- Titanium Compression Driver
- Kapton Voice Coil with Flat Wire
- Titanium Diaphragm
- Strontium Magnet

New Products for 2013



APCD-900

Voice coil kits for FR series drives

- 3" Kapton Voice Coil with Flat Wire
- High Temp (155°)
- Push Style Binding Post

SPECIFICATIONS

Power (P.M.P.O)

Power (R.M.S)

Frequency Response

Sensitivity

Driver

Voice Coil

Magnet Dimension

APCD-940FR

180 Watts

90 Watts

600-23.000Hz

115dB

2" Exit Driver

3" Kapton Voice

145x8mm Strontium Magnet

APCD-976FR

180 Watts

90 Watts

600-24.000Hz

100dB

2" Exit Driver

3" Kapton Voice

190x20mm Strontium Magnet



APCD-940FR



APCD-976FR

APCDAD-775

- Horn Adapter
- Outer Diameter: Ø 150 mm
- Height: 20 mm
- Thread: 1 3/8"

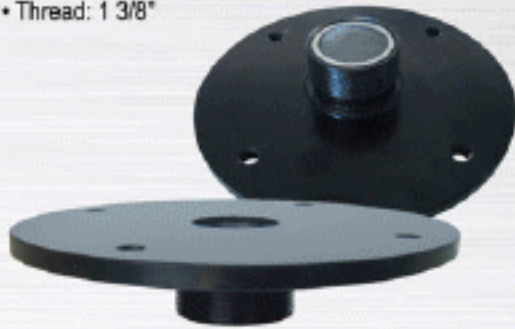

APCDAD-2550

- Horn Adapter
- Outer Diameter: Ø 126 mm
- Height: 20 mm
- Thread: 1 3/8"

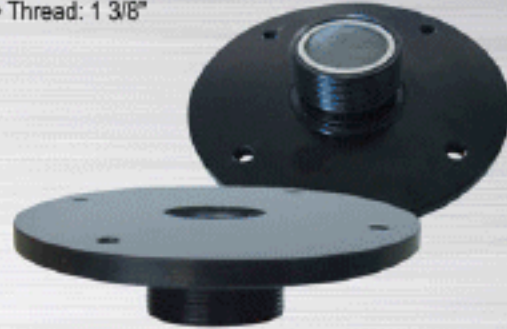

APCDAD-34FR-MD
Replacement voice coil
for APCD-34Z3-MD



APCDAD-44FR-MD
Replacement voice coil
for APCD-44Z3-MD



APCDAD-50FR-MD
Replacement voice coil
for APCD-50Z3-MD

Horn adapter converts a bolt on to a screw on type

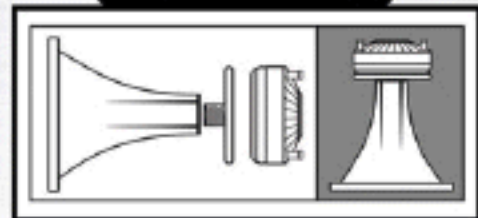

SPECIFICATIONS

Power (P.M.P.O)

Power (R.M.S)

Frequency Response

Sensitivity

Driver

Voice Coil

Magnet Dimension

APCD-34FR

30 Watts

15 Watts

1.5K-18KHz

104 dB

8 ohm

34.4mm (1.35")

90mm - Ferrite

APCD-44FR

40 Watts

20 Watts

1K-20K Hz

104 dB

8 ohm

44.4mm (1.75")

110mm - Ferrite

APCD-50FR

50 Watts

25 Watts

1.5K-20K Hz

105 dB

8 ohm

51.6mm (2")

134mm - Ferrite



APCD-34FR



APCD-44FR



APCD-50FR



When did you first hear of Audiopipe?

• In 2006, I started hearing about the company by word of mouth, friends saying that they heard some subs that sounded really good! A classmate had 2 15" subs and from that day I decided to look into Audiopipe products.

Why did you pick Audiopipe?

• Because of the way they outperform other car audio companies in quality and price! Audiopipe makes great equipment that can really take beating and since I've started using them I've never had a problem. I've only used Audiopipe ever since I bought my first pair of 12" and I've suggested Audiopipe to friends and people who want to sound loud with great sound quality without spending a lot of money.

How long have you been using Audiopipe?

• Around 5 years, and still turning heads! It's funny to see people turn around way before being close to them.

Which Audiopipe products do you use and which have you used in the past?

Pretty much I still use everything, just changed some things here and there:

- ATX-3720 (2)
- APMB-6ND (2)
- APMB-6900 (2)
- APMB-8 (8)
- APS6997 (2)
- ATX-3230 (2)
- APSB-120 (1)
- AP-3002 (1)
- AP-2004 (1)
- SPLIT-3003 (1)
- XV-3 (1)
- EQ-4X (1)
- EQ-7X (1)
- AP-15001D (1)
- TXX-APX12BL (4)
- APMB-6SB (2)
- ATQ-3725 (2)

I think that's about it.



AUDIOPIPE

Please explain your experience with Audiopipe:

It's been amazing, especially when people listen to my car and can't believe that its **Audiopipe** that is playing. I've lived in Puerto Rico all my life and car audio has been part of it; almost every car, including golf karts, off-road vehicles and coolers have some type of sound system, mostly "Vocated" (mids and highs). **Audiopipe** has been looked upon as "a speaker that's not loud" for as long as I can remember, but I stayed with Audiopipe because it was affordable and I knew I could make something happen with them. I still remember I use to work on my car every day, looking for ways to be as loud as I could while still producing a clean sound. One night at the street races in Plaza Las Americas, a mall in Puerto Rico, with a few friends just hanging out I heard loud music around 6 parking spots away, it was a white Scion xB. It had 8" 8" mid ranges and a 12" sub from another company and @ the time I only had the APMB-6ND (2), APMB-8 (2), APMB-6900 (2), ATX-3230 (2) and TXX-APX12BL (2). I was outmatched, it's a speaker company that's well known for their sound, but after 15 minutes of going back and forth with music and people dancing to what we were playing he closed up the car and turned it off! I was amazed he did that, in a way he gave up, and after playing 2 more songs I closed up too. My friends and I headed to where the owner of the car was with his friends and we shook hands; the first thing he asked me was "what speakers do you have?" I said "**Audiopipe**". He looked shocked and started asking exactly what I had because he couldn't believe it, we showed our cars to each other and pretty much made new friends and got a little respect. After that I grew very confident in **Audiopipe** and dedicated myself to prove that it doesn't take thousands of dollars to sound loud, and to know that I did it in an affordable way it just felt even better. I recommend this company to any car audio fanatic because I know they won't regret it; quality products for an affordable price, you can't go wrong with **Audiopipe**!

**TUNER
INSTALLER
BUILDER**

Carlos David Rios
Trujillo Alto, Puerto Rico



PB-1020

1 to 2 Power Distribution Block

- 24 Kt Gold Finish
- One 0 or 4 Gauge Input and two 0 or 4 Gauge Outputs
- Inner Steps Ensure Perfect Recessed Fit of 0 and 4 Gauge Cable
- Base is Precision Machined

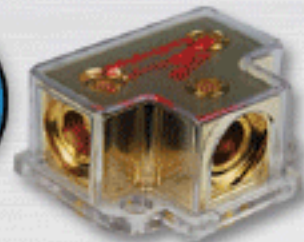

PB-2010XT

Power Distribution Block

- 24 Kt Gold Finish
- Base is Precision Machined

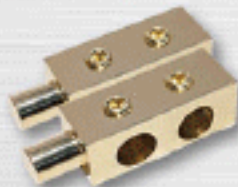

PB-5010XT

Power Distribution Block

- 24 Kt Gold Finish
- Base is Precision Machined



PB-1442

4 to 2 Power Distribution Block

- 24 Kl. Gold Finish.
- One 4 Gauge Input and Four 8 Gauge Outputs.
- Inner Steps Ensure Perfect Recessed Fit of 4 And 8 Gauge Power Cable Into Block.
- Net Weight: 160 Gram.
- Base Is Precision Machined.

PB-1044

1 to 4 Power Distribution Block

- 24 Kl. Gold Finish.
- One 1/0 Gauge Input and Four 4 Gauge Outputs.
- Inner Steps Ensure Perfect Recessed Fit of 4 And 8 Gauge Cable.
- Net Weight: 160 Gram.
- Base Is Precision Machined.

PB-1448

1 to 4 Power Distribution Block

- 24 Kl. Gold Finish.
- One 4 Gauge Input and Four 8 Gauge Outputs.
- Inner Steps Ensure Perfect Recessed Fit of 4 And 8 Gauge Power Cable Into Block.
- Net Weight: 160 Gram.
- Base Is Precision Machined.



PB-1442



PB-1044



PB-1048

BT-200P / BT-200N

Battery Terminal

- 24 Kt. Gold Finish.
- Available in Positive or Negative Terminal Models.
- Accepts 5/16" Terminals on Top and One 8 Gauge Wire on Each Side.

BT-200P Positive
BT-200N Negative



BT-100P / BT-100N

Wingnut Terminal

- 24 Kt. Gold Finish.
- Available in Positive or Negative Terminal Models.
- Accepts 5/16" Terminals.

BT-100P Positive
BT-100N Negative



BT-300

Battery Side Post Extender

- 24 Kt. Gold Finish.
- Mount Leads Directly to Battery.
- Net Weight: 40 Gram.



BT-350

Battery Side Post Extender

- 24 Kt. Gold Finish.
- Mount Leads Directly to Battery.
- Net Weight: 50 Gram.



BT-400

Battery Side Post Terminal

- 24 Kt. Gold Finish.
- Net Weight: 50 Gram.



BGT-02G

Grounding Adapter

- Internal Ring Allows Use of 0 or 4 Gauge Cable.
- 24 Kt. Gold Finish.

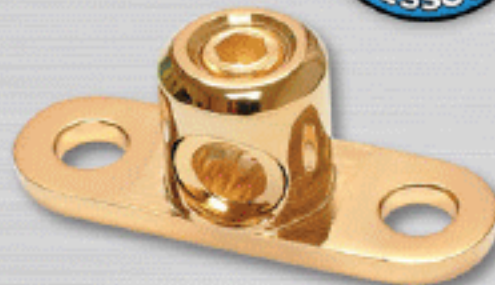

BTC-1-0

BTC-1-4

BTC-1-8

Heavy Duty Ring Terminal

- Ring Terminal with 24 Kt. Gold Finish.
- Set Screw Design, No Crimping Required.
- Available in 4 Different Wire Sizes.

BTC-1-0 1/0
BTC-1-4 4
BTC-1-8 8



BT-705P / BT-705N

Multi-Feed Battery Connections System

- Multi-feed Battery Terminals.
- Unique Design Allows up to 4 Power Cables to be Connected Directly to the Battery Post
- These Units are Precision Machined.
- 24 Kt. Gold Finish.
- Available in Positive or Negative Terminal Models.
- Has 4 Separate Outputs : One up to 1/0 Gauge, One up to 2 Gauge, Two Up to 8 Gauge.
- Inner Steps Ensure Perfect Recessed Fit of Cable into Block.

BT-705P Positive
BT-705N Negative





CQ-1100

Economic Type ANE (ANL)
Fuse Block

- 24 Kt. Gold Finish.
- Use ANE (ANL) Fuse up to 500 Amps.
- Accepts 0 to 4 Gauge Cable Wire.
- Clear Snap-on Dust Cover.



CQ-1111

Heavy Duty ANE (ANL) Fuse Block

- 24 Kt. Gold Finish Screws.
- Use ANE (ANL) Fuse up to 500 Amps.
- Accepts 0 to 4 Gauge Cable Wire.
- Clear Snap-on Dust Cover.
- Base is Precision Machined.

MFB-200

2 Position MAXI Fuse Block

- 24 Kt. Gold Finish.
- Accepts Dual MAXI Type Fuses.
- Set Screw Design- No Crimping Required.
- Accepts One 4 Gauge Input and Two 8 Gauge Output.



CQ-1111



MFB-200



FBG-3428

2 Position AGU Fuse Block

- 24 Kt. Gold Finish.
- Accepts Two AGU Fuses.
- One 3-Way 4 Gauge Input and Two 8 Gauge Outputs
- Inner Steps Ensure Perfect Recessed Fit of 4 and 8 Gauge Power Cable into Block.
- Base is Precision Machined.
- Water Resistant.



FBG-3438

3 Position AGU Fuse Block

- 24 Kt. Gold Finish.
- Accepts Two AGU Fuses.
- One 3-Way 4 Gauge Input and Two 8 Gauge Outputs
- Inner Steps Ensure Perfect Recessed Fit of 4 and 8 Gauge Power Cable into Block.
- Base is Precision Machined.
- Water Resistant.

FBG-3448

4 Position AGU Fuse Block

- 24 Kt. Gold Finish.
- Accepts Two AGU Fuses.
- One 3-Way 4 Gauge Input and Two 8 Gauge Outputs
- Inner Steps Ensure Perfect Recessed Fit of 4 and 8 Gauge Power Cable into Block.
- Base is Precision Machined.
- Water Resistant.



FBG-3438



FBG-3448



FBA-3448

4 Position AFC Fuse Block

- 24 Kt. Gold Finish Screws.
- Accepts Four AFC Fuses.
- One 3-Way 4 Gauge Input and Four 8 Gauge Outputs.
- Inner Steps Ensure Perfect Recessed Fit of 4 and 8 Gauge Power Cable into Block.
- Water Resistant.
- Platinum Base is Precision Machined.



FBA-3428

2 Position AFC Fuse Block

- 24 Kt. Gold Finish Screws.
- Accepts Two AFC Fuses.
- One 3-Way 4 Gauge Input and Two 8 Gauge Outputs.
- Inner Steps Ensure Perfect Recessed Fit of 4 and 8 Gauge Power Cable into Block.
- Water Resistant.
- Platinum Base is Precision Machined

FBA-3438

3 Position AFC Fuse Block

- 24 Kt. Gold Finish Screws.
- Accepts Three AFC Fuses.
- One 3-Way 4 Gauge Input and Three 8 Gauge Outputs.
- Inner Steps Ensure Perfect Recessed Fit of 4 and 8 Gauge Power Cable into Block.
- Water Resistant.
- Platinum Base is Precision Machined.



FBA-3428



FBA-3438



FBA-3448

FBP-53448

4 Position AGU Fuse Block

- 24 Kl. Gold Finish Screws.
- Accepts Four AGU Fuses.
- One 3-Way 4 Gauge Input and Four 8 Gauge Outputs.
- Inner Steps Ensure Perfect Recessed Fit of 4 and 8 Gauge Power Cable into Block.
- Water Resistant.
- Platinum Base is Precision Machined.



FBP-53428

2 Position AGU Fuse Block

- 24 Kl. Gold Finish Screws.
- Accepts Two AGU Fuses.
- One 3-Way 4 Gauge Input and Two 8 Gauge Outputs.
- Inner Steps Ensure Perfect Recessed Fit of 4 and 8 Gauge Power Cable into Block.
- Water Resistant.
- Platinum Base is Precision Machined.

FBP-53438

3 Position AGU Fuse Block

- 24 Kl. Gold Finish Screws.
- Accepts Three AGU Fuses.
- One 3-Way 4 Gauge Input and Three 8 Gauge Outputs.
- Inner Steps Ensure Perfect Recessed Fit of 4 and 8 Gauge Power Cable into Block.
- Water Resistant.
- Platinum Base is Precision Machined.



FBP-53428



FBP-53438



FBP-53448



BTP-34-0

Heavy Duty Ring Terminal

- For 0 Gauge Wire.
- 24 Kt. Gold Finish Screws.
- Set Screws Design, No Crimping Required.
- Platinum Body is Precision Machined.

BTP-36-4

Heavy Duty Ring Terminal

- For 4 Gauge Wire.
- 24 Kt. Gold Finish Screws.
- Set Screws Design, No Crimping Required.
- Platinum Body is Precision Machined.

BTP-37-8

Heavy Duty Ring Terminal

- For 8 Gauge Wire.
- Pressure Nut Design, No Crimping Required.
- Platinum Body is Precision Machined.



BTP-509N
BTP-509P

Multi-feed Battery Connections System

- 24 Kt. Gold Finish Screws.
- One 0 Gauge and Two 4 Gauge Outputs
- Inner Steps Ensure Perfect Recessed Fits 4 and 8 Gauge Power Cable into Terminal.
- Platinum Body is Precision Machine

BTP-705N
BTP-705P

Multi-feed Battery Connections System

- 24 Kt. Gold Finish Screws.
- Has 4 Separate Outputs : One 0 Gauge, One 4 Gauge & Two 8 Gauge.
- Inner Steps Ensure Perfect Recessed Fits Cable into Block.
- Platinum Body is Precision Machined.

BTP-709N
BTP-709P

Multi-feed Battery Connections System

- 24 Kt. Gold Finish Screws.
- Has 4 Separate Outputs : One 0 Gauge, One 4 Gauge & Two 8 Gauge.
- Inner Steps Ensure Perfect Recessed Fits Cable into Block.
- Platinum Body is Precision Machined.

HIGH CAPACITY



BTP-509



BTP-705



BTP-709

BTD-800N

Multi-feed Battery Connections System

- Negative
- 24 Kt. Gold Finish Screws.
- Has 4 Separate Outputs : One 0 Gauge, One 4 Gauge & Two 8 Gauge.
- Inner Steps Ensure Perfect Recessed Fits Cable into Block.
- Platinum Body Is Precision Machined.

BTD-800P

Multi-feed Battery Connections System with Digital Display

- Positive
- 24 Kt. Gold Finish Screws.
- Has 4 Separate Outputs : One 0 Gauge, One 4 Gauge & Two 8 Gauge.
- Inner Steps Ensure Perfect Recessed Fits Cable into Block.
- Platinum Body Is Precision Machined.



BTD-800P

PBP-51428

Power Distribution Block

- 24 Kt. Gold Finish Screws.
- One 0 or 4 Gauge Input and Two 4 or 8 Gauge Outputs.
- Inner Steps Ensure Perfect Recessed Fits 4 and 8 Gauge Power Cable into Block.
- Platinum Base is Precision Machined.

PBP-51448

Power Distribution Block

- 24 Kt. Gold Finish Screws.
- One 0 or 4 Gauge Input and Four 4 or 8 Gauge Outputs.
- Inner Steps Ensure Perfect Recessed Fits 4 and 8 Gauge Power Cable into Block.
- Platinum Base is Precision Machined.

BGT-02P

Grounding Adapter

- 24 Kt. Gold Finish Screws.
- Accepts 0 or 4 Gauge Cable.
- Platinum Body is Precision Machined.



BGT-02P



BTD-800N



PBP-51428



**HIGH
CAPACITY**
ACCESSORIES

PBP-51448



AFC-P1414

distribution
Block

eye™
CANDY

**HIGH
CAPACITY**
accessories



AFC-P1414

Power Distribution Block

- Distributes Positive and Negative Cable Connections
- Accepts One 0 or 4 Gauge Input and Four 8 Gauge Outputs
- With Super Bright LED
- 24 Kt. Gold Finish Screws
- Platinum Base is Precision Machined
- Clear Blue Bottom Housing Adds Eye Candy Effect
- AFC Type Fuse

PDC-P1414

Power Distribution Block

- Distributes Positive and Negative Cable Connections
- Accepts One 0 or 4 Gauge Input and Two 4 or 8 Gauge Outputs
- With Super Bright LED
- 24 Kt. Gold Finish Screws
- Platinum Base is Precision Machined
- Clear Blue Bottom Housing Adds Eye Candy Effect
- AGU Type Fuse

distribution
Block

**HIGH
CAPACITY**
accessories



AFC-P1414



PDC-P1414

CQ-1221P

ANL Fuse Block

- Accepts One 0 Gauge or 4 Gauge Input and 0 or 4 Gauge Output
- With Super Bright Blue LED Status Indicator
- 24 Kt. Gold Finish Screws
- Platinum Base is Precision Machined
- Black Bottom Housing Adds Eye Candy Effect

CQ-1221PD

ANL Fuse Block

- Accepts One 0 or 4 Gauge Input and One 0 or 4 Gauge Output
- With Digital Voltmeter and Super Bright LED
- 24 Kt. Gold Finish Screws
- Platinum Base is Precision Machined
- Black Bottom Housing Adds Eye Candy Effect



CQ-3422P

2 Position ANL Fuse Block

- Accepts One 0 or 4 Gauge Input and Two 4 or 8 Gauge Outputs
- With Super Bright Blue LED Status Indicator
- 24 Kt. Gold Finish Screws
- Platinum Base is Precision Machined
- Black Bottom Housing Adds Eye Candy Effect

CQ-3422PD

2 Position ANL Fuse Block

- Accepts One 0 or 4 Gauge Input and Two 4 or 8 Gauge Outputs
- With Digital Voltmeter and Super Bright LED
- 24 Kt. Gold Finish Screws
- Platinum Base is Precision Machined
- Black Bottom Housing Adds Eye Candy Effect





ACCESSORIES



ACAP-6000

New Products
for 2013



| MODEL | ACAP-2000 | ACAP-3500 | ACAP-6000 |
|--------------------|---------------------------|----------------------------|----------------------------|
| High Voltage | 2.0 Farad Power Capacitor | 3.5 Farad Power Capacitor | 6 Farad Power Capacitor |
| VDC: | 20Max. 24V Surge | 20Max. 24V Surge | 20Max. 24V Surge |
| E.S.R.: | 0.002 Ω or less | 0.002 Ω or less | 0.002 Ω or less |
| Terminals: | 1/4-28 Thread | 1/4-28 Thread | M6 Thread |
| Digital: | Display | Display & Status Indicator | Display & Status Indicator |
| Digital Indicator: | Electronic Protection | Electronic Protection | Electronic Protection |



ACAP-2000

POWER
capacitor



New Products
for 2013



ACAP-3500

POWER
capacitor



New Products
for 2013

N5P-80

- 80 Amp Manual Reset Circuit Breaker
- 24 KL. Gold Finish Screws.
 - Perfect Fit for 4 Gauge Power Cable.
 - Includes Collar Adaptor for 8 Gauge Power Cable.
 - Platinum Base is Precision Machined.

N5P-150

- 150 Amp Manual Reset Circuit Breaker
- 24 KL. Gold Finish Screws.
 - Perfect Fit for 4 Gauge Power Cable.
 - Includes Collar Adaptor for 8 Gauge Power Cable.
 - Platinum Base is Precision Machined.

N5P-200

- 200 Amp Manual Reset Circuit Breaker
- 24 KL. Gold Finish Screws.
 - Perfect Fit for 4 Gauge Power Cable.
 - Includes Collar Adaptor for 8 Gauge Power Cable.
 - Platinum Base is Precision Machined.



CB-100A

Manually Resettable Circuit Breaker

- 100 Amp
- Platinum plated Terminals
- Water Resistant
- High Heat/High Temp Resistant
- 12V

CB-150A

Manually Resettable Circuit Breaker

- 150 Amp
- Platinum plated Terminals
- Water Resistant
- High Heat/High Temp Resistant
- 12V

CB-200A

Manually Resettable Circuit Breaker

- 200 Amp
- Platinum plated Terminals
- Water Resistant
- High Heat/High Temp Resistant
- 12V



CB-100A



CB-150A



CB-200A



FUSES

NQ-6

In-line AFC Fuse Holder

- Unique See-thru Material.
- Clear Housing with Mounting Clip.
- All Metal Parts are 24 Kt. Plate Finish.
- Accepts AFC Fuse up to 80 Amps.
- Perfect Fit for 4 Gauge Power Cable.
- Connect Base is Precision Machined.



N5-C CLEAR

In-Line AGU Fuse Holder

- Unique See-Thru Material.
- Clear Housing with Mounting Clip.
- All Metal Parts are 24 Kt. Gold Finish.
- Accepts AGU Fuse up to 80 Amps.
- Perfect Fit for 4 Gauge Power Cable.
- Set Screw Design - No Crimping Required.
- Connect Base is Precision Machined.



N10BL

In-Line AGU Fuse Holder

- Unique See-Thru Material.
- Clear Housing with Mounting Clip.
- All Metal Parts are 24 Kt. Gold Finish.
- Accepts AGU Fuse up to 80 Amps.
- Perfect Fit for 4 Gauge Power Cable.
- Set Screw Design - No Crimping Required.
- Connect Base is Precision Machined.
- with BLUE LED

N10RD

In-Line AGU Fuse Holder

- Unique See-Thru Material.
- Clear Housing with Mounting Clip.
- All Metal Parts are 24 Kt. Gold Finish.
- Accepts AGU Fuse up to 80 Amps.
- Perfect Fit for 4 Gauge Power Cable.
- Set Screw Design - No Crimping Required.
- Connect Base is Precision Machined.
- with RED LED



10TH ANNIVERSARY

CQ-6204

Heavy Duty AGU Fuse Holder

- 1 Ft. (0.3M) 4GA Red Power Cable
- Gold N2 Type Fuse Holder
- Gold Plated 60A AGU Fuse
- Gold Base is Precision Machined

CQ-6208

Heavy Duty AGU Fuse Holder

- 1 Ft. (0.3M) 8GA Red Power Cable
- Gold N2 Type Fuse Holder
- Gold Plated 60A AGU Fuse
- Gold Base is Precision Machined



CQ-7304P

Blue Heavy Duty AGU Fuse Holder

- 1 Ft. (0.3M) 4GA Blue Power Cable
- Platinum AGU Type Fuse Holder
- Platinum 60A AGU Fuse
- With Blue LED Status Indicator
- Platinum Base is Precision Machined

CQ-7304 Red

Heavy Duty AGU Fuse Holder

- 1 Ft. (0.3M) 4GA Red Power Cable
- Gold AGU Type Fuse Holder
- Gold Plated 60A AGU Fuse
- With Red LED Status Indicator
- Gold Base is Precision Machined



CQ-7304P



AGU Fuse Holder



CQ-7304 Red



FUSES

CQ-9300



ANL Type Fuse

CQ-9300

Heavy Duty ANL Fuse Holder

- GOLD Plated ANL Type Fuse Holder
- 1 Foot (0.3M) 0 Ga RED Power Cable
- Gold Plated 150A ANL fuse
- 12V

CQ-2300

Heavy Duty ANE (ANL) Fuse Holder

- Water Resistant.
- All Metal Parts are 24 Kt. Gold Finish.
- Use ANE (ANL) Fuse up to 300 Amps.
- Accepts 0 to 4 Gauge Cable Wire.
- Clear Housing Includes Two Nylon Covers.
- Perfect Contact for Power Cable.
- Set Screw Design - No Crimping Required.

ANL Fuse Holder

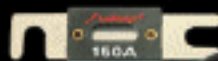

CQ-2300

CQ-9300P



CQ-9300P

Heavy Duty ANL Fuse Holder

- 1 Ft. (0.3M) 0GA Blue Power Cable
- Platinum ANL Type Fuse Holder
- Platinum 150A ANL Fuse

CQ-9500P

Heavy Duty ANL Fuse Holder

- 1 Ft. (0.3M) 0GA Blue Power Cable
- Platinum ANL Type Fuse Holder
- Platinum 150A ANL Fuse
- With Blue LED Status Indicator
- Platinum Base is Precision Ma-



CQ-9500P

**CQ-209P-16**

Standard Glass Fuse Holder

B = 5 A

C = 100M Ω Min.D = 5M Ω at 1A DC

E = AC 1000 V Min.

F = P.P.

G = 16# AWG / 8"

Loop Bayonet Type

CQ-209P-18

Standard Glass Fuse Holder

B = 5 A

C = 100M Ω Min.D = 5M Ω at 1A DC

E = AC 1000 V Min.

F = P.P.

G = 18# AWG / 8"

Loop Bayonet Type



CQ-209P-16



CQ-209P-18

Specification Guide Codes:

B= Rated Current

C= Insulation Resistance at 500 V DC

D= Contact Resistance

E= Dielectric Strength for 60 Seconds

F= Body Material

G= Supply Standard UL Wire-AWG/Length

CQ-211C-10

ATC Fuse Holder

B = 30 A

C = 100M Ω Min.D = 5M Ω at 1A DC

E = AC 1000 V Min.

F = P.V.C.

G = 10# AWG / 8" Loop

Water Resistance Type

CQ-211C-12

ATC Fuse Holder

B = 30 A

C = 100M Ω Min.D = 5M Ω at 1A DC

E = AC 1000 V Min.

F = P.V.C.

G = 12# AWG / 8" Loop

Water Resistance Type

CQ-211M

Maxi Fuse Holder

B = 60 A

C = 100M Ω Min.D = 5M Ω at 1A DC

E = AC 3000 V Min.

F = P.V.C.

G = 8# AWG / 8" Loop

Water Resistance Type

CQ-211M-4

Maxi Fuse Holder

B = 60 A

C = 100M Ω Min.D = 5M Ω at 1A DC

E = AC 3000 V Min.

F = P.V.C.

G = 4# AWG / 8" Loop

Water Resistance Type

CQ-211N-12

ATC Fuse Holder

B = 30 A

C = 100M Ω Min.D = 5M Ω at 1A DC

E = AC 2000 V Min.

F = Nylon with Glass Fiber

G = 12# AWG / 8" Loop

Heavy Duty Type



CQ-211C-10



CQ-211C-12



CQ-211N-12



CQ-211M



CQ-211M-4

CQ-210-10

Standard Glass Fuse Holder
 B = 20 A
 C = 100M Ω Min.
 D = 5M Ω at 1A DC
 E = AC 2000 V Min.
 F = Bakelite.
 G = 10# AWG / 8" Loop
 Screw Type



CQ-210-10

CQ-210-12

Standard Glass Fuse Holder
 B = 20 A
 C = 100M Ω Min.
 D = 5M Ω at 1A DC
 E = AC 2000 V Min.
 F = Bakelite.
 G = 12# AWG / 8" Loop
 Screw Type



CQ-210-12

CQ-207-14

AST Fuse Holder
 B = 30 A C = 100M Ω Min.
 D = 5M Ω at 1A DC
 E = AC 1000 V Min.
 F = P.V.C.
 G = 12# AWG / 12" Loop



CQ-207-14

Specification Guide Codes:

B= Rated Current

C= Insulation Resistance at 500 V DC

D= Contact Resistance

E= Dielectric Strength for 60 Seconds

F= Body Material

G= Supply Standard UL Wire-AWG/Length

CQ-ADATM-16

ATM mini add a fuse holder Tap
 B= 20A
 C= 100M Ω Min
 D= 5m Ω At 1A DC
 E= AC 1000V Min
 F= Nylon
 G= #16-UL 1015 RED
 Wire #14-UL 3266
 RED Wire

CQ-ADATC-16

ATC add a fuse holder Tap
 Holder
 B= 20A
 C= 100M Ω Min
 D= 5m Ω At 1A DC
 E= AC 1000V Min
 F= Nylon
 G= #16-UL 1015 RED
 Wire #14-UL 3266
 RED Wire

AQK-12

Quick Disconnect
 • 12" Long 2 Pin
 10GA Wire



CQ-ADATM-16

CQ-ADATC-16

New Products
for 2015



AFC Type Fuse

(MIDI)

Midget Car Fuses

- Transparent Body
- Voltage Rating: 32V
- Ampere Rating: 30, 40, 50, 60, 70, 80, 100, 120, 150
- 5 PCs Per Blister Pack

AFC FUSES

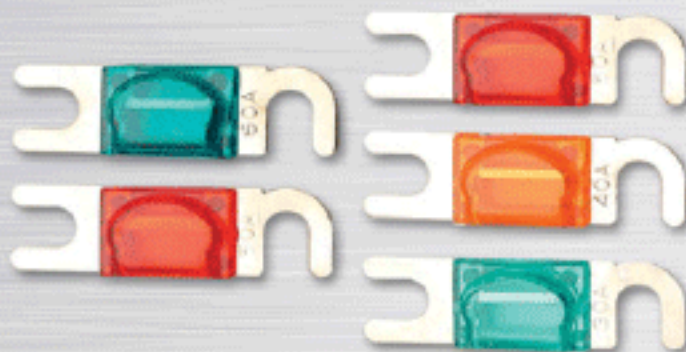

AFC Fuses

ANL Type Fuse

Gold Plated High Performance Fuses

- Visible Through Mica Window
- Voltage Rating: 32V
- Ampere Rating: 60, 70, 80, 100, 130, 150, 175, 200, 225, 250, 300.
- 2 PCs per Blister

AGU Type Fuse

Gold Plated Midget Car Fuses

- 10.3Ø x 38.10mm (13/32 x 1-1/2 inch)
- Voltage Rating: 32 V/125 V/250 V
- Ampere Rating: 1, 2, 3, 4, 5, 6, 7-1/2, 10, 15, 20, 25, 30, 35, 40, 50, 60, 70, 80, 100.
- Replaces AGU and 4AG Fuses
- 5 PCs per Blister Pack



ANL Fuses



AGU Fuses

AST (Mini-Blade Type)

Terminal Car Fuses

- Transparent Body
- Voltage Rating: 32V
- Ampere Rating Body Color
 - 3 A Violet
 - 4 A Pink
 - 5 A Tan
 - 7-1/2 A Brown
 - 10 A Red
 - 15 A Lt. Blue
 - 20 A Yellow
 - 25 A Natural
 - 30 A Lt. Green
- Replaces Min and ATM Fuses
- 5 PCs per Blister Pack

AST FUSES



Maxi Type Fuse

Terminal Car Fuses

- Transparent Body
- Voltage Rating: 32V
- Ampere Rating Body Color
 - 20 A Yellow
 - 30 A Lt. Green
 - 35 A Lt. Red
 - 40 A Orange
 - 50 A Red
 - 60 A Lt. Blue
 - 70 A Tan
 - 80 A Transparent
- 5 PCs per Blister Pack

ATC Type Fuse (Blade Type)

Terminal Car Fuses

- Transparent Body
- Voltage Rating: 32V
- Ampere Rating Body Color
 - 3 A Violet
 - 4 A Pink
 - 5 A Tan
 - 7-1/2 A Brown
 - 10 A Red
 - 15 A Lt. Blue
 - 20 A Yellow
 - 25 A Natural
 - 30 A Lt. Green
- 10 PCs per Blister Pack



ATC Fuses

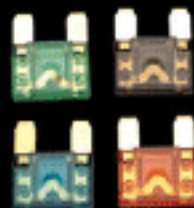

Maxi Type Fuses



CABLES

ACM-3

ACM-6

ACM-12

ACM-10

ACM-15

ACM-20

ACM-25

ACM-F-2M

ACM-M-2F

• Oxygen Free High Heat Resistant RCA Cables for Amplifiers

• Platinum Plugs with 24 Kt. Gold-plated Connectors

• Heavy Duty Flexible Jacket

• PE Foam, Aluminum Foil

• Spiral Shield Design



Competition *SERIES*
REDUCED HEAD



10TH ANNIVERSARY

ACP-3
ACP-6
ACP-10
ACP-12
ACP-15
ACP-20
ACP-25
ACP-F-2M
ACP-M-2F

- Oxygen Free High Heat Resistant RCA Cables for Amplifiers
- 24 Kl. Gold-plated RCA Connectors
- Twist Pair Construction
- Spiral Shielded Design
- Clear Flexible Jacket

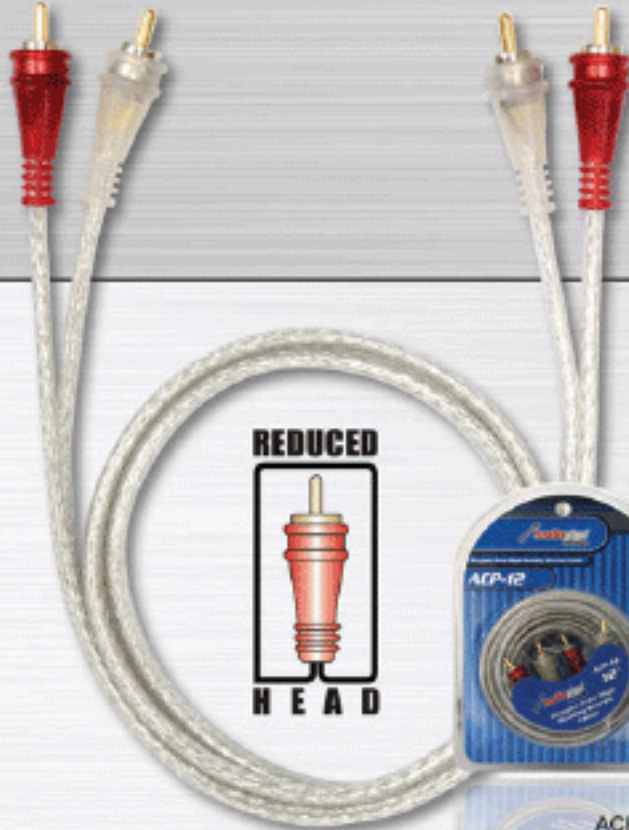

ACP-F-2M

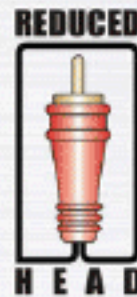

ACP-12

AMBU-41.5
AMBU-43
AMBU-417

- Oxygen Free Y Cable Adapter
Two RCA Plugs to Four RCA Plugs
- Oxygen Free Y Cable Adapter
Female to Two Males
- Reduce Head
- Oxygen Free Gold Patch Cords





CABLES

- AMP-1.5**
- AMP-3**
- AMP-6**
- AMP-10**
- AMP-12**
- AMP-15**
- AMP-17**
- AMP-20**
- AMP-25**
- AMP-Y-F-2M**
- AMP-Y-M-2F**

- Oxygen Free High Heat Resistant RCA Cables for Amplifiers
- 24 Kt. Gold-plated RCA Connectors
- Excellent Noise Rejection
- Clear Flexible Jacket



REDUCED



HEAD



- AMP-RA 3**
- Oxygen Free 3' RCA Cable

- AMP-RA 6**
- Oxygen Free 6' RCA Cable

- AMP-RA 17**
- Oxygen Free 17' RCA Cable

Oxygen Free Gold Patch Cords

REDUCED



HEAD



AMP-PP-10

1



- 10' RCA to 1/4" Audio Cable
- High Quality Stereo Cable
- Reduced Head

AMP-35-6

2

- 6 Feet
- 3.5mm Stereo Plug to RCA Plugs
- Reduced Head
- iPod®-Compatible

AMP-3535-3

3

- 3 Feet
- 3.5mm Stereo Plug to 3.5mm Stereo Plug
- iPod®-Compatible

AMP-3535-6

4



- 6 Feet
- 3.5mm Stereo Plug to 3.5mm Stereo Plug
- iPod®-Compatible

AMP-3535-12

5

- 12 Feet
- 3.5mm Stereo Plug to 3.5mm Stereo Plug
- iPod®-Compatible

AMP-3535-25

6

- 25 Feet
- 3.5mm Stereo Plug to 3.5mm Stereo Plug
- iPod®-Compatible



1

AMP-PP-10



2

AMP-35-6



3

AMP-3535-3



4

AMP-3535-6



5

AMP-3535-12



6

AMP-3535-25

AMP-RR-018

- Oxygen Free 18" High Quality Stereo Cable



REDUCED



HEAD



AMP-RR-018



CABLES

BMS-700X

700 Watts Power Kit

- 17 Ft. 2 RCA Plugs to 2 RCA Plugs with Signal Wire
- 17 Ft. 10 AWG Red Primary Wire
- 3 Ft. 10 AWG Black Primary Wire
- 30 Amp ATC Fuse
- 10 AWG Fuse Holder
- Gold Ring Terminal Red Color
- Gold Ring Terminal Black Color
- Gold Plated Spade Terminal Black Color
- Gold Plated Spade Terminal Red Color
- Butt Splices 2Pcs
- 10 Assorted Cable Ties
- 3 Ft. Split Loom Tubing

BMS-700X



OXYGEN free

BMS

Bin Master Series

Allows for products to be conveniently stored for internal shop installers

BMS-1500X

1500 Watts Power Kit

- 17 Ft. 2 RCA Plugs to 2 RCA Plugs with Signal Wire
- 17 Ft. 8 AWG Red Primary Wire
- 3 Ft. 8 AWG Black Primary Wire
- 60 Amp AGU Fuse
- 25 Ft. 18 AWG Speaker Wire
- 8 AWG Fuse Holder
- Gold Ring Terminal Red Color
- Gold Ring Terminal Black Color
- Gold Plated Spade Terminal Black Color
- Gold Plated Spade Terminal Red Color

OXYGEN free



BMS-1500X

10TH ANNIVERSARY

BMS-1.5
BMS-3
BMS-6
BMS-10
BMS-12
BMS-15
BMS-17
BMS-20
BMS-25



High Heat Resistance Cables
 • Oxygen Free High Heat Resistant RCA Cables for Amplifiers
 • 24 Kt. Gold-plated RCA Connectors



BMS-35-6
BMS-3535-6
BMS-3535-25

High Heat Resistance Cables
 • Oxygen Free High Heat Resistant RCA Cables for Amplifiers
 • 24 Kt. Gold-plated RCA Connectors
 • Excellent Noise Rejection
 • Clear Flexible Jacket



BMS-Y-F-2M
BMS-Y-M-2F

High Heat Resistance Cables
 • Oxygen Free High Heat Resistant RCA Cables for Amplifiers
 • 24 Kt. Gold-plated RCA Connectors
 • Excellent Noise Rejection
 • Clear Flexible Jacket



BMS-2100X

2100 Watts Power Kit
 • 17 Ft. 2 RCA Plugs to 2 RCA Plugs with Signal Wire
 • 17 Ft. 4 AWG Red Primary Wire
 • 3 Ft. 4 AV Black Primary Wire
 • 80 Amp AGU Fuse
 • 25 Ft. 16 AWG Speaker Wire
 • AGU Fuse Holder
 • Gold Ring Terminal Red Color
 • Gold Ring Terminal Black Color
 • Gold Plated Spade Terminal Black Color
 • Gold Plated Spade Terminal Red Color
 • Butt Splices 2Pcs
 • 10 Assorted Cable Ties
 • 3 Ft. Split Loom Tubing



BMS-RD1

Car Installation Kit
 12 14-16 Gauge Crimp Caps
 2 14-16 Gauge Ring Terminals
 3 14-16 Gauge Butt Connectors
 2 1/2" Self-tapping Screws
 10 4' Tie-wraps



BMS-RA 3
BMS-RA 6
BMS-RA 10
BMS-RA 12
BMS-RA 15
BMS-RA 20
BMS-RA Y2F
BMS-RA M2M
BMS-RA F2M

High Heat Resistance Cables
 • Oxygen Free High Heat Resistant RCA Cables for Amplifiers
 • 24 Kt. Gold-plated RCA Connectors
 • Excellent Noise Rejection
 • Clear Flexible Jacket

*New Products
 for 2013*





CABLES

AMP-BLS-YF-2M

AMP-BLS-YM-2F

AMP-BLS-3

AMP-BLS-6

AMP-BLS-17

- Oxygen Free High Heat Resistant RCA Cables for Amplifiers
- Platinum Plugs with 24 Kt. Gold-plated Connectors
- Heavy Duty Flexible Jacket
- PE Foam, Aluminum Foil
- Spiral Shield Design



flexible CABLES



- Cable#12BLS**
 - 500ft Free Power Cable
 - Blue Color
- Cable#14BLS**
 - 500ft Free Power Cable
 - Blue Color
- Cable#16BLS**
 - 500ft Free Power Cable
 - Blue Color

10TH ANNIVERSARY

PS-0-25 Black

- 25ft 0 gauge Oxygen Free power cable
- Black Color

PS-0-25 Red

- 25ft 0 gauge Oxygen Free power cable
- Red Color

PS-0-100 Black

- 100ft 0 gauge Oxygen Free power cable
- Black Color



PS-0-100 Red

- 100ft 0 gauge Oxygen Free power cable
- Red Color



PS-0-25 Black



flexible
CABLES

PS-4B 250ft

- 250Ft. 4 Gauge Oxygen Free Power Cable
- BLUE Color

PS-8B 250ft

- 250Ft. 8 Gauge Oxygen Free Power Cable
- BLUE Color

PS-4R 250ft

- 250Ft. 4 Gauge Oxygen Free Power Cable
- RED Color

PS-8R 250ft

- 250Ft. 8 Gauge Oxygen Free Power Cable
- RED Color

flexible
CABLES

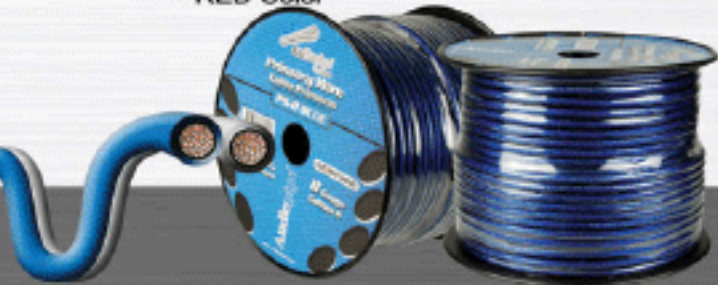

PS-0 BL

- 100ft 0 gauge Oxygen Free Power Cable
- Blue Color

PS-4 BL

- 250ft 4 gauge Oxygen Free Power Cable
- Blue Color

PS-0 25 BL

- 25ft 0 gauge Oxygen Free Power Cable
- Blue Color

PS-8 BL

- 250ft 8 gauge Oxygen Free Power Cable
- Blue Color



flexible
CABLES

OXYGEN
free



CABLES

AP-10-100

100' 10 Gauge Primary Wire
Available in Black, Blue,
Yellow and Red



AP-12-100

100' 12 Gauge Primary Wire
Available in Black, Blue,
Yellow and Red



AP-14-100

100' 14 Gauge Primary Wire
Available in Black, Blue,
Yellow and Red



AP-16-100

100' 16 Gauge Primary Wire
Available in Black, Blue,
Yellow and Red



AP-18-100

100' 18 Gauge Primary Wire
Available in Black, Blue,
Yellow and Red



10TH ANNIVERSARY

AP-12-500

500' 12 Gauge Primary Wire
Available in Black, Blue, Yellow
Green, Red, White and Orange



AP-14-500

500' 14 Gauge Primary Wire
Available in Black, Blue, Yellow
Green, Red, White and Orange



AP-16-500

500' 16 Gauge Primary Wire
Available in Black, Blue, Yellow
Green, Red, White and Orange



AP-18-500

500' 18 Gauge Primary Wire
Available in Black, Blue, Yellow,
Green, Red, White, Orange, Purple
Brown and Gray





CABLES

PW-0 25 FT

PW-0 25ft

- 25Ft. 0 Gauge Oxygen Free Power Cable
- Available in Red, Black, Silver, Purple & Blue



PW-0 100ft

- 100Ft. 0 Gauge Oxygen Free Power Cable
- Available in Red, Black, Silver & Blue



PW-8 250ft

- 250Ft. 8 Gauge Oxygen Free Power Cable
- Available in Red, Black, Silver, Purple & Blue



PW-10 250ft

- 250Ft. 10 Gauge Oxygen Free Power Cable
- Available in Red, Black, Silver, Purple & Blue



Standard Gauge - 8



Standard Gauge - 10

10TH ANNIVERSARY

PW-4 100ft

- 100Ft. 4 Gauge Oxygen Free Power Cable
- Available in Red, Black, Silver, Purple & Blue



PW-4 250ft

- 250Ft. 4 Gauge Oxygen Free Power Cable
- Available in Red, Black, Silver, Purple & Blue



PW-0 25 FT



C4P-R100

Speed Cable

- Nine 18-Gauge OFHC Wires in Black Jacket, 8 EIA Color-Coded Speaker Wires, and Blue Turn-On. Can Also Be Used For Alarms, Hydraulics, Trailer Hitches, Etc. High temperature Chemical Resistant Clear Jacket.
- 100 Ft. Roll.





CABLES

SPEAKER CABLES



Cable#10 Clear 25'

10 Gauge Clear

Cable#10 Clear 50'

10 Gauge Clear

Cable#10 Clear 100'

10 Gauge Clear

Cable#10 Black 100'

10 Gauge Black

Cable#12 Clear 25'

12 Gauge Clear

Cable#12 Clear 50'

12 Gauge Clear

Cable#12 Clear 100'

12 Gauge Clear

Cable#12 Clear 500'

12 Gauge Clear

Cable#12 Black 500'

12 Gauge Black/Red

Cable#14 Clear 25'

14 Gauge Clear

Cable#14 Clear 50'

14 Gauge Clear

Cable#14 Clear 100'

14 Gauge Clear

Cable#14 Clear 500'

14 Gauge Clear

Cable#14 Black 500'

14 Gauge Black/Red

Cable#16 Clear 500'

16 Gauge Clear

Cable#16 Clear 1000'

16 Gauge Clear

Cable#16 Black 1000'

16 Gauge Black/Red

Cable#18 Clear 25'

18 Gauge Clear

Cable#18 Clear 50'

18 Gauge Clear

Cable#18 Clear 100'

18 Gauge Clear

Cable#18 Clear 500'

18 Gauge Clear

Cable#18 Clear 1000'

18 Gauge Clear

Cable#18 Black 1000'

18 Gauge Black/Red

Cable#20 Clear 1000'

20 Gauge Clear

Cable#20 Black 1000'

20 Gauge Black/Red

Cable#22 Clear 1000'

22 Gauge Clear

Cable#22 Black 1000'

22 Gauge Black/Red

Cable#24 Black 1000'

24 Gauge Black/Clear

10TH ANNIVERSARY

Flat Competition Cables



- CF-10-100** 10 Gauge Flat Clear Cable
- CF-12-100** 12 Gauge Flat Clear Cable
- CF-14-100** 14 Gauge Flat Clear Cable

Cable#8 CLEAR 300FT

- Speaker Cable
- 300 Ft. (91.44 Meters)
- 8 Gauge
- Clear



- Cable#10 25Ft** Speaker Cable - 25 Feet
- Cable#10 50Ft** Speaker Cable - 50 Feet
- Cable#10 100Ft** Speaker Cable - 100 Feet





INSTALLATION HITS

PK-2100PX



AGU Type Fuse



**INSTALLATION
KITS**

**4
Gauge**

2100Watts

SPECIFICATIONS

Power

Primary Wire I

Primary Wire II

Speaker Wire

Fuse Holder

Fuse Type

Loom Tubing

Cable Ties

PK-700PX

700 Watts

17' 10 AWG Red

3' 10 AWG Silver

25' 16 AWG

30 AMP ATC

ATC

3' Split Loom Tubing

10 Assorted



PK-1500PX

1500 Watts

17' 8 AWG Red

3' 8 AWG Silver

25' 16 AWG

60 AMP AGU

AGU

3' Split Loom Tubing

10 Assorted



PK-2100PX

2100 Watts

17' 4 AWG Red

3' 4 AWG Silver

25' 16 AWG

80 AMP AGU

ATC

3' Split Loom Tubing

10 Assorted



**INSTALLATION
KITS**

**10
Gauge**

2CH

**17' ft.
Power Cable**

30 AMP



PK-700PX



**INSTALLATION
KITS**

**8
Gauge**

2CH

**17' ft.
Power Cable**

60 AMP

PK-1500PX

10TH ANNIVERSARY

PK-3000PX



ANL Type Fuse



**INSTALLATION
KITS**



3000Watts

SPECIFICATIONS

| | PK-3000PX |
|-----------------|----------------------|
| Power | 3000 Watts |
| Primary Wire I | 17' 4 AWG Red |
| Primary Wire II | 3' 4 AWG Silver |
| Speaker Wire | 25' 16 AWG |
| Fuse Holder | 250 AMP ANL |
| Fuse Type | ANL |
| Loom Tubing | 3' Split Loom Tubing |
| Cable Ties | 10 Assorted |

PK-3000PX

| | |
|-----------------|----------------------|
| Power | 3000 Watts |
| Primary Wire I | 17' 4 AWG Red |
| Primary Wire II | 3' 4 AWG Silver |
| Speaker Wire | 25' 16 AWG |
| Fuse Holder | 250 AMP ANL |
| Fuse Type | ANL |
| Loom Tubing | 3' Split Loom Tubing |
| Cable Ties | 10 Assorted |

Amplifier Installation Kit

- 16 Ft Clear Blue 0 Gauge Power Wire
- 3 Ft. Clear Silver 4 Gauge Power Wire with Terminal
- 16 Ft. 2 RCA Plugs to 2 RCA Plugs with Remote Lead
- 1Pc Heavy Duty Anl Fuse Block Waterproof with 1 Ft. 0 Gauge Clear Ring Terminal
- 1 Pc 250 amp ANL Fuse
- 10 Pcs 18 cm Cable Ties
- 10 Pcs Screws
- 1Pc 0 Gauge to four 4 gauge power distribution block

**INSTALLATION
KITS**

**4
Gauge**





INSTALLATION KITS

SPECIFICATIONS

| | |
|------------------------|----------------------------------|
| Power | PK-2500 CPR 2500 Watts |
| Primary Wire I | 17' 4 AWG Red |
| Primary Wire II | 3' 4 AWG Silver |
| Speaker Wire | 25' 16 AWG |
| Fuse | 80 AMP AFC |
| Fuse Holder | NQ-6 |
| Loom Tubing | 3' Split Loom Tubing |
| Cable Ties | 10 Assorted |

Amplifier Installation Kit

- 17 Ft. 2 RCA Plugs to 2 RCA Plugs with Signal Wire
- Gold Terminal Red Color
- Gold Terminal black color
- Gold Spade Terminal black Color
- Gold Spade Terminal red color
- But Splices 2Pcs



PW-0 CPR-25 BK

- 25Ft. 0 Gauge Oxygen Free Power Cable
- BLACK Color

PW-0 CPR-100 BK

- 100Ft. 0 Gauge Oxygen Free Power Cable
- BLACK Color

PW-4 CPR-100 BK

- 100Ft. 0 Gauge Oxygen Free Power Cable
- BLACK Color

PW-0 CPR-25 RD

- 25Ft. 0 Gauge Oxygen Free Power Cable
- RED Color

PW-0 CPR-100 RD

- 100Ft. 0 Gauge Oxygen Free Power Cable
- RED Color

PW-4 CPR-100 RD

- 100Ft. 0 Gauge Oxygen Free Power Cable
- RED Color



PW-0 CPR-25RD



PW-0 CPR-100BK



PW-4 CPR-100BK

PK-2100X

Amplifier Installation Kit

- 17 Ft. 2 RCA Plugs to 2 RCA Plugs with Signal Wire
- 17 Ft. 4 GA Red Power Wire
- 3 Ft. 4 GA Black Power Wire
- 25 Ft. 16 AWG Speaker Wire
- 80 AGU Fuse
- 25Ft. 16AWG Speaker Wire
- AGU Fuse Holder
- NO-6 Fuse Holder
- Gold Ring Terminal Red Color
- Gold Ring Terminal Black color
- Gold Plated Spade Terminal Black Color
- Gold Plated Spade Terminal Red color
- 2Pcs Butt Splices
- 10 Assorted Cable Ties
- 3 Ft. Split Loom Tubing

PK-2100X

AGU Type Fuse



**INSTALLATION
KITS**

2100Watts



SPECIFICATIONS

Power

- Red Power Cable
- Black Power Cable
- Speaker Wire
- Fuse Holder
- Fuse Type
- Loom Tubing
- Cable Ties

PK-700X

- 700 Watts
- 17' 10 AWG Red
- 3' 10 AWG Black
- 25' 16 AWG
- 30 AMP ATC
- ATC
- 3' Split Loom Tubing
- 10 Assorted

PK-750X

- 750 Watts
- 17' 10 AWG Red
- 3' 10 AWG Silver
- 25' 16 AWG
- 40 AMP AGU
- AGU
- 3' Split Loom Tubing
- 10 Assorted

PK-1500X

- 1500 Watts
- 17' 8GA Red
- 3' 8GA Black
- 25' 16 AWG
- 60 AGU Fuse
- AGU
- 3' Split Loom Tubing
- 10 Assorted

PK-2150X

- 2150 Watts
- 17' 4 AWG Red
- 3' 4 AWG Silver
- 25' 16 AWG
- 80 AMP AFC
- AFC
- 3' Split Loom Tubing
- 10 Assorted

**INSTALLATION
KITS**



PK-700X



PK-1500X

**INSTALLATION
KITS**





Spade Terminals (Blister Pack)

- PBTS-4 4/PK 4 Gauge
- PBTS-8 8/PK 8 Gauge
- PBTS-10 8/PK 10 Gauge



| | | |
|---|---|--|
| <p>Platinum Ring Terminals (Blister Pack)</p> <ul style="list-style-type: none"> PBTRP-0 2/PK 0 Gauge PBTRP-4 4/PK 4 Gauge PBTRP-8 8/PK 8 Gauge PBTRP-10 8/PK 10 Gauge | <p>Quick Disconnect Terminals (Bulk Pack)</p> <ul style="list-style-type: none"> PTD-18R 18 Gauge Red PTD-18B 18 Gauge Black PTD-16R 16 Gauge Red PTD-16B 16 Gauge Black PTD-10R 10 Gauge Red PTD-10B 10 Gauge Black | <p>Spade Terminals (Bulk Pack)</p> <ul style="list-style-type: none"> PTS-4R 4 Gauge Red PTS-4B 4 Gauge Black PTS-6R 6 Gauge Red PTS-6B 6 Gauge Black PTS-8R 8 Gauge Red PTS-8B 8 Gauge Black PTS-10R 10 Gauge Red PTS-10B 10 Gauge Black PTS-14R 14 Gauge Red PTS-14B 14 Gauge Black |
|---|---|--|



PBTRP-0



PTD-10R



PTS-6R

Female Terminals

(Blister Pack)

| | | |
|---------|------|----------|
| PBTB-4 | 4/PK | 4 Gauge |
| PBTB-8 | 8/PK | 8 Gauge |
| PBTB-10 | 8/PK | 10 Gauge |

Ring Terminals

(Blister Pack)

| | | |
|---------|------|----------|
| PBTR-0 | 2/PK | 0 Gauge |
| PBTR-4 | 4/PK | 4 Gauge |
| PBTR-6 | 4/PK | 6 Gauge |
| PBTR-8 | 8/PK | 8 Gauge |
| PBTR-10 | 8/PK | 10 Gauge |



Ring Terminals (Bulk Pack)

| | |
|---------|----------------|
| PTR-0R | 0 Gauge Red |
| PTR-0B | 0 Gauge Black |
| PTR-4R | 4 Gauge Red |
| PTR-4B | 4 Gauge Black |
| PTR-6R | 6 Gauge Red |
| PTR-6B | 6 Gauge Black |
| PTR-8R | 8 Gauge Red |
| PTR-8B | 8 Gauge Black |
| PTR-10R | 10 Gauge Red |
| PTR-10B | 10 Gauge Black |

Female Terminals (Bulk Pack)

| | |
|---------|----------------|
| PTB-4R | 4 Gauge Red |
| PTB-4B | 4 Gauge Black |
| PTB-8R | 8 Gauge Red |
| PTB-8B | 8 Gauge Black |
| PTB-10R | 10 Gauge Red |
| PTB-10B | 10 Gauge Black |



PBTR-0



PBTB-4



Protective Loom

LM-12-100 Ø1/2" Black

LM-14-100 Ø1/4" Black

LM-38-100 Ø3/8" Black

LM-BU-12-100 Ø1/2" Blue

LM-BU-14-100 Ø1/4" Blue

LM-BU-38-100 Ø3/8" Blue

LM-CR-12-100 Ø1/2" Chrome

LM-CR-14-100 Ø1/4" Chrome



LM-BU-14-100



LM-CR-14-100

Cable Ties

- CT-4BUV 4" UV Resistant Cable Ties Black
- CT-6BUV 6" UV Resistant Cable Ties Black
- CT-8BUV 8" UV Resistant Cable Ties Black
- CT-10BUV 10" UV Resistant Cable Ties Black
- CT-14BUV 14" UV Resistant Cable Ties Black

Cable Ties

- CTR-4BUV 4" UV Resistant Cable Ties with Tie Down Ring
- CTR-6BUV 6" UV Resistant Cable Ties with Tie Down Ring
- CTR-8BUV 8" UV Resistant Cable Ties with Tie Down Ring
- CTR-14BUV 14" UV Resistant Cable Ties with Tie Down Ring

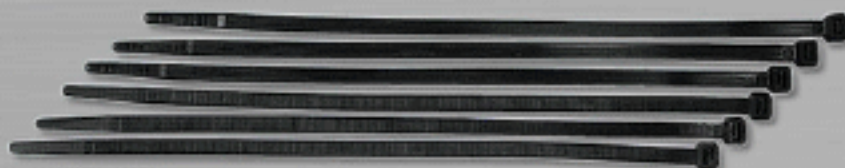

CT-4BUV



CTR-4BUV

P-119BL

Gold RCA Jack to RCA Jack Connector
with Plastic Body
• 4 pcs Pack Qty - Available in Blister



P-120BL

Gold RCA Plug to RCA Plug Connector
with Plastic Body
• 4 pcs Pack Qty - Available in Blister



Q-121

**HIGH
CAPACITY**



Q-119

• Gold RCA Jack to
RCA Jack Connector
• 2 pcs Pack Qty - Available
in Blister



Q-120

• Gold RCA Plug to
RCA Plug Connector
• 2 pcs Pack Qty - Available
in Blister



Q-121

• Gold Right Angle RCA Jack to
RCA Plug Connector
• 2 pcs Pack Qty - Available
in Blister

P-121BL

Gold Right Angle RCA Jack to RCA Plug
Connector with Plastic Body Blister Packing
• 4 pcs Pack Qty - Available in Blister

**HIGH
CAPACITY**



PRCA-120

Nickel Contact Platinum RCA Plug

**HIGH
CAPACITY**



**AP-V-3****3"**

3' 75 Ohm RCA Video Cable

- Gold plated corrosion resistant connectors
- Flexible and Durable PVC outer jacket
- Actual 75 Ohm coaxial cable
- Micro-Line strands of braided
- Oxygen free copper
- Large color-coded textured rubber grip

AP-V-6**6"**

6' 75 Ohm RCA Video Cable

- Gold plated corrosion resistant connectors
- Flexible and Durable PVC outer jacket
- Actual 75 Ohm coaxial cable
- Micro-Line strands of braided
- Oxygen free copper
- Large color-coded textured rubber grip

AP-V-12**12"**

12' 75 Ohm RCA Video Cable

- Gold plated corrosion resistant connectors
- Flexible and Durable PVC outer jacket
- Actual 75 Ohm coaxial cable
- Micro-Line strands of braided
- Oxygen free copper
- Large color-coded textured rubber grip

AP-V-15**15"**

15' 75 Ohm RCA Video Cable

- Gold plated corrosion resistant connectors
- Flexible and Durable PVC outer jacket
- Actual 75 Ohm coaxial cable
- Micro-Line strands of braided
- Oxygen free copper
- Large color-coded textured rubber grip

AP-V-20**20"**

20' 75 Ohm RCA Video Cable

- Gold plated corrosion resistant connectors
- Flexible and Durable PVC outer jacket
- Actual 75 Ohm coaxial cable
- Micro-Line strands of braided
- Oxygen free copper
- Large color-coded textured rubber grip



CRX-203

2 Way Passive Crossover Network

- Gold Plated Screw Terminals
- 150 Watts RMS/ 300 Watts Peak
- High Grade Polymer Capacitors
- Ferrite And Air Cooled Spools
- Woofer Frequency: 20Hz-5.6kHz
- Tweeter Frequency: 5kHz-20kHz
- 12dB per Octave Slope (4 Ω)
- Enclosed ABS Cabinet



CRX-203

CRX-303

3 Way Passive Crossover Network

- Gold Plated Screw Terminals
- 150 Watts RMS/ 300 Watts Peak
- High Grade Polymer Capacitors
- Ferrite and Air Cooled Spools
- Woofer Frequency: 20Hz-800Hz
- Midrange Frequency: 700Hz-4kHz
- Tweeter Frequency: 5kHz-20kHz
- 12dB per Octave Slope (4 Ω)
- Enclosed ABS Cabinet



CRX-303

Bass Block / Inline Filter

Non-Polar 10% Capacitor

| | | | |
|---------------|-------------|---------------------------------|--------------------|
| BB-14 | 14 μ F | For 3.5" To 4" Speaker | 2.8kHz @4 Ω |
| BB-99 | 99 μ F | For 5 1/4" To 6 1/2" Speaker | 400Hz @4 Ω |
| BB-133 | 133 μ F | For 6"X9" -5"X7" -6"X8" Speaker | 300Hz @4 Ω |
| BB-199 | 199 μ F | For 10" Speaker | 200Hz @4 Ω |

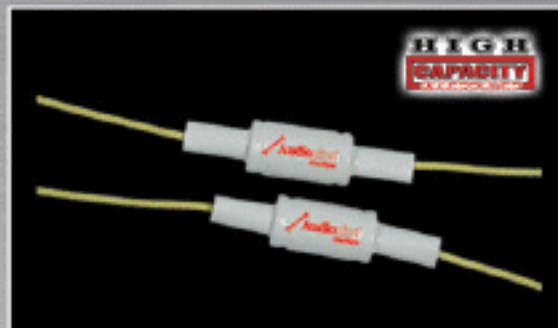
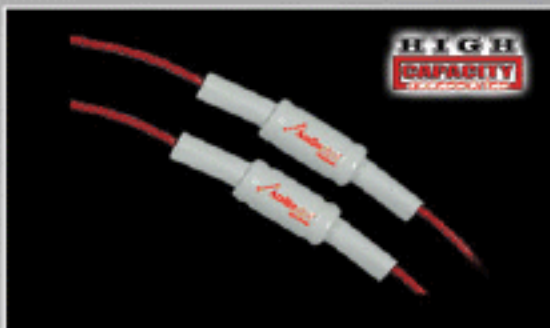



MVA-04

HIGH
CAPACITY
ACCESSORIES



MVA-04
Multi Video Amplifier



VT-100

Game Connector

- For connecting DC to AC Power inverte and game unit
- Convenient on/off Switch
- Golden plated RCA Audio/Video Connector



VT-300

DC to AC Inverter Game Plate

- DC to AC Inverter Game Plate
- Designed for used with XBOX, Nintendo Gamecube, Sony Playstation (III) and Sega Dreamcast System.
- AC-110 Volt with Power Indicator Light.
- On/OFF Switch with Power Indicator Light.
- Color Coed Audio/Video RCA Jacks

VA-002

Single 3.5mm Coaxial Diversity Antenna



VA-004

4 Way Diversity Antenna

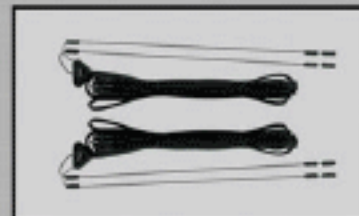

RFM-3.5

HIGH
CAPACITY
accessories



Adds 3.5mm auxiliary input to a Head Unit without auxiliary input

RFM-3.5

- Input Voltage: 12V DV
- 2 Frequency Channels (87.9 or 88.3 MHz)
- Connects to any Factory or After Marker Head Unit Without Auxiliary Input
- Channel Switch for Alternate FM Frequencies
- Strong Durable Metal Case for Installing Behind the Head Unit
- Female Stereo RCA Adapters
- Remote On/Off Switch

RFM-300

Wired FM Stereo Modulator

- 2 Channel RCA Input
- Adjustable Gain
- Dual Frequency 88.7MHz or 89.1MHz

RFM-500

Wireless FM Stereo Modulator

- 4 Channel RCA Audio Input
- On / Off Switch
- Adjustable Output Level
- Multiple Frequency Selections

HIGH
CAPACITY
accessories



RFM-300

HIGH
CAPACITY
accessories



RFM-500



APNR-160

APNR-160

Ground Loop Isolator

- Noise Elimination Between Car Stereo, EQ, CB or Car Amp
- RCA Signal Isolator

APNR-210

Ground Loop Isolator

- 20 Amp High Quality Noise Suppressor Isolation Transformer



APNR-160



APNR-210



APNR-3002

APNR-1002

Hi/Low Impedance Adaptor

- Full DC Isolation
- Converts from 10-25 Watts per Channel Pre-Amp Output
- Line Output Converter Adjustable
- Adjustable from 0 to 1,000 Mv

APNR-2002

Hi/Low Impedance Adaptor

- Full DC Isolation
- Converts from 15-35 Watts per Channel Pre-Amp Output
- Line Output Converter Adjustable
- Adjustable from 0 to 1,000 Mv

APNR-3002

Hi/Low Impedance Adaptor

- Full DC Isolation
- Converts from 25-55 Watts per Channel Pre-Amp Output
- Line Output Converter Adjustable
- Adjustable from 0 to 1,000 Mv



APNR-1002



APNR-2002



APNR-3002



APNR-MLRM

- Remote Expander
- Max Output Current: 30A
- Control the 12V Output of Remote
- Full DC Isolation
- Line Output Converter Adjustable
- Adjustable from 0 to 1,000 Millivolts
- Converts from 45-65 Watts per Channel Pre-Amp Output



APNR-RM

- Line Output Converter with Remote Turn On
- Gold Female RCA Output
- Line Output Converter Adjustable
- Converts from 10 to 25 Watts per Channel to Pre-Amp Output
- Remote Turn On Circuit



APNR-RM4

- Hi/Low Impedance Adaptor
- Full DC Isolation
- Converts from 45-65 Watts per Channel Pre-Amp Output
- Line Output Converter Adjustable
- Adjustable from 0 to 1,000 Mv

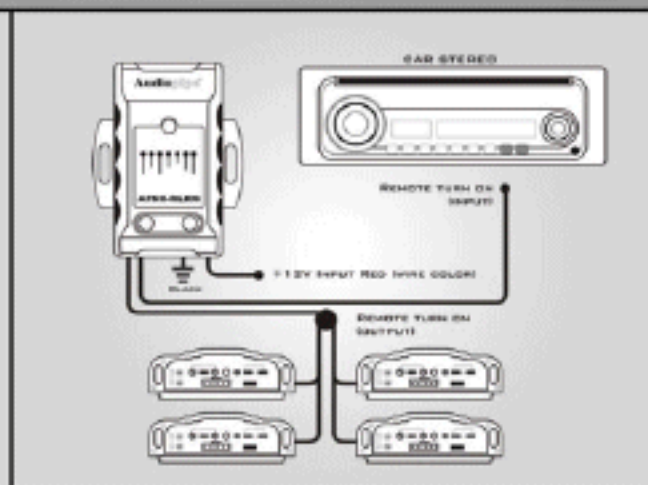
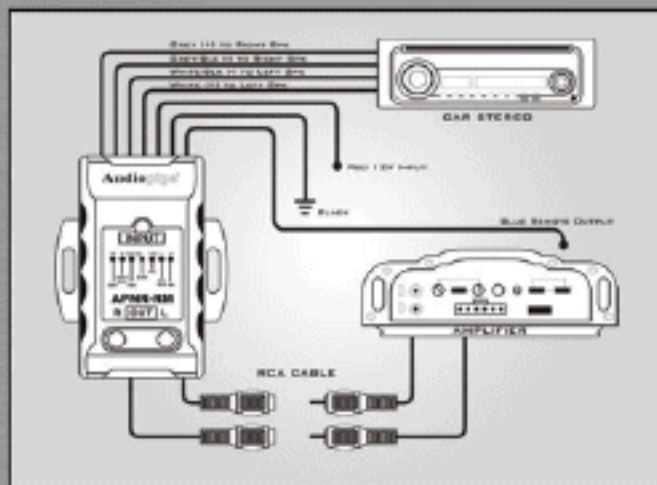

NR-10

Noise Suppressor

- 5 Amp
- Eliminates Engine and Alternator Noise
- CB and Car Radio Use

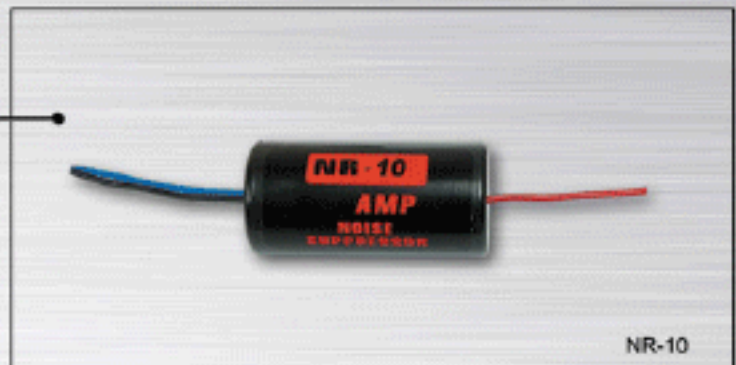

NR-35

Line Output Converter

- Gold Female RCA Output
- Converts from 2 to 10 Watts per Channel to Pre-Amp Output
- Line Output Converter Fixed

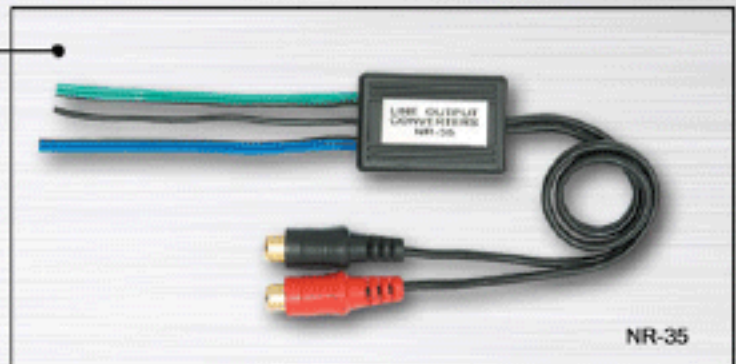

NR-100

Hi/Low Impedance Adaptor

- Full DC Isolation
- Converts from 10-25 Watts per Channel Pre-Amp Output
- Line Output Converter Adjustable
- Adjustable from 0 to 1,000 Millivolts



NR-16

Ground Loop Isolator

- Noise Elimination Between Car Stereo, EQ, CB or Car Amp
- RCA Signal Isolator



APSW-425BTV

Marine AM/FM player w/wireless smartphone connection

- High Power 25Watts x 4
- Front/Rear RCA Output
- Aux Input
- Optional remote control input
- Wireless Smartphone connection to stream your music



APSW-218WR

Marine Wired Control

- Controls Features on main unit
- 13 Ft extension cable
- Water resistant
- IP66
- Include mounting hardware



Pipedream LED's come in two different styles. We have the thin strip Series NL-F2 and NL-F5 of LED's which are great for motorcycles, engine bays and interiors on just about any vehicle and the NL-F10 Series has a thicker and bulkier rubber housing which makes them completely weather proof. The thin strips come in a variety of sizes and colors. The 12" and 24" strips are great for the end consumer and are very installer friendly because they come with 3M double sided tape, making them a breeze to install. The 16' roll is more of an installer item; It is marked every three LED's where they can be cut for exact sizing (on the mark, it has two solder points, a positive and a negative, which allows you to continue using the entire roll). The thicker and bulkier LED's style is great for any application where the lights are likely to get wet. They can be used on boats, ATV's, jet skis, golf carts, and everything else you want to light up. These LED's come in 10", 20", and a 6" pack which can all be cut every three LED's.

AUDIOPIPE MARINE

APNL-408CNT

Marine LED Light Controller

- 10 Selectable color
- Speed control
- Brightness control
- Solid, Fade function
- Sound control dances to the beat of the music
- Controls 1 -2 -3 or 4 8ft. RGB Strips



**New Products
for 2013**

MLD-LST8MULTI

16Ft. Flexible RGB LED Strip

- Compatible w/APNL-408CNT
- Cutable every 3 LED
- Water proof socket
- Water tight seal
- 6FL Foot harness
- High grade epoxy



**New Products
for 2013**

Flexible LED Strip



I-PMC-TWH I-PMC-TBK

SWS
Salt Water Series



I-PMC-TBK



I-PMC-TWH

**WEATHER
PROOF**

**New Products
for 2013**



*Does not include device



I-PMC-TWH

I-PMC-TBK

Marine Weatherproof Cover for Multimedia Devices.
Four foam pads included for different kinds of players:

- Model P for Telephones
- Model N for Small Players
- Model C for Classic Players
- Model T for Photo Type Players

The I-PMC-T weatherproof multimedia cover offers a safe docking station on your water vessel or off road vehicle. This cover is made to keep you at ease and know that your multimedia device is safe and will not get wet.

The I-PMC-T weatherproof multimedia cover is small and compact making very easy to install in the smallest center consoles.

AUDIOPIPE MARINE

PMC-2000

SW5
Salt Water Series

**WEATHER
PROOF**

**New Products
for 2013**



PMC-2000

Marine Weatherproof Radio Cover Housing

- Designed and tested for Outdoor use, Performs in Harsh Environments
- Materials are treated against corrosion
- 600 Hours UV stabilized test (ASTM D4329, ASTM D2244) for Protection against damage from sunlight
- 400 Hours salt water splash test (ASTM 81177)
- Removable design allows for installation in areas of limited space and for users who would like to remove their equipment from their boat



Pre-installed Cables for
Weatherproof Seal



PMC-2000



PMC-3000

- Marine radio cover
- Stainless steel hardware
- UV coated Painted cover
- White Color



PMC-3007B

- Marine radio cover
- Stainless steel hardware
- UV coated painted cover
- Black Color

- Keep your audio marine radio player protected from wind and surf
- Fully sealed waterproof cover
- Poly-carbonate tinted front panel; UV-stabilized ABS plastic housing
- Includes stainless steel, rust-proof mounting hardware
- Compatible with dual shaft, DIN and removable DIN size receivers

SPEAKER SIZE
6
INCHES

ATVP-1200

SW5

Salt Water Series

WEATHER
PROOF

AMPLIFIED

Loaded with two APSW-6032BK

New Products
for 2013

200Watts

ATVP-1200

ATV Off Road Amplified System

- 200 Watts Power (P.M.P.O.)
- 100 Watts Power (R.M.S)
- Frequency Response: 45~20 KHZ
- Sensitivity: 90DB
- Rubber Surround Impp Cone
- Titanium Dome Diaphragm High Performance Tweeter
- 15 Oz Magnet
- 12V
- Water Resistant
- Loaded with two APSW-6032BK

New Products
for 2013

ATVP-3200

ATV Off Road Amplified System

- 350 Watts Power (P.M.P.O.)
- 175 Watts Power (R.M.S.)
- Frequency Response: 45-25 KHz
- Sensitivity: 90 dB
- Rubber Surround Plano Black IMPP Cone
- Titanium Dome Diaphragm High Performance Tweeter
- 22 Oz Magnet
- 12V
- Water Resistant
- Loaded with two APSW-8032BK

New Products
for 2013



Multimedia Player Carrying
Case INCLUDED



AUDIOPIPE MARINE



ATVP-3200

AMPLIFIED



- **Weather Resistant**
Speakers are air tight in a sealed compartment so no water penetrates
- **Anticorrosion PCB**
Amplifier is coated with an anticorrosion epoxy to prolong the life of the unit
- **Removable amplifier**
In case of damage to the amplifier it is removable for easy repairing
- **Extended cord**
Two part power cigarette adapter is conveniently extended ensuring perfect for any use

**WEATHER
PROOF**

AMPLIFIED SYSTEM

350Watts

Max Power

Loaded with two APSW-8032BK

**New Products
for 2013**



Ap**TWEETERS & RADIOS****APSW-3725****WEATHER
PROOF****3 3/4"****LOUD****300Watts****BIGGEST
Marine Tweeter**

| | |
|---------------------|------------------|
| Output Power (PMPO) | 300 Watts |
| Output Power (RMS) | 150 Watts |
| Magnet Structure | 20 Oz |
| Impadance | 4 Ohm |
| Input Sensitivity | 99dB |
| Frequency Response | 2K-25KHz |

SWS
Salt Water Series

APSWVC-3725
Replacement Voice Coil for APSW-3725

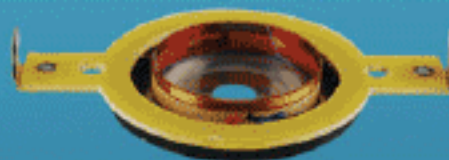

For several years now there has been a void in the marine industry for a great sound quality, high power tweeter. After many months of rigorous testing we finally got what everyone was looking for. **Audiopipe Marine** has now designed a 300w 3 1/4" tweeter. This is not your average tweeter. This is the **BIGGEST** marine tweeter. Now we give the customer the option of installing one of our coaxial speakers by themselves or adding the mega tweeter to add more high frequencies to your sound system. If **LOUD** is what you're looking for than look no further than the **Audiopipe Marine's** mega marine tweeter.

Features:

APSW-3250 has a high strength white powder coat with Anti-UV protection.

The main frame of the tweeter has three slits which allows any water that is splashed into the tweeter to drain out and not deposit in the tweeter. **Audiopipe** is etched around the main frame of the tweeter. Specially designed magnet which keeps the connections tucked and makes it very easy to install.

10TH ANNIVERSARY

AUDIOPIPE MARINE

AP5W-2500IU

Marine Stereo AM/FM/CD/iPod®/ with front 3.5 and USB input

Made for



iPod



iPhone

**WEATHER
PROOF**

*New Products
for 2013*



Audiopipe Marine has had great success with the MINI series of amplifiers. Up to now there were four amplifiers in the line which have done very well in the marine market being that they pack a powerful punch and can be installed in very tight spaces. This MINI series of amplifiers are a perfect fit for a small bay boat or a big center console boat. Now we're adding the APMR-4080MIN. So if you're in need of power but don't have the space for a big amplifier look no further than Audiopipe Marine's MINI line of amplifiers.

- AM/FM/LW-MPX PLL Tuning Radio
- 24 Presets Stations
- Single CD player w/ CD-R, CD-RW, MP3 compatible
- Mechanical Slide Down Datachable Panel
- 4 x 40 watts max. Power Output
- iPod®/iPhone® compatible
- Front USB & AUX IN
- 2 Pair RCA output

SWIS
Salt Water Series



HI-SPEED
CERTIFIED USB



iPod®

PRO-06BK

PRO-205BK

8" models include tripod stand for bookshelf mount and bracket for wall mount.

PRO-06BK

PRO-06WH

PRO-205WH

PRO-08WH
PRO-06WH

- 6" Speaker
- Max Power: 100 Watts
- Sensitivity: 90 dB
- Impedance: 8 Ohm
- Frequency Response: 70-20K Hz
- 3 Year UV Resistant Housing
- Anti Corrosive Aluminum Grill, Water resistant!
- Flashes LED to the Music
- White Color

PRO-08WH

- 8" Speaker
- Max Power: 160 Watts
- Sensitivity: 92 dB
- Impedance: 8 Ohm
- Frequency Response: 60-20K Hz
- 3 Year UV Resistant Housing
- Anti Corrosive Aluminum Grill, Water resistant!
- Flashes LED to the Music
- White Color

PRO-205WH

- 2x5.25" Speaker
- Max Power: 120 Watts
- Sensitivity: 92 dB
- Impedance: 8 Ohm
- Frequency Response: 60-20K Hz
- 3 Year UV Resistant Housing
- Anti Corrosive Aluminum Grill, Water resistant!
- Flashes LED to the Music
- White Color

PRO-06BK

- 6" Speaker
- Max Power: 100 Watts
- Sensitivity: 90 dB
- Impedance: 8 Ohm
- Frequency Response: 70-20K Hz
- 3 Year UV Resistant Housing
- Anti Corrosive Aluminum Grill, Water resistant!
- Flashes LED to the Music.
- Black Color

PRO-08BK

- 8" Speaker
- Max Power: 160 Watts
- Sensitivity: 92 dB
- Impedance: 8 Ohm
- Frequency Response: 60-20K Hz
- 3 Year UV Resistant Housing
- Anti Corrosive Aluminum Grill, Water resistant!
- Flashes LED to the Music
- Black Color

PRO-205BK

- 2x5.25" Speaker
- Max Power: 120 Watts
- Sensitivity: 92 dB
- Impedance: 8 Ohm
- Frequency Response: 60-20K Hz
- 3 Year UV Resistant Housing
- Anti Corrosive Aluminum Grill, Water resistant!
- Flashes LED to the Music.
- Black Color

AUDIOPIPE MARINE

APSW-8000TW

- 8" High End Coaxial
- 2-Way Marine Speaker
- 400 Watts Power (PMPO)
- 200 Watts Power (RMS)
- Frequency Response: 45-20,000Hz
- Sensitivity: 90 dB
- Rubber Surround IMPP Cone
- Soft Dome Diaphragm High Performance Tweeter
- 22 Oz Magnet
- Size: 17" x 10-1/2"

**WEATHER
PROOF**

SPEAKER SIZE
8
INCHES

Mounting Clamp Insert;

Sizes:

- 1-3/4", 1-1/2", 1-7/8", 1-5/8"
- 2", 2-1/4", 2-1/2", 2-3/8"



APMR-R3F-MT

- 3" Round flat mount
- Sold separately



JETSKI KIT

APSW-2504JS

PUSH BUTTON SWITCHES INCLUDED



POWER VOL-DOWN VOL-UP MUTE



APSW-2504JS: A complete waterproof sound system for your PWC which allows you to connect any multimedia device through a standard 3.5mm cable that is incorporated into the system.

Ap**SUBWOOFERS**

APSW-4032

- 4" Coaxial 2-Way Marine Speaker
- 100 Watts Power (P.M.P.O.)
- 50 Watts Power (R.M.S.)
- Frequency Response: 45-20 KHz
- Sensitivity: 90 dB
- Rubber Surround Piano Black IMPP Cone
- Titanium Dome Diaphragm High Performance Tweeter
- Mounting Depth: 70mm (2 3/4")
- 15 Oz Magnet

WEATHER PROOF
SPEAKER SIZE
4
INCHES

SWS
Salt Water Series
100Watts
WEATHER PROOF
 APSW-6032

WEATHER PROOF
 APSW-6932

WEATHER PROOF
 APSW-8032

APSW-6032

New Products for 2013

- 6.5" Coaxial 2-Way Marine Speaker
- 200 Watts Power (P.M.P.O.)
- 100 Watts Power (R.M.S.)
- Frequency Response: 45-20 KHz
- Sensitivity: 90 dB
- Rubber Surround Piano Black IMPP Cone
- Titanium Dome Diaphragm High Performance Tweeter
- Mounting Depth: 70mm (2 3/4")
- 15 Oz Magnet

APSW-6932

New Products for 2013

- 6"x 9" Coaxial 2-Way Marine Speaker
- 300 Watts Power (P.M.P.O.)
- 150 Watts Power (R.M.S.)
- Frequency Response: 40-20 KHz
- Sensitivity: 93 db
- Rubber Surround Piano Black IMPP Cone
- Titanium Dome Diaphragm High Performance Tweeter
- Mounting Depth: 92mm (3 5/8")
- 20 Oz Magnet

APSW-8032

New Products for 2013

- 8" Coaxial 2-Way Marine Speaker
- 350 Watts Power (P.M.P.O.)
- 175 Watts Power (R.M.S.)
- Frequency Response: 45-25 KHz
- Sensitivity: 90 dB
- Rubber Surround Piano Black IMPP Cone
- Titanium Dome Diaphragm High performance Tweeter
- Mounting Depth: 70mm (3 1/2")
- 22 Oz Magnet

APSW-1031

- 10" Subwoofer Marine Speaker
- 500 Watts Power (PMPO)
- 250 Watts Power (RMS)
- Frequency Response: 28-1,500Hz
- Sensitivity: 88 dB
- Rubber Surround Piano Black IMPP Cone
- White ABS Basket
- Mounting Depth: 117MM (4.6")
- 30 Oz Magnet

SWS
Salt Water Series

New Products for 2013
WEATHER PROOF**10TH ANNIVERSARY**

AUDIOPIPE MARINE



APSW-6502BK

6.5" Coaxial 2-Way

Marine / ATV Speaker

- 200 Watts Power (P.M.P.O.)
- 100 Watts Power (R.M.S.)
- Frequency Response: 45-20 KHz
- Sensitivity: 90 dB
- Rubber Surround Piano Black IMPP Cone
- Titanium Dome Diaphragm High Performance
Tweeter
- Mounting Depth: 70mm (2 3/4")
- 15 Oz Magnet

APSW-8502BK

8" Coaxial 2-Way

Marine / ATV Speaker

- 350 Watts Power (P.M.P.O.)
- 175 Watts Power (R.M.S.)
- Frequency Response: 45-25 KHz
- Sensitivity: 90 dB
- Rubber Surround Piano Black IMPP Cone
- Titanium Dome Diaphragm High Performance
Tweeter
- Mounting Depth: 70mm (3 1/2")
- 22 Oz Magnet



SWS

Salt Water Series

Fully Painted Non-Corrosive Heatsink Specially Coated Circuit Boards for Marine Use



APMR-2002

WEATHER PROOF



1000 watts



Remote Sub-Woofer Volume Control

APMR-1504

4 Channel Marine Amplifier

- Built-in Variable High Pass & Low Pass Crossover.
- RCA Line Input/Output Jacks.
- Electronic Protection Circuitry to Protect The Amplifier from Short Circuit, DC Offset & Thermal Overload.
- Remote Sub-Woofer Volume Control.
- 55mm(H) x 176mm(W) x 382mm(L).
- 2.2 inches(H) x 6.9 inches(W) x 15 inches(L).
- Frequency Response: 20Hz - 20kHz
- Signal to Noise Ratio: 95dB
- Channel Separation: >65dB
- Total Harmonic Distortion: <0.05%
- Speaker Impedance: 2Ω To 4Ω
- Input Sensitivity: 0.25V - 5V
- Crossover Frequency: 55Hz - 5.5KHz 12dB Stereo
- Bass Boost: 0-18dB @ 45Hz
- Output Power (RMS):
 - Stereo 4 Ch - 75W x 4 @ 4Ω
 - Stereo 4 Ch - 150W x 4 @ 2Ω
 - Bridge 2 Ch - 300W x 2 @ 4Ω

APMR-2002

2 Channel Marine Amplifier

- Built-in Variable High Pass & Low Pass Crossover.
- RCA Line Input/Output Jacks.
- Electronic Protection Circuitry to Protect The Amplifier from Short Circuit, DC Offset & Thermal Overload.
- Remote Sub-Woofer Volume Control.
- 55mm(H) x 176mm(W) x 260mm(L).
- 2.2 inches(H) x 6.9 inches(W) x 10.2 inches(L).
- Frequency Response: 20Hz - 20kHz
- Signal to Noise Ratio: 100dB
- Channel Separation: >75dB
- Total Harmonic Distortion: <0.05%
- Speaker Impedance: 2Ω To 4Ω
- Input Sensitivity: 0.25V - 5V
- Crossover Frequency: 55Hz - 5.5KHz 12dB Stereo
- Bass Boost: 0-18dB @ 45Hz
- Output Power (RMS):
 - Stereo 2 Ch - 100W x 2 @ 4Ω
 - Stereo 2 Ch - 150W x 2 @ 2Ω
 - Bridge 1 Ch - 300W x 1 @ 4Ω

AUDIOPIPE MARINE

APMR-4080MIN

- 1200 Watts
- 4 Channel MOSFET Marine Amplifier
- Frequency Response: 10Hz - 30 KHz
- Input Level: 0.2 - 6V
- THD: <0.05%
- 4x80W@ 4 Ohm
- 4x115W@ 2 Ohm
- Maximum Power Output 2x230W



1200 watts



APMR-1200MIN

600 watts

WEATHER PROOF



APMR-1300MIN

1000 watts

WEATHER PROOF

APMR-1200MIN

- 600 Watts
- 1 Channel MOSFET Marine Amplifier
- Frequency Response: 8Hz - 180 KHz
- Input Level: 0.2 - 5V
- THD: <0.15%
- 230W@4 Ohm
- 400W@2 Ohm
- 550W@1 Ohm

APMR-1300MIN

- 1000 Watts
- 1 Channel MOSFET Marine Amplifier
- Input Level: 0.2 - 5V
- THD: <0.15%
- Frequency Response: 8Hz - 180 KHz
- 300W@4 Ohm
- 600W@2 Ohm
- 1000W@1 Ohm

APMR-2075MIN

- 1000 Watts
- 2 Channel MOSFET Marine Amplifier
- Input Level: 0.2 - 5V
- THD: <0.05%
- Frequency Response: 5Hz - 30 KHz
- 2x75W@4 Ohm
- 2x110W@2 Ohm



APMR-2075

1000 watts

WEATHER PROOF



APMR-4080MIN

1200 watts

WEATHER PROOF

SWS
Salt Water Series



PKIP-1500

PKIP-2100



PKIP-1500

1500 Watts Power Kit



- 17 Ft. 2 RCA Plugs to 2 RCA Plugs with Signal Wire
- 17 Ft. 8 AWG White Primary Wire
- 17 Ft. 8 AWG Black Primary Wire
- 60 Amp AGU Fuse
- 25 Ft. 18 AWG White Speaker Wire
- 8 AWG Fuse Holder
- Marine Grade Ring Terminal White Color
- Marine Grade Ring Terminal Black Color
- Black Spade Terminal Black Color
- Black Spade Terminal White Color
- Butt Splices 2Pcs
- 10 Assorted Cable Ties
- 3 Ft. Split Loom Tubing

PKIP-2100

2100 Watts Power Kit



- 17 Ft. 2 RCA Plugs to 2 RCA Plugs with Signal Wire
- 17 Ft. 4 AWG White Primary Wire
- 17 Ft. 4 AWG Black Primary Wire
- 80 Amp AGU Fuse
- 25 Ft. 16 AWG White Speaker Wire
- AGU Fuse Holder
- Marine Grade Ring Terminal White Color
- Marine Grade Ring Terminal Black Color
- Black Spade Terminal Black Color
- Black Spade Terminal White Color
- Butt Splices 2Pcs
- 10 Assorted Cable Ties
- 3 Ft. Split Loom Tubing

AUDIOPIPE MARINE

APMR-100ANT

SWS
Salt Water Series



APMR-100ANT

Marine Antenna (40")

- Application: AM/FM
- Frequency: 550-1600kHz, 88-108 MHz
- Length: 40" (1016mm)
- Motorola Type Connector Attached

APMR-300ANT

Marine Antenna (59")

- Application: AM/FM
- Antenna in white ABS case:
32 cm(L) x 3.2cm (W)
- Coaxial Cable 75 Ohms: Length 150 cm
- RCA male Plug: Chrome Plated Brass



APMR-100ANT



APMR-300ANT

Ap**IP CABLE SERIES**

IP-2RCA-3
• Oxygen Free 3' RCA
Audio Cable



**New Products
for 2013**

**MARINE
Grade**



IP-2RCA-6
• Oxygen Free 6' RCA
Audio Cable



Conveniently connects Equipment such as marine head units to amplifiers or audio processors.



IP-2RCA-12
• Oxygen Free 12' RCA
Audio Cable



**New Products
for 2013**

**SW5
Salt Water Series**



IP-2RCA-25
• Oxygen Free 25' RCA
Audio Cable



10TH ANNIVERSARY

AUDIOPIPE MARINE



IP-YF2M-06

• Oxygen Free Shielded "Y" RCA Audio Cable



UV protected white PVC

Jacket is flexible and makes our cables easy to route through tight spaces, twisted-pair arrangement for outstanding sound transfer and superior noise rejection.

IP-YM2F-06

• Oxygen Free Shielded "Y" RCA Audio Cable





MSC-12-250TC

New Products
for 2013



MARINE
Grade

WEATHER
PROOF

SWS
Salt Water Series

- Audiopipe Flexible PVC Tin Copper Plated OFC wire 12AWG
- 12 Gauge
 - 250'
 - 2x252/0.12TC
 - OD4.5x9



MSC-16-500TC

- Audiopipe Flexible PVC Tin Copper Plated OFC wire 12AWG
- 16 Gauge
 - 500'
 - 2x100/0.12TC
 - OD3.5x7

MARINE
Grade

SWS
Salt Water Series



New Products
for 2013

WEATHER
PROOF

AUDIOPIPE MARINE



New Products
for 2013

WEATHER
PROOF

MSC-12-25TC

• Tin Plated OFC Speaker Cable

100% Oxygen Free Marine Grade, Tinned Cooper, Fine Strand Speaker Wire, White Flexible PVC Jacket Makes it ideal for any Marine Speaker System Installation.

Audiopipe Flexible PVC Tin Copper Plated OFC wire
12AWG 2x100/0.12TCOD3.5x7 1FT



MARINE
Grade

New Products
for 2013

WEATHER
PROOF

MSC-16-25TC

• Tin Plated OFC Speaker Cable

100% Oxygen Free Marine Grade, Tinned Cooper, Fine Strand Speaker Wire, White Flexible PVC Jacket Makes it ideal for any Marine Speaker System Installation.

Audiopipe Flexible PVC Tin Copper Plated OFC wire
12AWG 2x100/0.12TCOD3.5x7 1FT



MARINE
Grade



IPod® COMPATIBLE

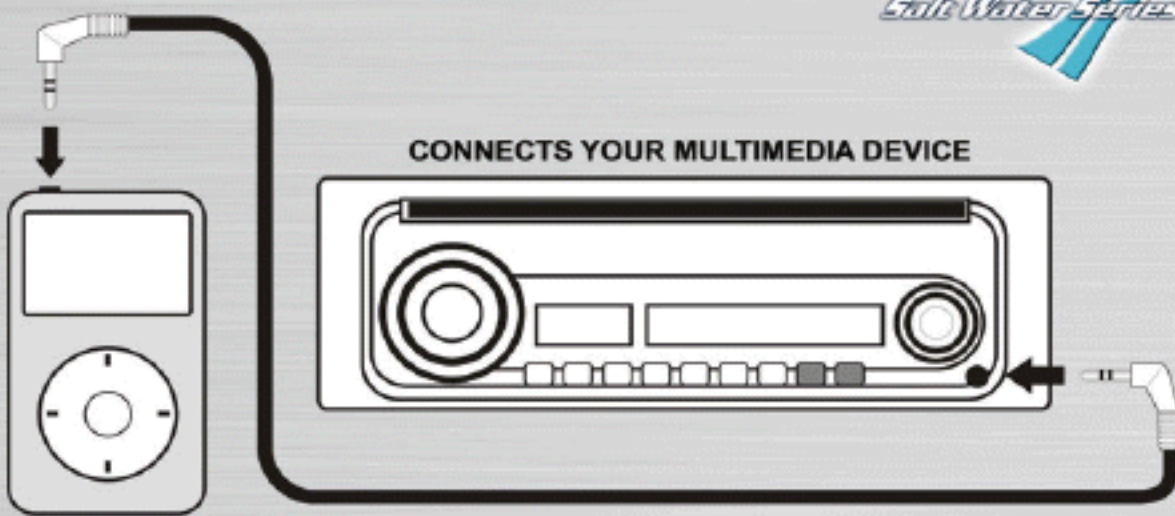

IP-2535-6

- 6 feet
- 3.5mm Stereo Plug to 2.5mm Stereo Plug
- New right angle design

IP-35-6

- 6 feet
- 3.5mm Stereo Plug to RCA Plug
- New right angle design

IP-3535-3 (3 feet)

IP-3535-6 (6 feet)

IP-3535-12 (12 feet)

IP-3535-25 (25 feet)

- 3.5mm Stereo Plug to 3.5mm Stereo Plug
- New right angle design

IP-35V35V

- 6 feet
- 3.5mm Stereo Video Cable

WEATHER PROOF



NEW RIGHT ANGLE DESIGN

IP-2535-6

WEATHER PROOF



NEW RIGHT ANGLE DESIGN

IP-35-6

WEATHER PROOF



NEW RIGHT ANGLE DESIGN

IP-3535-6

AUDIOPIPE MARINE

PDC-P1414

Power Distribution Block

- Distributes Positive and Negative Cable Connections
- Accepts One 0 or 4 Gauge Input and Two 4 or 8 Gauge Outputs
- With Super Bright LED
- 24 Kt. Gold Finish Screws
- Platinum Base is Precision Machined
- AGU Type Fuse



AGU Type Fuse



AFC-P1414

Power Distribution Block

- Distributes Positive and Negative Cable Connections
- Accepts One 0 or 4 Gauge Input and Four 8 Gauge Outputs
- With Super Bright LED
- 24 Kt. Gold Finish Screws
- Platinum Base is Precision Machined
- AFC Type Fuse



AFC Type Fuse





NL-F1010CW
Completely weather proof Strip which comes in WHITE & BLUE. Can be cut every three LED



10"



NL-F1020CW
Completely weather proof strip which comes in WHITE & BLUE. Can be cut every three LED



20"



NL-F1072CW
Completely weather proof Strip which comes in RED, WHITE & BLUE. Can be cut every three LED



72"



NL-F512CB
Weather resistant Strip which comes in RED, WHITE & BLUE. A clearly marked line shows exactly where to cut every three LED's



12"



NL-F524CB
Weather resistant strip which comes in RED, WHITE & BLUE. A clearly marked line shows exactly where to cut every three LED's



24"

NL-FK100R

- Output Controller (RGB) & Remote, & 1pc of harness
- DC socket change to power cable



New Products for 2013

NL-F216C

Weather resistant Roll which comes in RED, WHITE, BLUE, GREEN, PURPLE & ORANGE. A clearly-marked line shows exactly here to cut every three LED's. Solder spots provide contacts to attach wire.



New Products for 2013

NL-FK200R

- 2 Output Controller (RGB) & Remote, & 2pcs of harness
- DC socket change to power cable

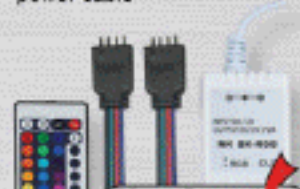

New Products for 2013



16'



NL-KT116LEDM
LED Flexible Strip

- A clearly marked line shows exactly where to cut
- 24 key super thin IR remote controller allows user to conveniently set color and control patterns
- Retains memory of color and pattern
- Create a stunning light show on your motorcycle, car, truck, boat just about anything



16' x 2



NL-KT216LEDM
LED Flexible Strip

- A clearly marked line shows exactly where to cut
- 24 key super thin IR remote controller allows user to conveniently set color and control patterns
- Retains memory of color and pattern
- Create a stunning light show on your motorcycle, car, truck, boat just about anything

AUDIOPIPE MARINE

MLDST-4WH (white)
MLDST-4BL (blue)
MLDST-4GR (green)
MLDST-4RD (red)
 4" LED Strip

MLDST-8WH (white)
MLDST-8BL (blue)
MLDST-8GR (green)
MLDST-8RD (red)
 8" LED Strip

MLDST-12WH (white)
MLDST-12BL (blue)
MLDST-12GR (green)
MLDST-12RD (red)
 12" LED Strip

MLDST-20WH (white)
MLDST-20BL (blue)
MLDST-20GR (green)
MLDST-20RD (red)
 20" LED Strip



MLD-F424WK
 LED Flexible Strip

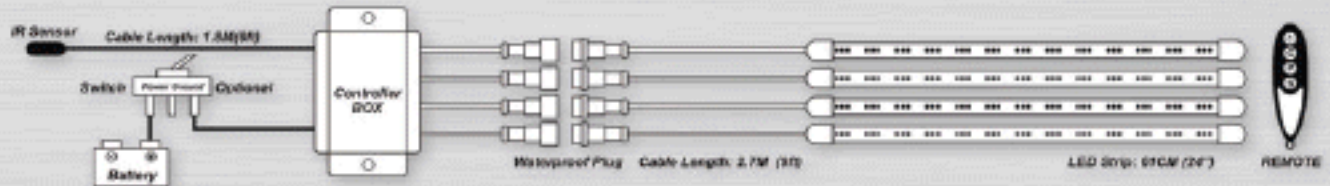

LED Bulb Conversion for Halogen - G4

MLD-G4-06



MLD-G4-09



All of our LED Strips come on a flexible circuit with an adhesive backing. They are customizable from 3 inches and longer. Durability, energy efficiency, and practically maintenance free, makes this product ideal for many types of applications.

