

Mopar®

PLYMOUTH & DODGE BODY PANELS



Our Name Says It All!™



**AUTHENTIC
RESTORATION™
PRODUCT**

MOPAR, JEEP, DODGE, HEMI, PLYMOUTH, RAM, SRT, CHRYSLER and related logos, vehicle model names and trade dress are trademarks of Chrysler Group LLC used under license. © 2015 Chrysler Group LLC

Check out these Hot New Parts!

Here at AMD, we are constantly striving to bring you more and better parts for your Dodge / Plymouth restoration project.

1967-76 A-Body



Page 6

A-Body Rear Underseat Pan



Page 7

1963-65 Plymouth B-Body Full Quarters



Page 25

1971-74 Charger Power Bulge & Ramcharger Hoods



Page 19

A-, B, & E-Body Lower Quarter Patches are Back!!



YOU ASKED FOR IT, and HERE IT IS!

For years our customers have been asking us for the parts and accessory items they need when restoring their Dodge or Plymouth muscle car. So we have added a "Parts & Accessories" section to our catalog with a collection of clips, screws, moldings, lock sets, emblems and more to help you finish your project. This new section starts on Page 51.

Superbird & Daytona Back Glass & Molding Sets



Page 34

Parts & Accessories!



Pages 51-66

NEW!

AMD
AUTO METAL DIRECT
Our Name Says It All!™

mopar AUTHENTIC RESTORATION PRODUCT
MOPAR, BEEF, DODGE, HEMI, PLYMOUTH, RAM, SEI, CHRYSLER and related logos, vehicle model names and trade dress are trademarks of Chrysler Group LLC, used under license. © 2013 Chrysler Group LLC.

"A" Body

With light weight bodies and hot motors, A-Body Dodge and Plymouth muscle cars quickly became favorites. The 273, 318, 340, and 360 engines are the stuff of legend today, and Chrysler's unique slant-six has to be the unchallenged king of inline six cylinder engines. Add these great engines to stylish body designs, low initial purchase price, and available factory graphics and it's easy to see why these cars were so popular. Today you can get top quality Chrysler licensed reproduction body panels for your A-Body, from the restoration professionals at Auto Metal Direct. **Call now!**

Some items listed below are not shown in the exploded view on the next page.

#	Part Description	Page #	#	Part Description	Page #
100	Front Bumper.....	4	540	Door Handle.....	59
101	Bumper Bolt Set.....	4	546	Window Handle.....	59
105	Front Bumper Bracket Set.....	4	547	Window Regulator Parts.....	60
106	Front Bumper Stabilizer Bracket.....	4	548	Door Vent Hole Plugs.....	60
125	Front Valance.....	5	550	Door Glass.....	14
142	Headlight Adjuster Kit.....	51	560	Vent Glass.....	14
153	Grille Hardware Kit.....	52	562	Vent Window Weatherstrips.....	60
200	Front Fender.....	5	570	Outside Mirrors.....	60
202	Front Fender Bolt Kit.....	52	580	Front Door Seal.....	61
205	Fender Patch, Lower Rear.....	5	635	Vinyl Top Molding Set.....	8
240	Side Marker Lens.....	52	640	Package Tray Patch.....	8
245	Turn Signal Fender Gasket.....	52	650	Deck Filler Panel.....	8
250	Front Inner Fender.....	5	654	Deck Filler Inside Corner Bracket.....	8
251	Front Inner Fender Splash Shield.....	5	655	Lower Back Window Frame.....	8
260	Inner Fender Cowl Brackets.....	5	660	Back Glass.....	14
298	Exterior Trim Screw Set.....	54	670	Back Glass Moulding Set.....	14
300	Hood.....	6	700	Quarter Panel, OE Style.....	8-9
301	Hood Bumpers.....	54	710	Quarter Panel Skins.....	9
310	Hood Hinge Retainer.....	54	750	Door Jamb Lock Pillar.....	9
330	Hood Moulding.....	55	753	U-Jamb Seal.....	62
340	Battery Tray.....	6	755	Quarter Panel Patch, Lower Rear.....	9
341	Battery Hold Down Kit.....	55	760	Inner Wheelhouse.....	10
351	Lower Radiator Support.....	6	770	Outer Wheelhouse.....	10
354	Under-Hood Bolt Kit.....	55	795	Quarter Glass.....	14
357	Radiator Cap.....	56	798	Quarter Window Rollers.....	62
361	Steering Column Seal & Grommet.....	56	800	Trunk Floor.....	10
362	Firewall Pads.....	56	810	Trunk Lock Support.....	10
370	Firewall.....	6	815	Trunk Bolt Kit.....	62
376	Lower Door A Pillar.....	6	816	Spare Tire Stud, Sing Nut, Hardware Set.....	10
380	Windshield.....	13	818	Front Jack Bracket.....	10
384	Window Ribbon Seal.....	14	825	Trunk Gutter.....	10
395	Torsion Bar Crossmember.....	6	827	Trunk Locks.....	62
400	Front Floor Pan.....	6	840	Trunk Floor Extension.....	10
405	Front Floor Pan Halves.....	7	841	Trunk Floor Extension Endcap.....	11
407	Bucket Seat Brackets.....	7	842	Trunk Floor Extension Brace.....	11
410	Rear Floor Pan/Footwell Area.....	7	855	Trunk Panel Molding & Clip Kit.....	63
415	Manual Transmission Shifter Tunnel.....	7	860	Rear Crossmember Shock Mount.....	11
416	Shift Rod Seal.....	57	865	Rear Leaf Spring Mount.....	11
440	Inner Rocker Panel.....	7	870	Rear Crossmember.....	11
441	Emergency Cable Bracket.....	7	871	Rear Crossmember Extension.....	11
442	Floor Wiring Cover.....	7	880	Gas Tank Straps.....	11
445	Sill Plates.....	57	881	Gas Tank Sending Unit.....	11
448	Sill Plate and Extension.....	57	890	Gas Tanks.....	11
450	Outer Rocker Panel.....	7	891	Gas Cap.....	63
451	Front Rocker Panel Endcap.....	7	895	Rear Frame Rail.....	11
455	Rocker Molding Clip Kit.....	58	900	Tail Light Panel.....	11
462	Ignition Lock.....	58	910	Tail Light Bracket.....	12
488	Interior Trim Screw Set.....	58	920	Tail Light Panel Reinforcement Brackets.....	12
490	Console Bracket Set.....	7	945	License Plate Bumper.....	64
499	Complete Glass Kits.....	13	960	Rear Valance Panel.....	12
510	Door Skin.....	8	970	Rear Bumper Bracket Set.....	12
520	Door Hinge, Upper.....	8	975	Rear Bumper Filler.....	12
525	Door Hinge, Lower.....	8	990	Rear Bumper.....	12-13
531	Door Handle / Lock Gaskets.....	59	998	Paint Gasket Set.....	64
532	Door Latch / Lock Kits.....	59	999	Emblems.....	65
536	Door Lock Knob.....	59			
537	Door Lock.....	59			

NEW! Find all kinds of parts and accessories for your Dodge or Plymouth, page 51-66.



"A" Body



Dodge

Dart
Demon
Dart Sport

Plymouth

Barracuda (1967-69 only)
Duster
Scamp
Valiant

LH = Driver Side
RH = Passenger Side



Can't find your part
in our catalog? Many
new "A"-Body items are
being developed!
Call Us!

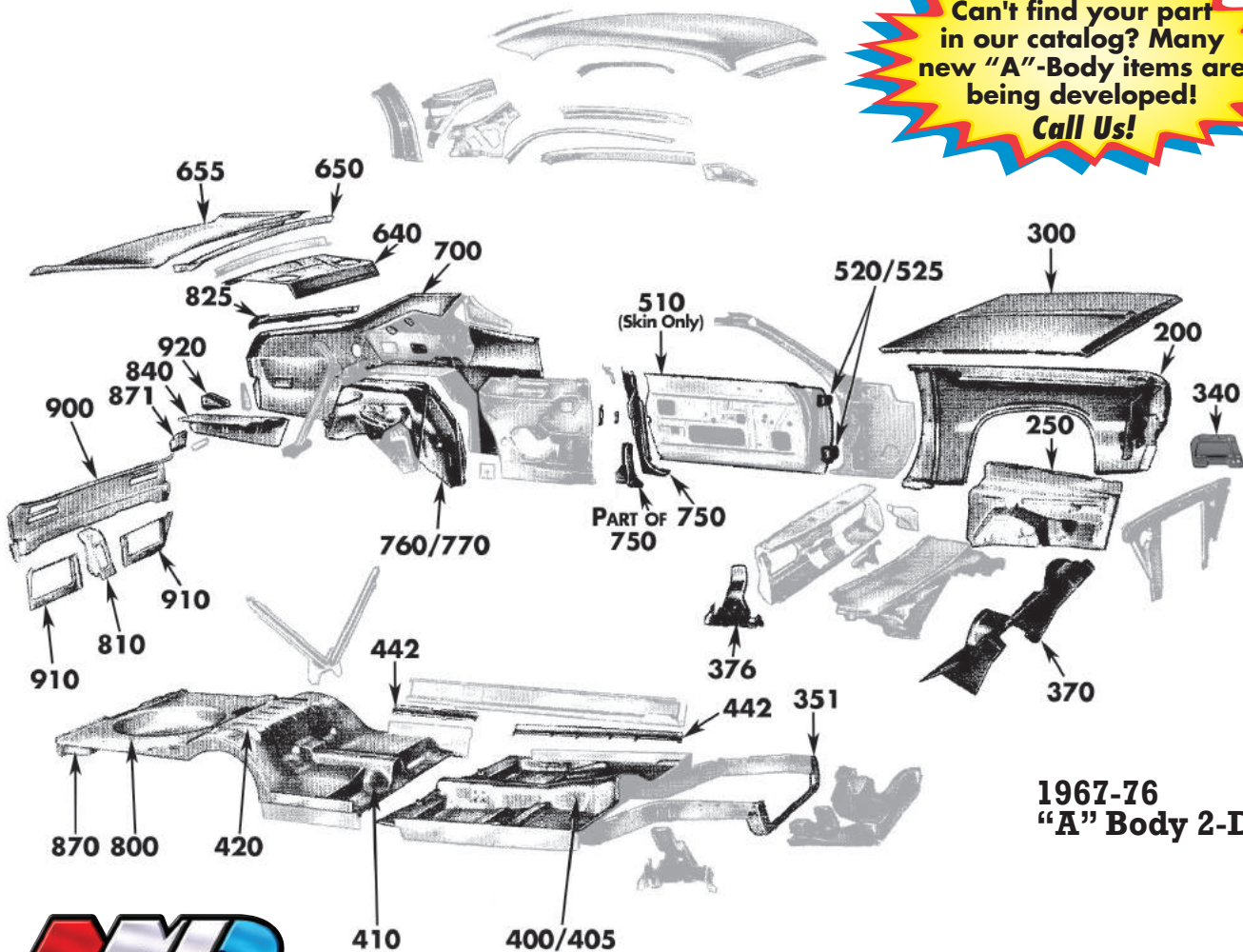

1967-76
"A" Body 2-Door



Our Name Says It All!



MOPAR, BEE, DODGE, HEAR, PLYMOUTH, RAM, SEV, CHRYSLER and related logos, vehicle model names and trade dress are trademarks of Chrysler Group LLC, used under license. © 2015 Chrysler Group LLC.

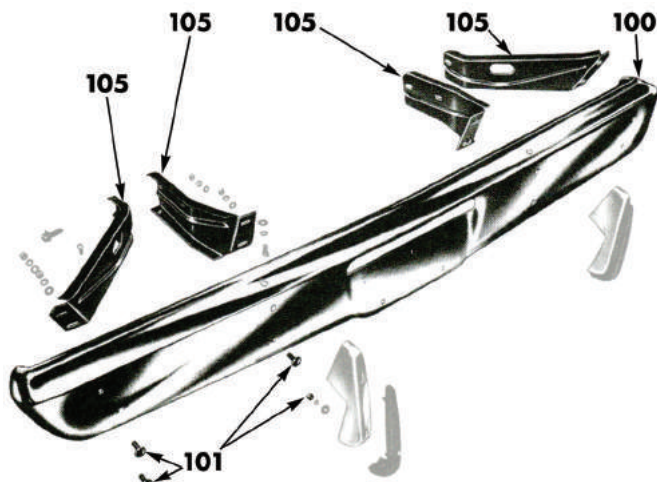

100) Front Bumper

, **, *, indicates bumper bolt sets required. See section 101, below.*

Dart



YEAR	DESCRIPTION	PART #
67-69		100-2067***
70-71	without Jack Slots.....	100-2070*

Barracuda



67-69	(also Fits Rear).....	100-1267***
-------	-----------------------	-------------------

Duster / Scamp



70-71	also 67-70 Valiant, without Jack Slots.....	100-1370***
-------	---	-------------------



71-72	with Jack Slots.....	100-1371***
-------	----------------------	-------------------

Demon



1971	without Jack Slots.....	100-2070*
------	-------------------------	-----------------

, **, *, indicates bumper bolt sets required. See section 101, below.*

101) Bumper Bolt Set

(Bolt, Flat & Lock Washers, Nut)

*	16 Pieces (4 bolts).....	101-1000-16S
**	24 Pieces (6 bolts).....	101-1000-24S
***	32 Pieces (8 bolts).....	101-1000-32S



105) Bumper Bracket Set

Dart



YEAR	DESCRIPTION	PART #
67-69	Front Set, 4 Pieces.....	105-2067-S



67-69	Front/Rear Set, 8 Pieces.....	105-2067-1S
-------	-------------------------------	-------------

Barracuda



67-69	Front Set, 4 Pieces.....	105-1267-S
-------	--------------------------	------------

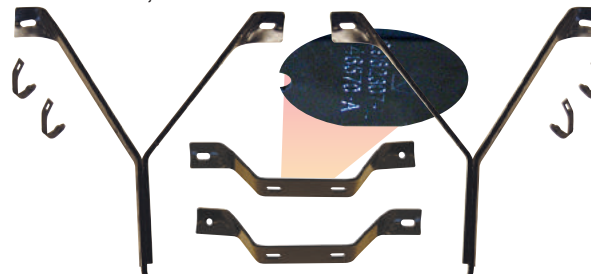

67-69	Front/Rear/Outer Set, 10 Pieces.....	105-1267-1S
-------	--------------------------------------	-------------

Duster / Scamp



70-72 and 67-70 Valiant,	Front Set, 4 Pieces (pictured).....	105-1370-S
--------------------------	-------------------------------------	------------



70-72 and 67-70 Valiant,	Front/Rear Set, 8 Pieces.....	105-1370-1S
--------------------------	-------------------------------	-------------

106) Bumper Stabilizer Bracket

Barracuda

67-69	Front/Rear.....	106-1267-S
-------	-----------------	------------



125) Front Valance

Dart



YEAR	DESCRIPTION	PART #
70-72		125-2070

Barracuda



67-69		125-1267
-------	--	----------

Demon



71-72		125-2070
-------	--	----------

Don't be fooled by cheap reproductions. Save time and money by always demanding AMD brand parts.

200) Front Fender

Dart



1968	LH (pictured)	200-2068-L
1968	RH	200-2068-R
1969	LH	200-2069-L
1969	RH	200-2069-R



70-71	LH (pictured)	200-2070-L
70-71	RH	200-2070-R

Duster / Scamp



70-71	LH	200-1370-L
70-71	RH	200-1370-R
1972	LH	200-1372-L
1972	RH	200-1372-R
73-74	LH	200-1373-L
73-74	RH	200-1373-R

200) Front Fender, continued

Demon



All fenders are made on AMD steel tools.

YEAR	DESCRIPTION	PART #
1971	LH (pictured)	200-2070-L
1971	RH	200-2070-R

205) Front Fender Patch

Includes fender brace.

Dart

67-72	LH (pictured)	205-2067-L
67-72	RH	205-2067-R

Duster / Demon / Dart Sport

70-76	LH (pictured)	205-1370-L
70-76	RH	205-1370-R

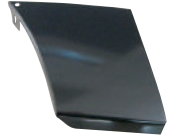

9" to 10"

250) Front Inner Fender

A-Body



67-74	LH	250-1067-L
67-74	RH	250-1067-R
67-74	Pair	250-1067-P

251) Splash Shield

Fits behind front wheel between fender and firewall.



Dart / Demon

68-76	Pair (pictured)	251-2067-P
-------	-----------------	------------

Barracuda

67-69	Pair	251-1267-P
-------	------	------------

Duster / Scamp

70-76	Pair (pictured)	251-1370-P
-------	-----------------	------------

260) Inner Fender to Cowl Brackets

67-76	LH	260-1067-L
67-76	RH	260-1067-R

300) Hood

Dart

68-69	GTS / Swinger (will also fit 1967)	300-2067
-------	------------------------------------	----------

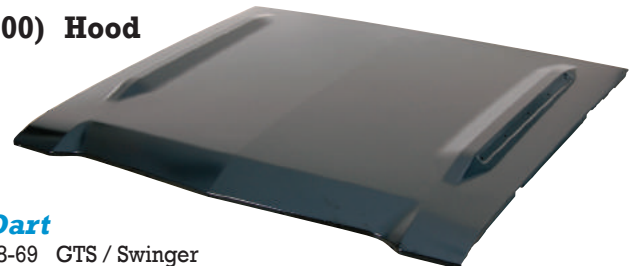

Our Name Says It All!



340) Battery Tray

A-Body



YEAR	DESCRIPTION	PART #
67-74	(pictured).....	340-1067

351) Lower Radiator Support

A-Body



67-76	351-1067
-------	-------	----------

370) Firewall, Full OE Style

A-Body



67-76	with AC.....	370-1067-AC
67-76	without AC (pictured)	370-1067

376) Lower A Pillar Patch

Patches area below lower door hinge.

A-Body

67-76	LH.....	376-1067-L
67-76	RH (pictured)	376-1067-R



387) Starter Splash Shield

Mounts to left hand frame rail.

A-Body

67-72	LH, automatic transmission only.....	387-1466
-------	--------------------------------------	----------



395) Torsion Bar Crossmember

A-Body



67-76	395-1067
-------	-------	----------

400) Front Floor Pan, Full OE Style

Complete coverage, like original.

Comes with fasteners and brackets for speedometer cable, emergency brake cable seat belts, and rear seat retainer.



Dart / Scamp

YEAR	DESCRIPTION	PART #
67-74	Full OE Style	400-1067

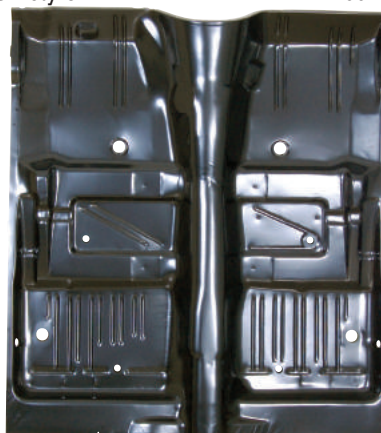

Barracuda / Duster / Demon / Dart Sport / Valiant

67-69 Barracuda, 70-76 Duster, 71-72 Demon, 73-76 Dart Sport, 67-71 Valiant

67-76	Full OE Style	400-1267
-------	---------------------	----------

405) Front Floor Pan, Half

Does not include top area of transmission tunnel.



Dart / Scamp

67-76	LH (pictured, left)	405-1067-L
67-76	RH (pictured, right)	405-1067-R



Our Name Says It All!™



MOPAR, BEEF, DOODLE, HORN, PLYMOUTH, RAM, SRT, CHRYSLER and related logos, vehicle model names and trade dress are trademarks of Chrysler Group LLC, used under license. © 2013 Chrysler Group LLC.

405) Front Floor Pan, Half, continued
Does not include top area of transmission tunnel.

Barracuda / Duster / Demon / Dart Sport / Valiant

67-69 Barracuda, 70-76 Duster, 71-72 Demon, 73-76 Dart Sport, 67-71 Valiant

YEAR	DESCRIPTION	PART #
67-76	LH	405-1267-L
67-76	RH.....	405-1267-R

407) Bucket Seat Brackets

Included with all AMD floor pans. Required when changing from bench to bucket seats



67-76	4-Piece Set.....	407-1067-S
-------	------------------	------------

410) Rear Floor Pan / Footwell

Includes rear seat retainer brackets.

Dart / Scamp



67-76	LH.....	410-1067-L
67-76	RH.....	410-1067-R
67-76	Pair.....	410-1067-P

415) Manual Transmission Shifter Tunnel

Fits AMD and OE floor pans.



A-Body

67-74	415-1067
-------	-------	----------

420) Rear Floor Pan / Under Rear Seat, Full OE Style



A-Body

67-76	420-1067
-------	-------	----------

440) Inner Rocker Panel

Dart / Scamp



67-76	LH.....	440-2067-L
67-76	RH.....	440-2067-R

440) Inner Rocker Panel, continued

Barracuda / Duster / Demon / Dart Sport / Valiant

67-69 Barracuda, 70-76 Duster, 71-72 Demon, 73-76 Dart Sport, 67-71 Valiant



YEAR	DESCRIPTION	PART #
67-76	LH.....	440-1370-L
67-76	RH.....	440-1370-R

450) Outer Rocker Panel

Dart / Scamp



67-76	LH.....	450-2067-L
67-76	RH.....	450-2067-R

Barracuda / Duster / Demon / Dart Sport / Valiant

67-69 Barracuda, 70-76 Duster, 71-72 Demon, 73-76 Dart Sport, 67-71 Valiant



67-76	LH.....	450-1370-L
67-76	RH.....	450-1370-R

451) Front Rocker Panel Endcap

A-Body

67-76	LH.....	451-1067-L
67-76	RH.....	451-1067-R



441) Emergency Cable Bracket

Included with all AMD floor pans.

A-Body

67-76	441-1466
-------	-------	----------



442) Floor Wiring Cover

Use when replacing floorpan.

Dart / Scamp



67-76	4 Pieces.....	442-2067-S
-------	---------------	------------

Barracuda / Duster / Demon / Dart Sport / Valiant

67-69 Barracuda, 70-76 Duster, 71-72 Demon, 73-76 Dart Sport, 67-71 Valiant



67-69	4 Pieces.....	442-1267-S
-------	---------------	------------

490) Console Bracket Set

A-Body

67-76	Automatic Transmission, 3 Pieces.....	490-1067-AS
67-76	Manual Transmission, 3 Pieces.....	490-1067-MS



510) Door Skin
Dart / Scamp



YEAR	DESCRIPTION	PART #
68-72	LH.....	510-2068-L
68-72	RH.....	510-2068-R

Duster / Demon / Dart Sport
70-76 Duster, 71-72 Demon, 73-76 Dart Sport

70-76	LH.....	510-1370-L
70-76	RH.....	510-1370-R

520) Door Hinge, Upper
A-Body

NEW!
Not Rebuilt

67-74	LH.....	520-1067-L
67-74	RH.....	520-1067-R

Upper / Lower Set

67-74	4 Pieces.....	520-1067-S
-------	---------------	------------



525) Door Hinge, Lower
A-Body

NEW!
Not Rebuilt

67-74	LH.....	525-1466-L
67-74	RH.....	525-1466-R

630) Drip Rail Molding
6-Piece Sets.



Dart / Scamp

67-76	Dart, 72-76 Scamp.....	630-2067-S
-------	------------------------	------------

Barracuda

67-69	Fastback.....	630-1267-1S
67-69	Coupe Notchback (pictured).....	630-1267-2S

Duster / Demon / Dart Sport

70-76	630-1370-S
-------	-------	------------

635) Vinyl Top Molding

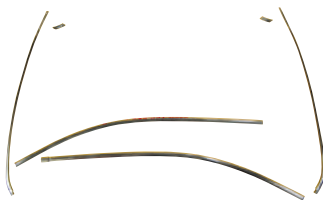

Dart / Scamp

67-76	Dart, 72-76 Scamp, 2-Door Hardtop, 6-Piece Set.....	635-2067-S
-------	---	------------

650) Deck Filler Panel
Dart / Scamp



67-76	650-2067
-------	-------	----------

Barracuda



67-69	Coupe.....	650-1267
-------	------------	----------

Duster/ Demon/ Dart Sport:
Area Under Back Window

Required for repairs in deck filler/rear package tray area. These pieces sandwich together.

640) Package Tray Patch



70-76	Below Window Frame.....	640-1370-1
-------	-------------------------	------------

650) Deck Filler Panel



70-76	650-1370
-------	-------	----------

655) Lower Back Window Frame



70-76	655-1370
-------	-------	----------

654) Deck Filler Inside Corner Bracket

Use when replacing deck filler panels and/or quarter panels.



Dart

YEAR	DESCRIPTION	PART #
67-76	LH.....	654-2067-2L
67-76	RH.....	654-2067-2R

700) Quarter Panel, OE Style

Complete coverage, like original.

Dart / Scamp



1967	LH (pictured).....	700-2067-L
1967	RH.....	700-2067-R



1968	LH (pictured).....	700-2068-L
1968	RH.....	700-2068-R



1969	LH (pictured).....	700-2069-L
1969	RH.....	700-2069-R
70-71	LH, also 1971 Scamp.....	700-2070-L
70-71	RH, also 1971 Scamp.....	700-2070-R



Our Name Says It All!™



MOPAR, BEEF, DOODLE, HEMA, PLYMOUTH, RAM, SRT, CHRYSLER and related logos, vehicle model names and trade dress are trademarks of Chrysler Group LLC, used under license. © 2013 Chrysler Group LLC.

700) Quarter Panel, OE Style

Complete coverage, like original.

Dart / Scamp

YEAR	DESCRIPTION	PART #
72-76	LH.....	700-2072-L
72-76	RH.....	700-2072-R

Barracuda



Will fit Coupe and Convertible with modifications.

Fastback

1967	LH.....	700-1267-L
1967	RH.....	700-1267-R
1968	LH.....	700-1268-L
1968	RH.....	700-1268-R
1969	LH (pictured).....	700-1269-L
1969	RH.....	700-1269-R

Duster / Demon / Dart Sport

70-76 Duster, 71-72 Demon, 73-76 Dart Sport



70-71	LH.....	700-1370-L
70-71	RH.....	700-1370-R
72-76	LH (pictured).....	700-1372-L
72-76	RH.....	700-1372-R

710) Quarter Panel Skin

Except for upper edge, our full skins will meet and attach to mating parts like OE (wheelhouse, door jamb, and tail light panel area). Top edge of panel bends over upper body line about 1/2 inch.

Dart / Scamp



1967	LH (pictured).....	710-2067-L
1967	RH.....	710-2067-R
1968	LH.....	710-2068-L
1968	RH.....	710-2068-R
1969	LH.....	710-2069-L
1969	RH.....	710-2069-R
70-71	LH.....	710-2070-L
70-71	RH.....	710-2070-R
72-76	LH.....	710-2072-L
72-76	RH.....	710-2072-R

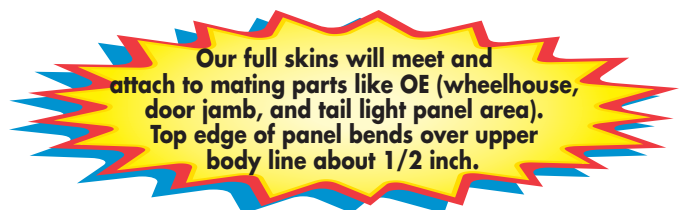

Our full skins will meet and attach to mating parts like OE (wheelhouse, door jamb, and tail light panel area). Top edge of panel bends over upper body line about 1/2 inch.

710) Quarter Panel Skin, continuedd

Duster / Demon / Dart Sport

70-71 Duster, 71-72 Demon, 73-76 Dart Sport



YEAR	DESCRIPTION	PART #
70-71	LH (pictured).....	710-1370-L
70-71	RH.....	710-1370-R
72-76	LH.....	710-1372-L
72-76	RH.....	710-1372-R

750) Door Jamb Lock Pillar

Includes bracket on back side for door striker support

Dart / Scamp

67-76	LH (pictured).....	750-2067-L
67-76	RH (pictured).....	750-2067-R

Duster / Demon / Dart Sport

70-76 Duster, 71-72 Demon, 73-76 Dart Sport

70-76	LH.....	750-1370-L
70-76	RH.....	750-1370-R



755) Quarter Panel Patch, Lower Rear

Dart / Scamp

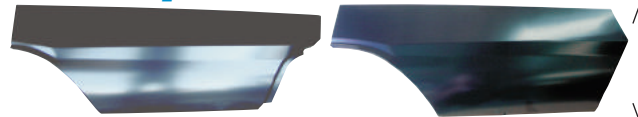

67-69	LH (pictured, left).....	755-2067-1L
67-69	RH.....	755-2067-1R
70-76	LH (pictured, right).....	755-2070-1L
70-76	RH.....	755-2070-1R

Barracuda



67-69	LH (pictured, left).....	755-1267-L
67-69	RH (pictured, right).....	755-1267-R

Duster / Demon / Dart Sport

70-76 Duster, 71-72 Demon, 73-76 Dart Sport



70-76	LH (pictured, left).....	755-1370-1L
70-76	RH (pictured, right).....	755-1370-1R



Our Name Says It All!



MOPAR, BEE, DOGGE, HEAR, PLYMOUTH, RAM, SEI, CHRYSLER and related logos, vehicle model names and trade dress are trademarks of Chrysler Group LLC, used under license. © 2013 Chrysler Group LLC.

760) Inner Wheelhouse

A-Body



YEAR	DESCRIPTION	PART #
67-76	LH.....	760-1370-L
67-76	RH.....	760-1370-R

770) Outer Wheelhouse

Use when replacing quarter panels.

Dart / Scamp



67-74	LH.....	770-1067-L
67-74	RH.....	770-1067-R

Barracuda / Duster / Demon / Dart Sport

67-69 Barracuda, 70-76 Duster, 71-72 Demon, 73-76 Dart Sport



67-76	LH	770-1267-L
67-76	RH	770-1267-R

800) Trunk Floor Pan, Full OE Style

A-Body

Uses larger style gas tank filler seal (F-307R).

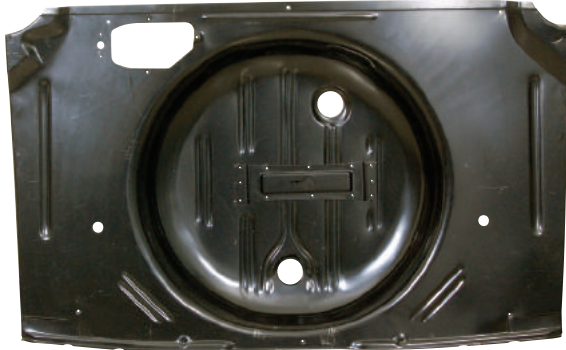

67-76 Includes 1968-Up gas tank bracket.800-1370

810) Trunk Lock Support

Use when replacing trunk floor and/or tail light panel.

Dart

70-73810-1070

Duster / Demon / Dart Sport

70-73 Duster, 71-72 Demon, 73-76 Dart Sport

70-76 (pictured).....810-1370



818) Jack Bracket

Dart / Scamp

YEAR	DESCRIPTION	PART #
67-76	Front (pictured).....	818-1067-3L
67-76	Spring Hook (pictured) .	818-1570-1L
67-76	Front/Rear Brackets, All 3 Pieces.....	818-1067-S

Duster / Demon / Barracuda

70-76 Duster, 71-72 Demon, 67-69 Barracuda

67-76	Front (pictured).....	818-1067-3L
67-76	Spring Hook (pictured).....	818-1570-1L
67-76	Front/Rear Brackets, All 3 Pieces.....	818-1370-S

825) Trunk Gutter

Use when replacing quarter panel.

Dart / Scamp



67-69	LH, 3-Piece Set (pictured).....	825-2067-L
67-69	RH, 3-Piece Set.....	825-2067-R
67-69	LH/RH Set, 6 Pieces.....	825-2067-S
70-76	Use 67-69 Set and discard lower piece. Lower piece not available for 1970-Up models.	

Duster / Demon / Dart Sport

70-76 Duster, 71-72 Demon, 73-76 Dart Sport



70-76	LH.....	825-1370-L
70-76	RH.....	825-1370-R
70-76	Pair.....	825-1370-S

840) Trunk Floor Extension

Use when replacing quarter panels and/or trunk floors.

Dart / Scamp

67-69	LH (pictured).....	840-1067-L
67-69	RH (pictured)	840-1067-R
70-74	LH.....	840-1070-L
70-74	RH.....	840-1070-R

Barracuda

67-69	LH.....	840-1267-L
67-69	RH	840-1267-R

Duster / Demon / Dart Sport

70-76 Duster, 71-72 Demon, 73-76 Dart Sport

70-76	LH.....	840-1370-L
70-76	RH	840-1370-R



See our new line of AMD Apparel on Page 66!



Our Name Says It All!™



MOPAR, BEEB, DOODLE, HEM, PLYMOUTH, RAM, SEI, CHRYSLER and related logos, vehicle model names and trade dress are trademarks of Chrysler Group LLC, used under license. © 2015 Chrysler Group LLC.

841) Trunk Floor Extension Endcap
Required when replacing quarter panel.

Duster / Demon / Dart Sport

70-76 Duster, 71-72 Demon,
 73-76 Dart Sport

YEAR	DESCRIPTION	PART #
70-76	LH	841-1370-L
70-76	RH	841-1370-R



842) Trunk Floor Extension Brace

*Mounts on bottom of extension,
 see Section 840.*

A-Body

67-76	LH=RH, Sold each	842-1370
-------	-----------------------	----------



860) Upper Rear Crossmember / Shock Mount

A-Body



67-76	860-1067
-------	-------	----------

865) Leaf Spring Mount



Front

Rear

A-Body, Front

67-76	LH.....	865-1067-1L
67-76	RH.....	865-1067-1R

A-Body, Rear

67-76	LH.....	865-1067-2L
67-76	RH.....	865-1067-2R

870) Rear Crossmember

A-Body



67-76	870-1067
-------	-------	----------

871) Rear Crossmember Extension

67-76	Pair.....	871-1067-P
-------	-----------	------------



880) Gas Tank Straps

A-Body



63-66	One Strap Required	880-1063
1967	One Strap Required	880-1067
63-76	Pair	880-1068-P

881) Gas Tank Sending Unit

A-Body

63-76	3/8", with Return	881-1063-3R
63-76	5/16".....	881-1063-5



890) Gas Tank

Now offering a complete line of Spectra Premium Industries brand gas tanks. These tanks are the best on the market and have an OE appearance. All popular models in stock at competitive prices.



YEAR	DESCRIPTION	PART #
1963	with Grommet.....	890-1063
64-66	Small, 2" Filler.....	890-1064
1967	Large, 2 1/4" Filler	890-1067
68-70	without Vent Pipe	890-1068
70-71	with 4 Side Vent Pipes	890-1070-4
71-76	with 1 Front Vent Pipe	890-1071

895) Rear Frame Rail, OE Style



67-76	LH.....	895-1067-L
67-76	RH.....	895-1067-R

900) Tail Light Panel

Dart



67-69	Outer Lower.....	900-2067
-------	------------------	----------



67-69	Inner Lower	900-2067-1
-------	-------------------	------------

68-69	Outer Tail Light Mount, LH.....	900-2068-L
68-69	Outer Tail Light Mount, RH.....	900-2068-R



Duster



70-71	900-1370
-------	-------	----------



1972	900-1372
1973	900-1373

Demon



71-72	900-2371
-------	-------	----------



910) Tail Light Bracket

Use when replacing tail light panel.

Duster / Demon

YEAR	DESCRIPTION	PART #
70-71	LH (pictured).....	910-1370-L
70-71	RH.....	910-1370-R
1972	LH (pictured).....	910-1372-L
1972	RH.....	910-1372-R



920) Tail Light Panel Reinforcement Bracket / Rear Jack Bracket

Dart

67-69	LH.....	920-1067-L
67-69	RH.....	920-1067-R
67-69	Pair.....	920-1067-P



Duster / Demon / Dart Sport

70-76 Duster, 71-72 Demon, 73-76 Dart Sport

70-76	LH	920-1370-L
70-76	RH	920-1370-R
70-76	Pair (pictured).....	920-1370-P

960) Rear Valance Panel

Dart / Scamp



70-72 Will fit 1973 with minor modifications.....960-2070

Barracuda

Back-up light holes must be cut for 1967 & 1969 models.



68-69 without Tips, will fit 1967 models960-1267



68-69 with Tips, will fit 1967 models 960-1267-T

970) Rear Bumper Bracket Set

Dart



67-69 Set970-2067-S



67-69 Front/Rear Set, 8 Pieces105-2067-1S

970) Rear Bumper Bracket Set, continued
Barracuda

YEAR	DESCRIPTION	PART #
67-69	Set	970-1267-S

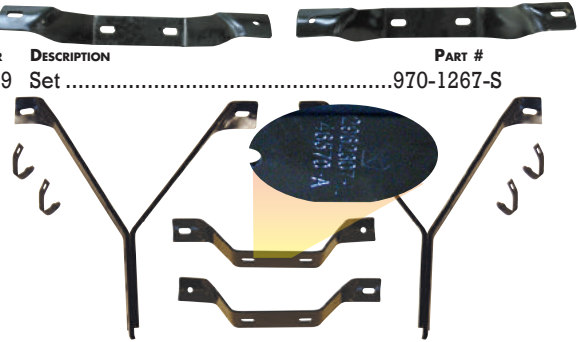

67-69 Front/Rear/Outer Set, 10 Pieces.....105-1267-1S

Duster

70-72	Set, 4 Pieces	970-1370-S
-------	---------------------	------------

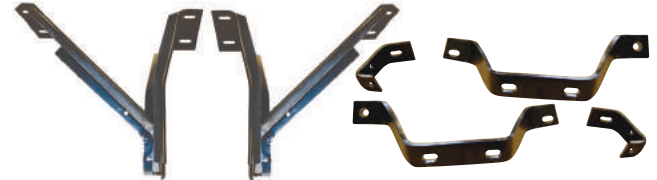

70-72 Front/Rear Set, 8 Pieces105-1370-1S

990) Rear Bumper

, **, *, indicates bumper bolt sets required. See section 101, next page.*

Dart

68-69	990-2068	**
-------	-------	----------	-------	----



1970 without Jack Slots990-2070***

Barracuda

67-69	(also Fits Front).....	100-1267	***
-------	------------------------	----------	-------	-----



70-71 also 67-70 Valiant, without Jack Slots990-1370**



71-72 with Jack Slots990-1371**

Can't find your part in our catalog? Many new "A"-Body items are being developed! Call Us!

For years our customers have been asking us for the parts and accessory items they need when restoring their Dodge or Plymouth muscle car. So we now have a large selection of moldings, bolt kits, rubber bumpers, seals and other parts to finish your restoration. See our **NEW Parts & Accessories** section, starting on page 51.



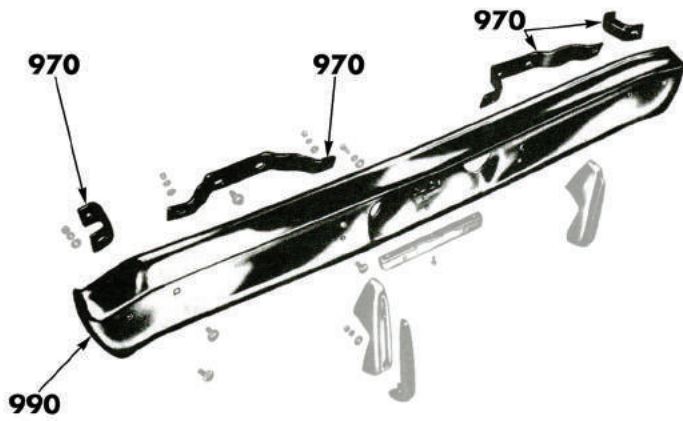

990) Rear Bumper

* **, ***, indicates bumper bolt sets required.
See section 101, below.

Demon



YEAR	DESCRIPTION	PART #
1971	without Jack Slots	990-1370 **
71-72	with Jack Slots	990-1371 **

101) Bumper Bolt Set

(Bolt, Flat & Lock Washers, Nut)

*	16 Pieces (4 bolts)	101-1000-16S
**	24 Pieces (6 bolts)	101-1000-24S
***	32 Pieces (8 bolts)	101-1000-32S



FINALLY, you can get **quality**, great-fitting glass for your A-Body Dodge or Plymouth muscle car! This premium reproduction glass from Auto Metal Direct has the correct thickness and fit, is licensed by Chrysler, and includes the authentic Pentastar logo. (Not date coded)



Glass

Buy a Kit & Save!

499) Complete Glass Kit

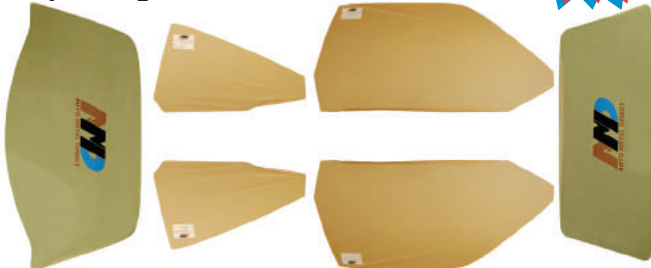

Dart / Scamp

YEAR	DESCRIPTION	PART #
67-74	Clear	499-2067-CS
67-74	Tinted	499-2067-TS

Duster / Demon / Dart Sport

70-76 Duster, 71-72 Demon, 73-76 Dart Sport

70-72	Clear, with 6 Hole Door Glass	499-1370-CS
70-72	Tinted, with 6 Hole Door Glass	499-1370-TS
73-74	Clear, with 5 Hole Door Glass	499-1373-CS
73-74	Tinted, with 5 Hole Door Glass	499-1373-TS
74-76	Clear, with 7 Hole Door Glass	499-1374-CS
74-76	Tinted, with 7 Hole Door Glass	499-1374-TS

All **AMP** glass is the same thickness as OE.

380) Windshield



Dart / Barracuda

YEAR	DESCRIPTION	PART #
67-76	Dart, 67-69 Barracuda	
67-76	Clear	380-1067-C
67-76	Tinted	380-1067-T

Duster / Demon / Dart Sport

70-76	Duster, 71-72 Demon, 73-76 Dart Sport	
70-76	Clear	380-1370-C
70-76	Tinted	380-1370-T

384) Windshield Gaskets

A-Body

68-76	2-Door Hardtop, except Duster, Demon, & Dart Sport, Accepts Trim	G-WCRD690
68-69	Convertible Only, Accepts Trim..	G-WCRD690A

Barracuda

1967 Except Convertible, Accepts Trim..G-WCRD690B

Duster / Demon / Dart Sport

70-76	Duster, 71-72 Demon, 73-76 Dart Sport	
70-76	Accepts Trim	G-WCRD759

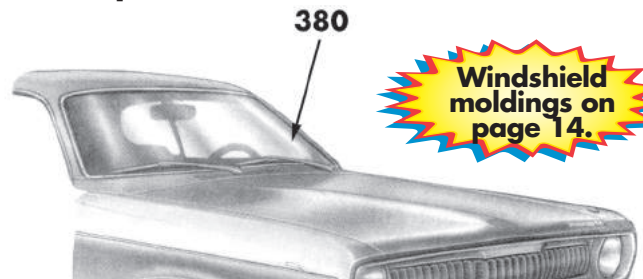

AMP
AUTO METAL DIRECT
Our Name Says It All!

Authentic Restoration Product
MOPAR, BEEF, DODGE, HEAR, PLYMOUTH, RAM, SEI, CHRYSLER and related logos, vehicle model names and trade dress are trademarks of Chrysler Group LLC, used under license. © 2011 Chrysler Group LLC

385) Windshield Molding

Dart / Scamp / Barracuda

YEAR	DESCRIPTION	PART #
68-76 Dart, 71-76 Scamp, 68-69 Barracuda		
68-76	2-Door Hardtop, 5-Piece Set.....	385-2067-S

Duster / Demon / Dart Sport

YEAR	DESCRIPTION	PART #
70-76 Duster, 71-72 Demon, 73-76 Dart Sport		
70-76	5-Piece Set.....	385-1370-S

550) Door Glass

Dart



68-72	LH, Clear (pictured, left).....	550-2067-CL
68-72	RH, Clear (pictured, right).....	550-2067-CR
68-72	LH, Tinted.....	550-2067-TL
68-72	RH, Tinted.....	550-2067-TR

Duster / Demon / Dart Sport

70-76 Duster, 71-72 Demon, 73-76 Dart Sport		
with 6 Holes		
70-72	LH, Clear.....	550-1370-CL
70-72	RH, Clear.....	550-1370-CR
70-72	LH, Tinted.....	550-1370-TL
70-72	RH, Tinted.....	550-1370-TR

with 5 Holes

73-74	LH, Clear.....	550-1373-CL
73-74	RH, Clear.....	550-1373-CR
73-74	LH, Tinted.....	550-1373-TL
73-74	RH, Tinted.....	550-1373-TR

with 7 Holes

74-76	LH, Clear.....	550-1374-CL
74-76	RH, Clear.....	550-1374-CR
74-76	LH, Tinted.....	550-1374-TL
74-76	RH, Tinted.....	550-1374-TR

560) Vent Glass

Dart/ Barracuda

68-72	LH, Clear (pictured).....	560-2067-CL
68-72	RH, Clear.....	560-2067-CR
68-72	LH, Tinted.....	560-2067-TL
68-72	RH, Tinted.....	560-2067-TR

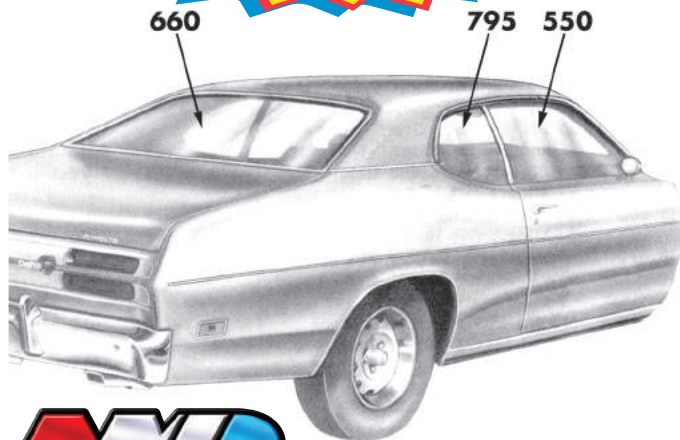
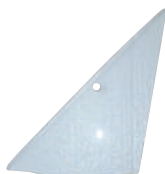

795) Quarter Glass

Dart



YEAR	DESCRIPTION	PART #
68-72	LH, Clear (pictured).....	795-2067-CL
68-72	RH, Clear (pictured).....	795-2067-CR
68-72	LH, Tinted.....	795-2067-TL
68-72	RH, Tinted.....	795-2067-TR

Duster / Demon / Dart Sport

70-76 Duster, 71-72 Demon, 73-76 Dart Sport		
70-72	LH, Clear.....	795-1370-CL
70-72	RH, Clear.....	795-1370-CR
70-72	LH, Tinted.....	795-1370-TL
70-72	RH, Tinted.....	795-1370-TR
73-76	LH, Clear.....	795-1373-CL
73-76	RH, Clear.....	795-1373-CR
73-76	LH, Tinted.....	795-1373-TL
73-76	RH, Tinted.....	795-1373-TR

660) Back Glass

Dart



67-72	Clear (pictured).....	660-2067-C
67-72	Tinted.....	660-2067-T

Duster / Demon / Dart Sport

70-76 Duster, 71-72 Demon, 73-76 Dart Sport		
70-76	Clear.....	660-1370-C
70-76	Tinted.....	660-1370-T

661) Rear Window Gasket

A-Body

68-76	2-Door Hardtop, Except Duster, Demon, Dart Sport, Accepts Trim.....	G-WCRDB3861
-------	---	-------------

Duster / Demon / Dart Sport

70-76	Accepts Trim.....	G-WCRDB4932
70-76	Rear Window Lockstrip, Black.....	G-WLS900

670) Glass Molding

Dart / Scamp

67-76	Dart, 71-76 Scamp 4-Piece Set.....	670-2067-S
-------	------------------------------------	------------

Duster / Demon / Dart Sport

70-76	Duster, 71-72 Demon, 73-76 Dart Sport 4-Piece Set.....	670-1370-S
-------	--	------------

384) Window Ribbon Seal

Required on any windshield or back glass that does not use a rubber seal/gasket.



ALL	3/8" x 15'.....	384-1000-3
ALL	5/16" x 15'.....	384-1000-5



"B" Body

Dodge

330/440
Charger
Coronet
Dart (1962)
Polara (1963-64)
Super Bee

Plymouth

Belvedere
Fury (1962-64)
GTX
Road Runner
Satellite
Savoy (1962-64)

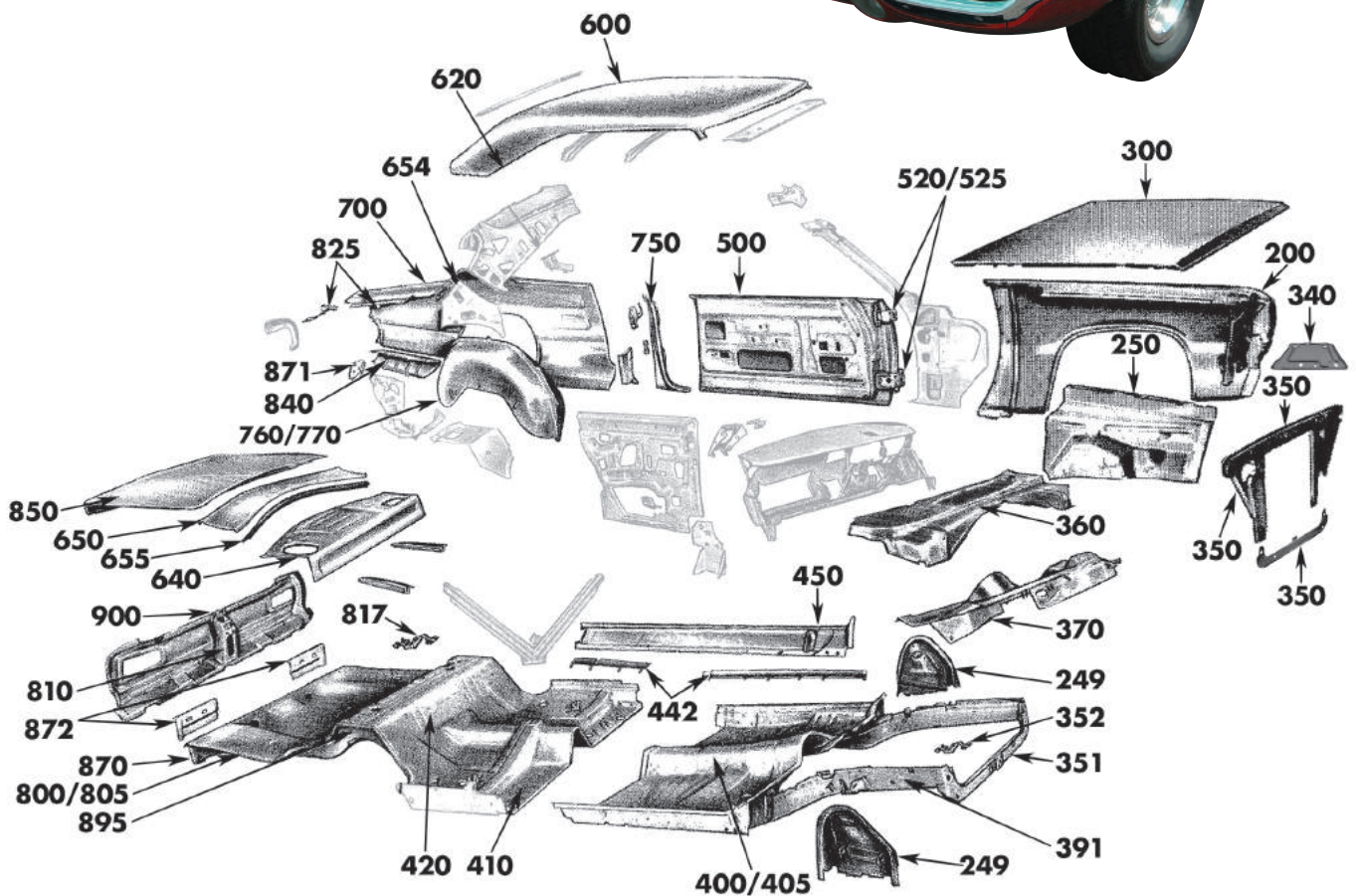

1962-74
"B" Body 2-Door

AMP
AUTO METAL DIRECT
Our Name Says It All!

Authentic Restoration Product
MOPAR, BEE, DODGE, HEMI, PLYMOUTH, RAM, SEI, CHRYSLER and related logos, vehicle model names and trade dress are trademarks of Chrysler Group LLC, used under license. © 2015 Chrysler Group LLC

“B” Body

Back in the day, whenever you heard the unmistakable rumble of a big-block Mopar engine on the road, there was a very good chance it would be a B-Body muscle car, whether a Charger, Roadrunner, Super Bee, GTX, or Coronet RT. Today muscle car enthusiasts worship these special cars *(as you often see reflected in prices on the auction block!)*, but for many years it has been tough to find good quality body parts. Here at Auto Metal Direct we REALLY know Mopar cars inside and out. Check out the parts on the following pages!

Some items listed below are not shown in the exploded view on the previous page.

#	Part Description	#	#	Part Description	Page #
100	Front Bumper.....	17	545	Door Window Regulator.....	23
101	Bumper Bolt Set.....	17	550	Door Glass.....	34
105	Front Bumper Bracket Set.....	17	560	Vent Glass.....	34
106	Front Stabilizer Bracket (Corner).....	17	562	Vent Window Support Bracket.....	23
110	Front Bumper Guards & Bumperettes.....	17	570	Outside Mirrors.....	60
120	Front Bumper Shield Lower.....	18	600	Roof Skin.....	23
125	Front Valance.....	18	610	Upper Rear Roof Bow.....	23
130	Lower Grille Panel.....	18	620	Drip Rail.....	23
151	Grille / Headlight Support.....	18	635	Vinyl Top Molding Set.....	23
200	Front Fender.....	18	640	Package Tray.....	23
205	Front Fender Patch.....	18	650	Deck Filler Panel.....	23
220	Front Fender Brace.....	18	651	Deck Filler Panel Center Support.....	23
250	Front Inner Fender.....	18	654	Deck Filler Corner Brackets & Patch.....	24
251	Fender Rear Splash Shield.....	19	655	Lower Rear Window Frame.....	24
255	Front Inner Fender Cover/Plate.....	19	656	Deck Filler Panel Lower Plenum.....	24
260	Inner Fender to Cowl Bracket.....	19	660	Back Glass.....	34
280	Antenna.....	53	670	Back Glass Molding Set.....	34
300	Hood.....	19	700	Quarter Panel, OE Style.....	24-25
301	Hood Scoop.....	19	710	Quarter Panel Skin.....	25-26
310	Hood Hinges.....	19	725	Quarter Panel Patch, Lower Front.....	26
320	Hood Insert Set.....	19	750	Door Jamb Pillar.....	26
340	Battery Tray.....	19	755	Quarter Panel Patch, Lower Rear.....	26
350	Radiator Support.....	20	760	Inner Wheelhouse.....	26
351	Lower Radiator Support.....	20	761	Wheelhouse Vapor Canister Shield.....	27
352	K Member to Radiator Support Brace.....	20	764	Deck Support.....	27
353	Inner Fender Splash Shield.....	20	770	Outer Wheelhouse.....	27
355	Fan Shroud.....	55	776	Quarter Panel Lower Rear Valance Corner.....	27
360	Upper Cowl.....	20	795	Quarter Glass.....	34
370	Firewall.....	20	796	Quarter Glass Latch Assembly.....	34
376	Cowl Side Hinge Panel.....	20	800	Trunk Floor, Full.....	27
380	Windshield.....	33	805	Trunk Floor Halves.....	27
384	Window Ribbon Seal.....	34	810	Trunk Lock Support.....	27
385	Windshield Molding Set.....	34	816	Spare Tire Hardware.....	27
391	Front Frame Rail.....	20	817	Spare Tire Hold Down Bracket.....	27-28
395	Torsion Bar Crossmember.....	20	818	Jack Bracket.....	28
400	Front Floor Pan, Full.....	20	820	Trunk Floor Brace.....	28
405	Front Floor Pan, Halves.....	21	825	Trunk Gutter.....	28-29
407	Bucket Seat Brackets.....	20	840	Trunk Floor Extension.....	29
410	Rear Floor Pan / Footwell Area.....	21	841	Trunk Floor Extension End Cap.....	29
415	Manual Transmission Shifter Tunnel.....	21	850	Deck Lid.....	30
420	Rear Floor Pan/Under Rear Seat.....	21	860	Upper Rear Crossmember (Shock Mount).....	30
425	Main Floor Pan Support Set.....	21	865	Rear Leaf Spring Mount.....	30
437	Rocker to Frame Lower Splash Shield.....	21	870	Rear Crossmember.....	30
440	Inner Rocker Panel.....	21	871	Rear Crossmember Extension.....	30
441	Emergency Cable Bracket.....	22	872	Quarter Panel Inner Reinforcement.....	30
442	Floor Wiring Cover.....	22	880	Gas Tank Straps.....	30
445	Sill Plates.....	57	881	Gas Tank Sending Units.....	30
450	Outer Rocker Panel.....	21	890	Gas Tanks.....	31
451	Rocker Box / Rocker End Cap.....	21	891	Gas Tank Necks.....	31
488	Interior Trim Screw Sets.....	58	895	Rear Frame Rail, OE Style.....	31
490	Console Bracket Set.....	22	900	Tail Light Panel.....	31
499	Complete Glass Kits.....	33	920	Tail Light Panel Reinforcement Brackets.....	31
500	Door Shell, OE Style.....	22	960	Rear Valance.....	32
510	Door Skin.....	22	962	Trunk Floor to Valance Reinforcement.....	32
520	Door Hinge, Upper.....	22	970	Rear Bumper Bracket Set.....	32
525	Door Hinge, Lower.....	22	980	Rear Bumper Guards.....	32
			990	Rear Bumper.....	32
			999	Emblems.....	65



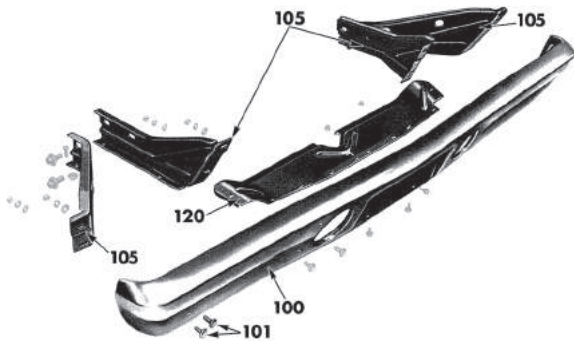

100) Front Bumper

** **, *** indicates bumper bolt sets required. See section 101, below.*

Charger



YEAR	DESCRIPTION	PART #
68-69	includes Bumperettes	100-2668***
1970	100-2670
1971	100-2671*
1972	100-2672*

Coronet



68-69	Coronet/Super Bee	100-2468***
-------	-------------------------	-------------------

Road Runner / GTX



68-69	100-1468***
1970	100-1470***
1971	100-1471*
1972	100-1472*

** **, *** indicates bumper bolt sets required. See section 101, below.*

101) Bumper Bolt Set

(Bolt, Flat & Lock Washers, Nut)

*	16 Pieces (4 bolts)	101-1000-16S
**	24 Pieces (6 bolts)	101-1000-24S
***	32 Pieces (8 bolts)	101-1000-32S



105) Front Bumper Bracket Set

Charger



68-69	Front Bracket Set.....	105-2668-S
-------	------------------------	------------



68-69	Center Bar	105-2668-2
-------	------------------	------------



68-69	Front/Rear/Center/ Outer Set, 9 Pieces	105-2668-1S
-------	---	-------------

105) Front Bumper Bracket Set, continued

Coronet



YEAR	DESCRIPTION	PART #
68-69	Front Set, 4 Pieces	105-2468-S



68-69	Front/Rear Set, 6 Pieces	105-2468-1S
-------	--------------------------------	-------------

Road Runner / GTX



68-69	Front Set, 4 Pieces	105-1468-S
-------	---------------------------	------------



68-69	Front/Rear Set, 6 Pieces	105-1468-1S
-------	--------------------------------	-------------



1970	Front Set, 4 Pieces	105-1470-S
------	---------------------------	------------



1970	Front/Rear Set, 6 Pieces	105-1470-1S
------	--------------------------------	-------------

106) Front Bumper Corner / Stabilizer Bracket

Charger

68-69	Pair	106-2668-S
-------	------------	------------



110) Front Bumper Guards

Included with Charger bumper.

Charger

68-69	Pair (pictured).....	110-2668-P
-------	----------------------	------------



120) Front Bumper Shield, Lower

Fits below bumper between bumper brackets

Coronet



68-69	120-2468
-------	-------	----------

Road Runner / GTX



68-69	120-1468
-------	-------	----------



1970	120-1470
------	-------	----------



125) Front Valance

B-Body



YEAR	DESCRIPTION	PART #
1963	Dodge	125-2463



1963	Plymouth	125-1463
------	----------------	----------

Charger



68-69	125-2668
-------	-------	----------



1970	125-2670
------	-------	----------



71-72	125-2671
-------	-------	----------



73-74	125-2673
-------	-------	----------

Road Runner / GTX



71-72	125-1471
-------	-------	----------

130) Lower Grille Panel

Road Runner / GTX



68-69	130-1468
-------	-------	----------

151) Grille / Headlight Support, Full OE Style

Upper Grille Reinforcement Fender Tie Bar

Charger



68-69	151-2668
-------	-------	----------

155) Lower Grille Molding

Plymouth

70	X155-1470
----	-------	-----------

200) Front Fender

Charger



YEAR	DESCRIPTION	PART #
1968	LH	200-2668-L
1968	RH	200-2668-R
1969	LH	200-2669-L
1969	RH	200-2669-R

Road Runner / GTX



1968	LH	200-1468-L
1968	RH	200-1468-R
1969	LH	200-1469-L
1969	RH	200-1469-R

205) Front Fender Patch, Lower Rear

Includes brace.

Dodge

63-64	LH	205-1463-L
63-64	RH	205-1463-R
1965	LH	205-1464-L
1965	RH	205-1464-R



Charger

68-69	LH	205-2668-L
68-69	RH	205-2668-R

Plymouth

1963	LH	205-1463-L
1963	RH	205-1463-R
64-65	LH	205-1464-L
64-65	RH	205-1464-R

Road Runner / GTX

68-69	LH	205-1468-L
68-69	RH	205-1468-R
71-72	LH	205-1471-L
71-72	RH	205-1471-R

220) Front Fender Brace

Connects lower front of fender to bumper bracket.

B-Body, except Charger



68-69	LH/RH	220-1468
68-69	Pair	220-1468-P

250) Front Inner Fender



66-70	LH	250-1466-L
66-70	RH	250-1466-R
66-70	Pair	250-1466-P



251) Fender Rear Splash Shield

Fits behind front wheel between fender and firewall.

B-Body

1963	Pair	251-1463-P
1964	Pair	251-1464-P
1965	Pair	251-1465-P

Dodge B-Body

1964	Pair	251-2464-P
68-70	Pair (includes Charger)	251-2468-P

Plymouth B-Body

1964	Pair	251-1464-P
68-70	Pair	251-1468-P



255) Front Inner Fender Cover / Plate

B-Body

62-65	Pair	255-1462-P
66-70	Pair	255-1466-P
71-72	Pair	255-1570-P



260) Inner Fender to Cowl Bracket

Use when replacing inner fender or cowl.

Lower

66-70	LH	260-1466-1L
66-70	RH	260-1466-1R

Upper

66-70	Pair	260-1466-P
66-70	LH	260-1466-L
66-70	RH	260-1466-R



Replace the rusted, bent, or missing original Hood on your Charger, Roadrunner, GTX, or Satellite, with these beautiful brand-new top-quality reproduction Hoods from craftsmen who really know Dodge and Plymouth muscle car sheet metal.

301) Hood Scoop

YEAR	DESCRIPTION	PART #	PRICE
70-71	70 Plymouth Air Grabber/ 71-up Ram Charger Hood Scoop (included with Air Grabber Hood).....	301-1470	



310) Hood Hinge Set

B-Body

68-70	LH & RH, includes springs, Pair	310-1468-P
-------	---------------------------------------	-------	------------

NEW!
Not Rebuilt



340) Battery Tray

B-Body

62-65	with Brace (pictured, left)	340-1462
66-69	340-1466
70-72	340-1570
73-74	(pictured, right)	340-1473

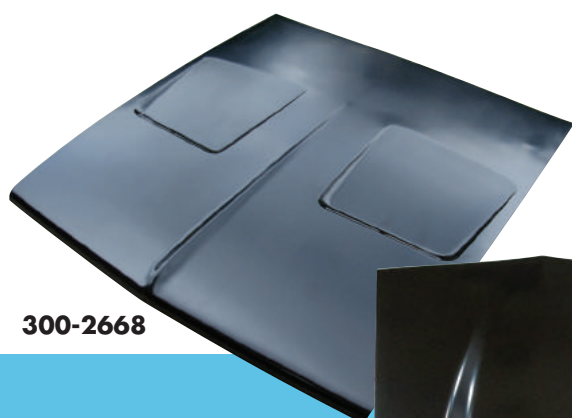

300-2668

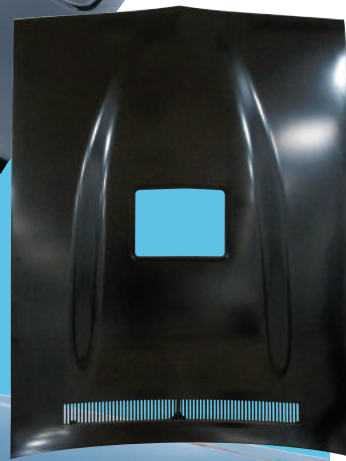

300-2671-2S

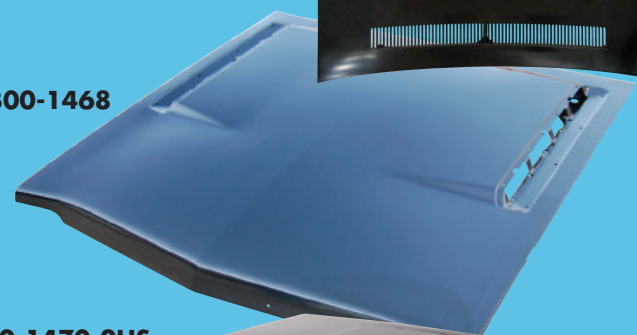

300-1468

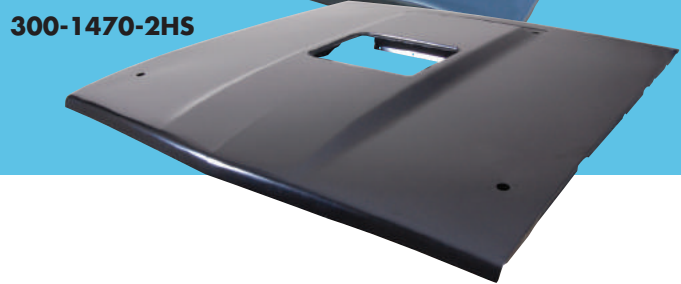

300-1470-2HS

Hoods

A brand new Steel Hood is the only way to go!

Eliminate the rust, dents, body-filler, and hood scoop holes found in old worn B-Body hoods with a brand new steel factory-style Hood from Auto Metal Direct. All underside bracing and brackets are faithful reproductions of originals, and are manufactured on our own steel tools. Fully coated with EDP, these gorgeous hoods will look great on your car for a very long time.

300) Hoods

Charger

68-69	Hood	300-2668
71-74	Charger Power Bulge Hood	300-2671-1
71-74	Charger Ramcharger Hood (includes Scoop)	300-2671-2S

Road Runner

Standard

68-69	Road Runner/GTX Hood	300-1468
68-69	2 Latch Locations	300-1468-A
1970	without Pin Holes	300-1470-1
1970	with Pin Holes	300-1470-1H

Fresh Air

1970	with Pin Holes, includes Scoop	300-1470-2HS
1970	without Pin Holes, includes Scoop	...	300-1470-2S



Our Name Says It All!



350) Radiator Support Assembly

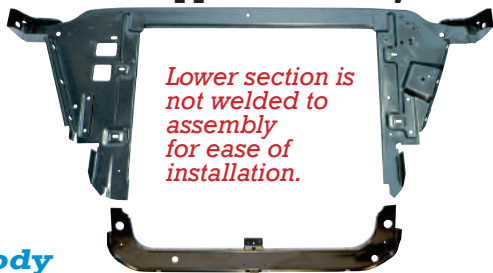

B-Body

YEAR	DESCRIPTION	PART #
66-68	(pictured)	350-1466-S
66-68	Core Support (Upper Section Only)	350-1466
69-70		350-1469-S
69-70	Core Support (Upper Section Only)	350-1469
71-72		350-1570-S
71-72	Upper section only. For the upper and lower Kit use # 350-1570-S	350-1570

351) Lower Radiator Support

B-Body

66-70	(pictured at bottom of above photo)	351-1466
71-72		351-1570

352) K-Member to Radiator Support Brace

B-Body

66-70		352-1466
-------	--	----------

353) Front Inner Fender Splash Shield

Screws to valance panel and front fender.

Charger



68-69	Pair	353-2668-S
-------	------	------------

360) Cowl



66-70	Upper Cowl	360-1466
-------	------------	----------



68-70	Lower Cowl / Plenum	360-1466-1
-------	---------------------	------------

370) Firewall, Full OE Style



66-70	without AC	370-1466
66-70	with AC (pictured)	370-1466-AC

376) Cowl Side Hinge Panel

B-Body

YEAR	DESCRIPTION	PART #
66-70	LH	376-1466-2L
66-70	RH	376-1466-2R



387) Starter Splash Shield

Mounts to left hand Frame Rail.

B-Body

66-70	LH, auto trans only	387-1466
-------	---------------------	----------



391) Front Frame Rail

Shock Tower included with Rail.

B-Body



66-70	LH	391-1466-L
66-70	RJ	391-1466-R

395) Torsion Bar Crossmember

B-Body



66-70		395-1466
71-72		395-1570

400) Front Floor Pan, Full OE Style

Complete coverage like original.

B-Body

Comes with fasteners and brackets for speedometer cable, emergency brake cable and seat belts

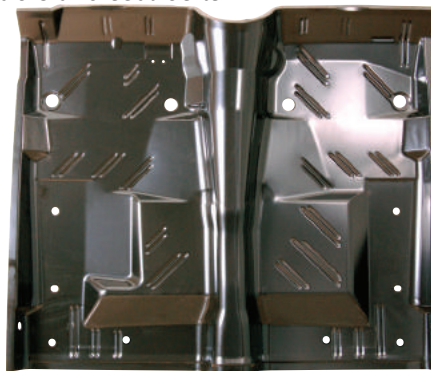

62-65	Full OE Style	400-1462
-------	---------------	----------



66-70	Full OE Style	400-1466
71-72	Full OE Style (fits 73-74 with minor modifications)	400-1571
	1971-74 comes with brackets for bucket seats and speedometer cable.	

405) Front Floor Pan, Half

Does not include top area of transmission tunnel.



B-Body

YEAR	DESCRIPTION	PART #
66-70	LH (pictured).....	405-1466-L
66-70	RH (pictured)	405-1466-R
71-73	LH.....	405-1571-L
71-73	RH.....	405-1571-R

407) Bucket Seat Brackets

*Included with all AMD floor pans.
Required when changing from
bench to bucket seats*

66-70	4-Piece Set.....	407-1466-S
-------	------------------	------------



410) Rear Floor Pan /Footwell Area

*Connects to Full Floor Pan to give
complete OE style floor coverage.*

Dodge B-Body



1962	Pair (pictured).....	410-1462-P
1962	LH.....	410-1462-L
1962	RH.....	410-1462-R
63-64	LH.....	410-2463-L
63-64	RH.....	410-2463-R
1962	Pair (pictured).....	410-1462-P
1965	LH.....	410-1462-L
1965	RH.....	410-1462-R

Plymouth B-Body

1962	Pair (pictured).....	410-1462-P
62-65	LH.....	410-1462-L
62-65	RH.....	410-1462-R

B-Body



66-70	Pair.....	410-1466-P
66-70	LH.....	410-1466-L
66-70	RH.....	410-1466-R
1971	Pair (modify for 1972) (pictured).....	410-1471-P
1971	LH (modify for 1972).....	410-1471-L
1971	RH (modify for 1972).....	410-1471-R

**Make sure you
test-fit all items before
priming and painting.**



Our Name Says It All!



415) Manual Transmission Shifter Tunnel

Fits AMD and OE floor pans.

B-Body

YEAR	DESCRIPTION	PART #
66-70	(pictured).....	415-1466
71-74	without Console.....	415-1471
71-74	with Console.....	415-1570



420) Rear Floor Pan / Under Rear Seat, Full OE Style

B-Body

*Includes brackets for
emergency brake cable,
exhaust hanger, pinion
snubber and rear seat.*

68-70	420-1468
-------	-------	----------

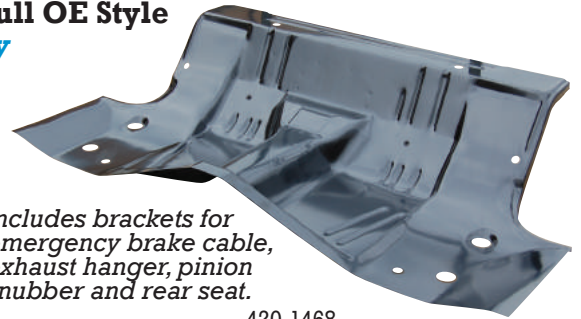

425) Main Floor Pan Support Set

Use when replacing floorpan.

B-Body

66-70	4 Pieces	425-1466-S
71-74	4 Pieces	425-1570-S



437) Rocker to Frame Lower Splash Shield



Fits between front of rocker panel and frame rail

B-Body

68-70	LH, 2-Pieces	437-1468-L
68-70	RH, 2-Pieces.....	437-1468-R
68-70	4-Piece Set (pictured)	437-1468-S

440) Inner Rocker Panel

B-Body

66-70	LH.....	440-1466-L
66-70	RH.....	440-1466-R



450) Outer Rocker Panel

B-Body

68-70	LH.....	450-1468-L
68-70	RH.....	450-1468-R



451) Rocker Panel End Cap

B-Body

68-70	LH.....	451-1468-L
68-70	RH.....	451-1468-R



441) Emergency Cable Bracket

Included with all AMD floor pans.

B-Body

YEAR	DESCRIPTION	PART #
66-70	441-1466



442) Floor Wiring Cover

Use when replacing floorpan.

B-Body



66-70	4 Pieces	442-1466-S
-------	----------------	------------

490) Console Bracket Set

B-Body

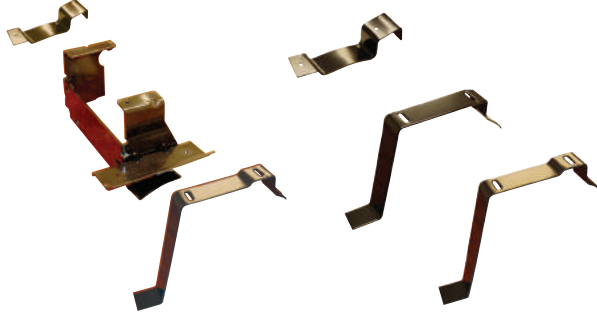

66-70	Automatic Transmission, 3 pieces (pictured, left)	490-1466-AS
66-70	Manual Transmission, 3 pieces (pictured, right)	490-1466-MS
71-74	Automatic Transmission	490-1570-AS
71-74	Manual Transmission	490-1570-MS

500) Door Shell, OE Style

B-Body, except Charger



1968	LH (pictured)	500-1468-L
1968	RH	500-1468-R
69-70	LH	500-1469-L
69-70	RH	500-1469-R

500) Door Shell, OE Style, continued

Charger

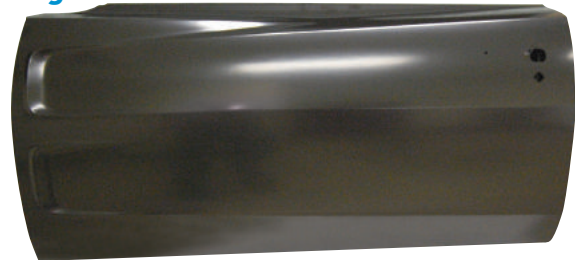

YEAR	DESCRIPTION	PART #
1968	LH	500-2668-L
1968	RH	500-2668-R
69-70	LH	500-2669-L
69-70	RH	500-2669-R

510) Door Skin

B-Body, except Charger

63-65	LH	510-1463-L
63-65	RH	510-1463-R



68-70	LH (pictured)	510-1468-L
68-70	RH	510-1468-R

Charger



68-70	LH	510-2668-L
68-70	RH	510-2668-R

520) Front Door Hinge, Upper

B-Body

62-65	LH	520-1462-L
62-65	RH	520-1462-R
66-70	LH	520-1466-L
66-70	RH	520-1466-R
71-74	LH	520-1471-L
71-74	RH	520-1471-R

NEW!
Not Rebuilt



525) Front Door Hinge, Lower

B-Body

62-65	LH	525-1462-L
62-65	RH	525-1462-R
66-70	LH	525-1466-L
66-70	RH	525-1466-R
71-74	LH	525-1471-L
71-74	RH	525-1471-R

NEW!
Not Rebuilt



Upper/Lower Sets

62-65	4-Piece Set	520-1462-S
66-70	4 Pieces	520-1466-S
71-74	4 Pieces	520-1471-S

Buy a Set and Save!

562) Vent Window Support Bracket

Always rusted. Mounts in the bottom of the door.

B-Body

YEAR	DESCRIPTION	PART #
62-65	LH.....	562-1462-L
62-65	RH.....	562-1462-R



600) Roof Skin, OE Style



B-Body, except Charger

68-70	600-1468
-------	-------	----------



Charger

68-70	600-2668
-------	-------	----------

610) Upper Rear Roof Bow

Fits above rear window under roof skin.

Charger



68-70	610-2668-1
-------	-------	------------

620) Drip Rail

Use when replacing Roof Skin. Drip Rail Moldings attach to these.

B-Body



68-70	Pair (includes Charger)	620-1468-S
-------	-------------------------------	------------

630) Drip Rail Molding



B-Body

68-70	Plymouth, 8-Piece Set (pictured)	630-1468-S
68-70	Dodge, 8-Piece Set.....	630-2468-S

635) Vinyl Top Molding



Charger

68-70	4-Piece Set (pictured)	635-2668-S
-------	------------------------------	------------

Dodge B-Body, except Charger

68-70	?-Piece Set.....	635-2468-S
-------	------------------	------------

Plymouth B-Body

68-70	2-Piece Set.....	635-1468-S
-------	------------------	------------

640) Package Tray

B-Body, except Charger



YEAR	DESCRIPTION	PART #
68-70	640-1468

Package Tray Extension / Support

68-70	LH.....	640-1468-L
68-70	RH.....	640-1468-R



Charger

Package Tray Extension / Support

68-70	LH.....	640-2668-L
68-70	RH.....	640-2668-R



68-70	Speaker Panel.....	640-2668
-------	--------------------	----------

68-70	Trim Retainer.....	640-2668-1
-------	--------------------	------------

650) Deck Filler Panel

B-Body, except Charger



68-70	650-1468
-------	-------	----------

Charger



68-70	650-2668
-------	-------	----------

Plymouth B-Body



71-74	650-1471
-------	-------	----------

651) Deck Filler Panel Center Support

Use when replacing deck filler panel.

B-Body, except Charger



68-70	Use 2 per Car	651-1468
-------	---------------------	----------



Our Name Says It All!



MOPAR, BEE, DODGE, HEAR, PLYMOUTH, RAM, SEI, CHRYSLER and related logos, vehicle model names and trade dress are trademarks of Chrysler Group LLC, used under license. © 2015 Chrysler Group LLC.

654) Deck Filler Corner Brackets & Patch
B-Body, except Charger



YEAR	DESCRIPTION	PART #
Outside Patch		
68-70	LH	654-1468-1L
68-70	RH	654-1468-1R
Inside Corner Bracket, OE Style		
68-70	LH	654-1468-2L
68-70	RH	654-1468-2R
Filler Patch Set		
68-70	4 Pieces (pictured)	654-1468-S
Back Glass Lower Corner Filler		
68-70	LH	654-1468-3L
68-70	RH	654-1468-3R

655) Lower Rear Window Frame
Use when replacing deck filler panel and/or package tray.

B-Body, except Charger

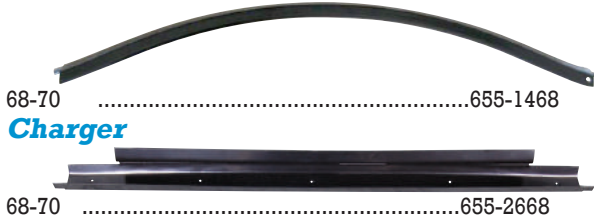

68-70	655-1468
Charger		
68-70	655-2668

656) Deck Filler Panel Lower Plenum

Charger
Fits under Deck Filler Panel

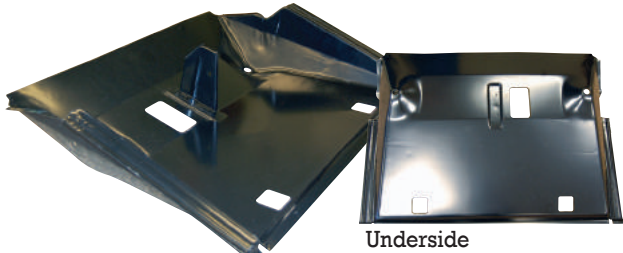

68-70	656-2668
-------	-------	----------

700) Quarter Panel, OE Style
Complete coverage like originals.

Charger



YEAR	DESCRIPTION	PART #
1968	LH (pictured)	700-2668-L
1968	RH	700-2668-R
1969	LH	700-2669-L
1969	RH	700-2669-R
1970	LH	700-2670-L
1970	RH	700-2670-R



1971	LH (pictured)	700-2671-L
1971	RH	700-2671-R
1972	LH	700-2672-L
1972	RH	700-2672-R

Coronet



1968	LH (pictured)	700-2468-L
1968	RH	700-2468-R
1969	LH	700-2469-L
1969	RH	700-2469-R

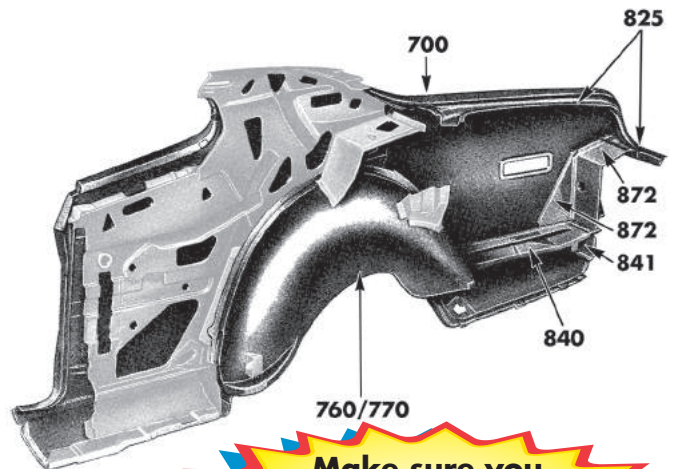

Make sure you test-fit all items before priming and painting.

Now Available!

Sheet Metal Installation Videos

Shot in HD, these DVDs combine the clear vision of the helmet cam and the easy teaching style of nationally recognized car builder, Craig Hopkins. No matter what your skill level, these DVDs will help you get professional results!

See Page 64



Our full skins will meet and attach to mating parts (wheelhouse, door jamb, and tail light panel area). Top edge of panel bends over upper body line about 1/2 inch

700) Quarter Panel, OE Style

Complete coverage like originals.

Plymouth B-Body



YEAR	DESCRIPTION	PART #
	<i>Correct for 1964 Hardtop, fits all 2-Door 1963-65's with slight modifications.</i>	
63-65	LH (pictured).....	700-1463-L
63-65	RH.....	700-1463-R

Road Runner / GTX



1968	LH (pictured).....	700-1468-L
1968	RH.....	700-1468-R
1969	LH.....	700-1469-L
1969	RH.....	700-1469-R



1970	LH.....	700-1470-L
1970	RH.....	700-1470-R



1971	LH (pictured).....	700-1471-L
1971	RH.....	700-1471-R
1972	LH.....	700-1472-L
1972	RH.....	700-1472-R

710) Quarter Panel Skin

Charger



YEAR	DESCRIPTION	PART #
1968	LH (pictured).....	710-2668-L
1968	RH.....	710-2668-R



1969	LH (pictured).....	710-2669-L
1969	RH.....	710-2669-R
1970	LH.....	710-2670-L
1970	RH.....	710-2670-R



1971	LH (pictured).....	710-2671-L
1971	RH.....	710-2671-R
1972	LH.....	710-2672-L
1972	RH.....	710-2672-R

Coronet



1968	LH (pictured).....	710-2468-L
1968	RH.....	710-2468-R
1969	LH.....	710-2469-L
1969	RH.....	710-2469-R

We Install What We Sell!

You already know that you can get premium sheet metal parts for your muscle car from Auto Metal Direct (AMD). Our panels fit and include all correct-as-original clips, tabs, flanges, bends & seams.

We are so confident in the quality and fit of our parts, that we have developed our own installation center!



Our Name Says It All!



Our full skins will meet and attach to mating parts (wheelhouse, door jamb, and tail light panel area). Top edge of panel bends over upper body line about 1/2 inch

710) Quarter Panel Skin, continued
Road Runner / GTX



YEAR	DESCRIPTION	PART #
1968	LH (pictured).....	710-1468-L
1968	RH.....	710-1468-R
1969	LH.....	710-1469-L
1969	RH.....	710-1469-R



1970	LH (pictured).....	710-1470-L
1970	RH.....	710-1470-R
1971	LH.....	710-1471-L
1971	RH.....	710-1471-R



1972	LH.....	710-1472-L
1972	RH.....	710-1472-R

750) Door Jamb Lock Pillar
Includes bracket on back side for door striker support

B-Body, except Charger

Sedan		
68-70	LH.....	750-1468-1L
68-70	RH.....	750-1468-1R
Hardtop		
68-70	LH.....	750-1468-2L
68-70	RH.....	750-1468-2R

Charger

68-70	LH.....	750-2668-2L
68-70	RH (pictured).....	750-2668-2R



755) Quarter Panel Patch, Lower Rear
Charger



YEAR	DESCRIPTION	PART #
68-70	LH (pictured, left).....	755-2668-1L
68-70	RH.....	755-2668-1R
71-72	LH.....	755-2671-1L
71-72	RH.....	755-2671-1R

Coronet



68-69	LH (pictured, left).....	755-2468-1L
68-69	RH (pictured, right).....	755-2468-1R

Road Runner / GTX



66-67	LH (pictured, left).....	755-1466-L
66-67	RH.....	755-1466-R
68-70	LH (pictured, right).....	755-1468-1L
68-70	RH.....	755-1468-1R
73-74	LH.....	755-1473-L
73-74	RH.....	755-1473-R

Plymouth B-Body



63-65	LH (pictured, left).....	755-1463-L
63-65	RH (pictured, right).....	755-1463-R
71-72	LH.....	755-1471-1L
71-72	RH.....	755-1471-1R

760) Inner Wheelhouse
B-Body



63-65	LH (pictured, left).....	760-1463-L
63-65	RH (pictured, right).....	760-1463-R



66-70	LH (pictured, left).....	760-1466-L
66-70	RH.....	760-1466-R
71-74	LH (pictured, right).....	760-1471-L
71-74	RH.....	760-1471-R

See our new line of AMD Apparel on Page 66!



761) Wheelhouse Vapor Canister Shield

Use when replacing LH wheelhouse.

B-Body



YEAR	DESCRIPTION	PART #
71-72	Front, LH Only (pictured, left)	761-1471-1
71-72	Rear, LH Only (pictured, right)	761-1471-2

764) Deck Support

Mounts from wheelhouse to deck filler.

B-Body, except Charger

68-70	LH	764-1468-1L	Inquire
68-70	RH	764-1468-1R	Inquire

Charger

Upper			
68-70	LH (pictured)	764-2668-2L	
68-70	RH	764-2668-2R	
Lower			
68-70	LH (pictured)	764-2668-1L	
68-70	RH	764-2668-1R	



770) Outer Wheel House

Use when replacing quarter panels.

Dodge B-Body



YEAR	DESCRIPTION	PART #
68-70	LH (pictured, left)	770-2468-L
68-70	RH	770-2468-R

Charger

71-72	LH (modify for 73-74)	770-2671-L
71-72	RH (modify for 73-74)	770-2671-R

Plymouth B-Body

63-65	LH (pictured)	770-1463-L
63-65	RH	770-1463-R
68-70	LH	770-1468-L
68-70	RH	770-1468-R
71-74	LH	770-1471-L
71-74	RH	770-1471-R



776) Lower Rear Quarter Panel to Valance Corner

Charger

Fits between quarter and valance panels

68-70	LH	776-2668-L
68-70	RH (pictured)	776-2668-R



Trunk Floors

Trunk Floors available in Full OE Style or split versions.

800) Trunk Floor, OE Style

B-Body

62-65	Full	800-1462
66-67	Full	800-1466
68-70	Full, OE Style	800-1468
71-73	Full, OE Style	(modify for 1974)
		800-1471

Charger

68-70	Full, OE Style	800-2668
-------	----------------	----------

805) Trunk Floor Halves

All split floors have lap seams, ready to weld.

B-Body

68-70	LH	805-1468-L
68-70	RH	805-1468-R
71-73	LH	805-1471-L
71-73	RH	805-1471-R

Charger

68-70	LH	805-2668-L
68-70	RH	805-2668-R

Detail of lap seam on split floor sections.



Detail of differences in rear flange of Charger and B-Body trunk floors.



AMP
AUTO METAL DIRECT
Our Name Says It All!

Authentic Restoration Product
MOPAR, BEEF, DODGE, HEAR, PLYMOUTH, RAM, SEI, CHRYSLER and related logos, vehicle model names and trade dress are trademarks of Chrysler Group LLC, used under license. © 2015 Chrysler Group LLC.

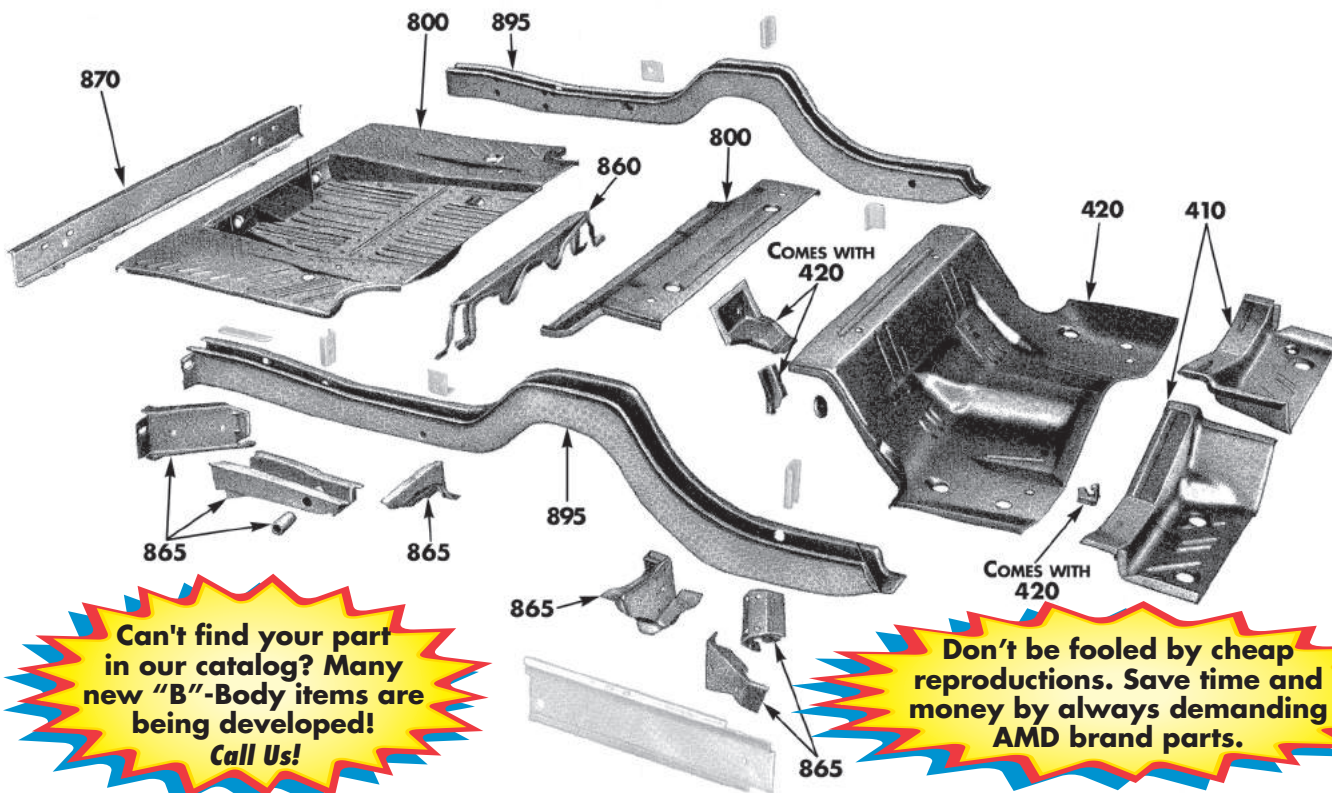

Can't find your part in our catalog? Many new "B"-Body items are being developed! Call Us!

Don't be fooled by cheap reproductions. Save time and money by always demanding AMD brand parts.

810) Trunk Lock Support

Use when replacing trunk floor and/or taillight panel.

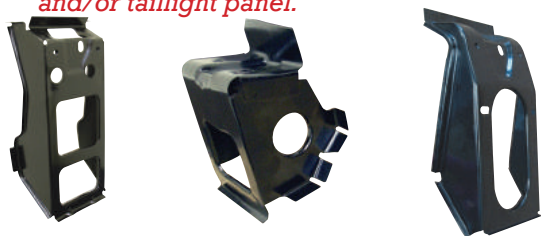

Charger

YEAR	DESCRIPTION	PART #
68-70	(pictured, left)	810-2668

Coronet

1969		810-2469
------	--	----------

Road Runner / GTX

68-69	(pictured, center)	810-1468
1970	(pictured, right)	810-1470

816) Spare Tire Stud, Wing Nut, Hardware Set

B-Body

YEAR	DESCRIPTION	PART #
1968	All	816-1468-2S
68-74	Hardtop (with 70 or 78 Series spare)	816-1468-9S
68-70	Convertible (with 70 or 78 Series spare)	816-1468-7S
1970	Convertible (with 60 Series spare)	816-1468-9S
71-74	(with 60 Series spare)	816-1471-10S



Spare Tire Stud Wing Nut

Wing Nut Only.....816-1468-1



Spare Tire Stud (Only)

1968	All, Hook on Bottom	816-1468-2
Other Years, with bolt hole on bottom		
	7 1/2" with 5 1/4" thread	816-1468-7
	9 1/4" with 4 1/2" thread	816-1468-9
	10 1/2" with 4 1/2" thread	816-1471-10

Now Available!

For years our customers have been asking us for the parts and accessory items they need when restoring their Dodge or Plymouth muscle car. So we now have a large selection of moldings, bolt kits, rubber bumpers, seals and other parts to finish your restoration. See our **NEW Parts & Accessories** section, starting on page 51.



817) Spare Tire Hold-Down Bracket

Use when replacing trunk floor.

B-Body

62-65		817-1462
66-67		817-1466
1968		817-1468-1
68-70	Convertible	817-1471
69-70	(pictured)	817-1468-2
71-72		817-1471



Charger

68-70	Spare Tire Support, 2-Piece Set	817-2668-S
-------	---------------------------------	------------



Our Name Says It All!™



818) Jack Bracket

B-Body

YEAR	DESCRIPTION	PART #
68-70	except Charger, includes Wingnut (pictured, left) 818-1468-1S	
71-73	2-Piece Set (pictured, right) 818-1471-S	

Charger

68-70	Front (pictured)..... 818-2668-1	
68-70	Spring Hook (pictured)..... 818-1570-1L	
68-70	Rear (pictured)..... 818-1570-2L	
68-70	Front/Rear Brackets, All 3 Pieces..... 818-2668-S	



820) Trunk Floor Brace

Use when replacing trunk floor.

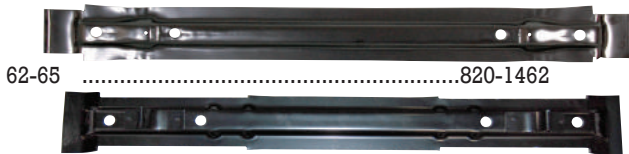

62-65 820-1462

68-70 Brace Set, 3 Pieces 820-1468-S



71-73 Brace Set, 2 Pieces 820-1471-P

825) Trunk Gutter

Use when replacing quarter panel.

Dodge, except Charger



Upper

68-70	LH..... 825-2468-1L
68-70	RH..... 825-2468-1R

Lower

1968	LH..... 825-2468-L
1968	RH..... 825-2468-R
1969	LH..... 825-2469-L
1969	RH..... 825-2469-R

Trunk Gutter Set (Upper / Lower)

1968	4 Pieces 825-2468-S
1969	4 Pieces (pictured)..... 825-2469-S

Charger

68-70	Pair (pictured)..... 825-2668-P
68-70	LH..... 825-2668-L
68-70	RH..... 825-2668-R
71-74	Pair..... 825-2671-S
71-74	LH..... 825-2671-L
71-74	RH..... 825-2671-R



825) Trunk Gutter, continued

Use when replacing quarter panel.

Road Runner / GTX



YEAR	DESCRIPTION	PART #
68-70	Upper, LH.....	825-1468-1L
68-70	Upper, RH.....	825-1468-1R
1968	Lower, LH.....	825-1468-L
1968	Lower, RH.....	825-1468-R
1968	Set, 4 Pieces (pictured)	825-1468-S
1969	Lower, LH.....	825-1469-L
1969	Lower, RH.....	825-1469-R
1969	Set, 4 Pieces.....	825-1469-S
1970	Lower, LH.....	825-1470-L
1970	Lower, RH.....	825-1470-R
1970	Set, 4 pieces.....	825-1470-S
71-74	LH.....	825-1471-L
71-74	RH.....	825-1471-R
71-74	Pair.....	825-1471-S

840) Trunk Floor Extension

Use when replacing quarter panels and/or trunk floor.

B-Body



62-65	LH.....	840-1462-L
62-65	RH.....	840-1462-R

Dodge B-Body

68-70	LH.....	840-2468-L
68-70	RH.....	840-2468-R

Charger

68-70	LH.....	840-2668-L
68-70	RH.....	840-2668-R
71-74	LH.....	840-2671-L
71-74	RH.....	840-2671-R

Plymouth B-Body



68-70	LH.....	840-1468-L
68-70	RH.....	840-1468-R

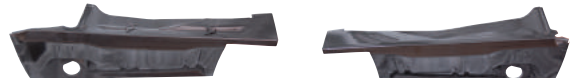

71-74	LH.....	840-1471-L
71-74	RH.....	840-1471-R

841) Trunk Floor Extension Endcap

B-Body

71-74	LH.....	841-1471-L
71-74	RH.....	841-1471-R



Our Name Says It All!





850) Deck Lid
Charger



YEAR	DESCRIPTION	PART #
68-69	modify for Spoiler Holes on '70	850-2668

860) Upper Rear Crossmember / Shock Mount
B-Body



66-70		860-1466
-------	--	----------

865) Leaf Spring Mount
B-Body, front



66-70	LH, Front	865-1466-1L
66-70	RH, Front	865-1466-1R

Dodge B-Body, rear

66-70	LH, Rear	865-2466-2L
66-70	RH, Rear	865-2466-2R
66-70	Set, Rear, 4 Pieces	865-2466-S

Plymouth B-Body, rear

66-70	LH, Rear	865-1466-2L
66-70	RH, Rear	865-1466-2R
66-70	Set, 4 Pieces (pictured)	865-1466-S

870) Rear Crossmember
B-Body



68-70		870-1468
-------	--	----------

Reinforcement (except Charger)
Welds to crossmember.

68-70	LH	871-1468-2L
68-70	RH	871-1468-2R



871) Rear Crossmember Extension
B-Body, except Charger

68-70	LH	871-1468-1L
68-70	RH	871-1468-1R



Charger

71-72	LH	871-2671-L
71-72	RH	871-2671-R



872) Quarter Panel Inner Reinforcement
Required when replacing quarter panel



Charger

YEAR	DESCRIPTION	PART #
71-72	LH (pictured, left)	872-2671-1L
71-72	RH (pictured, left)	872-2671-1R
Extension		
71-72	LH	872-2671-2L
71-72	RH (pictured, center)	872-2671-2R
Inner Support		
71-72	LH (pictured, right)	872-2671-L
71-72	RH	872-2671-R

Road Runner / GTX



872-1471-1L	872-1471-1R	872-1471-2L	872-1471-2R
Extension			
71-72	LH	872-1471-2L	
71-72	RH	872-1471-2R	
Inner Support			
71-72	LH	872-1471-1L	
71-72	RH	872-1471-1R	

880) Gas Tank Straps



B-Body

62-65	One Strap Required	880-1462
66-67	One Strap Required	880-1466
68-70	Pair	880-1468-P
71-73	Pair	880-1471-P

C-Body

67-73	Pair	880-1669-P
-------	------	------------

881) Gas Tank Sending Unit

B-Body

62-65	3/8"	881-1462-3
62-65	5/16" (pictured)	881-1462-5
66-67	3/8"	881-1466-3
66-67	5/16"	881-1466-5
68-70	3/8", with Return	881-1468-3R
68-70	5/16"	881-1468-5
71-73	3/8", with Return	881-1471-3R
71-73	5/16"	881-1471-5



AMP is the answer...

...because rust never sleeps.

Don't be fooled by cheap reproductions. Save time and money



890) Gas Tank

Now offering a complete line of Spectra Premium Industries brand gas tanks. These tanks are the best on the market and have an OE appearance. All popular models in stock at competitive prices.



B-Body, except Charger

YEAR	DESCRIPTION	PART #
62-63	without Grommet.....	890-1462
64-65	without Grommet.....	890-1464
68-70	with 2 Front Vent Pipes.....	890-1468-2
1970	with 4 Front Vent Pipes.....	890-1470-4

B-Body, including Charger

66-67	890-1466
71-72	with 4 Side Vent Pipes.....	890-1471
72-73	with 4 Front Vent Pipes.....	890-1472
74-76	890-1474

Charger Only

68-70	without EEC, 2 Front Vent Pipes.....	890-2668
1970	with EEC, 4 Side Vent Pipes.....	890-2670

C-Body

67-73	with 2 Vent Pipes.....	890-1667-1
67-73	with 4 Vent Pipes.....	890-1667-2

891) Gas Tank Neck

B-Body

68-70	with Cap (except Charger).....	891-1468
68-70	Gas Tank Neck Seal.....	891-1068-1

895) Rear Frame Rail, OE Style



B-Body

68-70	LH.....	895-2468-L
68-70	RH.....	895-2468-R

900) Tail Light Panel

Charger

Brackets for holding tail lights are already welded in place.



1968	900-2668
------	-------	----------



69-70	900-2669
-------	-------	----------

Make sure you test-fit all items before priming and painting.



Our Name Says It All!



900) Tail Light Panel, continued

Coronet

Brackets for holding tail lights are already welded in place.



YEAR	DESCRIPTION	PART #
1969	900-2469

Road Runner



1968	Lower.....	900-1468
------	------------	----------



1969	Lower.....	900-1469
------	------------	----------



1970	Holes for Plymouth letters are pre-drilled.....	900-1470
------	---	----------



900) Outer Tail Light Mount

Road Runner

1968	LH.....	900-1468-L
1968	RH.....	900-1468-R
1969	LH.....	900-1469-L
1969	RH (pictured).....	900-1469-R



920) Tail Light Panel

Reinforcement Bracket

Use when replacing taillight panel.

Charger



69-70	Pair.....	920-2669-P
-------	-----------	------------

Now Available!

For years our customers have been asking us for the parts and accessory items they need when restoring their Dodge or Plymouth muscle car. See our **NEW Parts & Accessories** section, starting on page 51.

PLYMOUTH

960) Rear Valance

Dodge B-Body

YEAR	DESCRIPTION	PART #	PRICE
1963		960-2463	
Charger			
1968	without Light Holes	960-2668	
69-70	with Light Holes	960-2669	
71-72	without Tips	960-2671	
71-72	with Tips	960-2671-T	
73-74	without Tips	960-2673	
73-74	with Tips	960-2673-T	
Road Runner			
1971	without Tips	960-1471	
1971	with Tips	960-1471-T	

962) Trunk Floor to Valance Reinforcement

Use when replacing trunk floor.

Charger	
68-70	Pair962-2668-S

970) Rear Bumper Bracket Set

Charger

68-70	Set, 2 Pieces970-2668-S
-------	-------------------------------

68-69	Front/Rear/Center/Outer Set, 9 Pieces105-2668-1S
-------	---

970) Rear Bumper Bracket Set, continued

Coronet

YEAR	DESCRIPTION	PART #
68-69	Set, 2 Pieces	970-2468-S
68-69	Front/Rear Set, 6 Pieces	105-2468-1S

Road Runner

68-69	Set, 2 Pieces	970-1468-S
68-69	Front/Rear Set, 6 Pieces	105-1468-1S
1970	Set, 2 Pieces	970-1470-S
1970	Front/Rear Set, 6 Pieces	105-1470-1S

980) Rear Bumper Guards

Included with Charger bumper.

Charger

68-70	Pair980-2668-P
-------	----------------------

981) Rear Bumper Guard Brackets

Charger

68-70	Pair981-2668-P
-------	----------------------

990) Rear Bumper

, **, *, indicates bumper bolt sets required. See section 101, below.*

Plymouth B-Body

1963990-1463*
1964990-1464*
1965990-1465*

Charger

68-70	with BUMPERETTES990-2668*
1971	without BUMPERETTES990-2671*
1972	without BUMPERETTES990-2672*

Coronet

68-69	Chrome990-2468***
-------	--------	---------------	----------

Road Runner / GTX

1968990-1468***
1969990-1469***
1970990-1470**
1971990-1471**

, **, *, indicates bumper bolt sets required. See section 101, below.*

101) Bumper Bolt Set

(Bolt, Flat & Lock Washers, Nut)

*	16 Pieces (4 bolts)101-1000-16S
**	24 Pieces (6 bolts)101-1000-24S
***	32 Pieces (8 bolts)101-1000-32S



FINALLY, you can get **quality**, great-fitting glass for your B-Body Dodge or Plymouth muscle car! This premium reproduction glass from Auto Metal Direct has the correct thickness and fit, is *licensed by Chrysler*, and includes the authentic Pentastar logo. (Not date coded)



Glass

499) Complete Glass Kit

Buy a Kit & Save!

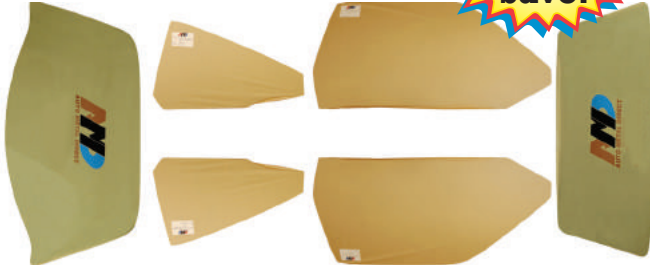

B-Body Hardtop

1963	Clear	499-1463-CS
1963	Tinted	499-1463-TS
64-65	Clear	499-1464-CS
64-65	Tinted	499-1464-TS
68-70	Clear	499-1468-CS
68-70	Tinted	499-1468-TS

Dodge B-Body Sedan

68-70	Clear	499-2468-CSS
68-70	Tinted	499-2468-TSS

Dodge Charger

68-70	Clear	499-2668-CS
68-70	Tinted	499-2668-TS
1971	Clear	499-2671-CS
1971	Tinted	499-2671-TS

Plymouth B-Body

68-70	Clear	499-1468-CSS
68-70	Tinted	499-1468-TSS
1971	Clear	499-1471-CS
1971	Tinted	499-1471-TS

380) Windshield

B-Body



62-63	All, Clear	380-1462-C
62-63	All, Tinted	380-1462-T
64-65	All, Clear	380-1464-C
64-65	All, Tinted	380-1464-T
66-67	Clear	380-1466-C
66-67	Tinted	380-1466-T
66-70	Convertible, Clear	380-1466-C
66-70	Convertible, Tinted	380-1466-T
68-70	Hardtop / Sedan, Clear	380-1468-C
68-70	Hardtop / Sedan, Tinted	380-1468-T
71-74	Clear	380-1471-C
71-74	Tinted	380-1471-T

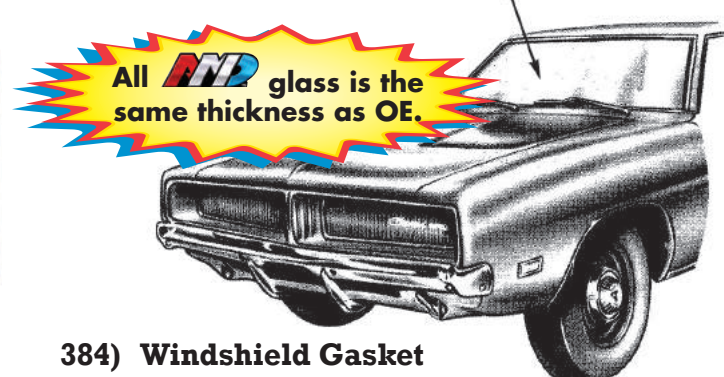

384) Windshield Gasket

B-Body

YEAR	DESCRIPTION	PART #
64-65	Except Convertible, Accepts Trim .G-WCRD647	
64-65	Convertible, Accepts Trim	G-WCRD647A
66-70	Convertible Only, Accepts Trim.....	G-WCRD671
66-67	2-Door Hardtop, Accepts Trim	G-WCRD671B
68-70	Except Convertible, Accepts Trim .G-WCRD715	

385) Windshield Molding Set

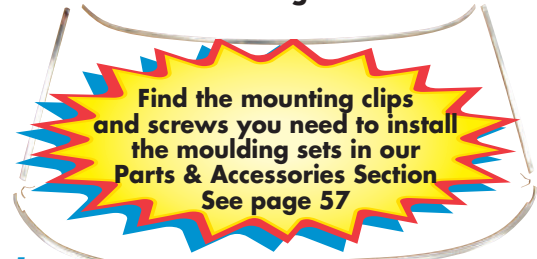

B-Body

68-70	385-1468-S
-------	-------	------------

550) Door Glass

B-Body Hardtop



68-70	LH, Clear	550-1468-CL
68-70	RH, Clear	550-1468-CR
68-70	LH, Tinted	550-1468-TL
68-70	RH, Tinted	550-1468-TR
71-74	LH, Clear	550-1471-CL
71-74	RH, Clear	550-1471-CR
71-74	LH, Tinted	550-1471-TL
71-74	RH, Tinted	550-1471-TR

B-Body Sedan

68-70	LH, Clear	550-1468-CSL
68-70	RH, Clear	550-1468-CSR
68-70	LH, Tinted	550-1468-TSL
68-70	RH, Tinted	550-1468-TSR



Our Name Says It All!



MOPAR, JEEP, DODGE, PLYMOUTH, RAM, SEV, CHRYSLER and related logos, vehicle model names and trade dress are trademarks of Chrysler Group LLC, used under license. © 2011 Chrysler Group LLC.

560) Vent Glass

B-Body

YEAR	DESCRIPTION	PART #
68-70	LH, Clear.....	560-1468-CL
68-70	RH, Clear	560-1468-CR
68-70	LH, Tinted	560-1468-TL
68-70	RH, Tinted	560-1468-TR



795) Quarter Glass



B-Body

Hardtop

68-70	LH, Clear.....	795-1468-CL
68-70	RH, Clear	795-1468-CR
68-70	LH, Tinted	795-1468-TL
68-70	RH, Tinted	795-1468-TR

Dodge B-Body

Sedan

68-70	LH, Clear.....	795-2468-CSL
68-70	RH, Clear	795-2468-CSR
68-70	LH, Tinted	795-2468-TSL
68-70	RH, Tinted	795-2468-TSR

Dodge Charger

1971	LH, Clear.....	795-2671-CL
1971	RH, Clear	795-2671-CR
1971	LH, Tinted	795-2671-TL
1971	RH, Tinted	795-2671-TR

Plymouth B-Body

Sedan

68-70	LH, Clear.....	795-1468-CSL
68-70	RH, Clear	795-1468-CSR
68-70	LH, Tinted	795-1468-TSL
68-70	RH, Tinted	795-1468-TSR

Hardtop

1971	LH, Clear.....	795-1471-CL
1971	RH, Clear	795-1471-CR
1971	LH, Tinted	795-1471-TL
1971	RH, Tinted	795-1471-TR
73-74	LH, Clear.....	795-1473-CL
73-74	RH, Clear	795-1473-CR
73-74	LH, Tinted	795-1473-TL
73-74	RH, Tinted	795-1473-TR

796) Quarter Glass Latch Assembly

B-Body



68-70	Pair.....	796-1468-P
-------	-----------	------------

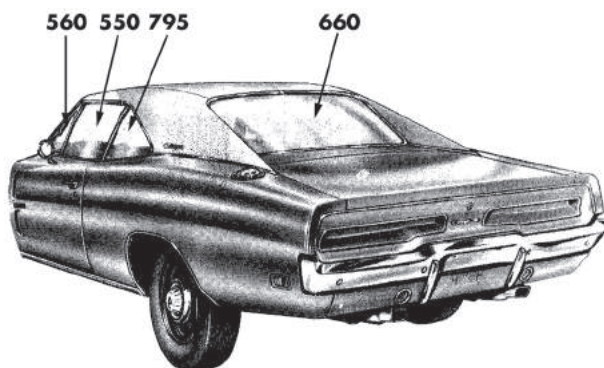

660) Back Glass



B-Body

YEAR	DESCRIPTION	PART #
68-70	Clear	660-1468-C
68-70	Tinted	660-1468-T
71-74	Clear	660-1471-C
71-74	Tinted	660-1471-T

Dodge Charger

68-70	Clear	660-2668-C
68-70	Tinted	660-2668-T

Daytona & Charger 500

With date codes (in parentheses)

1969	Clear (Sept 68).....	660-2669-1C
1969	Clear, with Molding Set (Sept 68) .	660-2669-1CS
1969	Clear (April 69).....	660-2669-2C
1969	Clear, with Molding Set (April 69)	660-2669-2CS
1969	Clear (June 69).....	660-2669-3C
1969	Clear, with Molding Set (June 69)	660-2669-3CS

Superbird

1970	Clear (99M)	660-1470-1C
1970	Clear, with Molding Set (99M).....	660-1470-1CS

384) Window Ribbon Seal

Required on any windshield or back glass that does not use a rubber seal/gasket.



ALL	3/8" x 15'.....	384-1000-3
ALL	5/16" x 15'.....	384-1000-5

670) Back Glass Molding Set

B-Body



68-70	670-1468-S
-------	-------	------------

Dodge Charger



68-70	670-2668-S
-------	-------	------------

Daytona & Charger 500

1969	5-Piece Set.....	670-2669-1S
------	------------------	-------------

Also sold in kit with glass, above

Superbird

1970	4-Piece Set.....	670-1470-1S
------	------------------	-------------

Also sold in kit with glass, above



Our Name Says It All!™



"E" Body

Dodge

Challenger
Challenger R/T

Plymouth

Barracuda
'Cuda

LH = Driver Side
RH = Passenger Side



**Can't find your part
in our catalog? Many
new "E"-Body items are
being developed!
Call Us!**

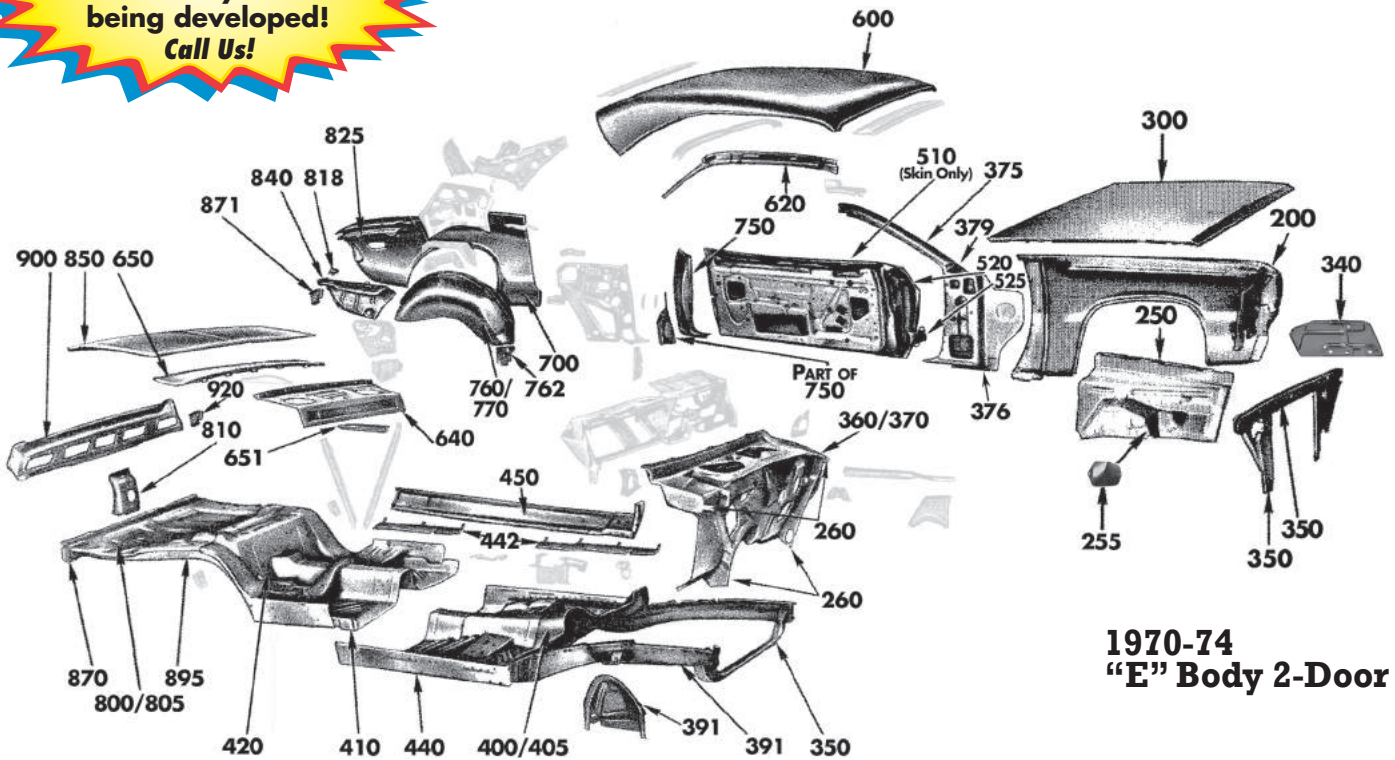

**1970-74
"E" Body 2-Door**



"E" Body

In 1970, Dodge/Plymouth introduced a sleek new body style - the E-Body Challenger and Barracuda - their first real contenders in the pony-car market.

Some items listed below are not shown in the exploded view on the previous page.

#	Part Description	Page #	#	Part Description	Page #
100	Front Bumper.....	37	520	Door Hinge, Upper.....	43
101	Bumper Bolt Set.....	37	525	Door Hinge, Lower.....	43
105	Front Bumper Bracket Set.....	37	531	Door Handle / Lock Gaskets.....	59
110	Front Bumper Guard Cushions.....	51	545	Door Window Regulators.....	43
125	Front Valance.....	37	550	Door Glass.....	52
130	Header Panel.....	38	600	Roof Skin.....	43
135	Parking Lamp Lenses.....	51	620	Drip Rail.....	43
153	Grille Hardware Kit.....	52	635	Vinyl Top Molding Set.....	43
200	Front Fender.....	38	640	Package Tray.....	43
201	Fender Louver Set.....	38	650	Deck Filler Panel.....	43
202	Headlight Bracket Set.....	38	651	Deck Filler Panel Center Support.....	43
205	Fender Patch, Lower Rear.....	38	660	Back Glass.....	50
230	Wheel Opening Moulding.....	52	670	Back Glass Molding Set.....	50
250	Front Inner Fender.....	38	700	Quarter Panel, OE Style.....	43-44
255	Front Inner Fender Cover / Plate.....	38	710	Quarter Panel Skins.....	44
260	Inner Fender to Cowl Bracket.....	39	750	Door Jamb Lock Pillar.....	44
261	Fender to Cowl Bracket.....	39	755	Quarter Panel Patch, Lower Rear.....	44
280	Antenna.....	53	760	Inner Wheelhouse.....	44
298	Exterior Trim Screw Set.....	54	762	Inner Wheelhouse Bracket.....	44
300	Hood.....	39	770	Outer Wheelhouse.....	44
305	Body Bumper Kit.....	54	795	Quarter Glass.....	49
310	Hood Hinges.....	39	797	Quarter Glass Window Regulator Track.....	44
320	Hood Insert Set.....	39	800	Trunk Floor, Full.....	45
321	Hood Trim Ring.....	39	805	Trunk Floor, Halves.....	45
340	Battery Tray.....	39	810	Trunk Lock Support.....	45
350	Radiator Support.....	39	816	Spare Tire Hardware.....	45
351	Radiator Support.....	40	817	Spare Tire Hold Down Bracket.....	45
354	Under Hood Bolt Kit.....	55	818	Jack Bracket.....	45
355	Fan Shroud.....	55	820	Trunk Floor Brace.....	45
360	Upper Cowl.....	40	825	Trunk Gutter.....	46
370	Firewall / Lower Cowl.....	40	827	Trunk Lock Shield.....	46
375	Windshield Post (A Pillar).....	40	840	Trunk Floor Extension.....	46
376	Cowl Side Hinge Panel.....	40	850	Deck Lid.....	46
379	Windshield Corner to Cowl Patch.....	40	860	Upper Rear Crossmember (Shock Mount).....	46
380	Windshield.....	49	865	Rear Leaf Spring Mount.....	46
384	Window Ribbon Seal.....	50	870	Rear Crossmember.....	46
385	Windshield Molding Set.....	50	871	Rear Crossmember Extension.....	46
391	Front Frame Rail.....	41	880	Gas Tank Straps.....	46
395	Torsion Bar Crossmember.....	41	881	Gas Tank Sending Unit.....	46
400	Front Floor Pan, Full.....	41	885	Exhaust Heat Shields.....	47
405	Front Floor Pan, Halves.....	41	890	Gas Tanks.....	47
410	Rear Floor Pan / Footwell Area.....	41	895	Rear Frame Rail.....	47
415	Four-Speed Shifter Tunnel.....	41	900	Taillight Panel.....	47
420	Rear Floor Pan / Under Rear Seat.....	41	920	Taillight Panel Reinforcement Brackets.....	47
425	Main Floor Pan Support Set.....	41	960	Rear Valance.....	47
426	Rear Floor Pan Reinforcement.....	42	961	Rear Valance Bracket.....	48
437	Rocker to Frame Lower Splash Shield.....	42	970	Rear Bumper Bracket.....	48
440	Inner Rocker Panel.....	42	975	Rear Bumper Filler.....	48
441	Emergency Brake Cable Bracket.....	42	980	Rear Bumper Guards.....	48
442	Floor Wiring Cover.....	42	981	Rear Bumper Guard Brackets.....	48
450	Outer Rocker Panel.....	42	990	Rear Bumper.....	48
451	Rocker Panel Endcap.....	42	998	Paint Gaskets.....	64
462	Ignition and Door Lock Sets.....	58	999	Emblems.....	65
488	Interior Trim Screw Set.....	59			
490	Console Bracket Set.....	42			
499	Complete Glass Kits.....	49			
510	Door Skin.....	42			



Our Name Says It All!™



MOPAR, BEE, DODGE, HEMI, PLYMOUTH, RAM, SEI, CHRYSLER and related logos, vehicle model names and trade dress are trademarks of Chrysler Group LLC, used under license. © 2015 Chrysler Group LLC.

100) Front Bumper

* **, ***, indicates bumper bolt sets required.
See section 101, below.

Challenger

YEAR	DESCRIPTION	PART #
70-71	without Jack Slots	100-2570
71-72	with Jack Slots	100-2572
73-74	100-2573

Barracuda

70-71	without Jack Slots	100-1570
71-72	with Jack Slots	100-1572
73-74	100-1573

* **, ***, indicates bumper bolt sets required.
See section 101, below.

101) Bumper Bolt Set

(Bolt, Flat & Lock Washers, Nut)

- * 16 Pieces
(4 bolts) 101-1000-16S
- ** 24 Pieces
(6 bolts) 101-1000-24S
- *** 32 Pieces
(8 bolts) 101-1000-32S



You'll need other parts for your Dodge or Plymouth project, and you'll find them right here in this catalog, See our NEW Parts & Accessories section starting on page 51.

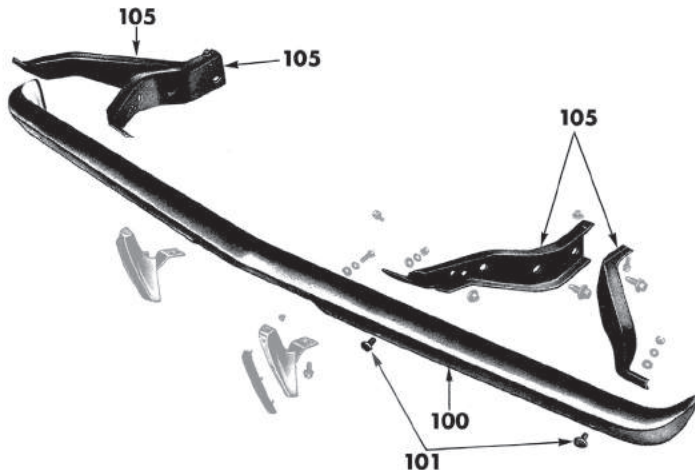

105) Front Bumper Bracket Sets

Challenger

YEAR	DESCRIPTION	PART #
70-72	Front Set	105-2570-S

70-72	Front/Rear Set.....	105-2570-1S
-------	---------------------	-------------

Barracuda

70-72	Front Set	105-1570-S
-------	-----------------	------------

70-72	Front/Rear Set.....	105-1570-1S
-------	---------------------	-------------

125) Front Valance

Challenger

70-71	125-2570
72-74	125-2572

Barracuda

1970	125-1570
72-74	125-1570
1971	125-1571



130) Header Panel
Barracuda



YEAR	DESCRIPTION	PART #
1970		130-1570



1971		130-1571
72-74		130-1572

200) Front Fender
Challenger



70-71	LH	200-2570-L
70-71	RH	200-2570-R



72-74	LH	200-2572-L
72-74	RH	200-2572-R

Barracuda

1970	LH	200-1570-L
1970	RH	200-1570-R



1971	LH, with Louver Cutouts	200-1571-2L
1971	RH, with Louver Cutouts	200-1571-2R



All fenders are made on AFD steel tools.

72-74	LH	200-1572-L
72-74	RH	200-1572-R

201) Fender Louver Set

Barracuda

YEAR	DESCRIPTION	PART #
1971	Set of 4	201-1571-S

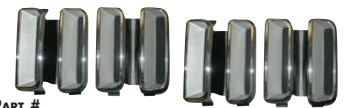

202) Headlight Bracket Set

Barracuda

1971		202-1571-S
------	--	------------



205) Front Fender Patch, Lower Rear
Includes Fender Brace.

Challenger

70-74	LH	205-2570-L
70-74	RH	205-2570-R



Barracuda

70-74	LH	205-1570-L
70-74	RH	205-1570-R

250) Front Inner Fender
E-Body



70-71	LH (pictured, left)	250-1570-L
70-71	RH	250-1570-R
70-71	Pair	250-1570-P
72-74	LH (pictured, right)	250-1572-L
72-74	RH	250-1572-R
72-74	Pair	250-1572-P

255) Front Inner Fender Cover/Plate
E-Body

70-74	Pair	255-1570-P
-------	------	------------



Now Available!

Sheet Metal Installation Videos

Shot in HD, these DVDs combine the clear vision of the helmet cam and the easy teaching style of nationally recognized car builder, Craig Hopkins. No matter what your skill level, these DVDs will help you get professional results!

See Page 64.



260) Inner Fender to Cowl Bracket

Use when replacing inner fender or cowl.

E-Body



YEAR	DESCRIPTION	PART #
70-74	(pictured, left)	260-1570-1P

Upper

70-74	LH	260-1570-2L
70-74	RH	260-1570-2R
70-74	Pair (pictured, above, right)	260-1570-2P

Lower

70-74	LH	260-1570-L
70-74	RH	260-1570-R
70-74	Pair (pictured, right)	260-1570-P



261) Fender to Cowl Bracket

E-Body

70-74	Pair	261-1570-P
-------	------------	------------



310) Hood Hinge

E-Body

NEW!
Not Rebuilt



70-74	Pair, includes Springs	310-1570-P
-------	------------------------------	------------

320) Hood Insert Set

Challenger



70-74	R/T, includes Block Off Plates	320-2570-S
-------	--------------------------------------	------------

321) Hood Trim Ring



Challenger

YEAR	DESCRIPTION	PART #
70-74	(pictured)	321-2570

Barracuda

70-74	321-1570
-------	-------	----------

340) Battery Tray

Correct reproduction of original style tray.



E-Body

70-74	340-1570
-------	-------	----------

350) Radiator Support Assembly

Lower section is not welded to assembly for ease of installation.

E-Body



71-72	350-1570-S
-------	-------	------------

71-72	Upper section only. For the upper and lower Kit use # 350-1570-S	350-1570
-------	--	----------

Hoods

Replace the rusted, bent, or missing original Hood on your 'Cuda, or Challenger, with these beautiful brand new, top quality reproduction Hoods from craftsmen who really know Dodge and Plymouth muscle cars.

300) Hood

Challenger R/T Rallye

70-74	without Pin Holes	300-2570-1
70-74	with Pin Holes	300-2570-1H

Challenger, Shaker Hood

70-74	without Pin Holes	300-2570-2
<i>Includes Trim Ring</i>		
70-74	without Pin Holes	300-2570-2S
70-74	with Pin Holes	300-2570-2HS

70-74	without Pin Holes	300-1570-2
70-74	with Pin Holes	300-1570-2H

Barracuda, Shaker Hood

70-74	without Pin Holes	300-1570-2
70-74	with Pin Holes	300-1570-2H
<i>Includes Trim Ring</i>		
70-74	without Pin Holes	300-1570-2S
70-74	with Pin Holes	300-1570-2HS

New Lower Prices!

300-2570-1H



300-1570-2S

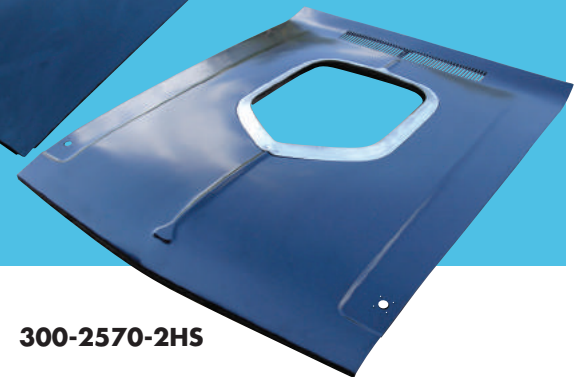
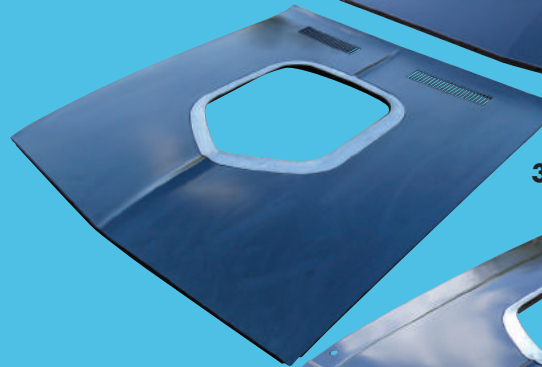

300-2570-2HS



Our Name Says It All!



MOPAR, BEE, DODGE, HEMI, PLYMOUTH, RAM, SEI, CHRYSLER and related logos, vehicle model names and trade dress are trademarks of Chrysler Group LLC, used under license. © 2011 Chrysler Group LLC.

351) Radiator Support

E-Body



YEAR	DESCRIPTION	PART #
70-74	Lower.....	351-1570

360) Upper Cowl

See Upper / Lower Sets under Section 370.

E-Body



70-74	Screw-On Screens.....	360-1570-1
70-74	Clip-On Screens	360-1570-2

370) Firewall

E-Body



70-74	without AC.....	370-1570
-------	-----------------	----------



70-74	with AC.....	370-1570-AC
-------	--------------	-------------



Don't be fooled by cheap reproductions. Save time and money by always demanding AMD brand parts.

Save \$\$\$ when you buy a set!

Upper/Lower Sets



YEAR	DESCRIPTION	PART #
Screw-On Screens		
70-74	with AC.....	370-1570-1ACS
70-74	without AC.....	370-1570-1S

Clip-On Screens

70-74	with AC, Upper/Lower Set.....	370-1570-2ACS
70-74	without AC, Upper/Lower Set.....	370-1570-2S

375) A-Pillar Windshield Post

Area where windshield rests.

E-Body

70-74	LH.....	375-1570-L
70-74	RH.....	375-1570-R



376) Cowl Side Hinge Panel

E-Body



Outer

Inner

Outer		
70-74	LH.....	376-1570-1L
70-74	RH.....	376-1570-1R
Inner		
70-74	LH.....	376-1570-2L
70-74	RH.....	376-1570-2R

379) Lower Windshield Corner to Cowl Patch

Repairs rust in corner of windshield

E-Body

70-74	2 Pieces, LH (pictured)	379-1570-L
70-74	2 Pieces, RH.....	379-1570-R
70-74	4-Piece Set.....	379-1570-S
70-74	LH (pictured).....	379-1570-1L
70-74	RH.....	379-1570-1R



Our Name Says It All!™



391) Front Frame Rail
Shock Tower included with Rail.
E-Body



YEAR	DESCRIPTION	PART #
70-74	LH.....	391-1570-L
70-74	RH.....	391-1570-R

395) Torsion Bar Crossmember
E-Body



70-74	Requires 70-72 Transmission Bracket.....	395-1570
-------	---	----------

400) Front Floor Pan, Full OE Style
Complete coverage, like original.
E-Body



1970	with Flange.....	400-1570
	<i>Includes bucket seat, emergency brake cable and speedometer cable brackets</i>	
71-74	without Flange.....	400-1571
	<i>Includes bucket seat and speedometer cable brackets</i>	

405) Front Floor Pan, Half
E-Body



1970	with Flange, LH.....	405-1570-L
1970	with Flange, RH.....	405-1570-R
71-74	without Flange, LH.....	405-1571-L
71-74	without Flange, RH.....	405-1571-R

410) Rear Floor Pan/Footwell Area
Connects to Full Floor Pan to give complete OE style floor coverage.
Challenger



YEAR	DESCRIPTION	PART #
1970	Pair.....	410-2570-P
1970	LH.....	410-2570-L
1970	RH.....	410-2570-R
71-74	Pair.....	410-2571-P
71-74	LH.....	410-2571-L
71-74	RH.....	410-2571-R



Side view - 1970



Side view - 1971-74

Barracuda

1970	Pair.....	410-1570-P
1970	LH.....	410-1570-L
1970	RH.....	410-1570-R
71-74	Pair.....	410-1571-P
71-74	LH.....	410-1571-L
71-74	RH.....	410-1571-R

415) Manual Transmission Shifter Tunnel
Fits AMD and OE floor pans.



70-74	with or without Console.....	415-1570
-------	------------------------------	----------

420) Rear Floor Pan / Under Rear Seat, Full OE Style
E-Body

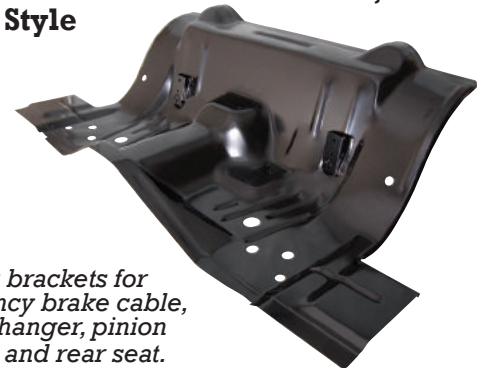

Includes brackets for emergency brake cable, exhaust hanger, pinion snubber and rear seat.

70-74	420-1570
-------	-------	----------

425) Main Floor Pan Support Set
Use when replacing main floor pan.
E-Body



70-74	4 Pieces.....	425-1570-S
-------	---------------	------------



426) Rear Floor Pan Reinforcement

*Use when replacing rear floor pans.
Mounts between floor pan and inner side panel.*



E-Body

YEAR	DESCRIPTION	PART #
70-74	Pair	426-1570

437) Rocker to Frame Lower Splash Shield

Fits between front of rocker panel & frame rail



E-Body

70-74	LH, 2 Pieces	437-1570-L
70-74	RH, 2 Pieces	437-1570-R
70-74	4-Piece Set	437-1570-S

440) Inner Rocker Panel

Challenger

1970	LH	440-2570-L
1970	RH	440-2570-R
71-74	LH	440-2571-L
71-74	RH	440-2571-R

Barracuda

1970	LH	440-1570-L
1970	RH	440-1570-R
71-74	LH	440-1571-L
71-74	RH	440-1571-R

450) Outer Rocker Panel

Challenger



70-74	LH	450-2570-L
70-74	RH	450-2570-R

Barracuda



70-74	68" Long, LH	450-1570-L
70-74	68 3/4" Long, RH	450-1570-R

451) Rocker Panel Endcap

E-Body

70-74	LH (pictured, left)	451-1570-L
70-74	RH (right)	451-1570-R



441) Emergency Brake Cable Bracket

Included with 1970 AMD floor pans.

E-Body

1970		441-1570
------	--	----------



Make sure you test-fit all items before priming and painting.

442) Floor Wiring Cover

Challenger



YEAR	DESCRIPTION	PART #
70-74	2 Pieces	442-2570-S

Barracuda



70-74	2 Pieces	442-1570-S
-------	----------	------------

490) Console Bracket Set

E-Body



70-74	Automatic Transmission, 3 Pieces	490-1570-AS
70-74	Manual Transmission, 2 Pieces	490-1570-MS

510) Door Skin, OE Style

Challenger



70-74	LH	510-2570-L
70-74	RH	510-2570-R

Barracuda



70-74	LH	510-1570-L
70-74	RH	510-1570-R

Now Available!

Now find all of the small miscellaneous door parts that you need to finish the job: door & window handles and cranks, lock sets, glass guides, and more! See our **NEW Parts & Accessories** section, starting on page 51.



520) Door Hinge, Upper

E-Body

YEAR	DESCRIPTION	PART #
70-74	LH.....	520-1570-L
70-74	RH.....	520-1570-R
70-74	Upper/Lower Set, 4 Pieces	520-1570-S



525) Door Hinge, Lower

E-Body

YEAR	DESCRIPTION	PART #
70-74	LH.....	525-1570-L
70-74	RH.....	525-1570-R



545) Door Window Regulator



Challenger

1970	LH (pictured, left)	545-2570-L
1970	RH.....	545-2570-R
71-74	LH.....	545-2571-L
71-74	RH.....	545-2571-R

Barracuda

1970	LH	545-1570-L
1970	RH	545-1570-R
71-74	LH	545-1571-L
71-74	RH.....	545-1571-R

600) Roof Skin, OE Style



Challenger

70-74	600-2570
-------	-------	----------



Barracuda

70-74	600-1570
-------	-------	----------

620) Drip Rail

Use when replacing Roof Skin.
Drip Rail Moldings attach to these.



Challenger

70-74	Pair (pictured).....	620-2570-S
-------	----------------------	------------

Barracuda

70-74	Pair.....	620-1570-S
-------	-----------	------------

635) Vinyl Top Molding Set

Challenger

70-74	(pictured)	635-2570-S
-------	---------------------	------------

Barracuda

70-74	635-1570-S
-------	-------	------------



640) Package Tray Speaker Panel

Challenger



YEAR	DESCRIPTION	PART #
70-74	640-2570

Barracuda



70-74	640-1570
-------	-------	----------

650) Deck Filler Panel



Challenger

70-74	(pictured).....	650-2570
-------	-----------------	----------

Barracuda

70-74	650-1570
-------	-------	----------

651) Deck Filler Panel Center Support

Use when replacing deck filler
panel and/or package tray.

Challenger

70-74	(pictured, right).....	651-2570
-------	------------------------	----------

Barracuda

70-74	(pictured, left)	651-1570
-------	------------------------	----------



700) Quarter Panel, OE Style

Complete coverage,
like original.

Challenger



70-71	LH, OE Style	700-2570-L
70-71	RH, OE Style.....	700-2570-R



72-74	LH, OE Style	700-2572-L
72-74	RH, OE Style.....	700-2572-R



Our Name Says It All!



700) Quarter Panel, OE Style, continued

Complete coverage, like original.

Barracuda



YEAR	MODEL	PART #
70-71	LH, OE Style	700-1570-L
70-71	RH, OE Style	700-1570-R



72-74	LH, OE Style	700-1572-L
72-74	RH, OE Style	700-1572-R

Our full skins will meet and attach to mating parts (wheelhouse, door jamb, and tail light panel area). Top edge of panel bends over upper body line about 1/2 inch

710) Quarter Panel Skin

Challenger



70-71	LH	710-2570-L
70-71	RH	710-2570-R
72-74	LH (pictured)	710-2572-L
72-74	RH	710-2572-R

Barracuda



70-71	LH (pictured)	710-1570-L
70-71	RH	710-1570-R
72-74	LH	710-1572-L
72-74	RH	710-1572-R

750) Door Jamb Lock Pillar

Includes bracket on back side for door striker support

Challenger

YEAR	DESCRIPTION	PART #
70-74	LH	750-2570-L
70-74	RH (pictured)	750-2570-R

Barracuda

70-74	LH	750-1570-L
70-74	RH	750-1570-R



755) Quarter Panel Patch, Lower Rear

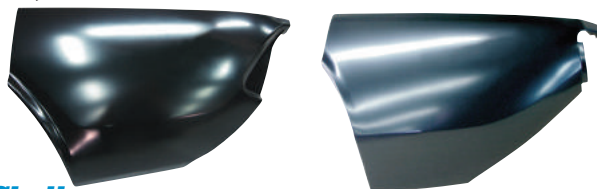

14" to 15"

Challenger

70-74	LH	755-2570-1L
70-74	RH	755-2570-1R

Barracuda

70-74	LH (pictured, right)	755-1570-1L
70-74	RH	755-1570-1R

760) Inner Wheelhouse

E-Body



70-74	LH	760-1570-L
70-74	RH	760-1570-R

762) Rear Seat Belt Anchor Bracket

Mounts on front of inner wheel house.

E-Body

70-71	LH	762-1570-L
70-71	RH	762-1570-R
70-71	Pair	762-1570-P



770) Outer Wheelhouse

Use when replacing quarter panels.



Challenger

70-74	LH (pictured, left)	770-2570-L
70-74	RH	770-2570-R

Barracuda

70-74	LH (pictured, right)	770-1570-L
70-74	RH	770-1570-R

810) Trunk Lock Support

Use when replacing trunk floor and/or taillight panel.



Challenger

70-74	(pictured, right)	810-2570
-------	-------------------	----------

Barracuda

70-74	(pictured, left)	810-1570
-------	------------------	----------



Our Name Says It All!™



MOPAR, BEEB, DOODLE, HEMA, PLYMOUTH, RAM, SEB, CHRYSLER and related logos, vehicle model names and trade dress are trademarks of Chrysler Group LLC, used under license. © 2013 Chrysler Group LLC.

816) Spare Tire Hardware

E-Body

Stud Only

YEAR	DESCRIPTION	PART #
	6" with 2 1/2" Thread	816-1570-6
	8" with 2 1/2" Thread	816-1570-8

Spare Tire Hardware Set

70-74	with Full Size Spare	816-1570-6S
70-74	with Space Saver Spare	816-1570-8S



817) Spare Tire Hold Down Bracket

E-Body



Hardtop

70-74 (pictured, left)817-1570-1

Convertible

70-71 (pictured, right)817-1570-2

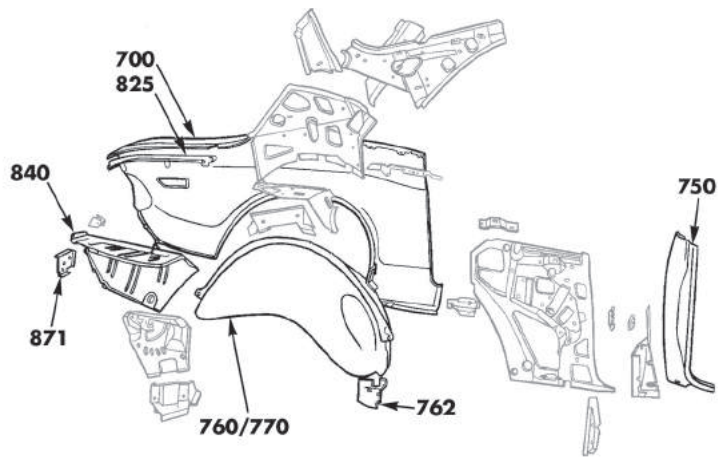

818) Jack Bracket

E-Body



Picture, left to right

YEAR	DESCRIPTION	PART #
70-74	Front	818-1570-3L
70-74	Spring Hook	818-1570-1L
70-74	Rear	818-1570-2L
70-74	Front/Rear Set, All 3 Pieces	818-1570-S

820) Trunk Floor Brace Set

Use when replacing trunk floor.

E-Body



70-74 2 Pieces 820-1570-P

Trunk Floors

800) Trunk Floor, OE Style

Barracuda

YEAR	MODEL	PART #
1970	800-1570
71-74	800-1571

Challenger

1970	800-2570
71-74	800-2571

805) Trunk Floor Halves

All split floors have lap seams, ready to weld.

Barracuda

1970	LH.....	805-1570-L
1970	RH.....	805-1570-R
71-74	LH.....	805-1571-L
71-74	RH.....	805-1571-R

Challenger

1970	LH.....	805-2570-L
1970	RH.....	805-2570-R
71-74	LH.....	805-2571-L
71-74	RH.....	805-2571-R

Trunk Floors available in Full OE Style or split versions.



800-1570

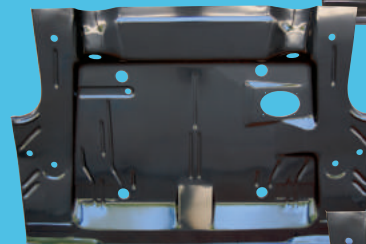

800-2571

Detail of lap seam on split floor sections.

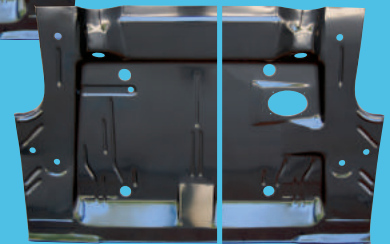

805-2571-L

805-2571-R



Our Name Says It All!



MOPAR, BEE, DOODLE, HEAR, PLYMOUTH, RAM, SEI, CHRYSLER and related logos, vehicle model names and trade dress are trademarks of Chrysler Group LLC, used under license. © 2015 Chrysler Group LLC.

825) Trunk Gutter

Use when replacing quarter panel.

Challenger

YEAR	DESCRIPTION	PART #
70-74	LH.....	825-2570-L
70-74	RH.....	825-2570-R
70-74	Pair.....	825-2570-S

Barracuda

70-74	LH.....	825-1570-L
70-74	RH (pictured).....	825-1570-R
70-74	Pair.....	825-1570-S



827) Trunk Lock Shield

Use when replacing tail light panel.

Barracuda



70-71	Covers Lock Mechanism.....	827-1570
-------	----------------------------	----------

840) Trunk Floor Extension



Challenger

70-74	LH.....	840-2570-L
70-74	RH.....	840-2570-R

Barracuda

70-74	LH.....	840-1570-L
70-74	RH.....	840-1570-R

Find gas caps, filler tubes, gaskets & more in our NEW Parts & Accessories section, page 51

860) Upper Rear Crossmember / Shock Mount



YEAR	DESCRIPTION	PART #
70-74	860-1570

865) Leaf Spring Mount

E-Body



70-74	LH, Front.....	865-1570-1L
70-74	RH, Front.....	865-1570-1R

870) Rear Crossmember



70-74	870-1570
-------	-------	----------

871) Rear Crossmember Extension

70-74	LH.....	871-1570-L
70-74	RH.....	871-1570-R



880) Gas Tank Straps

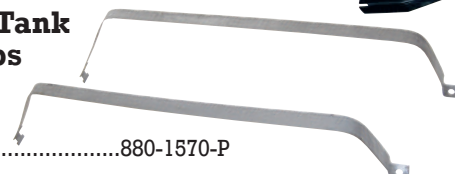

70-74	Pair.....	880-1570-P
-------	-----------	------------

881) Gas Tank Sending Unit

E-Body

70-74	3/8", with Return (pictured).....	881-1570-3R
70-74	5/16".....	881-1570-5



Deck Lids

Did you know that there were **several different deck lid configurations for Challengers and Barracudas?** So why settle for a "one-style-fits-all" replacement? Here at Auto Metal Direct, we've gone the extra mile to produce the finest E-Body deck lids on the market, and **we offer five different deck lid configurations.** Call and order the correct deck lid for your E-Body today!

850) Deck Lid

Challenger

70-74	without Spoiler Holes.....	850-2570-1
70-71	with Spoiler Holes.....	850-2570-2

Barracuda

70-74	without Spoiler Holes.....	850-1570-1
1970	with Spoiler Holes.....	850-1570-2
1971	with Spoiler Holes.....	850-1571

Don't waste time and money trying to fix an inferior quality piece. Do it right the first time. AMD deck lids are the smart choice.



885) Exhaust Heat Shield



E-Body

YEAR	DESCRIPTION	PART #
70-74	Pair	885-1570-S

890) Gas Tank

Now offering a complete line of Spectra Premium Industries brand gas tanks. These tanks are the best on the market and have an OE appearance. All popular models in stock at competitive prices.



Challenger

1970	without Vent Pipes	890-2570
71-72	with 4 Side Vent Pipes	890-2571-4
72-74	with 4 Front Vent Pipes	890-2572-4

Barracuda

1970	with 1 Side Vent Pipes	890-1570-1
71-72	with 4 Side Vent Pipes	890-1571
72-74	with 4 Front Vent Pipes	890-1572-4

895) Rear Frame Rail

E-Body



70-74	LH	895-1570-L
70-74	RH	895-1570-R

Comes with loose emergency brake cable brackets for both 1970 and 1971-74 models.

900) Tail Light Panel

Challenger



1970	900-2570
------	-------	----------

Barracuda



70-71	900-1570
-------	-------	----------

1972 and 73-74 versions come with tail light brackets attached.



1972	900-1572
------	-------	----------

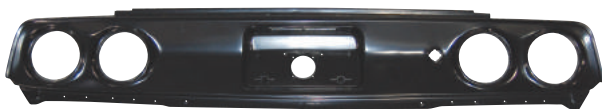

73-74	900-1573
-------	-------	----------

920) Tail Light Panel Reinforcement

Required when replacing tail light panel or quarter panel.

Barracuda

70-74	Pair	920-1570-S
-------	------	------------



Rear Valances

Did you know that there were **six different rear valance panels for E-Body Barracudas?** So why settle for a "one-style-fits-all" replacement? Here at Auto Metal Direct, we've gone the extra mile to duplicate **all 6 versions of the panels.** Call and order the correct rear valance panel for your E-Body today!

960) Rear Valance Panel

Challenger



70-71	without Tips	960-2570
70-71	without Tips, with Brackets, Set	960-2570-S



70-71	with Tips	960-2570-T
70-71	with Tips, with Brackets, Set	960-2570-TS



72-74	without Tips	960-2572
72-74	with Tips	960-2572-T

Barracuda



1970	without Tips	960-1570
1970	without Tips, with Brackets, Set	960-1570-S



1970	with Tips	960-1570-T
1970	with Tips, with Brackets, Set	960-1570-TS



71-72	without Tips	960-1571
71-72	without Tips, with Brackets, Set	960-1571-S



71-72	with Tips	960-1571-T
71-72	with Tips, with Brackets, Set	960-1571-TS



73-74	without Tips	960-1573
73-74	without Tips, with Brackets, Set	960-1573-S



73-74	with Tips	960-1573-T
73-74	with Tips, with Brackets, Set	960-1573-TS



Our Name Says It All!



961) Rear Valance Brackets

Required when replacing valance panels.

Challenger

70-71 Pair (right)961-2570

72-74 Challenger brackets are welded onto the valance itself, so no additional brackets are required.

Barracuda

1970 Pair (far right)961-1570

71-74 Pair (at right).....961-1571



981) Rear Bumper Guard Brackets



Challenger

YEAR	DESCRIPTION	PART #
70-72	Set (pictured, left).....	981-2570-S

Barracuda

70-72	Set (pictured, right).....	981-1570-S
-------	----------------------------	------------

970) Rear Bumper Bracket Set

Challenger

YEAR	DESCRIPTION	PART #
70-72	970-2570-S



70-72 Front/Rear Set.....105-2570-1S

Barracuda

70-72	970-1570-S
-------	-------	------------

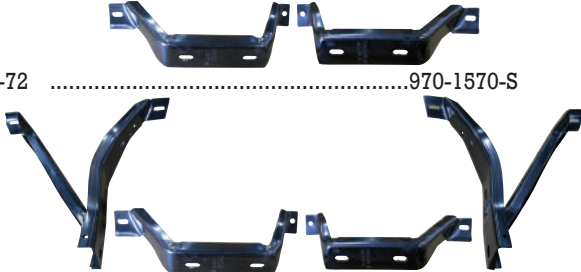

70-72 Front/Rear Set.....105-1570-1S

975) Rear Bumper Filler

Fits between tail light panel and bumper.

Challenger

70-72	975-2570
-------	-------	----------



980) Rear Bumper Guards

Challenger

70-72 Pair (pictured).....980-2570-P

70-72 Cushions, Pair..... F-360R

Barracuda

70-72 Pair.....980-1570-P

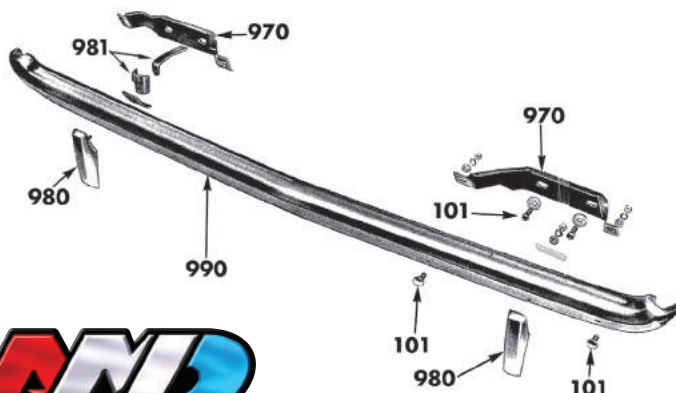
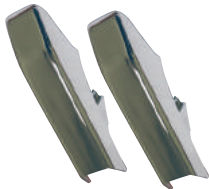

990) Rear Bumper

*** **, *** indicates bumper bolt sets required. See section 101, below.*

Challenger

70-71	without Jack Slots.....	990-2570*
-------	-------------------------	----------	--------

71-72	with Jack Slots.....	990-2572*
-------	----------------------	----------	--------

1973	with Jack Slots.....	990-2573*
------	----------------------	----------	--------

1974	with Jack Slots.....	990-2574*
------	----------------------	----------	--------

Barracuda

70-71	without Jack Slots.....	990-1570*
-------	-------------------------	----------	--------

71-72	with Jack Slots.....	990-1572*
-------	----------------------	----------	--------

1973	with Jack Slots.....	990-1573*
------	----------------------	----------	--------

1974	with Jack Slots.....	990-1574*
------	----------------------	----------	--------

*** **, *** indicates bumper bolt sets required. See section 101, below.*

101) Bumper Bolt Set

(Bolt, Flat & Lock Washers, Nut)

- * 16 Pieces (4 bolts) 101-1000-16S
- ** 24 Pieces (6 bolts) 101-1000-24S
- *** 32 Pieces (8 bolts) 101-1000-32S



Our Name Says It All!™



MOPAR, BEEF, DODGE, HEMI, PLYMOUTH, RAM, SEV, CHRYSLER and related logos, vehicle model names and trade dress are trademarks of Chrysler Group LLC, used under license. © 2013 Chrysler Group LLC.

FINALLY, you can get **quality**, great-fitting glass for your E-Body Dodge or Plymouth muscle car! This premium reproduction glass from Auto Metal Direct has the correct thickness and fit, is *licensed by Chrysler*, and includes the authentic Pentastar logo. (Not date coded)



Glass

Buy a Kit & Save!

499) Complete Glass Kit

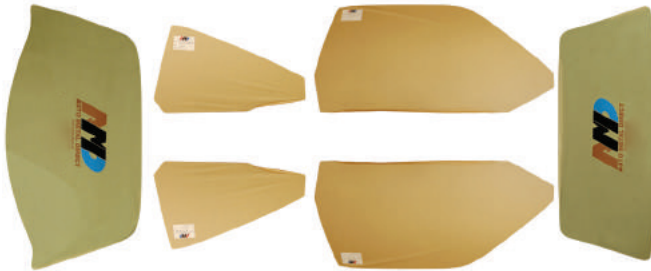

E-Body Convertible

YEAR	DESCRIPTION	PART #
70-74	Clear	499-1570-CVS
70-74	Tinted	499-1570-TVS

Challenger

Hardtop

70-74	Clear	499-2570-CS
70-74	Tinted	499-2570-TS

Barracuda

Hardtop

70-74	Clear	499-1570-CS
70-74	Tinted	499-1570-TS

380) Windshield



E-Body

70-74	Clear	380-1570-C
70-74	Tinted	380-1570-T

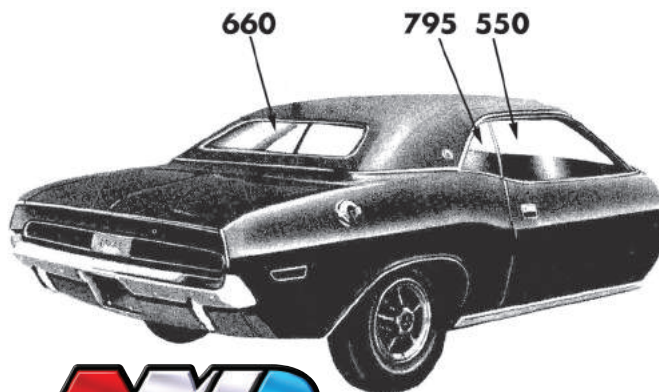

550) Door Glass E-Body

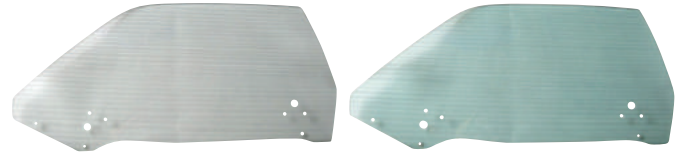

Convertible

YEAR	DESCRIPTION	PART #
70-71	LH, Clear	550-1570-CVL
70-71	RH, Clear	550-1570-CVR
70-71	LH, Tinted	550-1570-TVL
70-71	RH, Tinted	550-1570-TVR

Hardtop

70-74	LH, Clear (pictured, left)	550-1570-CL
70-74	RH, Clear	550-1570-CR
70-74	LH, Tinted (pictured, right)	550-1570-TL
70-74	RH, Tinted	550-1570-TR

795) Quarter Glass

E-Body Convertible

70-71	LH, Clear	795-1570-CVL
70-71	RH, Clear	795-1570-CVR
70-71	LH, Tinted	795-1570-TVL
70-71	RH, Tinted	795-1570-TVR

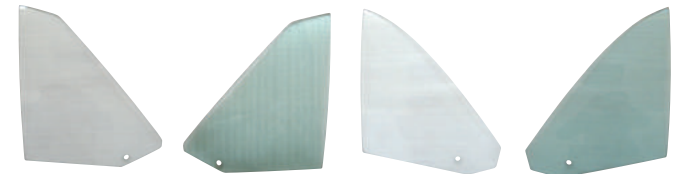

Challenger

Hardtop

70-74	LH, Clear (pictured, left)	795-2570-CL
70-74	RH, Clear	795-2570-CR
70-74	LH, Tinted	795-2570-TL
70-74	RH, Tinted (pictured, left center)	795-2570-TR

Barracuda

Hardtop

70-74	LH, Clear (pictured, right center)	795-1570-CL
70-74	RH, Clear	795-1570-CR
70-74	LH, Tinted	795-1570-TL
70-74	RH, Tinted (pictured, right)	795-1570-TR

Convertible

70-71	LH, Clear (pictured, right center)	795-1570-CVL
70-71	RH, Clear	795-1570-CVR
70-71	LH, Tinted	795-1570-TVL
70-71	RH, Tinted (pictured, right)	795-1570-TVR

All AMD glass is the same thickness as OE.



797) Quarter Window Regulator Track Set

Regulator roller rides in track.



E-Body

YEAR	DESCRIPTION	PART #
70-74	LH/RH.....	797-1570-S

660) Back Glass

Barracuda

70-74	Clear	660-1570-C
70-74	Tinted	660-1570-T

Challenger

70-74	Clear	660-2570-C
70-74	Tinted	660-2570-T

385) Windshield Molding Set



E-Body

70-74	5 Pieces	385-1570-S
-------	----------------	------------

670) Back Glass Molding Set



Challenger

70-74	4-Piece Set.....	670-2570-S
-------	------------------	------------



Barracuda

70-74	5-Piece Set.....	670-1570-S
-------	------------------	------------

384) Window Ribbon Seal

Required on any windshield or back glass that does not use a rubber seal/gasket.



ALL	3/8" x 15'.....	384-1000-3
ALL	5/16" x 15'.....	384-1000-5



Now Available!

Sheet Metal Installation Videos

Shot in HD, these DVDs combine the clear vision of the helmet cam and the easy teaching style of nationally recognized car builder, Craig Hopkins. No matter what your skill level, these DVDs will help you get professional results!

Dodge Dart Quarter Panel Replacement

YEAR	MODEL	PART #
	Dodge Dart	
	Quarter Panel Replacement.....	CHP-1

After Paint... Sanding for Success

After Paint... Sanding for Success	CHP-2
--	-------

Installing Front Sheet Metal

Installing Front Sheet Metal	CHP-3
------------------------------------	-------

Door Skinning 101

Door Skinning 101	CHP-4
-------------------------	-------

MIG Welding Automotive Sheetmetal

MIG welding automotive sheet metal has just become a lot less frustrating. You quickly learn professional techniques because you see and hear about methods that will improve your welding.

Auto Body MIG Welding	CHP-5
-----------------------------	-------

Panel Perfect

Panel Perfect.....	CHP-6
--------------------	-------

Full Floor Install

Full Floor Install.....	CHP-7
-------------------------	-------

Patch Panel Installation

Almost 2 hours of methods and tips that will give you professional results with your "do-it-yourself" project.

Patch Panel Install.....	CHP-8
--------------------------	-------



Our Name Says It All!™



MOPAR, BEEF, DODGE, HEMI, PLYMOUTH, RAM, SEI, CHRYSLER and related logos, vehicle model names and trade dress are trademarks of Chrysler Group LLC, used under license. © 2013 Chrysler Group LLC.

Parts & Accessories



YOU ASKED FOR IT, and HERE IT IS!

For years our customers have been asking us for the parts and accessory items they need when restoring their Dodge or Plymouth muscle car.

Welcome to the all-new Parts and Accessories section of the AMD catalog.

This just makes good sense. After all, when we ship your sheet metal body parts to you, they arrive in a large cardboard box, which has LOTS of empty space inside. When we fill those empty spaces in the box, there is normally no extra shipping cost! You can save big, while getting all the parts you need to finish that restoration project!

So, go ahead! Look through the following pages filled with our terrific selection of premium quality parts and accessories for your favorite Dodge or Plymouth muscle car. Then, when you find everything you need, just place your order online, call our order desk, or use an order form and send it through the mail. Or...perhaps you would rather call our friendly and experienced Dodge/Plymouth parts experts, and let them help you through the simple ordering process.

Sheet Metal Patch



19 gauge. Can be used to patch any part or form any shape.

YEAR	DESCRIPTION	PART #
	36" x 43" (pictured)	PATCH-1
	36" x 21 1/2"	PATCH-2

110) Front Bumper Guard Cushions



B-Body

1970 Road Runner, Pair (pictured) F-468-9

115) Front Bumper Fillers

E-Body

70-74 Challenger, Pair F-064-5



128) Front Valance Bolt Kit

Dodge B-Body

1970 Coronet A-270801

Charger

68-69 (pictured)..... A-270800

1970 A-270801

1971 A-270803

Plymouth B-Body

1971 A-270804

E-Body

70-71 Challenger & Cuda A-270802

72-74 Challenger & Cuda A-270805



131) Header Panel Bolt Kit

E-Body

Barracuda

70-71 A-270841

72-74 (pictured)..... A-270842



135) Parking Lamp & Turn Signal Lens

B-Body

YEAR	MODEL	PART #
except Charger		
68-69	Front, Pair	F-151-2
Charger		
68-70	Front, Pair	F-150-1
71-74	Front, Pair	A-200104

E-Body

70-71 Challenger, Pair F-552-3

142) Headlamp Adjuster Kits

A & B-Body

2 Headlight Set	
66-67 Set	A-280524
68-71 Set	A-280526
72-78 Set (pictured)	A-280528



B-Body

4 Headlight Set	
63-65 Set	A-280555
66-67 Set	A-280525
68-71 Set	A-280527
72-78 Set	A-280529

E-Body

2 Headlight Set	
70-71 Set	A-280526
72-74 Set	A-280528
4 Headlight Set	
70-71 Set	A-280527
72-74 Set	A-280529

151) Front Filler Panel Bolt Kit

B-Body

66-70 except 68-70 Charger, Each A-270875

153) Grille Hardware Kit

A-Body

Dart	
67-68 28 Pieces	A-271137
1969 32 Pieces	A-271138
70-71 46 Pieces	A-271139
1972 47 Pieces	A-271141
Barracuda	
67-68 26 Pieces	A-271127
1969 28 Pieces	A-271128
Duster	
70-71	A-271140
1972 34 Pieces	A-271142
1973	A-271143



Our Name Says It All!



MOPAR, BEE, DODGE, HEAR, PLYMOUTH, RAM, SEV, CHRYSLER and related logos, vehicle model names and trade dress are trademarks of Chrysler Group LLC, used under license. © 2013 Chrysler Group LLC.

153) Grille Hardware Kit

A-Body, continued

YEAR	MODEL	PART #
Demon		
1971	46 Pieces	A-271139
1972	47 Pieces	A-271141

B-Body

except Charger

1967	Coronet	A-271150
1968	29 Pieces	A-271154
1969	32 Pieces	A-271157
1970	Coronet, 56 Pieces	A-271162

Charger

68-69	70 Pieces	
	(pictured)	A-271156
1970	36 Pieces	A-271161



Plymouth B-Body

except GTX and Sport Satellite

1968		A-271153
1969	30 Pieces	A-271158
1970	36 Pieces	A-271160

GTX, Satellite, Belvedere

1966	Satellite	A-271151
1967	GTX, Satellite, Belvedere, 40 Pieces	A-271152
1968	GTX, Satellite, 54 Pieces	A-271155
1969	GTX, Sport Satellite, 30 Pieces	A-271159

E-Body

Charger

1970	(pictured)	A-271120
1971		A-271122
1971	R/T	A-271121
72-74		A-271123



Barracuda

1970		A-271129
1971		A-271130
72-74		A-271131

Grille Molding Clip Set

B-Body

1968	Charger	A-270279
------	---------	----------

Grille Retainers

A-Body

Dart / Valiant

70-71	5 Pieces	A-270228
-------	----------	----------



Grille To Headlamp Bezel Retainer

E-Body

Charger

1971		A-C143
------	--	--------

Barracuda

70-74		A-C143
-------	--	--------

203) Fender Bolt Kit

A-Body

67-70	62 Pieces	A-270705
-------	-----------	----------

B-Body

68-70	62 Pieces	A-270704
-------	-----------	----------

E-Body

70-74	(pictured)???	A-270700
70-74	& 70 AAR, with Studs	A-270708

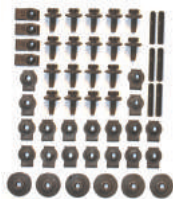

230) Wheel Opening Molding

A-Body

YEAR	MODEL	PART #
Dart		
67-74		230-2067-S
Duster		
70-76	4-Piece Set	230-1370-S



B-Body

Charger

68-70	Set of 4 (pictured, left)	X230-2668-S
-------	---------------------------	-------------

Coronet

68-70	Set of 4	F-CRWM
-------	----------	--------

E-Body

Charger

70-74	Set of 4 (pictured, right)	F-CWM
-------	----------------------------	-------

240) Side Markers

A & B-Body

1969	Reflectors, Set of 4 ...	S-BSM2R
1970	Plymouth, 4-Piece Lens Set	S-200103



E-Body

70-71	Barracuda, Set of 4	F-CSM1R
-------	------------------------	---------



245) Turn Signal Bullit Lens

Plymouth B-Body

67-69	Fender Mounted, Pair	A-200100
-------	----------------------	----------

Turn Signal Fender Gaskets

A-Body

70-72	Pair	A-151003
-------	------	----------

B-Body

1969	Pair	A-151003
------	------	----------

E-Body

1970	Charger, Pair	A-151003
------	---------------	----------



251) Splash Shield Seals

A-Body

Dart

67-69	(pictured)	A-150933
-------	------------	----------

B-Body

66-70		A-150900
-------	--	----------

68-69	Dodge	A-150905
-------	-------	----------

1970		A-150912
------	--	----------

Polara

63-64		A-150916
-------	--	----------

E-Body

70-74		A-150901
-------	--	----------



Our Name Says It All!™



Splash Shield Seal, Front

A-Body

YEAR	MODEL	PART #
68-74		A-150914

Barracuda

67-69		A-150908
-------	--	----------

B-Body

63-65		A-150903
66-67		A-150907
68-69		A-150910
73-74	(pictured)	A-150934



Charger

68-69		A-150909
1970		A-150911

Splash Shield Seals, Rear

B-Body

64-65	Dodge (pictured)	A-150922
63-64	Polara	A-150917



Splash Shield Seals, Rear Inner

B-Body

63-64	(pictured)	A-150902
63-65		A-150906

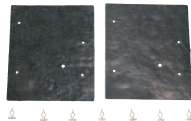

Fender Shield Gasket, Rear

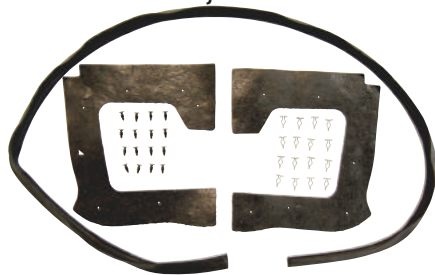

B-Body

66-67	Rear, Set (pictured)	F-SR1
68-70	Rear, Set (pictured)	F-SR2

Inner Fender Seal

B-Body

68-70		A-150925
66-67	Pair	A-150927
63-65	Plymouth, Rear (pictured)	A-150932



Charger

73-74	Charger & 400/440	A-150915
-------	-------------------	----------

Head Light Splash Shields

Dodge B-Body

1963		A-150919
1964		A-150920
1965		A-150921
66-67	Coronet (pictured)	A-150943
68-70		A-150948



Charger

73-74	Pair	A-150913
-------	------	----------

Plymouth B-Body

1963		A-150930
1964		A-150928
1965		A-150929
1966		A-150931
71-72	Pair (pictured)	A-150944
73-74	Road Runner, Satellite, Pair	A-150949



Head Light Dust Shield

YEAR	MODEL	PART #
1971	Road Runner, GTX (pictured)	A-150945

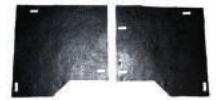

280) Antenna



A-Body

68-Up		S-PA1
-------	--	-------

B-Body

68-70		S-PB7
-------	--	-------

E-Body

70-74	Challenger	X-280-2570
70-74	Barracuda	X-280-1570

Antenna Mast

A, B, E-Body

65-74	3-Stage	F-658A
-------	---------	--------

Antenna Nut

A, B, E-Body

65-67	Small	F-918
68-74	Large	F-875

Antenna Adapter

A-Body

68-74	(pictured)	F-927A
-------	------------	--------

B-Body

Except Charger

65-67		F-977
68-70		F-924

Charger

68-70	Each	F-925B
-------	------	--------

E-Body

Challenger

1970	T/A Challenger, Each	F-924
70-74	Except T/A, Each (pictured)	F-164

Barracuda

70-74	Except AAR, Each	F-162
1970	AAR Cuda, Each	F-925B

298) Exterior Trim Screw Sets

A-Body

Dart

1969	52 Screws	A-271214
70-72	56 Screws	A-271215

Barracuda

67-69	54 Screws	A-271222
-------	-----------	----------

Duster

70-71	41 Screws	A-271201
72-73	41 Screws	A-271202

B-Body

Charger

66-67	95 Screws	A-271224
68-70	51 Screws	A-271225
1971	62 Screws	A-271226
1973	78 Screws (pictured)	A-271228

Coronet

1965	60 Screws	A-271230
66-67	71 Screws	A-271231
1969	69 Screws	A-271233



Our Name Says It All!



298) Exterior Trim Screw Sets, continued

B-Body, continued

Road Runner

YEAR	MODEL	PART #
1969	51 Screws.....	A-271204
1970	49 Screws.....	A-271205

Belvedere

1964	18 Screws.....	A-271237
1965	64 Screws.....	A-271238
1967	53 Screws.....	A-271240

Satellite

1966	63 Screws.....	A-271242
1968	64 Screws.....	A-271244

E-Body

Challenger

70-74	64 Screws.....	A-271200
-------	----------------	----------

Barracuda

70-74	63 Screws.....	A-271223
-------	----------------	----------

305) Hood Bumpers

66-74	Rubber Hood Stop, Each	A-150000
-------	---------------------------------	----------



Rubber Bumper Hood Stop

Each	A-151005
------------	----------

Hood Pop-Up Spring

A-Body

67-74	Each	F-974
-------	------------	-------



B-Body

66-67	except Charger	F-974
68-69	F-730
71-74	F-375

Charger

66-67	(pictured).....	F-974A
1970	F-375

Plymouth B-Body

1970	F-730
------	-------	-------

C-Body

66-67	F-974
68-69	F-730
70-73	F-375

E-Body

70-74	Each	F-375
-------	------------	-------

305) Body Bumper Kit

A-Body

67-70	Set	F-BBK12
1971	Set	F-BBK13
72-74	except 1973 Hardtop, Set	F-BBK14
1973	Hardtop, Set	F-BBK15

B-Body

64-65	Set	F-BBK00
66-67	Set	F-BBK01
68-69	except Charger, Set....	F-BBK03
68-70	Charger.....	F-BBK05
1970	except Charger, Set (pictured).....	F-BBK04



1971	Set	F-BBK06
1972	Set	F-BBK06A
73-74	Set	F-BBK17

Charger

68-70	Set	F-BBK05
-------	-----------	---------

305) Body Bumper Kit, continued

Plymouth B-Body

YEAR	MODEL	PART #
64-65	Set	F-BBK00
66-67	Set	F-BBK01
68-69	Set	F-BBK02
1970	Set	F-BBK02A
1971	Set	F-BBK06
1972	Set	F-BBK06A
73-74	Set	F-BBK16

E-Body

Challenger

1970	Set	F-BBK10
1971	Set	F-BBK11
72-74	Set	F-BBK11A

Barracuda

1970	Set	F-BBK07
1971	Set	F-BBK08
1972	Set	F-BBK09
1973	Set	F-BBK08A
1974	Set	F-BBK09

310) Hood/Trunk Hinge Retainer Clip

A-Body

67-76	Hood Hinges, 4 Pieces,.....	A-270230
-------	-----------------------------	----------

E-Body

70-74	Trunk Hinges, 2 Pieces	A-270230
-------	------------------------------	----------



313) Hood Pin & Cable



A, B, & E-Body

Hood Pin Set

18" Set (pictured)	F-HPS18
23" Set	F-HPS23
25" Set	F-HPS25

Hood Pin Cable

18", Pair	F-HPC18
23", Pair	F-HPC23
25", Pair	F-HPC25

315) Underhood Seal Clip

A-Body

66-74	Each	F-489
1967	10 Required, Set.....	F-904
68-74	Set of 10 (pictured)...	F-489-10

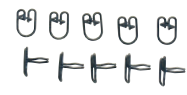

B-Body

66-74	Each	F-489
66-67	12 Required, Set (pictured).....	F-904
68-70	Set of 10	F-489-10
71-74	Set of 11	F-489-11



E-Body

66-74	Each	F-489
70-74	Set of 11	F-489-11

320) Air Grabber Mounting Bolt Kit

Dodge B-Body

69-70	Kit	A-270765
71-72	Kit (pictured).....	A-270766

Plymouth B-Body

1969	Kit	A-270765
1970	Road Runner, GTX, Kit	A-270766



Our Name Says It All!™



Shaker Bubble to Base Bolt Kit

E-Body

YEAR MODEL PART #
70-71 Kit (pictured)..... A-270667



330) Hood Molding

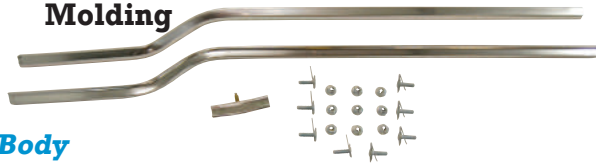

A-Body

67-69 Dart, 3 Piece Set (pictured) F-ABH

E-Body

Challenger

1970 F-CBM3

Hood Lip Molding Clip Set

E-Body

1970 Challenger, Set A-270273



Hood Lip Molding Screw Kit

B-Body

1967 GTX & Belvedere, Kit A-270285

340) Battery Tray Brace

A-Body

Manufactured to OEM specifications, dipped in corrosion resistant primer. Includes correct J-nut and mounting bolt.

67-76 (pictured)..... A-100129

B-Body

67-70 3-Piece Set..... A-100130

66-70 Lower "S" Brace
(pictured)..... A-100126

66-70 Upper Brace, Long
(pictured)..... A-100127

1971 (pictured)..... A-100128

E-Body

70-74 (pictured)..... A-100128

341) Battery Hold Down Kit

A-Body

60-65 Kit..... A-280204

66-69 (pictured)..... A-280205

70-76 A-280203

B-Body

60-65 Kit (pictured)..... A-280204

66-69 A-280205

70-71 A-280203

72-74 Kit A-280206

E-Body

70-71 (pictured)..... A-280203

72-74 Kit A-280206

Battery Hold Down Stud

A, B, E-Body

8 1/2" F-89

7" F-814

348) Radiator Shield

B-Body

66-67 A-150904



Radiator Seals

Charger

YEAR MODEL PART #
73-74 Pair
(pictured)..... A-150946



354) Under Hood Bolt Kit

A-Body

67-69 except Barracuda, 90 Pieces A-270707

B-Body

68-69 100 Pieces A-270703

1970 100 Pieces (pictured) A-270706

E-Body

70-71 A-270701

72-74 A-270702



357) Radiator Cap

A, B, E-Body



64-69 16#, Small Rivet F-107

64-74 14#, Large Rivet F-982A

70-74 16#, Large Rivet F-982R

359) Body Underhood Strap Kit

A-Body

64-69 Kit..... F-USK01

70-74 Kit..... F-USK05

B-Body

64-65 Kit..... F-USK07

66-70 Kit (pictured)..... F-USK02

71-72 Kit..... F-USK04

73-74 Kit..... F-USK06

E-Body

1970 Kit..... F-USK03

71-74 Kit..... F-USK04



361) Firewall Parts

Firewall Gaskets

A-Body

67-72 without AC,
with Wiper Pivots
(pictured)..... A-151322

67-72 with AC,
with Wiper Pivots.... A-151323

73-74 without AC, with Wiper Pivots A-151324

73-74 with AC, with Wiper Pivots A-151325

B-Body

62-64 without AC, with Wiper Pivots A-151326

66-70 without AC, with Wiper Pivots A-151328

66-70 with AC, with Wiper Pivots A-151329

71-74 without AC, with Wiper Pivots A-151330

71-74 with AC, with Wiper Pivots A-151331

E-Body

70-74 without AC, with Wiper Pivots A-151330

70-74 with AC, with Wiper Pivots A-151331



Our Name Says It All!



Wiper Pivot Seal Kit

A-Body		
YEAR	MODEL	PART #
67-76	Kit.....	A-151301
B-Body		
62-65	Kit.....	A-151302
66-70	Kit.....	A-151303
E-Body		
70-74	Kit.....	A-151304

Steering Column Seal

B-Body	
62-65	Hard Seal..... A-150941



Firewall Cowl Flap

B-Body	
62-65 A-150937

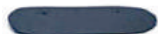

Firewall Plug

B-Body	
62-65	Oval..... A-150938



Clutch Rod Plug

A, B, E-Body	
66-74 A-280157



Fresh Air Vent to Cowl Seal

B-Body	
66-70	without AC (pictured)..... A-151030
71-74	Drivers' Side, without AC..... A-150964



E-Body	
70-74	without AC..... A-150964

Frame Splash Shield

B-Body	
68-70 A-150926

362) Firewall Pads

A-Body	
Dart	
67-76	with A/C..... A-151073
Barracuda	
67-69	without AC..... A-151074
Duster / Demon / Dart Sport	
70-76 Duster, 71-72 Demon, 73-76 Dart Sport	
70-76	with A/C..... A-151073
B-Body	
68-70	without AC, 2 Pieces..... A-151063
68-70	with AC, 3 Pieces..... A-151064
71-74	without AC..... A-151069
Belvedere / Fury	
63-65 A-151060
E-Body	
70-74	without AC..... A-151066
70-74	with AC..... A-151067

365) Heater Box Parts

Heater Box Seal Kit

A-Body		
YEAR	MODEL	
67-72	without AC (pictured).....	A-151090
B-Body		
66-70	A-151091
71-74	A-151093
E-Body		
70-74	A-151092

Heater Box to Cowl Seal

B-Body		
71-74	Passenger Side, without AC.....	
		A-150963
E-Body		
70-74	Passenger Side, without AC.....	A-150963

Heater Box Screw Set

B-Body		
66-70	without AC, Stainless Steel, 56 Screws.....	
		A-270281

382) Windshiled Washer Hose Kit

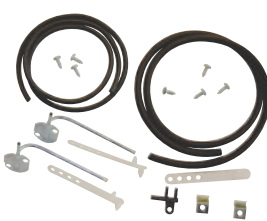
A-Body		
67-74	with Electric Pump (pictured).....	
		F-WWK8
67-74	with Manual Pump ...	F-WWK9
B-Body		
66-67	F-WWK1
68-70	(pictured).....	F-WWK2
71-72	F-WWK3
E-Body		
70-74	with Electric Pump & Steel Hood	F-WWK5
70-74	with Manual Pump & Steel Hood	F-WWK6

Washer Hose T-Connector

A-Body		
Clear, Each (pictured).....		
		F-912
B-Body		
66-70	Black, Each	F-702
71-74	Black, Each (pictured)	F-077B
E-Body		
70-74	Black, Each (pictured).....	F-077B

385) Windshield Molding Clip Set

A-Body		
Dart		
68-75	Set	A-270090
Duster / Demon / Dart Sport		
70-76 Duster, 71-72 Demon, 73-76 Dart Sport		
70-76	Set	A-270084
Barracuda		
68-69	Fastback, Set	A-270081
68-69	Coupe, Set	A-270088
Scamp		
72-75	Set	A-270090



385) Windshield Molding Clip Set, continued

B-Body

YEAR	MODEL	PART #
64-65	Hardtop, Set	A-270247
66-67	& 1968 Early, except Charger, Set	A-270053
68-70	except Charger, Set (pictured)	A-270013
71-74	Set	A-270031

Charger

68-70	Set	A-270079
-------	-----	----------

E-Body

1970	Set	A-270029
71-74	Set	A-270085



416) Shift Boot/Trim Ring Screw Kit

A, B, E-Body

67-74		A-270298
-------	--	----------



Body Shifter Boot to Transmission Tunnel

A & B-Body

67-74	Console A/T	A-150942
-------	-------------	----------

E-Body

70-74	Console A/T	A-150942
-------	-------------	----------



427) Body Plug Kit

A-Body

67-69	Set	F-BPK5
70-74	Set	F-BPK6

B-Body

except Charger

66-67		F-BPK7
1968		F-BPK11
1969		F-BPK12
1970		F-BPK13
71-72		F-BPK14
73-74		F-BPK15



Charger

66-67		F-BPK9
73-74		F-BPK16

Satellite / Belvedere

64-65		F-BPK18
-------	--	---------

E-Body

Barracuda

1970	Set	F-BPK1
1970	with 2 Shock Mount Plugs, Set	F-BPK1A
71-74	Set	F-BPK3

Challenger

1970	Set (pictured)	F-BPK2
1970	with 2 Shock Mount Plugs, Set	F-BPK2A
71-74	Set	F-BPK3

445) Sill Plate



A-Body

67-76	Pair	A-180017
-------	------	----------

B-Body

66-67		A-180018
68-70		A-180019



Our Name Says It All!



Sill Plate Extension

B-Body

YEAR	MODEL	PART #
68-70	Pair	S-SPB3

Sill Plate Screw Sets

A-Body

67-76	14 Screws	A-271106
-------	-----------	----------

B-Body

62-65	Coupe, 28 Screws (pictured)	A-271100
-------	-----------------------------	----------

62-65	Convertible, 26 Screws	A-271101
-------	------------------------	----------

66-67	12 Screws	A-271102
-------	-----------	----------

68-70	14 Screws	A-271103
-------	-----------	----------

71-74	12 Screws	A-271104
-------	-----------	----------

E-Body

70-74	12 Screws	A-271107
-------	-----------	----------



452) Rocker Molding Clip Kit

A-Body

67-73	Set	A-270271
73-74	Set	A-270270

B-Body

68-70	except Charger (pictured)	A-270280
-------	---------------------------	----------

68-70	LH/RH Pair	X452-1468-P
-------	------------	-------------

67-73		A-270271
-------	--	----------

E-Body

Challenger

72-74	Set	A-270270
-------	-----	----------

Barracuda

71-74	Set	A-270270
-------	-----	----------



Ignition & Door Locks

A, B, E-Body

66-68	without illumination (pictured)	A-280547
-------	---------------------------------	----------

70-71	without illumination	A-280548
-------	----------------------	----------

72-85	without Tilt & Telescoping Wheel	A-280550
-------	----------------------------------	----------



Door Locks

E-Body

70-74	Pair (pictured)	A-280563
-------	-----------------	----------



488) Interior Trim Screw Sets



A-Body

Dart

YEAR	DESCRIPTION	PART #
67-69	2-Door, 107 Screws	A-271036
70-72	Hardtop, 106 Screws	A-271025

Barracuda

1967	Coupe, 90 Screws	A-271012
1967	Fastback, 141 Screws	A-271013
1967	Convertible, 97 Screws	A-271020
68-69	Coupe, without Fold-Down Seat, 83 Screws	A-271014
68-69	Coupe, with Fold-Down Seat, 117 Screws	A-271024

Duster / Valiant

70-71	Hardtop, 82 Screws (pictured)	A-271010
1972	Sedan, 63 Screws	A-271023
1974	98 Screws	A-271022

B-Body

Charger

66-67	2-Door, 167 Screws	A-271008
1968	99 Screws	A-271021
69-70	108 Screws	A-271009
71-74	SE 2-Door, 84 Screws	A-271004
71-74	R/T 2-Door, 103 Screws	A-271005

Coronet

1965	440 Hardtop, 116 Screws	A-271052
1965	500 Hardtop, 138 Screws	A-271051
1966	440	A-271056
1966	500 2-Door, 113 Screws	A-271054
1968		A-271047
1968	2-Door Hardtop, 137 Screws	A-271044
69-70	440/500 2-Door Hardtop, 120 Screws	A-271045

Road Runner

1968	95 Screws	A-271016
69-70	Hardtop	A-271018
69-70	Convertible, 116 Screws	A-271017
71-74	94 Screws	A-271019

GTX

1967	2-Door Hardtop, 113 Screws	A-271006
1968	Hardtop, 104 Screws	A-271033
69-70	GTX & Super Bee Hardtop	A-271018
69-70	GTX & Super Bee Convertible, 116 Screws	A-271017

Belvedere

1964	Hardtop, 116 Screws	A-271079
1965	2-Door, 147 Screws	A-271042
1966	2-Door, 116 Screws	A-271046

488) Interior Trim Screw Sets, continued

B-Body, continued

YEAR	DESCRIPTION	PART #
Satellite		
1965	2-Door, 147 Screws	A-271042
1966	2-Door, 116 Screws	A-271046
1967	2-Door Hardtop, 113 Screws	A-271006
1968	2-Door Hardtop, 104 Screws	A-271015
Fury		
1963	Hardtop, 98 Screws	A-271030
1963	Sport Fury Convertible, 117 Screws	A-271029
1964	2-Door Hardtop, 116 Screws	A-271032

E-Body

70-74	Hardtop, 164 Screws	A-271002
-------	---------------------	----------

491) Interior Console Screw Set

B-Body

68-70	Console with Automatic Transmission, 42 Screws	A-271114
68-70	Console with Manual Transmission, 46 Screws	A-271115
71-74	20 Screws	A-271113

Charger

66-67	47 Screws (pictured)	A-271112
-------	----------------------	----------

E-Body

70-74	20 Screws	A-271113
-------	-----------	----------



Console Lid Mount Kit

Correct acorn-style nuts to mount console lid.

66-70		A-270282
-------	--	----------



521) Door Hinge Hardware Kit

Kit includes all pins and springs for both doors.

A, B, E-Body		
66-76		A-280004KIT



Door Hinge Pin Kit

A-Body

66-76	Kit	A-280004
-------	-----	----------

B-Body

62-65		A-280034
66-74	Kit	A-280004
71-74	Both Doors	A-280035

E-Body

70-74	Kit	A-280004
-------	-----	----------



Our Name Says It All!™



MOPAR, BEER, DOODLE, HEMA, PLYMOUTH, RAM, SEI, CHRYSLER and related logos, vehicle model names and trade dress are trademarks of Chrysler Group LLC, used under license. © 2013 Chrysler Group LLC.

530) Outside Door Handles, *Include Hardware*

A-Body

YEAR	DESCRIPTION	PART #
1967	Pair.....	MP5230
1968	with Black Push Buttons, Pair.....	CHZHDL001
69-70	Pair.....	MP5230

B-Body

66-67	with Chrome Push Buttons, Pair.....	MP5210
1968	Also Some Early 69, with Black Push Buttons, Pair.....	CHZHDL001
69-70	Pair.....	MP5230
71-72	Pair.....	CHBHDL712
73-74	Pair.....	CHBHDL734

E-Body

Challenger

70-74	Pair.....	CHEHDL705
-------	-----------	-----------

Barracuda

70-74	Pair.....	CHEHDL704
-------	-----------	-----------

531) Door Handle / Lock Gaskets

A-Body

62-66	Pair.....	A-151031
67-72	A-151001
73-76	Set.....	A-151004

B-Body

62-65	Pair.....	A-151031
66-67	(pictured).....	A-151002
68-70	A-151001

E-Body

70-74	A-151000
-------	-------	----------

Door Lock Gaskets

62-65	A-151031
-------	-------	----------



532) Door Latch / Lock Clip Sets

For the linkage & rod clips



B-Body

66-67	(pictured, left).....	A-270500
68-70	(pictured, right).....	A-270501

Outside Door Handle Rod Clip

A, B, E-Body

64-66	Each.....	A-270026
-------	-----------	----------

Door Lock Rod Clip

68-72	LH (pictured).....	A-280092
68-72	RH.....	A-280091

Door Window Hardware Kit

E-Body

70-72	A-280086
-------	-------	----------



536) Door Lock Knob

A, B, E-Body

64-74	Chrome, Each (pictured)...	A-180044
64-74	Black, Pair.....	A-180119

Door Lock Ferrule

Correct Stainless Steel, sold "each".

A, B, E-Body

72-76	Each.....	A-180234
-------	-----------	----------

Door Lock Cylinder Retainer

66-85	All.....	A-280540
-------	----------	----------

540) Inside Door Handle

A & B-Body

67-72	Pair.....	A-180112
-------	-----------	----------

546) Window Crank Handle

68-74	Correct Style.....	S-EF-3616
All	Door/Window Handle Screw, Each.....	A-270245

547) Door Window Parts

Door Window Hardware Kit

B-Body

62-65	A-280070
-------	-------	----------

E-Body

73-74	(pictured).....	A-280087
-------	-----------------	----------

Window Regulator Arm Clip

A, B, E-Body

66-74	Each.....	A-270006
-------	-----------	----------

Window Regulator Rivet

A, B, E-Body

66-70	A-Rivet
-------	-------	---------

Rear Door Glass Guide

E-Body

70-74	A-270005
-------	-------	----------

Door Window Roller

A-Body

67-74	Each.....	A-280075
-------	-----------	----------

E-Body

73-74	Each (pictured).....	A-280088
-------	----------------------	----------

Fastener Roller

E-Body

73-74	Each.....	A-280089
-------	-----------	----------

Door Glass Bushing

E-Body

73-74	Each.....	A-280090
-------	-----------	----------

Door Glass Up Stop

E-Body

70-74	Each.....	A-RIVET2
-------	-----------	----------

Door Track

A-Body

68-72	Each.....	A-RIVET3
-------	-----------	----------

E-Body

70-74	Each.....	A-RIVET3
-------	-----------	----------

548) Door Vent Hole Plugs

A, B-Body

Black.....	A-180099-100
White.....	A-180099-200
Dark Blue.....	A-180099-330
Light Blue.....	A-180099-332
Dark Green Metallic.....	A-180099-434
Burnt Orange.....	A-180099-540
Red.....	A-180099-550
Gold.....	A-180099-630
Ember Gold.....	A-180099-637



Door Panel Clip

A, B, E-Body

YEAR	MODEL	PART #
Most cars		A-270515



570) Outside Mirrors



A-Body

67-74 LH, Chrome, Remote with Hardware, Gasket, and Trim Bezel	F-508R
67-74 RH, Chrome with Hardware, Gasket, and Trim Bezel (goes with 508R) (pictured)	F-869R
67-74 LH=RH, with Hardware, Gasket and Pentastar	F-834

B-Body

62-65 Twin Post Mirror	A-130005
67-70 LH, Chrome, Remote with Hardware, Gasket, and Trim Bezel	F-508R
67-70 RH, Chrome with Hardware, Gasket, and Trim Bezel (goes with 508R)	F-869R
67-70 LH=RH, with Hardware, Gasket and Pentastar	F-834

Mirror Mounting Screw Kit

B-Body

71-74 Each	A-270275
------------	----------



E-Body

70-74 Each	A-270275
------------	----------



Outside Mirror Gaskets

A-Body

67-70	A-151038
-------	----------

B-Body

67-70 (pictured)	A-151038
71-76 LH	A-151039
71-76 RH	A-151040



E-Body

1970 EA	A-151041
71-74 LH	A-151039
71-74 RH	A-151040

575) Molding Clip Sets

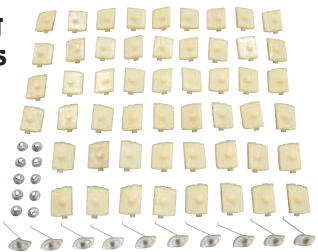

A-Body

1969 Dart, Side Molding Clip Set (pictured)	A-270277
---	----------

E-Body

70-71 Challenger, Door Top Molding Clip Set	A-270289
---	----------

580) Front Door Seal

A-Body

YEAR	DESCRIPTION	PART #
67-72		A-150206

B-Body

66-67 Coupe / Convertible	A-150205
---------------------------	----------

581) Door Lock Pillar Seals

B-Body

68-70 Pair	F-474-5
------------	---------

E-Body

70-74 Pair (pictured)	F-664-5
-----------------------	---------



Door Frame

Plug Kit

62-76 (pictured)	A-280154
------------------	----------



612) Dome Light Lens & Bezel

A-Body

66-76 Round, except 67-69 Barracuda	S-EF3916
-------------------------------------	----------

B-Body

66-76 Round, 66-67 Charger, Each	S-EF3916
----------------------------------	----------

E-Body

66-76 Round, 70-71 Challenger SE, and 70-71 Barracuda Gran Coupe, Each	S-EF3916
--	----------

621) Drip Rail Seal

A-Body

67-76 Pair	A-150960
------------	----------

B-Body

71-74 Set	A-150962
-----------	----------

E-Body

70-71 Pair	A-150961
72-74 Set	A-150962

635) Vinyl Top Molding Clip Set

B-Body

71-74 Charger, Set	A-270502
--------------------	----------



670) Rear Window Molding Clip Set

A-Body

1962 (pictured)	A-270248
-----------------	----------

Dart

68-75	A-270089
-------	----------

Barracuda

68-69 Fastback	A-270033
68-69 Coupe	A-270051

Duster / Demon / Dart Sport

70-76 Duster, 71-72 Demon, 73-76 Dart Sport

70-76	A-270083
-------	----------

Valiant Scamp

72-76	A-270089
-------	----------

B-Body

1962 (pictured, above)	A-270248
66-67	A-270215
68-70 except Charger	A-270017
71-74	A-270032

Charger

68-70	A-270080
-------	----------

E-Body

1970	A-270030
71-74	A-270086

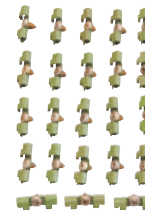

Our Name Says It All!™



Rear Window Molding Screw Set

B-Body

YEAR	MODEL	PART #
1963	A-270249
64-65	Sedan (pictured)	A-270250
64-65	Hardtop	A-270253



Quarter Panel Scoop

E-Body

Challenger

1971	Decals, 4-Piece Set.....	A-260001
------	-----------------------------	----------



753) Quarter U-Jamb Seal

A-Body

67-72	Coupe / Convertible, Each	A-150201
-------	---------------------------------	----------

B-Body

64-65	Hardtop	A-150209
66-67	Coupe / Convertible, Each	A-150200
68-70	Coupe / Sedan, Pair	F-464-5

Plymouth B-Body

71-74	Hardtop / Sedan, Each	A-150204
-------	-----------------------------	----------

Quarter U-Jamb Pillar Seals

B-Body

68-70	Pair (pictured).....	F-464-5
-------	-------------------------	---------



E-Body

70-74	Pair	F-180-1
-------	------------	---------

798) Quarter Window Hardware Kit

B-Body

62-65	A-280071
-------	-------	----------

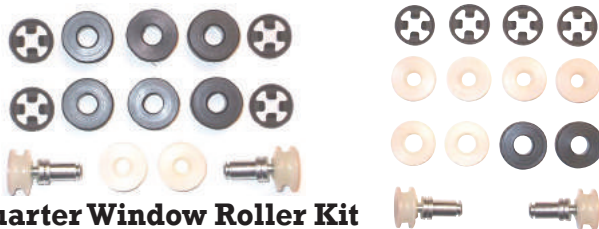

Quarter Window Roller Kit

A-Body

1967	A-280073
67-72	(pictured, left)	A-280084

B-Body

66-70	(pictured, right).....	A-280083
66-67	A-280073

E-Body

70-74	(pictured, at right) ...	A-280085
-------	--------------------------	----------



Quarter Window Rollers

A-Body

YEAR	MODEL	PART #
64-67	Each	A-280097
67-72	White Roller with Small Hole, 2 Needed (pictured)	A-280079
67-72	Black Roller, 6 needed (pictured).....	A-280081
67-72	White Roller with Pin, 2 needed (pictured)	A-280082

B-Body

66-67	A-280097
66-70	White Roller with Small Hole, 4 Needed (pictured)	A-280079
67-70	White Roller with Large Hole, 2 needed (pictured)	A-280080
66-70	Black Roller, 2 needed (pictured).....	A-280081
67-70	White Roller with Pin, 2 needed (pictured)	A-280082



815) Trunk Bolt Kit

A-Body

67-69	Kit, 16 Pieces.....	A-270726
-------	---------------------	----------

B-Body

68-70	Kit, 7 Pieces	A-270725
-------	---------------------	----------

E-Body

Challenger

70-71	Kit	A-270720
72-74	Kit	A-270721

Barracuda

70-71	Kit	A-270722
1972	Kit	A-270723
73-74	Kit	A-270724

818) Jack Bracket Felt Strip

A, B, E-Body

67-76	A-150220
-------	-------	----------



824) Trunk Weatherstrip

A-Body

70-72	15' (pictured, left)	F-TW730
73-76	15' (pictured, right).....	F-TW830

Barracuda

67-69	except Fastback.....	F-TW11
67-69	Fastback	F-TW12

B-Body

except Charger

66-67	F-TW1
68-69	F-TW5
1970	F-TW7
71-72	15'	F-TW730
73-74	15'	F-TW830

Charger

66-67	F-TW2
68-70	F-TW9

Plymouth B-Body

68-69	F-TW6
-------	-------	-------

E-Body

70-72	12 1/2'	F-TW729
73-74	12 1/2'	F-TW829



827) Trunk Lock Kit

Comes with Lock, Keys, Retainer and All Shafts.

A, B, E-Body

YEAR	MODEL	PART #
66-72	(pictured)	A-280541
73-89		A-280551



Trunk Lock

B-Body

59-65		A-280562
-------	--	----------

855) Trunk, Deck & Quarter Molding

Trunk & Quarter Moldings

E-Body

Challenger

1970	Set of 3 (pictured)	F-CBM1
71-74	Set of 3	F-CBM2



Trunk & Quarter Moldings Hardware

E-Body Challenger

70-74	Hardware Set (pictured, above with molding)	F-CBM4
-------	---	--------

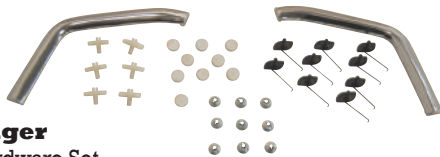

Trunk Panel Clip Kit

A-Body

Dart

1969	GT, Trunk Panel	A-270278
------	-----------------	----------



Deck Lid Clip Kit

B-Body

1970	GTX	A-270274
------	-----	----------



862) Body Frame Rail Bumper

B-Body

66-70	Small, Triangular, 2 1/2" (318, 361, 383, 440)	F-933
66-70	Large, Round, 3" (HEMI, 440-6, 440 4 SP) (pictured, left)	F-934
71-72	Large, Triangular, 2 1/2" (pictured, right)	F-841
71-74	Small, Triangular, 2" (SB & BB)	F-843



E-Body

70-72	Large, Triangular, 2 1/2"	F-841
70-74	Small, Triangular, 2" (SB & BB)	F-843

Pinnion Snubber Bumper

Dodge/Plymouth	F-906
----------------	-------

880) Fuel Tank J-Bolt

A, B, E-Body

YEAR	MODEL	PART #
All	Each	A-270394



881) Sending Unit Filter

A, B, E-Body

5/16" Filter (pictured)	A-240076
3/8" Filter	A-240077



Sending Unit Float

A, B, E-Body

Brass	A-240075
-------	----------



888) Gas Cap

A-Body

67-76	Chrome (left)	A-240079
67-76	Primer (right)	A-240080

Barracuda

67-69	Flip Up	F-339A
-------	---------	--------

B-Body

Charger

69-70	Flip-Up (pictured)	F-878
1968	Flip-Up	F-339A

GTX

1967		F-339A
------	--	--------



E-Body

Challenger

70-74	Flip Up	F-435R
-------	---------	--------

Flip Up Gas Cap Trim Ring

E-Body

70-74	Challenger, Each	F-666R
-------	------------------	--------

891) Filler Tube Kit

B-Body

66-67	(1-859A+2-860A) (pictured)	F-TEA
66-67	(1-859A+2-860A+1-598R)	F-TEAG



Filler Tube Elbow with Clamps

B-Body

66-67		F-859A
-------	--	--------



Vent Line Elbow with Clamps

B-Body

66-67	2 Required	F-860A
-------	------------	--------



Vent Tube Thru Trunk Floor Grommet

B-Body

66-67		F-598R
-------	--	--------



Filler Neck To Body Seal

E-Body

Challenger

70-74	Each	A-150002
-------	------	----------



Our Name Says It All!™



MOPAR, BEE, DOODLE, HEMI, PLYMOUTH, RAM, SEI, CHRYSLER and related logos, vehicle model names and trade dress are trademarks of Chrysler Group LLC, used under license. © 2013 Chrysler Group LLC.

Filler Neck Grommet

A-Body

YEAR	MODEL	PART #	PRICE
63-66	1 3/4" Diameter, Single Lip	A-240081	
68-69	2" Diameter, Single Lip	891-1068-1	

B-Body

68-69	2" Diameter Single Lip	891-1068-1	
70	2" Diameter Double Lip	891-1570-1	
71-up	2" Diameter Single Lip	891-1068-1	

E-Body

70-74	2" Diameter Double Lip	891-1570-1	
-------	------------------------	------------	--

C-Body

65	1 3/4" Diameter Single Lip	A-240081	
----	----------------------------	----------	--

Fuel Filler Tube to Trunk Floor Seal



A-Body

67-69		F-918R	
70-74	Each (pictured, left)	F-307R	

B-Body

68-70	Charger (pictured, center)	F-539	
-------	----------------------------	-------	--

E-Body

70-74	Each (pictured, right)	F-151R	
-------	------------------------	--------	--

930) Rear Finish Panel Hardware Kit

B-Body

1968	GTx Sport Satellite	A-270286	
------	---------------------	----------	--

945) License Plate Bumper

A, B, E-Body

59-70	OEM	A-150001	
-------	-----	----------	--



952) Tail Light Covers

Dodge B-Body

Quality Reproduction Covers

Except Charger

1970		A-100200	
------	--	----------	--

Plymouth B-Body

1970		A-100201	
------	--	----------	--



964) Rear Valance Bolt Kit

B-Body

1971	Plymouth	A-270821	
------	----------	----------	--

E-Body

70-71	Kit	A-270822	
72-74	Kit	A-270823	

975) Rear Bumper Filler

A-Body

Duster / Demon / Dart Sport

70-76 Duster, 71-72 Demon,
73-76 Dart Sport

70-76	Pair	S-P3617	
-------	------	---------	--

B-Body

66-67	Must be Notched / Punched (pictured)	F-967R	
-------	---	--------	--



976) Rear Body To Bumper Seal

B-Body

66-67		A-150936	
-------	--	----------	--



Miscellaneous Hardware

3/16" Speed Nut, sold each	K-11501047
1/8" Speed Nut, sold each	K-11502547

998) Paint Gasket Set

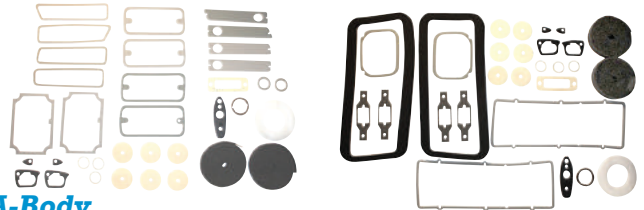

A-Body

YEAR DESCRIPTION

Dart

1967	Set	A-151032
1968	Set	A-151006
1969	Set	A-151007
1970	Swinger, Set	A-151022
1971	Swinger, Set (pictured, left)	A-151023
1972	Swinger, Set	A-151024

Barracuda

1967	Set	A-151035
1968	Set	A-151036
1969	Set	A-151037

Duster

70-71	Set	A-151028
1972	Set	A-151029

Demon

1971	Set	A-151025
1972	Set (pictured, right)	A-151026

Scamp

70-71	Set	A-151050
1972	Set	A-151051

B-Body

Charger

66-67	Set	A-151027
1968	Set	A-151008
1969	Set	A-151011
1970	Set	A-151014
1971	except R/T, Set	A-151042
1971	Charger R/T, Set	A-151043
1972	except Rallye, Set	A-151044
1972	Rallye, Set	A-151045
73-74	Set	A-151046

Coronet / Super Bee

1968	Set	A-151009
1969	Set	A-151012
1970	Set	A-151015

Road Runner / GTx

1968	Set	A-151010
1969	Set	A-151013
1970	Set	A-151016
1971	Set	A-151047

Satellite

1968	Set	A-151010
1969	Set	A-151013
1970	Set	A-151033
1971	Set	A-151047
1972	Set	A-151048
73-74	Set	A-151049

E-Body

Challenger

1970	Set	A-151017
1971	Set	A-151019
72-74	Set	A-151020

Barracuda

1970	Set	A-151018
1971	Set	A-151034
72-74	Set	A-151021



Our Name Says It All!



MOPAR, BEE, DOGGE, HEAR, PLYMOUTH, RAM, SET, CHRYSLER and related logos, vehicle model names and trade dress are trademarks of Chrysler Group LLC, used under license. © 2011 Chrysler Group LLC

999) Emblems

Hood Insert Emblem

B-Body

Road Runner

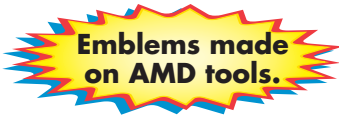

YEAR	DESCRIPTION	PART #
1969	"383"	999-1469-31

Grille Letters

E-Body

Challenger



1970	Grille Emblem	999-2570-11
------	---------------	-------------

Front Fender Emblem

E-Body

Challenger



1970		999-2570-21
------	--	-------------

Door Panel Emblem

B-Body

Road Runner



1968	"Road Runner"	999-1468-51
------	---------------	-------------

Door Emblems



1969	Set, "Road Runner"	999-1469-51S
1969	"Road"	999-1469-51
1969	"Runner"	999-1469-52

Tail Panel Emblem

B-Body

Charger



69-70	non R/T, "Charger"	999-2670-91
-------	--------------------	-------------

Plymouth B-Body



1970	"Plymouth" B	999-1470-91
------	--------------	-------------



Now Available!

Sheet Metal Installation Videos

Shot in HD, these DVDs combine the clear vision of the helmet cam and the easy teaching style of nationally recognized car builder, Craig Hopkins. No matter what your skill level, these DVDs will help you get professional results!

Dodge Dart Quarter Panel Replacement

Dodge Dart Quarter Panel Replacement..CHP-1

After Paint... Sanding for Success

After Paint... Sanding for SuccessCHP-2

Installing Front Sheet Metal

Installing Front Sheet MetalCHP-3

Door Skinning 101

Door Skinning 101CHP-4

MIG Welding Automotive Sheetmetal

MIG welding automotive sheet metal has just become a lot less frustrating. You quickly learn professional techniques because you see and hear about methods that will improve your welding.

Auto Body MIG WeldingCHP-5

Panel Perfect

Panel Perfect.....CHP-6

Full Floor Install

Full Floor Install.....CHP-7

Patch Panel Installation

Almost 2 hours of methods and tips that will give you professional results with your "do-it-yourself" project.

Patch Panel Install.....CHP-8



Our Name Says It All!™



MOPAR, BEEF, DOODLE, HEMA, PLYMOUTH, RAM, SEI, CHRYSLER and related logos, vehicle model names and trade dress are trademarks of Chrysler Group LLC, used under license. © 2013 Chrysler Group LLC.



335) Valve Covers, OE Style Plymouth / Dodge Big Block

YEAR	DESCRIPTION	PART #
1964	Max Wedge, Raw Zinc, Pair	335-1064-1BP
64-65	Raw Zinc, Pair	335-1064-BP
64-65	Street Wedge, Chrome, Pair	335-1064-BCP
66-67	Raw Zinc, Pair	335-1066-BP
1967	440 Magnum, Chrome, Pair	335-1067-BCP
1968	Raw Zinc, Pair	335-1068-BP
1969	Raw Zinc, Pair	335-1069-BP
1970	Raw Zinc, Pair	335-1070-BP
1971	Raw Zinc, Pair	335-1071-BP

Plymouth / Dodge Small Block

1970	T/A AAR, Raw Zinc, Pair	335-1070-2P
70-71	Raw Zinc, Pair	335-1070-1P
72-Up	Raw Zinc, Pair	335-1072-1P

336) Valve Cover Accessories

(Cork, like original)

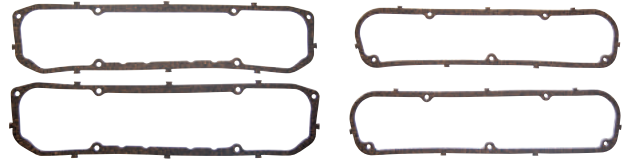

- 64-72 Big Block, 2-Piece Set (left)336-1064-S
- 70-up Small Block, 2-Piece Set (right)336-1070-1S

Valve Cover Rubber Ring

- 67-72 Small336-1067-1
- 70-72 Large336-1070-1

Valve Cover Bolt Kit

A, B, E-Body

- 64-74 All Small Blocks (pictured)..... A-270740
- 64-74 All Big Blocks..... A-270741

337) Mopar Oil Filler Cap

- 70-72 (pictured)337-1070

Oil Filler Breather Cap



- 64-67 Small, Painted (pictured, left).....337-1064
- 64-67 Small, Chrome337-1064-C
- 64-69 with PCV Mount (pictured, right).....337-1064-1
- 64-69 Chrome, with PCV Mount.....337-1064-1C

- 68-69 Tall, Painted, with 1 Hose Outlet (pictured, left)337-1068
- 68-69 Tall, Chrome, with 1 Hose Outlet (pictured, right)337-1068-C



- 70-Up Unpainted, with 1 Hose Outlet (pictured, left)337-1070-1
- 70-Up Unpainted, with 2 Hose Outlets (pictured, center)337-1070-2
- 70-Up Unpainted, with 3 Hose Outlets (pictured, right)337-1070-3



Apparel

AMD Fleece Jacket

UltraClub Men's Iceberg Fleece Full-Zip Jacket with AMD logo. Stay warm while looking "iceberg cool" in this smooth-looking, luxuriously cozy fleece jacket.

Key Features:

- Anti-pill 100% polyester
- 13.75 oz (linear)
- Elasticized cuffs
- Extra-roomy nylon-reinforced pockets with zipper closure

Black, Small.....	BLKFLEECE-SML
Black, Medium	BLK-FLEECEMED
Black, Large	BLK-FLEECELG
Black, X Large	BLK-FLEECEXLG
Black, XX Large (2XL) **	BLK-FLEECEXXL
Black, XXX Large (3XL) **	BLK-FLEECEXXXL

AMD Hoodie

Port & Company - Classic Pullover Hooded Sweatshirt with AMD logo. Crafted for comfort, this lighter weight sweatshirt is perfect for relaxing and it's a real value.

Key Features:

- Blend
- 7.8 oz, 50/50 cotton/poly fleece
- Two-ply hood
- Dyed-to-match drawcord
- Set-on sleeves
- Front pouch pocket

Black, Small	BLKHOODIE-SML
Black, Medium	BLK-HOODIEMED
Black, Large	BLK-HOODIELG
Black, XLG**	BLK-HOODIEXLG
Black, XX Large**	BLK-HOODIEXXLG
Black, XXX Large***	BLK-HOODIEXXXL

AMD T-Shirt

Sport-Tek Ultimate Performance T-Shirt with AMD Logo. A soft hand combines with sweat-wicking performance to make training (or lounging) cooler and drier. Raglan sleeves with flatlock stitching add comfort and easy movement.

APP	Black, Small.....	BLKT-SML
APP	Black, Medium	BLKT-MED
APP	Black, Large	BLKT-LG
APP	Black, XLARGE	BLKT-XLG
APP	Black, XX Large (2 XL) *	BLKT-XXL
APP	Black, AMD T-Shirt XXX Large*** 3 XL ***	BLKT-XXXL

AMD Baseball Cap

Brushed Twill Low Profile Cap with AMD logo. The great classic look and lightweight feel make this cap an all-around favorite.

Black AMD Baseball Cap	CAP-BLK
Tan AMD Baseball Cap	CAP-TAN

AMD Embroidered Beanie

Black	BLK-BEANIE
-------------	------------

AMD Fleece Jacket



AMD Hoodie



AMD T-Shirt



AMD Baseball Caps



AMD is the answer...

...because rust never sleeps.

Don't be fooled by cheap reproductions. Save time and money



Our Name Says It All!™



MOPAR, BEEP, DOODLE, HEM, PLYMOUTH, RAM, SEI, CHRYSLER and related logos, vehicle model names and trade dress are trademarks of Chrysler Group LLC, used under license. © 2013 Chrysler Group LLC.