

BETTER BUILT

A Division of Daws Manufacturing Co., Inc.

2016 PRODUCT CATALOG



Life. Better Built.



Known as the "Original Aluminum Truck Toolbox", the Better Built name is synonymous with the best quality and best selling aluminum and steel truck tool boxes on the market today. The Better Built product line features include:



Locking Stainless Steel Paddle Handles



Patented "Up and Over" Latch Rod & Static Cam



Auto-Lift Shocks & Reinforced Lid Braces

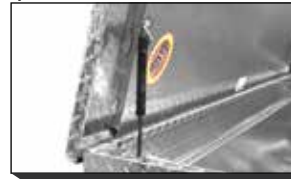

Lid Opens Nearly 90 Degrees



Patented Integral Ends & 1-Piece Body Construction

Built for performance enthusiasts, the Special Edition Crown Series Boxes are built with the following features in addition to our standard Better Built features:



Locking Pull Handles



2-Stage Automotive-Grade Rotary Latches



Durable Foam-Filled Lid With Welded C-Channel



Premium Auto-Lift Gas Powered Shocks



Premium Weather Seal Lid and Self-Adjusting Striker

The newest member of the Better Built family, the Shotgun Latch Elite Series (SLE) is the first series to carry the all-new, stylish Shotgun Latch system. Built exclusively in-house, the Shotgun Latch provides one-touch easy opening of the box.



Patent-Pending Shotgun Latch for Easy Opening



Organization System With Four Dividers Included



Washable Liner With Drain



Interior LED Lighting



D-Ring Mount Points For Securing Cargo

Created for the working professionals, the Heavy Duty Series is the highest quality, most feature-rich truck box line on the market. HD Boxes are built with the following features above and beyond our other product lines:



Locking Push Buttons With 4-Stage Rotary Latches



Offset Crossbroken Foam-Filled Lid Opens Nearly 90 Degrees



Heavy Duty Level Holders, Storage Trays And Patented Quantum® Storage System



Heavy Duty Auto-Lift Gas Powered Shocks And Small Parts Partition



Patented Self-Adjusting Lid Striker And Climate Seal Weather Stripping

TABLE OF CONTENTS

CROWN SERIES

- 6 Low Profile Box
- 8 Crossover Box
- 10 Slimline Box
- 12 Two-Lid Box
- 14 Quantum® ATB Box
- 15 Chest Box
- 16 Top Mount Box
- 17 Side Mount Box
- 18 Underbody Box
- 19 Recreational
- 22 Loading Ramps
- 24 Quantum® Rack
- 26 Storage Racks
- 27 Site Safes

SEC SERIES

- 30 Low Profile Box
- 32 Crossover Box
- 34 X2 Crossover Box
- 35 Slimline Box
- 36 Two-Lid Box
- 38 Chest Box
- 39 Side Mount Box
- 40 Fishing Box

SLE SERIES

- 44 Low Profile Box
- 47 Slimline Box

HD SERIES

- 50 Crossover Box
- 52 Chest Box
- 54 Top Mount Box
- 56 Side Mount Box
- 58 Underbody Box
- 60 Site Safes
- 62 Headache Racks
- 63 Drawer Boxes
- 64 Transfer Tanks

- 66 Accessories



2016

A WELCOME FROM THE PRESIDENT...

For over two decades, we have taken pride in our products and dedication to quality. Innovation, quality products, customer service and a philosophy of responding to our customers' needs are among the many reasons Better Built has become the leader in the truck accessory aftermarket industry.

Simply put, being Better Built means a higher standard in everything we do.

That's why we would like to personally invite you to become part of the Better Built Family. When you do, you will experience what truly makes our products and company the best in the industry.

S
E
R
I
E
S
CROWN



BETTER
A Division of Daws M



BETTER BUILT

Manufacturing Co., Inc.

Page 6

LOW PROFILE

Page 8

CROSSOVER

Page 10

SLIMLINE

Page 12

TWO-LID

Page 14

QUANTUM[®] ATB

Page 15

CHEST BOX

Page 16

TOP MOUNT

Page 17

SIDE MOUNT

Page 18

UNDERBODY

Page 19

RECREATIONAL

Page 22

LOADING RAMPS

Page 24

QUANTUM[®] RACK

Page 26

STORAGE RACKS

Page 27

SITE SAFES

LOW PROFILE

CROWN S E R I E S

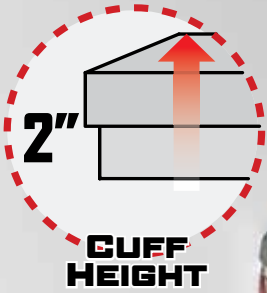

MORE VISIBILITY

Lower profile design allows for greater visibility through the rear window of your truck.



SELF-ADJUSTING STRIKERS

CONTINUOUS ALUMINUM PIANO HINGE

SOLID ONE-PIECE BODY CONSTRUCTION

100% FULLY WELDED SEAMS

WEATHER RESISTANT SEALS

REINFORCED LID BRACE

Low Profile DESIGN FOR MORE VISIBILITY!

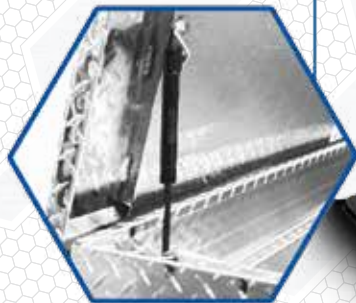

AUTO-LIFT SHOCKS

The "auto-lift" self-rising shock allows easy single handed entry.



HEAVY DUTY 5 POCKET TRAY INCLUDED!

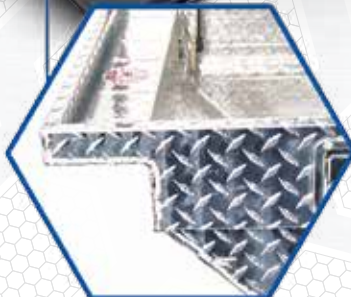

PATENTED INTEGRAL END

A Better Built patented design, the end of the box is made of a solid piece of metal for additional strength and durability.



STATIC CAM LATCH

The Static Cam Latch guides the striker into the lock and increases security against break-ins.



PATENTED LATCH ROD

The patented "Up and Over" rod moves the locking system away from the working space of the tool box, keeping it from being damaged.

LOW PROFILE CROSSOVER BOX

DESCRIPTION	ALUMINUM PART #		DIMENSIONS					
	BRITE	GLOSS BLACK	A	B	C	D	E	F
71" Low Profile	73010910	-	71"	63.25"	11"	13"	20"	16.5"
69" Low Profile	73010911	73210095	69"	60"	11"	13"	20"	16.5"
69" Universal Wedge	73012123	73212124	69"	44"	11"	13"	20"	16.5"
67" Low Profile	73010913	-	67"	56.5"	11"	13"	20"	16.5"
63" Low Profile	73010914	-	63"	54"	11"	13"	20"	16.5"
63" Universal Wedge	73012112	73212113	63"	38"	11"	13"	20"	16.5"
61.5" Universal Corner Cut	73010912	73210096	61.5"	51"	11"	13"	20"	16.5"
61.5" Universal Wedge	73010798	73210799	61.5"	36"	11"	13"	20"	16.5"
56.5" Low Profile	73010915	-	56.5"	46"	11"	13"	20"	16.5"

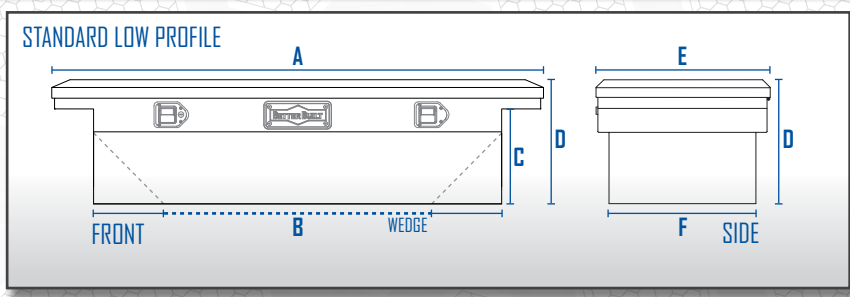

DESCRIPTION

The Crown Series Low Profile design allows for greater visibility through the rear window of your truck. This stylish design complements any fullsize or compact truck.

This tool box is also available in a Universal Wedge design to accommodate most wheel wells.



69" GLOSS BLACK LOW PROFILE CROSSOVER

UNIVERSAL ALUMINUM CROSSOVER

DEEP UNIVERSAL ALUMINUM CROSSOVER

WHITE STEEL CROSSOVER

BLACK STEEL CROSSOVER

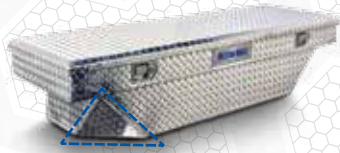

* CORNER CUT



** STAIR CUT



SELF-ADJUSTING STRIKERS

CONTINUOUS ALUMINUM PIANO HINGE

SOLID ONE-PIECE BODY CONSTRUCTION

100% FULLY WELDED SEAMS

WEATHER RESISTANT SEALS

REINFORCED LID BRACE

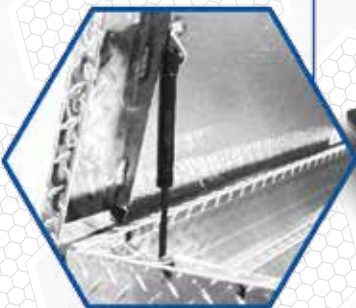

AUTO-LIFT SHOCKS

The "auto-lift" self-rising shock allows easy single handed entry.



HEAVY DUTY 5 POCKET TRAY INCLUDED!

PADDLE HANDLE LATCH

The locking paddle handle latch is easy to open while providing extra security. The inside of the latch features a patented "Up and Over" rod allowing you to open the box from either side.



STATIC CAM LATCH

The Static Cam Latch guides the striker into the lock and increases security against break-ins.

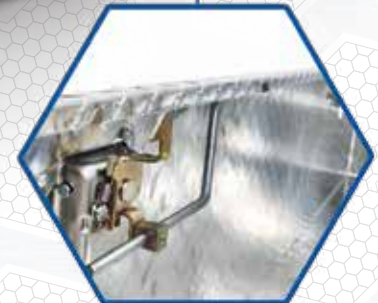

PATENTED LATCH ROD

The patented "Up and Over" rod moves the locking system away from the working space of the tool box, keeping it from being damaged.

UNIVERSAL BOXES

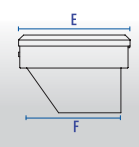
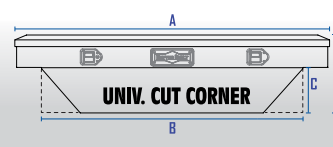
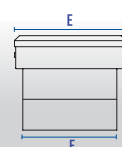
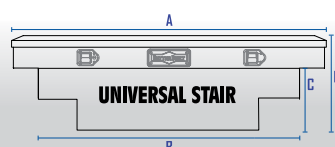
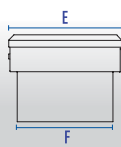
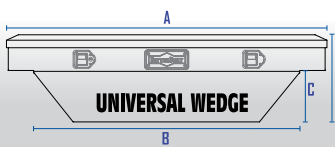

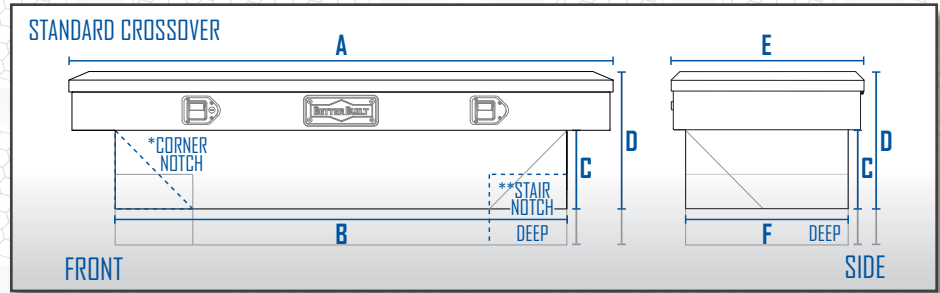

STANDARD CUFF CROSSOVER BOX



BRITE UNCOATED



GLOSS BLACK

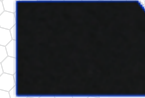

BLACK STEEL



WHITE STEEL

STANDARD	ALUMINUM PART #		STEEL PART #		DIMENSIONS					
	BRITE	GLOSS BLACK	WHITE	BLACK	A	B	C	D	E	F
71" Crossover	73010965	73210939	-	-	71"	60.5"	8.5"	13"	20"	16.5"
69" Crossover	73010899	73210938	73210169	73210128	69"	58"	8.5"	13"	20"	16.5"
67" Crossover	73012069	-	-	-	67"	56"	8.5"	13"	20"	16.5"
67" Universal Corner Cut	73012072	-	-	-	67"	56"	8.5"	13"	20"	16.5"
63" Crossover	73010884	-	73210170	73210129	63"	51"	8.5"	13"	20"	16.5"
63" Universal Corner Cut	73012110	73212111	-	-	63"	52"	7.5"	13"	20"	16.5"
61.5" Crossover	73010869	73210943	-	-	61.5"	50.5"	8.5"	13"	20"	16.5"
61.5" Universal Corner Cut	73010854	-	-	-	61.5"	51"	8.5"	13"	20"	16.5"
56.5" Crossover	73010839	-	-	-	56.5"	45.5"	8.5"	13"	20"	16.5"
51" Crossover	73010824	-	-	-	51"	40"	8.5"	13"	20"	16.5"

DEEP	ALUMINUM PART #				DIMENSIONS					
	BRITE	GLOSS BLACK	WHITE	BLACK	A	B	C	D	E	F
71" Crossover	73010966	-	-	-	71"	60.5"	14"	19"	20"	16.5"
69" Crossover	73010951	73210094	-	-	69"	56.5"	14"	19"	20"	16.5"
67" Crossover	73012082	-	-	-	67"	56"	14"	19"	20"	16.5"
63" Crossover	73010885	-	-	-	63"	51"	14"	19"	20"	16.5"
63" Universal Stair Cut	73012238	-	-	-	63"	52"	14"	19"	20"	16.5"
61.5" Crossover	73010870	-	-	-	61.5"	50.5"	14"	19"	20"	16.5"
61.5" Universal Stair Cut	73010855	-	-	-	61.5"	39"	14"	19"	20"	16.5"
56.5" Crossover	73010840	-	-	-	56.5"	45.5"	14"	19"	20"	16.5"
51" Crossover	73010825	-	-	-	51"	40"	14"	19"	20"	16.5"



SELF-ADJUSTING STRIKERS

CONTINUOUS ALUMINUM PIANO HINGE

SOLID ONE-PIECE BODY CONSTRUCTION

100% FULLY WELDED SEAMS

STAINLESS STEEL LOCKING PADDLE HANDLE LATCHES

WEATHER RESISTANT SEALS

REINFORCED LID BRACE

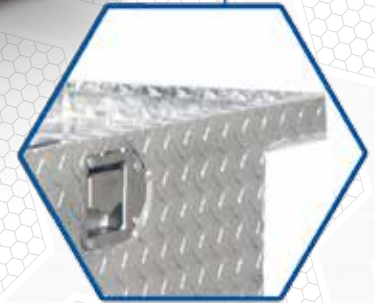
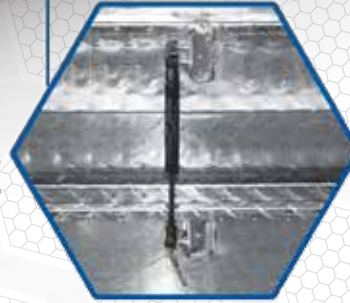
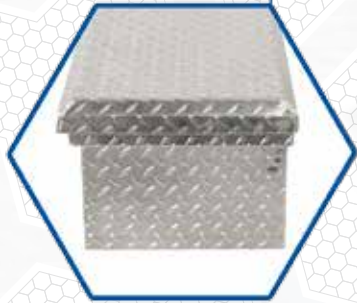

SLIM DESIGN

The narrow design allows for more room in the bed of your truck, taking up only 12 inches of space.

PREMIUM SHOCK

The premium shock provides maximum stability for the lid.

LOW PROFILE

The Low Profile design is stylish and provides greater visibility from the cab of your truck.

SLIMLINE LOW PROFILE

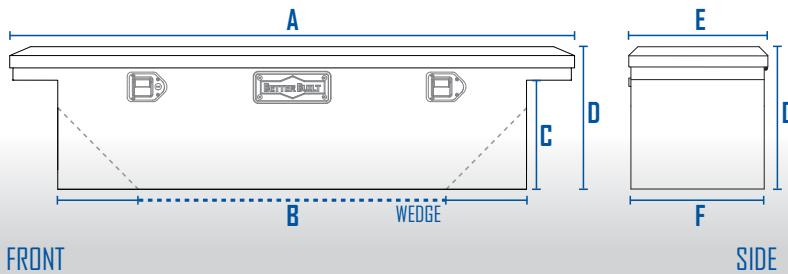

SLIMLINE LOW PROFILE WEDGE

BLACK SLIMLINE LOW PROFILE WEDGE



SLIMLINE LOW PROFILE BOX

DESCRIPTION	ALUMINUM PART #		DIMENSIONS						
	BRITE	GLOSS BLACK	A	B	C	D	E	F	
69" Slimline Low Profile	73010284	73210283	69"	60"	10"	13"	12.5"	12"	
61.5" Slimline Low Profile Wedge	73010286	73210285	61.5"	36"	10"	12"	12.5"	12"	



BRITE UNCOATED



GLOSS BLACK

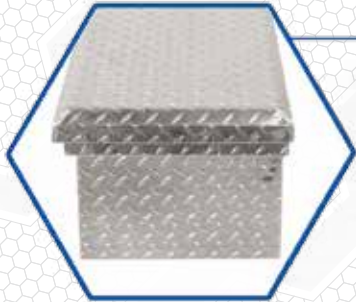
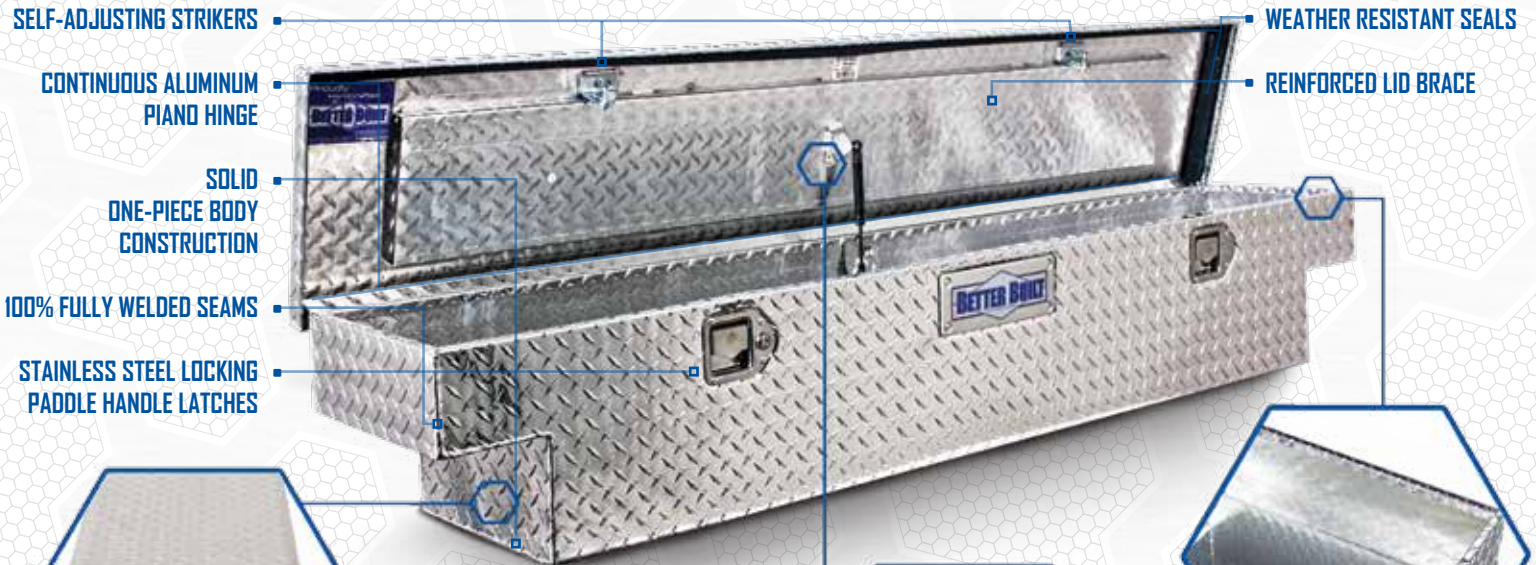

SLIM DESIGN

The narrow design allows for more room in the bed of your truck, taking up only 12 inches of space.

PREMIUM SHOCK

The premium shock provides maximum stability for the lid.

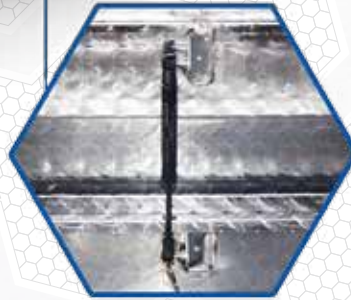

PATENTED INTEGRAL END

A Better Built patented design, the end of the box is made of a solid piece of metal. This gives the box additional strength and creates a small parts storage area.

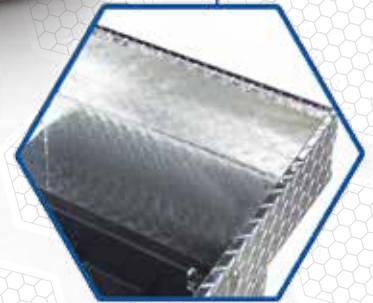

SLIMLINE CROSSOVER

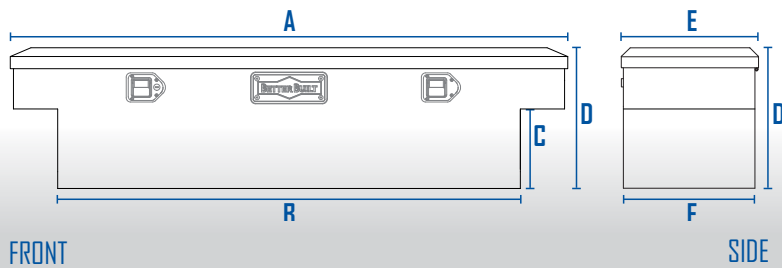

69" BLACK SLIMLINE CROSSOVER**



SLIMLINE CROSSOVER BOX



BRITE UNCOATED



GLOSS BLACK

DESCRIPTION	ALUMINUM PART #		DIMENSIONS						
	BRITE	GLOSS BLACK	A	B	C	D	E	F	
69" Slimline Crossover, Dual Shock	73010280	73210279	69"	58"	10"	16"	12.5"	12"	
69" Slimline Crossover, Single Shock	73010813	-	69"	58"	10"	16"	12.5"	12"	
63" Slimline Crossover, Single Shock	73010282	73210281	63"	52"	10.5"	16"	12.5"	12"	
61.5" Slimline Crossover, Single Shock	73010812	73212410	61.5"	50"	10.5"	16"	12.5"	12"	

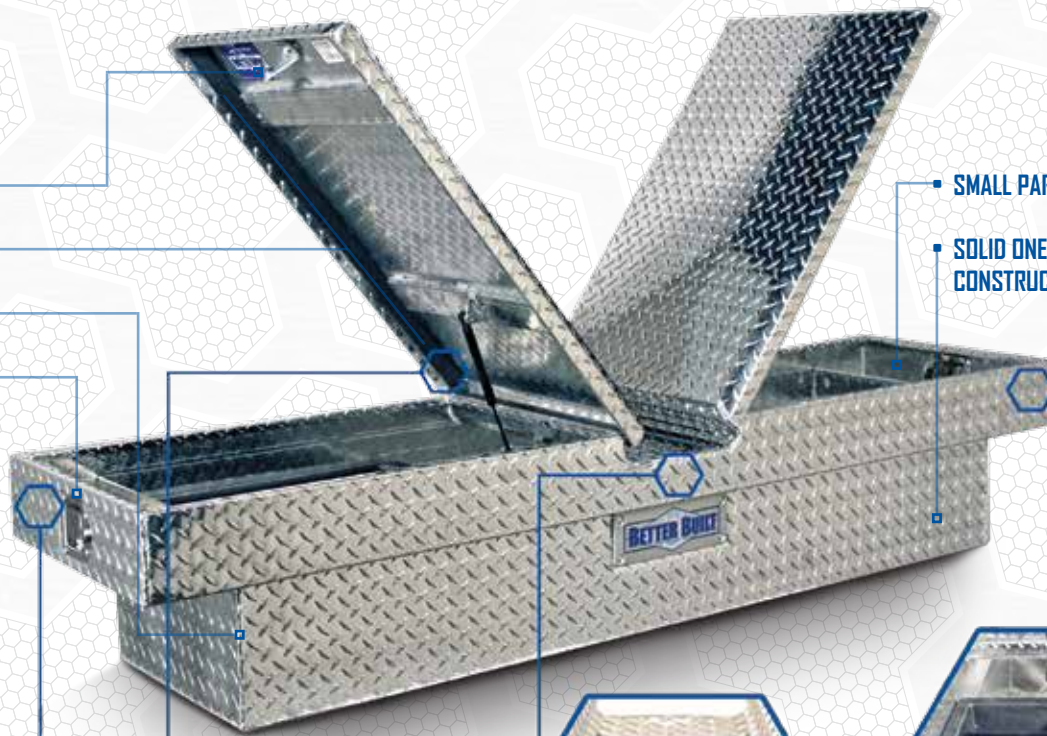

SELF-ADJUSTING STRIKERS

WEATHER RESISTANT SEALS

100% FULLY WELDED SEAMS

STAINLESS STEEL LOCKING
PADDLE HANDLE LATCHES

SMALL PARTS STORAGE AREA

SOLID ONE-PIECE BODY
CONSTRUCTION



STATIC CAM LATCH

The Static Cam Latch guides the striker into the lock and increases security against break-ins.

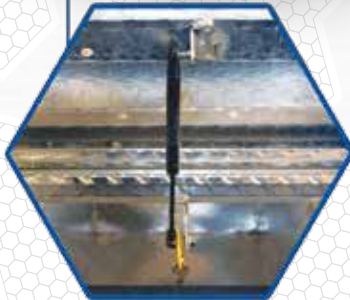

AUTO-LIFT SHOCKS

The "auto-lift," self-rising shock allows easy, single handed entry from both ends of the box.



WIDE CHANNEL

The stylish channel allows room for the lid to open and increases visibility from the cab of your truck.

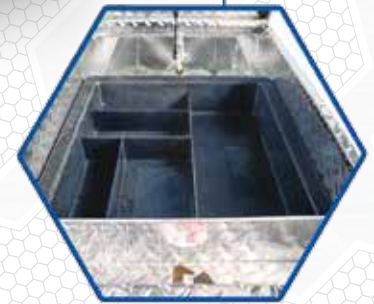

INTEGRAL END

A Better Built patented design, the end of the box is made of a solid piece of metal. This gives the box additional strength and creates a small parts storage area.

UNIVERSAL TWO-LID



* CORNER CUT

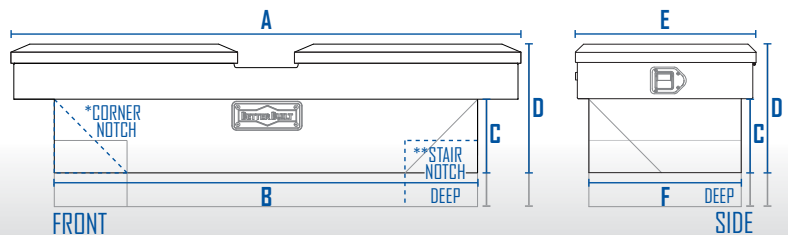

DEEP TWO-LID



DEEP UNIVERSAL TWO-LID



TWO-LID CROSSOVER BOX

STANDARD	ALUMINUM PART #		DIMENSIONS					
	BRITE		A	B	C	D	E	F
71" Crossover	74010957		71"	60.5"	8"	13"	20"	16.5"
69" Crossover	74010891		69"	58"	8"	13"	20"	16.5"
67" Crossover	74012084		67"	56"	8"	13"	20"	16.5"
67" Universal Corner Cut	74012073		67"	42"	8"	13"	20"	16.5"
63" Crossover	74010876		63"	52"	8"	13"	20"	16.5"
63" Universal Corner Cut	74012109		63"	42"	8"	13"	20"	16.5"
61.5" Crossover	74010861		61.5"	49"	8"	13"	20"	16.5"
61.5" Universal Corner Cut	74010846		61.5"	51"	8"	13"	20"	16.5"
56.5" Crossover	74010831		56.5"	45.5"	8"	13"	20"	16.5"
51" Crossover	74010816		51"	40"	8"	13"	20"	16.5"

DEEP	ALUMINUM PART #		DIMENSIONS					
	BRITE		A	B	C	D	E	F
71" Crossover	74010958		71"	60.5"	14"	19"	20"	16.5"
69" Crossover	74010892		69"	58"	14"	19"	20"	16.5"
67" Crossover	74012085		67"	56"	14"	19"	20"	16.5"
63" Crossover	74010877		63"	52"	14"	19"	20"	16.5"
63" Universal Stair Cut	74012233		63"	41"	14"	19"	20"	16.5"
61.5" Crossover	74010862		61.5"	49"	14"	19"	20"	16.5"
61.5" Universal Stair Cut	74010847		61.5"	38"	14"	19"	20"	16.5"
56.5" Crossover	74010832		56.5"	45.5"	14"	19"	20"	16.5"



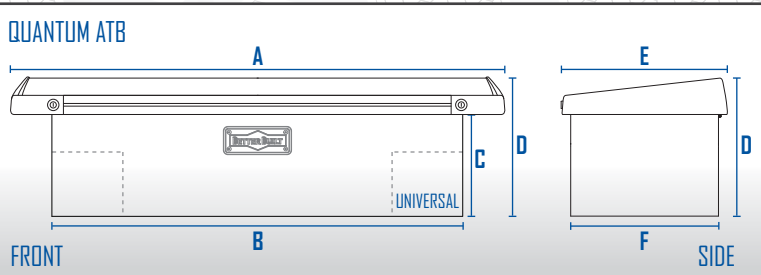

QUANTUM ATB BOX

DESCRIPTION	ALUMINUM PART #		DIMENSIONS					
	BRITE	GLOSS BLACK	A	B	C	D	E	F
71" Crossover	70011172	70211151	71"	63"	11"	13"	23"	17"
69" Universal Stair Cut	70011304	-	69"	47"	11"	13"	23"	17"
69" Crossover	70011167	70214046	69"	61"	11"	13"	23"	17"
67" Crossover	70011306	-	67"	59"	11"	13"	23"	17"
63" Crossover	70011307	70211152	63"	55"	11"	13"	23"	17"
61.5" Crossover	70011168	-	61.5"	52"	11"	13"	23"	17"
61.5" Universal Stair Cut	70011318	-	61.5"	38"	11"	13"	23"	17"
56.5" Crossover	70011308	-	56.5"	46"	11"	13"	23"	17"





OFFSET LID

The offset lid allows your lid to open nearly 90 degrees, even while sitting flush against your truck cab.



BRITE UNCOATED



GLOSS BLACK

MOBILITY

The Chest Box can be used in your truck or for household storage, making it simple and easy to transfer items.

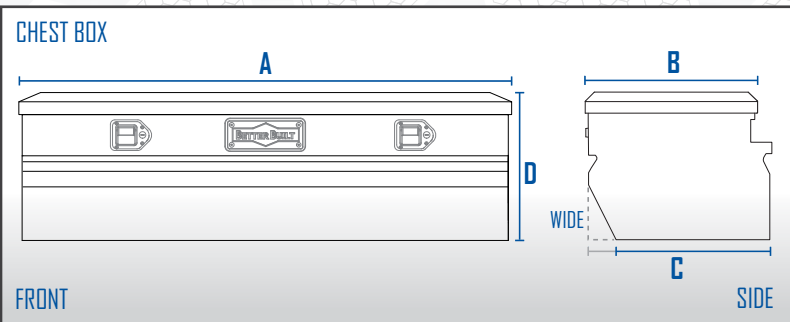
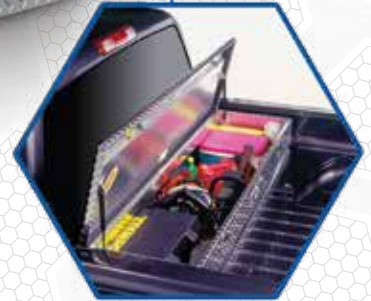

CHEST BOX

STANDARD	ALUMINUM PART #		DIMENSIONS			
	BRITE	GLOSS BLACK	A	B	C	D
60" Chest Box	62012331	62210937	60"	20"	15.75"	18"
56" Chest Box	62060192	62210098	56"	20"	15.75"	18"
48" Chest Box	62012330	62210278	48"	20"	15.75"	18"
36" Chest Box	62012329	62210277	36"	20"	15.75"	18"

WIDE	ALUMINUM PART #		DIMENSIONS			
	BRITE	GLOSS BLACK	A	B	C	D
60" Chest Box	62011323	-	60"	24"	24"	18"
56" Chest Box	62011330	-	56"	24"	24"	18"
48" Chest Box	62011324	-	48"	24"	24"	18"
36" Chest Box	62011325	-	36"	24"	24"	18"

TOP MOUNT

CROWN SERIES

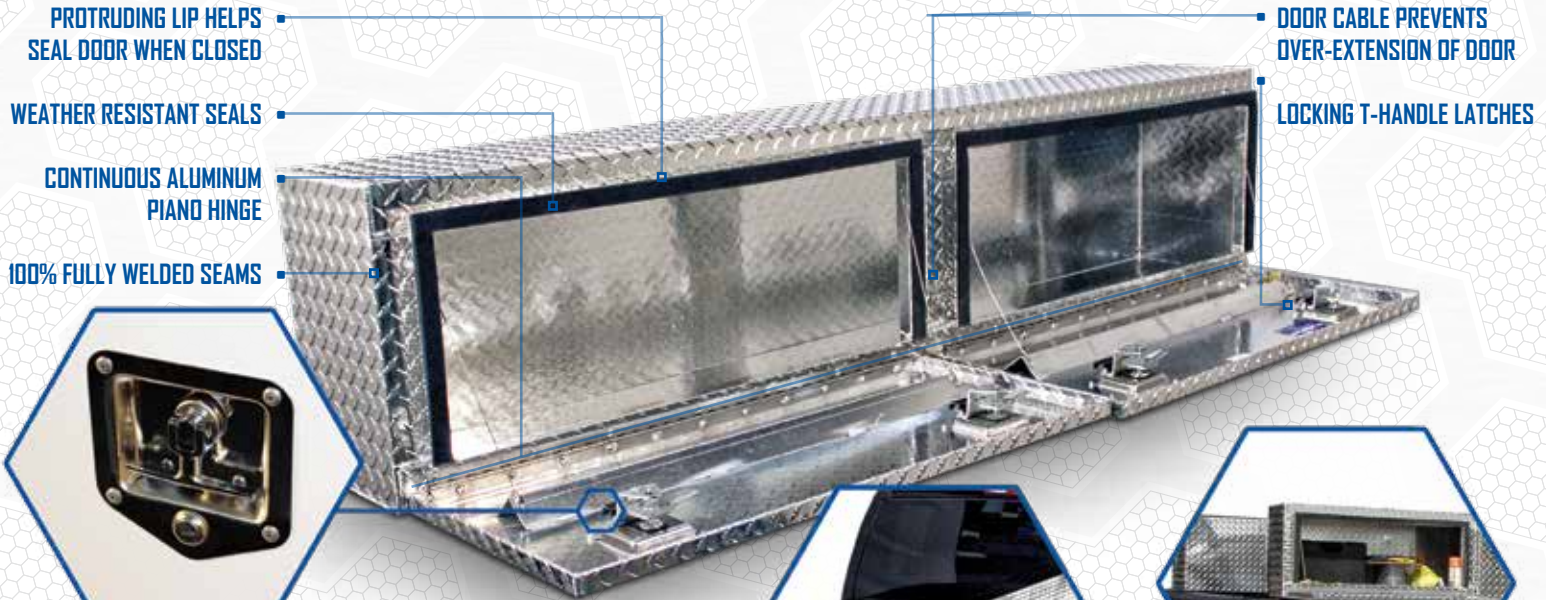

T-HANDLE LATCH

The locking T-handle latches are easy to use and provide superior security.

72 IN. BLACK STEEL



SPACE SAVING

The Top Mount sits on top of the truck bed rails, saving valuable storage space inside the truck bed.

EASY INSTALL

Top Mount boxes are easy to install to the bed rail of any truck. Legs are included for greater stability.



BRITE UNCOATED

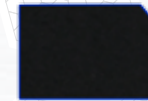

BLACK STEEL



WHITE STEEL

SINGLE DOOR TOP MOUNT

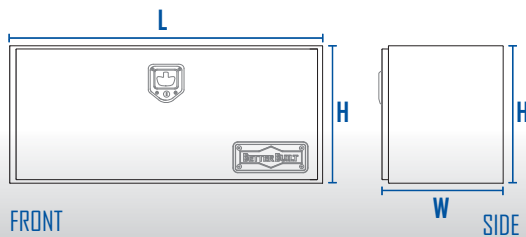

DOUBLE DOOR TOP MOUNT

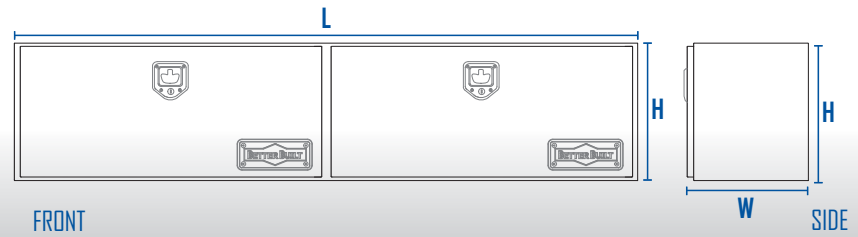

TOP MOUNT BOX

DESCRIPTION	ALUMINUM PART #		STEEL PART #		DIMENSIONS		
	BRITE	WHITE	BLACK	LENGTH	WIDTH	HEIGHT	
96" Top Mount, Double Door	64010147	64210152	64210123	96"	12"	16"	
90" Top Mount, Double Door	64010146	-	-	90"	12"	16"	
72" Top Mount, Double Door	64010145	64210151	64210122	72"	12"	16"	
60" Top Mount, Single Door	64010144	64210150	64210121	60"	12"	16"	
48" Top Mount, Single Door	64010143	64210149	64210120	48"	12"	16"	

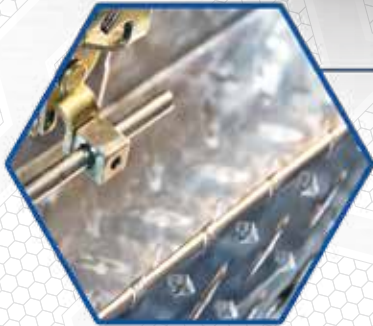

SMALL PARTS AREA

The Side Mount features a small parts partition running the length of the box for extra storage.

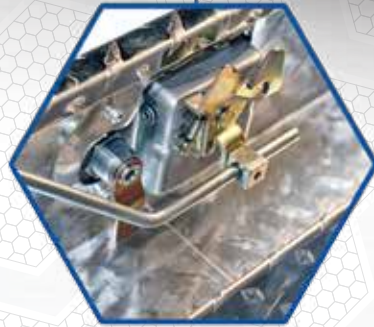

PATENTED LATCH ROD

The patented "Up and Over" rod moves the locking system away from the working space of the tool box, keeping it from being damaged.

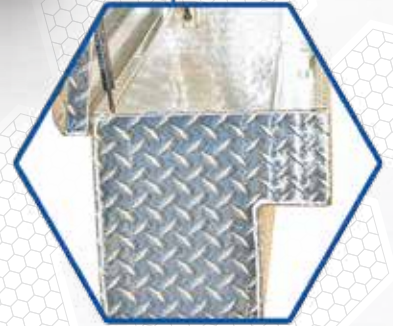

NARROW DESIGN

The Side Mount sits on the truck side rails, leaving plenty of room for additional storage space in the truck bed. Legs are included for greater stability.



BRITE UNCOATED



GLOSS BLACK

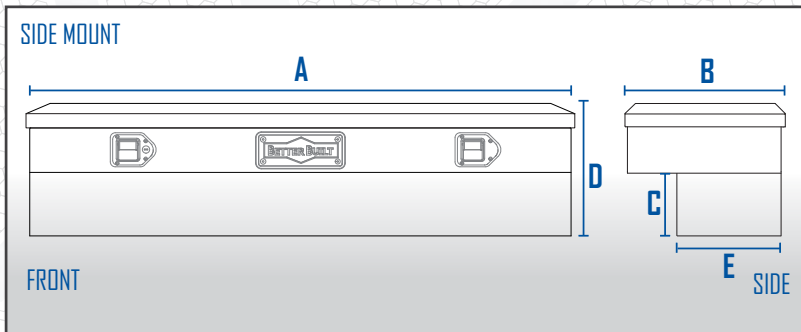

SIDE MOUNT BOX

DESCRIPTION	ALUMINUM PART #		DIMENSIONS				
	BRITE	GLOSS BLACK	A	B	C	D	E
72" Side Mount	63012335	-	72"	11.5"	6"	11"	8"
60" Side Mount	63060190	-	60"	11.5"	6"	11"	8"
48" Side Mount	63012334	63210944	48"	11.5"	6"	11"	8"



MOUNTS EASILY
The Underbody box mounts below the truck, providing convenient additional storage space.



FULL PIANO HINGE
Full piano hinge provides durability and security for the life of the box.



LOCKING LATCH
The zinc-coated T-handle latches provide solid maximum security while using a minimum of space.

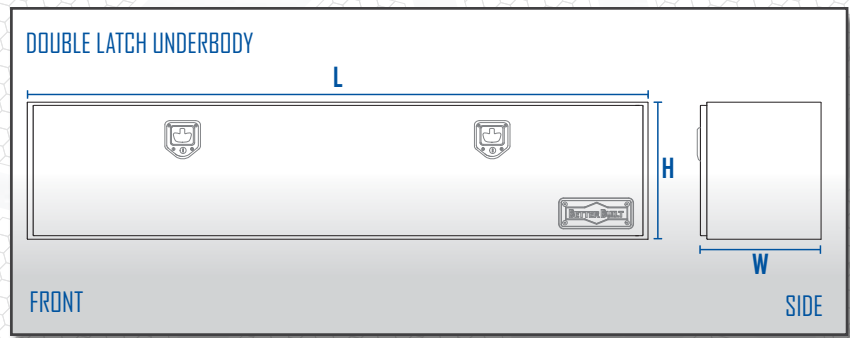

UNDERBODY BOX

DESCRIPTION	ALUMINUM PART #		STEEL PART #		DIMENSIONS		
	BRITE	WHITE	BLACK	LENGTH	WIDTH	HEIGHT	
24"-18" Underbody, Single Latch	65010156	65210165	65210124	24"	17"	18"	
36"-18" Underbody, Single Latch	65010157	65210166	65210125	36"	17"	18"	
48"-18" Underbody, Double Latch	65010158	65210167	65210126	48"	17"	18"	
60"-18" Underbody, Double Latch	65010159	65210168	65210127	60"	17"	18"	
72"-18" Underbody, Double Latch	65010160	-	-	72"	17"	18"	
36"-24" Underbody, Single Latch	65010161	-	-	36"	24"	23"	
48"-24" Underbody, Double Latch	65010162	-	-	48"	24"	23"	
60"-24" Underbody, Double Latch	65010163	-	-	60"	24"	23"	
72"-24" Underbody, Double Latch	65010164	-	-	72"	24"	23"	



Wheel Well Box

Our Wheel Well boxes feature a universal design to accommodate a variety of truck styles. Unit can be mounted on passenger or driver side. Two styles available.



Tote Box

The Better Built Tote Box is a truck-box-on-the-go. Made from the same high-quality materials and built to the same standards as our dependable truck boxes.

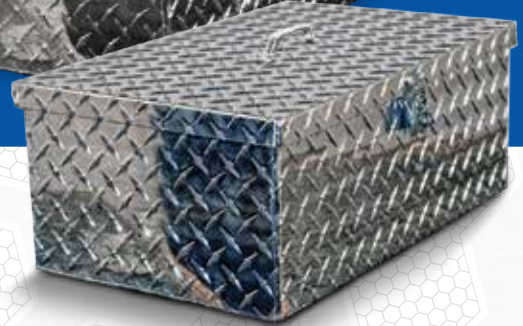

ATV Box

Perfect for your ATV or your truck, SUV or garage, the Better Built ATV Box gives you space where you need it.



Tool Tower Box

The lightweight Tool Tower Box takes up only 18 inches of space, leaving plenty of room in the truck bed for transporting your tools with ease and mobility.



BRITE UNCOATED

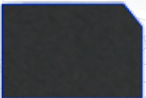

MATTE BLACK



GLOSS BLACK

RECREATIONAL BOXES

DESCRIPTION	ALUMINUM PART #			DIMENSIONS		
	BRITE	MATTE BLACK	GLOSS BLACK	LENGTH	WIDTH	HEIGHT
48" Wheel Well Box	68012344	-	-	48"	8"	18"
48" Wheel Well w/ Drawers	68012346	-	-	48"	8"	18"
60" Wheel Well Box	68012345	-	-	60"	8"	18"
20" Tote Box	67011336	-	-	20"	12"	7.75"
30" Tote Box	67011337	-	-	30"	12"	12"
20" ATV Box	67011386	67210276	-	20"	12"	10.5"
30" ATV Box	67011387	67210275	-	30"	12"	11"
Tool Tower Box	68010172	-	-	18"	8"	18"
Tool Tower Box w/ Drawers	-	-	29217125	18"	7.5"	15.5"



Dog Box

For avid hunters, the Better Built dog box is a must! Available in both single and two-door configurations. Made from the same durable, dependable lightweight diamond plate aluminum as our trend-setting truck boxes. Vented side panels allow for greater air flow throughout the box. Lightweight and easily removable, the open-bottom design allows for easy truck bed cleaning.



Truck Gun Box

Transport your hunting rifles in style with our sleek, durable truck gun box. Made to the same standards as our truck boxes and notched to fit over almost any wheel well. 5" thick dual-slotted foam interior accommodates two full-size rifles.

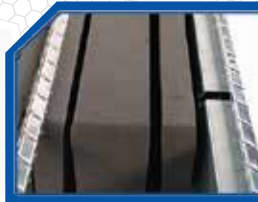

* Wood 4x4s not included

Multi Chute Game Feeder

The Better Built Multi Chute Game Feeder features eight feeder chutes (four per side), a locking, weather resistant lid, and durable, powder coated aluminum construction, with a feed holding capacity of 600 lbs. and an empty weight of just 175 lbs.



RECREATIONAL BOXES

DESCRIPTION	ALUMINUM PART #	DIMENSIONS		
	BRITE	LENGTH	WIDTH	HEIGHT
36" Single Door Dog Box	29010139	36"	48"	24"
48" Double Door Dog Box	29010140	48"	48"	24"
60" Double Door Dog Box	29010141	60"	48"	24"
69" Double Door Dog Box	29010142	69"	48"	24"
Wheel Well Truck Gun Box	63010274	64.5"	10"	18"
Multi Chute Game Feeder*	29211703	52.75"	63.75"	58.25"

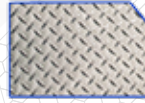

BRITE UNCOATED



GLOSS BLACK



Slant Lid RV Box

On the go? Take it with you in one of our Slant Lid RV boxes. Like our durable truck chests, the Slant Lid RV Box fits securely in the back of your RV, truck, camper or fifth wheel.



V-Top RV Box

Our V-Top boxes give you twice the convenience in a single, easy to install box. The deep center V-channel provides clear access for hooking up gooseneck trailers. Box contents are easily accessible, no matter which side you're on.

Trailer Tongue Box

A box "trailer-made" for your horse or utility trailer. Great for storing tie downs, wheel chocks and other various towing items. Includes auto-lift shocks for ease of opening. Fits perfectly on most trailers.

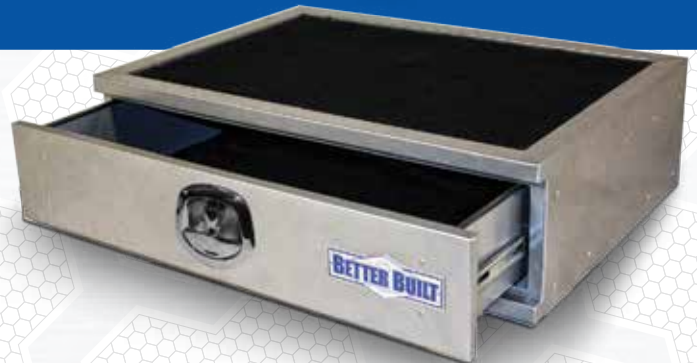

SUV Drawer Box

Ideal for keeping your gear out of sight and safely secured in your SUV. Made of rugged aluminum with a corrosion-resistant powder coated finish, it will provide years of reliable security. Available for both midsize and fullsize SUVs.

RECREATIONAL BOXES

DESCRIPTION	ALUMINUM PART #		DIMENSIONS		
	BRITE	GLOSS BLACK	LENGTH	WIDTH	HEIGHT
56" Slant Lid	62010215	-	56"	19"	19"
56" Slant Lid, Wide	62011310	-	56"	28"	19"
59" V-Top, 2 Lids	62011171	-	59"	22"	17"
Short Trailer Box	66012336	66212322	34"-16"	19"	18"
Tall Trailer Box	66012214	66212323	34"-21"	14"	22"
Tall Trailer Box, Steel	-	66212324	34"-21"	14"	22"
Wide Trailer Box	66010148	66212321	39"-21"	16.5"	12"

SUV DRAWER BOXES

DESCRIPTION	ALUMINUM PART #	DIMENSIONS		
		SILVER	LENGTH	WIDTH
SUV Drawer Box Short	76217119	26"	37"	10.5"
SUV Drawer Box Long	76217118	55"	23"	10.5"

LOADING RAMPS

CROWN
S E R I E S



500 lb.

Folding Arched

96 FR - 500 lb. Capacity (each ramp)
Folds for easy transportation
Sold as a pair (2 ramps)
Includes safety strap for secure loading



Fixed Arched

95 SR - 750 lb. Capacity (each ramp)
Heavy Duty Mono Threshold Bar
Sold as a pair (2 ramps)
Includes safety strap for secure loading



750 lb.



750 lb.

Steel Center Folding

30 SFR - 750 lb. Capacity (each ramp)
Extends to 80", stylish black powder coat
Each folding ramp sold individually
Includes safety strap for secure loading



Bi-Fold Extended

284 FR - 1,500 lb. Capacity
750 lb. Capacity per panel
Panels separate for greater utility
Includes safety strap for secure loading



1,500 lb.



Tri-Fold

156 FR - 1,500 lb. Capacity
500 lb. Capacity per panel
Great for ATVs and lawn tractors
Includes safety strap for secure loading



1,500 lb.



1,500 lb.

Tri-Fold Extended

184 FR - 500 lb. Capacity per Panel
Includes safety strap for secure loading
Fully extended, 46" wide
Longer length for easier loading & handling



Ramp-It™ Ends

The Ramp-It kit is a great alternative to manufactured ramps. Easy to assemble, it has a 700 lb. capacity (not including boards)
Great for all types of equipment



700 lb.
(not including boards)

*EVENLY DISTRIBUTED LOAD PER RAMP/PANEL

DESCRIPTION	PART #	DIMENSIONS	PER PANEL CAPACITY	OVERALL CAPACITY	WEIGHT
Folding Arched (pair)	25710065	91" x 11" x 2"	500 lbs.	1,000 lbs.*	20 lbs.
Fixed Arched (pair)	25712183	91" x 11" x 2"	750 lbs.	1,500 lbs.*	20 lbs.
Steel Center Folding (Black)	25810067	80" x 11" x 10.5"	750 lbs.	750 lbs.*	25 lbs.
Bi-Fold Extended	25710070	82" x 48" x 2"	750 lbs.	1,500 lbs.*	25 lbs.
Tri-Fold	25712193	69" x 46" x 1.25"	500 lbs.	1,500 lbs.*	30 lbs.
Tri-Fold Extended	25710046	91" x 46" x 2"	500 lbs.	1,500 lbs.*	60 lbs.
8" Ramp-It Ends Kit	25710006	Fits 2" x 8" boards	-	-	-

⚠ DANGER

IMPROPER USE WILL RESULT IN SERIOUS INJURY OR DEATH.

NEVER ride any vehicle up or down the loading ramp.

DO NOT exceed the load capacity.

ALWAYS secure the ramp safety straps to the ramp and vehicle before use.

BEWARE the pinch points when folding and unfolding the ramp.



⚠ WARNING

NEVER RIDE ANY VEHICLE UP OR DOWN LOADING RAMPS

Quantum[®] Accessories

Expand and enhance your Quantum Rack storage system with optional accessories, including our Cargo Lock, Box Mount, Cleat Tie-Down Kits and Headache Rack Insert.

Cargo Lock Kit



Part # 29710691

Box Mount Kit



Part # 29710692

Cleat Tie-Down Kit



Part # 29710693

Headache Rack Insert



Part # 29210689



QUANTUM[®] RACK

Part # 29710690

QUANTUM[®] RACK FEATURES



- Fits most full-size and compact trucks.
- Top rail width fully adjustable to fit most any truck.
- Built in accessory track allows for easy mounting of optional accessories.
- Installs in 4 easy steps and bolts together with stainless steel hardware.
- Durable Quantum Silver™ powder coat finish.
- Handles loads up to 800 lbs.

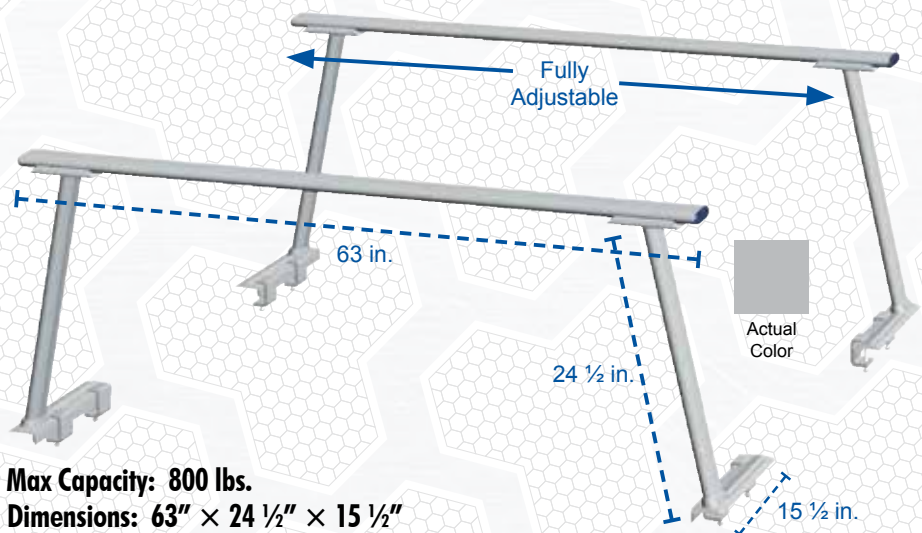

Max Capacity: 800 lbs.
Dimensions: 63" × 24 1/2" × 15 1/2"



Perfect for both work...



...and for play!

STORAGE RACKS

CROWN
S E R I E S



Dimensions: 27" × 1 1/2" × 57 5/8"

Y-Ladder Rack

Allows storage of long, awkward items that will not fit in your truck bed. Designed to fit any truck bed. Weight Capacity: 250 lbs. per set

Part # 29710002



Matte Black
Bumper
Buddy

Bumper Buddy

Available in both lightweight aluminum and heavy duty steel in three durable powder-coat finishes:

Brite <input type="checkbox"/>	Gloss Black <input type="checkbox"/>	Matte Black <input type="checkbox"/>
(Aluminum Only)	(Aluminum Only)	(Steel Only)
Part # 21710701	Part # 21210702	Part # 21210730



Brite
Bumper
Buddy

Folding Knuckle

Optional folding knuckle accessory for easy, compact storage.

Part # 21710700



Max Capacity: 500 lbs.
Dimensions: 49 1/4" × 22 1/4" × 4"



60" SITE SAFE
(CASTER WHEEL KIT SOLD SEPARATELY)

Crown Series
Site Safes
Made From
18 Gauge Steel

CASTER WHEEL KIT

Sold Separately. Part # 29812062



- Mounting Hardware Included
- Supports up to 1100 lbs. (275 ea.)
- Two Lockable Rotating Wheels
- Two Stationary Wheels

Secure, on-site storage constructed of heavy duty steel with a reinforced lid. Site Safes provides the security and durability to meet your industrial demands.

SITE SAFE JOBSITE BOX

DESCRIPTION	PART #	DIMENSIONS		
	BLUE	LENGTH	WIDTH	HEIGHT
60" Site Safe	37211297	60"	24"	25"
48" Site Safe	37211296	48"	23"	25"
36" Site Safe	37211295	36"	17"	25"



60" SITE SAFE

48" SITE SAFE

36" SITE SAFE

SITE SAFE BOXES

Choose from
3 Different Sizes:

**36", 48"
and 60"**



A Division of Daws M

Page 30

LOW PROFILE

Page 32

CROSSOVER

Page 34

X2 BOX

Page 35

SLIMLINE

Page 36

TWO-LID

Page 38

CHEST BOX

Page 39

SIDE MOUNT

Page 40

FISHING BOX



SEC
SERIES

LOW PROFILE

SEC SERIES

SELF-ADJUSTING STRIKERS

CONTINUOUS ALUMINUM PIANO HINGE

SOLID ONE-PIECE BODY CONSTRUCTION

100% FULLY WELDED SEAMS

PREMIUM WEATHER RESISTANT SEALS

REINFORCED FOAM FILLED LID WITH WELDED C-CHANNEL BRACE



CHROME LOCKING PULL HANDLES

Stylish industry exclusive locking pull handle latches allow you to lock or unlock your box from either side. Features a durable chrome finish.

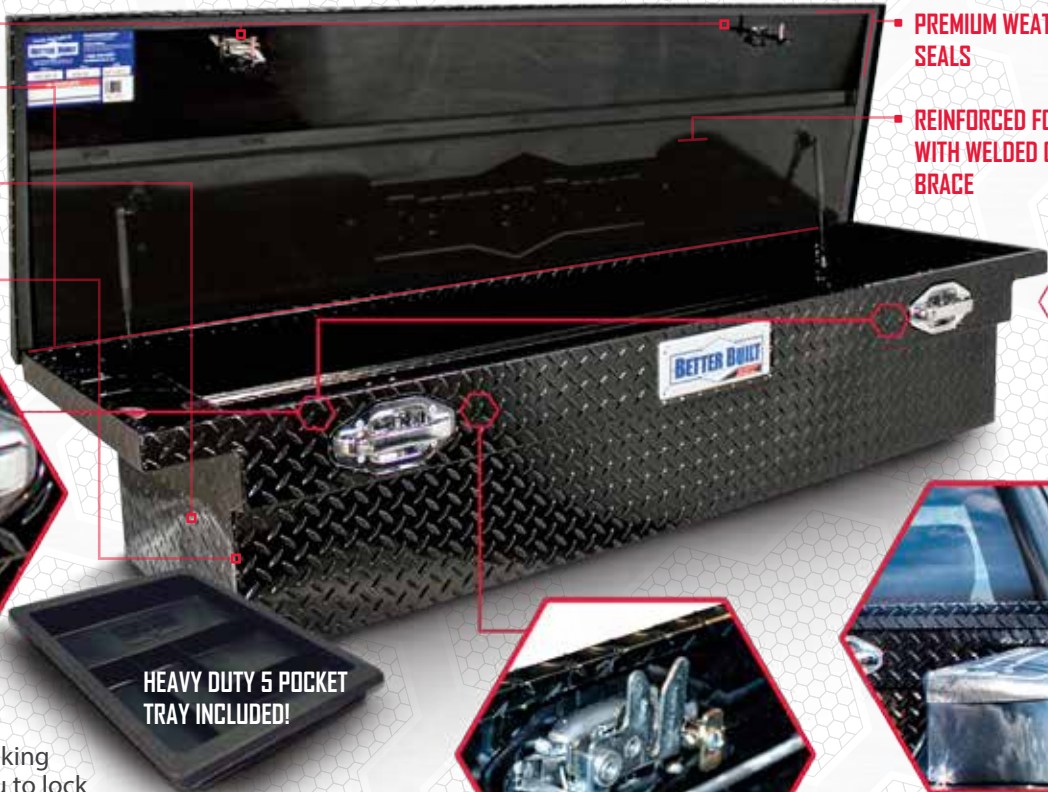

HEAVY DUTY 5 POCKET TRAY INCLUDED!



ROTARY LATCHES

The 2-stage automotive-grade rotary latch provides extra security and protection for the contents of your box.



STYLISH DESIGN

The stylish low profile look complements any fullsize or compact truck. Various applications available.

SEC UNIVERSAL LOW PROFILE



* CORNER CUT

SEC DEEP UNIVERSAL LOW PROFILE



** STAIR CUT

DESCRIPTION

The SEC Low Profile design allows for greater visibility through the rear window of your truck. This stylish design complements any fullsize or compact truck.

This tool box is also available in a Universal Wedge design to accommodate wheel wells, and in a deep design for more storage space for larger items.

SEC LOW PROFILE WEDGE

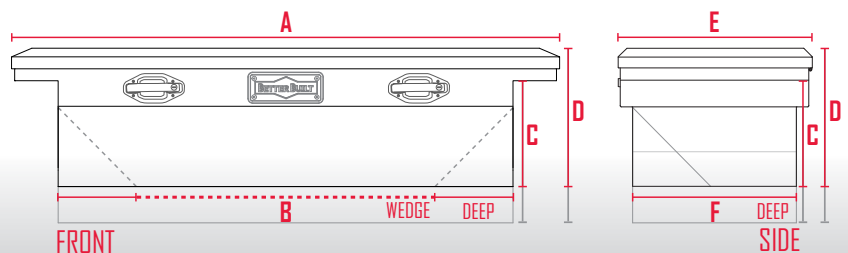

SEC LOW PROFILE BOX



BRITE UNCOATED



GLOSS BLACK

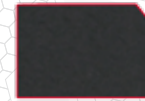

MATTE BLACK



QUANTUM SILVER

STANDARD	ALUMINUM PART #				DIMENSIONS					
	BRITE	GLOSS BLACK	MATTE BLACK	QUANTUM SILVER	A	B	C	D	E	F
71" Crossover	79011002	79210920	79211098	79212532	71"	62"	11"	13"	20"	16.5"
69" Crossover	79011003	79210919	79211099	79212530	69"	60"	11"	13"	20"	16.5"
69" Universal Stair Cut	79010947	79210948	-	-	69"	45"	11"	13"	20"	16.5"
69" Universal Wedge	-	-	79211103	79212531	69"	45"	11"	13"	20"	16.5"
67" Crossover	79011007	-	-	-	67"	56.5"	11"	13"	20"	16.5"
63" Crossover	79011010	79210918	79211100	79212528	63"	54"	11"	13"	20"	16.5"
63" Universal Wedge	79011056	79211057	79211104	79212529	63"	39"	11"	13"	20"	16.5"
61.5" Universal Corner Notch	79011005	79210917	-	-	61.5"	52"	11"	13"	20"	16.5"
61.5" Universal Wedge	79011000	79211001	-	-	61.5"	35"	11"	13"	20"	16.5"
56.5" Crossover	79011054	79210916	-	-	56"	46"	11"	13"	20"	16.5"

DEEP	BRITE	GLOSS BLACK	MATTE BLACK	QUANTUM SILVER	A	B	C	D	E	F
	71" Crossover	79010902	79210922	79211101	79212535	71"	62"	15"	19"	20"
71" Universal Wedge	79011068	79211070	79211106	79212536	71"	47"	15"	19"	20"	16.5"
69" Crossover	79010901	79210921	79211102	79212533	69"	60"	15"	19"	20"	16.5"
69" Universal Wedge	79011067	79211069	79211105	79212534	69"	44"	15"	19"	20"	16.5"
61.5" Universal Stair Cut	79010946	-	-	-	61.5"	39"	15"	19"	20"	16.5"



69" SEC GLOSS BLACK CROSSOVER
FEATURING CHROME PULL HANDLES

SELF-ADJUSTING STRIKERS

CONTINUOUS ALUMINUM PIANO HINGE

SOLID ONE-PIECE BODY CONSTRUCTION

100% FULLY WELDED SEAMS

WEATHER RESISTANT SEALS

REINFORCED FOAM FILLED LID WITH WELDED C-CHANNEL BRACE

STAINLESS STEEL LOCKING PULL HANDLE ROTARY LATCHES



AUTO-LIFT SHOCKS

The "auto-lift" self-rising shock allows easy single handed entry.



HEAVY DUTY 5 POCKET TRAY INCLUDED!



ROTARY LATCHES

The 2-stage automotive-grade rotary latch provides extra security and protection for the contents of your box.

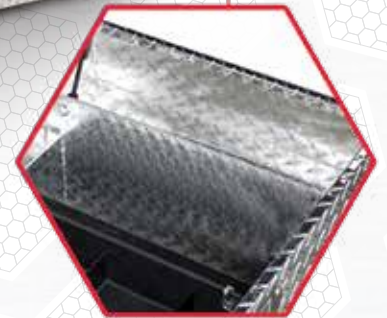

INTEGRAL END

A Better Built patented design, the end of the box is made of a solid piece of metal. This gives the box additional strength and creates a small parts storage area.

SEC WIDE CROSSOVER



* TRAY NOT INCLUDED

DESCRIPTION

The SEC Crossover Tool Box is far above the industry standard in crossover truck tool boxes. Available in uncoated brite or powder coated finishes. Also available in a deep tub design.

SEC DEEP CROSSOVER

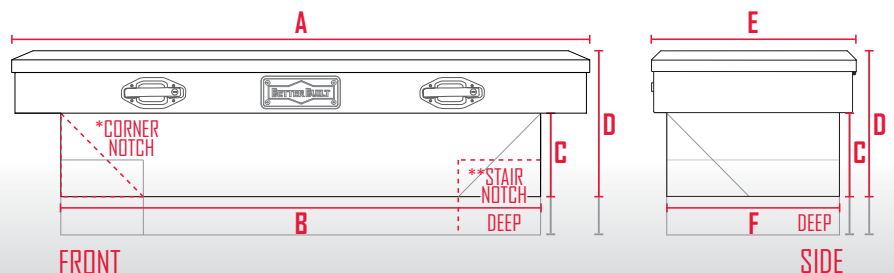

SEC CROSSOVER BOX



BRITE UNCOATED



GLOSS BLACK

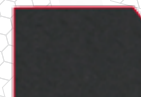

MATTE BLACK



QUANTUM SILVER

STANDARD	ALUMINUM PART #				DIMENSIONS					
	BRITE	GLOSS BLACK	MATTE BLACK	QUANTUM SILVER	A	B	C	D	E	F
71" Crossover	79011016	79210984	79211093	79212525	71"	60.5"	8"	13"	20"	16.5"
71" Crossover, Wide	79011066	79212419	79212418	79212519	71"	60.5"	8"	13"	26"	23.5"
69" Crossover	79011012	79210986	79211094	79212524	69"	58.5"	8"	13"	20"	16.5"
69" Crossover, Wide	79011065	79212420	79212417	79212518	69"	58.5"	8"	13"	26"	23.5"
67" Crossover	79011031	-	-	-	67"	56"	8"	13"	20"	16.5"
63" Crossover	79011025	79210988	79211095	79212523	63"	52"	8"	13"	20"	16.5"
63" Universal Corner Cut	79010936	79211055	-	-	63"	52"	8"	13"	20"	16.5"
61.5" Crossover	79011014	79210989	-	-	61.5"	51"	8"	13"	20"	16.5"
61.5" Universal Corner Cut	79011018	79210990	-	-	61.5"	51"	8"	13"	20"	16.5"
56.5" Crossover	79011023	79210991	-	-	56.5"	45.5"	8"	13"	20"	16.5"
51" Crossover	79010929	-	-	-	51"	40"	8"	13"	20"	16.5"

DEEP	BRITE	GLOSS BLACK	MATTE BLACK	QUANTUM SILVER	A	B	C	D	E	F
71" Crossover	79011016	79210984	79211093	79212525	71"	60.5"	14"	19"	20"	16.5"
69" Crossover	79011020	79210987	79211097	79212526	69"	58.5"	14"	19"	20"	16.5"
67" Crossover	79011047	-	-	-	67"	56"	14"	19"	20"	16.5"
63" Crossover	79011044	-	-	-	63"	52"	14"	19"	20"	16.5"
63" Universal Stair Cut	79011004	-	-	-	63"	41"	14"	19"	20"	16.5"
61.5" Crossover	79011040	-	-	-	61.5"	50.5"	14"	19"	20"	16.5"
61.5" Universal Stair Cut	79011035	79211760	-	-	61.5"	39.5"	14"	19"	20"	16.5"
56.5" Crossover	79011034	-	-	-	56.5"	45.5"	14"	19"	20"	16.5"
51" Crossover	79010930	-	-	-	51"	40"	14"	19"	20"	16.5"

DEEP AND WIDE	BRITE	GLOSS BLACK	MATTE BLACK	QUANTUM SILVER	A	B	C	D	E	F
71" Crossover	79010924	-	79212414	79212517	71"	60.5"	11"	16"	25"	22.5"
69" Crossover	79010923	-	79212413	79212516	69"	52"	11"	16"	25"	22.5"



69" SEC MATTE BLACK CROSSOVER
FEATURING BLACK PULL HANDLES

X2 END OPENING BOX

SEC
SERIES

SELF-ADJUSTING STRIKERS

AUTO-LIFT SHOCKS

CONTINUOUS ALUMINUM
PIANO HINGE

SOLID ONE-PIECE BODY
CONSTRUCTION

END OPENING LOCKING
PUSH BUTTON ROTARY
LATCHES

PREMIUM WEATHER RESISTANT
SEALS

REINFORCED FOAM FILLED LID
WITH WELDED C-CHANNEL BRACE

100% FULLY WELDED SEAMS



HAWKBILL LATCHES

The Hawkbill latching system provides ultimate security for the contents of your box.



HEAVY DUTY 5 POCKET
TRAY INCLUDED!

LOCKING PUSH BUTTON LATCHES

Stylish locking push button latches allow you to lock or unlock your box from either side.

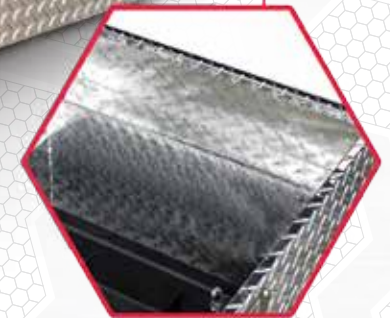

INTEGRAL END

A Better Built patented design, the end of the box is made of a solid piece of metal. This gives the box additional strength and creates a small parts storage area.

X2 END OPENING BOX

STANDARD	ALUMINUM PART #				DIMENSIONS					
	BRITE	GLOSS BLACK	MATTE BLACK	QUANTUM SILVER	A	B	C	D	E	F
71" Crossover	79011750	79212429	79212435	79212542	71"	60.5"	8"	14"	20"	16.5"
69" Crossover	79011752	79212427	79212433	79212540	69"	52"	8"	14"	20"	16.5"
61.5" Universal Corner-Cut	79011754	79212425	79212431	79212538	61.5"	49"	8"	14"	20"	17.5"

DEEP	ALUMINUM PART #				DIMENSIONS					
	BRITE	GLOSS BLACK	MATTE BLACK	QUANTUM SILVER	A	B	C	D	E	F
71" Crossover	79011751	79212428	79212434	79212541	71"	60.5"	14"	20"	20"	16.5"
69" Crossover	79011753	79212426	79212432	79212539	69"	58.5"	14"	20"	20"	16.5"
61.5" Compact Crossover	79011755	79212424	79212430	79212537	61.5"	50.5"	14"	20"	20"	16.5"

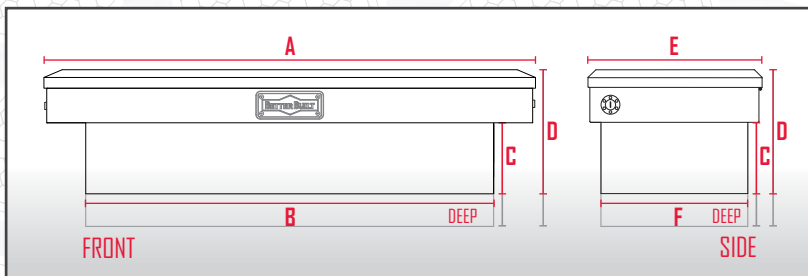



SELF-ADJUSTING STRIKERS

CONTINUOUS ALUMINUM PIANO HINGE

SOLID ONE-PIECE BODY CONSTRUCTION

100% FULLY WELDED SEAMS

PREMIUM WEATHER RESISTANT SEALS

REINFORCED FOAM FILLED LID

AUTO-LIFT SHOCKS

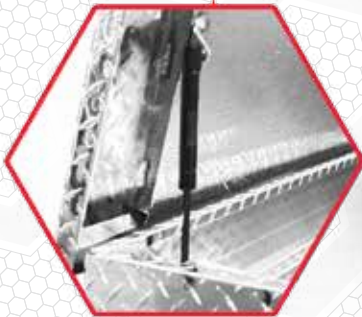

AUTO-LIFT SHOCKS

The "auto-lift," self-rising shock allows easy single handed entry.

SLIM TUB DESIGN

The Slimline Boxes allow for more room in the bed of the truck, taking up only 12 inches of space.

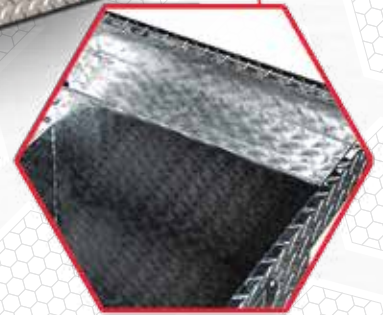
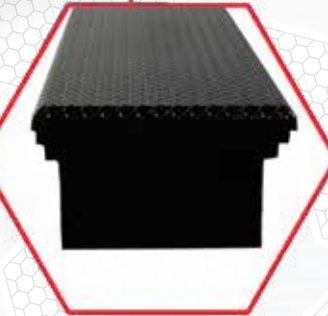

INTEGRAL END

A Better Built patented design, the end of the box is made of a solid piece of metal. This gives the box additional strength and creates a small parts storage area.

DESCRIPTION

Our Low Profile Slimline boxes features a space-saving 12in. deep narrow design that offers secure storage while saving space in the bed of your truck.

LOW PROFILE SLIMLINE BOX



DESCRIPTION	ALUMINUM PART #				DIMENSIONS					
	BRITE	GLOSS BLACK	MATTE BLACK	QUANTUM SILVER	A	B	C	D	E	F
71" Crossover	79011052	79210904	79212423	79212522	71"	62"	10"	12"	13.5"	12"
69" Crossover	79011051	79210903	79212422	79212521	69"	60"	10"	12"	13.5"	12"
61.5" Universal Wedge	79011050	79211759	79212421	79212520	61.5"	38"	10"	12"	13.5"	12"

SLIMLINE BLACK

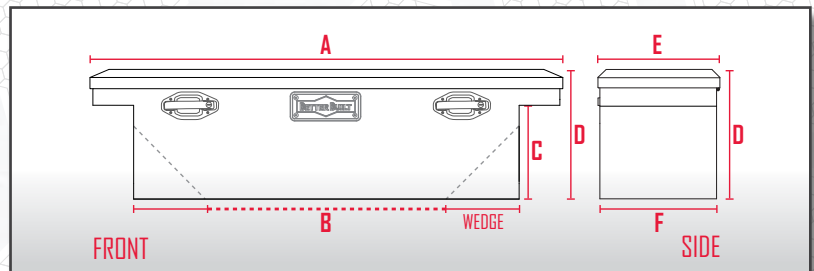

SELF-ADJUSTING STRIKERS

WEATHER RESISTANT SEALS

100% FULLY WELDED SEAMS

STAINLESS STEEL LOCKING
PULL HANDLE ROTARY
LATCHES

REINFORCED FOAM FILLED LID

SOLID ONE-PIECE BODY
CONSTRUCTION



ROTARY LATCH

The 2-Stage automotive-grade rotary latch provides superior security for your contents.



HEAVY DUTY 5 POCKET
TRAY INCLUDED!

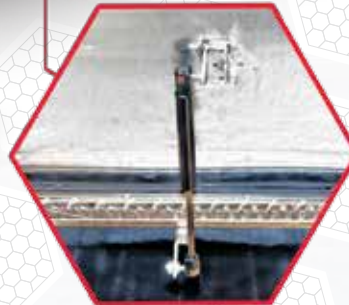

AUTO-LIFT SHOCKS

The "auto-lift" self-rising shock allows easy, single handed entry.



INTEGRAL END

A Better Built patented design, the end of the box is made of a solid piece of metal. This gives the box additional strength and creates a small parts storage area.

DESCRIPTION

The SEC Two-Lid Tool box is also known as the Gull-Wing box because the lids open like a seagull's wings. This allows for easy access from either side of the truck.

Each side of the lid has a locking automotive-grade rotary latch to secure your valuable items. On the interior of each end of the box, a small parts partition provides convenient storage of smaller items.

UNIVERSAL TWO-LID

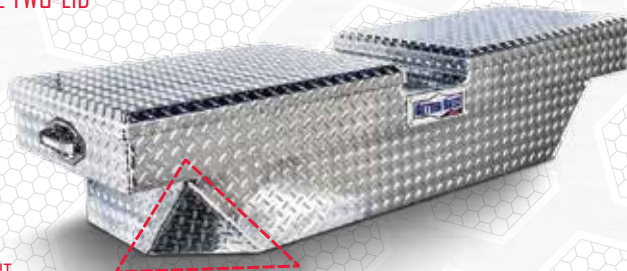

* CORNER CUT

DEEP UNIVERSAL TWO-LID

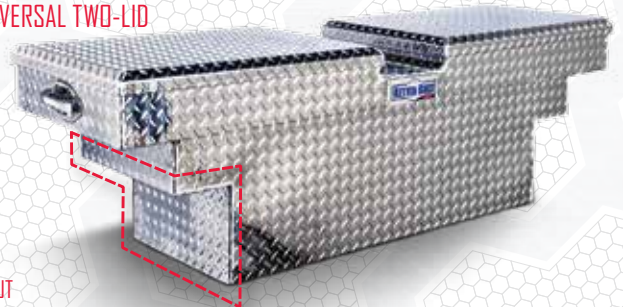

** STAIR CUT

SEC TWO-LID CROSSOVER BOX

STANDARD	ALUMINUM PART #				DIMENSIONS					
	BRITE	GLOSS BLACK	MATTE BLACK	QUANTUM SILVER	A	B	C	D	E	F
71" Crossover	79011021	-	-	-	71"	60.5"	8"	13"	20"	16.5"
69" Crossover	79011013	-	-	-	69"	58.5"	8"	13"	20"	16.5"
67" Crossover	79011045	-	-	-	67"	56"	8"	13"	20"	16.5"
63" Universal Corner Cut	79010934	-	-	-	63"	38"	8"	13"	20"	16.5"
63" Crossover	79011042	-	-	-	63"	52"	8"	13"	20"	16.5"
61.5" Universal Corner Cut	79011024	-	-	-	61.5"	51"	8"	13"	20"	16.5"
61.5" Crossover	79011032	-	-	-	61.5"	49"	8"	13"	20"	16.5"
56.5" Crossover	79011037	-	-	-	56.5"	45.5"	8"	13"	20"	16.5"
51" Crossover	79010927	-	-	-	51"	40"	8"	13"	20"	16.5"

DEEP	ALUMINUM PART #				DIMENSIONS					
	BRITE	GLOSS BLACK	MATTE BLACK	QUANTUM SILVER	A	B	C	D	E	F
71" Crossover	79011048	-	-	-	71"	60.5"	14"	19.5"	20"	16.5"
69" Crossover	79011030	-	-	-	69"	58.5"	14"	19.5"	20"	16.5"
67" Crossover	79011046	-	-	-	67"	56"	14"	19.5"	20"	16.5"
63" Universal Stair Cut	79010935	-	-	-	63"	41"	14"	19.5"	20"	16.5"
63" Crossover	79011043	-	-	-	63"	52"	14"	19.5"	20"	16.5"
61.5" Universal Stair Cut	79011041	-	-	-	61.5"	38"	14"	19.5"	20"	16.5"
61.5" Crossover	79011039	-	-	-	61.5"	49"	14"	19.5"	20"	16.5"
56.5" Crossover	79011038	-	-	-	56.5"	45.5"	14"	19.5"	20"	16.5"

DEEP TWO-LID

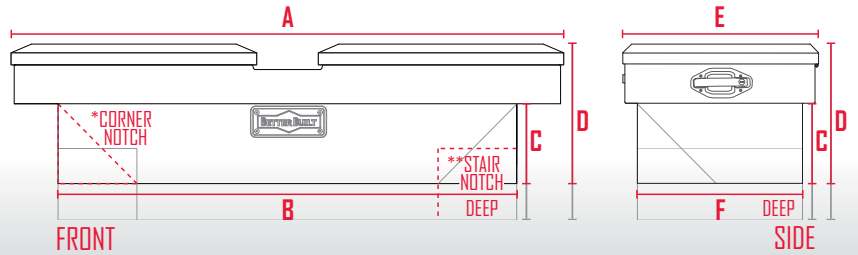

CHEST BOX

SEC
SERIES

SELF-ADJUSTING STRIKERS

CONTINUOUS ALUMINUM
PIANO HINGE

SOLID ONE-PIECE BODY
CONSTRUCTION

WEATHER RESISTANT SEALS

REINFORCED FOAM FILLED
LID

AUTO-LIFT SHOCKS



OFFSET LID

The recessed lid allows the lid to open nearly 90 degrees, even while sitting flush against your truck cab.



ROTARY LATCH

The 2-stage automotive-grade Rotary Latch system provides a higher level of security for the box.



CHROME LOCKING PULL HANDLES

Stylish industry exclusive locking pull handle latches allow you to lock or unlock your box from either side. Features a durable chrome finish.

DESCRIPTION

The SEC Truck Chest Box is an excellent alternative to the standard crossover. It leaves the bed rails of your truck unobstructed for other uses. It can be used both in your truck and for household storage.



60" CHEST BOX*

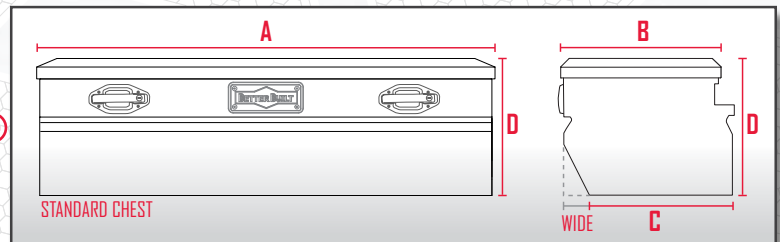

SEC CHEST BOX

DESCRIPTION	ALUMINUM PART #				DIMENSIONS			
	BRITE	GLOSS BLACK	MATTE BLACK	QUANTUM SILVER	A	B	C	D
60" Chest Box*	79011015	79210994	79212439	79212545	60"	17.5"	16"	18"
60" Chest Box, Wide	79010982	-	79212441	79212547	60"	21.5"	24"	18"
56" Chest Box*	79010983	79210993	-	-	56"	17.5"	16"	18"
48" Chest Box*	79010981	79210992	79212437	79212544	48"	21.5"	24"	18"
48" Chest Box, Wide	79011017	-	79212440	79212546	48"	17.5"	16"	18"
40" Chest Box*	79011062	-	-	-	41"	17.5"	16"	18"
36" Chest Box*	79011063	79211761	79212436	79212543	36"	17.5"	16"	18"

* Width at base = 15 3/4"

- SELF-ADJUSTING STRIKERS
- CONTINUOUS ALUMINUM PIANO HINGE
- SOLID ONE-PIECE BODY CONSTRUCTION
- 100% FULLY WELDED SEAMS
- PREMIUM WEATHER RESISTANT SEALS
- REINFORCED FOAM FILLED LID



PREMIUM SHOCKS

Our premium gas shocks allow easy, single handed entry.

ROTARY LATCH

The 2-stage automotive-grade rotary latch provides premium security for the contents of your box.



CHROME LOCKING PULL HANDLES

Stylish industry exclusive locking pull handle latches allow you to lock or unlock your box from either side. Features a durable chrome finish.

71" SIDE MOUNT



DESCRIPTION

The SEC Side Mount box is a perfect storage solution for extra room beyond your crossover truck box. The side facing lid allows for easy access and saves truck bed space.

SEC SIDE MOUNT BOX

DESCRIPTION	ALUMINUM PART #				DIMENSIONS				
	BRITE	GLOSS BLACK	MATTE BLACK	QUANTUM SILVER	A	B	C	D	E
72" Side Mount	79010999	79211762	-	-	72"	12"	6"	12"	8"
60" Side Mount	79011033	79210996	79212412	79212515	60"	12"	6"	12"	8"
48" Side Mount*	79011019	79210995	79212411	79212514	48"	12"	6"	12"	8"
36" Side Mount	79012451	79212445	79124446	79212444	36"	12"	6"	12"	8"

* 1 latch

SIDE MOUNT

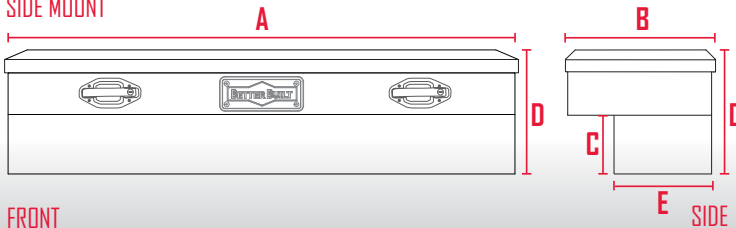

FRONT

SIDE

48" SIDE MOUNT BLACK



FISHING BOX

SEC
SERIES

SELF-ADJUSTING STRIKERS

CONTINUOUS ALUMINUM
PIANO HINGE

SOLID ONE-PIECE BODY
CONSTRUCTION

OFFSET ROD HOLDERS

WEATHER RESISTANT SEALS

REINFORCED C-CHANNEL
FOAM FILLED LID

AUTO-LIFT SHOCKS

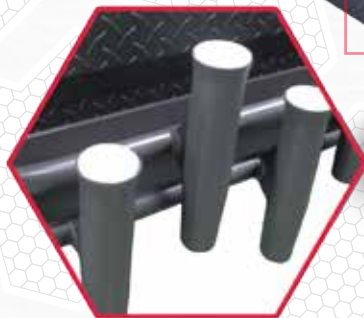

OFFSET ROD HOLDERS

The eight offset rod holders fit most standard fishing rods on the market.



LOCKING PULL HANDLES

Stylish industry exclusive locking pull handle latches allow you to lock or unlock your box from either side. Features a durable powder coat finish.



INTEGRAL END

A Better Built patented design, the end of the box is made of a solid piece of metal. This gives the box additional strength and creates a small parts storage area.

SEC GLOSS BLACK FISHING BOX



* TRAY NOT INCLUDED

DESCRIPTION

The SEC Fishing Box is one of our most exciting products to date! Built by sportsmen for sportsmen, don't leave for your next outing without one in your truck!

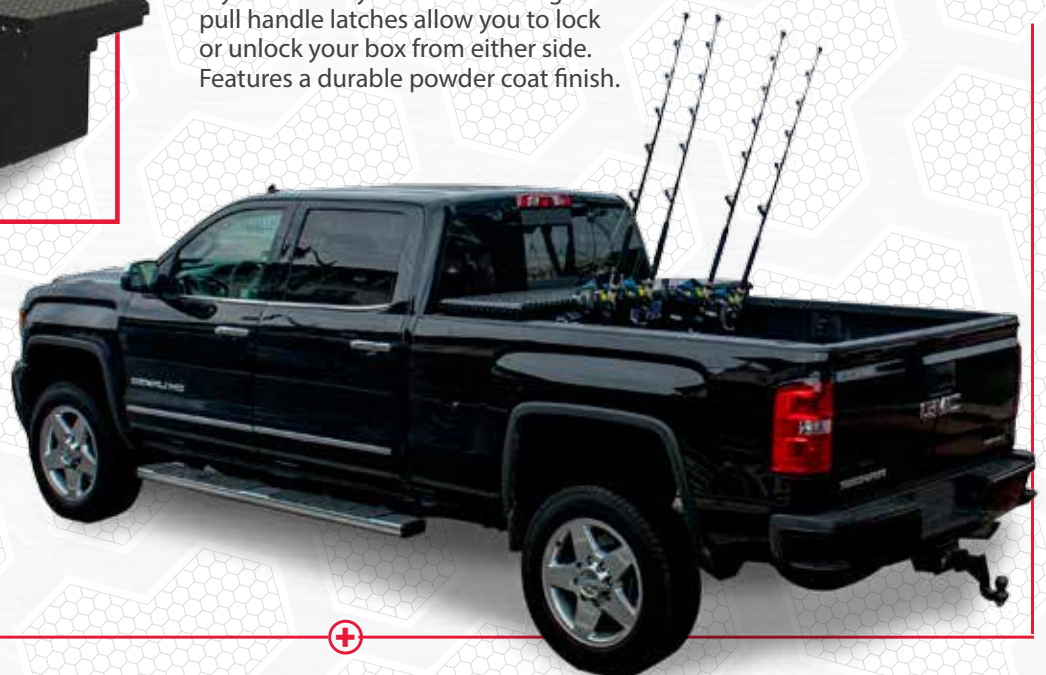

Introducing the **NEW** Fishing Box crossover!

NEW



Before you embark on your next fishing trip, make sure all of your gear and tackle survive the trip. With eight offset rod holders and plenty of room for all of your tackle and gear, make Better Built's Fishing Box a part of your next outdoor adventure!

SEC QUANTUM SILVER FISHING BOX

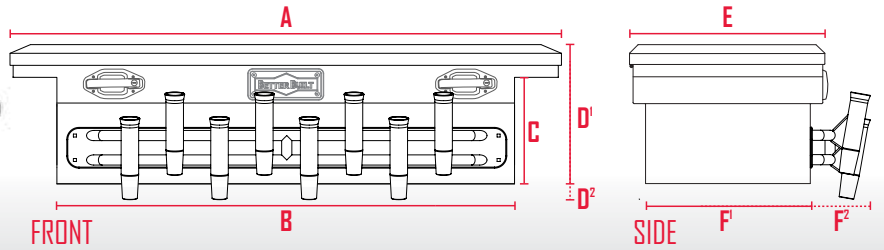

SEC FISHING BOX



BRITE UNCOATED

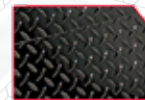

GLOSS BLACK

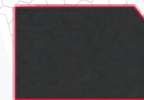

MATTE BLACK



QUANTUM SILVER

DESCRIPTION	PART #	DIMENSIONS								
		ALUMINUM	A	B	C	D ¹	D ²	E	F ¹	F ²
69" Low Profile Fishing Box, Brite	7901113		69"	60"	11"	13.75"	3.5"	20"	16.5"	7.5"
69" Low Profile Fishing Box, Gloss Black	7921111		69"	60"	11"	13.75"	3.5"	20"	16.5"	7.5"
69" Low Profile Fishing Box, Matte Black	7921110		69"	60"	11"	13.75"	3.5"	20"	16.5"	7.5"
69" Low Profile Fishing Box, Quantum Silver	7921112		69"	60"	11"	13.75"	3.5"	20"	16.5"	7.5"



S
E
R
V
E
S

US
FM

BETTER

A Division of Daws M

BETTER BUILT

Manufacturing Co., Inc.

SLE

BETTER BUILT

BETTER BUILT

Page 44

LOW PROFILE

Page 47

SLIMLINE

Introducing the **NEW** Shotgun Latch!

Better Built is proud to introduce our newest product innovation, the **Shotgun Latch Elite series.**

Our brand new, patent-pending Shotgun Latch was designed entirely in-house and is only available on Better Built-brand boxes.



Get Organized with Interior Dividers!



Washable Interior Liner with Drain!



Find What You Need, Even At Night!



D-Ring Mount Points for Securing Cargo



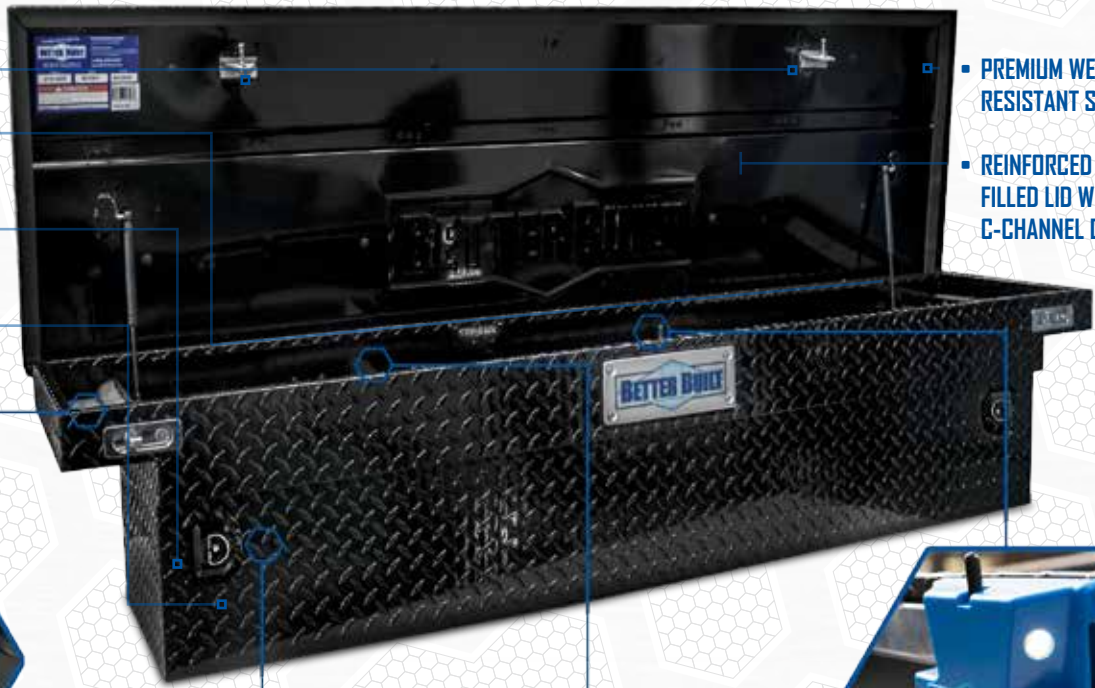

SELF-ADJUSTING STRIKERS

CONTINUOUS ALUMINUM
PIANO HINGE

SOLID ONE-PIECE BODY
CONSTRUCTION

100% FULLY WELDED SEAMS

PREMIUM WEATHER
RESISTANT SEALS

REINFORCED FOAM
FILLED LID WITH STURDY
C-CHANNEL DESIGN



SHOTGUN ROTARY LATCH SYSTEM

Our two-stage automotive-grade latches, combined with the elegance of our brand-new Shotgun Latch are what separates our boxes from our competition.



D-RING MOUNT POINTS

Our heavy duty D-Ring mounts allow for added cargo stability.

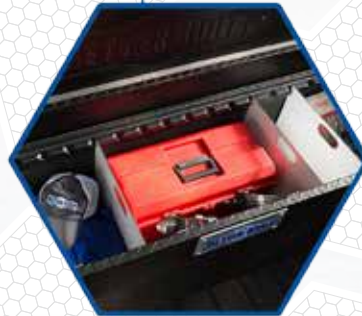

MULTI-DIVIDER SYSTEM

Includes four removable slats for creating handy individual compartments. **The liner is both removable and washable.**



INTERIOR LIGHTING

The stylish interior LED lighting makes locating items a snap, even at night. The lights turn on when the box is opened, and off when closed! **No wasted time, no wasted batteries!**



BRITE UNCOATED



GLOSS BLACK

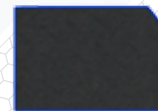

MATTE BLACK



QUANTUM SILVER

DESCRIPTION

The Shotgun Latch series of crossovers is the newest generation of Better Built truck tool box. It has an end opening quick-pull latch system for maximum security and convenience.

The front facing rotary handles make it easy to open the box from the side of your truck while providing a more secure locking system.





69" DEEP MATTE BLACK
SHOTGUN LATCH BOX

69" STANDARD QUANTUM SILVER
SHOTGUN LATCH BOX

SLE LOW PROFILE BOX

STANDARD	ALUMINUM PART #				DIMENSIONS					
	BRITE	GLOSS BLACK	MATTE BLACK	QUANTUM SILVER	A	B	C	D	E	F
71" Shotgun Box with Organization	77013069	77213066	77213067	77213068	71"	62"	11"	14.5"	20"	16.5"
69" Shotgun Box with Organization	77013065	77213062	77213063	77213064	69"	60"	11"	14.5"	20"	16.5"
69" Wedge Shotgun Box with Organization	77013094	77213091	77213092	77213093	69"	60"	11"	14.5"	20"	16.5"
63" Shotgun Box with Organization	77013074	77213071	77213072	77213073	63"	54"	11"	14.5"	20"	16.5"
63" Wedge Shotgun Box with Organization	77013097	77213094	77213095	77213096	63"	54"	11"	14.5"	20"	16.5"

DEEP	BRITE	GLOSS BLACK	MATTE BLACK	QUANTUM SILVER	A	B	C	D	E	F
71" Shotgun Box with Organization	77013016	77213013	77213014	77213015	71"	62"	15"	18.5"	20"	16.5"
69" Shotgun Box with Organization	77013012	77213009	77213010	77213011	69"	60"	15"	18.5"	20"	16.5"
69" Wedge Shotgun Box with Organization	77013004	77213001	77213002	77213003	63"	50"	15"	18.5"	20"	16.5"
63" Shotgun Box with Organization	77013020	77213017	77213018	77213019	63"	54"	15"	18.5"	20"	16.5"
63" Wedge Shotgun Box with Organization	77013008	77213005	77213006	77213007	63"	54"	15"	18.5"	20"	16.5"

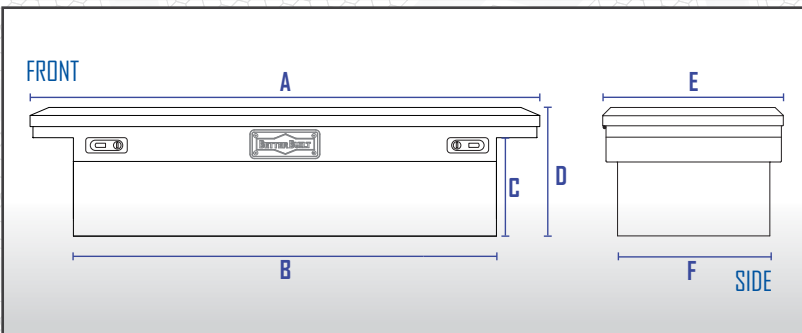

MATTE BLACK
LOW PROFILE



SELF-ADJUSTING STRIKERS

SMALL PARTS PARTITION

WEATHER RESISTANT SEALS

REINFORCED LID BRACE

PREMIUM SHOCKS



AUTO-LIFT SHOCKS

The Side Mount features auto-lift shocks for easy opening and closing of the lid.



PATENTED LATCH ROD

The patented "Up and Over" rod moves the locking system away from the working area of the tool box to prevent damage.

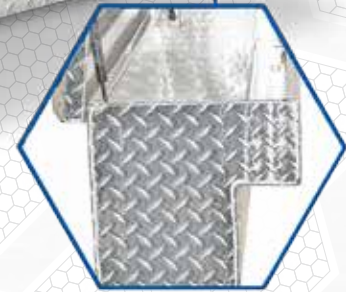

NARROW DESIGN

The Side Mount sits on the truck side rails, leaving plenty of room for additional storage space in the truck bed. Legs are included for greater stability.

DESCRIPTION

The Shotgun Latch series of side mounts is the newest generation of Better Built truck tool boxes. It has an end opening quick-pull latch system for maximum security and convenience.



BRITE UNCOATED



GLOSS BLACK

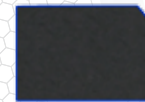

MATTE BLACK



QUANTUM SILVER

BRITE 36" SHOTGUN LATCH BOX

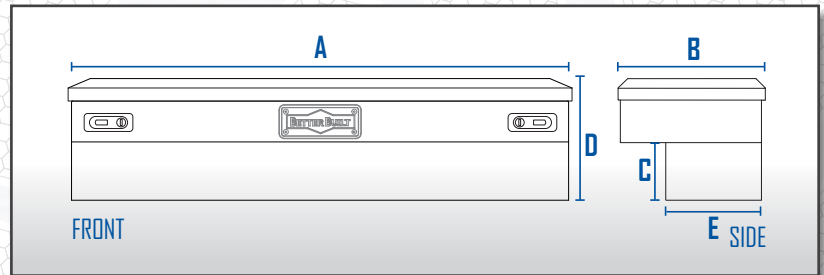

SLE SIDE MOUNT BOX

DESCRIPTION	ALUMINUM PART #				DIMENSIONS				
	BRITE	GLOSS BLACK	MATTE BLACK	QUANTUM SILVER	A	B	C	D	E
48" Shotgun Latch Side Mount, Chrome Latch	77013089	77213086	-	-	48"	12"	6"	12"	8"
48" Shotgun Latch Side Mount, Black Latch	-	-	77213087	77213088	48"	12"	6"	12"	8"
36" Shotgun Latch Side Mount, Chrome Latch	77013085	77213082	-	-	36"	12"	6"	12"	8"
36" Shotgun Latch Side Mount, Black Latch	-	-	77213083	77213084	36"	12"	6"	12"	8"

BETTER

A Division of Daws M

Page 50

CROSSOVER

Page 52

CHEST BOX

Page 54

TOP MOUNT

Page 56

SIDE MOUNT

Page 58

UNDERBODY

Page 60

SITE SAFE

Page 62

HEADACHE RACK

Page 63

DRAWER BOXES

Page 64

TRANSFER TANKS

Page 66

ACCESSORIES



R BUILT®

Manufacturing Co., Inc.

HD HEAVY DUTY

TO THE S



NEARLY 90° AUTO LIFT HD SHOCKS AND POWER PORTAL

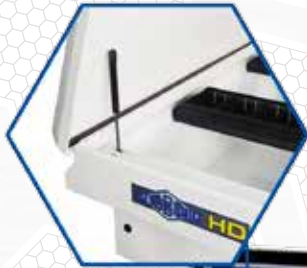

HEAVY DUTY FOAM FILLED LID



PATENTED SELF-ADJUSTING STRIKER



SMALL PARTS PARTITION WITH SHOCK GUARD

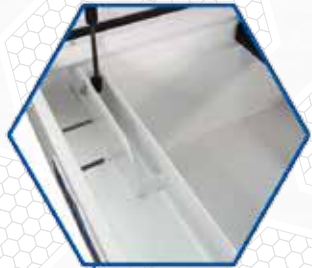

LOCKED UNLOCKED
4-Stage Automotive-Grade Rotary Latches With Billet Push Button Locks



New Heavy Duty Keys Included



Heavy Duty Non-Slip Mat Included



Includes 2 Steel Storage Trays that integrate with the Quantum® Storage System Latch Rail and 4 interchangeable dividers to fit your needs.



Free No-Drill Grip-Rite® Mounting Kit Included!



PATENTED QUANTUM® STORAGE SYSTEM

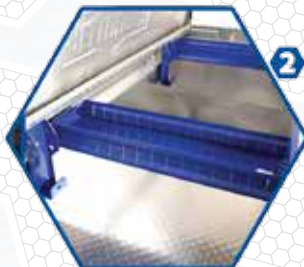

REMOVABLE STEEL LEVEL HOLDERS

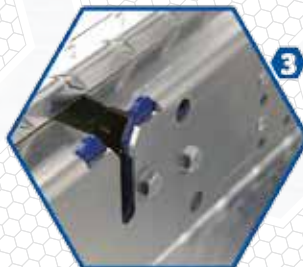

4-STAGE AUTOMOTIVE-GRADE ROTARY LATCH

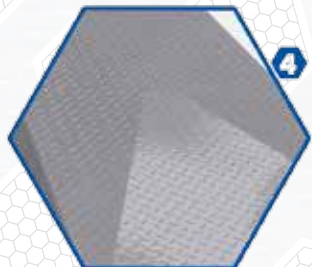

CROSSBROKEN LID

71" STANDARD BLACK STEEL



71" WIDE WHITE STEEL





GLOSS BLACK 71" CROSSOVER

HD CROSSOVER BOX

STANDARD	ALUMINUM PART #		STEEL PART #		DIMENSIONS					
	QUANTUM SILVER	GLOSS BLACK	WHITE	BLACK	A	B	C	D	E	F
71" Crossover	37234810	37224267	37224176	37224189	70.5"	59"	7"	13"	22"	19"
71" Deep Crossover	37234811	37224268	37224177	37224190	70.5"	59"	13"	19"	22"	19"
71" Deep & Wide Crossover	37234812	37224269	37224178	37224191	70.5"	59"	13"	16"	28"	24.5"
67" Crossover	37234816	37224273	37224182	37224195	67"	56"	7"	13"	22"	19"
67" Deep Crossover	37234817	37224274	37224183	37224196	67"	56"	13"	19"	22"	19"
63" Crossover	37234818	37224275	37224184	37224197	63"	52"	7"	13"	22"	19"

LOW PROFILE	ALUMINUM PART #		STEEL PART #		DIMENSIONS					
	QUANTUM SILVER	GLOSS BLACK	WHITE	BLACK	A	B	C	D	E	F
71" Crossover	37234837	37224326	37224338	37224332	70.5"	59.5"	9"	13"	22"	19"
71" Deep Crossover	37234838	37224327	37224339	37224333	70.5"	59.5"	16"	19"	22"	19"
71" Deep & Wide Crossover	37234840	37224328	37224340	37234334	70.5"	59.5"	13"	16"	28"	24.5"

BLACK ALUMINUM DEEP



WIDE QUANTUM SILVER ALUMINUM

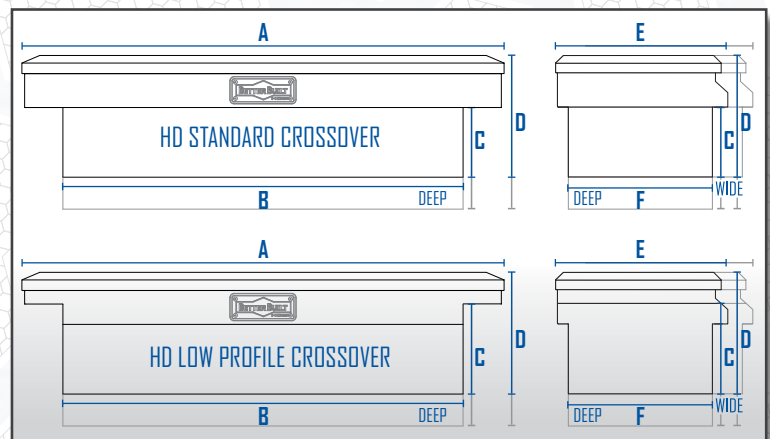

CROSSOVER FEATURES

- Climate Lock Seal
- Solid Full Length Piano Hinge
- Small Part Storage Partition
- Auto-Lift Heavy Duty Shocks
- Abrasion Resistant Powder Coat
- Heavy Duty Foam-Filled Lid
- Patented Self-Adjusting Striker
- Cross Broken Lid for Strength
- Power Portal - Easy Access Point To Run Electricity Into the Box
- Patented Quantum® Storage System Latch Rail, Compatible with Any of Your Peg Board Accessories
- 4-Stage Automotive-Grade Rotary Billet Push Button Latches, with a High Polish Shine

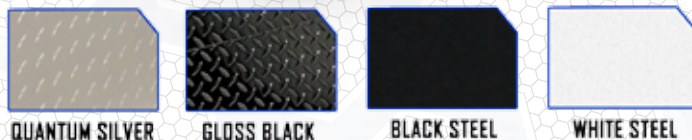

CLIMATE LOCK SEAL



HEAVY DUTY FOAM FILLED LID



PATENTED SELF-ADJUSTING STRIKERS



LOCKED UNLOCKED
4-Stage Automotive-Grade Rotary Latches With Billet Push Button Locks



New Heavy Duty Keys Included



Heavy Duty Non-Slip Mat Included



OFFSET LID OPENS NEARLY 90°



HEAVY DUTY GAS POWERED AUTO-LIFT SHOCKS

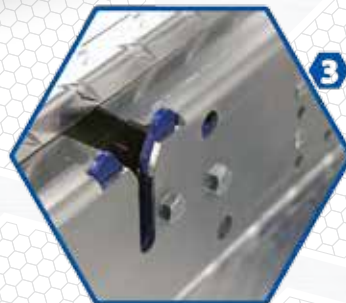

4-STAGE AUTOMOTIVE-GRADE ROTARY LATCH



LOCKING PUSH BUTTON

BLACK ALUMINUM CHEST BOX



QUANTUM SILVER ALUMINUM CHEST BOX



PUSH BUTTON BILLET LOCKS



PATENTED QUANTUM[®] STORAGE SYSTEM

CHEST BOX FEATURES

- Climate Lock Seal
- Solid Full Length Piano Hinge
- Auto-Lift Heavy Duty Shocks
- 90° Lid Opening and Offset Lid
- Abrasion Resistant Powder Coat
- Heavy Duty Foam-Filled Lid
- Patented Self-Adjusting Striker
- Cross Broken Lid for Strength
- Patented Quantum[®] Storage System Latch Rail, Compatible with Any of Your Peg Board Accessories
- Billet Push Buttons With 4-Stage Automotive-Grade Rotary Latches, a High Polish Shine

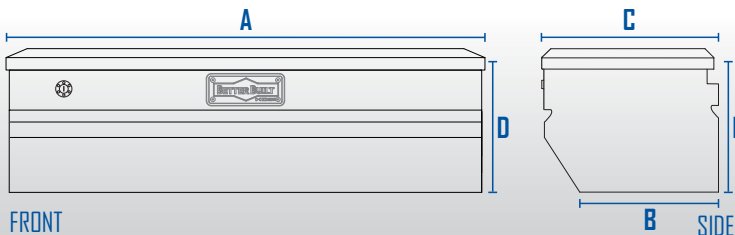

BLACK STEEL CHEST BOX



QUANTUM SILVER



GLOSS BLACK

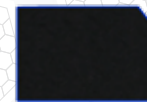

BLACK STEEL



WHITE STEEL

HD CHEST BOX

DESCRIPTION	ALUMINUM PART #			STEEL PART #		DIMENSIONS			
	QUANTUM SILVER	GLOSS BLACK	WHITE	BLACK	A	B	C	D	
60" Chest	37234826	37224292	37224210	37224214	60"	15.75"	20"	18"	
48" Chest	37234827	37224293	37224211	37224215	48"	15.75"	20"	18"	

TOP MOUNT

HD
SERIES



46" WHITE STEEL TOP MOUNTS



BLACK STEEL TOP MOUNT 60 IN.



New Heavy
Duty Keys
Included

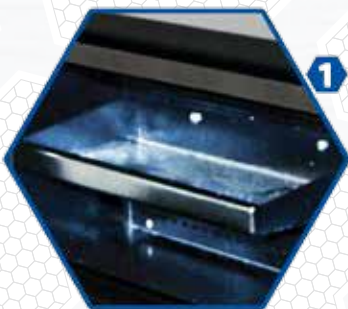

REMOVABLE STEEL
SHELVES



HEAVY DUTY 3-POINT
LOCKS



DUAL LOCKING CAM
ACTION LATCHES

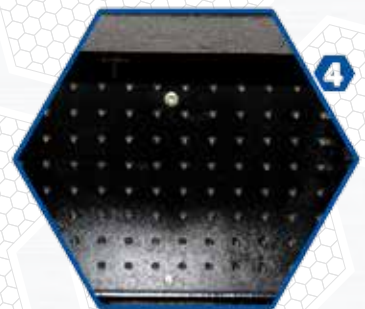

INTERIOR PEGBOARD FOR
HANGING TOOLS

Top Mount boxes easily install to the bed rail of any truck. Legs included for greater stability. Available in steel or aluminum, in four powder coated finishes.



QUANTUM SILVER ALUMINUM 72 IN.



WHITE STEEL 46 IN.

**ABRASION RESISTANT
POWDER COAT FINISH**



TOP MOUNT FEATURES

- Heavy Duty Climate Lock Seal
- Solid Full Length Piano Hinge
- Steel Door Cables Prevents Over-Extension of Door
- 90° Door Opening and Offset Door
- Abrasion Resistant Powder Coat
- Removable Shelves and Peg Board That Fits Any Pegboard Accessories
- Heavy Duty Dual Locking Cam Action Latches, with 3-Point Locks

BLACK STEEL 60 IN.



QUANTUM SILVER



GLOSS BLACK

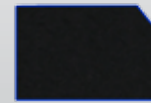

BLACK STEEL



WHITE STEEL

HD TOP MOUNT

* Incorporates 2 doors

DESCRIPTION	ALUMINUM PART #		STEEL PART #		DIMENSIONS		
	QUANTUM SILVER	GLOSS BLACK	WHITE	BLACK	LENGTH	WIDTH	HEIGHT
96" Top Mount*	37234832	37224313	-	-	96"	16"	18"
90" Top Mount*	37234833	37224314	-	-	90"	16"	18"
71" Top Mount*	37234834	37224315	37224231	37224237	72"	16"	18"
60" Top Mount	37234835	37224316	37224232	37224238	60"	16"	18"
46" Top Mount	37234836	37224317	37224233	37224239	46"	16"	18"

DOUBLE DOOR TOP MOUNT

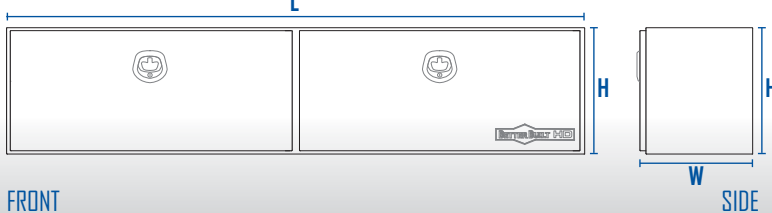

SINGLE DOOR TOP MOUNT

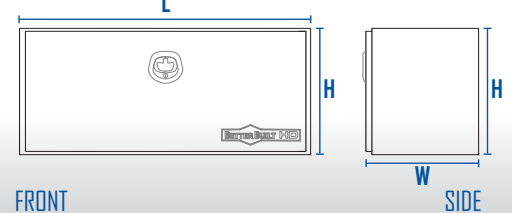

SIDE MOUNT

HD SERIES

HEAVY DUTY FOAM FILLED LID



PATENTED SELF-ADJUSTING STRIKER



CLIMATE LOCK WEATHER SEAL

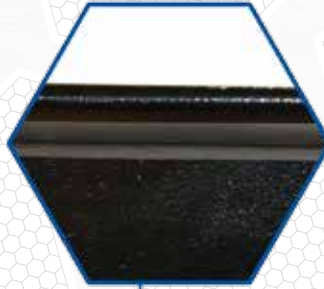

HEAVY DUTY AUTO-LIFT SHOCKS

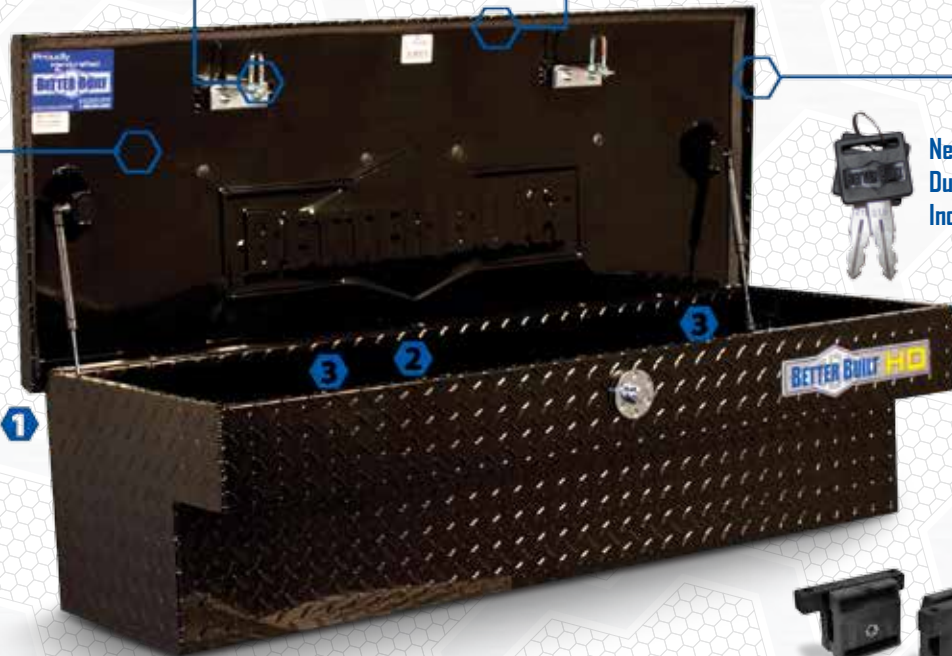

New Heavy Duty Keys Included



LOCKED UNLOCKED
4-Stage Automotive-Grade Rotary Latches With Billet Push Button Locks



Free No-Drill Grip-Rite® Mounting Kit Included!

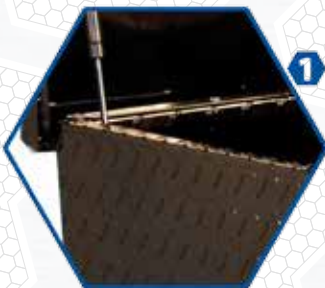

LID OPENS NEARLY 90°



PATENTED QUANTUM® STORAGE SYSTEM



4-STAGE AUTOMOTIVE-GRADE ROTARY LATCH



HEAVY DUTY POWDER COAT FINISH

Side Mount boxes easily install to the bed rail of any truck. Legs included for greater stability. Available in steel or aluminum.



46" QUANTUM SILVER SIDE MOUNTS

SIDE MOUNT FEATURES

- Climate Lock Seal
- Solid Full Length Piano Hinge
- Auto-Lift Heavy Duty Shocks
- Abrasion Resistant Powder Coat
- Heavy Duty Foam-Filled Lid
- Patented Self-Adjusting Striker
- Cross Broken Lid for Strength
- Patented Quantum® Storage System
- 4-Stage Automotive-Grade Rotary Latches

71" SIDE MOUNT

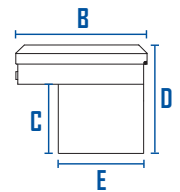
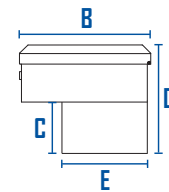
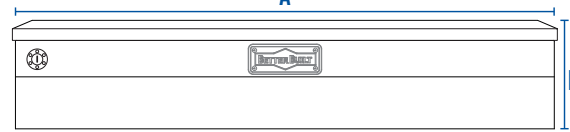

46" SIDE MOUNT

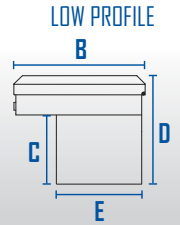
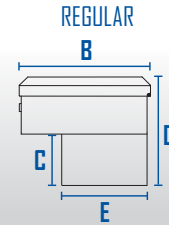
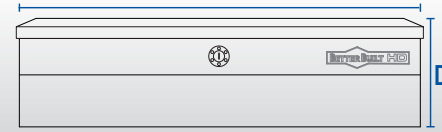

HD SIDE MOUNT



STANDARD	ALUMINUM PART #		STEEL PART #		DIMENSIONS				
	QUANTUM SILVER	GLOSS BLACK	WHITE	BLACK	A	B	C	D	E
72" Side Mount	37234822	37224283	37224200	37224205	72"	17"	7.5"	13"	12.5"
60" Side Mount	37234823	37224284	37224201	37224206	60"	17"	7.5"	13"	12.5"
46" Side Mount	37234824	37224285	37224202	37224207	46"	17"	7.5"	13"	12.5"

LOW PROFILE	ALUMINUM PART #		STEEL PART #		DIMENSIONS				
	QUANTUM SILVER	GLOSS BLACK	WHITE	BLACK	A	B	C	D	E
46" Side Mount	37234844	37224346	37224350	37224348	46"	17"	10"	13"	12.5"



BLACK STEEL SIDE MOUNT



WHITE STEEL SIDE MOUNT



UNDERBODY BOX

HD
SERIES

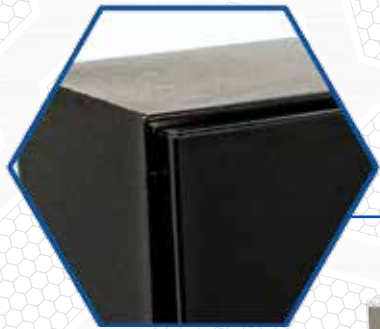

**ABRASION RESISTANT
POWDER COATING**

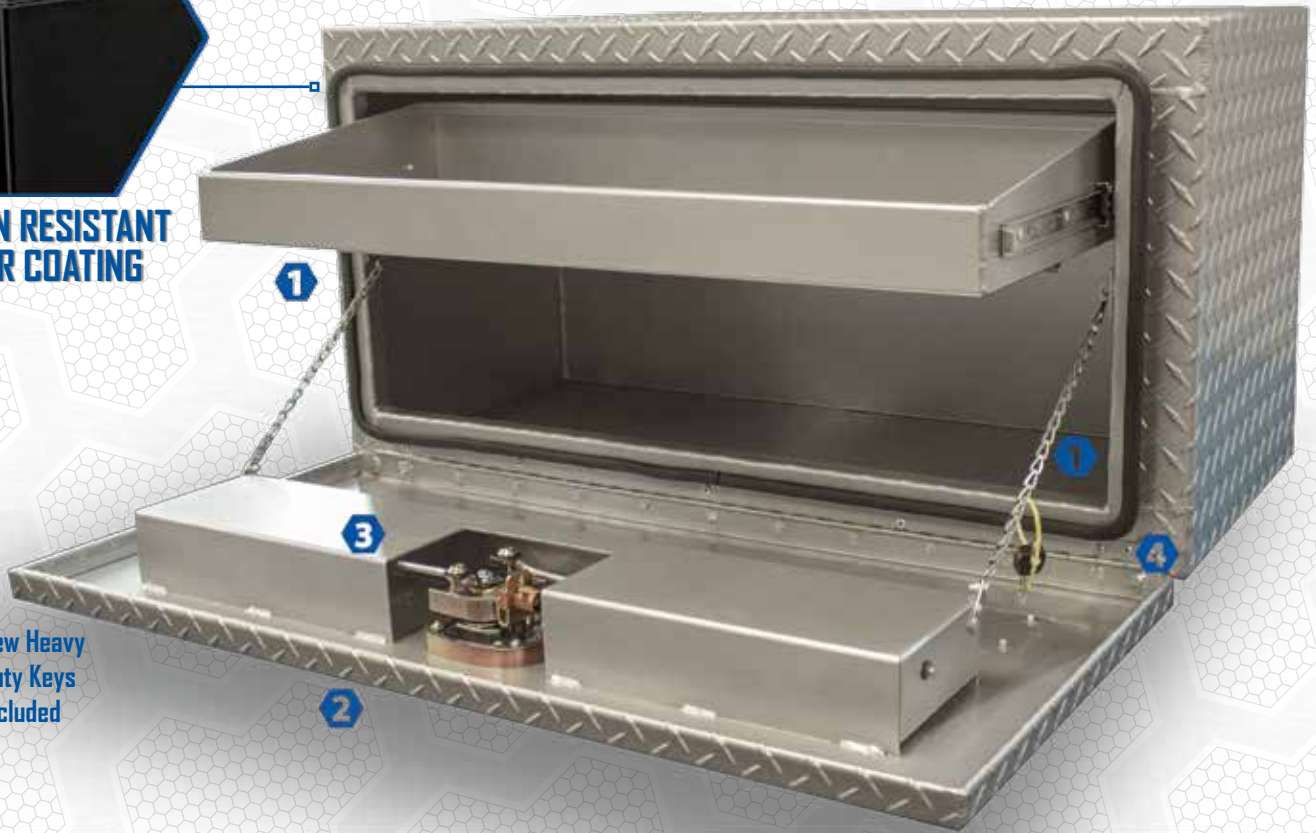

**New Heavy
Duty Keys
Included**



**DROP-DOOR DESIGN
AND SLIDING SHELF**



**HEAVY DUTY 3-POINT
LATCHES**



**DUAL LOCKING CAM
ACTION LOCKS**

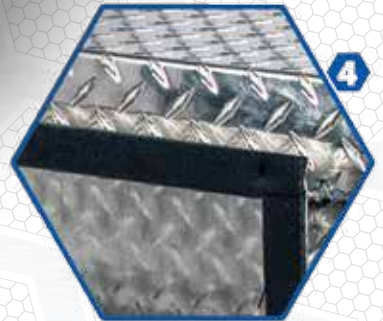

**CLIMATE LOCK WEATHER
SEAL**

Our Heavy Duty Underbody boxes are the perfect solution for extra storage under your trailer or flatbed. Available in black or white steel, black aluminum, or Quantum Silver™ aluminum.

QUANTUM SILVER ALUMINUM UNDER BODY 24 IN.

BLACK ALUMINUM UNDER BODY 24 IN.

29221128 - UNDERBODY INSTALLATION KIT



BLACK STEEL 60 IN.

UNDERBODY FEATURES

- Climate Lock Seal
- Solid Full Length Piano Hinge
- Heavy Duty Abrasion Resistant Powder Coat Finish Inside and Out
- Dual Locking Cam Action Heavy Duty 3-point Latches, with a High Polish Shine
- Heavy Duty Steel Door Chains Prevent Over Extension of Door



QUANTUM SILVER



GLOSS BLACK

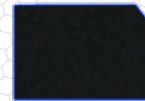

BLACK STEEL



WHITE STEEL

* Double latch design

HD UNDERBODY BOX

DESCRIPTION	ALUMINUM PART #			STEEL PART #		DIMENSIONS		
	QUANTUM SILVER	GLOSS BLACK	WHITE	BLACK	LENGTH	WIDTH	HEIGHT	
60" Underbody*	37234828	37224302	37224218	37224224	60"	17"	18"	
48" Underbody*	37234829	37224303	37224219	37224225	48"	17"	18"	
36" Underbody	37234830	37224304	37224220	37224226	36"	17"	18"	
24" Underbody	37234831	37224305	37224221	37224227	24"	17"	18"	

DOUBLE LATCH UNDERBODY

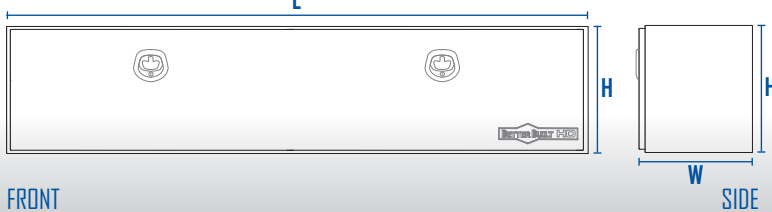

SINGLE LATCH UNDERBODY

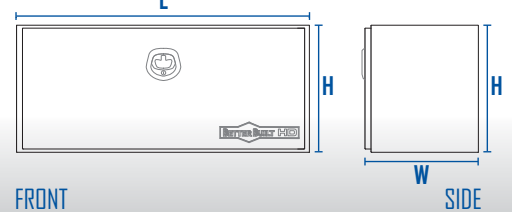

HD SITE SAFES

HD
SERIES



60" HD SITE SAFE



36" HD SITE SAFE

- Available in 36", 48" and 60" sizes
- Durable powder coat finish
- Secure on site storage
- Stowable Handles
- Removable Parts Trays
- Made From 16 Gauge Steel



Locking Lid Props (36")
Auto-lift Shocks (48" & 60")

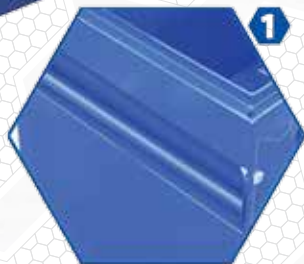

Stowable Handles



Hideaway Padlock

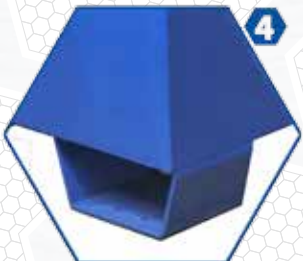

Multifunctional Feet

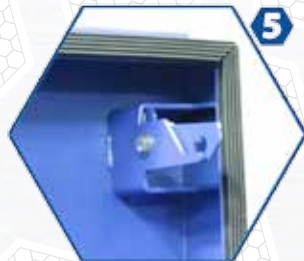

Hawkbill Latch &
Weather Stripping



Removable Parts Trays



48" HD SITE SAFE

CASTER WHEEL KIT

Sold Separately. Part # 29812062



- Mounting Hardware Included
- Supports up to 1100 lbs. (275 ea.)
- Two Lockable Rotating Wheels
- Two Stationary Wheels



48" HD SITE SAFE



60" SITE SAFE XL



Drop Front Design
With High Quality
Lift-Assist Shocks



Foldable Center
Shelf



Hideaway Padlock &
Hawkbill Latching
System



60" SITE SAFE XL

HD SITE SAFES

DESCRIPTION	PART #	DIMENSIONS		
	BLUE	LENGTH	WIDTH	HEIGHT
60" HD Site Safe (NEW!)	37212272	60"	25.5"	29"
48" HD Site Safe (NEW!)	37212273	48"	23"	29"
36" HD Site Safe (NEW!)	37212274	36"	17"	24"
60" HD Site Safe XL (NEW!)	37210269	60"	46"	30"

Secure, on-site storage constructed of heavy duty steel with a reinforced lid. Our HD Site Safes provide the security and durability you need for your industrial demands.

HD HEADACHE RACKS

HD
SERIES

DESCRIPTION

Our new HD Headache Racks are the ideal solution for protecting your truck's cab and passengers from truck bed cargo damage, while simultaneously offering plenty of visibility from the rear window.



QUANTUM SILVER HD HEADACHE RACK



GLOSS BLACK HD HEADACHE RACK



Part # 29710693

Cleat Tie-Downs compatible with Quantum™ Channel (sold separately)

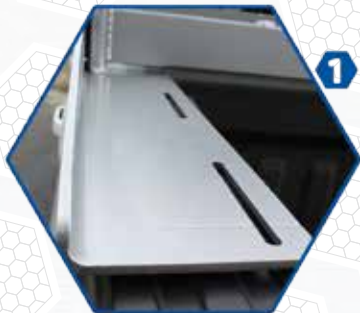

BEDRAIL MOUNTING SLOTS



QUANTUM™ CHANNEL



REAR LIGHT CUTOUT



REINFORCED GUARD

HD HEADACHE RACKS

DESCRIPTION	COLOR	
	QUANTUM SILVER	GLOSS BLACK
HD Headache Rack - Chevy / Ford F-150 / GMC / Nissan / Toyota (NEW!)	29210697	29210735
HD Headache Rack - Dodge Ram and Ford F-250 / F-350 (NEW!)	29210699	29210736



HD HEADACHE RACK WITH SIDE MOUNTS AND 71" CROSSOVER

All headache racks are made of durable light aluminum tubing and sheeting.

Suitable for
Law Enforcement Use



HD SUV DRAWER BOX w/ TOP RAIL

The new and improved SUV Drawer Boxes incorporate many features requested by law enforcement and military personnel, making them suitable for both, as well as civilian use.

- Secure design prevents intrusion
- Top rails provide additional storage



HD TRUCK BED DRAWER BOXES

Our new HD truck bed drawer boxes are the perfect solution for plumbers, welders and any other profession that use small parts and tools on a daily basis, both on and off the jobsite.

- Removable dividers
- Locking T-handle latches
- 3 sizes to choose from

HD DRAWER BOXES

DESCRIPTION	ALUMINUM PART #	STEEL PART #	DIMENSIONS		
	SILVER	WHITE	LENGTH	WIDTH	HEIGHT
HD SUV Drawer Box Short	76217120	-	28.5"	40"	23.25"
Truck Bed Drawer Box, Wide (4 Rows, 24 Dividers)	-	37210266	48"	40"	9"
Truck Bed Drawer Box, Tall (3 Rows, 18 Dividers)	-	37210267	48"	30"	12.5"
Truck Bed Drawer Box, Tall & Wide (4 Rows, 24 Dividers)	-	37210268	48"	40"	12.5"

TRANSFER TANKS

HD
SERIES

All tanks are 100% quality inspected with dual pressure and leak tests.

98 GALLON T-TOP TANK

100 GALLON L-TANK

200 GALLON RECTANGLE

36 GALLON VERTICAL

150 GALLON RECTANGLE

100 GALLON RECTANGLE

36 GALLON VERTICAL

50 GALLON SQUARE

75 GALLON ALUMINUM L-TANK



BRITE UNCOATED

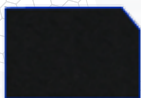

BLACK STEEL



WHITE STEEL

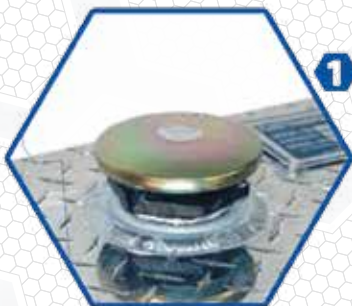

LOCKABLE CAP

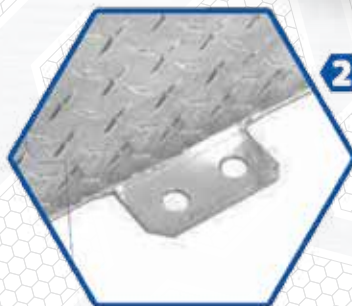

MOUNTING KIT INCLUDED



DESCRIPTION	ALUMINUM PART #		STEEL PART #		DIMENSIONS		
	BRITE	WHITE	BLACK	LENGTH	WIDTH	HEIGHT	
200 Gallon Rectangle Storage Tank	-	37224244	-	62"	28"	28"	
150 Gallon Rectangle Storage Tank	-	37224243	-	48"	28"	28"	
100 Gallon Rectangle Transfer Tank	37024151	29224164	29211677	45 1/4"	24"	24"	
100 Gallon L-Shape Transfer Tank	37024149	29224167	29211581	60"	31"	29"	
98 Gallon T-Top Transfer Tank	-	29221497	29222000	60"	33"	25"	
88 Gallon L-Shape Transfer Tank	37024150	29224163	29211579	54 1/4"	31"	24"	
75 Gallon L-Shape Transfer Tank	37024158	-	-	48 1/4"	31"	24"	
75 Gallon L-Shape Transfer Tank (Steel Only)	-	29224162	29211580	42 3/4"	31"	24"	
75 Gallon Combo Transfer Tank	37024159	-	-	48 1/4"	31"	24"	
75 Gallon Combo Transfer Tank (Steel Only)	-	29224168	29211676	42 3/4"	31"	24"	
50 Gallon Square Transfer Tank	37024152	29224165	29211583	24"	24"	24"	
42 Gallon L-Shape Transfer Tank	-	29224095	29224100	27"	31"	24"	
36 Gallon Vertical Transfer Tank	37024153	29224166	29211584	45 1/4"	11"	17"	

PUMP INCLUDED (see pic below)	BRITE	WHITE	BLACK	LENGTH	WIDTH	HEIGHT
91 Gallon Transfer Tanks w/ Pump Included (NEW!)	-	29211733	-	55"	30"	23 1/2"



75 GALLON COMBO TRANSFER TANK

50 GALLON SQUARE TANK



100 GALLON RECTANGLE TANK

36 GALLON VERTICAL TANK

BETTER BUILT TANK FEATURES:

- Easy Transport of Non-Flammable liquid
- Overfill Restriction/Automatic Shutoff
- Constructed of Extra Heavy Weight Tread Plate Aluminum or 14 Gauge Steel
- Lockable Cap and Coupler
- Flush Mounted Dual 2" Reinforced Bungs
- Reinforced Pump Mounting Location
- Fully Welded Mounting Brackets
- Includes a Mounting Kit
- Baffles Add Strength While Preventing Contents From Shifting

WARNING

This tank DOES NOT MEET Department of Transportation regulations for flammable tanks (such as gasoline).

These transfer tanks are designed and manufactured to be used as a liquid transfer tank. **ONLY**. These are **SOLELY FOR PRIVATE USE** and not for interstate commerce or commercial applications. These are **NOT** designed for use as an auxiliary fuel tank to be connected to your vehicle's primary fuel system. Their intended use and design **DOES NOT** meet Title 49 of the U.S. Federal Register, governing transportation. These tanks **MUST BE VENTED AT ALL TIMES** to allow for expansion and to prevent any vacuum formation during liquid removal. These Liquid Transfer Tanks are intended for use with combustible fuels only (such as diesel fuels). These tanks **DO NOT MEET** Department of Transportation regulations for flammable fuels (such as gasoline).



ACCESSORIES



Grip-Rite® Mounting Kit

Don't drill holes in your truck. Use Better Built's Grip-Rite truck box mounting system to install your truck tool box without damaging your truck bed.

Part # 29510402

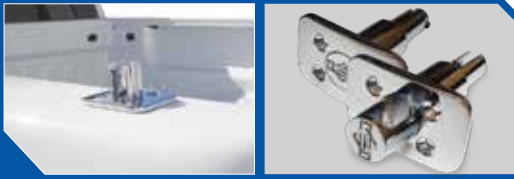

Stake Pocket Pop-Up

Removable clamping tie down anchor that includes adjustable tie down straps to secure your load. Easy to install / remove without harming your truck body or finish.

Part # 29910008

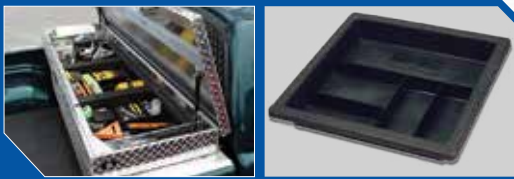

5 Pocket Organizer Tray

Made of durable plastic, the 5 pocket tray is great for keeping small items organized and easily accessible. Fits most major brands of truck boxes.

Part # 23512470



Diamond-Brite® Polish

Give your truck box that "like new" shine, and keep it looking great for years to come. Diamond-Brite Polish also works great on any non-coated metal material. 8 oz. size.

Part # 29810184

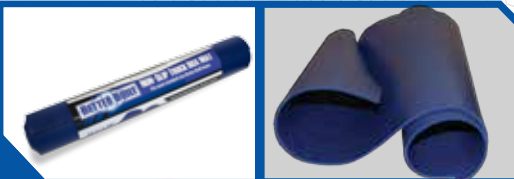

Truck Box Mat

Keep your items from sliding around in your truck box. Better Built truck box liner has a soft finish to protect your items from damage. Can be cut to fit any size box.

Part # 29410017



Cleat Tie-Down Kit

Easily mounts on any truck box. Provides a durable cleat tie down for attaching rope or bungee cord. Made from durable, rust-proof cast aluminum powder coated finish.

Part # 29710693



LED Truck Box Light

Bright white LED truck tool box light comes with three settings, and attaches with a magnet or with a clip. Requires 3 "AA" Batteries (not included).

Part # 29510016



Hitch Step

With extra grip padding, this steel step attaches to your hitch and aids in safely loading and unloading items in your truck bed or SUV. Works with any size truck.

Part # 99219050

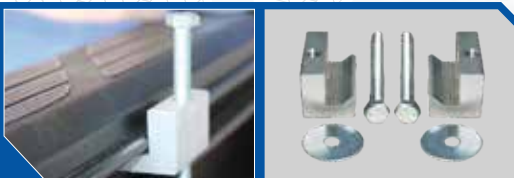

Toyota Mounting Kit

No drill, easy to install installation for your Better Built truck box for your Toyota pickup truck. For Toyota trucks featuring the Toyota Track System only. All others, use Grip-Rites above.

Part # 24201631