

# CFR

## PERFORMANCE

CATALOG 6



**ADS**  
Accessory Drive Systems

**Black-tie**  
Electro Deposit Primer

**EMC**  
Evolution Modular Cooling

**R.F.C.**  
Retro Flined Collection

It's all about  
**Character**





CFR Performance is a major automotive supplier and distributor of car and truck accessories. We are part of a family owned and operated tradition of automotive excellency, which dates back to the late 1970's. Since then we have put together some new and innovative products to provide for our customers. At CFR, we use our long tradition of wisdom in automotive business and customer satisfaction to provide you with superior quality and cost effective products.

Over the years, our product line has grown to more than 3000 part numbers and is constantly growing. We are entirely customer focused, shipping most stock orders within twenty-four hours. Our mission at CFR Performance is to provide the highest innovative quality performance products to our customers at competitive pricing without lowering our company standards.



<b>ADS systems</b>	<b>3-4</b>
<b>LS Parts/ Black Tie</b>	<b>5-6</b>
<b>EMC radiator info</b>	<b>7</b>
<b>Air Cleaners &amp; Accessories</b>	<b>8-12</b>
<b>Valve Covers &amp; Accessories</b>	<b>13-26</b>
<b>Dress up Kits</b>	<b>27-28</b>
<b>Timing Chain Covers &amp; Accessories</b>	<b>29-30</b>
<b>Oil Pans &amp; Accessories</b>	<b>31-47</b>
<b>Flywheel Covers &amp; Transmission pans</b>	<b>48</b>
<b>Dipsticks</b>	<b>49-50</b>
<b>Pulleys &amp; Pulley kits</b>	<b>51-58</b>
<b>Brackets &amp; Accessories</b>	<b>59-63</b>
<b>Radiators &amp; Accessories</b>	<b>64-72</b>
<b>Cooling</b>	<b>73-74</b>
<b>Distributors</b>	<b>75</b>
<b>Transmission/Throttle Cable Kits, Fuel Lines &amp; Block Plates</b>	<b>76</b>
<b>Alternators, Starters &amp; Master Cylinder Covers</b>	<b>77</b>
<b>Power Steering Pumps &amp; Power Steering Overflow Tanks</b>	<b>78</b>
<b>Interior Dress up Accessories</b>	<b>79-81</b>
<b>Headlights &amp; Battery Trays</b>	<b>82</b>
<b>Body Parts</b>	<b>83-84</b>
<b>Headers</b>	<b>85-87</b>
<b>Differential Covers and Gaskets</b>	<b>88-93</b>

**PRODUCTS**

# ADS

Accessory Drive Systems

The CFR Performance Accessory Drive System is the first economical complete engine front drive kit to be offered on the market. These systems include:

- Water Pump Power Steering Pump
- Alternator Crank Shaft Pulley
- Water Pump Pulley Power Steering Pulley
- Alternator Pulley
- Alternator Fan Power Steering Bracket
- Alternator Bracket Complete Hardware Pack
- Gates Brand Belts
- Complete Detailed Instructions



Full kit as shown

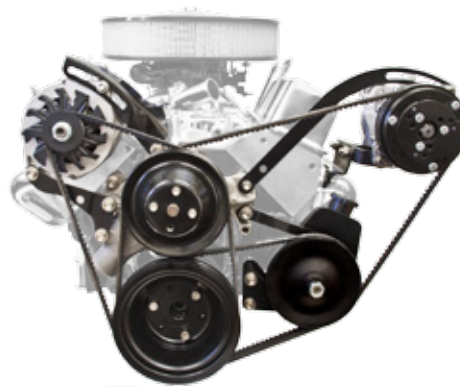
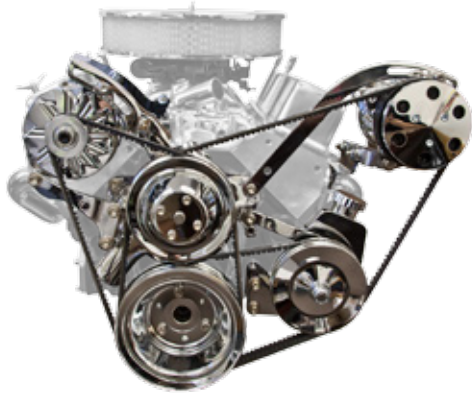

**Small Block Chevy**  
SBC LWP Billet Systems V-belt  
HZ-3911-M-KIT (Machined)  
HZ-3911-POL-KIT (Polished)  
HZ-3911-C-KIT (Chrome)  
HZ-3911-AIR (Chrome)

**SBC LWP OEM look**  
Steel Systems V-Belt  
HZ-3911-S-C-KIT (Chrome)  
HZ-3911-S-PBK-KIT (Black)  
HZ-3911-C-AIR (Chrome)  
HZ-3911-PBK-AIR (Black)

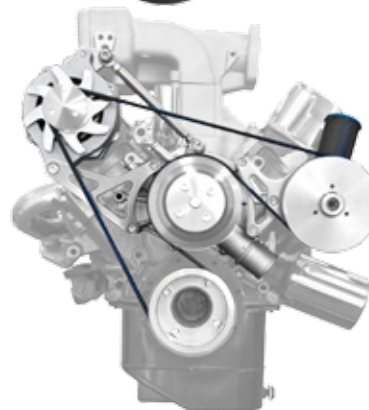
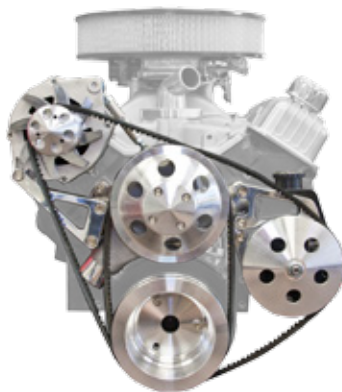

**Ford**  
SBF Billet Serpentine Systems  
HZ-4300-M-KIT (Machined)  
HZ-4300-POL-KIT (Polished)  
HZ-4300-C-KIT (Chrome)  
HZ-4300-PBL-KIT (Blue)

CFR Performance Accessory Drive Systems are engineered to fit correctly the first time and look fantastic for years to come. All CFR Performance products are backed by a full 1 year warranty to insure complete customer satisfaction and reliability.



## ADS Serpentine Kits



SBC

**ADS-5100-M-KIT** Machined  
**ADS-5100-POL-KIT** Polished  
**ADS-5100-PBK-KIT** Black



Serpentine Kit Includes:

- Aluminum Reverse Water Pump
- 120 Amp, 1 wire Alternator
- SD-7 Peanut Style A/C Compressor
- Aluminum Type II Power Steering Pump
- Belt Tensioner with Aluminum Cover
- 6061-T6 Aluminum Pulleys with Protective Wear Coating
- 6061-T6 One Piece Billet Bracket
- Gates 6-Groove Belt & Hardware
- Remote Power Steering Reservoir Tank
- A/C Manifold



\*LS1/LS3

**ADS-5300-M-KIT** Machined  
**ADS-5300-POL-KIT** Polished  
**ADS-5300-PBK-KIT** Black

\*If installing on a 4.8, 5.3, 6.0 LS Truck Motor you will be required to change the harmonic balancer to a "Camaro Type"



BBC

**ADS-5200-M-KIT** Machined  
**ADS-5200-POL-KIT** Polished  
**ADS-5200-PBK-KIT** Black



SBF 302

**ADS-5400-M-KIT** Machined  
**ADS-5400-POL-KIT** Polished  
**ADS-5400-PBK-KIT** Black

Accessory Finish

KIT	W/P	Alt	A/C Comp.	P/S
Machined	N	N	N	N
Polished	N	C	C	N
Black	N	N	N	N
Finish	Natural: N		Chrome: C	



Oldsmobile

**ADS-6000-POL-KIT** Polished  
**ADS-6000-PBK-KIT** Black



Mopar Small Block

**ADS-5700-M-KIT** Machined  
**ADS-5700-POL-KIT** Polished  
**ADS-5700-PBK-KIT** Black



Pontiac

**ADS-5900-POL-KIT** Polished  
**ADS-5900-PBK-KIT**



## LS Parts Showcase



LS Water Neck  
Aluminum

- HZ-6145-POL** Polished
- HZ-6145-C** Chrome
- HZ-6145-PBK** Black EDP



LS1 / LS3  
Serpentine Kit

- ADS-5300-M-KIT** Machined
- ADS-5300-POL-KIT** Polished
- ADS-5300-PBK-KIT** Black

\* If installing on a 4.8, 5.3, 6.0 LS Truck Motor you will be required to change the harmonic balancer to a "Camaro Type"

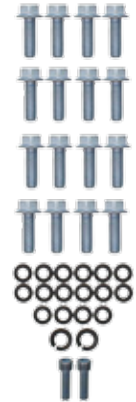

LS Oil Pan Bolt kit  
**HZ-9906-KIT**

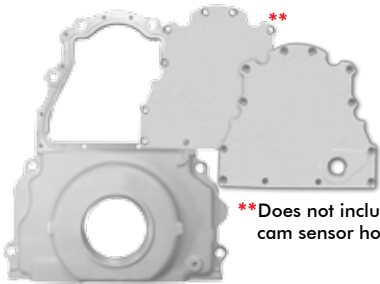

LS Timing Cover  
Two Piece

- HZ-6008-POL** Polished
- HZ-6009-POL** Polished

\*\* Does not include cam sensor hole.



LS Throttle Body  
**HZ-5092-POL** Polished  
92mm



LS Valve Cover Adapter  
**HZ-8000**



\*\* Adapter allows the use of early style valve covers for a vintage look



LS Manifold Kit  
**HZ-5030-POL** Polished

Top Mount  
Throttle Body Opening



Chevy LS1 1997-Up Flexible Dipstick 17-1/8"

- CFR-1999** Chrome
- CFR-1999-PBK** Black EDP



Chevy LS1, LS3, LS6  
1999-2001 Oil Pan Gasket  
**HZ-7499**



Straight Fitting

- HZ-9733-PBK** Black EDP
- HZ-9733-C** Chrome
- HZ-9733-Z** Zinc
- HZ-9733-R** Raw

Fits 1968-'72 Nova, 1965-'72 Chevelle, 1967-'69 Camaro, Can also be used on other applications check dimensions for clearance. Engine application: GM LS Series. Features wet sump, 7 quart capacity, 6" deep baffled trap-door baffling improving oil control and -10AN fittings for remote filter, uses stock dipstick



Pick up  
**HZ-9735-PBK**



Angled Fitting

- HZ-9734-PBK** Black EDP
- HZ-9734-C** Chrome
- HZ-9734-Z** Zinc
- HZ-9734-R** Raw



# Black-tie

Electro Deposit Primer

EDP, is an electronically applied process in which metal parts are given an electric charge and immersed in an opposite charged paint solution. The electric current then attracts and secures the paint solution to the part to provide unparalleled coverage to the entire part including corners, edges and recessed areas. This provides an excellent rust resistant coating with an even and continuous film without pinholes over the entire surface. The superior quality of EDP can be used as is with its OEM style satin black finish or is the perfect base for powder coating or custom painting. EDP is also environmentally friendly as the electro coat produces little or no HAPS (Hazardous Air Pollutants) or VOCs (Volatile Organic Compounds) and is OSHA, ROHS and EPA compliant.



**HZ-4870-PBK**



**HZ-2195BOX-PBK**



**HZ-9215-PBK**



**HZ-9122-PBK**



**HZ-4935-PBK**



**HZ-7005-PBK**



**HZ-9316-PBK**



**HZ-9601-PBK**



**HZ-4815-PBK**

**EDP BLACK TIE**

## EMC Evolution Modular Cooling

This is the most extreme modular system available for any application. Our engineers have conducted extensive research to determine this is the optimum combination of size and volume for maximum cooling efficiency in extreme applications. These advanced cooling modules also include 7 separate 3/8-24" threaded bungs for attaching optional mounting bracket kits and hardware allowing the unique option of using this radiator as a traditional top and bottom tank design or the modern cross-flow design.



**EMC-X2**  
Evolution Modular Cooling  
850 HP Rated

Part #	Size
<b>HZ-40010-X2</b>	22" x 19"
<b>HZ-40011-X2</b>	24" x 19"
<b>HZ-40012-X2</b>	26" x 19"
<b>HZ-40016-X2</b>	31" x 19"

Part #	Size
<b>HZ-40010-X3</b>	22" x 19"
<b>HZ-40011-X3</b>	24" x 19"
<b>HZ-40012-X3</b>	26" x 19"
<b>HZ-40016-X3</b>	31" x 19"

**EMC-X3**  
Evolution Modular Cooling  
1250 HP Rated

The EMC=X2 has an oversized 2 1/4" thick cooling core with two rows of 1" high volume and high flow heat transfer tubes with an optimized 15 fins per inch of cooling power.

The EMC=X3 has a huge 3 1/2" thick cooling core with three rows of 7/8" high volume and high flow heat transfer tubes with an optimized 15 fins per inch of cooling power

7 separate AN-20 bungs allowing the ultimate in universal configuration. We have adapter fittings for the AN-20 bungs to allow the following attachments:



Part #	Description
<b>HZ-40030</b>	20AN Male to 1.25" Radiator Hose Fitting
<b>HZ-40031</b>	20AN Male to 1.75" Radiator Hose Fitting
<b>HZ-40032</b>	20AN Male to 1.50" Radiator Hose Fitting
<b>HZ-40033</b>	20AN Male to -16AN Male Coupling
<b>HZ-40034</b>	20AN Male to -20AN Male Coupling
<b>HZ-40035</b>	20AN Male to 1/2" NPT Adapter
<b>HZ-40036</b>	20AN Male to 3/8" NPT Adapter
<b>HZ-40037</b>	20AN Male Plug
<b>HZ-40038</b>	20AN male to 2 1/8" Filler Neck
<b>HZ-40040</b>	Radiator Overflow Fitting
<b>HZ-40041</b>	20AN O-Ring
<b>HZ-40045</b>	Aluminum Angled Mounting Bracket
<b>HZ-40046</b>	Aluminum Flat Mounting Bracket



## AIR CLEANER ACCESSORIES

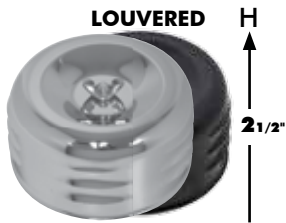

LOUVERED  
H  
2 1/2"  
W 4 1/2"

**HZ-2339-C**  
**HZ-2339-PBK** Black



OPEN  
H  
3"  
W 4"

**HZ-2171-C** Chrome

### Mini Air Cleaners

Steel with paper element & raised base.

Fits 1BBL or 2BBL carbs with 2 1/16" or 2 5/8" necks.



**Knurled Air Cleaner Nut**  
1/4-20"

**HZ-2183-C**  
**HZ-2183-PBK** Black & Chrome Steel



**Air Cleaner Wing Nut**  
1/4-20"

**HZ-2184-C** Chrome Steel



**Air Cleaner Wing Nut**  
1/4-20" & 5/16-18"

**HZ-2180-C** Black & Chrome Steel



**Smog Tube Fitting.**  
Fits 5/8" and 3/4" hoses.  
**HZ-2192**

**Straight Air Cleaner Bolt.**  
1/4 - 20 x 5"  
**HZ-7196**



**Straight Air Cleaner Bolt.**  
1/4 - 20 x 4"  
**HZ-2196**



**Aluminum Air Cleaner Stud.**  
1/4-20 x 5 5/8"  
**HZ-6802**



**Off-Set Air Cleaner Bolt.**  
**HZ-5196** 1/4 - 20 x 6"  
**HZ-5197** 5/16-18 x 6"

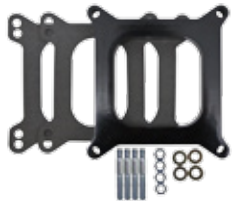

PHENOLIC OPEN CARBURETOR ADAPTER KIT WITH GASKET & HARDWARE

**HZ-8301** 1"  
**HZ-8302** 2"

## Phenolic Carb Spacers

Complete with gaskets and hardware

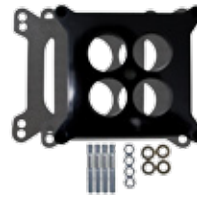

PHENOLIC PORTED CARBURETOR ADAPTER KIT 1 11/16" PORTS WITH GASKET & HARDWARE

**HZ-8311** 1"  
**HZ-8312** 2"

## ALUMINUM SCOOPS

**Single or Dual Quad Bug Catcher Style Scoop.**  
H: 5"  
W: 13 1/2"  
L: 20 1/2"



**HZ-8007-PBK**  
**HZ-8007-POL** Polished & Black

**Single or Dual 4 Barrel, Hilborn Style**  
H: 5"  
W: 9 1/2"  
L: 20"  
Includes both base plates.



**HZ-8001-3-PBK**  
**HZ-8001-3-POL** Fined Polished & Black

**Dual 4 Barrel, Shotgun Style Scoop.**  
Includes both H: 6"  
base plates. W: 11 1/4"  
L: 20 1/2"



**HZ-8006-3-PBK** Fined Black

**HZ-8006-3-POL** Fined Polished

**HZ-8006-POL** Smooth Polished

**Single 4 Barrel, Hilborn Style Scoop.**  
Includes both H: 5"  
base plates. W: 9 1/2"  
L: 13 1/2"



**HZ-8002-PBK**  
**HZ-8002-POL** Smooth Polished & Black



**HZ-8002-3-PBK**  
**HZ-8002-3-POL** Fined Polished & Black



**HZ-8002-4-PBK**  
**HZ-8002-4-POL** 6-Fined Polished & Black

## STEEL AIR CLEANER TOPS



**1988-92 Chevy/GM**  
Single Wing Nut  
(15-3/8" x 1-7/8")

**HZ-2146T-C** Chrome  
**HZ-2146T-PBK** Black EDP



**1993-95 Chevy/GM Truck**  
Dual Wing Nut  
(15-3/8" x 1-7/8")

**HZ-2147T-C** Chrome  
**HZ-2147T-PBK** Black EDP



**Universal**  
Single Wing Nut  
(14" x 3/4")

**HZ-2148T-C** Chrome  
**HZ-2148T-PBK** Black EDP



**Chevy/Ford/Mopar**  
Single Wing Nut  
(14" x 3/4") / (12" x 3/4")\*\*

**HZ-2195T-C** Chrome  
**HZ-2195T-PBK** Black EDP

\*\***HZ-1148T-C** Chrome **12"**  
\*\***HZ-1148T-PBK** Black EDP

## STEEL AIR CLEANER BASES



**Flat Base 14"**  
5-1/8" Carb Neck

**HZ-2148B-C** Chrome  
**HZ-2148B-PBK** Black EDP



**Recessed Base 14"**  
5-1/8" Carb Neck

**HZ-2195B-C** Chrome  
**HZ-2195B-PBK** Black EDP



**Off-Set Base 14"**  
5-1/8" Carb Neck

**HZ-5195B-C** Chrome  
**HZ-5195B-PBK** Black EDP



**Hi-Lip Base 14"**  
5-1/8" Neck

**HZ-7195B-C** Chrome  
**HZ-7195B-PBK** Black EDP

\*\***HZ-6195B-C** Chrome **12"**  
\*\***HZ-6195B-PBK** Black EDP

Rises filter 3/4"  
above carb flange



Will fit all 5-1/8"  
carb flanges

Drops filter 1-1/8"  
below carb flange



Will not clear  
electric chokes

Sets filter 1-1/2"  
off carb flange



Off-set for distributor or  
firewall clearance

Drops filter 7/8"  
below carb flange



Will clear  
electric chokes

**NEW!**

## REPLACEMENT AIR FILTERS

Oval Air filters are 2" tall and Round Air Filters are 2-3" tall



**12"x 2" Oval Air Filter**

**HZ-2123**  
Paper  
**HZ-3122-RED**  
Washable/Reusable



**14"x 3" Round Air Filter**

**HZ-2113**  
Paper  
**HZ-3143-RED**  
Washable/Reusable



**15"x 2" Oval Air Filter**

**HZ-2133**  
Paper  
**HZ-3152-RED**  
Washable/Reusable



**14"x 2" Round Air Filter**  
**HZ-2112**  
Paper



**14"x 2" Round Air Filter**  
**HZ-3142-RED**  
Washable/Reusable



**12"x 3" Round Air Filter**  
**HZ-3123-RED**  
Washable/Reusable



## STEEL AIR CLEANER SETS

Air Cleaner Sets include steel top & base, 3" filter, mounting stud and nut.  
Fits single carbs with 5-1/8" neck



**14"**  
**Recessed Base**

- HZ-2195BOX-C** Chrome
- HZ-2195BOX-W-C** Chrome (Washable Filter)
- HZ-2195BOX-PBK** Black EDP
- HZ-2195BOX-W-PBK** Black EDP (Washable Filter)



**14"**  
**Flat Base**

- HZ-3195BOX-C** Chrome
- HZ-3195BOX-W-C** Chrome (Washable Filter)
- HZ-3195BOX-PBK** Black EDP
- HZ-3195BOX-W-PBK** Black EDP (Washable Filter)



**14"**  
**Off-Set Base**

- HZ-5195BOX-C** Chrome
- HZ-5195BOX-W-C** Chrome (Washable Filter)
- HZ-5195BOX-PBK** Black EDP
- HZ-5195BOX-W-PBK** Black EDP (Washable Filter)



**14"**  
**Hi-Lip Base**

- HZ-7195BOX-C** Chrome
- HZ-7195BOX-W-C** Chrome (Washable Filter)
- HZ-7195BOX-PBK** Black EDP
- HZ-7195BOX-W-PBK** Black EDP (Washable Filter)



**14"**  
**Flat Base**

- HZ-2148BOX-C** Chrome
- HZ-2148BOX-W-C** Chrome (Washable Filter)
- HZ-2148BOX-PBK** Black EDP
- HZ-2148BOX-W-PBK** Black EDP (Washable Filter)



**12"**  
**Flat Base**

- HZ-1148BOX-W-C** Chrome (Washable Filter)
- HZ-1148BOX-W-PBK** Black EDP (Washable Filter)

## 12" OVAL ALUMINUM AIR CLEANER SETS

All oval air cleaner sets include top, base, 2" paper filter & mounting stud



Smooth Polished  
**HZ-6020-POL**  
Smooth Chrome  
**HZ-6020-C**  
Black EDP  
**HZ-6020-PBK**  
11-7/8" x 8-1/4" x 3"  
**Neck 5-1/8"**



Ball Milled Polished  
**HZ-6020-1-POL**  
Ball Milled Chrome  
**HZ-6020-1-C**  
Black EDP  
**HZ-6020-1-PBK**  
11-7/8" x 8-1/4" x 3"  
**Neck 5-1/8"**



Flamed Polished  
**HZ-6020-2-POL**  
Flamed Chrome  
**HZ-6020-2-C**  
11-7/8" x 8-1/4" x 3"  
**Neck 5-1/8"**



Full Fined Polished  
**HZ-6020-3-POL**  
Full Fined Black  
**HZ-6020-3-PBK**  
11-7/8" x 8-1/4" x 3"  
**Neck 5-1/8"**



Partial Fined Polished  
**HZ-6020-4-POL**  
Partial Fined Black  
**HZ-6020-4-PBK**  
11-7/8" x 8-1/4" x 3"  
**Neck 5-1/8"**

## 15" OVAL ALUMINUM AIR CLEANER SETS

All oval air cleaner sets include top, base, 2" paper filter & mounting stud



Smooth Polished  
**HZ-6021-POL**  
Smooth Chrome  
**HZ-6021-C**  
Black EDP  
**HZ-6021-PBK**  
15" x 8-1/4" x 3"  
**Neck 5-1/8"**



Ball Milled Polished  
**HZ-6021-1-POL**  
Ball Milled Chrome  
**HZ-6021-1-C**  
Black EDP  
**HZ-6021-1-PBK**  
15" x 8-1/4" x 3"  
**Neck 5-1/8"**



Flamed Polished  
**HZ-6021-2-POL**  
Flamed Chrome  
**HZ-6021-2-C**  
15" x 8-1/4" x 3"  
**Neck 5-1/8"**



Full Fined Polished  
**HZ-6021-3-POL**  
Full Fined Black  
**HZ-6021-3-PBK**  
15" x 8-1/4" x 3"  
**Neck 5-1/8"**



Partial Fined Polished  
**HZ-6021-4-POL**  
Partial Fined Black  
**HZ-6021-4-PBK**  
15" x 8-1/4" x 3"  
**Neck 5-1/8"**

## 19" OVAL ALUMINUM AIR CLEANER SETS

All oval air cleaner sets include top, base, 2" paper filter & mounting stud



Smooth Polished (Dual Quad)  
**HZ-6029-POL**  
19-1/8" x 9-1/8" x 2-1/2"  
**Neck 5-1/8"**



Ball Milled Polished (Dual Quad)  
**HZ-6029-1-POL**  
19-1/8" x 9-1/8" x 2-1/2"  
**Neck 5-1/8"**



\* Will not fit 409 dual quad carbs



## OVAL ALUMINUM AIR CLEANER TOPS & BASES

Air cleaner tops include mounting stud



**12"**  
Smooth Polished  
**HZ-6020T-POL**  
Smooth Chrome  
**HZ-6020T-C**  
Black EDP  
**HZ-6020T-PBK**  
11-7/8" x 8-1/4"



**12"**  
Ball Milled Polished  
**HZ-6020T-1-POL**  
Ball Milled Chrome  
**HZ-6020T-1-C**  
Black EDP  
**HZ-6020T-1-PBK**  
11-7/8" x 8-1/4"



**12"**  
Flamed Polished  
**HZ-6020T-2-POL**  
Flamed Chrome  
**HZ-6020T-2-C**  
11-7/8" x 8-1/4"



**12"**  
Full Finned Polished  
**HZ-6020T-3-POL**  
Full Finned Black  
**HZ-6020T-3-PBK**  
11-7/8" x 8-1/4"



**12"**  
Partial Finned Polished  
**HZ-6020T-4-POL**  
Partial Finned Black  
**HZ-6020T-4-PBK**  
11-7/8" x 8-1/4"

**15"**  
Smooth Polished  
**HZ-6021T-POL**  
Smooth Chrome  
**HZ-6021T-C**  
Black EDP  
**HZ-6021T-PBK**  
15" x 8-1/4"

**15"**  
Ball Milled Polished  
**HZ-6021T-1-POL**  
Ball Milled Chrome  
**HZ-6021T-1-C**  
Black EDP  
**HZ-6021T-1-PBK**  
15" x 8-1/4"

**15"**  
Flamed Polished  
**HZ-6021T-2-POL**  
Flamed Chrome  
**HZ-6021T-2-C**  
15" x 8-1/4"

**15"**  
Full Finned Polished  
**HZ-6021T-3-POL**  
Full Finned Black  
**HZ-6021T-3-PBK**  
15" x 8-1/4" ~ 3"

**15"**  
Partial Finned Polished  
**HZ-6021T-4-POL**  
Partial Finned Black  
**HZ-6021T-4-PBK**  
15" x 8-1/4" x 3"



**HZ-6020B-POL / HZ-6020B-PBK HZ-6021B-POL / HZ-6021B-PBK**

## 14" ROUND ALUMINUM AIR CLEANER SETS

All round air cleaner sets include top, base, 3" paper filter & mounting stud



Smooth Polished  
**HZ-6801-POL**  
Smooth Chrome  
**HZ-6801-C**  
Black EDP  
**HZ-6801-PBK**  
14" x 3"  
**Neck 5-1/8"**



Ball Milled Polished  
**HZ-6801-1-POL**  
Ball Milled Chrome  
**HZ-6801-1-C**  
Black EDP  
**HZ-6801-1-PBK**  
14" x 3"  
**Neck 5-1/8"**



Flamed Polished  
**HZ-6801-2-POL**  
Flamed Chrome  
**HZ-6801-2-C**  
14" x 3"  
**Neck 5-1/8"**



Full Finned Polished  
**HZ-6801-3-POL**  
Full Finned Black  
**HZ-6801-3-PBK**  
14" x 3"  
**Neck 5-1/8"**



Partial Finned Polished  
**HZ-6801-4-POL**  
Partial Finned Black  
**HZ-6801-4-PBK**  
14" x 3"  
**Neck 5-1/8"**

## 14" ROUND ALUMINUM AIR CLEANER TOPS

Air cleaner tops include mounting stud



Smooth Polished  
**HZ-6801T-POL**  
Smooth Chrome  
**HZ-6801T-C**  
Black EDP  
**HZ-6801T-PBK**



Ball Milled Polished  
**HZ-6801T-1-POL**  
Ball Milled Chrome  
**HZ-6801T-1-C**  
Black EDP  
**HZ-6801T-1-PBK**



Flamed Polished  
**HZ-6801T-2-POL**  
Flamed Chrome  
**HZ-6801T-2-C**



Full Finned  
**HZ-6801T-3-POL**  
Full Finned Black  
**HZ-6801T-3-PBK**



Partial Finned  
**HZ-6801T-4-POL**  
Partial Finned Black  
**HZ-6801T-4-PBK**

## CHEVY BIG BLOCK STEEL VALVE COVERS



**Chevy 1965-95 396-427-454-502**

Baffled - Smooth

Tall: 3-5/8"

**HZ-9235-C** Chrome  
**HZ-9235-PO** Orange  
**HZ-9235-PBK** Black

Short: 2-5/8"

**HZ-9236-C** Chrome  
**HZ-9236-PO** Orange  
**HZ-9236-PBK** Black



**Chevy 1965-95 396-427-454-502**

Baffled - 454 Logo

Tall: 3-5/8"

**HZ-9843-C** Chrome  
**HZ-9844-C** Chrome  
**HZ-9844-PCMB** Black  
**HZ-9844-PCG** Grey  
**HZ-9844-PCO** Orange  
Powder Coated

Short: 2-5/8"



**1965-72 Chevy 396-427-454**

Baffled - OEM Style w/ Dripper Rails

Short: 2-1/4"

**HZ-9503-1-C** Chrome  
**HZ-9503-1-PO** Orange  
**HZ-9503-1-PBK** Black



**1965-72 Chevy 396-402-427-454**

Baffled - OEM Style

Tall: 2-3/4"

**HZ-9503T-C** Chrome  
**HZ-9503T-PO** Orange  
**HZ-9503T-PBK** Black

Short: 2-1/4"

**HZ-9503-C** Chrome  
**HZ-9503-PO** Orange  
**HZ-9503-PBK** Black



**1965-72 Chevy 396-427-454**

Baffled - OEM Style

Tall: 2-3/4"

**\*\*HZ-9504T-C** Chrome  
**\*\*HZ-9504T-PO** Orange  
**\*\*HZ-9504T-PBK** Black

Short: 2-1/4"

**\*\*HZ-9504-C** Chrome  
**\*\*HZ-9504-PO** Orange  
**\*\*HZ-9504-PBK** Black



**1965-72 Chevy 396-427-454**

Baffled - OEM Style w/ Dripper Rails

Short: 2-1/4"

**\*\*HZ-9504-1-C** Chrome  
**\*\*HZ-9504-1-PO** Orange  
**\*\*HZ-9504-1-PBK** Black

**\*\*HZ-9504** models feature a recessed corner to fit Corvettes & cars w/ power brakes.

## CHEVY BIG BLOCK - ALUMINUM VALVE COVERS



**1965-95 Chevy 396-427-454-502**

Baffled - Smooth Polished

Tall: 3-11/16"

**HZ-8051-POL**  
**HZ-8051-PCMB** Powder Coated  
Matte Black



**1965-95 Chevy 396-427-454-502**

Baffled - Ball Milled Polished

Tall: 3-11/16"

**HZ-8051-1-POL**  
**HZ-8051-1-PCMB** Powder Coated  
Matte Black



**1965-95 Chevy 396-427-454-502**

Baffled - Flamed Polished

Tall: 3-11/16"

**HZ-8051-2-POL**



**1965-95 Chevy 396-427-454-502**

Baffled - Retro Finned Polished

Tall: 3-11/16"

**HZ-8051-3-POL**  
**HZ-8051-3-PBK** Black



**1965-95 Chevy 396-427-454-502**

Baffled - Polished

Tall: 3-11/16". Circle track racing.

Driver side has 1-3/8" O.D. tubes.

**HZ-8059-POL / HZ-8059-PCMB** Powder Coated  
Matte Black



**1965-95 Chevy 396-427-454-502**

Baffled - Smooth Polished

Short: 2-7/8"

**\*HZ-8041-POL** - w/o Breather Holes



**1965-95 Chevy 396-427-454-502**

Baffled - OEM Style Polished

Short: 2-7/8" **\*HZ-8042-POL**



**1965-95 Chevy 396-427-454-502**

Baffled - Ball Milled Polished

Short: 2-7/8" **\*HZ-8043-POL**



**1965-95 Chevy 396-427-454-502**

Baffled - Flamed Polished

Short: 2-7/8" **\*HZ-8044-POL**

\*The rear corner of each cover is slanted for cars with power brakes.



## CHEVY SMALL BLOCK - STEEL VALVE COVERS



**1958-86 Chevy**  
283-305-327-350-400 Baffled  
**Tall:** 3-5/8" **HZ-9215-C** Chrome  
**HZ-9215-PBK** Black EDP  
**HZ-9215-PO** Orange

**Short:** 2-5/8" **HZ-9216-C** Chrome  
**HZ-9216-PBK** Black EDP  
**HZ-9216-PO** Orange



**1958-86 Chevy**  
283-305-327-350-400 Baffled  
**Tall:** 3-5/8" **HZ-9215-F** Chrome Flames  
**Short:** 2-5/8" **HZ-9216-F** Chrome Flames



**1958-86 Chevy**  
283-305-327-350-400  
Baffled - Chrome  
Von Hot Rod Pinstriping Special Edition  
**Tall:** 3-5/8" **HZ-9215-V**  
**Short:** 2-5/8" **HZ-9216-V**



**1958-86 Chevy**  
283-305-327-350-400  
Baffled - OEM Style. **Short:** 2-5/8"  
**HZ-9518-C** Chrome  
**HZ-9518-PO** Orange  
**HZ-9518-PBK** Black EDP  
**HZ-9518-R** Raw



**1958-86 Chevy**  
283-305-327-350-400  
Baffled **Tall:** 3-5/8"  
**HZ-9519-C** Chrome  
**HZ-9519-PBK** Black EDP  
**HZ-9519-PO** Orange



**1958-86 Chevy 327**  
Baffled - 327 Logo  
**Tall:** 3-5/8" **HZ-9853-C** Chrome  
**HZ-9853-PBK** Black EDP  
**Short:** 2 5/8" **HZ-9854-C** Chrome  
**HZ-9854-PBK** Black EDP



**1958-86 Chevy 350**  
Baffled - 350 Logo  
**Tall:** 3-5/8" **HZ-9841-C** Chrome  
**HZ-9841-PBK** Black EDP  
**Short:** 2 5/8" **HZ-9842-C** Chrome  
**HZ-9842-PBK** Black EDP

## CHEVY SMALL BLOCK - STEEL CENTER BOLT COVERS



**1987-00 Chevy 5.0L & 5.7L V8**  
Baffled - OEM Style  
**Height:** 2-3/8"

**HZ-9702-C** Chrome  
**HZ-9702-PBK** Black EDP  
**HZ-9702-R** Unplated

**Tall:** 3-11/16"

**HZ-9705-C** Chrome

**HZ-9705-PBK** Black EDP



**1987-00 Chevy 5.0L & 5.7L V8**  
Baffled - OEM Style One Hole only  
**Height:** 2-3/8"

**HZ-9703-C** Chrome  
**HZ-9703-PBK** Black EDP



**1987-00 Chevy 5.0L & 5.7L V8**  
Baffled - OEM Style Two Hole only  
**Height:** 2-3/8"

**HZ-9704-C** Chrome  
**HZ-9704-PBK** Black EDP



**1987-00 Chevy 5.0L & 5.7L V8**  
Baffled - OEM Style  
**Height:** 2-3/8". Caps fit over existing OEM covers.  
**HZ-9460-C** Chrome

**NEW!**

## CHEVY SMALL BLOCK - ALUMINUM CENTER BOLT VALVE COVERS



**1987-97 Chevy 5.0L & 5.7L V8**  
Unbaffled - Smooth Polished  
**Tall:** 3-11/16"  
**HZ-8031-H-POL**



**1987-97 Chevy 5.0L & 5.7L V8**  
Baffled - Smooth Polished  
**Tall:** 3-11/16" **HZ-8032-POL**  
**Short:** 2-9/16" **HZ-6991-POL**



**1987-97 Chevy 5.0L & 5.7L V8**  
Baffled - Ball Milled  
**Tall:** 3-11/16" **HZ-8033-POL** Polished  
**Short:** 2-9/16" **HZ-6991-POL** Polished  
**HZ-6991C-1** Chrome

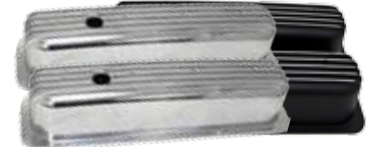

**1987-97 Chevy 5.0L & 5.7L V8**  
Baffled - Retro Finned  
**Tall:** 3-11/16" **HZ-8033-3-POL** Polished  
**HZ-8033-3-PBK** Black  
**HZ-8033-3-H** w/o Breather Holes  
**Short:** 2-9/16" **HZ-6991-3-POL** Polished  
**HZ-6991-3-PBK** Black



**1987-97 Chevy 5.0L & 5.7L V8**  
Baffled - Flamed Polished  
**Short:** 2-9/16" **HZ-6991-2-POL**



**1987-97 Chevy 5.0L & 5.7L V8**  
Baffled - Ball Milled Polished  
**Tall:** 3-11/16" **HZ-8233-POL**



**1987-97 Chevy 5.0L & 5.7L V8**  
Baffled: Flamed Polished  
**Tall:** 3-11/16" **HZ-8234-POL**

## CHEVY SMALL BLOCK - CIRCLE TRACK VALVE COVERS



**1987-97 Chevy 5.0L & 5.7L V8**  
Baffled - Polished  
**Tall:** 3-11/16". Center bolt style. Driver side has 1-3/8" O.D. tubes.  
**HZ-8039-POL**

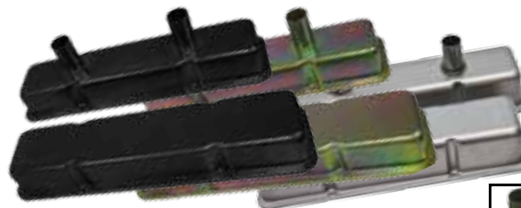

**1958-86 Chevy 283-305-327-350-400**  
Baffled  
**Tall:** 3-3/8". Driver side has 1-1/2" O.D. tubes.  
**HZ-7215-PBK** Black EDP  
**HZ-7215-Z** Zinc  
**HZ-7215-R** Unplated



Welded Breather Tubes

**Short:** 2-5/8". Driver side has 1-1/2" O.D. tubes.  
**HZ-7216-Z** Zinc  
**HZ-7216-R** Unplated



**1958-86 Chevy 283-305-327-350-400**  
Baffled - Polished  
**Tall:** 3-11/16". Driver side has 1-3/8" O.D. tubes.  
**HZ-6140-POL**



## CHEVY SMALL BLOCK ALUMINUM VALVE COVERS



**1958-86 Chevy**  
283-305-327-350-400  
Baffled - Smooth  
Tall: 3-11/16"  
**HZ-6033-POL** Polished  
**HZ-6033-C** Chrome



**1958-86 Chevy**  
283-305-327-350-400  
Baffled - Ball Milled  
Tall: 3-11/16"  
**HZ-6033-1-POL** Polished  
**HZ-6033C-1** Chrome



**1958-86 Chevy**  
283-305-327-350-400  
Baffled - Flamed  
Tall: 3-11/16"  
**HZ-6033-2-POL** Polished  
**HZ-6033C-2** Chrome



**1958-86 Chevy**  
283-305-327-350-400  
Baffled - Smooth  
Tall: 3-11/16"  
**HZ-6720-POL** Polished  
**HZ-6720-C** Chrome  
  
**Short: 2-9/16"**  
**HZ-6031-POL** Polished  
**HZ-6031-C** Chrome



**1958-86 Chevy**  
283-305-327-350-400  
Baffled - Ball Milled  
Tall: 3-11/16"  
**HZ-6720-1-POL** Polished  
**HZ-6720C-1** Chrome  
  
**Short: 2-9/16"**  
**HZ-6031-1-POL** Polished  
**HZ-6031C-1** Chrome



**1958-86 Chevy**  
283-305-327-350-400  
Baffled - Flamed  
Tall: 3-11/16"  
**HZ-6720-2-POL** Polished  
**HZ-6720C-2** Chrome  
  
**Short: 2-9/16"**  
**HZ-6031-2-POL** Polished  
**HZ-6031C-2** Chrome



**HZ-6720-3**



**HZ-6031-3-H**

**1958-86 Chevy**  
283-305-327-350-400  
Baffled - Retro Finned  
Tall: 3-11/16"  
**HZ-6720-3-POL**  
**HZ-6720-3-H-POL** w/o Breather Holes  
**HZ-6720-3-PBK**  
**Short: 2-9/16"** **HZ-6031-3-POL**  
**HZ-6031-3-H-POL** w/o Breather Holes  
**HZ-6031-3-PBK**

## CHEVY SMALL BLOCK STAMPED ALUMINUM ANODIZED VALVE COVERS

Light weight aluminum has a 45% weight reduction compared to steel.  
1958-86 Chevy 283-305-327-350-400. Baffled and 3-3/8" tall

1-1/2"  
O.D. Tubes



**HZ-8215-PBK** Black  
**HZ-8215-RED** Red  
**HZ-8215-PBL** Blue  
**HZ-8215-R** Raw  
**HZ-8215-SIL** Silver



**HZ-8115-R** Raw  
**HZ-8115-PBK** Black  
**HZ-8115-RED** Red  
**HZ-8115-PBL** Blue  
**HZ-8115-SIL** Silver



**HZ-8519-RED** Red  
**HZ-8519-PBK** Black  
**HZ-8519-SIL** Silver  
**HZ-8519-PBL** Blue  
**HZ-8519-R** Raw

Twist-in  
Cap

## CHEVY STRAIGHT/INLINE 6 - STEEL VALVE COVERS



**\*1962-74 Chevy 194-230-250-292 L6**  
Baffled w/ Side Plates  
Height: 3-1/2"

**HZ-9233-KIT-C**  
**HZ-9233-KIT-PBK**  
**HZ-9341-C** Side Plate only  
**HZ-9341-PBK**  
**HZ-9233-C** Valve Cover only  
**HZ-9233-PBK**

\*Will not fit engines or heads with integral intake manifold.



**1952-62 Chevy 235 L6 w/ Side Plate**  
Unbaffled - Height: 3-7/8"

**HZ-9107/HZ-9108**  
**HZ-9107-C** Valve Cover only  
**HZ-9107-PBK**  
**HZ-9108-C** Side Plate only  
**HZ-9108-PBK**



**1942-53 Chevy 216 L6 - Unbaffled**  
Height: 4-1/4"

**HZ-9110-C** Chrome  
**HZ-9110-PBK** Black EDP

## CHEVY V6 CYLINDER - STEEL VALVE COVERS



**1985-93 Chevy 4.3L V6**  
Baffled - Ball Milled  
Short: 2-1/2" **HZ-7458-C** Chrome  
**HZ-7458-PBK** Black EDP



**1980-84 Chevy 229 3.8L V6**  
Unbaffled - Smooth  
Short: 2-1/2" **HZ-9039-C** Chrome

## FORD BIG BLOCK - STEEL VALVE COVERS



**1957-76 Ford FE 352-390-406-427-428**  
Baffled - Height: 3-7/8"  
**HZ-9296-C** Chrome  
**HZ-9296-PBK** Black EDP



**1968-97 Ford 429-460**  
Baffled - Height: 3-1/2"  
**HZ-9297-C** Chrome  
**HZ-9297-PBK** Black EDP



## FORD SMALL BLOCK - STEEL VALVE COVERS



**1955-64 Ford Y-Block**  
272-292-312  
Baffled - OEM Style  
Height: 3-1/2"

**HZ-7541-C** Chrome  
**HZ-7541-PBK** Black EDP



**1962-85 Ford**  
260-289-302-351W-5.0L  
Baffled - Smooth  
Height: 3-1/2"

**HZ-9237-C** Chrome  
**HZ-9237-PBL** Painted Blue  
**HZ-9237-PBK** Black EDP  
**HZ-9237-R** Unplated



**1962-85 Ford**  
260-289-302-351W-5.0L  
Baffled - Flamed  
Height: 3-1/2"

**HZ-9237-F** Chrome Flames



**1969-82 Ford**  
351C-351M-400M-BOSS 302  
Baffled - Smooth  
Height: 3-5/8"

**HZ-9295-C** Chrome  
**HZ-9295-PBK** Black EDP



**1986-95 Ford Mustang 5.0L V8**  
Unbaffled - OEM Style Smooth  
Height: 3-1/2"

**HZ-9239-C** Chrome  
**HZ-9239-PBK** Black EDP

## FORD SMALL BLOCK - CIRCLE TRACK RACING VALVE COVERS



**1962-85 Ford** 260-289-302-351W  
Baffled - Zinc  
Stock Height: 3-1/2" **HZ-7225-Z**

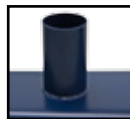

Welded  
Breather Tubes



**1962-85 Ford** 260-289-302-351W  
Baffled - Painted Blue  
Stock Height: 3-1/2" **HZ-7225-PBL**

**FORD SMALL BLOCK - ALUMINUM VALVE COVERS**



**1962-85 Ford** 289-302-351W-5.0L  
Baffled - Smooth  
**Height:** 3-13/16"  
**HZ-6728-POL** Polished  
**HZ-6728-C** Chrome  
**HZ-6728-H** w/o Breather Holes  
**HZ-6728-PCMB** Black



**1962-85 Ford** 289-302-351W-5.0L  
Baffled - Ball Milled  
**Height:** 3-13/16"  
**HZ-6728-1-POL** Polished  
**HZ-6728C-1** Chrome

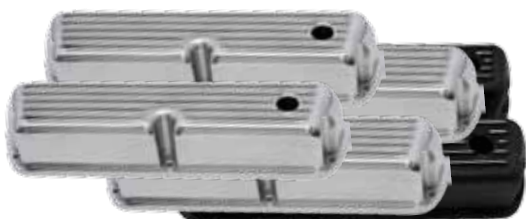

**1962-85 Ford** 289-302-351W-5.0L  
Baffled - Polished Retro Finned  
**Height:** 3-13/16"  
**HZ-6728-3-POL** Polished  
**HZ-6728-3-PBK** Black  
**HZ-6728-H-POL** w/o Breather Holes



**1962-85 Ford** 289-302-351W-5.0L  
Baffled - Flamed  
**Height:** 3-13/16"  
**HZ-6728-2-POL** Polished  
**HZ-6728C-2** Chrome

**FORD L6/V6 CYLINDER - STEEL VALVE COVERS**



**1960-83 Ford** 144-170-200-250 L6  
Baffled - Smooth  
**Height:** 4-1/4" **HZ-9338-C** Chrome  
**HZ-9338-PBK** Black EDP



**1965-89 Ford** 240-300 L6  
Baffled - Smooth  
**Height:** 3-1/4" **HZ-9357-C** Chrome  
**HZ-9357-PBK** Black EDP



**1982-04 Ford**  
232 3.8L V6  
Baffled - Smooth  
**Height:** 2-3/4"  
**HZ-9432-C** Chrome

**BUICK - STEEL VALVE COVERS**



**1968-81 Buick 350 V8**  
Unbaffled - Smooth  
Height: 2-13/16"  
**HZ-7554-C**  
**HZ-7554-PBK**



**1975-88 Buick 231/3.8L V6**  
Unbaffled - Smooth  
Height: 3"  
**HZ-4964-C**  
Will not fit some models with  
air conditioning.

**PONTIAC - STEEL VALVE COVERS**



**1959-79 Pontiac**  
301-326-350-389-400-421-428-455  
Baffled - Smooth  
Tall: 3-1/2"  
**HZ-9300-C**  
**HZ-9300-PBK**



**1959-79 Pontiac**  
301-326-350-389-400-421-428-455  
Unbaffled - Smooth  
Short: 2-5/8"  
**HZ-9461-C**  
**HZ-9461-PBK**

**PONTIAC - ALUMINUM VALVE COVERS**



**Pontiac 326-455**  
Baffled - Finned Aluminum  
Height: 4"  
**HZ-6032-3-POL**  
**HZ-6032-3-PBK**

**CADILLAC - STEEL VALVE COVERS**



**1968-84 Cadillac 368-425-472-500**  
**1977-79 Cadillac 425**  
**1980-84 Cadillac 368**  
Unbaffled - Smooth  
Height: 2-13/16" **HZ-9521-C**  
**HZ-9521-PBK**



## OLDSMOBILE - STEEL VALVE COVERS



**1964-88 Oldsmobile**  
330-350-400-425-455  
Baffled - Smooth  
Tall: 3-3/8" **HZ-9391-1-POL**  
**HZ-9391-1-PBK**



**1964-80 Oldsmobile**  
330-350-400-425-455  
Baffled - Smooth  
Short: 2-13/16" **HZ-9391-POL**  
**HZ-9391-PBK**

## AMC/JEEP - STEEL VALVE COVERS



**\*1964-88 AMC/Jeep**  
199-232-258 L6  
Baffled - Smooth  
Height: 3-1/2" **HZ-9339-C**  
**HZ-9339-PBK**



**1968-79 AMC/Jeep**  
304-360-390-401 V8  
Unbaffled - Smooth  
Height: 3-1/8" **HZ-9174-C**  
**HZ-9174-PBK**

\*Will not fit models w/ plastic valve covers.

## MOPAR - STEEL VALVE COVERS



**1967-89 Chrysler**  
318-340-360  
Baffled - Smooth  
Height: 3-1/4" **HZ-9298-C**  
**HZ-9298-PBK**



**1958-88 Chrysler 383-426-440**  
Baffled  
Height: 3-3/4" **HZ-9299-C**  
**HZ-9299-PBK**



**1958-80 Chrysler Slant 6**  
170-198-225  
Unbaffled - Smooth  
Height: 4-1/2" **HZ-9520-C**  
**HZ-9520-PBK**

## VALVE COVER GASKETS

\*All gaskets sold in a pair.

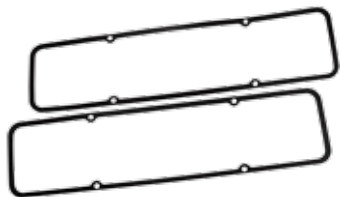

**HZ-7484**  
1955-86 SBC  
283-305-327-350-400  
Rubber Steel Core



**HZ-7485**  
1965-85 BBC  
396-402-427-454  
Rubber Steel Core



**HZ-7485-W**  
1965-85 BBC  
396-402-427-454  
Cork Steel Core

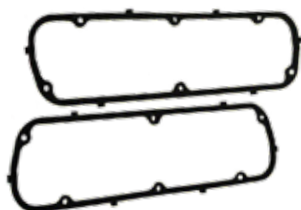

**HZ-7486**  
1962-85 SBF  
260-289-302-351W  
Rubber Steel Core



**HZ-7488**  
1987-Up  
Chevy/GM Center Bolt  
Rubber Core

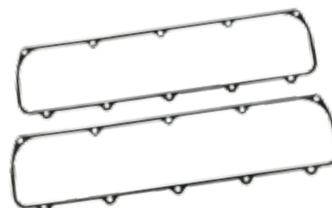

**HZ-7490**  
1964-88  
Oldsmobile 330-455  
Rubber Steel Core



**HZ-7491**  
1969-82 SBF  
351C-400M  
Rubber Steel Core



**HZ-7492**  
1957-76 BBF  
360-390  
Rubber Steel Core



**HZ-7493**  
1968-97 BBF  
429-460  
Rubber Steel Core



**HZ-7494**  
1967-89  
Chrysler 318-340-380 V8  
Rubber Steel Core



**HZ-7495**  
1958-88  
Chrysler 383-426-440 V8  
Rubber Steel Core

## STEEL BREATHERS

Type	Push-In	Dia	2-3/4"	Fits	1-1/4"	Tubes	5/8"
------	---------	-----	--------	------	--------	-------	------



**HZ-4870-C**  
Chrome



**HZ-4870-PBK**  
Black EDP



**HZ-4870-PO**  
Orange



**HZ-4870F**  
Chrome



**HZ-9241-C**  
Chrome  
**HZ-9241-PBK**  
Black EDP



**HZ-4802-C**  
Oil Filler Cap  
**Dia** 2-1/2"  
**Fits** 1-1/4"

## STEEL BREATHERS SETS



**HZ-4870-C-SET** Chrome  
**HZ-4870-PBK-SET** Black EDP  
**HZ-4870-PO-SET** Orange



**HZ-4870F-SET** Chrome Flamed



**HZ-9241-C-SET** Chrome  
**HZ-9241-PBK-SET** Black EDP



**HZ-9241F-SET** Chrome Flamed

## PCV VALVE



**Billet Aluminum PCV Valve.**  
Push-in style w/ 3/4" neck  
1-1/4" holes  
**HZ-6116-POL** Polished  
**HZ-6116-C** Chrome

## ALUMINUM BREATHERS

Type	Push-In	Dia	2-3/8"	Fits	1-1/4"	Tubes	5/8"
------	---------	-----	--------	------	--------	-------	------



PCV Valve  
**HZ-6100-POL** Polished  
**HZ-6100-C** Chrome  
**HZ-6100-PBK** Black



Ball Milled PCV Valve  
**HZ-6100-POL-1** Polished  
**HZ-6100-C-1** Chrome



Flamed PCV Valve  
**HZ-6100-POL-2** Polished  
**HZ-6100-C-2** Chrome



**NEW!**  
Retro Finned PCV Valve  
**HZ-6120-POL** Polished  
**HZ-6120-PBK** Black



Breather  
**HZ-6101-POL** Polished  
**HZ-6101-C** Chrome  
**HZ-6101-PBK** Black



Ball Milled Breather  
**HZ-6101-POL-1** Polished  
**HZ-6101-C-1** Chrome



Flamed Breather  
**HZ-6101-POL-2** Polished  
**HZ-6101-C-2** Chrome



**NEW!**  
Retro Finned Breather  
**HZ-6119-POL** Polished  
**HZ-6119-PBK** Black

## ALUMINUM BREATHERS SETS



Smooth  
**HZ-6111-POL** Polished  
**HZ-6111-C** Chrome



Ball Milled  
**HZ-6112-POL** Polished  
**HZ-6112-C** Chrome



Flamed  
**HZ-6113-POL** Polished  
**HZ-6113-C** Chrome



Red Flamed  
**HZ-6113C-RED** Chrome



## HIGH PERFORMANCE WASHABLE BREATHERS



**HZ-6130-C**

Clamp-on  
fits 1-1/2" tubes w/shield  
Chrome Steel



**HZ-6131-C**

Clamp-on  
fits 1-3/8" tubes w/shield  
Chrome Steel



**HZ-6132-C**

Clamp-on  
fits 1-1/2" tubes  
Chrome Steel



**HZ-6133-C**

Clamp-on  
fits 1-3/8" tubes  
Chrome Steel

## RUBBER GROMMETS

1/8" wide groove in grommet for aluminum v/c's & 1/4" wide groove in grommet for steel v/c's



**HZ-4877**

Breather Grommet  
O.D. 1-1/4" I.D. 1"  
Steel



**HZ-4998**

PCV Grommet  
O.D. 1-1/4" I.D. 3/4"  
Steel



**HZ-9359**

PCV Oil  
Baffle Grommet  
O.D. 1-1/4" I.D. 3/4"  
Steel



**HZ-4879**

Breather Grommet  
O.D. 1-1/4" I.D. 1"  
Aluminum



**HZ-4880**

PCV Grommet  
O.D. 1-1/4" I.D. 3/4"  
Aluminum



**HZ-9361**

PCV Oil  
Baffle Grommet  
O.D. 1-1/4" I.D. 3/4"  
Aluminum



**HZ-9358**

Oil Baffle Grommet  
O.D. 1-1/4" I.D. 1"  
Steel



**HZ-9360**

Oil Baffle Grommet  
O.D. 1-1/4" I.D. 1"  
Aluminum



**HZ-4878**

Breather/PCV Grommet  
(Must be cut before use)  
O.D. 1-1/4" I.D. 1"  
Steel

## CHROME OIL CAPS & PLUGS



**HZ-4804-C**  
**HZ-4804-PBK**

Universal Chrome Steel  
Valve Cover Oil Cap  
Twist-In  
1-1/4"



**HZ-9170-C**

Universal Chrome Top/Rubber  
Base Valve Cover Oil Cap  
Push-In  
1-1/4"



**HZ-9696-C**

1987-UP Chevy/GM Chrome  
Plastic Valve Cover Oil Cap  
Screw-In



**HZ-9696B-C**

1987-UP Chevy/GM Chrome  
Billet Aluminum Valve Cover Oil Cap  
Screw-In



**HZ-9696B-POL**

1987-UP Chevy/GM Polished  
Billet Aluminum Valve Cover Oil Cap  
Screw-In



**HZ-9787-C**

Universal Chrome Top Rubber/Base  
Valve Cover Oil Cap w/ Oil Logo  
Push-In  
1-1/4"

## VALVE COVER BOLT KITS & HOLD-DOWNS

**\*1/4"-20 Threads:** 1955-86 Chevy V8, 1958-79 Oldsmobile V8, 1964-90 Ford 260-289-302-351W V8, 1959-90 Chrysler V8 (not Hemi).

**\*\*5/16"-18 Threads:** 1958-UP Ford SB 332-352-390-406-427 & Ford BB 429-460 V8, 1955-77 Pontiac V8.



**\*HZ-7283-C**  
**\*HZ-7283-PBK**

1-3/8" Tall Valve Covers  
Hex Mini Bolts  
(1/4"-20 X 1-3/8" Studs)  
Universal 1 Piece

**\*\*HZ-7284-C**  
**\*\*HZ-7284-PBK**

1-3/8" Tall Valve Covers  
Hex Mini Bolts  
(5/16"-18 X 1-1/2" Studs)  
Universal 1 Piece



**\*HZ-7281-C**  
**\*HZ-7281-PBK**

Steel Acorn Nut Bolt 1" Tall  
1/4-20 X 7/8" 1 3/8" Studs  
Universal 1 Piece  
or 8 piece set



Chrome

**\*HZ-4137-C**  
3-1/2" Tall 2 Piece  
Valve Cover Wing Nuts  
(1/4"-20 X 1" Studs)  
Universal 1 Piece



**\*\*HZ-4138-C**

3-1/2" Tall 2 Piece  
Valve Cover Wing Nuts  
(5/16"-18 X 1" Studs)  
Universal 1 Piece



Chrome

**\*HZ-9120-C**  
4" Tall T-Bar 1 Piece  
Valve Cover Wing Nuts  
(1/4"-20 X 1-3/8" Studs)

**\*HZ-4936-C**  
5" Tall T-Bar 1 Piece  
Valve Cover Wing Nuts  
(1/4"-20 X 1-3/8" Studs)

**\*\*HZ-9672-C**  
5" Tall T-Bar  
Valve Cover Wing Nuts  
(5/16"-18 X 1-1/2" Studs)  
Universal 1 Piece



**\*HZ-9670-C**  
4" Tall T-Bar  
Valve Cover Wing Nuts  
(1/4"-20 X 1-3/8" Studs)  
Universal 1 Piece



**\*HZ-9812-C** Chrome  
**\*HZ-9812-PBK** Black  
Center Bolt Steel Valve Cover Bolt  
Hex Head bolts  
(1/4"-20 x 3/12" Studs)  
Chevy/GMC 4.3L,  
5.0L & 5.7L  
HZ-9702, HZ-9703, HZ-9704  
8 Pieces



**HZ-9813-C** Chrome  
**HZ-9813-PBK** Black  
Steel Center Valve Cover Bolt  
HZ-9705  
8 Pieces



**HZ-9067-C** Chrome  
**HZ-9067-PBK** Black

Valve Cover  
Mini Hold Down Tabs  
(1-1/2" wide, 1/4" Bolt Hole)  
SBC 1 Piece



**HZ-4993-C** Chrome  
**HZ-4993-PBK** Black

Valve Cover  
Hold Down Tabs/  
Spreader Bars  
SBC 1 Piece



**HZ-9640-C** Chrome  
**HZ-9640-PBK** Black

Valve Cover  
Hold Down Tabs/  
Spreader Bars  
BBC 14 Pieces



**Stainless Steel**  
**HZ-8096**  
Center Bolt Tall  
Aluminum Valve  
Cover Bolt (1/4"-20 x 5")  
Chevy/GMC 4.3L,  
5.0L & 5.7L  
8 Pieces



Chrome  
**HZ-150**  
3/4" Tall Valve Cover  
Hex Head bolts  
(1/4"-20 Thread)  
Universal 1 Piece

## ALUMINUM WIRE LOOM SETS

These wire looms can handle up to a 9.5 mm wire and come complete with four L-brackets that are adjustable and all the necessary hardware for installation. *NOTE: Will not fit center bolt valve covers (see HZ-6089 below).*

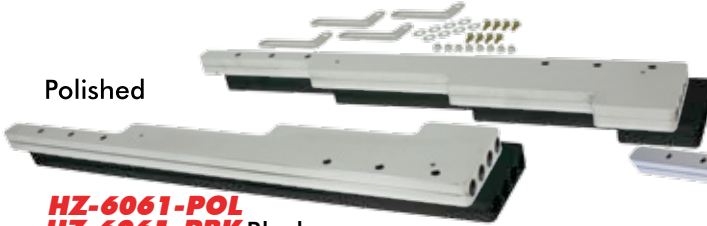

Polished

**HZ-6061-POL**  
**HZ-6061-PBK** Black

Universal Billet Aluminum Wire Loom Set - Smooth



Chrome

**HZ-6061-C**

Universal Billet Aluminum Wire Loom Set - Smooth



Polished

**HZ-6061-1-POL**  
**HZ-6061-1-PBK** Black

Universal Billet Aluminum Wire Loom Set - Ball Milled

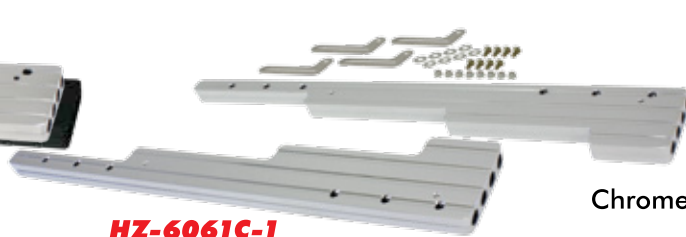

Chrome

**HZ-6061C-1**

Universal Billet Aluminum Wire Loom Set - Ball Milled



Polished

**HZ-6061-2-POL**  
Universal Billet Aluminum Wire Loom Set - Flamed



Chrome

**HZ-6061C-2**  
Universal Billet Aluminum Wire Loom Set - Flamed

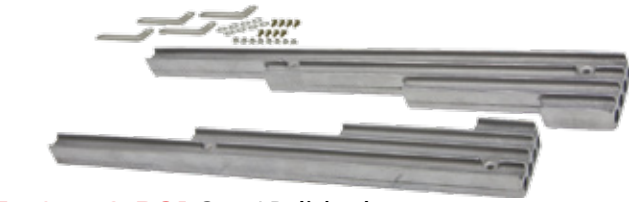

**HZ-6061-3-POL** Cast/ Polished  
Universal Cast Aluminum Wire Loom Set - Full Finned



**HZ-6061-3-PBK** Cast/ Black  
Universal Cast Aluminum Wire Loom Set - Full Finned

## WIRE LOOM BRACKET KIT

**Aluminum Wire Loom Bracket Kit.** Necessary brackets that mount wire looms to center bolt valve covers. *They do not work with the early model valve covers (mount bolts on the side of the heads).* **HZ-6089**



## WIRE CLAMP SET

Set of 4 aluminum clamps and bolts.

**9.5 Mm HZ-1702**  
**7.7 Mm HZ-1703**  
**6.0 Mm HZ-1704**  
**4.5 Mm HZ-1705**



WIRE LOOMS



## CHEVY BIG BLOCK



**HZ-3026-C**

Part #	Engine	Type	Finish
<b>HZ-3027-C</b>	1965-90 BBC 396-402-427-454	Short Smooth	Chrome
<b>HZ-3027-PBK</b>		Short Smooth	Black EDP
<b>HZ-3026-C</b>		Tall Smooth	Chrome
<b>HZ-3026-PBK</b>		Tall Smooth	Black EDP

**Kit Includes:**

- 1 Pair Steel Baffled Valve Covers - HZ-9236/9235
- 1 Steel Timing Chain Cover - HZ-4935
- 1 Steel Timing Tab - HZ-4961
- 1 Steel Engine Dipstick w/ Tube - HZ-4958
- 1 Steel Push-In Breather Cap - HZ-4870
- 1 Rubber Push-In Breather Grommet - HZ-4878
- 1 Rubber Push-In PCV Grommet - HZ-4998

## CHEVY SMALL BLOCK



**HZ-3023-PBK**

Part #	Engine	Type	Finish
<b>HZ-3023-C</b>	1958-86 SBC 283-305-327-350	Short Smooth	Chrome
<b>HZ-3023F</b>		Short Flamed	Chrome
<b>HZ-3023-PBK</b>		Short Smooth	Black EDP
<b>HZ-3024-C</b>		Tall Smooth	Chrome
<b>HZ-3024F</b>		Tall Flamed	Chrome
<b>HZ-3024-PBK</b>		Tall Smooth	Black EDP

**Kit Includes:**

- 1 Pair Steel Baffled Valve Covers - HZ-9216/9215
- 1 Steel Timing Chain Cover - HZ-4934
- 1 Steel Timing Tab - HZ-4960
- 1 Steel Engine Dipstick w/ Tube - HZ-4957
- 1 Steel Push-In Style Breather Cap - HZ-4870
- 1 Rubber Push-In Breather Grommet - HZ-4878
- 1 Rubber Push-In PCV Grommet - HZ-4998

## CHEVY SMALL BLOCK



Part #	Engine	Type	Finish
<b>HZ-3022-PBK</b>	1958-86 SBC 283-305-327-350	Tall Smooth	Black EDP

**Kit Includes:**

- 1 1958-79 Stock OEM Style Oil Pan - HZ-7005-PBK
- 1 Pair 1958-86 Tall Steel Valve Covers - HZ-9215-PBK
- 1 14" Air Cleaner Set w/ Recessed Base - HZ-2195BOX-PBK
- 1 Steel Breather Set - HZ-4870-PBK-SET
- 1 Air Cleaner Wing Nut w/ 5/16" threads - HZ-2180

## CHEVY TRUCK



**HZ-3125**

Part #	Engine	Type	Finish
<b>HZ-3125-C</b>	1988-92 5.0L & 5.7L	Ball Milled	Chrome
<b>HZ-3126-C</b>	1993-94 5.0L & 5.7L	Ball Milled	Chrome

**Kit Includes:**

- 1 Pair Chrome Steel Valve Cover Caps - HZ-9460
- 8 Chrome Steel Center Valve Cover Bolts - HZ-9812
- 1 Chrome Steel Air Cleaner Top - HZ-2146T/2147T
- 1 Chrome Plastic Brake Cylinder Top Cover - HZ-9635
- 1 Chrome Plastic Power Steering Cap Cover - HZ-9257
- 1 Chrome Plastic Screw-In Style Oil Cap - HZ-9696

## FORD SMALL BLOCK

Part #	Engine	Type	Finish
<b>HZ-3025-C</b>	1962-85 SBF 260-289-302-351W-5.0L	Smooth	Chrome
<b>HZ-3025F</b>		Flamed	Chrome
<b>HZ-3025-PBK</b>		Smooth	Black

### Kit Includes:

- 1 Pair Steel Baffled Valve Covers - HZ-9237
- 12 Steel Valve Cover Wing Nuts - HZ-4137
- 12 Steel Valve Cover Mini Tabs - HZ-9067
- 2 Steel Push-In Style Breather Caps - HZ-4870
- 2 Rubber Push-In Style Breather Grommets - HZ-4878



**HZ-3025F**



**HZ-3025-PBK**

## MOPAR SMALL BLOCK

Part #	Engine	Type	Finish
<b>HZ-3029-C</b>	64-73 Chrysler 318-340-360	Smooth	Chrome
<b>HZ-3029-PBK</b>		Smooth	Black

### Kit Includes:

- 1 Pair Steel Baffled Valve Covers - HZ-9298
- 10 Steel Valve Cover Wing Nuts - HZ-4137
- 10 Steel Valve Cover Mini Tabs - HZ-9067
- 2 Steel Push-In Breather Caps - HZ-4870
- 2 Rubber Push-In Breather Grommets - HZ-4878



**HZ-3029-C**



**HZ-3029-PBK**

## PONTIAC V8

Part #	Engine	Type	Finish
<b>HZ-3030-C</b>	1959-77 Pontiac 326-350-389-400-421-425-455	Tall Smooth	Chrome
<b>HZ-3030-PBK</b>		Tall Smooth	Black

### Kit Includes:

- 1 Pair Steel Baffled Valve Covers - HZ-9300
- 8 Steel Valve Cover Wing Nuts - HZ-4138
- 8 Steel Valve Cover Spreader Bars - HZ-9641
- 1 Steel Push-In Breather Cap - HZ-4870
- 1 Rubber Push-In Breather Grommet - HZ-4878
- 1 Rubber PCV Grommet - HZ-4998



**HZ-3030-C**



**HZ-3030-PBK**

## STEEL TIMING CHAIN COVERS

Will not fit LT1 engines & will not clear double roller timing chains without machining

### CHEVY BIG BLOCK



Cover Only



Timing Cover Set

**HZ-4935-C-SET** Chrome  
**HZ-4935-PBK-SET** Black EDP  
**HZ-4935-PO-SET** Orange  
**HZ-4935-R-SET** Raw  
**HZ-4935-Z-SET** Zinc

**HZ-4935-C** (COVER ONLY) Chrome  
**HZ-4935-PBK** (COVER ONLY) Black EDP  
**HZ-4935-PO** (COVER ONLY) Orange  
**HZ-4935-R** (COVER ONLY) Raw  
**HZ-4935-Z** (COVER ONLY) Zinc

1966-90 Chevy Big Block  
 (396-454)

### CHEVY SMALL BLOCK



**HZ-4934-PBK-L** Black(5")  
**HZ-4934-PBK-T** Black(4-1/4")  
 1955-95 Chevy Small Block  
 Timing Tab Attached



Cover Only



Timing Cover Set

**HZ-4934-1-C-SET** Chrome  
**HZ-4934-1-PBK-SET** Black EDP  
**HZ-4934-1-PO-SET** Orange  
**HZ-4934-1-R-SET** Raw  
**HZ-4934-1-Z-SET** Zinc

**HZ-4934-1-C** Chrome (COVER ONLY)  
**HZ-4934-1-PBK** Black EDP (COVER ONLY)  
**HZ-4934-1-PO** Orange (COVER ONLY)  
**HZ-4934-1-R** Raw (COVER ONLY)  
**HZ-4934-1-Z** Zinc (COVER ONLY)

1955-95 Chevy Small Block  
 Fits Roller Cam



Cover Only



Timing Cover Set



**HZ-7122-SET**



**HZ-7123-PBK-SET**

**HZ-7122-C-SET** Chrome  
**HZ-7122-PBK-SET** Black EDP  
 1955-95 Chevy Small Block  
 Two-Piece

**HZ-7123-C-SET** Chrome  
**HZ-7123-PBK-SET** Black EDP  
 1955-95 Chevy Small Block  
 Two-Piece Fits Roller Cam

1955-95 Chevy Small Block



## CHEVY BIG BLOCK



**BBC Timing Cover Gen 5/6**  
**HZ-8268-POL** Polished **\*\*HZ-8269-POL** Polished  
**HZ-8268-PBK** Black **\*\*HZ-8269-PBK** Black  
 Gen 5 **\*\*Gen 6**

## LS

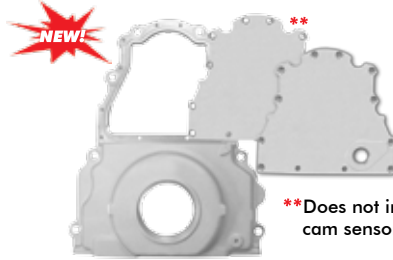

**LS Timing Cover - Two Piece**  
**HZ-6008-POL** Polished  
**\*\*HZ-6009-POL** Polished

\*\* Does not include cam sensor hole.

## MOPAR BIG BLOCK



**1958-79 Mopar Big Block**  
**HZ-9392-C-SET** Chrome  
**HZ-9392-PBK-SET** Black EDP

## ALUMINUM TIMING CHAIN COVERS

Will not fit LT1 engines & will not clear double roller timing chains without machining

### CHEVY BIG BLOCK



**HZ-8267-POL-SET**  
**HZ-8267-POL** (COVER ONLY)  
 1966-90 Chevy Big Block  
 (396-454)

### CHEVY SMALL BLOCK



**HZ-6010-POL-SET** Polished  
**HZ-6010C-SET** Chrome  
**HZ-6010-PBK-SET** Black  
**HZ-6010-POL** (COVER ONLY) Polished  
**HZ-6010C** (COVER ONLY) Chrome  
**HZ-6010-PBK** (COVER ONLY) Black  
 1955-95 Chevy Small Block



**HZ-5258-S-SET** Silver  
**HZ-5258-PBK-SET** Black  
**HZ-5258-PBL-SET** Blue  
**HZ-5258-RED-SET** Red  
 1955-95 Chevy Small Block  
**Fits Roller Cam**

## TIMING TABS



**HZ-4961-C**  
**HZ-4961-PBK**  
 BBC Chrome Steel w/ Pointer  
**Balancer 8"**



**HZ-4960-C**  
**HZ-4960-PBK**  
 SBC Chrome Steel w/ Pointer  
**Balancer 8"**



**HZ-9178-C**  
**HZ-9178-PBK**  
 SBC Chrome Adjustable w/ Pointer  
**Balancer 7"**



**HZ-9179-C**  
**HZ-9179-PBK**  
 SBC Chrome Adjustable w/ Pointer  
**Balancer 8"**



**HZ-8273-POL**  
 BBC Polished Aluminum  
**Balancer 8"**



**HZ-6041-POL**  
**HZ-6041-C**  
 SBC Aluminum  
**Balancer 6"/7"**



**HZ-9393-C**  
**HZ-9393-PBK**  
 Mopar Steel w/ Pointer  
**Balancer 8"**



**HZ-9180-C**  
**HZ-9180-PBK**  
 BBC Chrome Steel w/ Pointer  
**Balancer 8"**

## CHEVY BIG BLOCK STOCK OIL PANS



**HZ-9294-C**  
Chrome

Chevy big block stock capacity oil pan. You can use the original oil pump pickup. This oil pan does not fit Gen V motors with a one-piece rear main seal or 1962-67 Chevy II with steering behind the crossmember. **Oil pan is baffled.**

Engine	Year	Dipstick	Qts	Pickup	Sump
396-402-427-454	1965-90	Passenger	4	Stock	Rear

**HZ-9294-PBK**  
Black EDP

**HZ-9294-PO**  
Orange

**HZ-9294-Z**  
Zinc

**HZ-9294-R**  
Unplated

Inside View



**HZ-9394-C**  
Chrome

Chevy big block EDP black truck oil pan. Has a 2-piece rear seal. It is constructed of high quality steel and features a rear sump design with a dipstick provision on the passenger side. Works with 2WD and 4WD trucks. **Oil pan is baffled.**

Engine	Year	Dipstick	Qts	Pickup	Sump
396-402-427-454	1965-90	Passenger	6	Stock	Rear

**HZ-9394-PBK**  
Black EDP

**HZ-9394-Z**  
Zinc

**HZ-9394-R**  
Unplated

Inside View



## CHEVY BIG BLOCK ALUMINUM OIL PANS

**NEW!**



**HZ-8440-POL** Polished  
**HZ-8440-PBK** Black

Aluminum 1965-90 Chevy BB 396-402-427-454 gen 4 oil pan.

Engine	Year	Dipstick	Qts	Pickup	Sump
396-402-427-454	1965-90	Passenger	4	Stock	Rear

Inside View



**HZ-8441-POL** Polished  
**HZ-8441-PBK** Black

Aluminum 1991-up Chevy BB 396-402-427-454 gen 5, 6 oil pan.

Engine	Year	Dipstick	Qts	Pickup	Sump
427-454-502	91-Up	Passenger	4	Stock	Rear

## CHEVY BIG BLOCK RACING OIL PANS

Chevy big block street/strip racing oil pan. 8-1/4" deep with 1 trap door. **Oil pan is baffled.** \*Will not fit 1962-67 Chevy II Nova or V8 Vega/Monza.

Engine	Year	Dipstick	Qts	Pickup	Sump
396-402-427-454	1965-90	Passenger	6	HZ-9730	Rear

**HZ-9728-PBK**  
Black EDP

**HZ-9728-PO**  
Orange

**HZ-9728-Z**  
Zinc

Inside View



**HZ-9728-C**  
Chrome

## CHEVY SMALL BLOCK RACING OIL PANS



**HZ-7101-Z**  
Zinc

Inside View



Chevy small block Champ style racing oil pan. 7" deep with 6 trap doors, 2 runners and 3 crank scrapers. Fits using the stock starter. Fits engine with two-piece rear main seal. **Oil pan is baffled.**

Engine	Year	Dipstick	Qts	Pickup	Sump
283-305-327-350-400	1958-79	Driver	7	HZ-7102 or HZ-7103	Rear

**HZ-7101-PBK**  
Black EDP



**HZ-7101-R**  
Unplated



**HZ-7301-Z**  
Zinc

Inside View

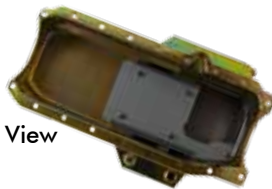

Chevy small block Champ style racing oil pan. 7" deep with 6 trap doors, 2 runners and 3 crank scrapers. Fits using the stock starter. Fits engine with One piece rear main seal. **Oil pan is baffled.**

Engine	Year	Dipstick	Qts	Pickup	Sump
283-305-327-350-400	1986-02	Passenger	7	HZ-7102 or HZ-7103	Rear

**HZ-7301-PBK**  
Black EDP



**HZ-7301-R**  
Unplated



**HZ-7104-Z**  
Zinc



**\*\*HZ-7204-Z**  
Zinc

\*\* Includes Inspection Bung

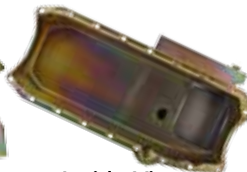

Inside View

Chevy small block circle track racing claimer style oil pan. 7-1/4" deep with 2 trap doors and fits using the stock starter. Fits engine with two-piece rear main seal. **Oil pan is baffled.**

Engine	Year	Dipstick	Qts	Pickup	Sump
283-305-327-350-400	1958-79	Driver	6	HZ-7106	Rear

**\*\*HZ-7204-PBK**  
Black EDP



**HZ-7104-PBK**  
Black EDP



**HZ-7104-R**  
Unplated

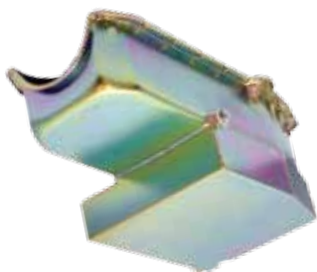

**HZ-7113-Z**  
Zinc

Inside View

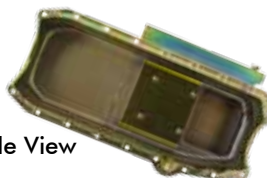

Chevy small block circle track racing oil pan. 7-1/4" deep with 2 trap doors, crankshaft scrapper and removable tray. Fits using the stock starter. Fits engine with two-piece rear main seal. **Oil pan is baffled.**

Engine	Year	Dipstick	Qts	Pickup	Sump
283-305-327-350-400	1958-79	Driver	8	HZ-7114	Rear

**HZ-7113-PBK**  
Black EDP





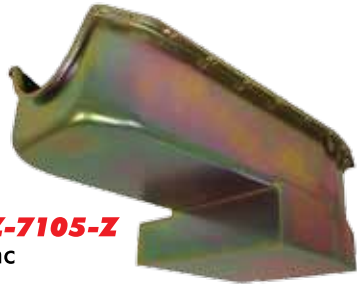

**HZ-7105-Z**  
Zinc

Chevy small block circle track racing claimer style oil pan. 7 1/4" deep with 2 trap doors and fits using the stock starter. Fits engine with two-piece rear main seal. **Oil pan is baffled.**

Engine	Year	Dipstick	Qts	Pickup	Sump
283-305-327-350-400	1980-85	Passenger	6	HZ-7106	Rear

Inside View



**HZ-7105-PBK**  
Black EDP



**HZ-7105-R**  
Unplated



**\*HZ-7108-Z**  
Zinc

Chevy small block High Performance oil pan. Features 2 trap doors, crank scraper with windage tray and reinforced rails. Fits engine with two-piece rear main seal. **Oil pan is baffled.**

Engine	Year	Dipstick	Qts	Pickup	Sump
283-305-327-350-400	1958-79	Driver	4	HZ-7106	Rear

Inside View



**\*HZ-7108-PBK**  
Black EDP

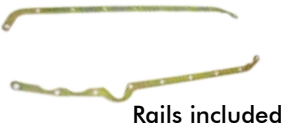

Rails included

\*Will not fit 1962-67 Chevy II Nova or V8 Vega/Monza.

## CHEVY SMALL BLOCK RACING OIL PANS



**HZ-7208-Z**  
Zinc

Chevy small block High Performance oil pan. Features 2 trap doors, crank scraper with windage tray and reinforced rails. Fits engine with two-piece rear main seal. **Oil pan is baffled.**

Engine	Year	Dipstick	Qts	Pickup	Sump
305-327-350	1980-85	Passenger	4	HZ-7106	Rear

Inside View



**HZ-7208-PBK**  
Black EDP



**HZ-7208-R**  
Unplated

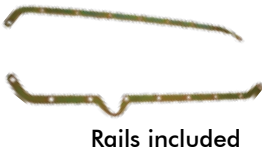

Rails included



**\*HZ-7480-C**  
Chrome

Chevy Small Block street/strip racing oil pan. 8-1/4 Deep. Will not work on applications with power steering. Fits engine with two-piece rear main seal. Notched sump for clearing the steering linkage. **Oil pan is baffled.**

Engine	Year	Dipstick	Qts	Pickup	Sump
1958-79 283-305-327-350-400	1962-67 Nova/Chevy II	Driver	6	HZ-9727	Rear

Inside View

**\*HZ-7480-PBK**  
Black EDP



**\*HZ-7480-Z**  
Zinc

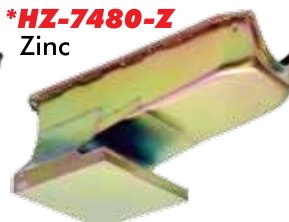

**\*HZ-7480-R**  
Unplated



\* Will not work on applications with power steering.

## CHEVY SMALL BLOCK RACING OIL PANS



**\*HZ-7481-C**  
Chrome

Inside View

Chevy Small Block street/strip racing oil pan. 8 1/4 Deep. Fits engine with Two-piece rear main seal. Will not work on applications with power steering. Notched sump for clearing the steering linkage. **Oil pan is baffled.**

Engine	Year	Dipstick	Qts	Pickup	Sump
1980-85 305-400	1962-67 Nova/Chevy II	Passenger	6	HZ-9727	Rear



**\*HZ-7481-PBK**  
Black EDP



**\*HZ-7481-Z**  
Zinc

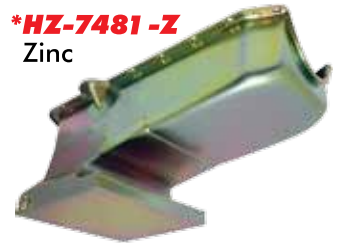

**\*HZ-7482-C**  
Chrome

Inside View

Chevy Small Block street/strip racing oil pan. 8-1/4 Deep. Will not work on applications with power steering. Fits engine with One-piece rear main seal. Notched sump for clearing the steering linkage. **Oil pan is baffled.**

Engine	Year	Dipstick	Qts	Pickup	Sump
1986-02 305-400	1962-67 Nova/Chevy II	Passenger	6	HZ-9727	Rear



**\*HZ-7482-PBK**  
Black EDP



**\*HZ-7482-Z**  
Zinc



**\*\*HZ-9725-C**  
Chrome

Inside View

Chevy small block street/strip racing oil pan. 7 quart capacity. 8-1/4" deep with 1 trap door. Fits engine with Two-piece rear main seal. **Oil pan is baffled.**

Engine	Year	Dipstick	Qts	Pickup	Sump
283-305-327-350-400	1958-79	Driver	7	HZ-9727	Rear

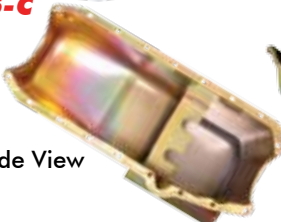

**\*\*HZ-9725-Z**  
Zinc



**\*\*HZ-9725-PO**  
Orange



**\*\*HZ-9725-PBK**  
Black EDP



\* Will not work on applications with power steering.

\*\* Does not fit 1962-1967 Chevy II or Vega Monza V8.

## CHEVY SMALL BLOCK RACING OIL PANS

Chevy Small Block street/strip racing oil pan. 8-1/4 Deep. Fits engine with two-piece rear main seal. Oil pan is baffled.

Engine	Year	Dipstick	Qts	Pickup	Sump
305-350	1980-85	Passenger	7	HZ-9727	Rear

**HZ-9731-C** Chrome

**HZ-9731-PBK** Black EDP

**HZ-9731-Z** Zinc

Chevy small block street/strip racing oil pan. 8-1/4" deep with 1 trap door. Fits engine with One-piece rear main seal. Oil pan is baffled.

Engine	Year	Dipstick	Qts	Pickup	Sump
305-350	1986-02	Passenger	7	HZ-9727	Rear

**HZ-9732-C** Chrome

**HZ-9732-PBK** Black EDP

**HZ-9732-Z** Zinc

## CHEVY SMALL BLOCK OEM STYLE OIL PANS

Chevy small block stock OEM style replacement Steel oil pan. The oil pan is notched on the front sump for clearance of the crossmember. Fits engine with two-piece rear main seal. Oil pan is baffled.

Engine	Year	Dipstick	Qts	Pickup	Sump
283-305-327-350-400	1958-79	Driver	4	Stock	Rear

**HZ-7005-C** Chrome

**HZ-7005-PBK** Black EDP

**HZ-7005-PO** Orange

**HZ-7005-Z** Zinc

**HZ-7005-R** Unplated

**HZ-7006-C** Chrome

**HZ-7006-PBK** Black EDP

**HZ-7006-PO** Orange

**HZ-7006-R** Unplated





Engine	Year	Dipstick	Qts	Pickup	Sump
283-305-327-350	1986-02	Driver	4	Stock	Rear



## CHEVY SMALL BLOCK STOCK OIL PANS

Chevy small block stock capacity oil pan. Fits engine with two-piece rear main seal. Oil pan is baffled.



Engine	Year	Dipstick	Qts	Pickup	Sump
262-267-283-305-327-350-400	1958-79	Driver	4	Stock	Rear

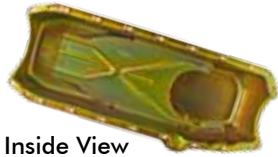

Chevy small block stock capacity oil pan. Fits engine with two-piece rear main seal. Oil pan is baffled.

Engine	Year	Dipstick	Qts	Pickup	Sump
305-350	1980-85	Passenger	4	Stock	Rear

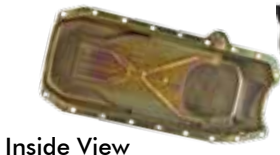

Chevy small block oil pan. Fits engine with one-piece rear main seal. Oil pan is baffled.

Engine	Year	Dipstick	Qts	Pickup	Sump
305-350	1986-02	Passenger	4	Stock	Rear

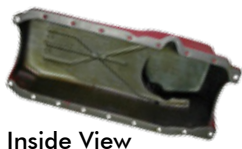

\* Will not fit V8 Vega, Monza, 302 High Performance engines or 1962-67 Chevy II Novas and some Corvettes.

## CHEVY SMALL BLOCK ALUMINUM OIL PANS



Chevy small block finned aluminum oil pan. Use early-style thick front seal. Comes with bolt kit. Fits engine with two-piece rear main seal. Will not accommodate windage tray. **Oil pan is not baffled.**

Engine	Year	Dipstick	Qts	Pickup	Sump
262-267-283-305-327-350-400	1958-79	Driver	4	Stock	Rear

**\*HZ-8442-POL**  
Polished  
**\*HZ-8442-C**  
Chrome Aluminum

Inside View

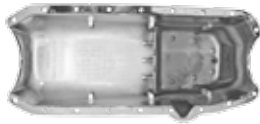

**HZ-8442-PBK**  
Black



Chevy small block stock capacity aluminum retro finned. Fits engine with two-piece rear main seal. Will not accommodate windage tray. **Oil pan is not baffled.**

Engine	Year	Dipstick	Qts	Pickup	Sump
305-350	1980-85	Passenger	4	Stock	Rear

**\*HZ-8443-POL**  
Polished

Inside View



**HZ-8443-PBK**  
Black



Chevy small block finned aluminum oil pan. Fits engine with one-piece rear main seal. Will not accommodate windage tray. **Oil pan is not baffled.**

Engine	Year	Dipstick	Qts	Pickup	Sump
305-350 V8	1986-02	Passenger	4	Stock	Rear

**HZ-8444-POL**  
Polished

Inside View



**HZ-8444-PBK**  
Black

\* Will not fit V8 Vega, Monza, 302 High Performance engines or 1962-67 Chevy II Novas and some Corvettes.



## GM LS SERIES STEEL OIL PANS

Fits 1968-'72 Nova, 1965-'72 Chevelle, 1967-'69 Camaro, Can also be used on other applications check dimensions for clearance. Engine application: GM LS Series.

Features wet sump, 7 quart capacity, 6" deep baffled trap-door baffling improving oil control and -10AN fittings for remote filter, uses stock dipstick

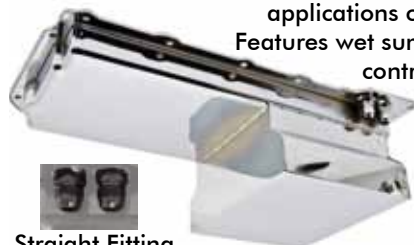

Straight Fitting

**HZ-9733-C**  
Chrome

Engine	Year	Qts	Pickup	Sump
OEM LS Engine/Swap	1965-72	7	HZ-9735	Rear

Inside View



**HZ-9733-PBK**  
Black EDP

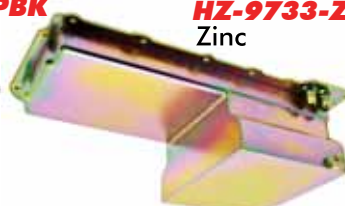

**HZ-9733-Z**  
Zinc



**HZ-9733-R**  
Raw



Angled Fitting

Engine	Year	Qts	Pickup	Sump
OEM LS Engine/Swap	1965-72	7	HZ-9735	Rear

**HZ-9734-C**  
Chrome

**HZ-9734-PBK**  
Black EDP

**HZ-9734-Z**  
Zinc

**HZ-9734-R**  
Raw

Inside View

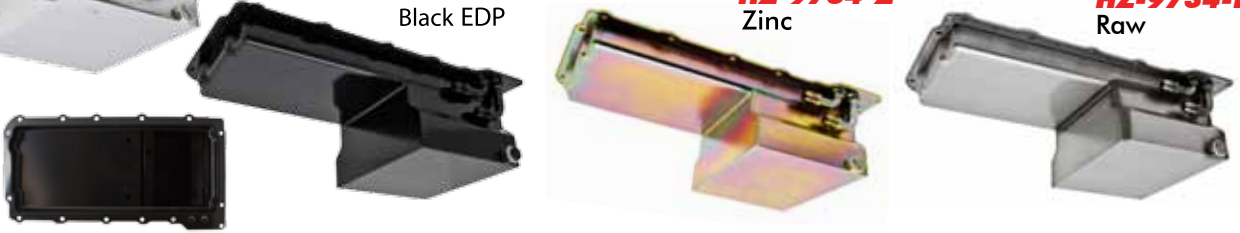

## FORD BIG BLOCK STOCK OIL PANS

Ford FE stock capacity oil pan. Does not fit trucks, vans, or 428CJ. Oil pan is baffled.



**HZ-9330-C**  
Chrome

Engine	Year	Dipstick	Qts	Pickup	Sump
352-390-406-427-428 FE	1958-76	Timing Cover	4	Stock	Front

**HZ-9330-PBK**  
Black EDP

**HZ-9330-PBL**  
Blue

**HZ-9330-R**  
Unplated

**HZ-9330-Z**  
Zinc

Inside View



Ford big block chrome oil pan. Fits most front sump production chassis except Mustang II. Oil pan is not baffled.



**HZ-9343-C**  
Chrome

Engine	Year	Dipstick	Qts	Pickup	Sump
429-460 V8	1968-78	Timing Cover	4	Stock	Front

**HZ-9343-PBK**  
Black EDP

**HZ-9343-R**  
Unplated

**HZ-9343-Z**  
Zinc

Inside View



## FORD SMALL BLOCK RACING OIL PANS

Ford small block street/strip racing oil pan. Also fits two wheel drive trucks and vans. Factory front sump applications only. Oil pan is baffled. Dimensions: 10"(L) x 12.5"(W) x 9"(D).



**HZ-7474-C**  
Chrome

Engine	Year	Dipstick	Qts	Pickup	Sump
260-289-302	1965-87	Timing Cover	7	HZ-7421	Front

Inside View

**HZ-7474-PBK**  
Black EDP

**HZ-7474-R**  
Unplated

**HZ-7474-Z**  
Zinc





## FORD SMALL BLOCK RACING OIL PANS

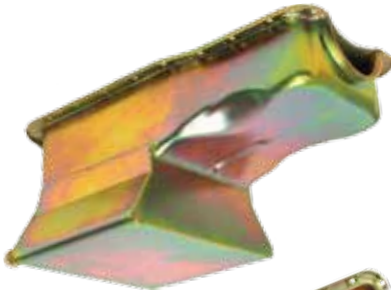

Ford small block street/strip racing oil pan. Also fits two wheel drive trucks and vans. Factory front sump applications only. **Oil pan is baffled.** Dimensions: 10"(L) x 12.5"(W) x 9"(D).

Engine	Year	Dipstick	Qts	Pickup	Sump
351W	1965-87 Windsor V8	Timing Cover	7	HZ-7422	Front

**HZ-7475-Z**  
Zinc



Inside View

**HZ-7475-PBK**  
Black EDP



**HZ-7475-C**  
Chrome



**HZ-7475-R**  
Unplated



Ford small block street/strip racing oil pan has a 9" deep sump. Fits Fox-Body style. **Oil pan is baffled.**

Engine	Year	Dipstick	Qts	Pickup	Sump
5.0L (302)	1979-93 Mustang	*Driver	7	HZ-9451	Dual

**HZ-9450-Z**  
Zinc



Inside View

**HZ-9450-PBK**  
Black EDP



\*NOTE: A stock 5.0 dipstick tube can be used (through the block) however it must be installed (pressed in) before the oil pan is bolted up or it will bind. If you want to use the side oil pan bung, you will need to purchase our dipstick kit HZ-9452E and the original oil dipstick location (through the block) must then be plugged.



Ford small block street/strip racing oil pan has a 9" deep sump. Fits Fox-Body style. We recommended using a high volume oil pump. **Oil pan is baffled.**

Engine	Year	Dipstick	Qts	Pickup	Sump
351W	1979-93 Mustang	*Driver	7	HZ-9449	Dual

**HZ-9448-Z**  
Zinc



Inside View

**HZ-9448-PBK**  
Black EDP



\*NOTE: A stock 5.0 dipstick tube can be used (through the block) however it must be installed (pressed in) before the oil pan is bolted up or it will bind. If you want to use the side oil pan bung, you will need to purchase our dipstick kit HZ-9452E and the original oil dipstick location (through the block) must then be plugged.

## FORD SMALL BLOCK RACING OIL PANS

Ford small block street/strip racing oil pan. Fits passenger cars only. Oil pan is baffled. Dimensions: 8-3/4"(L) x 13-1/4"(W) x 8-1/4"(D).

Engine	Year	Dipstick	Qts	Pickup	Sump
351C-351M-400	1970-82	Timing Cover	8	Stock	Front

**HZ-9309-C**  
Chrome

**HZ-9309-PBK**  
Black EDP

**HZ-9309-Z**  
Zinc

\*Must Use High Volume Oil Pump.  
Recommended oil pump: Melling P/N: M-84AHV  
Recommended oil pump pickup: Melling P/N: 84-AS1

Inside View

## FORD SMALL BLOCK STOCK OIL PANS

Ford Mustang stock capacity oil pan. Oil pan is not baffled. Pan has hole for stock low oil sender. If not used, must be plugged with dealer item: E4AZ-6A828A plug and E4AZ-6C626B washer.

Engine	Year	Dipstick	Qts	Pickup	Sump
5.0L (302)	1983-93 Mustang	Timing Cover	4	7427	Dual

**HZ-9754-C**  
Chrome

**HZ-9754-PBK**  
Black EDP

**HZ-9754-Z**  
Zinc

**HZ-9754-R**  
Unplated

Inside View

**NEW!**

Engine	Year	Dipstick	Qts	Pickup	Sump
351 Windsor	83-93 351W	Timing Cover	4	7428-PBK	Dual

**HZ-9755-C**  
Chrome

**HZ-9755-PBK**  
Black EDP

**HZ-9755-Z**  
Zinc

**HZ-9755-R**  
Unplated

Inside View

Ford small block stock capacity oil pan. Fits two wheel drive trucks and vans. Factory front sump applications only. Oil pan is not baffled.

Engine	Year	Dipstick	Qts	Pickup	Sump
351W	1969-81	Timing Cover	4	Stock	Front

**HZ-9532-C**  
Chrome

**HZ-9532-PBK**  
Black EDP

**HZ-9532-PBL**  
Blue

**HZ-9532-Z**  
Zinc

**HZ-9532-R**  
Unplated

Inside View

## FORD SMALL BLOCK STOCK OIL PANS



**HZ-9078-C**  
Chrome

Ford small block stock capacity oil pan. Fits two wheel drive trucks and vans. Factory front sump applications only. **Oil pan is not baffled.**

Engine	Year	Dipstick	Qts	Pickup	Sump
260-289-302	1962-82	Timing Cover	4	Stock	Front

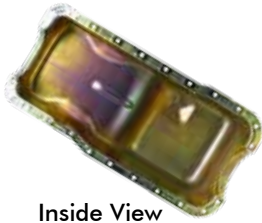

Inside View

**HZ-9078-PBK**  
Black EDP



**HZ-9078-PBL**  
Blue



**HZ-9078-R**  
Unplated



**HZ-9078-Z**  
Zinc

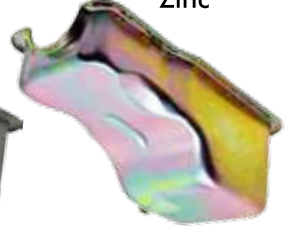

OIL PANS



**HZ-9310-C**  
Chrome

Ford small block stock capacity oil pan. Front sump pan for passenger cars only. **Oil pan is baffled.**

Engine	Year	Dipstick	Qts	Pickup	Sump
351C-351M-400	1970-82 Passenger Cars	Timing Cover	4	Stock	Front



Inside View

**HZ-9310-PBK**  
Black EDP



**HZ-9310-R**  
Unplated



**HZ-9310-Z**  
Zinc



## FORD SMALL BLOCK ALUMINUM OIL PANS



**HZ-8445-POL**  
Polished

Ford small block finned aluminum stock capacity oil pan. Fits two wheel drive trucks and vans. Factory front sump applications only. **Oil pan is not baffled.**

Engine	Year	Dipstick	Qts	Pickup	Sump
260-289-302	1962-82	Timing Cover	4	Stock	Front



Inside View

**HZ-8445-PBK**  
Black





## FORD SMALL BLOCK TRUCK OIL PANS



**HZ-9791-C**  
Chrome

Inside View

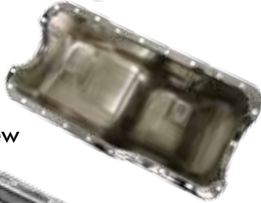

Ford 351W Windsor small block truck oil pan. Rear sump truck. Fits Bronco, F150, F250 Pickup, F350, E150, E250 Vans, E350 and Class C Motorhomes. Oil pan is not baffled.

Engine	Year	Dipstick	Qts	Pickup	Sump
5.8L 351W	1988-97 Trucks/Vans	Timing Cover	4	Stock	Rear

**HZ-9791-PBK**  
Black EDP



**HZ-9791-Z**  
Zinc

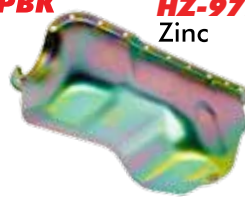

Engine	Year	Dipstick	Qts	Pickup	Sump
351 Windsor 5.8L	81-87 351W	Driver Side	4	Stock	Rear



**HZ-8791-C**  
Chrome



**HZ-8791-PBK**  
Black EDP



**HZ-8791-Z**  
Zinc



Ford small block truck oil pan. Fits Bronco, F100, F150, F250 Pickup, F350, E150, E250 Vans, and Class C Motorhomes. Oil pan is not baffled.

Engine	Year	Dipstick	Qts	Pickup	Sump
4.2L 256-5.0L 302	1980-96 Trucks/Vans	Timing Cover	4	Stock	Rear



**HZ-9792-C**  
Chrome

Inside View



**HZ-9792-PBK**  
Black EDP



**HZ-9792-Z**  
Zinc



Engine	Year	Dipstick	Qts	Pickup	Sump
Ford 302 5.0L	81-84 302	Driver Side	4	Stock	Rear



**HZ-8792-C**  
Chrome



**HZ-8792-PBK**  
Black EDP



**HZ-8792-Z**  
Zinc



## GENERAL MOTORS STOCK OIL PANS

Chevy/GM 229 V6 3.8L chrome steel oil pan.



**HZ-7459-C**  
Chrome

Inside View



Engine	Year	Dipstick	Qts	Pickup	Sump
229 V6 3.8L	1980-84	Passenger	4	Stock	Rear

**HZ-7459-Z**  
Black EDP



**HZ-7459-R**  
Unplated



**HZ-7459-Z**  
Zinc



Chevy/GM stock capacity chrome steel oil pan fits engines with a 1-piece rear main seal, 1982-1986 2WD S-10 pickup trucks, 1981-1989 2WD S-15 pickup trucks, 1982-1986 Chevy Camaros and Pontiac Firebirds. **Oil pan is baffled.**



**HZ-7465-C**  
Chrome

Inside View



Engine	Year	Dipstick	Qts	Pickup	Sump
V6 2.8L	1981-89	Passenger	4	Stock	Rear

**HZ-7465-PBK**  
Black EDP



**HZ-7465-R**  
Unplated



**HZ-7465-Z**  
Zinc

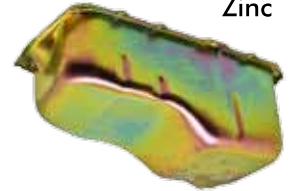

Chevy/GM steel stock capacity oil pan fits engines with a one-piece rear main seal. **Oil pan is baffled.**



**HZ-7466-C**  
Chrome

Inside View



Engine	Year	Dipstick	Qts	Pickup	Sump
262 V6 4.3L	1986-95	Passenger	4	Stock	Rear

**HZ-7466-PBK**  
Black EDP



**HZ-7466-R**  
Unplated



**HZ-7466-Z**  
Zinc

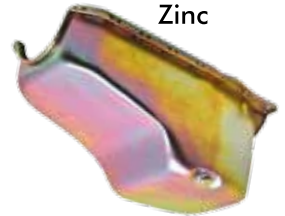

Pontiac steel oil pan. **Oil pan is baffled.**



**HZ-9337-C**  
Chrome

Inside View



Engine	Year	Dipstick	Qts	Pickup	Sump
265-301-326-350-389 -400-421-428-455	1959-81	Passenger	4	Stock	Rear

**HZ-9337-PBK**  
Black EDP



**\*HZ-9337-R**  
Unplated



**HZ-9337-Z**  
Zinc

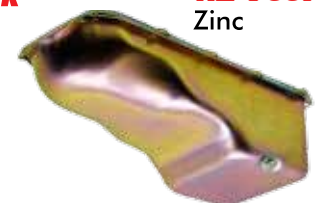

\* Also available without baffle. **HZ-9337-RA**

## GENERAL MOTORS STOCK OIL PANS

Buick chrome oil pan fits engines with 14 bolt pattern. Must use first design oil pump pickup.



**HZ-9590-C**  
Chrome



Inside View

**HZ-9590-R**  
Unplated



**HZ-9590-Z**  
Zinc



Engine	Year	Dipstick	Qts	Pickup	Sump
231 V6 14 Bolt	1975-83	Stock	4	Stock	Front



**HZ-9397-C**  
Chrome

Inside View



**HZ-9397-PBK**  
Black EDP



**HZ-9397-R**  
Unplated



**HZ-9397-Z**  
Zinc

Oldsmobile chrome oil pan. Will not fit 1975 400 engines. Oil pan is baffled.

Engine	Year	Dipstick	Qts	Pickup	Sump
330-350-400-425-455	1964-80	Driver	4	Stock	Rear

## OLDSMOBILE RACING OIL PAN

Oldsmobile oil pan. Will not fit 1975 400 engines Oil pan is baffled.



**HZ-9398-C**  
Chrome

Inside View



**HZ-9398-Z**  
Black EDP



**HZ-9398-Z**  
Zinc

Engine	Year	Dipstick	Qts	Pickup	Sump
307-455	1965-UP	Driver	8	9399-PBK	Rear

## HUMMER H1 OIL PANS

Hummer H1 black oil pan. Oil pan is baffled.



**HZ-9793-PBK**  
Black EDP

**HZ-9794-PBK**  
Black EDP



Inside View

Engine	Dipstick	Sump
6.5L Turbo Diesel	Driver	Rear

Engine	Dipstick	Sump
6.2L Turbo Diesel	Driver	Rear



## MOPAR STOCK OIL PANS

Chrysler/Mopar small block oil pan. Will not fit trucks, vans or 360 engines. Oil pan is not baffled.



**HZ-9311-C**  
Chrome

Inside View 

Engine	Year	Dipstick	Qts	Pickup	Sump
273-318-340	1964-87	Timing Cover	4	Stock	Center



**HZ-9311-PBK**  
Black EDP



**HZ-9311-R**  
Unplated



**HZ-9311-Z**  
Zinc

Chrysler/Mopar small block chrome oil pan. Will not fit trucks or vans. Oil pan is not baffled.



**HZ-9344-C**  
Chrome

Inside View 

Engine	Year	Dipstick	Qts	Pickup	Sump
360	1971-80	Timing Cover	4	Stock	Center



**HZ-9344-PBK**  
Black EDP



**HZ-9344-R**  
Unplated



**HZ-9344-Z**  
Zinc

Chrysler/Mopar Hemi big block chrome oil pan. Will not fit trucks or vans. Fits B and E Body Dodge Charger, Coronet, Super Bee, Challenger or Plymouth, GTX and Barracuda. Oil pan is baffled.



**HZ-9496-C**  
Chrome

Inside View 

Engine	Year	Dipstick	Qts	Pickup	Sump
361-383-400-413-440 B & RB-Hemi 426	1967-87	Block	5	Stock	Center



**HZ-9496-PBK**  
Black EDP



**HZ-9496-R**  
Unplated



**HZ-9496-Z**  
Zinc

Chrysler/Mopar Hemi big block chrome extra capacity oil pan. Comes with oil control baffles and drain plug. Fits B and E Body Dodge Charger, Coronet, Super Bee, Challenger or Plymouth, GTX and Barracuda. Oil pan is baffled.



**HZ-9497-C**  
Chrome

Inside View 

Engine	Year	Dipstick	Qts	Pickup	Sump
361-383-400-413-440 B & RB-Hemi 426	1967-87	Block	6	Stock	Center



**HZ-9497-PBK**  
Black EDP



**HZ-9497-R**  
Unplated



**HZ-9497-Z**  
Zinc

## MOPAR STOCK OIL PANS

Chrysler/Mopar chrome OEM style stock capacity oil pan. Includes drain plug. Oil pan is not baffled.



**HZ-7477-C**  
Chrome

**HZ-7477-PBK**  
Black EDP

**HZ-7477-R**  
Unplated

**HZ-7477-Z**  
Zinc

Engine	Year	Dipstick	Qts	Pickup	Sump
Hemi 392	1955-58	Block	5	Stock	Rear

Inside View

## MOPAR RACING OIL PANS

Chrysler/Mopar Hemi big block zinc street/strip racing oil pan. Features a 7" center sump design. Oil pan is baffled.



**HZ-7117-C**  
Chrome

**HZ-7117-PBK**  
Black EDP

**HZ-7117-R**  
Unplated

**HZ-7117-Z**  
Zinc

Engine	Year	Dipstick	Qts	Pickup	Sump
361-383-400-440 B & RB-Hemi 426	1967-87	Block	7	<b>HZ-7118</b> <b>HZ-7119</b>	Center

Inside View

## OIL PAN HARDWARE & RAILS



**HZ-9902-KIT**

SBC Silver Zinc  
18 Self locking pieces  
Includes plug



**HZ-9062**

Magnetic Chrome Oil  
Pan/Transmission Pan  
Drain Plug



**HZ-9061**

Chrome Oil Pan/  
Transmission Pan  
Drain Plug



**HZ-9061-PBK**

EDP Black Oil Pan/  
Transmission Pan  
Drain Plug



Chrome  
**HZ-9901**

Chevy SB 90 V6 & Oldsmobile  
1/4"-20 x 1/2" (14)  
5/16"-18 x 1/2" (4)



Chrome  
**HZ-9903**

Chevy BB, Pontiac, Mopar  
5/16"-18 x 1/2" (24)  
1/4"-20 x 1/2" (4)



Chrome  
**HZ-9904**

Ford 289-351  
C/W & AMC 290-401  
5/16"-18 x 3/4" (6)  
1/4"-20 x 1/2" (18)



Chrome  
**HZ-9905**

Buick V6 & Ford 390-428  
5/16"-18 x 3/4" (20)



Oil Pan Reinforced Rails  
1958-79 Chevy Small Block  
**HZ-9004-Z** Zinc  
**HZ-9004-PBK** Black EDP



Oil Pan Reinforced Rails  
1980-85 Chevy Small Block  
**HZ-9091-Z** Zinc



Oil Pan Reinforced Rails  
1986-02 Chevy Small Block  
**HZ-9413-Z** Zinc  
**HZ-9413-PBK** Black EDP



Oil Pan Reinforced Rails  
1986-95 Chevy/GM 262 4.3L  
**HZ-7467-PBK** Black EDP

## **NEW!** OIL PAN GASKETS

### **HZ-7496**

Chevy SB 1980-85  
two piece rear main seal  
1 Piece Rubber



### **HZ-7497**

Chevy SB 1986-02  
one piece rear main seal  
1 Piece Rubber



### **HZ-7489**

Chevy SB 1958-79  
1 Piece Rubber

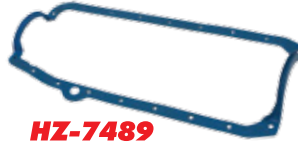

### **HZ-7460**

Mopar BB 361 - 440  
1957-78  
1 Piece Rubber



### **HZ-7470**

Ford 5.0L 302  
1986-1995  
1 Piece Rubber



### **HZ-7471**

Ford SB 351W 5.8L  
1969-1997  
1 Piece Rubber



### **HZ-7473**

Ford SB 260, 289, 302W  
1962-87  
1 Piece Rubber



### **HZ-7478**

Chevy BB Gen V-VI  
1991-2000  
1 Piece Rubber



### **HZ-7498**

Chevy BB Gen IV  
1965-90 454  
1 Piece Rubber



### **HZ-7499**

Chevy LS  
1999-2001  
Steel



### **HZ-7476**

Ford 351C -351-400  
1970-82  
four piece set - Cork



## OIL PUMP PICKUPS



### **HZ-7102**

Chevy Small Block  
Circle Track Style  
5/8" Dia. Inlet Hole Pump  
Oil Pan: HZ-7101



### **HZ-7103**

Chevy Small Block  
Circle Track Style  
3/4" Dia. Inlet Hole Pump  
Oil Pan: HZ-7101



### **HZ-7106**

Chevy Small Block  
1958-85  
Circle Track Style  
Oil Pan: HZ-7104, HZ-7105



### **HZ-7107**

Chevy Small Block  
Circle Track/Racing  
Style Oil Pan:  
HZ-7104/HZ-7108



### **HZ-7110**

Chevy Small Block  
Road Race Style  
Oil Pan:  
HZ-7108/HZ-7108-1



### **HZ-7114**

Chevy Small Block  
Circle Track Style  
Oil Pan: HZ-7113



### **HZ-7421**

Ford Small Block  
Drag Racing Style  
260-289-302  
(Front Sump)  
Oil Pan: HZ-7474



### **HZ-7422**

Ford Small Block  
Drag Racing Style  
351W (Front Sump)  
Oil Pan: HZ-7475



### **HZ-9010**

Chevy/GM 1965-93  
Stock Capacity V6, V8  
Oil Pan:  
HZ-7005, HZ-9005



### **HZ-9011**

Chevy Big Block  
Stock Capacity  
Oil Pan:  
HZ-9294/HZ-9294-2



### **HZ-9727**

Chevy Small Block  
1958-02  
Drag Racing Style  
Oil Pan:  
HZ-9725/HZ-9726/HZ-9731/  
HZ-9732/HZ-7480



### **HZ-9730**

Chevy Big Block  
Drag Racing Style  
Oil Pan:  
HZ-9728/HZ-9729



### **HZ-9449**

Ford Small Block  
Drag Racing Style 351W  
(Dual Sump)  
Oil Pan: HZ-9448



### **HZ-7427**

Ford Small Block  
Stock Capacity  
5.0L Mustang  
(Front Sump)  
Oil Pan: HZ-9754



### **HZ-9451**

Ford Small Block  
Drag Racing Style 260-  
289-302 (Front Sump)  
Oil Pan: HZ-9450



### **HZ-7118/7119**

Mopar  
3/8"-18 Threads  
B&RB Engines/ 1/2"-  
14 Threads Stock 426  
Oil Pan: HZ-7117



### **HZ-9399**

Oldsmobile 1964-80  
330-455  
Oil Pan: HZ-9397



### **HZ-9735**

LS Oil pan  
Oil Pan: HZ-9733/  
HZ-9734



## CHEVY/GM FLEX PLATE COVERS

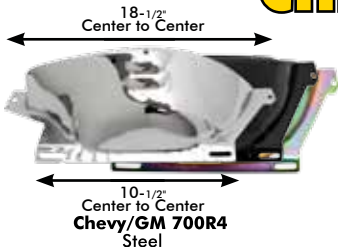

**Chevy/GM 700R4 Steel**  
**HZ-9587-C** Chrome  
**HZ-9587-PBK** Black EDP  
**HZ-9587-Z** Zinc

**Chevy/GM Turbo TH-350/TH-400 Steel**  
**HZ-9588-C** Chrome  
**HZ-9588-PBK** Black EDP  
**HZ-9588-Z** Zinc

**Chevy/GM Turbo TH-350/TH-400 Aluminum**  
 Comes w/ 4 bolts and 4 washers.  
**HZ-8607-POL** Polished  
**HZ-8607-C** Chrome  
**HZ-8607-PBK** Black EDP

**Chevy/GM Powerglide Chrome Steel**  
**HZ-9417-C** Chrome  
**HZ-9417-PBK** Black EDP  
**HZ-9417-Z** Zinc

## ALUMINUM TRANSMISSION PANS

**Chevy/GM Finned Polished Aluminum Transmission Pans.** Comes with drain plug, bolts and gasket. Finned style sump helps to dissipate heat.



**Chevy/GM Turbo TH-350**  
**HZ-8491-KIT-POL** Polished  
**HZ-8491-KIT-PBK** Black

Depth: 2-1/4"

**Chevy/GM Turbo TH-400**  
**HZ-8492-KIT-POL** Polished  
**HZ-8492-KIT-PBK** Black

Depth: 2-1/4"

**Chevy/GM 700R4-4L60E-4L65E**  
**HZ-8493-KIT-POL** Polished  
**HZ-8493-KIT-PBK** Black

Depth: 2-7/8"

## STEEL TRANSMISSION PANS

NOTE: All transmission pans include drain plugs.



**Chevy/GM Powerglide**  
 Depth: 2"  
**HZ-9124-C** Chrome  
**HZ-9124-PBK** Black EDP  
**HZ-9124-Z** Zinc

**Chevy/GM Turbo TH-200**  
 Depth: 2-5/8"  
**HZ-9123-C** Chrome  
**HZ-9123-PBK** Black EDP  
**HZ-9123-Z** Zinc

**Chevy/GM Turbo TH-350**  
**HZ-9122-C** Depth: 2-1/4"  
**HZ-9122-PBK**  
**HZ-9122-Z**  
**HZ-9198-C** Depth: 3-1/2"  
**HZ-9198-PBK**  
**HZ-9198-Z**

**Chevy/GM Turbo TH-400**  
**HZ-9121-C** Depth: 2"  
**HZ-9121-PBK**  
**HZ-9121-Z**  
**HZ-9197-C** Depth: 3"  
**HZ-9197-PBK**  
**HZ-9197-Z**

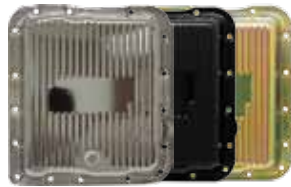

**Mopar 727**

**HZ-9128-C** Chrome  
**HZ-9128-PBK** Black EDP  
**HZ-9129-C** Depth: 1-3/4"  
**HZ-9129-PBK**

**Chevy/GM 700R4-4L60E-4L65E**  
 Depth: 2-5/8"  
**HZ-7599-C** Chrome  
**HZ-7599-PBK** Black EDP  
**HZ-7599-Z** Zinc  
**HZ-9712-C** Depth: 3-5/8"

**Ford C4**

**HZ-9531-C** (Case Fill) Depth: 2-3/8"  
**HZ-9531-1** (Pan Fill) Depth: 2-3/8"  
**HZ-9531-1-PBK**  
**HZ-9531-1-Z**

**Ford C6**  
 Depth: 2-3/8"

**HZ-9125-C** Chrome  
**HZ-9125-PBK** Black EDP  
**HZ-9125-Z** Zinc

## TRANSMISSION PAN BOLTS & GASKETS



**Chevy/GM Turbo TH-350/TH-400 Allen Head Bolts**  
**HZ-8490**

**Chevy/GM 700R4 Allen Head Bolts**  
**HZ-8494**

**Chevy/GM Turbo TH-350**  
**HZ-8491-GKT**

**Chevy/GM Turbo TH-400**  
**HZ-8492-GKT**

**Chevy/GM 700R4-4L60E-4L65E**  
**HZ-8493-GKT**

## **NEW!** ENGINE OIL DIPSTICKS

Always compare length and markings with stock dipstick before installing



**1962-69 Ford 302 Flexible Dipstick 17"-1/8"**  
**CFR-1994**  
**CFR-1994-PBK** Black EDP



**1986-95 Ford (Fox) 302 Flexible Dipstick 17"-1/8"**  
**CFR1995**  
**CFR-1995-PBK** Black EDP



**1980-UP SBC Flexible Dipstick. 19-5/8"**  
**CFR-2001**  
**CFR-2001-PBK** Black EDP



**1957-79 SBC Flexible Dipstick. 20-1/8"**  
**CFR-2002**  
**CFR-2002-PBK** Black EDP



**1955-79 SBC Dipstick 19"**  
**HZ-4957-C** Chrome  
**HZ-4957-PBK** Black EDP



**SBF Dipstick 20-1/4"**  
**HZ-9221-C** Chrome  
**HZ-9221-PBK** Black EDP



**HZ-9221D-C w/ Billet Handle.**  
**HZ-9221D-PBK** Black EDP



**Mopar Small Block Dipstick 21"**  
**HZ-9224-C** Chrome  
**HZ-9224-PBK** Black EDP



**HZ-9224D-C w/ Billet Handle.**  
**HZ-9224D-PBK** Black EDP



**Mopar Big Block Dipstick 23"**  
**HZ-9225-C** Chrome  
**HZ-9225-PBK** Black EDP



**HZ-9225D-C w/ Billet Handle.**  
**HZ-9225D-PBK** Black EDP



**1955-79 SBC Dipstick  
w/ Billet Handle 19"**  
**HZ-4957D-C** Chrome  
**HZ-4957D-PBK** Black EDP



**Chevy LS1 1997-Up Flexible Dipstick 17-1/8"**  
**CFR-1999**  
**CFR-1999-PBK** Black EDP



**1965-90 BBC Flexible Dipstick 21"**  
**CFR-2000**  
**CFR-2000-PBK** Black EDP



**1965-90 BBC Dipstick 21"**  
**HZ-4958-C** Chrome  
**HZ-4958-PBK** Black EDP



**1965-90 BBC Dipstick  
w/ Billet Handle 21"**  
**HZ-4958D-C** Chrome  
**HZ-4958D-PBK** Black EDP



**1965-79 V8 Dipstick  
17-1/21"**  
 (Will Not Fit 389 or 403 Engines)  
**HZ-9405-C** Chrome  
**HZ-9405-PBK** Black EDP



**HZ-9405D-C w/ Billet Handle.**  
**HZ-9405D-PBK** Black EDP



**1980-85 SBC Dipstick. 23"**  
**HZ-9420-C** Chrome  
**HZ-9420-PBK** Black EDP



**HZ-9420D-C w/ Billet Handle.**  
**HZ-9420D-PBK** Black EDP



**SBF Drag Racing Dipstick. 24-1/8"**  
 (For HZ-9450 & HZ-9450-1 Oil Pan)

**HZ-9452E-C** Chrome  
**HZ-9452E-PBK** Black EDP

## NEW! TRANSMISSION DIPSTICKS

Always compare length and markings with stock dipstick before installing

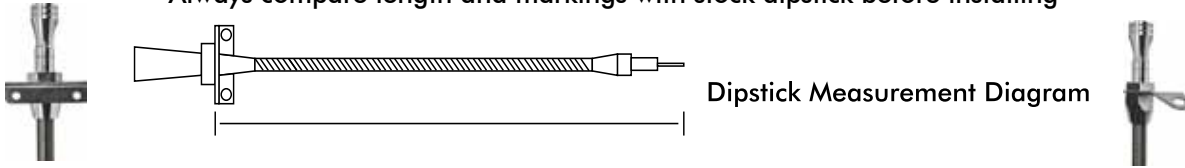

### Fire Wall Mount Dipsticks.

<b>CFR-3000</b>	Ford AOD	39-1/4"
<b>CFR-3001</b>	Ford C6	28-3/4"
<b>CFR-3002</b>	Chevy/GM Powerglide	27"
<b>CFR-3003</b>	Chevy/GM 700R4	28-7/8"
<b>CFR-3004</b>	Chevy/GM TH-350/TH-400	27-3/16"
<b>CFR-3005</b>	Chevy/GM 4L60E	27-5/8"
<b>CFR-3007</b>	Mopar Torqueflite A-904	28"
<b>CFR-3009</b>	Mopar 727	27-3/8"

### Trans Mount Dipsticks.

<b>CFR-3101</b>	Ford C6	13-3/4"
<b>CFR-3103</b>	Chevy Turbo TH-350	15-3/8"
<b>CFR-3104</b>	Chevy Turbo TH-400	15-5/8"
<b>CFR-3105</b>	Chevy Turbo 700R4	13-1/4"



★ Features a stainless steel braided dipstick ★

## TRANSMISSION DIPSTICKS

Always compare length and markings with stock dipstick before installing



**Chevy/GM TH-350 Trans Dipstick. 34"**  
(Bell Housing Mount)  
**HZ-4994-C** Chrome  
**HZ-4994-PBK** Black EDP



**Chevy/GM TH-350 Trans Dipstick. 27"**  
(Bell Housing Mount)  
**HZ-9421-C** Chrome  
**HZ-9421-PBK** Black EDP



**Chevy/GM TH-350 Trans Dipstick. 34"**  
(Bell Housing Mount) W/Billet Handle  
**HZ-4994D-C** Chrome  
**HZ-4994D-PBK** Black EDP



**Chevy/GM TH-350 Trans Dipstick. 27"**  
(Bell Housing Mount) W/Billet Handle  
**HZ-9421D-C** Chrome  
**HZ-9421D-PBK** Black EDP



**Chevy/GM TH-400 Trans Dipstick. 25"**  
(Bell Housing Mount)  
**HZ-4995-C** Chrome  
**HZ-4995-PBK** Black EDP



**Chevy/GM Powerglide Trans Dipstick. 23"**  
(Bell Housing Mount)  
**HZ-9422-C** Chrome  
**HZ-9422-PBK** Black EDP



**Chevy/GM TH-400 Trans Dipstick. 25"**  
(Bell Housing Mount) W/Billet Handle  
**HZ-4995D-C** Chrome  
**HZ-4995D-PBK** Black EDP





**Chevy/GM Powerglide Trans Dipstick. 23"**  
(Bell Housing Mount) W/Billet Handle  
**HZ-9422D-C** Chrome  
**HZ-9422D-PBK** Black EDP





## CHEVY BIG BLOCK STEEL PULLEYS

Short water Pump (swp) fits 55-68-bolt circle is 1.75"  
Long Water Pump (lwp) fits 69-85-bolt circle is 2.30"

### WATER PUMP PULLEYS

1955-68 <b>SHORT (SWP)</b>	1969-85 <b>LONG (LWP)</b>
<b>DOUBLE GROOVE</b>	<b>DOUBLE GROOVE</b>
 <p><b>HZ-9815-C</b> Chrome <b>HZ-9815-PBK</b> Black EDP (Steel) Diameter: 6-3/8" Depth: 2-3/4"</p>	 <p><b>HZ-9723-C</b> Chrome <b>HZ-9723-PBK</b> Black EDP (Steel) Diameter: 6-1/8" Depth: 2-7/8"</p>

### CRANKSHAFT PULLEYS

1955-68 <b>SHORT (SWP)</b>		1969-85 <b>LONG (LWP)</b>
<b>SINGLE GROOVE</b>	<b>DOUBLE GROOVE</b>	<b>TRIPLE GROOVE</b>
 <p><b>HZ-9817-C</b> Chrome <b>HZ-9817-PBK</b> Black EDP (Steel) A/C Add-On Pulley Diameter: 6-11/16" Depth: 2-7/8" Use w/ <b>HZ-9816</b></p>	 <p><b>HZ-9816-C</b> Chrome <b>HZ-9816-PBK</b> Black EDP (Steel) Diameter: 7-3/4" Depth: 1-5/16"</p>	 <p><b>HZ-9724-C</b> Chrome <b>HZ-9724-PBK</b> Black EDP (Steel) Diameter: 7-3/4" Depth: 2-7/8"</p>

## CHEVY SMALL BLOCK STEEL PULLEYS

### WATER PUMP PULLEYS

1955-68 <b>SHORT (SWP)</b>		1969-85 <b>LONG (LWP)</b>	
<b>SINGLE GROOVE</b>	<b>DOUBLE GROOVE</b>	<b>SINGLE GROOVE</b>	<b>DOUBLE GROOVE</b>
 <p><b>HZ-9600-C</b> Chrome <b>HZ-9600-PBK</b> Black EDP Diameter: 6-3/16" Depth: 2-1/8"</p>	 <p><b>HZ-9601-C</b> Chrome <b>HZ-9601-PBK</b> Black EDP Diameter: 6-3/8" Depth: 2-13/16"</p>	 <p><b>HZ-9604-C</b> Chrome <b>HZ-9604-PBK</b> Black EDP Diameter: 7-1/8" Depth: 2-3/8"</p>	 <p><b>HZ-9605-C</b> Chrome <b>HZ-9605-PBK</b> Black EDP Diameter: 6-1/4" Depth: 2-3/4"</p>

## CHEVY SMALL BLOCK STEEL PULLEYS

Short water Pump (swp) fits 55-68-bolt circle is 1.75"  
 Long Water Pump (lwp) fits 69-85-bolt circle is 2.30"

### CRANKSHAFT PULLEYS

#### 1955-68 **SHORT (SWP)**

##### SINGLE GROOVE



**HZ-9817-C** Chrome  
**HZ-9817-PBK** Black EDP  
 A/C Add-On Pulley  
 Diameter: 6-11/16"  
 Depth: 2-7/8"  
 Use w/ **HZ-9603**



**HZ-9602-C** Chrome  
**HZ-9602-PBK** Black EDP  
 Diameter: 6-11/16"  
 Depth: 11/16"

##### DOUBLE GROOVE



**HZ-9603-C** Chrome  
**HZ-9603-PBK** Black EDP  
 Diameter: 7-3/16"  
 Depth: 1-5/16"

##### TRIPLE GROOVE



**HZ-8963-C** Chrome  
**HZ-8963-PBK** Black EDP  
 Diameter: 7-1/4"  
 Depth: 2-1/16"

#### 1969-85 **LONG (LWP)**

##### SINGLE GROOVE



**HZ-9606-C** Chrome  
**HZ-9606-PBK** Black EDP  
 Diameter: 7-3/4"  
 Depth: 2-3/4"

##### DOUBLE GROOVE



**HZ-9607-C** Chrome  
**HZ-9607-PBK** Black EDP  
 Diameter: 6-7/8"  
 Depth: 2-3/4"

##### TRIPLE GROOVE



**HZ-9608-C** Chrome  
**HZ-9608-PBK** Black EDP  
 Diameter: 7-3/4"  
 Depth: 2-5/8"

## CHEVY BIG BLOCK ALUMINUM PULLEYS

### WATER PUMP PULLEYS

#### 1955-68 **SHORT (SWP)**

##### SINGLE GROOVE



**HZ-8840-M** Machined  
**HZ-8840-C** Chrome  
**HZ-8840-POL** Polished  
**HZ-8840-PBK** Black EDP  
 Diameter: 6-7/16"  
 Depth: 2-3/4"

##### DOUBLE GROOVE



**HZ-8842-M** Machined  
**HZ-8842-C** Chrome  
**HZ-8842-POL** Polished  
**HZ-8842-PBK** Black EDP  
 Diameter: 6-9/16"  
 Depth: 2-7/8"

#### 1969-85 **LONG (LWP)**

##### DOUBLE GROOVE







**HZ-8844-M** Machined  
**HZ-8844-C** Chrome  
**HZ-8844-POL** Polished  
**HZ-8844-PBK** Black EDP  
 Diameter: 6-1/4"  
 Depth: 2-3/4"

## CHEVY BIG BLOCK ALUMINUM PULLEYS CRANKSHAFT PULLEYS

1955-68 <b>SHORT (SWP)</b>			1969-85 <b>LONG (LWP)</b>
<b>SINGLE GROOVE</b>	<b>DOUBLE GROOVE</b>	<b>TRIPLE GROOVE</b>	<b>TRIPLE GROOVE</b>
			
<b>HZ-8841-M</b> Machined <b>HZ-8841-C</b> Chrome <b>HZ-8841-POL</b> Polished <b>HZ-8841-PBK</b> Black EDP Diameter: 6-3/8" Depth: 3/4"	<b>HZ-8843-M</b> Machined <b>HZ-8843-C</b> Chrome <b>HZ-8843-POL</b> Polished <b>HZ-8843-PBK</b> Black EDP Diameter: 6-3/8" Depth: 1-3/8"	<b>HZ-8849-M</b> Machined <b>HZ-8849-C</b> Chrome <b>HZ-8849-POL</b> Polished <b>HZ-8849-PBK</b> Black EDP Diameter: 6-3/8" Depth: 2"	<b>HZ-8845-M</b> Machined <b>HZ-8845-C</b> Chrome <b>HZ-8845-POL</b> Polished <b>HZ-8845-PBK</b> Black EDP Diameter: 7-3/4" Depth: 3"

## CHEVY SMALL BLOCK ALUMINUM PULLEYS WATER PUMP PULLEYS

1955-68 <b>SHORT (SWP)</b>		1969-85 <b>LONG (LWP)</b>	
<b>SINGLE GROOVE</b>	<b>DOUBLE GROOVE</b>	<b>SINGLE GROOVE</b>	<b>DOUBLE GROOVE</b>
			
<b>HZ-9478-M</b> Machined <b>HZ-9478-C</b> Chrome <b>HZ-9478-POL</b> Polished <b>HZ-9478-PBK</b> Black EDP Diameter: 6-9/16" Depth: 3"	<b>HZ-9479-M</b> Machined <b>HZ-9479-C</b> Chrome <b>HZ-9479-POL</b> Polished <b>HZ-9479-PBK</b> Black EDP Diameter: 6-9/16" Depth: 2-7/8"	<b>HZ-9482-M</b> Machined <b>HZ-9482-C</b> Chrome <b>HZ-9482-POL</b> Polished <b>HZ-9482-PBK</b> Black EDP Diameter: 6-9/16" Depth: 2-1/4"	<b>HZ-9483-M</b> Machined <b>HZ-9483-C</b> Chrome <b>HZ-9483-POL</b> Polished <b>HZ-9483-PBK</b> Black EDP Diameter: 6-9/16" Depth: 2-7/8"

## CRANKSHAFT PULLEYS

1955-68 <b>SHORT (SWP)</b>		
<b>SINGLE GROOVE</b>	<b>DOUBLE GROOVE</b>	<b>TRIPLE GROOVE</b>
		
<b>HZ-9480-M</b> Machined <b>HZ-9480-C</b> Chrome <b>HZ-9480-POL</b> Polished <b>HZ-9480-PBK</b> Black EDP Diameter: 6-9/16" Depth:	<b>HZ-9481-M</b> Machined <b>HZ-9481-C</b> Chrome <b>HZ-9481-POL</b> Polished <b>HZ-9481-PBK</b> Black EDP Diameter: 6-5/8" Depth:	<b>HZ-8858-M</b> Machined <b>HZ-8858-C</b> Chrome <b>HZ-8858-POL</b> Polished <b>HZ-8858-PBK</b> Black EDP Diameter: 6-7/16" Depth: 1-15/16"



## CHEVY SMALL BLOCK ALUMINUM PULLEYS CRANKSHAFT PULLEYS

1969-85 **LONG (LWP)**

### SINGLE GROOVE



**HZ-9484-M** Machined  
**HZ-9484-C** Chrome  
**HZ-9484-POL** Polished  
**HZ-9484-PBK** Black EDP  
Diameter: 6-9/16"  
Depth: 2-3/4"

### DOUBLE GROOVE



**HZ-9485-M** Machined  
**HZ-9485-C** Chrome  
**HZ-9485-POL** Polished  
**HZ-9485-PBK** Black EDP  
Diameter: 6-9/16"  
Depth: 2-11/16"

### TRIPLE GROOVE



**HZ-9486-M** Machined  
**HZ-9486-C** Chrome  
**HZ-9486-POL** Polished  
**HZ-9486-PBK** Black EDP  
Diameter: 6-9/16"  
Depth: 2-3/4"

## CHEVY ALUMINUM SERPENTINE PULLEY SETS

6 groove CNC machined billet aluminum. Fits 283-400 engines.  
(Requires reverse rotation water pump)



**HZ-8700-M** (Machined)  
**HZ-8700-POL** (Polished)  
Aluminum billet 6 groove serpentine pulley set. Fits short water pump  
**Diameters -**  
Crank: 6-7/8"  
Alternator: 4-3/8"  
Water Pump: 5-5/8"  
\*Power Steering: 5-3/4"  
\*(Key Way)



**HZ-8701-M** (Machined)  
**HZ-8701-POL** (Polished)  
Aluminum billet 6 groove serpentine pulley set. Fits Long water pump  
**Diameters -**  
Crank: 6-3/8"  
Alternator: 4-3/8"  
Water Pump: 5-7/8"  
\*Power Steering: 5-3/4"  
\*(Key Way)



**HZ-04400-POL** (Polished)  
1988-92 Chevy Camaro/Pontiac Firebird 305/350 V8  
Crank Dia. 6-7/8" Alternator Dia. 1-7/8"



**HZ-05061-POL** (Polished)  
1994-96 GM Truck 7.4L 454 V8  
Crank Dia. 5-7/8" Alternator Dia. 3"

## FORD SMALL BLOCK 289 STEEL PULLEYS

**Ford Small Block Steel Water Pump Pulleys 1964-73** (For California Smog Pump)

### SINGLE GROOVE



**HZ-9770-C** Chrome  
**HZ-9770-PBK** Black EDP  
 Diameter: 6.125"  
 65-66 Single Groove  
 Water Pump Pulley

### DOUBLE GROOVE



**HZ-9775-C** Chrome  
**HZ-9775-PBK** Black EDP  
 Diameter: 5.875"  
 65-66 Double Groove  
 Water Pump Pulley

### TRIPLE GROOVE



**HZ-9773-C** Chrome  
**HZ-9773-PBK** Black EDP  
 Diameter: 5.897"  
 64-73 Triple Groove  
 Water Pump Pulley

**Ford Small Block Steel Crankshaft Pulleys 1964-66**

### SINGLE GROOVE



**HZ-9771-C** Chrome  
**HZ-9771-PBK** Black EDP  
 Diameter: 6.312"  
 65-66 Single Groove  
 Crankshaft Pulley

### DOUBLE GROOVE



**HZ-9774-C** Chrome  
**HZ-9774-PBK** Black EDP  
 Diameter: 6.687"  
 64-66 Double Groove  
 Crankshaft Pulley

### TRIPLE GROOVE



**HZ-9772-C** Chrome  
**HZ-9772-PBK** Black EDP  
 Diameter: 6.75"  
 65-66 Triple Groove  
 Crankshaft Pulley

## PULLEY MOUNTING BOLTS

**HZ-7756**  
**Pcs 4**



Water Pump Pulley  
 Nose Bolt Kit  
 5/16"-24 x 3/4" Flat Head Cap Screw

**HZ-9912**  
**Pcs 4**



Water Pump Pulley  
 Bolt Kit  
 5/16"-24 x 3/4" Flat Head Socket

**HZ-9924**  
**Pcs 3**



Crank Pulley/Lower  
 Pulley Bolt Kit  
 3/8"-24 x 1"

**HZ-9925**  
**Pcs 3**



Crank Pulley/Lower  
 Pulley Bolt Kit  
 7/16"-20 x 1"

## WATER PUMP IDENTIFICATION

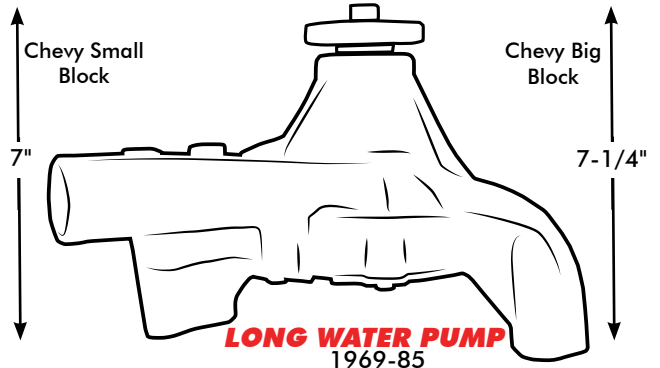
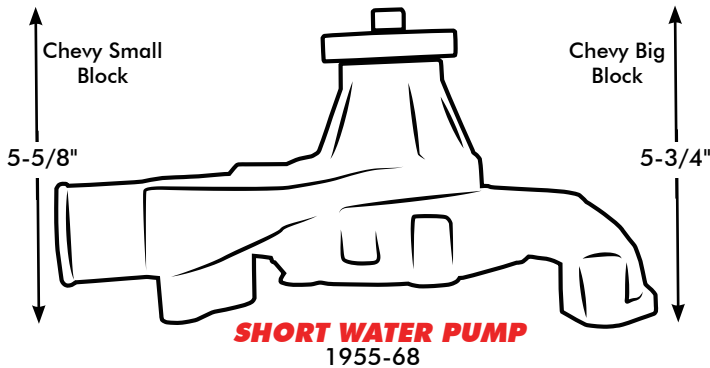

PULLEYS

## CHEVY SMALL BLOCK ALUMINUM LONG WATER PUMP KITS



Part #	Kit Includes:	Pump	Finish
<b>HZ-9485-C-KIT</b>	<b>Pulleys:</b> Single Groove Power Steering(HZ-8848), Double Groove Water Pump(HZ-9483) W/ Nose(HZ-9489), Double Groove Crank(HZ-9485), Single Groove Alternator W/Fan & Nose (HZ-8867,HZ-9487), Mounting Bolts	LWP	Chrome
<b>HZ-9485-M-KIT</b>			Machined
<b>HZ-9485-POL-KIT</b>			Polished
Pulley's Only			



Part #	Kit Includes:	Pump	Finish
<b>HZ-4304-C-KIT</b>	<b>Pulleys:</b> Single Groove Power Steering(HZ-8848), Double Groove Water Pump(HZ-9483) W/ Nose(HZ-9489), Double Groove Crank(HZ-9485), Single Groove Alternator W/Fan & Nose (HZ-8867,HZ-9487), Mounting Bolts	LWP	Chrome
<b>HZ-4304-M-KIT</b>			Machined
<b>HZ-4304-POL-KIT</b>			Polished
<b>Brackets:</b> Power Steering Bracket (HZ-4302), Alternator Bracket (HZ-4304), Mounting Hardware			
Pulley's and Brackets			

## CHEVY SMALL BLOCK ALUMINUM SHORT WATER PUMP KITS



Part #	Kit Includes:	Pump	Finish
<b>HZ-9481-C-KIT</b>	<b>Pulleys:</b> Single Groove Power Steering(HZ-8848), Double Groove Water Pump(HZ-9479) W/ Nose(HZ-9488), Double Groove Crank(HZ-9481), Single Groove Alternator W/Fan & Nose (HZ-8867,HZ-9487), Mounting Bolts	SWP	Chrome
<b>HZ-9481-M-KIT</b>			Machined
<b>HZ-9481-POL-KIT</b>			Polished
Pulley's Only			

Part #	Kit Includes:	Pump	Finish
<b>HZ-6407-C-KIT</b>	<b>Pulleys:</b> Single Groove Power Steering(HZ-8848), Double Groove Water Pump(HZ-9479) W/ Nose(HZ-9488), Double Groove Crank(HZ-9481), Single Groove Alternator W/Fan & Nose (HZ-8867,HZ-9487), Mounting Bolts	SWP	Chrome
<b>HZ-6407-M-KIT</b>			Machined
<b>HZ-6407-POL-KIT</b>			Polished
<b>Brackets:</b> Type 2 Power Steering Bracket(HZ-6407), Alternator Bracket (HZ-6405), Mounting Hardware			
Pulley's and Brackets			



## POWER STEERING PULLEYS

**1967-84 Chevy/GM Power Steering Pulleys.**  
Chevy/GM key way units  
V Belt, Single Groove  
Diameter: 5-3/4"



Steel

**HZ-8948-C**

Chrome

**HZ-8948-PBK**

Black EDP

**1967-84 Chevy/GM Power Steering Pulleys.**  
Chevy/GM key way units  
V Belt, Single Groove  
Diameter: 5-3/4"



Aluminum

**HZ-8848-M** **HZ-8848-POL**

Machined Polished

**HZ-8848-C** **HZ-8848-PBK**

Chrome Black EDP

**Type II Power Steering Pulleys.** Chevy/GM/Ford  
press fit application.  
V Belt, Single Groove  
Diameter: 4-5/16"



Aluminum

**HZ-8851-C**

Chrome

**HZ-8851-POL**

Polished

**HZ-8851-PBK**

Black EDP

**1967-84 Chevy/GM Power Steering Pulleys.**  
Chevy/GM key way units  
V Belt, Double Groove  
Diameter: 5-3/4"



Steel

**HZ-8949-C**

Chrome

**HZ-8949-PBK**

Black EDP

**1967-84 Chevy/GM Power Steering Pulleys.**  
Chevy/GM key way units  
V Belt, Double Groove  
Diameter: 5-3/4"



Aluminum

**HZ-8846-M** **HZ-8846-POL**

Machined Polished

**HZ-8846-C** **HZ-8846-PBK**

Chrome Black EDP

**Type II Power Steering Pulleys.** Chevy/GM/Ford  
press fit application.  
Serpentine, Single Groove  
Diameter: 4-5/16"



Aluminum

**HZ-8852-C**

Chrome

**HZ-8852-POL**

Polished

**HZ-8852-PBK**

Black EDP

## PULLEY NOSE & BOLTS



Short (SWP) 1955-68  
SBC Aluminum Water Pump Nose - 3"

**HZ-9488-M** Machined

**HZ-9488-C** Chrome

**HZ-9488-POL** Polished

**HZ-9488-PBK** Black EDP



**HZ-7756**

Water Pump Pulley  
Nose Bolt Kit (5/16-24 x 3/4" Hex Head Cap Screw)



Long (LWP) 1969-85  
SBC Aluminum Water Pump Nose - 3"

**HZ-9489-M** Machined

**HZ-9489-C** Chrome

**HZ-9489-POL** Polished

**HZ-9489-PBK** Black EDP



SBC Aluminum A/C Clutch Cover - 5"  
Sanden #508

**HZ-8850-M** Machined

**HZ-8850-C** Chrome

**HZ-8850-POL** Polished

**HZ-8850-PBK** Black EDP

## ALTERNATOR NOSE/FAN



Diameter: 2-7/8"

**HZ-9487-M** Machined

**HZ-9487C** Chrome

**HZ-9487-POL** Polished

**HZ-9487-PBK** Black EDP



**HZ-8867-M** Machined

**HZ-8867-C** Chrome

**HZ-8867-POL** Polished

**HZ-8867-PBK** Black EDP

## FORD 5.0 MUSTANG - ALUMINUM SERPENTINE PULLEY SETS



**HZ-02010-C**

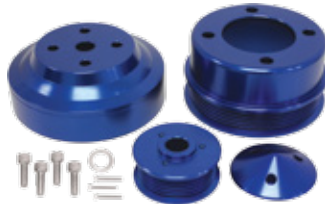

**HZ-02010-PBL**



**HZ-02010-PBK**

1979-93 Ford Mustang 5.0L Billet Aluminum Serpentine Pulley Sets. Underdrive pulley sets come with 6-groove alternator, crank and water pump pulley.

<b>HZ-02010-M</b> Machined	<b>HZ-02010-PBL</b> Blue
<b>HZ-02010-C</b> Chrome	<b>HZ-02010-PBK</b> Black
<b>HZ-02010-POL</b> Polished	

## FORD 5.0 MUSTANG - ALUMINUM POWER STEERING PULLEYS

**HZ-02011-C**



**HZ-02011-PBL**

**HZ-02011-PBK**

1979-93 Ford Mustang 5.0L Power Steering Pulleys. 6-groove billet aluminum power steering pump pulleys.

<b>HZ-02011-M</b> Machined	<b>HZ-02011-PBK</b> Black
<b>HZ-02011-C</b> Chrome	<b>HZ-02011-PBL</b> Blue
<b>HZ-02011-POL</b> Polished	

**\*One Time Use Only\***

## FORD MUSTANG - LATE MODEL ALUMINUM PULLEY SETS



1999-00  
**HZ-02255-POL** Polished  
**HZ-02255-M** Machined  
 4.6L Ford Mustang GT  
 Alternator, Crank, Water Pump



**HZ-02250-POL** Polished  
**HZ-02250-M** Machined  
 1996-98 4.6L Ford Mustang GT & Cobra  
 Alternator, Crank, Water Pump

**STEEL ALTERNATOR BRACKETS**  
**CHEVY BIG BLOCK - SHORT WATER PUMP**



**1969-UP BBC Chrome Lower Alternator Bracket.** Fits Chevy 396-402-427-454 big block engines. (SWP)  
**HZ-9502-C** Chrome  
**HZ-9502-PBK** Black EDP



**1955-68 SBC Chrome Lower Alternator Bracket.** Fits Chevy 396-402-427-454 big block engines. (SWP)  
**HZ-9758-C** Chrome

**CHEVY BIG BLOCK - LONG WATER PUMP**



**1969-UP BBC Chrome Alternator Bracket.** OEM style top and bottom bracket fits Chevy 396-402-427-454 big block engines. (LWP)  
**HZ-9318-9638-C** Chrome



**1969-75 SBC & BBC Upper Alternator Bracket.** Fits 305-327-350-400 Chevy small block engines and 396-402-427-454 big block engines. (LWP)  
**HZ-9320-C** Chrome

**CHEVY SMALL BLOCK - SHORT WATER PUMP**



**1955-68 SBC Chrome Low Mount Alternator Bracket.** Fits Chevy 283-305-327-350 small block engines. Includes mounting hardware. (SWP)  
**HZ-7758-C** Chrome



**1965-68 SBC Chrome Water Pump Mounted Alternator Top Bracket.** OEM style bracket fits Chevy 265-283-305-327-350 small block engines. (SWP)  
**HZ-9315-C** Chrome



**1955-68 SBC Chrome Lower Alternator Bracket.** Fits Chevy 265-283-302-307-327-350 small block engines. (SWP)  
**HZ-9758-C** Chrome



**Universal SBC Chrome Upper Alternator/Generator Bracket.** (SWP)  
**HZ-9079-C** Chrome



**Universal SBC Chrome Upper Alternator/Generator Bracket.** (SWP)  
**HZ-9325-C** Chrome  
**HZ-9325-PBK** Black EDP

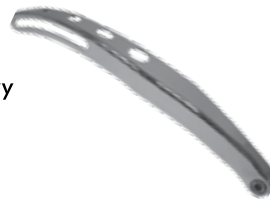

**1965-68 SBC Chrome Upper Alternator Bracket.** Fits Chevy 283-305-327-350 265-small block engines. (SWP)  
**HZ-9319-C** Chrome



## STEEL ALTERNATOR BRACKETS CHEVY SMALL BLOCK - LONG WATER PUMP



### 1969-75 SBC Chrome Water Pump Mounted Alternator Bracket Set.

OEM style bracket set fits Chevy 305-327-350-400 small block engines. (LWP)

**HZ-9316-C** Chrome  
**HZ-9316-PBK** Black EDP



### 1969-86 SBC Chrome Water Pump Mounted Alternator Bracket Set.

OEM style bracket set fits Chevy 305-327-350-400 small block engines. (LWP)

**HZ-9317-C** Chrome  
**HZ-9317-PBK** Black EDP



**1969-75 SBC & BBC Upper Alternator Bracket.** Fits Chevy 305-327-350-400 small block engines and 396-402-427-454 big block engines. (LWP)

**HZ-9320-C** Chrome



**1979-86 SBC Chrome Upper Alternator Bracket.** Fits Chevy 305-327-350-400 small block engines. (LWP)

**HZ-9321-C** Chrome



**1969-86 SBC Chrome Lower Alternator Bracket.** Fits Chevy 305-327-350-400 small block engines. (LWP)

**HZ-9637-C** Chrome

## FORD SMALL BLOCK



### 1965-69 Ford Chrome Alternator Bracket Set.

OEM style set fits Ford 289-302 small block engines.

**HZ-9455-C** Chrome  
**HZ-9455-PBK** Black EDP



### Mopar Big Block Alternator Bracket Set.

Fits Chrysler/Dodge/Mopar engines.

**HZ-9457-C** Chrome

## STEEL HEADER BRACKETS

**1955-68 Universal header slide bracket and base.**  
Bracket base attaches at #1 Cylinder exhaust port for tubular headers.



Base

**HZ-9322-C** Chrome  
**HZ-9322-PBK** Black EDP



Slide

**HZ-9323-C** Chrome  
**HZ-9323-PBK** Black EDP  
Driver Side Only

## ALUMINUM ALTERNATOR BRACKETS

### CHEVY BIG BLOCK



**BBC Aluminum Alternator Bracket Sets.**

Fits Chevy 396-402-427-454-502 engines. Driver side mount. Mounting hardware included. (SWP)

**HZ-6421-C** Chrome

**HZ-6421-POL** Polished



**BBC Aluminum Alternator Bracket Sets.**

Fits Chevy 396-402-427-454-502 engines. Passenger side mount. Mounting hardware included. (LWP)

**HZ-6423-C** Chrome

**HZ-6423-POL** Polished

### CHEVY SMALL BLOCK - SHORT WATER PUMP



**SBC Aluminum Alternator Bracket Sets.**

Fits Chevy 262-267-283-302-305-307-327-350-400 engines. Driver side mount. Mounting hardware included. (SWP)

**HZ-6425-C** Chrome

**HZ-6425-POL** Polished

### CHEVY SMALL BLOCK - LONG WATER PUMP

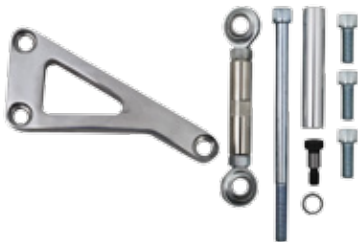

**SBC Aluminum Alternator Bracket Sets.**

Fits Chevy 283-305-327-350-400 engines. Passenger side mount. Mounting hardware included. (LWP)

**HZ-4324-C** Chrome

**HZ-4324-POL** Polished

### FORD SMALL BLOCK



**1979-93 Ford 5.0L Mustang Aluminum Alternator Bracket Sets.**

Driver side mount. Mounting hardware included.

**HZ-4320-C** Chrome

**HZ-4320-POL** Polished

**POWER STEERING BRACKETS**

**CHEVY SMALL BLOCK- LONG/ SHORT WATER PUMP**



**HZ-9200-PBK** Black EDP



Small Block Chevy Short water Pump & Long Water Pump Chrome Steel Saginaw Power Steering Bracket Set Complete with mounting hardware



**HZ-9200-C** Chrome

**CHEVY SMALL BLOCK - LONG WATER PUMP**



**1963-87 SBC Aluminum Power Steering Bracket Sets.** Fits Chevy 283-305-327-350-400 engines. Driver side mount. Mounting hardware included. (LWP)

**HZ-4322-C** Chrome  
**HZ-4322-POL** Polished

**FORD SMALL BLOCK**

**1979-93 Ford 5.0L Mustang Aluminum Power Steering Bracket Sets.** Driver side mount. Mounting hardware included.



**HZ-4326-C** Chrome  
**HZ-4326-POL** Polished  
**HZ-4326-PBK** Black  
**HZ-4326-PBL** Blue





## AIR CONDITIONING BRACKETS CHEVY SMALL/ BIG BLOCK- LONG/ SHORT WATER PUMP



**HZ-6426-C** Chrome  
**HZ-6426-POL** Polished

**SBC Aluminum Air Conditioning Bracket Set.**  
Fits Chevy Small Block 262-267-283-302-305-327-350-400 Engines. Mounting hardware included. (SWP) Passenger side mount.



**HZ-9324-C-KIT** Chrome  
**HZ-9324-PBK-KIT** Black EDP

**SBC Steel Air Conditioning Bracket Sets.**  
Fits Chevy Small Block 262-267-283-302-305-327-350-400 Engines. Driver side only adjustable mount. Mounting hardware included. (SWP/LWP)



**HZ-6422-C** Chrome  
**HZ-6422-POL** Polished

**BBC Billet Aluminum Air Conditioning Bracket Sets.**  
Fits Chevy Big Block Engines. Mounting hardware included. (SWP) Passenger side mount.

## ALUMINUM ADAPTOR BRACKETS FORD SMALL BLOCK



**Ford Small Block 351W aluminum adaptor bracket.** Adapts the mounting hole on a head to use standard small block Ford brackets on a 351W block. Mounting hardware included.

**HZ-4351-C** Chrome  
**HZ-4351-M** Machined  
**HZ-4351-POL** Polished

## ADJUSTABLE STAINLESS STEEL TENSION RODS

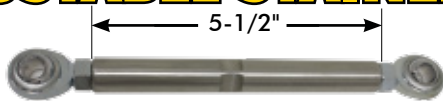

**HZ-4307**  
**HZ-4307-POL** Polished

**Adjustable Tensioning Rod  
Chevy/Ford/Mopar.**

5-1/2" Stainless steel rod. Diameter: 5/8"

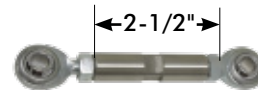

**HZ-4308**  
**HZ-4308-POL** Polished

**Adjustable Tensioning Rod  
Chevy/Ford/Mopar.**

2-1/2" Stainless steel rod. Diameter: 5/8"



**HZ-4309**  
**HZ-4309-POL** Polished

**Adjustable Tensioning Rod  
Chevy/Ford/Mopar.**

7" Stainless steel rod. Diameter: 5/8"



**HZ-4310**  
**HZ-4310-POL** Polished

**Adjustable Tensioning Rod  
Chevy/Ford/Mopar.**

8-1/2" Stainless steel rod. Diameter: 5/8"

## EMC Evolution Modular Cooling

This is the most extreme modular system available for any application. Our engineers have conducted extensive research to determine this is the optimum combination of size and volume for maximum cooling efficiency in extreme applications. These advanced cooling modules also include 7 separate 3/8-24" threaded bungs for attaching optional mounting bracket kits and hardware allowing the unique option of using this radiator as a traditional top and bottom tank design or the modern cross-flow design.



7-3/8-24" Threaded Bungs



15 Fins per inch

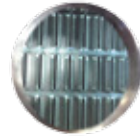

850 HP Rated

Part #	Size
<b>HZ-40010-X2</b>	22" x 19"
<b>HZ-40011-X2</b>	24" x 19"
<b>HZ-40012-X2</b>	26" x 19"
<b>HZ-40016-X2</b>	31" x 19"

Part #	Size
<b>HZ-40010-X3</b>	22" x 19"
<b>HZ-40011-X3</b>	24" x 19"
<b>HZ-40012-X3</b>	26" x 19"
<b>HZ-40016-X3</b>	31" x 19"



1250 HP Rated

The EMC=X2 has an oversized 2 1/4" thick cooling core with two rows of 1" high volume and high flow heat transfer tubes with an optimized 15 fins per inch of cooling power.

The EMC=X3 has a huge 3 1/2" thick cooling core with three rows of 7/8" high volume and high flow heat transfer tubes with an optimized 15 fins per inch of cooling power

7 separate AN-20 bungs allowing the ultimate in universal configuration. We have adapter fittings for the AN-20 bungs to allow the following attachments:



Part #	Description
<b>HZ-40030</b>	20AN Male to 1.25" Radiator Hose Fitting
<b>HZ-40031</b>	20AN Male to 1.75" Radiator Hose Fitting
<b>HZ-40032</b>	20AN Male to 1.50" Radiator Hose Fitting
<b>HZ-40033</b>	20AN Male to -16AN Male Coupling
<b>HZ-40034</b>	20AN Male to -20AN Male Coupling
<b>HZ-40035</b>	20AN Male to 1/2" NPT Adapter
<b>HZ-40036</b>	20AN Male to 3/8" NPT Adapter
<b>HZ-40037</b>	20AN Male Plug
<b>HZ-40038</b>	20AN male to 2 1/8" Filler Neck
<b>HZ-40040</b>	Radiator Overflow Fitting
<b>HZ-40041</b>	20AN O-Ring
<b>HZ-40045</b>	Aluminum Angled Mounting Bracket
<b>HZ-40046</b>	Aluminum Flat Mounting Bracket

## DIRECT FIT ALUMINUM RADIATOR MODULES

\*Module includes Show Polished Radiator, Chrome Shroud, Chrome Fan and Chrome Radiator Cap \*

**Direct Fit Aluminum Radiators Features.** All of CFR Performance's direct fit aluminum radiators include: mounting brackets that position the radiator in the stock location, 2-row furnace brazed core with 1" tubes, machined billet filler water neck with overflow fitting, and furnace brazed tanks, and epoxy free construction.

**1959-72 Chevy Impala Direct Fit Aluminum Radiators.** These radiators also fit for 1964-67 Chevy Chevelle. \*

**HZ-5972-POL-KIT** Polished  
\***HZ-5972-AT-POL-KIT** Polished



**Overall Size:** 28-5/8"W x 19-1/2"H x 3"D  
**Core Size:** 20-3/4"W x 18-1/4"H x 2-1/4"D  
\* Features Built-in Automatic Transmission Cooler.

**1970-81 Chevy Camaro/Chevelle/Nova Direct Fit Aluminum Radiators.** Features a built-in Temperature Sensor Bung. \*



**HZ-7081-POL-KIT** Polished  
\***HZ-7081-AT-POL-KIT** Polished  
\*\***HZ-7081-DP-POL-KIT** Polished (LS Ready)

**Overall Size:** 31.25"W x 19.5"H x 3"D  
**Core Size:** 26"W x 17.75"H x 2.25"D  
\* Features Built-in Automatic Transmission Cooler.  
\*\* Uses Dual Pass Cooling System.

**1967-69 Chevy Camaro Direct Fit Aluminum Radiator.** Features a built-in Temperature Sensor Bung. Small Block Chevy \*

**HZ-6769-POL-KIT** Polished  
\***HZ-6769-AT-POL-KIT** Polished



Dual 12" Fans

**Overall Size:** 28-1/4"W x 19-1/2"H x 3-1/4"D  
**Core Size:** 25-3/4"W x 18-1/2"H x 2-1/4"D  
\* Features Built-in Automatic Transmission Cooler.

**1979-93 Ford 5.0L 302 Direct Fit Aluminum Radiator.** \*



**HZ-79MU-ML-POL-KIT** Polished  
\***HZ-79MU-AT-POL-KIT** Polished

**Overall Size:** 28-7/8"W x 19"H x 3-1/8"D  
**Core Size:** 24-3/8"W x 18-5/8"H x 2-1/4"D  
\* Features Built-in Automatic Transmission Cooler.

**1957 Chevy Straight/Inline 6 Cylinder Direct Fit Aluminum Radiator.** Designed for Chevy passenger cars with engines running a short or long style water pump. Features a built-in automatic transmission cooler, temperature sensor bung, and drain petcock with mounting clips.

**HZ-5700-6-POL-KIT** Polished  
**Overall Size:** 23-1/8"W x 23-1/4"H x 3"D  
**Core Size:** 21-7/8"W x 17-1/4"H x 2-1/2"D



**1955-56 Chevy V6 Cylinder Direct Fit Aluminum Radiator.** Features a built-in automatic transmission cooler, temperature sensor bung, and drain petcock with mounting clips.

**HZ-5556-6-POL-KIT** Polished  
**Overall Size:** 23-1/8"W x 23"H x 3-3/4"D  
**Core Size:** 21-3/4"W x 16-1/2"H x 2-1/2"D



**1955-57 Chevy V8 Direct Fit Aluminum Radiator.** Designed for engines running a short style water pump. Features a built-in automatic transmission cooler, temperature sensor bung, and drain petcock with mounting clips.

**HZ-5557-8-POL-KIT** Polished  
**Overall Size:** 23-1/4"W x 23"H x 3"D  
**Core Size:** 21-3/4"W x 16-1/2"H x 2-1/2"D





## DIRECT FIT ALUMINUM RADIATOR MODULES

\*Module includes Natural Radiator, Shroud, Black Fan and Polished Radiator Cap\*

**Direct Fit Aluminum Radiators Features.** All of CFR Performance's direct fit aluminum radiators include: mounting brackets that position the radiator in the stock location, 2-row furnace brazed core with 1" tubes, machined billet filler water neck with overflow fitting, and furnace brazed tanks, and epoxy free construction.

### 1959-72 Chevy Impala Direct Fit Aluminum Radiators.

These radiators also fit for 1964-67 Chevy Chevelle. \*

**HZ-5972-KIT**  
**\*HZ-5972-AT-KIT**

Natural



**Overall Size:** 28-5/8"W x 19-1/2"H x 3"D

**Core Size:** 20-3/4"W x 18-1/4"H x 2-1/4"D

\* Features Built-in Automatic Transmission Cooler.

### 1970-81 Chevy Camaro/Chevelle/Nova Direct Fit Aluminum Radiators.

Features a built-in Temperature Sensor Bung. \*

Natural



**HZ-7081-KIT**  
**\*HZ-7081-AT-KIT**  
**\*\*HZ-7081-DP-KIT**

**Overall Size:** 31.25"W x 19.5"H x 3"D

**Core Size:** 26"W x 17.75"H x 2.25"D

\* Features Built-in Automatic Transmission Cooler.

\*\* Uses Dual Pass Cooling System.



Natural

### 1957 Chevy Straight/Inline 6 Cylinder Direct Fit Aluminum Radiator.

Designed for Chevy passenger cars with engines running a short or long style water pump. Features a built-in automatic transmission cooler, temperature sensor bung, and drain petcock with mounting clips.

**HZ-5700-6-KIT**

**Overall Size:** 23-1/8"W x 23-1/4"H x 3"D

**Core Size:** 21-7/8"W x 17-1/4"H x 2-1/2"D

### 1955-56 Chevy V6 Cylinder Direct Fit Aluminum Radiator.

Features a built-in automatic transmission cooler, temperature sensor bung, and drain petcock with mounting clips.

**HZ-5556-6-KIT**

**Overall Size:** 23-1/8"W x 23"H x 3-3/4"D

**Core Size:** 21-3/4"W x 16-1/2"H x 2-1/2"D



Natural

### 1967-69 Chevy Camaro Direct Fit Aluminum Radiator.

Features a built-in Temperature Sensor Bung. Small Block Chevy \*

**HZ-6769-KIT**  
**\*HZ-6769-AT-KIT**

Natural



Dual 12" Fans

**Overall Size:** 28-1/4"W x 19-1/2"H x 3-1/4"D

**Core Size:** 25-3/4"W x 18-1/2"H x 2-1/4"D

\* Features Built-in Automatic Transmission Cooler.

### 1979-93 Ford 5.0L 302 Direct Fit Aluminum Radiator.

Natural



**HZ-79MU-ML-KIT**  
**\*HZ-79MU-AT-KIT**

**Overall Size:** 28-7/8"W x 19"H x 3-1/8"D

**Core Size:** 24-3/8"W x 18-5/8"H x 2-1/4"D

\* Features Built-in Automatic Transmission Cooler.



Natural

### 1955-57 Chevy V8 Direct Fit Aluminum Radiator.

Designed for engines running a short style water pump. Features a built-in automatic transmission cooler, temperature sensor bung, and drain petcock with mounting clips.

**HZ-5557-8-KIT**

**Overall Size:** 23-1/4"W x 23"H x 3"D

**Core Size:** 21-3/4"W x 16-1/2"H x 2-1/2"D

## DIRECT FIT ALUMINUM RADIATORS

**Direct Fit Aluminum Radiators Features.** All of CFR Performance's direct fit aluminum radiators include: mounting brackets that position the radiator in the stock location, 2-row furnace brazed core with 1" tubes, machined billet filler water neck with overflow fitting, and furnace brazed tanks, and epoxy free construction.

### 1959-72 Chevy Impala Direct Fit Aluminum Radiators.

These radiators also fit for 1964-67 Chevy Chevelle.

<b>HZ-5972</b>	Natural
<b>HZ-5972-POL</b>	Polished
<b>*HZ-5972-AT</b>	Natural
<b>*HZ-5972-AT-POL</b>	Polished



**Overall Size:** 28-5/8"W x 19-1/2"H x 3"D

**Core Size:** 20-3/4"W x 18-1/4"H x 2-1/4"D

\* Features Built-in Automatic Transmission Cooler.

### 1967-69 Chevy Camaro Direct Fit Aluminum Radiator.

Features a built-in Temperature Sensor Bung.

<b>HZ-6769</b>	Natural
<b>HZ-6769-POL</b>	Polished
<b>*HZ-6769-AT</b>	Natural
<b>*HZ-6769-AT-POL</b>	Polished



**Overall Size:** 28-1/4"W x 19-1/2"H x 3-1/4"D

**Core Size:** 25-3/4"W x 18-1/2"H x 2-1/4"D

\* Features Built-in Automatic Transmission Cooler.

### 1970-81 Chevy Camaro/Chevelle/Nova Direct Fit Aluminum Radiators.

Features a built-in Temperature Sensor Bung.

<b>HZ-7081</b>	Natural
<b>HZ-7081-POL</b>	Polished
<b>*HZ-7081-AT</b>	Natural
<b>*HZ-7081-AT-POL</b>	Polished
<b>**HZ-7081-DP</b>	Natural
<b>**HZ-7081-DP-POL</b>	Polished

**Overall Size:** 31.25"W x 19.5"H x 3"D

**Core Size:** 26"W x 17.75"H x 2.25"D

Features Built-in Automatic Transmission Cooler.

\*\* Uses Dual Pass Cooling System.



### 1979-93 Ford 5.0L 302 Direct Fit Aluminum Radiator.

<b>HZ-79MU-ML</b>	Natural
<b>HZ-79MU-ML-POL</b>	Polished
<b>*HZ-79MU-AT</b>	Natural
<b>*HZ-79MU-AT-POL</b>	Polished

**Overall Size:** 28-7/8"W x 19"H x 3-1/8"D

**Core Size:** 24-3/8"W x 18-5/8"H x 2-1/4"D

\* Features Built-in Automatic Transmission Cooler.



### 1957 Chevy Straight/Inline 6 Cylinder Direct Fit Aluminum Radiator.

Designed for Chevy passenger cars with engines running a short or long style water pump. Features a built-in automatic transmission cooler, temperature sensor bung, and drain petcock with mounting clips.

<b>HZ-5700-6</b>	Natural
<b>HZ-5700-6-POL</b>	Polished

**Overall Size:** 23-1/8"W x 23-1/4"H x 3"D

**Core Size:** 21-7/8"W x 17-1/4"H x 2-1/2"D



### 1955-56 Chevy V6 Cylinder Direct Fit Aluminum Radiator.

Features a built-in automatic transmission cooler, temperature sensor bung, and drain petcock with mounting clips.

<b>HZ-5556-6</b>	Natural
<b>HZ-5556-6-POL</b>	Polished

**Overall Size:** 23-1/8"W x 23"H x 3-3/4"D

**Core Size:** 21-3/4"W x 16-1/2"H x 2-1/2"D



### 1955-57 Chevy V8 Direct Fit Aluminum Radiator.

Designed for engines running a short style water pump. Features a built-in automatic transmission cooler, temperature sensor bung, and drain petcock with mounting clips.

<b>HZ-5557-8</b>	Natural
<b>HZ-5557-8-POL</b>	Polished

**Overall Size:** 23-1/4"W x 23"H x 3"D

**Core Size:** 21-3/4"W x 16-1/2"H x 2-1/2"D



## ALUMINUM RADIATOR FAN SHROUDS

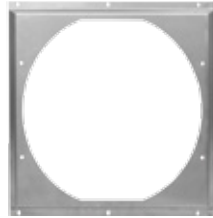

**HZ-1008-22** Natural  
**HZ-1008C-22** Chrome  
**Dimensions:** 16-5/8"x16-5/8"  
**Fan Size:** 14"  
**Compatible CFR Radiators:** **HZ-50010**  
**HZ-50020**

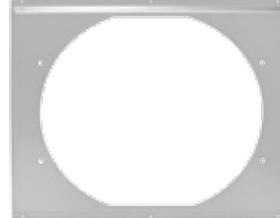

**HZ-1008-24** Natural  
**HZ-1008C-24** Chrome  
**Dimensions:** 18-5/8"x16-5/8"  
**Fan Size:** 14"  
**Compatible CFR Radiators:** **HZ-50011**  
**HZ-50021**

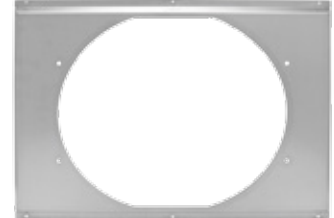

**HZ-1008-26** Natural  
**HZ-1008C-26** Chrome  
**Dimensions:** 20-5/8"x16-5/8"  
**Fan Size:** 14"  
**Compatible CFR Radiators:** **HZ-50012**  
**HZ-50022**

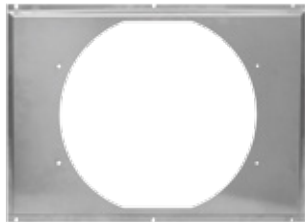

**HZ-1008-28** Natural  
**HZ-1008C-28** Chrome  
**Dimensions:** 22-5/8"x16-5/8"  
**Fan Size:** 14"  
**Compatible CFR Radiators:** **HZ-50014**  
**HZ-50024**

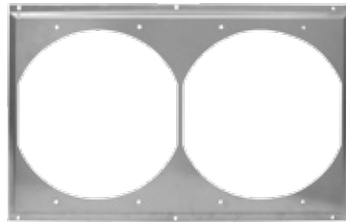

**HZ-1008-31** Natural  
**HZ-1008C-31** Chrome  
**Dimensions:** 25-5/8"x16-5/8"  
**Fan Size:** Two 12"  
**Compatible CFR Radiators:** **HZ-50016**  
**HZ-50026**



**HZ-1009-22** Natural  
**HZ-1009C-22** Chrome  
**Dimensions:** 16-5/8"x18-5/8"  
**Fan Size:** 16"  
**Compatible CFR Radiators:** **HZ-40010**  
**HZ-40020**  
**HZ-40210**  
**HZ-40220**

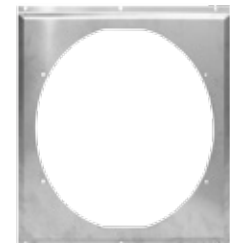

**HZ-1009-24** Natural  
**HZ-1009C-24** Chrome  
**Dimensions:** 18-5/8"x18-5/8"  
**Fan Size:** 16"  
**Compatible CFR Radiators:** **HZ-40011**  
**HZ-40021**  
**HZ-40211**  
**HZ-40221**

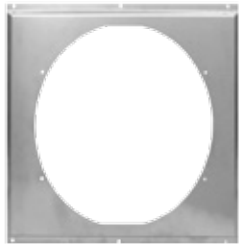

**HZ-1009-26** Natural  
**HZ-1009C-26** Chrome  
**Dimensions:** 20-5/8"x18-5/8"  
**Fan Size:** 16"  
**Compatible CFR Radiators:** **HZ-40012**  
**HZ-40022**  
**HZ-40212**  
**HZ-40222**  
**HZ-5972**  
**HZ-5972-POL**  
**HZ-5972-AT**  
**HZ-5972-AT-POL**



**HZ-1009-28** Natural  
**HZ-1009C-28** Chrome  
**HZ-1009-28B** Two 10" Fans  
**HZ-1009C-28B**  
**Dimensions:** 22-5/8"x18-5/8"  
**Fan Size:** 16"  
**Compatible CFR Radiators:** **HZ-40014**  
**HZ-40014-AT**  
**HZ-40024**  
**HZ-40214**  
**HZ-40224**  
**HZ-6769**  
**HZ-6769-AT**

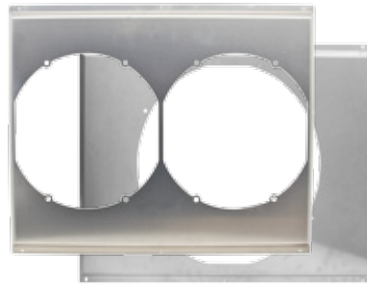

**HZ-1009-31** Natural  
**HZ-1009C-31** Chrome  
**HZ-1009-31B**  
**HZ-1009C-31B**  
**Dimensions:** 25-5/8"x18-5/8"  
**Fan Size:** 16"  
**Compatible CFR Radiators:** **HZ-40016**  
**HZ-40016-AT**  
**HZ-40026**  
**HZ-40216**  
**HZ-40226**  
**HZ-40226-O**  
**HZ-7081**  
**HZ-7081-AT**  
**HZ-7081-DP**

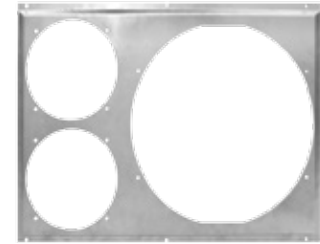

**HZ-1009-31-1** Natural  
**HZ-1009C-31-1** Chrome  
**Dimensions:** 25-5/8"x18-5/8"  
**Fan Size:** One 16" Two 8"  
**Compatible CFR Radiators:** **HZ-40016**  
**HZ-40016-AT**  
**HZ-40026**  
**HZ-40216**  
**HZ-40226-O**  
**HZ-7081**  
**HZ-7081-AT**  
**HZ-7081-DP**



## ALUMINUM RADIATOR FAN SHROUDS



**HZ-1009-34A**  
**HZ-1009-34B** Two 12" Fans  
**HZ-1009C-34A**  
**HZ-1009C-34B** Two 12" Fans  
**Dimensions:** 27-1/2"x18-1/2"  
**Fan Size:** One 16" or Two 12"

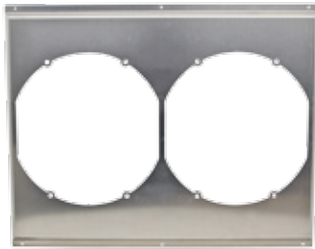

**HZ-1009-67**  
**HZ-1009C-67**  
**Dimensions:** 22-5/8"x18-5/8"  
**Fan Size:** Two 12"  
**Compatible**  
**CFR Radiators:** **HZ-6769**  
**HZ-6769-AT\***

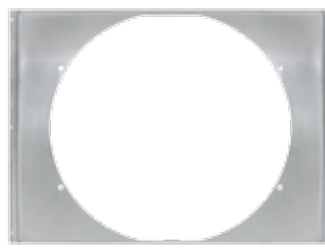

Fits 1955-Up Chevy Tri 5 Radiators.  
**HZ-1009-55**  
**HZ-1009C-55** Chrome  
**Dimensions:** 22-7/8"x17-1/2"  
**Fan Size:** 16"  
**Compatible**  
**CFR Radiators:** **HZ-5556-6**  
**HZ-5557-8**  
**HZ-5700-6**

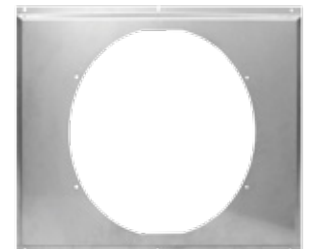

Fits 1973-95 Ford 5.0L 302 Radiators.  
**HZ-1009-79**  
**HZ-1009C-79** Chrome  
**Dimensions:** 24-5/8"x18-5/8"  
**Fan Size:** 16"  
**Compatible**  
**CFR Radiators:** **HZ-79MU-ML**  
**HZ-79MU-AT**

## ALUMINUM RADIATOR HOLELESS FAN SHROUDS

These fan shrouds are blank templates so you may design and drill your own electric fan, and bolt holes.



**HZ-1008H-22** Natural  
**Dimensions:** 16-5/8"x16-5/8"  
**Compatible**  
**CFR Radiators:** **HZ-50010**  
**HZ-50020**

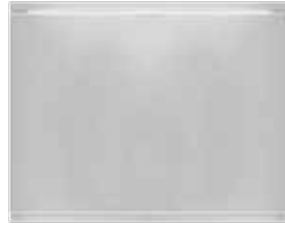

**HZ-1008H-26** Natural  
**Dimensions:** 20-5/8"x16-5/8"  
**Compatible**  
**CFR Radiators:** **HZ-50012**  
**HZ-50022**



**HZ-1008H-31** Natural  
**Dimensions:** 25-5/8"x16-5/8"  
**Compatible**  
**CFR Radiators:** **HZ-50016**  
**HZ-50026**



**HZ-1009H-22** Natural  
**Dimensions:** 16-5/8"x18-5/8"  
**Compatible**  
**CFR Radiators:** **HZ-40010**  
**HZ-40020**  
**HZ-40210**  
**HZ-40220**



**HZ-1009H-24** Natural  
**Dimensions:** 18-5/8"x18-5/8"  
**Compatible**  
**CFR Radiators:** **HZ-40011**  
**HZ-40021**  
**HZ-40211**  
**HZ-40221**



**HZ-1009H-26** Natural  
**Dimensions:** 20-5/8"x18-5/8"  
**Compatible**  
**CFR Radiators:** **HZ-40012**  
**HZ-40022**  
**HZ-40212**  
**HZ-40222**  
**HZ-5972**  
**HZ-5972-POL**  
**HZ-5972-AT**  
**HZ-5972-AT-POL**



**HZ-1009H-28** Natural  
**Dimensions:** 22-5/8"x18-5/8"  
**Compatible**  
**CFR Radiators:** **HZ-40014**  
**HZ-40014-AT**  
**HZ-40024**  
**HZ-40214**  
**HZ-40224**  
**HZ-6769**  
**HZ-6769-AT**



**HZ-1009H-31** Natural  
**Dimensions:** 25-5/8"x18-5/8"  
**Compatible**  
**CFR Radiators:** **HZ-40016**  
**HZ-40016-AT**  
**HZ-40026**  
**HZ-40216**  
**HZ-40226**  
**HZ-40226-O**  
**HZ-7081**  
**HZ-7081-AT**  
**HZ-7081-DP**

## HIGH PERFORMANCE ELECTRIC COOLING FANS

All fans have been anemometer tested to provide the most accurate CFM ratings



### Curved Blade

Part #	Size	CFM	Finish
<b>HZ-1014CU</b>	10"	1800	Black
<b>HZ-1002CU</b>	12"	2200	Black
<b>HZ-1002C-CU</b>	12"	2200	Chrome
<b>HZ-1003CU</b>	14"	2800	Black
<b>HZ-1009CU</b>	16"	2300	Black
<b>HZ-1009C-CU</b>	16"	2500	Chrome



### Flat Blade

Part #	Size	CFM	Finish
<b>HZ-1001-7</b>	7"	1500	Black
<b>HZ-1001-8</b>	8"	1700	Black

## MECHANICAL FAN SPACERS

Has 5/8" Pilot hole and comes complete with mounting hardware in a machined finish.



**HZ-1050**  
1/2"



**HZ-1051**  
1"



**HZ-1052**  
1-1/2"



**HZ-1053**  
2"



**HZ-1054**  
2-1/2"

## RADIATOR CAPS



**HZ-1950-POL**  
Finish: Polished  
Pressure: 16 lbs.



**HZ-1951-POL**  
Finish: Polished  
Pressure: 16 lbs.



**HZ-1952-POL**  
Finish: Polished  
Pressure: 22 lbs.



**HZ-5010-C**  
Finish: Chrome  
**HZ-5010-POL**  
Finish: Polished  
Pressure: 16 lbs.



**HZ-5010-C-CFR**  
Finish: Chrome  
**HZ-5010-POL-CFR**  
Finish: Polished  
Pressure: 16 lbs.



**HZ-5020-Z**  
Finish: Zinc  
Pressure: 16 lbs.

## ALUMINUM RADIATOR MOUNTING KITS

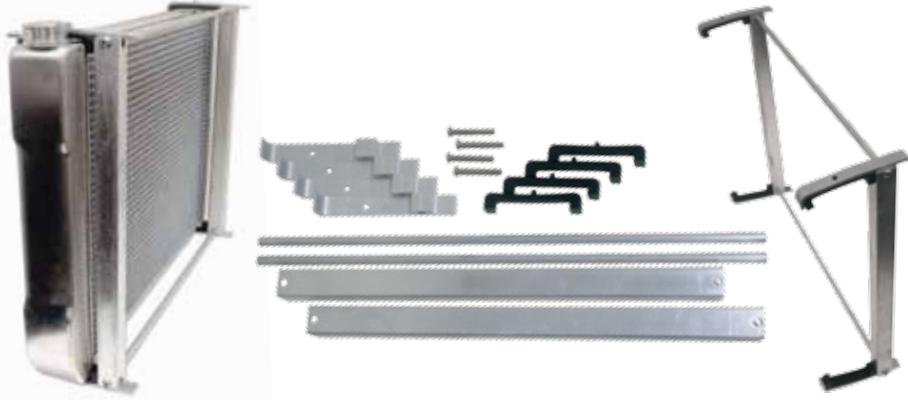

**CFR Universal Aluminum Radiator Mounting Kit.**  
Designed to hold CFR radiators in place. CFR Performance universal mounting kit makes the installation of your radiator simple.

Part #	Size
<b>HZ-41010</b>	22" x 19"
<b>HZ-41011</b>	24" x 19"
<b>HZ-41012</b>	26" x 19"
<b>HZ-41014</b>	28" x 19"
<b>HZ-41016</b>	31" x 19"
<b>HZ-51010</b>	22" x 16-1/2"
<b>HZ-51011</b>	24" x 16-1/2"
<b>HZ-51012</b>	26" x 16-1/2"
<b>HZ-51014</b>	28" x 16-1/2"
<b>HZ-51016</b>	31" x 16-1/2"



**Universal Electric Fan Mounting Brackets Kit.** Designed to mount 12" or 16" electric fans to your 19" tall radiator. Includes hardware.  
**HZ-1007-KIT**



**Universal Nylon Tie Mounting Kit.** Includes four 6-1/2" zip-tie pastic rods, four foam mounting pads and four lock tab clips. Secures all electric fans, and oil or transmission coolers to any vehicle.  
**HZ-406-KIT**

## AIR CONDITION PUMP

**Sanden Type Air Compressor.** Chrome housed pump for v-belt type pulleys.



**HZ-8900** Natural  
**HZ-8900-C** Chrome



**HZ-8901-C** Chrome  
508 Housing Serpentine.

**HZ-8902** Natural  
**HZ-8902-C** Chrome  
SD7 Serpentine.

## UNIVERSAL FAN SHROUDS



3" Wide x 20" Dia.

**HZ-9453**  
Chrome  
**HZ-9453-PBK**  
Black EDP



5-1/2" Wide x 20" Dia.

**HZ-9454**  
Chrome  
**HZ-9454-PBK**  
Black EDP



## NEW! STAINLESS STEEL RADIATOR HOSE KITS



**HZ-7302**

- HZ-7302**  
**HZ-7302-PBK** Black 12"
- HZ-7305**  
**HZ-7305-PBK** Black 24"
- HZ-7308**  
**HZ-7308-PBK** Black 36"
- HZ-7308**  
**HZ-7308-PBK** Black 48"



**HZ-7305**

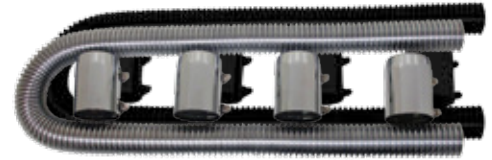

**HZ-7311**

Stainless Steel Hose Kits.

All kits include a stainless steel radiator hose, stainless steel ends, 1-1/4", 1-1/2" and 1-3/4" reducers, and hose clamps.

## NEW! STAINLESS STEEL HEATER HOSE KITS

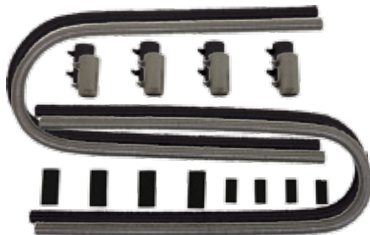

Universal Stainless Steel Hose Kit.

All kits include two 44" stainless steel heater hoses, four stainless steel ends, four 5/8" reducers, four 3/4" rubber sleeves and four hose clamps.

- HZ-7314**
- HZ-7314-PBK** Black

## RADIATOR OVERFLOW TANKS

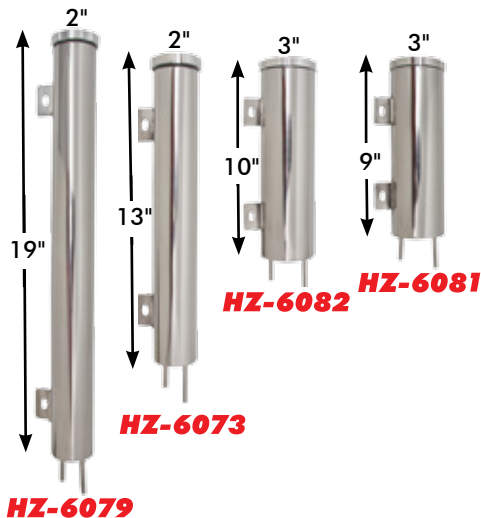

**Stainless Steel Radiator Overflow Tanks.** Universal polished stainless steel radiator reservoir tanks feature a twist-on style aluminum cap and come complete with hardware and mounting brackets.

**Overflow tank with release valve**



**HZ-6084**

Part #	Size	Capacity	Dia.
<b>HZ-6071</b>	11"	16 oz	2"
<b>HZ-6073</b>	13"	20 oz	2"
<b>HZ-6075</b>	15"	24 oz	2"
<b>HZ-6077</b>	17"	28 oz	2"
<b>HZ-6079</b>	19"	32 oz	2"
<b>HZ-6081</b>	9"	23 oz	3"
<b>HZ-6082</b>	10"	26 oz	3"
<b>HZ-6083</b>	16"	44 oz	3"
<b>HZ-6084</b>	8"	20 oz	3"

## WATER NECKS

All water necks include bolts and O-ring (except HZ-9228-G)



SBC/BBC  
(Early Model) V8  
**HZ-9228-C**  
Chrome Steel  
**HZ-9228-PBK**  
Black EDP  
**HZ-9228-G**  
Chrome Steel with Gasket



SBC/BBC  
(Late Model) V8  
**HZ-9229-C**  
Chrome Steel  
**HZ-9229-PBK**  
Black EDP



3/8" NPT Port  
BBF 429-460  
**HZ-9415-C**  
Chrome Steel  
**HZ-9415-PBK**  
Black EDP



1/2" NPT Port  
SBC/BBC 283-454  
(Late Model) V8  
**HZ-9468-C**  
Chrome Steel  
**HZ-9468-PBK**  
Black EDP



90 Degree  
1979-up Ford  
5.0L Mustang  
**HZ-9713-C**  
Chrome Steel  
**HZ-9713-PBK**  
Black EDP



1965-75 SBF  
260-351W Mustang  
**HZ-9714-C**  
Chrome Steel  
**HZ-9714-PBK**  
Black EDP



SBC BBC  
Straight-Up  
Aluminum  
**HZ-6002-POL**  
Polished  
**HZ-6002-C**  
Chrome  
**HZ-6002-PBK**  
Black EDP



SBC BBC  
45 Degree Swivel  
Aluminum  
**HZ-6003-POL**  
Polished  
**HZ-6003-C**  
Chrome  
**HZ-6003-PBK**  
Black EDP



SBC BBC  
90 Degree Swivel  
Aluminum  
**HZ-6014-POL**  
Polished  
**HZ-6014-C**  
Chrome  
**HZ-6014-PBK**  
Black EDP



SBC BBC  
15 Degree Swivel  
Aluminum  
**HZ-6015-POL**  
Polished  
**HZ-6015-C**  
Chrome  
**HZ-6015-PBK**  
Black EDP



Ford Cleveland  
351 5.8L  
Aluminum  
**HZ-9715-POL**  
Polished  
**HZ-9715-PBK**  
Black EDP



NEW!  
LS Water Neck  
Aluminum  
**HZ-6145-POL**  
Polished  
**HZ-6145-C**  
Chrome  
**HZ-6145-PBK**  
Black EDP

## HIGH FLOW ALUMINUM WATER PUMPS



1955-78 Short (SWP)  
SBC Mechanical Water Pump  
**HZ-WP2901** Natural  
**HZ-WP2901-C** Chrome  
**HZ-WP2901-POL** Polished



1969-84 Long (LWP)  
SBC Mechanical Water Pump  
**HZ-WP2902** Natural  
**HZ-WP2902-C** Chrome  
**HZ-WP2902-POL** Polished



1965-78 Short (SWP)  
BBC Mechanical Water Pump  
**HZ-WP2904** Natural



SBC Reverse rotation Long  
water pump Has 5/8" pilot  
(LWP)  
**HZ-WP2903** Natural  
**HZ-WP2903-C** Chrome  
**HZ-WP2903-POL** Polished



1969-87 Long (LWP)  
BBC Mechanical Water Pump  
**HZ-WP2905** Natural



1970-87  
SBF Mechanical Water Pump  
**HZ-WP302HP** Natural



1986-93 Reverse  
SBF Mechanical Water Pump  
**HZ-WP302L** Natural  
**HZ-WP302L-POL** Polished



SBC Reverse rotation short  
water pump Has 3/4" pilot  
(SWP)  
**HZ-WP2900**  
**HZ-WP2900-C**  
**HZ-WP2900-POL**

## ALUMINUM TRANSMISSION COOLERS



**HZ-0050-1**  
**Dual Line**

Part #	Size	Fitting
<b>HZ-0050-1</b>	12"	1/4" NPT
<b>HZ-0051-1</b>	15"	1/4" NPT
<b>HZ-0052-1</b>	18"	1/4" NPT
<b>HZ-0053-1</b>	24"	1/4" NPT
<b>HZ-0054-1</b>	30"	1/4" NPT





## DISTRIBUTORS



**HZ-D6001**



**HZ-D7002**



**HZ-D6003**

Part #	Application	Description
<b>HZ-D6001</b>	Chevy/GM SB/BB	<b>HEI Distributor Features:</b> 1) Fully CNC machined. 2) Polished housing. 3) Adjustable vacuum advance canister. 4) Premium caps with brass terminals. 5) Low saturation ignition module. 6) High output 50K volt coil through 7,500 RPM. 7) 4340 Chromoly steel bottom gear. 8) True spark alignment.
<b>HZ-D6002</b>	Ford SB 289/302W	
<b>HZ-D6003</b>	Ford SB 351W	
<b>HZ-D6004</b>	Ford 351C/460	
<b>HZ-D6006</b>	Chrysler 318	
<b>HZ-D6007</b>	Chrysler 440	
<b>HZ-D6009</b>	Oldsmobile	
<b>HZ-D7001</b>	Chevy/GM SB/BB	
<b>HZ-D7002</b>	Ford 289/302W	
<b>HZ-D7003</b>	Ford 351W	<b>Ready-to-Run Distributor Features:</b> 1) Maintenance-free magnetic pickup. 2) Increased output internal ignition. 3) Oversized steel shaft w/ extra long sintered bushing. 4) Adjustable mechanical advance. 5) Vacuum advance canister.
<b>HZ-D7004</b>	Ford 351C/460	
<b>HZ-D7007</b>	Chrysler 440	



**Chevy/GM Billet Aluminum Distributor Hold-Down Clamps.**  
**HZ-1091-RED**  
**HZ-1091-BLUE**  
**HZ-1091-CHROME**

**Steel Clamp**  
 Ford V8  
 OEM Style  
**HZ-1092**

**Steel Clamp**  
 Chevy V8  
 Competition Style  
**HZ-1093**

**Steel Clamp**  
 Chevy V8  
 OEM Style  
**HZ-1094**

**Steel Clamp**  
 Ford FE  
 Competition Style  
**HZ-1095**

## IGNITION COILS

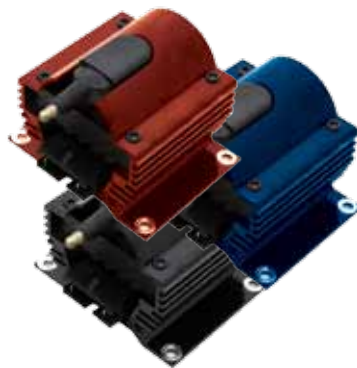

**Chevy/Ford/Mopar Ignition Super Coil.** This coil produces up to 70% more spark than your stock coils. This is perfect for street, strip, circle track and drag racing.  
**HZ-IC2041-RED**  
**HZ-IC2041-BLUE**  
**HZ-IC2041-BLACK**

**64-73 Ford Universal Steel Chrome Canister Coil Bracket, Universal fit**  
**HZ-9650**



**Chevy/GM Universal Steel Chrome Canister Coil Bracket, designed after factory GM mount.**  
**HZ-9366**



## TRANSMISSION KICKDOWN CABLE KITS



**Chevy/GM Turbo  
TH-350  
HZ-2003**



**Chevy/GM Turbo  
TH-350 (Tuned-Port)  
HZ-2004**



**Chrysler 727  
HZ-2005**



**Chevy/GM 4L60  
HZ-2006**



**Chevy/GM 700R4  
(Tuned-Port)  
HZ-2007**



**Chevy/GM 700R4  
HZ-2008**



**Chevy/GM Turbo  
TH-350 (56")  
HZ-6053**



**Ford C4  
HZ-2011**



**Ford C6  
HZ-2012**



**Chrysler 904  
HZ-2009**



**Tuned-Port - 24"  
HZ-2010**



**Universal - 24"  
HZ-6054**



**Universal - 36"  
HZ-6054X**

## THROTTLE RETURN SPRING KIT/BRACKETS



**Chrome Steel Carburetor Mounted  
Throttle Return Spring Kit. Fits  
Holley 2300/2305 2 barrel carburetors  
and 4150/4160 4 barrel carburetors.  
HZ-2083**



**Chevy/GM Small Block Chrome Steel  
Throttle Return Spring Bracket  
HZ-2291**

**Ford Small Block Chrome Steel  
Throttle Return Spring Bracket  
HZ-2297**

## CHROME HOLLEY FUEL LINES

**HZ-2197** Chrome 4BBL Holley Fuel Line 9-5/16"

**HZ-2198** Chrome 4BBL Holley Fuel Line 8-21/32"



## FUEL BLOCK OFF PLATES

**Fuel Pump Block Off Plates.** Designed to block off the fuel pump mounting on the cylinder block when a mechanical fuel pump is not used.



**HZ-2058-C  
Chrome Steel**



**HZ-6012-POL  
Polished Aluminum**

**HZ-6012-C  
Chrome Aluminum**

Chevy Big Block 396-402-427-454

Chrysler/Mopar Small Block 273-318-340-360

Chrysler/Mopar Big Block 361-383-400-440

Ford, Lincoln and Mercury Small & Big Block All engines except 351C-351M-400



**HZ-2057-C  
Chrome Steel**



**HZ-6013-POL  
Polished Aluminum**

**HZ-6013-C  
Chrome Aluminum**

Chevy Small Block

283-302-305-307-327-350-383-400



**HZ-2059-C  
Chrome Steel  
HZ-2059-PBK  
Black EDP**

Fuel Pump Mounting Plate

Chevy Small Block

283-302-305-307-327-350-383-400

## ALTERNATORS

\*Remanufactured in the U.S.A.

### Chevy/GM Alternator.



**HZ-3908-C** Chrome  
**HZ-3908-PBK** Black

Aluminum chevy alternator 120 amp cs 130 one wire



**HZ-3902** Natural  
**HZ-3902-C** Chrome  
**HZ-3902-PBK** Black

**Amp** 100  
**Type** Internal  
Has a 1 wire plug or can be used as a 3 wire set up V-Belt



### LS-1 Alternator

**HZ-3906** Natural  
**HZ-3906C** Chrome

**Amp** 120  
**Type** Internal  
1-Wire

### 1966-91 Ford/Mercury/Jeep Alternator.



**HZ-3904C** Chrome  
**Amp** 110  
**Type** External

\***HZ-3907-C** Chrome  
\***HZ-3907** Natural  
uses a 3 wire regulator

### 1985-93 Ford/Mercury Alternator.

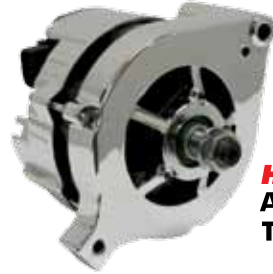

**HZ-3905C** Chrome  
**Amp** 75  
**Type** Internal

## MINI STARTERS

All HZ-S2107's have a clockable mounting base & will handle up to 11.1 compression ratio.



**HZ-S2104**



**HZ-S2107-C**



**HZ-S2107-PBK**



**HZ-S2107-RED**

Part #	Description	HP	Ratio	Finish
<b>HZ-S2104</b>	Chevy Small/Big Block Delco Style High Torque Staggered Bolt Pattern Starter	3	4.4:1	Standard
<b>HZ-S2107-C</b>	Chevy Small/Big Block Tilton Style High Torque Gear Reduction Starter	3	15:1	Chrome
<b>HZ-S2107-PBK</b>	Chevy Small/Big Block Tilton Style High Torque Gear Reduction Starter	3	15:1	Black
<b>HZ-S2107-RED</b>	Chevy Small/Big Block Tilton Style High Torque Gear Reduction Starter	3	15:1	Red

## MASTER CYLINDER COVERS



**HZ-9102**  
**HZ-9102-PBK**  
Dual Bail Cover  
Oval



**HZ-9100**  
**HZ-9100-PBK**  
Single Bail Cover  
Oval



**HZ-9101**  
**HZ-9101-PBK**  
Single Bail Cover  
Rectangle



## POWER STEERING PUMPS



**HZ-3911C** Chrome  
**HZ-3911-PBK** Black

**1955-72 Chevy/GM Chrome Power Steering Pumps.** They are the Saginaw style and use a key way type power steering pulley.



**HZ-3910C** Chrome  
**HZ-3910-PBK** Black

**Early Chevy/GM Chrome Power Steering Pumps.** They are the Saginaw style and use a key way type power steering pulley.



**HZ-3913** Natural  
**HZ-3913C** Chrome

**Type II Chevy/GM Power Steering Pump.** They use a press fit type power steering pulley.



**HZ-3915-PBK** Black  
Early Model Ford power Steering pump with plastic reservoir.



**HZ-3916-PBK** Black  
Late Model Ford power Steering pump with plastic reservoir.



**HZ-3914** Natural  
**Type II Chevy/GM Power Steering Pump.** With black plastic reservoir they use a press fit type power steering pulley.

## POWER STEERING OVERFLOW TANKS



1 Fitting  
**HZ-6080A**



2 Fittings  
**HZ-6080A-1**



3 Fittings  
**HZ-6080A-2**

**Universal Power Steering Overflow/Recovery Tanks.** Lightweight polished aluminum reservoir tanks are 6" tall and come with a polished billet aluminum cap and integrated bracket.

## POWER STEERING CAP COVER



**HZ-9257**  
Chrome Plastic Power Steering Cap Cover. Snaps over existing OEM Saginaw cap.

## 13-1/2" CHROME ALUMINUM STEERING WHEELS

13-1/2" 14" Chrome Billet Aluminum Steering Wheels. Universal chrome plated billet aluminum steering wheels feature a black leather half wrap over the front and billet chrome finger notches on the back. Mounting pattern: 9 hole.



**HZ-5506**



**HZ-5507**



**HZ-5508**



**HZ-5511**



**HZ-5512**



**HZ-5515**



**HZ-5516**



**HZ-5520**



**HZ-5520-9**

## STEERING WHEEL HORN BUTTONS & ADAPTORS

1967-94 Chevy/GM Chrome Plated Billet Aluminum Steering Wheel Horn Buttons & Adapters. Fits 1967-94 Chevy/GM splined steering columns. Available in 9 hole bolt pattern.



**9 Hole**  
ID: 3-1/4" OD: 3-1/2"  
**HZ-5500-1 - Smooth**



**9 Hole**  
ID: 3-1/4" OD: 4-5/8"  
**HZ-5500 - Smooth**



**9 Hole**  
ID: 3-1/4" OD: 4-5/8"  
**HZ-5500-W - Wood**  
**HZ-5500-H - Carbon Hydrographic**

**HZ-5530-PBK**  
Black Leather

**HZ-5530-W**  
Wood Hydrographic



**HZ-5530-C**  
Chrome plastic

**HZ-5530-H**  
Carbon Hydrographic  
Steering Wheel Half Wrap



**9 Hole**  
ID: 3-1/4" OD: 4-3/8"  
**HZ-5502 - Smooth**



**9 Hole**  
ID: 3-1/4" OD: 4-3/8"  
**HZ-5502-W - Wood**  
**HZ-5502-H - Carbon Hydrographic**

## BILLET ALUMINUM REAR VIEW MIRRORS

Rear view mirrors are universal style and windshield mount.

Part #	Size	Style	Finish
<b>HZ-1005</b>	9-3/8" x 2-5/16" x 3/8"	Flamed	Polished
<b>HZ-1005-C</b>	9-3/8" x 2-5/16" x 3/8"	Flamed	Chrome
<b>HZ-8625</b>	9-3/8" x 2-5/16" x 3/8"	Ball Milled	Polished
<b>HZ-8625-C</b>	9-3/8" x 2-5/16" x 3/8"	Ball Milled	Chrome
<b>HZ-5535</b>	11-1/4" x 2-5/8" x 1/4"	Smooth	Polished
<b>HZ-5535-C</b>	11-1/4" x 2-5/8" x 1/4"	Smooth	Chrome
<b>HZ-5535-1</b>	11-1/4" x 2-5/8" x 1/4"	Ball Milled	Polished
<b>HZ-5535C-1</b>	11-1/4" x 2-5/8" x 1/4"	Ball Milled	Chrome
<b>HZ-5535-2</b>	11-1/4" x 2-5/8" x 1/4"	Flamed	Polished
<b>HZ-5535C-2</b>	11-1/4" x 2-5/8" x 1/4"	Flamed	Chrome
<b>HZ-5536</b>	11" x 3" x 1/4"	Poker Suits	Polished
<b>HZ-5536-C</b>	11" x 3" x 1/4"	Poker Suits	Chrome
<b>HZ-5544</b>	5-7/8" x 4-1/2" x 3/8"	Poker Spade	Polished
<b>HZ-5544-C</b>	5-7/8" x 4-1/2" x 3/8"	Poker Spade	Chrome



**HZ-5535-C**



**HZ-8625**



**HZ-5535C-1**



**HZ-1005-C**



**HZ-5535-2**



**HZ-5544-C**



**HZ-5536-C**



## STEEL RADIATOR SUPPORT PANELS

All radiator support bars and radiator support panels come with mounting bolts.



1970-81 Chevy Camaro  
**Standard:** **HZ-9425-C** Chrome  
 (23-7/8" x 5-1/4") **HZ-9425-PBK** Black EDP



1968-73 Chevy Chevelle, 1968-79 Chevy Nova  
**Standard:** **HZ-9427-C** Chrome  
 (24" x 5-1/4") **HZ-9427-PBK** Black EDP



1970-81 Chevy Camaro  
**Heavy-Duty:** **HZ-9426-C** Chrome  
 (28-11/16" x 5-1/2") **HZ-9426-PBK** Black EDP



1968-77 Chevy Chevelle  
**Heavy-Duty:** **HZ-9428-C** Chrome  
 (31-1/8" x 5-3/4") **HZ-9428-PBK** Black EDP

## STEEL RADIATOR SUPPORT BARS



1967-69 Chevy Camaro/Pontiac Firebird  
**HZ-9175-C** Chrome  
**HZ-9175-PBK** Black EDP



1970-81 Chevy Camaro  
**HZ-9176-C** Chrome  
**HZ-9176-PBK** Black EDP

## MUSTANG HOOD STRUTS



**HZ-4000-C**  
 Hood strut lift kit 2005-13 Mustang



**HZ-4000-PBK**



**HZ-4001-PBK**  
 Hood strut lift kit 1994-2004 Mustang



**HZ-4002-PBK**  
 Hood strut lift kit 1979-1993 Mustang



## ALUMINUM HOOD LATCHES

Billet Aluminum upper hood latch 1967-81 Chevy Camaro



**HZ-7530-C**



**HZ-7530-PBK**



**HZ-7530-POL**

BODY PARTS

## HOOD PINS

**HZ-4051-C**

**HZ-4051-GOLD**

**HZ-4051-SILVER**

**Aluminum Hood Pin Kit** (flip over style).  
**Kit Includes:**  
 2 - 1/2" x 4" Chrome Steel Pins.  
 2 - 2-1/4" Steel Scuff Plates.  
 2 - 1/4" Flip Over Rings.  
 4 - 3/8" Jam Nuts.

**HZ-4051-BLUE**

**HZ-4051-BLACK**

**HZ-4051-RED**

**HZ-4049-C-KIT**

**Chrome Steel Hood Pin Kit** (flip over style)  
**Kit Includes:**  
 2 - 1/2" x 4" Chrome Steel Pins.  
 2 - 2-1/2" Steel Scuff Plates.  
 2 - 3/16" Flip Over Rings.  
 4 - 1/2" Jam Nuts.  
 2 - Lanyards

**HZ-4050-C-KIT**

**Chrome Steel Hood Pin Kit** (flip over style)  
**Kit Includes:**  
 2 - 1/2" x 4" Chrome Steel Pins.  
 2 - 2-1/2" Steel Scuff Plates.  
 2 - 1/4" Flip Over Rings.  
 4 - 1/2" Jam Nuts.

**HZ-160**  
**Hood Boss**  
 1/2"-20 x 7/8" Tall  
 Raw Steel

**HZ-4053**  
**Scuff Plate**  
 2-1/2" Outer Dimension  
 1/2" Inner Dimension  
 Stainless Steel

**HZ-4055**  
**Flip Over Pin**  
 1/4" Pin  
 Chrome Steel

## RAMS HORN SMALL BLOCK CHEVY MANIFOLDS



Fits most small block Chevy applications and provides optimal clearance for angle plug heads. Complete with mounting hardware and gaskets. Offers a distinctive vintage performance look with the durability of iron.

**HZ-9995-C**  
Chrome

**HZ-9995-CER-SIL**  
Ceramic Silver

**HZ-9995-CER-PBK**  
Ceramic Black

**HZ-9995-R**  
Raw

## CHEVY SMALL BLOCK - HUGGER STYLE HEADERS



**1955-UP Chevy Small Block "Hugger" Style Headers.** These 1-5/8" heavy-duty "Hugger" style headers have a 3/8" thick flange and fit 1955-UP Chevy small block 265-283-305-307-327-350-383-400 engines. Comes with collector reducers, bolts & gaskets. **NOTE: Will not work with angled spark plugs, or clear center motor mount.**

**HZ-9994-S**  
Stainless Steel

**HZ-9994-PBK**  
Black

**HZ-9994-CER**  
Ceramic

## CAMARO/CHEVELLE/NOVA/EL CAMINO - HEADERS

**Compatible Models:** 1967-81 Camaro (will not fit Z28 or 1967-69 Camaro w/ A/C). 1968-77 Chevelle. 1964-87 El Camino. 1964-83 Malibu. 1970-87 Monte Carlo. 1968-79 Chevy II/Nova.



**Chevy Small Block "Shorty" Style Headers.** These "Shorty" style headers have 1-5/8" tubing, a 3/8" flange, and a big 3" collector end. Includes studs, nuts & flange gaskets. **NOTE: Driver side is 25" total length, Passenger side is 26" total length. Will not fit Saginaw close ratio 825 power steering box.**

**HZ-9998-S**  
Stainless Steel

**HZ-9998-PBK**  
Black

**HZ-9998-CER**  
Ceramic

Will not work with angled spark plugs.

## CHEVY BIG BLOCK FULL LENGTH HEADERS



**Compatible Models:** 1967-69 Camaros, 1968-74 Novas, and 1968-72 Chevelles

**Chevy Big Block Headers.** Headers feature a 3/8" thick flange w/ oval ports, 1-5/8" primary tube, and 3" collectors.

**HZ-9992-S**  
Stainless Steel

**HZ-9992-PBK**  
Black

**HZ-9992-CER**  
Ceramic

\* All headers are not 50 state legal & can not be used on emission controlled vehicles.



## TRI-5 HEADERS



**Chevy Small Block Headers.**  
Tri-5 tight fit block hugger headers fits 1955-57 w/ 1.75" tubes and 2.5" collectors and 3/8" flange.

**HZ-9993-S**  
Stainless Steel

**HZ-9993-PBK**  
Black

**HZ-9993-CER**  
Ceramic

## CHEVY/GMC TRUCK HEADERS



**Chevy Small Block Headers.**  
fits 1966-72 GM truck long tube headers w/ 1.75" tubes and 2.5" collectors and 3/8" flange.

**HZ-5019-S**  
Stainless Steel

**HZ-5019-PBK**  
Black

**HZ-5019-CER**  
Ceramic

## CHEVY/GMC TRUCK HEADERS



**1988-95 Chevy Small Block Truck Headers.** Specially designed for Chevy/GMC pickup trucks. Medium length will fit both 2WD & 4WD trucks with 305/5.0L or 350/5.7L engines. Comes with bolt-on reducers, exhaust gaskets, collector gaskets & bolts. Heavy-duty 1-5/8" tube diameter, 3" collectors and 3/8" thick flange. Also features an O2 oxygen sensor bung.

**HZ-5018-S**  
Stainless Steel

**HZ-5018-PBK**  
Black

**HZ-5018-CER**  
Ceramic

## FORD 5.0 MUSTANG - SHORTY STYLE HEADERS

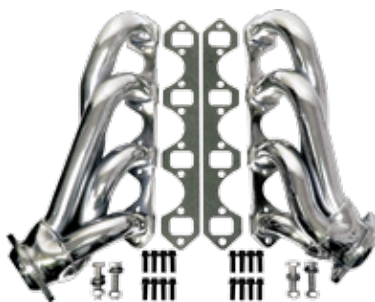

**1986-93 Ford Mustang 5.0L "Shorty" Style Headers.** These 1-5/8" steel "Shorty" style headers fit 1986-93 Ford Mustangs with (302) 5.0L engines. Includes bolts & gaskets.

**HZ-5001-S**  
Stainless Steel

**HZ-5001-PBK**  
Black

**HZ-5001-CER**  
Ceramic

\*All headers are not 50 state legal & can not be used on emission controlled vehicles.

## **NEW!** FORD HEADERS



**Ford Small Block Headers.**  
Fits 1963-77 260-302 5.0  
mustang/cougar/falcon, tube headers  
w/ 1-5/8" tubes and 3" collectors.

T304 Stainless Steel

**HZ-5003-S**  
Stainless Steel

## **NEW!** FORD TRI-Y HEADERS

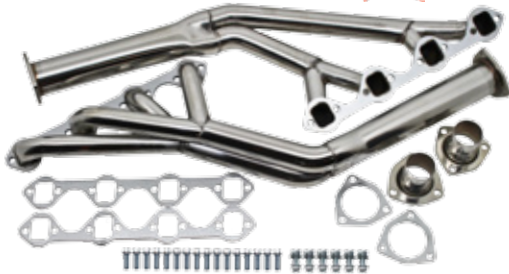

**Ford Tri-Y Headers.**  
Fits 1964-70 260-289-302  
mustang, tube headers w/ 1-1/2"  
tubes and 2.5" collectors.  
Will not fit GT-40p Heads or AOD  
Transmission.

T304 Stainless Steel

**HZ-5004-S**  
Stainless Steel

## **NEW!** OLDSMOBILE HEADERS



**Oldsmobile Headers.**  
Fits 1965-74 350-455  
442/cutlass/Delta 88/ Vista cruiser,  
tube headers w/ 1-1/2" tubes and  
2.5" collectors.

T304 Stainless Steel

**HZ-5012-S**  
Stainless Steel

## **NEW!** MOPAR HEADERS



**Mopar Headers.**  
Fits 1959-78 383-440 mopar/plymouth,  
tube headers w/ 1-1/2" tubes and 2.5"  
collectors.

T304 Stainless Steel

**HZ-5013-S**  
Stainless Steel

## CHEVY/GM CAR



**HZ-5078-POL**



**HZ-5082-POL**



**HZ-4787-C**



**HZ-4135-C**



**HZ-9538-C**



**HZ-9190-C**



**HZ-4786-C  
HZ-4786-PBK**



**HZ-9583-C  
HZ-9583-PBK**



**HZ-9072-C  
HZ-9072-PBK**



**HZ-9584-C  
HZ-9584-PBK**

Part #		Description	Ring Gear	Bolts
Steel	Aluminum			
<b>*HZ-4135-C</b>	<b>*HZ-5078-POL</b>	1984-87 Buick Grand National - Rear	8.5"	10
<b>*HZ-4135-C</b>	<b>*HZ-5078-POL</b>	1982-92 Chevy Camaro Z28 & IROC - Rear	8.5"	10
<b>*HZ-4135-C</b>	<b>*HZ-5078-POL</b>	1993-02 Chevy Camaro V8 (Will Not Fit Heavy-Duty) - Rear	8.5"	10
<b>HZ-9190-C</b>		1973-77 Chevy Camaro - Rear	7.5"	10
<b>*HZ-4135-C</b>	<b>*HZ-5078-POL</b>	1973-77 Chevy Camaro - Rear	8.5"	10
<b>HZ-4787,*HZ-9584</b>	<b>*HZ-5082-POL</b>	1964-72 Chevy Camaro - Rear	8.875"	12
<b>HZ-4786,*HZ-9583 HZ-4786-PBK</b>		1967-72 Chevy Camaro B, C, G, & K Axles - Rear	8.2"	10
<b>HZ-9072-C</b>		1982-UP Chevy Camaro & Pontiac Firebird - Rear	8.5"/8.6"	10
<b>HZ-9072-C</b>		1993-02 Chevy Camaro V6 & Pontiac Firebird V6 - Rear	8.5"/8.6"	10
<b>HZ-4787,*HZ-9584</b>	<b>*HZ-5082-POL</b>	1964-72 Chevy Chevelle - Rear	8.875"	12
<b>HZ-4787,*HZ-9584</b>	<b>*HZ-5082-POL</b>	El Camino 1964-1972	8.875"	12
<b>*HZ-4135-C</b>	<b>*HZ-5078-POL</b>	1982-92 Pontiac Firebird & Trans-Am - Rear	8.5"	10
<b>HZ-9072-C</b>		1994-96 Chevy Impala - Rear	8.5"/8.6"	10
<b>*HZ-4135-C</b>	<b>*HZ-5078-POL</b>	1964-72 Chevy/GM Intermediates - Rear	8.5"	10
<b>HZ-9190-C</b>		1964-72 Chevy/GM Intermediates - Rear	8.2"	10
<b>HZ-9538-C</b>		1964-72 Chevy/GM Intermediates - Rear	8.5"	10
<b>HZ-4787,*HZ-9584</b>	<b>*HZ-5082-POL</b>	1964-72 Chevy/GM Intermediates - Rear	8.875"	12
<b>HZ-4786,*HZ-9583 HZ-4786-PBK</b>		1964-72 Chevy/GM Intermediates B, C, G & K Axles - Rear	8.2"	10
<b>HZ-9072-C</b>		1978-UP Chevy/GM Intermediates - Rear	8.5"/8.6"	10
<b>HZ-4787,*HZ-9584</b>	<b>*HZ-5082-POL</b>	1965-67 Chevy Nova - Rear	8.875"	12

Differential cover includes drain plug.



## CHEVY/GM TRUCK & SUV



**HZ-4135-C**



**HZ-4876-C  
HZ-4876-PBK**



**HZ-4815-C  
HZ-4815-PBK**



**HZ-9069-C**



**HZ-9070-C**



**HZ-9071-C  
HZ-9071-PBK**



**HZ-9072-C  
HZ-9072-PBK**



**HZ-9583-C  
HZ-9583-PBK**



**HZ-9292-C  
HZ-9292-PBK**



**HZ-5072-POL**



**HZ-5073-POL**



**HZ-5075-POL**



**HZ-5078-POL**

Part #		Description	Ring Gear	Bolts
Steel	Aluminum			
<b>HZ-9070-C</b>	<b>*HZ-5073-POL</b>	1962-82 Chevy/GMC 1/2 Ton Only 2WD/4WD - Rear	8.75"	12
<b>HZ-4786,*HZ-9583</b>		1983-87 Chevy/GMC 1/2 Ton Only 2WD/4WD - Rear	8.2"	10
<b>*HZ-4135-C</b>	<b>*HZ-5078-POL</b>	1988-06 Chevy/GMC 1/2 Ton 1500 Silverado, Sierra 2WD/4WD - Rear	8.5"	10
<b>*HZ-9069-C</b>	<b>HZ-5077-POL</b>	1978-88 Chevy/GMC 1/2 & 3/4 Ton - Front	8.5"	10
<b>*HZ-4815-C HZ-4815-PBK</b>	<b>*HZ-5072-POL</b>	1967-77 Chevy/GMC 1/2 & 3/4 Ton 4WD - Front	Dana 44	10
<b>*HZ-4815 HZ-4815-PBK</b>	<b>*HZ-5072-POL</b>	1988-03 Chevy/GMC 3/4 & 1 Ton 2WD/4WD - Rear	Dana 44	10
<b>HZ-9071-C</b>	<b>HZ-5075-POL</b>	1973-01 Chevy/GMC 3/4 & 1 Ton Truck & SUV - Rear	10.5"	14
<b>HZ-9292-C</b>		1981-87 Chevy/GMC 3/4 & 1 Ton Truck 2WD - Rear	9.5"	14
<b>HZ-9071-C</b>	<b>HZ-5075-POL</b>	1973-00 Chevy/GMC 3/4 & 1 Ton Silverado, Sierra Truck & SUV 2WD/4WD - Rear	10.5"	14
<b>HZ-9072-C</b>		1985-98 Chevy/GMC Astro Van, Safari Van - Rear	7.5"/7.625"	10
<b>*HZ-4135-C</b>	<b>*HZ-5078-POL</b>	1988-92 Chevy/GMC Blazer, Jimmy Full-Size 2WD/4WD - Rear	8.5"	10
<b>HZ-9071-C</b>	<b>HZ-5075-POL</b>	2003-UP Hummer H2 6.0L - Rear	10.5"	14
<b>HZ-9072-C</b>		1982-04 Chevy/GMC S10, S15, Envoy, Olds Bravada - Rear	7.5"/7.625"	10
<b>HZ-9071-C</b>	<b>HZ-5075-POL</b>	2001-07 Chevy/GMC Silverado, Sierra 2500 HD 6.0L - Rear	10.5"	14
<b>HZ-9071-C</b>	<b>HZ-5075-POL</b>	1973-99 Chevy Suburban 3/4 Ton 2WD/4WD - Rear	10.5"	14
<b>*HZ-9069-C</b>	<b>HZ-5077-POL</b>	1977-91 Chevy Suburban 4WD - Front	8.5"	10
<b>*HZ-4135-C</b>	<b>*HZ-5078-POL</b>	1988-99 Chevy Suburban 2WD/4WD - Rear	8.5"	10
<b>*HZ-4135-C</b>	<b>*HZ-5078-POL</b>	1994-99 Chevy/GMC Tahoe, Yukon 2WD/4WD - Rear	8.5"	10
<b>HZ-9292-C HZ-9292-PBK</b>		1981-UP Chevy/GMC Truck - Rear	9.5"	14
	<b>HZ-5080-POL</b>	1995-up 3500 Dana 80 - Rear	13"	10

\*Differential cover includes drain plug.

DIFFERENTIAL COVERS

## MOPAR CAR & TRUCK



**HZ-9589-C**  
**HZ-9589-PBK**



**HZ-4816-C**  
**HZ-4816-PBK**



**HZ-9238-C**



**HZ-4815-C**  
**HZ-4815-PBK**



**HZ-4817-C**  
**HZ-4817-PBK**



**HZ-5072-POL**



**HZ-5076-POL**



**HZ-9589-C**  
**HZ-9589-PBK**

Part #		Description	Ring Gear	Bolts
Steel	Aluminum			
*HZ-9589-C		1961-89 Chrysler - Rear	8.25"	10
*HZ-9238-C		1999-03 Dodge Durango, Dakota 4WD Dana 25-27-30 - Front	Dana 30	10
*HZ-4817-C		1994-UP Dodge Durango, Dakota V8 2WD/4WD - Rear	9.25"	12
*HZ-4817-C		1974-93 Dodge Ram W100-150-200 Pickup - Rear	9.25"	12
*HZ-4817-C		1974-08 Dodge Ram 1500 1/2 Ton - Rear	9.25"	12
*HZ-4816-C	*HZ-5074/ HZ-5076	1972-99 Dodge Ram Pickup - Front	Dana 60	10
*HZ-4816-C	*HZ-5074/ HZ-5076	1972-03 Dodge Ram Pickup - Rear	Dana 60	12
*HZ-4815-C	*HZ-5072-POL	1972-06 Dodge Ram Pickup 4WD - Front	Dana 44	10
*HZ-4817-C		1974-UP Dodge Van - Rear	9.25"	12

Differential cover includes drain plug.

## FORD CAR - STEEL



**HZ-9293-C**



**HZ-9465-C**  
**HZ-9465-PBK**

Part #	Description	Ring Gear	Bolts
Steel			
<b>HZ-9293-C</b>	1979-94 Mercury Capri - Rear	7.5"	10
<b>HZ-9465-C</b>	1986-94 Mercury Capri - Rear	8.8"	10
<b>HZ-9293-C</b>	1978-82 Ford Fairmont - Rear	7.5"	10
<b>HZ-9293-C</b>	1979-03 Ford Mustang V8 - Rear	7.5"	10
<b>HZ-9293-C</b>	1979-00 Ford Mustang V6 and 4 Cylinder - Rear	7.5"	10
<b>HZ-9465-C</b>	1986-03 Ford Mustang V8 - Rear (will not fit Cobras)	8.8"	10

## FORD TRUCK & SUV



**HZ-9466-C**  
**HZ-9466-PBK**



**HZ-4815-C**  
**HZ-4815-PBK**



**HZ-9465-C**  
**HZ-9465-PBK**



**HZ-9467-C**



**HZ-4816-C**  
**HZ-4816-PBK**



**HZ-9238-C**



**HZ-5072-POL**



**HZ-5074-POL**



**HZ-5079-POL**



**HZ-9293-C**

Part #		Description	Ring Gear	Bolts
Steel	Aluminum			
<b>HZ-9293-C</b>		1984-98 Ford Aerostar Van - Rear	7.5"	10
<b>HZ-9465-C</b>		1990-97 Ford Aerostar Van V6 4.0L - Rear	8.8"	10
<b>HZ-9293-C</b>		1982-92 Ford Bronco II - Rear	7.5"	10
<b>HZ-9465-C</b>		1983-96 Ford Bronco 2WD/4WD - Rear	8.8"	10
<b>*HZ-4816-C</b>	<b>*HZ-5074/ HZ-5076</b>	1966-85 Ford Bronco 2WD/4WD - Rear	Dana 60	10
<b>*HZ-4815-C</b>	<b>*HZ-5072-POL</b>	1966-79 Ford Bronco 4WD - Front	Dana 44	10
<b>*HZ-9238-C</b>		1966-70 Ford Bronco - Front	Dana 30	10
<b>HZ-9466-C</b>	<b>HZ-5079-POL</b>	1986-06 Ford E-250, E-350 2WD/4WD - Rear	Sterling w/ 10.25"/10.50"	12
<b>HZ-9465-C</b>		1983-98 Ford E-150 Full-Size Van - Rear	8.8"	10
<b>HZ-9465-C</b>		1991-03 Ford Explorer 2WD/4WD - Rear	8.8"	10
<b>*HZ-4816-C</b>	<b>*HZ-5074/ HZ-5076</b>	199-UP Ford Excursion Super-Duty - Front	Dana 60	10
<b>HZ-9466-C</b>	<b>HZ-5079-POL</b>	2000-05 Ford Excursion 2WD/4WD - Rear	Sterling w/ 10.25"/10.50"	12
<b>HZ-9467-C</b>		1999-04 Ford Expedition 2WD/4WD - Rear	9.75"	12
<b>HZ-9465-C</b>		1986-03 Ford F-150 2WD/4WD - Rear	8.8"	10
<b>HZ-9466-C</b>	<b>HZ-5079-POL</b>	1986-UP Ford F-250, F-350 2WD/4WD - Rear	Sterling w/ 10.25"/10.50"	12
<b>*HZ-4815-C</b>	<b>*HZ-5072-POL</b>	1966-79 Ford F-100, F-150, F-250, F-350 4WD - Front	Dana 44	10
<b>*HZ-4816-C</b>	<b>*HZ-5074/ HZ-5076</b>	1966-85 Ford F-100, F-150, F-250, F-350 2WD/4WD - Rear	Dana 60	10
<b>*HZ-4816-C</b>	<b>*HZ-5074/ HZ-5076</b>	1999-UP Ford F-250, F-350 Super-Duty - Front	Dana 60	10
<b>*HZ-4816-C</b>	<b>*HZ-5074/ HZ-5076</b>	1972-97 Ford F-350 - Front	Dana 60	10
<b>HZ-9465-C</b>		1991-03 Mercury Mountaineer 2WD/4WD - Rear	8.8"	10
<b>HZ-9293-C</b>		1982-03 Ford Ranger - Rear	7.5"	10
	<b>HZ-5080-POL</b>	1995-up f350-450-550 2WD/4WD Dana 80 - Rear	13"	10

\*Differential cover includes drain plug.

DIFFERENTIAL COVERS



## JEEP TRUCK & SUV



**HZ-9711-C**  
**HZ-9711-PBK**



**HZ-9119-C**  
**HZ-9119-PBK**



**HZ-4815-C**  
**HZ-4815-PBK**

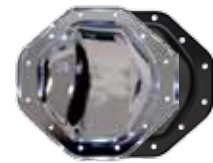

**HZ-4817-C**  
**HZ-4817-PBK**



**HZ-9238-POL**



**HZ-5072-POL**



**HZ-5081-POL**

Part #		Description	Ring Gear	Bolts
Steel	Aluminum			
* <b>HZ-4815 - C</b>	* <b>HZ-5072 - POL</b>	1974-86 Jeep Cherokee - Front	Dana 44	10
<b>HZ-9119 - C</b>	* <b>HZ-5081 - POL</b>	1981-84 Jeep Cherokee - Rear	Spicer 20 Corp.	12
* <b>HZ-4817 - C</b>		1994-99 Jeep Cherokee 4.0L - Rear	9.25"	10
* <b>HZ-9238 - C</b>		1941-03 Jeep CJ Series - Front	Dana 30	10
* <b>HZ-4815 - C</b>	* <b>HZ-5072 - POL</b>	1941-80 Jeep CJ Series - Rear	Dana 44	10
<b>HZ-9119 - C</b>	* <b>HZ-5081 - POL</b>	1976-85 Jeep CJ, Jeep CJ-5 - Rear	Spicer 20 Corp.	12
* <b>HZ-4817 - C</b>		1994-99 Jeep Grand Cherokee 4.0L - Rear	9.25"	10
* <b>HZ-9238 - C</b>		1960-74 IH Scout - Front	Dana 25-27-30	10
* <b>HZ-9238 - C</b>		1960-67 IH Scout - Rear	Dana 30	10
* <b>HZ-4815 - C</b>	* <b>HZ-5072 - POL</b>	1975-80 IH Scout - Front	Dana 44	10
* <b>HZ-4815 - C</b>	* <b>HZ-5072 - POL</b>	1967-80 IH Scout - Rear	Dana 44	10
* <b>HZ-4815 - C</b>	* <b>HZ-5072 - POL</b>	1974-86 Jeep J Series Trucks - Front	Dana 44	10
* <b>HZ-4815 - C</b>	* <b>HZ-5072 - POL</b>	1974-80 Jeep J Series Trucks - Rear	Dana 44	10
<b>HZ-9119 - C</b>	* <b>HZ-5081 - POL</b>	1981-84 Jeep J Series Trucks - Rear	Spicer 20 Corp.	12
* <b>HZ-4815 - C</b>	* <b>HZ-5072 - POL</b>	1974-86 Jeep Wagoneer - Front	Dana 44	10
<b>HZ-9119 - C</b>	* <b>HZ-5081 - POL</b>	1981-84 Jeep Wagoneer - Rear	Spicer 20 Corp.	12
<b>HZ-4817 - C</b>		1992-99 Jeep Wrangler 4.0L V6 - Rear	9.25"	10
* <b>HZ-9711 - C</b>		1986-90 Jeep XJ Midsize - Rear	Dana 35	10
* <b>HZ-9711 - C</b>		1986-90 Jeep YJ Wrangler Series - Rear	Dana 35	10

\*Differential cover includes drain plug.

## IMPORT TRUCK - CHROME STEEL



**HZ-9072-C**  
**HZ-9072-PBK**



**HZ-9293-C**



**HZ-9465-C**  
**HZ-9465-PBK**

Part #	Description	Bolts
<b>HZ-9072 - C</b>	1998-03 Isuzu - Rear	10
<b>HZ-9293 - C</b>	1994-03 Mazda 2300 - Rear	10
<b>HZ-9465 - C</b>	1994-03 Mazda 4000 - Rear	10

**DIFFERENTIAL COVER GASKETS**

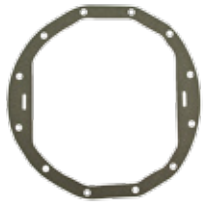

**HZ-7500**  
GM  
12 Bolt - Gray

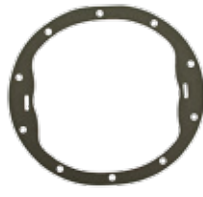

**HZ-7501**  
Gm 8.5 In R.G.  
10 Bolt - Gray



**HZ-7502**  
GM Truck  
12 Bolt - Gray

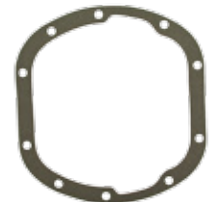

**HZ-7503**  
Dana 30  
10 Bolt - Gray

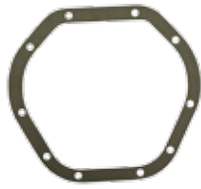

**HZ-7504**  
Dana 44  
Bolt - Gray

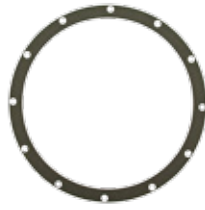

**HZ-7505**  
Jeep Corporate  
12 Bolt - Gray

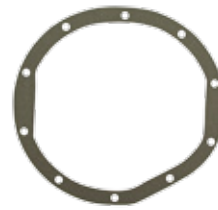

**HZ-7506**  
GM Truck 1/2 -3/4  
Ton Front Axle  
10 Bolt - Gray

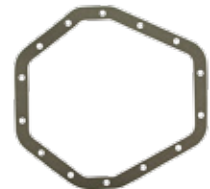

**HZ-7507**  
GM Truck  
14 Bolt - Gray

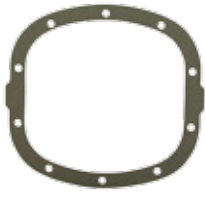

**HZ-7508**  
GM Car 7.5" R.G.  
10 Bolt - Gray



**HZ-7509**  
Dana 35  
10 Bolt - Gray



**HZ-7510**  
Dana 60/70  
10 Bolt - Gray

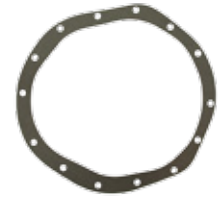

**HZ-7511**  
GM Truck 9.5" R.G.  
1/2-3/4 ton  
14 Bolt - Gray

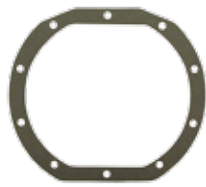

**HZ-7512**  
Ford 7.5" R.G.  
Bolt - Gray

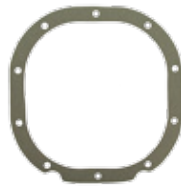

**HZ-7513**  
Ford Truck  
8.8" R.G.  
10 Bolt - Gray

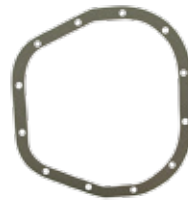

**HZ-7514**  
Ford Truck  
12 Bolt- Gray

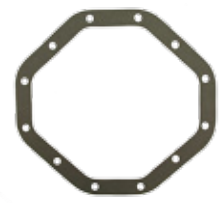

**HZ-7516**  
Chrysler 9.25" R.G.  
12 Bolt - Gray

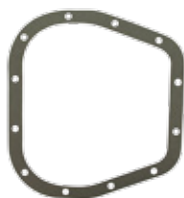

**HZ-7517**  
Ford 9.75" R.G.  
12 Bolt - Gray



**HZ-7518**  
Dana 80  
10 Bolt - Gray

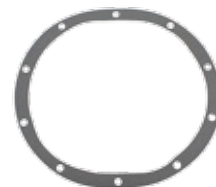

**HZ-7519**  
Mopar 8.25" R.G.  
10 Bolt - Gray

DIFFERENTIAL COVER GASKETS

Air Cleaners	8-12	Oil Pump Pickups	47
Air Cleaner Wing Nut	10	Pedals	81
Air Conditioning	71	Power Steering Bracket Kits	7
Air Conditioning Brackets	63	Power Steering Pulleys	55-56
Alternators	77	Power Steering Pump	78
Alternator Brackets	59-61	Power Steering Tanks	78
Battery Trays	82	Pulleys	51-58
Block Off Plates	12	Pulley Kits/Sets	51-58
Bolt Kits		Pulley Noses	57
Pulleys	55	Radiators	64-70
Oil Pan	46	Radiator Caps	70
Valve Covers	25	Radiator Hose Kits	72
Brackets	59-63	Radiator Mounting Kits	71
Breathers	23-24	Radiator Overflow Tanks	72
Column Dress Up Kit	81	Radiator Support Bars	83
Column Shifter	81	Radiator Support Panels	83
Cooling Fans	70	Scoops	10
Differential Covers	88-91	Smog Tube Fitting	10
Dipsticks	49-50	Starters	77
Distributors	75	Steering Wheels	79
Door & Window Handles	81	Steering Wheel Adaptors	80
Engine Dress Up Kits	27-28	Steering Wheel Horn Buttons	80
Fan Shrouds	68-71	Throttle Cable Kits	76
Flywheel Covers	48	Throttle Return Spring Kit	76
Fuel Line	76	Timing Covers	29-30
Grommets	24	Timing Tabs	30
Heater Hose Kit	72	Transmission Cable Kits	76
Hood Latches	83	Transmission Coolers	74
Hood Pins	84	Transmission Pans	48
Headers	85-87	Transmission Pan Bolts	48
Ignition Coil	75	Transmission Pan Gaskets	48
Louvered Style Air Cleaner	3	T-Bar Wing Nuts	25
Master Cylinder Covers	77	Valve Covers	13-26
Mirrors	80	Valve Cover Gaskets	22
Oil Caps	24	Valve Cover Hold-Down Tabs	25
Oil Filters	49	Valve Cover T-Bar Wing Nuts	25
Oil Filters Covers	49	Water Necks	73
Oil Pans	31-46	Water Pumps	73
Oil Pan Gaskets	47	Wire Loom Bracket Kit	26
Oil Pan Rails	46	Wire Loom Sets	26
Oil Plugs	24		