



PERFORMANCE
VEHICLES / PARTS / RACING

2018 CATALOG

ENTRY-LEVEL LS RETURNS!

IRON L96 6.0L ENGINE COMPLETES THE MENU



MODERN MUSCLE FOR YOUR VINTAGE HOT ROD

- LS/LT ENGINE SWAPS MADE EASIER!
- EXPANDED CONNECT & CRUISE SYSTEMS!
- NEW PERFORMANCE PARTS FOR LATE MODEL VEHICLES!



PAGE 210

NEW! L96 6.0L BRINGS THE TORQUE



PAGE 22

NEW! CAMARO SUSPENSION UPGRADE

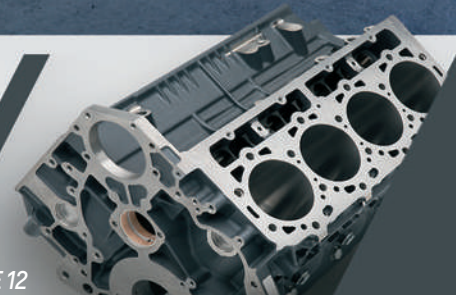

PAGE 12

NEW! DIESEL-POWERED LOW-END MUSCLE



PERFORMANCE
VEHICLES / PARTS / RACING

CHEVROLET PERFORMANCE PARTS COMPLIANCE WITH EMISSIONS STANDARDS

Motor vehicle emissions standards are intended to help achieve and maintain air quality goals that benefit human health and the environment. U.S. federal and state, and Canadian law prohibits knowingly removing, modifying, or making inoperative, or causing someone to remove or render inoperative, or otherwise tampering with, any part or element of design installed in compliance with motor vehicle emission standards on a motor vehicle or nonroad vehicle, or otherwise modifying any required emission and noise control system. Unless specifically noted to the contrary herein, vehicles equipped with Chevrolet Performance Parts may not meet emissions laws and regulations and should not be operated on public roads or used for any other use. The parts listed in this catalog are intended primarily for use in vehicles that are NOT:

- (1) "motor vehicles" designed for street use; or
- (2) off-road vehicles used for anything but competition.

U.S. federal and state, and Canadian provincial agencies have the authority to administer substantial monetary penalties against individuals and companies who do not comply with these laws. Chevrolet Performance customers are responsible for ensuring their use of Chevrolet Performance Parts complies with applicable federal, state/provincial and local laws, regulations and ordinances, and for ensuring that modified vehicles are operated in a manner that complies with applicable laws. In an effort to help consumers maintain compliance with emissions regulations, the product descriptions for many parts include emissions-related warnings and notices. This page summarizes the emissions-related information that you may see in this catalog.

PARTS INTENDED FOR COMPETITION USE ONLY

The Chevrolet Performance Catalog includes parts that are intended exclusively for use in competition vehicles that will only be driven on a track or off-road course. By "competition vehicles," GM means vehicles (i) used exclusively for competitions organized and sanctioned by a local or private body and (ii) not designed for use on public streets or highways. Consumers are strongly advised not to install parts accompanied by this warning on vehicles that will be driven on public roads, as they are not designed for that purpose. The product descriptions for such parts are accompanied by the following warning:



WARNING: NOT LEGAL FOR STREET USE

The "Checkered Flag" icon means this part is designed and intended for use in vehicles operated exclusively for competition: in racing or organized competition on courses separate from public streets or highways. Installation or use of this part on a vehicle operated on public streets or highways is likely to violate U.S., Canadian, as well as state and provincial laws and regulations relating to motor vehicle emissions.

PARTS THAT HAVE RECEIVED A CALIFORNIA EXECUTIVE ORDER

Manufacturers of add-on and modified emissions-related parts (aftermarket parts) that sell their product for use in California vehicles must obtain an exemption from the California Air Resources Board (CARB). This exemption is called an Executive Order (EO) and allows the part or modification to be installed on specific emission controlled vehicles and used in vehicles driven on public streets and highways. An exemption is granted if the product has been determined not to cause an increase in vehicle emissions from the production vehicles for which the part is intended, nor otherwise cause vehicles to be non-compliant with the vehicle emissions certification and anti-tampering laws.

Every EO part or modification comes with a unique assigned number, and comes with limitations and restrictions on the installation and use of the part. The EO number will appear on a special exemption label affixed to the part or its packaging. Consumers are advised to familiarize themselves with the EO and its limitations and restrictions to ensure that such parts are installed and used properly. The product descriptions for some parts listed in the Chevrolet Performance Catalog are accompanied by the "50 State" icon and the following notice:



The "50 State" icon means that this part has undergone an evaluation by CARB and that CARB has determined that the part or modification has been shown to not increase vehicle emissions when installed and used properly in the application(s) identified in the product description. CARB policy authorizes consumers to install and use these parts in vehicles driven on public streets and highways.

FOR MORE INFORMATION

General Motors is committed to performance parts development that allows enthusiasts to modify their vehicles and remain compliant with emissions requirements. The information provided here is intended to provide general guidance of interest to most consumers, and may not apply to all vehicles or all situations.



PERFORMANCE CENTER NEWS

NEW FOR 2018

- 4 Centennial Cruiser
- 6 General Motors' Factory One
- 8 New Corvette and Camaro Parts
- 10 New L96 Crate Engine
- 11 Expanded Connect & Cruise Lineup
- 12 New Duramax Diesel Block
- 14 2018 COPO Camaro Program
- 16 LS/LT Swaps
- 17 Web & Social Media

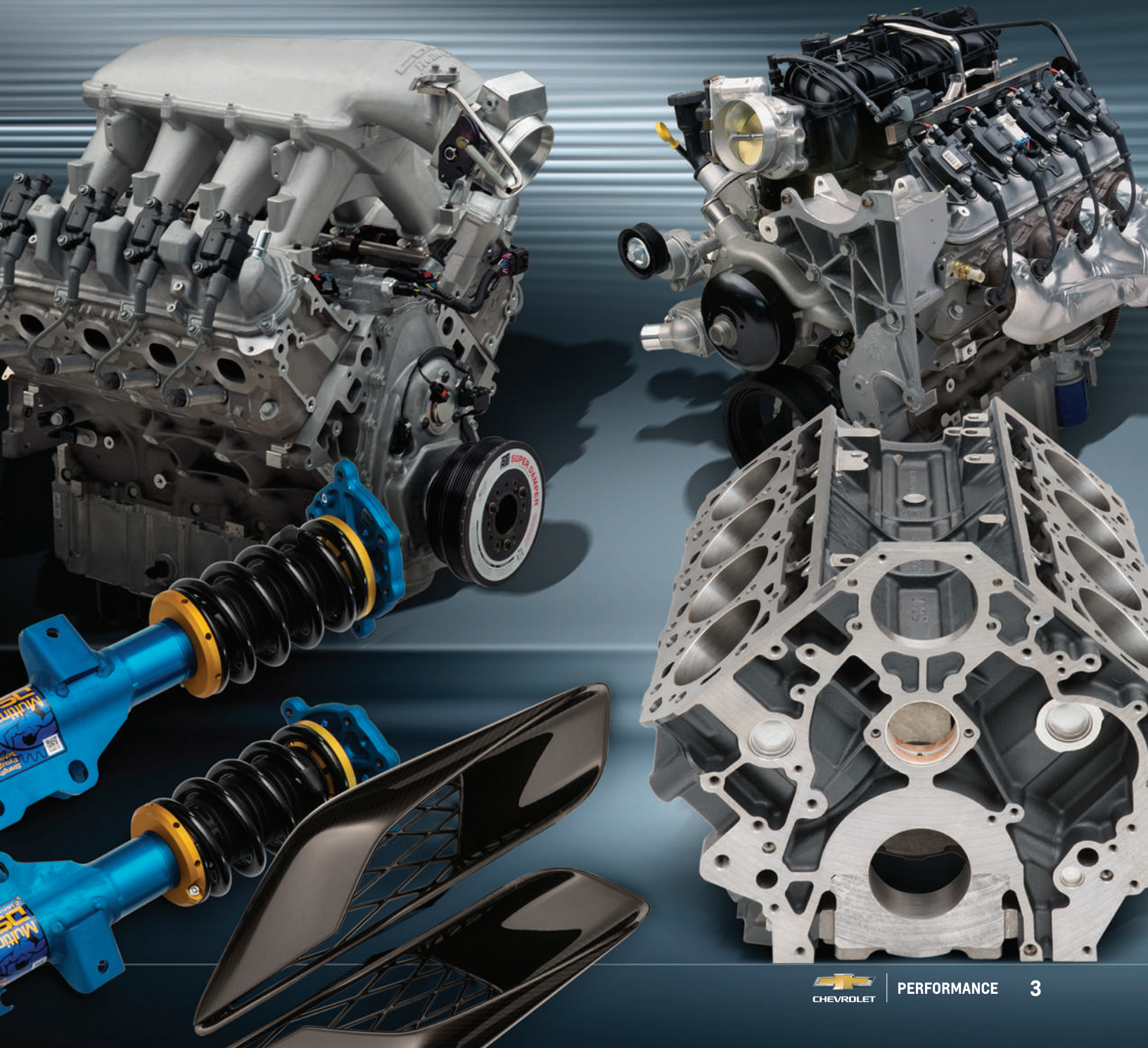

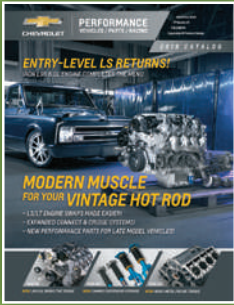

About the Cover

Our Chevrolet Performance engineers are never satisfied! Next up is the new LT1 Connect & Cruise package with a 4L70-E transmission. New technology meets old truck!



CENTENNIAL CRUISER

Chevrolet Celebrates 100 Years of Trucks with a Customized, Connect & Cruise-Powered 1967 C/10

It's been more than 100 years since Chevrolet introduced its first truck – a 1.5-ton commercial vehicle with a 2.8L engine that produced around 45 lb.-ft. of torque and had a top speed of 25 miles per hour. Times, technologies and capabilities evolved rapidly thereafter, bringing us to 2018 with trucks such as the Silverado 3500HD, which offers 910 lb.-ft. from its available Duramax 6.6L turbo-diesel engine.

About midway through that first century of Chevy trucks, the modern era of pickups was born with the 1960 introduction of the C/K series. The “C” was for two-wheel-drive trucks and the “K” designated four-wheel-drive models, while the entire lineup brought fresh styling and increased comfort to the trucks customers had relied on for decades. That was largely due to a new independent front suspension that greatly improved the ride and a frame design that allowed the cab to ride lower on it, for a sleeker look.

The second generation of the C/K platform debuted in 1967, building on the advances of the first generation. Many models featured a coil-spring rear suspension with trailing arms, similar in design to cars such as the Chevelle. The 1967 models also introduced new styling that would come to be seen as classic among trucks of the era. In fact, the '67 Chevy C/10 short-bed model is prized among today's hot rodders for its pure, timeless design.

To help celebrate its first century of trucks, Chevrolet built its own hot rod C/10, matching its great styling with Chevrolet Performance's Connect & Cruise crate powertrain system. The legendary ZZ6 is a classic Small-Block rated at 404 horsepower and 430 lb.-ft. of torque. It's backed by the Hydra-Matic 4L65-E electronically controlled four-speed automatic transmission.



The GM engineering build team had 90 days to transform the '67 C/10 into the "Centennial Cruiser," to celebrate 100 years of Chevrolet trucks.

The C/10 is painted Centennial Blue, matching the color of special-edition Silverado and Colorado production models that Chevrolet offers. And like the production trucks, this customized classic wears heritage-inspired Bowtie emblems.

Craftsmen in Chevrolet's garages built the C/10 in-house. In fact, they started with a solid, Western long-bed model and modified the frame and cargo box to give the vintage short-box proportions. They also lowered the suspension, added 18-inch front and 20-inch rear wheels and made more subtle styling enhancements than there are lb.-ft. churning out of the ZZ6 crate engine.

And speaking of the ZZ6, it's only one of the dozens of Connect & Cruise crate powertrain systems available for C/10s, Chevelle, Camaros and every other vintage Chevrolet project vehicle. That also includes emissions-compliant

E-ROD versions for vehicles subject to California emission standards. Each system matches the crate engine with a complementing transmission, as well as the engine and transmission controllers, installation kits and more. See page 104 for complete Connect & Cruise details.

From the classic Small-Block to the muscle-car Big-Block the modern LS and LT engines, including the all-new, 650-horsepower supercharged LT4, there's a Connect & Cruise system for every project dream.

This slammed, Centennial C/10 is Chevrolet's vision of celebrating 100 years of great trucks. What's yours?

GENERAL MOTORS' FACTORY ONE – WHERE IT ALL BEGAN

The roots of General Motors – and the global auto industry – were established more than 130 years ago in a modest factory in Flint, Mich.

Known as Durant-Dort Factory One, the building was recently restored and reopened as a meeting place and research library. It was built in 1880 by textile company Flint Woolen Mills, and acquired in 1886 by GM founder William Crapo "Billy" Durant and his partner, Josiah Dallas Dort, who established the Flint Road Cart Company.

Later, they renamed it the Durant-Dort Carriage Company and turned it into one of the world's largest carriage manufacturers. Durant parlayed its success to finance his venture into automobiles, taking control of Buick in 1904, forming General Motors in 1908 and starting Chevrolet three years later.

By the early 1900s, cars were quickly displacing horse-drawn carriages and the Durant-Dort Carriage Company closed. Other tenants came and went over the decades, but time and the elements were not kind to the building. In 2012, Kevin Kirbitz, a GM engineer, Flint native and automotive historian made a compelling case for its preservation.

GM committed to the purchase and restoration of the building, including replacing 17,000 carefully color-matched bricks, and installing a new roof and period-correct windows. Inside, the mechanical systems were replaced and interior walls removed to expose the 19th-century architectural elements.

Now it is available to the public for meetings, corporate and community events and more, with accommodations for up to 300 people. Factory One also serves as the new, permanent home of Kettering University's extensive automotive archives. Among the approximately 100,000 documents and artifacts is a 1908 letter from a New York law firm suggesting Durant call his new company General Motors. Papers from former GM leaders such as Harlow Curtice and Elliott "Pete" Estes, as well as innovator Charles Kettering, are also in the collection.

"Factory One is part of the very fabric of Flint, and its reopening is as much about the future as it is the past," said Kirbitz, now Factory One's operations manager. "It is a tremendous community asset and academic resource that will educate and inspire generations to come."



Main floor of the restored Durant-Dort Factory One, in Flint, Michigan, a carriage factory founded by General Motors founder William Crapo "Billy" Durant and partner Josiah Dallas Dort. GM transformed the East Wing of the facility into a conference and event space that can accommodate groups of up to 300.



Contemporary amenities blend with preserved woodwork inside the restored Durant-Dort Factory One, in Flint, Michigan.



The Kettering University Archives are housed in a climate-controlled enclosure within the restored Durant-Dort Factory One, in Flint, Michigan.

NEW PARTS EXPAND PERFORMANCE, PERSONALIZATION CHOICES FOR CAMARO, CORVETTE AND MORE!



That new Chevrolet Camaro or Corvette becomes truly yours when you personalize it with factory-engineered performance parts and accessories from Chevrolet Performance.

Available through your Chevy dealer and other authorized retailers, Chevrolet Performance offers components for nearly every new Chevy vehicle, including exciting collections for the Gen 6 Camaro, C7 Corvette, Sonic, Silverado, Colorado and more.

For 2018, we've added new chassis, brake and other accessories for Camaro, as well as accessories for Corvette, Colorado and Sonic. As with other other factory-engineered parts and accessories from Chevrolet Performance, all are designed and validated to the same standards as regular-production parts. That means they have the look, feel and durability of regular-production components.

Take a look at what's new and elsewhere in this catalog for all Chevrolet Performance has to offer to make your new Chevy truly yours!



Camaro Brembo® Rear Four-Piston Calipers in Red
(P/N 84300395) See page 23 for more details.



Corvette Carbon Fiber Quarter Panel Vents
(P/N 84347359) See page 47 for more details.



Camaro Sway Bar Suspension Upgrade System
(P/N 84242386) See page 21 for more details.



Corvette Transparent Carbon Fiber Roof Panel
(P/N 84141731) See page 53 for more details.



Camaro ZL1 1LE-Spec Multimatic DSSV® Lowering and Handling Suspension Upgrade System
(P/N 84352121) See page 22 for more details.



Camaro ZL1 1LE-Spec Suspension Upgrade System
(P/N 84352119) See page 22 for more details.



Camaro ZL1-Style Spoiler Kit
See page 29 for more details and part numbers.

NEW L96 6.0L CRATE ENGINE

Offers Heavy-Duty Performance For Late-Model and Vintage Trucks

Let's talk torque for a moment. If you thought only a vintage Big-Block could give your project truck the grunt for heavy lifting and trailering, Chevrolet Performance's new, LS-based L96 6.0L crate engine offers some pound-feet to consider.

As the stalwart standard engine in the Chevrolet Silverado 2500HD and 3500HD trucks, the L96 is designed to offer the work-ready pulling power heavy-duty truck owners depend on for cargo hauling and trailering.

Whether used to re-power a tired late-model truck or retro-fit into a classic truck intended to balance work and recreation, the L96 tops even the classic 454 Big-Block that was offered from the early-1970s through the early-1990s. It's rated at 360 horsepower, which is more than 50 percent greater than the 454 engines, while its 380 lb.-ft. of torque exceeds or is comparable to those Big-Blocks of yesteryear.

Better still, the L96 is a much lighter, more compact package than the old 454 engines, with aluminum cylinder heads and a lightweight composite intake manifold. That helps enhance its performance advantage in the vehicle by reducing overall mass and enabling a more favorable front-to-rear balance ratio.

The L96 uses a sturdy iron cylinder block and robust rotating assembly. That's matched with high-flow, cathedral-style cylinder heads that support great low-rpm torque and enable high-rpm horsepower. Additional features such as polymer-coated pistons with floating wrist pins enhance performance and refinement by reducing friction and noise.

Chevrolet Performance's new L96 crate engine kit is comprehensive and includes the engine assembly with a production intake manifold, throttle body assembly, ignition coils, water pump, balancer, exhaust manifolds and more. Chevrolet Performance also offers all the other components required to finish off the engine and get it running, including front-end accessory drive systems and an engine controller kit.

Accessory drive kit P/N 19258433 is recommended for applications without air conditioning and air conditioning add-on kit P/N 19260892 is recommended for systems with air conditioning. Our engine controller kit P/N 19356410 will get it running. See page 280 for more details on the accessory drive kits and page 297 for more information on the controller kit.

When it comes to powering your truck with the torque it needs for real work, the L96 offers classic Big-Block grunt with all the modern advantages of an LS engine – and the compactness of a classic Small-Block. That's a win-win under the hood!

See page 210 for more details and complete specifications.

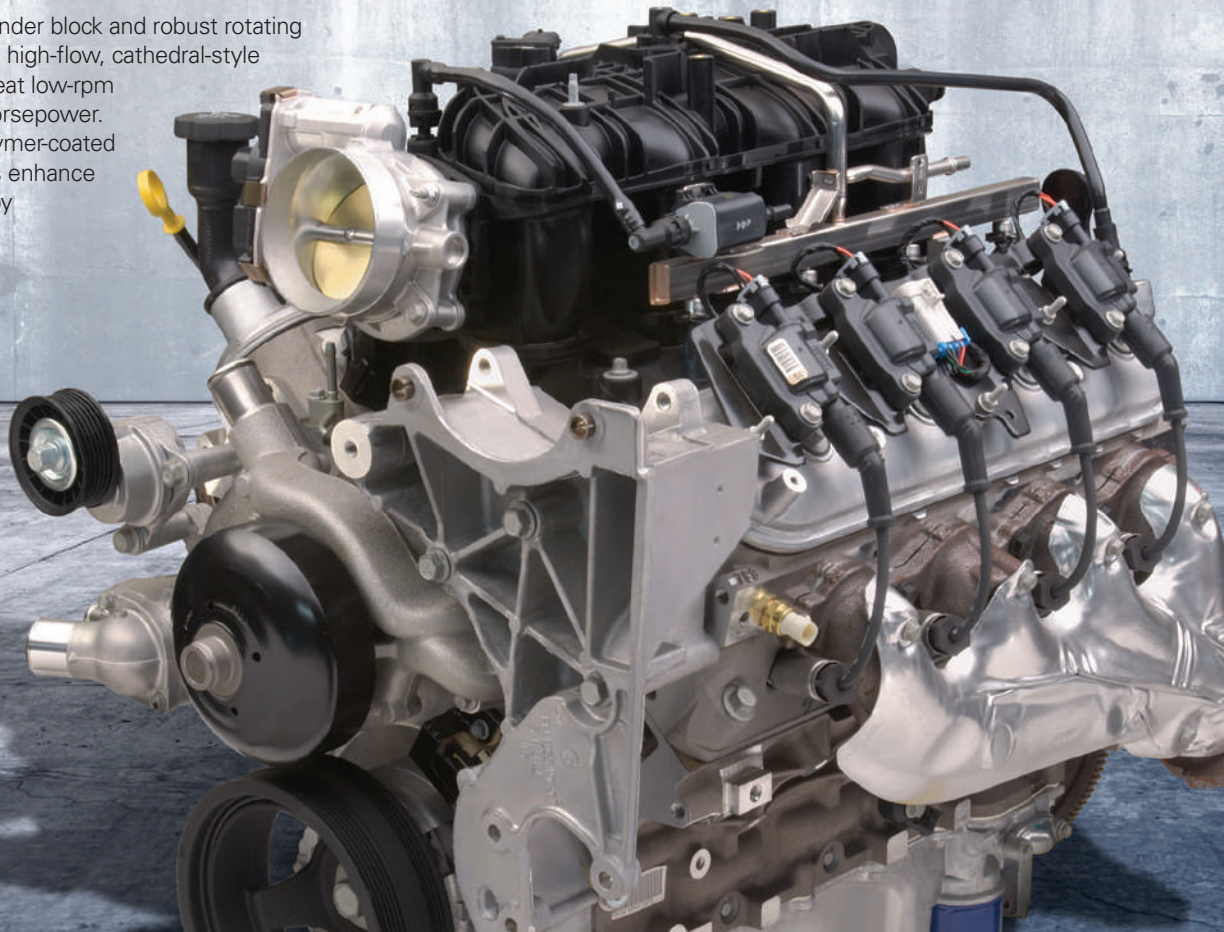

EXPANDED LINEUP OFFERS MORE CONNECT & CRUISE POWERTRAIN SYSTEM CHOICES

New LT4 and L96 Systems Bring Range to 64 Factory-Matched Options!

For 2018, Chevrolet Performance adds the 650-horsepower supercharged LT4 crate engine to our growing lineup of factory-matched Connect & Cruise Powertrain Systems. That brings the number of factory-matched powertrain combinations to 64.

The new LT4 crate engine is based on the powerhouse supercharged engine offered in the Corvette Z06 and Camaro ZL1. It's matched with the four- or eight-speed automatic transmissions.

Chevrolet Performance pioneered the concept of tailored crate engine-and-transmission combinations and the lineup includes LS, LT, Small-Block and Big-Block engines matched with electronically controlled overdrive automatic transmissions or Super Magnum six-speed manual transmissions. We even offer systems tailored for 4WD applications.

And for all you builders in California, our Connect & Cruise E-ROD systems are legal for installation in millions of 1995-and-earlier vehicles.

Our engineers did all the hard work, designing and calibrating carefully matched Connect & Cruise powertrain systems for optimal compatibility and performance, while also identifying the complementing engine and transmission controllers, torque converters and supporting installation kits, which include components such as oxygen sensors, the mass airflow meter, throttle pedal assembly and more.

See page 104 for more details and a complete rundown of all our Connect & Cruise combinations. Pick the system that's right for your project and get it running in less time and with less hassle – all from the crate engine innovator, Chevrolet Performance!

LT4 Wet Sump Connect & Cruise with 8L90-E Automatic Transmission

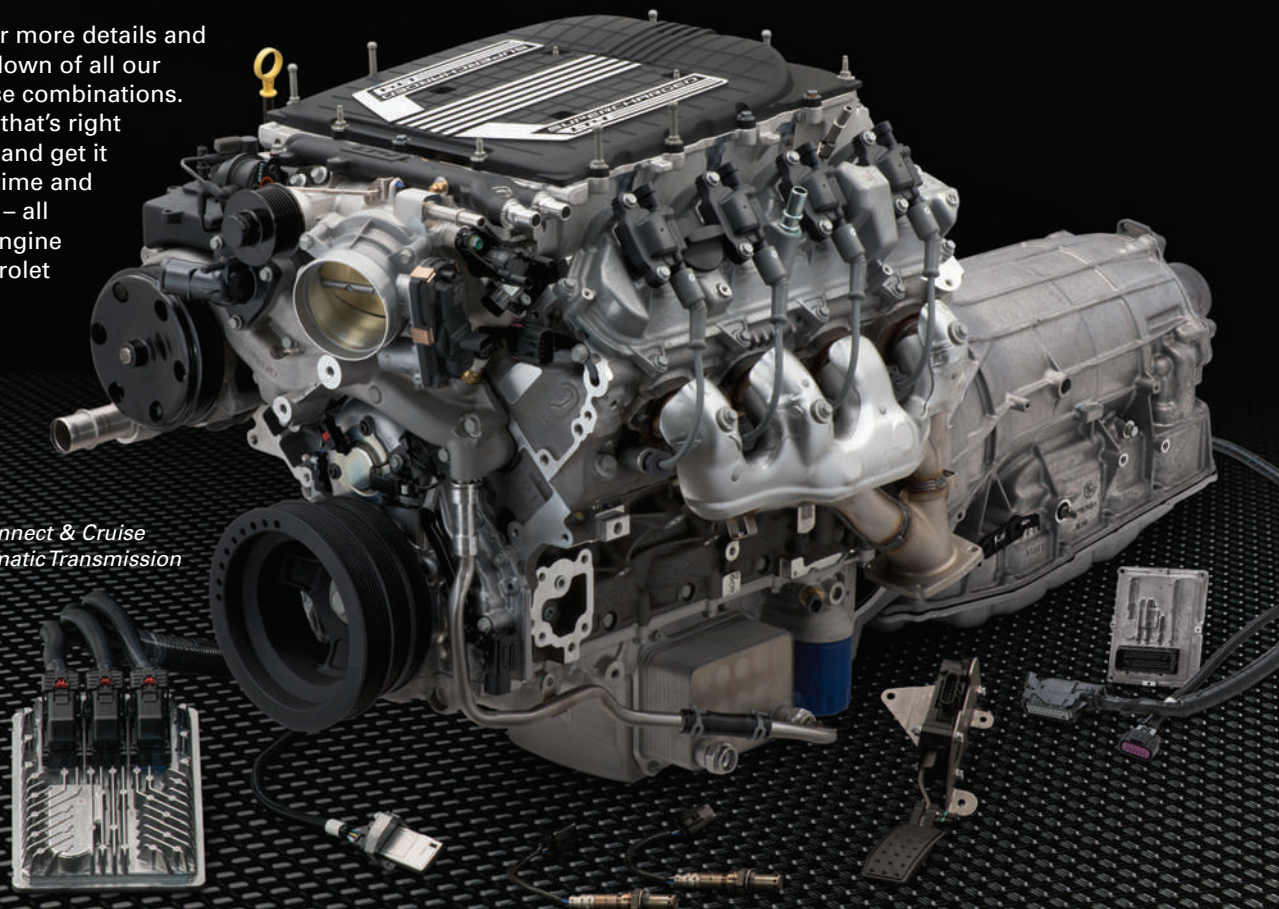

DURAMAX DIESEL BLOCK NOW AVAILABLE FROM CHEVROLET PERFORMANCE!

A modern legend was born in 2000, when General Motors introduced the Duramax 6.6L turbo-diesel engine for the 2001 Chevrolet Silverado 2500HD and 3500HD and other heavy-duty trucks.

The Duramax's development represented an entirely clean-sheet design, featuring a 90-degree V-8 configuration, with direct injection, four valves per cylinder in its high-swirl aluminum heads, and a turbocharger system that supported the engine's tremendous torque production with higher-rpm horsepower that enhanced responsiveness on the highway. The Duramax's electronically controlled common-rail fuel system optimized performance and efficiency. That, along with pilot injection, helped give the all-new Duramax segment-topping refinement and performance.

The first Duramax was given the LB7 engine code and boasted 300 horsepower and 520 lb.-ft. of torque. Continuous improvements and technological advancements steadily drew more horsepower and, more importantly, greater torque out of the engine. Today, the latest, second-generation L5P-code Duramax is rated at 445 horsepower and 910 lb.-ft. of torque – a stunning 75 percent leap in torque from the same 6.6L displacement as the original!

Nearly 20 years and more than two-million engines later, the Duramax 6.6L is renowned as much for its durability as its capability.

Chevrolet has long supported Duramax owners with original-equipment service parts for the entire engine, except for one: the engine block. That changes in 2018 with the availability of a brand-new Duramax block from Chevrolet Performance.

Based on the block used with 2010-2017 LML- and LGH-code production engines, the new block – P/N 12651877 – is compatible with all first-generation Duramax 6.6L engines, including engine codes LB7, LLY, LBZ and LMM.

The Duramax block features a strong cast iron foundation known for its durability, with induction-hardened cylinder walls and five nodular iron main bearings. A deep-skirt design and four bolts per main help ensure the block's strength, and enable more accurate location of the rotating assembly. A die-cast aluminum lower crankcase also strengthens the engine block and serves as the lower engine cover, while reducing its overall weight.

Chevrolet Performance's new Duramax block is the perfect starting point for building new life into a well-used truck. Chevrolet Performance also offers just about every additional production part to support building the engine, from the rotating assembly, camshaft and cylinder heads, to the injectors, oil pump, rocker covers and more. See the accompanying chart for a more complete list and part numbers.

Partial and complete Duramax crate engines are also available through Chevrolet dealers and other Chevrolet parts retailers.

Chevrolet Performance, however, is the only outlet for a brand-new Duramax engine block. Get yours today and build new life into your trusted truck!

DURAMAX PARTS

PART NAME	PART NUMBER
Block.....	12651877
Heads.....	12646217
Crank.....	12641925
Cam.....	12638804
Cam Bearings.....	Installed In The Block
Valves, Intake.....	12638805
Valves, Exhaust.....	97366946
Springs.....	98025825
Retainers.....	12636393
Rods.....	12636253
Pistons (Set Of 8).....	19301155
Front Cover.....	12624280
Injectors.....	19256590
Oil Pump.....	12644591
Rocker Cover, Lwr.....	12640380
Rocker Cover, Upr Left.....	12642769
Rocker Cover, Lwr Right.....	12642771
Lifters.....	97325546
Rocker Arm, Int.....	97365293
Rocker Arm, Exh.....	98004537
Rocker Shaft.....	97224903
Push Rods.....	97240416

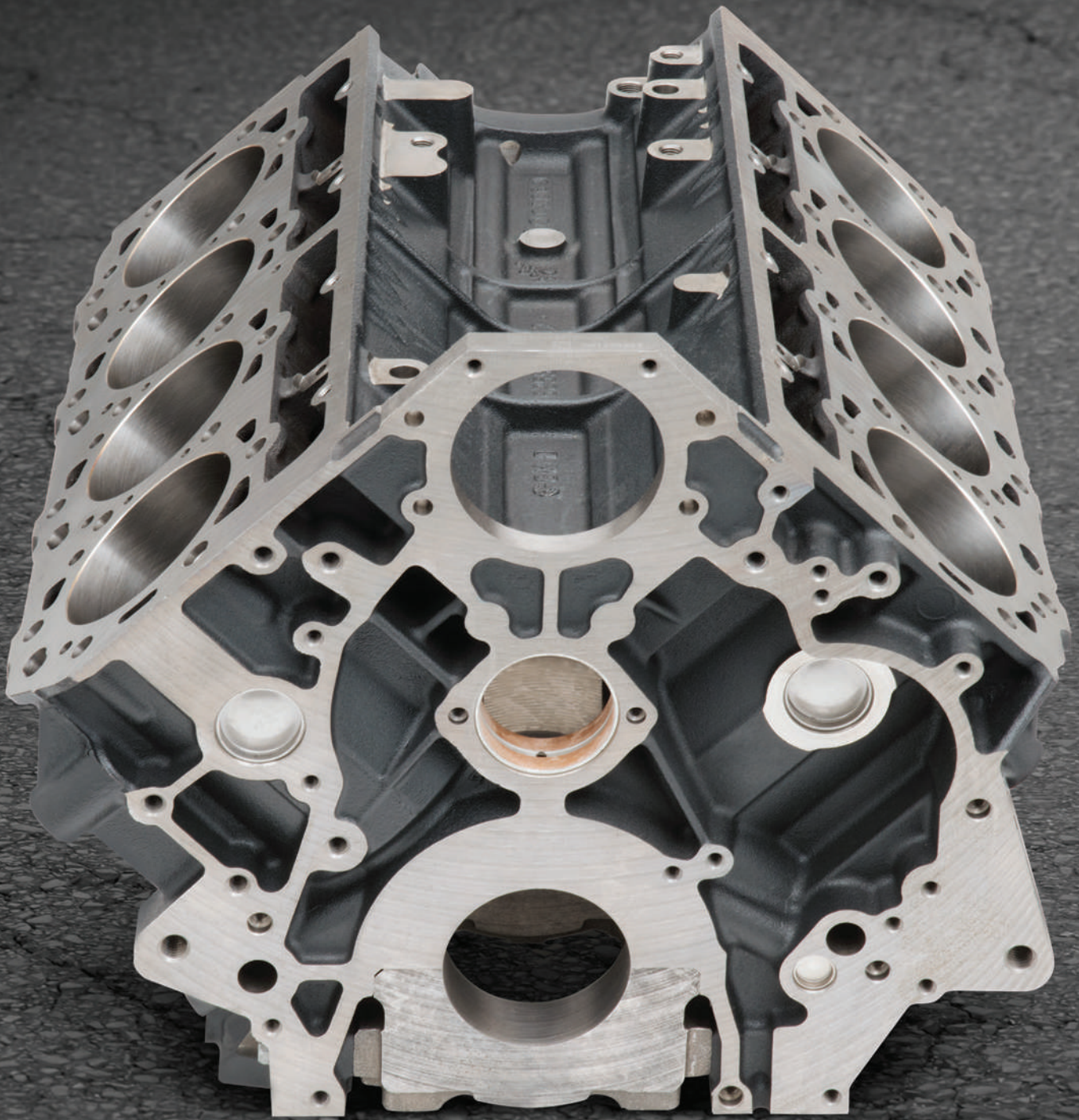

DURAMAX TIMELINE: 2001-2018

ENGINE CODE	YEARS	MAX HORSEPOWER	MAX TORQUE (lb.-ft.)
LB7	2001-2004	300	520
LLY	2004-2005	305	605
LBZ	2006-2007	360	650
LMM	2007-2010	365	660
LML/LGH	2010-2016	397	765
L5P (second-gen)	2017+	445	910

COPO CAMARO PROGRAM IS BACK – WITH A NEW 302 ENGINE FOR 2018

The 2018 COPO Camaro program extends the production legacy that was established in 1969 and re-started in 2012 to create special-order high-performance Camaro models with a single purpose: Win at the drag strip.

There's an all-new, high-revving 302 Small-Block engine offered to help racers do just that. Also new for 2018, customers can select the same Crush (orange) exterior color used on the production 2018 Camaro Hot Wheels® 50th Anniversary Special Edition, when they select the special option package.

As with the previous editions, the 2018 COPO Camaro models are designed for NHRA's Stock Eliminator classes. These production race cars are fitted with racing chassis and suspension components, including a unique solid rear axle system in place of a regular-production Camaro's independent rear axle.

Only 69 will be built for 2018 – the same number of 1969 COPO Camaros built with the legendary all-aluminum ZL1 Big-Block engine.

ADDITIONAL DETAILS INCLUDE:

- *Lightweight, adjustable coil-over strut front suspension*
- *Four-link rear suspension with double-adjustable coil-over shocks, Panhard bar and stabilizer bar*
- *Rear axle with an aluminum center section featuring a lightweight steel spool and 40-spline gun-drilled axle shafts*
- *Lightweight, drag-race manual four-wheel disc brakes (un-assisted)*
- *Custom manual steering rack*
- *Fuel cell with built-in high-pressure fuel pump*
- *Unique racing wire harness.*



The new 302 Small-Block racing engine offers customers a high-revving choice like no other in the COPO Camaro program's portfolio of available engines. It is based on the LT1 engine offered in the 2018 Camaro SS, but built for drag racing with unique components. It's displacement is derived from a shorter-stroke crankshaft than the production engine, which enables exceptional high-rpm capability.

Camaro has a history with the 302 engine. It was displacement of the Small-Block used in first-generation Z/28 models, from 1967-'69.

Additionally, racers can select from a variety of supercharged engines, including a supercharged 350 (5.7L) and a naturally aspirated 427 (7.0L) engine. All



Chevrolet Introduces Camaro Hot Wheels® 50th Anniversary Special Edition

In 1968, a year after Chevrolet introduced the Camaro, Mattel launched the iconic Hot Wheels® line of toy cars – and the “Custom Camaro” model was part of the original lineup of 16 toys.

To commemorate half a century of Hot Wheels, Chevrolet and Mattel have teamed up to create the 2018 Camaro Hot Wheels 50th Anniversary Special Edition. Offered on 2LT and 2SS models (coupe and convertible), this stylish, eye-catching package offers full-scale driving fun, with special features including:

- *Crush (orange) exterior color*
- *Satin Graphite stripes with Silver Ice accents*
- *Satin Graphite ground effects*
- *20-inch wheels in Satin Graphite with milled faces*
- *Special Hot Wheels fender badges*
- *Galvano chrome inserts in the lower grille*
- *Orange brake calipers*
- *Unique taillamp lenses*
- *Black bowtie emblems*
- *Jet Black interior with black suede and orange stitching*
- *Hot Wheels anniversary badge on the steering wheel*
- *Illuminated door sill plates with anniversary badge*
- *Premium carpeted floor mats with orange stitching and ghost stripes*
- *Orange knee pads on the doors*
- *Orange safety belts*

The 2018 Camaro Hot Wheels 50th Anniversary Special Edition goes on sale in the first quarter of 2018. See your Chevy dealer for more details.

are backed by an SFI-approved ATI TH400 three-speed automatic transmission.

Each COPO Camaro race car is built by hand, starting with production hardware, including the same body in white used for production models.

NOTE: The COPO Camaro is a purpose-built race car. It is intended for competition only.



2018 COPO Camaro Hot Wheels® 50th Anniversary Edition.

MAKE YOUR LS/LT SWAP DREAM A REALITY WITH HELP FROM MUSCLE RODS

LS and LT engine swaps are the hottest thing in hot rodding and Chevrolet Performance has you covered with the big stuff: crate engines, transmissions, control systems, accessory drive systems and more – and our Connect & Cruise and E-ROD Connect & Cruise systems bundle them all together for easy ordering.

When it comes to installing these powertrains in vintage vehicles, there are more and more installation kits hitting the market every day. Georgia-based Muscle Rods offers one of the broadest and most comprehensive roster of LS and LT swap kits in the industry, taking the trial and error out of installing the engines in most popular vintage GM cars and trucks. Their range of kits includes GM's A-body, F-body, G-body, X-body, B-body, Tri-5s, classic trucks, Corvettes and even the compact S-Series trucks.

From engine mounts and transmission crossmembers to exhaust headers and oil pans, Muscle Rods' kits were developed by installing LS and LT engines in the respective vehicles. They even offer EFI-ready fuel tanks and LS/LT-matched radiators, while bolt-in frame brackets help ensure the spot-on driveline angle. That eliminates the guesswork when it comes to installing your engine at home. And if an engine swap is beyond your wrench-turning reach, Muscle Rods offers a list of affiliated installation centers across the United States and Canada to help get the job done.



Get your swap done and be a part of the LS/LT revolution! See Muscle Rod's ad on page 401.



RECOMMENDED READING

The world of LS swaps is changing rapidly and Chevrolet Performance has added several recommended tech book titles from CarTech to help builders get through their projects with the latest information, recommended procedures and helpful tips. If you're diving into an LS or LT swap, consider cracking open one or more of these books before cracking open your tool box. See page 387 for more details.



How to Rebuild GM LS-Series Engines

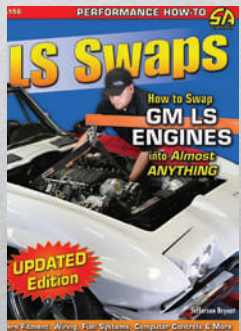

How to Swap LS Engines into Almost Anything

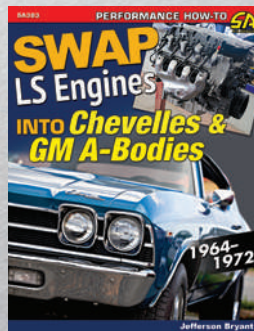

Swap LS Engines in Chevelles and GM A-Bodies, 1964-1972

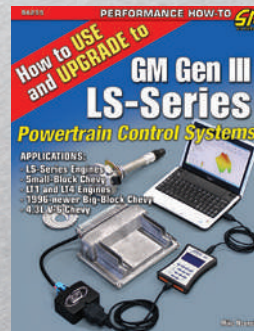

How to Use and Upgrade to GM Gen-III LS Series Powertrain Control Systems

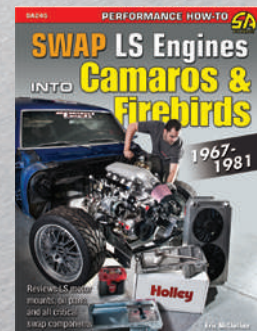

Swap LS Engines into Camaros and Firebirds, 1967-1981



PERFORMANCE

PERFORMANCE UPGRADES & ACCESSORIES

PERSONALIZE YOUR NEW CHEVY WITH PERFORMANCE UPGRADES AND ACCESSORIES

Your new Chevrolet makes a statement and with Chevrolet Performance's factory-engineered upgrades and accessories, you can make it more personal – a reflection of your style and performance tastes.

Available through your Chevy dealer and other authorized retailers, Chevrolet Performance offers components for nearly every new Chevy vehicle, including expanded collections for the Gen 6 Camaro, 2014 – 18 Corvette, as well as styling, performance and lifestyle accessories for Silverado, Colorado, Cruze, Sonic and more!

For peace of mind, Chevrolet Performance parts and accessories are designed and validated to the same standards as regular-production parts. That means they have the look, feel and durability of regular-production components – and we guarantee them, so you can be confident about your purchase.

When you shop Chevrolet Performance for upgrades and accessories, you know you're getting them straight from the source!



CAMARO PG. 20



CORVETTE PG. 44



CRUZE PG. 56



SONIC PG. 58





MALIBU PG. 60



SILVERADO PG. 62



COLORADO PG. 68



Gen 6 Camaro Performance Upgrades continued



GEN 6 CAMARO PERFORMANCE UPGRADES

PARTS TUNED JUST RIGHT FOR YOUR CAMARO

The Camaro has always inspired driving enthusiasts to look for new possibilities and to push the limits further – from the hottest street looks to more speed and agility on the track. Chevrolet Performance offers a lineup that can enhance the responsive braking and nimble handling of your Gen 6 Camaro – or make it turn heads while standing still. These parts are tuned to meet the high standards and match the distinctive driving characteristics of the Camaro.

Our lowering kit, which gives the LS/LT and SS models increased track feel and responsiveness, and our brake packages that resist corrosion and reduce vibration for race-inspired performance, will take your Camaro to the next level. When it comes to adding looks or speed, rely on Chevrolet Performance to give your Camaro the edge.

GEN 6 CAMARO PERFORMANCE UPGRADES



84233245
1LE Spec Handling Suspension Upgrade System

Enhance your vehicle's road-handling performance with this Suspension and Sway Bar Upgrade System. This system uses the same hardware and shock calibration as the production 1LE. The stiffer stabilizer bars, higher-rate springs and handling links reduce body roll and increase steering precision and feel. MR Shock calibration has been specially tuned to optimize ride and handling with the increased spring and stabilizer bar rates. Available exclusively for Camaro SS models with Magnetic Ride Control.

NOTE: Calibration requires programming at dealership (included).



84225254
Lowering Suspension Upgrade System

Optimize your vehicle's handling with this Lowering Suspension Upgrade System. It lowers vehicle's ride height by up to 20mm. Components include front and rear coil springs, front struts, rear shocks and replacement fasteners where required.

Lowering Suspension Upgrade System:

Part Number	Description
84225254	Camaro SS Coupe (without Magnetic Ride Control).
84225258	Camaro SS Convertible (without Magnetic Ride Control).
84225252	Camaro LS/LT Coupe (with 20" wheels).
84225256	Camaro LS/LT Convertible (with 20" wheels).



84242386 NEW!
Sway Bar Suspension Upgrade System

Enhance your vehicle's road-handling performance with this Sway Bar Suspension Upgrade System. Contents include stiffer front and rear stabilizer bars and front handling links. When combined with the Lowering Suspension Upgrade System, vehicle roll is reduced by 18%. (Available exclusively on Coupe models equipped with the 6.2L V8 LT1 engine, Lowering Suspension Upgrade System, and without Magnetic Ride Control.)

Gen 6 Camaro Performance Upgrades continued

84352121  **NEW!**
ZL1 1LE Spec Multimatic Lowering and Handling Suspension Upgrade System*

Born on the track, designed for the ZL1 1LE, and tested to the extreme in Trans Am TA4 competition, the ZL1 1LE Spec Multimatic Lowering and Handling Suspension Upgrade System is for the serious on-track enthusiast looking for the fastest times around a track at the sacrifice of street comfort. Multimatic DSSV dampers, combined with front and rear coil springs, and a ZL1 1LE spec front sway bar, reduce ride height by up to 10mm and offer a 22% decrease in roll gradient, a 245% increase in front spring stiffness, and – in Chevrolet Performance testing – up to 1.8-seconds a lap reduction around the Milford Proving Grounds' NE Course (compared to a stock Camaro SS). Track racers also benefit from the ability to adjust front ride height for corner weighting and track use, and the ability to quickly switch from street to track camber settings to optimize tire contact patch at any track.



84352119  **NEW!**
ZL1 1LE Spec Handling Component Suspension Upgrade System*

The perfect pair to the ZL1 1LE Spec Multimatic Lowering and Handling Suspension Upgrade System (PN 84352121), this competition use only, track tested ZL1 1LE Spec Handling Component Suspension Upgrade System provides racers with front ride links, front handling links, rear upper and lower trailing links, and rear knuckles complete with stiffer bushings and ball joints to reduce suspension flex. The 71% stiffer upper and lower trailing links (compared to the Camaro SS), 58% stiffer rear link inner bushings, and an additional 4% reduction in roll gradient (combined with the ZL1 1LE Spec Multimatic Lowering and Handling Suspension Upgrade System), result in improved on-track performance lap after lap.



84125309
6.2L Strut Tower Brace (Camaro SS Coupe)

Further enhance the chassis stiffness of your vehicle, resulting in a firmer feel behind the wheel and more direct steering response, with a lightweight Performance Strut Tower Brace. Available exclusively for SS models equipped with the 6.2L V8 (LT1) engine.



84329125
6.2L Cold Air Intake System



Enhance the sound, style and performance of your vehicle with this 6.2L Cold Air Intake System. This system reduces air intake restriction up to 17% at 360 g/sec and is legal in 50 states. It looks great under the hood, includes a high efficiency dry media air filter and all necessary installation hardware. Fits 2016-2018 6.2L Camaro.

This part has been granted an Executive Order from the California Air Resources Board. E.O. D-126-43

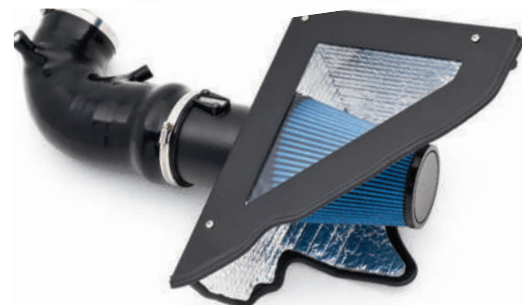



84242613 3.6L Cold Air Intake System

Add an element of performance-oriented style to your vehicle with this 3.6L Cold Air Intake System. It looks great under the hood and includes a reusable open-element air filter, a sealed compartment, required engine calibration and all necessary installation hardware. This upgrade creates up to a 15% reduction in pressure drop. Not available for sale in California, or California emissions states. Fits 2016-2017 3.6L Camaro.



23245470 Front 4-Piston Brembo® Brake Upgrade System in Red

Take the braking capability of your LS or LT to a higher level with the Chevrolet Performance Front 4-Piston Brembo® Brake Upgrade System in Red. Components include Brembo® four-piston aluminum calipers with performance brake pads and 13.6-inch x 1.2-inch (345mm x 30mm) vented and slotted Duralife™ rotors that are larger than the factory systems for LS and LT models (LS and LT feature 12.6-inch x 1.1-inch rotors/single piston calipers from factory). The Duralife™ rotors feature a hardened surface to reduce corrosion and provide quieter braking with less vibration. Available exclusively for LS and LT models.



23245471 Front 6-Piston Brembo® Brake Upgrade System in Red

Enhance the braking capability of your LS, LT or SS model with the Chevrolet Performance Front 6-Piston Brembo® Brake Upgrade System in Red featuring six-piston monoblock aluminum calipers with performance brake pads and two-piece, 14.6-inch x 1.3-inch (370mm x 34mm) vented and slotted Duralife™ rotors (cast-iron braking rings with aluminum hats). These performance brakes are for the serious track enthusiast looking for ultimate braking performance while maintaining street drivability – and they're larger than the factory systems for LS, LT and SS models (SS features 13.6-inch rotors/four-piston calipers from the factory). The Duralife™ rotors feature a hardened surface to reduce corrosion and provide quieter braking with less vibration. This front-brake kit is available for LS, LT and SS Camaro models without 1LE Package.

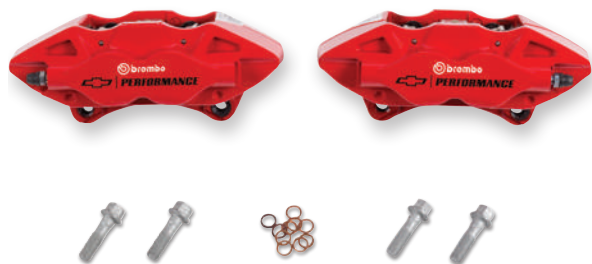

84300395 **NEW!** Rear 4-Piston Brembo® Brake Calipers in Red

Upgrade the look of your Camaro with these Rear 4-Piston Brembo Brake Calipers in Red. These rear-brake calipers are available for Camaro SS models without 1LE package and offer a perfect red color match to pair with the available 6-piston Front Brake Upgrade System.

Gen 6 Camaro Performance Upgrades continued

84100441
2.0L Cat-Back Dual Exhaust Upgrade System with Polished Tips

Upgrade the look and sound of your vehicle with this 2.0L Cat-Back Dual Exhaust Upgrade System with Polished Tips. It delivers a great performance sound and reduced restriction, while promoting increased power. This exhaust includes Active Noise Cancellation calibration for vehicles with Bose stereo system. Available for LS and LT models. Not compatible with accessory ground effects package.

NOTE: Not a direct bolt on. Requires cutting of pipe behind the catalytic converter.

Options include:

Part Number	Description
84100442	2.0L Exhaust Kit for use with Ground Effects Kit



84028864
3.6L Axle-Back Dual Exhaust Upgrade System with Polished Tips

Upgrade the look and sound of your vehicle with this 3.6L Axle-Back Dual Exhaust Upgrade System with Polished Tips. It adds a great performance sound and premium appearance without voiding the factory warranty. Available for LS and LT models. Not compatible with accessory ground effects package and dual mode factory installed performance exhaust (NPP).

Options include:

Part Number	Description
84028866	3.6L Exhaust Kit for use with Ground Effects Kit



84028865
6.2L Axle-Back Dual Exhaust Upgrade System with Polished Tips

Upgrade the look and sound of your vehicle with this 6.2L Axle-Back Dual Exhaust Upgrade System with Polished Dual-Wall Tips featuring the Chevrolet Bowtie logo. This exhaust system includes Active Noise Cancellation calibration for vehicles with Bose stereo system and is 50-state compliant. It provides great performance sound and decreased backpressure (up to 25% less) while promoting increased power. Rigorously tested to GM standards for durability, corrosion and performance, installation of this system will not void the vehicle warranty if performed by an authorized GM dealership. Available for SS models. Not compatible with accessory ground effects package and dual-mode factory installed performance exhaust (NPP).

Options include:

Part Number	Description
84028867	6.2L Exhaust Kit for use with Ground Effects Kit





Short-Throw Shifter **A**



2.0L Turbo and 3.6L Shift Knob and Boot **B**



6.2L Shift Knob and Boot **B**



2.0L Turbo Engine Cover **C**



3.6L Engine Cover **C**



6.2L Engine Cover **D**

GEN 6 CAMARO PERFORMANCE

A. 1LE Spec Short-Throw Shifter

Get quicker, more precise shifts in your manual-transmission Camaro with this Short-Throw Shifter kit. It's the same shifter used in the production 1LE and delivers shorter shifts. The kit includes the shifter and installation hardware.

Part Number	Description
24286952	For use with 2.0L Turbo and 3.6L (LS/LT)
24287123	For use with 6.2L (SS)

B. 1LE Spec Shift Knob and Boot **NEW!**

Add a sporty touch to the interior of your vehicle with the soft hand-stitched shift knob and boot in Black Suede.

Part Number	Description
24287140	For use with 2.0L Turbo and 3.6L (LS/LT)
24287141	For use with 6.2L (SS)

C. 2.0L Turbo and 3.6L Engine Covers

Give your Gen 6 Camaro's LS/LT or SS engine a stylish, show-quality upgrade with this engine cover. They are available to match most exterior colors, allowing you to complement or contrast the color choices to suit your style.

Engine Cover Options include:

Part Number	Description
12663899	2.0L Turbo Molded Nylon Engine Cover in Red
12663900	2.0L Turbo Molded Nylon Engine Cover in Blue
12663901	2.0L Turbo Molded Nylon Engine Cover in Black
12663903	3.6L Molded Nylon Engine Cover in Red
12663904	3.6L Molded Nylon Engine Cover in Blue
12663905	3.6L Molded Nylon Engine Cover in Black

D. 6.2L Molded Nylon Engine Cover in Red

Give your vehicle a stylish upgrade with this 6.2L Molded Nylon Engine Cover in Red, Black and Blue, allowing you to complement or contrast the exterior color of your vehicle. The LT1 Engine cover kit contains 3 components: LH side cover, RH side cover and intake manifold cover. Available exclusively for Camaro SS models.

12669894	6.2L Molded Nylon Engine Cover in Red
12669895	6.2L Molded Nylon Engine Cover in Black
12669896	6.2L Molded Nylon Engine Cover in Blue

GEN 6 CAMARO INTERIOR

A. Recaro Sport Seats

RECARO is synonymous with performance seating and those developed for the Camaro ZL1/1LE feature aggressive bolsters for high-performance driving. Compatible with 2016+ Gen 6 Camaro Coupe and Convertible models only.

NOTE: To maintain vehicle warranty, both driver AND passenger RECARO seats must be installed by an authorized dealer. Seats must match the original vehicle configuration.

Part Number	Description
84215636	Camaro Recaro Seat Kit Driver Non-Memory Coupe
84215640	Camaro Recaro Seat Kit Passenger Non-Memory Coupe
84215634	Camaro Recaro Seat Kit Driver Non-Memory Convertible
84215638	Camaro Recaro Seat Kit Passenger Non-Memory Convertible
84215632	Camaro Recaro Seat Kit Driver Memory Coupe
84215630	Camaro Recaro Seat Kit Driver Memory Convertible



A Recaro Sport Seats

B. Pedal Covers

These brushed aluminum Pedal Covers with raised rubber traction surfaces replace stock pedal covers to provide a sporty yet elegant finish to your interior.

Part Number	Description
84134668	Manual
84134669	Automatic



B Pedal Covers

C. Camaro Premium Carpet Floor Mats

Help protect the carpet of your Camaro from mud, water, road salt and dirt with these Premium Carpet Floor Mats.

Part Number	Description
23378906	SS Logo carpet mats – Red binding
23378905	SS Logo carpet mats – Gray binding
23378907	RS Logo carpet mats – Gray binding
23378908	RS Logo carpet mats – Red binding
23378909	ZL1 Logo carpet mats – Red binding
84054056	1LE Logo carpet mats – Gray binding
23283735	Chevrolet Performance Logo Carpet Mats – Red binding
23240679	Chevrolet Performance Logo Carpet Mats – Gray binding
23412245	All Weather Mats – Front and Rear, Black Only
23283733	Front and Rear Premium Carpet Floor Mats, Black with Mojave Binding and Camaro logo
23283734	Front and Rear Premium Carpet Floor Mats, Black with Torch Red and Camaro Logo
23240684	Front and Rear Premium Carpet Floor Mats, Black with Gray and Camaro Logo

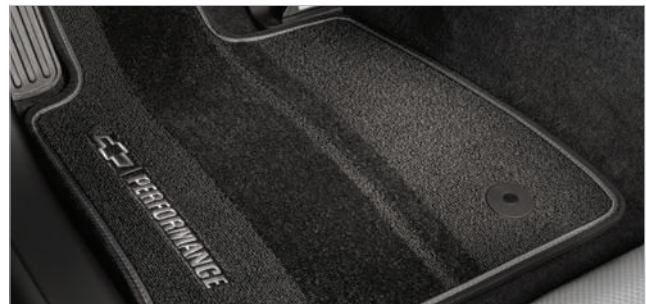

C Chevrolet Performance Premium Carpet Floor Mats

D. Camaro Fender Badges **NEW!**

Add styling detail to the side of your vehicle with a Chrome or Black "Camaro" Fender Badge.

Part Number	Description
23273557	Chrome (shown)
84152028	Black



D Camaro Fender Badges



Performance Center Cap **E**



20-Inch Wheel – 5-Spoke Gloss Black with Red Outline Stripe **F**



20-Inch Wheel – 5-Split-Spoke Machine Faced **F**



20-Inch Wheel – 5-Split-Spoke Low-Gloss Black **F**

GEN 6 CAMARO EXTERIOR

E. Center Caps

Add a finishing touch to your Camaro with these custom Center Caps specifically designed for Chevrolet wheels. They are made of durable material to help resist corrosion for long life.

Part Number	Description
19351755	Center Caps in Black with Silver Performance Logo (shown)
19352505	Center Caps in Silver with Camaro Tri-Shield
19351757	Center Caps in Silver with Red SS Logo
19353016	Center Caps in Black with Black Bowtie Logo
19351756	Center Caps in Silver with Red RS Logo
19332925	Center Caps in Gloss Black with a Silver Bowtie Logo
19351758	Center Caps in Black with Red SS Logo

F. Wheels

Add a high-performance appearance to your Camaro with these 20-Inch Aluminum Wheels. Use only GM-approved wheel and tire combinations.

Part Number	Description
23333839	20-Inch 5-Spoke Gloss Black Wheel with Red Outline Stripe – SS Front, LS/LT Front/Rear
23333848	20-Inch 5-Spoke Gloss Black Wheel with Red Outline Stripe – SS Rear
84015312	20-inch 5-Split-Spoke Machine Faced Wheels – SS Front, LS/LT Front/Rear
84015313	20-inch 5-Split-Spoke Machine Faced Wheels – SS Rear
23333843	20-inch 5-Split-Spoke Low-Gloss Black Wheels – SS Front, LS/LT Front/Rear
23333840	20-inch 5-Split-Spoke Low-Gloss Black Wheels – SS Rear

NOTE: Center Caps, Tires, Lugnuts, Tire Pressure Monitors, and Wheel Locks sold separately.

PERFORMANCE UPGRADES & ACCESSORIES

Gen 6 Camaro Exterior continued

A. Ground Effects Kit

Create a dramatic, ground-hugging appearance for your Camaro with this Ground Effects Package, available in select body colors.

Part Number	Year	Description
84116107	2016-2018	Black, for LS/LT with NPP Performance Exhaust
84116108	2016-2018	Black, for LS/LT without NPP Performance Exhaust
84116112	2016-2018	Mosaic Black Metallic, for LS/LT with NPP Performance Exhaust
84116113	2016-2018	Mosaic Black Metallic, for LS/LT without NPP Performance Exhaust
84116117	2016-2018	Nightfall Gray Metallic, for LS/LT with NPP Performance Exhaust
84116118	2016-2018	Nightfall Gray Metallic, for LS/LT without NPP Performance Exhaust
84116122	2016-2018	Silver Ice Metallic, for LS/LT with NPP Performance Exhaust
84116123	2016-2018	Silver Ice Metallic, for LS/LT without NPP Performance Exhaust
84116127	2016-2018	Summit White, for LS/LT with NPP Performance Exhaust
84116128	2016-2018	Summit White, for LS/LT without NPP Performance Exhaust
84116131	2016-2018	Bright Yellow, for LS/LT with NPP Performance Exhaust
84116132	2016-2018	Bright Yellow, for LS/LT without NPP Performance Exhaust
84116136	2016-2018	Red Hot, for LS/LT with NPP Performance Exhaust
84116137	2016-2018	Red Hot, for LS/LT without NPP Performance Exhaust
84116140	2016-2018	Garnet Red Tintcoat, for LS/LT with NPP Performance Exhaust
84116141	2016-2018	Garnet Red Tintcoat, for LS/LT without NPP Performance Exhaust
84116148	2016-2018	Hyper Blue Metallic, for LS/LT with NPP Performance Exhaust
84116149	2016-2018	Hyper Blue Metallic, for LS/LT without NPP Performance Exhaust
84116152	2017-2018	Arctic Blue Metallic, for LS/LT with NPP Performance Exhaust
84116153	2017-2018	Arctic Blue Metallic, for LS/LT without NPP Performance Exhaust
84116166	2016-2018	Black, for SS without NPP Performance Exhaust
84116167	2016-2018	Black, for SS with NPP Performance Exhaust
84116171	2016-2018	Mosaic Black Metallic, for SS without NPP Performance Exhaust
84116172	2016-2018	Mosaic Black Metallic, for SS with NPP Performance Exhaust
84116176	2016-2018	Nightfall Gray Metallic, for SS without NPP Performance Exhaust
84116177	2016-2018	Nightfall Gray Metallic, for SS with NPP Performance Exhaust
84116181	2016-2018	Silver Ice Metallic, for SS without NPP Performance Exhaust
84116182	2016-2018	Silver Ice Metallic, for SS with NPP Performance Exhaust
84116186	2016-2018	Summit White, for SS without NPP Performance Exhaust
84116187	2016-2018	Summit White, for SS with NPP Performance Exhaust
84116191	2016-2018	Red Hot, for SS without NPP Performance Exhaust
84116192	2016-2018	Red Hot, for SS with NPP Performance Exhaust
84116199	2016-2018	Bright Yellow, for SS without NPP Performance Exhaust
84116200	2016-2018	Bright Yellow, for SS with NPP Performance Exhaust
84116203	2016-2018	Garnet Red Tintcoat, for SS without NPP Performance Exhaust
84116204	2016-2018	Garnet Red Tintcoat, for SS with NPP Performance Exhaust



A Ground Effects Kit – Silver Ice Metallic



A Ground Effects Kit – Summit White



A Ground Effects Kit – Hyper Blue Metallic



A Ground Effects Kit – Red Hot



High Wing Spoiler **B**



ZL1 Spec Spoiler for SS **C**



Black Illuminated Bowtie Emblem **D**

B. High Wing Spoiler Kit

Personalize the look of your Camaro with a High Wing Spoiler Kit, available in several body colors. The factory-built SS spoiler deck lid hole pattern does NOT support installation of the Accessory spoiler after vehicle purchase, unless you have the RS package.

Part Number	Year	Description
23353001	2016-2018	High Wing Spoiler Kit, All LS/LT Coupes & SS with RS package Coupes, Silver Ice Metallic (shown)
23353002	2016-2018	High Wing Spoiler Kit, All LS/LT Coupes & SS with RS package Coupes, Summit White
23353003	2016-2018	High Wing Spoiler Kit, All LS/LT Coupes & SS with RS package Coupes, Black
23353004	2016-2018	High Wing Spoiler Kit, All LS/LT Coupes & SS with RS package Coupes, Mosaic Black Metallic
23353005	2016-2018	High Wing Spoiler Kit, All LS/LT Coupes & SS with RS package Coupes, Hyper Blue Metallic
23353006	2016-2018	High Wing Spoiler Kit, All LS/LT Coupes & SS with RS package Coupes, Arctic Blue Metallic
23353007	2016-2018	High Wing Spoiler Kit, All LS/LT Coupes & SS with RS package Coupes, Red Hot
23353008	2016-2018	High Wing Spoiler Kit, All LS/LT Coupes & SS with RS package Coupes, Bright Yellow
23353009	2016-2018	High Wing Spoiler Kit, All LS/LT Coupes & SS with RS package Coupes, Garnet Red Tintcoat
23353010	2016-2018	High Wing Spoiler Kit, All LS/LT Coupes & SS with RS package Coupes, Nightfall Gray Metallic

C. ZL1 Spec Spoiler **NEW!**

This aggressive ZL1-style Spoiler Kit reduces vehicle lift by 61% with a 3% increase in drag when installed on the Camaro SS while paired with the Camaro SS accessory ground effects or front splitter package.*

The Spoiler Kit can also be used alone to enhance your vehicle's styling. Available in select body colors or gloss black.

**Results as tested in a static wind tunnel in recommended track format with front tire deflectors removed.*

Part Number	Year	Description
84224815	2016-2018	Spoiler Kit, Garnet Red Tintcoat
84224809	2016-2018	Spoiler Kit, Silver Ice Metallic
84224810	2016-2018	Spoiler Kit, Summit White
84224811	2016-2018	Spoiler Kit, Bright Yellow
84224812	2016-2018	Spoiler Kit, Red Hot
84224813	2016-2018	Spoiler Kit, Mosaic Black Metallic
84224814	2016-2018	Spoiler Kit, Hyper Blue Metallic
84224816	2016-2018	Spoiler Kit, Nightfall Way Metallic
84224817	2016-2018	Spoiler Kit, Arctic Blue Metallic
84224808	2016-2018	Spoiler Kit, Black (shown)

D. Bowtie Emblems

Increase the visibility or add a stylish touch to your Camaro with these eye-catching exterior illuminated or non-illuminated Bowtie emblems.

Part Number	Description
23393028	Black Illuminated Front with Black Non-Illuminated Rear (shown)
23380121	Gold Illuminated Front Only
84219485	Black Non-Illuminated Front and Rear

Gen 6 Camaro Exterior continued

A. Blade Spoiler Kit

Personalize the look of your Coupe model with a custom, race-inspired Blade Spoiler Kit. Available on LS and LT models (factory option on SS models). The factory-built SS spoiler decklid hole pattern does NOT support installation of the Accessory spoiler after vehicle purchase. Not compatible with factory rally stripes.

Part Number	Year	Description
84016430	2016-2018	Blade Spoiler Kit, Nightfall Gray Metallic
84127959	2017-2018	Blade Spoiler Kit, Blue
84016426	2016-2018	Blade Spoiler Kit, Bright Yellow
84016422	2016-2018	Blade Spoiler Kit, Mosaic Black Metallic
84016424	2016-2018	Blade Spoiler Kit, Hyper Blue Metallic
84016429	2016-2018	Blade Spoiler Kit, Black
84016427	2016-2018	Blade Spoiler Kit, Red Hot (shown)
84016431	2016-2018	Blade Spoiler Kit, Summit White
84016425	2016-2018	Blade Spoiler Kit, Silver Ice Metallic
84016428	2016-2018	Blade Spoiler Kit, Garnet Red Tintcoat



A Blade Spoiler

B. 84314076

Wickerbill Spoiler in Black

Personalize your vehicle's looks with a race-inspired Wickerbill Spoiler in Black. Requires Blade Spoiler Kit or 1LE spoiler.

NOTE: Blade Spoiler sold separately



B Wickerbill Spoiler

C. 84136777

Alternative Finish Tail Lamps

Change it up with these Alternative Finish Tail Lamps. They are easy to install and change the entire look of the rear of your Camaro.



C Alternative Finish Tail Lamps

D. 23241386

Rear Blackout Decal

A Rear Blackout Decal can be added between the tail lamps of your Camaro to accentuate the vehicle's powerful style lines.



D Rear Blackout Decal



GEN 5 CAMARO PERFORMANCE UPGRADES

UPGRADES TO ENHANCE CAPABILITY ON THE STREET OR TRACK

The Gen 5 Camaro offers great performance capability, with special models including the 1LE, ZL1 and Z/28 earning the label of “legendary.” Chevrolet Performance has worked to make the most-popular performance parts from the hottest models available to all Camaro enthusiasts, giving Camaro V-6 and SS owners the tools to build strong-pulling, harder-cornering and quicker-stopping performance on the street or track. From the comprehensive Z/28 suspension kit to the ZL1 driveline package and brakes – along with shifters, cylinder heads, fuel system upgrades and even aerodynamic aids – we’ve got the components you need to transform your performance-hungry Gen 5 Camaro.

Better still, all of Chevrolet Performance’s Gen 5 Camaro components are the factory-engineered and validated components, so you know they’ll fit, perform and hold up with the confidence you can’t get with other aftermarket parts. Check out our extensive and unmatched collection and take your Camaro’s capability to the next level!

GEN 5 CAMARO PERFORMANCE UPGRADES



23464729 
Gen 5 Z/28 Suspension Kit*
(With DSSV® Dampers)

The Z/28 is the first high-volume production road car to employ racing-derived DSSV® (Dynamic Suspensions Spool Valve) damper technology from Multimatic. The dampers rely upon a pair of self-piloted spool valves to control fluid through tuned port shapes rather than conventional deflected disc dampers. The design of the inverted-monotube front strut and aluminum-body monotube rear hydraulic dampers offers maximum response, stiffness and tuning optimized for the track, with the highest level of damper predictability, accuracy and repeatability. The unique dampers are the center of a comprehensive suspension package that also includes higher-rate coil springs, smaller-diameter solid stabilizer bars, and higher-rate suspension bushings. The dampers are matched with optimized stiff spring rates and stabilizer bars in both the front and rear to reduce body movement in hard cornering and acceleration. Also included in the package are front ride and handling links, rear upper control arms, rear trailing links, and toe links, which have upgraded stiffer bushings designed to reduce cornering compliance and increase durability on the track.

The system includes:

Part Number	Description	QTY
22942442	Performance Emblem	1
22842513	Front Stability Bar Assembly	1
22812943	Rear Stability Bar	1
22761221	Rear Stability Bar Links	2
23105018	Right Side Ride Link	1
23105019	Left Side Ride Link	1
23105014	Left Side Handling Link	1
23105015	Right Side Handling Link	1
23104902	Right Rear Upper Control Arm	1

Part Number	Description	QTY
23104903	Left Rear Upper Control Arm	1
23104900	Rear Lower Trailing Arm	2
22845487	Rear Toe Link	2
22903661	Left Strut	1
22903662	Right Strut	1
23473509	Right Rear Shock Absorber	1
23473510	Left Rear Shock Absorber	1
23475839	Installation Instructions	1

NOTE: For 2010-2011 vehicles, kit 23484878 required for installation.

23484878
Gen 5 1LE & Z/28 Service Modification Kit
(2010-2011 Gen 5 Camaro model years only)

This kit includes the rear lower control arms and hardware necessary to properly install the stability bars included in the 1LE and Z/28 suspensions. This kit is needed for 2010 and 2011 model year Camaros only, as the size of the stabilizer bar clamp stud changed starting in 2012 for both the front and the rear bar clamps. Kit includes the braces and installation hardware (not shown).





23123398 (V-6 Camaro)
23123397 (V-8 Camaro, not shown)
Gen 5 Camaro 1LE Track Pack – Street

Upgrade your V-6 or SS Camaro's suspension with the same parts used in the 1LE Track Pack. This kit features a stiffer 27mm solid front stabilizer bar and a 28mm solid rear stabilizer bar for improved body control in cornering. The front struts were redesigned with improved damping curves for more body control and quicker response times. It also includes faster reacting rear monotube shocks to replace the V-6 and SS twin-tube design and combines them with a stiffer rear upper shock mount to increase vehicle agility, both are shared with the ZL1. The bushings in the rear toe link are replaced with spherical bushings to eliminate compliance in cornering, which is also common with the ZL1. The V-6 kit also includes the stiffer front springs used on the 1LE and SS variants.

23123397 V-8 system includes:

Part Number	Description	QTY
11516078	Nut-FRT STAB HYD SHF Link	2
22942442	Emblem-F/End UPR Tie Bar	1
23123399	Installation - ACSRY	1
11569638	Nut-FRT SUSP Strut MT	2
11516078	Nut-RR S/ABS (UPR)	2
22845487	Link ASM-RR SUSP ADJ	2
23115372	Absorber ASM-RR SHK	2

Part Number	Description	QTY
22922445	Mount ASM-RR S/ABS UPR	1
22922446	Mount ASM-RR S/ABS UPR	1
22761221	Link ASM-RR S/ABS UPR	2
22786260	Shaft ASM-RR STAB	1
22812942	Shaft ASM-FRT STAB	1
22812984	Strut ASM-FRT SUSP	1
22812985	Strut ASM-FRT SUSP	1

NOTE: For 2010-2011 vehicles, kit 23484878 required for installation.

NOTE: The V-6 1LE suspension kit requires use of SS brake kit P/N 23120542 and 23120543 (not included).



23120485
Gen 5 Camaro 1LE Strut Tower Brace

Firm up the ride characteristics of your Camaro with this lightweight, aluminum underhood tower-to-tower brace. The brace enhances chassis stiffness, contributing to a firmer feel behind the wheel and more-direct steering response. It is a direct bolt-on for 2011-2015 Camaro SS and V-6 models. Kit includes the brace and installation hardware (not shown).

Gen 5 Camaro Performance Upgrades continued



23120542
Gen 5 Camaro SS Brake Upgrade Kit for Camaro V-6

Upgrades the front and rear brakes for 2010-2015 Camaro V-6 models with the Brembo® front and rear brake components from the SS. The front rotors are 14-inch diameter, compared to the 12.6-inch diameter of the V-6 brakes, while the rear rotors are 14.4-inch diameter, compared to the stock 12.4-inch rotors. The SS calipers are aluminum Brembo® four-piston units for each corner. It's a more economical option for customers who want greater brake performance on the street and track, but don't need the performance of the ZL1 brakes. The kit includes two front rotors and calipers, two rear rotors and calipers, brake pads, master cylinder and installation hardware.

NOTE: Requires 20" wheels for caliper clearance.

The system includes:

Part Number	Description	QTY
23120544	Installation Sheet	1
22956541	Master Brake Cylinder	1
23131778	RR Brake Shield	1
23131777	LR Brake Shield	1
92229712	Front Hose	1
92229713	Front Hose	1
92229716	Rear Hose	2

Part Number	Description	QTY
21012386	Front and Rear Hose Washers	8
11569590	Front and Rear Hose Bolts	4
11611687	Rear Drive Shaft Nut	2
22907156	Front Pad Kit	1

23252398
Gen 5 Z/28 Brake Ducts

Brake ducts decrease "brake fade," increase brake component life, create secondary cooling of brake fluid and sustain brake pedal feel for longer periods of time. This is achieved by a supply of constant fresh air to the back of rotor area. This air supply improves convection of the brake rotor vanes, reducing heat build up compared to conventional air flow, thus increasing brake performance. Fits 2014-2015 SS and 1LE.





22959672 Gen 5 SS V-8 Camaro to ZL1 Brembo® Front Brake Conversion Kit¹

Upgrade the front brakes on your 2010-2015 Camaro SS with the larger brakes from the supercharged Camaro ZL1 – including racing-style two-piece, 14.6-inch front rotors and six-piston Brembo aluminum calipers, in black with the ZL1 logo. That gives improved performance over the 14-inch rotors/four-piston calipers on SS models.

The ZL1 two-piece rotors offer greater resistance to warping and potentially longer rotor life, as well as reduced weight. The design features a separate cast-iron rotor brake ring mounted to an aluminum “hat” that attaches the brake assembly to the wheel hub. The hat and brake ring cool at different rates, which helps the rotor dissipate heat more effectively. This racing-style disc design enhances braking performance under track operating conditions. Kit includes two rotors, two calipers, pads and mounting hardware.

Add the optional ZL1 rear caliper kit, P/N 23104466, to complement the style of the ZL1 front caliper.

NOTE: Requires 20" wheels for caliper clearance.

¹For V-6 Conversion use Complete Kit P/N 22989384 (front and rear)

The system includes:

Part Number	Description	QTY
22960684	Front Installation Sheet	1
20795300	ZL1 Front LH Rotor	1
20944529	ZL1 Front LH Caliper	1
20944530	ZL1 Front RH Caliper	1
25940448	SPO Front Caliper Pin Kit	2
25940447	SPO Front Service Pad Kit	1
20944523	ZL1 Front LH Hose	1
20944532	ZL1 Front LH Shield	1
20795302	ZL1 Front RH Rotor	1

Part Number	Description	QTY
20944522	ZL1 Front RH Hose	1
20944531	ZL1 Front RH Shield	1
11570788	Caliper-to-Knuckle Bolts	4
11569590	Front Hose Bolts	2
21012386	Front Hose Washers	4
22942442	Chevrolet Perf. Badge	1



23104466 Gen 5 SS V-8 Camaro to ZL1 Rear Conversion Kit

Make your SS rear brakes match the look of your front ZL1 conversion. Includes black ZL1 calipers and pads, hardware and instruction sheet.

NOTE: Requires 20" wheels for caliper clearance.

The system includes:

Part Number	Description	QTY
23117967	SSV-8 Rear Installation Sheet	1
20944518	ZL1 Rear LH Caliper	1
20944519	ZL1 Rear RH Caliper	1
89047744	SPO Rear Pad Kit	1
89047728	SPO Rear Caliper Pin Kit	2
21012386	Rear Hose Washers (not shown)	4

Gen 5 Camaro Performance Upgrades continued

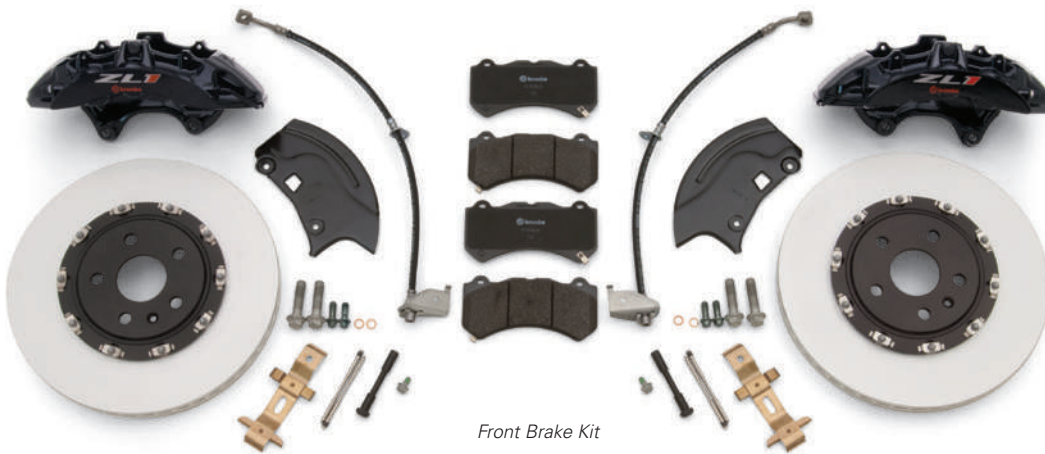

22989384
Gen 5 Camaro V-6 to ZL1 Brake Conversion Kit
(Complete Front & Rear Kit)

Upgrade the brakes on your 2010-2015 Camaro V-6 to the system used on the supercharged Camaro ZL1 – including racing-style two-piece, 14.6 front rotors with six-piston Brembo® front calipers, 14.4-inch rear rotors with 4-piston Brembo® rear calipers and a V-8-specific master cylinder. That compares to the 12.6-inch front and 12.4-inch rear rotors and single-piston sliding calipers on V-6 models.

NOTE: Requires 20" wheels for caliper clearance.

The front system includes:

Part Number	Description	QTY
22960684	Front Installation Sheet	1
20795300	ZL1 Front LH Rotor	1
20944529	ZL1 Front LH Caliper	1
20944530	ZL1 Front RH Caliper	1
25940448	Front Caliper Pin Kit	2
25940447	Front Service Pad Kit	1
20944523	ZL1 Front LH Hose	1
20944532	ZL1 Front LH Shield	1
20795302	ZL1 Front RH Rotor	1
20944522	ZL1 Front RH Hose	1
20944531	ZL1 Front RH Shield	1
11570788	Caliper to Knuckle Bolts	4
11569590	Front Hose Bolts	2
21012386	Front Hose Washers	4
22942442	Chevrolet Perf. Badge	1

The rear system includes:

Part Number	Description	QTY
22989385	Rear Installation Sheet	1
11515781	Rear Caliper-to-Knuckle Bolts	4
92245929	Rear Rotor	2
20944518	ZL1 Rear RH Caliper	1
20944519	ZL1 Rear LH Caliper	1
89047744	Rear Pad Kit	1
89047728	Rear Caliper Pin Kit	2
23131777	ZL1 Rear LH Shield	1
92229716	ZL1 Rear RH & LH Hose	2
23131778	ZL1 Rear RH Shield	1
21012386	Front & Rear Hose Washers	4
22956541	V-8 Master Cylinder	1
11569590	Rear Hose Bolts	2



23454578 Gen 5 Z/28 Air Intake*

A unique open air box intake system is used with the Z/28's LS7 engine, featuring a replaceable conical air filter, and delivers the highest airflow performance of any production Camaro filter system. The air cleaner seals around the bottom of the hood, reducing the chance recirculated hot air will be drawn into the engine. It is a bolt-on substitute for the intake system on the Camaro SS. The Z/28 air intake provides up to a 51% reduction in air restriction when compared to a standard LS3 equipped Camaro. Includes hardware that supports 1LE and SS PCV systems.

This performance air intake system is intended exclusively for use in competition vehicles that will only be driven on a track or off-road course. When installed, the performance air intake may cause your vehicle to no longer be emissions compliant. As a result, after installing this component, your vehicle should no longer be driven on public roads.

NOTE: No calibration support from GM is available. Not recommended for use on L99. Not available for sale in California, except as a direct replacement part for the Camaro Z/28.



23206771 Gen 5 Performance Exhaust Upgrade

Upgrade the look and sound of your Camaro's exhaust system with one of our tuned, emissions-legal bolt-on exhaust kits. They deliver a great performance sound and reduced restriction, which promotes increased power – especially when combined with other performance parts.

Part Number	Year	Description
23206771	2014-2015	V-8 (LS3) Off-Road Exhaust Upgrade Kit. with tips
23206772	2014-2015	V-8 (LS3) Exhaust Upgrade Kit with Tips
23206773	2014-2015	V-8 (LS3) Exhaust Upgrade Kit, No Tips
23206774	2014-2015	V-6 (LFX) Exhaust Upgrade Kit, with Tips
23206775	2014-2015	V-6 (LFX) Exhaust Upgrade Kit, without tips
92206990	2010-2013	V-6
92225673	2010-2013	V-6 with Ground Effects
92225672	2010-2013	V-8 LS3 with Ground Effects
92206992	2010-2013	V-8 LS3
92231570	2010-2013	V-8 LS3 Off-Road



23454579 Gen 5 Z/28 Exhaust Hook-Up Kit

Bolt-on better performance! This kit bolts an LS7 Z/28 cat-back exhaust to a LS3 Gen 5 Camaro. This is the only kit necessary to clamp the LS7 Z/28 exhaust (P/N 22906768) right up to your production LS3 equipped SS. The Z/28 Exhaust system provides up to 26% reduction in back pressure compared to a LS3-equipped Camaro.

23259294 Gen 5 Z/28 Cat-Back Exhaust System (not shown)

A complete kit with pipes, mufflers, hangers and exhaust tips assembled as a single unit. It features 2.75" pipes, with up to 26% less back pressure than a stock LS3 system.

NOTE: Gen 5 Z/28 exhaust system is compatible with cars equipped with dual mode exhaust (NPP). Cars not equipped with NPP exhaust must also apply rear valance panel. 2010-2013 – P/N 22815277. 2014-2015 – P/N 22915157.

Gen 5 Camaro Performance Upgrades continued

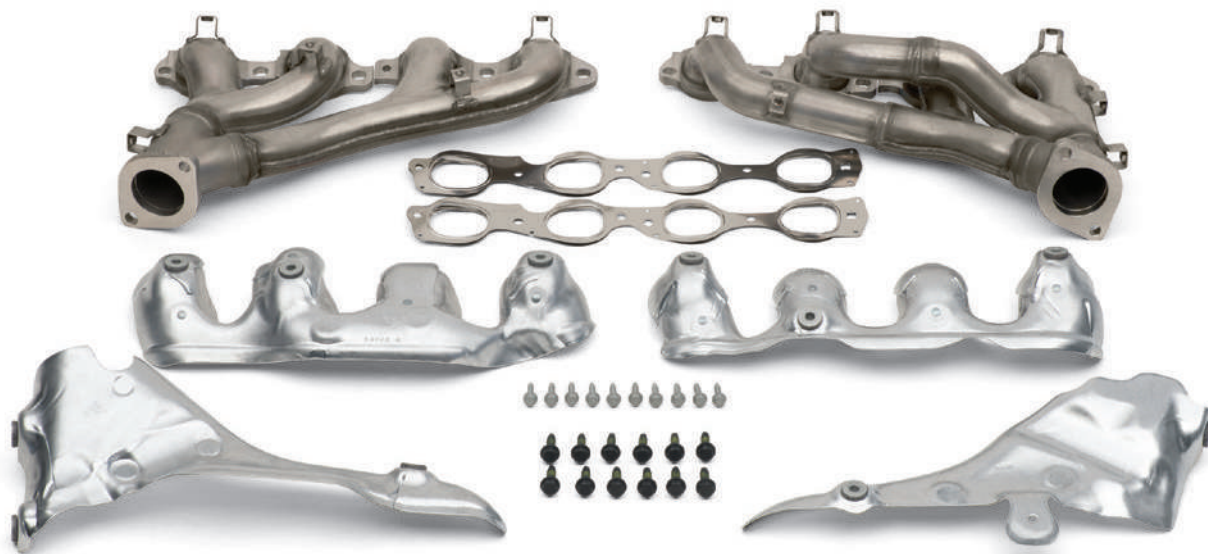

19302762

Gen 5 Z/28 Exhaust Manifold Package* (Gen 5 Camaro only)

The Z/28 high-flow exhaust manifolds will provide increased airflow to the Camaro LS3/L99 6.2L engine. This kit enables bolt-on installation of the Z/28 dual-mode exhaust system. However, it will not work with the production LS3/L99 exhaust system.

NOTE: No calibration support from GM is available.

23216684

Gen 5 Z/28 Rear Differential Module Cooler Kit

The Camaro Z/28 is equipped with an RDM cooling system that circulates cooled transmission fluid through a heat exchanger integrated into the RDM cover. This innovative system reduces oil temperature by over 100° F, helping the differential maintain cool, stable performance throughout the most aggressive track driving sessions. The Z/28 system has greater heat rejection capability than competitors' air cooled RDMs, helping to prevent differential component damage from high temperature oil degradation. The integral heat exchanger design also eliminates the weight, noise and complexity of a dedicated external pump and its associated hardware, seen in many aftermarket systems. This Z/28-based RDM cooling kit can be applied to any 2010-2015 Camaro SS with a manual transmission.

Kit Includes:

- Z/28 RDM cover with gasket
- Upper and lower fluid lines
- All mounting hardware, clips brackets, and bolts for proper installation





22959394
Gen 5 Camaro ZL1 HD Driveline Kit – Manual*

If you're building an ultimate-performance 2010-2015 Camaro, Chevrolet Performance's Camaro ZL1 Driveline Kit delivers the strength required to put big power to the pavement. This kit features the specialty components from the production Camaro ZL1, including a larger, stronger 9.9-inch cast iron differential housing, stronger axles and heavy-duty limited-slip differential. This patent-pending system is designed to ensure that the ZL1's tremendous power is delivered smoothly to the ground. A rear-differential cooler is incorporated and reduces temperatures in the differential by more than 100° F (fluid lines must be installed). Asymmetrical half-shafts – a 60mm hollow shaft on the right and a 33mm solid shaft on the left – offer different torsional stiffness rates, which work with the limited-slip differential to minimize the chance of wheel hop on hard launches. Also included is a stronger ZL1 prop shaft. The trans flange included in the kit will not be required for the SS1LE or Z/28 applications.

NOTE: This change will affect the indicated vehicle speed. Recalibration is required for accurate speedometer reading. Not available from Chevrolet Performance.

22959395
Gen 5 Camaro ZL1 HD Driveline Kit – Automatic* (not shown)

All the performance advantages of kit P/N 22959394 described above, but for vehicles equipped with an automatic transmission.

NOTE: This change will affect the indicated vehicle speed. Recalibration is required for accurate speedometer reading. Not available from Chevrolet Performance.

Manual system includes:

Part Number	Description	QTY
20931145	Propshaft	1
20931133	RDM	1
22960153	RDM Plug/cap	2
22953760	LH Halfshaft	1
22953759	RH Halfshaft	1
22960154	Trans Flange	1
89059464	Trans Flange Nut	2
89059465	Trans Flange Washer	1
22960155	I-Sheet	1
11611234	Driveshaft Nut	1
11611965	Driveshaft Washer	2
11611335	Prop-to-Trans Bolt	3
11611365	Prop-to-Trans Nut	3
11515758	Prop-to-Frame Bolt	2
11516878	RDM-to-Cradle Bolt	3
11516078	RDM-to-Cradle Nut	3
22942442	Chevrolet Performance Badge	1

Automatic system includes:

Part Number	Description	QTY
22960156	Propshaft	1
20931134	RDM	1
22960153	RDM Plug/cap	2
22953760	LH Halfshaft	1
22953759	RH Halfshaft	1
24256909	Trans Flange	1
24256278	Trans Flange Nut	1
22960155	I-Sheet	1
11611234	Driveshaft Nut	2
11611965	Driveshaft Washer	2
11611335	Prop-to-Trans Bolt	3
11611365	Prop-to-Trans Nut	3
11611336	Prop-to-RDM Bolt	3
11515758	Prop-to-Frame Bolt	2
11516878	RDM-to-Cradle Bolt	3
11516078	RDM-to-Cradle Nut	3
22942442	Chevrolet Performance Badge	1

Gen 5 Camaro Performance Upgrades continued

19301504 (fits 2010-2013 MY)

19329768 (fits 2014-2015 MY)

Gen 5 Camaro 1LE 3.91 Gear Kit



This lower (higher numerically) ratio rear drive gear kit will increase effective rear wheel torque multiplication in Gen 5 Camaros by 13% (over standard 3.45 ratio) in a manual transmission-equipped car, and 20% (over standard 3.27 ratio) in an automatic-equipped car. This gearset is the original equipment ratio found in the 2013 – 2015 1LE Camaro package. Reflash of the speedometer calibration by your dealer is included with the kit. GM provides a calibration and new certification label.

These parts have been granted an Executive Order (E.O.) from the California Air Resources Board. Part Number 19301504 E.O. D-126-35 and Part Number 19329768 E.O. D-126-37.



The kit includes:

Part Number	Description	QTY
22813040	Gear Kit (shown)	1
92230403	Gasket	1
92230584	Oil Seal	1
90538867	Nut	3
92138569	Bolt	3
92139104	Bolt	3
88900330	Limited-Slip Differential Oil Additive	1
19301909	Label Altered Vehicle Cert.	1
19301503	Instruction Sheet	1

23489551

Gen 5 Z/28 Aero Components Kit

Take your Camaro's handling performance to the next level with this kit. Select downforce-enhancing aero components from the Z/28 are offered in this bolt-on package, including the Z/28 front splitter, Z/28 rear spoiler, underbody closeout panel, and revised Gurney lip extensions. And for even greater rear downforce performance, the Z/28 Wickerbill Kit (shown below) is offered as a great addition to this kit.



The system includes:

Part Number	Description	QTY
23498354	Front Splitter Kit	1
23227595	Front Splitter Bracket Kit	1
23481656	Rear Blade Spoiler Kit	1
23222454	Gurney Lip Extension Kit	1
23459995	Underbody Closeout Panel Kit (not shown)	1

23200130

Gen 5 Z/28 Wickerbill Spoiler Kit

The rear spoiler kit contains everything you need to boost the downward force you are looking for on the rear wheels. The wicker blade spoiler extension rigidly attaches with 7 bolts that ensure a lifetime of durability. The spoiler and extension wicker can add over 110 lbs. at speeds above 125 mph. The kit includes, instruction sheet, rear wicker extension, installation drill template, and attaching fasteners. Compatible with the Rear Blade Spoiler (sold separately).





23322214
Gen 5 Camaro Short-Throw Suede-Wrapped Shifter Kit

Get quicker, more precise shifts in your manual-transmission Camaro SS with Chevrolet Performance's Camaro ZL1 shifter kit. This is the same shifter used in the production ZL1, which delivers shorter shifts than the shifter in the SS. The kit includes the shifter, installation hardware and a suede micro-fiber shift knob with contrast stitching.

23157703
Gen 5 Camaro Short-Throw Leather-Wrapped Shifter Kit (not shown)

The production Camaro Performance Package shifter delivers shorter, more precise shifts for a greater feeling of control and more immediate performance. It is a direct replacement for the standard manual shifter on 2010-2015 Camaro SS models and is similar to the Camaro ZL1 shifter, but with a leather-wrapped shift knob. The kit includes the shifter, shift knob and installation hardware.

19300535 
LS3 Power Upgrade Kit – Basic*
(Heads and Cam Only)

Increase the power of the LS3 engine in your Corvette or Camaro SS by 40 horsepower with Chevrolet Performance's high-performance heads-and-cam kit. Developed by Chevrolet Performance engineers as a direct replacement for the factory-installed heads and camshaft (tuning required), the kit includes our CNC-ported LS3 cylinder heads, which flow more than 350 cfm (intake side), with 276cc intake runners and 2.165"/1.590" valves. The high-lift LS7 camshaft makes the most of the heads' generous airflow attributes, holding the big valves open so the engine can process more air. This kit fits other LS-family engines with at least 4.000" bores. Contents include the camshaft and fully assembled cylinder heads. Head gaskets and cylinder head bolts must be purchased separately.

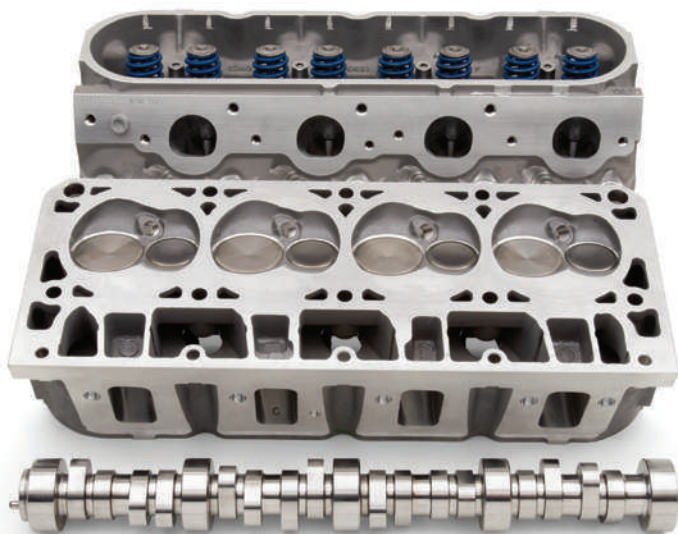

19301990
LS3 Power Upgrade Kit – Deluxe*
(Heads, Cam and Components) (not shown)

Same as 19300535 (above), but includes cylinder heads, camshaft and components needed to complete the job. New calibration included.

This part has been granted an Executive Order (E.O.) from the California Air Resources Board. E.O. D-126-45



The kit includes:

Part Number	Description	QTY
88958758	CNC LS3 Cyl Head	2
12638426	LS7 Camshaft	1
12623754	Camshaft Sprocket	1
11588723	Cam Bolts	3
12610046	Head Gasket	2
19258707	Head Bolts	20
12602540	Cover	2
12617944	Exhaust Manifold Gasket	2
12557840	Crankshaft Bolt	1

Gen 5 Camaro Performance Upgrades continued

88958758

LS3 CNC-Ported Cylinder Head*

Airflow equals power, and this LS3 CNC-ported head flows nearly 10-percent more than the stock cylinder head to promote greater power across the rpm band.

19328743

LS9 CNC-Ported Head Assembly* (not shown)

Lightweight and strong, this LS9 CNC-ported head delivers big-time performance! It features roto-cast design for additional casting strength and is CNC-Ported to same specs as P/N 88958758 LS3 design. It is assembled with lightweight LS9 components including titanium intake valves, sodium-filled exhaust valves and high-performance beehive-style valve springs.

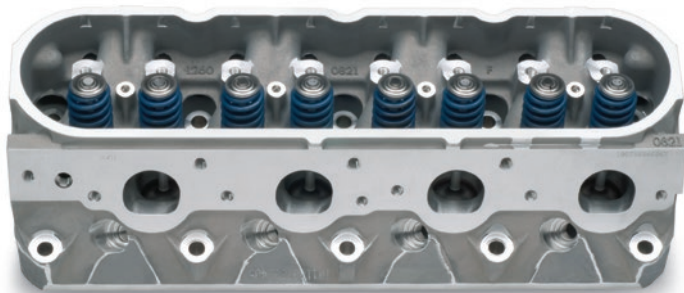

12653073

Gen 5 Camaro 1LE PCV System

Crankcase ventilation system designed for the track-oriented Camaro 1LE package, designed for excellent oil separation and crankcase return during high-performance driving and high-load cornering. Simple catch-can-type design screws into oil-fill port in the rocker cover of V-8 and V-6 models.



19303293

Gen 5 ZL1 Fuel Pump

Get greater performance with a track-proven fuel pump! The high-capacity fuel pump module from the 2012 Camaro ZL1 drops right into 2010+ Camaro fuel tanks and supports about 600 hp.

NOTE: When combined with service part 22756513 and 22756514 fuel pickups, you can expand the amount of fuel available during road course usage with your Camaro.



THE ULTIMATE TRACK GEN 5 CAMARO SS SELECTION

Kit Description	Part Numbers per Model/Year				
	Camaro 1LE 2014-2015	Camaro 1LE 2013	Camaro SS 2014-2015	Camaro SS 2012-2013	Camaro SS 2010-2011
Z/28 RDM	23172755	23172755	23172755	23172755	23172755
Z/28 RDM Cooling System Kit ¹	23216684	23216684	23216684	23216684	23216684
Z/28 Half Shaft (Left)	23473010	23473010	23473010	23473010	23473010
Z/28 Half Shaft (Right)	23473011	23473011	23473011	23473011	23473011
Z/28 Aero Package ²	23489551	—	23489551	—	—
Z/28 Wicker Kit	23200130	—	23200130	—	—
Z/28 Suspension Kit	23464729	23464729	23464729	23464729	23464729
ZL1 Engine Mounts	20952437	20952437	20952437	20952437	20952437
Z/28 Concentric Slave Cylinder	24266013	24266013	24266013	24266013	24266013
Z/28 Induction	23454578	23454578	23454578	23454578	23454578
Z/28 Brake Ducts	23252398	—	23252398	—	—
LS7 Exhaust Adapter	23454579	23454579	23454579	23454579	23454579
LS7 Exhaust System	23259294	23259294	23259294**	23259294**	23259294**
ZL1 Brake Upgrade Kit	22959672	22959672	22959672	22959672	22959672
LS3 Power Upgrade Kit – Deluxe	19301990	19301990	19301990	19301990	19301990
ZL1 Wheel Hubs/Bearings	25954415	25954415	25954415	25954415	25954415
1LE Wheels – Front, 20" x 10"	—	—	22798741	22798741	22798741
1LE Wheels – Rear, 20" x 11"	—	—	22798743	22798743	22798743
1LE Tires – Left	—	—	88878548	88878548	88878548
1LE Tires – Right	—	—	88878549	88878549	88878549
1LE PCV System	—	—	12653073	12653073	12653073
Camaro 1LE Strut Tower Brace	—	—	23120485	23120485	23120485
Short Throw Shifter (Suede) ³	—	—	19299460	19299460	19299460
ZL1 Fuel Pump	—	—	19303293	19303293	19303293
ZL1 Fuel Pickup Hose	—	—	22756513	22756513	22756513
ZL1 Fuel Pickup Pipe	—	—	22756514	22756514	22756514
1LE Suspension Adapter Kit ⁴	—	—	—	—	23484878

¹ For Manual Cars only

² See page 40 for details

³ Alternate P/N 23157703, Leather Gear Knob

⁴ Needed for Z/28 Suspension Upgrade

**Vehicles without Dual Mode (NPP) exhaust systems
require rear valance panel:
P/N 22815277 (2010-2013)
P/N 22915157 (2014-2015)



CORVETTE PERFORMANCE UPGRADES

FUNCTIONALLY DESIGNED, PERFORMANCE PROVEN

Corvette is a triumph of design, engineering and passion for performance – it was born on the track. For owners looking to amplify their braking, cornering or looks, Chevrolet Performance has a lineup of parts tuned just right for Corvette. These parts are engineered to meet the high standards and match the distinct driving characteristics of this legendary sports car.

While there are thousands of looks to create, there is only one choice when it comes to customizing your Corvette – Chevrolet Performance parts. Only Chevrolet Performance gives you the advantage of parts that were designed, engineered, tested and backed by Chevrolet. Many have been developed in the same studios and tested on the same tracks as the Corvette itself. Get the peace of mind that comes from using genuine Chevrolet Performance Parts.



CORVETTE PERFORMANCE UPGRADES

23336064
Corvette Handling Suspension Upgrade System

This suspension package was developed to improve the on-track handling capabilities of the Corvette Stingray, including Z51-equipped models. Developed for racing, the Corvette Stingray T1 Suspension Kit has been tuned with a unique front stabilizer bar paired with the rear stabilizer bar from the Grand Sport, lower control arms with stiffer handling bushings, and track-optimized passive shocks. Roll Stiffness has been increased (40% Front, 20% Rear). This kit is homologated for SCCAs Touring 1 Class, and is designed to maintain eligibility for most club racing sanctioning bodies.

NOTE: For Grand Sport and Z06 customers, the lower control arms from the T1 kit are available individually under 23336059 (RR), 23336060 (LR), 23336061 (RF), and 23336062 (LF) respectively.



100 Octane Calibration (not shown)



This calibration is optimized for track use with 100 octane fuel. If used on the street with lower octane fuel, 93 octane rating or less, driveability issues may be experienced. In particular it is possible that detonation, or spark knock, may occur in hot climates or hot running conditions with fuel that has a lower octane rating than 100. Spark knock results in the ECM retarding spark timing which will/may result in reduced engine performance. We recommend using 100 octane fuel with this calibration to maintain peak engine performance.

This part has been granted an Executive Order (E.O.) from the California Air Resources Board. E.O. D-126-41

Part Number	Description
12677967	For 2015-2016 Z06 Corvette Models

Corvette Magnetic Ride Suspension Calibration Upgrade (not shown)

Continuous on-track and street development combined with the pursuit of perfection have pushed our Corvette engineers to develop updated tuning strategies and algorithms for existing Magnetic Selective Ride Control equipped Corvettes. Each calibration is independently tuned for its respective chassis; updates Tour, Sport, and Track modes, and includes independent compression and rebound calibration for front and rear dampers individually, allowing for precise control of heave, pitch, and roll under a wide variety of situations to fine tune the vehicle's response. Corvette Magnetic Ride Suspension Calibration Upgrades improve ride quality and handling feel, and have been rigorously verified and tested to ensure the system continues to communicate with the rest of the vehicle systems.

Part Number	Model Year	Description
84353680	2015	Z06 with Z07 package, without Track Mode Calibration Update.
84353681	2015	Z06 with Z07 package, with Track Mode Calibration Update.
84353682	2016	Z06 with Z07 package, without Track Mode Calibration Update.
84353683	2016	Z06 with Z07 package, with Track Mode Calibration Update.
84375893	2015	Z06
84375892	2016	Z06
84375894	2017	Z06
84353677	2014	Z51, with MR
84353678	2015	Z51, with MR
84353684	2016	Z51, with MR
84353685	2016	Stingray, with MR
84353686	2017	Stingray, with MR

Corvette Performance Upgrades continued

23386143

Corvette Stingray Z51 Brake Kit*

Give your 2014+ Corvette Stingray the braking capability of the Z51 package. The Z51 Brake Kit features slotted rotors with diameters measuring 345mm in front and 338mm in rear. This increases the overall diameter in relation to your "standard" Corvette Stingray's 321mm front rotors and increases the brake torque up to 57% on average. This kit also features high performance pads, which provide greater resistance to brake fade at track condition rotor temperatures over 500°C. Coupled with the Z51 Brake cooling kit, this system will match the braking performance of the Z51 brake system.

NOTE: The mass dampers were removed from the stock Z51 pads in order to fit inside of the base Stingray wheels. Mass dampers are used to tune the system for brake noise, and therefore this kit is not warrantied for noise performance.



23386144 (Front)

23386145 (Rear)

Corvette Z06 Brake Kits (Iron Rotors) for Stingray with Z51*

The Z06 standard brake upgrade kit for Z51 vehicles features two-piece iron slotted rotors, measuring 370mm x 34mm in the front and 365mm x 26mm in the rear with aluminum mono-block six-piston and four-piston fixed calipers, respectively. The front calipers feature vented pistons for improved pad and brake fluid cooling, including pads 39% larger than those found on the stock Z51 vehicle. These calipers offer differentiated piston diameters of 30, 34, and 38mm (leading to trailing) to ensure more even pad pressure for improved pad wear.

NOTE: These brakes will not fit under stock base or Z51 wheels. Requires a minimum 4mm wheel clearance between the outboard face of the caliper and the inner wheel spoke. This application is for off-road use only because the stock Z51 wheels do not fit over the Z06 brakes. Any failures occurring as a result of the non-production wheels selected by the customer would not be covered.



Front Brake Kit

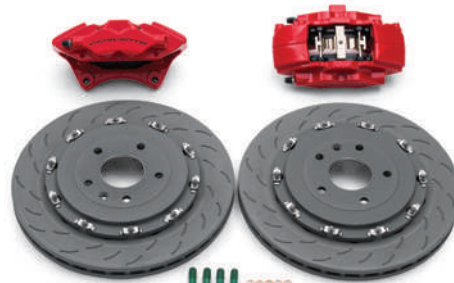

Rear Brake Kit

84150313

Corvette Z06 Front Brake Cooling Duct System

Enhance the stopping performance of your vehicle with the Front Brake Cooling Duct System. The kit includes brake ducts and deflectors that transport air from the front grille through the wheel wells to effectively cool the front brakes and expel heat. This increases airflow by 16% (based of CFD analysis) to increase stopping performance by reducing temperature and brake fade. Available on Stingray base trim only.

NOTE: Brake ducts performance is optimized when used with Z06 Grille Kit (page 47).





Corvette Z06 Spec Grille System

Further enhance the air flow to your vehicle with a Corvette Z06 Grille System specifically designed to provide maximum air flow to the radiator and brake cooling ducts. The 17% additional air flow (compared to Z51 and based on CFD analysis) can help keep your vehicle running cooler on the track. Additionally, the inlet ramps to the brake cooling ducts were optimized to balance the air flow demands of brake cooling and engine cooling. (Not for Z06 models. For vehicles with front camera but not grille inserts.)

Grille System Options include:

Part Number	Year	Description
84115259	2014-2017	With Front Camera
84115258	2014-2018	Without Front Camera

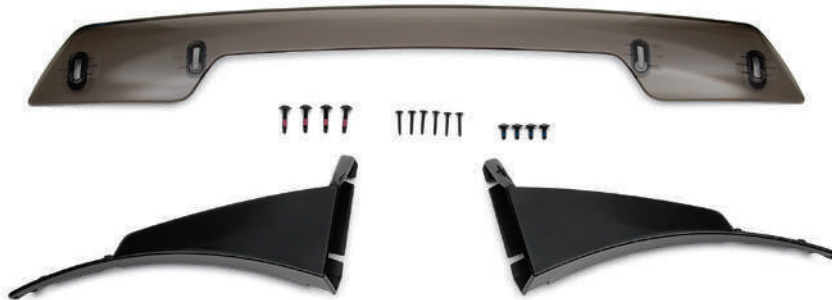

84056038 Corvette Z06 Spec Aero Package Level 3

Add a new dimension of downforce to your Corvette Z06 with a Performance Aero Kit Downforce Package. This Level 3 Aero Package is an upgrade exclusively for Level 2-equipped Corvette Z06 models and adds elements from the Z07 Performance Package, including larger end plates to the front splitter, as well as an adjustable, transparent wickerbill on the rear spoiler for track use. With this package, the Corvette Z06 delivers the most aerodynamic downforce of any production car that GM has ever tested.



23373152 (black)



84347359 (carbon fiber)



Corvette Quarter Panel Vents

Substantial airflow is critical for maintaining cooling performance on the track. The quarter vents offer larger openings for increased airflow to the transmission oil cooler and differential cooler – an approximately 25% improvement over the airflow of the Z51 at track speeds (based on CFD analysis).

Grille System Options include:

Part Number	Year	Description
23373152	2015-2018	Black, for Z51
84347359	2015-2018	Carbon Fiber, for Z06 and Z51

Corvette Performance Upgrades continued

23385708

Corvette Z06 Spec Carbon Fiber Underbody Braces*

These carbon fiber underbody braces are about 17% lighter than the aluminum braces on the Corvette Stingray, while maintaining original overall torsional stiffness.



23376530

Corvette Z06 600-Watt Radiator Fan

Developed to meet the Z06's track cooling requirements, this powerful, 600-watt radiator cooling fan increases the fan speed over the Stingray's 500-Watt system for greater airflow and enhanced cooling capability. It is a direct replacement for the standard Corvette Stingray cooling fan on pre-2015 Z51 and all base 2014+ models.



84201727

Corvette Secondary Radiator

This radiator adds additional cooling capability to manual transmission Corvettes that see regular track use. This kit includes the lines and hardware necessary to mount and plumb this additional radiator to the front of any manual transmission-equipped Stingray. This includes base Stingray, Z51, and Z06 cars. With the addition of this kit to a Z51 manual transmission car, the radiator fluid temperatures are lowered 25° F along with the engine oil temperatures down 15° F. Addition of the Z06 grill (page 47) further enhances the cooling capacity of this kit with radiator fluid temperatures lowered 27° F and engine oil temperatures down 18° F.

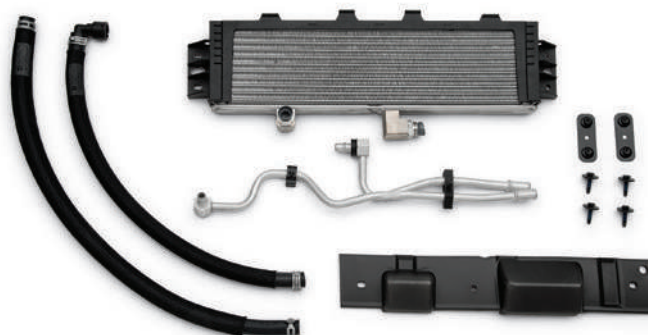

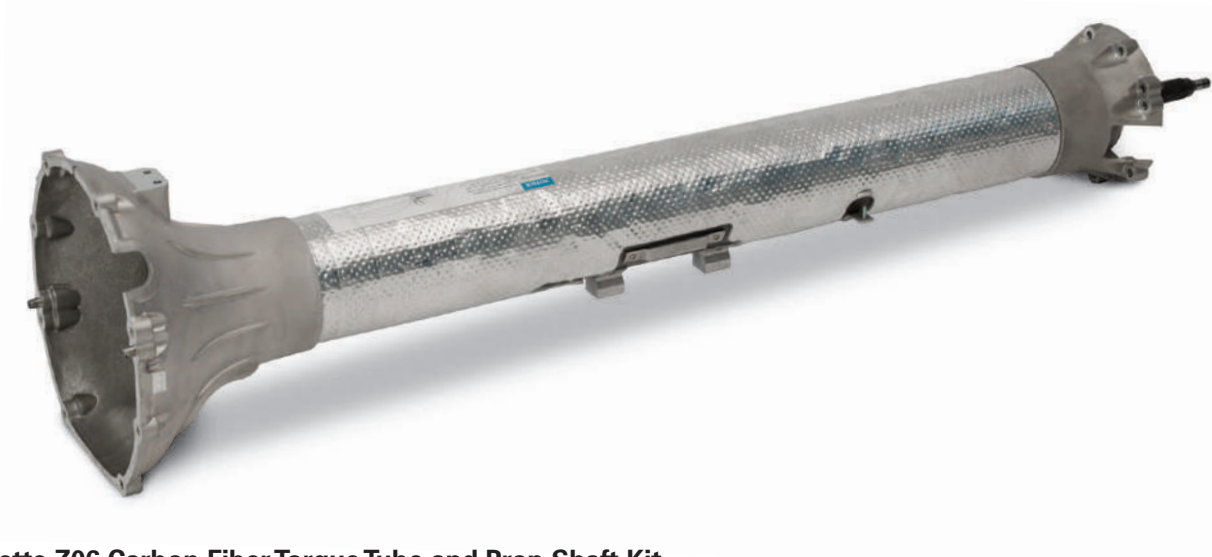

Corvette Z06 Carbon Fiber Torque Tube and Prop Shaft Kit

Drop a few pounds on your Stingray with the Z06 Carbon Fiber Torque Tube assembly. It saves almost 15.5 pounds (7 Kg) compared to the Stingray's steel-intensive torque tube. Chevrolet Performance's Corvette Z06 Carbon Fiber Torque Tube and Prop Shaft Kit (P/Ns 23228000, 23401477, 23227999 and 23401476) features the torque tube assembly and the Corvette Z06 prop shaft with high-temperature couplings. The higher-temperature rubber couplers in the prop shaft can withstand

the higher temperatures typically encountered at the track. Applications vary by transmission and model year. See your Chevrolet Performance dealer for the correct part number for your vehicle.

Torque Tube and Prop Shaft Kit Options include:

Part Number	Description
23228000	Manual (shown)
23227999	Automatic



23229542 Corvette Stingray Heat Shield

Protect your prop shaft from heat! This larger heat shield helps protect the prop shaft from high temperatures seen with track use. It is only required for 2014 Corvette Stingray models. It is included on 2015+ models.

Corvette Z06 Prop Shaft Assembly with High-Temp Couplers (not shown)

Handle track temps better! The Corvette Z06's internal prop shaft includes rubber couplers designed for higher temperatures and, combined with the larger heat shield, results in increased durability during track use. They are only needed for vehicles manufactured before June 2, 2015. Includes prop shaft assembly only.

Prop Shaft Assembly Options include:

Part Number	Description
23366291	Manual
23366290	Automatic

Corvette Z06 Carbon Fiber Torque Tube Housing (not shown)

When every pound matters, trim weight without compromising performance. The Corvette Z06's Carbon Fiber Torque Tube Housing saves almost 15.5 pounds (7 Kg) compared to the Stingray's steel-intensive torque tube. Includes the torque tube housing assembly only.

Torque Tube Housing Options include:

Part Number	Description
23366289	Manual
23366287	Automatic

CORVETTE INTERIOR

A. Z06 Floor Console Lid

Add some flair to your Corvette Z06 interior with an embroidered Floor Console Lid, featuring a distinctive Z06 logo. Available in Gray, Black, Blue or Kalahari to match your Z06's interior.

Part Number	Year	Description
23296453	2015-2018	Floor Console Lid - Leather, Z06, Gray
23296454	2015-2018	Floor Console Lid - Leather, Z06, Black
23296455	2015-2018	Floor Console Lid - Leather, Z06, Kalahari
23296456	2015-2018	Floor Console Lid - Leather, Z06, Blue
23296461	2015-2018	Floor Console Lid - Z06, Kalahari



A Z06 Floor Console Lid – Black

B. Grand Sport Floor Console Lid **NEW!**

Add some flair to your vehicle's interior with an embroidered Floor Console Lid featuring the Grand Sport logo.

Part Number	Year	Description
84255359	2017-2018	Floor Console Lid - Leather, Grand Sport, Med Ash Gray
84255353	2017-2018	Floor Console Lid - Grand Sport, Jet Black
84255354	2017-2018	Floor Console Lid - Grand Sport, Med Ash Gray
84255355	2017-2018	Floor Console Lid - Grand Sport, Adrenaline Red
84255356	2017-2018	Floor Console Lid - Grand Sport, Kalahari
84255358	2017-2018	Floor Console Lid - Leather, Grand Sport, Jet Black
84255360	2017-2018	Floor Console Lid - Leather, Grand Sport, Adrenaline Red
84255361	2017-2018	Floor Console Lid - Leather, Grand Sport, Kalahari



B Grand Sport Console Lid

C. Grand Sport Premium Carpet Cargo Mat

Keep the cargo area of your vehicle protected and well-detailed with a Premium Carpeted Cargo Mat with the Grand Sport logo. It features rich, detailed embroidery. Available exclusively on Grand Sport convertible models.

Part Number	Year	Description
23469813	2017-2018	Grand Sport Coupe, Cargo Premium Carpet Mat, Black with Grand Sport Logo
23409866	2017-2018	Grand Sport Convertible, Cargo Premium Carpet Mat, Black with Grand Sport Logo



C Grand Sport Premium Carpet Cargo Mat

D. Grand Sport Floor Mat

Add a custom appearance and protect your vehicle's front carpet with Premium Carpeted Front Floor Mats featuring the Grand Sport Logo. They offer a precise factory fit and protect the interior from dirt, mud and debris.

Part Number	Year	Description
23484153	2017-2018	Premium Carpeted Floor Mats, Black with Blue Binding
23384149	2017-2018	Premium Carpeted Front Floor Mats, Jet Black with Jet Black Binding
23384150	2017-2018	Premium Carpeted Front Floor Mats, Jet Black with Gray Binding
23384151	2017-2018	Premium Carpeted Front Floor Mats, Jet Black with Adrenaline Red Binding
23384152	2017-2018	Premium Carpeted Front Floor Mats, Jet Black with Kalahari Binding
23384154	2017-2018	Premium Carpeted Front Floor Mats, Gray with Gray Binding



D Grand Sport Floor Mat



Grand Sport Door Sill Plate **E**



Underhood Liner, Black with Crossed Flags and Grand Sport Logos **F**



Corvette Center Caps **G**



Z06 10-Spoke Black Painted Wheel **H**



Z06 10-Spoke Nickel Pearl Painted Wheel **I**

E. 23279545 Grand Sport Door Sill Plates

Add a stylish accent to the entry area of your vehicle with these aluminum Door Sill Plates featuring the Grand Sport logo.

F. 23321670 Underhood Liner, Black with Crossed Flags and Grand Sport Logos

Complement your vehicle's unique approach to refined power with an Underhood Liner in Black with the Crossed Flags and Grand Sport logos. The liner attaches to the underside of the hood and completes the vehicle's performance backdrop.

G. Corvette Center Caps

Add an extra element of beauty to your Corvette with a unique Center Cap.

Part Number	Description
19301417	Jake Logo, Argent Background
19301418	Stingray Logo
19301420	Z51 Logo, Chrome
19301415	Crossed-Flag Logo, Argent Background (shown)
19301416	Crossed-Flag Logo, Black Background
19301421	Z51 Logo, Metallic Gray
19302357	Carbon Logo (shown)
19331659	Jake Logo, Black Background (shown)
19301419	Stingray Logo

CORVETTE WHEELS

H. 19- and 20-Inch Wheels (Z06 only) – Black Painted With Machine Groove

Personalize your Corvette Z06 vehicle with these 19- and 20-Inch Wheels validated to GM specifications. Use only GM-approved wheel and tire combinations.

Part Number	Year	Description
23251387	2016-2018	19-inch Wheel - Front Wheel - Black Painted With Machine Groove - 6Z9 (Z06 Only)
23319267	2016-2018	20-inch Wheel - Rear Wheel - Black Painted With Machine Groove - 6Z9 (Z06 Only)

NOTE: Center Caps, Tires, Lugnuts, Tire Pressure Monitors, and Wheel Locks sold separately.

I. 19- and 20-Inch Wheels (Z06 only) – Nickel Pearl Painted With Machine Groove

Personalize your Corvette Z06 vehicle with these 19- and 20-Inch Wheels validated to GM specifications. Use only GM-approved wheel and tire combinations.

Part Number	Year	Description
23251390	2016-2018	19-inch Wheel - Front Wheel - Nickel Pearl Painted - 5Z8 (Z06 Only)
23319266	2016-2018	20-inch Wheel - Rear Wheel - Nickel Pearl Painted - 5Z8 (Z06 Only)

NOTE: Center Caps, Tires, Lugnuts, Tire Pressure Monitors, and Wheel Locks sold separately.

CORVETTE EXTERIOR

A. High Wing Spoiler

Bring a completely different look to your vehicle with a matching body-color High Wing Spoiler Kit. It takes the color scheme a step further by replacing the standard Black spoiler. Not available on Grand Sport or Z06 models.

Part Number	Year	Description
22908984	2014-2018	High Wing Spoiler, Black
22908985	2014-2018	High Wing Spoiler, Crystal Red
22881387	2014-2018	High Wing Spoiler, Paint to Match
22908983	2014-2018	High Wing Spoiler, Silver
22908987	2014-2018	High Wing Spoiler, Torch Red
22908982	2014-2018	High Wing Spoiler, Velocity Yellow
22908986	2014-2018	High Wing Spoiler, Cyber
23214209	2017-2018	High Wing Spoiler, Yell-O Tint
23214210	2017-2018	High Wing Spoiler, Addiction Red
23322549	2017-2018	High Wing Spoiler, Opulent Blue Metallic

Wickerbill

Part Number	Year	Description
23486749	2014-2018	Wickerbill Spoiler, Black

B. 84133913

Z06 Spec Spoiler – Visible Carbon Fiber - 2016-2018 MY

Add style to your vehicle with this Spoiler Kit. Its distinctive appearance is sure to make your vehicle stand out. Available in Exposed Carbon Fiber, it replaces the standard Spoiler.

C. Z06 Spec Spoiler – Body Color w/ Wicker

Retain the original performance of your vehicle while taking the aggressive appearance a step further with a Z06-Style Spoiler Kit. It adds pronounced gurney-style flaps.

Part Number	Year	Description
84056041	2016-2018	Spoiler Kit - Z06-Style, Red
84165141	2016-2018	Spoiler Kit - Z06-Style, Blue
84165142	2016-2018	Spoiler Kit - Z06-Style, Gray
84056044	2016-2018	Spoiler Kit - Z06-Style, White
84056042	2016-2018	Spoiler Kit - Z06-Style, Paint to Match

D. Ground Effects

Accentuate the sleek, expressive exterior of your Corvette Stingray with these eye-catching Ground Effects. Includes front splitter and side rocker panels.

Part Number	Year	Description
84139800	2014-2018	Ground Effects, Carbon Flash (Visible Carbon Fiber)
84139815	2014-2018	Ground Effects, Paint to Match
84139794	2014-2018	Ground Effects, White
84139812	2014-2018	Ground Effects, Blue
84139809	2014-2018	Ground Effects, Gray
84139791	2014-2018	Ground Effects, Red
84139797	2014-2018	Ground Effects, Painted Carbon Fiber in Carbon Flash

Side Rockers Kit (not shown)

Accentuate your vehicle's expressive body lines with this attention-grabbing Rocker Panel Moldings Package.

Part Number	Year	Description
84139818	2014-2018	Visible Carbon Fiber
84139819	2014-2018	Carbon Flash
84139820	2014-2018	Prime



A High-Wing Spoiler with Wickerbill



B Carbon Fiber Spoiler



C Z06 Spec Spoiler – Body Color w/ Wicker



D Ground Effects



Transparent Roof **E**



Grand Sport Cover **F**



Indoor Vehicle Cover – C7R Corvette Racing **F**



Outdoor, All-Weather Vehicle Cover – Stingray Logo, Gray **F**

E. 84141731 NEW!

Transparent Roof

Advanced materials and the option of open-air motoring enjoyment blend together in this Removable Roof Panel in Carbon Fiber that is fully transparent. Chevrolet's dedication to precision engineering and correct fit extends to producing the panel on the same factory tooling used to manufacture the original factory panel. A custom storage bag, sold separately, ensures kid-gloves-quality stowage and features the Corvette logo.

F. Vehicle Covers

Keep your performance investment clean and protected with a choice of indoor or outdoor Vehicle Covers. The soft Indoor Dust Cover helps keep dust and light debris off, and when circumstances dictate outdoor storage, an Outdoor All-Weather Vehicle Cover helps to shield the finish from the elements, offering waterproof, breathable protection. Great looks are always important, and both versions have you covered with Corvette-specific logos. Each includes a duffle-style storage bag to keep the cover clean and neatly out of the way when not in use.

Grand Sport Cover

Part Number	Year	Description
84025014	2017-2018	Vehicle Cover, Rendered Grand Sport Indoor Cover
23249342	2017-2018	Vehicle Cover, Embossed Grand Sport Indoor Cover

Indoor Covers

Part Number	Year	Description
23142888	2015-2018	Vehicle Cover, Indoor Dust Cover, Embossed Logo, Red (shown)
23481362	2015-2018	Vehicle Cover, C7R Corvette Racing, Indoor (Fits 2014-2016 Vehicles) (shown)
23142881	2015-2018	Vehicle Cover, Indoor Dust Cover, Crossed-Flag Logo, Gray
23142882	2015-2018	Vehicle Cover, Indoor Dust Cover, Crossed-Flag Logo, Kalahari
23142883	2015-2018	Vehicle Cover, Black Stingray Logo (shown)
23187874	2015-2018	Vehicle Cover, For Z06, Indoor, Galvanized Cool
23187875	2015-2018	Vehicle Cover, For Z06, Indoor, Blue

Outdoor Covers

Part Number	Year	Description
23142884	2015-2018	Vehicle Cover, Outdoor All-Weather, Stingray Logo, Black
23142885	2015-2018	Vehicle Cover, Outdoor All-Weather, Stingray Logo, Gray (shown)
23187877	2015-2018	Vehicle Cover, For Z06, Outdoors, Redline
23187876	2015-2018	Vehicle Cover, For Z06, Outdoors, Black



THE ULTIMATE TRACK CORVETTE STINGRAY

The C7 Corvette Stingray is one of the most track-capable sports cars you can buy – particularly when it's equipped with the available, track-tested Z07 package, with its performance eclipsed only by the supercharged Corvette Z06. From aerodynamic aids designed to produce cornering-enhancing downforce and high-speed stability to the larger brakes and unique drivetrain elements required to support the 650-hp Z06's higher performance capability, it's a world-class supercar.

Many of the Z06's special components can be applied to the Stingray (including Z51 models) to enhance handling, braking, cooling and downforce performance, elevating its capability on the track for quicker lap times and a greater overall feeling of confidence in turns and on straights. Chevrolet Performance engineers have hand-picked the Z06 parts and other components that offer the greatest performance enhancements, with most of them offered as direct replacements for the stock corresponding Stingray parts.

No one has spent more time developing Corvette performance components than Chevrolet and our new range of components is the result of countless hours of testing. They not only perform, but when applied to your Stingray, you can trust they will fit and perform as expected, with production-level durability. Mix and match the parts to build your own ultimate Stingray track car. It's the capability of the Z06 straight from Chevrolet Performance!

THE ULTIMATE TRACK CORVETTE STINGRAY SELECTION

Kit Description	Part Numbers	Trim	Transmission	Restrictions
Z51 Front/Rear Brakes	23386143	Non-Z51	Man. or Auto.	Recommended to buy with brake ducts
Z06 Front Brakes	23386144	Z51	Man. or Auto.	Requires new wheels or wheel spacers
Z06 Rear Brakes	23386145	Z51	Man. or Auto.	Requires new wheels or wheel spacers
T1 Suspension Kit	23336064	Non-Z51 or Z51	Man. or Auto.	Vehicles with FE1/FE3
T1 Right Rear Control Arm	23336059	Z06 or GS	Man. or Auto.	N/A
T1 Left Rear Control Arm	23336060	Z06 or GS	Man. or Auto.	N/A
T1 Right Front Control Arm	23336061	Z06 or GS	Man. or Auto.	N/A
T1 Left Front Control Arm	23336062	Z06 or GS	Man. or Auto.	N/A
Carbon Fiber Underbody Braces	23385708	Non-Z51 or Z51	Man. or Auto.	N/A
Manual Transmission Carbon Fiber Driveshaft Complete Assembly	23228000	Non-Z51 or Z51	Man.	N/A
Automatic Transmission Carbon Fiber Driveshaft Complete Assembly	23227999	Non-Z51 or Z51	Auto.	N/A
Larger Driveshaft Heat Shield ³	23229542	Non-Z51 or Z51	Man. or Auto.	N/A
Manual Transmission Internal Prop-Shaft Assembly including higher temp couplers ²	23366291	Non-Z51 or Z51	Man.	N/A
Automatic Transmission Internal Prop-Shaft Assembly including higher temp couplers ²	23366290	Non-Z51 or Z51	Auto.	N/A
Manual Transmission Carbon Fiber Torque Tube Housing Assembly	23366289	Non-Z51 or Z51	Man.	N/A
Automatic Transmission Carbon Fiber Torque Tube Housing Assembly	23366287	Non-Z51 or Z51	Auto.	N/A
Z06 Transmission Cooler Duct ¹	23212340	Z51	Man.	N/A
Z06 Transmission Fluid Pump (internal to transmission)	19180060	Z51	Man.	N/A
Z06 Large Core Transmission Cooler (manual, rpo: mek) ¹	23283460	Z51	Man.	N/A
Pipe, Transmission Fluid clr inl & otlt, rear large core manual transmission line ¹	23212375	Z51	Man.	N/A
Z06 Grille w/o camera	23387122	Non-Z51 or Z51	Man. or Auto.	Base car should buy brake ducts to fill the hole
Z06 Grille w/camera ⁵	84020980	Non-Z51 or Z51	Man. or Auto.	Base car should buy brake ducts to fill the hole
Quarter Panel Vent ¹	23373152	Z51	Man. or Auto.	N/A
Z51 Brake Ducts	23383592	Non-Z51	Man. or Auto.	N/A
600W Radiator Fan ⁴	23376530	Non-Z51 or Z51	Man. or Auto.	N/A
Auxiliary Laydown Radiator	84037858	Non-Z51, Z51 & Z06	Man.	N/A
C7 Front Compartment Air Deflector	23135212	Non-Z51, Z51 & Z06	Man. or Auto.	Track use only, must be removed for daily driving
C6 Z06 Rear Duct (eps cooler)	15842373	Non-Z51, Z51 & Z06	Man. or Auto.	Track use only, must be removed for daily driving
Ground Effects - exposed carbon fiber	23495173	Non-Z51 or Z51	Man. or Auto.	Must be purchased with Rear Spoiler Kit
Ground Effects - carbon flash	23495172	Non-Z51 or Z51	Man. or Auto.	Must be purchased with Rear Spoiler Kit
Ground Effects - arctic white	23495175	Non-Z51 or Z51	Man. or Auto.	Must be purchased with Rear Spoiler Kit
Ground Effects - Laguna blue/blue my mind	23495176	Non-Z51 or Z51	Man. or Auto.	Must be purchased with Rear Spoiler Kit
Ground Effects - shark gray metallic/fusion gray metallic	23495177	Non-Z51 or Z51	Man. or Auto.	Must be purchased with Rear Spoiler Kit
Ground Effects - torch red	23495179	Non-Z51 or Z51	Man. or Auto.	Must be purchased with Rear Spoiler Kit
Z06 Rear Spoiler w/stage 1 - carbon flash metallic	23303055	Non-Z51	Man. or Auto.	Must be purchased with Ground Effects
Z06 rear Spoiler w/stage 1 - white arctic	23301862	Non-Z51	Man. or Auto.	Must be purchased with Ground Effects
Z06 rear Spoiler w/stage 1 - Laguna blue/blue my mind	23301863	Non-Z51	Man. or Auto.	Must be purchased with Ground Effects
Z06 rear Spoiler w/stage 1 - shark gray metallic/fusion gray metallic	23301860	Non-Z51	Man. or Auto.	Must be purchased with Ground Effects
Z06 rear Spoiler w/stage 1 - torch red	23301864	Non-Z51	Man. or Auto.	Must be purchased with Ground Effects
Z06 rear Spoiler w/stage 3 bridge - carbon flash metallic	23409284	Z51	Man. or Auto.	Must be purchased with Ground Effects
Z06 rear Spoiler w/stage 3 bridge - white arctic	23409283	Z51	Man. or Auto.	Must be purchased with Ground Effects
Z06 rear Spoiler w/stage 3 bridge - Laguna blue/blue my mind	23409281	Z51	Man. or Auto.	Must be purchased with Ground Effects
Z06 rear Spoiler w/stage 3 bridge - shark gray metallic/fusion gray metallic	23409282	Z51	Man. or Auto.	Must be purchased with Ground Effects
Z06 rear Spoiler w/stage 3 bridge - torch red	23409280	Z51	Man. or Auto.	Must be purchased with Ground Effects
Z51 Spoiler - carbon flash metallic	22989472	Non-Z51	Man. or Auto.	N/A
Z51 Spoiler - white arctic	22967764	Non-Z51	Man. or Auto.	N/A
Z51 Spoiler - Berlin blue metallic/night race blue metallic	22967765	Non-Z51	Man. or Auto.	N/A
Z51 Spoiler - torch red	22966767	Non-Z51	Man. or Auto.	N/A
Z51 Spoiler - crystal red tintcoat	22967769	Non-Z51	Man. or Auto.	N/A
Z51 Spoiler - black	22967771	Non-Z51	Man. or Auto.	N/A
Z51 Spoiler - switchblade silver/blade silver metallic	22967773	Non-Z51	Man. or Auto.	N/A
Z51 Spoiler - velocity yellow tintcoat	22967774	Non-Z51	Man. or Auto.	N/A
Z51 Spoiler - unripened green metallic	22967763	Non-Z51	Man. or Auto.	N/A
Z51 Spoiler - Laguna blue/blue my mind	22967770	Non-Z51	Man. or Auto.	N/A

¹ For Coupe body style only

² For models manufactured before 06/02/2015

³ 2014 model year only

⁴ 2014+ model years for Non-Z51, 2014 model year for Z51

⁵ 2014-2017 model year only



CRUZE PERFORMANCE UPGRADES

Lowering Suspension Upgrade System

Further enhance the handling performance of your vehicle with front and rear springs from the Lowering Suspension Upgrade System. The springs are designed to help keep the vehicle well balanced and improve its cornering capability by reducing body roll and improving traction. Reduces ride height up to 10mm.

Part Number	Year	Description
84105410	2017-2018	Suspension Lowering Kit, LT / Premier Hatch and Sedan Models
84105409	2017-2018	Suspension Lowering Kit, L / LS Sedan Models



84105410



84105409

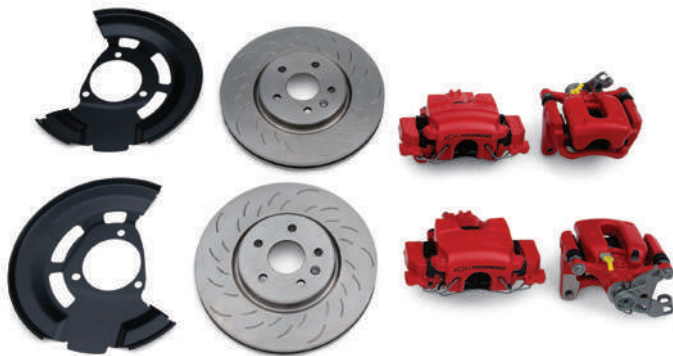

Front and Rear Brake System **A**



Performance Exhaust – Hatchback for RS Models **B**



Spoiler **C**



17" Wheels **D**



18" Wheels **D**

CRUZE PERFORMANCE UPGRADES

A. 23261507

Front and Rear Brake Upgrade System in Red

Improve your vehicle's looks and performance with a Chevrolet Performance Front and Rear Brake Upgrade System in Red. It features red front calipers with the Chevrolet Performance logo, matching red rear calipers and larger 11.8-inch x 1.0-inch (300mm x 26mm) vented and slotted Duralife™ rotors. Duralife™ rotors feature a hardened surface to reduce corrosion and provide quieter braking with less vibration. This kit is a direct replacement for the original brakes and includes all necessary hardware and installation instructions. Available for Cruze models equipped with 16" or larger factory and Chevrolet Accessory wheels.

B. 1.4L Turbo Cat-Back Single Exhaust Upgrade System

Chevrolet Performance Exhaust Parts are engineered, developed and tested to exceed your expectations for fit and function. This upgrade for Cruze includes a High Flow Exhaust System for optimum engine breathing and performance. See dealer for details. This exhaust will not void your warranty.

Part Number	Year	Description
23233811	2014-2016	1.4L Turbo with High Flow Exhaust System, for RS Models
23494247	2012-2016	1.4L Turbo with High Flow Exhaust System, for Non-RS Models
84152664	2017-2018	1.4L Turbo with High Flow Exhaust System, for Sedan - Back Pressure Reduced by up to 50%
84152662	2017-2018	1.4L Turbo Performance Exhaust Hatchback for Non-RS Models - Back Pressure Reduced by up to 50%
84152660	2017-2018	1.4L Turbo Performance Exhaust Hatchback for RS Models - Back Pressure Reduced by up to 50%

CRUZE EXTERIOR

C. Spoiler

Add a sporty flair to your Cruze Sedan with a Rear Spoiler Kit. Available in a variety of colors.

Part Number	Year	Description
84037060	2016-2018	Rear Spoiler Kit, Silver Ice Metallic
84037061	2016-2018	Rear Spoiler Kit, Mosaic Black Metallic
84037063	2016-2018	Rear Spoiler Kit, Kinetic Blue Metallic
84037064	2016-2018	Rear Spoiler Kit, Paint to Match
84037065	2016-2018	Rear Spoiler Kit, Summit White

D. Wheels

Personalize your vehicle with these 17- and 18-Inch Wheels validated to GM specifications. Use only GM-approved wheel and tire combinations.

Part Number	Year	Detail
23322703	2016-2018	17" Wheel
84012907	2016-2018	18" Wheel

NOTE: Center Caps, Tires, Lugnuts, Tire Pressure Monitors, and Wheel Locks sold separately.



SONIC PERFORMANCE UPGRADES

Lowering Suspension Upgrade System

This Lowering Suspension Upgrade System utilizes new front and rear springs, front struts and rear shocks to reduce ride height by 20mm. Kit also includes unique jounce bumpers for improved ride performance. Compatible with both Sedan and Hatchback without sports package.

Part Number	Year	Description
23158161	2012-2018	Sport Suspension Kit, Non-RS (shown)
23158162	2012-2018	Sport Suspension Kit, RS





1.4L Turbo Cat-Back Single Exhaust Upgrade System with Polished Tips **A**



1.4L Turbo Performance Air Intake **B**



Ambient Lighting Kit **C**



Black Bowtie – Front **D**



Black Bowtie – Rear **D**

SONIC PERFORMANCE UPGRADES

A. 1.4L Turbo Cat-Back Single Exhaust Upgrade System with Polished Tips

Get the horsepower boost you need for your Sonic! The High Flow Exhaust System features dual-walled and angle-cut T-304 stainless tips.

Part Number	Year	Description
23444736	2012-2016	Exhaust Kit (1.4L turbo - Base Hatchback)
23444737	2012-2016	Exhaust Kit (1.4L turbo - RS Hatchback)
23451716	2012-2018	Exhaust Kit (1.4L turbo - Sedan)
84154146	2017-2018	Exhaust Kit (1.4L turbo - RS Hatchback)

NOTE: 2012-2014 vehicles require a new high capacity 2014 manual clutch P/N 19303797.

19303797

Sonic Performance Clutch Kit (not shown)

This increased torque capacity system includes a larger-than-stock flywheel, clutch disk and pressure plate, along with new attaching bolts.

NOTE: Must be used on 2012-2014 Sonics that have installed P/N's 23444736, 23444737, 23451716 Exhaust Kits.

B. 84151449

1.4L Turbo Performance Air Intake

Upgrade the look and performance of your Sonic with the Performance Air Intake. This intake utilizes a high flow air filter. The clear cover adds a custom look and preserves the life of your filter. This system has been rigorously tested to GM standards for durability, corrosion, and performance.

NOTE: Valid only for MY 2012-2015. Not legal to sell or install this Kit on vehicles registered in California emission states.

SONIC INTERIOR

C. 95319699

Ambient Lighting Kit – 2014-2018 MY

This Ambient Lighting Kit provides accent lighting to the footwell area of your Sonic with a touch of the on/off switch. Set your mood with six colors (Blue, Red, Green, White, Purple and Orange) and two intensity levels (Low and High). Change colors manually or allow the system to cycle through the colors automatically.

SONIC EXTERIOR

D. 42475824

Black Bowtie Emblem Package – 2018 MY **NEW!**

Dress up and accent the exterior of your Sonic with this front and rear Bowtie Emblem Package. Fits all models.



MALIBU

PERFORMANCE UPGRADES

23393264

Lowering Suspension Upgrade System

This Lowering Suspension Upgrade System uses new springs to lower Malibu's center of gravity for optimized handling and an improved stance. It lowers the Malibu by 10mm. For use with 2.0L Turbo engine (LTG) only.

NOTE: Usage limited to 2.0L-equipped vehicles only





Bowtie Emblems **A**



Badge Kit – Door **B**



Badge Kit – Rear **B**



Ground Effects Package **C**



Spoiler Kit **D**



Accessory Grille **E**

MALIBU EXTERIOR

A. 23384199

Black Bowtie Emblem Package – 2018 MY

Dress up your vehicle with these distinctive front and rear Black Bowtie Emblems.

B. 84023560

Badge Kit – Door “Malibu” – Rear “Malibu 2.0T” – 2018 MY

Dress up and accent the exterior of your Malibu with this stylish Badge Kit featuring distinctive nameplates in Gloss Black.

NOTE: Malibu “LT” emblem not available. Black “LT” emblem replacement not part of this kit.

C. Ground Effects Package

Create a dramatic, ground-hugging appearance for your Malibu with this Ground Effects Package, available in select body colors.

Part Number	Year	Description
84116606	2017-2018	Ground Effects Kit, Mosaic Black Metallic
84116607	2017-2018	Ground Effects Kit, Silver Ice Metallic
84116608	2017-2018	Ground Effects Kit, Cajun Red Tintcoat
84116609	2017-2018	Ground Effects Kit, Summit White
84116610	2017-2018	Ground Effects Kit, Blue Velvet

D. Spoiler Kit

Add a sporty appearance to your vehicle with this low-profile Flush Mount Rear Spoiler that extends the width of the deck-lid. Available in a variety of exterior colors.

Part Number	Year	Description
84055129	2017-2018	Spoiler Kit, Prime Unpainted (shown, custom painted)
84045130	2017-2018	Spoiler Kit, Blue Velvet
84045131	2017-2018	Spoiler Kit, Cajun Red Tintcoat
84045132	2017-2018	Spoiler Kit, Summit White
84045133	2017-2018	Spoiler Kit, Mosaic Black Metallic
84045134	2017-2018	Spoiler Kit, Silver Ice Metallic

E. 84188548

Accessory Grille – 2016-2018 MY

Personalize the front end of your Malibu with this sporty Grille featuring a unique Black Painted finish and surround.

NOTE: Black Bowtie not included with Grille purchase. Gloss Black Bowtie Emblem (A) must be purchased separately if desired.

SILVERADO PERFORMANCE UPGRADES



84263234

Front 6-Piston Brembo® Brake Upgrade System in Red

The Front 6-Piston Brembo Brake Upgrade System in Red features Brembo® six-piston, fixed aluminum calipers loaded with brake pads clamping on larger-than-stock 16.1-inch x 1.3-inch (410 x 32mm) Duralife™ rotors. Provides an 84% increase in brake pad area and a 42% increase in rotor area for increased brake system thermal capacity. Duralife™ rotors feature a hardened surface to reduce corrosion and provide quieter braking with less vibration. This brake package includes all necessary hardware and installation instructions. This front brake system is available for any light-duty 2014+ Silverado and light-duty 2015+ Tahoe/Suburban with 20-inch to 22-inch original equipment or GM accessory wheels (except SEU wheels).





5.3L Cat-Back Single Exhaust Upgrade System with Polished Tip **A**



5.3L Cold Air Intake System **B**



Exhaust Tip – Bowtie Logo **C**

SILVERADO PERFORMANCE UPGRADES

A. Performance Exhaust Kits

5.3L Cat-Back Single Exhaust Upgrade System with Polished Tip

Upgrade the look, sound and overall performance of your vehicle's exhaust system with this 5.3L Cat-Back Single Exhaust Upgrade System with Polished Tip designed for Models equipped with the 5.3L V8 engine. This kit yields real horsepower gains of 10 horsepower¹ at 5,600 rpm with increased 3-inch diameter piping. It features a direct bolt-on design with no cutting required and is made from 304 Stainless Steel, including a highly polished 4.5-inch exhaust tip.

¹Estimated power based upon SAE test procedure J1349.

Part Number	Year	Description
23462044	2014-2018	Performance Exhaust - Silverado 1500 with 5.3L V-8 (LWB)
23462045	2014-2018	Performance Exhaust - Silverado 1500 with 5.3L V-8 (SWB)

6.2L Cat-Back Single Exhaust Upgrade System with Polished Tip (not shown)

Upgrade the look, sound and overall performance of your vehicle's exhaust system with this 6.2L Cat-Back Single Exhaust Upgrade System with Polished Tip designed for Models equipped with the 6.2L V8 engine. This kit yields real horsepower gains of 7 horsepower¹ at 5600 with increased 3.5-inch diameter piping. It features a direct bolt-on design with no cutting required and is made from 304 Stainless Steel, including a highly polished 4.5-inch exhaust tip.

¹Estimated power based upon SAE test procedure J1349.

Part Number	Year	Description
23462042	2014-2016	Performance Exhaust - Silverado 1500 with 6.2L V-8 (LWB)
23462043	2017-2018	Performance Exhaust - Silverado 1500 with 6.2L V-8 (SWB)

B. 5.3L Cold Air Intake System

Upgrade the performance and look of your vehicle with this 5.3L Cold Air Intake System. This system improves air flow by up to 15% and looks great under the hood. It features a fully enclosed air box to keep the air entering the system as cold as possible for optimal performance. The 5.3L Cold Air Intake System is rigorously tested to GM standards for durability, corrosion and performance.

The following parts have been granted an Executive Order (E.O.) from the California Air Resources Board.
P/N 84089441 – E.O. D-126-43. P/N 84016022 – E.O. D-126-40

Part Number	Year	Description
84016022	2014-2016	Performance Air Intake - Silverado 1500, Tahoe, and Suburban with 5.3L V-8.
84089441	2017-2018	Performance Air Intake - Silverado 1500, Tahoe, and Suburban with 5.3L V-8 (Fits 2014-2018 5.3L Silverado and Sierra)

C. Exhaust Tip

Add a sporty appearance to your Silverado with Dual-Walled Exhaust Tips made from highly polished, stainless steel.

Part Number	Year	Description
22799814	2014-2018	Bowtie Logo, Dual-Wall, Angle Cut, 4" Diameter, L83 5.3L Highly Polished (shown)
22911703	2014-2018	No Logo, Dual-Wall, Angle Cut, 4" Diameter, L96 6.0L, Highly Polished
23435023	2014-2018	No Logo, Dual-Wall, Angle Cut, 4" Diameter, L86 6.2L, Highly Polished



SILVERADO INTERIOR

A. Floor Liners

Help protect the interior of your Silverado from the elements with All-Weather Floor Mats that help channel and isolate moisture. Front mats feature a secure anchoring system to help keep them in place.

Part Number	Year	Description
84073612	2015-2018	Chevy Front Floor Liner Kit - Jet Black W/O Manual 4X4 Floor Shifter
84073613	2015-2018	Chevy Front Floor Liner Kit 413P - Cocoa W/O Manual 4X4 Floor Shifter (shown)
84073614	2015-2018	Chevy Front Floor Liner Kit 514Q - Dune W/O Manual 4X4 Floor Shifter (shown)
23237402	2015-2018	PU Crew Cab 2nd Row Floor Liner Kit - Jet Black
23237403	2015-2018	PU Crew Cab 2nd Row Floor Liner - Kit Cocoa
23237404	2015-2018	PU Double Cab 2nd Row Floor Liner Kit - Jet Black
23237405	2015-2018	PU Double Cab 2nd Row Floor Liner Kit - Cocoa
23416204	2015-2018	Chevy Cab Reg Front Floor Liner Kit - Cocoa W/O Manual 4X4 Floor Shifter
23416205	2016-2018	Chevy Cab Reg Front Floor Liner Kit - Jet Black With Manual 4X4 Floor Shifter
23416206	2016-2018	Chevy Cab Reg Front Floor Liner Kit - Cocoa With Manual 4X4 Floor Shifter
84051558	2016-2018	Crew and Double Cab Front Floor Liner Kit - Black with Chrome Logo, for Vehicles W/O Manual 4X4 Shifter



A Floor Liners – Cocoa



A Floor Liners – Dune

SILVERADO EXTERIOR

B. Fuel Door

Add some extra personality to your all-new Silverado with this great looking Chrome Fuel Door.

Part Number	Year	Description
23441975	2016-2018	Chrome, 6'6" Standard Box and 8' Long Box
23441976	2014-2018	Chrome, 5'8" Short Box, Crew Cab

C. Off-Road Assist Steps

Get in and out of your Silverado with ease with these stylish Off-Road Step Bars.

Part Number	Year	Description
84164550	2016-2018	3" Off-Road, Black for Double Cab w/Standard Box
84192278	2016-2018	3" Off-Road, Black for Crew Cab
84192279	2016-2018	3" Off-Road, Black for Double Cab



B Fuel Door



C Off-Road Assist Steps – Rectangular



Black Non-Illuminated Bowtie Emblem **D**



Gold Illuminated Bowtie Emblem **D**



Grille – Bright Chrome **E**



Nudge Bar **F**

D. Bowtie Emblems

Increase the visibility or add a stylish touch to your Silverado with these eye-catching exterior illuminated or non-illuminated Bowtie emblems.

Part Number	Year	Description
23303572	2016-2018	Black Non-Illuminated Front Grille and Tailgate LD (shown)
84129741	2017-2018	Black Illuminated Front Grille Non-Illuminated tailgate LD
84129740	2017-2018	Gold Illuminated Front Grille, Non-Illuminated tailgate LD (shown)
23463799	2017-2018	Black front Grille Non-Illuminated HD
23385942	2017-2018	Black Illuminated Front Grille, Non-Illuminated tailgate HD
23306537	2017-2018	Gold Illuminated Front Grille, Illuminated HD

E. Grille

Enhance the front end of your 2016-2017 Silverado with this Grille. It's designed specifically for your vehicle.

Part Number	Year	Description
84134045	2016-2018	Grille, Bright Chrome, with Chevrolet embossed logo. (shown)
84134046	2016-2018	Grille, Silver Ice Metallic
84134047	2016-2018	Grille, Red Hot
84134048	2016-2018	Grille, Summit White
84134049	2016-2018	Grille, Black
84134051	2017-2018	Grille, Graphite Metallic
84194933	2018	Grille, Havana Metallic

F. 84100464

Nudge Bar – 2016-2018 MY

Both on- and off-road, the front bumper-mounted Tubular Nudge Bar for Silverado 1500 offers rugged style while helping to protect the front end from minor obstacles or brush. Not available with Front Park Assist (UD5); requires removal of Recovery Hooks.

PERFORMANCE UPGRADES & ACCESSORIES

Silverado Exterior continued

A. 84219815

Sport Bar

Create a rugged, off-road appearance for your Silverado with this bed-mounted Chevrolet Sport Bar.



A Sport Bar



B Sport Bar Off-Road Lights

B. Sport Bar Off-Road Lights

Enhance off-road driving and illuminate the area in front of your Silverado with this Off-Road, Front Roof-Mounted Lamp.

Part Number	Year	Description
84168417	2016-2018	Lamp, Front Roof-Mounted, Off-Road (with factory fog lamps)
84168418	2016-2018	Lamp, Front Roof-Mounted, Off-Road (without factory fog lamps)

SILVERADO BED PRODUCTS

C. Bed Rails

Create a custom look for your vehicle with these versatile Bed Side Rails in Black or Chrome. They include the Chevrolet Bowtie Logo on the rear of rail.

Part Number	Year	Description
84134643	2017-2018	Bed Rails, Chrome, 6' 6" Bed
84134644	2017-2018	Bed Rails, Black, 6.6' Bed
84134646	2017-2018	Bed Rails, Chrome, 5.8' Bed
84134647	2017-2018	Bed Rails, Black, 5.8' Bed



C Bed Rails

D. Tool Box

This hardworking Tool Box can handle up to 250 lbs. of storage and has many great features; it mounts securely to the bed of your vehicle without drilling. Integrated handle makes it easy to remove and carry, and it has a removable sliding tray with rubber mat.

Part Number	Year	Description
19170990	2014-2018	Stationary, Bowtie Logo, Diamond Patterned
19260344	2014-2018	Gull-Wing Tool Box by UWS - a division of Thule®
19299117	2014-2018	Cross-Over Deep-Well Aluminum Toolbox by UWS - a division of Thule®
19302652	2014-2018	Low-Profile Tool Box by UWS - a division of Thule®
19303349	2014-2018	Black Low-Profile Single Lid Tool Box



D Tool Box

E. Rocker Guard – 2017-2018

Add a custom, rugged touch of style to your Silverado with these Black Rocker Guards.

Part Number	Year	Description
84114518	2017-2018	LD Crew Cab
84114519	2017-2018	LD Extended Cab
84192276	2017-2018	HD Crew Cab
84192277	2017-2018	HD Extended Cab

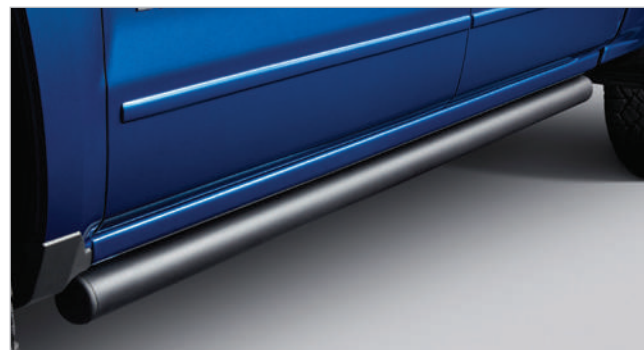

E Rocker Guard

SILVERADO WHEELS & ACCESSORIES

F. Wheels

Personalize your vehicle with these attractive Accessory Wheels, validated to GM specifications. Available with center cap and lugnuts. Use only GM-approved tire and wheel combinations.



22-Inch Wheel – 6-Spoke High-Gloss Black **F**



22-Inch Wheel – 7-Spoke Silver **F**



22-Inch Wheel – 6-Split-Spoke Chrome **F**

Part Number	Year	Description
23431106	2015-2018	20-Inch-Wheel - 5-Spoke Black
19301160	2014-2018	22-Inch Wheel - 5-Split-Spoke Ultra Bright Machined High-Gloss Black
19301162	2014-2018	22-Inch Wheel - 6-Spoke High-Gloss Black
19301163	2014-2018	22-Inch Wheel - 7-Spoke Silver
19301164	2014-2018	22-Inch Wheel - 7-Spoke Silver with Black Inserts (shown)
19301157	2014-2018	22-Inch Wheel - 6-Spoke Chrome
19301159	2014-2018	22-Inch Wheel - 7-Split-Spoke Chrome
19301161	2015-2018	22-Inch Wheel - 6-Split-Spoke Ultra Bright Machined Manooagian Silver
19301156	2014-2018	22-Inch Wheel - 6-Split-Spoke Chrome

NOTE: Center Caps, Tires, Lugnuts, Tire Pressure Monitors, and Wheel Locks sold separately.

Center Caps (not shown)

These Custom Center Caps are specifically designed for your Silverado wheels and feature the Chevy Bowtie logo. They're made of durable material to resist corrosion for a long life.

Part Number	Year	Description
19301595	2014-2015	Center Cap, Brushed Aluminum
19301597	2014-2015	Center Cap, Bright Aluminum
19301593	2014-2015	Center Cap, Chrome
19333202	2016-2018	Center Cap, Black Bowtie.
84245099	2016-2018	Black Cap, Silver Bowtie



COLORADO PERFORMANCE UPGRADES

3.6L Cold Air Intake System



Upgrade the performance and look of your vehicle with this 3.6L Cold Air Intake System, which reduces air intake restriction up to 20% at peak rated airflow of 240 g/sec. This system not only improves air flow, it also looks great under the hood. It features a fully enclosed air box to keep the air entering the system as cold as possible for optimal performance. The 3.6L Cold Air Intake System is rigorously tested to GM standards for durability, corrosion and performance and is legal in all 50 states.

The following parts have been granted an Executive Order (E.O.) from the California Air Resources Board. P/N 84366628 – E.O. D-126-43, P/N 23342235 – E.O. D-126-39.



Part Number	Year	Description
23342235	2015-2016	Performance Air Intake - With 3.6L V-6.
84366628	2017-2018	Performance Air Intake - Colorado with 3.6L V-6



3.6L Cat-Back Single Exhaust Upgrade System with Polished Tip **A**



Transfer Case Skid Shield – 2015+ Colorado **B**



Tailgate Spoiler and Side Bed Rails **C D**



ZR2 Spare Tire Carrier **E**

COLORADO PERFORMANCE UPGRADES

A. 3.6L Cat-Back Single Exhaust Upgrade System with Polished Tip

Upgrade the look, sound and overall performance of your vehicle's exhaust system with this 3.6L Cat-Back Single Exhaust Upgrade System with Polished Tip designed for Long Wheelbase Models equipped with the 3.6L V6 engine. This kit yields real horsepower gains of 10 horsepower¹ with increased 3-inch diameter piping. It features a direct bolt-on design with no cutting required and is made from 304 Stainless Steel, including a highly polished 4-inch exhaust tip featuring the Chevrolet Bowtie logo.

¹Estimated power based upon SAE test procedure J1349

Part Number	Year	Description
23206304	2015-2016	Colorado with 3.6L V-6 (LWB)
23460296	2015-2016	Colorado with 3.6L V-6 (SWB)
84179065	2017-2018	Colorado with 3.6L V-6 (LWB)
84179066	2017-2018	Colorado with 3.6L V-6 (SWB)

B. 23282726 Transfer Case Skid Shield

Add some peace of mind and underbody protection to your truck with this stout, bolt-on Transfer Case Skid Shield.

C. 84127088 Tailgate Spoiler

Add style to your vehicle with this Tailgate Spoiler Kit. Its distinctive appearance is sure to make your vehicle stand out. Available in mold in color black.

D. Side Bed Rails

Create a custom look for your vehicle with these versatile Bed Side Rails in Black or Chrome. They include the Chevrolet Bowtie Logo on the rear of rail.

Part Number	Year	Description
84134637	2015-2018	Bed Rails, Chrome, 6'2" Bed
84134640	2015-2018	Bed Rails, Chrome, 5'2" Bed
84134638	2015-2018	Bed Rails, Black, 6'2" Bed
84134641	2015-2018	Bed Rails, Black, 5'2" Bed

E. 84235106 ZR2 Spare Tire Carrier **NEW!**

Off-road or on, the unique Colorado ZR2 Spare Tire Carrier relocates the existing full-size spare from underneath your Colorado into the bed of your truck, adding functionality and style. Designed to allow easy access to the spare tire and still allow maximum bed space for additional accessories, the Spare Tire Carrier is ready for your next adventure.

COLORADO EXTERIOR

A. Chevrolet Performance Bodyside Decal Package

Make your Colorado stand out in a crowd with these Chevrolet Performance Logo graphics.

Part Number	Year	Description
23341116	2016-2018	Colorado Extended Cab
23341115	2016-2018	Colorado Crew Cab



A Chevrolet Performance Logo Bodyside Decal Package

B. Decal/Stripe Package

Make your Colorado stand out in a crowd with this Hood & Tailgate Stripe Package.

Part Number	Year	Description
23199906	2016-2018	Decal/Stripe Package, Hood & Tailgate Stripe Package for Crew Cab
23199907	2016-2018	Decal/Stripe Package, Hood & Tailgate Stripe Package for Extended Decal Cab



B Decal/Stripe Hood



B Decal/Stripe Tailgate

C. 23325905

Sport Bar

Create a rugged, off-road appearance for your Colorado with this bed-mounted Chevrolet Sport Bar.

D. Off-Road Light Kits

Enhance your truck's rugged, off-road appearance and provide further illumination with these Front Roof Mounted Off Road Lamps. The package includes two lights, brackets, harnesses and interior headlamp switch. Requires Sport Bar. (For vehicles without Foglamps).

Part Number	Year	Description
84168417	2016-2018	Off-Road Light Kit w/Fog Lamps
84168418	2016-2018	Off-Road Light Kit w/o Fog Lamps



C D Sport Bar and Off-Road Light Kits

E. 23232340

Door Sill Plates With Chevrolet Performance Logo – 2016-2018 MY

Stylish Stainless Steel Door Sill Plates accent the entry area. Plates feature the Chevrolet Performance logo.

F. Bowtie Emblems **NEW!**

Further accent your vehicle's exterior styling with these distinctive Bowtie Emblems in Black for the grille and tailgate. For an extra level of distinction, the grille Bowtie is also illuminated. (For ZR2).

Part Number	Year	Description
23385939	2016-2018	Black Illuminated Bowtie
84154346	2016-2018	Black Illuminated Bowtie ZR2 (shown)
23307910	2016-2018	Gold Illuminated Bowtie
84154345	2016-2018	Gold Illuminated Bowtie ZR2
23219389	2016-2018	Black Bowtie Kit, Non-Illuminated
23303572	2016-2018	Black Bowtie ZR2 Kit, Non-Illuminated



E Chevrolet Performance Logo Door Sill Plates



F Bowtie Emblems



Chevrolet Performance Logo Interior Trim Badge **G**



Premium All-Weather Floor Liners (Jet Black) **H**



18-Inch Black Aluminum Wheel (non off-road use) **I**



17-Inch Black Aluminum Wheel (off-road use) shown with Goodyear Wrangler DuraTrac Off-Road Tire **J** **K**

COLORADO INTERIOR

G. 84152637

Performance Interior Trim Badge – 2016-2018 MY

Dress up your Colorado interior with this Performance Logo Interior Trim Badge from GM Accessories.

84231123

Interior Ambient Light Kit (not shown)

Enhance your vehicle interior's styling and sophistication with this Ambient Lighting package. This package provides soft glow, accent lighting for the footwell and cupholder areas of your vehicle in a choice of several colors.

H. Premium All-Weather Floor Liners

Premium Floor Liners take all-weather floor mat coverage even further with raised edges to follow and protect floor and trim contours. They feature a textured, anti-slip pattern that traps debris and water while providing optimum carpet coverage.

Part Number	Year	Description
84056631	2015-2018	Chevy Front Floor Liner Kit Jet Black
23381382	2015-2018	Chevy/GMC Crew Cab 2nd-Row Floor Liner Kit Jet Black
23381376	2015-2018	Chevy/GMC Extended Cab 2nd-Row Floor Liner Kit Jet Black
84128019	2015-2018	Chevy Floor Liner Kit Chrome Badge

COLORADO WHEELS & TIRES

I. 23343591

18-Inch Aluminum Wheel – 2016-2018 MY

Personalize your Colorado with this attractive 18-inch Black Aluminum Wheel, validated to GM specifications. Use only GM-approved wheel and tire combinations. Not compatible with off road tire.

Part Number	Year	Description
23307840	2015-2018	18-Inch Black Aluminum Wheel (shown)
23464384	2015-2018	18-Inch Polished Aluminum Wheel

NOTE: Center Caps, Tires, Lugnuts, Tire Pressure Monitors, and Wheel Locks sold separately.

J. 23343590

17-Inch Black Aluminum Wheel – 2015-2018 MY

Add a personal sense of style to your Colorado with this 17-inch Black Finish Wheel Kit. Use only GM-approved wheel and tire combinations.

NOTE: Center Caps, Tires, Lugnuts, Tire Pressure Monitors, and Wheel Locks sold separately.

K. 19325357

Off-Road Tire – 2015-2018 MY

This 17-inch Goodyear Wrangler DuraTrac off-road tire has been specifically designed for your vehicle. Use only GM-approved wheel and tire combinations.



PERFORMANCE

COPO

C A M A R O



TAKE PART IN CHEVROLET'S FACTORY RACING LEGACY!

Chevrolet Performance's COPO Camaro program advances the racing legacy established almost 50 years ago by performance-minded dealers who used the COPO special-order system to produce high-horsepower, factory-engineered Camaros that weren't officially offered by Chevrolet.

Today, racers have the opportunity to purchase factory-built 2018 COPO Camaro race cars – only 69 will be built – and builders can select from Chevrolet Performance's extensive lineup of COPO Camaro production racing engines and parts to help construct their own race car, including the same body in white used for the production race cars.

With Chevrolet Performance's official COPO Camaro engines and components, you're part of one of the most enduring legacies in drag racing.

Be part of the COPO history!



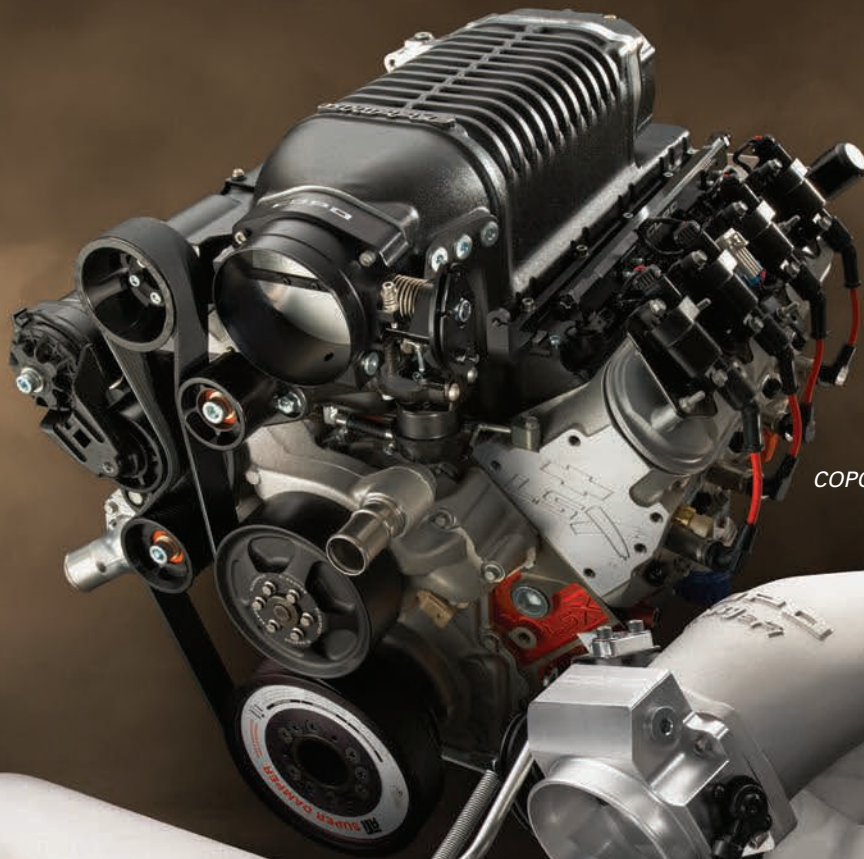

COPO 350 SC

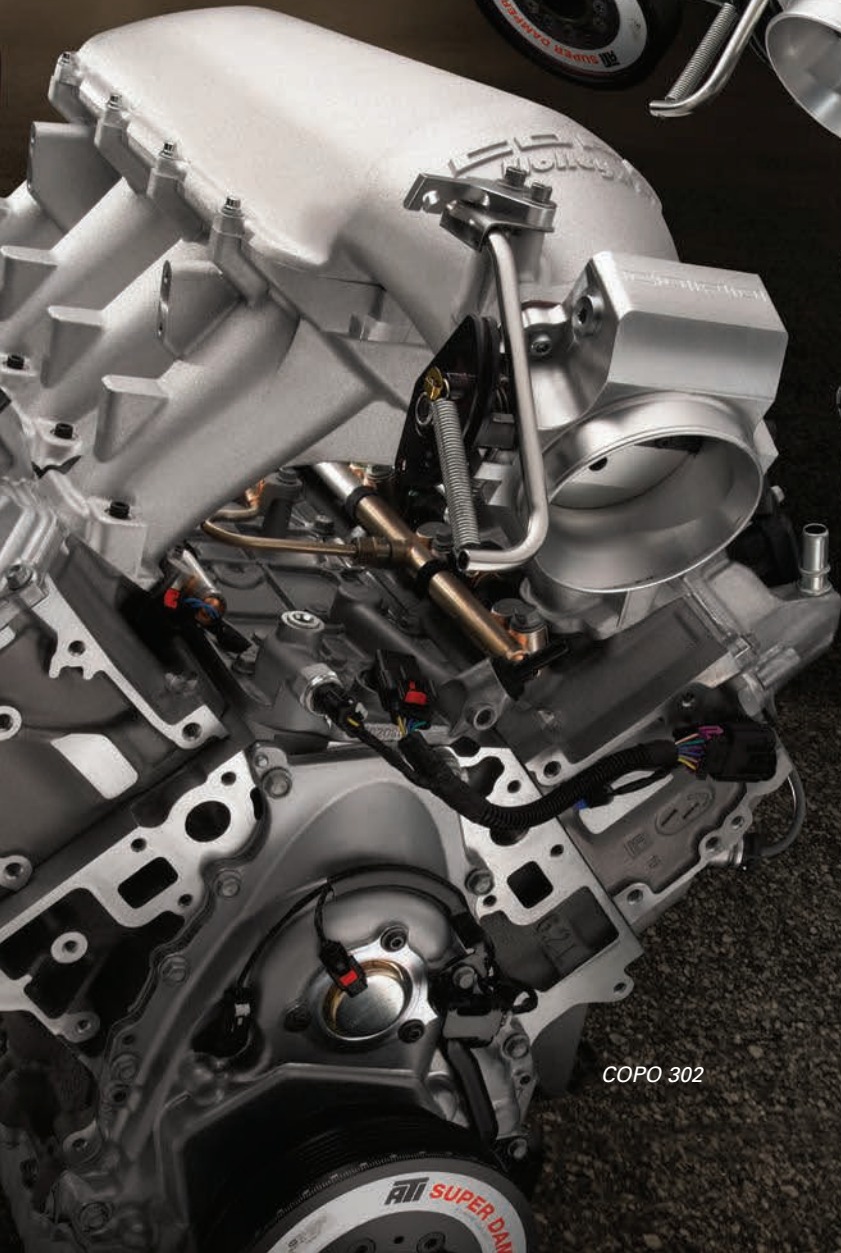

COPO 302

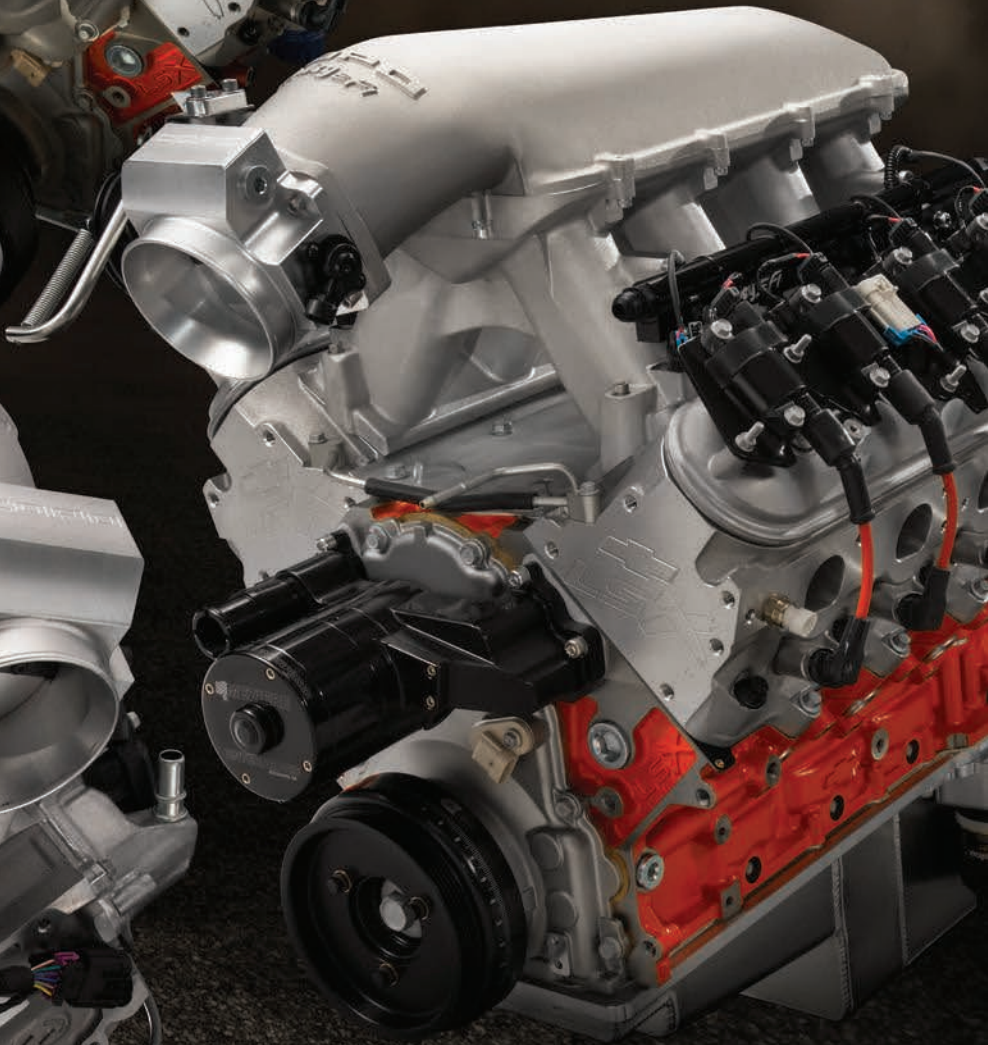

COPO 427

COPO CAMARO PROGRAM



COPO Crate Engines

Chevrolet Performance's COPO crate engines are engineered for NHRA's Stock Eliminator class, offering sportsman racers a range of factory-developed-and-assembled racing engines.

The 6.2L N/A LT-based engine makes a COPO race car eligible for FS/C, FS/D and FS/E, while the 427 N/A engine puts a GEN 6 COPO in FS/A, FS/B or FS/C. The 350 S/C engine makes the COPO race car eligible for FS/XX, FS/AA and FS/A. NHRA Stock Eliminator classes are based primarily on curb weight and horsepower ratings.

Chevrolet Performance engineers designed and tested the engines with the same methods used to develop production engines, ensuring their performance and durability; and each engine is hand-assembled in a specialty build facility.

COPO Vehicle Components

Chevrolet Performance's COPO Camaro vehicle components are factory-engineered or factory-approved – and all are approved by NHRA for competition. They enable racers to build their cars to comparable standards of the production race cars, with a full range of high-performance parts.

Additional components such as the LSX Bowtie block are available from Chevrolet Performance.

COPO Camaro Build Book

Chevrolet Performance's *COPO Camaro Build Book* (P/N 88958767) provides a step-by-step look at the assembly of the production race cars through hundreds of color photos, which can assist racers when it comes to building their own race cars.

NOTE: Content is based on Gen 5 COPO race cars.

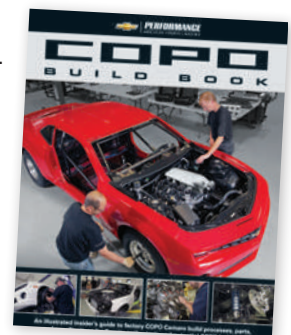



19368682 **NEW!** COPO 302 – A High-Revving Successor to the Legendary Z/28 Small Block

The COPO 302 builds on the high-rpm legacy of the original 302 Small Block that powered the first-generation Camaro Z/28. It's based on the production LT1 engine, but with a shorter, 3-inch stroke – just like the original 302. The rest of the engine is built for high-rpm power and strength, with a unique camshaft profile, super-strong valvetrain, an all-forged rotating assembly, CNC-ported heads and a Holley Hi-Ram intake manifold.

TECH SPECS

Displacement:	311 cu in (5.0L)
Compression Ratio:	12.5:1
Cylinder Block:	Gen V aluminum
Bore x Stroke (in):	4.00 x 3.000
Crankshaft:	Forged steel
Connecting Rods:	Forged steel
Pistons:	Forged aluminum
Cylinder Heads:	CNC-ported LT1 aluminum
Induction:	Natural
Intake Manifold:	Holley Hi-Ram
Camshaft Type:	Hydraulic roller
Camshaft Lift (in):	.641 intake/.641 exhaust
Camshaft Duration (@ .050 in):	240° intake/284° exhaust



19351766 (2016-2017) COPO LT – NHRA Rated at 410 hp

The COPO LT is a high-power blend of the latest technologies and proven horsepower-building elements. It builds on the strength of the LT 6.2L engine found in the production Corvette Stingray and Camaro SS, and adds a very hot camshaft, an all-forged rotating assembly, CNC-ported heads and a Holley Hi-Ram intake manifold similar to the one on the COPO 427. It all adds up to high-rpm horsepower for low ETs.

TECH SPECS

Displacement:	376 cu in (6.2L)
Compression Ratio:	12.4:1
Cylinder Block:	Gen V aluminum
Bore x Stroke (in):	4.062 x 3.622
Crankshaft:	Forged steel
Connecting Rods:	Forged steel
Pistons:	Forged aluminum
Cylinder Heads:	CNC-ported LT1 aluminum
Induction:	Natural
Intake Manifold:	Holley Hi-Ram
Camshaft Type:	Hydraulic roller
Camshaft Lift (in):	.641 intake/.641 exhaust
Camshaft Duration (@ .050 in):	242° intake/285° exhaust



19351762 (2016-2018)

COPO 427 – NHRA Rated at 470 hp

The legendary COPO Camaro program got its start nearly 50 years ago with specialty 427 engines, and the latest COPO 427 racing crate engine builds on that legacy. It is built on the LSX engine block and features a high-compression rotating assembly, high-flow LS7 heads and a Holley Hi-Ram intake manifold for high-rpm power. You've got history on your side with the COPO 427!

TECH SPECS

Displacement:	427 cu in (7.0L)
Compression Ratio:	13.5:1
Cylinder Block:	LSX iron
Bore x Stroke (in):	4.125 x 4.000
Crankshaft:	Forged steel
Connecting Rods:	Forged steel
Pistons:	Forged dome
Cylinder Heads:	LSX-LS7 aluminum six-bolt
Induction:	Natural
Intake Manifold:	Holley Hi-Ram
Camshaft Type:	Hydraulic roller
Camshaft Lift (in.):	.630 intake/.630 exhaust
Camshaft Duration (@.050 in):	233° intake/276° exhaust

19351764 (2014-2018)

COPO 350 SC – NHRA Rated at 580 hp

The COPO 350 Supercharged is the same engine offered exclusively in 2014-2017 COPO Camaro race cars. It features the high-performance LSX engine block, forged internals that stand up to the cylinder pressures generated by forced induction, LSX cylinder heads with six-bolt clamping strength and a 2.9L Whipple screw-type supercharger.

TECH SPECS

Displacement:	350 cu in (5.7L)
Compression Ratio:	10.2:1
Cylinder Block:	LSX cast-iron
Bore x Stroke (in):	4.065 x 3.370
Crankshaft:	Forged steel
Connecting Rods:	Forged steel
Pistons:	Forged dome
Cylinder Heads:	LSX/LS7 aluminum 6-bolt
Induction:	Boosted
Intake Manifold:	2.9L Whipple
Camshaft Type:	Hydraulic roller
Camshaft Lift (in):	.640 intake/.640 exhaust
Camshaft Duration (@.050 in):	244° intake/255° exhaust

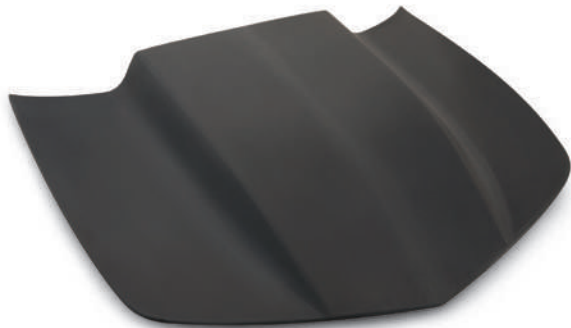

Gen 5 Body-in-White **A**Gen 5 COPO Camaro Cowl-Induction Hood (Top) **B**Gen 5 COPO Camaro Cowl-Induction Hood (Underside) **B**

COPO VEHICLE COMPONENTS

Build your own COPO Camaro race car with the same parts used on the production models, including the unique, lightweight hood emblazoned with the COPO name and drivetrain mount kits that make installing a high-performance powertrain and racing-style solid rear axle easier – and without time-consuming fabrication. Start with one of our Chevrolet Performance Camaro bodies-in-white and build your COPO your way!

A. 19243374

Camaro Body-in-White – Gen 5 (limited to stock on hand)

Chevrolet Performance's Gen 5 Camaro Body-in-White is the smart choice and affordable foundation on which to build a COPO replica or other Camaro race car. It includes an assembled body structure, with the front fenders, hood, roof, doors, rear quarters and trunk lid. The structure also includes the complete floorpans and chassis rails. It is delivered as a painted body shell (color availability is limited), with no additional components or materials. The bodies do not have vehicle identification numbers, so they may be used only as racing vehicles that will never be licensed for street driving.

B. 22950678

COPO Camaro Cowl-Induction Style Hood – Gen 5

Lightweight composite hood with high-rise cowl-induction styling to clear tall racing engines, featuring the Chevrolet Bowtie and the COPO logo embossed on the underside. Designed for hinged/strut opening or adaptable to racing hood pins. Delivered ready to paint.

23177465

COPO Carbon Fiber Hood – Gen 5 (not shown)

Want to take off 12 lbs. in a few minutes? Swap out your composite COPO hood for this high-tech carbon-fiber piece to improve your launch times.



BUILDER'S TIP

COPO PARTS DIRECT – THE OFFICIAL LICENSED SUPPLIER FOR GEN 5 AND 6 COPO CAMAROS

Now going on the seventh year since the COPO Camaro was reintroduced as the ultimate "Chevrolet Performance Part," P/N 20129562, the legacy continues with Chevrolet Performance building 69 COPO Camaros for 2018.



CRATE ENGINES

AND ENGINE COMPONENTS

IF YOU CAN DREAM IT, WE'VE GOT THE CRATE ENGINE FOR IT!

There's nothing like the satisfaction of pouring yourself into a project. Whether it's restoring a muscle car, powering a race car or building the hot rod you've dreamt about since childhood.

Chevrolet Performance's expansive range of factory-engineered crate engines helps make your dream a reality. From production-based packages such as the LS3 and 650-hp supercharged LT4 to specialty high-performance engines like the ZZ6, ZZ427/480 and LSX454, our diverse range means we've got the crate engine you need – along with the supporting parts to finish the installation quicker and get your project on the road faster.

For the ultimate in crate-engine convenience, Chevrolet Performance's Connect & Cruise powertrain systems match a high-performance LS, new LT, Small-Block or Big-Block crate engine with a factory-matched transmission, including all the necessary controllers and installation hardware. We also offer a line of E-ROD crate engine packages, which have been granted a CARB EO for 1995-and-earlier vehicles in California.

Chevrolet Performance pioneered our high-performance crate engine half a century ago and we've never stopped working to offer enthusiasts new and more powerful solutions for their projects.

You've got a dream in your garage. We've got the crate engine to get it on the street or race track.

*ZZ6 Connect & Cruise
Crate Powertrain System*





ZZ427/480
Crate Engine

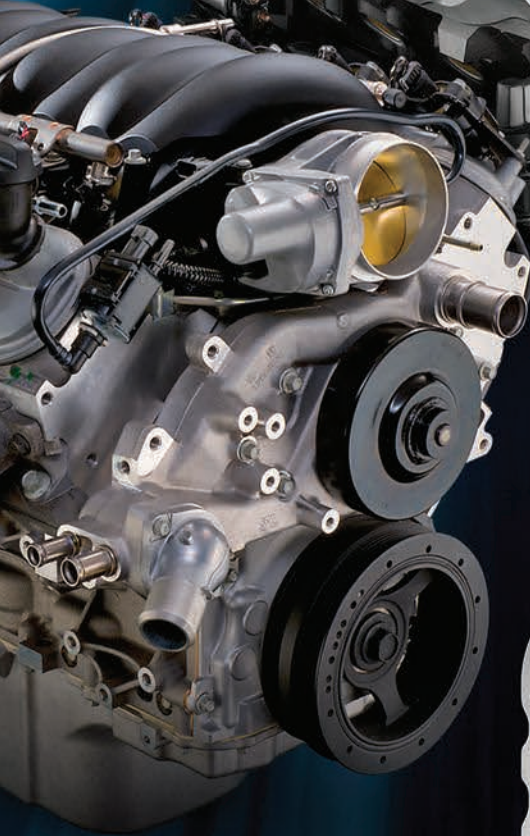

LS3 6.2L
Crate Engine



LSX454 Crate Engine



Bowtie 572/620
Cylinder Head Assembly

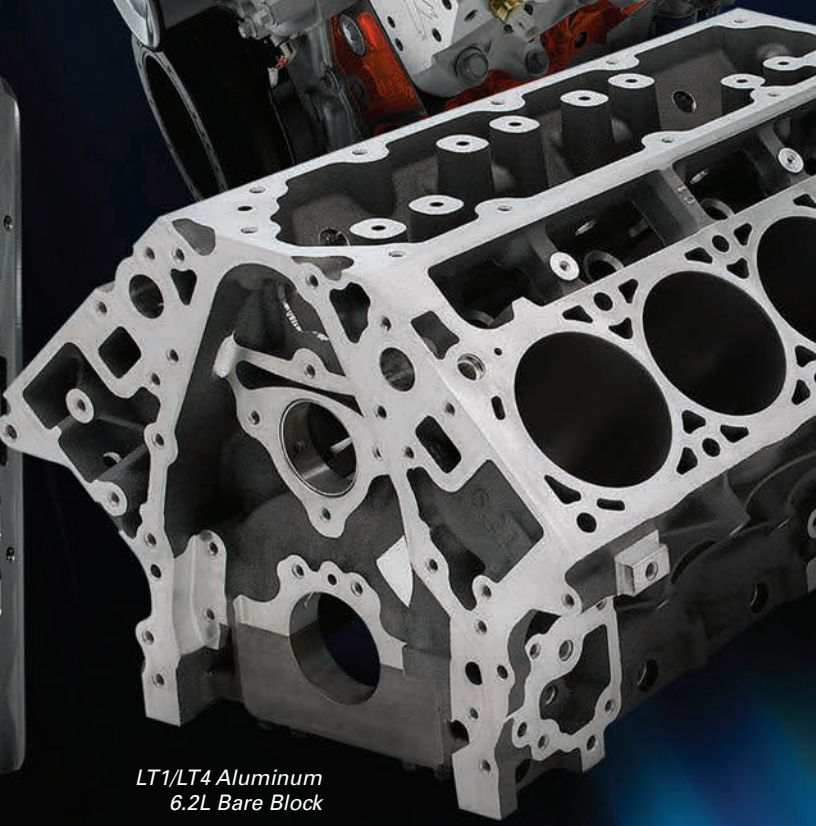

LT1/LT4 Aluminum
6.2L Bare Block



Crate Engine Quick Reference Charts

Chevy Small-Block V-8

Part Number	Description	Engine Size	Weight	hp	Torque	Trans*	Page
19355658	350/290 Base	350 cu in	352	308	347	A	116
19355659	350/290 Deluxe	350 cu in	518	308	347	A	118
19355662	350 HO Turn-Key – with iron Vortec Heads	350 cu in	575	333	381	A	120
19355660	350 HO Base – with iron Vortec Heads	350 cu in	298	333	381	A	121
19355661	350 HO Deluxe – with iron Vortec Heads	350 cu in	481	333	381	A	121
19355815	Ram Jet 350 – PFI with iron Vortec Heads	350 cu in	517	345	396	A	122
19367080	SP350/357 Base	350 cu in	300	357	407	A	124
19367082	SP350/357 Deluxe	350 cu in	450	357	407	A	126
19367084	SP350/357 Turn-Key	350 cu in	575	357	407	A	128
19333157	SP350/385 Base	350 cu in	510	385	405	A	130
12670966	SP/ZZ Partial Engine	350 cu in	540	N/A	N/A	A	131
19333158	SP350/385 Turn-Key	350 cu in	410	385	405	A	132
19351532	ZZ6 Base	350 cu in	405	405	406	A	134
19351533	ZZ6 Turn-Key	350 cu in	410	405	406	A	136
19355720	HT383	383 cu in	405	323	444	B	138
19355719	383 Partial Engine	383 cu in	335	N/A	N/A	B	139
19355721	HT383E	383 cu in	450	323	444	B	140
19355672	SP383 Deluxe	383 cu in	410	435	445	B	142

Chevy Circle Track Racing Engines

Part Number	Description	Engine Size	Weight	hp	Torque	Trans*	Page
88869602	CT350	350 cu in	451	350	396	N/A	146
88869604	CT400	350 cu in	466	404	406	N/A	148
19331563	CT525	376 cu in	415	533	477	N/A	150

Chevy LS/LT Small-Block V-8

Part Number	Description	Engine Size	Weight	hp	Torque	Trans*	Page
12677741	L96 6.0L	6.0L	614	360	380	A	210
19369326	LS3 6.2L – Corvette Gen IV V-8	6.2L	415	430	425	A	212
19369333	LS376/480 – EFI LS3 Gen IV V-8	6.2L	415	495	473	B	214
19369335	LS376/515 – carbureted LS3 Gen IV V-8	6.2L	415	533	477	B	216
19369338	LS376/525 – EFI LS3 Gen IV V-8	6.2L	415	525	486	B	218
19329008	DR525 with Gen 4 F-Car Oil Pan	376 cu in	415	525	498	B	220
19329009	DR525 with Muscle Car Oil Pan	376 cu in	415	525	494	B	220
19331507	LSA 6.2L	6.2L	435	556	551	C	222
19260165	LS9 6.2L	6.2L	435	638	604	N/A	224
19329246	LS7 7.0L – Camaro Z/28	7.0L	440	505	470	B	226
19328728	LT1 6.2L with wet sump	6.2L	425	460	465	E	228
19329997	LT1 6.2L with dry sump	6.2L	425	460	465	E	228
19355405	LT1 6.2L with wet sump – for Connect & Cruise/8 speed auto.	6.2L	N/A	455	455	G	228
19332702	LT4 6.2L SC with dry sump	6.2L	N/A	650	650	N/A	230
19368622	LT4 6.2L SC with wet sump – for Connect & Cruise/8 speed auto.	6.2L	N/A	650	650	F	230
19355378	LT 376/535	6.2L	425	535	470	H	232
19328837	LTG 2.0L Turbocharged – rear wheel drive	2.0L	390	272	295	D	234
12677823	LTG 2.0L Turbocharged – front wheel drive	2.0L	390	272	295	D	234

Chevy LSX Small-Block V-8

Part Number	Description	Engine Size	Weight	hp	Torque	Trans*	Page
19332312	LSX376-B8	6.2L	531	476	475	C	242
19355575	LSX376-B15	6.2L	539	473	444	C	244
19355573	LSX454	7.4L	525	627	586	C	246
19260835	LSX454R	7.4L	597	776	649	N/A	248

Chevy Big-Block V-8

Part Number	Description	Engine Size	Weight	hp	Torque	Trans*	Page
19331572	ZZ427/480	427 cu in	520	480	490	C	302
12568774	454 HO – with iron heads and roller cam	454 cu in	590	438	500	C	304
12498778	454 Partial Engine	454 cu in	361	N/A	N/A	C	305
19331574	ZZ454/440	454 cu in	522	469	519	C	306
88890534	HT502 – truck replacement engine	502 cu in	557	406	541	C	308
12568782	502 Partial Engine	502 cu in	402	N/A	N/A	C	309
12568778	502 HO – with iron heads and roller cam	502 cu in	602	461	558	C	310
19331576	ZZ502 Base – with aluminum heads	502 cu in	504	508	580	C	312
19331579	ZZ502 Deluxe – with aluminum heads	502 cu in	611	508	580	C	314
12499121	Ram Jet 502 – PFI with aluminum heads	502 cu in	608	502	568	C	316
19331583	ZZ572/620 Deluxe	572 cu in	580	621	645	C	318
19331581	ZZ572/620 Base	572 cu in	514	621	645	C	319
19331585	ZZ572/720R Deluxe	572 cu in	677	727	680	C	320

GM Parts Crate Engines¹

Description	Engine Size	Weight	hp	Torque	Trans*	Page
3.8L V-6	3.8L	–	200	230	N/A	379
4.3L LU3	4.3L	–	180–200	245–260	N/A	379
4.8L LR4	4.8L	–	275	285–290	N/A	379
5.3L LM7/L59	5.3L	–	285	325–330	N/A	380
5.7L Gen 0	5.7L	–	195	N/A	N/A	380
5.7L Gen 1E	5.7L	–	N/A	N/A	N/A	380
5.7L Gen 1	5.7L	–	N/A	N/A	N/A	381
6.0L LQ4	6.0L	–	325	370	N/A	381
7.4L L19/L29	7.4L	–	230–270	N/A	N/A	381

¹This is a sample listing of GM Parts Crate Engines. Please see your GM dealer for the entire GM engine portfolio.

NOTE: Weights include crates and all packaging material. Approximate crate weight is 30 lbs.

*Recommended Transmissions

Trans	Part Number	Description	Page
A	19368611	SuperMatic™ 4L65-E Four-Speed Automatic (remanufactured)	368
B	19368613	SuperMatic™ 4L70-E Four-Speed Automatic (remanufactured)	368
C	19300175	SuperMatic™ 4L85-E Four-Speed Automatic	368
D	19368645	LTG 4-Speed Automatic – Rear Wheel Drive (remanufactured)	377
E	19368614	SuperMatic™ 4L70-E Four-Speed Automatic – LT1	368
F	19368615	SuperMatic™ 4L75-E Four-Speed Automatic (remanufactured)	368
G	19367134	SuperMatic™ 8L90-E Eight-Speed Automatic – LT1	369
H	19367135	SuperMatic™ 8L90-E Eight-Speed Automatic – LT4	369





Torque Converter Quick Reference Chart

Automatic Transmission Torque Converter Match Listing

Engine P/N	Description	Displac.	hp	Torque	4L60 Family		4L80 Family	
					Fits SuperMatic 4L65-E, 4L70-E (LS bell) and 4L75-E		Fits SuperMatic 4L85-E	
					Converter P/N	Stall Range	Converter P/N	Stall Range
Chevy Small-Block V-8								
19355659	350/290 Deluxe	350 cu in	308	347	19299800	2,400-2,800	N/A	N/A
19355662	350 HO Turn-Key – with Iron Vortec Heads	350 cu in	333	381	19299800	2,400-2,800	N/A	N/A
19355815	Ram Jet 350 – PFI with Iron Vortec Heads	350 cu in	345	396	19299800	2,400-2,800	19299804	2,400-2,800
19367080	SP350/357 Base	350 cu in	357	407	19299800	2,400-2,800	19299804	2,400-2,800
19367082	SP350/357 Deluxe	350 cu in	357	407	19299800	2,400-2,800	19299804	2,400-2,800
19367084	SP350/357 Turn-Key	350 cu in	357	407	19299800	2,400-2,800	19299804	2,400-2,800
19333157	SP350/385 Base	350 cu in	385	405	19299801	3,000-3,400	19299805	3,000-3,400
19333158	SP350/385 Turn-Key	350 cu in	385	405	19299801	3,000-3,400	19299805	3,000-3,400
19351532	ZZ6 Base	350 cu in	405	406	19299801	3,000-3,400	19299805	3,000-3,400
19351533	ZZ6 Turn-Key	350 cu in	405	406	19299801	3,000-3,400	19299805	3,000-3,400
19355720	HT383 Base – Performance Engine	383 cu in	323	444	19299800	2,400-2,800	19299804	2,400-2,800
19355672	SP383 Deluxe	383 cu in	435	445	19299801	3,000-3,400	19299805	3,000-3,400
Chevy LS/LT/LSX V-8								
12677741	L96 6.0L	6.0L	360	380	19299802	2,400-2,800	19299806	2,400-2,800
19369326	LS3 6.2L – Corvette Gen IV V-8	6.2L	430	425	19299802	2,400-2,800	19299806	2,400-2,800
19369331	LS3 6.2L – E-Rod Kit with automatic	6.2L	430	425	19299802	2,400-2,800	19299806	2,400-2,800
19369333	LS376/480 – LS3 Gen IV V-8	6.2L	495	473	19299803	3,000-3,400	19299807	3,000-3,400
19369335	LS376/515 – carbureted LS3 Gen IV V-8	6.2L	533	477	19299803	3,000-3,400	19299807	3,000-3,400
19369338	LS376/525 – LS3 Gen IV ASA Camshaft	6.2L	525	486	19299803	3,000-3,400	19299807	3,000-3,400
19329008	DR525 6.2L with Gen IV F - Car Oil Pan	6.2L	525	498	N/A	N/A	N/A	N/A
19329009	DR525 6.2L with Muscle Car Oil Pan	6.2L	525	494	N/A	N/A	N/A	N/A
19331507	LSA 6.2L SC – Gen IV V-8 (with 4L75-E)	6.2L	556	551	19299802	2,400-2,800	19299806	2,400-2,800
19260165	LS9 6.2L SC – Gen IV V-8 (with 4L75-E)	6.2L	638	604	19299802	2,400-2,800	19299806	2,400-2,800
19329246	LS7 7.0L – Corvette Z06	7.0L	505	470	19299803	3,000-3,400	19299807	3,000-3,400
	Optional LS7 (depending on application)	7.0L	505	470	19299802	2,400-2,800	19299806	2,400-2,800
19332312	LSX376 – B8	6.2L	476	475	19299802	2,400-2,800	19299806	2,400-2,800
19355575	LSX376 – B15	6.2L	473	444	N/A	N/A	N/A	N/A
19355573	LSX454 (with 4L75-E)	7.4L	627	586	19299803	3,000-3,400	19299807	3,000-3,400
19260835	LSX454R	7.4L	776	649	N/A	N/A	N/A	N/A
19328728	LT1 6.2L with wet sump	6.2L	460	465	19299802	2,400-2,800	19299806	2,400-2,800
19329997	LT1 6.2L with dry sump	6.2L	460	465	19299802	2,400-2,800	19299806	2,400-2,800
19355405	LT1 6.2L with wet sump – for Connect & Cruise/8-speed auto.	6.2L	455	455	24280634	N/A	24280634	N/A
19355378	LT376/535	6.2L	535	470	19299802	3,000-3,400	N/A	N/A
19332702	LT4 6.2L SC with dry sump	6.2L	650	650	19299802	N/A	19299806	N/A
19555404	LT4 6.2L SC with wet sump – for Connect & Cruise/8-speed auto.	6.2L	650	650	24280634	N/A	24280634	N/A
Chevy Big-Block V-8								
19331572	ZZ427/480	427 cu in	480	490	19299801	3,000-3,400	19299805	3,000-3,400
12568774	454 HO – with iron heads and roller cam	454 cu in	438	500	19299800	2,400-2,800	19299804	2,400-2,800
19351574	ZZ454/440 – 440 horsepower with aluminum heads	454 cu in	469	519	19299800	2,400-2,800	19299804	2,400-2,800
88890534	HT502 – truck replacement engine	502 cu in	406	541	19299800	2,400-2,800	19299804	2,400-2,800
12568778	502 HO – with iron heads and roller cam	502 cu in	461	558	19299800	2,400-2,800	19299804	2,400-2,800
19331576	ZZ502/502 Base – with aluminum heads	502 cu in	508	580	19299801	3,000-3,400	19299805	3,000-3,400
19331579	ZZ502 Deluxe – with aluminum heads	502 cu in	508	580	19299801	3,000-3,400	19299805	3,000-3,400
12499121	Ram Jet 502 – PFI with aluminum heads	502 cu in	502	568	19299801	3,000-3,400	19299805	3,000-3,400
19331583	ZZ572/620 Deluxe (with 4L75-E)	572 cu in	621	645	19299803	3,000-3,400	19299805	3,000-3,400
19331585	ZZ572/720R Deluxe	572 cu in	727	680	N/A	N/A	19299805	3,000-3,400



Engine Power and Torque Ratings Test Procedures

All Chevrolet Performance crate engines were tested in a controlled environment on a dynamometer following the Society of Engineers (SAE) standard test procedures J1349 for net power testing or J1995 for gross power testing. Atmospheric correction factors for J1349 use a temperature of 77°F and a barometric pressure of 29.31 inHg. The J1995 correction factors are derived from SAE test J607 correcting to standard temperature and pressure conditions of 60°F and 29.92 inHg. Formally declared values meet the requirements within SAE test standard J2723.

Different Levels of Engine Assemblies

Recognizing that each customer has unique needs, Chevrolet Performance offers four distinct levels of Crate Engines, covering the gamut from starter Partial engines to complete Turn-Key engines that are ready to be dropped into your favorite vehicle. This variety gives builders the opportunity to customize an engine as much or as little as they need to meet their expectations.

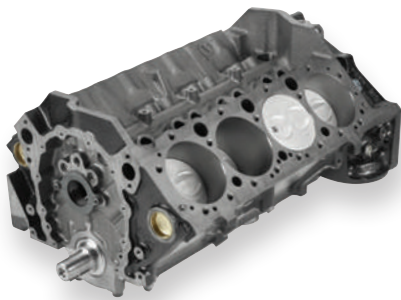

Partial Engine

This is for the builder who wants to start essentially from the block up. These engines typically include the block and reciprocating assembly. It allows the builder to choose the heads, cam and intake combination he/she wants.



Base

The Base engine assembly typically includes, block, crank, pistons, cam, heads and valve covers, but allows the builder to pick the carburetor/injection system and intake manifold they desire.



Deluxe

The Deluxe crate engines are essentially ready to fire up, as they ship with the distributor installed, harmonic balancer bolted on and the carburetor in the crate. All you need to do is put the parts together and go!

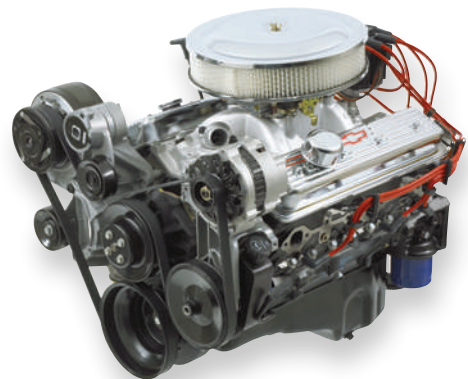

Turn-Key

We told our engineers to have some fun and assemble engines the way they think it should be done ... we then took their combinations, built them up and put them in a crate that ships right to your dealer. The Turn-Key engines represent an outstanding value, and they are perfect for enthusiasts who have built a chassis and need reliable power to get it down the road.

FEATURED ENGINES

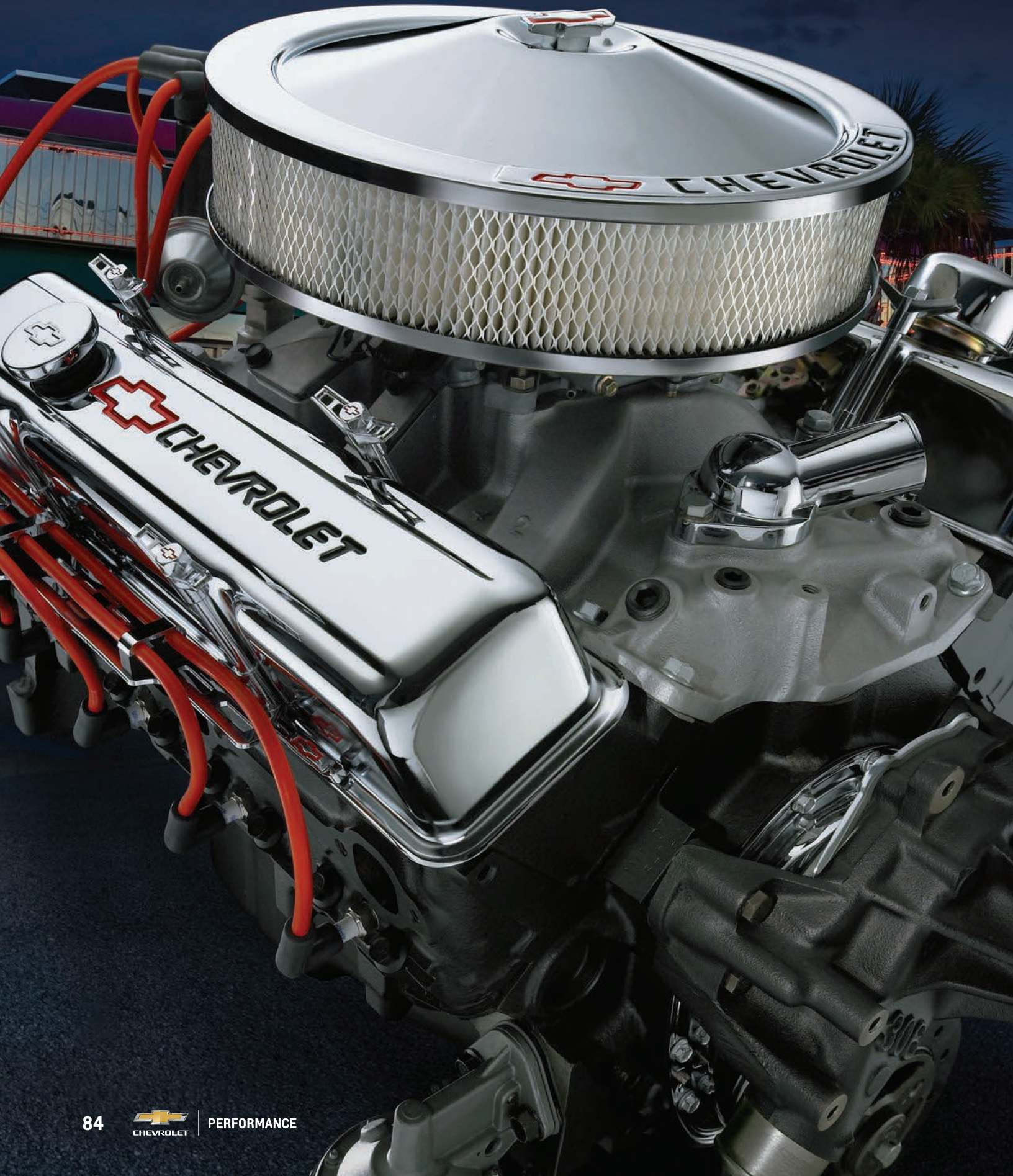



350/290

AFFORDABLE PERFORMANCE YOU CAN COUNT ON!

Rebuilding a Chevy Small-Block is as American as college football on a Saturday afternoon, but Chevrolet Performance's value-packed 350/290 crate engine eliminates the time and guesswork, offering strong performance straight out of the crate. Better still, it starts with a brand-new Chevy block with four-bolt mains for exceptional strength – a feature most used blocks don't have – while a smooth hydraulic camshaft helps make it a sweetheart on the street. Our 350/290 Deluxe package shown here includes chrome dress-up accessories.

Image shown:

350/290 DELUXE  CRATE ENGINE	308 HP	347 LB.-FT. @3,900 RPM	19355659 PART NO
---	---------------	----------------------------------	----------------------------

NOTE: Engine may not come with all the parts shown in photo. See your dealer for more details.

To learn more about this engine, please turn to page 118.



CT525



WIN BIG WITH THIS DURABLE LS3-BASED RACING ENGINE!

Chevrolet Performance's CT525 circle track crate engine is based on the proven LS3 6.2L production engine and offers serious power for serious racing series, including Super Late Model and similar classes. The engine is lightweight and strong, using an aluminum block with cross-bolted six-bolt main caps and high-flow LS3 cylinder heads, along with unique features adapted for racing, including a carburetor intake manifold, six-quart racing oil pan and more. Best of all, it delivers big power with the durability you can count on race after race. Let Chevrolet Performance help drive you to the checkered flag!

Image shown:

CT525 CRATE ENGINE	533 HP @6,600 RPM	477 LB.-FT. @5,200 RPM	19331563 PART NO
------------------------------	-----------------------------	----------------------------------	----------------------------

NOTE: Engine may not come with all the parts shown in photo. See your dealer for more details.

To learn more about this engine, please turn to page 150.

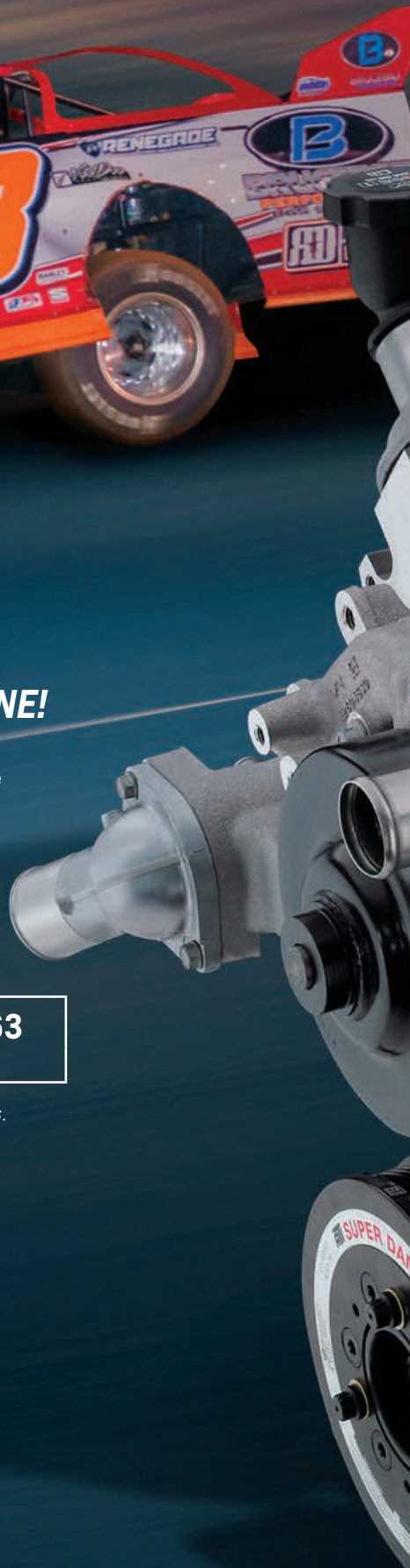

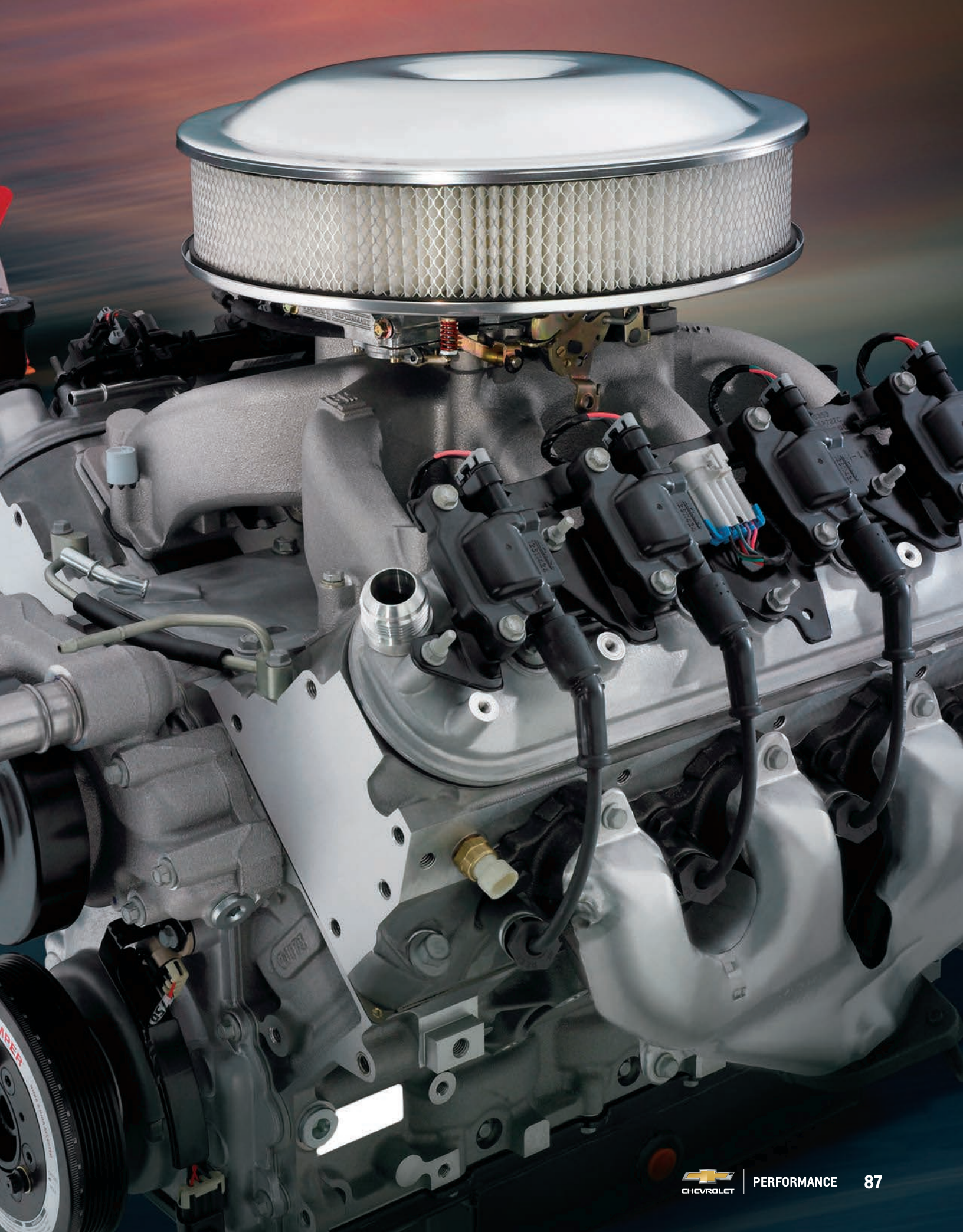

LS3 **CONNECT & CRUISE**

CRATE POWERTRAIN SYSTEM



EVERYTHING YOU NEED TO POWER YOUR PROJECT!

Nobody offers a more comprehensive lineup of high-performance crate engines, transmissions and controllers than Chevrolet Performance – and our Connect & Cruise Powertrain Systems bring them all together with factory-matched combinations that take the guesswork out of powering your project. The LS3 Connect & Cruise systems feature the 430-hp crate engine, 4L65-E four-speed automatic or T56 Super Magnum six-speed manual transmissions, engine and transmission controller kits, transmission installation kit, torque converter (with automatic transmission) and more. You supply the car, or truck, and we'll supply the powertrain!

Image shown:

LS3 CONNECT & CRUISE CRATE POWERTRAIN SYSTEM	4L65-E TRANSMISSION	430 HP @5,900 RPM	425 LB.-FT. @4,600 RPM
--	-------------------------------	-----------------------------	----------------------------------

NOTE: Engine may not come with all the parts shown in photo. See your dealer for more details.

To learn more about this engine, please turn to page 109.





FEATURED ENGINES



LS7 7.0L



THE ONE AND ONLY 427 LS ENGINE WITH 505 HP!

With a pedigree established on the racetrack, the 505-hp, 427-cubic-inch (7.0L) LS7 was the heart of the world-renowned C6 Corvette Z06 and the Gen 5 Camaro Z/28, and will go down as one of the greatest Chevrolet Performance engines of all time – and it's ready to power your project! Competition-proven, high-flow cylinder heads and lightweight components, including titanium rods and intake valves, make the LS7 a legendary engine. It's hand-assembled at GM's Performance Build Center, in Bowling Green, Ky., with true high-performance techniques, like deck plate honing. Chevrolet Performance's LS7 crate engine is based on the Z/28's dry-sump application, which requires an external oil tank and oil lines.

Image shown:

LS7 7.0L CRATE ENGINE	505 HP @6,300 RPM	470 LB.-FT. @4,800 RPM	19329246 PART NO
---------------------------------	-----------------------------	----------------------------------	----------------------------

NOTE: Engine may not come with all the parts shown in photo. See your dealer for more details.

To learn more about this engine, please turn to page 226.



FEATURED ENGINES

LT1 6.2L



THE FUTURE OF CRATE ENGINE PERFORMANCE!

Chevrolet Performance's LT1 crate engine is based on the Gen V Small-Block powering today's Corvette Stingray and Camaro SS. It is our highest-tech Small-Block ever, with advanced technologies such as direct injection, variable valve timing, piston-cooling oil squirters and more, all working to make great power with surprising efficiency. Chevrolet Performance's LT1 crate engine is rated at 460 horsepower and 465 lb.-ft. of torque and is offered with wet- and dry-sump oiling systems (dry-sump kit requires an external oil tank and oil lines). If you're looking for a high-tech heart to power your next project, the LT1 will drive it into the future.

Image shown:

LT1 6.2L WET SUMP CRATE ENGINE	460 HP @6,000 RPM	465 LB.-FT. @4,600 RPM	19328728 PART NO
--	-----------------------------	----------------------------------	----------------------------

NOTE: Engine may not come with all the parts shown in photo. See your dealer for more details.

To learn more about this engine, please turn to page 228

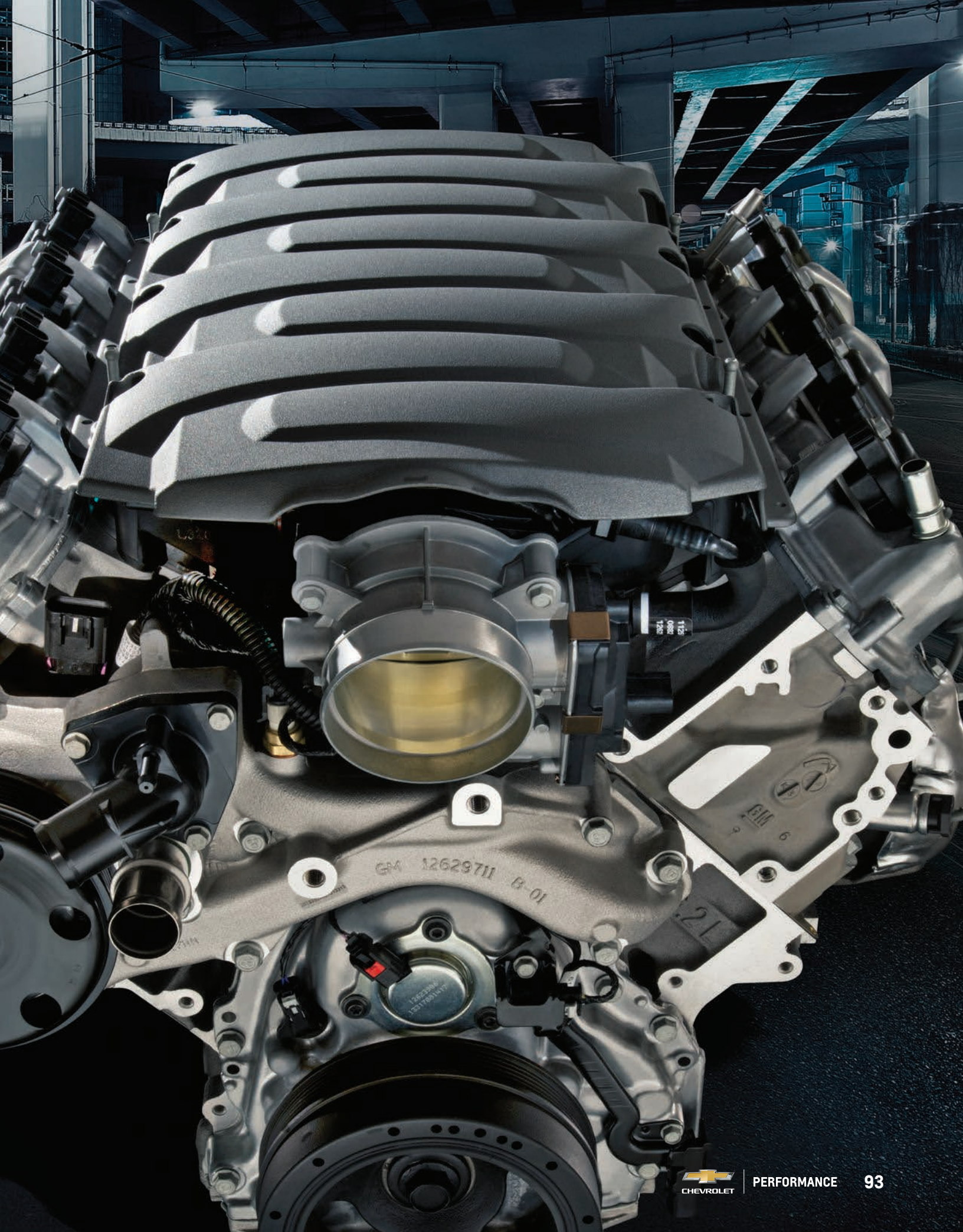

GPA 12629711 B-01

1125
Date
1280



FEATURED ENGINES

LT4 6.2L



SUPERCHARGED HIGH-TECH HORSEPOWER!

With its unique four-lobe rotors spinning at more than 20,000 rpm to generate 9 pounds of boost, the intercooled supercharging system of Chevrolet Performance's direct-injected LT4 crate engine generates 640 horsepower. It's the most powerful production-based engine ever from Chevrolet and it is available for your project – assuming your vehicle has the drivetrain strength to stand up to 630 lb.-ft. of torque! Chevrolet Performance's LT4 crate engine is offered with wet- and dry-sump oiling systems (dry-sump kit requires an external oil tank and oil lines). There's nothing like supercharged horsepower and there's not a more powerful production-based crate engine from Chevrolet Performance!

Image shown:

LT4 6.2L WET SUMP CRATE ENGINE	640 HP @6,400 RPM	630 LB.-FT. @3,600 RPM	19368622 PART NO
--	-----------------------------	----------------------------------	----------------------------

NOTE: Engine may not come with all the parts shown in photo. See your dealer for more details.

To learn more about this engine, please turn to page 230.



LSX454



LS VERSATILITY WITH BIG-BLOCK CAPABILITY!

Starting with our super-strong iron LSX Bowtie Block, Chevrolet Performance's LSX454 crate engine is the perfect contemporary choice for classic vehicle performance! And with its compact dimensions and lighter weight, you can boast Big-Block displacement with the compact dimensions of a modern LS engine. With the recommended 850-cfm carburetor (P/N 19170095), the LSX454 is capable of 627 hp and 586 lb.-ft. of torque, making it more powerful than the original 454 engine produced by Chevrolet. Use it to give your classic a modern makeover!

Image shown:

LSX454 CRATE ENGINE	627 HP @6,300 RPM	586 LB.-FT. @5,100 RPM	19355573 PART NO
-------------------------------	-----------------------------	----------------------------------	----------------------------

NOTE: Engine may not come with all the parts shown in photo. See your dealer for more details.

To learn more about this engine, please turn to page 246.



FEATURED ENGINES

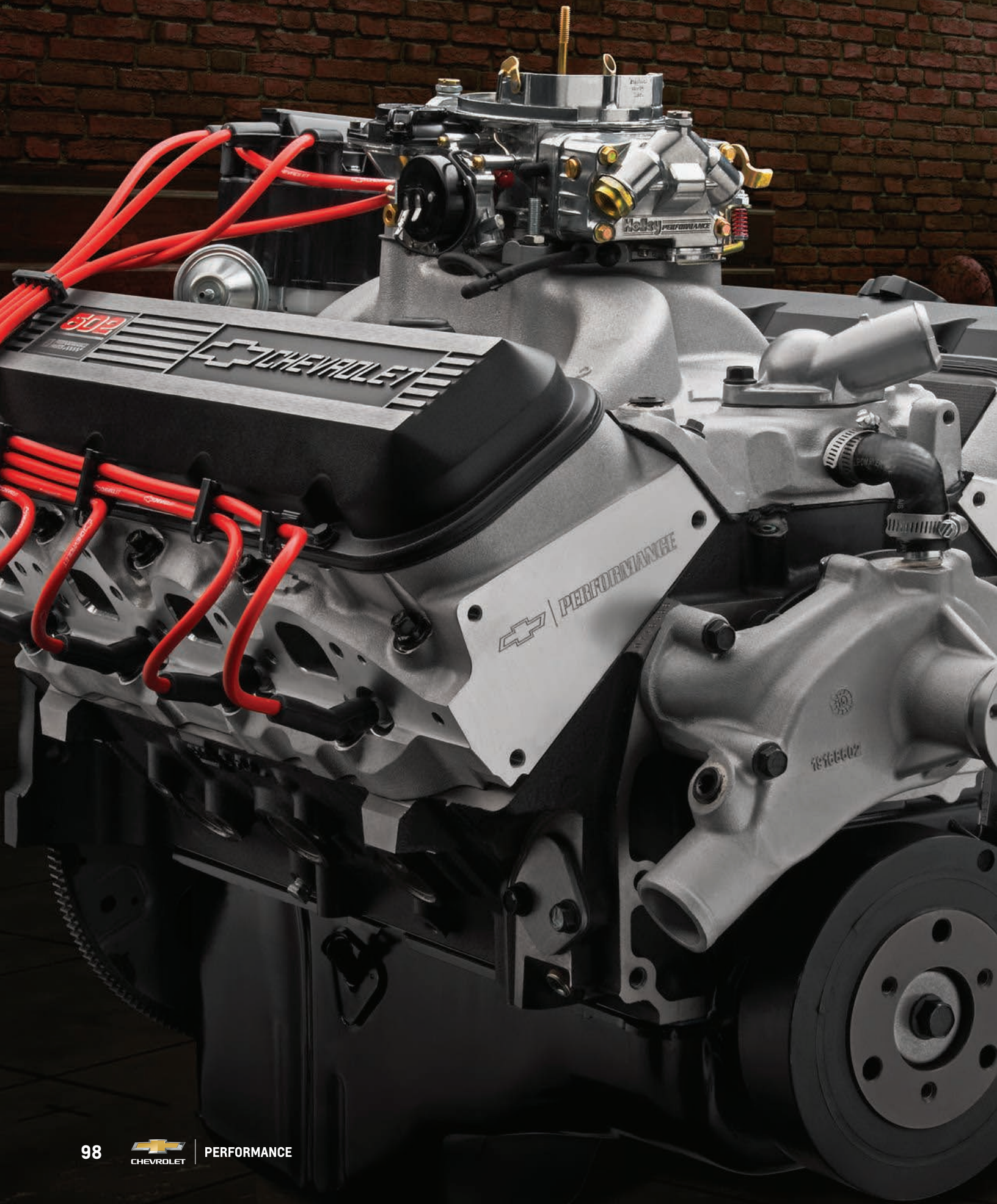

ZZ502



BIG TORQUE ON TAP!

There's nothing like the visceral experience of a true Chevy Big-Block and with our best selling ZZ502/502 crate engine – it's delivered with a massive 580 lb.-ft. of pure tire-turning torque! We start with the latest-generation cylinder block, top it with high-flow oval-port heads and complement it with a hydraulic roller cam that helps ensure excellent drivability. Our Deluxe crate engine package includes an HEI distributor, starter, aluminum intake, Holley 870-cfm carburetor and more – just about everything you need to transform your project vehicle into a true torque monster!

Image shown:

ZZ502/502 DELUXE CRATE ENGINE	508 HP @5,200 RPM	580 LB.-FT. @3,000 RPM	19331579 PART NO
---	-----------------------------	----------------------------------	----------------------------

NOTE: Engine may not come with all the parts shown in photo. See your dealer for more details.

To learn more about this engine, please turn to page 314.

ZZ572/620

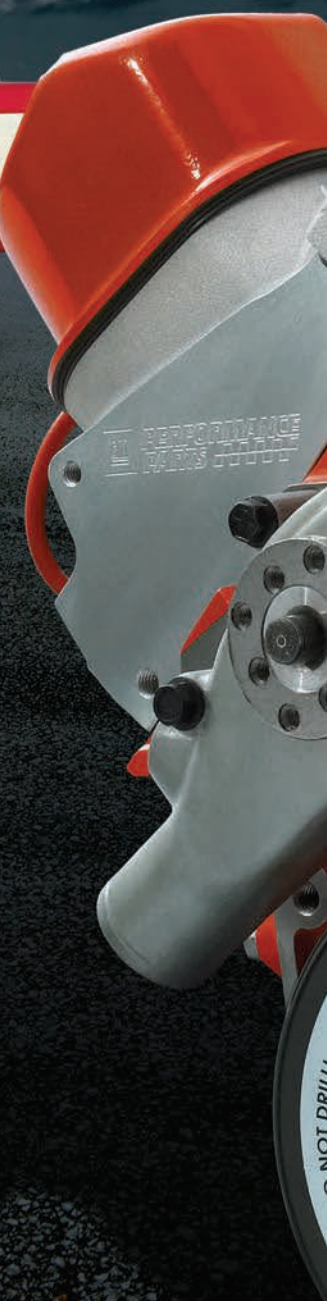

BIG BLOCK POWER FOR THE STREET OR STRIP!

There's no replacement for displacement with Chevrolet Performance's uncompromising ZZ572/620. It's our most powerful street/strip Big-Block and its all-forged rotating assembly helps ensure that every one of its 620 horsepower and 650 lb.-ft. are delivered with count-on-it durability. The engine also features high-flow, aluminum rectangular-port heads and a smooth hydraulic roller camshaft. Our Deluxe crate engine package includes an HEI distributor, starter, aluminum intake, Holley 850-cfm carburetor, cast aluminum valve covers and more. The ZZ572/620 is the ultimate street/strip Big-Block. Just make sure your project vehicle can handle all the power!

Image shown:

ZZ572/620 DELUXE CRATE ENGINE	621 HP @5,400 RPM	645 LB.-FT. @4,200 RPM	19331583 PART NO
---	-----------------------------	----------------------------------	----------------------------

NOTE: Engine may not come with all the parts shown in photo. See your dealer for more details.

To learn more about this engine, please turn to page 318.



572 CHEVROLET

PERFORMANCE PARTS

GM
8976923

PERFORMANCE PARTS

RECOMMENDED MAINTENANCE
 CHECK OIL AND FILTER CHANGE OIL AND FILTER EVERY 3,000 MILES
 CHECK WATER PUMP AND BELT TENSION EVERY 10,000 MILES
 CHECK FUEL AND AIR FILTERS EVERY 15,000 MILES
 CHECK VALVE CLEARANCE EVERY 100,000 MILES
 CHECK TIRE PRESSURE EVERY 1,000 MILES
 CHECK BRAKE PADS AND DISCS EVERY 10,000 MILES
 CHECK DRIVE SHAFTS EVERY 100,000 MILES
 CHECK BATTERY WATER LEVELS EVERY 10,000 MILES
 CHECK COOLANT LEVELS EVERY 10,000 MILES
 CHECK SERVO BRAKE CABLES EVERY 10,000 MILES
 CHECK STEERING AND SHOCKS EVERY 10,000 MILES
 CHECK WAX EVERY 10,000 MILES
 CHECK WASHERS EVERY 10,000 MILES
 CHECK WAX EVERY 10,000 MILES

NASCAR APPROVED
 GM PART #8906814 - U.S. PATENT #5,225,287
 897 MANUFACTURED CERTIFIED - CONFORMS TO SFI SPEC. 14.1

DO NOT USE ZERO BALANCE
 THE UNIT IS ZERO BALANCE

OFFSET
 HOLE

ZZ572/720R



THE ULTIMATE BIG BLOCK RACING ENGINE!

Let's be clear, Chevrolet Performance's ZZ572/720R crate engine is designed for one thing: winning on the strip. It's the biggest, baddest and most-powerful Big-Block we offer and it can help put your race car in the 9s or better. Inside the super-strong, four-bolt block is an all-forged rotating assembly, which is matched with cavernous rectangular-port aluminum cylinder heads with huge 113cc intake ports and 2.25/1.88-inch valves. Our Deluxe crate engine package includes an HEI distributor, starter, aluminum intake, Holley Dominator carburetor and more. The ZZ572/720R offers the power to win. It's up to you to get across the finish line first!

Image shown:

ZZ572/720R DELUXE CRATE ENGINE	727 HP @6,300 RPM	680 LB.-FT. @4,900 RPM	19331585 PART NO
--	-----------------------------	----------------------------------	----------------------------

NOTE: Engine may not come with all the parts shown in photo. See your dealer for more details.

To learn more about this engine, please turn to page 320.

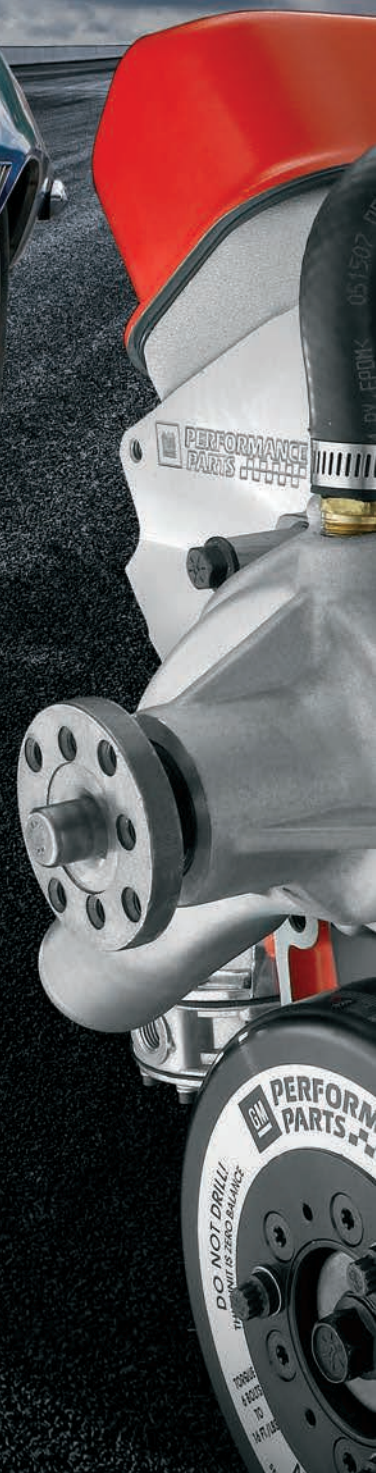

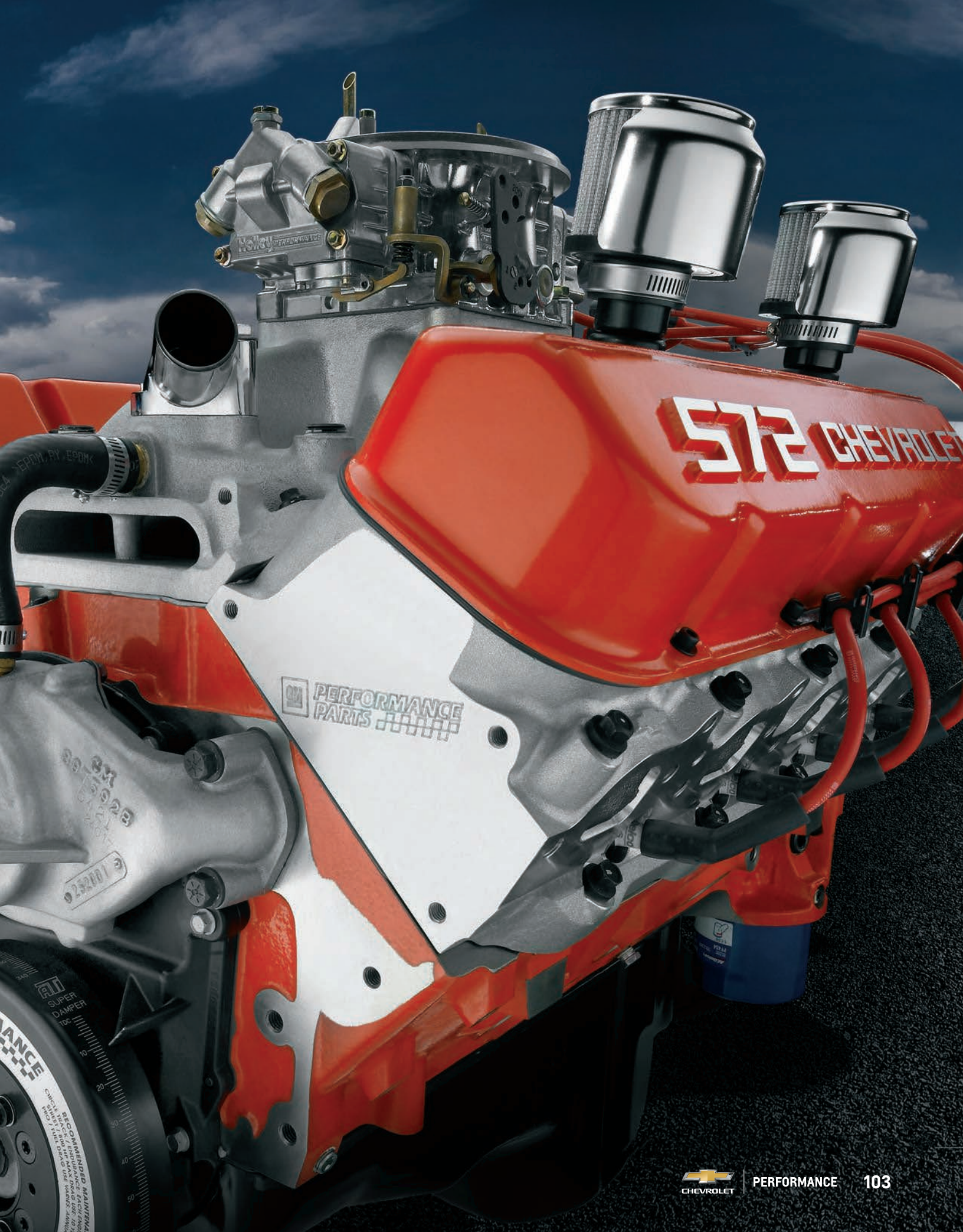

GM PERFORMANCE PARTS

572 CHEVROLET

ADVANCED
RACING
CHEVROLET
SUPER
DAMPER
TOC
RECOMMENDED MAINTENANCE
SCHEDULE
SEE OWNER'S MANUAL FOR
DETAILED INFORMATION
REGARDING MAINTENANCE
SCHEDULES AND PROCEDURES
FOR YOUR VEHICLE
©2014 GM Corp. All rights reserved.





PERFORMANCE

CONNECT & CRUISE

CRATE POWERTRAIN SYSTEMS

*LT1 6.2L Connect & Cruise System
with 8-Speed Automatic Transmission*

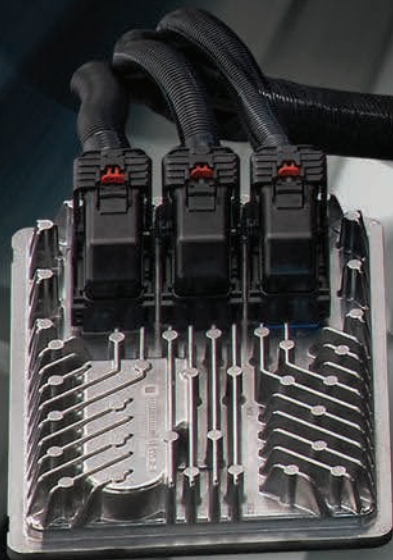

FACTORY MATCHED ENGINE AND TRANSMISSION COMBOS!

Our engineers did all the hard work, designing and calibrating carefully matched Connect & Cruise powertrain systems for optimal compatibility and performance, while also identifying the complementing engine and transmission controllers, torque converters and supporting installation kits. The specially calibrated controllers are designed for retrofit installations in older vehicles, for easier and quicker installation – and more importantly – operation without the need for third-party tuning.

The Connect & Cruise lineup also includes emissions-compliant E-ROD, LT1, LS3 and LSA systems. (See page 236 for details about E-ROD kit contents.)

Pick the Connect & Cruise powertrain that's right for your project and get it running in less time and with less hassle – all from the crate engine innovator, Chevrolet Performance!



LS3 6.2L Engine

SuperMatic™ 4L65-E Four-Speed Automatic Transmission

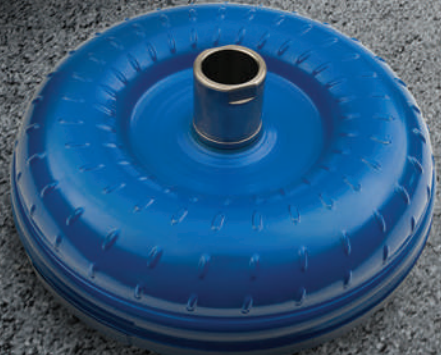
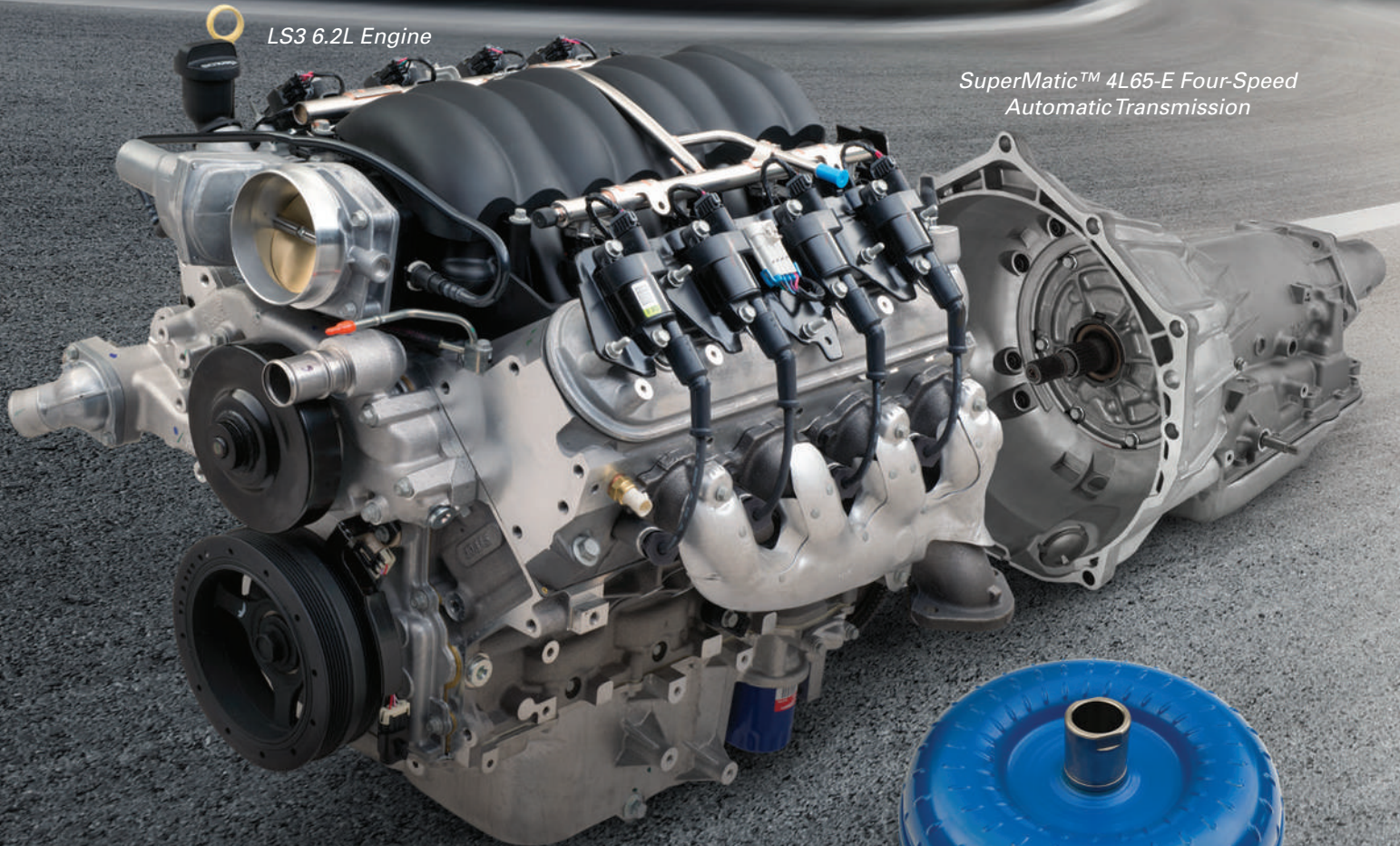

SuperMatic™ Torque Converter



Engine Controller Module & Harness



SuperMatic™ Transmission Controller

CONNECT & CRUISE BUILDER'S GUIDE

Each Chevrolet Performance Connect & Cruise Crate Powertrain System includes:

- **Instruction sheet**
- **Brand-new, fully assembled crate engine**
- **Automatic or manual transmission**
- **SuperMatic™ transmission control module and harness (automatic transmission only)**
- **Calibrated engine control module**
- **Two oxygen sensors and mounting bosses (for installation in the exhaust system)**
- **Mass airflow meter and mounting boss (for installation in the air intake system)**
- **Throttle pedal assembly (for use with the electronically operated throttle)**
- **Assembled wiring harness with fuse box and necessary cam sensor and MAP sensor jumpers**
- **Oil pressure sensor that is compatible with the harness**

NOTE: All components, engine, transmission, transmission installation kit, torque converter and controllers are ordered and delivered separately.

To facilitate a complete installation, the builder will need to source additional components to complete the engine assembly and get the vehicle running, including:

- Fuel tank and fuel lines (re-circulating or returnless)
- Fuel pump – 58 psi (400 kPa) for all engines except LSA / 65 psi (450 kPa) for LSA
- Air induction system that incorporates the mass airflow sensor

Additionally, all engines require a Front-End Accessory Drive system. The instruction manual included with each kit offers recommendations and Chevrolet Performance offers several configurations to suit different applications. Each allows the installer to easily delete air conditioning. See pages 280-287 for applications and part numbers.

Chevrolet Performance recommends the LS1 Engine Installation Guide P/N 88959384, which illustrates basic procedures and offers helpful tips on installing an LS engine into older vehicles.

About Chevrolet Performance Engine and Transmission Controllers

The Connect & Cruise engine controller and SuperMatic™ transmission controller are designed for true stand-alone performance in older vehicles. All that's needed to get a vehicle running with the engine controller are power and ground sources, a high-pressure fuel pump and an electric cooling fan. For all engines except the LSA, Chevrolet Performance recommends a 58-psi (400 kPa) fuel pump. The LSA requires a 65-psi (450 kPa) pump.

Chevrolet Performance's specially calibrated engine controller does not utilize a number of features associated with production-model systems, eliminating the possibility of "trouble codes" being set. It also includes a SES (service engine soon) LED indicator embedded in the fuse box.

The SuperMatic™ transmission controller is the most fully integrated and user-friendly transmission control system on the market. Only a few connections are required to get the transmission ready for operation in your vehicle – and it is designed for tuning-free compatibility for the Connect & Cruise systems' engine control modules.

NOTE: Installing an electronically controlled automatic transmission in an older vehicle with a mechanical speedometer requires an aftermarket signal converter.

FUEL INJECTED ENGINES WITH AUTOMATIC TRANSMISSIONS

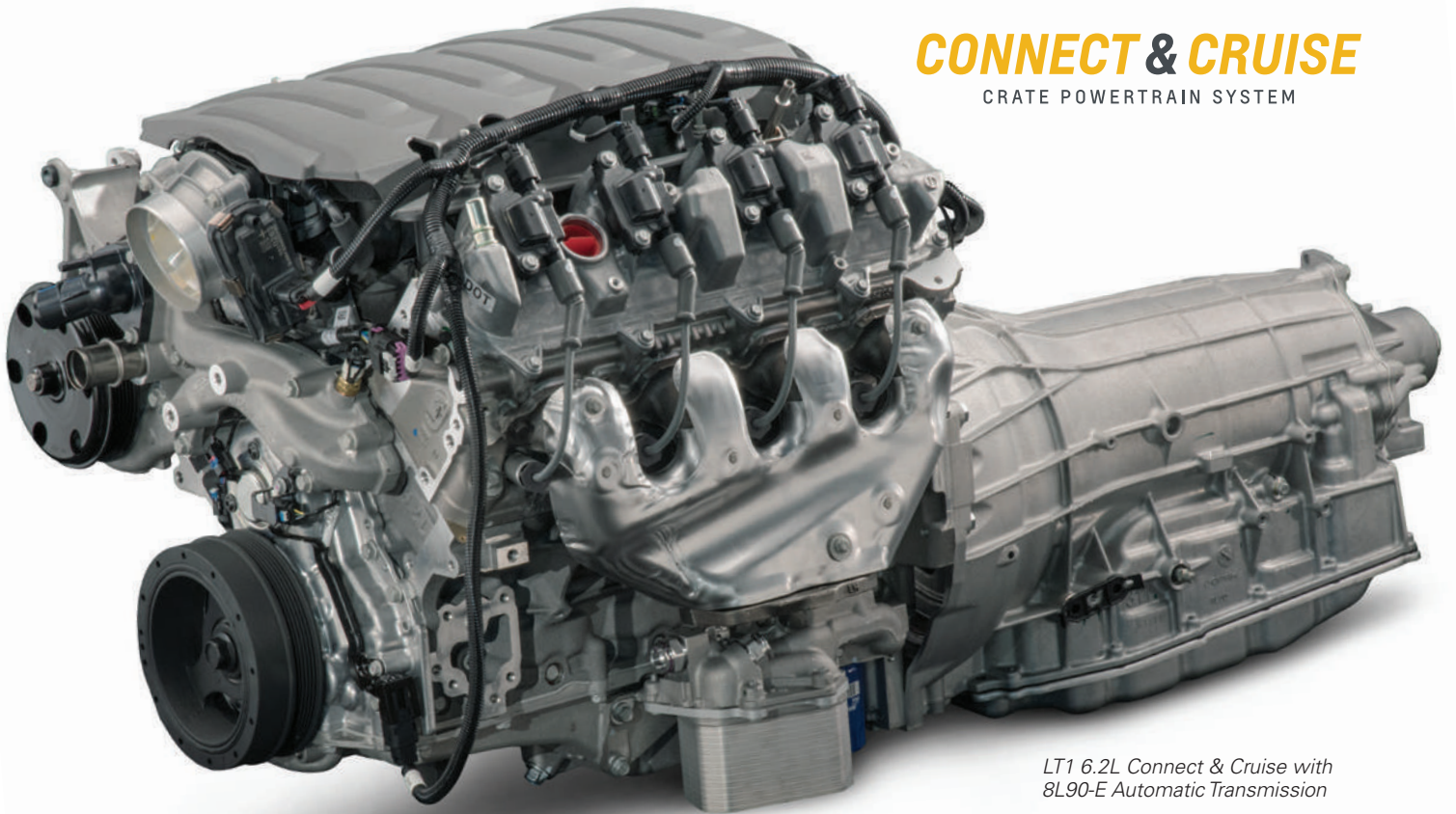

CONNECT & CRUISE
CRATE POWERTRAIN SYSTEM

*LT1 6.2L Connect & Cruise with
8L90-E Automatic Transmission*

Chevrolet Performance's Connect and Cruise systems make it simple to optimize performance and minimize hassle. Our engineers have paired the right engine, transmission and controllers with our LS/LT crate engines to take the guesswork out of your build. It is the easy, economical way to get you on the road quickly!

Select your crate powertrain system from the chart on the following page.

NOTE: All components, engine, transmission, transmission installation kit, torque converter and controllers are ordered and delivered separately.

LS-SERIES

Connect & Cruise System	Engine	Engine Controller	Transmission Installation Kit	Transmission	Torque Converter	Transmission Controller
L96 6.0L 2WD w/4L65-E	12677741	19356410	19259117	19368611	19299802	19302405
L96 6.0L 4WD w/4L70-E	12677741	19356410	19259117	19368612	19299802	19302405
LS3 6.2L 2WD w/4L65-E	19369326	19354328	19259117	19368611	19299802	19302405
LS3 6.2L 4WD w/4L70-E	19369326	19354328	19259117	19368612	19299802	19302405
LS3 6.2L E-ROD w/4L65-E	19369331	included with E-ROD kit	19259117	19368611	19299802	19302405
LS376/480 w/4L70-E	19369333	19354330	19259117	19368613	19299803	19302405
LS376/525 w/4L70-E	19369338	19354332	19259117	19368613	19299803	19302405
LS376/525 w/4L75-E	19369338	19354332	19259117	19368615	19299803	19302405
LSA 6.2L SC w/4L75-E	19331507	19354336	19259117	19368615	19299802	19302405
LSA 6.2L SC w/4L85-E	19331507	19354336	19259119	19300175	19299806	19302410
LSA 6.2L SC E-ROD w/4L75-E	19257456	included with E-ROD kit	19259117	19368615	19299802	19302405
LSA 6.2L SC E-ROD w/4L85-E	19257456	included with E-ROD kit	19259119	19300175	19299806	19302410
LS7 7.0L w/4L70-E	19329246	19354334	19259117	19368613	19299802 or 19299803	19302405
LS7 7.0L w/4L75-E	19329246	19354334	19259117	19368615	19299802 or 19299803	19302405
LT1 6.2L Wet Sump w/4L70-E	19355405	19368833	19329416	19368614	19299802	19302405
LT1 6.2L Dry Sump w/4L70-E	19329997	19368831	19329416	19368614	19299802	19302405
LT1 E-ROD Wet Sump w/4L70-E	12682080	included with E-ROD kit	19329416	19368614	19299802	19302405
LT1 6.2L SC Wet Sump w/8-Speed	19355405	19368835	24283284	19367134	included with trans.	included with trans.
LT4 6.2L SC Wet Sump w/4L75-E	19368622	19368843	19329416	19368615	19299802	19302405
LT4 6.2L Dry Sump w/4L75-E	19332702	19368843	19329416	19368615	19299802	19302405
LT4 6.2L SC Wet Sump w/8-Speed	19355404	19368845	24284144	19367135	included with trans.	included with trans.
LT376/535 w/4L75-E	19355378	19368837	19329416	19368615	19299803	19302405

CARBURETED ENGINES WITH AUTOMATIC TRANSMISSIONS

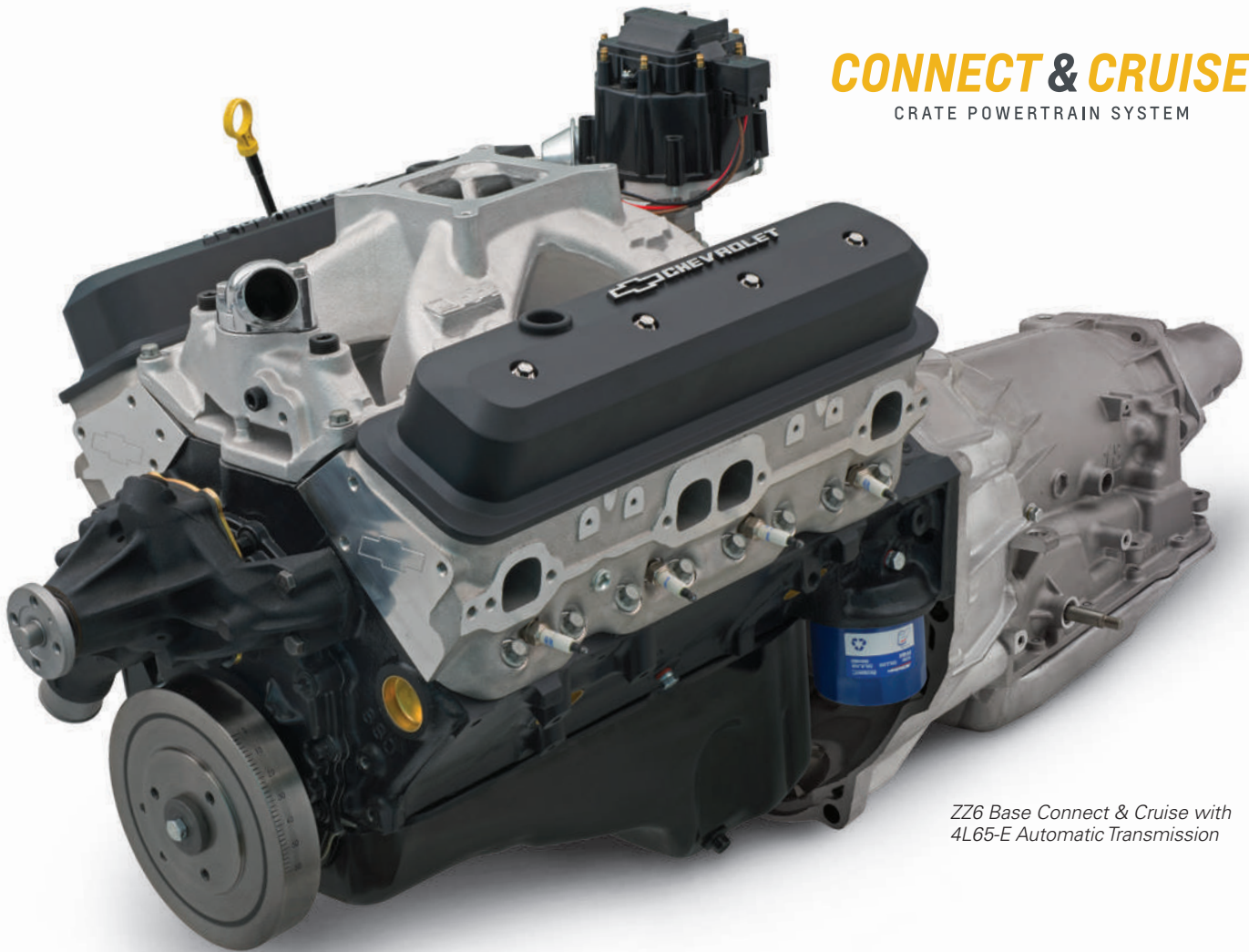

CONNECT & CRUISE
CRATE POWERTRAIN SYSTEM

*ZZ6 Base Connect & Cruise with
4L65-E Automatic Transmission*

Chevrolet Performance has expanded the Connect & Cruise Powertrain lineup with new systems pairing Gen I Small-Block, Big-Block and even carbureted LS engines. Whether you are looking to power your project vehicle or simply give new life to your work truck, Chevrolet Performance has the Crate Powertrain System to help meet your needs!

Select your crate powertrain system from the chart on the following page.

NOTE: All components, engine, transmission, transmission installation kit, torque converter and controllers are ordered and delivered separately.

LS-SERIES

Connect & Cruise System	Engine	Transmission Installation Kit	Transmission	Torque Converter	Transmission Controller
LS 376/515 w/4L70-E	19369335	19259117	19368613	19299803	19332775

SMALL-BLOCK

Connect & Cruise System	Engine	Transmission Installation Kit	Transmission	Torque Converter	Transmission Controller
350/290 Deluxe w/4L65-E	19355659	19332781	19368611	19299800	19332775
350 HO Turn-Key w/4L65-E	19355662	19332781	19368611	19299800	19332775
Ram Jet 350 w/4L65-E	19355815	19332781	19368611	19299800	19332775
SP350/357 Turn-Key w/4L65-E	19367084	19332781	19368611	19299801	19332775
SP350/385 Base w/4L65-E	19333157	19332781	19368611	19299801	19332775
SP350/385 Turn-Key w/4L65-E	19333158	19332781	19368611	19299801	19332775
ZZ6 Base w/4L65-E	19351532	19332781	19368611	19299801	19332775
ZZ6 Turn-Key w/4L65-E	19351533	19332781	19368611	19299801	19332775
HT383 w/4L70-E	19355720	19332781	19368613	19299800	19332775
SP383 Deluxe w/4L70-E	19355672	19332781	19368613	19299801	19332775

BIG-BLOCK

Connect & Cruise System	Engine	Transmission Installation Kit	Transmission	Torque Converter	Transmission Controller
ZZ427/480 w/4L70-E	19331572	19332781	19368613	19299801	19332775
454 HO w/4L85-E	12568774	19332784	19300175	19299804	19332780
ZZ454/440 w/4L85-E	19331574	19332784	19300175	19299804	19332780
HT502 w/4L85-E	88890534	19332784	19300175	19299804	19332780
502 HO w/4L85-E	12568778	19332784	19300175	19299804	19332780
ZZ502/502 Deluxe w/4L85-E	19331579	19332784	19300175	19299805	19332780
Ram Jet 502 w/4L85-E	12499121	19332784	19300175	19299805	19332780
ZZ572/620 Deluxe w/4L85-E	19331583	19332784	19300175	19299805	19332780
ZZ572/720R Deluxe w/4L85-E	19331585	19332784	19300175	19299805	19332780

CARBURETED AND FUEL INJECTED ENGINES WITH MANUAL TRANSMISSIONS

CONNECT & CRUISE
CRATE POWERTRAIN SYSTEM

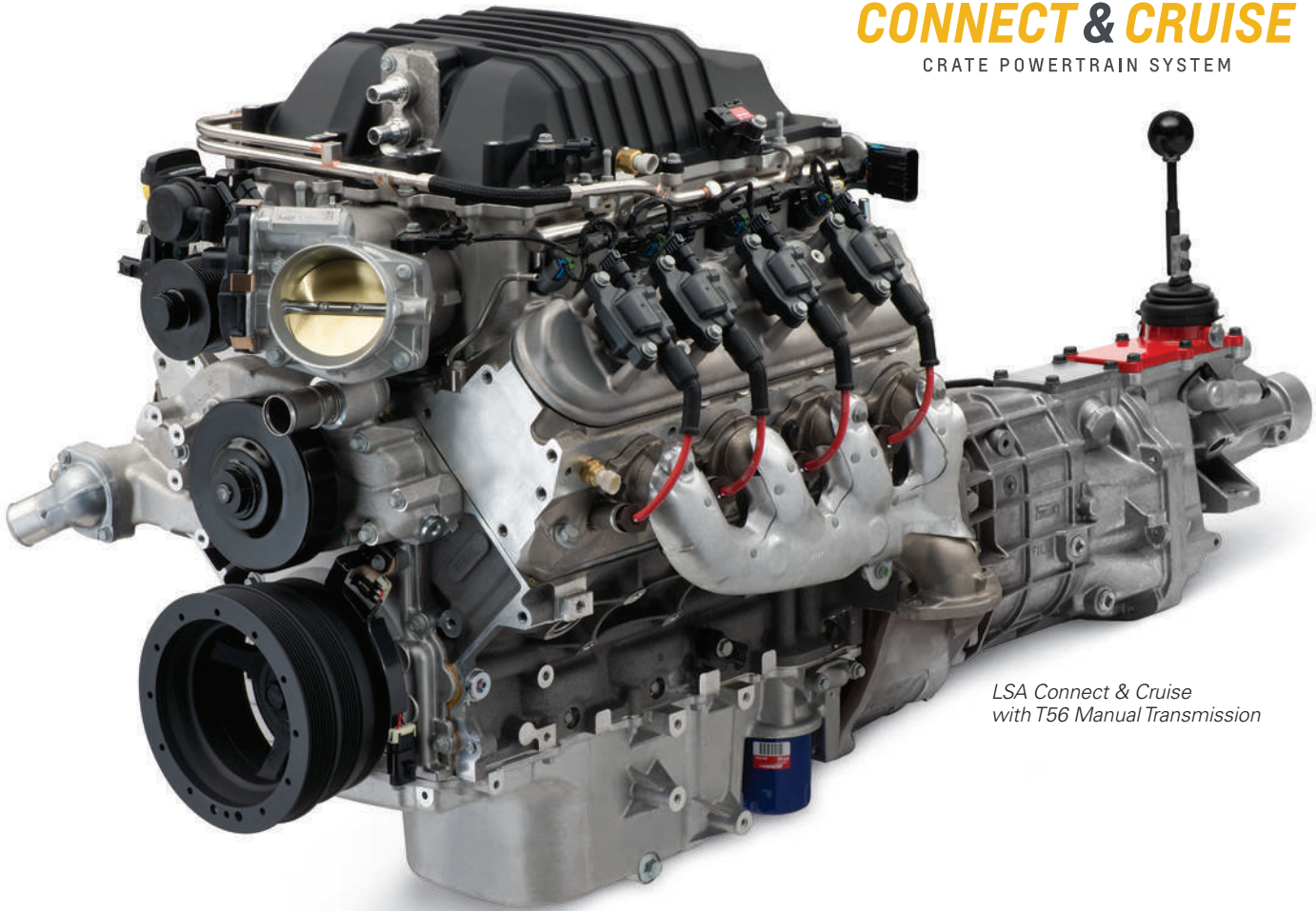

*LSA Connect & Cruise
with T56 Manual Transmission*

Chevrolet Performance knows there are a lot of enthusiasts who like to do their own shifting. So our Engineers have developed a full line of packages that pair LS, LT and a wide range of our Small- and Big-Block engines with our robust T56 Super Magnum Six-Speed Manual Transmission.

Select your crate powertrain system from the chart on the following page.

NOTE: All components, engine, transmission, transmission installation kit, torque converter and controllers are ordered and delivered separately.

LS-SERIES

Connect & Cruise System	Engine	Engine Controller	Transmission Installation Kit	Transmission
LS3 6.2L w/T56	19369326	19354328	19301625	19352208
LS3 6.2L E-ROD w/T56	19369331	included with E-ROD kit	19301625	19352208
LS376/480 w/T56	19369333	19354330	19301625	19352208
LS376/515 w/T56	19369335	N/A	19301625	19352208
LS376/525 w/T56	19369338	19354332	19301625	19352208
LSA 6.2L SC w/T56	19331507	19354336	19329912	19352208
LSA 6.2L SC E-ROD w/T56	19357456	included with E-ROD kit	19329912	19352208
LS9 6.2L SC w/T56	19260165	19354338	19331083	19352208
LS7 7.0L SC w/T56	19329246	19354334	19301625	19352208
LT1 6.2L Wet Sump w/T56	19355405	19368833	19329912	19352208
LT1 6.2L Dry Sump w/T56	19329997	19368831	19329912	19352208
LT4 6.2L SC Wet Sump w/T56	19368822	19368843	19329912	19352208
LT4 6.2L SC Dry Sump w/T56	19332702	19368841	19339912	19352208
LT376/535 w/T56	19355378	12677124	19329912	19352208

SMALL-BLOCK

Connect & Cruise System	Engine	Engine Controller	Transmission Installation Kit	Transmission
SP383 Deluxe w/T56	19355672	—	19329900	19352208
SP350/357 Turn-Key w/T56	19367084	—	19329900	19352208
SP350/385 Turn-Key w/T56	19333158	—	19329900	19352208
Ram Jet 350 w/T56	19355815	—	19329900	19352208

BIG-BLOCK

Connect & Cruise System	Engine	Engine Controller	Transmission Installation Kit	Transmission
ZZ427/480 w/T56	19331572	—	19329902	19352208
ZZ454/440 w/T56	19331574	—	19329901	19352208
Ram Jet 502 w/T56	12499121	—	19329901	19352208
427 Anniversary w/T56	19166392	—	19329902	19352208
ZZ502/502 Deluxe w/T56	19331579	—	19329901	19352208
ZZ572/620 Deluxe w/T56	19331583	—	19329902	19352208



SMALL-BLOCK

CRATE ENGINES

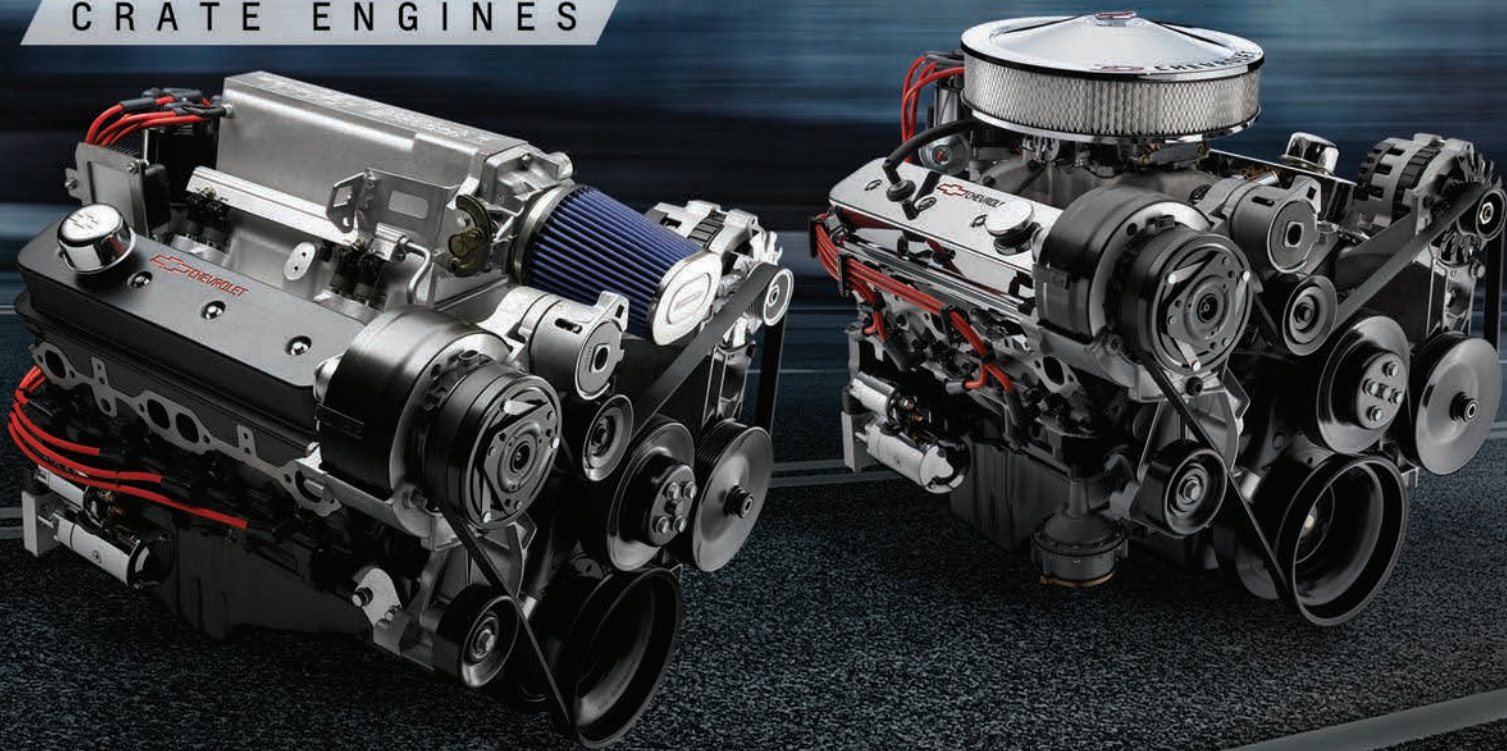

A PERFORMANCE ICON BACKED BY 60+ YEARS OF EXPERIENCE!

The Chevrolet Small-Block fundamentally changed the world of performance more than six decades ago and this icon of American horsepower is pulling stronger than ever in Chevrolet Performance's diverse range of crate engines.

Our engineers have built in LS-inspired valvetrain technologies to expand the performance range of some of our Small-Block crate engines, while other classics of our lineup continue to offer great power for just about every project budget.

All of our Small-Block crate engines are built with brand-new parts, from the cylinder block and rotating assembly to the heads – and nearly every one of our Small-Block engines uses a block with four-bolt main caps, for great strength and durability.

The Small-Block's legacy is unmatched in the industry and nobody knows how to build them better than Chevrolet Performance!

You can find these Chevrolet Performance Small-Block Engines on the following pages:

350/290 BASE.....	116	SP350/385 BASE.....	130
350/290 DELUXE.....	118	SP350/385 TURN-KEY.....	132
350 HO TURN-KEY.....	120	ZZ6 BASE.....	134
RAM JET 350.....	122	ZZ6 TURN-KEY.....	136
SP350/357 BASE.....	124	HT 383.....	138
SP350/357 DELUXE.....	126	HT383E.....	140
SP350/357 TURN-KEY.....	128	SP383 DELUXE.....	142





*Engines Shown From Left:
Ram Jet 350, 350 HO, ZZ6 Base*



350/290 Base

19355658

308 hp
@ 5,100 rpm

347 lb.-ft.
@ 3,900 rpm

DYNO CHART

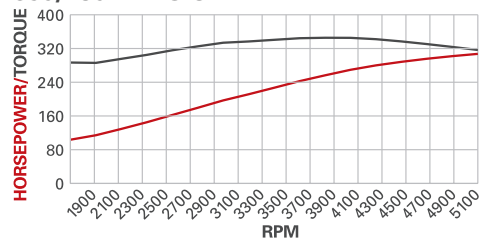

OUR BEST CRATE ENGINE VALUE DELIVERS ALL YOU EXPECT IN A POWERFUL SMALL-BLOCK!

The value-priced Chevrolet Performance Small-Block crate engine is also our best seller – and it’s easy to understand why. The 350/290 Base Small-Block features four-bolt mains for strength and makes a great economical alternative to rebuilding a tired, two-bolt main core. Use it to re-power your budget Camaro project!

Inside the 350/290 Base are quality parts, including a hydraulic-flat-tappet camshaft and durable aluminum pistons that produce an 8.0:1 compression ratio. We offer the 350/290 in a base form, allowing you to add the induction and other accessories. That’s great for builders swapping over the intake manifold, carburetor and other components when re-powering a vehicle.

Chevrolet Performance has all the components to build up the 350/290 Base into a high-performance, great-looking street engine, too – from an aluminum intake and carburetor (we recommend the 670-cfm Holley four-barrel, P/N 19170092) to the distributor, water pump and more. Save the time and hassle of rebuilding your old engine by ordering the 350/290 Base and finishing it to your own specifications.

NOTE: Refer to page 83 for the complete horsepower and torque testing procedures.

TECH SPECS

Part Number:	19355658
Engine Type:	Chevy Small-Block V-8
Displacement (cu in):	350
Bore x Stroke (in):	4.000 x 3.480
Block (P/N 10066034):	Cast-iron with 4-bolt main caps
Crankshaft (P/N 93426651):	Nodular iron
Connecting Rods (P/N 10108688):	Powdered metal steel
Pistons (P/N 93422884):	Cast-aluminum
Camshaft Type (P/N 3896962):	Hydraulic flat tappet
Valve Lift (in):	.450 intake / .460 exhaust
Camshaft Duration (@.050 in):	222° intake / 222° exhaust
Cylinder Heads (P/N 93438649):	Iron; 76cc chambers
Valve Size (in):	1.94 intake / 1.50 exhaust
Compression Ratio:	8.0:1
Rocker Arms (P/N 10089648):	Stamped steel
Rocker Arm Ratio:	1.5:1
Recommended Fuel:	Regular pump
Ignition Timing:	32° Total @ 4,000 rpm
Maximum Recommended rpm:	5,100
Balanced:	Internal

INSTALLATION NOTES

- Use neutral balance harmonic damper P/N 12551537
- Use internally balanced flexplate P/N 471529 for automatic transmission or flywheel P/N 14085720 for manual transmission (not included)
- Power ratings based on tests with Holley 670-cfm carburetor P/N 19170092 (not included)
- Does not accept Chevrolet Performance roller lifter assemblies
- Not intended for marine applications
- See the Valve Covers section on page 174 for selection of chrome, polished and aluminum valve covers
- Pre-1986-style 2-piece rear main seal block
- Recommended for use in vehicles with 6,000 GVW or less

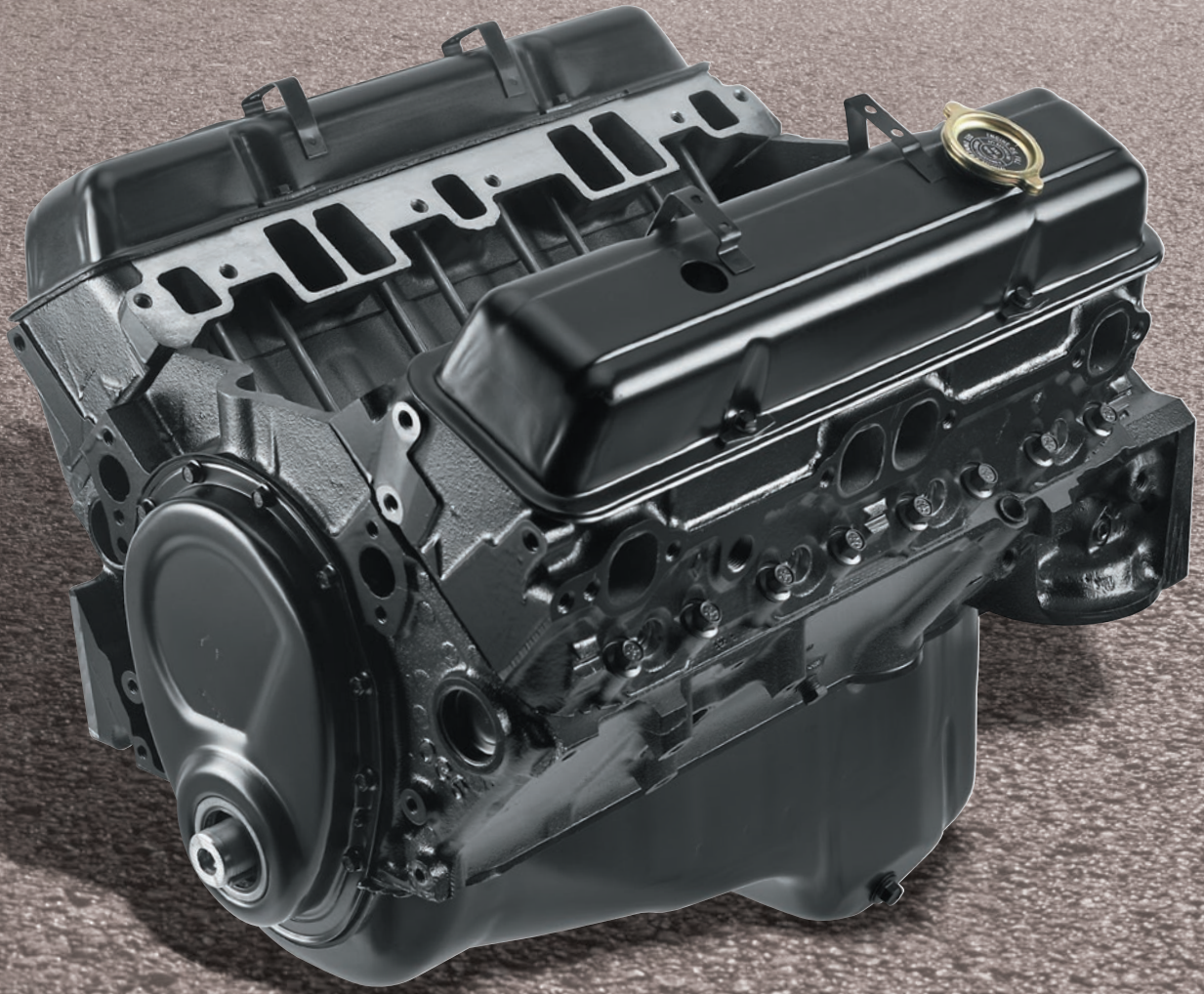

19368611
SuperMatic™ 4L65-E Four-Speed Automatic Transmission (remanufactured)
 Electronically controlled four-speed overdrive transmission. Suitable for engines producing up to 430 lb.-ft. of torque.

See page 366 for torque converter applications.

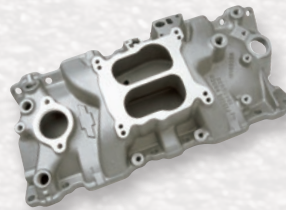

10185063
Dual Plane Intake Manifold
 Delivers good low-end and mid-range torque for daily driving.

See page 189 for details.

AVAILABLE ENGINE-RELATED PARTS & ACCESSORIES

See page 152 for our complete line of Small-Block components



93440806
HEI Distributor
 Page 188



12361146
High-Torque Mini Starter
 Page 196



19299800
Torque Converter
 Page 366



19170092
Carburetor, Holley 670-cfm
 Page 198



19332781
Transmission Installation Kit
 Page 370



19332775
Transmission Controller
 Page 371

350/290 Deluxe

19355659

308 hp

@ 5,100 rpm

347 lb.-ft.

@ 3,900 rpm

DYN0 CHART

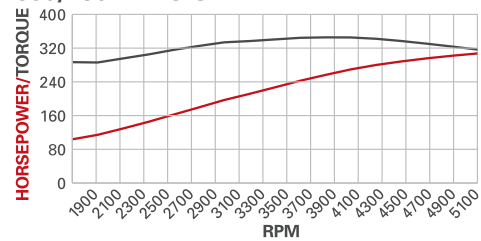

AN AFFORDABLE ICON

The 350 Small-Block is the cornerstone of the performance world – the most popular high-performance Small-Block crate engine. The 350/290 Deluxe, with 308 hp and 347 lb.-ft. of torque, adds an aluminum intake manifold* and chrome dress-up kit to create one of the most stylish and value-driven engines on the market.

Like all Chevrolet Performance Small-Block crate engines, the engine is built with a cast-iron block. It's got four-bolt main caps – a feature that's almost impossible to find in cores – and it's filled with a tough rotating assembly, featuring aluminum pistons delivering an 8.0:1 compression ratio. You'll feel the power every time you sit in the driver's seat!

Chevrolet Performance has all the parts needed to get your project vehicle running, from the carburetor to the starter and distributor, to the plug wires and more.

*Holley 670-cfm carburetor P/N 19170092 recommended (not included).

NOTE: Refer to page 83 for the complete horsepower and torque testing procedures.

TECH SPECS

Part Number:	19355659
Engine Type:	Chevy Small-Block V-8
Displacement (cu in):	350
Bore x Stroke (in):	4.000 x 3.480
Block (P/N 10066034):	Cast-iron with 4-bolt main caps
Crankshaft (P/N 93426651):	Nodular iron
Connecting Rods (P/N 10108688):	Powdered metal steel
Pistons (P/N 93422884):	Cast-aluminum
Intake Manifold (P/N 10185063):	Dual plane
Camshaft Type (P/N 3896962):	Hydraulic flat tappet
Valve Lift (in):	.450 intake / .460 exhaust
Camshaft Duration (@.050 in):	222° intake / 222° exhaust
Cylinder Heads (P/N 93438649):	Iron; 76cc chambers
Valve Size (in):	1.94 intake / 1.50 exhaust
Compression Ratio:	8.0:1
Rocker Arms (P/N 10089648):	Stamped steel
Rocker Arm Ratio:	1.5:1
Recommended Fuel:	Regular pump
Ignition Timing:	32° Total @ 4,000 rpm
Maximum Recommended rpm:	5,100
Balanced:	Internal

INSTALLATION NOTES

- Use neutral balance harmonic damper P/N 12551537
- Use internally balanced flexplate P/N 471529 for automatic transmission or flywheel P/N 14085720 for manual transmission (not included)
- Power ratings based on tests with Holley 670-cfm carburetor P/N 19170092 (not included)
- Does not accept Chevrolet Performance roller lifter assemblies
- Not intended for marine applications
- Pre-1986-style 2-piece rear main seal block
- Recommended for use in vehicles with 6,000 GVW or less



Chrome parts are not assembled on engine

Shown with 670-cfm carburetor (not included)



19368611
SuperMatic™ 4L65-E Four-Speed Automatic Transmission (remanufactured)
 Electronically controlled four-speed overdrive transmission. Suitable for engines producing up to 430 lb.-ft. of torque.

See page 366 for torque converter applications.



19299800
Torque Converter
 Designed to provide long life when matched with a SuperMatic™ transmission.

See page 366 for details.

AVAILABLE ENGINE-RELATED PARTS & ACCESSORIES

See page 152 for our complete line of Small-Block components



93440806
HEI Distributor
 Page 188



12361051
Spark Plug Wire Set
 Page 197



12361146
High-Torque Mini Starter
 Page 196



19170092
Carburetor, Holley 670-cfm
 Page 198



19332781
Transmission Installation Kit
 Page 370



19332775
Transmission Controller
 Page 371

350 HO Turn-Key

19355662

333 hp

@ 5,100 rpm

381 lb.-ft.

@ 3,700 rpm

DYNO CHART

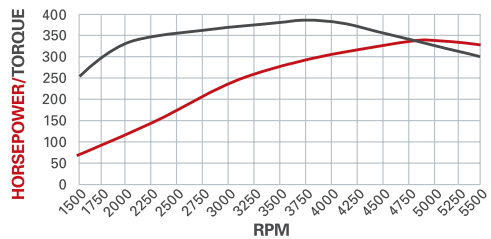

THE CLASSIC 350 READY TO ROCK!

Forget rebuilding! Our 350 HO is assembled with all-new parts and high-flow heads, giving you more power than just about any production-spec Small-Block ever installed at the factory: 333 hp and a satisfying 381 lb.-ft. of torque. It's affordable power with dependability you can count on.

A cast-iron block with four-bolt main caps is the foundation for the 350 HO, which is topped with iron Vortec heads fitted with 1.94/1.50-inch valves. Its durable rotating assembly has aluminum pistons delivering a 9.0:1 compression ratio, while a hydraulic flat-tappet camshaft requires no periodic lash adjustments.

As one of our Turn-Key crate engines, the 350 HO Turn-Key comes with the intake manifold and distributor installed. It also includes the carburetor, front-accessory kit, starter, fuel pump and spark plug wires (not installed).

The 350 HO is also available in "Deluxe" and "Base" configurations. See next page for information.

NOTE: Refer to page 83 for the complete horsepower and torque testing procedures.

TECH SPECS

Part Number:	19355662
Engine Type:	Chevy Small-Block V-8
Displacement (cu in):	350
Bore x Stroke (in):	4.000 x 3.480
Block (P/N 10105123):	Cast-iron with 4-bolt main caps
Crankshaft (P/N 10243070):	Nodular iron
Connecting Rods (P/N 10108688):	Powdered metal steel
Pistons (P/N 88954280):	Cast-aluminum
Intake Manifold (P/N 12496820):	Dual plane
Camshaft Type (P/N 24502476):	Hydraulic flat tappet
Valve Lift (in):	.435 intake / .460 exhaust
Cylinder Heads (P/N 12558060):	Vortec iron; 64cc chambers
Valve Size (in):	1.940 intake / 1.500 exhaust
Compression Ratio:	9.0:1 nominal
Rocker Arms (P/N 10089648):	Stamped steel
Rocker Arm Ratio:	1.5:1
Water Pump (P/N 19201601):	Cast iron, long-style
Flexplate (P/N 14088765):	12.750"
Recommended Fuel:	Premium pump
Ignition Timing:	32° Total @ 4,000 rpm
Maximum Recommended rpm:	5,100
Balanced:	External

INSTALLATION NOTES

- Comes with 12.750" externally balanced 153-tooth automatic transmission flexplate. Requires externally balanced flywheel for manual transmission. See chart on page 183
- Has right-side oil dipstick
- Requires fuel line from fuel pump to carburetor
- Fuel pump pressure is pre-set; fuel pressure regulator not required
- Some assembly and minor engine tuning required
- Not intended for marine applications
- Chevrolet Performance Front Accessory Drive Kits include a Reverse Rotation Water Pump

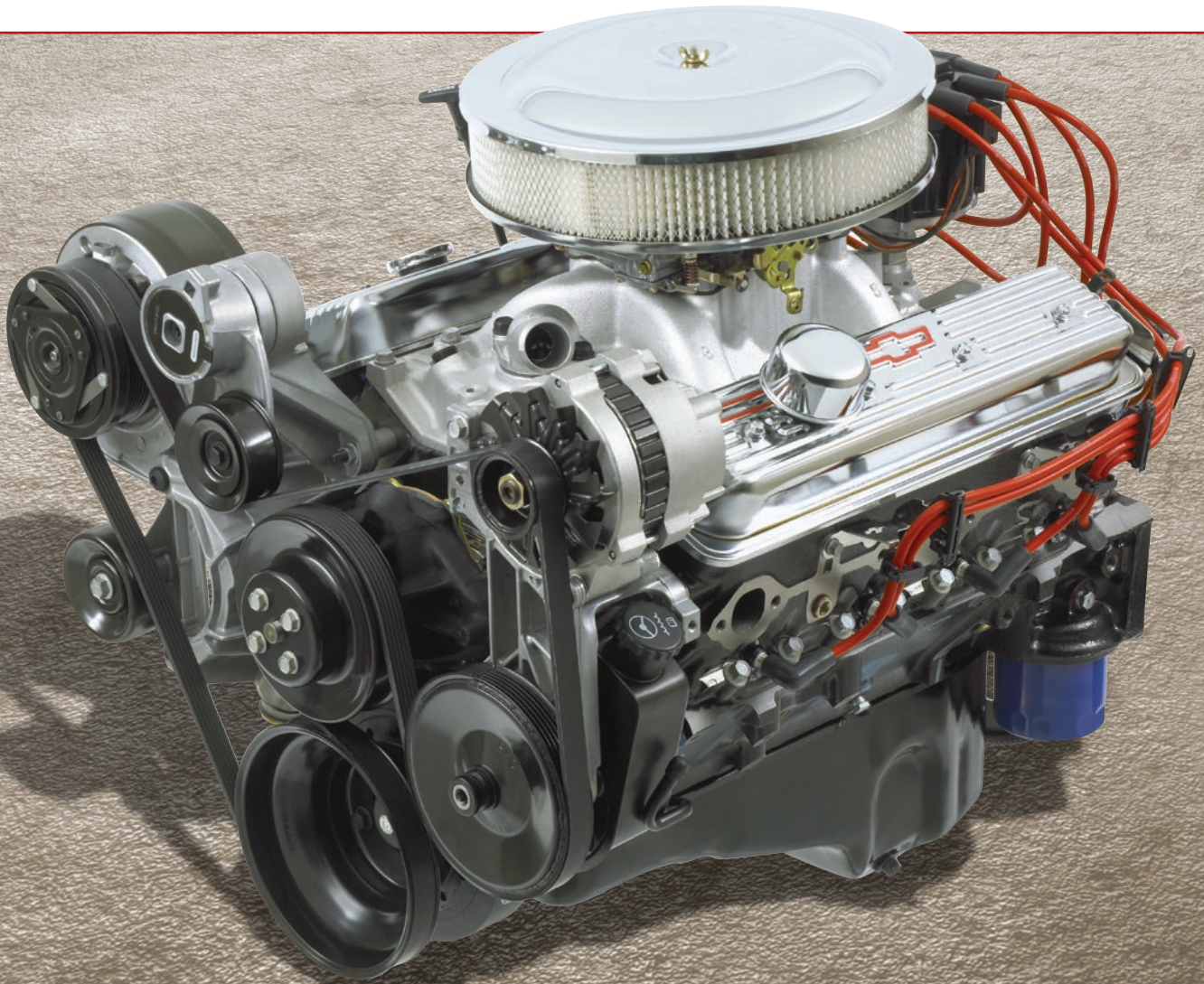

19355661
350 HO Deluxe
 Like the 350 HO Turn-Key crate engine, the 350 HO Deluxe is rated at 333 horsepower and 381 lb.-ft. of torque. The intake manifold, carburetor and distributor are installed.



19355660
350 HO Base
 All the same important, power-building elements as the Turn-Key and Deluxe versions, but it comes without an intake manifold, carburetor or distributor.

AVAILABLE ENGINE-RELATED PARTS & ACCESSORIES

See page 152 for our complete line of Small-Block components



19368611
SuperMatic™ 4L65-E
Automatic Transmission
 (remanufactured)
 Page 368



12497985
Aluminum Chrome
Valve Covers
 Page 174



12361146
High-Torque
Mini Starter
 Page 196



19299800
Torque Converter
 Page 366



19332781
Transmission
Installation Kit
 Page 370



19332775
Transmission
Controller
 Page 371

Ram Jet 350

19355815

345 hp

@ 5,000 rpm

396 lb.-ft.

@ 3,600 rpm

DYN0 CHART

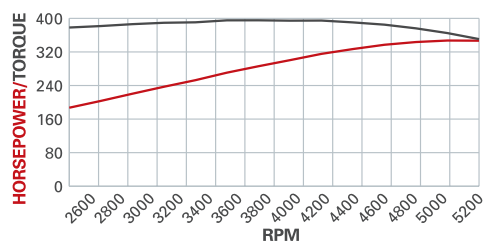

VINTAGE STYLE AND MODERN PERFORMANCE

Chevrolet Performance's unique Ram Jet 350 combines the classic look of the original Rochester mechanical injection system with the dependability and optimized performance of contemporary port fuel injection. It's the perfect combination for a project vehicle, producing 345 hp and 396 lb.-ft. of torque. Our engineers tweaked the calibration on this iconic engine, and the result is a broadened torque curve and 22 more horsepower at 5,200 rpm – which means better drivability and power over a broader rpm spectrum than ever before!

A cast-iron engine block is matched with a durable rotating assembly that delivers a pump-gas-friendly 9.0:1 compression ratio, as well as a smooth hydraulic roller camshaft that complements power delivery with a great idle quality. The engine's unique intake manifold and plenum is 9.75 inches tall, offering plenty of clearance to fit under the hood of most vehicles without modifications.

The Ram Jet 350 crate engine kit includes a MEFI 4 engine controller, wiring harness and a detailed instruction guide to make adding this retro-style EFI system a complete DIY project. Additional components are required, including a high-pressure fuel pump and front-end accessory drive system.

NOTE: Refer to page 83 for the complete horsepower and torque testing procedures.

TECH SPECS

Part Number:	19355815
Engine Type:	Chevy Small-Block V-8
Displacement (cu in):	350
Bore x Stroke (in):	4.000 x 3.480
Block:	Cast-iron with 2-bolt main caps
Crankshaft (P/N 10243070):	Cast-iron
Connecting Rods (P/N 10108688):	Powdered metal steel
Pistons (P/N 12571703):	Hypereutectic aluminum
Intake Manifold (P/N 12498032):	Ram Jet PFI design
Camshaft Type (P/N 14097395):	Hydraulic roller
Valve Lift (in):	.431 intake / .451 exhaust
Camshaft Duration (@.050 in):	196° intake / 206° exhaust
Cylinder Heads (P/N 12528913):	Vortec iron; 64cc chambers
Valve Size (in):	1.940 intake / 1.500 exhaust
Compression Ratio:	9.0:1 nominal
Rocker Arms (P/N 19210729):	Aluminum roller style
Rocker Arm Ratio:	1.5
Recommended Fuel:	Premium pump
Ignition Timing:	34° Total @ 4,000 rpm
Maximum Recommended rpm:	5,200
Balanced:	External

NOTE: Distributor with melonized steel gear **MUST** be used with long-blocks and Partial engines with steel camshafts, or engine damage will occur.

INSTALLATION NOTES

- Comes with externally balanced, manual transmission flywheel; change to externally balanced flexplate for automatic transmission applications. See chart on page 183
- Installer to supply 12-volt power source and fuel pump
- See instructions for fuel pump recommendation
- Not intended for marine applications
- **IMPORTANT!** For a safe, proper and trouble-free engine break-in, the MEFI 4 computer has a "green" mode that controls rpm during the break-in period. During this period, engine speed is limited to 4,000 rpm in the first hour, 4,500 rpm in the second hour and 5,200 rpm in the third hour

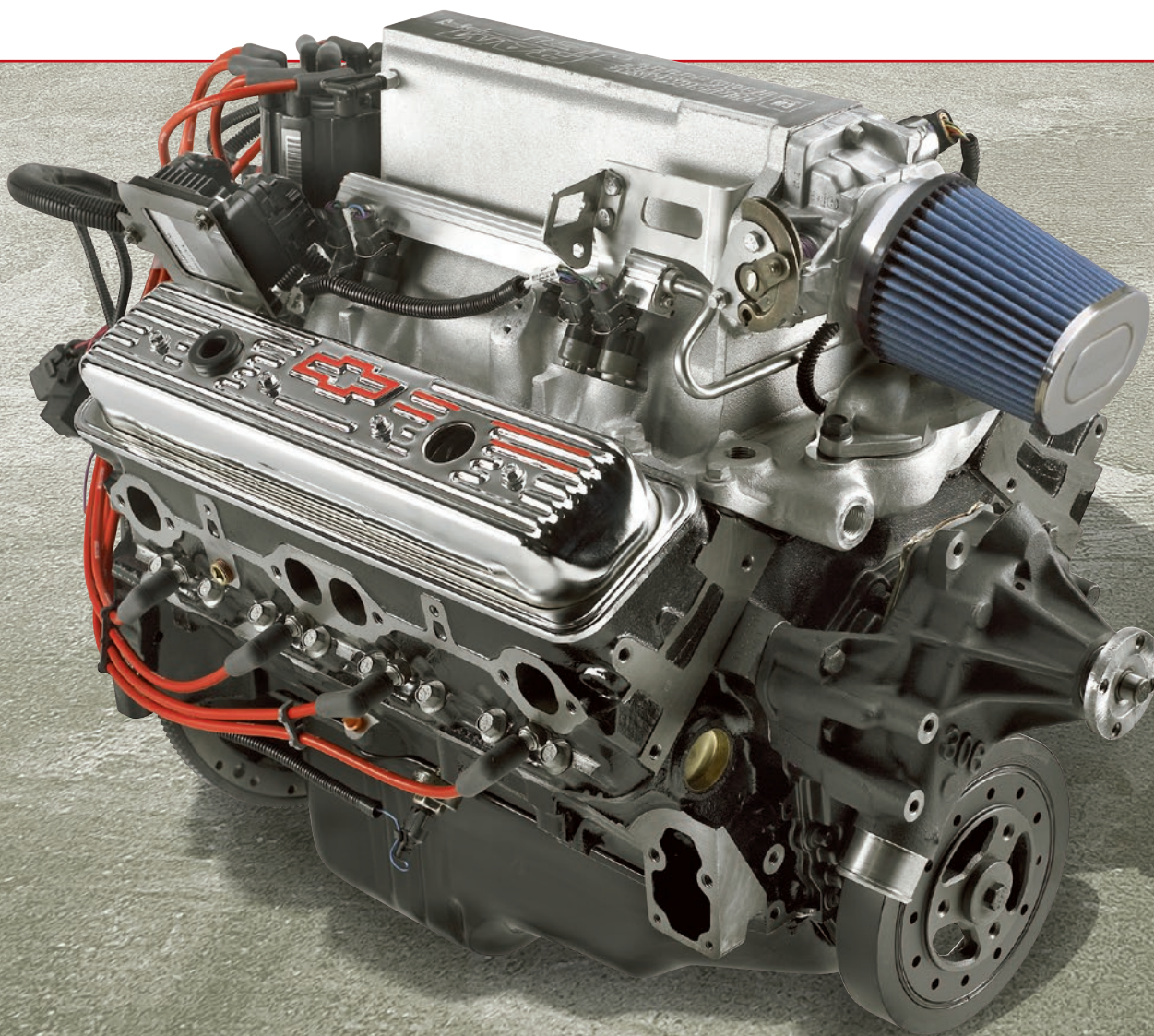

19368611
SuperMatic™ 4L65-E Four-Speed Automatic Transmission (remanufactured)

Electronically controlled four-speed overdrive transmission. Suitable for engines producing up to 430 lb.-ft. of torque.

See page 366 for torque converter applications.

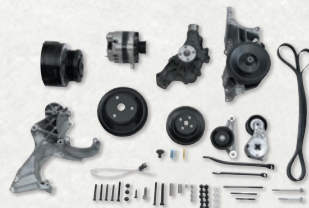

12497698
Serpentine Accessory Drive System

The complete kit you need to finish off the crate engine in your vehicle.

See page 186 for details.

AVAILABLE ENGINE-RELATED PARTS & ACCESSORIES

See page 152 for our complete line of Small-Block components



10465143
Lightweight Starter (remanufactured)

Page 196



12497979
Aluminum Black Crinkle Valve Covers

Page 175



12361146
High-Torque Mini Starter

Page 196



19299800
Torque Converter

Page 366



19332781
Transmission Installation Kit

Page 370



19332775
Transmission Controller

Page 371

SP350/357 Base

19367080

357 hp

@ 5,500 rpm

407 lb.-ft.

@ 4,000 rpm

DYNO CHART

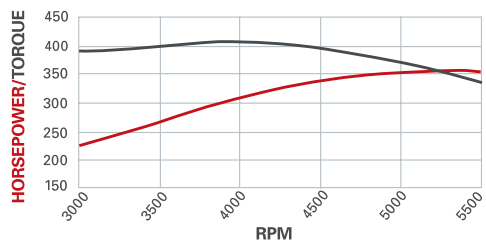

A NEW STANDARD FOR AFFORDABLE SMALL-BLOCK PERFORMANCE!

If it's affordable performance you're looking for to power your project vehicle, Chevrolet Performance's SP350/357 delivers! With 357 horsepower and a deep reserve of low-rpm torque, it quickly reminds you why Chevrolet's original 350 Small-Block has been the industry benchmark for decades.

The SP350/357 leverages the strength of a strong rotating assembly secured in a brand-new block with four-bolt mains, along with economical Vortec iron cylinder heads. A roller camshaft optimizes drivability and airflow capability. It all adds up to a 24-horsepower gain over our 350 HO crate engine – and a great, affordable alternative to rebuilding.

Our base crate engine package includes an assembled long block, including the oil pan and balancer. You finish it off your way, with the ignition system, induction system and additional accessories.

For more complete crate engines, see the SP350/357 Deluxe P/N 19367082 (page 126) and the SP350/357 Turn-Key P/N 19367084 (page 128).

NOTE: Refer to page 83 for the complete horsepower and torque testing procedures.

TECH SPECS

Part Number:	19367080
Engine Type:	Chevy Small-Block V-8
Displacement (cu in):	350
Bore x Stroke (in):	4.000 x 3.480
Block: (P/N 10105123)	Cast iron with 4-bolt main caps
Crankshaft (P/N 10243070):	Nodular Iron
Connecting Rods (P/N 10108688):	Powdered metal
Pistons (P/N 88894280):	Cast aluminum
Intake Manifold (P/N 12676887):	Dual plane
Camshaft Type (P/N 12677151):	Hydraulic roller
Valve Lift (in):	0.473 intake / 0.473 exhaust
Camshaft Duration (@.050 in):	215° intake / 223° exhaust
Cylinder Heads: (P/N 12558060)	Cast iron; as cast with 64cc chambers
Valve Size (in):	1.940 intake / 1.500 exhaust
Compression Ratio:	9.0:1 nominal
Rocker Arms (P/N 10089648):	Stamped steel
Rocker Arm Ratio:	1.5:1
Recommended Fuel:	Premium pump
Ignition Timing:	32° Total @ 4,000 rpm
Maximum Recommended rpm:	5,600
Balanced:	External

INSTALLATION NOTES

- Use the Holley 670-cfm 4-barrel carburetor P/N 19170092 to achieve the listed horsepower and torque
- Requires intake manifold, carburetor, distributor, spark plug wires and water pump to complete assembly
- Requires feed line from fuel pump to carburetor
- Not intended for marine applications

NOTE: Distributor with melonized steel gear **MUST** be used with long-blocks and Partial engines with steel camshafts, or engine damage will occur.

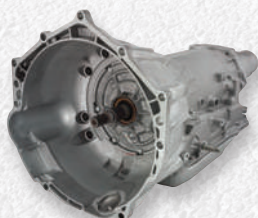

19368611
SuperMatic™ 4L65-E Four-Speed Automatic Transmission (remanufactured)
 Electronically controlled four-speed overdrive transmission. Suitable for engines producing up to 430 lb.-ft. of torque.

See page 366 for torque converter applications.



19299800
Torque Converter
 Designed to provide long life when matched with a SuperMatic™ transmission.

See page 366 for details.

AVAILABLE ENGINE-RELATED PARTS & ACCESSORIES

See page 152 for our complete line of Small-Block components



Photo Not Available

12676887
Intake Manifold



93440806
HEI Distributor
 Page 188



12361051
Spark Plug Wire Set
 Page 197



19170092
Carburetor, Holley 670-cfm
 Page 198



12361146
High-Torque Mini Starter
 Page 196



88894341
Water Pump, Long-Style Cast Iron
 Page 185

SP350/357 Deluxe

19367082

357 hp

@ 5,500 rpm

407 lb.-ft.

@ 4,000 rpm

DYNO CHART

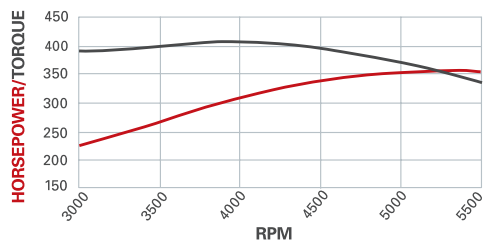

POWER, DURABILITY AND AFFORDABILITY IN THE CLASSIC SMALL-BLOCK 350!

As the latest in Chevrolet Performance's Street Performance crate engine lineup, the SP350/357 is designed as an affordable performer to match just about any budget. Better still, it uses stronger components and modern technology to make it a better alternative to rebuilding.

Based on the value-driven 350 HO crate engine, our engineers swapped the flat-tappet camshaft for a hydraulic roller and added the latest Small-Block intake manifold design. Together, they help build more power across the rpm band – 357 horsepower and 407 lb.-ft. of tire-turning torque

The SP350/357 leverages the strength of a strong rotating assembly secured in a brand-new block with four-bolt mains, along with economical Vortec iron cylinder heads. Its durable assembly is designed to offer years of high-performance excitement at an excellent value.

Our SP350/357 Deluxe package includes the intake manifold, distributor, damper and flexplate. Chevrolet Performance also offers the SP350/357 Base crate engine, P/N 19367080.

NOTE: Refer to page 83 for the complete horsepower and torque testing procedures.

TECH SPECS

Part Number:	19367082
Engine Type:	Chevy Small-Block V-8
Displacement (cu in):	350
Bore x Stroke (in):	4.000 x 3.480
Block (P/N 10105123):	Cast iron with 4-bolt main caps
Crankshaft (P/N 10243070):	Nodular Iron
Connecting Rods (P/N 10108688):	Powdered metal
Pistons (P/N 88894280):	Cast aluminum
Intake Manifold (P/N 12676887):	Dual plane
Camshaft Type (P/N 12677151):	Hydraulic roller
Valve Lift (in):	0.473 intake / 0.473 exhaust
Camshaft Duration (@.050 in):	215° intake / 223° exhaust
Cylinder Heads:	Cast iron; as cast with 64cc chambers
Valve Size (in):	1.940 intake / 1.500 exhaust
Compression Ratio:	9.0:1 nominal
Rocker Arms (P/N 12367346):	Stamped steel
Rocker Arm Ratio:	1.5:1
Recommended Fuel:	Premium pump
Ignition Timing:	32° Total @ 4,000 rpm
Maximum Recommended rpm:	5,600
Balanced:	External
Flexplate (P/N 14088765):	12.750"

INSTALLATION NOTES

- Holley 4-barrel carb included but not installed on engine
- Comes with 12.750" externally balanced 153-tooth automatic transmission flexplate. Requires externally balanced flywheel for manual transmission. See chart on page 183
- Requires fuel line from fuel pump to carburetor
- Not intended for marine applications

NOTE: Distributor with melonized steel gear **MUST** be used with long-blocks and Partial engines with steel camshafts, or engine damage will occur.

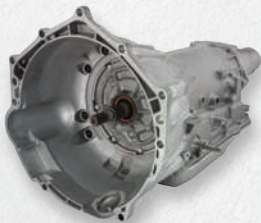

19368611
SuperMatic™ 4L65-E Four-Speed Automatic Transmission (remanufactured)

Electronically controlled four-speed overdrive transmission. Suitable for engines producing up to 430 lb.-ft. of torque.

See page 366 for torque converter applications.



19299800
Torque Converter

Designed to provide long life when matched with a SuperMatic™ transmission.

See page 366 for details.

AVAILABLE ENGINE-RELATED PARTS & ACCESSORIES

See page 152 for our complete line of Small-Block components



88894341
Water Pump, Long-Style Cast Iron

Page 185



6415325
Fuel Pump, High Capacity, Small-Block

Page 199



12361146
High-Torque Mini Starter

Page 196

SP350/357 Turn-Key

19367084

357 hp

@ 5,500 rpm

407 lb.-ft.

@ 4,000 rpm

DYNO CHART

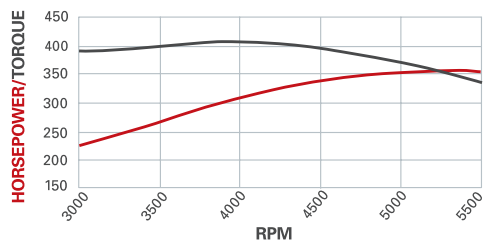

AN AFFORDABLE SMALL-BLOCK PERFORMER READY TO RUN!

Chevrolet Performance’s line of Street Performance engines offers great power at a great value – and the latest is the SP350/357. It leverages the strength of a strong rotating assembly and matches it with modern valvetrain technology to support great high-rpm capability.

Economical iron cylinder heads deliver excellent airflow, while the latest intake manifold technology and a new hydraulic roller camshaft optimize airflow to push 357 horsepower and more than 400 lb.-ft. of torque! Better still, the engine is built with a durable nodular iron crankshaft and powdered metal connecting rods set in a brand-new block with four-bolt mains. That’s a feature you won’t find on most rebuildable cores.

Our SP350/357 Turn-Key package comes complete with the distributor, carburetor and balancer installed. The starter, fuel pump, air conditioning pump, alternator, front-end accessory drive kit and more are also included, ready to bolt on.

Chevrolet Performance also offers the SP350/357 Base crate engine, P/N 19367080 as well as the SP350/357 Deluxe P/N 19367082. See previous pages for details.

NOTE: Refer to page 83 for the complete horsepower and torque testing procedures.

TECH SPECS

Part Number:	19367084
Engine Type:	Chevy Small-Block V-8
Displacement (cu in):	350
Bore x Stroke (in):	4.000 x 3.480
Block (P/N 10105123):	Cast iron with 4-bolt main caps
Crankshaft (P/N 10243070):	Nodular Iron
Connecting Rods (P/N 10108688):	Powdered metal
Pistons (P/N 88894280):	Cast aluminum
Intake Manifold (P/N 12676887):	Dual plane
Camshaft Type (P/N 12677151):	Hydraulic roller
Valve Lift (in):	0.473 intake / 0.473 exhaust
Camshaft Duration (@.050 in):	215° intake / 223° exhaust
Cylinder Heads:	Cast iron; as cast with 64cc chambers
Valve Size (in):	1.940 intake / 1.500 exhaust
Compression Ratio:	9.0:1 nominal
Rocker Arms (P/N 12367346):	Stamped steel
Rocker Arm Ratio:	1.5:1
Recommended Fuel:	Premium pump
Ignition Timing:	32° Total @ 4,000 rpm
Maximum Recommended rpm:	5,600
Balanced:	External
Flexplate (P/N 14088765):	12.750"

INSTALLATION NOTES

- Front-End Accessory Drive included but not installed for shipment
- Comes with 12.750" externally balanced 153-tooth automatic transmission flexplate. Requires externally balanced flywheel for manual transmission. See chart on page 183
- Requires fuel supply line from fuel pump to carburetor
- Not intended for marine applications

NOTE: Distributor with melonized steel gear **MUST** be used with long-blocks and Partial engines with steel camshafts, or engine damage will occur.

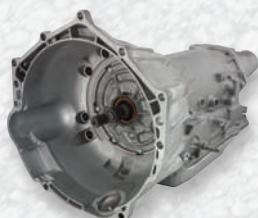
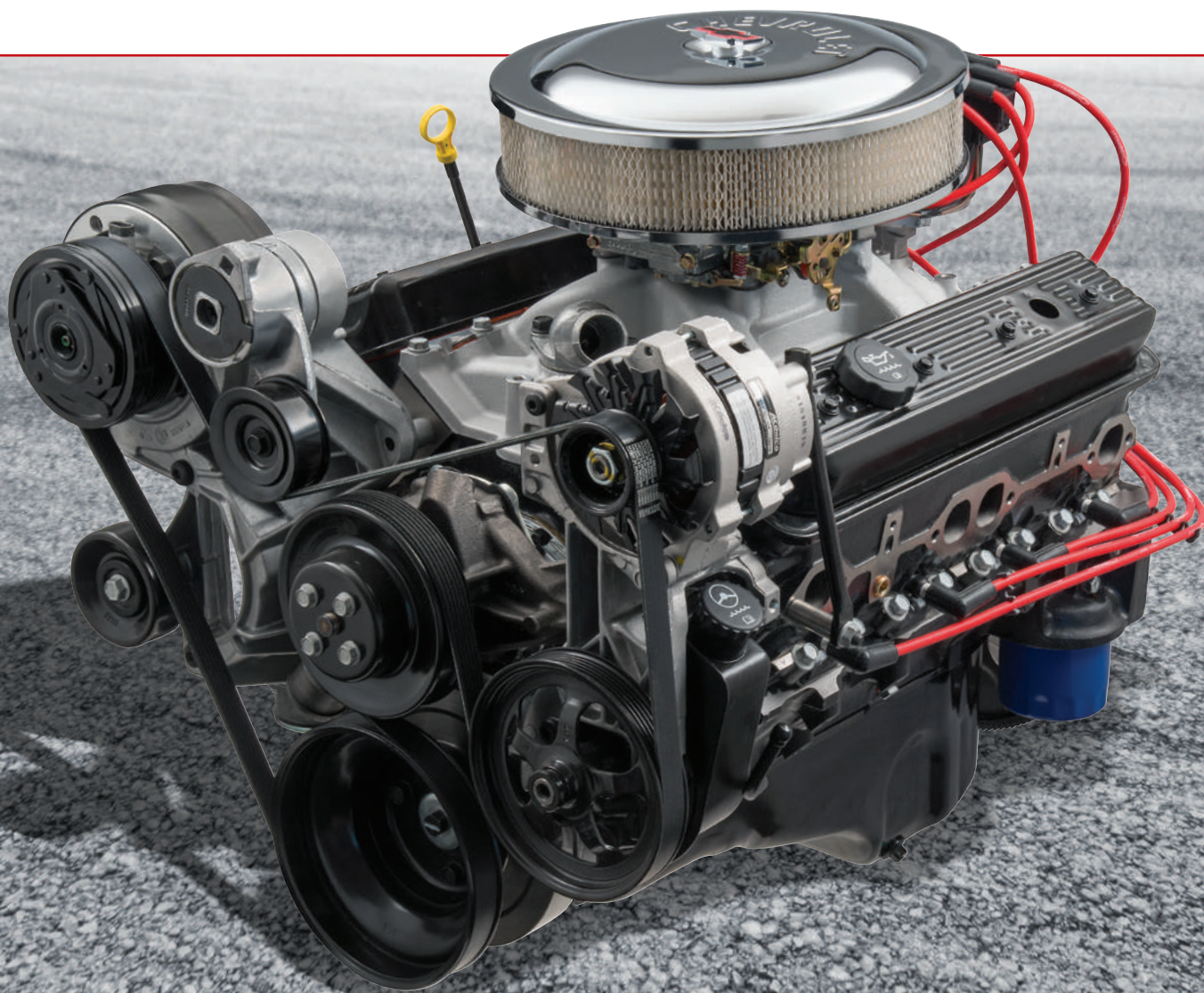

19368611
SuperMatic™ 4L65-E Four-Speed Automatic Transmission
 Electronically controlled four-speed overdrive transmission. Suitable for engines producing up to 430 lb.-ft. of torque.

See page 366 for torque converter applications.



19299800
Torque Converter
 Designed to provide long life when matched with a SuperMatic™ transmission.

See page 366 for details.

AVAILABLE ENGINE-RELATED PARTS & ACCESSORIES

See page 152 for our complete line of Small-Block components



19210728
Roller Rocker Arm Set, 1.5:1 Ratio
 Page 173



19332775
Transmission Controller
 Page 371



12497979
Aluminum Black Crinkle Valve Covers
 Page 175



19332781
Transmission Installation Kit
 Page 370

SP350/385 Base

19333157

385 hp

@ 5,600 rpm

405 lb.-ft.

@ 3,600 rpm

DYN0 CHART

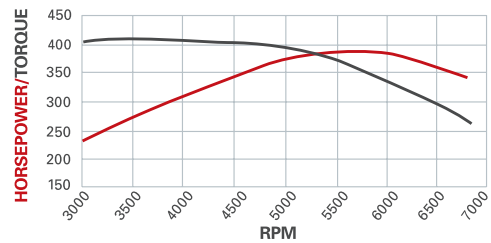

THE FOUNDATION FOR A HIGH-REVVING 350 SMALL-BLOCK!

Our SP350/385 crate engine incorporates modern technologies such as a beehive-type valve springs to take the classic 350 Small-Block to new levels of high-rpm performance – without sacrificing the signature torque that has made it the benchmark of V-8 engines for nearly half a century.

In fact, the 385 hp rating of the engine is complemented by excellent low-rpm torque, with the SP350/385 generating 405 lb.-ft. of torque at 3,600 rpm. It's all due to the high-flow, lightweight aluminum cylinder heads. They're based on the proven Fast Burn design, with large intake runners and 2.00/1.55-inch valves. The beehive valve springs enable greater high-rpm performance and durability, allowing the engine to rev higher to make the most of every cubic foot of air drawn through it.

As with all of Chevrolet Performance's Small-Block crate engines, the SP350/385 is built with a cast-iron block with four-bolt mains. It also features a forged steel crankshaft, an aggressive hydraulic roller camshaft and durable, high-silicon pistons. In this value-driven Base crate engine package, it also includes the intake manifold, distributor, water pump, damper and flexplate. Other accessories are required to finish it – all available from Chevrolet Performance.

NOTE: Refer to page 83 for the complete horsepower and torque testing procedures.

TECH SPECS

Part Number:	19333157
Engine Type:	Chevy Small-Block V-8
Displacement (cu in):	350
Bore x Stroke (in):	4.000 x 3.480
Block, P/N 10243870:	Cast-iron with 4-bolt main caps
Crankshaft, P/N 12670965:	Forged steel, shot peened
Connecting Rods (P/N 10108688):	Powdered metal
Pistons (P/N 10159436):	Hypereutectic aluminum
Intake Manifold (P/N 12366573):	Dual plane
Camshaft Type (P/N 10185071):	Hydraulic roller
Valve Lift (in):	.474 intake / .510 exhaust
Camshaft Duration (@.050 in):	208° intake / 221° exhaust
Cylinder Heads (P/N 19300955):	Fast Burn aluminum; 62cc chambers
Valve Size (in):	2.000 intake / 1.550 exhaust
Compression Ratio:	9.6:1 nominal
Rocker Arms (P/N 10089648):	Stamped steel
Rocker Arm Ratio:	1.5:1
Recommended Fuel:	Premium pump
Ignition Timing:	36° Total @ 4,000 rpm
Maximum Recommended rpm:	5,800
Balanced:	External
Flexplate (P/N 14088765):	12.750"

NOTE: Distributor with melonized steel gear **MUST** be used with long-blocks and Partial engines with steel camshafts, or engine damage will occur.

INSTALLATION NOTES

- Use the Holley 770-cfm 4-barrel carburetor P/N 19170093 to achieve the listed horsepower and torque
- Requires four-barrel carburetor, spark plug wires and additional components to complete assembly
- Comes with 12.750" externally balanced 153-tooth automatic transmission flexplate. Requires externally balanced flywheel for manual transmission. See chart on page 183
- Requires fuel line from fuel pump to carburetor
- Some assembly and minor engine tuning required
- Not intended for marine applications

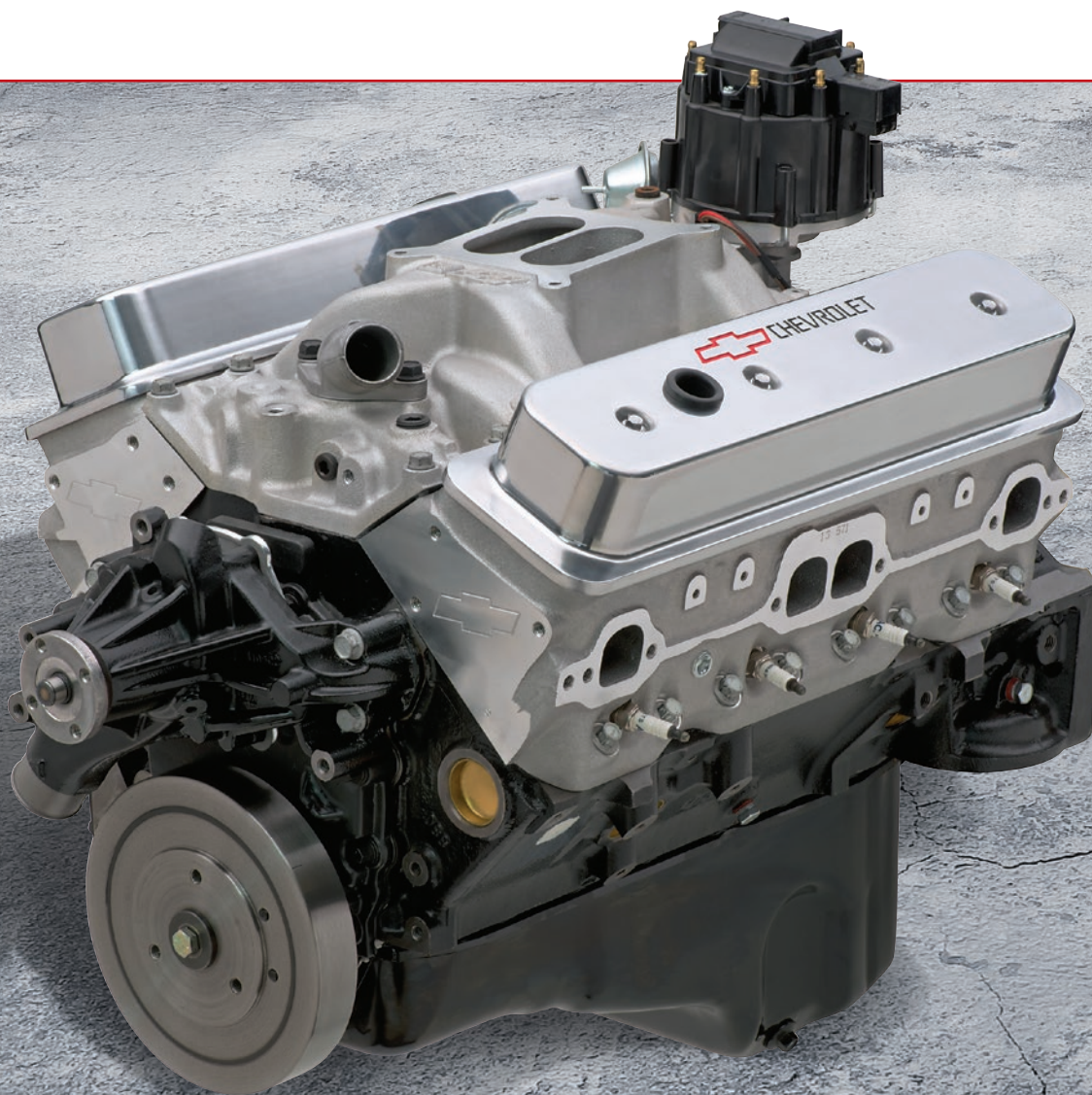

12670966
SP/ZZ Partial Engine
 The SP350 Partial is based on the popular ZZ4 partial engine assembly and includes the forged steel crankshaft, high-silicon pistons and connecting rods.

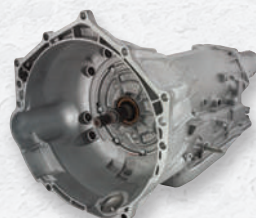

19368611
SuperMatic™ 4L65-E Four-Speed Automatic Transmission (remanufactured)
 Electronically controlled four-speed overdrive transmission. Suitable for engines producing up to 430 lb.-ft. of torque.
 See page 366 for torque converter applications.

AVAILABLE ENGINE-RELATED PARTS & ACCESSORIES

See page 152 for our complete line of Small-Block components



19210728
Roller Rocker Arm Set, 1.5:1 Ratio
 Page 173



19170093
Carburetor, Holley 770-cfm
 Page 198



12361146
High-Torque Mini Starter
 Page 196



19299800
Torque Converter
 Page 366



19332781
Transmission Installation Kit
 Page 370



19332775
Transmission Controller
 Page 371

SP350/385 Turn-Key

19333158

385 hp
@ 5,600 rpm

405 lb.-ft.
@ 3,600 rpm

DYNO CHART

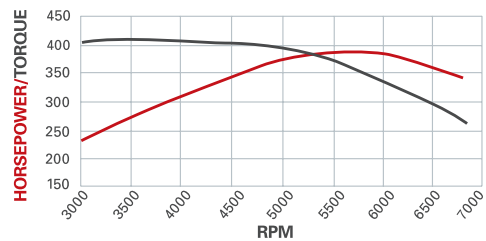

THE CLASSIC 350 SMALL-BLOCK WITH MODERN FEATURES

As part of Chevrolet Performance's new line of Street Performance engines, the SP350 offers contemporary engine features on the classic Small-Block architecture, for a unique blend of the low-rpm torque 350 engines have always been known for, and is also higher-rpm performance comparable.

The SP350's unique capability lies in its lightweight aluminum cylinder heads, which feature a valvetrain with beehive-style valve springs, similar to the design of the high-revving LS engine family. They enable greater high-rpm performance and durability, allowing the engine to rev higher and maximize the airflow capability of the heads – all without sacrificing the 350's signature torque.

Our SP350 Turn-Key package comes complete with the distributor and balancer installed. The carburetor, starter, fuel pump air conditioning pump, alternator, Front-End Accessory Drive Kit and more are also included, ready to bolt on.

NOTE: Refer to page 83 for the complete horsepower and torque testing procedures.

TECH SPECS

Part Number:	19333158
Engine Type:	Chevy Small-Block V-8
Displacement (cu in):	350
Bore x Stroke (in):	4.000 x 3.480
Block (P/N 10243870):	Cast-iron with 4-bolt main caps
Crankshaft (P/N 12670965):	Forged steel, shot peened
Connecting Rods (P/N 10108688):	Powdered metal
Pistons (P/N 10159436):	Hypereutectic aluminum
Intake Manifold (P/N 12366573):	Dual plane
Camshaft Type (P/N 10185071):	Hydraulic roller
Valve Lift (in):	.474 intake / .510 exhaust
Camshaft Duration (@.050 in):	208° intake / 221° exhaust
Cylinder Heads (P/N 19300955):	Fast Burn aluminum; 62cc chambers
Valve Size (in):	2.000 intake / 1.550 exhaust
Compression Ratio:	9.6:1 nominal
Rocker Arms (P/N 10089648):	Stamped steel
Rocker Arm Ratio:	1.5:1
Recommended Fuel:	Premium pump
Ignition Timing:	36° Total @ 4,000 rpm
Maximum Recommended rpm:	5,800
Balanced:	External
Flexplate (P/N 14088765):	12.750"

NOTE: Distributor with melonized steel gear **MUST** be used with long-blocks and Partial engines with steel camshafts, or engine damage will occur.

INSTALLATION NOTES

- SP350 Base Engine, P/N 19333157 is also available
- Comes with 12.750" externally balanced 153-tooth automatic transmission flexplate. Requires externally balanced flywheel for manual transmission. See chart on page 183
- Requires fuel line from fuel pump to carburetor
- Some assembly and minor engine tuning required
- Not intended for marine applications

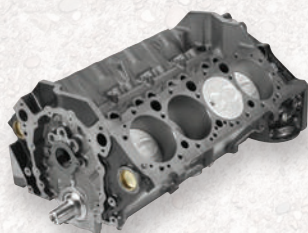
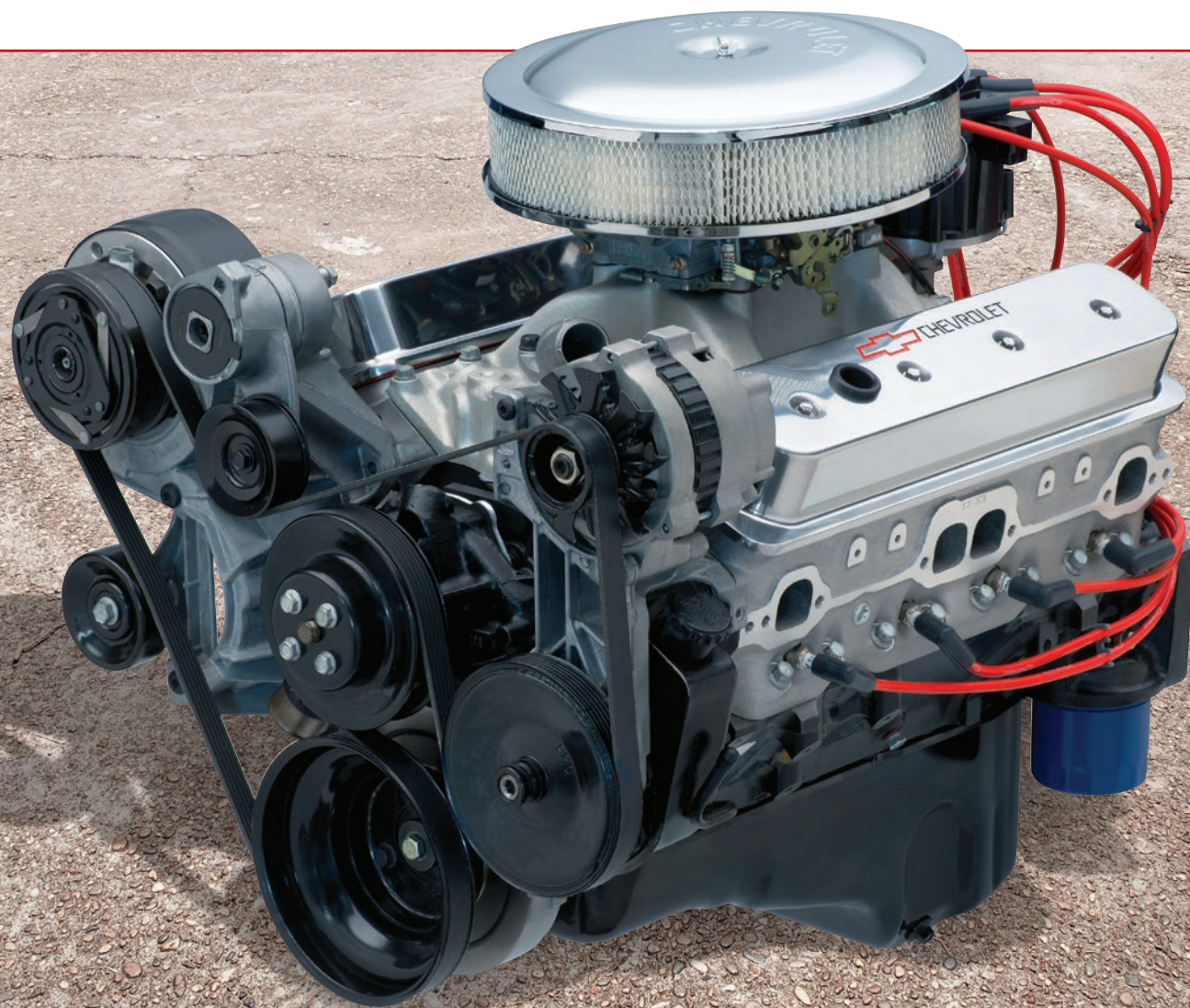

12670966
SP/ZZ Partial Engine
 The SP350 Partial is based on the popular ZZ4 partial engine assembly and includes the forged steel crankshaft, high-silicon pistons and connecting rods.

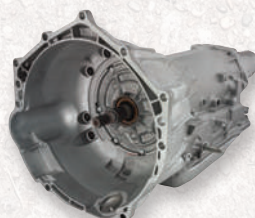

19368611
SuperMatic™ 4L65-E Four-Speed Automatic Transmission (remanufactured)
 Electronically controlled four-speed overdrive transmission. Suitable for engines producing up to 430 lb.-ft. of torque.

See page 366 for torque converter applications.

AVAILABLE ENGINE-RELATED PARTS & ACCESSORIES

See page 152 for our complete line of Small-Block components



19210728
Roller Rocker Arm Set, 1.5:1 Ratio
 Page 173



12497979
Aluminum Black Crinkle Valve Covers
 Page 175



12361146
High-Torque Mini Starter
 Page 196



19299800
Torque Converter
 Page 366



19332781
Transmission Installation Kit
 Page 370



19332775
Transmission Controller
 Page 371

ZZ6 Base

19351532

405 hp
@ 5,600 rpm

406 lb.-ft.
@ 4,600 rpm

DYNO CHART

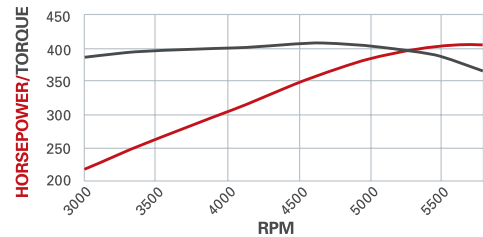

CHEVROLET PERFORMANCE'S ICONIC 350-BASED 'ZZ' ENGINE FAMILY CONTINUES THE LEGACY

Chevrolet Performance's ZZ6 delivers more power than any 350 Small-Block ever installed in a production vehicle. Rated at 405 hp and 406 lb.-ft. of torque, it derives its range-topping performance from unique, lightweight aluminum cylinder heads that enable optimal airflow at high rpm.

The cylinder head casting is based on the proven Fast Burn design, with large intake runners and 2.00/1.55-inch valves. Beehive-style valve springs deliver greater high-rpm performance and durability. Their egg-shaped profiles have less reciprocating mass in motion, require less spring pressure for greater valve control and handle valvetrain stresses more efficiently. They allow the ZZ6 to rev higher to make the most of every cubic inch of air drawn through it.

The ZZ6 also uses an aggressive hydraulic roller camshaft that supports the engine's high-rpm airflow capability while maintaining excellent low-speed drivability. This Base crate engine kit includes the intake manifold, distributor, water pump, damper and flexplate – and the distinctive, aluminum valve covers that distinguish this crate engine as the latest in the ZZ legacy!

NOTE: Refer to page 83 for the complete horsepower and torque testing procedures.

TECH SPECS

Part Number:	19351532
Engine Type:	Chevy Small-Block
Displacement (cu in):	350
Bore x Stroke (in):	4.000 x 3.48
Block (P/N 10243870):	Cast-iron with 4-bolt mains
Crankshaft (P/N 12670965):	Forged steel, shot peened
Connecting Rods (P/N 10108688):	Forged powder metal
Pistons (P/N 10159436):	Hypereutectic aluminum
Intake Manifold (P/N 12496822):	Single plane aluminum
Carburetor (P/N 19170093):	770 cfm Holley
Camshaft Type (P/N 10185071):	Steel hydraulic roller
Valve Lift (in):	.474 intake/.510 exhaust
Camshaft Duration (@.050 in):	208° intake/221° exhaust
Cylinder Heads (P/N 19300955):	Fast Burn aluminum; 62cc chambers
Valve Size (in):	2.000 intake / 1.550 exhaust
Compression Ratio:	9.7:1 nominal
Rocker Arms (P/N 19210724):	Aluminum roller style
Rocker Arm Ratio:	1.5:1
Recommended Fuel:	Premium pump
Distributor (P/N 93440806):	HEI
Ignition timing:	36° Total @ 4,000 rpm
Maximum Recommended rpm:	5,800 rpm
Balanced:	External
Flexplate (P/N 14088765):	12.750"

NOTE: Distributor with melonized steel gear **MUST** be used with long-blocks and Partial engines with steel camshafts, or engine damage will occur.

INSTALLATION NOTES

- Requires four-barrel carburetor, spark plug wires and additional components to complete assembly
- Comes with 12.750" externally balanced 153-tooth automatic transmission flexplate. Requires externally balanced flywheel for manual transmission. See chart on page 183
- Requires fuel line from fuel pump to carburetor
- Some assembly and minor engine tuning required
- Not intended for marine applications

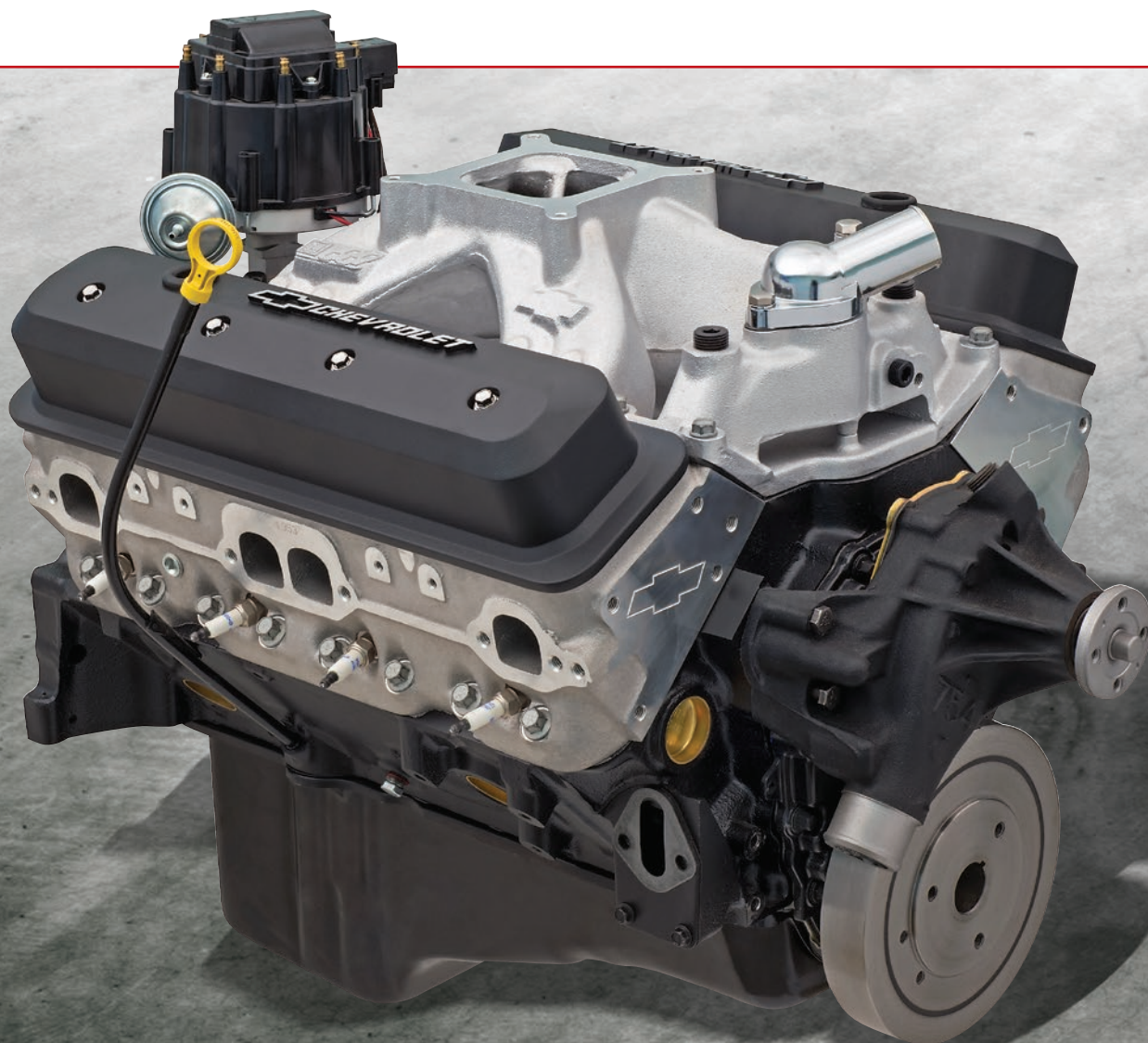

12670966
SP/ZZ Partial Engine
 The ZZ6 is based on the popular ZZ4 partial engine assembly and includes the forged steel crankshaft, high-silicon pistons and connecting rods.



19368611
SuperMatic™ 4L65-E Four-Speed Automatic Transmission (remanufactured)
 Electronically controlled four-speed overdrive transmission. Suitable for engines producing up to 430 lb.-ft. of torque.

See page 366 for torque converter applications.

AVAILABLE ENGINE-RELATED PARTS & ACCESSORIES

See page 152 for our complete line of Small-Block components



12361146
High-Torque Mini Starter
 Page 196



12361051
Spark Plug Wire Set
 Page 197



19170093
Carburetor, Holley 770-cfm
 Page 198



19299800
Torque Converter
 Page 366



19332781
Transmission Installation Kit
 Page 370



19332775
Transmission Controller
 Page 371

ZZ6 Turn-Key

19351533

405 hp

@ 5,600 rpm

406 lb.-ft.

@ 4,600 rpm

DYN0 CHART

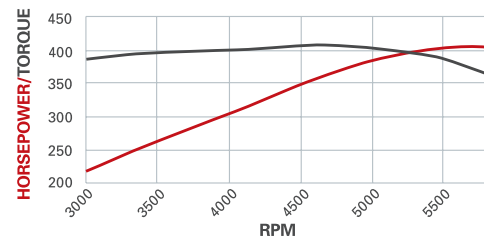

THE ULTIMATE 'ZZ' 350-BASED CRATE ENGINE FROM CHEVROLET PERFORMANCE!

Chevrolet Performance's ZZ6 is one of the most powerful 350-based crate engines in the more than 25-year history of the 'ZZ' crate engine lineup. It uses aluminum Fast Burn cylinder heads equipped with LS-style beehive valve springs for greater high-rpm performance. It's rated at 405 horsepower and 406 lb.-ft. of torque – more than any GEN I Small-Block engine ever offered in a production Chevrolet muscle car or Corvette!

The ZZ6 is built with a cast-iron block with four-bolt mains, along with a forged steel crankshaft, an aggressive hydraulic roller camshaft and durable, high-silicon pistons. Motorsports-inspired valve covers distinguish this crate engine at a glance, too – along with Chevy "Bowtie" insignias in the ends of the cylinder heads that let everyone know you've got the latest Chevrolet Performance hardware under the hood.

This Turn-Key engine package includes the distributor, and balancer installed. The carburetor, starter, fuel pump, air conditioning pump, alternator, single belt Front-End Accessory Drive Kit and more are also included. Chevrolet Performance offers the ZZ6 350 base engine (P/N 19351532) at a lower price, allowing you to finish the engine yourself.

NOTE: Refer to page 83 for the complete horsepower and torque testing procedures.

TECH SPECS

Part Number:	19351533
Engine Type:	Chevy Small-Block
Displacement (cu in):	350
Bore x Stroke (in):	4.000 x 3.48
Block (P/N 10243870):	Cast-iron with 4-bolt mains
Crankshaft (P/N 12670965):	Forged steel, shot peened
Connecting Rods (P/N 10108688):	Forged powder metal
Pistons (P/N 10159436):	Hypereutectic aluminum
Intake Manifold (P/N 12496822):	Single plane aluminum
Carburetor (P/N 19170093):	770 cfm Holley
Camshaft (P/N 10185071):	Steel hydraulic roller
Valve Lift (in):	.474 intake/.510 exhaust
Camshaft Duration (@.050 in):	208° intake / 221° exhaust
Cylinder Heads (P/N 19300955):	Fast Burn aluminum; 62cc chambers
Valve Size (in):	2.000 intake / 1.550 exhaust
Compression Ratio:	9.7:1 nominal
Rocker Arms (P/N 19210724):	Aluminum roller style
Rocker Arm Ratio:	1.5:1
Recommended Fuel:	Premium pump
Distributor (P/N 93440806):	HEI
Ignition timing:	36° Total @ 4,000 rpm
Maximum Recommended rpm:	5,800 rpm
Balanced:	External
Flexplate (P/N 14088765):	12.750"

NOTE: Distributor with melonized steel gear **MUST** be used with long-blocks and Partial engines with steel camshafts, or engine damage will occur.

INSTALLATION NOTES

- Comes with 12.750" externally balanced 153-tooth automatic transmission flexplate. Requires externally balanced flywheel for manual transmission. See chart on page 183
- Requires fuel line from fuel pump to carburetor
- Some assembly and minor engine tuning required
- Not intended for marine applications

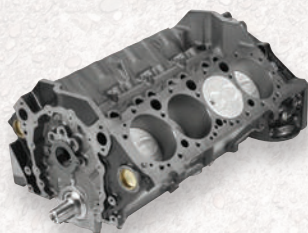
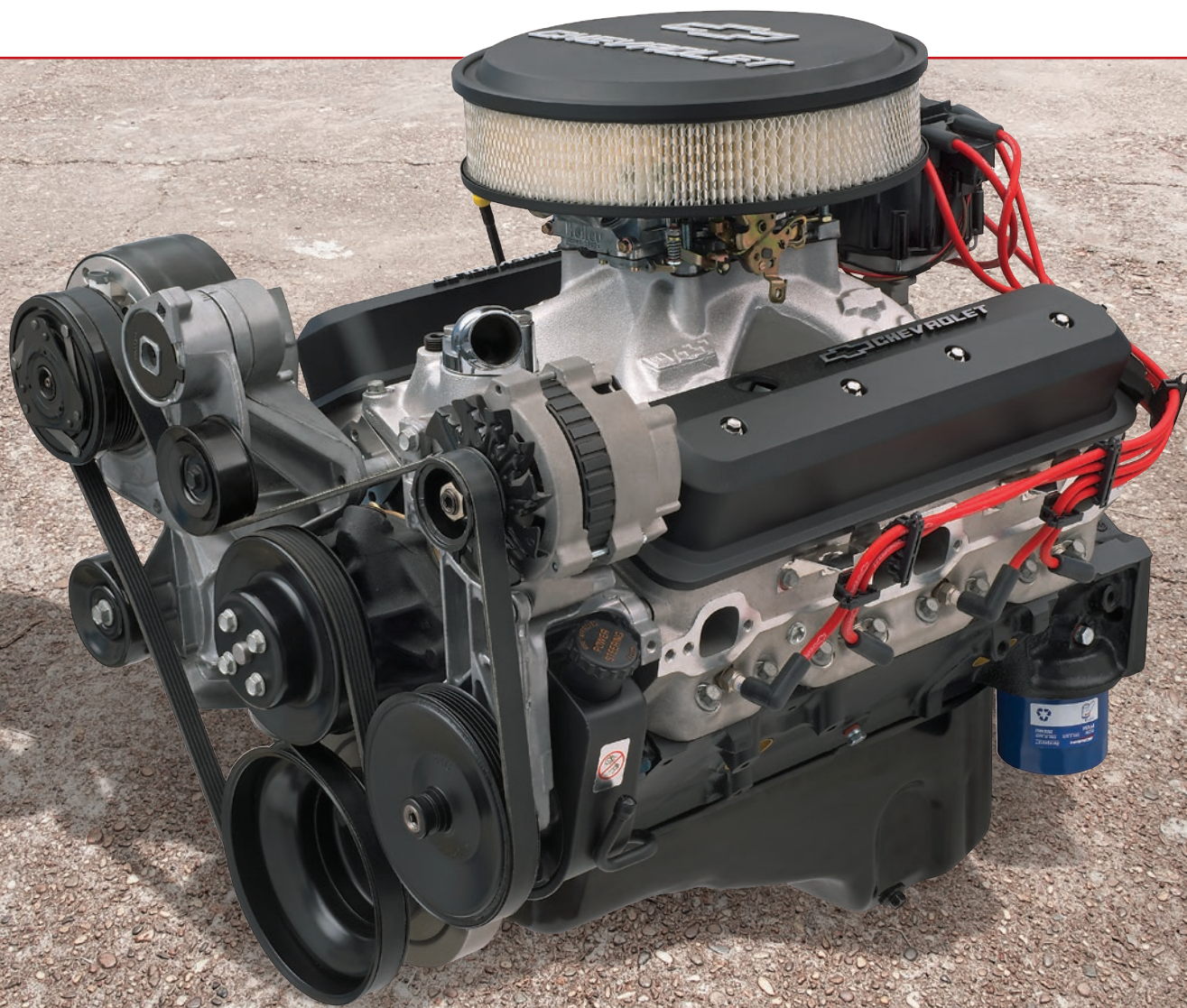

12670966
SP/ZZ Partial Engine
 The ZZ6 is based on the popular ZZ4 partial engine assembly and includes the forged steel crankshaft, LT1-style high-silicon pistons and connecting rods.

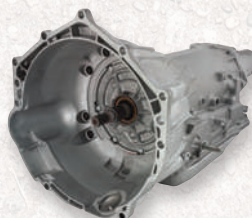

19368611
SuperMatic™ 4L65-E Four-Speed Automatic Transmission (remanufactured)
 Electronically controlled four-speed overdrive transmission. Suitable for engines producing up to 430 lb.-ft. of torque.
 See page 366 for torque converter applications.

AVAILABLE ENGINE-RELATED PARTS & ACCESSORIES

See page 152 for our complete line of Small-Block components



12361146
High-Torque Mini Starter
 Page 196



12497985
Aluminum Chrome Valve Covers
 Page 174



12480127
Short Aluminum Valve Covers
 Page 174



19299800
Torque Converter
 Page 366



19332781
Transmission Installation Kit
 Page 370



19332775
Transmission Controller
 Page 371

HT383

19355720

323 hp
@ 4,200 rpm

444 lb.-ft.
@ 3,000 rpm

DYNO CHART

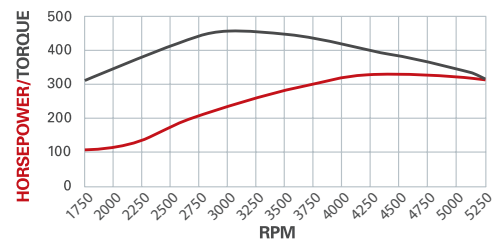

BIG TORQUE FOR YOUR TRUCK

Got a pre-1980 GM truck with a tired Small-Block? Forget the rebuild and take your trusty truck's capability to the next level with our big-torque HT383 stroker engine. Its extra displacement and unique parts are designed to build a wide, flat torque curve that maintains at least 400 lb.-ft. between 2,500 and 4,000 rpm. The 323 hp and 444 lb.-ft. of torque is power you simply won't get with a stock-type rebuild.

Built for true truck strength, the engine starts with a cast-iron block with four-bolt main caps – a strength-enhancing feature most production blocks don't have. We then fill the block with a forged steel stroker crankshaft and a smooth hydraulic roller camshaft, then top it off with iron Vortec heads. Its 9.1:1 compression ratio is perfect for regular gasoline at many altitudes and engine loads.

NOTE: Refer to page 83 for the complete horsepower and torque testing procedures.

TECH SPECS

Part Number:	19355720
Engine Type:	Chevy Small-Block V-8
Displacement (cu in):	383
Bore x Stroke (in):	4.005 x 3.800
Block (P/N 88962516):	Cast-iron with 4-bolt main caps
Crankshaft (P/N 12489436):	4340 forged steel
Connecting Rods (P/N 19355754):	Heavy-duty, forged steel
Pistons (P/N 12499103):	Hypereutectic aluminum
Intake Manifold (P/N 12496820):	Dual plane aluminum
Camshaft Type (P/N 14097395):	Hydraulic roller
Valve Lift (in):	.431 intake / .451 exhaust
Camshaft Duration (@.050 in):	196° intake / 206° exhaust
Cylinder Heads (P/N 12558060):	Vortec iron; 64cc chambers
Valve Size (in):	1.940 intake / 1.500 exhaust
Compression Ratio:	9.1:1
Rocker Arms (P/N 10089648):	Stamped steel
Rocker Arm Ratio:	1.5:1
Water Pump (P/N 88894341):	Cast iron
Recommended Fuel:	Regular pump
Ignition Timing:	32° Total @ 4,000 rpm
Maximum Recommended rpm:	5,000
Balanced:	External
Flexplate (P/N 14088765):	12.750"

INSTALLATION NOTES

- Requires addition of carburetor, ignition and starter (not included)
- Rochester Quadrajets or Holley 670-cfm carburetor recommended
- Comes with 12.750" externally balanced 153-tooth automatic transmission flexplate. Requires externally balanced flywheel for manual transmission. See chart on page 183
- Has right-side oil dipstick
- Not intended for marine applications

NOTE: Distributor with melonized steel gear **MUST** be used with long-blocks and Partial engines with steel camshafts, or engine damage will occur.

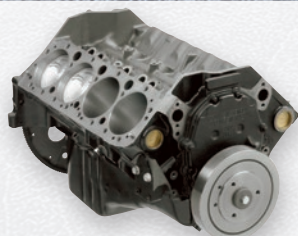
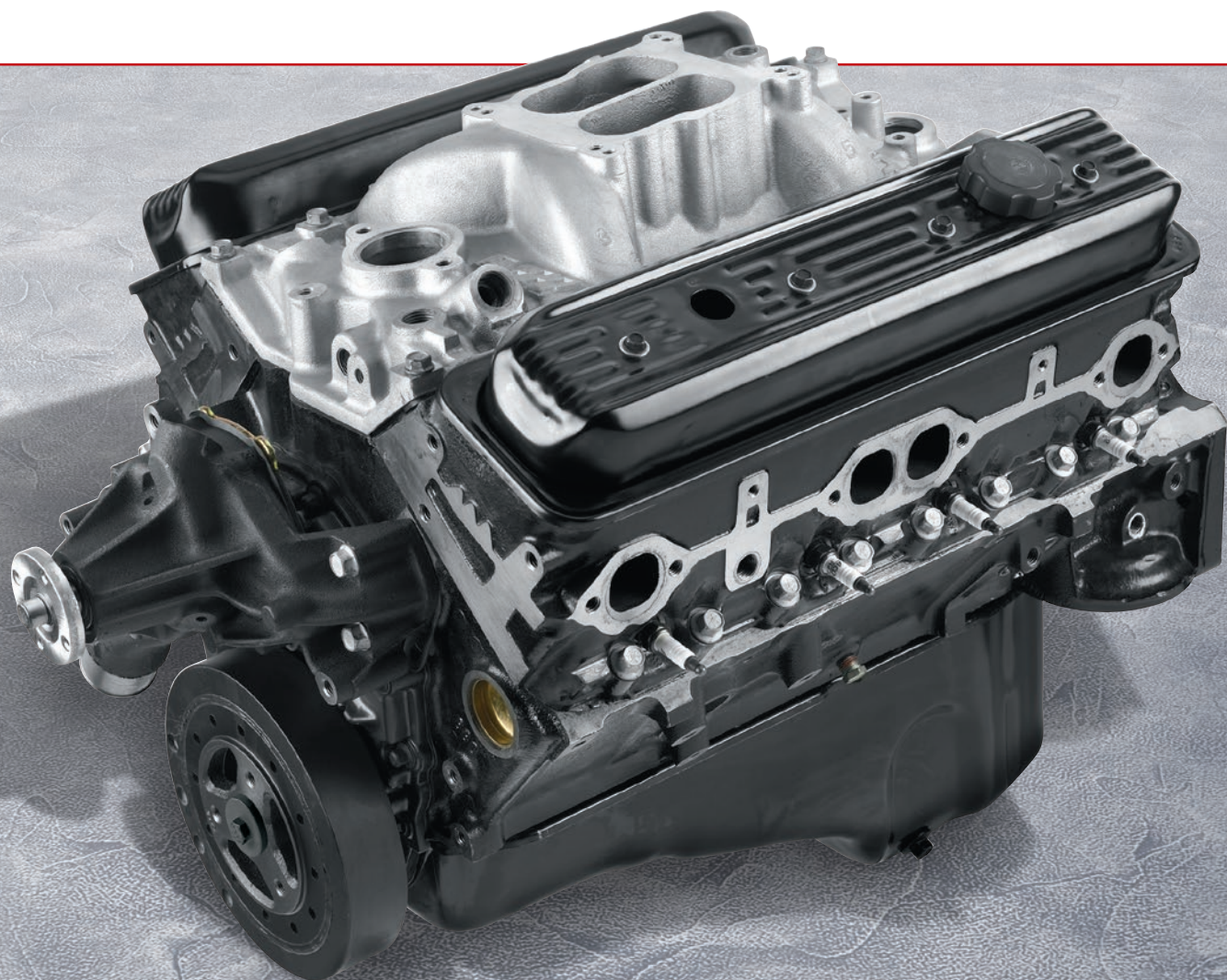

19355719

383 Partial Engine

The heart of the HT383 comes with 4.005-inch-bore/3.800-inch-stroke reciprocating assembly already installed, including a forged steel stroker crankshaft, heavy-duty connecting rods and durable aluminum-alloy pistons.



19368613

SuperMatic™ 4L70-E Four-Speed Automatic Transmission (remanufactured)

A durable, easy-cruising four-speed overdrive automatic transmission; electronically controlled for more precise, fuel-saving performance.

See page 366 for torque converter applications.

AVAILABLE ENGINE-RELATED PARTS & ACCESSORIES

See page 152 for our complete line of Small-Block components



93440806
HEI Distributor

Page 188



12497985
Aluminum Chrome Valve Covers

Page 174



19299800
Torque Converter

Page 366



19170092
Carburetor, Holley 670-cfm

Page 198



19332781
Transmission Installation Kit

Page 370



19332775
Transmission Controller

Page 371

HT383E

19355721

323 hp
@ 4,200 rpm

444 lb.-ft.
@ 3,000 rpm

/ **GREATER TORQUE**

/ **ENHANCED TOWING**

/ **BETTER ALTERNATIVE TO A REBUILD**

/ **INCLUDES ALL NEW PARTS**

BOLT-IN REPLACEMENT STROKER FOR TRUCKS

Chevrolet Performance's HT383E crate engine is an affordable and more powerful direct replacement for the tired 350 engine in your 1996-99 full-size GM truck or SUV. The larger displacement delivers up to 323 hp at 4,200 rpm and a whopping 444 lb.-ft. of torque. It is extra power you won't get with a stock-type rebuild or reconditioned used engine.

Like our standard HT383, this crate engine starts with a cast-iron block with four-bolt main caps, a forged steel crankshaft, a smooth hydraulic roller camshaft and a set of iron Vortec heads. Its 9.1:1 compression ratio is perfect for regular gasoline at all altitudes and engine loads. It also includes a new distributor, water pump and other components that would need to be replaced during a rebuild.

The HT383E is designed to replace the L31 5.7-liter engine in half-ton models of the Silverado, Suburban, Tahoe, Sierra and Yukon. Simply swap the intake manifold, throttle body, exhaust manifolds and other accessories from the original 350.

NOTE: Refer to page 83 for the complete horsepower and torque testing procedures.

TECH SPECS

Part Number:	19355721
Engine Type:	Chevy Small-Block V-8
Displacement (cu in):	383
Bore x Stroke (in):	4.005 x 3.800
Block (P/N 88962516):	Cast-iron with 4-bolt main caps
Crankshaft (P/N 12489436):	4340 forged steel
Connecting Rods (P/N 19355754):	Heavy-duty, forged steel
Pistons (P/N 12499103):	Hypereutectic aluminum
Camshaft Type (P/N 14097395):	Hydraulic roller
Valve Lift (in):	.431 intake / .451 exhaust
Camshaft Duration (@.050 in):	196° intake / 206° exhaust
Cylinder Heads (P/N 12558060):	Vortec iron; 64cc chambers
Valve Size (in):	1.940 intake / 1.500 exhaust
Compression Ratio:	9.1:1
Rocker Arms (P/N 10089648):	Stamped steel
Rocker Arm Ratio:	1.5:1
Water Pump (P/N 89060527):	Cast-iron
Recommended Fuel:	Regular pump
Maximum Recommended rpm:	5,000
Balanced:	External
Flexplate (P/N 14088765):	12.750"

NOTE: Distributor with melonized steel gear **MUST** be used with long-blocks and Partial engines with steel camshafts, or engine damage will occur.

INSTALLATION NOTES

- Requires the reuse of the stock intake manifold, wiring harness, and fuel injection system
- Due to calibration variances between half, three-quarter- and one-ton vehicles, this engine is designed for half-ton trucks and SUVs only
- This engine is not emissions-legal in CA or states that have adopted CA emissions regulations
- Comes with 12.750" externally balanced 153-tooth automatic transmission flexplate. Requires externally balanced flywheel for manual transmission. See chart on page 183
- Has right-side dipstick
- Not available as a Partial Engine

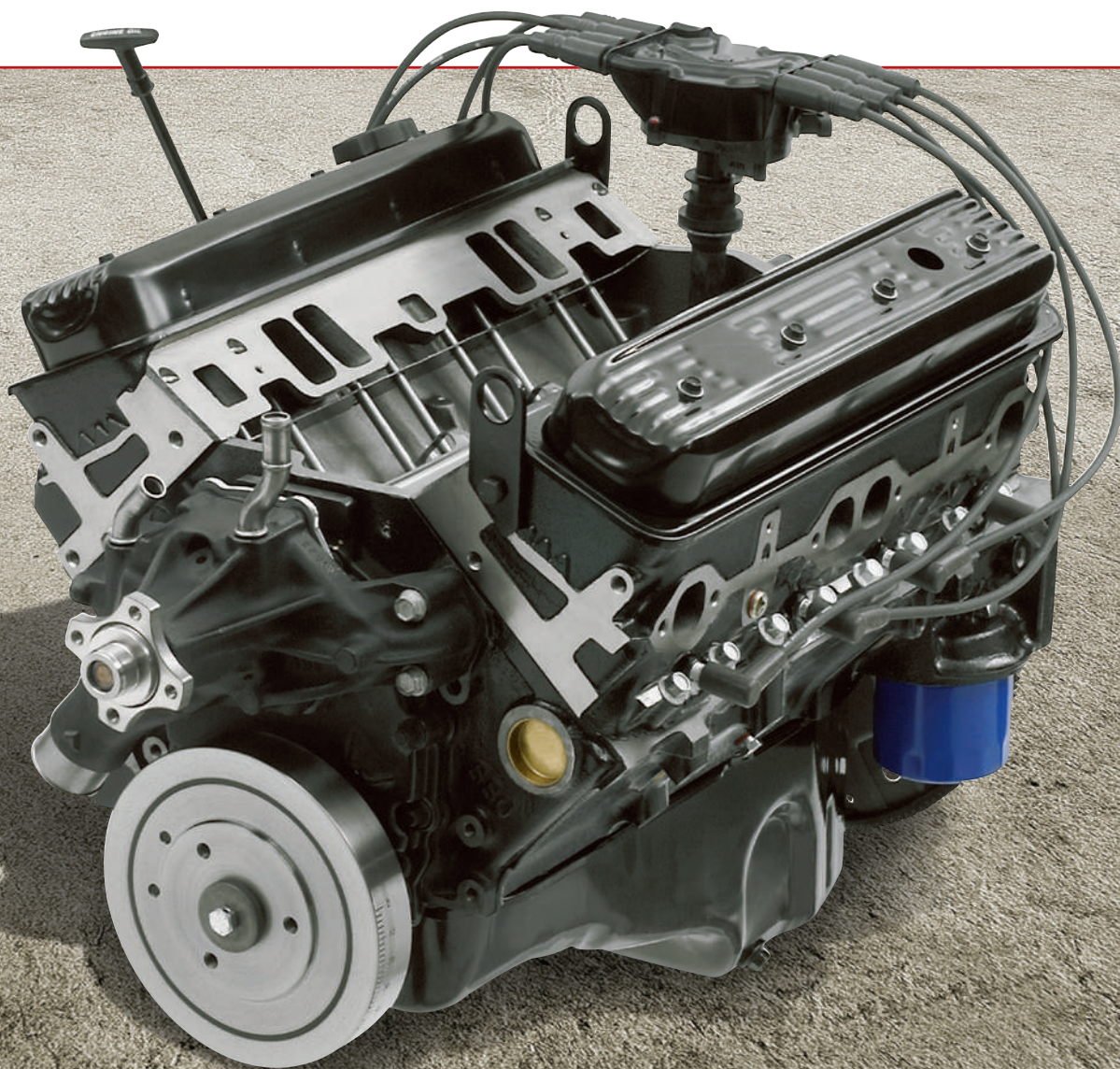

19368613
SuperMatic™ 4L70-E Four-Speed Automatic Transmission

A durable, easy-cruising four-speed overdrive automatic transmission; electronically controlled for more precise, fuel-saving performance.

See page 366 for torque converter applications.

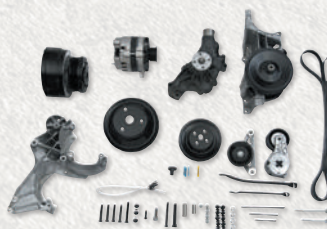

12497698
Serpentine Accessory Drive System

The complete kit you need to finish off the crate engine in your vehicle.

See page 176 for details.

AVAILABLE ENGINE-RELATED PARTS & ACCESSORIES

See page 152 for our complete line of Small-Block components



12497979
Aluminum Black Crinkle Valve Covers
 Page 175



19210728
Roller Rocker Arm Set, 1.5:1 Ratio
 Page 173



19299800
Torque Converter
 Page 366



24502521
Spark Plug Wires 135° Boot
 Page 197



19332781
Transmission Installation Kit
 Page 370



19332775
Transmission Controller
 Page 371

SP383 Deluxe

19355722

435 hp

@ 5,600 rpm

445 lb.-ft.

@ 4,600 rpm

DYN0 CHART

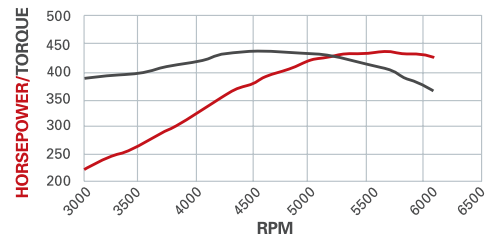

OUR LATEST TWIST ON THE BIG-TORQUE 383 STROKER!

When it comes to cranking serious torque from the classic Small-Block, it's hard to beat the 383 stroker combination, which uses a long, 3.800-inch stroke with 4.005-inch bores to generate exceptional low-end pulling power and surprising high-rpm horsepower.

Chevrolet Performance's stroker crate engine is part of our range of Street Performance engines and is designed for optimal performance on the street and the occasional trip down the quarter-mile.

It features lightweight aluminum cylinder heads based on the proven Fast Burn design, with large intake runners and 2.00/1.55-inch valves. Beehive-style valve springs enable great high-rpm performance and durability, allowing the SP383 to rev higher and build more horsepower. The result is 435 exhilarating horsepower and 445 lb.-ft. of seat-tugging torque.

Like all of our 350-based crate engines, it is built with a cast-iron block with four-bolt mains. It also features a forged steel crankshaft, an aggressive hydraulic roller camshaft and a high-flow, aluminum intake manifold. Use the Holley 770-cfm four-barrel carburetor, P/N 19170093 to achieve the listed horsepower and torque ratings.

NOTE: Refer to page 83 for the complete horsepower and torque testing procedures.

TECH SPECS

Part Number:	19355722
Engine Type:	Chevy Small-Block V-8
Displacement (cu in):	383
Bore x Stroke (in):	4.005 x 3.800
Block (P/N 88962516):	Cast-iron with 4-bolt main caps
Crankshaft (P/N 12489436):	Forged steel
Connecting Rods (P/N 19355754):	Heavy-duty, forged steel
Pistons (P/N 12499103):	Hypereutectic aluminum
Intake Manifold (P/N 2496822):	Single plane
Camshaft Type (P/N 19210723):	Hydraulic roller
Valve Lift (in):	.509 intake / .528 exhaust
Camshaft Duration (@.050 in):	222° intake / 230° exhaust
Cylinder Heads (P/N 19300955):	Fast Burn aluminum; 62cc chambers
Valve Size (in):	2.000 intake / 1.550 exhaust
Compression Ratio:	9.6:1
Rocker Arms (P/N 19210724):	Aluminum roller style
Rocker Arm Ratio:	1.5:1
Recommended Fuel:	Premium pump
Ignition Timing:	36° Total at 4,000 rpm
Maximum Recommended rpm:	6,000
Balanced:	External
Flexplate (P/N 14088765):	12.750"

NOTE: Distributor with melonized steel gear **MUST** be used with long-blocks and Partial engines with steel camshafts, or engine damage will occur.

INSTALLATION NOTES

- Requires addition of carburetor, ignition, fuel pump, and starter (not included)
- 435 horsepower rating achieved during GM testing with the high-rise single-plane intake manifold (P/N 12496822) and a 770-cfm carburetor with vacuum secondaries (P/N 19170093)
- Chevrolet Performance dual-plane intake manifold (P/N 12366573) may be used to avoid hood clearance problems, but peak power may decrease by approximately 15-20 horsepower
- Comes with 12.750" externally balanced 153-tooth automatic transmission flexplate. Requires externally balanced flywheel for manual transmission. See chart on page 183
- Not intended for marine applications

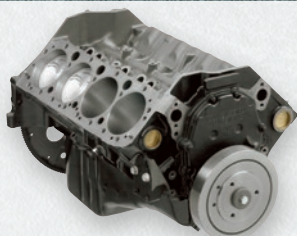
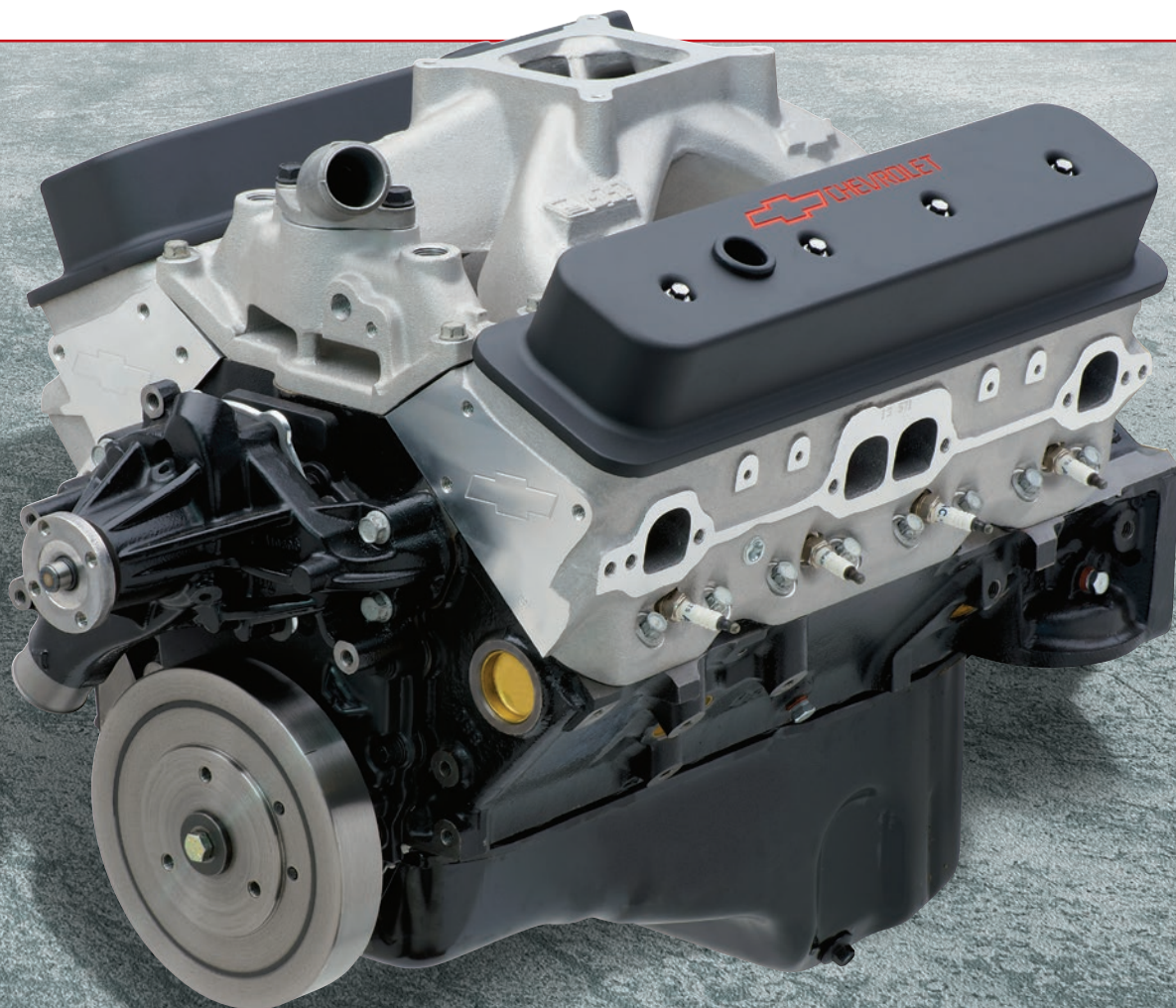

19355719

383 Partial Engine

The heart of the SP383 comes with 4.005-inch-bore/3.800-inch-stroke reciprocating assembly already installed, including a forged steel crankshaft, heavy-duty connecting rods and durable aluminum-alloy pistons.

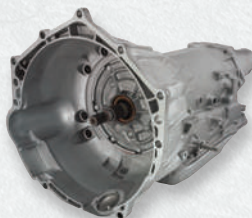

19368613

SuperMatic™ 4L70-E Four-Speed Automatic Transmission (remanufactured)

A durable, easy-cruising four-speed overdrive automatic transmission; electronically controlled for more precise, fuel-saving performance.

See page 366 for torque converter applications.

AVAILABLE ENGINE-RELATED PARTS & ACCESSORIES

See page 152 for our complete line of Small-Block components



93440806
HEI Distributor

Page 188



12497698
Serpentine Accessory Drive System

Page 186



19170093
Carburetor, Holley 770-cfm

Page 198



19299801
Torque Converter

Page 366



19332781
Transmission Installation Kit

Page 370



19332775
Transmission Controller

Page 371



PERFORMANCE

CIRCLE TRACK

C R A T E E N G I N E S

*Engines Shown From Left:
CT525, CT350, CT400*

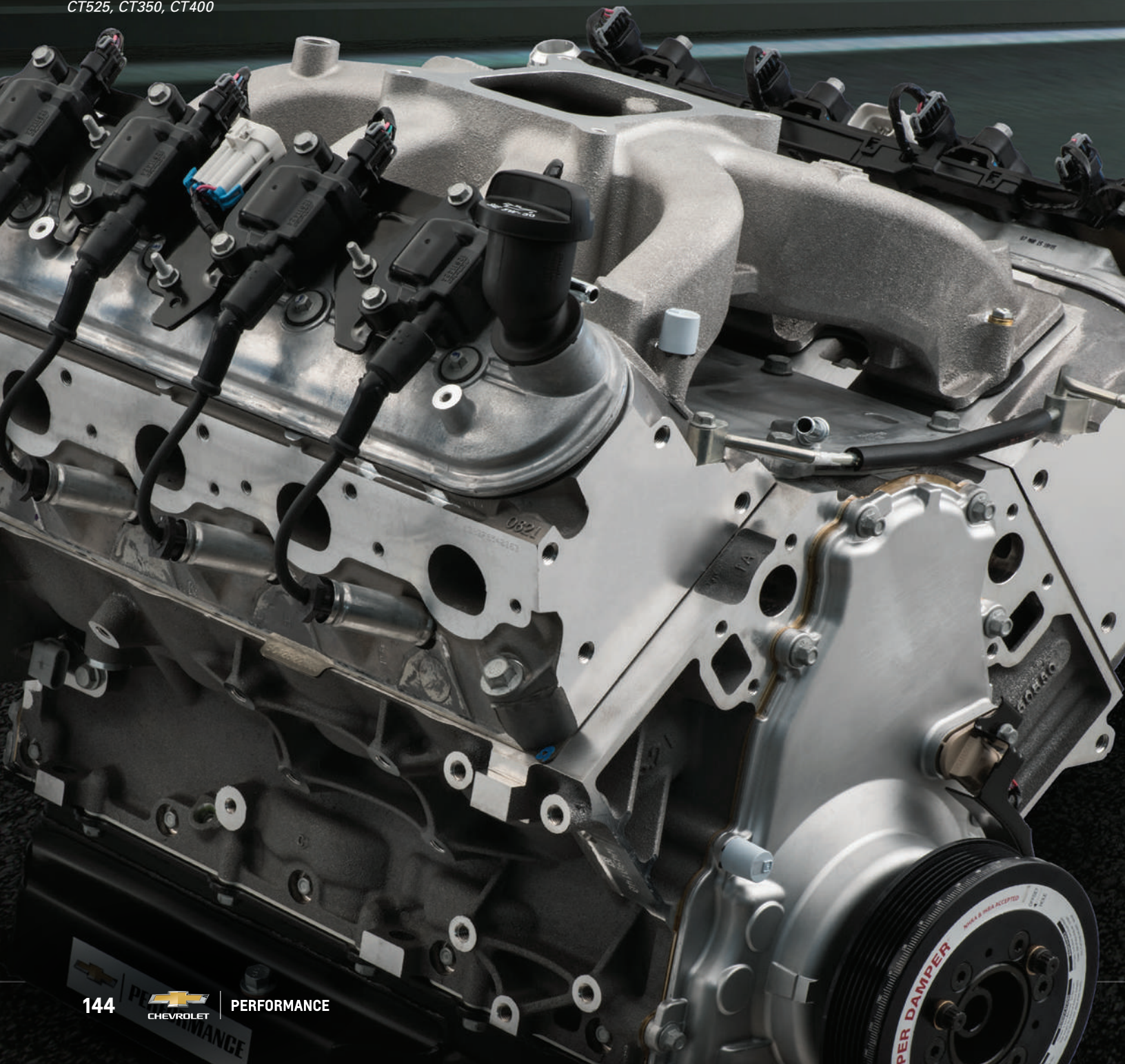



ENGINEERED FOR WINNING PERFORMANCE!

One race does not make a season on the track. That's why Chevrolet Performance Circle Track crate engines are engineered to offer the durability to chase the checkered flag week after week and race after race.

Every Chevrolet Performance Circle Track crate engine is built with brand-new parts, from the oil pan to the intake manifold and the entire rotating assembly. In fact, our 350 engines feature blocks with four-bolt mains – a strength-enhancing feature you won't find on most used blocks.

From the CT350 and CT400 to the LS-based CT525, using a Chevrolet Performance Circle Track crate engine means you may spend less time under the hood and more time focused on your winning racing program.

Trust Chevrolet Performance to deliver the durability you need to chase your racing dreams!

You can find these Chevrolet Performance Circle Track Engines on the following pages:

CT350	146
CT400	148
CT525	150

CT350

88869602

350 hp

@ 5,400 rpm

396 lb.-ft.

@ 3,800 rpm

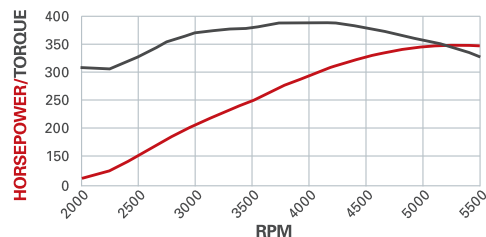
DYNO CHART

POWERFUL, DURABLE AND AFFORDABLE!

Chevrolet Performance's durable CT350 is the engine budget-conscious racers can depend on for competitive performance and low maintenance. At 350 hp, it is a perfect fit for a large number of short track racers.

It is based on our popular 350 HO high-performance street crate engine and features a strong four-bolt-main block and iron Vortec cylinder heads. A unique dual-pattern camshaft helps deliver more than 300 lb.-ft. of torque between 2,000 and 5,500 rpm – peaking at 396 lb.-ft. at 3,800 rpm. With that much pulling power, you can hold a gear, keeping the engine in its sweet spot for quicker laps.

We assemble the CT350 with an 8-quart circle track racing oil pan, balancer, HEI distributor and an aluminum high-rise, dual-plane intake manifold. Add your carburetor, starter, spark plugs, wires and water pump – all available from Chevrolet Performance – and you'll be ready for the green flag!

NOTE: Refer to page 83 for the complete horsepower and torque testing procedures.

TECH SPECS

Part Number:	88869602
Engine Type:	Chevy Small-Block V-8
Displacement (cu in):	350
Bore x Stroke (in):	4.000 x 3.480
Block (P/N 10105123):	Cast-iron with 4-bolt main caps
Crankshaft (P/N 10243070):	Nodular iron
Connecting Rods (P/N 10108688):	Powdered metal steel
Pistons (P/N 88894280):	Hypereutectic aluminum
Intake Manifold (P/N 12366573):	Dual-plane aluminum
Camshaft Type (P/N 24502476):	Hydraulic flat tappet
Valve Lift (in):	.435 intake / .460 exhaust
Camshaft Duration (@.050 in):	212° intake / 222° exhaust
Cylinder Heads (P/N 12558060):	Vortec iron; 64cc chambers
Valve Size (in):	1.940 intake / 1.500 exhaust
Compression Ratio:	9.12:1 Nominal
Rocker Arms (P/N 10089648):	Stamped steel
Rocker Arm Ratio:	1.5:1
Recommended Fuel:	Premium pump
Ignition Timing:	34° Total @ 4,000 rpm
Maximum Recommended rpm:	5,500
Balanced:	External

INSTALLATION NOTES

- Requires addition of carburetor, starter, water pump, plug wires and exhaust system (not included)
- Requires an externally balanced flywheel (not included). See page 183 for flywheel selection
- The 8-quart circle track oil pan is 8 inches deep at the sump. It will clear most GM rear-steer chassis with stock engine location
- For CircleTrack Racing only – Not intended for street use
- CircleTrack racing engines from Chevrolet Performance include anti-tampering seals installed

NOTE: Distributor with melonized steel gear **MUST** be used with long-blocks and Partial engines with steel camshafts, or engine damage will occur.



AVAILABLE ENGINE-RELATED PARTS & ACCESSORIES

See page 152 for our complete line of Small-Block components



88894341
Water Pump,
Long-Style
Page 185



12361146
High-Torque
Mini Starter
Page 196



12342071
Air Cleaner,
Classic Design
Page 198



12355612
Fuel Pump, Street
Performance
Page 199



19170092
Carburetor, Holley
670-cfm
Page 198



12361051
Spark Plug Wire Set
Page 197

CT400

88869604

404 hp
@ 5,600 rpm

406 lb.-ft.
@ 4,600 rpm

DYNO CHART

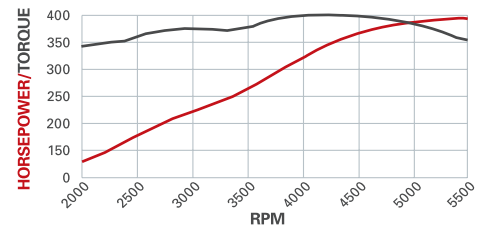

HIGH-REVVING PERFORMANCE AND DURABILITY

Chevrolet Performance’s CT400 racing crate engine now features Fast Burn cylinder heads with LS-style beehive valve springs that enable great high-rpm performance and durability. They allow the engine to rev higher to make the most of every cubic inch of air drawn through it. The result is a durable engine with 404 hp at 5,600 rpm and 406 lb.-ft. of torque at 4,600 rpm.

The beehive springs are part of the lightweight aluminum cylinder head assemblies, which are based on the proven Fast Burn design, with large intake runners and 2.00/1.55-inch valves. The CT400 also has a tough bottom end, anchored by a forged steel crankshaft and strong aluminum pistons installed in a brand-new block with four-bolt mains.

The assembly also includes an open-plenum high-rise intake manifold, a racing-only 8-quart circle track oil pan with a dual kick-out design, a valve cover breather kit and aluminum roller rocker arms.

NOTE: Refer to page 83 for the complete horsepower and torque testing procedures.

TECH SPECS

Part Number:	88869604
Engine Type:	Chevy Small-Block V-8
Displacement (cu in):	350
Bore x Stroke (in):	4.000 x 3.480
Block (P/N 10243870):	Cast-iron with 4-bolt main caps
Crankshaft (P/N 12670965):	Forged steel shot peened
Connecting Rods (P/N 10108688):	Powdered metal
Pistons (P/N 10159436):	Hypereutectic aluminum
Intake Manifold (P/N 12496822):	Single-plane aluminum
Camshaft Type (P/N 10185071):	Steel hydraulic roller
Valve Lift (in):	.474 intake / .510 exhaust
Camshaft Duration (@.050 in):	208° intake / 221° exhaust
Cylinder Heads (P/N 19300955):	Fast Burn aluminum; 62cc chambers
Valve Size (in):	2.000 intake / 1.550 exhaust
Compression Ratio:	9.72:1 Nominal
Rocker Arms (P/N 19210724):	Aluminum; roller style
Rocker Arm Ratio:	1.5:1
Recommended Fuel:	Premium pump
Ignition Timing:	36° Total @ 4,000 rpm
Maximum Recommended rpm:	5,800
Balanced:	External

INSTALLATION NOTES

- Requires addition of carburetor, starter, ignition, plug wires, water pump, distributor and exhaust system (not included)
- Requires an externally balanced flywheel (not included). See page 183 for flywheel selection
- The 8-quart circle track oil pan is 7 inches deep at the sump. It will clear most GM rear-steer chassis with stock engine location
- For Circle Track Racing only – Not intended for street use
- Circle Track racing engines from Chevrolet Performance include anti-tampering seals installed

NOTE: Distributor with melonized steel gear **MUST** be used with long-blocks and Partial engines with steel camshafts, or engine damage will occur.

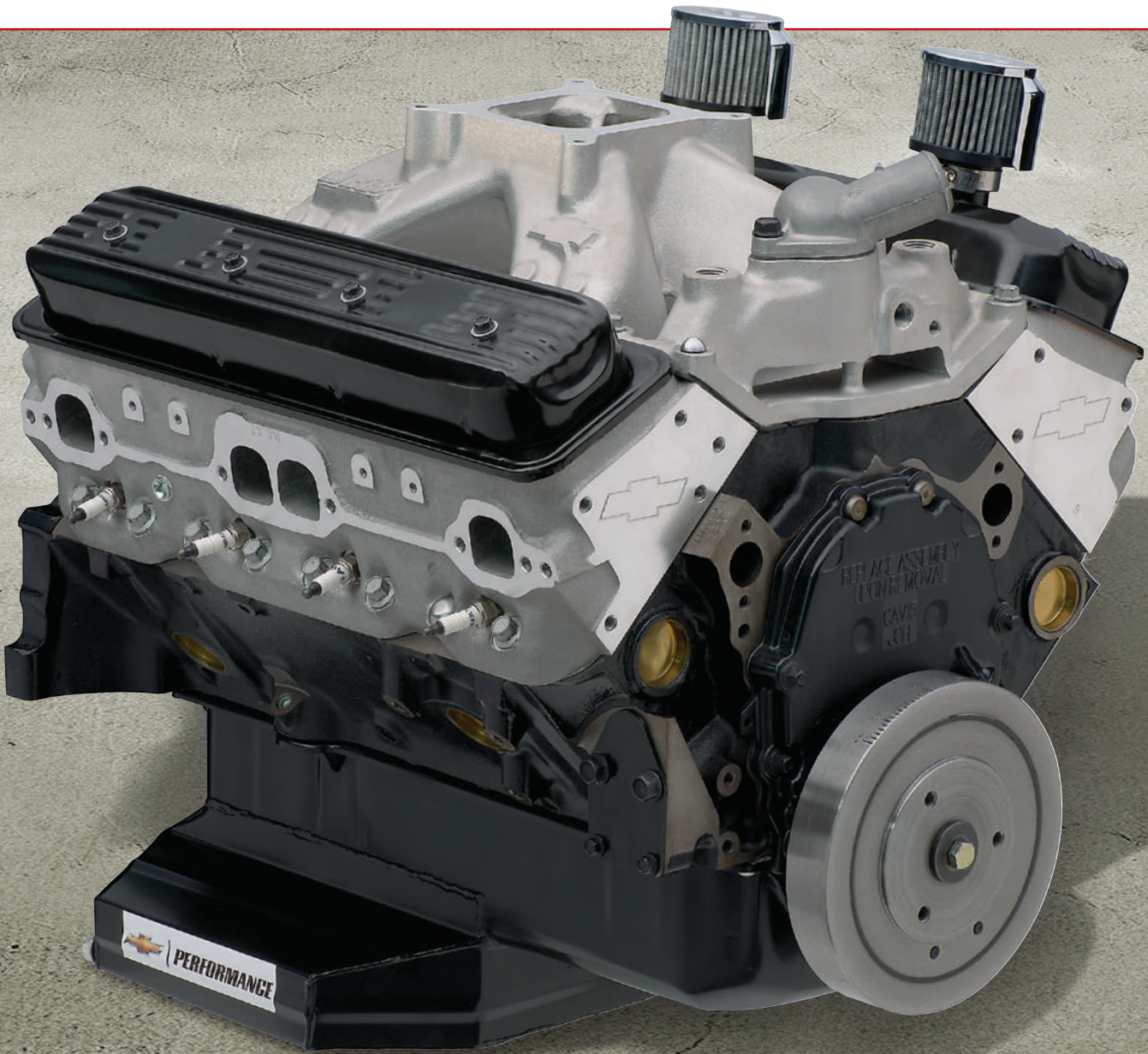

AVAILABLE ENGINE-RELATED PARTS & ACCESSORIES

See page 152 for our complete line of Small-Block components



88961867
Distributor, Aluminum
Billet HEI
Page 188



12361146
High-Torque
Mini Starter
Page 196



12342071
Air Cleaner,
Classic Design
Page 198



12355612
Fuel Pump, Street
Performance
Page 199



19170092
Carburetor, Holley
670-cfm
Page 198



12361051
Spark Plug Wire Set
Page 197

CT525

19331563

533 hp

@ 6,600 rpm

477 lb.-ft.

@ 5,200 rpm

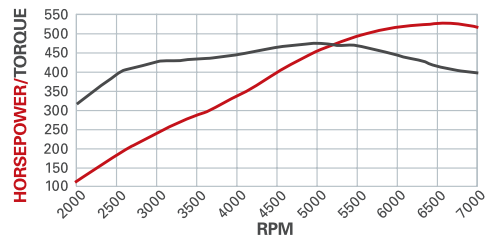

LIGHTWEIGHT, HIGH-RPM LS POWER!

Chevrolet Performance's deep-breathing, high-revving CT525 6.2L crate engine is based on the LS engine family and delivers serious power for serious racing series, including Super Late Model and modifieds.

It is based on the 6.2L LS3, but we've adapted it to circle track racing with a carbureted intake manifold, a high-lift roller camshaft, 6-quart racing oil pan and more. The engine is lightweight and strong, using an aluminum block with cross-bolted 6-bolt main caps and high-flow LS3 rectangular-port cylinder heads. This combination produces 533 hp at 6,600 rpm and a hefty 477 lb.-ft. of torque at 5,200 rpm.

The CT525 6.2L comes with coil-near-plug ignition, and an SFI-certified balancer. All that's needed to complete the assembly is a carburetor, starter and our LS/LSX Ignition Controller P/N 19355863 – all available from Chevrolet Performance.

NOTE: Refer to page 83 for the complete horsepower and torque testing procedures.

TECH SPECS

Part Number:	19331563
Engine Type:	LS-Series Gen IV Small-Block V-8
Displacement (cu in):	376 (6.2L)
Bore x Stroke (in):	4.065 x 3.62 (103.25 x 92mm)
Block (P/N 12673475):	Cast-aluminum with 6-bolt, cross-bolted main caps
Crankshaft (P/N 12597569):	Nodular Iron
Connecting Rods (P/N 12649190):	Powdered metal
Pistons (P/N 19207287):	Hypereutectic aluminum
Camshaft Type (P/N 88958770):	Hydraulic roller
Valve Lift (in):	.525 intake / .525 exhaust
Camshaft Duration (@.050 in):	226° intake / 236° exhaust
Cylinder Heads (P/N 12629063):	LS3 rectangular port; aluminum as-cast with 68cc chambers
Valve Size (in):	2.165 intake / 1.590 exhaust
Compression Ratio:	10.7:1 Nominal
Rocker Arms (P/N 12669995 int):	Investment-cast, roller trunnion
Rocker Arms (P/N 12681275 exh):	Investment-cast, roller trunnion
Rocker Arm Ratio:	1.7:1
Recommended Fuel:	Premium pump
Reluctor Wheel:	58x
Maximum Recommended rpm:	6,700
Balanced:	Internal

INSTALLATION NOTES

- Use LS/LSX ignition controller P/N 19355863 (not included, shown on next page)
- Requires addition of carburetor, starter, fuel system, exhaust system, and front accessory drive system
- The 6-quart circle track oil pan is designed to clear most GM rear-steer chassis with stock engine location. Requires external oil filter and cooler (will increase capacity to approximately 8 quarts)
- For Circle Track Racing only – Not intended for street use.
- The CT525 does not include a water pump or factory exhaust manifolds
- Circle Track racing engines from Chevrolet Performance include anti-tampering seals installed

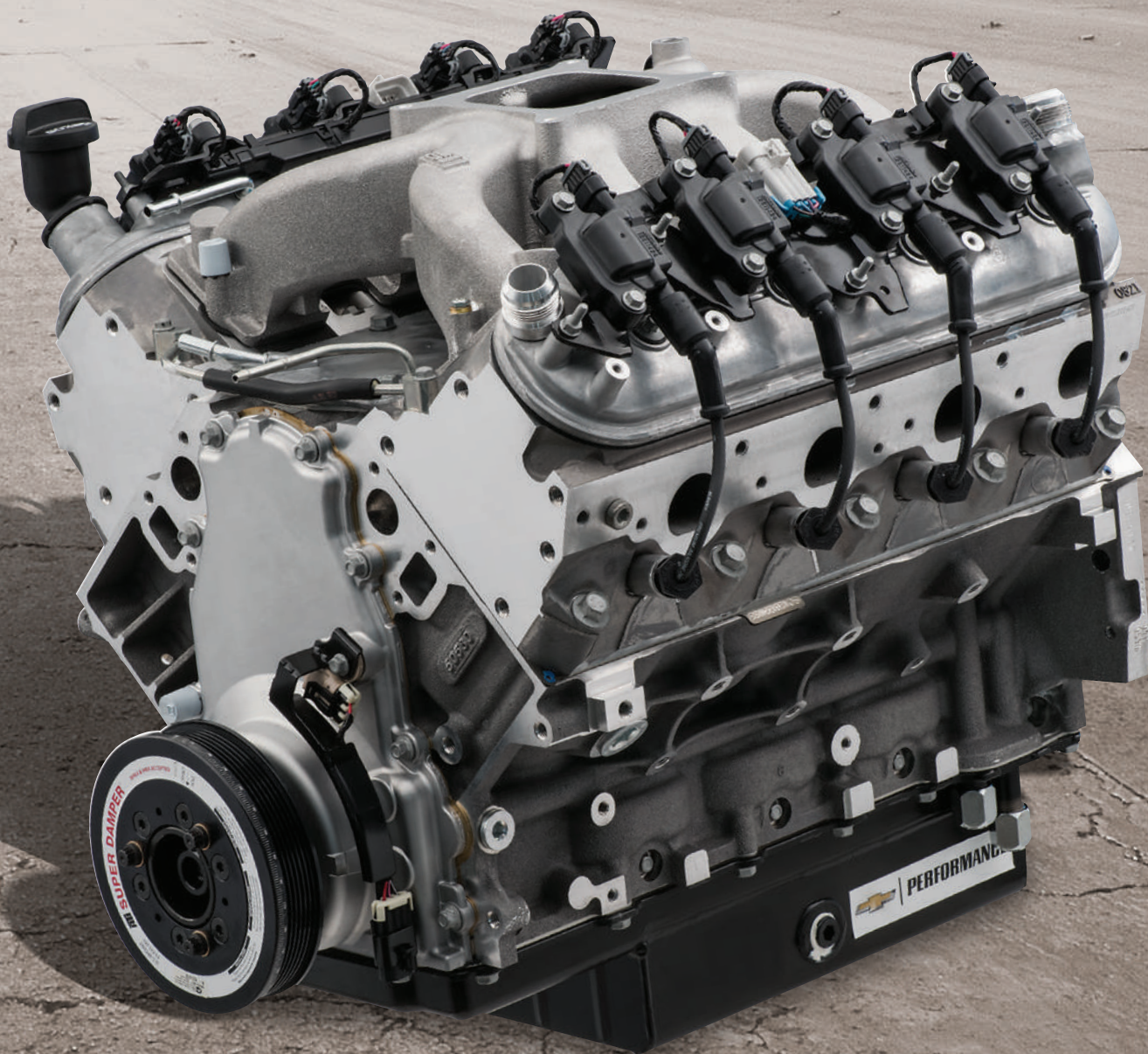

AVAILABLE ENGINE-RELATED PARTS & ACCESSORIES

See page 250 for our complete line of LS-Series components



19355863
LS/LSX Ignition Controller
Page 298



12342071
Air Cleaner, Classic Design
Page 295



19170092
Carburetor, Holley 670-cfm
Page 295



10465385
LS-Series Starter
Page 294



SMALL-BLOCK

ENGINE COMPONENTS

YOUR ONLY SOURCE FOR NEW FACTORY-ENGINEERED CHEVROLET PERFORMANCE PARTS!

When it comes to building the Small-Block engine for the project vehicle of your dreams, you don't want to sacrifice performance or durability – and that's why you should trust Chevrolet Performance.

We've been designing, testing and manufacturing Small-Block parts since 1955 and our engineers know what it takes to offer high-performance with great durability. Our latest parts such as beehive-style valve springs and high-flow aluminum heads leverage the high-flow attributes of the LS family to offer an unprecedented level of Small-Block capability.

Better still, all of our Small-Block parts, from tough four-bolt cylinder blocks and forged rotating parts to intake manifolds and more are brand new. That means there's no reason to settle for used, reconditioned or "seasoned" parts, because Chevrolet Performance parts are competitively priced, while also offering great peace of mind.

Check out our comprehensive lineup of blocks, heads, rotating parts and more and you'll find exactly what you need to build the performance engine for your project, because when it comes to Small-Block power, nobody has more experience than Chevrolet Performance!

You can find these Chevrolet Performance Small-Block Engine Components on the following pages:

BLOCKS AND COMPONENTS	154	CRANKSHAFTS	182
CYLINDER HEADS	162	OIL PANS, OIL PUMPS, GASKETS AND COMPONENTS	186
VALVE COMPONENTS	171	INTAKE MANIFOLDS	189
VALVE COVERS	174	FUEL AND ELECTRICAL COMPONENTS	196
CAMSHAFTS	179		
PISTONS AND PISTON RINGS	181		

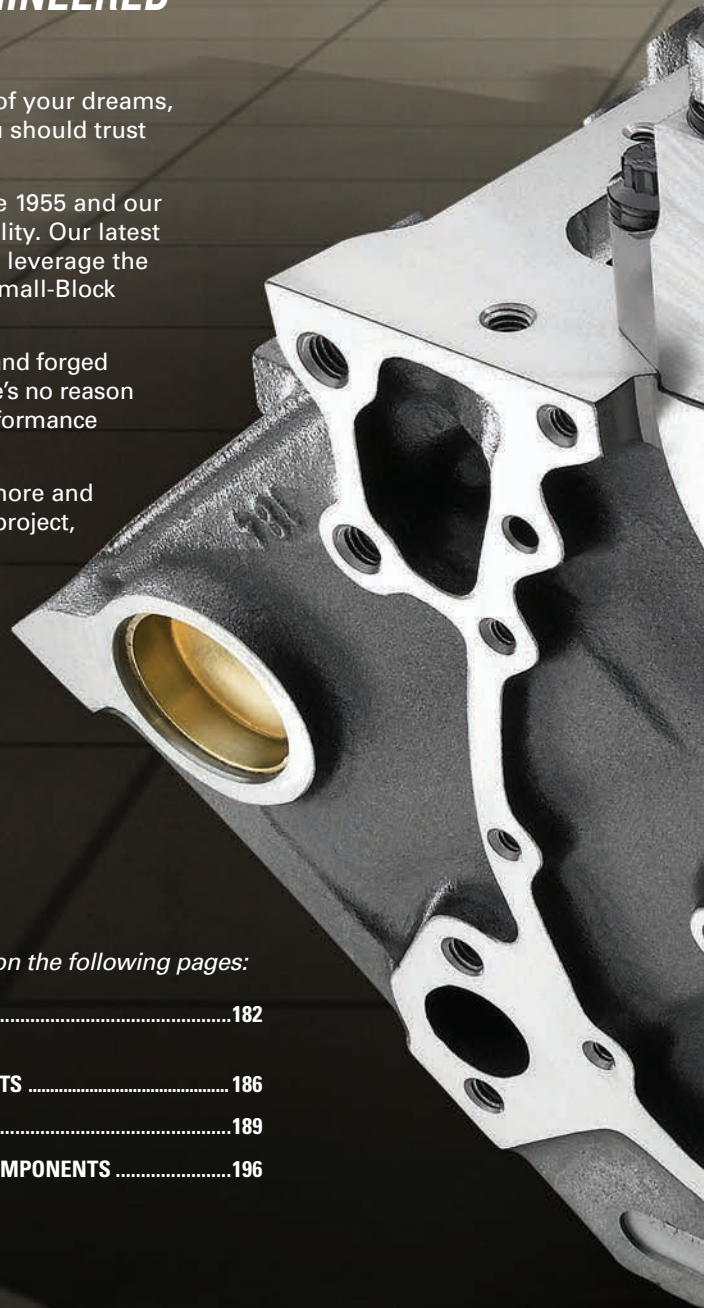



*Bowtie
Sportsman Block*



Chevy Small-Block Quick Reference Chart

Cast-Iron Small-Blocks

Part Number	Cast #	Deck Height	Lifter Pattern	Cyl Wall	Bore Range	Main Bolt	Main Bolt Degree	Cap Material	Crank Jnl Size	Oiling	Seal Type	Max Stroke	Weight (lbs)	Max HP	Usage	Page Number
10243869	10243878	9.025"	Std	Open	3.737" – 3.840"	2	Straight	Iron	350	Wet	1 pc	3.750"	185	350	Street	Disc.
10105123	14093638	9.025"	Std	Open	4.000" – 4.030"	4	Straight	Gray iron	350	Wet	1 pc	3.750"	181	350	Street	155
88962516	—	9.025"	Std	Open	4.004" – 4.030"	4	Straight	Gray iron	350	Wet	1 pc	3.800"	181	450	Street	155
10066034	—	9.025"	Std	Open	4.000" – 4.030"	4	Straight	Gray iron	350	Wet	2 pc	3.750"	181	350	Street	155
12480174	10051184	9.025"	Std	Siamese	3.980" – 4.155"	4	20°	Nodular	350	Wet	1 pc	3.750"	196	500	Amateur	156
12480047	10051184	9.025"	Std	Siamese	3.980" – 4.155"	4	20°	Nodular	350	Wet	2 pc	3.750"	208	500	Amateur	157
12480175	10051184	9.025"	Std	Siamese	4.117" – 4.155"	4	20°	Nodular	350	Wet	1 pc	3.750"	196	500	Amateur	157
12480157	10051184	9.025"	Std	Siamese	4.117" – 4.155"	4	20°	Nodular	350	Wet	2 pc	3.750"	196	500	Amateur	157
12480049	10051184	9.025"	Std	Siamese	3.980" – 4.155"	4	20°	Nodular	400	Wet	2 pc	3.750"	208	500	Amateur	157
24502503	10051184	9.025"	Std	Siamese	3.980" – 4.155"	4	20°	Steel	350	Wet	2 pc	3.750"	208	700	Pro	158

Short-Deck Cast-Iron Small-Blocks

Part Number	Cast #	Deck Height	Lifter Pattern	Cyl Wall	Bore Range	Main Bolt	Main Bolt Degree	Cap Material	Crank Jnl Size	Oiling	Seal Type	Max Stroke	Weight (lbs)	Max HP	Usage	Page Number
24502650	24502650C	8.325"	None	Siamese	3.980" – 4.185"	4	20°	Steel	283	Dry	2 pc	3.250"	167	800	Pro	159

Aluminum Small-Blocks

Part Number	Cast #	Deck Height	Lifter Pattern	Cyl Wall	Bore Range	Main Bolt	Main Bolt Degree	Cap Material	Crank Jnl Size	Oiling	Seal Type	Max Stroke	Weight (lbs)	Max HP	Usage	Page Number
10185075	10134398	9.025"	Std	Siamese	3.986" – 4.135"	4	20°	Steel	350	Wet	2 pc	3.750"	90	800	Pro	Disc.
10134400	10134398	9.025"	Std	Siamese	4.117" – 4.135"	4	20°	Steel	400	Dry	2 pc	3.750"	89	800	Pro	160
24502495	24502495	9.525"	Std	Siamese	4.117" – 4.135"	4	20°	Steel	400	Dry	2 pc	4.125"	101	850	Pro	160



BUILDER'S TIP

383 SMALL-BLOCK BASICS

If you're building your own 383-cid Small-Block, you probably know you need the 3.750-inch crankshaft from a 400 engine to use in a 350 cylinder block. But it doesn't simply drop in without modifications. The 2.650-inch main journals must be machined down to match the 350 block's 2.450-inch journals; and depending on the rods used, the cylinder block may require machining to prevent interference at the oil pan rail area and bottom of the bores. Fortunately, the 400 crank's 2.100-inch rod journals match the 350's, but the 400 crank is externally balanced. A counterweighted torsional damper and properly balanced flywheel must be used with it.

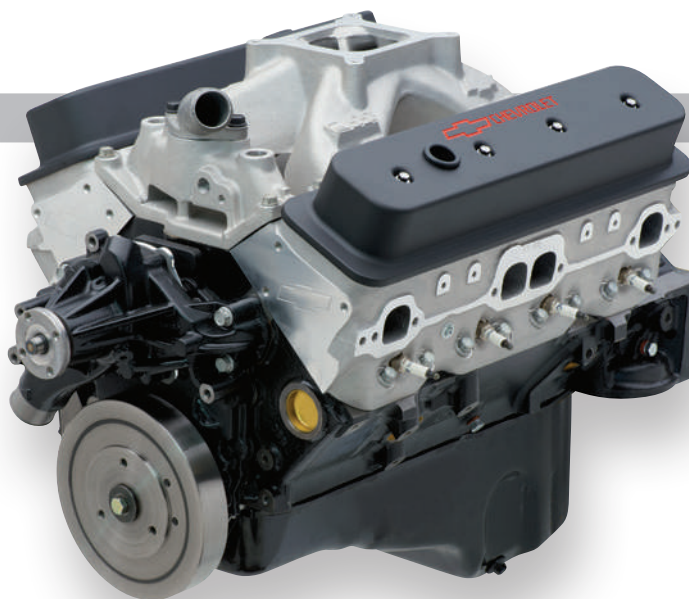

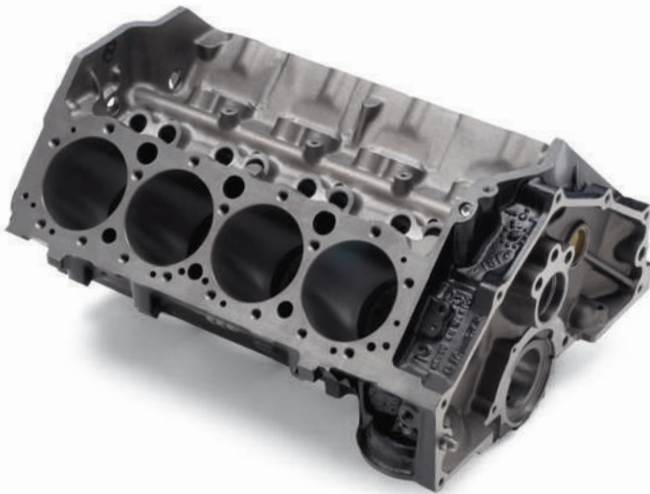
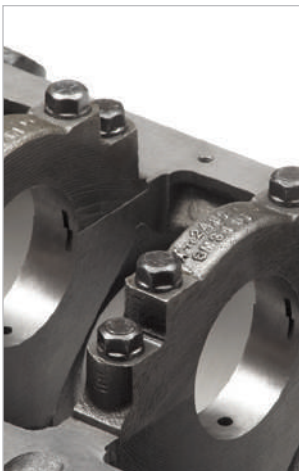
Production-Based Block (top, front) **A**Production-Based Block (top, rear) **A**Straight 4-Bolt Mains **A**Production-Based Block (top, front) **A**

Deck Height Diagram

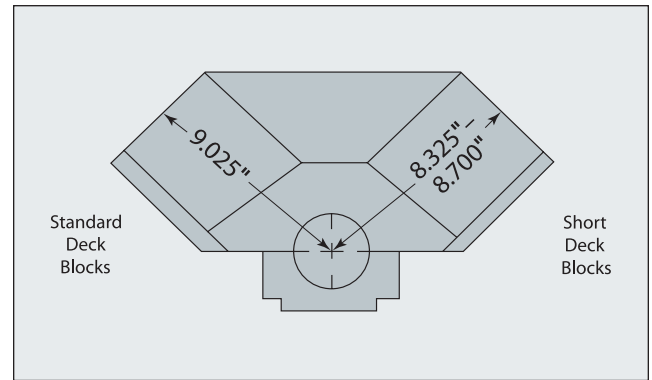

PRODUCTION-BASED BLOCKS

When building a mild Small-Block performance engine or a replacement for a stock engine, production-based blocks from Chevrolet Performance give you strength, accuracy and peace of mind that can't be assured in a rebuilt core. And unlike so many of the used cores, nearly all of ours feature four-bolt main caps for extra strength. Each cylinder block is machined to production-spec tolerances and is manufactured to the exact specifications of pre-1986 or 1986-later engines.

Production-Based Block Technical Notes:

- Standard 350 main journal sizes
- Non-siamese bores
- Production-spec cylinder wall thickness
- Lifter valleys machined for hydraulic-roller and flat-tappet valvetrains

See the chart on page 154 for complete specifications

A. 10105123

350 Bare Block (1986 – Later Style), 1-Piece Rear Main Seal

- Cast-iron 4-bolt block
- 4.000" bore
- Machined for hydraulic roller or flat tappets

88962516

383 Bare Block (1986 – Later Style), 1-Piece Rear Main Seal

- Cast-iron 4-bolt block
- 4.005" bore
- Torque plate honed
- Cleared for 3.800" stroker crankshaft
- Machined for hydraulic roller or flat tappets

10066034

350 Bare Block (Pre-1986 Style), 2-Piece Rear Main Seal

- Cast-iron 4-bolt block
- 4.000" bore
- Can be used for 302, 327, or 350 engines
- Machined for flat tappets only
- Used in 1973-1985 GM Goodwrench 350 engines

BOWTIE SPORTSMAN BLOCKS

Step up to serious racing performance when you choose a Chevrolet Performance Sportsman Block. These iron blocks provide a rock-solid foundation for any application in the 350 – 500-horsepower range, be it drag strip, circle track or high-performance project vehicle. These highly versatile blocks are available in a variety of finish options that enable maximum flexibility for building a wide range of engine combos. Most of the blocks have siamesed cylinder walls¹ and 4-bolt main caps² that are secured with Grade-8 bolts. Chevrolet Performance Bowtie Sportsman Blocks have 9.025-inch deck heights.

NOTE: Bowtie blocks are called out by main journal sizes (i.e., 283, 350 or 400) and then by bore size (i.e., 283, 305, 350 or 400) if the bore is not standard to the main size. Example: P/N 24502650 – “283 Main-350 Bore size” – has standard 283 main journal sizes; however the bore is standard 350 size.

Bowtie Sportsman Block Technical Notes:

- Standard 9.025-inch deck height
- Nominal cylinder wall thickness is 0.340-inch
- Minimum cylinder wall bore thickness on 4.155-inch bore is 0.225-inches (excluding P/N 10051181, 10051183, and 10185047)
- Extra-thick deck surfaces have blind-tapped bolt holes for improved head gasket sealing
- Priority main oiling system
- Main bearing bulkheads are 0.900-inch thick and use Grade-8 bolts
- All five cam bearing locations require 2.000-inch O.D. (1.867-inch I.D.) bearings P/N 12370843 (except block P/N 10051183)
- Tall lifter bore blocks may require clearancing the top of the lifter bores for some roller lifters
- Lifter valley oil scavenging boss below bell housing flange is present, but not drilled and tapped
- Oil dipstick holes are not drilled
- Timing system clearance must be checked

See the chart on page 154 for complete specifications.

4-Bolt 350 Main Blocks

A. 12480174

350 Bowtie Sportsman Block, 1-Piece Rear Main Seal

- CNC-machined cast-iron competition block
- +/-0.005" machining tolerances
- 4-bolt nodular mains, splayed caps on center 3 mains
- 3.980" finished bore
- 4.155" max bore (siamesed cylinder bores)
- Tall lifter bores
- Comes with rear seal adapter



A Sportsman Block (top, front)

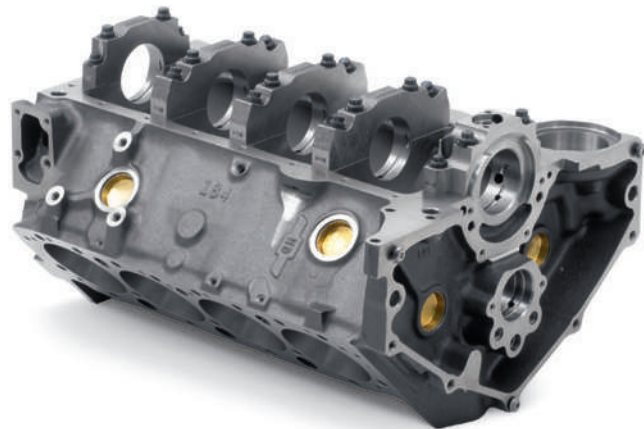

A Sportsman Block (bottom, rear, for use with 1-piece seal adapter)

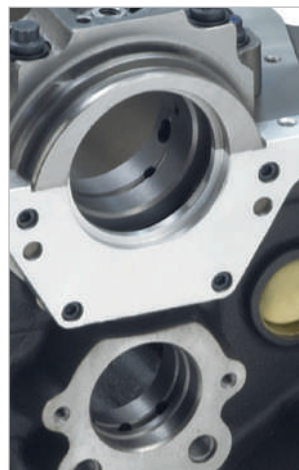

A 2-Piece Rear Main Seal



A 4-Bolt Splayed Main Caps

¹Siamesed cylinder walls have thicker cylinder wall material with no water between the bores. This allows for a bigger bore; a bigger bore allows for more cubic inches and more power!

²4-bolt mains have more material and more fasteners holding the crank in the block (4-bolts per main instead of just 2). 4-bolt mains help maintain the integrity of the block when you drop the hammer!

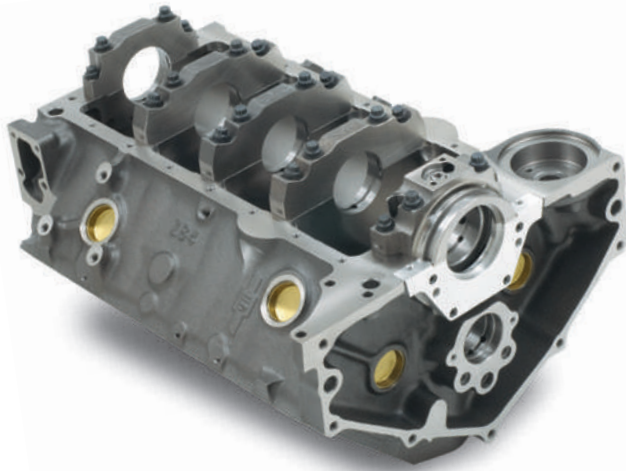

350 Bowtie Sportsman Block, 2-Piece Rear Main Seal **B**



350 Bowtie Sportsman Block, 2-Piece Rear Main Seal **B**



350 Bowtie Sportsman Block, Valley (top, front) **B**

B. 12480047

350 Bowtie Sportsman Block, 2-Piece Rear Main Seal

- CNC-machined cast-iron competition block
- +/-0.005" machining tolerances
- 4-bolt nodular mains, splayed caps on center three mains
- 3.980" finished bore
- 4.155" max bore (siamesed cylinder bores)
- Tall lifter bores

12480175

350 Main, 400 Bore Size Bowtie Sportsman Block, 1-Piece Rear Main Seal (not shown)

- CNC-machined cast-iron competition block
- +/-0.005" machining tolerances
- 4-bolt nodular mains, splayed caps on center three mains
- 4.117" finished bore
- 4.155" max bore (siamesed cylinder bores)
- Tall lifter bores
- Comes with rear seal adapter

12480157

350 Main, 400 Bore Size Bowtie Sportsman Block, 2-Piece Rear Main Seal (not shown)

- CNC-machined cast-iron competition block
- +/-0.005" machining tolerances
- 4-bolt nodular mains, splayed caps on center three mains
- 4.117" finished bore
- 4.155" max bore (siamesed cylinder bores)
- Tall lifter bores

4-Bolt 400 Main Blocks

12480049

400 Main, 350 Bore Size Bowtie Sportsman Block, 2-Piece Rear Main Seal (not shown)

- CNC-machined cast-iron competition block
- +/-0.005" machining tolerances
- 4-bolt nodular mains, splayed caps on center three mains
- 3.980" finished bore
- 4.155" max bore (siamesed cylinder bores)
- Tall lifter bores

CHEVROLET PERFORMANCE RACE BLOCKS

Chevrolet Performance Race Blocks are all about serious horsepower. Precision is the operative word for them, from start to finish, so you can depend on them to get you to the finish line first. Chevrolet Performance Race Blocks use only the highest-grade materials and machining techniques. The blocks are CNC-machined¹ with closer tolerances than Bowtie blocks. Race blocks feature full race-prep machining and 4-bolt splayed² main caps. Chevrolet Performance Race Blocks have proven themselves repeatedly in NASCAR and NHRA-sanctioned races. Chevrolet Performance race blocks have the power and reliability to put your car in the winner's circle.

See the chart on page 154 for complete specifications.

Chevrolet Performance Race Block Technical Notes:

- Precision CNC-machining means +/- 0.001-inch tolerances
- Cylinder bore wall thickness is 0.225" minimum at 4.155" bore
A sonic bore check data sheet is provided with block
- Nominal wall thickness of cylinder bores is 0.340"
- Cylinder decks, front and rear of case, oil pan rail surfaces and head dowel pins are blueprinted
- Extra-thick deck surfaces have blind-tapped head bolt holes for superior head gasket sealing
- Enlarged cam bosses allow custom machining for larger bearings
- Non-standard cam bearings are required (see each block for details)
- Extra-thick main bearing bulkhead is machined at 5°
- Bearing cap inner bolts are spread 0.210" to allow machining for 400 journal crankshafts
- Premium quality main studs and SAE 8620 steel main bearing caps
- Priority main oiling system
- Billet wet sump rear main cap can be adapted to dry sump with plugs
- 2-piece rear main crankshafts and pre-1986 oil pans are required
- Use of some aftermarket mechanical roller lifters may require clearing top of lifter bores
- Timing system clearance should be checked before engine assembly
- Lifter valley oil scavenging boss below bell housing flange is not drilled or tapped
- Oil dipstick holes are not drilled

24502503

350 Cast-Iron Bowtie Race Block (not shown)

- Cast-iron competition block right out of the box
- 4-bolt steel mains, 20° splayed caps on center three mains
- 2.000" O.D. cam bearings (1.867" I.D.) required at all five locations
- 3.980" finished bore
- 4.155" max bore (siamesed cylinder bores)
- 9.025" deck height
- Oil galleries for dry sump system are oversized and tapped for pipe plugs
- Supplied with sonic data sheet
- Tested to over 700 horsepower!

¹CNC (computer numerical controlled) machining guarantees exact tolerances. Chevrolet Performance offers more CNC-machined blocks than anyone.

²Splayed main caps have additional material for added strength in securing the crankshaft. This reduces the chance of "throwing" a crankshaft.



A Short-Deck Race Block (top, front)

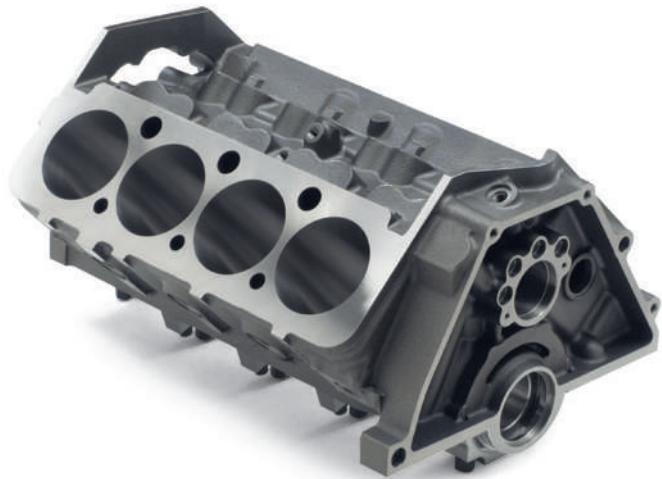

A Short-Deck Race Block (top, rear)

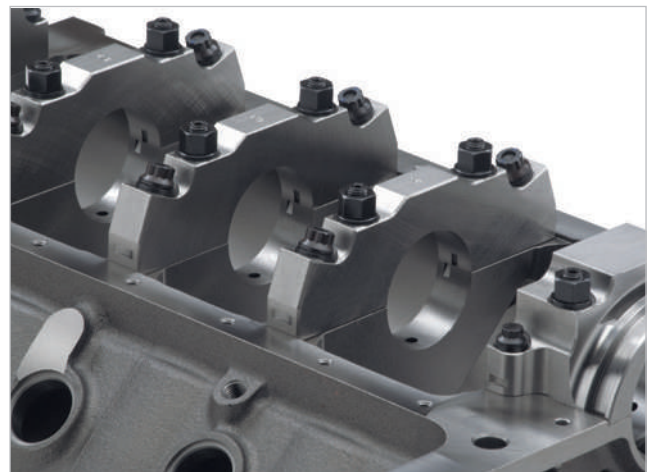

A 4-Bolt Splayed Main Caps

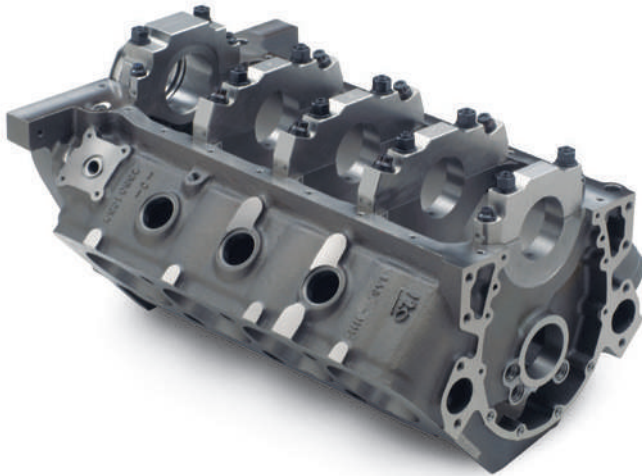
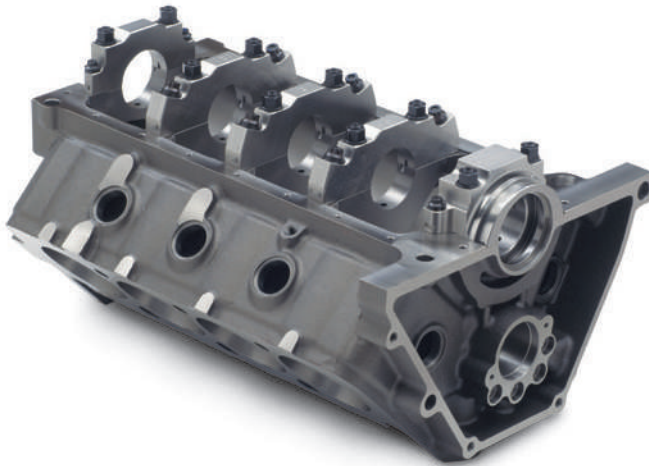
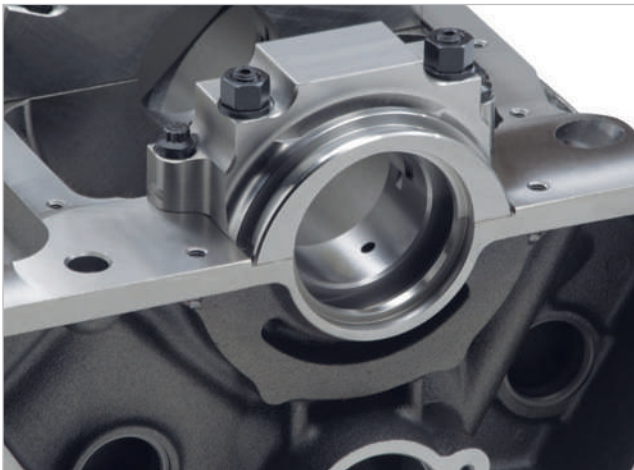
Short-Deck Race Block (bottom, front) **A**Short-Deck Race Block (bottom, rear) **A**2-Piece Rear Main Seal **A****A. 24502650****283 Main, 350 Bore Size Short-Deck Bowtie Race Block**

- CNC cast-iron competition block designed for competition use or restricted oval track racing!
- 4-bolt steel mains, 20° splayed caps on center three mains
- 8.325" deck (Standard deck blocks are 9.025"), can be machined to 8.200" deck height
- Camshaft is raised 0.433" to 4.955"
- Cam bearing bores machined for 2.250" O.D. x 1.875 roller bearings
- 3.980" rough bore
- 4.185" max bore (minimum of .250" cylinder bore wall thickness)
- Integral oil restrictors
- Must use Big-Block water pump, must raise water pump with adapters for balancers larger than 6"
- Olds Aurora V-8 bell housing bolt pattern (12.25" max flywheel diameter)
- Lifter holes and cylinder head bolt holes are not drilled
- Will accept standard, SB2.2 and splayed valve lifter patterns
- Can be machined to accept any Small-Block Chevy cylinder head
- Shorter-than-production pushrods required
- Tested to over 800 horsepower!
- Water jacket core plugs are 1.5" press-in style
- Oil galley plugs are AN O-ring style

SMALL-BLOCK COMPONENTS

ALUMINUM RACE BLOCKS

Less weight and the same great horsepower are the benefits of a Chevrolet Performance Aluminum Race Block. Chevrolet Performance Aluminum Race Blocks provide the same competition-level strength and reliability of our cast-iron Race Blocks, but their lighter weight improves chassis dynamics. The super-tough A-356 aluminum competition blocks are CNC-machined to +/- 0.005-inch tolerances. Chevrolet Performance Aluminum Race Blocks are ideal for competition applications or high horsepower turbocharged engines.*

See chart on page 154 for complete specifications.

Chevrolet Performance Aluminum Race Block

Technical Notes:

- Extra-thick deck surface with blind-tapped head bolt holes for improved head gasket sealing
- Centrifugally spun cast-iron cylinder sleeves
- 2-piece rear-main crankshafts and pre-1986 oil pans required
- Enlarged cam bosses allow machining for larger cam bearings
- 2.000" O.D. (1.867" I.D.) cam bearings P/N 12370843 required
- Blocks may require clearancing at top of lifter bores (0.842") for some roller lifters
- Timing system clearance should be checked before engine assembly
- Extra-thick main bearing bulkhead machined at 5°
- Premium main studs and steel main bearing caps
- Priority main oiling system
- Billet wet sump rear main cap can be converted to dry sump with plugs
- Oil dipstick holes not drilled
- Comes with dowel pins

A. 10134400

400 Aluminum Bare Block

- A-356 aluminum competition block
- CNC-machined
- Siamesed bores with increased wall thickness
- 4.117" rough-finished bore
- 4.135" maximum bore
- 3.750" maximum stroke
- Splayed 4-bolt steel mains
- 400 main size
- Dry sump use only
- Tested to more than 800 horsepower!

24502495

400 Aluminum Tall Deck Bare Block (not shown)

- A-356 aluminum competition block
- CNC-machined
- Siamesed bores with increased wall thickness
- 4.117" rough-finished bore
- 4.135" maximum bore
- 4.125" maximum stroke
- Splayed 4-bolt steel mains
- 400 main size
- Dry sump use only
- Tested to more than 800 horsepower!



A 400 Aluminum Race Block (top, front)



A 400 Aluminum Race Block (top, rear)



A 400 Aluminum Race Block (bottom, rear)

* Proposed applications have not been specifically tested or validated by Chevrolet Performance.

Universal Engine Lift Brackets **B**Freeze Plug, 1-5/8" brass **C** Cylinder Sleeve, Standard **D**Main Bearing Kit 350 Engine, Standard **E**Main Bearing Bolt Kit, Sportsman Blocks **F**

CYLINDER BLOCK COMPONENTS

B. 12363238**Universal Engine Lift Brackets**

- Designed to bolt to the end of cylinder heads for removal and installation of the engine
- Made from 0.200" steel and have .880" x 1.000" hook slots
- Use with 3/8" or 7/16" bolts
- Includes two brackets and two 7/16" bolts

C. 94673017**Freeze Plug, 1-5/8" Brass**

- Corrosion-resistant brass freeze plug is recommended for marine applications

10121044**Rear Oil Seal, 2-Piece Design (not shown)**

- Rear oil seal for V-8 and V-6 engines with pre-1985 style 2-piece oil seal design
- Used by many NASCAR teams for superior leak protection

D. 12480004**Cylinder Sleeve, Standard**

- Standard-bore steel cylinder sleeve for late-design aluminum Small-Block V-8 and 90° V-6 aluminum blocks, including P/N 10134400, P/N 10134351, P/N 10185075, and P/N 10134371

NOTE: Sleeve has 3.980" bore; can be overbored to 4.135".

12480018**Oil Galley Plugs, Aluminum Blocks (not shown)**

- Replacement oil galley plugs for all GM aluminum engine blocks, size AN -06

E. 12499102**Main Bearing Kit, 350 Engine, Standard**

- Complete main bearing kit for 350-cubic-inch Small-Block V-8 with standard-size mains

F. 12480108**Main Bearing Bolt Kit, Sportsman Blocks**

- Sturdy main bearing cap bolts designed specifically for the following Chevrolet Performance Sportsman Racing Blocks: P/N 12480047, P/N 12480049, P/N 12480157, P/N 12480159, P/N 12480174 and P/N 12480175
- Bolts are Grade-8 with 12-point heads and black oxide-coated

SMALL-BLOCK COMPONENTS

FRONT COVERS, TIMING POINTERS AND FUEL PUMP BLOCK-OFF PLATE

A. 3991435

Timing Pointer, 6.750" and 7" Balancer

- Steel timing pointer bolts onto engines with 6.750" or 7" balancers
- Pointer is not chrome

B. 12342089

Small-Block Chrome Timing Cover

- Attractive chrome cover for 1969–1991 Small-Block V-8 and all 90° V-6 engines
- Direct replacement for covers that use bolt-on timing pointer
- Supplied with GM oil seal (replacement oil seal P/N 10111769)

C. 12562818

Front Cover

- With crank trigger plug
- Includes bolts, seal and gasket

D. 12341998

Small-Block Fuel Pump Block-Off Plate

- Plate has stamped Bowtie logo
- Special non-asbestos gasket included



A Timing Pointer, 6.75" & 7" Balancer



B Small-Block Chrome Timing Cover



C Front Cover with Bolts, Seal and Gasket



D Small-Block Fuel Pump Block-Off Plate



Timing Covers: Additional Required Components

Part Number	Bolts (Quantity)	Seals (Quantity)	Gasket (Quantity)	Bolt Grommets (Quantity)	Engine Application
12342089	11561767 (10)	14090906 (1)	10108435 (1)	N/A	88869602, 19210009, 19210007, 19210008
12562818	10213293 (6) 12551135 (2)	10228655 (1)	N/A	10213294 (8)	12499101, 12499106, 12499101, 88869604, 19301294, 19301295 19301293, 24502609, 88958603, 19201330

V-6 90° Cylinder Heads: Quick Reference Chart

Part Number	Description	Casting Number	Material	Port Size	Port Type	Valve Spring	Chamber CC's	Int Vlv	Exh Vlv	Plug Type	Heat Riser	Rocker Stud	Notes	Page Number
10134359	18° V-6	12480009	Aluminum	215	Raised	18°	43	2.150"	1.620"	Angled	No	Shaft	No seats/guides	382
12480009	18° V-6	12480009	Aluminum	215	Raised	18°	43	2.150"	1.620"	Angled	No	Shaft	As cast ports	382

Small-Block Cylinder Heads: Quick Reference Chart

Part Number	Description	Casting Number	Material	Port Size	Port Type	Valve Angle	Chbr CC's	Int Vlv	Exh Vlv	Exh Port	Plug Type	Heat Riser	Rocker Stud	Notes	Page Number
19300956	Fast Burn ZZ6	12367712	Alum	210	Vortec	23	62	2.000	1.550	LT4	Angled	No	Screw-in	Bare 19300955	N/S
19300955	Fast Burn ZZ6	12367712	Alum	210	Vortec	23	62	2.000	1.550	LT4	Angled	No	Screw-in	Assembly	165
12529093	Vortec	10239906 or 12558062	Iron	170	Vortec	23	64	1.940	1.500	LT4	Straight	No	Press	Bare 12558060	N/S
12558060	Vortec	10239906 or 12558062	Iron	170	Vortec	23	64	1.940	1.500	LT4	Straight	No	Press	Assembly	163
25534351	Small-Port Vortec Bowtie	25534351	Iron	185	Vortec	23	66	2.000	1.550	LT4	Straight	No	Screw-in	Bare 25534421	N/S
19331473	Large-Port Vortec Bowtie	25534371	Iron	225	Vortec	23	66	2.000	1.550	LT4	Straight	No	Screw-in	Bare 25534446	N/S
19331470	Small-Port Vortec Bowtie	25534351	Iron	185	Vortec	23	66	2.000	1.550	LT4	Straight	No	Screw-in	Assembly	164
19331472	Large-Port Vortec Bowtie	25534371	Iron	225	Vortec	23	66	2.000	1.550	LT4	Straight	No	Screw-in	Assembly	164
24502580	18° Semi	10134363	Alum	215	18°	18	60	—	—	18°	Angled	No	Shaft	No seats/guides	166
24502615	15°	10134363	Alum	210	18°	15	35-37	—	—	18°	Angled	No	Shaft	No seats/guides	166
12480129	SB2.2	12480011	Alum	—	SB2.2	SB2.2	48	2.150	1.625	SB2.2	Angled	No	Shaft	No seats/guides	169
12480011	SB2.2 Bare	12480011	Alum	—	SB2.2	SB2.2	48	2.150	1.625	SB2.2	Angled	No	Shaft	No seats/guides	169
88958667	ROX SB2.2	88958667	Alum	—	SB2.2	SB2.2	28	2.150	1.625	SB2.2	—	—	Shaft	No seats/guides	N/S
12480146	Rough Bare Splay	10185040	Alum	—	Splayed	Splay	45	2.200	1.650	Splayed	Angled	No	Shaft	Rough mach 24502517	167
12480147	Semi-Machined Splay	10185040	Alum	—	Splayed	Splay	45	2.200	1.650	Splayed	Angled	No	Shaft	Semi-mach 12480146	167
24502517	Splayed Valve	10185040	Alum	—	Splayed	Splay	45	2.200	1.650	Splayed	Angled	No	Shaft	No seats/guides	167
12480153	ROX Splayed	12480153	Alum	—	Splayed	Splay	—	—	—	Splayed	—	—	Shaft	No seats/guides	168

Cast-Iron Vortec Cylinder Head (exhaust) **E**Cast-Iron Vortec Cylinder Head (intake) **E**Cast-Iron Vortec Cylinder Head (combustion chamber) **E**

SERVICE REPLACEMENT HEADS

These cylinder heads are direct replacements for OEM heads on 1987-and-newer GM Small-Block V-8 engines. Save time and worry by replacing tired or damaged cylinder heads with new ones from Chevrolet Performance.

Service Replacement Head Technical Notes:

- Cast-Iron
- Use 1.940"/1.500" valves
- Straight spark plug design
- No heat risers provided

93438649 ⓘ

Cylinder Head Assembly With Valves For 290 HP (not shown)

This cast-iron cylinder head is for use on 350/290 hp crate engines and Goodwrench base 350 V-8 (P/N 10067353).

- Bare head P/N 93438648
- 12-bolt (6 per side) intake manifold pattern
- 76cc combustion chamber

This head is assembled with the following components:

12550909	Exhaust Valves	10241744	Intake Spring Retainer
10241743	Intake Valves	14042575	Exhaust Spring Retainer
94666580	Valve Springs	10212810	Intake Seals
24503856	Valve Locks	12564852	Exhaust Seals

VORTEC CYLINDER HEADS

An easy way to gain 20-40 horsepower on any 1955-and-newer Small-Block Chevrolet V-8 (except later-style LT1/LT4 engines with reverse-flow cooling) is by installing a set of Vortec cylinder heads. These value-priced cast-iron cylinder heads use modified combustion chambers and high velocity port technology to provide improved performance. Vortec cylinder heads significantly outflow non-Vortec service replacement cylinder heads and earlier OEM cast-iron heads. These cylinder heads are ideal for applications up to 350 horsepower, but they require Vortec-specific intake manifolds.

E. 12558060 ⓘ

Cast-iron Vortec Cylinder Head Assembly

- Completely assembled with 1.940"/1.500" valves
- Uses bare head 12529093
- 64cc combustion chamber
- Straight spark plugs
- No heat risers
- Requires Vortec-specific intake manifold
- Camshafts with more than 0.475" lift require machining valve guide bosses and checking valve seal to valve spring retainer clearance
- Can be machined for 2.020"/1.600" valves
- Rocker arm studs can be pinned or drilled and tapped to 3/8"
- Valve spring seat diameter is 1.280"
- Casting number 10239906 or 12558062

This head is assembled with the following components

10241743	Intake Valves	10241744	Valve Spring Retainer
12550909	Exhaust Valves	10212810	Intake Seals
10212811	Valve Springs	12564852	Exhaust Seals
24503856	Valve Locks		

VORTEC BOWTIE CYLINDER HEADS

Vortec Bowtie cylinder heads are the most powerful cast-iron heads offered by Chevrolet Performance. These upgraded production cylinder heads are ideal for 400-450 horsepower street and racing (great for circle track applications) engines. Vortec Bowtie cylinder heads come with bigger valves, a thicker deck surface and 66cc combustion chambers. The heads provide outstanding low-lift flow numbers (the more air you flow, the more potential power) and Fast Burn performance all in an affordable, cast-iron head.

Vortec Bowtie Cylinder Head Technical Notes:

- Cast-iron small runner or large runner cylinder heads*
- 66cc combustion chambers
- 0.450" deck thickness
- Hardened exhaust valve seats
- Machined for 2.000"/1.550" valves
- Maximum 0.530" valve lift (without modifications)
- Straight spark plug design
- No heat risers
- Drilled and tapped for 7/16"-14 screw-in studs
- Dual bolt patterns for Vortec and early style intake manifolds (Vortec intakes P/N 12366573, 12496820, 12496821, 12496822 or 12489371)
- Use intake gasket P/N 89017465 for Vortec intakes or dual pattern intake gasket P/N 19301685 for early model intakes or Vortec design intake manifolds
- Dual bolt patterns for perimeter-style and center-bolt valve covers
- Vortec intake manifold three-step torque specs: 2 lb.-ft.; 9 lb.-ft.; 11 lb.-ft.

A. 19331470

Small-Port Vortec Bowtie Cylinder Head Assembly

- Completely assembled, ready to bolt on
- 185cc intake ports
- 65cc exhaust ports
- Use Fel-Pro® P/N 1470 exhaust gasket
- Bare head P/N 19331471, available separately

19331472

Large-Port Vortec Bowtie Head Assembly (not shown)

- Completely assembled, ready to bolt-on
- Improved air flow (281 cfm @ 0.600")
- 225cc intake ports
- 77cc exhaust ports
- 65cc combustion chambers
- Use Fel-Pro® P/N 1470 exhaust gasket (minor trimming may be necessary)
- Bare head P/N 19331473, available separately

This head is assembled with the following components:

12555331	Intake valves (4)	19301708	Valve spring retainers (8)
12551313	Exhaust valves (4)	19301709	Valve stem key (16)
12625033	Valve springs (8)	12552126	Valve rocker arm studs (8)
19301707	Valve spring seats (8)	10168519	Valve guides (8)
10212810	Valve stem seals (8)	12346004	Valve rocker arm stud sealer

*Larger intake and exhaust ports allow for a greater volume of air to pass through the engine. The more air you flow, the more power you can make.

BUILDER'S TIP

MACHINING THE VORTEC HEAD FOR GREATER VALVE LIFT

The Small-Block Vortec cylinder head delivers great airflow, but is limited to valve lift of about 0.450-inch in stock form – otherwise the valve stem seals will be crushed. The valve guide bosses can be easily machined down to provide greater stem seal clearance. You'll want about 0.050-inch stem-to-retainer clearance at maximum valve lift. Also, the spring seats are easily machined to accept larger-diameter valve springs that are necessary to complement a higher-lift camshaft.



A Small-Port Vortec Bowtie Heads (intake)

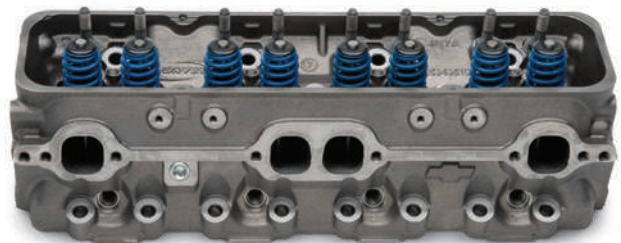

A Small-Port Vortec Bowtie Head (exhaust)

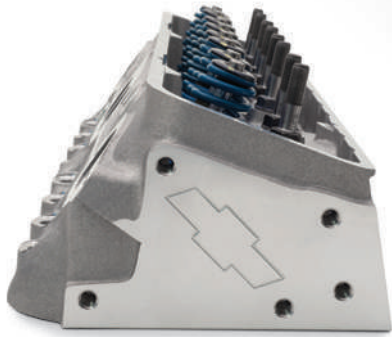

A Small-Port Vortec Bowtie Head (combustion chamber)

Fast Burn Cylinder Head **B**Fast Burn Cylinder Head (intake) **B**Fast Burn Cylinder Head (exhaust) **B**Fast Burn Cylinder Head (combustion chamber) **B**

ALUMINUM FAST BURN HEADS

Chevrolet Performance's Fast Burn 23-degree cylinder heads deliver maximum performance for Small-Block engines. An aluminum head casting – distinguished by Chevy Bowtie logos at each end – and a valvetrain with high-rpm, LS-style beehive-type valve springs stretches the performance range of the heads to enable greater power at a higher rpm! Fast Burn technology delivers more horsepower by increasing cylinder pressures, which maximizes the air/fuel mixture's combustion. The 62cc combustion chamber is designed for use with flat-top pistons. The CNC-machined Fast Burn heads require no additional porting for optimal performance, so all you need to do is bolt them onto your Small-Block and go! They can be used on any Small-Block engine with at least 4.000-inch bores and the standard-flow coolant system. Not for use on Gen II 1992-96 LT1/LT4 engines with reverse-flow cooling system.

B. 19300955 ⓘ

Fast Burn Aluminum Cylinder Head Assembly

- CNC-machined aluminum performance cylinder head
- Completely assembled with 2.000"/1.550" valves
- 210cc intake port, roof raised .240"
- 78cc D-shaped exhaust ports, raised .200" – requires Fel-Pro® exhaust gasket P/N 1470 (may require minor trimming)
- 62cc combustion chamber, .400" deck (can be milled up to .060")
- No heat riser
- Angled spark plugs (5/8" hex, 3/4" reach, tapered plugs)
- 1.48" valve spring seat diameter
- Use head gaskets with stainless steel fire rings
- Raised, machined rocker rails
- .530" maximum valve lift (without modifications)
- Screw-in studs (3/8" top, 7/16" bottom)
- New "time-serts" prevents oil migration through rocker studs
- Dual bolt patterns for perimeter-bolt and center-bolt valve covers
- Dual bolt patterns for Vortec and early-model intake manifolds
- Machined bare head P/N 19300956
- Use intake gasket P/N 19301685

This head is assembled with the following components:

12555331	Intake valves (4)	19301708	Valve spring retainers (8)
12551313	Exhaust valves (4)	19301709	Valve stem key (16)
12625033	Valve springs (8)	12552126	Valve rocker arm studs (8)
19301707	Valve spring seats (8)	10168519	Valve guides (8)
10212810	Valve stem seals (8)	12346004	Valve rocker arm stud sealer

ALUMINUM RACING CYLINDER HEADS

The same superior Chevrolet Performance technology that professional NASCAR and NHRA racers have used to win races for decades is available for you to use in your racecar. The Chevrolet Performance Aluminum Racing Cylinder Heads are part of an extensive family of high-performance inline-valve heads, designed specifically for race-winning engines.

Chevrolet Performance Aluminum Racing Cylinder Heads start with castings designed with thicker decks and manifold flange areas. The combustion chambers are designed for competition and air passages are maximized for high-velocity airflow. These cylinder heads thrive on high compression and high rpm. Used in conjunction with optimized short-block, intake and valvetrain combos, these heads are part of an "instant-on" powerplant – the kind of engine that will put you in the winner's circle.

Chevrolet Performance engineers dramatically altered the valve architecture to improve airflow and maximize efficiency. These aluminum racing cylinder heads are only available unported, so you must have them custom-ported to your specific requirements.

Aluminum Racing Head Technical Notes:

- Made of 355-T7 aluminum
- Extra-thick decks for angle milling or heavy flat milling
- Extra port material for professional porting
- Recommended for use with 4.000" to 4.155" cylinder bores
- Revised location angled spark plugs (14mm, 5/8" hex, 3/4" reach, gasketed plugs)
- Raised and revised location intake and exhaust ports for superior airflow above 0.600" valve lift
- Modified valve angles (not production 23°)
- Longer-than-stock valves required
- Designed for aftermarket shaft-mount rocker systems
- Perimeter-bolt-pattern-type valve covers required
- Specific 18°/15° intake manifold bolt patterns
- Recommended intake manifolds: P/N 24502481 or 24502653 (with valley plate P/N 24502654)
- Intake manifold gasket P/N 10185007

A. 24502580

Semi-Finished 18° Cylinder Head

- Fully machined, semi-finished, no seats or guides
- Non-CNC ports and combustion chamber are "as-cast"
- 60cc "as-cast" combustion chambers
- Designed for up to 2.200"/1.625" valves
- 215cc "as-cast" intake ports
- .080" extra material on deck face, and .055" on intake face

24502615

Semi-Finished 15° Cylinder Head

- Fully machined, semi-finished, no seats or guides
- Non-CNC ported, ports and combustion chamber are "as-cast"
- Great head for NHRA Comp-Eliminator, both V-8 and 4-cylinder applications!
- Casting has been "rolled" 2°, Valve-guides are also tipped 1°
- 210cc "as-cast" intake ports
- 35-37cc "as-cast" combustion chamber
- Capable of over 900 horsepower
- Multi-NHRA world records

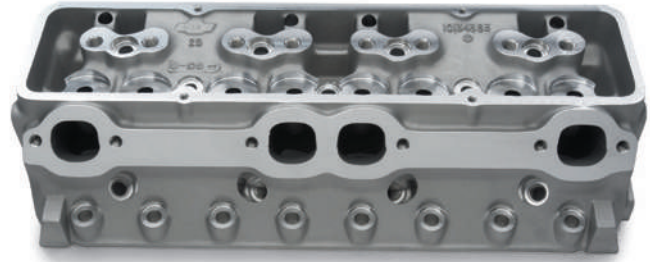

A 15°/18° Cylinder Head (exhaust)

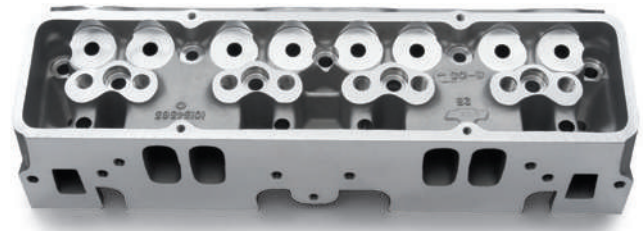

A 15°/18° Cylinder Head (intake)

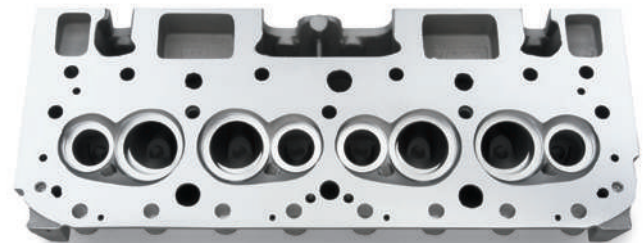

A 15°/18° Cylinder Head (combustion chamber)

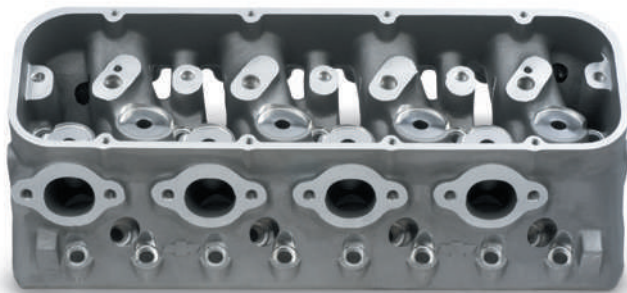
Splayed-Valve Head (exhaust) **B**Splayed-Valve Head (intake) **B**Splayed-Valve Head (combustion chamber) **B**

SPLAYED-VALVE ALUMINUM RACE CYLINDER HEADS

Chevrolet Performance Splayed-Valve Aluminum Race Cylinder Heads are extremely aggressive, all-out competition heads and not intended for street use. Splayed valves point both intake and exhaust valves at the center of the cylinder bore. As the valves open, they move away from the edges of the bore. That allows maximum-size valves to be installed without increasing bore size. The result is dramatically increased airflow, compared to inline-valve-design cylinder heads.

The castings have a 0.240-inch minimum port wall thickness, which leaves ample room for extensive custom porting. Intake valves are angled 16-degrees to the deck surface and splayed 4-degrees. Exhaust valve angles are 11-degrees with a 4-degree splay. Making more than 1,000 naturally aspirated horsepower with these cylinder heads is easily achievable.

Aluminum Splayed Valve Race Head Technical Notes:

- Made of 355-T7 aluminum
- No valve seats or guides provided
- Extra-thick decks for angle milling or heavy flat milling
- Extra port material (0.240") for professional porting
- Completely revised intake and exhaust ports provide ultimate airflow potential
- 45cc "as-cast" combustion chambers
- Modified valve angles (16° x 4° intake, and 11° x 4° exhaust)
- Designed for longer-than-stock 2.200" and 1.650" valves
- Valve spring pads accommodate 1.625" diameter springs
- Revised location angled spark plugs (14mm, 5/8" hex, 3/4" reach, gasketed plugs)
- Designed for aftermarket shaft-mount rocker systems
- Custom-fabricated intake manifold required
- P/N 10185042 intake manifold gasket required
- Valve cover gaskets P/N 10185043 required

12480146

Rough-Machined Splayed-Valve Aluminum Cylinder Head (not shown)

- Main surfaces are machined, exhaust bolt pattern is machined
- Head bolt and dowel holes, intake bolt holes, spark plug holes and pushrod holes are not machined
- Valve guides, valve seats, valve spring seats and rocker stands are not machined
- Valve locations and angles may be relocated
- 240cc "as-cast" intake ports
- 78cc "as-cast" exhaust ports
- 45cc "as-cast" combustion chambers

12480147

Semi-Machined Splayed-Valve Aluminum Cylinder Head (not shown)

- Main surfaces are machined; exhaust bolt pattern, valve guides and spark plug holes are machined
- Head bolt holes, dowel holes, intake bolt holes, pushrod holes are not machined
- Valve seats, spring seats and rocker stands are not machined
- 240cc "as-cast" intake ports
- 78cc "as-cast" exhaust ports
- 45cc "as-cast" combustion chambers
- Same casting as P/N 12480146

B. 24502517

Splayed-Valve Aluminum Cylinder Head

- Semi-machined aluminum race head
- 240cc "as-cast" intake ports
- 78cc "as-cast" exhaust ports
- 45cc "as-cast" combustion chambers
- Same casting as P/N 12480146

SMALL-BLOCK COMPONENTS

Splayed-Valve Aluminum Race Cylinder Heads continued

A. 12480153

Splayed-Valve 4.500 Bore Center Aluminum Cylinder Head

- Semi-machined aluminum race head
- Great for NHRA competition with dual carburetors
- As-cast ports and combustion chambers for professional finishing
- Use mid-deck block with 4.500" main bore machining
- Special larger head-bolt pattern, 3/8" fasteners, 19 holes
- 240cc "as-cast peanut" intake ports
- 78cc "as-cast peanut" exhaust ports
- 40cc "as-cast" combustion chambers

88958684

Splayed-Valve 4.500 Bore Center Aluminum Cylinder Head Cubed (not shown)

- Great for NHRA competition with dual carburetors
- 240cc "as-cast peanut" intake ports
- 78cc "as-cast peanut" exhaust ports
- "Cubed" aluminum race head
- Bare head, no seats or guides

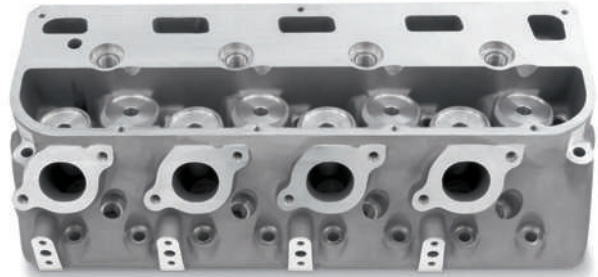

A Splayed-Valve 4.500 Bore Center Cylinder Head (exhaust)

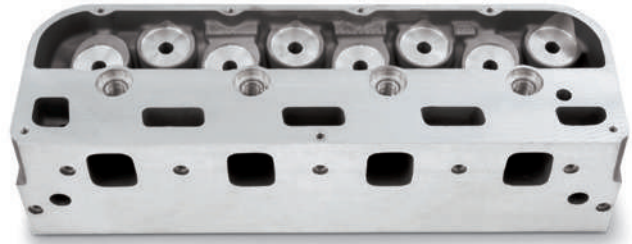

A Splayed-Valve 4.500 Bore Center Cylinder Head (intake)

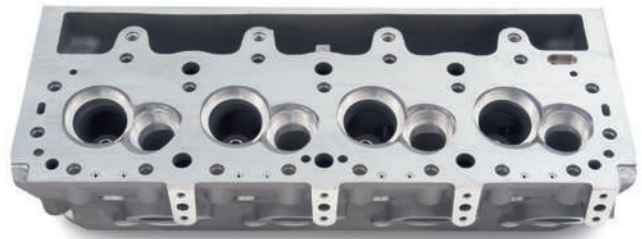

A Splayed-Valve 4.500 Bore Center Cylinder Head (combustion chamber)

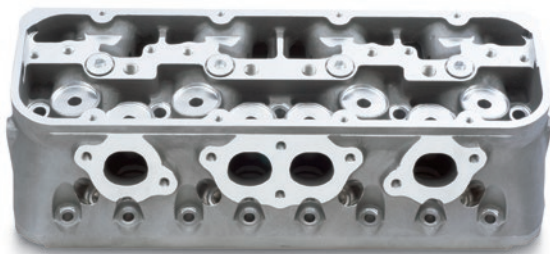
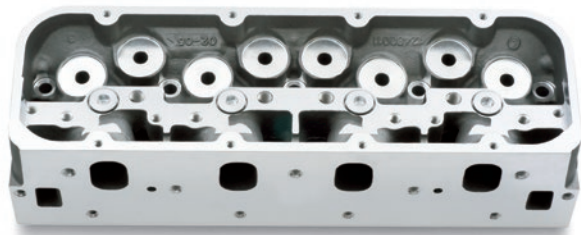
SB2.2 Cylinder Head (exhaust) **B**SB2.2 Cylinder Head (intake) **B**SB2.2 Cylinder Head (combustion chamber) **B**

SB2.2 NASCAR RACE CYLINDER HEADS

The Chevrolet Performance SB2.2 NASCAR racing head was designed to improve durability, simplify preparation procedures, and reduce the overall cost of building and maintaining a Small-Block Chevrolet racing engine. It is ideal for single, four-barrel carburetor applications due to having "mirror" design intake ports and all eight ports being angled toward the center of the engine. Spark plug holes were moved toward the bore center for improved combustion efficiency. 48cc combustion chambers permit 12.1:1-compression-ratio flat-top pistons.

Aluminum SB2.2 NASCAR Race Head Technical Notes:

- 355-T7 X-rayed and "hipped"* aluminum competition cylinder heads
- Extra-thick decks for heavy flat milling
- Extra material around ports for professional porting
- Combustion chambers are very small, shallow and wedge shaped
- Precision T-washers installed in all four center head bolt bosses
- Designed for longer-than-stock 2.150" and 1.625" valves
- Valve spring pads accommodate 1.625" diameter springs
- Modified valve angles, 11° x 4° intake and 8° x 0° exhaust
- Designed for aftermarket shaft-mount rocker systems
- Revised location angled spark plugs (14mm, 5/8" hex, 3/4" reach, gasketed plugs)
- Requires specific left- and right-hand pistons
- Valve cover P/N 12480006
- Replacement AN -08 intake port plugs available as P/N 12480171

B. 12480011

Semi-Finished SB2.2 Aluminum Cylinder Head

- Aluminum NASCAR-accepted head
- Bare head, no seats or guides installed
- Standard .500" guide holes
- As cast "peanut" ports
- 48cc "as-cast" combustion chamber

12480129

Semi-Finished SB2.2 Aluminum Cylinder Head (not shown)

- Aluminum NASCAR-accepted head
- Bare head, no seats or guides
- Reduced size .375" diameter guide holes
- "As-cast peanut" ports
- 48cc "as-cast" combustion chamber

*HIP is the acronym for Hot Isostatic Pressure. This process puts the heads in a sealed vessel where a vacuum is first used to remove room air and any possible contaminants. The vessel is filled with high pressure nitrogen (up to 30,000-psi) and then heated to the required temperature and sustained for a determined amount of time. The cooling process is also a controlled procedure to ensure maximum strength and proper heat treat. This extreme high pressure and heat removes almost 100% of the internal porosities that are generated during the casting process. The material integrity, strength and fatigue life increases significantly.



Cylinder Heads: Additional Required Components

Part Number	Head Gaskets (Quantity)	Bolts (Quantity)	Spark Plug	Engine Application
93438649	10105117 (2)	10168525 (14), 10168526 (4), 10168527 (16)	N/A	12499529
93438648	10105117 (2)	10168525 (14), 10168526 (4), 10168527 (16)	N/A	12499529
12558060	10105117 (2) OR 12557236 (2)	10168525 (14), 10168526 (4), 10168527 (16)	19300749	88869602, 19210009, 12499101, 19210007, 19210008
19300955	10105117 (2) OR 12557236 (2)	10168525 (14), 10168526 (4), 10168527 (16)	5614210	88869604, 19301295, 19301293, 19301294
12556463	12557236 (2)	10168525 (14), 10168526 (4), 10168527 (16)	5614210	24502609, 88958603, 19201330
25534446	10105117 (2), 10185054 (2) or 12363763 (2)	10168525 (14), 10168526 (4), 10168527 (16)	N/A	12366573, 12496820, 12496822, 12496820

OVERHAUL GASKET KITS

A. 19201171

Rebuild Gasket Kit

- Fits 350 HO, HT383 and Circle Track engines P/N 88958602 and P/N 88869602

This kit includes the following items:

Part Number	Description	Quantity
10105117	Head Gaskets	2
10108676	Oil Pan Gasket Set	1
12555771	Rear Main Seal Housing Gasket	1
89017465	Intake Manifold Gasket Set	1
10105135	Water Outlet Gasket	1
10108435	Front Cover Gasket	1
12560223	Fuel Pump Adapter Gasket	1
3754587	Water Pump Gaskets	2
10108445	Distributor Gasket	1
10046089	Valve Cover Gaskets	2
12554314	Crankshaft Rear Main Seal	1

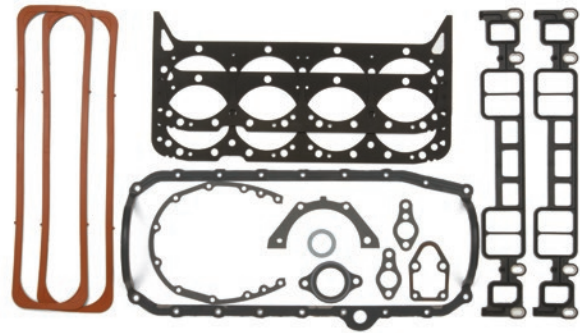

A Rebuild Gasket Kit

B. 19201172

Rebuild Gasket Kit

- Fits Fast Burn 385, ZZ5, SP350, ZZ6, ZZ383, SP383 and Circle Track engines P/N 88958604 and P/N 88869604

This kit includes the following items:

Part Number	Description	Quantity
12557236	Head Gaskets	2
10108676	Oil Pan Gasket Set	1
12555771	Rear Main Seal Housing Gasket	1
19301685	Intake Manifold Gasket Set	1
10105135	Water Outlet Gasket	1
12560223	Fuel Pump Adapter Gasket	1
3754587	Water Pump Gaskets	2
10108445	Distributor Gasket	1
10046089	Valve Cover Gaskets	2
12554314	Crankshaft Rear Main Seal	1
12554314	Crankshaft Rear Main Seal	1

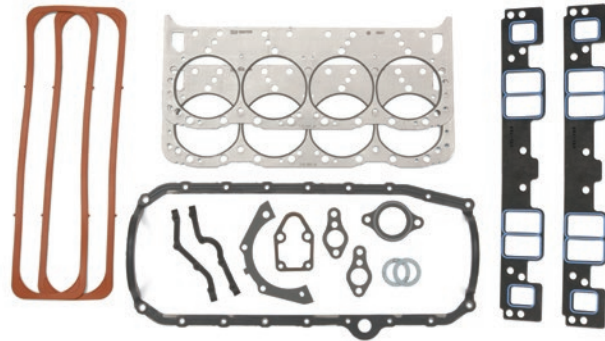

B Rebuild Gasket Kit

CYLINDER HEAD GASKETS, HEAD BOLTS AND STUDS

Chevrolet Performance cylinder head gaskets, cylinder head bolts and cylinder head studs are the finest-quality parts available. Their superior construction ensures optimum sealing between cylinder heads and the engine block.

Gasket packages contain one gasket unless otherwise specified. Head gaskets are available in a variety of materials and thicknesses. Use the proper gasket to maintain compression ratios and minimum piston-to-cylinder-head clearances.

C. 10105117

Composition Head Gasket

- Composition head gasket with stainless steel fire ring
- For stock or mildly modified engines with 4.0" cylinder bores
- Fits cast-iron or aluminum heads
- Used on Ram Jet 350
- 0.028" compressed thickness

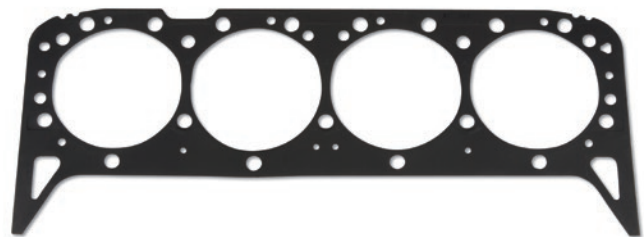

C Composition Head Gasket

3830711

Steel Shim Head Gasket (not shown)

- For stock and mildly modified engines with 4.0" cylinder bores
- 0.026" compressed thickness

12557236

Composition Head Gasket (not shown)

- Stainless steel fire rings
- Fits aluminum or cast-iron heads
- Used on ZZ4 and 350 HO engines
- 0.051" compressed thickness

D. 10185054

Heavy-Duty Composition Head Gasket

- Teflon-coated
- Pre-flattened wire O-rings around each cylinder
- For competition engines with cylinder bores of 4.0" to 4.125"
- 0.041" compressed thickness

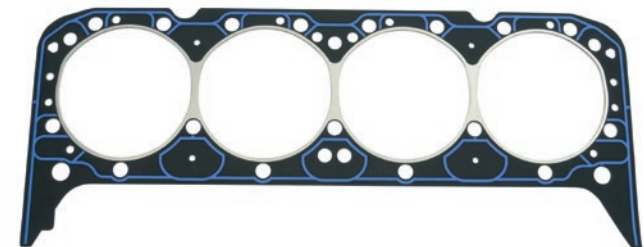

D Heavy-Duty Composition Head Gasket

NOTE: Drill steam holes when used on 400-ci Small-Blocks. Gasket does not require re-torquing.

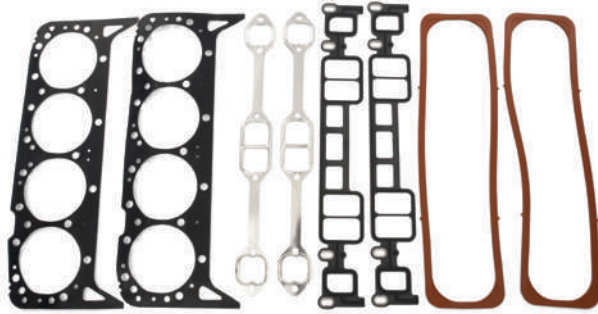

Cylinder Head Installation Kit **E**

10168457

LT1 Head Gasket, Aluminum Head (not shown)

- Composition gasket for 1992-2001 aluminum head LT1 engines
- 0.050" compressed thickness

E. 12499223

Cylinder Head Installation Kit (5.7L L31 Engine)

- Comprehensive kit
- Includes 2 cylinder head gaskets, 2 valve cover gaskets, 2 intake manifold gasket sets and 2 exhaust manifold gaskets
- 0.028" compressed thickness

Part Number	Description	Quantity
10105117	Cylinder Head Gaskets	2
10046089	Valve Cover Gaskets	2
89017465	Intake Manifold Gaskets	2
12550033	Exhaust Manifold Gaskets	2

14011040

Hardened Washer (not shown)

- 0.450" I.D. x 0.778" O.D.
- Sold individually

F. 10051155

Hardened Washer

- 0.450" I.D. x 0.750" O.D.
- Sold individually
- For Phase 6 and raised-runner aluminum heads



Hardened Washer **F**

Cylinder Head Stud Nut **G**

G. 14044866

Cylinder Head Stud Nut

- Magnafluxed 12-point 4037 steel 7/16"-20 nut
- Sold individually

H. 585927

Cylinder Head Dowel Pin

- Dowel pin 5/16" diameter by 9/16" long
- For all Small-Block V-8 and 90° V-6 engines



Cylinder Head Dowel Pin **H**



Cylinder Head Bolt Kit **I**

I. 12495499

Cylinder Head Bolt Kit

- For iron or aluminum heads
- Includes 14 of P/N 10168525, 4 of P/N 10168526, 16 of P/N 10168527, and thread sealant

SMALL-BLOCK VALVES

J. Intake Valves

Part Number	Valve Size	Stem Size	Description
10241743	1.940"	11/32"	Stock replacement valve used in all of our crate engines except CT350/400, Fast Burn 385 and ZZ383/425
12555331	2.000"	11/32"	Stock replacement valve used in the 1996 LT4 engine, and in our CT400, Fast Burn 385 and ZZ383/425 also in LT4 and Fast Burn heads
12363757	2.000"	11/32"	Stainless steel valves with undercut stems to improve air flow, single groove design, chrome plated stems to reduce wear, hardened tips to withstand high loads

K. Exhaust Valves

Part Number	Valve Size	Stem Size	Description
12550909	1.500"	11/32"	Stock replacement valve used in all of our crate engines except CT350/400, Fast Burn 385 and ZZ383/425
12551313	1.550"	11/32"	Stock replacement valve used in the 1996 LT4 engine, and in our CT400, Fast Burn 385 and ZZ383/425; also in LT4 and Fast Burn heads



Intake Valve **J**

Exhaust Valve **K**

SMALL-BLOCK VALVE SPRINGS

Part Number	Spring Type	Outside Diameter	Pressure at Installed Height	Solid Height	Average Weight (lbs @ in)	Retainer Part Number	Valve Seal Kit	Technical Notes
94666580	Single w/ damper	1.241"	80# @ 1.700"	1.150"	267	14003715	10132715	Production spring for 350/290 HP engines
10134358	Single w/ damper	1.273"	110# @ 1.700"	1.160"	356	14003974	10132715	Chrome silicone steel; use with aluminum heads P/N 12556463; orange color code
330585	Dual	1.379"	140# @ 1.750"	1.150"	325	—	10132715	Use with cam P/N 3927140, and all moderate lift racing cams
10206040	Single spring	1.300"	85# @ 1.780"	1.260"	373	10168424	N/A	1992–1993 LT1 production Corvette engine
12625033	Single spring	1.320"	101# @ 1.780"	1.220"	332	19301708	N/A	CT400, ZZ5, ZZ6, SP383, SP383 (Beehive Spring)
12499224	Spring kit	1.320"	101# @ 1.780"	1.220"	332	19301708	N/A	Kit of 16 springs P/N 12625033 (Beehive Spring)
10212811	Single spring	1.250"	80# @ 1.700"	1.200"	256	10241744	N/A	CT350/350, 350HO engines
19154761	Spring kit	1.250"	80# @ 1.700"	1.200"	256	10241744	N/A	Kit of 16 Springs P/N 10212811 (see above)



19300952

Beehive Spring Conversion Kit

Convert the valvetrain on your aluminum Fast Burn heads to the beehive-type system used on Chevrolet Performance's latest Fast Burn heads (P/N 19300955) – and used on the SP350, ZZ5, ZZ6, SP383 and ZZ383 crate engines, and CT400 – to gain greater high-rpm capability and valvetrain stability. The springs, retainers and other hardware are direct replacements for the conventional springs and hardware, with no machining of the valve spring seat required. The engine's existing intake and exhaust valves are retained, allowing installation without cylinder head removal if compressed air or another method is used to hold the valves closed. The engine's existing rocker arms are also retained. The kit comes with components to convert a pair of cylinder heads, including:

Part Number	Description	Quantity
12625033	Spring	16
19301708	Cap	16
19301707	Seat	16
19301709	Keeper	32

NOTE: The conversion kit is intended only for Fast Burn heads and is not compatible with Vortec heads because of insufficient room for the spring seats.

Service Kit Includes:

Part Number	Description	Quantity
12499224	Spring	16
19303149	Cap	8
19303150	Seat	8
19302868	Keeper	16

NOTE: Must use with P/N 19210728 or P/N 1921079 Rocker Arms for adequate clearance.

VALVE SPRING COMPONENTS

Part Number	Description	Technical Notes
10212809	LT4 Valve Spring Shim	Lightweight shims as used on 1996 LT4 Corvette special LT service heads P/N 12363287, and Fast Burn heads. Use with spring P/N 12551483
10185066	Spring Shim	Used on ZZ3 series 350 HO engines. Spacer is 1.350" O.D. x 0.561" I.D. x .050" thick
3875916	Spring Shim	55/64" I.D. x 1-31/64" O.D. x 0.015" thick
10212810	Valve Stem Seal	Used on LT4 and ZZ4 heads as well as Chevrolet Performance Parts head assemblies P/N 25534421, 25534431, 12363287 and 12464298
12511890	Valve Stem Seal Kit	Late-model V-8 seal kit for 11/32" diameter valve stems. Includes eight intake seals, eight exhaust seals and 16 oil stem seals NOTE: Check for seal-to-guide interference with high-lift cams
10241744	Valve Spring Retainer	Used on 350 HO, 350 Ram Jet and HT383
10045007	Valve Spring Retainer	For all ZZ3 series engines. NOTE: When converting ZZ3, ZZ1 or ZZ2 engines to ZZ3 series cap, valve spring shield must be removed and add cap P/N 10045007, seal P/N 460483, and spacer P/N 10185066
19171528	LT4 Valve Spring Cap Kit	Kit for 5.7L LT4 engines. Includes 16 P/N 10212808 lightweight retainers. Use with spring kit P/N 12495494 and key kit P/N 12495503 Used on ZZ4, Fast Burn, LT4 and iron Vortec Bowtie heads
19169661	Heavy Duty Vortec Valve Spring Retainer	Fits Fast Burn and Vortec Bowtie cylinder heads. Designed for circle track racing
12495503	Valve Spring Key Kit	Kit includes 32 keys of P/N 24503856 for 11/32" valve stems. Use on all Small-Block V-8 engines

Rocker Arm Kit, Steel, 1.5 Ratio **A**Roller Rocker Arm Set **B**Rocker Arm (top) with
adjuster nut **B**Rocker Arm (bottom) **B**Adjuster Nut for Roller
Rocker Arm **C**"Kool Nut" **D**

ROCKER ARMS

A. 12495490

Rocker Arm Kit, Steel, 1.5 Ratio (set of 16)

- Self-aligning, high-quality rockers have a nominal 1.5:1 ratio
- Includes 16 stamped steel rockers with pivot balls and nuts
- Use P/N 10089648 for single service part; for 3/8" studs

NOTE: Not recommended for mechanical lifter camshafts.

Aluminum Roller Rocker Arm 3/8" Studs

These Chevrolet Performance aluminum roller rocker arms resemble the ones used in the 1996 Corvette LT4 engine, except the trunnions have been machined to fit early-model 3/8-inch rocker studs. The arms are self-aligning with improved stiffness. They will accommodate up to 0.575" valve lift. They are available in 1.5:1 and 1.6:1 ratios.

B. 19210728

Roller Rocker Arm Set, 1.5:1 Ratio

- Set of 16, 3/8" stud 1.5:1 ratio roller rockers
- Use P/N 19210724 for single service part

19210729

Roller Rocker Arm Set, 1.6:1 Ratio (not shown)

- Set of 16, 3/8" stud 1.6:1 ratio roller rockers
- Use P/N 19210725 for single service part

NOTE: When using a high-lift camshaft, check valve spring coil bind, retainer-to-seal clearance and piston-to-valve clearance. Check for adequate pushrod clearance when using on cast-iron heads. It may be necessary to remove valve cover drippers for proper rocker arm clearance.

NOTE: P/N 19210729 cannot be used on ZZ3 engines with orange valve springs.

C. 19210725

Adjuster Nut for Roller Rocker Arm

- 3/8" adjustment nut
- Used on both aluminum rocker arm kits P/N 12370838 and P/N 12370839

D. 19210731

"Kool Nut" (single)

- Special rocker arm nuts are used on GM Circle Track engine P/N 88869602, 88958602
- Can be used with any stamped steel rocker arm

SMALL-BLOCK COMPONENTS

VALVE COVERS

People can't see the beautiful porting artistry inside your Chevrolet Performance aluminum cylinder heads, but they can, and do, see the valve covers. To make sure your GM engine looks as great as it runs, Chevrolet Performance offers a wide selection of precision-engineered, branded valve covers. The valve covers are either aluminum or stamped steel. They're designed to seal tightly and minimize the chance of oil leakage. Taller competition valve covers are made to easily clear high performance valvetrain components.

NOTE: Valve covers are sold in pairs unless otherwise specified. Valve covers cannot be used with 15° or 18° heads unless otherwise stated.

A. 10185064

Tall Aluminum Valve Covers

- Competition racing valve cover displays the Chevrolet name and Bowtie logo
- Natural cast finish
- No holes for PCV or oil fill, but has bosses for drilling them
- Designed for pre-1986 engines with perimeter hold downs
- Can be used with 15° and 18° heads
- Use P/N 10185052 for single service part

B. 12480127

Short Aluminum Valve Covers

- Cast-aluminum Chevy Bowtie-design valve cover is similar to P/N 10185064 except it is a short style with a PVC hole in both covers (grommets included)
- Natural cast finish
- Designed for pre-1986 engines with perimeter hold downs
- Covers have oil baffle
- Not to be used with the 350/290 crate engine

NOTE: For use with 1.5 ratio stamped rocker arms only.

C. 24502466

Tall Valve Covers, No Logo

- Create your own custom valve covers!
- Cast-aluminum valve cover is similar to P/N 10185064, but has no logo
- Cast with extra material to permit milling a custom logo

NOTE: Sold as single piece. Order 2 per engine.

D. 12341670

Chrome Short Valve Covers

- Short chrome valve covers, with baffle
- For use on pre-1986 engines with perimeter hold downs
- Chevrolet and the Bowtie logo are embossed on top

NOTE: For use with 1.5 ratio stamped rocker arms only.

E. 12497978

Polished Aluminum Valve Covers, Center Bolt Design

- Die-cast aluminum valve covers
- Polished to a bright shine
- Approximately 1/4" taller than production covers
- For use on 1986-and-newer engines with center hold-downs
- Kit includes bolts, washers and seals
- Installed on ZZ5 and SP350 crate engines

NOTE: Use valve cover gasket P/N 10046089 and replacement bolt and seal kit P/N 12497980.

12497985

Chrome-Finish Aluminum Valve Covers, Center Bolt Design (not shown)

- Die-cast with chrome finish
- Approximately 1/4" taller than production covers
- For use on 1986-and-newer engines with center hold-downs
- Kit includes bolts, washers and seals

NOTE: Use valve cover gasket P/N 10046089 and replacement bolt and seal kit P/N 12497980.



A Tall Aluminum Valve Covers



B Short Aluminum Valve Covers



C Tall Valve Covers, No Logo



D Chrome Short Valve Covers



E Polished Aluminum Valve Covers, Center Bolt Design



Aluminum Black Crinkle Valve Covers, Center Bolt Design **F**



Original Corvette V-8 Valve Covers **G**



Mid-Year Corvette Valve Covers **H**



Black Slant-Edge Valve Covers **I**



Natural Gray Slant-Edge Valve Covers **J**

F. 12497979 ⓘ

Aluminum Black Crinkle Valve Covers, Center Bolt Design

- Die-cast with black crinkle finish
- Approximately 1/4" taller than production covers
- For use on 1986-and-newer engines with center hold-downs
- Kit includes bolts, washers and seals
- Factory installed on new SP383 crate engines

NOTE: Use valve cover gasket P/N 10046089 and replacement bolt and seal kit P/N 12497980.

G. 3726086

Original Corvette V-8 Valve Covers

- 1956-1959 V-8
- Off-set bolt holes will not fit newer V-8 heads

NOTE: Sold as single piece. Order 2 per engine.

H. Mid-Year Corvette Valve Covers

- These mid-year, finned Corvette valve covers are polished to a high luster

474208

- 1970-1977
- Has breather hole with Corvette "crossed flag" emblem

474207

- 1970-1977
- Has breather hole and an oil-filler cap provision
- Cap not included

I. 19351534

Black Slant-Edge Valve Covers

- Includes bolt kit P/N 19351801 and gromet kit P/N 12341988
- Factory installed on ZZ6 crate engines
- Die cast with black crinkle finish
- For use on 1986-and-newer engines with center hold-downs
- Fits Fast Burn aluminum and Bowtie cast iron heads with center hold-downs

J. 19351803

Natural Gray Slant-Edge Valve Covers

- Includes bolt kit P/N 19351801 and gromet kit P/N 12341988
- Die cast with natural finish
- For use on 1986-and-newer engines with center hold-downs
- Fits Fast Burn aluminum and Bowtie cast iron heads with center hold-downs

SMALL-BLOCK COMPONENTS

Valve Covers continued

A. 25534359

Circle Track Valve Covers, Center Bolt Design

- Sheet metal valve cover kit designed for Gen I design circle track engines equipped with center hold-down cylinder heads
- Covers equipped with 2 breather pipes on 1 cover and no pipes on the other

NOTE: Use breather kit P/N 25534355 (2 come in kit).



A Circle Track Valve Covers, Center Bolt Design

B. 25534420

Pontiac 301-455 Valve Covers

- Stylish covers fit 301-455 cubic-inch Pontiac engines manufactured from 1965-1979
- Designed for stock valvetrains and may not clear aftermarket rocker arms, springs or stud girdles
- Each cover has one 1.220" hole on left side for oil fill cap; or grommet for PCV or fresh air inlet
- Covers have a natural aluminum finish with machined Pontiac name and logo
- Includes 2 covers and grommet kit P/N 12341988

NOTE: Does not fit Small-Block Chevy heads.



B Pontiac 301-455 V-8 Valve Covers

ADAPTERS, HARDWARE AND BREATHERS

C. 12497980

Chrome Bolt Kit, Center Bolt Design

- Service replacement parts for 1986-and-newer center hold-down design, die-cast aluminum valve covers in chrome, crinkle, and polished finishes
- Will not fit production valve covers

12356818

Chrome Hold-Down Bolt (not shown)

- Chrome valve cover hold-down bolt
- Used on all 1986-and-newer engines with center hold-down design stamped valve covers

NOTE: Package contains 1 bolt. Order 4 per valve cover.

10066008

Black Hold-Down Bolt (not shown)

- Black valve cover hold-down bolt
- Used on all 1986-and-newer engines with center hold-down design stamped valve covers

NOTE: Package contains 1 bolt. Order 4 per valve cover.



C Chrome Bolt Kit, Center Bolt Design

D Oil Baffle Tube

D. 88962074

Oil Baffle Tube

- Pushes easily into most valve covers that have an oil baffle
- Requires breather P/N 25534355; used on ZZ572 engines



E Circle Track Breather

E. 25534355

Circle Track Breather

- Special breathers are for circle track valve covers used on circle track and ZZ572 engines
- Chrome breathers are 1-3/8" hose-clamp-style with the Bowtie logo on top
- Installs on the left-side of each valve cover
- Kit includes two breathers



Valve Covers: Additional Required Components

Part Number	Gaskets (Qty)	Bolts (Qty)	Grommets (Qty)	Oil Fillers (Qty)	Engine Application
25534359	10046089 (2)	N/A	3989350 (1)	93439687 (1)	88869602, 88958603, 88958604, 88869604
12497979	10046089 (2)	12497980 (8)	12341988 (8)	N/A	Small-Block
12497985	10046089 (2)	12497980 (8)	12341988 (8)	N/A	Small-Block
12497978	10046089 (2)	12497980 (8)	12341988 (8)	N/A	Small-Block

Push-In Oil Filler Cap **F**Hold-Down Clamps **G**Spring Bar Retainer **H**Spring Bar Retainer, Chrome-Plated **I****F. 12341993****Push-In Oil Filler Cap**

- For valve covers with 1.22" hole

19131218**Chrome Push-In Breather (not shown)**

- 2-3/4" O.D. x 1-1/2" tall with 3/4" nipple
- Used on our Fast Burn 385, ZZ4 and 350 engines

G. 12341986**Hold-Down Clamps**

- Clamps to minimize distortion of valve cover flanges on 1955-1986 Chevrolet Small-Block V-8 and 90° V-6 engines
- 4 clamps per package; order 2 per engine

H. 14082321**Spring Bar Retainer**

- Special steel retainers prevent oil leaks
- Use under the valve cover bolts
- Distribute clamping force over a large area and prevent deformation of the flanges
- Narrow retainers are engineered to fit pre-1986 engines with perimeter-style hold downs

NOTE: Package contains 1 retainer. Order 4 per valve cover.

I. 14044820**Spring Bar Retainer, Chrome-Plated**

- Similar to retainer P/N 14082321 described above
- Chrome-plated to match chrome valve covers

NOTE: Package contains 1 retainer. Order 4 per valve cover.

3933964**Valve Cover Gasket (not shown)**

- Cork-type gasket
- Fits all valve covers with perimeter hold-down bolts
- 1 gasket per package

10046089**Valve Cover Gasket (not shown)**

- For '86 and newer center hold down design valve covers

SMALL-BLOCK PUSHRODS

Pushrods are that critical connection between the camshaft and the rocker arms. These seemingly innocuous parts play a very important role in the combustion process. That's why Chevrolet Performance pushrods are designed for heavy-duty street and competition applications. They are case-hardened for use with pushrod guideplates.

Pushrods are available in standard and 0.100-inch extended lengths. The longer pushrods can be used to restore correct valvetrain geometry when using a high-lift camshaft with a small base circle. They are also recommended when longer-than-stock valves are installed.



Heavy-Duty Pushrod Kit (0.100" longer than stock)

Part Number	Material	Diameter	Length	Usage	Description
14044874	1010 steel	5/16"	7.724"	Flat tappet	(1) Heavy-duty heat-treated .075" wall, hardened tip inserts; standard length.
366277	1010 steel	5/16"	7.824"	Flat tappet	(1) Heavy-duty heat-treated .075" wall, hardened tip inserts. +.100" long
10046173	1010 steel	5/16"	7.122"	Hyd. roller	(1) Heavy-duty heat-treated .060" wall, standard length; for use in early ZZ-series engines with guideplates
12371041	1010 steel	5/16"	7.122"	Hyd. roller	(16) Heavy-duty .060" wall, standard length; for use in 2nd design ZZ-series engines without guideplates Use P/N 10241740 for single piece
10241740	1010 steel	5/16"	7.122"	Hyd. roller	(1) Heavy-duty .060" wall, standard length; for use in 2nd design ZZ-series engines without guideplates

SMALL-BLOCK GUIDEPLATES

3973418

Pushrod Guideplate, Cast-Iron Head (not shown)

- For use with production and Bowtie cast-iron cylinder heads with screw-in studs
- Can also be used with aluminum Bowtie V-6 head
- Should not be used with self-aligning rockers
- Pushrod slots are 0.325"
- For 90° V-6, use on cylinders 1, 2, 5 and 6; guideplate must be ground to clear valve cover hold-down bolts
- Four required per head

ROCKER ARM STUDS

3921912

Screw-In Rocker Stud, 7/16" Big-Block Style (not shown)

- Beefy 7/16" Big-Block V-8 rocker studs
- Improve valvetrain stability of any Small-Block V-8 or 90° V-6 racing engine by minimizing rocker stud flex
- Fits any Small-Block V-8 or 90° V-6 cylinder head machined for screw-in studs
- Requires rocker arm for 7/16" stud



A Screw-In Rocker Stud Kit Gen II LT1, LT4 style

A. 12371058

Screw-In Rocker Stud Kit, Gen II LT1, LT4 Style

- 3/8" studs are used on all late-model Gen II LT1, LT4.
- Kit includes 16 pieces; for single stud usage, use P/N 12552126
- Lower thread section is 7/16-14

VALVE LIFTERS AND COMPONENTS

B. 12371042

Hydraulic Roller Lifter Kit

- Designed for 1986-and-later engines
- Second-design lifters are used in late-model 350 HO engines and use a higher checkball spring preload
- Includes 16 lifters of P/N 17120735, 8 valve lifter guides, 1 valve lifter guide retainer, 4 retainer bolts, and 4 retainer washers
- This lifter kit plus pushrod kit P/N 12371041 and a roller-tappet design camshaft converts your engine to a roller-lifter engine
- For single lifter usage, use P/N 17120735

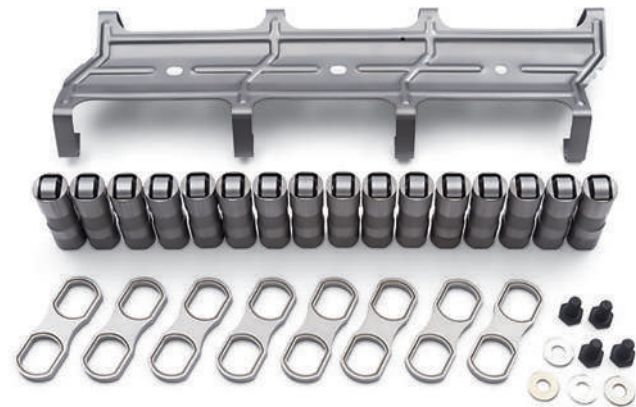

B Hydraulic Roller Lifter Kit

C. 88958652

Valve Lifter Guide, "Quick Cam"

- For use on Gen I GM Small-Blocks (block must be drilled and tapped)
- For use with hydraulic roller lifters only
- Makes it possible to remove the camshaft without removing the intake and lifters
- Enough friction in the guide to hold the lifters in place if the rocker arms are backed off and the camshaft is rotated two full revolutions to push up the lifters

NOTE: Package services one lifter bank.



C Valve Lifter Guide, "Quick Cam"



Flat Tappet Lifter

D Hydraulic Lifter Kit



SMALL-BLOCK CAMSHAFTS AND COMPONENTS

A great deal of exacting engineering, extensive development/testing, and precision manufacturing practices go into every Chevrolet Performance camshaft. In many ways, the camshaft can be considered the heart of a high-performance engine. This vital function is why Chevrolet Performance puts so much effort into making sure its camshafts deliver maximum power and drivability.

NOTE: IMPORTANT! Distributor with melonized steel gear **MUST** be used with steel camshafts or engine damage will occur.

Part Number	Description	Duration @ .050" Lift (deg)	Maximum Lift (in) w/1.5 rocker*	Lobe Centerline (deg)	Technical Notes
3896962	Hydraulic flat tappet	I: 222 / E: 222	I: .450 / E: .460	114	Used in 350/290 HP crate engine
24502476	Hydraulic flat tappet	I: 212 / E: 222	I: .435 / E: .460	112.5	Used in 350 HO and CT350 engines
14097395	Hydraulic roller design	I: 196 / E: 206	I: .431 / E: .451	109	For the HT383 truck engine with 1.5 rockers
10185071	Hydraulic roller tappet	I: 208 / E: 221	I: .474 / E: .510	112	For ZZ3, 350 HO, ZZ4, Fast Burn 385 engines; use with spring P/N 10134358 or 12551483
24502586 (1.5 rocker)	Hydraulic roller (Gen II LT4 hot cam)	I: 218 / E: 228	I: .492 / E: .492	112	Service only; for all V-8 engines with roller cams. (See note below chart)
24502586 (1.6 rocker)	Hydraulic roller (Gen II LT4 hot cam)	I: 218 / E: 228	1.6 rocker I: .525 / E: .525	112	Service only; for all V-8 engines with roller cams. (See note below chart)
12480002 (1.6 rocker)	Hydraulic roller (Gen II LT4 hot cam kit)	I: 218 / E: 228	1.6 rocker I: .525 / E: .525	112	Same as P/N 24502586 except this is a kit that includes 1.6 ratio aluminum rockers, valve springs, and retainers (See below for content)
19210723	Hydraulic roller design	I: 222 / E: 230	I: .509 / E: .528	112	Off-highway use only; contains eccentric for mechanical fuel pump
19244485	Hydraulic roller design	I: 234 / E: 242	I: .539 / E: .558	112	Off-highway use only; contains eccentric for mechanical fuel pump

*Unless otherwise specified

NOTE: The Gen II LT4 camshaft P/N 24502586 was designed to be used in many different engines. The following change may be necessary for correct engine assembly: For LT1 and L98 engines (pre-1996) the dowel pin in the end of the camshaft must be pushed in so extension from end of cam is .30" +/- .01". For 1996 LT1 and LT4 engines, the dowel pin is in the correct position extending .620" from the end of the camshaft. This cam has a fuel pump lobe.

CAMSHAFT KITS, RETAINERS AND REAR COVER KITS

Part Number	Description	Technical Notes
12499229	5.7L Vortec Camshaft Install Kit (not shown)	Convenient, inclusive kit. Includes 2 water pump gaskets, intake manifold gasket set, 2 valve cover gaskets, a distributor gasket and a front crankshaft seal assembly
10088128	Camshaft Retainer (not shown)	First design with 3.620" bolt center as used on ZZ3, ZZ1 and ZZ2 engines
10168501	Camshaft Retainer (not shown)	Second design with 3.294" bolt center as used on ZZ3 and ZZ4 engines
24502459	Camshaft Rear Cover Kit (not shown)	Cover and O-ring gasket for sealing rear camshaft hole on all "CNC" aluminum and iron blocks. Includes bolts



12480002 350 Hot Cam Kit

Off-highway kit converts production Gen II LT1 engine for showroom stock racing. Improves Small-Block originally equipped with roller tappet camshaft for significant horsepower gains. For roller lifter blocks only. Lifters are not included (re-use original roller lifters).

This kit includes the following items:

Part Number	Description	Quantity
24502586	Camshaft	1
19210729	Roller Rocker Arms	16
12551483	Valve Springs	16
19169661	Retainers	16
24503856	Valve Keys	16
10212809	Valve Spring Shims	16

SMALL-BLOCK COMPONENTS

CONNECTING RODS AND COMPONENTS

A. 12495071

Connecting Rod Kit

- High-quality, 5.700" powdered metal (PM) connecting rods
- For competition or street applications below 500 horsepower
- Replaces the old "pink rods" and are the same rods used in Gen II LT1 and LT4 Corvette engines
- Includes 8 P/N 10108688 rods, available individually

19332460

383 Connecting Rod Kit, 3rd Design (not shown)

383-cubic-inch engines

- Third design, PM rod machined for clearance
- Standard 0.927" pin and 2.100" rod journal
- Uses standard bolt and nut

B. 17800761

Connecting Rod Bearing Kit, 350 and 383 Engine (standard)

- 8 heavy-duty bearing sets
- Second design, without chamfer
- For all 383-cubic-inch engines

C. 12491166

Connecting Rod Stud and Nut Kit, 383 Engine

- Studs and 12-point nuts (16 each) for all 383-cubic-inch engines
- Use with connecting rod P/N 12497624



A Connecting Rod Kit



B Connecting Rod Bearing Kit, 350 and 383 Engine



C Connecting Rod Stud and Nut Kit, 383 Engine



PISTONS AND PISTON RINGS

Compressing the air/fuel mixture and dealing with the explosive forces inside an engine's cylinders isn't a job for weak parts. That's why Chevrolet Performance pistons are premium quality and factory-tested to withstand the rigors of high-performance street and competition engines. Chevrolet Performance pistons are available in a variety of compression ratios and bore sizes. They're sold individually, unless otherwise specified, and wrist pins are included.

Pistons

Part Number	Engine Size	Compression Ratio	Head Chamber Volume	Size	Pin Type	Technical Notes
93422884	350	8.5:1	76cc	Standard	Pressed	350/290 HP
10159436	350	10:1	58cc	Standard	Pressed	5.7L HO, ZZ4 and LT1; high silicon aluminum
12514101	350	9.1:1	64cc	Standard	Pressed	350-cid 300 hp and 330 hp service engine with "SP" ID
88962542	383	9.1:1 / 9.7:1*	64cc / 62cc	Standard	Pressed	383 engine, first or second design
88962748	383	9.1:1 / 9.7:1*	64cc / 62cc	+0.005	Pressed	383 engine, second design
88962749	383	9.1:1 / 9.7:1*	64cc / 62cc	+0.030	Pressed	383 engine, first or second design
12499103	383	9.1:1 / 9.7:1*	64cc / 62cc	+0.005	Pressed	Kit containing 8 of P/N 88962748 (383 engine, second design)
12499104	383	9.1:1 / 9.7:1*	64cc / 62cc	+0.030	Pressed	Kit containing 8 of P/N 88962749 (383 engine, second design)

*Compression Ratio based on .028" thick head gasket.

Piston Rings

Part Number	Bore Size	Oversize	Ring Thickness	Description
12528817	4.000"	Standard	—	Low tension rings for ZZ4, LT1, and LT4 engines
12499135	4.000"	Standard	—	Premium quality standard-size rings for 1st design 383 engines
12499136	4.000"	+ .030"	—	Premium quality rings for 383 engines
12499107	4.000"	+ .005"	—	Set of 8 ring packs
12499231	4.000"	Standard	—	Set of 8 ring packs of P/N 12528817



BUILDER'S TIP

CAST VS. FORGED – PICKING THE RIGHT PISTONS

It's the classic engine builder's dilemma: cast or forged pistons? Conventional wisdom holds that forged aluminum pistons are hands-down the stronger option. And while it's true they are generally stronger than hypereutectic cast aluminum pistons, it's not to say cast pistons are weak. In fact, modern hypereutectic pistons are made with higher silicon content and offer exceptional strength, as well as thermal properties that generally make them quieter. When determining which piston material to use on your project, a good rule of thumb is this: go forged if the engine is targeted at more than 550 horsepower and/or uses a power-adder, such as a supercharger, turbo or nitrous. Otherwise, save a little money and use the sturdy, modern hypereutectic pistons.

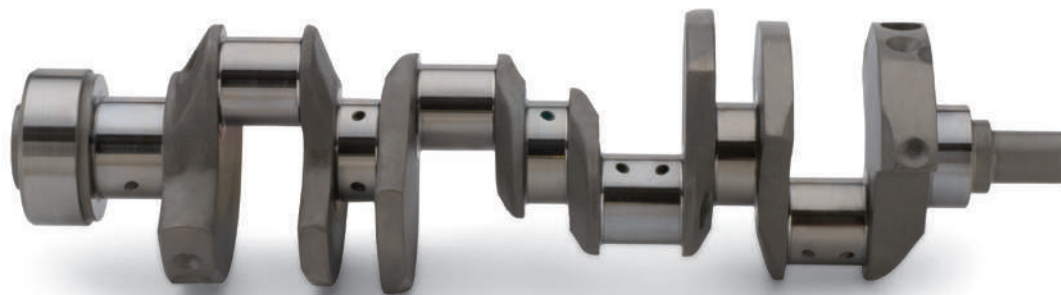

CRANKSHAFTS

A crankshaft is that massive piece of convoluted steel that holds the whole engine together. An engine is essentially a pump, and without a strong crankshaft, the pump won't work. Chevrolet Performance puts the same top-quality engineering and manufacturing processes into its crankshafts as it does all its parts. These crankshafts are the same ones used in Chevrolet Performance crate engines. The crankshafts are available in cast-iron and forged steel. Forged crankshafts should be used for higher-horsepower applications.

Part Number	Description	Technical Notes
14088526	Crankshaft, Cast-Iron (not shown)	Nodular cast-iron with 3.480" stroke and 2.100" diameter rod journals. 1-piece rear main seal crankshaft for 300- and 330-horsepower engines. NOTE: This crank does not have a pilot bearing
12670965	Crankshaft, Forged Steel (used in late-style ZZ4, ZZ5 and ZZ6 engine; not shown)	Forged 1053 steel crankshaft used in post-November 1998 ZZ4 engines. Replaces all cast or steel ZZ4 crankshafts. NOTE: Must be used with connecting rod P/N 10108688 and piston P/N 10159436
12489436	Crankshaft, 383-Cubic-Inch Forged Steel (shown above)	Forged 4340 steel crankshaft used to create 383-cubic-inch engines with 3.800" stroke. Rod journals are 2.100". Mains are standard 350 size. NOTE: Should be used with connecting rods P/N 19169670, bearing kit P/N 17800761, standard pistons P/N 88962748 or 0.030" oversize pistons P/N 88962749, balancer P/N 12498008, and 1986-and-later one-piece crank seal design flywheel or flexplate
14061685	Roller Pilot Bearing (not shown)	Used in high-performance manual transmission applications



ZZ6 and CT400 Engine Balancer
(P/N 19301706)



383 Crate Engine Balancer w/1-Piece Crank Seal
(P/N 12498008)



Racing Balancer
(P/N 24502534 & 24502535)

BALANCERS AND PULLEYS

Balancers are relatively small parts that play a big role in how smooth an engine runs. Balancers are also known as torsional dampers or harmonic balancers, which is indicative of how they help control unwanted crankshaft vibrations. By controlling vibrations, Chevrolet Performance balancers help engines run smoothly, which also extends engine life.

Small-Block Balancers

Part Number	Engine Application	Outside Diameter	Technical Notes
12551537	1969-up 305 and 350; 90V-6 competition (not shown)	6.750"	Smaller size for limited clearance. Timing mark is 10 degrees before keyway centerline. Use with timing pointer P/N 3991435
19301706	1970-74 350; ZZ6 and CT 400 crate engine	8"	Nodular iron. Inertia ring is 1-11/16" wide. Use with timing pointer P/N 3991436. For externally balanced engines
12498008	383 crate engine with 1-piece crank seal	8"	Use with 383 engine components and crankshaft P/N 12489436. For externally balanced engines. Counter weight can be removed for neutral balance
24502534	All racing. Accepts standard pulleys	7.074"	NASCAR-approved and specially tuned up to 9,000 rpm. Uses standard crank hub diameter
24502535	All racing	7.074"	NASCAR-approved and specially tuned. Use with large-diameter 1.598" crankshaft hub

Pulleys and Bolts

Part Number	Engine Application	Technical Notes
19355269	Crankshaft Pulley, 6-5/8" (not shown)	Two-groove, high-rpm, 6-5/8" pulley. For engines with short water pump. NOTE: Can be used with a water pump pulley and belt P/N 9433722 without an idler pulley or alternator.
9440024	Crankshaft Bolt (not shown)	Positive retention 7/16"-20 x 2-1/4" bolt for engines with tapped crank snouts. Use with washer P/N 14001829



Lightweight Flywheel, 1986-up



Standard-Weight Flywheel, 1986-up



12-3/4" Flexplate



14" Flexplate

FLYWHEELS AND FLEXPATES

At the opposite end of the crankshaft from the balancer are flywheels and flexplates, which connect the engine to either manual (flywheels) or automatic (flexplates) transmissions. Chevrolet Performance offers both internally and externally balanced flywheels and flexplates. It is critical that you use the correct design for your engine application.

IMPORTANT: All Chevy Small-Block and Big-Block engines with one-piece crankshaft seal require an externally balanced flywheel or flexplate.

Small-Block Flywheels

Part Number	Year of Engine	Outside Diameter	Crank Flange Bolt Pattern	Clutch Diameter	Starter Ring Gear Teeth	Technical Notes
14085720	1955–1985	12.750"	3.580"	10.400"	153	For 2-piece crank seal. Lightweight nodular iron; weighs approximately 15 pounds
3991469	1955–1985	14"	3.580"	10.400"; 11.000"	168	For 2-piece crank seal
14088646	1986–up	12.750"	3.000"	10.000"	153	For 1-piece crank seal. Lightweight nodular iron; weighs approximately 17 pounds
14088650	1986–up	12.750"	3.000"	10.400"	153	Standard-weight flywheel for 1-piece crank seal
14088648	1986–up	14"	3.000"	11.000"; 11.850"	168	For 1-piece crank seal

Small-Block Flexplates

Part Number	Year of Engine	Outside Diameter	Crank Flange Bolt Pattern	Clutch Diameter	Starter Ring Gear Teeth	Technical Notes
471598	1955–1985	14"	3.580"	10.750"; 11.500"	168	For internally balanced engine with 2-piece crank seal
471529*	1955–1985	12.750"	3.580"	9.750"; 10.750"	153	For internally balanced engine with 2-piece crank seal
14088765*	1986–up	12.750"	3.000"	10.750"	153	For externally balanced 1-piece crank seal
12554824	1986–up	14"	3.000"	11.500"	168	Heavy-duty flexplate with increased thickness for 1-piece crank seal, externally balanced
14088761	1986–up	14"	3.000"	10.750"; 11.500"	168	For 1-piece crank seal, externally balanced

*Will not work with new SuperMatic™ torque converters

Bolts

Part Number	Description	Technical Notes
12337973	Flywheel Bolt (not shown)	Fits all Chevy Small-Block V-8, Big-Block V-8 and 90° V-6 engines. Sold individually; 6 required per engine
3727207	Flexplate Bolt (not shown)	Fits all Chevy Small-Block V-8, Big-Block V-8 and 90° V-6 engines. Sold individually; 6 required per engine



BUILDER'S TIP

SMALL-BLOCK OIL PUMP OVERKILL

Over the years, many engine builders have employed Big-Block oil pumps on high-performance Small-Blocks. Unless you're building a dedicated racing engine, that's not necessarily a great idea. There are advantages to the Big-Block pump, but with its 3/4-inch pickup tube, it's very easy to suck all the oil out of a standard-capacity Small-Block oil pan, starving the engine at higher rpm. For most street/strip combinations, a Small-Block pump with the standard 5/8-inch pickup tube is adequate. If you're going to try the Big-Block pump, make sure to use a large-capacity pan and don't let the oil level get low!

TIMING CHAINS AND SPROCKETS

The timing chain connects the crankshaft to the camshaft and ensures those two key components work in a synchronized manner. Chevrolet Performance's strong, accurate timing chains and sprockets provide top performance and dependable service.

A. 12371043

Single Roller Timing Chain Kit

- Performance kit for all 1987-and-newer engines with roller lifter camshaft, except LT1, LT4 and LS-Series
- Includes chain P/N 14088783, crank sprocket P/N 14088784, cam sprocket P/N 12552129, retainers and bolts

NOTE: Will not work with flat tappet camshafts or LT1 and LT4 engines.

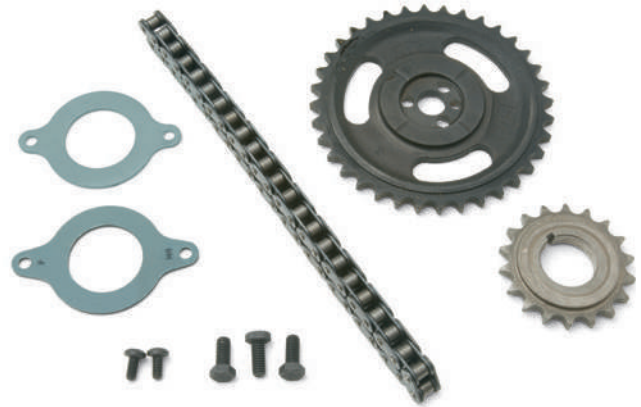

A Single Roller Timing Chain Kit

B. 12370835

Extreme-Duty Timing Chain Kit, LT1 and LT4 Engines

- Performance upgrade, extreme-duty timing chain kit for Gen II 1995-and-newer LT1 and LT4 engines
- Includes roller timing chain P/N 14088783, crank sprocket P/N 14088784, camshaft sprocket P/N 10214880 and water pump gear P/N 12551728
- Use with pin-drive camshaft only

14088783

Roller Timing Chain (not shown)

- Heavy-duty, single-roller chain for ZZ-design 350 HO engine
- Use with crank sprocket P/N 14088784 and cam sprocket P/N 12552129

14088784

Crankshaft Sprocket (not shown)

- Single-roller-type for ZZ-design 350 HO engine

12552129

Camshaft Sprocket (not shown)

- Single-roller-type for ZZ-design 350 HO engine



B Extreme-Duty Timing Chain Kit, LT1 and LT4 Engines

C. 9424877

Camshaft Bolt

- 5/16"-18 x 0.750" bolt (3 required)

12554553

Camshaft Dowel Pin (not shown)

12555887

LT4 Timing Chain (not shown)

- Quiet roller design for all LT4 engines
- Use with crank sprocket P/N 12555886 and cam sprocket P/N 12555885

D. 12367600

LT1/LT4 Front Cover Plug

- Covers the hole on the front cover of a 1996 LT4 engine when original distributor is removed and replaced with rear-mounted distributor
- Must be used with 1995 to 1997 timing covers. Will not fit the earlier covers that had non-vented opti-spark units

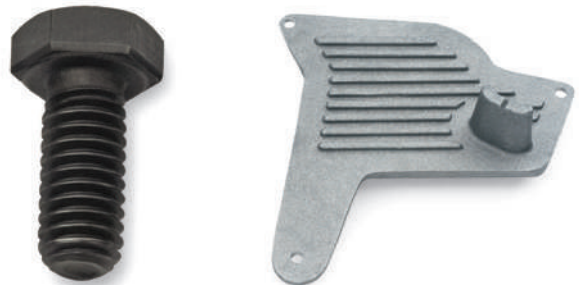

C Camshaft Bolt

D LT1/LT4 Front Cover Plug

Water Pump, Long-Style **E**Aluminum Water Pump, Short-Style **F**Water Pump Pulley **G**

WATER PUMPS, PULLEYS AND COMPONENTS

E. 88894341

Water Pump, Long-Style

- Clockwise (standard) rotation
- Late-style cast-iron pump with long mounting legs, reinforced snout and 3/4" diameter shaft
- End of shaft is reduced to 5/8" diameter
- Use with 350 HO, 383 and ZZ4 engines

F. 19168604

Aluminum Water Pump, Short-Style

- Saves weight over comparable iron pump
- Casting has short-style mounting legs used on pre-1982 Corvettes
- Pump has reinforced 3/4" diameter snout and a large hub with dual bolt patterns

NOTE: Pump housing has a boss which can be drilled and tapped for a cam stop. Can be used with the ZZ4 engine with composite front timing cover by exchanging the bolts that hold the rear sheet metal plate to the pump with pan-head bolts P/N 14010976 or equivalent aftermarket bolts.

NOTE: Cam stop boss may interfere on engines with 8" damper. Some clearancing may be required.

25534390

R0X Water Pump Housing with Cassette (not shown)

- Housing bolts directly to the block
- Block openings are spread to 9.400"
- Standard front inlet and outlet openings
- Includes Water Pump Cassette P/N 25534391

G. 3942992

Water Pump Pulley

- Fits 1971-and-newer and short-leg water pumps with large hubs

NOTE: Must be modified to fit water pump with 3/4" shaft.

89060527

Water Pump, Cast Iron (not shown)

- Counterclockwise (reverse) rotation
- For use with a Chevrolet Performance serpentine accessory drive
- Used in Chevrolet Performance Front-End Accessory Drive Kits and on Turn-Key engines

ACCESSORY DRIVE SYSTEMS

A. 12497698

Serpentine Accessory Drive System, with Air Conditioning

- Fits Gen I-style engines
- Deluxe kit includes all the components and hardware necessary to install on an engine with air conditioning, including water pump, alternator, power steering pump and idler bracket; belt included

The system includes:

10055800	Secondary Air Injector Pump Bracket
88964863	Air Compressor Assembly (CR4)
10129569	Idler Belt Pulley Bracket
19201601	Water Pump Kit
10055880	Water Pump Pulley
10055879	Crankshaft Pulley
19152464	Alternator Assembly – 105 AMP (reman)
88987962	Alternator Connector (with lead)
10055798	Drive Belt Tensioner Assembly
88986814	Belt (fan, water pump, A/C, power steering pump, and alternator)
10105212	Alternator and Power Steering Bracket
19319858	Power Steering Pump (reman)
12605677	Power Steering Pulley

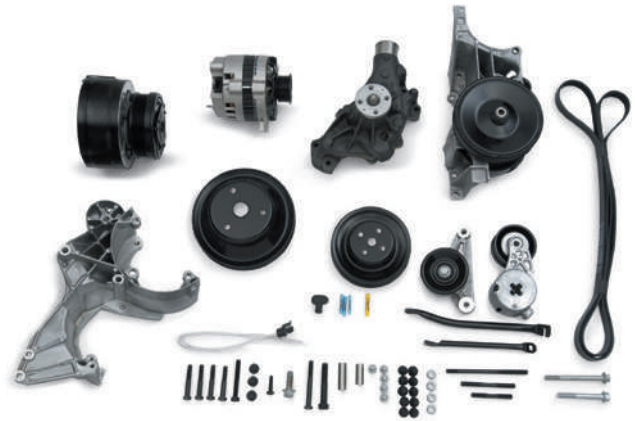

A Serpentine Accessory Drive System, with Air Conditioning

12497697

Serpentine Accessory Drive System, without Air Conditioning (not shown)

- Fits Gen I-style engines
- Deluxe kit includes all the components and hardware necessary to install on an engine without air conditioning, including water pump, alternator, power steering pump and idler bracket; belt included
- Includes all components from above kit, minus air compressor assembly

OIL PANS, OIL PUMPS, GASKETS AND COMPONENTS

Oil is your engine's lifeblood and a high-quality Chevrolet Performance oil pan keeps it where it belongs. Our properly designed and manufactured oil pans fit right and, along with matching gaskets, prevent leaks for years of trouble-free service. Chevrolet Performance has oil pans for street and competition applications.

(Oil pans are sold without dipsticks or other hardware unless otherwise specified.)

It's important to note that Chevrolet V-8 and V-6 engines were redesigned in 1986 to include a one-piece rear main seal. That change required a correspondingly new oil pan design. For pre-1986 engines, there is a newer one-piece pan gasket available. Oil pans and gaskets are not interchangeable between early and late design engines. Blocks that have been machined for a one-piece rear main seal require seal adapter P/N 10051118 and must use the newer-style oil pan and gasket.

B. 12557558

Oil Pan, 1986-1992 F-Car and ZZ4

- Four-quart pan used on ZZ4 crate engines and 1986-92 Camaro and Firebird
- Internal baffling and right-hand dipstick
- Designed for 1-piece rear main and 1-piece oil pan gasket
- Fits with crankshaft seal adapter P/N 10051118 (discontinued)

NOTE: Use with oil pan rail reinforcement P/N 12553058 (LH) and 12553059 (RH).

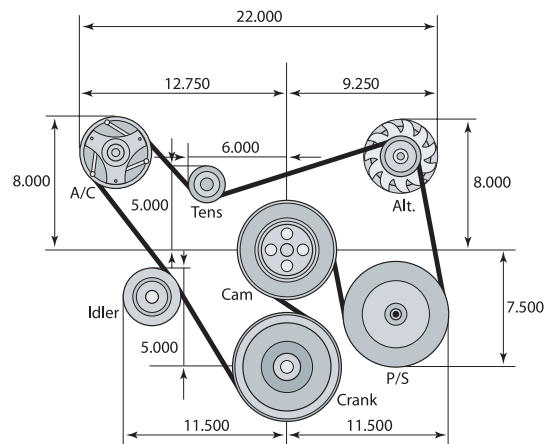

A Serpentine Accessory Drive System, with Air Conditioning



B Oil Pan, 1986–1992 F-Car and ZZ4



Circle Track "Late Model" Oil Pan **C**



Windage Tray **D**



Windage Tray **E**

25534353

Circle Track "Factory Stock" Oil Pan (not shown)

- Special black-powder-coated 8-quart circle track pan is used in the Circle Track engine P/N 88869602
- 8" sump has a single 3.5" kickout on the right-hand side
- Includes a fully louvered windage tray, oil scraper, three trap doors, oil level plug, and 3/4" oil pick-up tube
- 8" deep

C. 25534354

Circle Track "Late-Model" Oil Pan

- Special black-powder-coated, 8-quart circle track pan is used in the factory stock engines P/N 88958603 and P/N 88869604
- 7" sump has a 3.500" kickout on both sides
- Includes a fully louvered windage tray, three crankshaft scrapers, six trap doors, two runners, an oil temperature fitting provision, oil level plug, and 5/8" oil pick-up tube
- 7" deep
- Oil pickup tube available separately P/N 19171997

10108676

Oil Pan Gasket, 1-Piece Rear Main Seal (not shown)

- Neoprene 1-piece gasket for 1986-and-newer engines

D. 3927136

Windage Tray

- Separates the oil in the pan sump from the rotating crank assembly to reduce aeration of the oil
- Aids in oil control and minimizes oil slosh under hard braking
- Use with oil pan P/N 360450

NOTE: Requires five mounting studs P/N 14087508 for 1968-and-later blocks. Use mounting studs P/N 3872718 with pre-1968 blocks. On 400-cubic-inch Small-Blocks the baffle requires modifying by elongating mounting holes. Check tray clearance with long-stroke crankshafts and/or non-stock connecting rods.

E. 12554816

Windage Tray

- Flat oil pan baffle used with 1986-1996 Corvette pan P/N 10055765
- For 1968-and-newer blocks, use five mounting studs P/N 14087508
- For pre-1968 blocks, use studs P/N 3872718

Oil Filter Adapter



Oil Pump, High Volume



OIL PUMPS & FILTERS

Part Number	Description	Technical Notes
93427692	Oil Pump, High-Pressure Gen II LT1/LT4-Style (not shown)	Production-style high-pressure 1993-1997 LT1/LT4 oil pump with 1.200" gears. Produces 60-70-psi oil pressure; screen not included
14044872	Oil Pump, High Volume	High-volume pump has 1.500" gears for increased volume. Approximately 25 percent more capacity than a production pump at standard pressure; pick-up not included
10046007	Oil Pump Bolt (not shown)	Fits all models, 7/16"-14 x 2 3/8"
3998287	Oil Pump Shaft (not shown)	Fits all 1959-and-newer engines
3764554	Oil Pump Shaft Retainer (not shown)	Fits all 1959-and-newer engines. Use with oil pump shaft P/N 3998287
3848911	Oil Pump Spring (not shown)	Regulates oil pressure at approximately 70 psi. Use with high-volume pump, P/N 93427692 NOTE: Minimum recommended oil pressure for off-highway use is 65 psi at engine operating speed.
19299222	Oil Filter Adapter	Mounts a spin-on cartridge for Gen I and II Small-Block V-8s. Contains a filter bypass valve and requires two attaching bolts, P/N 3951644
24241872	Magnetic Drain Plug (not shown)	Catches and holds small pieces of metal before they can cause engine damage

DISTRIBUTORS AND COMPONENTS

High-quality, durable and dependable Chevrolet Performance distributors optimize the performance of your GM engine. These distributors are interchangeable among standard GM Small-Block and Big-Block V-8s. For tall-deck engines, use adjustable slip collar distributor P/N 10093387.

NOTE: Melonized distributor gear P/N 10456413 is required on all Chevrolet Performance crate engines, or serious damage will occur.

A. 93440806

Distributor, HEI

- Cast aluminum distributor for all Small-Block and Big-Block V-8 engine assemblies
- High-performance mechanical advance curve
- Vacuum advance canister included
- Use connector P/N 12167658 to attach tachometer and 12-volt power supply wire to distributor
- Includes module P/N 19180771, cap P/N 19110931 and rotor P/N 19110934



A Distributor, HEI

B. 88961867

Distributor, Billet HEI

- CNC-machined billet aluminum housing provides great strength
- Ball-bearing guide, oversized shaft and long sintered bushing for stability
- Offers mechanical advance and vacuum advance
- Includes brass terminal cap
- Use connector P/N 12167658 to attach tachometer and 12-volt power supply wire to distributor

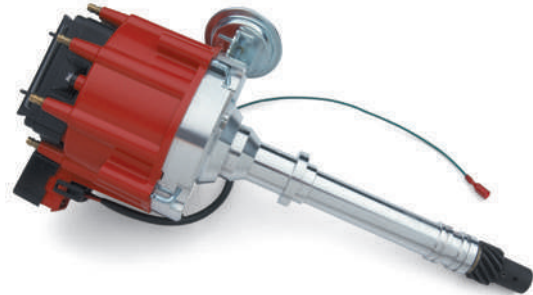

B Distributor, Billet HEI

C. 1104060

Distributor, Ram Jet 350 and Ram Jet 502

- Used on the fuel-injected Ram Jet 350 and Ram Jet 502
- Includes ignition module P/N 10482830, cap P/N 19166099 and rotor P/N 10477219

1103952

Distributor, Late-Model EFI (not shown)

- Used on late-model V-8 engines with fuel injection and computer controls
- Kit includes ignition module, cap and rotor

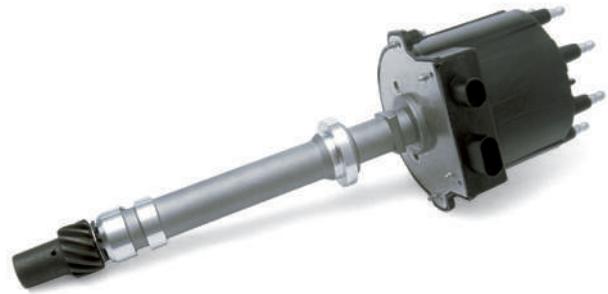

C Distributor, Ram Jet 350 & Ram Jet 502

D. 10093387

Distributor, Adjustable Slip Collar

- Designed for competition use
- Billet aluminum housing
- Ball-bearing guide
- Adjustable mechanical advance
- Magnetic pickup
- Uses standard cap and rotor
- Adjustable slip collar for tall-deck blocks or to compensate for cylinder head or block machining

19052845

Distributor Gear (not shown)

- Melonized gear for distributor P/N 1103952

10456413

Distributor Gear (not shown)

- Melonized iron gear is required on all Chevrolet Performance crate engines
- **NOTE:** Supplied on distributor P/N 93440806.

12167658

Connector, HEI Distributor Power and Tachometer (not shown)

- Used to attach the power and tachometer wires to the cap of the HEI distributor

12498335

Coil, HEI (not shown)

- Production HEI coil

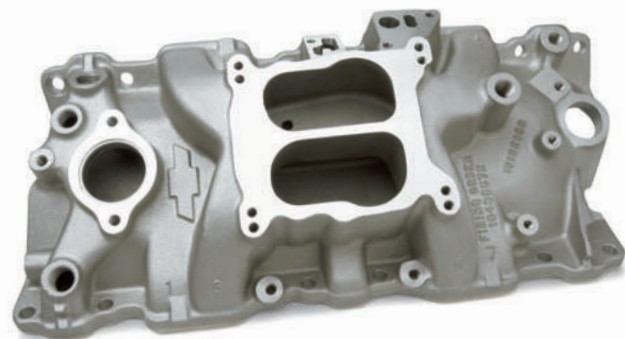
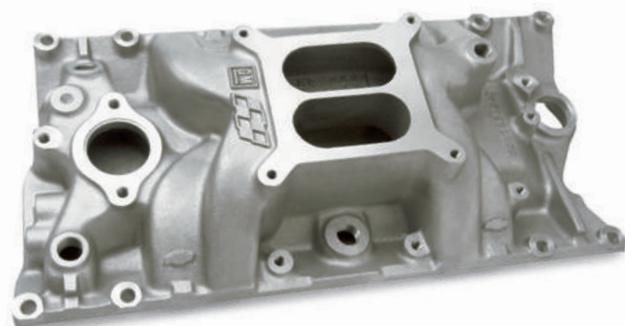
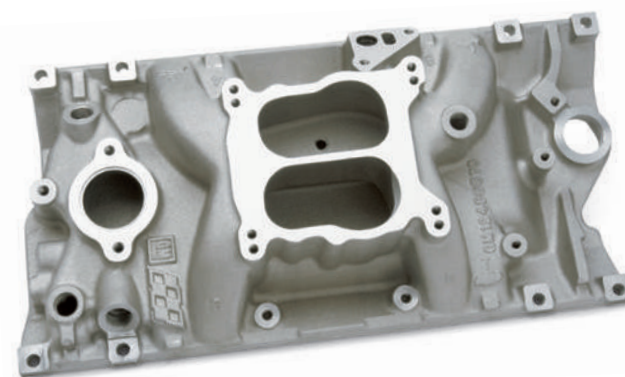

D Distributor, Adjustable Slip Collar

Intake Manifold, ZZ Series **E**Intake Manifold, Vortec Head Design **F**Intake Manifold, Vortec Head Design (Dual-Pattern Carb Mount) **G**

INTAKE MANIFOLDS, GASKETS AND COMPONENTS

Intake manifolds distribute the air/fuel mixture to the appropriate cylinders. Intake manifold design is geared toward the end usage, whether that is a street performance engine or an all-out competition application. The wide range of Chevrolet Performance intake manifolds means there is an ideal manifold for your every need. There are cast-iron and aluminum intake manifolds for carbureted and fuel injected applications. Chevrolet Performance intake manifolds were designed specifically for GM engines, so you know they will deliver O.E. performance.

E. 10185063 ⓘ

Intake Manifold, ZZ Series

- Aluminum manifold used on all 350 HO engines
- Can be used on all Small-Blocks through 1986
- Dual-pattern carburetor flange is approximately 1/2" lower than the 1970 LT1 intake, yet produces the same horsepower
- Provisions for all late-model accessory brackets, EGR, and an integral hot-air choke
- A heat shield can be mounted underneath for improved performance

NOTE: Open carburetor spacer is not recommended for use with dual-plane intake manifolds.

F. 12366573 ⓘ

Intake Manifold, Vortec Head Design

- Designed for 283-400-cubic-inch engines using Vortec cylinder heads P/N 12558060, P/N 19300956, P/N 19300955, P/N 19331470, or P/N 19331472
- Has 4-bolts per side to attach it to these cylinder heads
- Aluminum high-rise design maximizes horsepower and delivers a broad torque curve
- Accepts a square-bore 4150-style carburetor and includes externally plumbed hot water crossover passage
- Use manifold gasket P/N 89017465 and eight attachment bolts, P/N 12550027

NOTE: Vortec heads were originally released on 1996-1999 truck engines. Check for hood clearance, especially with Corvette.

NOTE: Open carburetor spacer is not recommended for use with dual-plane intake manifolds.

G. 12496820 ⓘ

Intake Manifold, Vortec Head Design (Dual-Pattern Carb Mount)

- This dual-bolt-pattern aluminum manifold will work with all Vortec cylinder heads P/N 12529093, P/N 12558060, P/N 19300956, P/N 19300995, P/N 19331470, or P/N 19331472
- Will accept Holley or Quadrajets-style carburetors
- Will accept an EGR valve, P/N 17052693
- To block EGR port, use P/N 12556596
- Requires intake manifold gasket kit P/N 19301685 and 8 special manifold bolts, P/N 12550027

NOTE: Open carburetor spacer is not recommended for use with dual-plane intake manifolds.

SMALL-BLOCK COMPONENTS

Intake Manifolds, Gaskets and Components continued

A. 12496821

Intake Manifold, Vortec Head Design for TBI

- Designed for throttle-body fuel injection
- Aluminum intake will work with all Vortec cylinder heads, including P/N 12558060, P/N 19300956, P/N 19300955, P/N 19331470, or P/N 19331472
- Also accepts EGR

NOTE: The exhaust manifold from 1996-and-newer pickup trucks with RPO L31 350 engine, P/N 12557828, is drilled and tapped to accept an EGR tube. EGR pipe P/N 10220275 can be used with EGR Valve P/N 19210662 and gasket P/N 12337972. This manifold is primarily intended for use with Vortec heads on pre-1996 engine blocks. Blocks manufactured in 1995 or earlier have thermostat bypass passage from the block directly to the water pump. If manifold is used on 1996 and later engines (which do not have the bypass in the block), you must run a coolant bypass line from the manifold to the 5/8" hose nipple on the water pump (passenger's side). Suggested routing is from the 3/8 NPSF boss on manifold to the water pump.

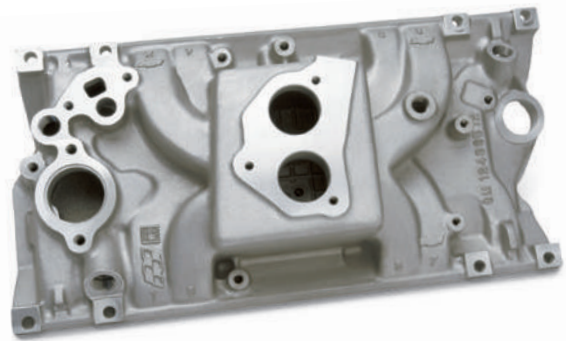

A Intake Manifold, Vortec Head Design for TBI

B. 12496822

Intake Manifold, Eliminator Vortec Head Design

- Designed to deliver the most power and torque with Vortec cylinder head P/N 12529093, P/N 12558060, P/N 19300956, P/N 19300955, P/N 19331470 or P/N 19331472
- Use intake manifold gasket kit P/N 19301685 and 8 special manifold bolts P/N 12550027

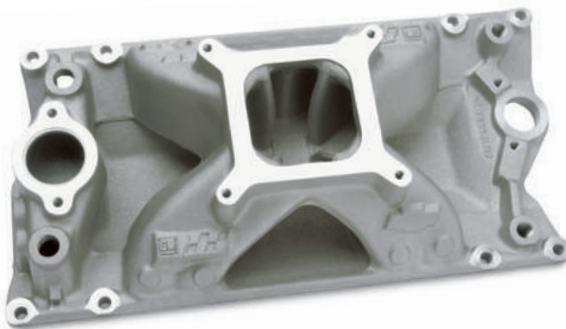

B Intake Manifold, Eliminator Vortec Head Design

C. 24502592

LT1 Intake Manifold

- Fits 1992-1996 Gen II LT1 engines and permits the use of a carburetor
- Long runners increase engine torque up to 30 lb.-ft. without sacrificing top-end horsepower
- There are no water coolant holes on this manifold

12676887

SP 350/357 Dual-Plane Intake Manifold (not shown)

- Original Equipment on SP 350/357 Engine
- Dual-Plane Design for Maximum torque
- Designed for 4150-style 4 bbl carb
- Fits late-model Vortec style heads
- Do not use a carb spacer with this manifold

NOTE: Open carburetor spacer is not recommended for use with dual-plane intake manifolds.



C LT1 Intake Manifold

BOWTIE COMPETITION MANIFOLDS

A. 24502481

Intake Manifold, 18° Competition

- Developed for NASCAR's shorter tracks and works well on Trans-Am-series engines
- Features smaller runners and less plenum volume, which enhances mid-range torque
- Aluminum intake fits 18° heads casting
- Manifold is ideal for 310-cubic-inch road racing and 358-cubic-inch short track engines
- Manifold flanges are 0.590" thick to promote a good gasket seal
- An auxiliary water line boss at the rear of the casting improves water flow
- Weight 22.5 lbs
- Volume 2700cc



A Intake Manifold, 18° Competition

B. 24502653

Intake Manifold, Spider Design

- A 2-piece 'dry' aluminum manifold "spider" consisting of the runners and plenum only
- The runners, called the spider assembly by racers, along with valley plate assembly – the common term for the bottom section of the intake (see P/N 24502654 below) – are designed for use with the 18° cylinder heads with a date code of June 1996 or newer



B Intake Manifold, Spider Design

C. 24502654

Valley Plate Assembly

- Universal aluminum valley plate is designed for use with 18° cylinder heads
- Can be used with dedicated 2-piece manifold spiders, existing 1-piece intake manifolds which have been properly machined for use as a dry manifold, or fabricated manifold designs
- Valley plate has cast-in integral passages to equalize coolant flow from the front and the rear of the cylinder heads
- Fits heads dated June 1996 and later

NOTE: Important information about gasket matching: Gasket flanges are machined to provide the proper port alignment with standard runner locations. Runners in heads and manifold must be matched by engine builder. Often, the gasket will line up with the top of the port so removal is required at the bottom of the port. Gaskets that can be used with this manifold are: Fel-Pro® P/N 1205 and P/N 1206, and Mr. Gasket® P/N 102. Always match the gasket to the cylinder head you plan to use to ensure a correct fit.



C Valley Plate Assembly

Intake Manifold, Spider Restrictor Design – SB2.2 **D**Intake Manifold, Spider Design – SB2.2 **E**Valley Plate Assembly, SB2.2 **F**

NASCAR INTAKE MANIFOLDS

D. 12480096

Intake Manifold, Spider Restrictor Design – SB2.2

- Aluminum manifold has more material in the runners and plenum to accept more flexibility in porting
- Designed for NASCAR restrictor-plate racing and is used with valley plate assembly P/N 12370840 (see below)

E. 88958617

Intake Manifold, Spider Design – SB2.2

- Designed for NASCAR-style racing and high-rpm engines
- Additional aluminum in the runners and plenum allows more flexibility in porting
- Must be used with valley plate assembly P/N 12370840 or P/N 88958659

12370840

Valley Plate Assembly, SB2.2 (not shown)

- Aluminum valley cover is used with manifold runners P/N 12480096 and P/N 88958617 on SB2.2 cylinder heads for NASCAR racing

F. 88958659

Valley Plate Assembly, SB2.2

- Aluminum valley cover is used with manifold runners P/N 12480096, P/N 88958617 and P/N 88958691
- Does not incorporate an inspection cover, but has revised integral water passage for improved coolant flow from the front and rear of the cylinder heads
- Uses AN -24 fitting for water outlet; can use reducer for -20 fitting

88958670

Valley Plate Assembly, R0X (not shown)

- Fits R0X manifold and R0X head P/N 88958667



Intake Manifolds: Additional Required Components

Part Number	Gaskets (Quantity)	Bolts (Quantity)	Engine Application
12366573	89017465 (1)	12550027 (8)	88869602, 19351532, 19351533
12496820	89017465 (1)	12550027 (8)	19210009, 19332529, 19210008
12496822	89017465 (1)	12550027 (8)	88869604, 19351532, 19351533, Vortec Heads
10185063	12525810 (1)	14091544 (8), 88891769 (2)	24502906, 88958603
12489371	89017465 (1)	12550027	12499120, 12499120
12496821	89017465 (1)	12550027 (8)	Vortec Head for TBI
24502481	10185007	N/A	18° high-port racing heads
24502653	10185007	N/A	18° high-port racing heads
24502654	10185007	N/A	18° high-port racing heads



Additional components required for installation.



PERFORMANCE

193

SMALL-BLOCK COMPONENTS

COVERS AND PLUGS

A. 6269414

Cover, EGR Valve

- Covers the EGR valve port on the 350 HO manifold P/N 10185063
- Use gasket P/N 12554530 and screw P/N 9442184 with washer P/N 9439511

B. 12556596

Plug, EGR Pipe Hole

- 7/8"-15 plug is used to seal off EGR pipe holes on intake manifold P/N 12496820 and P/N 12496821

CHROME WATER NECKS

C. 12342024

Water Neck

- Chrome water neck with neoprene O-ring and chrome bolts
- For 1966-1975 full-size Chevrolet, Camaro, and Chevelle V-8 engines

10108470

Aluminum Water Outlet (not shown)

- Natural finish



A Cover, EGR Valve



B Plug, EGR Pipe Hole

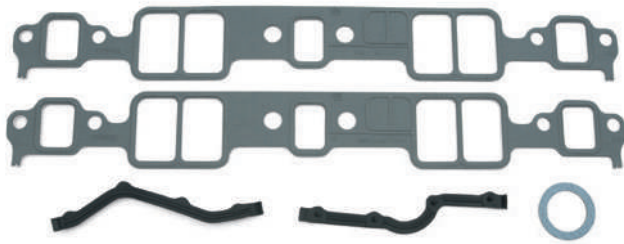
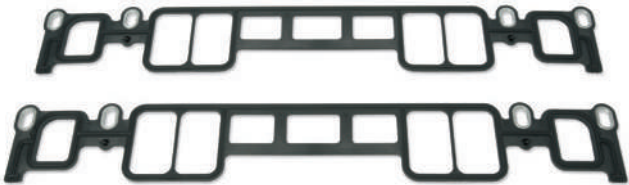

C Water Neck

Gasket Kit, 1971-1986 and ZZ350 **E**Gasket Kit, Fast Burn Aluminum Vortec Design **F**Gasket Kit, Production Vortec Design **G**Gasket Kit, LT4 **H**

INTAKE MANIFOLD GASKETS

E. 10147994

Gasket Kit, 1971-1986 and ZZ350

- For 302-350 high-performance Small-Blocks built from 1971-1986, and all ZZ350 high-performance engines
- Gaskets fit standard intake port location
- Do not use with raised runner cylinder heads
- Includes 2 gaskets

F. 19301685

Gasket Kit, Fast Burn Aluminum Vortec Design

- Designed for Vortec heads, P/N 12558060, P/N 19300955 and P/N 19300956 only
- Gasket thickness is 0.120" (1/8"), post size is 1.080" x 2.160" with tapered wall, Print-O-Seal design
- Has both early style 6-bolt pattern and Vortec 4-bolt pattern
- Includes 2 gaskets

G. 89017465

Gasket Kit, Production Vortec Design

- Production gasket for all Vortec-design cylinder heads (4-bolt attachment to cylinder heads P/N 12529093 and P/N 12558060)
- Requires the use of GM attachment bolt P/N 12550027, because the bolt has a ball design on the end that seats in the head so it will not crush the intake manifold gasket
- Includes 2 gaskets

H. 12528884

Gasket Kit, LT4

- Used on the LT4 engine P/N 12371172
- Can be used with all LT4 heads and is designed not to cover part of the cylinder head opening – as production gaskets do
- Includes 2 gaskets

10185042

Gasket Kit, Splayed-Valve (not shown)

- Used only on the splayed-valve V-8 cylinder heads P/N 24502517
- Includes 2 gaskets

10185007

Gasket Kit, 18-Degree High Port Heads (not shown)

- Used only with V-8 18° high port cylinder heads P/N 10134363 and P/N 24502580
- Includes 2 gaskets

12524653

Gasket Kit, LT1 4-bbl Conversion (not shown)

- Required when installing a 4-bbl manifold on any LT1 engine
- Includes 2 gaskets

STARTERS AND ALTERNATORS

Flywheels with two different diameters are used on Chevrolet Small-Block, Big-Block, and 90° V-6 engines. Large flywheels are 14" in diameter and have 168 teeth on the starter ring gear. Small-diameter flywheels are 12.750" in diameter, with 153 teeth on the ring gear.

This difference in flywheel diameters requires two distinct starter housings. Starter noses used with large-diameter flywheels have two offset bolt holes, while starters for small flywheels have two bolt holes that are parallel to the back of the block. Most Chevy blocks are drilled for both types of starters.

Starters

A. 12361146 ⓘ

High-Torque Mini Starter

- Gear reduction starter is designed for 1958-1996 V-8 and all 90° V-6 engines
- Compact design provides increased clearance
- Weighs only 10.5 pounds and has a gear reduction of 3.75:1
- Equipped with a dual bolt pattern for 12.750" (153-tooth) and 14" (168-tooth) flywheels
- Housing can be rotated to clear exhaust systems
- Includes starter, mounting bolts, shims, gaskets and electrical connectors

NOTE: Not recommended for competition use.

B. 12363128 ⓘ

High-Torque Mini Starter, Chrome

- Same as starter P/N 12361146 (see above), but with a chrome housing

C. 10465143 ⓘ

Lightweight Starter (remanufactured)

- Lightweight high-performance starter was originally used on 1993-1997 Camaros and Firebirds with the LT1 engine
- Can be used on any Small-Block or Big-Block engine with a 12.750", 153-tooth flywheel

D. 19302919 ⓘ

Lightweight Starter, Big-Block and Small-Block

- Gear reduction starter can be used on Big-Block and Small-Block engines with a 14", 168-tooth flywheel

Alternators

88958690

Alternator, 90-Amp, Competition Use (not shown)

- Proven in NASCAR use
- CS121 design housing
- Serpentine belt pulley
- Hand-assembled and dyno-tested



A High-Torque Mini Starter



B High-Torque Mini Starter, Chrome

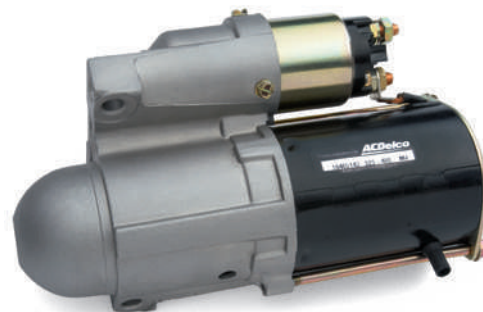

C Lightweight Starter, 12.750" Flywheel (remanufactured)



D Lightweight Starter, 14" Flywheel



Starters: Additional Required Components

Part Number	Bolts (Quantity)	Engine Application
12361146	14097279 (1), 14097278 (1)	Small-Block (except LT or LS Engines)
10465143	14097279 (1), 14097278 (1)	Small-Block (except LT or LS Engines) and 19210009, 19351533
12363128	14097278 (1)	Small-Block (except LT or LS Engines)
19302919	12338064 (2)	Big-Block and 12499121, 19331579, 12499121, 12371171



Rev Limiter for CD Ignition Controller **E**Chevrolet Bowtie Spark Plug Wire Set (90° Boots Shown) **F**Spark Plug Wire Set (135° Boot Shown) **G**Wire Loom Kit **H**

ELECTRONIC CONTROL REV LIMITER

E. 10037379

Rev Limiter for CD Ignition Controller

- Plugs directly into the GM High Performance CD Ignition Controller P/N 10037378
- The rpm limit is set with plug-in rpm modules
- Kit is supplied with 6,000, 7,000, and 8,000 rpm modules

CHASSIS WIRING HARNESS

If you're building a hot rod or restoring an old muscle car, Chevrolet Performance inclusive wiring harness kits make a great replacement for old, worn or damaged wires. These universal wiring kits come with the wires pre-installed on the fuse block, so wiring the vehicle is simply a matter of mounting the fuse block and routing the wires. Each wire is preprinted with the necessary application and is GM-color-coded. The kits also come with all necessary fuses, flashers, horn relay, tach leads, wire ties and grommets. High-temperature, 275°F wire is used – one size larger than factory specs. In all, it's everything you need to electrify your vintage GM car or truck!

12355691

12-Circuit Wiring Harness (not shown)

- Basic system is wired for: heat/air conditioning, brake lights, coil, electric fan, emergency flashers, gauges/dash instruments, headlamps, horn, radio, turn signals, wipers, dome light and third brake light.

NOTE: These universal systems will re-wire any car, truck or competition vehicle using a GM-keyed column. Kits come with extra-long wire to accommodate almost any vehicle.

SPARK PLUG WIRES

F. 12361051

Chevrolet Bowtie Logo Wires

Chevrolet Performance spark plug wire kits are designed to fit your GM engine, eliminating the guesswork in selecting the correct length. These performance 8mm spark plug wires exhibit only 600 ohms per foot of resistance, with high noise suppression capabilities. Features include red wires with white Chevrolet insignia and black boots. Manufactured with double-wall silicone construction.

- Kits include a 10° coil wire for engines, such as Ram Jet 350 and ZZ572 engines that have remote-coil HEI, plus four wire separators and HEI terminals and boots for the distributor cap.
- Custom-fit set designed to be used with black wire loom P/N 12495502 or chrome wire loom P/N 12342049.

G. 24502521

GM Racing Wires

- Superior quality racing plug wires used by NASCAR teams. Designed to route over the valve cover, with 135° spark plug boots.

H. 12496806

Wire Loom Kit

- Stainless-steel supports with the Bowtie logo laser-cut in each of the six supports.
- Twelve retainers, bolts and washers are supplied to bolt to the side of the head.
- Use with spark plug wire set P/N 12361051.



Spark Plug Wires: Additional Required Components

Part Number	Engine Type	Loom Number	Logo	Ends	Routing	Engine Application
12361051	Small-Block	12496806	Bowtie	90°	Below valve covers	Small-Block with 90° spark plug boots
24502521	NASCAR	N/A	None	135°	Over valve covers	



Additional components required for installation.



PERFORMANCE

197

SMALL-BLOCK COMPONENTS

CARBURETORS AND THROTTLE BODIES

Chevrolet Performance has the right carburetor or throttle body to complete your new crate engine, or give life to your rebuilt engine. All carburetors feature show-car-quality polished finish and include all necessary bolts and gaskets.

Carburetors

19170097

Carburetor, Holley 650-cfm (not shown)

- Holley 4150-style 650-cfm 4-bbl carburetor
- Mechanical secondaries
- Manual choke
- Four-corner idle adjustment
- Power valve blowout protection
- Replaces Holley 4160 600-cfm carburetor P/N 12497147

A. 19170092

Carburetor, Holley 670-cfm

- Holley 4160-style 670-cfm 4-bbl carburetor
- Dual-feed fuel bowls with center-hung floats
- Vacuum secondaries
- Electric choke
- Power valve blowout protection
- Quick-change adjustable vacuum secondary

19170093

Carburetor, Holley 770-cfm (not shown)

- Holley 4160-style 770-cfm 4-bbl carburetor
- Dual-feed fuel bowls with center-hung floats
- Vacuum secondaries
- Automatic electric choke
- Quick-change adjustable vacuum secondary
- Recommended for Small-Block and Big-Block engines, including street, competition, towing and off-road vehicles
- Replaces Holley 4160 750-cfm carburetor P/N 12485506

Throttle Bodies

17096144

Throttle Body, Ram Jet 350 (not shown)

- Used on the Ram Jet 350 crate engine
- Use throttle body gasket P/N 12551240 and bolt P/N 11588714 for installation
- Single 75mm blades

AIR CLEANERS

B. 12342071

Air Cleaner, Chevrolet-Logo Classic Design

- 14" round classic-style air cleaner
- Has chrome lid with embossed Chevrolet name and Bowtie attaching nut
- Fits most 4-bbl and 2-bbl carburetors
- Does not fit Dominator-style carburetors

C. 12342080

Air Cleaner, Chevrolet-Logo High-Performance Design

- 14" round high-performance-style air cleaner
- Has chrome lid with embossed Chevrolet name
- Fits most 4-bbl and 2-bbl carburetors
- Does not fit Dominator-style carburetors

NOTE: Check clearance between hood and top of air cleaner. Minimum clearance is 3.750" from top of carburetor gasket area to underside of hood.

D. 19351805

Air Cleaner, Low-Profile Bowtie Chevrolet Design

- Cast aluminum flat lid with hidden carb stud mount
- Flat black with machined logo
- 14" round high-performance style
- Fits most 4-bbl and 2-bbl carburetors
- Matches black slant-edge valve cover P/N 19351534



A Carburetor, Holley 670-cfm



B Air Cleaner, Chevrolet Logo Classic Design



C Air Cleaner, Chevrolet Logo High-Performance Design



D Air Cleaner, Low-Profile Bowtie Chevrolet Design

Air Cleaner, Ram Jet 350 **E**Fuel Pump, High Capacity **F**Fuel Pump, Street Performance **G**Fuel Pump, Competition **H**Fuel Filter **I**Small-Block Fuel Pump Block-Off Plate **J**Electric Fuel Pump **K**Electric Fuel Pump, High-Output **L****E. 12498951****Air Cleaner, Ram Jet 350**

- Designed for use with throttle body on Ram Jet 350 crate engine
- Can be used on other applications

FUEL PUMPS AND COMPONENTS**F. 6415325****Fuel Pump, High Capacity, Small-Block**

- For use on carbureted engines
- Pump has 7 psi shutoff pressure and free flowing rate of 30 gph
- Lower housing can be rotated to reposition inlet and outlet ports

G. 12355612**Fuel Pump, Street Performance, Small-Block**

- For use on carbureted engines
- Pump has 7 psi shutoff pressure and a free-flow rating of 110 gph
- Lower housing can be rotated to reposition inlet and outlet ports
- 3/8" - 18 inlet

H. 12355613**Fuel Pump, Competition, Small-Block**

- For use on carbureted racing engines
- Pump has 9 psi shutoff pressure and a free-flow rating of 115 gph
- Lower housing can be rotated to reposition inlet and outlet ports
- 1/2" - 14 inlet

I. 854619**Fuel Filter**

- High-capacity in-line filter
- Suitable for all high-performance carbureted applications
- 5/16" inlet and outlet

J. 12341998**Small-Block Fuel Pump Block-Off Plate**

- Plate has stamped Bowtie logo
- Special non-asbestos gasket included

ELECTRIC FUEL PUMPS**K. 6472657****Electric Fuel Pump**

- For use on all carbureted engines
- Flows 30-40 gph at 6-9 psi

L. 25115899**Electric Fuel Pump, High-Output**

- Heavy-duty 12-volt electric rotary pump
- Flows 72 gph at 6-8 psi



PERFORMANCE

SMALL-BLOCK LS/LT-SERIES

CRATE ENGINES



Engines Shown From Left:
LT4, LS3, LSA





MORE CHOICES FOR TODAY'S HOTTEST ENGINE SWAPS!

LS and LT engine swaps are the hottest trend in building performance cars. Chevrolet Performance's crate engine lineup offers more choices for your project.

More than production-based crate engines, our engineers have developed factory high-performance crate engines such as the LS3-based LS376/525 and more. And when it comes to our latest high-tech horsepower, we offer the 650-horsepower supercharged LT4 from the Corvette Z06 and Camaro ZL1.

Better still, we offer more of the supporting components, including engine controller kits, front-end accessory drive kits, oil pan options and more, to finish off the installation of your project.

If you're making the upgrade to LS or LT power, trust Chevrolet Performance for the industry's widest selection. You'll find exactly what you're looking for, with the assurance of factory engineering.

You can find these Chevrolet Performance Small-Block LS-Series Engines on the following pages:

LS9.....	210	LS9.....	224
LS3.....	212	LS7.....	226
LS376/480.....	214	LT1.....	228
LS376/515.....	216	LT4.....	230
LS376/525.....	218	LT376/535.....	232
DR525.....	220	LTG 2.0L TURBOCHARGED.....	234
LSA.....	222	E-ROD SYSTEMS.....	236

The LS/LT Engine Family Tree

Everything you wanted to know about GM's 21st-century Small-Block, but were afraid to ask!

LS HERITAGE

The engine family commonly called the LS series debuted in 1997. General Motors called it the Gen III Small-Block, with the iron-block versions in trucks and the all-aluminum LS1 version introduced in the then-new C5 Corvette. A year later, the LS1 replaced the Gen II LT1 Small-Block in Camaros and Firebirds. The LS1 displaced 5.7 liters, similar to the previous-generation Small-Block, but the cubic-inch measurement differed slightly: 346 for the LS1 vs. the traditional 350 cubes.

In 1999, the Gen III platform spawned the higher-performance LS6 that was standard in the Corvette Z06. In 2005, the Gen IV branch of the LS family was born, differing from the Gen III with cast-in provisions for fuel-saving cylinder deactivation, larger displacements and revised camshaft sensing. The performance versions of the Gen IV include the LS2, LS3, LS9 supercharged and LS7.

GM has continued to refer to its modern V-8 engine family as Gen III and Gen IV, but to the enthusiasts who quickly grasped the tremendous performance potential of the engines, every engine based on the platform is nicknamed "LS." The range of production engines from the LS platform is wide. On the truck side, iron-block engines have included 4.8L and 5.3L versions, as well as all-aluminum 6.0L and 6.2L premium engines. Car engines include 5.3L, 5.7L, 6.0L, 6.2L and 7.0L displacements – including some configured for front-wheel-drive.

GEN III VS GEN IV

Despite some significant differences between Gen III and Gen IV cylinder blocks, all LS engines share common traits that include:

- 4.400" bore centers (like the original Small-Block)
- 6-bolt, cross-bolted main bearing caps
- Center main thrust bearing
- 9.240" deck height
- 4-bolt-per-cylinder head bolt pattern
- 0.842" lifter bores
- Distributorless, coil-near-plug ignition system

The most distinguishing differences between Gen III and Gen IV cylinder blocks are larger bores (on some engines), different camshaft position sensor locations – front timing cover area on Gen IV blocks and top-rear position on Gen III blocks – and, on most Gen IV blocks, cast-in provisions for GM's Active Fuel Management cylinder deactivation system.

There is great interchangeability between all LS engines, including between Gen III and Gen IV versions. Cylinder heads, crankshafts, intake manifolds and more can be mixed and matched – but the devil is in the details. Not every head matches every intake manifold and not every crankshaft works with every engine combination. Will Handzel's "How to Build High-Performance Chevy LS1/LS6 V-8s" – P/N 88958786 – is a great reference source that outlines the more specific differences and interchangeability among Gen III-based engines.

LS1/LS6

LS1 5.7L (346-cu-in) engines were produced between the 1997 and 2004 model years in the United States (Corvette, Camaro, Firebird and GTO) and stretching into 2005 in other markets (primarily Australia). The LS6 was introduced in 2001 in the Corvette Z06 and was manufactured through 2005, where it also was found in the Cadillac CTS-V. The LS1 and LS6 share a 5.7L displacement, but the LS6 production engine uses a unique block casting with enhanced strength, greater bay-to-bay breathing capability and other minor differences. The heads, intake manifolds and camshaft also are unique LS6 parts.

LS2/L76/L77

In 2005, the LS2 6.0L (364 cu in) engine and the Gen IV design changes debuted. In GM performance vehicles, it was offered in the Corvette, GTO and even the heritage-styled SSR roadster. It was the standard engine in the Pontiac G8 GT (L76) and is now the V-8 offered in the Chevrolet Caprice Police Pursuit Vehicle (L77). This engine is one of the most adaptable in the LS family, as LS1, LS6, LS3 and L92/L94 cylinder heads work well on it.

LS3/L99

Introduced on the 2008 Corvette, the LS3 brought LS-based performance to an unprecedented level: 430 horsepower from 6.2L (376 cu in). The LS3 block not only had larger bores than the LS2, but a strengthened casting to support more powerful applications, including the LS9 supercharged engine of the Corvette ZR1. The LS3 was also the standard engine in the fifth-generation Camaro SS and was offered in the Pontiac G8 GXP. The L99 version was equipped with GM's fuel-saving Active Fuel Management cylinder deactivation system and was standard on fifth-gen Camaro SS models equipped with an automatic transmission. A unique version of the LS3 used in some Corvette Grand Sport applications incorporated a dry-sump oiling system.

LS4

Perhaps the most unique application of the LS engine in a car, the LS4 was a 5.3L version used in the front-wheel-drive Chevrolet Impala SS and Pontiac Grand Prix GXP. The LS4 had an aluminum block and unique, low-profile front-end accessory system, including a "flattened" water pump, to accommodate the transverse mounting position within the Impala and Grand Prix. It was rated at 303 horsepower and 323 lb.-ft. of torque.

LS7

A legend in its own time. The LS7 was the standard engine in the C6 Corvette Z06 and fifth-generation Camaro Z/28. Its 7.0L displacement (427 cubic inches) made it the largest LS engine offered in production vehicles. Unlike LS1/LS6, LS2 and LS3 engines, the LS7 uses a Siamese-bore cylinder block design, which was required for its big, 4.125-inch bores. Competition-proven heads and lightweight components, such as titanium rods and intake valves, made the LS7 a street-tuned racing engine, with 505 horsepower. Chevrolet Performance's crate engine reflects the Camaro Z/28 version, which features a unique Tri-Y exhaust manifold design.

LS9

The LS9 was the 6.2L supercharged and charge-cooled engine of the C6 Corvette ZR1, rated at 638 horsepower. The LS9 used a strengthened 6.2L block with stronger, Rotocast cylinder heads and a sixth-generation 2.3L Roots-type supercharger. Like the LS7, it used a dry-sump oiling system.

LSA

This supercharged 6.2L engine powered the 2009-15 Cadillac CTS-V series and the 2012-15 Camaro ZL1. Although similar to the LS9 in design, it was built with several differences, including hypereutectic pistons vs. the LS9's forged pistons; and a smaller, 1.9L supercharger. It also has an eight-bolt flywheel vs. the LS9's nine-bolt pattern. The LSA has a unique charge-cooler design on top of the supercharger – with differences between the Cadillac and Camaro ZL1 applications. It was rated at 556 horsepower in the CTS-V and 580 horsepower in the Camaro ZL1. Chevrolet Performance's crate engine reflects the Camaro ZL1 application.

GEN III & GEN IV VORTEC TRUCK ENGINES

Although performance car engines have typically carried "LS" designations, truck engines built on this platform have been dubbed Vortec. They are generally distinguished by iron cylinder blocks and smaller displacements than car engines. Interestingly, a 5.7L Vortec "LS" engine has never been offered. Here's a quick rundown of the previous and current-production LS truck engines:

- 4.8L – The smallest-displacement LS engine (293 cu in); it uses an iron block with 3.78-inch bores and aluminum heads.
- 5.3L – The most common LS truck engine, it uses the same iron block with 3.78-inch bores as the 4.8L, but with a larger, 3.62-inch stroke (327 cu. in.). Later versions equipped for Active Fuel Management and 2010-and-newer versions feature variable valve timing (cam phasing). Manufactured with iron and aluminum cylinder blocks.

Gen III, IV, Small-Block Crate Engines

Part Number	Description	Liters	CID	Block Material	HP	Torque	Bore	Stroke
19165628 (discontinued)	LS327/327	5.3	327	CI	327	347	3.780	3.622
17801267 (discontinued)	LS1	5.7	346	AL	350	365	3.898	3.622
19165484 (discontinued)	LS2	6.0	364	AL	400	400	4.000	3.622
17802134 (discontinued)	LS364/440	6.0	364	AL	440	404	4.000	3.622
12677741	L96	6.0	364	CI	360	380	4.000	3.622
19369333	LS376/480	6.2	376	AL	495	473	4.065	3.622
19369335	LS376/515	6.2	376	AL	533	477	4.065	3.622
19369338	LS376/525	6.2	376	AL	525	486	4.065	3.622
19369326	LS3	6.2	376	AL	430	425	4.065	3.622
19331507	LSA	6.2	376	AL	556	551	4.065	3.622
19260165	LS9	6.2	376	AL	638	604	4.065	3.622
19331563*	CT525	6.2	376	AL	533	477	4.065	3.622
19329246	LS7	7.0	427	AL	505	470	4.125	4.000
19332312	LSX376 B-8	6.2	376	CI	476	475	4.060	3.622
19355575	LSX376 B-15	6.2	376	CI	473	444	4.060	3.622
19355573	LSX454	7.4	454	CI	627	586	4.185	4.125
19260835	LSX454R	7.4	454	CI	776	649	4.185	4.125

*For circle-track racing only. Not for street use.

- 6.0L – Used primarily in ¾-ton and 1-ton trucks, the 6.0L (364 cu. in.) uses an iron block (LY6) or aluminum block (L76) and aluminum heads, with provisions for Active Fuel Management; some equipped with variable valve timing.
- 6.2L – Commonly referred to by its L92, L9H or L94 engine codes, the 6.2L (376 cu. in.) engine uses an aluminum block and heads, and incorporates advanced technology including variable valve timing. The L92 is used primarily as a high-performance engine for the Cadillac Escalade and GMC Yukon Denali.

MORE ABOUT THE VORTEC 5.3L

With more than 10 years in service in millions of Chevy and GMC trucks, vans and SUVs, the Vortec 5.3L engine is poised to become the classic 350 Small-Block of the LS engine family. With millions in service, they are readily available and affordable on the used-engine market. Most feature iron cylinder blocks, but some have an aluminum engine block that is about 80 pounds lighter. Adapting a 5.3L to a hot rod project is easier with Chevrolet Performance's 5.3L controller kit, part number 19256514, which is tailored to retro-fit installations by "turning off" some of the production features that are unnecessary for a vintage car, including the cylinder-deactivating Active Fuel Management. It covers 2007-2009 applications (non-cam-phased) with the following engine codes:

- LC9 (2007-2009) • LH8 (2008-2009) • LMG (2007-2009)
- LY5 (2007-2009) • LMF (2008-2009)

LSX CRATE ENGINES

Chevrolet Performance LSX series of crate engines is based on the LSX Bowtie Block and uses a number of production-based and LSX high-performance parts to deliver ultimate-performance engines that were never offered in production vehicles. They include:

- LSX376-B8 – An economical crate engine that uses the LSX block, LS3 rotating parts and the LS3 cylinder heads. It is offered without an oil pan or induction system, so that they can be tailored for the project vehicle.
- LSX376-B15 – Designed to accommodate additional power adders, or boost up to 15 PSI, includes forged pistons, forged crank and 6-bolt LSX-LS3 cylinder heads.
- LSX454 – The displacement of the classic big-block, with an all-forged rotating assembly and LSX-LS7 six-bolt cylinder heads. It is rated at 627 hp with a carburetor and 580 with an LS7 fuel injection system.
- LSX454R – A high-compression (13.1:1) version of the LSX454 designed for drag racing, featuring a mechanical roller cam, high rise intake and more. It is capable of more than 750 horsepower.

NON-PRODUCTION CYLINDER BLOCKS

C5R: Developed for the factory-backed Corvette racing program, the C5R cylinder block has been manufactured in comparatively small quantities since 2000. They are manufactured with a unique aluminum alloy for greater strength and undergo a variety of specialized machining and inspection processes, including "hipping" to increase strength and X-raying that ensures against unacceptable porosity. A Siamese bore design with 4.117-inch finished bores enables 7.0L (427-cu-in) displacements. The C5R uses billet steel main caps with premium, 4340 fasteners. Racing-quality head studs are also included. All LS series heads will work with the C5R block, but maximum performance depends on maximum airflow.

LSX Bowtie Block (standard and tall-deck): Introduced in 2007, the LSX Bowtie Block is a durable and affordable cast iron casting that was designed to support extreme high-performance combinations, including provisions for six-bolts-per-cylinder head fastening. It has a Siamese bore design with 3.880-inch bores that must be finished to 3.898-inches – with a 4.200-inch recommended maximum bore. Maximum stroke can reach 4.25-inches, but rotating assembly interference on the cylinder must be taken into account for strokes greater than 4.125-inches; heavy metal is required for crankshaft balancing of larger-stroke combinations. Standard versions feature decks 0.020-inch taller than LS production blocks, with the tall-deck version manufactured with a 9.720-inch semi-finished deck height. The oiling system is a true priority-main system and all LS Small-Block heads work with the engine. Higher-airflow heads, such as LS7, LSX-DR, LSX-CT and C5R, are recommended.

CRANKSHAFTS

Generally, LS crankshafts are similar in design, with identical 2.100-inch rod and 2.560-inch main journal sizes and a common rear main seal. All LS engines use iron crankshafts except the LS7, LS9, LSA and LSX454; they used forged steel cranks (4.00-inch stroke on the LS7; 3.62-inch stroke on the LS9 and LSA; and 4.125-inch on the LSX454).

The crankshaft sensing function of the distributorless ignition system depends on reading the toothed reluctor wheel on the crankshaft. Early LS engines mostly used 24-tooth wheels and upgraded a few years ago to 58-tooth (also known as 58x) wheels. When building an LS engine, it is imperative the correct reluctor wheel is used with the compatible crankshaft position sensor and ignition controller.

The crankshafts are mostly interchangeable, but the snouts on LS7 and LS9 crankshafts are approximately 1-inch longer to accommodate their two-stage oil pumps that work with the engines' dry-sump oiling systems – the same goes for certain Corvette applications of the LS3, which was available with a dry-sump system, as well. These forged crankshafts can be used on wet-sump engines by using a few specific components and/or modifications.

The LS Engine Family Tree continued on next page



LS/LT-SERIES CRATE ENGINES

The LS Engine Family Tree continued

SPECIAL NOTE ABOUT CRANKSHAFT BOLT PATTERNS

Almost all LS-engine crankshafts use a 6-bolt flywheel/flexplate bolt pattern, but the LS9 uses a 9-bolt pattern and the LSA, LT1, LT4 and LSX454 engines use an 8-bolt pattern.

CONNECTING RODS

LS connecting rods are very similar and interchangeable. Most are made of forged powdered metal, while the LS7 and LS9 rods are forged titanium – with the LS9 rods featuring a unique forging designed for the pressure and power level of forced induction. Rod lengths are similar, too, at 6.098-inch for 5.3L, 5.7L, 6.0L and 6.2L (including LSA) engines. The 4.8L engine uses 6.275-inch rods and the LS7 uses 6.067-inch rods. The LS9 uses 5.990-inch rods. Since 2006, LS rods use bushed small ends. Also, LS6 rod bolts, P/N 11600158, offer a strength-enhancing upgrade to pre-2000 engines.

PISTONS

The LS9 is the only production LS engine with forged aluminum pistons; all the others use hypereutectic (cast) aluminum alloy pistons – varied mostly by diameter to accommodate various bore sizes. LS cast pistons shouldn't be used on applications greater than approximately 550 horsepower. Also, the LS7 piston's inner bracing requires the use of the matching LS7 connecting rod.

GEN V SMALL BLOCK: ENTER THE 'LT' ENGINES

Introduced on the seventh-generation C7 Corvette Stingray and GM's full-size trucks and SUVs for 2014, the Gen V Small Block ushered in the next era of historic engine family.

Dubbed EcoTec3 in the new trucks – including a 4.3L V-6, 5.3L V-8 and 6.2L V-8 – and carrying historic "LT" designations in the Corvette, the Gen V engine family delivers greater efficiency, performance and durability, thanks to a combination of advanced technologies including direct injection, Active Fuel Management (cylinder deactivation) and camshaft phasing (variable valve timing) that support an advanced combustion system.

Structurally, the Gen-V small-block is similar to the Gen III/IV engines, including a deep-skirt cylinder block. Refinements and new or revised components are used throughout, including a revised cooling system and all-new cylinder heads. The engine is also designed to accommodate an engine-driven high-pressure fuel pump for the direct-injection system.

As builders adapt the LT1-or the supercharged LT4 variant-to their project cars, it's logical to ask about the differences between the LS family and the new LT engines and whether parts interchangeability is as easy – or even possible – as it was between the Gen III and Gen IV engines.

The short answer is no. Despite significant similarities in the basic architecture, there are a number of key differences between the new LT family and the LS family that prohibit simple interchangeability.

Here's a look at how the LT and LS families differ in those key areas, comparing the LT1 to the LS3 – with most of the LT1 features also matching the features on the supercharged LT4:

NOTE: While structurally similar, almost none of the parts and components from the Gen V are interchangeable with Gen III and Gen IV engines.

CYLINDER BLOCK AND OILING SYSTEM

Like every Small-Block generation before it, the Gen V cylinder block shares a 90-degree cylinder angle and 4.400-inch bore centers. The LT1's bore and stroke dimensions are: 4.06-inches x 3.62-inches – the same as the LS3. Compared to the Gen IV versions, the Gen V's aluminum cylinder block casting is all-new, but based on the same basic architecture. It was refined and modified to accommodate the mounting of the engine-driven fuel pump and vacuum pump. It also incorporates new engine mount attachments, new knock sensor locations, improved sealing and oil-spray piston cooling.

The oiling system is revised and features a new, dual-pressure-control and variable-displacement vane pump with increased flow capacity. As with the Gen-III/Gen-IV engines, the oil pump is driven by the crankshaft. Variable displacement enables the pump to efficiently deliver oil pump flow as demanded.

All Gen-V engines feature oil-spray piston cooling, in which oil-spraying jets in the engine block drench the underside of each piston and the surrounding cylinder wall with an extra layer of cooling, friction-reducing oil.

CAMSHAFT DESIGN AND CAMSHAFT PHASING

As with the LS3, the LT1 uses a hydraulic roller-lifter camshaft. It is also located in the same position relative to the crankshaft as the LS3, but importantly the LT1's camshaft features an all-new "trilobe" at the rear to drive the engine-mounted, high-pressure fuel pump for the direct-injection combustion system. There's no such extra lobe on the LS3 camshaft, which negates cam swaps between the engines.

For the record, the LT1 camshaft's specifications list include: 0.551/0.524-intake/exhaust lift, 200/207 degrees intake/exhaust duration at 0.050 tappet lift and a 116.5-degree lobe separation angle. The LS3's cams specs are: 0.511/0.525-inch lift, 204/211 degrees duration and a 117-degree lobe separation angle.

Camshaft phasing (variable valve timing), which works with Active Fuel Management to enhance fuel economy, optimizes engine performance for given demands and conditions. A vane-type phaser is installed on the front of the camshaft to change its angular orientation relative to the sprocket, thereby adjusting the timing of valve operation on the fly. It is a cam phasing system that adjusts camshaft timing at the same rate for both intake and exhaust valves. The system allows linear delivery of torque, with near-peak levels over a broad rpm range, and high specific output (horsepower per liter of displacement) without sacrificing overall engine response, or driveability. It also provides another effective tool for controlling exhaust emissions. The vane phaser is actuated by hydraulic pressure and flow from engine oil, and managed by a solenoid that controls oil flow to the phaser.

ROTATING ASSEMBLY AND WINDAGE TRAY

Within the LT1 block is a durable rotating assembly that includes a strong, 1538MV forged steel crankshaft and 6.125-inch-long, powder-metal connecting rods, as well as high-strength, hypereutectic pistons.

Most LS3 production engines have an admittedly tough nodular iron crankshaft that is known to support high horsepower levels, even under higher boost levels. The crankshafts in C6 Corvette models with the Z51 handling package included a dry-sump oiling system that necessitated a longer crank snout to accommodate the unique oil pump. Those cranks were forged steel.

If you order the production-based Chevrolet Performance LS3 crate engine – part number 19258770 – you'll get the standard oil pump and cast crankshaft.

The LT1's 6.125-inch connecting rod length is the same length as the LS3, but the profile of the rod itself is slightly different to enhance strength.

As for the piston design, the LS3 features conventional flat-top design, while the LT1 has a unique head topography that is essential to the direct injection system. The "bowl" and shape of the top of the piston head is designed to promote thorough mixing of the air and fuel – a dished center section helps direct the fuel spray from the injector, which protrudes into the combustion chamber rather than into the intake manifold on the LS3's conventional port injection design.

The crankshaft in the LT1 Small-Block is located with nodular main bearing caps, which is a significant upgrade over the LS3's conventional gray iron main caps. They're stronger and can better absorb vibrations and other harmonics to help produce smoother, quieter performance. They also maintain the optimal crankcase "windows" that were perfected on the LS3's Gen IV architecture.

A redesigned windage tray is also used with the LT1, which features a unique oil scraper designed to enhance performance and efficiency by improving oil flow control and bay-to-bay crankcase breathing.

CYLINDER HEAD DESIGN

The Gen V's all-new cylinder head design builds on the excellent, racing-proven airflow attributes of previous Small-Block heads and matches it with an all-new direct-injection combustion system. It supports tremendous airflow at higher rpm for a broad horsepower band, along with strong, low-rpm torque.

Compared to the LS3 cylinder head design, the LT1 head features a smaller, 59cc combustion chamber, which is designed to complement the volume of the piston dish. The smaller chamber size and dished pistons work together to produce an 11.5:1 compression ratio vs. the LS3's 10.7:1 compression ratio.

The spark plug angle and depth have been modified with the LT1 head, too, to protrude farther into the chamber, placing the electrode closer to the center of the combustion to support the direct injection system. In addition to the new combustion chamber design, the Gen V head features large, straight and rectangular intake ports that feature a slight twist to enhance mixture motion. This is complemented by a reversal of the intake and exhaust valve positions as compared to the Gen-Gen III/IV design. The exhaust port shapes are optimized for the new valve locations, with new port opening locations at the manifold face.

VALVES AND VALVETRAIN

Large, lightweight intake and exhaust valves are used in the LT1 heads, with 2.13-inch hollow intake and 1.59-inch hollow sodium exhaust valves. The lightweight valves enable the engine to rev quickly and capably to greater than 6,000 rpm. LS3 valves measure 2.165 inches intake and 1.59 inches exhaust.

The LT1's valves are held at new 12.5 degrees intake/12 degrees exhaust angles vs. the LS3's 15-degree angle. Additionally, the valves are splayed at 2.61 degrees intake/2.38 degrees exhaust to reduce shrouding and enable greater airflow.

Roller-pivot rocker arms are used in the LT1 and feature a 1.8 ratio vs. the 1.7 ratio of LS3 rockers. The LT1's reversed valve location also eliminates the offset design of the LS3's intake-side rocker arms. Also: the LT1 uses 8.7mm (outside diameter) pushrods that provide greater stiffness than the LS3's 7.9mm design. That enables improved high-speed valvetrain performance.

DIRECT INJECTION FUEL SYSTEM

Direct injection is featured on all Gen V engines. The technology moves the point where fuel feeds into an engine closer to the point where it ignites, enabling greater combustion efficiency. It fosters a more complete burn of the fuel in the air-fuel mixture, and it operates at a lower temperature than conventional port injection. That allows the mixture to be leaner (less fuel and more air), so less fuel is required to produce the equivalent horsepower of a conventional, port injection fuel system.

This represents one of the fundamental differences between the engines. The LT1 features direct injection, with injectors positioned in the cylinder heads, while the LS3 features a conventional port injection system, with injectors located in the intake manifold. That difference alone makes it impossible to simply swap heads and intakes between the LT and LS families.

The pistons play an integral role in the direct injection system, as they feature dished heads designed to direct the fuel spray for a more complete combustion. Design of this advanced combustion system was optimized after thousands of hours of computational analysis, representing one of the most comprehensively engineered combustion systems ever developed by General Motors.

The direct injection system features very high fuel pressure, up to 2,175 psi (15 MPa) on most engines and as high as 2,900 psi (20 MPa) on the supercharged LT4 variant, requiring a high-pressure, engine-driven fuel pump in addition to a conventional, fuel-tank-mounted pump. On all Gen V engines, the pump is mounted in the "valley" between cylinder heads – beneath the intake manifold. It is driven by the camshaft at the rear of the engine.

Gen V Small-Block Crate Engines

RPO Code	Displacement (cu/in/Liters)	Compression Ratio	Horsepower	Torque (lb.-ft.)
LV3	262 / 4.3	11.0:1	285 @ 5,300 rpm	305 @ 3,900 rpm
L83	325 / 5.3	11.0:1	355 @ 5,600 rpm	383 @ 4,100 rpm
L86	376 / 6.2	11.5:1	420 @ 5,600 rpm	460 @ 4,100 rpm
LT1	376 / 6.2	11.5:1	460 @ 6,000 rpm	465 @ 4,600 rpm
LT376/535	376 / 6.2	11.5:1	535 @ 6,300 rpm	470 @ 4,600 rpm
LT4	376 / 6.2	10.0:1	650 @ 6,400 rpm	650 @ 3,600 rpm

LT1-SPECIFIC FEATURES

In addition to the features that compare and contrast with the LS3, the new LT1 has a number of unique components that simply aren't shared with previous LS engines, including:

- PCV-integrated rocker covers designed to reduce oil consumption
- Cylinder deactivation that shuts down four cylinders in certain light-load driving conditions – and featuring unique, "collapsible" valve lifters for the deactivating cylinders
- Four-into-one short-header-type exhaust manifolds similar to the LS7 design, but made of cast iron
- Single-bore 87mm throttle body
- Revamped cooling system with a new, offset water pump design
- The use of electric power steering on production models means there's no provision for a conventional power steering pump on the accessory drive system.

In summary, the lineage between the LS3 and the LT1 is clear, but where the LS3 was an evolution of previous LS engines, the LT1 is more of new species. Therefore, mixing and matching parts between the LT and LS families isn't practical or, in most cases, feasible.

LV3 4.3L

The 4.3L V-6 is the smallest Gen V engine and is based on the V-8 versions, but with two fewer cylinders – a design lineage that dates back to the previous 4.3L V-6, which was itself a Gen-II Small-Block with a pair of cylinders removed. The bore and stroke dimensions are 3.92-inch (99.6 mm) bore x 3.62-inch (92 mm) stroke, for a displacement of 262 cubic inches. It is used in the Chevrolet Silverado 1500 and GMC Sierra 1500, where it is rated at 285 horsepower and 305 lb.-ft. of torque.

L83 5.3L

The L83 is the workhorse of GM's full-size trucks and SUVs, including the Chevrolet Silverado 1500, Tahoe and Suburban, as well as the GMC Sierra 1500 and Yukon lineups. It has a smaller bore – 3.78 inches (96 mm) – than other Gen V engines, but the same 3.62-inch (92 mm) stroke shared by all of them. It is rated at 355 hp and 383 lb.-ft. of torque.

L86 6.2L

The L86 6.2L is the largest, most powerful Gen 5 engine offered in GM's trucks and SUVs, delivering 420 hp and 460 lb.-ft. of torque. A forged steel crank is unique among the truck engines, along with its larger 4.06 (103.25 mm) bore diameter. This engine is available in the Silverado 1500 and Sierra 1500, and is standard in the GMC Yukon and Cadillac Escalade.

LT1 6.2L

It's the standard engine in the C7 Corvette Stingray and Camaro SS, where it is rated at up to 460 horsepower and 465 lb.-ft. of torque (with the optional exhaust system). It shares the same basic configuration and 4.065 x 3.622 bore/stroke dimensions as the L86, but features other unique components to generate its higher output.

LT4 6.2L SUPERCHARGED

The supercharged LT4 engine is the power behind the C7 Corvette Z06 and Camaro ZL1, delivering a stunning 650 hp and 650 lb.-ft. of torque. Each component of the rotating assembly, from the crankshaft to the piston rings, is unique to the LT4 to support the cylinder pressures the boosted engine is capable of generating, as well as the unique requirements for a lower compression ratio. The cylinder heads are unique, too, and it also uses a new, more compact and more efficient 1.7L Eaton TVS supercharger, which spins faster to make boost quicker.



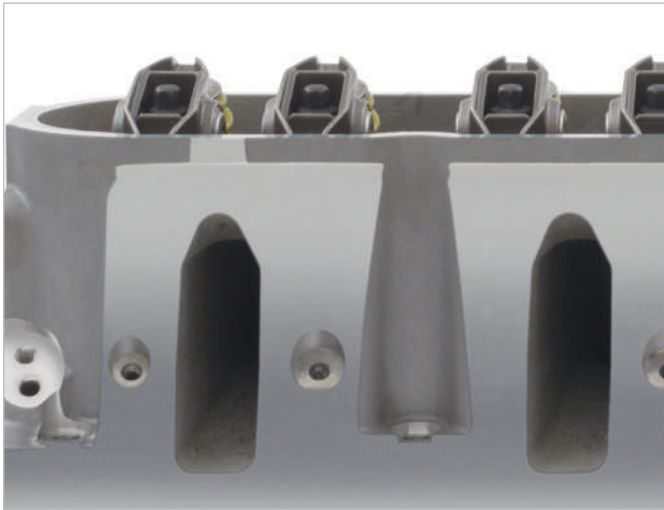

A Cathedral Intake Port and Bolt Pattern

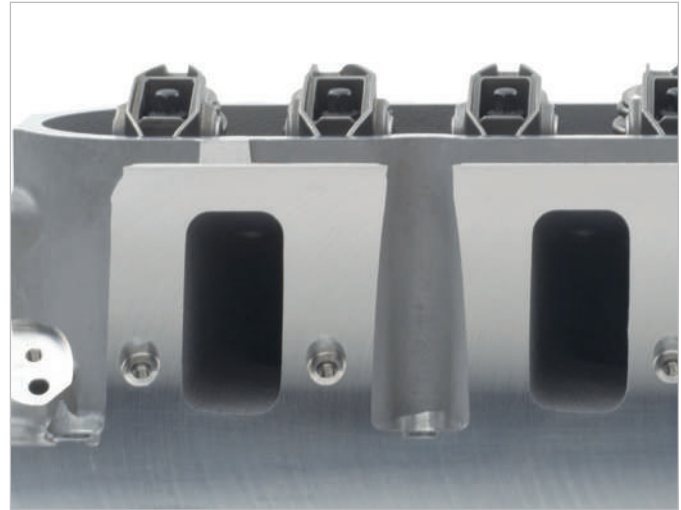

B LS3 Intake Port and Bolt Pattern

CYLINDER HEADS – INTAKE PORT DESIGN

Cylinder head interchangeability enables great parts mixing to build custom LS engine combinations, but the heads must be matched with intake manifolds that have compatible intake port configurations. The port sizes and shapes include:

Cathedral port

Introduced on the LS1 engine and used also on the LS6 and LS2, cathedral-port heads are named for the unique shape of the top of the intake port. Intake manifolds for LS1, LS2, LS6 and Vortec engines with cathedral-port heads are mostly interchangeable. (Photo A)

Rectangular port – LS7-style

The second LS intake runner design debuted on the Corvette Z06's LS7 engine. This rectangular design supports the straight-through airflow design of the heads. They feature 270cc intake ports and the ports and combustion chambers are CNC-ported from the factory. Use only with the LS7 intake manifold. The LSX-LS7 head features the same port design, but with six-bolt clamping vs. the production four-bolt pattern. (Photo C)

Rectangular port – L92/LS3 style

Similar to the LS7 design, but the ports are a little taller and a little narrower. They flow more than cathedral-port heads, but not as much

as LS7 heads. In addition to the L92 6.2L engines, this port shape is also used on LS3 engines and some 6.0L truck engines, as well as the Corvette ZR1's LS9 and Cadillac CTS-V's LSA supercharged engines. Intake manifold bolt patterns are unique to this port design. (Photo B)

C5R heads

These heads pioneered the rectangular-port design, but because they are designed for professional finishing, their final shape and size depends on whomever is performing the porting (not shown).

CYLINDER HEADS – VALVES AND RECOMMENDED APPLICATIONS

Each LS cylinder head has specific valve sizes, locations and valve angles. Here's an overview of them:

Cathedral-port heads

Designed for smaller-displacement engines, these heads have the smallest valves; 2.000-inch intake and 1.500-inch exhaust, and they're held at a 15-degree angle. They also have the closest valve spacing, which limits the maximum valve size. LS6 valves include lightweight hollow-stem intake and sodium-filled exhaust parts; all others in this family feature solid-stem construction. (Photo A)

LS Compatibility—Heads vs. Intakes

Engine	INTAKES			HEADS						
	Part Number	Manifold Type	Port Type	12559855 Std LS1	12564824 (discon.) Std LS6/LS2	12562319 Std LQ9	88958622 (discon.) CNC LS6	12629064 Std L76/L92	12629063 Std LS3	88958758 CNC LS3
LS1/LS6	88894339	EFI	Cathedral	Yes	Yes	Yes	Yes	No	No	No
LS2/LQ4	88958675	4-bbl	Cathedral	Yes	Yes	Yes	Yes	No	No	No
LS3	12638197	EFI	L92	No	No	No	No	Yes	Yes	Yes
L92/LS3	25534416	4-bbl w/inj	L92	No	No	No	No	Yes	Yes	Yes
L92/LS3	25534401	4-bbl	L92	No	No	No	No	Yes	Yes	Yes
L92/LS3	19244037	LSX 4-bbl	L92	No	No	No	No	Yes	Yes	Yes
L92/LS3	19244035	LSX 4-bbl	L92	No	No	No	No	Yes	Yes	Yes
LS7	12644568	EFI	LS7	No	No	No	No	No	No	No
LS7	25534413	4-bbl w/inj	LS7	No	No	No	No	No	No	No
LS7	25534394	4-bbl	LS7	No	No	No	No	No	No	No
LSX454	19244033	LSX 4-bbl	LS7	No	No	No	No	No	No	No
LSX-CT	19257854	LSX 4-bbl	LSX-CT	No	No	No	No	No	No	No
LSX454R	19257851	LSX 4-bbl	LSX-DR	No	No	No	No	No	No	No

No=not compatible Yes=direct compatibility



C LS7 Intake Port and Bolt Pattern



D LSX-CT and LSX-DR Ports

L92/LS3 heads

Similar in design to the LS7 head, the L92 heads don't flow quite as much and the valves are correspondingly smaller: 2.165-inch on the intake side and 1.590-inch on the exhaust side. They are held at a 15-degree angle and also require offset rocker arms. These heads/valves require at least a 4.00-inch bore, but work best on an engine with a 4.065-inch bore. Valve-to-piston clearance must be checked when using them on an engine originally equipped with cathedral-port heads. (Photo B)

LS7 heads

Using LS-Series' largest production valves – 2.200-inch on the intake side and 1.610-inch on the exhaust – the LS7 heads offer tremendous airflow, but they require an engine with no less than 4.100-inch bores. The intake valves are made of titanium and the exhaust valves are sodium-filled; they are held at a 12-degree angle. That and their large size require offset rocker arms on the intake side. Valve-to-piston clearance must be checked when using these heads with pistons not designed for the LS7 engine. (Photo C)

C5R

Designed for engines with at least 4.125-inch bores, these heads can accommodate 2.200-inch intake and 1.650-inch exhaust valves; they are held at an 11-degree angle and their spacing is unique. When using on an engine not originally designed for C5R pistons, valve-to-piston clearance must be checked. (not shown)

LSX-CT and LSX-DR

CT and DR are in-line heads, with a valve angle of 11 degrees. The CT head was designed specifically for 410 CID sprint car applications, with 2.200-inch intake and 1.610-inch exhaust valve sizes, with valve placement modified and optimized for 4.125-inch bores. DR heads were designed for 410-plus CID, high rpm drag racing applications. Valve placement was spread from the CT to allow up to 2.280-inch and 1.620-inch valves. Larger valve sizes require a 4.165-inch minimum bore. (Photo D)

LS Compatibility—Heads vs. Intakes (continued)

INTAKES				HEADS						
Engine	Part Number	Manifold Type	Port Type	19354245 LSX-L92 Small Bore	19354243 LSX-LS3	19354244 LSX-LS9	12578450 Std CNC LS7	19354239 LSX-LS7	19330896 LSX-CT	19330894 LSX-DR
LS1/LS6	88894339 (discon.)	EFI	Cathedral	No	No	No	No	No	No	No
LS2/LQ4	88958675	4-bbl	Cathedral	No	No	No	No	No	No	No
LS3	12674428	EFI	L92	Yes	Yes	Yes	No	No	No	No
L92/LS3	25534416	4-bbl w/inj	L92	Yes	Yes	Yes	No	No	No	No
L92/LS3	25534401	4-bbl	L92	Yes	Yes	Yes	No	No	No	No
L92/LS3	19244037	LSX 4-bbl	L92	Yes	Yes	Yes	No	No	No	No
L92/LS3	19244035	LSX 4-bbl	L92	Yes	Yes	Yes	No	No	No	No
LS7	12644568	EFI	LS7	No	No	No	Yes	Yes	No	No
LS7	25534413	4-bbl w/inj	LS7	No	No	No	Yes	Yes	No	No
LS7	25534394	4-bbl	LS7	No	No	No	Yes	Yes	No	No
LSX454	19244033	LSX 4-bbl	LS7	No	No	No	Yes	Yes	No	No
LSX-CT	19257854	LSX 4-bbl	LSX-CT	No	No	No	No	No	Yes	Yes
LSX454R	19257851	LSX 4-bbl	LSX-DR	No	No	No	No	No	Yes	Yes

No=not compatible Yes=direct compatibility



A LS6 Rockers

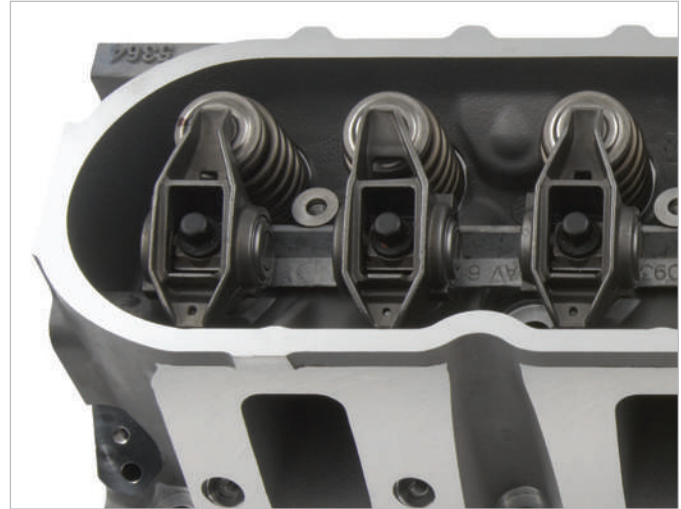

B L92 Rockers

VALVETRAIN

LS-Series valvetrain systems are very universal. All production engines use investment-cast rockers with roller trunnions. They attach to a bolt-down mounting bracket (except for LS7 and LSX applications that have machined pedestals) that makes installation fast and easy. All production engines feature 1.7-ratio rockers, except the LS7, which uses 1.8-ratio rockers. Rockers are specific to their cylinder head families. Here's a look at the various applications:

Cathedral-port heads

Use interchangeable rockers on the intake and exhaust sides P/N 10214664. (Photo A)

L92/LS3 heads

Use specific, offset intake rockers P/N 12569167 and non-offset exhaust rockers P/N 10214664. (Photo B)

LS7 heads

Use specific, offset intake rockers P/N 12579615 and non-offset exhaust rockers (P/N 12579617). (Photo C)

LSX-DR heads

LSX-DR heads require racing-style shaft mount rocker systems. Chevrolet Performance offers a 1.90:1-ratio rocker arm kit (P/N 19201808). (Photo D)

LS Compatibility—Heads vs. Blocks

BLOCKS			HEADS						
Engine	Part Number	Bore Size	12559855 (discon.) Std LS1	12564824 (discon.) Std LS6/LS2	12562319 Std LQ9	88958622 (discon.) CNC LS6	12629064 Std L76/L92	12629063 Std LS3	88958758 CNC LS3
LS1/LS6	12561166 (discon.)	3.890"	Yes	Yes	Yes	Yes	No	No	No
LS2/L76	12602691	4.000"	Yes	Yes	Yes	Yes	Yes	Yes	Yes
L92/LS3	12623967	4.065"	Yes	Yes	Yes	Yes	Yes	Yes	Yes
LSA	12673476	4.065"	Yes	Yes	Yes	Yes	Yes	Yes	Yes
LS9	12623969	4.065"	Yes	Yes	Yes	Yes	Yes	Yes	Yes
LS7	19213580	4.125"	Yes	Yes	Yes	Yes	Yes	Yes	Yes
C5R	12480030	4.120" - 4.160"	Yes	Yes	Yes	Yes	Yes	Yes	Yes
LSX Std. Deck ¹	19260093	3.890"	*	*	*	*	*	*	*
LSX Tall Deck ¹	19260100	3.890" - 4.200"	*	*	*	*	*	*	*
LSX376	19260095	4.085"	Yes	Yes	Yes	Yes	Yes	Yes	Yes
LSX454	19260099	4.185"	Yes	Yes	Yes	Yes	Yes	Yes	Yes

No=not compatible Yes=direct compatibility *4.00" minimum bore
¹LSX Semi-Finished - needs finish bore/hone and deck height machined

BUILDER'S TIP

ENSURING WINDAGE TRAY CLEARANCE ON LS ENGINES

When building a custom LS engine combination, care must be taken to make sure the connecting rods don't interfere with the windage tray. To do that, set the windage tray over the installed rotating assembly carefully and rotate the crankshaft. If any of the connecting rods touch the tray, you'll have to use a specially designed windage tray for longer-stroke cranks.



C LS7 Rockers

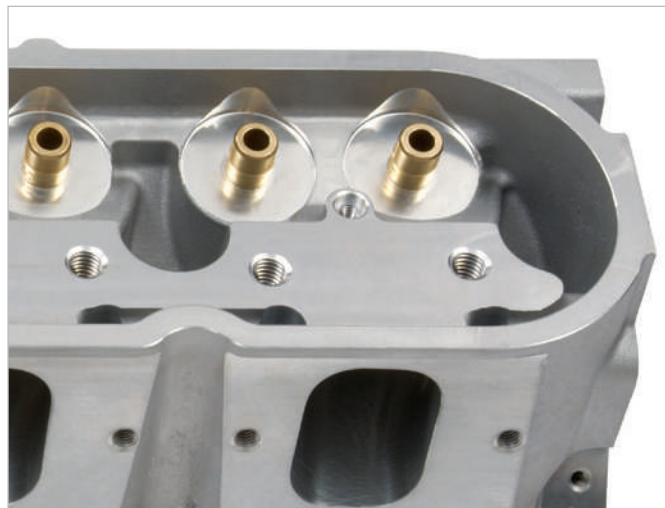

D LSX-DR Rocker Stand Pads

HEAD-TO-BLOCK COMPATIBILITY

Because of their comparatively small bores – 3.89 inches – LS1 and LS6 engines can only use LS1, LS6 and LS2 heads. Using heads designed for larger engines will cause valve-to-block interference. The larger, 4.00-inch bore of the LS2 enables it to use LS1/LS6 heads, as well as L92-style heads (including LS3, LS9 and LSA engines). The 6.2L engines (LS3, L92, etc.) can use any head, except for the LS7 and C5R, while the 7.0L LS7 and C5R blocks can use any LS-series head. LS7 blocks should be matched with heads designed for at least 4.10-inch bores; and 4.125-inch bores are preferred.

Most LS production cylinder blocks share the same cylinder head bolt pattern and the same size head bolts – four 11mm bolts per cylinder (20 in total) and five upper, 8mm bolts. Early LS1 and LS6 engines used different-length 11mm bolts, but engines from 2004 and later use same-length bolts. LS9 engines use stronger, 12mm head bolts.

Non-production blocks, such as Chevrolet Performance's LSX block and the C5R, offer the same head-bolt pattern as production blocks. All LS heads will bolt up to them, but care must be taken to select the most compatible heads based on the appropriate bore size. Because of their large bores, heads designed for at least 4.10-inch bores should be used and 4.125-inch bores are preferred, such as the L92/LS3 or LS7 heads.

Chevrolet Performance's LSX cylinder heads use 10 11mm and 13 8mm head bolts, or eight more than a regular-production LS head. That's more than 50 percent more head bolts than production heads, supplying superior clamping strength.

All cylinder heads used with the LSX tall-deck block require the appropriate intake manifold designed for tall-deck applications because the higher deck of the block widens the dimension between the heads' manifold-mounting positions.

LS Compatibility—Heads vs. Blocks (continued)

BLOCKS			HEADS						
Engine	Part Number	Bore Size	19354245 LSX-L92	19354243 LSX-LS3	19354244 LSX-LS9	12578450 Std CNC LS7	19354239 LSX-LS7	19330896 LSX-CT	19330894 LSX-DR
LS1/LS6	12561166 (discon.)	3.890"	Yes	No	No	No	No	No	No
LS2/L76	12602691	4.000"	Yes	Yes	Yes	No	No	No	No
L92/LS3	12623967	4.065"	Yes	Yes	Yes	No	No	No	No
LSA	12623968	4.065"	Yes	Yes	Yes	No	No	No	No
LS9	12621983	4.065"	Yes	Yes	Yes	No	No	No	No
LS7	19213580	4.125"	Yes	Yes	Yes	Yes	Yes	Yes	Yes
C5R	12480030	4.120" - 4.160"	Yes	Yes	Yes	Yes	Yes	Yes	Yes
LSX Std. Deck ¹	19260093	3.890"	**	**	**	**	**	**	**
LSX Tall Deck ¹	19260100	3.890" - 4.200"	**	**	**	**	**	**	**
LSX376	19260095	4.085"	Yes	Yes	Yes	No	No	No	No
LSX454	19260099	4.185"	Yes	Yes	Yes	Yes	Yes	Yes	Yes

No=not compatible Yes=direct compatibility *4.00" minimum bore **4.125" minimum bore
¹LSX Semi-Finished - needs finish bore/hone and deck height machined



BUILDER'S TIP

PRIMING THE LS ENGINE

If you're used to building classic Small-Block and Big-Block engines, you've probably used an electric drill or similar tool in the distributor hole to drive the oil pump and prime the engine prior to start-up. LS engines don't use distributors, so engine priming must be performed in other ways. First of all, fill the oil pump pickup with oil when assembling the engine. That will ensure a quantity of oil is in the pump when the engine is started for the first time. Also, disconnect either the fuel supply or ignition system when it's time to start the engine and allow the engine to "roll over" for approximately 30 seconds. That allows oil to circulate through the engine without the engine running. Removing spark plugs will allow the engine to prime faster with less load on the bearings. Then, reconnect the fuel or ignition and fire up your LS engine!

L96

12677741



360 hp

@ 5,400 rpm

380 lb.-ft.

@ 4,200 rpm

DYNO CHART

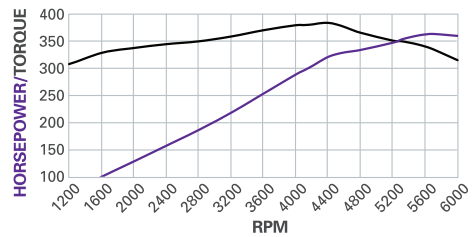

HEAVY-DUTY LS POWER FOR YOUR TRUCK!

Chevrolet Performance’s L96 6.0L crate engine is based on the same work-ready powerhouse offered in Silverado HD trucks – and it’s ready to go to work for you in a late-model truck or project vehicle that needs a fresh engine or a dual-purpose vintage truck built for work and fun.

Thanks to the advantage of its high-flow cylinder heads and other technologies, the L96 offers more than 50-percent more horsepower than the 454 Big-Block offered in Chevy trucks from the 1970s through the early 1990s. It delivers more torque, too, than most production 454 engines, while cranking it out in a lighter, more compact package.

Chevrolet Performance’s inclusive crate engine kit includes the engine assembly with a production high torque intake manifold, throttle body assembly, ignition coils, water pump, balancer and more. You’ll need to add a front-end accessory drive system and an engine controller, but we’ve got that covered, too.

Use accessory drive kit P/N 19369108 for applications without air conditioning and air conditioning add-on kit P/N 19260892 with AC. You’ll also want engine controller kit P/N 19356410 to get it all running. See page 280 for more details on the accessory drive kits and page 296 for more information on the controller kit.

The L96 offers classic Big-Block grunt with all the modern advantages of an LS engine. Talk about the best of both worlds!

NOTE: Refer to page 83 for the complete horsepower and torque testing procedures.

ENGINE TECH SPECS

Part Number:	12677741
Engine Type :	Gen IV Small-Block V-8
Displacement (cu in):	364 cu in (6.0L)
Bore x Stroke (in):	4.000 x 3.622 (101.6 x 92mm)
Block (P/N 12609999):	Cast iron with 6-bolt, cross-bolted main caps
Crankshaft (P/N 12588613):	Nodular iron
Connecting Rods (P/N 12649190):	Powdered metal
Pistons (P/N 12589804):	Hypereutectic aluminum (with polymer coating) with floating wrist pins
Camshaft Type (P/N 12626660):	Hydraulic roller
Valve Lift (in):	0.476" intake / 0.476" exhaust
Camshaft Duration (@.050 in):	193° intake / 200° exhaust
Cylinder Heads (P/N 12629062):	Aluminum
Valve Size (in):	2.000 intake / 1.550 exhaust
Compression Ratio:	9.6:1
Rocker Arms (P/N 12669995 int):	Investment cast, roller trunnion
Rocker Arms (P/N 12681275 exh):	Investment cast, roller trunnion
Rocker Arm Ratio:	1.7:1
Recommended fuel:	Regular unleaded
Maximum Recommended rpm:	6,000
Reluctor Wheel:	58X
Balanced:	Internal

INSTALLATION NOTES

- Assembly does not include electronics
- Includes electronic throttle body
- Use L96 engine controller, P/N 19356410 for engine operation. Includes electronic throttle pedal required for throttle input to the ECU
- Not intended for marine use

NEW

LS/LT-SERIES CRATE ENGINES

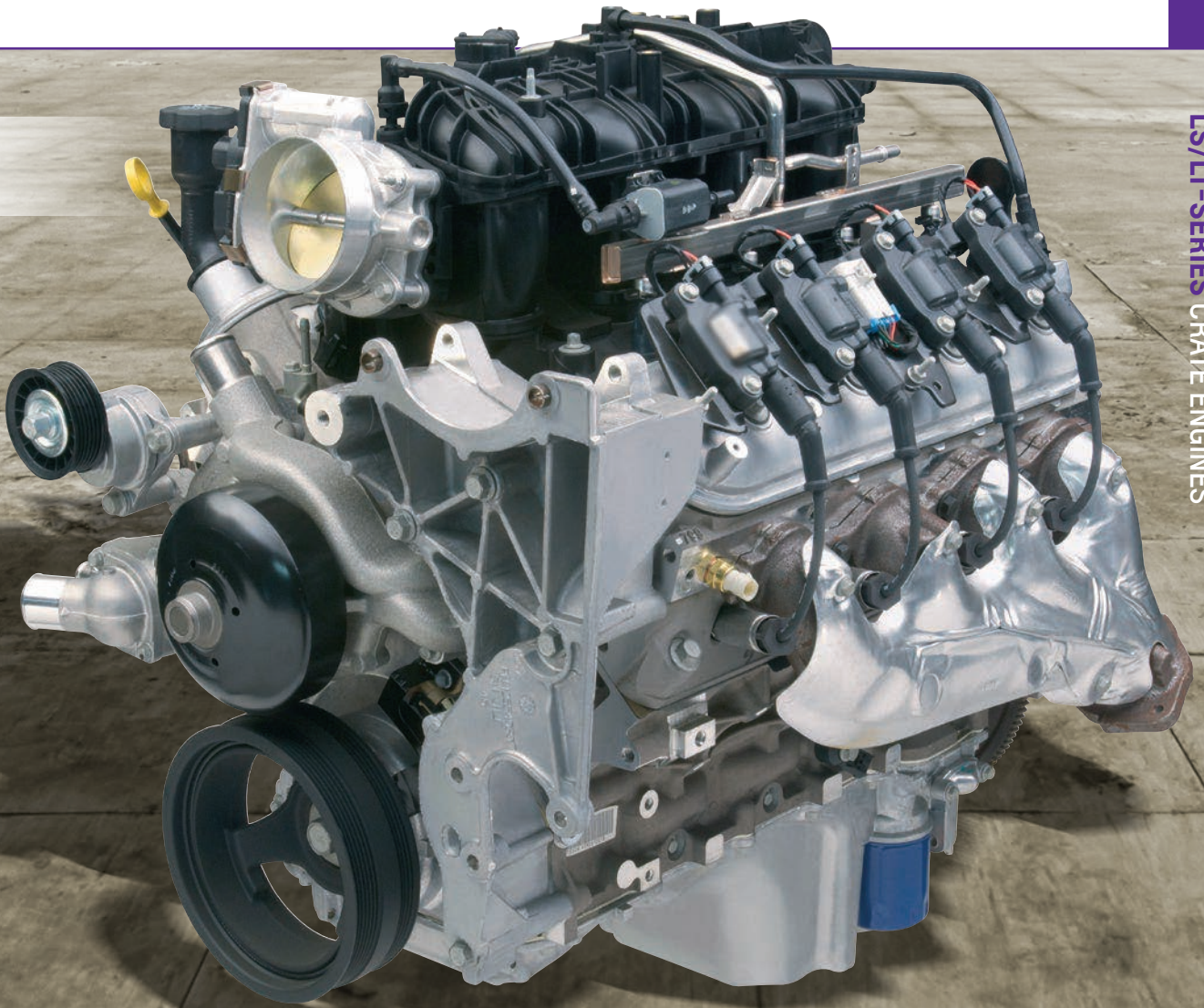

19368611
SuperMatic™ 4L65-E Four-Speed Automatic Transmission (remanufactured)

A durable, easy-cruising four-speed overdrive automatic transmission; electronically controlled for more precise, fuel-saving performance.

See page 366 for torque converter applications.



19302406
Transmission Controller

Required when using a GM electronically controlled automatic transmission. Includes wiring harness.

See page 371 for details.

AVAILABLE ENGINE-RELATED PARTS & ACCESSORIES

See page 250 for our complete line of LS-Series components



19356410
L96 Controller Kit

Page 297



19352208
T56 Super Magnum Six-Speed Manual Transmission

Page 372



19329620
LS/LT Bell Housing

Page 372



19299802
SuperMatic™ Torque Converter

Page 366



LS3

19301326

430 hp
@ 5,900 rpm

425 lb.-ft.
@ 4,600 rpm

DYNO CHART

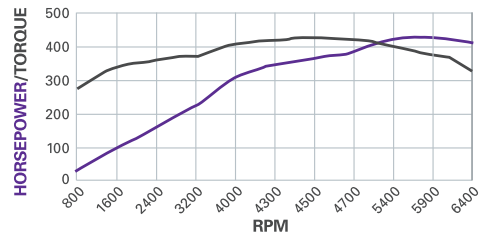

A NEW CLASSIC!

As the standard engine in the fifth-generation Camaro SS and C6 Corvette, the high-revving, deep-breathing LS3 6.2L is poised to go down in history as one of Chevrolet’s best and most versatile engines. It’s no surprise that enthusiasts and builders have made it one of the most popular LS swap engines.

The LS3 is filled with components designed for high performance and longevity. The aluminum block is filled with a sturdy reciprocating assembly that combines with L92-type rectangular-port heads to deliver a 10.7:1 compression ratio. A high-lift, hydraulic roller camshaft complements the LS3’s tremendous airflow capability and enhances its broad torque curve. Out-of-the-crate Horsepower is 430, with an impressive 425 lb.-ft. torque.

Our LS3 crate engine comes complete from the SS-specific oil pan to the ignition system. It also includes the intake manifold assembly with injectors and throttle body, exhaust manifolds, water pump, balancer, 58x reluctor wheel and 14-inch automatic-transmission flexplate. The SS oil pan doesn’t suit all applications. Use the vehicle-specific oil pan for original LS-powered vehicles or Chevrolet Performance’s Muscle Car Oil Pan Kit P/N 19212593 for older vehicles.

NOTE: Refer to page 83 for the complete horsepower and torque testing procedures.

TECH SPECS

Part Number:	19301326
Engine Type:	LS-Series Gen IV Small-Block V-8
Displacement (cu in):	376 cu in (6.2L)
Bore x Stroke (in):	4.065 x 3.622 (103.25 x 92mm)
Block (P/N 12623967):	Cast-aluminum with 6-bolt, cross-bolted main caps
Crankshaft (P/N 12685659):	Nodular iron
Connecting Rods (P/N 12649190):	Powdered metal
Pistons (P/N 19207287):	Hypereutectic aluminum
Camshaft Type (P/N 12623063):	Hydraulic roller
Valve Lift (in):	.551 intake / .522 exhaust
Camshaft Duration (@.050 in):	204° intake / 211° exhaust
Cylinder Heads (P/N 12629063):	Aluminum L92-style port; as cast with 68cc chambers
Valve Size (in):	2.165 intake / 1.590 exhaust
Compression Ratio:	10.7:1
Rocker Arms (P/N 12669995 int):	Investment-cast, roller trunnion
Rocker Arms (P/N 12681275 exh):	Investment-cast, roller trunnion
Rocker Arm Ratio:	1.7:1
Recommended Fuel:	Premium pump
Maximum Recommended rpm:	6,600
Reluctor Wheel:	58x
Balanced:	Internal

INSTALLATION NOTES

- Assembly does not include any electronics
- Use LS3 Controller Kit, P/N 19344328 for engine operation. Kit includes electronic throttle pedal, which is required for throttle input to the ECU (see page 297)
- Includes Chevy SS wet sump oil pan
- Not intended for marine applications
- Front-End Accessory Drive Kits are available in several configurations (see page 280 for application)



Also available as an
E-ROD system
See page 238 for details



19368611
SuperMatic™ 4L65-E Four-Speed Automatic Transmission (remanufactured)

A durable, easy-cruising four-speed overdrive automatic transmission; electronically controlled for more precise, fuel-saving performance.

See page 366 for torque converter applications.



19302405
Transmission Controller

Required when using a GM electronically controlled automatic transmission. Includes wiring harness.

See page 371 for details.

AVAILABLE ENGINE-RELATED PARTS & ACCESSORIES

See page 250 for our complete line of LS-Series components



19354328
LS3 Controller Kit

Page 297



19352208
T56 Super Magnum Six-Speed Manual Transmission

Page 372



19329620
LS/LT Bell Housing

Page 372



19299802
SuperMatic™ Torque Converter

Page 366



19155067
Corvette Accessory Drive Kit

Page 281



19301246
Air Inlet Kit for LS-Based Crate Engine Installation

Page 291

LS376/480

19369333



495 hp

@ 6,200 rpm

473 lb.-ft.

@ 5,000 rpm

DYNO CHART

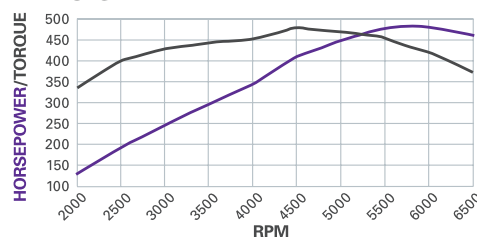

THE HOT CAM ADDS HEAT TO THE LS3

Our engineers took a production LS3 6.2L (376 cubic inches) and swapped the stock camshaft for the racing-inspired LS Hot Cam (P/N 88958753), which delivered a stunning 495 horsepower and 473 lb.-ft. of torque. That's nearly 14 percent more power and torque from a simple camshaft change!

We wasted no time in adding that terrific combination – dubbed LS376/480 – to our crate engine portfolio. The key to the power boost is the Hot Cam's 0.525-inch lift on both the intake and exhaust sides, along with 219-degree/228-degree duration specs. That's less lift on the intake side than the stock LS3 cam, but considerably more duration, allowing the valves to stay open longer to draw in more air from the rectangular-port L92-style heads.

The crate engine package includes the intake manifold, throttle body and fuel rail, along with the ignition system and exhaust manifolds. Use it with the LS376/480 controller kit P/N 19354330, which includes a special pedal for use with the engine's electronically controlled throttle.

NOTE: Refer to page 83 for the complete horsepower and torque testing procedures.

TECH SPECS

Part Number:	19369333
Engine Type:	LS-Series Gen IV Small-Block V-8
Displacement (cu in):	376 cu in (6.2L)
Bore x Stroke (in):	4.065 x 3.622 (103.25 x 92mm)
Block (P/N 12623967):	Cast-aluminum with 6-bolt, cross-bolted main caps
Crankshaft (P/N 12685659):	Nodular iron
Connecting Rods (P/N 12649190):	Powdered metal
Pistons (P/N 19207287):	Hypereutectic aluminum
Camshaft Type (P/N 88958753):	Hydraulic roller
Valve Lift (in):	.525 intake / .525 exhaust
Camshaft Duration (@.050 in):	219° intake / 228° exhaust
Cylinder Heads (P/N 12629063):	Aluminum L92-style port; as cast with 68cc chambers
Valve Size (in):	2.165 intake/ 1.590 exhaust
Compression Ratio:	10.7:1
Rocker Arms (P/N 12669995 int):	Investment-cast, roller trunnion
Rocker Arms (P/N 12681275 exh):	Investment-cast, roller trunnion
Rocker Arm Ratio:	1.7:1
Recommended Fuel:	Premium pump
Maximum Recommended rpm:	6,600
Reluctor Wheel:	58x
Balanced:	Internal

INSTALLATION NOTES

- Assembly does not include any electronics
- Use LS376/480 Controller Kit, P/N 19354330 for engine operation. Kit includes electronic throttle pedal, which is required for throttle input to the ECU (see page 297)
- Includes Chevy SS wet sump oil pan
- Not intended for marine applications
- Front-End Accessory Drive Kits are available in two configurations (see page 280 for application)

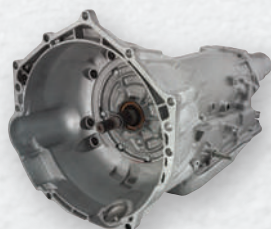
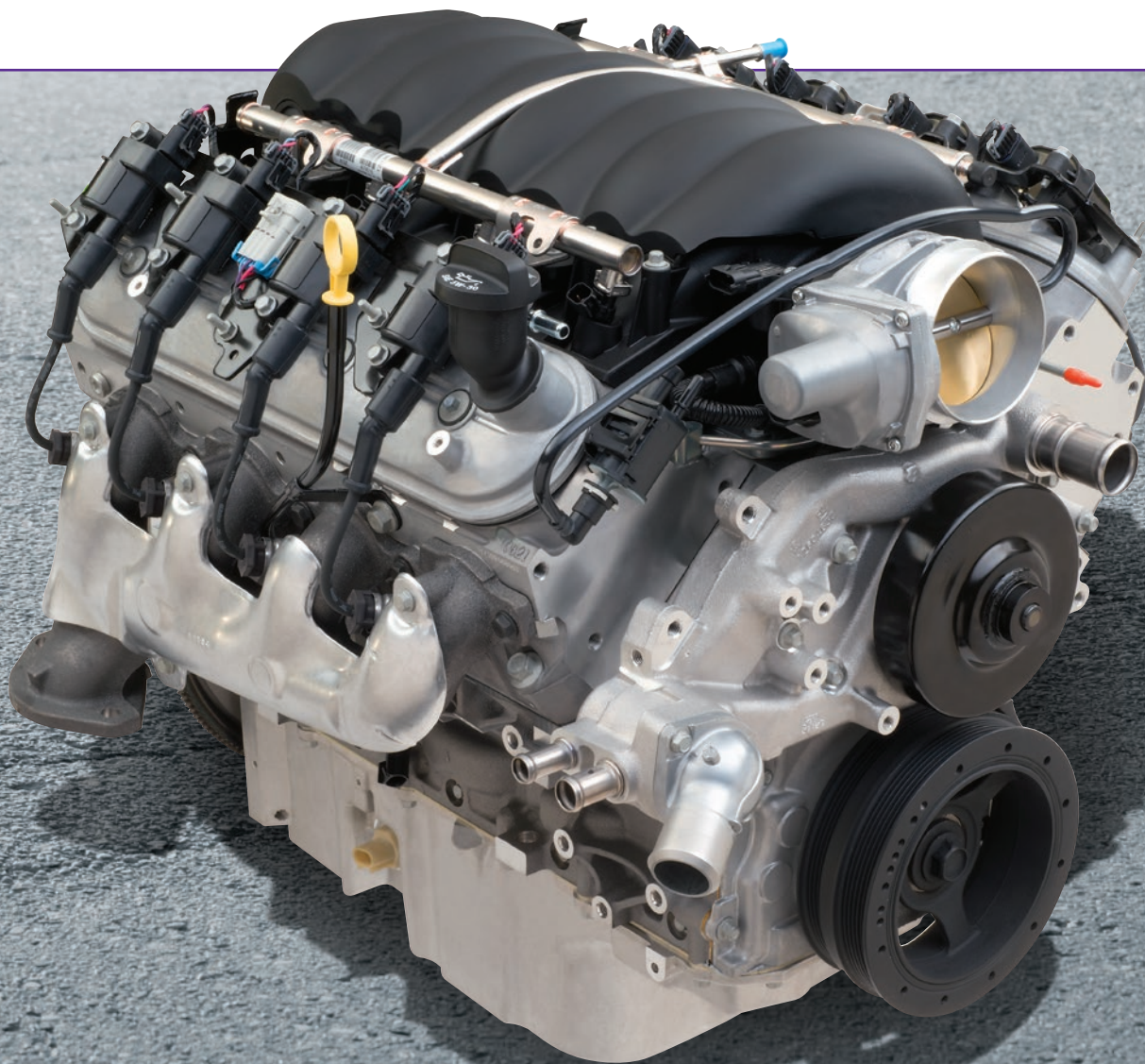

19368613
SuperMatic™ 4L70-E Four-Speed Automatic Transmission (remanufactured)

A durable, easy-cruising four-speed overdrive automatic transmission; electronically controlled for more precise, fuel-saving performance.

See page 366 for torque converter applications.



19302405
Transmission Controller

Required when using a GM electronically controlled automatic transmission. Includes wiring harness.

See page 371 for details.

AVAILABLE ENGINE-RELATED PARTS & ACCESSORIES

See page 250 for our complete line of LS-Series components



19354330
LS376/480 Controller Kit
 Page 297



19352208
T56 Super Magnum Six-Speed Manual Transmission
 Page 372

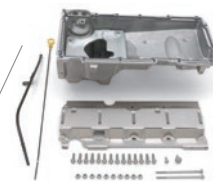

19212593
Muscle Car Oil Pan Kit
 Page 289



19299803
SuperMatic™ Torque Converter
 Page 366



19155067
Corvette Accessory Drive Kit
 Page 281



19301246
Air Inlet Kit for LS-Based Crate Engine Installation
 Page 291

LS376/515

19369335



533 hp
@ 6,600 rpm

477 lb.-ft.
@ 5,200 rpm

DYNO CHART

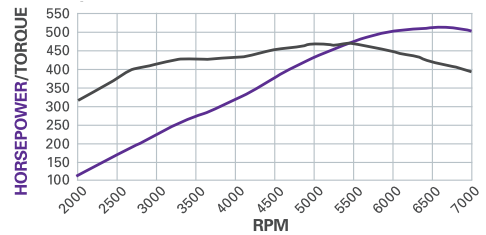

BIG POWER FOR LATE-MODEL VEHICLES

Using the LS3 engine as its foundation, the LS376/515 crate engine adds Chevrolet Performance’s racing-derived ASA Hot Cam and a carbureted intake system to produce 533 horsepower at a high-revving 6,600 rpm and 477 lb.-ft. of torque at 5,200 rpm. It’s a great engine for resto-mod classic and late-model muscle cars.

The assembly includes an SS oil pan and LS3 cylinder heads, with high-flow, rectangular-port intake passages, as well as our unique, spider-type carburetor intake manifold. At the heart of the engine is the ASA Hot Cam, which extends the performance range of the LS3 with more duration. That means it holds open the valves longer, enabling greater airflow at higher rpm. Wind it out yourself and you’ll see what we mean!

You’ll need our LS/LSX Ignition Controller P/N 19171130 and Holley 770-cfm Carburetor P/N 19170093 to get the engine running. And if you’re installing it in an older vehicle, use our Muscle Car Oil Pan kit P/N 19212593.

NOTE: Refer to page 83 for the complete horsepower and torque testing procedures.

TECH SPECS

Part Number:	19369335
Engine Type:	LS-Series Gen IV Small-Block V-8
Displacement (cu in):	376 cu in (6.2L)
Bore x Stroke (in):	4.065 x 3.622 (103.25 x 92mm)
Block (P/N 12623967):	Cast-aluminum with 6-bolt, cross-bolted main caps
Crankshaft (P/N 12685659):	Nodular iron
Connecting Rods (P/N 12649190):	Powdered metal
Pistons (P/N 19207287):	Hypereutectic aluminum
Camshaft Type (P/N 88958770):	Hydraulic roller
Valve Lift (in):	.525 intake / .525 exhaust
Camshaft Duration (@.050 in):	226° intake / 236° exhaust
Cylinder Heads (P/N 12629063):	Aluminum L92-style port; as cast with 68cc chambers
Valve Size (in):	2.165 intake / 1.590 exhaust
Compression Ratio:	10.7:1
Rocker Arms (P/N 12669995 int):	Investment-cast, roller trunnion
Rocker Arms (P/N 12681275 exh):	Investment-cast, roller trunnion
Rocker Arm Ratio:	1.7:1
Recommended Fuel:	Premium pump
Maximum Recommended rpm:	6,600
Reluctor Wheel:	58x
Balanced:	Internal

INSTALLATION NOTES

- Assembly does not include any electronics
- Use LS/LSX Ignition Controller P/N 19355418 (includes harness) (see page 297)
- Includes Chevy SS wet sump oil pan
- Not intended for marine applications
- 770-cfm carb P/N 19170093 recommended for daily street use
- Front-End Accessory Drive Kits are available in two configurations (see page 280 for application)

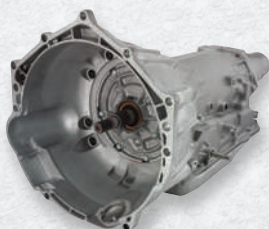
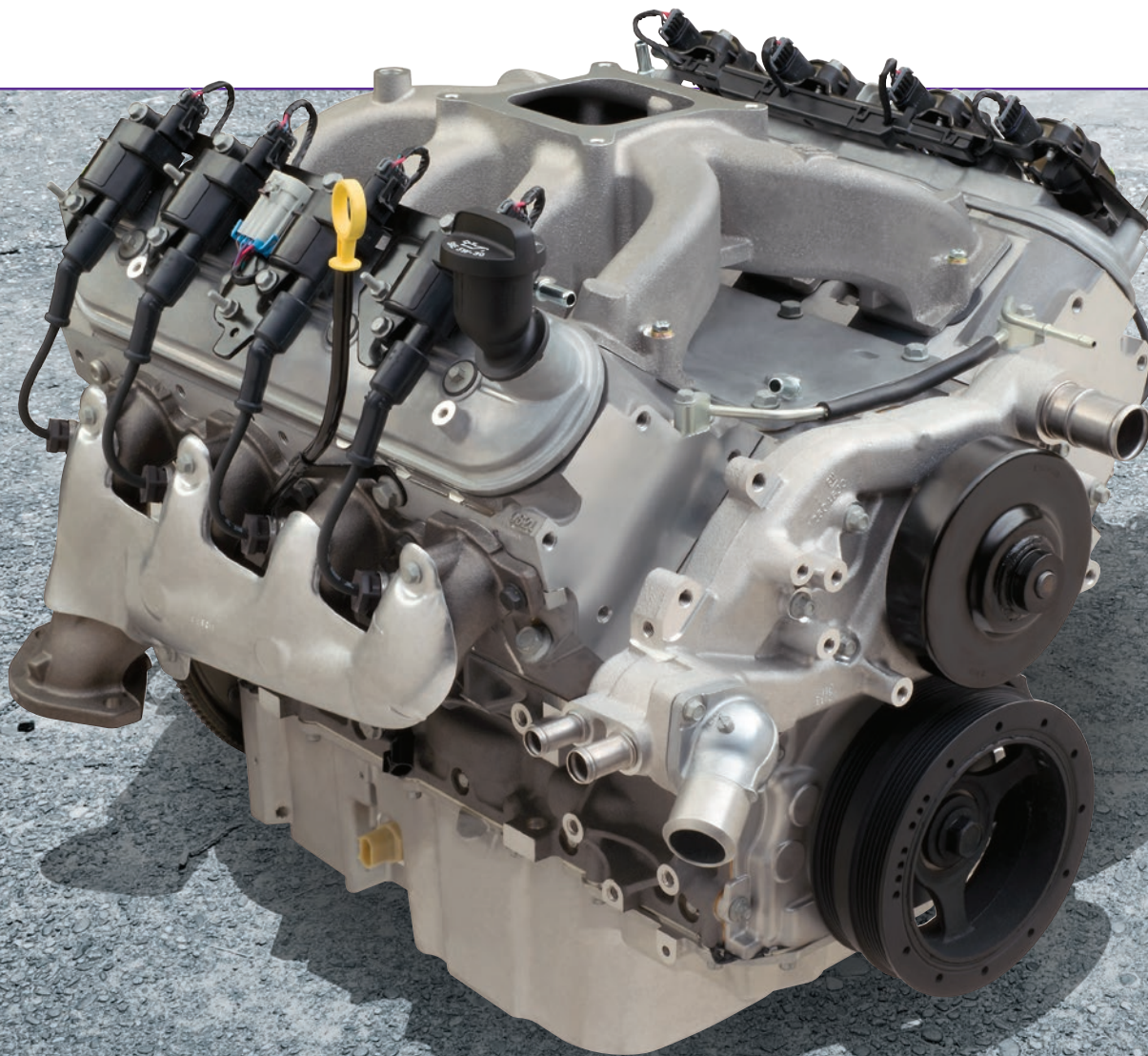

19368613
SuperMatic™ 4L70-E Four-Speed Automatic Transmission (remanufactured)

A durable, easy-cruising four-speed overdrive automatic transmission; electronically controlled for more precise, fuel-saving performance.

See page 366 for torque converter applications.



19332775
Transmission Controller

Required when using a GM electronically controlled automatic transmission. Includes wiring harness.

See page 371 for details.

AVAILABLE ENGINE-RELATED PARTS & ACCESSORIES

See page 250 for our complete line of LS-Series components



19170093
Carburetor, Holley 770-cfm

Page 295



19355418
LS/LSX Ignition Controller

Page 298



19212593
Muscle Car Oil Pan Kit

Page 289



19299803
SuperMatic™ Torque Converter

Page 366



19155067
Corvette Accessory Drive Kit

Page 281



19301246
Air Inlet Kit for LS-Based Crate Engine Installation

Page 291

LS376/525

19369338



525 hp
@ 6,200 rpm

486 lb.-ft.
@ 5,200 rpm

DYNO CHART

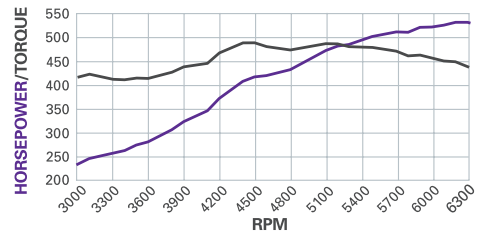

OUR MOST POWERFUL NATURALLY ASPIRATED 6.2L!

With Chevrolet Performance’s aggressive ASA camshaft – developed for the high-rpm world of circle-track racing – installed in the LS3 6.2L engine, it comes alive with 525 uncompromising horsepower. That makes it the most powerful naturally aspirated 6.2L street engine in our portfolio – and one that has an edge to it. You’ll notice it in the idle quality and you’ll feel it when the revs quickly climb.

The ASA camshaft is a hydraulic roller with .525-inch lift on both sides, along with 226 degrees duration on the intake side and 236 degrees on the exhaust side. Coupled with a tight, 110-degree lobe separation angle, it helps the engine deliver excellent throttle response and breathe exceptionally well at high rpm. And for durability, we complement the cam with higher-rate valve springs.

You’ll need tuning to make the most of the engine in a late-model GM vehicle. If you plan to use the engine in a vintage car, you’ll need controller kit P/N 19354332, which includes the throttle pedal to match its electronically controlled throttle body.

NOTE: Refer to page 83 for the complete horsepower and torque testing procedures.

TECH SPECS

Part Number:	19369338
Engine Type:	LS-Series Gen IV Small-Block V-8
Displacement (cu in):	376 cu in (6.2L)
Bore x Stroke (in):	4.065 x 3.622 (103.25 x 92mm)
Block (P/N 12623967):	Cast aluminum with 6-bolt, cross-bolted main caps
Crankshaft (P/N 12685659):	Nodular iron
Connecting Rods (P/N 12607475):	Powdered metal
Pistons (P/N 19207287):	Hypereutectic aluminum
Camshaft Type (P/N 88958770):	Hydraulic roller
Valve Lift (in):	.525 intake / .525 exhaust
Camshaft Duration (@.050 in):	226° intake / 236° exhaust
Cylinder Heads (P/N 12629063):	Aluminum L92-style port; as cast with 68cc chambers
Valve Size (in):	2.165 intake / 1.590 exhaust
Compression ratio:	10.7:1
Rocker Arms (P/N 12669995 int):	Investment cast, roll trunnion
Rocker Arms (P/N 12681275 exh):	Investment cast, roll trunnion
Rocker Arm Ratio:	1.7:1
Recommended Fuel:	Premium pump
Maximum Recommended rpm:	6,600
Reluctor Wheel:	58x
Balanced:	Internal

INSTALLATION NOTES

- Assembly does not include any electronics
- Use LS376/525 Engine Controller Kit for engine operation, P/N 19354332 (see page 297)
- Includes Chevy SS wet sump oil pan
- Not intended for marine applications
- Front-End Accessory Drive Kits are available in several configurations (see page 280 for application)

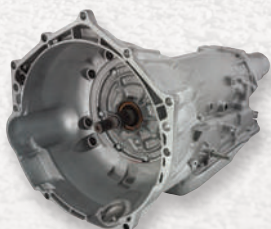
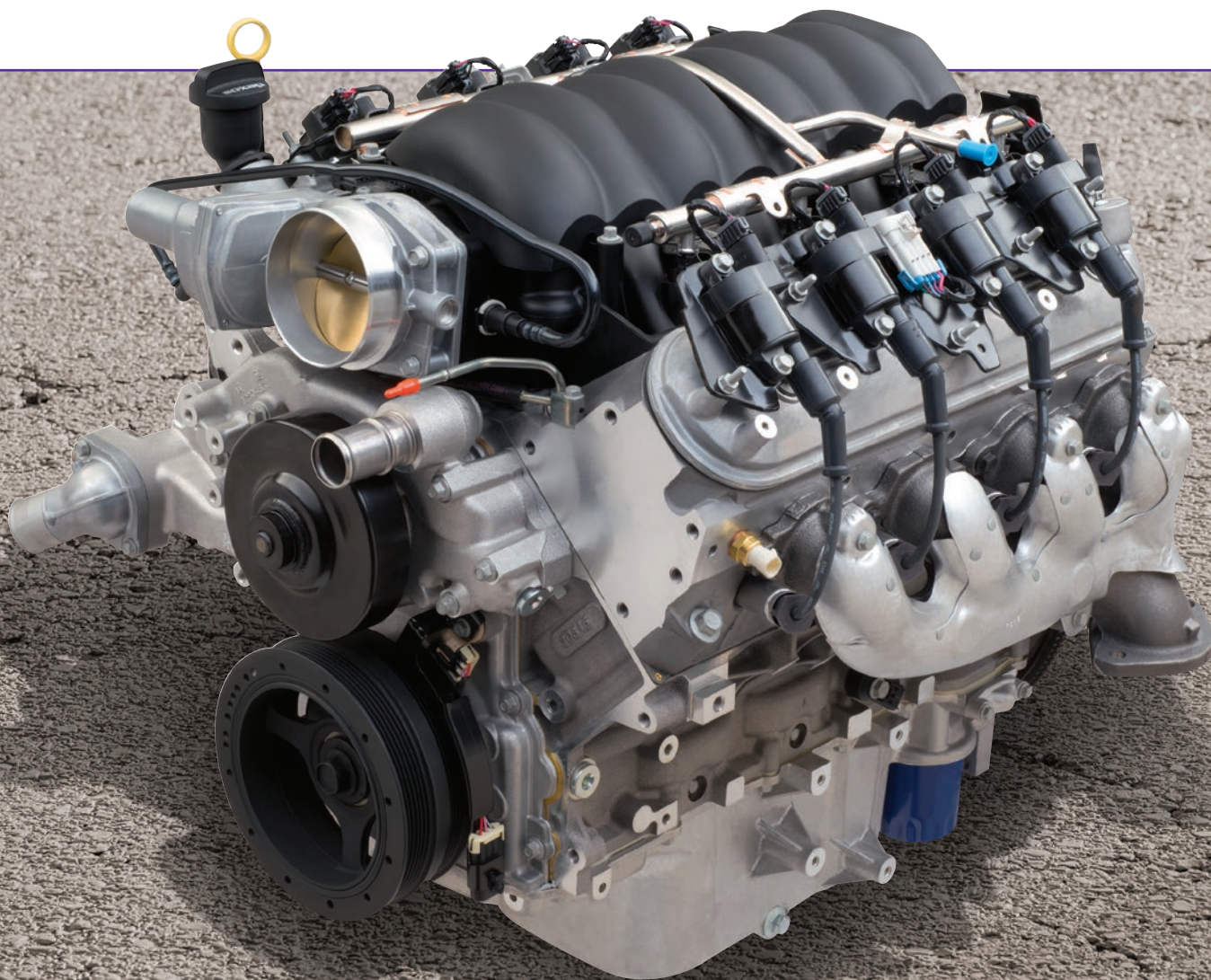

19368613
SuperMatic™ 4L70-E Four-Speed Automatic Transmission (remanufactured)

A durable, easy-cruising four-speed overdrive automatic transmission; electronically controlled for more precise, fuel-saving performance.

See page 366 for torque converter applications.



19302405
Transmission Controller

Required when using a GM electronically controlled automatic transmission. Includes wiring harness.

See page 371 for details.

AVAILABLE ENGINE-RELATED PARTS & ACCESSORIES

See page 250 for our complete line of LS-Series components



19354332
LS376/525 Controller Kit

Page 297



19352208
T56 Super Magnum Six-Speed Manual Transmission

Page 372

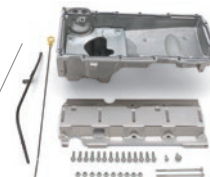

19212593
Muscle Car Oil Pan Kit

Page 289



19299803
SuperMatic™ Torque Converter

Page 366



19155067
Corvette Accessory Drive Kit

Page 281



19301246
Air Inlet Kit for LS-Based Crate Engine Installation

Page 291

DR525

19329009

525 hp

@ 6,200 rpm

494 lb.-ft.

@ 4,400 rpm

with Muscle Car Oil Pan

19329008

525 hp

@ 6,200 rpm

498 lb.-ft.

@ 4,400 rpm

with Gen 4 F-Car Oil Pan (not shown)

BIG POWER FOR LSX STOCK DRAG RACING

Chevrolet Performance's DR525 sealed drag racing crate engine signals an important advancement for drag racing, enabling exciting heads-up racing at a lower cost than custom-built engines. It's an approach Chevrolet Performance implemented in a number of circle track racing series, providing racers a high-performance engine at a great value.

The DR525 is designed as the spec engine for NMCA's LS Stock racing class in the LSX Showdown Challenge Series. The 6.2L (376 cubic inches) naturally aspirated engine is rated at 525 horsepower with 498 lb.-ft. torque, and features several tamper-proof seals to ensure class compliance. And while it is the spec engine for the LS Stock class, it is legal in other NMCA/LSX Showdown Challenge classes – and other drag racing series.

It is offered with two part numbers: 19329009 (includes Chevrolet Performance's Muscle Car Oil Pan) or 19329008 (includes fourth-generation F-body oil pan). Chevrolet Performance's custom-calibrated E67-type engine control system – P/N 19354340 (sold separately) – must be used with the DR525 in the LS Stock class. It features a tamper-proof engine control unit.

NOTE: Refer to page 83 for the complete horsepower and torque testing procedures.

TECH SPECS

Part Number:	19329009 (w/muscle car oil pan) 19329008 (w/Gen 4 F-car oil pan)
Engine Type:	LS-Series Gen IV Small-Block V-8
Displacement (cu in):	376 cu in (6.2L)
Bore x Stroke (in):	4.065 x 3.622 (103.25 x 92mm)
Block (P/N 12623967):	Cast aluminum with 6-bolt, cross-bolted main caps
Crankshaft (P/N 12685659):	Nodular iron
Connecting Rods (P/N 12607475):	Powdered metal
Pistons (P/N 19207287):	Hypereutectic aluminum
Camshaft Type (P/N 88958770):	Hydraulic roller
Valve Lift (in):	.525 intake / .525 exhaust
Camshaft Duration (@.050 in):	226° intake / 236° exhaust
Cylinder Heads (P/N 12629063):	Aluminum L92-style port; as cast with 68cc chambers
Valve Size (in):	2.165 intake / 1.590 exhaust
Compression ratio:	10.7:1
Rocker Arms (P/N 12669995 int):	Investment cast, roller trunnion
Rocker Arms (P/N 12681275 exh):	Investment cast, roller trunnion
Rocker Arm Ratio:	1.7:1
Recommended Fuel:	Premium pump
Maximum Recommended rpm:	6,600
Reluctor Wheel:	58x
Balanced:	Internal

INSTALLATION NOTES

- Assembly does not include any electronics
- Use DR525 Engine Controller Kit for engine operation, P/N 19354340 (see page 297)
- Intended for off-road, drag racing vehicles
- Not intended for marine applications
- Front-End Accessory Drive Kit, P/N 19329418, not included with engine assembly (see page 285)

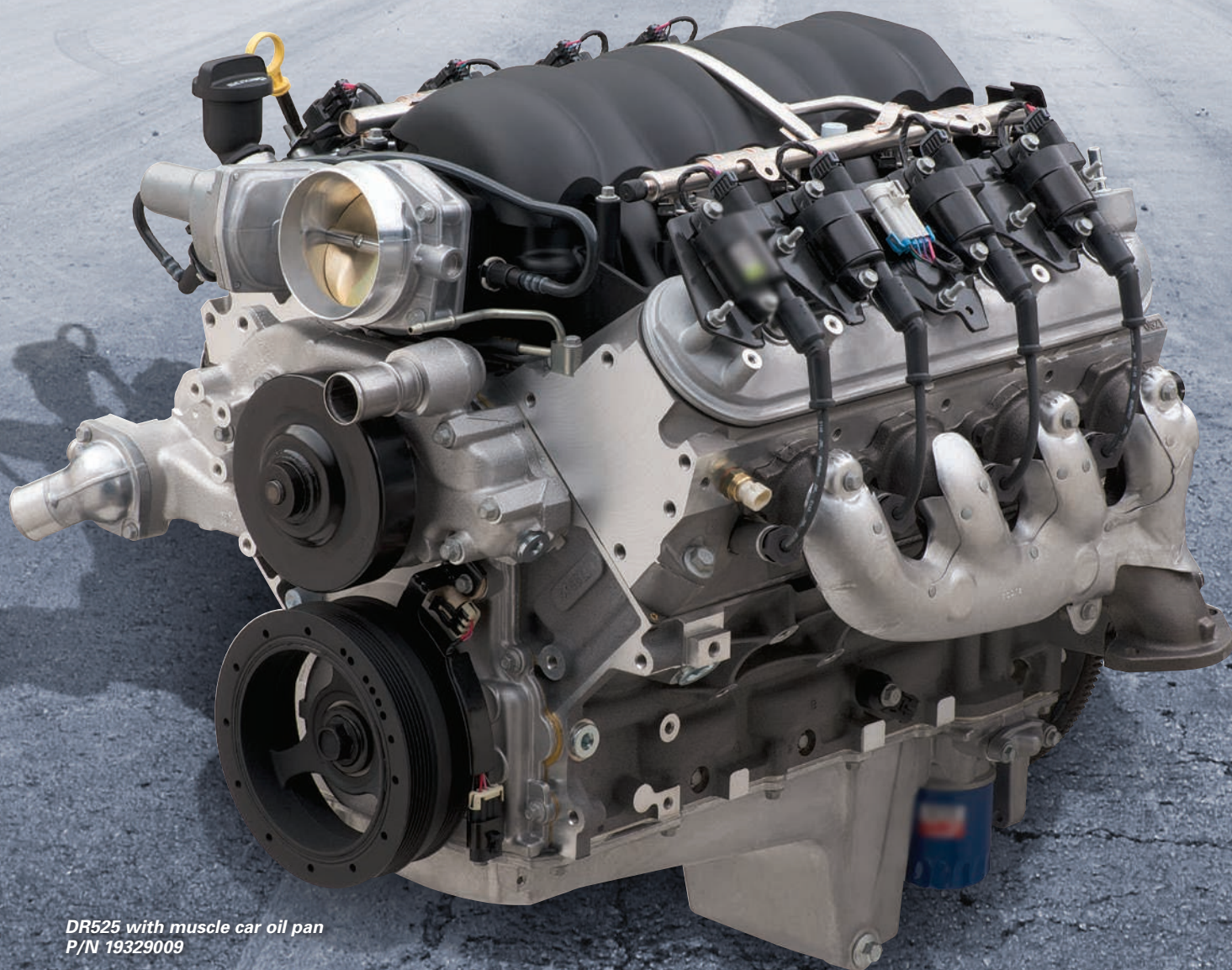

DR525 with muscle car oil pan
P/N 19329009

AVAILABLE ENGINE-RELATED PARTS & ACCESSORIES

See page 250 for our complete line of LS-Series components



19354340
Controller and Harness
Page 297

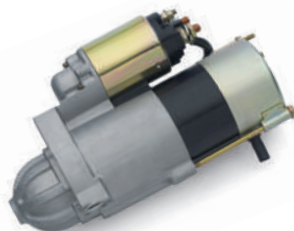

10465385
LS-Series Starter
Page 294



19301246
Air Inlet Kit for LS-Based Crate
Engine Installation
Page 291

LSA

19331507



556 hp

@ 6,100 rpm

551 lb.-ft.

@ 3,800 rpm

DYNO CHART

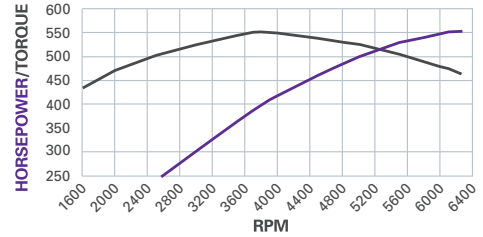

ZL1 CAMARO POWER FOR YOUR PERFORMANCE VEHICLE!

Chevrolet Performance’s LSA 6.2L SC supercharged crate engine is an increasingly popular choice for project vehicle builders, thanks to its great balance of performance and value.

We’ve updated the LSA package with the production variant from the fifth-generation Camaro ZL1, featuring 556 horsepower and 551 lb.-ft. of torque. The ZL1-based assembly also has a different intercooler assembly with repositioned coolant inlet and outlet ports, which makes installation easier for many retro-fit applications.

What hasn’t changed are the core components that made the original engine tough and refined, including a unique aluminum cylinder block casting that’s home to a forged steel crankshaft and super-tough reciprocating parts, and integrated piston-cooling oil jets. It also features high-flow cylinder heads that support the airflow pushed by a 1.9L Eaton TVS supercharger.

Our ZL1 supercharged crate engine package comes fully dressed, from the top of the charge-cooled supercharger assembly to the ignition system, water pump, balancer and more.

It also includes an 8-bolt crankshaft flange that may require an adapter for use with some transmissions. Use with LSA Controller Kit P/N 19354336.

NOTE: Refer to page 83 for the complete horsepower and torque testing procedures.

TECH SPECS

Part Number:	19331507
Engine Type:	LS-Series Gen IV Small-Block V-8
Displacement (cu in):	376 cu in (6.2L)
Bore x Stroke (in):	4.065 x 3.622 (103.25 x 92mm)
Block (P/N 12623968):	Cast-aluminum with 6-bolt, cross-bolted main caps
Crankshaft (P/N 12603616):	Forged steel with 8-bolt flange
Connecting Rods (P/N 12604857):	Powdered metal
Pistons (P/N 12625119):	Hypereutectic aluminum
Camshaft Type (P/N 12623064):	Hydraulic roller
Valve Lift (in):	.492 intake / .480 exhaust
Camshaft Duration (@.050 in):	198° intake / 216° exhaust
Cylinder Heads (P/N 12626958):	Aluminum L92-style port; as cast with 68cc chambers
Valve Size (in):	2.160 intake / 1.590 exhaust
Compression Ratio:	9.1:1
Rocker Arms (P/N 12669995 int):	Investment-cast, roller trunnion
Rocker Arms (P/N 12681275 exh):	Investment-cast, roller trunnion
Rocker Arm Ratio:	1.7:1
Recommended Fuel:	Premium pump
Maximum Recommended rpm:	6,600
Reluctor Wheel:	58x
Balanced:	Internal

INSTALLATION NOTES

- Assembly does not include any electronics or accessory drive components
- Use LSA Controller Kit P/N 19354336, available for non-original applications. Kit includes ECM, wiring harness, O² sensors and throttle pedal for ETC operation (see page 297)
- Coolant pump included P/N 22901367
- 8-bolt crank flange
- Not intended for marine applications
- Includes flexplate
- See page 282 for LSA Accessory Drive System
- Assembled with ZL1 Camaro wet sump oil pan

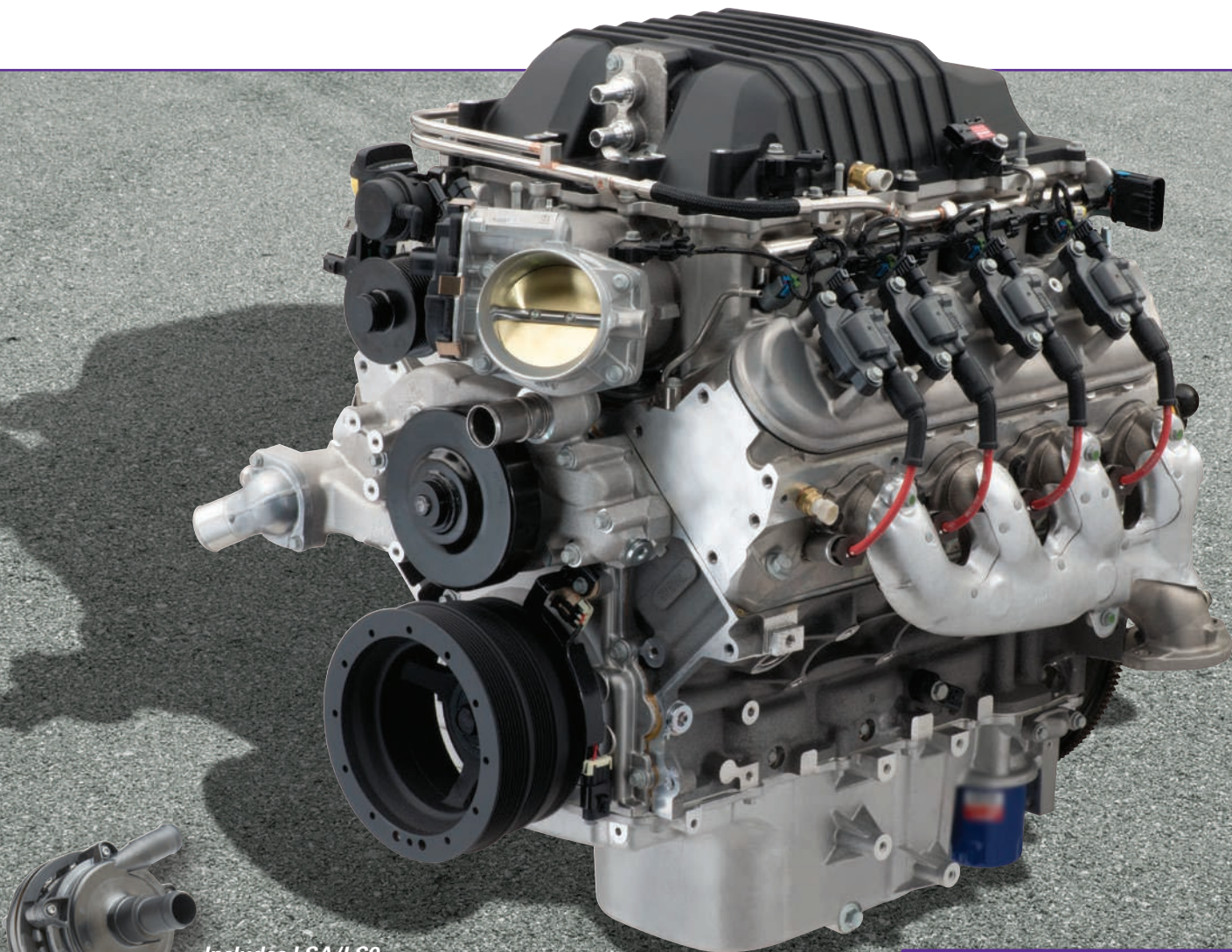

Includes LSA/LS9
Intercooler Fluid
Pump P/N 22901367



Also available as an
E-ROD system
See page 239 for details

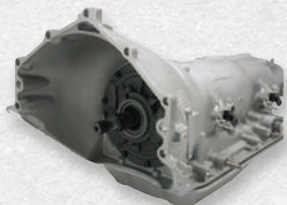

19300175
**SuperMatic™ 4L85-E Four-Speed
Automatic Transmission**
Features five-pinion gearsets, heat-treated stator
shaft splines, induction-hardened turbine shaft,
seven-plate clutch and specific valve-body calibration.
See page 366 for torque converter applications.



19302410
Transmission Controller
Required when using a GM
electronically controlled automatic
transmission. Includes wiring harness.
See page 371 for details.

AVAILABLE ENGINE-RELATED PARTS & ACCESSORIES

See page 250 for our complete line of LS-Series components



19354336
LSA Controller Kit
Page 297



19243525
**LSA Accessory Drive
System w/o AC**
Page 282



19212593
**Muscle Car
Oil Pan Kit**
Page 289



19299806
**SuperMatic™
Torque Converter**
Page 366



19244106
**LSA Accessory Drive
System AC Add-On Kit**
Page 282



19301246
**Air Inlet Kit for
LS-Based Crate
Engine Installation**
Page 291

LS9

19260165



638 hp

@ 6,500 rpm

604 lb.-ft.

@ 3,800 rpm

DYNO CHART

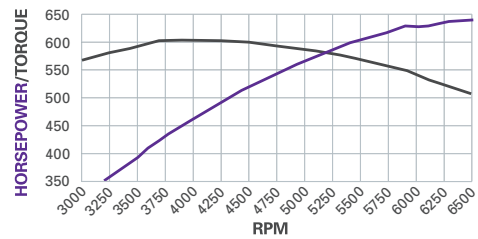

THE LAST OF A LEGEND!

When the C6 Corvette ZR1 went out of production, so did its unique LS9 supercharged engine. Chevrolet Performance acquired a finite number of them for use as crate engines and when they're gone, they're gone! Rated at 638 hp and 604 lb.-ft. of torque, the LS9 is a beast!

The engine is a technological marvel. High-rpm-validated lightweight reciprocating parts, including titanium intake valves, are used, along with high-flow cylinder heads that draw the charge forced on them by a sixth-generation supercharger. It has a high-helix (twist) design that helps the "blower" deliver greater power at the low end and sustains it longer through the rpm band for broad, on-demand power whether off-idle or at speed.

Our crate engine assembly includes the dry sump oil pan and provisions for the charge cooler's liquid cooling system. You'll need an external oil tank (not available from Chevrolet Performance), external coolant tank (for the charge cooler) and our LS9 Controller Kit, P/N 19354338, to get it running in your project vehicle. It also includes a 9-bolt crankshaft flange that may require an adapter for use with some transmissions.

NOTE: Refer to page 83 for the complete horsepower and torque testing procedures.

TECH SPECS

Part Number:	19260165
Engine Type:	LS-Series Gen IV Small-Block V-8
Displacement (cu in):	376 cu in (6.2L)
Bore x Stroke (in):	4.065 x 3.622 (103.25 x 92mm)
Block:	Cast-aluminum with 6-bolt, cross-bolted main caps
Crankshaft (P/N 12641693):	Forged steel with 9-bolt flange
Connecting Rods (P/N 12624231):	Forged titanium
Pistons (P/N 19180414):	Forged aluminum
Camshaft Type (P/N 12638427):	Hydraulic roller
Valve Lift (in):	.562 intake / .558 exhaust
Camshaft Duration (@.050 in):	211° intake / 230° exhaust
Cylinder Heads (P/N 12621774):	Aluminum L92-style ports; as cast with 68cc chambers
Valve Size (in):	2.160 titanium intake / 1.590 hollow, sodium-filled exhaust
Compression Ratio:	9.1:1
Rocker Arms (P/N 12669995 int):	Investment-cast, roller trunnion
Rocker Arms (P/N 12681275 exh):	Investment-cast, roller trunnion
Rocker Arm Ratio:	1.7:1
Recommended Fuel:	Premium pump
Maximum Recommended rpm:	6,600
Reluctor Wheel:	58x
Balanced:	Internal

INSTALLATION NOTES

- 14" manual transmission flywheel included
- Assembly does not include any electronics
- Use LS9 Engine Controller Kit for engine operation, P/N 19354338 (see page 297)
- Forged pistons with oil-spray cooling
- Includes Corvette dry sump oil pan – requires production or aftermarket oil lines and oil tank (not included)
- Not intended for marine applications
- Crankshaft has unique 9-bolt flywheel mounting pattern

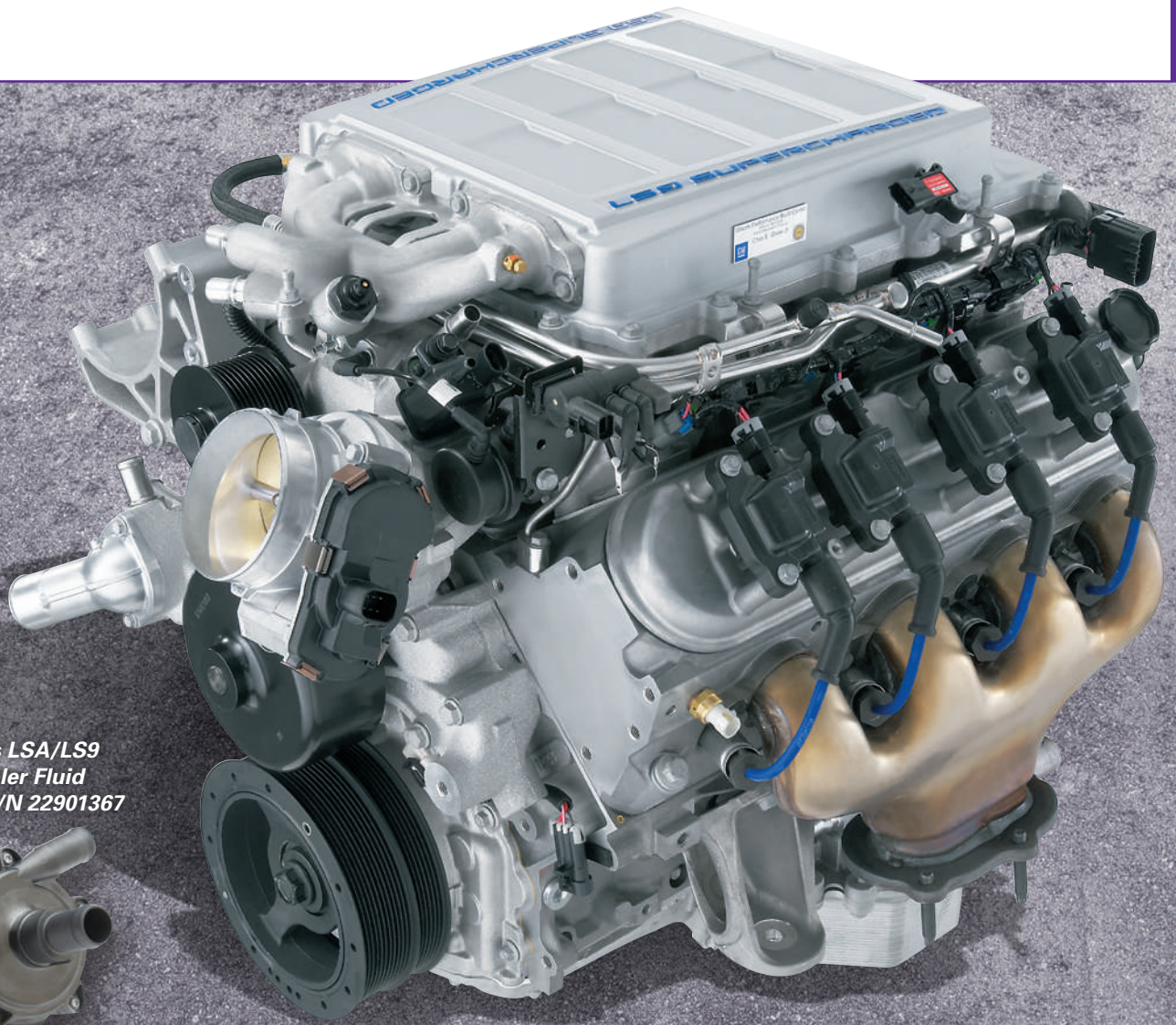

Includes LSA/LS9
Intercooler Fluid
Pump P/N 22901367



AVAILABLE ENGINE-RELATED PARTS & ACCESSORIES

See page 250 for our complete line of LS-Series components

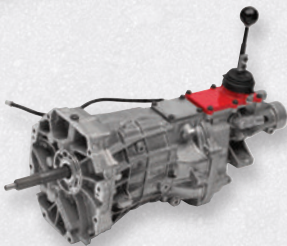

**19352208
T56 Super Magnum Six-Speed
Manual Transmission**

Designed for retro-fit installations,
with 700 lb.-ft. capacity.

See page 372 for details.

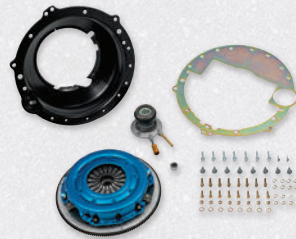

**19331083
Transmission Installation Kit**

For LS9 engines with 9-bolt flange.
Includes bell housing, clutch,
flywheel and hardware.

See page 375 for details.



**19243524
LS9 Accessory Drive System w/AC**
Page 283



**19354338
LS9 Controller Kit**
Page 297



**19301246
Air Inlet Kit for LS-Based Crate Engine Installation**
Page 291

LS7

19329246



505 hp
@ 6,300 rpm

470 lb.-ft.
@ 4,800 rpm

DYNO CHART

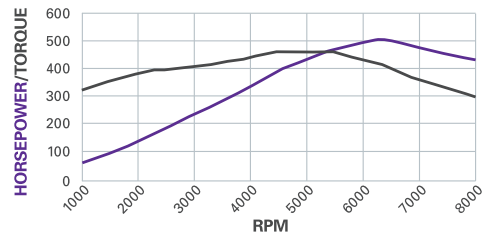

A FUTURE CLASSIC

With its classic 427-cubic-inch displacement and racing-derived features, including featherweight titanium connecting rods, the 505-hp LS7 7.0L made its mark in the C6 Corvette Z06 and advanced its legacy in the fifth-generation Camaro Z/28.

Chevrolet Performance’s powerful LS7 crate engine is based on the production specifications of the Gen 5 Z/28 application, including unique Tri-Y exhaust manifolds, which are designed to take advantage of the engine’s firing order to deliver a combination of pulse separation of adjacent firing cylinders and improved scavenging – all for optimal performance.

The LS7 is hand-assembled at the Performance Build Center at GM’s Bowling Green, Ky., assembly plant. It uses a unique cylinder block casting with pressed-in steel cylinder liners to accommodate the engine’s large, 4.125-inch cylinder bores – with deck-plate boring and honing for optimized bore geometry. The bottom end is complemented by high-flow, CNC-ported heads featuring large-volume, straight-passage intake runners and 2.20-inch titanium intake valves.

Our crate engine package includes a dry-sump oil pan. Builders will need to supply the external oil tank and oil lines to the engine, but the rest of the assembly is fully dressed. Use LS7 Controller Kit P/N 19354334 to get it running in your project vehicle.

NOTE: Refer to page 83 for the complete horsepower and torque testing procedures.

TECH SPECS

Part Number:	19329246
Engine Type:	LS-Series Small-Block V-8
Displacement (cu in):	427 (7.0L)
Bore x Stroke (in):	4.125 x 4.000 (104.8 x 101.6mm)
Block (P/N 12602689):	Cast-aluminum with 6-bolt steel main bearing caps
Crankshaft (P/N 12611649):	Forged steel
Connecting Rods (P/N 12661677):	Forged titanium
Pistons:	Hypereutectic aluminum
Camshaft Type (P/N 12638426):	Hydraulic roller
Valve Lift (in):	.593 intake / .588 exhaust
Camshaft Duration (@.050 in):	211° intake / 230° exhaust
Cylinder Heads (P/N 12578449):	CNC ported LS7-style ports 70cc CNC combustion chambers
Valve size (in):	2.200 titanium intake, 1.610 sodium-filled exhaust
Compression Ratio:	11.0:1
Rocker Arms:	Investment-cast, roller trunnion
Rocker Arm Ratio:	1.8:1 (offset, intake only)
Recommended Fuel:	Premium pump
Maximum Recommended rpm:	7,000
Reluctor Wheel:	58x
Balanced:	Internal

INSTALLATION NOTES

- Assembly does not include any electronics
- Use LS7 Controller Kit P/N 19354334 for engine operation. Kit includes electronic throttle pedal, which is required for throttle input to the ECU (see page 297)
- Comes assembled with 14" Camaro Z/28 168-tooth manual transmission flywheel
- LS7 is the same size and mounts the same as other LS-Series engines
- Includes Camaro Z/28 dry sump oil pan – requires production or aftermarket oil lines and oil tank (not included)
- Use oil hose adapters P/N 25534412 to adapt to AN -12 fittings
- Not intended for marine applications
- See page 280 for Front-End Accessory Drive Kit options

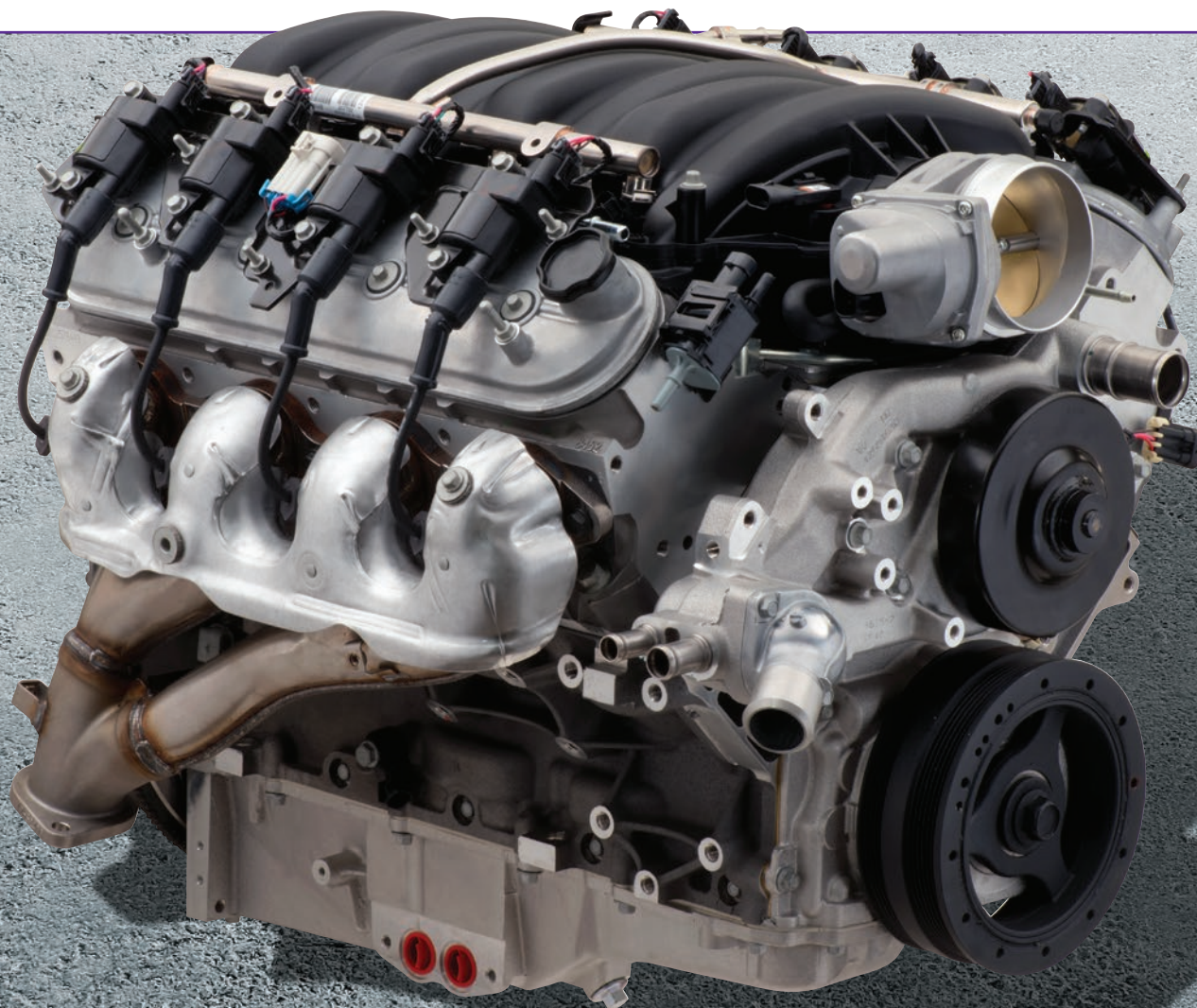

19368613
SuperMatic™ 4L70-E Four-Speed Automatic Transmission (remanufactured)

A durable, easy-cruising four-speed overdrive automatic transmission; electronically controlled for more precise, fuel-saving performance.

See page 366 for torque converter applications.



19302405
Transmission Controller

Required when using a GM electronically controlled automatic transmission. Includes wiring harness.

See page 371 for details.

AVAILABLE ENGINE-RELATED PARTS & ACCESSORIES

See page 250 for our complete line of LS-Series components



19354334
LS7 Controller Kit
 Page 297



19155067
Corvette Accessory Drive Kit
 Page 281



10465385
LS-Series Starter
 Page 294



19299803
SuperMatic™ Torque Converter
 Page 366











25534412
Oil Hose Adapters
 Page 294



19301246
Air Inlet Kit for LS-Based Crate Engine Installation
 Page 291

LT1

19328728	  	460 hp @ 6,000 rpm	465 lb.-ft. @ 4,600 rpm	with wet sump (shown)
19329997	  	460 hp @ 6,000 rpm	465 lb.-ft. @ 4,600 rpm	with dry sump
19355405	  	455 hp @ 6,000 rpm	455 lb.-ft. @ 4,400 rpm	with wet sump for use with Connect and Cruise 8-speed automatic package

THE NEXT GENERATION IS HERE!

Introduced on the seventh-generation Corvette Stingray, the LT1 6.2L opened the next chapter in the long, historic legacy of the Small-Block engine – and gives your project vehicle a high-tech heart transplant with an unprecedented balance of performance and efficiency!

The LT1 is architecturally similar to the LS family of engines, but with a unique block casting, cylinder head design, oiling system and more. It also combines advanced technologies including direct injection, Active Fuel Management¹ (cylinder deactivation) and continuously variable valve timing to support an advanced combustion system.

Our LT1 6.2L crate engine is rated at 460 horsepower and 465 lb.-ft. of torque; and it is offered with a wet-sump or dry-sump oiling system. A controller specially designed for retro-fit application using an automatic transmission is available.

¹Chevrolet Performance control kits do not utilize the AFM components on this crate engine

NOTE: Refer to page 83 for the complete horsepower and torque testing procedures.

TECH SPECS

Part Numbers:	19328728 (wet sump) 19329997 (dry sump) 19355405 (wet sump C&C)
Engine Type:	Direct Injection spark ignition Gen V Small-Block V-8
Displacement (cu in):	376 cu in 6.2L
Bore x Stroke (in):	4.065 x 3.622 (103.25 x 92mm)
Block (P/N 12619171):	Cast-aluminum with 6-bolt nodular iron main bearing caps
Crankshaft:	Forged steel
Connecting Rods:	Forged powdered metal
Pistons:	Hypereutectic aluminum
Camshaft Type (P/N 12629512):	Billet steel roller
Valve Lift (in):	0.561 intake / 0.531 exhaust
Camshaft Duration (@0.050 in):	242° intake / 244° exhaust
Cylinder Heads (P/N 12678633):	Aluminum, rectangular port D/I
Valve Size (in):	2.130 intake / 1.590 exhaust
Compression ratio:	11.5:1
Rocker Arms (P/N 12619829 int):	Investment-cast, roller trunnion
Rocker Arms (P/N 12619829 exh):	Investment-cast, roller trunnion
Rocker Arm Ratio:	1.81:1
Recommended Fuel:	Premium pump
Maximum Recommended rpm:	6,600
Reluctor Wheel:	58x
Balanced:	Internal

INSTALLATION NOTES

- Engines shipped with high-pressure direct-injection fuel pump installed
- Dry Sump Engine, P/N 19329997, requires production or after-market oil lines and external oil tank (not included)
- Dry Sump Engine, P/N 19329997, comes with a Corvette oil pan. Use oil hose adaptors P/N 25534412 to adapt AN-12 fittings
- Assembly does not include any electronics
- Select the right Controller Kit for your LT1 Engine (see chart on page 297)
- Not intended for marine applications
- Front-End Accessory Drive Kit, P/N 12679459, can be ordered separately (see page 285)
- For LT1 P/N 19355405 use P/N 12678595 FEAD w/o air and P/N 19332591 A/C add-on kit
- 8-bolt crankshaft flange
- Shipped with 14" flexplate

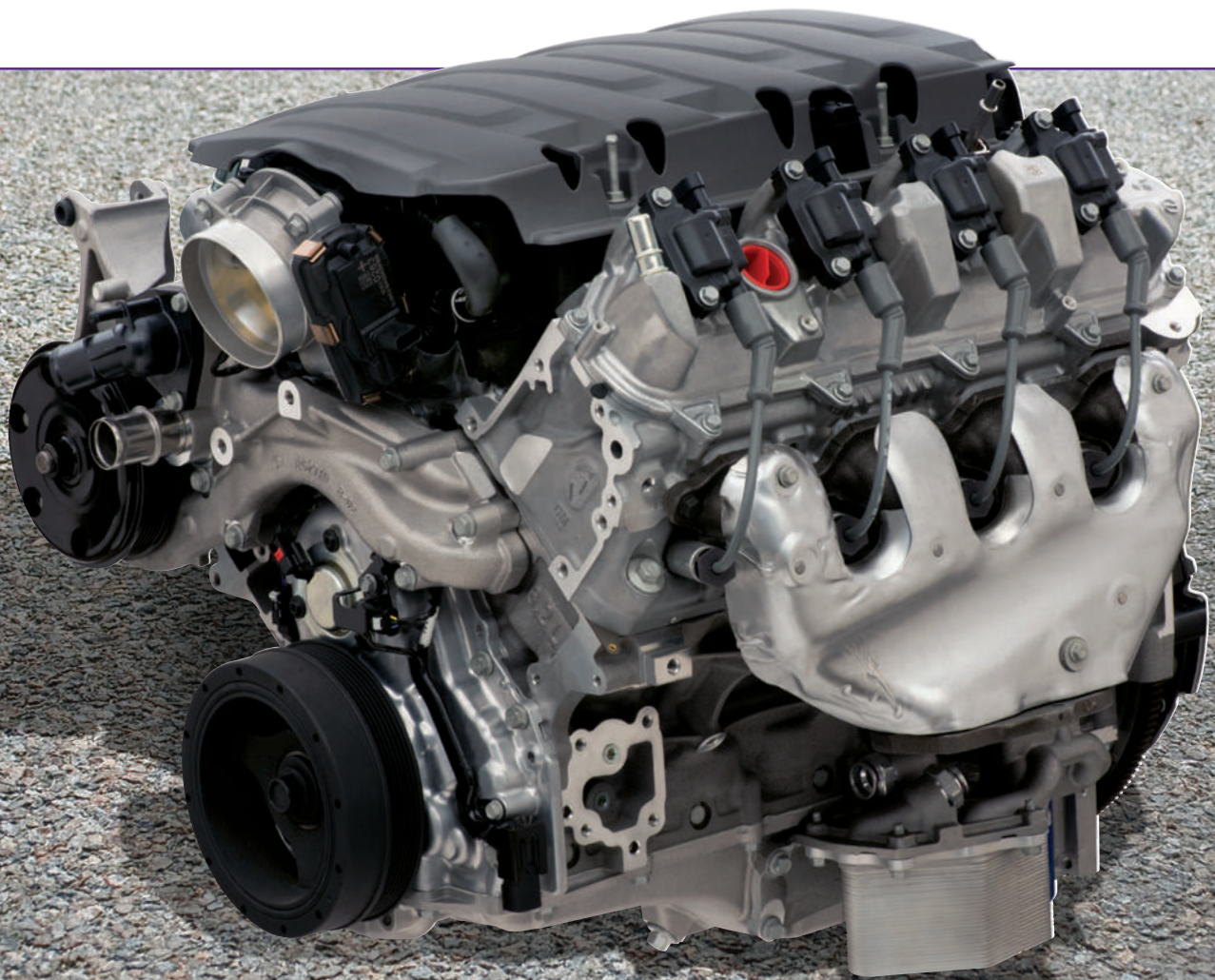

Also available as an E-ROD system
See page 239 for details

IMPORTANT NOTE: There has been a running change in the High Fuel Pressure Sensor on LT1 and LT4 production engines. It is critical that the correct engine part number and the correct engine controller be paired to ensure proper operation of the transmission. (See chart below).

LT1 Engine Controller/Transmission Compatibility Chart

Engine Description	Engine P/N	Fuel Pressure Sensor	Transmission Type	Controller kit P/N
LT1 Wet Sump	19328728	4 Pin	4-Speed Automatic or T56 Super Magnum	19368831
LT1 Wet Sump	19355405	3 Pin	4-Speed Automatic or T56 Super Magnum	19368833
LT1 Wet Sump	19355405	3 Pin	8-Speed Automatic	19368835



See page 297 for details.

AVAILABLE ENGINE-RELATED PARTS & ACCESSORIES

See page 250 for our complete line of LS-Series components



19352208
T56 Super Magnum Six-Speed Manual Transmission
Page 372



19329620
LS/LT Manual Bell Housing
Page 372

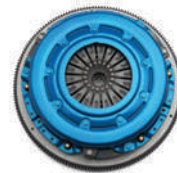

19329635
LS/LT Dual-Disc Clutch
Page 373



12679459
LT1 Accessory Drive System
Page 285



19125817
Aluminum Automatic Bell Housing
Page 369



25534412
Oil Hose Adapters
Page 294

LT4

19332702	  	650 hp @ 6,400 rpm	650 lb.-ft. @ 3,600 rpm	with dry sump
19368622	  	650 hp @ 6,400 rpm	650 lb.-ft. @ 3,600 rpm	with wet sump for use with Connect and Cruise 8-speed automatic package

SUPERCHARGED POWER FROM THE C7 CORVETTE Z06!

As the heart of the Corvette Z06, the supercharged LT4 6.2L SC is the most powerful engine ever offered in a regular-production Chevrolet. It features a more-efficient, more-compact 1.7L Eaton R1740 TVS supercharger, which spins at up to 20,000 rpm. That's enough to generate more than 9 pounds of boost and help produce 640 horsepower and 630 lb.-ft. of torque.

The LT4 is based on the same Gen V Small-Block architecture as the LT1 engine, with several unique features designed to support its higher output and the greater cylinder pressures created by forced induction. They include Rotocast A356T6 aluminum cylinder heads that are stronger and handle heat better than conventional castings, lightweight titanium intake valves and stronger forged aluminum pistons.

NOTE: Refer to page 83 for the complete horsepower and torque testing procedures.

TECH SPECS

Part Number:	19332702 (dry sump) 19368622 (wet sump C&C)
Engine Type:	Gen V Small-Block V-8
Displacement (cu in):	376 cu in (6.2L)
Bore x Stroke (in):	4.065 x 3.622 (103.25 x 92mm)
Block:	Cast aluminum with 6-bolt, cross-bolted main caps
Crankshaft:	Forged steel
Connecting Rods:	Forged powdered-metal steel
Pistons:	Forged aluminum
Camshaft Type:	Hydraulic roller
Valve Lift (in):	.492 intake / .551 exhaust
Camshaft Duration (@.050 in):	189° intake / 223° exhaust
Cylinder Heads:	A356T6 Rotocast aluminum; as cast with 65.5cc chambers
Valve Size (in):	2.130 intake / 1.590 exhaust
Compression ratio:	10:1
Rocker Arms (P/N 12619829):	Investment cast, roller bearing trunnion
Rocker Arm Ratio:	1.81:1
Recommended Fuel:	Premium pump
Maximum Recommended rpm:	6,600
Reluctor Wheel:	58x
Balanced:	Internal

INSTALLATION NOTES

- Assembly does not include any electronics
- Select the right Controller Kit for your LT4 Engine (see chart on page 297)
- Dry Sump Engine requires production or after-market oil lines and oil tank (not included)
- Flywheel included
- Not intended for marine applications
- Crankshaft has 8-bolt flywheel mounting pattern
- Engine includes direct injection, VVT and Active Fuel Management
- Chevrolet Performance control kits do not use the Active Fuel Management components on this crate engine

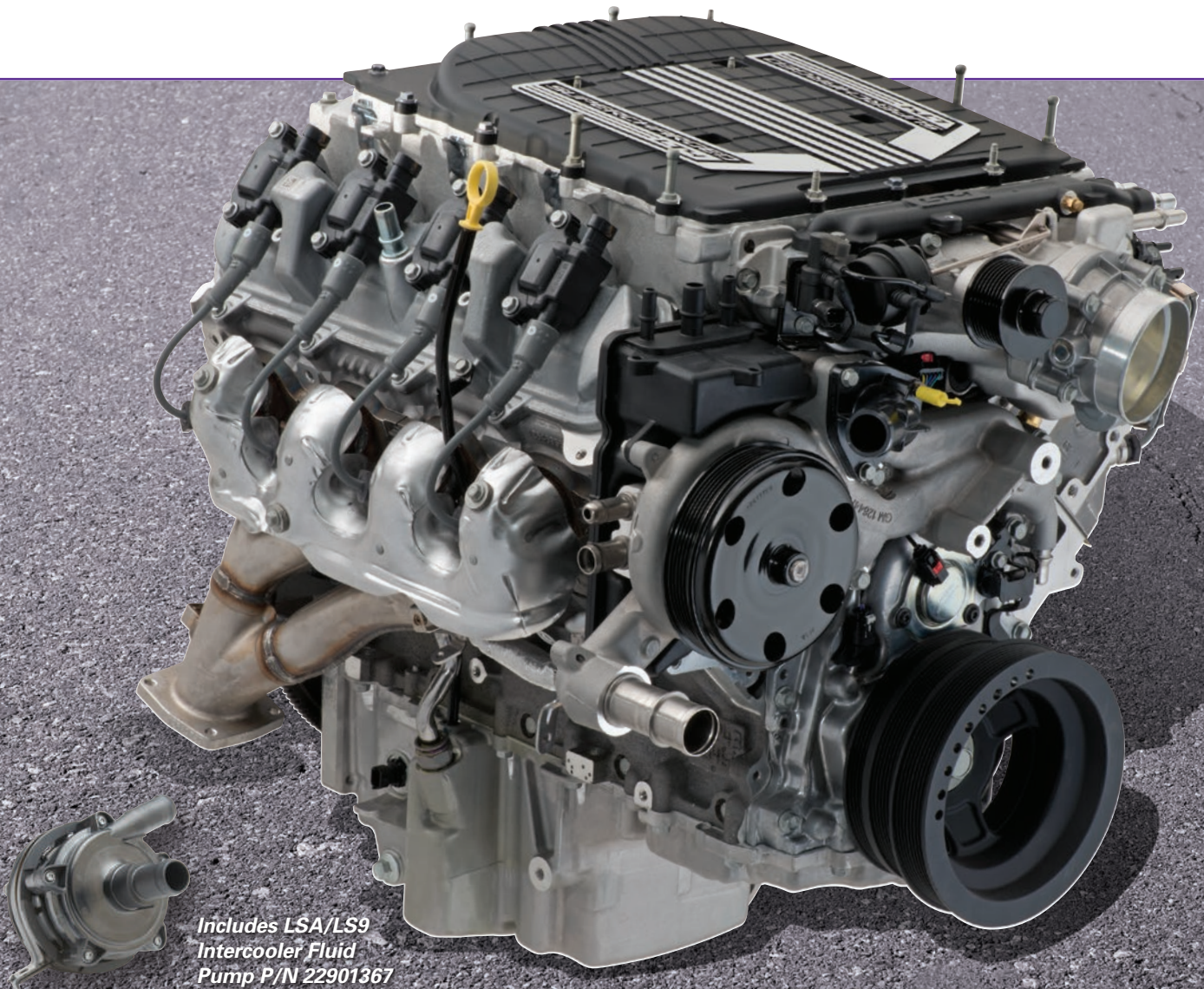

Includes LSA/LS9 Intercooler Fluid Pump P/N 22901367

IMPORTANT NOTE: There has been a running change in the High Fuel Pressure Sensor on LT1 and LT4 production engines. It is critical that the correct engine part number and the correct engine controller be paired to ensure proper operation of the transmission. (See chart below).

LT4 Engine Controller/Transmission Compatibility Chart

Engine Description	Engine P/N	Fuel Pressure Sensor	Transmission Type	Controller kit P/N
LT4 Wet Sump [CTS-V]	19355404	3 Pin	4-Speed Automatic or T56 Super Magnum	19368843
LT4 Wet Sump [CTS-V]	19355404	3 Pin	8-Speed Automatic	19368845
LT4 Wet Sump [Camaro ZL-1]	19368622	3 Pin	4-Speed Automatic or T56 Super Magnum	19368843
LT4 Wet Sump [Camaro ZL-1]	19368622	3 Pin	8-Speed Automatic	19368845



See page 297 for details.

AVAILABLE ENGINE-RELATED PARTS & ACCESSORIES

See page 250 for our complete line of LS-Series components



19352208
T56 Super Magnum Six-Speed Manual Transmission
Page 372



19329912
Transmission Installation Kit
Page 375



19339110
LT4 Wet Sump Accessory Drive System w/o AC
Page 286



19301246
Air Inlet Kit for LS-Based Crate Engine Installation
Page 291



25534412
Oil Hose Adapters
Page 294



19369109
LT4 Dry Sump Accessory Drive System
Page 287

LT376/535

19355378

**535 hp**

@ 6,300 rpm

470 lb.-ft.

@ 4,600 rpm

FACTORY-ENGINEERED PERFORMANCE FOR THE NEW LT ENGINE FAMILY!

Chevrolet Performance engineers have wasted no time digging into the new LT engine family to mine more power – and they've delivered it in the LT376/535.

It builds on the technologies and capability of the LT1 6.2L offered in the Corvette Stingray and Camaro SS, extending them with CNC-ported heads and our high-lift LT1 Hot Cam to deliver 535 naturally aspirated horsepower. It also employs the production direct injection fuel system, which enables more precise fuel delivery that supports a high 11.5:1 compression ratio, which translates into big power.

Chevrolet Performance's comprehensive crate engine kit includes the engine assembly with a production intake manifold, throttle body assembly, ignition coils, water pump, balancer and more.

Believe us: The LT376/535 loves to rev and achieving those 535 horses is an exercise in exhilaration. Give your project this high-tech heart transplant and enjoy the ride!

NOTE: Refer to page 83 for the complete horsepower and torque testing procedures.

ENGINE TECH SPECS

Part Number:	19355378
Engine Type:	Gen V Small-Block V-8
Displacement (cu in):	376 cu in (6.2L)
Bore x Stroke (in):	4.062 x 3.622 (103.25 x 92mm)
Block:	Cast aluminum with 6-bolt, cross-bolted main caps
Crankshaft:	Forged steel
Connecting Rods:	Forged powdered metal with specific machining
Pistons:	Hypereutectic aluminum
Camshaft Type:	Hydraulic roller (billet steel)
Valve Lift (in):	.577 intake / .577 exhaust
Camshaft Duration (@.050 in):	228° intake / 248° exhaust
Cylinder Heads:	Cast aluminum; CNC-ported with 58cc chambers
Valve Size (in):	2.130 intake / 1.590 exhaust
Compression ratio:	11.5:1
Rocker Arms:	Investment cast, roller trunnion
Rocker Arm Ratio:	1.81:1
Recommended Fuel:	Premium pump
Maximum Recommended rpm:	6,600
Reluctor Wheel:	58X
Balanced:	Internal

INSTALLATION NOTES

- Direct bolt-in replacement for Corvette and Camaro originally equipped with LT1 V8
- Engine is shipped without exhaust manifolds. Production manifolds will work, but engine performance is optimized with competition-style exhaust headers
- Assembly does not include any electronics
- Use LT376/535 Engine Controller Kit for engine operation, P/N 12677124 (see page 297)
- Not intended for marine applications
- This configuration is available only with a wet sump oiling system

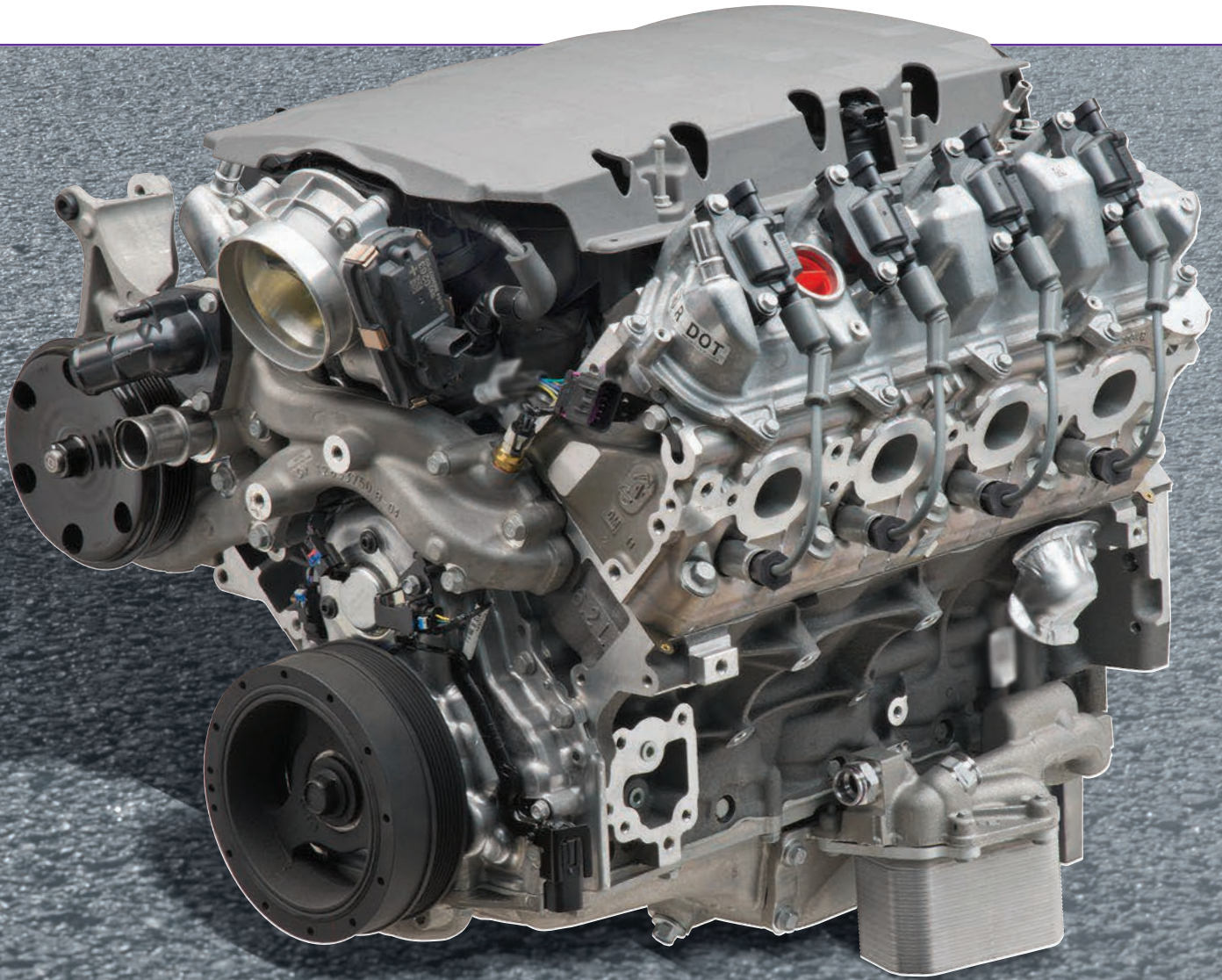

19352208
T56 Super Magnum Six-Speed Manual Transmission
 Designed for retro-fit installations, with 700 lb.-ft. capacity.
 See page 372 for details.



12677124
LT376/535 Controller Kit
 See page 297 for details.

AVAILABLE ENGINE-RELATED PARTS & ACCESSORIES

See page 250 for our complete line of LS-Series components

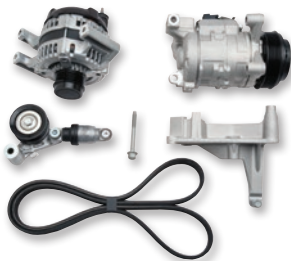

12679459
LT1 Accessory Drive System
 Page 285



19368615
SuperMatic™ 4L75-E Four-Speed Transmission (remanufactured)
 Page 368



19299803
SuperMatic™ Torque Converter
 Page 366

LTG 2.0L Turbocharged

19328837    / **272 hp** / **295 lb.-ft.** Rear Wheel Drive
@ 5,500 rpm @ 3,000 rpm

12677823    / **272 hp** / **295 lb.-ft.** Front Wheel Drive (not shown)
@ 5,500 rpm @ 3,000 rpm

TURBOCHARGED EXCITEMENT IN A SMALL PACKAGE

Used in many performance sedans throughout General Motors' global portfolio, the LTG 2.0L Turbocharged four-cylinder is one of the most power-dense engines in the industry. And thanks to advanced technologies, such as direct injection, it is a surprisingly efficient performer. It's a great choice for custom tuner cars or to make a statement in your hot rod, with its compact – and lightweight – capabilities.

The LTG is rated at 272 horsepower at 5,500 rpm and 295 lb.-ft. of torque at 3,000 rpm. Its torque curve is broad and robust, delivering 90 percent (260 lb.-ft.) of its peak torque from 1,700 rpm to 5,500 rpm – for a great feeling of immediate power at all speeds. Peak torque is sustained from 3,000 to 4,600 rpm.

The turbocharger generates up to 20 pounds of boost and its twin-scroll design helps optimize the usable power from the engine, virtually eliminating turbo lag and helping deliver a broad power band. Electronically controlled supporting components, including the wastegate and bypass, help optimize performance and efficiency.

NOTE: Refer to page 83 for the complete horsepower and torque testing procedures.

Additional engine features include:

- Aluminum engine block with cast-in-place iron liners
- Forged steel crankshaft
- Pistons with jet-spray cooling
- Modular balance shaft system in the oil pan
- Rotocast aluminum cylinder head with sodium-filled exhaust valves
- Dual overhead camshafts with continuously variable valve timing
- Direct injection with cam-driven high-pressure fuel pump
- Two-stage variable-displacement oil pump
- Assembly shipped with flywheel and clutch assembly (installed) – P/N 19328837
- Engine kit does not include electronics
- Not intended for marine applications

NOTE: Use with Chevrolet Performance engine controller kit P/N 19328839 (see on page 297), for manual-transmission applications only. Fabrication is required to incorporate a charge cooler for the air-to-air intercooling system. A high-pressure fuel pump suitable for direct injection is also required.

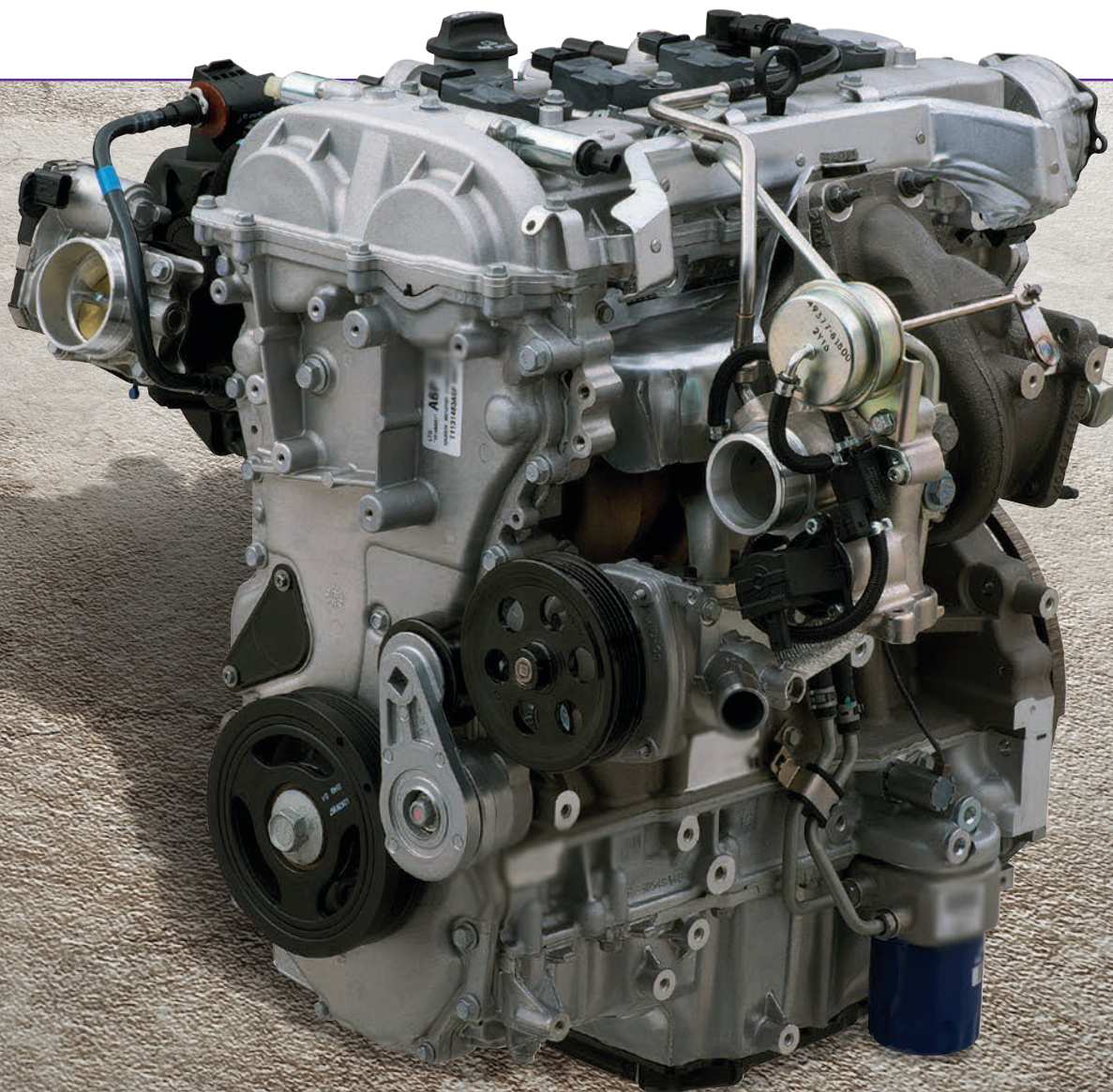

19368645
LTG Four-Speed Automatic Transmission – Rear-Wheel Drive (remanufactured)
 See page 377 for details.



LTG Rear Wheel Drive Engine Controller Kit
19328839
 Manual Transmission Only
19354439
 Automatic Transmission Only
 See page 297 for details.

AVAILABLE ENGINE-RELATED PARTS & ACCESSORIES



19331714
Exhaust Flange Kit
 Contains exhaust flange and gasket to match turbo outlet to aid in fabrication of exhaust system.



19329020
LTG Accessory Drive System
 Includes alternator, AC compressor and more to complete engine assembly.



19332838
LTG Rear Wheel Drive Engine Completion Kit

- Includes required PCV hose
- Includes duct assembly for turbo inlet, throttle body inlet and turbo outlet tubes
- Includes all clamps and inlet air pressure sensor
- Does not include charge air cooler



PERFORMANCE

E-ROD

CRATE ENGINE SYSTEMS

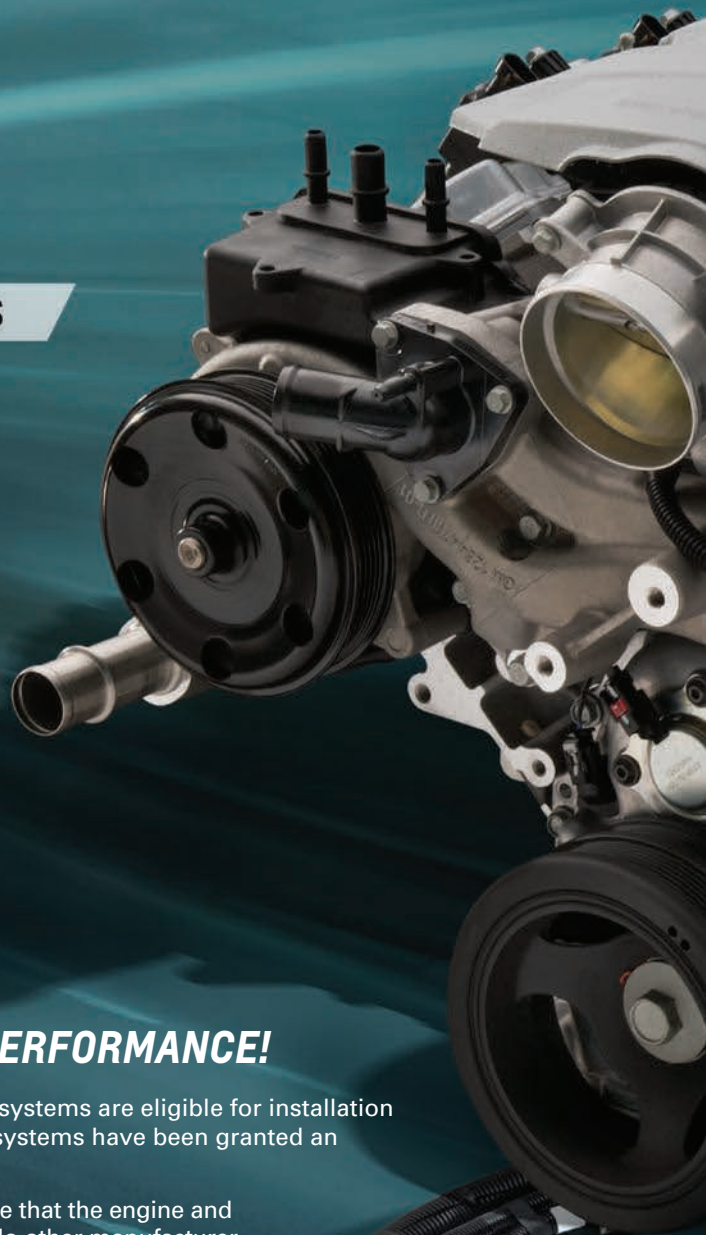

STREET-LEGAL POWER FROM CHEVROLET PERFORMANCE!

Chevrolet Performance's lineup of E-ROD high-performance crate engine systems are eligible for installation in millions of 1995-and-earlier vehicles in California. E-ROD crate engine systems have been granted an official California Air Resources Board (CARB) E.O. number.

That means you can build the car or truck of your dreams with the assurance that the engine and supporting components have been granted an official CARB E.O. number. No other manufacturer offers similar systems.

The E-ROD line up includes the LT1 6.2L, LS3 6.2L and supercharged LSA 6.2L. Each Crate Engine System includes emissions equipment and more, to be granted a CARB E.O., and each is available in a Connect & Cruise Powertrain System that pairs it with a high-performance transmission.

With Chevrolet Performance's E-ROD crate engine systems, you'll build your project with 50-state street-legal power.

LT1 6.2L

CARB EO#: D-126-46

LS3 6.2L

CARB EO#: D-126-32

LSA 6.2L

CARB EO#: D-126-33

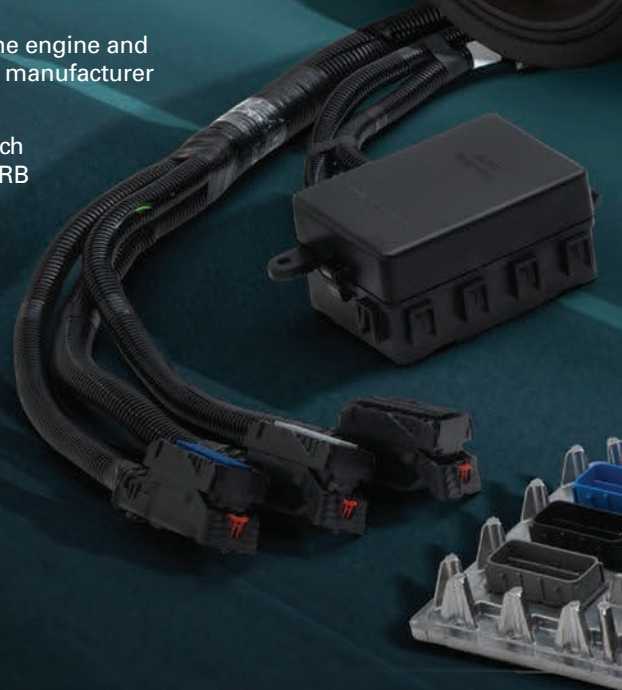





E-ROD SYSTEMS HAVE IT ALL

Each E-ROD crate engine system carries an official California Air Resources Board (CARB) E.O. number and includes complete emissions equipment, along with the engine controller and harness needed to get the engine running. The primary elements of each kit include:

- Chevrolet Performance crate engine
- Engine control module
- Exhaust manifolds
- Catalytic converters
- Mass airflow sensor and sensor boss
- Oxygen sensors and sensor bosses
- Air filter
- Accelerator pedal
- Evaporative emissions canister
- Instruction manual

BUILDER'S NOTE

To facilitate a complete E-ROD installation, the builder will need to source additional components to complete the assembly and get the vehicle running, including:

- Fuel tank
- Fuel lines (re-circulating or returnless)
- Fuel pump – 58 psi (400 kPa) for LC9 and LS3 or 65 psi (450 kPa) for LSA
- Fuel tank vent line from the tank to the evaporative emissions canister
- Purge line from the canister to the engine purge solenoid
- Air induction system that incorporates the mass airflow sensor
- Exhaust system behind the catalytic converters.

All E-ROD engines require a front-end accessory drive system suitable to the vehicle. The instruction manual included with each kit offers recommendations for the accessory drive kit, as well as the transmission, gear ratios and more. Chevrolet offers several configurations of accessory drive systems to suit different applica-



E-ROD LS3 6.2L SYSTEM

- CARB EO#: D-126-32
- Horsepower: 430 @ 5,900 rpm
- Torque: 425 lb.-ft. @ 4,600 rpm



Rated at a strong 430 hp, the original E-ROD crate engine delivers big power with California emissions compliance for countless pre-1995 cars, trucks and SUVs. Along with great power, its aluminum block and heads, and composite intake manifold make it a lightweight performer, too, meaning your project vehicle will likely enjoy weight balance – with less weight over the front axle. We recommend the 4L65-E transmission to match with the E-ROD LS3, which Chevrolet Performance also offers as an inclusive Connect & Cruise E-ROD crate powertrain system.

Part Number	Description
19369331	w/40-Tooth Reluctor Wheel Transmission*
19257234	w/17-Tooth Reluctor Wheel Transmission*

See page 212 for complete engine details.

Also available as a Connect & Cruise Package (see page 104).

tions; and each allows the installer to easily delete air conditioning. See pages 280-287 for applications and part numbers.

Chevrolet Performance recommends the LS1 Engine Installation Guide P/N 88959384, which illustrates basic procedures and offers helpful tips on installing an LS engine into older vehicles.

E-ROD systems do not come with a transmission. Chevrolet Performance recommends the SuperMatic™ 4L70-E – P/N 19368613 – four-speed automatic overdrive transmission, along with Chevrolet Performance's SuperMatic™ transmission controller P/N 19302405, for LC9 and LS3 systems. The LSA, with higher torque output, should use the SuperMatic™ 4L85-E, P/N 19300175, along with the SuperMatic™ transmission controller, P/N 19302410.

*GM automatic transmissions are typically equipped with 40-tooth reluctor wheels for vehicle speed sensor output. GM late-model manual transmissions are typically equipped with a 17-tooth reluctor wheel. The Chevrolet Performance T56 Super Magnum six-speed manual (P/N 19329795) is equipped with a 40-tooth reluctor wheel.



E-ROD LT1 6.2L SYSTEM

- CARB EO#: D-126-46
- Horsepower: 455 @ 6,000 rpm
- Torque: 465 lb.-ft. @ 4,600 rpm



Introduced on the seventh-generation Corvette Stingray and Gen 6 Camaro SS, the LT1 6.2L V-8 opened the next chapter in the long, historic legacy of the Small-Block engine. It is architecturally similar to the LS family of Small-Block engines, but with a unique block casting, cylinder head design, oiling system and more. It also combines advanced technologies including direct injection and continuously variable valve timing to support an advanced combustion system. Chevrolet Performance's new LT1 crate engine – offered with a wet-sump oiling system – and a controller specially designed for retro-fit applications is included.

Part Number	Description
12682080	w/40-Tooth Reluctor Wheel Transmission*

See page 228 for complete engine details.

Also available as a Connect & Cruise Package (see page 104).

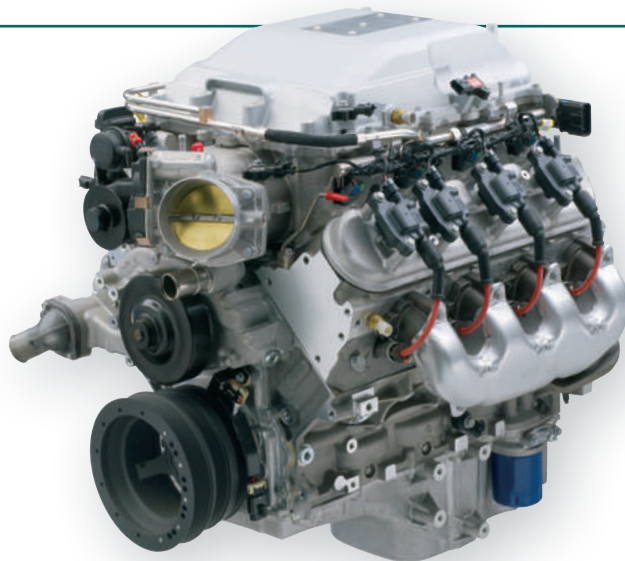

E-ROD LSA 6.2L SC SYSTEM

- CARB EO#: D-126-33
- Horsepower: 556 @ 6,100 rpm
- Torque: 551 lb.-ft. @ 3,800 rpm



The Cadillac CTS-V's 6.2L supercharged LSA engine delivers 556 hp with refinement that is rare in the world of high performance. It is smooth, quiet and well-balanced – all while delivering breathtaking power. The engine features a unique aluminum cylinder block casting that houses a forged steel crankshaft and integrated piston-cooling oil jets, along with high-flow cylinder heads that support the airflow enabled by a 1.9L supercharger with four-lobe, high-twist rotors. The E-ROD LSA comes fully dressed, from the top of the charge-cooled supercharger assembly to the ignition system.

Part Number	Description
19257456	w/40-Tooth Reluctor Wheel Transmission*
19257460	w/17-Tooth Reluctor Wheel Transmission*

See page 222 for complete engine details.

Also available as a Connect & Cruise Package (see page 104).



About the E-ROD Engine Controller

The engine control module included with each E-ROD crate engine system is designed for true stand-alone performance in older vehicles. It does not engage a number of features associated with production-model systems, eliminating the possibility of "trouble codes" being set. It also includes a SES (service engine soon) LED indicator embedded in the fuse box.

All that's needed to get a vehicle running with the engine controller are power and ground sources, a high-pressure fuel pump and an electric cooling fan.



PERFORMANCE

SMALL-BLOCK

LSX-SERIES

CRATE ENGINES



Engines Shown From Left:
LSX376-B15, LSX376-B8, LSX454



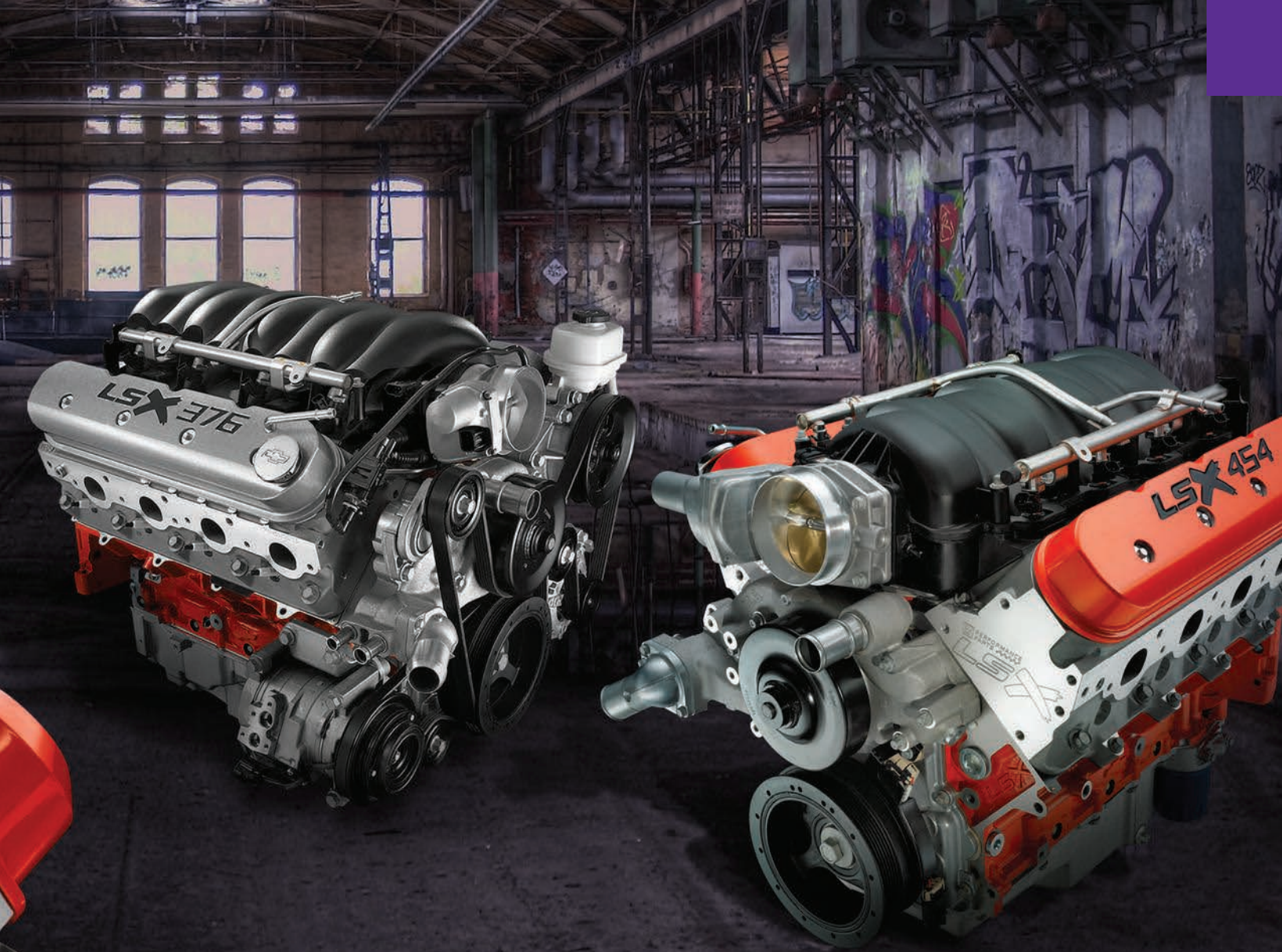

MAX HORSEPOWER FOR THE STREET OR STRIP!

Chevrolet Performance's LSX crate engines take LS power to the next level, with racing-engineered combinations that deliver power with strength. Each is based on the high-performance LSX Bowtie block, which is designed to support extreme performance combinations, including supercharging, turbocharging and nitrous.

And when it comes to boost, the LSX376-B8 and LSX376-B15 crate engines are specially designed for the high-pressure demands of forced induction, with forged crankshafts and pistons. LSX cylinder heads complement that tough block with tremendous airflow and six-bolts-per-cylinder clamping strength that supports power adders of all types.

The LSX454R is the biggest, baddest LSX engine in Chevrolet Performance's arsenal – a 750-horsepower, naturally aspirated drag racing power plant that's capable of propelling your race car down the track in 9 seconds or less. If your race car can handle the power, the LSX454R can help you win.

When big LS power is what you need, Chevrolet Performance LSX crate engines deliver big time!

You can find these Chevrolet Performance LSX Engines on the following pages:

LSX376-B8	242	LSX454	246
LSX376-B15	244	LSX454R	248

NOTE: LSX376-B8, LSX376-B15 and LSX454 engines do not include intake manifolds.

LSX376-B8

19332312    **476 hp** @ 5,900 rpm / **475 lb.-ft.** @ 4,700 rpm

DYNO CHART

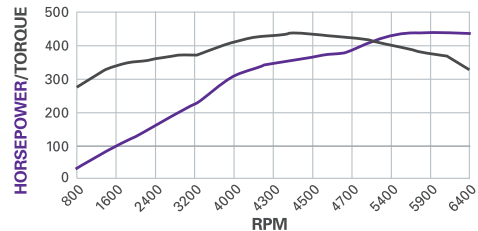

BUILD BOOST ON A BUDGET

Chevrolet Performance takes the economical LSX Bowtie standard-deck block, adds blower-friendly 9.0:1 forged pistons and combines them with the LS3’s high-flow, rectangular-port heads to create an affordable foundation for supercharged and turbocharged combinations.

The LSX376-B8 is designed for lower-boost applications, up to about 8 pounds. That’s suitable for most supercharger and turbo kits that are designed to be used with production-based applications. This engine is delivered without an intake manifold and other accessories to enable the installer to tailor the induction system to suit the blower or turbo system. Our 476 horsepower and 475 torque ratings are based on testing with the production-style, normally aspirated fuel injection system. Horsepower and torque will vary with a supercharger or turbo system.

If your forced induction system is projected to create more than 8 pounds of boost, Chevrolet Performance recommends the LSX376-B15 (P/N 19355575 – see page 244).

NOTE: Refer to page 83 for the complete horsepower and torque testing procedures.

TECH SPECS

Part Number:	19332312
Engine Type:	LSX-Series Gen IV Small-Block V-8
Displacement (cu in):	376 cu in (6.2L)
Bore x Stroke (in):	4.065 x 3.622 (103.25 x 92 mm)
Block (P/N 19260095):	LSX cast-iron with 6-bolt, cross-bolted main caps
Crankshaft (P/N 12685659):	Nodular iron
Connecting Rods (P/N 12649190):	Powdered metal
Pistons (P/N 19244016):	Forged aluminum
Camshaft Type (P/N 12623063):	Hydraulic roller
Valve Lift (in):	.551 intake / .522 exhaust
Camshaft Duration (@.050 in):	204° intake / 211° exhaust
Cylinder Heads (P/N 12629063):	LS3 rectangular port; with “as cast” 68cc chambers
Valve Size (in):	2.160 intake / 1.590 exhaust
Compression ratio:	9.0:1
Rocker Arms (P/N 12669995 int):	Investment-cast, roll trunnion
Rocker Arms (P/N 12681275 exh):	Investment-cast, roll trunnion
Rocker Arm Ratio:	1.7:1
Recommended Fuel:	Regular pump
Maximum Recommended rpm:	6,600
Reluctor Wheel:	58x
Balanced:	Internal

INSTALLATION NOTES

- Assembly does not include any electronics
- Not intended for marine applications
- Requires LS/LSX Ignition Controller P/N 19355418 for carbureted applications
- Standard LS 6-bolt crank flange
- Assembly shipped without intake manifold or oil pan (dust shield installed for shipment)
- Recommended max boost – 8 psi

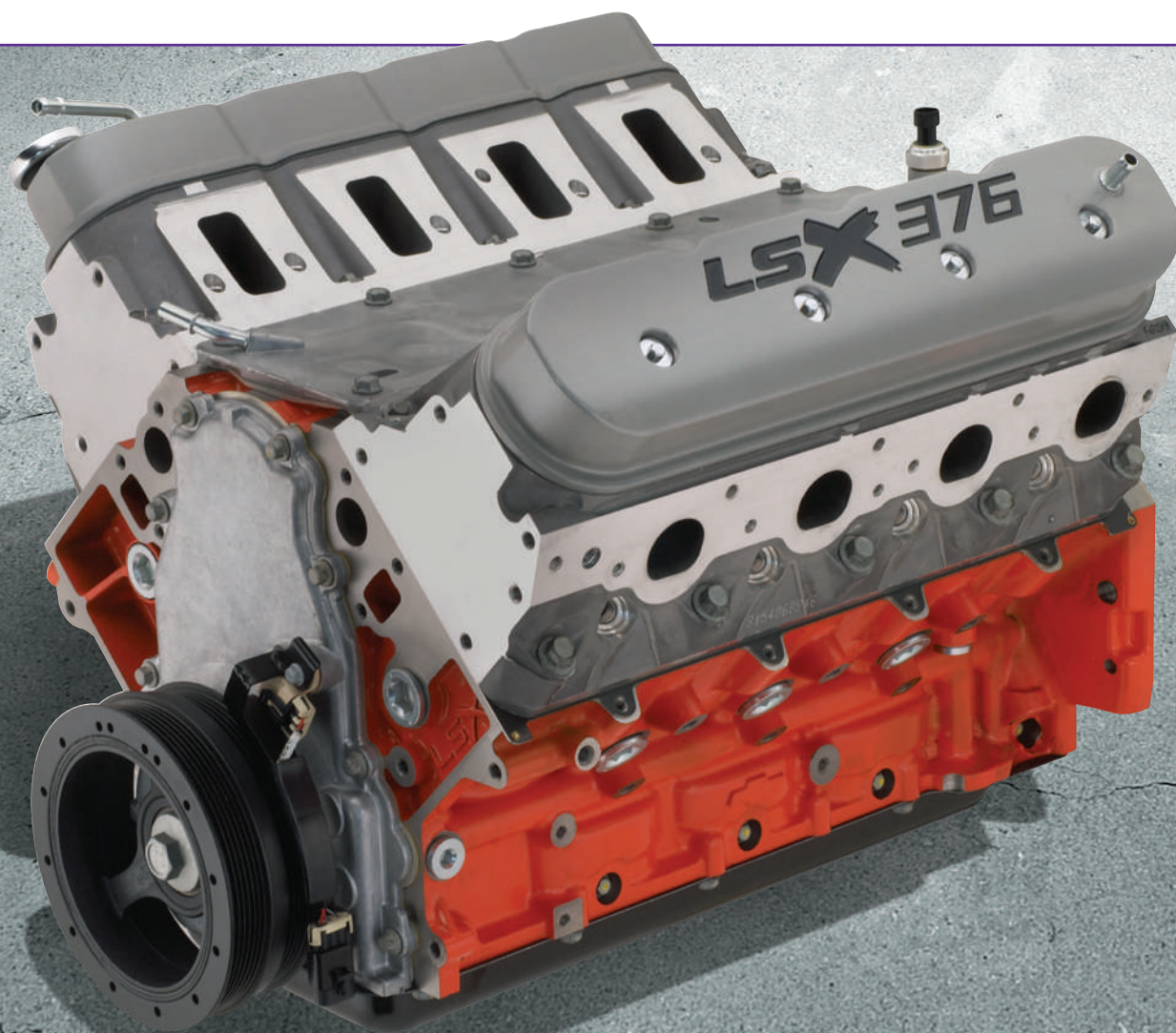

19300175
SuperMatic™ 4L85-E
4-Speed Transmission
 Features five-pinion gearsets, heat-treated stator shaft splines, induction-hardened turbine shaft, seven-plate clutch and specific valve-body calibration.
 See page 366 for torque converter applications.



19302410
Transmission Controller
 Required when using a GM electronically controlled automatic transmission. Includes wiring harness.
 See page 371 for details.

AVAILABLE ENGINE-RELATED PARTS & ACCESSORIES

See page 250 for our complete line of LS-Series components



19244035
LSX-LS3 Single-Plane
Standard Deck 4-bbl
Manifold
 Page 292



19301246
Air Inlet Kit for
LS-Based Crate
Engine Installation
 Page 291



12674428
LS3 Intake Manifold
Assembly
 Page 290



19212593
Muscle Car
Oil Pan Kit
 Page 289

LSX376 Completion Components
Electronic Fuel Injection

LS3 intake manifold	12674428
Ignition coil kit	19257878
Engine controller kit (non-supercharged (LS3))	19354328
High flow / 60PSI (400kPa) fuel pump (not available from Chevrolet Performance)	

Carburetor Fuel System

Intake manifold (Single-plane)	19244035
Intake manifold (Dual-plane)	19244037
Carburetor	19170095
Air cleaner	12342071
Ignition controller	19355418
Ignition coil kit	19257878
Fuel pump	6472657



LSX376-B15

19355575



473 hp

@ 6,000 rpm

444 lb.-ft.

@ 5,000 rpm

DYNO CHART

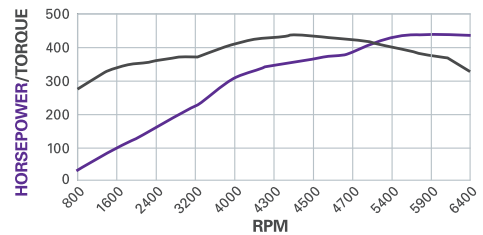

FORGED INTERNALS SUPPORT MORE BOOST!

For builders who want to stretch the performance of a turbocharged or supercharged combination, Chevrolet Performance’s LSX376-B15 is the foundation they need! Its durable, all-forged rotating assembly supports up to 15 pounds of boost. Our ratings of 473 hp and 444 lb.-ft. are only an indication of what the engine is capable of.

Additionally, the engine is topped off with high-flow, LSX-LS3 6-bolt rectangular-port heads to create an affordable foundation for supercharged and turbocharged combinations. We deliver the LSX376-B15 without an intake manifold and other accessories, allowing you to tailor the induction system and other features to suit the forced-induction setup of your choice.

Our horsepower and torque ratings are based on testing with the production-style, normally aspirated fuel injection system. The power you make with a supercharger or turbo will vary.

NOTE: Refer to page 83 for the complete horsepower and torque testing procedures.

TECH SPECS

Part Number:	19355575
Engine Type:	LSX-Series Gen IV Small-Block V-8
Displacement (cu in):	376 cu in (6.2L)
Bore x Stroke (in):	4.065 x 3.622 (103.25 x 92 mm)
Block (P/N 19260095):	LSX cast-iron with 6-bolt, cross-bolted main caps
Crankshaft (P/N 12603616):	Forged steel
Connecting Rods (P/N 12604857):	Forged powdered metal
Pistons (P/N 19259381):	Forged aluminum
Camshaft Type (P/N 12638426):	Hydraulic roller
Valve Lift (in):	.560 intake / .555 exhaust
Camshaft Duration (@.050 in):	210° intake / 230° exhaust
Cylinder Heads (P/N 19354243):	LSX-LS3 rectangular port; with “as cast” 68cc chambers and 6-bolt attachment
Valve Size (in):	2.160 intake / 1.550 exhaust
Compression ratio:	9.0:1
Rocker Arms (P/N 12669995 int):	Investment-cast, roll trunnion
Rocker Arms (P/N 12681275 exh):	Investment-cast, roll trunnion
Rocker Arm Ratio:	1.7:1
Recommended Fuel:	Regular pump
Maximum Recommended rpm:	6,600
Reluctor Wheel:	58x
Balanced:	Internal

INSTALLATION NOTES

- Assembly does not include any electronics
- Not intended for marine applications
- Requires LS/LSX Ignition Controller P/N 19355418 for carbureted applications
- LSX 8-bolt crank flange
- Assembly shipped without intake manifold or oil pan (dust shield installed for shipment)
- Recommended max boost – 15 psi

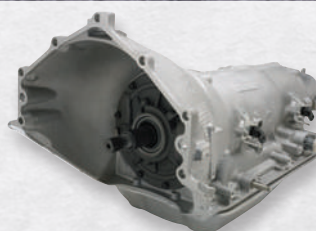
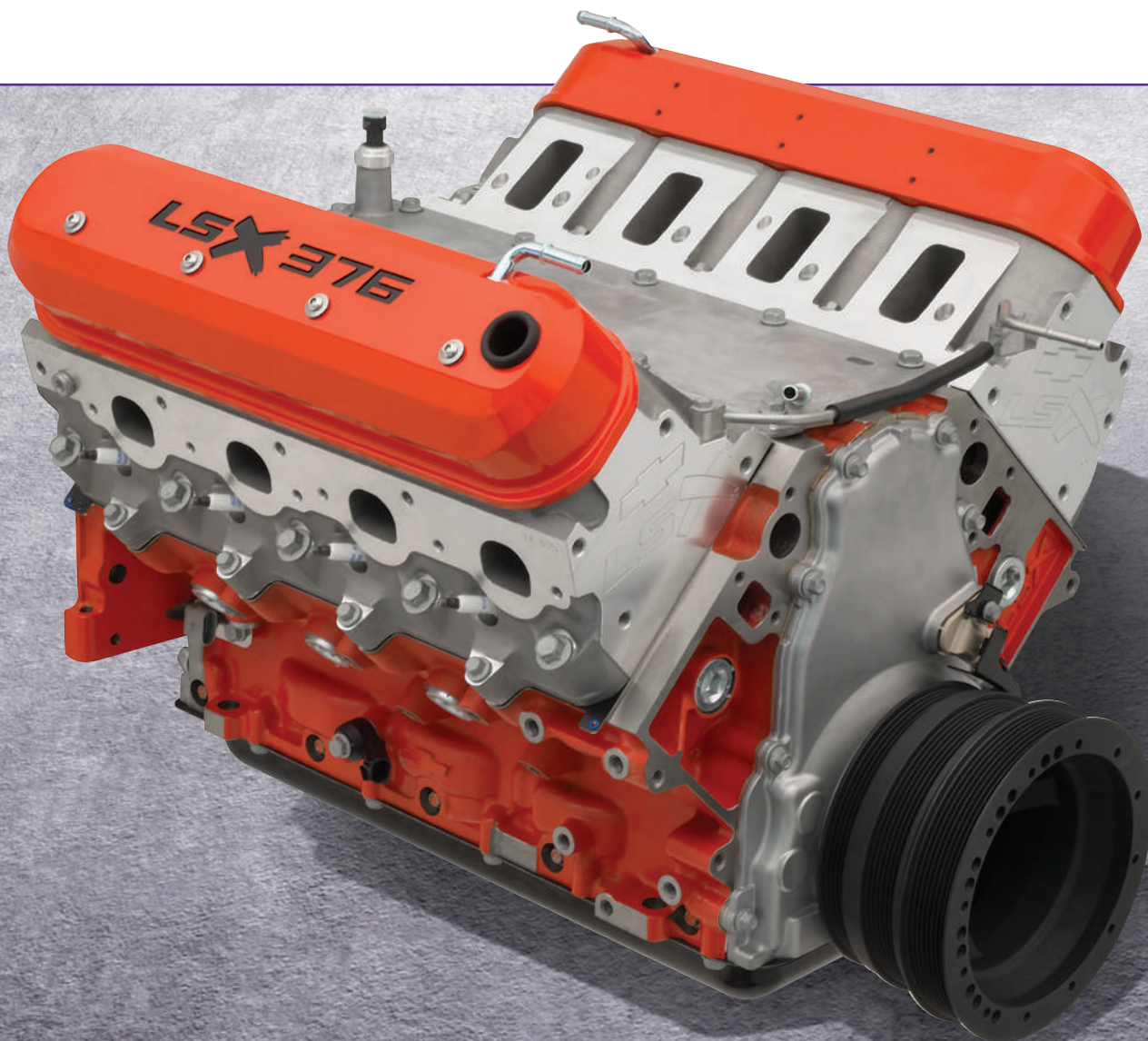

19300175
SuperMatic™ 4L85-E
4-Speed Transmission

Features five-pinion gearsets, heat-treated stator shaft splines, induction-hardened turbine shaft, seven-plate clutch and specific valve-body calibration.

See page 366 for torque converter applications.



19302410
Transmission Controller

Required when using a GM electronically controlled automatic transmission. Includes wiring harness.

See page 371 for details.

AVAILABLE ENGINE-RELATED PARTS & ACCESSORIES

See page 250 for our complete line of LS-Series components



19244035
LSX-LS3 Single-Plane
Standard Deck 4-bbl
Manifold

Page 292



19301246
Air Inlet Kit for
LS-Based Crate
Engine Installation

Page 291



22901367
LSA Intercooler
Fluid Pump

Page 291



12674428
LS3 Intake Manifold
Assembly

Page 290



19212593
Muscle Car
Oil Pan Kit

Page 289



19352208
T56 Super Magnum
Six-Speed Manual
Transmission

Page 372



LSX454

19355573



627 hp

@ 6,300 rpm

586 lb.-ft.

@ 5,100 rpm

DYNO CHART

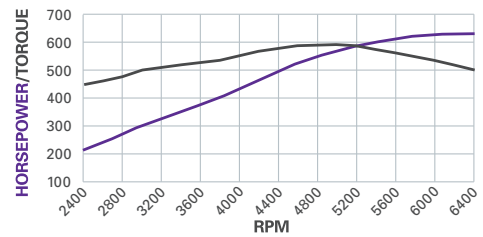

AN LSX WITH BIG-BLOCK POWER!

With the LSX Bowtie block, we've built a 21st century 454 with our latest technology. It's lighter and more compact than an original Big-Block 454 – while delivering Big-Block output of 627 hp and 586 lb.-ft. – but requires no more space under the hood than a production LS engine.

The LSX454 is filled with an all-forged, super-tough rotating assembly and features a pair of our deep-breathing LSX six-bolt cylinder heads. It also comes dressed with great-looking, orange powder-coated valve covers with engraved "LSX454" logos.

Chevrolet Performance delivers the engine without an intake manifold and other accessories. Use LSX-LS7 single-plane carbureted intake manifold P/N 19244033. The LSX454 valve covers do not include provisions for mounting ignition coil brackets. Aftermarket or custom relocation brackets must be obtained. It also includes an 8-bolt crankshaft flange that may require an adapter for use with some transmissions.

NOTE: Refer to page 83 for the complete horsepower and torque testing procedures.

TECH SPECS

Part Number:	19355573
Engine Type:	LSX-Series Gen IV Small-Block V-8
Displacement (cu in):	454 cu in (7.4L)
Bore x Stroke (in):	4.185 x 4.125 (106.3 x 104.8 mm)
Block (P/N 19260099):	LSX cast-iron with 6-bolt, cross-bolted main caps
Crankshaft (P/N 19244018):	4340 forged steel with 8-bolt flange
Connecting Rods (P/N 19166964):	4340 forged steel
Pistons (P/N 19166958):	Forged aluminum
Camshaft Type (P/N 19166972):	Hydraulic roller
Valve Lift (in):	.648 intake / .648 exhaust
Camshaft Duration (@.050 in):	236° intake / 246° exhaust
Cylinder Heads (P/N 19354239):	Aluminum LSX-LS7 port; with "as cast" 70cc chambers
Valve Size (in):	2.200 titanium intake/1.610 hollow, sodium-filled exhaust
Compression ratio:	11.0:1
Rocker Arms (P/N 12579615 int):	Investment-cast, roll trunnion
Rocker Arms (P/N 12579617 exh):	Investment-cast, roll trunnion
Rocker Arm Ratio:	1.8:1
Recommended Fuel:	Premium pump
Maximum Recommended rpm:	7,100
Reluctor Wheel:	58x
Balanced:	Internal

INSTALLATION NOTES

- Assembly does not include any electronics
- Requires LS7 pattern intake manifold
- Assembly shipped without an intake manifold (see page 292)
- Requires the purchase and installation of an oil pan (see page 289) (dust shield installed for shipment)
- Not intended for marine applications
- Requires LS/LSX Ignition Controller P/N 19355418 when using a carburetor
- LSX 8-bolt crank flange
- Requires premium fuel

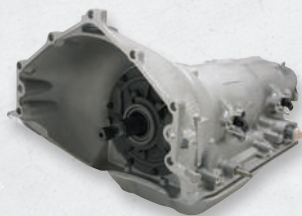
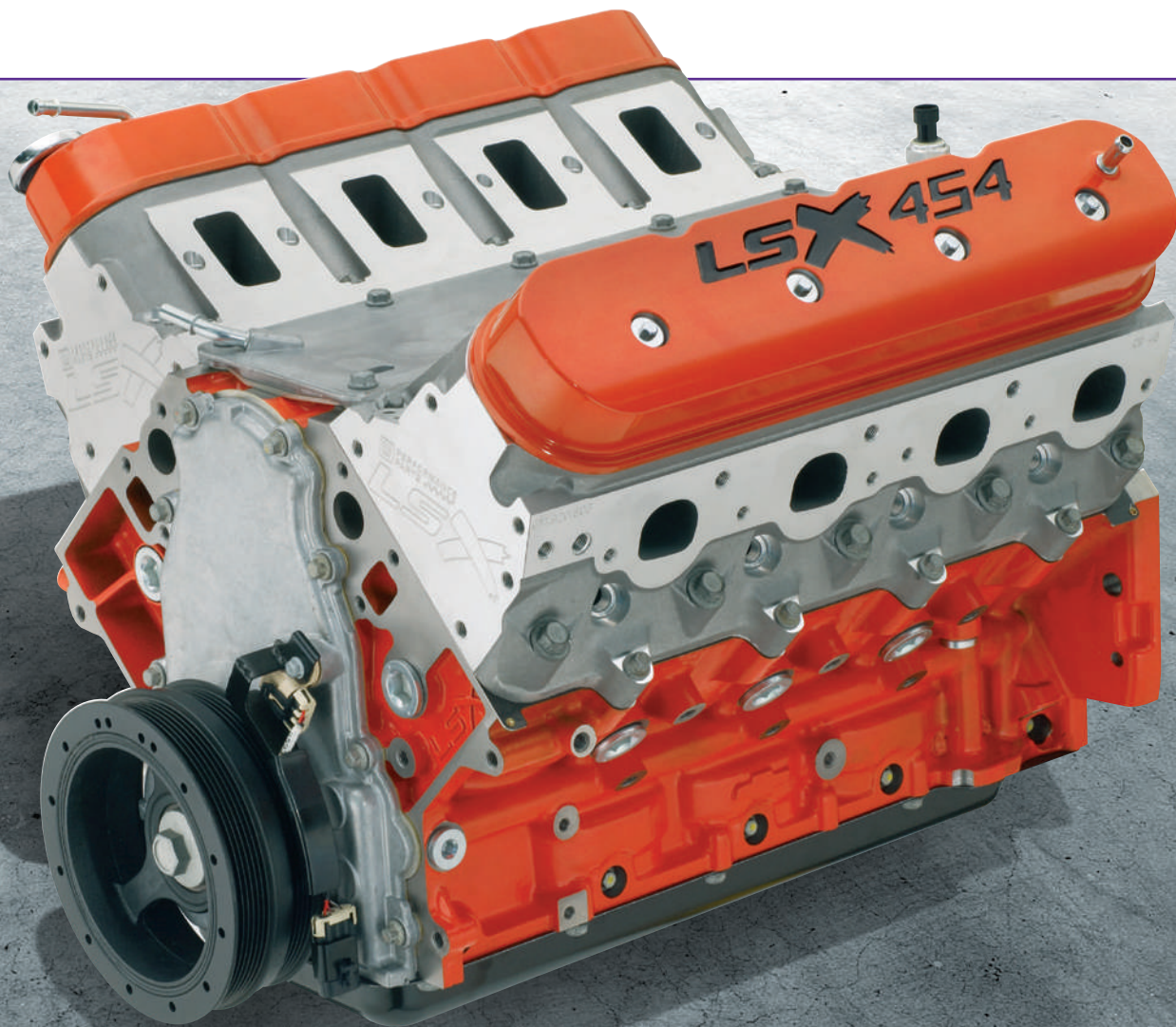

19300175
SuperMatic™ 4L85-E
4-Speed Transmission

Features five-pinion gearsets, heat-treated stator shaft splines, induction-hardened turbine shaft, seven-plate clutch and specific valve-body calibration.

See page 366 for torque converter applications.

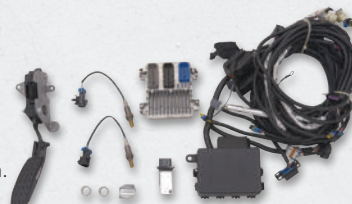

19354344 Manual
19354342 Automatic
LSX454 Engine
Controller Kit

See page 297 for details.

AVAILABLE ENGINE-RELATED PARTS & ACCESSORIES

See page 250 for our complete line of LS-Series components



12644568
LS7 Production Intake
Manifold Assembly
 Page 290



19301246
Air Inlet Kit for
LS-Based Crate
Engine Installation
 Page 291



19355418
LS/LSX Ignition
Controller
 Page 298



19244033
LSX-LS7 Standard
Deck 4-bbl Manifold
 Page 292

LSX454 Completion components

Electronic Fuel Injection

- LS7 intake manifold **12644568**
- Ignition coil kit **19257878**
- Engine controller kit **19354344**
 or **19354342**

High flow / 60 psi (400kPa) fuel pump (not available from Chevrolet Performance)

Carburetor Fuel System

- Intake manifold (single-plane) **19244033**
- Carburetor **19170095**
- Air cleaner **12342071**
- Ignition controller **19355418**
- Ignition coil kit **19257878**
- Fuel pump **6472657**



LSX454R

19260835



776 hp

@ 7,000 rpm

649 lb.-ft.

@ 5,100 rpm

DYNO CHART

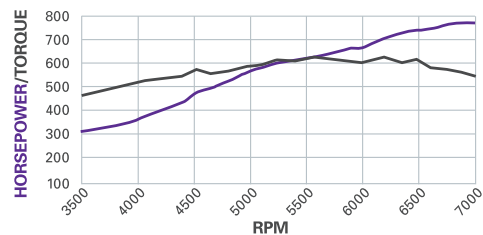

OUR MOST POWERFUL LS ENGINE EVER!

Quite simply, the LSX454R drag racing engine is the most powerful LS crate engine ever from Chevrolet Performance – and it’s designed to do one thing: help you win races with great durability.

For the record, this 13.1:1, naturally aspirated and single Dominator-fed big-inch LS engine is officially rated at 776 horsepower at 7,000 rpm and 649 lb.-ft. of torque at 5,100 rpm. It breathes through our high-flow LSX DR six-bolt cylinder heads that have 313cc intake runners. More than power, this engine was built for durability. Its bottom end includes our tough LSX Bowtie cylinder block and it’s filled with an all-forged rotating assembly.

During development, engineers simulated the equivalent of 600 back-to-back drag strip passes on the engine dyno, ensuring you can expect to spend your time at the track working on the car’s performance, rather than spending it on maintenance. It’s an engine you can depend on to go round after round, season after season!

NOTE: Refer to page 83 for the complete horsepower and torque testing procedures.

TECH SPECS

Part Number:	19260835
Engine Type:	LS-Series Small-Block V-8
Displacement (cu in):	454 cu in (7.4L)
Bore x Stroke (in):	4.185 x 4.125 (106.3 x 104.8 mm)
Block (P/N 19260099):	LSX cast iron with 6-bolt cylinder head attachment
Crankshaft (P/N 19244018):	4340 forged steel
Connecting Rods (P/N 19166964):	4340 forged steel
Pistons (P/N 19166958):	4032 forged aluminum
Camshaft Type (P/N 19166975):	Mechanical roller
Camshaft Lift (in):	.738 intake / .738 exhaust
Camshaft Duration (@.050 in):	250° intake / 270° exhaust
Cylinder Heads (P/N 19166979):	Drag race cylinder heads 6-bolt LSX aluminum
Valve size (in):	2.250 x 6.370 intake 1.625 x 6.400 exhaust
Compression Ratio:	13.1:1
Rocker Arms (P/N 19201808):	Shaft mounted with needle bearing fulcrum and tip
Rocker Arm Ratio:	1.9:1
Recommended Fuel:	Race fuel (110 octane minimum)
Maximum Recommended rpm:	7,100
Reluctor Wheel:	58x
Balanced:	Internal

INSTALLATION NOTES

- Intended for off-road use only!
- Requires race fuel (110 octane minimum)
- Not intended for marine use
- Requires LS/LSX Ignition Controller P/N 19355418
- Oil pan not included (see page 289)
(Dust shield installed for shipment)
- LSX 8-bolt crank flange
- Uses 4500-series carburetor (included)



AVAILABLE ENGINE-RELATED PARTS & ACCESSORIES

See page 250 for our complete line of LS-Series components



19355418
LS/LSX Ignition Controller *Page 298*



19212593
Muscle Car Oil Pan Kit *Page 289*

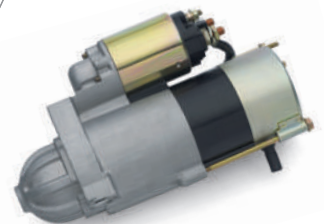

10465385
LS-Series Starter *Page 294*



LS/LT/LSX-SERIES

ENGINE COMPONENTS

YOUR ONE AND ONLY FACTORY SOURCE FOR HIGH-PERFORMANCE ENGINE PARTS!

Chevrolet Performance is the factory source for high-performance parts for LS, LT and LSX engines, from power-adding components such as ported cylinder heads and camshafts to the blocks, rotating parts, oil pans and virtually everything else you need to build an engine or facilitate an engine swap.

All of our LS, LT and LSX parts are factory-engineered and manufactured to the same quality standards as production engines, so you can trust Chevrolet Performance to offer exceptional performance, fit and durability.

It's a new era of technologically advanced high-performance and whether you're building an LS engine for your resto-mod Chevelle or looking to add a few more horses to your late model Camaro SS, you won't find a more comprehensive lineup of power-building LS, LSX or LT parts than Chevrolet Performance.

Build the future today!

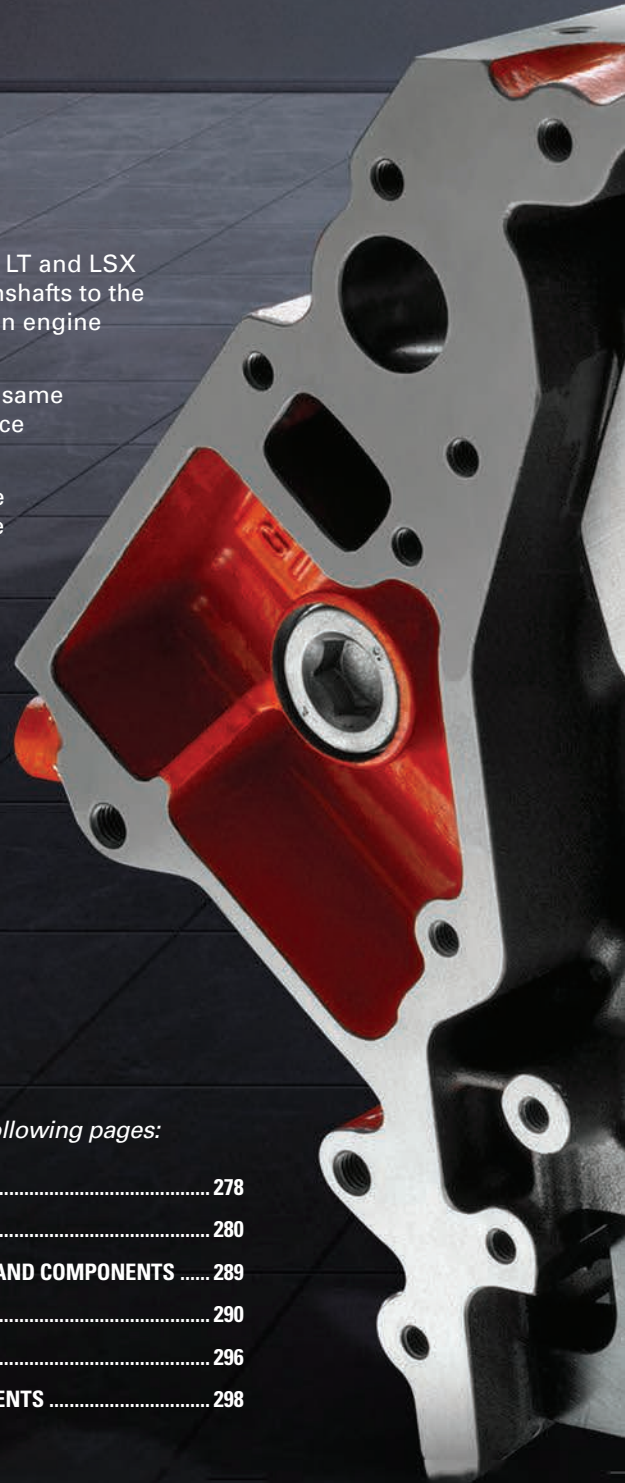

You can find these Chevrolet Performance LS/LT/LSX Engine Components on the following pages:

BLOCKS AND COMPONENTS	252	CRANKSHAFTS	278
CYLINDER HEADS	262	ACCESSORY DRIVE SYSTEMS	280
VALVE COMPONENTS	271	OIL PANS, OIL PUMPS, GASKETS AND COMPONENTS	289
VALVE COVERS	272	INTAKE MANIFOLDS	290
CAMSHAFTS	275	ENGINE CONTROL MODULES	296
PISTONS AND PISTON RINGS	277	FUEL AND ELECTRICAL COMPONENTS	298



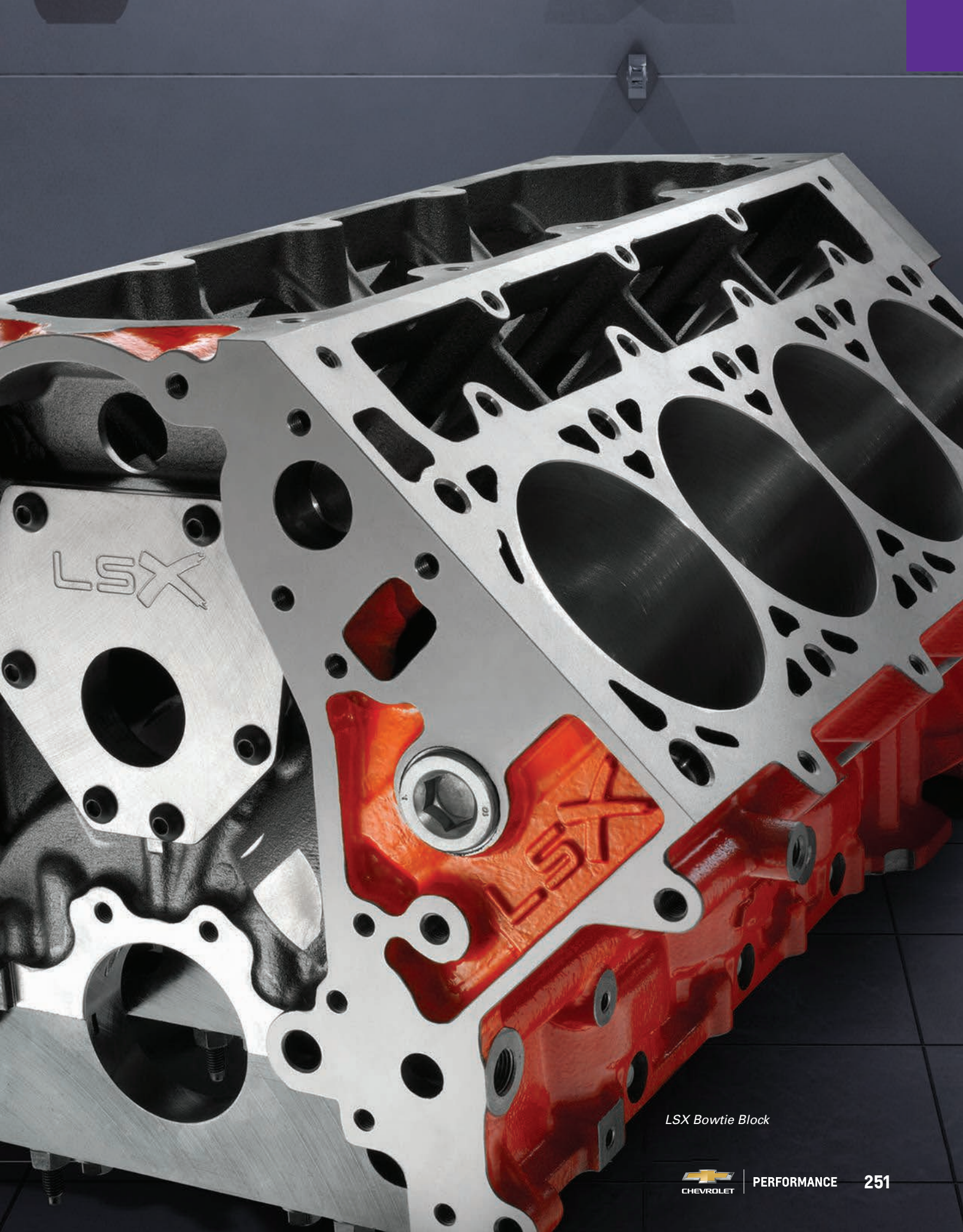

LSX Bowtie Block



Chevy LS/LT/LSX-Series Blocks Quick Reference Chart

Origin	Part Number	Material	Deck Height	Bore	Main Bolt	Cap Material	Crank Jnl. Dia.	Oiling	Rear Main Seal	Max Stroke	Max HP	Usage	Page Number
LS1/LS6	12561166	Alum	9.240"	3.898"	6	Iron	Std. LS (2.56")	Wet/Dry	1 pc	4.00"	450	Street	Disc.
Gen IV 6.0L	12609999	Iron	9.240"	4.000"	6	Iron	Std. LS (2.56")	Wet/Dry	1 pc	4.00"	500	Street	252
LS2	12602691	Alum	9.240"	4.000"	6	Iron	Std. LS (2.56")	Wet/Dry	1 pc	4.00"	450	Street	253
LS3/L92	12623967	Alum	9.240"	4.065"	6	Iron	Std. LS (2.56")	Wet/Dry	1 pc	4.00"	525	Street	253
LSA	12673476	Alum	9.240"	4.065"	6	Nodular Iron	Std. LS (2.56")	Wet/Dry	1 pc	4.50"	800	Street/Pro	254
LS9	12623969	Alum	9.240"	4.065"	6	1045 Steel	Std. LS (2.56")	Wet/Dry	1 pc	4.50"	900	Street/Pro	254
LS7	19213580	Alum	9.240"	4.125"	6	Steel	Std. LS (2.56")	Wet/Dry	1 pc	4.10"	550	Street	255
LT1	19329617	Alum	9.240"	4.065"	6	Nodular Iron	Std. LS (2.56")	Wet/Dry	1 pc	4.125"	465	Street	256
C5R	12480030	Alum	9.240"	4.117"-4.160"	6	Steel	Std. LS (2.56")	Wet/Dry	1 pc	4.10"	900	Pro	257
LSX	19260093*	Iron	9.260"	3.880"	6	1045 Steel	Std. LS (2.56")	Wet/Dry	1 pc	4.25"	1500+	Street/Pro	259
LSX	19260100*	Iron	9.720"	3.880"	6	1045 Steel	Std. LS (2.56")	Wet/Dry	1 pc	4.50"	1500+	Street/Pro	259
LSX	19260095**	Iron	9.240"	4.065"	6	1045 Steel	Std. LS (2.56")	Wet/Dry	1 pc	4.25"	1500+	Street/Pro	259
LSX	19260099**	Iron	9.240"	4.185"	6	1045 Steel	Std. LS (2.56")	Wet/Dry	1 pc	4.25"	1500+	Street/Pro	259

*Semi-finished block
 **Full machined block

PRODUCTION CYLINDER BLOCKS

The LS-Series cylinder block is the foundation for the serious performance achievements that are driving a new generation of street and racing enthusiasts. Features include a deep-skirt casting (the block side extends below the crankshaft centerline); 6-bolt cross-bolted main caps, strong and lightweight aluminum alloy casting (most production blocks) and provisions for the latest in engine control management. The cam-in-block configuration brings inherent torque to every LS engine, with production-based blocks capable of supporting combinations of 500 horsepower or more. The Corvette ZR1's unique 6.2L block, for example, supports the engine's 638-horsepower rating. Chevrolet Performance's high-performance iron LSX cylinder block supports more than 2,000 forced-induction horses!

Whether you're building a mild street engine or an Outlaw racing engine, starting with a strong LS cylinder block brings the assurance that you'll make the power you need with a durable foundation.

A. 12609999

Gen IV 6.0L Cast-Iron Block

- Direct replacement for LY6 and L96 production engines
- Production cast-iron block
- Production oiling system
- 6-bolt iron main bearing caps
- 4.000" Bore
- 9.240" deck height
- No provision for Active Fuel Management
- Supports 500+ horsepower!



A Gen IV 6.0L Cast-Iron Block (top, front)

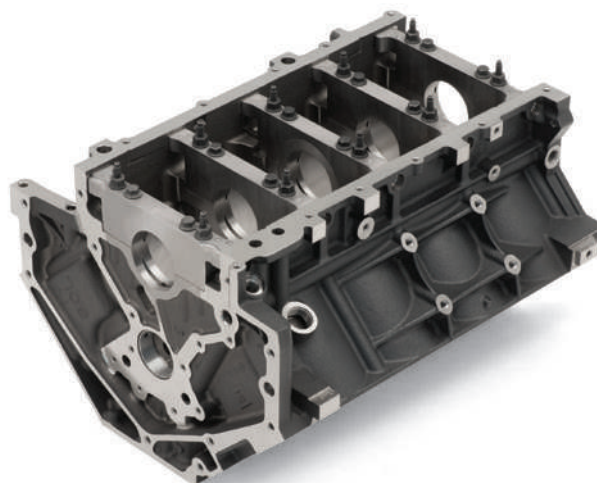

A Gen IV 6.0L Cast-Iron Block (bottom, rear)



LS3/L92 Aluminum 6.2L Bare Block (top, front) **B**

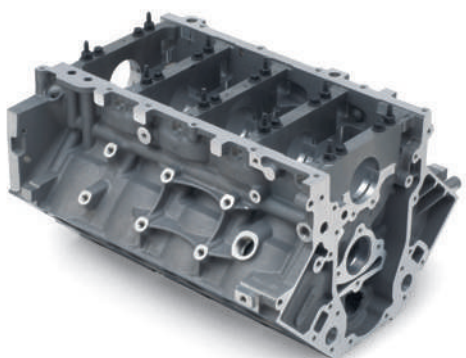

LS3/L92 Aluminum 6.2L Bare Block (bottom, front) **B**

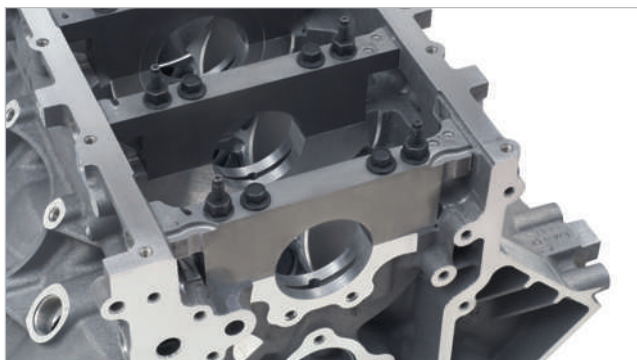

LS3/L92 Aluminum 6.2L Bare Block (bottom, rear) **B**



LS3/L92 Aluminum 6.2L Bare Block (top, front) **B**

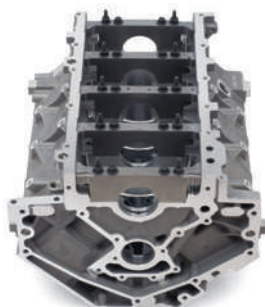

LS3/L92 Aluminum 6.2L Bare Block (bottom, front) **B**

Deck Height Diagram

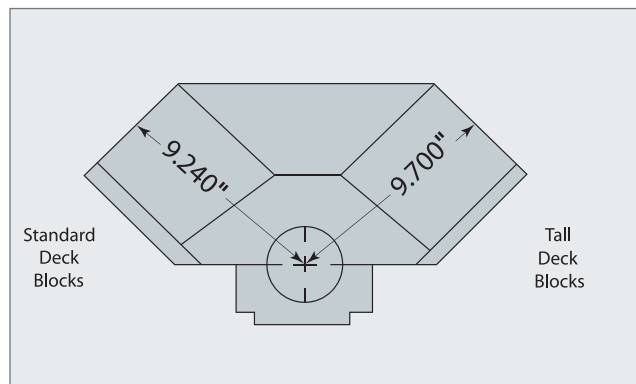

12602691

LS2 Aluminum 6.0L Bare Block (not shown)

- Direct replacement for 2005-2008 LS2 Corvette, SSR, GTO 6.0L and TrailBlazer SS
- Production 319-T5 aluminum block with iron sleeves
- Production oiling system
- Forged powdered metal 6-bolt main bearing caps
- 9.240" deck height
- Use only LS1, LS6, LS2, L92/LS3-style cylinder heads
- 4.000" finished bore (101.6mm)
- Provisions for Active Fuel Management
- Great for stroker cranks for even more cubes
- Tested to over 450 horsepower!

B. 12673475

LS3/L92 Aluminum 6.2L Bare Block

- Direct replacement for:
 - 2009-2012 L9H
 - 2010-2012 L94
 - 2008-2013 LS3
 - 2010-2013 L99
 - 2007-2008 L92
- Production aluminum block with iron sleeves
- Production oiling system
- Forged powdered metal 6-bolt main bearing caps
- 9.240" deck height
- Use only LS1, LS6, LS2, L92/LS3-style cylinder heads
- 4.065" finished bore (103.25mm)
- Provisions for Active Fuel Management
- Great for stroker cranks for even more cubes
- Tested to over 500 horsepower!

LS-Series Blocks continued

12673476

LSA 6.2L Bare Block (not shown)

- Direct replacement for 2009-2012 Cadillac CTS-V 6.2L supercharged engine and 2012 ZL1 Camaro
- Production cast-aluminum block with iron sleeves
- Production oiling system
- 6-bolt iron main bearing caps
- 9.240" deck height
- Not for use with LS7 or LSX-LS7 heads
- 4.065" finished bore (103.25mm)
- Includes oil squirters (8) for piston cooling
- No provision for active fuel management
- Rated for more than 550 horsepower

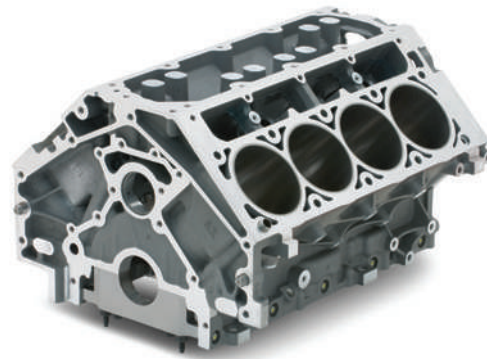

A LS9 6.2L Bare Block (top, rear)

A. 12623969

LS9 6.2L Bare Block

- Direct replacement for 2009-2012 Corvette ZR1 6.2L supercharged engine
- Production cast-aluminum block with iron sleeves
- Deck plate honed
- Production oiling system
- 6-bolt steel main bearing caps with dowel pins
- 9.240" deck height
- Not for use with LS7 or LSX/LS7 heads
- 4.065" finished bore (103.25mm)
- Includes oil squirters (8) for piston cooling
- No provision for Active Fuel Management
- Rated for more than 635 horsepower

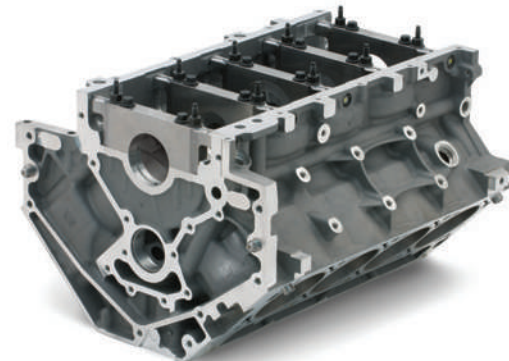

A LS9 6.2L (bottom, rear)



A LS9 6.2L (top, front)

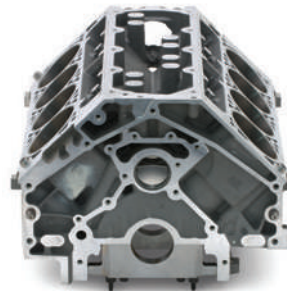

A LS9 6.2L (top, rear)

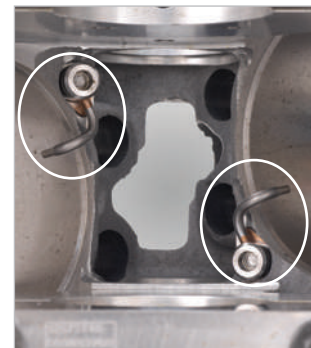

A LSA-LS9 6.2L Piston Oilers

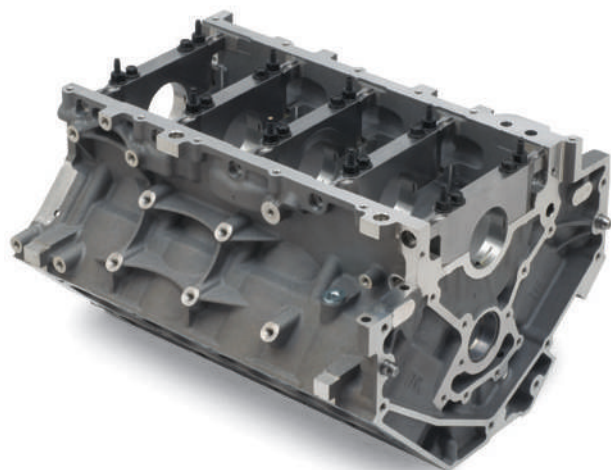

LS7 7.0L Corvette Bare Block (bottom, rear) **B**

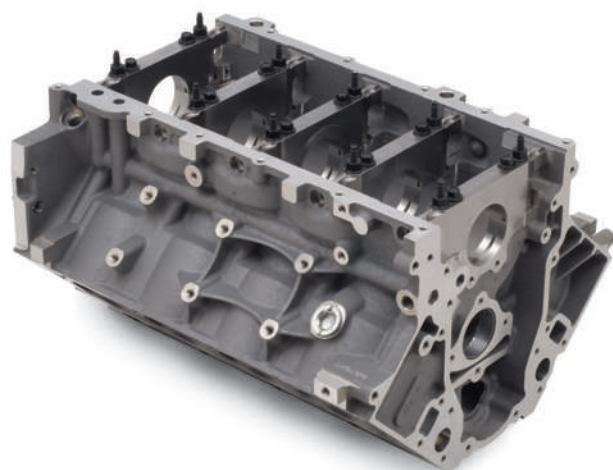

LS7 7.0L Corvette Bare Block (bottom, front) **B**

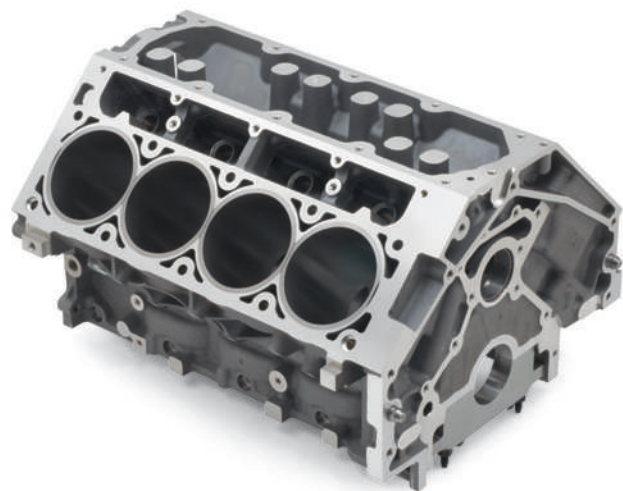

LS7 7.0L Corvette Bare Block (top, rear) **B**

B. 19213580

LS7 7.0L Corvette Bare Block

- Direct replacement for 2006-2014 7.0L LS7 engine
- Production 319-T5 aluminum block with pressed-in iron sleeves
- Production oiling system
- 6-bolt dowel located steel main bearing caps
- 9.240" deck height
- For use with any LS or LSX series head
- 4.125" finished bore (104.78mm), deck plate honed
- Siamese cylinder bores for large bore size
- No provision for active fuel management
- Based on C5R block development
- Tested to over 500 horsepower!

Parts required to complete your LS7 Block:

Part Number	QTY	Description
12570471	1	Valley Cover
11588949	6	Plug
12589016	1	Camshaft Retainer
11611351	1	Plug
11610259	1	Plug, Cylinder Head
11515756	5	M8 x 1.25 Flanged Hex Head Bolt
12570326	4	Dowel, Cylinder Head Locating
12639250	1	Rear Cover Assembly
12573460	1	Oil Plug
12618422	1	Windage Tray
09427693	4	Plug
01453658	2	Dowel, Bell housing Locating
12561663	1	Plug
12677836	1	Oil Pressure Sensor
12585546	1	Crankshaft Position Sensor
12598293	1	Cover
12585673	1	Seal - Front Cover
12633904	1	Gasket - Front Cover
11515758	8	Bolt
12591720	1	Sensor - Camshaft position
11588712	1	Bolt

25534412

Oil Hose Adapters (shown on page 260)

- Kit adapts the production LS7 oil pan to aftermarket AN-style hoses for aftermarket dry sump oil tanks
- Bolts directly to LS7 oil pan, and has AN male outlet for AN -12 fittings
- Includes 1 adapter, 2 fittings, 2 bolts, and 2 sealing gaskets

LS-Series Blocks continued

A. 19329617

LT1/LT4 Aluminum 6.2L Bare Block

- Direct replacement for 2014-2017 Stingray and 2015-2017 Camaro SS LT1
- Production aluminum block with iron sleeves
- Production oiling system
- 9.240" deck height
- Nodular Iron 6-bolt main bearing caps
- Use only with LT1-style cylinder heads
- 4.065" finished bore (103.25mm)
- Provisions for Active Fuel Management
- Provision for direct fuel injection

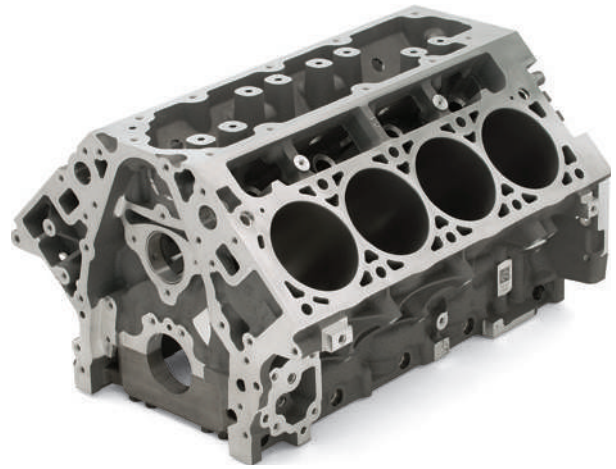

A LT1/LT4 Aluminum 6.2L Bare Block (top, front)

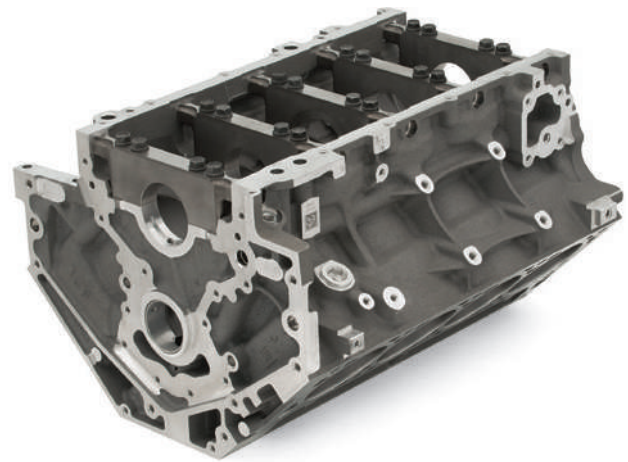

A LT1/LT4 Aluminum 6.2L Bare Block (bottom, rear)



A Bore Detail

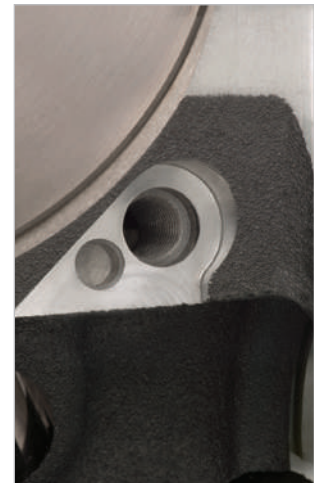

A Squirters Detail

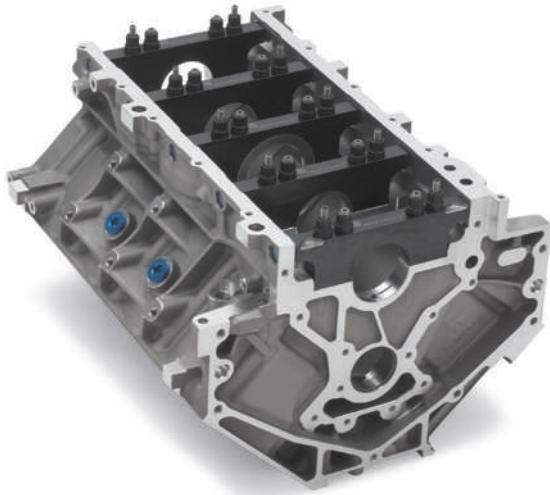
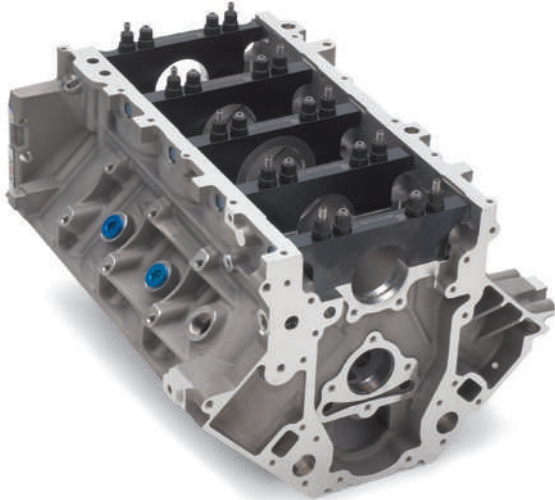
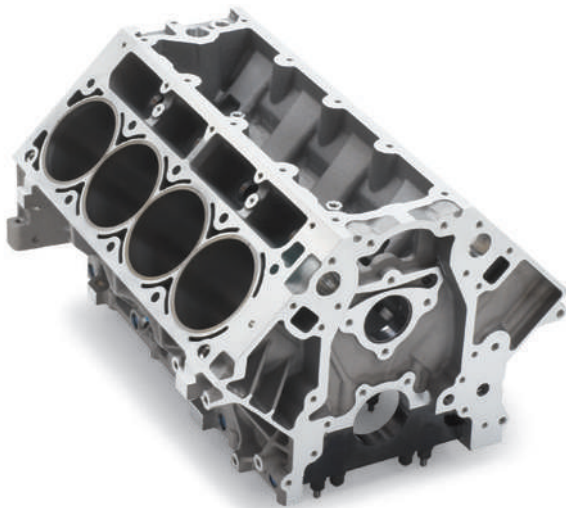
Aluminum C5R Racing Block (bottom, rear) **B**Aluminum C5R Racing Block (bottom, front) **B**Aluminum C5R Racing Block (top, front) **B**

B. 12480030 Aluminum C5R Racing Block

The ultimate GM aluminum LS block, the C5R was originally designed for Chevrolet's factory-backed Corvette racing program. It was developed to support more than 440 cubic inches and up to 900 horsepower – and it proved itself by powering the Corvette team to wins at LeMans, Daytona and nearly every track they encountered. This is a non-production, purpose-built cylinder block manufactured with proprietary materials and machined to the highest tolerances – and using premium, racing-spec hardware. If you're looking for the ultimate aluminum cylinder block to support your horsepower desires, the race-proven C5R is it!

- Premium "hipped" * and X-rayed 356-T6M aluminum-alloy block casting
- 9.240" deck height
- Production-style oiling system
- 6-bolt dowel-located steel main bearing caps
- 4340 premium main cap fasteners
- For use with any LS or LSX series head
- Unique cylinder liner material for maximum durability
- Siamesed cylinders to support larger bores
- 4.117" finished bore
- 4.160" maximum bore
- Fully blueprinted and squared
- Production camshaft location and cam bores
- Includes premium head studs
- Anodized aluminum O-ring core plugs
- No Active Fuel Management provisions
- Supports more than 900 horsepower

**HIP is the acronym for Hot Isostatic Pressure. This process puts the blocks in a sealed vessel where a vacuum is first used to remove room air and any possible contaminants. The vessel is filled with high pressure nitrogen (up to 30,000-psi) and then heated to the required temperature and sustained for a determined amount of time. The cooling process is also a controlled procedure to ensure maximum strength and proper heat treat. This extreme high pressure and heat removes almost 100% of the internal porosities that are generated during the casting process. The material integrity, strength and fatigue life increase significantly.*



LSX BOWTIE BLOCK

Delivering the seemingly impossible combination of professional racing-level strength and entry-level affordability, the LSX Bowtie Block is our next revolution in high-performance engine-building. This durable iron-block casting is based primarily on GM's production LS7 block, but designed with more material in key areas – including thicker deck and bores – to support displacements of 454 cubic inches or more, and unique six-bolts-per-cylinder-head-clamping capability that enables forced-induction and nitrous combinations of greater than 2,000 horsepower.

Because the LSX Bowtie block is based on production LS blocks, all of the LS-Series Gen IV cylinder heads, crankshafts, oil pans, camshafts, and accessories bolt right up to it. There is also a tall-deck version for building even larger engines. Chevrolet Performance delivers the LSX Bowtie Block semi-finished, allowing you to finish it to your needs. Whether you're building a "tame" 500-horse street engine for your hot rod or a 1,700 horsepower turbo engine for an Outlaw drag racer, the LSX Bowtie Block is the foundation for an unbeatable combination – at an unbeatable price!

LSX Bowtie Block specs and features include:

- CNC-machined cast-iron block
- True priority main oiling
- 6-head bolts per cylinder
- Standard 4.400" bore spacing
- Extra-thick siamese cylinder bores
- Semi-finished, machined thicker decks
- LS7-style, 6-bolt dowel-located billet main bearing caps
- Wet-sump and dry-sump oiling capability
- Production-style deep-skirt head bolt holes
- Production bolt hole and thread sizes
- Maintains production exterior accessory mounting provisions
- Front motor plate mounting holes added
- Additional material cast around cam bearings for greater strength
- 8mm exterior/interior fifth- and sixth-head bolt holes
- Standard 0.842" lifter bores
- Accommodates all LS oil pumps and oil pans
- External oil pump feed (rear of block)
- Main web bay-to-bay breathing holes to support greater horsepower
- Includes unique cam retainer, rear cover and lifter retainers

For the advanced LSX competition engine builder, you will fully enjoy the following features of the new LSX Bowtie Block:

- Front oil feed holes can be plugged/restricted for mechanical flat tappet or mechanical roller lifter applications
- Can be machined safely to 9.200" deck height
- Maximum 4.200" bore at .200" minimum wall thickness (naturally aspirated applications)
- Head bolt holes can be machined for 1/2" studs
- Cam bores can be machined to accept 60mm roller bearings
- Can be machined for larger diameter lifters and/or 1.060" bronze bushings
- Front oil feed lines can be plugged and external oil pump and/or aftermarket dry sump systems can be used via oil pump feed at rear of block – may be required with certain large stroke/aluminum rod combinations
- Belt cam drive systems can be accommodated – some machining will be required
- Front motor plate can be used for racing chassis applications (sprint car, drag racing, truck pulling, etc.).
- Threaded water plugs can be used for external heaters or coolers
- Extra stock for main bearing align-honed
- 400 mPa tensile strength iron

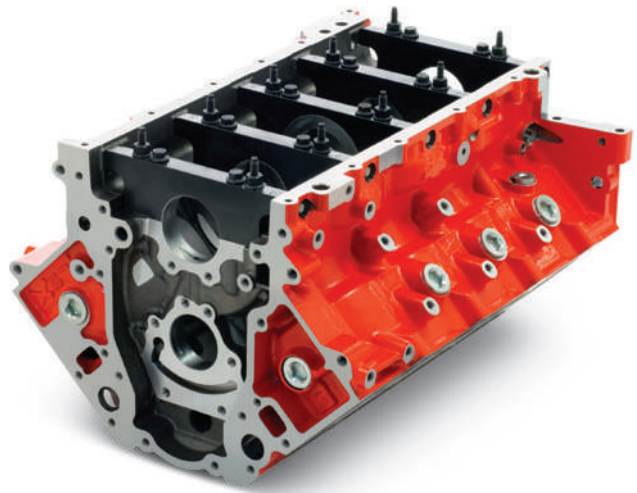

A LSX Bowtie Block (bottom, front)



A LSX Bowtie Block (top, rear)

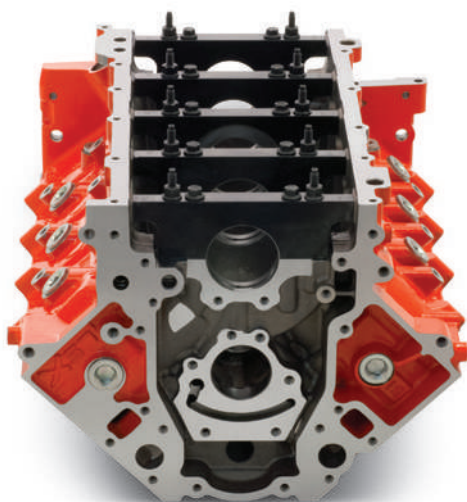

A LSX Bowtie Block (top, front)

LSX Bowtie Block (bottom, front) **A**Lifter Boss Detail **A**Bay-to-Bay Breathing Pocket Detail **A**Deck Detail **A**

Semi-Finished Blocks

A. 19260093

LSX Bowtie Block – Semi-finished, Standard Deck

- 3.880" semi-finished siamese cylinder bores
- 9.260" semi-finished standard deck height (ready to be decked)
- 4.250" maximum stroke (professional engine builders only!)
- Capable of 364- to 482-cubic-inch displacements
- Orange powder-coated finish
- Accepts all LS and LSX Series heads, cranks, cams, etc.
- Approximate finished weight is 225 pounds

19260100

LSX Bowtie Block – Semi-finished, Tall Deck (not shown)

- 3.880" semi-finished siamese cylinder bores
- 9.720" semi-finished standard deck height (ready to be decked)
- 4.500" maximum stroke (small base circle camshafts required)
- Capable of 364- to 500-cubic-inch displacements or more!
- Orange powder-coated finish
- Accepts Gen IV LS and LSX Series heads, cranks, cams, etc.
- Approximate finished weight is 250 pounds

LSX Blocks include the following:

19244460	Cam Thrust Plate
19166179	Rear Cover
19166182	Tappet Guides

Other service parts for your LSX Block:

19166178	Gasket – Cam Thrust Plate, O-Ring
19166180	O-Ring – Rear Cover
19166181	O-Ring – Rear Cover
19211434	Main Cap Dowel (10-piece kit)

Finished Blocks

LSX finished blocks are completely machined and are ready for assembly. Save time and money.

19260095

LSX376 Production Block (not shown)

- 4.065" bore
- Fully CNC machined
- Deck plate honed
- Align-honed main bearings
- Deck height 9.240" (production)
- Billet-steel main caps
- Includes all hardware
- Used in LSX376 crate engine

19260099

LSX454 Production Block (not shown)

- 4.185" bore
- Fully CNC machined
- Deck plate honed
- Align-honed main bearings
- Deck height 9.240" (production)
- Billet-steel main caps
- Includes all hardware
- Used in LSX454 crate engine

CYLINDER BLOCK COMPONENTS

A. Gen III Bare Block Completion Components

Part Number	QTY	Description
12577927	1	Valley Cover
12561211	1	Cam Sensor
12561243	1	Front Cover (with seal)
1453658	2	Transmission Alignment Dowel
12589016	1	Cam Retainer Plate
11561455	4	Cam Retainer Bolts
12588670	1	Timing Chain Damper
12560228	1	Crankshaft Sensor
12570326	4	Head Locating Dowels
12595365	4	Lifter Guide
12639250	1	Rear Cover (with seal)
varies	-	Required Water and Oil Plugs
varies	-	Required Mounting Bolts

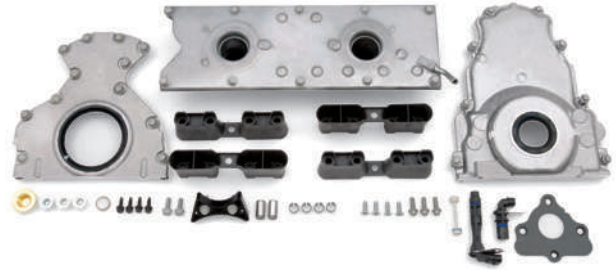

A Bare Block Completion Components, Gen III

B. 19299099

Gen IV Block Completion Kit – Non D.O.D.

- Complete your LSX or GEN IV production engine with production components

Part Number	QTY	Description
12633906	1	Front Engine Cover
12599296	1	Valley Cover
12570326	4	Head Locator Dowels
12585546	1	Crankshaft Sensor
11515756	1	Crank Sensor Bolt
12588670	1	Timing Chain Damper



B LSX Block Completion Kit

C. 25534412

Oil Hose Adapters

- Kit adapts the production LT1 and LS7 Oil Pan to aftermarket AN-style hoses for aftermarket dry sump oil tanks
- Bolts directly to oil pan, and has AN male outlet for AN -12 fittings
- Includes 1 adapter, 2 fittings, 2 bolts, and 2 sealing gaskets

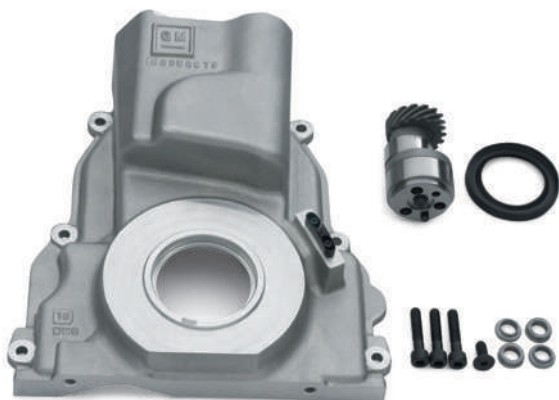

C Oil Hose Adapter

LS2, LS3 Front Timing Cover **D**LS Front Distributor Drive Cover **E**Rear Block Cover **F****FRONT COVERS****12561243****LS1, LS6 Front Timing Cover (not shown)**

- For LS1 and LS6 engines
- No cam sensor

D. 12633906**LS2, LS3 Front Timing Cover**

- For LS2 and LS3 engines
- Cover only. Does not come with cam sensor, bolts, or seals

12594939**L92 Front Timing Cover (not shown)**

- For engines with VVT such as L92
- Cover only. Does not come with cam sensor, bolts, or seals

12598293**LS7 Front Timing Cover (not shown)**

- Also fits LS9 engines
- Required for 2-stage oil pump clearance
- Cover only. Does not come with cam sensor, bolts, or seals

E. 88958679**LS Front Distributor Drive Cover**

- Assembly is manufactured for applications where a 4-bbl carburetor and distributor are required
- For all LS-Series engines except LS7 and LS9

NOTE: Distributor and mechanical fuel pump not included. Uses Small-Block Ford-style distributor and mechanical fuel pump. Special water pump, accessory drive and damper required.

12633904**Front Cover Gasket (not shown)**

- For all LS-Series engines

12585673**Front Crank Seal (not shown)**

- For all LS-Series engines

11515758**Front Cover Bolt (not shown)**

- Requires 8 per engine
- For all LS-Series engines

REAR COVERS**F. 12639250****Rear Block Cover**

- Includes seals and bolts
- For all production LS engine blocks (will not work on LSX blocks)

19166179**LSX Rear Block Cover (not shown)**

- Does not include bolts or seals
- For use on LSX blocks only

89060436**Rear Crank Seal (not shown)**

- For all LS-Series engines

LS/LT/LSX-Series Cylinder Heads: Quick Reference Chart

Part Number	Description	Material Size	Port Size	Valve Angle	Chamber Vlv.	Int Vlv.	Exh Type	Int Port Type	Ex Port Type	Rocker	Notes	Page Number
12629049	Bare LS2 & LS6	Aluminum	210	15 deg	64.5	2.000	1.550	Cathedral	Std LS	Bolt-down	Bare LS2/LS6	N/S
12629062	Stock L92	Aluminum	260	15 deg	70	2.165	1.590	L92	Std LS	Bolt-down	Solid stem valves	263
12629063	Stock LS3	Aluminum	260	15 deg	68.4	2.165	1.590	L92	Std LS	Bolt-down	Hollow/solid	263
88958758	CNC LS3	Aluminum	276	15 deg	68.5	2.165	1.590	L92	Std LS	Bolt-down	Hollow/solid	263
12578450	Bare LS7	Aluminum	270	12 deg	70	2.200	1.610	LS7	Std LS	Bolt-down	Bare LS7	N/S
12578449	Stock LS7	Aluminum	270	12 deg	70	2.200	1.610	LS7	Std LS	Bolt-down	Titanium/sodium-filled valves	264
19328743	LS9 CNC	Aluminum	276	15 deg	68.4	2.165	1.590	L92	Std LS	Bolt-down	Titanium/sodium-filled valves	263
12626958	LSA Cylinder Head	Aluminum	260	15 deg	68.4	2.165	1.590	L92	Std LS	Bolt-down	CTS-V and Z-28 Assembly	264
19329839	LT1 CNC Cylinder Head	Aluminum	N/A	Splayed	N/A	2.130	1.590	LT-1	LT-1	Bolt-down	CNC Runners	265
12678792	LT1 Cylinder Head	Aluminum	N/A	Splayed	N/A	2.130	1.590	LT-1	LT-1	Bolt-down	Corvette Assembly	265
25534393	C5R	Aluminum	210	11 deg	38	2.180	1.630	C5R	Std LS	Shaft	As-cast, no seats/guides	264
19201807	LSX-L92 Small Bore	Aluminum	260	15 deg	70	2.000	1.550	L92	Std LS	Bolt-down	Solid/solid valves	266
19354243	LSX-LS3	Aluminum	260	15 deg	70	2.165	1.590	L92	Std LS	Bolt-down	Hollow/solid valves	266
19354239	LSX-LS7	Aluminum	270	12 deg	70	2.200	1.610	LS7	Std LS	Bolt-down	Titanium/sodium-filled valves	267
19354240	LSX-LS7 Bare	Aluminum	N/A	12 deg	70	2.200	1.610	LS7	LS7	LS7	N/A, As-cast	267
19354242	LSX-LS7 Bare	Aluminum	270	12 deg	70	2.200	1.610	LS7	Std LS	Bolt-down	Fully CNC-machined	266
19354241	LSX-LS7 Assembly	Aluminum	270	12 deg	70	2.200	1.610	LS7	Std LS	Bolt-down	Fully CNC-machined	267
19330896	LSX-CT	Aluminum	302	11 deg	45	2.200	1.610	LSX-CT	LSX-CT/DR	Shaft	Fully CNC-machined bare head	269
19202985	LSX-CT Cylinder Head	Aluminum	N/A	11 deg	-	-	-	-	-	Shaft	As-cast, not machined	269
19166979	LSX-DR	Aluminum	313	11 deg	50	2.250-2.280	1.600-1.650	LSX-DR	LSX-CT/DR	Shaft	Fully CNC-machined bare head	267
19202986	LSX-DR Cylinder Head	Aluminum	N/A	11 deg	-	-	-	-	-	Shaft	As-cast, not machined	268

THE LS FAMILY PRODUCTION AND C5R ALUMINUM HEADS

Great cylinder-head airflow has been a key enabler of the LS-Series' exceptional performance. Chevrolet Performance delivers those power-building attributes to you with a range of production-style aluminum heads – from the LS6 heads for smaller-displacement engines to LS7 style heads for 427-inch-and-larger combinations, our aluminum heads benefit from Chevrolet Performance's extensive research and development program, providing maximum airflow. Many of our assembled heads use premium machining and materials, including CNC finishing and porting, along with lightweight, hollow-stem valves, sodium-filled exhaust valves and – on some heads – lightweight titanium intake valves.

NOTE: Chevrolet Performance heads will not fit 4.8L and 5.3L engines, due to their smaller bore sizes.

Aluminum LS Family Head Technical Notes:

- Manufactured from 319-T5 aluminum alloy
- High-efficiency combustion chambers
- Symmetrical intake and exhaust ports
- Angled spark plugs (14mm; 5/8" hex; 3/4" reach; taper-seat plugs)
- 15° valve angle (except C5R and LS7)
- Bolt-down-type rocker arms (except LSX-DR, LSX-CT)
- Center-bolt valve cover hold-downs
- Fits Gen III and Gen IV Small-Blocks only

BUILDER'S TIP

TIERED PERFORMANCE CYLINDER HEAD STRATEGY DELIVERS OPTIONS

Cylinder head selection is one of the most important contributors to an engine's performance, because it ultimately determines how much air the engine can process to generate horsepower. The heads for regular-production LS-family engines are renowned for exceptional airflow attributes and offer significant power-building capability with traditional machining that enhances the volume of the intake ports and/or reduces restriction within the ports.

Chevrolet Performance's tiered strategy for LS cylinder head performance offers builders choices to fit a variety of performance goals and budgets. The first tier is our production-based heads, such as the LS3 head (P/N 12629063), which offer good out-of-box performance and are an excellent upgrade for earlier LS engines (as long as they have at least a 4.000" bore). The next tier is ported production heads, such as the LS3 CNC-ported head (P/N 88958758), which deliver significantly greater intake-port airflow at a value-driven cost.

For production-based engines using forced induction – supercharging or turbocharging – the LS9 CNC-ported heads are the ultimate solution, delivering greater strength and heat management properties through a unique production process with the A356T6 alloy.

The top tier of Chevrolet Performance's cylinder head ladder is the maximum-performance LSX heads, which are based on the design of production heads but include strength-enhancing features such as thicker decks, to support high-horsepower street and racing combinations. They also have a six-bolts-per-cylinder design vs. the four-bolt design of production LS heads, for exceptional clamping strength with supercharging, turbocharging and nitrous oxide. The six-bolt heads must be used with Chevrolet Performance LSX Bowtie cylinder block.

With Chevrolet Performance cylinder heads, there's a choice for every horsepower aspiration and budget.

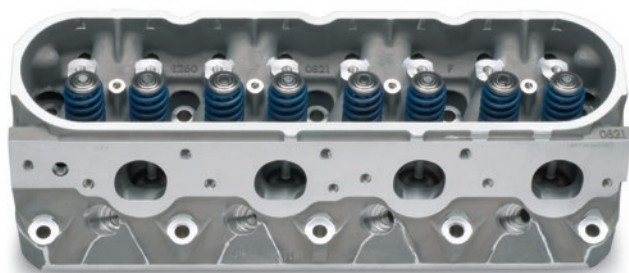

LS3 CNC-Ported Cylinder Head Assembly (exhaust) **A**



LS3 CNC-Ported Cylinder Head Assembly (intake) **A**



LS3 CNC-Ported Cylinder Head Assembly (combustion chamber) **A**



LS3 CNC-Ported Cylinder Head Assembly (exhaust detail) **A**



LS3 CNC-Ported Cylinder Head Assembly (intake detail) **A**

12629062 ⓘ

L92 Cylinder Head Assembly (not shown)

- Aluminum performance head
- Fits any LS family engine with 4.000" bore or larger
- 2.165" solid stem intake, and 1.590" solid stem exhaust valves
- .510" max valve lift
- As-cast L92 style intake ports
- D-shaped exhaust ports
- As-cast combustion chambers

Head P/N 12629062 assembled with the following:

12627970	Intake Valves	10166344	Valve Spring Retainers
12582719	Exhaust Valves	12482063	Intake Valve Stem Seals
12589774	Valve Springs	12482062	Exhaust Valve Stem Seals
10166345	Valve Locks		

L92 Head Flow Data (4.000" Bore):

Lift	0.200"	0.300"	0.400"	0.500"	0.600"
Intake	151	208	256	294	316
Exhaust	111	152	174	183	189

12629063 ⓘ

LS3 Cylinder Head Assembly (not shown)

- Aluminum performance head
- Fits any LS family engine with 4.000" bore or larger
- 2.165" hollow stem intake, and 1.590" solid stem exhaust valves
- .550" max valve lift
- As-cast L92 style intake ports
- D-shaped exhaust ports
- As-cast combustion chambers

A. 88958758 ⓘ

LS3 CNC-Ported Cylinder Head Assembly

- CNC-ported version of the LS3 cylinder head
- Flows about 10-percent more than the production head – more than 350 cfm (intake side) at .600" lift
- 276cc intake runners and 92cc exhaust ports
- Fits all LS engines with 4.000" bore or larger
- 2.165" hollow stem intake, and 1.590" solid stem exhaust valves
- .550" max valve lift
- D-shaped exhaust ports

Heads 12629063 and 88958758 assembled with the following:

12569427	Intake Valves	10166344	Valve Spring Retainers
12582719	Exhaust Valves	12482063	Intake Valve Stem Seals
12625033	Valve Springs	12482062	Exhaust Valve Stem Seals
10166345	Valve Locks		

19328743 ⓘ

LS9 CNC-Ported Head Assembly (not shown)

- Special A356-T6 aluminum Roto-cast head casting for greater strength. The mold is rotated during production to create a more solid casting that virtually eliminates porosity
- Reinforced webbing and thicker deck (for minimal distortion) makes it an excellent choice for supercharged and turbo-charged engine combinations
- CNC-ported for approximately 10 percent greater airflow (intake side) than the regular-production cylinder head (similar to LS3 CNC-ported head P/N 88958758)
- As-cast 66.5cc combustion chamber volume
- Fully assembled with production LS9 2.165" (55mm) titanium intake valves and sodium-filled 1.590" (40mm) exhaust valves; and beehive-type valve springs
- Valve springs rated for .570" max lift
- Can be used on LS engines with at least a 4.000" bore using standard 11mm head bolts in place of the LS9's 12mm head bolts

Head P/N 19328743 assembled with the following:

12605524	Titanium Intake Valve (2.165")	12596508	Valve Spring Caps
12605525	Sodium Filled Exhaust Valve (1.590")	10166345	Valve Stem Keys
12625033	LS9 Beehive Valve Spring	12482063	Valve Seal-Intake (Integral Seal & Spring Seat)
12482062	Valve Seal-Exhaust (Integral Seal & Spring Seat)	12596509	Rocker Arm Wear Pads (Intake valve only)

LS-Series Cylinder Heads continued

A. 12578449 ⓘ

LS7 CNC-Ported Cylinder Head Assembly

- 356-T6 aluminum head
- Fully CNC'd ports and chambers
- LS7 rectangle port design
- Assembled with 2.200" titanium intake and 1.610" sodium-filled exhaust valves
- 12° valve angle
- Minimum 4.100" bore
- 270cc CNC'd intake ports, 85cc CNC'd exhaust ports
- 70cc CNC'd combustion chambers
- Capable of over 600 horsepower
- Bare head P/N 12578450 available separately

Head P/N 12578449 assembled with the following:

12591644	Intake Valves	12596508	Valve Spring Retainers
12618110	Exhaust Valves	12482063	Intake Valve Stem Seals
12621428	Valve Springs	12482062	Exhaust Valve Stem Seals
10166345	Valve Locks	12596509	Intake Valve Lash Cap

LS7 Head Flow Data:

Lift	0.100"	0.200"	0.300"	0.400"	0.500"	0.550"	0.600"	0.700"
Intake	71	145	222	271	315	332	348	352
Exhaust	60	120	159	192	207	214	219	221

12626958 ⓘ

LSA Cylinder Head Assembly (not shown)

- CTS-V and ZL1 6.2L production cylinder head assembly
- High-strength aluminum casting for supercharged application
- Premium steel intake and exhaust valves
- Completely Assembled

NOTE: Uses 10 8mm & 20 11mm head bolts



A LS7 CNC-Ported Cylinder Head Assembly (exhaust)



A LS7 CNC-Ported Cylinder Head Assembly (intake)

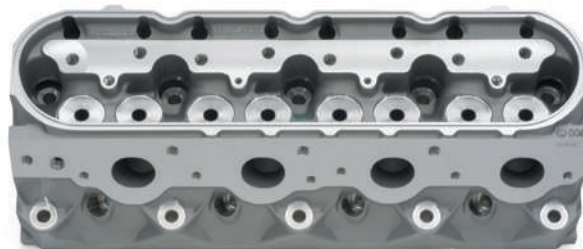

B Bare C5R Racing Cylinder Head (exhaust)

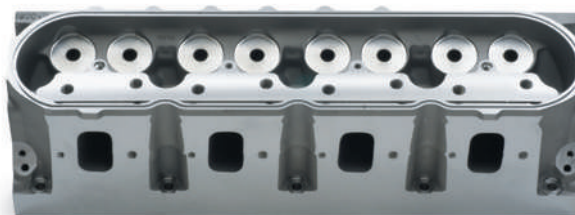

B Bare C5R Racing Cylinder Head (intake)



B Bare C5R Racing Cylinder Head (combustion chamber)

B. 25534393 ⓘ

Bare C5R Racing Cubed Cylinder Head

- The images (B) to the right represent the P/N 25534393 cubed (unmachined) product. Chevrolet Performance does not supply a fully machined version of the C5R head. Image is for reference only.
- 355-T7 "as-cast" Aluminum racing head
- Professional porting and machining of combustion chambers required
- No seats or guide machining
- C5R rectangle-port design – requires aftermarket rectangle-port intake manifolds
- Designed for big bore (4.100" min) LS7/C5R/LSX blocks
- 210cc "as-cast" intake ports
- 70cc "as-cast" exhaust ports, same as production LS6
- 30cc "as-cast" combustion chambers
- All fasteners are metric
- Capable of over 800 horsepower!
- Standard LS exhaust port design

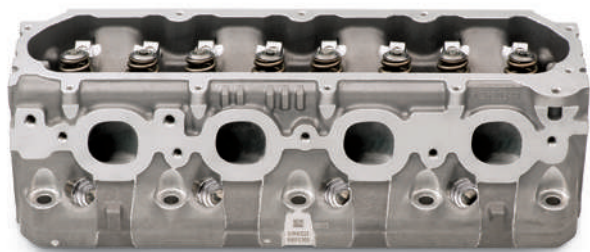

LT1 CNC Cylinder Head Assembly (exhaust) **C**

12678972 ⓘ

LT1 Cylinder Head Assembly (not shown)

- Replacement for production cylinder head assembly
- Fully assembled
- Machined for direct fuel injection

C. 19329839 ⓘ

LT1 CNC Cylinder Head Assembly

- Fully assembled
- Machined for direct fuel injection
- CNC machine-ported intake and exhaust runners
- Included in P/N 19333525 Head and Hot Cam Kit (See page 274)

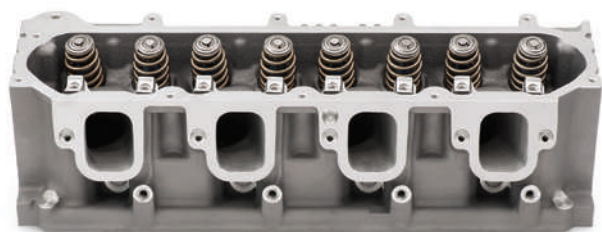

LT1 CNC Cylinder Head Assembly (intake) **C**



LT1 CNC Cylinder Head Assembly (combustion chamber) **C**



LS-Series Cylinder Heads: Additional Required Components

Part Number	Gaskets (Quantity)	Bolts (Quantity)	Spark Plug	Engine Application
88958622	12589226 (2) OR 19170418	11562524 (20), 12558840 (10)	12571164	CNC LS6
12629064	12610046 (2) OR 19170419	11562524 (20), 12558840 (10)	12571164	L9H
12629063	12610046 (2) OR 19170419	11562524 (20), 12558840 (10)	12571164	LS3
88958758	12610046 (2) OR 19170419	11562524 (20), 12558840 (10)	12571164	CNC LS3
12578449	12582179 (2) OR 19170419	11562524 (20), 12558840 (10)	12571165	MY06/07 LS7
12626958	12610046 (2) OR 19170419	11562524 (20), 12558840 (10)	12571164	LSA
19328743	12610046 (2) OR 19170419	11562524 (20), 12558840 (10)	12571164	LS9
25534393	12582179 (2) OR 19170419	11562524 (20), 12558840 (10)	12571164	C5R

LSX CYLINDER HEADS

Extending the performance range of the LSX platform are Chevrolet Performance's 6-bolt LSX cylinder heads. Many are capable of flowing more than 400 cfm and their 6-bolts-per-cylinder clamping design gives them exceptional strength. Your horsepower-building potential can be nearly unlimited with LSX heads.

These aluminum masterpieces of performance feature port and chamber designs based on popular and performance-proven production-style heads, such as the LS3/L92 and LS7 heads. They are easily identified by the engraved LSX logo on the ends.

All LSX heads are made of 356-T6 aluminum and feature a 5/8" thick deck that allows plenty of room for builder-specified combinations. Additional features include:

- Uses 11mm (10) and 8mm (13) head bolts (not included, see drawing on page 269)
- Accommodates production valvetrain components (except for Drag Race and Circle Track heads)
- Includes premium beehive-type valve springs (except for Drag Race and Circle Track heads)
- Extra material cast in the port areas to accommodate professional porting
- Valve guides for 8mm valve stems, except DR & CT

Racing-specific LSX-DR (Drag Racing) and LSX-CT (Circle-Track) heads feature raised runner designs and other unique features designed to maximize performance at the track.

LSX Street Heads

Four LSX street head configurations are offered: The LSX-LS7 head, the LSX-LS3 head, the LSX-LS9 head and the LSX-L92 Small Bore head. The LSX-L92 head features smaller combustion chambers that are compatible with smaller-bore LS1 and LS6 engines. The street heads accommodate valve springs with up to 1.37" diameter bases, but can be machined for larger springs.

19201807

LSX-L92 Small Bore Cylinder Head (not shown)

- LS3/L92 Port Configuration
- "As cast" runners and combustion chamber
- 15° valve angle
- Assembled with 2.00" intake and 1.55" exhaust valves
- 250cc intake port and 80cc exhaust port
- 70cc combustion chamber
- Intake flow – 280 cfm@ .600" lift / Exhaust flow – 180 cfm@ .700" lift
- Beehive valve springs
- Uses LS3/L92 style rocker arms (offset)
- 3.890" minimum bore size
- Uses LS3/L92 style intake manifold

19354243

LSX-LS3 Cylinder Head (not shown)

- L92 style rectangle port design
- Assembled with 2.165" hollow stem intake and 1.590" solid stem exhaust valves
- 15° valve angle; minimum 4.000" bore
- 260cc "as-cast" intake ports, 80cc "as-cast" exhaust ports
- 70cc "as-cast" combustion chambers
- Uses LS3 rocker arms/LS7 bolts

19354242

LSX-LS7 CNC-Ported Bare Cylinder Head (not shown)

- Fully CNC Ported
- 6-bolt-per-cylinder bolt pattern
- LS7 style rectangle port design
- 12° valve angle; minimum 4.100" bore
- 70cc "as-cast" combustion chambers
- Uses LS7 rocker arms/LS7 bolts
- 397 cfm@0.700" intake, 230 cfm@0.700" exhaust

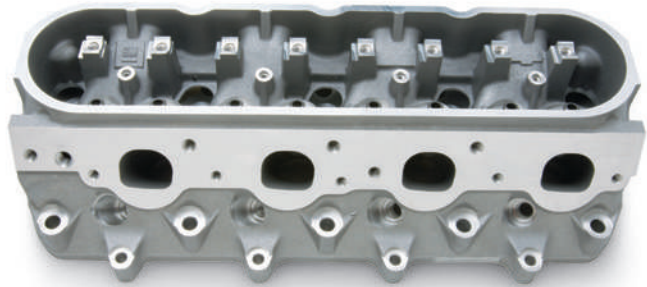

A LSX-LS7 Cylinder Head Assembly (exhaust)



A LSX-LS7 Cylinder Head Assembly (intake)

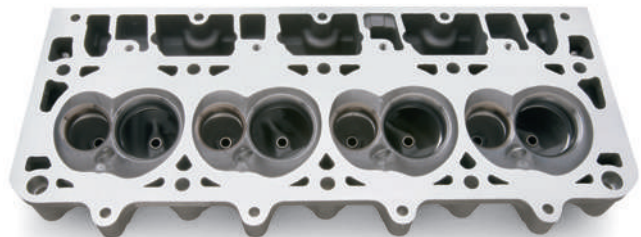

A LSX-LS7 Cylinder Head Assembly (combustion chamber)

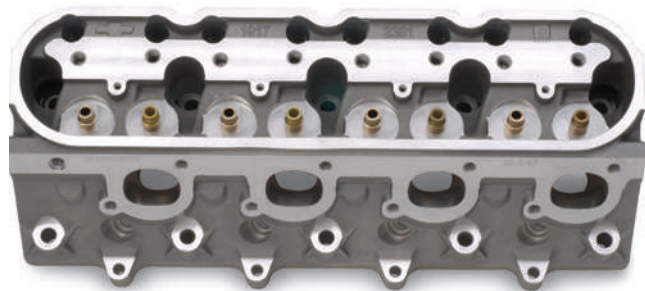
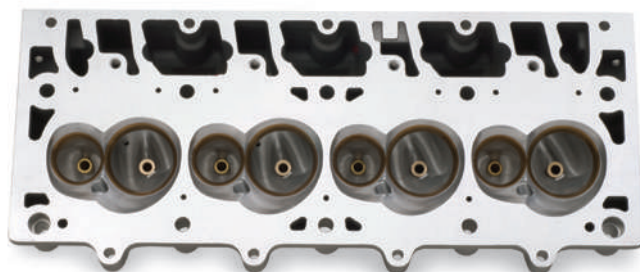
LSX-DR CNC-Ported Cylinder Head (exhaust) **B**LSX-DR CNC-Ported Cylinder Head (intake) **B**LSX-DR CNC-Ported Cylinder Head (combustion chamber) **B****19354241****LSX-LS7 CNC-Ported Cylinder Head Assembly (not shown)**

- Fully CNC Ported
- 6-bolt-per-cylinder bolt pattern
- LS7 style rectangle port design
- Assembled with 2.200" titanium intake and 1.610" sodium-filled exhaust valves
- 12° valve angle; minimum 4.100" bore
- 70cc "as-cast" combustion chambers
- Handles .650" lift with premium springs
- Uses LS7 rocker arms/LS7 bolts
- Uses P/N 19257879 bare head (shown)
- 397 cfm@0.700" intake, 230 cfm@0.700" exhaust

A. 19354239**LSX-LS7 Cylinder Head Assembly – As Cast**

- 6-bolt-per-cylinder bolt pattern
- LS7 style rectangle port design
- Assembled with 2.200" titanium intake and 1.610" sodium-filled exhaust valves
- 12° valve angle; minimum 4.100" bore
- 270cc "as-cast" intake ports, 85cc "as-cast" exhaust ports
- 70cc "as-cast" combustion chambers
- Handles .650" lift with premium springs
- Uses LS7 rocker arms/LS7 bolts

19354240**LSX-LS7 Bare Cylinder Head – As Cast (not shown)**

- Used in P/N 19201806

19354244**LSX-LS9 Cylinder Head Assembly (not shown)**

- L92 style rectangle port design
- Assembled with 2.165" titanium intake and 1.590" sodium-filled exhaust valves
- 15° valve angle; minimum 4.000" bore
- 260cc "as-cast" intake ports, 80cc "as-cast" exhaust ports
- 70cc "as-cast" combustion chambers
- Uses LS3 rocker arms/LS7 bolts

LSX-DR and LSX-CT Heads

The LSX-CT (Circle-Track) and LSX-DR (Drag Racing) cylinder heads feature raised-runner designs for improved airflow. Intake port configuration is similar to the competition-derived C5R head, but the ports are raised an amazing 10mm and the intake manifold bolt pattern is spread to accommodate additional port configurations. Additional features include:

- 11° valve angle (same as C5R head)
- Accommodates up to 1.660" diameter valve springs
- Raised rocker rails
- Requires shaft-mount rockers
- May require special valve covers to clear shaft-mount rockers
- Provisions for down-nozzle machining
- 9° intake manifold angle – requires new LSX DR or LSX CT intake manifolds
- Unique LSX-CT/DR exhaust bolt pattern

B. 19166979**LSX-DR CNC-Ported Cylinder Head**

- Fully CNC ported
- 356-T6 aluminum racing head, 5/8" thick deck
- LSX-DR rectangle intake port design – requires LSX-DR intake manifold
- LSX-CT/DR spread port exhaust port pattern
- Cast-in down-nozzle bosses (not machined)
- Designed for up to 2.280" intake and 1.620" exhaust valves (4.165" minimum bore)
- Machined for 1.660" valve springs; 11° valve angle
- Minimum 4.125" bore
- 313cc CNC'd intake ports, 116cc CNC'd exhaust ports
- 50cc CNC'd combustion chambers
- Requires 19201808 shaft-mount Rocker Kit
- Capable of over 900 naturally aspirated horsepower!
- Installed on LSX454R engine assembly

LSX Cylinder Heads continued

A. 19202986

LSX-DR Cylinder Head

- Rough machined seats and guides for cylinder head porters to work their magic!
- 356-T6 aluminum racing head, 5/8" thick deck
- LSX-DR rectangle intake port design – requires LSX-DR intake manifold
- LSX-CT/DR spread port exhaust port pattern
- Cast-in down-nozzle bosses (not machined)
- Designed for up to 2.280" intake and 1.620" exhaust valves (4.165" minimum bore)
- Machined for 1.660" valve springs, 11° valve angle
- Minimum 4.125" bore
- Requires 19201808 shaft-mount Rocker Kit
- Capable of over 900 naturally aspirated horsepower!
- Installed on LSX454R engine assembly

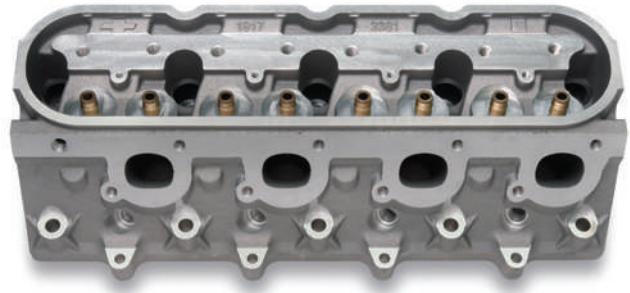

A LSX-DR Cylinder Head (exhaust)



A LSX-DR Cylinder Head (intake)



A LSX-DR Cylinder Head (combustion chamber)

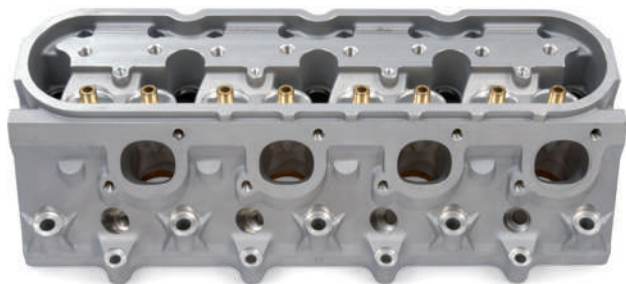

LSX-CT CNC-Ported Cylinder Head (exhaust) **B**



LSX-CT CNC-Ported Cylinder Head (intake) **B**

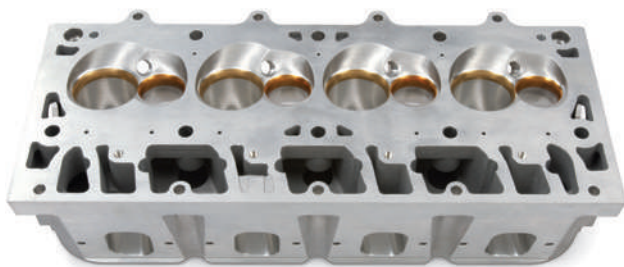

LSX-CT CNC-Ported Cylinder Head (combustion chamber) **B**

B. 19330896

LSX-CT CNC-Ported Cylinder Head

- Fully CNC-ported
- 356-T6 aluminum racing head
- 5/8" thick deck
- LSX-CT rectangle-intake port design – requires LSX-CT intake manifold
- LSX-CT/DR spread-port exhaust port pattern
- Cast-in down-nozzle bosses (not machined)
- Designed for 2.200" intake and 1.610" exhaust valves
- Machined for 1.625" valve springs
- 11° valve angle
- Minimum 4.125" bore
- 302cc CNC'd intake ports
- 109cc CNC'd exhaust ports
- 45cc CNC'd combustion chambers
- Capable of over 850 naturally aspirated horsepower!

19202985

LSX-CT Cylinder Head (not shown)

- Rough machined seats and guides
- Ready for custom porting

LS/LSX HEAD-BOLT PATTERNS

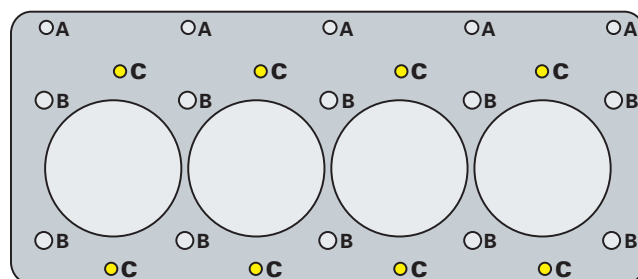

A	Standard LS	8mm	Bolt/Stud
B	Standard LS	11mm	Bolt/Stud
C	LSX	8mm	Bolt/Stud



BUILDER'S TIP

BUILDING A CARBURETED LS ENGINE

For some vintage cars, a carbureted induction system is more aesthetically appropriate, while some racecars depend on a carburetor, based on class rules or other reasons. Building a carbureted LS engine is just as easy as assembling a production-style fuel injected version. You'll still need all the sensors of an injected engine, but you simply replace the injection manifold with one of the Chevrolet Performance carbureted intakes – they're available for LS1/LS2/LS6-style cathedral-port heads, L92/LS3-style heads and LS7 heads. Then, add your favorite four-barrel and plug it all into one of our pre-programmed controllers. Add a 12-volt power source and your carbureted LS engine will deliver a balanced combination of vintage looks and modern engine management dependability!

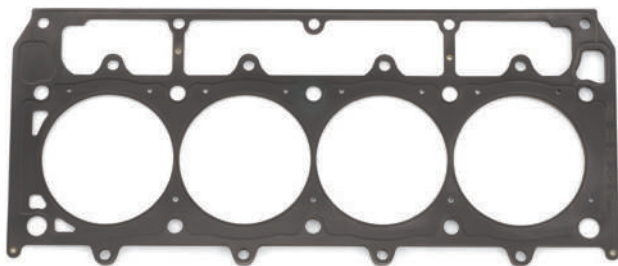

LSX 4.100" Bore MLS Head Gasket Kit

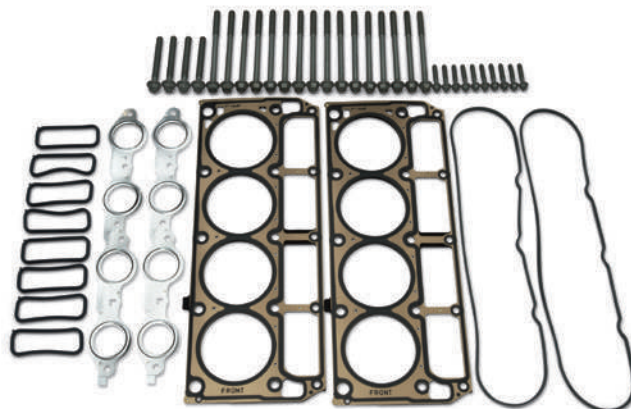

LS1 Cylinder Head Installation Kit (F-Car)

CYLINDER HEAD GASKET AND BOLT KITS

Part Number	Description	Technical Notes
12498544	Cylinder Head Gasket Kit (not shown)	2 head gaskets for 1997-2001 LS1 Camaro/Firebird and Corvette engines. Also fits 2001 LS6 Corvette engine
19170418	LSX 4.100 Bore MLS Head Gasket Kit	Multi-layer steel gaskets for naturally aspirated and forced induction applications. 0.051" thick. Includes 1 LH and 1 RH gasket. For standard LS and LSX 6-bolt pattern blocks and heads. For bores up to 4.100"
19170419	LSX 4.200 Bore MLS Head Gasket Kit (not shown)	Multi-layer steel gaskets for naturally aspirated and forced induction applications. 0.051" thick. Includes 1 LH and 1 RH gasket. For standard LS and LSX 6-bolt pattern blocks and heads. For bores up to 4.200"
19170420	LSX 4.250 Bore MLS Head Gasket Kit (not shown)	Multi-layer steel gaskets for naturally aspirated applications. 0.051" thick. Includes 1 LH and 1 RH gasket. For standard LS and LSX 6-bolt pattern blocks and heads. For bores up to 4.250"
12498545	Cylinder Head Bolt Kit (1997-2003, not shown)	Kit of 15 head bolts for 1998-2003 LS1 Camaro/Firebird and 1997-2003 Corvette; and 2001-2003 LS6 Corvette. 1 kit per cylinder head; order 2 per engine. Head bolts cannot be reused on these engines. NOTE: IMPORTANT! LS-Series engines produced from January 2004 forward have a new "short-style" head bolt design. Earlier head bolts will not fit. Order P/N 17800568 for engines produced from January 2004 and later.
17800568	Cylinder Head Bolt Kit, Gen III and Gen IV (not shown)	Kit of 15 bolts for LS-Series engines produced from January 2004 and later. Bolts are 5mm shorter than previous design. Services single engine head only
19257453	Cylinder Head Bolt Kit - Std. Deck LSX Block (not shown)	Contains additional bolts for standard-deck LSX 6-bolt heads. Contains bolts for 2 heads (1-engine). NOTE: Engine set requires 2 - 17800568 bolt sets for conventional GEN III & GEN IV engines. For complete LSX set, order: 2 - 17800568 - GEN III & GEN IV bolt kits, 1 - 19257453 - LSX Standard Deck Bolt Kit.
19257452	Cylinder Head Bolt Kit - Tall Deck LSX Block (not shown)	Contains additional bolts for tall-deck LSX 6-bolt heads. Contains bolts for 2 heads (1-engine). NOTE: Engine set requires 2 - 17800568 bolt sets for conventional GEN III & GEN IV engines. For complete LSX set, order: 2 - 17800568 - GEN III & GEN IV bolt kits, 1 - 19257452 - LSX Tall Deck Bolt Kit.
12499217	LS1 Cylinder Head Installation Kit (F-Car)	Comprehensive cylinder head installation kit for 2002 Camaro and Firebird models equipped with the LS1 engine. Kit includes 2 head gaskets, 2 valve cover gaskets, 8 intake manifold gaskets, 2 exhaust manifold gaskets, 2 intake manifold-to-block seals, 20 long-head bolts and 10 short-head bolts.
12589226	LS1/LS6 Head Gasket (not shown)	Single gasket, 2 required. For naturally aspirated LS1 and LS6 5.7L engines. 0.051" thick. 3.920" max bore. Standard LS bolt pattern.
12589227	LS2, L76 Head Gasket (not shown)	Single gasket, 2 required. For naturally aspirated LS2 and L76 6.0L engines. 0.051" thick. 4.020" max bore. Standard LS bolt pattern.
12610046	LS3, L92 Head Gasket (not shown)	Single gasket, 2 required. For naturally aspirated LS3/L92 6.2L engines. 0.051" thick. 4.080" max bore. Standard LS bolt pattern.
12582179	LS7 Head Gasket (not shown)	Single gasket, 2 required. For naturally aspirated LS7 7.0L engines. 0.051" thick. 4.140" max bore. Standard LS bolt pattern.

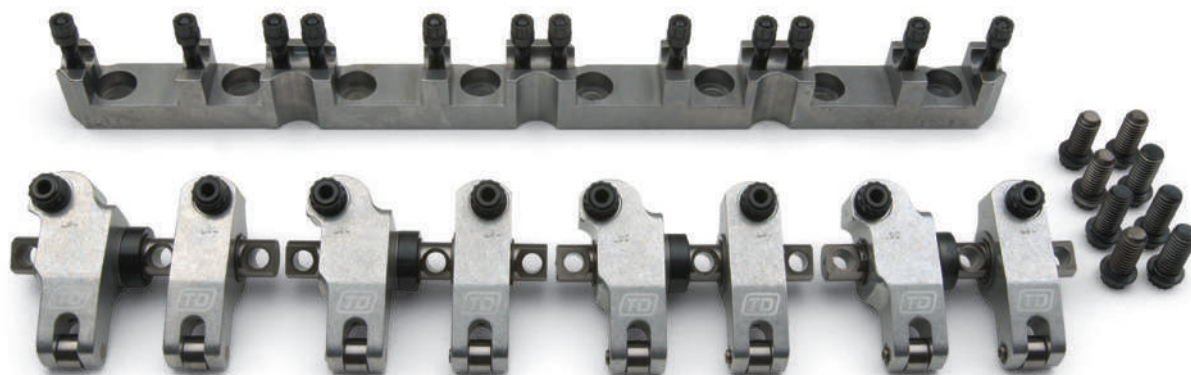

LSX454R Rocker Arm Kit

ROCKER ARMS AND ROCKER ARM BOLTS

Part Number	Description	Technical Notes
12681275	Rocker Arm (not shown)	For LS1, LS2 and LS6 intake and exhaust valves. For L92, LS9 and LS3 exhaust valves Straight design, no offset. 1.7:1 ratio.
12669995	Rocker Arm (not shown)	Intake rockers for L92, LS9 and LS3 style heads only. Offset design. 1.7:1 ratio
12579615	Rocker Arm (not shown)	Intake rockers for LS7 style heads only. Offset design. 1.8:1 ratio
12579617	Rocker Arm (not shown)	Exhaust rockers for LS7 style heads only. Straight design, no offset. 1.8:1 ratio
12560961	Rocker Arm Bolts (not shown)	For cathedral port and L92 style heads. 16 required per engine
11588791	Rocker Arm Bolts (not shown)	For LS7 & LSX style heads. 16 required per engine
12552203	Rocker Arm Stand (not shown)	For LS1, LS2 and LS6 style heads only. Sold individually. Requires 1 per cylinder head.
12600936	Rocker Arm Stand (not shown)	For L92, LS9 and LS3 style heads only. Sold individually. Requires 1 per cylinder head
19201808	LSX454R Rocker Arm Kit	1.9:1 ratio. Fits DR head only. Full-roller bearing tips. Full-roller bearing trunnion. Set is for two heads. Requires special valve cover for clearance

LS-SERIES PUSHRODS

Part Number	Material	Diameter	Length	Usage	Description
12593344	1010 steel	3/8"	7.750	LS7	Production pushrod, individually packed
10238852	1010 steel	5/16"	7.325	LS1, LS2, LS3, LS6, L92	Production pushrod, individually packed

LS-SERIES INTAKE VALVES

Part Number	Valve Size	Stem Size	Description
12617533	2.165"	8mm	Stock replacement valve used in L92 engines
12605223	2.165"	8mm	Stock replacement solid-stem valve used in LSA engines
12569427	2.165"	8mm	Stock replacement hollow-stem valve used in LS3 engines
12605524	2.165"	8mm	Stock replacement titanium valve used in LS9 engines
12591644	2.200"	8mm	Stock replacement titanium valve used in LS7 engines

LS-SERIES EXHAUST VALVES

Part Number	Valve Size	Stem Size	Description
12563064	1.500"	8mm	Stock replacement solid-stem valve used in LS2 engines
12582719	1.590"	8mm	Stock replacement solid-stem valve used in L92 and LS3 engines
12605525	1.590"	8mm	Stock replacement sodium-filled stem valve used in LS9 engines
12618110	1.610"	8mm	Stock replacement sodium-filled stem valve used in LS7 engines

VALVE SPRINGS AND SPRING KITS

Part Number	Description	Technical Notes
12499224	LS Valve Spring Kit (not shown)	Beehive style springs. Used on LS3, LS2/LS6 cylinder heads. Installed height - 1.800" @ 90 lbs. pressure. Max lift -.550". 1.250" @ 295 lbs. pressure. Includes 16 of P/N 12625033
12625033	Valve Springs (not shown)	Beehive style springs. Standard LS6/LS3 springs. Use cap P/N 10166344. 1.250" @ 295 lbs. pressure. Installed height - 1.800" @ 90 lbs. pressure. Max lift -.550"
12589774	Valve Springs (not shown)	Beehive style springs. Standard L76/L92 springs. Installed height - 1.800" @ 90 lbs. pressure. Max lift -.520". 1.300" @ 264 lbs. pressure
12621428	Valve Springs (not shown)	Beehive style springs. Used on LS7 cylinder heads. Installed height - 1.960" @ 101 lbs. pressure. 1.368" @ 310 lbs. pressure. Max lift -.600"

LS/LT/LSX-SERIES COMPONENTS

LS VALVE COVERS

Nothing finishes off your engine like a great-looking set of valve covers straight from GM. Our new collection of LS valve covers allows you to personalize your LS-powered project with a custom look. Choose from 8 great styles, available in natural, powder-coated, polished and chrome finishes, with callouts for your favorite nameplate, vehicle and more. These valve covers are designed and built to production specs and include a production-type O-ring gasket for a leak-free fit. No matter if you're driving a new Corvette or a Pro-Touring-style, LS3-powered '61 Chevy, we've got the perfect set of valve covers for it.

NOTE: The valve covers feature the standard bolt pattern, but **DO NOT** have provisions for production-style coil mounts. Aftermarket or custom coil relocation brackets must be used. Additional features include:

- PCV system (except P/N 25534398 and P/N 25534399)
- Sold in pairs (except P/N 25534398 and P/N 25534399)
- Integrated oil fill
- Accommodates tall-style rockers
- Includes hardware and O-ring gasket

A. 19156433

Valve Cover Kit – CHEVROLET, Chrome

- Chrome finish with black CHEVROLET lettering

B. 19156428

Valve Cover Kit – CORVETTE, Polished

- Polished finish with black CORVETTE lettering

C. 19171497

Valve Cover Kit – LSX454

- Black finish with red LSX logo

D. 19171502

Valve Cover Kit – Polished

- Polished finish with no logos



A Valve Cover Kit – Chevrolet, Chrome



B Valve Cover Kit – CORVETTE, Polished



C Valve Cover Kit – LSX454

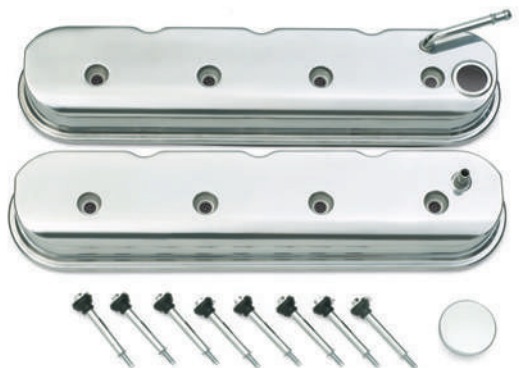

D Valve Cover Kit – Polished



Valve Cover Kit – LSX376, Orange/Black **E**



Valve Cover Kit – LSX454, Orange/Black **F**



LS Center-Bolt Competition Valve Cover (with breather hole) **G**



LS Center-Bolt Competition Valve Cover **H**

19171270

LSX376 (not shown)

- Gray/Black
- Used on LSX376-B8 engine

E. 19332317

LSX376

- Orange/Black
- Used on LSX376-B15 engine

F. 19332313

LSX454

- Orange/Black
- Used on LSX454 engine

19259058

LSX454R (not shown)

- Orange/Black
- Used on LSX454R engine

G. 25534398

LS Center-Bolt Competition Valve Cover (with breather hole)

- Lightweight aluminum valve cover designed for production center-bolt LS-Series cylinder heads
- Includes bolts and seal
- Sold individually
- Natural finish

H. 25534399

LS Center-Bolt Competition Valve Cover

- Lightweight aluminum valve cover designed for production center-bolt LS-Series cylinder heads
- Includes bolts and seal
- Sold individually
- Natural finish

HARDWARE AND BREATHERS

Part Number	Description	Technical Notes
12341993	Push-In Oil Filler Cap	Round oil filler cap with Bowtie logo for valve covers with 1.220" diameter hole
12573338	Oil Fill Cap	Production / For LS1 engines
12573337	Oil Fill Cap	Production / For L92 engines
12643759	Oil Fill Cap	Production / For LS3 engines
12577215	Valve Cover Bolt	Requires 4 per valve cover / For L92 engines

VALVE LIFTERS AND COMPONENTS

12499225

LS-Series Camshaft Lifter Kit (not shown)

- Set of 16 lifters for LS-Series engines
- Same lifter used in LS2 and LS7 P/N 17122490 (single lifter)

12595365

Lifter Guide (not shown)

- Works in Gen III and IV applications (except with AFM)

Valve Lifters and Components continued



88958689

Racing Hydraulic Roller Lifter Kit

If your Gen III or Gen IV application calls for sustained high-rpm's, this Racing Hydraulic Roller Lifter Kit is a must. It features reduced mass internal componentry for higher limiting speeds and to accommodate aggressive camshaft designs. Improved valvetrain dynamics and stability deliver more horsepower and better high-rpm performance – tested to 8,000 rpm! Set includes 16 lifters.

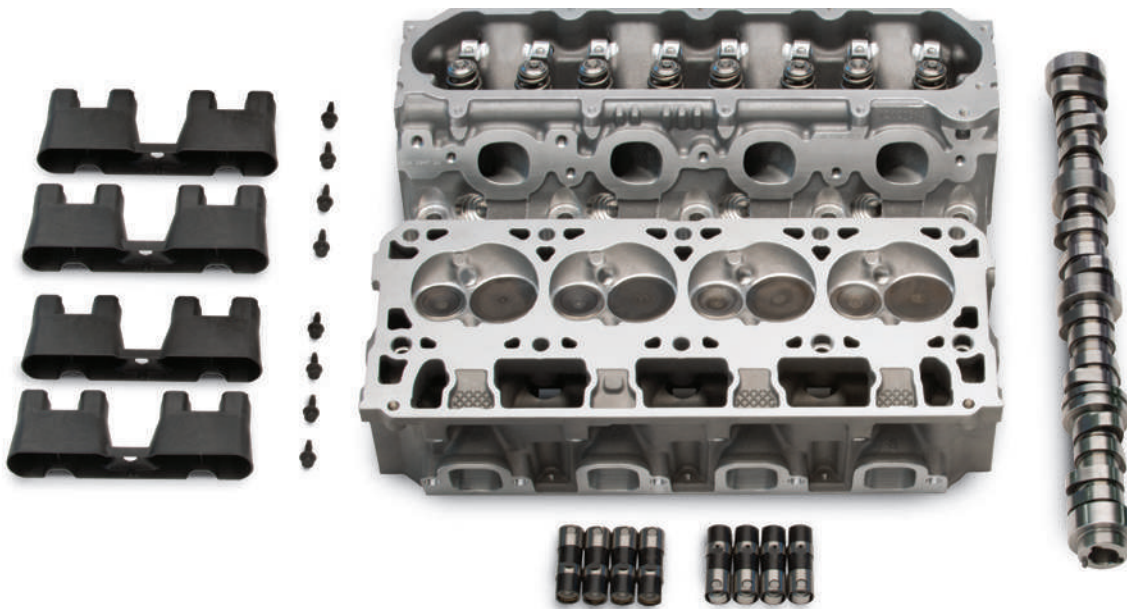

19333525

LT1 Head/Hot Cam Kit

Increase your already-strong LT1 with these CNC ported heads and camshaft designed specifically for direct injection. This is the first "Hot Cam" for the Gen V LT1.

NOTE: Installation of this kit will affect engine variable valve timing and Active Fuel Management operation. Recalibration is required for accurate engine operation (not available from GM).

This Kit Includes:

Part Number	Description	QTY
19303897	Camshaft	1
12595365	Valve Lifter Guide	4
12648846	Valve Lifters	8
19329839	CNC Cylinder Head Assembly	2



LS/LT-SERIES CAMSHAFTS

All LS camshafts are compatible with production-style LSX and C5R blocks, as well as all of our cylinder heads – although piston-to-valve clearance must be checked on some applications. We offer a broad range of production and racing-style camshafts that are factory-engineered to deliver maximum performance when paired with our high-flow cylinder heads. Save yourself the time and expense of going to an aftermarket camshaft supplier and build your LS engine with a genuine GM cam. We've also got the valvetrain components you need to finish the engine, including lightweight components designed for high-rpm performance.

Part Number	Description	Duration @ .050" Lift (deg)	Maximum Lift (in) w/1.7 rocker**	Lobe Separation (deg)	Technical Notes
12565308	2002-2004 LS6 Cam	I: 204 / E: 218	I: .550 / E: .550	117.5	Cam requires valve spring P/N 12586484
88958770	ASA Cam	I: 226 / E: 236	I: .525 / E: .525	110	Cam requires valve spring P/N 12586484; "ASA" cam for off-highway use
19355738	Hot Cam Kit	I: 219 / E: 228	I: .525 / E: .525	112	Kit includes 16 LS6 valve springs retainers
88958753	LS Hot Cam	I: 219 / E: 228	I: .525 / E: .525	112	Same cam as in kit P/N 12480033
19166972	LSX454 Cam (shown)	I: 236 / E: 246	I: .612 / E: .612	110	Max lift with 1.8 rockers .648/.648, 3-bolt design. NOTE: Not compatible with production-style variable-valve timing configurations or production valve springs.
88958766	Showroom Stock Cam	I: 239 / E: 251	I: .570 / E: .570	106.5	Showroom Stock racing design; requires hollow-stem intake valves P/N 12565311, hollow-stem exhaust valves P/N 12565312, valve springs P/N 12586484, and aftermarket notched pistons OR machined stock pistons
12638426	LS7	I: 211 / E: 230	I: .558 / E: .558	121	Stock LS7 camshaft, will not work on Gen III engines. Max lift with 1.8 rockers .593/.588
12561721	LQ9: 2002-2006 LS1: 2001-2004	I: 196 / E: 201	I: .467 / E: .479	116	Stock cam for 2002-2006 LQ9 and 2001-2004 LS1 engines
88958772	LS Stage 2 Cam	I: 227 / E: 239	I: .551 / E: .551	108	Max lift with 1.8 rockers .583/.583
88958773	LS Stage 3 Cam	I: 233 / E: 276	I: .595 / E: .595	107	Max lift with 1.8 rockers .630/.630
12623064	LSA Cam	I: 198 / E: 216	I: .480 / E: .480	122.5	Stock LSA Cam
12638427	LS9 Cam	I: 211 / E: 230	I: .562 / E: .562	122.5	Stock LS9 Cam
19303897	LT1 Hot Cam	I: .577 / E: .577	I: .228 / E: .248	116.5	

**Except where otherwise noted in Technical Notes.



BUILDER'S TIP

TECH TERM: LOBE SEPARATION ANGLE

Lobe separation angle (LSA) is the measurement in camshaft degrees between the maximum lift points – known as centerlines – of the intake and exhaust lobes. It affects the engine's power curve, idle quality, vacuum production and more through its effect on valve overlap (the brief period where the intake and exhaust valves for a cylinder are open). A tighter (narrower) LSA contributes to a narrow power band that moves torque lower in the rpm range, while increasing overlap for high-rpm horsepower. A rougher idle and lower vacuum at idle are byproducts. On the other hand, a wider LSA broadens the power band and moves torque higher in the rpm range. There is less overlap, which enhances idle quality and vacuum. Supercharged engines generally benefit more from a wider LSA because they don't require the scavenging effects that come with greater overlap. A couple of Chevrolet Performance camshafts provide the perfect examples: The cam for the naturally aspirated LSX454 engine, P/N 19166972, has a comparatively tight 110-degree lobe separation angle, while the production-based camshaft for the supercharged LS9 is a wide, 122.5 degrees.

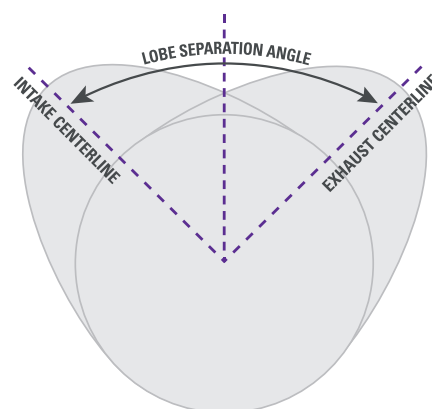

LS CONNECTING RODS & COMPONENTS

A. 12568734

1997-2004 Connecting Rod

- Connecting rod for use on all 1997-2004 production Corvettes and 1998-2002 Camaro/Firebird with LS1/LS6
- Press fit design
- 6.098" C-C length
- Sold individually

12649190

Connecting Rod (not shown)

- Connecting rod used in 2005-2007 LS2 and 2008-2012 LS3 engines has bronze bushing
- 6.098" C-C length
- Sold individually

11610158

LS6 Rod Bolts (not shown)

- Recommended for use in performance Gen III engines
- Bolts have greater strength than pre-2000 rod bolts
- 1 bolt per package; order 2 per connecting rod

89017573

Rod Bearing (not shown)

- 1 required per connecting rod
- For all LS-Series engines, except LS7 and LS9

89017811

LS7 Rod Bearing (not shown)

- 1 required per connecting rod
- For LS7 and LS9 engines only

Main Bearings - LS Engines (not shown)

Part Number	Position	Per Engine	Description
89017877	1, 2, 4, 5	4	LS7 or LS9
89017808	3 (thrust)	1	LS7 or LS9
89017571	1, 2, 4, 5	4	Non-LS7 or LS9
89017572	3 (thrust)	1	Non-LS7 or LS9

LSX CONNECTING RODS

Like our new crankshafts, the new LSX connecting rods from Chevrolet Performance are made of high-strength, 4340 forged steel to deliver worry-free performance for your high-horsepower, high-revving LS engine. Additional strength comes in the rod's I-beam design and its chamfered big end fits great with filleted cranks, like our LSX crankshafts.

B. 19166964

LSX Connecting Rod Kit, 6.000"

- 2.100" journals (big end)
- 0.866" bushed small ends
- MUST be used with LSX forged pistons – not compatible with production pistons
- Includes 7/16" 12-point, SAE 8740 rod bolts
- Caps are dowel located
- Weight-matched, sold in sets of 8

C. 19259254

LSX454 Rotating Assembly

Build your own "LSX Stroker" with this rotating assembly used in our powerful LSX454 crate engine. Order LSX fully-machined block P/N 19244057 to build your own engine.

Kit Includes:

Part Number	QTY	Description
19244018	1	Crankshaft, 4340 Forged Steel with 8-bolt flange (4.125" stroke)
19166964	8	Connecting Rods, 4340 Forged Steel
19166958	8	Pistons, Forged Aluminum with coated skirts (4.185" bore)

NOTE: Also includes performance piston rings, rod and main bearings (not shown).



A 1997-2004 Connecting Rods

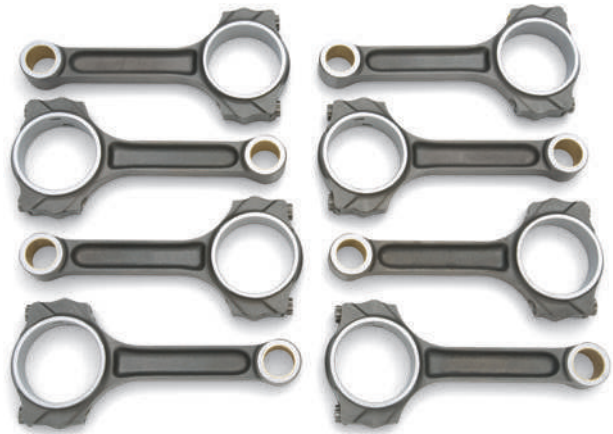

B LSX Connecting Rod Kit, 6.000"



C LSX454 Rotating Assembly



LSX376 Piston (dished), 4.065" bore



LSX454 Piston, 4.185" bore

LSX PISTONS

Complete your all-LSX rotating assembly with LSX forged aluminum pistons from Chevrolet Performance. They're lightweight and tough, enabling higher revs and dependable performance, even with high-boost and nitrous-assisted applications. They're made of 4032 forged aluminum and available in 4.065" and 4.185" bores. Additional details include:

- Flat-top or dished designs with valve relief cut-outs
- High-tech skirt coating
- Forced pin oiling
- Pistons come with wrist pins and rings

Part Number	Description	Technical Notes
19244016	LSX376 Piston, 4.065" bore	14cc dish that lowers compression to approx. 9:1 (with most standard LS cylinder heads). Optimized for supercharged and turbocharged combinations. Use with stock-type connecting rods only
19166958	LSX454 Piston, 4.185" bore	Forged dished piston with valve reliefs. Must be used with LSX rods. Lightweight, includes rings and wrist pins. 4.185" bore, .866" wrist pin size. 1.2mm compression ring lands and a 2.0mm oil control ring land. NOTE: Not compatible with production-style LS connecting rods. Must be used only with new LSX connecting rods with 0.866" wrist pin bores.

LS-SERIES PISTONS AND PISTON RINGS

Premium-quality hypereutectic aluminum alloy pistons are used on most production LS engines (the LS9 supercharged uses forged aluminum). They are lightweight, durable and promote quieter operation. Chevrolet Performance offers production and oversized pistons for many applications. They're sold individually, unless otherwise specified. Check the accompanying chart for part numbers, specs, sizes and applications.

LS-Series Pistons

Part Number	Engine Size	Bore Size	Oversize	Rod Length	Pin Type	Comp Ratio	With Chamber	Description
88984245	5.7L	3.898"	—	Standard	Pressed	—	65	Hypereutectic LS1 and LS6 replacement
88984246	5.7L	3.898"	+ .010"	Standard	Pressed	—	65	Hypereutectic LS1 and LS6 replacement
19178305	6.0L	4.000"	—	Standard	Floated	10.9	65	Hypereutectic LS2 and LQ9 replacement
89017479	6.0L	4.000"	+ .020"	6.098"	Floated	10.9	65	Hypereutectic LS2 and LQ9 replacement

LS-Series Rings

Part Number	Bore Size	Oversize	Ring Thickness	Description
89017484	4.000"	—	1.2, 1.5, 2.5mm	Production ring pack for '05-'06 LS2, '06 L76
88894243	4.000"	—	1.5, 1.5, 3.0mm	Production ring pack for '05-'06 LQ9
89017776	4.125"	—	1.2, 1.2, 2.0mm	Production ring pack for '06 LS7
89017777	4.125"	+ .020"	1.2, 1.2, 2.0mm	Oversize LS7 ring pack



Crankshaft Assembly 1997-2004



Reluctor Wheel, 24x

LS CRANKSHAFTS AND COMPONENTS

Our LS crankshafts are strong, precision-machined components that will support your high-horsepower aspirations. Choose from our nodular cranks up to 3.622-inch-stroke and our premium, forged-steel 4.125-inch-stroke crankshafts for larger-displacement combinations – and don't forget the proper reluctor wheel!

Part Number	Description	Technical Notes
12588612	LS2 Crankshaft Assembly	Nodular cast 3.622" stroke crankshaft assembly has 58x reluctor wheel installed. Used on 2006-2007 Corvettes. Balanced for 4.000" bore engines
89060436	Rear Crank Seal	Requires 1 per engine. For all LS-Series engines
12557583	Roller Pilot Bearing	Used in high-performance manual transmission applications. Use when input shaft protrudes 3-6mm (.079-.112") beyond bell housing
14061685	Roller Pilot Bearing	Used in high-performance manual transmission applications. Use when input shaft protrudes 23-24mm (.906-.945") beyond bell housing
12611649	LS7 Forged Steel Crankshaft	Forged 4" stroke crankshaft for LS7 engine. Includes 58x reluctor wheel. Rebalancing required if LS7 rods and pistons are not used. Machine .886" from snout for use in wet-sump applications
12559353	Reluctor Wheel, 24x (shown)	24-tooth crankshaft position sensor timing wheel for 1997-2005 engines
12586768	Reluctor Wheel, 58x	58-tooth crankshaft position sensor timing wheel for 2006 and newer engine
12641691	LSA Crankshaft	Forged 3.622" stroke. 8-bolt flexplate/flywheel pattern
12674745	Gen V LT1 (Wet Sump) Crankshaft	Forged 3.622" stroke. 8-bolt flywheel pattern
12674744	Gen V LT1 (Dry Sump) Crankshaft	Forged 3.622" stroke. 8-bolt flywheel pattern
12674746	Gen V LT4 (Wet Sump) Crankshaft	Forged 3.622" stroke. 8-bolt flywheel pattern
12674743	Gen V LT4 (Dry Sump) Crankshaft	Forged 3.622" stroke. 8-bolt flywheel pattern

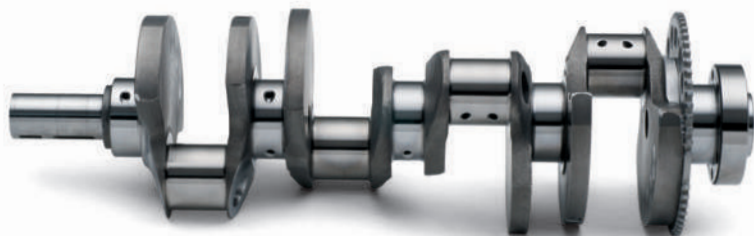

LSX Crankshaft, 4.125" stroke

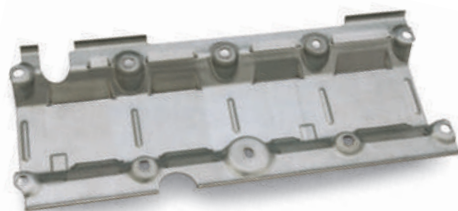

LSX Windage Tray Kit, for 4.125" strokes

LSX CRANKSHAFTS AND COMPONENTS

Chevrolet Performance LSX crankshafts are made from 4340 forged steel (most production LS cranks are cast) and have generous fillets. Our LSX forged crankshafts deliver exceptional strength and durability, whether you're building an engine for the street or track. Additional features include:

- 2.100" rod journals
- 8-bolt flexplate/flywheel pattern
- Comes with 58x reluctor wheel
- Reluctor wheel can be swapped for use with LS1/LS2/LS6 controller
- Designed for internal balancing (must be balanced prior to use in engine)
- Requires the use of chamfered rods (see our LSX connecting rod selection)

Part Number	Description	Technical Notes
19244018	LSX Crankshaft, 4.125" stroke	4340 premium steel. 4.125" stroke. Requires balancing. Includes 58x reluctor wheel. 8-bolt flexplate/flywheel required
19244049	LSX Windage Tray Kit (not shown)	For 4.000" strokes. Includes all matching hardware. Some notching may be required
19202609	LSX Windage Tray Kit	For 4.125" strokes. Includes all matching hardware. Some notching may be required depending on application

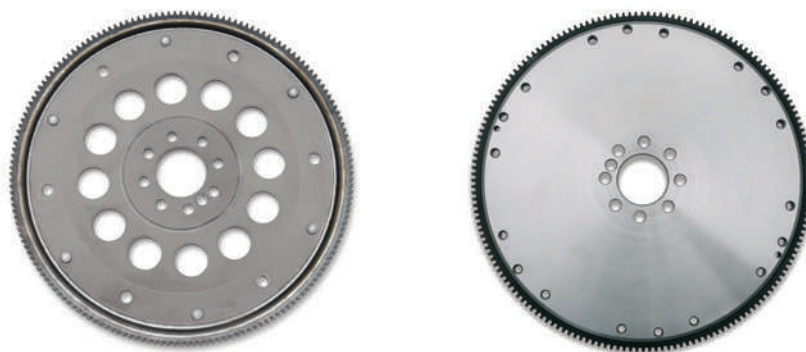

FLYWHEELS AND FLEXPLATES

At the opposite end of the crankshaft from the balancer are flywheels and flexplates, which connect the engine to either manual (flywheels) or automatic (flexplates) transmissions. Chevrolet Performance offers both internally and externally balanced flywheels and flexplates. It is critical you use the correct design for your engine application.

NOTE: For Transmission Installation kits, see pages 369-370

LS Engine Flywheels

Part Number	Year of Engine	Outside Diameter	Crank Flange Bolt Pattern	Converter Bolt Pattern Diameter	Starter Ring Gear Teeth	Technical Notes
12571611	1997 - up	14" (359mm)	6-bolt LS pattern 3.110" (79mm)	11.5" Single Disc	168	Flywheel used for LS engines with 6-bolt crankshaft flange
24240678	2009 - up	14"	8-bolt	9.5" Dual Disc	168	LSA Production Dual Mass with 8-bolt crankshaft flange (also fits LSX454)
12598613	2009 - up	14"	9-bolt	10" Dual Disc	168	LS9 Production with 9-bolt crankshaft flange

LS Engine Flexplates

Part Number	Year of Engine	Outside Diameter	Crank Flange Bolt Pattern	Converter Bolt Pattern Diameter	Starter Ring Gear Teeth	Technical Notes
12654640	1997 - up	14"	6-bolt LS pattern 3.110" (79mm)	11.062" (281mm)	168	Flexplate used for LS engines - fits stock LS-4L60 family torque converter
19260102	1997 - up	14"	6-bolt LS pattern 3.110" (79mm)	11.5" (292.1mm)	168	Flexplate only used together with Spacer 1256352 and Bolts 19257940 (4L80 family)
12636325	2009 - up	14"	8-Bolt	11.062" (281mm)	168	LSA Production Flexplate (also fits LSX-454)
19125691	2009 - up	14"	8-Bolt	11.5" (291.1mm)	168	Modified LSA 12636325 Flexplate (see above) for use in flywheel kit 19125597
12620099	2014 - up	14"	8-Bolt LS/LT pattern	11.062" (281mm)	168	Production Gen V truck flexplate

TIMING CHAINS AND SPROCKETS

Part Number	Description	Technical Notes
12588670	LS2 Timing Chain Damper (not shown)	Production LS2 damper. Will not fit LS1 and LS6 blocks fitted with P/N 88958607 (P/N 88958607 is no longer serviced). For use with standard oil pumps
12581276	Timing Chain Damper (not shown)	Production LS7 damper. 1.1mm thinner than P/N 12588670. For use with LS7 2-stage oil pump
12576407	1X Camshaft Sprocket (not shown)	Fits all LS cams with 3-bolt design. 1X camshaft gear. 3-bolt design; uses 3 bolts P/N 12556127
12586481	Camshaft Sprocket (not shown)	Fits all LS cams with 3-bolt design. 4X camshaft gear. 3-bolt design; uses 3 bolts P/N 12556127
12585994	VVT Camshaft Sprocket (not shown)	Combination camshaft sprocket and VVT activator. Production on 2007-2008 Cadillac Escalade L92 engines. Single-bolt design; use bolt P/N 12588151. 4X camshaft gear
12556582	Crankshaft Sprocket (not shown)	Fits non-LS7/LS9 applications. For standard single-stage oil pumps. Works with both cam sprockets P/N 12576407 and 12586481
12581278	Crankshaft Sprocket (not shown)	For use with 2-stage LS7 or LS9 oil pump only. Works with cam sprockets P/N 12576407 and P/N 12586481
12646386	Timing Chain (not shown)	Fits 1997-2009 LS-based engines
12626407	Timing Chain Tensioner (not shown)	Requires 1 per engine. Includes retainer and bolts. For L92 and LS3 engines
12556127	Camshaft Sprocket Bolt (not shown)	For use with 3-bolt (non-VVT) cams. For LS1, LS2, LS6, LS9 and early LS7 engines
11561283	Camshaft Sprocket Bolt (not shown)	For use with single-bolt cams and non-VVT timing covers. For 2008-2009 LS3 and LS7 engines
12682000	Camshaft Sprocket Bolt (not shown)	Combination bolt and valve for Variable Valve Timing (VVT) engines. For L92 engines. Use with VVT camshaft sprocket P/N 12585994

BOLTS, DOWELS AND BEARINGS

Part Number	Description	Technical Notes
11569956	Flywheel Bolt (not shown)	Requires 6 per engine. For LS1, LS2, LS3, LS6, LS7 and L92 engines. Use for both automatic flexplates and manual flywheels
11505820	Flywheel Dowel (not shown)	For all LS-Series engines. Locating dowel pin for pressure plate
12561465	Pressure Plate Bolts (not shown)	6 pieces. 6 needed per flywheel. Used on all GM LS engine manual flywheels
14061685	Pilot Bearing (not shown)	Use with manual transmissions if the input shaft extends beyond the bell housing more than 20mm
12557583	Pilot Bearing (not shown)	Use with manual transmissions if the input shaft extends beyond the bell housing 5mm or less (or recessed slightly)

ACCESSORY DRIVE SYSTEMS

The easiest and most convenient way to finish your LS engine and get it ready to run in your vehicle is with one of our serpentine accessory drive systems. They include the accessories, brackets, drive belts and hardware your engine needs, saving you the time of sourcing them individually. They're all-inclusive systems that bolt right onto the engine for a factory fit and appearance.

A. 19155066 CTS-V Accessory Drive System, with A/C – Fixed Displacement Compressor

- Does not work on LS9 and LSA supercharged engines
- Most harmonic balancers do not line up correctly with the accessory drive system; damper P/N 12674582 is strongly recommended
- Air conditioning has separate belt; to delete air conditioning, do not install the belt, compressor or tensioner
- Fits all LS type engines, except production iron block applications
- Direct bolt-on for LS3 and LS7 engines

NOTE: Will not work with a cam-phased engine.

NOTE: Will not work on LS327 with cast-iron block.

NOTE: Water pump P/N 12681186 NOT included with kit.

NOTE: Includes fixed displacement compressor.

NOTE: Use P/N 19299069 for A/C add-on if Variable Displacement Compressor is needed.

The system includes:

Part Number	QTY	Description
12578548	1	Bracket–Air Conditioning
19130461	1	Compressor–Air Conditioning
12595289	1	Tensioner–Air Conditioning Belt
12578549	1	Belt–Air Conditioning Compressor
12578551	1	Bracket–Power Steering Pump
21997867	1	Pump–Power Steering
12578552	1	Pulley–Power Steering Pump
21997866	1	Reservoir–Power Steering Fluid
21997868	1	Hose–Power Steering Fluid Reservoir With Clamps
12578550	1	Bracket–Alternator
84009383	1	Alternator
12568996	1	Pulley–Belt Idler
12569301	1	Tensioner–Drive Belt
12578553	1	Belt–Water Pump/Alternator/ Power Steering
11515768	6	Bolt, Transaxle Br
11516360	4	Bolt - 10 x 1.50 x 90mm
11588751	3	Bolt - Hvy HX Acorn Flg Hd
11588744	2	Bolt - Hvy HX Acorn Flg Hd
11518075	3	Bolt - Hex Flg HD
11588747	3	Bolt, Alternator
11515760	2	Bolt Hvy Hex Flg

B. 19299070 CTS-V Accessory Drive System, without A/C

- Does not work on LS9 and LSA supercharged engines
- Most harmonic balancers do not line up correctly with the accessory drive system; damper P/N 12674582 is strongly recommended
- Fits all LS type engines, except production iron block applications
- Direct bolt-on for LS3 and LS7 engines

NOTE: Will not work with a cam-phased engine.

NOTE: Will not work on LS327 with cast iron block.

NOTE: Water pump P/N 12681186 NOT Included with kit.

The system includes:

Part Number	QTY	Description
12578551	1	Bracket–Power Steering Pump
21997867	1	Pump–Power Steering
12578552	1	Pulley–Power Steering Pump
21997866	1	Reservoir–Power Steering Fluid
21997868	1	Hose–Power Steering Fluid Reservoir With Clamps
12578550	1	Bracket–Alternator
84009383	1	Alternator
12568996	1	Pulley–Belt Idler
12569301	1	Tensioner–Drive Belt
12578553	1	Belt–Water Pump/Alternator/ Power Steering
11515768	2	Bolt, Transaxle Br
11588751	3	Bolt - Hvy HX Acorn Flg Hd
11588744	2	Bolt - Hvy HX Acorn Flg Hd
11518075	3	Bolt - Hex Flg HD
11588747	3	Bolt, Alternator
11515760	2	Bolt Hvy Hex Flg

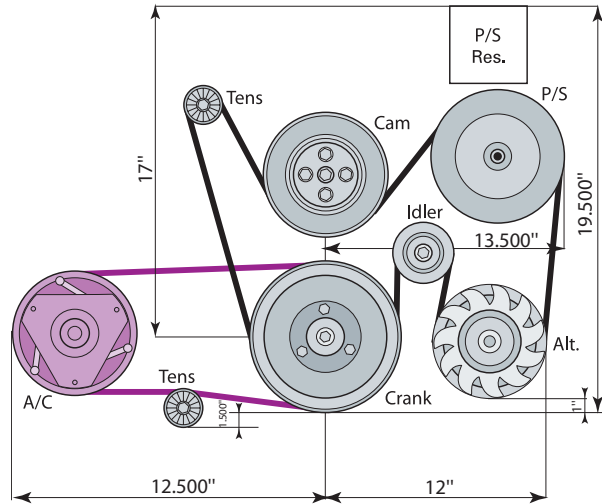

A CTS-V Accessory Drive System, with A/C – Fixed Displacement Compressor

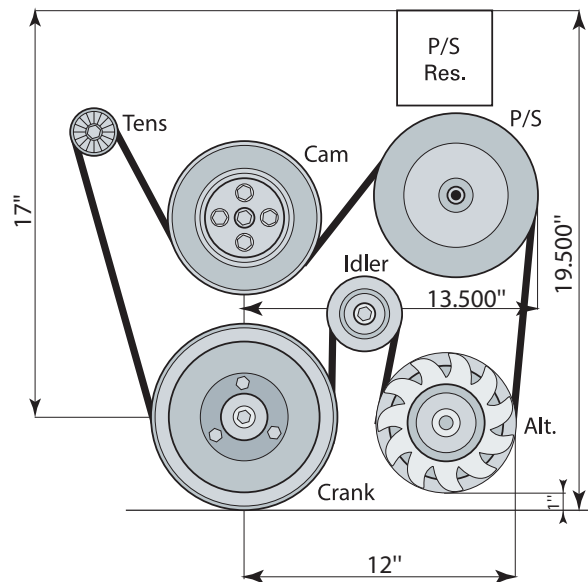

B CTS-V Accessory Drive System, without A/C

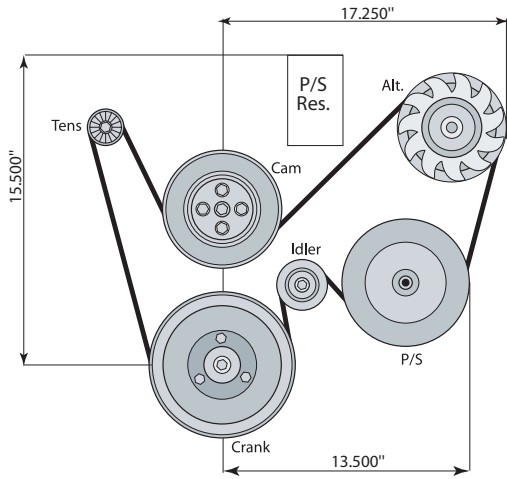

Corvette Accessory Drive System, without A/C **C**

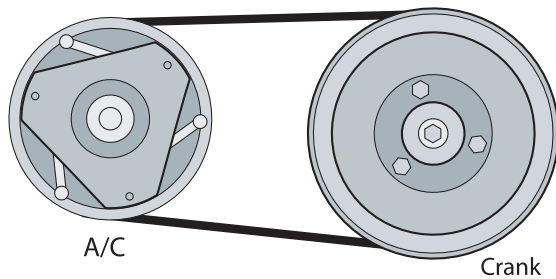

Corvette Accessory Drive System, A/C Add-on **D**

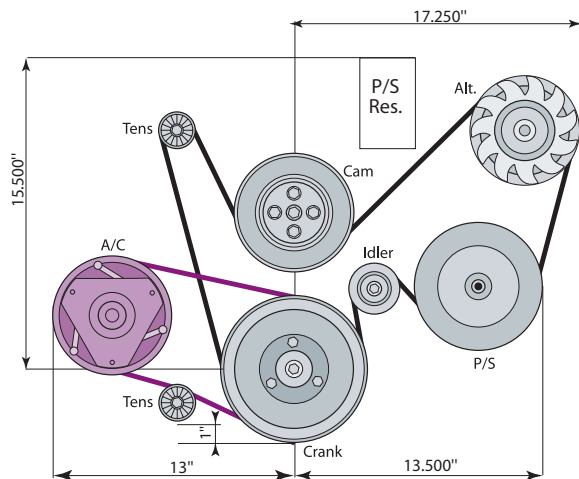

Corvette Accessory Drive System, with A/C **E**

C. 19257325
Corvette Accessory Drive System, without A/C

- Fits all Non-LSA and LS9 LS-type engines
- Most harmonic balancers do not line up correctly with the accessory drive system; damper P/N 12674582 is strongly recommended
- Direct bolt-on for LS3 & LS7 engines

NOTE: Use on LS327 iron block engine requires harmonic balancer P/N 12674582.

NOTE: Water pump P/N 12681186 NOT Included with kit.

NOTE: Will not work with cam-phased engine.

The system includes:

Part Number	QTY	Description
12555222	1	Bracket-Power Steering Fluid Reservoir
12578067	1	Bracket-Alternator and Power Steering Pump
25888970	1	Alternator
25960709	1	Pump-Power Steering
12568997	1	Pulley-Power Steering Pump
12555693	1	Brace-Power Steering Pump Front
15907878	1	Hose-Power Steering Fluid Reservoir With Clamps
26046502	1	Reservoir-Power Steering Fluid
12569301	1	Tensioner-Drive Belt
12568996	1	Pulley-Belt Idler
12636226	1	Belt-Water Pump/Alternator/Power Steering Pump
11515768	2	Bolt-10x1.5x40mm - 15mm Drive
11098341	1	Bolt-10x1.5x105mm - 15mm Drive
12552922	1	Bolt-10x1.5x160mm - 15mm Drive
11516357	3	Bolt-10x1.5x75mm - 15mm Drive
11588745	1	Bolt-10x1.5x65mm - 15mm Drive
11588751	2	Bolt-10x1.5x95mm - Drive
11515758	2	Bolt-8x1.25x30mm - 12mm Drive
10317982	1	Cap-Power Steering Fluid Reservoir
11516697	2	Bolt-8x1.25x85mm - 13mm Drive

D. 19299069
Corvette Accessory Drive System, A/C Add-on

Components needed to add A/C to your LS-equipped vehicle.

- Kit includes mounting bracket, bolts, belt, A/C compressor and instruction sheet
- Intended to be used in conjunction with P/N 19257325 GMPP kit for non-A/C applications. Not verified to work with any non-GM FEAD kit
- Includes variable displacement compressor

The system includes:

Part Number	QTY	Description
12556447	1	Stud-10 x 1.5x127mm - 7mm Drive
12569286	1	Bracket-Air Conditioning Compressor
11515768	1	Bolt-10x1.5x40mm - 15mm Drive
89019337	1	Compressor-Air Conditioning
15709703	1	Nut- 10x1.5mm - 15mm Drive
11098341	1	Bolt-10x1.5x105mm - 15mm Drive
12552922	1	Bolt-10x1.5x160mm - 15mm Drive
11516360	1	Bolt-10x1.5x90mm - 15mm Drive
12595289	1	Tensioner-Air Conditioning Compressor Belt
12636225	1	Belt-Air Conditioning Compressor (1040mm - Long)

E. 19155067
Corvette Accessory Drive System, with A/C

Includes all components in Kits P/N 19257325 and P/N 19299069.

- Fits all Non-LSA and LS9 LS-type engines
- Most harmonic balancers do not line up correctly with the accessory drive system; damper P/N 12620556 is strongly recommended
- Air conditioning has separate belt; to delete air conditioning, do not install the belt, compressor or tensioner
- Direct bolt-on for LS3 & LS7 engines

NOTE: Use on LS327 iron block engine requires harmonic balancer P/N 12674582.

NOTE: Water pump P/N 12681186 NOT Included with kit.

NOTE: Will not work with cam-phased engine.

LS/LT/LSX-SERIES COMPONENTS

Accessory Drive Systems continued

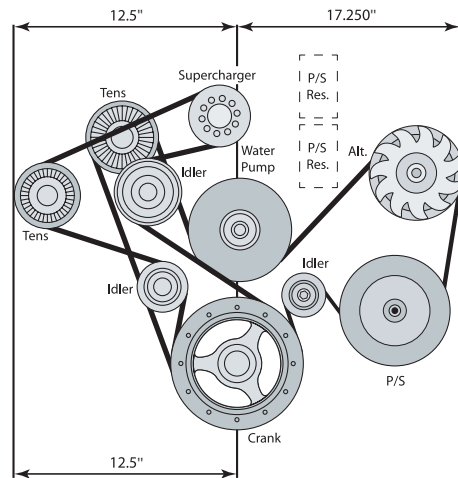
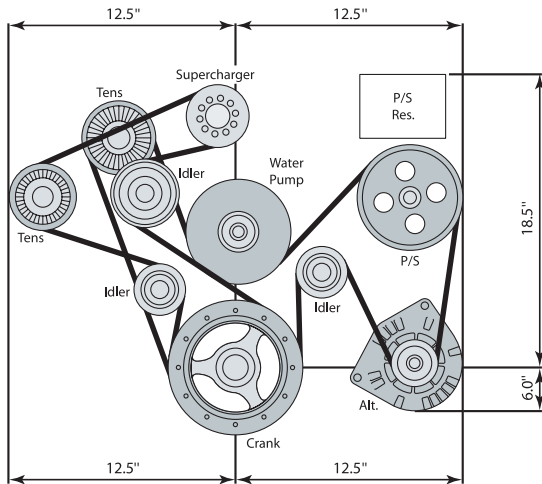

19243525

LSA Accessory Drive System, without A/C

The front engine assembly dress components used in the CTS-V, without A/C for installations in other vehicles.

- Includes all brackets, bolts, tensioners, pulleys, belts, alternator, P/S pump and instruction sheet

The system includes:

Part Number	QTY	Description
12578550	1	Bracket-Alternator
23480515	1	Alternator Asm
11588744	4	Bolt-Hvy Hx Acorn Flg Hd
11588751	3	Bolt-Hvy Hx Acorn Flg Hd
12611905	1	Bracket-P/S Pump
11515760	2	Bolt-Rad Uptr Mt
12686386	1	Pulley-P/S Pump
20806165	1	Pump Asm-P/S
22768353	1	Reservoir Asm-P/S Fluid
15224351	1	Hose Asm-P/S Fluid Rsvr Ottt
11588747	3	Bolt-Alternator
11570082	4	Bolt-Hfh, M8x1.25x29, 19 Th
12606501	1	Bracket-Belt Idler Pulley
11610074	3	Bolt-Hvy Hx Acorn Flg Hd
12606500	1	Bracket-Drv Belt Tensr
11588749	2	Bolt-Hvy Hx Acorn Flg Hd
11588742	1	Bolt-Hvy Hx Acorn Flg Hd
12628025	1	Tensioner Asm-Drv Belt
11571051	2	Bolt-Hex Washer Hd
12606031	1	Pulley Asm-Spchg Belt Idler
12606032	1	Pulley Asm-Belt Idler
12622452	1	Tensioner Asm-Spchg Belt
11588753	1	Bolt-Hvy Hx Acorn Flg Hd
12568996	1	Pulley Asm-Belt Idler
12628027	1	Belt-w/Pmp & Alternator & P/S Pump
12676726	1	Belt-Spchg

19244106

LSA Accessory Drive System A/C Add-On Kit (not shown)

Components needed to add A/C to your LSA-equipped vehicle.

- Kit includes mounting bracket, bolts, belt, A/C compressor and instruction sheet
- Intended to be used in conjunction with P/N 19243525 kit for non-A/C applications. Not verified to work with any non-GM FEAD kit

Part Number	QTY	Description
11516360	4	Bolt-Hex Flg Hd
12612514	1	Bracket-AC Cmpr
11571051	4	Bolt-Hex Washer Hd
19130461	1	Compressor Asm-AC
12623615	1	Tool-AC Cmpr Belt
19180340	1	Belt-AC Cmpr

19303242

Modified LSA Accessory Drive System, without A/C

Similar to LSA Accessory Drive Kit P/N 19243525, but designed for retro-fit applications with a relocated alternator and power steering pump to provide chassis clearance in older vehicles

- Includes power steering pump and two remote-mount reservoirs; builder to use the reservoir that provides the best fit for the application
- Requires fabrication of reservoir mounting bracket
- Requires reservoir-to-pump hose
- Can be used with either LSA A/C add-on or Corvette A/C add-on kit

The system includes:

Part Number	QTY	Description
12646194	1	Belt-w/pmp & Alternator & P/S Pump
12628025	1	Tensioner ASM-DRV Belt
11571051	2	Bolt/Screw-DRV Belt Tensr
12568996	1	Pulley ASM-Belt Idler
12676726	1	Belt-SPCHG
12622452	1	Tensioner ASM-SPCHG Belt
11588753	1	Bolt/Screw-SPCHG Belt Tensr
12606500	1	Bracket-SPCHG Belt Tensr
11588742	1	Bolt/Screw-SPCHG Belt Tensr Brkt
11588749	2	Bolt/Screw-SPCHG Belt Tensr Brkt
12606031	1	Pulley ASM-SPCHG Belt Idler
12606032	1	Pulley ASM-SPCHG Belt Idler
11588744	2	Bolt/Screw Belt Idler Pul
12606501	1	Bracket-SPCHG Belt Idler Pul
11570082	1	Bolt/Screw-SPCHG Belt Idler Pul Brkt
11610074	3	Bolt/Screw-SPCHG Belt Idler Pul Brkt
12578067	1	Bracket-Alternator/P/STG/ Pump
11516357	3	Bolt/Screw-Alternator Brkt
12555693	1	Brace-P/S Pump
11588745	1	Bolt/Screw
11588751	2	Bolt/Screw
11515758	2	Bolt/Screw
11516697	2	Bolt/Screw
12568997	1	Pulley-P/S Pump
25960709	1	P/S Pump
25888970	1	Alternator
22768353	1	P/S Pump Reservoir
26046502	1	P/S Pump Reservoir
10317982	1	Cap - P/S Reservoir
12555222	1	P/S Pump Reservoir Bracket
15306009	1	Connector

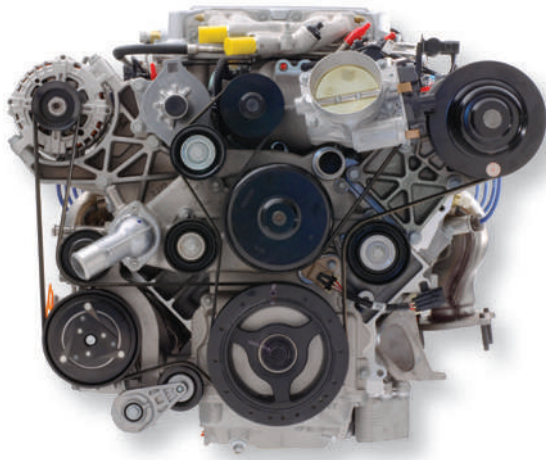

LS9 Accessory Drive System, with A/C **A**



LS9 Accessory Drive System, with A/C **A**

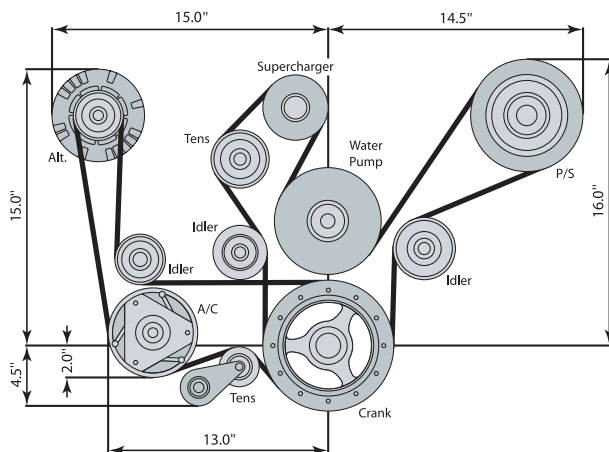

LS9 Accessory Drive System, with A/C **A**

**A. 19368945
LS9 Accessory Drive System, with A/C**

The Chevrolet Performance FEAD kit for the powerful LS9 is complete, as used in the ZR1 Corvette.

- Kit consists of all brackets, bolts, tensioners, pulleys, belts, alternator, P/S pump, idlers, and AC brackets, compressor and instruction sheets

The system includes:

Part Number	QTY	Description
15857665	1	Pump Asm-P/S
11588733	2	Bolt-Hvy Hx Acorn Flg Hd
12625875	1	Bracket Asm-P/S Pump
11588748	6	Bolt-Hvy Hx Acorn Flg Hd
15285644	1	Reservoir Asm-P/S Fluid
12598653	1	Pulley Asm-Belt Idler
11588745	1	Bolt-Drv Belt Tensr
12598654	1	Pulley Asm-Belt Idler
11588743	1	Bolt-Hvy Hx Acorn Flg Hd
12623061	1	Tensioner Asm-Drv Belt
11515767	5	Bolt-Trans Br Brkt
12602288	1	Bracket-AC Cmpr
12556447	1	Stud-Special M10 X 1.5 X 127
11571051	3	Bolt-Hex Washer Hd
12623062	1	Tensioner Asm-AC Cmpr Belt
12568996	1	Pulley Asm-Belt Idler
89019339	1	Compressor Asm-AC
11514597	1	Nut-Alternator
12552922	1	Bolt/Screw-AC Cmpr
11588751	2	Bolt-Hvy Hx Acorn Flg Hd
11588754	1	Bolt-Hvy Hex Acorn Flg Hd
25888947	1	Alternator Asm
11588744	2	Bolt-Hvy Hx Acorn Flg Hd
12602289	1	Bracket-Alternator & Drv Belt Tensr
12637321	1	Belt-Spchg & w/Pmp & P/S Pump
12627522	1	Belt-AC Cmpr

NOTE: This kit includes the generator bracket and bolts that are already attached to a Chevrolet Performance LS9 Crate Engine. This bracket must be bolted on the cylinder head prior to installing the water pump. If you do not have a Chevrolet Performance LS9 Crate Engine, you will also need to purchase separately the LS9 water pump kit (P/N 12622036), the LS9 lifter valley cover (P/N 12605719) and LS9 coolant air bleeds (P/N 12606242 and P/N 12606243) to use this FEAD kit. If you have a Chevrolet Performance LS9 Crate Engine, you do not need any of these additional parts.

LS/LT/LSX-SERIES COMPONENTS

Accessory Drive Systems continued

A. 19369108

LC9 5.3L Accessory Drive System, without A/C

The workhorse LC9 5.3L engine assemblies come with an alternator bracket attached. To complete the installation of your engine, the parts listed below will complete the factory-installed FEAD assembly.

These components are engineered for heavy-duty work-truck use, and will provide years of reliable service in your performance vehicle.

The system includes:

Part Number	QTY	Description
12626222	1	Drive Belt
12669569	1	Idler Pulley w/Bolt
22781131	1	Alternator
11516360	2	Alternator Bolts
20756714	1	P/S Pump
12554032	1	P/S Brace
11514597	2	P/S Brace Nuts
11515764	1	P/S Brace Bolt
12605677	1	P/S Pump Pulley
11515767	3	Stg Pump Mtg Bolt
19257882	1	Bolt 3/8" x 16
09440957	1	Nut 3/8" x 16
19258317	1	Washer

Power Steering Pump Pulley Install Tool (included)

NOTE: This kit is designed to include the necessary parts to install the complete kit on a Chevrolet Performance 5.3L Crate Engine. If you do not have a Chevrolet Performance 5.3L Crate Engine, you may need some additional hardware. The following parts are included with the Chevrolet Performance 5.3L Crate Engine and are not part of this kit:

Part Number	QTY	Description
11588747	2	Bolt, Tensioner
12609719	1	Tensioner
12554030	1	Bracket, Steering/Generator
11516744	4	Bolt, Bracket
19300488	1	Balancer
12557840	1	Bolt, Balancer
12681417	1	Kit, Water Pump (includes gaskets)
12551926	6	Bolt, Water Pump

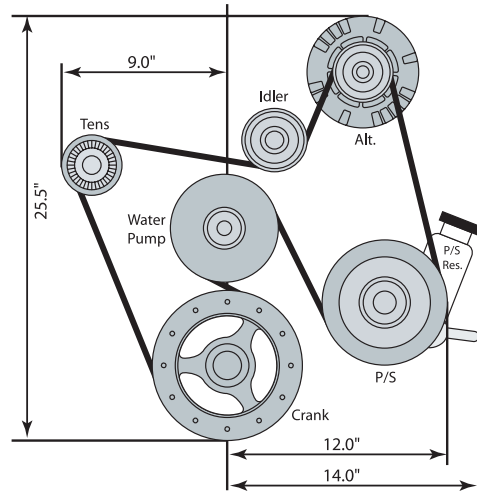

A LC9 5.3L Accessory Drive System

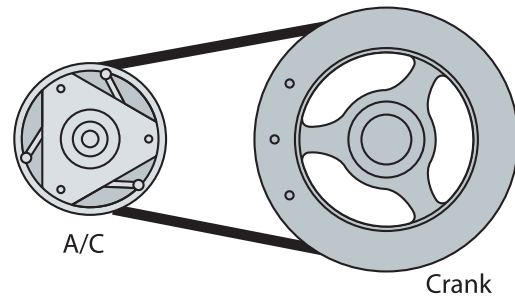

B LC9 5.3L A/C Add-on Kit

B. 19260892

LC9 5.3L Accessory Drive System A/C Add-on Kit

Components needed to add A/C to your LC9-equipped vehicle.

- Kit includes mounting bracket, bolts, belt, AC compressor and instruction sheet
- Intended to be used in conjunction with P/N 19258433 kit for non-AC applications. Not verified to work with any non-GM FEAD kit

The system includes:

Part Number	QTY	Description
25891791	1	AC Compressor
12643257	1	Mtg Bracket
11515767	3	Bracket Bolts
11516109	3	Comp Bolts-Long
11516503	1	Comp Bolt-Short
19210691	1	Belt Kit (w/Tool) AC

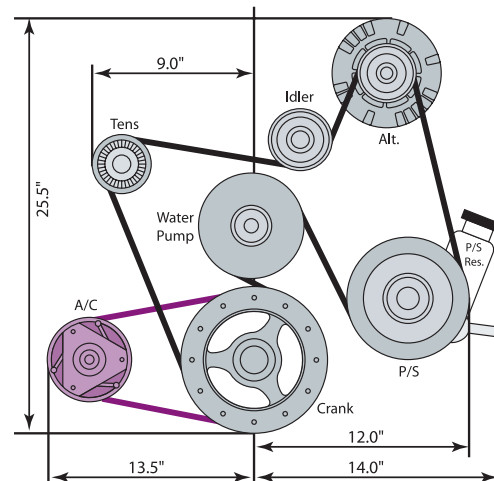

LC9 5.3L Accessory Drive System (19258433)
with LC9 5.3L A/C Add-on Kit (19260892)

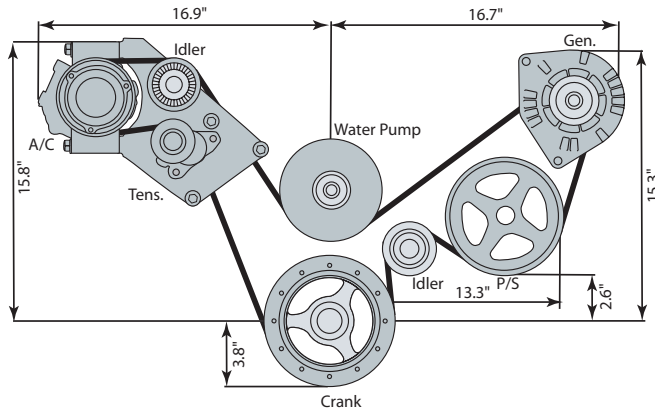

LS3 Accessory Drive System **C**

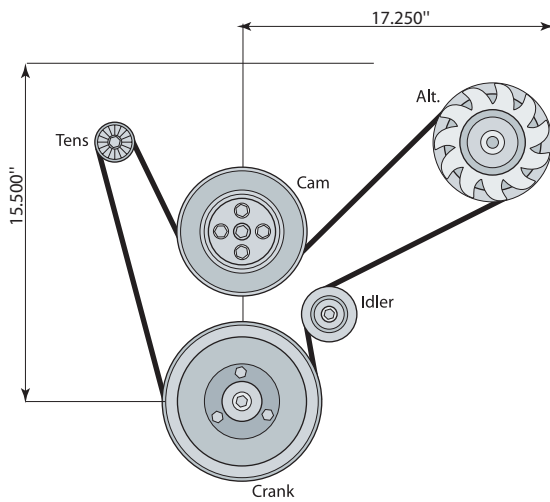

DR525 Accessory Drive System **D**

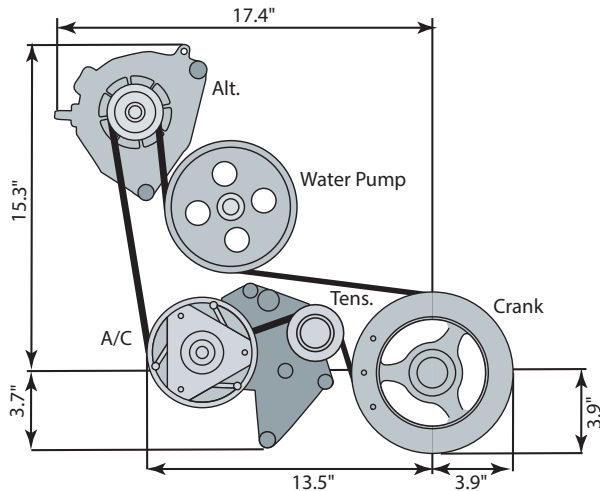

LT1 Accessory Drive System **E**

C. 19355805
LS3 Accessory Drive System

- High mount A/C provides clearance to frame
- Fits most non-LSA and non-LS9 SC engine

The system includes:

Part Number	QTY	Description
19331503	1	Instruction Sheet
19331504	1	Belt
19355804	1	Bracket
12568996	1	Pulley Asm - Belt Idler
12647765	1	Tensioner
25960709	1	Pump Asm - P/S
10317980	1	Cap Asm - P/S Fluid Reservoir
26046502	1	Reservoir Asm - P/S
12578067	1	Bracket Asm - Alt & P/S Pump
11516357	3	Bolt - Alt & P/S Bracket
11516697	2	Bolt - P/S Pump
11515758	2	Bolt - Brace & P/S Pump
12568997	1	Pulley - P/S Pump
25888970	1	Alternator Asm
11588745	1	Bolt - Alt & P/S Bracket
11588725	2	Tensioner
15907878	1	Hose - P/S Fluid Reservoir w/clamps
20762515	1	Compressor
22942442	1	Emblem
11588752	3	Bolt-Bracket to Head, M10x1.5x45
11588740	2	Bolt - Bracket
11546413	4	Bolt - Alternator & Bracket Compressor
12555693	1	Brace - P/S Pump Front
12580774	1	Pulley

D. 19329418
DR525 Accessory Drive System

- Fits all Non-LSA and LS9 LS-type engines
- Most harmonic balancers do not line up correctly with the accessory drive system; damper P/N 12674582 is strongly recommended
- Direct bolt-on for LS3 & LS7 engines

NOTE: Use on LS327 iron block engine requires harmonic balancer P/N 12674582.

NOTE: Water pump P/N 12681186 NOT Included with kit.

NOTE: Will not work with cam-phased engine.

The system includes:

Part Number	QTY	Description
12569301	1	Tensioner-Drive Belt
12568996	1	Pulley-Belt Idler
88984194	1	Belt-Water Pump/Generator
11515768	2	Bolt-10x1.5x40mm - 15mm Drive
11098341	1	Bolt-10x1.5x110mm - 15mm Drive
12552922	1	Bolt-10x1.5x160mm - 15mm Drive
11516357	3	Bolt-10x1.5x75mm - 15mm Drive
11588745	1	Bolt-10x1.5x65mm - 15mm Drive
11588751	2	Bolt-10x1.5x95mm - Drive
11515758	2	Bolt-8x1.25x30mm - 12mm Drive
11516697	2	Bolt-8x1.25x85mm - 13mm Drive

E. 12679459
LT1 Accessory Drive System

This package includes production mounting brackets, hardware and drive belt to mount the alternator and A/C compressor in the same configuration as the LT1 equipped Stingray.

NOTE: Power steering is not included, as the production car has electric assist.

The system includes:

Part Number	QTY	Description
84331091	1	Alternator
11546413	3	Bolt - Gen (2), Tensioner (1)
12668977	1	Tensioner
11588730	3	Bolt - Tensioner (1) Compressor (2)
12639512	1	Bracket, A/C Compressor
12651112	1	Belt - Alternator & A/C Compressor
11612159	1	Stud - A/C Compressor Bracket
11610091	1	Nut - M8x1.25
23370609	1	Compressor
11588694	1	Bolt - A/C Compressor to Bracket - Long bolt
11610074	1	Bolt - A/C Bracket
22942442	1	Emblem

LS/LT/LSX-SERIES COMPONENTS

Accessory Drive Systems continued

A. 12678595

LT1 Camaro Wet Sump Accessory Drive System, without A/C

- Fits GEN VI Camaro w/ LT1
- Includes alternator, brackets, tensioner and bolts
- Use A/C Add-on Kit P/N 19332591

The system includes:

Part Number	QTY	Description
12668983	1	Bracket
11588754	3	Bolt - Alternator & Tensioner
11588732	2	Alternator Bracket
22949467	1	Alternator
12643218	1	Belt
12669076	1	Tensioner
11610074	1	Bolt - Tensioner

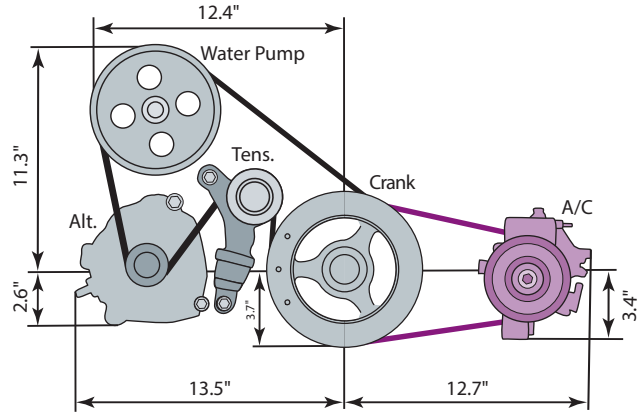

A LT1 Camaro Wet Sump Accessory Drive System (12678595) with LT4 Wet Sump & LT1 Camaro A/C Add-on Kit (19332591)

B. 19332590

LT4 Wet Sump Accessory Drive System, without A/C

- Fits GEN V LT4 Wet Sump engines
- Includes alternator, tensioners, brackets, belts, pulleys, bolts and instruction sheet
- Air conditioning has a separate belt – see kit P/N 19332591
- Production version of 2016 CTS-V and Camaro ZL1

The system includes:

Part Number	QTY	Description
12643218	1	Belt-Water Pump and Alternator
12668317	1	Belt-Supercharger
12668983	1	Bracket
11588732	2	Bolt-M8x1x70
11610074	4	Bolt-M8x1.25x45
22949467	1	Alternator
11588754	3	Bolt-M10x1.5x105
12686229	1	Tensioner
12678515	1	Pulley
12665845	1	Pulley
12678295	1	Pulley
12663624	1	Tensioner
11588753	2	Bolt-M10x1.5x105
12667164	1	Bracket
11588730	2	Bolt-M8x1.25x60



B LT4 Wet Sump Accessory Drive System, without A/C

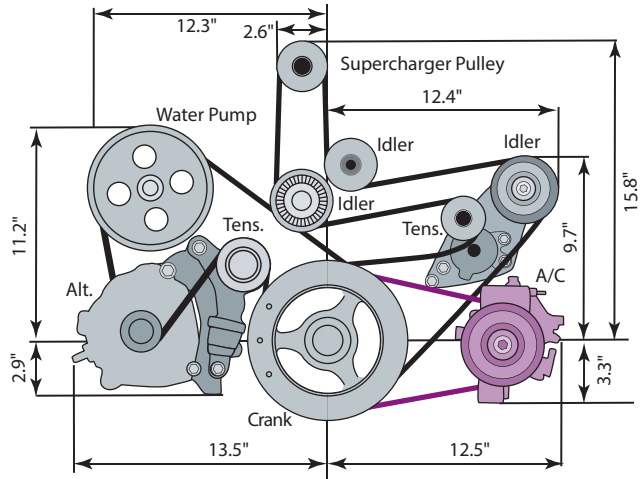

B LT4 Wet Sump (ZL1 Camaro) Accessory Drive System (19332590) with LT4 Wet Sump & LT1 Camaro A/C Add-on Kit (19332591)



LT4 Wet Sump & LT1 Camaro A/C Add-on Kit **C**

C. 19332591

LT4 Wet Sump & LT1 Camaro A/C Add-on Kit

- Kit includes mounting bracket, bolts, belt, compressor and instruction sheet
- Intended to be used in conjunction with P/N 19332590 or P/N 19339110 Chevy Performance kits
- Includes variable displacement compressor
- Production version of 2016 CTS-V

The system includes:

Part Number	QTY	Description
12643219	1	Belt
84313365	1	Compressor Unit
11588735	1	Bolt-M8x1.25x100
11588732	1	Bolt-M8x1x70
11561936	1	Stud
11610091	1	Nut-M8x1.25
12643221	4	Bracket
11610074	1	Bolt-M8x1.25x45
11588741	1	Bolt-M10x1.5x45

D. 19369109

LT4 Dry Sump Accessory Drive System, with A/C

- Fits GEN V LT4 Dry Sump engines
- Includes alternator, tensioners, brackets, belts, pulleys, bolts and instruction sheet
- Includes variable displacement compressor, does not require P/N 19332591 A/C Add-on Kit
- Production version of 2016 Z06 Corvette

The system includes:

Part Number	QTY	Description
12651112	1	Belt-Water Pump and Alternator
12639512	1	Bracket-Comp/Tensioner
11609989	3	Bolt-M10x1.5x85
84331091	1	Alternator
23370609	1	Compressor
12686272	1	Tensioner
11610074	1	Bolt-M8x1.25x45
11588694	1	Bolt-M8x1.25x120.8
11588730	7	Bolt-M8x1.25x60
11612159	1	Stud
11610091	1	Nut-M8x1.25
12663625	1	Belt-Supercharger
12678295	1	Pulley
12642706	2	Pulley
12678515	1	Pulley
12663624	1	Tensioner
12663102	1	Bracket-Tensioner
11588725	2	Bolt-M8x1.25x35
11518634	2	Bolt-M10x1.5x80

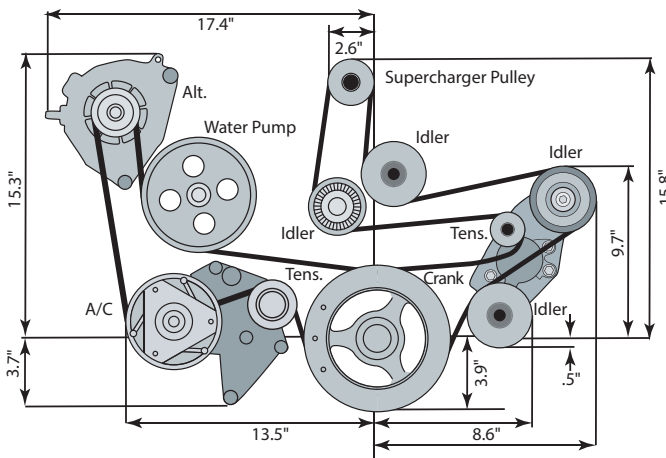

LT4 Dry Sump Accessory Drive System, with A/C **D**

Rear FEAD Clearance Dimensions

FEAD Part Number (Original Equipment Application)	Belt Track (front of block to rear edge of main drive bolt)		Belt Track (front of block to rear edge of supercharger belt)	
19299070 (CTS-V Non-Supercharged)	3"	6 Groove	—	—
19155066 (CTS-V Non-Supercharged)	3"	6 Groove	—	—
19155067 (Corvette Non-Supercharged)	3"	6 Groove	—	—
19257325 (Corvette Non-Supercharged)	3"	6 Groove	—	—
19329418 (Corvette Non-Supercharged)	3"	6 Groove	—	—
19243525 (CTS-V LSA Supercharged)	3"	6 Groove	4.5"	8 Groove
19243524 (Corvette LS9 Supercharged)	1.75"	6 Groove	2.75"	11 Groove
19258433 (Truck)	4.5"	6 Groove	—	—
Gen 4 Camaro/Firebird (LS1) (production)	4"	6 Groove	—	—
Gen 5 Camaro (LS3/L99) (production)	4.75"	6 Groove	—	—

AC Compressor for FEADs

Part Number	Application	Style	Belt Track (front of block to rear edge of belt)	
19130461	CTS-V	Fixed Disp	1.5"	4 Groove
89019337	Corvette	Variable Disp	1.5"	4 Groove
89019339	Corvette	Variable Disp	1.75"	6 Groove
25891791	Truck	Fixed Disp	3.5"	4 Groove

LS/LT/LSX-SERIES COMPONENTS

BALANCERS

A smooth-running engine depends on an effective balancer or torsional damper. Our dampers not only help LS engines run smoothly, they can extend engine life. Pick the right damper for your project from the list below.

19300488

Harmonic Balancer (not shown)

- Originally used on L92 engines
- For use in truck applications
- WILL NOT work with our Serpentine Accessory Drive Systems

A. 12553118

Harmonic Balancer

- Originally used on LS1 and LS2 engines
- For use in F-Car and GTO applications

B. 12675716

Harmonic Balancer

- Originally used on LS7 engines
- For use in Corvette applications
- Works with Chevrolet Performance Serpentine Accessory Drive System P/N 19155066 or P/N 19155067

12674582

Harmonic Balancer (not shown)

- For LS3 engines
- Works with Chevrolet Performance Serpentine Accessory Drive System P/N 19155066 or P/N 19155067

BALANCER BOLTS AND WASHERS

12557840

Balancer Bolt (not shown)

- For LS1, LS2, LS3, LS6 and L92 engines

11570163

Balancer Bolt (not shown)

- For LS7 engines

12674588

Friction Washer (not shown)

- For LS2, LS3, L99, LS7 and L92 engines

WATER PUMPS AND COMPONENTS

12681417 (not shown)

Water Pump

- '07 - '10 LS2 Trucks, Vans and SUVs

C. 12681186

Water Pump

- 2005 - 2007 LS2
- 2008 LS3
- 2007 - 2008 LS7

D. 19180610

Water Pump

- 2009 - 2010 LSA (CTS-V)
- 2009 - 2010 LS3 (Corvette)
- 2009 L76 SRX
- 2009 - 2010 LS7 (Corvette)

12630223

Water Pump Gasket (not shown)

- Requires 2 per engine
- For LS1, LS2, LS3, LS6, LS7 and L92 engines

12551926

Water Pump Bolt (not shown)

- Requires quantity of 6
- For LS1, LS2, LS3, LS6, LS7 and L92



A Harmonic Balancer – LS1 and LS2

B Harmonic Balancer – LS7



C Water Pump – LS2, LS3 and LS7 Engines

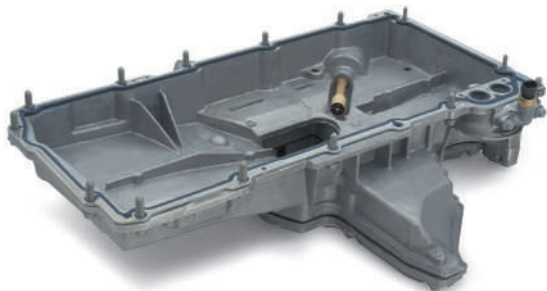
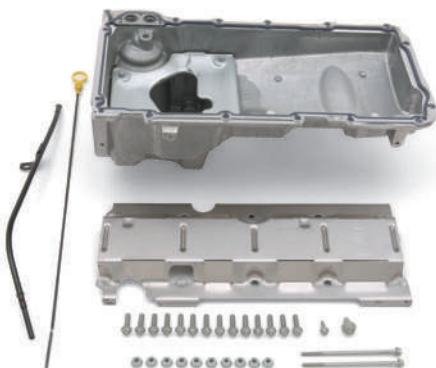

D Water Pump – 2009 LSA, LS3/LS7, L76 SRX Engines

Corvette Oil Pan – 2002-2004 LS6 **E**F-Car Oil Pan **F**LS Circle Track Oil Pan **G**Muscle Car Oil Pan Kit **H**

OIL PANS, OIL PUMPS, GASKETS AND COMPONENTS

E. 12561828**Corvette Oil Pan (2002-2004 LS6)**

- Used on 2002-2004 Corvettes with LS6

F. 12628771**F-Car Oil Pan**

- Used on 1998-2002 Camaro and Firebird LS1
- Uses PF48 oil filter

G. 19243065**LS Circle Track Oil Pan**

- Used on CT525 P/N 19331563
- 6-quart capacity (8-quart with remote filter and adaptor)
- Requires remote oil filter and adaptor
- Uses oil pan gasket P/N 12612350 (not included)

H. 19212593**Muscle Car Oil Pan Kit**

- Fits virtually all 1955-1995 GM front engine, RWD, V-8 cars
- 5-quart capacity
- Includes oil pan, dipstick and tube, gaskets, pickup tube, windage tray, and all mounting hardware
- Wet sump design
- Max stroke 3.620 w/windage tray

24241872**Magnetic Drain Plug (not shown)**

- Catches and holds small pieces of metal before they can cause damage

12612350**Oil Pan Gasket (not shown)**

- Requires 1 per engine
- Fits all LS-Series engines except LS7 and LS9

12612351**Oil Pan Gasket (not shown)**

- Requires 1 per engine
- For LS7 and LS9 engines

11515758**Oil Pan Bolt (not shown)**

- M8 x 30mm long
- Requires 12 per engine (use 13 with LS7 and LS9 engines)
- For LS1, LS2, LS6, LS7 and LS9 engines

12554990**Oil Pan Bolt (not shown)**

- M6 x 136mm long
- Requires 2 per engine
- For all LS-Series engines

12612289**Oil Pump (not shown)**

- For LS9 engines

12623097**Oil Pump (not shown)**

- 2-stage pump for LS7 engines
- Will not work on standard LS crankshafts
- Must use crank sprocket (P/N 12581278), timing damper (P/N 12581276), LS7 pickup tube (P/N 12580855), LS7 oil pan (P/N 12664619), and LS7 timing cover (P/N 12633907)

11519133**Oil Pump Bolt (not shown)**

- Requires 4 per engine
- For all LS-Series engines

LS INTAKE MANIFOLDS

A. 12644568

LS7 Production Intake Manifold Assembly

- Gen IV fuel injection nylon manifold used on the 2009 Corvette Z06 LS7 engine
- Fully assembled with injectors, fuel rail, 90mm ETC throttle body and gaskets
- For use only with LS7 and LSX/LS7-style cylinder heads

NOTE: Must use Controller Kit P/N 19354334.



A LS7 Production Intake Manifold Assembly

B. 12674428

LS3 Intake Manifold Assembly

- Gen IV fuel-injection nylon manifold used on the 2009 Corvette LS3
- Fully assembled with injectors, fuel rail, 90mm ETC throttle body and gaskets
- For use with LS3/L92 style cylinder heads



B LS3 Intake Manifold Assembly

C. 19244103

LS9 Supercharger

- Original Equipment on ZR1 Corvette
- Eaton twin-rotor 2.3L displacement
- Integrated dual-brick air-to-liquid intercooler
- Highly efficient 4-lobe rotor design
- Generates maximum boost pressure of 10.5 PSI
- Assembly includes:
 - Supercharger intake system with injectors
 - Cast cover and intercooler
 - Front pulley
 - Throttle body (not shown)
 - Gasket Set
 - Injector Harness (not shown)
 - Injectors (not shown)
 - Fuel Rails (not shown)



C LS9 Supercharger

D. 19300534

ZL1 Supercharger

- Original equipment on LSA-powered 2012-2014 ZL1 Camaro
- Highly efficient Eaton Twin-Vortices, high-helix rotors
- 1.9L displacement
- Integrated air-to-liquid intercooler with front-facing lines
- Approximately 9 lbs. psi boost on 6.2L engine
- Assembly includes:
 - Supercharger
 - Intake system with injectors
 - Ribbed cast cover and intercooler
 - Front pulley
 - Throttle body
 - Gasket set



D ZL1 Supercharger



LS9/LSA Intercooler Fluid Pump **E**



Air Inlet Kit **F**



LS2 4-bbl Intake Manifold **G**



LS7 4-bbl Intake Manifold **H**



LS3/L92 Style 4-bbl Intake Manifold **I**

E. 22901367
LS9/LSA Intercooler Fluid Pump

- Includes pump assembly
- Additional hoses and clamps required to connect pump inline with coolant circuit

F. 19301246
Air Inlet Kit for LS-Based Crate Engine Installation

- Designed for universal LS and LSX EFI crate engine installations
- Kit contains intake tubes with provisions for mass airflow meter and vacuum line, along with a reusable, high-performance air filter and mounting hardware
- Straight and elbow tubes provide the optimal distance between throttle opening and mass airflow meter, including the minimum length of straight tubing required for accurate mass airflow meter operation
- Includes polished intake tubes, couplers, worm-style clamps and a vacuum hose.
- Mass airflow meter provision accepts all GM production meters, (must be purchased separately).

NOTE: This is a universal kit and may not fit every application. Additional fabrication may be required, but the length of the straight tube must be maintained for accurate mass airflow meter operation.

G. 88958675 ⓘ
LS2 4-bbl Intake Manifold

- Allows you to install a 4-bbl carburetor on an LS-Series engine with cathedral ports (LS1, LS2, LS6)
- Cast aluminum open-plenum intake manifold accepts a 4150-style square-bore carburetor
- Bosses for EFI injectors for custom applications
- Bolts and instructions supplied

NOTE: LSX Ignition Controller P/N 19171130 is required for carbureted applications.

H. 25534394 ⓘ
LS7 4-bbl Intake Manifold

- Lightweight GM Racing design for use on LS7-style heads
- Reduced mass design, porting not recommended
- Includes mounting bolts and instructions
- Uses LS7 carb intake gasket set P/N 19172113
- Machined for 4150-style carburetors and has 3/8" NPT vacuum boss
- Also available with injector bosses, P/N 25534413

NOTE: LSX Ignition Controller P/N 19171130 is required for carbureted applications.

I. 25534401 ⓘ
LS3/L92-Style 4-bbl Intake Manifold

- Lightweight GM Racing design for use on LS3/L92-style cylinder heads
- Reduced mass design, porting not recommended
- Includes mounting bolts P/N 11609577 and instructions
- Uses L92 carb intake gasket set, P/N 19172114
- Machined for 4150-style carburetors and has 3/8" NPT vacuum boss
- Also available with injector bosses P/N 25534416

NOTE: LSX Ignition Controller P/N 19171130 is required for carbureted applications.

LSX INTAKE MANIFOLDS

The best way to feed an LSX engine is with air channeled through one of our LSX intake manifolds. They're designed to match the performance capability of our LSX heads and big-displacement rotating assemblies. LSX intake manifolds have a high-flow, spider-type design and are made of lightweight aluminum. They're cast with plenty of material for builder-specified port work; and the flanges are a minimum of 0.5"-thick to accommodate machining. Additional features include:

- Standard-deck and tall-deck versions
- Natural finish with LSX and GM logos
- Injector/nitrous bosses cast in place
- Comes with installation hardware

A. 19244037

LSX-LS3 Dual-Plane Standard Deck 4-bbl Manifold

- Dual-plane for low- and mid-range torque
- L92-style ports
- Injector/nitrous bosses cast-in
- Extra thick for professional porting
- 4150-style carburetor mounting provision
- Uses OEM O-ring gaskets and bolts (included)
- Tall-deck version available as P/N 19244036

B. 19244035

LSX-LS3 Single-Plane Standard Deck 4-bbl Manifold

- Single-plane design for mid-range and top-end power
- L92-style ports
- Injector/nitrous bosses cast-in
- Extra thick for professional porting
- 4150-style carburetor mounting provision
- Uses OEM O-ring gaskets and bolts (included)
- Tall-deck version available as P/N 19244034

C. 19244033

LSX-LS7 Single-Plane Standard Deck 4-bbl Manifold

- Single-plane design for mid-range and top-end power
- LS7-style port
- Injector/nitrous bosses cast-in
- Extra thick for professional porting
- 4150-style carburetor mounting provision
- Uses OEM O-ring gaskets and bolts (included)
- Tall deck version available as P/N 19244032

D. 19257854

LSX-CT Single-Plane Standard Deck 4-bbl Manifold

- Single-plane design for large displacement or high-rpm applications
- LSX-CT/DR-style port; minor port matching required for optimal port match
- Two-sets of injector/nitrous bosses are cast-in for extreme power capability
- Extra thick for professional porting and/or boosted applications
- 1/2" raised 4150-style carburetor mounting pad
- Tall deck version available as P/N 19257853



A LSX-LS3 Dual-Plane Standard Deck 4-bbl Manifold



B LSX-LS3 Single-Plane Standard Deck 4-bbl Manifold



C LSX-LS7 Single-Plane Standard Deck 4-bbl Manifold



D LSX-CT Single-Plane Standard Deck 4-bbl Manifold



LSX-DR Single-Plane Standard Deck 4-bbl Manifold **E**



LS Front Distributor Drive Cover **F**



LS7 Carburetor Intake Gasket **G**



L92/LS3 Carburetor Intake Gasket **H**



LS Header Flange **I**

E. 19257851

LSX-DR Single-Plane Standard Deck 4-bbl Manifold

- The ultimate drag racing single-plane for large displacement or high-rpm applications
- LSX-CT/DR-style port; minor port matching required for optimal port match
- Two-sets of injector/nitrous bosses are cast-in for extreme power capability
- Extra thick for professional porting and/or boosted applications
- 1" raised 4500 style carburetor mounting pad
- Tall-deck version available as P/N 19257852

F. 88958679

LS Front Distributor Drive Cover

- Assembly is manufactured for applications where a 4-bbl carburetor and distributor are required
- Can be combined with GM's Bowtie valve covers, P/N 25534398 and P/N 25534399, for a complete traditional-looking engine package
- For all LS-Series engines except LS7, LSA and LS9

NOTE: Distributor and mechanical fuel pump not included. Uses Small-Block Ford-style distributor and mechanical fuel pump. Special water pump, accessory drive and damper required.

INTAKE MANIFOLD GASKETS AND COMPONENTS

G. 19172113

LS7 Carb Intake Gasket

- For use with intake manifold P/N 25534394 or P/N 25534413
- Includes 2 gaskets

H. 19172114

L92/LS3 Carb Intake Gasket

- For use with intake manifold P/N 25534401 or P/N 25534416
- Includes 2 gaskets

19156564

LS2 Carb Intake Gasket (not shown)

- For use with intake manifold P/N 88958675
- Includes 2 gaskets

EXHAUST MANIFOLD/HEADER

I. 12480130

LS Header Flange

- These 3/8" thick steel header flanges are a great way to start a fabricated set of LS-Series headers for a racecar or street rod
- For stock LS1, LS2, LS3, LS6, LS7 and L92 (may require clearancing) exhaust ports
- Sold individually



Intake Manifolds: Additional Required Components

Part Number	Intake Gaskets	Bolts	Engine Application
25534394/25534413	19172113	Included with manifold	LS7 Carb Applications
25534401/25534416	19172114	Included with manifold	L76/L92 and LS3 Carb Applications
88958675	19156564	Included with manifold	LS2 Carb Applications

LS/LT/LSX-SERIES COMPONENTS

DRY SUMP COMPONENTS

A. 25534412

Dry Sump Oil Hose Adapters

- Kit adapts the production LT1, LT4, LS7 and LS9 oil pan to aftermarket AN-style hoses for aftermarket dry sump oil tanks
- Bolts directly to oil pan, and has AN male outlet for AN -12 fittings
- Includes 1 adapter, 2 fittings, 2 bolts, and 2 sealing gaskets

12603281

Oil Tank (not shown)

- Fits 2006-2008 Z06 Corvette

15210122

Oil Inlet Hose (not shown)

- Fits 2006-2013 Z06 Corvette

15210117

Oil Outlet Hose (not shown)

- Fits 2006-2013 Z06 Corvette



A Dry Sump Oil Hose Adapters

STARTERS

B. 10465385 ⓘ

LS-Series Starter

- Works with all LS-Series and Gen IV V-8 engines, including the LS1, LS2, LS3, LS6, LQ9, LQ4 and LS7

12652772

LT4 Starter (not shown)

- For 2015-2016 Z06 Corvette applications

89017844

Starter (reman, not shown)

- Requires 1 per engine
- For L92 engines

89017664

Starter (reman, not shown)

- Requires 1 per engine
- For 2005 Corvette applications
- For LS2 engines

89017847

Starter (reman, not shown)

- Requires 1 per engine
- For 2006-2007 Corvette applications
- For LS2, LS3 and LS7 engines

NOTE: All LS starters require one bolt P/N 11610787, and one bolt P/N 12561848.

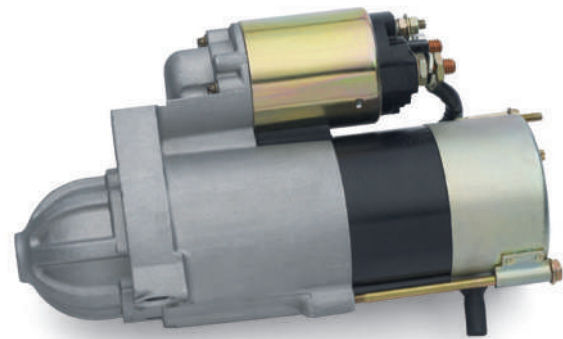

B LS-Series Starter



Starters: Additional Required Components

Part Number	Bolts (Quantity)	Engine Application
10465385	11610787 (1), 12561848 (1)	LS-Series



Carburetor, Holley 670-cfm **C**Carburetor, Holley 850-cfm **D**Carburetor, Holley 870-cfm **E**Air Cleaner, Chevrolet-Logo High-Performance Design **F**Air Cleaner, Chevrolet-Logo Classic Design **G**

CARBURETORS AND AIR CLEANERS

Chevrolet Performance has the right carburetor or throttle body to complete your new crate engine, or give life to your rebuilt engine. Then, top off your engine with one of our great-looking air cleaners.

Carburetors

C. 19170092

Carburetor, Holley 670-cfm

- Holley 4160-style 670-cfm 4-bbl carburetor
- Features show-car-quality polished finish
- Dual-feed center-hung fuel bowls
- Vacuum secondaries
- Electric choke
- Power valve blowout protection
- Quick-change adjustable vacuum secondary
- Bolts and gaskets included

19170093

Carburetor, Holley 770-cfm (not shown)

- Holley 4160-style 770-cfm 4-bbl carburetor
- Features show-car-quality polished finish
- Dual feed, center-hung float bowls
- Vacuum secondaries
- Automatic electric choke
- Quick-change adjustable vacuum secondary
- Recommended for Small-Block and Big-Block engines, including street, competition, towing and off-road vehicles
- Bolts and gaskets included
- Replaces Holley 4160 750-cfm carburetor P/N 12485506

D. 19170095

Carburetor, Holley 850-cfm

- Holley 4150-style 850-cfm 4-bbl carburetor
- Features show-car-quality polished finish
- Mechanical secondaries
- Electric choke
- Four-corner idle adjustment
- Power valve blowout protection
- Custom-calibrated for the ZZ572/620 crate engine
- Recommended for 502 crate engines and suitable for Big-Block engines, including street, competition, towing and off-road vehicles
- Bolts and gaskets included
- Replaces Holley 4160 850-cfm carburetor P/N 88961560

NOTE: Carburetor can only be recalibrated for use with other large-displacement engines.

E. 19170094

Carburetor, Holley 870-cfm

- Holley 4160-style 870-cfm 4-bbl carburetor
- Features show-car-quality polished finish
- Dual feed, center-hung float bowls
- Vacuum secondaries
- Automatic electric choke
- Quick-change adjustable vacuum secondary
- Recommended for 502 crate engines and suitable for Big-Block engines, including street, competition, towing and off-road vehicles
- Bolts and gaskets included
- Replaces 4150-style 850-cfm carburetor P/N 12366996

Air Cleaners

F. 12342080

Air Cleaner, Chevrolet-Logo High-Performance Design

- 14" round high-performance-style air cleaner
- Chrome lid with embossed Chevrolet name
- Fits most 4-bbl and 2-bbl carburetors

NOTE: Check clearance between hood and top of air cleaner. Minimum clearance is 3.75" from top of carburetor gasket area to underside of hood.

G. 12342071

Air Cleaner, Chevrolet-Logo Classic Design

- 14" round classic-style air cleaner
- Chrome lid with embossed Chevrolet name and Bowtie attaching nut
- Fits most 4-bbl and 2-bbl carburetors

Engine Control Modules and Harnesses



The engine control module is the brain of your Gen IV LS- or Gen V LT-powered project vehicle and Chevrolet Performance is your source for controllers designed for easy, “plug-and-play” installation and, in most applications, no need for third-party tuning adjustments.

Unlike controllers from regular-production vehicles, which may or may not come with a used engine, Chevrolet Performance controllers are uniquely calibrated for installation in older vehicles. That means many features required for late-model production vehicles are “turned off,” because they’re not required in older cars and trucks. That prevents the unnecessary triggering of diagnostic trouble codes that could possibly affect performance or require additional calibration adjustments.

Our inclusive kits deliver all the components required to plug into the engine and get it running – from the controller itself and the accompanying wire harness to the mass airflow sensor, oxygen sensors and even a throttle pedal assembly for engines equipped with an electronic throttle body. The kits also include detailed instructions to help you do it right the first time, even if you have no experience.

Most kits include:

- **Two oxygen sensors**
- **Two oxygen sensor mounting bosses (for installation in the exhaust system)**
- **A mass airflow meter**
- **A mass airflow meter mounting boss (for installation in the air intake system)**
- **A throttle pedal assembly (for use with the electronically operated throttle)**
- **A specific oil pressure sensor that is compatible with the harness (when needed)**
- **A complete wiring harness with fuse box and necessary cam sensor and MAP sensor jumpers**
- **Fuel pump power module for direct injected engines**
- **Fuel pressure sensor for direct injected engines**
- **The programmed controller**
- **An instruction sheet**

Each Chevrolet Performance controller kit is a true stand-alone system. All that’s needed to get a vehicle running with it are power and ground sources, a high-pressure fuel pump and an electric cooling fan.



QUICK INSTALLATION TIPS

Installing the ECM – The ECM is weather-resistant and can be mounted under the hood, but it should be placed to avoid extreme heat and away from potential splash. Chevrolet Performance does not recommend mounting it directly to the engine.

ACCELERATOR PEDAL – Chevrolet Performance’s controller kits are designed for use with factory-type electronic throttles (no conventional throttle cable) that require a matched accelerator pedal. The pedal contains an electronic sensor that conveys to the controller when and how much to open the throttle. The pedal should be mounted at least 2.5 inches to the right of the brake pedal and 2 inches below it. There should be at least 0.75-inch clearance between the pedal and the transmission tunnel/center console. The pedal has a wire harness that connects to the controller, requiring it to be fed through the firewall – possibly requiring a new hole. Use a grommet on the hole to prevent chafing of the harness.

MAF – The mass airflow meter that comes with some controller kits must be mounted in a 4-inch-diameter tube that has at least a 6-inch-long straight section. The kit includes the bracket and mounting bosses onto which the meter is secured on the tube – the tube must be cut to allow the meter to hang inside of it. The meter sensor must be mounted at the center of the straight section, making sure that is at least 10 inches from the throttle body. Orienting the MAF is essential for proper operation. The meter’s sensor should be mounted with the connector end pointed between horizontal and fully upright. Chevrolet Performance’s universal air induction kit – P/N 19301246 – works for most applications.

OXYGEN SENSORS – The oxygen sensors (one for each side of the exhaust) must be inserted in the exhaust stream ahead of the catalytic converters (if used). Holes are simply drilled into the exhaust tubing and the mounting bosses welded to them. After that, the oxygen sensors simply screw onto the mounting bosses and are connected to the wire harness.

ENGINE CONTROLLER KITS AND COMPONENTS

Part Number	Description	Technical Notes
19354324	LC9 5.3L Engine Controller Kit	Specially programmed for retrofit applications, for quicker and easier adaptation of GM's popular 5.3L V-8 for countless hot rod projects. Works with 2007-2009 5.3L engines with the following engine codes: LC9 (2007-2009), LH8 (2008-2009), LY5 (2007-2009), LMF (2008-2009) and LMG (2007-2009) – non-cam-phased engines. Does not engage cylinder-deactivating Active Fuel Management and other features not required for retrofit installations. For individual engine controller, use P/N 19256515 (included in kit)
19354326	LC9 5.3L Engine Controller Kit	Specially programmed for late model 5.3L LC9 Cam Phased engines (2010 and newer). Does not engage cylinder-deactivating Active Fuel Management and other features not required for retrofit installations. For individual engine controller, use P/N 19259916 (included in kit). This is the optimum off road kit for the LC9 5.3L engine, P/N 19259918
19356410	L96 6.0L Engine Controller Kit	Includes all components needed to run L96 6.0L crate engine, P/N 12677741
19354328	LS2/LS3 Engine Controller Kit	Includes all the components required to run the LS3 crate engine. Max rpm 6,600. For individual engine controller, use P/N 19258271 (included in kit)
19354330	LS376/480 Engine Controller Kit	Includes all the components required to run your LS376/480 crate engine, P/N 19369333. Max rpm 6,600. For individual engine controller, use P/N 19258268 (included in kit)
19354332	LS376/525 Engine Controller Kit	Includes all the components required to run LS376/525 crate engine, P/N 19369338. Max rpm 6,600. For individual engine controller, use P/N 19259291 (included in kit)
19354334	LS7 Engine Controller Kit	Includes all the components required to run your 2006-2013 LS7 crate engine, P/N 19244098. For individual engine controller, use P/N 19258554 (included in kit). Will run all M/Y LS7s with MAP sensor 12615801. Max rpm 7,100
19354336	LSA Engine Controller Kit	Includes all the components required to run LSA crate engine, P/N 19260164. Max rpm 6,200. For individual engine controller, use P/N 19259294 (included in kit)
19354338	LS9 Engine Controller Kit	Includes all components required to run LS9 crate engine, P/N 19260165. Max rpm 6,600. For individual engine controller, use P/N 19299463 (included in kit)
19368831	LT1 Wet & Dry Sump with 4 Pin Sensor & 4L/T56 transmission	Includes all components needed to run LT1 Wet Sump crate engine, P/N 19328728, with a 4-Pin fuel pressure sensor, with a 4-speed automatic or T56 Super Magnum manual transmission. Also includes an E-92 controller and fuel pump power module
19368833	LT1 Wet & Dry Sump with 3 Pin Sensor & 4L/T56 transmission	Includes all components needed to run LT1 crate engine, P/N 19355405, with 3-Pin fuel pressure sensor with a 4-speed automatic or T56 Super Magnum manual transmission. Also includes an E-92 controller and fuel pump power module
19368835	LT1 Wet & Dry Sump with 3 Pin Sensor & 8 speed transmission	Includes all components needed to run LT1 crate engine with 3-pin fuel sensor P/N 19355405 with an 8-speed Supermatic transmission. Includes [insert] controller, fuel pump power module and fuel pressure sensor for direct injection
19368837	LT1 with 3 Pin Sensor & 4L/T56 transmission	Includes all components needed to run LT376/535 crate engines, P/N 19355378. Includes E-92 controller, fuel pump power module and fuel pressure sensor for direct injection (4L/T56 only)
19368841	LT4 Wet & Dry Sump with 4 Pin Sensor & 4L/T56 transmission	Includes all components needed to run LT4 Wet Sump crate engine, P/N 19368622, with 4-Pin fuel pressure sensor with a 4-speed automatic or T56 Super Magnum manual transmission. Also includes E-92 controller and fuel pump power module
19366789	LT4 Wet Sump Engine Controller Kit (CTS-V and Camaro ZL-1)	Includes all components needed to run LT4 Wet Sump crate engine, P/N 19355404 for the CTS-V or P/N 19368622 for the Camaro ZL-1 with 3-Pin fuel pressure sensors with a 4-speed automatic or T56 Super Magnum manual transmission. Also includes an E-92 controller and fuel pump power module
19368845	LT4 Wet & Dry Sump with 3 Pin Sensor & 8 speed transmission	Includes all components needed to run LT4 Wet Sump crate engine, P/N 19355404 for the CTS-V or P/N 19368622 for the Camaro ZL-1 with 3-Pin fuel pressure sensors with an 8-speed Supermatic transmission. Also includes an E-92 controller and fuel pump power module
19331686	LTG FWD Engine Controller Kit	Includes all the components required to run LTG crate engine, P/N 12677823. Includes E-92 controller, fuel pump, power module and fuel pressure sensor for direct injection
19328839	LTG RWD Engine Controller Kit	Includes all components needed to run LTG crate engine P/N 19328837. Includes E-92 controller, fuel pump power module and fuel pressure sensor for direct injection
19354340	DR525 Engine Controller Kit	Engine controller and harness kit for operating DR525 racing engines P/N 19329009 and P/N 19329008. Includes throttle pedal for electronic throttle body communication. Note: The engine controller in this kit is a "factory-sealed unit, incorporating a tamper-proof design" to comply with rules mandated by the NMCA
19354344	LSX454 Engine Controller Kit for Manual Transmission	Includes all the components required to run LSX454 crate engine, P/N 19244611. Max rpm 7,100. For individual engine controller, use P/N 19244482 (included in kit)
19354342	LSX454 Engine Controller Kit for Automatic Transmission	Includes all the components required to run LSX454 crate engine, P/N 19244611. Max rpm 7,100. For individual engine controller, use P/N 19299841. NOTE: The controller will not function in a production vehicle unless all kit components are used. These controllers will not operate any of the production gauges. Aftermarket gauges are required
12480112	ECU, LS1 V-8 (not shown)	Calibrated for the LS1 Camaro/Firebird engine and can be used in a street rod or other early-model vehicles NOTE: Use with Camaro/Firebird LS1 engine and wire harness P/N 12480113
12480054	ECU, LS1/ASA Racing (not shown)	LS1 ECU is similar to P/N 16238212, but is calibrated for ASA racing only. Use with wire harness P/N 12480055
12480055	Wire Harness, LS1, ASA Racing (not shown)	Designed for ASA racing ECU P/N 12480054 only

LS/LT/LSX-SERIES COMPONENTS

A. 19355418 **NEW!**

LS/LSX Ignition Controller

- Distributorless plug-in ignition system for carbureted LS engines with 58x & 24x reluctor wheel
- Several pre-programmed timing curves provided
- Supplied software allows you to create custom vacuum advance curves, timing curves, program low and high rpm rev limiter and step retard
- Plugs into stock sensors (not provided)
- MAP sensor provided
- Compatible with all LS-Series ignition coils

B. 19355863 **NEW!**

LS CT525 Circle Track Engine Controller

- Required to operate CT525 Circle Track crate engine
- Preset timing curve and rev limiter
- Direct plug-in to factory LS sensors and coils
- Includes complete ignition wiring harness

12681668

Spark Plug (not shown)

- Requires 8 per engine
- AC 41-101
- For LS7, LSA and LS9 engines

12680072

Spark Plug (not shown)

- Requires 8 per engine
- AC 41-985
- For LS1, LS2, LS3, LS6 and L92 engines

19329681

Spark Plug Wire Shield (not shown)

- Requires 8 per engine
- For all LS-Series engines

SPARK PLUG WIRES

Chevrolet Performance spark plug wire kits are designed to fit your GM engine, eliminating the guesswork in selecting the correct length.

C. 19351568

Spark Plug Wire Set, LS-Series V-8

- Direct-fit wire set with factory-style boots and terminals
- Designed for over-valve-cover installation

FUEL PUMPS AND COMPONENTS

D. 6472657

Electric Fuel Pump

- For use on all carbureted engines
- Flows 30-40 gph at 6-9 psi

NEW!



A LS/LSX Ignition Controller

NEW!



B LS/LSX Circle Track Ignition Controller

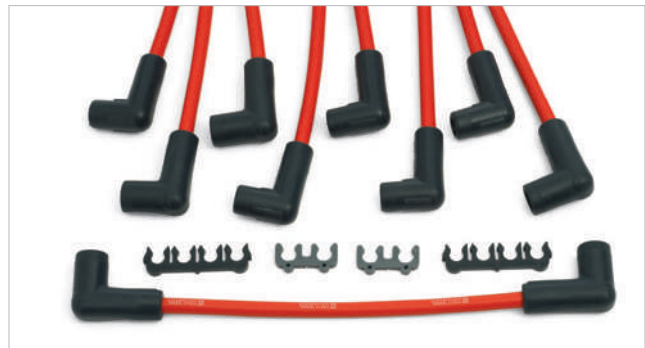

C Spark Plug Wire Set, LS Series V-8 (90° boot shown)

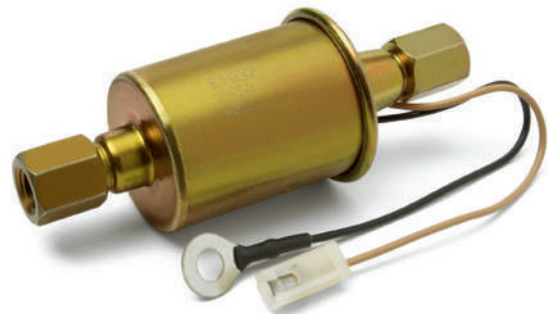

D Electric Fuel Pump

Camaro ZL1 Fuel Pump Module **E****E. 19303293****Camaro ZL1 Fuel Pump Module**

- Production fuel pump module for the 2012 Camaro ZL1 with supercharged LSA engine
- Supports approximately 600 horsepower
- Direct replacement for 2010+ Camaro SS fuel pump modules
- 250 liters per hour capacity at 65 psi
- Pulse-width modulated, eliminates need for conventional pressure regulator
- Kit includes fuel pump module/sender assembly tank seal and instruction sheet

NOTE: When combined with service part P/N 23193422 and P/N 22756514 fuel pickups, you can expand the amount of fuel available during road course usage on your Camaro.

F. 25115899**Electric Fuel Pump, High-Output**

- Heavy-duty 12-volt electric rotary pump
- Flows 72 gph at 6-8 psi

G. 854619**Fuel Filter**

- High-capacity in-line filter
- Suitable for all high-performance carbureted applications
- 5/16" inlet and outlet

19239926**LS Fuel Filter (not shown)**

- 99-03 Corvette stock fuel filter
- Built-in fuel pressure regulator
- Mounts to frame
- Supplies constant 55-61 PSI of fuel to engine and returns excess to fuel tank

Electric Fuel Pump, High Output **F**Fuel Filter **G**



BIG-BLOCK

CRATE ENGINES



BIG PERFORMANCE FROM THE BOWTIE BIG BLOCK!

Torque. Whether you need it to launch your vintage Camaro off the starting line or tow your trailer through the mountains, it's the pulling power to do it all with confidence – and when it comes to delivering big torque, nothing comes close to Chevrolet Performance's lineup of Big-Block engines brings it.

We are the only source for brand-new Chevrolet Performance Big-Block crate engines, built with brand-new parts and incorporating the latest cylinder block casting technology, which is stronger in many ways than previous production engines.

Our lineup of assembled, ready-to-install engines offers something for every budget and project so you can be on the road quicker. Use our classic 454 HO for your classic cruiser or our 502 HO to re-power your truck for great towing capability. Our 427 crate engines make great additions to classic Corvettes and COPO Camaro tributes, while racing engines like the ZZ572/720R provide your drag racer with awesome horsepower!

Each engine builds on more than half a century of design, validation and manufacturing expertise, offering an uncompromising balance of durability with the capability that comes only from the legendary Chevy Big-Block.

Torque is what it's all about and Chevrolet Performance is your source!

You can find these Chevrolet Performance Big-Block Engines on the following pages:

ZZ427/480.....	302	ZZ502/502 BASE.....	312
454 HO.....	304	ZZ502/502 DELUXE.....	314
ZZ454/440.....	306	RAM JET 502.....	316
HT502.....	308	ZZ572/620 DELUXE.....	318
502 HO.....	310	ZZ572/720R DELUXE.....	320



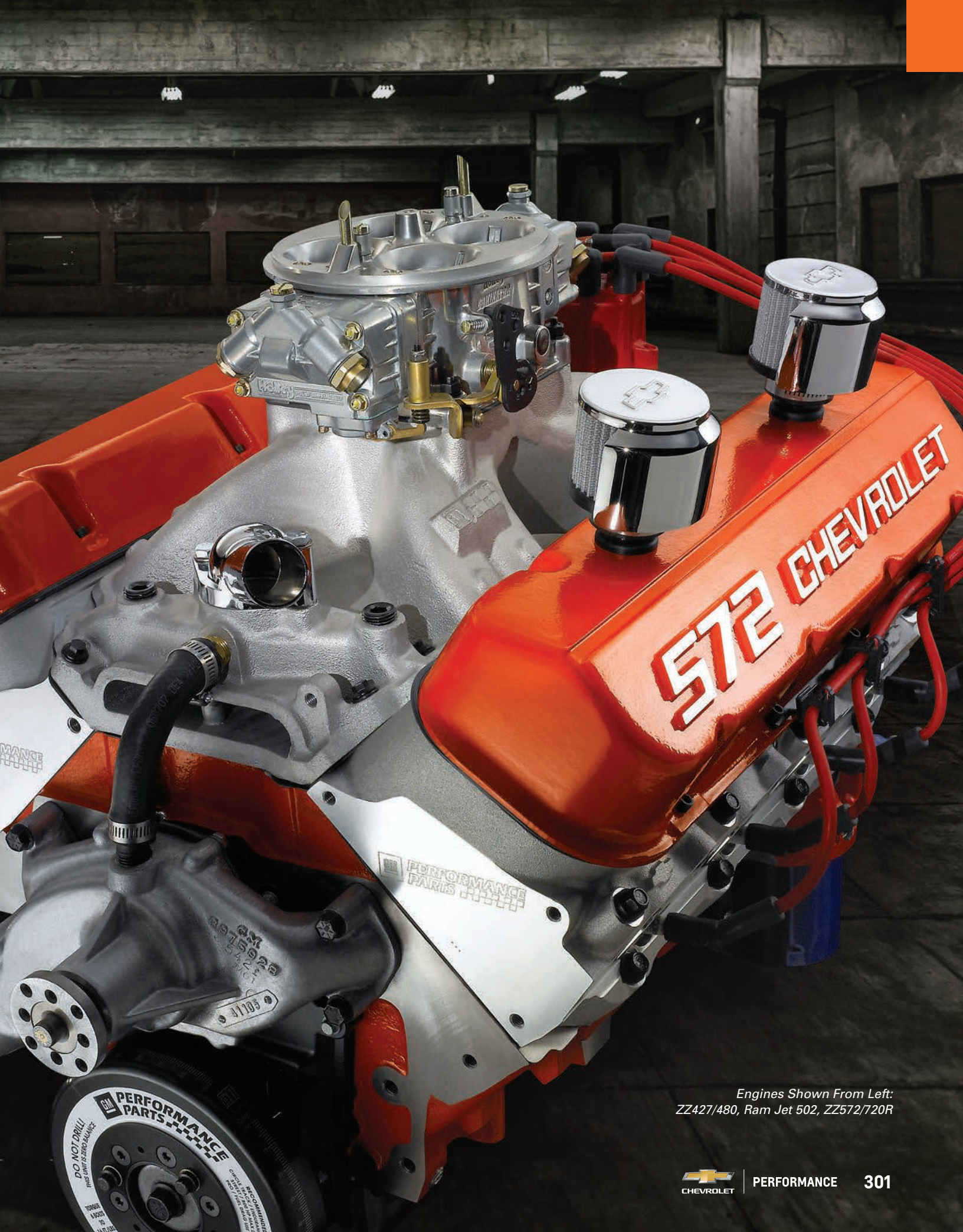

Engines Shown From Left:
ZZ427/480, Ram Jet 502, ZZ572/720R



ZZ427/480

19331572

480 hp

@ 6,000 rpm

490 lb.-ft.

@ 3,800 rpm

DYNO CHART

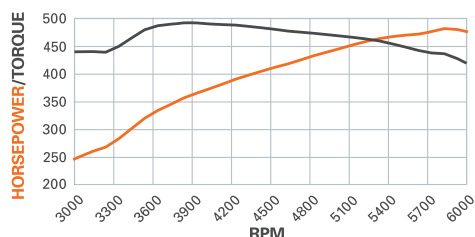

A MODERN TAKE ON THE CLASSIC L88

The L88 427 was the ultimate expression of Chevy's production Big-Block power, combining a rigid iron cylinder block with lightweight aluminum cylinder heads and a single, four-barrel carburetor. Our engineers have recreated that classic, raspy rat engine, but with updated components that can help enhance drivability – and performance!

Our engine assembly features our latest-generation block casting with four-bolt main caps, an all-forged rotating assembly for exceptional strength and durability, and a hydraulic roller camshaft instead of the original L88's flat-tappet cam, for greater drivability and a broader performance range. It also features aluminum oval-port cylinder heads with 2.19/1.88-inch valves and a pump-gas-friendly 10.1:1 compression ratio.

Whether you're building a '69 COPO Camaro resto-mod tribute, a modified mid-year Corvette or a street-tire class winner, this heritage-inspired crate engine delivers the performance that built the Big-Block's legendary reputation.

NOTE: Refer to page 83 for the complete horsepower and torque testing procedures.

TECH SPECS

Part Number:	19331572
Engine Type:	Chevy Big-Block V-8
Displacement (cu in):	427
Bore x Stroke (in):	4.250 x 3.750
Block (P/N 19170538):	Cast-iron with 4-bolt main caps
Crankshaft (P/N 19171620):	Forged steel
Connecting Rods (P/N 19211226):	Forged steel
Pistons (P/N 19171618):	Forged aluminum
Intake Manifold (P/N 12363406):	Dual plane
Camshaft Type (P/N 12366543):	Hydraulic roller
Valve Lift (in):	.527 intake / .544 exhaust
Camshaft Duration (@.050 in):	224° intake / 234° exhaust
Cylinder Heads (P/N 19331423):	Aluminum oval port, 110cc chambers
Valve Size (in):	2.190 intake / 1.880 exhaust
Compression Ratio:	10.1:1
Rocker Arms (P/N 19210726):	Aluminum roller style
Rocker Arm Ratio:	1.7:1
Distributor (P/N 88961867):	HEI type
Carburetor (P/N 19170093):	770-cfm
Water Pump (P/N 19168602):	Aluminum short-style
Spark Plugs and Wires:	Included
Flexplate (P/N 12561217):	14"
Recommended Fuel:	Premium pump
Ignition Timing:	36° Total @ 4,000 rpm
Maximum Recommended rpm:	6,400
Balanced:	Internal

NOTE: Distributor with melonized steel gear **MUST** be used with long-blocks and Partial engines with steel camshafts, or engine damage will occur.

INSTALLATION NOTES

- Due to crate fitment, the carburetor is shipped in a separate box and needs to be installed by an engine installer
- Requires addition of starter and fuel pump (not included)
- Clutch linkage bosses are drilled and tapped. When using cast-iron exhaust manifolds, lower head bolts may need to be replaced with bolts with shorter heads, for clearance
- Comes with an internally balanced 14" automatic transmission flexplate. See page 351 for a listing of manual transmission flywheels offered by Chevrolet Performance. Requires flywheel designed for internally balanced engines.
- Not intended for marine applications



19300175
SuperMatic™ 4L85-E
Four-Speed Transmission
 Direct bolt-on for Gen I Small-Block and all Big-Blocks. Improved valve body for firmer shifts. Includes additional clutch plates. Add up to 685 lb.-ft. torque.
 See page 366 for torque converter applications.



19332780
Transmission Controller
 Required when using a GM electronically controlled automatic transmission. Includes wiring harness.
 See page 371 for details.

AVAILABLE ENGINE-RELATED PARTS & ACCESSORIES

See page 322 for our complete line of Big-Block components



19299805
Torque Converter
 Page 366



19332784
Transmission
Installation Kit
 Page 370



12361146
High-Torque
Mini Starter
 Page 360



12342024
Chrome
Water Neck
 Page 359



19366895
Serpentine Accessory
Drive Belt System
With Air Conditioning
 Page 352



12342071
Air Cleaner
 Page 362

454 HO

12568774

438 hp

@ 5,300 rpm

500 lb.-ft.

@ 3,500 rpm

DYNO CHART

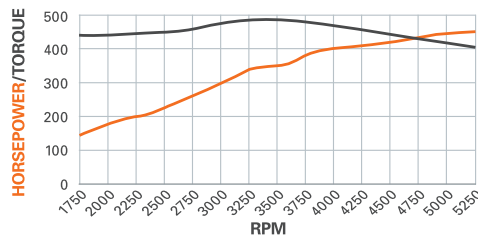

BIG TORQUE ON A BUDGET

Chevrolet Performance's 454 HO crate engine is a Big-Block bargain – an affordable engine with performance specs that will make you think it's 1970 all over again, including 438 horsepower and 500 asphalt-wrinkling lb.-ft. of torque.

A latest-generation block casting with four-bolt main caps is the Big-Block engine's foundation and features an all-forged rotating assembly for great strength and durability. It also uses a smooth hydraulic roller camshaft for excellent drivability and a broad performance range. Rectangular-port cylinder heads with large, 2.19/1.88-inch valves round out the assembly.

The engine package includes a water pump, balancer, 14-inch flexplate and an aluminum intake manifold all installed on the production line. Simply add a carburetor, ignition system and starter and the engine will be ready to roar. All of the necessary parts are available from Chevrolet Performance.

NOTE: Refer to page 83 for the complete horsepower and torque testing procedures.

TECH SPECS

Part Number:	12568774
Engine Type:	Chevy Big-Block V-8
Displacement (cu in):	454
Bore x Stroke (in):	4.250 x 4.000
Block (P/N 19170538):	Cast-iron with 4-bolt main caps
Crankshaft (P/N 14096983):	Forged steel
Connecting Rods (P/N 19170198):	Forged steel
Pistons (P/N 10215228):	Forged aluminum
Intake Manifold (P/N 19131359):	Dual plane
Camshaft Type (P/N 24502611):	Hydraulic roller
Camshaft Lift (in):	.510 intake / .540 exhaust
Camshaft Duration (@.050 in):	211° intake / 230° exhaust
Cylinder Heads (P/N 12562920):	Iron rectangular port; 118cc chambers
Valve Size (in):	2.190 intake / 1.880 exhaust
Compression Ratio:	8.75:1
Rocker Arms (P/N 19260993):	Stamped steel
Rocker Arm Ratio:	1.7:1
Water Pump (P/N 19168606):	Cast-iron, long-style
Flexplate (P/N 10185034):	14"
Recommended Fuel:	Premium pump
Ignition Timing:	36° Total @ 4,000 rpm
Maximum Recommended rpm:	5,500
Balanced:	External

NOTE: Distributor with melonized steel gear **MUST** be used with long-blocks and Partial engines with steel camshafts, or engine damage will occur.

INSTALLATION NOTES

- Requires addition of carburetor, starter, fuel pump, distributor and ignition system (not included)
- Clutch linkage bosses are now drilled and tapped. When using cast-iron exhaust manifolds, lower head bolts may need to be replaced with bolts with shorter heads, for clearance
- Comes with an externally balanced 14" automatic transmission flexplate; use flywheel P/N 14096987 and 11" clutch assembly for manual transmission applications
- Not intended for marine applications

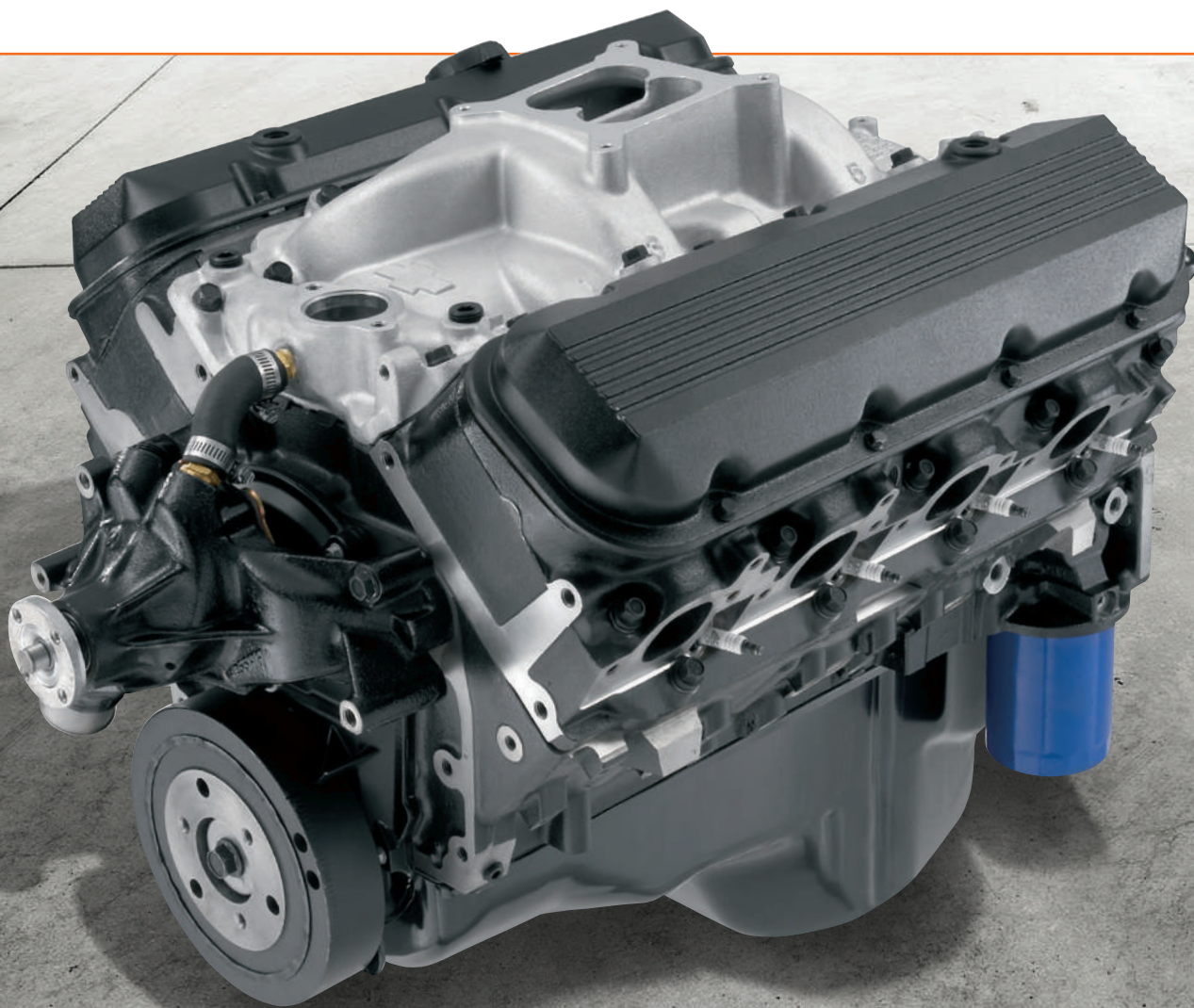

12498778 
454 Partial Engine

The sturdy foundation of the complete engine is the starting point of a custom engine build. Use externally balanced flywheel for manual transmission applications.



19300175
SuperMatic™ 4L85-E Four-Speed Transmission

Direct bolt-on for Gen I Small-Block and all Big-Blocks. Improved valve body for firmer shifts. Includes additional clutch plates. Add up to 685 lb.-ft. torque. See page 366 for torque converter applications.

AVAILABLE ENGINE-RELATED PARTS & ACCESSORIES

See page 322 for our complete line of Big-Block components



19299805
Torque Converter
 Page 366



19170093
Carburetor, Holley 770-cfm
 Page 361



19302919
Lightweight Starter
 Page 360



93440806
HEI Distributor
 Page 355



19332784
Transmission Installation Kit
 Page 370



19332780
Transmission Controller
 Page 371

ZZ454/440

19331574

469 hp

@ 5,500 rpm

519 lb.-ft.

@ 3,700 rpm

DYNO CHART

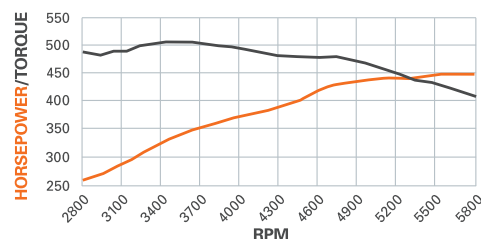

ALUMINUM HEADS ADD BIG POWER!

Our engineers took the tough 454 HO and matched it with a set of higher-flow, oval-port aluminum cylinder heads to pick up an additional 30 horses – while still delivering an awesome 519 lb.-ft. of torque. It's an affordable high-performance Big-Block for your project vehicle!

Aluminum oval-port cylinder heads with 2.19/1.88-inch valves process the airflow through this big-power Big-Block and save weight over iron heads. They're mounted on our latest-generation block casting with four-bolt main caps, which is filled with an all-forged rotating assembly for exceptional strength and durability. There's also a high-lift hydraulic roller camshaft for excellent drivability and a broad performance range.

The crate engine package includes a water pump, balancer, aluminum intake manifold and a 14-inch flexplate. Your Chevrolet Performance dealer can hook you up with the carburetor, starter, ignition system and other accessories required to get this big-power Big-Block up and running.

NOTE: Refer to page 83 for the complete horsepower and torque testing procedures.

TECH SPECS

Part Number:	19331574
Engine Type:	Chevy Big-Block V-8
Displacement (cu in):	454
Bore x Stroke (in):	4.250 x 4.000
Block (P/N 19170538):	Cast-iron with 4-bolt main caps
Crankshaft (P/N 14096983):	Forged steel
Connecting Rods (P/N 19170198):	Forged steel
Pistons (P/N 10215228):	Forged aluminum
Intake Manifold (P/N 12363420):	Dual plane
Camshaft Type (P/N 24502611):	Hydraulic roller
Camshaft Lift (in):	.510 intake / .540 exhaust
Camshaft Duration (@.050 in):	211° intake / 230° exhaust
Cylinder Heads (P/N 19331424):	Aluminum oval port; 110cc chambers
Valve Size (in):	2.190 intake / 1.880 exhaust
Compression Ratio:	9.6:1
Rocker Arms (P/N 12675724):	Stamped steel
Rocker Arm Ratio:	1.7:1
Water Pump (P/N 19168606):	Cast-iron, long-style
Flexplate (P/N 10185034):	14"
Recommended Fuel:	Premium pump
Ignition Timing:	36° Total @ 4,000 rpm
Maximum Recommended rpm:	5,500
Balanced:	External

NOTE: Distributor with melonized steel gear **MUST** be used with long-blocks and Partial engines with steel camshafts, or engine damage will occur.

INSTALLATION NOTES

- Requires addition of carburetor, starter, fuel pump, distributor and ignition system (not included)
- Clutch linkage bosses are now drilled and tapped. When using cast-iron exhaust manifolds, lower head bolts may need to be replaced with bolts with shorter heads, for clearance
- Comes with an externally balanced 14" automatic transmission flexplate; use flywheel P/N 14096987 and 11" clutch assembly for manual transmission applications
- Not intended for marine applications

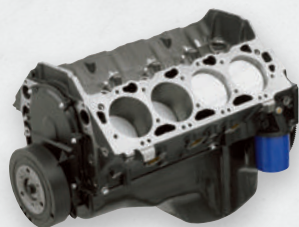
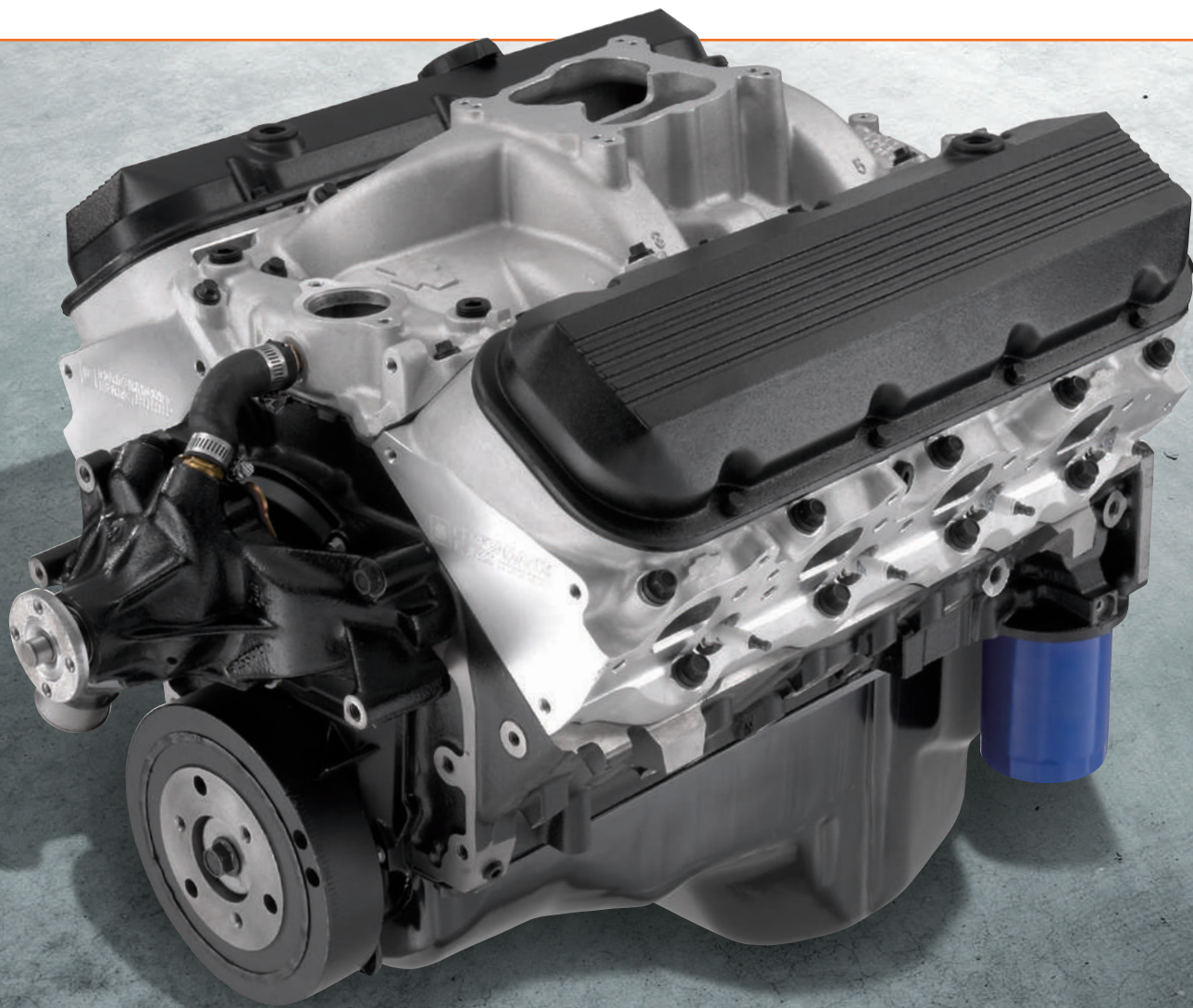

12498778
454 Partial Engine
 The sturdy foundation of the complete engine is the starting point of a custom engine build. Use externally balanced flywheel for manual transmission applications.

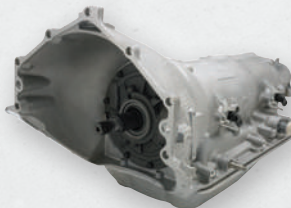

19300175
SuperMatic™ 4L85-E Four-Speed Transmission
 Direct bolt-on for Gen I Small-Block and all Big-Blocks. Improved valve body for firmer shifts. Includes additional clutch plates. Add up to 685 lb.-ft. torque. See page 366 for torque converter applications.

AVAILABLE ENGINE-RELATED PARTS & ACCESSORIES

See page 322 for our complete line of Big-Block components



19299805
Torque Converter
 Page 366



19170093
Carburetor, Holley 770-cfm
 Page 361



19302919
Lightweight Starter
 Page 360



19332784
Transmission Installation Kit
 Page 370



88961867
Distributor, Aluminum Billet HEI
 Page 355



19332780
Transmission Controller
 Page 371

HT502

88890534

406 hp
@ 4,200 rpm

541 lb.-ft.
@ 3,200 rpm

DYNO CHART

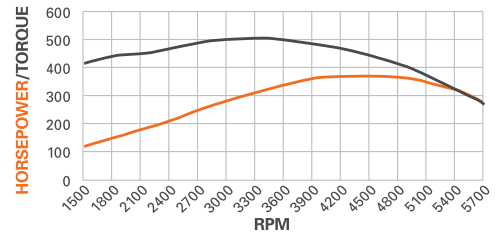

A BIG-INCH ALTERNATIVE TO REBUILDING

Don't bother repowering your trusty Big-Block-powered truck or project vehicle with a rebuild or reconditioned used engine. Our HT502 crate engine is an affordable alternative with more power than our factory installed Big-Block producing a whopping 541 lb.-ft. of trailer-tugging torque.

It is uniquely suited to pre-1978 trucks, but is adaptable to a variety of applications, and it's built with our latest-generation block casting with four-bolt main caps. An all-forged rotating assembly delivers exceptional strength and durability, while a mild 8.75:1 compression ratio is suitable for regular pump gasoline at all altitudes and engine loads.

Our assembly comes with the heads and a balancer installed. An induction system, ignition, starter, water pump and other accessories are required to finish the engine. All necessary components are available from Chevrolet Performance.

NOTE: Refer to page 83 for the complete horsepower and torque testing procedures.

TECH SPECS

Part Number:	88890534
Engine Type	Chevy Big-Block V-8
Displacement (cu in):	502
Bore x Stroke (in):	4.470 x 4.00
Block (P/N 19170540):	Cast-iron with 4-bolt main caps
Crankshaft (P/N 10183723):	Forged steel
Connecting Rods (P/N 19170198):	Forged steel, shot peened
Pistons (P/N 12533507):	Forged aluminum
Camshaft Type (P/N 12552296):	Hydraulic roller
Camshaft Lift (in):	.480 intake / .483 exhaust
Camshaft Duration (@.050 in):	204° intake / 209° exhaust
Cylinder Heads (P/N 12562917):	Iron oval port; 118cc chambers
Valve Size (in):	2.07 intake / 1.73 exhaust
Compression Ratio:	8.75:1
Rocker Arms (P/N 19260993):	Stamped steel
Rocker Arm Ratio:	1.7:1
Flexplate (P/N 10185034):	14"
Recommended Fuel:	Regular pump
Ignition Timing:	34° Total @ 4,000 rpm
Maximum Recommended rpm:	5,500
Balanced:	External

INSTALLATION NOTES

- Requires the addition of carburetor, intake manifold, water pump, fuel pump, starter, distributor and ignition system (not included)
- Clutch linkage bosses are now drilled and tapped. When using cast-iron exhaust manifolds, lower head bolts may need to be replaced with bolts with shorter heads, for clearance
- 502 engines now have a mechanical fuel pump boss!
NOTE: There is NO fuel pump lobe behind the boss.
- Comes with an externally balanced 14" automatic transmission flexplate. Use externally balanced flywheel P/N 14096987 and 11" clutch assembly for manual transmission applications
- Not intended for marine applications

NOTE: Distributor with melonized steel gear **MUST** be used with long-blocks and Partial engines with steel camshafts, or engine damage will occur.

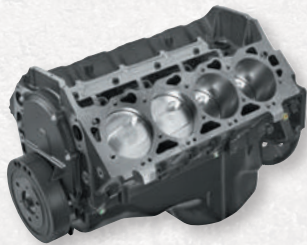

12568782
502 Partial Engine
 This brand-new Partial engine includes forged reciprocating components, as well as the balancer, oil pan and timing chain set.

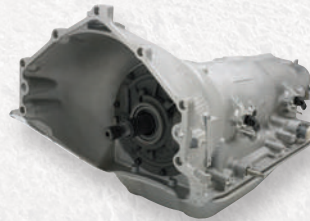

19300175
SuperMatic™ 4L85-E Four-Speed Transmission
 Direct bolt-on for Gen I Small-Block and all Big-Blocks. Improved valve body for firmer shifts. Includes additional clutch plates. Add up to 685 lb.-ft. torque. See page 366 for torque converter applications.

AVAILABLE ENGINE-RELATED PARTS & ACCESSORIES

See page 322 for our complete line of Big-Block components



19299805
Torque Converter
 Page 366



19170093
Carburetor, Holley 770-cfm
 Page 361



19302919
Lightweight Starter
 Page 360



19332784
Transmission Installation Kit
 Page 370



19168602
Aluminum Water Pump, Short-Style
 Page 352



19332780
Transmission Controller
 Page 371

502 HO

12568778

461 hp
@ 5,100 rpm

558 lb.-ft.
@ 3,400 rpm

DYNO CHART

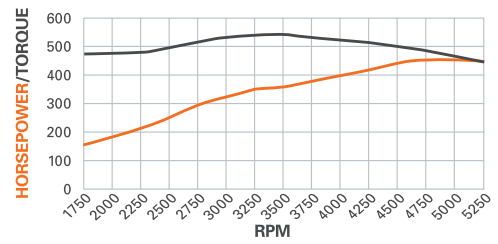

AN AFFORDABLE POWERHOUSE!

What will you do with 461 horsepower and 558 lb.-ft. of torque from Chevrolet Performance’s value-driven 502 HO crate engine? Whether you use it on the street, strip or even pulling a trailer with your workhorse truck, its performance range offers many possibilities. In fact, it makes nearly 500 lb.-ft. by only 1,500 rpm, meaning it has all the low-rpm grunt you can use!

To support all that torque, we build this Big-Block with our latest-generation block casting with four-bolt main caps, and complement it with an all-forged rotating assembly for exceptional strength and durability. A hydraulic roller camshaft is used for excellent drivability and a broad performance range; and an 8.75:1 compression ratio is suitable for regular pump gasoline at all altitudes and engine loads.

Our crate engine assembly includes an aluminum, dual-plane intake manifold, a water pump, 14-inch flexplate, balancer, all factory installed. You add the carburetor, starter and ignition system – all available from Chevrolet Performance.

NOTE: Refer to page 83 for the complete horsepower and torque testing procedures

TECH SPECS

Part Number:	12568778
Engine Type:	Chevy Big-Block V-8
Displacement (cu in):	502
Bore x Stroke (in):	4.470 x 4.000
Block (P/N 19170540):	Cast-iron with 4-bolt main caps
Crankshaft (P/N 10183723):	Forged steel
Connecting Rods (P/N 19170198):	Forged steel, shot peened
Piston and Ring Kit (P/N 12533507):	Forged aluminum
Intake Manifold (P/N 19131359):	Dual plane
Camshaft Type (P/N 24502611):	Hydraulic roller
Camshaft Lift (in):	.510 intake / .540 exhaust
Camshaft Duration (@.050 in):	211° intake / 230° exhaust
Cylinder Heads (P/N 12562920):	Iron rectangular port; 118cc chambers
Valve Size (in):	2.190 intake / 1.880 exhaust
Compression Ratio:	8.75:1
Rocker Arms (P/N 19260993):	Stamped steel
Rocker Arm Ratio:	1.7:1
Water Pump (P/N 19168606):	Cast-iron, long-style
Flexplate (P/N 10185034):	14"
Recommended Fuel:	Regular pump
Ignition Timing:	32° Total @ 4,000 rpm
Maximum Recommended rpm:	5,500
Balanced:	External

NOTE: Distributor with melonized steel gear **MUST** be used with long-blocks and Partial engines with steel camshafts, or engine damage will occur.

INSTALLATION NOTES

- Requires addition of carburetor, fuel pump, starter, distributor and ignition system (not included)
- Clutch linkage bosses are now drilled and tapped. When using cast-iron exhaust manifolds, lower head bolts may need to be replaced with bolts with shorter heads, for clearance
- 502 engines now have a mechanical fuel pump boss!
NOTE: There is a fuel pump lobe behind the boss.
- Comes with an externally balanced 14" automatic transmission flexplate. Use flywheel P/N 14096987 and 11" clutch assembly for manual transmission applications
- Not intended for marine applications

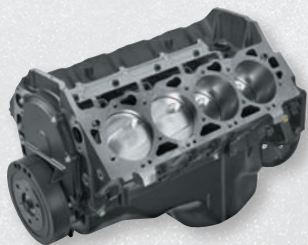
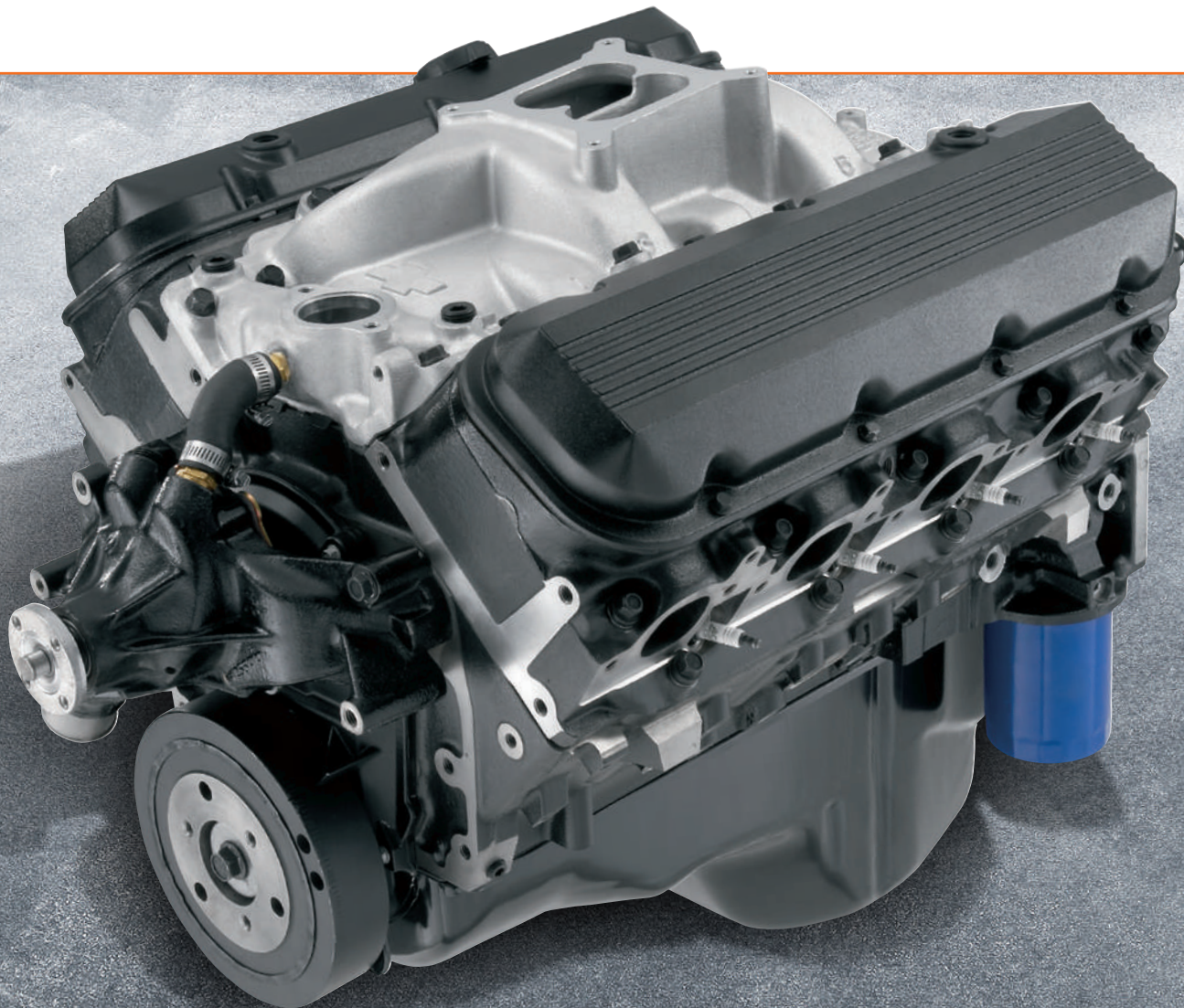

12568782
502 Partial Engine
 This brand-new Partial engine includes forged reciprocating components, as well as the balancer, oil pan and timing chain set.

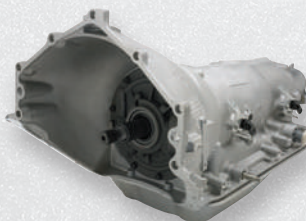

19300175
SuperMatic™ 4L85-E Four-Speed Transmission
 Direct bolt-on for Gen I Small-Block and all Big-Blocks. Improved valve body for firmer shifts. Includes additional clutch plates. Add up to 685 lb.-ft. torque. See page 366 for torque converter applications.

AVAILABLE ENGINE-RELATED PARTS & ACCESSORIES

See page 322 for our complete line of Big-Block components



19366895
Serpentine Accessory Drive Belt System With Air Conditioning
 Page 352



19170093
Carburetor, Holley 770-cfm
 Page 361



19302919
Lightweight Starter
 Page 360



19299805
Torque Converter
 Page 366



19332784
Transmission Installation Kit
 Page 370



19332780
Transmission Controller
 Page 371

ZZ502/502 Base

19331576

508 hp
@ 5,200 rpm

580 lb.-ft.
@ 3,600 rpm

DYNO CHART

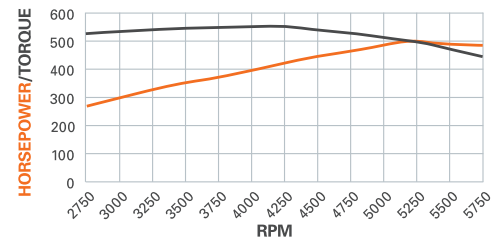

A DIY FOUNDATION FOR BIG TORQUE!

We offer the ZZ502/502 Base crate engine for the builder who wants the super-strong bottom end and high-flow aluminum oval-port cylinder heads, but also wants to finish the engine his or her way. It's a great foundation and it's up to you to make the most of it!

Like our complete ZZ502/502 Deluxe crate engine, a set of high-flow aluminum oval-port cylinder heads and a hydraulic roller camshaft designed to support low-rpm torque production enable it to hit the 500 lb.-ft. mark by approximately 2,500 rpm and hold it above the mark until around 5,000 rpm. It also features a latest-generation block casting with four-bolt main caps and an all-forged rotating assembly for exceptional strength and durability.

We rate the ZZ502/502 Base engine at 508 horsepower and 580 lb.-ft. of torque when it is finished with Chevrolet Performance aluminum intake manifold P/N 12363406 and Holley 870-cfm carburetor P/N 19170094. The other parts you need to complete the engine – including chrome dress-up parts – are available from Chevrolet Performance.

NOTE: Refer to page 83 for the complete horsepower and torque testing procedures.

TECH SPECS

Part Number:	19331576
Engine Type:	Chevy Big-Block V-8
Displacement (cu in):	502
Bore x Stroke (in):	4.470 x 4.000
Block (P/N 19170540):	Cast-iron with 4-bolt main caps
Crankshaft (P/N 10183723):	Forged steel
Connecting Rods (P/N 19170198):	Forged steel, shot peened
Pistons (P/N 12533507):	Forged aluminum
Camshaft Type (P/N 12366543):	Hydraulic roller
Camshaft Lift (in):	.527 intake / .544 exhaust
Camshaft Duration (@.050 in):	224° intake / 234° exhaust
Cylinder Heads (P/N 19331425):	Aluminum oval port; 110cc chambers
Valve Size (in):	2.250 intake / 1.880 exhaust; stainless steel
Compression Ratio:	9.6:1
Rocker Arms (P/N 12675724):	Stamped steel
Rocker Arm Ratio:	1.7:1
Flexplate (P/N 10185034):	14"
Recommended Fuel:	Premium pump
Ignition Timing:	32° Total @ 4,000 rpm
Maximum Recommended rpm:	5,800
Balanced:	External

NOTE: Distributor with melonized steel gear **MUST** be used with long-blocks and Partial engines with steel camshafts, or engine damage will occur.

INSTALLATION NOTES

- Clutch linkage bosses are now drilled and tapped. When using cast-iron exhaust manifolds, lower head bolts may need to be replaced with bolts with shorter heads, for clearance
- 502 engines now have a mechanical fuel pump boss!
NOTE: There is a fuel pump lobe behind the boss.
- Comes with an externally balanced 14" automatic transmission flexplate. Use flywheel P/N 14096987 and 11" clutch assembly for manual transmission applications
- Not intended for marine applications



See page 314 for ZZ502 Deluxe Engine details

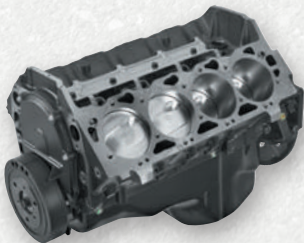

12568782
502 Partial Engine
 This brand-new Partial engine includes forged reciprocating components, as well as the balancer, oil pan and timing chain set.

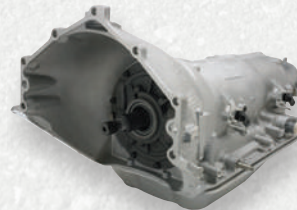

19300175
SuperMatic™ 4L85-E Four-Speed Transmission
 Direct bolt-on for Gen I Small-Block and all Big-Blocks. Improved valve body for firmer shifts. Includes additional clutch plates. Add up to 685 lb.-ft. torque.
 See page 366 for torque converter applications.

AVAILABLE ENGINE-RELATED PARTS & ACCESSORIES

See page 322 for our complete line of Big-Block components



19366895
Serpentine Accessory Drive Belt System With Air Conditioning
 Page 352



12363406
Intake Manifold
 Page 356



19170094
Carburetor, Holley 870-cfm
 Page 361



19299805
Torque Converter
 Page 366



19332784
Transmission Installation Kit
 Page 370



19332780
Transmission Controller
 Page 371

ZZ502/502 Deluxe

19331579

508 hp / **580 lb.-ft.**
@ 5,200 rpm / @ 3,600 rpm

DYNO CHART

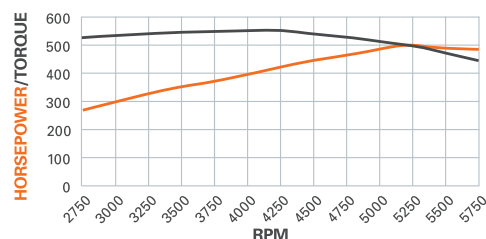

OUR MOST POPULAR BIG-BLOCK

The ZZ502/502 is one of the industry's benchmark crate engines, offering excellent value with a proven combination of performance that is suitable for the street or strip. With more than 500 horsepower and 580 lb.-ft. of torque, it demands your full attention.

Thanks to a combination of high-flow aluminum oval-port cylinder heads with 2.25/1.88-inch valves and a hydraulic roller camshaft designed to support low-rpm torque production, this torque monster tops the 500 lb.-ft. mark by approximately 2,500 rpm and doesn't dip below it until about 5,000 rpm. It also features a latest-generation block casting with four-bolt main caps and an all-forged rotating assembly for exceptional strength and durability.

Our Deluxe package comes complete from the oil pan to the carburetor, including an HEI distributor, plug wires, starter, water pump, balancer and an aluminum intake topped with a Holley 870-cfm four-barrel carburetor.

NOTE: Refer to page 83 for the complete horsepower and torque testing procedures.

TECH SPECS

Part Number:	19331579
Displacement (cu in):	502
Bore x Stroke (in):	4.470 x 4.000
Block (P/N 19170540):	Cast-iron with 4-bolt main caps
Crankshaft (P/N 10183723):	Forged steel
Connecting Rods (P/N 19170198):	Forged steel, shot peened
Pistons (P/N 12533507):	Forged aluminum
Intake Manifold (P/N 12363407):	Dual plane
Camshaft Type (P/N 12366543):	Hydraulic roller
Camshaft Lift (in):	.527 intake / .544 exhaust
Camshaft Duration (@.050 in):	224° intake / 234° exhaust
Cylinder Heads (P/N 19331425):	Aluminum oval port; 110cc chambers
Valve Size (in):	2.250 intake / 1.880 exhaust; stainless steel
Compression Ratio:	9.6:1
Rocker Arms (P/N 12675724):	Stamped steel
Rocker Arm Ratio:	1.7:1
Distributor (P/N 93440806):	HEI type
Carburetor (P/N 19170094):	870-cfm
Water Pump (P/N 19168602):	Aluminum, short-style
Spark Plugs and Wires:	Included
Starter (P/N 19302919):	Included
Flexplate (P/N 10185034):	14"
Recommended Fuel:	Premium pump
Ignition Timing:	32° Total @ 4,000 rpm
Maximum Recommended rpm:	5,800
Balanced:	External

NOTE: Distributor with melonized steel gear **MUST** be used with long-blocks and Partial engines with steel camshafts, or engine damage will occur.

INSTALLATION NOTES

- Due to crate fitment, the carburetor is shipped in a separate box and needs to be installed by an engine installer
- Clutch linkage bosses are now drilled and tapped. When using cast-iron exhaust manifolds, lower head bolts may need to be replaced with bolts with shorter heads, for clearance
- 502 engines now have a mechanical fuel pump boss!
NOTE: There is a fuel pump lobe behind the boss.
- Comes with an externally balanced 14" automatic transmission flexplate. Use flywheel P/N 14096987 and 11" clutch assembly for manual transmission applications
- Not intended for marine applications

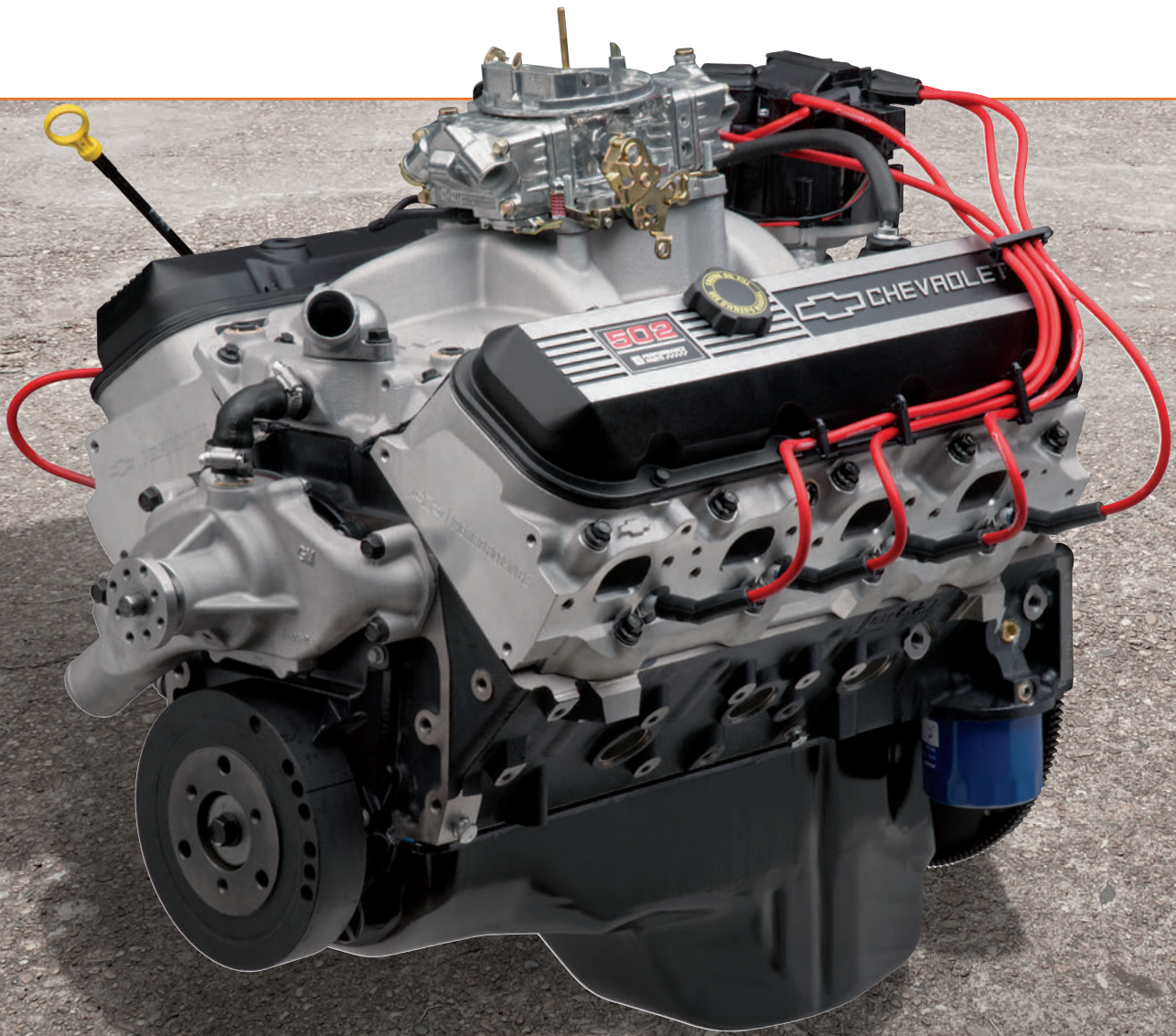

See page 312 for ZZ502/502 Base Engine details

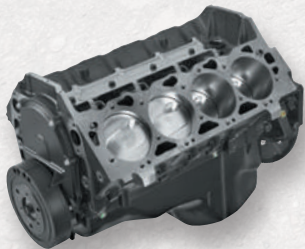

12568782
502 Partial Engine
 This brand-new Partial engine includes forged reciprocating components, as well as the balancer, oil pan and timing chain set.

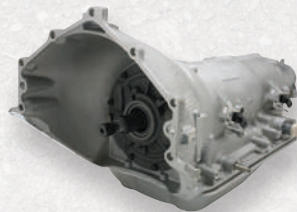

19300175
SuperMatic™ 4L85-E Four-Speed Transmission
 Direct bolt-on for Gen I Small-Block and all Big-Blocks. Improved valve body for firmer shifts. Includes additional clutch plates. Add up to 685 lb.-ft. torque.
 See page 366 for torque converter applications.

AVAILABLE ENGINE-RELATED PARTS & ACCESSORIES

See page 322 for our complete line of Big-Block components



19366895
Serpentine Accessory Drive Belt System With Air Conditioning
 Page 352



25534374
Orange Powder-Coated Valve Covers
 Page 344

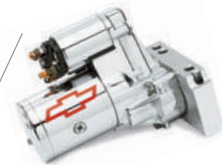

12363128
Chrome High-Torque Mini Starter
 Page 360



19299805
Torque Converter
 Page 366



19332784
Transmission Installation Kit
 Page 370



19332780
Transmission Controller
 Page 371

Ram Jet 502 with calibrated controller and wiring harness

12499121

502 hp @ 5,300 rpm / **568 lb.-ft.** @ 3,600 rpm

DYNO CHART

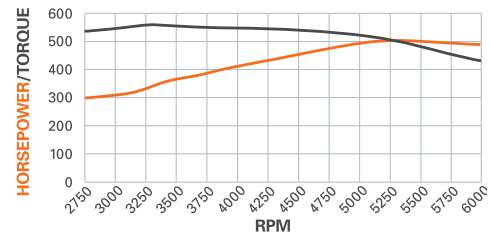

MAKE A STATEMENT UNDER THE HOOD!

The Ram Jet 502 blends the legendary torque and performance of the Big-Block with a modern port fuel injection system and tunnel ram-style high-rise intake manifold. It's a combination that offers uncompromising performance – including 502 hp and 568 lb.-ft. of torque – in a visually stunning presentation.

The unique Ram Jet fuel injection system stands 11 inches tall at its highest point and consists of a two-piece manifold/plenum assembly, eight injectors, a throttle body, and an updated MEFI 4 controller. Setup instructions are included, making it a simple, “plug-and-play” installation.

Supporting the Big-Block’s style and performance is a robust bottom end featuring an all-forged rotating assembly installed in a strong, latest-generation block casting with four-bolt main caps. It also has high-flow aluminum oval-port cylinder heads with 2.25/1.88-inch valves, and the engine package includes an aluminum short-style water pump and HEI distributor.

NOTE: Refer to page 83 for the complete horsepower and torque testing procedures.

TECH SPECS

Part Number:	12499121
Engine Type:	Chevy Big-Block V-8
Displacement (cu in):	502
Bore x Stroke (in):	4.470 x 4.000
Block (P/N 19170540):	Cast-iron with 4-bolt main caps
Crankshaft (P/N 10183723):	Forged steel
Connecting Rods (P/N 19170198):	Forged steel, shot peened
Pistons (P/N 12533507):	Forged aluminum
Camshaft Type (P/N 12366543):	Hydraulic roller
Camshaft Lift (in):	.527 intake / .544 exhaust
Camshaft Duration (@.050 in):	224° intake / 234° exhaust
Cylinder Heads (P/N 12363390):	Aluminum oval port; 110cc chambers
Valve Size (in):	2.250 intake / 1.880 exhaust; stainless steel
Compression Ratio:	9.6:1
Rocker Arms (P/N 12675724):	Stamped steel
Rocker Arm Ratio:	1.7:1
Distributor (P/N 1104060):	HEI type
Throttle Body (P/N 17113524):	Included
Water Pump (P/N 19168602):	Aluminum, short-style
Flexplate (P/N 10185034):	14"
Recommended Fuel:	Premium pump
Ignition Timing:	35° Total @ 4,000 rpm
Maximum Recommended rpm:	5,800
Balanced:	External

INSTALLATION NOTES

- Requires a 12-volt power source (and ground), coolant, exhaust system, fuel feed and fuel return line (to the fuel tank). An in-tank fuel pump is recommended
- Clutch linkage bosses are now drilled and tapped. When using cast-iron exhaust manifolds, lower head bolts may need to be replaced with bolts with shorter heads, for clearance
- 502 engines now have a mechanical fuel pump boss!
NOTE: There is a fuel pump lobe behind the boss.
- Not intended for marine applications
- IMPORTANT! For a safe, proper and trouble-free engine break-in, the MEFI 4 computer has a “green” mode that controls rpm during the break-in period. During this period, engine speed is limited to 4,000 rpm in the first hour, 4,500 rpm in the second hour and 5,500 rpm in the third hour

NOTE: Distributor with melonized steel gear MUST be used with long-blocks and Partial engines with steel camshafts, or engine damage will occur.

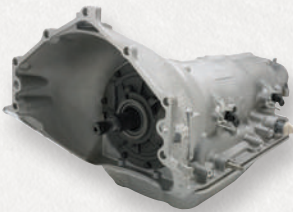
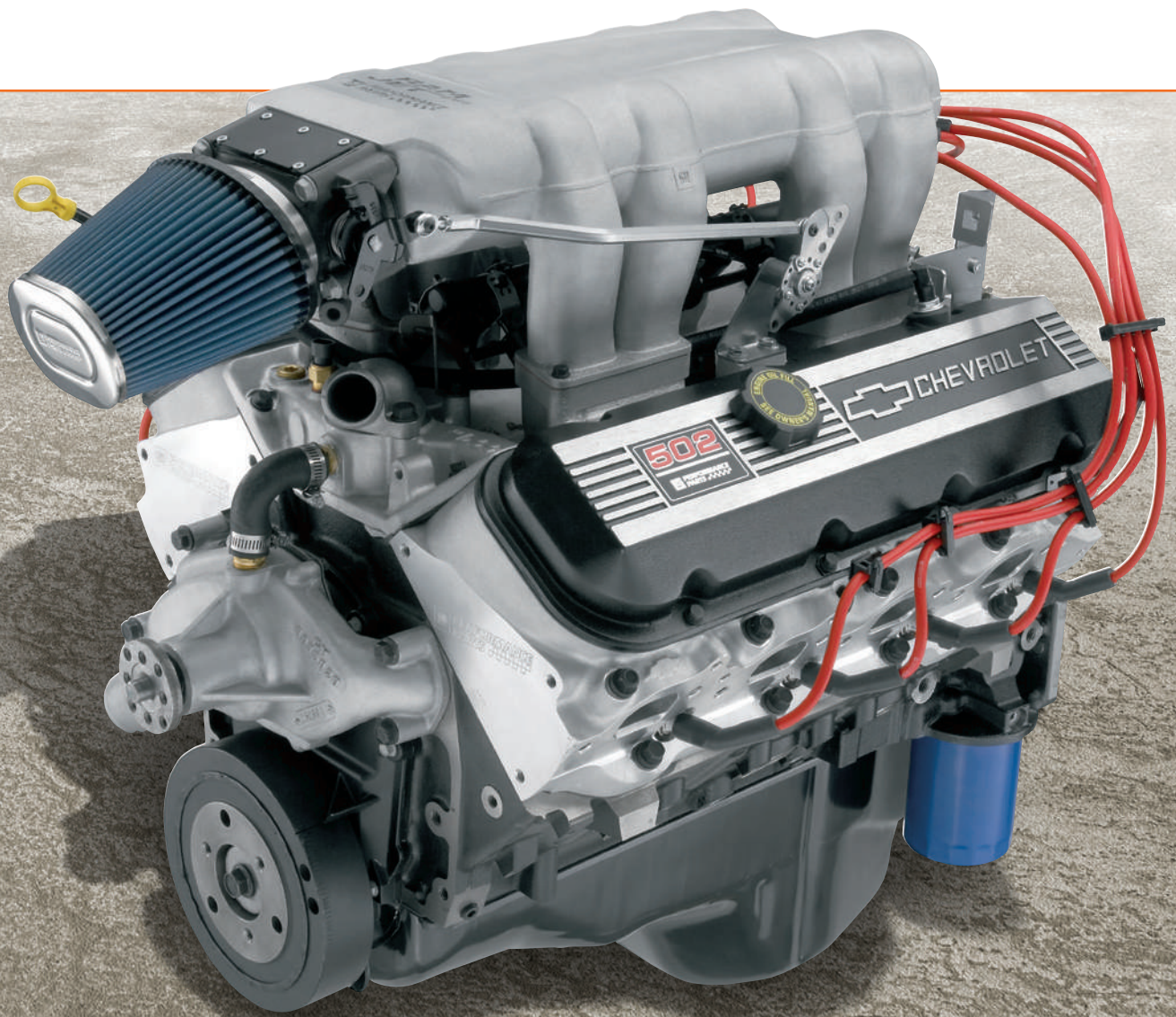

19300175
SuperMatic™ 4L85-E
Four-Speed Transmission

Direct bolt-on for Gen I Small-Block and all Big-Blocks. Improved valve body for firmer shifts. Includes additional clutch plates. Add up to 685 lb.-ft. torque.
See page 366 for torque converter applications.



19332780
Transmission Controller

Required when using a GM electronically controlled automatic transmission. Includes wiring harness.
See page 371 for details.

AVAILABLE ENGINE-RELATED PARTS & ACCESSORIES

See page 322 for our complete line of Big-Block components



19366895
Serpentine Accessory
Drive Belt System
With Air Conditioning
Page 352



25534374
Orange Powder-Coated
Valve Covers
Page 344



19302919
Lightweight
Starter
Page 360



19299805
Torque Converter
Page 366



25534323
Black Powder-Coated
Valve Covers
Page 344



19332784
Transmission
Installation Kit
Page 370

ZZ572/620 Deluxe

19331583

621 hp / **645 lb.-ft.**
@ 5,400 rpm / @ 4,200 rpm

DYNO CHART

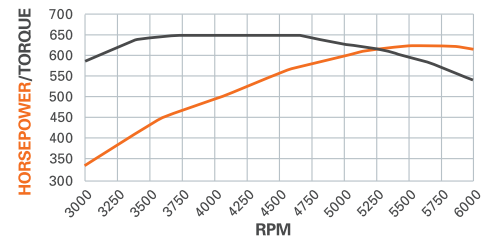

OUR BADDEST BIG-BLOCK STREET ENGINE

Proving the adage there's no replacement for displacement, the ZZ572/620 is the ultimate expression of Chevrolet Performance's engineering capability, wrapped up in a soul-stirring combination of performance and attitude. We build the ZZ572/620 with huge 4.560-inch bores and a 4.375-inch stroke to help it deliver 621 hp and a stunning 645 lb.-ft. of grunt!

Strength comes from a latest-generation tall-deck block casting with four-bolt main caps and an all-forged rotating assembly, while high-flow aluminum rectangular-port cylinder heads with massive 310cc intake passages, 1.88 inch raised exhaust ports and 118cc combustion chambers process tremendous airflow. A hydraulic roller camshaft with an impressive 0.632/0.632-inch lift and 254/264-degree duration specifications optimizes the airflow volume enabled by the large-port heads.

Chevrolet Performance delivers this Big-Block with an 850-cfm carburetor, HEI distributor, aluminum water pump and distinctive orange powder-coated valve covers that proudly proclaim the 572 legend.

NOTE: Refer to page 83 for the complete horsepower and torque testing procedures.

TECH SPECS

Part Number:	19331583
Engine Type:	Chevy Tall-Deck Big-Block V-8
Displacement (cu in):	572
Bore x Stroke (in):	4.560 x 4.375
Block (P/N 19212195):	Cast-iron with 4-bolt main caps
Crankshaft (P/N 88961554):	Forged steel
Connecting Rods (P/N 88962926):	Forged steel, shot peened
Pistons (P/N 88962925):	Forged aluminum
Intake Manifold (P/N 88961161):	Single plane
Camshaft Type (P/N 19210721):	Hydraulic roller
Camshaft Lift (in):	.632 intake / .632 exhaust
Camshaft Duration (@.050 in):	254° intake / 264° exhaust
Cylinder Heads (P/N 19331429):	Aluminum rectangular port, 118cc chambers
Valve Size (in):	2.250 intake / 1.88 exhaust; stainless steel
Compression Ratio:	9.6:1
Rocker Arms (P/N 19210726):	Aluminum roller style
Rocker Arm Ratio:	1.7:1
Distributor (P/N 88961867):	HEI
Carburetor (P/N 19170095):	850-cfm
Water Pump (P/N 19168602):	Aluminum, short-style
Spark Plugs and Wires:	Included
Flexplate (P/N 12561217):	14"
Recommended Fuel:	Premium pump
Ignition Timing:	36° Total @ 4,000 rpm
Maximum Recommended rpm:	6,000
Balanced:	Internal

INSTALLATION NOTES

- Due to crate fitment, the carburetor is shipped uninstalled and needs to be installed by an engine installer
- Clutch linkage boss is now drilled and tapped. When using cast-iron exhaust manifolds, lower head bolts may need to be replaced with bolts with shorter heads, for clearance
- Requires addition of starter and fuel pump (not included)
- Gen VI tall-deck block has machined mechanical fuel pump boss
- Comes with a 14" automatic transmission flexplate. Requires internally balanced flywheel for manual transmission applications
- Not intended for marine applications

NOTE: Distributor with melonized steel gear **MUST** be used with long-blocks and Partial engines with steel camshafts, or engine damage will occur.

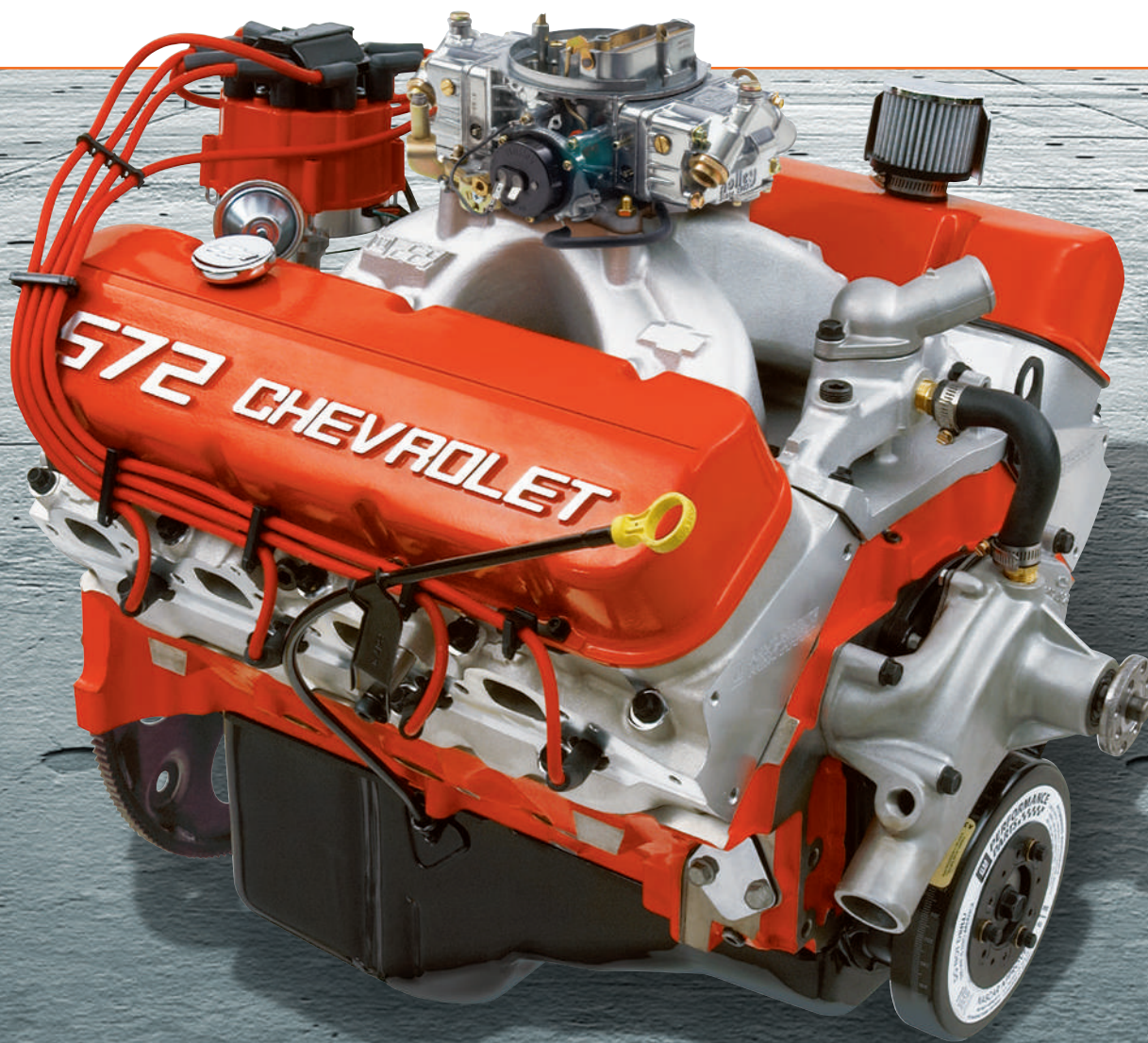

19331581
ZZ572/620 Base Engine
 The ZZ572/620 features rectangular-port aluminum cylinder heads that deliver 9.6:1 compression ratio in a pump-gas-friendly package.



19300175
SuperMatic™ 4L85-E Four-Speed Transmission
 Direct bolt-on for Gen I Small-Block and all Big-Blocks. Improved valve body for firmer shifts. Includes additional clutch plates. Add up to 685 lb.-ft. torque.
 See page 366 for torque converter applications.

AVAILABLE ENGINE-RELATED PARTS & ACCESSORIES

See page 322 for our complete line of Big-Block components



19366895
Serpentine Accessory Drive Belt System With Air Conditioning
 Page 352



19332784
Transmission Installation Kit
 Page 370



12361146
High-Torque Mini Starter
 Page 360



19299805
Torque Converter
 Page 366



12342024
Chrome Water Neck
 Page 359



19332780
Transmission Controller
 Page 371

ZZ572/720R Deluxe

19331585

727 hp
@ 6,300 rpm

680 lb.-ft.
@ 4,900 rpm

DYNO CHART

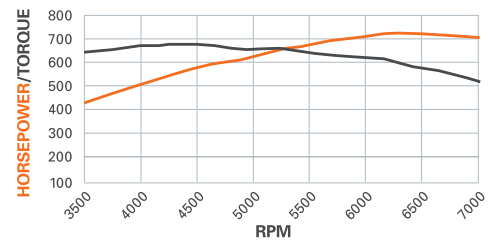

SERIOUS POWER FOR YOUR RACE CAR!

Don't wait weeks or months for a custom drag racing engine. The ZZ572/720R is the king of all Rat engines and is capable of pulling your bracket racer or heads-up challenger down the drag strip in the 9-second range. We deliver it fully assembled. You simply bolt on the included Dominator-style 1090-cfm carburetor, along with a starter and fuel pump (not included) and you're ready to go! With 727 hp at 6,300 rpm and 680 lb.-ft. at 4,900 rpm, you'll make quite an impression.

The engine assembly is all-business, starting with a latest-generation tall-deck block casting with four-bolt main caps, and an all-forged rotating assembly for exceptional strength and durability. A unique mechanical roller camshaft with 0.714/0.714-inch lift and 278/282-degree duration specifications complements high-flow aluminum rectangular-port cylinder heads with massive 310cc intake passages, 118cc raised exhaust ports and 118cc combustion chambers, moving big air through the engine efficiently to make huge power!

NOTE: Refer to page 83 for the complete horsepower and torque testing procedures.

TECH SPECS

Part Number:	19331585
Engine Type:	Chevy Tall-Deck Big-Block V-8
Displacement (cu in):	572
Bore x Stroke (in):	4.560 x 4.375
Block (P/N 19212195):	Cast-iron with 4-bolt main caps
Crankshaft (P/N 88961554):	Forged steel
Connecting Rods (P/N 88962926):	Forged steel, shot peened
Pistons (P/N 88963227):	Forged aluminum
Intake Manifold (P/N 88962218):	Single Plane
Camshaft Type (P/N 19210722):	Mechanical roller
Camshaft Lift (in):	.714 intake / .714 exhaust
Camshaft Duration (@.050 in):	278° intake / 282° exhaust
Cylinder Heads (P/N 19331430):	Aluminum rectangular port, 118cc chambers
Valve Size (in):	2.250 intake / 1.880 exhaust stainless steel
Compression Ratio:	12:1
Rocker Arms (P/N 19210726):	Aluminum roller style
Rocker Arm Ratio:	1.7:1
Distributor (P/N 10093387):	Electronic ignition
Carburetor (P/N 19170096):	1150-cfm Dominator
Water Pump (P/N 19168602):	Aluminum, short-style
Spark Plugs and Wires:	Included
Recommended Fuel:	Race gas
Ignition Timing:	35° Total @ 4,000 rpm
Maximum Recommended rpm:	6,750
Balanced:	Internal

NOTE: Distributor with melonized steel gear **MUST** be used with long-blocks and Partial engines with steel camshafts, or engine damage will occur.

INSTALLATION NOTES

- Due to crate fitment, the carburetor is shipped in a separate box and needs to be installed by an engine installer
- Clutch linkage boss is now drilled and tapped. When using cast-iron exhaust manifolds, lower head bolts may need to be replaced with bolts with shorter heads, for clearance
- Requires addition of starter, ignition coil, ignition box and fuel pump (not included)
- Gen VI tall-deck block has machined mechanical fuel pump boss
- Requires internally balanced flywheel for manual transmission applications
- Requires 110 octane or higher gasoline
- Not intended for marine applications

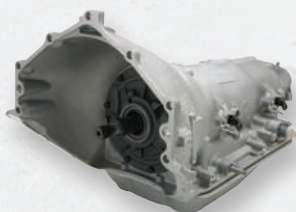

19300175
SuperMatic™ 4L85-E
Four-Speed Transmission

Direct bolt-on for Gen I Small-Block and all Big-Blocks. Improved valve body for firmer shifts. Includes additional clutch plates. Add up to 685 lb.-ft. torque.
See page 366 for torque converter applications.



19332780
Transmission Controller

Required when using a GM electronically controlled automatic transmission. Includes wiring harness.
See page 371 for details.

AVAILABLE ENGINE-RELATED PARTS & ACCESSORIES

See page 322 for our complete line of Big-Block components



12341999
Fuel Pump
Block-Off Plate
Page 333



19366895
Serpentine Accessory
Drive Belt System
With Air Conditioning
Page 352



19302919
Lightweight
Starter
Page 360



19299805
Torque Converter
Page 366



19332784
Transmission
Installation Kit
Page 370



12561217
14" Flexplate
Page 351



CHEVROLET | PERFORMANCE



502 Mark IV/Gen VI Bare Block



BIG-BLOCK

ENGINE COMPONENTS

BUILD BIG TORQUE WITH INDUSTRY-LEADING PARTS

Nobody has more experience engineering and building Big-Block engines than Chevrolet Performance, so you can trust our parts will deliver the power and that legendary torque you demand.

Our lineup of Big-Block parts starts with brand-new GM cylinder blocks that are stronger than previous production designs. They combine design elements of the Mark IV and Gen V designs, along with architecture improvements that give the block greater strength. We've even got an updated version of the legendary aluminum 427 block that's perfect for resto-mod projects and COPO tribute cars.

When it comes to the best-performing rotating parts and cylinder heads, including rectangular-port, oval-port and even lightweight aluminum heads, nobody has the Big-Block covered like Chevrolet Performance. There's no reason to settle for used, reconditioned or "seasoned" parts, because our parts are competitively priced and offer the performance you're looking for to build strength and big power.

Nothing else feels like a Big-Block – and nobody knows how to build them better than Chevrolet Performance!

You can find these Chevrolet Performance Big-Block Engine Components on the following pages:

BLOCKS AND COMPONENTS	324	CRANKSHAFTS	350
CYLINDER HEADS	334	OIL PANS, OIL PUMPS, GASKETS AND COMPONENTS	353
VALVE COMPONENTS	341	INTAKE MANIFOLDS	356
VALVE COVERS	344	FUEL AND ELECTRICAL COMPONENTS	362
CAMSHAFTS	348		
PISTONS AND PISTON RINGS	348		



A Better Big-Block

The classic Chevy Big-Block production engine was introduced in 1965. In the late 1980s, a new version arrived, designed for marine and fuel-injected applications. The early-style engines are known as Mark IV Big-Blocks, while the later style is referred to as the Gen V (and Gen VI) Big-Block. You can tell them at a glance by checking for a mechanical fuel pump mounting pad. If it has one, it's a Mark IV. If there's no fuel pump pad, it's a Gen V block.

Despite the fuel pump mounting pad difference in their castings, the cylinder blocks of the Mark IV and Gen V are based on the same design architecture. However, there are several other differences – particularly in the water jackets near the deck surfaces – that make some Mark IV and Gen V parts incompatible, including crucial components such as the cylinder head gaskets.

Chevrolet Performance revised the basic Big-Block architecture to commonize the Mark IV and Gen V, creating an all-new cylinder block casting that combines the features of both generations. It also incorporates significant updates and strength-enhancing features that make the Big-Block a stronger engine foundation with provisions to support 21st-century performance.

Although the basic Big-Block architecture is revised, Chevrolet Performance continues to offer two versions, each differentiated by performance and displacement capability. The Bowtie block continues to be the block of maximum performance. All of our crate engines use the revised Big-Block design.

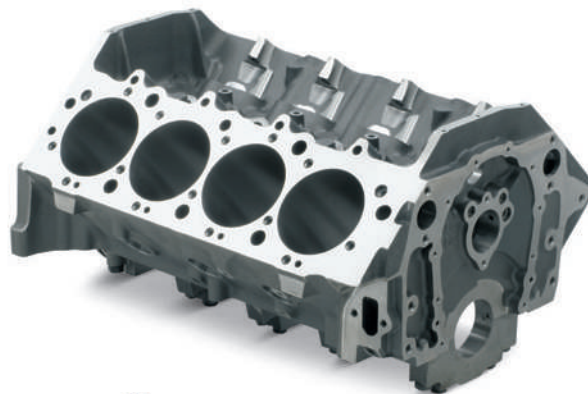

Here is what distinguishes the latest Chevrolet Performance Big-Blocks from earlier castings:

- Water jackets are revised near the deck surfaces so that Mark IV or Gen V head gaskets can be used interchangeably
- Oil pressure feed holes are added to the oil filter boss and front bulkhead to support oil feeds for superchargers, turbochargers, etc.
- The oil hole next to the camshaft bore at the front of the block is repositioned to enable safe machining of the cam bore to accept a 50mm roller camshaft bearing
- A mechanical fuel pump mounting pad is included, similar to the Mark IV
- A boss next to the distributor hole in the valley supports hardware for digital ignition equipment
- The front bulkhead is thicker and stronger, with marked provisions for a 10-bolt timing cover (non-Bowtie blocks are delivered with drilled and tapped holes for 6-bolt covers; remaining holes must be drilled and tapped at the prescribed positions)
- Non-Bowtie blocks are machined for 4-bolt parallel main caps; Bowtie blocks are machined for 4-bolt splayed caps
- Revised rear-of-block allowed for the machining of 1- or 2-piece main seals (similar to Gen V design)
- A front clutch boss is included for older muscle car applications
- 454 blocks have a slightly beefier main web than previous blocks
- All blocks are made with the standard production roller camshaft and lifter machining
- 502 and Bowtie blocks share the same main web, which is strengthened considerably from the Mark IV and the first-generation Gen V Bowtie block
- Bowtie blocks feature a distinctive water jacket design to allow up to 4.600" bores. These blocks can be identified by a "B" suffix behind the casting number

Two additional core plugs are featured in the rear bulkhead. They enhance the manufacturing process at the foundry and help improve overall quality. Also, a "Bowtie" logo and other identifying marks are incorporated on the Bowtie block, distinguishing it from previous generations.

Chevy Big-Block Quick Reference Chart

Production-Based Cast-Iron Blocks

Part Number	Casting Number	Deck Height	F Pump Boss	Cyl Wall	Bore Range	Main Bolt	Main Blt Degree	Cap Material	Crank Jnl. Dia.	Oiling	Seal Type	Max Stroke	Weight (lbs)	Max HP	Usage	Page Number
19170538	—	9.800"	Yes	Open	4.250"–4.310"	4	Straight	Cast-iron	2.750"	Wet	1 pc	4.250"	247	700	Street	326
19170540	—	9.800"	Yes	Siamese	4.470"–4.500"	4	Straight	Cast-iron	2.750"	Wet	1 pc	4.250"	269	700	Mod	326

Bowtie Cast-Iron Big-Blocks

Part Number	Casting Number	Deck Height	F Pump Boss	Cyl Wall	Bore Range	Main Bolt	Main Blt Degree	Cap Material	Crank Jnl. Dia.	Oiling	Seal Type	Max Stroke	Weight (lbs)	Max HP	Usage	Page Number
19212191	24502504B	9.800"	Yes	Siamese	4.494"–4.600"	4	16°	Nodular	2.750"	Wet	2 pc	4.500"	258	800	Sport	327
19212192	24502504B	9.800"	Yes	Siamese	4.494"–4.600"	4	16°	Nodular	2.750"	Wet	1 pc	4.500"	258	800	Sport	327
19212193	24502506B	10.200"	Yes	Siamese	4.494"–4.600"	4	16°	Nodular	2.750"	Wet	1 pc	4.500"	263	800	Sport	328
19212194	24502506B	10.200"	Yes	Siamese	4.494"–4.600"	4	16°	Nodular	2.750"	Wet	2 pc	4.500"	263	800	Sport	328
19212195	24502506B	10.200"	Yes	Siamese	4.560"–4.600"	4	16°	Nodular	2.750"	Wet	1 pc	4.500"	263	800	Sport	328
19212196	24502504B	9.800"	Yes	Siamese	4.240"–4.600"	4	16°	Steel	2.750"	Wet	2 pc	4.500"	281	1200	Pro	330
19212197	24502506B	10.200"	Yes	Siamese	4.240"–4.600"	4	16°	Steel	2.750"	Wet	2 pc	4.500"	296	1200	Pro	330

Aluminum ZL1 Block

Part Number	Casting Number	Deck Height	F Pump Boss	Cyl Wall	Bore Range	Main Bolt	Main Blt Degree	Cap Material	Crank Jnl. Dia.	Oiling	Seal Type	Max Stroke	Weight (lbs)	Max HP	Usage	Page Number
12370850	3946053	9.800"	Yes	Siamese	4.240"–4.300"	4	16°	Steel	2.750"	Wet	2 pc	4.375"	110	650	Pro	329
88958696*	88958695	9.800"	Yes	Siamese	4.250"–4.300"	4	16°	Steel	2.750"	Wet	1 pc	4.375"	110	650	Pro	N/A

*Used in Anniversary 427 P/N 19166392. Not available for service.

DRCE Blocks

Part Number	Casting Number	Deck Height	F Pump Boss	Cyl Wall	Bore Range	Main Bolt	Main Blt Degree	Cap Material	Crank Jnl. Dia.	Oiling	Seal Type	Max Stroke	Weight (lbs)	Max HP	Usage	Page Number
24502572	1A626	9.525"–9.000"	No	Siamese	4.500"–4.700"	4	16°	Steel	2.750"	Dry	2 pc	4.600"	255	1400+	Pro	331
25534406	CG	9.250"–9.000"	No	Siamese	4.590"–4.700"	4	22°	Steel	2.500"	Dry	2 pc	4.600"	N/A	1400+	Pro	331
25534400	CG	9.250"–9.000"	No	Siamese	4.590"–4.700"	4	22°	Steel	2.500"	Dry	2 pc	4.600"	N/A	1400+	Pro	331



BUILDER'S TIP

THRUST BEARING ALIGNMENT

On Small-Block and Big-Block engines, the thrust bearing alignment on the important #5 bearing is performed by installing only the #5 main cap and tightening its fasteners. With cap in place, the crankshaft is tapped forward or backward with a rubber mallet. When this is done, crankshaft endplay can be measured. For Small-Blocks, you're looking for between 0.005- and 0.007-inch; for Big-Blocks, the spec is 0.0065-0.0075-inch.

Deck Height Diagram

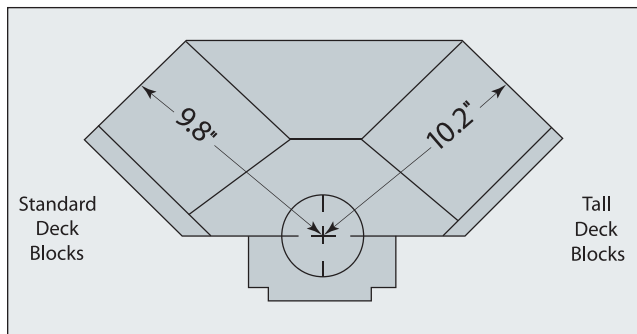

ENGINE BLOCKS

19170538

427/454 Bare Block (not shown)

- New design casting incorporating the best designs of Mark IV and Gen VI
- Production type cast-iron 4-bolt block
- 4.250" finished bore
- 4.310" max bore (non-siamese bore)
- Machined fuel pump pad
- Water jackets for use with Mark IV or Gen VI heads
- Revised oiling to allow for bigger cam bearings/cam lift
- Bolt boss (not machined) added near distributor hole like 8.1L
- Can be drilled for use with 10-bolt front timing cover
- Additional clearance added for roller timing chains
- Auxiliary oil pressure line added to front of block
- Racing style oil filter cast feature with added oil pressure port
- Additional boss for manual transmission clutch pivot (machined)
- Additional material added around lifter bosses

A. 19170540

502 Mark IV/Gen VI Bare Block

- New design casting incorporating the best designs of Mark IV and Gen VI
- Production-type cast-iron 4-bolt block
- Improved main bearing bulkheads—Bowtie block-style bulkhead
- Clearanced for bigger strokes
- 4.470" finished bore
- 4.500" max bore (siamese)
- Fuel pump pad has been added/machined
- Water jackets for use with Mark IV or Gen VI heads
- Revised oiling to allow for bigger cam bearings/cam lift
- Bolt boss (machined) added near distributor hole like 8.1L
- Can be drilled for use with 10-bolt front timing cover
- Additional clearance added for roller timing chains
- Auxiliary oil pressure line added to front of block
- Racing-style oil filter cast feature with added oil pressure port
- Two bosses added for manual transmission clutch pivot (machined)
- Additional material added around lifter bosses



A 502 Mark IV/Gen VI Bare Block (bottom, front)

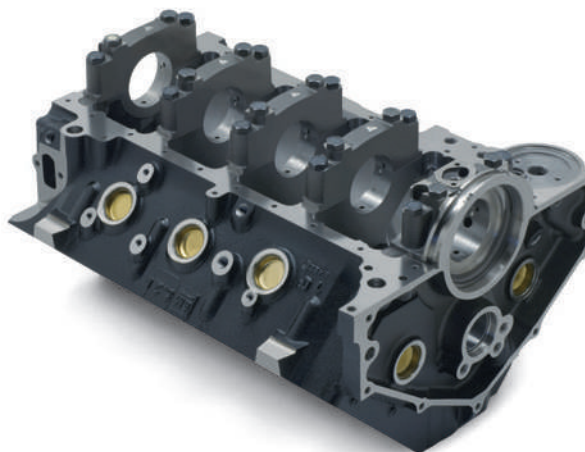

A 502 Mark IV/Gen VI Bare Block (bottom, rear)

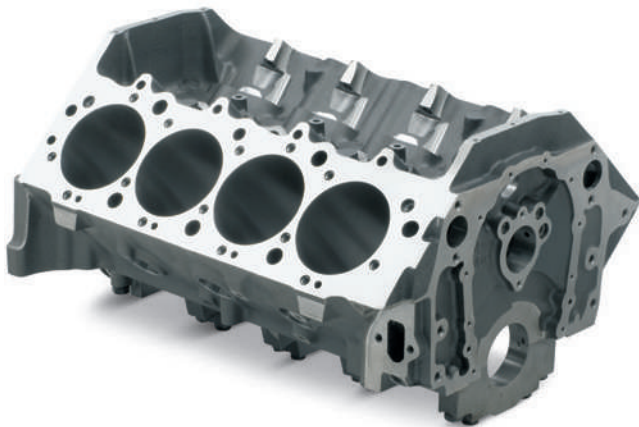
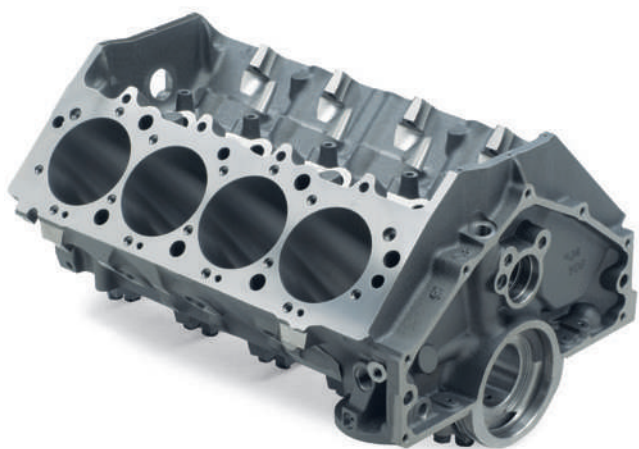
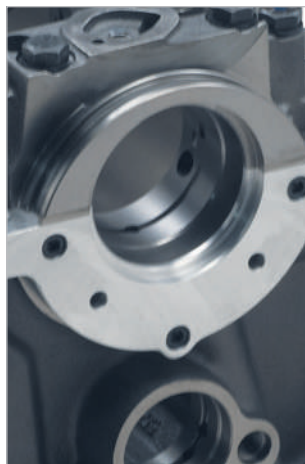

A 502 Mark IV/Gen VI Bare Block (top, rear)

Bowtie Sportsman Block (top, front) **B**Bowtie Sportsman Block (top, rear) **B**Top: Splayed Main Cap **C**
Bottom: Machined Bottom2-Piece Rear Main Seal **C**

BOWTIE SPORTSMAN BLOCKS

Big-Blocks with big power are what you get when you select a Chevrolet Performance Bowtie Sportsman block for your drag racing or competition application. These blocks comprise a full line of high-quality, precision-machined components based on performance-proven GM designs. The extensive lineup of blocks makes choosing the perfect block easy – and our quality and precision machining is second to none.

The blocks are CNC-machined, an automated process that guarantees precise tolerances. There are no approximations on these blocks – they're exactly right, which is critical to obtaining maximum performance. Chevrolet Performance offers more CNC-machined blocks than anyone.

The highest-quality materials are used to cast our Sportsman Bowtie blocks. They are also available as tall decks, allowing you to make more cubic inches with larger-stroke crankshafts. These blocks can easily be bored and stroked to 500-or-more cubic inches. They can be fitted with one-piece or two-piece crankshaft seals for a smaller chance of oil leaks (one-piece seals) or more aftermarket components attachments (two-piece seals).

The Bowtie Sportsman blocks are available with splayed main caps, which have additional material holding the crankshaft in place. The caps are splayed at 16 degrees. Chevrolet Performance uses splayed main caps throughout the entire line of performance-built Big-Blocks.

Chevrolet Performance Bowtie Sportsman Blocks are ideal for drag racers or street machines where the goal is 800 horsepower and long-lasting reliability.

Bowtie Sportsman Block Technical Notes:

- Available in short deck (9.800") or tall deck (10.200") configurations
- Blocks have clearance for 4.500" stroke crankshafts
- CNC-machined to +/- .005" tolerance
- Siamese cylinder bores
- Bore finishes are ready to hone to size
- Machined for mechanical fuel pump
- Machined for hydraulic roller and flat tappets
- Nodular iron 4-bolt main caps splayed 16° on the three center mains
- Priority main oiling system
- Blocks with a 1-piece Rear Main Seal use the 6-bolt, Gen VI-style front cover (P/N 10230954) and Gen VI-style oil pan
- Blocks with a 2-piece Rear Main Seal use the 10-bolt, Mark IV-style front cover and Mark IV-style oil pan

See chart on page 325 for complete specifications.

Standard Deck Sportsman Blocks

B. 19212192

Standard Deck Bowtie Sportsman Block

- 1-piece rear main seal
- CNC-machined cast-iron 4-bolt block
- 4.494" finished bore
- 4.600" max bore
- Tested to 800 horsepower!

C. 19212191

Standard Deck Bowtie Sportsman Block

- 2-piece rear main seal
- CNC-machined cast-iron 4-bolt block
- 4.494" finished bore
- 4.600" max bore
- Tested to 800 horsepower!

TALL DECK SPORTSMAN BLOCKS

A. 19212193

Tall Deck Bowtie Sportsman Bare Block

- 1-piece rear main seal
- CNC-machined cast-iron 4-bolt block
- 4.494" finished bore
- 4.600" max bore
- Tested to 800 horsepower!

19212194

Tall Deck Bowtie Sportsman Bare Block (not shown)

- 2-piece rear main seal
- CNC-machined cast-iron 4-bolt block
- 4.494" finished bore
- 4.600" max bore
- Tested to 800 horsepower!

19212195

Tall Deck 572 Bowtie Sportsman Bare Block (not shown)

- 1-piece rear main seal
- Uses Mark IV style front cover and oil pan mounting
- CNC-machined cast-iron 4-bolt block
- 4.560" fully honed bore
- 4.600" max bore
- Powder coated Chevy orange
- 5 windage tray bolts installed
- Tested to 800 horsepower!
- This is the block used for our 572 engines

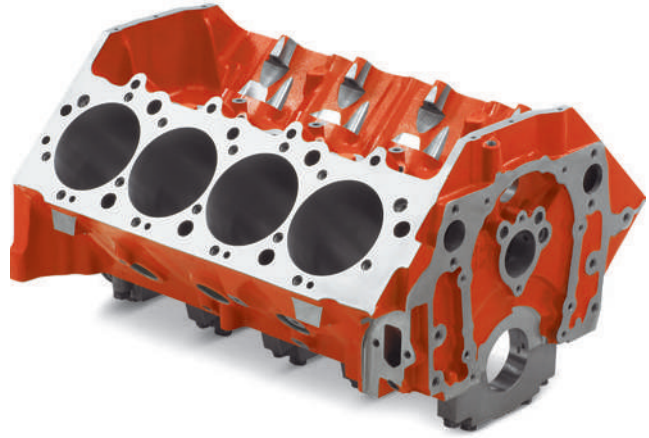

A Tall Deck Bowtie Sportsman Bare Block (top, front)

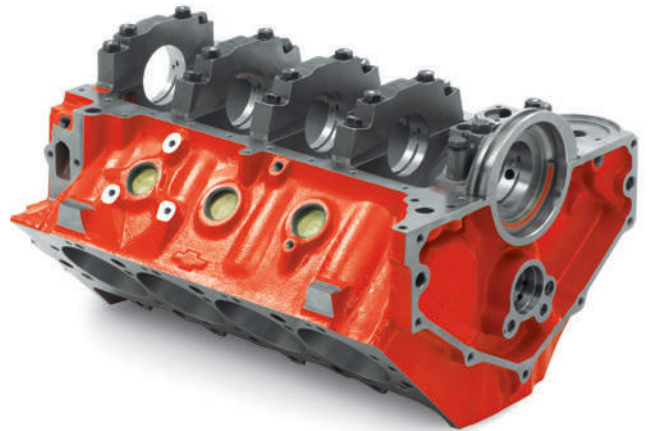

A Tall Deck Bowtie Sportsman Bare Block (bottom, rear)



A Machined Lifter Valley Detail

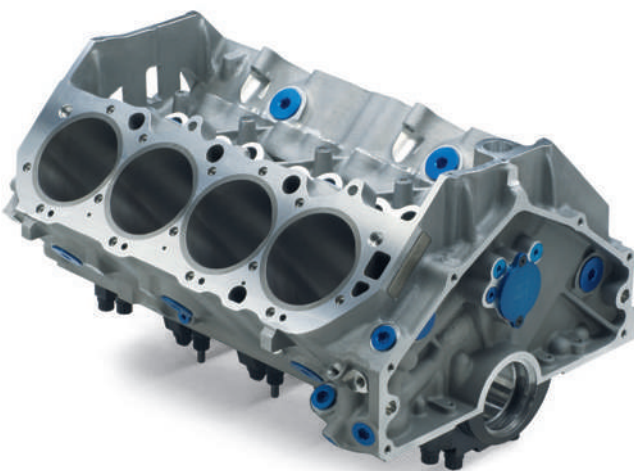
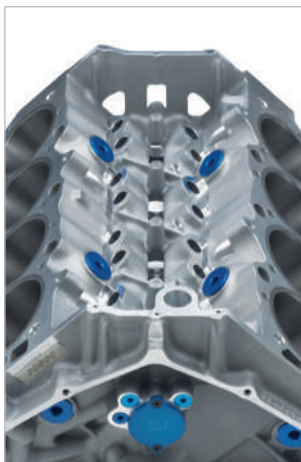

A 1-Piece Rear Main Seal

ZL1 Aluminum Big-Block (top, front) **B**ZL1 Aluminum Big-Block (top, rear) **B**ZL1 Aluminum Big-Block,
4-Bolt Mains **B**ZL1 Aluminum Big-Block,
Lifter Valley **B**

ZL1 ALUMINUM BIG-BLOCK

ZL1 was the legendary regular production option (RPO) code that struck fear into all competitors who came up against 1969 Camaros – and a couple of Corvettes – that were equipped with this fearsome 427-cubic-inch Big-Block from the factory. The price to own an original ZL1 has exceeded the value of many homes, but you can build your own ZL1-powered supercar thanks to Chevrolet Performance. By reintroducing this fabled aluminum Big-Block, Chevrolet Performance has made it possible for everyone to experience the raw horsepower and tremendous torque of the ZL1. The Chevrolet Performance ZL1 aluminum block is made from premium materials and is precision machined to blueprinted specifications.

See chart on page 325 for complete specifications.

ZL1 Aluminum Block Technical Notes:

- 356-T6M Aluminum block
- Standard deck height (9.800")
- 4.300" maximum bore
- 4.240" finished bore
- 4.375" maximum stroke
- Siamesed cylinder walls
- Centrifugally spun cast-iron cylinder sleeves
- Steel 4-bolt main caps splayed 16° on the three center mains (dowel located)
- Provision for hydraulic roller camshafts
- AN O-ring oil and water plugs
- Tested to 650 horsepower

B. 12370850

ZL1 Aluminum Big-Block

- 4.240" finished bore
- 4.300" max bore
- 4.375" max stroke
- Use cylinder sleeve (P/N 12480035)
- 2-piece rear main seal
- Uses Mark IV front timing cover

CAST-IRON BOWTIE RACE BLOCKS

If you're looking to build a drag racing engine capable of producing 1,200 horses or more, a Chevrolet Performance cast-iron Bowtie Race Block is your starting point. It is designed for engine builders who want to custom-machine their blocks for specific racing applications. Toward that end, these premium castings have thick deck surfaces, improved oiling, improved coolant flow and splayed 4-bolt steel bearing caps. Everything is secured with premium fasteners. The combination of a Chevrolet Performance cast-iron Bowtie Race Block and your unique engine building skills will put you down the track ahead of the competition.

See chart on page 325 for complete specifications.

Cast-iron Bowtie Race Block Technical Notes:

- Precision CNC-machining means +/- 0.005" tolerances
- Blocks are available in short deck (9.800") or tall deck (10.200")
- A sonic bore check data sheet is provided with each block
- Siamese cylinder bores
- Improved cooling around number-1 cylinder
- Accepts Mark IV or Gen V, VI cylinder heads
- Use Gen V head gaskets with Mark IV and Gen V cylinder heads
- Use Gen VI head gaskets with Gen VI cylinder heads
- Requires Mark IV design 2-piece rear main seal oil pans
- Requires Mark IV design crankshafts
- Can use Mark IV and Gen V, VI camshafts, timing sets, lifters and timing cover (aftermarket belt-drive timing covers may require clearancing)
- Blind-tapped head bolt holes; extra inner head bolt bosses provided
- 4-bolt SAE 8620 steel main caps splayed 16° on the three center mains
- Priority main oiling wet-sump system
- Provisions for dry-sump oil line provided
- Honed camshaft and crankshaft bores
- 0.842" lifter bores (maximum 1.06") may be relocated
- Distributor gear clearance at bottom of number-8 cylinder bore should be checked
- Machined mechanical fuel pump pad

19212196

Standard Deck Bowtie Race Bare Block (not shown)

- CNC-machined cast-iron 4-bolt block
- 4.240" finished bore
- 4.600" max bore (.250" min. wall thickness)
- Standard deck height (9.800")
- Lifter bosses are .300" taller than standard blocks
- Tested to 1,200 horsepower!

A. 19212197

Tall Deck Bowtie Race Bare Block

- CNC-machined cast-iron 4-bolt block
- 4.240" finished bore
- 4.600" max bore (.250 min. wall thickness)
- Tall deck height (10.200")
- Lifter bosses are .300" taller than standard blocks
- Tested to 1,200 horsepower!



A Tall Deck Bowtie Race Bare Block (top, front)

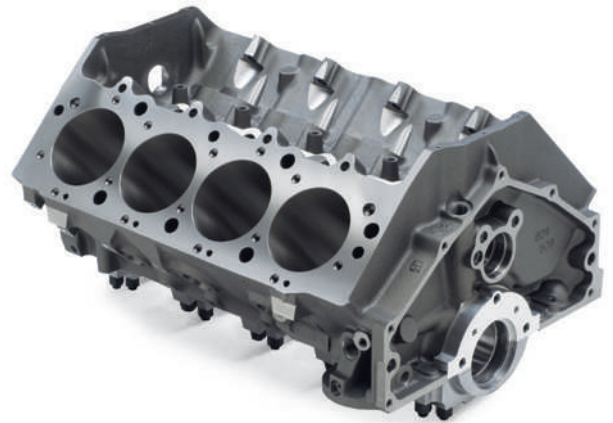

A Tall Deck Bowtie Race Bare Block (top, rear)

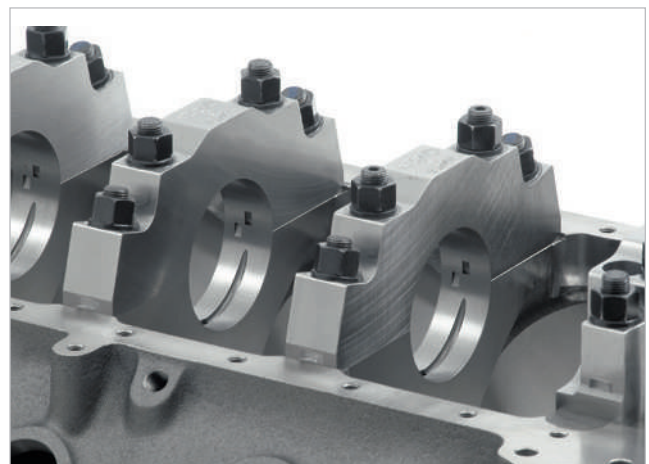

A Tall Deck Bowtie Race Bare Block, Nodular 4-Bolt Splayed Caps

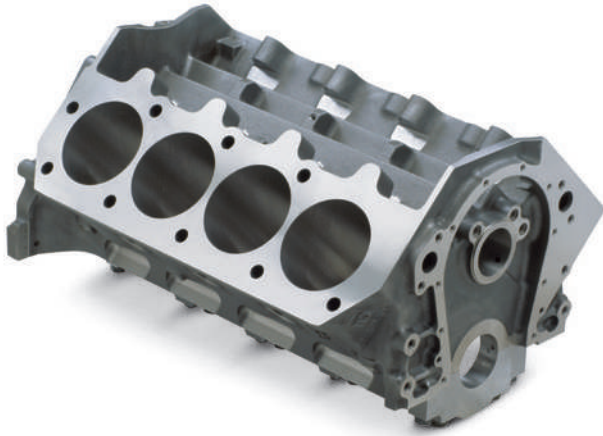
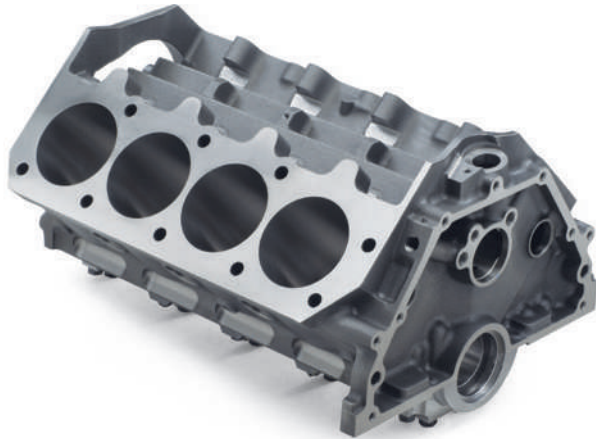
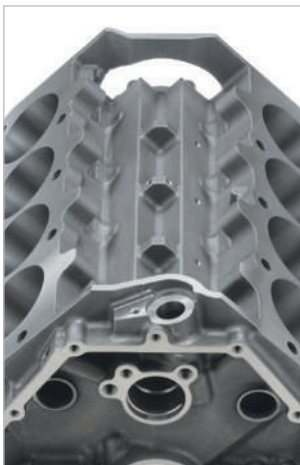
DRCE 2 Bare Block (top, front) **B**DRCE 2 Bare Block (top, rear) **B**DRCE 2 Lifter Valley **B**DRCE 2 Main Caps **B**

BIG-BLOCK DRCE BLOCKS

Chevrolet Performance Big-Block DRCE (Drag Racing Competition Engine) blocks are the foundation of many of the most powerful Pro Stock drag racing engines. The DRCE family of engine blocks was specifically designed with 500-cubic-inch Pro Stock engines in mind. They are the latest evolution of Pro Stock engine design. In order to build optimum performance, the DRCE blocks have bore spacing that allows for the preferable big bore/short-stroke crankshaft combination. The camshaft has been raised and the distributor moved.

The big-bore design un-shrouds the heads, which means bigger valves can be used. The result is maximized air/fuel mixtures. All DRCE blocks are sold solid, without lifter holes or head bolt holes, so any GM Big-Block cylinder heads may be used. The DRCE blocks are available in either gray iron or compacted graphite (an extremely high-strength material that helps the block combat bore distortion and crank deflection under stress).

See chart on page 325 for complete specifications.

DRCE Block Technical Notes:

- CNC-machined to +/- 0.005" tolerance
- Siamese cylinder bores with 4.900" spacing
- No lifter bosses, solid bar can be drilled as required
- No head-bolt holes
- Numbers two and four main bearing bulkheads moved 0.060"
- Bellhousing bolt pattern accommodates Chevy and Pontiac/Olds transmissions
- Uses Big-Block Chevrolet crank, camshaft, balancer, flywheel and water pump
- Requires camshaft with distributor gear behind rear bearing
- Priority main oiling dry-sump system
- Dual starter mounting locations
- Front-engine mounts only
- Each block is supplied with sonic test data sheet

B. 24502572

DRCE 2 Bare Block, Gray Iron

- CNC-machined iron 4-bolt block
- 9.525" deck height, may be machined to 9.000"
- Camshaft raised to 5.750"
- Cam tunnel accommodates 55mm cam bearings
- 4.500" semi-finished bore
- 4.700" max bore
- 4-bolt steel main caps, 16° splayed-on center three mains
- Oil pan rails spread .400" per side for additional stroke clearance
- Tested to 1,400-plus horsepower!

25534406

DRCE 3 Bare Block, Compacted Graphite* (not shown)

- CNC-machined compacted graphite material 4-bolt block
- 9.250" deck height, can be machined to 9.000"
- Camshaft raised to 7.067"
- Cam tunnel accommodates (9) 60mm cam bearings
- Cam tunnel is closed (no oil drain to rotating assembly)
- 4.590" semi-finished bore
- 4.700" max bore
- 2.500" crankshaft main journal
- 4-bolt steel doweled-after-assembly main caps, 22° splayed-on center three mains
- Highest-available quality main studs
- Oil pan rails spread to 12"
- Oil and water plugs are AN O-ring-style
- Tested to 1,400-plus horsepower!

25534400 – Discontinued

DRCE 3 Bare Block, Compacted Graphite* (not shown)

- Same as P/N 25534406
- Cam tunnel accommodates (9) 70mm cam bearings
- Available until current inventory is depleted

*Compacted graphite is an extremely high strength material that helps the block combat bore distortion and crank deflection under heavy loads – like making 1,400-plus horsepower at 10,000 rpm!

BIG-BLOCK COMPONENTS

CYLINDER BLOCK COMPONENTS

A. 6264902

O-Ring Seal (sold individually)

- Use under the rear main bearing cap on all 1991-and-newer Gen V and Gen VI 454 and 502 engines

3859927

Outer Main Cap Bolt, Mark IV (not shown)

- Used with Mark IV (1965-1990) cast-iron Big-Blocks with 4-bolt mains
- Sold individually; order 10 per engine

B. 10106461

Inner Main Cap Bolt, Gen V and Gen VI

- Used with Gen V and Gen VI (1991-and-newer) Big-Blocks with 4-bolt mains
- Sold individually; order 10 per engine

3909834

Inner Main Cap Bolt, Mark IV (not shown)

- Used with Mark IV (1965-1990) cast-iron Big-Blocks with 4-bolt mains
- Sold individually; order 10 per engine

C. 88962212

Main Bearings, 572 Engine

- Complete main bearing kit for 572 block with standard-size mains

12480035

Cylinder Sleeve, standard (not shown)

- Steel cylinder sleeve for aluminum block P/N 12370850 and P/N 88958696
- Sleeve has 4.240" bore and finish-bores to 4.250"

3902885

Windage Tray Stud (not shown)

- Used for mounting splash shield P/N 3967854

10224104

Windage Tray Stud, Gen V 454 and 502 (not shown)

- Used with Gen V 454 and 502 engines

D. 88958656

Windage Tray Bolt, 572

- Used with 572 engines



A O-Ring Seal

B Inner Main Cap Bolt (Gen V and Gen VI)

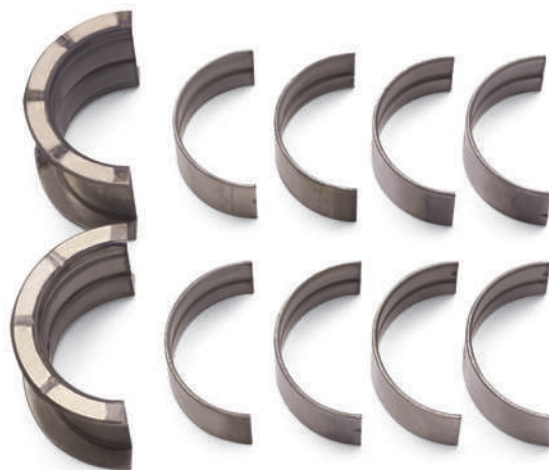

C Main Bearings, 572 Engine

FREEZE PLUGS AND OIL PLUGS

Part Number	Description	Quantity
03999200	Plug, Camshaft Bearing Hole	1
00444776	1/4 PTF Square Socket Plug	8
14090911	Plug, Water Outlet	1
08654382	1/8-27 NPTF 7/16 Head Plug	1
12558081	Pin, Cylinder Head Locating	4
1453658	Pin, Transmission	2



D Windage Tray Bolt, 572



Timing Chain Cover Gen V and Gen VI **E**



Big-Block Fuel Pump Block-Off Plate **F**

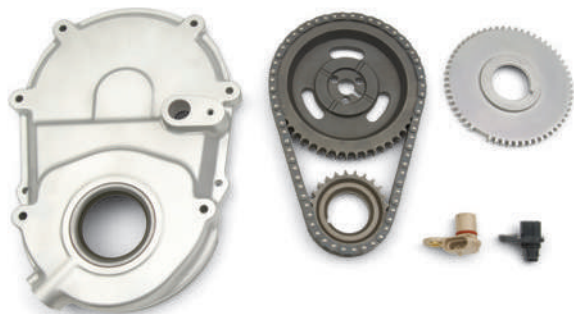

Big-Block Crank Trigger Ignition Conversion Kit **G**

FRONT COVERS, PLUGS AND BLOCK-OFF PLATES

E. 10230954

Timing Chain Cover, Gen V and VI

- Aluminum cover with timing indicator fits all 1996-and-newer Gen V and Gen VI engines
- Used on all Chevrolet Performance Big-Block crate engines

11609914

Front Oil Galley Plug (not shown)

- Fits front oil galley (cam tunnel) holes
- .030" oil squirter hole for cooling and lubricating the timing chain

F. 12341999

Big-Block Fuel Pump Block-Off Plate

- Plate has stamped Bowtie logo
- Special non-asbestos gasket included

G. 19260247

Big-Block Crank Trigger Ignition Conversion Kit

- Enables the use of the latest aftermarket electronic control systems
- 58x reluctor ring for installation on the front of the crankshaft timing gear
- 4x camshaft gear
- New design front cover with camshaft position and crankshaft position sensors
- Double-row timing chain for greater durability, stability and timing accuracy
- Requires aftermarket ignition controller capable of 58x signal (not included)
- Coil packs are not included

NOTE: Minor machining of the cylinder block and the damper is required.

! Timing Covers: Additional Required Components

Part Number	Bolts (Quantity)	Seals (Quantity)	Gasket (Quantity)	Engine Application
11562458	11562458 (6)	10191640 (1)	10198910 (1)	12498793, 12498777, 12498778, 12371054, 12498827, 12498792, 12498826, 24502620, 12568779, 12568778, 12499121, 19201332, 12371054, 88890534, 24502618, 12568774, 12371204, 12568782, 12497323, 12496963, 12371171, 19166392, 19166393

BUILDER'S TIP

VALVE-TO-PISTON CLEARANCE CONSIDERATIONS

A custom engine combination should always raise the concern of valve-to-piston clearance. And while camshaft lift is commonly thought of as the primary culprit of valve/piston interference, the overlap period – when the piston nears top-dead center and the intake valve is starting to open and the exhaust valve is closing – brings the valves and piston closest together. So, don't assume the gross lift specs are all you have to worry about; duration and lobe separation are equally important, making a careful clearance inspection all the more important.

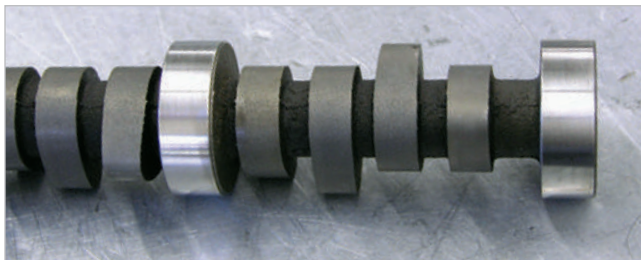

Big-Block Cylinder Heads: Quick Reference Chart

Part Number	Description	Casting Number	Material	Port Size	Port Type	Valve Angle	Chbr (cc)	Int Vlv (in)	Exh Vlv (in)	Ex Port	Plug Type	Heat Riser	Rocker Stud	Notes	Page Number
12562920	Gen V, VI BBC	12562934	Iron	325	Rect	BBC	118	2.180	1.880	Square	Std	yes	Screw-in	Ass'd 2925's	334
12562925	Gen V, VI BBC	12562934	Iron	325	Rect	BBC	118	2.180	1.880	Square	Std	yes	Screw-in	7/16 accy holes	334
12562926	Gen V, VI BBC	12562934	Iron	325	Rect	BBC	118	2.180	1.880	Square	Std	yes	Screw-in	3/8 accy holes	334
12562917	Gen V, VI BBC	12562932	Iron	—	Round	BBC	118	2.070	1.720	Square	Std	yes	Screw-in	HT 502 head	N/S
19331425	Oval alum	12363391	Alum	290	Oval	BBC	110	2.250	1.880	Square	Std	no	Screw-in	Semi-open, oval port	335
19331424	Oval alum	12363391	Alum	290	Oval	BBC	110	2.190	1.880	Square	Std	no	Screw-in	Semi-open, oval port	335
19331422	Oval alum	12363391	Alum	290	Oval	BBC	110	2.190	1.880	Square	Std	no	Screw-in	Bare 3392	335
19331427	NHRA L88	12363401	Alum	315	Rect	BBC	118	2.190	1.880	Square	Std	no	Screw-in	Bare, NHRA legal	336
19331428	Rect alum	12363401	Alum	300	Rect	BBC	118	2.250	1.880	Square	Std	no	Screw-in	Assembled	336
19331426	Rect alum	12363401	Alum	300	Rect	BBC	118	2.250	1.880	Square	Std	no	Screw-in	Bare 3400	336
12363425	BBC Bowtie	14044861	Alum	380	Rect	BBC	115	2.190	1.880	Square	Std	no	Screw-in	Bare, raised int/exh	337
19331429	572/620	—	Alum	310	Rect	BBC	118	2.250	1.880	Square	Std	no	Screw-in	ZZ572/620	337
19331430	572/720	—	Alum	310	Rect	BBC	118	2.250	1.880	Square	Std	no	Screw-in	ZZ572/720R	337
24502585	DRCE 2	—	Alum	—	Peanut	DRCE 2	—	—	—	DRCE	—	no	Shaft	Pro Stock-raw	338
25534404	DRCE 3	—	Alum	—	Peanut	DRCE 3	—	—	—	DRCE	—	no	Shaft	Pro Stock-raw	339

SERVICE REPLACEMENT HEADS

Chevrolet Performance service replacement cylinder heads are direct replacements on most 1990-and-later GM Big-Block 454-cubic-inch and 502-cubic-inch engines. These cylinder heads meet GM's stringent quality standards and provide excellent service and durability not found in used cylinder heads. The cylinder heads have rectangular intake ports.*

Service Replacement Head Technical Notes:

- Cast-iron
- Rectangular intake ports
- Machined for 2.180"/1.880" (3/8" stems) valves
- Non-adjustable rocker arm design
- Heads have heat risers
- Will not work on production Mark IV cylinder blocks

A. 12562925 ⓘ

Bare Cast-Iron Gen V and Gen VI Cylinder Head

- Bare cast-iron head
- 118cc combustion chambers
- 7/16" accessory bolt holes

12562926 ⓘ

Bare Cast-Iron Gen V and Gen VI Cylinder Head (not shown)

- Bare cast-iron head
- Machined for 2.180"/1.880" 3/8" stem valves
- 118cc combustion chambers
- 3/8" accessory bolt holes (otherwise identical to P/N 12562920)

12562920 ⓘ

Cast-Iron Gen V and Gen VI Cylinder Head Assembly (not shown)

- Cast-iron head
- Completely assembled with 2.180"/1.880" valves
- 118cc combustion chambers
- Uses P/N 12562925 bare casting

This head is assembled with the following components:

14097045**	Intake Valves	12550421	Valve Spring Retainer
14097049	Exhaust Valves	3947880	Valve Locks
14097002	Valve Springs	3875916	Valve Spring Shims

NOTE: Will not work on L29 engines.

*Rectangular intake ports are larger in volume and designed to enhance high-rpm horsepower. They are an ideal street head for those Big-Block enthusiasts who want more power from a street car that sees a lot of drag-strip action.

**Part not available



A Bare Cast-Iron Gen V and Gen VI Cylinder Head (exhaust)

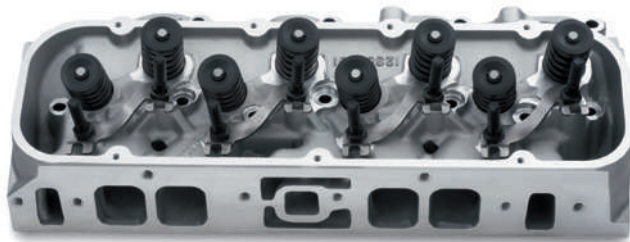
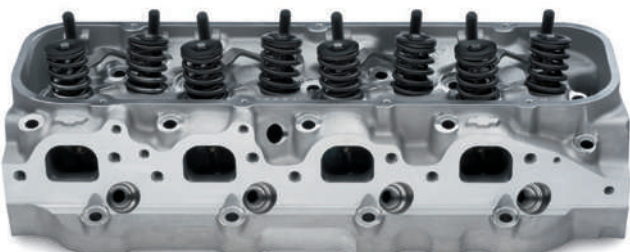

A Bare Cast-Iron Gen V and Gen VI Cylinder Head (intake)

Bare Cast-Iron Gen V and Gen VI Cylinder Head (combustion chamber) **A**Bowtie Oval-Port Aluminum Cylinder Head (intake) **B**Bowtie Oval-Port Aluminum Cylinder Head (exhaust) **B**Bowtie Oval-Port Aluminum Cylinder Head (combustion chamber) **B**

ALUMINUM BOWTIE STREET CYLINDER HEADS

Chevrolet Performance Bowtie high-performance street cylinder heads are an ideal combination of street drivability and drag-strip performance. They provide a broad power range with ample low-end torque, excellent throttle response, good mid-range torque and enough top-end power to beat your competitors to the finish line. Chevrolet Performance Bowtie street cylinder heads are designed for high-performance applications, with thick deck surfaces and high-velocity airflow passages. The heads are manufactured to precise machining tolerances.

Chevrolet Performance Bowtie street cylinder heads are available in either rectangular or oval intake port configurations. Rectangular intake ports are larger in volume and are designed to enhance high-rpm horsepower. These heads are best for vehicles that see frequent drag-strip action. Cylinder heads with oval intake ports are smaller in volume and are designed for greater low-rpm torque. Oval port heads are best for street applications where lots of bottom end, off-the-line power is desired.

Bowtie Street Cylinder Head Technical Notes:

- Made from 356-T6 aluminum
- Available in rectangular- or oval-port designs
- Will work on Mark IV and Gen V, VI blocks
- 9/16"-thick decks
- As-cast intake and exhaust ports
- No heat risers
- 1.55" valve spring seat diameter
- Heli-coiled 7/16" screw-in rocker stud holes
- Designed for use with 3/8" pushrods
- Use intake gasket P/N 12366985 and bolt kit P/N 12367959
- Use head gasket P/N 12363414 for bores to 4.370" and P/N 12363413 for bores 4.470" to 4.540" (Mark IV)
- Use head gasket P/N 12363412 for bores to 4.370" and P/N 12363411 for bores 4.470" to 4.540" (Gen V, VI)
- Use head bolt kit P/N 12367779

Oval Port Heads

19331422 ⓘ

Bowtie Oval-Port Aluminum Cylinder Head, Bare (not shown)

- Fully machined
- Semi-finished for 2.190"/1.880" valves
- Bronze guides can be finished to 11/32" or 3/8"
- 290cc high-velocity oval intake ports
- 110cc exhaust ports
- 110cc semi-open combustion chambers

B. 19331424 ⓘ

Bowtie Oval-Port Aluminum Cylinder Head Assembly

- Completely assembled with 2.190"/1.880" 11/32" stem valves
- 290cc oval intake ports
- 110cc exhaust ports
- 110cc combustion chambers

This head is assembled with the following components:

12366986	2.190" Intake Valves	3875916	Valve Spring Shims
12366988	1.880" Exhaust Valves	3860038	Pushrod Guideplates
12462970	Valve Springs	3921912	Rocker Arm Studs

19331425 ⓘ

Bowtie Oval-Port Aluminum Cylinder Head Assembly (not shown)

- Completely assembled with 2.250"/1.880" 11/32" stem valves
- 290cc oval intake ports
- 110cc exhaust ports
- 110cc combustion chambers

This head is assembled with the following components:

12366987	2.250" Intake Valves	3875916	Valve Spring Shims
12366988	1.880" Exhaust Valves	3860038	Pushrod Guideplates
12462970	Valve Springs	3921912	Rocker Arm Studs

Bowtie Street Heads *continued*

19331427

Bowtie Rectangular-Port Aluminum Bare Cylinder Head (not shown)

This NHRA-legal aluminum cylinder head is a replacement for the L88 Big-Block cylinder heads used on 1968-1971 Corvettes and 1969 Camaros.

- Aluminum performance cylinder head
- 315cc rectangular intake ports
- Replacement head for P/N 14011076
- Machined for 2.250"/1.880" 11/32" valve stems
- 110cc exhaust ports
- 118cc combustion chambers

19331426

Bowtie Rectangular-Port Aluminum Bare Cylinder Head (not shown)

- Bare aluminum performance head
- Machined for 2.250"/1.880" valves
- 300cc rectangular intake port
- 110cc exhaust port
- 118cc combustion chamber

A. 19331428

Bowtie Rectangular-Port Aluminum Cylinder Head Assembly

- Aluminum performance head
- Completely assembled with 2.250"/1.880" 11/32" stem valves
- 300cc rectangular intake port
- 110cc exhaust port
- 118cc combustion chamber
- Uses bare head P/N 19331426

This head is assembled with the following components:

12366987	2.250" Intake Valves	3875916	Valve Spring Shims
12366988	1.880" Exhaust Valves	3860038	Pushrod Guideplates
12462970	Valve Springs	3921912	Rocker Arm Studs



A Bowtie Rectangular-Port Aluminum Cylinder Head Assembly (intake)

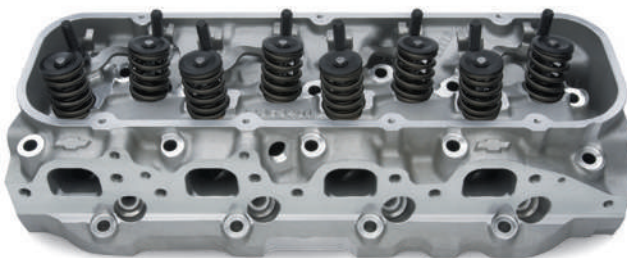

A Bowtie Rectangular-Port Aluminum Cylinder Head Assembly (exhaust)



A Bowtie Rectangular-Port Aluminum Cylinder Head Assembly (combustion chamber)



Bowtie 572/620 Cylinder Head Assembly **B**

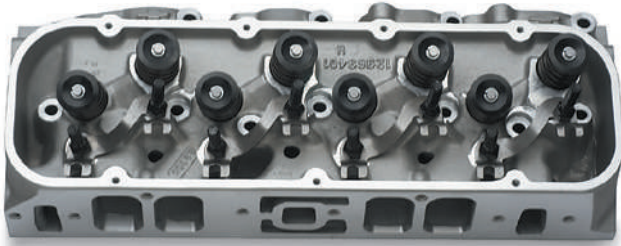

Bowtie 572/620 Cylinder Head Assembly (intake) **B**



Bowtie 572/620 Cylinder Head Assembly (exhaust) **B**



Bowtie 572/620 Cylinder Head Assembly (combustion chamber) **B**

B. 19331429 ⓘ

Bowtie 572/620 Cylinder Head Assembly

- Aluminum head assembly
- Used in the 572/620 Chevrolet Performance crate engine
- Completely assembled with 2.250"/1.880" 11/32" stem valves
- Valve springs for hydraulic roller cams for up to .632" lift
- 310cc rectangular intake port
- 118cc exhaust port – raised 5/8"
- 118cc combustion chamber
- Not recommended for engines smaller than 572 cid

This head is assembled with the following components:

12366987	2.250" Intake Valves	88963935	Valve Spring Locators
88963128	1.880" Exhaust Valves	88963936	Valve Seals
88963934	Valve Springs	3921912	Rocker Arm Studs
88963937	Valve Spring Shims	3860038	Pushrod Guideplates

19331430 ⓘ

Bowtie 572/720R Cylinder Head Assembly (not shown)

- Aluminum racing head assembly
- Used in the 572/720R Chevrolet Performance crate engine
- Completely assembled with 2.250"/1.880" 11/32" stem valves
- Mechanical roller valve springs – not for use with hydraulic roller cams
- Good to .720" valve lift
- 310cc rectangular intake port
- 118cc exhaust port – raised 5/8"
- 118cc combustion chamber
- Not recommended for engines smaller than 572 cid

This head is assembled with the following components:

12366987	2.250" Intake Valves	88963935	Valve Spring Locators
88963128	1.880" Exhaust Valves	88963936	Valve Seals
19172596	Valve Springs	3921912	Rocker Arm Studs
88963937	Valve Spring Shims	3860038	Pushrod Guideplates

BOWTIE RACE CYLINDER HEADS

Monster-cubic-inch stroker Big-Blocks need lots of air to maximize their performance potential and Chevrolet Performance Bowtie race cylinder heads are designed for that task. They are made of 356-T6 aluminum with huge, raised intake ports, larger valves, smaller combustion chambers and two additional head bolts for increased clamping force. The runners are purposely left smaller, so there is ample room for custom porting by the engine builder.

Bowtie Race Head Technical Notes:

- 356-T6 Aluminum
- 9/16" thick decks
- No heat risers
- Will work on Mark IV cylinder block
- Heli-coiled 7/16" screw-in rocker stud holes
- As-cast intake and exhaust ports

12363425

Bowtie Racing Cylinder Head (not shown)

- Aluminum racing head
- Machined for 2.190"/1.880" valves (+.400" long required)
- 380cc rectangular intake ports – raised .100"
- 110cc exhaust port – raised .750", vanes in port floor ("W" port)
- 115cc "open chamber" combustion chamber
- Rocker cover rails raised .250"
- Two additional head bolt holes in valley
- Pushrod guide plates P/N 3860038 must be ground for clearance

DRCE PRO STOCK CYLINDER HEADS

Chevrolet Performance DRCE (Drag Racing Competition Engine) Pro Stock cylinder heads are the choice of NHRA Pro Stock champions, so you know these are the best heads available. When races are won by thousandths of a second there's no room for second-best parts. The Chevrolet Performance DRCE aluminum cylinder heads were specifically designed for the DRCE 2 engine block P/N 24502572 and intended for NHRA Drag Racing Pro Stock competition applications.

Special features of these heads include high-capacity water jackets, symmetrical-port layout, ample wall material for custom porting, thick deck surfaces (7/8") to facilitate angle milling and reduced weight casting to minimize CNC-machining time. A typical CNC-prepped cylinder head without valves or valvetrain weighs approximately 40 pounds.

DRCE Pro Stock Race Cylinder Head Technical Notes:

- T355-T7M aluminum construction
- Complies with NHRA Pro Stock 500-cid, 4.900" bore spacing rules
- Symmetrical intake port layout
- Intake and exhaust ports are extremely small "peanut ports"
- 7/8" thick decks allow for angle milling or heavy flat milling
- Requires professional porting and machining
- High-capacity self-purging water jackets
- Custom aftermarket rocker arm assemblies required

A. 24502585

DRCE 2 Raw Aluminum Cylinder Head

- Raw aluminum casting, not machined
- Accommodates 10°–14° x 5° intake and 5°–9° x 2.5° exhaust valve angles
- Designed to work on DRCE 2 block P/N 24502572



A DRCE 2 Raw Aluminum Cylinder Head (exhaust)

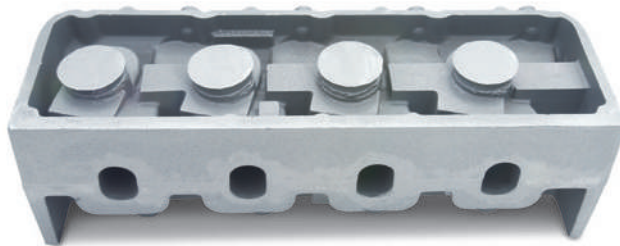

A DRCE 2 Raw Aluminum Cylinder Head (intake)



A DRCE 2 Raw Aluminum Cylinder Head (combustion chamber)

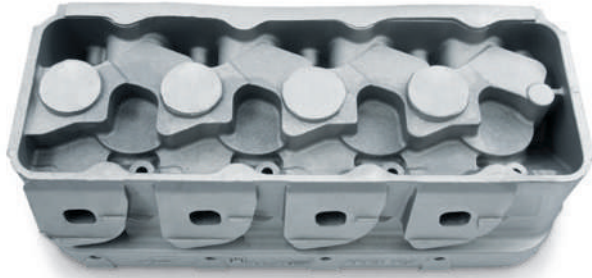

DRCE 3 Aluminum Cylinder Head Casting (exhaust) **B**

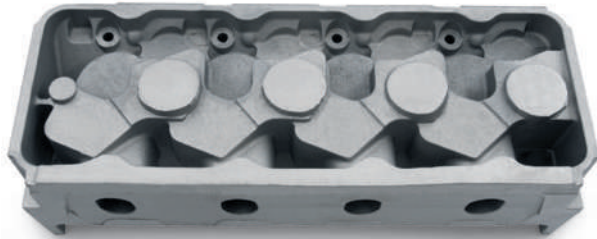

DRCE 3 Aluminum Cylinder Head Casting (intake) **B**

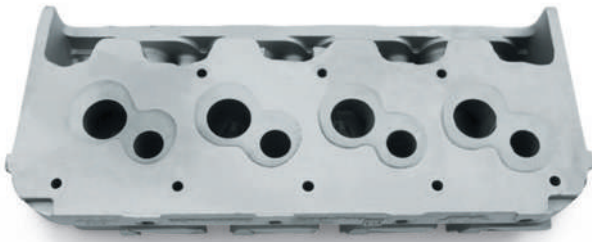

DRCE 3 Aluminum Cylinder Head Casting (combustion chamber) **B**

B. 25534404

DRCE 3 Aluminum Cylinder Head Casting

- Raw aluminum casting, not machined
- Newest design DRCE – rocker arm mounting pads and valve spring seat pads allow greater flexibility with valve angles and locations than DRCE 2
- Designed to work on DRCE 3 block and DRCE 2 P/N 24502572

25534387

DRCE 3 Water Jacket Plug (not shown)

- For ends of DRCE 3 cylinder head casting P/N 25534404
- Aluminum AN -16 with internal hex for Allen wrench
- Includes O-ring
- Sold individually; use 2 per head

25534388

DRCE 3 Water Jacket Plug (not shown)

- For water jacket access holes of DRCE 3 cylinder head casting P/N 25534404
- Aluminum AN -08 with internal hex for Allen wrench
- Includes O-ring
- Sold individually; use 8 per head



Cylinder Heads: Additional Required Components

Part Number	Gaskets (Quantity)	Bolts (Quantity)	Spark Plug	Engine Application
12562920	14097001 (2) OR 12555728 (2)	10141204 (24), 10141205 (8)	19157985	24502620, 12568778, 24502618, 12568774
12562926	14097001 (2) OR 12555728 (2)	10141204 (24), 10141205 (8)	19157985	24502620, 12568778, 24502618, 12568774
12562925	14097001 (2) OR 12555728 (2)	10141204 (24), 10141205 (8)	19157985	24502620, 12568778, 24502618, 12568774
19331425	12363411 (2)	12367779 (1 Kit)	19307141	12499121, 19201332, 12371204, 12497323, 12496963, 12371171, 19331579, 19331578, 19331576
19331424	12555728 (2)	88960333 (16), 88960334 (8)	19307141	12498777
19331422	12555728 (2)	88960333 (16), 88960334 (8)	19307141	12498777, 19331574
19331430	88961561 (2)	88960333 (16), 88960334 (8)	19302733	12498827, 12498826, 19201334, 19331585
19331429	88961561 (2)	88960333 (16), 88960334 (8)	19302731	12498792, 19331581

CYLINDER HEAD GASKETS

Secure sealing between the cylinder heads and the block is a critical component of making reliable horsepower, so Chevrolet Performance puts the same engineering excellence and manufacturing precision into their gaskets, head bolts, and cylinder head studs as the blocks and heads they secure. Big-Block cylinder head gaskets are available in a variety of materials and thicknesses. Piston-to-head clearances should be considered when selecting gaskets. Use Gen V for 1991-1992 applications. Gasket packages contain one gasket unless otherwise specified.

A. 12363414

Composition Head Gasket, 1965-1990

- With pre-flattened copper wire ring and permatorque/blue stripe coating for engines with aluminum heads
- Bore sizes between 4.250" and 4.370"
- Use with Mark IV (1965-1990) engines only
- Compressed thickness is 0.039"

12363412

Composition Head Gasket, 1991-newer (not shown)

- For 1991-and-newer Gen V and Gen VI Big-Blocks with aluminum heads and 4.250" to 4.370" bore size
- Has pre-flattened wire ring and stainless core which makes it ideal for saltwater marine use
- Compressed thickness is 0.039"

12555728

Head Gasket, 454 Engine (not shown)

- Head gasket for 1991-2000 Gen V 454 Big-Blocks

B. 12366984

Head Gasket Kit, 502 Engine

- For all Gen V and Gen VI 502 Big-Blocks with cast-iron heads
- Has additional water hole for improved cooling of siamesed cylinder walls
- Includes 2 gaskets (right and left) per package
- Compressed thickness is 0.041"

12363411

Composition Head Gasket, 1991-newer (not shown)

- For Gen V and Gen VI Big-Blocks with aluminum heads and 4.375" to 4.540" bore size
- Has pre-flattened wire ring and stainless core which makes it ideal for saltwater marine use
- Compressed thickness is 0.039"

C. 88961561

Head Gasket, 572 Engine

- With pre-flattened wire ring for all 572 Big-Blocks with either cast-iron or aluminum heads
- Compressed thickness is 0.030"

HEAD BOLTS AND STUDS

12367779

Cylinder Head Bolt Kit (not shown)

- Universal kit for cast-iron and aluminum Big-Block heads
- Includes (8) 7/16-14 x 2.08" bolts P/N 88960334, (24) 7/16-14 x 4.060" bolts P/N 88960333, (8) 7/16-14 x 5.06" bolts P/N 88960332, and (40) hardened washers P/N 14011040
- Use part numbers above for replacement parts
- Use thread sealant on all Big-Blocks except 502, due to blind bolt holes



A Composition Head Gasket (1965-1990)

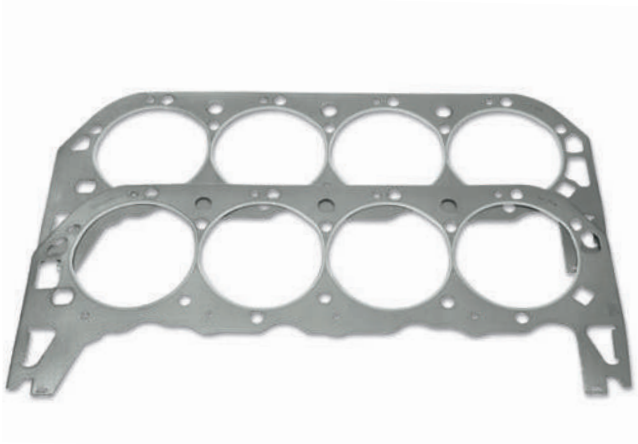

B Head Gasket Kit, 502 Engine



C Head Gasket, 572 Engine

Intake Valve, 2.250" **D**Exhaust Valve, 1.880" **E**Big-Block Dual Valve Spring, 1.540" **F**

BIG-BLOCK VALVES

Intake Valves

12556317 (not shown)

- Valve Size: 2.190" / Stem Size: 3/8"
- Stock replacement valve for Gen V and Gen VI 454 and 502 HO engines.

12366986 (not shown)

- Valve Size: 2.190" / Stem Size: 11/32"
- Stainless-steel valve with undercut chrome-plated stems, single-groove design, hardened tips
- Used on ZZ454, ZZ427 and the Anniversary Edition 427 crate engines.

D. 12366987

- Valve Size: 2.250" / Stem Size: 11/32"
- Stainless-steel valve with undercut chrome-plated stems, single-groove design, hardened tips
- Used on ZZ502 and ZZ572

Exhaust Valves

14097049 (not shown)

- Valve Size: 1.880" / Stem Size: 3/8"
- Stock replacement valve for Gen V and Gen VI 454 and 502 HO engines.

12366988 (not shown)

- Valve Size: 1.880" / Stem Size: 11/32"
- Stainless-steel valve with undercut chrome-plated stems, single-groove design, hardened tips
- Used on ZZ454, ZZ427 and the Anniversary Edition 427 crate engines.

E. 88963128

- Valve Size: 1.880" / Stem Size: 11/32"
- Stainless-steel valve with undercut chrome-plated stems, single-groove design, hardened tips
- Used on ZZ502 and ZZ572

BIG-BLOCK VALVE SPRINGS

F. 88963934

Dual Spring

- Outside Diameter: 1.540"
- Pressure Installed at Height: 197# @1.800"
- Retainer P/N 12366990
- Valve Seal Kit P/N 88963936
- Used with 572/620 HP engines
- 1 Valve spring, order 16 per engine

19172596

Dual Spring (not shown)

- Outside Diameter: 1.567"
- Pressure Installed at Height: 230# @2.000"
- Retainer P/N 12366990
- Valve Seal Kit P/N 88963936
- Used with 572/720 HP engines
- 1 Valve spring, order 16 per engine

Valve Spring Retainer



Valve Spring Key



VALVE SPRING COMPONENTS

Part Number	Description	Technical Notes
12550421	Valve Spring Retainer	For 1991-and-newer Gen V and Gen VI engines
3947880	Valve Spring Key	Hardened steel split locks for production and racing engines. Color-coded purple. Sold individually, order 32 per engine
12550422	Valve Stem Seal (not shown)	Seal for 1991-and-newer Gen V and Gen VI engines. The valve guide boss must be machined slightly for seal to retain clearance when using high-lift cams
88963936	Valve Spring Seal (not shown)	Use with all 572 engines
3875916	Spring Shim (not shown)	55/64" I.D. x 1 31/64" O.D. x 0.015" thick
88963937	Spring Shim (not shown)	Shim for all 572 engines
88963935	Valve Spring Locator (not shown)	Valve spring locator for setting the valve spring in the right location on all 572 engines



Roller Rocker Arm Set, 1.7:1 Ratio

ROCKER ARMS

Steel Rocker Arms – Steel rocker arms are designed for long-term durability. Chevrolet Performance steel rocker arms are intended for 454- and 502-cubic-inch Big-Blocks. Rocker arm kits include one rocker arm and ball.

Aluminum Roller Big-Block Rocker Arm for 7/16" Studs – Chevrolet Performance aluminum roller rocker arms have bearings and fulcrums with an extra-wide design for improved load distribution. The rockers are lubricated with pressurized oil. The rockers have a 1.7:1 ratio for 7/16" studs. The roller-tip axle is made from 4130 steel and the roller tip is machined and ground from 8620 steel.

NOTE: Not for use with production-height valve covers.

Part Number	Description	Technical Notes
19260993	Steel Rocker Arm Assembly (not shown) (Net Lash Design)	Designed for use on Gen V and Gen VI design 454- and 502-cubic-inch HO engines. The rocker arms have long slots for high-lift camshafts. NOTE: Kit includes rocker arm and ball. One rocker assembly per package; order 16 per engine.
19355321	L-18 Design Steel Long-Slot Rocker Arm, 1.7:1 Ratio (not shown)	These 1.7:1 ratio hardened steel rocker arms have elongated slots to provide extra clearance for high-lift (.600" and greater) camshafts. Use with all 396-502 Big-Block heads with adjustable rockers. Each assembly includes rocker arm as well as the ball and nut. NOTE: Can be used on any Gen V or Gen VI by using rocker stud P/N 12368941. Will not work with ZZ502 valve covers.
19210726	Aluminum Roller Rocker Arm Set, 1.7:1 Ratio	Set includes 16 roller rocker arms and nuts for 7/16" studs. Used on 572-cubic-inch Big-Block engines. Use P/N 19244484 for single replacement part



Intake Pushrod, Roller Lifter Style

PUSHRODS

Chevrolet Performance offers a complete line of premium-quality, heavy-duty pushrods for most GM Big-Block engines. Pushrods are that critical link between the camshaft and the rocker arms. These seemingly innocuous parts play a very important role in the combustion process. Two materials are used: 1010 mild steel for high-performance street cars, power boats, and limited competition applications, and 4130 chrome-moly steel for maximum-performance racing engines. Chevrolet Performance pushrods are case-hardened for use with pushrod guideplates. Pushrods are available in standard and extended lengths. Check the usage chart below to verify proper applications.

Part Number	Material	Diameter	Length	Usage	Port	Description
10227762	1010 steel	3/8"	7.592"	Hyd. roller	Intake	(1) heavy-duty heat-treated .060" for use in Gen VI 454 and 502 engines with hydraulic roller lifters
10227763	1010 steel	3/8"	8.569"	Hyd. roller	Exhaust	(1) heavy-duty heat-treated .060" for use in Gen VI 454 and 502 engines with hydraulic roller lifters
12368081	1010 steel	3/8"	7.592"–8.569"	Hyd. roller	—	Kit of (8) P/N 10227762 and (8) P/N 10227763
88961559	4130 steel	3/8"	7.900"	Hyd. roller	Intake	Chrome-moly 1-piece for 572/620 (Tall Deck Block)
88961558	4130 steel	3/8"	8.900"	Hyd. roller	Exhaust	Chrome-moly 1-piece for 572/620 (Tall Deck Block)
88962284	4130 steel	3/8"	8.550"	Mech. roller	Intake	Chrome-moly 1-piece for 572/720 (Tall Deck Block) for engines built May 2010 or prior
88962283	4130 steel	3/8"	9.525"	Mech. roller	Exhaust	Chrome-moly 1-piece for 572/720 (Tall Deck Block) for engines built May 2010 or prior
19330131	4130 steel	3/8"	9.750"	Mech. roller	Exhaust	Chrome-moly 1-piece for 572/720 (Tall Deck Block) built after May 2010
19330132	4130 steel	3/8"	8.750"	Mech. roller	Intake	Chrome-moly 1-piece for 572/720 (Tall Deck Block) built after May 2010



BUILDER'S TIP

SHIMMING THE WAY TO CORRECT VALVE SPRING HEIGHT

The correct valve spring height is important to prevent coil bind and ensure uniform spring pressure among all the valves. Don't assume the installed height (with the valve closed) is correct out of the box. Each spring's height should be carefully measured and recorded. Shims – typically sold in 0.015" heights – can be used to bring the springs to the manufacturer's specifications. The important thing about installing them is to be sure that they go beneath the spring seat. Don't simply slip them on over the top of the spring seat. With 16 valve springs to measure, it's a long, tedious process, but an important one for performance and engine longevity.

VALVE COVERS

Top off your high-performance Big-Block with a pair of handsome Chevrolet Performance valve covers. These stylish, precision-fit valve covers come in a variety of finishes and colors. They're made out of die-cast aluminum or heavy-gauge stamped steel. Quality construction methods provide better sealing and less chance of leakage from deflection caused by over-tightened fasteners. Competition valve covers are designed to clear taller valvetrains.

NOTE: Valve covers are sold in pairs unless otherwise specified.

A. 12342093 ⓘ

Short Chrome Bowtie Valve Covers

- Show-quality covers embossed with the famous Bowtie logo and Chevrolet name
- Standard height, for use with 1965-1994 engines
- May not clear brake booster on some Corvette models

B. 12495488 ⓘ

Custom Aluminum Valve Covers

- Die-cast aluminum valve covers are black with a brushed aluminum finish on top revealing the Chevrolet name and Bowtie logo
- Can be finished with a custom engine designation badge (see page 346) not included
- For use on 1965-1994 engines
- Includes 2 covers, 1 grommet P/N 10198941, 1 grommet P/N 10198949, oil cap P/N 15681150 and 14 retaining bolts

C. 12371244 ⓘ

Aluminum Competition Design Valve Covers

- Display the Chevrolet name and Bowtie logo in natural aluminum finish, or paint to match engine or vehicle color
- No holes for PCV or oil fill, but bosses for drilling them
- Can be used on most Big-Block Chevrolet cylinder heads
- Use P/N 12370836 for single replacement part

NOTE: Use with valve cover gasket P/N 14085759.

D. 25534323 ⓘ

Aluminum Competition Design Valve Covers, Black Powder-Coat

- Display the Chevrolet name and Bowtie logo in black powder-coated covers
- No holes for PCV or oil fill, but bosses for drilling them
- Can be used on most Big-Block Chevrolet cylinder heads

NOTE: Use with valve cover gasket P/N 14085759.

E. 25534374 ⓘ

Aluminum Competition Design Valve Covers, Orange Powder-Coat

- Display the Chevrolet name and Bowtie logo in orange powder-coated covers
- One hole each cover for PCV or oil fill
- Can be used on most Big-Block Chevrolet cylinder heads

NOTE: Use with valve cover gasket P/N 14085759.



A Short Chrome Bowtie Valve Covers



B Custom Aluminum Valve Covers (shown with badge)



C Aluminum Competition Design Valve Covers



D Aluminum Competition Design Valve Covers, Black Powder-Coat



E Aluminum Competition Design Valve Covers, Orange Powder-Coat



Valve Covers, "572 Chevrolet" **F**



Valve Covers, "427 Chevrolet", Natural Appearance **G**



Valve Covers, "427 Chevrolet", Black Powder-Coat **H**

F. 12499200 ⓘ

Valve Covers, "572 Chevrolet"

- Used on all 572-cubic-inch crate engines and can be used on most Big-Blocks
- Cast aluminum with "572 Chevrolet" as part of the casting
- One cover has oil fill and breather holes and the second cover has the breather hole only

NOTE: Requires push-in oil cap P/N 12341993, breather P/N 25534355 and breather tube P/N 88962074 that incorporates a baffle in the tube.

G. 19202588 ⓘ

Valve Covers, "427 Chevrolet", Natural Appearance

- Natural finish
- Used on the Anniversary Edition 427 crate engine
- Can be used on any Big-Block engine

H. 19202589 ⓘ

Valve Covers, "427 Chevrolet", Black Powder-Coat

- Used on the ZZ427/480 crate engine
- Can be used on any Big-Block engine



Valve Covers: Additional Required Components

Part Number	Gaskets (Qty)	Bolts (Qty)	Grommets (Qty)	Oil Fillers (Qty)	Engine Application
12342093	14085759 (2)	88961871 (4)	12341988 (1)	12341993 (1)	12499121, 19201332, 12371204, 12497323, 12496963, 12371171, 19331579, 19331578, 19331576, Mark IV, V, VI BB
12495488	14085759 (2), OR Mark IV, V, VI (2)	25520079	10198941 OR 3989350	15681150	12499121, 19201332, 12371204, 12497323, 12496963, 12371171, 19331579, 19331578, 19331576, Mark IV, V, VI BB
12371244	14085759 (2)	88961871 (4)	N/A	12341993 (1)	12498793, 12498827, 12498792, 12498826, 19201333, 19201334, 19311581
25534323	14085759 (2)	88961871 (4)	N/A	12341993 (1)	12498793, 12498827, 12498792, 12498826, 19201333, 19201334, 19311581
25534374	14085759 (2)	88961871 (4)	N/A	12341993 (1)	12498793, 12498827, 12498792, 12498826, 19201333, 19201334, 19311581
12499200	14085759 (2)	88961871 (4)	12341988 (1)	12341993 (1)	12498793, 12498827, 12498792, 12498826, 19201333, 19201334, 19311581
19202588	14085759 (2)	88961871 (4)	12341988 (1)	12341993 (1)	12498793, 12498827, 12498792, 12498826, 19201333, 19201334, 19311581
19202589	14085759 (2)	88961871 (4)	12341988 (1)	12341993 (1)	12498793, 12498827, 12498792, 12498826, 19201333, 19201334, 19311581



Additional components required for installation.



HARDWARE AND BREATHERS

88962074

Oil Baffle Tube (not shown)

- Pushes easily into most valve covers that have an oil baffle
- Requires breather P/N 25534355, used on ZZ572 engines

A. 25534355

ZZ572 Breather

- Special breathers for the ZZ572 valve covers
- Chrome breathers are 1-3/8", hose-clamp-style with the Bowtie logo on top
- Use with oil baffle tube P/N 88962074
- Includes 2 breathers



A ZZ572 Breather

B. 12341993

Push-In Oil Filler Cap

- For valve covers with 1.220" hole

19131218

Chrome Push-In Breather (not shown)

- 2-3/4" O.D. x 1-1/2" tall with 3/4" nipple
- Use with rubber grommet P/N 3894337



B Push-In Oil Filler Cap

3894337

Rubber Grommet, Bowtie Valve Covers (not shown)

- Has 15/16" I.D. x 17/32" O.D.
- Can be used to plug the oil filler hole in Bowtie valve covers or to mount a push-in breather

14085759

Valve Cover Gasket (not shown)

- Steel-reinforced gasket fits all Big-Block Chevy valve covers
- Order 2 per engine

VALVE COVER BADGES

Designed to fit mounting area on valve covers P/N 12495488 (see page 344), these good-looking badges will fit some other Big-Block valve covers.

NOTE: 1 badge per package. Order 2 per engine.

C. 19355535

Valve Cover Badge, "454"

19355536

Valve Cover Badge, "502"



C Valve Cover Badges

ROCKER ARM STUDS AND ACCESSORIES

D. 3896648

Rocker Adjusting Nut

- Positive locking 7/16"-20 nut for all Big-Block V-8s

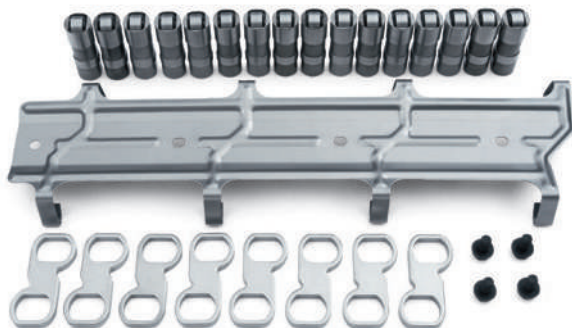

D Rocker Adjusting Nut

Pushrod Guide Plate (3/8") **E**Hydraulic Lifter Kit **F**Hydraulic Roller Lifter Installation Kit **G**Mechanical Roller Lifter, ZZ572/720R **H**

BIG-BLOCK GUIDE PLATES

E. 3860038

Pushrod Guide Plate, 3/8"

- Designed for all 1965-1990 iron and aluminum cylinder heads with 3/8" diameter pushrods
- Slotted style with hardened steel construction, aligns rocker arms with valve stem tips on Big-Block's splayed-valve head
- 8 required for each engine

NOTE: Use with screw-in rocker stud P/N 3921912.

3879620

Pushrod Guide Plate, 7/16" (not shown)

- Similar to guide plate described above, but for use with heavy-duty 7/16" diameter pushrods

12562369

Pushrod Guide Plate (Gen V 454/502 style)(not shown)

- Used on all Gen V 454 and 502 engines with 3/8" diameter pushrods

VALVE LIFTERS AND COMPONENTS

F. 12371044

Hydraulic Lifter Kit, set of 16

- For use on all 396, 427, 454, and 502 engines that use hydraulic flat tappet lifters
- For single-service replacement use P/N 5232720

17120060

Hydraulic Roller Lifter, ZZ572/620 (not shown)

- Roller valve lifters used on the ZZ572/620 engines
- Use with camshaft P/N 19210721, intake pushrod P/N 88961559, exhaust pushrod P/N 88961558 and rocker arm P/N 19210726

G. 12371056

Hydraulic Roller Lifter Installation Kit

- Hydraulic roller lifter retainer kit can be used on all Gen VI 454 and 502 engines that are machined for hydraulic roller lifters
- Includes 16 roller lifters P/N 17120061, 8 lifter guides, 1 lifter guide retainer and 4 retainer bolts
- For single-service replacement lifter, use P/N 17120061

NOTE: These lifters allow more oil to the rocker arms than the late-model truck roller lifters.

H. 19356323

Mechanical Roller Lifter, ZZ572/720R

- Mechanical roller valve lifters used on the ZZ572/720R engines
- Use with camshaft P/N 19210722, intake pushrod P/N 88962284, exhaust pushrod P/N 88962283 and rocker arm P/N 19210726
- Kit of 16 lifters

12551397

Roller Tappet Guides (not shown)

- Roller tappet guides used with all 502 engines and 454 HO engines
- Used with roller camshaft engines
- Sold individually; order 8 per engine

12551399

Roller Tappet Guide Retainer (not shown)

- Roller tappet guide retainer used with all 502 engines and 454 HO engines
- Used with roller camshaft engines
- Order only 1 per engine



BIG-BLOCK CAMSHAFTS

The camshaft is one of the most important factors in determining an engine's overall performance profile and capability. The wide array of precision-engineered, extensively tested camshafts from Chevrolet Performance allows you to choose the best cam for your application. In order to avoid possible engine damage, a distributor with a melonized steel gear must be used with steel camshafts.

Part Number	Description	Duration @ .050" Lift (deg)	Maximum Lift (in)	Lobe Centerline (deg)	Technical Notes
12366543	Steel hydraulic roller	I: 224 / E: 234	I: .527 / E: .544	110	For 502/502 special engine. Must use distributor gear P/N 10456413
24502611	Steel hydraulic roller	I: 211 / E: 230	I: .510 / E: .540	112	For 454 and 502 HO engines. Must use distributor gear P/N 10456413
19210721	Steel hydraulic roller	I: 254 / E: 264	I: .632 / E: .632	112	For ZZ572/620 engine
19210722	Steel hydraulic roller	I: 278 / E: 282	I: .714 / E: .714	112	For ZZ572/720 engine

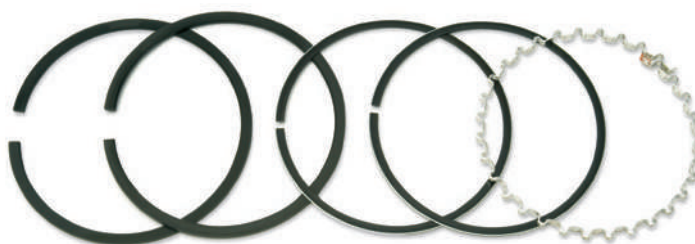

PISTONS AND PISTON RINGS

Pistons and rings operate in a very explosive environment, so they have to be extremely tough. Chevrolet Performance pistons and rings are designed to withstand the rigors of high-performance engines. The pistons are factory-tested for quality assurance. Chevrolet Performance pistons are sold in a variety of sizes and compression ratios. There are pistons for GM Big-Block engines ranging in displacement from 427 cubic inches to 572 cubic inches. Pistons are sold individually and are fitted with wrist pins.

NOTE: Part numbers are for one piston; order eight per engine.

Big-Block Pistons

Part Number	Engine Size	Bore Size	Oversize	Rod Length	Pin Type	Compression Ratio	Chamber Size	Ring Size	Description
12533507	502	4.470"	—	6.135"	Pressed	8.75:1	118cc	5/64", 1/16", 3/16"	Forged Gen V and Gen VI 502 replacement
88962925	572	4.560"	—	6.535"	Floating	9.6:1	118cc	1/16", 1/16", 3/16"	Forged 572/620
88963227	572	4.560"	—	6.535"	Floating	12.0:1	118cc	1/16", 1/16", 3/16"	Forged 572/720R

Big-Block Piston Rings

Part Number	Bore Size	Oversize	Ring Thickness	Description
12523921	4.250"	Standard	5/64", 5/64", 3/16"	Standard-size ring pack for Gen V 454 HO
12524293	4.470"	Standard	5/64", 1/16", 3/16"	Standard-size low-tension ring pack for all 502 engines
12524294	4.470"	+ .030"	5/64", 1/16", 3/16"	Oversize low-tension ring pack for all 502 engines
12499212	4.560"	Standard	1/16", 1/16", 3/16"	Standard-size ring pack for 572 engines

Camshaft Bearings, 572 Engine **A**Forged Steel Connecting Rod **B**572 Connecting Rod **C**572 Connecting Rod Bearing Kit **D**

CAMSHAFT COMPONENTS

A. 12499434

Camshaft Bearings, 572 Engine

- Five standard-size premium camshaft bearings for the ZZ572 engine

CONNECTING RODS AND COMPONENTS

B. 19170198

Forged Steel Connecting Rod

- Magnafluxed 4340 steel with heavy-duty 7/16" bolts
- Machined for pressed piston pins and color-coded white
- Used in Gen V 454 and 502 engines
- 6.135" c-c length

19211226

427 Forged Connecting Rod (not shown)

- 4340 Steel with 7/16" heavy duty bolts
- Machined for pressed piston pins
- Used in 427 Anniversary and ZZ427 engines
- Big end chamfered for large crank pin radius
- 6.135" c-c length

C. 88962926

572 Connecting Rod

- Forged 4340 steel H-beam for all 572 engines
- 6.535" c-c length
- Use rod bearing P/N 88961556

D. 88961556

572 Connecting Rod Bearing Kit

- Standard-size, premium connecting rod bearings
- Includes all 8 rod bearing sets



Crankshaft, Forged Steel (Gen V and Gen VI 502)

CRANKSHAFTS

Crankshafts are a critical, central component of any engine. Strength and durability are important traits of a great crankshaft. Chevrolet Performance crankshafts are precision-engineered to be both strong and durable. Chevrolet Performance understands how catastrophic crankshaft failure can be, so that's why our crankshafts are manufactured to such exacting specifications and tested to withstand the forces of high-performance engines. These crankshafts are the same tough parts used in Chevrolet Performance crate engines.

Part Number	Description	Technical Notes
14096983	Crankshaft, Forged Steel (Gen V and Gen VI 454) (not shown)	Externally balanced. Forged 1053 steel crankshaft with 1-piece rear main seal
10183723	Crankshaft, Forged Steel (Gen V and Gen VI 502)	Externally balanced. Cross-drilled. Nitride-treated forged 1053 steel crankshaft with 1-piece rear main seal. Forging P/N 14097044
19171620	Crankshaft, Forged Steel (Gen V and Gen VI 427)(not shown)	Steel crankshaft with 3.750" stroke for 1991-and-later, 427-cubic-inch engines. 1-piece rear main seal. Requires chamfered connecting rods (P/N 19211226 or 88962926) and rod bearings P/N 88961556. Used in ZZ427 and Anniversary Edition 427 engines. Internally balanced
14061685	Roller Pilot Bearing (not shown)	Used in high-performance manual transmission applications

BALANCERS

Balancers are relatively small parts that play a big role in helping engines run smoothly. Balancers are also known as torsional dampers or harmonic balancers, which is indicative of how they help control unwanted crankshaft vibrations. By controlling vibrations, Chevrolet Performance balancers help engines run smoothly, which also extends engine life.

10216339

454 and 502 with 4.000" stroke crank, 1970 to present (not shown)

- 8" Outside Diameter
- Counterweighted for externally balanced engines

A. 88962814

427/572 Balancer

- 8" Outside Diameter
- This internal balance damper is designed with inner and outer shells
- Utilizes matched O-rings to control destructive crankshaft vibrations
- Black zinc chromate finish
- Laser engraved 360° timing marks



A 427/572 Balancer

14096987 Flywheel
(see chart below)



12561217 Flexplate
(see chart below)



FLYWHEELS AND FLEXPLATES

Chevrolet Performance offers both internally and externally balanced flywheels and flexplates. It is critical that you use the correct design for your specific engine application. Engines with one-piece crankshaft seals require externally balanced flywheels or flexplates (except for ZZ427, ZZ572/620, ZZ572/720R and the Anniversary Edition 427). Check the accompanying charts to find the correct parts for specific engine applications.

Big-Block Flywheels

Part Number	Year of Engine	Outside Diameter	Crank Flange Bolt Pattern	Clutch Diameter	Starter Ring Gear Teeth	Technical Notes
14085720	1965-present	12.750"	3.580"	10.4"	153	Lightweight nodular iron; weighs approximately 15 lbs; for internally balanced engines
3991469	1965-present	14"	3.580"	11"	168	Use with internally balanced engines
3993827	1970-1990	14"	3.580"	11"	168	Counterweighted for externally balanced 454 Mark IV 2-piece rear seal engines; use with balancer P/N 10216339
14096987	1991-present	14"	3.580"	11"	168	Lightweight nodular iron. For externally balanced engines
12582964	1965-present	14"	3.580"	11.500"	168	Used with 427 or 572 crate engine. Internally balanced

Big-Block Flexplates

Part Number	Year of Engine	Outside Diameter	Crank Flange Bolt Pattern	Converter Bolt Pattern	Starter Ring Gear Teeth	Technical Notes
10185034	1991-up	14"	3.580"	10.750" and 11.500"	168	Use with forged steel crank. Has dual-converter bolt pattern (502 & 454 1-piece rear main seal)
12561217	1991-up	14"	3.580"	11.500"	168	427 crate engine production internally balanced (.100" thick)
471598	1965-present	14"	3.580"	10.750" and 11.500"	168	For internally balanced engines. Use with 572/620 crate engine. Has dual-converter pattern (.120" thick)
14001992	1970-1990	14"	3.580"	11.500"	168	For externally balanced 454 Mark IV 2-piece rear main seal engines

Bolts and Dowels

Part Number	Description	Technical Notes
12337973	Flywheel Bolt (not shown)	Fits all Chevy Small-Block V-8, Big-Block V-8 and 90° V-6 engines. Sold individually; 6 required per engine
10046031	Flywheel Dowel (Big-Block, not shown)	Highly recommended for all high-performance and competition Big-Block engines
1453658	Bellhousing Dowel, Clutch Housing/Transmission Dowel (Big-Block) (not shown)	Use with Big-Block engine. Sold individually; 2 required per engine
3727207	Flexplate Bolt (not shown)	Fits all Chevy Small-Block V-8, Big-Block V-8 and 90° V-6 engines. Sold individually; 6 required per engine



Timing Chain Kit, 502 (second design Gen VI) **B**



Timing Chain, 502 (second-design Gen VI) **C**



Camshaft Bolt **D**

TIMING CHAINS AND SPROCKETS

Chevrolet Performance's strong, accurate timing chains and sprockets provide top performance and dependable service.

B. 12371053

Timing Chain Kit, 502 (second design Gen VI)

- Heavy-duty timing chain kit for all second-design 502 Gen VI roller-lifter engines with aluminum front timing cover
- Kit includes chain P/N 10114177, crankshaft sprocket P/N 12550039, camshaft sprocket P/N 12551401, camshaft retainer and bolts
- Also used in 572

C. 10114177

Timing Chain, 502 (second-design Gen VI)

- Single-roller design for all second-design 502 Gen VI engines
- Use with crankshaft sprocket P/N 12550039 and camshaft sprocket P/N 12551401

12554553

Camshaft Dowel Pin (not shown)

D. 9424877

Camshaft Bolt

- 5/16"-18 x 0.75" bolt

WATER PUMPS AND ACCESSORY DRIVE SYSTEMS

A. 19168602

Aluminum Water Pump, Short-Style

- Lightweight standard-rotation pump has reinforced snout and large-diameter hub with dual bolt patterns for early-and late-model pulleys
- Has short mounting legs
- Use with early-design V-belt drive rotation

B. 19168606

Cast-iron Water Pump, Long-Style

- Same standard-rotation pump used on all Chevrolet Performance 454 and 502 crate engines
- Not for use with a serpentine belt system

C. 19366895

Serpentine Accessory Drive Belt System, with Air Conditioning

- Deluxe kit includes all the components and hardware necessary to install on a 9.800" deck or 10.200" tall deck engine (including bolts, nuts and spacer)
- Belt included

The system includes:

19152476	Alternator Assembly (cs130, reman)
19319858	Power Steering Pump (reman)
19168601	Water Pump Kit
88964862	A/C Compressor, R134a
10187612	A/C Compressor Bracket
10187613	A/C Compressor Bracket
10108470	Water Outlet
19245468	Crankshaft Pulley
88986828	Belt (water pump, A/C, alternator)
88986813	Belt (fan, water pump, A/C)
12552359	Tensioner
10129560	Idler Pulley
19367392	Fan and Water Pump Pulley
6272959	Thermal Bypass Hose Connector
11610236	Clamp
1485552	Heater Hose
12605677	Power Steering Pump Pulley
88961892	Power Steering Bracket (tall deck)
10187611	Alternator Bracket
10187610	Alternator/Power Steering Bracket

19172806

Serpentine Accessory Drive Belt System, without Air Conditioning (not shown)

- Deluxe kit includes all the components and hardware necessary to install on a 9.800" deck or 10.200" tall deck engine
- Kit includes hardware and belt

The system includes:

19152476	Alternator Assembly (cs130, reman)
19319858	Power Steering Pump (reman)
19168601	Water Pump Kit
10108470	Water Outlet
19245468	Crankshaft Pulley
88986828	Belt (water pump, A/C, alternator)
88986813	Belt (fan, water pump, A/C)
12552359	Tensioner
10085760	Fan and Water Pump Pulley
6272959	Thermal Bypass Hose Connector
11610236	Clamp
1485552	Heater Hose
12605677	Power Steering Pump Pulley
88961892	Power Steering Bracket (tall deck)
10187611	Alternator Bracket
10187610	Alternator/Power Steering Bracket
10055890	Idler Pulley

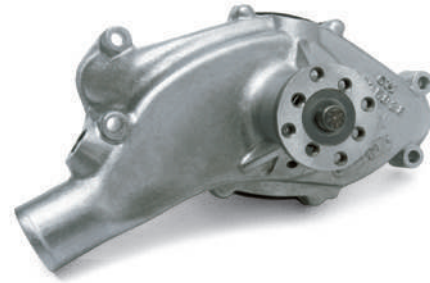

A Aluminum Water Pump, Short-Style



B Cast-iron Water Pump, Long-Style



C Serpentine Accessory Drive Belt System, with Air Conditioning

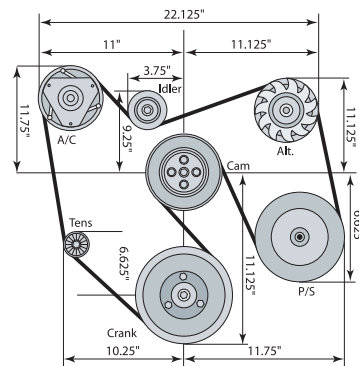

C Serpentine Accessory Drive Belt System, with A/C (Diagram)

Corvette Oil Pan (1965-1974) **D**6-Quart Oil Pan, Gen V and Gen VI **E**4-Quart Oil Pan Kit, Gen V and Gen VI **F**Dipstick Tube, 6-Quart **G**Dipstick Tube, 4-Quart **H**

OIL PANS, OIL PUMPS, GASKETS AND COMPONENTS

Oil is an engine's lifeblood and a high quality Chevrolet Performance oil pan is what keeps it where it belongs. Properly designed and manufactured oil pans fit right, and when used with matching Chevrolet Performance gaskets, prevent leaks. We have oil pans for street and competition applications. Oil pans are sold without dipsticks or other hardware unless otherwise noted.

D. 14091356

Corvette Oil Pan, 1965-1974

- 5-quart pan has a trap-door baffle that controls oil slosh during cornering and heavy braking
- Windage tray is included and requires four mounting studs, P/N 3902885
- Used on LS7 engine assembly P/N 3965774

E. 10240721

6-Quart Oil Pan, Gen V and Gen VI

- Six-quart pan fits all 1991-and-newer Gen V and Gen VI, 427, 454, 502 and 572 engines

F. 12495360

4-Quart Oil Pan Kit, Gen V and Gen VI

- Fits 1991-and-newer Gen V and Gen VI 427, 454 and 502 engines
- Fits many early-model Chevelles and Camaros
- Includes a 4-quart oil pan, 4 main cap-bolts, oil pump screen, oil level tube, oil level gauge, and oil pan gasket
- Pan is not available separately

NOTE: Not intended for competition or spirited street driving. Oil sump capacity is insufficient for performance driving. Oil system starvation may result from expended high RPM operation, hard cornering or rapid acceleration.

12557083

Dipstick, 6-Quart (not shown)

- For use with production 6-quart oil pan P/N 10240721 or P/N 14103141
- Use oil dipstick tube P/N 12550533 and seal P/N 274244

G. 12550533

Dipstick Tube, 6-Quart

- For use with production 6-quart oil pan P/N 10240721 or P/N 14103141
- Use oil dipstick P/N 12557083 and seal P/N 274244

274244

Oil Dipstick Tube Seal, 6-Quart (not shown)

- For use with the production 6-quart oil pan P/N 10240721 or P/N 14103141
- Use oil dipstick tube P/N 12550533 and dipstick P/N 12557083

3989391

Dipstick, 4-Quart (not shown)

- For use with 4-quart oil pan kit P/N 12495360 for all Gen V and Gen VI engines
- Use dipstick tube P/N 329231

H. 329231

Dipstick Tube, 4-Quart

- For use with 4-quart oil pan kit P/N 12495360
- Use oil dipstick P/N 3989391

BIG-BLOCK COMPONENTS

Oil Pans, Oil Pumps, Gaskets and Accessories continued

A. 14097040

Windage Tray

- Use with the Gen V and Gen VI 454 and 502 engines



A Windage Tray



B Windage Tray

B. 3967854

Windage Tray

- Separates the oil from the spinning crank assembly to reduce aeration of the oil, aids in oil control and minimizes oil slosh under hard braking
- Use with oil pan P/N 14091356
- Requires four mounting studs P/N 3902885

C. 88962187

Windage Tray, 572 Engine

- Used on all 572-cubic-inch engines
- Use with oil pan P/N 14091356
- Requires four mounting studs P/N 88958656



C Windage Tray, 572 Engine

D. 19131250

Oil Pump and Pick-Up, 572 Engine

- For use with all 572-cubic-inch engines
- Use with oil pan P/N 10240721, oil pan gasket P/N 19213986 and windage tray P/N 88962187



D Oil Pump and Pick-Up, 572 Engine

E. 3865886

Oil Pump Shaft

- Heavy-duty all-metal
- Intermediate shaft fits all Big-Block engines

19210599

Oil Pump and Pick-Up, Gen V and Gen VI (not shown)

- For use with the Gen V and Gen VI 454 and 502 engines with 1-piece rear main seal
- Pump has 1.300" gears and will fit Mark IV engines
- Distance from the mounting surface to the bottom of the screen is 5.870"

NOTE: Tack-welding pick-up tube to pump is recommended.

3955281

Oil Pump Pick-Up (not shown)

- Distance from pump mounting surface to lowest point of screen is 4.880"

NOTE: Weld or braze the pick-up tube to the pump cover for off-highway applications.



E Oil Pump Shaft

F. 19299222

Oil Filter Adapter, fits Mark IV Blocks only

- Mounts a spin-on cartridge oil filter
- Contains a filter bypass valve used on all V-8 engines

G. 25013759

Oil Cooler Bypass Valve

- For high-performance and Bowtie Big-Blocks with 4-bolt main bearing caps
- Must be installed in the rear hole behind the oil filter adapter bolt to route oil through the cooler

24241872

Magnetic Drain Plug (not shown)

- Catches and holds small pieces of metal before they can cause engine damage



F Oil Filter Adapter

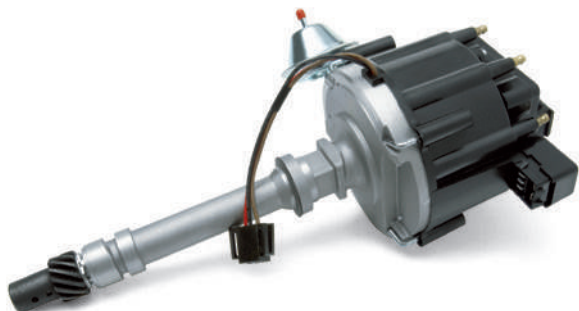
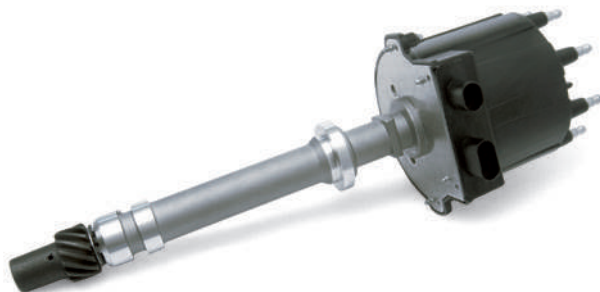

G Oil Cooler Bypass Valve

Distributor, HEI **H**Distributor, Billet HEI **I**Distributor, Ram Jet 350 & Ram Jet 502 **J**Distributor, Adjustable Slip Collar **K**

DISTRIBUTORS AND COMPONENTS

The high-quality distributors in this group are interchangeable with Small-Block Chevrolet V-8 components. Chevrolet Performance distributors cannot be used with Tall-Deck Bowtie blocks, except adjustable distributor P/N 10093387.

H. 93440806

Distributor, HEI

- Cast aluminum
- High-performance mechanical advance curve
- Vacuum advance canister included
- Use connector P/N 12167658 to attach tachometer and 12-volt power supply wire to distributor
- Includes module P/N 19180771, cap P/N 19110931 and rotor P/N 19110934

I. 88961867

Distributor, Billet HEI

- Chevrolet Performance's most powerful and durable distributor
- For strength and high rpm stability the oversized shaft is guided by a sealed ball bearing and long sintered bushing
- Treated coating on the shaft provides low friction
- Advance assembly features chrome-moly weights that slide on nylon pads for smooth timing advancement through the entire rpm range
- Vacuum advance canister and billet aluminum housing is CNC-machined for greater accuracy
- Has melonized cam drive gear P/N 10456413 for steel roller camshafts
- High-quality cap with brass terminals

J. 1104060

Distributor, Ram Jet 350 and Ram Jet 502

- Used on the fuel-injected Ram Jet 350 and Ram Jet 502
- Includes ignition module P/N 10482830, cap P/N 19166099 and rotor P/N 10477219

1103952

Distributor, Late-Model EFI (not shown)

- Used on late-model V-8 engines with fuel injection and computer controls
- Kit includes ignition module, cap and rotor

K. 10093387

Distributor, Competition Adjustable Slip Collar

- Designed primarily for competition use
- Billet-aluminum housing, ball-bearing guide and adjustable mechanical-advance assembly
- Magnetic pickup provides accurate trigger signals to Chevrolet CDI Ignition Box (not included)
- Uses a standard Chevrolet V-8 cap and rotor
- Will clear most induction systems
- Slip collar that can be adjusted to make up for block or head machining, or a tall-deck Bowtie block

19052845

Distributor Gear (not shown)

- Melonized iron gear is required on all crate engines with steel roller camshafts

10456413

Distributor Gear (not shown)

- Melonized iron gear is required on all Chevrolet Performance crate engines

NOTE: Supplied on distributors P/N 93440806 and P/N 88961867

12167658

Connector, HEI Distributor Power and Tachometer (not shown)

- Used to attach the power and tachometer wires to the cap of the HEI distributor

12498335

Coil, HEI (not shown)

- Production HEI coil

INTAKE MANIFOLDS, GASKETS AND COMPONENTS

The wide range of Chevrolet Performance intake manifolds are cast-iron and aluminum for carbureted and fuel injected applications. These intake manifolds were designed specifically for GM engines so you know they will deliver optimum performance. Due to the profile of some Chevrolet Performance high-rise intake manifolds, hood clearance should be carefully checked before ordering an intake manifold.

A. 14097092

Intake Manifold – Oval-Port, iron, spread bore

- Economical iron 4-bbl intake manifold
- Fits all 396–502 engines with large oval-port heads

NOTE: Open carburetor spacer is not recommended with use of dual-plane manifolds.



A Intake Manifold – Oval Port, iron

B. 19131359

High-Rise Intake Manifold – Rectangular-Port, square bore, Holley Carburetors

- Aluminum, dual-plane manifold can be used with high-performance cast-iron or aluminum rectangular port heads
- Same as used on 454 HO and 502 HO engine assemblies

NOTE: Ports do not match Bowtie cylinder heads P/N 14044861 and P/N 12363425.

NOTE: Open carburetor spacer is not recommended with use of dual-plane manifolds.



B High-Rise Intake Manifold – Rectangular Port

C. 12363420

High-Rise Intake Manifold – Oval-Port

- Designed for all 396-502 engines with GM aluminum heads (1975 and earlier) and large oval-port iron heads
- Has a dual-plane design with spread bore flange and a dual-bolt pattern
- Has no provisions for a hot-air choke, but will accept a divorced choke or electric choke
- Accepts air conditioning and alternator brackets
- Use intake manifold gasket P/N 12366985 and bolt kit P/N 12367959

NOTE: May not fit on many Corvette models. Manifold height is 6" at the rear and 4.5" in front. Check for hood clearance before ordering.

NOTE: Open carburetor spacer is not recommended with use of dual-plane manifolds.



C High-Rise Intake Manifold – Oval Port

12363421

High-Rise CNC-Port-Matched Intake Manifold – Oval-Port, spread bore (not shown)

- Similar manifold design as P/N 12363420 (see above), but it is "CNC" port-matched to Chevrolet Performance oval-port aluminum cylinder heads

NOTE: Open carburetor spacer is not recommended with use of dual-plane manifolds.

D. 12363406

Intake Manifold – Oval-Port, square bore, Holley Carburetors

- Same as manifold P/N 12363420 (see above), but designed for use with a Holley carburetor
- Dual-plane design requires bolt kit P/N 12367959, which includes 16 bolts (8740 chrome-moly 3/8-16 x 1.5" with 3/8" hex head and 16 5/8" O.D. washers), and manifold gasket kit P/N 12366985
- Accepts air conditioning and alternator brackets and a late-model water neck

NOTE: Will not fit production Corvettes, and may not fit Chevilles. Manifold carb flange height is 4.450".

NOTE: Open carburetor spacer is not recommended with use of dual-plane manifolds.



D Intake Manifold – Oval Port, Holley Carburetors



CNC-Port-Matched Intake Manifold – Oval Port, Holley Carburetors **E**

E. 12363407
CNC-Port-Matched Intake Manifold – Oval-Port, square bore, Holley Carburetors

- Same as P/N 12363406 (see previous page), except it has been CNC-port-matched for GM aluminum oval-port heads with large oval-port heads (1975-and-older), and all aluminum heads with oval-ports

NOTE: Open carburetor spacer is not recommended with use of dual-plane manifolds.

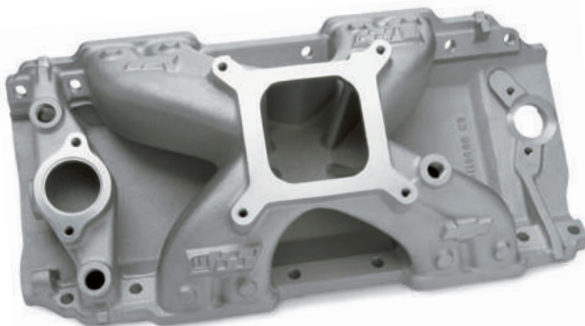

Intake Manifold – ZZ572/620 Engine **F**

F. 88961161
Intake Manifold – ZZ572/620 Engine, square bore, Holley Carburetors

- Aluminum single-plane intake manifold is used on the ZZ572/620 engine
- The carburetor flange is for a 4150-style carburetor
- Use intake gasket P/N 88962213
- For tall-deck blocks

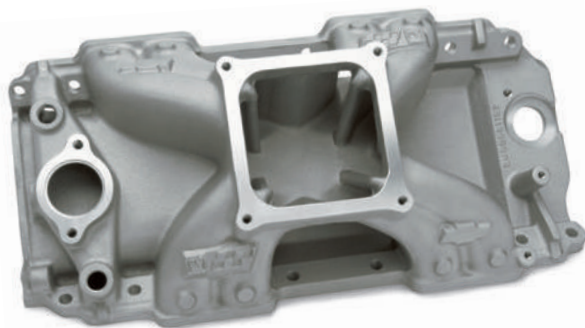

Intake Manifold – ZZ572/720R Engine **G**

G. 88962218
Intake Manifold – ZZ572/720R Engine

- Aluminum single-plane intake manifold is used on the ZZ572/720R engine
- The carburetor flange is for a 4500 Dominator-style carburetor
- Use intake gasket P/N 88962213
- For tall-deck blocks



Intake Manifolds: Additional Required Components

Part Number	Gaskets (Qty)	Bolts (Qty)	Engine Application
12464484	12366985 (1)	12497460 (1)	12499121
12464482	12366985 (1)	12367959 (1)	12499121
88961161	88962213 (1)	12367959 (1)	19201333, 19331583
12363420	12366985 (1)	12367959 (1)	12498777, 19331574, BB oval-port high-rise
12363407	12366985 (1)	12367959 (1)	19201332, 12371171, 19331579, CNC version of 12363406
19131359	12506106 (2)	10198997 (14)	12568774, BB dual-plane
88962218	88962213 (1)	12367959 (1)	19201334, 19331585

RAM JET 502 COMPONENTS

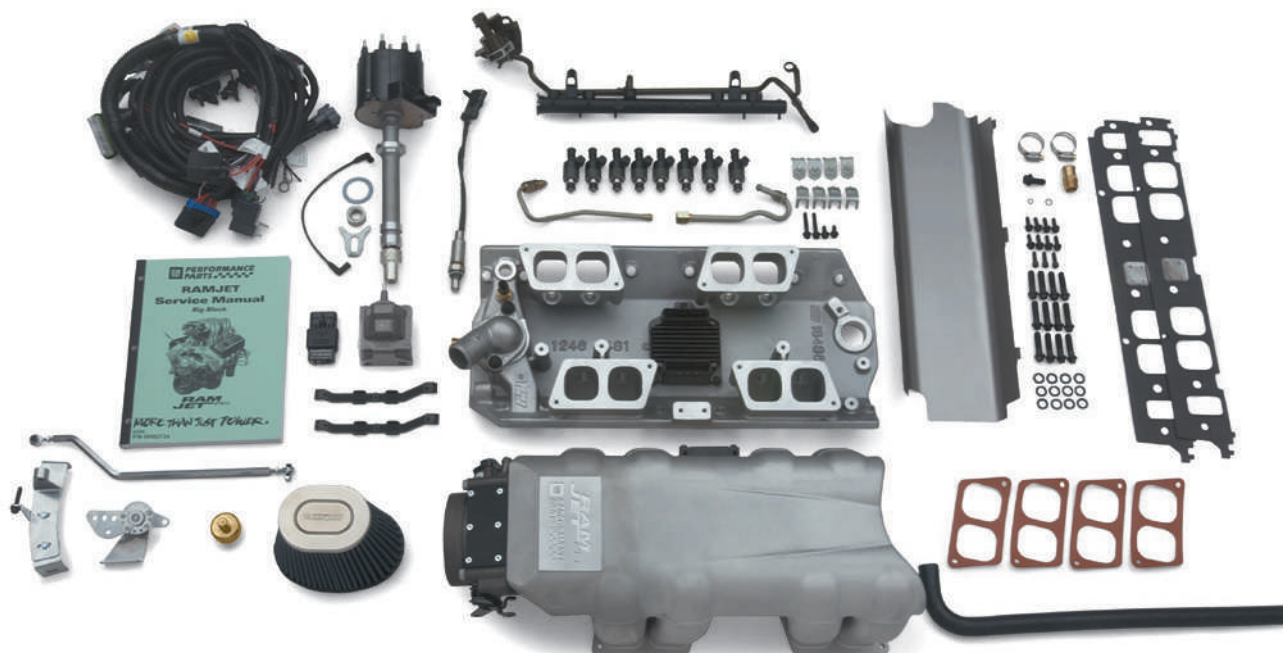

Ram Jet Fuel Injection Kit, with MEFI-4 Electronics

- Retro-fit fuel injection kit is calibrated for a 502/502 Chevrolet Performance engine and is the same as used on the Ram Jet 502 P/N 12499121
- May be used on other Big-Block applications by replacing the ECU unit with an aftermarket unit with the proper calibration
- Includes brackets, sensors, bolts, nuts, gaskets and other small parts, including:

Part Number	Description	Quantity
88962744	Instruction Manual	1
12489400	Diagnostic Trouble Code Tool	1
12555320	Intake Manifold Oil Shield	1
12366985	Gasket Package	1
12367959	Bolt/Screw Package	1
12489372	Upper Intake Manifold Gasket	1
12487372	Fuel Feed Hose	1
10216948	Tube Assembly-Fuel Press Regulator	1
88961968	Engine Harness Assembly	1
10456208	Knock Sensor	1
12489595	Bracket Assembly, Transmission Cable	1
12489596	Bracket Assembly, Transmission, Throttle Cable	1
12489597	Rod, Throttle Control	1
1104060	Distributor	2
1115491	Ignition Coil	1
12464482	Lower Intake Manifold	1
12464484	Upper Intake Manifold	1
17113524	Body Assembly Throttle	1
12490257	Air Filter Kit	1
12569240	MAP Sensor	1
25036751	Intake Air Temperature Sensor	1
17113222	Fuel Injector Retainer Kit	1
17120039	Rail Assembly, Multi-Port Fuel Injection	1
19245527	Fuel Pressure Regulator Assembly	1
88962718	Module Assembly Engine Cont.	1
15326386	Coolant Temperature Sensor	1
19178918	O2 Sensor	1
12487373	Connector, Fuel Rtn. Line	1

Electronic Control Units & Components

88962718

ECU, Ram Jet 502 (not shown)

- Replacement ECU for all Ram Jet 502 engines (MEFI 3 P/N 12497323 or MEFI 4 P/N 12499121)
- MEFI 4 Ram Jet engine is a closed-loop system that gives a much smoother idle and improved performance

NOTE: Replacing the ECU on MEFI 3 Ram Jet engine P/N 12497323 requires using new wire harness kit P/N 12499117, or jumper wire P/N 88963118 to use MEFI 4 ECU as an open-loop system.

12499117

MEFI 4 ECU & Wire Harness Kit, Ram Jet 502 (not shown)

- Module/harness kit is used to convert a Ram Jet 502 from MEFI 3 to the newer MEFI 4 design, which offers improved idle and performance through a closed-loop system
- Includes module P/N 88962718, wire harness P/N 88961968, oxygen sensor P/N 19178918, intake air temp sensor P/N 25036751 and oxygen sensor fitting P/N 15156588

NOTE: The ECU is programmed with a "green mode" that controls the rpm for the break-in period. During this period, engine speed is limited to 4,000 rpm in the first hour, 4,500 rpm in the second hour and 5,500 rpm in the third hour.

88963118

Jumper Harness, MEFI 3 to MEFI 4 (not shown)

- Allows an MEFI 4 module to be used with an MEFI 3 wiring system (to stay as an open-loop system)
- Fits both Big-Block and Small-Block engines

88961968

MEFI 4 ECU Harness, Ram Jet 502 (not shown)

- Used in the MEFI 4 Ram Jet 502 P/N 12499121 with the MEFI 4 closed-loop oxygen sensor-equipped system
- Use with MEFI 4 ECU P/N 88962718



Lower Manifold, 502 Ram Jet **A**



Upper Manifold, 502 Ram Jet **B**



Oil Shield **C**

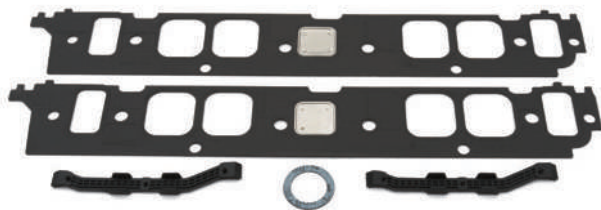

Gasket, Aluminum Oval-Port Heads **D**



Bolt Kit, Intake Manifold **E**



Water Neck **F**

A. 12464482 ⓘ

Lower Manifold, 502 Ram Jet

- Aluminum lower portion of the intake manifold is used on Ram Jet 502 crate engine P/N 12499121
- Use with upper manifold P/N 12464484 (see below), upper manifold gasket P/N 12489372 and bolt package P/N 12497460

B. 12464484 ⓘ

Upper Manifold, 502 Ram Jet

- Aluminum upper portion of the intake manifold is used on Ram Jet 502 crate engine P/N 12499121
- Use with lower manifold P/N 12464482 (see above), upper manifold gasket P/N 12489372 and bolt package P/N 12497460

MANIFOLD GASKETS AND COMPONENTS

C. 12555320

Oil Shield

- Isolates hot engine oil from the air/fuel mixture

D. 12366985

Gasket, Aluminum Oval-Port Heads

- Designed for Big-Block aluminum heads P/N 12363390, P/N 12363392, P/N 12363399, P/N 19331425, P/N 19331424 and P/N 19331422
- Use with manifold P/N 12363406, P/N 12363407, P/N 12363420 or P/N 12363421

88962213

Intake Manifold Gasket (not shown)

- Use on all Big-Block engines with rectangular intake port heads 396- through 572-cubic-inch
- Includes 2 gaskets

12506106

Gasket, 454 and 502 Engines (not shown)

- Used on 454 and 502 engines; with restricted heat cross-over passages
- 1 gasket per package; order 2 per engine.

E. 12367959

Bolt Kit, Intake Manifold

- For any Big-Block Chevrolet engine
- Includes 16 bolts: 3/8"-16 x 1.5" with wide, underhead flange with a 7/16" hex head
- Rated at 170,000 psi and will give consistent torque load
- Includes 16 hardened flat washers

***NOTE:** Four of these washers are smaller in diameter for use around the front water passages.*

CHROME WATER NECKS

F. 12342024

Water Neck

- Chrome water neck with neoprene O-ring and chrome bolts
- For 1966-1975 full-size Chevrolet, Camaro, and Chevelle V-8 engines

10108470

Aluminum Water Outlet (not shown)

STARTERS

Flywheels with two different diameters are used on Chevrolet Small-Block, Big-Block, and 90° V-6 engines. Large flywheels are 14" in diameter and have 168 teeth on the starter ring gear. Small-diameter flywheels are 12.750" in diameter, with 153 teeth on the ring gear.

This difference in flywheel diameters requires two distinct starter housings. Starter noses used with large-diameter flywheels have two offset bolt holes, while starters for small flywheels have two bolt holes that are parallel to the back of the block. Most Chevy blocks are drilled for both types of starters.

A. 12361146 ⓘ

High-Torque Mini Starter

- Gear reduction starter is designed for 1958-1996 V-8 and all 90° V-6 engines
- Compact design provides increased clearance
- Weighs only 10.5 pounds and has a gear reduction of 3.75:1
- Equipped with a dual bolt pattern for 12.750" (153-tooth) and 14" (168-tooth) flywheels
- Housing can be rotated to clear exhaust systems
- Includes starter, mounting bolts, shims, gaskets and electrical connectors

NOTE: Not recommended for competition use.

B. 12363128 ⓘ

High-Torque Mini Starter, Chrome

- Same as starter P/N 12361146 (see above), but with a chrome housing

C. 10465143 ⓘ

Lightweight Starter (remanufactured)

- Lightweight high-performance starter was originally used on 1993-1997 Camaros and Firebirds with the LT1 engine
- Can be used on any Small-Block or Big-Block engine with a 12.750", 153-tooth flywheel

D. 19302919 ⓘ

Lightweight Starter, Big-Block and Small-Block

- Gear reduction starter can be used on Big-Block and Small-Block engines with a 14", 168-tooth flywheel

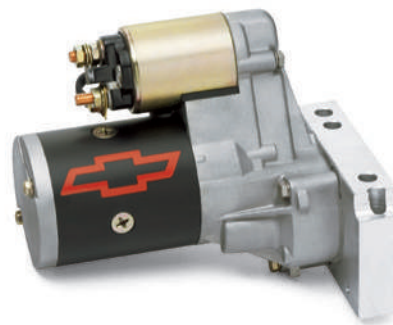

A High-Torque Mini Starter

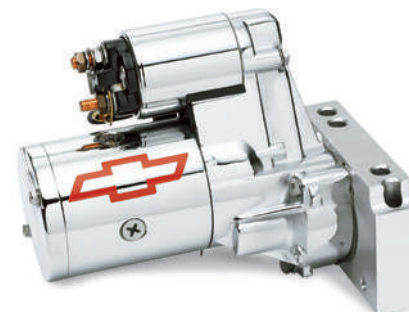

B High-Torque Mini Starter, Chrome



C Lightweight Starter, 12.750" Flywheel (remanufactured)



D Lightweight Starter, 14" Flywheel



Starters: Additional Required Components

Part Number	Bolts (Qty)	Engine Application
12361146	12338064 (2)	Big-Block
10465143	12338064 (2)	Big-Block
12606096, 19302919	12338064 (2)	Big-Block and 12499121, 12496962, 12497323, 12371171, 19201332
12363128	12338064 (2)	Big-Block

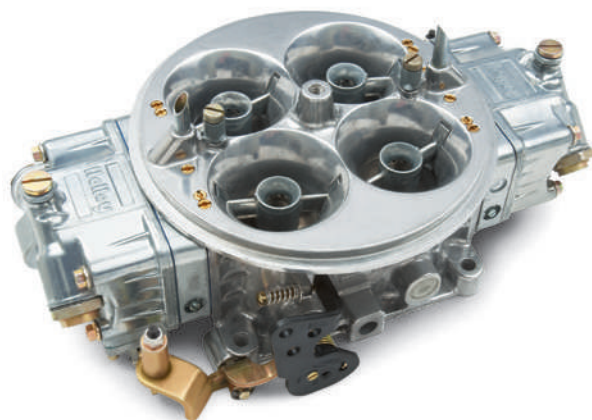

Carburetor, Holley 850-cfm **E**Carburetor, Holley 870-cfm **F**Carburetor, Holley Dominator 1150-cfm **G**

CARBURETORS AND THROTTLE BODIES

Chevrolet Performance has the right carburetor or throttle body to complete your new crate engine, or give life to your rebuilt engine. Then, top off your engine with one of our great-looking air cleaners.

Carburetors

19170093

Carburetor, Holley 770-cfm (not shown)

- Holley 4160-style 770-cfm 4-bbl carburetor
- Features show-car-quality polished finish
- Dual feed, center-hung float bowls
- Vacuum secondaries
- Automatic electric choke
- Quick-change adjustable vacuum secondary
- Recommended for Small-Block and Big-Block engines, including street, competition, towing and off-road vehicles
- Bolts and gaskets included
- Replaces Holley 4160 750-cfm carburetor P/N 12485506

E. 19170095

Carburetor, Holley 850-cfm

- Holley 4150-style 850-cfm 4-bbl carburetor
- Features show-car-quality polished finish
- Mechanical secondaries
- Electric choke
- Four-corner idle adjustment
- Power valve blowout protection
- Custom-calibrated for the ZZ572/620 crate engine
- Recommended for 502 crate engines and suitable for Big-Block engines, including street, competition, towing and off-road vehicles
- Bolts and gaskets included
- Replaces Holley 4160 850-cfm carburetor P/N 88961560

NOTE: Carburetor can only be recalibrated for use with other large-displacement engines.

F. 19170094

Carburetor, Holley 870-cfm

- Holley 4160-style 870-cfm 4-bbl carburetor
- Features show-car-quality polished finish
- Dual feed, center-hung float bowls
- Vacuum secondaries
- Automatic electric choke
- Quick-change adjustable vacuum secondary
- Recommended for 502 crate engines and suitable for Big-Block engines, including street, competition, towing and off-road vehicles
- Bolts and gaskets included
- Replaces 4150-style 850-cfm carburetor P/N 12366996

G. 19170096

Carburetor, Holley Dominator 1150-cfm

- Dominator-style 1150-cfm 4-bbl carburetor
- Features show-car-quality polished finish
- Mechanical secondaries
- Four-corner idle adjustment
- Power valve blowout protection
- Custom-calibrated for the ZZ572/720R crate engine
- Bolts and gaskets included
- Replaces 4500-style 1090-cfm carburetor P/N 88962217

Throttle Bodies

17113524

Throttle Body, Ram Jet 502 (not shown)

- Used on the Ram Jet 502 crate engine
- Use throttle body gasket P/N 10105379 and bolt P/N 11516344 for installation
- Dual 49.9mm blades

AIR CLEANERS

A. 12342080

Air Cleaner, Chevrolet-Logo, High-Performance Design

- 14" round high-performance style air cleaner has chrome lid with embossed Chevrolet name
- Fits most 4-bbl and 2-bbl carburetors
- Will not fit Dominator-style carburetors
- Bowtie nut not included

NOTE: Check clearance between hood and top of air cleaner. Minimum clearance is 3.750" from top of carburetor gasket area to underside of hood.



A Air Cleaner, Chevrolet Logo, High Performance Design

B. 12342071

Air Cleaner, Chevrolet-Logo, Classic Design

- 14" round classic-style air cleaner has chrome lid with embossed Chevrolet name and Bowtie attaching nut
- Fits most 4-bbl and 2-bbl carburetors
- Will not fit Dominator-style carburetors

12490257

Air Cleaner, Ram Jet 502 (not shown)

- Designed for use with throttle body on Ram Jet 502 crate engine
- Can be used on other applications



B Air Cleaner, Chevrolet Logo, Classic Design

SPARK PLUG WIRES

C. 12368384

Chevrolet Bowtie Logo Wires

Chevrolet Performance spark plug wire kits are designed to fit your GM engine, eliminating the guesswork in selecting the correct length. These performance 8mm spark plug wires exhibit only 600 ohms per foot of resistance, with high noise suppression capabilities. Features include red wires with white Chevrolet insignia and black boots. Manufactured with double-wall silicone construction.

- Kits include a 10" coil wire for engines, such as Ram Jet 350 and ZZ572 engines that have remote-coil HEI, plus four wire separators and HEI terminals and boots for the distributor cap.
- Custom-fit set designed to be used with black wire loom P/N 12495502

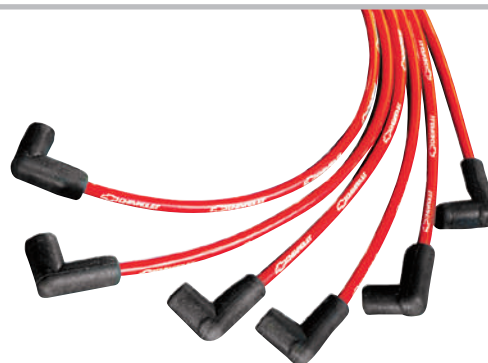

C Spark Plug Wires, Chevrolet Bowtie Logo

D. 12495502

Wire Loom Kit, Big Block

- Used on late-model Big-Block trucks
- Supplied with one left-hand support P/N 12553397, one right-hand support P/N 12553398, three four-wire retainers P/N 88891792, two three-wire retainers P/N 12163607, two two-wire retainers P/N 12132229, and two single-wire retainers P/N 12132228



D Wire Loom Kit, Big-Block

Electric Fuel Pump **E**Camaro ZL1 Fuel Pump Module **F**Electric Fuel Pump, High Output **G**Fuel Filter **H**

ELECTRIC FUEL PUMPS AND COMPONENTS

E. 6472657

Electric Fuel Pump

- For use on all carbureted engines
- Flows 30-40 gph at 6-9 psi

F. 19303293

Camaro ZL1 Fuel Pump Module

- Production fuel pump module for the 2012 Camaro ZL1 with supercharged LSA engine
- Supports approximately 600 horsepower
- Direct replacement for 2010+ Camaro SS fuel pump modules
- 250 liters per hour capacity at 65 psi
- Pulse-width modulated, eliminates need for conventional pressure regulator
- Kit includes fuel pump module/sender assembly tank seal and instruction sheet

G. 25115899

Electric Fuel Pump, High-Output

- Heavy-duty 12-volt electric rotary pump
- Flows 72 gph at 6-8 psi

19245530

Fuel Pressure Regulator Kit (not shown)

- Used on Ram Jet 502 crate engine
- Fits other fuel-injected engines

H. 854619

Fuel Filter

- High-capacity inline filter
- Suitable for all high-performance carbureted applications
- 5/16" inlet and outlet

TRANSMISSIONS

AND COMPONENTS

FACTORY-MATCHED SUPERMATIC AUTOMATIC TRANSMISSIONS FOR CHEVROLET PERFORMANCE CRATE ENGINES

Complementing your Chevrolet Performance crate engine with a factory-engineered performance transmission is a cinch with our comprehensive lineup of automatic transmissions, torque converters and installation kits.

Our four- and eight-speed automatic overdrive transmissions enhance the drivability of your vintage vehicle by enabling lower engine speeds on the highway, meaning you can drive farther more comfortably.

Each transmission kit is engineered with factory-matched torque capacity ratings, helping ensure the transmission you purchase will stand up to the power of your engine. Our SuperMatic transmissions offer the ultimate in automatic transmission capability for higher-power Small-Block, Big-Block and LS/LSX and LT engines.

Chevrolet Performance also supports your transmission purchase with installation kits and electronic controller kits that offer plug-and-play convenience that helps get your project finished faster!

IMPORTANT! Chevrolet Performance does not include a torque converter with automatic transmissions. A variety of torque converters for 4L60- and 4L80-series transmissions tailored for the wide variety of our crate engines' performance specifications are available. Select the transmission that's just right for your project and select the torque converter to match its performance. See page 366 for more details.

NOTE: Chevrolet Performance's electronically controlled transmissions are not compatible with the mechanical speedometers in older vehicles. An aftermarket signal converter or electronically compatible replacement speedometer is required.

HYDRA-MATIC TRANSMISSION FAMILY TREES

4L60-E Series

The Hydra-Matic 4L60/4L65/4L70/4L75 family of transmissions is differentiated primarily by gearset design. Each planetary gearset in the 4L60 has four pinion gears. There are five pinion gears in the 4L65 and 4L70, but the 4L70 has a higher torque rating. The external dimensions and mounting provisions are identical for each transmission in the 4L60 family. The maximum torque capacity for each includes:

4L60-E – 380 lb.-ft. | 4L65-E – 430 lb.-ft.
4L70-E – 495 lb.-ft. | 4L75-E – 650 lb.-ft.

4L80-E Series

The production-based Hydra-Matic 4L80 and SuperMatic 4L85 transmissions are differentiated by gearset design. Each planetary gearset in the 4L80 has four pinion gears, while the 4L85 has five pinion gears. The external dimensions and mounting provisions are identical for each. The maximum torque capacity for each includes:

4L80-E – 440 lb.-ft. | 4L85-E – 685 lb.-ft.

NOTE: Chevrolet Performance's Automatic 4-speed Transmissions are remanufactured to General Motors Specifications. Chevrolet Performance Automatic 8-Speed Transmissions and Manual Transmissions are all new.

The majority of components in Chevrolet Performance Transmissions are New. In some cases, individual components are no longer manufactured by General Motors and in these few cases, reclaimed components are rebuilt to perform to General Motors specifications and high quality standards.

Big-Block SuperMatic™
Torque Converter



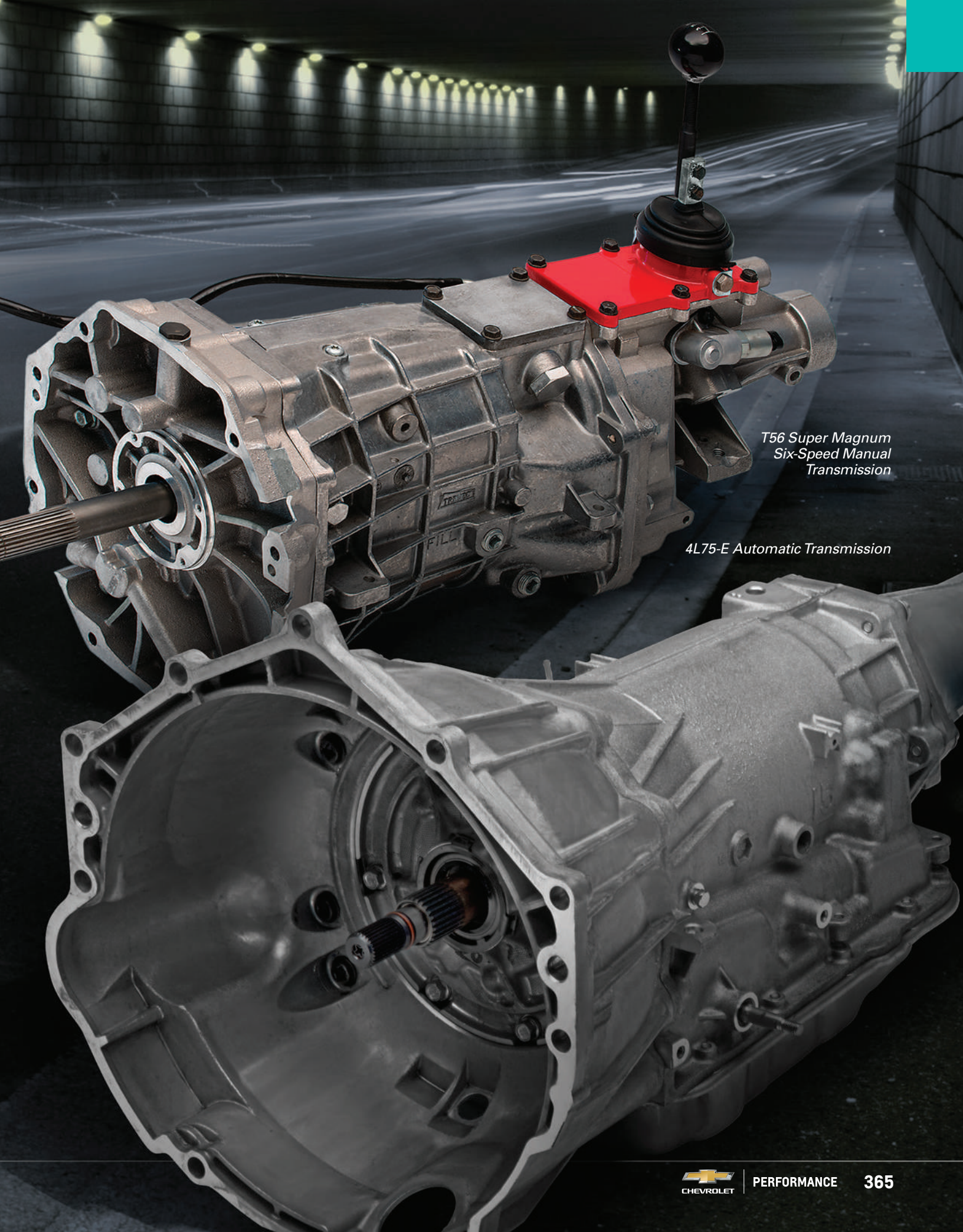

*T56 Super Magnum
Six-Speed Manual
Transmission*

4L75-E Automatic Transmission



NOTE: Must use 14" (168-tooth) Flexplate with SuperMatic™ Torque Converters.

Performance SuperMatic™ Torque Converters

The SuperMatic™ Torque Converters from Chevrolet Performance are designed to provide long life when matched with a SuperMatic™ Transmission. Each converter incorporates the following features:

- **Steel billet front cover**
- **Custom stator**
- **Fully furnace-brazed pump and turbine**
- **“Heavy-duty” lock-up clutch**
- **All internal components static balanced**
- **Fully vector balanced as an assembly**
- **Designed for Chevrolet Performance crate engines and automatic transmissions**
- **No external adapters needed to fit Chevrolet Performance crate engines.**

Part Number	Stall Range	Application
19299800	2,400-2,800 rpm stall	4L60/65/70/75-E (late “LS” V-8 transmission) mate to early Gen 1 SB/BB (dual bolt pattern – 10.75” and 11.5”) Note: Will not fit 153-tooth flexplate
19299801	3,000-3,400 rpm stall	4L60/65/70/75-E (late “LS” V-8 transmission) mate to early Gen 1 SB/BB (dual bolt pattern – 10.75” and 11.5”) Note: Will not fit 153-tooth flexplate
19299802	2,400-2,800 rpm stall	4L60/65/70/75-E (late “LS” V-8 transmission) mate to LS V-8 engine (single bolt pattern – 11.062”)
19299803	3,000-3,400 rpm stall	4L60/65/70/75-E (late “LS” V-8 transmission) mate to LS V-8 engine (single bolt pattern – 11.062”)
19299804	2,400-2,800 rpm stall	4L80-E/4L85-E – mate to early Gen 1 SB/BB (dual bolt pattern – 10.75” and 11.5”)
19299805	3,000-3,400 rpm stall	4L80-E/4L85-E – mate to early Gen 1 SB/BB (dual bolt pattern – 10.75” and 11.5”)
19299806	2,400-2,800 rpm stall	4L80-E/4L85-E – mate to LS V-8 engine (extended pilot)(single bolt pattern – 11.062”)
19299807	3,000-3,400 rpm stall	4L80-E/4L85-E – mate to LS V-8 engine (extended pilot)(single bolt pattern – 11.062”)

Converters are a kit that includes converter-to-flexplate bolts and instructions.

Torque Converter Quick Reference Chart

Automatic Transmission Torque Converter Match Listing

Engine P/N	Description	Displac.	Hp	Torque	4L60 Family		4L80 Family	
					Converter P/N	Stall Range	Converter P/N	Stall Range

Chevy Small-Block V-8

19244450	350/290 Deluxe	350 cu in	300	335	19299800	2,400-2,800	N/A	N/A
19210009	350 HO Turn-Key – with Iron Vortec Heads	350 cu in	333	381	19299800	2,400-2,800	N/A	N/A
12499120	Ram Jet 350 – PFI with Iron Vortec Heads	350 cu in	351	403	19299800	2,400-2,800	19299804	2,400-2,800
12677167	SP350/357 Base	350 cu in	357	407	19299800	2,400-2,800	19299804	2,400-2,800
12677170	SP350/357 Deluxe	350 cu in	357	407	19299800	2,400-2,800	19299804	2,400-2,800
12677177	SP350/357 Turn-Key	350 cu in	357	407	19299800	2,400-2,800	19299804	2,400-2,800
19333157	SP350/385 Base	350 cu in	385	405	19299801	3,000-3,400	19299805	3,000-3,400
19333158	SP350/385 Turn-Key	350 cu in	385	405	19299801	3,000-3,400	19299805	3,000-3,400
19351532	ZZ6 Base	350 cu in	405	406	19299801	3,000-3,400	19299805	3,000-3,400
19351533	ZZ6 Turn-Key	350 cu in	405	406	19299801	3,000-3,400	19299805	3,000-3,400
19332529	HT383 Base – Performance Engine	383 cu in	323	444	19299800	2,400-2,800	19299804	2,400-2,800
19332532	SP383 Deluxe	383 cu in	435	445	19299801	3,000-3,400	19299805	3,000-3,400

Chevy LS/LT/LSX V-8

12677741	L96 6.0L	6.0L	360	380	19299802	2,400-2,800	19299806	2,400-2,800
19369326	LS3 6.2L – Corvette Gen IV V-8	6.2L	430	425	19299802	2,400-2,800	19299806	2,400-2,800
19369331	LS3 6.2L – E-Rod Kit Automatic	6.2L	430	425	19299802	2,400-2,800	19299806	2,400-2,800
19369333	LS376/480 – LS3 Gen IV V-8	6.2L	495	473	19299803	3,000-3,400	19299807	3,000-3,400
19369335	LS376/515 – Carbureted LS3 Gen IV V-8	6.2L	533	477	19299803	3,000-3,400	19299807	3,000-3,400
19369338	LS376/525 – LS3 Gen IV ASA Camshaft	6.2L	525	486	19299803	3,000-3,400	19299807	3,000-3,400
19329008	DR525 with Gen IV F car oil pan	6.2L	525	498	N/A	N/A	N/A	N/A
19329009	DR525 with muscle car oil pan	6.2L	525	494	N/A	N/A	N/A	N/A
19331507	LSA 6.2L SC – Gen IV V-8 (with 4L75-E)	6.2L	556	551	19299802	2,400-2,800	19299806	2,400-2,800
19260165	LS9 6.2L SC – Gen IV V-8 (with 4L75-E)	6.2L	638	604	19299802	2,400-2,800	19299806	2,400-2,800
19244098	LS7 7.0L – Corvette Z06	7.0L	505	470	19299803	3,000-3,400	19299807	3,000-3,400
	Optional LS7 (depending on application)	7.0L	505	470	19299802	2,400-2,800	19299806	2,400-2,800
19332321	LSX376 – B8	6.2L	476	475	19299802	2,400-2,800	19299806	2,400-2,800
19299306	LSX376 – B15	6.2L	473	444	N/A	N/A	N/A	N/A
19260833	LSX454 (with 4L75-E)	7.4L	627	586	19299803	3,000-3,400	19299807	3,000-3,400
19260835	LSX454R	7.4L	776	649	N/A	N/A	N/A	N/A
19328728	LT1 6.2L with wet sump	6.2L	460	465	19299802	2,400-2,800	19299806	2,400-2,800
19329997	LT1 6.2L with dry sump	6.2L	460	465	19299802	2,400-2,800	19299806	2,400-2,800
19355405	LT1 6.2L with wet sump – for Connect & Cruise/ 8-speed auto.	6.2L	455	455	24280634	N/A	24280634	N/A
19355378	LT376/535	6.2L	535	470	19299803	3,000-3,400	N/A	N/A
19332702	LT4 6.2L SC with dry sump (with 4L75-E)	6.2L	650	650	19299802	N/A	19299806	N/A
19355404	LT4 6.2L SC with wet sump – for Connect & Cruise/ 8-speed auto.	6.2L	650	650	24280634	N/A	24280634	N/A

Chevy Big-Block V-8

19166393	ZZ427/480	427 cu in	480	490	19299801	3,000-3,400	19299805	3,000-3,400
12568774	454 HO – with iron heads and roller cam	454 cu in	438	500	19299800	2,400-2,800	19299804	2,400-2,800
19351574	ZZ454/440 – 440 horsepower with aluminum heads	454 cu in	469	519	19299800	2,400-2,800	19299804	2,400-2,800
88890534	HT502 – truck replacement engine	502 cu in	406	541	19299800	2,400-2,800	19299804	2,400-2,800
12568778	502 HO – with iron heads and roller cam	502 cu in	461	558	19299800	2,400-2,800	19299804	2,400-2,800
19331576	ZZ502/502 base engine – with aluminum heads	502 cu in	508	580	19299801	3,000-3,400	19299805	3,000-3,400
19331579	ZZ502 Deluxe – with aluminum heads	502 cu in	508	580	19299801	3,000-3,400	19299805	3,000-3,400
12499121	Ram Jet 502 – PFI with aluminum heads	502 cu in	502	568	19299801	3,000-3,400	19299805	3,000-3,400
19331583	ZZ572/620 Deluxe (with 4L75-E)	572 cu in	621	645	19299803	3,000-3,400	19299805	3,000-3,400
19331585	ZZ572/720R Deluxe	572 cu in	727	680	N/A	N/A	19299805	3,000-3,400

AUTOMATIC TRANSMISSIONS & COMPONENTS

A. 19368611

SuperMatic™ 4L65-E Four-Speed Automatic Transmission – LS-Series V-8 (remanufactured)

- Similar in design to the 4L60-E
- Electronically controlled four-speed overdrive transmission
- Features five-pinion gearsets, heat-treated stator shaft splines, induction-hardened turbine shaft, seven-plate 3.4 clutch
- Gear ratios: 1st: 3.06, 2nd: 1.62, 3rd: 1.00, 4th: 0.70
- Use SuperMatic™ converter for direct bolt up to Gen I and Gen II engines
- Add up to 430 lb.-ft. of torque
- Does not include torque converter (See pages 366-367 for options)

NOTE: Use with electronic controller P/N 19332775 for carbureted and Ram Jet applications. Use with electronic controller P/N 19302405 with Chevrolet Performance LS fuel injected applications.

19368612

SuperMatic™ 4L70-E Four-Speed Automatic Transmission (not shown, but looks similar to 4L65-E)

- Based on the 4L60-E/4L65-E
- Increased horsepower and torque capacity
- Features five-pinion gearsets, heat-treated stator shaft splines, induction-hardened turbine shaft, seven-plate clutch and specific valve-body calibration
- Gear ratios: 1st: 3.06, 2nd: 1.62, 3rd: 1.00, 4th: 0.70
- Torque converter not included (See pages 366-367)
- Add up to 495 lb.-ft. of torque

Part Number	Description
19368612	Four-Wheel Drive (not shown)
19368613	Two-Wheel Drive (not shown)
19368614	Two-Wheel Drive, 2014-15 LT1 (not shown)

NOTE: Use with electronic controller P/N 19332775 for carbureted and Ram Jet applications. Use with electronic controller P/N 19302405 with Chevrolet Performance LS fuel injected applications.

B. 19368615

SuperMatic™ 4L75-E Four-Speed Transmission (remanufactured)

- Based on the 4L65-E/4L70-E
- 650 lb.-ft. torque capacity makes it an alternative to the 4L80-E when space is an issue in the vehicle
- Features five-pinion gearsets, heat-treated stator shaft splines, induction-hardened turbine shaft, 8-friction-plate 3-4 clutch and specific valve-body calibration
- Unique, high-strength input housing
- Higher-capacity servo
- Larger 2-4 band
- Gear ratios: 1st: 3.06, 2nd: 1.62, 3rd: 1.00, 4th: 0.70

NOTE: Use with electronic controller P/N 19332775 for carbureted and Ram Jet applications. Use with electronic controller P/N 19302405 with Chevrolet Performance LS fuel injected applications.

C. 19300175

SuperMatic™ 4L85-E Four-Speed Transmission

- Improved valve body for firmer shifts
- Direct bolt-on for Gen I Small-Block and all Big-Blocks
- Does not include torque converter (See pages 366-367 for options)
- Includes additional clutch plates
- Gear ratios: 1st: 2.48, 2nd: 1.48, 3rd: 1.00, 4th: 0.75
- Add up to 690 lb.-ft. of torque

NOTE: Use with electronic controller P/N 19332780 for carbureted and Ram Jet applications. Use with electronic controller P/N 19302410 with Chevrolet Performance LS fuel injected applications. Torque converter not included. See automatic transmission torque converter match listing chart on page 367.

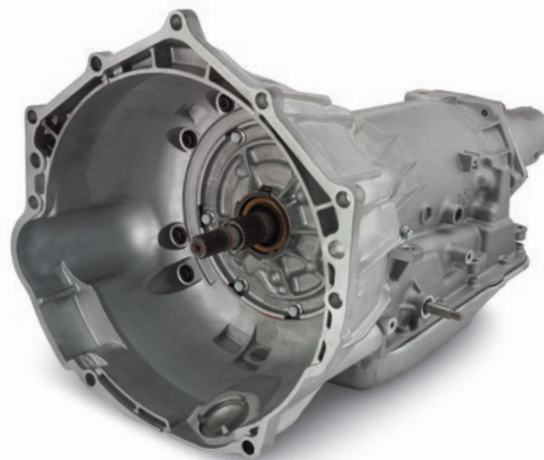

A SuperMatic™ 4L65-E



B SuperMatic™ 4L75-E

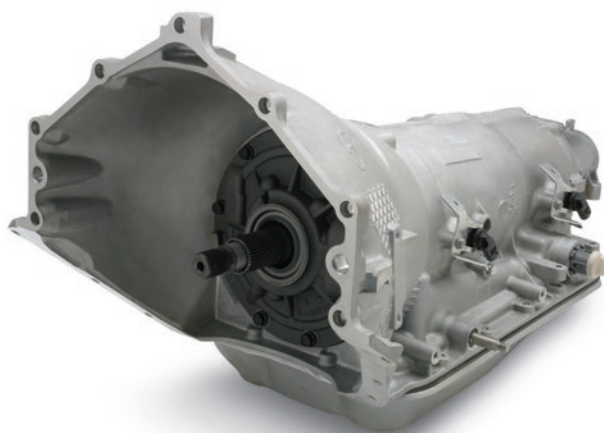

C SuperMatic™ 4L85-E



SuperMatic™ 8L90-E Transmission **D**



8L90-E with Slip Yoke **D**



Gen V LT1 A/T Bell Housing Kit **E**

D. SuperMatic™ 8L90-E Eight-Speed Transmission

Chevrolet Performance has adapted the production-based 8L90-E eight-speed automatic transmission for use with the LT1 and LT4 crate engines. A numerically high 4.56 first gear ratio offers strong take-off performance while a wide 7.0:1 overall ratio helps enhance cruising efficiency. Two versions are available: a slip-yoke design for use with the LT1 engine and a slip-yoke design to be used with the LT4. Additional highlights:

- Four gearsets for greater efficiency
- Five clutches – two brake clutches and three rotating clutches
- World-class upshift speeds
- Friction-reducing features include synthetic fluid
- Gear ratios: 1st: 4.56, 2nd: 2.97, 3rd: 2.08, 4th: 1.69, 5th: 1.27, 6th: 1.00, 7th: 0.85, 8th: 0.65, reverse: 3.82
- Controller and harness included
- Torque converter included (engine specific)

19367134

SuperMatic™ 8L90-E Transmission for LT1 Crate Engine (slip yoke)

- Use with LT1 crate engines P/N 19328728 (wet sump) or P/N 19329997 (dry sump)
- Includes torque converter, controller and harness
- Must be used with compatible engine controller (P/N 19355167)

19367135

SuperMatic™ 8L90-E Transmission for LT4 Crate Engine (slip yoke)

- Use with LT4 crate engines P/N 19368622 (wet sump) or P/N 19332702 (dry sump)
- Includes torque converter, controller and harness
- Must be used with compatible engine controller (P/N 19355174)

E. 19125817

Bell Housing Kit – LT Engine

- Unique bell housing kit enables 1996–later 4L60, 4L65, 4L70 and 4L75 four-speed automatic transmissions to be matched with the Gen V LT1 engine.
- Use with 8-bolt flexplate kit P/N 19329416

Transmission Installation Kits – 8L90-E (not shown)

Chevrolet Performance offers installation kits to make the installation of your 8-speed automatic quick and easy.

- Includes covers, bolts, cooler lines, etc
- Kits are specific for each engine.

NOTE: The pre-programmed transmission controller and wiring harness are specific to each 8-speed transmission, and are included with the transmission package.

24283284

8L90-E Installation Kit for LT1 & LT4 (slip yoke only)

24284144

8L90-E Installation Kit for LT4 (fixed yoke only)

IMPORTANT NOTE: There has been a running change in the High Fuel Pressure Sensor on LT1 and LT4 production engines. It is critical that the correct engine part number and the correct engine controller be paired to ensure proper operation of the transmission. (See chart below).

Engine Controller/Transmission Compatibility for LT1 and LT4

Engine Description	Engine P/N	Fuel Pressure Sensor	Transmission Type	Engine Controller kit P/N
LT1 Wet Sump	19328728	4 Pin	4-Speed Automatic or T56 Super Magnum	19303137
LT1 Wet Sump	19355405	3 Pin	4-Speed Automatic or T56 Super Magnum	19355458
LT1 Wet Sump	19355405	3 Pin	8-Speed Automatic SuperMatic™	19355167
LT4 Wet Sump	19368622	4 Pin	4-Speed Automatic or T56 Super Magnum	19331517
LT4 Wet Sump [CTS-V]	19355404	3 Pin	4-Speed Automatic or T56 Super Magnum	19366789
LT4 Wet Sump [CTS-V]	19355404	3 Pin	8-Speed Automatic SuperMatic™	19355174
LT4 Wet Sump [Camaro ZL1]	19368622	3 Pin	4-Speed Automatic or T56 Super Magnum	19366789
LT4 Wet Sump [Camaro ZL1]	19368622	3 Pin	8-Speed Automatic SuperMatic™	19355174

Automatic Transmissions & Components continued

A. 19259117

Transmission Installation Kit – 4L60/4L70 Series

- Use with 4L60, 4L65, 4L70 and 4L75-E transmissions on LS engines with 6-bolt crankshaft flange
- Includes flexplate, flexplate covers, fasteners and instruction sheet
- Does not fit LSA, LSX454, LS9, LT1 or LT4 engines

19329416

Transmission Installation Kit – 4L60/4L70 Series (not shown)

- Use with 4L60, 4L65, 4L70 and 4L75-E transmissions on LS engines with 8-bolt crankshaft flange
- Includes flexplate, flexplate covers, fasteners and instruction sheet
- Fits LSA, LSX454, LT1, LT4

19332781

Transmission Installation Kit – 4L60/4L70 Series (not shown)

- Use with 4L60, 4L65, 4L70 and 4L75-E transmissions on Small-Block and Big-Block crate engines with 6-bolt crankshaft flange
- Designed to be used with SuperMatic™ converters
- Does not include flexplate

B. 19259119

Transmission Installation Kit – 4L80 Series

- Use with all LS engines to mate transmission fully with the engine
- Includes flywheel cover, hardware and fastener torque specs
- Does not include flexplate
- Use flexplate 12654640 for 6-bolt crankshaft engines and SuperMatic™ converters
- Use flexplate 12636325 for 8-bolt crankshaft engines and SuperMatic™ converters
- All production converters must use crankshaft adapters (see kits below)

19332784

Transmission Installation Kit – 4L80 Series

- Use with all Big-Block crate engines to mate transmission fully with the engine
- Includes flywheel cover, hardware and fastener torque specs
- Designed to be used with SuperMatic™ Converters
- Does not include flexplate

C. 19125597

8-Bolt Crankshaft Adapter Kit – LSA/LSX454

- Use with LSA, LSX454 and LSX454R crate engines with 8-bolt crankshaft flange
- Includes flexplate, adapter hub and hardware
- Provides the correct converter pilot support for production 4L80/85 style torque converters
- Conventional 6-bolt flexplates do not bolt up to LSA and LSX454 engines

D. 6-Bolt Crankshaft Adapter Kit – LS Engine

- For use with Gen I style (Turbo 350/400, 700R4, 4L60, 4L60-E and 4L85-E) transmission on Gen III- and Gen IV-engines
- Flexplate 19260102 has only 11.5" (4L80-style) torque converter bolt pattern. Other applications may need to modify flexplate to use

For 6-Bolt Crankshaft Adapter, order the following parts:

Part Number	QTY	Part
12563532	1	Crankshaft Spacer
19260102	1	Flexplate
19257940	6	Mounting Bolts

NOTE: Only 11.5" bolt circle. For individual flywheel and flexplate components see pages 183, 279 and 351.



A Transmission Installation Kit – 4L60/4L70 Series

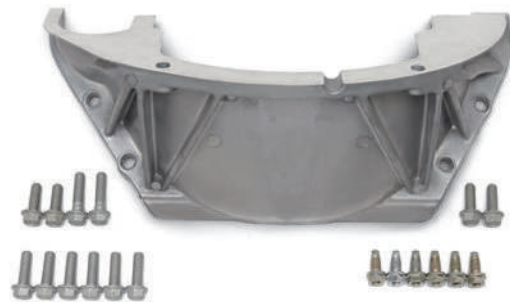

B Transmission Installation Kit – 4L80 Series



C 8-Bolt Crankshaft Adapter Kit

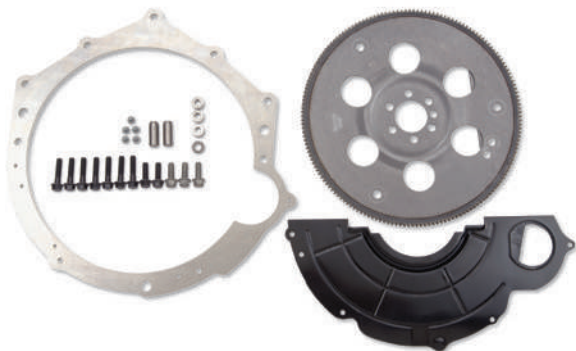

D 6-Bolt Crankshaft Adapter Kit

Transmission Adapter Kit **E**SuperMatic™ Transmission Control System for LS and LT **F**SuperMatic™ Transmission Control System
(Carbureted Engine Applications) **G****E. 19154766****Transmission Adapter Kit**

- Allows installation of Gen III/IV-style 4L60-E/4L65-E transmission onto Gen I and II engines using production-style torque converter
- Includes spacer ring, shims, dowels, bolts and flexplate
- Works on one-piece rear main seal engines only (e.g., Ram Jet 350)

TRANSMISSION CONTROL SYSTEMS**F. SuperMatic™ Transmission Control Systems for LS and LT**

- Pre-programmed – provides full function transmission operation after completing connections
- No laptop programming required
- Only compatible with E-67 and E-92 based Chevrolet Performance electronic LS and LT engine control systems
- Optional features for personal preferences
 - Gearshift timing
 - Multiple shift patterns
 - Manual shift mode
 - Supports most “Tap Shifters” or wheel-mounted paddles
 - On-Board data logging
- Connect and cruise – simple connections with no additional wiring required. Connect the clearly marked leads to the engine control harness, and you’re ready to cruise!

19302405 (shown)

- 1996-2008 4L60-E family transmissions
- Compatible with P/N 19368611, 19368613, 19368612, 19368615 and 19368614 Chevrolet Performance SuperMatic™
- Revised, more compact design for easier installation in smaller areas
- Enhanced shift pressure performance for improved shift control
- Compatible with OBD-II code readers

19302410

- 1993-Up 4L80-E family transmissions
- Compatible with P/N 19300175 Chevrolet Performance SuperMatic™
- Revised, more compact design for easier installation in smaller areas
- Enhanced shift pressure performance for improved shift control
- Compatible with OBD-II code readers

G. SuperMatic™ Transmission Control Systems for Carbureted Small-Block, Big-Block and Ram Jet Engines

- Pre-programmed – provides full function transmission operation after completing connections
- No laptop programming required
- Only compatible with carbureted or Ram Jet engine applications
- Optional features for personal preferences
 - Gearshift timing
 - Multiple shift patterns
 - Manual shift mode
 - Supports most “Tap Shifters” or wheel-mounted paddles
 - On-Board data logging
- Plug and play – Simple connections with no additional wiring required. Connect the clearly marked leads to the engine control harness, and you’re ready to cruise!

19332775

- 1996-2008 4L60-E family transmissions
- Compatible with P/N 19368611, 19368613, 19368612, 19368615 and 19368614 Chevrolet Performance SuperMatic™
- Revised, more compact design for easier installation in smaller areas
- Enhanced shift pressure performance for improved shift control
- Compatible with OBD-II code readers
- For Carbureted Small-Block, Big-Block and Ram Jet Engines

19332780

- 1993-Up 4L80-E family transmissions
- Compatible with P/N 19300175 Chevrolet Performance SuperMatic™
- Revised, more compact design for easier installation in smaller areas
- Enhanced shift pressure performance for improved shift control
- Compatible with OBD-II code readers
- For Carbureted Small-Block, Big-Block and Ram Jet Engines

MANUAL TRANSMISSIONS AND COMPONENTS

A. 19352208

T56 Super Magnum Six-Speed Manual Transmission

- High-torque capacity TREMEC six-speed manual designed for custom, retro-fit installations with Chevrolet Performance crate engines
- 700 lb.-ft. maximum torque capacity
- Exterior case similar to fourth-generation F-body transmission with the stronger, high-capacity gear sets, input shaft and output shaft used in the TREMEC TR6060
- 26-spline input shaft
- 31-spline output shaft
- Gear ratios: 2.66 (1), 1.78 (2), 1.30 (3), 1.00 (4), 0.80 (5), 0.63 (6)
- Slip-yoke design
- 40-tooth reluctor ring that's necessary for use with electronic vehicle speed sensors used with Chevrolet Performance controllers
- Two-position shifter plate included, with third position built into the transmission
- Kit includes shifter handle and Chevrolet Performance-logo ball-type shift knob (See page 375)
- Approximately 33.6 inches long with bell housing attached (bell housing included in separate installation kits)



A T56 Super Magnum 6-Speed Manual Transmission

B. 19329025

Bell Housing Kit – Small-Block and Big-Block Engines

- Allows T56 Super Magnum transmission P/N 19352208 to bolt up to a Gen I Small-Block and all Big-Block engines
- SFI steel bell housing
- Includes Block-Saver Plate and attaching hardware
- 5.950" deep
- Clutch kit not included. Use clutch kit P/N 19329633 for Small-Block and P/N 19329634 for Big-Block
- Designed for hydraulic concentric slave cylinder release bearing P/N 24264182 (See page 375)



B Small-Block, Big-Block T56 Bell Housing

C. 19329620

Bell Housing Kit – LS and LT Engines

- Allows T56 Super Magnum transmission P/N 19352208 to bolt up to any Gen III/Gen IV LS engine or Gen V LT engine
- SFI steel bell housing
- Includes Block-Saver Plate and attaching hardware
- 5.555" deep
- Clutch kit not included. Use clutch kit P/N 19329635, for engines with 8-bolt flange, including LT engines, P/N 19331082, for engines with 9-bolt flange and P/N 19331079, for engines with 6-bolt flange
- Designed for hydraulic concentric slave cylinder release bearing P/N 24264182 (See page 375)



C LS/LT T56 Bell Housing



T56 Super Magnum Installation Kit **D**

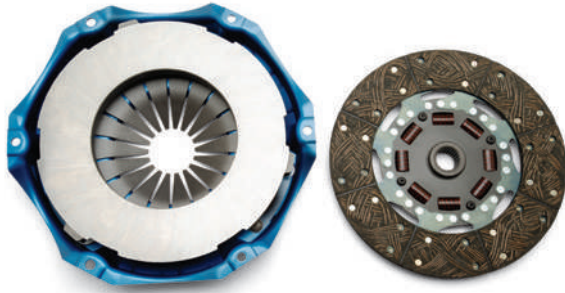

Clutch Kit - Small-Block **E**

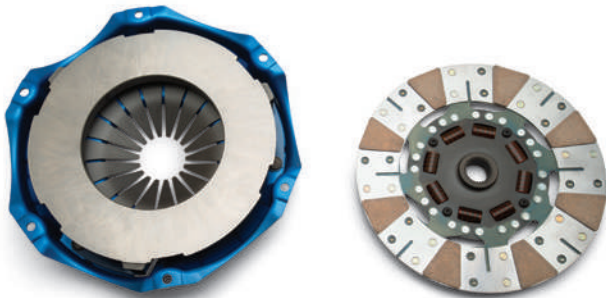

Clutch Kit - Big-Block **F**

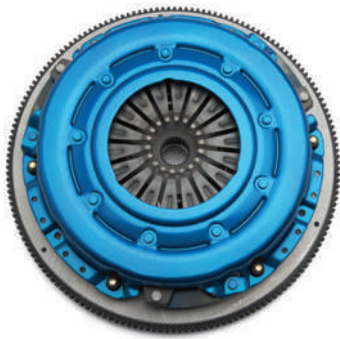

Clutch Kit, Dual-Disc - LS/LT, 8-Bolt Crank **G**

D. 19301625
Transmission Installation Kit - TREMEC T56 Super Magnum for LS engines with 6-bolt flange

- Use with T56 Super Magnum transmission P/N 19352208 and LS engines except LSA, LSX376-B15, LSX454 and LSX454R
- LS7-style flywheel with 6-bolt flange
- LS7-style high-strength clutch and pressure plate
- Fourth-generation F-body-type bell housing and clutch release bearing included
- Kit includes dust covers, hardware and instructions

E. 19329633
Clutch Kit - Small-Block Engines

- High-performance single-disc clutch that fits production Small-Block flywheels
- Rated for 450 lb.-ft. of torque
- Fits 168-tooth flywheel, P/N 14088648
- Kit includes pressure plate and additional hardware

F. 19329634
Clutch Kit - Big-Block Engines

- High-performance single-disc clutch that fits production Big-Block flywheels
- Rated for 650 lb.-ft. of torque
- Fits 168-tooth flywheel:
 - P/N 14096987 - 454 & 502 crate engines (externally balanced)
 - P/N 12582964 - 427 & 572 crate engines (internally balanced)
- Kit includes pressure plate and additional hardware

G. 19329635
Clutch Kit - LS/LT Engines, 8-Bolt Crank

- High-performance dual-disc clutch and flywheel package for LS and LT engines with 8-bolt flywheel flange
- Will not fit LS engines with 6-bolt flange
- Rated for 800 lb.-ft. of torque
- Kit includes flywheel, pressure plate, clutch disc and additional hardware

19331082
Clutch Kit - LS9 Engine, 9-Bolt Crank (not shown)

- High-performance dual-disc clutch and flywheel package for LS9 engines with 9-bolt flywheel flange
- Rated for 800 lb.-ft. of torque
- Kit includes flywheel, pressure plate, clutch disc and additional hardware

19331079
Clutch Kit - LS3/LS7 Engines, 6-Bolt Crank (not shown)

- High-performance dual-disc clutch and flywheel package for all LS engines with 6-bolt flywheel flange
- Rated for 800 lb.-ft. of torque
- Kit includes flywheel, pressure plate, clutch disc and additional hardware

Manual Transmissions & Components continued

A. 19329900

Transmission Installation Kit – TREMECT56 Super Magnum for Small-Block

- Use with T56 Super Magnum transmission P/N 19352208 Small-Block engines with one-piece rear main seal
- Not for use with 350/290 HP (P/N 12499529) and 350/290 HP Deluxe (P/N 19244450) crate engines, which use a two-piece main seal
- Use transmission installation kit P/N 19329902 for 350/290 HP engines with two-piece main seal
- Super Magnum bell housing
- 1986-later flywheel
- High-strength clutch and pressure plate
- Kit includes dust covers, pilot bearing, hardware and instructions



A Transmission Installation Kit – TREMECT56 Super Magnum for Small-Block

B. 19329901

Transmission Installation Kit – TREMECT56 Super Magnum for 454 and 502 Big-Block

- Use with T56 Super Magnum transmission P/N 19352208 and 454 and 502 crate engines (externally balanced)
- Not for use with 427/572 engines that are internally balanced
- Super Magnum bell housing
- Externally balanced flywheel
- High-strength clutch and pressure plate
- Kit includes dust covers, pilot bearing, hardware and instructions



B Transmission Installation Kit – TREMECT56 Super Magnum for 454 and 502 Big-Block

C. 19329902

Transmission Installation Kit – TREMECT56 Super Magnum for 427 and 572 Big-Block

- Use with T56 Super Magnum transmission P/N 19352208 and 427 and 572 crate engines (internally balanced)
- Use also with 350/290 HP crate engines with two-piece main seal
- Not for use with 454 and 502 engines that are externally balanced
- Super Magnum bell housing
- Internally balanced flywheel
- High-strength clutch and pressure plate
- Kit includes dust covers, pilot bearing, hardware and instructions



C Transmission Installation Kit – TREMECT56 Super Magnum for 427 and 572 Big-Block



Transmission Installation Kit - TREMEC T56 Super Magnum for LS Engines **D**



Chevrolet Performance Shifter Handle Kit **E**



Chevrolet Performance-Logo Shifter Ball Kit **F**



Hydraulic Concentric Slave Cylinder Release Bearing **G**

D. 19329912
Transmission Installation Kit - TREMEC T56 Super Magnum for LS/LT engines with 8-bolt flange

- Use with T56 Super Magnum transmission P/N 19352208 and LSA, LSX376-B15, LSX454 and LSX454R engines
- Use with T56 Magnum transmission P/N 19352208 and new LT1 crate engines P/Ns 19328728 (wet sump) and 19329997 (dry sump), and LT4 crate engines P/Ns 19368622 (wet sump) and 19332702 (dry sump)
- Super Magnum bell housing
- High-strength clutch and pressure plate
- Kit includes dust covers, pilot bearing, hardware and instructions

D. 19331080
Transmission Installation Kit - TREMEC T56 Super Magnum for LS engines with 6-bolt flange

- Use with T56 Super Magnum transmission P/N 19329795 and all LS engines
- Super Magnum bell housing
- High-strength clutch and pressure plate
- Kit includes hydraulic slave cylinder, pilot bearing, hardware and instructions

D. 19331083
Transmission Installation Kit - TREMEC T56 Super Magnum for LS9 engines with 9-bolt flange

- Use with T56 Super Magnum transmission P/N 19329795 and LS9 engines
- Super Magnum bell housing
- High-strength clutch and pressure plate
- Kit includes hydraulic slave cylinder, pilot bearing, hardware and instructions

E. 19301622
Chevrolet Performance Shifter Handle Kit

- Includes a black shifter handle and installation hardware

F. 19301623
Chevrolet Performance-Logo Shifter Ball Kit

- Give your Tremec® T56 or T56 Super Magnum six-speed-equipped project a distinctive, heritage-inspired look with a classic ball-style shift knob emblazoned with the Chevrolet Performance logo
- Includes the Chevrolet Performance-logo ball-style shift knob and installation hardware

G. 24264182
Hydraulic Concentric Slave Cylinder Release Bearing

- Gen 4 F-Car (LS1) release bearing
- Used for Chevrolet Performance bell housings and clutch packages

Manual Transmissions & Components continued

A. 92246731

TR6060 Six-Speed Manual Transmission

- A direct replacement transmission for your Camaro SS
- Rated to handle 420 lb.-ft. of torque
- Works with any Chevrolet Performance LS crate engines except LSA and LSX454
- Equipped with 26-spline input shaft and a fixed-yoke production style output shaft
- Includes release bearing
- Use with installation kit P/N 19259271
- Requires body-mounted shifter (not included)

24264047

TR6060 Six-Speed Manual Transmission (not shown)

- High-torque-capacity transmission used in the Cadillac CTS-V Series with the 556-hp/551-lb.-ft. LSA supercharged 6.2L engine
- Direct fit with LSA and LSX454 crate engines with 8-bolt crankshaft flange
- Equipped with 26-spline input shaft and a fixed-yoke production style output shaft
- Includes release bearing
- Use with installation kit P/N 19259270
- Requires body-mounted shifter (not included)

B. 19259270

Transmission Installation Kit – TREMEC TR6060 (MG9) – 8-Bolt Flange

- Use with TR6060 6-speed transmission P/N 24264047 only with LSA, LSX454 and LSX454R engines
- Includes flywheel with 8-bolt flange, high-strength clutch and pressure plate, dust covers, hardware and instruction sheet
- Clutch release bearing is included with the transmission assembly

C. 19259271

Transmission Installation Kit – TREMEC TR6060 (MG10) – 6-Bolt Flange

- Use with TR6060 6-speed transmission P/N 92246731 on all LS engines except LSA, LS9, LSX454 and LSX454R
- Includes flywheel with 6-bolt flange, high-strength clutch and pressure plate, dust covers, hardware and instruction sheet
- Clutch release bearing is included with the transmission assembly

D. 24255748

LSX/LS7 Clutch Kit

- 11.5" clutch single disc
- Fits 26-spline shaft
- Pressure plate and clutch disc

24260226

LS9 Clutch Kit (not shown)

- 10.5" clutch dual disc
- Fits 26-spline shaft
- Dual-mass clutch and pressure plate for LS9 Corvette ZR1

12570806

LS2 Clutch Kit (not shown)

- 11.5" clutch single disc
- Fits 26-spline shaft
- Flywheel, clutch and pressure plate kit for LS2 GTO engines

12581650

LS1 Clutch Kit (not shown)

- 11.5" clutch single disc
- Fits 26-spline shaft
- Flywheel with pressure plate and disc for LS1 Camaro engines

24266013

Release Bearing (actuator) (not shown)

* Included with Transmission Kit P/N 92246731

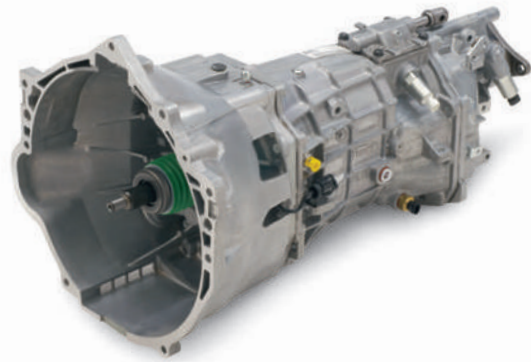

A TR6060 Six-Speed Manual Transmission



B Transmission Installation Kit – TREMEC TR6060 (MG9) – 8-Bolt Flange



C Transmission Installation Kit – TREMEC TR6060 (MG10) – 6-Bolt Flange

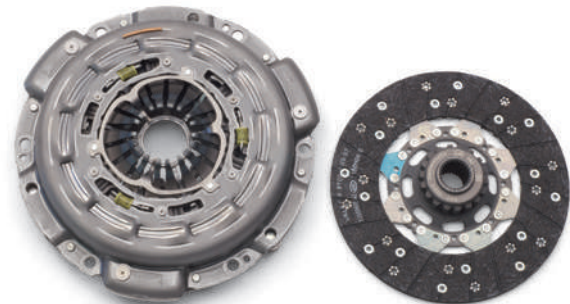

D LSX/LS7 Clutch Kit

LTG 4-Speed Automatic Transmission – Rear Wheel Drive **E**LTG Transmission 6-Speed Manual – Rear Wheel Drive **F**LTG 6-Speed Manual – Front Wheel Drive **G**LTG Clutch Package **H**LTG Six-Speed Manual Transmission Install Kit – FWD **I****24502513****4L60/700R4 Transmission Swap Kit (not shown)**

- Adapts the 4L60 or 700R4 automatic transmission (non-electronic version) for use in early model vehicles, with or without an engine management computer
- Includes instruction sheet, throttle valve spring for carbureted engines, a normally closed fourth-gear clutch switch and wiring connector for the torque converter

NOTE: For individual flywheel and flexplate components see pages 183, 279 and 351.

4-CYLINDER TRANSMISSIONS & COMPONENTS**E. 19368645****LTG Four-Speed Automatic Transmission – Rear Wheel Drive (remanufactured)**

- Electronically controlled four-speed overdrive transmission
- Features five-pinion gearsets, heat-treated stator shaft splines, induction-hardened turbine shaft, seven-plate 3.4 clutch
- Gear ratios: 1st: 3.06, 2nd: 1.62, 3rd: 1.00, 4th: 0.70
- Use SuperMatic™ converter for direct bolt up to Gen I and Gen II engines
- Add up to 430 lb.-ft. of torque
- Does not include torque converter (See below)

24284066**LTG Four-Speed Automatic Controller Kit – Rear Wheel Drive (not shown)**

- Electronic controller required for use with LTG transmission P/N 19368645

24284129**LTG Four-Speed Automatic Torque Converter (not shown)**

- 3,800 RPM stall speed
- Rear-wheel-drive transmission

4-CYLINDER TRANSMISSIONS & COMPONENTS**F. 19328976****LTG Transmission**

- Production 6-speed Manual Transmission
- Rear-wheel-drive configuration

G. 24284070**LTG Six-Speed Manual Transmission – Front Wheel Drive**

- GM F40-6 six-speed manual transmission for use with LTG 2.0L Turbocharged crate engine P/N 19328837 in front-wheel-drive applications
- Lightweight all-aluminum case
- Three overdriven gears
- Gear ratios: 1st: 3.92, 2nd: 2.04, 3rd: 1.32, 4th: 0.95, 5th: 0.76, 6th: 0.62, reverse: 3.75
- Use with installation kit P/N 24283758

H. 24251131**LTG Clutch Package**

- Production 6-speed Manual Clutch (included with LTG engine package)

19328978**LTG Six-Speed Manual Installation Kit – Front Wheel Drive (not shown)**

- Includes all hardware and fasteners needed to make the transmission operational

I. 24283758**LTG Six-Speed Manual Installation Kit – Front Wheel Drive**

- Includes hardware, shift cables and shifter to match the six-speed manual transmission P/N 24284070 to the LTG crate engine in front-wheel-drive applications



Engines

NEW LIFE FOR YOUR BABY!

As part of General Motors, Chevrolet Performance is able to offer a wide and diverse range of crate engines and partial engines beyond our high-performance Small-Block, Big-Block and LS engines. They are based on regular-production engines and make great swap choices for replacing a tired engine, while also enabling creative engine builders to start with an economical production engine and add their preferred power-building accessories.

NOTE: Engines depicted in photographs are representative of several part numbers and may not show all items included.

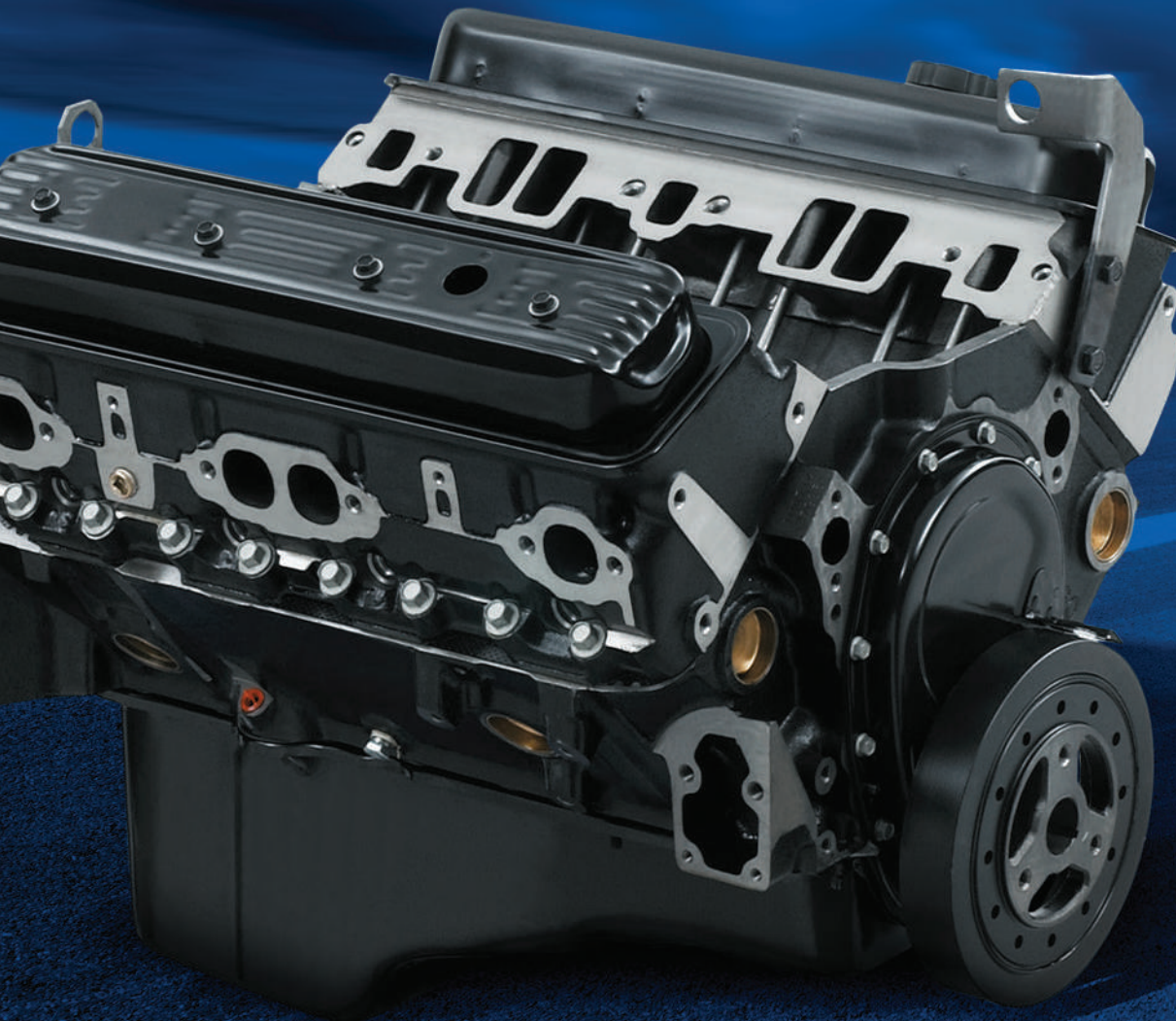

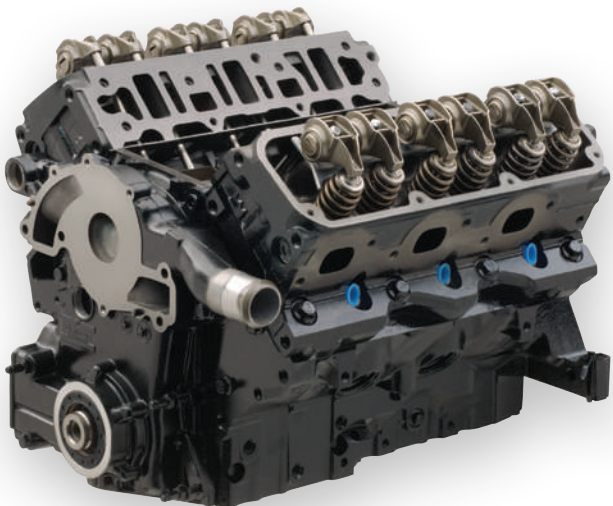

3.8L V-6

With its reputation for power and reliability, the 3800 Series III V-6 is the “Small-Block Chevy” engine of the V-6 world.

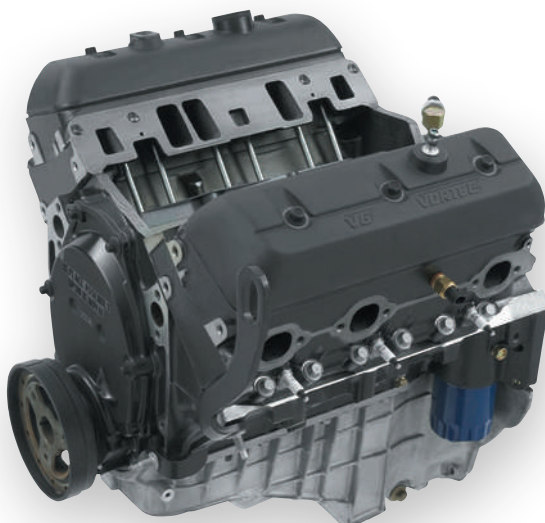

4.3L LU3

Based on the architecture of the original Small-Block V-8, but minus two cylinders, the 4.3L V-6 – also known as the Vortec 4300 – is a popular and powerful motivator in thousands of GM trucks. Engine assemblies are available in economical remanufactured configurations, all built to the exacting standards of regular-production engines.



4.8L LR4/LY2/L20

This economical 4.8L LS-series engine serves as the entry-level V-8 in many GM full-size trucks, where it also is known as the Vortec 4800. It delivers all of the strength, durability and performance attributes of its larger-displacement cousins. It uses the same iron cylinder block as the 5.3L LS, but has a smaller stroke. It is rated at 275 horsepower. Available remanufactured for 2001-2015 applications.

5.3L LM7/L59/LC9/LH8

Used in thousands of GM trucks, SUVs and vans since 1999, the 5.3L V-8 that's also known as the Vortec 5300, is respected for its great performance and efficiency. Horsepower is rated starting at 285, with torque at approximately 330 lb.-ft. GM Parts offers the 5.3L in new and economical remanufactured packages for 1999-2017 applications.



5.7L GEN 0 – P/N 12681429

All new - not remanufactured! The classic 350 is offered here in our most economical Small-Block engine assembly. Designed to replace production engines used from 1973-1985, it features a durable, yet value-driven, short-block assembly and iron cylinder heads with early-style perimeter hold-downs. Better still, it includes a stronger four-bolt main block and smooth flat tappet hydraulic camshaft.



5.7L GEN 1E

The 5.7L L31 Vortec 350 engine is found in thousands of 1996-2002 Chevrolet/GMC pick ups, sport utility vehicles and vans. All new, from oil pan to valve covers, they feature Vortec-style cast-iron cylinder heads for maximum power and efficiency, a one-piece rear main seal, hydraulic roller lifters and center-style valve cover hold-downs. The 12530282 features 2-bolt main caps, the 12530283 features 4-bolt main caps and heavy-duty cylinder heads. These are direct-replacement engines for 1996-2002 L31-equipped vehicles.

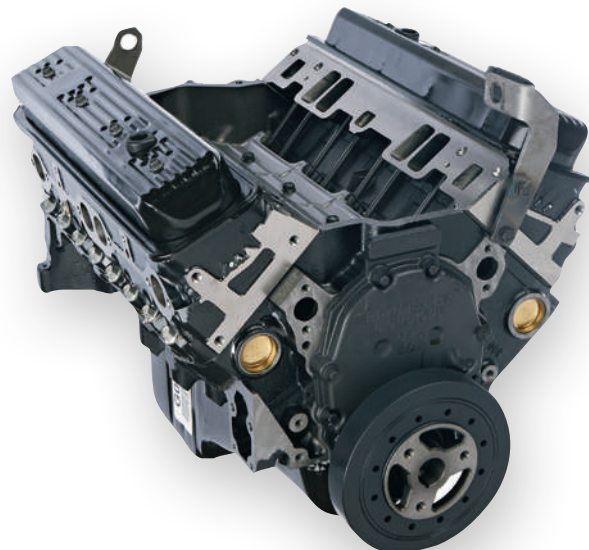



5.7L GEN 1 – P/N 12681430

All new – not remanufactured! This basic 5.7L/350-cubic-inch is designed for 1987-1995, 8,500 lb and under, light-duty truck applications, as it uses the later-style one-piece rear main seal and cylinder heads with center-style valve cover hold-downs. But it is adaptable to almost unlimited Small-Block applications. The bottom end is durable, with two-bolt mains. Additional details include a gear-driven oil pump assembly and a machined fuel pump pad, but no hole for the fuel pump pushrod. (210HP@4,000 and 300 lb.-ft.@2,800.)

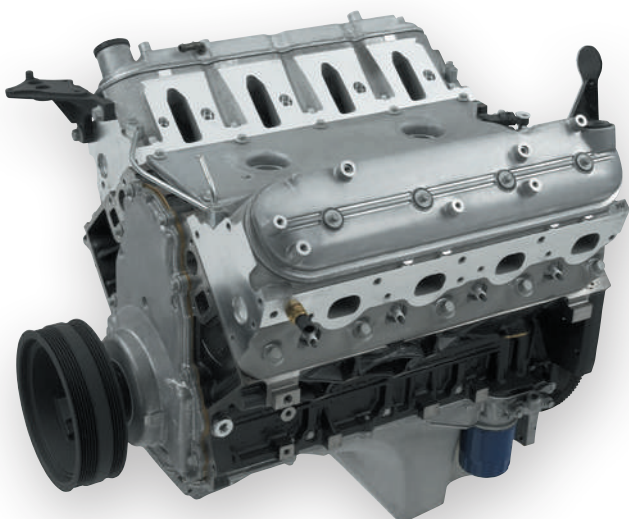

6.0L LQ4/LQ9

Used in a variety of 2001-07 GM trucks and SUVs, our iron-block 6.0L LS-series engine offers big power and exceptional torque (up to 325 horsepower and 370 lb.-ft. of torque, depending on the application). Our affordable 6.0L engine assembly is delivered without induction or ignition systems, and is offered in brand-new or remanufactured packages.

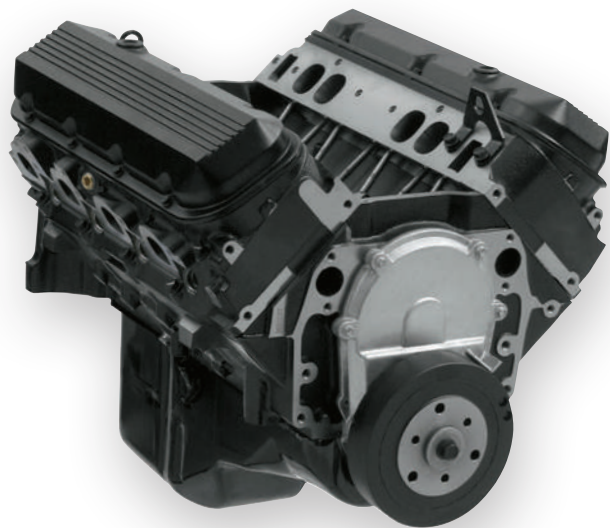

7.4L L19/L29

Our 7.4L engine assembly delivers the big torque you need for pulling a trailer and other heavy loads. A four-bolt main block enhances strength, and a later-style one-piece rear main seal reduces the chance of an oil leak. Designed for trucks, SUVs and vans built from 1980-2000; offered in new and remanufactured packages. CNG and LPG compatible variations are available.

V-6 90° Cylinder Head Quick Reference Chart

Part Number	Description	Casting Number	Material	Port Size	Port Type	Valve Spring	Chamber CC's	Int Vlv	Exh Vlv	Plug Type	Heat Riser	Rocker Stud	Notes
10134359	18° V-6	12480009	Aluminum	215	Raised	18°	43	2.150"	1.620"	Angled	No	Shaft	No seats/guides
12480009	18° V-6	12480009	Aluminum	215	Raised	18°	43	2.150"	1.620"	Angled	No	Shaft	As cast ports

V-6 90° CYLINDER HEADS

A. 10134359 

18° Aluminum Cylinder Head

- Low-port 18° aluminum cylinder head for maximum-effort competition engines
- Offers significant improvements over conventional head designs with 18° valve angles (vs. older 23° angles) and 43cc combustion chambers
- Spark plug holes are centrally located and valve centerlines are relocated
- Exhaust ports are high-flow
- Head face has an extra 0.080" of material for 9.1:1 compression, and up to 2.200" intake valves can be used
- Shallow wedge-shaped combustion chambers allow builders to achieve high compression ratios with small piston domes
- Heads do not include valve seats or guides
- Aftermarket shaft-mounted rocker arm assemblies and pushrods are required
- Piston domes and valve pockets must be matched to the revised combustion chamber design

12480009 

18° Aluminum Cylinder Head (not shown)

- Low-port 18° aluminum cylinder head for competition engines
- Identical to P/N 10134359 (see above), except that it has a new-design intake port for the Daytona Dash Racing Series

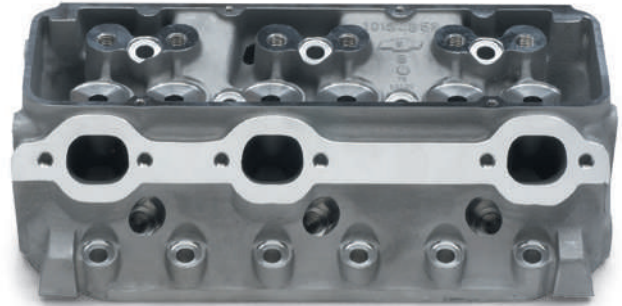

A 18° Aluminum Cylinder Head (exhaust)

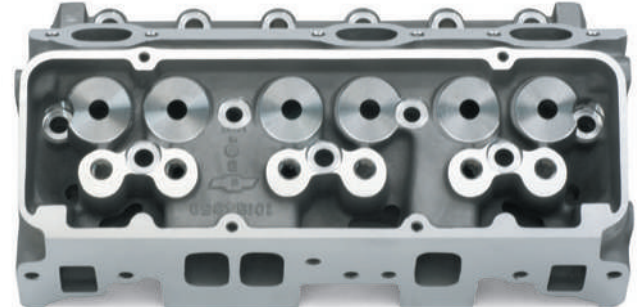

A 18° Aluminum Cylinder Head (top/intake)

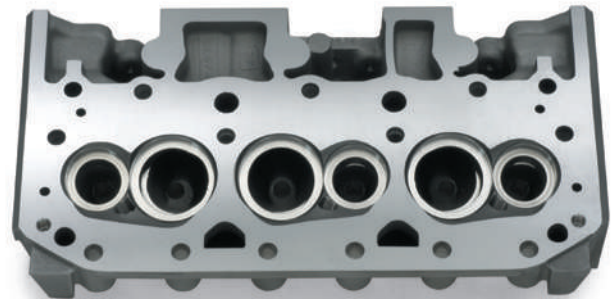

A 18° Aluminum Cylinder Head (combustion chamber)

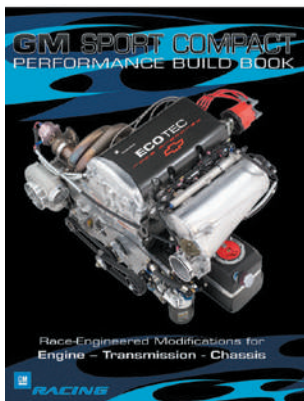
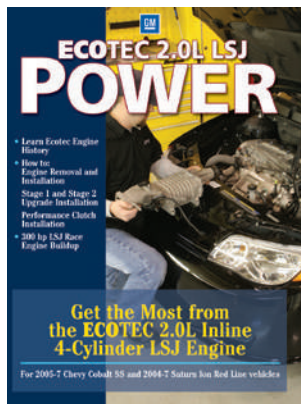
Exhaust Header Flange **B**Ecotec Exhaust Camshaft Blank **C**Sport Compact Build Book **D**Ecotec 2.0L LSJ Power Book **E****ECOTEC****B. 88958632****Exhaust Header Flange**

- Use this 0.375" thick steel flange as the starting point for your custom header system

Camshafts**88958648****Ecotec Performance Camshaft Set (not shown)**

- For increased power in naturally aspirated and turbocharged engines
- Duration @ 0.050" lift is 247° on the intake and 249° on the exhaust
- Maximum lift is 0.499" for the intake and 0.499" on the exhaust
- Lobe centerline is 116°

C. 88958612**Ecotec Exhaust Camshaft Blank**

- Heat-treated camshaft blank for grinding custom-profile exhaust cam

Crankshafts**88958631****Ecotec Crankshaft Pulley (not shown)**

- Billet pulley has a reduced diameter to minimize the horsepower-robbing drag of the alternator and air conditioning compressor

Intake Manifolds, Gaskets and Components**88958633****Ecotec Intake Manifold Flange Set (not shown)**

- 0.555"-thick aluminum flanges can be used to fabricate your own custom intake manifold

Build Books**D. 88958728****Sport Compact Build Book**

- Describes all the parts and procedures needed to transform your stock Ecotec engine into a high-performance racing engine for drag racing or drifting competition
- Also includes race modifications for a 4T65-E automatic transmission

E. 88958686**Ecotec 2.0L LSJ Power Book**

Step-by-step guide to boosting the horsepower and torque in this versatile four-cylinder powerplant.

- Detailed instructions on engine removal/reinstallation
- Special instructions on Installing Stage 1 and Stage 2 upgrade kits
- Build a 300-plus horsepower Ecotec!

2.0L TURBO PERFORMANCE

Enhance the performance of your 2.0L Turbo with Genuine GM products from Chevrolet Performance.

A. 19212670

Performance Turbocharger Upgrade Kit for Cobalt, Solstice, Sky and HHR



- For 2007-2009 Pontiac Solstice GXP, 2007-2009 Saturn Sky Redline, 2008-2010 HHR SS, 2008-2010 Cobalt SS
- Increases horsepower up to 290 @ 5,200 rpm and torque up to 340 lb.-ft.
- Includes new calibration (flashed by your local dealer) and two new MAP sensors
- Premium fuel required

This part has been granted an Executive Order (E.O.) from the California Air Research Board. EO#: D-126-29 for 2007-2010 MY



A Performance Calibration

CHASSIS, SUSPENSION AND BRAKES

Cobalt SS, Saturn ION Red Line

B. 88958710

Heavy-Duty Front Steering Knuckle for Chevrolet Cobalt SS, Saturn ION Red Line, Left-hand

- Designed to provide enhanced load capacity for off-road use
- Designed to use the existing interfaces to the bearing, brake caliper, strut and control arm
- Installation requires caliper mounting bolts P/N 11570091, lower ball joint bolt P/N 11589341 and nut P/N 11517996 included with the kit
- Bearing spacer plate needs modification for installation
- Specific suspension point geometry – may induce increased tire wear during street duty



B Heavy-Duty Steering Knuckle, Left-Hand

W-Body: 2000-2005 Monte Carlo and Impala; 1997-2003 Grand Prix

C. 12498648

Strut Tower Braces

- Install these easy bolt-on braces on your car to reduce body flex for firmer feel when cornering
- Includes hardware and installation instructions



C Strut Tower Braces

D. 12498642

Heavy-Duty Rear Stabilizer Bar

- Fits Pontiac Grand-Prix 1997-2003 and Chevrolet Monte Carlo 2000-2005
- For reduced body roll, install this thick, 19mm rear bar
- Includes bushings



D Heavy-Duty Rear Stabilizer Bar

E. 12498643

Heavy-Duty Front Stabilizer Bar

- Fits Pontiac Grand-Prix 1997-2003 and Chevrolet Monte Carlo 2000-2005
- Get the look and feel of performance with this sturdy 34mm front bar
- Includes bushings and end links



E Heavy-Duty Front Stabilizer Bar



High-Performance Front Brake Upgrade Kit **D**

D. 12498644

High-Performance Front Brake Upgrade Kit

- Fits Pontiac Grand-Prix 1997-2003 and Chevrolet Monte Carlo 2000-2005
- Attain increased braking performance with 12" vented disc rotors and high-performance brake pads
- Includes rotors, caliper mounting brackets, pads and bushings

NOTE: Monte Carlo and Impala models already have this system installed as standard production. Will not fit stock Grand Prix "crosslace" wheels and spare tire may not fit. Heat generated by performance brake pads can cause rotor warping if not allowed to cool sufficiently between severe uses.

E. 12498646

Heavy-Duty Front Brake Caliper Brackets

- Fits Pontiac Grand-Prix 1997-2003 and Chevrolet Monte Carlo 2000-2005
- Same brackets used in brake kit P/N 12498644 (see above)
- Includes brackets, bushings and pins
- Rotors equivalent to P/N 12498647 must be used

FACTORY ENGINEERED RACE PARTS F&Y CAR

Lightweight Racing Aluminum Driveshaft

Lose less power in the transfer from the transmission to the rear axle. These lightweight aluminum driveshafts are designed for F-cars equipped with the MM6 six-speed manual transmission:

12564004

Aluminum Driveshaft (not shown)

- 1998-1999 LS1 with MM6 transmission

12480094

SACHS Shock Absorber, Front (not shown)

- Tuned for use with the T1 suspension package (see below)
- Sold individually; order 2 per vehicle

12480095

SACHS Shock Absorber, Rear (not shown)

- Tuned for use with the T1 suspension package (see below)
- Sold individually; order 2 per vehicle

12480093

Camber Spacer Kit (not shown)

- 2 kits required per wheel

Kit includes one of each of the following:

12480071	Camber Plate, Large	12480076	Camber Plate, Small
15688857	Bolt, Lower Control Arm	11516382	Nut, Lower Control Arm

12480080

C5 Transmission Oil Cooler Kit (not shown)

- Intended for cars equipped with the six-speed manual transmission and has been updated for use on Z06 and export-model Corvettes
- Includes transmission pump, cooler assembly, wiring harness, plumbing kit, filter bracket, thermal switch, brackets and fasteners

25534430

C6 Corvette T1 Suspension Kit for C6 Corvette (not shown)

- Approved by the SCCA for racing in the T1 class
- Similar to the championship-winning C5 kit, but made to fit the C6

Kit includes one of each of the following:

25534418	Spring-Front	25534419	Spring-Rear
12480065	Stabilizer Bar Front	25534433	Stabilizer Rear (4 required)
12480067	Link-Anti-Roll Bar (4 required)	12480068	Isolator-Front Anti-Roll Bar (2 required)
12480069	Isolator-Rear Anti-Roll (2 required)	25534436	Arm-Front Upper LH
25534437	Arm-Front Upper RH	25534438	Arm-Front Lower LH
25534439	Arm-Front Lower RH	25534442	Arm-Rear Lower LH
25534443	Arm-Rear Lower RH		



Heavy-Duty Front Brake Caliper Brackets **E**

MISCELLANEOUS PARTS & MANUALS

BOOKS AND MANUALS

Get the most from your vehicle and its Chevrolet Performance parts. These books and manuals provide insider information and technical tips from direct sources within General Motors. They are invaluable for building an engine for the street or race track.

A. 24502488

Chevrolet Power

- Seventh edition of the time-tested guide to building competition engines for oval track racing, drag racing, road racing and marine applications
- Includes information on Small-Block, Big-Block, 90° V-6 and 60° V-6
- Contains more than 600 photos, illustrations, blueprints and charts

88962723

Service Manual, Ram Jet 350 (MEFI 4) (not shown)

- Covers the installation and service of the MEFI 4 Ram Jet 350 P/N 12499120

B. 12486610

Service Manual, Ram Jet 502 (MEFI 3)

- Covers the installation and service of the MEFI 3 Ram Jet 502 P/N 12497323

88962724

Service Manual, Ram Jet 502 (MEFI 4, not shown)

- Covers the installation and service of the MEFI 4 Ram Jet 502 P/N 12499121

C. 88958728

Sport Compact Build Book

- Describes all the parts and procedures needed to transform your stock Ecotec engine into a high-performance racing engine for drag racing or drifting competition
- Also includes race modifications for a 4T65-E automatic transmission

D. 88958767

COPO Build Book

- The COPO Build Book provides all the information you need to build your own COPO Camaro including specs, part numbers and more.

NOTE: Based on construction of Gen 5 Camaro

24502570

Motorsports Aurora V-8 Engine Handbook (not shown)

- Covers component selection and recommendations, as well as engine building procedures, for engines used in specific racing series

E. 88958697

Solstice Performance

- 132 pages show how to take advantage of the performance capabilities of the Pontiac Solstice
- Loaded with almost 900 images and detailed technical information to help everyone from the beginner to the expert
- Shows how a Sports Car Club of America (SCCA) road racing Solstice is created, along with the buildup of a 'drifting' Solstice and a brute-performance Solstice

F. 88959384

LS1 Engine Kit Installation Guide

- Detailed instructions to help you install an LS1 engine in your older vehicle
- Includes notes and technical explanations for necessary parts, along with part numbers you can order from your GM dealer to get the job done easily

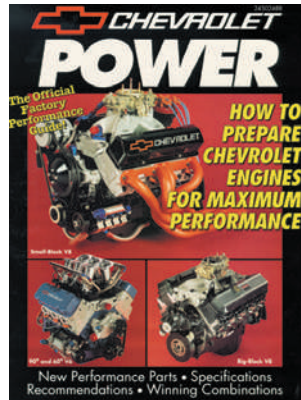

A Chevrolet Power

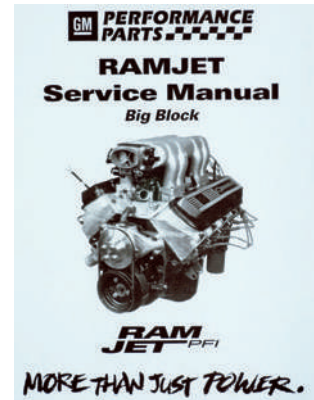

B Service Manual, Ram Jet 502 (MEFI 3)



C Sport Compact Build Book

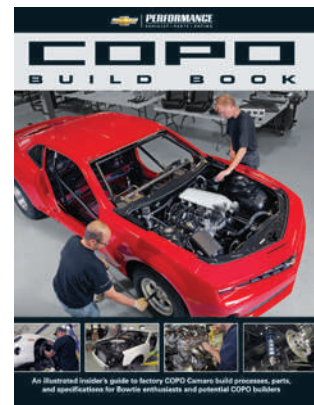

D COPO Build Book



E Solstice Performance



F LS1 Engine Kit Installation Guide

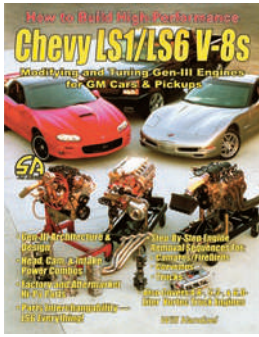

High-Performance Chevy LS1/LS6 V-8's **G**



LS-Series – How to Rebuild Book **H**

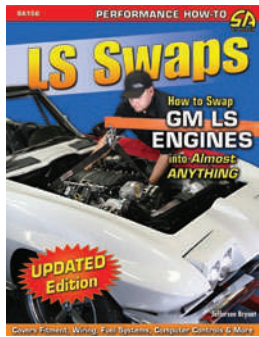

LS Swaps – Swap LS Engines Into Almost Anything **I**

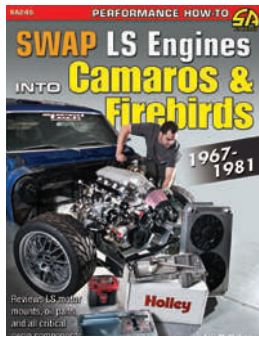

Swap LS Engines Into Camaros & Firebirds **J**

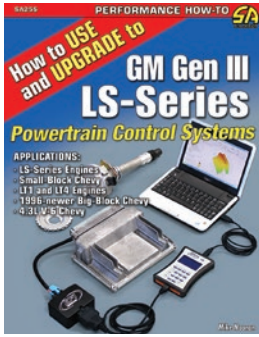

GM Gen III LS-Series Powertrain Control Systems **K**

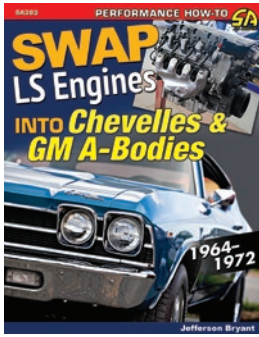

Swap LS Engines Into Chevelles & A-Bodies **L**



Circle Track Techbook **M**

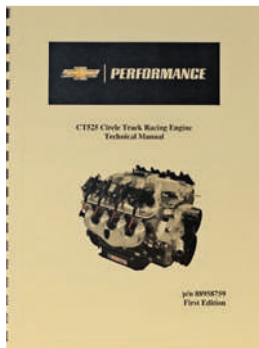

Circle Track Techbook (CT525) **N**

- G. 88958786 High-Performance Chevy LS1/LS6 V-8s**
- 160 pages discuss the LS-Series engine architecture and design, parts interchangeability along with step-by-step engine removal sequences for many GM vehicles with LS-Series engines
 - Shows how to build, modify and tune LS engines
-
- H. 88958764 NEW! LS-Series "How to Rebuild" Book**
- A complete reference that shows how to rebuild an LS-Series engine
 - Includes tips and modification procedures to improve power and economy
 - More than 600 step-by-step color photos
-
- I. 19369196 NEW! LS Swaps – How to Swap GM LS Engines Into Almost Anything**
- From Motor Mounts, Adapter Plates and Transmission Mounts to Wiring Harnesses and Engine Management Systems, this comprehensive book addresses many of the issues involved with today's hottest engine swap going
-
- J. 19369198 NEW! Swap LS Engines into Camaros & Firebirds – 1967-1981**
- Contains 409 color photos illustrating swapping LS Engines into GEN I and GEN II F-bodies that will guide you through each crucial step in your project
-
- K. 19369197 NEW! How to Use and Upgrade to GM GEN III LS-Series Powertrain Control Systems**
- A deep dive into understanding the Small-Block Engine Family Generations and comparing GEN III engine controllers
-
- L. 19369195 NEW! Swap LS Engines into Chevelles & GM A-Bodies – 1964-1972**
- Detailed step-by-step instructions for installing LS powerplants into Chevelles, Buick GS, Olds Cutlass and Pontiac GTO. Contains over 400 color photos
-
- M. 88958668 Circle Track Techbook**
- Technical manual for GM Circle Track crate engines P/N 88869602, P/N 88958602, P/N 88958603, P/N 88958604 and P/N 88869604
 - Covers all details regarding rebuilding specifications, including parts lists
 - 47 pages with photos and details on valve machining, valve springs, camshafts and other factory specifications
-
- N. 88958759 Circle Track Techbook (CT525)**
- Technical manual for Chevrolet Performance CT525 Circle Track engine P/N 19271821
 - Covers all engine specifications, component part numbers, installation tips and rebuilding specifications

GM Licensed Parts

NEW! Chevy Bowtie Rear End Diff Covers in Signature Black Crinkle

These Chevy Bowtie Differential Covers not only look great, but also add key performance upgrades to your rear housing in high horsepower situations! Designed to stiffen up the main cap area, the housing flex of the differential is reduced, giving gear life an increase and the amount of ring deflection a decrease.

- Reduces Housing Flex
- Increases Gear Life
- Decreases Ring Deflection
- CNC Milled Chevy Bowtie Emblem
- Available in 7.5 GM, 8.2/8.5 GM (10 Bolt) and Passenger Car (12 Bolt) Rear Housings

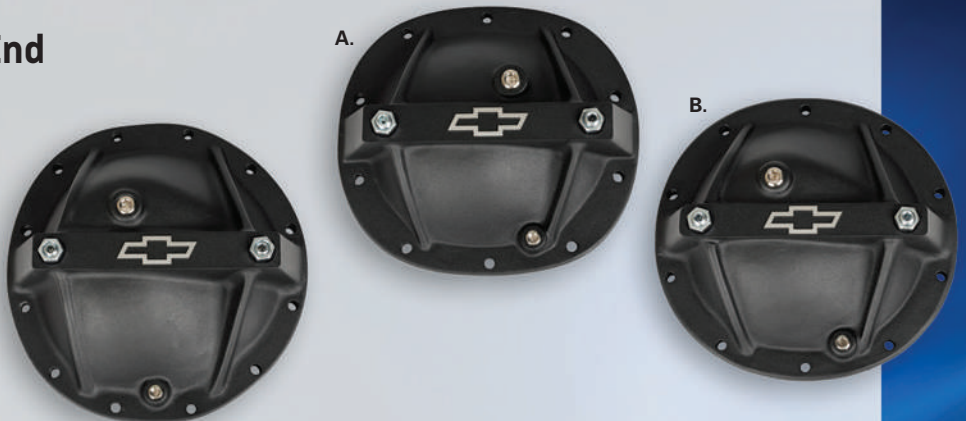

- A. 141-695 GM, 7.5 (10 Bolt)
- B. 141-696 GM, 8.2/8.5 (10 Bolt)
- C. 141-697 GM, 12 Bolt, Passenger Car

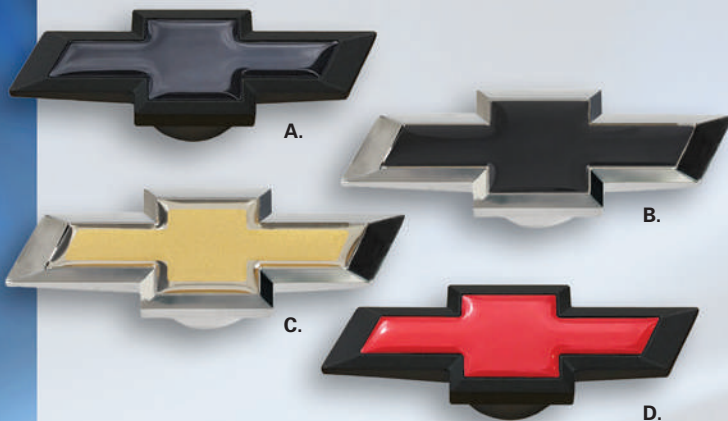

- A. 141-339 Black Crinkle Bowtie, Black Emblem
- B. 141-338 Chrome Bowtie, Black Emblem
- C. 141-336 Chrome Bowtie, Gold Emblem
- D. 141-335 Black Crinkle Bowtie, Red Emblem

NEW! Extra-Large Air Cleaner Center Nuts

Four Styles to Choose from to Personalize your Air Cleaner Look!

Give any center nut style air cleaner an exciting new look with a prominent Extra-Large Bowtie Air Cleaner Nut, a quick and easy upgrade that'll give your air cleaner a distinctive eye-catching look.

- Fits both 1/4"-20 and 5/16"-18 studs.
- Extra-large size
- Contoured 3D Bowtie
- Dual threaded for easy install
- Available in four popular styles

CHEVROLET & Bowtie Emblem Slant-Edge Series Air Cleaners & Valve Covers

The perfect way to complete your dress-up look with premium style.

Slant-Edge Series dress-up parts bring your engine look together in head-turning fashion. With eight different finishes, it's never been easier to customize your look!



LS SLANT-EDGE VALVE COVERS

These new valve covers are taller than stock valve covers, and can accommodate a wide variety of large valvetrain applications. Oil fill hole, and cap (passenger side cover), PCV (driver's side cover) included. Threaded mounting holes for the Integrated Ignition Coil Bracket included. Sold in Pairs. U.S. Pat. D657,798.

LSX, CHEVROLET AND BOWTIE LOGOS

Fits GM LS engines

- Chevy® Orange, LSX®, raised logo 141-257
- Chevy® Orange, raised logo 141-261
- Black Crinkle, raised logo 141-262
- Black Crinkle, LSX®, raised logo 141-256
- Cast Gray Crinkle, raised logo 141-263
- Polished, recessed red/black logo 141-264
- Chrome, recessed red/black logo 141-265
- Polished, no logo 141-266

INTEGRATED IGNITION COIL BRACKET

- Coil bracket for LS 1st Gen style coils 69520
- Coil bracket for LS 4th & 5th Gen style coils 69521

SPARK PLUG WIRES

- MSD 8.5mm Wires, P/N 39849, are recommended

COIL RELOCATION EXTENSION CORDS

- 18" Extension Cord 69525
- 46" Extension Cord 69526



LS Slant-Edge Valve Covers, LSX, Chevrolet and Bowtie Logos

DIE-CAST VALVE COVERS

These premium die-cast aluminum valve covers are manufactured to GM specifications and are equipped with internal oil drippers (Small-Block only) and baffles. The valve covers are highlighted with recessed and raised Bowtie and Chevrolet logos. Available in tall only. Sold in pairs.

A. Chevrolet Big-Block, 1965 – 1996

- Chrome, recessed logo (shown, A) 141-140
- Black crinkle, recessed logo (not shown) 141-141
- Polished, recessed logo (not shown) 141-142

B. Chevrolet Small-Block V-8, 1958 – 1986

- Polished, recessed logo (not shown) 141-108
- Black crinkle, recessed logo (not shown) 141-116
- Chrome, recessed logo (not shown) 141-117
- Chevy® Orange, recessed logo (not shown) 141-118
- Black Crinkle, raised logo (shown, B) 141-119
- Chevy® Orange, raised logo (not shown) 141-120
- Carbon-Style, recessed logo (not shown) 141-121

LATE-MODEL DIE-CAST VALVE COVERS

Late-model valve covers are the tall, center hold-down-style and come with mounting bolts and appropriate washers. All late-model valve covers come with baffles and grommets. Sold in pairs.

C. Chevrolet Small-Block V-8, 1987 – Pre-LS

- Polished, with baffle (not shown) 141-130
- Black crinkle, with baffle (not shown) 141-131
- Chrome, with baffle (shown, C) 141-132
- Replacement bolt and washer kit (not shown) 141-133
- Polished, no logo, with baffle (not shown) 141-134

SLANT-EDGE DIE-CAST VALVE COVERS

These tall, slant-edge die-cast valve covers have a progressive design and a modern look. Offered with raised or recessed Chevrolet and Bowtie logos, plus no logo. The valve covers are baffled and sold in pairs. U.S. Pat. D580,954.

D-G. Chevrolet Small-Block V-8, 1958 – 1986

- Polished, raised logo (not shown) 141-920
- Black crinkle, raised logo (shown, D) 141-921
- Chrome, raised logo (shown, E) 141-922
- Metallic gray, recessed logo (not shown) 141-923
- Chevy® Orange, raised logo (not shown) 141-924
- Cast gray crinkle, raised logo (not shown) 141-925
- Polished, no logo (not shown) 141-926
- Polished, recessed red/black logo (not shown) 141-927
- Black crinkle, recessed logo (not shown) 141-928
- Chrome, recessed red/black logo (shown, F) 141-930
- Powdercoat-ready, raised logo (shown, G) 141-939

H. New Collector's Series

- Red, raised logo (shown, H) 141-931
- Blue, raised logo (not shown) 141-932
- Green, raised logo (not shown) 141-933
- Yellow, raised logo (not shown) 141-934
- White, raised logo (not shown) 141-935



A 141-140



B 141-119



C 141-132



D 141-921



E 141-922



F 141-930



G 141-939



H 141-931



141-751 **I**

141-784 **J**



141-905 **K**

141-811 **L**



141-812 **M**

141-787 **N**



141-840 **O**

141-844 **P**

STAMPED VALVE COVERS

These heavy-gauge stamped steel valve covers are designed to prevent leakage. The high-quality chromed covers feature Chevrolet and Bowtie logos. They are available in both tall and short (production height) designs. Some valve covers have oil baffles for PCV hookups. The valve covers are sold in pairs with necessary grommets, unless otherwise specified.

NOTE: Production height Chevy Small-Block valve covers and valve covers with baffles will not clear most stud girdle applications.

I-K. Chevrolet Small-Block V-8, 1958 – 1986

- Chrome, tall, no baffle (not shown)..... 141-101
- Chrome, short, with baffle (not shown) 141-102
- Chrome, tall, with baffle (not shown)..... 141-103
- Metallic gray, tall, with baffle (not shown) 141-361
- Carbon-Style, tall, with baffle (not shown) 141-712
- Black crinkle, short, with baffle (not shown) 141-750
- Black crinkle, tall, with baffle (shown, I) 141-751
- Chevy® orange, tall, with baffle (shown, J) 141-784
- Chrome, short, with baffle, black/red logo (not shown).. 141-899
- Chrome, tall, with baffle, black/red (shown, K) 141-905

L-N. Chevrolet Big-Block V-8, 1965 – 1996

- Chrome, short, with baffle (not shown) 141-114
- Chrome, tall, with baffle (not shown)..... 141-115
- Black crinkle, short, with baffle (not shown) 141-810
- Black crinkle, tall, with baffle (shown, L) 141-811
- Chrome, short, with baffle, black/red logo (shown, M)... 141-812
- Chrome, tall, with baffle, black/red (not shown) 141-813
- Chevy® orange, short, with baffle (not shown) 141-789
- Chevy® orange, tall, with baffle (shown, N) 141-787

O-P. Slant-Edge Small-Block Center Bolt Valve Covers

- Black crinkle, raised emblem (shown O)..... 141-840
- Chrome, recessed red/black emblem (shown P) 141-844
- Chevy orange, raised emblem (not shown) 141-841
- Cast gray crinkle, raised emblem (not shown) 141-842
- Polished, recessed red/black emblem (not shown)... 141-843
- Black crinkle, recessed red emblem (not shown) 141-845
- Polished, no emblem (not shown) 141-846

Personalize your engine with a distinctive component combo in three easy steps:

- (1) Select your preferred color theme, choosing from various offerings in classic chrome, chrome with recessed painted logos, black crinkle, metallic gray, polished, clear anodized or one of the many new colors offered.
- (2) Select your basic materials, choosing from stamped steel, die-cast aluminum, stamped aluminum, fabricated aluminum, or carbon fiber.
- (3) Consider the importance of functionality, internal and external clearance, weight, mechanical strength, and surface finish characteristics.

...the result will be an appearance that is uniquely yours.



Plating more than four times thicker than some aftermarket parts.

2-PIECE DIE-CAST ALUMINUM VALVE COVERS

Valvetrain maintenance is greatly simplified with 2-piece die-cast aluminum valve covers. The top section has a diagonal cut and a retained gasket for a tight, leak-free seal. The valve covers feature oversized bolts for fast removal. These tall valve covers will clear roller rockers and stud girdles. These valve covers are available in a variety of styles/finishes with and without Bowties and/or Chevrolet logos. The valve covers are sold in pairs and include an Allen wrench and required grommets. U.S. Pat. Nos. 7,343,890, D543,998S

A-B. Chevrolet Small-Block V-8, 1958 – 1986

- Polished, recessed logo (shown, A) 141-910
- Black crinkle, recessed logo (shown, B)..... 141-911
- Chrome, recessed logo (not shown) 141-912
- Polished, raised logo (not shown) 141-913
- Black crinkle, raised logo (not shown) 141-914
- Polished, no logo (not shown) 141-915
- Replacement gasket kit (2) (not shown)..... 141-916

NOTE: Will not fit cylinder heads with rectangular raised internal sections near the valve cover mounting surface, unless such sections are milled off.



A 141-910

B 141-911

LATE-MODEL STAMPED-STEEL VALVE COVERS

These short-style valve covers are the center hold-down design for later Small-Block engines. They have baffles and grommets, but are not supplied with mounting bolts (except 141-105). Sold in pairs.

C. Chevrolet Small-Block V-8, 1987 – Pre-LS

- Chrome, tall (shown, C) 141-105
- Chrome, short (not shown) 141-107
- Black crinkle, short (not shown) 141-907
- Metallic gray, short (not shown) 141-908



C 141-105

D 141-710

NEW DRESS-UP KITS

Chevy Orange and Carbon-Style Engine Dress-up Kits are the latest looks for your small-block Chevy! These limited edition kits won't be around forever, so get one while you can.

Note: Carbon-Style parts are stamped steel with a decorative finish.

D-E. Chevrolet Small-Block V-8, 1958 – 1986

- Carbon-Style (shown, D) 141-710
- Chevy® Orange (shown, E)..... 141-780



E 141-780

F 141-758

DELUXE DRESS-UP KITS

These dress-up kits include one pair of tall valve covers, an air cleaner, timing chain cover, breather cap, 8 wing nuts and 8 hold-down clamps.

F-G. Deluxe Dress-Up Kits

- Metallic gray (not shown) 141-360
- Black crinkle (shown, F) 141-758
- Chrome, black/red logos (shown, G) 141-900

Kit Number	141-360	141-758	141-900
Valve Covers	141-361	141-751	141-905
Air Cleaner	141-362	141-752	141-906
Timing Chain Cover	141-363	141-753	141-904
Air Breather Cap	141-365	141-754	141-616
8 wing Nuts	141-364 x2	141-756 x2	141-902 x2
8 hold-down Clamps	141-366 x2	141-757 x2	141-903 x2



G 141-900

H 141-002

H. Chevrolet Small-Block V-8, 1958 – 1986

- Includes 2 short baffled Bowtie valve covers (141-102), plus Bowtie timing chain cover with GM production oil seal installed (141-215), 2 black/red Bowtie 4-wire looms (141-636), 1 Bowtie push-in air breather (141-616), oil dipstick (141-550), timing tab for 8" Balancer (141-202), and 2 grommets (air breather cap and PCV) (not shown)..... 141-001
- Includes two short baffled Bowtie valve covers (141-102), plus 8 Bowtie valve cover wingnuts (141-600), 4 valve cover hold-down clamps (141-610), 2 black/red Bowtie 4-wire looms (141-636), 1 Bowtie push-in air breather cap (141-616), oil dipstick (141-550), and 2 grommets (air breather cap and PCV) (shown, H).. 141-002



141-302 **I**

141-752 **J**



141-785 **K**

141-906 **L**

141-692 **M**



141-831 **N**

141-834 **O**

141-835 **P**



141-339 **Q**

141-335 **R**

141-338 **S**

AIR CLEANERS

These steel air cleaners are available in the classic GM style and the newer, high-performance look. They feature the Chevrolet logo and come with maximum flow ACDelco air filter elements* and mounting hardware. The classic air cleaners include die-cast Bowtie center nuts (except P/N 141-906). The air filter bases are recessed for a low profile and maximum hood clearance (a minimum of 3.750" from the top of carburetor gasket area to hood underside).

* 14" x 3" Filter (A212CW), 10" x 2-53/64" Filter (A773)

I-L. 14" Steel Air Cleaners

- 14" Classic with Bowtie center nut (shown, I)..... 141-302
- 14" High-performance (not shown)..... 141-307
- 14" Metallic gray (not shown)..... 141-831
- 14" Black crinkle (shown, J)..... 141-752
- 14" Carbon-style (not shown)..... 141-834
- 14" Chevy® Orange (shown, K)..... 141-785
- 14" Chrome, black/red logo (shown, L)..... 141-906

10" Steel Air Cleaners

- 10" High-performance (not shown)..... 141-315

SUPER-LIGHT 14" AIR CLEANERS

Weight savings can be had by using air cleaners made of aircraft aluminum. The aluminum air cleaners are available in clear anodized or black anodized finishes. These air cleaners come with a 3" tall ACDelco filter element, all necessary mounting hardware and standard wingnuts.

M. 14" Super-Light Air Cleaners

- Black anodized aluminum, no logo (not shown)..... 141-690
- Clear anodized aluminum, no logo (not shown)..... 141-691
- Black anodized aluminum, Chevrolet Bowtie logo (shown, M)..... 141-692
- Clear anodized aluminum, Chevrolet Bowtie logo (not shown)..... 141-693

N-P. Slant-Edge Air Cleaners

- Black Crinkle, raised emblem (not shown)..... 141-830
- Chevy® Orange, raised emblem (shown, N)..... 141-831
- Cast Gray Crinkle, raised emblem (not shown)..... 141-832
- Polished, recessed red/black emblem (not shown)..... 141-833
- Black Crinkle, recessed red emblem (shown, O)..... 141-834
- Chrome, recessed red/black emblem (shown, P)..... 141-835

AIR CLEANER CENTER NUTS

Add some extra flair to your custom air cleaner by topping it with a distinctive GM or Bowtie chrome plated zinc, or black crinkle die-cast center nut. The center nuts are available in small and large sizes. They fit both 1/4"-20 and 5/16"-18 studs.

Q-S. Extra-Large Air Cleaner Center Nuts

- Black Crinkle Bowtie, black emblem (shown, Q)..... 141-339
- Black Crinkle Bowtie, red emblem (shown, R)..... 141-335
- Chrome Bowtie, black emblem (shown, S)..... 141-338
- Chrome Bowtie, gold emblem..... 141-336

Large and Small Air Cleaner Center Nuts

- Bowtie, small (not shown)..... 141-322
- Bowtie, large (not shown)..... 141-333
- Bowtie, black crinkle, large (not shown)..... 141-369
- Hi-tech Bowtie, small (not shown)..... 141-328
- Hi-tech Bowtie, large (not shown)..... 141-323
- Hi-tech GM, small (not shown)..... 141-332
- Hi-tech GM, large (not shown)..... 141-327

VALVE COVER MINI NUTS & WINGNUTS

These custom valve cover mini nuts and wingnuts feature a Bowtie logo on the top of each fastener. Separate studs are included for precise gasket positioning. The wingnuts fit Chevrolet Big-Block, Small-Block, and V-6 cylinder heads. Sold 4 per package.

A-E. Valve Cover Mini Nuts

- Chevy® Orange (shown, A)..... 141-601
- Polished aluminum (shown, B)..... 141-917
- Black crinkle (shown, C) 141-759
- Metallic gray (shown, D) 141-367
- Chrome, with red Bowtie (shown, E) 141-909



A 141-601 **B** 141-917 **C** 141-759 **D** 141-367 **E** 141-909

F-I. Valve Cover Wingnuts

- Chrome (shown, F)..... 141-600
- Metallic gray (shown, G) 141-364
- Black crinkle (shown, H)..... 141-756
- Chrome, with red Bowtie (shown, I) 141-902



F 141-600 **G** 141-364 **H** 141-756 **I** 141-902

AIR BREATHER CAPS

Air breather caps with raised Bowtie logos are available in a variety of finishes to complement die-cast or stamped valve covers. Use on valve covers with grommets fitting 1.220" holes unless otherwise specified. The breather caps are available in traditional domed-style and push-in, 3"-diameter air-filter-element style. Air breather/PCV grommet kit available: P/N 141-615.

Push-In, Rectangular

- Chrome (not shown) 141-619

J-L. Push-In, 3" Diameter

- Metallic gray (not shown)..... 141-365
- Chevy® Orange (shown, J)..... 141-786
- Chrome (shown, K) 141-616
- Black crinkle (shown, L) 141-754



J 141-786 **K** 141-616 **L** 141-754

Push-On, 3" Diameter, For Use with Oil Filler Tube, 1.820" Opening

- Chrome (not shown) 141-617

Twist-On, 3" Diameter

- Chrome (not shown) 141-618

These popular push-in filter air breathers, with the raised Bowtie logo stamped prominently in the top, are offered in two styles: with the heat-shield hood and without. 3" diameter. Fits valve covers with 1.220" holes.

M-N. Push-In Filter Air Breathers

- Black crinkle, with hood (not shown) 141-613
- Black crinkle, without hood (shown, M) 141-614
- Chrome, with hood (shown, N)..... 141-621
- Chrome, without hood (not shown) 141-622



M 141-614 **N** 141-621

Clamp-On Filter Air Breather, Fits 1-3/8th

- Chrome, with hood (not shown) 141-625

WATER NECKS

These Chevrolet water necks utilize neoprene O-ring gaskets instead of regular gaskets – eliminating leakage. Supplied with chrome bolts.

- V-8, 1955-1965, Chevy II V-8 1965, Corvette 1956-1963 (not shown)..... 141-500
- Chevrolet, Camaro, and Chevelle V-8s, 1966-1975 (not shown) 141-501

MASTER CYLINDER COVERS

These GM dual line master cylinder covers are offered for the most popular applications. Supplied with clips and a precisely positioned GM logo. PDB = Power Disc Brakes

- Single clip, 5" x 2-3/8", PDB (not shown) 141-225
- Single clip, 5-5/8" x 3", PDB or manual (not shown)..... 141-227



141-366 **O**

141-757 **P**

141-903 **Q**

VALVE COVER HOLD-DOWN CLAMPS

Valve cover hold-down clamps distribute the load over a wider area to minimize valve cover distortion and possible leakage. The clamps feature Bowtie logos and fit stamped valve covers for Chevrolet Small-Block V-8 and V-6/90-degree engines through 1986 (4 clamps per package).

O-Q. Hold-Down Clamps

- Chrome, no logo (not shown)..... 141-610
- Metallic gray (shown, O)..... 141-366
- Black crinkle (shown, P)..... 141-757
- Chevy® Orange (not shown)..... 141-782
- Chrome, red Bowtie (shown, Q)..... 141-903

TIMING CHAIN COVERS

Add a distinctive look to the front of any Chevrolet Small-Block or Big-Block engine with a custom timing cover that's accented with Chevrolet and Bowtie logos. These stamped-steel covers are engineered to GM specifications and come with a GM production oil seal pre-installed. The covers use bolt-on timing pointers.



141-363 **R**

141-753 **S**

141-904 **T**

R-U. Chevrolet Small-Block V-8 1969 – 1991 and V-6/90°

- Metallic gray (shown, R)..... 141-363
- Black crinkle (shown, S)..... 141-753
- Chevy® Orange (not shown)..... 141-783
- Chrome, black/red logo (shown, T)..... 141-904
- Chrome (shown, U)..... 141-215

V. Chevrolet Big-Block 1965-1990

- Chrome (shown, V)..... 141-216

Striking die-cast timing covers, supplied with separate GM production oil seal. Bowtie logo directly cast into the upper surface.

W. Die-Cast Aluminum, Chevrolet Small-Block V-8 1965-1990

- Polished (shown, W)..... 141-217
- Chrome (not shown)..... 141-218



141-215 **U**

141-216 **V**

HARMONIC BALANCER COVERS

Enhanced looks and engine timing accuracy are benefits of installing a custom aluminum harmonic balancer cover. More than just a dress-up item, the precision-degreed Small-Block and Big-Block covers are mounted directly through the center hub, which eliminates any timing inaccuracies caused by outer inertia ring slippage. The balancer covers are marked with a Bowtie logo, Top Dead Center and proper timing degrees. They are available in black and chrome finishes. U.S. Patent 5,675,078

Chevrolet Small-Block, 6-3/4"

- Black (not shown)..... 141-727
- Chrome (not shown)..... 141-725

Chevrolet Small-Block, 8"

- Black (not shown)..... 141-728
- Chrome (not shown)..... 141-726

X. Chevrolet Big-Block

- Black (shown, X)..... 141-730
- Chrome (not shown)..... 141-729



141-217 **W**

141-730 **X**

CHROME ALTERNATORS

These chrome (with red Bowtie logo) alternators are totally new with no rebuilt components, so they perform as well as they look. The quality is assured with generous over-spec amperage and an individual Quality Assurance graph that documents operating performance. The alternators include a machined pulley.

A. 100% New Chrome Alternators

- 1973-1986 internal regulator (not shown) 141-656
- 100 amp, 1-wire (shown, A) 141-657
- 60 amp, 1-wire (not shown) 141-658
- 80 amp, 1-wire (not shown) 141-659
- 120 amp, 1-wire (not shown)..... 141-660



A 141-657



B 141-683

ALTERNATOR BRACKET

Alternator Bracket

- Top bracket bolts to manifold (not shown) 141-402

HEI DISTRIBUTORS

These high quality, 100% new, and dependable HEI distributors set the standard in ignition, loaded with premium components like the original GM-meltonized distributor gear and sintered steel weights to optimize GM engine performance. Includes an adjustable vacuum advance for fine-tuning the rate and amount of advance that will result in increased power and eliminate harmful detonation.

B. Chevrolet Small- and Big-Block, 1955 – 1982

- Yellow cap, with coil (not shown) 141-681
- Black cap, with coil (not shown)..... 141-682
- Red cap, with coil (shown, B)..... 141-683

BOWTIE HIGH PERFORMANCE ELECTRIC FANS

Auxiliary electric fans can improve engine performance and increase gas mileage, as well as prevent overheating in congested traffic. The fans are available in 10", 12", 14", heavy-duty 15" with thermostat, and 16" sizes to fit most popular cars and trucks. Their ultra-thin design is great for cramped locations. The 15" fan has an adjustable 180-240° F thermostat, and pulls 2,800 cfm, bolting to the radiator supports with supplied sturdy brackets. Installation is easy with basic hand tools. The fans feature a red Bowtie logo.

C-D. Bowtie High Performance Electric Fans

- 10" fan (not shown) 141-641
- 12" fan (not shown) 141-642
- 14" fan (shown, C) 141-644
- 15" fan with adjustable thermostat (shown, D) 141-647
- 16" fan (not shown) 141-646



C 141-644



D 141-647

ELECTRIC WATER PUMPS

Electric water pumps help race- and high-performance street engines save weight and eliminate high-rpm impeller drag. The lightweight, but durable, die-cast aluminum pumps are epoxy-powder-coated in four colors (plus chrome and polished finishes) for corrosion resistance. The flow rate is more than 35 gallons per minute. The units are decorated with a red Bowtie logo. A stepped fitting (1" pipe to 1.750" hose) and weather-tight connector are included.

E-G. Electric Water Pumps

Finish	Big-Block	Small-Block
Polished	141-670 (shown, E)	141-654
Chrome	141-671	141-650
Red	141-672	141-652
Blue	141-673	141-653
Black	141-674	141-651 (shown, G)
Orange	141-675 (shown, F)	141-655



E 141-670



F 141-675

HEAVY-DUTY HIGH-TORQUE MINI STARTER

High-torque, gear-reduction design. 100% New, not rebuilt. Offset design results in more clearance between the oil pan and the starter, and can be rotated for additional chassis clearance. Has 15-to-1 compression for maximum cranking!

H. High-Torque Mini Starter

- Heavy-duty, 2.0 KW starter (shown, H)..... 141-684



G 141-651



H 141-684



141-232 **I**



141-233 **J**

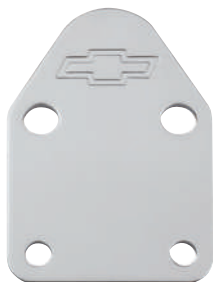

BOWTIE LOGO FREEZE PLUG INSERTS

Make your engine block Bowtie all the way with decorative machined billet aluminum Bowtie logo freeze plug inserts. These are NOT freeze plug replacements. They fit all Chevy Small-Block engines except the LS-Series. Two per package.

I-J. Freeze Plug Inserts

- Black, raised logo (shown, I) 141-232
- Red, recessed logo (shown, J)..... 141-233

PUSH-IN OIL FILLER CAP

A raised, embossed Bowtie logo adorns the top of this push-in filler cap that fits valve covers with 1.220" holes.

K. Oil Filler Cap

- Black crinkle (shown, K) 141-629
- Chrome (not shown) 141-630

TWIST-ON OIL FILLER CAP

A large, white-on-blue epoxy-coated GM logo highlights this large, twist-on oil filler cap. It fits Chevrolet-style holes and includes a non-asbestos gasket.

Twist-On Oil Filler Cap

- Chrome with GM logo (not shown)..... 141-631

FUEL PUMP BLOCK-OFF PLATES

These Chevrolet V-8 fuel pump block-off plates feature a stamped Bowtie logo and come with a special non-asbestos gasket.

L. Fuel Pump Block-Off Plates

- Small-Block, chrome (shown, L) 141-210
- Big-Block, chrome (not shown) 141-211
- Small-Block, black crinkle (not shown) 141-212
- Big-Block, black crinkle (not shown) 141-213

141-629 **K**141-210 **L**141-714 **M**141-636 **N**141-200 **O**141-550 **P**

LINEAR WIRE LOOMS

Messy spark plug wires can detract from an otherwise sharp engine, but those unruly wires can easily be tamed with Bowtie logo linear wire looms. The looms attach to the valve cover bolts and hold the wires in a neat parallel arrangement. A patented nylon wedge allows the wire holders to be opened and closed individually. One pair per package.

M. Linear Wire Looms

- Chrome, Small-Block V-8, 1959-1986 (not shown)..... 141-638
- Chrome, Big-Block V-8, 1965-1991 (not shown) 141-639
- Black Crinkle, Small-Block V-8, 1959-1986 (shown, M) 141-714

IGNITION WIRE LOOMS

These ignition wire looms feature black nylon separators with Bowtie and Chevrolet logos in red. They're mounted on chrome stems. They fit Small-Blocks from 1959-1986 and Big-Blocks from 1965-1991. Two per package.

N. Ignition Wire Looms

- Wire looms (shown, N) 141-636

TIMING POINTERS

Chrome, bolt-on timing pointers are available for 6.750" or 7" balancers and 8" balancers on Small-Block Chevrolet engines from 1969-1990 and Big-Blocks from 1965-1991.

O. Chevrolet Small-Block V-8 or V-6/90°, 1969 – 1990

- 6-3/4" or 7" balancer (shown, O)..... 141-200
- 8" balancer (not shown)..... 141-202

Chevrolet Big-Block, 1965 – 1991

- 8" balancer (not shown)..... 141-201

OIL DIPSTICK KITS

Chrome dipstick kits are available for a large variety of Chevrolet Small-Block and Big-Block engines. The kits include the dipstick tube and a hooked handle dipstick that has the Bowtie logo stamped near the fill indicator mark.

P. Chevrolet Oil Dipstick Kits

- Small-Block V-8, through 1977 (shown, P)..... 141-550
- Small-Block V-8, 1978-1981 (not shown) 141-551
- Big-Block V-8, 1965-1991 (not shown) 141-553



GM

Restoration
Parts

THE MOST AUTHENTIC AND ACCURATE PARTS FOR YOUR RESTORATION

It was a chance find, based on a story recounted by a friend of a friend. But there it was – the classic muscle car you'd been searching for, hidden beneath a dusty tarp in an old barn. You worked hard, but finally convinced the stubborn farmer to sell it.

With the car safely in your garage, the exuberance of the thrill of the hunt morphs into the realization that a careful and accurate restoration is needed to bring that vintage car back to its original glory. That means more hunting for the right parts; everything from the carburetor to the clamps that hold the fuel lines in place.

GM knows it's the little things that count with a restoration. With countless resources for restoration components, assurance that you're getting the most authentic and best-fitting parts comes when you buy officially licensed GM Restoration Parts. They're made by manufacturers who build to GM's specifications and label them accordingly. Many even use original tooling for unparalleled accuracy in look, feel and performance.

You can find licensed GM Restoration Parts for everything from the grille badge for a 1969 Camaro to the body shell itself for that Camaro. That's right – an entire classic Camaro body!

Before purchasing any reproduction parts for your valuable project, make sure the manufacturer is licensed by GM Restoration Parts. With mint condition on your mind, licensed GM Restoration Parts are the only parts that should go into your barn-find beauty.

Get The OER[®] Advantage. . . It's Almost Unfair!

Authentic Quality Reproduction Parts for Classic American Muscle

ORIGINAL QUALITY • ORIGINAL APPEARANCE



Original Fit

Appearance is extremely important in reproduction parts, but just as important is the way the part fits. You will appreciate OER[®] reproductions. Parts are designed to fit as closely to the original as possible. Each part is checked and rechecked to ensure proper fit and function.

Superior Quality

It's one thing to manufacture a reproduction part, it's another to duplicate the quality. OER[®] uses the finest quality materials and workmanship to ensure the finished part meets or exceeds original equipment specifications. In fact, many OER[®] products are superior to the original.

Authentic Appearance

Each OER[®] part is manufactured to original specifications, down to the smallest detail. Consistent quality control methods ensure an exact duplicate every time.

OER[®] Officially Licensed Products

Many OER[®] products are officially licensed by the original manufacturers assuring the highest quality reproductions available.

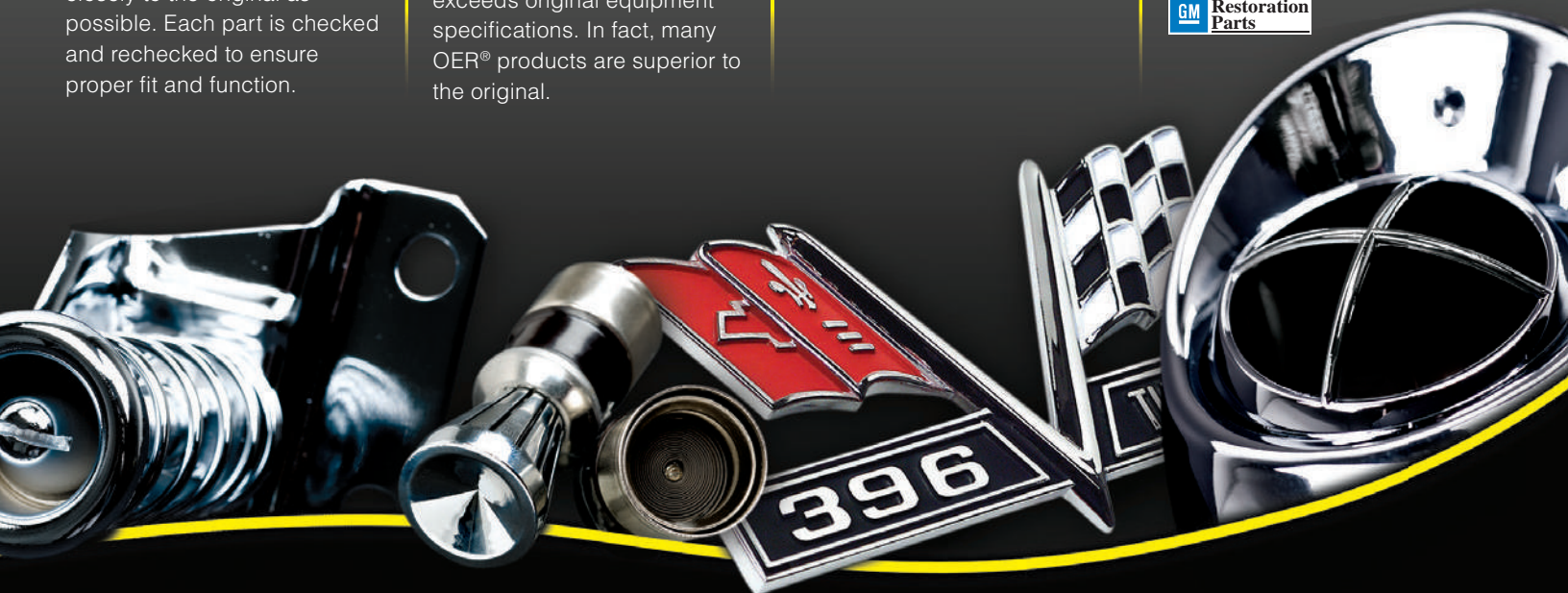

OER ORIGINAL EQUIPMENT REPRODUCTION

LT and LS Conversion Kits

Easy Bolt-in Swap Kits!

Made specifically for your make and model.

Installing the power and efficiency of late model LT and LS engines is quick and easy with Muscle Rods Conversion Kits. Each kit is engineered for a great fit in your specific chassis - without the need for time-consuming and frustrating trial and error.



CHEVROLET

PERFORMANCE
VEHICLES / PARTS / RACING

Muscle Rods kits include bolt-in frame brackets that locate your engine precisely and ensure the correct driveline angle.

Each kit includes an oil pan matched to your vehicle and uses OEM-type oil filters.



Stainless steel 1-7/8" long-tube or mid-length headers are built specifically for our kits and unleash the power of the LT and LS engines.

Our Sure-Fit crossmembers support all early and late model transmissions including the new 6 and 8 speed automatics.

No generic "hope-it-fits" parts or guesswork here, all Muscle Rods Conversion Kits were developed by installing real engines and transmissions in actual project vehicles. This optimal engine placement ensures the best fit of all other components in the completed swap.

1955-2005 GM Muscle Cars and Trucks

MRTM
MUSCLE RODS



Designed
and Built in
the USA

WHERE WINNING STARTS >

**FRANK HAWLEY'S DRAG RACING SCHOOL AND THE
CHEVROLET PERFORMANCE ZZ572/720R
— KEYS TO DRAG RACING SUCCESS.**



Victories don't come easy on the ¼-Mile Strip, that's why serious racers leave nothing to chance. They know the best foundation is learning from the best — the Pros at Frank Hawley's Drag Racing School — and powering their race cars with the sport's most dependable power — the ZZ572/720R from Chevrolet Performance!





**TRUE GM ORIGINAL
EQUIPMENT PARTS BRAND**

ACDelco GM Original Equipment parts are held to the highest standards of quality and are built to the exact specifications of your vehicle. That's why ACDelco is true General Motors Original Equipment.

Right from the start,
ACDelco parts appear
in more than 2 million
vehicles GM produces
in the U.S. per year.

ACDelco

BE CERTAIN.

INNOVATION STARTS WITH THE ORIGINAL

COPO

PARTS DIRECT

OFFICIAL PARTS SUPPLIER FOR GEN 5 & 6 COPO CAMAROS



CHEVROLET

PERFORMANCE
VEHICLES / PARTS / RACING



LIFE, LIBERTY, AND THE PURSUIT OF POWER.



CT350
350 HP



CT400
404 HP



CT525
533 HP

On dirt or asphalt, every driver has a path to victory with an affordable, powerful crate engine designed, engineered, and tested for Circle Track by Chevrolet Performance.

CIRCLE TRACK CRATE ENGINES

FIND NEW ROADS™



PERFORMANCE
VEHICLES / PARTS / RACING

INDEX

A

ACCESSORY DRIVE KITS

Small-Block	186
LS-Series	280
Big-Block.....	352

AIR CLEANERS

Small-Block	198
LS-Series	295
Big-Block.....	362

ALTERNATORS

Small-Block	196
-------------------	-----

B

BALANCERS, PULLEYS, & COMPONENTS

Small-Block	182
LS-Series	288
Big-Block.....	350

BLOCKS (SEE CYLINDER BLOCKS)

BOOKS & MANUALS.....	386
----------------------	-----

C

CAMARO PARTS & ACCESSORIES	20
----------------------------------	----

CAMSHAFTS & COMPONENTS

Small-Block	179
LS-Series	275
Big-Block.....	348

CARBURETORS

Small-Block	198
LS-Series	295
Big-Block.....	361

CHEVY V-6 CYLINDER HEADS	382
--------------------------------	-----

COBALT PERFORMANCE	384
--------------------------	-----

COLORADO UPGRADES AND ACCESSORIES.....	68
--	----

CONNECT & CRUISE CRATE POWERTRAIN SYSTEMS	104
---	-----

CONNECTING RODS & HARDWARE

Small-Block	180
LS-Series	276
Big-Block.....	349

COPO PROGRAM.....	72
-------------------	----

CORVETTE UPGRADES & ACCESSORIES	44
---------------------------------------	----

CRANKSHAFTS & COMPONENTS

Small-Block	182
LS-Series	278
Big-Block.....	350

CRATE ENGINES

Small-Block Crate Engines

350/290 Base	116
350/290 Deluxe.....	118
350 HO Turn-Key.....	120
Ram Jet 350.....	122
SP350/357 Base.....	124
SP350/357 Deluxe	126
SP350/357 Turn-Key	128
SP350/385 Base.....	130
SP350/385 Turn-Key	132
ZZ6 Base	134
ZZ6 Turn-Key.....	136
HT383.....	138
HT383E	140
SP383 Deluxe	142

Circle Track Crate Engines

CT350.....	146
CT400.....	148
CT525.....	150

LS-Series Crate Engines

L96	210
LS3	212
LS376/480	214
LS376/515	216
LS376/525	218
DR525	220
LSA.....	222
LS9	224
LS7	226
LT1.....	228
LT4.....	230
LT 376/535.....	232
LTG.....	234
EROD Systems.....	238

LSX-Series Crate Engines

LSX376-B8.....	242
LSX376-B15	244
LSX454	246
LSX454R	248

Big-Block Crate Engines

ZZ427/480	302
454 HO	304
ZZ454/440	306
HT502.....	308
502 HO	310
ZZ502/502 Base.....	312
ZZ502/502 Deluxe	314
Ram Jet 502.....	316
ZZ572/620 Deluxe	318
ZZ572/720R Deluxe.....	320

CRUZE UPGRADES & ACCESSORIES	56
------------------------------------	----

CYLINDER BLOCKS

Diesel Block and Components.....	12
Small-Block	154
LS/LT/LSX-Series	252
Big-Block.....	326

CYLINDER BLOCK COMPONENTS

Small-Block	161
LS-Series	260
Big-Block.....	332

CYLINDER HEADS

Small-Block	163
LS-Series	263
Big-Block.....	334

CYLINDER HEAD GASKETS & COMPONENTS

Small-Block	170
LS-Series	270
Big-Block.....	340

D

DIESEL BLOCKS & COMPONENTS	12
----------------------------------	----

DISTRIBUTORS & COMPONENTS

Small-Block	188
Big-Block.....	355

E

ECOTEC	383
--------------	-----

ECUs & COMPONENTS.....	296
------------------------	-----

ENGINE CONTROLLER MODULES.....	296
--------------------------------	-----



E-ROD PACKAGES	238
EXHAUST	
Camaro	24, 37
Colorado	69
Cruze	57
Silverado	63
Sonic	59
EXHAUST MANIFOLDS/HEADERS & COMPONENTS	
LS-Series	293
F	
FLYWHEELS/FLEXPLATES & COMPONENTS	
Small-Block	183
LS-Series	279
Big-Block	351
FRONT COVERS & TIMING POINTERS	
Small-Block	162
LS-Series	261
Big-Block	333
FUEL PUMPS	
Small-Block	199
LS-Series	298
Big-Block	363
H	
HEADS (SEE CYLINDER HEADS)	
I	
IGNITION SYSTEM & COMPONENTS	
Small-Block	196
LS-Series	298
INTAKE MANIFOLDS, GASKETS & COMPONENTS	
Small-Block	189
LS-Series	290
Big-Block	356
L	
LICENSED PARTS	
Dress Parts	388
M	
MALIBU UPGRADES & ACCESSORIES	60
O	
OIL PANS & COMPONENTS	
Small-Block	186
LS-Series	289
Big-Block	353
OIL PUMPS & COMPONENTS	
Small-Block	187
LS-Series	289
Big-Block	354
P	
PISTONS & PISTON RINGS	
Small-Block	181
LS-Series	277
LSX-Series	277
Big-Block	348
R	
RESTORATION PARTS	398
ROCKER ARMS, STUDS & COMPONENTS	
Small-Block	173
LS-Series	271
Big-Block	342
S	
SERVICE MANUALS	386
SONIC UPGRADES & ACCESSORIES	58
SILVERADO UPGRADES & ACCESSORIES	62
SPARK PLUG WIRES & LOOM KITS	
Small-Block	197
LS-Series	298
Big-Block	362
STARTERS	
Small-Block	196
LS-Series	294
Big-Block	360
SUPERCHARGERS	
LS-Series	290
T	
TIMING CHAIN KITS & COMPONENTS	
Small-Block	184
LS-Series	279
Big-Block	351
TORQUE CONVERTERS	366
TRANSMISSIONS, CONTROLLERS & COMPONENTS	364
V	
VALVES, VALVE SPRINGS & SHIMS	
Small-Block	171
LS-Series	271
Big-Block	341
VALVE COVERS	
Small-Block	174
LS-Series	272
Big-Block	344
VALVE LIFTERS	
Small-Block	178
LS-Series	273
Big-Block	347
W	
WATER PUMPS	
Small-Block	185
LS-Series	288
Big-Block	352
WHEELS & ACCESSORIES	
Camaro	27
Colorado	71
Corvette	51
Cruze	57
Silverado	67

ENGINEERED FOR SUPREMACY



The LT4 is the most powerful production engine ever conceived by Chevrolet engineers – delivering supercharged horsepower with Variable Valve Timing and Direct Injection to help maintain impeccable efficiency. Because of its capabilities, the LT4 can take your rebuild or project to supercar status – proving its prowess in Chevrolet's top-of-the-line 2017 Camaro ZL1 and 2018 Camaro ZL1-1LE. The supercharged 6.2L V8 was the engine of choice for the 1970 Camaro rebuild unveiled at SEMA.

UNCHAIN THE POWER OF THE LT4

LT4 650 HP / 650 LB-FT

FIND NEW ROADS™



PERFORMANCE
VEHICLES / PARTS / RACING

Learn more about performance engine parts we have.