



# Catalog

# 2020



# Automotive Gaskets

Cometic Gasket - An Exclusive NASCAR Performance Product

## Carburetor Gaskets

Designed by engineers, validated by the winners circle. Cometic carburetor gaskets are manufactured from performance grade materials that resist swelling from various types of fuel. Can be custom ordered to your exact specifications.

Part #	Application	Material
C15184	Holley2BBL Carb Open Plenum	.039" Fiber
C5282	Holley2BBL Carb 2 Hole 1.750"	.047" Fiber
C5263	Holley41504BBL Carb Open Plenum	.047" Fiber
C5262	Holley41504BBL 4 Hole 1.750"	.047" Fiber
C15238	Holley45004BBL Carb Open Plenum	.047" Fiber
C15239	Holley45004BBL 4 Hole 1.750" Gasket	.047" Fiber
C5280	Holley390CFM4BBL Carb 4 Hole 1-19/32"	.047" Fiber
C15181	Carter AFB 4BBL Square Bore 4 Hole	.039" Fiber
C15183	Rochester Quadjet 4BBL Spread Bore	.039" Fiber
C15240	Weber48MM Carb	.047" Fiber
C5388	Holley Airhorn Carb	.060" Fiber
C15241	Holley Float Bowl	.062" MP
C15242	Holley2 Circuit Metering Block	.062" MP
C15243	Holley3 Circuit Metering Block	.062" MP
C15244	Holley/Quik Fuel Power Valve	.062" MP



## Differential Gaskets

Cometic Differential Gaskets are offered for the most popular differentials in the industry. Made from performance inspired materials and engineered to be the best sealing gasket you can find. Don't see what you are looking for? Simply send us your used gasket and we can custom make exactly what you need.

Part #	Application	Material
C14006-060	Nissan Titan XD	.060" AFM
C15212	AMC 12 Bolt	.125" Fiber
C15213	Dana 25,27,30 10 Bolt	.032" AFM
C15214	Dana 35 10 Bolt	.060" AFM
C15215	Dana 44	.060" AFM
C15216	Dana 44/GM 8.75" Corvette/Viper	.032" AFM
C15217	Dana 60/70	.060" AFM
C15218	Dana 80 10 Bolt	.032" AFM
C15219	Dodge 7.25" 10 Bolt Front Axle	.032" AFM
C15220	Dodge 8.25" 10 Bolt Rear Axle	.032" AFM
C15221	Ford 10.5" 12 Bolt	.032" AFM
C15222	Ford 8" 10 Bolt	.032" AFM
C15223	Ford 8.8" 10 Bolt	.060" AFM
C5848-032	Ford 9" 10 Bolt	.032" AFM
C15225	Ford 9.75" 12 Bolt	.060" AFM
C15226	GM "O" AXLE 12 Bolt Irregular	.060" AFM
C15227	GM 1/2 TON 12 Bolt	.032" AFM
C15228	GM 12 Bolt	.060" AFM
C15229	GM 7.5" 10 Bolt Rear Axle	.032" AFM
C15230	GM 7.75" 9 Bolt Front Axle	.032" AFM
C15231	GM 8.5" 1/2 & 3/4 Ton 10 Bolt	.032" AFM
C15232	GM 8.5" 10 Bolt	.060" AFM
C15233	GM 9.5" 1/2 & 3/4 Ton 14 Bolt	.060" AFM
C15234	GM Truck 14 Bolt	.060" AFM
C15235	Legend Car 10 Bolt	.032" AFM
C15236	Sprint Midget 10-Bolt Quick Change	.060" AFM
C15237	Winter Quick Change 10 Bolt	.060" AFM

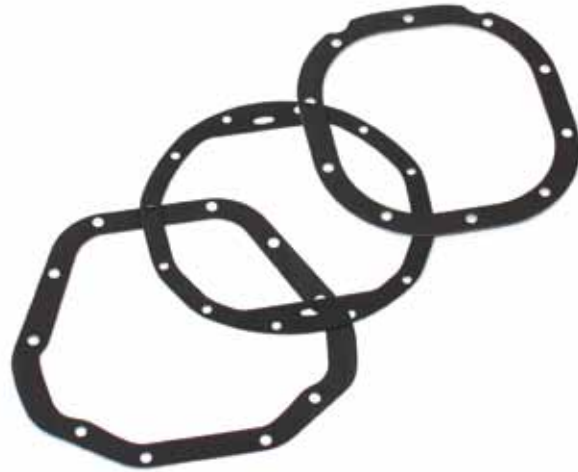

## Transmission Gaskets

Why trust your expensive transmission to some flimsy paper gasket? Keep your transmission fluid and gear lube where it belongs with our Aluminum Foamet Material (AFM) Gaskets. AFM consists of an aluminum core and features a foam rubber coating bonded to both sides. Ideal for sealing less than perfect surfaces and can be installed without the use of additional sealers!

Part #	Application	Material
C15246	Dodge 727/46Re Pan	.060" AFM
C15247	Ford A4Ld/4R44E/4R55E 1993-05	.060" AFM
C15248	Ford C-4/C-5 11 Bolt 1970-86	.060" AFM
C15249	Ford C-63 Speed 17 Bolt	.060" AFM
C15250	Gm 4L80E 1991-10	.060" AFM
C15251	Gm Th700-R4/4L60E 1982-03	.060" AFM
C15252	Gm Powerglide 2Spd Trans Pan	.075" AFM
C15253	Gm Turbo 400 Trans Pan	.075" AFM
C15254	Gm Turbo 350 Pan Trans	.075" AFM
C15255	Muncie M21 Gasket Kit - No Seals	AFM
C15469	Dodge/Chrysler/AMC 904 Torqueflite	.060" AFM

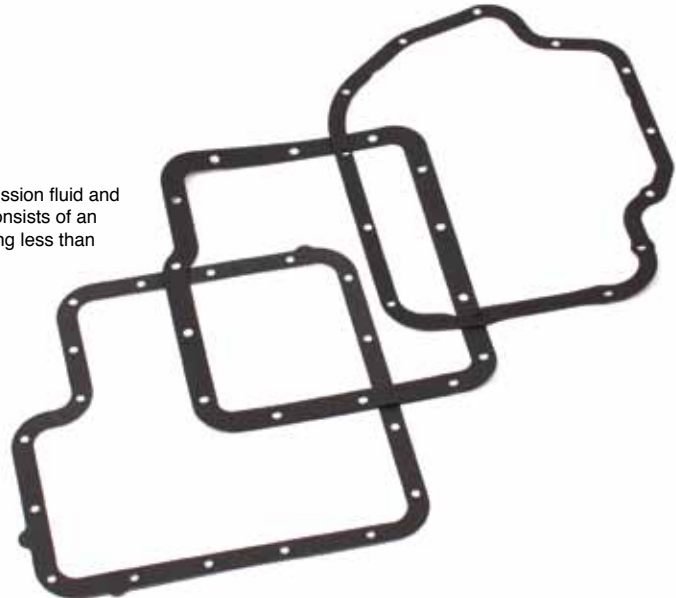

## Valve Cover Gaskets & Sets

Race inspired designs and materials ensure that these valve cover gaskets will perform well above the OE standard. Cosmetic valve cover gaskets surpass the quality and ability of typical cork or paper gaskets offered by other manufactures. Withstands blowing out, over tightening, and high vacuum all at an affordable price.

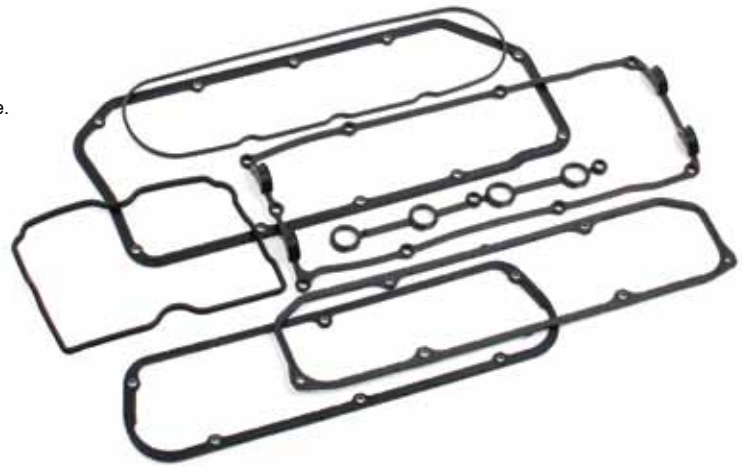

### DOMESTIC

Part #	Application
C15438	Chevy LT1/LT4 3.6L/6.2L 2014-2017
C5976	Chrysler 426 HEMI V8
C5983	Chrysler Big Block Wedge
C15468	Chrysler 318/340/360 LA V8 1964-1992
C5193	Chrysler/Dodge 5.7/6.1L Hemi 03+Up Set - 1 Head
C5177	Ford 4.6L DOHC 1996-98
C5178	Ford 4.6L SOHC 1996-04
C5179	Ford 4.6L SOHC 2002-04 Truck
C15467	Ford 429/460 Big Block V8
C15442	Ford 5.0L 2014-2017 / 5.2L 2015-2018 Set
C5974	Ford Small Block 289,302,351W
C5975	GM Big Block MARK 4/5/6
C15245	GM LS V8 GEN III/IV 1999-14
C5973	GM Small Block 18/23* V8
C15440	Olds 330/350/400/403/455
C5044	Pontiac 265/301/350/400/428/455

### SPORT COMPACT

Part #	Application
C4643	Ford Zetec 2.0L DOHC 1995-97 / Set
C4644	Ford Zetec 2.0L DOHC 1998-04 / Set
C15445	Ford Focus ST 2.0L/2.3L 2012-2018
C4653	Ford 2300 2.3L SOHC 1974-93 / Set
C4701	Honda 1.5L 4 CYL 88-95 / Set
C4628	Honda B16A2/3 & B18C1/C594-01/S
C4665	Honda D16Y5/7/8/96-00/Set
C4655	Honda D16Z6 VTEC 92-95/Set
C4706	Honda DOHC 1.6L 86-89 / Set
C4679	Honda/Acura B18A1/B1 1990-01/Set
C14111	Honda L15B7 / L15BA / L15BE
C14012	Honda/Acura K20 /K23/K24
C4781	Mazda B6 1.6L 1989-93 / Set
C4788	Mazda MX-6 FS-DE 2.0L 91-97 / Set
C4722	Mitsubishi DOHC 24V 3.0L 91-00 / Set
C4691	Mitsubishi Eclipse 2.0L 89-94 / Set
C4713	Mitsubishi Galant SOHC 24V 3.0L 88-96 / Set
C15046	Mitsubishi/Dodge 2.0L 420A 95-99 / Set
C4607	Nissan CA18DE/DET 1989-1993 / Set
C4906	Nissan E15T 1.5L SOHC 1983-84 / Set
C4631	Nissan KA24DE 2.4L 1993-01 FWD / Set
C4761	Nissan KA24DE 2.4L DOHC 1991-94 / Set
C4766	Nissan KA24DE 2.4L DOHC 1995-98 / Set
C4552	Nissan RB20/25/26 1988-02/Set
C4730	Nissan SR16/20VE 1.6L 1997-01 / Set
C4747	Nissan SR20DE 2.0L DOHC 1991-96 FWD / Set
C4753	Nissan SR20DET S13 DOHC 88-93 / Set
C4755	Nissan SR20DET S14 DOHC 94-98 / Set

### SPORT COMPACT

Part #	Application
C4773	Nissan VG30DE 3.0L V6 90-99 / Set
C4871	Subaru EJ22E SOHC 90-96 / Set
C4880	Subaru EJ255 DOHC 06-07 / Left
C4881	Subaru EJ255 DOHC 06-07 / Right
C4873	Subaru EJ25D DOHC 96-99 / Set
C4863	Subaru WRX EJ205 02-05 / Right
C4864	Subaru WRX EJ205 02-05 / Left
C4642	Subaru EJ25 SOHC 1999-05 / Set
C4928	Subaru EJ257 DOHC 2004-06 / Left
C4929	Subaru EJ257 DOHC 2004-06 / Right
C4935	Toyota 22R/RE/REC 81-85 / Set
C4830	Toyota 2RZ-FE 2.4L 4 CYL 95-02 / Set
C4807	Toyota 4A-GE 1.6L 84-92 / Set
C4820	Toyota 5S-FE 2.2L 4 CYL 90-97 / Set
C4851	Toyota Supra 2JZ-GE/GTE 93-97 / Set
C4838	Toyota Supra 7M-GTE 87-92 / Set
C4608	Toyota 3S-GTE 1991-1995 / Set

### DIESEL

Part #	Application
C15056	Cummins 3.9L 4BT 4CYL DIESEL / Set
C5614	Cummins 5.9L 24V DIESEL 1998.5-02 / Set
C15066	Cummins 5.9L 12V DIESEL 1992-98 / Set
C15070	Cummins 5.9L 24VCR DIESEL 2003-07 / Set
C15143	Ford 6.0L Powerstroke 2003-08 / Set
C15151	Ford 6.4L Powerstroke 2008-10 / Set
C15162	Ford 7.3L Powerstroke 1994-97 / Each
C15163	Ford 7.3L Powerstroke 1998-02 / Each

## Turbo Gaskets

Manufactured from a high grade stainless steel, these turbocharger gaskets get the job done the first time! The embossed spring steel maintains a torque set and won't burn through or push out. Does not require additional sealers.

Part #	Application
C4514	Turbo Inlet Flange T3 Garrett
C4515	Turbo Inlet Flange T25 Garrett
C4516	Turbo Inlet Flange T4 Garrett
C4513	Turbo Inlet Flange T4 Divided
C4517	Turbo Inlet Flange T6 Garrett
C5723-030	Subaru WRX Turbo to Up Pipe
C5736-030	Subaru WRX Turbo to Down Pipe
C15154	Ford 6.4L Powerstroke 2008-10



## Valve Stem Seals

New age engine builds require new age valve stem seals and we have them! These viton steel body (VSB) seals are available for most applications ranging from automotive to off road dirt bikes. Sold in packs of 16. [See page 150 for additional Valve Stem Seals](#)

Part#	Valve Stem O.D.	Guide O.D.	Height	Overall O.D.
3225V-16	6mm	11mm	9.3mm	13.4mm
3262V-16	7mm	11mm	9.5mm	14.4mm
3516P-16	8mm	.492"	.470"	.616"
3237V-16	5/16"	.500"	.517"	.562"
3235V-16	5/16"	.531"	.516"	.677"
3188V-16	11/32"	.500"	.531"	.623"
3228V-16	11/32"	.530"	.527"	.674"
3195V-16	3/8"	.500"	.531"	.623"
3198V-16	3/8"	.625"	.531"	.742"





Cometic Gasket - An Exclusive NASCAR Performance Product



### 2 Pc Viton Rear Main Seals

Description	Part #
Buick W / Side Rails 196,231,252 .....	C5707
Chevy 283-400 .....	C5680
Chevy BB 396-454 .....	C5682
Chrysler 273,318,340 .....	C5683
Chrysler 360 .....	C5684
Chrysler 361-440 & Hemi .....	C5686
Ford 289,302, .....	C5688
Ford 351C,M,351W .....	C5689



### Engine Crankshaft Seals Wet & Dry Sump Applications

Description	Signal Part #	TTS Part #	Cometic Part #
JESEL Small Block Crank B/Drive F.C. ...	86587	T-13527	C5376
JESEL Big Block Crank B/Drive F.C. ....	86622	T13553 Rev. B	C5377
JESEL (SEL 38000) Cam .....	86586	T13561 Rev. B	C5435
Aluminum GM Sprint 400 Main .....	86410	T-13675	C5672
Chevy Small Block Rear Split Seal .....	86625	T-13675-DL	C5379
Chevy Big Block Rear Split Seal .....	86665	T-13676	C5381
Dodge R5 Small Block Rear Crank .....	14255	T-14255	C5396
Ford Rear Crankseal W/302 Crank .....	85742	T-13584	C5384
Ford Rear Crankseal 302 .....	13610	T-13610	C5385
Ford Front Crankseal 302 & 351 .....	85338	T-13690	C5386
Ford R.R. Crankseal 351 .....	85339	T-14053	C5391
Ford 351 Front Crank Yates Drive .....	85741	T-14276	C5490
GM Small Block Front Crankseal .....	86990	T-13852	C5378



### Timing Cover Gasket Sets

Description	Part #
AMC 290-401 V8 66-88 .....	C5046
AMC 4/6 Cyl 2.5/3.8/4.0/4.2L 65-06 .....	C5047
Buick V6/Small V8 66-87 (Rope Seal) .....	C5048
Buick V6/Small V8 66-87 (Radial Seal) .....	C5049
Buick 400/430/455 V8 67-74 .....	C5050
GM Small Block V8/V6 75-95 (Thick Front Seal) .....	C5051
GM Small Block V8 57-74 (Thin Front Seal) .....	C5052
GM 4/6 Cyl 151/230/250/192 63-89 .....	C5053
GM Small Block LT1 V8 92-94 .....	C5054
GM Small Block LT1 V8 92-97 .....	C5055
GM Small Block LS V8 98-11 .....	C5056
GM Big Block V8 65-95 .....	C5057
GM Big Block V8 96-00 .....	C5058
Chrysler Magnum V6/V8 92-96 .....	C5059
Chrysler Magnum V6/V8 97-98 .....	C5060
Chrysler LA Small Block V8 64-91 .....	C5061
Chrysler 5.7/6.1L Hemi 03-UP .....	C5202
Chrysler Wedge/426 Hemi V8 58-79 .....	C5062
Chrysler Early Hemi V8 55-59 .....	C5063
Ford Small Block V8 62-78 .....	C5064
Ford Small Block V8 79-97 .....	C5065
Ford 351C/351M/400 V8 70-81 .....	C5066
Ford 352/360 FE V8 58-60 .....	C5067
Ford 332-428 FE V8 61-71 .....	C5068
Ford 429/460 Big Block 68-85 .....	C5069
Olds 260-455 V8 64-90 .....	C5070
Pontiac 265-455 V8 63-81 .....	C5071

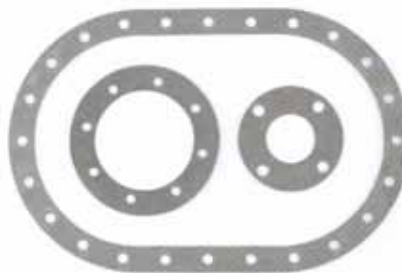

### Fuel Cell Gasket Kit

Description	Part #
Vent Neck Gasket .059" CFM20, .....	C5507
8 Bolt Vent Gasket .059" CFM20, Fill Plate Gasket .059" CFM20	



### Sheet Materials

Part #	Description
C15180HTS .....	10" X 10" X .060" HTS
C15346FC .....	24" X 6" X .060" FC
C15346HTS .....	24" X 6" X .060" HTS
C15346TNG .....	24" X 6" X .060" TNG
C15354F .....	.36" X 9" X .031" Fiber
C15358TNG .....	12" X 12" X .060" TNG
C15384 .....	10" X 26" X 1/16" CORK/RUBBER (w/Cutting Tool)
C15385 .....	10" X 26" X 1/32" Fiber (w/Cutting Tool)

### ATI Damper Re-build Viton O-Rings

Description	Part #
6" Damper Rebuild Kit (3-Ring) .....	C5393
7" Damper Rebuild Kit (3-Ring) .....	C5982-070
6" Damper Rebuild Kit (4-Ring) .....	C5632



Made in the U.S.A.

# TABLE OF CONTENTS

## MLS

### Multi Layer Steel

MLS Gaskets are comprised of multiple embossed layers of both AMP (Advanced Multi-Polymer Coating) and uncoated stainless steel. The embossed outer layers of the gaskets meet the demands of a variety of harsh sealing environments, load conditions and surface finishes. Requires less clamp load creating less bore distortion and conforms load distribution across the sealing area. The center or shim layer is an uncoated stainless steel layer which can be varied to accommodate multiple thickness requirements.

**No sealants or re-torque required.**



3 Layer **MLS Style** Cross Section

**Available thickness:**

.027", .030", .036", .040", .045", .051", .056", .060", .066", .070", .075", .080", .086", .092", .098", .120", .140"

### MLS Head Gaskets

Make	Pg.
Austin	67
AMC	6
BMW	70
Buick	7
Cadillac	8
Chevrolet	10
Chevrolet Diesel	25
Chrysler/Dodge	27
Coventry Climax	75
Cummins Diesel	41
Ecotec 4 Cylinder	9,82
Ferrari	76
Fiat/Lancia	76
Ford	46
Ford Diesel	64
Ford/Lotus/Cosworth	77
Honda/Acura	83
Hyundai	95
Jaguar	96
LSJ Ecotec 2.0L	9,82
Mazda	99
Mercedes Benz	102
MG	103
Mini	103
Mitsubishi	104
Nissan	107
Oldsmobile	65
Peugeot/Citroen	123
Pontiac	66
Porsche	123
Renault	125
Rover	126
Saab	127
Subaru	127
Toyota	139
Triumph	150
TVR	150
Vauxhall/Opel	151
VW/Audi	151
Volvo	148

### COPPER Head Gaskets

Make	Pg.
Buick V6 192-231-252 Stage I & II	7
GM / Chevy 18/23 Degree Small Block	12
GM / Chevy LS	16
GM / Chevy LSX / LHS	19
GM / Chevy Big Block MK4	22
Chrysler 318-360 LA	30
Chrysler 383-440 Wedge	36
Chrysler Early Hemi 354-392	37
Chrysler 426 Hemi	38
Ford Non SVO 260-351W	56
Ford 429-460	62
Austin Sprite Mark I & II	69

## MLX

### Multi Layer Xtreme

MLX Gaskets utilize an integrated "stopper" layer for combustion chamber sealing and improved clamp load around the cylinder without increasing bore distortion. MLX technology can be found in the applications below and are made from the same materials as our MLS Head Gaskets.

**No sealants or re-torque required.**



3 Layer **MLx Style** Cross Section



4 Layer **MLx Style** Cross Section



5 Layer **MLx Style** Cross Section

### MLX Head Gaskets

Application	Pg.
Ecotec 4 Cylinder	9,82
3.6L LY7/LLT/LFX	11
4.2L Inline 6 LL8 Vortec 4200	12
Vortec 4200 LL8, 18/23 Degree SBC	12
SBC w/All Pro Heads, Dart/Brodix	14
Chevy R07.2	14
LS1/LS2/LS3/LS6	16
LS7, LS9/LSA	18
LS Next Block, LSX	19
LT1 6.2L	21
GM 5.2 Prostock	25
6.6L Duramax	26
2.4L DOHC Turbo 4 Cylinder	28
5.7L Hemi	31
6.1L Hemi	33
6.2L Hellcat, 6.4L Apache, 7.0L Drag Pack	34
Chrysl/Dodge R6 V8	36
8.0/8.3L V10, 8.4L V10	40
Cummins 3.9L 4BT	41
Cummins 5.9L 12v 6BT	42
Cummins 5.9L 24v ISB Inline	43
Cummins 5.9L CR	44
Cummins 6.7L	45
Ford 1.6L Sigma	46,77
Ford 2.3L EcoBoost	49
Ford 3.5L EcoBoost	50
Ford 4.6/5.4L SOHC/DOHC	51
Ford 5.0L Coyote	53
Ford 5.8L Trinity V8	54
Ford Windsor SB V8	56
Ford New Boss 302 Block	58
Ford RY45 V8, FR9 V8	59
Ford 6.8L V10	61
Ford Prostock Racing V8	63
Ford 6.0L Powerstroke, 6.2L SOHC Raptor	64
Ford 6.4L Powerstroke, Ford 6.7L Scorpion	65,66
7.3L Powerstroke	66
Ford/Lotus 2.7L EcoBoost	78
BMW M50B25/28 2.5/2.8L	73
BMW M5430L, N55B30A 3.0L Inline 6	74
Honda D Series	83
Honda B Series	86,88
Honda K Series	91
Honda H Series	93
Hyundai 2.0L & 3.8L DOHC V6	95
Jaguar AJ133 5.0L	99
Mazda MZR 2.3L DOHC	102
Mini 1.6L Turbo Prince	103
Mitsu EVO X 4B11T	104
Mitsu 2.0L 4G63/4G63T	105
Mitsu 2.0L 4B11T	106
Nissan 2.0L SR20DE/DET S14	112
Nissan GT-R VR38DETT	121
Nissan TB48DE, VK56DE 5.6L	123
Rover 5.0L V8 LR-V8	126
Subaru FA20 DOHC	127
Subaru EJ205 DOHC	128
Subaru EJ22E SOHC	129

## STREETPRO

### Top & Bottom End Gasket Kits

StreetPro is a product line of Cometic Gasket manufactured by Cometic Gasket. Geared toward the street rodder who is looking to purchase a kit with all necessary gaskets and seals needed for your rebuild.



### MLX Head Gaskets

Make	Pg.
Subaru EJ25D DOHC	131
Subaru EJ251/EJ253	132,133
Subaru EJ255	133,134
Subaru EJ257	135,137
Toyota 2ZZ-GE 1.8L	141
Toyota 2JZ-GE 3.0L	146
Toyota 1FZ-FE 4.5L	149
Vauxhall 16V	151
Volkswagen/Audi 1.4L	151

### STREET PRO KITS

Make	Pg.
BMW	70,72
Buick	8
Chevrolet	11,13,17,20,22
Chevrolet Diesel	26
Chrysler/Dodge	27,31,32,33,37, 38,39
Cummins	42,43,44,45,46
Ford	48,49,52,55,57, 61,62, 64,65,66
Ford Diesel	63,64,65,66
Ford/Lotus	80,82
Honda/Acura	84,85,86,87,88, 89,90
Mazda	100,101
Mitsubishi	104,106,107
Nissan	109,110,111,112, 113,114,115,116, 117,118,119,120
Oldsmobile	67
Pontiac	69
Subaru	129,130,131,132,133, 134,135,136, 137
Toyota	140,141,143,144,146, 147

### Miscellaneous Gaskets & Accessories

Application	Pg.
Molded Rubber Valve Cover Gaskets	4
MLS Exhaust Gaskets	154
Valve Stem Seals	3,155
2PC Rear Main Seals	4
Rear End Gaskets	2
Carburetor Gaskets	2
Fuel Cell Gasket Kit	154
High Vacuum Crank Seals	154
Turbo Gaskets	3
Timing Cover Sets	4
Damper Rebuild O-rings	4
Cometic Block & Head Cleaner	165
Klotz Lubricants	165
Transmission Gaskets	2
Karting Gaskets	156
UTV Gaskets	161



Cometic Gasket - An Exclusive NASCAR Performance Product

# AMC

## 4.0L Inline 6 242ci 1987-2006

87-01 Cherokee, 93-04 Grand Cherokee, 87-90 Wagoneer, 87-92 Comanche, 91-06 Wrangler

### Head Gaskets

#### MLS Head Gaskets

Bore	Thickness	Pkg Qty	Part #
3.950	.....050"	.....1	C5987-050
4.000	.....050"	.....1	C5988-050
4.060	.....050"	.....1	C5989-050

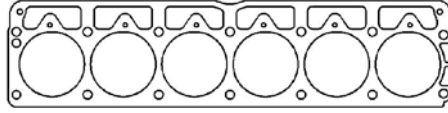

Additional thicknesses available see page 4

### Individual Gaskets

#### Timing Cover Set

Application	Part #
3.8/4.0/4.2L I6 1965-2006	C5047

## 290-401ci V8

### Head Gaskets

#### MLS Head Gaskets

**Fits: 290 1966-69, 304 1970-78, 343 1967-69, 360 1970-91**

Bore	Thickness	Pkg Qty	Part #
3.810"	.....040"	.....1	C5669-040
4.140"	.....040"	.....1	C5674-040

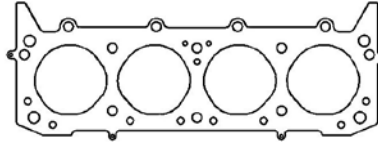

Additional thicknesses available see page 4

#### MLS Head Gaskets

**Fits: 390 1970 & 401 1972-74**

Bore	Thickness	Pkg Qty	Part #
4.250"	.....040"	.....1	C5937-040
4.380"	.....040"	.....1	C5938-040

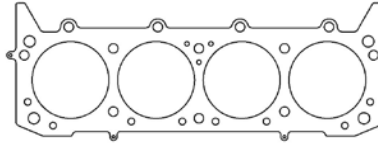

#### MLS Head Gaskets

**Fits: INDY 401 Aluminum Heads**

Bore	Thickness	Pkg Qty	Part #
4.380"	.....040"	.....1	C5409-040
4.380"	.....080"	.....1	C5409-080

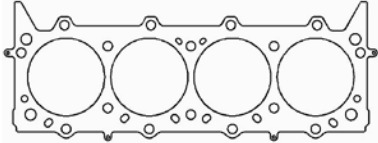

### Individual Gaskets

#### Exhaust Gasket Set

Application	Part #
304-401ci w/Dogleg Ports	C5161-064
304-401ci w/Rectangle Ports	C5101-064

#### Intake Gasket Set

Application	Part #
290-401 V8 1970-91 1.13" x 2.22"	C15002-060
390/401 Indy Head 1.20" x 2.30"	C15003-060

#### Valve Cover Gasket (sold individually)

Application	Part #
390/401ci V8 Indy Head	C5115-188

#### Timing Cover Set

Application	Part #
290-401ci V8 1966-88	C5046



Cometic Gasket - An Exclusive NASCAR Performance Product

# BUICK

## 192, 231, 252ci V6 Stock, Stage I, and Stage II

### Head Gaskets

#### MLS Head Gaskets

Bore	Thickness	Pkg Qty	Part #
3.860"	.040"	1	C5691-040
4.020"	.040"	1	C5692-040
4.090"	.040"	1	C5693-040

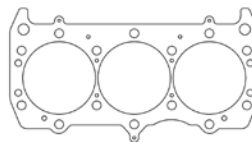

Additional thicknesses available  
see page 4

#### Copper Head Gaskets

Bore	Thickness	Pkg Qty	Part #
3.860"	.043"	1	C15407-043

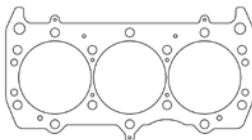

### Individual Gaskets

#### Exhaust Gasket Set

Application	Part #
Stock & Stage I Ports	C5696-064
Stage II Ports	C5791-064

#### Valve Cover Gasket (sold individually)

Application	Part #
Iron & Aluminum Heads	C5697-188

#### Intake Gasket Set

Application	Part #
Stock & Stage I Ports	C5694-060
Stage II Ports	C5792-060

#### Timing Cover Set

Application	Part #
66-87 V6/Small V8 w/Rope Seal	C5048
66-87 V6/Small V8 w/Radial Seal	C5049

#### Oil Pan Gasket

Application	Part #
20 Bolt	C5700-094

#### Rear Main Seal

Application	Part #
2 Piece w/Side Rails	C5707

## 3800 Series II V6 1996-2003

### Head Gaskets

#### MLS Head Gasket - Left Side

Bore	Thickness	Pkg Qty	Part #
3.840"	.066"	1	C5720-066

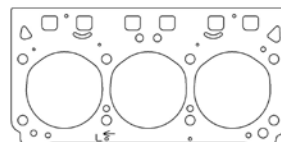

Additional thicknesses available  
see page 4

#### MLS Head Gasket - Right Side

Bore	Thickness	Pkg Qty	Part #
3.840"	.066"	1	C5721-066

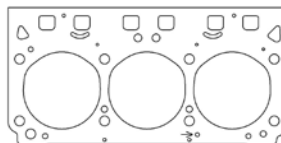



Cometic Gasket - An Exclusive NASCAR Performance Product

# BUICK

## 400, 430 & 455 V8 - All Years

### Head Gaskets

#### MLS Head Gaskets

Bore	Thickness	Pkg Qty	Part #
4.312"	.....040"	.....1.....	<b>C5753-040</b>
4.385"	.....040"	.....1.....	<b>C5754-040</b>
4.400"	.....040"	.....1.....	<b>C5755-040</b>

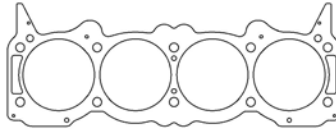

Additional thicknesses available see page 4

### Individual Gaskets

#### Exhaust Gasket Set

Application	Part #
All Years .....	<b>C5776-064</b>

#### Valve Cover Gasket (sold individually)

Application	Part #
Olds 330/350/400/403/455 - Molded Rubber .....	<b>C15440</b>
Olds 330/350/400/403/455 - Fiber .....	<b>C5774-094</b>

#### Intake Gasket Set

Application	Part #
1967-71 1.172" x 2.453" Port.....	<b>C5143-060</b>
1972-76 1.156" x 2.420" Port.....	<b>C5775-060</b>

#### Timing Cover Set

Application	Part #
1967-76 Water Pump Gasket .....	<b>C5144-031</b>
1970-76 455 Water Outlet Gasket.....	<b>C15004-031</b>

#### Oil Pan Gasket

Application	Part #
1967-76 4pc Set .....	<b>C5145</b>

#### Timing Cover Set

Application	Part #
67-74 400, 430, 455 V8 .....	<b>C5050</b>

### Gasket Kits



To purchase a complete gasket kit order both top end and bottom end gasket kit

#### TOP END GASKET KIT



Application	Part #
Big Block 455ci 1970-76 4.385" Bore.....	<b>PRO1011T</b>

#### BOTTOM END GASKET KIT



Application	Part #
Big Block 455ci 1970-76.....	<b>PRO1011B</b>

# CADILLAC

## Northstar 4.6L 32v V8 1993-2011

### Head Gaskets

#### MLS Head Gasket - Left Side

Bore	Thickness	Pkg Qty	Part #
3.700"	.....066"	.....1.....	<b>C5717-066</b>

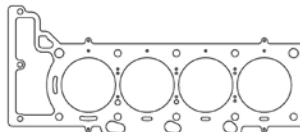

Additional thicknesses available see page 4





Cometic Gasket - An Exclusive NASCAR Performance Product

# CADILLAC

## Northstar 4.6L 32v V8 1993-2011

### Head Gaskets

#### MLS Head Gasket - Right Side

Bore	Thickness	Pkg Qty	Part #
3.700"	.066"	1	C5716-066

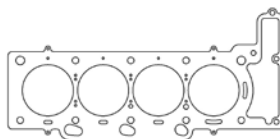

Additional thicknesses available see page 4

# CHEVROLET / GM

## ECOTEC 4 Cylinder

### Head Gaskets

#### MLS Head Gasket - LSJ 2.0L

Bore	Thickness	Pkg Qty	Part #
87mm	.027"	1	C5921-027

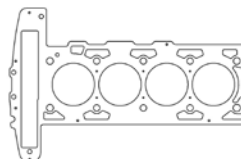

Additional thicknesses available see page 4

#### MLX Head Gasket - LSJ 2.0L

Bore	Thickness	Pkg Qty	Part #
87mm	.040"	1	C5032-040

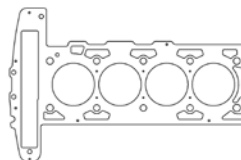

#### MLX Head Gasket - LNF 2.0L 08-10

Bore	Thickness	Pkg Qty	Part #
88mm	.032"	1	C15256-032

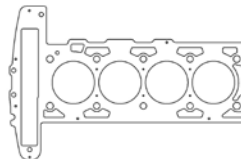

#### MLX Head Gasket - LTG 2.0L DOHC

Bore	Thickness	Pkg Qty	Part #
87mm	.028"	1	C4964-028

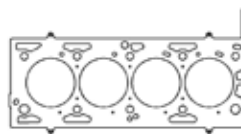

#### MLS Head Gaskets - L61/L42 2.2L DOHC

Bore	Thickness	Pkg Qty	Part #
87mm	.040"	1	C5768-040
89mm	.040"	1	C5804-040

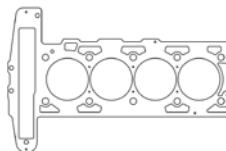

### Individual Gaskets

#### MLS Exhaust Gasket

Application	Part #
2000-2009 2.2/2.4L	C4150-030

## 2.2L 134ci "LN2": Cavalier/Sunfire FWD 1998-02, S-10/Sonoma RWD 1994-03

### Head Gaskets

#### MLS Head Gaskets

Bore	Thickness	Pkg Qty	Part #
90mm	.030"	1	C5914-030
93mm	.030"	1	C5915-030

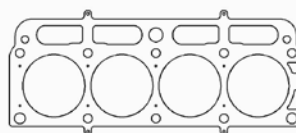

Additional thicknesses available see page 4



Cometic Gasket - An Exclusive NASCAR Performance Product

# CHEVROLET / GM

## 2.4L 146ci "LD9" Twin Cam 1996-2001

### Head Gaskets

#### MLS Head Gasket - 1996-99 w/EGR

Bore	Thickness	Pkg Qty	Part #
3.595"	.030"	1	C5298-030

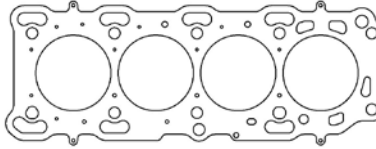

Additional thicknesses available see page 4

#### MLS Head Gaskets - 1999-01 w/o EGR

Bore	Thickness	Pkg Qty	Part #
3.595"	.030"	1	C5866-030
3.595"	.075"	1	C5866-075

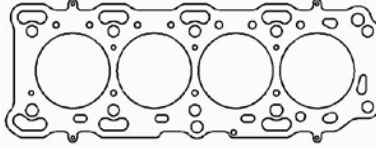

## 2.5L 153ci 1965-1979/3.0L VORTEC 3000 (Marine)

### Head Gasket

#### MLS Head Gasket

Bore	Thickness	Pkg Qty	Part #
4.100"	.045"	1	C5956-045

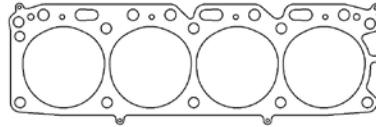

Additional thicknesses available see page 4

## 3.1/3.4/3.9L 60 Degree V6

### Head Gaskets

#### MLS Head Gasket - 3.1L 1993-99

Bore	Thickness	Pkg Qty	Part #
91mm	.051"	1	C5220-051

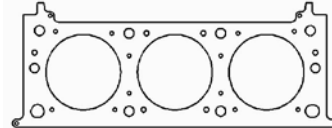

Additional thicknesses available see page 4

#### MLS Head Gasket - 3.4L 1993-05

Bore	Thickness	Pkg Qty	Part #
95mm	.051"	1	C5266-051

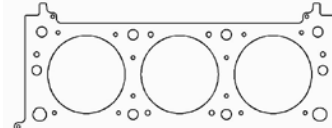

#### MLS Head Gasket - 3.9L 2006-11 Left Side

Bore	Thickness	Pkg Qty	Part #
101mm	.051"	1	C5226-051

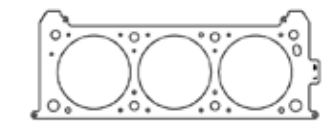

#### MLS Head Gasket - 3.9L 2006-11 Right Side

Bore	Thickness	Pkg Qty	Part #
101mm	.051"	1	C5227-051

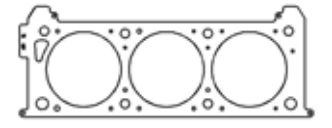

### Individual Gaskets

#### Exhaust Gasket Set

Application	Part #
1993-05 3.1/3.4L V6	C15005-064



Cometic Gasket - An Exclusive NASCAR Performance Product

# CHEVROLET / GM

## 3.6L LY7/LLT/LFX V6 2004-Present

### Head Gaskets

<b>MLX Head Gasket - Left Side</b>			
Bore	Thickness	Pkg Qty	Part #
98mm	.044"	1	C5029-044

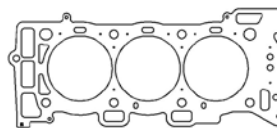

Additional thicknesses available see page 4

<b>MLX Head Gasket - Right Side</b>			
Bore	Thickness	Pkg Qty	Part #
98mm	.044"	1	C5028-044

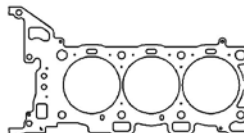

## 4.3L 229/262ci 90 Degree V6 1985-2009

### Head Gaskets

<b>MLS Head Gaskets</b>			
Bore	Thickness	Pkg Qty	Part #
4.060"	.040"	1	C5739-040
4.120"	.040"	1	C5740-040
4.155"	.040"	1	C5741-040

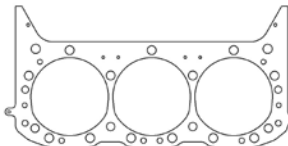

Additional thicknesses available see page 4

### Individual Gaskets

<b>Valve Cover Gasket (sold individually)</b>	
Application	Part #
4.3L V6 .188" ML Material	C15006-188

<b>Timing Cover Set</b>	
Application	Part #
1985-95 w/Thick Front OP Seal	C5051

<b>Intake Gasket Set</b>	
Application	Part #
4.3L V6 .060" Fiber	C15007-060

<b>Water Pump Gasket</b>	
Application	Part #
.018" AFM Material	C5299-018

<b>Exhaust Gasket Set</b>	
Application	Part #
1985-92 4.3L V6 .064" AM	C15008-064

<b>Oil Pan Gasket</b>	
Application	Part #
4 Piece Set	C5496

<b>Fuel Pump Mounting Gasket</b>	
Application	Part #
1985-96 4.3L V6 .020" Fiber	C15009-020

<b>Rear Main Seal Kit</b>	
Application	Part #
1 Piece Design	C5106

### Gasket Kits



To purchase a complete gasket kit order both top end and bottom end gasket kit

#### TOP END GASKET KIT



Application	Part #
4.3L V6 1985-93 4.120" Bore	PRO1006T

#### BOTTOM END GASKET KIT



Application	Part #
4.3L V6 1985-93	PRO1006B



Cometic Gasket - An Exclusive NASCAR Performance Product

# CHEVROLET / GM

## 194, 230, 250, 292 Inline 6 1962-84

### Head Gaskets

#### MLS Head Gasket

Bore	Thickness	Pkg Qty	Part #
4.125"	.040"	1	C5699-040

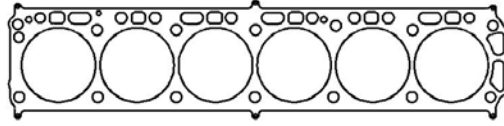

### Individual Gaskets

#### Intake/Exhaust Gasket Set

Application	Part #
292 I6 Intake .059" CFM	C15010-059

#### Timing Cover Set

Application	Part #
4/6 Cyl 151/230/250/292	C5053

## 4.2L Inline 6 "LL8" Vortec 4200 2002-09

### Head Gaskets

#### MLX Head Gasket

Bore	Thickness	Pkg Qty	Part #
3.710"	.040"	1	C15374-040

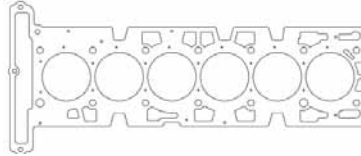

Additional thicknesses available see page 4

## 18/23 Degree Small Block V8 262-400ci (\*has steam holes)

### Head Gaskets

#### MLS Head Gaskets - Round Bore

Bore	Thickness	Pkg Qty	Part #
4.060"	.040"	1	C5245-040
4.100"	.040"	1	C5246-040
4.125"	.040"	1	C5247-040*
4.165"	.040"	1	C5248-040*
4.200"	.040"	1	C5249-040*

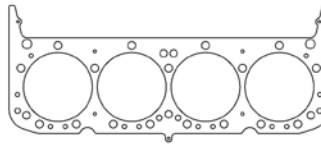

Additional thicknesses available see page 4

#### MLS Head Gaskets - Valve Pocketed Bore

Bore	Thickness	Pkg Qty	Part #
4.060"	.040"	1	C5269-040
4.100"	.040"	1	C5270-040
4.125"	.040"	1	C5271-040*
4.165"	.040"	1	C5272-040*
4.200"	.040"	1	C5273-040*

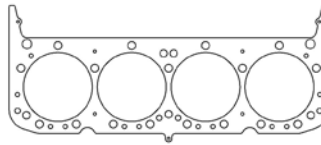

#### MLX Head Gaskets - Round Bore

Bore	Thickness	Pkg Qty	Part #
4.165"	.040"	1	C5031-040
4.220"	.040"	1	C5786-040

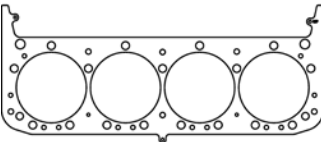

#### Copper Head Gaskets - Round Bore

Bore	Thickness	Pkg Qty	Part #
4.165"	.043"	1	C15411-043

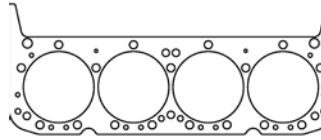

#### Copper Head Gaskets - Valve Pocketed Bore

Bore	Thickness	Pkg Qty	Part #
4.200"	.043"	1	C15412-043

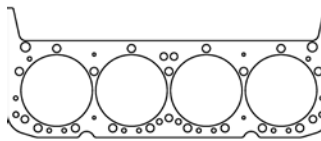

See page 13 for additional gaskets



Cometic Gasket - An Exclusive NASCAR Performance Product

# CHEVROLET / GM

## 18/23 Degree Small Block V8 262-400ci

### Individual Gaskets

Valve Cover Gaskets (sold individually)	
Application	Part #
18/23° Molded Rubber.....	<b>C5973</b>
Splayed Valve Heads .....	<b>C5390-094</b>

Oil Pan Gasket Kit	
Application	Part #
1955-79 LH Dipstick 4pc Kit .....	<b>C5295-094</b>
1980-85 RH Dipstick 4pc Kit.....	<b>C5294</b>
1986-97 1 pc Molded Rubber .....	<b>C5072</b>

Intake Gasket Set	
Application	Part #
18° Heads 1.35" X 2.25" Port.....	<b>C5541-060</b>
23° Heads 1.24" X 1.97" Port.....	<b>C5544-060</b>
23° Heads 1.24" x 2.10" Port .....	<b>C5545-060</b>
23° Heads 1.28" x 2.17" Port .....	<b>C5528-060</b>
305/350 w/TPI 85-92 Set.....	<b>C15198</b>
China Rail Gaskets.....	<b>C5536-060</b>

Exhaust Gasket Set	
Application	Part #
18° 1.50" x 1.47" .064" AM.....	<b>C5314-064</b>
23° 1.45" x 1.48" .030" MLS.....	<b>C5892-030</b>
23° 1.50" Round .030" MLS .....	<b>C5891-030</b>
23° 1.45" x 1.60" .030" MLS .....	<b>C5894-030</b>
23° 1.625" Round .030" MLS.....	<b>C5893-030</b>
23° 1.55" x 1.45" .030" MLS.....	<b>C15190-030</b>

Timing Cover Set	
Application	Part #
1957-74 w/Thin Front OP Seal .....	<b>C5052</b>
1975-95 w/Thick Front OP Seal .....	<b>C5051</b>

Fuel Pump Mounting Gaskets	
Application	Part #
2 Bolt - .032" AFM.....	<b>C5389-032</b>
4 Bolt - .032" AFM.....	<b>C15012-032</b>

Water Pump Gaskets	
Application	Part #
Water Pump MTG Gasket .....	<b>C5299-018</b>
Water Pump Backing Plate Gasket .....	<b>C15011-032</b>

Rear Main Seal Kit	
Application	Part #
2 Piece Viton .....	<b>C5680</b>
1 Piece Viton .....	<b>C5106</b>

### Individual Gaskets

Thermostat Gasket	
Application	Part #
.047" Fiber .....	<b>C5538-047</b>

Distributor Gasket	
Application	Part #
.060" Fiber .....	<b>C5531-060</b>

### Gasket Kits



To purchase a complete gasket kit order both top end and bottom end gasket kit

#### TOP END GASKET KIT



Application	Part #
350ci (67-85) & 400ci (70-76) 4.165" Bore ...	<b>PRO1003T</b>
350ci TPI (87-92), TBI (86-93) 4.100" Bore..	<b>PRO1004T</b>
ZZ4 Crate Engine 4.080" Bore .....	<b>PRO1026T</b>

#### BOTTOM END GASKET KIT

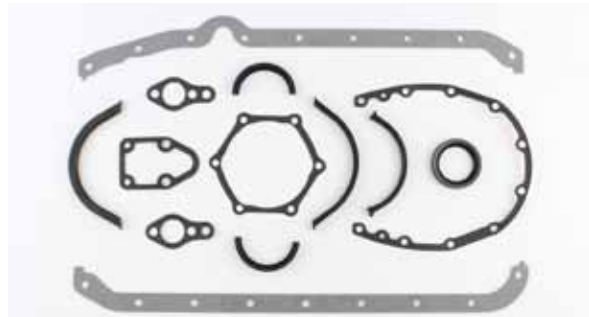

Application	Part #
350ci (67-79) & 400ci (70-76).....	<b>PRO1003B</b>
350ci (86-93) 1pc Rear Main.....	<b>PRO1004B</b>



Cometic Gasket - An Exclusive NASCAR Performance Product

# CHEVROLET / GM

## Small Block V8 - Aftermarket & Race

### Head Gaskets

#### MLS Head Gaskets - Vortec Head

Bore	Thickness	Pkg Qty	Part #
4.080"	.040"	1	C5474-040
4.165"	.040"	1	C5410-040

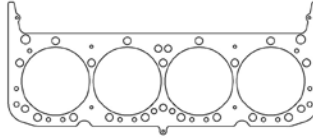

Additional thicknesses available see page 4

#### MLS Head Gasket - Edelbrock RPM Heads

Bore	Thickness	Pkg Qty	Part #
4.135"	.040"	1	C5274-040

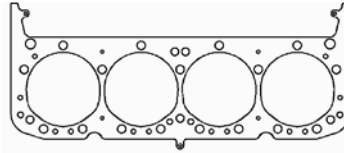

#### MLS Head Gaskets - Brodix BD2000

Bore	Thickness	Pkg Qty	Part #
4.030"	.040"	1	C5404-040
4.125"	.040"	1	C5405-040
4.135"	.040"	1	C5406-040
4.160"	.040"	1	C5407-040
4.200"	.040"	1	C5408-040

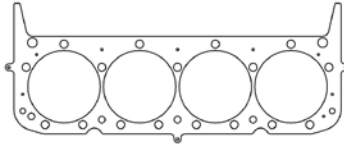

#### MLS Head Gaskets - Brodix Heads

Bore	Thickness	Pkg Qty	Part #
4.030"	.040"	1	C5399-040
4.125"	.040"	1	C5400-040
4.135"	.040"	1	C5401-040
4.160"	.040"	1	C5402-040
4.200"	.040"	1	C5403-040

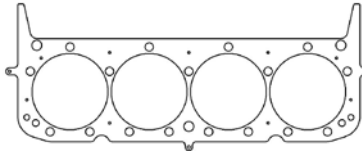

### Head Gaskets

#### MLX Head Gasket - All Pro Heads

Bore	Thickness	Pkg Qty	Part #
4.220"	.040"	1	C5551-040

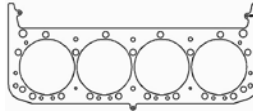

Additional thicknesses available see page 4

**NEW!**

#### MLS Head Gasket - Dart/Brodix 4.5" Bore Spacing

Bore	Thickness	Pkg Qty	Part #
4.270"	.036"	1	C5215-036
4.270"	.040"	1	C5215-040
4.270"	.045"	1	C5215-045

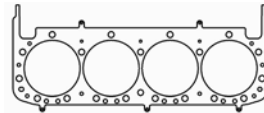

#### MLX Head Gasket - Dart/Brodix 4.5" Bore Spacing

Bore	Thickness	Pkg Qty	Part #
4.310"	.040"	1	C15208-040

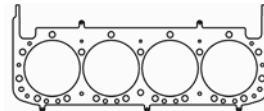

### Individual Gaskets

#### Intake Manifold Gaskets

Application	Part #
23° Dart Cast Iron	C5528-060
Brodix BD2000	C5421-060
Brodix WP 12S	C5425-059
Brodix WP 247	C5426-059
Brodix WP 262	C5427-059
Brodix GB 2000	C5423-059
Brodix Track 1 & Spec Head	C5414-059
Brodix Street	C5416-059
China Rail Gaskets	C5536-060

#### Exhaust Manifold Gaskets

Application	Part #
Brodix GB 2000 - .064" AM	C5422-064
Brodix Track 1 - .064" AM	C5415-064
Brodix Street - .064" AM	C5417-064
Brodix/All Pro 286 (7 Bolt) MLS	C5040-030
Brodix/Dart 13° 4.4/4.5" Spacing	C5039-030

#### Oil Pan Gasket

Application	Part #
Dart Iron Eagle/Rocket Block	C5104-094



Cometic Gasket - An Exclusive NASCAR Performance Product

# CHEVROLET / GM

## 350 & 400 SB2 Race V8

### Head Gaskets

#### MLS Head Gaskets

Bore	Thickness	Pkg Qty	Part #
4.125"	.040"	1	C5321-040
4.165"	.040"	1	C5323-040
4.190"	.040"	1	C5472-040
4.200"	.040"	1	C5324-040

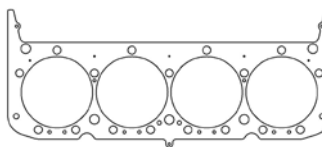

Additional thicknesses available  
see page 4

### Individual Gaskets

#### Valve Cover Gasket (sold individually)

Application	Part #
SB2 - .188" Thickness	C5235-188

#### Timing Cover Gasket

Application	Part #
SB2 - .020" RC	C5533-020

#### Intake Manifold Set

Application	Part #
SB2 - 2.085" x 1.560" Ports	C5311-031
SB2 - MLS	C5819-040

#### Water Pump Gasket

Application	Part #
Water Pump MTG Gasket	C5299-018
Water Pump Backing Plate Gasket	C15011-032

#### Intake Valley Plate Gaskets

Application	Part #
Stock Opening - .060" AFM	C5647-060
.970" Holes - .060" AFM	C5308-060
.625"/.750" Holes - .060" AFM	C5307-060

#### Exhaust Manifold Gaskets

Application	Part #
1.50" x 1.60" Ports - MLS	C5552-065
1.90" x 1.63" Ports - MLS	C5836-030

#### Rear Main Seal

Application	Part #
Dual Lip/High Vacuum	C5379

#### Oil Pan Gasket

Application	Part #
SB2 - 4pc Set	C5553-060

#### Distributor Gasket

Application	Part #
.060" Fiber	C5531-060

#### Fuel Pump Mounting Gasket

Application	Part #
4 Bolt - .032" AFM	C15012-032

## R07.2 Race V8

### Head Gasket

#### MLX Head Gasket

Bore	Thickness	Pkg Qty	Part #
4.220"	.040"	1	C5577-040

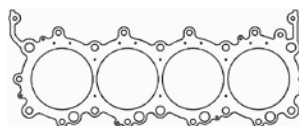

Additional thicknesses available  
see page 4

### Individual Gaskets

#### Rubber Seal/O-Ring Kit

Application	Part #
R07.2	C5979

#### Valve Cover Gasket (sold individually)

Application	Part #
Nitrile Formed Rubber O-Ring	C15013



Cometic Gasket - An Exclusive NASCAR Performance Product

# CHEVROLET / GM

## LT1/LT4 350ci 1992-1996

### Head Gaskets

#### MLS Head Gaskets

Bore	Thickness	Pkg Qty	Part #
4.040"	.040"	1	C5645-040
4.100"	.040"	1	C5646-040

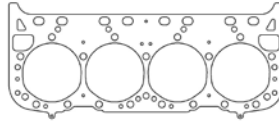

Additional thicknesses available see page 4

### Individual Gaskets

#### Valve Cover Gasket (sold individually)

Application	Part #
.094" Thickness	C15014-094

#### Exhaust Manifold Gaskets

Application	Part #
1.52" x 1.51" Ports, MLS	C5895-030

#### Intake Manifold Set

Application	Part #
LT1/LT4 - 2.085" x 1.560" Ports	C15015-060

#### Throttle Body Gasket Gasket

Application	Part #
1992-97 LT1/LT4	C15016-060

#### Oil Pan Gasket Set

Application	Part #
1992-97 1 pc Molded Rubber	C5072

#### Rear Main Seal Kit

Application	Part #
1 Piece Viton	C5106

#### Exhaust Pipe Gaskets

Application	Part #
Header Collector Gasket	C15017-064
Y-Pipe Gasket	C15018-064

#### Timing Cover Sets

Application	Part #
1992-94	C5054
1994-97	C5055

#### Water Pump Gasket

Application	Part #
Water Pump Mounting Gasket	C15019-031

## LS1/LS6 5.7L, LS2 6.0L, & LS3 6.2L

### Head Gaskets

#### MLS Head Gaskets

Bore	Thickness	Pkg Qty	Part #
3.810"	.051"	1	C15361-051
3.910"	.051"	1	C5475-051
4.060"	.051"	1	C5751-051
4.100"	.051"	1	C5489-051
4.130"	.051"	1	C5317-051
4.160"	.051"	1	C5318-051
4.190"	.051"	1	C5319-051

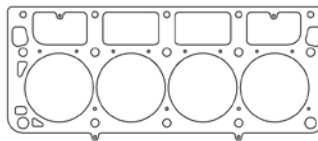

Additional thicknesses available see page 4

#### MLX Head Gaskets

Bore	Thickness	Pkg Qty	Part #
4.040"	.051"	1	C5505-051
4.150"	.040"	1	C5014-040
4.150"	.052"	1	C5514-052

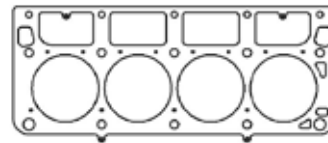

#### Copper Head Gaskets

Bore	Thickness	Pkg Qty	Part #
4.100"	.050"	1	C15408-050

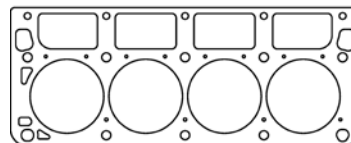

### Individual Gaskets

#### Valve Cover Gasket (sold individually)

Application	Part #
99-14 LS V8 - Center Bolt	C5170
Valve Cover Grommet Set	C15030

#### Exhaust Manifold Gaskets

Application	Part #
97-13 LS V8 - Round Port	C5818-030





Cometic Gasket - An Exclusive NASCAR Performance Product

# CHEVROLET / GM

## LS1/LS6 5.7L, LS2 6.0L, & LS3 6.2L

### Individual Gaskets

#### Intake Manifold Gaskets

Application	Part #
99-05 5.7/6.0L Car Intake.....	<b>C5165</b>
99-05 5.3/6.0L Truck Intake.....	<b>C5166</b>
LS3/L92 Carb Intake Gaskets.....	<b>C15022-060</b>
08-13 LS3 6.2L Car Intake.....	<b>C5037</b>
07-13 6.0/6.2L Truck Intake.....	<b>C15024</b>
Gen III LS1/LS6 Valley Gasket.....	<b>C15026</b>
Gen IV LS w/D.O.D. Valley Gasket.....	<b>C15023</b>
Gen IV LS w/o D.O.D. Valley Gasket.....	<b>C15025</b>

#### Throttle Body Gaskets

Application	Part #
97-05 4.8/5.3/5.7L.....	<b>C5168</b>
99-05 6.0L.....	<b>C5169</b>
2005 5.3/6.0L SUV.....	<b>C15020</b>
06-13 4.8/5.3/6.0/6.2L.....	<b>C15021</b>

#### Rear Main Seal Kit

Application	Part #
1997-13 LS V8.....	<b>C5172</b>

#### Fuel Injector O-Ring Set

Application	Part #
Upper and Lower O-Rings.....	<b>C15027</b>

#### Oil Pan Gasket Set

Application	Part #
97-13 LS V8 (not Vette).....	<b>C5173</b>

#### Exhaust Pipe Gaskets

Application	Part #
Graphite Exhaust Pipe.....	<b>C15028</b>
Metal Ring Exhaust Pipe.....	<b>C15029</b>

#### Valve Stem Seals

Application	Part #
97-01 LS V8.....	<b>3516PB-16</b>
02-13 LS V8 - Hat Style.....	<b>3256V-16</b>

#### Cooling/Water Pump Gaskets

Application	Part #
99-13 LS V8 (pair) Molded.....	<b>C5174</b>
99-13 LS V8 (pair) .031" Fiber.....	<b>C15032-031</b>
99-13 Water Pump Backing O-ring.....	<b>C15033</b>
97-13 Coolant Bypass Seals.....	<b>C15034</b>

#### Timing Cover Set

Application	Part #
1997-13 LS V8.....	<b>C5056</b>

#### Cam Plate Gasket

Application	Part #
with Recessed Bolts.....	<b>C15031</b>

#### Knock Sensor Grommet Kit

Application	Part #
1999-2013 - 2 Pack.....	<b>C15035</b>

#### Thermostat Seal

Application	Part #
2004-13 Gen IV.....	<b>C15036</b>

### Gasket Kits



To purchase a complete gasket kit order both top end and bottom end gasket kit

#### TOP END GASKET KIT



Application	Part #
1997-05 LS1 5.7L (Car Only) 4.100" Bore.....	<b>PRO1007T</b>
LS3/L92 6.2L Carbureted 4.060" Bore.....	<b>PRO1035T</b>
1999-01 6.0L (Truck Only) 4.100" Bore.....	<b>PRO1008T</b>
2001-10 4.8/5.3L Truck/Van/SUV 3.840" Bore.....	<b>PRO1040T</b>
2001-07 6.0L Truck/Van/SUV 4.060" Bore.....	<b>PRO1041T</b>
2005-07 6.0L Truck/Van/SUV 4.100" Bore.....	<b>PRO1037T</b>
2007-10 6.0/6.2L Truck/Van/SUV 4.100" Bore.....	<b>PRO1036T</b>
2009-11 LS3 6.2L (Car Only).....	<b>PRO1043T</b>

#### BOTTOM END GASKET KIT



Application	Part #
4.8/5.3/5.7/6.0/6.2L LS V8.....	<b>PRO1040B</b>
with flat mount Cam Plate Bolts	
4.8/5.3/5.7/6.0/6.2L LS V8.....	<b>PRO1036B</b>
with recessed Cam Plate Bolts	



Cometic Gasket - An Exclusive NASCAR Performance Product

# CHEVROLET / GM

## LS7 7.0L V8

### Head Gaskets

#### MLS Head Gasket

Bore	Thickness	Pkg Qty	Part #
4.150"	.....051"	.....1	C5889-051

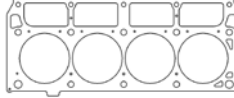

Additional thicknesses available  
see page 4

#### MLX Head Gasket

Bore	Thickness	Pkg Qty	Part #
4.150"	.....052"	.....1	C5030-052

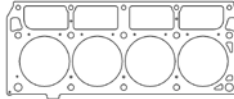

### Individual Gaskets

#### Valve Cover Gasket (sold individually)

Application	Part #
99-13 LS V8 - Center Bolt .....	C5170
Valve Cover Grommet Set.....	C15030

#### Intake Manifold Gaskets

Application	Part #
LS7 2006-13 w/Carb Intake.....	C5167-060
Gen IV LS w/o D.O.D. Valley Gasket .....	C15025

#### Exhaust Manifold Gaskets

Application	Part #
2006-13 D-Port - MLS .....	C5073-030

#### Valve Stem Seals

Application	Part #
05-13 LS7 V8 - Hat Style.....	3256V-16

#### Fuel Injector O-Ring Set

Application	Part #
Upper and Lower O-Rings.....	C15027

#### Timing Cover Set

Application	Part #
1997-13 LS V8.....	C5056

#### Cooling/Water Pump Gaskets

Application	Part #
99-13 LS V8 (pair) Molded .....	C5174
99-13 LS V8 (pair) .031" Fiber.....	C15032-031
99-13 Water Pump Backing O-ring.....	C15033
97-13 Coolant Bypass Seals .....	C15034

#### Rear Main Seal Kit

Application	Part #
1997-13 LS V8.....	C5172

## LS9/LSA 6.2L 2009-2013

### Head Gaskets

#### MLX Head Gasket - Right Side

Bore	Thickness	Pkg Qty	Part #
4.100"	.....051"	.....1	C5985-051

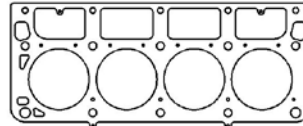

Additional thicknesses available  
see page 4

#### MLX Head Gasket - Left Side

Bore	Thickness	Pkg Qty	Part #
4.100"	.....051"	.....1	C5986-051

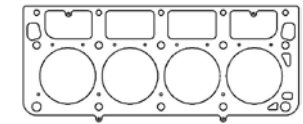

### Individual Gaskets

#### Valve Cover Gasket (sold individually)

Application	Part #
99-13 LS V8 - Center Bolt .....	C5170
Valve Cover Grommet Set.....	C15030

#### Valve Stem Seals

Application	Part #
09-13 LS V8 - Hat Style.....	3256V-16

#### Exhaust Manifold Gaskets

Application	Part #
09-13 LS V8 - Round Port .....	C5818-030

#### Oil Pan Gasket Set

Application	Part #
97-13 LS V8 (Pan to Block).....	C5173

#### Intake Manifold Gaskets

Application	Part #
Gen IV LS w/o D.O.D. Valley Gasket .....	C15025

#### Timing Cover Set

Application	Part #
1997-13 LS V8.....	C5056

See page 19 for additional gaskets



Cometic Gasket - An Exclusive NASCAR Performance Product

# CHEVROLET / GM

## LS9/LSA 6.2L 2009-2013

### Individual Gaskets

#### Cooling/Water Pump Gaskets

Application	Part #
99-13 LS V8 (pair) Molded .....	C5174
99-13 LS V8 (pair) .031" Fiber.....	C15032-031
99-13 Water Pump Backing O-ring.....	C15033
97-13 Coolant Bypass Seals .....	C15034

#### Rear Main Seal Kit

Application	Part #
1997-13 LS V8.....	C5172

## GM/DART LS NEXT BLOCK

### Head Gaskets

**NEW!**

#### MLX Head Gasket - Right Side

Bore	Thickness	Pkg Qty	Part #
4.200"	.044"	1	C15362-044
4.200"	.052"	1	C15362-052
4.200"	.060"	1	C15362-060

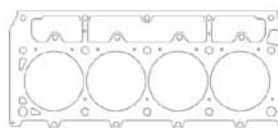

Additional thicknesses available see page 4

1/2" & 3/8" Stud Hole Combination

**NEW!**

#### MLX Head Gasket - Left Side

Bore	Thickness	Pkg Qty	Part #
4.200"	.044"	1	C15363-044
4.200"	.052"	1	C15363-052
4.200"	.060"	1	C15363-060

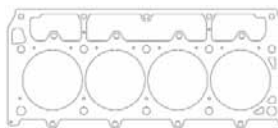

## LSX RACE BLOCK

### Head Gaskets

#### MLS Head Gaskets - Right Side

Bore	Thickness	Pkg Qty	Part #
4.125"	.051"	1	C5933-051
4.125"	.140"	1	C5933-140
4.185"	.051"	1	C5935-051

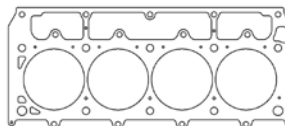

Additional thicknesses available see page 4

#### MLS Head Gaskets - Left Side

Bore	Thickness	Pkg Qty	Part #
4.125"	.051"	1	C5934-051
4.185"	.051"	1	C5936-051

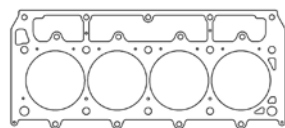

#### MLX Head Gaskets - Right Side

Bore	Thickness	Pkg Qty	Part #
4.100"	.040"	1	C5075-040
4.150"	.040"	1	C5702-040
4.200"	.040"	1	C5077-040

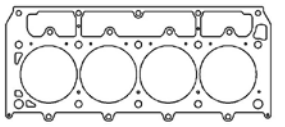

#### MLX Head Gaskets - Left Side

Bore	Thickness	Pkg Qty	Part #
4.100"	.040"	1	C5076-040
4.150"	.040"	1	C5703-040
4.200"	.040"	1	C5078-040

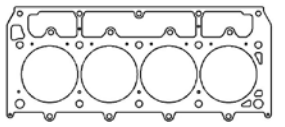

#### Copper Head Gaskets - Left Side

Bore	Thickness	Pkg Qty	Part #
4.100"	.043"	1	C15409-043

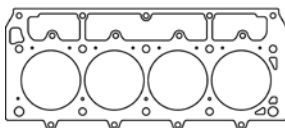

#### Copper Head Gaskets - Right Side

Bore	Thickness	Pkg Qty	Part #
4.100"	.043"	1	C15410-043

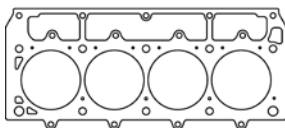

See page 20 for additional gaskets



Cometic Gasket - An Exclusive NASCAR Performance Product

# CHEVROLET / GM

## LSX RACE BLOCK

### Individual Gaskets

#### Oil Pan Gasket Set

Application	Part #
97-13 LS V8 (Pan to Block).....	<b>C5173</b>

#### Timing Cover Set

Application	Part #
1997-13 LS V8.....	<b>C5056</b>

#### Valve Cover Gasket (sold individually)

Application	Part #
99-13 LS V8 - Center Bolt .....	<b>C5170</b>
Valve Cover Grommet Set.....	<b>C15030</b>

#### Intake Manifold Gaskets

Application	Part #
LS7 2006-13 w/Carb Intake.....	<b>C5167-060</b>
LSX-DR Head - Lrg Port.....	<b>C15037-060</b>
Gen IV LS w/o D.O.D. Valley Gasket .....	<b>C15025</b>

#### Cooling/Water Pump Gaskets

Application	Part #
99-13 LS V8 (pair) Molded .....	<b>C5174</b>
99-13 LS V8 (pair) .031" Fiber.....	<b>C15032-031</b>
99-13 Water Pump Backing O-ring.....	<b>C15033</b>
97-13 Coolant Bypass Seals .....	<b>C15034</b>

#### Exhaust Manifold Gaskets

Application	Part #
2006-13 D-Port - MLS .....	<b>C5073-030</b>
LSX-DR .064" AM .....	<b>C15038-064</b>

#### Valve Stem Seals

Application	Part #
09-13 LS V8 - Hat Style.....	<b>3256V-16</b>

### Gasket Kits



To purchase a complete gasket kit order both top end and bottom end gasket kit

#### TOP END GASKET KIT



Application	Part #
LSX w/LS7 Carb Intake 4.125" Bore .....	<b>PRO1025T</b>

#### BOTTOM END GASKET KIT

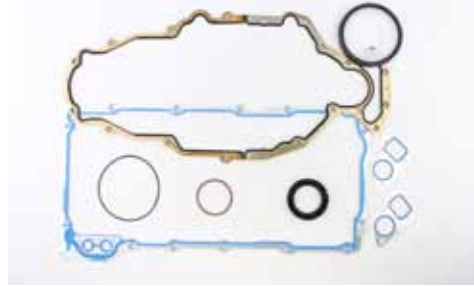

Application	Part #
LSX V8.....	<b>PRO1025B</b>

## LS1/LS6 5.7L, LS2 6.0L, & LS3 6.2L w/Darton M.I.D. Sleeves

### Head Gaskets

#### MLS Head Gasket

Bore	Thickness	Pkg Qty	Part #
3.910" .....	.040" .....	1 .....	<b>C5788-040</b>
4.125" .....	.040" .....	1 .....	<b>C5789-040</b>
4.165" .....	.040" .....	1 .....	<b>C5790-040</b>

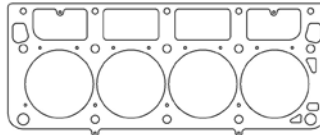

Additional thicknesses available see page 4

## L83 / 5.3L EcoTec3

### Head Gaskets

**NEW!**

#### MLS Head Gasket

Bore	Thickness	Pkg Qty	Part #
3.875" .....	0.058 .....	1 .....	<b>C15426-058</b>

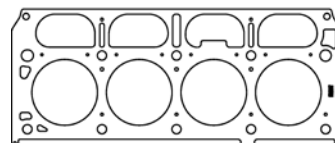

Additional thicknesses available see page 4



Cometic Gasket - An Exclusive NASCAR Performance Product

# CHEVROLET / GM

## LT1/LT4 6.2L V8 2014+UP

### Head Gasket

MLX Head Gasket			
Bore	Thickness	Pkg Qty	Part #
4.100"	.051"	1	C5038-051
4.150"	.051"	1	C15203-051
4.200"	.051"	1	C15202-051

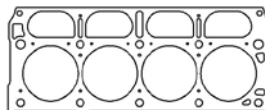

Additional thicknesses available see page 4

### Individual Gaskets

Exhaust Manifold Gasket	
Application	Part #
2014+ 1.920" Port - .021" MLS	C5020-021

**NEW!**

Valley Pan Gasket	
Application	Part #
2014+ LT1/LT4 Valley Pan	C15437

**NEW!**

Valve Cover Set	
Application	Part #
2014+ LT1/LT4	C15438

## Holden 308 V8

### Head Gaskets

**NEW!**

MLS Head Gaskets			
Bore	Thickness	Pkg Qty	Part #
4.100"	.040"	1	C5806-040
4.200"	.040"	1	C5807-040
4.200"	.060"	1	C5807-060

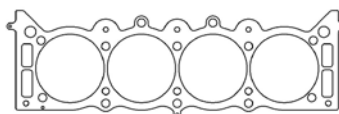

Additional thicknesses available see page 4

**NEW!**

Valve Cover Gasket (sold individually)	
Application	Part #
308 V8 Fiber Valve Cover	C1548-188

**NEW!**

Fuel Pump Gasket	
Application	Part #
308 V8 Fiber Distributor Gasket	C15456-031

**NEW!**

Intake Manifold Gaskets	
Application	Part #
253 / 308 Red Motor	C15454-060

**NEW!**

Exhaust Manifold Gaskets	
Application	Part #
253 / 308 Red / Blue Black	C15453-042

**NEW!**

Timing Cover Set	
Application	Part #
308 V8 Timing Cover	C15450-032

**NEW!**

Water Pump Gasket	
Application	Part #
Holden 308 V8 Water Pump	C15451-032

**NEW!**

Oil Pump Pickup Gasket	
Application	Part #
308 V8 AFM Oil Pump Gasket	C15452-032

**NEW!**

Distbutor Gasket	
Application	Part #
.....	C15457-031

## 348ci 1958-61/409ci 1961-65 "W" V8

### Head Gaskets

MLS Head Gaskets			
Bore	Thickness	Pkg Qty	Part #
4.200"	.040"	1	C5255-040
4.375"	.040"	1	C5256-040
4.437"	.040"	1	C5219-040

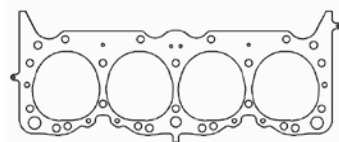

Additional thicknesses available see page 4

### Individual Gaskets

Intake Manifold Gasket	
Application	Part #
409ci V8 - .059" CFM	C15039-059

Exhaust Manifold Gasket	
Application	Part #
409ci V8 - .064" AM	C15040-064



Cometic Gasket - An Exclusive NASCAR Performance Product

# CHEVROLET / GM

## Big Block V8 - Gen4 1965-90 396,402,427,454ci

### Head Gaskets

#### MLS Head Gaskets

Bore	Thickness	Pkg Qty	Part #
4.320"	.040"	1	C5816-040
4.375"	.040"	1	C5329-040
4.540"	.040"	1	C5330-040
4.630"	.040"	1	C5331-040

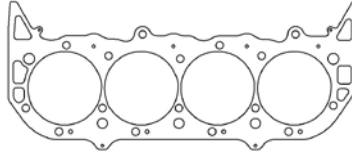

Additional thicknesses available  
see page 4

**NEW!**

#### Copper Head Gaskets

Bore	Thickness	Pkg Qty	Part #
4.320"	.043"	1	C15413-043
4.530"	.043"	1	C15414-043
4.630"	.043"	1	C15415-043

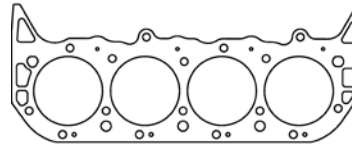

### Individual Gaskets

#### Valve Cover Gasket (sold individually)

Application	Part #
Molded Rubber .188"	C5975

#### Intake Manifold Gaskets

Application	Part #
Rect Port 1.75" x 2.50" - .060" KF	C5649-060
Oval Port 1.82" x 2.05" - .060" KF	C15041-060

#### Exhaust Manifold Gaskets

Application	Part #
1.85" x 1.90" Sq Port - MLS	C5897-030
1.920" Round Port - MLS	C5896-030
2.000" Round Port - MLS	C5349-030
2.130" Round Port - MLS	C5996-030
2.200" Round Port - MLS	C5350-030
2.250" Round Port - MLS	C5251-030

#### Rear Main Seal Kit

Application	Part #
2pc 1965-90 - Silicone	C5086
2pc 1965-90 - Viton	C5682

#### Cooling/Water Pump Gaskets

Application	Part #
Water Pump Mounting - Req 2	C5347-039
Water Outlet	C5346-047

#### Timing Cover Sets

Application	Part #
1965-95 BBC V8	C5057

#### Oil Pan Gasket Set

Application	Part #
4pc Kit	C5344

### Gasket Kits



To purchase a complete gasket kit order both top end and bottom end gasket kit

#### TOP END GASKET KIT



Application	Part #
454ci 1970-85 4.275" Bore	PRO1005T

#### BOTTOM END GASKET KIT



Application	Part #
Big Block Gen4	PRO1005B



Cometic Gasket - An Exclusive NASCAR Performance Product

# CHEVROLET / GM

## Big Block V8 - Gen5/6 1991-00 454, 502ci

### Head Gaskets

#### MLS Head Gaskets

Bore	Thickness	Pkg Qty	Part #
4.320"	.040"	1	C5817-040
4.375"	.040"	1	C5332-040
4.540"	.040"	1	C5333-040
4.630"	.040"	1	C5334-040

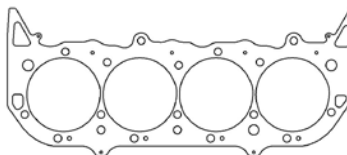

Additional thicknesses available see page 4

### Individual Gaskets

#### Valve Cover Gasket (sold individually)

Application	Part #
Molded Rubber .188"	C5975

#### Intake Manifold Gaskets

Application	Part #
Rect Port 1.75" x 2.50" - .060" KF	C5649-060
Oval Port 1.82" x 2.05" - .060" KF	C15041-060

#### Exhaust Manifold Gaskets

Application	Part #
1.85" x 1.90" Sq Port - MLS	C5897-030
1.920" Round Port - MLS	C5896-030
2.000" Round Port - MLS	C5349-030
2.130" Round Port - MLS	C5996-030
2.200" Round Port - MLS	C5350-030
2.250" Round Port - MLS	C5251-030

#### Timing Cover Sets

Application	Part #
1990-95 BBC V8	C5057
1996-00 BBC V8	C5058

#### Cooling/Water Pump Gaskets

Application	Part #
Water Pump Mounting - Req 2	C5347-039
Water Outlet	C5346-047

#### Rear Main Seal Kit

Application	Part #
2pc 1991-00 Gen 5/6 - Viton	C5087

#### Oil Pan Gasket Set

Application	Part #
1pc Molded Rubber	C15077

## Big Block V8 - Aftermarket, Race, & Marine Blocks

### Head Gaskets

#### MLS Head Gaskets - Mercury Gen4/5/6 w/4 Bolts in Lifter Valley

Bore	Thickness	Pkg Qty	Part #
4.500"	.051"	1	C5634-051
4.530"	.051"	1	C5635-051
4.580"	.051"	1	C5636-051
4.600"	.051"	1	C5637-051

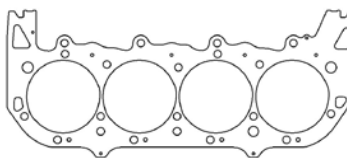

Additional thicknesses available see page 4

#### MLS Head Gaskets - Mercury 1050 Gen 4 w/2 Slotted Lifter Valley Bolts

Bore	Thickness	Pkg Qty	Part #
4.500"	.051"	1	C5638-051
4.530"	.051"	1	C5639-051
4.580"	.051"	1	C5640-051
4.600"	.051"	1	C5641-051

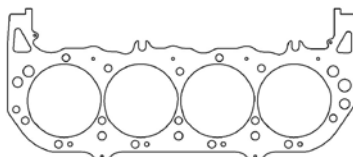

#### MLS Head Gaskets - Mercury Marine 526/625 Gen

Bore	Thickness	Pkg Qty	Part #
4.470"	.040"	1	C5760-040

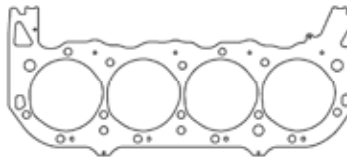

See page 24 for additional gaskets



Cometic Gasket - An Exclusive NASCAR Performance Product

# CHEVROLET / GM

## Big Block V8 - Aftermarket, Race, & Marine Blocks

### Head Gaskets

#### MLS Head Gaskets - Mercury 8.1L 496 - Right Side

Bore	Thickness	Pkg Qty	Part #
4.280"	.051"	1	C5761-051
4.350"	.051"	1	C5762-051
4.450"	.051"	1	C5763-051

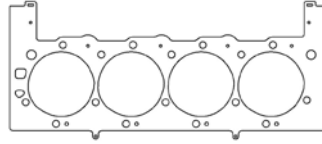

Additional thicknesses available  
see page 4

#### MLS Head Gaskets - Mercury 8.1L 496 - Left Side

Bore	Thickness	Pkg Qty	Part #
4.280"	.051"	1	C5764-051
4.350"	.051"	1	C5765-051
4.450"	.051"	1	C5766-051

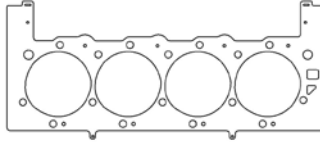

#### MLS Head Gaskets - Brodix Big Duke/Big Brodie

Bore	Thickness	Pkg Qty	Part #
4.310"	.040"	1	C5432-040
4.570"	.040"	1	C5433-040
4.630"	.040"	1	C5434-040

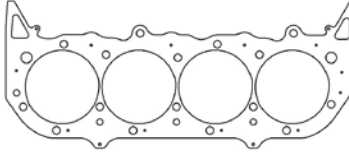

#### MLS Head Gaskets - ZL1 1969 7.0L 427ci Aluminum Round Bore

Bore	Thickness	Pkg Qty	Part #
4.250"	.040"	1	C5746-040
4.300"	.040"	1	C5747-040
4.375"	.040"	1	C5759-040

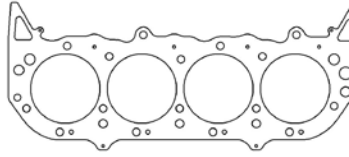

### Individual Gaskets

**NEW!**

#### Valve Cover Gasket (sold individually)

Application	Part #
SR-20 FML .094" Fiber w/ Steel	C15460
Molded Rubber .188"	C5975

**NEW!**

#### Intake Manifold Gaskets

Application	Part #
Brodix SR-20 -.060KF	C15459-060
Brodix Big Brodie Oval -.060" KF	C5430-060
Brodix Big Brodie Rectangle-.060" KF	C5428-060
Brodix Big Duke -.060" KF	C5419-060
Mercury 1050 - MLS	C5821-051

#### Exhaust Manifold Gaskets

Application	Part #
Brodix Big Brodie -.064" AM	C5429-064
Brodix Big Duke -.064" AM	C5418-064
Mercury 525/625 EFI - MLS	C15364-030
Mercury 1050 - MLS	C5820-051

#### Rear Main Seal Kits

Application	Part #
2pc 1965-90 - Silicone	C5086
2pc 1965-90 - Viton	C5682
1pc 1991-00 Gen 5/6 - Viton	C5087

#### Timing Cover Sets

Application	Part #
1965-95 BBC V8	C5057
1996-00 BBC V8	C5058

#### Oil Pan Gasket Set

Application	Part #
4pc Kit 1965-90	C5344
4pc Kit Bolt Holes@Mains	C5254
1pc Molded Rubber 91-00	C15077

#### Cooling/Water Pump Gaskets

Application	Part #
Water Pump Mounting - Req 2	C5347-039
Water Outlet	C5346-047





Cometic Gasket - An Exclusive NASCAR Performance Product

# CHEVROLET / GM

## Prostock Racing V8

### Head Gaskets

<b>MLS Head Gaskets - DRCE-2 4.900" Bore Centers 500ci</b>			
Bore	Thickness	Pkg Qty	Part #
4.675"	.051"	1	C5449-051
4.700"	.051"	1	C5450-051
4.780"	.051"	1	C5451-051

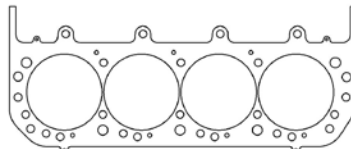

Additional thicknesses available see page 4

<b>MLS Head Gaskets - DRCE-3 4.900" Bore Centers 500ci</b>			
Bore	Thickness	Pkg Qty	Part #
4.675"	.051"	1	C5796-051
4.700"	.051"	1	C5797-051
4.780"	.051"	1	C5798-051

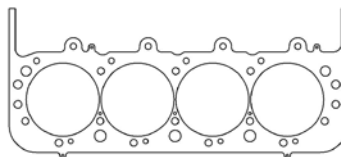

<b>MLS Head Gasket - IHRA 5.00" Bore Centers 800ci</b>			
Bore	Thickness	Pkg Qty	Part #
4.755"	.040"	1	C5850-040

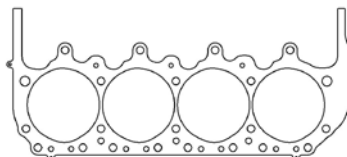

<b>MLX Head Gasket - 5.20" Bore Centers</b>			
Bore	Thickness	Pkg Qty	Part #
4.860"	.040"	1	C5013-040

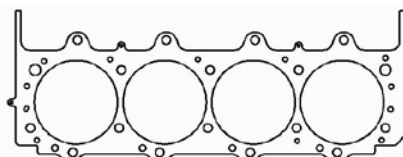

<b>MLS Head Gaskets - BRODIX 5.0 Bore Space Big Block V8</b>			
Bore	Thickness	Pkg Qty	Part #
4.700"	.041"	1	C15397-041
4.760"	.041"	1	C15398-041
4.795"	.041"	1	C15399-041

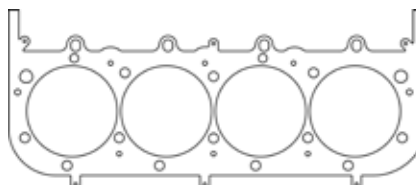

## 6.5L Diesel V8 1992-00

### Head Gaskets

<b>MLS Head Gaskets - Right Side</b>			
Bore	Thickness	Pkg Qty	Part #
4.100"	.045"	1	C5885-045

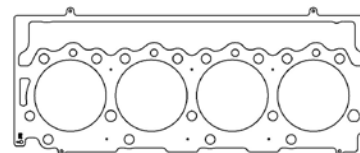

Additional thicknesses available see page 4

<b>MLS Head Gaskets - Left Side</b>			
Bore	Thickness	Pkg Qty	Part #
4.100"	.045"	1	C5884-045

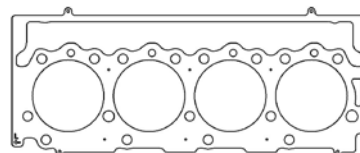

<b>Head Bolt Kit</b>	
Bore	Part #
ARP 190,000 psi	COM-0001



Cometic Gasket - An Exclusive NASCAR Performance Product

# CHEVROLET / GM

## 6.6L Duramax Diesel V8 2001-16

### Head Gaskets

#### MLX Head Gaskets - Right Side

Bore	Thickness	Pkg Qty	Part #
4.130"	.....053"	.....1	<b>C15375-053</b>
4.130"	.....062"	.....1	<b>C15375-062</b>

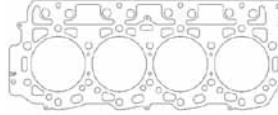

Additional thicknesses available  
see page 4

#### MLX Head Gaskets - Left Side

Bore	Thickness	Pkg Qty	Part #
4.100"	.....053"	.....1	<b>C15376-053</b>
4.100"	.....062"	.....1	<b>C15376-062</b>

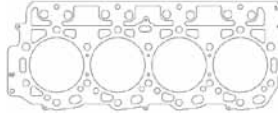

#### MLS Head Gaskets - Right Side

Bore	Thickness	Pkg Qty	Part #
4.100"	.....040"	.....1	<b>C5882-040</b>

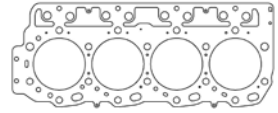

#### MLS Head Gaskets - Left Side

Bore	Thickness	Pkg Qty	Part #
4.100"	.....040"	.....1	<b>C5883-040</b>

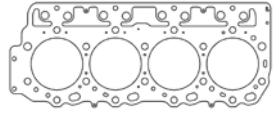

### Individual Gaskets

#### Exhaust Manifold Gaskets

Application	Part #
2001-16 8mm Bolts - MLS	<b>C15042-030</b>

#### Rear Main Seal Kit

Application	Part #
2001-07	<b>C15044</b>

#### Timing Cover Set

Application	Part #
2001-15	<b>C15045</b>

#### Oil Pan Gasket Set

Application	Part #
2001-10 17 Bolt - .060" KF	<b>C15043</b>

### Gasket Kits



To purchase a complete gasket kit order both top end and bottom end gasket kit

#### TOP END GASKET KITS



Application	Part #
6.6L Duramax 2001-04 4.100" Bore	<b>PRO3008T</b>
6.6L Duramax 2005-07 4.100" Bore	<b>PRO3009T</b>

#### BOTTOM END GASKET KIT



Application	Part #
6.6L Duramax 2001-07	<b>PRO3008B</b>



Cometic Gasket - An Exclusive NASCAR Performance Product

# CHRYSLER / DODGE

## 2.0L DOHC 4cyl ECC/420A 1995-99

### Head Gaskets

MLS Head Gaskets			
Bore	Thickness	Pkg Qty	Part #
87.5mm	.040"	1	C5497-040
88.5mm	.040"	1	C5498-040

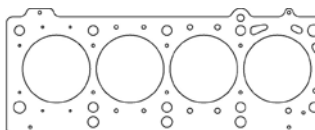

Additional thicknesses available see page 4

### Individual Gaskets

Valve Cover Gasket Set	
Application	Part #
1995-99 2.0L DOHC	C15046

Cam Seal Set	
Application	Part #
Pair - 48 x 35 x 7	C15049

Intake Manifold Gaskets	
Application	Part #
Intake Manifold Gasket - .060" AFM	C15047-060
Intake Plenum Gasket - .031" Fiber	C15048-031

Front Crank Seal Set	
Application	Part #
1995-99 2.0L DOHC	C15053

Exhaust Manifold Gasket	
Application	Part #
2.040" X 1.100" Port - MLS	C4161-030

Oil Pan Gasket Set	
Application	Part #
Molded Rubber	C15050

Throttle Body Gasket	
Application	Part #
Molded Rubber	C15051

Rear Main Seal	
Application	Part #
1995-99 2.0L DOHC	C15052

Valve Stem Seal Set (16 Pack)	
Application	Part #
5 x 10.8 x 18.3 x 16.9 - Hat Style	3180V-16

### Gasket Kits



To purchase a complete gasket kit order both top end and bottom end gasket kit

#### TOP END GASKET KIT



Application	Part #
1995-99 420A 2.0L DOHC 87.5mm Bore	PRO2005T

#### BOTTOM END GASKET KIT



Application	Part #
1995-99 420A 2.0L DOHC	PRO2005B



Cometic Gasket - An Exclusive NASCAR Performance Product

# CHRYSLER / DODGE

**2.4L DOHC Turbo 4cyl 2003-05 Neon SRT4, 2004-10 PT Cruiser, 2005-06 Jeep Wrangler**

## Head Gaskets

### MLS Head Gaskets

Bore	Thickness	Pkg Qty	Part #
87.5mm	.030"	1	C4548-030
90mm	.030"	1	C4549-030

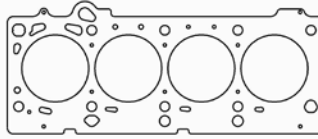

Additional thicknesses available see page 4

**NEW!**

### MLX Head Gaskets

Bore	Thickness	Pkg Qty	Part #
88.5mm	.040"	1	C15449-040

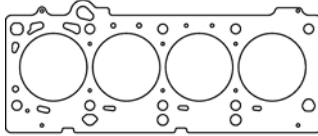

## 2.2L DOHC 4cyl 1991-93

## Head Gaskets

### MLS Head Gaskets

Bore	Thickness	Pkg Qty	Part #
89.5mm	.066"	1	C5733-066

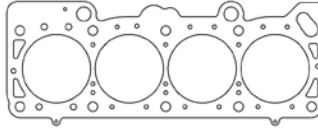

Additional thicknesses available see page 4

## 2.2L SOHC 4cyl 1982-90, 2.5L SOHC 4cyl 1986-95

## Head Gaskets

### MLS Head Gaskets

Bore	Thickness	Pkg Qty	Part #
89.5mm	.066"	1	C5734-066

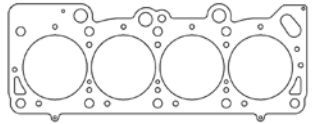

Additional thicknesses available see page 4

## 3.5L SOHC V6 1999-10, 4.0L SOHC V6 2007-11

## Head Gaskets

### MLS Head Gasket - Right Side

Bore	Thickness	Pkg Qty	Part #
96.5mm	.075"	1	C5015-075

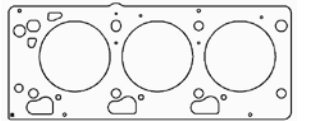

Additional thicknesses available see page 4

### MLS Head Gasket - Left Side

Bore	Thickness	Pkg Qty	Part #
96.5mm	.075"	1	C5016-075

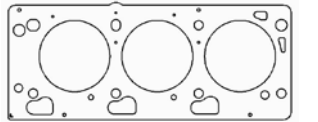

## 3.7L SOHC V6 2002-13 Powertech "EKG"

## Head Gaskets

### MLS Head Gasket

Bore	Thickness	Pkg Qty	Part #
95mm	.030"	1	C5794-030

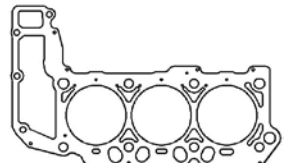

Additional thicknesses available see page 4



Cometic Gasket - An Exclusive NASCAR Performance Product

# CHRYSLER / DODGE

## 4.0L Inline 6 242ci 1987-2006

87-01 Cherokee, 93-04 Grand Cherokee, 87-90 Wagoneer, 87-92 Comanche, 91-06 Wrangler

### Head Gaskets

#### MLS Head Gaskets

Bore	Thickness	Pkg Qty	Part #
3.950	.050"	1	C5987-050
4.000	.050"	1	C5988-050
4.060	.050"	1	C5989-050

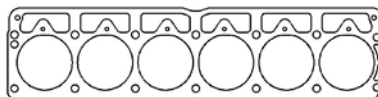

Additional thicknesses available see page 4

### Individual Gaskets

#### Timing Cover Set

Application	Part #
3.8/4.0/4.2L I6 1965-2006	C5047

## 4.7L SOHC V8 1999-13 Powertech

### Head Gaskets

#### MLS Head Gaskets - 1999-07

Bore	Thickness	Pkg Qty	Part #
93mm	.030"	1	C5213-030
95mm	.030"	1	C5214-030

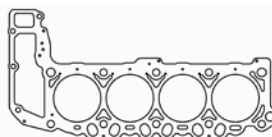

Additional thicknesses available see page 4

#### MLS Head Gasket - 2008-13

Bore	Thickness	Pkg Qty	Part #
94mm	.030"	1	C5803-030

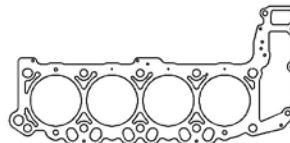

## Polyspherical 318 V8 1957-67 (A Engine)

### Head Gaskets

#### MLS Head Gaskets

Bore	Thickness	Pkg Qty	Part #
4.030"	.040"	1	C15296-040

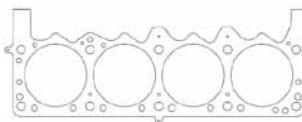

Additional thicknesses available see page 4

## 5.2L & 5.9L Magnum V8 1992-03

### Head Gaskets

#### MLS Head Gaskets

Bore	Thickness	Pkg Qty	Part #
4.040"	.040"	1	C5554-040
4.040"	.120"	1	C5565-120

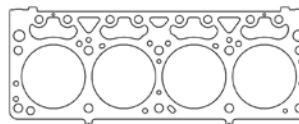

Additional thicknesses available see page 4

### Individual Gaskets

#### Valve Cover Gasket (sold individually)

Application	Part #
10 Bolt - .047" KF	C5557-047

#### Oil Pan Gasket Set

Application	Part #
4pc Set	C5560-094

#### Intake Manifold Gaskets

Application	Part #
2.150" x 1.140" Port - .047" KF	C5555-047
China Rail Gaskets	C5556-047

#### Timing Cover Sets

Application	Part #
1992-96	C5059
1997-03	C5060

See page 30 for additional gaskets



Cometic Gasket - An Exclusive NASCAR Performance Product

# CHRYSLER / DODGE

## 5.2L & 5.9L Magnum V8 1992-03

### Individual Gaskets

#### Intake Manifold Gaskets

Application	Part #
2.150" x 1.140" Port - .047" KF.....	C5555-047
China Rail Gaskets.....	C5556-047

#### Timing Cover Sets

Application	Part #
1992-96 .....	C5059
1997-03 .....	C5060

#### Exhaust Manifold Gasket

Application	Part #
1.195" x 1.675" - .064" AM.....	C5558-064

#### Rear Main Seal

Application	Part #
2pc Viton .....	C5564

#### Cooling/Water Pump Gaskets

Application	Part #
Water Pump Cover Gasket.....	C5561-018
Thermostat Gasket.....	C5562-018

#### Fuel Pump Gasket

Application	Part #
Fuel Pump to Block .....	C5642-031

## 318/340/360ci V8 "LA" 1964-92

### Head Gaskets

#### MLS Head Gaskets

Bore	Thickness	Pkg Qty	Part #
4.040"	.040"	1.....	C5633-040
4.080"	.040"	1.....	C5622-040
4.125"	.040"	1.....	C5457-040
4.180"	.040"	1.....	C5456-040

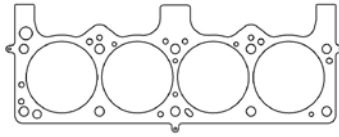

Additional thicknesses available  
see page 4

#### MLS Head Gaskets - w/318A Engine Quest or Edelbrock Heads

Bore	Thickness	Pkg Qty	Part #
4.040"	.040"	1.....	C5916-040
4.080"	.040"	1.....	C5917-040
4.125"	.040"	1.....	C5918-040
4.180"	.040"	1.....	C5919-040

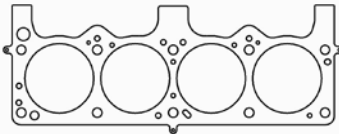

#### Copper Head Gaskets

Bore	Thickness	Pkg Qty	Part #
4.200"	.043"	1.....	C15416-043

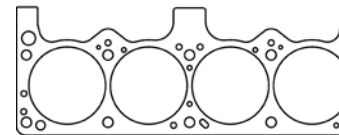

### Individual Gaskets

**NEW!**

#### Valve Cover Gasket (sold individually)

Application	Part #
Molded Rubber.....	C15468
5 Bolt - .094" KF.....	C5623-094

#### Timing Cover Set

Application	Part #
1964-91 Set.....	C5061

#### Intake Manifold Gaskets

Application	Part #
1.170" x 2.300" - .060" KF .....	C5624-060
China Rail Gaskets.....	C5625-060

#### Oil Pan Gasket Sets

Application	Part #
4pc 318/340ci V8.....	C5627-094
4pc 360ci V8.....	C5508-094

#### Exhaust Manifold Gaskets

Application	Part #
1.205" x 1.845" - .064" AM.....	C5628-064
1.310" x 1.640" - MLS.....	C5901-030

#### Rear Main Seal Kit

Application	Part #
273/318/340ci 2pc - Viton.....	C5683
360ci 2pc - Viton.....	C5684

See page 31 for additional gaskets



Cometic Gasket - An Exclusive NASCAR Performance Product

# CHRYSLER / DODGE

## 318/340/360ci V8 "LA" 1964-92

### Individual Gaskets

Cooling / Water Pump Gaskets	
Application	Part #
Water Pump Gasket .....	C15054-060
Thermostat Gasket .....	C5574-018

Fuel Pump Gasket	
Application	Part #
Fuel Pump to Block .....	C5642-031

### Gasket Kits



To purchase a complete gasket kit order both top end and bottom end gasket kit

#### TOP END GASKET KIT



Application	Part #
1968-89 318, 1968-73 340, 1971-80 360 ..... 4.080" Bore	PRO1000T

#### BOTTOM END GASKET KITS



Application	Part #
360ci V8.....	PRO1000B
318/340ci V8.....	PRO1002B

## 5.7L Hemi V8 2003-Present

### Head Gaskets

MLX Head Gaskets - Right Side			
Bore	Thickness	Pkg Qty	Part #
4.000"	.....040"	.....1.....	C15315-040

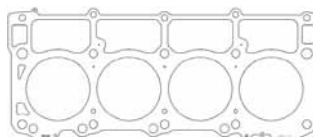

Additional thicknesses available see page 4

MLX Head Gaskets - Left Side			
Bore	Thickness	Pkg Qty	Part #
4.000"	.....040"	.....1.....	C15316-040

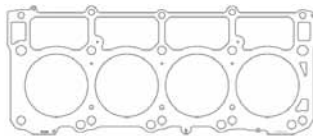

MLS Head Gaskets - Right Side			
Bore	Thickness	Pkg Qty	Part #
3.950"	.....027"	.....1.....	C5467-027
4.100"	.....027"	.....1.....	C5749-027

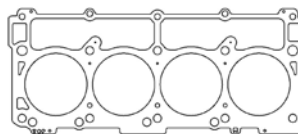

Additional thicknesses available see page 4

MLS Head Gaskets - Left Side			
Bore	Thickness	Pkg Qty	Part #
3.950"	.....027"	.....1.....	C5468-027
4.100"	.....027"	.....1.....	C5750-027

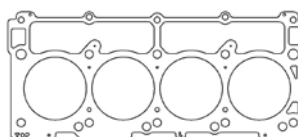

See page 32 for additional gaskets



Cometic Gasket - An Exclusive NASCAR Performance Product

# CHRYSLER / DODGE

## 5.7L Hemi V8 2003-Present

### Individual Gaskets

#### Valve Cover Gasket (sold individually)

Application	Part #
Molded Rubber (Need 2) .....	<b>C5193</b>

#### Thermostat Housing Gasket

Application	Part #
Molded Rubber .....	<b>C5198</b>

#### Intake Manifold Gasket Set

Application	Part #
Molded Rubber - Set of 8 .....	<b>C5196</b>

#### Oil Pan Gasket Set

Application	Part #
Intergrated Windage Tray .....	<b>C5201</b>

#### Throttle Body Gasket

Application	Part #
Molded Rubber .....	<b>C5199</b>

#### Timing Cover Set

Application	Part #
2003-15 5.7L Hemi .....	<b>C5202</b>

#### Exhaust Gaskets

Application	Part #
MLS Exhaust Gaskets - Pair .....	<b>C5854-030</b>

#### Rear Main Seal Kit

Application	Part #
Seal and Housing Gasket.....	<b>C5203</b>

#### Valve Stem Seal Set (16 Pack)

Application	Part #
Hat Style - Viton Steel Body - EXH.....	<b>3260V-16</b>
Hat Style - Viton Steel Body - INT .....	<b>3261V-16</b>

#### Water Pump Gasket

Application	Part #
Molded Rubber .....	<b>C5204</b>

### Gasket Kits



To purchase a complete gasket kit order both top end and bottom end gasket kit

#### TOP END GASKET KIT



Application	Part #
2003-08 5.7L V8 3.950 Bore .....	<b>PRO1022T</b>

#### BOTTOM END GASKET KIT



Application	Part #
2003-08 5.7L V8 .....	<b>PRO1022B</b>

## 6.1L Hemi V8 2005-10

### Head Gaskets

#### MLS Head Gaskets

Bore	Thickness	Pkg Qty	Part #
4.100"	.....040"	.....1.....	<b>C5876-040</b>
4.125"	.....040"	.....1.....	<b>C5441-040</b>
4.185"	.....040"	.....1.....	<b>C5042-040</b>
4.250"	.....040"	.....1.....	<b>C5890-040</b>

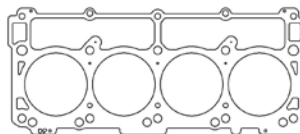

Additional thicknesses available see page 4

See page 33 for additional gaskets





Cometic Gasket - An Exclusive NASCAR Performance Product

# CHRYSLER / DODGE

## 6.1L Hemi V8 2005-10

### MLX Head Gasket

Bore	Thickness	Pkg Qty	Part #
4.100"	.040"	1	C15149-040
4.100"	.044"	1	C15149-044
4.100"	.054"	1	C15149-054
4.100"	.058"	1	C15149-058

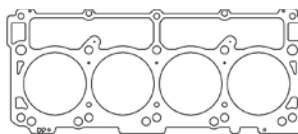

Additional thicknesses available see page 4

### MLS Head Gaskets - Aluminum Sleeved Block

Bore	Thickness	Pkg Qty	Part #
4.055"	.040"	1	C5525-040
4.125"	.070"	1	C5526-070
4.125"	.075"	1	C5526-075
4.125"	.040"	1	C5526-040
4.185"	.040"	1	C5527-040

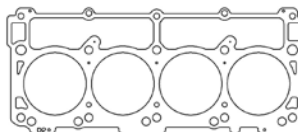

### Individual Gaskets

#### Valve Cover Gasket (sold individually)

Application	Part #
Molded Rubber (Need 2)	C5193

#### Thermostat Housing Gasket

Application	Part #
Molded Rubber	C5198

#### Intake Manifold Gasket Set

Application	Part #
6.1L - .060" KF	C5197

#### Oil Pan Gasket Set

Application	Part #
Intergrated Windage Tray	C5201

#### Throttle Body Gasket

Application	Part #
Molded Rubber	C5199

#### Timing Cover Set

Application	Part #
2003-15 6.1L Hemi	C5202

#### Exhaust Gaskets

Application	Part #
MLS Exhaust Gaskets - Pair	C5872-030

#### Rear Main Seal Kit

Application	Part #
Seal and Housing Gasket	C5203

#### Valve Stem Seal Set (16 Pack)

Application	Part #
Hat Style - Viton Steel Body - EXH	3260V-16
Hat Style - Viton Steel Body - INT	3261V-16

#### Water Pump Gasket

Application	Part #
Molded Rubber	C5204

### Gasket Kits



To purchase a complete gasket kit order both top end and bottom end gasket kit

#### TOP END GASKET KIT



Application	Part #
2005-10 6.1L Hemi V8 4.125" Bore	PRO1023T

#### BOTTOM END GASKET KIT

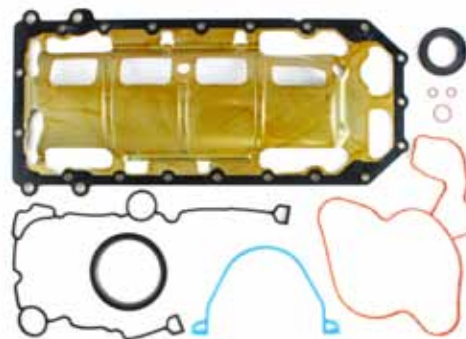

Application	Part #
2005-10 6.1L Hemi V8	PRO1023B



Cometic Gasket - An Exclusive NASCAR Performance Product

# CHRYSLER / DODGE

## 6.2L Hemi V8 2015-Present "Hellcat"

### Head Gaskets

**NEW!**

#### MLX Head Gasket - Right Side

Bore	Thickness	Pkg Qty	Part #
4.150"	.....040"	.....1	C15292-040
4.150"	.....054"	.....1	C15292-054

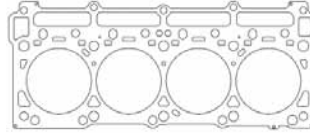

Additional thicknesses available  
see page 4

**NEW!**

#### MLX Head Gasket - Left Side

Bore	Thickness	Pkg Qty	Part #
4.150"	.....040"	.....1	C15293-040
4.150"	.....054"	.....1	C15293-054

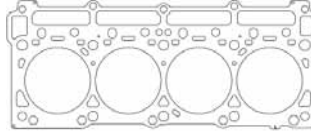

Additional thicknesses available  
see page 4

## 6.4L Hemi V8 2011-Present "Apache"

### Head Gaskets

#### MLS Head Gasket - Right Side

Bore	Thickness	Pkg Qty	Part #
4.120"	.....040"	.....1	C5026-040

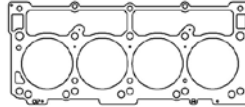

Additional thicknesses available  
see page 4

#### MLS Head Gasket - Left Side

Bore	Thickness	Pkg Qty	Part #
4.120"	.....040"	.....1	C5027-040

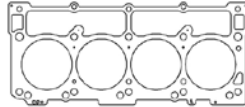

**NEW!**

#### MLX Head Gasket - Right Side

Bore	Thickness	Pkg Qty	Part #
4.150"	.....040"	.....1	C15172-040
4.150"	.....054"	.....1	C15172-054

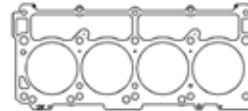

Additional thicknesses available  
see page 4

**NEW!**

#### MLX Head Gasket - Left Side

Bore	Thickness	Pkg Qty	Part #
4.150"	.....040"	.....1	C15173-040
4.150"	.....054"	.....1	C15173-054

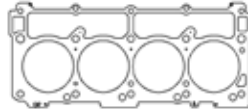

## 7.0L Hemi V8 2016-Present "Drag Pak"

### Head Gaskets

#### MLX Head Gasket - Right Side

Bore	Thickness	Pkg Qty	Part #
4.200"	.....054"	.....1	C15391-054

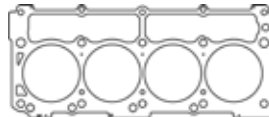

Additional thicknesses available  
see page 4

#### MLX Head Gasket - Left Side

Bore	Thickness	Pkg Qty	Part #
4.200"	.....054"	.....1	C15392-054

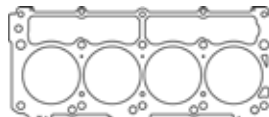



Cometic Gasket - An Exclusive NASCAR Performance Product

# CHRYSLER / DODGE

## Small Block V8 - A-8 Sprint & A-4 Midget

### Head Gaskets

<b>MLS Head Gaskets - A-8 Sprint Block</b>			
Bore	Thickness	Pkg Qty	Part #
4.165"	.040"	1	<b>C5828-040</b>
4.200"	.040"	1	<b>C5829-040</b>
4.250"	.040"	1	<b>C5830-040</b>

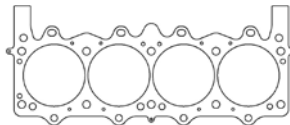

Additional thicknesses available see page 4

<b>MLS Head Gaskets - A-4 Midget Block</b>			
Bore	Thickness	Pkg Qty	Part #
4.165"	.040"	1	<b>C5831-040</b>
4.200"	.040"	1	<b>C5832-040</b>

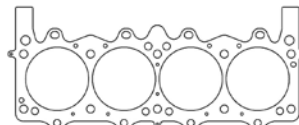

### Individual Gaskets

<b>Valve Cover Gasket (sold individually)</b>	
Application	Part #
Midget & Sprint Head	<b>C5784-060</b>

<b>Oil Pan Gasket Set</b>	
Application	Part #
Midget Block - .060" AFM	<b>C5596-060</b>

<b>Intake Manifold Gasket</b>	
Application	Part #
A-4 Midget Intake Gasket	<b>C5590</b>

## Small Block V8 - R3 Block w/W2, W7, W8, or W9 Heads

### Head Gaskets

<b>MLS Head Gaskets - R3 Block w/W2 Heads</b>			
Bore	Thickness	Pkg Qty	Part #
4.100"	.040"	1	<b>C5567-040</b>
4.200"	.040"	1	<b>C5466-040</b>

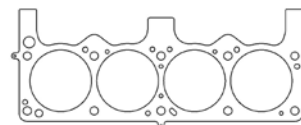

Additional thicknesses available see page 4

<b>MLS Head Gaskets - R3 Block w/W7, W8, W9 Heads</b>			
Bore	Thickness	Pkg Qty	Part #
4.060"	.040"	1	<b>C5579-040</b>
4.100"	.040"	1	<b>C5580-040</b>
4.165"	.040"	1	<b>C5581-040</b>
4.185"	.040"	1	<b>C5582-040</b>

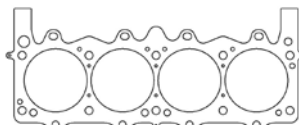

### Individual Gaskets

<b>Valve Cover Gaskets (sold individually)</b>	
Application	Part #
W2/W5/W7/W9 Heads	<b>C5568-094</b>
W8 Heads	<b>C5592-094</b>

<b>Thermostat Gasket</b>	
Application	Part #
R3 Block	<b>C5574-018</b>

<b>Intake Manifold Gaskets</b>	
Application	Part #
W2 Heads 1.35" x 2.07"	<b>C5569-060</b>
W7/W8/W9 Heads 1.45" x 2.20"	<b>C5586-031</b>
China Rail Gaskets	<b>C5625-060</b>

<b>Oil Pan Gasket</b>	
Application	Part #
R3 Block - Rails Only	<b>C5575-094</b>

<b>Exhaust Gaskets</b>	
Application	Part #
W2 Heads 1.47" x 1.45"	<b>C5571-064</b>
W7/W8/W9 Heads D-Port	<b>C5593-064</b>

<b>Timing Cover Gasket</b>	
Application	Part #
R3 Block - .018" AFM	<b>C5576-018</b>

<b>Water Pump Gasket</b>	
Application	Part #
R3 Block	<b>C5573-018</b>

<b>Fuel Pump Gasket</b>	
Application	Part #
R3 Block - .031" Fiber	<b>C5642-031</b>



Cometic Gasket - An Exclusive NASCAR Performance Product

# CHRYSLER / DODGE

## Small Block V8 - R4 Block w/P5 Heads

### Head Gaskets

#### MLS Head Gaskets

Bore	Thickness	Pkg Qty	Part #
4.200"	.040"	1	C5801-040
4.250"	.040"	1	C5800-040

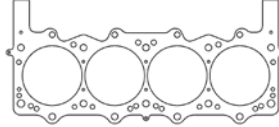

Additional thicknesses available  
see page 4

## Small Block V8 - R6 Race Block

### Head Gaskets

#### MLX Head Gasket - Right Side

Bore	Thickness	Pkg Qty	Part #
4.220"	.040"	1	C5670-040

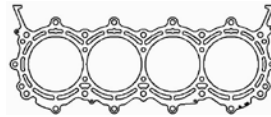

Additional thicknesses available  
see page 4

#### MLX Head Gasket - Left Side

Bore	Thickness	Pkg Qty	Part #
4.220"	.040"	1	C5671-040

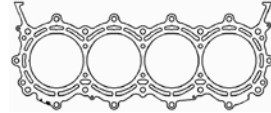

## Big Block Wedge 361, 383, 400, 413, 426, & 440ci V8

### Head Gaskets

#### MLS Head Gaskets

Bore	Thickness	Pkg Qty	Part #
4.250"	.040"	1	C5459-040
4.350"	.040"	1	C5460-040
4.380"	.040"	1	C5461-040
4.410"	.040"	1	C5462-040
4.500"	.040"	1	C5464-040
4.600"	.040"	1	C5799-040

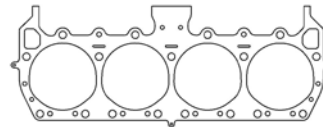

Additional thicknesses available  
see page 4

#### Copper Head Gaskets

Bore	Thickness	Pkg Qty	Part #
4.400"	.043"	1	C15417-043

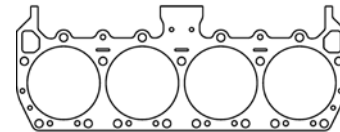

### Individual Gaskets

#### Valve Cover Gasket (sold individually)

Application	Part #
Molded Rubber	C5983

#### Oil Pan Gasket

Application	Part #
Big Block Wedge V8-.060"AFM	C5617-060

#### Intake Manifold Gaskets

Application	Part #
2.31" x 1.23" - .060" KF	C5611-060
China Rail Gaskets	C5612-060

#### Exhaust Gaskets

Application	Part #
1.85" x 1.35" - .064" AM	C5619-064
1.78" x 1.46" - .030" MLS	C5902-030

#### Water Pump Gaskets

Application	Part #
Pump to Block - Pair	C5615-032

#### Timing Cover Gasket Set

Application	Part #
Big Block Wedge V8	C5062

#### Thermostat Gasket

Application	Part #
Big Block Wedge V8	C5616-018

#### Fuel Pump Gasket

Application	Part #
Fuel Pump to Block	C5642-031

#### Rear Main Seal Kit

Application	Part #
2pc Viton	C5686

See page 37 for StreetPro gaskets



Cometic Gasket - An Exclusive NASCAR Performance Product

# CHRYSLER / DODGE

## Big Block Wedge 361, 383, 400, 413, 426, & 440ci V8

### Gasket Kits



To purchase a complete gasket kit order both top end and bottom end gasket kit

#### TOP END GASKET KIT



Application	Part #
Big Block Wedge V8 4.410" Bore.....	<b>PRO1001T</b>

#### BOTTOM END GASKET KIT



Application	Part #
Big Block Wedge V8.....	<b>PRO1001B</b>

## 392 Hemi V8 1957-58

### Head Gaskets

#### MLS Head Gaskets

Bore	Thickness	Pkg Qty	Part #
4.000"	.040"	1	<b>C5210-045</b>
4.100"	.040"	1	<b>C5211-045</b>

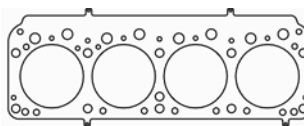

Additional thicknesses available see page 4

#### Copper Head Gaskets

Bore	Thickness	Pkg Qty	Part #
4.060"	.043"	1	<b>C15418-043</b>

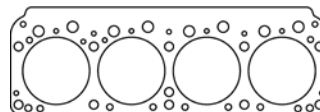

### Individual Gaskets

#### Valve Cover Gaskets

Application	Part #
392 Hemi - 188" ML (pair) .....	<b>C5236-188</b>

#### Oil Pan Gasket Set

Application	Part #
1958-59 4pc Set .....	<b>C15055</b>

#### Intake Manifold Gasket Set

Application	Part #
Includes Valley Gasket .....	<b>C5237</b>

#### Distributor Gasket

Application	Part #
392 Hemi - .031" Fiber.....	<b>C5239-031</b>

#### Exhaust Gaskets

Application	Part #
1957-58 - .064" AM.....	<b>C5238-064</b>

#### Timing Cover Gasket Set

Application	Part #
1955-59 Early Hemi.....	<b>C5063</b>

#### Cooling/Water Pump Gaskets

Application	Part #
Pump to Block - 4 Pack .....	<b>C5228-060</b>
Water Outlet .....	<b>C5229-060</b>
Water Inlet .....	<b>C5230-032</b>

#### Carburetor Gasket Kits

Application	Part #
392 Hemi 2bbl Kit .....	<b>C5240</b>
392 Hemi 4bbl Kit .....	<b>C5241</b>

See page 38 for StreetPro gaskets



Cometic Gasket - An Exclusive NASCAR Performance Product

# CHRYSLER / DODGE

## 392 Hemi V8 1957-58

### Gasket Kits



To purchase a complete gasket kit order both top end and bottom end gasket kit

#### TOP END GASKET KIT



Application	Part #
392 Hemi V8 1957-58 4.100" Bore.....	<b>PRO1028T</b>

#### BOTTOM END GASKET KIT



Application	Part #
392 Hemi V8 1957-58.....	<b>PRO1028B</b>

## 426 Hemi 1966 & Later (Gasket bores .060" larger than listed)

### Head Gaskets

#### MLS Head Gaskets

Bore	Thickness	Pkg Qty	Part #
4.250"	.040"	1	<b>C5445-040</b>
4.280"	.040"	1	<b>C5454-040</b>
4.310"	.040"	1	<b>C5455-040</b>
4.375"	.040"	1	<b>C5446-040</b>
4.500"	.040"	1	<b>C5447-040</b>

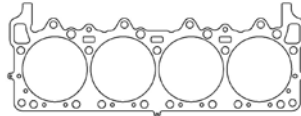

Additional thicknesses available see page 4

**NEW!**

#### Copper Head Gaskets

Bore	Thickness	Pkg Qty	Part #
4.320"	.043"	1	<b>C15419-043</b>

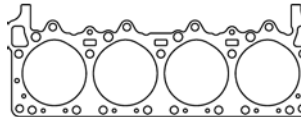

### Individual Gaskets

#### Valve Cover Gasket (sold individually)

Application	Part #
Molded Rubber.....	<b>C5976</b>

#### Oil Pump Gasket

Application	Part #
426 Hemi .....	<b>C5604-032</b>

#### Intake Manifold Gaskets

Application	Part #
1.85" x 2.00" - .047" KF .....	<b>C5598-047</b>

#### Oil Pan Gasket

Application	Part #
426 Hemi - .060" AFM .....	<b>C5606-060</b>

#### Exhaust Gaskets

Application	Part #
1.84" x 1.89" - .030" MLS.....	<b>C5965-030</b>

#### Fuel Pump Gasket

Application	Part #
Fuel Pump to Block .....	<b>C5642-031</b>

See page 39 for StreetPro gaskets



Cometic Gasket - An Exclusive NASCAR Performance Product

# CHRYSLER / DODGE

**426 Hemi 1966 & Later (Gasket bores .060" larger than listed)**

## Individual Gaskets

Cooling / Water Pump Gaskets	
Application	Part #
Pump to Block - Pair .....	<b>C5601-018</b>
Pump to Housing .....	<b>C5602-032</b>
Thermostat Gasket .....	<b>C5603-018</b>

Distributor Gasket	
Application	Part #
426 Hemi .....	<b>C5607-060</b>

Rear Main Seal Kit	
Application	Part #
2pc Viton .....	<b>C5686</b>

## Gasket Kits



To purchase a complete gasket kit order both top end and bottom end gasket kit

### TOP END GASKET KIT



Application	Part #
426 Hemi 7.0L 1966-71 4.100" Bore .....	<b>PRO1021T</b>

### BOTTOM END GASKET KIT



Application	Part #
426 Hemi 7.0L 1966-71 .....	<b>PRO1021B</b>

# 8.0L V10 1992-Early 96, (Gen 1 Viper)

## Head Gaskets

MLS Head Gaskets			
Bore	Thickness	Pkg Qty	Part #
4.030"	.051"	1	<b>C5113-051</b>
4.165"	.051"	1	<b>C5114-051</b>

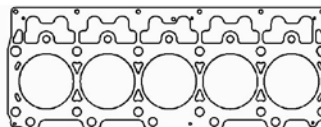

Additional thicknesses available see page 4

## Individual Gaskets

Intake Manifold Gaskets	
Application	Part #
1992+Up - .039" Fiber .....	<b>C5827-039</b>

Exhaust Manifold Gaskets	
Application	Part #
1992-E96 - .030" MLS .....	<b>C5679-030</b>

# 8.0/8.3L V10 Late 1996-07, (Gen 2/3 Viper)

## Head Gaskets

MLS Head Gasket			
Bore	Thickness	Pkg Qty	Part #
4.060"	.051"	1	<b>C5814-051</b>
4.125"	.051"	1	<b>C5815-051</b>
4.165"	.051"	1	<b>C5816-051</b>

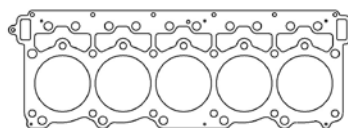

Additional thicknesses available see page 4

See page 40 for StreetPro gaskets



Cometic Gasket - An Exclusive NASCAR Performance Product

# CHRYSLER / DODGE

## 8.0/8.3L V10 Late 1996-07, (Gen 2/3 Viper)

### Head Gaskets

#### MLX Head Gasket w/1/2" Studs

Bore	Thickness	Pkg Qty	Part #
4.125"	.054"	1	C5585-054

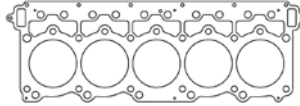

Additional thicknesses available see page 4

#### MLX Head Gasket w/9/16" Studs

Bore	Thickness	Pkg Qty	Part #
4.125"	.054"	1	C5487-054

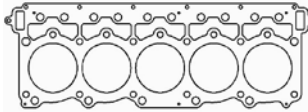

### Individual Gaskets

#### Intake Manifold Gasket

Application	Part #
1992-Up - .039" Fiber	C5827-039

#### Exhaust Manifold Gaskets

Application	Part #
1996-03 Gen 2 - .020" MLS	C5825-020
2004-05 Gen 3 - .030" MLS	C5865-030

## 8.4L V10 2008-10, (Gen 4 Viper)

### Head Gaskets

#### MLS Head Gasket

Bore	Thickness	Pkg Qty	Part #
4.125"	.045"	1	C5107-045

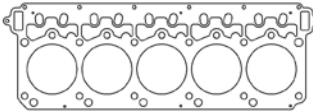

Additional thicknesses available see page 4

#### MLX Head Gasket w/9/16" Studs

Bore	Thickness	Pkg Qty	Part #
4.125"	.054"	1	C5504-054

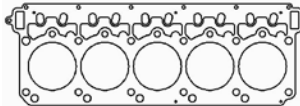

### Individual Gaskets

#### Exhaust Manifold Gasket Set

Application	Part #
2010 - Up MLS	C15150-040

## 8.4L V10 2013-17 (Gen 5 Viper)

### Head Gaskets

#### MLS Head Gasket - Left Side

Bore	Thickness	Pkg Qty	Part #
4.125"	.040"	1	C15377-040

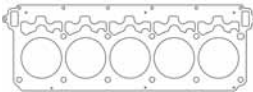

Additional thicknesses available see page 4

#### MLS Head Gasket - Right Side

Bore	Thickness	Pkg Qty	Part #
4.125"	.040"	1	C15378-040

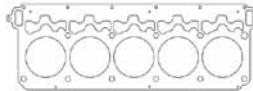

**NEW!**

#### MLX Head Gasket - Left Side

Bore	Thickness	Pkg Qty	Part #
4.125"	.040"	1	C15431-040
4.125"	.049"	1	C15431-049
4.125"	.052"	1	C15431-052

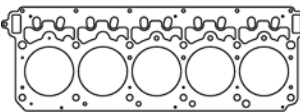

**NEW!**

#### MLS Head Gasket - Right Side

Bore	Thickness	Pkg Qty	Part #
4.125"	.040"	1	C15432-040
4.125"	.049"	1	C15432-049
4.125"	.052"	1	C15432-052

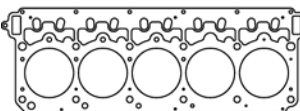





Cometic Gasket - An Exclusive NASCAR Performance Product

# CHRYSLER / DODGE

## Prostock Hemi 500ci V8

### Head Gaskets

<b>MLS Head Gaskets - Gen1 Hemi 99</b>			
Bore	Thickness	Pkg Qty	Part #
4.660"	.051"	1	C5444-051
4.685"	.051"	1	C5443-051
4.700"	.051"	1	C5442-051
4.720"	.051"	1	C5438-051

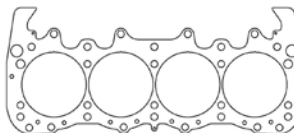

Additional thicknesses available see page 4

<b>MLS Head Gaskets - Gen2 "DPS2"</b>			
Bore	Thickness	Pkg Qty	Part #
4.750"	.050"	1	C5045-050

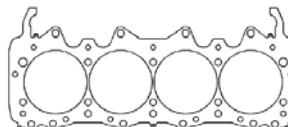

# CUMMINS

## 3.9L 4BT Diesel 4cyl 1983+

### Head Gasket

<b>MLX Head Gasket</b>			
Bore	Thickness	Pkg Qty	Part #
4.100"	.061"	1	C5591-061

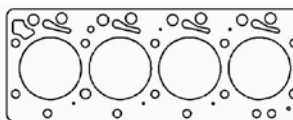

Additional thicknesses available see page 4

### Individual Gaskets

<b>Valve Cover Gasket Set</b>	
Application	Part #
3.9L 4BT	C15056

<b>Thermostat Housing Seal</b>	
Application	Part #
3.9L 4BT	C15059

<b>Intake Manifold Gaskets</b>	
Application	Part #
3.9L 4BT	C15057

<b>Oil Pan Gasket</b>	
Application	Part #
3.9L 4BT - .031" Fiber	C15060

<b>Exhaust Manifold Gaskets Set</b>	
Application	Part #
3.9L 4BT - 4 Pack	C15058

<b>Rear Main Seal</b>	
Application	Part #
3.9L 4BT	C15062

<b>Valve Stem Seal</b>	
Application	Part #
8x12.3x12x17 Viton - Need 8	3164V

<b>Pushrod Cover Gasket</b>	
Application	Part #
3.9L 4BT 1983-97	C15064

<b>Timing Cover Seal</b>	
Application	Part #
3.9L 4BT	C15063

<b>Fuel Pump Gaskets</b>	
Application	Part #
Fuel Pump Gasket	C5389-032
Injection Pump Gasket	C15061

<b>Water Pump Gasket</b>	
Application	Part #
3.9L 4BT 1983-97 - O-Ring	C15065

See page 42 for StreetPro gasket kits



Cometic Gasket - An Exclusive NASCAR Performance Product

# CUMMINS

## 3.9L 4BT Diesel 4cyl 1983+

### Gasket Kits



To purchase a complete gasket kit order both top end and bottom end gasket kit

#### TOP END GASKET KIT



Application	Part #
3.9L 4BT 4cyl Diesel 4.100" Bore.....	<b>PRO3000T</b>

#### BOTTOM END GASKET KIT



Application	Part #
3.9L 4BT 4cyl Diesel.....	<b>PRO3000B</b>

## 5.9L 12v 6BT Inline 6 Diesel 1992-98

### Head Gasket

#### MLX Head Gasket

Bore	Thickness	Pkg Qty	Part #
4.100"	.061"	1	<b>C5955-061</b>

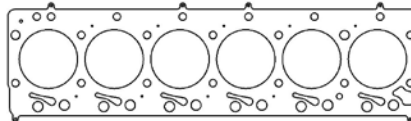

Additional thicknesses available see page 4

### Individual Gaskets

#### Valve Cover Gasket Set

Application	Part #
5.9L 6BT 1992-98.....	<b>C15066</b>

#### Thermostat Housing Seal

Application	Part #
5.9L 6BT 1992-98.....	<b>C15059</b>

#### Intake Manifold Gasket Set

Application	Part #
5.9L 6BT 1992-98.....	<b>C15067</b>

#### Oil Pan Gasket

Application	Part #
5.9L 6BT 1992-98.....	<b>C15068</b>

#### Exhaust Manifold Gaskets Set

Application	Part #
5.9L 6BT 1992-98 - .040" MLS.....	<b>C5725-040</b>

#### Rear Main Seal

Application	Part #
5.9L 6BT 1992-98.....	<b>C15062</b>

#### Valve Stem Seal

Application	Part #
8x12.3x12x17 Viton - Need 12.....	<b>3164V</b>

#### Pushrod Cover Gasket

Application	Part #
5.9L 6BT 1989-99.....	<b>C15069</b>

#### Timing Cover Seal

Application	Part #
5.9L 6BT 1992-98.....	<b>C15063</b>

#### Fuel Pump Gasket

Application	Part #
Fuel Pump Gasket.....	<b>C5389-032</b>
Injection Pump Gasket.....	<b>C15061</b>

#### Water Pump Gasket

Application	Part #
3.9L 4BT 1983-98 - O-Ring.....	<b>C15065</b>

See page 43 for StreetPro gasket kits



Cometic Gasket - An Exclusive NASCAR Performance Product

# CUMMINS

## 5.9L 12v 6BT Inline 6 Diesel 1992-97

### Gasket Kits



To purchase a complete gasket kit order both top end and bottom end gasket kit

#### TOP END GASKET KIT



Application	Part #
5.9L 6BT I6 Diesel 92-98 4.100" Bore .....	<b>PRO3001T</b>

#### BOTTOM END GASKET KIT



Application	Part #
5.9L 6BT I6 Diesel 92-98 .....	<b>PRO3001B</b>

## 5.9L 24v ISB Inline 6 Diesel 1998.5-02

### Head Gasket

#### MLX Head Gasket

Bore	Thickness	Pkg Qty	Part #
4.100"	.061"	1	<b>C5855-061</b>

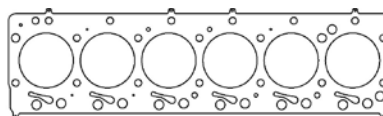

Additional thicknesses available see page 4

### Individual Gaskets

#### Valve Cover Gasket Set

Application	Part #
5.9L ISB 1998.5-02 .....	<b>C5614</b>

#### Oil Pan Gasket

Application	Part #
5.9L 6BT 1998.5-02 .....	<b>C15068</b>

#### Intake Manifold Gasket Set

Application	Part #
5.9L ISB 1998.5-02 .....	<b>C15067</b>

#### Rear Main Seal

Application	Part #
5.9L 6BT 1998.5-02 .....	<b>C15062</b>

#### Exhaust Manifold Gaskets Set

Application	Part #
5.9L ISB 1998.5-02 .....	<b>C5726-040</b>

#### Pushrod Cover Gasket

Application	Part #
5.9L 6BT 1998.5-02 .....	<b>C15069</b>

#### Valve Stem Seals

Application	Part #
Intake VSS - Yellow (Need 12) .....	<b>3214V</b>
Exhaust VSS-Green(Need 12) .....	<b>3215V</b>

#### Water Pump Gasket

Application	Part #
3.9L 4BT 1998.5-02 - O-Ring .....	<b>C15065</b>

#### Timing Cover Seal

Application	Part #
5.9L 6BT 1998.5-02 .....	<b>C15063</b>

See page 44 for StreetPro gasket kits



Cometic Gasket - An Exclusive NASCAR Performance Product

# CUMMINS

## 5.9L 24v ISB Inline 6 Diesel 1998.5-02

### Gasket Kit



To purchase a complete gasket kit order both top end and bottom end gasket kit

#### TOP END GASKET KIT

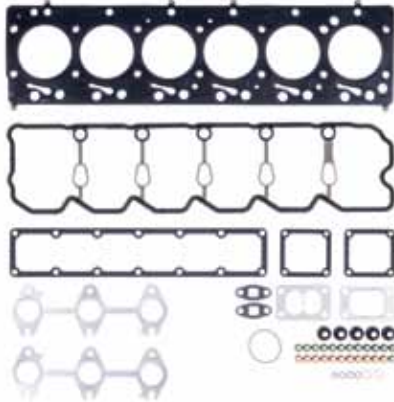

Application	Part #
5.9L 24v ISB 6cyl 1998.5-02 .....	<b>PRO3002T</b>

#### BOTTOM END GASKET KIT



Application	Part #
5.9L 24v ISB 6cyl 1998.5-02 .....	<b>PRO3002B</b>

## 5.9L 24v ISB Common Rail Inline 6 Diesel 2003-07

### Head Gasket

#### MLX Head Gasket

Bore	Thickness	Pkg Qty	Part #
4.100"	.....061"	.....1.....	<b>C5597-061</b>

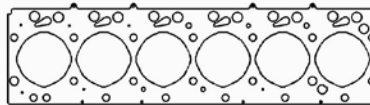

Additional thicknesses available see page 4

### Individual Gaskets

#### Fuel Injector Seal Kit

Application	Part #
5.9L Common Rail 2003-07.....	<b>C15072</b>

#### Valve Stem Seals

Application	Part #
Intake VSS - Yellow (Need 12) .....	<b>3218V</b>
Exhaust VSS-Green(Need 12) .....	<b>3219V</b>

#### Valve Cover Gasket Set

Application	Part #
5.9L Common Rail 2003-07.....	<b>C15070</b>

#### Pushrod Cover Gasket

Application	Part #
5.9L Common Rail 2003-07.....	<b>C15071</b>

#### Intake Manifold Gasket Set

Application	Part #
5.9L Common Rail 2003-07.....	<b>C15067</b>

#### Thermostat Seal

Application	Part #
5.9L Common Rail 2003-07.....	<b>C15073</b>

#### Exhaust Manifold Gaskets Set

Application	Part #
5.9L Common Rail 2003-07.....	<b>C5726-040</b>

**NEW!**

#### Oil Pan Gasket

Application	Part #
AFM Material (Includes Pump Pick Up).....	<b>C15470</b>

See page 45 for StreetPro gasket kits



Cometic Gasket - An Exclusive NASCAR Performance Product

# CUMMINS

## 5.9L 24v ISB Common Rail Inline 6 Diesel 2003-07

### Gasket Kit



#### TOP END GASKET KIT

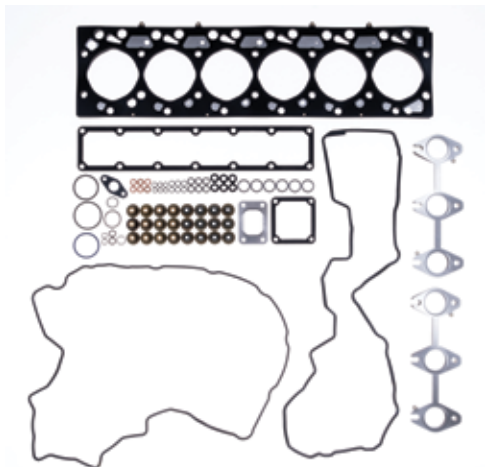

Application	Part #
5.9L 24v Common Rail 03-07 .....	<b>PRO3003T</b>

## 6.7L 24v ISB Inline 6 Diesel 2007.5+Up

### Head Gasket

**NEW!**

#### MLX Head Gasket

Bore	Thickness	Pkg Qty	Part #
4.312"	.052"	1	<b>C5609-052</b>
4.312"	.056"	1	<b>C5609-056</b>
4.312"	.089"	1	<b>C5609-089</b>

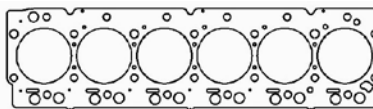

Additional thicknesses available see page 4

### Individual Gaskets

#### Valve Stem Seal

Application	Part #
VSS - Yellow (Need 24) .....	<b>3218V</b>

#### Rear Main Seal

Application	Part #
6.7L 24v ISB 2007.5+Up .....	<b>C15062</b>

#### Intake Gasket Set

Application	Part #
6.7L 24v ISB 2007.5+Up .....	<b>C15076</b>

#### Timing Cover Seal

Application	Part #
6.7L 24v ISB 2007.5+Up .....	<b>C15063</b>

#### Exhaust Manifold Gaskets Set

Application	Part #
6.7L 24v ISB 2007.5+Up (MLS) .....	<b>C5726-040</b>

#### Water Pump Gasket

Application	Part #
6.7L 24v ISB 2007.5+Up .....	<b>C15065</b>

#### Thermostat Seal

Application	Part #
6.7L 24v ISB 2007.5+Up .....	<b>C15073</b>

#### Oil Cooler Gasket Set

Application	Part #
6.7L 24v ISB 2007.5+Up .....	<b>C15075</b>

#### Oil Pan Gasket

Application	Part #
6.7L 24v ISB 2007.5+Up .....	<b>C15074</b>

#### Pushrod Cover Gasket

Application	Part #
6.7L 24v ISB 2007.5+Up .....	<b>C15071</b>

See page 46 for StreetPro gasket kits



Cometic Gasket - An Exclusive NASCAR Performance Product

# CUMMINS

## 6.7L 24v ISB Inline 6 Diesel 2007.5+Up

### Gasket Kits



To purchase a complete gasket kit order both top end and bottom end gasket kit

#### TOP END GASKET KIT

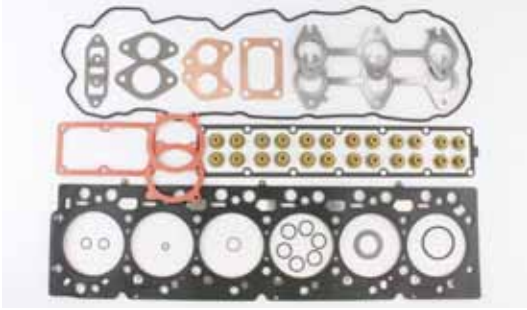

Application	Part #
6.7L 24v ISB 6cyl 2007.5+Up 4.312" Bore .....	<b>PRO3004T</b>

#### BOTTOM END GASKET KIT



Application	Part #
6.7L 24v ISB 6cyl 2007.5+Up.....	<b>PRO3004B</b>

# FORD

## 1.6L Sigma 2011-16

### Head Gasket

#### MLX Head Gasket

Bore	Thickness	Pkg Qty	Part #
82mm	.....028"	.....1	<b>C4963-028</b>

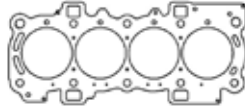

Additional thicknesses available see page 4

## 1.6L & 1.8L CVH 4cyl 1985-93

### Head Gasket

#### MLS Head Gasket

Bore	Thickness	Pkg Qty	Part #
83mm	.....051"	.....1	<b>C5756-051</b>

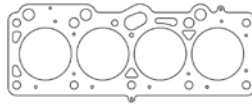

Additional thicknesses available see page 4

## 1.9L CVH 4cyl 1985-96

### Head Gasket

#### MLS Head Gasket

Bore	Thickness	Pkg Qty	Part #
82mm	.....051"	.....1	<b>C5136-051</b>

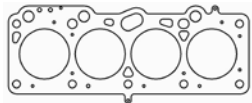

Additional thicknesses available see page 4

## 2.0L SOHC/DOHC NEP/YB Group A

### Head Gasket

#### MLS Head Gasket

Bore	Thickness	Pkg Qty	Part #
92.5mm	.....040"	.....1	<b>C4218-040</b>

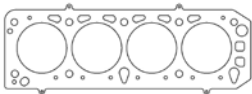

Additional thicknesses available see page 4

See page 47 for additional gaskets



Cometic Gasket - An Exclusive NASCAR Performance Product

# FORD

## 2.0L SOHC/DOHC NEP/YB Group A

### Individual Gaskets

<b>Intake Gasket Set</b>	
Application	Part #
Cosworth YB .....	<b>C4502</b>

<b>Oil Pan Gasket</b>	
Application	Part #
Cosworth YB Rails only .....	<b>C4640</b>

<b>Exhaust Manifold Gasket Set</b>	
Application	Part #
Cosworth YB .....	<b>C4334</b>

<b>Front Cover Gasket</b>	
Application	Part #
Cosworth YB.....	<b>C4641</b>

<b>Valve Cover Gaskets</b>	
Application	Part #
Early YB Engine - .060" AFM.....	<b>C4635</b>
Late YB Engine - .060" AFM.....	<b>C4636</b>

<b>Cooling/Water Pump Gasket</b>	
Application	Part #
Water Pump Gasket .....	<b>C4637</b>
Water Outlet Gasket .....	<b>C4638</b>
Thermostat Gasket.....	<b>C4639</b>

## 2.0L ZETEC DOHC 4cyl 1995-04

### Head Gasket

<b>MLS Head Gasket</b>			
Bore	Thickness	Pkg Qty	Part #
87mm .....	.027" .....	1.....	<b>C4279-027</b>

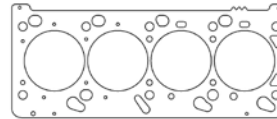

Additional thicknesses available see page 4

### Individual Gaskets

<b>Valve Cover Gaskets</b>	
Application	Part #
2.0L Zetec DOHC 1995-97 .....	<b>C4643</b>
2.0L Zetec DOHC 1998-04.....	<b>C4644</b>

<b>Valve Stem Seals</b>	
Application	Part #
2.0L Zetec 1995-97 (16pk) .....	<b>3181V-16</b>
2.0L Zetec 1998-04 (16pk) .....	<b>3182V-16</b>

<b>Exhaust Manifold Gasket Set</b>	
Application	Part #
2.0L Zetec 1994-04 .....	<b>C4645</b>

<b>Oil Pan Gasket</b>	
Application	Part #
2.0L Zetec 1995-04 .....	<b>C4649</b>

<b>Intake Gasket Sets</b>	
Application	Part #
2.0L Zetec 1998-04 .....	<b>C4646</b>
2.0L Zetec 1995-97 .....	<b>C4647</b>

<b>Thermostat Gaskets</b>	
Application	Part #
2.0L Zetec 1995-04 - Seal .....	<b>C4651</b>
2.0L Zetec 1995-04 - Housing .....	<b>C4652</b>

<b>Cam Seal</b>	
Application	Part #
2.0L Zetec 1994-04 .....	<b>C4648</b>

<b>Rear Main Seal Set</b>	
Application	Part #
2.0L Zetec 1995-04 .....	<b>C4650</b>

See page 48 for StreetPro gasket kits



Cometic Gasket - An Exclusive NASCAR Performance Product

# FORD

## 2.0L ZETEC DOHC 4cyl 1995-04

### Gasket Kits



To purchase a complete gasket kit order both top end and bottom end gasket kit

#### TOP END GASKET KITS



Application	Part #
2.0L Zetec DOHC 1995-97 87mm Bore .....	<b>PRO2029T</b>
2.0L Zetec DOHC 1998-04 87mm Bore .....	<b>PRO2030T</b>

#### BOTTOM END GASKET KITS



Application	Part #
2.0L Zetec DOHC 1995-97 .....	<b>PRO2029B</b>
2.0L Zetec DOHC 1998-04 .....	<b>PRO2030B</b>

## 2.3L "2300" SOHC 1974-97 4cyl

### Head Gaskets

#### MLS Head Gaskets

Bore	Thickness	Pkg Qty	Part #
3.830"	.040"	1	<b>C5369-040</b>
3.940"	.040"	1	<b>C5709-040</b>

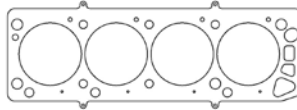

Additional thicknesses available see page 4

### Individual Gaskets

#### Valve Cover Gaskets

Application	Part #
2300 2.3L 1974-93 .....	<b>C4653</b>

#### Exhaust Manifold Gasket Set

Application	Part #
2300 2.3L 1974-93 .....	<b>C5372-064</b>

#### Intake Gasket Set

Application	Part #
2300 2.3L .....	<b>C5371-060</b>

#### Oil Pan Gaskets

Application	Part #
2300 2.3L 1974-2/19/86 .....	<b>C5373</b>
2300 2.3L 2/20/86-1990 .....	<b>C4669</b>
2300 2.3L 1991-92 .....	<b>C4741</b>
2300 2.3L 1993 .....	<b>C4778</b>

#### Valve Stem Seals

Application	Part #
2300 2.3L 1974-93 (need 8) .....	<b>3168V</b>

#### Rear Main Seal Sets

Application	Part #
2300 2.3L 1974-81 2pc .....	<b>C5688</b>
2300 2.3L 1982-93 1pc .....	<b>C5189</b>

#### Water Pump Gasket

Application	Part #
2300 2.3L 1974-93 .....	<b>C4654</b>

See page 49 for StreetPro gasket kits





Cometic Gasket - An Exclusive NASCAR Performance Product

# FORD

## 2.3L "2300" SOHC 1974-97 4cyl

### Gasket Kits



To purchase a complete gasket kit order both top end and bottom end gasket kit

#### TOP END GASKET KIT



Application	Part #
2300 2.3L 1974-97 3.830" Bore.....	<b>PRO2031T</b>

#### BOTTOM END GASKET KIT



Application	Part #
2300 2.3L 1974-97 .....	<b>PRO2031B</b>

## 2.0L 2012-15 EcoBoost DOHC

### Head Gasket

#### MLS Head Gasket

Bore	Thickness	Pkg Qty	Part #
89mm	.....034"	.....1	<b>C15317-040</b>



Additional thicknesses available see page 4

## 2.3L 2016-17 EcoBoost DOHC: 2016-2017 Ford Focus RS

### Head Gasket

#### MLS Head Gasket

Bore	Thickness	Pkg Qty	Part #
89mm	.....040"	.....1	<b>C15249-040</b>

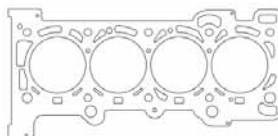

Additional thicknesses available see page 4

### Individual Gaskets

**NEW!**

#### Valve Cover Gasket

Application	Part #
Valve Cover Gasket .....	<b>C15445</b>

## 2.0L 2003-11 & 2.3L 2003-08 Duratec DOHC

### Head Gaskets

#### MLS Head Gasket

Bore	Thickness	Pkg Qty	Part #
89.5mm	.....018"	.....1	<b>C5843-018</b>
92mm	.....018"	.....1	<b>C5842-018</b>

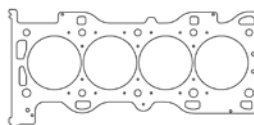

Additional thicknesses available see page 4

### Individual Gaskets

#### Intake Gasket Set

Application	Part #
2.3L Duratec 2003-08.....	<b>C4842-060</b>

#### Exhaust Manifold Gaskets

Application	Part #
2.3L Duratec (w/ extra port).....	<b>C4840-064</b>
2.3L Duratec (w/o extra port).....	<b>C4841-064</b>



Cometic Gasket - An Exclusive NASCAR Performance Product

# FORD

## 2.5L Duratec DOHC 2009 - Present

### Head Gasket

#### MLS Head Gasket

Bore	Thickness	Pkg Qty	Part #
90mm	.....040"	.....1	C5906-040

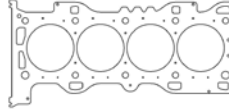

Additional thicknesses available see page 4

## 3.5L EcoBoost V6 2010-Present

### Head Gaskets

#### MLX Head Gasket - Right Side

Bore	Thickness	Pkg Qty	Part #
92.5mm	.....040"	.....1	C5452-040

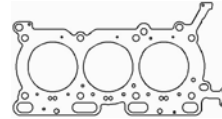

Additional thicknesses available see page 4

#### MLX Head Gasket - Left Side

Bore	Thickness	Pkg Qty	Part #
92.5mm	.....040"	.....1	C5453-040

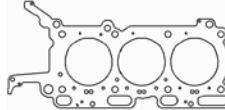

## 3.5L EcoBoost V6 2017+

### Head Gaskets

#### MLX Head Gasket - Right Side

Bore	Thickness	Pkg Qty	Part #
95mm	.....040"	.....1	C15463-040

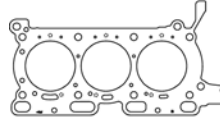

Additional thicknesses available see page 4

#### MLX Head Gasket - Left Side

Bore	Thickness	Pkg Qty	Part #
95mm	.....040"	.....1	C15464-040

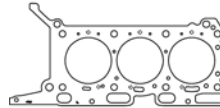

## 3.9L AJ35 DOHC V8 2003-06

### Head Gaskets

#### MLS Head Gasket - Right Side

Bore	Thickness	Pkg Qty	Part #
87mm	.....030"	.....1	C5770-030
93mm	.....030"	.....1	C5771-030

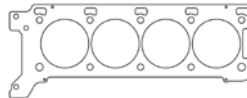

Additional thicknesses available see page 4

#### MLS Head Gasket - Left Side

Bore	Thickness	Pkg Qty	Part #
87mm	.....030"	.....1	C5772-030
93mm	.....030"	.....1	C5773-030

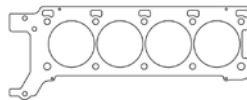

## 4.0L Falcon Inline 6 1998-02

### Head Gasket

#### MLS Head Gasket

Bore	Thickness	Pkg Qty	Part #
3.695"	.....040"	.....1	C4597-040



Additional thicknesses available see page 4

## 4.0L V6 1997-2010

### Head Gaskets

#### MLS Head Gasket - Left Side

Bore	Thickness	Pkg Qty	Part #
103mm	.....040"	.....1	C15382-040

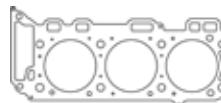

Additional thicknesses available see page 4



Cometic Gasket - An Exclusive NASCAR Performance Product

# FORD

## 4.0L V6 1997-2010

### MLS Head Gasket - Right Side

Bore	Thickness	Pkg Qty	Part #
103mm	.040"	1	C15381-040

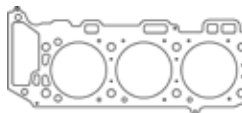

Additional thicknesses available  
see page 4

## 4.0L Barra Inline 6 DOHC 2002-Present

### Head Gasket

#### MLS Head Gasket

Bore	Thickness	Pkg Qty	Part #
93mm	.030"	1	C5957-030

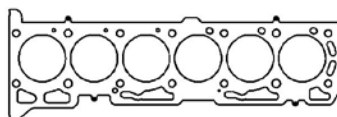

Additional thicknesses available  
see page 4

## 4.6L & 5.4L SOHC/DOHC Modular V8

### Head Gaskets

#### MLS Head Gaskets - Right Side

Bore	Thickness	Pkg Qty	Part #
92mm	.030"	1	C5119-030
94mm	.030"	1	C5503-030

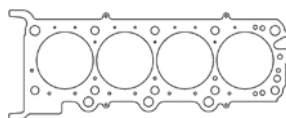

Additional thicknesses available  
see page 4

#### MLS Head Gaskets - Left Side

Bore	Thickness	Pkg Qty	Part #
92mm	.030"	1	C5118-030
94mm	.030"	1	C5502-030

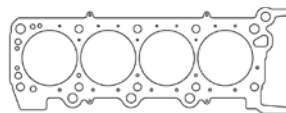

#### MLX Head Gaskets - Right Side

Bore	Thickness	Pkg Qty	Part #
92mm	.032"	1	C15258-032
94mm	.032"	1	C15260-032

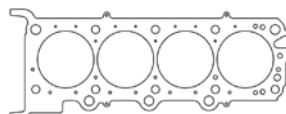

#### MLX Head Gaskets - Left Side

Bore	Thickness	Pkg Qty	Part #
92mm	.032"	1	C15259-032
94mm	.032"	1	C15261-032

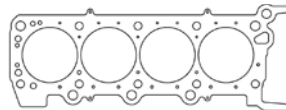

### Individual Gaskets

#### Valve Cover Gasket Sets

Application	Part #
4.6L DOHC 1996-98	C5177
4.6L SOHC 1996-04	C5178
4.6L SOHC 2002-04 Truck	C5179

#### Intake Gaskets

Application	Part #
4.6L DOHC 1998	C5180
4.6L DOHC 1996-97	C5181
4.6L DOHC 1996-98 - Cover	C5182
4.6L DOHC 1996-98 - Plenum	C5183
4.6L SOHC 1995-00	C5184
4.6L SOHC 2000-04 Truck	C5185
4.6L SOHC 00-04 Truck Plenum	C5186
4.6L SOHC 97-99 Truck Plenum	C5187

#### Exhaust Gaskets

Application	Part #
4.6/5.4L SOHC 1991-01	C5853-030
4.6L DOHC 1993-99	C5012-030
5.4L Shelby Mustang 2007	C5805-030

#### Throttle Body Gaskets

Application	Part #
SOHC 1996-01 Spacer-TB	C15078
DOHC 1996-98 .020" Fiber	C15079
SOHC 1996-00 Spacer-Manifold	C15080
4.6L SOHC 1999-11 - Rubber	C15081

#### Oil Pan Gasket

Application	Part #
4.6/5.4L 1996-04	C5188

#### Rear Main Seal

Application	Part #
4.6/5.4L 1996-04 - 1pc	C5189

#### Front Crank Seals

Application	Part #
4.6/5.4L SOHC/DOHC 1996-99	C5192
4.6/5.4L SOHC 2000-04	C5191

#### Water Pump O-Ring

Application	Part #
4.6/5.4L SOHC/DOHC 1992-09	C5190



Cometic Gasket - An Exclusive NASCAR Performance Product

# FORD

## 4.6L & 5.4L SOHC/DOHC Modular V8

### Gasket Kits



To purchase a complete gasket kit order both top end and bottom end gasket kit

#### TOP END GASKET KITS



Application	Part #
4.6L DOHC 1996-98 92mm Bore .....	<b>PRO1017T</b>
4.6L SOHC 1996-98 92mm Bore .....	<b>PRO1018T</b>
4.6L SOHC 1999-04 92mm Bore .....	<b>PRO1019T</b>
4.6L SOHC 1997-04 Truck 92mm Bore.....	<b>PRO1020T</b>

#### BOTTOM END GASKET KITS

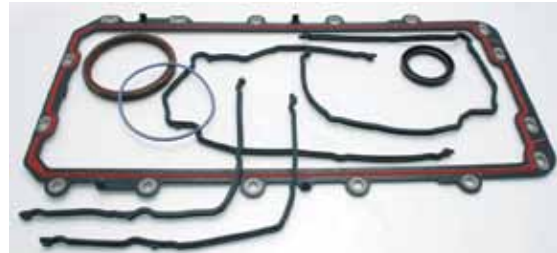

Application	Part #
4.6L DOHC 1996-98 .....	<b>PRO1017B</b>
4.6L SOHC 1996-98 .....	<b>PRO1018B</b>
4.6L SOHC 1999-04 .....	<b>PRO1019B</b>
4.6L SOHC 1997-04 Truck .....	<b>PRO1020B</b>

## 4.6L SOHC 3v Heads Modular 2005-10

### Head Gaskets

#### MLS Head Gasket - Right Side

Bore	Thickness	Pkg Qty	Part #
94mm	.....030"	.....1	<b>C5970-030</b>

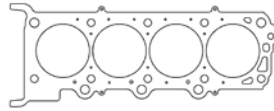

Additional thicknesses available see page 4

#### MLS Head Gasket - Left Side

Bore	Thickness	Pkg Qty	Part #
94mm	.....030"	.....1	<b>C5969-030</b>

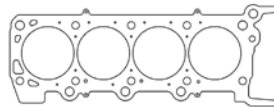

### Individual Gaskets

#### Exhaust Gaskets

Application	Part #
4.6/5.4L 3V Heads - MLS D-Port.....	<b>C5997-030</b>
4.6/5.4L 3V Heads - MLS .....	<b>C5852-030</b>

## 5.4L SOHC 3v Heads Modular 2004-14

### Head Gaskets

#### MLS Head Gasket - Right Side

Bore	Thickness	Pkg Qty	Part #
94mm	.....030"	.....1	<b>C5972-030</b>

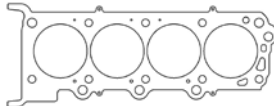

Additional thicknesses available see page 4

#### MLS Head Gasket - Left Side

Bore	Thickness	Pkg Qty	Part #
94mm	.....030"	.....1	<b>C5971-030</b>

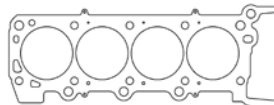

### Individual Gaskets

#### Exhaust Gaskets

Application	Part #
4.6/5.4L 3V Heads - MLS D-Port.....	<b>C5997-030</b>
4.6/5.4L 3V Heads - MLS .....	<b>C5852-030</b>



Cometic Gasket - An Exclusive NASCAR Performance Product

# FORD

## 5.0L "Coyote" DOHC Modular V8 2011-14

### Head Gaskets

#### MLS Head Gasket - Left Side

Bore	Thickness	Pkg Qty	Part #
94mm	.040"	1	C5287-040

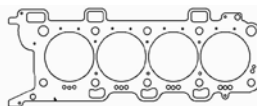

Additional thicknesses available  
see page 4

#### MLS Head Gasket - Right Side

Bore	Thickness	Pkg Qty	Part #
94mm	.040"	1	C5286-040

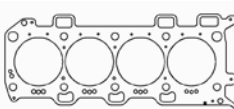

#### MLX Head Gasket - Left Side

Bore	Thickness	Pkg Qty	Part #
94mm	.040"	1	C15368-040

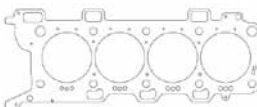

#### MLX Head Gasket - Right Side

Bore	Thickness	Pkg Qty	Part #
94mm	.040"	1	C15367-040



### Individual Gaskets

#### Exhaust Gaskets

Application	Part #
5.0L DOHC Coyote - MLS	C5392-030

**NEW!**

#### Intake Manifold Gasket Set

Application	Part #
2011-2014 5.0L	C15444

## 5.0L "Coyote" DOHC Modular V8 2015-17

### Head Gaskets

#### MLS Head Gasket - Left Side

Bore	Thickness	Pkg Qty	Part #
94mm	.040"	1	C15370-040
94mm	.045"	1	C15370-045
94mm	.051"	1	C15370-051
94mm	.070"	1	C15370-070

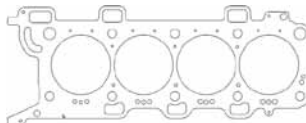

Additional thicknesses available  
see page 4

#### MLS Head Gasket - Right Side

Bore	Thickness	Pkg Qty	Part #
94mm	.040"	1	C15369-040
94mm	.045"	1	C15369-045
94mm	.051"	1	C15369-051
94mm	.070"	1	C15369-070



**NEW!**

#### MLX Head Gasket - Left Side

Bore	Thickness	Pkg Qty	Part #
94mm	.040"	1	C15366-040
94mm	.051"	1	C15366-051

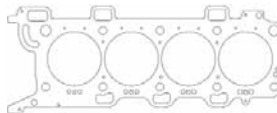

**NEW!**

#### MLX Head Gasket - Right Side

Bore	Thickness	Pkg Qty	Part #
94mm	.040"	1	C15365-040
94mm	.051"	1	C15365-051

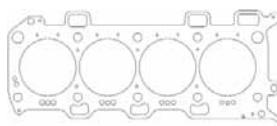

### Individual Gaskets

#### Exhaust Gaskets

Application	Part #
5.0L DOHC Coyote - MLS	C5392-030

**NEW!**

#### Valve Cover Gasket Set

Application	Part #
Ford 5.0L/5.2L 2014-2018	C15442

**NEW!**

#### Intake Manifold Gasket Set

Application	Part #
Molded Rubber Intake	C15465

**NEW!**

#### Water Pump Gasket

Application	Part #
Ford 5.0L 2011-17 / 5.2L 2015-18	C5190



Cometic Gasket - An Exclusive NASCAR Performance Product

# FORD

## 5.0L "Coyote" DOHC Modular V8 2018+

### Head Gaskets

**NEW!**

#### MLS Head Gasket - Right Side

Bore	Thickness	Pkg Qty	Part #
94.5mm	.030"	1	C15435-030

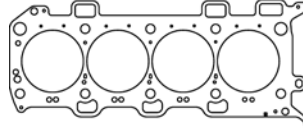

Additional thicknesses available see page 4

**NEW!**

#### MLS Head Gasket - Left Side

Bore	Thickness	Pkg Qty	Part #
94.5mm	.030"	1	C15436-030

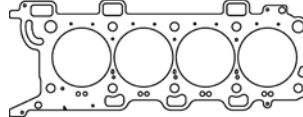

## 5.2L "Voodoo" DOHC Modular V8 2015-2018

### Head Gaskets

**NEW!**

#### MLS Head Gasket - Left Side

Bore	Thickness	Pkg Qty	Part #
95mm	0.036"	1	C15388-036
95mm	.040"	1	C15388-040

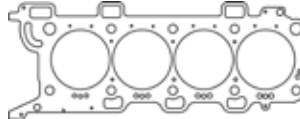

Additional thicknesses available see page 4

**NEW!**

#### MLS Head Gasket - Right Side

Bore	Thickness	Pkg Qty	Part #
95mm	.036"	1	C15387-036
95mm	.040"	1	C15387-040

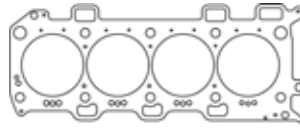

### Individual Gaskets

**NEW!**

#### Valve Cover Gasket Set

Application	Part #
Ford 5.0L/5.2L 2014-18	C15442

## 5.8L "Trinity" DOHC Modular V8 2013-14

### Head Gaskets

**NEW!**

#### MLX Head Gasket - Left Side

Bore	Thickness	Pkg Qty	Part #
95.25mm	.051"	1	C5017-051
95mm	.055"	1	C5017-055

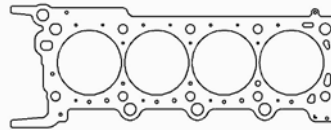

Additional thicknesses available see page 4

**NEW!**

#### MLX Head Gasket - Right Side

Bore	Thickness	Pkg Qty	Part #
95.25mm	.030"	1	C5018-051
95mm	.055"	1	C5018-055

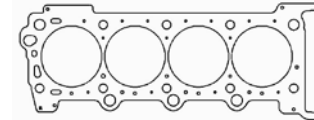

## 4.6/5.4L 2v/4v Modular V8 w/Darton Solid Sleeves

### Head Gaskets

#### MLS Head Gasket - Left Side

Bore	Thickness	Pkg Qty	Part #
95.25mm	.040"	1	C5856-040

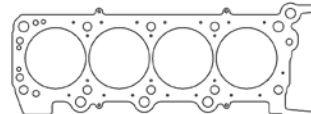

Additional thicknesses available see page 4

#### MLS Head Gasket - Right Side

Bore	Thickness	Pkg Qty	Part #
95.25mm	.030"	1	C5857-040

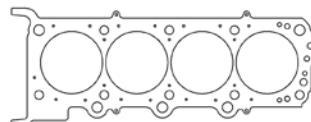



Cometic Gasket - An Exclusive NASCAR Performance Product

# FORD

## 4.6/5.4L 2v/4v Modular V8 w/Darton M.I.D. Sleeves

### Head Gaskets

#### MLS Head Gasket - Left Side

Bore	Thickness	Pkg Qty	Part #
95.25mm	.....040"	.....1	<b>C5858-040</b>

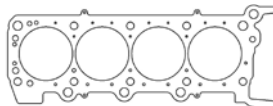

Additional thicknesses available see page 4

#### MLS Head Gasket - Right Side

Bore	Thickness	Pkg Qty	Part #
95.25mm	.....030"	.....1	<b>C5859-040</b>

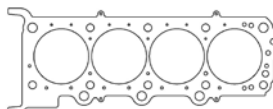

## 239, 256, 272, 292, 312 Y-Block V8 1956-64

### Head Gasket

#### MLS Head Gasket - Left Side

Bore	Thickness	Pkg Qty	Part #
3.860"	.....040"	.....1	<b>C15170-040</b>

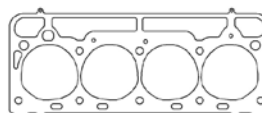

Additional thicknesses available see page 4

#### MLS Head Gasket - Right Side

Bore	Thickness	Pkg Qty	Part #
3.860"	.....040"	.....1	<b>C15171-040</b>

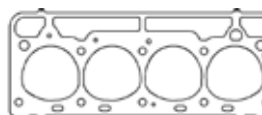

### Individual Gaskets

#### Exhaust Gasket Set

Application	Part #
Y-Block 1956-64	<b>C15082-064</b>

#### Oil Pan Gasket

Application	Part #
Y-Block 1956-64	<b>C15084</b>

#### Intake Gasket Set

Application	Part #
Y-Block 1956-64	<b>C15083</b>

#### Timing Cover Gasket

Application	Part #
Y-Block 1956-64	<b>C15085</b>

#### Valve Cover Gasket (sold individually)

Application	Part #
Y-Block 1956-64	<b>C15086</b>

#### Water Pump O-Ring

Application	Part #
Y-Block 1956-64	<b>C15087</b>

### Gasket Kits



To purchase a complete gasket kit order both top end and bottom end gasket kit

#### TOP END GASKET KIT



Application	Part #
239-312 Y-Block 1956-64 3.860" Bore	<b>PRO1039T</b>

#### BOTTOM END GASKET KIT



Application	Part #
239-312 Y-Block 1956-64	<b>PRO1039B</b>



Cometic Gasket - An Exclusive NASCAR Performance Product

# FORD

## Windsor Small Block V8 SVO & non-SVO 1962-00

### Head Gaskets

#### MLS Head Gaskets - SVO Round Bore

Bore	Thickness	Pkg Qty	Part #
4.030"	.040"	1	C5478-040
4.060"	.040"	1	C5479-040
4.080"	.040"	1	C5480-040
4.100"	.040"	1	C5481-040
4.155"	.040"	1	C5483-040
4.195"	.051"	1	C5509-051
4.200"	.040"	1	C5485-040

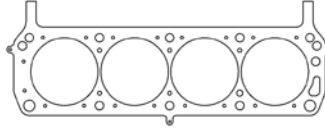

Additional thicknesses available  
see page 4

#### MLX Head Gasket - SVO Round Bore

Bore	Thickness	Pkg Qty	Part #
4.100"	.040"	1	C15372-040
4.200"	.040"	1	C5757-040

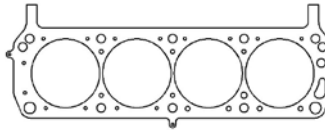

#### MLS Head Gaskets - non SVO Round Bore

Bore	Thickness	Pkg Qty	Part #
4.030"	.040"	1	C5511-040
4.060"	.040"	1	C5512-040
4.080"	.040"	1	C5513-040
4.100"	.040"	1	C5514-040
4.155"	.040"	1	C5515-040
4.200"	.040"	1	C5517-040

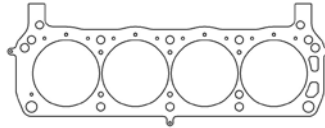

#### MLX Head Gasket - non-SVO Round Bore

Bore	Thickness	Pkg Qty	Part #
4.100"	.040"	1	C15371-040
4.200"	.040"	1	C5025-040

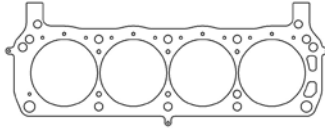

#### Copper Head Gaskets

Bore	Thickness	Pkg Qty	Part #
4.000"	.043"	1	C15420-043

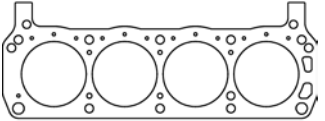

### Individual Gaskets

#### Valve Cover Gasket (sold individually)

Application	Part #
289/302/351-Molded Rubber	C5974
SVO, M6049 Heads .094" KF	C5659-094

#### Timing Cover Sets

Application	Part #
260/289/302/351W 1962-78	C5064
302/351W 1979-97	C5065

#### Intake Manifold Gaskets

Application	Part #
N351 2.120" x 1.280"	C5652-060
M6049 Yates 3C 2.00" x 1.35"	C5268-047
China Rail Gaskets	C5653-060

#### Oil Pan Gasket Sets

Application	Part #
289/302 4pc Kit	C15091
351W 4pc Kit	C5279-094
351W 4pc Kit - For Stokers	C15092

#### Exhaust Manifold Gaskets

Application	Part #
N351 1.585" x 1.681" .064" AM	C5655-064
351W 1.52" x 1.57" MLS	C15176-030
289/302 1.120" x 1.480" MLS	C5898-030
289/302 1.127" x 1.750" MLS	C5899-030
Yates 1.725" x 1.890" .064" AM	C5357-064
Yates MLS Ind Ports (8 pcs)	C5665-040

#### Rear Main Seals

Application	Part #
289/302 Viton 2pc 1968-82	C5688
351W Viton 2pc 1969-83	C5689
289/302 1pc 1983-01	C5189
351W 1pc 1983-01	C15090
351W w/302 Crank	C5384

See page 57 for additional gaskets





Cometic Gasket - An Exclusive NASCAR Performance Product

# FORD

## Windsor Small Block V8 SVO & non-SVO 1965-00

### Individual Gaskets

Carb/Throttle Body Gaskets	
Application	Part #
Holley 4bbl Open Plenum Carb.....	C5263
5.0L 1986-93 TB Gasket.....	C15099
5.0/5.8L 85-97 Truck TB Gasket.....	C15100
3.8/5.0L 89-95 TB Gasket.....	C15101

Water Pump Gaskets	
Application	Part #
289/302/351W 67-91 WP Gasket .....	C5662-060
302/351W 69-85 Cover Plate .....	C5353
289/302 63-65.5 Plate to Block .....	C15093
289/302/351W 63-69 Pump to Plate .....	C15094
351W 80-87 Water Pump Plate.....	C15095
302/351W 86-97 Pump to Plate .....	C15096
351W 88-95 Pump to Block.....	C15097
302 91-01 Plate to Block Gsk.....	C15098

Fuel Pump Gasket	
Application	Part #
Small Block Ford .....	C5389-060

### Gasket Kits



To purchase a complete gasket kit order both top end and bottom end gasket kit

#### TOP END GASKET KITS



Application	Part #
289ci 65-68 & 302ci 68-85 4.100" Bore.....	PRO1015T
302ci EFI 86-95 4.100" Bore .....	PRO1016T
351ci Windsor 69-87 4.100" Bore.....	PRO1013T
351ci Windsor EFI 88-95 4.100" Bore .....	PRO1014T

#### BOTTOM END GASKET KITS



Application	Part #
289/302ci 65-95.....	PRO1015B
351ci Windsor 69-95.....	PRO1013B

## Small Block Ford V8 - Aftermarket & Race

### Head Gaskets

MLS Head Gaskets-SVO Yates w/Valve Pockets-LHS			
Bore	Thickness	Pkg Qty	Part #
4.100"	.040"	1	C5358-040
4.180"	.040"	1	C5364-040
4.200"	.040"	1	C5366-040

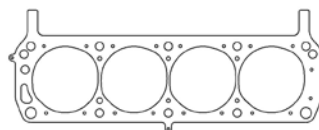

Additional thicknesses available see page 4

MLS Head Gaskets-SVO Yates w/Valve Pockets-RHS			
Bore	Thickness	Pkg Qty	Part #
4.100"	.040"	1	C5359-040
4.180"	.040"	1	C5365-040
4.200"	.040"	1	C5367-040

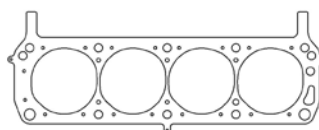

See page 58 for additional gaskets



Cometic Gasket - An Exclusive NASCAR Performance Product

## Small Block Ford V8 - Aftermarket & Race

### Head Gaskets

#### MLS Head Gaskets - Brodix Track 1, Edelbrock RPM Performer, AFR Heads w/Coolant Channels

Bore	Thickness	Pkg Qty	Part #
4.030"	.040"	1	C5909-040
4.080"	.040"	1	C5910-040
4.100"	.040"	1	C5911-040
4.155"	.040"	1	C5912-040
4.200"	.040"	1	C5913-040

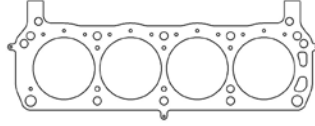

Additional thicknesses available see page 4

#### MLS Head Gaskets - New Boss 302 Blocks (will not work with OEM non-SVO heads)

Bore	Thickness	Pkg Qty	Part #
4.030"	.040"	1	C5958-040
4.080"	.040"	1	C5959-040
4.100"	.040"	1	C5960-040
4.155"	.040"	1	C5961-040
4.200"	.040"	1	C5962-040

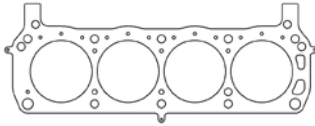

#### MLX Head Gasket - New Boss 302 Block

Bore	Thickness	Pkg Qty	Part #
4.080"	.040"	1	C5132-040
4.100"	.040"	1	C5133-040
4.155"	.040"	1	C5134-040
4.180"	.040"	1	C5135-040

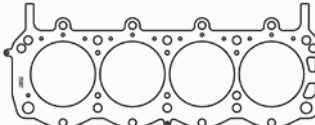

#### MLS Head Gasket-Brodix ASCS Head/R452 Block

Bore	Thickness	Pkg Qty	Part #
4.125"	.040"	1	C5217-040

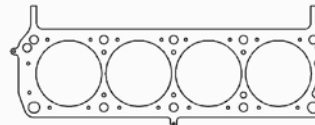

## 351 Cleveland, 351 Modified, & 400ci V8

### Head Gasket

#### MLS Head Gasket

Bore	Thickness	Pkg Qty	Part #
4.100"	.040"	1	C5871-040

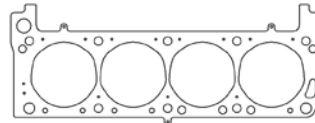

Additional thicknesses available see page 4

### Individual Gaskets

#### Valve Cover Gasket (sold individually)

Application	Part #
351C/351M/400 .125" KF	C5659-125

#### Oil Pan Gasket Set

Application	Part #
351C/351M/400 1970-81	C5278-094

#### Intake Manifold Gaskets

Application	Part #
351C/351M/400 4bbl Heads	C15102
351C/351M/400 2bbl Heads	C15103

#### Water Pump Gaskets

Application	Part #
Backing Plate Gasket	C5353
Water Pump Gasket w/Cast Iron Pump	C5662-060

See page 59 for additional gaskets



Cometic Gasket - An Exclusive NASCAR Performance Product

# FORD

## 351 Cleveland, 351 Modified, & 400ci V8

### Individual Gaskets

<b>Exhaust Manifold Gasket</b>	
Application	Part #
351C/351M/400 4bbl Heads.....	<b>C15104</b>

<b>Timing Cover Set</b>	
Application	Part #
351C/351M/400 1970-81.....	<b>C5066</b>

<b>Fuel Pump Gasket</b>	
Application	Part #
351C/351M/400 .031" Fiber.....	<b>C15105</b>

<b>Rear Main Seals</b>	
Application	Part #
351C/351M/400 - 2pc Poly.....	<b>C5088</b>
351C/351M/400 - 2pc Viton.....	<b>C5689</b>

## Ford RY45 V8

### Head Gaskets

<b>MLX Head Gaskets - Right Side</b>			
Bore	Thickness	Pkg Qty	Part #
4.290"	.....040"	.....1.....	<b>C15338-040</b>

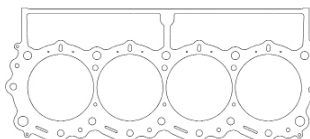

Additional thicknesses available see page 4

<b>MLX Head Gaskets - Left Side</b>			
Bore	Thickness	Pkg Qty	Part #
4.290"	.....040"	.....1.....	<b>C15337-040</b>

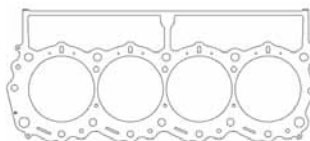

## Ford FR9 Race V8

### Head Gaskets

<b>MLX Head Gaskets - Right Side</b>			
Bore	Thickness	Pkg Qty	Part #
4.190"	.....040"	.....1.....	<b>C5587-040</b>

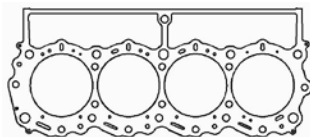

Additional thicknesses available see page 4

<b>MLX Head Gaskets - Left Side</b>			
Bore	Thickness	Pkg Qty	Part #
4.190"	.....040"	.....1.....	<b>C5588-040</b>

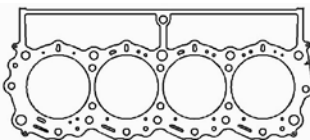

### Individual Gaskets

<b>Intake Manifold Gaskets</b>	
Application	Part #
FR9 V8 - 2.05" x 1.39" .060" KF.....	<b>C15106-060</b>

<b>Exhaust Manifold Gaskets</b>	
Application	Part #
FR9 V8 - .030" MLS.....	<b>C15107-030</b>

## Ford Flathead V8 1932-53

### Head Gaskets

<b>MLS Head Gasket - 1932-38 21 Bolt</b>			
Bore	Thickness	Pkg Qty	Part #
3.156"	.....040"	.....1.....	<b>C5870-040</b>

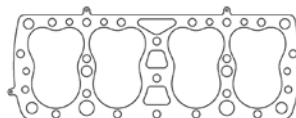

Additional thicknesses available see page 4

See page 60 for additional gaskets



Cometic Gasket - An Exclusive NASCAR Performance Product

# FORD

## Ford Flathead V8 1932-53

### Head Gaskets

#### MLS Head Gasket - 1938-48 24 Bolt

Bore	Thickness	Pkg Qty	Part #
3.250"	.051"	1	C5908-051
3.375"	.051"	1	C5108-051

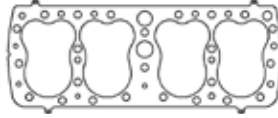

Additional thicknesses available  
see page 4

#### MLS Head Gasket - 1949-53 24 Bolt - RHS

Bore	Thickness	Pkg Qty	Part #
3.375"	.051"	1	C15088-051
3.375"	.092"	1	C15088-092

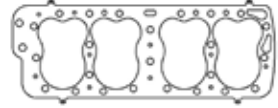

#### MLS Head Gasket - 1949-53 24 Bolt - LHS

Bore	Thickness	Pkg Qty	Part #
3.375"	.051"	1	C15089-051
3.375"	.092"	1	C15089-092

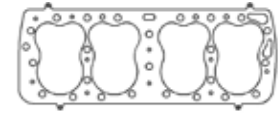

### Individual Gaskets

#### Carburetor Gaskets (sold individually)

Application	Part #
Holley Air Cleaner Gasket .....	C15108
59A, 8BA, 8CM 2bbl Gasket.....	C15109

#### Timing Cover Gaskets

Application	Part #
59A 1945-48 .015" Fiber.....	C15134
8BA/8CM 1948-53 .015" Fiber.....	C15135

#### Intake Manifold Gaskets

Application	Part #
59A 1945-48 .060" KF .....	C15120
8BA/8CM 1948-53 .060" KF .....	C15121

#### Water Pump Gaskets

Application	Part #
59A 1945-48 .015" Fiber.....	C15136
8BA/8CM 1948-53 .015" Fiber.....	C15137

#### Exhaust Manifold Gaskets

Application	Part #
59A, 8BA, 8CM 1945-53 8PK.....	C15116

#### Fuel Pump Gaskets

Application	Part #
59A 45-48 Fuel Pump Stand .....	C15117
59A 46-53 Fuel Pump Cover .....	C15118
8BA/8CM 48-53 Fuel Pump Mount.....	C15119

#### Distributor Gaskets

Application	Part #
59A 45-48 Distributor Base.....	C15110
59A 45-48 Distributor Cap Cover.....	C15111
59A Distributor Terminal Housing.....	C15112
59A 32-41 Distributor Base.....	C15113
59A 32-41 Distributor Cap Cover.....	C15114
59A Distributor Coil Base.....	C15115

#### Oil Pump/Pan Gaskets

Application	Part #
59A 32-41 Oil Pump Drive Cover .....	C15122
59A 45-48 Oil Pump Drive Cover .....	C15123
59A 45-48 Oil Pump Mounting.....	C15126
59A 45-48 Oil Pump Screen Cover .....	C15127
8BA/8CM 48-53 Oil Pump Drive Cover .....	C15130
8BA/8CM 48-53 Oil Pump Relief Nut .....	C15132
59A 45-48 Drain Plug Gasket.....	C15124
59A 1938 Drain Plug Gasket .....	C15125
8BA/8CM 48-53 Drain Plug Gasket.....	C15133
8BA/8CM Oil Pan Clean Out.....	C15128
8BA/8CM Oil Pan Gasket.....	C15129
8BA/8CM Dipstick Tube Gasket.....	C15131

## 352, 390, 406, 410, 427, & 428 FE V8

### Head Gaskets

#### MLS Head Gaskets - Top Oiler

Bore	Thickness	Pkg Qty	Part #
4.080"	.040"	1	C5833-040
4.165"	.040"	1	C5834-040
4.250"	.040"	1	C5835-040
4.300"	.040"	1	C5523-040
4.400"	.040"	1	C5840-040

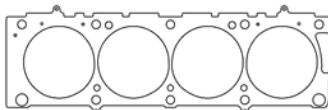

Additional thicknesses available  
see page 4

See page 61 for additional gaskets



Cometic Gasket - An Exclusive NASCAR Performance Product

# FORD

## 352, 390, 406, 410, 427, & 428 FE V8

### Head Gaskets

MLS Head Gasket - SOHC Side Oiler			
Bore	Thickness	Pkg Qty	Part #
4.400"	.040"	1	C5841-040

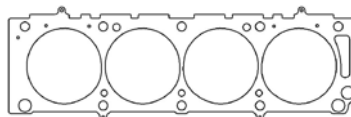

Additional thicknesses available see page 4

### Individual Gaskets

Valve Cover Gaskets (sold individually)	
Application	Part #
All FE & 428CJ/SCJ	C5138-188
427 SOHC LHS	C15138-188
427 SOHC RHS	C15139-188

Timing Cover Sets	
Application	Part #
352/360 1958-60	C5067
332-428 1961-71	C5068

Intake Manifold Gaskets	
Application	Part #
STD/Low Riser 428CJ/SCJ	C5137-060
427 SOHC	C15140-060

Oil Pan Gasket	
Application	Part #
FE V8 1961-71	C5141-125

Exhaust Manifold Gaskets	
Application	Part #
352-410 FE & 428CJ/SCJ MLS	C5922-030
427 SOHC .064" AM	C15141-064

Rear Main Seal	
Application	Part #
FE V8 1961-71	C5142

Water Pump Gaskets	
Application	Part #
FE V8 1961-71 (Pair)	C5140-031

### Gasket Kits



To purchase a complete gasket kit order both top end and bottom end gasket kit

#### TOP END GASKET KIT



Application	Part #
352, 390, 410, 428 FE V8 4.300" Bore	PRO1027T

#### BOTTOM END GASKET KIT



Application	Part #
352, 390, 410, 428 FE V8	PRO1027B

## 6.8L V10

**NEW!**

MLX Head Gaskets - Right Side			
Bore	Thickness	Pkg Qty	Part #
92.5mm	.040"	1	C15462-040

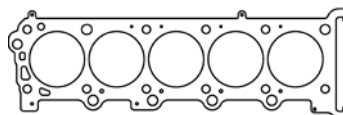

Additional thicknesses available see page 4

**NEW!**

MLX Head Gaskets - Left Side			
Bore	Thickness	Pkg Qty	Part #
92.5mm	.040"	1	C15461-040

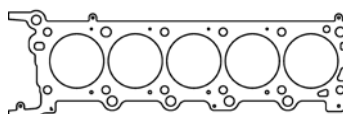



Cometic Gasket - An Exclusive NASCAR Performance Product

# FORD

## 429ci 7.0L & 460ci 7.5L Big Block V8

### Head Gaskets

#### MLS Head Gaskets

Bore	Thickness	Pkg Qty	Part #
4.400"	.040"	1	C5666-040
4.440"	.060"	1	C15400-040
4.500"	.040"	1	C5667-040
4.600"	.040"	1	C15142-040
4.670"	.040"	1	C5668-040

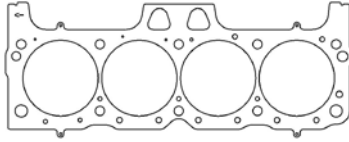

Additional thicknesses available see page 4

#### Copper Head Gaskets

Bore	Thickness	Pkg Qty	Part #
4.520"	.043"	1	C15421-043

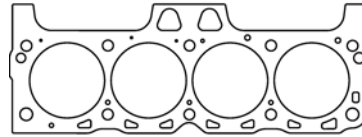

### Individual Gaskets

#### Valve Cover Gaskets (sold individually)

Application	Part #
429/460 Big Block Molded Rubber	C15467
429/460 Big Block .125" KF	C5205-125

#### Timing Cover Set

Application	Part #
429/460 1968-85	C5069

#### Intake Manifold Gaskets

Application	Part #
Stock 429/460 Heads	C5043-060
CJ/SCJ 2.24" x 2.60" Port	C5206-060

#### Oil Pan Gasket

Application	Part #
429/460 4 pc set	C5125-094

#### Exhaust Manifold Gaskets

Application	Part #
429/460 Oval Port - .030" MLS	C5900-030

#### Rear Main Seal

Application	Part #
429/460 Big Block 2pc	C5208

#### Water Pump Gaskets

Application	Part #
429/460 Big Block	C5209-031

### Gasket Kits



To purchase a complete gasket kit order both top end and bottom end gasket kit

#### TOP END GASKET KIT



Application	Part #
429/460ci Big Block V8 68-78 4.500" Bore	PRO1012T

#### BOTTOM END GASKET KIT

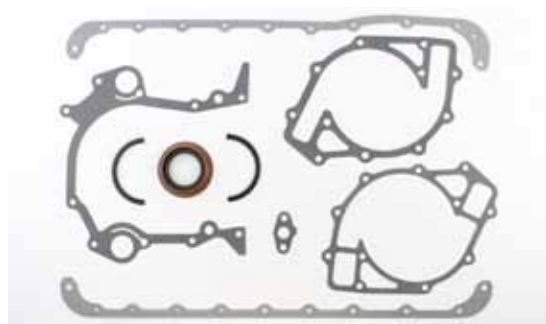

Application	Part #
429/460ci Big Block V8 68-78	PRO1012B



Cometic Gasket - An Exclusive NASCAR Performance Product

# FORD

## Prostock Racing V8

### Head Gaskets

<b>MLS Head Gaskets - D/E460 PROSTOCK</b>			
Bore	Thickness	Pkg Qty	Part #
4.600"	.045"	1	C5731-045
4.685"	.045"	1	C5732-045

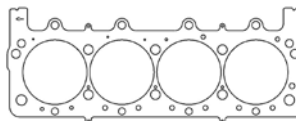

Additional thicknesses available see page 4

**NEW!**

<b>MLS Head Gaskets - A460/C460 PROSTOCK</b>			
Bore	Thickness	Pkg Qty	Part #
4.500"	.045"	1	C15446-045
4.600"	.045"	1	C5743-045
4.685"	.045"	1	C5744-045

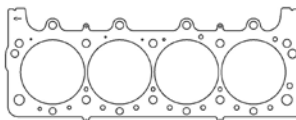

<b>MLS Head Gaskets- A500 PROSTOCK - LHS</b>			
Bore	Thickness	Pkg Qty	Part #
4.600"	.045"	1	C5727-045
4.685"	.045"	1	C5729-045

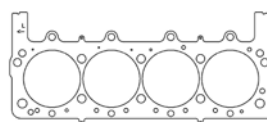

<b>MLS Head Gaskets - A500 PROSTOCK - RHS</b>			
Bore	Thickness	Pkg Qty	Part #
4.600"	.045"	1	C5728-045
4.685"	.045"	1	C5730-045

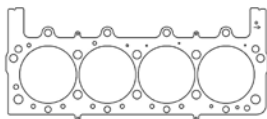

<b>MLS Head Gasket - 460 w/Hemi 14 Bolt Head</b>			
Bore	Thickness	Pkg Qty	Part #
4.700"	.040"	1	C5888-040

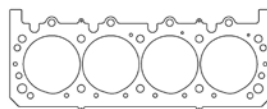

<b>MLS Head Gasket - JC50 500ci PROSTOCK - LHS</b>			
Bore	Thickness	Pkg Qty	Part #
4.735"	.052"	1	C5284-052

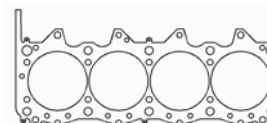

<b>MLS Head Gasket - JC50 500ci PROSTOCK - RHS</b>			
Bore	Thickness	Pkg Qty	Part #
4.735"	.052"	1	C5285-052

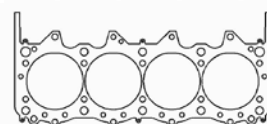

<b>MLS Head Gaskets - 800ci W/5.0" Bore Centers</b>			
Bore	Thickness	Pkg Qty	Part #
4.770"	.040"	1	C5875-040
4.770"	.040"	1	C5875-051

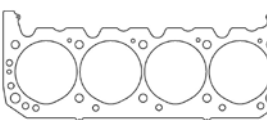

### Individual Gaskets

<b>Exhaust Manifold Gaskets</b>	
Application	Part #
JC50 500ci - .030" MLS	C5257-030

## 6.0L Powerstroke Diesel 2003-08

### Head Gaskets

<b>MLX Head Gasket - 2003-06 18mm Dowels</b>			
Bore	Thickness	Pkg Qty	Part #
96mm	.062"	1	C5589-062

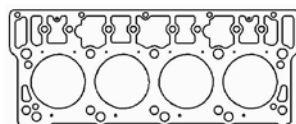

Additional thicknesses available see page 4

See page 64 for additional gaskets



Cometic Gasket - An Exclusive NASCAR Performance Product

# FORD

## 6.0L Powerstroke Diesel 2003-08

### Head Gaskets

#### MLX Head Gasket - 2007-08 20mm Dowels

Bore	Thickness	Pkg Qty	Part #
96mm	.....062"	.....1	<b>C5984-062</b>

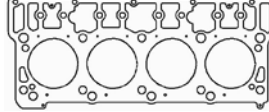

Additional thicknesses available see page 4

### Individual Gaskets

#### Valve Cover Gasket Set

Application	Part #
6.0L Powerstroke 03-08	<b>C15143</b>

#### HPOP Cover Gasket

Application	Part #
6.0L Powerstroke 03-07	<b>C15145</b>

#### Intake Manifold Gasket Set

Application	Part #
6.0L Powerstroke 03-08	<b>C15144</b>

#### Oil Cooler O-Ring Kit

Application	Part #
6.0L Powerstroke 03-07	<b>C15146</b>

#### Exhaust Manifold Gasket

Application	Part #
6.0L Powerstroke 03-08 - MLS	<b>C5089-030</b>

#### Cylinder Head Dowels (sold individually)

Application	Part #
6.0L Powerstroke 03-06 18mm	<b>C15147</b>
6.0L Powerstroke 07-08 20mm	<b>C15148</b>

#### Valve Stem Seals (sold individually)

Application	Part #
6.0L Powerstroke 03-08 (Req 32)	<b>3217V</b>

### Gasket Kits



To purchase a complete gasket kit order both top end and bottom end gasket kit

#### TOP END GASKET KITS

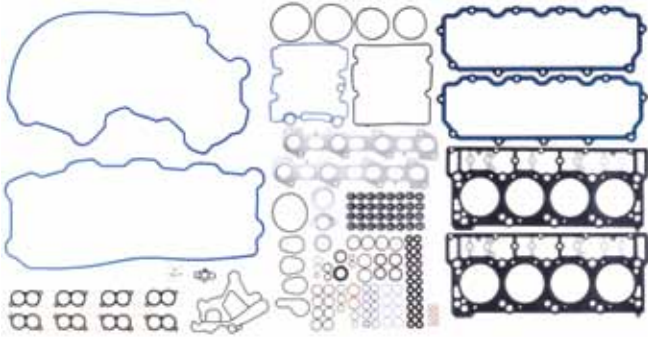

Application	Part #
6.0L Powerstroke 03-06 96mm Bore	<b>PRO3005T</b>
6.0L Powerstroke 07-08 96mm Bore	<b>PRO3006T</b>

#### BOTTOM END GASKET KIT

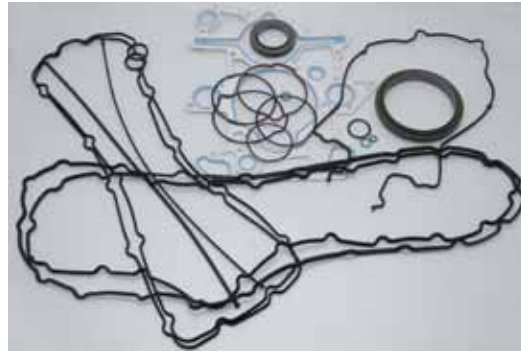

Application	Part #
6.0L Powerstroke 03-08	<b>PRO3005B</b>

## 6.2L SOHC Raptor

### Head Gasket

**NEW!**

#### MLX Head Gasket

Bore	Thickness	Pkg Qty	Part #
4.125"	.....0.054	.....1	<b>C15430-054</b>

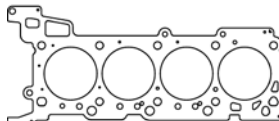

Additional thicknesses available see page 4

**NEW!**

#### MLX Head Gasket

Bore	Thickness	Pkg Qty	Part #
4.125"	.....0.054	.....1	<b>C15429-054</b>

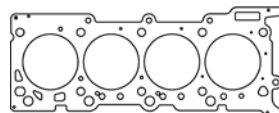





Cometic Gasket - An Exclusive NASCAR Performance Product

# FORD

## 6.4L Powerstroke Diesel 2008-10

### Head Gasket

**NEW!**

<b>MLX Head Gasket</b>			
Bore	Thickness	Pkg Qty	Part #
103mm	.....062"	.....1	<b>C5610-062</b>
103mm	.....067"	.....1	<b>C5610-067</b>

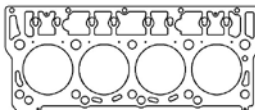

Additional thicknesses available see page 4

<b>MLX Head Gasket - REV B</b>			
Bore	Thickness	Pkg Qty	Part #
103mm	.....062"	.....1	<b>C15175-062</b>

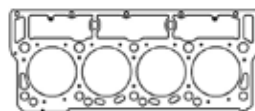

### Individual Gaskets

<b>Valve Cover Gasket Set</b>	
Application	Part #
6.4L Powerstroke 08-10	<b>C15151</b>

<b>Turbo Mounting Kit</b>	
Application	Part #
6.4L Powerstroke 08-10	<b>C15154</b>

<b>Intake Manifold Gasket Set</b>	
Application	Part #
6.4L Powerstroke 08-10	<b>C15152</b>

<b>Fuel Injector Seal Kit</b>	
Application	Part #
6.4L Powerstroke 08-10 (pack of 8)	<b>C15155</b>

<b>Exhaust Manifold Gasket</b>	
Application	Part #
6.4L Powerstroke 08-10 - MLS	<b>C5089-030</b>

<b>Oil Cooler O-Ring Kit</b>	
Application	Part #
6.4L Powerstroke 08-10	<b>C15156</b>

<b>Valve Stem Seals (sold individually)</b>	
Application	Part #
6.4L Powerstroke 08-10 (Req 32)	<b>3217V</b>

<b>Cooling/Water Pump Gaskets</b>	
Application	Part #
Thermostat Housing Seal	<b>C15157</b>
Lower Coolant Hose Gasket	<b>C15158</b>
Upper Coolant hose Gasket	<b>C15159</b>

### Gasket Kits



To purchase a complete gasket kit order both top end and bottom end gasket kit

#### TOP END GASKET KIT

#### BOTTOM END GASKET KIT

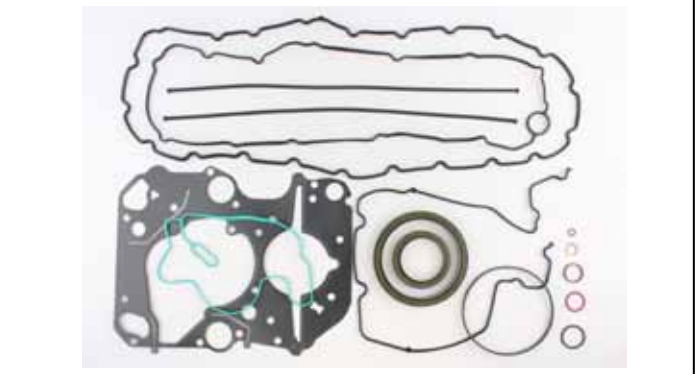
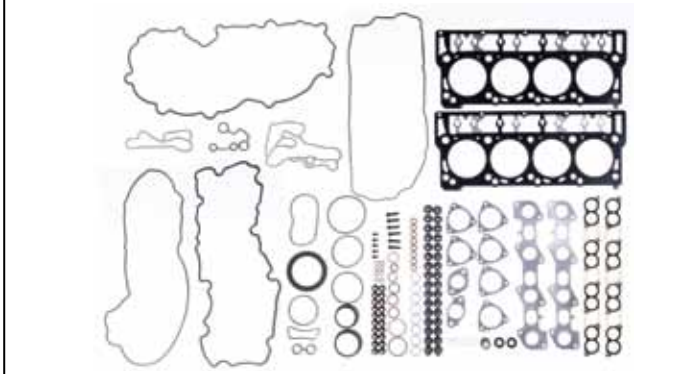

Application	Part #
6.4L Powerstroke 08-10 103mm Bore	<b>PRO3007T</b>

Application	Part #
6.4L Powerstroke 08-10	<b>PRO3007B</b>

## 6.7L Scorpion Diesel 2011-17

### Head Gaskets

**NEW!**

<b>MLX Head Gasket - RHS</b>			
Bore	Thickness	Pkg Qty	Part #
100mm	.....053"	.....1	<b>C15160-053</b>
100mm	.....062"	.....1	<b>C15160-062</b>

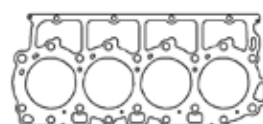

Additional thicknesses available see page 4



Cometic Gasket - An Exclusive NASCAR Performance Product

# FORD

## 6.7L Scorpion Diesel 2011-17

### Head Gaskets

**NEW!**

#### MLX Head Gasket - LHS

Bore	Thickness	Pkg Qty	Part #
100mm	.053"	1	C15161-053
100mm	.062"	1	C15161-062

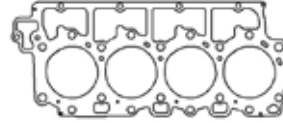

### Individual Gaskets

**NEW!**

#### Oil Pan Gaskets

Application	Part #
.060" AFM Material	C15466-060

## 7.3L Powerstroke Diesel 1994-03

### Head Gasket

#### MLS Head Gasket

Bore	Thickness	Pkg Qty	Part #
4.140"	.066"	1	C5839-066

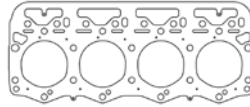

Additional thicknesses available see page 4

#### MLX Head Gasket

Bore	Thickness	Pkg Qty	Part #
4.140"	.067"	1	C15390-067

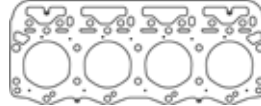

### Individual Gaskets

#### Valve Cover Gaskets (sold individually)

Application	Part #
7.3L Powerstroke 94-97	C15162
7.3L Powerstroke 98-03	C15163

#### HPOP Gaskets

Application	Part #
7.3L Powerstroke 94-95	C15164
7.3L Powerstroke 96-03	C15165

#### Intake Manifold Gasket Set

Application	Part #
7.3L Powerstroke .060" AFM	C5090-060

#### Valve Stem Seals (sold individually)

Application	Part #
7.3L Powerstroke (need 16)	3216V

#### Exhaust Manifold Gaskets

Application	Part #
7.3L Powerstroke .064" AM	C5091-064

### Gasket Kits



To purchase a complete gasket kit order both top end and bottom end gasket kit

#### TOP END GASKET KIT



Application	Part #
7.3L Powerstroke 1994-03 4.140" Bore	PRO3010T

#### BOTTOM END GASKET KIT



Application	Part #
7.3L Powerstroke 1994-03	PRO3010B



Cometic Gasket - An Exclusive NASCAR Performance Product

# OLDSMOBILE

## 330, 350, 400, 403, & 455ci V8

### Head Gasket

MLS Head Gaskets			
Bore	Thickness	Pkg Qty	Part #
4.125"	.040"	1	C5808-040
4.200"	.040"	1	C5809-040
4.270"	.040"	1	C5811-040
4.400"	.040"	1	C5810-040

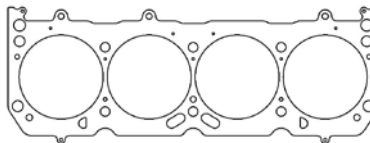

Additional thicknesses available see page 4

### Individual Gaskets

Valve Cover Gasket (sold individually)	
Application	Part #
330-455ci Olds V8 .188" Molded Rubber	C15440

Timing Cover Set	
Application	Part #
330-455ci Olds V8 1964-90	C5070

Intake Manifold Gaskets	
Application	Part #
330, 350, & 403 Small V8	C5216-030
400 & 455 Big V8	C5813-060

Water Pump Gaskets	
Application	Part #
330-455ci V8 1968-76 w/AC	C15166
330-455ci V8 1964-90	C15167

Exhaust Manifold Gaskets	
Application	Part #
330-455ci V8 Stock Port .064" AM	C5812-064
330-455ci V8 1.45"x1.92" MLS	C5904-030

Oil Pan Gasket Kit	
Application	Part #
330-455ci Olds V8 4pc Kit	C5822-094

### Gasket Kits

To purchase a complete gasket kit order both top end and bottom end gasket kit

#### TOP END GASKET KIT



Application	Part #
Olds 455ci V8 1968-76 4.200" Bore	PRO1009T

#### BOTTOM END GASKET KIT



Application	Part #
Olds 455ci V8 1968-76	PRO1009B



Cometic Gasket - An Exclusive NASCAR Performance Product

# OLDSMOBILE

## 371 J-2 Golden Rocket 1957-58

### Head Gasket

#### MLS Head Gasket

Bore	Thickness	Pkg Qty	Part #
4.190"	.040"	1	C5129-040

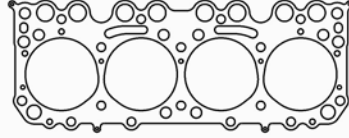

Additional thicknesses available see page 4

### Individual Gaskets

#### Intake Manifold Gaskets

Application	Part #
371 J-2 Golden Rocket .060" KF	C5130-060

#### Exhaust Manifold Gasket Set

Application	Part #
371 J-2 Golden Rocket .059" CFM	C5131-059

# PONTIAC

## 389 & 421ci V8

### Head Gaskets

#### MLS Head Gaskets-389 (63-67) & 421 (63-66)

Bore	Thickness	Pkg Qty	Part #
4.300"	.040"	1	C15262-040
4.300"	.060"	1	C15262-060
4.300"	.080"	1	C15262-080

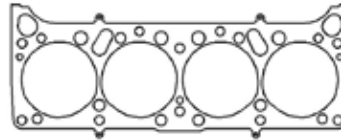

Additional thicknesses available see page 4

## 326, 350, 400, 428, & 455ci V8

### Head Gaskets

#### MLS Head Gaskets-326 (63-67) & 350 (68-77)

Bore	Thickness	Pkg Qty	Part #
3.750"	.040"	1	C5767-040
3.950"	.040"	1	C5710-040

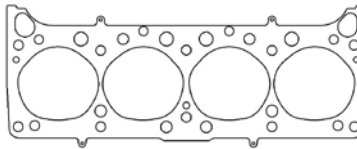

Additional thicknesses available see page 4

#### MLS Head Gaskets-400 (68-79), 428 (68-69), 455 (70-76)

Bore	Thickness	Pkg Qty	Part #
4.160"	.040"	1	C5711-040
4.200"	.040"	1	C5769-040
4.300"	.040"	1	C5712-040
4.380"	.040"	1	C5846-040
4.400"	.040"	1	C5847-040

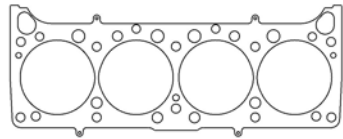

### Individual Gaskets

#### Molded Rubber Valve Cover Gaskets (sold individually)

Application	Part #
All Models w/Stock Heads	C5044

#### Timing Cover Set

Application	Part #
265-455ci V8 193-81	C5071

#### Intake Manifold Gaskets

Application	Part #
400, 428, & 455ci .060" KF	C5778-060
326-455ci .060" HTS w/o EGR	C15197-060

#### Oil Pan Gasket Kit

Application	Part #
400, 428, & 455ci 4 pc kit	C5176-094

#### Exhaust Manifold Gaskets

Application	Part #
400, 428, & 455ci .064" AM	C5147-064
400, 428, & 455ci D-Port MLS	C5905-030

#### Water Pump Gasket

Application	Part #
400, 428, & 455ci .031" Fiber	C5149-031

See page 69 for StreetPro gasket kits



Cometic Gasket - An Exclusive NASCAR Performance Product

# PONTIAC

**326, 350, 400, 428, & 455ci V8**

## Gasket Kits



To purchase a complete gasket kit order both top end and bottom end gasket kit

### TOP END GASKET KIT



<b>Application</b>	<b>Part #</b>
Big Block 455ci 7.5L 1970-76 4.200" Bore .....	<b>PRO1010T</b>

### BOTTOM END GASKET KIT



<b>Application</b>	<b>Part #</b>
Big Block 455ci 7.5L 1970-76.....	<b>PRO1010B</b>

# AUSTIN

**1000cc 4 Cylinder 1958-65 Healey Sprite Mark I & II**

## Head Gasket

<b>Copper Head Gasket</b>			
Bore	Thickness	Pkg Qty	Part #
67.5mm	.043"	1	<b>C4145-043</b>

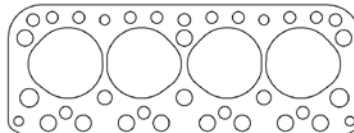

Additional thicknesses available see page 4

**1300cc 4 Cylinder Austin Mini**

## Head Gasket

<b>NEW! MLS Head Gasket</b>			
Bore	Thickness	Pkg Qty	Part #
72mm	.030"	1	<b>C14046-030</b>
72.5mm	.030"	1	<b>C14073-030</b>
73mm	.030"	1	<b>C4146-030</b>
73.5mm	.030"	1	<b>C14038-030</b>

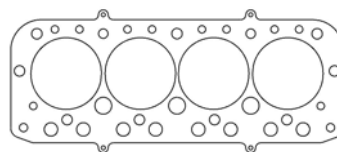

Additional thicknesses available see page 4



Cometic Gasket - An Exclusive NASCAR Performance Product

# BMW

## M10 4 Cylinder

### Head Gaskets

MLS Head Gasket - 1573/1773cc 1963-77			
Bore	Thickness	Pkg Qty	Part #
86mm	.051"	1	C4292-051

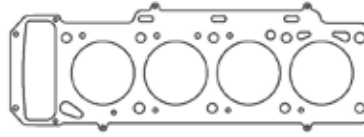

Additional thicknesses available see page 4

MLS Head Gasket - 1766/1990cc M10B18/M10B20 1975-88			
Bore	Thickness	Pkg Qty	Part #
90mm	.051"	1	C4293-051

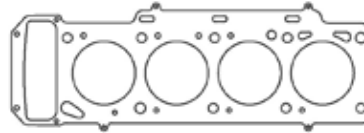

### Individual Gaskets

Valve Cover Gasket	
Application	Part #
BMW M10B18/B20 .125" Cork	C4794-125

Oil Pan Gasket Kit	
Application	Part #
BMW M10B18/B20 .062" KF	C4796-062

Intake Manifold Gasket Set	
Application	Part #
BMW M10B18/B20 .060" KF	C4793

Rear Main Seal	
Application	Part #
BMW M10B18/B20	C4797

Exhaust Manifold Gasket Set	
Application	Part #
BMW M10B18/B20 .064" AM	C4883

Thermostat Gasket	
Application	Part #
BMW M10B18/B20 .031" Fiber	C4795-031

### Gasket Kits



To purchase a complete gasket kit order both top end and bottom end gasket kit

#### TOP END GASKET KIT



Application	Part #
M10 1.8/2.0L 1966-88 90mm Bore	PRO2027T

#### BOTTOM END GASKET KIT



Application	Part #
M10 1.8/2.0L 1966-88	PRO2027B

## M42 1.8L, M44 1.9L 318is 1989-00, 318ti 1992-00, Z3 1996-01

### Head Gaskets

MLS Head Gaskets			
Bore	Thickness	Pkg Qty	Part #
85mm	.060"	1	C4348-060
86mm	.060"	1	C4349-060

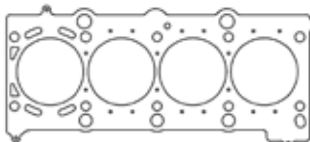

Additional thicknesses available see page 4



Cometic Gasket - An Exclusive NASCAR Performance Product

# BMW

## S14B20 1990cc 1986-91, S14B23 2302cc 1986-91 M3 86-91, 320is 1988-91

### Head Gaskets

MLS Head Gaskets			
Bore	Thickness	Pkg Qty	Part #
93.4mm	.....051"	.....1	C4294-051
94.5mm	.....051"	.....1	C4295-051

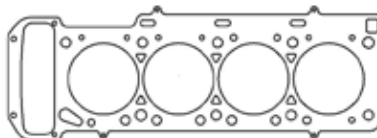

Additional thicknesses available see page 4

## M50B20 2.0L 1989-98 320i 1991-95, 520i 1991-95

### Head Gasket

MLS Head Gasket			
Bore	Thickness	Pkg Qty	Part #
82mm	.....070"	.....1	C4332-070

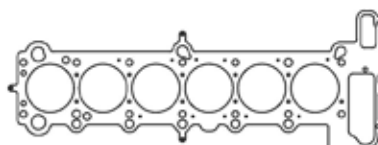

Additional thicknesses available see page 4

## M54tuB22 2.2L 1999-Up 320i, 320ci, 520i 00-03, Z3 01-02, Z4 03-Up

### Head Gasket

MLS Head Gasket			
Bore	Thickness	Pkg Qty	Part #
81mm	.....030"	.....1	C4351-030

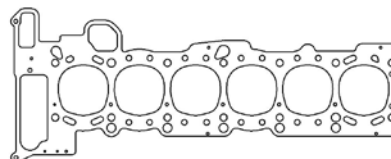

Additional thicknesses available see page 4

## M20B20 SOHC 12v 2.0L Inline 6 320 1977-82, 520 1977-81

### Head Gasket

MLS Head Gasket			
Bore	Thickness	Pkg Qty	Part #
81mm	.....070"	.....1	C4393-070

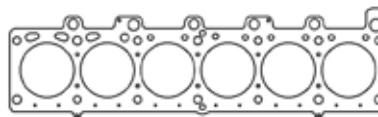

Additional thicknesses available see page 4

## M20B25/27 SOHC 12v 2.5/2.7L Inline 6 323i 77-86, Z1 88-93, 525e 83-87, 528e 1981, 325e 83-87

### Head Gasket

MLS Head Gasket			
Bore	Thickness	Pkg Qty	Part #
85mm	.....070"	.....1	C4394-070

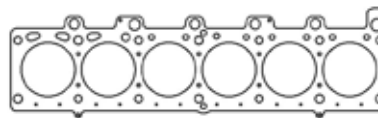

Additional thicknesses available see page 4

See page 72 for additional gaskets



Cometic Gasket - An Exclusive NASCAR Performance Product

# BMW

**M20B25/27 SOHC 12v 2.5/2.7L Inline 6 323i 77-86, Z1 88-93, 525e 83-87, 528e 1981, 325e 83-87**

## Individual Gaskets

### Valve Cover Gasket

Application	Part #
BMW M20 2.5/2.7L .059" CFM.....	<b>C4800-059</b>

### Oil Pan Gasket

Application	Part #
BMW M20 2.5/2.7L.....	<b>C4801-060</b>

### Intake Manifold Gasket Set

Application	Part #
325e 1984-87 Small Port.....	<b>C4884</b>
325/325is 87-93 Normal Ports.....	<b>C4885</b>

### Rear Main Seal

Application	Part #
BMW M20 2.5/2.7L.....	<b>C4802</b>

### Exhaust Manifold Gasket Set

Application	Part #
BMW M20 2.5/2.7L .064" AM .....	<b>C4798-064</b>

### Timing Cover Set

Application	Part #
BMW M20 2.5/2.7L.....	<b>C4803</b>

### Thermostat Gasket

Application	Part #
BMW M20 2.5/2.7L.....	<b>C4799</b>

### Water Pump Gasket

Application	Part #
BMW M20 2.5/2.7L .020" Fiber .....	<b>C4804-020</b>

## Gasket Kits



To purchase a complete gasket kit order both top end and bottom end gasket kit

### TOP END GASKET KIT



Application	Part #
BMW M20 2.5/2.7L 85mm Bore .....	<b>PRO2028T</b>

### BOTTOM END GASKET KIT

Application	Part #
BMW M20 2.5/2.7L.....	<b>PRO2028B</b>

**M30B25/B28 2.5/2.8L Inline 6, 628Csi 79-81, 525 73-78, 525i 78-81, 525 73-81**

## Head Gasket

### MLS Head Gasket

Bore	Thickness	Pkg Qty	Part #
88mm	.070"	1	<b>C4475-070</b>

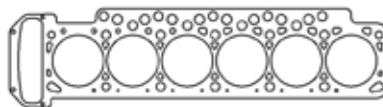

Additional thicknesses available see page 4





Cometic Gasket - An Exclusive NASCAR Performance Product

# BMW

**M50B25/28 2.5/2.8L Inline 6, 328i 95-00, 528i 95-99, 728i 95-99, Z3 97-99, 325i 91-95, 525i 92-95, 525ix 92-95**

### Head Gasket

<b>MLS Head Gasket</b>			
Bore	Thickness	Pkg Qty	Part #
85mm	.070"	1	C4328-070
85mm	.092"	1	C4328-092

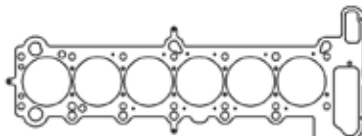

Additional thicknesses available see page 4

**NEW!**

<b>MLX Head Gasket</b>			
Bore	Thickness	Pkg Qty	Part #
85mm	.067"	1	C14010-067
85mm	.073"	1	C14010-073
85mm	.142"	1	C14010-142

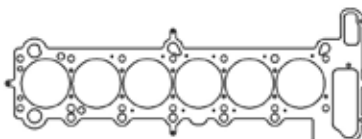

**M54tuB25/B28 2.5/2.8L & M52B25/M54B30 325i 01-05, 325xi 01-05, 325Ci 01-06, 525i 01-03, Z3 01-06, X5 01-06**

### Head Gasket

<b>MLS Head Gasket</b>			
Bore	Thickness	Pkg Qty	Part #
85mm	.030"	1	C4352-030

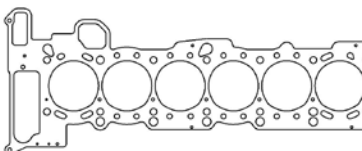

Additional thicknesses available see page 4

**M30B30/B32 3.0/3.2L Inline 6 635Csi 76-84, 630Cs 1979, 633Csi 76-79**

### Head Gasket

<b>MLS Head Gasket</b>			
Bore	Thickness	Pkg Qty	Part #
90mm	.070"	1	C4476-070

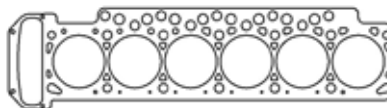

Additional thicknesses available see page 4

**S50B30/S52B32 3.0/3.2L Inline 6 (E36) M3 96-99, M Roadster 96-00, M Coupe 96-00 (US Models ONLY)**

### Head Gasket

**NEW!**

<b>MLS Head Gasket</b>			
Bore	Thickness	Pkg Qty	Part #
87mm	.066"	1	C4329-066
87mm	.070"	1	C4329-070
87mm	.075"	1	C4329-075

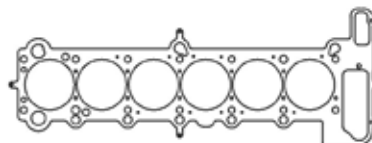

Additional thicknesses available see page 4

**S50B30/S52B32 3.0/3.2L Inline 6 (E36) M3 92-00 (Euro Models Only)**

### Head Gasket

**NEW!**

<b>MLS Head Gasket</b>			
Bore	Thickness	Pkg Qty	Part #
87mm	.066"	1	C4508-066
87mm	.070"	1	C4508-070
87mm	.075"	1	C4508-075

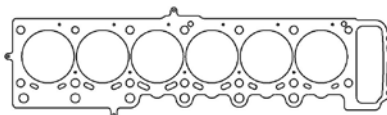

Additional thicknesses available see page 4



Cometic Gasket - An Exclusive NASCAR Performance Product

# BMW

**N54B30 3.0L Inline 6 (E60) 535i 07-10, (E90/E91/E92/E93) 335i 07-10, (E82/E88) 135i 07-10, X6 08-10, Z4 09-16**

**NEW!**

### Head Gasket

#### MLX Head Gasket

Bore	Thickness	Pkg Qty	Part #
85mm	.....044"	.....1	C15257-044
85mm	.....052"	.....1	C15257-052

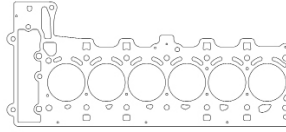

Additional thicknesses available see page 4

**N55B30A 3.0L Inline 6 335i 11-16, 435i 14-16, 535i 11-17, M2 14-17, X6 11-17**

**NEW!**

#### MLX Head Gasket

Bore	Thickness	Pkg Qty	Part #
85mm	.....059"	.....1	C15476-059

Additional thicknesses available see page 4

**S54B32 3.2L Inline 6 M3 (E46) 01-06, Z3 (E36) 01-02, Z4 (E85) 06-Up**

### Head Gasket

#### MLS Head Gasket

Bore	Thickness	Pkg Qty	Part #
87.5mm	.....070"	.....1	C4505-070

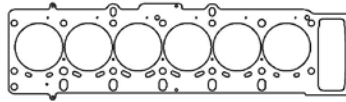

Additional thicknesses available see page 4

**M30B34 3.4L Inline 6, 5 Series 85-88, 6 Series 85-87, 7 Series 85-87**

### Head Gasket

#### MLS Head Gasket

Bore	Thickness	Pkg Qty	Part #
93mm	.....070"	.....1	C4477-070

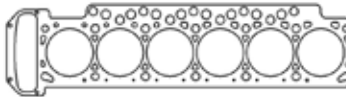

Additional thicknesses available see page 4

**S38B35 3.5L Inline 6 M5 84-92, M5i 84-92, M6 84-92**

### Head Gasket

#### MLS Head Gasket

Bore	Thickness	Pkg Qty	Part #
95mm	.....070"	.....1	C4478-070

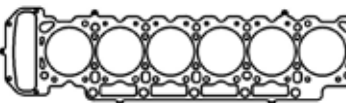

Additional thicknesses available see page 4

**S65B40 4.0L V8 M3 (E90, E92, E93) 2007+Up**

### Head Gaskets

#### MLS Head Gaskets

Bore	Thickness	Pkg Qty	Part #
93mm	.....027"	.....1	C5111-027
94mm	.....027"	.....1	C5112-027

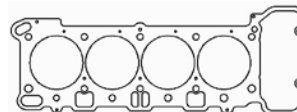

Additional thicknesses available see page 4

**S63/N63 Alpina B6/B7 11-18, 550i 11-17, 650i 12-18, 750i 09-18, M5 13-16, M6 12-18, X5 10-18, X6 08-18**

**NEW!**

### Head Gasket

#### MLS Head Gasket

Bore	Thickness	Pkg Qty	Part #
90mm	.....040"	.....1	C15475-040

Additional thicknesses available see page 4



Cometic Gasket - An Exclusive NASCAR Performance Product

# BMW

## N62 4.4L V8 X5 04, 745i 04, 745Ci 04, 545i 04, 645Ci 04

### Head Gasket

MLS Head Gasket			
Bore	Thickness	Pkg Qty	Part #
94mm	.027"	1	C4374-027



Additional thicknesses available see page 4

## S85B50 5.0L V10 M5 05-Up, M6 05-Up

### Head Gaskets

**NEW!**

MLS Head Gaskets			
Bore	Thickness	Pkg Qty	Part #
93mm	.027"	1	C4528-027
94.5mm	.027"	1	C4529-027
94.5mm	.045"	1	C14087-045
94.5mm	.051"	1	C4529-051

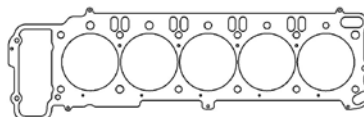

Additional thicknesses available see page 4

# COVENTRY CLIMAX

## FWA SOHC 1.1L 1098cc

### Head Gasket

CFM-20 Head Gasket			
Bore	Thickness	Pkg Qty	Part #
74mm	.059"	1	C4301-059

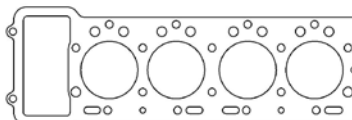

Additional thicknesses available see page 4

## FWB/FWE SOHC 1.2L & 1.5L

### Head Gasket

CFM-20 Head Gasket			
Bore	Thickness	Pkg Qty	Part #
78mm	.043"	1	C4139-043

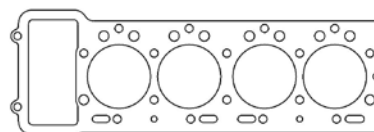

Additional thicknesses available see page 4

## FPF DOHC 2.0L

### Head Gasket

CFM-20 Head Gasket			
Bore	Thickness	Pkg Qty	Part #
82mm	.059"	1	C4267-059

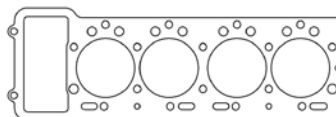

Additional thicknesses available see page 4

## FWA/FWB/FWE SOHC 2.0L

### Head Gasket

CFM-20 Head Gasket			
Bore	Thickness	Pkg Qty	Part #
80mm	.043"	1	C4229-043

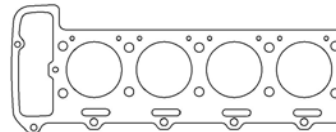

Additional thicknesses available see page 4



Cometic Gasket - An Exclusive NASCAR Performance Product

# FERRARI

## 308 V8 2v 1974-81

### Head Gaskets

#### MLS Head Gaskets

Bore	Thickness	Pkg Qty	Part #
81mm	.045"	1	C4430-045
89mm	.045"	1	C4395-045

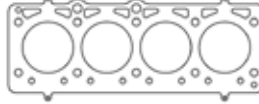

Additional thicknesses available see page 4

## 308 V8 4v 1982-84

### Head Gaskets

#### MLS Head Gaskets

Bore	Thickness	Pkg Qty	Part #
83mm	.045"	1	C4428-045
89mm	.045"	1	C4429-045



Additional thicknesses available see page 4

## F40 2.9L Twin Turbo V8 1987-92

### Head Gasket

#### MLS Head Gasket

Bore	Thickness	Pkg Qty	Part #
84mm	.060"	1	C4482-060

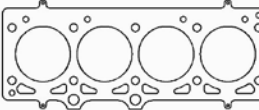

Additional thicknesses available see page 4

# FIAT / LANCIA

## 138.A2 1.5L 1498cc 14 Bolt Head:1986-88 X1/9

### Head Gasket

#### MLS Head Gasket

Bore	Thickness	Pkg Qty	Part #
88mm	.044"	1	C4952-044

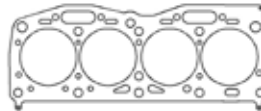

Additional thicknesses available see page 4

## D50

### Head Gasket

#### CFM-20 Head Gasket

Bore	Thickness	Pkg Qty	Part #
79mm	.059"	1	C4131-059

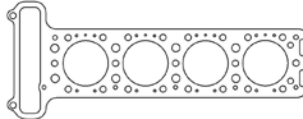

Additional thicknesses available see page 4

## D50 Long Block

### Head Gasket

#### CFM-20 Head Gasket

Bore	Thickness	Pkg Qty	Part #
79mm	.059"	1	C4307-059

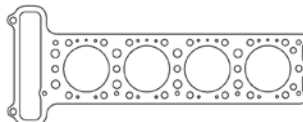

Additional thicknesses available see page 4

## Lancia Delta

### Head Gasket

#### MLS Head Gasket

Bore	Thickness	Pkg Qty	Part #
85mm	.040"	1	C4124-040

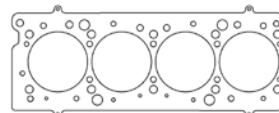

Additional thicknesses available see page 4



Cometic Gasket - An Exclusive NASCAR Performance Product

# FORD / LOTUS

## 1.6L Sigma 2011-16

### Head Gasket

<b>MLX Head Gasket</b>			
Bore	Thickness	Pkg Qty	Part #
82mm	.028"	1	C4963-028

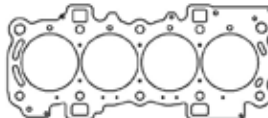

Additional thicknesses available see page 4

## 1.7L Zetec-S 1997-02 Puma

### Head Gasket

<b>MLS Head Gasket</b>			
Bore	Thickness	Pkg Qty	Part #
83mm	.010"	1	C4223-010

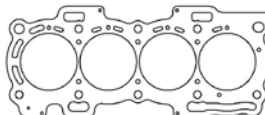

Additional thicknesses available see page 4

## 2.0L SOHC/DOHC NEP/YB Group A

### Head Gasket

<b>MLS Head Gasket</b>			
Bore	Thickness	Pkg Qty	Part #
92.5mm	.040"	1	C4218-040

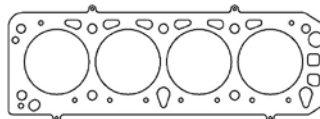

Additional thicknesses available see page 4

### Individual Gaskets

<b>Intake Gasket Set</b>	
Application	Part #
Cosworth YB	C4502

<b>Oil Pan Gasket</b>	
Application	Part #
Cosworth YB Rails only	C4640

<b>Exhaust Manifold Gasket Set</b>	
Application	Part #
Cosworth YB	C4334

<b>Front Cover Gasket</b>	
Application	Part #
Cosworth YB	C4641

<b>Valve Cover Gaskets</b>	
Application	Part #
Early YB Engine - .060" AFM	C4635
Late YB Engine - .060" AFM	C4636

<b>Cooling/Water Pump Gasket</b>	
Application	Part #
Water Pump Gasket	C4637
Water Outlet Gasket	C4638
Thermostat Gasket	C4639

## 2.0L 2012-15 EcoBoost DOHC

### Head Gasket

<b>MLS Head Gasket</b>			
Bore	Thickness	Pkg Qty	Part #
89mm	.034"	1	C15317-034
89mm	.066"	1	C15317-066

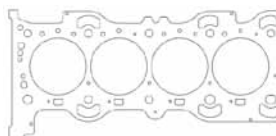

Additional thicknesses available see page 4

## 2.3L 2016-17 EcoBoost DOHC: 2016-2017 Ford Focus RS

### Head Gasket

<b>MLS Head Gasket</b>			
Bore	Thickness	Pkg Qty	Part #
89mm	.040"	1	C15294-040

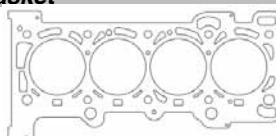

Additional thicknesses available see page 4

<b>Valve Cover Gasket</b>	
Application	Part #
Valve Cover Gasket	C15445



Cometic Gasket - An Exclusive NASCAR Performance Product

# FORD / LOTUS

## 2.7L EcoBoost

### Head Gasket

**NEW!**

#### MLX Head Gaskets - Right Side

Bore	Thickness	Pkg Qty	Part #
85.6mm	0.036	1	C15447-036

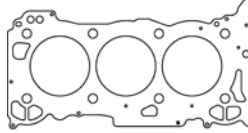

Additional thicknesses available see page 4

**NEW!**

#### MLX Head Gaskets - Left Side

Bore	Thickness	Pkg Qty	Part #
85.6mm	0.036	1	C15448-036

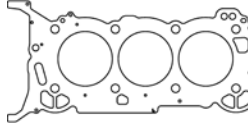

## Cosworth Ford 4cyl - BDG Belt Driven

### Head Gasket

#### MLS Head Gasket

Bore	Thickness	Pkg Qty	Part #
91mm	.040"	1	C4494-040

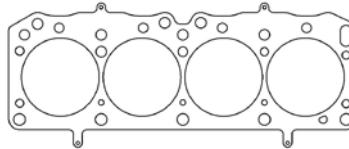

Additional thicknesses available see page 4

### Individual Gaskets

#### Valve Cover Gasket

Application	Part #
BDG - Belt Driven .060" AFM	C4886

## Cosworth Ford 4cyl - FVA 1.6L/FVC 1.8L Gear Driven

### Head Gaskets

#### MLS Head Gaskets

Bore	Thickness	Pkg Qty	Part #
87mm	.040"	1	C4138-040
88mm	.040"	1	C4135-040

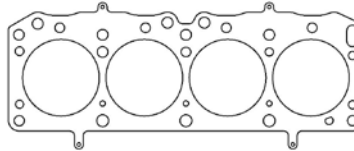

Additional thicknesses available see page 4

### Individual Gaskets

#### Valve Cover Gasket

Application	Part #
FVA/FVC .060" AFM	C4887

#### Oil Pan Gasket

Application	Part #
FVA/FVC .060" AFM (Rails only)	C4891

#### Exhaust Gasket Set

Application	Part #
FVA/FVC .064" AM (4 Pack)	C4888

#### Rear Cover Gasket

Application	Part #
FVA/FVC .060" AFM	C4892

#### Thermostat Housing Gasket

Application	Part #
FVA/FVC .060" AFM	C4889

#### Oil Pump Gasket

Application	Part #
FVA/FVC .060" AFM	C4893

#### Front Cylinder Head Cover Gasket

Application	Part #
FVA/FVC .060" AFM	C4890

#### Front Lower Cover Gasket

Application	Part #
FVA/FVC .012" Fiber	C4894



Cometic Gasket - An Exclusive NASCAR Performance Product

# FORD / LOTUS

## Cosworth Ford 4cyl 1.1-2.0L - BDA Series/Lotus Twin Cam, All Pushrod, Chain, & Belt Driven (Kent Engine)

### Head Gaskets

MLS Head Gaskets			
Bore	Thickness	Pkg Qty	Part #
82mm	.040"	1	C4102-040
83mm	.040"	1	C4103-040
84mm	.040"	1	C4140-040
85mm	.040"	1	C4133-040
86mm	.040"	1	C4142-040
87mm	.040"	1	C4143-040

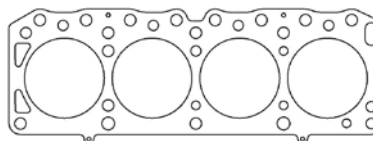

Additional thicknesses available see page 4

### Individual Gaskets

Valve Cover Gaskets	
Application	Part #
Lotus Twin Cam Chain Driven	C4895
BDA Belt Driven .060" AFM	C4896

Oil Pan Gasket	
Application	Part #
BDA Series .060" AFM (Rails only)	C4891

Exhaust Gasket Sets	
Application	Part #
Lotus Twin Cam 2 Bolt (4pk)	C4355-064
BDA 4 Bolt (4pk)	C4353-064
BDA 3 Bolt (4pk)	C4354-064

Rear Cover Gasket	
Application	Part #
FBDA Series .060" AFM	C4892

Intake Gasket Set	
Application	Part #
BDA Series	C4897

Oil Pump Gasket	
Application	Part #
BDA Series .060" AFM	C4893

Thermostat Housing Gasket	
Application	Part #
BDA Series .060" AFM	C4889

Front Lower Cover Gasket	
Application	Part #
BDA Series .012" Fiber	C4894

## 2.0L ZETEC DOHC 4cyl 1995-04

### Head Gasket

MLS Head Gasket			
Bore	Thickness	Pkg Qty	Part #
87mm	.027"	1	C4279-027

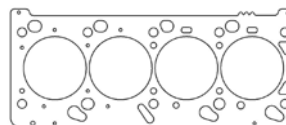

Additional thicknesses available see page 4

### Individual Gaskets

Valve Cover Gaskets	
Application	Part #
2.0L Zetec DOHC 1995-97	C4643
2.0L Zetec DOHC 1998-04	C4644

Valve Stem Seals	
Application	Part #
2.0L Zetec 1995-97 (16pk)	3181V-16
2.0L Zetec 1998-04 (16pk)	3182V-16

Exhaust Gasket Sets	
Application	Part #
2.0L Zetec 1994-04	C4645

Oil Pan Gasket	
Application	Part #
2.0L Zetec 1995-04	C4649

Intake Gasket Set	
Application	Part #
2.0L Zetec 1998-04	C4646
2.0L Zetec 1995-97	C4647

Thermostat Gaskets	
Application	Part #
2.0L Zetec 1995-04 - Seal	C4651
2.0L Zetec 1995-04 - Housing	C4652

See page 80 for additional gaskets



Cometic Gasket - An Exclusive NASCAR Performance Product

# FORD / LOTUS

## 2.0L ZETEC DOHC 4cyl 1995-04

### Individual Gaskets

Cam Seal Set	
Application	Part #
2.0L Zetec 1994-04 .....	<b>C4648</b>

Rear Main Seal Set	
Application	Part #
2.0L Zetec 1995-04 .....	<b>C4650</b>

### Gasket Kits



To purchase a complete gasket kit order both top end and bottom end gasket kit

#### TOP END GASKET KITS

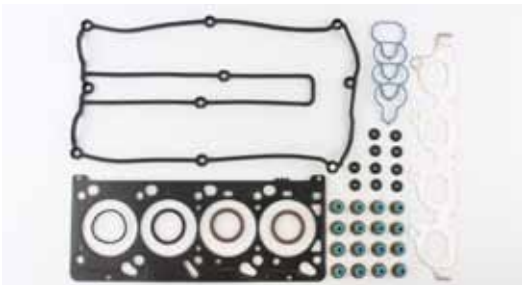

Application	Part #
2.0L Zetec DOHC 1995-97 87mm Bore .....	<b>PRO2029T</b>
2.0L Zetec DOHC 1998-04 87mm Bore .....	<b>PRO2030T</b>

#### BOTTOM END GASKET KITS



Application	Part #
2.0L Zetec DOHC 1995-97 .....	<b>PRO2029B</b>
2.0L Zetec DOHC 1998-04 .....	<b>PRO2030B</b>

## 2.3L "2300" SOHC 1974-97 4cyl

### Head Gaskets

MLS Head Gaskets			
Bore	Thickness	Pkg Qty	Part #
3.830"	.....040"	1 .....	<b>C5369-040</b>
3.940"	.....040"	1 .....	<b>C5709-040</b>

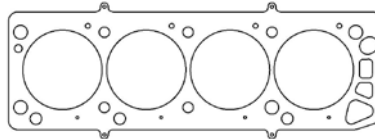

Additional thicknesses available see page 4

### Individual Gaskets

Valve Cover Gasket	
Application	Part #
2300 2.3L 1974-93 .....	<b>C4653</b>

Exhaust Gasket Set	
Application	Part #
2300 2.3L 1974-93 .....	<b>C5372-064</b>

Intake Gasket	
Application	Part #
2300 2.3L .....	<b>C5371-060</b>

Valve Stem Seals	
Application	Part #
2300 2.3L 1974-93 (need 8) .....	<b>3168V</b>

Oil Pan Gaskets	
Application	Part #
2300 2.3L 1974-2/19/86 .....	<b>C5373</b>
2300 2.3L 2/20/86-1990 .....	<b>C4669</b>
2300 2.3L 1991-92 .....	<b>C4741</b>
2300 2.3L 1993 .....	<b>C4778</b>

Rear Main Seal Sets	
Application	Part #
2300 2.3L 1974-81 2pc .....	<b>C5688</b>
2300 2.3L 1982-93 1pc .....	<b>C5189</b>

Water Pump Gasket	
Application	Part #
2300 2.3L 1974-93 .....	<b>C4654</b>

See page 81 for StreetPro gasket kits





Cometic Gasket - An Exclusive NASCAR Performance Product

# FORD / LOTUS

## 2.3L "2300" SOHC 1974-97 4cyl

### Gasket Kits



To purchase a complete gasket kit order both top end and bottom end gasket kit

#### TOP END GASKET KIT



Application	Part #
2300 2.3L 1974-97 3.830" Bore.....	<b>PRO2031T</b>

#### BOTTOM END GASKET KIT

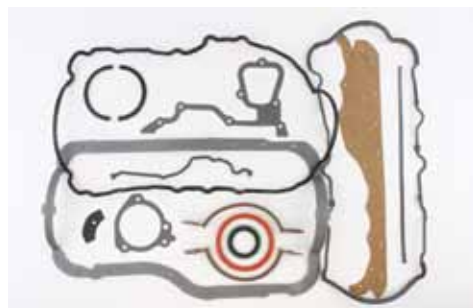

Application	Part #
2300 2.3L 1974-97 .....	<b>PRO2031B</b>

## 2.0L 2003-11 & 2.3L 2003-08 Duratec DOHC

### Head Gaskets

#### MLS Head Gaskets

Bore	Thickness	Pkg Qty	Part #
89.5mm	.....018"	.....1	<b>C5843-018</b>
92mm	.....018"	.....1	<b>C5842-018</b>

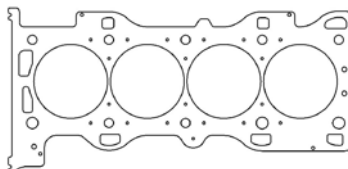

Additional thicknesses available see page 4

### Individual Gaskets

#### Intake Gasket

Application	Part #
2.3L Duratec 2003-08.....	<b>C4842-060</b>

#### Exhaust Manifold Gaskets

Application	Part #
2.3L Duratec (w/ extra port).....	<b>C4840-064</b>
2.3L Duratec (w/o extra port).....	<b>C4841-064</b>

## 2.5L Duratec DOHC 2009 - Present

### Head Gasket

#### MLS Head Gasket

Bore	Thickness	Pkg Qty	Part #
90mm	.....040"	.....1	<b>C5906-040</b>

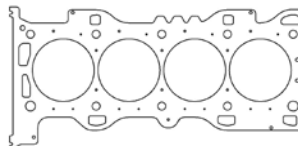

Additional thicknesses available see page 4

## 3.0L Essex V6 1966-88

### Head Gasket

#### MLS Head Gasket

Bore	Thickness	Pkg Qty	Part #
95mm	.....040"	.....1	<b>C4971-040</b>



Additional thicknesses available see page 4



Cometic Gasket - An Exclusive NASCAR Performance Product

# CHEVROLET / GM

## ECOTEC 4 Cylinder

### Head Gaskets

#### MLS Head Gasket - LSJ 2.0L

Bore	Thickness	Pkg Qty	Part #
87mm	.....027"	.....1	C5921-027

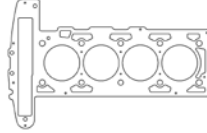

Additional thicknesses available  
see page 4

#### MLX Head Gasket - LSJ 2.0L

Bore	Thickness	Pkg Qty	Part #
87mm	.....040"	.....1	C5032-040

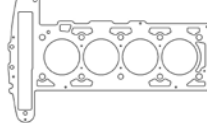

#### MLX Head Gasket - LNF 2.0L 08-10

Bore	Thickness	Pkg Qty	Part #
88mm	.....032"	.....1	C15256-032

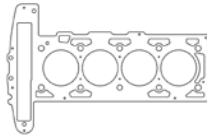

#### MLX Head Gasket - LTG 2.0L DOHC

Bore	Thickness	Pkg Qty	Part #
87mm	.....028"	.....1	C4964-028

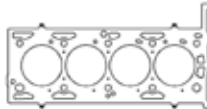

#### MLS Head Gaskets - L61/L42 2.2L DOHC

Bore	Thickness	Pkg Qty	Part #
75mm	.....075"	.....1	C5768-075
87mm	.....040"	.....1	C5768-040
89mm	.....040"	.....1	C5804-040

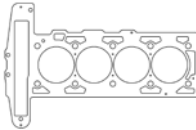

**NEW!**

#### MLX Head Gasket - LES 2.4L

Bore	Thickness	Pkg Qty	Part #
89.6mm	.....036"	.....1	C15422-036

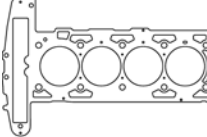

### Individual Gaskets

#### MLS Exhaust Gasket

Application	Part #
2000-2009 2.2/2.4L	C4150-030

## 2.2L 134ci "LN2": Cavalier/Sunfire FWD 1998-02, S-10/Sonoma RWD 1994-03

### Head Gaskets

#### MLS Head Gaskets

Bore	Thickness	Pkg Qty	Part #
90mm	.....030"	.....1	C5914-030
93mm	.....030"	.....1	C5915-030

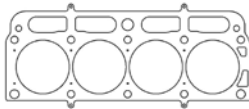

Additional thicknesses available  
see page 4

## 2.4L 146ci "LD9" Twin Cam 1996-2001

### Head Gaskets

#### MLS Head Gasket - 1996-99 w/EGR

Bore	Thickness	Pkg Qty	Part #
3.595"	.....030"	.....1	C5298-030

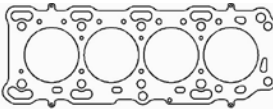

Additional thicknesses available  
see page 4

#### MLS Head Gaskets - 1999-01 w/o EGR

Bore	Thickness	Pkg Qty	Part #
3.595"	.....030"	.....1	C5866-030
3.595"	.....075"	.....1	C5866-075

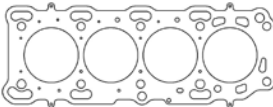



Cometic Gasket - An Exclusive NASCAR Performance Product

# HONDA

## L15B7 1.5L DOHC VTC Turbo

**NEW!**

### Head Gaskets

#### MLS Head Gasket

Bore	Thickness	Pkg Qty	Part #
73.5mm	.....024"	.....1	<b>C14019-024</b>

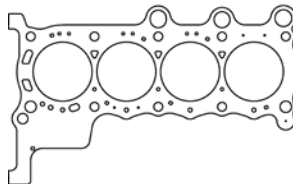

Additional thicknesses available see page 4

### Individual Gaskets

**NEW!**

#### Valve Cover Gasket Set

Application	Part #
L15B7, L15BA, L15BE	<b>C14111</b>

## D15B1/B2/B7 1988-95, D16A6/A7 1988-91 SOHC

**NEW!**

### Head Gaskets

#### MLX Head Gasket

Bore	Thickness	Pkg Qty	Part #
79mm	.....032"	.....1	<b>C14005-040</b>
79mm	.....040"	.....1	<b>C14005-032</b>

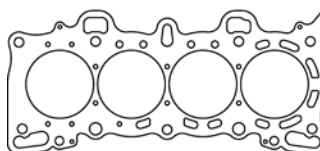

Additional thicknesses available see page 4

#### MLS Head Gaskets

Bore	Thickness	Pkg Qty	Part #
75.5mm	.....030"	.....1	<b>C4117-030</b>
76mm	.....030"	.....1	<b>C4118-030</b>
77mm	.....030"	.....1	<b>C4119-030</b>
78mm	.....030"	.....1	<b>C4120-030</b>
79mm	.....030"	.....1	<b>C4121-030</b>

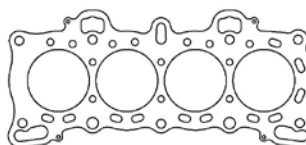

### Individual Gaskets

#### Valve Cover Gasket Set

Application	Part #
D15B1/B2/B7, D16A6/A7	<b>C4701</b>

#### Oil Pan Gasket

Application	Part #
D15B1/B2/B7, D16A6/A7	<b>C4660</b>

#### Intake Gasket

Application	Part #
D15B1/B2/B7, D16A6/A7	<b>C4702-060</b>

#### Rear Main Seal Set

Application	Part #
D15B1/B2/B7, D16A6/A7	<b>C4663</b>

#### Exhaust Manifold Gasket

Application	Part #
D15B1/B2/B7, D16A6/A7 - MLS	<b>C4164-030</b>

#### Front Crank/Oil Pump Seal

Application	Part #
D15B1/B2/B7, D16A6/A7	<b>C4664</b>

#### Valve Stem Seals (sold individually)

Application	Part #
D15B1/B2/B7, D16A6/A7	<b>3170V</b>

#### Timing Cover Dust Seal Sets

Application	Part #
D15B1/B2/B7, D16A6/A7 - Lower	<b>C4661</b>
D15B1/B2/B7, D16A6/A8 - Upper	<b>C4898</b>

#### Cam Seal

Application	Part #
D15B1/B2/B7, D16A6/A7	<b>C4703</b>

#### Water Pump Mounting O-ring

Application	Part #
D15B1/B2/B7, D16A6/A7	<b>C4700</b>

#### Thermostat Seal Set

Application	Part #
D15B1/B2/B7, D16A6/A7	<b>C4704</b>

See page 84 for StreetPro gasket kits



Cometic Gasket - An Exclusive NASCAR Performance Product

# HONDA

## D15B1/B2/B7 1988-95, D16A6/A7 1988-91 SOHC

### Gasket Kits



To purchase a complete gasket kit order both top end and bottom end gasket kit

#### TOP END GASKET KITS



Application	Part #
D15B1/B2/B7 88-95 76mm Bore .....	<b>PRO2032T</b>
D16A6/A7 88-91 76mm Bore .....	<b>PRO2034T</b>

#### BOTTOM END GASKET KIT



Application	Part #
D15B1/B2/B7, D16A6/A7 .....	<b>PRO2032B</b>

## D16A1/A9 DOHC 1986-89

### Head Gaskets

#### MLS Head Gaskets

Bore	Thickness	Pkg Qty	Part #
75.5mm	.030"	1	<b>C4522-030</b>
76mm	.030"	1	<b>C4524-030</b>
77mm	.030"	1	<b>C4525-030</b>
78mm	.030"	1	<b>C4526-030</b>

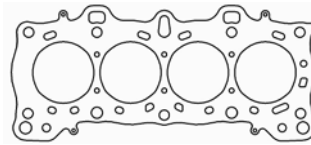

Additional thicknesses available  
see page 4

### Individual Gaskets

#### Valve Cover Gasket Set

Application	Part #
D16A1/A9 1986-89 .....	<b>C4706</b>

#### Oil Pan Gasket

Application	Part #
D16A1/A9 1986-89 .....	<b>C4660</b>

#### Intake Gasket

Application	Part #
D16A1/A9 1986-89 .....	<b>C4707-046</b>

#### Rear Main Seal Set

Application	Part #
D16A1/A9 1986-89 .....	<b>C4663</b>

#### Exhaust Manifold Gasket

Application	Part #
D16A1/A9 1986-89 .....	<b>C4708</b>

#### Front Crank/Oil Pump Seal

Application	Part #
D16A1/A9 1986-89 .....	<b>C4664</b>

#### Valve Stem Seals (sold individually)

Application	Part #
D16A1/A9 1986-89 .....	<b>3177V</b>

#### Water Pump Mounting O-ring

Application	Part #
D16A1/A9 1986-89 .....	<b>C4700</b>

#### Cam Seal

Application	Part #
D16A1/A9 1986-89 .....	<b>C4709</b>

#### Thermostat Seal

Application	Part #
D16A1/A9 1986-89 .....	<b>C4710</b>

See page 85 for StreetPro gasket kits



Cometic Gasket - An Exclusive NASCAR Performance Product

# HONDA

## D16A1/A9 DOHC 1986-89

### Gasket Kits



To purchase a complete gasket kit order both top end and bottom end gasket kit

#### TOP END GASKET KIT



Application	Part #
D16A1/A9 1986-89 76mm Bore .....	<b>PRO2033T</b>

#### BOTTOM END GASKET KIT



Application	Part #
D16A1/A9 1986-89 .....	<b>PRO2033B</b>

## D16Z6, D16Y5/Y7/Y8, D15Z1 1992-00 SOHC

### Head Gaskets

#### MLS Head Gaskets

Bore	Thickness	Pkg Qty	Part #
75.5mm .....	.030"	1 .....	<b>C4251-030</b>
76mm .....	.030"	1 .....	<b>C4195-030</b>
77mm .....	.030"	1 .....	<b>C4196-030</b>
78mm .....	.030"	1 .....	<b>C4167-030</b>
79mm .....	.030"	1 .....	<b>C4197-030</b>

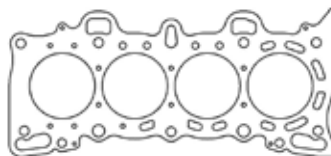

Additional thicknesses available see page 4

### Individual Gaskets

#### Valve Cover Gasket Sets

Application	Part #
D16Z6 1992-95 .....	<b>C4655</b>
D16Y5/Y7/Y8 1996-00 .....	<b>C4665</b>

#### Throttle Body Gaskets

Application	Part #
D16Z6 1992-95 .....	<b>C4657-032</b>
D16Y5/Y7/Y8 1996-00 .....	<b>C4667-032</b>

#### Intake Gaskets

Application	Part #
D16Z6 1992-95 .....	<b>C4702-060</b>
D16Y5/Y7/Y8 1996-00 .....	<b>C4666</b>

#### Oil Pan Gaskets

Application	Part #
D16Z6 1992-95 .....	<b>C4660</b>
D16Y5/Y8 1996-00 .....	<b>C4670</b>
D16Y7 1996-00 .....	<b>C4899</b>

#### Exhaust Manifold Gasket

Application	Part #
D16Z6, D16Y5/Y7/Y8 - MLS .....	<b>C4164-030</b>

#### Rear Main Seal Set

Application	Part #
D16Z6, D16Y5/Y7/Y8 .....	<b>C4663</b>

#### Valve Stem Seals (sold individually)

Application	Part #
D16Z6, D16Y5/Y7/Y8 .....	<b>3170V</b>

#### Front Crank/Oil Pump Seal

Application	Part #
D16Z6, D16Y5/Y7/Y8 .....	<b>C4664</b>

#### Cam Seal

Application	Part #
D16Z6, D16Y5/Y7/Y8 .....	<b>C4658</b>

#### Timing Cover Dust Seal Set

Application	Part #
D16Z6, D16Y5/Y7/Y8 - Lower .....	<b>C4661</b>

#### Thermostat Seal

Application	Part #
D16Z6, D16Y5/Y7/Y8 .....	<b>C4659</b>

#### Water Pump Mounting O-ring

Application	Part #
D16Z6, D16Y5/Y7/Y8 .....	<b>C4662</b>

See page 86 for StreetPro gasket kits



Cometic Gasket - An Exclusive NASCAR Performance Product

# HONDA

## D16Z6, D16Y5/Y7/Y8, D15Z1 1992-00 SOHC

### Gasket Kits



To purchase a complete gasket kit order both top end and bottom end gasket kit

#### TOP END GASKET KITS



Application	Part #
D16Z6 1992-95 76mm Bore.....	<b>PRO2000T</b>
D16Y5/Y7/Y8 1996-00 76mm Bore.....	<b>PRO2001T</b>

#### BOTTOM END GASKET KIT



Application	Part #
D16Z6 1992-95.....	<b>PRO2000B</b>
D16Y5/Y7/Y8 1996-00.....	<b>PRO2001B</b>

## D17A1, A2, A6 1.7L SOHC 2001-05

### Head Gaskets

#### MLS Head Gaskets

Bore	Thickness	Pkg Qty	Part #
76mm	.....027"	.....1.....	<b>C4474-027</b>
77mm	.....027"	.....1.....	<b>C4473-027</b>
78mm	.....027"	.....1.....	<b>C4472-027</b>
79mm	.....027"	.....1.....	<b>C4471-027</b>

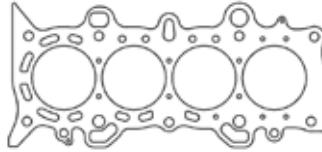

Additional thicknesses available see page 4

### Individual Gaskets

#### Valve Stem Seals (sold individually)

Application	Part #
D17A1/A2/A6.....	<b>3170V</b>

#### Rear Main Seal

Application	Part #
D17A1/A2/A6.....	<b>C4678</b>

#### Cam Seal

Application	Part #
D17A1/A2/A6.....	<b>C4658</b>

#### Water Pump Mounting O-ring

Application	Part #
D17A1/A2/A6.....	<b>C4662</b>

## B16A2/A3, B18C1/C5 1.6/1.8L DOHC VTEC

### Head Gaskets

**NEW!**

#### MLX Head Gasket

Bore	Thickness	Pkg Qty	Part #
85mm	.....043"	.....1.....	<b>C4999-043</b>

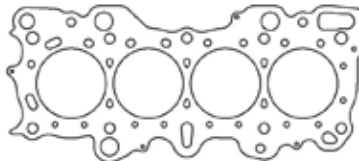

Additional thicknesses available see page 4

See page 87 for additional gaskets



Cometic Gasket - An Exclusive NASCAR Performance Product

# HONDA

## B16A2/A3, B18C1/C5 1.6/1.8L DOHC VTEC

### Head Gaskets

MLS Head Gaskets			
Bore	Thickness	Pkg Qty	Part #
81mm	.030"	1	C4231-030
81.5mm	.030"	1	C4232-030
82mm	.030"	1	C4168-030
83mm	.030"	1	C4189-030
84mm	.030"	1	C4188-030
85mm	.030"	1	C4182-030

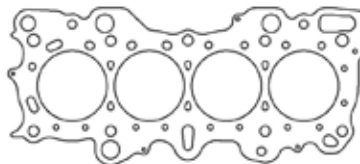

Additional thicknesses available see page 4

### Individual Gaskets

Valve Cover Gasket Set	
Application	Part #
B16A2/A3 & B18C1/C5	C4628

Thermostat Seal	
Application	Part #
B16A2/A3 & B18C1/C5	C4659

Intake Gaskets	
Application	Part #
B16A2/A3 & B18C5	C4671-060
B18C1	C4674

Throttle Body Gaskets	
Application	Part #
B16A3/B18C1 94-95	C4672-032
B16A2/B18C1/C5 96-01	C4656-032

Exhaust Manifold Gasket	
Application	Part #
B16A2/A3 & B18C1/C5 - MLS	C4151-030

Oil Pan Gasket	
Application	Part #
B16A2/A3 & B18C1/C5	C4676

Valve Stem Seals (sold individually)	
Application	Part #
D16Z6, D16Y5/Y7/Y8	3170V

Rear Main Seal	
Application	Part #
B16A2/A3 & B18C1/C5	C4678

Cam Seal Set	
Application	Part #
B16A2/A3 & B18C1/C5	C4675

Water Pump Mounting O-ring	
Application	Part #
B16A2/A3 & B18C1/C5	C4677

### Gasket Kits



To purchase a complete gasket kit order both top end and bottom end gasket kit

#### TOP END GASKET KIT

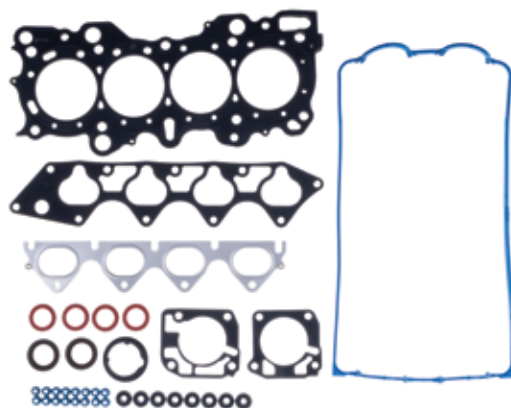

Application	Part #
B16A2/A3, B18C5 82mm Bore	PRO2002T
B18C1 GS-R 82mm Bore	PRO2003T

#### BOTTOM END GASKET KIT



Application	Part #
B16A2/A3, B18C1/C5	PRO2003B



Cometic Gasket - An Exclusive NASCAR Performance Product

# HONDA

## B18A1/B18B1 1.8L DOHC non-VTEC 1990-01

### Head Gaskets

#### MLS Head Gaskets

Bore	Thickness	Pkg Qty	Part #
81mm	.030"	1	C4238-030
81.5mm	.030"	1	C4239-030
82mm	.030"	1	C4173-030
83mm	.030"	1	C4181-030
84mm	.030"	1	C4180-030
85mm	.030"	1	C4175-030

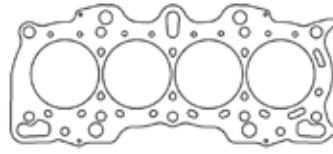

Additional thicknesses available see page 4

**NEW!**

#### MLX Head Gasket

Bore	Thickness	Pkg Qty	Part #
85mm	.043"	1	C14000-043

### Individual Gaskets

#### Valve Cover Gasket Set

Application	Part #
B18A1/B1	C4679

#### Throttle Body Gasket

Application	Part #
B18A1/B1	C4681

#### Intake Gasket

Application	Part #
B18A1/B1 .094" KF	C4680-094

#### Thermostat Seal

Application	Part #
B18A1/B1	C4659

#### Exhaust Manifold Gasket

Application	Part #
B18A1/B1 - .030" MLS	C4151-030

#### Oil Pan Gasket Set

Application	Part #
B18A1/B1	C4676

#### Valve Stem Seals (sold individually)

Application	Part #
B18A1/B1	3177V

#### Rear Main Seal Set

Application	Part #
B18A1/B1	C4678

#### Cam Seal Set

Application	Part #
B18A1/B1	C4709

#### Water Pump Mounting O-ring

Application	Part #
B18A1/B1	C4677

### Gasket Kits



To purchase a complete gasket kit order both top end and bottom end gasket kit

#### TOP END GASKET KIT



Application	Part #
B18A1/B1 1990-01 82mm Bore	PRO2004T

#### BOTTOM END GASKET KIT



Application	Part #
B18A1/B1 1990-01	PRO2004B





Cometic Gasket - An Exclusive NASCAR Performance Product

# HONDA

## B Series Hybrid (VTEC Head/non-VTEC Block)

### Head Gaskets

MLS Head Gaskets			
Bore	Thickness	Pkg Qty	Part #
81mm	.030"	1	C4237-030
81.5mm	.030"	1	C4236-030
82mm	.030"	1	C4191-030
83mm	.030"	1	C4192-030
84mm	.030"	1	C4193-030
84.5mm	.030"	1	C4241-030
85mm	.030"	1	C4194-030

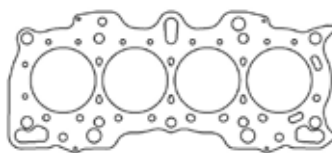

Additional thicknesses available see page 4

### Individual Gaskets

Valve Cover Gasket Set	
Application	Part #
B16A2/A3 & B18C1/C5	C4628

Thermostat Seal	
Application	Part #
B Series	C4659

Intake Gaskets	
Application	Part #
B16A2/A3 & B18C5	C4674
B18C1	C4671-060

Throttle Body Gaskets	
Application	Part #
B16A3/B18C1 94-95	C4672-032
B16A2/B18C1/C5 96-01	C4656-032

Exhaust Manifold Gasket	
Application	Part #
B16A2/A3 & B18C1/C5 - MLS	C4151-030

Oil Pan Gasket Set	
Application	Part #
B Series	C4676

Valve Stem Seals (sold individually)	
Application	Part #
B16A2/A3 & B18C1/C5	3170V

Rear Main Seal Set	
Application	Part #
B Series	C4678

Cam Seal Set	
Application	Part #
B16A2/A3 & B18C1/C5	C4675

Water Pump Mounting O-ring	
Application	Part #
B Series	C4677

### Gasket Kits



To purchase a complete gasket kit order both top end and bottom end gasket kit

#### TOP END GASKET KITS



Application	Part #
B20 w/B18C1 Head (GS-R) 84.5mm Bore	PRO2049T
B20 w/B16A2/A3/B18C5 Head 84.5mm Bore	PRO2050T

#### BOTTOM END GASKET KIT



Application	Part #
B Series	PRO2004B



Cometic Gasket - An Exclusive NASCAR Performance Product

# HONDA

## B20B4, B20Z2 2.0L DOHC non-VTEC 1997-01

### Head Gasket

MLS Head Gasket			
Bore	Thickness	Pkg Qty	Part #
85mm	.030"	1	C4250-030

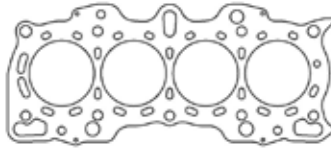

Additional thicknesses available see page 4

### Individual Gaskets

Valve Cover Gasket Set	
Application	Part #
B20B4, B20Z2	C4679

Thermostat Seal	
Application	Part #
B20B4, B20Z2	C4659

Intake Gasket	
Application	Part #
B20B4, B20Z2 .094" KF	C4680-094

Oil Pan Gasket Set	
Application	Part #
B18A1/B1	C4676

Exhaust Manifold Gasket	
Application	Part #
B20B4, B20Z2 - .030" MLS	C4151-030

Rear Main Seal	
Application	Part #
B20B4, B20Z2	C4678

Valve Stem Seals (sold individually)	
Application	Part #
B20B4, B20Z2	3177V

Water Pump Mounting O-ring	
Application	Part #
B20B4, B20Z2	C4677

Cam Seal Set	
Application	Part #
B20B4, B20Z2	C4709

### Gasket Kits



To purchase a complete gasket kit order both top end and bottom end gasket kit

#### TOP END GASKET KIT



Application	Part #
B20B4, B20Z2 85mm Bore	PRO2035T

#### BOTTOM END GASKET KIT



Application	Part #
B Series	PRO2004B



Cometic Gasket - An Exclusive NASCAR Performance Product

# HONDA

## B20A5 2.0L 1988-91

### Head Gaskets

#### MLS Head Gaskets

Bore	Thickness	Pkg Qty	Part #
81.5mm	.045"	1	C4564-045
82mm	.045"	1	C4565-045
83mm	.045"	1	C4566-045
84mm	.045"	1	C4567-045

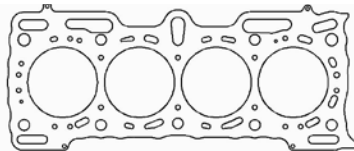

Additional thicknesses available see page 4

## F20B 2.0L DOHC 1997-01

### Head Gasket

#### MLS Head Gasket

Bore	Thickness	Pkg Qty	Part #
86mm	.027"	1	C4634-027
86mm	.036"	1	C4634-036

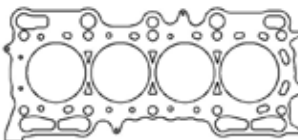

Additional thicknesses available see page 4

## B21A1 2.1L 1990-91

### Head Gaskets

#### MLS Head Gaskets

Bore	Thickness	Pkg Qty	Part #
84mm	.040"	1	C4586-040
83mm	.045"	1	C4585-045
84mm	.045"	1	C4586-045

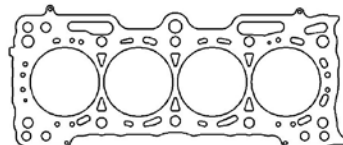

Additional thicknesses available see page 4

## K20A1, K20A2, K20A3 2.0L 2001+, K24A 2.4L 2003+

**NEW!**

### Head Gaskets

#### MLS Head Gaskets

Bore	Thickness	Pkg Qty	Part #
86mm	.030"	1	C4300-030
87mm	.040"	1	C4311-040
87.5mm	.030"	1	C14039-030
89mm	.030"	1	C4313-030
90mm	.040"	1	C14043-040

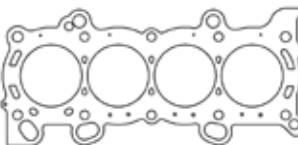

Additional thicknesses available see page 4

#### MLX Head Gaskets

Bore	Thickness	Pkg Qty	Part #
89mm	.032"	1	C4596-032
89mm	.036"	1	C4596-036
89mm	.044"	1	C4596-044

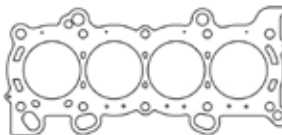

Additional thicknesses available see page 4

### Individual Gaskets

#### Exhaust Manifold Gaskets

Application	Part #
K20A1/A3 2002-04 - MLS	C4160-030
K20A2 - MLS	C4162-030

#### Rear Main Seal

Application	Part #
K-Series 2002+	C4705

#### Intake Gasket

Application	Part #
K20A2/A3 2001+	C4668

**NEW!**

#### Oil Pan Gasket

Application	Part #
K20A1/A2/A3 2002-2013	C14011-060



Cometic Gasket - An Exclusive NASCAR Performance Product

# HONDA

## K20C1 2015-Present Civic Type R

### Head Gaskets

**NEW!**

#### MLS Head Gaskets

Bore	Thickness	Pkg Qty	Part #
86mm	.028"	1	C14020-028
88mm	.028"	1	C14021-028

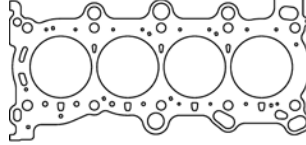

Additional thicknesses available see page 4

### Individual Gaskets

**NEW!**

#### Turbo/Exhaust Gasket Kit

Application	Part #
K20C1 2015-Present	C14013-039

## K20Z3 2.0L 2006-11

### Head Gaskets

#### MLS Head Gaskets

Bore	Thickness	Pkg Qty	Part #
86mm	.030"	1	C4561-030
87mm	.030"	1	C4562-030

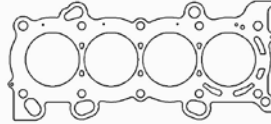

Additional thicknesses available see page 4

### Individual Gaskets

**NEW!**

#### Valve Cover Gasket

Application	Part #
K-Series 2002+	C14012

**NEW!**

#### Exhaust Manifold Gasket

Application	Part #
K20 Exhaust - AM Material	C14007-064

#### Rear Main Seal

Application	Part #
K-Series 2002+	C4705

**NEW!**

#### Throttle Body Gaskets

Application	Part #
2.0L K20Z3 Fiber	C14008-031

**NEW!**

#### Oil Pan Gasket

Application	Part #
K20A1/A2/A3 2002-2013	C14011-060

## K24Z2/K24Z7 2.4L 2012-15

### Head Gaskets

#### MLS Head Gaskets

Bore	Thickness	Pkg Qty	Part #
87mm	.030"	1	C4594-030
89mm	.030"	1	C4595-030
89mm	.036"	1	C4595-036

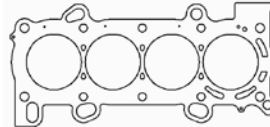

Additional thicknesses available see page 4

### Individual Gaskets

#### Rear Main Seal

Application	Part #
K-Series 2002+	C4705

**NEW!**

#### Exhaust Manifold Gasket

Application	Part #
K24Z2 / K24Z3 / K24Z6 / K24Z7	C14013-039



Cometic Gasket - An Exclusive NASCAR Performance Product

# HONDA

## H22A1/H22A2 2.2L DOHC VTEC 1992-96

### Head Gaskets

MLS Head Gaskets			
Bore	Thickness	Pkg Qty	Part #
87mm	.030"	1	C4255-030
88mm	.030"	1	C4198-030
89mm	0.03	1	C4185-030

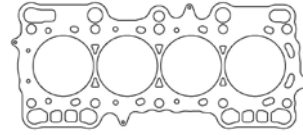

Additional thicknesses available see page 4

**NEW!**

MLX Head Gaskets			
Bore	Thickness	Pkg Qty	Part #
89mm	.032"	1	C14015-032

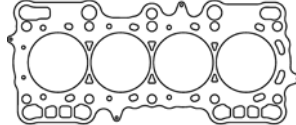

### Individual Gaskets

Exhaust Manifold Gasket	
Application	Part #
H22A1/H22A2 - MLS	C4155-030

Water Pump Gasket	
Application	Part #
H22A1/H22A2	C4244

Valve Stem Seals (sold individually)	
Application	Part #
H22A1/H22A2	3170V

Oil Pan Gasket Set	
Application	Part #
H22A1/H22A2	C4158

Thermostat Seal	
Application	Part #
H22A1/H22A2	C4659

Rear Main Seal	
Application	Part #
H22A1/H22A2	C4678

## H22A4 1997-01, H22A7 1998-03 2.2L DOHC

### Head Gaskets

MLS Head Gaskets			
Bore	Thickness	Pkg Qty	Part #
87mm	.018"	1	C4252-018
87mm	.030"	1	C4252-030
88mm	.030"	1	C4253-030
89mm	.030"	1	C4254-030

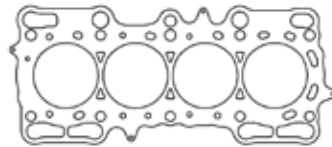

Additional thicknesses available see page 4

### Individual Gaskets

Exhaust Manifold Gasket	
Application	Part #
H22A4/H22A7 - MLS	C4155-030

Water Pump Gasket	
Application	Part #
H22A4/H22A7	C4244

Valve Stem Seals (sold individually)	
Application	Part #
H22A4/H22A7	3170V

Oil Pan Gasket Set	
Application	Part #
H22A4/H22A7	C4158

Thermostat Seal	
Application	Part #
H22A4/H22A7	C4659

Rear Main Seal	
Application	Part #
H22A4/H22A7	C4678

## H23A1 2.3L DOHC VTEC 1992-96

### Head Gaskets

MLS Head Gaskets			
Bore	Thickness	Pkg Qty	Part #
87.5mm	.030"	1	C4553-030
88mm	.030"	1	C4554-030
89mm	0.03	1	C4555-030

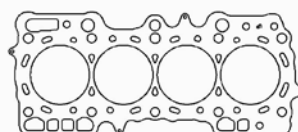

Additional thicknesses available see page 4



Cometic Gasket - An Exclusive NASCAR Performance Product

# HONDA

## F22A1/A4 / A6 (90-93 Accord, 92-96 Prelude SOHC 16V)

### Head Gaskets

**NEW!**

#### MLS Head Gaskets

Bore	Thickness	Pkg Qty	Part #
85mm	.045"	1	C14017-045

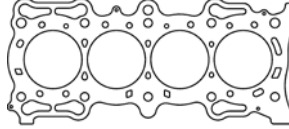

Additional thicknesses available see page 4

## F22B1/B4/B5/B8 2.2L SOHC 1994-97, \*F23A1 1998-02

### Head Gaskets

#### MLS Head Gaskets

Bore	Thickness	Pkg Qty	Part #
86mm	.027"	1	C4618-027
87mm	.027"	1	C4619-027*
88mm	.027"	1	C4620-027*
89mm	.027"	1	C4621-027*

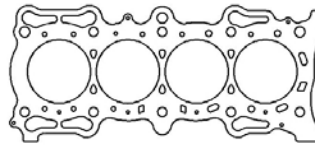

Additional thicknesses available see page 4

### Individual Gaskets

#### Exhaust Manifold Gasket

Application	Part #
F22B1/F23A1 1994-01 .064" AM	C4190-064

## F20C1/C2, F22C1 2.0/2.2L DOHC VTEC 1999-09

### Head Gaskets

#### MLS Head Gaskets

Bore	Thickness	Pkg Qty	Part #
87.5mm	.030"	1	C4625-030
88mm	.030"	1	C4626-030
88.5mm	.030"	1	C4627-030
89mm	.030"	1	C4335-030

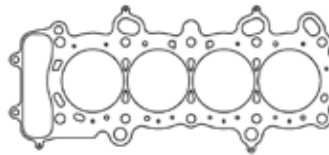

Additional thicknesses available see page 4

### Individual Gaskets

#### Exhaust Manifold Gasket

Application	Part #
F20C1/C2 99-09 - MLS	C4159-030

## C30A1, C32B1 DOHC 3.0/3.2L V6 1991-05

### Head Gaskets

#### MLS Head Gaskets

Bore	Thickness	Pkg Qty	Part #
91mm	.030"	1	C4550-030
93mm	.030"	1	C4551-030
95mm	.030"	1	C4277-030

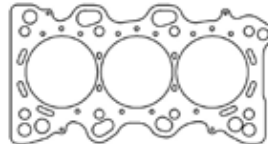

Additional thicknesses available see page 4

## J32A2 3.5L SOHC V6 2001-04 Stock and Darton Sleeves

### Head Gaskets

#### MLS Head Gasket

Bore	Thickness	Pkg Qty	Part #
90mm	.027"	1	C4382-027

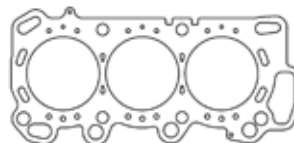

Additional thicknesses available see page 4



Cometic Gasket - An Exclusive NASCAR Performance Product

# HYUNDAI

## 2.0L Theta II Turbo 4 Cylinder

2019 Genesis G70, 2010-14 Gensis Coupe, 2011 Sonata Limited, 2018-Up Kia Stinger, 2009-2013 Kia Forte

### Head Gaskets

#### MLX Head Gasket

Bore	Thickness	Pkg Qty	Part #
88mm	.032"	1	C4953-032

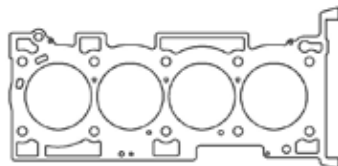

Additional thicknesses available see page 4

## 3.8L G6DA DOHC V6

2007-11 Azera, 2007-10 Entourage, 2009-12 Genesis, 2007-11 Veracruz, 2006-10 Kia Sendona, 2007-09 Kia Sorento

### Head Gaskets

#### MLX Head Gasket - Left Side

Bore	Thickness	Pkg Qty	Part #
98mm	.032"	1	C4632-032

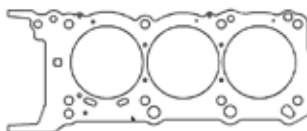

Additional thicknesses available see page 4

#### MLX Head Gasket - Right Side

Bore	Thickness	Pkg Qty	Part #
98mm	.032"	1	C4633-032

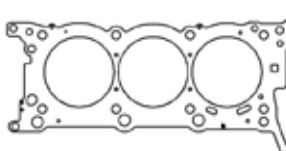

Additional thicknesses available see page 4

# JAGUAR

## 3.4L DOHC Inline 6

48-53 XK120, 54-57 XK140, 57-61 XK150, 50-57 Mark VII, 56-58 Mark VIII, 57-59 Mark I, 59-67 Mark II, 67-68 340 Mark II, 63-68 S-Type

### Head Gaskets

#### MLS Head Gaskets

Bore	Thickness	Pkg Qty	Part #
83mm	.040"	1	C4281-040
85mm	.040"	1	C4303-040

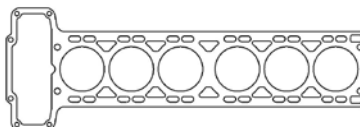

Additional thicknesses available see page 4

#### CFM-20 Head Gasket

Bore	Thickness	Pkg Qty	Part #
83mm	.059"	1	C4302-059
85mm	.059"	1	C4304-059

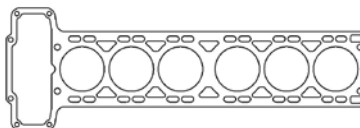

Additional thicknesses available see page 4

### Individual Gaskets

#### Cam Cover Gasket Set

Application	Part #
3.4/3.8/4.2L (Trim to Fit)	C4545-060

#### Oil Pan Gasket

Application	Part #
3.4/3.8/4.2L .060" AFM	C4259-060

#### Intake Manifold Gaskets

Application	Part #
3.8/4.2L Str Port Head	C4230-060
3.4/3.8L B Type Head	C4244-060

#### Engine Cover Gaskets

Application	Part #
Front Main Seal Gasket	C4673-188
Rear Main Seal Gasket	C4901-188

See page 96 for additional gaskets



Cometic Gasket - An Exclusive NASCAR Performance Product

# JAGUAR

## 3.4L DOHC Inline 6

48-53 XK120, 54-57 XK140, 57-61 XK150, 50-57 Mark VII, 56-58 Mark VIII, 57-59 Mark I,  
59-67 Mark II, 67-68 340 Mark II, 63-68 S-Type

### Individual Gaskets

Exhaust Manifold Gasket	
Application	Part #
3.4/3.8/4.2L.....	C4217-059

Timing Cover Gasket	
Application	Part #
3.4/3.8/E4.2L .018" AFM.....	C4336-018

Thermostat Gaskets	
Application	Part #
Series 1 1965-67 .....	C4375-060
Series 2 1968-71 .....	C4379-060

Engine Oil Gaskets	
Application	Part #
Oil Feed Gasket.....	C4949-032
Oil Filter Housing Gasket.....	C4179-032

Breather Cover Gasket Set	
Application	Part #
3.4/3.8/4.2L.....	C4544-060

Water Pump Gasket	
Application	Part #
3.4/3.8/E4.2L .018" AFM.....	C4337-018

## 3.8L DOHC Inline 6

58-61 XK150 3.8, 58-61 XK150 3.8S, 58-61 Mark IX, 61-64 Mark X 3.8, 59-67 Mark II, 61-64 E-Type Series 1 3.8,  
63-68 S-Type 3.8

### Head Gaskets

**NEW!**

MLS Head Gaskets			
Bore	Thickness	Pkg Qty	Part #
88mm	.040"	1	C4282-040
88.5mm	.050"	1	C14082-050
89mm	.040"	1	C4306-040

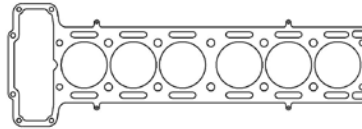

Additional thicknesses available  
see page 4

**NEW!**

CFM-20 Head Gasket			
Bore	Thickness	Pkg Qty	Part #
87mm	.059"	1	C4305-059
88mm	.059"	1	C14041-059
89mm	.059"	1	C4125-059

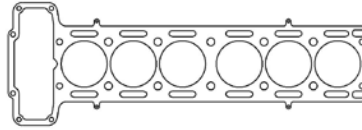

Additional thicknesses available  
see page 4

### Individual Gaskets

Cam Cover Gasket Set	
Application	Part #
3.4/3.8/4.2L (Trim to Fit) .....	C4545-060

Oil Pan Gasket	
Application	Part #
3.4/3.8/4.2L .060" AFM .....	C4259-060

Intake Manifold Gaskets	
Application	Part #
3.8/4.2L Str Port Head.....	C4230-060
3.4/3.8L B Type Head.....	C4244-060

Engine Cover Gaskets	
Application	Part #
Front Main Seal Gasket.....	C4673-188
Rear Main Seal Gasket .....	C4901-188

Exhaust Manifold Gasket	
Application	Part #
3.4/3.8/4.2L.....	C4217-059

Timing Cover Gasket	
Application	Part #
3.4/3.8/E4.2L .018" AFM.....	C4336-018

Thermostat Gaskets	
Application	Part #
Series 1 1965-67 .....	C4375-060
Series 2 1968-71 .....	C4379-060

Engine Oil Gaskets	
Application	Part #
Oil Feed Gasket.....	C4949-032
Oil Filter Housing Gasket.....	C4179-032

Breather Cover Gasket Set	
Application	Part #
3.4/3.8/4.2L.....	C4544-060

Water Pump Gasket	
Application	Part #
3.4/3.8/E4.2L .018" AFM.....	C4337-018





Cometic Gasket - An Exclusive NASCAR Performance Product

# JAGUAR

## 3.9/4.2L AJ33 V8 UK Engine

### Head Gaskets

#### MLS Head Gasket - Left Side

Bore	Thickness	Pkg Qty	Part #
93mm	.030"	1	C4376-030

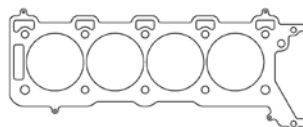

Additional thicknesses available see page 4

#### MLS Head Gasket - Right Side

Bore	Thickness	Pkg Qty	Part #
93mm	.030"	1	C4377-030

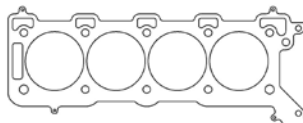

Additional thicknesses available see page 4

## 3.9/4.2L AJ30/AJ35 V8 US Engine

### Head Gaskets

#### MLS Head Gaskets - Left Side

Bore	Thickness	Pkg Qty	Part #
87mm	.030"	1	C5772-030
93mm	.030"	1	C5773-030

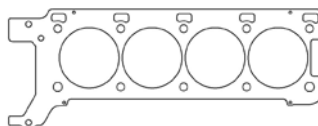

Additional thicknesses available see page 4

#### MLS Head Gaskets - Right Side

Bore	Thickness	Pkg Qty	Part #
87mm	.030"	1	C5770-030
93mm	.030"	1	C5771-030

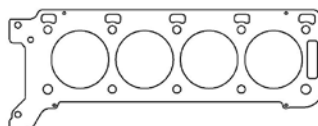

Additional thicknesses available see page 4

## 4.2L Inline 6 65-67 Series 1, 64-66 Mark X 4.2, 66-68 420

### Head Gaskets

#### CFM-20 Head Gasket

Bore	Thickness	Pkg Qty	Part #
93mm	.059"	1	C4338-059

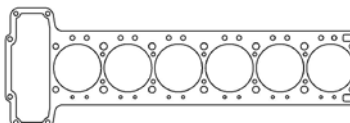

Additional thicknesses available see page 4

### Individual Gaskets

#### Cam Cover Gasket Set

Application	Part #
3.4/3.8/4.2L (Trim to Fit)	C4545-060

#### Oil Pan Gasket

Application	Part #
3.4/3.8/4.2L .060" AFM	C4259-060

#### Intake Manifold Gaskets

Application	Part #
3.8/4.2L Str Port Head	C4230-060
3.4/3.8L B Type Head	C4244-060

#### Main Seal Gasket

Application	Part #
Rear Main Seal Gasket	C4901-188

#### Exhaust Manifold Gasket

Application	Part #
3.4/3.8/4.2L	C4217-059

#### Timing Cover Gasket

Application	Part #
3.4/3.8/E4.2L .018" AFM	C4336-018

#### Thermostat Gaskets

Application	Part #
Series 1 1965-67	C4375-060
Series 2 1968-71	C4379-060

#### Engine Oil Gaskets

Application	Part #
Oil Feed Gasket	C4949-032
Oil Filter Housing Gasket	C4179-032

#### Breather Cover Gasket Set

Application	Part #
3.4/3.8/4.2L	C4544-060

#### Water Pump Gasket

Application	Part #
3.4/3.8/E4.2L .018" AFM	C4337-018



Cometic Gasket - An Exclusive NASCAR Performance Product

# JAGUAR

## 4.2L Inline 6 68-70 E-Type Series 2, 68-73 XJ6 4.2 Series 1

### Head Gaskets

#### CFM-20 Head Gasket

Bore	Thickness	Pkg Qty	Part #
93mm	.059"	1	C4220-059

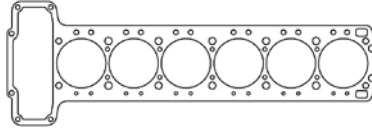

Additional thicknesses available see page 4

### Individual Gaskets

#### Cam Cover Gasket Set

Application	Part #
3.4/3.8/4.2L (Trim to Fit)	C4545-060

#### Oil Pan Gasket

Application	Part #
3.4/3.8/4.2L .060" AFM	C4259-060

#### Intake Manifold Gaskets

Application	Part #
3.8/4.2L Str Port Head	C4230-060
3.4/3.8L B Type Head	C4244-060

#### Main Seal Gasket

Application	Part #
Rear Main Seal Gasket	C4901-188

#### Exhaust Manifold Gasket

Application	Part #
3.4/3.8/4.2L	C4217-059

#### Timing Cover Gasket

Application	Part #
4.2L 1970+Up .018" AFM	C4902-018

#### Thermostat Gaskets

Application	Part #
Series 1 1965-67	C4375-060
Series 2 1968-71	C4379-060

#### Engine Oil Gaskets

Application	Part #
Oil Feed Gasket	C4949-032
Oil Filter Housing Gasket	C4179-032

#### Breather Cover Gasket Set

Application	Part #
3.4/3.8/4.2L	C4544-060

#### Water Pump Gasket

Application	Part #
3.4/3.8/E4.2L .018" AFM	C4337-018
4.2L 1970+Up .018" AFM	C4903-018

## 4.2L Hi-Performance Inline 6 1973-87 XJ6 4.2 Series 3

### Head Gaskets

#### MLS Head Gaskets

Bore	Thickness	Pkg Qty	Part #
3.670"	.040"	1	C4128-040
3.690"	.040"	1	C4127-040

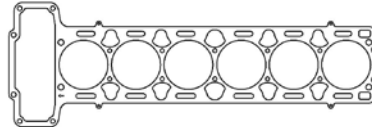

Additional thicknesses available see page 4

### Individual Gaskets

#### Cam Cover Gasket Set

Application	Part #
3.4/3.8/4.2L (Trim to Fit)	C4545-060

#### Oil Pan Gasket

Application	Part #
3.4/3.8/4.2L .060" AFM	C4259-060

#### Intake Manifold Gaskets

Application	Part #
3.8/4.2L Str Port Head	C4230-060
3.4/3.8L B Type Head	C4244-060

#### Main Seal Gasket

Application	Part #
Rear Main Seal Gasket	C4901-188

See page 99 for additional gaskets



Cometic Gasket - An Exclusive NASCAR Performance Product

# JAGUAR

## 4.2L Hi-Performance Inline 6 1973-87 XJ6 4.2 Series 3

### Individual Gaskets

Exhaust Manifold Gasket	
Application	Part #
3.4/3.8/4.2L.....	<b>C4217-059</b>

Timing Cover Gasket	
Application	Part #
4.2L 1970+Up .018" AFM .....	<b>C4902-018</b>

Thermostat Gaskets	
Application	Part #
Series 1 1965-67 .....	<b>C4375-060</b>
Series 2 1968-71 .....	<b>C4379-060</b>

Engine Oil Gaskets	
Application	Part #
Oil Feed Gasket.....	<b>C4949-032</b>
Oil Filter Housing Gasket.....	<b>C4179-032</b>

Breather Cover Gasket Set	
Application	Part #
3.4/3.8/4.2L.....	<b>C4544-060</b>

Water Pump Gasket	
Application	Part #
4.2L 1970+Up .018" AFM .....	<b>C4903-018</b>

## 5.0L V8 AJ133 2009+Up XF, XJ, XK, XFR, XJR, XKR, 2011+Up XKR-S, 2013+Up XFR-S, F-Type Convertible, 2014+Up F-Type Coupe

### Head Gaskets

MLX Head Gasket - Left Side			
Bore	Thickness	Pkg Qty	Part #
93mm .....	.040" .....	1 .....	<b>C15001-040</b>

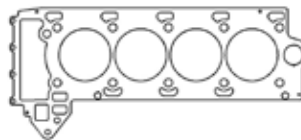

Additional thicknesses available see page 4

MLX Head Gasket - Right Side			
Bore	Thickness	Pkg Qty	Part #
93mm .....	.040" .....	1 .....	<b>C15000-040</b>

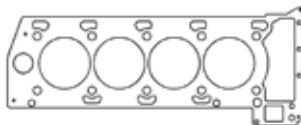

Additional thicknesses available see page 4

## 5.3L V12 1971-93

### Head Gaskets

CFM-20 Head Gaskets - Left Side			
Bore	Thickness	Pkg Qty	Part #
93mm .....	.059" .....	1 .....	<b>C4330-059</b>
97mm .....	.059" .....	1 .....	<b>C4221-059</b>

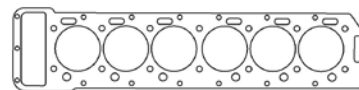

Additional thicknesses available see page 4

CFM-20 Head Gaskets - Right Side			
Bore	Thickness	Pkg Qty	Part #
93mm .....	.059" .....	1 .....	<b>C4331-059</b>
97mm .....	.059" .....	1 .....	<b>C4222-059</b>

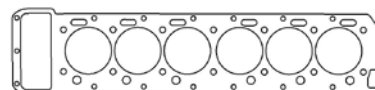

Additional thicknesses available see page 4

# MAZDA

## B6 1.6L DOHC 16V 1989-93 1597cc

### Head Gaskets

MLS Head Gasket			
Bore	Thickness	Pkg Qty	Part #
80mm .....	.040" .....	1 .....	<b>C4122-040</b>

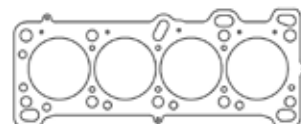

Additional thicknesses available see page 4

See page 100 for additional gaskets



Cometic Gasket - An Exclusive NASCAR Performance Product

# MAZDA

## B6 1.6L DOHC 16V 1989-93 1597cc

### Individual Gaskets

Valve Cover Gasket Set	
Application	Part #
B6 1.6L 89-93.....	C4781

Rear Main Seal Set	
Application	Part #
B6 1.6L 89-93.....	C4783

Intake Manifold Gasket	
Application	Part #
B6 1.6L 89-93 .060" KF.....	C4779-060

Oil Pump Gasket Set	
Application	Part #
B6 1.6L 89-93.....	C4784

Exhaust Manifold Gasket	
Application	Part #
B6 1.6L 89-93 .030" MLS.....	C4165-030

Oil Pan Gasket Set	
Application	Part #
B6 1.6L 89-93 (Requires RTV).....	C4785

Cam Seal Set	
Application	Part #
B6 1.6L 89-93 (2 Pack).....	C4780

Water Pump Gasket	
Application	Part #
B6 1.6L 89-93.....	C4786

Valve Stem Seals (sold individually)	
Application	Part #
B6 1.6L 89-93.....	3169V

Thermostat Gasket	
Application	Part #
B6 1.6L 89-93 .046" Fiber.....	C4782-046

### Gasket Kits



To purchase a complete gasket kit order both top end and bottom end gasket kit

#### TOP END GASKET KIT



Application	Part #
B6 1.6L 89-93 80mm Bore.....	PRO2036T

#### BOTTOM END GASKET KIT



Application	Part #
B6 1.6L 89-93.....	PRO2036B

## BP 1.8L DOHC 16V 1994-97 1839cc

### Head Gaskets

MLS Head Gaskets			
Bore	Thickness	Pkg Qty	Part #
83mm	.....040"	.....1.....	C4560-040
84mm	.....040"	.....1.....	C4568-040
85mm	.....040"	.....1.....	C4569-040

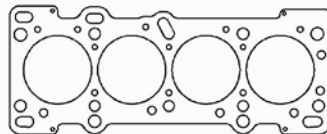

Additional thicknesses available see page 4



Cometic Gasket - An Exclusive NASCAR Performance Product

# MAZDA

## BP 1.8L DOHC 16V 2001-05 1839cc

### Head Gaskets

MLS Head Gaskets			
Bore	Thickness	Pkg Qty	Part #
84mm	.040"	1	C4983-040
85mm	.040"	1	C4984-040

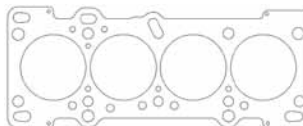

Additional thicknesses available see page 4

## FS-DE 2.0L DOHC 16V 1993-03 1991cc 1999-06 Kia Carens

### Head Gaskets

MLS Head Gaskets			
Bore	Thickness	Pkg Qty	Part #
84mm	.030"	1	C5844-030
84.5mm	.027"	1	C5845-027

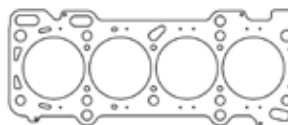

Additional thicknesses available see page 4

### Individual Gaskets

Valve Cover Gasket Set	
Application	Part #
FS-DE 2.0L DOHC	C4788

Oil Pan Gasket Set	
Application	Part #
FS-DE 2.0L DOHC	C4790-062

Intake Manifold Gasket	
Application	Part #
FS-DE 2.0L DOHC	C4787-046

Rear Main Seal Set	
Application	Part #
FS-DE 2.0L DOHC	C4791

Exhaust Manifold Gasket	
Application	Part #
FS-DE 2.0L DOHC .030" MLS	C4171-030

Water Pump Gasket	
Application	Part #
FS-DE 2.0L DOHC	C4792-031

Cam Seal Set	
Application	Part #
FS-DE 2.0L DOHC (2 Pack)	C4780

Thermostat Gasket	
Application	Part #
FS-DE 2.0L DOHC	C4789

Valve Stem Seals (sold individually)	
Application	Part #
FS-DE 2.0L DOHC	3225V

### Gasket Kits



To purchase a complete gasket kit order both top end and bottom end gasket kit

#### TOP END GASKET KIT



Application	Part #
FS-DE 2.0L DOHC 93-03 84mm Bore	PRO2037T

#### BOTTOM END GASKET KIT



Application	Part #
FS-DE 2.0L DOHC 93-03	PRO2037B



Cometic Gasket - An Exclusive NASCAR Performance Product

# MAZDA

## MZR 2.3L DOHC 16V 2261cc 2006-10

### Head Gasket

MLS Head Gasket			
Bore	Thickness	Pkg Qty	Part #
89mm	.....030"	.....1	C4481-030

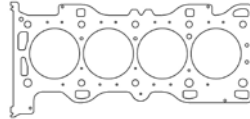

Additional thicknesses available see page 4

MLX Head Gasket			
Bore	Thickness	Pkg Qty	Part #
89mm	.....028"	.....1	C4970-028

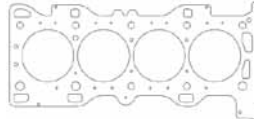

### Timing Cover Gasket

**NEW!**

Timing Cover Gasket	
Application	Part #
2006-08 MZR 2.3L	C14028

## MZR 2.5L DISI DOHC 16V 2488cc 2009

### Head Gasket

MLS Head Gasket			
Bore	Thickness	Pkg Qty	Part #
90mm	.....040"	.....1	C5906-040

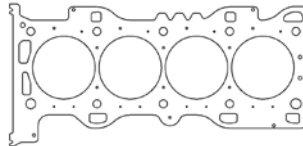

Additional thicknesses available see page 4

# MERCEDES BENZ

## M120 6.0/7.0L V12 92-02 600SEC, 600SEL, 600SL, 1997 CLK-GTR

### Head Gaskets

MLS Head Gasket - Left Side			
Bore	Thickness	Pkg Qty	Part #
90mm	.....051"	.....1	C4501-051

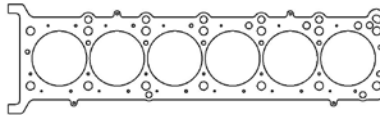

Additional thicknesses available see page 4

MLS Head Gasket - Right Side			
Bore	Thickness	Pkg Qty	Part #
90mm	.....051"	.....1	C4500-051

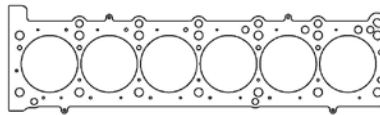

## M120 7.3L V12 99-10 Pagani Zonda, 99-05 AMG SL73

### Head Gaskets

MLS Head Gasket - Left Side			
Bore	Thickness	Pkg Qty	Part #
91.5mm	.....051"	.....1	C4504-051

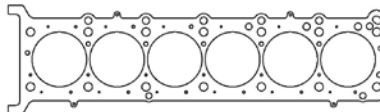

Additional thicknesses available see page 4

MLS Head Gasket - Right Side			
Bore	Thickness	Pkg Qty	Part #
91.5mm	.....051"	.....1	C4503-051

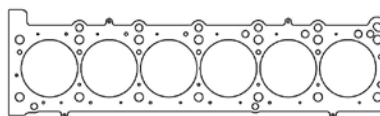



Cometic Gasket - An Exclusive NASCAR Performance Product

# MG

## Midget 1275cc Austin Series A

### Head Gasket

#### MLS Head Gasket

Bore	Thickness	Pkg Qty	Part #
74mm	.....040"	.....1	<b>C4148-040</b>

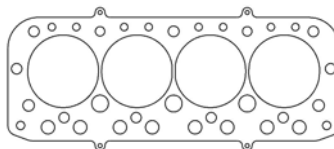

Additional thicknesses available see page 4

## MGA1500/1600/1600 MKII Series B

### Head Gasket

#### MLS Head Gasket

Bore	Thickness	Pkg Qty	Part #
74mm	.....040"	.....1	<b>C4359-040</b>

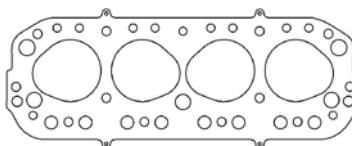

Additional thicknesses available see page 4

## MGB 1.8L 18G/18GA

### Head Gasket

#### MLS Head Gasket

Bore	Thickness	Pkg Qty	Part #
83mm	.....040"	.....1	<b>C4147-040</b>

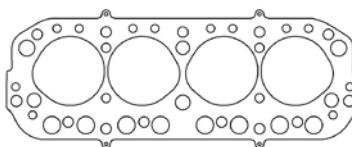

Additional thicknesses available see page 4

# MINI

## 1.6L Tritec/Pentagon 1999-06

### Head Gasket

#### MLS Head Gasket

Bore	Thickness	Pkg Qty	Part #
78.5mm	.....027"	.....1	<b>C4308-027</b>

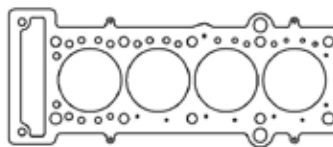

Additional thicknesses available see page 4

## 1.6L Turbo Prince/N14B16C/N14B16A/N18B16A/N18B16C 2007-2013

### Head Gasket

#### MLX Head Gasket

Bore	Thickness	Pkg Qty	Part #
78mm	.....032"	.....1	<b>C4617-032</b>
78mm	.....036"	.....1	<b>C4617-036</b>
78mm	.....040"	.....1	<b>C4617-040</b>

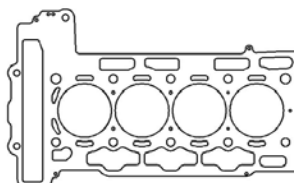

Additional thicknesses available see page 4



Cometic Gasket - An Exclusive NASCAR Performance Product

# MITSUBISHI

**2.0L 4G63/4G63-T DOHC** Eclipse 90-99, Galant 89-92, EVO 1-3 92-95

## Head Gaskets

### MLS Head Gaskets

Bore	Thickness	Pkg Qty	Part #
85.5mm	.051"	1	C4233-051
86mm	.051"	1	C4234-051
87mm	.051"	1	C4235-051

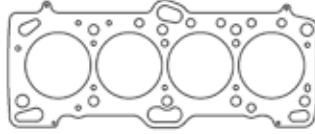

Additional thicknesses available see page 4

### MLX Head Gasket

Bore	Thickness	Pkg Qty	Part #
87mm	.050"	1	C4957-050

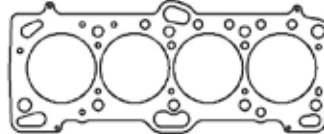

Additional thicknesses available see page 4

## Individual Gaskets

### Valve Cover Gasket Set

Application	Part #
4G63/T 89-94	C4691

### Throttle Body Gaskets

Application	Part #
4G63/T 91-94	C4693
4G63/T 95-97	C4904

### Intake Manifold Gasket

Application	Part #
4G63/T 89-94	C4692-060

### Oil Pan Gaskets

Application	Part #
4G63/T 89-92	C4695
4G63/T 93-94	C4698

### Exhaust Manifold Gasket

Application	Part #
4G63/T 89-94 .030" MLS	C4199-030

### Water Pump Gasket Set

Application	Part #
4G63/T 89-94	C4696

### Cam Seal Set

Application	Part #
4G63/T 89-94 (2 Pack)	C4905

### Rear Main Seal Set

Application	Part #
4G63/T 89-92	C4697
4G63/T 93-94	C4699

### Valve Stem Seals (sold individually)

Application	Part #
4G63/T 89-94	3173V

### Thermostat Gasket Set

Application	Part #
4G63/T 89-94	C4694

## Gasket Kits



To purchase a complete gasket kit order both top end and bottom end gasket kit

### TOP END GASKET KIT



Application	Part #
4G63/T 89-94 84mm Bore	PRO2006T

### BOTTOM END GASKET KITS



Application	Part #
4G63/T 89-92	PRO2006B
4G63/T 93-94	PRO2007B





Cometic Gasket - An Exclusive NASCAR Performance Product

# MITSUBISHI

## 2.0L 4G63/4G63-T DOHC:EVO 4-8 96-05

### Head Gaskets

#### MLS Head Gaskets

Bore	Thickness	Pkg Qty	Part #
85mm	.051"	1	C4157-051
86mm	.051"	1	C4156-051
87mm	.051"	1	C4591-051

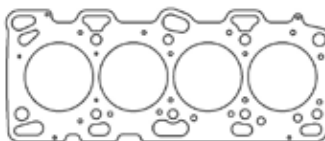

Additional thicknesses available see page 4

#### MLX Head Gasket

Bore	Thickness	Pkg Qty	Part #
87mm	.032"	1	C4956-050
87mm	.044"	1	C4956-050
87mm	.050"	1	C4956-050

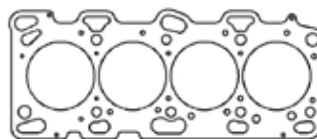

Additional thicknesses available see page 4

## 2.0L DOHC 4cyl ECC/420A 1995-99

### Head Gaskets

#### MLS Head Gaskets

Bore	Thickness	Pkg Qty	Part #
87.5mm	.040"	1	C5497-040
88.5mm	.040"	1	C5498-040

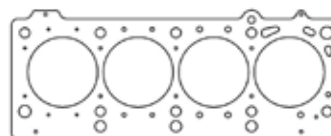

Additional thicknesses available see page 4

### Individual Gaskets

#### Valve Cover Gasket Set

Application	Part #
1995-99 2.0L DOHC	C15046

#### Cam Seal Set

Application	Part #
Pair - 48 x 35 x 7	C15049

#### Intake Manifold Gaskets

Application	Part #
Intake Manifold Gasket - .060" AFM	C15047-060
Intake Plenum Gasket - .031" Fiber	C15048-031

#### Front Crank Seal Set

Application	Part #
1995-99 2.0L DOHC	C15053

#### Exhaust Manifold Gasket

Application	Part #
2.040" X 1.100" Port - MLS	C4161-030

#### Oil Pan Gasket

Application	Part #
Molded Rubber	C15050

#### Throttle Body Gasket

Application	Part #
Molded Rubber	C15051

#### Rear Main Seal

Application	Part #
1995-99 2.0L DOHC	C15052

#### Valve Stem Seals Set (16 Pack)

Application	Part #
5 x 10.8 x 18.3 x 16.9 - Hat Style	3180V-16

See page 106 for StreetPro gasket kits



Cometic Gasket - An Exclusive NASCAR Performance Product

# MITSUBISHI

## 2.0L DOHC 4cyl ECC/420A 1995-99

### Gasket Kits



To purchase a complete gasket kit order both top end and bottom end gasket kit

#### TOP END GASKET KIT



Application	Part #
1995-99 420A 2.0L DOHC 88.5mm Bore.....	<b>PRO2005T</b>

#### BOTTOM END GASKET KIT



Application	Part #
1995-99 420A 2.0L DOHC.....	<b>PRO2005B</b>

## 2.0L 4B11T Turbo 2007+: EVO X 2007-15

### Head Gaskets

#### MLX Head Gaskets

Bore	Thickness	Pkg Qty	Part #
88mm	.....044"	.....1	<b>C4483-044</b>
90mm	.....044"	.....1	<b>C4484-044</b>

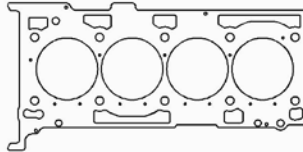

Additional thicknesses available  
see page 4

## 3.0L 6G72 SOHC/DOHC 24v V6 1988-00

### Head Gaskets

#### MLS Head Gaskets

Bore	Thickness	Pkg Qty	Part #
93mm	.....051"	.....1	<b>C4243-051</b>
95mm	.....051"	.....1	<b>C4240-051</b>

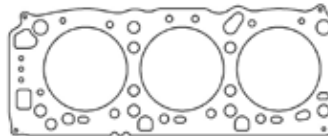

Additional thicknesses available  
see page 4

### Individual Gaskets

#### Valve Cover Gasket Sets

Application	Part #
1988-96 3.0L V6 SOHC.....	<b>C4713</b>
1991-00 3.0L V6 DOHC .....	<b>C4722</b>

#### Oil Pan Gaskets

Application	Part #
1988-96 3.0L V6 SOHC.....	<b>C4717</b>
1991-00 3.0L V6 DOHC .....	<b>C4727</b>

#### Intake Manifold Gasket Sets

Application	Part #
1988-96 3.0L V6 SOHC.....	<b>C4714</b>
1991-00 3.0L V6 DOHC .....	<b>C4723</b>

#### Water Pump Gasket Sets

Application	Part #
1988-96 3.0L V6 SOHC.....	<b>C4719</b>
1991-00 3.0L V6 DOHC .....	<b>C4728-020</b>

#### Exhaust Manifold Gasket Sets

Application	Part #
1988-96 3.0L V6 SOHC.....	<b>C4715-042</b>
1991-00 3.0L V6 DOHC .....	<b>C4724-064</b>

#### Rear Main Seal Set

Application	Part #
1988-00 3.0L V6 SOHC/DOHC.....	<b>C4720</b>

See page 107 for additional gaskets



Cometic Gasket - An Exclusive NASCAR Performance Product

# MITSUBISHI

## 3.0L 6G72 SOHC/DOHC 24v V6 1988-00

### Individual Gaskets

Cam Seal Sets	
Application	Part #
1988-96 3.0L V6 SOHC (2) .....	<b>C4905</b>
1991-00 3.0L V6 DOHC (4) .....	<b>C4725</b>

Oil Pump Gasket Kits	
Application	Part #
1988-96 3.0L V6 SOHC .....	<b>C4721</b>
1991-00 3.0L V6 DOHC .....	<b>C4729</b>

Valve Stem Seals (sold individually)	
Application	Part #
1988-96 3.0L V6 SOHC .....	<b>3157V</b>
1991-00 3.0L V6 DOHC .....	<b>3163V</b>

Thermostat Gaskets	
Application	Part #
1988-96 3.0L V6 SOHC .....	<b>C4716-032</b>
1991-00 3.0L V6 DOHC .....	<b>C4726</b>

### Gasket Kits



To purchase a complete gasket kit order both top end and bottom end gasket kit

#### TOP END GASKET KITS



Application	Part #
1988-96 3.0L V6 SOHC 93mm Bore .....	<b>PRO2038T</b>
1991-00 3.0L V6 DOHC 93mm Bore .....	<b>PRO2039T</b>

#### BOTTOM END GASKET KITS



Application	Part #
1988-96 3.0L V6 SOHC .....	<b>PRO2038B</b>
1991-00 3.0L V6 DOHC .....	<b>PRO2039B</b>

# NISSAN

## 1.5L E15, E15S, E15T SOHC Pulsar 80-86, Ninja Gayin 84-94, Sunny 80-86

### Head Gasket

MLS Head Gasket			
Bore	Thickness	Pkg Qty	Part #
77mm .....	.040" .....	1 .....	<b>C4178-040</b>

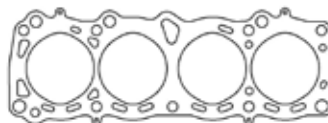

Additional thicknesses available see page 4

### Individual Gaskets

Valve Cover Gasket Set	
Application	Part #
E15T 1983-84 .....	<b>C4906</b>

Cam Seal	
Application	Part #
E15T 1983-84 .....	<b>C4910</b>

Intake Manifold Gasket	
Application	Part #
E15T 1983-84 .....	<b>C4907</b>

Rear Main Seal Set	
Application	Part #
E15T 1983-84 .....	<b>C4763</b>

See page 108 for additional gaskets



Cometic Gasket - An Exclusive NASCAR Performance Product

# NISSAN

## 1.5L E15, E15S, E15T SOHC Pulsar 80-86, Ninja Gayin 84-94, Sunny 80-86

### Individual Gaskets

#### Exhaust Manifold Gaskets

Application	Part #
1982-83 E15S SOHC .....	<b>C4908</b>
1983-84 E15T SOHC .....	<b>C4909</b>

#### Front Crank Set

Application	Part #
E15T 1983-84.....	<b>C4912</b>

#### Valve Stem Seals (sold individually)

Application	Part #
E15T 1983-84.....	<b>3159V</b>

#### Water Pump Gasket Set

Application	Part #
E15T 1983-84.....	<b>C4913</b>

## 1.6L MR16DDT Juke 2011-2017, 2017-Present Sentra SR Turbo & NISMO

### Head Gasket

#### MLS Head Gasket

Bore	Thickness	Pkg Qty	Part #
81mm .....	.032"	1.....	<b>C4965-032</b>

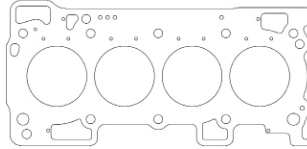

Additional thicknesses available  
see page 4

## 1.8L CA18 SOHC

Skyline R31 88-90, Skyline R32 GXi 88-90, Skyline HR31 85-91, Silvia Turbo 84-89, 180SX 81-83, 200SX 84-88, Bluebird Turbo 91-93, Bluebird 83-85, 200SX Turbo 84-87, Pulsar 81-83, Sunny 88-91

### Head Gaskets

#### MLS Head Gasket

Bore	Thickness	Pkg Qty	Part #
85mm .....	.051"	1.....	<b>C4479-051</b>

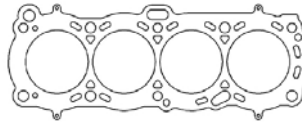

Additional thicknesses available  
see page 4

## 1.8L CA18 DOHC

Skyline HR31 85-91, Silvia Turbo 89-90, 180SX P/S13 89-90, 200SX S13-U 89-93, Bluebird Turbo 87-89, Bluebird 87-89, 200SX Turbo 89-93, Pulsar, Sunny N13/B12 Coupe mid 80s

### Head Gaskets

#### MLS Head Gasket

Bore	Thickness	Pkg Qty	Part #
85mm .....	.051"	1.....	<b>C4480-051</b>

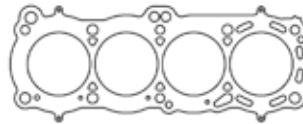

Additional thicknesses available  
see page 4

### Individual Gaskets

#### Valve Cover Gasket Set

Application	Part #
CA18DE/DET 1.8L.....	<b>C4607</b>

#### Throttle Body Gaskets

Application	Part #
CA18DE/DET 1.8L (pair) .....	<b>C4740-032</b>

#### Intake Manifold Gasket Set

Application	Part #
CA18DE/DET 1.8L.....	<b>C4742</b>

#### Rear Main Seal Set

Application	Part #
CA18DE/DET 1.8L.....	<b>C4737</b>

#### Exhaust Manifold Gasket Set

Application	Part #
CA18DE/DET 1.8L MLS 4pcs.....	<b>C4523</b>

#### Water Pump Gasket

Application	Part #
CA18DE/DET 1.8L.....	<b>C4736-018</b>



Cometic Gasket - An Exclusive NASCAR Performance Product

# NISSAN

**1.8L CA18 DOHC** Skyline HR31 85-91, Silvia Turbo 89-90, 180SX P/S13 89-90, 200SX S13-U 89-93, Bluebird Turbo 87-89, Bluebird 87-89, 200SX Turbo 89-93, Pulsar, Sunny N13/B12 Coupe mid 80s

### Individual Gaskets

Cam Seal Set	
Application	Part #
CA18DE/DET 1.8L (pair) .....	<b>C4739</b>

Oil Pump Gasket	
Application	Part #
CA18DE/DET 1.8L.....	<b>C4738-020</b>

Valve Stem Seals (sold individually)	
Application	Part #
CA18DE/DET 1.8L.....	<b>3175V</b>

Front Crank Seal	
Application	Part #
CA18DE/DET 1.8L.....	<b>C4914</b>

### Gasket Kits



To purchase a complete gasket kit order both top end and bottom end gasket kit

#### TOP END GASKET KIT

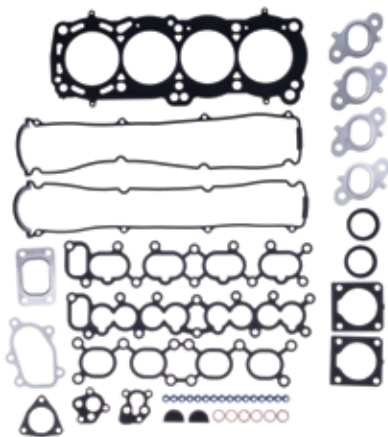

Application	Part #
CA18DE/DET 1.8L 85mm Bore.....	<b>PRO2018T</b>

#### BOTTOM END GASKET KIT



Application	Part #
CA18DE/DET 1.8L.....	<b>PRO2018B</b>

## 2.0L FJ20E/ET 240RS 83-85, Skyline DR30 83-85, Silvia 83-85

### Head Gaskets

MLS Head Gaskets			
Bore	Thickness	Pkg Qty	Part #
90mm	.....051"	.....1.....	<b>C4326-051</b>
91mm	.....051"	.....1.....	<b>C4327-051</b>

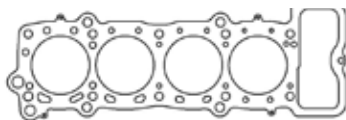

Additional thicknesses available see page 4

## 1.6L SR16VE/2.0L SR20VE DOHC 97-01 Pulsar, Lucino, Primera, Bluebird, Wingroad, Sunny

### Head Gasket

MLS Head Gaskets			
Bore	Thickness	Pkg Qty	Part #
87mm	.....040"	.....1.....	<b>C4600-040</b>
88mm	.....040"	.....1.....	<b>C4601-040</b>

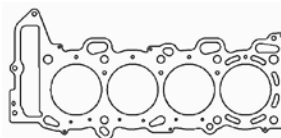

Additional thicknesses available see page 4

### Individual Gaskets

Valve Cover Gasket Set	
Application	Part #
SR16VE/SR20VE .....	<b>C4730</b>

Throttle Body Gasket	
Application	Part #
SR16VE/SR20VE .....	<b>C4733-018</b>

See page 110 for additional gaskets



Cometic Gasket - An Exclusive NASCAR Performance Product

# NISSAN

**1.6L SR16VE/2.0L SR20VE DOHC** 97-01 Pulsar, Lucino, Primera, Bluebird, Wingroad, Sunny

### Individual Gaskets

Intake Manifold Gasket Set	
Application	Part #
SR16VE/SR20VE .....	<b>C4731</b>

Rear Main Seal	
Application	Part #
SR16VE/SR20VE .....	<b>C4734</b>

Exhaust Manifold Gasket Set	
Application	Part #
SR16VE/SR20VE .....	<b>C4732-064</b>

Oil Pump Gasket	
Application	Part #
SR16VE/SR20VE .....	<b>C4735-020</b>

Valve Stem Seals (sold individually)	
Application	Part #
SR16VE/SR20VE .....	<b>3175V</b>

Front Crank Seal	
Application	Part #
SR16VE/SR20VE .....	<b>C4915</b>

### Gasket Kits



To purchase a complete gasket kit order both top end and bottom end gasket kit

#### TOP END GASKET KIT

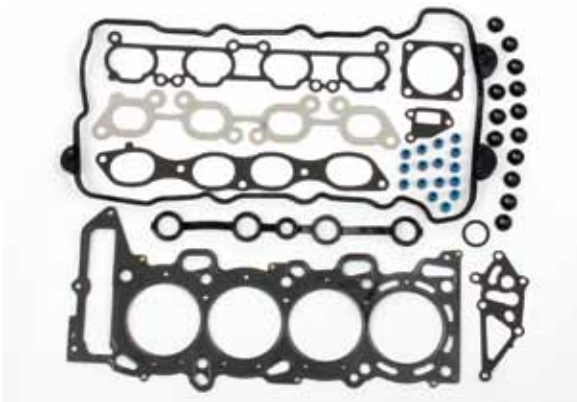

Application	Part #
SR16VE/SR20VE 88mm Bore .....	<b>PRO2053T</b>

#### BOTTOM END GASKET KIT



Application	Part #
SR16VE/SR20VE .....	<b>PRO2053B</b>

# 2.0L SR20DE/DET DOHC FWD

91-92/94-97 180SX, 95-98 200SX SE-R, 96-98 Almera, 90/92-95/97-01 Avenir, 89/91-93/95-98 Bluebird, 98-00 Liberty, 91-02 Infinity G20, 91-93 NX2000, 91-00 Pulsar, 91-94/98-01 Sentra

### Head Gaskets

MLS Head Gaskets			
Bore	Thickness	Pkg Qty	Part #
87mm .....	.030" .....	1 .....	<b>C4575-030</b>
88.5mm .....	.030" .....	1 .....	<b>C4130-030</b>

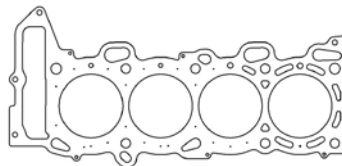

Additional thicknesses available see page 4

### Individual Gaskets

Valve Cover Gasket Sets	
Application	Part #
SR20DE/DET FWD 91-96 .....	<b>C4747</b>
SR20DE/DET FWD 97-01 .....	<b>C4730</b>

Thermostat Gasket Set	
Application	Part #
SR20DE/DET FWD 91-01 .....	<b>C4916</b>

See page 111 for additional gaskets



Cometic Gasket - An Exclusive NASCAR Performance Product

# NISSAN

## 2.0L SR20DE/DET DOHC FWD

91-92/94-97 180SX, 95-98 200SX SE-R, 96-98 Almera, 90/92-95/97-01 Avenir, 89/91-93/95-98 Bluebird, 98-00 Liberty, 91-02 Infinity G20, 91-93 NX2000, 91-00 Pulsar, 91-94/98-01 Sentra

### Individual Gaskets

#### Intake Manifold Gaskets

Application	Part #
SR20DE/DET FWD 91-93 .....	C4746
SR20DE/DET FWD 94-01 .....	C4749

#### Oil Pan Gasket

Application	Part #
SR20DE/DET FWD 91-01 .....	C4744-156

#### Exhaust Manifold Gasket Set

Application	Part #
SR20DE/DET FWD 91-01 MLS .....	C4200-030

#### Water Pump Gasket

Application	Part #
SR20DE/DET FWD 91-01 .....	C4745-031

#### Throttle Body Gasket

Application	Part #
SR20DE/DET FWD 91-01 .....	C4733-018

#### Oil Pump Gasket

Application	Part #
SR20DE/DET FWD 91-01 .....	C4743

#### Valve Stem Seals (sold individually)

Application	Part #
SR20DE/DET FWD 91-01 .....	3175V

#### Front Crank Seal

Application	Part #
SR20DE/DET FWD 91-01 .....	C4915

### Gasket Kits



To purchase a complete gasket kit order both top end and bottom end gasket kit

#### TOP END GASKET KIT



Application	Part #
SR20DE/DET FWD 91-96 87mm Bore .....	PRO2012T
SR20DE/DET FWD 97-01 87mm Bore .....	PRO2011T

#### BOTTOM END GASKET KIT



Application	Part #
SR20DE/DET FWD 91-01 .....	PRO2012B

## 2.0L SR20DE/DET DOHC S13 1989-93

### Head Gasket

#### MLS Head Gasket

Bore	Thickness	Pkg Qty	Part #
87.5mm .....	.045" .....	1 .....	C4324-045

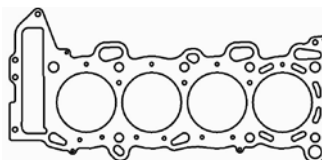

Additional thicknesses available see page 4

See page 112 for additional gaskets



Cometic Gasket - An Exclusive NASCAR Performance Product

# NISSAN

## 2.0L SR20DE/DET DOHC S13 1989-93

### Individual Gaskets

Valve Cover Gasket Set	
Application	Part #
SR20DE/DET S13 89-93.....	<b>C4753</b>

Throttle Body Gasket	
Application	Part #
SR20DE/DET S13 89-93.....	<b>C4733-018</b>

Intake Manifold Gasket Set	
Application	Part #
SR20DE/DET S13 89-93.....	<b>C4752</b>

Thermostat Gasket Set	
Application	Part #
SR20DE/DET S13 89-93.....	<b>C4758</b>

Exhaust Manifold Gasket Set	
Application	Part #
SR20DE/DET S13 89-93 MLS .....	<b>C4200-030</b>

Rear Main Seal Set	
Application	Part #
SR20DE/DET S13 89-93.....	<b>C4743</b>

Valve Stem Seals (sold individually)	
Application	Part #
SR20DE/DET S13 - EXH .....	<b>3158V</b>
SR20DE/DET S13 - INT .....	<b>3175V</b>

Front Crank Seal	
Application	Part #
SR20DE/DET S13 89-93.....	<b>C4915</b>

### Gasket Kits



To purchase a complete gasket kit order both top end and bottom end gasket kit

#### TOP END GASKET KIT



Application	Part #
SR20DE/DET S13 w/o VC Set 87.5mm Bore ..	<b>PRO2008T</b>
SR20DE/DET S13 89-93 88mm Bore .....	<b>PRO2053T</b>

#### BOTTOM END GASKET KIT



Application	Part #
SR20DE/DET S13 89-93.....	<b>PRO2010B</b>

## 2.0L SR20DE/DET DOHC S14 1994-98

### Head Gaskets

**NEW!**

#### MLS Head Gaskets

Bore	Thickness	Pkg Qty	Part #
86mm	.051"	1	<b>C14052-051</b>
87mm	.040"	1	<b>C14034-040</b>
87mm	.051"	1	<b>C14056-051</b>
87.5mm	.045"	1	<b>C4576-045</b>
88.5mm	.045"	1	<b>C4283-045</b>

#### MLX Head Gaskets

Bore	Thickness	Pkg Qty	Part #
87mm	.040"	1	<b>C4950-040</b>
88mm	.040"	1	<b>C4951-040</b>

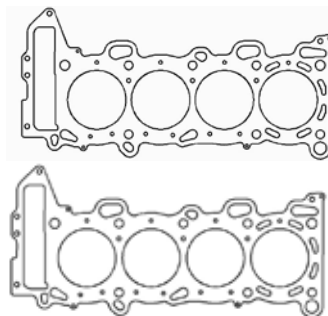

Additional thicknesses available see page 4





Cometic Gasket - An Exclusive NASCAR Performance Product

# NISSAN

## 2.0L SR20DE/DET DOHC S14 1994-98

### Individual Gaskets

Valve Cover Gasket Set	
Application	Part #
SR20DE/DET S14 94-98.....	<b>C4755</b>

Throttle Body Gasket	
Application	Part #
SR20DE/DET S14 94-98.....	<b>C4754-032</b>

Intake Manifold Gasket Set	
Application	Part #
SR20DE/DET S14 94-98.....	<b>C4749</b>

Thermostat Gasket Set	
Application	Part #
SR20DE/DET S14 94-98.....	<b>C4758</b>

Exhaust Manifold Gasket Set	
Application	Part #
SR20DE/DET S14 94-98 MLS .....	<b>C4200-030</b>

Rear Main Seal Set	
Application	Part #
SR20DE/DET S14 94-98.....	<b>C4743</b>

Valve Stem Seals (sold individually)	
Application	Part #
SR20DE/DET S14 - EXH .....	<b>3158V</b>
SR20DE/DET S14 - INT .....	<b>3175V</b>

Front Crank Seal	
Application	Part #
SR20DE/DET S14 94-98.....	<b>C4915</b>

### Gasket Kit



To purchase a complete gasket kit order both top end and bottom end gasket kit

#### TOP END GASKET KIT

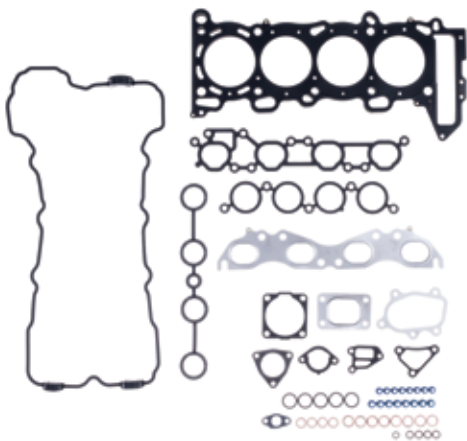

Application	Part #
SR20DE/DET S14 94-98 87.5mm Bore .....	<b>PRO2009T</b>

#### BOTTOM END GASKET KIT



Application	Part #
SR20DE/DET S14 94-98.....	<b>PRO2010B</b>

## 2.0L SR20DE/DET DOHC GTiR RNN14 AWD 1990-94

### Head Gaskets

MLS Head Gaskets			
Bore	Thickness	Pkg Qty	Part #
87.5mm .....	.040" .....	1 .....	<b>C4543-040</b>
88mm.....	.040" .....	1 .....	<b>C4577-040</b>

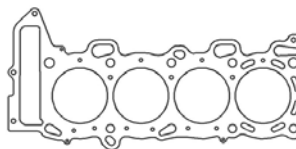

Additional thicknesses available see page 4

### Individual Gaskets

Valve Cover Gasket Set	
Application	Part #
SR20DE/DET GTiR RNN14 .....	<b>C4747</b>

Throttle Body Gasket	
Application	Part #
SR20DE/DET GTiR RNN14 .....	<b>C4756-018</b>

See page 114 for additional gaskets



Cometic Gasket - An Exclusive NASCAR Performance Product

# NISSAN

## 2.0L SR20DE/DET DOHC GTiR RNN14 AWD 1990-94

### Individual Gaskets

Intake Manifold Gasket Set	
Application	Part #
SR20DE/DET GTiR RNN14 .....	<b>C4757-018</b>

Thermostat Gasket Set	
Application	Part #
SR20DE/DET GTiR RNN14 .....	<b>C4758</b>

Exhaust Manifold Gasket Set	
Application	Part #
SR20DE/DET GTiR RNN14 MLS .....	<b>C4200-030</b>

Rear Main Seal Set	
Application	Part #
SR20DE/DET GTiR RNN14 .....	<b>C4743</b>

Valve Stem Seals (sold individually)	
Application	Part #
SR20DE/DET GTiR - EXH.....	<b>3158V</b>
SR20DE/DET GTiR - INT .....	<b>3175V</b>

Front Crank Seal	
Application	Part #
SR20DE/DET GTiR RNN14 .....	<b>C4915</b>

### Gasket Kits



To purchase a complete gasket kit order both top end and bottom end gasket kit

#### TOP END GASKET KIT



Application	Part #
SR20DE/DET GTiR RNN14 87.5mm Bore.....	<b>PRO2010T</b>

#### BOTTOM END GASKET KIT



Application	Part #
SR20DE/DET GTiR RNN14 .....	<b>PRO2010B</b>

## 2.0L RB20E/DE/DET Inline 6 Laurel 1988-93, Skyline R32 1988-93, Cefiro 1988-93

### Head Gaskets

MLS Head Gaskets			
Bore	Thickness	Pkg Qty	Part #
80mm .....	.040" .....	1.....	<b>C4495-040</b>

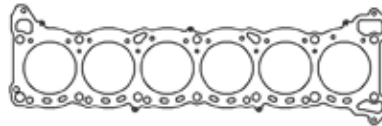

Additional thicknesses available see page 4

### Individual Gaskets

Valve Cover Gasket Set	
Application	Part #
RB20E/DE/DET 88-93.....	<b>C4552</b>

Throttle Body Gasket	
Application	Part #
RB20E/DE/DET 88-93.....	<b>C4733-018</b>

Intake Manifold Gasket Set	
Application	Part #
RB20E/DE/DET 88-93.....	<b>C4759</b>

Rear Main Seal	
Application	Part #
RB20E/DE/DET 88-93.....	<b>C4770.....</b>

See page 115 for additional gaskets



Cometic Gasket - An Exclusive NASCAR Performance Product

# NISSAN

## 2.0L RB20E/DE/DET Inline 6 Laurel 1988-93, Skyline R32 1988-93, Cefiro 1988-93

### Individual Gaskets

Exhaust Manifold Gasket	
Application	Part #
RB20E/DE/DET 88-93 MLS .....	C4177-030

Oil Pump Gasket	
Application	Part #
RB20E/DE/DET 88-93 .....	C4769-020

Cam Seal Set	
Application	Part #
RB20E/DE/DET 88-93 (pair) .....	C4739

Front Crank Seal	
Application	Part #
RB20E/DE/DET 88-93 .....	C4914

Valve Stem Seals (sold individually)	
Application	Part #
RB20E/DE/DET 88-93 .....	3175V

Oil Pan Gasket	
Application	Part #
RB20E/DE/DET 88-93 .....	C14117-094

### Gasket Kits



To purchase a complete gasket kit order both top end and bottom end gasket kit

#### TOP END GASKET KIT

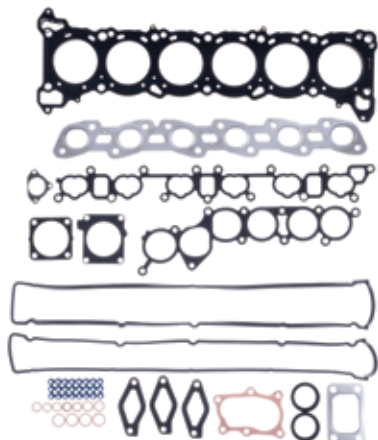

Application	Part #
RB20E/DE/DET 88-93 80mm Bore .....	PRO2015T

#### BOTTOM END GASKET KIT



Application	Part #
RB20E/DE/DET 88-93 .....	PRO2017B

## 2.4L KA24DE DOHC: 1991-98 240SX

### Head Gaskets

MLS Head Gaskets			
Bore	Thickness	Pkg Qty	Part #
90mm .....	.040"	1 .....	C4285-040
91mm .....	.040"	1 .....	C4286-040

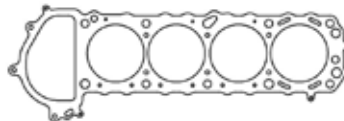

Additional thicknesses available see page 4

### Individual Gaskets

Valve Cover Gasket Sets	
Application	Part #
KA24DE 1991-94 .....	C4761
KA24DE 1995-98 .....	C4766

Oil Pan Gasket	
Application	Part #
KA24DE 1991-98 .....	C4764-060

Intake Manifold Gasket Set	
Application	Part #
KA24DE 1991-98 .....	C4760

Water Pump Gasket	
Application	Part #
KA24DE 1991-98 .....	C4765-031

See page 116 for additional gaskets



Cometic Gasket - An Exclusive NASCAR Performance Product

# NISSAN

## 2.4L KA24DE DOHC: 1991-98 240SX

### Individual Gaskets

<b>Exhaust Manifold Gasket</b>	
Application	Part #
KA24DE 1991-98 MLS .....	<b>C4201-030</b>

<b>Rear Main Seal Set</b>	
Application	Part #
KA24DE 1991-98.....	<b>C4763</b>

<b>Throttle Body Gasket</b>	
Application	Part #
KA24DE 1991-98.....	<b>C4733-018</b>

<b>Thermostat Gasket Set</b>	
Application	Part #
KA24DE 1991-98.....	<b>C4762</b>

<b>Valve Stem Seals (sold individually)</b>	
Application	Part #
KA24DE 1991-98.....	<b>3158V</b>

<b>Front Crank Seal</b>	
Application	Part #
KA24DE 1991-98.....	<b>C4915</b>

### Gasket Kits



To purchase a complete gasket kit order both top end and bottom end gasket kit

#### TOP END GASKET KITS



Application	Part #
KA24DE 1991-94 90mm Bore.....	<b>PRO2014T</b>
KA24DE 1995-98 90mm Bore.....	<b>PRO2013T</b>

#### BOTTOM END GASKET KIT



Application	Part #
KA24DE 1991-98.....	<b>PRO2014B</b>

## 2.5L QR25DE DOHC 2002-06 FWD *Sentra SE-R/SE-R Spec V, Altima Base/S/SL*

### Head Gasket

<b>MLS Head Gasket</b>			
Bore	Thickness	Pkg Qty	Part #
90mm	.....030"	.....1	<b>C4615-030</b>

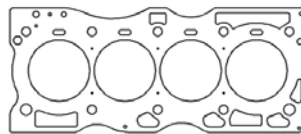

Additional thicknesses available see page 4

### Individual Gaskets

<b>Intake Manifold Gasket Set</b>	
Application	Part #
QR25DE FWD 02-06.....	<b>C4748</b>

<b>Throttle Body Gasket</b>	
Application	Part #
QR25DE FWD 02-06.....	<b>C4911</b>



Cometic Gasket - An Exclusive NASCAR Performance Product

# NISSAN

## 2.5L QR25DE DOHC 2007-12 FWD *Sentra SE-R/SE-R Spec V, Altima Base/S/Hybrid, Rogue S/SL/S Krom/SV*

### Head Gasket

MLS Head Gasket			
Bore	Thickness	Pkg Qty	Part #
90mm	.....030"	.....1	<b>C4614-030</b>

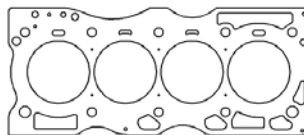

Additional thicknesses available  
see page 4

### Individual Gaskets

Water Inlet Gasket	
Application	Part #
QR25DE FWD 07-12	<b>C4751</b>

Water Outlet Gasket	
Application	Part #
QR25DE FWD 07-12	<b>C4917</b>

## 2.5L QR25DE DOHC 2005-12 RWD

*05-10 Frontier XE, 08-10 Frontier SE, 05 X-Trail LE/SE/XE, 11-12 Frontier S/SV*

### Head Gasket

MLS Head Gasket			
Bore	Thickness	Pkg Qty	Part #
90mm	.....030"	.....1	<b>C4616-030</b>

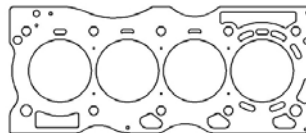

Additional thicknesses available  
see page 4

### Individual Gaskets

Water Outlet Gasket	
Application	Part #
QR25DE RWD 05-12	<b>C4918</b>

Water Pump Gasket Set	
Application	Part #
QR25DE RWD 05-12	<b>C4919</b>

## L23, L24S, L24E, L26 Non-Turbo Inline 6 1970-84: 240/260/280Z, Cedric, Fairlady, Datsun 810, Maxima

### Head Gasket

MLS Head Gasket			
Bore	Thickness	Pkg Qty	Part #
85mm	.....036"	.....1	<b>C4579-036</b>
85mm	.....040"	.....1	<b>C4579-040</b>
85mm	.....070"	.....1	<b>C4579-070</b>

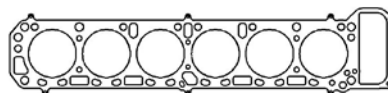

Additional thicknesses available  
see page 4

## L28E, L28S, L28ES Non-Turbo Inline 6 1975-80: 280Z, 280ZX Patrol, Fairlady, Detric, Laurel

### Head Gasket

MLS Head Gasket			
Bore	Thickness	Pkg Qty	Part #
89mm	.....040"	.....1	<b>C4580-040</b>

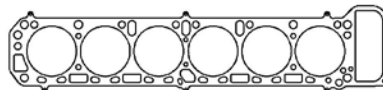

Additional thicknesses available  
see page 4



Cometic Gasket - An Exclusive NASCAR Performance Product

# NISSAN

## RB25DET 2.5L Inline 6 *Patrol 89-93, Skyline 89-93, Skyline GT-R 89-02*

### Head Gaskets

#### MLS Head Gaskets

Bore	Thickness	Pkg Qty	Part #
86mm	0.051"	1	C4317-051
87mm	0.051"	1	C4318-051

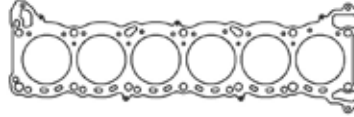

Additional thicknesses available see page 4

### Individual Gaskets

#### Valve Cover Gasket Set

Application	Part #
RB25DET	C4552

#### Throttle Body Gasket

Application	Part #
RB25DET	C4767

#### Intake Manifold Gasket Set

Application	Part #
RB25DET	C4768

#### Rear Main Seal

Application	Part #
RB25DET	C4770

#### Exhaust Manifold Gasket

Application	Part #
RB25DET MLS	C4177-030

#### Oil Pump Gasket

Application	Part #
RB25DET	C4769-020

#### Cam Seal Set

Application	Part #
RB25DET (pair)	C4739

#### Front Crank Seal

Application	Part #
RB25DET	C4914

#### Valve Stem Seals (sold individually)

Application	Part #
RB25DET	3175V

**NEW!**

#### Oil Pan Gasket

Application	Part #
RB20 /RB RB25 88-02	C14117-094

### Gasket Kits



To purchase a complete gasket kit order both top end and bottom end gasket kit

#### TOP END GASKET KIT



Application	Part #
RB25DET 87mm Bore	PRO2016T

#### BOTTOM END GASKET KIT



Application	Part #
RB25DET	PRO2017B



Cometic Gasket - An Exclusive NASCAR Performance Product

# NISSAN

**RB26DET 2.6L DOHC Inline 6** Patrol 89-93, Skyline 89-93, Skyline GT-R 89-02

## Head Gaskets

### MLS Head Gaskets

Bore	Thickness	Pkg Qty	Part #
86mm	.....051"	.....1	<b>C4319-051</b>
87mm	.....051"	.....1	<b>C4320-051</b>
88mm	.....051"	.....1	<b>C4321-051</b>

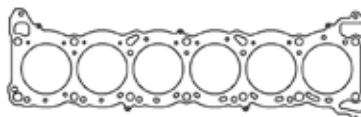

Additional thicknesses available see page 4

## Individual Gaskets

### Valve Cover Gasket Set

Application	Part #
RB26DET	<b>C4552</b>

### Throttle Body Gasket Set

Application	Part #
RB26DET - 6 Pack	<b>C4920</b>

### Intake Manifold Gasket

Application	Part #
RB26DET	<b>C4372</b>

### Rear Main Seal

Application	Part #
RB26DET	<b>C4770</b>

### Exhaust Manifold Gasket

Application	Part #
RB26DET MLS	<b>C4202-030</b>

### Oil Pump Gasket

Application	Part #
RB20E/DE/DET 88-93	<b>C4769-020</b>

### Cam Seal Set

Application	Part #
RB26DET (pair)	<b>C4739</b>

### Front Crank Seal

Application	Part #
RB20E/DE/DET 88-93	<b>C4914</b>

### Valve Stem Seals (sold individually)

Application	Part #
RB25DET - EXH	<b>3158V</b>
RB25DET - INT	<b>3175V</b>

## Gasket Kits



To purchase a complete gasket kit order both top end and bottom end gasket kit

### TOP END GASKET KIT



Application	Part #
RB26DET 87mm Bore	<b>PRO2017T</b>

### BOTTOM END GASKET KIT



Application	Part #
RB26DET	<b>PRO2017B</b>



Cometic Gasket - An Exclusive NASCAR Performance Product

# NISSAN

## RB30DE 3.0L DOHC Inline 6 Patrol 89-93

### Head Gaskets

#### MLS Head Gaskets

Bore	Thickness	Pkg Qty	Part #
86mm	.....051"	.....1	C4322-051
87mm	.....051"	.....1	C4323-051

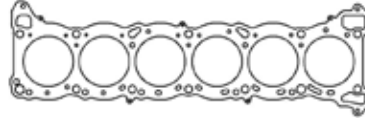

Additional thicknesses available see page 4

## VG30DE/DETT 3.0L 24v DOHC V6 1990-99

### Head Gaskets

#### MLS Head Gaskets

Bore	Thickness	Pkg Qty	Part #
88mm	.....045"	.....1	C4346-045
90mm	.....045"	.....1	C4347-045

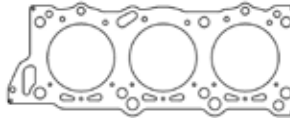

Additional thicknesses available see page 4

#### Valve Cover Gasket Set

Application	Part #
VG30DE/DETT	C4773

#### Oil Pan Gasket

Application	Part #
VG30DE/DETT	C4776

#### Intake Manifold Gasket Set

Application	Part #
VG30DE/DETT	C4772

#### Rear Main Seal Set

Application	Part #
VG30DE/DETT	C4775

#### Exhaust Manifold Gasket Set

Application	Part #
VG30DE/DETT	C4771-064

#### Front Crank Seal

Application	Part #
VG30DE/DETT	C4914

#### Thermostat Gasket

Application	Part #
VG30DE/DETT	C4774-031

#### Water Pump Gasket

Application	Part #
VG30DE/DETT	C4777-015

#### Cam Seals (sold in pairs)

Application	Part #
VG30DE/DETT (need 2 pairs)	C4739

### Gasket Kits



To purchase a complete gasket kit order both top end and bottom end gasket kit

#### TOP END GASKET KIT



Application	Part #
VG30DE/DETT 88mm Bore	PRO2040T

#### BOTTOM END GASKET KIT



Application	Part #
VG30DE/DETT	PRO2040B





Cometic Gasket - An Exclusive NASCAR Performance Product

# NISSAN

## VQ30DE/VQ35DE 3.0/3.5L DOHC V6

350Z 03-06, G35 03-06, Altima 02-06, I35 02-04, Maxima 02-04, Pathfinder 01-04, Skyline 01-06

### Head Gaskets

#### MLS Head Gaskets - Left Side

Bore	Thickness	Pkg Qty	Part #
96mm	.030"	1	C4345-030
98mm	.030"	1	C4344-030
100mm	.030"	1	C4343-030
101.5mm	.030"	1	C4381-030



Additional thicknesses available see page 4

#### MLS Head Gaskets - Right Side

Bore	Thickness	Pkg Qty	Part #
96mm	.030"	1	C4361-030
98mm	.030"	1	C4362-030
100mm	.030"	1	C4363-030
101.5mm	.030"	1	C4380-030



Additional thicknesses available see page 4

### Individual Gaskets

#### Exhaust Manifold Gasket Set

Application	Part #
VQ30DE/VQ35DE	C4921-064

## VQ35HR/VQ37VHR 3.5/3.7L DOHC V6 G35 07-08, 350Z 07-08, G37 08-Up, 370Z 09-Up

### Head Gaskets

#### MLS Head Gasket - Left Side

Bore	Thickness	Pkg Qty	Part #
97mm	.030"	1	C4593-030
97mm	.075"	1	C4593-075

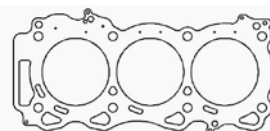

Additional thicknesses available see page 4

#### MLS Head Gasket - Right Side

Bore	Thickness	Pkg Qty	Part #
97mm	.030"	1	C4592-030
97mm	.075"	1	C4592-075

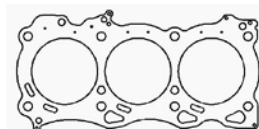

Additional thicknesses available see page 4

### Individual Gaskets

#### Exhaust Manifold Gasket Set

Application	Part #
VQ35HR/VQ37VHR	C4921-064

## VR38DETT 3.8L DOHC V6 GT-R 08-Up

### Head Gaskets

#### MLX Head Gaskets - Left Side

Bore	Thickness	Pkg Qty	Part #
96mm	.032"	1	C4570-032
100mm	.032"	1	C4572-032

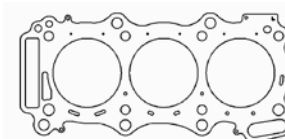

Additional thicknesses available see page 4

#### MLX Head Gaskets - Right Side

Bore	Thickness	Pkg Qty	Part #
96mm	.032"	1	C4571-032
100mm	.032"	1	C4573-032

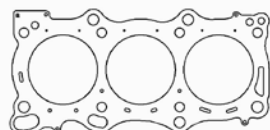

Additional thicknesses available see page 4



Cometic Gasket - An Exclusive NASCAR Performance Product

# NISSAN

## VK45DE 4.5L V8 Infinity Q45 02-06

### Head Gaskets

#### MLS Head Gasket - Left Side

Bore	Thickness	Pkg Qty	Part #
93.5mm	.036"	1	C4486-036

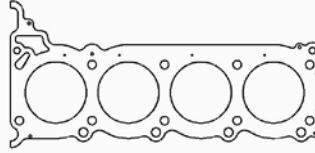

Additional thicknesses available see page 4

#### MLS Head Gasket - Right Side

Bore	Thickness	Pkg Qty	Part #
93.5mm	.036"	1	C4485-036

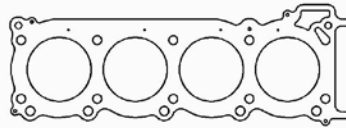

Additional thicknesses available see page 4

## TB48DE 4.8L DOHC Inline 6 2001-Up

### Head Gaskets

#### MLS Head Gasket

Bore	Thickness	Pkg Qty	Part #
100.5mm	.030"	1	C4511-030

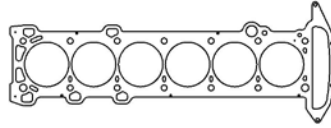

Additional thicknesses available see page 4

#### MLx Head Gasket

Bore	Thickness	Pkg Qty	Part #
100.5mm	.040"	1	C4599-040

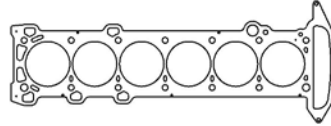

## CEV8D1 5.0L DOHC Cummings Nissan Titan XD

**NEW!**

#### Oil Pan Gaskets

Application	Part #
Lower Oil Pan	C14001
6 Speed Oil Pan	C14002
7 Speed Oil Pan	C14003

**NEW!**

#### Front Differential Gasket

Application	Part #
4WD - 16 Bolt Differential	C14006-060

**NEW!**

#### Timing Cover

Application	Part #
Timing Cover	C14023

## VK56DE 5.6L DOHC V8 2004-Up Armada, 2004-Up Titan, 2004-10 QX56, 2008-12 Pathfinder

### Head Gaskets

#### MLS Head Gasket - Left Side

Bore	Thickness	Pkg Qty	Part #
100mm	.040"	1	C4922-040

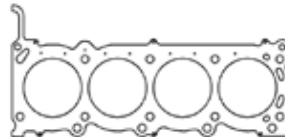

Additional thicknesses available see page 4

#### MLS Head Gasket - Right Side

Bore	Thickness	Pkg Qty	Part #
100mm	.040"	1	C4923-040

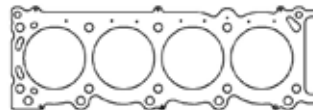

Additional thicknesses available see page 4

See page 123 for additional gaskets



Cometic Gasket - An Exclusive NASCAR Performance Product

# NISSAN

**VK56DE 5.6L DOHC V8** 2004-Up Armada, 2004-Up Titan, 2004-10 QX56, 2008-12 Pathfinder

## Head Gaskets

<b>MLX Head Gasket - Left Side</b>			
Bore	Thickness	Pkg Qty	Part #
102.7mm	.....040"	.....1	<b>C4610-040</b>

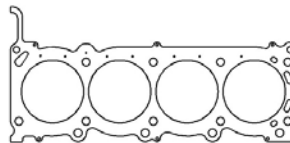

Additional thicknesses available see page 4

<b>MLX Head Gasket - Right Side</b>			
Bore	Thickness	Pkg Qty	Part #
102.7mm	.....040"	.....1	<b>C4609-040</b>

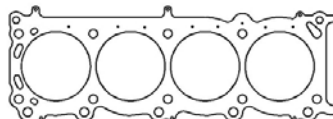

Additional thicknesses available see page 4

## Individual Gaskets

<b>Exhaust Manifold Gasket Set</b>	
Application	Part #
VK56VD 2010-2016 MLS	<b>C4959-030</b>

<b>Exhaust Manifold Gasket Set</b>	
Application	Part #
VK56DE 2004-09 Oval Port MLS	<b>C4961-030</b>
VK56DE 2004-09 Oval Port AM	<b>C4967-064</b>

<b>Oil Pan Gasket</b>	
Application	Part #
Nissan/Suzuki VK56DE, VQ40, VQ40DE 05-17	<b>C14114-060</b>

# PEUGEOT/CITROEN

**TU5J4 1.6L 16v: 106 1997-05**

## Head Gaskets

<b>MLS Head Gasket</b>			
Bore	Thickness	Pkg Qty	Part #
79mm	.....060"	.....1	<b>C4493-060</b>

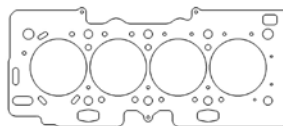

Additional thicknesses available see page 4

**XU9J4, XU9J4Z 1.9L DOHC, XU10J2, XU10J4 2.0L** 405 M1-16, 605 S/SR1

## Head Gaskets

<b>MLS Head Gaskets</b>			
Bore	Thickness	Pkg Qty	Part #
84mm	.....051"	.....1	<b>C4225-051</b>
85mm	.....051"	.....1	<b>C4226-051</b>
86.5mm	.....051"	.....1	<b>C4227-051</b>
88mm	.....051"	.....1	<b>C4228-051</b>

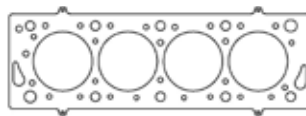

Additional thicknesses available see page 4

# PORSCHE

**924 2.0L 1976-85**

## Head Gasket

<b>MLS Head Gasket</b>			
Bore	Thickness	Pkg Qty	Part #
88mm	.....050"	.....1	<b>C4542-050</b>

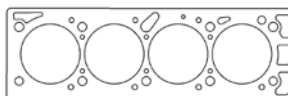

Additional thicknesses available see page 4



Cometic Gasket - An Exclusive NASCAR Performance Product

# PORSCHE

## 944 2.5L 1982-91

### Head Gaskets

#### MLS Head Gasket

Bore	Thickness	Pkg Qty	Part #
100.5mm	.....040"	.....1	C4272-040
103mm	.....040"	.....1	C4273-040

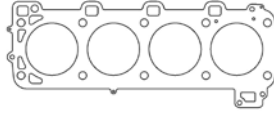

Additional thicknesses available  
see page 4

#### Cam Cover Gasket

Application	Part #
944 2.5L 82-91	C4925

#### Intake Manifold Gasket Set

Application	Part #
944 2.5L 82-91 - 4pcs	C4924

## 944 2.7L 1989, 3.0L 1989-91

### Head Gasket

#### MLS Head Gasket

Bore	Thickness	Pkg Qty	Part #
106mm	.....040"	.....1	C4274-040

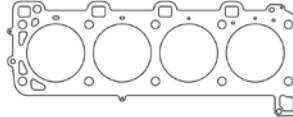

Additional thicknesses available  
see page 4

#### Cam Cover Gasket

Application	Part #
944 2.7/3.0L	C4925

#### Intake Manifold Gasket Set

Application	Part #
944 2.7/3.0L - 4pcs	C4924

## 996 3.6L Twin Turbo 2001-04

### Head Gasket

**NEW!**

#### MLS Head Gasket

Bore	Thickness	Pkg Qty	Part #
102mm	.....040"	.....1	C4492-040
104.5mm	.....030"	.....1	C14076-030
104mm	.....040"	.....1	C14077-040

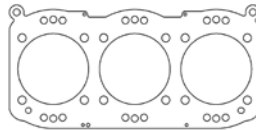

Additional thicknesses available  
see page 4

## 997 3.6L Twin Turbo 2006-08

### Head Gasket

**NEW!**

#### MLS Head Gasket

Bore	Thickness	Pkg Qty	Part #
106.5mm	.....030"	.....1	C14049-030

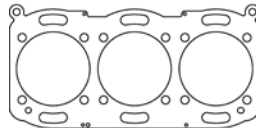

Additional thicknesses available  
see page 4

#### MLX Head Gasket

Bore	Thickness	Pkg Qty	Part #
102mm	.....032"	.....1	C4926-032

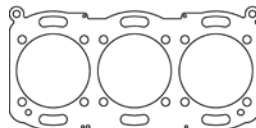



Cometic Gasket - An Exclusive NASCAR Performance Product

# PORSCHE

## Cayenne GTS 4.5L 2003-06 V8

### Head Gaskets

#### MLS Head Gasket - Left Side

Bore	Thickness	Pkg Qty	Part #
95mm	.....027"	.....1	<b>C4535-027</b>

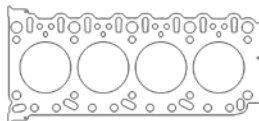

Additional thicknesses available see page 4

#### MLS Head Gasket - Right Side

Bore	Thickness	Pkg Qty	Part #
95mm	.....027"	.....1	<b>C4536-027</b>

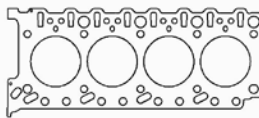

#### Intake Manifold Gasket Set

Application	Part #
Cayenne 4.5L 03-06 (pair)	<b>C4927</b>

## 928 4.7/5.0L 1983-97

### Head Gaskets

#### MLS Head Gaskets - Left Side

Bore	Thickness	Pkg Qty	Part #
100mm	.....045"	.....1	<b>C5781-045</b>
104mm	.....045"	.....1	<b>C5783-045</b>

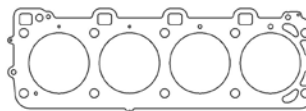

Additional thicknesses available see page 4

#### MLS Head Gaskets - Right Side

Bore	Thickness	Pkg Qty	Part #
100mm	.....045"	.....1	<b>C5780-045</b>
104mm	.....045"	.....1	<b>C5782-045</b>

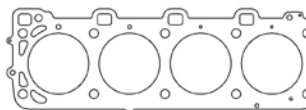

# RENAULT

## F4P 16v 1.8L, F4R 16v 2.0L Laguna 98-Up, Clio 01-Up

### Head Gaskets

#### MLS Head Gaskets

Bore	Thickness	Pkg Qty	Part #
83mm	.....030"	.....1	<b>C4518-030</b>
84.5mm	.....030"	.....1	<b>C4519-030</b>

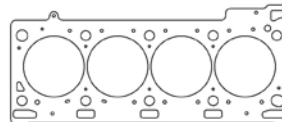

Additional thicknesses available see page 4

## F7P 16v 1.8L, F7R 16v 2.0L

R19 89-96, Clio 91-97, Megane Coupe 95-99, Clio Williams 93-95, Spider Sport 1995

### Head Gaskets

#### MLS Head Gaskets

Bore	Thickness	Pkg Qty	Part #
83mm	.....051"	.....1	<b>C4539-051</b>
84mm	.....051"	.....1	<b>C4540-051</b>

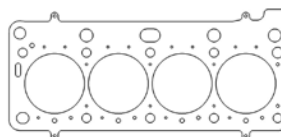

Additional thicknesses available see page 4



Cometic Gasket - An Exclusive NASCAR Performance Product

# ROVER

## 15G V8 1970-93, 21D-25D V8 1970-93, 35D-38D 1970-93

Range Rover 1970-89, Discovery 1989-93

### Head Gaskets

#### MLS Head Gasket

Bore	Thickness	Pkg Qty	Part #
89mm	.040"	1	C4367-040
94mm	.040"	1	C4368-040
96mm	.040"	1	C4369-040

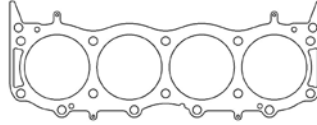

Additional thicknesses available see page 4

#### Exhaust Manifold Gasket Set

Application	Part #
Rover V8 .064" AM	C4966-064

## 35D-38D, 40D, 42D-46D V8 1994-Up Discovery 1994-Up

### Head Gaskets

#### MLS Head Gaskets

Bore	Thickness	Pkg Qty	Part #
89mm	.040"	1	C4366-040
94mm	.040"	1	C4365-040
96mm	.040"	1	C4364-040

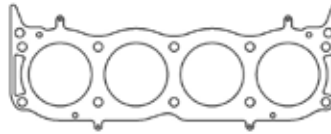

Additional thicknesses available see page 4

#### Exhaust Manifold Gasket Set

Application	Part #
Rover V8 .064" AM	C4966-064

## 5.0L V8 "LR-V8"

2009-Up Discovery, Range Rover Sport, Range Rover Sport SC, Range Rover, Range Rover SC

### Head Gaskets

#### MLX Head Gaskets - Left Side

Bore	Thickness	Pkg Qty	Part #
93mm	.040"	1	C15001-040

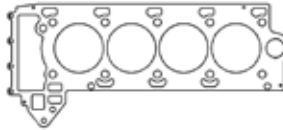

Additional thicknesses available see page 4

#### MLX Head Gaskets - Right Side

Bore	Thickness	Pkg Qty	Part #
93mm	.040"	1	C15000-040

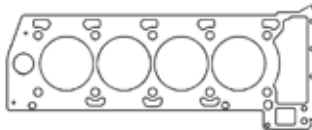

Additional thicknesses available see page 4



Cometic Gasket - An Exclusive NASCAR Performance Product

# SAAB

## B204 1985cc/B234 2290cc Turbo 2.0L: 1995-99 9-3, 9-5, 900

### Head Gaskets

#### MLS Head Gaskets

Bore	Thickness	Pkg Qty	Part #
91mm	.030"	1	C4974-030

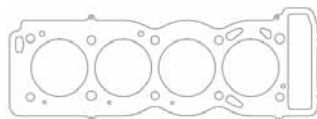

Additional thicknesses available see page 4

## B205 1985cc/B235 2290cc Turbo 2.0L: 1999-09 9-3, 9-5

### Head Gaskets

#### MLS Head Gaskets

Bore	Thickness	Pkg Qty	Part #
91mm	.030"	1	C4973-030

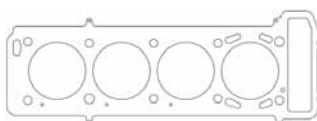

Additional thicknesses available see page 4

# SUBARU

## FA20DIT DOHC 2.0L 2015+Up WRX 2014+Up Forester XT

### Head Gaskets

**NEW!**

#### MLX Head Gasket - Left Side

Bore	Thickness	Pkg Qty	Part #
89.5mm	.032"	1	C4954-032

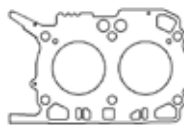

Additional thicknesses available see page 4

#### MLX Head Gasket - Right Side

Bore	Thickness	Pkg Qty	Part #
89.5mm	.032"	1	C4955-032



## FA20 DOHC 2.0L 2012+Up BRZ

### Head Gaskets

**NEW!**

#### MLX Head Gasket - Left Side

Bore	Thickness	Pkg Qty	Part #
89.5mm	.032"	1	C4589-032

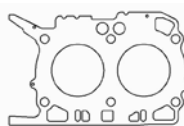

Additional thicknesses available see page 4

#### MLX Head Gasket - Right Side

Bore	Thickness	Pkg Qty	Part #
89.5mm	.032"	1	C4588-032

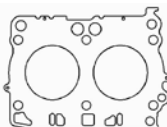

**NEW!**

#### Intake Manifold Gasket Set

Application	Part #
FA20 - Driver Side and Passenger Side.....	C14025

**NEW!**

#### Throttle Body Gasket

Application	Part #
FA20 2012 BRZ+.....	C14024

#### Exhaust Gaskets

Application	Part #
MLS 1.825" Round Port / .030" Thick.....	C4204-030



Cometic Gasket - An Exclusive NASCAR Performance Product

# SUBARU

## EJ20E SOHC 2.0L 16v JDM 1990-97 Legacy, 1995-97 Impreza

### Head Gasket

#### MLS Head Gasket

Bore	Thickness	Pkg Qty	Part #
93mm	.....040"	.....1	<b>C4260-040</b>

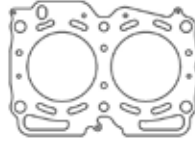

Additional thicknesses available  
see page 4

## EJ205 DOHC 2.0L 16v 2002-05 WRX, 2004-05 Saab 9-2X Aero

### Head Gasket

#### MLX Head Gasket

Bore	Thickness	Pkg Qty	Part #
93mm	.....041"	.....1	<b>C4590-041</b>

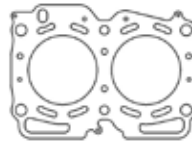

Additional thicknesses available  
see page 4

### Individual Gaskets

#### Valve Cover Gasket Sets

Application	Part #
EJ205 02-05 - Left Side.....	<b>C4863</b>
EJ205 02-05 - Right Side .....	<b>C4864</b>

#### Valve Stem Seals (sold individually)

Application	Part #
EJ205 02-05 - Exhaust (Brown) .....	<b>3264V</b>
EJ205 02-05 - Intake (Black) .....	<b>3265V</b>

#### Intake Manifold Gaskets

Application	Part #
EJ205 02-05 .....	<b>C4857-039</b>

#### Rear Main Seal

Application	Part #
EJ205 02-05 .....	<b>C4856</b>

#### Exhaust Gaskets

Application	Part #
EJ205 02-05 Manifold MLS (2).....	<b>C4204-030</b>
EJ205 02-05 Exhaust Pipe (2).....	<b>C4856-064</b>
EJ205 02-05 Crossover (2) .....	<b>C4859-064</b>

#### Front Crank Seal

Application	Part #
EJ205 02-05 .....	<b>C4857</b>

#### Throttle Body Gasket

Application	Part #
EJ205 02-05 .....	<b>C4855-060</b>

#### Water Pump Gasket

Application	Part #
EJ205 02-05 .....	<b>C4860-018</b>

### Individual Gaskets

#### Cam Seal Set

Application	Part #
EJ205 02-05 - 4 Pack .....	<b>C4858</b> .....

#### Thermostat Gasket

Application	Part #
EJ205 02-05 .....	<b>C4861</b>

See page 129 for additional gaskets





Cometic Gasket - An Exclusive NASCAR Performance Product

# SUBARU

**EJ205 DOHC 2.0L 16V 2002-05 WRX, 2004-05 Saab 9-2X Aero**

## Gasket Kits



### GASKET KIT

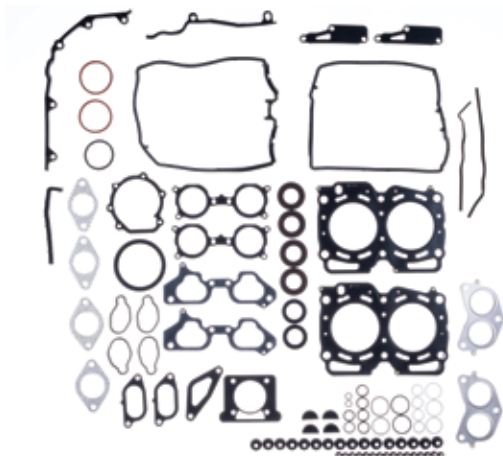

Application	Part #
EJ205 02-03 93.5mm Bore.....	<b>PRO2044C</b>

### GASKET KIT



Application	Part #
EJ205 04-05 .....	<b>PRO2023C</b>

**EJ22E SOHC 2.2L 16V 1990-96 Legacy, 1993-96 Impreza**

## Head Gasket

Additional thicknesses available see page 4

### MLS Head Gasket

Bore	Thickness	Pkg Qty	Part #
98mm	.....040"	.....1.....	<b>C4262-040</b>
100mm	.....040"	.....1.....	<b>C4985-040</b>

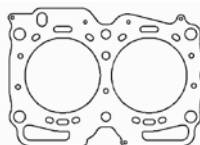

### MLX Head Gasket

Bore	Thickness	Pkg Qty	Part #
101mm	.....041"	.....1.....	<b>C4986-041</b>

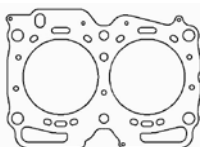

## Individual Gaskets

### Valve Cover Gasket Set

Application	Part #
EJ22E SOHC .....	<b>C4871</b>

### Thermostat Gasket

Application	Part #
EJ22E SOHC .....	<b>C4861</b>

### Intake Manifold Gasket Set

Application	Part #
EJ22E SOHC .....	<b>C4868-060</b>

### Oil Pan Gasket

Application	Part #
EJ22E SOHC - Cork.....	<b>C4869-125</b>

### Exhaust Gaskets

Application	Part #
EJ22E SOHC MLS .....	<b>C4204-030</b>

### Rear Main Seal

Application	Part #
EJ22E SOHC .....	<b>C4856</b>

### Throttle Body Gasket

Application	Part #
EJ22E SOHC.....	<b>C4867-060</b>

### Front Crank Seal

Application	Part #
EJ22E SOHC .....	<b>C4857</b>

See page 130 for additional gaskets



Cometic Gasket - An Exclusive NASCAR Performance Product

# SUBARU

## EJ22E SOHC 2.2L 16v 1990-96 Legacy, 1993-96 Impreza

### Cam Seal Set

Application	Part #
EJ22E SOHC - 2 pack.....	<b>C4870</b>

### Water Pump Gasket

Application	Part #
EJ22E SOHC .....	<b>C4860-018</b>

### Valve Stem Seals (sold individually)

Application	Part #
EJ22E SOHC - Exhaust (Brown).....	<b>3264V</b>
EJ22E SOHC - Intake (Black) .....	<b>3265V</b>

### Timing Cover Set

Application	Part #
EJ22E SOHC .....	<b>C4862</b>

### Gasket Kit



### GASKET KIT



Application	Part #
EJ22E SOHC 98mm Bore .....	<b>PRO2026C</b>

## EJ22ET SOHC 2.2L 16v Turbo 1991-94 Legacy

### Head Gasket

#### MLS Head Gasket

Bore	Thickness	Pkg Qty	Part #
98mm .....	.051" .....	1 .....	<b>C4263-051</b>

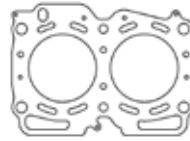

Additional thicknesses available see page 4

### Individual Gaskets

#### Valve Cover Gasket Set

Application	Part #
EJ22ET SOHC Turbo.....	<b>C4871</b>

#### Oil Pan Gasket

Application	Part #
EJ22ET SOHC Turbo .....	<b>C4869-125</b>

#### Intake Manifold Gasket Set

Application	Part #
EJ22ET SOHC Turbo.....	<b>C4868-060</b>

#### Rear Main Seal

Application	Part #
EJ22ET SOHC Turbo .....	<b>C4856</b>

#### Cam Seal Set

Application	Part #
EJ22ET SOHC Turbo - 2pcs .....	<b>C4870</b>

#### Front Crank Seal

Application	Part #
EJ22ET SOHC Turbo .....	<b>C4857</b>

#### Valve Stem Seals (sold individually)

Application	Part #
EJ22ET SOHC - Exhaust (Brown).....	<b>3264V</b>
EJ22ET SOHC - Intake (Black) .....	<b>3265V</b>

#### Water Pump Gasket

Application	Part #
EJ22ET SOHC Turbo .....	<b>C4860-018</b>



Cometic Gasket - An Exclusive NASCAR Performance Product

# SUBARU

## EJ25D DOHC 2.5L 16v 1998 Impreza RS, 1996-99 Legacy/Outback, 1998 Forester

### Head Gasket

MLX Head Gasket			
Bore	Thickness	Pkg Qty	Part #
101mm	.....051"	.....1	<b>C4578-051</b>



Additional thicknesses available  
see page 4

### Individual Gaskets

Valve Cover Gasket Set	
Application	Part #
EJ25D DOHC	<b>C4873</b>

Thermostat Gasket	
Application	Part #
EJ25D DOHC	<b>C4861</b>

Intake Manifold Gasket Set	
Application	Part #
EJ25D DOHC	<b>C4872-059</b>

Oil Pan Gasket	
Application	Part #
EJ25D DOHC - Cork	<b>C4869-125</b>

Exhaust Gaskets	
Application	Part #
EJ25D DOHC MLS	<b>C4204-030</b>

Timing Cover Set	
Application	Part #
EJ25D DOHC	<b>C4862</b>

Throttle Body Gasket	
Application	Part #
EJ25D DOHC	<b>C4867-060</b>

Rear Main Seal	
Application	Part #
EJ25D DOHC	<b>C4856</b>

Cam Seal Set	
Application	Part #
EJ25D DOHC - 4pcs	<b>C4866</b>

Front Crank Seal	
Application	Part #
EJ25D DOHC	<b>C4857</b>

Valve Stem Seals (sold individually)	
Application	Part #
EJ25D DOHC - Exhaust (Brown)	<b>3264V</b>
EJ25D DOHC - Intake (Black)	<b>3265V</b>

Water Pump Gasket	
Application	Part #
EJ25D DOHC	<b>C4860-018</b>

### Gasket Kit



#### GASKET KIT



Application	Part #
EJ25D DOHC 1996-99 101mm Bore	<b>PRO2025C</b>



Cometic Gasket - An Exclusive NASCAR Performance Product

# SUBARU

## EJ251/EJ253 SOHC 2.5L 16v

(EJ251): 09/00-03/03 Impreza, 00-02,04 Outback Sport, 11/01-03/04 Forester, 06/99-06/06 Legacy/Outback, 06/02-04/06 Baja  
 (EJ253): 01/04-Up Forester, 04/03+Up Impreza, 11/03-04/09 Legacy/Outback

### Head Gasket

#### MLX Head Gasket

Bore	Thickness	Pkg Qty	Part #
101mm	.....032"	.....1	<b>C4578-032</b>

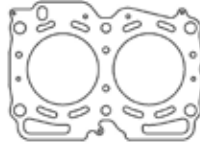

Additional thicknesses available  
see page 4

### Individual Gaskets

#### Valve Cover Gasket Set

Application	Part #
EJ251 SOHC	<b>C4642</b>

#### Throttle Body Gasket

Application	Part #
EJ251 SOHC	<b>C4874-060</b>

#### Intake Manifold Gasket Set

Application	Part #
EJ251 SOHC	<b>C4875-060</b>

#### Thermostat Gasket

Application	Part #
EJ251 SOHC	<b>C4861</b>

#### Exhaust Gaskets

Application	Part #
EJ251 SOHC MLS	<b>C4204-030</b>

#### Rear Main Seal

Application	Part #
EJ251 SOHC	<b>C4856</b>

#### Cam Seal Set

Application	Part #
EJ251 SOHC 2pcs	<b>C4870</b>

#### Front Crank Seal

Application	Part #
EJ251 SOHC	<b>C4857</b>

#### Valve Stem Seals (sold individually)

Application	Part #
EJ251 SOHC - Exhaust (Brown)	<b>3264V</b>
EJ251 SOHC - Intake (Black)	<b>3265V</b>

#### Water Pump Gasket

Application	Part #
EJ251 SOHC	<b>C4860-018</b>

### Gasket Kit



#### GASKET KIT



Application	Part #
EJ251 SOHC 1999-05 101mm Bore	<b>PRO2022C</b>



Cometic Gasket - An Exclusive NASCAR Performance Product

# SUBARU

## EJ253 SOHC 2.5L 16V 02/09-12/14 Legacy/Outback non-turbo

### Head Gaskets

<b>MLX Head Gasket - "Improved Cooling Heads"</b>			
Bore	Thickness	Pkg Qty	Part #
101mm	.....032"	.....1	<b>C4622-032</b>

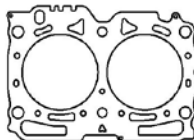

Additional thicknesses available see page 4

### Individual Gaskets

<b>Intake Manifold Gasket Set</b>	
Application	Part #
EJ253 SOHC	<b>C4875-060</b>

<b>Thermostat Gasket</b>	
Application	Part #
EJ253 SOHC	<b>C4861</b>

<b>Exhaust Gaskets</b>	
Application	Part #
EJ253 SOHC MLS	<b>C4204-030</b>

<b>Rear Main Seal</b>	
Application	Part #
EJ253 SOHC	<b>C4856</b>

<b>Cam Seal Set</b>	
Application	Part #
EJ253 SOHC 2pcs	<b>C4870</b>

<b>Front Crank Seal</b>	
Application	Part #
EJ253 SOHC	<b>C4857</b>

<b>Valve Stem Seals (sold individually)</b>	
Application	Part #
EJ253 SOHC - Exhaust (Brown)	<b>3264V</b>
EJ253 SOHC - Intake (Black)	<b>3265V</b>

<b>Water Pump Gasket</b>	
Application	Part #
EJ253 SOHC	<b>C4860-018</b>

<b>Oil Pan Gasket</b>	
Application	Part #
EJ255/ EJ257 - Cork	<b>C4869-125</b>

**NEW!**

## EJ255 DOHC 2.5L 16v Turbo 02/03-04/06 Baja Turbo3-03/05 Forester XT, 02/03-06/06 Legacy/Outback Turbo

### Head Gasket

<b>MLX Head Gasket</b>			
Bore	Thickness	Pkg Qty	Part #
101mm	.....032"	.....1	<b>C4578-032</b>

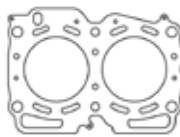

Additional thicknesses available see page 4

## EJ255 DOHC 2.5L 16v Turbo 01/05-03/08 Forester XT, 04/05-03/08 Impreza WRX, 11/05-04/09 Legacy/Outback Turbo

### Head Gasket

<b>MLX Head Gasket - "Improved Cooling Heads"</b>			
Bore	Thickness	Pkg Qty	Part #
101mm	.....032"	.....1	<b>C4622-032</b>

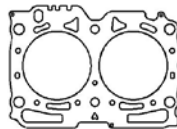

Additional thicknesses available see page 4

### Individual Gaskets

<b>Valve Cover Gasket Sets</b>	
Application	Part #
EJ255 06-07 - Left Side	<b>C4880</b>
EJ255 06-07 - Right Side	<b>C4881</b>

<b>Throttle Body Gasket</b>	
Application	Part #
EJ255 DOHC 06-07	<b>C4877-060</b>

<b>Intake Manifold Gasket Set</b>	
Application	Part #
EJ255 DOHC 06-07	<b>C4857-039</b>

<b>Thermostat Gasket</b>	
Application	Part #
EJ255 DOHC 06-07	<b>C4861</b>

See page 134 for additional gaskets



Cometic Gasket - An Exclusive NASCAR Performance Product

# SUBARU

**EJ255 DOHC 2.5L 16v Turbo** 01/05-03/08 Forester XT, 04/05-03/08 Impreza WRX,  
11/05-04/09 Legacy/Outback Turbo

## Individual Gaskets

### Exhaust Gaskets

Application	Part #
EJ255 06-07 Manifold MLS (2).....	<b>C4204-030</b>
EJ255 06-07 Crossover (2) .....	<b>C4859-064</b>

### Cam Seal Sets

Application	Part #
EJ255 06-07 Exhaust Seals (2).....	<b>C4878</b>
EJ255 06-07 Intake Seals (2).....	<b>C4879</b>

### Valve Stem Seals (sold individually)

Application	Part #
EJ255 DOHC - Exhaust (Brown).....	<b>3264V</b>
EJ255 DOHC - Intake (Black).....	<b>3265V</b>

### Rear Main Seal

Application	Part #
EJ255 DOHC 06-07.....	<b>C4856</b>

### Front Crank Seal

Application	Part #
EJ255 DOHC 06-07.....	<b>C4857</b>

### Water Pump Gasket

Application	Part #
EJ255 DOHC 06-07.....	<b>C4860-018</b>

### Timing Cover Set

Application	Part #
EJ255 DOHC 06-07.....	<b>C4862</b>

## Gasket Kit



### GASKET KIT



Application	Part #
EJ255 DOHC 2006-07 101mm Bore.....	<b>PRO2045C</b>

**EJ255 DOHC 2.5L 16v Turbo** 04/08-Up Forester XT, 04/08-Up Impreza WRX, 02/09-Up Legacy/Outback Turbo

## Head Gasket

### MLX Head Gasket

Bore	Thickness	Pkg Qty	Part #
101mm	.....032"	.....1.....	<b>C4587-032</b>

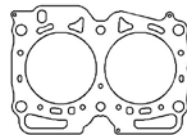

Additional thicknesses available  
see page 4

## Individual Gaskets

### Valve Cover Gasket Sets

Application	Part #
EJ255 08-Up - Left Side.....	<b>C4880</b>
EJ255 08-Up - Right Side.....	<b>C4881</b>

### Throttle Body Gasket

Application	Part #
EJ255 DOHC 08-Up.....	<b>C4882</b>



Cometic Gasket - An Exclusive NASCAR Performance Product

# SUBARU

## EJ255 DOHC 2.5L 16v Turbo 04/08-Up Forester XT, 04/08-Up Impreza WRX, 02/09-Up Legacy/Outback Turbo

### Individual Gaskets

Intake Manifold Gasket Set	
Application	Part #
EJ255 DOHC 08-Up .....	<b>C4857-039</b>

Thermostat Gasket	
Application	Part #
EJ255 DOHC 08-Up .....	<b>C4861</b>

Exhaust Gaskets	
Application	Part #
EJ255 08-Up Manifold MLS (2) .....	<b>C4204-030</b>

Rear Main Seal	
Application	Part #
EJ255 DOHC 08-Up .....	<b>C4856</b>

Cam Seal Sets	
Application	Part #
EJ255 08-Up Exh Seals (2) .....	<b>C4878</b>
EJ255 08-Up Intake Seals (2) .....	<b>C4879</b>

Front Crank Seal	
Application	Part #
EJ255 DOHC 08-Up .....	<b>C4857</b>

Valve Stem Seals (sold individually)	
Application	Part #
EJ255 DOHC - Exhaust (Brown) .....	<b>3264V</b>
EJ255 DOHC - Intake (Black) .....	<b>3265V</b>

Water Pump Gasket	
Application	Part #
EJ255 DOHC 08-Up .....	<b>C4860-018</b>

### Gasket Kit



### GASKET KIT



Application	Part #
EJ255 DOHC 2008-Up 101mm Bore .....	<b>PRO2046C</b>

## EJ257 DOHC 2.5L 16v Turbo 04/07-2017 Impreza Sti

### Head Gasket

MLX Head Gasket			
Bore	Thickness	Pkg Qty	Part #
101mm	.....032"	.....1	<b>C4578-032</b>



Additional thicknesses available see page 4

See page 136 for additional gaskets



Cometic Gasket - An Exclusive NASCAR Performance Product

# SUBARU

**EJ257 DOHC 2.5L 16v Turbo 10/02-06/07 Impreza STi**

## Individual Gaskets

### Valve Cover Gasket Sets

Application	Part #
EJ257 04-06 - Left Side.....	<b>C4928</b>
EJ257 04-06 - Right Side .....	<b>C4929</b>
EJ257 2007 - Left Side.....	<b>C4880</b>
EJ257 2007 - Right Side.....	<b>C4881</b>

### Intake Manifold Gasket Set

Application	Part #
EJ257 DOHC 04-07.....	<b>C4857-039</b>

### Exhaust Gaskets

Application	Part #
EJ257 04-07 Manifold MLS (2).....	<b>C4204-030</b>
EJ257 04-07 Crossover (1) .....	<b>C5718</b>

### Cam Seal Sets

Application	Part #
EJ257 04-07 Exh Seals (2).....	<b>C4878</b>
EJ257 04-07 Intake Seals (2).....	<b>C4879</b>

### Valve Stem Seals (sold individually)

Application	Part #
EJ257 DOHC - Exhaust (Brown).....	<b>3264V</b>
EJ257 DOHC - Intake (Black).....	<b>3265V</b>

### Throttle Body Gasket

Application	Part #
EJ257 DOHC 04-07.....	<b>C4877-060</b>

### Thermostat Gasket

Application	Part #
EJ257 DOHC 04-07.....	<b>C4861</b>

### Timing Cover Set

Application	Part #
EJ257 DOHC 2007.....	<b>C4862</b>

### Rear Main Seal

Application	Part #
EJ257 DOHC 04-07.....	<b>C4856</b>

### Front Crank Seal

Application	Part #
EJ257 DOHC 04-07.....	<b>C4857</b>

### Water Pump Gasket

Application	Part #
EJ257 DOHC 04-07.....	<b>C4860-018</b>

## Gasket Kits



### GASKET KIT

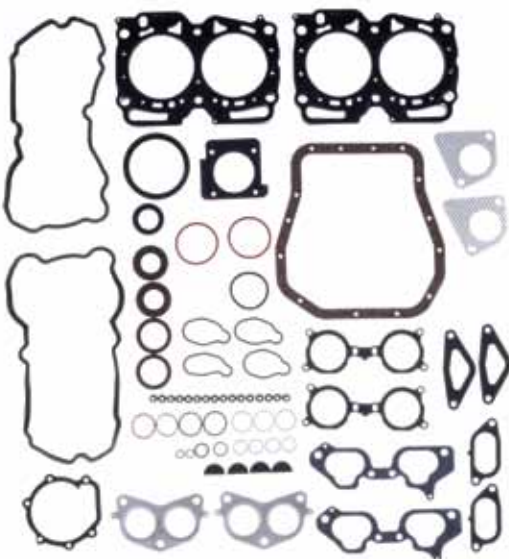

Application	Part #
EJ257 DOHC 04-06 101mm Bore.....	<b>PRO2024C</b>

### GASKET KIT

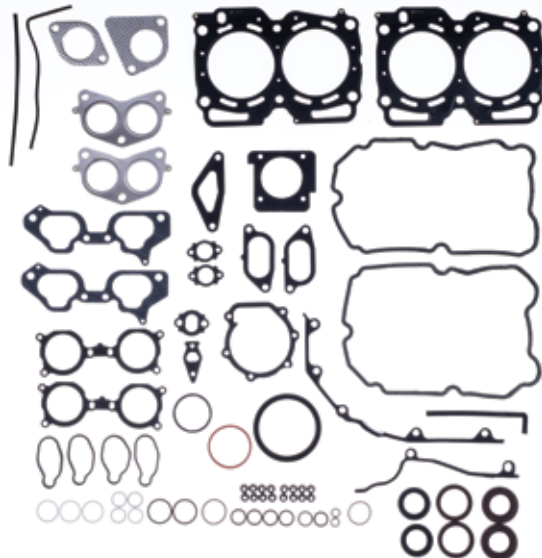

Application	Part #
EJ257 DOHC 2007 101mm Bore .....	<b>PRO2047C</b>





Cometic Gasket - An Exclusive NASCAR Performance Product

# SUBARU

## EJ257 DOHC 2.5L 16v Turbo 04/07-Up Impreza Sti

### Head Gasket

<b>MLX Head Gasket</b>			
Bore	Thickness	Pkg Qty	Part #
101mm	.....032"	.....1	<b>C4587-032</b>

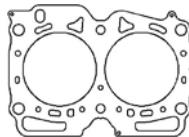

Additional thicknesses available see page 4

### Individual Gaskets

<b>Valve Cover Gasket Sets</b>	
Application	Part #
EJ257 08+Up - Left Side .....	<b>C4880</b>
EJ257 08+Up - Right Side.....	<b>C4881</b>

<b>Throttle Body Gasket</b>	
Application	Part #
EJ257 DOHC 08-Up.....	<b>C4877-060</b>

<b>Intake Manifold Gasket Set</b>	
Application	Part #
EJ257 DOHC 08-Up.....	<b>C4857-039</b>

<b>Thermostat Gasket</b>	
Application	Part #
EJ257 DOHC 08-Up.....	<b>C4861</b>

<b>Exhaust Gaskets</b>	
Application	Part #
EJ257 08+Up Manifold MLS (2) .....	<b>C4204-030</b>
EJ257 08+Up Crossover (1).....	<b>C5718</b>

<b>Timing Cover Set</b>	
Application	Part #
EJ257 DOHC 08-Up.....	<b>C4862</b>

<b>Cam Seal Set</b>	
Application	Part #
EJ257 08+Up 4pcs .....	<b>C4876</b>

<b>Rear Main Seal</b>	
Application	Part #
EJ257 DOHC 08-Up.....	<b>C4856</b>

<b>Valve Stem Seals (sold individually)</b>	
Application	Part #
EJ257 DOHC - Exhaust (Brown).....	<b>3264V</b>
EJ257 DOHC - Intake (Black).....	<b>3265V</b>

<b>Front Crank Seal</b>	
Application	Part #
EJ257 DOHC 08-Up.....	<b>C4857</b>

<b>Oil Pan Gasket</b>	
Application	Part #
EJ255/ EJ257 - Cork .....	<b>C4869-125</b>

<b>Water Pump Gasket</b>	
Application	Part #
EJ257 DOHC 08-Up.....	<b>C4860-018</b>

**NEW!**

### Gasket Kit



#### GASKET KIT



Application	Part #
EJ257 DOHC 08-Up 101mm Bore .....	<b>PRO2048C</b>



Cometic Gasket - An Exclusive NASCAR Performance Product

# SUBARU

## EZ30 3.0L Flat 6 Legacy/Outback

### Head Gaskets

#### MLS Head Gasket - Left Side

Bore	Thickness	Pkg Qty	Part #
90mm	.....040"	.....1	<b>C5861-040</b>

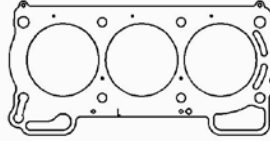

Additional thicknesses available  
see page 4

#### MLS Head Gasket - Right Side

Bore	Thickness	Pkg Qty	Part #
90mm	.....040"	.....1	<b>C5860-040</b>

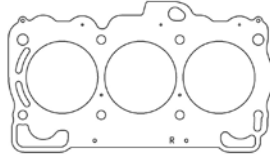

Additional thicknesses available  
see page 4

## EZ30D 3.0L Flat 6 2003-09 Legacy/Outback, 2006-07 Tribeca

### Head Gaskets

#### MLS Head Gasket - Left Side

Bore	Thickness	Pkg Qty	Part #
90mm	.....040"	.....1	<b>C4623-040</b>

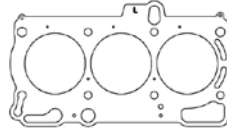

Additional thicknesses available  
see page 4

#### MLS Head Gasket - Right Side

Bore	Thickness	Pkg Qty	Part #
90mm	.....040"	.....1	<b>C4624-040</b>

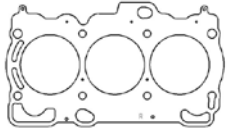

Additional thicknesses available  
see page 4

## EZ36D 3.6L Flat 6 2010-12 Legacy 3.6R / Outback, 2008-14 Tribeca

### Individual Gaskets

**NEW!**

#### Oil Pan Gasket

Application	Part #
EJ255/ EJ257/ EZ36D - Cork	<b>C4869-125</b>

## EG33 3.3L Flat 6 3318cc 1992-96 SVX

### Head Gaskets

#### MLS Head Gaskets

Bore	Thickness	Pkg Qty	Part #
98mm	.....066"	.....1	<b>C4340-066</b>
100mm	.....066"	.....1	<b>C4341-066</b>
102mm	.....066"	.....1	<b>C4342-066</b>

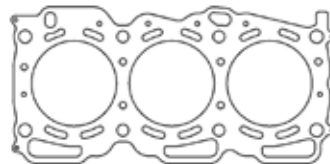

Additional thicknesses available  
see page 4



Cometic Gasket - An Exclusive NASCAR Performance Product

# TOYOTA

**3E 1.5L, 4E 1.3L, 5E 1.5L** 1986-98 Corolla, Corona, Starlet, Tercel, Paseo, Sera

## Head Gaskets

### MLS Head Gaskets

Bore	Thickness	Pkg Qty	Part #
75mm	.040"	1	C4602-040
76mm	.040"	1	C4603-040



Additional thicknesses available  
see page 4

**2T 1.6l, 2TC 1.6L, 3T 1.8L, 3TC 1.8L** 1970-84 Corolla, 1970-76 Sprinter, 1970-76 Celica,  
1970-76 Carina, 1970-84 Corona, 1978-84 Camry

## Head Gaskets

### MLS Head Gaskets

Bore	Thickness	Pkg Qty	Part #
87mm	.040"	1	C4258-040
89mm	.040"	1	C4176-040

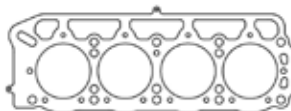

Additional thicknesses available  
see page 4

### Exhaust Manifold Gasket

Application	Part #
3TC 1.8L	C4930

**4A-GE, 4A-GEC, 4A-GELC 16v 1587cc** 1984-92 Corolla, 1989 Carina, 1989 Sprinter,  
1984-89 MR2, 1989-89 Celica

## Head Gaskets

### MLS Head Gaskets

Bore	Thickness	Pkg Qty	Part #
81mm	.040"	1	C4170-040
83mm	.040"	1	C4166-040



Additional thicknesses available  
see page 4

## Individual Gaskets

### Valve Cover Gasket Set

Application	Part #
4A-GE 84-92 16v	C4807

### Thermostat Gasket

Application	Part #
4A-GE 84-92 16v	C4809

### Intake Gasket Set

Application	Part #
4A-GE 84-92 16v	C4806

### Timing Cover Dust Seal Set

Application	Part #
4A-GE 84-92 16v	C4811

### Exhaust Manifold Gasket

Application	Part #
4A-GE 84-92 16v .042" AM	C4805-042

### Rear Main Seal

Application	Part #
4A-GE 84-92 16v	C4810

### Cam Seal Set

Application	Part #
4A-GE 84-92 16v 2pcs	C4808

### Front Crank Seal

Application	Part #
4A-GE 84-92 16v	C4931

### Valve Stem Seals (sold individually)

Application	Part #
4A-GE 84-92 16v	3225V

### Water Pump Gasket

Application	Part #
4A-GE 84-92 16v	C4812-039

See page 140 for StreetPro gasket kits



Cometic Gasket - An Exclusive NASCAR Performance Product

# TOYOTA

**4A-GE, 4A-GEC, 4A-GELC 16v 1587CC** 1984-92 Corolla, 1989 Carina, 1989 Sprinter,  
1984-89 MR2, 1989-89 Celica

## Gasket Kits



### TOP END GASKET KIT



Application	Part #
4A-GE 84-92 16v 81mm Bore .....	<b>PRO2041T</b>

### TOP END GASKET KIT



Application	Part #
4A-GE 84-92 16v .....	<b>PRO2041B</b>

**4A-GE 1.6L 20v 1587CC** 1991-95 Corolla, 1996-01 Carina, 1991-00 Sprinter

## Head Gaskets

### MLS Head Gaskets

Bore	Thickness	Pkg Qty	Part #
81mm .....	.040"	1 .....	<b>C4604-040</b>
83mm .....	.040"	1 .....	<b>C4605-040</b>

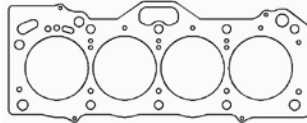

Additional thicknesses available  
see page 4

## Individual Gaskets

### Intake Manifold Gasket

Application	Part #
4A-GE 20v Small Port .....	<b>C4932-031</b>

### Exhaust Manifold Gasket

Application	Part #
4A-GE 20v .064" AM.....	<b>C4933-064</b>

**1ZZ-FE 1.8L DOHC 1997-08**

## Head Gaskets

### MLS Head Gaskets

Bore	Thickness	Pkg Qty	Part #
80mm .....	.027"	1 .....	<b>C4496-027</b>
82mm .....	.027"	1 .....	<b>C4497-027</b>

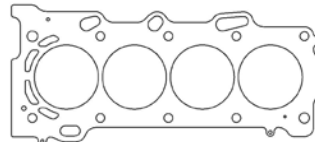

Additional thicknesses available  
see page 4

## Individual Gaskets

### Intake Manifold Gasket

Application	Part #
1ZZ-FE .032" AFM .....	<b>C4934-032</b>

### Exhaust Manifold Gasket

Application	Part #
1ZZ-FE 98-02 .030" MLS.....	<b>C4205-030</b>



Cometic Gasket - An Exclusive NASCAR Performance Product

# TOYOTA

**2ZZ-GE 1.8L DOHC 1795cc** 00-05 Celica, 05-06 Corolla, 03-06 Matrix/Vibe, 05-11 Lotus Elise, 06-10 Lotus Exige

## Head Gasket

**NEW!**

### MLX Head Gasket

Bore	Thickness	Pkg Qty	Part #
82.5mm	.....028"	.....1	<b>C4962-028</b>
82.5mm	.....040"	.....1	<b>C14051-040</b>

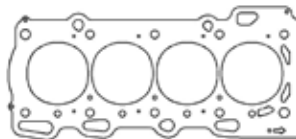

Additional thicknesses available see page 4

**3S-GE/3S-GTE 2.0L DOHC Turbo 1998cc** 1989-94 Celica, 1990-94 MR2

## Head Gasket

### MLS Head Gasket

Bore	Thickness	Pkg Qty	Part #
87mm	.....040"	.....1	<b>C4314-040</b>

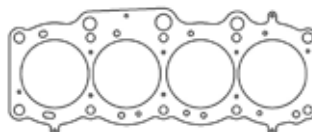

Additional thicknesses available see page 4

## Individual Gaskets

### Valve Cover Gasket Set

Application	Part #
3S-GT/GTE 91-95	<b>C4608</b>

### Oil Pan Gasket

Application	Part #
3S-GT/GTE 91-95	<b>C4817-062</b>

### Intake Manifold Gasket Set

Application	Part #
3S-GT/GTE 88-95	<b>C4813</b>

### Timing Cover Dust Seal Set

Application	Part #
3S-GT/GTE 89-94	<b>C4811</b>

### Exhaust Manifold Gasket

Application	Part #
3S-GT/GTE 89-95 MLS	<b>C4206-030</b>

### Water Pump Gasket

Application	Part #
3S-GT/GTE 89-94	<b>C4818-031</b>

### Cam Seal Set

Application	Part #
3S-GT/GTE 89-95	<b>C4808</b>

### Rear Main Seal Set

Application	Part #
3S-GT/GTE 89-94	<b>C4815</b>

### Valve Stem Seals (sold individually)

Application	Part #
3S-GT/GTE 89-95	<b>3225V</b>

### Oil Pump Gasket Set

Application	Part #
3S-GT/GTE 89-94	<b>C4816</b>

## Gasket Kits



### TOP END GASKET KIT

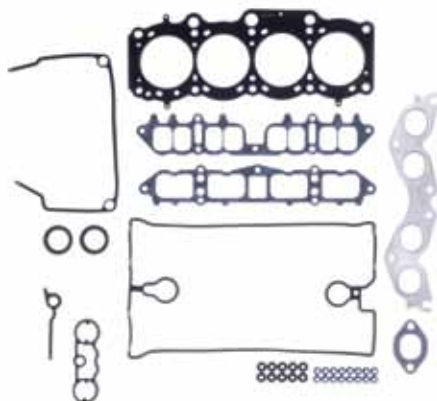

Application	Part #
3S-GT/GTE 89-94 87mm Bore	<b>PRO2019T</b>

### BOTTOM END GASKET KIT



Application	Part #
3S-GT/GTE 89-94	<b>PRO2019B</b>



Cometic Gasket - An Exclusive NASCAR Performance Product

# TOYOTA

## 3S-GE/3S-GTE 2.0L DOHC Turbo 3rd Gen, ST205 1994-99

### Head Gasket

MLS Head Gasket			
Bore	Thickness	Pkg Qty	Part #
87mm	.....040"	.....1	<b>C4606-040</b>

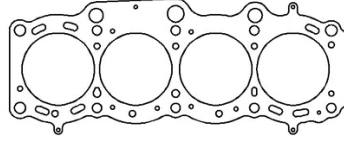

Additional thicknesses available see page 4

## 20R 2.2L 1974-81 Corona, 1974-81 Celica, 1974-81 Hi-Lux

### Head Gasket

MLS Head Gasket			
Bore	Thickness	Pkg Qty	Part #
92mm	.....040"	.....1	<b>C4268-040</b>

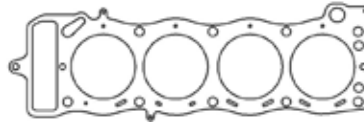

Additional thicknesses available see page 4

## 5S-FE 2.2L 2164CC 1990-97 Camry, 1990-97 Celica, 1990-97 MR2

### Head Gasket

MLS Head Gasket			
Bore	Thickness	Pkg Qty	Part #
88mm	.....040"	.....1	<b>C4315-040</b>

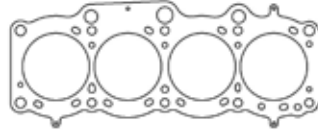

Additional thicknesses available see page 4

### Individual Gaskets

Valve Cover Gasket Set	
Application	Part #
5S-FE 1990-97	<b>C4820</b>

Oil Pan Gasket	
Application	Part #
5S-FE 1990-97	<b>C4817-062</b>

Intake Manifold Gasket Set	
Application	Part #
5S-FE 1990-97	<b>C4819-046</b>

Water Pump Gasket	
Application	Part #
5S-FE 1990-97	<b>C4818-031</b>

Exhaust Manifold Gasket	
Application	Part #
5S-FE 1990-97 MLS	<b>C4206-030</b>

Rear Main Seal Set	
Application	Part #
5S-FE 1990-97	<b>C4823</b>

Cam Seal Set	
Application	Part #
5S-FE 1990-97	<b>C4821</b>

Oil Pump Gasket Set	
Application	Part #
5S-FE 1990-97	<b>C4824</b>

Valve Stem Seals (sold individually)	
Application	Part #
5S-FE 1990-97	<b>3225V</b>

Thermostat Gasket Set	
Application	Part #
5S-FE 1990-97	<b>C4822</b>

See page 143 for StreetPro gasket kits



Cometic Gasket - An Exclusive NASCAR Performance Product

# TOYOTA

**5S-FE 2.2L 2164CC** 1990-97 Camry, 1990-97 Celica, 1990-97 MR2

## Gasket Kits



### TOP END GASKET KIT



Application	Part #
5S-FE 1990-97 88mm Bore.....	<b>PRO2042T</b>

### BOTTOM END GASKET KIT



Application	Part #
5S-FE 1990-97 .....	<b>PRO2042B</b>

**22R/22R-TEC 2.4L** 1982-85 Celica, 1981-95 Hi-Lux, 1981-82 Corona, 1984-95 4 Runner

## Head Gasket

**NEW!**

### MLS Head Gasket

Bore	Thickness	Pkg Qty	Part #
93mm .....	.040"	1.....	<b>C14086-040</b>
94mm .....	.040"	1.....	<b>C14074-040</b>
95mm .....	.040"	1.....	<b>C4269-040</b>

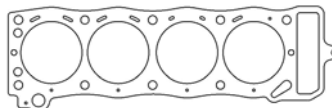

Additional thicknesses available see page 4

## Individual Gaskets

### Valve Cover Gasket Set

Application	Part #
22R 2.4L 81-85.....	<b>C4935</b>

### Oil Pan Gasket

Application	Part #
22R 2.4L 81-85.....	<b>C4940</b>

### Intake Manifold Gasket Set

Application	Part #
22R 2.4L 81-85.....	<b>C4936</b>

### Water Pump Gasket Set

Application	Part #
22R 2.4L 81-85.....	<b>C4941</b>

### Exhaust Manifold Gaskets

Application	Part #
22R 2.4L 81-82.....	<b>C4937-064</b>
22R 2.4L 83-84.....	<b>C4938-064</b>
22R 2.4L 85-87.....	<b>C4939-064</b>

### Timing Cover Sets

Application	Part #
22R 2.4L 81-84.....	<b>C4942</b>
22R 2.4L 1985 .....	<b>C4943</b>

### Valve Stem Seals (sold individually)

Application	Part #
22R 2.4L 81-85.....	<b>3157V</b>

### Rear Main Seal

Application	Part #
22R 2.4L 81-85.....	<b>C4944</b>



Cometic Gasket - An Exclusive NASCAR Performance Product

# TOYOTA

**2RZ-FE 2.4L 1995-04, 3RZ-FE 2.7L 1997-04**

## Head Gaskets

### MLS Head Gaskets

Bore	Thickness	Pkg Qty	Part #
96mm	.....040"	.....1	<b>C4598-040</b>
97mm	.....040"	.....1	<b>C4245-040</b>

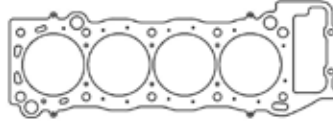

Additional thicknesses available see page 4

## Individual Gaskets

### Valve Cover Gasket Set

Application	Part #
2RZ/3RZ.....	<b>C4830</b>

### Thermostat Gasket Set

Application	Part #
2RZ/3RZ.....	<b>C4831</b>

### Intake Manifold Gaskets

Application	Part #
2RZ/3RZ 95-99 .....	<b>C4826-018</b>
2RZ/3RZ 95-99 Plenum.....	<b>C4827-032</b>
2RZ/3RZ 99-04.....	<b>C4828-032</b>
2RZ/3RZ 99-04 Plenum.....	<b>C4829-032</b>

### Oil Pan Gasket

Application	Part #
2RZ/3RZ.....	<b>C4834</b>

### Timing Cover Sets

Application	Part #
2RZ/3RZ.....	<b>C4833</b>

### Exhaust Manifold Gasket

Application	Part #
2RZ/3RZ MLS .....	<b>C4207-030</b>

### Water Pump Gasket

Application	Part #
2RZ/3RZ.....	<b>C4835-020</b>

### Valve Stem Seals (sold individually)

Application	Part #
2RZ/3RZ.....	<b>3225V</b>

### Rear Main Seal Set

Application	Part #
2RZ/3RZ.....	<b>C4832</b>

## Gasket Kits



### TOP END GASKET KIT



Application	Part #
2RZ/3RZ 97-04 97mm Bore .....	<b>PRO2043T</b>

### BOTTOM END GASKET KIT



Application	Part #
2RZ/3RZ 97-04.....	<b>PRO2043B</b>





Cometic Gasket - An Exclusive NASCAR Performance Product

# TOYOTA

**2AZ-FE 2.4L DOHC** 2002-09 Camry, 2009-11 Matrix, 2009-10 Pontiac Vibe, 2009-11 Corolla ZRS, 2002-09 Solara, 2004-08 RAV4, 2001-08 Highlander, 2005-10 Scion tC, 2008-12 Scion xB

### Head Gaskets

MLS Head Gaskets			
Bore	Thickness	Pkg Qty	Part #
89mm	.027"	1	C4507-027
92mm	.027"	1	C4506-027

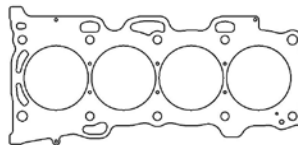

Additional thicknesses available see page 4

### Individual Gaskets

Exhaust Manifold Gasket	
Application	Part #
2AZ-FE .030" MLS	C4203-030

**7M-GE/7M-GTE 3.0L Inline 6 24v 2954cc** 1986-92 Supra, 1988-92 Cressida

### Head Gaskets

MLS Head Gaskets			
Bore	Thickness	Pkg Qty	Part #
84mm	.051"	1	C4278-051
86mm	.051"	1	C4275-051

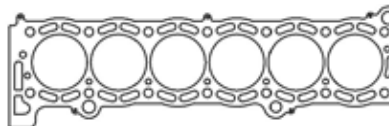

Additional thicknesses available see page 4

### Individual Gaskets

Valve Cover Gasket Set	
Application	Part #
7M-GE/GTE 86-92	C4838

Thermostat Gasket	
Application	Part #
7M-GE/GTE 86-92	C4839

Intake Manifold Gasket Set	
Application	Part #
7M-GE/GTE 86-92	C4837-031

Oil Pan Gasket	
Application	Part #
7M-GE/GTE 86-92	C4845-062

Exhaust Manifold Gasket	
Application	Part #
7M-GE/GTE 86-92 MLS	C4208-030

Timing Cover Set	
Application	Part #
7M-GE/GTE 86-92	C4844

Cam Seal Set	
Application	Part #
7M-GE/GTE 86-92 2pcs	C4808

Water Pump Gasket Set	
Application	Part #
7M-GE/GTE 86-92	C4846-031

Valve Stem Seals (sold individually)	
Application	Part #
7M-GE/GTE 86-92	3225V

Rear Main Seal Set	
Application	Part #
7M-GE/GTE 86-92	C4843

Throttle Body Gasket	
Application	Part #
7M-GE/GTE 86-92	C4836-032

Front Crank/Balance Shaft Seals	
Application	Part #
7M-GE/GTE 86-92 Front Crank	C4945
7M-GE/GTE 86-92 Balance Shaft	C4946

See page 146 for StreetPro gasket kits



Cometic Gasket - An Exclusive NASCAR Performance Product

# TOYOTA

**7M-GE/7M-GTE 3.0L Inline 6 24v 2954cc 1986-92 Supra, 1988-92 Cressida**

## Gasket Kits



### TOP END GASKET KIT

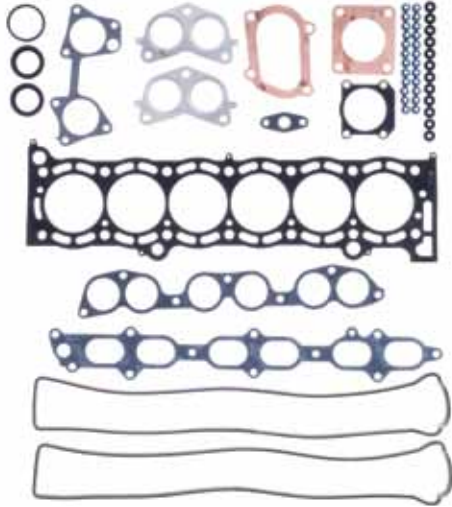

Application	Part #
7M-GE/GTE 86-92 84mm Bore .....	<b>PRO2020T</b>

### BOTTOM END GASKET KIT



Application	Part #
7M-GE/GTE 86-92.....	<b>PRO2020B</b>

# 1JZ-GE/GTE 2.5L Inline 6 24v

## Head Gaskets

**NEW!**

### MLS Head Gaskets

Bore	Thickness	Pkg Qty	Part #
87mm	.051"	1	<b>C14036-051</b>

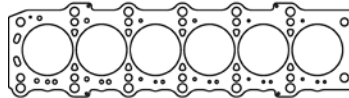

Additional thicknesses available see page 4

## Individual Gaskets

**NEW!**

### Exhaust Manifold Gasket

Application	Part #
Turbo Exhaust Manifold - .059" thick.....	<b>C14119-059</b>

# 2JZ-GE/GTE 3.0L Inline 6 24v 1993-02 Supra, 1993-95 GS300, 1993-00 SC300

## Head Gasket

**NEW!**

### MLS Head Gasket

Bore	Thickness	Pkg Qty	Part #
87mm	.051"	1	<b>C4276-051</b>
87mm	.060"	1	<b>C4276-060</b>

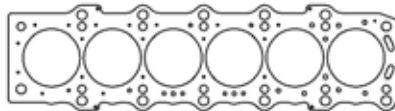

**NEW!**

### MLX Head Gasket

Bore	Thickness	Pkg Qty	Part #
87mm	.052"	1	<b>C14016-052</b>

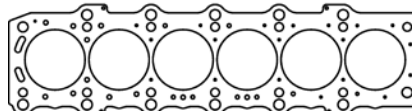

See page 147 for additional gaskets



Cometic Gasket - An Exclusive NASCAR Performance Product

# TOYOTA

## 2JZ-GE/GTE 3.0L Inline 6 24v 1993-02 Supra, 1993-95 GS300, 1993-00 SC300

### Individual Gaskets

Valve Cover Gasket Set	
Application	Part #
2JZ-GE/GTE.....	C4851

Throttle Body Gasket	
Application	Part #
2JZ-GE.....	C4848

Intake Manifold Gasket	
Application	Part #
2JZ-GE.....	C4849

Thermostat Gasket Set	
Application	Part #
2JZ-GE/GTE.....	C4852

Exhaust Manifold Gaskets	
Application	Part #
2JZ-GE .064" AM.....	C4847-064
2JZ-GTE .030" MLS.....	C4209-030

Water Pump Gasket	
Application	Part #
2JZ-GE/GTE.....	C4854-031

Cam Seal Set	
Application	Part #
2JZ-GE.....	C4849

Rear Main Seal	
Application	Part #
2JZ-GE/GTE.....	C4853

Valve Stem Seals (sold individually)	
Application	Part #
2JZ-GE/GTE.....	3225V

**NEW!**

Oil Pan Gasket	
Application	Part #
Automatic Transmission.....	C14118

### Gasket Kits



**TOP END GASKET KIT**



Application	Part #
2JZ-GE 93-98 87mm Bore.....	PRO2021T

**BOTTOM END GASKET KIT**



Application	Part #
2JZ-GE/GTE 93-98.....	PRO2021B



Cometic Gasket - An Exclusive NASCAR Performance Product

# TOYOTA

## 5VZ-FE 3.4L V6 95-99 Tacoma, 95-98 T100, 95-99 4 Runner, 2000-04 Tundra, 96-99 Landcruiser, 00 Hi-Lux

### Head Gaskets

#### MLS Head Gasket - Left Side

Bore	Thickness	Pkg Qty	Part #
98mm	.....040"	.....1	<b>C4215-040</b>

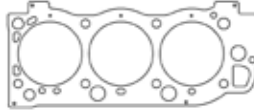

Additional thicknesses available see page 4

#### MLS Head Gasket - Right Side

Bore	Thickness	Pkg Qty	Part #
98mm	.....040"	.....1	<b>C4214-040</b>

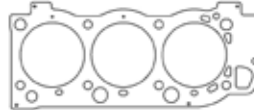

Additional thicknesses available see page 4

## 1UZ-FE 4.0L 32v V8 w/o VVTi 98-00 GS400, 91-00 LS400, 91-00 SC400

### Head Gaskets

**NEW!**

#### MLS Head Gasket - Left Side

Bore	Thickness	Pkg Qty	Part #
89mm	.....040"	.....1	<b>C4137-040</b>
92.5mm	.....051"	.....1	<b>C4137-051</b>

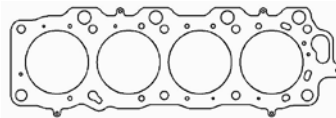

Additional thicknesses available see page 4

**NEW!**

#### MLS Head Gasket - Right Side

Bore	Thickness	Pkg Qty	Part #
89mm	.....040"	.....1	<b>C4136-040</b>
92.5mm	.....051"	.....1	<b>C4136-051</b>

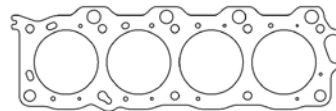

Additional thicknesses available see page 4

## 3UR-FE 2006+

### Head Gaskets

**NEW!**

#### MLS Head Gasket - Left Side

Bore	Thickness	Pkg Qty	Part #
97mm	.....034"	.....1	<b>C4993-034</b>

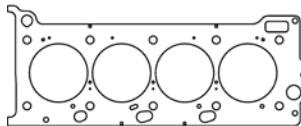

Additional thicknesses available see page 4

**NEW!**

#### MLS Head Gasket - Right Side

Bore	Thickness	Pkg Qty	Part #
97mm	.....034"	.....1	<b>C4994-034</b>

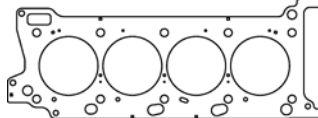

Additional thicknesses available see page 4

## 2GR-FE 3.5L V6 3456CC 2005 Avalon, 2006 RAV4, 2008 Highlander

### Head Gaskets

#### MLS Head Gasket - Left Side

Bore	Thickness	Pkg Qty	Part #
94.5mm	.....045"	.....1	<b>C4582-045</b>

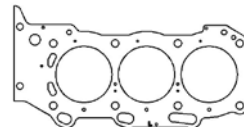

Additional thicknesses available see page 4

#### MLS Head Gasket - Right Side

Bore	Thickness	Pkg Qty	Part #
94.5mm	.....045"	.....1	<b>C4581-045</b>

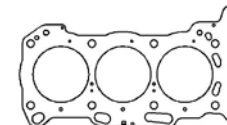

Additional thicknesses available see page 4



Cometic Gasket - An Exclusive NASCAR Performance Product

# TOYOTA

**1GR-FE 4.0L V6** 2003-09 4Runner, 2007-09 FJ Cruiser, 2005-15 Tacoma, 2005-10 Tundra, 2002-11 Landcruiser

## Head Gaskets

**NEW!**

### MLS Head Gasket - Left Side

Bore	Thickness	Pkg Qty	Part #
95.5mm	.....027"	.....1	<b>C4556-027</b>
96.5mm	.....036"	.....1	<b>C14058-036</b>
96.5mm	.....045"	.....1	<b>C14054-045</b>

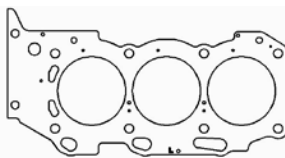

Additional thicknesses available see page 4

**NEW!**

### MLS Head Gasket - Right Side

Bore	Thickness	Pkg Qty	Part #
95.5mm	.....027"	.....1	<b>C4557-027</b>
96.5mm	.....036"	.....1	<b>C14045-036</b>
96.5mm	.....045"	.....1	<b>C14065-045</b>

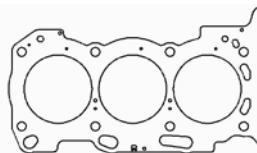

Additional thicknesses available see page 4

## Individual Gaskets

**NEW!**

### Oil Pan Gasket

Application	Part #
05-17 1GR-FE, 2TR-FE	<b>C14113-060</b>

**NEW!**

### Transmission Pan Gasket

Application	Part #
03-17 1GR-FE, 2UZ-FE, 3UR (AutoTrans)	<b>C14122-060</b>

**1FZ-FE 4.5L DOHC Inline 6** 1995-98 Landcruiser, 1995-98 Lexus 450

## Head Gaskets

### MLS Head Gasket

Bore	Thickness	Pkg Qty	Part #
101.5mm	.....053"	.....1	<b>C4530-053</b>

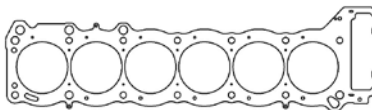

Additional thicknesses available see page 4

### MLX Head Gasket

Bore	Thickness	Pkg Qty	Part #
101.5mm	.....040"	.....1	<b>C4611-040</b>

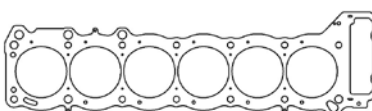

Additional thicknesses available see page 4

**2UZ-FE 4.7L 32v V8** 1998 Landcruiser, 2004 GX470, 2004 4 Runner, 2001-04 Tundra, 2001-04 Sequoia, 1998-00 LX470

## Head Gaskets

### MLS Head Gaskets - Left Side

Bore	Thickness	Pkg Qty	Part #
92mm	.....040"	.....1	<b>C4358-040</b>
98mm	.....040"	.....1	<b>C4212-040</b>

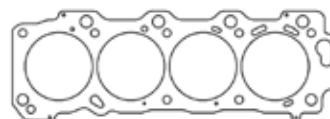

Additional thicknesses available see page 4

### MLS Head Gaskets - Right Side

Bore	Thickness	Pkg Qty	Part #
92mm	.....040"	.....1	<b>C4357-040</b>
98mm	.....040"	.....1	<b>C4211-040</b>

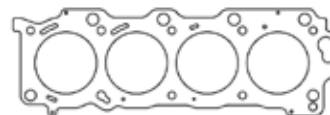

Additional thicknesses available see page 4

## Individual Gaskets

**NEW!**

### Oil Pan Gasket

Application	Part #
05-17 1GR-FE, 2TR-FE	<b>C14113-060</b>

**NEW!**

### Transmission Pan Gasket

Application	Part #
03-17 1GR-FE, 2UZ-FE, 3UR (AutoTrans)	<b>C14122-060</b>



Cometic Gasket - An Exclusive NASCAR Performance Product

# TOYOTA

## PH11 Race V8

### Head Gaskets

#### MLS Head Gasket - Left Side

Bore	Thickness	Pkg Qty	Part #
4.200"	.....040"	.....1.....	C5584-040

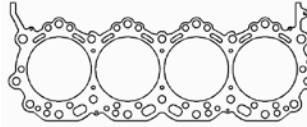

Additional thicknesses available see page 4

#### MLS Head Gasket - Right Side

Bore	Thickness	Pkg Qty	Part #
4.200"	.....040"	.....1.....	C5583-040

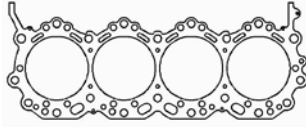

Additional thicknesses available see page 4

# TRIUMPH

## 1966-74 Spitfire 1500cc

### Head Gasket

#### Copper Head Gasket

Bore	Thickness	Pkg Qty	Part #
74mm	.....043"	.....1.....	C4153-043

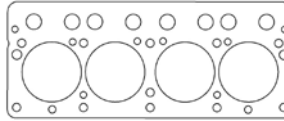

Additional thicknesses available see page 4

## 1961-65 TR4 2138cc Pushrod

### Head Gasket

#### CFM-20 Head Gasket

Bore	Thickness	Pkg Qty	Part #
88mm	.....043"	.....1.....	C4152-043

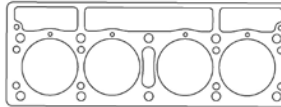

Additional thicknesses available see page 4

## 1969-71 TR6 2498cc Inline 6 Pushrod

### Head Gasket

#### Copper Head Gasket

Bore	Thickness	Pkg Qty	Part #
76mm	.....043"	.....1.....	C4154-043

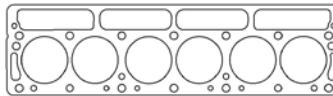

Additional thicknesses available see page 4

# TVR

## Speed 6 3.6/4.0L 1999-06 Tuscon, 1996-06 Cerbera, 2002-06 Tamora, 2002-06 T350, 2004-06 Sagaris

### Head Gaskets

#### MLS Head Gasket

Bore	Thickness	Pkg Qty	Part #
96.5mm	.....060"	.....1.....	C4527-060

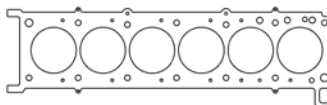

Additional thicknesses available see page 4



Cometic Gasket - An Exclusive NASCAR Performance Product

# VAUXHALL/OPEL

**C16XE, X16XE/X16XEL, Y16XE** 1994-98 Astra, 1993-94 Corsa B GSI, 1994-00 Tigra 16v

### Head Gasket

MLS Head Gasket			
Bore	Thickness	Pkg Qty	Part #
82mm	.....051"	.....1	<b>C4257-051</b>

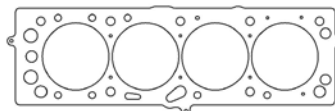

Additional thicknesses available see page 4

**20XE/C20XE/X20LET** 1992-97 Calibra Turbo, 1987-91 Kadett E 16v, 1993-95 Vectra A Turbo

### Head Gasket

MLS Head Gasket			
Bore	Thickness	Pkg Qty	Part #
88mm	.....051"	.....1	<b>C4216-051</b>

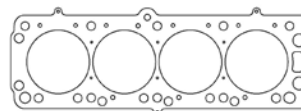

Additional thicknesses available see page 4

MLX Head Gasket			
Bore	Thickness	Pkg Qty	Part #
88mm	.....050"	.....1	<b>C4960-050</b>

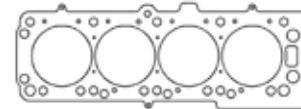

Additional thicknesses available see page 4

**CIH/E, CIH/S, CIH/S/E 2.0L** 83-88 Manta B, 1978-81 Ascona, 76-80 Rekord, 1983-84 Monza, 77-79 Kadett,

### Head Gasket

MLS Head Gasket			
Bore	Thickness	Pkg Qty	Part #
97mm	.....051"	.....1	<b>C4512-051</b>

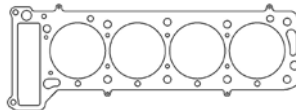

Additional thicknesses available see page 4

# VOLKSWAGEN/AUDI

**1.4L 1390cc DOHC TFSI 2007+: BMY, BLG**

### Head Gaskets

MLX Head Gasket			
Bore	Thickness	Pkg Qty	Part #
77mm	.....032"	.....1	<b>C4980-032</b>

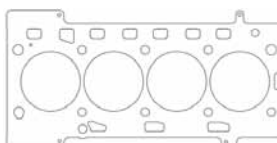

Additional thicknesses available see page 4

Exhaust Manifold Gasket Sets	
Application	Part #
1.4L DOHC 16v MLS	<b>C4975-030</b>

**1.8L** AGB, 2H, GX, HT, JH, JN, MZ, PG, PF, RD, RV, PL 2.0L: 9A - Golf Mk2/Mk3, Jetta Mk2/Mk3, Passat B2/B3/B4, Audi 80/100, Seat Ibiza Mk2

### Head Gaskets

MLS Head Gaskets			
Bore	Thickness	Pkg Qty	Part #
83mm	.....051"	.....1	<b>C4247-051</b>
85mm	.....051"	.....1	<b>C4246-051</b>

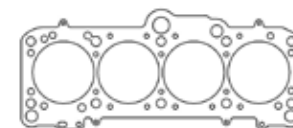

Additional thicknesses available see page 4

### Individual Gaskets

Exhaust Manifold Gasket Sets	
Application	Part #
1.8L 8v MLS - 4pcs	<b>C4163-030</b>
1.8L 16v MLS - 4pcs	<b>C4210-030</b>



Cometic Gasket - An Exclusive NASCAR Performance Product

# VOLKSWAGEN/AUDI

## 1.8L Turbo 1998-06

AEB, AGU, AJH, APH, ARX, ARZ, ATW, AUM, AVC, AWD, AWL, AWT, AWW, BJX, BKF, BKV, CFMA, AYP, CED, AMB, AWM, AJQ, APP, ARY, ATC, AUQ, AWP, BEK, BNU, BEX, BVR, AMU, AMK, BAM, BEA

### Head Gaskets

#### MLS Head Gaskets

Bore	Thickness	Pkg Qty	Part #
82mm	.....051"	.....1	C4558-051
85mm	.....051"	.....1	C4559-051

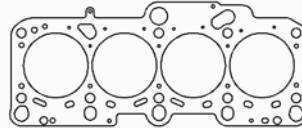

Additional thicknesses available see page 4

## 2.0L TFSI 16v DOHC

Golf GTI 2004-Up, A3, A4, A6, Jetta, Passat 2005-Up, TT, EOS 2006-Up, Seat Leon 2005-Up  
(AXX, BPY, BWA, BPJ, BUL, BWE, BRC, BWT, BYK)

### Head Gasket

#### MLS Head Gasket

Bore	Thickness	Pkg Qty	Part #
83.5mm	.....051"	.....1	C4541-051

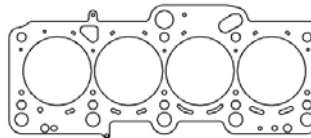

Additional thicknesses available see page 4

#### Exhaust Manifold Gasket Sets

Application	Part #
2.0L DOHC 16v MLS 2005-14.....	C4972-030

## 2.0L 16v DOHC 2008-11(chain driven) A3, A4, A6, A3, A4, A5, Q5, TT, 2009-11 CC, 08-11 Jetta, 08-10 Passat

### Head Gaskets

#### MLS Head Gasket

Bore	Thickness	Pkg Qty	Part #
82.5mm	.....040"	.....1	C4976-040
84mm	.....040"	.....1	C4977-040

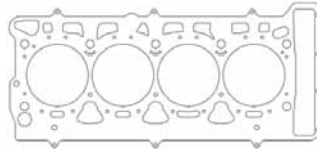

Additional thicknesses available see page 4

#### Exhaust Manifold Gasket Sets

Application	Part #
2.0L DOHC 16v MLS 2005-14.....	C4972-030

## 2.0L 16v DOHC 2012-Present (chain driven): A1, A3, A4, A5, Q3, Q5, TT

### Head Gaskets

#### MLS Head Gasket

Bore	Thickness	Pkg Qty	Part #
83mm	.....040"	.....1	C4978-040
84mm	.....040"	.....1	C4979-040

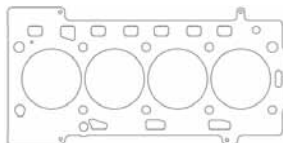

Additional thicknesses available see page 4

#### Exhaust Manifold Gasket Sets

Application	Part #
2.0L DOHC 16v MLS 2005-14.....	C4972-030





Cometic Gasket - An Exclusive NASCAR Performance Product

# VOLKSWAGEN/AUDI

**1.8L 16V DOHC** (CNSA, CNSB, CPRA, CPKA, CXBA, CXBB)  
**2.0L 16v DOHC** (CJXC, CXBB, CXCA, CNTC, CPPA, CPLA CXCB, CYFB, CYMC, CYNB, CZRA, DBPA, EA113)

## Head Gaskets

**NEW!**

<b>MLX Head Gasket</b>			
Bore	Thickness	Pkg Qty	Part #
83mm	.036"	1	C14009-036

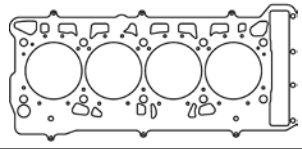

Additional thicknesses available see page 4

**3.2L VR6 24v 2004-09: Golf Mk4 R32**

## Head Gaskets

<b>MLS Head Gasket</b>			
Bore	Thickness	Pkg Qty	Part #
83mm	.030"	1	C4968-030

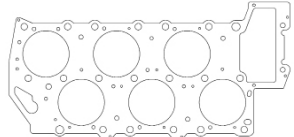

Additional thicknesses available see page 4

## Individual Gaskets

**NEW!**

<b>Throttle Body Gasket</b>	
Application	Part #
.....	C14027-060

**NEW!**

<b>Intake Manifold Gasket</b>	
Application	Part #
2007-08 Eos, 2003-04 Golf .....	C14029

# VOLVO

**B18A/B/D 1.8L 1961-68, B20A/B/E/F 2.0L 1969-81**

## Head Gasket

<b>MLS Head Gasket</b>			
Bore	Thickness	Pkg Qty	Part #
86mm	.045"	1	C4287-045
90mm	.045"	1	C4288-045
92mm	.045"	1	C4289-045

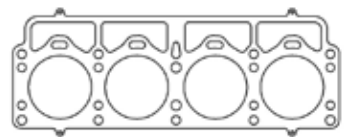

Additional thicknesses available see page 4

**B19A/E/ET 2.0L 1976-84, B20E/F/K/ET/FT 2.0L 1985-95, B21E/F/T/FT 2.1L 1975-85**

## Head Gasket

<b>MLS Head Gasket</b>			
Bore	Thickness	Pkg Qty	Part #
92mm	.045"	1	C4498-045
92mm	.098"	1	C4498-098
93mm	.045"	1	C14085-045
100.5mm	.045"	1	C14093-045

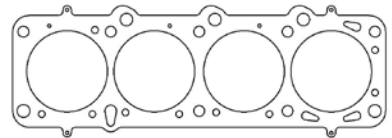

Additional thicknesses available see page 4

**B23AE/E/F/FT 2.3L 1978-84, B230A/E/F/FT/K 2.3L 1985-98, B243F 1989-95**

## Head Gasket

<b>MLS Head Gasket</b>			
Bore	Thickness	Pkg Qty	Part #
97mm	.045"	1	C4499-045
98mm	0.051	1	C14094-051

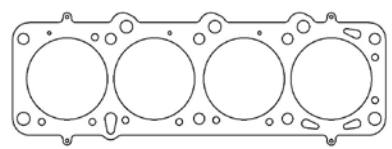

Additional thicknesses available see page 4



Cometic Gasket - An Exclusive NASCAR Performance Product

# MLS Exhaust Manifold Gaskets

- Designed for extreme cylinder pressures
- Maintains a torque set
- Resists corrosion, will not burn through or push out
- Withstands different combinations of cylinder head & exhaust manifold materials
- No sealants are required



## Domestic Exhaust Gaskets

Description	Material	Pkg Qty	Part#
<b>CHRYSLER / DODGE</b>			
<b>318, 340 &amp; 360</b>			
1.310" x 1.640" Port	MLS .030"	2	C5901-030
<b>361, 383, 400, 413, 426 &amp; 440</b>			
1.780" x 1.460" Port	MLS .030"	2	C5902-030
<b>426 Hemi</b>			
1.840" x 1.890" Port Stock	MLS .030"	2	C5965-030
2.310" x 2.810" Port Top Fuel	MLS .030"	2	C5903-030
<b>5.7L Hemi V8</b>			
1.460" x 1.390" Port	MLS .030"	2	C5854-030
<b>6.1L Hemi V8</b>			
2.082" x 1.508" Port	MLS .030"	2	C5872-030
<b>Viper V10</b>			
Gen I 1992-96	MLS .030"	2	C5679-030
Gen II 1996-02	MLS .020"	2	C5825-020
Gen III 2003-07	MLS .030"	2	C5865-030
Gen IV 2008-12	MLS .040"	2	C15150-040
<b>CUMMINS</b>			
5.9L 12V 16 Diesel 92-97	MLS .040"	2	C5725-040
5.9L 24V / Common Rail 98-08	MLS .040"	2	C5726-040
<b>FORD</b>			
<b>289, 302 &amp; 351</b>			
1.120" x 1.480" Port Square	MLS .030"	2	C5898-030
1.127" x 1.750" Port Oval	MLS .030"	2	C5899-030
All Yates Head 3 Piece Spring Steel	MLS .040"	8	C5665-040
<b>332 &amp; 390</b>			
1.560" x 2.320" Port	MLS .030"	1	C5922-030
<b>4.6L DOHC &amp; SOHC, 5.4L SOHC</b>			
4.6L / 5.4L 3V Head	MLS .030"	2	C5852-030
4.6L / 5.4L 3V Head D-Ports	MLS .030"	2	C5997-030
4.6L SOHC 1991-01, 5.4L Triton 99-Up	MLS .030"	2	C5853-030
4.6L / 5.4L DOHC 93-99	MLS .030"	2	C5012-030
5.0L Modular V8 2011	MLS .030"	2	C5392-030
5.4L Shelby Mustang 2007	MLS .030"	2	C5805-030
6.2L "BOSS" V8 2010+	MLS .030"	2	C5041-030
<b>429 &amp; 460</b>			
1.250" x 2.080" Oval Port	MLS .030"	2	C5900-030
1.550" x 2.350" Oval Port	MLS .030"	2	C5998-030
<b>RACE</b>			
JC50 500ci - Pro Stock	MLS .030"	2	C5257-030
FR9 V8	MLS .030"	2	C15107-030
<b>DIESEL</b>			
6.0/6.4L Powerstroke	MLS .300"	2	C5089-030
<b>GM</b>			
<b>V8 Small Block 262, 265, 283, 302, 307, 327, 350, 400 &amp; LT1</b>			
1.400" Square Port	MLS .030"	2	C5548-030
1.500" Round Port	MLS .030"	2	C5891-030
1.450" x 1.480" Port	MLS .030"	2	C5892-030
1.625" Round Port	MLS .030"	2	C5893-030
1.450" x 1.600" Port	MLS .030"	2	C5894-030
LT1 1.520" x 1.510" Port	MLS .030"	2	C5895-030
Brodix 12B Raised D Port	MLS .030"	2	C5927-030
Brodix / Weldtech 12 x 12 D Port	MLS .030"	2	C5928-030
GM/Brodix 13 Degree 4.4/4.5" Spacing	MLS .030"	2	C5039-030
Brodix/All Pro 286	MLS .030"	2	C5040-030
<b>SB2 Race</b>			
1.500" x 1.600"	MLS .065"	2	C5552-065
SB2	MLS .030"	2	C5836-030
<b>Big Block</b>			
1.920" Round Port	MLS .030"	2	C5896-030
2.000" Round Port	MLS .030"	2	C5349-030
2.130" Round Port	MLS .030"	2	C5996-030
2.200" Round Port	MLS .030"	2	C5350-030
2.250" Round Port	MLS .030"	2	C5251-030
1.850" x 1.900" Port	MLS .030"	2	C5897-030
Mercury Big Block 1050	MLS .051"	2	C5820-051
Mercury Marine 525/552 EFI	MLS .051"	2	C15364-030

Description	Material	Pkg Qty	Part#
<b>GM</b>			
<b>LS Series V8</b>			
LS Series V8	MLS .030"	2	C5818-030
LS7 D-Port 06-14	MLS .030"	2	C5073-030
GEN V LT1 6.2L 1.920" Port	MLS .021"	2	C5020-021
<b>DIESEL</b>			
6.6L Duramax 01-04	MLS .030"	2	C15042-030
Pontiac V8 326, 350, 400, 421, 428 & 455 D Port	MLS .030"	2	C5905-030
<b>OLDS</b>			
<b>330, 350, 400, 403 &amp; 455</b>			
1.450" x 1.920" Port	MLS .030"	2	C5904-030
<b>UNIVERSAL Header Collector</b>			
3.000" Dia. x 3.875" Bolt Circle	MLS .030"	1	C5907-030

## Import Exhaust Gaskets

Description	Material	Pkg Qty	Part#
<b>GM</b>			
Ecotec 2.2L - 1.720" x 1.090" 00-Up	MLS .030"	1	C4150-030
<b>HONDA</b>			
All B Series - 1.850" x 1.340" 94-01	MLS .030"	1	C4151-030
H22A1/A2/A4 - 1.770" x 1.380" 92-01	MLS .030"	1	C4155-030
F20C1/C2 - 2.030" x 1.730" 00-Up	MLS .030"	1	C4159-030
K20A1/A3 - 1.820" x 1.540" 01-04	MLS .030"	1	C4160-030
K20A2 - 1.975" x 1.730" 02-06	MLS .030"	1	C4162-030
D15/16 - 1.860" x 1.390" 92-00	MLS .030"	1	C4164-030
<b>MAZDA</b>			
B6 16V - 1.765" x 1.020" 89-93	MLS .030"	1	C4165-030
FS-DE - 2.045" x 1.375" 91-03	MLS .030"	1	C4171-030
<b>MITSUBISHI</b>			
4G63T/4G64 - 2.287" x 1.615" 89-99	MLS .030"	1	C4199-030
420A - 2.040" x 1.100" 95-98	MLS .030"	1	C4161-030
<b>NISSAN</b>			
VK56XD 2010-16	MLS .030"	1	C4959-030
VK56DE 2004-09	MLS .030"	1	C4961-030
CA18 DOHC - 1.621" x 1.232"	MLS .030"	1	C4523-030
SR20DE/T - 2.050" x 1.580" 91-02	MLS .030"	1	C4200-030
KA24DE - 1.575" Square 91-98	MLS .030"	1	C4201-030
RB26 - 1.665" x 1.420" 89-02	MLS .030"	2	C4202-030
RB20/RB25 - 1.340" x 1.575"	MLS .030"	1	C4177-030
<b>SCION</b>			
2AZ-FE 2.4L - 1.890" Round 01-Up	MLS .030"	1	C4203-030
<b>SUBARU</b>			
All EJ Motors - 1.825" Round 93-Up	MLS .030"	2	C4204-030
<b>TOYOTA</b>			
1ZZFE - 1.732" Round 98-02	MLS .030"	1	C4205-030
3S-GTE/5S-FE - 1.690" x 1.415" 89-97	MLS .030"	1	C4206-030
2RZ/3RZ-FE - 1.730" x 1.460" 95-Up	MLS .030"	1	C4207-030
7MGTE - 1.412" Round 87-92	MLS .030"	1	C4208-030
2JZGTE - 1.600" x 1.220" 93-Up	MLS .030"	2	C4209-030
<b>VW/AUDI</b>			
2.0L 05-14	MLS .030"	4	C4972-030
1.4L 07-Up	MLS .030"	4	C4975-030
2.0L - 1.525" Round 85-96	MLS .030"	4	C4210-030



Cometic Gasket - An Exclusive NASCAR Performance Product

## Valve Stem Seals

Available for most applications ranging from automotive to off road dirt bikes. Valve stem seals are defined first by the actual measurement of the valve stem OD itself then by the guide OD. Proper seal height and width will be determined by valve spring clearance. **Sold in packs of sixteen.**



Umbrella

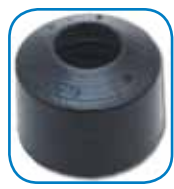

Positive All Rubber



Positive Ring & Spring



Positive Ring & Band



O-Ring



Metal Jacket



Metal Jacket "Hat"

### Metric Valve Stem

Part #	Stem OD	Guide OD	Height	OD	Type / Matl.
3154V-16	8.0mm	12.0mm	9.6mm	15.5mm	Metal Jacket/Viton
3158V-16	6.0mm	10.7mm	11.5mm	13.8mm	Metal Jacket/Viton
3159V-16	6.0mm	11.75mm	15.0mm	14.6mm	Metal Jacket/Viton
3162V-16	7.0mm	15.0mm	14.0mm	14.3mm	Metal Jacket/Viton
3163V-16	5.5mm	11.8mm	12.0mm	14.8mm	Metal Jacket/Viton
3164V-16	8.0mm	12.3mm	12.0mm	17.0mm	Ring & Band/Viton
3168V-16	7.5mm	14.0mm	13.0mm	16.8mm	Metal Jacket/Viton
3169V-16	5.5mm	12.0mm	13.8mm	14.5mm	Metal Jacket/Viton (no int rubber)
3170V-16	5.0mm	11.0mm	10.0mm	12.85mm	Metal Jacket/Viton
3172V-16	6.0mm	9.8mm	10.0mm	13.2mm	Metal Jacket/Viton
3173V-16	5.5mm	11.8mm	12.0mm	14.75mm	Metal Jacket/Viton
3225V-16	6mm	11mm	9.3mm	13.4mm	Metal Jacket/Viton
3174V-16	8.5mm	12.5mm	2.0mm	11.9mm	O-ring/Viton
3175V-16	5.5mm	9.5mm	11.4mm	12.75mm	Metal Jacket/Viton
3176V-16	5.0mm	10.6mm	11.6mm	14.15mm	Metal Jacket/Viton
3177V-16	6.0mm	12.0mm	10.0mm	13.7mm	Metal Jacket/Viton
3180V-16	5.0mm	10.8mm	18.3mm	16.9mm	Metal Jacket (Hat)/Viton
3181V-16	5.5mm	11.6mm	20.2mm	17.2mm	Metal Jacket (Hat)/Viton
3182V-16	5.0mm	11.8mm	21.0mm	17.15mm	Metal Jacket (Hat)/Viton
3262V-16	7.0mm	11mm	9.5mm	14.4mm	Metal Jacket/Viton
3264V-16	5.0mm	11mm	8mm	13.4mm	Metal Jacket EXH/Viton
3265V-16	5.0mm	11mm	8mm	13.4mm	Metal Jacket INT/Viton
3516P-16	8.0mm	0.492	0.470	0.616	Metal Jacket/Poly

### 1/4" Valve Stem

Part #	Stem OD	Guide OD	Height	OD	Type / Matl.
3184V-16	1/4	0.435	0.392	0.531	Metal Jacket/Viton
3232V-16	1/4	0.476	0.517	0.562	Metal Jacket/Viton (no int rubber)
3258V-16	1/4	0.476	0.646	1.106	Metal Jacket (Hat)/Viton
3259V-16	1/4	0.48	0.794	1.106	Metal Jacket (Hat)/Viton

### 5/16" Valve Stem

Part #	Stem OD	Guide OD	Height	OD	Type / Matl.
3057V-16	5/16	0.438	0.445	0.600	Ring & Band/Viton
3060V-16	5/16	0.562	0.461	0.710	Ring & Band/Viton
3061V-16	5/16	0.562	0.461	0.710	Ring & Band/Viton
3064V-16	5/16	0.563	0.580	0.712	Metal Jacket/Viton
3222V-16	5/16	0.514	0.403	0.610	Metal Jacket/Viton
3235V-16	5/16	0.531	0.516	0.677	Metal Body/Viton
3236V-16	5/16	0.491	0.531	0.623	Metal Body/Viton
3237V-16	5/16	0.476	0.517	0.562	Metal Body/Viton (no int rubber)
3216V-16	5/16	0.562	1.085	1.3888	Metal Jacket (Hat)/Viton

### 11/32" Valve Stem

Part #	Stem OD	Guide OD	Height	OD	Type / Matl.
3012V1-16	11/32	0.500	0.540	0.640	Ring & Band/Viton
3013N1-16	11/32	0.520	0.470	0.690	Positive 2-Ring/Nitrile
3014N1-16	11/32	0.530	0.485	0.710	Ring & Band/Nitrile
3024V1-16	11/32	0.530	0.485	0.710	Ring & Band/Viton
3066V1-16	11/32	0.563	0.470	0.690	Ring & Band/Viton
3188V-16	11/32	0.500	0.531	0.623	Metal Jacket/Viton
3192V-16	11/32	0.562	0.485	0.677	Ring & Band/Viton
3223V-16	11/32	0.472	0.435	0.677	Metal Jacket/Viton
3228V-16	11/32	0.530	0.527	0.674	Metal Jacket/Viton
3245V-16	11/32	0.583	0.400	0.740	Metal Jacket/Viton

### 3/8" Valve Stem

Part #	Stem OD	Guide OD	Height	OD	Type / Matl.
3017N1-16	3/8	0.623	0.470	0.790	Positive-2-Ring/Nitrile
3050V-16	3/8	0.750	0.830	0.875	Umbrella Seal/Viton
3185T-16	3/8	0.562	0.415	0.66	Teflon Steel Body/Teflon
3195V-16	3/8	0.500	0.531	0.623	Metal Jacket/Viton
3196V-16	3/8	0.530	0.516	0.677	Metal Jacket/Viton
3197V-16	3/8	0.562	0.516	0.661	Metal Jacket/Viton
3198V-16	3/8	0.625	0.531	0.742	Metal Jacket/Viton

### Misc. Valve Stem

Part #	Stem OD	Guide OD	Height	OD	Type / Matl.
3199V-16	0.276	0.476	0.517	0.562	Metal Jacket/Viton (no int rubber)
3240V-16			0.975	0.970	Metal Jacket (Hat)/Viton
3255V-16	0.287	0.49	0.887	1.185	Metal Jacket (Hat) INT/Viton
3256V-16	0.287	0.49	0.887	1.185	Metal Jacket (Hat) EXH/Viton
3260V-16	0.281	0.53	1.035	1.372	Metal Jacket (Hat)/Viton
3261V-16	0.281	0.53	1.14	1.255	Metal Jacket (Hat)/Viton
3214V-16	0.265	0.500	0.555	0.645	Metal Jacket /Intake
3215V-16	0.265	0.500	0.555	0.638	Metal Jacket /Exhaust
3217V-16	0.265		1.020	1.000	Metal Jacket (Hat)/Viton
3218V-16	0.265	0.500	0.635	1.126	Metal Jacket /Intake/Yellow
3219V-16	0.265	0.500	0.635	0.645	Metal Jacket /Exhaust/Green
3246V-16	0.198	0.334	0.390	0.482	Metal Jacket /Viton
3257V-16	0.204		0.555	0.645	Metal Jacket /



# Karting Gaskets



Cometic Gasket - An Exclusive NASCAR Performance® Product

## BRIGGS & STRATTON

Model	Year	Bore Size	Top End Kit #	Component #	Component Description	OEM Part #
<b>5HP RAPTOR</b>	All	68.5MM	C104	H0694043F	68.5mm Bore Head Gasket Comp. Fiber	
				IR081047F	Intake Gasket (1.400" Spacing)	
				IR084015F	Carburetor Mount Gasket Tillotson	
				IR085125KF	Intake Gasket (1.800" Spacing)	
				EX113020C	Exhaust Gasket Copper	
				EX113042AM	Exhaust Gasket Fiber	
				CB021060F	Fuel Tank Mounting Gasket	
				CB023015R	Carburetor Diaphragm Gasket	
				EC102047F	Breather Cover Gasket	
				EC103015F	Side Cover Gasket .015"	
				EC103020F	Side Cover Gasket .020"	
• Suggested Oil: Klotz KL-870						
<b>ANIMAL</b>	All	69.5MM	C187	H3590040S	69.5mm Head Gasket Multi-Layer Steel	555698
			C200	H3590SP1040S	70.5mm Head Gasket Multi-Layer Steel	555698
		70.5MM	IR786060AFM	Intake Gasket	691885	
			EC1424060AFM	Cylinder Head Plate Gasket	694088	
			EC1426060AFM	Breather Cover Gasket	691890	
EC1425032AFM	Side Cover Gasket	699485				
• Suggested Oil: Klotz KL-870						
<b>LO206</b>	All	69.5MM	C199	H3590SP2060HTS	69.5mm Head Gasket Graphite	555723
				IR786060AFM	Intake Gasket	691885
				EC1424060AFM	Cylinder Head Plate Gasket	694088
				EC1426060AFM	Breather Cover Gasket	691890
EC1425032AFM	Side Cover Gasket	699485				
• Suggested Oil: Klotz KL-870						
<b>WORLD FORMULA</b>	All	69.5MM	C188	H3590040S	69.5mm Head Gasket Multi-Layer Steel	555698
				IR1376015F	Intake Gasket	557044
				EX1676059F	Exhaust Gasket	691893
				EC1424060AFM	Cylinder Head Plate Gasket	694088
				EC1426060AFM	Breather Cover Gasket	691890
EC1425032AFM	Side Cover Gasket	699485				
• Suggested Oil: Klotz KL-870						

## HONDA

Model	Year	Bore Size	Top End Kit #	Component #	Component Description	OEM Part #
<b>GX200 CLONE</b>	All	68MM	C192	H3096010S	68mm Head Gasket	
				IR836020F	Intake Gasket	
				CB307020F	Carburetor Flange Gasket	
				IR1381094KF	Air Filter Adapter Gasket	
				EX1033042AM	Exhaust Gasket	
				VC207047KF	Valve Cover Gasket	
				EC1453020F	Side Cover Gasket	
• Suggested Oil: Klotz KL-870						
<b>STOCK SHIFTER CR125</b>	97-99	55MM	C189	H0225010S	55mm Head Gasket	12251-KZ4-A91
				B0314018AFM	Base Gasket	12191-KZ4-L10
				B0009018AFM	Base Gasket '97 Cylinders Only	2191-KZ4-860
				IR003018AFM	Intake Reed Gasket	14132-K56-701
				EX006042AM	Exhaust Gasket	18291-KZ4-700
				PV001018AFM	Right Power Valve Gasket	12108-KZ4-700
				PV002018AFM	Left Power Valve Gasket	12109-KZ4-700
				PV003018AFM	Upper Power Valve Gasket	12112-KZ4-700
				R19X3V	Water Outlet O-ring	91312-KE7-003
• Suggested Oil: Klotz KL-104						
<b>STOCK SHIFTER00 CR125</b>		54MM	C190	H0928010S	54mm Head Gasket	12251-KZ4-A91
				B0314018AFM	Base Gasket	12191-KZ4-L10
				IR003018AFM	Intake Reed Gasket	14132-K56-701
				EX006042AM	Exhaust Gasket	18291-KZ4-700
				PV091032AFM	Power Valve Gasket	12108-KZ4-A90
R19X3V	Water Outlet O-Ring	91312-KE7-003				
• Suggested Oil: Klotz KL-104						
<b>STOCK SHIFTER CR125</b>	01-02	54MM	C191	H0928010S	54mm Head Gasket	12251-KZ4-A91
				B0490018AFM	Base Gasket	12191-KZ4-L10
				EX006042AM	Exhaust Gasket	18291-KZ4-700
				IR003018AFM	Intake Gasket Reed To Carb Boot	14132-K56-701
				PV091032AFM	Power Valve Gasket	12108-KZ4-A90
				R124S	Expansion Cham O-Rings (2 Req.)	
R19X3V	Water Outlet O-Ring	91312-KE7-003				
• Suggested Oil: Klotz KL-104						



# Karting Gaskets



Cometic Gasket - An Exclusive NASCAR Performance® Product

## HONDA

Model	Year	Bottom End Kit #	List Price	Component #	Component Description	OEM Part #
<b>STOCK SHIFTER CR125</b>	97-02	C189BE		EC083032AFM	Inner Clutch Cover Gasket	11394-KZ4-A90
				EC185020F	Center Case Gasket	11191-KZ4-620
				EC228	Clutch Cover Gasket	91311-KS6-700
				EC510060AFM	Magneto Cover Gasket	11352-KS6-700
				IR003018AFM	Intake Gasket	14132-KY4-970
				WP033018AFM	Water Pump Gasket	19229-KZ-620
				R16X3V	Fill Plus O-Ring	91303-800-000
				R20X2V	Output Shaft O-Ring	94109-12000
				WA133	Water Pump Drain Plug Gasket	90543-273-000
				WA117	Drain Plug Gasket	94109-12000

## IAME

Model	Year	Bore Size	Top End Kit #	Component #	Component Description	OEM Part #
<b>MINI SWIFT</b>	All	41.8MM	C193	H4377005C	Head Gasket .005"	A-61049
				B1358015F	Base Gasket	EBP-85045
				IR1380020F	Intake Gasket	A-61822
				EX1684059F	Exhaust Gasket	A-61360
				WA146	Copper Washer	
• Suggested Oil: Klotz KL-104						
<b>LEOPARD</b>	08-Later	54MM	C194	R143V	Inner Head O-Ring	DBP-95049
				R249B	Outer Head O-Ring	B-25820
				R8X1.5V	Stud O-Ring (4 Req.)	B-25825
				B1354015F	Base Gasket	BP-25045
				IR1370032AFM	Intake Manifold Gasket	11810
				IR1371031F	Intake Reed Block Gasket	11805-A
				CB456039F	Carburetor Gasket	10360-A
				EX1674059F	Exhaust Gasket	B-85360
WA082063C	Temp Sensor Washer	B-25845				
• Suggested Oil: Klotz KL-104						
<b>LEOPARD MY09</b>	All	54MM	C195	R143V	Inner Head O-Ring	DBP-95049
				R249B	Outer Head O-Ring	B-25820
				R8X1.5V	Stud O-Ring (4 Req.)	B-25825
				B1213015F	Base Gasket	EBP-125045
				IR1368031F	Intake Manifold Gasket	F-11810
				IR1369031F	Intake Reed Block Gasket	F-11805
				CB456039F	Carburetor Gasket	10360-A
				EX1674059F	Exhaust Gasket	B-85360
WA082063C	Temp Sensor Washer	B-25845				
• Suggested Oil: Klotz KL-104						
<b>X30</b>	All	54MM	C196	R59X2.5V	Inner Head O-Ring	D-37049
				R246B	Outer Head O-Ring	F-38820
				R8X1.5V	Stud O-Ring (4 Req.)	B-25825
				B1213015F	Base Gasket .015"	EBP-125045
				IR1369031F	Intake Manifold Gasket	F-11805
				IR1368032AFM	Intake Reed Block Gasket	X30125810
				CB456039F	Carburetor Gasket	10360-A
				EX1673059F	Exhaust Gasket	B-75360
				WA213043C	Temp Sensor Washer	B-25845
				WA214050C	Water Pipe Washer	B-25835
				EC2206032AFM	Magneto Cover Gasket	X30125878
				R329B	Magneto Damper O-Ring	X30125853

## PRD

Model	Year	Bore Size	Top End Kit #	Component #	Component Description	OEM Part #
<b>PRD FIREBALL</b>	All	54MM	C197	R143V	Inner Head O-Ring	9012555
				R249B	Outer Head O-Ring	9011555
				R015V	Stud O-Ring (4 Req.)	9024555
				B1355012F	Base Gasket	9057555A
				IR1374020F	Intake Manifold Gasket	9101555
				IR1375020F	Intake Reed Block Gasket	9100555
				CB457020F	Carburetor Gasket	9107555
				EX1675064AM	Exhaust Gasket	9021555

• Suggested Oil: Klotz KL-104



# Karting Gaskets

## ROTAX

Model	Year	Bore Size	Top End Kit #	Component #	Component Description	OEM Part #
FR125 MAX EVO	All	54MM	C198	R037V	Inner Head O-Ring	250 160
				R155B	Outer Head O-Ring	250 280
				R118B	Spark Plug O-Ring	430 782
				B1356012F	Base Gasket .012"	650 480
				B1356015F	Base Gasket .015"	650 481
				B1356020F	Base Gasket .020"	650 482
				B1356031F	Base Gasket .031"	650 483
				IR1377031F	Intake Manifold Gasket	250 521
				EX1677059F	Exhaust Gasket	250 271
				PV154031F	Power Valve Gasket	250 231

• Suggested Oil: Klotz KL-104

## YAMAHA

Model	Year	Bore Size	Top End Kit #	Component #	Component Description	OEM Part #
KT100	All	54MM	C134	H0524032C	Head Gasket	
				B0308015F	Base Gasket	
				CB030015F	Intake Carb Spacer (2 Req.)	
				CB031015F	Intake Manifold to Carb Gasket	
				EX131	Exhaust Gasket	
				EC181012F	Center Case Gasket	
YF200R1	All	71MM	C184	H1795036S	Head Gasket Multi-Layer Steel	F21-304-30
				IR369018AFM	Intake Gasket	F21-310-00
				EX476042AM	Exhaust Gasket	F21-309-00
				EC758018AFM	Tillostson Flange Gasket	F21-318-00
				EC759020RC	Side Cover Gasket	F21-317-00
				VC076060AFM	Valve Cover Gasket	F21-314-00
				VC077032AFM	Valve Cover Baffle	F21-315-00

• Suggested Oil: Klotz KL-104

• Suggested Oil: Klotz KL-870



## Karting Gasket Illustrations



B0009018AFM



B0308015F



B0314018AFM



B0490018AFM



B1213015F



B1354015F



B1355012F



B1356012F



B1358015F



CB021060F

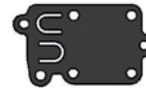

CB023015R



CB030015F



CB031015



CB307020F



CB456039F



CB457020F



EC083032AFM



EC102047F



EC103015F



EC103020F



EC181012F



EC185020F



EC510050AFM



EC758018AFM



# Karting Gasket Illustrations



EX1675064AM



EX1676059F



EX1677059F



EX1684059F



H0225010S



H0694043F

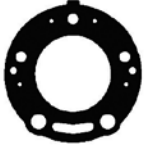

H0928010S



H1795036S



H3096010S



H3590040S



H4377005C



IR003018AFM



IR081047F



IR084015F



IR085125KF



IR369018AFM



IR786060AFM



IR836020F



IR836029F



IR1368031F



IR1369031F

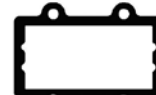

IR1370032AFM



IR1371031F



IR1374020F

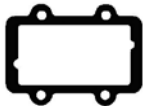

IR1375020F



IR1376015F



IR1377031F



IR1380020



IR1381094KF



PV001018AFM



PV002018AFM



PV003018AFM



PV091032AFM



PV154031F



VC076060AFM



VC077032AFM



VC207047KF



EC759020RC



EC1424060AFM

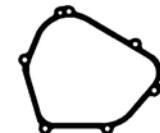

EC1425032AFM



EC1426060AFM

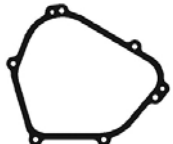

EC1453020F

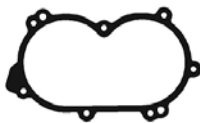

EC2206032AFM



EX1576SP1



EX006042AM



EX476042AM



EX1033042AM



EX1673059F



EX1674059F



# UTV Gaskets



Cometic Gasket - An Exclusive NASCAR Performance® Product

## ARCTIC CAT UTV PROWLER 650



Base                      Cam Chain                      Clutch Cover                      Head

Model	Year	Bore Size	Top End Kit	Component Part#	Component Description	OEM Part #
Prowler 650	06-09	98 mm	C7220	H1735SP3027S	Head Gasket 98mm Bore	0830-124
				H1735SP4027S	Head Gasket 100mm Bore	0830-124
		100 mm	C7022	B0647014RC	Base Gasket	0830-084
				EX657	Exhaust Gasket	0412-338
				EC377032AFM	Cam Chain Tens. Gasket	0830-018
				OS020	2 Req.-Cam Chain Tens. O-ring	0830-107
				R22X2.5V	Coolant Line O-ring	0830-007
				R45X3V	Intake O-ring	0830-090
				R54X2V	2 Req.-Valve Cover O-rings	0830-004
<b>Bottom End Gaskets Available Separately</b>						
				Component Part#	Component Description	OEM Part #
				EC1142032AFM	Clutch Cover Gasket	0830-116
				EC1143032AFM	Magneto Cover Gasket	0830-128
				EC1141032AFM	Primary Cover Gasket	0830-174

## PROWLER 700XT LTD

Model	Year	Bore Size	Top End Kit	Component Part#	Component Description	OEM Part #
Prowler 700 XT LTD	08-15	103.5mm	C3597-EST	H2223SP4027S	Head Gasket	0830-112
				B0760014RC	Base Gasket	0830-111
X700	11-17			EX657	Exhaust Gasket	0412-338
				OS020	Cam Chain Tensioner Gasket	0830-107
				EC377032AFM	Cam Chain Tens. Gasket	0830-018
				3186V	Valve Seals	0830-186
				R22X2.5V	Water Outlet O-ring	0830-007
				R124V	Valve Cover O-rings 2 req.	0830-215
				R008B	Intake O-ring	0423-182
				R124V	Oil Fill Cap O-ring	0830-215
				R54X2V	Inspection Cap O-ring	0830-004
<b>Bottom End Gaskets Available Separately</b>						
				Component Part#	Component Description	OEM Part #
				EC1142032AFM	Clutch Cover Gasket	0830-116
				EC1143032AFM	Magneto Cover Gasket	0830-128
				EC1141032AFM	Primary Cover Gasket	0830-174

## PROWLER/WILDCAT 1000

Model	Year	Bore Size	Top End Kit	Component Part#	Component Description	OEM Part #
Prowler/ Wildcat 1000	10-17	93.5mm	C3568-EST	H2399SP6027S	Head Gasket	0830-209
				B1155014RC	Base Gasket	0830-193
				EX657	Exhaust Gasket	0412-338
				EC2035032AFM	Cam Chain Tensioner Gasket 2 Req.	0830-134
				3186V	Valve Seals 8 Req.	0830-186
				R118V	Water Outlet O-ring	0830-007
				OS384	Water Inlet Seal	0830-120
				R54X2V	Valve Cover O-rings 4 req.	0830-004
				R45X3V	Intake O-ring 2 req.	0830-090





# UTV Gaskets



Cometic Gasket - An Exclusive NASCAR Performance® Product

## CAN-AM/BOMBARDIER UTV COMMANDER 1000



Head



Base

Model	Year	Bore Size	Top End Kit	Component Part#	Component Description	OEM Part #
Commander11-16 1000		92mm	C3459-EST	H2653018S	Head Gasket 92mm 2 Req.	420630195
		93mm	C3460-EST	H2653SP1018S	Head Gasket 93mm 2 Req.	
Maverick 13-15		94mm	C3461-EST	H2653SP2018S	Head Gasket 94mm 2 Req.	420230515
		96mm	C3462-EST	H2653SP5018S	Head Gasket 95mm 2 Req.	
				3186V	Valve Stem Seal 8 Req.	
			R117V	Cam Chain Tensioner O-ring	420430370	
			R15X1.5V	Cam Adjuster O-ring	420250890	
			EX696	Header Gasket 2 Req.	707600317	
			B0895010RC	Base Gasket 2 Req.	420630210	

### Bottom End Gaskets Available Separately

Component Part#	Component Description	OEM Part #
EC1142032AFM	Clutch Cover Gasket	0830-116
EC1143032AFM	Magneto Cover Gasket	0830-128
EC1141032AFM	Primary Cover Gasket	0830-174

## HONDA UTV FL250 ODYSSEY

Model	Year	Bore Size	Top End Kit	Component Part#	Component Description	OEM Part #
FL250 Odyssey	73-77	72 mm	C7140	H0182043F	Head Gasket 72mm	12251-358-306
				B0137020F	Base Gasket 73-76	12191-357-306
				B0395020F	Base Gasket 77-84	12191-381-306

## FL350R ODYSSEY



Base



Exhaust



Head



Valve Cover

Model	Year	Bore Size	Top End Kit	Component Part#	Component Description	OEM Part #
FL350R Odyssey	85	82 mm	C7229	B0204020F	Base Gasket	12191-VM0-772
				H0344043F	Head Gasket	12254-VM0-013

## PILOT FL-400



Exhaust



Intake

Model	Year	Bore Size	Top End Kit	Component Part#	Component Description	OEM Part #
Pilot FL-400	89-91	82 mm	C7024	H0015043F	Head Gasket	12251-HE0-000
				B0020020F	Base Gasket	12191-HE0 000/010
				EX009042AM	Exhaust Gasket	18291-HE0 000/010
				IR004018AFM	Intake Gasket	14132-KAE- 000/430-000



# UTV Gaskets



Cometic Gasket - An Exclusive NASCAR Performance® Product

## KAWASAKI UTV

### KRF750 Teryx



Head



Base

Model	Year	Bore Size	Top End Kit	Component Part#	Component Description	OEM Part #
KRF750 Teryx (SXS)	08-14	85mm	C3284-EST	H2624SPA010S	Head Gasket 85mm	11004-0011
		90 mm	C3251-EST	H2624SP1010S	Head Gasket 90mm	11004-0011
				B0951020RC	Base Gasket	11061-0063
				EX361	Exhaust Gasket 2 req	11009-1894
				WA114	Coolant Drain Washer 2 Req	
				R55X2V	Rocker Cap O-Ring 4 Req	92055-0112
				R19X2V	Plug Cover O-Ring 2 Req	92055-1146
				3242V	Valve Stem Seals 8 Req	92049-1218

## POLARIS UTV

### RZR170



Exhaust



Head

Model	Year	Bore Size	Top End Kit	Component Part#	Component Description	OEM Part #
RZR170	09-16	61mm	C3596-EST	B1318020RC	Cylinder Base Gasket	0454459
				H4194010S	Cylinder Head Gasket	0454365
				IR1308020F	Intake Manifold Gasket	0453451
				R024V	Intake Manifold O-ring	0452459
				R049B	Cylinder Head Cover O-ring	0454363
				EC2131032AFM	Cylinder Head Breather	0454640
				EC2132060AFM	Air Injection Gasket	0452808
				EC2133060AFM	Air Injection Tube Gasket	0454454
				EX886042AM	Exhaust Gasket	0453672
				3234V	Valve Seal	0452390
				EC2134032AFM	Cam Chain Tensioner Gasket	0452417

### RZR 570

Model	Year	Bore Size	Top End Kit	Component Part#	Component Description	OEM Part #
RZR 570	12,14-18	99mm	C3528-EST	B1171014RC	Base Gasket	5254903
				H3609021S	Head Gasket 99mm Bore	5813676
				3231V	Valve Seals 4 Req.	3610161
				EX817	Exhaust Gasket	5253989
				3254V	Valve Spring Seat With Seal	3610212
				EC1654020RC	Cam Chain Tensioner	5813449

### RANGER RZR 800 (SXS)

Model	Year	Bore Size	Top End Kit	Component Part#	Component Description	OEM Part #
Ranger	08	80 mm	C3250	H2761030S	Head Gasket 80mm Bore	5247359
RZR 800 (SXS)		82 mm	C3507	H2761SP2030S	Head Gasket 82mm Bore	
				B0940010RC	Base Gasket	5247360
				EX452SP1064AM	Exhaust Gasket	5811511

### RANGER RZR 800 (SXS)

Model	Year	Bore Size	Top End Kit	Component Part#	Component Description	OEM Part #
Ranger	11-13	80 mm	C3506	H3657010S	Head Gasket 80mm Bore	5254357
RZR 800 (SXS)		82 mm	C3508	H3657SP2010S	Head Gasket 82mm Bore	
				B0940010RC	Base Gasket	5247360
				EX452SP1064AM	Exhaust Gasket	5811511



# UTV Gaskets



Cometic Gasket - An Exclusive NASCAR Performance® Product

## POLARIS UTV

### XP900

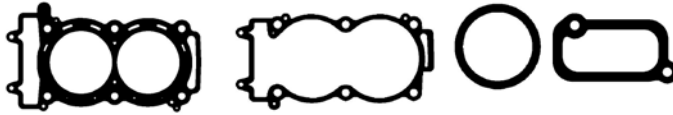

Head Base Cam Chain Tensioner Water Inlet

Model	Year	Bore Size	Top End Kit	Component Part#	Component Description	OEM Part #
XP900	11-14	93.5mm 96mm	C3446-EST C3447-EST	H3336018S	Head Gasket 93.5mm Bore	5813439
				H3336SP1018S	Head Gasket 93.5mm Bore	
				B1079014RC	Base Gasket	5253037
				EC1654020RC	Cam Chain Tensioner	5813449
				WP383032AFM	Water Inlet Gasket	5813521
				EX817 3231V	Exhaust Gasket 2 req. Valve Seals 8 Req.	5253989 3610161

### XP1000

Model	Year	Bore Size	Top End Kit	Component Part#	Component Description	OEM Part #
RZR XP1000	14-19	94mm	C3546-EST	H3892018S	Head Gasket 94mm Bore	5813737
RZR XP4 1000		96mm	C3563-EST	H3892SP1018S	Head Gasket 96mm Bore	5813737
900 Ace,	16-19			B1079014RC	Base Gasket	5253037
General 1000				EC1654020RC	Cam Chain Tensioner Gasket	5813449
Ranger 1000	18-19			EX1408064AM	Header Gasket	3610184
RZR 1000	16-19			3254V	Valve Spring Seat With Seal	3610212
RZR XP	16-19			MR135	Thermostat Seal	5413948
Turbo				MR136	Water Outlet O-ring	5813736

## YAMAHA UTV

### RHINO 660



Base Starter Cover Mag Cover Clutch Cover Timing Chain Tensioner Head

Model	Year	Bore Size	Top End Kit	Component Part#	Component Description	OEM Part #
RHINO 660 04-07 (SXS)		100 mm 101 mm 102 mm 103 mm 105 mm	C7044-EST C7900-EST C7798-EST C3042-EST C7909-EST	H1481SP2030S	Head Gasket 100mm	3YF-11181-00
				H1481030S	Head Gasket 101mm	
				H1191030S	Head Gasket 102mm	
				H2174030S	Head Gasket 103mm	
				H1191SP1030S	Head Gasket 105mm	
				B0532010RC	Base Gasket	3YF-11351-00
				EX361	Exhaust Gasket 2 Req.	3YF-14613-01-00
				EC584018AFM	Cam Chain Tensioner Gasket	4DW-12213-00
				3187V	Valve Seal 5 Req.	5H0-12119-00-00
				R016B	Radiator Hose O-ring	93210-18417-00
				R113B	Valve Cover Plug O-ring	93210-13657-00
				R114S	Oil Tank O-ring	93210-16629-00
				R116B	Cam Chain Tensioner Cap O-ring	11101/93210-19522-00
				R117B	Dipstick O-ring	93210-21190-00
				R124B	Tappet Cover O-ring	93210-32172-00
				R155S	Cylinder Base O-ring	11256/93211-01467-00
				R71X2.5B	Intake Valve Adj. Cover O-ring	93210-71360-00
				WA081080C	Oil Line Washers 4 Req.	90430-08204
				WA082063C	Oil line Washers 4 Req.	90430-10171



# UTV Gaskets



Cometic Gasket - An Exclusive NASCAR Performance® Product

## YAMAHA UTV



Model	Year	Bore Size	Top End Kit	Component Part#	Component Description	OEM Part #
RHINO	06-13	103 mm	C3142-EST	H2449027S	Head Gasket	3B4-11181-00-00
700		104 mm	C3143-EST	H2449SP2027S	Head Gasket 104mm Bore	3B4-11181-00-00
		105.5 mm	C3144-EST	H2465027S	Head Gasket 105.5mm Bore	3B4-11181-00-00
				B0855010RC	Base Gasket	1S3-11351-00-00
				EX361	Exhaust Gasket 2 Req.	3YF-14613-01-00
				R034V	Throttle Body O-ring	4WV-14147-10-00
				R126V	Water Pump O-ring	93210-33786-00
				R131B	Thermostat O-ring	93210-41042-00
				R240V	Cam Cover O-ring	93210-96601-00
				R79X2.5V	Valve Cover O-rings 2 Req.	93210-78544-00
				3187V	Valve Seal 4 Req.	5H0-12119-00-00
				EC584018AFM	Cam Chain Tensioner Gasket	4DW-12213-00

## WOLVERINE R-SPEC YXE700

Model	Year	Bore Size	Top End Kit	Component Part#	Component Description	OEM Part #
Wolverine Spec YXE700	2016	103mm	C3599-EST	EC2098032AFM	Cam Chain Tensioner Gasket	2MB-E2213-00-R-00
				MA0164	Cam Chain Tensioner Crush Gasket	2MB-E21E2-00-00
				B1306010RC	Cylinder Base Gasket	2MB-E1351-00-00
				H4173023S	103mm Bore Head Gasket	2MB-E1181-00-00
				VC362018AFM	Valve Cover Breather Gasket	2MB-E131B-00-00
				EX045	Header Gasket	3EG-14613-00-00
				WA117	Oil Line Banjo Bolt Crush Gaskets	2MB-E1195-00-00
				3187V	Exhaust Valve Seal	2MB-E2129-00-00
				3187V	Intake Valve Seal	2MB-E2119-00-00
				R125V	Water Outlet O-ring	2MB-E2843-00-00

## YXZ1000R

Model	Year	Bore Size	Top End Kit	Component Part#	Component Description	OEM Part #
YXZ1000R	2016	82.5mm	C3617	EC1152032AFM	Cam Chain Tensioner Gasket	2C0-12213-00-00
				R116B	Fill Plug O-ring	93210-19123-00
				WA116	Cylinder Head Drain Plug Crush Washer	90430-08119-00
				H4270016S	Cylinder Head Gasket	2HC-11181-00-00
				EX651	Exhaust Gasket 3 Req	4FM-14613-00-00
				3168V	Valve Stem Seal 12 Req.	2HC-12119-00-00



Klotz Synthetic Lubricants are designed and engineered to be the best lubricants in the motorsports industry. Race tested and formulated for all engine types, Klotz offers a full line of Estorlin Synthetic Racing Oils, Power Additives, and Aerosols needed to keep your engine protected and performing at an optimal level.

Racers, engine builders, and performance enthusiasts around the world rely on Klotz to get them to the checkered flag. Be Fast, Be First with Klotz Synthetic Lubricants.

## ESTORLIN® RACING PERFORMANCE SYNTHETIC ENGINE LUBRICANT



Part#	Desc.
KE-925	5W/20 Qt.
KE-930	10W/30 Qt.
KE-935	5W/30 Qt.
KE-940	10W/40 Qt.
KE-950	20W/50 Qt.
KE-954	15W/40 Qt.
KE-955	15W/50 Qt.
KE-915	15W/55 Qt.

Also available by the Case & 5 Gallon Pail



## UPLON® FUEL LUBE

- Provides upper cylinder and fuel pump lubrication
- Blends with methanol alcohol, ethanol, nitromethane and gasoline
- Maintains constant fuel pressure

Part#	Desc.
KL-106	Pint
KL-107	Quart

Also available by the Case

## ESTORLIN® FREE-GEAR® HYPOID SYNTHETIC GEAR LUBRICANT

Part#	Desc.
KE-960	75W/75 Qt.
KE-970	75W/80 Qt.

Also available by the Case & 5 Gallon Pail



## ESTORLIN® FREE-GEAR® MANUAL TRANSMISSION SYNTHETIC GEAR LUBRICANT

Part#	Desc.
KE-965	75W/75 Qt.
KE-975	75W/80 Qt.
KE-980	75W/90 Qt.
KE-990	80W/90 Qt.
KE-994	75W/140 Qt.
KE-995	75W/110 Qt.

Also available by the Case & 5 Gallon Pail



## Additives & Aerosols

	Part #	Size
Assembly Lube	KL-311	12oz.
Fogon - Storage & Afterrun Lubricant	KL-612	6oz.
	KL-610	16oz.
Foam Air Filter Oil	KL-606	15.25oz
Fabric Air Filter Oil	KL-607	15.25
Air Filter Cleaner	KL-608	15.25oz
Plug & Contact Cleaner	KL-609	12.5oz
Ethanol Gasoline Faze separation Treatment	KL-603	16oz.
Storbilizer	KL-613	16oz.
Cometic Engine Block & Head Surface Cleaner	C1047	15.25oz





## 2-STROKE LUBRICANTS Available Individually, Case, 30 gal. & 55 gal. drum



## 4-STROKE LUBRICANTS Available Individually, Case, 30 gal. & 55 gal. drum



### SUPER TECHNIPLATE®

Part#	Description
KL-103-1	1 Pint Bottle
KL-100-1	1 Quart Bottle
KL-109-1	1/2 Gallon Bottle
KL-101-1	1 Gallon Bottle

### ORIGINAL TECHNIPLATE®

Part#	Description
KL-200-1	1 Quart Bottle
KL-205-1	1 Gallon Bottle

### BeNOL® RACING CASTOR LUBRICANT

Part#	Description
BC-175-1	1 Pint Bottle
BC-172-1	1 Quart Bottle
BC-179-1	1/2 Gallon Bottle
BC-171-1	1 Gallon Bottle

### MOTORCYCLE TECHNIPLATE® TC-2

Part#	Description
KL-300-1	1 Quart Bottle
KL-301-1	1 Gallon Bottle

### R-50® RACING TECHNIPLATE®

Part#	Description
KL-102-1	1 Pint Bottle
KL-104-1	1 Quart Bottle
KL-105-1	1 Gallon Bottle

### MOTORCYCLE TECHNIPLATE® TC-W3

Part#	Description
KL-302-1	1 Quart Bottle

### 50:1 TECHNIPLATE® TC-W3

Part#	Description
KL-305-1	1 Pint Bottle
KL-304-1	1 Quart Bottle

### SKICRAFT® TECHNIPLATE®

Part#	Description
KL-306-1	1 Quart Bottle
KL-307-1	1 Gallon Bottle

### RACING SYNTHETIC FORK & SHOCK FLUID

Part#	Description
KL-505-1	1 Quart Bottle 5W
KL-515-1	1 Quart Bottle 10W
KL-515-1	1 Quart Bottle 15W

### ATV/UTV SYNTHETIC ENGINE LUBRICANT

Part#	Description
ATVUTV-040-1	0W/40 1 Qt. Bottle
ATVUTV-550-1	5W/50 1 Qt. Bottle

### ATV/UTV SYNTHETIC ENGINE LUBRICANT WITH INTEGRATED TRANSMISSION

Part#	Description
ATVUTV-1040-1	10W/40 1 Qt. Bottle

### MX4® TECHNIPLATE®

Part#	Description
KL-860-1	10W/40 1 Qt. Bottle
KL-870-1	10W/30 1 Qt. Bottle
KL-880-1	15W/50 1 Qt. Bottle

### MOTORCYCLE TECHNIPLATE® WITH INTEGRATED TRANSMISSION

Part#	Description
KL-815-1	15W/50 1 Qt. Bottle
KL-830-1	10W/30 1 Qt. Bottle
KL-840-1	10W/40 1 Qt. Bottle
KL-850-1	20W/50 1 Qt. Bottle

### SIDE X SIDE SYNTHETIC ENGINE LUBRICANT

Part#	Description
KL-802	5W/50 1 Qt. Bottle
KL-805	10W/50 1 Qt. Bottle
KL-803	10W/30 1 Qt. Bottle
KL-806	15W/50 1 Qt. Bottle

### PURE ESTORLIN® MARINE

Part#	Description
KE-330	10W/30 1 Qt. Bottle
KE-331	10W/30 1 Gallon Bottle
KE-340	25W/40 1 Qt. Bottle
KE-341	25W/30 1 Gallon Bottle
KE-334	10W/40 1 Qt. Bottle
KE-335	10W/30 1 Gallon Bottle

### PURE ESTORLIN® KART LUBRICANT

Part#	Description
KE-220-1	1 Quart Bottle 0W/20
KE-230-1	1 Quart Bottle 0W/30
KE-240-1	1 Quart Bottle 0W/40
KE-225-1	1 Quart Bottle 5W/20



## V-TWIN LUBRICANTS

### TRANSMISSION GEAR LUBE

Part#	Description
KH-GL90-1	80W/90 1 Qt. Bottle
KH-GL140-1	75W/140 1 Qt. Bottle

### GEAR AND CHAIN CASE LUBRICANT

Part#	Description
KH-S80-1	1 Qt. Bottle

### PRIMARY CASE LUBRICANT

Part#	Description
KH-C80-1	1 Qt. Bottle



### MULTI-VISCOSITY SYNTHETIC ENGINE LUBRICANT

- Recommended for the Harley Davidson Pre-Evolution, Evolution and Twin Cam
- Certified warranty compliant
- Custom formulated for the V-Twin air-cooled engines
- Reduces engine temperature and detonation
- High temperature film strength improving anti-wear protection

Part#	Description
KH-1040-1	10W/40 1 Qt. Bottle
KH-2050-1	20W/50 1 Qt. Bottle
KH-2560-1	25W/60 1 Qt. Bottle

### MULTI-VISCOSITY SYNTHETIC ENGINE LUBRICANT

- Recommended for the Yamaha, Victory and Indian engines
- Certified warranty compliant
- Custom formulated for the v-twin air-cooled engines
- Reduces engine temperature and detonation
- High temperature film strength improves anti-wear protection

Part#	Description
KV-2040-1	20W/40 1 Qt. Bottle
KV-1560-1	5W/60 1 Qt. Bottle

### STRAIGHT WEIGHT SYNTHETIC ENGINE LUBRICANT

- Custom formulated for the Harley-Davidson Pre-evolution engines
- Certified warranty compliant
- Reduces friction for Less Drag-More Power®
- High temperature film strength improving antiwear protection
- Reduces engine temperature and detonation

Part#	Description
KH-50-1	SAE 50 1 Qt. Bottle
KH-60-1	SAE 60 1 Qt. Bottle
KH-70-1	SAE750 1 Qt. Bottle



## LUBES

	Part#	Size
ATV/UTV Front/Rear End Differential Lube	ATV/UTV-8090-1	1 qt.
Flex Drive® 30 Transmission Lubricant	KL-506-1	1 qt.
Chain Case Lube	KL-500-1	12.oz
Chain Lube Aerosol	KL-605-1	15.25oz
KLR® Clean Chain Lube	KL-611-1	16oz
Jet Pump Lube	KL-511-1	4oz.



Cometic Gasket - An Exclusive NASCAR Performance Product

## Product Development

Cometic provides our customers with quality products, born of exhaustive research and development. Cometic's Superflow 902S dynamometer positions us at the forefront of gasket design and technology. Our state-of-the-art testing facilities and processes provide Cometic with the resources necessary to analyze gasket designs and materials in the most extreme conditions, ensuring that your gasket won't fail when you need it the most.



Gasket contact pressure is validated by Fuji film at our in-house research and development center.

## Promotional Items



Part #	Description
DC15.....	Package Decal 5.25" x 1.75"
DC06.....	Decal Sheet 5.5" x 8.5"
DC10.....	Embroidered Patch 2" x 5"
DC04.....	Trailer Decal 6" x 19"
DC03.....	Decal 3.125" x 9"
DC11.....	Banner 3' x 8'
DC17.....	StreetPro Decal 1.625" x 9"
DC13.....	Dealer Open House Kit (100) DC01, (2) DC04, (2) DC11, (2) DC12, (10) 40% Off Retail Certificates, (25) Catalogs
DC12.....	Adjustable Embroidered Hat





Made in the U.S.A.

# OEM Production

## One Source for Prototyping to Full Production

- Prototyping with economical tooling options.
- Full production Capabilities
- Quick turnaround
- In-house tool & die capabilities
- ISO 9001:2008 Certified
- We can assist in developing a sealing solution for nearly any environment.
- Personal attention by our dedicated staff. We currently supply production to many customers in the automotive, marine, powersports, industrial, and power generator industries.
- Stamping, Laser Cutting, Rubber Injection Molding and 5 Axis Machining

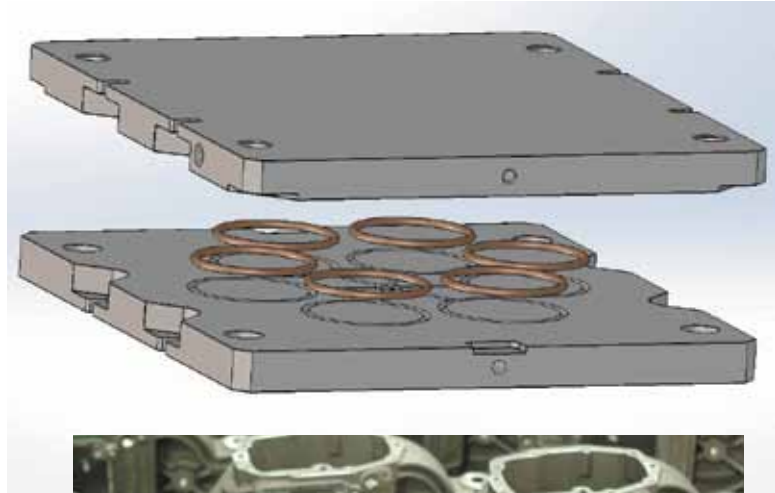

## Flexibility is Key

We understand many variables go into determining design, volume, and production forecasts. We are accustomed to working in an ever changing environment.

Maintain knowledge base and part awareness during the transition from the early stages of development all the way through production, without the hassle of changing suppliers.

Inventory turns are important. We can work together for a delivery solution that best fits your inventory level and cash flow needs.

