



# Performance Automotive Gaskets Domestic and Import



## Gasket Development

Cometic provides customers with quality products, born of exhaustive research and development.

Cometic's Superflow 902S Dynamometer positions us at the forefront of gasket design and technology by giving us the ability to analyze gasket designs and materials in the most extreme conditions. Alongside our in-house research and development, we also collaborate with our partners racing on Sunday at the highest level, ensuring that your gasket won't fail when you need it most.



## Custom Gaskets

Need to change a gasket bore size? Thickness or both? Do you need a complete gasket design and execution? The process starts with a simple phone call.

Cometic's in-house technical sales team can accommodate virtually any engine configuration: from naturally aspirated to the most exotic turbo or nitrous injected engines. Our commitment is to provide innovative, quality gaskets while maximizing your engine's power and performance. When customization is vital, Cometic delivers!

How does Cometic do it? The process starts and ends under one roof in Concord, Ohio. Once the technical sales team understands your needs, design engineers draw the gasket with state-of-the-art software, and then it is off to manufacturing. Your gasket is efficiently manufactured from quality materials and then shipped. If special tooling is required, Cometic will provide a pre-production estimate for approval.

The passion for racing runs deep in our technical sales and engineering teams. We understand the importance of perfection in your next engine build because we are right there with you racing on weekends.



# OEM Production Gaskets

Cometic is your one source for OEM gaskets, from prototyping to full production.

We currently develop sealing solutions in nearly every environment for many customers in the automotive, marine, powersports, industrial, and power generator industries. Prototyping is essential and economical with our different tooling options and quick turnaround due to our in-house tool and die department. Not only are we ISO 9001:2008 Certified, but we also have stamping, laser cutting, rubber injecting molding, and 5-axes machining capabilities.

Flexibility and communication are key. Cometic understands that many variables in determining the design, volume, and production forecasts. We are accustomed to working in an ever-changing environment, maintaining knowledge base and part awareness during the transition from the early stages of development through production, without the hassle of changing suppliers. Inventory turns are essential. We can work together for a delivery solution that best fits your inventory level and cash flow needs.

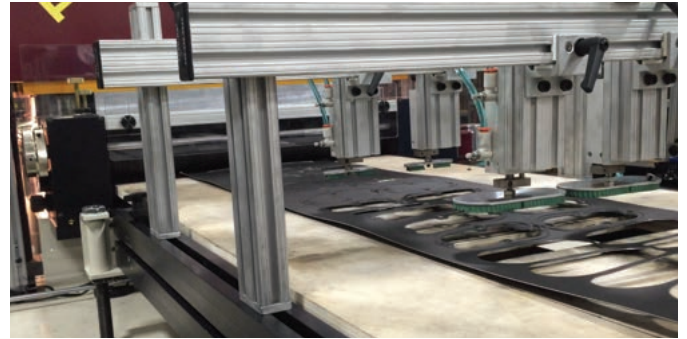

# Partner Relationships

Cometic's gaskets are the industry standard for championship-winning teams and engine builders across multiple disciplines of both professional and amateur motorsports. Since its inception in 1989, Cometic has built relationships with the most reputable engine builders in the industry. Those relationships create the foundation on which Cometic's gaskets are engineered, validated and manufactured for everyday use, or in the most competitive and demanding environments.





# Automotive Gaskets

Cometic Gasket - An Exclusive NASCAR Performance Product

## Carburetor Gaskets

Designed by engineers, validated by the winner's circle. Cometic carburetor gaskets are manufactured from performance grade materials that resist swelling from various types of fuel. Can be custom ordered to your exact specifications.

Part #	Application	Material
C15184	Holley 2bbl Carb Open Plenum	.039" FIBER
C5282	Holley 2bbl Carb 2 Hole 1.750"	.047" FIBER
C5263	Holley 4150 4bbl Carb Open Plenum	.047" FIBER
C5262	Holley 4150 4bbl 4 Hole 1.750"	.047" FIBER
C15238	Holley 4500 4bbl Carb Open Plenum	.047" FIBER
C15239	Holley 4500 4bbl 4 Hole 1.750" Gasket	.047" FIBER
C5280	Holley 390 Cfm 4bbl Carb 4 Hole 1-19/32"	.047" FIBER
C15181	Carter Afb 4bbl Square Bore 4 Hole	.039" FIBER
C15183	Rochester Quadrajct 4bbl Spread Bore	.039" FIBER
C15240	Weber 48mm Carb	.047" FIBER
C5388	Holley Airhorn Carb	.060" FIBER
C15241	Holley Float Bowl	.062" MP
C15242	Holley 2 Circuit Metering Block	.062" MP
C15243	Holley 3 Circuit Metering Block	.062" MP
C15244	Holley/Quik Fuel Power Valve	.062" MP

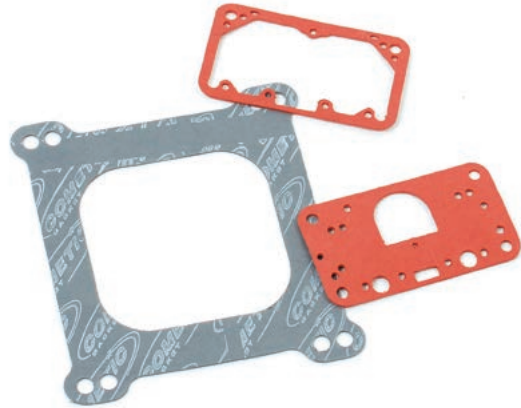

## Differential Gaskets

Cometic Differential Gaskets are offered for the most popular differentials in the industry. Made from performance inspired materials and engineered to be the best sealing gasket you can find. Don't see what you are looking for? Simply send us your used gasket and we can custom make exactly what you need.

Part #	Application	Material
C14006-060	Nissan Titan XD	.060" AFM
C15212	AMC 12 Bolt	.125" FIBER
C15213	Dana 25,27,30 10 Bolt	.032" AFM
C15214	Dana 35 10 Bolt	.060" AFM
C15215	Dana 44	.060" AFM
C15216	Dana 44/GM 8.75" Corvette/Viper	.032" AFM
C15217	Dana 60/70	.060" AFM
C15218	Dana 80 10 Bolt	.032" AFM
C15219	Dodge 7.25" 10 Bolt Front Axle	.032" AFM
C15220	Dodge 8.25" 10 Bolt Rear Axle	.032" AFM
C15221	Ford 10.5" 12 Bolt	.032" AFM
C15222	Ford 8" 10 Bolt	.032" AFM
C15223	Ford 8.8" 10 Bolt	.060" AFM
C5848-032	Ford 9" 10 Bolt	.032" AFM
C15225	Ford 9.75" 12 Bolt	.060" AFM
C15226	GM "O" Axle 12 Bolt Irregular	.060" AFM
C15227	GM 1/2 Ton 12 Bolt	.032" AFM
C15228	GM 12 Bolt	.060" AFM
C15229	GM 7.5" 10 Bolt Rear Axle	.032" AFM
C15230	GM 7.75" 9 Bolt Front Axle	.032" AFM
C15231	GM 8.5" 1/2 & 3/4 Ton 10 Bolt	.032" AFM
C15232	GM 8.5" 10 Bolt	.060" AFM
C15233	GM 9.5" 1/2 & 3/4 Ton 14 Bolt	.060" AFM
C15234	GM Truck 14 Bolt	.060" AFM
C15235	Legend Car 10 Bolt	.032" AFM
C15236	Sprint Midget 10-Bolt Quick Change	.060" AFM
C15237	Winter Quick Change 10 Bolt	.060" AFM

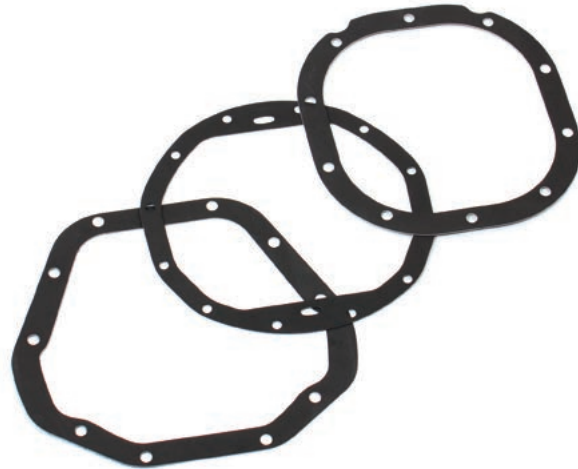

## Transmission Gaskets

Why trust your expensive transmission to some flimsy paper gasket? Keep your transmission fluid and gear lube where it belongs with our Aluminum Foamet Material (AFM) Gaskets. AFM consists of an aluminum core and features a foam rubber coating bonded to both sides. Ideal for sealing less than perfect surfaces and can be installed without the use of additional sealers!

Part #	Application	Material	List
C15246	Dodge 727/46RE Pan	.060" AFM	
C15247	Ford A4LD/4R44E/4R55E 1993-05	.060" AFM	
C15248	Ford C-4/C-5 11 Bolt 1970-86	.060" AFM	
C15249	Ford C-6 3 Speed 17 Bolt	.060" AFM	
C15250	GM 4L80E 1991-10	.060" AFM	
C15251	GM TH700-R4/4L60E 1982-03	.060" AFM	
C15252	GM Powerglide 2Spd Trans Pan	.075" AFM	
C15253	GM Turbo 400 Trans Pan	.075" AFM	
C15254	GM Turbo 350 Pan Trans	.075" AFM	
C15255	Muncie M21 Gasket Kit - No Seals	AFM	
C15469	DOD/CHRY/AMC 904 Torqueflite	.060" AFM	

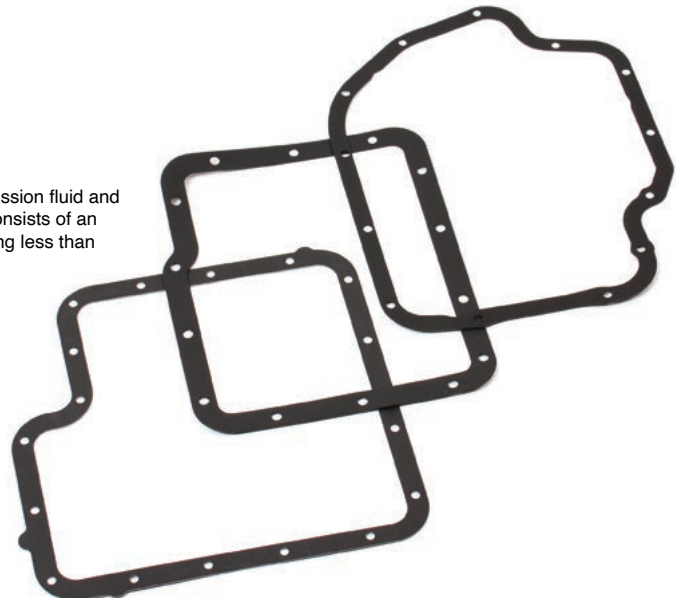

## Valve Cover Gaskets & Sets

Race inspired designs and materials ensure that these valve cover gaskets will perform well above the OE standard. Cosmetic valve cover gaskets surpass the quality and ability of typical cork or paper gaskets offered by other manufactures. Withstands blowing out, over tightening, and high vacuum all at an affordable price.

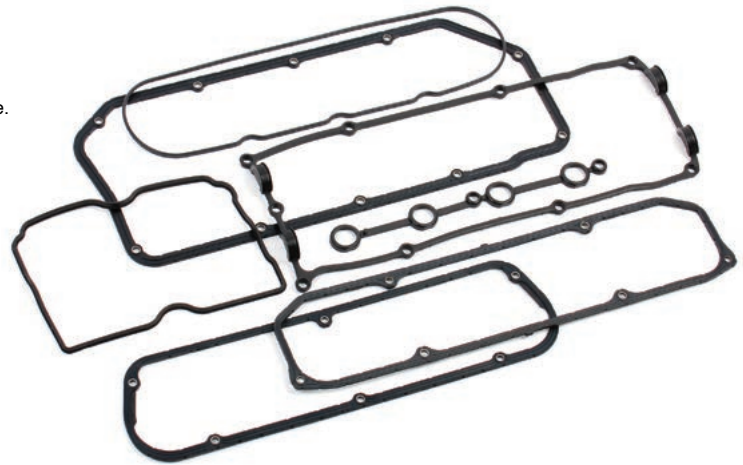

### DOMESTIC

Part #	Application
C15579	Buick 400/430/455 1967-76
C15438	Chevy LT1/LT4 5.3L/6.2L 2014-2017
C5983	Chrysler Big Block Wedge
C15468	Chrysler 318/340/360 LA V8 1964-1992
C5193	Chrysler/Dodge 5.7/6.1L Hemi 2003+Up Set - 1 Head
C5177	Ford 4.6L DOHC 1996-98
C5178	Ford 4.6L SOHC 1996-04
C5179	Ford 4.6L SOHC 2002-04 Truck
C5974	Ford Small Block 289,302,351W
C15467	Ford 429/460 Big Block V8
C15442	Ford 5.0L 2014-2017 / 5.2L 2015-2018 Set
C5975	GM Big Block Mark 4/5/6
C15245	GM LS V8 Gen 3/4 1999-14
C5973	GM Small Block 18/23* V8
C15440	Olds 330/350/400/403/455
C5044	Pont 265/301/350/400/428/455

### SPORT COMPACT

Part #	Application
C4643	Ford Zetec 2.0L DOHC 1995-97 / Set
C4644	Ford Zetec 2.0L DOHC 1998-04 / Set
C15445	Ford Focus ST 2.0L/2.3L 2012-2018
C4653	Ford 2300 2.3L SOHC 1974-93 / Set
C4701	Honda D15B1/D15B2/D15B7/D16A6/D16A7 88-95 / Set
C4628	Honda B16A2/3, B17A1, & B18C1/C5 94-01 / Set
C4665	Honda D16B5 & D16Y5/7/8 96-00 / Set
C4655	Honda D16Z6 VTEC 92-95 / Set
C4706	Honda D16A1/D16A8/D16A9 86-89 / Set
C4679	Honda B18A1/B1 1990-01 / Set
C14111	Honda L15B7
C14012	Honda K20/K23/K24
C4781	Mazda B6ZE 1.6L 1989-93 / Set
C4788	Mazda MX-6 FS-DE 2.0L 91-97 / Set
C4722	Mitsubishi 6G72 DOHC 24V 3.0L 91-99 / Set
C4691	Mitsubishi 4G63/4G63T 2.0L 90-99 / Set
C4713	Mitsubishi 6G72 SOHC 24V 3.0L 88-96 / Set
C15046	Mitsu/Dodge 2.0L 420A/ECC 95-99 / Set
C4607	Nissan CA16DE/CA18DE/CA18DET 1987-1993 / Set
C4906	Nissan E13/E15/E16 1982-89 / Set
C4631	Nissan KA24DE-A 2.4L 1993-01 Fwd / Set
C4761	Nissan KA24DE 2.4L DOHC 1990-94 / Set
C4766	Nissan KA24DE 2.4L DOHC 1995-04 / Set
C4552	Nissan RB20/25/26 1988-02 / Set
C4730	Nissan SR16VE/SR20VE/SR20DE 97-02 Fwd / Set
C4747	Nissan SR20DE Fwd, SR20DET Awd 91-96 / Set
C4753	Nissan SR20DE/SR20DET S13 DOHC 88-93 Rwd / Set
C4755	Nissan SR20DE/SR20DET S14/S15 DOHC 94-98 Rwd / Set

List

### SPORT COMPACT

Part #	Application	List
C4773	Nissan VG30DE/VG30DETT 3.0L V6 90-99 / Set	
C4871	Subaru EJ22E SOHC 90-96 / Set	
C4880	Subaru EJ255 06-Up, EJ257 08-Up / Left	
C4881	Subaru EJ255 06-Up, EJ257 08-Up / Right	
C4873	Subaru EJ25D DOHC 96-99 / Set	
C4863	Subaru WRX EJ205 02-05 / Right	
C4864	Subaru WRX EJ205 02-05 / Left	
C4642	Subaru EJ251 SOHC 1999-05 / Set	
C4928	Subaru EJ257 DOHC 2004-07 / Left	
C4929	Subaru EJ257 DOHC 2004-07 / Right	
C4935	Toyota 20R/22R/22R-E 75-85 / Set	
C4830	Toyota 2RZ-FE/3RZ-FE 4 Cyl 95-04 / Set	
C4807	Toyota 4A-GE/4A-GEZ 1.6L 16-Valve 84-92 / Set	
C4820	Toyota 5S-FE 2.2L 4 Cyl 90-97 / Set	
C4851	Toyota Supra 2JZ-GE/2JZ-GTE 93-98 / Set	
C4838	Toyota Supra 7M-GE/7M-GTE 86-92 / Set	
C4608	Toyota 3S-GTE 1990-1995 / Set	

### DIESEL

Part #	Application	List
C15056	Cummins 3.9L 4Bt 4Cyl Diesel / Set	
C5614	Cummins 5.9L 24V Diesel 1998.5-02 / Set	
C15066	Cummins 5.9L 12V Diesel 1992-98 / Set	
C15070	Cummins 5.9L 24Vcr Diesel 2003-07 / Set	
C15143	Ford 6.0L Power Stroke 2003-08 / Set	
C15151	Ford 6.4L Power Stroke 2008-10 / Set	
C15162	Ford 7.3L Power Stroke 1994-97 / Each	
C15163	Ford 7.3L Power Stroke 1998-03 / Each	

## Turbo Gaskets

Manufactured from a high grade stainless steel, these turbocharger gaskets get the job done the first time! The embossed spring steel maintains a torque set and won't burn through or push out. Does not require additional sealers.



Part #	Application	Material	List
C15585	Turbo Inlet Flange Gasket, T3/GT30R	.016" Stainless	
C15586	Turbo Inlet Flange Gasket, T3 Divided	.016" Stainless	
C15584	Turbo Inlet Flange Gasket, T4 Rectangular	.016" Stainless	
C15590	Turbo Inlet Flange Gasket, T04 Divided	.016" Stainless	
C15587	Turbo Inlet Flange Gasket, T25/T28/GT25	.016" Stainless	
C15589	Turbo Inlet Flange Gasket, T06	.016" Stainless	
C15588	Turbo Inlet Flange Gasket, T06 Divided	.016" Stainless	
C15591	Turbo Inlet Flange Gasket, GT30R/GT35R/GT40R	.016" Stainless	

Part #	Application	Material	List
C15596	Discharge Flange Gasket, GT Series 2.5"	.016" Stainless	
C15595	Discharge Flange Gasket, GT Series 3"	.016" Stainless	
C15594	Discharge Flange Gasket, GT32 6 Bolt	.016" Stainless	
C15593	Discharge Flange Gasket, K03/K04 4 Bolt	.016" Stainless	
C15592	Wastegate Flange Gasket, Tial Style	.016" Stainless	
C5723-030	Subaru WRX Turbo To Up Pipe		
C5736-030	Subaru WRX Turbo To Downpipe		
C15154	Ford 6.4L Power Stroke 2008-10, Mounting Kit		

## Valve Stem Seals

New age engine builds require new age valve stem seals and we have them! These viton steel body (VSB) seals are available for most applications ranging from automotive to off road dirt bikes. Sold in packs of 16. [See page 150 for additional Valve Stem Seals](#)

Part#	Valve Stem O.D.	Guide O.D.	Height	Overall O.D.	List
3262V-16	7mm	11mm	9.5mm	14.4mm	
3516P-16	8mm	.492"	.470"	.616"	
3237V-16	5/16"	.500"	.517"	.562"	
3235V-16	5/16"	.531"	.516"	.677"	
3188V-16	11/32"	.500"	.531"	.623"	
3228V-16	11/32"	.530"	.527"	.674"	
3195V-16	3/8"	.500"	.531"	.623"	
3198V-16	3/8"	.625"	.531"	.742"	





### 2 Pc Viton Rear Main Seals

Description	Part #
Buick W / Side Rails 196,231,252.....	C5707
Chevy 283-400.....	C5680
Chevy BB 396-454.....	C5682
Chrysler 273,318,340.....	C5683
Chrysler 360.....	C5684
Chrysler 361-440 & Hemi.....	C5686
Ford 289,302.....	C5688
Ford 351C,351M,351W.....	C5689

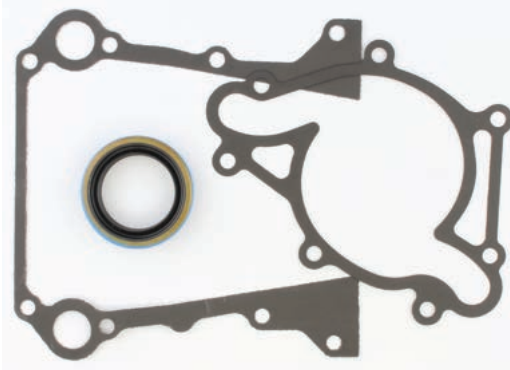

### Timing Cover Gasket Sets

Description	Part #
AMC 290-401 V8 66-88.....	C5046
AMC 4/6 Cyl 2.5/3.8/4.0/4.2L 65-06.....	C5047
Buick V6/Small V8 66-87 (Rope Seal).....	C5048
Buick V6/Small V8 66-87 (Radial Seal).....	C5049
Buick 400/430/455 V8 67-74.....	C5050
GM Small Block V8/V6 75-95 (Thick Front Seal).....	C5051
GM Small Block V8 57-74 (Thin Front Seal).....	C5052
GM 4/6 Cyl 151/230/250/192 63-89.....	C5053
GM Small Block LT1 V8 92-94.....	C5054
GM Small Block LT1 V8 94-97.....	C5055
GM Small Block LS V8 97-Up.....	C5056
GM Big Block V8 65-95.....	C5057
GM Big Block V8 96-00.....	C5058
Chrysler Magnum V6/V8 92-96.....	C5059
Chrysler Magnum V6/V8 97-03.....	C5060
Chrysler LA Small Block V6/V8 64-91.....	C5061
Chrysler 5.7/6.1/6.2/6.4L Hemi 03-UP.....	C5202
Chrysler Wedge/426 Hemi V8 58-79.....	C5062
Chrysler Early Hemi V8 55-59.....	C5063
Ford Small Block V8 62-78.....	C5064
Ford Small Block V8 79-97.....	C5065
Ford 351C/351M/400 V8 70-81.....	C5066
Ford 352/360 FE V8 58-60.....	C5067
Ford 332-428 FE V8 61-71.....	C5068
Ford 429/460 Big Block 68-85.....	C5069
Olds 260-455 V8 64-90.....	C5070
Pontiac 265-455 V8 63-81.....	C5071



### Engine Crankshaft Seals Wet & Dry Sump Applications

Description	Signal	TTS	Cometic	List
	Part #	Part #	Part #	
JESEL Small Block Crank B/Drive F.C.....	86587	T-13527	C5376	
JESEL Big Block Crank B/Drive F.C.....	86622	T13553 Rev.B	C5377	
JESEL (SEL 38000) Cam.....	86586	T13561 Rev.B	C5435	
Aluminum GM Sprint 400 Main.....	86410	T-13675	C5672	
Chevy Small Block Rear Split Seal.....	86625	T-13675-DL	C5379	
Chevy BB Rear Double Split Seal 2 PC.....	86665	T-13676-DS	C5381	
Chevy BB Rear Single Split Seal.....	86665	T-13676-SS	C15560	
Chevy BB Rear Double Split Seal 2 PC.....	86665	T-13676-DS	C5381	
Chevy BB Rear Single Split Seal.....	86665	T-13676-SS	C15560	
Dodge R5 Small Block Rear Crank.....	14255	T-14255	C5396	
Ford Rear Crankseal W/302 Crank.....	85742	T-13584	C5384	
Ford Rear Crankseal 302.....	13610	T-13610	C5385	
Ford Front Crankseal 302 & 351.....	85338	T-13690	C5386	
Ford R.R. Crankseal 351.....	85339	T-14053	C5391	
Ford 351 Front Crank Yates Drive.....	85741	T-14276	C5490	
GM Small Block Front Crankseal.....	86990	T-13852	C5378	

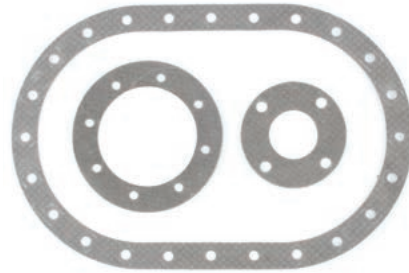

### Fuel Cell Gasket Kit

Description	Part #
Vent Neck Gasket .059" CFM20.....	C5507
8 Bolt Vent Gasket .059" CFM20, Fill Plate Gasket .059" CFM20	



### Sheet Materials

Part #	Description
C15180HTS.....	10" X 10" X .060" HTS.....
C15346FC.....	24" X 6" X .060" FC.....
C15346HTS.....	24" X 6" X .060" HTS.....
C15346TNG.....	24" X 6" X .060" TNG.....
C15354F.....	36" X 9" X .031" Fiber.....
C15358TNG.....	12" X 12" X .060" TNG.....
C15384.....	10" X 26" X 1/16" CORK/RUBBER (w/Cutting Tool).....
C15385.....	10" X 26" X 1/32" Fiber (w/Cutting Tool).....

### ATI Damper Re-build Viton O-Rings

Description	Part #
6" Damper Rebuild Kit (3-Ring).....	C5393
7" Damper Rebuild Kit (3-Ring).....	C5982-070
6" Damper Rebuild Kit (4-Ring).....	C5632



# TABLE OF CONTENTS

## MLS

### Multi Layer Steel

MLS Gaskets are comprised of multiple embossed layers of both AMP (Advanced Multi-Polymer Coating) and uncoated stainless steel. The embossed outer layers of the gaskets meet the demands of a variety of harsh sealing environments, load conditions and surface finishes. Requires less clamp load creating less bore distortion and conforms load distribution across the sealing area. The center or shim layer is an uncoated stainless steel layer which can be varied to accommodate multiple thickness requirements.

**No sealants or re-torque required.**



3 Layer MLS Style Cross Section

**Available thickness:**

.027", .030", .036", .040", .045", .051", .056", .060", .066", .070", .075", .080", .086", .092", .098", 120", .140"

### MLS Head Gaskets

Make	Pg.
AMC	6
AUSTIN	70
BMW	71
BUICK	7
CADILLAC	8
CHEVROLET / GM	9, 84
CHEVROLET DIESEL	25
CHRYSLER / DODGE	27
COVENTRY CLIMAX	77
CUMMINS	41, 126
FERRARI	77
FIAT / LANCIA	78
FORD	46
FORD / LOTUS	78
HOLDEN	85
HONDA / ACURA	85
HYUNDAI	98
JAGUAR	99
MAZDA	103
MERCEDES BENZ	106
MG	107
MINI	107
MITSUBISHI	108
NISSAN	111
OLDSMOBILE	68
PEUGEOT/CITROEN	127
PONTIAC	69
PORSCHE	127
RENAULT	129
ROVER	130
SAAB	130
SUBARU	131
TOYOTA	143
TRIUMPH	154
TVR	154
VAUXHALL/OPEL	155
VOLKSWAGEN/AUDI	155
VOLVO	157

### MLS Head Gaskets

Application	Pg.
Ecotec 4 Cylinder	9, 84
3.6L LY7/LLT/LFX	11
4.2L Inline 6 LL8 Vortec 4200	12
Vortec 4200 LL8	12
18/23 Degree SBC	12
SBC w/All Pro Heads, Dart/Brodix	14
Chevy R07.2	15
LS1/LS2/LS3/LS6	16
LS7, LS9/LSA	18
LS Next Block, LSX	19
Gen-4 Chevy Big Block V8	22
LT1 6.2L	21
GM 5.2 Prostock	25
6.6L Duramax	26
2.4L DOHC Turbo 4 Cylinder	28
5.7L Hemi	31
6.1L Hemi	33

## MLX

### Multi Layer Xtreme

MLX Gaskets utilize an integrated "stopper" layer for combustion chamber sealing and improved clamp load around the cylinder without increasing bore distortion. MLX technology can be found in the applications below and are made from the same materials as our MLS Head Gaskets.

**No sealants or re-torque required.**



3 Layer MLx Style Cross Section



4 Layer MLx Style Cross Section



5 Layer MLx Style Cross Section

### MLX Head Gaskets

Application	Pg.
6.2L Hellcat, 6.4L Apache, 7.0L Drag Pack	34
Chrys/Dodge Big Block V8	36
Chrys/Dodge R6 V8	36
8.0/8.3L V10, 8.4L V10	40
Cummins 3.9L 4BT	41
Cummins 5.9L 12v 6BT	42
Cummins 5.9L 24v ISB Inline	43
Cummins 5.9L CR	44
Cummins 6.7L	45
Ford 1.6L Sigma	46, 78
Ford 3.5L EcoBoost	50
Ford 4.6/5.4L SOHC/DOHC	52
Ford 5.0L Coyote	53, 54
Ford 5.8L Trinity V8	55
Ford Windsor SB V8	57
Ford New Boss 302 Block	59
Ford RY45 V8, FR9 V8	60
6.2L SOHC Raptor	64
Ford 6.8L V10	65
Ford Prostock Racing V8	64
Ford 6.0L Powerstroke	65
Ford 6.4L Powerstroke, Ford 6.7L Scorpion	66
7.3L Powerstroke	67
BMW N54B30 3.0/3.2L	75
BMW M50B25/28 2.5/2.8L	74
BMW N54B30 3.0L	75
BMW B58	75
BMW M5430L, N55B30A 3.0L Inline 6	75
Honda D Series	86
Honda B Series	89
Honda K Series	94
Honda H Series	96
Hyundai 2.0L & 3.8L DOHC V6	98
Jaguar AJ133 5.0L	102
Mazda MZR 2.3L DOHC	106
Mini 1.6L Turbo Prince	107
Mitsu EVO X 4B11T	110
Mitsu 2.0L 4G63/4G63T	108
Nissan 2.0L SR20DE/DET S14	116
Nissan GT-R VR38DETT	125
Nissan TB48DE, VK56DE 5.6L	126, 127
Rover 5.0L V8 LR-V8	130
Subaru FA20 DOHC	131
Subaru EJ205 DOHC	132
Subaru EJ22E SOHC	133
Toyota 2ZZ-GE 1.8L	145
Toyota 2JZ-GE/GTE 3.0L	150
Toyota B58 3.0L	152
Toyota 1FZ-FE 4.5L	153
Vauxhall/Opel 20XE/C20XE/X20LET	155
Volkswagen/Audi 1.8/ 2.0L 16V DOHC	157

### Fel-Pro to Cometec Cross Compatibilities

Application	Pg.
Fel-Pro to Cometec Cross Compatibilities	160

## STREETPRO

### Top & Bottom End Gasket Kits

StreetPro is a product line of Cometec Gasket geared toward the street rodder who is looking to purchase a kit with all necessary gaskets and seals needed for your rebuild.

### STREET PRO KITS

Make	Pg.
BMW	71, 73
Buick	8
Chevrolet	11, 13, 17, 20, 22
Chevrolet Diesel	26
Chrysler/Dodge	27, 31, 32, 33, 37, 38, 39
Cummins	42-46
Ford	48, 49, 52, 56, 58, 62, 63, 65
Ford Diesel	65, 66, 67
Ford/Lotus	81, 82
Honda/Acura	86, 87, 89-93
Mazda	104, 105
Mitsubishi	108, 110, 111
Nissan	113-120, 122, 123, 124
Oldsmobile	68
Pontiac	70
Subaru	132, 133, 135, 136, 138, 139, 140, 141
Toyota	144-148, 150, 151

## SEG

### Spring Energized Gasket

SEG Gaskets utilize an Inconel jacketed ring and spring with an MLS carrier for ring location and fluid sealing. The resilient nature of the seal ensures useful elastic recovery during service. This recovery aids in the ability of the seal to accommodate minor distortions in the clamped joint, making it conducive for elevated temperature and cylinder pressures like that seen in extremely high horsepower, forced induction applications.



### SEG Head Gaskets

Make	Pg.
GM LS1/LS2/LS3/LS6	16
GM LSX Race Block	19
GM LT1/LT4 2014+	21

### COPPER Head Gaskets

Make	Pg.
Buick V6 192-231-252 Stage I & II	7
GM / Chevy 18/23 Degree Small Block	12
GM / Chevy LS	16
GM / Chevy LSX	20
GM / Chevy Big Block Gen-4	22
Chrysler 318-360 LA	30
Chrysler 383-440 Wedge	36
Chrysler Early Hemi 354-392	37
Chrysler 426 Hemi	38
Ford 429-460	63
Austin Sprite Mark I & II	70

### Miscellaneous Gaskets & Accessories

Application	Pg.
Molded Rubber Valve Cover Gaskets	3
MLS Exhaust Gaskets	158
Valve Stem Seals	3, 159
2PC Rear Main Seals	4
Rear End Gaskets	2
Carburetor Gaskets	2
Fuel Cell Gasket Kit	4
High Vacuum Crank Seals	4
Turbo Gaskets	3
Timing Cover Sets	4
Damper Rebuild O-rings	4
Cometic Block & Head Cleaner	169
Klotz Lubricants	169
Transmission Gaskets	2
Karting Gaskets	161
UTV Gaskets	164



# AMC

**4.0L Inline 6 242ci 1987-2006: 87-01 Cherokee, 93-04 Grand Cherokee, 87-90 Wagoneer, 87-92 Comanche, 91-06 Wrangler**

### Head Gaskets

#### MLS Head Gaskets

Bore	Thickness	Pkg Qty	Part #
3.950"	.050"	1	C5987-050
4.000"	.050"	1	C5988-050
4.060"	.050"	1	C5989-050

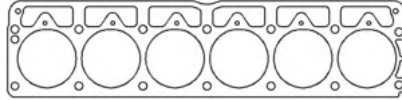

Additional thicknesses available see page 5

### Individual Gaskets

#### Timing Cover Set

Application	Part #
3.8/4.0/4.2L I6 1965-2006	C5047

## 290-401ci V8

### Head Gaskets

#### MLS Head Gaskets

**Fits: 290 1966-69, 304 1970-78, 343 1967-69, 360 1970-91**

Bore	Thickness	Pkg Qty	Part #
3.810"	.040"	1	C5669-040
4.140"	.040"	1	C5674-040

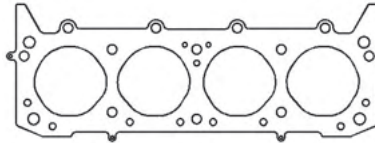

Additional thicknesses available see page 5

#### MLS Head Gaskets

**Fits: 390 1970 & 401 1972-74**

Bore	Thickness	Pkg Qty	Part #
4.250"	.040"	1	C5937-040
4.380"	.040"	1	C5938-040

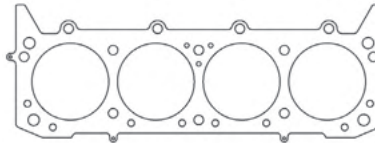

#### MLS Head Gaskets

**Fits: INDY 401 Aluminum Heads**

Bore	Thickness	Pkg Qty	Part #
4.380"	.040"	1	C5409-040
4.380"	.080"	1	C5409-080

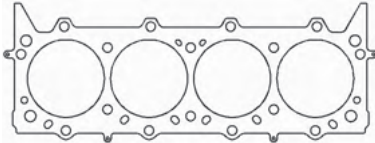

### Individual Gaskets

#### Exhaust Gasket Set

Application	Part #
304-401ci w/Dogleg Ports	C5161-064
304-401ci w/Rectangle Ports	C5101-064

#### Intake Gasket Set

Application	Part #
290-401 V8 1970-91 1.13" x 2.22"	C15002-060
390/401 Indy Head 1.20" x 2.30"	C15003-060

#### Valve Cover Gasket (sold individually)

Application	Part #
390/401ci V8 Indy Head	C5115-188

#### Timing Cover Set

Application	Part #
290-401ci V8 1966-88	C5046





# BUICK

## 196, 231, 252ci V6 Stock, Stage I, and Stage II

**NEW!**

### Head Gaskets

#### MLS Head Gaskets - Stock

Bore	Thickness	Pkg Qty	Part #
3.860"	.040"	1	C15577-040

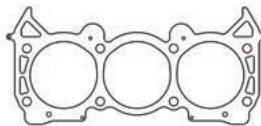

Additional thicknesses available see page 5

#### MLS Head Gaskets - Stage I, Stagell

Bore	Thickness	Pkg Qty	Part #
3.860"	.040"	1	C5691-040
4.020"	.040"	1	C5692-040
4.090"	.040"	1	C5693-040

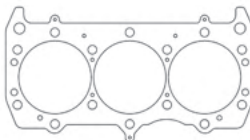

#### Copper Head Gaskets

Bore	Thickness	Pkg Qty	Part #
3.860"	.043"	1	C15407-043

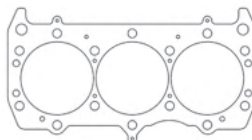

### Individual Gaskets

#### Exhaust Gasket Set

Application	Part #
Stock & Stage I Ports	C5696-064
Stage II Ports	C5791-064

#### Valve Cover Gasket (sold individually)

Application	Part #
Iron & Aluminum Heads	C5697-188

#### Intake Gasket Set

Application	Part #
Stock & Stage I Ports	C5694-060
Stage II Ports	C5792-060

#### Timing Cover Set

Application	Part #
66-87 V6/Small V8 w/Rope Seal	C5048
66-87 V6/Small V8 w/Radial Seal	C5049

#### Oil Pan Gasket

Application	Part #
20 Bolt	C5700-094

#### Rear Main Seal

Application	Part #
2 Piece w/Side Rails	C5707

## 3800 Series II/III V6 L26, L32, L36, L67 1995-2009

### Head Gaskets

#### MLS Head Gasket - Left Side

Bore	Thickness	Pkg Qty	Part #
3.840"	.066"	1	C5720-066

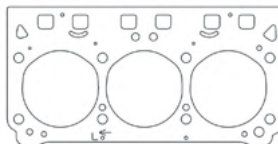

Additional thicknesses available see page 5

#### MLS Head Gasket - Right Side

Bore	Thickness	Pkg Qty	Part #
3.840"	.066"	1	C5721-066

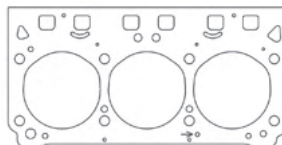



# BUICK

## 400, 430 & 455 V8 - All Years

### Head Gaskets

#### MLS Head Gaskets

Bore	Thickness	Pkg Qty	Part #
4.312"	.040"	1	C5753-040
4.385"	.040"	1	C5754-040
4.400"	.040"	1	C5755-040

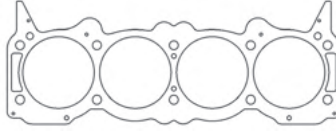

Additional thicknesses available see page 5

### Individual Gaskets

#### Exhaust Gasket Set

Application	Part #
All Years	C5776-064

**NEW!**

#### Valve Cover Gasket (sold individually)

Application	Part #
Buick 400/430/455 1967-76 .188" Molded Rubber	C15579
Buick 400/430/455 1967-76 V8 .094" KF	C5774-094

#### Intake Gasket Set

Application	Part #
1967-71 1.172" x 2.453" Port	C5143-060
1972-76 1.156" x 2.420" Port	C5775-060

#### Water Pump Gasket

Application	Part #
1967-76 Water Pump Gasket	C5144-031
1967-76 Water Outlet Gasket	C15004-031

#### Oil Pan Gasket

Application	Part #
1967-76 4pc Set	C5145

#### Timing Cover Set

Application	Part #
67-76 400, 430, 455 V8	C5050

### Gasket Kits



To purchase a complete gasket kit order both top end and bottom end gasket kit

#### TOP END GASKET KIT



Application	Part #
Big Block 455ci 1970-76 4.385" Bore	PRO1011T

#### BOTTOM END GASKET KIT

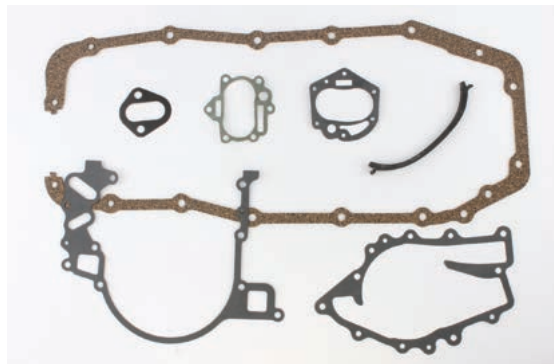

Application	Part #
Big Block 455ci 1970-76	PRO1011B

# CADILLAC

## Northstar 4.6L 32v V8 L37, LD8 FWD 1993-2011

### Head Gaskets

#### MLS Head Gasket - Left Side

Bore	Thickness	Pkg Qty	Part #	List Price
3.700"	.066"	1	C5717-066	

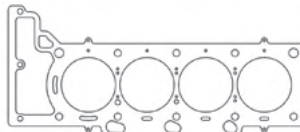

Additional thicknesses available see page 5



# CADILLAC

Northstar 4.6L 32v V8 L37, LD8 FWD 1993-2011

## Head Gaskets

### MLS Head Gasket - Right Side

Bore	Thickness	Pkg Qty	Part #
3.700"	.....066"	.....1	<b>C5716-066</b> .....

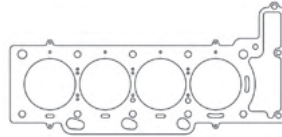

Additional thicknesses available  
see page 5

# CHEVROLET / GM

## ECOTEC 4 Cylinder

**NEW!**

## Head Gaskets

### MLX Head Gasket - L3A/LE2/LFV/LV7/LYX 1.4L/1.5L 17-20

Bore	Thickness	Pkg Qty	Part #
75mm	.....044"	.....1	<b>C15565-044</b> .....

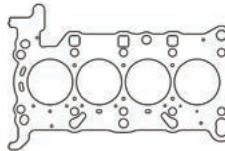

Additional thicknesses available  
see page 5

### MLS Head Gasket - LSJ 2.0L

Bore	Thickness	Pkg Qty	Part #
87mm	.....027"	.....1	<b>C5921-027</b> .....

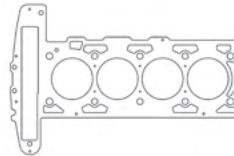

### MLX Head Gasket - LSJ 2.0L

Bore	Thickness	Pkg Qty	Part #
87mm	.....040"	.....1	<b>C5032-040</b> .....

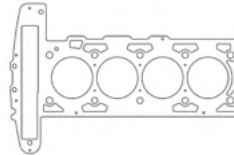

### MLX Head Gasket - LNF 2.0L 08-10

Bore	Thickness	Pkg Qty	Part #
88mm	.....032"	.....1	<b>C15256-032</b> .....

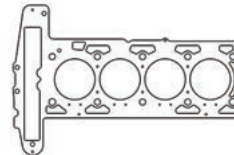

### MLX Head Gasket - LTG 2.0L DOHC

Bore	Thickness	Pkg Qty	Part #
87mm	.....028"	.....1	<b>C4964-028</b> .....

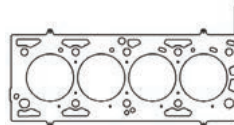

### MLS Head Gaskets - L61/L42 2.2L DOHC

Bore	Thickness	Pkg Qty	Part #
87mm	.....040"	.....1	<b>C5768-040</b> .....
89mm	.....040"	.....1	<b>C5804-040</b> .....

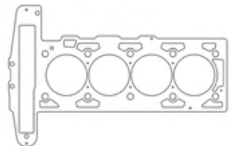

**NEW!**

### MLX Head Gaskets - LAT/LE5/LE9 Gen-2 ECOTEC 2.4L

Bore	Thickness	Pkg Qty	Part #
89.6mm	.....036"	.....1	<b>C15422-036</b> .....

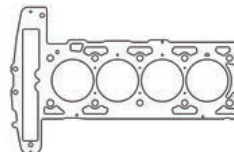

## Individual Gaskets

### MLS Exhaust Gasket - L42/L61/LAT/LE5 Gen-1/2 ECOTEC 2.2/2.4L

Application	Part #
2000-2009 2.2/2.4L	<b>C4150-030</b> .....



## CHEVROLET / GM

### 2.2L 134ci "L43/LN2": Cavalier/Sunfire FWD 1998-02, S-10/Sonoma RWD 1998-03

#### Head Gaskets

##### MLS Head Gaskets

Bore	Thickness	Pkg Qty	Part #
90mm	.030"	1	C5914-030
93mm	.030"	1	C5915-030

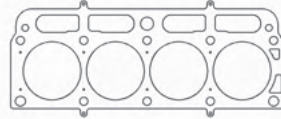

Additional thicknesses available  
see page 5

### 2.4L 146ci "LD9" Twin Cam 1996-01

#### Head Gaskets

##### MLS Head Gasket - 1996-99 w/EGR

Bore	Thickness	Pkg Qty	Part #
3.595"	.030"	1	C5298-030

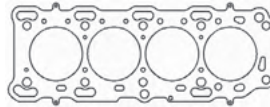

Additional thicknesses available  
see page 5

##### MLS Head Gaskets - 1999-01 w/o EGR

Bore	Thickness	Pkg Qty	Part #
3.595"	.030"	1	C5866-030
3.595"	.075"	1	C5866-075

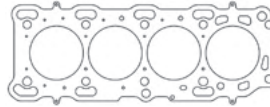

### 2.5L 153ci 1965-79 / 3.0L VORTEC 3000 (Marine)

#### Head Gasket

##### MLS Head Gasket

Bore	Thickness	Pkg Qty	Part #
4.100"	.045"	1	C5956-045

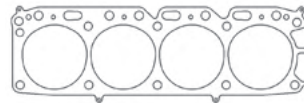

Additional thicknesses available  
see page 5

### 3.1L L82/LG8, 3.4L LA1 Gen-3 60 Degree V6

#### Head Gaskets

##### MLS Head Gaskets - 3.1L L82/LG8 1993-05

Bore	Thickness	Pkg Qty	Part #
91mm	.051"	1	C5220-051

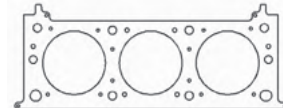

Additional thicknesses available  
see page 5

##### MLS Head Gaskets - 3.4L LA1 1996-05

Bore	Thickness	Pkg Qty	Part #
95mm	.051"	1	C5266-051

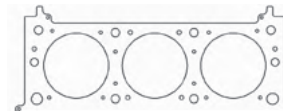

#### Individual Gaskets

##### Exhaust Gasket Set

Application	Part #
1993-05 3.1/3.4L V6	C15005-064

### 3.5L LZ4/LZE, 3.9L LGD/LZ8/LZ9/LZG High Value V6 2006-2011

##### MLS Head Gaskets - Left Side

Bore	Thickness	Pkg Qty	Part #
101mm	.051"	1	C5226-051

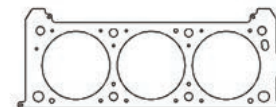

Additional thicknesses available  
see page 5

##### MLS Head Gaskets - Right Side

Bore	Thickness	Pkg Qty	Part #
101mm	.051"	1	C5227-051

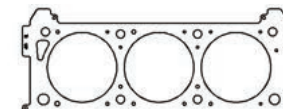



# CHEVROLET / GM

## 3.6L LF3/LF4/LFR/LFX/LFY/LLT/LWR/LY7 High Feature V6 2004-Present

### Head Gaskets

<b>MLX Head Gasket - Left Side</b>			
Bore	Thickness	Pkg Qty	Part #
98mm	.044"	1	<b>C5029-044</b>

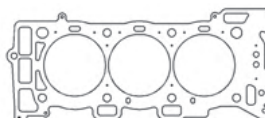

Additional thicknesses available see page 5

<b>MLX Head Gasket - Right Side</b>			
Bore	Thickness	Pkg Qty	Part #
98mm	.044"	1	<b>C5028-044</b>

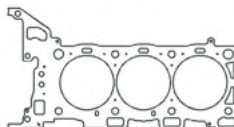

## 4.3L 262ci 90 Degree V6 1985-2014

### Head Gaskets

<b>MLS Head Gaskets</b>			
Bore	Thickness	Pkg Qty	Part #
4.060"	.040"	1	<b>C5739-040</b>
4.120"	.040"	1	<b>C5740-040</b>
4.155"	.040"	1	<b>C5741-040</b>

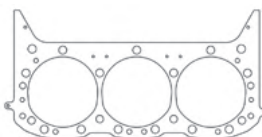

Additional thicknesses available see page 5

### Individual Gaskets

<b>Valve Cover Gasket (sold individually)</b>	
Application	Part #
4.3L V6 .125" Molded Rubber, Center Bolt ..	<b>C15006-125</b> .....
4.3L V6 .188" ML Material, Perimeter Bolt...	<b>C15006-188</b> .....

<b>Timing Cover Set</b>	
Application	Part #
1985-95 w/Thick Front OP Seal .....	<b>C5051</b> .....

<b>Intake Gasket Set</b>	
Application	Part #
4.3L V6 .060" Fiber, No EGR Passage .....	<b>C15007-060</b> .....

<b>Water Pump Gasket</b>	
Application	Part #
.018" AFM Material .....	<b>C5299-018</b> .....

<b>Exhaust Gasket Set</b>	
Application	Part #
1985-92 4.3L V6 .064" AM.....	<b>C15008-064</b> .....

<b>Oil Pan Gasket</b>	
Application	Part #
1978-95 4 Piece Set.....	<b>C5496</b> .....

<b>Fuel Pump Mounting Gasket</b>	
Application	Part #
1985-96 4.3L V6 .020" Fiber .....	<b>C15009-020</b> .....

<b>Rear Main Seal Kit</b>	
Application	Part #
1 Piece Design .....	<b>C5106</b> .....

### Gasket Kits



To purchase a complete gasket kit order both top end and bottom end gasket kit

#### TOP END GASKET KIT



Application	Part #
4.3L V6 1985-93 4.120" Bore .....	<b>PRO1006T</b> .....

#### BOTTOM END GASKET KIT



Application	Part #
4.3L V6 1985-93.....	<b>PRO1006B</b> .....



# CHEVROLET / GM

## 194, 230, 250, 292 Inline 6 1962-89

### Head Gaskets

MLS Head Gasket			
Bore	Thickness	Pkg Qty	Part #
4.125"	.040"	1	C5699-040

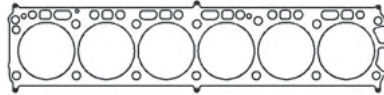

Additional thicknesses available see page 5

### Individual Gaskets

Intake/Exhaust Gasket Set	
Application	Part #
292 I6 Intake .059" CFM	C15010-059

Timing Cover Set	
Application	Part #
4/6 Cyl 151/230/250/292	C5053

## 4.2L Inline 6 "LL8" Vortec 4200 2002-09

### Head Gaskets

MLX Head Gasket			
Bore	Thickness	Pkg Qty	Part #
3.710"	.040"	1	C15374-040

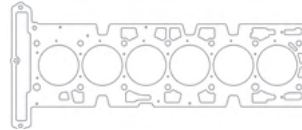

Additional thicknesses available see page 5

## 18/23 Degree Small Block V8 262-400ci (\*has steam holes)

### Head Gaskets

MLS Head Gaskets - Round Bore			
Bore	Thickness	Pkg Qty	Part #
4.060"	.027"	1	C5245-027
4.060"	.030"	1	C5245-030
4.060"	.040"	1	C5245-040
4.060"	.051"	1	C5245-051
4.100"	.040"	1	C5246-040
4.125"	.040"	1	C5247-040*
4.165"	.027"	1	C5248-027*
4.165"	.040"	1	C5248-040*
4.165"	.051"	1	C5248-051*
4.200"	.040"	1	C5249-040*
4.200"	.045"	1	C5249-045*
4.200"	.051"	1	C5249-051*
4.200"	.060"	1	C5249-060*

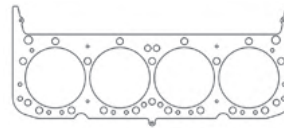

Additional thicknesses available see page 5

MLS Head Gaskets - Valve Pocketed Bore			
Bore	Thickness	Pkg Qty	Part #
4.060"	.040"	1	C5269-040
4.100"	.040"	1	C5270-040
4.125"	.040"	1	C5271-040*
4.165"	.040"	1	C5272-040*
4.200"	.040"	1	C5273-040*

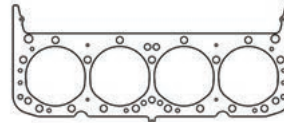

MLX Head Gaskets - Round Bore			
Bore	Thickness	Pkg Qty	Part #
4.165"	.040"	1	C5031-040
4.200"	.040"	1	C15575-040
4.220"	.040"	1	C5786-040*

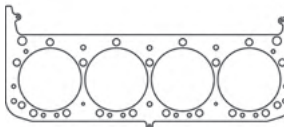

Copper Head Gaskets - Round Bore			
Bore	Thickness	Pkg Qty	Part #
4.165"	.043"	1	C15411-043

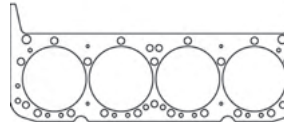

**NEW!**

Copper Head Gaskets - No Steam Holes			
Bore	Thickness	Pkg Qty	Part #
4.200"	.043"	1	C15412-043

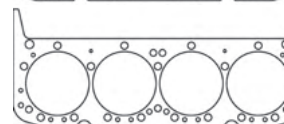



# CHEVROLET / GM

## 18/23 Degree Small Block V8 262-400ci (\*has steam holes)

### Individual Gaskets

Valve Cover Gaskets (sold individually)	
Application	Part #
18/23° Molded Rubber.....	<b>C5973</b> .....
Splayed Valve Heads .....	<b>C5390-094</b> .....

Intake Gasket Set	
Application	Part #
18* Heads 1.35" X 2.25" Port .....	<b>C5541-060</b> .....
23* Heads 1.24" X 1.98" Port .....	<b>C5544-060</b> .....
23* Heads 1.28" x 2.17" Port.....	<b>C5528-060</b> .....
305/350 w/TPI 1985-92 Set.....	<b>C15198</b> .....
End Seal Gaskets .....	<b>C5536-060</b> .....

Timing Cover Set	
Application	Part #
1957-74 w/Thin Front OP Seal.....	<b>C5052</b> .....
1975-95 w/Thick Front OP Seal .....	<b>C5051</b> .....

Water Pump Gaskets	
Application	Part #
Water Pump MTG Gasket .....	<b>C5299-018</b> .....
Water Pump Backing Plate Gsk .....	<b>C15011-032</b> .....

Thermostat Gasket	
Application	Part #
.047" Fiber .....	<b>C5538-047</b> .....

Oil Pan Gasket Kit	
Application	Part #
1955-79 LH Dipstick 4pc Kit .....	<b>C5295-094</b> .....
1980-85 RH Dipstick 4pc Kit.....	<b>C5294</b> .....
1955-85 Dual Dipstick 1 pc Molded Rubber....	<b>C15546</b> .....
1986-97 1 pc Molded Rubber .....	<b>C5072</b> .....

Exhaust Gasket Set	
Application	Part #
18* 1.50" x 1.47" .064" AM.....	<b>C5314-064</b> .....
23* 1.45" x 1.48" .030" MLS .....	<b>C5892-030</b> .....
23* 1.50" Round .030" MLS.....	<b>C5891-030</b> .....
23* 1.45" x 1.60" .030" MLS .....	<b>C5894-030</b> .....
23* 1.625" Round .030" MLS.....	<b>C5893-030</b> .....
23* 1.55" x 1.45" .030" MLS .....	<b>C15190-030</b> .....

Fuel Pump Mounting Gaskets	
Application	Part #
2 Bolt - .032" AFM.....	<b>C5389-032</b> .....
4 Bolt - .032" AFM.....	<b>C15012-032</b> .....

Rear Main Seal Kit	
Application	Part #
2 Piece SN .....	<b>C5680</b> .....
1 Piece SN.....	<b>C5106</b> .....

Distributor Gasket	
Application	Part #
.060" Fiber .....	<b>C5531-060</b> .....

### Gasket Kits



To purchase a complete gasket kit order both top end and bottom end gasket kit

#### TOP END GASKET KIT

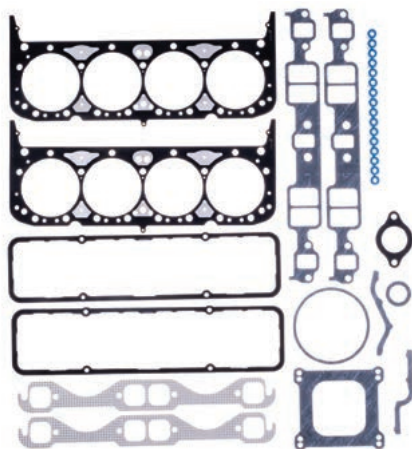

Application	Part #
350ci (67-85) & 400ci (70-76) 4.165" Bore...	<b>PRO1003T</b> .....
350ci TPI (87-92), TBI (86-93) 4.100" Bore ..	<b>PRO1004T</b> .....
ZZ4 Crate Engine 4.080" Bore .....	<b>PRO1026T</b> .....

#### BOTTOM END GASKET KIT

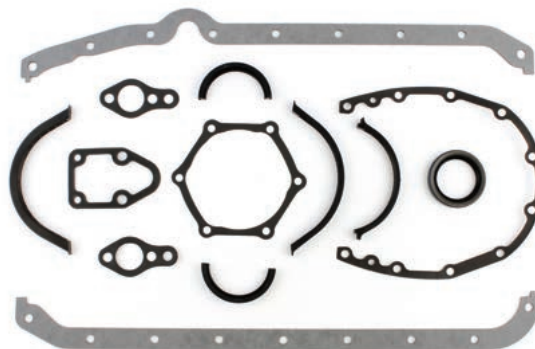

Application	Part #
350ci (67-79) & 400ci (70-76).....	<b>PRO1003B</b> .....
350ci (86-93) 1pc Rear Main.....	<b>PRO1004B</b> .....



# CHEVROLET / GM

## Small Block V8 - Aftermarket & Race

### Head Gaskets

#### MLS Head Gaskets - Vortec Head

Bore	Thickness	Pkg Qty	Part #
4.080"	.040"	1	C5474-040
4.165"	.040"	1	C5410-040

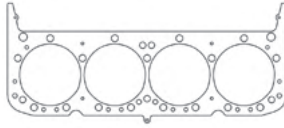

Additional thicknesses available  
see page 5

#### MLS Head Gasket - Edelbrock RPM Heads

Bore	Thickness	Pkg Qty	Part #
4.135"	.040"	1	C5274-040

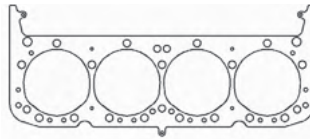

#### MLS Head Gaskets - Brodix BD2000

Bore	Thickness	Pkg Qty	Part #
4.030"	.040"	1	C5404-040
4.125"	.040"	1	C5405-040
4.135"	.040"	1	C5406-040
4.160"	.040"	1	C5407-040
4.200"	.040"	1	C5408-040

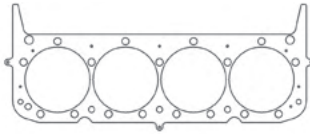

#### MLS Head Gaskets - Brodix Heads

Bore	Thickness	Pkg Qty	Part #
4.030"	.040"	1	C5399-040
4.125"	.040"	1	C5400-040
4.135"	.040"	1	C5401-040
4.160"	.040"	1	C5402-040
4.200"	.040"	1	C5403-040

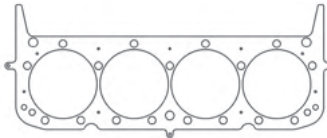

#### MLX Head Gasket - All Pro Heads

Bore	Thickness	Pkg Qty	Part #
4.220"	.040"	1	C5551-040

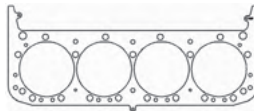

#### MLS Head Gasket - Dart/Brodix 4.5" Bore Spacing

Bore	Thickness	Pkg Qty	Part #
4.270"	.036"	1	C5215-036
4.270"	.040"	1	C5215-040
4.270"	.045"	1	C5215-045

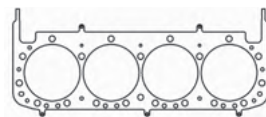

#### MLX Head Gasket - Dart/Brodix 4.5" Bore Spacing

Bore	Thickness	Pkg Qty	Part #
4.310"	.040"	1	C15208-040

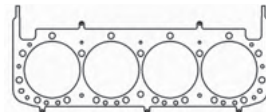

### Individual Gaskets

#### Intake Manifold Gaskets

Application	Part #
23° Dart Cast Iron	C5528-060
Brodix BD2000	C5421-060
Brodix WP 12S	C5425-059
Brodix WP 247	C5426-059
Brodix WP 262	C5427-059
Brodix GB 2000	C5423-059
Brodix Track 1 & Spec Head	C5414-059
Brodix Street	C5416-059
End Seal Gaskets	C5536-060

#### Exhaust Manifold Gaskets

Application	Part #
Brodix GB 2000 - .064" AM	C5422-064
Brodix Track 1 - .064" AM	C5415-064
Brodix Street - .064" AM	C5417-064
Brodix/All Pro 286 (7 Bolt) MLS	C5040-030
Brodix/Dart 13° 4.4/4.5" Spacing	C5039-030

#### Oil Pan Gasket

Application	Part #
Dart Iron Eagle/Rocket Block	C5104-094





# CHEVROLET / GM

## 350 & 400 SB2 Race V8

### Head Gaskets

<b>MLS Head Gaskets</b>			
Bore	Thickness	Pkg Qty	Part #
4.125"	.040"	1	<b>C5321-040</b>
4.165"	.040"	1	<b>C5323-040</b>
4.190"	.040"	1	<b>C5472-040</b>
4.200"	.040"	1	<b>C5324-040</b>

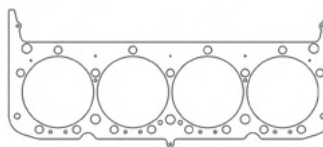

Additional thicknesses available  
see page 5

### Individual Gaskets

<b>Valve Cover Gasket (sold individually)</b>	
Application	Part #
SB2 - .188" Thickness	<b>C5235-188</b>

<b>Timing Cover Gasket</b>	
Application	Part #
SB2 - .020" RC	<b>C5533-020</b>

<b>Intake Manifold Set</b>	
Application	Part #
SB2 - 2.085" x 1.560" Ports	<b>C5311-031</b>
SB2 - MLS	<b>C5819-040</b>

<b>Water Pump Gasket</b>	
Application	Part #
Water Pump MTG Gasket	<b>C5299-018</b>
Water Pump Backing Plate Gsk	<b>C15011-032</b>

<b>Intake Valley Plate Gaskets</b>	
Application	Part #
Stock Opening - .060" AFM	<b>C5647-060</b>
.970" Holes - .060" AFM	<b>C5308-060</b>
.625"/.750" Holes - .060" AFM	<b>C5307-060</b>

<b>Exhaust Manifold Gaskets</b>	
Application	Part #
1.50" x 1.60" Ports - MLS	<b>C5552-065</b>
1.90" x 1.63" Ports - MLS	<b>C5836-030</b>

<b>Rear Main Seal</b>	
Application	Part #
Dual Lip/High Vacuum	<b>C5379</b>

<b>Oil Pan Gasket</b>	
Application	Part #
SB2 - 4pc Set	<b>C5553-060</b>

<b>Distributor Gasket</b>	
Application	Part #
.060" Fiber	<b>C5531-060</b>

<b>Fuel Pump Mounting Gasket</b>	
Application	Part #
4 Bolt - .032" AFM	<b>C15012-032</b>

## R07.2 Race V8

### Head Gasket

<b>MLX Head Gasket</b>			
Bore	Thickness	Pkg Qty	Part #
4.220"	.040"	1	<b>C5577-040</b>

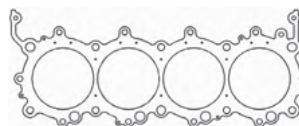

Additional thicknesses available  
see page 5

### Individual Gaskets

<b>Rubber Seal/O-Ring Kit</b>	
Application	Part #
R07.2	<b>C5979</b>

<b>Valve Cover Gasket (sold individually)</b>	
Application	Part #
Nitrile Formed Rubber O-Ring	<b>C15013</b>



# CHEVROLET / GM

## LT1 / LT4 350ci 1992-96

### Head Gaskets

#### MLS Head Gaskets

Bore	Thickness	Pkg Qty	Part #
4.040"	.040"	1	C5645-040
4.100"	.040"	1	C5646-040

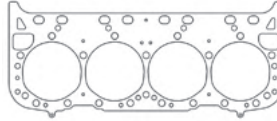

Additional thicknesses available  
see page 5

### Individual Gaskets

#### Valve Cover Gasket (sold individually)

Application	Part #
.094" Thickness	C15014-094

#### Exhaust Manifold Gaskets

Application	Part #
1.52" x 1.51" Ports, MLS	C5895-030

#### Intake Manifold Set

Application	Part #
LT1/LT4 - 2.085" x 1.560" Ports	C15015-060

#### Throttle Body Gasket Gasket

Application	Part #
1992-97 LT1/LT4	C15016-060

#### Oil Pan Gasket Set

Application	Part #
1992-97 1 pc Molded Rubber	C5072

#### Rear Main Seal Kit

Application	Part #
1 Piece Viton	C5106

#### Exhaust Pipe Gaskets

Application	Part #
Header Collector Gasket	C15017-064
Y-Pipe Gasket	C15018-064

#### Timing Cover Sets

Application	Part #
1992-94	C5054
1994-97	C5055

#### Water Pump Gasket

Application	Part #
Water Pump Mounting Gasket	C15019-031

## LS1 / LS6 5.7L, LS2 6.0L, & LS3 6.2L

### Head Gaskets

#### MLS Head Gaskets

Bore	Thickness	Pkg Qty	Part #
3.810"	.051"	1	C15361-051
3.910"	.040"	1	C5475-040
3.910"	.051"	1	C5475-051
4.060"	.040"	1	C5751-040
4.060"	.051"	1	C5751-051
4.100"	.040"	1	C5489-040
4.100"	.051"	1	C5489-051
4.130"	.051"	1	C5317-051
4.160"	.051"	1	C5318-051
4.190"	.051"	1	C5319-051

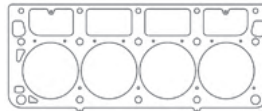

Additional thicknesses available  
see page 5

#### MLX Head Gaskets

Bore	Thickness	Pkg Qty	Part #
4.040"	.051"	1	C5505-051
4.150"	.040"	1	C5014-040
4.150"	.052"	1	C5014-052

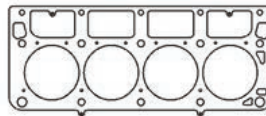

**NEW!**

#### SEG Head Gaskets, With SEG Rings

Bore	Thickness	Pkg Qty	Part #
4.150"	.051"	1	C15540-051
4.200"	.051"	1	C15542-051

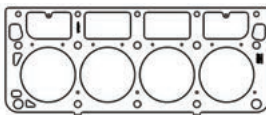

#### Copper Head Gaskets

Bore	Thickness	Pkg Qty	Part #
4.100"	.050"	1	C15408-050

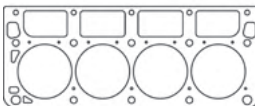

### Individual Gaskets

#### Valve Cover Gasket (sold individually)

Application	Part #
99-14 LS V8 - Center Bolt	C5170
Valve Cover Grommet Set	C15030

#### Exhaust Manifold Gaskets

Application	Part #
97-13 LS V8 - Round Port	C5818-030



# CHEVROLET / GM

## LS1 / LS6 5.7L, LS2 6.0L, & LS3 6.2L

### Individual Gaskets

#### Intake Manifold Gaskets

Application	Part #
99-05 5.7/6.0L Car Intake	C5165
99-05 5.3/6.0L Truck Intake	C5166
LS3/L92 Carb Intake Gaskets	C15022-060
08-13 LS3 6.2L Car Intake	C5037
07-13 6.0/6.2L Truck Intake	C15024
Gen III LS1/LS6 Valley Gasket	C15026
Gen IV LS w/D.O.D. Valley Gasket	C15023
Gen IV LS w/o D.O.D. Valley Gasket	C15025

#### Fuel Injector O-Ring Set

Application	Part #
Upper and Lower O-Rings	C15027

#### Exhaust Pipe Gaskets

Application	Part #
Graphite Exhaust Pipe	C15028
Metal Ring Exhaust Pipe	C15029

#### Cooling/Water Pump Gaskets

Application	Part #
99-13 LS V8 (pair) Molded	C5174
99-13 LS V8 (pair) .031" Fiber	C15032-031
99-13 Water Pump Backing O-ring	C15033
97-13 Coolant Bypass Seals	C15034

#### Knock Sensor Grommet Kit

Application	Part #
1999-2013 - 2 Pack	C15035

#### Throttle Body Gaskets

Application	Part #
97-05 5.7L	C5168
99-05 4.8/5.3/6.0L	C5169
2005 5.3/6.0L SUV	C15020
06-13 4.8/5.3/6.0/6.2L	C15021

#### Rear Main Seal Kit

Application	Part #
1997-13 LS V8	C5172

#### Oil Pan Gasket Set

Application	Part #
97-13 LS V8 (not Vette)	C5173

#### Valve Stem Seals

Application	Part #
97-01 LS V8	3516PB-16
02-13 LS V8 - Hat Style	3256V-16

#### Timing Cover Set

Application	Part #
1997-Up LS V8	C5056

#### Cam Plate Gasket

Application	Part #
with Recessed Bolts	C15031

#### Thermostat Seal

Application	Part #
2004-13 Gen IV	C15036

### Gasket Kits



To purchase a complete gasket kit order both top end and bottom end gasket kit

#### TOP END GASKET KIT



Application	Part #
1997-05 LS1/LS6 5.7L (Car Only)	PRO1007T
LS3/L92 6.2L Carbureted 4.060" Bore	PRO1035T
1999-01 6.0L (Truck Only) 4.100" Bore	PRO1008T
2001-10 4.8/5.3L Truck/Van/SUV 3.840" Bore	PRO1040T
2001-07 6.0L Truck/Van/SUV 4.060" Bore	PRO1041T
2005-07 6.0L Truck/Van/SUV 4.100" Bore	PRO1037T
2007-10 6.0/6.2L Truck/Van/SUV 4.100" Bore	PRO1036T
2009-11 LS3 6.2L (Car Only)	PRO1043T

#### BOTTOM END GASKET KIT

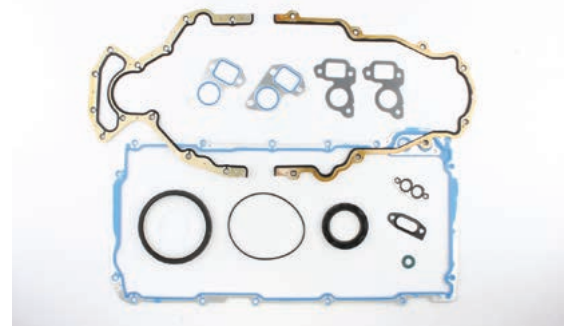

Application	Part #
4.8/5.3/5.7/6.0/6.2L LS V8	PRO1040B
with flat mount Cam Plate Bolts	
4.8/5.3/5.7/6.0/6.2L LS V8	PRO1036B
with recessed Cam Plate Bolts	



# CHEVROLET / GM

## LS7 7.0L V8

### Head Gaskets

#### MLS Head Gasket

Bore	Thickness	Pkg Qty	Part #
4.150"	.....051"	.....1	C5889-051

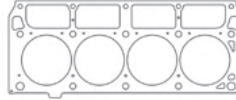

Additional thicknesses available  
see page 5

#### MLX Head Gasket

Bore	Thickness	Pkg Qty	Part #
4.150"	.....052"	.....1	C5030-052

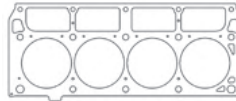

### Individual Gaskets

#### Valve Cover Gasket (sold individually)

Application	Part #
99-13 LS V8 - Center Bolt	C5170
Valve Cover Grommet Set	C15030

#### Intake Manifold Gaskets

Application	Part #
LS7 2006-13 w/Carb Intake	C5167-060
Gen IV LS w/o D.O.D. Valley Gasket	C15025

#### Exhaust Manifold Gaskets

Application	Part #
2006-13 D-Port - MLS	C5073-030

#### Valve Stem Seals

Application	Part #
05-13 LS7 V8 - Hat Style	3256V-16

#### Fuel Injector O-Ring Set

Application	Part #
Upper and Lower O-Rings	C15027

#### Timing Cover Set

Application	Part #
1997-Up LS V8	C5056

#### Cooling/Water Pump Gaskets

Application	Part #
99-13 LS V8 (pair) Molded	C5174
99-13 LS V8 (pair) .031" Fiber	C15032-031
99-13 Water Pump Backing O-ring	C15033
97-13 Coolant Bypass Seals	C15034

#### Rear Main Seal Kit

Application	Part #
1997-13 LS V8	C5172

## LS9/LSA 6.2L 2009-2013: 09-13 Corvette ZR1, 09-15 Cadillac CTS-V, 12-15 Camaro ZL1

### Head Gaskets

#### MLX Head Gasket - Right Side

Bore	Thickness	Pkg Qty	Part #
4.100"	.....051"	.....1	C5985-051

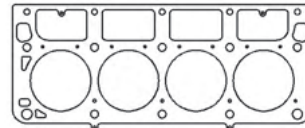

Additional thicknesses available  
see page 5

#### MLX Head Gasket - Left Side

Bore	Thickness	Pkg Qty	Part #
4.100"	.....051"	.....1	C5986-051

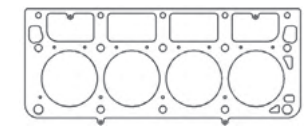

### Individual Gaskets

#### Valve Cover Gasket (sold individually)

Application	Part #
99-13 LS V8 - Center Bolt	C5170
Valve Cover Grommet Set	C15030

#### Valve Stem Seals

Application	Part #
09-13 LS V8 - Hat Style	3256V-16

#### Exhaust Manifold Gaskets

Application	Part #
09-13 LS V8 - Round Port	C5818-030

#### Oil Pan Gasket Set

Application	Part #
97-13 LS V8 (Pan to Block)	C5173

#### Intake Manifold Gaskets

Application	Part #
Gen IV LS w/o D.O.D. Valley Gasket	C15025

#### Timing Cover Set

Application	Part #
1997-Up LS V8	C5056

See page 19 for additional gaskets



# CHEVROLET / GM

**LS9/LSA 6.2L 2009-2013: 09-13 Corvette ZR1, 09-15 Cadillac CTS-V, 12-15 Camaro ZL1**

## Individual Gaskets

Cooling/Water Pump Gaskets	
Application	Part #
99-13 LS V8 (pair) Molded .....	<b>C5174</b> .....
99-13 LS V8 (pair) .031" Fiber.....	<b>C15032-031</b> .....
99-13 Water Pump Backing O-ring.....	<b>C15033</b> .....
97-13 Coolant Bypass Seals .....	<b>C15034</b> .....

Rear Main Seal Kit	
Application	Part #
1997-13 LS V8.....	<b>C5172</b> .....

# GM/DART LS NEXT BLOCK

## Head Gaskets

MLX Head Gasket - Right Side			
Bore	Thickness	Pkg Qty	Part #
4.200" .....	.044" .....	1 .....	<b>C15362-044</b> .....
4.200" .....	.052" .....	1 .....	<b>C15362-052</b> .....
4.200" .....	.060" .....	1 .....	<b>C15362-060</b> .....

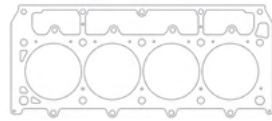

Additional thicknesses available see page 5

1/2" & 3/8" Stud Hole Combination

MLX Head Gasket - Left Side			
Bore	Thickness	Pkg Qty	Part #
4.200" .....	.044" .....	1 .....	<b>C15363-044</b> .....
4.200" .....	.052" .....	1 .....	<b>C15363-052</b> .....
4.200" .....	.060" .....	1 .....	<b>C15363-060</b> .....

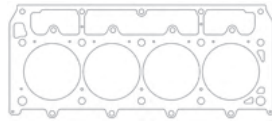

# LSX RACE BLOCK

## Head Gaskets

**NEW!**

MLS Head Gaskets - Right Side			
Bore	Thickness	Pkg Qty	Part #
4.060" .....	.056" .....	1 .....	<b>C15527-056</b> .....
4.125" .....	.051" .....	1 .....	<b>C5933-051</b> .....
4.185" .....	.051" .....	1 .....	<b>C5935-051</b> .....

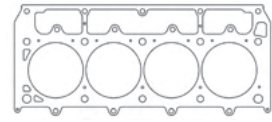

Additional thicknesses available see page 5

**NEW!**

MLS Head Gaskets - Left Side			
Bore	Thickness	Pkg Qty	Part #
4.060" .....	.056" .....	1 .....	<b>C15526-056</b> .....
4.125" .....	.051" .....	1 .....	<b>C5934-051</b> .....
4.185" .....	.051" .....	1 .....	<b>C5936-051</b> .....

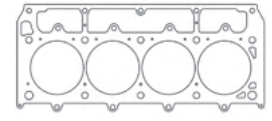

MLX Head Gaskets - Right Side			
Bore	Thickness	Pkg Qty	Part #
4.100" .....	.040" .....	1 .....	<b>C5075-040</b> .....
4.165" .....	.040" .....	1 .....	<b>C5702-040</b> .....
4.200" .....	.040" .....	1 .....	<b>C5077-040</b> .....

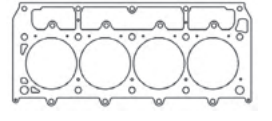

MLX Head Gaskets - Left Side			
Bore	Thickness	Pkg Qty	Part #
4.100" .....	.040" .....	1 .....	<b>C5076-040</b> .....
4.165" .....	.040" .....	1 .....	<b>C5703-040</b> .....
4.200" .....	.040" .....	1 .....	<b>C5078-040</b> .....

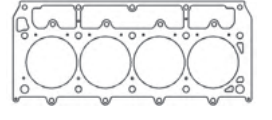

**NEW!**

SEG Head Gaskets - Right Side, With SEG Rings, 6 Bolt Kit			
Bore	Thickness	Pkg Qty	Part #
4.150" .....	.051" .....	1 .....	<b>C15531-051</b> .....
4.200" .....	.051" .....	1 .....	<b>C15537-051</b> .....

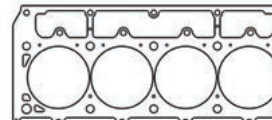

**NEW!**

SEG Head Gaskets - Left Side, With SEG Rings, 6 Bolt Kit			
Bore	Thickness	Pkg Qty	Part #
4.150" .....	.051" .....	1 .....	<b>C15532-051</b> .....
4.200" .....	.051" .....	1 .....	<b>C15538-051</b> .....

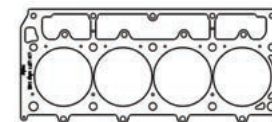

See page 20 for additional gaskets



# CHEVROLET / GM

## LSX RACE BLOCK

### Head Gaskets

#### Copper Head Gaskets - Left Side

Bore	Thickness	Pkg Qty	Part #
4.100"	.043"	1	C15409-043

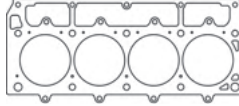

#### Copper Head Gaskets - Right Side

Bore	Thickness	Pkg Qty	Part #
4.100"	.043"	1	C15410-043

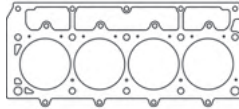

### Individual Gaskets

#### Valve Cover Gasket (sold individually)

Application	Part #
99-13 LS V8 - Center Bolt	C5170
Valve Cover Grommet Set	C15030

#### Exhaust Manifold Gaskets

Application	Part #
2006-13 D-Port - MLS	C5073-030
LSX-DR .064" AM	C15038-064

#### Intake Manifold Gaskets

Application	Part #
LS7 2006-13 w/Carb Intake	C5167-060
LSX-DR Head - Lrg Port	C15037-060
Gen IV LS w/o D.O.D. Valley Gasket	C15025

#### Valve Stem Seals

Application	Part #
09-13 LS V8 - Hat Style	3256V-16

#### Oil Pan Gasket Set

Application	Part #
97-13 LS V8 (Pan to Block)	C5173

#### Cooling/Water Pump Gaskets

Application	Part #
99-13 LS V8 (pair) Molded	C5174
99-13 LS V8 (pair) .031" Fiber	C15032-031
99-13 Water Pump Backing O-ring	C15033
97-13 Coolant Bypass Seals	C15034

#### Timing Cover Set

Application	Part #
1997-Up LS V8	C5056

### Gasket Kits



To purchase a complete gasket kit order both top end and bottom end gasket kit

#### TOP END GASKET KIT

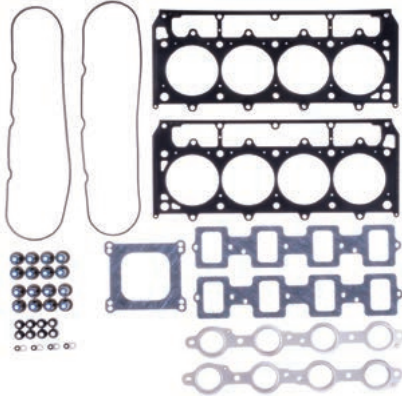

Application	Part #
LSX w/LS7 Carb Intake 4.125" Bore	PRO1025T

#### BOTTOM END GASKET KIT

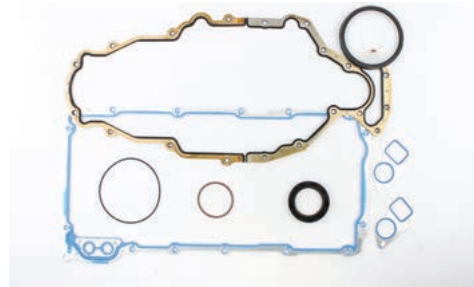

Application	Part #
LSX V8	PRO1025B

## LS1 / LS6 5.7L, LS2 6.0L, & LS3 6.2L w/Darton M.I.D. Sleeves

### Head Gaskets

#### MLS Head Gasket

Bore	Thickness	Pkg Qty	Part #
3.910"	.040"	1	C5788-040
4.125"	.040"	1	C5789-040
4.165"	.040"	1	C5790-040

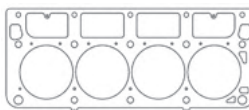

Additional thicknesses available  
see page 5



# CHEVROLET / GM

## L83 / 5.3L EcoTec3

### Head Gaskets

#### MLS Head Gasket

Bore	Thickness	Pkg Qty	Part #
3.875"	0.058"	1	C15426-058

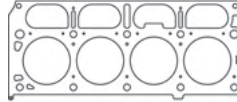

### Individual Gaskets

**NEW!**

#### Valve Cover Set

Application	Part #
2014+ L83 5.3L Valve Cover Set	C15438

## LT1 / LT4 6.2L V8 2014+UP

### Head Gasket

#### MLX Head Gasket

Bore	Thickness	Pkg Qty	Part #
4.100"	.051"	1	C5038-051
4.150"	.051"	1	C15203-051
4.200"	.051"	1	C15202-051

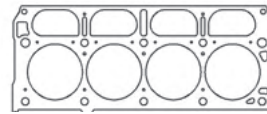

Additional thicknesses available see page 5

**NEW!**

#### SEG Head Gaskets, With SEG Rings

Bore	Thickness	Pkg Qty	Part #
4.150"	.051"	1	C15597-051
4.200"	.051"	1	C15598-051

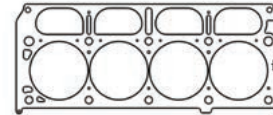

### Individual Gaskets

#### Exhaust Manifold Gasket

Application	Part #
2014+ 1.920" Port - .021" MLS	C5020-021

#### Valley Pan Gasket

Application	Part #
2014+ LT1/LT4 Valley Pan	C15437

#### Valve Cover Set

Application	Part #
2014+ LT1/LT4 Valve Cover Set	C15438

**NEW!**

#### Intake Manifold Gaskets

Application	Part #
2014+ LT1 Set of 8	C15599

## 348ci 1958-61 / 409ci 1961-65 "W" V8

### Head Gaskets

#### MLS Head Gaskets

Bore	Thickness	Pkg Qty	Part #
4.200"	.040"	1	C5255-040
4.375"	.040"	1	C5256-040
4.437"	.040"	1	C5219-040

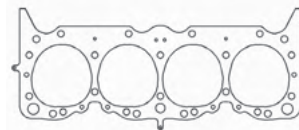

Additional thicknesses available see page 5

### Individual Gaskets

**NEW!**

#### Intake Manifold Gasket

Application	Part #
409ci V8 - .059" CFM	C15039-059
348-409ci V8 - .060 FC, Small Port	C15600-060

#### Exhaust Manifold Gasket

Application	Part #
409ci V8 - .064" AM	C15040-064



# CHEVROLET / GM

**Big Block V8 - Gen4 1965-90 396,402,427,454ci**

## Head Gaskets

### MLS Head Gaskets

Bore	Thickness	Pkg Qty	Part #
4.320"	.040"	1	C5816-040
4.375"	.040"	1	C5329-040
4.375"	.051"	1	C5329-051
4.540"	.040"	1	C5330-040
4.540"	.051"	1	C5330-051
4.630"	.040"	1	C5331-040
4.630"	.045"	1	C5331-045
4.630"	.051"	1	C5331-051
4.630"	.060"	1	C5331-060

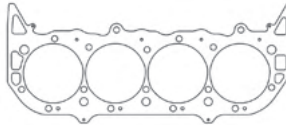

Additional thicknesses available  
see page 5

**NEW!**

### MLX Head Gaskets

Bore	Thickness	Pkg Qty	Part #
4.560"	.040"	1	C15561-040

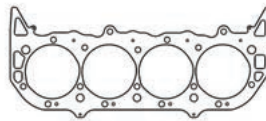

### Copper Head Gaskets

Bore	Thickness	Pkg Qty	Part #
4.320"	.043"	1	C15413-043
4.530"	.043"	1	C15414-043
4.630"	.043"	1	C15415-043

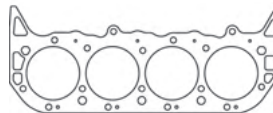

## Individual Gaskets

### Valve Cover Gasket (sold individually)

Application	Part #
Molded Rubber .188"	C5975

### Intake Manifold Gaskets

Application	Part #
Rect Port 1.75" x 2.50" - .060" KF	C5649-060
Oval Port 1.82" x 2.05" - .060" KF	C15041-060

### Timing Cover Sets

Application	Part #
1965-95 BBC V8	C5057

### Rear Main Seal Kit

Application	Part #
2pc 1965-90 - Silicone	C5086
2pc 1965-90 - SN	C5682

### Exhaust Manifold Gaskets

Application	Part #
1.85" x 1.90" Sq Port - MLS	C5897-030
1.920" Round Port - MLS	C5896-030
2.000" Round Port - MLS	C5349-030
2.130" Round Port - MLS	C5996-030
2.200" Round Port - MLS	C5350-030
2.250" Round Port - MLS	C5251-030

### Oil Pan Gasket Set

Application	Part #
4pc Kit	C5344
1 pc Molded Rubber	C15550

### Cooling/Water Pump Gaskets

Application	Part #
Water Pump Mounting - Req 2	C5347-039
Water Outlet	C5346-047

## Gasket Kits



To purchase a complete gasket kit order both top end and bottom end gasket kit

### TOP END GASKET KIT

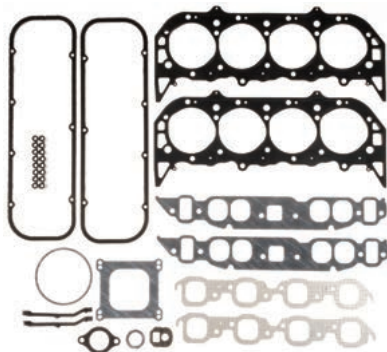

Application	Part #
454ci 1970-85 4.275" Bore	PRO1005T

### BOTTOM END GASKET KIT



Application	Part #
Big Block Gen4	PRO1005B





# CHEVROLET / GM

## Big Block V8 - Gen 5/6 1991-00 454, 502ci

### Head Gaskets

#### MLS Head Gaskets

Bore	Thickness	Pkg Qty	Part #
4.320"	.040"	1	C5817-040
4.375"	.040"	1	C5332-040
4.540"	.040"	1	C5333-040
4.540"	.051"	1	C5333-051
4.630"	.040"	1	C5334-040

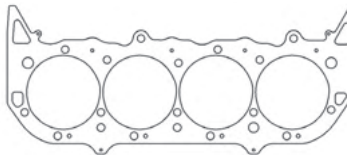

Additional thicknesses available  
see page 5

### Individual Gaskets

#### Valve Cover Gasket (sold individually)

Application	Part #
Molded Rubber .188"	C5975

#### Intake Manifold Gaskets

Application	Part #
Rect Port 1.75" x 2.50" - .060" KF	C5649-060
Oval Port 1.82" x 2.05" - .060" KF	C15041-060

#### Exhaust Manifold Gaskets

Application	Part #
1.85" x 1.90" Sq Port - MLS	C5897-030
1.920" Round Port - MLS	C5896-030
2.000" Round Port - MLS	C5349-030
2.130" Round Port - MLS	C5996-030
2.200" Round Port - MLS	C5350-030
2.250" Round Port - MLS	C5251-030

#### Timing Cover Sets

Application	Part #
1990-95 BBC V8	C5057
1996-00 BBC V8	C5058

#### Cooling/Water Pump Gaskets

Application	Part #
Water Pump Mounting - Req 2	C5347-039
Water Outlet	C5346-047

#### Rear Main Seal Kit

Application	Part #
1pc 1991-00 Gen 5/6 - SN	C5087

#### Oil Pan Gasket Set

Application	Part #
1pc Molded Rubber	C15077

## Big Block V8 - Aftermarket, Race, & Marine Blocks

### Head Gaskets

#### MLS Head Gaskets - Mercury Gen4/5/6 w/4 Bolts in Lifter Valley

Bore	Thickness	Pkg Qty	Part #
4.500"	.051"	1	C5634-051
4.530"	.051"	1	C5635-051
4.580"	.051"	1	C5636-051
4.600"	.051"	1	C5637-051

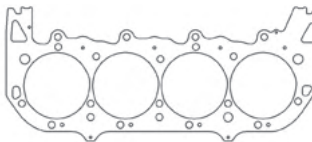

Additional thicknesses available  
see page 5

#### MLS Head Gaskets - Mercury 1050 Gen 4 w/2 Slotted Lifter Valley Bolts

Bore	Thickness	Pkg Qty	Part #
4.500"	.051"	1	C5638-051
4.530"	.051"	1	C5639-051
4.580"	.051"	1	C5640-051
4.600"	.051"	1	C5641-051

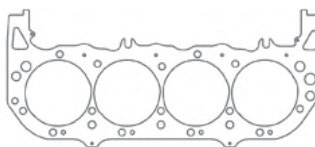

#### MLS Head Gaskets - Mercury Marine 525/625 Gen VI

Bore	Thickness	Pkg Qty	Part #
4.470"	.040"	1	C5760-040

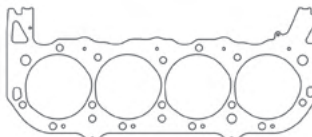

See page 24 for additional gaskets



# CHEVROLET / GM

## Big Block V8 - Aftermarket, Race, & Marine Blocks

### Head Gaskets

#### MLS Head Gaskets - Mercury 8.1L 496 - Right Side

Bore	Thickness	Pkg Qty	Part #
4.280"	.051"	1	C5761-051
4.350"	.051"	1	C5762-051
4.450"	.051"	1	C5763-051

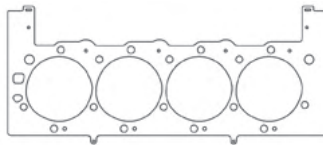

Additional thicknesses available  
see page 5

#### MLS Head Gaskets - Mercury 8.1L 496 - Left Side

Bore	Thickness	Pkg Qty	Part #
4.280"	.051"	1	C5764-051
4.350"	.051"	1	C5765-051
4.450"	.051"	1	C5766-051

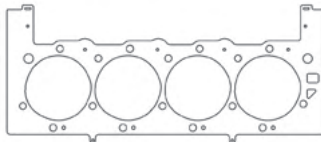

#### MLS Head Gaskets - Brodix Big Duke/Big Brodie

Bore	Thickness	Pkg Qty	Part #
4.310"	.040"	1	C5432-040
4.570"	.040"	1	C5433-040
4.630"	.040"	1	C5434-040

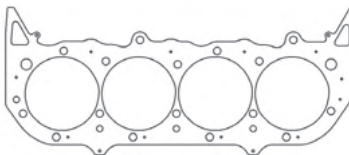

#### MLS Head Gaskets - ZL1 1969 7.0L 427ci Aluminum Round Bore

Bore	Thickness	Pkg Qty	Part #
4.250"	.040"	1	C5746-040
4.300"	.040"	1	C5747-040
4.375"	.040"	1	C5759-040

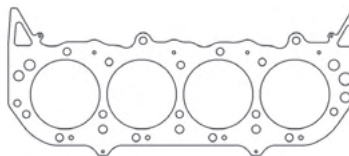

### Individual Gaskets

#### Valve Cover Gasket (sold individually)

Application	Part #
SR-20 FML .094" Fiber w/ Steel	C15460
Molded Rubber .188"	C5975

#### Exhaust Manifold Gaskets

Application	Part #
Brodix Big Brodie - .064" AM	C5429-064
Brodix Big Duke - .064" AM	C5418-064
Mercury 525/625 EFI - MLS	C15364-030
Mercury 1050 - MLS	C5820-051

#### Timing Cover Sets

Application	Part #
1965-95 BBC V8	C5057
1996-00 BBC V8	C5058

#### Cooling/Water Pump Gaskets

Application	Part #
Water Pump Mounting - Req 2	C5347-039
Water Outlet	C5346-047

#### Intake Manifold Gaskets

Application	Part #
Brodix SR-20 -.060KF	C15459-060
Brodix Big Brodie Oval - .060" KF	C5430-060
Brodix Big Brodie Rectangle-.060" KF	C5428-060
Brodix Big Duke - .060" KF	C5419-060
Mercury 1050 - MLS	C5821-051

#### Rear Main Seal Kits

Application	Part #
2pc 1965-90 - Silicone	C5086
2pc 1965-90 - SN	C5682
1pc 1991-00 Gen 5/6 - SN	C5087

#### Oil Pan Gasket Set

Application	Part #
4pc Kit 1965-90	C5344
4pc Kit Bolt Holes@Mains	C5254
1pc Molded Rubber 91-00	C15077



# CHEVROLET / GM

## Pro Stock Racing V8

### Head Gaskets

<b>MLS Head Gaskets - DRCE-2 4.900" Bore Centers 500ci</b>			
Bore	Thickness	Pkg Qty	Part #
4.675"	.051"	1	C5449-051
4.700"	.051"	1	C5450-051
4.780"	.051"	1	C5451-051

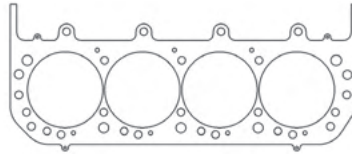

Additional thicknesses available  
see page 5

<b>MLS Head Gaskets - DRCE-3 4.900" Bore Centers 500ci</b>			
Bore	Thickness	Pkg Qty	Part #
4.675"	.051"	1	C5796-051
4.700"	.051"	1	C5797-051
4.780"	.051"	1	C5798-051

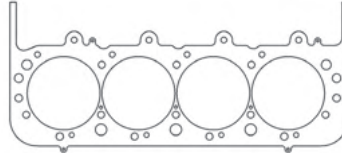

<b>MLS Head Gasket - IHRA 5.00" Bore Centers 800ci</b>			
Bore	Thickness	Pkg Qty	Part #
4.755"	.040"	1	C5850-040

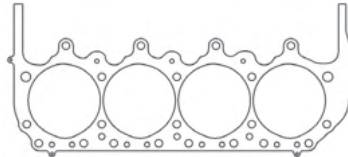

<b>MLX Head Gasket - 5.20" Bore Centers</b>			
Bore	Thickness	Pkg Qty	Part #
4.860"	.040"	1	C5013-040

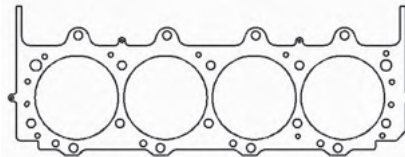

<b>MLS Head Gaskets - BRODIX 5.0 Bore Space Big Block V8</b>			
Bore	Thickness	Pkg Qty	Part #
4.700"	.041"	1	C15397-041
4.760"	.041"	1	C15398-041
4.795"	.041"	1	C15399-041

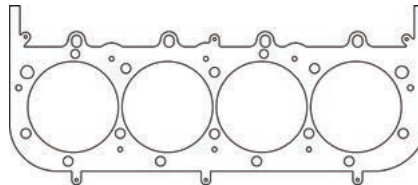

## 6.5L Diesel V8 1992-00

### Head Gaskets

<b>MLS Head Gaskets - Right Side</b>			
Bore	Thickness	Pkg Qty	Part #
4.100"	.045"	1	C5885-045

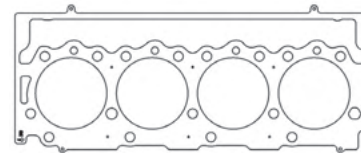

Additional thicknesses available  
see page 5

<b>MLS Head Gaskets - Left Side</b>			
Bore	Thickness	Pkg Qty	Part #
4.100"	.045"	1	C5884-045

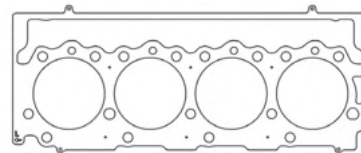

<b>Head Bolt Kit</b>	
Bore	Part #
ARP 190,000 psi	COM-0001



# CHEVROLET / GM

## 6.6L Duramax Diesel V8 2001-16

### Head Gaskets

#### MLX Head Gaskets - Right Side

Bore	Thickness	Pkg Qty	Part #
4.130"	.....053"	.....1	<b>C15375-053</b> .....
4.130"	.....062"	.....1	<b>C15375-062</b> .....

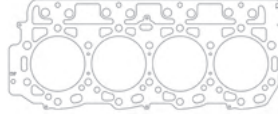

Additional thicknesses available  
see page 5

#### MLX Head Gaskets - Left Side

Bore	Thickness	Pkg Qty	Part #
4.130"	.....053"	.....1	<b>C15376-053</b> .....
4.130"	.....062"	.....1	<b>C15376-062</b> .....

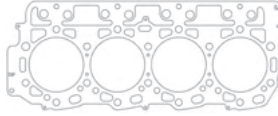

#### MLS Head Gaskets - Right Side

Bore	Thickness	Pkg Qty	Part #
4.100"	.....040"	.....1	<b>C5882-040</b> .....

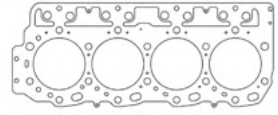

#### MLS Head Gaskets - Left Side

Bore	Thickness	Pkg Qty	Part #
4.100"	.....040"	.....1	<b>C5883-040</b> .....

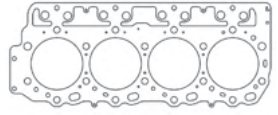

### Individual Gaskets

#### Exhaust Manifold Gaskets

Application	Part #
2001-16 8mm Bolts - MLS, Pair .....	<b>C15042-040</b> .....

#### Rear Main Seal Kit

Application	Part #
2001-07 .....	<b>C15044</b> .....

#### Timing Cover Set

Application	Part #
2001-15 .....	<b>C15045</b> .....

#### Oil Pan Gasket Set

Application	Part #
2001-10 17 Bolt - .060" KF .....	<b>C15043</b> .....

### Gasket Kits



To purchase a complete gasket kit order both top end and bottom end gasket kit

#### TOP END GASKET KITS

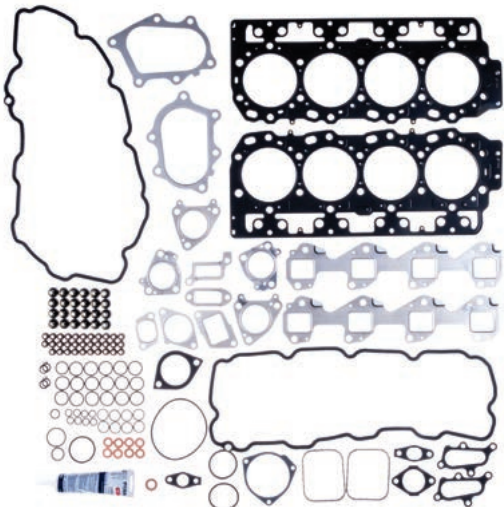

Application	Part #
6.6L Duramax 2001-04 4.100" Bore .....	<b>PRO3008T</b> .
6.6L Duramax 2005-07 4.100" Bore .....	<b>PRO3009T</b> ....

#### BOTTOM END GASKET KIT

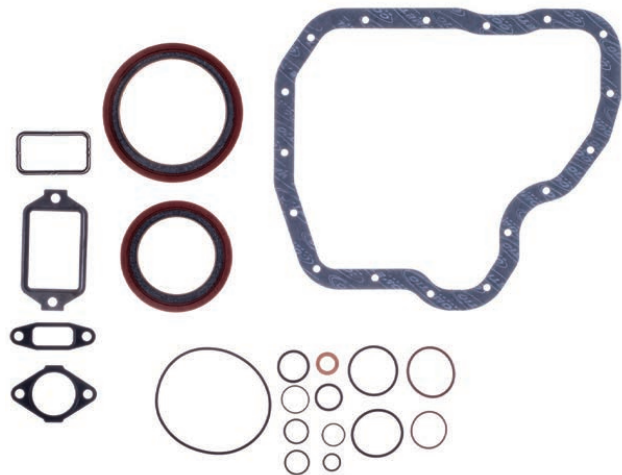

Application	Part #
6.6L Duramax 2001-07 .....	<b>PRO3008B</b> .....



# CHRYSLER / DODGE

## 2.0L DOHC 4cyl ECC / 420A 1995-99

### Head Gaskets

MLS Head Gaskets			
Bore	Thickness	Pkg Qty	Part #
87.5mm	.040"	1	C5497-040
88.5mm	.040"	1	C5498-040

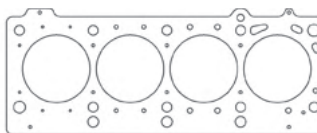

Additional thicknesses available see page 5

### Individual Gaskets

Valve Cover Gasket Set	
Application	Part #
1995-99 2.0L DOHC	C15046

Cam Seal Set	
Application	Part #
Pair - 48 x 35 x 7	C15049

Intake Manifold Gaskets	
Application	Part #
Intake Manifold Gasket - .060" AFM	C15047-060
Intake Plenum Gasket - .031" Fiber	C15048-031

Front Crank Seal Set	
Application	Part #
1995-99 2.0L DOHC	C15053

Exhaust Manifold Gasket	
Application	Part #
2.040" X 1.100" Port - MLS	C4161-030

Oil Pan Gasket Set	
Application	Part #
Molded Rubber	C15050

Throttle Body Gasket	
Application	Part #
Molded Rubber	C15051

Rear Main Seal	
Application	Part #
1995-99 2.0L DOHC	C15052

Valve Stem Seal Set (16 Pack)	
Application	Part #
5 x 10.8 x 18.3 x 16.9 - Hat Style	3180V-16

### Gasket Kits



To purchase a complete gasket kit order both top end and bottom end gasket kit

#### TOP END GASKET KIT

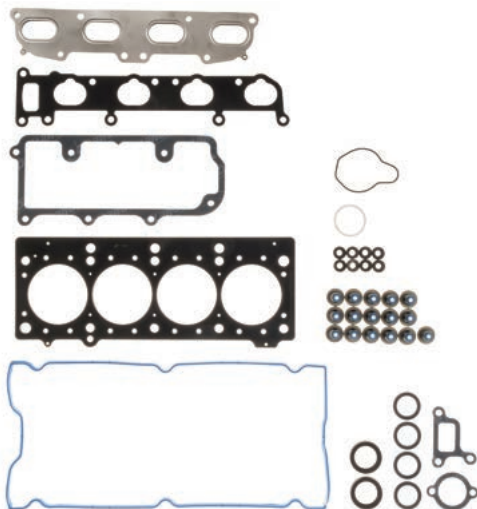

Application	Part #
1995-99 420A 2.0L DOHC 87.5mm Bore	PRO2005T

#### BOTTOM END GASKET KIT

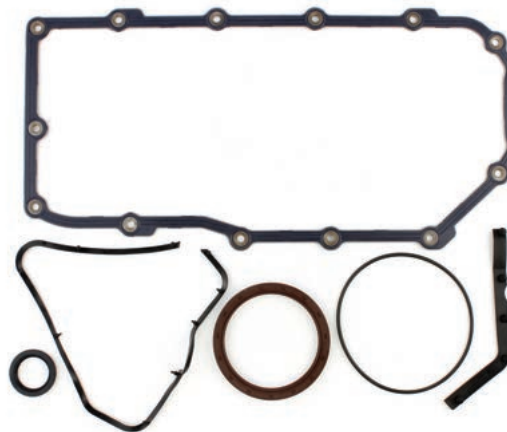

Application	Part #
1995-99 420A 2.0L DOHC	PRO2005B



# CHRYSLER / DODGE

## 2.4L DOHC Turbo 4cyl 2003-05 Neon SRT4, 2002-10 PT Cruiser, 2003-06 Jeep Wrangler

### Head Gaskets

#### MLS Head Gaskets

Bore	Thickness	Pkg Qty	Part #
87.5mm	.030"	1	C4548-030
90mm	.030"	1	C4549-030

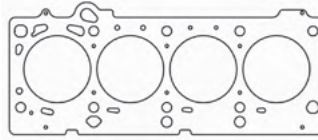

Additional thicknesses available see page 5

#### MLX Head Gaskets

Bore	Thickness	Pkg Qty	Part #
88.5mm	.040"	1	C15449-040

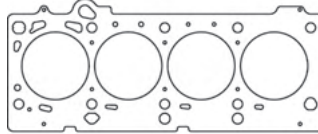

## 2.2L DOHC 4cyl 1991-93

### Head Gaskets

#### MLS Head Gaskets

Bore	Thickness	Pkg Qty	Part #
89.5mm	.066"	1	C5733-066

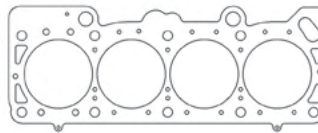

Additional thicknesses available see page 5

## 2.2L SOHC 4cyl 1982-90, 2.5L SOHC 4cyl 1986-95

### Head Gaskets

#### MLS Head Gaskets

Bore	Thickness	Pkg Qty	Part #
89.5mm	.066"	1	C5734-066

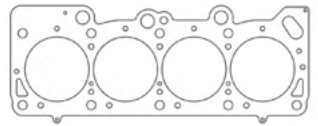

Additional thicknesses available see page 5

## 3.5L SOHC V6 1999-10, 4.0L SOHC V6 2007-11

### Head Gaskets

#### MLS Head Gasket - Right Side

Bore	Thickness	Pkg Qty	Part #
96.5mm	.075"	1	C5015-075

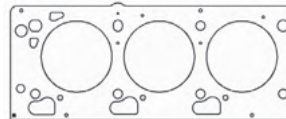

Additional thicknesses available see page 5

#### MLS Head Gasket - Left Side

Bore	Thickness	Pkg Qty	Part #
96.5mm	.075"	1	C5016-075

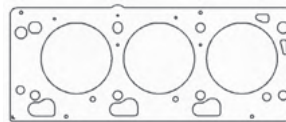

## 3.7L SOHC V6 2002-13 PowerTech "EKG"

### Head Gaskets

#### MLS Head Gasket

Bore	Thickness	Pkg Qty	Part #
95mm	.030"	1	C5794-030

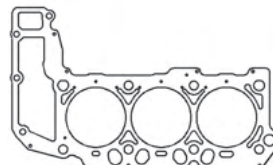

Additional thicknesses available see page 5



## CHRYSLER / DODGE

### 4.0L Inline 6 242ci 1987-2006: 87-01 Cherokee, 93-04 Grand Cherokee, 87-90 Wagoneer, 87-92 Comanche, 91-06 Wrangler

#### Head Gaskets

MLS Head Gaskets			
Bore	Thickness	Pkg Qty	Part #
3.950	.050"	1	C5987-050
4.000	.050"	1	C5988-050
4.060	.050"	1	C5989-050

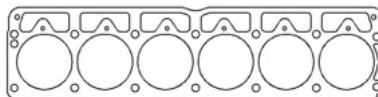

Additional thicknesses available see page 5

#### Individual Gaskets

Timing Cover Set	
Application	Part #
3.8/4.0/4.2L I6 1965-2006	C5047

### 4.7L SOHC V8 1999-13 PowerTech

#### Head Gaskets

MLS Head Gaskets - 1999-07			
Bore	Thickness	Pkg Qty	Part #
93mm	.030"	1	C5213-030
95mm	.030"	1	C5214-030

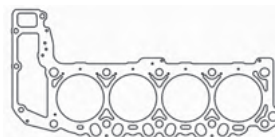

Additional thicknesses available see page 5

MLS Head Gasket - 2008-13			
Bore	Thickness	Pkg Qty	Part #
94mm	.030"	1	C5803-030

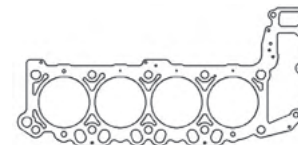

### Polyspherical 318 V8 1957-67 (A Engine)

#### Head Gaskets

MLS Head Gaskets			
Bore	Thickness	Pkg Qty	Part #
4.030"	.040"	1	C15296-040

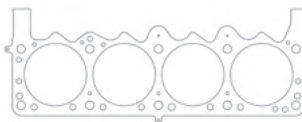

Additional thicknesses available see page 5

### 5.2L & 5.9L Magnum V8 1992-03

#### Head Gaskets

MLS Head Gaskets			
Bore	Thickness	Pkg Qty	Part #
4.040"	.040"	1	C15535-040
4.040"	.051"	1	C15535-051
4.040"	.060"	1	C15535-060

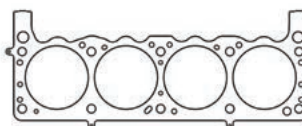

Additional thicknesses available see page 5

#### Individual Gaskets

Valve Cover Gasket (sold individually)	
Application	Part #
10 Bolt - .047" KF	C5557-047

Oil Pan Gasket Set	
Application	Part #
4pc Set	C5560-094

Intake Manifold Gaskets	
Application	Part #
2.150" x 1.140" Port - .047" KF	C5555-047
End Rail Gaskets	C5556-047

Timing Cover Sets	
Application	Part #
1992-96	C5059
1997-03	C5060

See page 30 for additional gaskets



# CHRYSLER / DODGE

## 5.2L & 5.9L Magnum V8 1992-03

### Individual Gaskets

#### Exhaust Manifold Gasket

Application	Part #
1.195" x 1.675" - .064" AM.....	C5558-064.....

#### Rear Main Seal

Application	Part #
2pc SN .....	C5564.....

#### Cooling/Water Pump Gaskets

Application	Part #
Water Pump Cover Gasket .....	C5561-018.....
Thermostat Gasket .....	C5562-018.....

#### Fuel Pump Gasket

Application	Part #
Fuel Pump to Block .....	C5642-031.....

## 318/340/360ci V8 "LA" 1964-92

### Head Gaskets

#### MLS Head Gaskets

Bore	Thickness	Pkg Qty	Part #
4.040"	.040"	1	C5633-040.....
4.080"	.040"	1	C5622-040.....
4.125"	.040"	1	C5457-040.....
4.180"	.040"	1	C5456-040.....

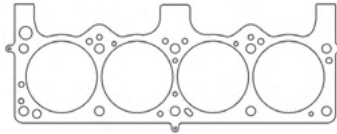

Additional thicknesses available  
see page 5

#### MLS Head Gaskets - w/318A Engine Quest or Edelbrock Heads

Bore	Thickness	Pkg Qty	Part #
4.040"	.040"	1	C5916-040.....
4.080"	.040"	1	C5917-040.....
4.125"	.040"	1	C5918-040.....
4.180"	.040"	1	C5919-040.....

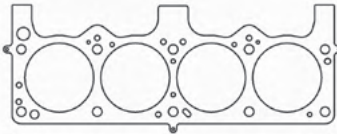

#### Copper Head Gaskets

Bore	Thickness	Pkg Qty	Part #
4.200"	.043"	1	C15416-043.....

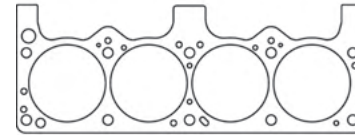

### Individual Gaskets

#### Valve Cover Gasket (sold individually)

Application	Part #
Molded Rubber.....	C15468.....
5 Bolt - .094" KF.....	C5623-094.....

#### Timing Cover Set

Application	Part #
1964-91 Set.....	C5061.....

#### Intake Manifold Gaskets

Application	Part #
1.170" x 2.300" - .060" KF .....	C5624-060.....
China Rail Gaskets.....	C5625-060.....

#### Oil Pan Gasket Sets

Application	Part #
4pc 318/340ci V8.....	C5627-094.....
4pc 360ci V8.....	C5508-094.....

#### Exhaust Manifold Gaskets

Application	Part #
1.205" x 1.845" - .064" AM.....	C5628-064.....
1.310" x 1.640" - MLS .....	C5901-030.....

#### Rear Main Seal Kit

Application	Part #
273/318/340ci 2pc - SN .....	C5683.....
360ci 2pc - SN .....	C5684.....

#### Cooling / Water Pump Gaskets

Application	Part #
Water Pump Gasket .....	C15054-060.....
Thermostat Gasket .....	C5574-018.....

#### Fuel Pump Gasket

Application	Part #
Fuel Pump to Block .....	C5642-031.....

See page 31 for StreetPro gaskets





# CHRYSLER / DODGE

## 318 / 340 / 360ci V8 "LA" 1964-92

### Gasket Kits



To purchase a complete gasket kit order both top end and bottom end gasket kit

#### TOP END GASKET KIT

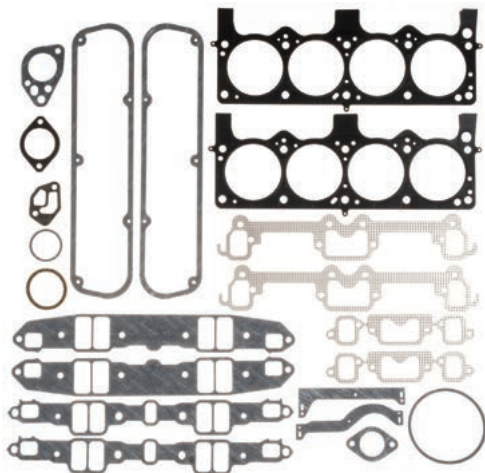

#### BOTTOM END GASKET KITS

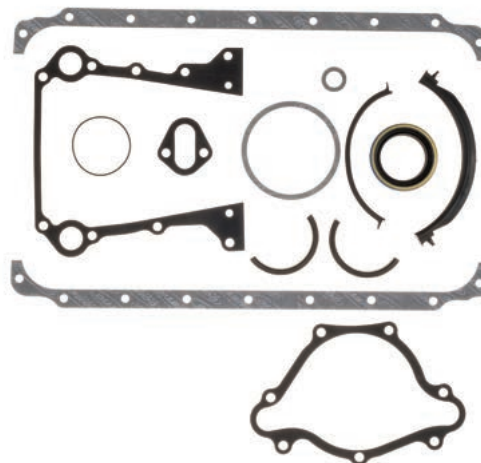

Application	Part #
1968-89 318, 1968-73 340, 1971-80 360 ..... 4.080" Bore	<b>PRO1000T</b> .....

Application	Part #
360ci V8.....	<b>PRO1000B</b> .....
318/340ci V8.....	<b>PRO1002B</b> .....

## 5.7L Hemi V8 2003-Present

### Head Gaskets

#### MLX Head Gaskets - Right Side

Bore	Thickness	Pkg Qty	Part #
4.000"	.....040"	.....1.....	<b>C15315-040</b> .....

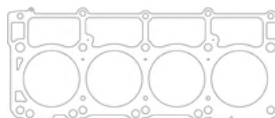

Additional thicknesses available  
see page 5

#### MLX Head Gaskets - Left Side

Bore	Thickness	Pkg Qty	Part #
4.000"	.....040"	.....1.....	<b>C15316-040</b> .....

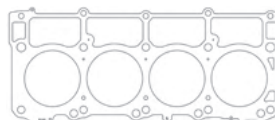

#### MLS Head Gaskets - Right Side

Bore	Thickness	Pkg Qty	Part #
3.950"	.....027"	.....1.....	<b>C5467-027</b> .....
4.100"	.....027"	.....1.....	<b>C5749-027</b> .....
4.100"	.....040"	.....1.....	<b>C5749-040</b> .....

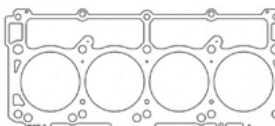

Additional thicknesses available  
see page 5

#### MLS Head Gaskets - Left Side

Bore	Thickness	Pkg Qty	Part #
3.950"	.....027"	.....1.....	<b>C5468-027</b> .....
4.100"	.....027"	.....1.....	<b>C5750-027</b> .....
4.100"	.....040"	.....1.....	<b>C5750-040</b> .....

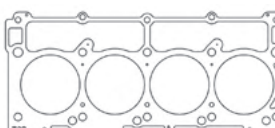

See page 32 for additional gaskets



# CHRYSLER / DODGE

## 5.7L Hemi V8 2003-Present

### Individual Gaskets

Valve Cover Gasket (sold individually)	
Application	Part #
Molded Rubber (Need 2)	C5193

Thermostat Housing Gasket	
Application	Part #
Molded Rubber	C5198

Intake Manifold Gasket Set	
Application	Part #
Molded Rubber - Set of 8	C5196

Oil Pan Gasket Set	
Application	Part #
Intergrated Windage Tray	C5201

Throttle Body Gasket	
Application	Part #
Molded Rubber	C5199

Timing Cover Set	
Application	Part #
2003-Up 5.7L Hemi	C5202

Exhaust Gaskets	
Application	Part #
MLS Exhaust Gaskets - Pair 2003-08	C5854-030

Rear Main Seal Kit	
Application	Part #
Seal and Housing Gasket	C5203

Valve Stem Seal Set (16 Pack)	
Application	Part #
Hat Style - Viton Steel Body - EXH	3260V-16
Hat Style - Viton Steel Body - INT	3261V-16

Water Pump Gasket	
Application	Part #
Molded Rubber	C5204

### Gasket Kits



To purchase a complete gasket kit order both top end and bottom end gasket kit

#### TOP END GASKET KIT

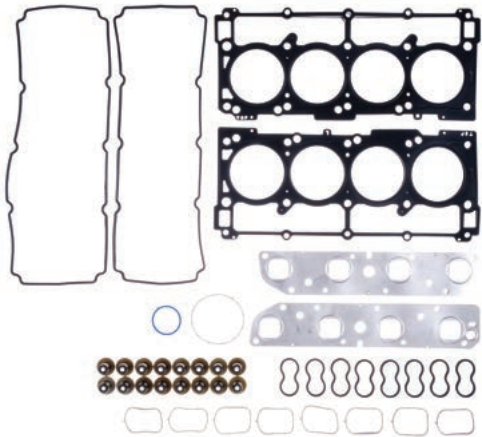

Application	Part #
2003-08 5.7L V8 3.950 Bore	PRO1022T

#### BOTTOM END GASKET KIT

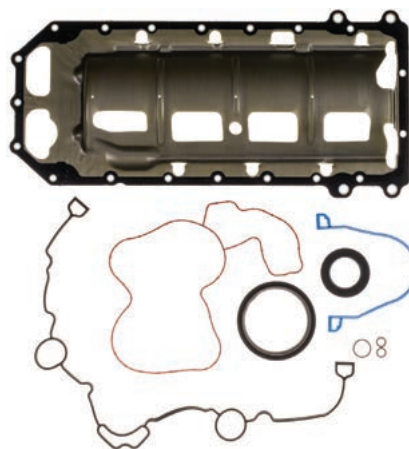

Application	Part #
2003-08 5.7L V8	PRO1022B

## 6.1L Hemi V8 2005-10

### Head Gaskets

#### MLS Head Gaskets

Bore	Thickness	Pkg Qty	Part #
4.100"	.040"	1	C5876-040
4.125"	.036"	1	C5441-036
4.125"	.040"	1	C5441-040
4.185"	.040"	1	C5042-040
4.250"	.040"	1	C5890-040

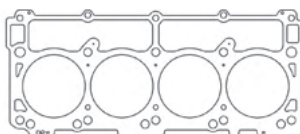

Additional thicknesses available see page 5



# CHRYSLER / DODGE

## 6.1L Hemi V8 2005-10

### MLX Head Gasket

Bore	Thickness	Pkg Qty	Part #
4.100"	.040"	1	C15149-040
4.100"	.044"	1	C15149-044
4.100"	.054"	1	C15149-054
4.100"	.058"	1	C15149-058

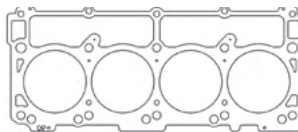

Additional thicknesses available see page 5

### MLS Head Gaskets - Aluminum Sleeved Block

Bore	Thickness	Pkg Qty	Part #
4.055"	.040"	1	C5525-040
4.125"	.070"	1	C5526-070
4.125"	.075"	1	C5526-075
4.125"	.040"	1	C5526-040
4.185"	.040"	1	C5527-040

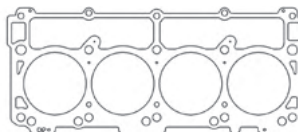

### Individual Gaskets

#### Valve Cover Gasket (sold individually)

Application	Part #
Molded Rubber (Need 2)	C5193

#### Thermostat Housing Gasket

Application	Part #
Molded Rubber	C5198

#### Intake Manifold Gasket Set

Application	Part #
6.1L - .060" KF	C5197

#### Oil Pan Gasket Set

Application	Part #
Intergrated Windage Tray	C5529

#### Throttle Body Gasket

Application	Part #
Molded Rubber	C5199

#### Timing Cover Set

Application	Part #
2003-Up 5.7L Hemi	C5202

#### Exhaust Gaskets

Application	Part #
MLS Exhaust Gaskets - Pair	C5872-030

#### Rear Main Seal Kit

Application	Part #
Seal and Housing Gasket	C5203

#### Valve Stem Seal Set (16 Pack)

Application	Part #
Hat Style - SN Steel Body	3260V-16

#### Water Pump Gasket

Application	Part #
Molded Rubber	C5204

### Gasket Kits



To purchase a complete gasket kit order both top end and bottom end gasket kit

#### TOP END GASKET KIT

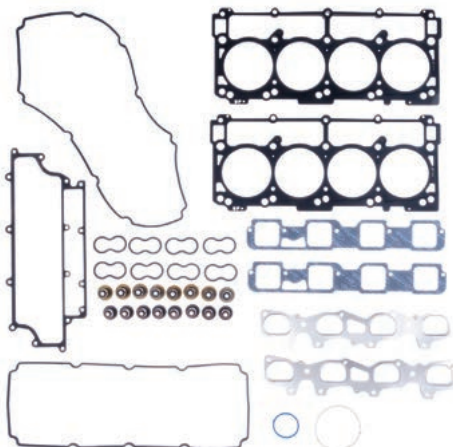

Application	Part #
2005-10 6.1L Hemi V8 4.125" Bore	PRO1023T

#### BOTTOM END GASKET KIT

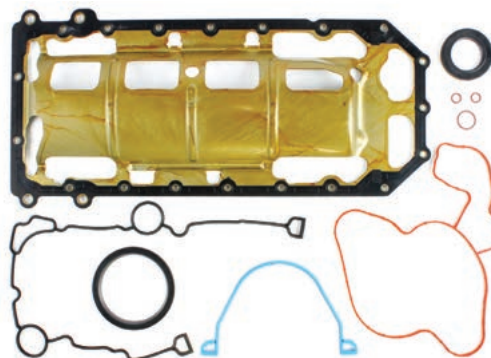

Application	Part #
2005-10 6.1L Hemi V8	PRO1023B



# CHRYSLER / DODGE

## 6.2L Hemi V8 2015-Present "Hellcat"

### Head Gaskets

#### MLX Head Gasket - Right Side

Bore	Thickness	Pkg Qty	Part #
4.150"	.....040"	.....1	<b>C15292-040</b>
4.150"	.....054"	.....1	<b>C15292-054</b>

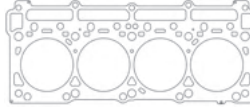

Additional thicknesses available  
see page 5

#### MLX Head Gasket - Left Side

Bore	Thickness	Pkg Qty	Part #
4.150"	.....040"	.....1	<b>C15293-040</b>
4.150"	.....054"	.....1	<b>C15293-054</b>

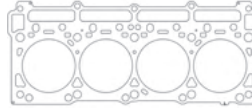

### Individual Gaskets

**NEW!**

#### Timing Cover Gasket

Application	Part #
2015-Up 6.2L Hemi	<b>C5202</b>

## 6.4L Hemi V8 2011-Present "Apache"

### Head Gaskets

#### MLS Head Gasket - Right Side

Bore	Thickness	Pkg Qty	Part #
4.120"	.....040"	.....1	<b>C5026-040</b>

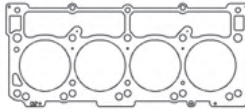

Additional thicknesses available  
see page 5

#### MLS Head Gasket - Left Side

Bore	Thickness	Pkg Qty	Part #
4.120"	.....040"	.....1	<b>C5027-040</b>

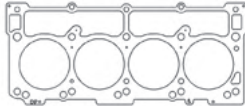

#### MLX Head Gasket - Right Side

Bore	Thickness	Pkg Qty	Part #
4.150"	.....040"	.....1	<b>C15172-040</b>
4.150"	.....054"	.....1	<b>C15172-054</b>

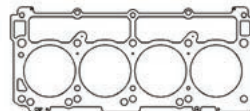

Additional thicknesses available  
see page 5

#### MLX Head Gasket - Left Side

Bore	Thickness	Pkg Qty	Part #
4.150"	.....040"	.....1	<b>C15173-040</b>
4.150"	.....054"	.....1	<b>C15173-054</b>

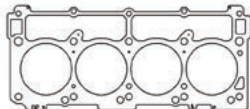

### Individual Gaskets

**NEW!**

#### Timing Cover Gasket

Application	Part #
2011-Up 6.4L Hemi	<b>C5202</b>

## 7.0L Hemi V8 2016-Present "Drag Pak"

### Head Gaskets

#### MLX Head Gasket - Right Side

Bore	Thickness	Pkg Qty	Part #
4.200"	.....054"	.....1	<b>C15391-054</b>

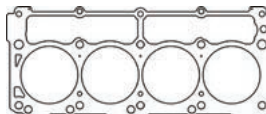

Additional thicknesses available  
see page 5

#### MLX Head Gasket - Left Side

Bore	Thickness	Pkg Qty	Part #
4.200"	.....054"	.....1	<b>C15392-054</b>

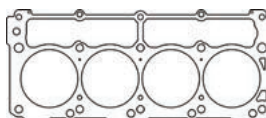



# CHRYSLER / DODGE

## Small Block V8 - A-8 Sprint & A-4 Midget

### Head Gaskets

MLS Head Gaskets - A-8 Sprint Block			
Bore	Thickness	Pkg Qty	Part #
4.165"	.040"	1	C5828-040
4.200"	.040"	1	C5829-040
4.250"	.040"	1	C5830-040

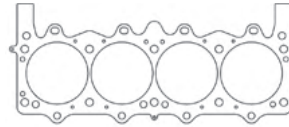

Additional thicknesses available  
see page 5

MLS Head Gaskets - A-4 Midget Block			
Bore	Thickness	Pkg Qty	Part #
4.165"	.040"	1	C5831-040
4.200"	.040"	1	C5832-040

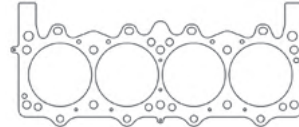

### Individual Gaskets

Valve Cover Gasket (sold individually)	
Application	Part #
Midget & Sprint Head	C5784-060

Oil Pan Gasket Set	
Application	Part #
Midget Block - .060" AFM	C5596-060

Intake Manifold Gasket	
Application	Part #
A-4 Midget Intake Gasket	C5590

## Small Block V8 - R3 Block w/W2, W7, W8, or W9 Heads

### Head Gaskets

MLS Head Gaskets - R3 Block w/W2 Heads			
Bore	Thickness	Pkg Qty	Part #
4.100"	.040"	1	C5567-040
4.200"	.040"	1	C5466-040

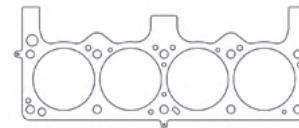

Additional thicknesses available  
see page 5

MLS Head Gaskets - R3 Block w/W7, W8, W9 Heads			
Bore	Thickness	Pkg Qty	Part #
4.060"	.040"	1	C5579-040
4.100"	.040"	1	C5580-040
4.165"	.040"	1	C5581-040
4.185"	.040"	1	C5582-040



### Individual Gaskets

Valve Cover Gaskets (sold individually)	
Application	Part #
W2/W5/W7/W9 Heads	C5568-094
W8 Heads	C5592-094

Thermostat Gasket	
Application	Part #
R3 Block	C5574-018

Intake Manifold Gaskets	
Application	Part #
W2 Heads 1.35" x 2.07"	C5569-060
W7/W8/W9 Heads 1.45" x 2.20"	C5586-031
End Rail Gaskets	C5625-060

Oil Pan Gasket	
Application	Part #
R3 Block - Rails Only	C5575-094

Exhaust Gaskets	
Application	Part #
W2 Heads 1.47" x 1.45"	C5571-064
W7/W8/W9 Heads D-Port	C5593-064

Timing Cover Gasket	
Application	Part #
R3 Block - .018" AFM	C5576-018

Water Pump Gasket	
Application	Part #
R3 Block	C5573-018

Fuel Pump Gasket	
Application	Part #
R3 Block - .031" Fiber	C5642-031



# CHRYSLER / DODGE

## Small Block V8 - R4 Block w/P5 Heads

### Head Gaskets

#### MLS Head Gaskets

Bore	Thickness	Pkg Qty	Part #
4.200"	.040"	1	C5801-040
4.250"	.040"	1	C5800-040

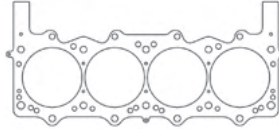

Additional thicknesses available  
see page 5

## Small Block V8 - R6 Race Block

### Head Gaskets

#### MLX Head Gasket - Right Side

Bore	Thickness	Pkg Qty	Part #
4.220"	.040"	1	C5670-040

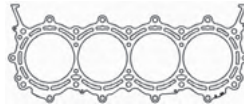

Additional thicknesses available  
see page 5

#### MLX Head Gasket - Left Side

Bore	Thickness	Pkg Qty	Part #
4.220"	.040"	1	C5671-040

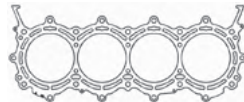

## Big Block Wedge 361, 383, 400, 413, 426, & 440ci V8

### Head Gaskets

#### MLS Head Gaskets

Bore	Thickness	Pkg Qty	Part #
4.250"	.040"	1	C5459-040
4.350"	.040"	1	C5460-040
4.380"	.040"	1	C5461-040
4.410"	.040"	1	C5462-040
4.500"	.040"	1	C5464-040
4.600"	.040"	1	C5799-040

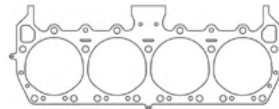

Additional thicknesses available  
see page 5

**NEW!**

#### MLX Head Gaskets

Bore	Thickness	Pkg Qty	Part #
4.500"	.040"	1	C15562-040

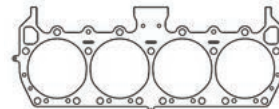

#### Copper Head Gaskets

Bore	Thickness	Pkg Qty	Part #
4.400"	.043"	1	C15417-043

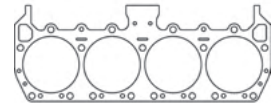

### Individual Gaskets

#### Valve Cover Gasket (sold individually)

Application	Part #
Molded Rubber	C5983

#### Oil Pan Gasket

Application	Part #
Big Block Wedge V8-.060"AFM	C5617-060

#### Intake Manifold Gaskets

Application	Part #
2.31" x 1.23" - .060" KF	C5611-060
End Rail Gaskets	C5612-060

#### Exhaust Gaskets

Application	Part #
1.85" x 1.35" - .064" AM	C5619-064
1.78" x 1.46" - .030" MLS	C5902-030

#### Water Pump Gaskets

Application	Part #
Pump to Block - Pair	C5615-032

#### Timing Cover Gasket Set

Application	Part #
Big Block Wedge V8	C5062

#### Thermostat Gasket

Application	Part #
Big Block Wedge V8	C5616-018

#### Fuel Pump Gasket

Application	Part #
Fuel Pump to Block	C5642-031

#### Rear Main Seal Kit

Application	Part #
2pc SN	C5686



# CHRYSLER / DODGE

## Big Block Wedge 361, 383, 400, 413, 426, & 440ci V8

### Gasket Kits



To purchase a complete gasket kit order both top end and bottom end gasket kit

#### TOP END GASKET KIT

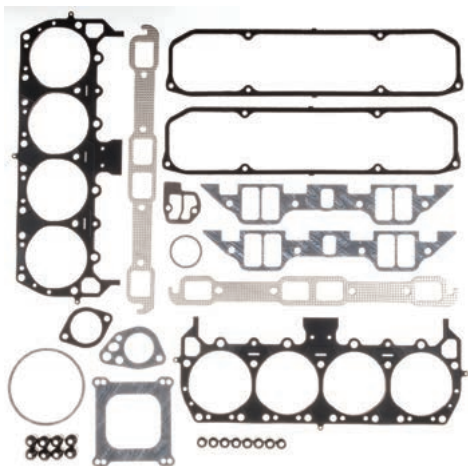

Application	Part #
Big Block Wedge V8 4.410" Bore .....	<b>PRO1001T</b> .....

#### BOTTOM END GASKET KIT

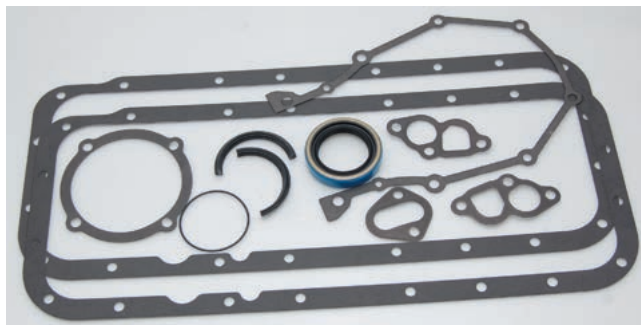

Application	Part #
Big Block Wedge V8 .....	<b>PRO1001B</b> .....

## 392 Hemi V8 1957-58

### Head Gaskets

MLS Head Gaskets			
Bore	Thickness	Pkg Qty	Part #
4.000"	.040"	1	<b>C5210-045</b> .....
4.100"	.040"	1	<b>C5211-045</b> .....

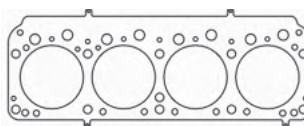

Additional thicknesses available see page 5

Copper Head Gaskets			
Bore	Thickness	Pkg Qty	Part #
4.060"	.043"	1	<b>C15418-043</b> .....

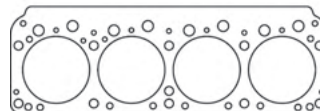

### Individual Gaskets

Valve Cover Gaskets	
Application	Part #
392 Hemi - 188" ML (pair) .....	<b>C5236-188</b> .....

Oil Pan Gasket Set	
Application	Part #
1958-59 4pc Set .....	<b>C15055</b> .....

Intake Manifold Gasket Set	
Application	Part #
Includes Valley Gasket .....	<b>C5237</b> .....

Distributor Gasket	
Application	Part #
392 Hemi - .031" Fiber .....	<b>C5239-031</b> .....

Exhaust Gaskets	
Application	Part #
1957-58 - .064" AM .....	<b>C5238-064</b> .....

Timing Cover Gasket Set	
Application	Part #
1955-59 Early Hemi .....	<b>C5063</b> .....

Cooling/Water Pump Gaskets	
Application	Part #
Pump to Block - 4 Pack .....	<b>C5228-060</b> .....
Water Outlet .....	<b>C5229-060</b> .....
Water Inlet .....	<b>C5230-032</b> .....

Carburetor Gasket Kits	
Application	Part #
392 Hemi 2bbl Kit .....	<b>C5240</b> .....
392 Hemi 4bbl Kit .....	<b>C5241</b> .....

See page 38 for StreetPro gaskets



# CHRYSLER / DODGE

## 392 Hemi V8 1957-58

### Gasket Kits



To purchase a complete gasket kit order both top end and bottom end gasket kit

#### TOP END GASKET KIT

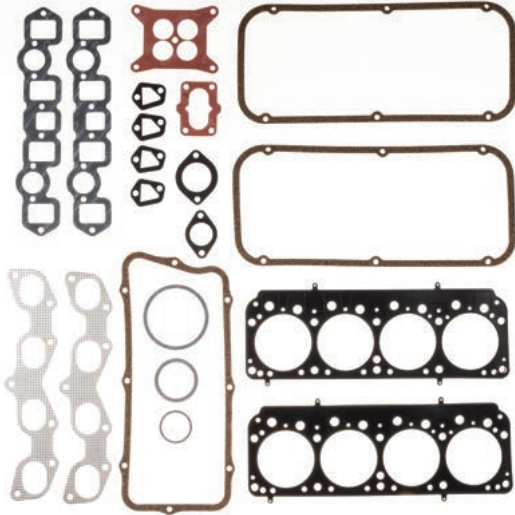

Application	Part #
392 Hemi V8 1957-58 4.100" Bore.....	<b>PRO1028T</b> .....

#### BOTTOM END GASKET KIT

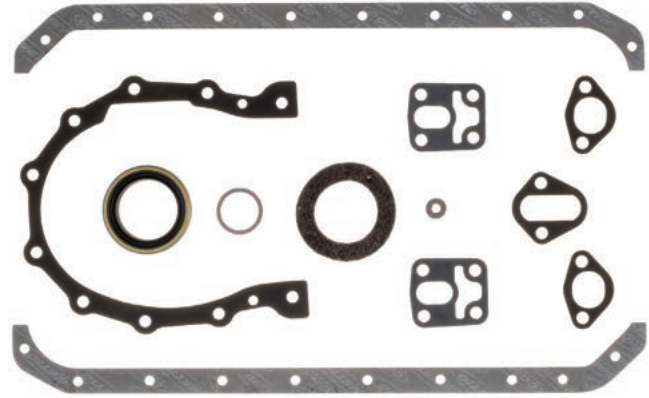

Application	Part #
392 Hemi V8 1957-58.....	<b>PRO1028B</b> .....

## 426 Hemi 1966 & Later

### Head Gaskets

#### MLS Head Gaskets (Gasket bores .060" larger than listed)

Bore	Thickness	Pkg Qty	Part #
4.250"	.040"	1	<b>C5445-040</b> .....
4.280"	.040"	1	<b>C5454-040</b> .....
4.310"	.040"	1	<b>C5455-040</b> .....
4.375"	.040"	1	<b>C5446-040</b> .....
4.500"	.040"	1	<b>C5447-040</b> .....

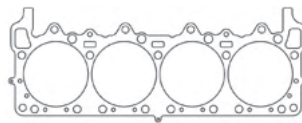

Additional thicknesses available see page 5

#### Copper Head Gaskets

Bore	Thickness	Pkg Qty	Part #
4.320"	.043"	1	<b>C15419-043</b> .....

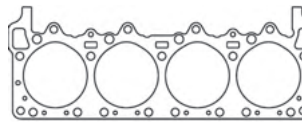

### Individual Gaskets

#### Valve Cover Gasket (sold individually)

Application	Part #
Molded Rubber.....	<b>C5976</b> .....

#### Oil Pump Gasket

Application	Part #
426 Hemi .....	<b>C5604-032</b> .....

#### Intake Manifold Gaskets

Application	Part #
1.85" x 2.00" - .047" KF .....	<b>C5598-047</b> .....

#### Oil Pan Gasket

Application	Part #
426 Hemi - .060" AFM .....	<b>C5606-060</b> .....

#### Exhaust Gaskets

Application	Part #
1.84" x 1.89" - .030" MLS.....	<b>C5965-030</b> .....

#### Fuel Pump Gasket

Application	Part #
Fuel Pump to Block .....	<b>C5642-031</b> .....





# CHRYSLER / DODGE

## 426 Hemi 1966 & Later (Gasket bores .060" larger than listed)

### Individual Gaskets

Cooling / Water Pump Gaskets	
Application	Part #
Pump to Block - Pair .....	C5601-018 .....
Pump to Housing .....	C5602-032 .....
Thermostat Gasket .....	C5603-018 .....

Rear Main Seal Kit	
Application	Part #
2pc SN .....	C5686 .....

**NEW!**

Timing Cover Gasket Set	
Application	Part #
426 Hemi .....	C5062 .....

Distributor Gasket	
Application	Part #
426 Hemi .....	C5607-060 .....

### Gasket Kits



To purchase a complete gasket kit order both top end and bottom end gasket kit

#### TOP END GASKET KIT

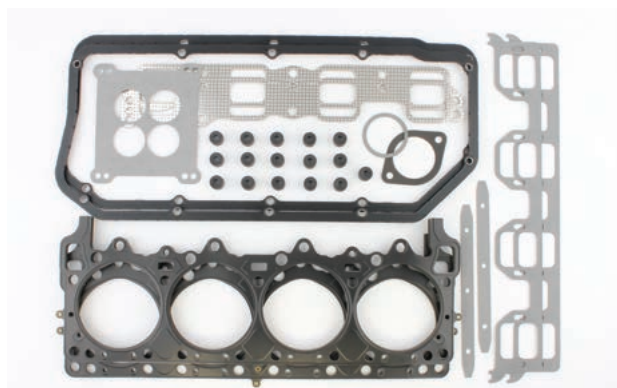

Application	Part #
426 Hemi 7.0L 1966-71 4.100" Bore .....	PRO1021T ...

#### BOTTOM END GASKET KIT

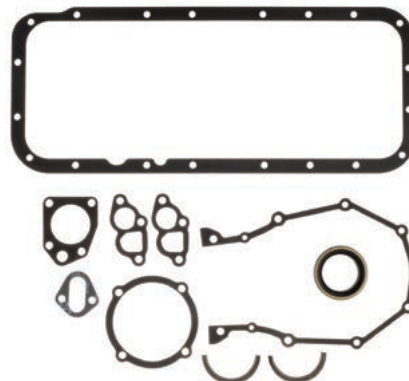

Application	Part #
426 Hemi 7.0L 1966-71 .....	PRO1021B .....

## 8.0L V10 1992-Early 96 (Gen 1 Viper)

### Head Gaskets

MLS Head Gaskets			
Bore	Thickness	Pkg Qty	Part #
4.030"	.051"	1	C5113-051 .....
4.165"	.051"	1	C5114-051 .....

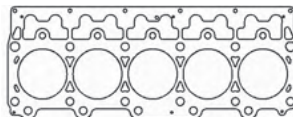

Additional thicknesses available see page 5

### Individual Gaskets

Intake Manifold Gaskets	
Application	Part #
1992-1996 Gen 1 - .039" Fiber .....	C5827-039 .....

Exhaust Manifold Gaskets	
Application	Part #
1992-96 Gen 1 - .030" MLS .....	C5679-030 .....

## 8.0 / 8.3L V10 Late 1996-07 (Gen 2/3 Viper)

### Head Gaskets

MLS Head Gasket			
Bore	Thickness	Pkg Qty	Part #
4.060"	.051"	1	C5814-051 .....
4.125"	.051"	1	C5815-051 .....
4.165"	.051"	1	C5816-051 .....

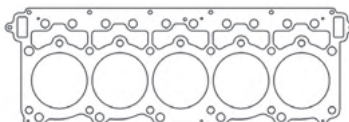

Additional thicknesses available see page 5

See page 40 for StreetPro gaskets



# CHRYSLER / DODGE

## 8.0 / 8.3L V10 Late 1996-07, (Gen 2/3 Viper)

### Head Gaskets

#### MLX Head Gasket w/1/2" Studs

Bore	Thickness	Pkg Qty	Part #
4.125"	.054"	1	C5585-054

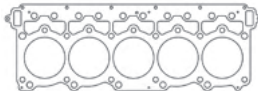

Additional thicknesses available  
see page 5

#### MLX Head Gasket w/9/16" Studs

Bore	Thickness	Pkg Qty	Part #
4.125"	.054"	1	C5487-054



### Individual Gaskets

#### Intake Manifold Gasket

Application	Part #
1996-2002 Gen 2 - .039" Fiber	C5827-039

#### Exhaust Manifold Gaskets

Application	Part #
1996-03 Gen 2 - .020" MLS	C5825-020
2004-07 Gen 3 - .030" MLS	C5865-030

**NEW!**

#### Water Pump Gasket

Application	Part #
1996-02 Gen 2 - .032" AFM	C15582

**NEW!**

#### Oil Filter Adapter Gasket

Application	Part #
1996-02 Gen 2 - .032" AFM	C15583

**NEW!**

#### Timing Cover Gasket

Application	Part #
1996-02 Gen 2 - .032" AFM	C15581

**NEW!**

#### Oil Pan Gasket

Application	Part #
1996-02 Gen 2 - .225" 3 Layer AFM	C15507

## 8.4L V10 2008-10, (Gen 4 Viper)

### Head Gaskets

#### MLS Head Gasket

Bore	Thickness	Pkg Qty	Part #
4.125"	.045"	1	C5107-045

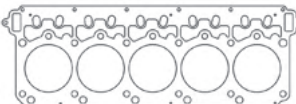

Additional thicknesses available  
see page 5

#### MLX Head Gasket w/9/16" Studs

Bore	Thickness	Pkg Qty	Part #
4.125"	.054"	1	C5504-054

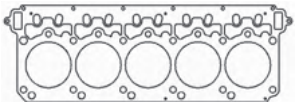

### Individual Gaskets

#### Exhaust Manifold Gasket Set

Application	Part #
2008-2010 Gen-4 MLS	C15150-040

## 8.4L V10 2013-17 (Gen 5 Viper)

### Head Gaskets

#### MLS Head Gasket - Left Side

Bore	Thickness	Pkg Qty	Part #
4.125"	.040"	1	C15377-040

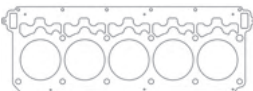

Additional thicknesses available  
see page 5

#### MLS Head Gasket - Right Side

Bore	Thickness	Pkg Qty	Part #
4.125"	.040"	1	C15378-040

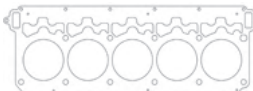

#### MLX Head Gasket - Left Side

Bore	Thickness	Pkg Qty	Part #
4.125"	.040"	1	C15431-040
4.125"	.049"	1	C15431-049
4.125"	.052"	1	C15431-052

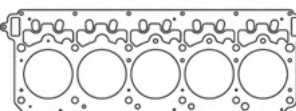



# CHRYSLER / DODGE

## 8.4L V10 2013-17 (Gen 5 Viper)

### Head Gaskets

#### MLS Head Gasket - Right Side

Bore	Thickness	Pkg Qty	Part #
4.125"	.040"	1	C15432-040
4.125"	.049"	1	C15432-049
4.125"	.052"	1	C15432-052

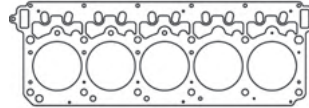

Additional thicknesses available  
see page 5

**NEW!**

### Individual Gaskets

#### Exhaust Manifold Gasket Set

Application	Part #
2013-2017 Gen-5 MLS	C15150-040

## Pro Stock Hemi 500ci V8

### Head Gaskets

#### MLS Head Gaskets - Gen1 Hemi 99

Bore	Thickness	Pkg Qty	Part #
4.660"	.051"	1	C5444-051
4.685"	.051"	1	C5443-051
4.700"	.051"	1	C5442-051
4.720"	.051"	1	C5438-051

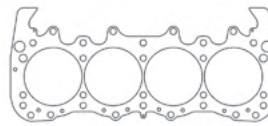

Additional thicknesses available  
see page 5

#### MLS Head Gaskets - Gen2 "DPS2"

Bore	Thickness	Pkg Qty	Part #
4.750"	.050"	1	C5045-050

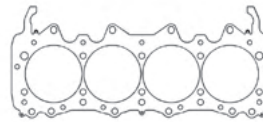

# CUMMINS

## 3.9L 4BT Diesel 4cyl 1983+

### Head Gasket

#### MLX Head Gasket

Bore	Thickness	Pkg Qty	Part #
4.100"	.061"	1	C5591-061

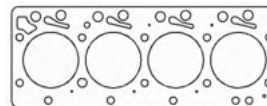

Additional thicknesses available  
see page 5

### Individual Gaskets

#### Valve Cover Gasket Set

Application	Part #
3.9L 4BT	C15056

#### Thermostat Housing Seal

Application	Part #
3.9L 4BT	C15059

#### Intake Manifold Gaskets

Application	Part #
3.9L 4BT	C15057

#### Oil Pan Gasket

Application	Part #
3.9L 4BT - .031" Fiber	C15060

#### Exhaust Manifold Gaskets Set

Application	Part #
3.9L 4BT - 4 Pack	C15058

#### Rear Main Seal

Application	Part #
3.9L 4BT	C15062

#### Valve Stem Seal

Application	Part #
8x12.3x12x17 Viton - Need 8	3164V

#### Pushrod Cover Gasket

Application	Part #
3.9L 4BT 1983-97	C15064

#### Timing Cover Seal

Application	Part #
3.9L 4BT	C15063

#### Fuel Pump Gaskets

Application	Part #
Fuel Pump Gasket	C5389-032
Injection Pump Gasket	C15061

#### Water Pump Gasket

Application	Part #
3.9L 4BT 1983-97 - O-Ring	C15065

See page 42 for StreetPro gasket kits



# CUMMINS

## 3.9L 4BT Diesel 4cyl 1983+

### Gasket Kits



To purchase a complete gasket kit order both top end and bottom end gasket kit

#### TOP END GASKET KIT

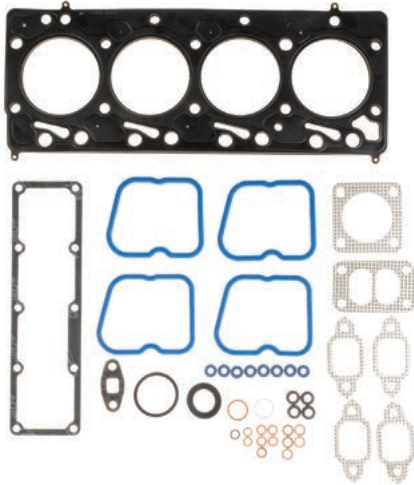

Application	Part #
3.9L 4BT 4cyl Diesel 4.100" Bore .....	<b>PRO3000T</b> .....

#### BOTTOM END GASKET KIT

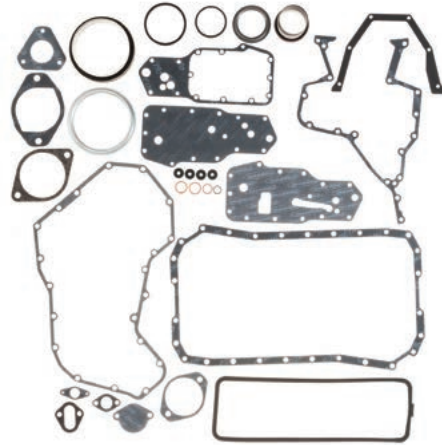

Application	Part #
3.9L 4BT 4cyl Diesel.....	<b>PRO3000B</b> .....

## 5.9L 12v 6BT Inline 6 Diesel 1992-98

### Head Gasket

#### MLX Head Gasket

Bore	Thickness	Pkg Qty	Part #
4.100"	.061"	1	<b>C5955-061</b> .....

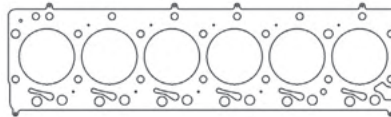

Additional thicknesses available see page 5

### Individual Gaskets

#### Valve Cover Gasket Set

Application	Part #
5.9L 6BT 1992-98 .....	<b>C15066</b> .....

#### Thermostat Housing Seal

Application	Part #
5.9L 6BT 1992-98 .....	<b>C15059</b> .....

#### Intake Manifold Gasket Set

Application	Part #
5.9L 6BT 1992-98 .....	<b>C15067</b> .....

#### Oil Pan Gasket

Application	Part #
5.9L 6BT 1992-98 .....	<b>C15068</b> .....

#### Exhaust Manifold Gaskets Set

Application	Part #
5.9L 6BT 1992-98 - .040" MLS .....	<b>C5725-040</b> .....

#### Rear Main Seal

Application	Part #
5.9L 6BT 1992-98 .....	<b>C15062</b> .....

#### Valve Stem Seal

Application	Part #
8x12.3x12x17 SN - Need 12 .....	<b>3164V</b> .....

#### Pushrod Cover Gasket

Application	Part #
5.9L 6BT 1989-99 .....	<b>C15069</b> .....

#### Timing Cover Seal

Application	Part #
5.9L 6BT 1992-98 .....	<b>C15063</b> .....

#### Fuel Pump Gasket

Application	Part #
Fuel Pump Gasket .....	<b>C5389-032</b> .....
Injection Pump Gasket .....	<b>C15061</b> .....

#### Water Pump Gasket

Application	Part #
3.9L 4BT 1983-98 - O-Ring .....	<b>C15065</b> .....



# CUMMINS

## 5.9L 12v 6BT Inline 6 Diesel 1992-98

### Gasket Kits



To purchase a complete gasket kit order both top end and bottom end gasket kit

#### TOP END GASKET KIT

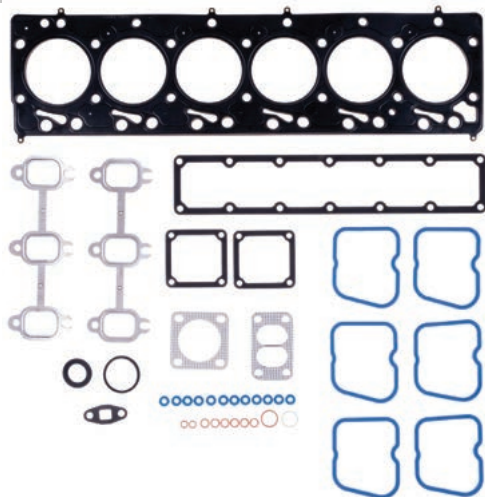

<b>Application</b>	<b>Part #</b>
5.9L 6BT I6 Diesel 92-98 4.100" Bore .....	<b>PRO3001T</b> .....

#### BOTTOM END GASKET KIT

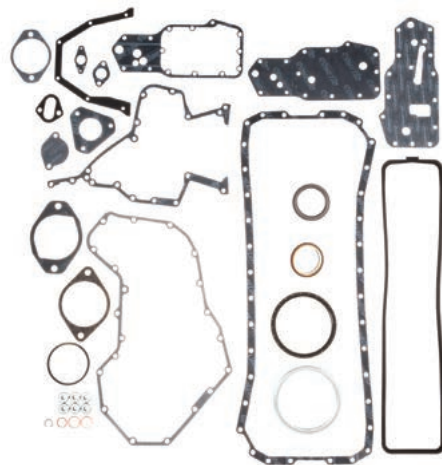

<b>Application</b>	<b>Part #</b>
5.9L 6BT I6 Diesel 92-98 .....	<b>PRO3001B</b> .....

## 5.9L 24v ISB Inline 6 Diesel 1998.5-02

### Head Gasket

#### MLX Head Gasket

Bore	Thickness	Pkg Qty	Part #
4.100"	.....061"	.....1.....	<b>C5855-061</b> .....

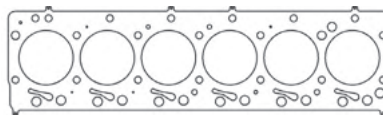

Additional thicknesses available see page 5

### Individual Gaskets

#### Valve Cover Gasket Set

<b>Application</b>	<b>Part #</b>
5.9L ISB 1998.5-02 .....	<b>C5614</b> .....

#### Oil Pan Gasket

<b>Application</b>	<b>Part #</b>
5.9L 6BT 1998.5-02 .....	<b>C15068</b> .....

#### Intake Manifold Gasket Set

<b>Application</b>	<b>Part #</b>
5.9L ISB 1998.5-02 .....	<b>C15067</b> .....

#### Rear Main Seal

<b>Application</b>	<b>Part #</b>
5.9L 6BT 1998.5-02 .....	<b>C15062</b> .....

#### Exhaust Manifold Gaskets Set

<b>Application</b>	<b>Part #</b>
5.9L ISB 1998.5-02 .....	<b>C5726-040</b> .....

#### Pushrod Cover Gasket

<b>Application</b>	<b>Part #</b>
5.9L 6BT 1998.5-02 .....	<b>C15069</b> .....

#### Valve Stem Seals

<b>Application</b>	<b>Part #</b>
Intake VSS - Yellow (Need 12) .....	<b>3214V</b> .....
Exhaust VSS-Green(Need 12) .....	<b>3215V</b> .....

#### Water Pump Gasket

<b>Application</b>	<b>Part #</b>
3.9L 4BT 1998.5-02 - O-Ring .....	<b>C15065</b> .....

#### Timing Cover Seal

<b>Application</b>	<b>Part #</b>
5.9L 6BT 1998.5-02 .....	<b>C15063</b> .....

See page 44 for StreetPro gasket kits



# CUMMINS

## 5.9L 24v ISB Inline 6 Diesel 1998.5-02

### Gasket Kit



To purchase a complete gasket kit order both top end and bottom end gasket kit

#### TOP END GASKET KIT

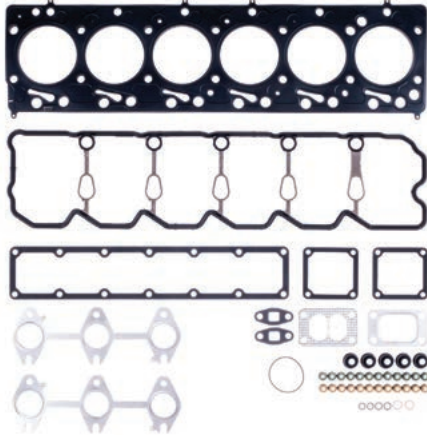

Application	Part #
5.9L 24v ISB 6cyl 1998.5-02 .....	<b>PRO3002T</b> .....

#### BOTTOM END GASKET KIT

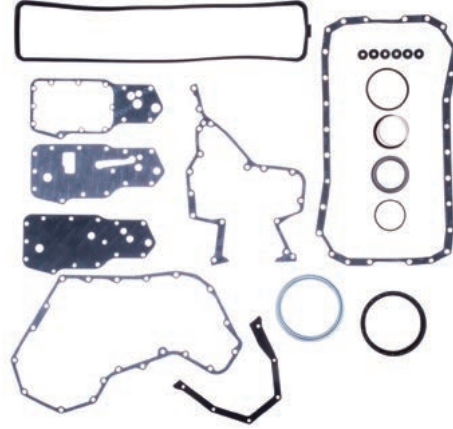

Application	Part #
5.9L 24v ISB 6cyl 1998.5-02 .....	<b>PRO3002B</b> .....

## 5.9L 24v ISB Common Rail Inline 6 Diesel 2003-07

### Head Gasket

#### MLX Head Gasket

Bore	Thickness	Pkg Qty	Part #
4.100"	.....061"	.....1	<b>C5597-061</b> .....

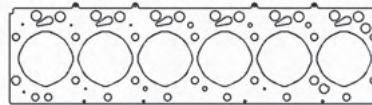

Additional thicknesses available see page 5

### Individual Gaskets

#### Fuel Injector Seal Kit

Application	Part #
5.9L Common Rail 2003-07 .....	<b>C15072</b> .....

#### Valve Stem Seals

Application	Part #
Intake VSS - Yellow (Need 12) .....	<b>3218V</b> .....
Exhaust VSS-Green(Need 12) .....	<b>3219V</b> .....

#### Valve Cover Gasket Set

Application	Part #
5.9L Common Rail 2003-07 .....	<b>C15070</b> .....

#### Pushrod Cover Gasket

Application	Part #
5.9L Common Rail 2003-07 .....	<b>C15071</b> .....

#### Intake Manifold Gasket Set

Application	Part #
5.9L Common Rail 2003-07 .....	<b>C15067</b> .....

#### Thermostat Seal

Application	Part #
5.9L Common Rail 2003-07 .....	<b>C15073</b> .....

#### Exhaust Manifold Gaskets Set

Application	Part #
5.9L Common Rail 2003-07 .....	<b>C5726-040</b> .....

#### Oil Pan Gasket Kit

Application	Part #
AFM Material (Includes Pump Pick Up) .....	<b>C15470</b> .....

See page 45 for StreetPro gasket kits

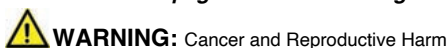



# CUMMINS

## 5.9L 24v ISB Common Rail Inline 6 Diesel 2003-07

### Gasket Kit



#### TOP END GASKET KIT

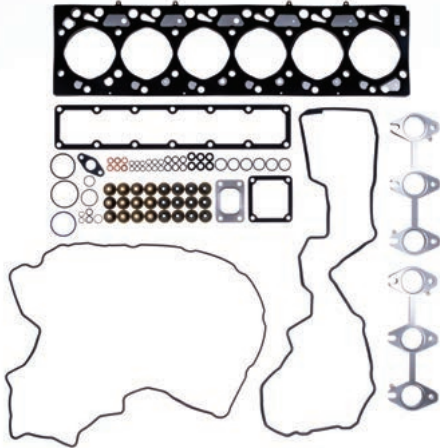

Application	Part #
5.9L 24v Common Rail 03-07 .....	PRO3003T .....

#### BOTTOM END GASKET KIT

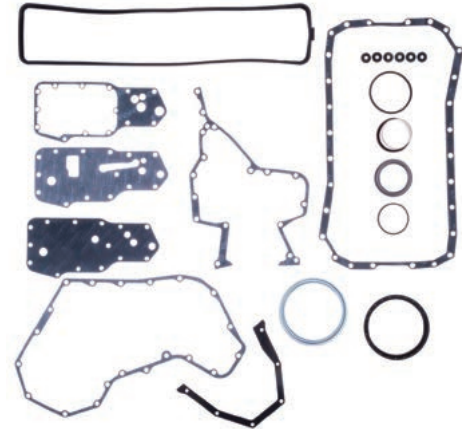

Application	Part #
5.9L 24v Common Rail 03-07 .....	PRO3002B .....

## 6.7L 24v ISB Inline 6 Diesel 2007.5+Up

### Head Gasket

#### MLX Head Gasket

Bore	Thickness	Pkg Qty	Part #
4.312"	.052"	1	C5609-052
4.312"	.056"	1	C5609-056
4.312"	.089"	1	C5609-089

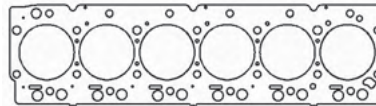

Additional thicknesses available  
see page 5

### Individual Gaskets

#### Valve Stem Seal

Application	Part #
VSS - Yellow (Need 24) .....	3218V .....

#### Rear Main Seal

Application	Part #
6.7L 24v ISB 2007.5+Up .....	C15062 .....

#### Intake Gasket Set

Application	Part #
6.7L 24v ISB 2007.5+ .....	C15076 .....

#### Timing Cover Seal

Application	Part #
6.7L 24v ISB 2007.5+Up .....	C15063 .....

#### Exhaust Manifold Gaskets Set

Application	Part #
6.7L 24v ISB 2007.5+Up (MLS) .....	C5726-040 .....

#### Water Pump Gasket

Application	Part #
6.7L 24v ISB 2007.5+Up .....	C15065 .....

#### Thermostat Seal

Application	Part #
6.7L 24v ISB 2007.5+Up .....	C15073 .....

#### Oil Cooler Gasket Set

Application	Part #
6.7L 24v ISB 2007.5+Up .....	C15075 .....

#### Oil Pan Gasket

Application	Part #
6.7L 24v ISB 2007.5+Up .....	C15074 .....

#### Pushrod Cover Gasket

Application	Part #
6.7L 24v ISB 2007.5+Up .....	C15071 .....

See page 46 for StreetPro gasket kits



# CUMMINS

## 6.7L 24v ISB Inline 6 Diesel 2007.5+Up

### Gasket Kits



To purchase a complete gasket kit order both top end and bottom end gasket kit

#### TOP END GASKET KIT

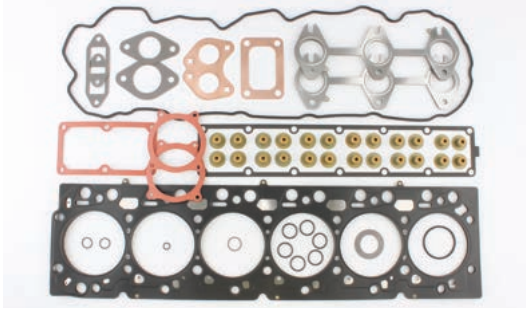

#### BOTTOM END GASKET KIT

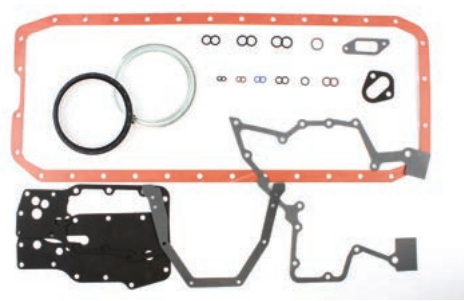

Application	Part #
6.7L 24v ISB 6cyl 2007.5+Up 4.312" Bore .....	<b>PRO3004T</b> ....

Application	Part #
6.7L 24v ISB 6cyl 2007.5+Up .....	<b>PRO3004B</b> .....

# FORD

## 1.6L Duratec Ti-VCT 2011-16

### Head Gasket

#### MLX Head Gasket

Bore	Thickness	Pkg Qty	Part #
82mm	.....028"	.....1	<b>C4963-028</b> .....

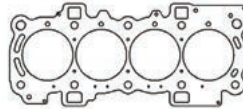

Additional thicknesses available  
see page 5

## 1.6L & 1.8L CVH 4cyl 1985-93

### Head Gasket

#### MLS Head Gasket

Bore	Thickness	Pkg Qty	Part #
83mm	.....051"	.....1	<b>C5756-051</b> .....

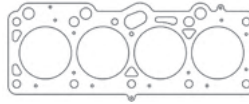

Additional thicknesses available  
see page 5

## 1.9L CVH 4cyl 1985-96

### Head Gasket

#### MLS Head Gasket

Bore	Thickness	Pkg Qty	Part #
82mm	.....051"	.....1	<b>C5136-051</b> .....

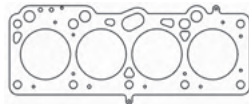

Additional thicknesses available  
see page 5

## 2.0L SOHC/DOHC NEP/YB Group A

### Head Gasket

#### MLS Head Gasket

Bore	Thickness	Pkg Qty	Part #
92.5mm	.....040"	.....1	<b>C4350-040</b> .....

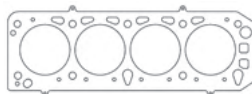

Additional thicknesses available  
see page 5

See page 47 for additional gaskets





# FORD

## 2.0L SOHC / DOHC NEP/YB Group A

### Individual Gaskets

<b>Intake Gasket Set</b>	
Application	Part #
Cosworth YB .....	<b>C4502</b> .....

<b>Oil Pan Gasket</b>	
Application	Part #
Cosworth YB Rails only .....	<b>C4640</b> .....

<b>Exhaust Manifold Gasket Set</b>	
Application	Part #
Cosworth YB .....	<b>C4334</b> .....

<b>Front Cover Gasket</b>	
Application	Part #
Cosworth YB.....	<b>C4641</b> .....

<b>Valve Cover Gaskets</b>	
Application	Part #
Early YB Engine - .060" AFM.....	<b>C4635</b> .....
Late YB Engine - .060" AFM.....	<b>C4636</b> .....

<b>Cooling/Water Pump Gasket</b>	
Application	Part #
Water Pump Gasket .....	<b>C4637</b> .....
Water Outlet Gasket .....	<b>C4638</b> .....
Thermostat Gasket.....	<b>C4639</b> .....

## 2.0L ZETEC DOHC 4cyl 1995-04

### Head Gasket

<b>MLS Head Gasket</b>			
Bore	Thickness	Pkg Qty	Part #
87mm .....	.027" .....	1.....	<b>C4279-027</b> .....

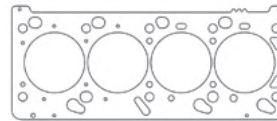

Additional thicknesses available  
see page 5

### Individual Gaskets

<b>Valve Cover Gaskets</b>	
Application	Part #
2.0L Zetec DOHC 1995-97 .....	<b>C4643</b> .....
2.0L Zetec DOHC 1998-04.....	<b>C4644</b> .....

<b>Valve Stem Seals</b>	
Application	Part #
2.0L Zetec 1995-97 (16pk) .....	<b>3181V-16</b> .....
2.0L Zetec 1998-04 (16pk) .....	<b>3182V-16</b> .....

<b>Exhaust Manifold Gasket Set</b>	
Application	Part #
2.0L Zetec 1994-04 .....	<b>C4645</b> .....

<b>Oil Pan Gasket</b>	
Application	Part #
2.0L Zetec 1995-04 .....	<b>C4649</b> .....

<b>Intake Gasket Sets</b>	
Application	Part #
2.0L Zetec 1998-04 .....	<b>C4646</b> .....
2.0L Zetec 1995-97 .....	<b>C4647</b> .....

<b>Thermostat Gaskets</b>	
Application	Part #
2.0L Zetec 1995-04 - Seal .....	<b>C4651</b> .....
2.0L Zetec 1995-04 - Housing .....	<b>C4652</b> .....

<b>Cam Seal</b>	
Application	Part #
2.0L Zetec 1994-04 .....	<b>C4648</b> .....

<b>Rear Main Seal Set</b>	
Application	Part #
2.0L Zetec 1995-04 .....	<b>C4650</b> .....

See page 48 for StreetPro gasket kits



# FORD

## 2.0L Zetec DOHC 4cyl 1995-04

### Gasket Kits



To purchase a complete gasket kit order both top end and bottom end gasket kit

#### TOP END GASKET KITS

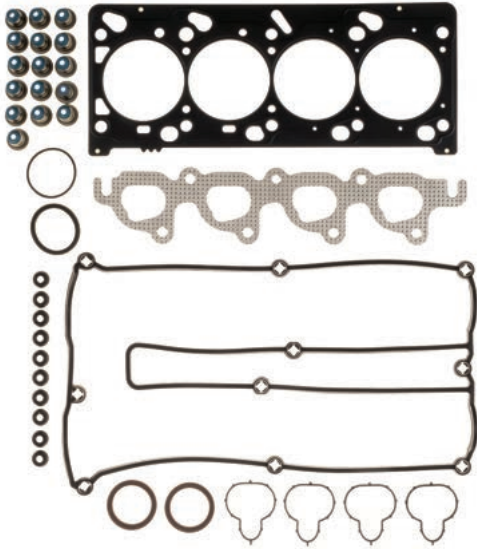

Application	Part #
2.0L Zetec DOHC 1995-97 87mm Bore .....	<b>PRO2029T</b> .....
2.0L Zetec DOHC 1998-04 87mm Bore .....	<b>PRO2030T</b> .....

#### BOTTOM END GASKET KITS



Application	Part #
2.0L Zetec DOHC 1995-97 .....	<b>PRO2029B</b> .....
2.0L Zetec DOHC 1998-04 .....	<b>PRO2030B</b> .....

## 2.3L "2300" SOHC 1974-97 4cyl

### Head Gaskets

#### MLS Head Gaskets

Bore	Thickness	Pkg Qty	Part #
3.830"	.....040"	.....1	<b>C5369-040</b> .....
3.940"	.....040"	.....1	<b>C5709-040</b> .....

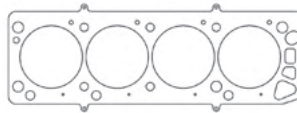

Additional thicknesses available  
see page 5

### Individual Gaskets

#### Valve Cover Gaskets

Application	Part #
2300 2.3L 1974-93 .....	<b>C4653</b> .....

#### Exhaust Manifold Gasket Set

Application	Part #
2300 2.3L 1974-93 .....	<b>C5372-064</b> .....

#### Intake Gasket Set

Application	Part #
2300 2.3L .....	<b>C5371-060</b> .....

#### Oil Pan Gaskets

Application	Part #
2300 2.3L 1974-2/19/86 .....	<b>C5373</b> .....
2300 2.3L 2/20/86-1990 .....	<b>C4669</b> .....
2300 2.3L 1991-92 .....	<b>C4741</b> .....
2300 2.3L 1993 .....	<b>C4778</b> .....

#### Valve Stem Seals

Application	Part #
2300 2.3L 1974-93 (need 8) .....	<b>3168V</b> .....

#### Rear Main Seal Sets

Application	Part #
2300 2.3L 1974-81 2pc.....	<b>C5688</b> .....
2300 2.3L 1982-93 1pc.....	<b>C5189</b> .....

#### Water Pump Gasket

Application	Part #
2300 2.3L 1974-93 .....	<b>C4654</b> .....

See page 49 for StreetPro gasket kits



# FORD

## 2.3L "2300" SOHC 1974-97 4cyl

### Gasket Kits



To purchase a complete gasket kit order both top end and bottom end gasket kit

#### TOP END GASKET KIT

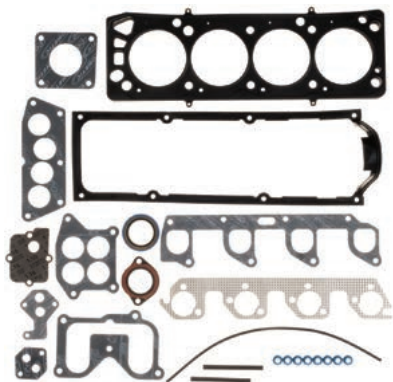

Application	Part #
2300 2.3L 1974-97 3.830" Bore.....	PRO2031T ....

#### BOTTOM END GASKET KIT

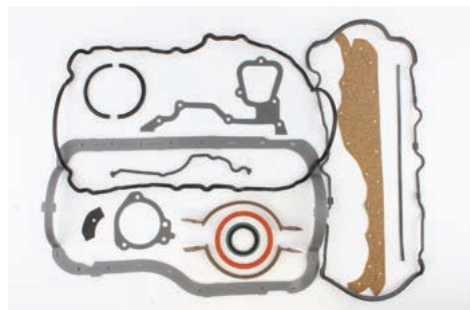

Application	Part #
2300 2.3L 1974-97 .....	PRO2031B .....

## 2.0L 2012-15 EcoBoost DOHC: 2013-2015 Ford Focus ST, 2011-2015 Ford Explorer

### Head Gasket

#### MLS Head Gasket

Bore	Thickness	Pkg Qty	Part #
89mm	.....034"	.....1.....	C15317-034 .....
89mm	.....040"	.....1.....	C15317-040 .....

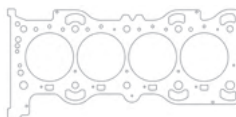

Additional thicknesses available see page 5

## 2.3L EcoBoost DOHC: 2016-2018 Ford Focus RS

### Head Gasket

#### MLS Head Gasket

Bore	Thickness	Pkg Qty	Part #
89mm	.....040"	.....1.....	C15294-040 .....

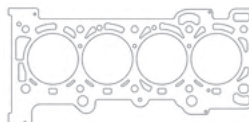

Additional thicknesses available see page 5

### Individual Gaskets

#### Valve Cover Gasket

Application	Part #
Valve Cover Gasket .....	C15445 .....

## 2.0L 2003-11 & 2.3L 2003-08 Duratec/Mazda MZR DOHC

### Head Gaskets

#### MLS Head Gasket

Bore	Thickness	Pkg Qty	Part #
89.5mm	.....018"	.....1.....	C5843-018 .....
92mm	.....018"	.....1.....	C5842-018 .....

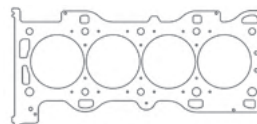

Additional thicknesses available see page 5

### Individual Gaskets

#### Intake Gasket Set

Application	Part #
2.3L Duratec 2003-08.....	C4842-060 .....

#### Exhaust Manifold Gaskets

Application	Part #
2.3L Duratec (w/ extra port) .....	C4840-064 .....
2.3L Duratec (w/o extra port) .....	C4841-064 .....



# FORD

## 2.7L EcoBoost

### Head Gaskets

#### MLX Head Gasket - Right Side

Bore	Thickness	Pkg Qty	Part #
85.6mm	.036"	1	C15447-036

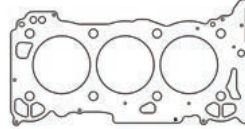

Additional thicknesses available  
see page 5

#### MLX Head Gasket - Left Side

Bore	Thickness	Pkg Qty	Part #
85.6mm	.036"	1	C15448-036

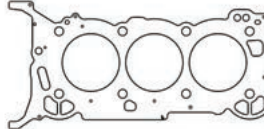

## 3.5L Cyclone Duratec V6 2010-Present

### Head Gaskets

#### MLX Head Gasket - Right Side

Bore	Thickness	Pkg Qty	Part #
92.5mm	.040"	1	C5452-040

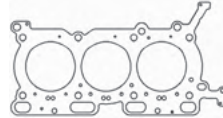

Additional thicknesses available  
see page 5

#### MLX Head Gasket - Left Side

Bore	Thickness	Pkg Qty	Part #
92.5mm	.040"	1	C5453-040

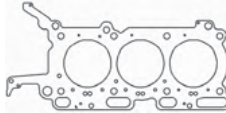

## 3.5L Cyclone EcoBoost V6 First Gen 2011-2016

### Head Gaskets

**NEW!**

#### MLS Head Gasket - Right Side

Bore	Thickness	Pkg Qty	Part #
95mm	.047"	1	C15554-047

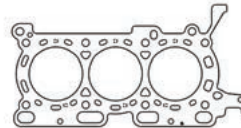

Additional thicknesses available  
see page 5

**NEW!**

#### MLS Head Gasket - Left Side

Bore	Thickness	Pkg Qty	Part #
95mm	.047"	1	C15555-047

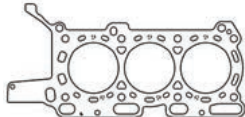

## 3.5L Cyclone EcoBoost V6 (D35 Second Gen) 2017+ 150 SVT Raptor, Lincoln Navigator

### Head Gaskets

#### MLS Head Gasket - Right Side

Bore	Thickness	Pkg Qty	Part #
95mm	.040"	1	C15463-040
97.5mm	.040"	1	C15473-040

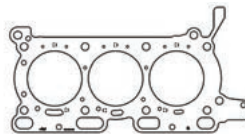

Additional thicknesses available  
see page 5

#### MLS Head Gasket - Left Side

Bore	Thickness	Pkg Qty	Part #
95mm	.040"	1	C15464-040
97.5mm	.040"	1	C15474-040

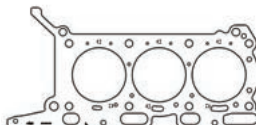



# FORD

## 3.9L AJ30/AJ35 DOHC V8 2000-06

### Head Gaskets

#### MLS Head Gasket - Right Side

Bore	Thickness	Pkg Qty	Part #
87mm	.030"	1	C5770-030
93mm	.030"	1	C5771-030

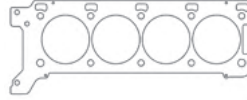

Additional thicknesses available  
see page 5

#### MLS Head Gasket - Left Side

Bore	Thickness	Pkg Qty	Part #
87mm	.030"	1	C5772-030
93mm	.030"	1	C5773-030

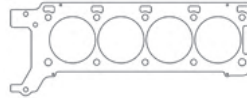

## 4.0L V6 1997-2010

#### MLX Head Gasket - Left Side

Bore	Thickness	Pkg Qty	Part #
103mm	.040"	1	C15382-040

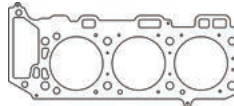

Additional thicknesses available  
see page 5

#### MLX Head Gasket - Right Side

Bore	Thickness	Pkg Qty	Part #
103mm	.040"	1	C15381-040

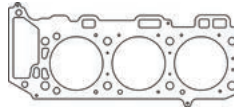

## 4.6L & 5.4L SOHC / DOHC Modular V8

### Head Gaskets

#### MLS Head Gaskets - Left Side

Bore	Thickness	Pkg Qty	Part #
92mm	.030"	1	C5118-030
94mm	.030"	1	C5502-030

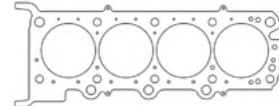

Additional thicknesses available  
see page 5

#### MLS Head Gaskets - Right Side

Bore	Thickness	Pkg Qty	Part #
92mm	.030"	1	C5119-030
94mm	.030"	1	C5503-030

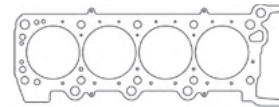

### Individual Gaskets

#### Valve Cover Gasket Sets

Application	Part #
4.6L DOHC 1996-98	C5177
4.6L SOHC 1996-04	C5178
4.6L SOHC 2002-04 Truck	C5179

#### Throttle Body Gaskets

Application	Part #
SOHC 1996-01 Spacer-TB	C15078
DOHC 1996-98 .020" Fiber	C15079
SOHC 1996-00 Spacer-Manifold	C15080
4.6L SOHC 1999-11 - Rubber	C15081

#### Intake Gaskets

Application	Part #
4.6L DOHC 1998	C5180
4.6L DOHC 1996-97	C5181
4.6L DOHC 1996-98 - Cover	C5182
4.6L DOHC 1996-98 - Plenum	C5183
4.6L SOHC 1995-00	C5184
4.6L SOHC 2000-04 Truck	C5185
4.6L SOHC 00-04 Truck Plenum	C5186
4.6L SOHC 97-99 Truck Plenum	C5187

#### Oil Pan Gasket

Application	Part #
4.6/5.4L 1996-04	C5188

#### Rear Main Seal

Application	Part #
4.6/5.4L 1996-04 - 1pc	C5189

#### Front Crank Seals

Application	Part #
4.6/5.4L SOHC/DOHC 1996-99	C5192
4.6/5.4L SOHC 2000-04	C5191

#### Exhaust Gaskets

Application	Part #
4.6/5.4L SOHC 1991-01	C5853-030
4.6L DOHC 1993-99	C5012-030
5.4/5.8L Shelby GT500 2007-14	C5805-030

#### Water Pump O-Ring

Application	Part #
4.6/5.4L SOHC/DOHC 1992-09	C5190



# FORD

## 4.6L & 5.4L SOHC/DOHC Modular V8

### Gasket Kits



To purchase a complete gasket kit order both top end and bottom end gasket kit

#### TOP END GASKET KITS

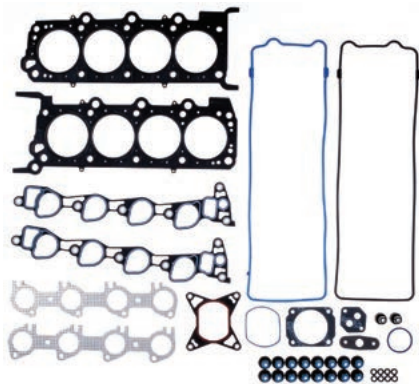

Application	Part #
4.6L DOHC 1996-98 92mm Bore .....	<b>PRO1017T</b> .....
4.6L SOHC 1996-98 92mm Bore .....	<b>PRO1018T</b> .....
4.6L SOHC 1999-04 92mm Bore .....	<b>PRO1019T</b> .....
4.6L SOHC 1997-04 Truck 92mm Bore.....	<b>PRO1020T</b> .....

#### BOTTOM END GASKET KITS

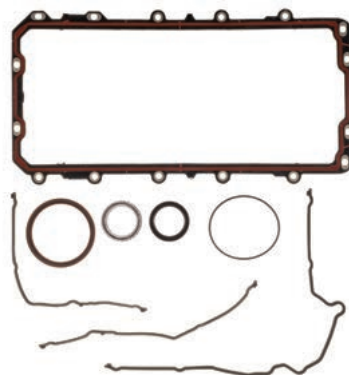

Application	Part #
4.6L DOHC 1996-98 .....	<b>PRO1017B</b> .....
4.6L SOHC 1996-98 .....	<b>PRO1018B</b> .....
4.6L SOHC 1999-04 .....	<b>PRO1019B</b> .....
4.6L SOHC 1997-04 Truck .....	<b>PRO1020B</b> .....

## 4.6L SOHC 3v Heads Modular 2005-10

### Head Gaskets

#### MLS Head Gasket - Left Side

Bore	Thickness	Pkg Qty	Part #
94mm	.030"	1	<b>C5969-030</b> .....
94mm	.040"	1	<b>C5969-040</b> .....

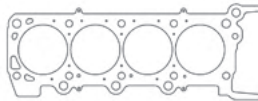

Additional thicknesses available  
see page 5

#### MLS Head Gasket - Right Side

Bore	Thickness	Pkg Qty	Part #
94mm	.030"	1	<b>C5970-030</b> .....
94mm	.040"	1	<b>C5970-040</b> .....

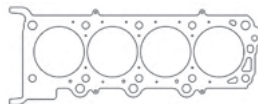

**NEW!**

#### MLX Head Gasket - Left Side

Bore	Thickness	Pkg Qty	Part #
94mm	.032"	1	<b>C15556-032</b> .....
94mm	.040"	1	<b>C15556-040</b> .....
94mm	.052"	1	<b>C15556-054</b> .....

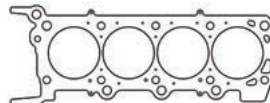

**NEW!**

#### MLX Head Gasket - Right Side

Bore	Thickness	Pkg Qty	Part #
94mm	.032"	1	<b>C15557-032</b> .....
94mm	.040"	1	<b>C15557-040</b> .....
94mm	.052"	1	<b>C15557-054</b> .....

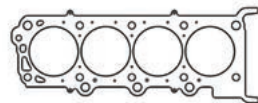

### Individual Gaskets

#### Exhaust Gaskets

Application	Part #
4.6/5.4L 3V Heads - MLS D-Port .....	<b>C5997-030</b> .....
4.6/5.4L 3V Heads - MLS .....	<b>C5852-030</b> .....



# FORD

## 5.4L SOHC 3v Heads Modular 2004-14

### Head Gaskets

#### MLS Head Gasket - Left Side

Bore	Thickness	Pkg Qty	Part #
94mm	.030"	1	C5971-030

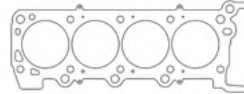

Additional thicknesses available  
see page 5

#### MLS Head Gasket - Right Side

Bore	Thickness	Pkg Qty	Part #
94mm	.030"	1	C5972-030

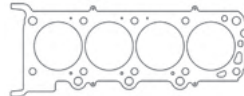

### Individual Gaskets

#### Exhaust Gaskets

Application	Part #
4.6/5.4L 3V Heads - MLS D-Port	C5997-030
4.6/5.4L 3V Heads - MLS	C5852-030

## 5.0L Gen-1 "Coyote" DOHC Modular V8 2011-2014

### Head Gaskets

#### MLS Head Gasket - Left Side

Bore	Thickness	Pkg Qty	Part #
94mm	.040"	1	C5287-040
94mm	.045"	1	C5287-045
94mm	.056"	1	C5287-056

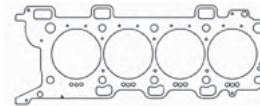

Additional thicknesses available  
see page 5

#### MLS Head Gasket - Right Side

Bore	Thickness	Pkg Qty	Part #
94mm	.040"	1	C5286-040
94mm	.045"	1	C5286-045
94mm	.056"	1	C5286-056

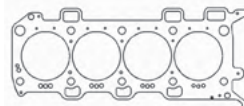

#### MLX Head Gasket - Left Side

Bore	Thickness	Pkg Qty	Part #
94mm	.040"	1	C15368-040

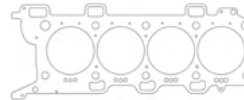

#### MLX Head Gasket - Right Side

Bore	Thickness	Pkg Qty	Part #
94mm	.040"	1	C15367-040

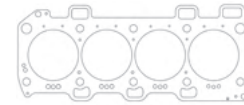

### Individual Gaskets

#### Exhaust Gaskets

Application	Part #
5.0L DOHC Coyote - HTS	C5392HTS
5.0L DOHC Coyote - MLS	C5392-030

#### Intake Manifold Gasket Set

Application	Part #
2011-2014 5.0L	C15444

**NEW!**

#### Valve Stem Seals (32 Pack)

Application	Part #
Hat Style - Viton Steel Body - INT/EXH	3268V-32

**NEW!**

#### Timing Cover Set

Application	Part #
Ford 5.0L Coyote 2011-2020	C15493

**NEW!**

#### Valve Cover Set

Application	Part #
Ford 5.0L 2011-2014	C15576



# FORD

## 5.0L Gen-2 "Coyote" DOHC Modular V8 2015-2017

### Head Gaskets

#### MLS Head Gasket - Left Side

Bore	Thickness	Pkg Qty	Part #
94mm	.040"	1	C15370-040
94mm	.045"	1	C15370-045
94mm	.051"	1	C15370-051
94mm	.070"	1	C15370-070

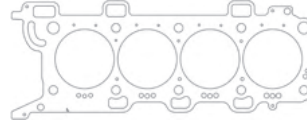

Additional thicknesses available  
see page 5

#### MLS Head Gasket - Right Side

Bore	Thickness	Pkg Qty	Part #
94mm	.040"	1	C15369-040
94mm	.045"	1	C15369-045
94mm	.051"	1	C15369-051
94mm	.070"	1	C15369-070

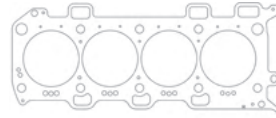

#### MLX Head Gasket - Left Side

Bore	Thickness	Pkg Qty	Part #
94mm	.040"	1	C15366-040
94mm	.051"	1	C15366-051

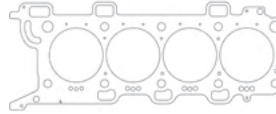

#### MLX Head Gasket - Right Side

Bore	Thickness	Pkg Qty	Part #
94mm	.040"	1	C15365-040
94mm	.051"	1	C15365-051

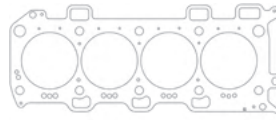

### Individual Gaskets

#### Exhaust Gaskets

Application	Part #
5.0L DOHC Coyote - MLS	C5392-030

#### Valve Cover Gasket Set

Application	Part #
Ford 5.0L/5.2L 2014-2018	C15442

#### Intake Manifold Gasket Set

Application	Part #
Molded Rubber Intake Set of 8	C15465

**NEW!**

#### Valve Stem Seals (32 Pack)

Application	Part #
Hat Style - Viton Steel Body - INT/EXH	3268V-32

**NEW!**

#### Timing Cover Set

Application	Part #
Ford 5.0L Coyote 2011-2017	C15493

## 5.0L Gen-3 "Coyote" DOHC Modular V8 2018+

### Head Gaskets

#### MLS Head Gasket - Right Side

Bore	Thickness	Pkg Qty	Part #
94.5mm	.030"	1	C15435-030

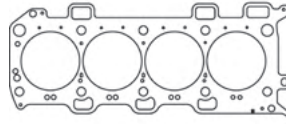

Additional thicknesses available  
see page 5

#### MLS Head Gasket - Left Side

Bore	Thickness	Pkg Qty	Part #
94.5mm	.030"	1	C15436-030

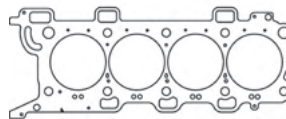

**NEW!**

#### MLX Head Gasket - Right Side

Bore	Thickness	Pkg Qty	Part #
94.5mm	.040"	1	C15548-040

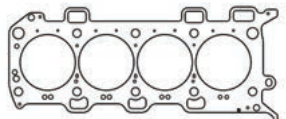

**NEW!**

#### MLX Head Gasket - Left Side

Bore	Thickness	Pkg Qty	Part #
94.5mm	.040"	1	C15549-040

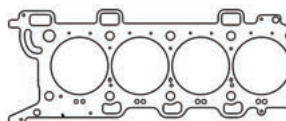





# FORD

## 5.0L "Coyote" DOHC Modular V8 2018+

### Individual Gaskets

**NEW!**

#### Exhaust Gaskets

Application	Part #
5.0L DOHC Coyote - HTS .....	<b>C5392HTS</b> .....
5.0L DOHC Coyote - MLS .....	<b>C5392-030</b> .....

## 5.2L "Voodoo" DOHC Modular V8 2015-18

### Head Gaskets

#### MLS Head Gasket - Left Side

Bore	Thickness	Pkg Qty	Part #
95mm .....	.036" .....	1 .....	<b>C15388-036</b> .....
95mm .....	.040" .....	1 .....	<b>C15388-040</b> .....

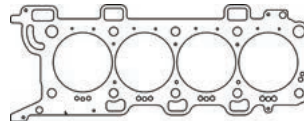

Additional thicknesses available  
see page 5

#### MLS Head Gasket - Right Side

Bore	Thickness	Pkg Qty	Part #
95mm .....	.036" .....	1 .....	<b>C15387-036</b> .....
95mm .....	.040" .....	1 .....	<b>C15387-040</b> .....

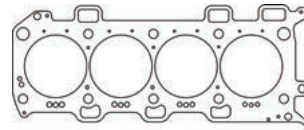

### Individual Gaskets

#### Valve Cover Gasket Set

Application	Part #
Ford 5.2L 2015-2018 .....	<b>C15442</b> .....

**NEW!**

#### Intake Gasket Set

Application	Part #
Molded Rubber Intake Set of 8 .....	<b>C15444</b> .....

**NEW!**

#### Timing Cover Set

Application	Part #
Ford 5.0L Coyote 2011-2017; .....	<b>C15493</b> .....
5.2L Voodoo 2015-2018 .....	

**NEW!**

#### Exhaust Gasket

Application	Part #
5.2L DOHC Voodoo - MLS 2015-2020 .....	<b>C15601-030</b> .....

## 5.8L "Trinity" DOHC Modular V8 2013-14

### Head Gaskets

#### MLX Head Gasket - Left Side

Bore	Thickness	Pkg Qty	Part #
95.25mm .....	.051" .....	1 .....	<b>C5017-051</b> .....
95mm .....	.055" .....	1 .....	<b>C5017-055</b> .....

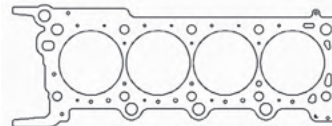

Additional thicknesses available  
see page 5

#### MLX Head Gasket - Right Side

Bore	Thickness	Pkg Qty	Part #
95.25mm .....	.030" .....	1 .....	<b>C5018-051</b> .....
95mm .....	.055" .....	1 .....	<b>C5018-055</b> .....

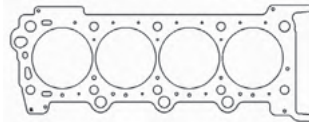

## 4.6/5.4L 2v/4v Modular V8 w/Darton Solid Sleeves

### Head Gaskets

#### MLS Head Gasket - Left Side

Bore	Thickness	Pkg Qty	Part #
95.25mm .....	.040" .....	1 .....	<b>C5856-040</b> .....

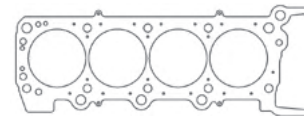

Additional thicknesses available  
see page 5

#### MLS Head Gasket - Right Side

Bore	Thickness	Pkg Qty	Part #
95.25mm .....	.030" .....	1 .....	<b>C5857-040</b> .....

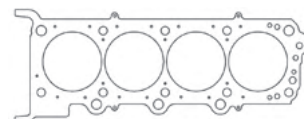



# FORD

## 4.6/5.4L 2v/4v Modular V8 w/Darton M.I.D. Sleeves

### Head Gaskets

#### MLS Head Gasket - Left Side

Bore	Thickness	Pkg Qty	Part #
95.25mm	.....040"	.....1	<b>C5858-040</b>

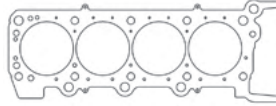

Additional thicknesses available  
see page 5

#### MLS Head Gasket - Right Side

Bore	Thickness	Pkg Qty	Part #
95.25mm	.....030"	.....1	<b>C5859-040</b>

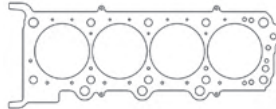

## 239, 256, 272, 292, 312 Y-Block V8 1956-64

### Head Gasket

#### MLS Head Gasket - Right Side

Bore	Thickness	Pkg Qty	Part #
3.860"	.....040"	.....1	<b>C15170-040</b>

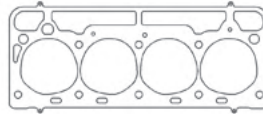

Additional thicknesses available  
see page 5

#### MLS Head Gasket - Left Side

Bore	Thickness	Pkg Qty	Part #
3.860"	.....040"	.....1	<b>C15171-040</b>

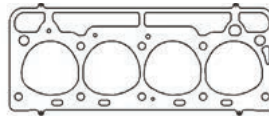

### Individual Gaskets

#### Exhaust Gasket Set

Application	Part #
Y-Block 1956-64	<b>C15082-064</b>

#### Oil Pan Gasket

Application	Part #
Y-Block 1956-64	<b>C15084</b>

#### Intake Gasket Set

Application	Part #
Y-Block 1956-64	<b>C15083</b>

#### Timing Cover Gasket

Application	Part #
Y-Block 1956-64	<b>C15085</b>

#### Valve Cover Gasket (sold individually)

Application	Part #
Y-Block 1956-64	<b>C15086</b>

#### Water Pump O-Ring

Application	Part #
Y-Block 1956-64	<b>C15087</b>

### Gasket Kits



To purchase a complete gasket kit order both top end and bottom end gasket kit

#### TOP END GASKET KIT

#### BOTTOM END GASKET KIT

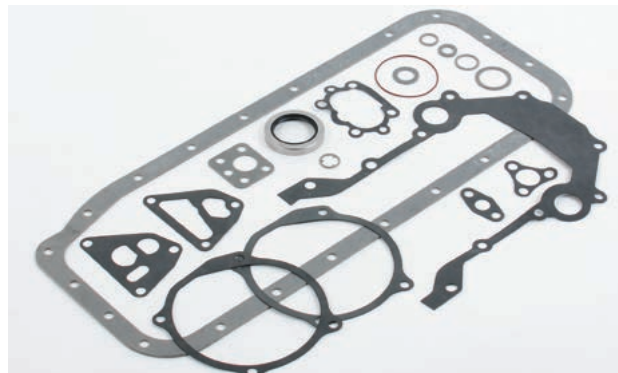
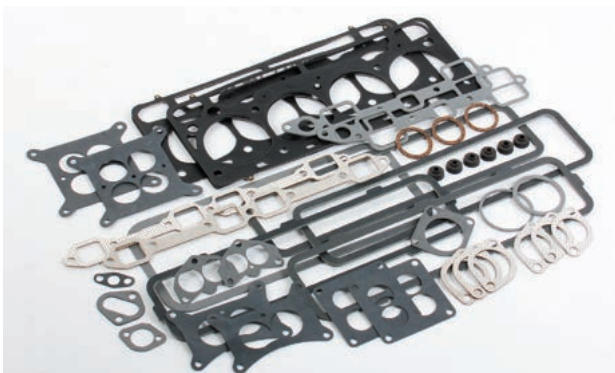

Application	Part #
239-312 Y-Block 1956-64 3.860" Bore	<b>PRO1039T</b>

Application	Part #
239-312 Y-Block 1956-64	<b>PRO1039B</b>



# FORD

## Windsor Small Block V8 SVO & non-SVO 1962-00

### Head Gaskets

<b>MLS Head Gaskets - SVO Round Bore</b>			
Bore	Thickness	Pkg Qty	Part #
4.030"	.040"	1	<b>C5478-040</b>
4.060"	.040"	1	<b>C5479-040</b>
4.080"	.040"	1	<b>C5480-040</b>
4.100"	.040"	1	<b>C5481-040</b>
4.155"	.040"	1	<b>C5483-040</b>
4.195"	.051"	1	<b>C5509-051</b>
4.200"	.040"	1	<b>C5485-040</b>

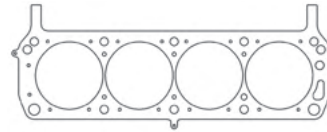

Additional thicknesses available  
see page 5

<b>MLX Head Gasket - SVO Round Bore</b>			
Bore	Thickness	Pkg Qty	Part #
4.100"	.040"	1	<b>C15372-040</b>
4.200"	.040"	1	<b>C5757-040</b>

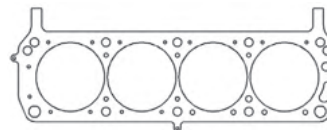

<b>MLS Head Gaskets - non SVO Round Bore</b>			
Bore	Thickness	Pkg Qty	Part #
4.030"	.027"	1	<b>C5511-027</b>
4.030"	.040"	1	<b>C5511-040</b>
4.060"	.040"	1	<b>C5512-040</b>
4.080"	.040"	1	<b>C5513-040</b>
4.100"	.040"	1	<b>C5514-040</b>
4.155"	.040"	1	<b>C5515-040</b>
4.155"	.051"	1	<b>C5515-051</b>
4.200"	.040"	1	<b>C5517-040</b>

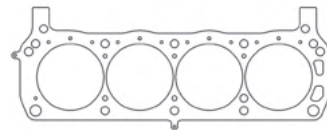

<b>MLX Head Gasket - non-SVO Round Bore</b>			
Bore	Thickness	Pkg Qty	Part #
4.100"	.040"	1	<b>C15371-040</b>
4.200"	.040"	1	<b>C5025-040</b>

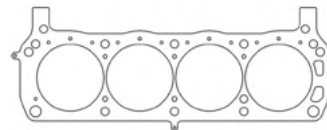

### Individual Gaskets

<b>Valve Cover Gasket (sold individually)</b>	
Application	Part #
289/302/351-Molded Rubber.....	<b>C5974</b>
SVO, M6049 Heads .094" KF.....	<b>C5659-094</b>

<b>Timing Cover Sets</b>	
Application	Part #
260/289/302/351W 1962-78.....	<b>C5064</b>
302/351W 1979-97.....	<b>C5065</b>

<b>Intake Manifold Gaskets</b>	
Application	Part #
N351 2.120" x 1.280".....	<b>C5652-060</b>
M6049 Yates 3C 2.00" x 1.35".....	<b>C5268-047</b>
China Rail Gaskets.....	<b>C5653-060</b>

<b>Oil Pan Gasket Sets</b>	
Application	Part #
289/302 4pc Kit.....	<b>C15091</b>
351W 4pc Kit.....	<b>C5279-094</b>
351W 4pc Kit - For Stokers.....	<b>C15092</b>

<b>Exhaust Manifold Gaskets</b>	
Application	Part #
N351 1.585" x 1.681" .064" AM.....	<b>C5655-064</b>
351W 1.52" x 1.57" MLS.....	<b>C15176-030</b>
289/302 1.120" x 1.480" MLS.....	<b>C5898-030</b>
289/302 1.127" x 1.750" MLS.....	<b>C5899-030</b>
Yates 1.725" x 1.890" .064" AM.....	<b>C5357-064</b>
Yates MLS Ind Ports (8 pcs).....	<b>C5665-040</b>

<b>Rear Main Seals</b>	
Application	Part #
289/302 Viton 2pc 1968-82.....	<b>C5688</b>
351W Viton 2pc 1969-83.....	<b>C5689</b>
289/302 1pc 1983-01.....	<b>C5189</b>
351W 1pc 1983-01.....	<b>C15090</b>
351W w/302 Crank.....	<b>C5384</b>

See page 57 for additional gaskets

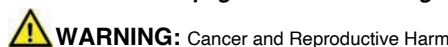



# FORD

## Windsor Small Block V8 SVO & non-SVO 1965-00

### Individual Gaskets

#### Carb/Throttle Body Gaskets

Application	Part #
Holley 4bbl Open Plenum Carb.....	<b>C5263</b>
5.0L 1986-93 TB Gasket.....	<b>C15099</b>
5.0/5.8L 85-97 Truck TB Gasket.....	<b>C15100</b>
3.8/5.0L 89-95 TB Gasket.....	<b>C15101</b>

#### Fuel Pump Gasket

Application	Part #
Small Block Ford .....	<b>C5389-060</b>

#### Water Pump Gaskets

Application	Part #
289/302/351W 67-91 WP Gasket.....	<b>C5662-060</b>
302/351W 69-85 Cover Plate .....	<b>C5353</b>
289/302 63-65.5 Plate to Block .....	<b>C15093</b>
289/302/351W 63-69 Pump to Plate .....	<b>C15094</b>
351W 80-87 Water Pump Plate .....	<b>C15095</b>
302/351W 86-97 Pump to Plate .....	<b>C15096</b>
351W 88-95 Pump to Block.....	<b>C15097</b>
302 91-01 Plate to Block Gasket.....	<b>C15098</b>

### Gasket Kits



To purchase a complete gasket kit order both top end and bottom end gasket kit

#### TOP END GASKET KITS

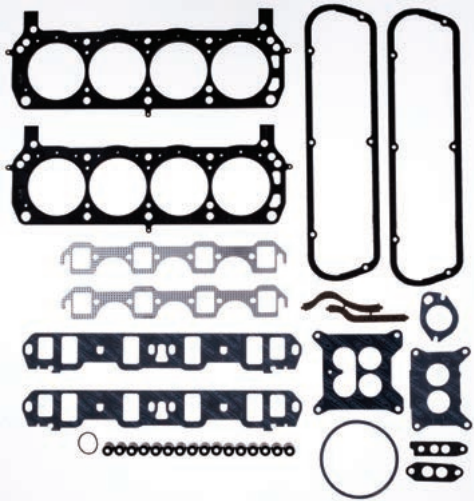

Application	Part #
289ci 65-68 & 302ci 68-85 4.100" Bore.....	<b>PRO1015T</b>
302ci EFI 86-95 4.100" Bore .....	<b>PRO1016T</b>
351ci Windsor 69-87 4.100" Bore.....	<b>PRO1013T</b>
351ci Windsor EFI 88-95 4.100" Bore .....	<b>PRO1014T</b>

#### BOTTOM END GASKET KITS

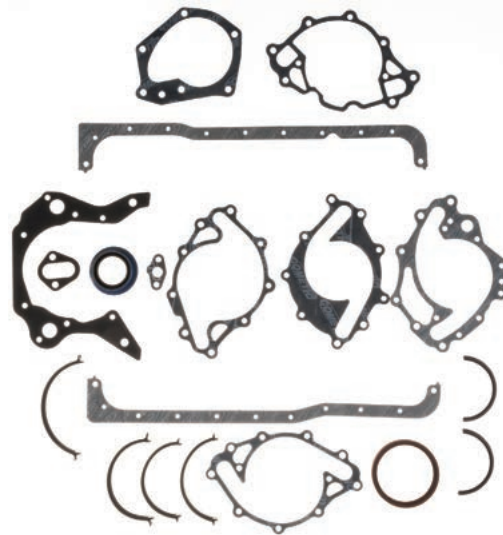

Application	Part #
289/302ci 65-95.....	<b>PRO1015B</b>
351ci Windsor 69-95.....	<b>PRO1013B</b>

## Small Block Ford V8 - Aftermarket & Race

### Head Gaskets

#### MLS Head Gaskets-SVO Yates w/Valve Pockets-LHS

Bore	Thickness	Pkg Qty	Part #
4.100"	.....040"	.....1	<b>C5358-040</b>
4.180"	.....040"	.....1	<b>C5364-040</b>
4.200"	.....040"	.....1	<b>C5366-040</b>

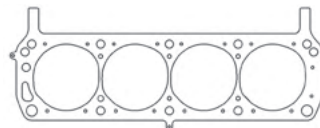

Additional thicknesses available see page 5

#### MLS Head Gaskets-SVO Yates w/Valve Pockets-RHS

Bore	Thickness	Pkg Qty	Part #
4.100"	.....040"	.....1	<b>C5359-040</b>
4.180"	.....040"	.....1	<b>C5365-040</b>
4.200"	.....040"	.....1	<b>C5367-040</b>

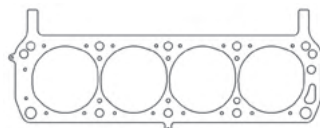

See page 59 for StreetPro gasket kits



# FORD

## Small Block Ford V8 - Aftermarket & Race

### Head Gaskets

Additional thicknesses available  
see page 5

<b>MLS Head Gaskets - Brodix Track 1, Edelbrock RPM Performer, AFR Heads w/Coolant Channels</b>			
Bore	Thickness	Pkg Qty	Part #
4.030"	.040"	1	C5909-040
4.080"	.040"	1	C5910-040
4.100"	.040"	1	C5911-040
4.155"	.040"	1	C5912-040
4.200"	.040"	1	C5913-040

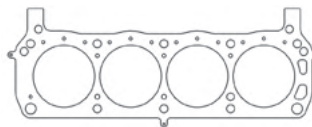

<b>MLS Head Gaskets - New Boss 302 Blocks (will not work with OEM non-SVO heads)</b>			
Bore	Thickness	Pkg Qty	Part #
4.030"	.040"	1	C5958-040
4.080"	.040"	1	C5959-040
4.100"	.040"	1	C5960-040
4.155"	.040"	1	C5961-040
4.200"	.040"	1	C5962-040

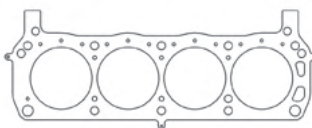

<b><i>NEW!</i> MLX Head Gaskets - New Boss 302 Blocks M6010-BOSS302 (will not work with OEM non-SVO heads)</b>			
Bore	Thickness	Pkg Qty	Part #
4.200"	.040"	1	C15373-040

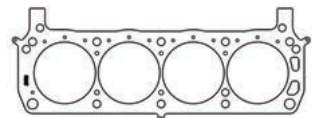

<b><i>NEW!</i> MLS Head Gasket - Right Side 302/351W '62-'01 SVO Heads with valve pocket</b>			
Bore	Thickness	Pkg Qty	Part #
4.150"	.040"	1	C15551-040

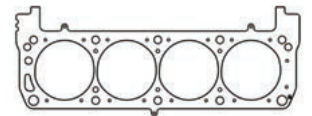

<b><i>NEW!</i> MLS Head Gasket - Left Side 302/351W '62-'01 SVO Heads with valve pocket</b>			
Bore	Thickness	Pkg Qty	Part #
4.150"	.040"	1	C15552-040

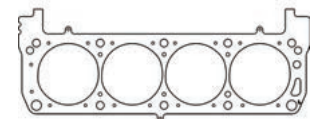

<b>MLS Head Gasket - World Products Man O'War 10 Degree Heads-6 Bolts per Cylinder</b>			
Bore	Thickness	Pkg Qty	Part #
4.080"	.040"	1	C5132-040
4.100"	.040"	1	C5133-040
4.155"	.040"	1	C5134-040
4.180"	.040"	1	C5135-040



<b>MLS Head Gasket-Brodix ASCS Head/R452 Block</b>			
Bore	Thickness	Pkg Qty	Part #
4.125"	.040"	1	C5217-040

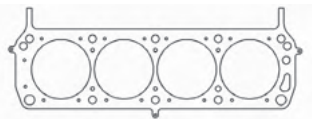



# FORD

## 351 Cleveland, 351 Modified, & 400ci V8

### Head Gasket

#### MLS Head Gasket

Bore	Thickness	Pkg Qty	Part #
4.100"	.040"	1	C5871-040

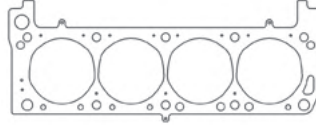

Additional thicknesses available  
see page 5

### Individual Gaskets

#### Valve Cover Gasket (sold individually)

Application	Part #
351C/351M/400 .125" KF	C5659-125

#### Oil Pan Gasket Set

Application	Part #
351C/351M/400 1970-81	C5278-094

#### Intake Manifold Gaskets

Application	Part #
351C/351M/400 4bbl Heads	C15102
351C/351M/400 2bbl Heads	C15103

#### Water Pump Gaskets

Application	Part #
Backing Plate Gasket	C5353
Water Pump Gasket w/Cast Iron Pump	C5662-060

#### Exhaust Manifold Gasket

Application	Part #
351C/351M/400 4bbl Heads	C15104

#### Timing Cover Set

Application	Part #
351C/351M/400 1970-81	C5066

#### Fuel Pump Gasket

Application	Part #
351C/351M/400 .031" Fiber	C15105

#### Rear Main Seals

Application	Part #
351C/351M/400 - 2pc Poly	C5088
351C/351M/400 - 2pc Viton	C5689

## Ford RY45 V8

### Head Gaskets

#### MLX Head Gaskets - Right Side

Bore	Thickness	Pkg Qty	Part #
4.290"	.040"	1	C15338-040

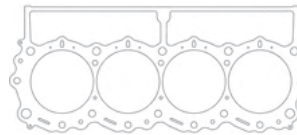

Additional thicknesses available  
see page 5

#### MLX Head Gaskets - Left Side

Bore	Thickness	Pkg Qty	Part #
4.290"	.040"	1	C15337-040

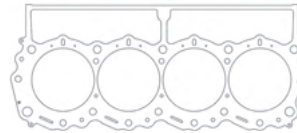

## Ford FR9 Race V8

### Head Gaskets

#### MLX Head Gaskets - Right Side

Bore	Thickness	Pkg Qty	Part #
4.190"	.040"	1	C5587-040

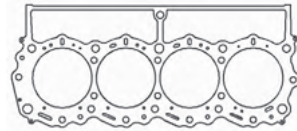

Additional thicknesses available  
see page 5

#### MLX Head Gaskets - Left Side

Bore	Thickness	Pkg Qty	Part #
4.190"	.040"	1	C5588-040

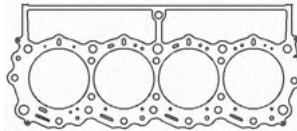

### Individual Gaskets

#### Intake Manifold Gaskets

Application	Part #
FR9 V8 - 2.05" x 1.39" .060" KF	C15106-060

#### Exhaust Manifold Gaskets

Application	Part #
FR9 V8 - .030" MLS	C15107-030



# FORD

## Ford Flathead V8 1932-53

### Head Gaskets

<b>MLS Head Gasket - 1932-38 21 Bolt</b>			
Bore	Thickness	Pkg Qty	Part #
3.156"	.....040"	.....1	<b>C5870-040</b> .....

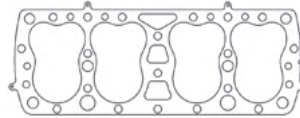

Additional thicknesses available  
see page 5

<b>MLS Head Gasket - 1938-48 24 Bolt</b>			
Bore	Thickness	Pkg Qty	Part #
3.250"	.....051"	.....1	<b>C5908-051</b> .....
3.375"	.....051"	.....1	<b>C5108-051</b> .....

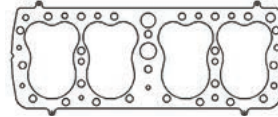

<b>MLS Head Gasket - 1949-53 24 Bolt - RHS</b>			
Bore	Thickness	Pkg Qty	Part #
3.375"	.....051"	.....1	<b>C15088-051</b> .....
3.375"	.....092"	.....1	<b>C15088-092</b> .....

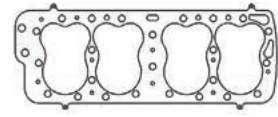

<b>MLS Head Gasket - 1949-53 24 Bolt - LHS</b>			
Bore	Thickness	Pkg Qty	Part #
3.375"	.....051"	.....1	<b>C15089-051</b> .....
3.375"	.....092"	.....1	<b>C15089-092</b> .....

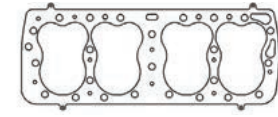

### Individual Gaskets

<b>Carburetor Gaskets (sold individually)</b>	
Application	Part #
Holley Air Cleaner Gasket .....	<b>C15108</b> .....
59A, 8BA, 8CM 2bbl Gasket.....	<b>C15109</b> .....

<b>Timing Cover Gaskets</b>	
Application	Part #
59A 1945-48 .015" Fiber.....	<b>C15134</b> .....
8BA/8CM 1948-53 .015" Fiber.....	<b>C15135</b> .....

<b>Intake Manifold Gaskets</b>	
Application	Part #
59A 1945-48 .060" KF .....	<b>C15120</b> .....
8BA/8CM 1948-53 .060" KF .....	<b>C15121</b> .....

<b>Water Pump Gaskets</b>	
Application	Part #
59A 1945-48 .015" Fiber.....	<b>C15136</b> .....
8BA/8CM 1948-53 .015" Fiber.....	<b>C15137</b> .....

<b>Exhaust Manifold Gaskets</b>	
Application	Part #
59A, 8BA, 8CM 1945-53 8PK.....	<b>C15116</b> .....

<b>Fuel Pump Gaskets</b>	
Application	Part #
59A 45-48 Fuel Pump Stand .....	<b>C15117</b> .....
59A 46-53 Fuel Pump Cover .....	<b>C15118</b> .....
8BA/8CM 48-53 Fuel Pump Mount.....	<b>C15119</b> .....

<b>Distributor Gaskets</b>	
Application	Part #
59A 45-48 Distributor Base.....	<b>C15110</b> .....
59A 45-48 Distributor Cap Cover.....	<b>C15111</b> .....
59A Distributor Terminal Housing .....	<b>C15112</b> .....
59A 32-41 Distributor Base.....	<b>C15113</b> .....
59A 32-41 Distributor Cap Cover.....	<b>C15114</b> .....
59A Distributor Coil Base.....	<b>C15115</b> .....

<b>Oil Pump/Pan Gaskets</b>	
Application	Part #
59A 32-41 Oil Pump Drive Cover .....	<b>C15122</b> .....
59A 45-48 Oil Pump Drive Cover .....	<b>C15123</b> .....
59A 45-48 Oil Pump Mounting.....	<b>C15126</b> .....
59A 45-48 Oil Pump Screen Cover .....	<b>C15127</b> .....
8BA/8CM 48-53 Oil Pump Drive Cover .....	<b>C15130</b> .....
8BA/8CM 48-53 Oil Pump Relief Nut .....	<b>C15132</b> .....
59A 45-48 Drain Plug Gasket.....	<b>C15124</b> .....
59A 1938 Drain Plug Gasket.....	<b>C15125</b> .....
8BA/8CM 48-53 Drain Plug Gasket.....	<b>C15133</b> .....
8BA/8CM Oil Pan Clean Out.....	<b>C15128</b> .....
8BA/8CM Oil Pan Gasket.....	<b>C15129</b> .....
8BA/8CM Dipstick Tube Gasket .....	<b>C15131</b> .....



# FORD

## 352, 390, 406, 410, 427, & 428 FE V8

### Head Gaskets

#### MLS Head Gaskets - Top Oiler

Bore	Thickness	Pkg Qty	Part #
4.080"	.040"	1	C5833-040
4.165"	.040"	1	C5834-040
4.250"	.040"	1	C5835-040
4.300"	.040"	1	C5523-040
4.400"	.040"	1	C5840-040

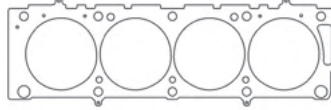

Additional thicknesses available see page 5

#### MLS Head Gasket - SOHC Side Oiler

Bore	Thickness	Pkg Qty	Part #
4.400"	.040"	1	C5841-040

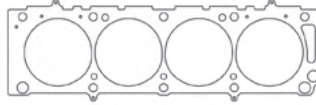

### Individual Gaskets

#### Valve Cover Gaskets (sold individually)

Application	Part #
All FE & 428CJ/SCJ	C5138-188
427 SOHC LHS	C15138-188
427 SOHC RHS	C15139-188

#### Timing Cover Sets

Application	Part #
352/360 1958-60	C5067
332-428 1961-71	C5068

#### Intake Manifold Gaskets

Application	Part #
STD/Low Riser 428CJ/SCJ	C5137-060
427 SOHC	C15140-060

#### Oil Pan Gasket

Application	Part #
FE V8 1961-71	C5141-125

#### Exhaust Manifold Gaskets

Application	Part #
352-410 FE & 428CJ/SCJ MLS	C5922-030
427 SOHC .064" AM	C15141-064

#### Rear Main Seal

Application	Part #
FE V8 1961-71	C5142

#### Water Pump Gaskets

Application	Part #
FE V8 1961-71 (Pair)	C5140-031 3.97

### Gasket Kits



To purchase a complete gasket kit order both top end and bottom end gasket kit

#### TOP END GASKET KIT

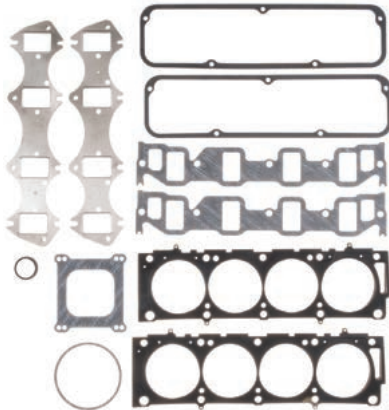

Application	Part #
352, 390, 410, 428 FE V8 4.300" Bore	PRO1027T

#### BOTTOM END GASKET KIT



Application	Part #
352, 390, 410, 428 FE V8	PRO1027B





# FORD

## 429ci 7.0L & 460ci 7.5L Big Block V8

### Head Gaskets

MLS Head Gaskets			
Bore	Thickness	Pkg Qty	Part #
4.400"	.040"	1	C5666-040
4.440"	.040"	1	C15400-040
4.500"	.040"	1	C5667-040
4.600"	.040"	1	C15142-040
4.670"	.040"	1	C5668-040

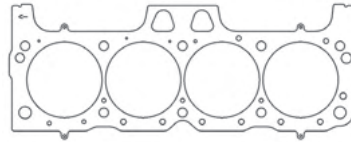

Additional thicknesses available see page 5

Copper Head Gaskets			
Bore	Thickness	Pkg Qty	Part #
4.520"	.043"	1	C15421-043

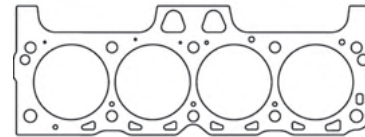

### Individual Gaskets

Valve Cover Gaskets (sold individually)	
Application	Part #
429/460 Big Block Molded Rubber	C15467
429/460 Big Block .125" KF	C5205-125

Timing Cover Set	
Application	Part #
429/460 1968-85	C5069

Intake Manifold Gaskets	
Application	Part #
Stock 429/460 Heads	C5043-060
CJ/SCJ 2.24" x 2.60" Port	C5206-060

Oil Pan Gasket	
Application	Part #
429/460 4 pc set	C5125-094

Exhaust Manifold Gaskets	
Application	Part #
429/460 Oval Port - .030" MLS	C5900-030

Rear Main Seal	
Application	Part #
429/460 Big Block 2pc	C5208

Water Pump Gaskets	
Application	Part #
429/460 Big Block	C5209-031

### Gasket Kits



To purchase a complete gasket kit order both top end and bottom end gasket kit

#### TOP END GASKET KIT



Application	Part #
429/460ci Big Block V8 68-78 4.500" Bore	PRO1012T

#### BOTTOM END GASKET KIT

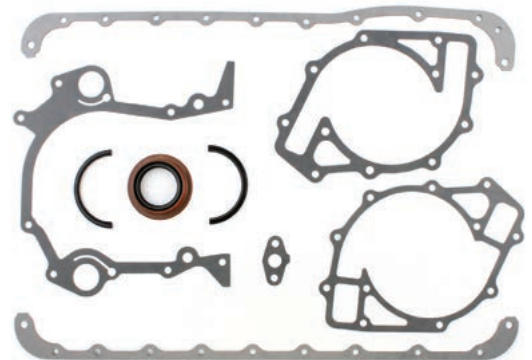

Application	Part #
429/460ci Big Block V8 68-78	PRO1012B



# FORD

## Pro Stock Racing V8

### Head Gaskets

<b>MLS Head Gasket - D/E460 PRO STOCK</b>			
Bore	Thickness	Pkg Qty	Part #
4.600"	.045"	1	C5731-045
4.685"	.045"	1	C5732-045

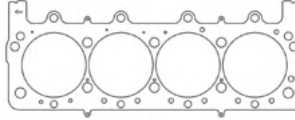

Additional thicknesses available  
see page 5

<b>MLS Head Gaskets - A460/C460 PRO STOCK</b>			
Bore	Thickness	Pkg Qty	Part #
4.500"	.045"	1	C15446-045
4.600"	.045"	1	C5743-045
4.685"	.045"	1	C5744-045

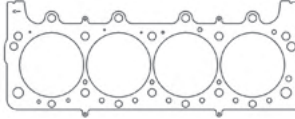

<b>MLS Head Gaskets- A500 PRO STOCK - LHS</b>			
Bore	Thickness	Pkg Qty	Part #
4.600"	.045"	1	C5727-045
4.685"	.045"	1	C5729-045

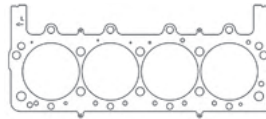

<b>MLS Head Gaskets - A500 PRO STOCK - RHS</b>			
Bore	Thickness	Pkg Qty	Part #
4.600"	.045"	1	C5728-045
4.685"	.045"	1	C5730-045

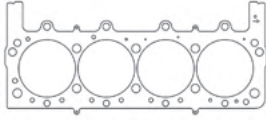

<b>MLS Head Gasket - 460 w/Hemi 14 Bolt Head</b>			
Bore	Thickness	Pkg Qty	Part #
4.700"	.040"	1	C5888-040

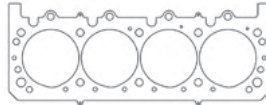

<b>MLS Head Gasket - JC50 500ci PRO STOCK - LHS</b>			
Bore	Thickness	Pkg Qty	Part #
4.735"	.052"	1	C5284-052

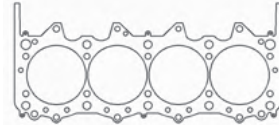

<b>MLS Head Gasket - JC50 500ci PRO STOCK - RHS</b>			
Bore	Thickness	Pkg Qty	Part #
4.735"	.052"	1	C5285-052

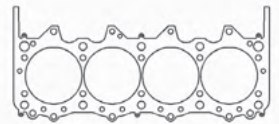

<b>MLS Head Gaskets - 800ci W/5.0" Bore Centers</b>			
Bore	Thickness	Pkg Qty	Part #
4.770"	.040"	1	C5875-040
4.770"	.051"	1	C5875-051

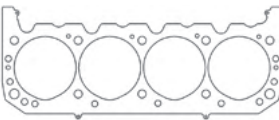

### Individual Gaskets

<b>Exhaust Manifold Gaskets</b>	
Application	Part #
JC50 500ci - .030" MLS	C5257-030

## 6.2L SOHC Raptor 2010-13

### Head Gasket

<b>MLX Head Gasket</b>			
Bore	Thickness	Pkg Qty	Part #
4.125"	0.054	1	C15430-054

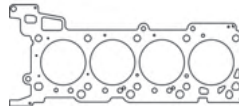

Additional thicknesses available  
see page 5

<b>MLX Head Gasket</b>			
Bore	Thickness	Pkg Qty	Part #
4.125"	0.054	1	C15429-054

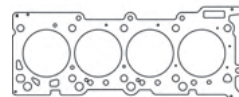



# FORD

## 6.8L V10

### MLX Head Gaskets - Right Side

Bore	Thickness	Pkg Qty	Part #
92.5mm	.040"	1	C15462-040

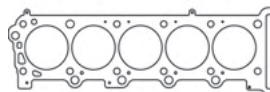

Additional thicknesses available  
see page 5

### MLX Head Gaskets - Left Side

Bore	Thickness	Pkg Qty	Part #
92.5mm	.040"	1	C15461-040

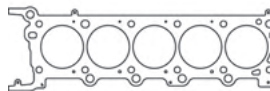

## 6.0L Power Stroke Diesel 2003-08

### Head Gaskets

#### MLX Head Gasket - 2003-06 18mm Dowels

Bore	Thickness	Pkg Qty	Part #
96mm	.062"	1	C5589-062

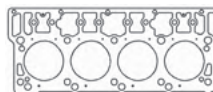

Additional thicknesses available  
see page 5

#### MLX Head Gasket - 2007-08 20mm Dowels

Bore	Thickness	Pkg Qty	Part #
96mm	.062"	1	C5984-062

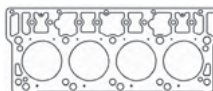

### Individual Gaskets

#### Valve Cover Gasket Set

Application	Part #
6.0L Power Stroke 03-08	C15143

#### Valve Stem Seals (sold individually)

Application	Part #
6.0L Power Stroke 03-08 (Req 32)	3217V

#### Intake Manifold Gasket Set

Application	Part #
6.0L Power Stroke 03-08	C15144

#### HPOP Cover Gasket

Application	Part #
6.0L Power Stroke 03-08	C15145

#### Exhaust Manifold Gasket

Application	Part #
6.0L Power Stroke 03-08 - MLS	C5089-030

#### Oil Cooler O-Ring Kit

Application	Part #
6.0L Power Stroke 03-08	C15146

#### Throttle Body Gasket

Application	Part #
6.0L Power Stroke 03-08	C15153

#### Cylinder Head Dowels (sold individually)

Application	Part #
6.0L Power Stroke 03-06 18mm	C15147
6.0L Power Stroke 07-08 20mm	C15148

### Gasket Kits



To purchase a complete gasket kit order both top end and bottom end gasket kit

#### TOP END GASKET KITS

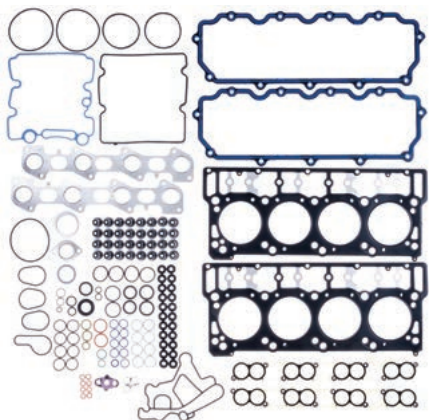

Application	Part #
6.0L Power Stroke 03-06	PRO3005T
6.0L Power Stroke 07-08	PRO3006T

#### BOTTOM END GASKET KIT

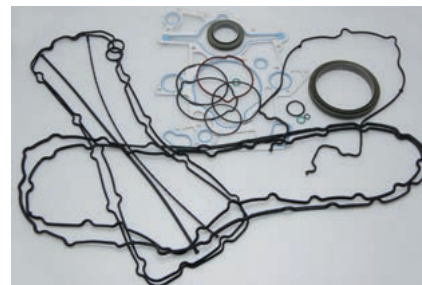

Application	Part #
6.0L Power Stroke 03-08	PRO3005B



# FORD

## 6.4L Power Stroke Diesel 2008-2010

### Head Gasket

<b>MLX Head Gasket</b>			
Bore	Thickness	Pkg Qty	Part #
103mm	.....062"	.....1	<b>C5610-062</b> .....
103mm	.....067"	.....1	<b>C5610-067</b> .....

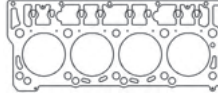

Additional thicknesses available  
see page 5

<b>MLX Head Gasket - REV B</b>			
Bore	Thickness	Pkg Qty	Part #
103mm	.....062"	.....1	<b>C15175-062</b> .....

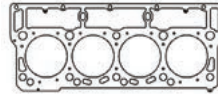

### Individual Gaskets

<b>Valve Cover Gasket Set</b>	
Application	Part #
6.4L Power Stroke 08-10.....	<b>C15151</b> .....

<b>Turbo Mounting Kit</b>	
Application	Part #
6.4L Power Stroke 08-10.....	<b>C15154</b> .....

<b>Intake Manifold Gasket Set</b>	
Application	Part #
6.4L Power Stroke 08-10.....	<b>C15152</b> .....

<b>Fuel Injector Seal Kit</b>	
Application	Part #
6.4L Power Stroke 08-10 (pack of 8).....	<b>C15155</b> .....

<b>Exhaust Manifold Gasket</b>	
Application	Part #
6.4L Power Stroke 08-10 - MLS.....	<b>C5089-030</b> .....

<b>Oil Cooler O-Ring Kit</b>	
Application	Part #
6.4L Power Stroke 08-10.....	<b>C15156</b> .....

<b>Valve Stem Seals (sold individually)</b>	
Application	Part #
6.4L Power Stroke 08-10 (Req 32).....	<b>3217V</b> .....

<b>Cooling/Water Pump Gaskets</b>	
Application	Part #
Thermostat Housing Seal.....	<b>C15157</b> .....
Lower Coolant Hose Gasket.....	<b>C15158</b> .....
Upper Coolant hose Gasket.....	<b>C15159</b> .....

<b>Throttle Body Gasket</b>	
Application	Part #
6.0L Power Stroke 03-10.....	<b>C15153</b> .....

<b>NEW! Cylinder Head Dowels (sold each)</b>	
Application	Part #
6.4L Power Stroke 08-10 20mm.....	<b>C15148</b> .....

### Gasket Kits



To purchase a complete gasket kit order both top end and bottom end gasket kit

#### TOP END GASKET KIT

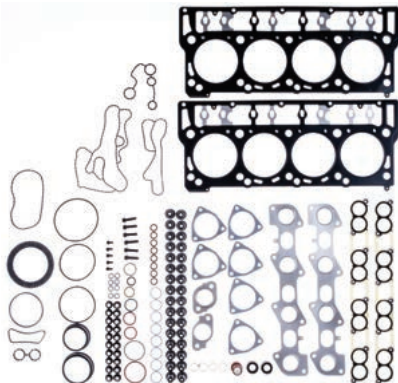

Application	Part #
6.4L Power Stroke 08-10 99mm Bore.....	<b>PRO3007T</b> ....

#### BOTTOM END GASKET KIT

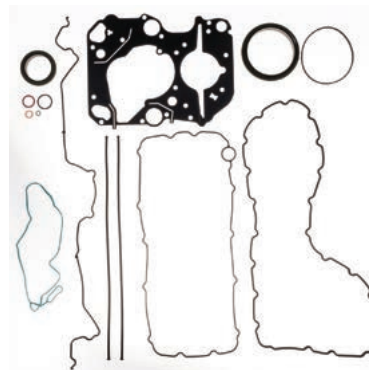

Application	Part #
6.4L Power Stroke 08-10.....	<b>PRO3007B</b> .....

## 6.7L Power Stroke Scorpion Diesel 2011-17

### Head Gaskets

<b>MLX Head Gasket - RHS</b>			
Bore	Thickness	Pkg Qty	Part #
100mm	.....053"	.....1	<b>C15160-053</b> .....
100mm	.....062"	.....1	<b>C15160-062</b> .....

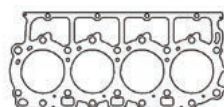

Additional thicknesses available  
see page 5



# FORD

## 6.7L Power Stroke Scorpion Diesel 2011-17

### Head Gaskets

#### MLX Head Gasket - LHS

Bore	Thickness	Pkg Qty	Part #
100mm	.....053"	.....1	<b>C15161-053</b> .....
100mm	.....062"	.....1	<b>C15161-062</b> .....

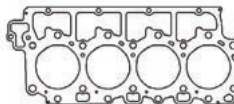

Additional thicknesses available  
see page 5

### Individual Gaskets

**NEW!**

#### Exhaust Manifold Gaskets

Application	Part #
6.7L Power Stroke Scorpion MLS	<b>C15487-030</b>

#### Oil Pan Gaskets

Application	Part #
.060" AFM Material	<b>C15466-060</b>

## 7.3L Power Stroke Diesel 1994-03

### Head Gasket

#### MLS Head Gasket

Bore	Thickness	Pkg Qty	Part #
4.140"	.....066"	.....1	<b>C5839-066</b> .....



Additional thicknesses available  
see page 5

#### MLX Head Gasket

Bore	Thickness	Pkg Qty	Part #
4.140"	.....067"	.....1	<b>C15390-067</b> .....

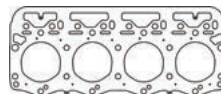

### Individual Gaskets

#### Valve Cover Gaskets (sold individually)

Application	Part #
7.3L Power Stroke 94-97	<b>C15162</b>
7.3L Power Stroke 98-03	<b>C15163</b>

#### HPOP Gaskets

Application	Part #
7.3L Power Stroke 94-95	<b>C15164</b>
7.3L Power Stroke 96-03	<b>C15165</b>

#### Intake Manifold Gasket Set

Application	Part #
7.3L Power Stroke .060" AFM	<b>C5090-060</b>

#### Valve Stem Seals (sold individually)

Application	Part #
7.3L Power Stroke (need 16)	<b>3216V</b>

#### Exhaust Manifold Gaskets

Application	Part #
7.3L Power Stroke .064" AM	<b>C5091-064</b>

### Gasket Kits

**STREETPRO**  
by Cometic Gasket

To purchase a complete gasket kit order both top end and bottom end gasket kit

#### TOP END GASKET KIT

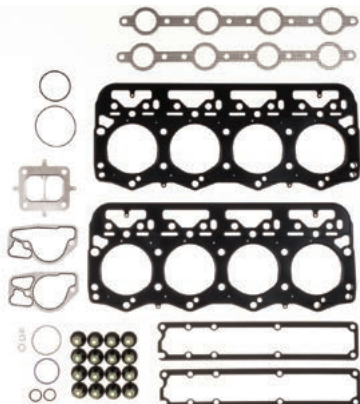

Application	Part #
7.3L Power Stroke 1994-03	<b>PRO3010T</b>

#### BOTTOM END GASKET KIT



Application	Part #
7.3L Power Stroke 1994-03	<b>PRO3010B</b>



# OLDSMOBILE

**330, 350, 400, 403, & 455ci V8**

## Head Gasket

### MLS Head Gaskets

Bore	Thickness	Pkg Qty	Part #
4.125"	.040"	1	C5808-040
4.200"	.040"	1	C5809-040
4.270"	.040"	1	C5811-040
4.400"	.040"	1	C5810-040

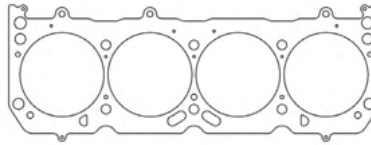

Additional thicknesses available see page 5

## Individual Gaskets

### Valve Cover Gasket (sold individually)

Application	Part #
330-455ci Olds V8 .188" Molded Rubber	C15440

### Timing Cover Set

Application	Part #
330-455ci Olds V8 1964-90	C5070

### Intake Manifold Gaskets

Application	Part #
330, 350, & 403 Small V8	C5216-030
400 & 455 Big V8	C5813-060

### Water Pump Gaskets

Application	Part #
330-455ci V8 1968-76 w/AC	C15166
330-455ci V8 1964-90	C15167

### Exhaust Manifold Gaskets

Application	Part #
330-455ci V8 Stock Port .064" AM	C5812-064
330-455ci V8 1.45"x1.92" MLS	C5904-030

### Oil Pan Gasket Kit

Application	Part #
330-455ci Olds V8 4pc Kit	C5822-094

## Gasket Kits



To purchase a complete gasket kit order both top end and bottom end gasket kit

### TOP END GASKET KIT

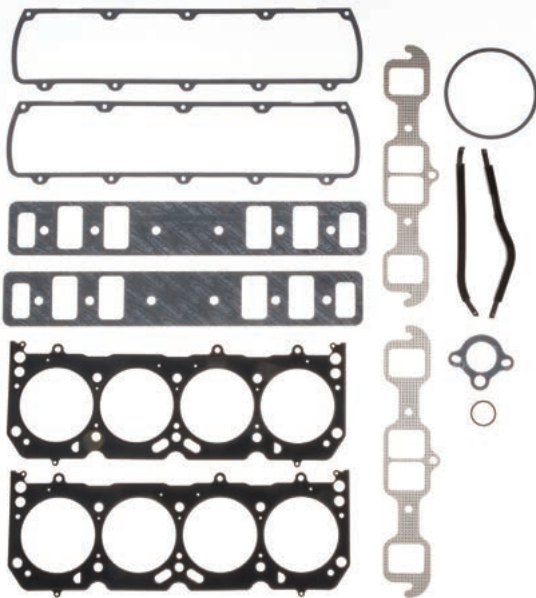

Application	Part #
Olds 455ci V8 1968-76 4.200" Bore	PRO1009T

### BOTTOM END GASKET KIT



Application	Part #
Olds 455ci V8 1968-76	PRO1009B



# OLDSMOBILE

## 370/371 J-2 Golden Rocket 1957-60

### Head Gasket

MLS Head Gasket			
Bore	Thickness	Pkg Qty	Part #
4.190"	.040"	1	C5129-040

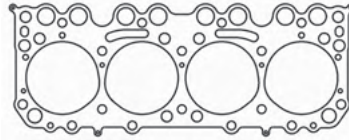

Additional thicknesses available see page 5

### Individual Gaskets

Intake Manifold Gaskets	
Application	Part #
371 J-2 Golden Rocket .060" KF	C5130-060

Exhaust Manifold Gasket Set	
Application	Part #
371 J-2 Golden Rocket .059" CFM	C5131-059

# PONTIAC

## 389 & 421ci V8

### Head Gaskets

MLS Head Gaskets-389 (63-67) & 421 (63-66)			
Bore	Thickness	Pkg Qty	Part #
4.300"	.040"	1	C15262-040
4.300"	.060"	1	C15262-060
4.300"	.080"	1	C15262-080

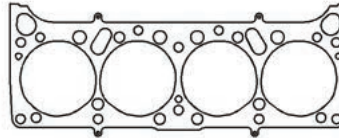

Additional thicknesses available see page 5

## 326, 350, 400, 428, & 455ci V8

### Head Gaskets

MLS Head Gaskets-326 (63-67) & 350 (68-77)			
Bore	Thickness	Pkg Qty	Part #
3.750"	.040"	1	C5767-040
3.950"	.040"	1	C5710-040

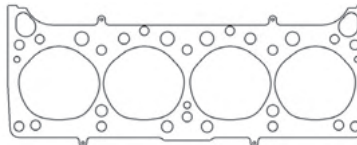

Additional thicknesses available see page 5

MLS Head Gaskets-400 (68-79), 428 (68-69), 455 (70-76)			
Bore	Thickness	Pkg Qty	Part #
4.160"	.040"	1	C5711-040
4.200"	.040"	1	C5769-040
4.300"	.040"	1	C5712-040
4.380"	.040"	1	C5846-040
4.400"	.040"	1	C5847-040

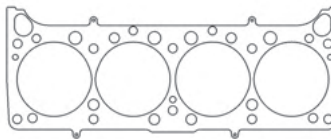

### Individual Gaskets

Molded Rubber Valve Cover Gaskets (sold individually)	
Application	Part #
All Models w/Stock Heads	C5044

Timing Cover Set	
Application	Part #
265-455ci V8 193-81	C5071

Intake Manifold Gaskets	
Application	Part #
400, 428, & 455ci .060" KF	C5778-060
326-455ci .060" HTS w/o EGR	C15197-060

Oil Pan Gasket Kit	
Application	Part #
400, 428, & 455ci 4 pc kit	C5176-094

Exhaust Manifold Gaskets	
Application	Part #
400, 428, & 455ci .064" AM	C5147-064
400, 428, & 455ci D-Port MLS	C5905-030

Water Pump Gasket	
Application	Part #
400, 428, & 455ci .031" Fiber	C5149-031

See page 70 for StreetPro gasket kits



# PONTIAC

326, 350, 400, 428, & 455ci V8

## Gasket Kits



To purchase a complete gasket kit order both top end and bottom end gasket kit

### TOP END GASKET KIT



Application	Part #
Big Block 455ci 7.5L 1970-76 4.200" Bore .....	PRO1010T ...

### BOTTOM END GASKET KIT

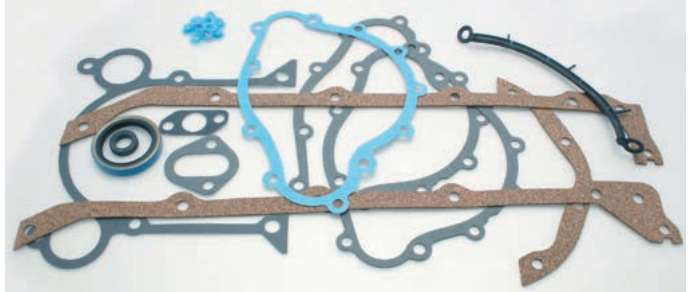

Application	Part #
Big Block 455ci 7.5L 1970-76.....	PRO1010B.....

# AUSTIN

1000cc 4 Cylinder 1958-65 Healey Sprite Mark I & II

## Head Gasket

### Copper Head Gasket

Bore	Thickness	Pkg Qty	Part #
67.5mm	.043"	1	C4145-043

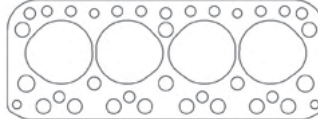

Additional thicknesses available see page 5

1300cc 4 Cylinder Austin Mini

## Head Gasket

### MLS Head Gasket

Bore	Thickness	Pkg Qty	Part #
72mm	.030"	1	C14046-030
72.5mm	.030"	1	C14073-030
73mm	.030"	1	C4146-030
73.5mm	.030"	1	C14038-030

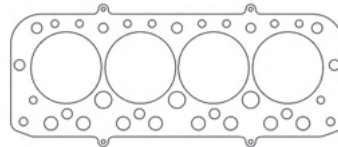

Additional thicknesses available see page 5





# BMW

## M10 4 Cylinder

### Head Gaskets

<b>MLS Head Gasket - 1573/1773cc M116/M118 1963-77</b>			
Bore	Thickness	Pkg Qty	Part #
86mm	.051"	1	C4292-051

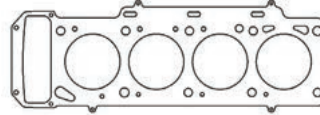

Additional thicknesses available see page 5

<b>MLS Head Gasket - 1766/1990cc M10B18/M10B20 1975-88</b>			
Bore	Thickness	Pkg Qty	Part #
90mm	.051"	1	C4293-051

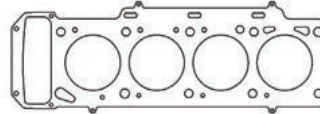

### Individual Gaskets

<b>Valve Cover Gasket</b>	
Application	Part #
BMW M10B18/B20 .125" Cork	C4794-125

<b>Oil Pan Gasket Kit</b>	
Application	Part #
BMW M10B18/B20 .062" KF	C4796-062

<b>Intake Manifold Gasket Set</b>	
Application	Part #
BMW M10B18/B20 .060" KF	C4793

<b>Rear Main Seal</b>	
Application	Part #
BMW M10B18/B20	C4797

<b>Exhaust Manifold Gasket Set</b>	
Application	Part #
BMW M10B18/B20 .064" AM	C4883

<b>Thermostat Gasket</b>	
Application	Part #
BMW M10B18/B20 .031" Fiber	C4795-031

### Gasket Kits



To purchase a complete gasket kit order both top end and bottom end gasket kit

#### TOP END GASKET KIT

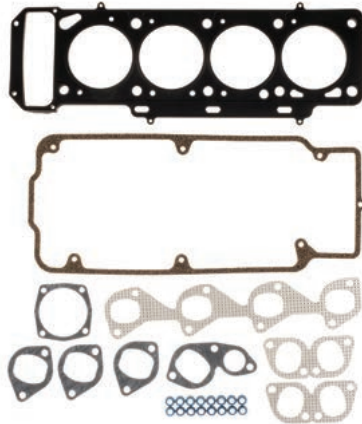

Application	Part #
M10 1.8/2.0L 1966-88 90mm Bore	PRO2027T

#### BOTTOM END GASKET KIT



Application	Part #
M10 1.8/2.0L 1966-88	PRO2027B

## M42 1.8L, M44 1.9L 318is 1989-00, 318ti 1992-00, Z3 1996-01

### Head Gaskets

<b>MLS Head Gaskets</b>			
Bore	Thickness	Pkg Qty	Part #
85mm	.060"	1	C4348-060
86mm	.060"	1	C4349-060

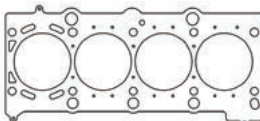

Additional thicknesses available see page 5

### Individual Gaskets



<b>Exhaust Manifold Gasket Set</b>	
Application	Part #
M42B18/M44B18 .060" HTS	C14130-060



# BMW

**S14B20 1990cc 1986-91, S14B23 2302cc 1986-91 M3 86-91, 320is 1988-91**

### Head Gaskets

#### MLS Head Gaskets

Bore	Thickness	Pkg Qty	Part #
93.4mm	.....051"	.....1	C4294-051
94.5mm	.....051"	.....1	C4295-051

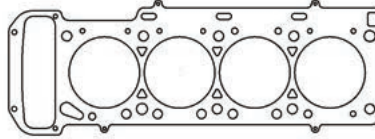

Additional thicknesses available  
see page 5

**M50B20 2.0L 1989-98 320i 1991-95, 520i 1991-95**

### Head Gasket

#### MLS Head Gasket

Bore	Thickness	Pkg Qty	Part #
82mm	.....070"	.....1	C4332-070

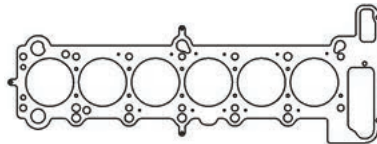

Additional thicknesses available  
see page 5

**M54tuB22 2.2L 1999-Up 320i, 320ci, 520i 00-03, Z3 2001-02, Z4 2003-Up**

### Head Gasket

#### MLS Head Gasket

Bore	Thickness	Pkg Qty	Part #
81mm	.....030"	.....1	C4351-030

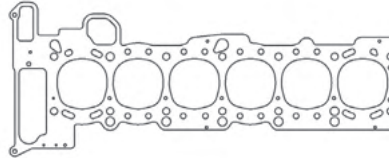

Additional thicknesses available  
see page 5

**M20B20 SOHC 12v 2.0L Inline 6 320 1977-82, 520 1977-81**

### Head Gasket

#### MLS Head Gasket

Bore	Thickness	Pkg Qty	Part #
81mm	.....070"	.....1	C4393-070

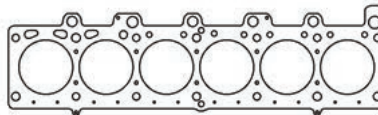

Additional thicknesses available  
see page 5

**M20B25/27 SOHC 12v 2.5/2.7L Inline 6 323i 1977-86, Z1 1988-93, 525e 1983-87, 528e 1981, 325e 1983-87**

### Head Gasket

#### MLS Head Gasket

Bore	Thickness	Pkg Qty	Part #
85mm	.....070"	.....1	C4394-070

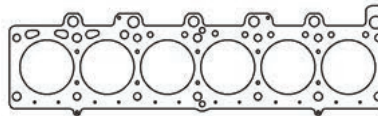

Additional thicknesses available  
see page 5

See page 73 for additional gaskets



# BMW

**M20B25/27 SOHC 12v 2.5 / 2.7L Inline 6 323i 1977-86, Z1 1988-93, 525e 1983-87, 528e 1981, 325e 1983-87**

### Individual Gaskets

Valve Cover Gasket	
Application	Part #
BMW M20 2.5/2.7L .059" CFM .....	<b>C4800-059</b> .....

Oil Pan Gasket	
Application	Part #
BMW M20 2.5/2.7L .....	<b>C4801-060</b> .....

Intake Manifold Gasket Set	
Application	Part #
325e 1984-87 Small Port .....	<b>C4884</b> .....
325/325is 87-93 Normal Ports .....	<b>C4885</b> .....

Rear Main Seal	
Application	Part #
BMW M20 2.5/2.7L .....	<b>C4802</b> .....

Exhaust Manifold Gasket Set	
Application	Part #
BMW M20 2.5/2.7L .064" AM .....	<b>C4798-064</b> .....

Timing Cover Set	
Application	Part #
BMW M20 2.5/2.7L .....	<b>C4803</b> .....

Thermostat Gasket	
Application	Part #
BMW M20 2.5/2.7L .....	<b>C4799</b> .....

Water Pump Gasket	
Application	Part #
BMW M20 2.5/2.7L .020" Fiber .....	<b>C4804-020</b> .....

### Gasket Kits



To purchase a complete gasket kit order both top end and bottom end gasket kit

#### TOP END GASKET KIT

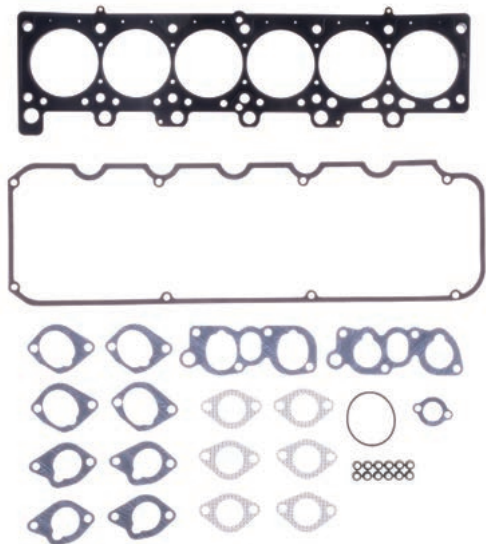

Application	Part #
BMW M20 2.5/2.7L 85mm Bore .....	<b>PRO2028T</b> .....

#### BOTTOM END GASKET KIT

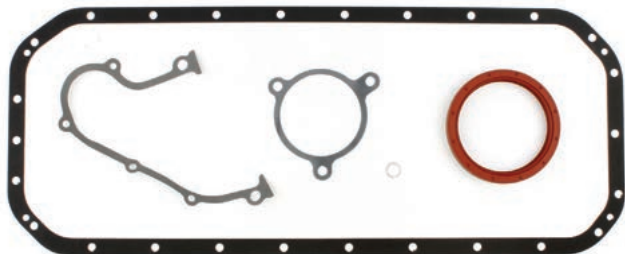

Application	Part #
BMW M20 2.5/2.7L .....	<b>PRO2028B</b> .....

**M30B25/B28 2.5/2.8L Inline 6, 628Csi 1979-81, 525 1973-78, 525i 1978-81, 525 1973-81**

### Head Gasket

MLS Head Gasket			
Bore	Thickness	Pkg Qty	Part #
88mm .....	.070" .....	1 .....	<b>C4475-070</b> .....

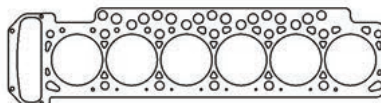

Additional thicknesses available see page 5



# BMW

**M50B25/28 2.5/2.8L Inline 6, 328i 1995-00, 528i 1995-99, 728i 1995-99, Z3 1997-99, 325i 1991-95, 525i 1992-95, 525ix 1992-95**

## Head Gasket

### MLS Head Gasket

Bore	Thickness	Pkg Qty	Part #
85mm	.070"	1	C4328-070
85mm	.092"	1	C4328-092
85mm	.140"	1	C4328-140

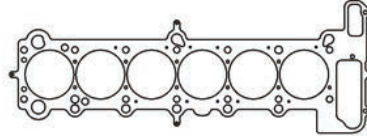

Additional thicknesses available see page 5

### MLX Head Gasket

Bore	Thickness	Pkg Qty	Part #
85mm	.067"	1	C14010-067
85mm	.073"	1	C14010-073
85mm	.142"	1	C14010-142

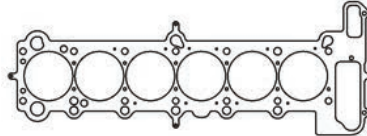

## Individual Gaskets

**NEW!**

### Exhaust Header Gasket Set

Application	Part #
M50B25/28 .060" HTS	C14128-060

**NEW!**

### Timing Cover

Application	Part #
M50B25 .020" Fiber	C14129

**M54tuB25/B28 2.5/2.8L & M52B25/M54B30 325i 2001-05, 325xi 2001-05, 325Ci 2001-06, 525i 2001-03, Z3 2001-06, X5 2001-06**

## Head Gasket

### MLS Head Gasket

Bore	Thickness	Pkg Qty	Part #
85mm	.030"	1	C4352-030

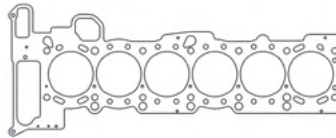

Additional thicknesses available see page 5

**M30B30/B32 3.0/3.2L Inline 6 635Csi 1976-84, 630Cs 1979, 633Csi 1976-79**

## Head Gasket

### MLS Head Gasket

Bore	Thickness	Pkg Qty	Part #
90mm	.070"	1	C4476-070

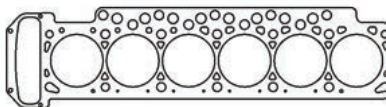

Additional thicknesses available see page 5

**S50B30/S52B32 3.0/3.2L Inline 6 (E36) M3 96-99, M Roadster 96-00, M Coupe 96-00 (US Spec ONLY)**

## Head Gasket

### MLS Head Gasket

Bore	Thickness	Pkg Qty	Part #
87mm	.066"	1	C4329-066
87mm	.070"	1	C4329-070
87mm	.075"	1	C4329-075

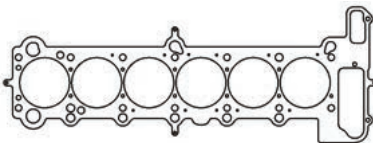

Additional thicknesses available see page 5

## Individual Gaskets

**NEW!**

### Exhaust Header Gasket Set

Application	Part #
M52/S52	C14131-060



# BMW

## S50B30/S52B32 3.0/3.2L Inline 6 (E36) M3 1992-00 (Euro Models Only)

### Head Gasket

MLS Head Gasket			
Bore	Thickness	Pkg Qty	Part #
87mm	.....066"	.....1	C4508-066
87mm	.....070"	.....1	C4508-070
87mm	.....075"	.....1	C4508-075

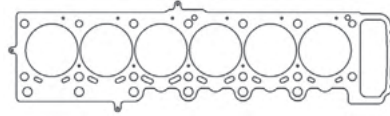

Additional thicknesses available see page 5

## N54B30 3.0L Inline 6 (E60) 535i 2007-10, (E90 / E91 / E92 / E93) 335i 2007-10, (E82 / E88) 135i 2007-10, X6 2008-10, Z4 2009-16

### Head Gasket

MLX Head Gasket			
Bore	Thickness	Pkg Qty	Part #
85mm	.....044"	.....1	C15257-044
85mm	.....048"	.....1	C15257-048
85mm	.....052"	.....1	C15257-052

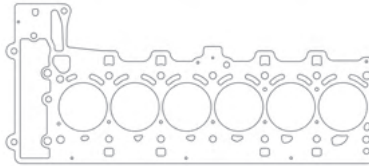

Additional thicknesses available see page 5

## N55B30/N55B30M0/N55B30O0/N55B30T0/N55HP 3.0L Inline 6 335i 2011-16, 435i 2014-16, 535i 11-17, M2 2014-17, X6 2011-17

### MLX Head Gasket

Bore	Thickness	Pkg Qty	Part #
85mm	.....059"	.....1	C15476-044

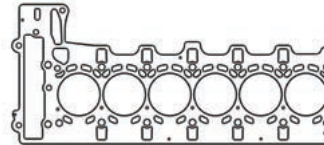

Additional thicknesses available see page 5

## S54B32 3.2L Inline 6 M3 (E46) 2001-06, Z3 (E36) 2001-02, Z4 (E85) 2006-Up

### Head Gasket

MLS Head Gasket			
Bore	Thickness	Pkg Qty	Part #
87.5mm	.....070"	.....1	C4505-070

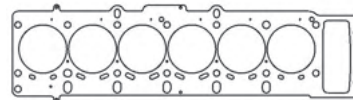

Additional thicknesses available see page 5

## S55B30T0 3.0L Inline 6 M2 Competition 19-20, M3 15-18, M4 15-20

**NEW!**

### MLS Head Gasket

Bore	Thickness	Pkg Qty	Part #
85mm	.....044"	.....1	C14133-044

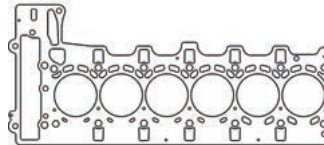

Additional thicknesses available see page 5

## B58B30C/B58B30M0/B58B30M1 3.0L Inline 6 340i 16-18, 640i 16-18, M240i 17-20, X3 18-19

**NEW!**

### MLS Head Gasket

Bore	Thickness	Pkg Qty	Part #
83mm	.....036"	.....1	C14121-036

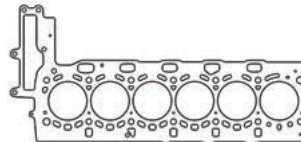

Additional thicknesses available see page 5



# BMW

## M30B34/M30B35 3.4L Inline 6, 5 Series 1985-88, 6 Series 1985-87, 7 Series 1985-87

### Head Gasket

#### MLS Head Gasket

Bore	Thickness	Pkg Qty	Part #
93mm	.070"	1	C4477-070

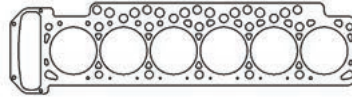

Additional thicknesses available  
see page 5

## S38B35 3.5L Inline 6 M5 1984-92, M5i 1984-92, M6 1984-92

### Head Gasket

#### MLS Head Gasket

Bore	Thickness	Pkg Qty	Part #
95mm	.070"	1	C4478-070

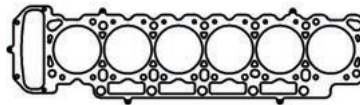

Additional thicknesses available  
see page 5

## S65B40 4.0L V8 M3 (E90, E92, E93) 2007+Up

### Head Gaskets

#### MLS Head Gaskets

Bore	Thickness	Pkg Qty	Part #
93mm	.027"	1	C5111-027
94mm	.027"	1	C5112-027

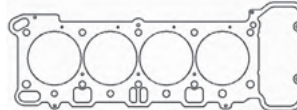

Additional thicknesses available  
see page 5

## N63B44/S63B44 Alpina B6/B7 11-18, 550i 11-17, 650i 12-18, 750i 09-18, M5 13-16, M6 12-18, X5 10-18, X6 08-18

### Head Gasket

#### MLS Head Gasket

Bore	Thickness	Pkg Qty	Part #
90mm	.040"	1	C15475-032
90mm	.040"	1	C15475-040

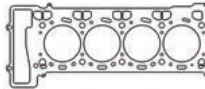

Additional thicknesses available  
see page 5

## N62B44 4.4L V8 X5 04, 745i 04, 745Ci 04, 545i 04, 645Ci 04

### Head Gasket

#### MLS Head Gasket

Bore	Thickness	Pkg Qty	Part #
94mm	.027"	1	C4374-027

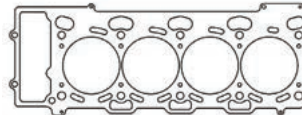

Additional thicknesses available  
see page 5

## S85B50 5.0L V10 M5 2005-Up, M6 2005-Up

### Head Gaskets

#### MLS Head Gaskets

Bore	Thickness	Pkg Qty	Part #
93mm	.027"	1	C4528-027
94.5mm	.027"	1	C4529-027
94.5mm	.045"	1	C4529-045
94.5mm	.051"	1	C4529-051

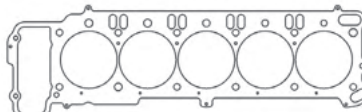

Additional thicknesses available  
see page 5



# COVENTRY CLIMAX

## FWA SOHC 1.1L 1098cc

### Head Gasket

CFM-20 Head Gasket			
Bore	Thickness	Pkg Qty	Part #
74mm	.043"	1	C4301-043
74mm	.059"	1	C4301-059

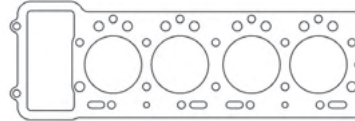

Additional thicknesses available  
see page 5

## FWB/FWE SOHC 1.2L & 1.5L

### Head Gasket

CFM-20 Head Gasket			
Bore	Thickness	Pkg Qty	Part #
78mm	.043"	1	C4139-043
78mm	.059"	1	C4139-059

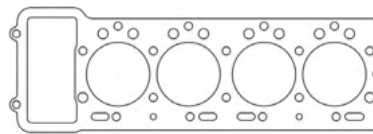

Additional thicknesses available  
see page 5

## FWA/FWB/FWE SOHC 2.0L

### Head Gasket

CFM-20 Head Gasket			
Bore	Thickness	Pkg Qty	Part #
80mm	.043"	1	C4229-043
80mm	.059"	1	C4229-059

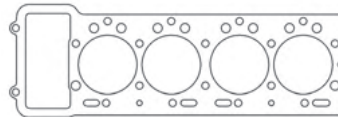

Additional thicknesses available  
see page 5

## FPF DOHC 1.5L

### Head Gasket

CFM-20 Head Gasket			
Bore	Thickness	Pkg Qty	Part #
82mm	.043"	1	C4267-043
82mm	.059"	1	C4267-059

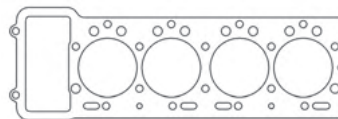

Additional thicknesses available  
see page 5

# FERRARI

## 308 V8 2v 1974-81

### Head Gaskets

MLS Head Gaskets			
Bore	Thickness	Pkg Qty	Part #
81mm	.045"	1	C4430-045
89mm	.045"	1	C4395-045

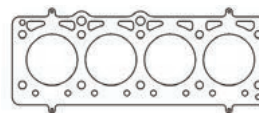

Additional thicknesses available  
see page 5

## 308 V8 4v 1982-84

### Head Gaskets

MLS Head Gaskets			
Bore	Thickness	Pkg Qty	Part #
83mm	.045"	1	C4428-045
89mm	.045"	1	C4429-045

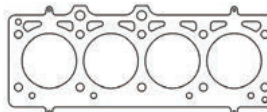

Additional thicknesses available  
see page 5



# FERRARI

## F40 2.9L Twin Turbo V8 1987-92

### Head Gasket

#### MLS Head Gasket

Bore	Thickness	Pkg Qty	Part #
84mm	.....067"	.....1	C4482-067

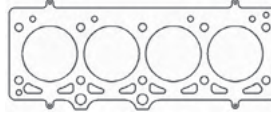

Additional thicknesses available see page 5

# FIAT / LANCIA

## 138.A2 1.5L 1498cc 14 Bolt Head:1986-88 X1/9

### Head Gasket

#### MLS Head Gasket

Bore	Thickness	Pkg Qty	Part #
88mm	.....044"	.....1	C4952-044

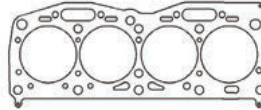

Additional thicknesses available see page 5

## Lancia Delta

### Head Gasket

#### MLS Head Gasket

Bore	Thickness	Pkg Qty	Part #
85mm	.....040"	.....1	C4124-040

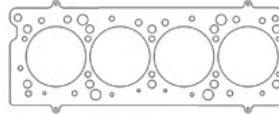

Additional thicknesses available see page 5

# FORD / LOTUS

## 1.6L Duratec Ti-VCT 2011-16

### Head Gasket

#### MLX Head Gasket

Bore	Thickness	Pkg Qty	Part #
82mm	.....028"	.....1	C4963-028

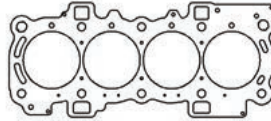

Additional thicknesses available see page 5

## 1.7L Zetec-S 1997-02 Puma

### Head Gasket

#### Rubber Coated Stainles Head Gasket

Bore	Thickness	Pkg Qty	Part #
83mm	.....010"	.....1	C4223-010

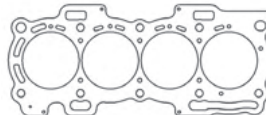

Additional thicknesses available see page 5





# FORD / LOTUS

## 2.0L SOHC/DOHC NEP/YB Group A

### Head Gasket

**NEW!**

#### MLS Head Gasket

Bore	Thickness	Pkg Qty	Part #
92.5mm	.040"	1	C4350-040

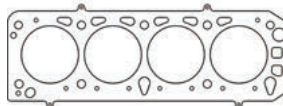

Additional thicknesses available  
see page 5

### Individual Gaskets

#### Intake Gasket Set

Application	Part #
Cosworth YB	C4502

#### Oil Pan Gasket

Application	Part #
Cosworth YB Rails only	C4640

#### Exhaust Manifold Gasket Set

Application	Part #
Cosworth YB	C4334

#### Front Cover Gasket

Application	Part #
Cosworth YB	C4641

#### Valve Cover Gaskets

Application	Part #
Early YB Engine - .060" AFM	C4635
Late YB Engine - .060" AFM	C4636

#### Cooling/Water Pump Gasket

Application	Part #
Water Pump Gasket	C4637
Water Outlet Gasket	C4638
Thermostat Gasket	C4639

## 2.0L 2012-15 EcoBoost DOHC

### Head Gasket

#### MLS Head Gasket

Bore	Thickness	Pkg Qty	Part #
89mm	.034"	1	C15317-034
89mm	.066"	1	C15317-066

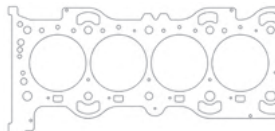

Additional thicknesses available  
see page 5

## 2.3L EcoBoost DOHC: 2016-2018 Ford Focus RS

### Head Gasket

#### MLS Head Gasket

Bore	Thickness	Pkg Qty	Part #
89mm	.040"	1	C15294-040

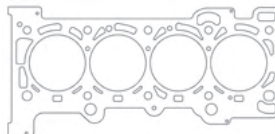

Additional thicknesses available  
see page 5

#### Valve Cover Gasket

Application	Part #
Valve Cover Gasket	C15445



# FORD / LOTUS

## Cosworth Ford 4cyl - FVA 1.6L/FVC 1.8L Gear Driven

### Head Gaskets

#### MLS Head Gaskets

Bore	Thickness	Pkg Qty	Part #
87mm	.040"	1	C4138-040
88mm	.040"	1	C4135-040

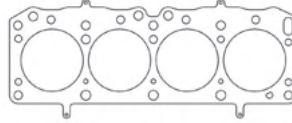

Additional thicknesses available  
see page 5

### Individual Gaskets

#### Valve Cover Gasket

Application	Part #
FVA/FVC .060" AFM	C4887

#### Oil Pan Gasket

Application	Part #
FVA/FVC .060" AFM (Rails only)	C4891

#### Exhaust Gasket Set

Application	Part #
FVA/FVC .064" AM (4 Pack)	C4888

#### Rear Cover Gasket

Application	Part #
FVA/FVC .060" AFM	C4892

#### Thermostat Housing Gasket

Application	Part #
FVA/FVC .060" AFM	C4889

#### Oil Pump Gasket

Application	Part #
FVA/FVC .060" AFM	C4893

#### Front Cylinder Head Cover Gasket

Application	Part #
FVA/FVC .060" AFM	C4890

#### Front Lower Cover Gasket

Application	Part #
FVA/FVC .012" Fiber	C4894

## Cosworth Ford 4cyl 1.1-2.0L - BDA Series/Lotus Twin Cam, All Pushrod, Chain, & Belt Driven

### Head Gaskets

#### MLS Head Gaskets

Bore	Thickness	Pkg Qty	Part #
82mm	.040"	1	C4102-040
83mm	.040"	1	C4103-040
84mm	.040"	1	C4140-040
85mm	.040"	1	C4133-040
86mm	.040"	1	C4142-040
87mm	.040"	1	C4143-040

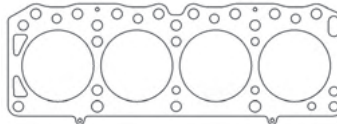

Additional thicknesses available  
see page 5

#### MLS Head Gaskets - BDG

Bore	Thickness	Pkg Qty	Part #
91mm	.040"	1	C4494-040

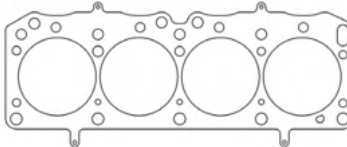

### Individual Gaskets

#### Valve Cover Gaskets

Application	Part #
Lotus Twin Cam Chain Driven	C4895
BDA Belt Driven .060" AFM	C4896

#### Oil Pan Gasket

Application	Part #
BDA Series .060" AFM (Rails only)	C4891

#### Exhaust Gasket Sets

Application	Part #
Lotus Twin Cam 2 Bolt (4pk)	C4355-064
BDA 4 Bolt (4pk)	C4353-064
BDA 3 Bolt (4pk)	C4354-064

#### Rear Cover Gasket

Application	Part #
-------------	--------

#### Intake Gasket Set

Application	Part #
BDA Series/Lotus Twin Cam	C4897

#### Oil Pump Gasket

Application	Part #
BDA Series/Lotus Twin Cam .060" AFM	C4893

#### Thermostat Housing Gasket

Application	Part #
BDA Series/Lotus Twin Cam .060" AFM	C4889

#### Front Lower Cover Gasket

Application	Part #
BDA Series .012" Fiber	C4894



# FORD / LOTUS

## 2.0L Zetec DOHC 4cyl 1995-04

### Head Gasket

MLS Head Gasket			
Bore	Thickness	Pkg Qty	Part #
87mm	.027"	1	C4279-027

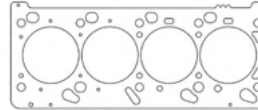

Additional thicknesses available see page 5

### Individual Gaskets

Valve Cover Gaskets	
Application	Part #
2.0L Zetec DOHC 1995-97	C4643
2.0L Zetec DOHC 1998-04	C4644

Valve Stem Seals	
Application	Part #
2.0L Zetec 1995-97 (16pk)	3181V-16
2.0L Zetec 1998-04 (16pk)	3182V-16

Exhaust Gasket Sets	
Application	Part #
2.0L Zetec 1994-04	C4645

Oil Pan Gasket	
Application	Part #
2.0L Zetec 1995-04	C4649

Intake Gasket Set	
Application	Part #
2.0L Zetec 1998-04	C4646
2.0L Zetec 1995-97	C4647

Thermostat Gaskets	
Application	Part #
2.0L Zetec 1995-04 - Seal	C4651
2.0L Zetec 1995-04 - Housing	C4652

Cam Seal Set	
Application	Part #
2.0L Zetec 1994-04	C4648

Rear Main Seal Set	
Application	Part #
2.0L Zetec 1995-04	C4650

### Gasket Kits



To purchase a complete gasket kit order both top end and bottom end gasket kit

#### TOP END GASKET KITS

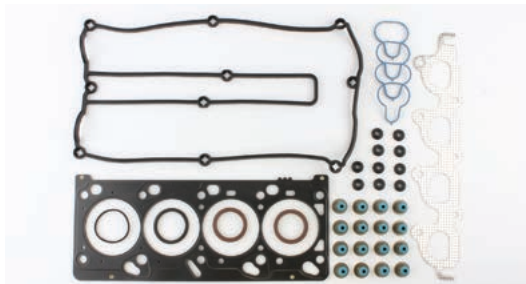

Application	Part #
2.0L Zetec DOHC 1995-97 87mm Bore	PRO2029T
2.0L Zetec DOHC 1998-04 87mm Bore	PRO2030T

#### BOTTOM END GASKET KITS

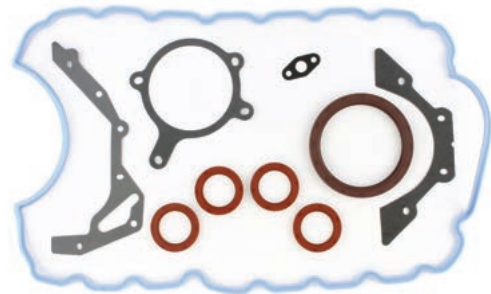

Application	Part #
2.0L Zetec DOHC 1995-97	PRO2029B
2.0L Zetec DOHC 1998-04	PRO2030B



# FORD / LOTUS

## 2.3L "2300" SOHC 1974-97 4cyl

### Head Gaskets

#### MLS Head Gaskets

Bore	Thickness	Pkg Qty	Part #
3.830"	.....040"	.....1	<b>C5369-040</b> .....
3.940"	.....040"	.....1	<b>C5709-040</b> .....

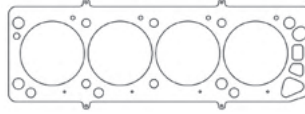

Additional thicknesses available  
see page 5

### Individual Gaskets

#### Valve Cover Gasket

Application	Part #
2300 2.3L 1974-93.....	<b>C4653</b> .....

#### Exhaust Gasket Set

Application	Part #
2300 2.3L 1974-93.....	<b>C5372-064</b> .....

#### Intake Gasket

Application	Part #
2300 2.3L.....	<b>C5371-060</b> .....

#### Valve Stem Seals

Application	Part #
2300 2.3L 1974-93 (need 8).....	<b>3168V</b> .....

#### Oil Pan Gaskets

Application	Part #
2300 2.3L 1974-2/19/86.....	<b>C5373</b> .....
2300 2.3L 2/20/86-1990.....	<b>C4669</b> .....
2300 2.3L 1991-92.....	<b>C4741</b> .....
2300 2.3L 1993.....	<b>C4778</b> .....

Additional thicknesses available  
see page 4

#### Rear Main Seal Sets

Application	Part #
2300 2.3L 1974-81 2pc.....	<b>C5688</b> .....
2300 2.3L 1982-93 1pc.....	<b>C5189</b> .....

#### Water Pump Gasket

Application	Part #
2300 2.3L 1974-93.....	<b>C4654</b> .....

### Gasket Kits



To purchase a complete gasket kit order both top end and bottom end gasket kit

#### TOP END GASKET KIT



Application	Part #
2300 2.3L 1974-97 3.830" Bore.....	<b>PRO2031T</b> .....

#### BOTTOM END GASKET KIT

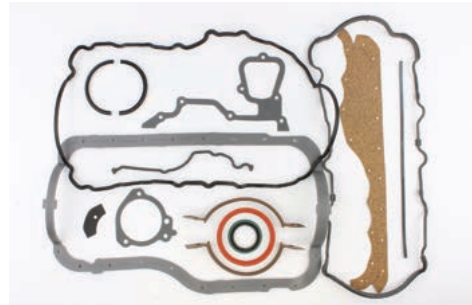

Application	Part #
2300 2.3L 1974-97.....	<b>PRO2031B</b> .....



# FORD / LOTUS

## 2.0L 2003-11 & 2.3L 2003-08 Duratec/Mazda MZR DOHC

### Head Gaskets

<b>MLS Head Gaskets</b>			
Bore	Thickness	Pkg Qty	Part #
89.5mm	.....018"	.....1	<b>C5843-018</b> .....
92mm	.....018"	.....1	<b>C5842-018</b> .....

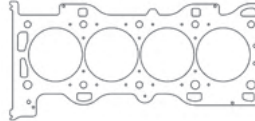

Additional thicknesses available  
see page 5

### Individual Gaskets

<b>Intake Gasket</b>	
Application	Part #
2.3L Duratec 2003-08 .....	<b>C4842-060</b> .....

<b>Exhaust Manifold Gaskets</b>	
Application	Part #
2.3L Duratec (w/ extra port) .....	<b>C4840-064</b> .....
2.3L Duratec (w/o extra port) .....	<b>C4841-064</b> .....

## 3.0L Essex V6 1966-88

### Head Gasket

<b>MLS Head Gasket</b>			
Bore	Thickness	Pkg Qty	Part #
95mm	.....040"	.....1	<b>C4971-040</b> .....



Additional thicknesses available  
see page 5

## 4.0L Barra Inline 6 DOHC 2002-Present

### Head Gaskets

<b>MLS Head Gasket</b>			
Bore	Thickness	Pkg Qty	Part #
93mm	.....030"	.....1	<b>C5957-030</b> .....

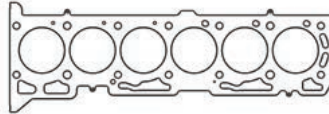

Additional thicknesses available  
see page 5

## 4.0L Intech Inline 6 1998-02

### Head Gaskets

<b>MLS Head Gasket</b>			
Bore	Thickness	Pkg Qty	Part #
3.695"	.....040"	.....1	<b>C4597-040</b> .....



Additional thicknesses available  
see page 5



**GM**

**ECOTEC 4 Cylinder**

**NEW!**

**Head Gaskets**

**MLX Head Gasket - L3A/LE2/LFV/LV7/LYX 1.4L/1.5L 17-20**

Bore	Thickness	Pkg Qty	Part #
75mm	.....044"	.....1	<b>C15565-044</b> .....

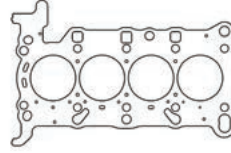

Additional thicknesses available  
see page 5

**MLS Head Gasket - LSJ 2.0L**

Bore	Thickness	Pkg Qty	Part #
87mm	.....027"	.....1	<b>C5921-027</b> .....

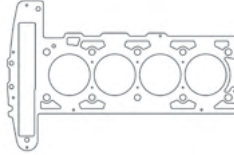

**MLX Head Gasket - LSJ 2.0L**

Bore	Thickness	Pkg Qty	Part #
87mm	.....040"	.....1	<b>C5032-040</b> .....

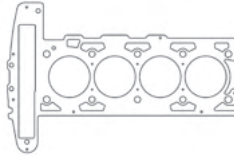

**MLX Head Gasket - LNF 2.0L 08-10**

Bore	Thickness	Pkg Qty	Part #
88mm	.....032"	.....1	<b>C15256-032</b> .....

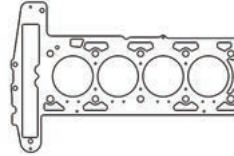

**MLX Head Gasket - LTG 2.0L DOHC**

Bore	Thickness	Pkg Qty	Part #
87mm	.....028"	.....1	<b>C4964-028</b> .....

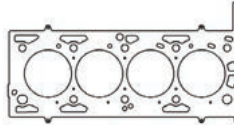

**MLS Head Gaskets - L61/L42 2.2L DOHC**

Bore	Thickness	Pkg Qty	Part #
87mm	.....040"	.....1	<b>C5768-040</b> .....
89mm	.....040"	.....1	<b>C5804-040</b> .....

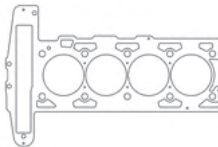

**NEW!**

**MLX Head Gaskets - LAT/LE5/LE9 Gen-2 ECOTEC 2.4L**

Bore	Thickness	Pkg Qty	Part #
89.6mm	.....036"	.....1	<b>C15422-036</b> .....

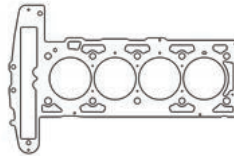

**Individual Gaskets**

**MLS Exhaust Gasket - L42/L61/LAT/LE5 Gen-1/2 ECOTEC 2.2/2.4L**

Application	Part #
2000-2009 2.2/2.4L .....	<b>C4150-030</b> .....

**2.2L 134ci "L43/LN2": Cavalier/Sunfire FWD 1998-02, S-10/Sonoma RWD 1998-03**

**Head Gaskets**

**MLS Head Gaskets**

Bore	Thickness	Pkg Qty	Part #
90mm	.....030"	.....1	<b>C5914-030</b> .....
93mm	.....030"	.....1	<b>C5915-030</b> .....

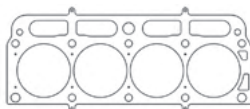

Additional thicknesses available  
see page 5



# GM

## 2.4L 146ci "LD9" Twin Cam 1996-2001

### Head Gaskets

MLS Head Gasket - 1996-99 w/EGR			
Bore	Thickness	Pkg Qty	Part #
3.595"	.030"	1	C5298-030

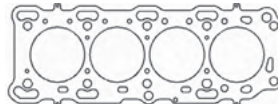

Additional thicknesses available  
see page 5

MLS Head Gaskets - 1999-01 w/o EGR			
Bore	Thickness	Pkg Qty	Part #
3.595"	.030"	1	C5866-030
3.595"	.075"	1	C5866-075

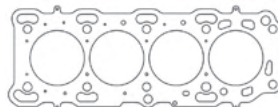

# HOLDEN

## Holden 253/304/308 V8

### Head Gaskets

MLS Head Gasket			
Bore	Thickness	Pkg Qty	Part #
4.100"	.040"	1	C5806-040
4.200"	.040"	1	C5807-040
4.200"	.060"	1	C5807-060

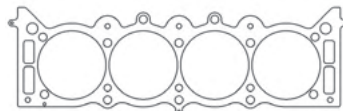

Additional thicknesses available  
see page 5

### Individual Gaskets

**NEW!**

Valve Cover Gasket (sold individually)	
Application	Part #
253/304/308 V8	C15458-188

Fuel Pump Gasket	
Application	Part #
253/304/308 V8	C15456-031

Intake Gasket	
Application	Part #
253/304/308 V8	C15454-060

Exhaust Manifold Gaskets	
Application	Part #
253/304/308 V8	C15453-042

Timing Cover Set	
Application	Part #
253/304/308 V8	C15450-032

Water Pump Gasket	
Application	Part #
253/304/308 V8	C15451-032

Oil Pump Pickup Gasket	
Application	Part #
253/304/308 V8	C15452-032

Distbutor Gasket	
Application	Part #
253/304/308 V8	C15457-031

# HONDA / ACURA

## L15B7 1.5L DOHC VTC Turbo

### Head Gaskets

MLS Head Gasket			
Bore	Thickness	Pkg Qty	Part #
73.5mm	.024"	1	C14019-024

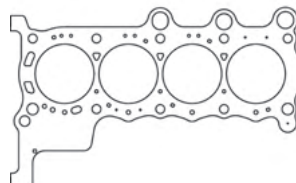

Additional thicknesses available  
see page 5

### Individual Gaskets

Valve Cover Gasket Set	
Application	Part #
L15B7	C14111



# HONDA / ACURA

## D15B1/B2/B7/B8 1988-95, D16A6/A7 1988-91 SOHC

### Head Gaskets

#### MLX Head Gasket

Bore	Thickness	Pkg Qty	Part #
79mm	.....032"	.....1	<b>C14005-040</b>
79mm	.....040"	.....1	<b>C14005-032</b>

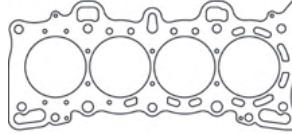

Additional thicknesses available  
see page 5

#### MLS Head Gaskets

Bore	Thickness	Pkg Qty	Part #
75.5mm	.....030"	.....1	<b>C4117-030</b>
76mm	.....030"	.....1	<b>C4118-030</b>
77mm	.....030"	.....1	<b>C4119-030</b>
78mm	.....030"	.....1	<b>C4120-030</b>
79mm	.....030"	.....1	<b>C4121-030</b>

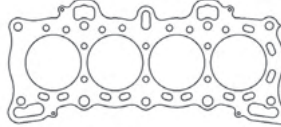

### Individual Gaskets

#### Valve Cover Gasket Set

Application	Part #
D15B1/B2/B7, D16A6/A7	<b>C4701</b>

#### Oil Pan Gasket

Application	Part #
D15B1/B2/B7, D16A6/A7	<b>C4660</b>

#### Intake Gasket

Application	Part #
D15B1/B2/B7, D16A6/A7	<b>C4702-060</b>

#### Rear Main Seal Set

Application	Part #
D15B1/B2/B7, D16A6/A7	<b>C4663</b>

#### Exhaust Manifold Gasket

Application	Part #
D15B1/B2/B7, D16A6/A7 - MLS	<b>C4164-030</b>

#### Front Crank/Oil Pump Seal

Application	Part #
D15B1/B2/B7, D16A6/A7	<b>C4664</b>

#### Valve Stem Seals (sold individually)

Application	Part #
D15B1/B2/B7, D16A6/A7	<b>3170V</b>

#### Timing Cover Dust Seal Sets

Application	Part #
D15B1/B2/B7, D16A6/A7 - Lower	<b>C4661</b>
D15B1/B2/B7, D16A6/A8 - Upper	<b>C4898</b>

#### Cam Seal

Application	Part #
D15B1/B2/B7, D16A6/A7	<b>C4703</b>

#### Water Pump Mounting O-ring

Application	Part #
D15B1/B2/B7, D16A6/A7	<b>C4700</b>

#### Thermostat Seal Set

Application	Part #
D15B1/B2/B7, D16A6/A7	<b>C4704</b>

### Gasket Kits



To purchase a complete gasket kit order both top end and bottom end gasket kit

#### TOP END GASKET KITS



Application	Part #
D15B1/B2/B7 88-95 76mm Bore	<b>PRO2032T</b>
D16A6/A7 88-91 76mm Bore	<b>PRO2034T</b>

#### BOTTOM END GASKET KIT



Application	Part #
D15B1/B2/B7, D16A6/A7	<b>PRO2032B</b>





# HONDA / ACURA

## D16A1/A9 DOHC 1986-89

### Head Gaskets

MLS Head Gaskets			
Bore	Thickness	Pkg Qty	Part #
75.5mm	.030"	1	C4522-030
76mm	.030"	1	C4524-030
77mm	.030"	1	C4525-030
78mm	.030"	1	C4526-030

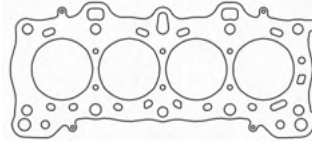

Additional thicknesses available  
see page 5

### Individual Gaskets

Valve Cover Gasket Set	
Application	Part #
D16A1/A9 1986-89	C4706

Oil Pan Gasket	
Application	Part #
D16A1/A9 1986-89	C4660

Intake Gasket	
Application	Part #
D16A1/A9 1986-89	C4707-046

Rear Main Seal Set	
Application	Part #
D16A1/A9 1986-89	C4663

Exhaust Manifold Gasket	
Application	Part #
D16A1/A9 1986-89	C4708

Front Crank/Oil Pump Seal	
Application	Part #
D16A1/A9 1986-89	C4664

Valve Stem Seals (sold individually)	
Application	Part #
D16A1/A9 1986-89	3177V

Water Pump Mounting O-ring	
Application	Part #
D16A1/A9 1986-89	C4700

Cam Seal	
Application	Part #
D16A1/A9 1986-89	C4709

Thermostat Seal	
Application	Part #
D16A1/A9 1986-89	C4710

### Gasket Kits



To purchase a complete gasket kit order both top end and bottom end gasket kit

#### TOP END GASKET KIT

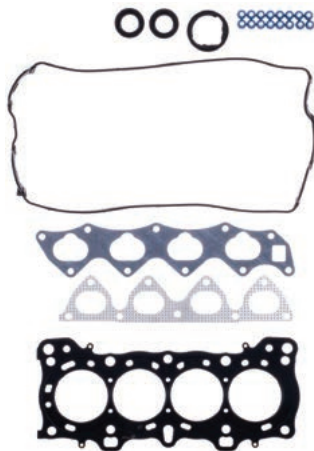

Application	Part #
D16A1/A9 1986-89	PRO2033T

#### BOTTOM END GASKET KIT



Application	Part #
D16A1/A9 1986-89	PRO2033B



# HONDA / ACURA

## D16Z6, D16Y5/Y7/Y8, D15Z1 1992-00 SOHC

### Head Gaskets

#### MLS Head Gaskets

Bore	Thickness	Pkg Qty	Part #
75.5mm	.030"	1	C4251-030
76mm	.030"	1	C4195-030
77mm	.030"	1	C4196-030
78mm	.030"	1	C4167-030
79mm	.030"	1	C4197-030

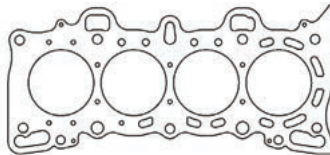

Additional thicknesses available  
see page 5

**NEW!**

#### MLX Head Gaskets

Bore	Thickness	Pkg Qty	Part #
79mm	.032"	1	C14134-032
79mm	.040"	1	C14134-040

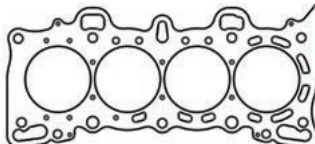

### Individual Gaskets

#### Valve Cover Gasket Sets

Application	Part #
D16Z6 1992-95	C4655
D16Y5/Y7/Y8 1996-00	C4665

#### Throttle Body Gaskets

Application	Part #
D16Z6 1992-95	C4657-032
D16Y5/Y7/Y8 1996-00	C4667-032

#### Intake Gaskets

Application	Part #
D16Z6 1992-95	C4702-060
D16Y5/Y7/Y8 1996-00	C4666

#### Oil Pan Gaskets

Application	Part #
D16Z6 1992-95	C4660
D16Y5/Y8 1996-00	C4670
D16Y7 1996-00	C4899

#### Exhaust Manifold Gasket

Application	Part #
D16Z6, D16Y5/Y7/Y8 - MLS	C4164-030

#### Rear Main Seal Set

Application	Part #
D16Z6, D16Y5/Y7/Y8	C4663

#### Valve Stem Seals (sold individually)

Application	Part #
D16Z6, D16Y5/Y7/Y8	3170V

#### Front Crank/Oil Pump Seal

Application	Part #
D16Z6, D16Y5/Y7/Y8	C4664

#### Cam Seal

Application	Part #
D16Z6, D16Y5/Y7/Y8	C4658

#### Timing Cover Dust Seal Set

Application	Part #
D16Z6, D16Y5/Y7/Y8 - Lower	C4661

#### Thermostat Seal

Application	Part #
D16Z6, D16Y5/Y7/Y8	C4659

#### Water Pump Mounting O-ring

Application	Part #
D16Z6, D16Y5/Y7/Y8	C4662

See page 89 for StreetPro gasket kits



# HONDA / ACURA

## D16Z6, D16Y5/Y7/Y8, D15Z1 1992-00 SOHC

### Gasket Kits



To purchase a complete gasket kit order both top end and bottom end gasket kit

#### TOP END GASKET KITS



Application	Part #
D16Z6 1992-95 76mm Bore .....	PRO2000T .....
D16Y5/Y7/Y8 1996-00 76mm Bore .....	PRO2001T .....

#### BOTTOM END GASKET KIT

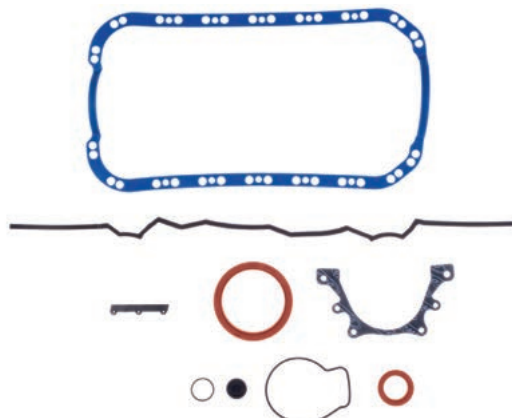

Application	Part #
D16Z6 1992-95.....	PRO2000B .....
D16Y5/Y7/Y8 1996-00.....	PRO2001B .....

## D17A1/D17A2/D17A6 1.7L SOHC 2001-05

### Head Gaskets

#### MLS Head Gaskets

Bore	Thickness	Pkg Qty	Part #
76mm .....	.027" .....	1 .....	C4474-027 .....
77mm .....	.027" .....	1 .....	C4473-027 .....
78mm .....	.027" .....	1 .....	C4472-027 .....
79mm .....	.027" .....	1 .....	C4471-027 .....

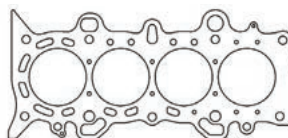

Additional thicknesses available see page 5

### Individual Gaskets

#### Valve Stem Seals (sold individually)

Application	Part #
D17A1/A2/A6.....	3170V.....

#### Rear Main Seal

Application	Part #
D17A1/A2/A6.....	C4678.....

#### Cam Seal

Application	Part #
D17A1/A2/A6.....	C4658.....

#### Water Pump Mounting O-ring

Application	Part #
D17A1/A2/A6.....	C4662.....

## B16A2/B16A3/B17A1/B18C1/B18C5 1.6/1.7/1.8L DOHC VTEC

### Head Gaskets

#### MLX Head Gasket

Bore	Thickness	Pkg Qty	Part #
85mm .....	.043" .....	1 .....	C4999-043 .....

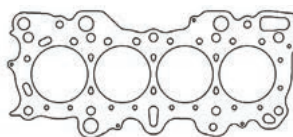

Additional thicknesses available see page 5

See page 90 for additional gaskets



# HONDA / ACURA

## B16A2/A3, B18C1/C5 1.6/1.8L DOHC VTEC

### Head Gaskets

#### MLS Head Gaskets

Bore	Thickness	Pkg Qty	Part #
81mm	.030"	1	C4231-030
81.5mm	.030"	1	C4232-030
82mm	.030"	1	C4168-030
83mm	.030"	1	C4189-030
84mm	.030"	1	C4188-030
85mm	.030"	1	C4182-030
86mm	.030"	1	C14061-030

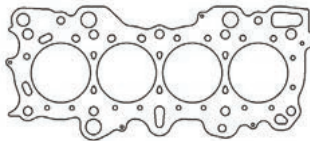

Additional thicknesses available  
see page 5

### Individual Gaskets

#### Valve Cover Gasket Set

Application	Part #
B16A2/A3 & B18C1/C5	C4628

#### Thermostat Seal

Application	Part #
B16A2/A3 & B18C1/C5	C4659

#### Intake Gaskets

Application	Part #
B16A2/A3 & B18C5	C4671-060
B18C1	C4674

#### Throttle Body Gaskets

Application	Part #
B16A3/B18C1 94-95	C4672-032
B16A2, B18C1/C5 96-01	C4656-032

#### Exhaust Manifold Gasket

Application	Part #
B16A2/A3 & B18C1/C5 - MLS	C4151-030

#### Oil Pan Gasket

Application	Part #
B16A2/A3 & B18C1/C5	C4676

#### Valve Stem Seals (sold individually)

Application	Part #
D16Z6, D16Y5/Y7/Y8	3170V

#### Rear Main Seal

Application	Part #
B16A2/A3 & B18C1/C5	C4678

#### Cam Seal Set

Application	Part #
B16A2/A3 & B18C1/C5	C4675

#### Water Pump Mounting O-ring

Application	Part #
B16A2/A3 & B18C1/C5	C4677

### Gasket Kits



To purchase a complete gasket kit order both top end and bottom end gasket kit

#### TOP END GASKET KIT

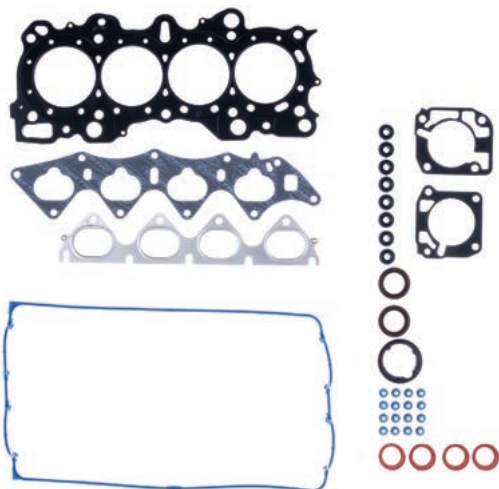

Application	Part #
B16A2/A3, B18C5 82mm Bore	PRO2002T
B18C1 GS-R 82mm Bore	PRO2003T

#### BOTTOM END GASKET KIT



Application	Part #
B16A2/A3, B18C1/C5	PRO2003B



# HONDA / ACURA

## B18A1/B18B1 1.8L DOHC non-VTEC 1990-01

### Head Gaskets

MLS Head Gaskets			
Bore	Thickness	Pkg Qty	Part #
81mm	.030"	1	C4238-030
81.5mm	.030"	1	C4239-030
82mm	.030"	1	C4173-030
83mm	.030"	1	C4181-030
84mm	.030"	1	C4180-030
85mm	.030"	1	C4175-030

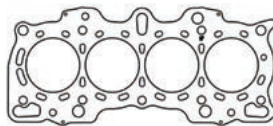

Additional thicknesses available see page 5

### Individual Gaskets

Valve Cover Gasket Set	
Application	Part #
B18A1/B1	C4679

Throttle Body Gasket	
Application	Part #
B18A1 1990-93	C4681
B18B1 1994-95 Manual, 1994-01 Auto Trans Only	C4672-032
B18B1 1996-01 Manual Trans Only	C4656-032

Intake Gasket	
Application	Part #
B18A1/B1 .094" KF	C4680-094

Thermostat Seal	
Application	Part #
B18A1/B1	C4659

Exhaust Manifold Gasket	
Application	Part #
B18A1/B1 - .030" MLS	C4151-030

Oil Pan Gasket Set	
Application	Part #
B18A1/B1	C4676

Valve Stem Seals (sold individually)	
Application	Part #
B18A1/B1	3177V

Rear Main Seal Set	
Application	Part #
B18A1/B1	C4678

Cam Seal Set	
Application	Part #
B18A1/B1	C4709

Water Pump Mounting O-ring	
Application	Part #
B18A1/B1	C4677

### Gasket Kits

To purchase a complete gasket kit order both top end and bottom end gasket kit

#### TOP END GASKET KIT

Application	Part #
B18A1/B1 1990-01 82mm Bore	PRO2004T

#### BOTTOM END GASKET KIT

Application	Part #
B18A1/B1 1990-01	PRO2004B



# HONDA / ACURA

## B Series Hybrid (VTEC Head/non-VTEC Block)

### Head Gaskets

#### MLS Head Gaskets

Bore	Thickness	Pkg Qty	Part #
81mm	.030"	1	C4237-030
81.5mm	.030"	1	C4236-030
82mm	.030"	1	C4191-030
83mm	.030"	1	C4192-030
84mm	.030"	1	C4193-030
84.5mm	.030"	1	C4241-030
85mm	.030"	1	C4194-030

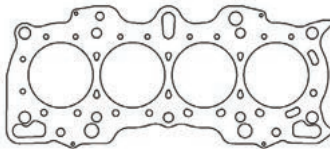

Additional thicknesses available  
see page 5

**NEW!**

#### MLX Head Gasket

Bore	Thickness	Pkg Qty	Part #
85mm	.043"	1	C14000-043

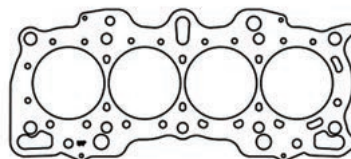

### Individual Gaskets

#### Valve Cover Gasket Set

Application	Part #
B16A2/A3 & B18C1/C5	C4628

#### Thermostat Seal

Application	Part #
B Series	C4659

#### Intake Gaskets

Application	Part #
B16A2/A3 & B18C5	C4674
B18C1	C4671-060

#### Throttle Body Gaskets

Application	Part #
B16A3/B18C1 94-95	C4672-032
B16A2, B18B1/C1/C5, B20Z2, F20C 96-01	C4656-032

#### Exhaust Manifold Gasket

Application	Part #
B16A2/A3 & B18C1/C5 - MLS	C4151-030

#### Oil Pan Gasket Set

Application	Part #
B Series	C4676

#### Valve Stem Seals (sold individually)

Application	Part #
B16A2/A3 & B18C1/C5	3170V

#### Rear Main Seal Set

Application	Part #
B Series	C4678

#### Cam Seal Set

Application	Part #
B16A2/A3 & B18C1/C5	C4675

#### Water Pump Mounting O-ring

Application	Part #
B Series	C4677

### Gasket Kits



To purchase a complete gasket kit order both top end and bottom end gasket kit

#### TOP END GASKET KITS

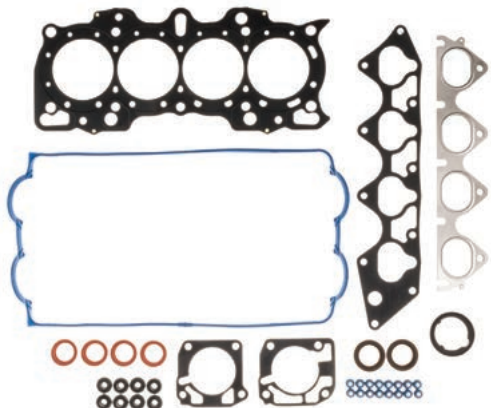

Application	Part #
B20 w/B18C1 Head (GS-R) 84.5mm Bore	PRO2049T
B20 w/B16A2/A3/B18C5 Head 84.5mm Bore	PRO2050T

#### BOTTOM END GASKET KIT



Application	Part #
B Series	PRO2004B



# HONDA / ACURA

## B20B4, B20Z2 2.0L DOHC non-VTEC 1997-01

### Head Gasket

MLS Head Gasket			
Bore	Thickness	Pkg Qty	Part #
85mm	.030"	1	C4250-030

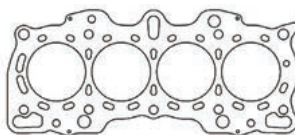

Additional thicknesses available  
see page 5

### Individual Gaskets

Valve Cover Gasket Set	
Application	Part #
B20B4, B20Z2	C4679

Thermostat Seal	
Application	Part #
B20B4, B20Z2	C4659

Intake Gasket	
Application	Part #
B20B4, B20Z2 .094" KF	C4680-094

Oil Pan Gasket Set	
Application	Part #
B18A1/B1	C4676

Exhaust Manifold Gasket	
Application	Part #
B20B4, B20Z2 - .030" MLS	C4151-030

Rear Main Seal	
Application	Part #
B20B4, B20Z2	C4678

Valve Stem Seals (sold individually)	
Application	Part #
B20B4, B20Z2	3177V

Water Pump Mounting O-ring	
Application	Part #
B20B4, B20Z2	C4677

Cam Seal Set	
Application	Part #
B20B4, B20Z2	C4709

**NEW!**

Throttle Body Gaskets	
Application	Part #
B20B4 With Auto Trans Only	C4657-032
B20B4 With Manual Trans Only	C4667-032
B20Z2 With Auto Trans Only	C4672-032
B20Z2 With Manual Trans Only	C4656-032

### Gasket Kits



To purchase a complete gasket kit order both top end and bottom end gasket kit

#### TOP END GASKET KIT

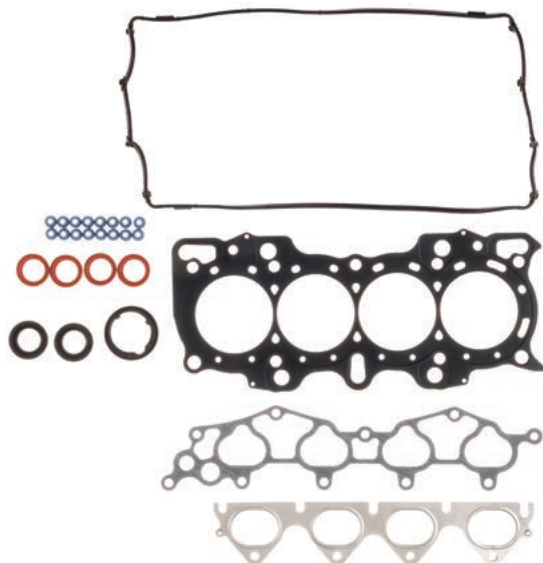

Application	Part #
B20B4, B20Z2 85mm Bore	PRO2035T

#### BOTTOM END GASKET KIT



Application	Part #
B Series	PRO2004B



# HONDA / ACURA

## B20A3/B20A5 2.0L 1988-91

### Head Gaskets

#### MLS Head Gaskets

Bore	Thickness	Pkg Qty	Part #
81.5mm	.045"	1	C4564-045
82mm	.045"	1	C4565-045
83mm	.045"	1	C4566-045
84mm	.045"	1	C4567-045

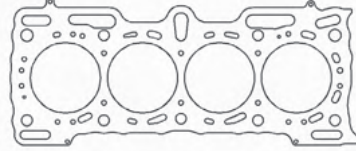

Additional thicknesses available  
see page 5

## F20B 2.0L DOHC 1997-01

### Head Gasket

#### MLS Head Gasket

Bore	Thickness	Pkg Qty	Part #
86mm	.027"	1	C4634-027
86mm	.036"	1	C4634-036

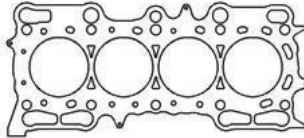

Additional thicknesses available  
see page 5

## B21A1 2.1L 1990-91

### Head Gaskets

#### MLS Head Gaskets

Bore	Thickness	Pkg Qty	Part #
84mm	.040"	1	C4586-040
83mm	.045"	1	C4585-045
84mm	.045"	1	C4586-045

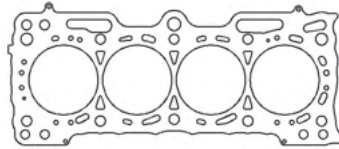

Additional thicknesses available  
see page 5

## K20A2/K20A3/K20Z1/K24A1

### Head Gaskets

#### MLS Head Gaskets

Bore	Thickness	Pkg Qty	Part #
86mm	.030"	1	C4300-030
86.5mm	.030"	1	C14079-030
87mm	.030"	1	C4311-030
87mm	.040"	1	C4311-040
87.5mm	.030"	1	C14039-030
88mm	.030"	1	C4312-030
89mm	.030"	1	C4313-030
90mm	.040"	1	C14043-040

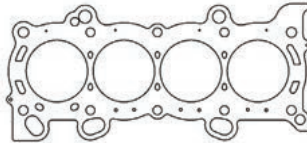

Additional thicknesses available  
see page 5

#### MLX Head Gaskets

Bore	Thickness	Pkg Qty	Part #
89mm	.032"	1	C4596-032
89mm	.036"	1	C4596-036
89mm	.044"	1	C4596-044

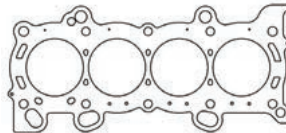

Additional thicknesses available  
see page 5

### Individual Gaskets

#### Exhaust Manifold Gaskets

Application	Part #
K20A1/A3 2002-04 - MLS	C4160-030
K20A2 - MLS	C4162-030

#### Rear Main Seal

Application	Part #
K-Series 2002+	C4705

#### Intake Gasket

Application	Part #
K20A2/A3 2001+	C4668

#### Oil Pan Gasket

Application	Part #
K20A1/A2/A3 2002-2013	C14011-060





# HONDA / ACURA

## K20C1/K20C4 2015-Present Civic Type R; 2018-Present Honda Accord/Acura RDX

### Head Gaskets

#### MLS Head Gaskets

Bore	Thickness	Pkg Qty	Part #
86mm	.028"	1	C14020-028
88mm	.028"	1	C14021-028

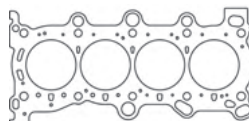

Additional thicknesses available  
see page 5

### Individual Gaskets

**NEW!**

#### Turbo/Exhaust Gasket Kit

Application	Part #
K20C1 MLS	C14022-020

## K20Z3 2.0L 2006-11

### Head Gaskets

#### MLS Head Gaskets

Bore	Thickness	Pkg Qty	Part #
86mm	.030"	1	C4561-030
87mm	.030"	1	C4562-030

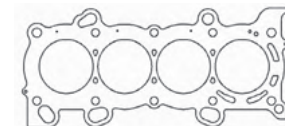

Additional thicknesses available  
see page 5

### Individual Gaskets

#### Valve Cover Gasket

Application	Part #
K-Series 2002+	C14012

#### Exhaust Manifold Gasket

Application	Part #
K20 Exhaust - AM Material	C14007-064

#### Rear Main Seal

Application	Part #
K-Series 2002+	C4705

**NEW!**

#### Intake Gasket

Application	Part #
K20Z3	C14095

#### Oil Pan Gasket

Application	Part #
K20A1/A2/A3 2002-2013	C14011-060

#### Throttle Body Gaskets

Application	Part #
2.0L K20Z3 Fiber	C14008-031

## K24Z2/K24Z7 2.4L 2012-15

### Head Gaskets

#### MLS Head Gaskets

Bore	Thickness	Pkg Qty	Part #
87mm	.030"	1	C4594-030
89mm	.030"	1	C4595-030
89mm	.036"	1	C4595-036

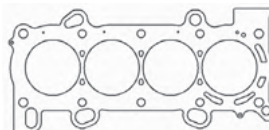

Additional thicknesses available  
see page 5

### Individual Gaskets

#### Rear Main Seal

Application	Part #
K-Series 2002+	C4705

#### Exhaust Manifold Gasket

Application	Part #
K24Z2 / K24Z3 / K24Z6 / K24Z7	C14013-039



# HONDA / ACURA

## H22A1/H22A2 2.2L DOHC VTEC 1992-96

### Head Gaskets

#### MLS Head Gaskets

Bore	Thickness	Pkg Qty	Part #
87mm	.....030"	1	C4255-030
88mm	.....030"	1	C4198-030
89mm	.....0.03	1	C4185-030

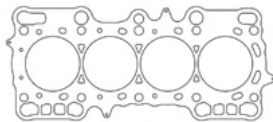

Additional thicknesses available  
see page 5

#### MLX Head Gaskets

Bore	Thickness	Pkg Qty	Part #
89mm	.....032"	1	C14015-032

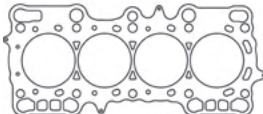

### Individual Gaskets

#### Exhaust Manifold Gasket

Application	Part #
H22A1/H22A2 - MLS	C4155-030

#### Water Pump Gasket

Application	Part #
H22A1/H22A2	C4948

#### Valve Stem Seals (sold individually)

Application	Part #
H22A1/H22A2	3170V

#### Oil Pan Gasket Set

Application	Part #
H22A1/H22A2	C4158

#### Thermostat Seal

Application	Part #
H22A1/H22A2	C4659

#### Rear Main Seal

Application	Part #
H22A1/H22A2	C4678

**NEW!**

#### Cam Seal Set

Application	Part #
H22A1	C4675

## H22A4 1997-01, H22A7 1998-03 2.2L DOHC

### Head Gaskets

#### MLS Head Gaskets

Bore	Thickness	Pkg Qty	Part #
87mm	.....018"	1	C4252-018
87mm	.....030"	1	C4252-030
88mm	.....030"	1	C4253-030
89mm	.....030"	1	C4254-030

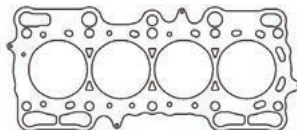

Additional thicknesses available  
see page 5

### Individual Gaskets

#### Exhaust Manifold Gasket

Application	Part #
H22A4/H22A7 - MLS	C4155-030

#### Water Pump Gasket

Application	Part #
H22A4/H22A7	C4948

#### Valve Stem Seals (sold individually)

Application	Part #
H22A4/H22A7	3170V

#### Oil Pan Gasket Set

Application	Part #
H22A4/H22A7	C4158

#### Thermostat Seal

Application	Part #
H22A4/H22A7	C4659

#### Rear Main Seal

Application	Part #
H22A4/H22A7	C4678

**NEW!**

#### Cam Seal Set

Application	Part #
H22A1	C4675



# HONDA

## H23A1 2.3L DOHC VTEC 1992-96

### Head Gaskets

MLS Head Gaskets			
Bore	Thickness	Pkg Qty	Part #
87.5mm	.030"	1	C4553-030
88mm	.030"	1	C4554-030
89mm	.030"	1	C4555-030

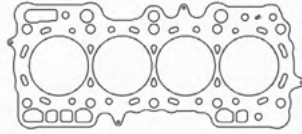

Additional thicknesses available see page 5

### Individual Gaskets

NEW!		Cam Seal Set	
Application		Part #	
H22A1		C4675	

## F22A1/A4 / A6 (1990-93 Accord, 1992-96 Prelude SOHC 16V)

### Head Gaskets

MLS Head Gaskets			
Bore	Thickness	Pkg Qty	Part #
85mm	.045"	1	C14017-045

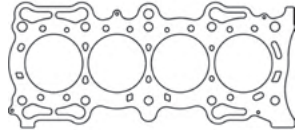

Additional thicknesses available see page 5

## F22B1/B4/B5/B8 2.2L SOHC 1994-97, \*F23A1 1998-02

### Head Gaskets

MLS Head Gaskets			
Bore	Thickness	Pkg Qty	Part #
86mm	.027"	1	C4618-027
87mm	.027"	1	C4619-027*
88mm	.027"	1	C4620-027*
89mm	.027"	1	C4621-027*

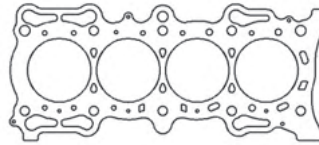

Additional thicknesses available see page 5

### Individual Gaskets

Exhaust Manifold Gasket	
Application	Part #
F22B1/F23A1 1994-01 .064" AM	C4190-064

## F20C1/C2, F22C1 2.0/2.2L DOHC VTEC 1999-09

### Head Gaskets

MLS Head Gaskets			
Bore	Thickness	Pkg Qty	Part #
87.5mm	.030"	1	C4625-030
88mm	.030"	1	C4626-030
88.5mm	.030"	1	C4627-030
89mm	.030"	1	C4335-030

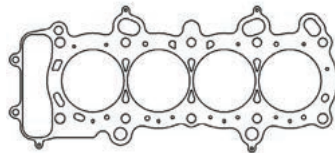

Additional thicknesses available see page 5

### Individual Gaskets

Exhaust Manifold Gasket	
Application	Part #
F20C1/C2 99-09 - MLS	C4159-030



# HONDA

## C30A1, C32B1 DOHC 3.0/3.2L V6 1991-05

### Head Gaskets

#### MLS Head Gaskets

Bore	Thickness	Pkg Qty	Part #
91mm	.030"	1	C4550-030
93mm	.030"	1	C4551-030
95mm	.030"	1	C4277-030

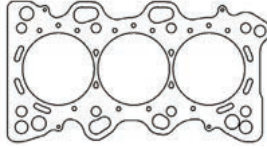

Additional thicknesses available  
see page 5

## J32A1/J32A2/J35A1/J35A3/J35A 3.5L SOHC V6 2001-2004 Stock and Darton Sleeves

### Head Gaskets

#### MLS Head Gasket

Bore	Thickness	Pkg Qty	Part #
90mm	.027"	1	C4382-027

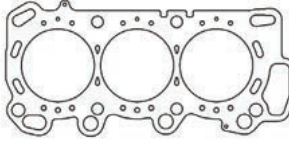

Additional thicknesses available  
see page 5

# HYUNDAI

## 2.0L Theta II Turbo 4 Cylinder, Genesis G70 2019, Gensis Coupe 2010-14, Sonata Limited 2011, Kia Stinger 2018-Up, Kia Forte 2009-2013

### Head Gaskets

#### MLX Head Gasket

Bore	Thickness	Pkg Qty	Part #
88mm	.032"	1	C4953-032

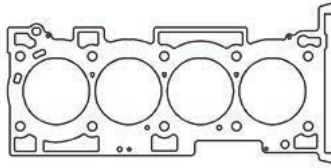

Additional thicknesses available  
see page 5

## 3.8L G6DA DOHC V6 Azera 2007-11, Entourage 2007-10, Genesis 2009-12, Veracruz 2007-11, Kia Sendona 2006-10, Kia Sorento 2007-09

### Head Gaskets

#### MLX Head Gasket - Left Side

Bore	Thickness	Pkg Qty	Part #
98mm	.032"	1	C4632-032

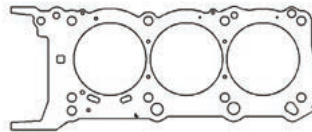

Additional thicknesses available  
see page 5

#### MLX Head Gasket - Right Side

Bore	Thickness	Pkg Qty	Part #
98mm	.032"	1	C4633-032

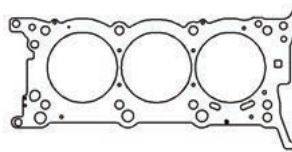



# JAGUAR

**3.4L DOHC Inline 6 XK120 1948-53, XK140 1954-57, XK150 1957-61, Mark VII 1950-57, Mark VIII 1956-58, Mark I 1957-59, Mark II 1959-67, 340 Mark II 1967-68, S-Type 1963-68**

## Head Gaskets

### MLS Head Gaskets

Bore	Thickness	Pkg Qty	Part #
83mm	.040"	1	C4281-040
85mm	.040"	1	C4303-040

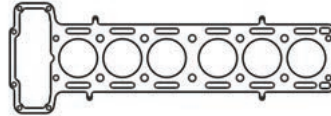

Additional thicknesses available see page 5

### CFM-20 Head Gasket

Bore	Thickness	Pkg Qty	Part #
83mm	.059"	1	C4302-059
85mm	.059"	1	C4304-059

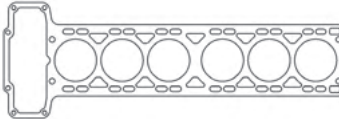

## Individual Gaskets

### Cam Cover Gasket Set

Application	Part #
3.4/3.8/4.2L (Trim to Fit)	C4545-060

### Oil Pan Gasket

Application	Part #
3.4/3.8/4.2L .060" AFM	C4259-060

### Intake Manifold Gaskets

Application	Part #
3.8/4.2L Str Port Head	C4230-060
3.4/3.8L B Type Head	C4244-060

### Engine Cover Gaskets

Application	Part #
Front Main Seal Gasket	C4673-188
Rear Main Seal Gasket	C4901-188

### Exhaust Manifold Gasket

Application	Part #
3.4/3.8/4.2L	C4217-059

### Timing Cover Gasket

Application	Part #
3.4/3.8/E4.2L .018" AFM	C4336-018

### Thermostat Gaskets

Application	Part #
Series 1 1965-67	C4375-060
Series 2 1968-71	C4379-060

### Engine Oil Gaskets

Application	Part #
Oil Feed Gasket	C4949-032
Oil Filter Housing Gasket	C4179-032

### Breather Cover Gasket Set

Application	Part #
3.4/3.8/4.2L	C4544-060

### Water Pump Gasket

Application	Part #
3.4/3.8/E4.2L .018" AFM	C4337-018

**3.8L DOHC Inline 6 XK150 3.8 1958-61, XK150 3.8S 1958-61, Mark IX 1958-61, Mark X 3.8 1961-64, Mark II 1959-67, E-Type Series 1 3.8 1961-64, S-Type 3.8 1963-68**

## Head Gaskets

### MLS Head Gaskets

Bore	Thickness	Pkg Qty	Part #
88mm	.040"	1	C4282-040
88.5mm	.050"	1	C14082-050
89mm	.040"	1	C4306-040

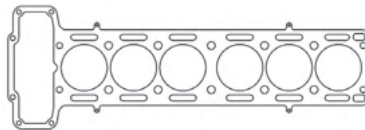

Additional thicknesses available see page 5

### CFM-20 Head Gasket

Bore	Thickness	Pkg Qty	Part #
87mm	.059"	1	C4305-059
88mm	.059"	1	C14041-059
89mm	.059"	1	C4125-059

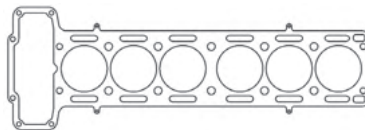

See page 100 for additional gaskets



# JAGUAR

**3.8L DOHC Inline 6 XK150 3.8 1958-61, XK150 3.8S 1958-61, Mark IX 1958-61, Mark X 3.8 1961-64, Mark II 1959-67, E-Type Series 1 3.8 1961-64, S-Type 3.8 1963-68**

## Individual Gaskets

Cam Cover Gasket Set	
Application	Part #
3.4/3.8/4.2L (Trim to Fit)	C4545-060

Oil Pan Gasket	
Application	Part #
3.4/3.8/4.2L .060" AFM	C4259-060

Intake Manifold Gaskets	
Application	Part #
3.8/4.2L Str Port Head	C4230-060
3.4/3.8L B Type Head	C4244-060

Engine Cover Gaskets	
Application	Part #
Front Main Seal Gasket	C4673-188
Rear Main Seal Gasket	C4901-188

Exhaust Manifold Gasket	
Application	Part #
3.4/3.8/4.2L	C4217-059

Timing Cover Gasket	
Application	Part #
3.4/3.8/E4.2L .018" AFM	C4336-018

Thermostat Gaskets	
Application	Part #
Series 1 1965-67	C4375-060
Series 2 1968-71	C4379-060

Engine Oil Gaskets	
Application	Part #
Oil Feed Gasket	C4949-032
Oil Filter Housing Gasket	C4179-032

Breather Cover Gasket Set	
Application	Part #
3.4/3.8/4.2L	C4544-060

Water Pump Gasket	
Application	Part #
3.4/3.8/E4.2L .018" AFM	C4337-018

## 4.0/4.2L AJ26/AJ26S/AJ27/AJ27S/AJ28/AJ33/AJ33S/AJ34/AJ34S V8 UK Engine

### Head Gaskets

MLS Head Gasket - Left Side			
Bore	Thickness	Pkg Qty	Part #
93mm	.030"	1	C4376-030

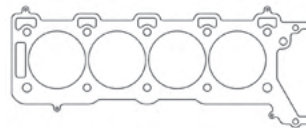

Additional thicknesses available see page 5

MLS Head Gasket - Right Side			
Bore	Thickness	Pkg Qty	Part #
93mm	.030"	1	C4377-030

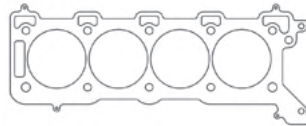

## 3.9L AJ30/AJ35 V8 US Engine

### Head Gaskets

MLS Head Gaskets - Left Side			
Bore	Thickness	Pkg Qty	Part #
87mm	.030"	1	C5772-030
93mm	.030"	1	C5773-030

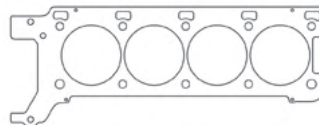

Additional thicknesses available see page 5

MLS Head Gaskets - Right Side			
Bore	Thickness	Pkg Qty	Part #
87mm	.030"	1	C5770-030
93mm	.030"	1	C5771-030

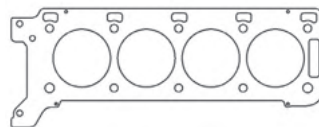



# JAGUAR

## 4.2L Inline 6 Series 1 1965-67, Mark X 4.2 1964-66, 420 1966-68

### Head Gaskets

#### CFM-20 Head Gasket

Bore	Thickness	Pkg Qty	Part #
93mm	.059"	1	C4338-059

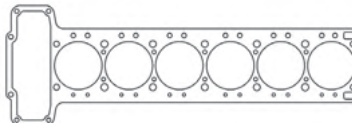

Additional thicknesses available  
see page 5

### Individual Gaskets

#### Cam Cover Gasket Set

Application	Part #
3.4/3.8/4.2L (Trim to Fit)	C4545-060

#### Oil Pan Gasket

Application	Part #
3.4/3.8/4.2L .060" AFM	C4259-060

#### Intake Manifold Gaskets

Application	Part #
3.8/4.2L Str Port Head	C4230-060
3.4/3.8L B Type Head	C4244-060

#### Main Seal Gasket

Application	Part #
Rear Main Seal Gasket	C4901-188

#### Exhaust Manifold Gasket

Application	Part #
3.4/3.8/4.2L	C4217-059

#### Timing Cover Gasket

Application	Part #
3.4/3.8/E4.2L .018" AFM	C4336-018

#### Thermostat Gaskets

Application	Part #
Series 1 1965-67	C4375-060
Series 2 1968-71	C4379-060

#### Engine Oil Gaskets

Application	Part #
Oil Feed Gasket	C4949-032
Oil Filter Housing Gasket	C4179-032

#### Breather Cover Gasket Set

Application	Part #
3.4/3.8/4.2L	C4544-060

#### Water Pump Gasket

Application	Part #
3.4/3.8/E4.2L .018" AFM	C4337-018

## 4.2L Inline 6 E-Type Series 2 1968-70, XJ6 4.2 Series 1 1968-73

### Head Gaskets

#### CFM-20 Head Gasket

Bore	Thickness	Pkg Qty	Part #
93mm	.059"	1	C4220-059

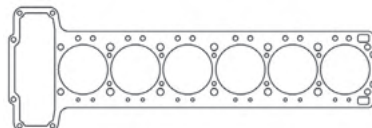

Additional thicknesses available  
see page 5

### Individual Gaskets

#### Cam Cover Gasket Set

Application	Part #
3.4/3.8/4.2L (Trim to Fit)	C4545-060

#### Oil Pan Gasket

Application	Part #
3.4/3.8/4.2L .060" AFM	C4259-060

#### Intake Manifold Gaskets

Application	Part #
3.8/4.2L Str Port Head	C4230-060
3.4/3.8L B Type Head	C4244-060

#### Seal Gasket

Application	Part #
Rear Main Seal Gasket	C4901-188

#### Exhaust Manifold Gasket

Application	Part #
3.4/3.8/4.2L	C4217-059

#### Timing Cover Gasket

Application	Part #
3.4/3.8/E4.2L .018" AFM	C4336-018
4.2L 1970+Up .018" AFM	C4902-018

See page 102 for additional gaskets



# JAGUAR

## 4.2L Inline 6 E-Type Series 2 1968-70, XJ6 4.2 Series 1 1968-73

### Individual Gaskets

#### Thermostat Gaskets

Application	Part #
Series 1 1965-67 .....	C4375-060 .....
Series 2 1968-71 .....	C4379-060 .....

#### Engine Oil Gaskets

Application	Part #
Oil Feed Gasket.....	C4949-032 .....
Oil Filter Housing Gasket.....	C4179-032 .....

#### Breather Cover Gasket Set

Application	Part #
3.4/3.8/4.2L.....	C4544-060 .....

#### Water Pump Gasket

Application	Part #
3.4/3.8/E4.2L .018" AFM.....	C4337-018 .....
4.2L 1970+Up .018" AFM .....	C4903-018 .....

## 4.2L Hi-Performance Inline 6 XJ6 4.2 Series 3 1973-87

### Head Gaskets

#### MLS Head Gaskets

Bore	Thickness	Pkg Qty	Part #
3.670"	.040"	1.....	C4128-040 .....
3.690"	.040"	1.....	C4127-040 .....

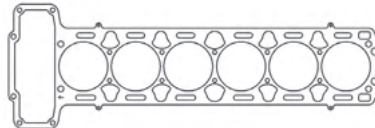

Additional thicknesses available  
see page 5

### Individual Gaskets

#### Cam Cover Gasket Set

Application	Part #
3.4/3.8/4.2L (Trim to Fit) .....	C4545-060 .....

#### Oil Pan Gasket

Application	Part #
3.4/3.8/4.2L .060" AFM .....	C4259-060 .....

#### Intake Manifold Gaskets

Application	Part #
3.8/4.2L Str Port Head .....	C4230-060 .....
3.4/3.8L B Type Head .....	C4244-060 .....

#### Main Seal Gasket

Application	Part #
Rear Main Seal Gasket .....	C4901-188 .....

#### Exhaust Manifold Gasket

Application	Part #
3.4/3.8/4.2L.....	C4217-059 .....

#### Timing Cover Gasket

Application	Part #
4.2L 1970+Up .018" AFM .....	C4902-018 .....

#### Thermostat Gaskets

Application	Part #
Series 1 1965-67 .....	C4375-060 .....
Series 2 1968-71 .....	C4379-060 .....

#### Engine Oil Gaskets

Application	Part #
Oil Feed Gasket.....	C4949-032 .....
Oil Filter Housing Gasket.....	C4179-032 .....

#### Breather Cover Gasket Set

Application	Part #
3.4/3.8/4.2L.....	C4544-060 .....

#### Water Pump Gasket

Application	Part #
4.2L 1970+Up .018" AFM .....	C4903-018 .....

## 5.0L V8 Jaguar AJ133/Land Rover LR-V8: 2009+Up XF, XJ, XK, XFR, XJR, XKR, 2011+Up XKR-S, 2013+Up XFR-S, F-Type Convertible, 2014+Up F-Type Coupe

### Head Gaskets

#### MLX Head Gasket - Left Side

Bore	Thickness	Pkg Qty	Part #
93mm	.040"	1.....	C15001-040 .....

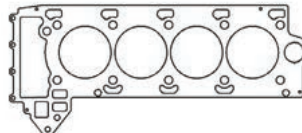

Additional thicknesses available  
see page 5

See page 103 for additional gaskets





# JAGUAR

**5.0L V8 Jaguar AJ133/Land Rover LR-V8: 2009+Up XF, XJ, XK, XFR, XJR, XKR, 2011-Up XKR-S, 2013+Up XFR-S, F-Type Convertible, 2014+Up F-Type Coupe**

<b>MLX Head Gasket - Right Side</b>			
Bore	Thickness	Pkg Qty	Part #
93mm	.040"	1	<b>C15000-040</b>

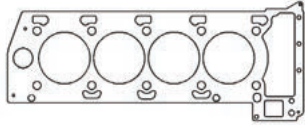

Additional thicknesses available see page 5

# 5.3L V12 1971-93

## Head Gaskets

<b>CFM-20 Head Gaskets - Left Side</b>			
Bore	Thickness	Pkg Qty	Part #
93mm	.059"	1	<b>C4330-059</b>
97mm	.059"	1	<b>C4221-059</b>

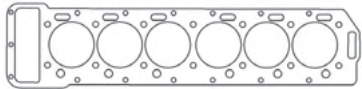

Additional thicknesses available see page 5

<b>CFM-20 Head Gaskets - Right Side</b>			
Bore	Thickness	Pkg Qty	Part #
93mm	.059"	1	<b>C4331-059</b>
97mm	.059"	1	<b>C4222-059</b>

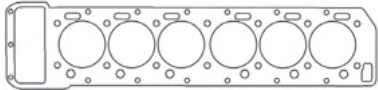

# MAZDA

# B6 1.6L DOHC 16V 1989-93 1597cc

## Head Gaskets

<b>MLS Head Gasket</b>			
Bore	Thickness	Pkg Qty	Part #
80mm	.040"	1	<b>C4122-040</b>

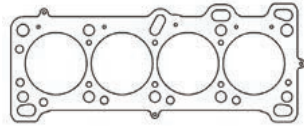

Additional thicknesses available see page 5

## Individual Gaskets

<b>Valve Cover Gasket Set</b>	
Application	Part #
B6 1.6L 89-93	<b>C4781</b>

<b>Rear Main Seal Set</b>	
Application	Part #
B6 1.6L 89-93	<b>C4783</b>

<b>Intake Manifold Gasket</b>	
Application	Part #
B6 1.6L 89-93 .060" KF	<b>C4779-060</b>

<b>Oil Pump Gasket Set</b>	
Application	Part #
B6 1.6L 89-93	<b>C4784</b>

<b>Exhaust Manifold Gasket</b>	
Application	Part #
B6 1.6L 89-93 .030" MLS	<b>C4165-030</b>

<b>Oil Pan Gasket Set</b>	
Application	Part #
B6 1.6L 89-93 (Requires RTV)	<b>C4785</b>

<b>Cam Seal Set</b>	
Application	Part #
B6 1.6L 89-93 (2 Pack)	<b>C4780</b>

<b>Water Pump Gasket</b>	
Application	Part #
B6 1.6L 89-93	<b>C4786</b>

<b>Valve Stem Seals (sold individually)</b>	
Application	Part #
B6 1.6L 89-93	<b>3169V</b>

<b>Thermostat Gasket</b>	
Application	Part #
B6 1.6L 89-93 .046" Fiber	<b>C4782-046</b>

See page 104 for additional gaskets



# MAZDA

## B6 1.6L DOHC 16V 1989-93 1597cc

### Gasket Kits



To purchase a complete gasket kit order both top end and bottom end gasket kit

#### TOP END GASKET KIT

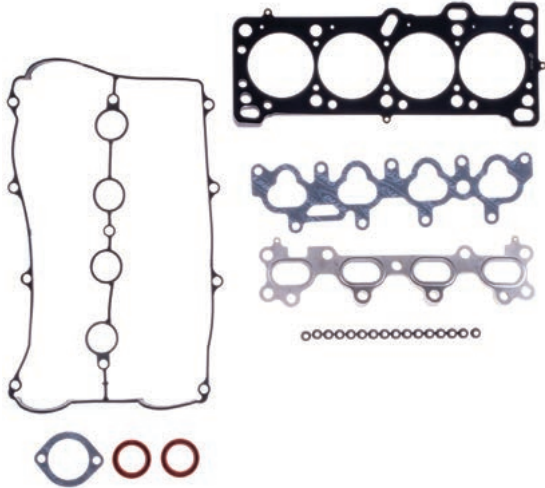

Application: B6 1.6L 89-93 80mm Bore  
Part #: PRO2036T

#### BOTTOM END GASKET KIT



Application: B6 1.6L 89-93  
Part #: PRO2036B

## BP 1.8L DOHC 16V 1994-00 1839cc

### Head Gaskets

#### MLS Head Gaskets

Bore	Thickness	Pkg Qty	Part #
83mm	.040"	1	C4560-040
84mm	.040"	1	C4568-040
85mm	.040"	1	C4569-040

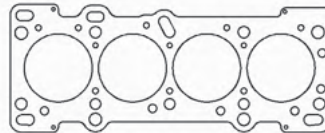

Additional thicknesses available see page 5

## BP-4W Turbo 1.8L DOHC 16V 2001-05 1839cc, 01-03 Miata, 2004-05 Miata Mazdaspeed

### Head Gaskets

#### MLS Head Gaskets

Bore	Thickness	Pkg Qty	Part #
84mm	.040"	1	C4983-040
85mm	.040"	1	C4984-040

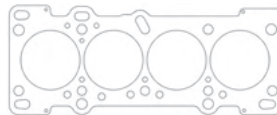

Additional thicknesses available see page 5



# MAZDA

**FS-DE 2.0L DOHC 16V 1993-03 1991cc 93-97 MX-5, 1999-06 Kia Carens, 93-97 Protégé**

### Head Gaskets

MLS Head Gaskets			
Bore	Thickness	Pkg Qty	Part #
84mm	.030"	1	C5844-030
84.5mm	.027"	1	C5845-027

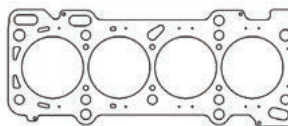

Additional thicknesses available see page 5

### Individual Gaskets

Valve Cover Gasket Set	
Application	Part #
FS-DE 2.0L DOHC	C4788

Oil Pan Gasket Set	
Application	Part #
FS-DE 2.0L DOHC	C4790-062

Intake Manifold Gasket	
Application	Part #
FS-DE 2.0L DOHC	C4787-046

Rear Main Seal Set	
Application	Part #
FS-DE 2.0L DOHC	C4791

Exhaust Manifold Gasket	
Application	Part #
FS-DE 2.0L DOHC .030" MLS	C4171-030

Water Pump Gasket	
Application	Part #
FS-DE 2.0L DOHC	C4792-031

Cam Seal Set	
Application	Part #
FS-DE 2.0L DOHC (2 Pack)	C4780

Thermostat Gasket	
Application	Part #
FS-DE 2.0L DOHC	C4789

Valve Stem Seals (sold individually)	
Application	Part #
FS-DE 2.0L DOHC	3225V

### Gasket Kits



To purchase a complete gasket kit order both top end and bottom end gasket kit

#### TOP END GASKET KIT



Application	Part #
FS-DE 2.0L DOHC 93-03 84mm Bore	PRO2037T

#### BOTTOM END GASKET KIT

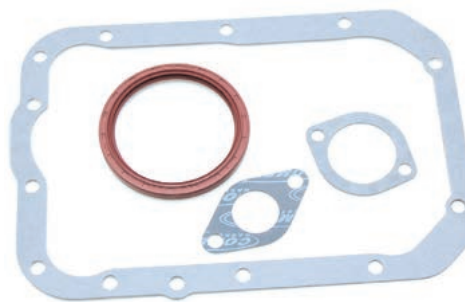

Application	Part #
FS-DE 2.0L DOHC 93-03	PRO2037B



# MAZDA

## MZR 2.3L DOHC 16V 2261cc 2006-13

### Head Gasket

MLS Head Gasket			
Bore	Thickness	Pkg Qty	Part #
89mm	.....030"	.....1	C4481-030

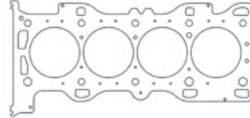

Additional thicknesses available see page 5

MLX Head Gasket			
Bore	Thickness	Pkg Qty	Part #
89mm	.....028"	.....1	C4970-028

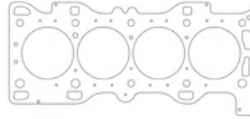

### Timing Cover Gasket

Timing Cover Gasket	
Application	Part #
2006-08 MZR 2.3L	C14028

## MZR 2.5L DISI DOHC 16V 2488cc 2009

### Head Gasket

MLS Head Gasket			
Bore	Thickness	Pkg Qty	Part #
90mm	.....040"	.....1	C5906-040

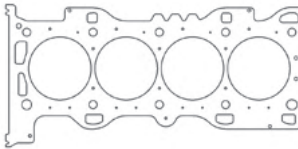

Additional thicknesses available see page 5

# MERCEDES BENZ

## Mercedes-Benz 6.0L M120; 6.9/7.0L M297 V12: 1992-02 600SEC, 600SEL, 600SL, 1997 CLK-GTR

### Head Gaskets

MLS Head Gasket - Left Side			
Bore	Thickness	Pkg Qty	Part #
90mm	.....051"	.....1	C4501-051

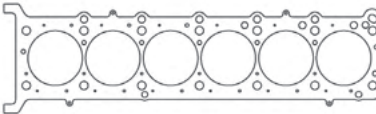

Additional thicknesses available see page 5

MLS Head Gasket - Right Side			
Bore	Thickness	Pkg Qty	Part #
90mm	.....051"	.....1	C4500-051

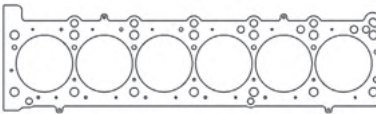

## Mercedes-Benz 7.3L M120/M297 V12: 99-10 Pagani Zonda, 99-05 AMG SL73

### Head Gaskets

MLS Head Gasket - Left Side			
Bore	Thickness	Pkg Qty	Part #
91.5mm	.....051"	.....1	C4504-051

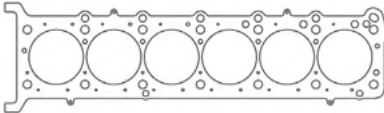

Additional thicknesses available see page 5

MLS Head Gasket - Right Side			
Bore	Thickness	Pkg Qty	Part #
91.5mm	.....051"	.....1	C4503-051

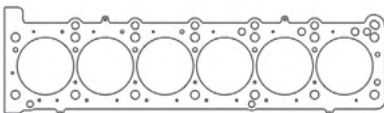



# MG

## Midget 1275cc Austin Series A

### Head Gasket

#### MLS Head Gasket

Bore	Thickness	Pkg Qty	Part #
74mm	.040"	1	C4148-040

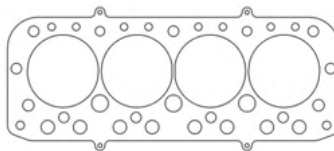

Additional thicknesses available  
see page 5

## MGA1500 / 1600 / 1600 MKII Series B

### Head Gasket

#### MLS Head Gasket

Bore	Thickness	Pkg Qty	Part #
74mm	.040"	1	C4359-040

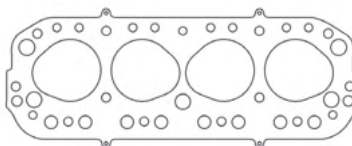

Additional thicknesses available  
see page 5

## MGB 1.8L 18G / 18GA

### Head Gasket

#### MLS Head Gasket

Bore	Thickness	Pkg Qty	Part #
83mm	.040"	1	C4147-040

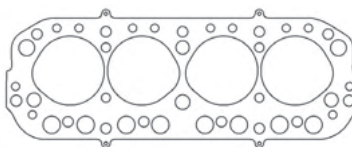

Additional thicknesses available  
see page 5

# MINI

## 1.6L Tritec/Pentagon 1999-06

### Head Gasket

#### MLS Head Gasket

Bore	Thickness	Pkg Qty	Part #
78.5mm	.027"	1	C4308-027

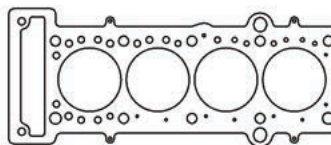

Additional thicknesses available  
see page 5

## 1.6L Turbo Prince / N14B16C / N14B16A / N18B16A / N18B16C 2007-13

### Head Gasket

#### MLX Head Gasket

Bore	Thickness	Pkg Qty	Part #
78mm	.032"	1	C4617-032
78mm	.036"	1	C4617-036
78mm	.040"	1	C4617-040

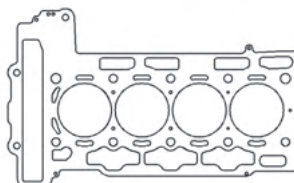

Additional thicknesses available  
see page 5



# MITSUBISHI

**2.0L 4G63/4G63-T DOHC: Eclipse 90-99, EVO 1-3 92-95**

## Head Gaskets

### MLS Head Gaskets

Bore	Thickness	Pkg Qty	Part #
85.5mm	.051"	1	C4233-051
86mm	.051"	1	C4234-051
87mm	.051"	1	C4235-051

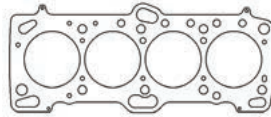

Additional thicknesses available  
see page 5

### MLX Head Gasket

Bore	Thickness	Pkg Qty	Part #
87mm	.050"	1	C4957-050

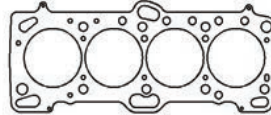

## Individual Gaskets

### Valve Cover Gasket Set

Application	Part #
4G63/T 89-94	C4691

### Throttle Body Gaskets

Application	Part #
4G63/T 91-94	C4693
4G63/T 95-97	C4904

### Intake Manifold Gasket

Application	Part #
4G63/T 89-94	C4692-060

### Oil Pan Gaskets

Application	Part #
4G63/T 89-92	C4695
4G63/T 93-94	C4698

### Exhaust Manifold Gasket

Application	Part #
4G63/T 89-94 .030" MLS	C4199-030

### Water Pump Gasket Set

Application	Part #
4G63/T 89-94	C4696

### Cam Seal Set

Application	Part #
4G63/T 89-94 (2 Pack)	C4905

### Rear Main Seal Set

Application	Part #
4G63/T 89-92	C4697
4G63/T 93-94	C4699

### Valve Stem Seals (sold individually)

Application	Part #
4G63/T 89-94	3173V

### Thermostat Gasket Set

Application	Part #
4G63/T 89-94	C4694

## Gasket Kits



To purchase a complete gasket kit order both top end and bottom end gasket kit

### TOP END GASKET KIT

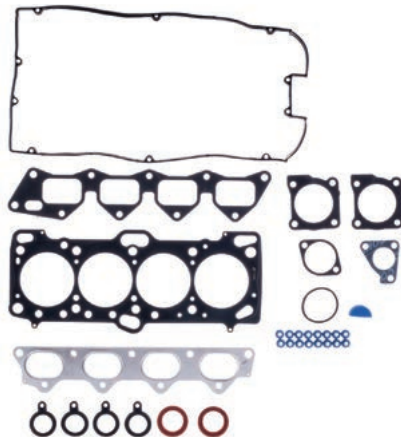

Application	Part #
4G63/T 89-94 84mm Bore	PRO2006T ...

### BOTTOM END GASKET KITS

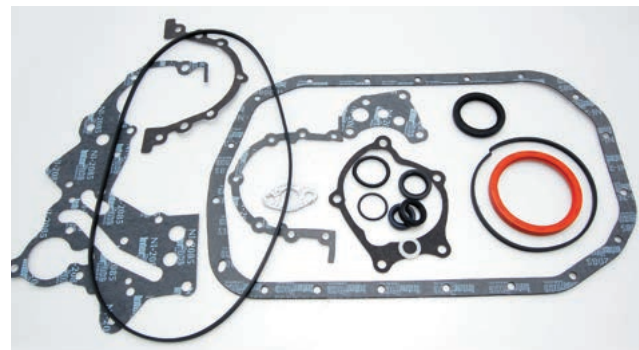

Application	Part #
4G63/T 89-92	PRO2006B
4G63/T 93-94	PRO2007B



# mitsubishi

## 2.0L 4G63 / 4G63-T DOHC:EVO 4-8 1996-05

### Head Gaskets

MLS Head Gaskets			
Bore	Thickness	Pkg Qty	Part #
85mm	.051"	1	C4157-051
86mm	.051"	1	C4156-051
87mm	.051"	1	C4591-051

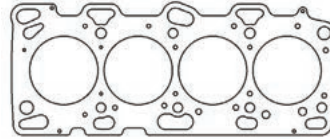

Additional thicknesses available see page 5

MLX Head Gasket			
Bore	Thickness	Pkg Qty	Part #
87mm	.032"	1	C4956-032
87mm	.044"	1	C4956-050
87mm	.050"	1	C4956-050

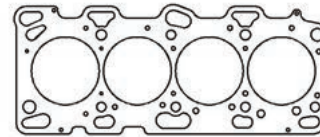

### Individual Gaskets

NEW! Exhaust Manifold Gasket	
Application	Part #
96-06 Evolution	C4199-030

## 2.0L DOHC 4cyl ECC/420A 1995-99

### Head Gaskets

MLS Head Gaskets			
Bore	Thickness	Pkg Qty	Part #
87.5mm	.040"	1	C5497-040
88.5mm	.040"	1	C5498-040

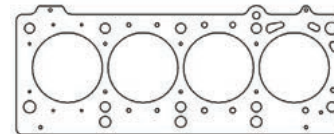

Additional thicknesses available see page 5

### Individual Gaskets

Valve Cover Gasket Set	
Application	Part #
1995-99 2.0L DOHC	C15046

Cam Seal Set	
Application	Part #
Pair - 48 x 35 x 7	C15049

Intake Manifold Gaskets	
Application	Part #
Intake Manifold Gasket - .060" AFM	C15047-060
Intake Plenum Gasket - .031" Fiber	C15048-031

Front Crank Seal Set	
Application	Part #
1995-99 2.0L DOHC	C15053

Exhaust Manifold Gasket	
Application	Part #
2.040" X 1.100" Port - MLS	C4161-030

Oil Pan Gasket	
Application	Part #
Molded Rubber	C15050

Throttle Body Gasket	
Application	Part #
Molded Rubber	C15051

Rear Main Seal	
Application	Part #
1995-99 2.0L DOHC	C15052

Valve Stem Seals Set (16 Pack)	
Application	Part #
5 x 10.8 x 18.3 x 16.9 - Hat Style	3180V-16

See page 110 for StreetPro gasket kits



# MITSUBISHI

## 2.0L DOHC 4cyl ECC/420A 1995-99

### Gasket Kits



To purchase a complete gasket kit order both top end and bottom end gasket kit

#### TOP END GASKET KIT

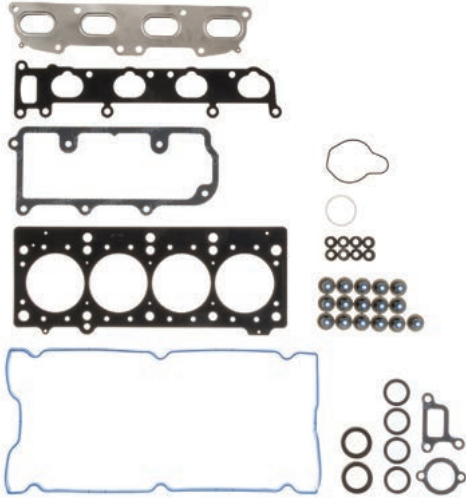

Application	Part #
1995-99 420A 2.0L DOHC 88.5mm Bore .....	<b>PRO2005T</b> ....

#### BOTTOM END GASKET KIT

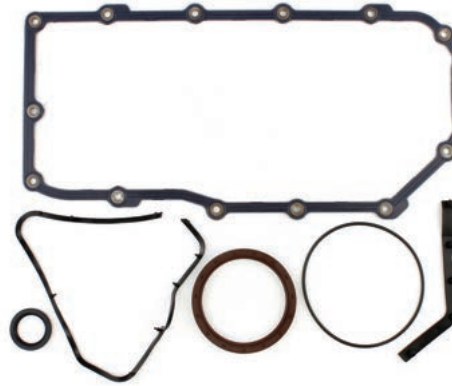

Application	Part #
1995-99 420A 2.0L DOHC .....	<b>PRO2005B</b> .....

## 2.0L 4B11T Turbo 2007+: EVO X 2007-15

### Head Gaskets

#### MLX Head Gaskets

Bore	Thickness	Pkg Qty	Part #
88mm	.....044"	.....1	<b>C4483-044</b> .....
90mm	.....044"	.....1	<b>C4484-044</b> .....

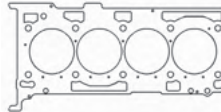

Additional thicknesses available  
see page 5

## 3.0L 6G72 SOHC/DOHC 24v V6 1988-00

### Head Gaskets

#### MLS Head Gaskets

Bore	Thickness	Pkg Qty	Part #
93mm	.....051"	.....1	<b>C4243-051</b> .....
95mm	.....051"	.....1	<b>C4240-051</b> .....

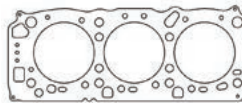

Additional thicknesses available  
see page 5

### Individual Gaskets

#### Valve Cover Gasket Sets

Application	Part #
1988-96 3.0L V6 SOHC .....	<b>C4713</b> .....
1991-00 3.0L V6 DOHC .....	<b>C4722</b> .....

#### Oil Pan Gaskets

Application	Part #
1988-96 3.0L V6 SOHC .....	<b>C4717</b> .....
1991-00 3.0L V6 DOHC .....	<b>C4727</b> .....

#### Intake Manifold Gasket Sets

Application	Part #
1988-96 3.0L V6 SOHC .....	<b>C4714</b> .....
1991-00 3.0L V6 DOHC .....	<b>C4723</b> .....

#### Water Pump Gasket Sets

Application	Part #
1988-96 3.0L V6 SOHC .....	<b>C4719</b> .....
1991-00 3.0L V6 DOHC .....	<b>C4728-020</b> .....

#### Exhaust Manifold Gasket Sets

Application	Part #
1988-96 3.0L V6 SOHC .....	<b>C4715-042</b> .....
1991-00 3.0L V6 DOHC .....	<b>C4724-064</b> .....

#### Rear Main Seal Set

Application	Part #
1988-00 3.0L V6 SOHC/DOHC .....	<b>C4720</b> .....





# MITSUBISHI

## 3.0L 6G72 SOHC/DOHC 24v V6 1988-00

### Individual Gaskets

Cam Seal Sets	
Application	Part #
1988-96 3.0L V6 SOHC (2) .....	<b>C4905</b> .....
1991-00 3.0L V6 DOHC (4) .....	<b>C4725</b> .....

Oil Pump Gasket Kits	
Application	Part #
1988-96 3.0L V6 SOHC .....	<b>C4721</b> .....
1991-00 3.0L V6 DOHC .....	<b>C4729</b> .....

Valve Stem Seals (sold individually)	
Application	Part #
1988-96 3.0L V6 SOHC .....	<b>3157V</b> .....
1991-00 3.0L V6 DOHC .....	<b>3173V</b> .....

Thermostat Gaskets	
Application	Part #
1988-96 3.0L V6 SOHC .....	<b>C4716-032</b> .....
1991-00 3.0L V6 DOHC .....	<b>C4726</b> .....

### Gasket Kits



To purchase a complete gasket kit order both top end and bottom end gasket kit

#### TOP END GASKET KITS

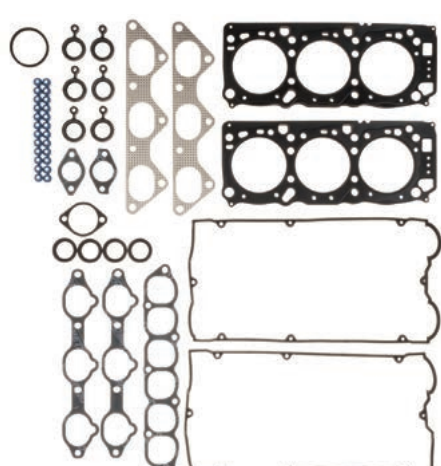

Application	Part #
1988-96 3.0L V6 SOHC 93mm Bore .....	<b>PRO2038T</b> .....
1991-00 3.0L V6 DOHC 93mm Bore .....	<b>PRO2039T</b> .....

#### BOTTOM END GASKET KITS

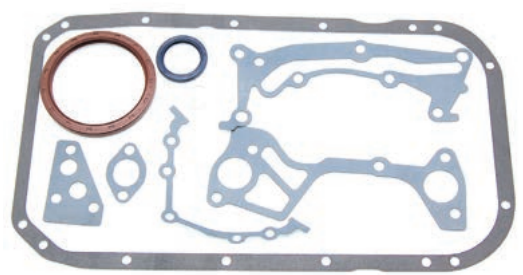

Application	Part #
1988-96 3.0L V6 SOHC .....	<b>PRO2038B</b> .....
1991-00 3.0L V6 DOHC .....	<b>PRO2039B</b> .....

# NISSAN

## 1.5L E15, E15S, E15T SOHC Pulsar 1980-86, Ninja Gayin 1984-94, Sunny 1980-86

### Head Gasket

MLS Head Gasket			
Bore	Thickness	Pkg Qty	Part #
77mm	.040"	1	<b>C4178-040</b> .....

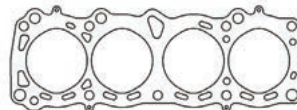

Additional thicknesses available see page 5

### Individual Gaskets

Valve Cover Gasket Set	
Application	Part #
E15T 1983-84 .....	<b>C4906</b> .....

Cam Seal	
Application	Part #
E15T 1983-84 .....	<b>C4910</b> .....

Intake Manifold Gasket	
Application	Part #
E15T 1983-84 .....	<b>C4907</b> .....

Rear Main Seal Set	
Application	Part #
E15T 1983-84 .....	<b>C4763</b> .....

See page 112 for additional gaskets



# NISSAN

## 1.5L E15, E15S, E15T SOHC Pulsar 1980-86, Ninja Gayin 1984-94, Sunny 1980-86

### Individual Gaskets

#### Exhaust Manifold Gaskets

Application	Part #
1982-83 E15S SOHC .....	<b>C4908</b> .....
1983-84 E15T SOHC .....	<b>C4909</b> .....

#### Front Crank Set

Application	Part #
E15T 1983-84 .....	<b>C4912</b> .....

#### Valve Stem Seals (sold individually)

Application	Part #
E15T 1983-84 .....	<b>3159V</b> .....

#### Water Pump Gasket Set

Application	Part #
E15T 1983-84 .....	<b>C4913</b> .....

## 1.6L MR16DDT Juke 2011-2017, 2017-Present Sentra SR Turbo & NISMO

### Head Gasket

#### MLS Head Gasket

Bore	Thickness	Pkg Qty	Part #
81mm .....	.032" .....	1 .....	<b>C4965-032</b> .....

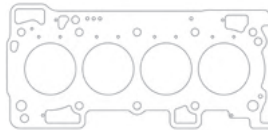

Additional thicknesses available  
see page 5

## 1.8L CA18 SOHC Skyline R31 1988-90, Skyline R32 GXi 1988-90, Skyline HR31 1985-91, Silvia Turbo 1984-89, 180SX 1981-83, 200SX 1984-88, Bluebird Turbo 1991-93, Bluebird 1983-85, 200SX Turbo 1984-87, Pulsar 1981-83, Sunny 1988-91

### Head Gaskets

#### MLS Head Gasket

Bore	Thickness	Pkg Qty	Part #
85mm .....	.051" .....	1 .....	<b>C4479-051</b> .....

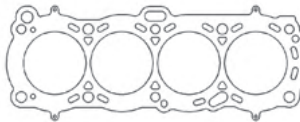

Additional thicknesses available  
see page 5

## 1.8L CA18 DOHC Skyline HR31 1985-91, Silvia Turbo 1989-90, 180SX P/S13 1989-90, 200SX S13-U 1989-93, Bluebird Turbo 1987-89, Bluebird 1987-89, 200SX Turbo 1989-93, Pulsar, Sunny N13/B12 Coupe mid 80s

### Head Gaskets

#### MLS Head Gasket

Bore	Thickness	Pkg Qty	Part #
85mm .....	.051" .....	1 .....	<b>C4480-051</b> .....

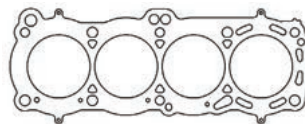

Additional thicknesses available  
see page 5

### Individual Gaskets

#### Valve Cover Gasket Set

Application	Part #
CA18DE/DET 1.8L .....	<b>C4607</b> .....

#### Throttle Body Gaskets

Application	Part #
CA18DE/DET 1.8L (pair) .....	<b>C4740-032</b> .....

#### Intake Manifold Gasket Set

Application	Part #
CA18DE/DET 1.8L .....	<b>C4742</b> .....

#### Rear Main Seal Set

Application	Part #
CA18DE/DET 1.8L .....	<b>C4737</b> .....

#### Exhaust Manifold Gasket Set

Application	Part #
CA18DE/DET 1.8L MLS 4pcs .....	<b>C4523</b> .....

#### Water Pump Gasket

Application	Part #
CA18DE/DET 1.8L .....	<b>C4736-018</b> .....

See page 113 for additional gaskets



# NISSAN

**1.8L CA18 DOHC: Skyline HR31 1985-91, Silvia Turbo 1989-90, 180SX P/S13 1989-90, 200SX S13-U 1989-93, Bluebird Turbo 1987-89, Bluebird 1987-89, 200SX Turbo 1989-93, Pulsar, Sunny N13/B12 Coupe mid 80s**

## Individual Gaskets

Cam Seal Set	
Application	Part #
CA18DE/DET 1.8L (pair) .....	C4739.....

Oil Pump Gasket	
Application	Part #
CA18DE/DET 1.8L.....	C4738-020.....

Valve Stem Seals (sold individually)	
Application	Part #
CA18DE/DET 1.8L.....	3175V.....

Front Crank Seal	
Application	Part #
CA18DE/DET 1.8L.....	C4914.....

## Gasket Kits

To purchase a complete gasket kit order both top end and bottom end gasket kit

### TOP END GASKET KIT

Application	Part #
CA18DE/DET 1.8L 85mm Bore.....	PRO2018T ..

### BOTTOM END GASKET KIT

Application	Part #
CA18DE/DET 1.8L.....	PRO2018B.....

**2.0L FJ20E/ET 240RS 1983-85, Skyline DR30 1983-85, Silvia 1983-85**

## Head Gaskets

MLS Head Gaskets			
Bore	Thickness	Pkg Qty	Part #
90mm .....	.051" .....	1.....	C4326-051 .....
91mm .....	.051" .....	1.....	C4327-051 .....

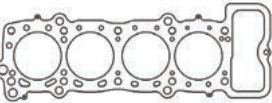

Additional thicknesses available see page 5

**1.6L SR16VE/2.0L SR20VE DOHC 1997-01 Pulsar, Lucino, Primera, Bluebird, Wingroad, Sunny**

## Head Gasket

MLS Head Gaskets			
Bore	Thickness	Pkg Qty	Part #
87mm .....	.040" .....	1.....	C4600-040 .....
88mm .....	.040" .....	1.....	C4601-040 .....



Additional thicknesses available see page 5

## Individual Gaskets

Valve Cover Gasket Set	
Application	Part #
SR16VE/SR20VE.....	C4730.....

Throttle Body Gasket	
Application	Part #
SR16VE/SR20VE.....	C4733-018.....

See page 114 for additional gaskets



# NISSAN

**1.6L SR16VE/2.0L SR20VE DOHC Pulsar, Lucino, Primera, Bluebird, Wingroad, Sunny 1997-01**

### Individual Gaskets

Intake Manifold Gasket Set	
Application	Part #
SR16VE/SR20VE .....	<b>C4731</b> .....

Rear Main Seal	
Application	Part #
SR16VE/SR20VE .....	<b>C4734</b> .....

**NEW!**

Exhaust Manifold Gasket Set	
Application	Part #
SR16VE/SR20VE .....	<b>C4732-064</b> .....
SR16VE/SR20VE MLS .....	<b>C4995-030</b> .....

Oil Pump Gasket	
Application	Part #
SR16VE/SR20VE .....	<b>C4735-020</b> .....

Valve Stem Seals (sold individually)	
Application	Part #
SR16VE/SR20VE .....	<b>3175V</b> .....

Front Crank Seal	
Application	Part #
SR16VE/SR20VE .....	<b>C4915</b> .....

### Gasket Kits



To purchase a complete gasket kit order both top end and bottom end gasket kit

#### TOP END GASKET KIT

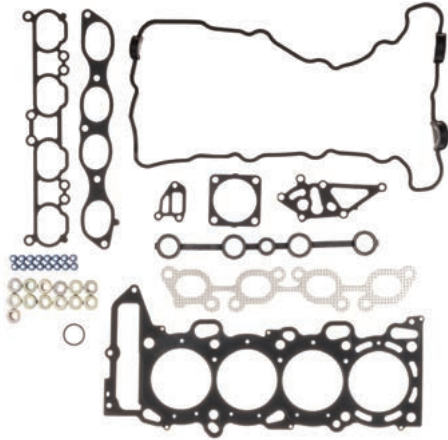

Application	Part #
SR16VE/SR20VE 88mm Bore .....	<b>PRO2053T</b> .....

#### BOTTOM END GASKET KIT



Application	Part #
SR16VE/SR20VE .....	<b>PRO2053B</b> .....

**2.0L SR20DE/DET DOHC FWD 180SX 1991-92/1994-97, 200SX SE-R 1995-98, Almera 1996-98, Avenir 1990/92/1995/97-01, Bluebird 1989/91-1993/95-98, Liberty 1998-00, Infinity G20 1991-02, NX2000 1991-93, Pulsar 1991-00, Sentra 1991-94/98-01**

### Head Gaskets

MLS Head Gaskets			
Bore	Thickness	Pkg Qty	Part #
87mm .....	.030" .....	1 .....	<b>C4575-030</b> .....
88.5mm .....	.030" .....	1 .....	<b>C4130-030</b> .....



Additional thicknesses available see page 5

### Individual Gaskets

Valve Cover Gasket Sets	
Application	Part #
SR20DE/DET FWD 91-96 .....	<b>C4747</b> .....
SR20DE/DET FWD 97-01 .....	<b>C4730</b> .....

Thermostat Gasket Set	
Application	Part #
SR20DE/DET FWD 91-01 .....	<b>C4916</b> .....

See page 115 for additional gaskets



# NISSAN

**2.0L SR20DE/DET DOHC FWD**  
 91-92/94-97 180SX, 95-98 200SX SE-R, 96-98 Almera, 90/92-95/97-01 Avenir,  
 89/91-93/95-98 Bluebird, 98-00 Liberty,  
 91-02 Infinity G20, 91-93 NX2000, 91-00 Pulsar, 91-94/98-01 Sentra

## Individual Gaskets

<b>Intake Manifold Gaskets</b>	
Application	Part #
SR20DE/DET FWD 91-93 .....	<b>C4746</b> .....
SR20DE/DET FWD 94-01 .....	<b>C4749</b> .....

<b>Oil Pan Gasket</b>	
Application	Part #
SR20DE/DET FWD 91-01 .....	<b>C4744-156</b> .....

<b>Exhaust Manifold Gasket Set</b>	
Application	Part #
SR20DE/DET FWD 91-01 MLS .....	<b>C4200-030</b> .....

<b>Water Pump Gasket</b>	
Application	Part #
SR20DE/DET FWD 91-01 .....	<b>C4745-031</b> .....

<b>Throttle Body Gasket</b>	
Application	Part #
SR20DE/DET FWD 91-01 .....	<b>C4733-018</b> .....

<b>Oil Pump Gasket</b>	
Application	Part #
SR20DE/DET FWD 91-01 .....	<b>C4743</b> .....

<b>Valve Stem Seals (sold individually)</b>	
Application	Part #
SR20DE/DET FWD 91-01 .....	<b>3175V</b> .....

<b>Front Crank Seal</b>	
Application	Part #
SR20DE/DET FWD 91-01 .....	<b>C4915</b> .....

## Gasket Kits

**STREETPRO** by Cometic Gasket To purchase a complete gasket kit order both top end and bottom end gasket kit

### TOP END GASKET KIT

### BOTTOM END GASKET KIT

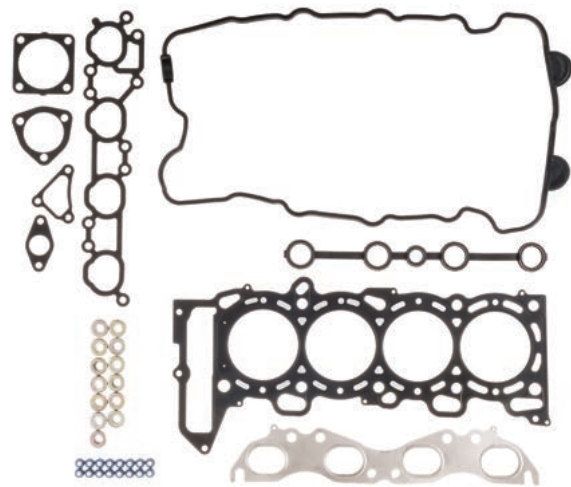

Application	Part #
SR20DE/DET FWD 91-96 87mm Bore .....	<b>PRO2012T</b> .....
SR20DE/DET FWD 97-01 87mm Bore .....	<b>PRO2011T</b> .....

Application	Part #
SR20DE/DET FWD 91-01 .....	<b>PRO2012B</b> .....

## 2.0L SR20DE/DET DOHC S13 1989-93

### Head Gasket

<b>MLS Head Gasket</b>			
Bore	Thickness	Pkg Qty	Part #
87.5mm .....	.045" .....	1 .....	<b>C4324-045</b> .....

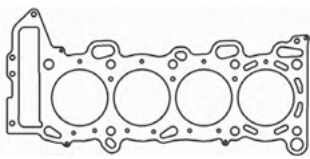

Additional thicknesses available see page 5



# NISSAN

## 2.0L SR20DE/DET DOHC S13 1989-93

### Individual Gaskets

#### Valve Cover Gasket Set

Application	Part #
SR20DE/DET S13 89-93.....	<b>C4753</b> .....

#### Intake Manifold Gasket Set

Application	Part #
SR20DE/DET S13 89-93.....	<b>C4752</b> .....

#### Exhaust Manifold Gasket Set

Application	Part #
SR20DE/DET S13 89-93 MLS .....	<b>C4200-030</b> .....

#### Valve Stem Seals (sold individually)

Application	Part #
SR20DE/DET S13 - EXH .....	<b>3158V</b> .....
SR20DE/DET S13 - INT .....	<b>3175V</b> .....

#### Throttle Body Gasket

Application	Part #
SR20DE/DET S13 89-93 .....	<b>C4733-018</b> .....

#### Thermostat Gasket Set

Application	Part #
SR20DE/DET S13 89-93.....	<b>C4758</b> .....

#### Rear Main Seal Set

Application	Part #
SR20DE/DET S13 89-93.....	<b>C4743</b> .....

#### Front Crank Seal

Application	Part #
SR20DE/DET S13 89-93.....	<b>C4915</b> .....

### Gasket Kits



To purchase a complete gasket kit order both top end and bottom end gasket kit

#### TOP END GASKET KIT

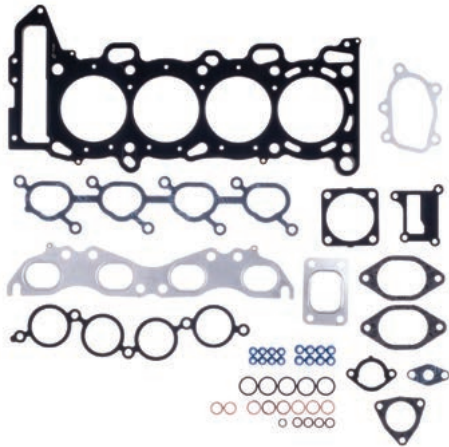

Application	Part #
SR20DE/DET S13 w/o VC Set 87.5mm Bore ..	<b>PRO2008T</b> ....
SR20DE/DET S13 89-93 88mm Bore .....	<b>PRO2053T</b> ...

#### BOTTOM END GASKET KIT

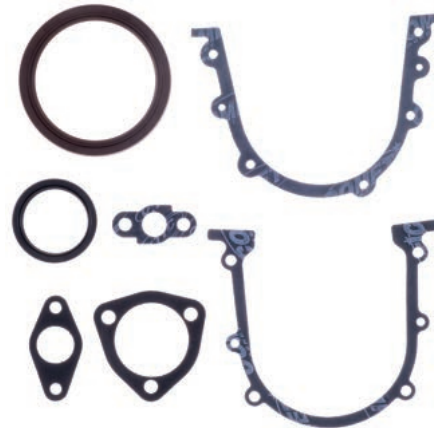

Application	Part #
SR20DE/DET S13 89-93.....	<b>PRO2010B</b> .....

## 2.0L SR20DE/DET DOHC S14 1994-98

### Head Gaskets

#### MLS Head Gaskets

Bore	Thickness	Pkg Qty	Part #
86mm .....	.051" .....	1.....	<b>C14052-051</b> .....
87mm .....	.040" .....	1.....	<b>C14056-040</b> .....
87mm .....	.051" .....	1.....	<b>C14056-051</b> .....
87.5mm.....	.045" .....	1.....	<b>C4576-045</b> .....
88.5mm.....	.045" .....	1.....	<b>C4283-045</b> .....

#### MLX Head Gaskets

Bore	Thickness	Pkg Qty	Part #
87mm .....	.040" .....	1.....	<b>C4950-040</b> .....
88mm .....	.040" .....	1.....	<b>C4951-040</b> .....

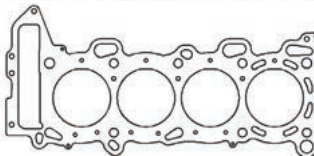
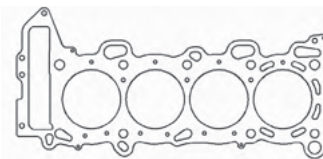

Additional thicknesses available  
see page 5



# NISSAN

## 2.0L SR20DE/DET DOHC S14 1994-98

### Individual Gaskets

Valve Cover Gasket Set	
Application	Part #
SR20DE/DET S14 94-96.....	<b>C4755</b> .....

Throttle Body Gasket	
Application	Part #
SR20DE/DET S14 94-96.....	<b>C4754-032</b> .....

Intake Manifold Gasket Set	
Application	Part #
SR20DE/DET S14 94-96.....	<b>C4749</b> .....

Thermostat Gasket Set	
Application	Part #
SR20DE/DET S14 94-96.....	<b>C4758</b> .....

Exhaust Manifold Gasket Set	
Application	Part #
SR20DE/DET S14 94-96 MLS.....	<b>C4200-030</b> .....

Rear Main Seal Set	
Application	Part #
SR20DE/DET S14 94-96.....	<b>C4743</b> .....

Valve Stem Seals (sold individually)	
Application	Part #
SR20DE/DET S14 - EXH.....	<b>3158V</b> .....
SR20DE/DET S14 - INT.....	<b>3175V</b> .....

Front Crank Seal	
Application	Part #
SR20DE/DET S14 94-96.....	<b>C4915</b> .....

### Gasket Kit



To purchase a complete gasket kit order both top end and bottom end gasket kit

#### TOP END GASKET KIT

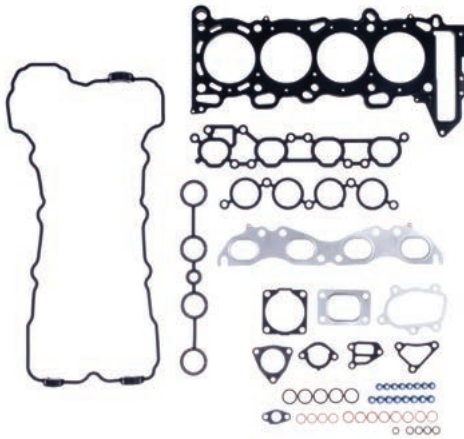

Application	Part #
SR20DE/DET S14 94-96 87.5mm Bore.....	<b>PRO2009T</b> .....

#### BOTTOM END GASKET KIT



Application	Part #
SR20DE/DET S14 94-96.....	<b>PRO2010B</b> .....

## 2.0L SR20DE/DET DOHC GTiR RNN14 AWD 1990-94

### Head Gaskets

MLS Head Gaskets			
Bore	Thickness	Pkg Qty	Part #
87.5mm.....	.040".....	1.....	<b>C4543-040</b> .....
88mm.....	.040".....	1.....	<b>C4577-040</b> .....

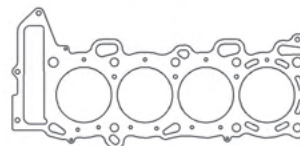

Additional thicknesses available see page 5

### Individual Gaskets

Valve Cover Gasket Set	
Application	Part #
SR20DE/DET GTiR RNN14.....	<b>C4747</b> .....

Throttle Body Gasket	
Application	Part #
SR20DE/DET GTiR RNN14.....	<b>C4756-018</b> .....

See page 118 for additional gaskets

**WARNING:** Cancer and Reproductive Harm



# NISSAN

## 2.0L SR20DE/DET DOHC GTiR RNN14 AWD 1990-94

### Individual Gaskets

Intake Manifold Gasket Set	
Application	Part #
SR20DE/DET GTiR RNN14 .....	<b>C4757-018</b> .....

Thermostat Gasket Set	
Application	Part #
SR20DE/DET GTiR RNN14 .....	<b>C4758</b> .....

Exhaust Manifold Gasket Set	
Application	Part #
SR20DE/DET GTiR RNN14 MLS .....	<b>C4200-030</b> .....

Rear Main Seal Set	
Application	Part #
SR20DE/DET GTiR RNN14 .....	<b>C4743</b> .....

Valve Stem Seals (sold individually)	
Application	Part #
SR20DE/DET GTiR - EXH.....	<b>3158V</b> .....
SR20DE/DET GTiR - INT .....	<b>3175V</b> .....

Front Crank Seal	
Application	Part #
SR20DE/DET GTiR RNN14 .....	<b>C4915</b> .....

### Gasket Kits



To purchase a complete gasket kit order both top end and bottom end gasket kit

#### TOP END GASKET KIT



Application	Part #
SR20DE/DET GTiR RNN14 87.5mm Bore .....	<b>PRO2010T</b> ....

#### BOTTOM END GASKET KIT

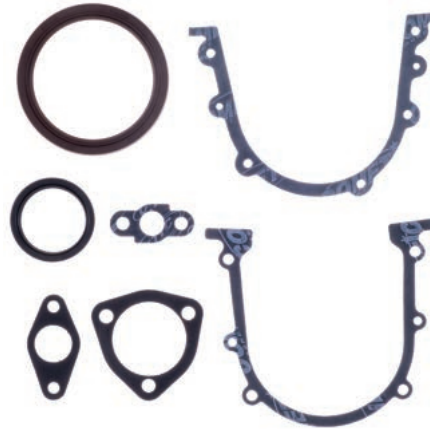

Application	Part #
SR20DE/DET GTiR RNN14 .....	<b>PRO2010B</b> .....

## 2.0L RB20E/DE/DET Inline 6 Laurel 1988-93, Skyline R32 1988-93, Cefio 1988-93

### Head Gaskets

MLS Head Gaskets - RB20DE/RB20DET			
Bore	Thickness	Pkg Qty	Part #
80mm .....	.040" .....	1 .....	<b>C4495-040</b> .....
80mm .....	.051" .....	1 .....	<b>C4495-051</b> .....

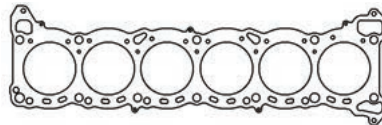

Additional thicknesses available see page 5

### Individual Gaskets

Valve Cover Gasket Set	
Application	Part #
RB20E/DE/DET 88-93.....	<b>C4552</b> .....

Throttle Body Gasket	
Application	Part #
RB20E/DE/DET 88-93.....	<b>C4733-018</b> .....

Intake Manifold Gasket Set	
Application	Part #
RB20E/DE/DET 88-93.....	<b>C4759</b> .....

Rear Main Seal	
Application	Part #
RB20E/DE/DET 88-93.....	<b>C4770</b> .....

See page 119 for additional gaskets





# NISSAN

## 2.0L RB20E/DE/DET Inline 6 Laurel 1988-93, Skyline R32 1988-93, Cefio 1988-93

### Individual Gaskets

Exhaust Manifold Gasket	
Application	Part #
RB20E/DE/DET 88-93 MLS .....	C4177-030 .....

Oil Pump Gasket	
Application	Part #
RB20E/DE/DET 88-93 .....	C4769-020 .....

Cam Seal Set	
Application	Part #
RB20E/DE/DET 88-93 (pair) .....	C4739 .....

Front Crank Seal	
Application	Part #
RB20E/DE/DET 88-93 .....	C4914 .....

Valve Stem Seals (sold individually)	
Application	Part #
RB20E/DE/DET 88-93 .....	3175V .....

Oil Pan Gasket	
Application	Part #
RB20E/DE/DET 88-93 .....	C14117-094 .....

### Gasket Kits



To purchase a complete gasket kit order both top end and bottom end gasket kit

#### TOP END GASKET KIT

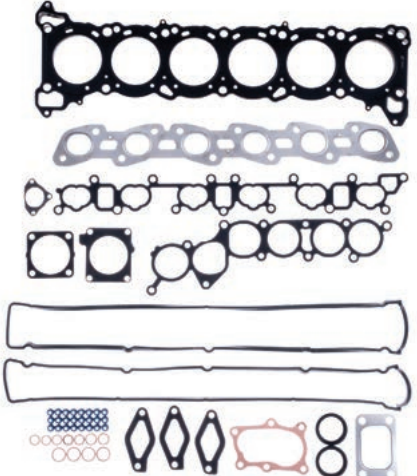

Application	Part #
RB20E/DE/DET 88-93 80mm Bore .....	PRO2015T .....

#### BOTTOM END GASKET KIT

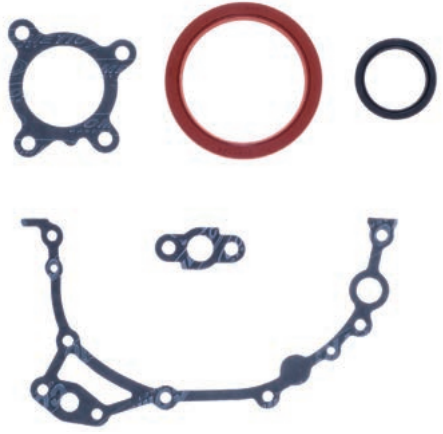

Application	Part #
RB20E/DE/DET 88-93 .....	PRO2017B .....

## 2.4L KA24DE DOHC: 1991-98 240SX

### Head Gaskets

MLS Head Gaskets			
Bore	Thickness	Pkg Qty	Part #
90mm .....	.040" .....	1 .....	C4285-040 .....
91mm .....	.040" .....	1 .....	C4286-040 .....

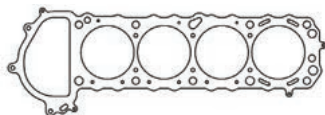

Additional thicknesses available see page 5

### Individual Gaskets

Valve Cover Gasket Sets	
Application	Part #
KA24DE 1991-94 .....	C4761 .....
KA24DE 1995-98 .....	C4766 .....

Oil Pan Gasket	
Application	Part #
KA24DE 1991-98 .....	C4764-060 .....

Intake Manifold Gasket Set	
Application	Part #
KA24DE 1991-98 .....	C4760 .....

Water Pump Gasket	
Application	Part #
KA24DE 1991-98 .....	C4765-031 .....

See page 120 for additional gaskets



# NISSAN

## 2.4L KA24DE DOHC: 1991-98 240SX

### Individual Gaskets

Exhaust Manifold Gasket	
Application	Part #
KA24DE 1991-98 MLS .....	C4201-030 .....

Rear Main Seal Set	
Application	Part #
KA24DE 1991-98.....	C4763.....

Throttle Body Gasket	
Application	Part #
KA24DE 1991-98.....	C4733-018 .....

Thermostat Gasket Set	
Application	Part #
KA24DE 1991-98.....	C4762.....

Valve Stem Seals (sold individually)	
Application	Part #
KA24DE 1991-98.....	3158V.....

Front Crank Seal	
Application	Part #
KA24DE 1991-98.....	C4915.....

### Gasket Kits



To purchase a complete gasket kit order both top end and bottom end gasket kit

#### TOP END GASKET KITS

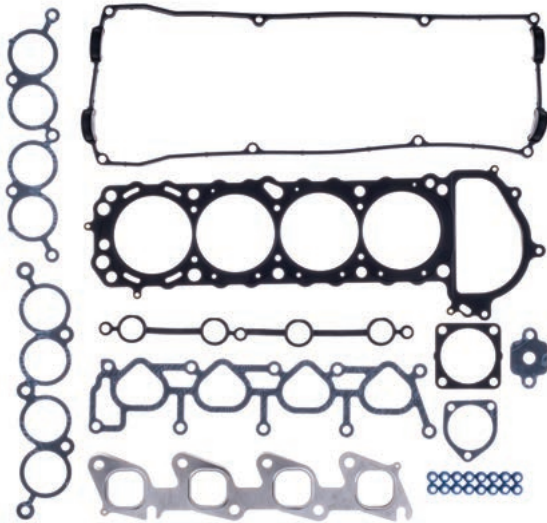

Application	Part #
KA24DE 1991-94 90mm Bore .....	PRO2014T .....
KA24DE 1995-98 90mm Bore.....	PRO2013T .....

#### BOTTOM END GASKET KIT



Application	Part #
KA24DE 1991-98.....	PRO2014B.....

## 2.5L QR25DE DOHC 2002-06 FWD: Sentra SE-R/SE-R Spec V, Altima Base/S/SL

### Head Gasket

MLS Head Gasket			
Bore	Thickness	Pkg Qty	Part #
90mm .....	.030" .....	1.....	C4615-030 .....



Additional thicknesses available see page 5

### Individual Gaskets

Intake Manifold Gasket Set	
Application	Part #
QR25DE FWD 02-06.....	C4748.....

Throttle Body Gasket	
Application	Part #
QR25DE FWD 02-06.....	C4711.....



# NISSAN

**2.5L QR25DE DOHC 2007-12 FWD: Sentra SE-R/SE-R Spec V, Altima Base/S/Hybrid, Rogue S/SL/S Krom/SV**

## Head Gasket

MLS Head Gasket			
Bore	Thickness	Pkg Qty	Part #
90mm	.030"	1	<b>C4614-030</b>

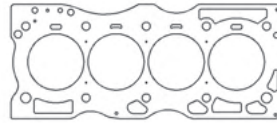

Additional thicknesses available  
see page 5

## Individual Gaskets

Water Inlet Gasket	
Application	Part #
QR25DE FWD 07-12	<b>C4751</b>

Water Outlet Gasket	
Application	Part #
QR25DE FWD 07-12	<b>C4917</b>

**2.5L QR25DE DOHC 2005-12 RWD: 05-10 Frontier XE, 08-10 Frontier SE, 05 X-Trail LE/SE/XE, 11-12 Frontier S/SV**

## Head Gasket

MLS Head Gasket			
Bore	Thickness	Pkg Qty	Part #
90mm	.030"	1	<b>C4616-030</b>

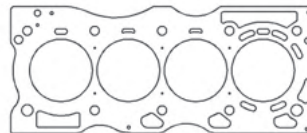

Additional thicknesses available  
see page 5

## Individual Gaskets

Water Outlet Gasket	
Application	Part #
QR25DE RWD 05-12	<b>C4918</b>

Water Pump Gasket Set	
Application	Part #
QR25DE RWD 05-12	<b>C4919</b>

**L23, L24S, L24E, L26 Non-Turbo Inline 6 1970-84: 240/260/280Z, Cedric, Fairlady, Datsun 810, Maxima**

## Head Gasket

MLS Head Gasket			
Bore	Thickness	Pkg Qty	Part #
85mm	.036"	1	<b>C4579-036</b>
85mm	.040"	1	<b>C4579-040</b>
85mm	.070"	1	<b>C4579-070</b>

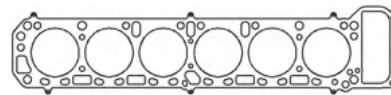

Additional thicknesses available  
see page 5

**L28E, L28S, L28ES Non-Turbo Inline 6 1975-80: 280Z, 280ZX Patrol, Fairlady, Dedic, Laurel**

## Head Gasket

MLS Head Gasket			
Bore	Thickness	Pkg Qty	Part #
89mm	.040"	1	<b>C4580-040</b>

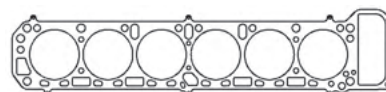

Additional thicknesses available  
see page 5



# NISSAN

## RB25DET 2.5L Inline 6: Patrol 89-93, Skyline 89-93, Skyline GT-R 89-02

### Head Gaskets

MLS Head Gaskets			
Bore	Thickness	Pkg Qty	Part #
86mm	0.051"	1	C4317-051
87mm	0.051"	1	C4318-051

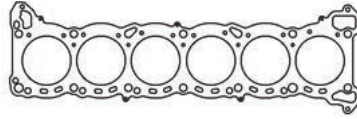

Additional thicknesses available see page 5

### Individual Gaskets

Valve Cover Gasket Set	
Application	Part #
RB25DET	C4552

Throttle Body Gasket	
Application	Part #
RB25DET	C4767

Intake Manifold Gasket Set	
Application	Part #
RB25DET	C4768

Rear Main Seal	
Application	Part #
RB25DET	C4770

Exhaust Manifold Gasket	
Application	Part #
RB25DET MLS	C4177-030

Oil Pump Gasket	
Application	Part #
RB25DET	C4769-020

Cam Seal Set	
Application	Part #
RB25DET (pair)	C4739

Front Crank Seal	
Application	Part #
RB25DET	C4914

Valve Stem Seals (sold individually)	
Application	Part #
RB25DET	3175V

Oil Pan Gasket	
Application	Part #
RB20 /RB RB25 88-02	C14117-094

### Gasket Kits



To purchase a complete gasket kit order both top end and bottom end gasket kit

#### TOP END GASKET KIT

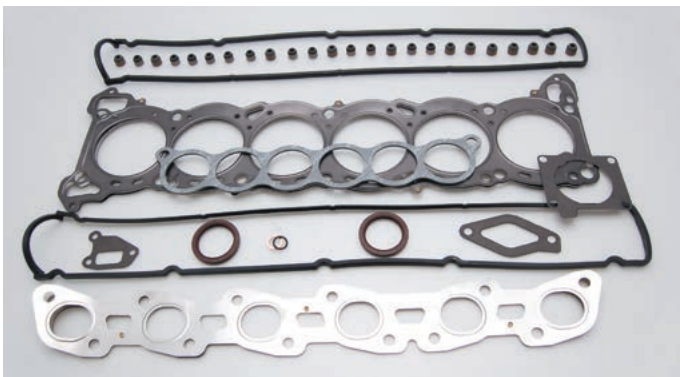

Application	Part #
RB25DET 87mm Bore	PRO2016T

#### BOTTOM END GASKET KIT

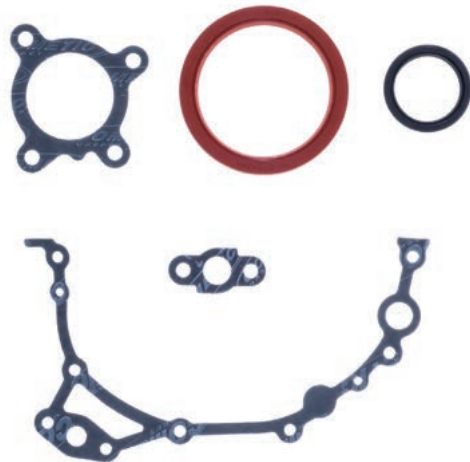

Application	Part #
RB25DET	PRO2017B



# NISSAN

## RB26DET 2.6L DOHC Inline 6 Patrol 89-93, Skyline 89-93, Skyline GT-R 89-02

### Head Gaskets

MLS Head Gaskets			
Bore	Thickness	Pkg Qty	Part #
86mm	.051"	1	C4319-051
87mm	.051"	1	C4320-051
88mm	.051"	1	C4321-051

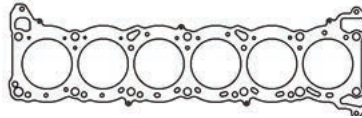

Additional thicknesses available see page 5

### Individual Gaskets

Valve Cover Gasket Set	
Application	Part #
RB26DET	C4552

Throttle Body Gasket Set	
Application	Part #
RB26DET - 6 Pack	C4920

Intake Manifold Gasket	
Application	Part #
RB26DET	C4372

Rear Main Seal	
Application	Part #
RB26DET	C4770

Exhaust Manifold Gasket	
Application	Part #
RB26DET MLS	C4202-030

Oil Pump Gasket	
Application	Part #
RB20E/DE/DET 88-93	C4769-020

Cam Seal Set	
Application	Part #
RB26DET (pair)	C4739

Front Crank Seal	
Application	Part #
RB20E/DE/DET 88-93	C4914

Valve Stem Seals (sold individually)	
Application	Part #
RB25DET - EXH	3158V
RB25DET - INT	3175V

### Gasket Kits

To purchase a complete gasket kit order both top end and bottom end gasket kit

#### TOP END GASKET KIT

Application	Part #
RB26DET 87mm Bore	PRO2017T

#### BOTTOM END GASKET KIT

Application	Part #
RB26DET	PRO2017B



# NISSAN

**RB30E/RB30ET/RB30S 3.0L DOHC Inline 6: Patrol 87-97, R31 Skyline 86-89, Holden Commodore VL 86-88**

### Head Gaskets

#### MLS Head Gaskets

Bore	Thickness	Pkg Qty	Part #
86mm	.....051"	.....1	C4322-051
87mm	.....051"	.....1	C4323-051

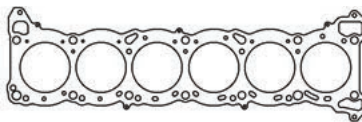

Additional thicknesses available see page 5

### Individual Gaskets

**NEW!**

#### Exhaust Manifold Gasket Set

Application	Part #
RB30DE	C14126-030

# VG30DE/DETT 3.0L 24v DOHC V6 1990-99

### Head Gaskets

#### MLS Head Gaskets

Bore	Thickness	Pkg Qty	Part #
88mm	.....045"	.....1	C4346-045
90mm	.....045"	.....1	C4347-045

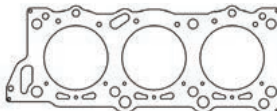

Additional thicknesses available see page 5

### Individual Gaskets

#### Valve Cover Gasket Set

Application	Part #
VG30DE/DETT	C4773

#### Oil Pan Gasket

Application	Part #
VG30DE/DETT	C4776

#### Intake Manifold Gasket Set

Application	Part #
VG30DE/DETT	C4772

#### Rear Main Seal Set

Application	Part #
VG30DE/DETT	C4775

#### Exhaust Manifold Gasket Set

Application	Part #
VG30DE/DETT	C4771-064

#### Front Crank Seal

Application	Part #
VG30DE/DETT	C4914

#### Thermostat Gasket

Application	Part #
VG30DE/DETT	C4774-031

#### Water Pump Gasket

Application	Part #
VG30DE/DETT	C4777-015

#### Cam Seals (sold in pairs)

Application	Part #
VG30DE/DETT (need 2 pairs)	C4739

### Gasket Kits



To purchase a complete gasket kit order both top end and bottom end gasket kit

#### TOP END GASKET KIT

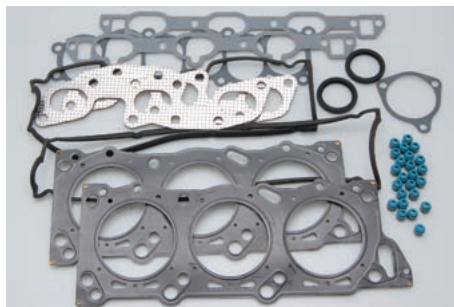

Application	Part #
VG30DE/DETT 88mm Bore	PRO2040T

#### BOTTOM END GASKET KIT

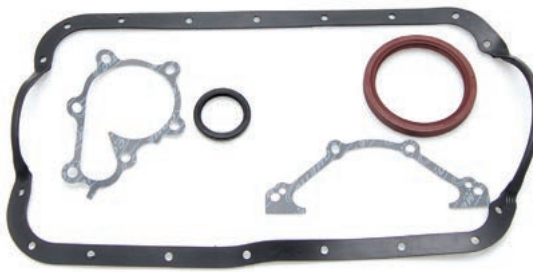

Application	Part #
VG30DE/DETT	PRO2040B-2



# NISSAN

**VQ30DE/VQ35DE 3.0/3.5L DOHC V6 350Z 03-06, G35 03-06, Altima 02-06, I35 02-04, Maxima 02-04, Pathfinder 01-04, Skyline 01-06**

## Head Gaskets

### MLS Head Gaskets - Left Side

Bore	Thickness	Pkg Qty	Part #
96mm	.030"	1	C4345-030
98mm	.030"	1	C4344-030
100mm	.030"	1	C4343-030
101.5mm	.030"	1	C4381-030

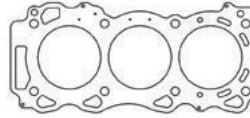

Additional thicknesses available  
see page 5

### MLS Head Gaskets - Right Side

Bore	Thickness	Pkg Qty	Part #
96mm	.030"	1	C4361-030
98mm	.030"	1	C4362-030
100mm	.030"	1	C4363-030
101.5mm	.030"	1	C4380-030

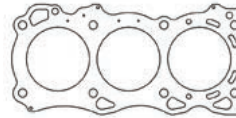

## Individual Gaskets

### Exhaust Manifold Gasket Set

Application	Part #
VQ30DE/VQ35DE	C4921-064

**VQ35DE V2/VQ35HR/VQ37VHR 3.5/3.7L DOHC V6: G35 07-08, 350Z 07-08, G37 08-Up, 370Z 09-Up**

## Head Gaskets

### MLS Head Gasket - Left Side

Bore	Thickness	Pkg Qty	Part #
97mm	.030"	1	C4593-030
97mm	.075"	1	C4593-075

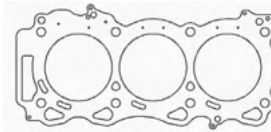

Additional thicknesses available  
see page 5

### MLS Head Gasket - Right Side

Bore	Thickness	Pkg Qty	Part #
97mm	.030"	1	C4592-030
97mm	.075"	1	C4592-075

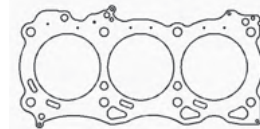

## Individual Gaskets

### Exhaust Manifold Gasket Set

Application	Part #
VQ35HR/VQ37VHR	C4921-064

**VR38DETT 3.8L DOHC V6: GT-R 08-Up**

## Head Gaskets

### MLX Head Gaskets - Left Side

Bore	Thickness	Pkg Qty	Part #
96mm	.032"	1	C4570-032
100mm	.032"	1	C4572-032

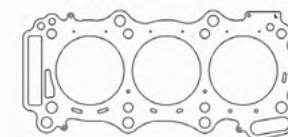

Additional thicknesses available  
see page 5

### MLX Head Gaskets - Right Side

Bore	Thickness	Pkg Qty	Part #
96mm	.032"	1	C4571-032
100mm	.032"	1	C4573-032

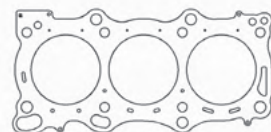



# NISSAN

## VK45DE 4.5L V8 Infinity Q45 02-06

### Head Gaskets

<b>MLS Head Gasket - Left Side</b>			
Bore	Thickness	Pkg Qty	Part #
93.5mm	.....036"	.....1	<b>C4486-036</b>

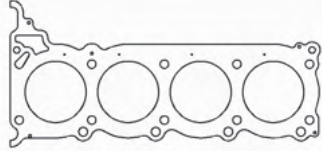

Additional thicknesses available  
see page 5

<b>MLS Head Gasket - Right Side</b>			
Bore	Thickness	Pkg Qty	Part #
93.5mm	.....036"	.....1	<b>C4485-036</b>

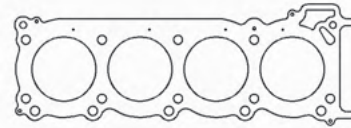

## TB48DE 4.8L DOHC Inline 6 2001-Up

### Head Gaskets

<b>MLS Head Gasket</b>			
Bore	Thickness	Pkg Qty	Part #
100.5mm	.....030"	.....1	<b>C4511-030</b>

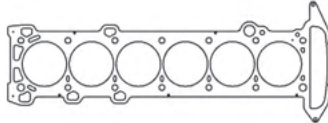

Additional thicknesses available  
see page 5

<b>MLx Head Gasket</b>			
Bore	Thickness	Pkg Qty	Part #
100.5mm	.....040"	.....1	<b>C4599-040</b>

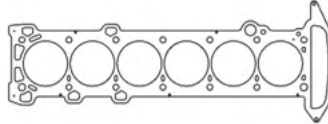

## CEV8D1 5.0L DOHC Cummings Nissan Titan XD

<b>Oil Pan Gaskets</b>	
Application	Part #
Lower Oil Pan	<b>C14001</b>
6 Speed Oil Pan	<b>C14002</b>
7 Speed Oil Pan (Gas Engine)	<b>C14003</b>

<b>Front Differential Gasket</b>	
Application	Part #
4WD - 16 Bolt Differential	<b>C14006-060</b>

<b>Crankshaft Seal</b>	
Application	Part #
Rear Main Seal Retainer Gasket	<b>C14023</b>

## VK56DE 5.6L DOHC V8: 2004-15 Armada, 2004-15 Titan, 2004-10 QX56, 2004-12 Pathfinder

### Head Gaskets

<b>MLS Head Gasket - Left Side</b>			
Bore	Thickness	Pkg Qty	Part #
100mm	.....040"	.....1	<b>C4922-040</b>

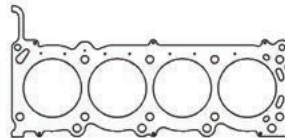

Additional thicknesses available  
see page 5

<b>MLS Head Gasket - Right Side</b>			
Bore	Thickness	Pkg Qty	Part #
100mm	.....040"	.....1	<b>C4923-040</b>

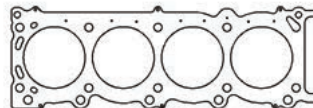

See page 123 for additional gaskets





# NISSAN

**VK56DE 5.6L DOHC V8** 2004-Up Armada, 2004-Up Titan, 2004-10 QX56, 2008-12 Pathfinder

### Head Gaskets

<b>MLX Head Gasket - Left Side</b>			
Bore	Thickness	Pkg Qty	Part #
102.7mm	.040"	1	<b>C4610-040</b>

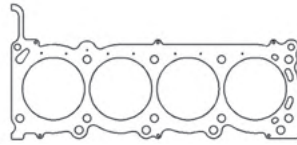

Additional thicknesses available  
see page 5

<b>MLX Head Gasket - Right Side</b>			
Bore	Thickness	Pkg Qty	Part #
102.7mm	.040"	1	<b>C4609-040</b>

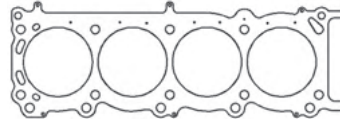

### Individual Gaskets

<b>Exhaust Manifold Gasket Set</b>	
Application	Part #
VK56VD 2010-2016 MLS	<b>C4959-030</b>

<b>Exhaust Manifold Gasket Set</b>	
Application	Part #
VK56DE 2004-09 Oval Port MLS	<b>C4961-030</b>
VK56DE 2004-09 Oval Port AM	<b>C4967-064</b>

<b>Oil Pan Gasket</b>	
Application	Part #
Nissan/Suzuki VK56DE, VQ40, VQ40DE 05-17	<b>C14114-060</b>

# PEUGEOT/CITROEN

**TU5J4 1.6L 16v: 106 1997-05**

### Head Gaskets

<b>MLS Head Gasket</b>			
Bore	Thickness	Pkg Qty	Part #
79mm	.060"	1	<b>C4493-060</b>

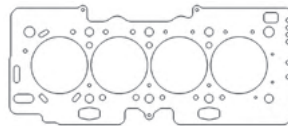

Additional thicknesses available  
see page 5

**XU9J4, XU9J4Z 1.9L DOHC, XU10J2, XU10J4 2.0L: 405 M1-16, 605 S/SR1**

### Head Gaskets

<b>MLS Head Gaskets</b>			
Bore	Thickness	Pkg Qty	Part #
84mm	.051"	1	<b>C4225-051</b>
85mm	.051"	1	<b>C4226-051</b>
86.5mm	.051"	1	<b>C4227-051</b>
88mm	.051"	1	<b>C4228-051</b>

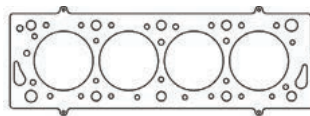

Additional thicknesses available  
see page 5

# PORSCHE

**924 2.0L 1976-85**

### Head Gasket

<b>MLS Head Gasket</b>			
Bore	Thickness	Pkg Qty	Part #
88mm	.050"	1	<b>C4542-050</b>

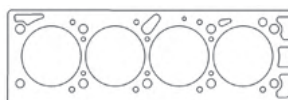

Additional thicknesses available  
see page 5



# PORSCHE

## 944 2.5L 1982-91

### Head Gaskets

#### MLS Head Gasket

Bore	Thickness	Pkg Qty	Part #
100.5mm	.....040"	.....1	C4272-040
103mm	.....040"	.....1	C4273-040

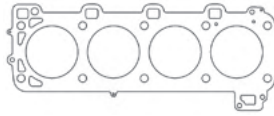

Additional thicknesses available  
see page 5

#### Cam Cover Gasket

Application	Part #
944 2.5L 82-91	C4925

#### Intake Manifold Gasket Set

Application	Part #
944 2.5L 82-91 - 4pcs	C4924

## 944 2.7L 1989, 3.0L 1989-91

### Head Gasket

#### MLS Head Gasket

Bore	Thickness	Pkg Qty	Part #
106mm	.....040"	.....1	C4274-040

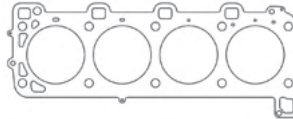

Additional thicknesses available  
see page 5

#### Cam Cover Gasket

Application	Part #
944 2.7/3.0L	C4925

#### Intake Manifold Gasket Set

Application	Part #
944 2.7/3.0L - 4pcs	C4924

## 996 3.6L Twin Turbo 2001-04

### Head Gasket

#### MLS Head Gasket

Bore	Thickness	Pkg Qty	Part #
102mm	.....040"	.....1	C4492-040
104mm	.....040"	.....1	C14077-040
104.5mm	.....030"	.....1	C14076-030

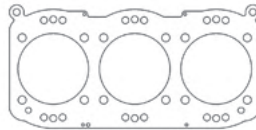

Additional thicknesses available  
see page 5

## 997 3.6L Twin Turbo 2006-08

### Head Gasket

#### MLS Head Gasket

Bore	Thickness	Pkg Qty	Part #
106.5mm	.....030"	.....1	C14049-030

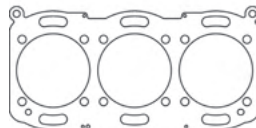

Additional thicknesses available  
see page 5

## 997 3.8L M97.01 2005-08

### Head Gasket

#### MLX Head Gasket

Bore	Thickness	Pkg Qty	Part #
102mm	.....032"	.....1	C4926-032

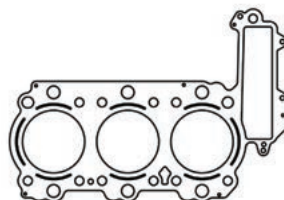

Additional thicknesses available  
see page 5



# PORSCHE

## Cayenne GTS 4.5L 2003-06 V8

### Head Gaskets

#### MLS Head Gasket - Left Side

Bore	Thickness	Pkg Qty	Part #
95mm	.....027"	.....1	<b>C4535-027</b>

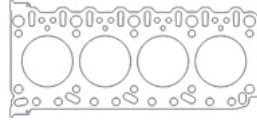

Additional thicknesses available  
see page 5

#### MLS Head Gasket - Right Side

Bore	Thickness	Pkg Qty	Part #
95mm	.....027"	.....1	<b>C4536-027</b>

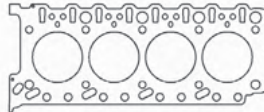

### Individual Gaskets

#### Intake Manifold Gasket Set

Application	Part #
Cayenne 4.5L 03-06 (pair)	<b>C4927</b>

## 928 4.7/5.0L 1983-97

### Head Gaskets

#### MLS Head Gaskets - Left Side

Bore	Thickness	Pkg Qty	Part #
100mm	.....045"	.....1	<b>C5781-045</b>
104mm	.....045"	.....1	<b>C5783-045</b>

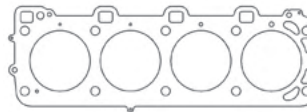

Additional thicknesses available  
see page 5

#### MLS Head Gaskets - Right Side

Bore	Thickness	Pkg Qty	Part #
100mm	.....045"	.....1	<b>C5780-045</b>
104mm	.....045"	.....1	<b>C5782-045</b>

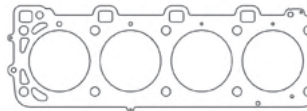

# RENAULT

## F4P 16v 1.8L, F4R 16v 2.0L: Laguna 98-Up, Clio 01-Up

### Head Gaskets

#### MLS Head Gaskets

Bore	Thickness	Pkg Qty	Part #
83mm	.....030"	.....1	<b>C4518-030</b>
84.5mm	.....030"	.....1	<b>C4519-030</b>

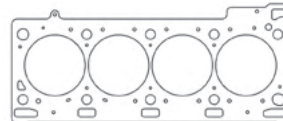

Additional thicknesses available  
see page 5

## F7P 16v 1.8L, F7R 16v 2.0L: R19 89-96, Clio 91-97, Megane Coupe 95-99, Clio Williams 93-95, Spider Sport 1995

### Head Gaskets

#### MLS Head Gaskets

Bore	Thickness	Pkg Qty	Part #
83mm	.....051"	.....1	<b>C4539-051</b>
84mm	.....051"	.....1	<b>C4540-051</b>

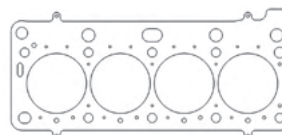

Additional thicknesses available  
see page 5



# ROVER

**15G V8 1970-93, 21D-25D V8 1970-93, 35D-38D 1970-93: Range Rover 1970-89, Discovery 1989-93**

## Head Gaskets

MLS Head Gasket			
Bore	Thickness	Pkg Qty	Part #
89mm	.040"	1	C4367-040
94mm	.040"	1	C4368-040
96mm	.040"	1	C4369-040

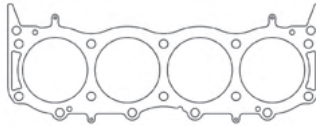

Additional thicknesses available see page 5

Exhaust Manifold Gasket Set	
Application	Part #
Rover V8 .064" AM	C4966-064

**35D-38D, 40D, 42D-46D V8 1994-Up: Discovery 1994-Up**

## Head Gaskets

MLS Head Gaskets			
Bore	Thickness	Pkg Qty	Part #
89mm	.040"	1	C4366-040
94mm	.040"	1	C4365-040
96mm	.040"	1	C4364-040

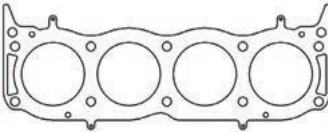

Additional thicknesses available see page 5

Exhaust Manifold Gasket Set	
Application	Part #
Rover V8 .064" AM	C4966-064

**5.0L V8 "LR-V8": 2009-Up Discovery, Range Rover Sport, Range Rover Sport SC, Range Rover, Range Rover SC**

## Head Gaskets

MLX Head Gaskets - Left Side			
Bore	Thickness	Pkg Qty	Part #
93mm	.040"	1	C15001-040

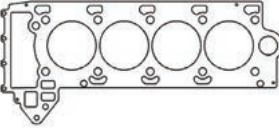

Additional thicknesses available see page 5

MLX Head Gaskets - Right Side			
Bore	Thickness	Pkg Qty	Part #
93mm	.040"	1	C15000-040

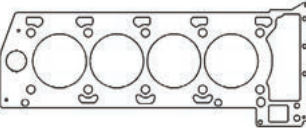

# SAAB

**B204 1985cc/B234 2290cc Turbo 2.0L: 1995-99 9-3, 9-5, 900**

## Head Gaskets

MLS Head Gaskets			
Bore	Thickness	Pkg Qty	Part #
91mm	.030"	1	C4974-030

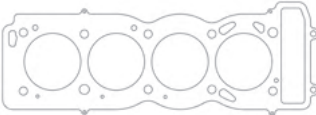

Additional thicknesses available see page 5



# SAAB

## B205 1985cc/B235 2290cc Turbo 2.0L: 1999-09 9-3, 9-5

### Head Gaskets

<b>MLS Head Gaskets</b>			
Bore	Thickness	Pkg Qty	Part #
91mm	.030"	1	C4973-030

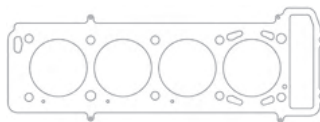

Additional thicknesses available see page 5

# SUBARU

## FA20DIT DOHC 2.0L: 2015+Up WRX 2014+Up Forester XT

### Head Gaskets

<b>MLX Head Gasket - Left Side</b>			
Bore	Thickness	Pkg Qty	Part #
89.5mm	.032"	1	C4954-032

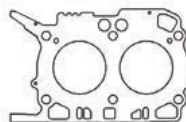

Additional thicknesses available see page 5

<b>MLX Head Gasket - Right Side</b>			
Bore	Thickness	Pkg Qty	Part #
89.5mm	.032"	1	C4955-032

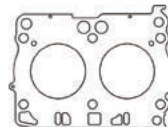

## FA20 DOHC 2.0L: 2012+Up BRZ/FRS/86

### Head Gaskets

<b>MLX Head Gasket - Left Side</b>			
Bore	Thickness	Pkg Qty	Part #
89.5mm	.032"	1	C4589-032

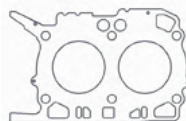

Additional thicknesses available see page 5

<b>MLX Head Gasket - Right Side</b>			
Bore	Thickness	Pkg Qty	Part #
89.5mm	.032"	1	C4588-032

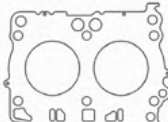

<b>Intake Manifold Gasket Set</b>	
Application	Part #
FA20 - Driver Side and Passenger Side	C14025

<b>Throttle Body Gasket</b>	
Application	Part #
FA20 2012 BRZ+	C14024

<b>Exhaust Gaskets</b>	
Application	Part #
MLS 1.825" Round Port / .030" Thick	C4204-030

## EJ20E SOHC 2.0L 16v JDM 1990-97 Legacy, 1995-97 Impreza

### Head Gasket

<b>MLS Head Gasket</b>			
Bore	Thickness	Pkg Qty	Part #
93mm	.040"	1	C4260-040

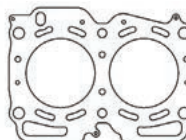

Additional thicknesses available see page 5



# SUBARU

## EJ205 DOHC 2.0L 16v 2002-05 WRX, 2004-05 Saab 9-2X Aero

### Head Gasket

MLX Head Gasket			
Bore	Thickness	Pkg Qty	Part #
93mm	.....041"	.....1	C4590-041

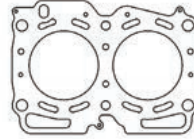

Additional thicknesses available  
see page 5

### Individual Gaskets

Valve Cover Gasket Sets	
Application	Part #
EJ205 02-05 - Left Side	C4863
EJ205 02-05 - Right Side	C4864

Valve Stem Seals (sold individually)	
Application	Part #
EJ205 02-05 - Exhaust (Brown)	3264V
EJ205 02-05 - Intake (Black)	3265V

Intake Manifold Gaskets	
Application	Part #
EJ205 02-05	C4857-039

Rear Main Seal	
Application	Part #
EJ205 02-05	C4856

**NEW!**

Exhaust Gaskets	
Application	Part #
EJ205 02-05 Manifold MLS (2)	C4204-030
EJ205 02-05 Exhaust Pipe (2)	C4856-064
EJ205 02-05 Crossover (2)	C4859-064
EJ205 02-05 Turbo To Up Pipe Gskt (1)	C5723-030
EJ205 02-05 Turbo To Downpipe Gskt (1)	C5736-030

Front Crank Seal	
Application	Part #
EJ205 02-05	C4857

Throttle Body Gasket	
Application	Part #
EJ205 02-05	C4855-060

Water Pump Gasket	
Application	Part #
EJ205 02-05	C4860-018

### Individual Gaskets

Cam Seal Set	
Application	Part #
EJ205 02-05 - 4 Pack	C4858

Thermostat Gasket	
Application	Part #
EJ205 02-05	C4861

### Gasket Kits

**STREETPRO**  
by Cometic Gasket

**GASKET KIT**

Application	Part #
EJ205 02-03 93.5mm Bore	PRO2044C

**GASKET KIT**

Application	Part #
EJ205 04-05	PRO2023C



# SUBARU

## EJ22E SOHC 2.2L 16v 1990-96 Legacy, 1993-96 Impreza

### Head Gasket

Additional thicknesses available see page 5

MLS Head Gasket			
Bore	Thickness	Pkg Qty	Part #
98mm	.....040"	.....1	<b>C4262-040</b> .....
100mm	.....040"	.....1	<b>C4985-040</b> .....

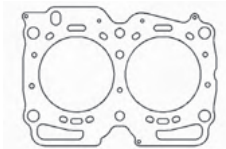

MLX Head Gasket			
Bore	Thickness	Pkg Qty	Part #
101mm	.....041"	.....1	<b>C4986-041</b> .....

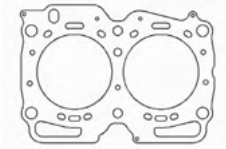

### Individual Gaskets

Valve Cover Gasket Set	
Application	Part #
EJ22E SOHC	<b>C4871</b> .....

Thermostat Gasket	
Application	Part #
EJ22E SOHC	<b>C4861</b> .....

Intake Manifold Gasket Set	
Application	Part #
EJ22E SOHC	<b>C4868-060</b> .....

Oil Pan Gasket	
Application	Part #
EJ22E SOHC - Cork	<b>C4869-125</b> .....

Exhaust Gaskets	
Application	Part #
EJ22E SOHC MLS	<b>C4204-030</b> .....

Rear Main Seal	
Application	Part #
EJ22E SOHC	<b>C4856</b> .....

Throttle Body Gasket	
Application	Part #
EJ22E SOHC	<b>C4867-060</b> .....

Front Crank Seal	
Application	Part #
EJ22E SOHC	<b>C4857</b> .....

Cam Seal Set	
Application	Part #
EJ22E SOHC - 2 pack	<b>C4870</b> .....

Water Pump Gasket	
Application	Part #
EJ22E SOHC	<b>C4860-018</b> .....

Valve Stem Seals (sold individually)	
Application	Part #
EJ22E SOHC - Exhaust (Brown)	<b>3264V</b> .....
EJ22E SOHC - Intake (Black)	<b>3265V</b> .....

Timing Cover Set	
Application	Part #
EJ22E SOHC	<b>C4862</b> .....

### Gasket Kit



#### GASKET KIT

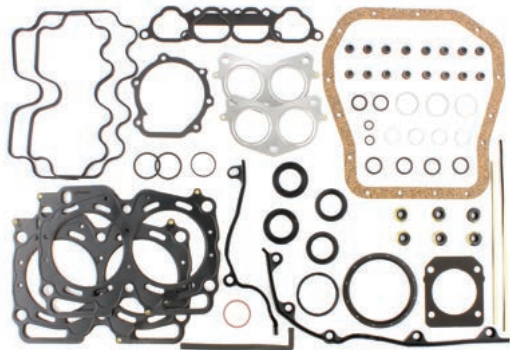

Application	Part #
EJ22E SOHC 98mm Bore	<b>PRO2026C</b> .....



# SUBARU

## EJ22ET SOHC 2.2L 16v Turbo 1991-94 Legacy

### Head Gasket

#### MLS Head Gasket

Bore	Thickness	Pkg Qty	Part #
98mm	.....051"	.....1	C4263-051

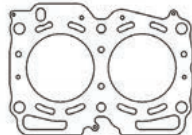

Additional thicknesses available  
see page 5

### Individual Gaskets

#### Valve Cover Gasket Set

Application	Part #
EJ22ET SOHC Turbo	C4871

#### Oil Pan Gasket

Application	Part #
EJ22ET SOHC Turbo	C4869-125

#### Intake Manifold Gasket Set

Application	Part #
EJ22ET SOHC Turbo	C4868-060

#### Rear Main Seal

Application	Part #
EJ22ET SOHC Turbo	C4856

#### Cam Seal Set

Application	Part #
EJ22ET SOHC Turbo - 2pcs	C4870

#### Front Crank Seal

Application	Part #
EJ22ET SOHC Turbo	C4857

#### Valve Stem Seals (sold individually)

Application	Part #
EJ22ET SOHC - Exhaust (Brown)	3264V
EJ22ET SOHC - Intake (Black)	3265V

#### Water Pump Gasket

Application	Part #
EJ22ET SOHC Turbo	C4860-018

## EJ25D DOHC 2.5L 16v 1998 Impreza RS, 1996-99 Legacy/Outback, 1998 Forester

### Head Gasket

#### MLS Head Gasket

Bore	Thickness	Pkg Qty	Part #
1101mm	.....052"	.....1	C4578-052

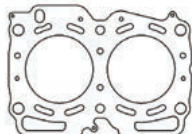

Additional thicknesses available  
see page 5

### Individual Gaskets

#### Valve Cover Gasket Set

Application	Part #
EJ25D DOHC	C4873

#### Thermostat Gasket

Application	Part #
EJ25D DOHC	C4861

#### Intake Manifold Gasket Set

Application	Part #
EJ25D DOHC	C4872-059

#### Oil Pan Gasket

Application	Part #
EJ25D DOHC - Cork	C4869-125

#### Exhaust Gaskets

Application	Part #
EJ25D DOHC MLS	C4204-030

#### Timing Cover Set

Application	Part #
EJ25D DOHC	C4862

#### Throttle Body Gasket

Application	Part #
EJ25D DOHC	C4867-060

#### Rear Main Seal

Application	Part #
EJ25D DOHC	C4856

#### Cam Seal Set

Application	Part #
EJ25D DOHC - 4pcs	C4866

#### Front Crank Seal

Application	Part #
EJ25D DOHC	C4957

#### Valve Stem Seals (sold individually)

Application	Part #
EJ25D DOHC - Exhaust (Brown)	3264V
EJ25D DOHC - Intake (Black)	3265V

#### Water Pump Gasket

Application	Part #
EJ25D DOHC	C4860-018





# SUBARU

**EJ25D DOHC 2.5L 16v 1998 Impreza RS, 1996-99 Legacy/Outback, 1998 Forester**

**Gasket Kit**

**STREETpro**  
by Cometic Gasket

**GASKET KIT**

Application	Part #
EJ25D DOHC 1996-99 101mm Bore .....	<b>PRO2025C</b> ...

**EJ251/EJ253 SOHC 2.5L 16v (EJ251): 09/00-03/03 Impreza, 00-02,04 Outback Sport, 11/01-03/04 Forester, 06/99-06/06 Legacy/Outback, 06/02-04/06 Baja (EJ253): 01/04-Up Forester, 04/03+Up Impreza, 11/03-04/09 Legacy/Outback**

**Head Gasket**

MLX Head Gasket			
Bore	Thickness	Pkg Qty	Part #
101mm	.....032"	.....1	<b>C4578-032</b> .....

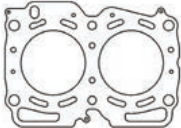

Additional thicknesses available see page 5

**Individual Gaskets**

Valve Cover Gasket Set	
Application	Part #
EJ251 SOHC .....	<b>C4642</b> .....

Throttle Body Gasket	
Application	Part #
EJ251 SOHC .....	<b>C4874-060</b> .....

Intake Manifold Gasket Set	
Application	Part #
EJ251 SOHC .....	<b>C4875-060</b> .....

Thermostat Gasket	
Application	Part #
EJ251 SOHC .....	<b>C4861</b> .....

Exhaust Gaskets	
Application	Part #
EJ251 SOHC MLS .....	<b>C4204-030</b> .....

Rear Main Seal	
Application	Part #
EJ251 SOHC .....	<b>C4856</b> .....

Cam Seal Set	
Application	Part #
EJ251 SOHC 2pcs .....	<b>C4870</b> .....

Front Crank Seal	
Application	Part #
EJ251 SOHC .....	<b>C4857</b> .....

Valve Stem Seals (sold individually)	
Application	Part #
EJ251 SOHC - Exhaust (Brown) .....	<b>3264V</b> .....
EJ251 SOHC - Intake (Black) .....	<b>3265V</b> .....

Water Pump Gasket	
Application	Part #
EJ251 SOHC .....	<b>C4860-018</b> .....

See page 136 for StreetPro gasket kits



# SUBARU

**EJ251/EJ253 SOHC 2.5L 16v (EJ251): 09/00-03/03 Impreza, 00-02,04 Outback Sport, 11/01-03/04 Forester, 06/99-06/06 Legacy/Outback, 06/02-04/06 Baja (EJ253): 01/04-Up Forester, 04/03+Up Impreza, 11/03-04/09 Legacy/Outback**

## Gasket Kit



### GASKET KIT

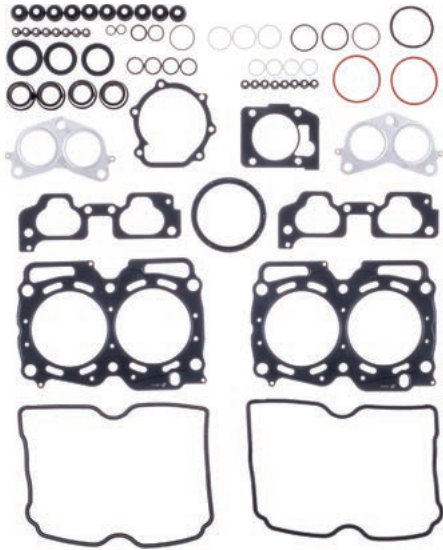

Application	Part #
EJ251 SOHC 1999-05 101mm Bore .....	<b>PRO2022C</b> .....

## EJ253 SOHC 2.5L 16v 02/09-12/14 Legacy/Outback non-turbo

### Head Gaskets

#### MLX Head Gasket - "Improved Cooling Heads"

Bore	Thickness	Pkg Qty	Part #
101mm .....	.032" .....	1 .....	<b>C4622-032</b> .....

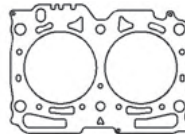

Additional thicknesses available  
see page 5

### Individual Gaskets

#### Intake Manifold Gasket Set

Application	Part #
EJ253 SOHC .....	<b>C4875-060</b> .....

#### Thermostat Gasket

Application	Part #
EJ253 SOHC .....	<b>C4861</b> .....

#### Exhaust Gaskets

Application	Part #
EJ253 SOHC MLS .....	<b>C4204-030</b> .....

#### Rear Main Seal

Application	Part #
EJ253 SOHC .....	<b>C4856</b> .....

#### Cam Seal Set

Application	Part #
EJ253 SOHC 2pcs .....	<b>C4870</b> .....

#### Front Crank Seal

Application	Part #
EJ253 SOHC .....	<b>C4947</b> .....

#### Valve Stem Seals (sold individually)

Application	Part #
EJ253 SOHC - Exhaust (Brown) .....	<b>3264V</b> .....
EJ253 SOHC - Intake (Black) .....	<b>3265V</b> .....

#### Water Pump Gasket

Application	Part #
EJ253 SOHC .....	<b>C4860-018</b> .....

#### Oil Pan Gasket

Application	Part #
EJ255/ EJ257 - Cork .....	<b>C4869-125</b> .....



# SUBARU

**EJ255 DOHC 2.5L 16v Turbo 02/03-04/06 Baja Turbo 3-03/05 Forester XT, 02/03-06/06 Legacy/Outback Turbo**

### Head Gasket

MLX Head Gasket			
Bore	Thickness	Pkg Qty	Part #
101mm	.....032"	.....1	<b>C4578-032</b> .....

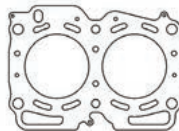

Additional thicknesses available  
see page 5

**EJ255 DOHC 2.5L 16v Turbo 01/05-03/08 Forester XT, 04/05-03/08 Impreza WRX, 11/05-04/09 Legacy/Outback Turbo**

### Head Gasket

MLX Head Gasket - "Improved Cooling Heads"			
Bore	Thickness	Pkg Qty	Part #
101mm	.....032"	.....1	<b>C4622-032</b> .....

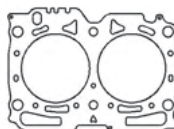

Additional thicknesses available  
see page 5

### Individual Gaskets

Valve Cover Gasket Sets	
Application	Part #
EJ255 06-07 - Left Side.....	<b>C4880</b> .....
EJ255 06-07 - Right Side.....	<b>C4881</b> .....

Throttle Body Gasket	
Application	Part #
EJ255 DOHC 06-07.....	<b>C4877-060</b> .....

Intake Manifold Gasket Set	
Application	Part #
EJ255 DOHC 06-07.....	<b>C4857-039</b> .....

Thermostat Gasket	
Application	Part #
EJ255 DOHC 06-07.....	<b>C4861</b> .....

NEW! Exhaust Gaskets	
Application	Part #
EJ255 06-07 Manifold MLS (2).....	<b>C4204-030</b> .....
EJ255 06-07 Crossover (2).....	<b>C4859-064</b> .....
EJ255 Turbo To Up Pipe Gasket (1).....	<b>C5723-030</b> .....
EJ255 Turbo To Downpipe Gasket (1).....	<b>C5736-030</b> .....

Rear Main Seal	
Application	Part #
EJ255 DOHC 06-07.....	<b>C4856</b> .....

Cam Seal Sets	
Application	Part #
EJ255 06-07 Exhaust Seals (2).....	<b>C4878</b> .....
EJ255 06-07 Intake Seals (2).....	<b>C4879</b> .....

Front Crank Seal	
Application	Part #
EJ255 DOHC 06-07.....	<b>C4947</b> .....

Valve Stem Seals (sold individually)	
Application	Part #
EJ255 DOHC - Exhaust (Brown).....	<b>3264V</b> .....
EJ255 DOHC - Intake (Black).....	<b>3265V</b> .....

Water Pump Gasket	
Application	Part #
EJ255 DOHC 06-07.....	<b>C4860-018</b> .....

Timing Cover Set	
Application	Part #
EJ255 DOHC 06-07.....	<b>C4862</b> .....

See page 138 for StreetPro gasket kits



# SUBARU

EJ255 DOHC 2.5L 16v Turbo 01/05-03/08 Forester XT, 04/05-03/08 Impreza WRX, 11/05-04/09 Legacy/Outback Turbo

## Gasket Kit



### GASKET KIT

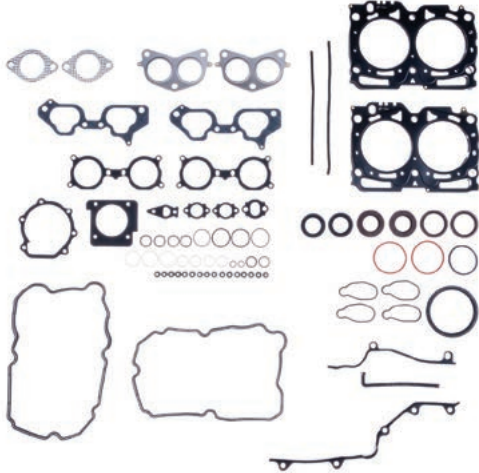

Application	Part #
EJ255 DOHC 2006-07 101mm Bore .....	PRO2045C ...

EJ255 DOHC 2.5L 16v Turbo 04/08-Up Forester XT, 04/08-Up Impreza WRX, 02/09-Up Legacy/Outback Turbo

## Head Gasket

### MLX Head Gasket

Bore	Thickness	Pkg Qty	Part #
101mm .....	.032" .....	1 .....	C4587-032 .....

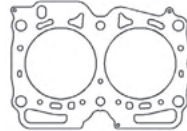

Additional thicknesses available  
see page 5

## Individual Gaskets

### Valve Cover Gasket Sets

Application	Part #
EJ255 08-Up - Left Side .....	C4880 .....
EJ255 08-Up - Right Side .....	C4881 .....

### Throttle Body Gasket

Application	Part #
EJ255 DOHC 08-Up .....	C4882 .....

### Intake Manifold Gasket Set

Application	Part #
EJ255 DOHC 08-Up .....	C4857-039 .....

### Thermostat Gasket

Application	Part #
EJ255 DOHC 08-Up .....	C4861 .....

**NEW!**

### Exhaust Gaskets

Application	Part #
EJ255 08-Up Manifold MLS (2) .....	C4204-030 .....
EJ255 Turbo To Up Pipe Gasket (1) .....	C5723-030 .....
EJ255 Turbo To Downpipe Gasket (1) .....	C5736-030 .....

### Rear Main Seal

Application	Part #
EJ255 DOHC 08-Up .....	C4856 .....

### Cam Seal Sets

Application	Part #
EJ255 08-Up Exh Seals (2) .....	C4878 .....
EJ255 08-Up Intake Seals (2) .....	C4879 .....

### Front Crank Seal

Application	Part #
EJ255 DOHC 08-Up .....	C4857 .....

See page 139 for additional gaskets





# SUBARU

## EJ255 DOHC 2.5L 16v Turbo 04/08-Up Forester XT, 04/08-Up Impreza WRX, 02/09-Up Legacy/Outback Turbo

### Individual Gaskets

Valve Stem Seals (sold individually)	
Application	Part #
EJ255 DOHC - Exhaust (Brown) .....	3264V .....
EJ255 DOHC - Intake (Black) .....	3265V .....

Water Pump Gasket	
Application	Part #
EJ255 DOHC 08-Up .....	C4860-018 .....

### Gasket Kit



**GASKET KIT**

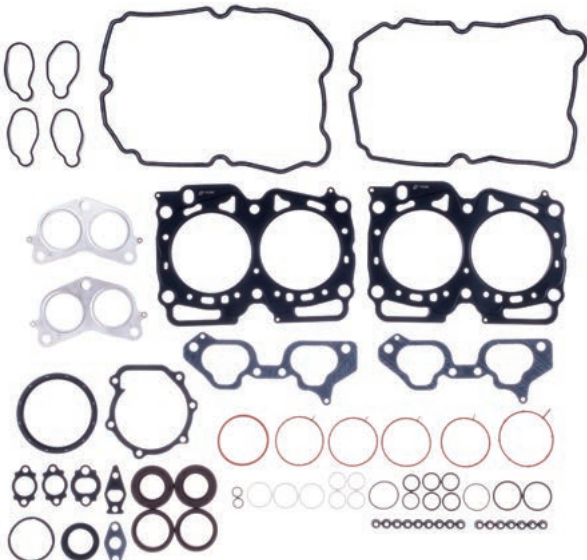

Application	Part #
EJ255 DOHC 2008-Up 101mm Bore .....	PRO2046C .....

## EJ257 DOHC 2.5L 16v Turbo 04/07-2017 Impreza Sti

### Head Gasket

MLX Head Gasket			
Bore	Thickness	Pkg Qty	Part #
101mm .....	.032" .....	1 .....	C4578-032 .....

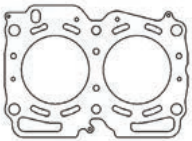

Additional thicknesses available  
see page 5

### Individual Gaskets

Valve Cover Gasket Sets	
Application	Part #
EJ257 04-07 - Left Side .....	C4928 .....
EJ257 04-07 - Right Side .....	C4929 .....

Throttle Body Gasket	
Application	Part #
EJ257 DOHC 04-07 .....	C4877-060 .....

Intake Manifold Gasket Set	
Application	Part #
EJ257 DOHC 04-07 .....	C4857-039 .....

Thermostat Gasket	
Application	Part #
EJ257 DOHC 04-07 .....	C4861 .....

See page 140 for additional gaskets



# SUBARU

## EJ257 DOHC 2.5L 16v Turbo 10/02-06/07 Impreza STi

### Individual Gaskets

**NEW!**

#### Exhaust Gaskets

Application	Part #
EJ257 04-07 Manifold MLS (2).....	<b>C4204-030</b> .....
EJ257 04-07 Crossover (1) .....	<b>C5718</b> .....
EJ255 Turbo To Up Pipe Gasket (1) .....	<b>C5723-030</b> .....
EJ255 Turbo To Downpipe Gasket (1).....	<b>C5736-030</b> .....

**NEW!**

#### Cam Seal Sets

Application	Part #
EJ257 04-07 Exh Seals (2).....	<b>C4878</b> .....
EJ257 04-07 Intake Seals (2).....	<b>C4879</b> .....

#### Valve Stem Seals (sold individually)

Application	Part #
EJ257 DOHC - Exhaust (Brown).....	<b>3264V</b> .....
EJ257 DOHC - Intake (Black).....	<b>3265V</b> .....

#### Timing Cover Set

Application	Part #
EJ257 DOHC 2007.....	<b>C4862</b> .....

#### Rear Main Seal

Application	Part #
EJ257 DOHC 04-07.....	<b>C4856</b> .....

#### Front Crank Seal

Application	Part #
EJ257 DOHC 04-07.....	<b>C4947</b> .....

#### Water Pump Gasket

Application	Part #
EJ257 DOHC 04-07.....	<b>C4860-018</b> .....

### Gasket Kits



#### GASKET KIT

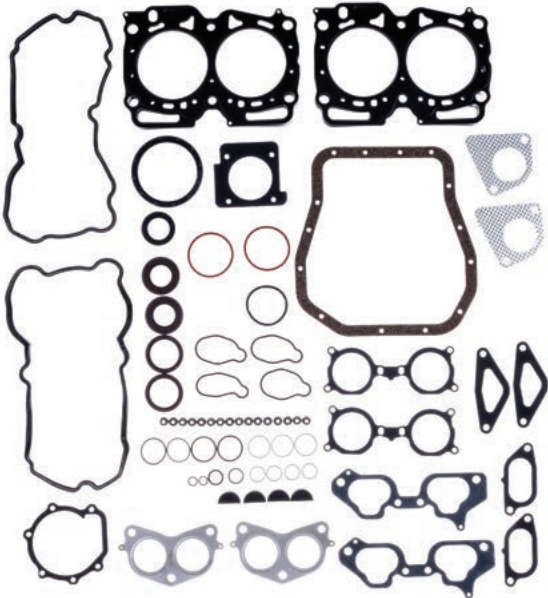

Application	Part #
EJ257 DOHC 04-06 101mm Bore.....	<b>PRO2024C</b> .....

#### GASKET KIT

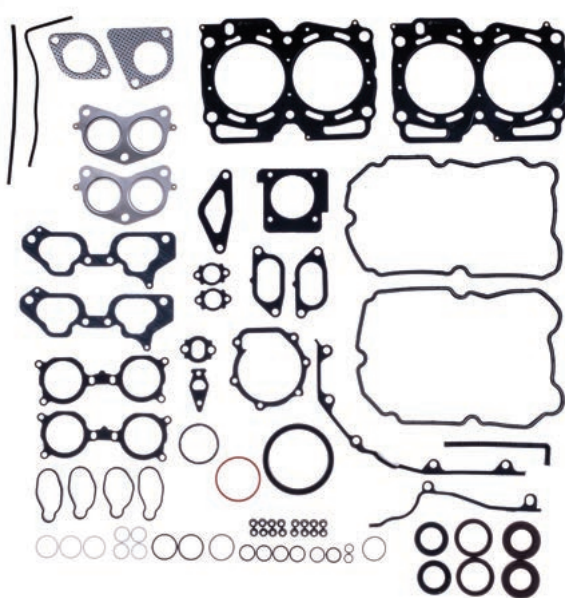

Application	Part #
EJ257 DOHC 2007 101mm Bore .....	<b>PRO2047C</b> .....



# SUBARU

## EJ257 DOHC 2.5L 16v Turbo 04/07-Up Impreza Sti

### Head Gasket

MLX Head Gasket			
Bore	Thickness	Pkg Qty	Part #
101mm	.....032"	.....1	<b>C4587-032</b>

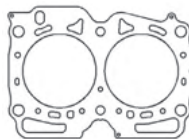

Additional thicknesses available see page 5

### Individual Gaskets

Valve Cover Gasket Sets	
Application	Part #
EJ257 08+Up - Left Side	<b>C4880</b>
EJ257 08-Up - Right Side	<b>C4881</b>

Throttle Body Gasket	
Application	Part #
EJ257 DOHC 08-Up	<b>C4877-060</b>

Intake Manifold Gasket Set	
Application	Part #
EJ257 DOHC 08-Up	<b>C4857-039</b>

Thermostat Gasket	
Application	Part #
EJ257 DOHC 08-Up	<b>C4861</b>

**NEW!**

Exhaust Gaskets	
Application	Part #
EJ257 08-Up Manifold MLS (2)	<b>C4204-030</b>
EJ257 08-Up Crossover (1)	<b>C5718</b>
EJ255 Turbo To Up Pipe Gasket (1)	<b>C5723-030</b>
EJ255 Turbo To Downpipe Gasket (1)	<b>C5736-030</b>

Timing Cover Set	
Application	Part #
EJ257 DOHC 08-Up	<b>C4862</b>

Cam Seal Set	
Application	Part #
EJ257 08+Up 4pcs	<b>C4876</b>

Rear Main Seal	
Application	Part #
EJ257 DOHC 08-Up	<b>C4856</b>

Valve Stem Seals (sold individually)	
Application	Part #
EJ257 DOHC - Exhaust (Brown)	<b>3264V</b>
EJ257 DOHC - Intake (Black)	<b>3265V</b>

Front Crank Seal	
Application	Part #
EJ257 DOHC 08-Up	<b>C4947</b>

Oil Pan Gasket	
Application	Part #
EJ255/ EJ257 - Cork	<b>C4869-125</b>

Water Pump Gasket	
Application	Part #
EJ257 DOHC 08-Up	<b>C4860-018</b>

### Gasket Kit

**GASKET KIT**

Application	Part #
EJ257 DOHC 08-Up 101mm Bore	<b>PRO2048C</b>



# SUBARU

## EZ30 3.0L Flat 6 Legacy/Outback

### Head Gaskets

<b>MLS Head Gasket - Left Side</b>			
Bore	Thickness	Pkg Qty	Part #
90mm	.....040"	.....1	<b>C5861-040</b>

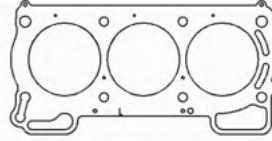

Additional thicknesses available  
see page 5

<b>MLS Head Gasket - Right Side</b>			
Bore	Thickness	Pkg Qty	Part #
90mm	.....040"	.....1	<b>C5860-040</b>

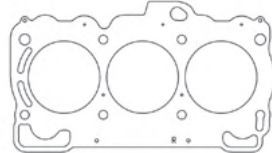

## EZ30D 3.0L Flat 6 2003-09 Legacy/Outback, 2006-07 Tribeca

### Head Gaskets

<b>MLS Head Gasket - Left Side</b>			
Bore	Thickness	Pkg Qty	Part #
90mm	.....040"	.....1	<b>C4623-040</b>

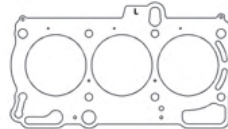

Additional thicknesses available  
see page 5

<b>MLS Head Gasket - Right Side</b>			
Bore	Thickness	Pkg Qty	Part #
90mm	.....040"	.....1	<b>C4624-040</b>

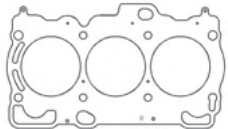

## EZ36D 3.6L Flat 6 2010-12 Legacy 3.6R / Outback, 2008-14 Tribeca

### Individual Gaskets

<b>Oil Pan Gasket</b>	
Application	Part #
EJ255/ EJ257/ EZ36D - Cork	<b>C4869-125</b>

## EG33 3.3L Flat 6 3318cc 1992-96 SVX

### Head Gaskets

<b>MLS Head Gaskets</b>			
Bore	Thickness	Pkg Qty	Part #
98mm	.....066"	.....1	<b>C4340-066</b>
100mm	.....066"	.....1	<b>C4341-066</b>
102mm	.....066"	.....1	<b>C4342-066</b>

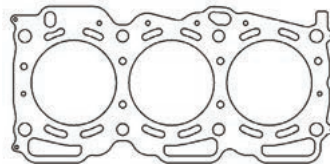

Additional thicknesses available  
see page 5





# TOYOTA

## 1.3L 4E-FE/4E-FTE/ 1.5L 5E-FE/5E-FHE: 1986-98 Corolla, Corona, Starlet, Tercel, Paseo, Sera

### Head Gaskets

MLS Head Gaskets			
Bore	Thickness	Pkg Qty	Part #
75mm	.040"	1	C4602-040
76mm	.040"	1	C4603-040

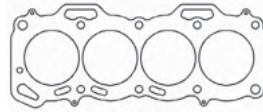

Additional thicknesses available see page 5

## 2T 1.6l, 2TC 1.6L, 3T 1.8L, 3TC 1.8L 1970-84 Corolla, 1970-76 Sprinter, 1970-76 Celica, 1970-76 Carina, 1970-84 Corona, 1978-84 Camry

### Head Gaskets

MLS Head Gaskets			
Bore	Thickness	Pkg Qty	Part #
87mm	.040"	1	C4258-040
89mm	.040"	1	C4176-040

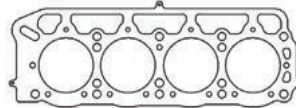

Additional thicknesses available see page 5

Exhaust Manifold Gasket	
Application	Part #
3TC 1.8L	C4930

## 4A-GE, 4A-GEC, 4A-GELC, 4A-GEZ 16v 1587cc: 1984-92 Corolla, 1989 Carina, 1989 Sprinter, 1984-89 MR2, 1989-89 Celica

### Head Gaskets

MLS Head Gaskets			
Bore	Thickness	Pkg Qty	Part #
81mm	.040"	1	C4170-040
83mm	.040"	1	C4166-040



Additional thicknesses available see page 5

### Individual Gaskets

Valve Cover Gasket Set	
Application	Part #
4A-GE 84-92 16v	C4807

Thermostat Gasket	
Application	Part #
4A-GE 84-92 16v	C4809

Intake Gasket Set	
Application	Part #
4A-GE 84-92 16v	C4806

Timing Cover Dust Seal Set	
Application	Part #
4A-GE 84-92 16v	C4811

Exhaust Manifold Gasket	
Application	Part #
4A-GE 84-92 16v .042" AM	C4805-042

Rear Main Seal	
Application	Part #
4A-GE 84-92 16v	C4810

Cam Seal Set	
Application	Part #
4A-GE 84-92 16v 2pcs	C4808

Front Crank Seal	
Application	Part #
4A-GE 84-92 16v	C4931

Valve Stem Seals (sold individually)	
Application	Part #
4A-GE 84-92 16v	3225V

Water Pump Gasket	
Application	Part #
4A-GE 84-92 16v	C4812-039

See page 140 for StreetPro gasket kits



# TOYOTA

**4A-GE, 4A-GEC, 4A-GELC 16v 1587cc 1984-92 Corolla, 1989 Carina, 1989 Sprinter, 1984-89 MR2, 1989-89 Celica**

## Gasket Kits

**TOP END GASKET KIT**

Application	Part #
4A-GE 84-92 16v 81mm Bore .....	<b>PRO2041T</b> .....

**TOP END GASKET KIT**

Application	Part #
4A-GE 84-92 16v .....	<b>PRO2041B</b> .....

# 4A-GE 1.6L 20v 1587cc 1991-95 Corolla, 1996-01 Carina, 1991-00 Sprinter

## Head Gaskets

<b>MLS Head Gaskets</b>			
Bore	Thickness	Pkg Qty	Part #
81mm	.040"	1	<b>C4604-040</b> .....
83mm	.040"	1	<b>C4605-040</b> .....

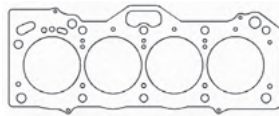

Additional thicknesses available  
see page 5

## Individual Gaskets

<b>Intake Manifold Gasket</b>	
Application	Part #
4A-GE 20v Small Port .....	<b>C4932-031</b> .....

<b>Exhaust Manifold Gasket</b>	
Application	Part #
4A-GE 20v .064" AM .....	<b>C4933-064</b> .....

# 1ZZ-FE 1.8L DOHC 1997-08

## Head Gaskets

<b>MLS Head Gaskets</b>			
Bore	Thickness	Pkg Qty	Part #
80mm	.027"	1	<b>C4496-027</b> .....
82mm	.027"	1	<b>C4497-027</b> .....

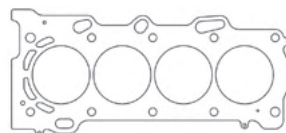

Additional thicknesses available  
see page 5

## Individual Gaskets

<b>Intake Manifold Gasket</b>	
Application	Part #
1ZZ-FE .032" AFM .....	<b>C4934-032</b> .....

<b>Exhaust Manifold Gasket</b>	
Application	Part #
1ZZ-FE 98-02 .030" MLS .....	<b>C4205-030</b> .....



# TOYOTA

**2ZZ-GE 1.8L DOHC 1795cc 00-05 Celica, 05-06 Corolla, 03-06 Matrix/Vibe, 05-11 Lotus Elise, 06-10 Lotus Exige**

### Head Gasket

MLX Head Gasket			
Bore	Thickness	Pkg Qty	Part #
82.5mm	.....028"	.....1	<b>C4962-028</b> .....
82.5mm	.....040"	.....1	<b>C4962-040</b> .....

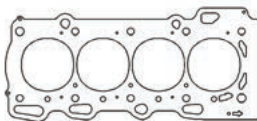

Additional thicknesses available see page 5

**3S-GE/3S-GTE 2.0L DOHC Turbo 1998cc 1989-94 Celica, 1990-94 MR2**

### Head Gasket

MLS Head Gasket			
Bore	Thickness	Pkg Qty	Part #
87mm	.....040"	.....1	<b>C4314-040</b> .....

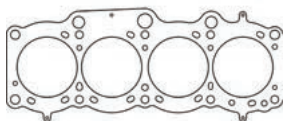

Additional thicknesses available see page 5

### Individual Gaskets

Valve Cover Gasket Set	
Application	Part #
3S-GTE 90-95 .....	<b>C4608</b> .....

Oil Pan Gasket	
Application	Part #
3S-GT/GTE 91-95 .....	<b>C4817-062</b> .....

Intake Manifold Gasket Set	
Application	Part #
3S-GT/GTE 88-95 .....	<b>C4813</b> .....

Timing Cover Dust Seal Set	
Application	Part #
3S-GT/GTE 89-94 .....	<b>C4811</b> .....

Exhaust Manifold Gasket	
Application	Part #
3S-GT/GTE 89-95 MLS .....	<b>C4206-030</b> .....

Water Pump Gasket	
Application	Part #
3S-GT/GTE 89-94 .....	<b>C4818-031</b> .....

Cam Seal Set	
Application	Part #
3S-GT/GTE 89-95 .....	<b>C4808</b> .....

Rear Main Seal Set	
Application	Part #
3S-GT/GTE 89-94 .....	<b>C4815</b> .....

Valve Stem Seals (sold individually)	
Application	Part #
3S-GT/GTE 89-95 .....	<b>3225V</b> .....

Oil Pump Gasket Set	
Application	Part #
3S-GT/GTE 89-94 .....	<b>C4816</b> .....

### Gasket Kits



#### TOP END GASKET KIT

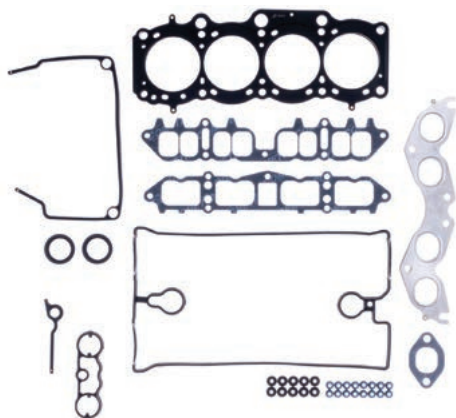

Application	Part #
3S-GTE 89-94 .....	<b>PRO2019T</b> .....

#### BOTTOM END GASKET KIT

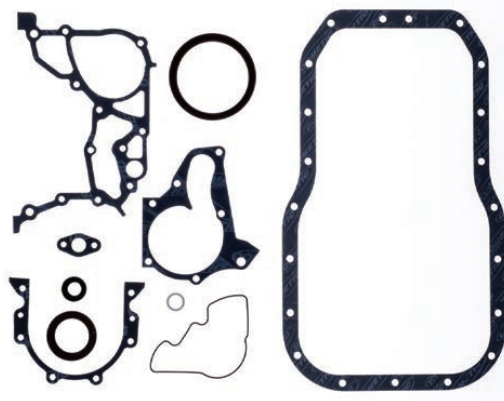

Application	Part #
3S-GT/GTE 89-94 .....	<b>PRO2019B</b> .....



# TOYOTA

## 3S-GE/3S-GTE 2.0L DOHC Turbo 3rd Gen, ST205 1994-99

### Head Gasket

#### MLS Head Gasket

Bore	Thickness	Pkg Qty	Part #
87mm	.....040"	.....1	<b>C4606-040</b> .....

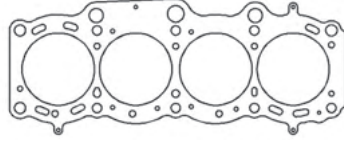

Additional thicknesses available  
see page 5

## 5S-FE 2.2L 2164cc 1990-97 Camry, 1990-97 Celica, 1990-97 MR2

### Head Gasket

#### MLS Head Gasket

Bore	Thickness	Pkg Qty	Part #
88mm	.....040"	.....1	<b>C4315-040</b> .....

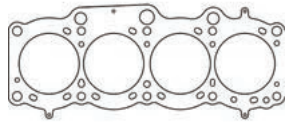

Additional thicknesses available  
see page 5

### Individual Gaskets

#### Valve Cover Gasket Set

Application	Part #
5S-FE 1990-97 .....	<b>C4820</b> .....

#### Oil Pan Gasket

Application	Part #
5S-FE 1990-97 .....	<b>C4817-062</b> .....

#### Intake Manifold Gasket Set

Application	Part #
5S-FE 1990-97 .....	<b>C4819-046</b> .....

#### Water Pump Gasket

Application	Part #
5S-FE 1990-97 .....	<b>C4818-031</b> .....

#### Exhaust Manifold Gasket

Application	Part #
5S-FE 1990-97 MLS .....	<b>C4206-030</b> .....

#### Rear Main Seal Set

Application	Part #
5S-FE 1990-97 .....	<b>C4823</b> .....

#### Cam Seal Set

Application	Part #
5S-FE 1990-97 .....	<b>C4821</b> .....

#### Oil Pump Gasket Set

Application	Part #
5S-FE 1990-97 .....	<b>C4824</b> .....

#### Valve Stem Seals (sold individually)

Application	Part #
5S-FE 1990-97 .....	<b>3225V</b> .....

#### Thermostat Gasket Set

Application	Part #
5S-FE 1990-97 .....	<b>C4822</b> .....

### Gasket Kits



#### TOP END GASKET KIT



Application	Part #
5S-FE 1990-97 88mm Bore .....	<b>PRO2042T</b> .....

#### BOTTOM END GASKET KIT

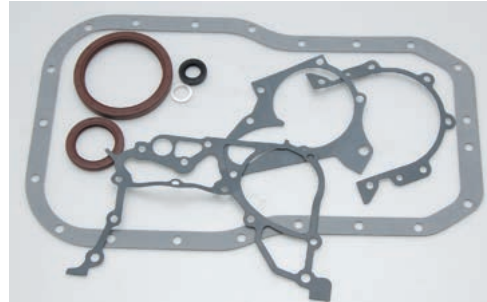

Application	Part #
5S-FE 1990-97 .....	<b>PRO2042B</b> .....



# TOYOTA

## 5S-FE 2.2L 2164cc 1990-97 Camry, 1990-97 Celica, 1990-97 MR2

### Gasket Kits



#### TOP END GASKET KIT



Application	Part #
5S-FE 1990-97 88mm Bore.....	<b>PRO2042T</b> ....

#### BOTTOM END GASKET KIT

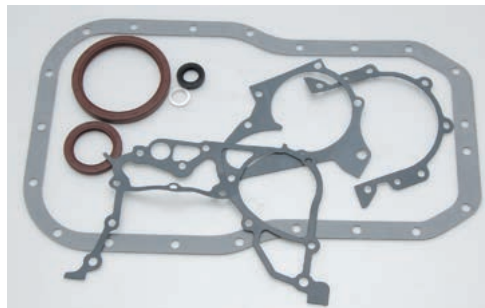

Application	Part #
5S-FE 1990-97 .....	<b>PRO2042B</b> .....

## 22R/22R-TEC 2.4L 1982-85 Celica, 1981-95 Hi-Lux, 1981-82 Corona, 1984-95 4 Runner

### Head Gasket

#### MLS Head Gasket

Bore	Thickness	Pkg Qty	Part #
93mm	.....040"	.....1.....	<b>C14086-040</b> .....
94mm	.....040"	.....1.....	<b>C14074-040</b> .....
95mm	.....040"	.....1.....	<b>C4269-040</b> .....

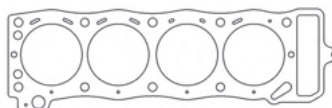

Additional thicknesses available see page 5

### Individual Gaskets

#### Valve Cover Gasket Set

Application	Part #
22R 2.4L 81-85.....	<b>C4935</b> .....

#### Oil Pan Gasket

Application	Part #
22R 2.4L 81-85.....	<b>C4940</b> .....

#### Intake Manifold Gasket Set

Application	Part #
22R 2.4L 81-85.....	<b>C4936</b> .....

#### Water Pump Gasket Set

Application	Part #
22R 2.4L 81-85.....	<b>C4941</b> .....

#### Exhaust Manifold Gaskets

Application	Part #
22R 2.4L 81-82.....	<b>C4937-064</b> .....
22R 2.4L 83-84.....	<b>C4938-064</b> .....
22R 2.4L 85-87.....	<b>C4939-064</b> .....

#### Timing Cover Sets

Application	Part #
22R 2.4L 81-84.....	<b>C4942</b> .....
22R 2.4L 1985 .....	<b>C4943</b> .....

#### Valve Stem Seals (sold individually)

Application	Part #
22R 2.4L 81-85.....	<b>3157V</b> .....

#### Rear Main Seal

Application	Part #
22R 2.4L 81-85.....	<b>C4944</b> .....



# TOYOTA

**2RZ-FE 2.4L 1995-04, 3RZ-FE 2.7L 1997-04**

## Head Gaskets

### MLS Head Gaskets

Bore	Thickness	Pkg Qty	Part #
96mm	.040"	1	C4598-040
97mm	.040"	1	C4245-040

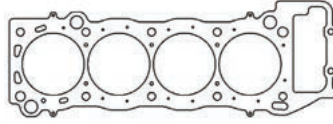

Additional thicknesses available  
see page 5

## Individual Gaskets

### Valve Cover Gasket Set

Application	Part #
2RZ/3RZ	C4830

### Thermostat Gasket Set

Application	Part #
2RZ/3RZ	C4831

### Intake Manifold Gaskets

Application	Part #
2RZ/3RZ 95-99	C4826-018
2RZ/3RZ 95-99 Plenum	C4827-032
2RZ/3RZ 99-04	C4828-032
2RZ/3RZ 99-04 Plenum	C4829-032

### Oil Pan Gasket

Application	Part #
2RZ/3RZ	C4834

### Timing Cover Sets

Application	Part #
2RZ/3RZ	C4833

### Exhaust Manifold Gasket

Application	Part #
2RZ/3RZ MLS	C4207-030

### Water Pump Gasket

Application	Part #
2RZ/3RZ	C4835-020

### Valve Stem Seals (sold individually)

Application	Part #
2RZ/3RZ	3225V

### Rear Main Seal Set

Application	Part #
2RZ/3RZ 97-04	C4832

## Gasket Kits

**STREETpro**  
by Comet Gasket

### TOP END GASKET KIT

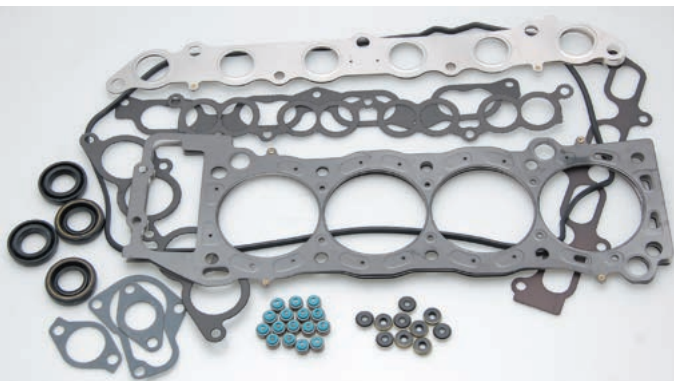

Application	Part #
2RZ/3RZ 97-04 97mm Bore	PRO2043T

### BOTTOM END GASKET KIT

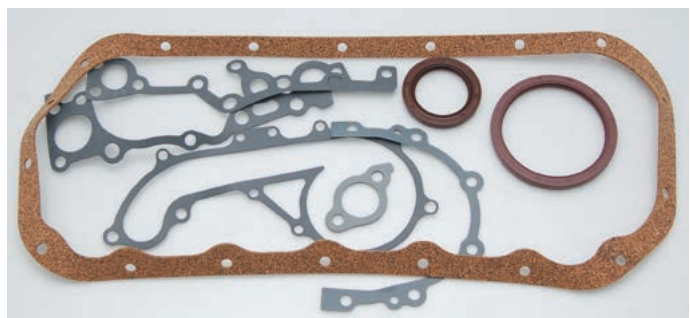

Application	Part #
2RZ/3RZ 97-04	PRO2043B



# TOYOTA

**2AZ-FE 2.4L DOHC 2002-09 Camry, 2009-11 Matrix, 2009-10 Pontiac Vibe, 2009-11 Corolla ZRS, 2002-09 Solara, 2004-08 RAV4, 2001-08 Highlander, 2005-10 Scion tC, 2008-12 Scion xB**

### Head Gaskets

MLS Head Gaskets			
Bore	Thickness	Pkg Qty	Part #
89mm	.027"	1	C4507-027
92mm	.027"	1	C4506-027

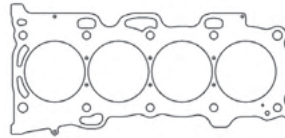

Additional thicknesses available see page 5

### Individual Gaskets

Exhaust Manifold Gasket	
Application	Part #
2AZ-FE .030" MLS	C4203-030

**7M-GE/7M-GTE 3.0L Inline 6 24v 2954cc 1986-92 Supra, 1988-92 Cressida**

### Head Gaskets

MLS Head Gaskets			
Bore	Thickness	Pkg Qty	Part #
84mm	.051"	1	C4278-051
86mm	.051"	1	C4275-051

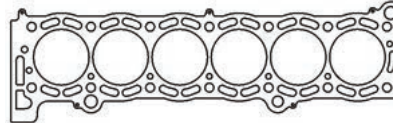

Additional thicknesses available see page 5

### Individual Gaskets

Valve Cover Gasket Set	
Application	Part #
7M-GE/GTE 86-92	C4838

Thermostat Gasket	
Application	Part #
7M-GE/GTE 86-92	C4839

Intake Manifold Gasket Set	
Application	Part #
7M-GE/GTE 86-92	C4837-031

Oil Pan Gasket	
Application	Part #
7M-GE/GTE 86-92	C4845-062

Exhaust Manifold Gasket	
Application	Part #
7M-GE/GTE 86-92 MLS	C4208-030

Timing Cover Set	
Application	Part #
7M-GE/GTE 86-92	C4844

Cam Seal Set	
Application	Part #
7M-GE/GTE 86-92 2pcs	C4808

Water Pump Gasket Set	
Application	Part #
7M-GE/GTE 86-92	C4846-031

Valve Stem Seals (sold individually)	
Application	Part #
7M-GE/GTE 86-92	3225V

Rear Main Seal Set	
Application	Part #
7M-GE/GTE 86-92	C4843

Throttle Body Gasket	
Application	Part #
7M-GE/GTE 86-92	C4836-032

Front Crank/Balance Shaft Seals	
Application	Part #
7M-GE/GTE 86-92 Front Crank	C4945
7M-GE/GTE 86-92 Balance Shaft	C4946

See page 150 for StreetPro gasket kits



# TOYOTA

## 7M-GE/7M-GTE 3.0L Inline 6 24v 2954cc 1986-92 Supra, 1988-92 Cressida

### Gasket Kits



#### TOP END GASKET KIT

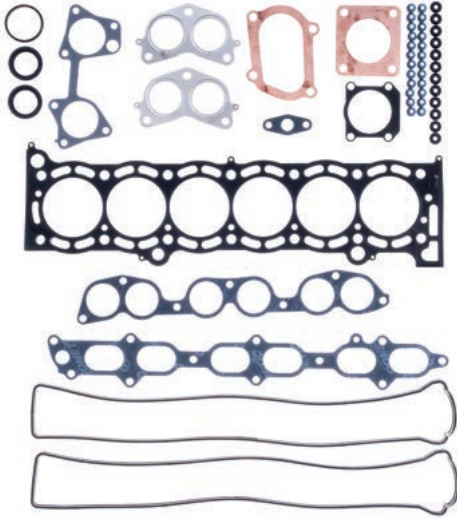

Application	Part #
7M-GE/GTE 86-92 84mm Bore .....	<b>PRO2020T</b> .....

#### BOTTOM END GASKET KIT

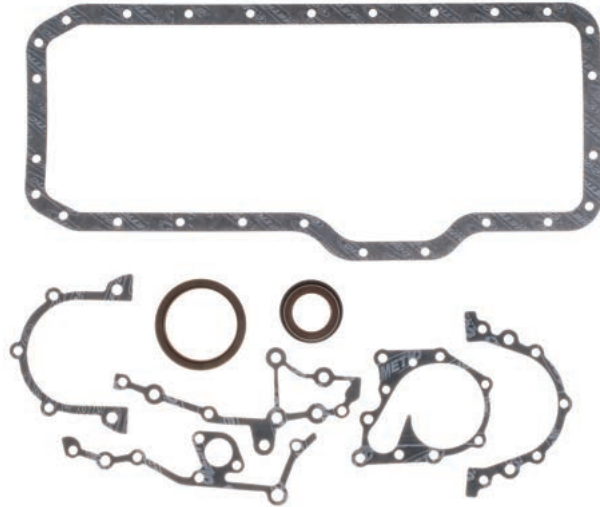

Application	Part #
7M-GE/GTE 86-92.....	<b>PRO2020B</b> .....

## 1JZ-GE/GTE 2.5L Inline 6 24v

### Head Gaskets

#### MLS Head Gaskets

Bore	Thickness	Pkg Qty	Part #
87mm	.051"	1	<b>C14036-051</b> .....

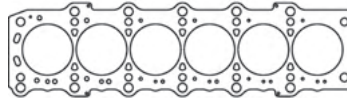

Additional thicknesses available  
see page 5

### Individual Gaskets

#### Turbo Exhaust Manifold Gasket

Application	Part #
Turbo Exh. Manifold .060" thick, VVTi Only .	<b>C14119-060</b> .....



#### Turbo Exhaust Manifold Gasket

Application	Part #
Exhaust to Head - Includes 2 Non VVT .....	<b>C14123-060</b> .....

## 2JZ-GE/GTE 3.0L Inline 6 24v 1993-02 Supra, 1993-95 GS300, 1993-00 SC300

### Head Gasket

#### MLS Head Gasket

Bore	Thickness	Pkg Qty	Part #
87mm	.051"	1	<b>C4276-051</b> .....
87mm	.060"	1	<b>C4276-060</b> .....

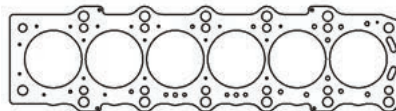

Additional thicknesses available  
see page 5

#### MLX Head Gasket

Bore	Thickness	Pkg Qty	Part #
87mm	.052"	1	<b>C14016-052</b> .....

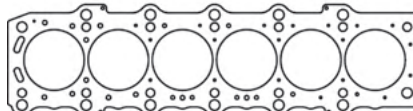

See page 151 for additional gaskets





# TOYOTA

**2JZ-GE/GTE 3.0L Inline 6 24v: 1993-02 Supra, 1993-03 GS300, 2001-03 IS300, 1993-00 SC300**

## Individual Gaskets

Valve Cover Gasket Set	
Application	Part #
2JZ-GE/GTE.....	C4851.....

Throttle Body Gasket	
Application	Part #
2JZ-GE.....	C4848.....

Intake Manifold Gasket	
Application	Part #
2JZ-GE.....	C4849.....

Thermostat Gasket Set	
Application	Part #
2JZ-GE/GTE.....	C4852.....

Exhaust Manifold Gaskets	
Application	Part #
2JZ-GE .064" AM.....	C4847-064.....
2JZ-GTE .030" MLS.....	C4209-030.....

Water Pump Gasket	
Application	Part #
2JZ-GE/GTE.....	C4854-031.....

Cam Seal Set	
Application	Part #
2JZ-GE.....	C4850.....

Rear Main Seal	
Application	Part #
2JZ-GE/GTE.....	C4853.....

Valve Stem Seals (sold individually)	
Application	Part #
2JZ-GE/GTE.....	3225V.....

Oil Pan Gasket	
Application	Part #
Automatic Transmission.....	C14118-060.....

## Gasket Kits



### TOP END GASKET KIT

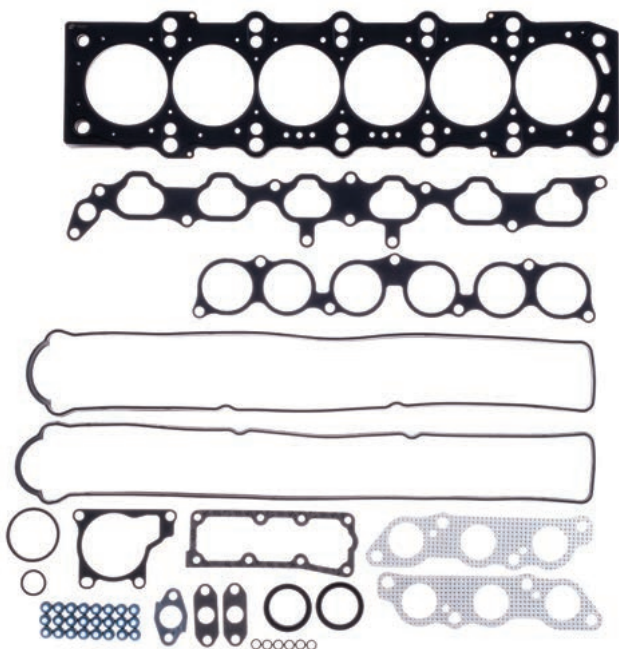

Application	Part #
2JZ-GE 93-98 87mm Bore.....	PRO2021T.....

### BOTTOM END GASKET KIT



Application	Part #
2JZ-GE/GTE 93-98.....	PRO2021B.....



# TOYOTA

## B58 3.0L Inline 6 B58B30C 2020 Toyota Supra

**NEW!**

### Head Gaskets

#### MLX Head Gasket

Bore	Thickness	Pkg Qty	Part #
83mm	.036"	1	C14121-036

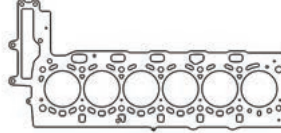

Additional thicknesses available  
see page 5

## 5VZ-FE 3.4L V6 95-99 Tacoma, 95-98 T100, 95-99 4 Runner, 00-04 Tundra, 96-99 Landcruiser, 00 Hi-Lux

### Head Gaskets

#### MLS Head Gasket - Left Side

Bore	Thickness	Pkg Qty	Part #
98mm	.040"	1	C4215-040

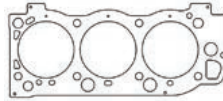

Additional thicknesses available  
see page 5

#### MLS Head Gasket - Right Side

Bore	Thickness	Pkg Qty	Part #
98mm	.040"	1	C4214-040

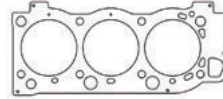

## 1UZ-FE 4.0L 32v V8 w/o VVTi 98-00 GS400, 91-00 LS400, 91-00 SC400

### Head Gaskets

#### MLS Head Gasket - Left Side

Bore	Thickness	Pkg Qty	Part #
89mm	.040"	1	C4137-040
92.5mm	.051"	1	C4137-051

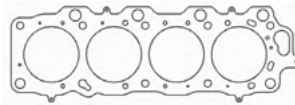

Additional thicknesses available  
see page 5

#### MLS Head Gasket - Right Side

Bore	Thickness	Pkg Qty	Part #
89mm	.040"	1	C4136-040
92.5mm	.051"	1	C4136-051

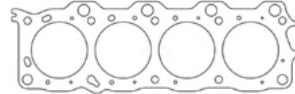

## 1UR-FE/1UR-FSE/2UR-FSE/2UR-GSE/3UR-FE/3UR-FBE 2006+

### Head Gaskets

#### MLS Head Gasket - Left Side

Bore	Thickness	Pkg Qty	Part #
97mm	.034"	1	C4993-034

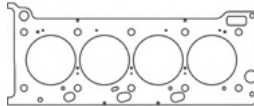

Additional thicknesses available  
see page 5

#### MLS Head Gasket - Right Side

Bore	Thickness	Pkg Qty	Part #
97mm	.034"	1	C4994-034

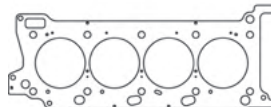

## 2GR-FE 3.5L V6 3456cc 2005 Avalon, 2006 RAV4, 2008 Highlander

### Head Gaskets

#### MLS Head Gasket - Left Side

Bore	Thickness	Pkg Qty	Part #
94.5mm	.045"	1	C4582-045

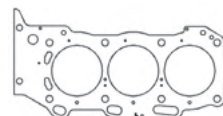

Additional thicknesses available  
see page 5

#### MLS Head Gasket - Right Side

Bore	Thickness	Pkg Qty	Part #
94.5mm	.045"	1	C4581-045

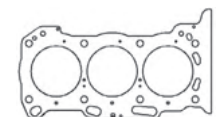



# TOYOTA

## 1GR-FE 4.0L V6: 4Runner 03-17, FJ Cruiser 07-09, Tacoma 05-15, Tundra 05-10, Landcruiser 02-11

### Head Gaskets

#### MLS Head Gasket - Left Side

Bore	Thickness	Pkg Qty	Part #
95.5mm	.027"	1	C4556-027
96.5mm	.036"	1	C14054-036
96.5mm	.045"	1	C14054-045

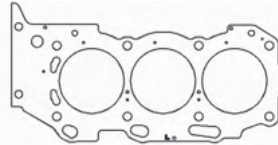

Additional thicknesses available see page 5

#### MLS Head Gasket - Right Side

Bore	Thickness	Pkg Qty	Part #
95.5mm	.027"	1	C4557-027
96.5mm	.036"	1	C14045-036
96.5mm	.045"	1	C14045-045



### Individual Gaskets

**NEW!**

#### Oil Pan Gasket

Application	Part #
05-17 Lower (1GR-FE/2GR/2TR-FE/2GR-FKS)	C14113-060
Automatic Trans - 19 Bolt (1UZ/2UZ/7MGTE)	C14118-060
Automatic Trans - 20 Bolt (1UR/3UR/4GR-FSE)	C14122-060

**NEW!**

#### Intake Manifold Gasket Set

Application	Part #
03-15 1GR-FE Set of 2	C14127-020

#### Exhaust Manifold Gasket Set

Application	Part #
07-15 1GR-FE Set of 2	C14116-064

## 1FZ-FE 4.5L DOHC Inline 6 1995-98 Landcruiser, 1995-98 Lexus 450

### Head Gaskets

#### MLS Head Gasket

Bore	Thickness	Pkg Qty	Part #
101.5mm	.053"	1	C4530-053

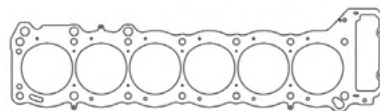

Additional thicknesses available see page 4

#### MLX Head Gasket

Bore	Thickness	Pkg Qty	Part #
101.5mm	.040"	1	C4611-040

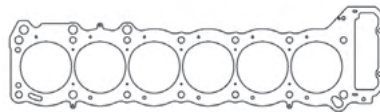

## 2UZ-FE 4.7L 32v V8 1998 Landcruiser, 2004 GX470, 2004 4 Runner, 2001-04 Tundra, 2001-04 Sequoia, 1998-00 LX470

### Head Gaskets

#### MLS Head Gaskets - Left Side

Bore	Thickness	Pkg Qty	Part #
92mm	.040"	1	C4358-040
98mm	.040"	1	C4212-040

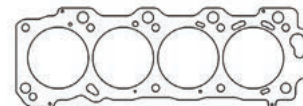

Additional thicknesses available see page 4

#### MLS Head Gaskets - Right Side

Bore	Thickness	Pkg Qty	Part #
92mm	.040"	1	C4357-040
98mm	.040"	1	C4211-040

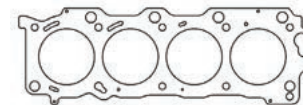

### Individual Gaskets

#### Oil Pan Gasket

Application	Part #
Automatic Trans - 20 Bolt (1UR/3UR/4GR-FSE)	C14122-060



# TOYOTA

## PH11 Race V8

### Head Gaskets

#### MLS Head Gasket - Left Side

Bore	Thickness	Pkg Qty	Part #
4.200"	.....040"	.....1	C5584-040



Additional thicknesses available  
see page 5

#### MLS Head Gasket - Right Side

Bore	Thickness	Pkg Qty	Part #
4.200"	.....040"	.....1	C5583-040



# TRIUMPH

## 1966-74 Spitfire 1500cc

### Head Gasket

#### Copper Head Gasket

Bore	Thickness	Pkg Qty	Part #
74mm	.....043"	.....1	C4153-043

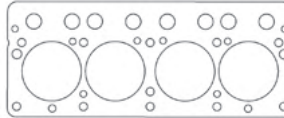

Additional thicknesses available  
see page 5

## 1961-65 TR4 2138cc Pushrod

### Head Gasket

#### CFM-20 Head Gasket

Bore	Thickness	Pkg Qty	Part #
88mm	.....043"	.....1	C4152-043

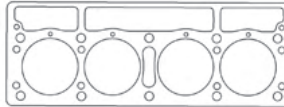

Additional thicknesses available  
see page 5

## 1969-71 TR6 2498cc Inline 6 Pushrod

### Head Gasket

#### Copper Head Gasket

Bore	Thickness	Pkg Qty	Part #
76mm	.....043"	.....1	C4154-043

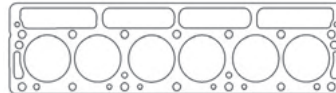

Additional thicknesses available  
see page 5

# TVR

Speed 6 3.6/4.0L 1999-06 Tuscon, 1996-06 Cerbera, 2002-06 Tamora, 2002-06 T350,  
2004-06 Sagaris

### Head Gaskets

#### MLS Head Gasket

Bore	Thickness	Pkg Qty	Part #
96.5mm	.....060"	.....1	C4527-060

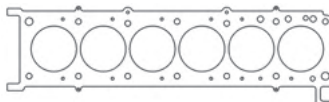

Additional thicknesses available  
see page 5



## VAUXHALL/OPEL

**C16XE, X16XE/X16XEL, Y16XE 1994-98 Astra, 1993-94 Corsa B GSI, 1994-00 Tigra 16v**

### Head Gasket

#### MLS Head Gasket

Bore	Thickness	Pkg Qty	Part #
82mm	.....051"	.....1	<b>C4257-051</b>

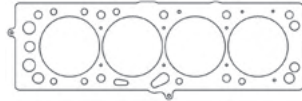

Additional thicknesses available  
see page 5

**20XE/C20XE/X20LET 1992-97 Calibra Turbo, 1987-91 Kadett E 16v, 1993-95 Vectra A Turbo**

#### MLS Head Gasket

Bore	Thickness	Pkg Qty	Part #
88mm	.....051"	.....1	<b>C4216-051</b>

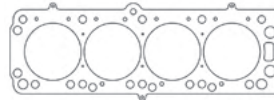

Additional thicknesses available  
see page 5

#### MLX Head Gasket

Bore	Thickness	Pkg Qty	Part #
88mm	.....050"	.....1	<b>C4960-050</b>

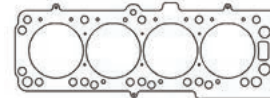

**CIH/E, CIH/S, CIH/S/E 2.0L 83-88 Manta B, 1978-81 Ascona, 76-80 Rekord, 1983-84 Monza, 77-79 Kadett,**

### Head Gasket

#### MLS Head Gasket

Bore	Thickness	Pkg Qty	Part #
97mm	.....051"	.....1	<b>C4512-051</b>

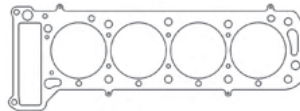

Additional thicknesses available  
see page 5

## VOLKSWAGEN/AUDI

**1.4L 1390cc DOHC TFSI 2007+: BMY, BLG**

### Head Gaskets

#### MLX Head Gasket

Bore	Thickness	Pkg Qty	Part #
77mm	.....032"	.....1	<b>C4980-032</b>

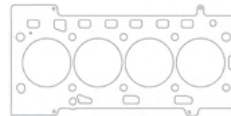

Additional thicknesses available  
see page 5

### Individual Gaskets

#### Exhaust Manifold Gasket Sets

Application	Part #
1.4L DOHC 16v MLS	<b>C4975-030</b>

**1.8L AGB, 2H, GX, HT, JH, JN, MZ, PG, PF, RD, RV, PL 2.0L: 9A - Golf Mk2/Mk3, Jetta Mk2/Mk3, Passat B2/B3/B4, Audi 80/100, Seat Ibiza Mk2**

### Head Gaskets

#### MLS Head Gaskets

Bore	Thickness	Pkg Qty	Part #
83mm	.....051"	.....1	<b>C4247-051</b>
85mm	.....051"	.....1	<b>C4246-051</b>

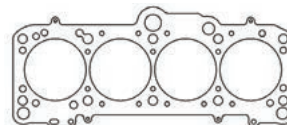

Additional thicknesses available  
see page 5

### Individual Gaskets

#### Exhaust Manifold Gasket Sets

Application	Part #
1.8L 8v MLS - 4pcs	<b>C4163-030</b>
1.8L 16v MLS - 4pcs	<b>C4210-030</b>



Cometic Gasket - An Exclusive NASCAR Performance Product

# VOLKSWAGEN/AUDI

## 1.8L Turbo 1998-06

AEB, AGU, AJH, APH, ARX, ARZ, ATW, AUM, AVC, AWD, AWL, AWT, AWW, BJX, BKF, BKV, CFMA, AYP, CED, AMB, AWM, AJQ, APP, ARY, ATC, AUQ, AWP, BEK, BNU, BEX, BVR, AMU, AMK, BAM, BEA

### Head Gaskets

#### MLS Head Gaskets

Bore	Thickness	Pkg Qty	Part #
82mm	.051"	1	C4558-051
85mm	.051"	1	C4559-051

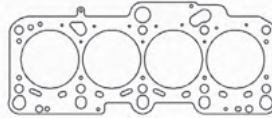

Additional thicknesses available see page 5

## 2.0L TFSI 16v DOHC

Golf GTI 2004-Up, A3, A4, A6, Jetta, Passat 2005-Up, TT, EOS 2006-Up, Seat Leon 2005-Up (AXX, BPY, BWA, BPJ, BUL, BWE, BRC, BWT, BYK)

### Head Gasket

#### MLS Head Gasket

Bore	Thickness	Pkg Qty	Part #
83.5mm	.051"	1	C4541-051

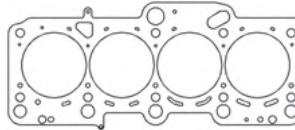

Additional thicknesses available see page 5

### Individual Gaskets

#### Exhaust Manifold Gasket Sets

Application	Part #
2.0L DOHC 16v MLS 2005-14	C4972-030

## 2.0L 16v DOHC 2008-11(chain driven) A3, A4, A6, A3, A4, A5, Q5, TT, 2009-11 CC, 08-11 Jetta, 08-10 Passat

### Head Gaskets

#### MLS Head Gasket

Bore	Thickness	Pkg Qty	Part #
82.5mm	.040"	1	C4976-040
84mm	.040"	1	C4977-040

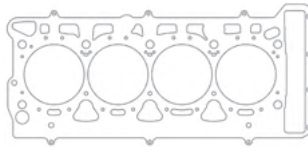

Additional thicknesses available see page 5

### Individual Gaskets

#### Exhaust Manifold Gasket Sets

Application	Part #
2.0L DOHC 16v MLS 2005-14	C4972-030

## 2.0L 16v DOHC 2012-Present (chain driven): A1, A3, A4, A5, Q3,Q5, TT

### Head Gaskets

#### MLS Head Gasket

Bore	Thickness	Pkg Qty	Part #
83mm	.040"	1	C4978-040
84mm	.040"	1	C4979-040

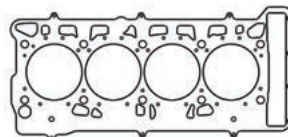

Additional thicknesses available see page 5

### Individual Gaskets

#### Exhaust Manifold Gasket Sets

Application	Part #
2.0L DOHC 16v MLS 2005-14	C4972-030



## VOLKSWAGEN/AUDI

**1.8L 16V DOHC (CNSA, CNSB, CPRA, CPKA, CXBA, CXBB)  
2.0L 16v DOHC (CJXC, CXBB, CXCA, CNTC, CPPA, CPLA CXCB, CYFB, CYMC,  
CYNB, CZRA, DBPA, EA113)**

### Head Gaskets

#### MLX Head Gasket

Bore	Thickness	Pkg Qty	Part #
83mm	.....036"	.....1	C14009-036

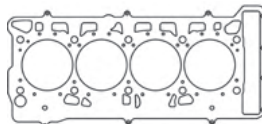

Additional thicknesses available  
see page 5

## 3.2L VR6 24v 2004-09: Golf Mk4 R32

### Head Gaskets

#### MLS Head Gasket

Bore	Thickness	Pkg Qty	Part #
83mm	.....030"	.....1	C4968-030

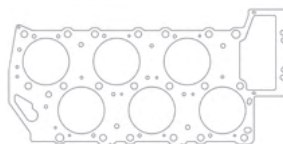

Additional thicknesses available  
see page 5

### Individual Gaskets

#### Throttle Body Gasket

Application	Part #
3.2L VR6	C14027-060

#### Intake Manifold Gasket

Application	Part #
2007-08 Eos, 2003-04 Golf	C14029-060

## VOLVO

## B18A/B/D 1.8L 1961-68, B20A/B/E/F 2.0L 1969-81

### Head Gasket

#### MLS Head Gasket

Bore	Thickness	Pkg Qty	Part #
86mm	.....045"	.....1	C4287-045
90mm	.....045"	.....1	C4288-045
92mm	.....045"	.....1	C4289-045

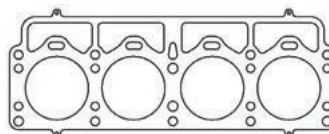

Additional thicknesses available  
see page 5

## B19A/E/ET 2.0L 1976-84, B20E/F/K/ET/FT 2.0L 1985-95, B21E/F/T/FT 2.1L 1975-85

### Head Gasket

#### MLS Head Gasket

Bore	Thickness	Pkg Qty	Part #
92mm	.....045"	.....1	C4498-045
92mm	.....098"	.....1	C4498-098
93mm	.....045"	.....1	C14085-045
100.5mm	.....045"	.....1	C14093-045

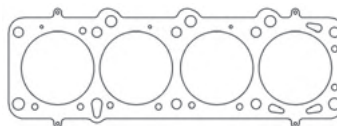

Additional thicknesses available  
see page 5

## B23AE/E/F/FT 2.3L 1978-84, B230A/E/F/FT/K 2.3L 1985-98, B243F 1989-95

### Head Gasket

#### MLS Head Gasket

Bore	Thickness	Pkg Qty	Part #
97mm	.....045"	.....1	C4499-045
98mm	.....051"	.....1	C14094-051

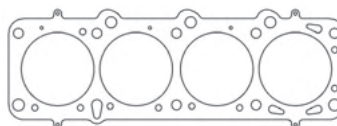

Additional thicknesses available  
see page 5



# MLS

## Exhaust Manifold Gaskets

- Designed for extreme cylinder pressures
- Maintains a torque set
- Resists corrosion, will not burn through or push out
- Withstands different combinations of cylinder head & exhaust manifold materials
- No sealants are required



### Domestic Exhaust Gaskets

Description	Material	Pkg Qty	Part#
<b>CHRYSLER / DODGE</b>			
<b>318, 340 &amp; 360</b>			
1.310" x 1.640" Port	MLS .030"	2	C5901-030
<b>361, 383, 400, 413, 426 &amp; 440</b>			
1.780" x 1.460" Port	MLS .030"	2	C5902-030
<b>426 Hemi</b>			
1.840" x 1.890" Port Stock	MLS .030"	2	C5965-030
2.310" x 2.810" Port Top Fuel	MLS .030"	2	C5903-030
<b>5.7L Hemi V8</b>			
1.460" x 1.390" Port	MLS .030"	2	C5854-030
<b>6.1L Hemi V8</b>			
2.082" x 1.508" Port	MLS .030"	2	C5872-030
<b>Viper V10</b>			
Gen I 1992-96	MLS .030"	2	C5679-030
Gen II 1996-02	MLS .020"	2	C5825-020
Gen III 2003-07	MLS .030"	2	C5865-030
Gen IV 2008-12	MLS .040"	2	C15150-040
<b>CUMMINS</b>			
5.9L 12V 16 Diesel 92-97	MLS .040"	2	C5725-040
5.9L 24V / Common Rail 98-08	MLS .040"	2	C5726-040
<b>FORD</b>			
<b>289, 302 &amp; 351</b>			
1.120" x 1.480" Port Square	MLS .030"	2	C5898-030
1.127" x 1.750" Port Oval	MLS .030"	2	C5899-030
All Yates Head 3 Piece Spring Steel	MLS .040"	8	C5665-040
<b>332 &amp; 390</b>			
1.560" x 2.320" Port	MLS .030"	2	C5922-030
<b>4.6L DOHC &amp; SOHC, 5.4L SOHC</b>			
4.6L / 5.4L 3V Head	MLS .030"	2	C5852-030
4.6L / 5.4L 3V Head D-Ports	MLS .030"	2	C5997-030
4.6L SOHC 1991-01, 5.4L Triton 99-Up	MLS .030"	2	C5853-030
4.6L / 5.4L DOHC 93-99	MLS .030"	2	C5012-030
5.0L Modular V8 2011	MLS .030"	2	C5392-030
5.2L DOHC Voodoo V8 2015-2020	MLS .030"	2	C15601-030
5.4L Shelby Mustang 2007	MLS .030"	2	C5805-030
6.2L "BOSS" V8 2010+	MLS .030"	2	C5041-030
<b>429 &amp; 460</b>			
1.250" x 2.080" Oval Port	MLS .030"	2	C5900-030
1.550" x 2.350" Oval Port	MLS .030"	2	C5998-030
<b>RACE</b>			
JC50 500ci - Pro Stock	MLS .030"	2	C5257-030
FR9 V8	MLS .030"	2	C15107-030
<b>DIESEL</b>			
6.0/6.4L Power Stroke	MLS .030"	2	C5089-030
Ford 6.7L Power Stroke 11-14	MLS .030"	2	C15487-030
<b>GM</b>			
<b>V8 Small Block 262, 265, 283, 302, 307, 327, 350, 400 &amp; LT1</b>			
1.400" Square Port	MLS .030"	2	C5548-030
1.500" Round Port	MLS .030"	2	C5891-030
1.450" x 1.480" Port	MLS .030"	2	C5892-030
1.625" Round Port	MLS .030"	2	C5893-030
1.450" x 1.600" Port	MLS .030"	2	C5894-030
LT1 1.520" x 1.510" Port	MLS .030"	2	C5895-030
Brodix 12B Raised D Port	MLS .030"	2	C5927-030
Brodix / Weldtech 12 x 12 D Port	MLS .030"	2	C5928-030
GM/Brodix 13 Degree 4.4/4.5" Spacing	MLS .030"	2	C5039-030
Brodix/All Pro 286	MLS .030"	2	C5040-030
<b>SB2 Race</b>			
1.500" x 1.600"	MLS .065"	2	C5552-065
SB2	MLS .030"	2	C5836-030
<b>Big Block</b>			
1.920" Round Port	MLS .030"	2	C5896-030
2.000" Round Port	MLS .030"	2	C5349-030
2.130" Round Port	MLS .030"	2	C5996-030
2.200" Round Port	MLS .030"	2	C5350-030
2.250" Round Port	MLS .030"	2	C5251-030
1.850" x 1.900" Port	MLS .030"	2	C5897-030
Mercury Big Block 1050	MLS .051"	2	C5820-051
Mercury Marine 525/552 EFI	MLS .051"	2	C15364-030

Description	Material	Pkg Qty	Part#
<b>GM</b>			
<b>LS Series V8</b>			
LS Series V8	MLS .030"	2	C5818-030
LS7 D-Port 06-14	MLS .030"	2	C5073-030
GEN V LT1 6.2L 1.920" Port	MLS .021"	2	C5020-021
<b>DIESEL</b>			
6.6L Duramax 01-16	MLS .040"	2	C15042-040
<b>PONTIAC</b>			
Pontiac V8 326, 350, 400, 421,	MLS .030"	2	C5905-030
<b>428 &amp; 455 D Port</b>			
<b>OLDS</b>			
<b>330, 350, 400, 403 &amp; 455</b>			
1.450" x 1.920" Port	MLS .030"	2	C5904-030
<b>UNIVERSAL Header Collector</b>			
3.000" Dia. x 3.875" Bolt Circle	MLS .030"	2	C5907-030

### Import Exhaust Gaskets

Description	Material	Pkg Qty	Part#
<b>GM</b>			
Ecotec 2.2L - 1.720" x 1.090" 00-Up	MLS .030"	1	C4150-030
<b>HONDA</b>			
All B Series - 1.850" x 1.340" 94-01	MLS .030"	1	C4151-030
H22A1/A2/A4 - 1.770" x 1.380" 92-01	MLS .030"	1	C4155-030
F20C1/C2 - 2.030" x 1.730" 00-Up	MLS .030"	1	C4159-030
K20A1/A3 - 1.820" x 1.540" 01-04	MLS .030"	1	C4160-030
K20A2 - 1.975" x 1.730" 02-06	MLS .030"	1	C4162-030
K20C1 - 3.26" x 1.66" 17-20	MLS .020"	1	C14022-020
D15/16 - 1.860" x 1.390" 92-00	MLS .030"	1	C4164-030
<b>MAZDA</b>			
B6 16V - 1.765" x 1.020" 89-93	MLS .030"	1	C4165-030
FS-DE - 2.045" x 1.375" 91-03	MLS .030"	1	C4171-030
<b>MINI</b>			
<b>MITSUBISHI</b>			
4G63T/4G64 - 2.287" x 1.615" 89-99	MLS .030"	1	C4199-030
420A - 2.040" x 1.100" 95-98	MLS .030"	1	C4161-030
<b>NISSAN</b>			
VK56XD 2010-16	MLS .030"	2	C4959-030
VK56DE 2004-09	MLS .030"	2	C4961-030
CA18 DOHC - 1.621" x 1.232"	MLS .030"	1	C4523
SR20DE/T - 2.050" x 1.580" 91-02	MLS .030"	1	C4200-030
KA24DE - 1.575" Square 91-98	MLS .030"	1	C4201-030
RB26 - 1.665" x 1.420" 89-02	MLS .030"	2	C4202-030
RB20/RB25 - 1.340" x 1.575"	MLS .030"	1	C4177-030
<b>SCION</b>			
2AZ-FE 2.4L - 1.890" Round 01-Up	MLS .030"	1	C4203-030
<b>SUBARU</b>			
All EJ Motors - 1.825" Round 93-Up	MLS .030"	2	C4204-030
<b>TOYOTA</b>			
1ZZFE - 1.732" Round 98-02	MLS .030"	1	C4205-030
3S-GTE/5S-FE - 1.690" x 1.415" 89-97	MLS .030"	1	C4206-030
2RZ/3RZ-FE - 1.730" x 1.460" 95-Up	MLS .030"	1	C4207-030
7MGTE - 1.412" Round 87-92	MLS .030"	1	C4208-030
2JZGTE - 1.600" x 1.220" 93-Up	MLS .030"	2	C4209-030
1UR-FE/3UR-FBE/3UR-FE 07-19	MLS .040"	1	C14125-040
<b>VW/AUDI</b>			
2.0L 05-14	MLS .030"	1	C4972-030
1.4L 07-Up	MLS .030"	1	C4975-030
2.0L - 1.525" Round 85-96	MLS .030"	4	C4210-030





## Valve Stem Seals

Available for most applications ranging from automotive to off road dirt bikes.  
 Valve stem seals are defined first by the actual measurement of the valve stem OD itself then by the guide OD. Proper seal height and width will be determined by valve spring clearance.  
**Sold in packs of sixteen.**



Umbrella



Positive All Rubber



Positive Ring & Spring

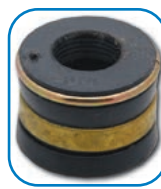

Positive Ring & Band



O-Ring



Metal Jacket



Metal Jacket "Hat"

### Metric Valve Stem

Part #	Stem OD	Guide OD	Height	OD	Type / Matl.
3154V-16	8.0mm	12.0mm	9.6mm	15.5mm	Metal Jacket/Viton
3158V-16	6.0mm	10.7mm	11.5mm	13.8mm	Metal Jacket/Viton
3159V-16	6.0mm	11.75mm	15.0mm	14.6mm	Metal Jacket/Viton
3162V-16	7.0mm	15.0mm	14.0mm	14.3mm	Metal Jacket/Viton
3163V-16	5.5mm	11.8mm	12.0mm	14.8mm	Metal Jacket/Viton
3164V-16	8.0mm	12.3mm	12.0mm	17.0mm	Ring & Band/Viton
3168V-16	7.5mm	14.0mm	13.0mm	16.8mm	Metal Jacket/Viton
3169V-16	5.5mm	12.0mm	13.8mm	14.5mm	Metal Jacket/Viton (no int rubber)
3170V-16	5.0mm	11.0mm	10.0mm	12.85mm	Metal Jacket/Viton
3172V-16	6.0mm	9.8mm	10.0mm	13.2mm	Metal Jacket/Viton
3173V-16	5.5mm	11.8mm	12.0mm	14.75mm	Metal Jacket/Viton
3225V-16	6mm	11mm	9.3mm	13.4mm	Metal Jacket/Viton
3174V-16	8.5mm	12.5mm	2.0mm	11.9mm	O-ring/Viton
3175V-16	5.5mm	9.5mm	11.4mm	12.75mm	Metal Jacket/Viton
3176V-16	5.0mm	10.6mm	11.6mm	14.15mm	Metal Jacket/Viton
3177V-16	6.0mm	12.0mm	10.0mm	13.7mm	Metal Jacket/Viton
3180V-16	5.0mm	10.8mm	18.3mm	16.9mm	Metal Jacket (Hat)/Viton
3181V-16	5.5mm	11.6mm	20.2mm	17.2mm	Metal Jacket (Hat)/Viton
3182V-16	5.0mm	11.8mm	21.0mm	17.15mm	Metal Jacket (Hat)/Viton
3262V-16	7.0mm	11mm	9.5mm	14.4mm	Metal Jacket/Viton
3264V-16	5.0mm	11mm	8mm	13.4mm	Metal Jacket EXH/Viton
3265V-16	5.0mm	11mm	8mm	13.4mm	Metal Jacket INT/Viton
3516P-16	8.0mm	0.492	0.470	0.616	Metal Jacket/Poly

### 1/4" Valve Stem

Part #	Stem OD	Guide OD	Height	OD	Type / Matl.
3184V-16	1/4	0.435	0.392	0.531	Metal Jacket/Viton
3232V-16	1/4	0.476	0.517	0.562	Metal Jacket/Viton (no int rubber)
3258V-16	1/4	0.476	0.646	1.106	Metal Jacket (Hat)/Viton
3259V-16	1/4	0.48	0.794	1.106	Metal Jacket (Hat)/Viton

### 5/16" Valve Stem

Part #	Stem OD	Guide OD	Height	OD	Type / Matl.
3057V-16	5/16	0.438	0.445	0.600	Ring & Band/Viton
3060V-16	5/16	0.562	0.461	0.710	Ring & Band/Viton
3061V-16	5/16	0.562	0.461	0.710	Ring & Band/Viton
3064V-16	5/16	0.563	0.580	0.712	Metal Jacket/Viton
3222V-16	5/16	0.514	0.403	0.610	Metal Jacket/Viton
3235V-16	5/16	0.531	0.516	0.677	Metal Body/Viton
3236V-16	5/16	0.491	0.531	0.623	Metal Body/Viton
3237V-16	5/16	0.476	0.517	0.562	Metal Body/Viton (no int rubber)
3216V-16	5/16	0.562	1.085"	1.3888	Metal Jacket (Hat)/Viton

### 11/32" Valve Stem

Part #	Stem OD	Guide OD	Height	OD	Type / Matl.
3012V1-16	11/32	0.500	0.540	0.640	Ring & Band/Viton
3013N1-16	11/32	0.520	0.470	0.690	Positive 2-Ring/Nitrile
3014N1-16	11/32	0.530	0.485	0.710	Ring & Band/Nitrile
3024V1-16	11/32	0.530	0.485	0.710	Ring & Band/Viton
3066V1-16	11/32	0.563	0.470	0.690	Ring & Band/Viton
3188V-16	11/32	0.500	0.531	0.623	Metal Jacket/Viton
3192V-16	11/32	0.562	0.485	0.677	Ring & Band/Viton
3223V-16	11/32	0.472	0.435	0.677	Metal Jacket/Viton
3228V-16	11/32	0.530	0.527	0.674	Metal Jacket/Viton
3245V-16	11/32	0.583	0.400	0.740	Metal Jacket/Viton

### 3/8" Valve Stem

Part #	Stem OD	Guide OD	Height	OD	Type / Matl.
3017N1-16	3/8	0.623	0.470	0.790	Positive-2-Ring/Nitrile
3050V-16	3/8	0.750	0.830	0.875	Umbrella Seal/Viton
3185T-16	3/8	0.562	0.415	0.66	Teflon Steel Body/Teflon
3195V-16	3/8	0.500	0.531	0.623	Metal Jacket/Viton
3196V-16	3/8	0.530	0.516	0.677	Metal Jacket/Viton
3197V-16	3/8	0.562	0.516	0.661	Metal Jacket/Viton
3198V-16	3/8	0.625	0.531	0.742	Metal Jacket/Viton

### Misc. Valve Stem

Part #	Stem OD	Guide OD	Height	OD	Type / Matl.
3199V-16	276	0.476	0.517	0.562	Metal Jacket/Viton (no int rubber)
3240V-16			0.975	0.970	Metal Jacket (Hat)/Viton
3255V-16	0.287	0.49	0.887	1.185	Metal Jacket (Hat) INT/Viton
3256V-16	0.287	0.49	0.887	1.185	Metal Jacket (Hat) EXH/Viton
3260V-16	0.281	0.53	1.035	1.372	Metal Jacket (Hat)/Viton
3261V-16	0.281	0.53	1.14	1.255	Metal Jacket (Hat)/Viton
3214V-16	0.265	0.500	0.555	0.645	Metal Jacket /Intake
3215V-16	0.265	0.500	0.555	0.638	Metal Jacket /Exhaust
3217V-16	0.265		1.020	1.000	Metal Jacket (Hat)/Viton
3218V-16	0.265	0.500	0.635	1.126	Metal Jacket /Intake/Yellow
3219V-16	0.265	0.500	0.635	0.645	Metal Jacket /Exhaust/Green
3246V-16	0.198	0.334	0.390	0.482	Metal Jacket /Viton
3257V-16	0.204		0.555	0.645	Metal Jacket /



## ***Fel-Pro to Cometic Cross Compatibilites***

<b>Fel-Pro</b>	<b>Cometic</b>	<b>Fel-Pro</b>	<b>Cometic</b>	<b>Fel-Pro</b>	<b>Cometic</b>
1003.....	C5272-040	6579.....	C5642-031	TCS45953.....	C5054
1008.....	C5456-040	12222.....	C5165	TCS45956.....	C5055
1009.....	C5462-040	30060.....	C5347-039	TCS45996.....	C5060
1013.....	C5871-040	35062.....	C5538-047	TCS46049.....	C5202
1014.....	C5249-040	1011-1.....	C5514-040	TCS5124-1.....	C5052
1016.....	C15262-040	1011-2.....	C5514-040	VS50068R.....	C5659-125
1018.....	C5667-040	1017-1.....	C5330-040	VS50090R.....	C5975
1020.....	C5840-040	1017-2.....	C5330-051	VS50184R.....	C15468
1021.....	C5481-040	1141L.....	C5118-036	VS50279B.....	C4800-059
1028.....	C5668-040	1141R.....	C5119-036	VS50293R.....	C15206
1035.....	C5709-040	1153-1.....	C4235-051	VS50304R1.....	C4820
1046.....	C5485-051	26182PT.....	C4558-045	VS50326R.....	C4701
1047.....	C5333-040	26192PT.....	C5489-051	VS50361R.....	C4781
1067.....	C5334-040	26208PT.....	C5015-075	VS50362R.....	C4679
1133.....	C5481-040	26209PT.....	C5016-075	VS50377R.....	C5178
1152.....	C5911-045	BS40245.....	C5564	VS50377R1.....	C5178
1200.....	C5694-060	BS40345-1.....	C4843	VS50384R.....	C4747
1201.....	C5792-060	BS40444.....	C4697	VS50390R.....	C4722
1204.....	C5544-060	BS40562.....	C4720	VS50396R.....	C15066-1
1210.....	C15041-060	BS40613.....	C5707	VS50455R.....	C15046
1212.....	C15041-060	BS40634.....	C4783	VS50477R.....	C5177
1230.....	C5043-060	BS40637.....	C4832	VS50498R.....	C4628
1231.....	C5206-060	BS40640.....	C5172	VS50499R.....	C4655
1234.....	C5598-060	BS40648.....	C4699	VS50504R.....	C5170
1277.....	C5541-031	MS90175.....	C5611-060	VS50574R.....	C4788
1282.....	C5541-060	MS93909.....	C4205-030	VS50581R.....	C4644
1298.....	C5342-060	MS96587.....	C5166	VS50625R.....	C5193
1423.....	C15342HTS	OS30542R.....	C4660	VS50820R.....	C15151
1804.....	C5344	OS30693R.....	C5173		
1810.....	C5279-094	OS34500R.....	C5072		
1811.....	C5278-094	TCS13198.....	C5053		
1827.....	C15092	TCS13417.....	C5070		
2900.....	C5680	TCS45002.....	C5050		
2901.....	C5688	TCS45060.....	C5057		
2904.....	C5682	TCS45061.....	C5066		
2912.....	C5379	TCS45117.....	C5047		
2919.....	C5106	TCS45906.....	C4816		
5152.....	C5299-018	TCS45907.....	C4816		



# Karting Gaskets



Cometic Gasket - An Exclusive NASCAR Performance Product

## BRIGGS & STRATTON

Model	Year	Bore Size	Top End Kit #	Component #	Component Description	OEM Part #
<b>5HP RAPTOR</b>	All	68.5MM	C104	H0694043F	68.5mm Bore Head Gasket Comp. Fiber	
				IR081047F	Intake Gasket (1.400" Spacing)	
				IR084015F	Carburetor Mount Gasket Tillotson	
				IR085125KF	Intake Gasket (1.800" Spacing)	
				EX113020C	Exhaust Gasket Copper	
				EX113042AM	Exhaust Gasket Fiber	
				CB021060F	Fuel Tank Mounting Gasket	
				CB023015R	Carburetor Diaphragm Gasket	
				EC102047F	Breather Cover Gasket	
				EC103015F	Side Cover Gasket .015"	
		EC103020F	Side Cover Gasket .020"			

• Suggested Oil: Klotz KL-870

<b>ANIMAL</b>	All	69.5MM	C187	H3590040S	69.5mm Head Gasket Multi-Layer Steel	555698
				70.5MM	C200	H3590SP1040S
				IR786060AFM	Intake Gasket	691885
				EC1424060AFM	Cylinder Head Plate Gasket	694088
				EC1426060AFM	Breather Cover Gasket	691890
		EC1425032AFM	Side Cover Gasket	699485		

• Suggested Oil: Klotz KL-870

<b>LO206</b>	All	69.5MM	C199	H3590SP2060HTS	69.5mm Head Gasket Graphite	555723
				IR786060AFM	Intake Gasket	691885
				EC1424060AFM	Cylinder Head Plate Gasket	694088
				EC1426060AFM	Breather Cover Gasket	691890
				EC1425032AFM	Side Cover Gasket	699485

• Suggested Oil: Klotz KL-870

<b>WORLD FORMULA</b>	All	69.5MM	C188	H3590040S	69.5mm Head Gasket Multi-Layer Steel	555698
				IR1376015F	Intake Gasket	557044
				EX1676059F	Exhaust Gasket	691893
				EC1424060AFM	Cylinder Head Plate Gasket	694088
				EC1426060AFM	Breather Cover Gasket	691890
		EC1425032AFM	Side Cover Gasket	699485		

• Suggested Oil: Klotz KL-870

## HONDA

Model	Year	Bore Size	Top End Kit #	List Price	Component #	Component Description	OEM Part #
<b>GX200 CLONE</b>	All	68MM	C192		H3096010S	68mm Head Gasket	
					IR836020F	Intake Gasket	
					CB307020F	Carburetor Flange Gasket	
					IR1381094KF	Air Filter Adapter Gasket	
					EX1033042AM	Exhaust Gasket	
					VC207047KF	Valve Cover Gasket	
					EC1453020F	Side Cover Gasket	

• Suggested Oil: Klotz KL-870

<b>STOCK SHIFTER CR125</b>	97-99	55MM	C189	H0225010S	55mm Head Gasket	12251-KZ4-A91
				B0314018AFM	Base Gasket	12191-KZ4-L10
				B0009018AFM	Base Gasket '97 Cylinders Only	2191-KZ4-860
				IR003018AFM	Intake Reed Gasket	14132-K56-701
				EX006042AM	Exhaust Gasket	18291-KZ4-700
				PV001018AFM	Right Power Valve Gasket	12108-KZ4-700
				PV002018AFM	Left Power Valve Gasket	12109-KZ4-700
				PV003018AFM	Upper Power Valve Gasket	12112-KZ4-700
				R19X3V	Water Outlet O-ring	91312-KE7-003

• Suggested Oil: Klotz KL-104

<b>STOCK SHIFTER CR125</b>	00	54MM	C190	H0928010S	54mm Head Gasket	12251-KZ4-A91
				B0314018AFM	Base Gasket	12191-KZ4-L10
				IR003018AFM	Intake Reed Gasket	14132-K56-701
				EX006042AM	Exhaust Gasket	18291-KZ4-700
				PV091032AFM	Power Valve Gasket	12108-KZ4-A90
				R19X3V	Water Outlet O-Ring	91312-KE7-003

• Suggested Oil: Klotz KL-104

<b>STOCK SHIFTER CR125</b>	01-02	54MM	C191	H0928010S	54mm Head Gasket	12251-KZ4-A91
				B0490018AFM	Base Gasket	12191-KZ4-L10
				EX006042AM	Exhaust Gasket	18291-KZ4-700
				IR003018AFM	Intake Gasket Reed To Carb Boot	14132-K56-701
				PV091032AFM	Power Valve Gasket	12108-KZ4-A90
				R124S	Expansion Cham O-Rings (2 Req.)	
				R19X3V	Water Outlet O-Ring	91312-KE7-003

• Suggested Oil: Klotz KL-104



# Karting Gaskets



Cometic Gasket - An Exclusive NASCAR Performance Product

## HONDA

Model	Year	Bottom End Kit #	List Price	Component #	Component Description	OEM Part#
<b>STOCK SHIFTER CR125</b>	97-02	C189BE		EC083032AFM	Inner Clutch Cover Gasket	11394-KZ4-A90
				EC185020F	Center Case Gasket	11191-KZ4-620
				EC228	Clutch Cover Gasket	91311-KS6-700
				EC510060AFM	Magneto Cover Gasket	11352-KS6-700
				IR003018AFM	Intake Gasket	14132-KY4-970
				WP033018AFM	Water Pump Gasket	19229-KZ-620
				R16X3V	Fill Plus O-Ring	91303-800-000
				R20X2V	Output Shaft O-Ring	94109-12000
				WA133	Water Pump Drain Plug Gasket	90543-273-000
				WA117	Drain Plug Gasket	94109-12000

## IAME

Model	Year	Bore Size	Top End Kit #	Component #	Component Description	OEM Part #
<b>MINI SWIFT</b>	All	41.8MM	C193	H4377005C	Head Gasket .005"	A-61049
				B1358015F	Base Gasket	EBP-85045
				IR1380020F	Intake Gasket	A-61822
				EX1684059F	Exhaust Gasket	A-61360
				WA146	Copper Washer	

• Suggested Oil: Klotz KL-104

<b>LEOPARD</b>	08-Later	54MM	C194	R143V	Inner Head O-Ring	DBP-95049
				R249B	Outer Head O-Ring	B-25820
				R8X1.5V	Stud O-Ring (4 Req.)	B-25825
				B1354015F	Base Gasket	BP-25045
				IR1370032AFM	Intake Manifold Gasket	11810
				IR1371031F	Intake Reed Block Gasket	11805-A
				CB456039F	Carburetor Gasket	10360-A
				EX1674059F	Exhaust Gasket	B-85360
				WA082063C	Temp Sensor Washer	B-25845

• Suggested Oil: Klotz KL-104

<b>LEOPARD MY09</b>	All	54MM	C195	R143V	Inner Head O-Ring	DBP-95049
				R249B	Outer Head O-Ring	B-25820
				R8X1.5V	Stud O-Ring (4 Req.)	B-25825
				B1213015F	Base Gasket	EBP-125045
				IR1368031F	Intake Manifold Gasket	F-11810
				IR1369031F	Intake Reed Block Gasket	F-11805
				CB456039F	Carburetor Gasket	10360-A
				EX1674059F	Exhaust Gasket	B-85360
				WA082063C	Temp Sensor Washer	B-25845

• Suggested Oil: Klotz KL-104

<b>X30</b>	All	54MM	C196	R59X2.5V	Inner Head O-Ring	D-37049
				R246B	Outer Head O-Ring	F-38820
				R8X1.5V	Stud O-Ring (4 Req.)	B-25825
				B1213015F	Base Gasket .015"	EBP-125045
				IR1369031F	Intake Manifold Gasket	F-11805
				IR1368032AFM	Intake Reed Block Gasket	X30125810
				CB456039F	Carburetor Gasket	10360-A
				EX1673059F	Exhaust Gasket	B-75360
				WA213043C	Temp Sensor Washer	B-25845
				WA214050C	Water Pipe Washer	B-25835
				EC2206032AFM	Magneto Cover Gasket	X30125878
				R329B	Magneto Damper O-Ring	X30125853

• Suggested Oil: Klotz KL-104

## PRD

Model	Year	Bore Size	Top End Kit #	Component #	Component Description	OEM Part #
<b>PRD FIREBALL</b>	All	54MM	C197	R143V	Inner Head O-Ring	9012555
				R249B	Outer Head O-Ring	9011555
				R015V	Stud O-Ring (4 Req.)	9024555
				B1355012F	Base Gasket	9057555A
				IR1374020F	Intake Manifold Gasket	9101555
				IR1375020F	Intake Reed Block Gasket	9100555
				CB457020F	Carburetor Gasket	9107555
				EX1675064AM	Exhaust Gasket	9021555

• Suggested Oil: Klotz KL-104

## ROTAX

Model	Year	Bore Size	Top End Kit #	List Price	Component #	Component Description	OEM Part #
<b>FR125 MAX EVO</b>	All	54MM	C198		R037V	Inner Head O-Ring	250 160
					R155B	Outer Head O-Ring	250 280
					R118B	Spark Plug O-Ring	430 782
					B1356012F	Base Gasket .012"	650 480
					B1356015F	Base Gasket .015"	650 481
					B1356020F	Base Gasket .020"	650 482
					B1356031F	Base Gasket .031"	650 483
					IR1377031F	Intake Manifold Gasket	250 521

• Suggested Oil: Klotz KL-104



# Karting Gaskets



Cometic Gasket - An Exclusive NASCAR Performance Product

## YAMAHA

Model	Year	Bore Size	Top End Kit #	Component #	Component Description	OEM Part #
KT100	All	54MM	C134	H0524032C	Head Gasket	
				B0308015F	Base Gasket	
				CB030015F	Intake Carb Spacer (2 Req.)	
				CB031015F	Intake Manifold to Carb Gasket	
				EX131	Exhaust Gasket	
				EC181012F	Center Case Gasket	

• Suggested Oil: Klotz KL-104

YF200R1	All	71MM	C184	H1795036S	Head Gasket Multi-Layer Steel	F21-304-30
				IR369018AFM	Intake Gasket	F21-310-00
				EX476042AM	Exhaust Gasket	F21-309-00
				EC758018AFM	Tillotson Flange Gasket	F21-318-00
				EC759020RC	Side Cover Gasket	F21-317-00
				VC076060AFM	Valve Cover Gasket	F21-314-00
				VC077032AFM	Valve Cover Baffle	F21-315-00

• Suggested Oil: Klotz KL-870



## Karting Gasket Illustrations

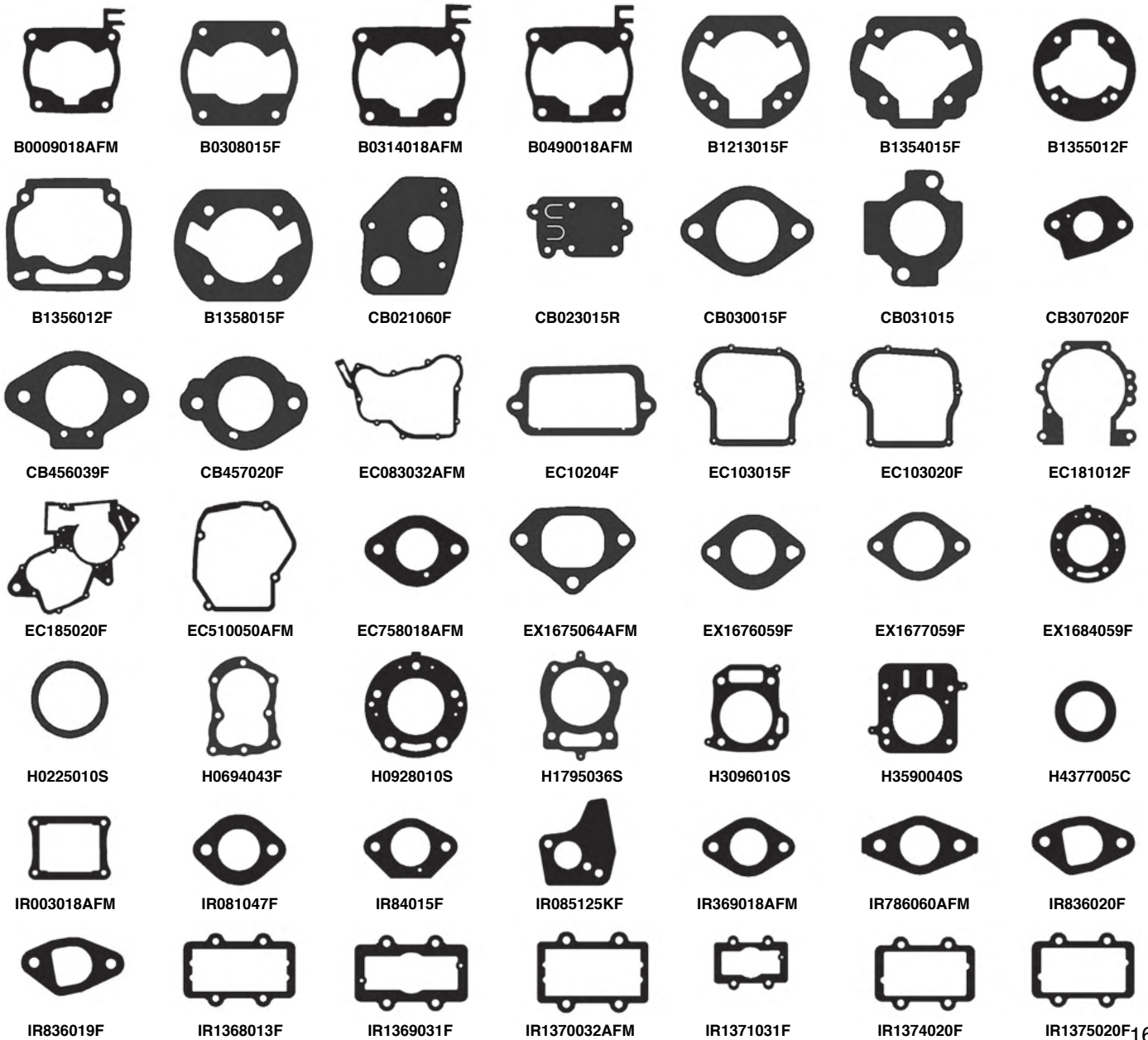



# Karting Gasket Illustrations

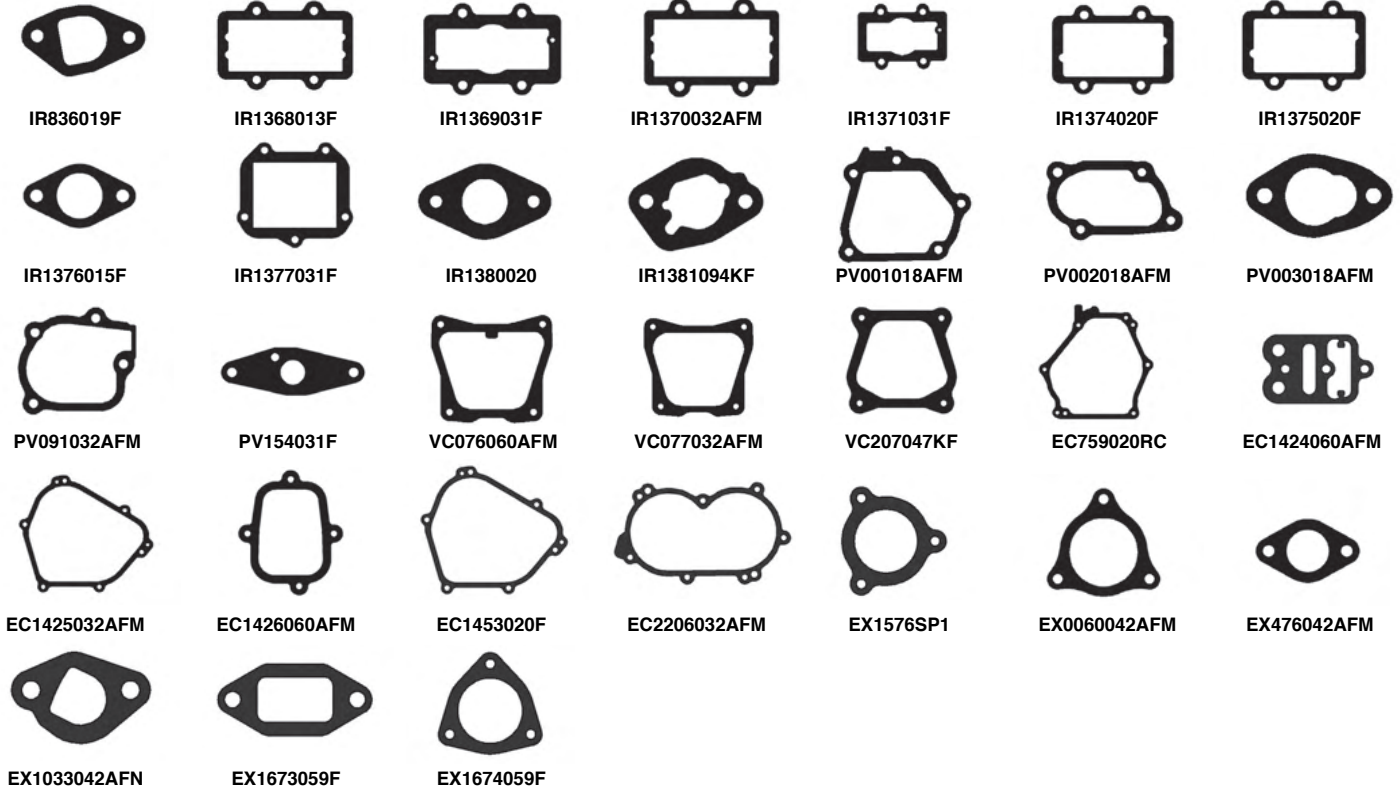

# UTV Gaskets

## ARCTIC CAT UTV PROWLER 550 XT

Model	Year	Bore Size	Top End Kit	Component Part#	Component Description	OEM Part #
Prowler 550 XT	09-15	94mm	C3741	H1962027S	Head Gasket	0830-097
				B0647014RC	Base Gasket	0830-084
				R22X2.5V	Water Outlet O-ring	0830-007
				3186V	Valve Stem Seal	0830-186
				R54X2V	Tappet Cover O-ring	0830-004
				EX657	Header Gasket	0412-338
				EC377032AFM	Cam Chain Tensioner gasket	0810-072
				R45X3V	Intake O-ring	0830-090

## PROWLER 650

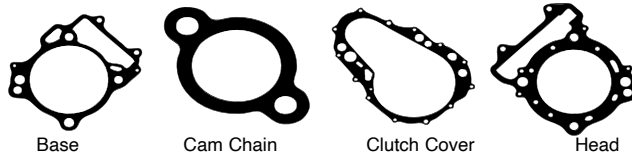

Model	Year	Bore Size	Top End Kit	Component Part#	Component Description	OEM Part #
Prowler 650	06-09	98 mm	C7220	H1735SP3027S	Head Gasket 98mm Bore	0830-124
		100 mm	C7022	H1735SP4027S	Head Gasket 100mm Bore	0830-124
				B0647014RC	Base Gasket	0830-084
				EX657	Exhaust Gasket	0412-338
				EC377032AFM	Cam Chain Tens. Gasket	0830-018
				OS020	2 Req.-Cam Chain Tens. O-ring	0830-107
				R22X2.5V	Coolant Line O-ring	0830-007
				R45X3V	Intake O-ring	0830-090
				R54X2V	2 Req.-Valve Cover O-rings	0830-004
<b>Bottom End Gaskets Available Separately</b>						
				<b>Component Part#</b>	<b>Component Description</b>	<b>OEM Part #</b>
				EC1142032AFM	Clutch Cover Gasket	0830-116
				EC1143032AFM	Magneto Cover Gasket	0830-128
				EC1141032AFM	Primary Cover Gasket	0830-174
				3186V	Valve Stem Seal	0830-186



# UTV Gaskets

## ARCTIC CAT UTV

### PROWLER 700XT LTD

Model	Year	Bore Size	Top End Kit
Prowler 700 XT LTD	08-15	103.5mm	C3597-EST
HDX700	11-17		

Component Part#	Component Description	OEM Part #
H2223SP4027S	Head Gasket	0830-112
B0760014RC	Base Gasket	0830-111
EX657	Exhaust Gasket	0412-338
OS020	Cam Chain Tensioner Gasket	0830-107
EC377032AFM	Cam Chain Tens. Gasket	0830-018
3186V	Valve Seals	0830-186
R22X2.5V	Water Outlet O-ring	0830-007
R124V	Valve Cover O-rings 2 req.	0830-215
R008B	Intake O-ring	0423-182
R124V	Oil Fill Cap O-ring	0830-215
R54X2V	Inspection Cap O-ring	0830-004

**Bottom End Gaskets Available Separately**

Component Part#	Component Description	OEM Part #
EC1142032AFM	Clutch Cover Gasket	0830-116
EC1143032AFM	Magneto Cover Gasket	0830-128
EC1141032AFM	Primary Cover Gasket	0830-174

### PROWLER/WILDCAT 1000

Model	Year	Bore Size	Top End Kit
Prowler Wildcat 1000	10-17	93.5mm	C3568-EST

Component Part#	Component Description	OEM Part #
H2399SP6027S	Head Gasket	0830-209
B1155014RC	Base Gasket	0830-193
EX657	Exhaust Gasket	0412-338
EC2035032AFM	Cam Chain Tensioner Gasket 2 Req.	0830-134
3186V	Valve Seals 8 Req.	0830-186
R118V	Water Outlet O-ring	0830-007
OS384	Water Inlet Seal	0830-120
R54X2V	Valve Cover O-rings 4 req.	0830-004
R45X3V	Intake O-ring 2 req.	0830-090

## CAN-AM/BOMBARDIER UTV

### COMMANDER 1000



Head Base

Model	Year	Bore Size	Top End Kit
Commander 1000	11-20	92mm	C3459-EST
Maverick	13-20	93mm	C3460-EST
		94mm	C3461-EST
		96mm	C3462-EST

Component Part#	Component Description	OEM Part #
H2653018S	Head Gasket 92mm 2 Req.	420630195
H2653SP1018S	Head Gasket 93mm 2 Req.	
H2653SP2018S	Head Gasket 94mm 2 Req.	
H2653SP5018S	Head Gasket 95mm 2 Req.	
3186V	Valve Stem Seal 8 Req.	420230515
R117V	Cam Chain Tensioner O-ring	420430370
R15X1.5V	Cam Adjuster O-ring	420250890
EX696	Header Gasket 2 Req.	707600317
B0895010RC	Base Gasket 2 Req.	420630210

**Bottom End Gaskets Available Separately**

Component Part#	Component Description	OEM Part #
EC1142032AFM	Clutch Cover Gasket	0830-116
EC1143032AFM	Magneto Cover Gasket	0830-128
EC1141032AFM	Primary Cover Gasket	0830-174

## HONDA UTV

### FL250 ODYSSEY

Model	Year	Bore Size	Top End Kit
FL250 Odyssey	73-77	72 mm	C7140

Component Part#	Component Description	OEM Part #
H0182043F	Head Gasket 72mm	12251-358-306
B0137020F	Base Gasket 73-76	12191-357-306
B0395020F	Base Gasket 77-84	12191-381-306



# UTV Gaskets

## HONDA UTV FL350R ODYSSEY

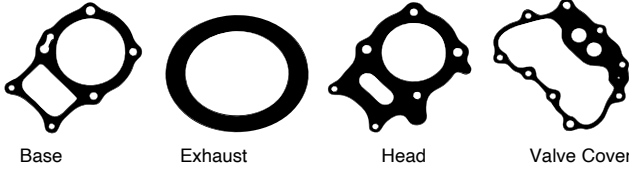

Model	Year	Bore Size	Top End Kit	Component Part#	Component Description	OEM Part #
FL350R	85	82 mm	C7229	B0204020F	Base Gasket	12191-VMO-772
Odyssey				H0344043F	Head Gasket	12254-VMO-013

## PILOT FL-400

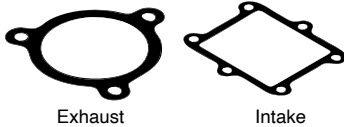

Model	Year	Bore Size	Top End Kit	Component Part#	Component Description	OEM Part #
Pilot	89-91	82 mm	C7024	H0015043F	Head Gasket	12251-HE0-000
FL-400				B0020020F	Base Gasket	12191-HE0-000/010
				EX009042AM	Exhaust Gasket	18291-HE0-000/010
				IR004018AFM	Intake Gasket	14132-KAE-000/430-000

Model	Year	Bore Size	Top End Kit	Component Part#	Component DescriptionList	OEM Part #
SXS700	14-20	102mm		EC036032AFM	Cam Chain Tensioner Gasket	12194-HC5-740
				3231V	Valve Stem Seals 4 req.	12209-KL4-005
				B0665010S	Base Gasket	12191-HN8-000
				H1835SP_027S	Head Gasket 102mm bore	12251-HN8-A61
				VC080010RC	Valve Cover Gasket	12315-HN8-000
				WA114	Head Screw Washers 6 req.	90441-706-000
				R57X2V	Tappet Cover O-Ring 2 req.	91308-500-000

## KAWASAKI UTV KRF750 Teryx

Model	Year	Bore Size	Top End Kit	Component Part#	Component Description	OEM Part #
KRF750	08-14	85mm	C3284-EST	H2624SPA010S	Head Gasket 85mm	11004-0011
Teryx (SXS)		90 mm	C3251-EST	H2624SP1010S	Head Gasket 90mm	11004-0011
				B0951020RC	Base Gasket	11061-0063
				EX361	Exhaust Gasket 2 req	11009-1894
				WA114	Coolant Drain Washer 2 Req	
				R55X2V	Rocker Cap O-Ring 4 Req	92055-0112
				R19X2V	Plug Cover O-Ring 2 Req	92055-1146
				3242V	Valve Stem Seals 8 Req	92049-1218

## POLARIS UTV RZR170

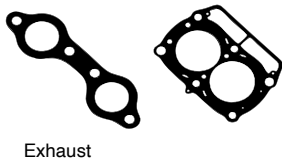

Model	Year	Bore Size	Top End Kit	Component Part#	Component Description	OEM Part #
RZR170	09-16	61mm	C3596-EST	B1318020RC	Cylinder Base Gasket	0454459
				H4194010S	Cylinder Head Gasket	0454365
				IR1308020F	Intake Manifold Gasket	0453451
				R024V	Intake Manifold O-ring	0452459
				R049B	Cylinder Head Cover O-ring	0454363
				EC2131032AFM	Cylinder Head Breather	0454640
				EC2132060AFM	Air Injection Gasket	0452808
				EC2133060AFM	Air Injection Tube Gasket	0454454
				EX886042AM	Exhaust Gasket	0453672
				3234V	Valve Seal	0452390
				EC2134032AFM	Cam Chain Tensioner Gasket	0452417

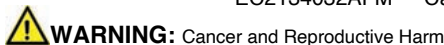





# UTV Gaskets

## POLARIS UTV

### RZR 570

Model	Year	Bore Size	Top End Kit	Component Part#	Component Description	OEM Part #
RZR 570	12,14-18	99mm	C3528-EST	B1171014RC	Base Gasket	5254903
				H3609021S	Head Gasket 99mm Bore	5813676
				3231V	Valve Seals 4 Req.	3610161
				EX817	Exhaust Gasket	5253989
				3254V	Valve Spring Seat With Seal Cam	3610212
				EC1654020RC	Chain Tensioner	5813449

### RANGER RZR 800 (SXS)

Model	Year	Bore Size	Top End Kit	Component Part#	Component Description	OEM Part #
Ranger	08	80 mm	C3250	H2761030S	Head Gasket 80mm Bore	5247359
RZR 800 (SXS)		82 mm	C3507	H2761SP2030S	Head Gasket 82mm Bore	
				B0940010RC	Base Gasket	5247360
				EX452SP1064AM	Exhaust Gasket	5811511

### RANGER RZR 800 (SXS)

Model	Year	Bore Size	Top End Kit	Component Part#	Component Description	OEM Part #
Ranger	11-13	80 mm	C3506	H3657010S	Head Gasket 80mm Bore	5254357
RZR 800 (SXS)		82 mm	C3508	H3657SP2010S	Head Gasket 82mm Bore	
				B0940010RC	Base Gasket	5247360
				EX452SP1064AM	Exhaust Gasket	5811511

### XP900



Head

Base

Cam Chain Tensioner

Water Inlet

Model	Year	Bore Size	Top End Kit	Component Part#	Component Description	OEM Part #
XP900	11-14	93.5mm	C3446-EST	H3336018S	Head Gasket 93.5mm Bore	5813439
		96mm	C3447-EST	H3336SP1018S	Head Gasket 93.5mm Bore	
				B1079014RC	Base Gasket	5253037
				EC1654020RC	Cam Chain Tensioner	5813449
				WP383032AFM	Water Inlet Gasket	5813521
				EX817	Exhaust Gasket 2 req.	5253989
				3231V	Valve Seals 8 Req.	3610161
				3254V	Valve Spring Seat with Seal 13-15 Models	3610212

### XP1000

Model	Year	Bore Size	Top End Kit	Component Part#	Component Description	OEM Part #
RZR XP1000	14-19	94mm	C3546-EST	H3892018S	Head Gasket 94mm Bore	5813737
RZR XP4 1000		96mm	C3563-EST	H3892SP1018S	Head Gasket 96mm Bore	5813737
900 Ace, General 1000	16-19			B1079014RC	Base Gasket	5253037
Ranger 1000	18-19			EC1654020RC	Cam Chain Tensioner Gasket	5813449
RZR 1000	16-19			EX1408064AM	Header Gasket	3610184
RZR XP	16-19			3254V	Valve Spring Seat With Seal	3610212
				MR135	Thermostat Seal	5413948



# UTV Gaskets

## YAMAHA UTV RHINO 660



Base Starter Cover Mag Cover Clutch Cover Timing Chain Tensioner

Model	Year	Bore Size	Top End Kit	Component Part#	Component Description	OEM Part #
RHINO 660 (SXS)	04-07	100 mm	C7044-EST	H1481SP2030S	Head Gasket 100mm	3YF-11181-00
		101 mm	C7900-EST	H1481030S	Head Gasket 101mm	
		102 mm	C7798-EST	H1191030S	Head Gasket 102mm	
		103 mm	C3042-EST	H2174030S	Head Gasket 103mm	
		105 mm	C7909-EST	H1191SP1030S	Head Gasket 105mm	
				B0532010RC	Base Gasket	3YF-11351-00
				EX361	Exhaust Gasket 2 Req.	3YF-14613-01-00
				EC584018AFM	Cam Chain Tensioner Gasket	4DW-12213-00
				3187V	Valve Seal 5 Req.	5H0-12119-00-00
				R016B	Radiator Hose O-ring	93210-18417-00
				R113B	Valve Cover Plug O-ring	93210-13657-00
				R114S	Oil Tank O-ring	93210-16629-00
				R116B	Cam Chain Tensioner Cap O-ring	11101/93210-19522-00
				R117B	Dipstick O-ring	93210-21190-00
				R124B	Tappet Cover O-ring	93210-32172-00
				R155S	Cylinder Base O-ring	11256/93211-01467-00
				R71X2.5B	Intake Valve Adj. Cover O-ring	93210-71360-00
				WA081080C	Oil Line Washers 4 Req.	90430-08204
				WA082063C	Oil line Washers 4 Req.	90430-10171

### RHINO 700

Model	Year	Bore Size	Top End Kit	Component Part#	Component Description	OEM Part #
RHINO 700	06-13	103 mm	C3142-EST	H2449027S	Head Gasket	3B4-11181-00-00
		104 mm	C3143-EST	H2449SP2027S	Head Gasket 104mm Bore	3B4-11181-00-00
		105.5 mm	C3144-EST	H2465027S	Head Gasket 105.5mm Bore	3B4-11181-00-00
				B0855010RC	Base Gasket	1S3-11351-00-00
				EX361	Exhaust Gasket 2 Req.	3YF-14613-01-00
				R034V	Throttle Body O-ring	4WV-14147-
				R126V	Water Pump O-ring	93210-33786-00
				R131B	Thermostat O-ring	93210-41042-00
				R240V	Cam Cover O-ring	93210-96601-00
				R79X2.5V	Valve Cover O-rings 2 Req.	93210-78544-00
				3187V	Valve Seal 4 Req.	5H0-12119-00-00
				EC584018AFM	Cam Chain Tensioner Gasket	4DW-12213-00

### WOLVERINE R-SPEC YXE700

Model	Year	Bore Size	Top End Kit	Component Part#	Component Description	OEM Part #
Wolverine Spec YXE700	2016	103mm	C3599-EST	EC2098032AFM	Cam Chain Tensioner Gasket	2MB-E2213-00-R-00
				MA0164	Chain Tensionor Gasket	2MB-E21E2-00-00
				B1306010RC	Cylinder Base Gasket	2MB-E1351-00-00
				H4173023S	103mm Bore Head Gasket	2MB-E1181-00-00
				VC362018AFM	Valve Cover Breather Gasket	2MB-E131B-00-00
				EX045	Header Gasket	3EG-14613-00-00
				WA117	Oil Line Banjo Bolt Crush Gaskets	2MB-E1195-00-00
				3187V	Exhaust Valve Seal	2MB-E2129-00-00
				3187V	Intake Valve Seal	2MB-E2119-00-00
				R125V	Water Outlet O-ring	2MB-E2843-00-00

### YXZ1000R

Model	Year	Bore Size	Top End Kit	Component Part#	Component Description	OEM Part #
YXZ1000R	2016	82.5mm	C3617	EC1152032AFM	Cam Chain Tensioner Gasket	2C0-12213-00-00
				R116B	Fill Plug O-ring	93210-19123-00
				WA116	Cylinder Head Drain Plug Crush Washer	90430-08119-00
				H4270016S	Cylinder Head Gasket	2HC-11181-00-00
				EX651	Exhaust Gasket 3 Req.	4FM-14613-00-00
				3168V	Valve Stem Seal 12 Req.	2HC-12119-00-00



Klotz Synthetic Lubricants are designed and engineered to be the best lubricants in the motorsports industry. Race tested and formulated for all engine types, Klotz offers a full line of Estorlin Synthetic Racing Oils, Power Additives, and Aerosols needed to keep your engine protected and performing at an optimal level.

Racers, engine builders, and performance enthusiasts around the world rely on Klotz to get them to the checkered flag. *Be Fast, Be First with Klotz Synthetic Lubricants.*

## ESTORLIN® RACING PERFORMANCE SYNTHETIC ENGINE LUBRICANT



Part#	Desc.
KE-925	5W/20 Qt.
KE-930	10W/30 Qt.
KE-935	5W/30 Qt.
KE-940	10W/40 Qt.
KE-950	20W/50 Qt.
KE-954	15W/40 Qt.
KE-955	15W/50 Qt.
KE-915	15W/55 Qt.

Also available by the Case & 5 Gallon Pail



## UPLON® FUEL LUBE

- Provides upper cylinder and fuel pump lubrication
- Blends with methanol alcohol, ethanol, nitromethane and gasoline
- Maintains constant fuel pressure

Part#	Desc.
KL-106	Pint
KL-107	Quart

Also available by the Case

## ESTORLIN® FREE-GEAR® HYPOID SYNTHETIC GEAR LUBRICANT

Part#	Desc.
KE-960	75W/75 Qt.
KE-970	75W/80 Qt.

Also available by the Case & 5 Gallon Pail



## ESTORLIN® FREE-GEAR® MANUAL TRANSMISSION SYNTHETIC GEAR LUBRICANT

Part#	Desc.
KE-965	75W/75 Qt.
KE-975	75W/80 Qt.
KE-980	75W/90 Qt.
KE-990	80W/90 Qt.
KE-994	75W/140 Qt.
KE-995	75W/110 Qt.

Also available by the Case & 5 Gallon Pail

## Additives & Aerosols

	Part #	Size
Assembly Lube	KL-311	12oz.
Fogon - Storage & Afterrun Lubricant	KL-612	6oz.
	KL-610	16oz.
Foam Air Filter Oil	KL-606	15.25oz
Fabric Air Filter Oil	KL-607	15.25
Air Filter Cleaner	KL-608	15.25oz
Plug & Contact Cleaner	KL-609	12.5oz
Ethanol Gasoline Faze separation Treatment	KL-603	16oz.
Storbilizer	KL-613	16oz.
Cometic Engine Block & Head Surface Cleaner	C1047	15.25oz





## 2-STROKE LUBRICANTS Available Individually, Case, 30 gal. & 55 gal. drum



## 4-STROKE LUBRICANTS Available Individually, Case, 30 gal. & 55 gal. drum



### SUPER TECHNIPLATE®

Part#	Description
KL-103-1	1 Pint Bottle
KL-100-1	1 Quart Bottle
KL-109-1	1/2 Gallon Bottle
KL-101-1	1 Gallon Bottle

### ORIGINAL TECHNIPLATE®

Part#	Description
KL-200-1	1 Quart Bottle
KL-205-1	1 Gallon Bottle

### BeNOL® RACING CASTOR LUBRICANT

Part#	Description
BC-175-1	1 Pint Bottle
BC-172-1	1 Quart Bottle
BC-179-1	1/2 Gallon Bottle
BC-171-1	1 Gallon Bottle

### MOTORCYCLE TECHNIPLATE® TC-2

Part#	Description
KL-300-1	1 Quart Bottle
KL-301-1	1 Gallon Bottle

### R-50® RACING TECHNIPLATE®

Part#	Description
KL-102-1	1 Pint Bottle
KL-104-1	1 Quart Bottle
KL-105-1	1 Gallon Bottle

### MOTORCYCLE TECHNIPLATE® TC-W3

Part#	Description
KL-302-1	1 Quart Bottle

### 50:1 TECHNIPLATE® TC-W3

Part#	Description
KL-305-1	1 Pint Bottle
KL-304-1	1 Quart Bottle

### SKICRAFT® TECHNIPLATE®

Part#	Description
KL-306-1	1 Quart Bottle
KL-307-1	1 Gallon Bottle

### RACING SYNTHETIC FORK & SHOCK FLUID

Part#	Description
KL-505-1	1 Quart Bottle 5W
KL-515-1	1 Quart Bottle 10W
KL-515-1	1 Quart Bottle 15W

### ATV/UTV SYNTHETIC ENGINE LUBRICANT

Part#	Description
ATVUTV-040-1	0W/40 1 Qt. Bottle
ATVUTV-550-1	5W/50 1 Qt. Bottle

### ATV/UTV SYNTHETIC ENGINE LUBRICANT WITH INTEGRATED TRANSMISSION

Part#	Description
ATVUTV-1040-1	10W/40 1 Qt. Bottle

### MX4® TECHNIPLATE®

Part#	Description
KL-860-1	10W/40 1 Qt. Bottle
KL-870-1	10W/30 1 Qt. Bottle
KL-880-1	15W/50 1 Qt. Bottle

### MOTORCYCLE TECHNIPLATE® WITH INTEGRATED TRANSMISSION

Part#	Description
KL-815-1	15W/50 1 Qt. Bottle
KL-830-1	10W/30 1 Qt. Bottle
KL-840-1	10W/40 1 Qt. Bottle
KL-850-1	20W/50 1 Qt. Bottle

### SIDE X SIDE SYNTHETIC ENGINE LUBRICANT

Part#	Description
KL-802	5W/50 1 Qt. Bottle
KL-805	10W/50 1 Qt. Bottle
KL-803	10W/30 1 Qt. Bottle
KL-806	15W/50 1 Qt. Bottle

### PURE ESTORLIN® MARINE

Part#	Description
KE-330	10W/30 1 Qt. Bottle
KE-331	10W/30 1 Gallon Bottle
KE-340	25W/40 1 Qt. Bottle
KE-341	25W/30 1 Gallon Bottle
KE-334	10W/40 1 Qt. Bottle
KE-335	10W/30 1 Gallon Bottle

### PURE ESTORLIN® KART LUBRICANT

Part#	Description
KE-220-1	1 Quart Bottle 0W/20
KE-230-1	1 Quart Bottle 0W/30
KE-240-1	1 Quart Bottle 0W/40
KE-225-1	1 Quart Bottle 5W/20



## V-TWIN LUBRICANTS

### TRANSMISSION GEAR LUBE

Part#	Description
KH-GL90-1	80W/90 1 Qt. Bottle
KH-GL140-1	75W/140 1 Qt. Bottle

### GEAR AND CHAIN CASE LUBRICANT

Part#	Description
KH-S80-1	1 Qt. Bottle

### PRIMARY CASE LUBRICANT

Part#	Description
KH-C80-1	1 Qt. Bottle



### MULTI-VISCOSITY SYNTHETIC ENGINE LUBRICANT

- Recommended for the Harley Davidson Pre-Evolution, Evolution and Twin Cam
- Certified warranty compliant
- Custom formulated for the V-Twin air-cooled engines
- Reduces engine temperature and detonation
- High temperature film strength improving anti-wear protection

Part#	Description
KH-1040-1	10W/40 1 Qt. Bottle
KH-2050-1	20W/50 1 Qt. Bottle
KH-2560-1	25W/60 1 Qt. Bottle

### MULTI-VISCOSITY SYNTHETIC ENGINE LUBRICANT

- Recommended for the Yamaha, Victory and Indian engines
- Certified warranty compliant
- Custom formulated for the v-twin air-cooled engines
- Reduces engine temperature and detonation
- High temperature film strength improves anti-wear protection

Part#	Description
KV-2040-1	20W/40 1 Qt. Bottle
KV-1560-1	5W/60 1 Qt. Bottle

### STRAIGHT WEIGHT SYNTHETIC ENGINE LUBRICANT

- Custom formulated for the Harley-Davidson Pre-evolution engines
- Certified warranty compliant
- Reduces friction for Less Drag-More Power®
- High temperature film strength improving antiwear protection
- Reduces engine temperature and detonation

Part#	Description
KH-50-1	SAE 50 1 Qt. Bottle
KH-60-1	SAE 60 1 Qt. Bottle
KH-70-1	SAE750 1 Qt. Bottle



## LUBES

	Part#	Size
ATV/UTV Front/Rear End Differential Lube	ATV/UTV-8090-1	1 qt.
Flex Drive® 30 Transmission Lubricant	KL-506-1	1 qt.
Chain Case Lube	KL-500-1	12.oz
Chain Lube Aerosol	KL-605-1	15.25oz
KLR® Clean Chain Lube	KL-611-1	16oz
Jet Pump Lube	KL-511-1	4oz.

Discover other performance fuel system parts on our website.