

COMETIC
GASKET



**POWERSPORT & V-TWIN
PERFORMANCE
GASKETS**



Cometic Gasket, Inc. - An Exclusive NASCAR Performance Product

COMETIC Custom Gaskets

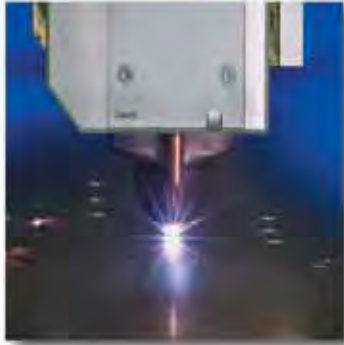
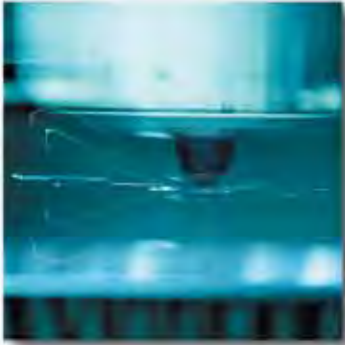

Cometic's custom gaskets can accommodate virtually any engine configuration from naturally aspirated, to the most exotic turbo and nitrous injected engines. Our commitment is to provide innovative, quality gaskets while maximizing your engine's power and performance. When customization is key, Cometic delivers!

Cometic has the ability to customize any gasket to meet your specific application. Need to change the bore size and/or thickness of a gasket? Or do you need a complete gasket design and execution? The process starts with a simple phone call. After Cometic's in-house Technical Sales Team understands your needs, they work directly with our design engineers to insure the gasket is drawn with state-of-the-art software and manufacture with the best materials possible with the most current and efficient manufacturing processes.

If special tooling is required, we'll provide a pre-production estimate for approval.

Your gasket is then made and shipped.

The lead-time on bore and thickness changes is just three days. A complete gasket design takes just two weeks.

The passion for racing runs deep in our Technical Sales and Engineering Teams. We understand the importance of perfection in your next engine build because we are right there with you racing on weekends.





Cometic Gasket, Inc., is a leading worldwide supplier of gaskets and engine sealing solutions for the Automotive Performance, Powersports, Original Equipment and Remanufactured Engine Industries.

All Cometic products are made in the United States with materials manufactured on American soil.

Launched by four partners including current Founder and CEO Bob Gorman in 1989, Cometic was originally dedicated exclusively to the powersports industry. Operating from a tiny 1,500 square foot manufacturing facility, the company produced a mere 900 SKUs in its first year.

Fast-forward to Cometic's 25th Anniversary in 2014. The company is now wholly owned by the Gorman family - and has grown into a global leader and innovator in the highly competitive engine supplier marketplace.

Housed in a 70,000 square-foot, state-of-the-art R&D and manufacturing center in Concord, Ohio, Cometic Gasket has maintained its deep roots in the powersports industry while expanding to service the Domestic Automotive, Sport Compact, V-twin, Marine, Diesel, Agricultural, Industrial and Stationary Power markets.

Today, Cometic Gasket offers over 85,000 SKUs, shipping gaskets and engine sealing solutions across the globe. Cometic is dedicated to customer satisfaction and provides quality products, delivered on time at a competitive price, designed for each customer's specific application. Cometic is an industry leader in manufacturing processes and committed to pairing the highest possible

quality materials with knowledgeable personnel. Cometic is also dedicated to continually improving all areas of its operations through employee development and involvement, as well as continual and comprehensive reviews of customer feedback.

To ensure superior performance across a wide variety of engine types and sizes, Cometic manufactures gaskets from

a comprehensive range of materials. Whether the situation calls for the latest in advanced technology like the MLS (Multi-Layer Steel) Gasket, or a synthetic blend such as Aramid Fiber, Cometic finds a solution. Cometic stays on the forefront of gasket design technology by utilizing in-house dynamometers and engine assembly rooms to bring its distributors, retailers and ultimately the end-user, the most reliable gaskets available today.

Cometic combines advanced materials with the most current manufacturing processes to provide custom-tailored solutions to meet the needs of each individual customer. Engineers analyze the environment in which the gasket will perform, select the proper material, and apply the appropriate technology to offer the best-performing

gaskets available in today's ever-changing marketplace. Cometic gaskets are the industry standard for championship-winning teams across multiple disciplines of both professional and amateur motorsports.



Performance Powersports & V-Twin Products Available for:

Artic Cat
Bombardier
Cobra
Gas Gas

Honda
Husaberg
Husqvarna
Kawasaki

Cometic Products

Dirt | ATV | UTV | PWC

Top-End Kits | Bottom-End Kits | Clutch and Mag Kits | Crank Seals | Individual Gaskets | Engine Seal Kits

Today's lightweight engines are producing more horsepower, higher cylinder pressures, clamp loads and extreme temperatures. Our commitment is to provide innovative, quality gaskets while maximizing your engine's power and performance. Cometic's gaskets are proudly made in the USA with materials manufactured on American soil. We are constantly updating and adding models to our ever growing library of gaskets.

Be sure to check out our NEW Clutch and Mag Kits made from AFM Material. AFM will not stick to the engine case making replacement quick and easy, no more scraping. The aluminum core gives the gasket strength for a superior seal and prevents the gasket from weeping or crawling out. All gasket kits (Top-End, Bottom-End, Clutch and Mag) are sold with the proper amount of gaskets for one application. Need just one gasket, not the entire kit? No problem, we offer individual gaskets.

Cometic is a proud sponsor of Ricky Carmichael, Team Green, The Orange Brigade & Kawasaki Factory Motocross to name a few.

Cycle Street

Head Gaskets | Base Gaskets | Engine Case Kits

For today's hi-horse power streetbikes, Cometic offers MLS head gaskets, base gaskets and engine case rebuild kits utilizing our best materials available! We have a complete line of streetbike applications from new to old.

Cometic is an industry leader in manufacturing processes and committed to pairing the highest possible quality materials with knowledgeable personnel. Cometic stays on the forefront of gasket design technology by utilizing in-house dynamometers and engine assembly rooms to bring its distributors, retailers and ultimately the end-user, the most reliable gaskets available today.



Top-End Kit

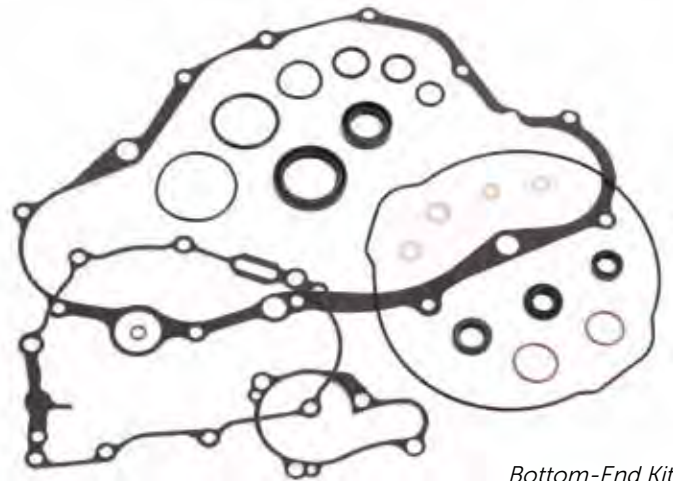

Bottom-End Kit



MLS Head Gasket cross section

KTM
LEM
Polaris
Suzuki

Yamaha
Can-Am Bombardier UTV
Aprilia
Ducati

Triumph
Harley-Davidson
Arctco
Sea Doo

Ski-Doo
John Deere
Rotax

Engine Seal Kits



V-Twin Kit



Clutch and Mag Kit

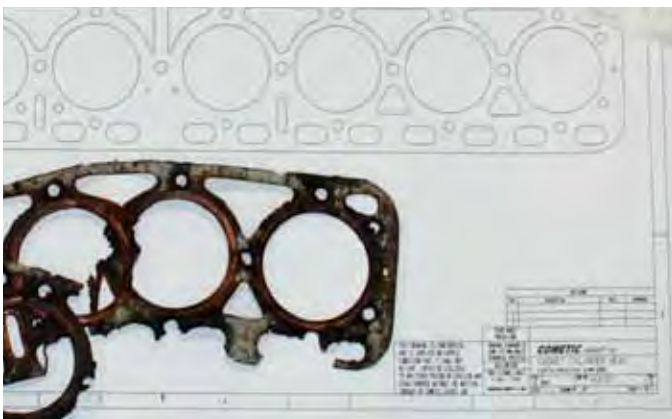
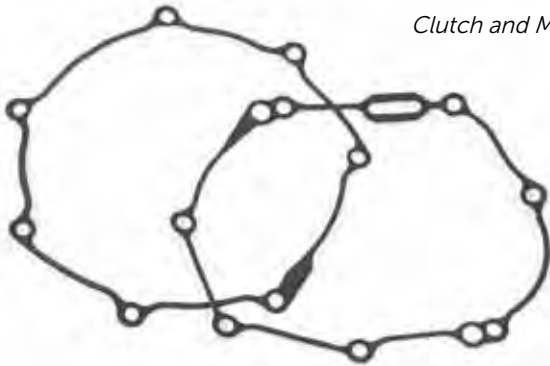

Harley-Davidson® | V-Twin

**Head Gaskets | Base Gaskets | Engine Only Kits | Rocker Box Kits
| Primary Kits | Transmission Kits**

Cometic Gasket has been servicing the American V-Twin Industry for over 25 years. Cometic offers a full line of gaskets for models from 1936 through current day models. Our gaskets can be ordered individually or as complete kits to do the entire job. Cometic also offers full on custom gaskets as well for shelf stock prices. So whether it's a stock bike or a fire breathing all out race machine Cometic has you covered.

All of Cometic's gaskets and seals have been tested on both the street and the track as well as vigorous Dyno shakedown. Rest assured every gasket has been methodically thought out before it is used in any application. Cometic uses it's EST "Extreme Sealing Technology" philosophy while making every gasket. Demand the best, Cometic to seal your engine.

Snowmobile

Complete Kits | Top-End Kits | Exhaust Kits | Intake Kits | Power Valve Kits | Crank Seal Kits

Cometic's Snowmobile gaskets and gasket kits are used by professionals in high-performance machines and as OE replacements worldwide.

Cometic combines advanced materials with the most current manufacturing processes to provide custom-tailored solutions to meet the needs of each individual customer. Engineers analyze the environment in which the gasket will perform, select the proper material, and apply the appropriate technology to offer the best-performing gaskets available in today's ever-changing marketplace.

Custom Gaskets

Need to change the bore size and/or thickness of a gasket? Or do you need a complete gasket design and execution?

The process starts with a simple phone call. After Cometic's in-house Technical Sales Team understands your needs, they work directly with our design engineers to insure the gasket is drawn with state-of-the-art software and manufactured with the best materials possible with the most current and efficient manufacturing processes. If special tooling is required, we'll provide a pre-production estimate for approval. Your gasket is then made and shipped. The lead-time on bore and thickness changes is just three days. A complete gasket design takes just two weeks.



GASKET MATERIALS

MLS® Multi Layer Steel Gaskets

The Cometic MLS gasket is comprised of three to five layers of Stainless Steel. Cometic uses Stainless steel for increased strength, its ability to rebound and corrosion resistance. The outer layers of the gasket are embossed and coated on both sides with a Viton rubber material designed to meet the demands of a variety of harsh sealing environments, load conditions and surface finishes. The Viton coating is heat resistant to 250C or 482F.

The center or shim layer of the gasket is comprised of an uncoated Stainless Steel layer, which can be varied to accommodate multiple thickness requirements. The MLS gasket is ideal for any kind of head and block combination.

By design the MLS gasket promotes an even torque load across the sealing surface allowing for measurable reduced bore distortion.

AFM (Aluminum Foam Material)

AFM is a chemically blown, compounded nitrile synthetic rubber bonded to an aluminum core with temperature resistance of over 250F. AFM material has an 85% recovery while maintaining strong torque retention. AFM does not require gasket sealers or re-tightening.

Available thickness: .018", .032", .060"

Rubber Coated Stainless Steel

A stainless steel core with a .001" thick coating of viton rubber on both sides.

Available thickness: .010", .014", .020"

Aramid Fiber

Is a premium hi-temperature, hi-density creep resistant material that requires no re-torquing and is fuel resistant. All Cometic fiber materials are asbestos free and require no additional sealants.

Available thickness: .012", .015", .020", .031", .039", .047", .060", .094", .125", .188

Copper (Dead Soft)

Available thickness: .005", .010", .016", .020", .027", .032", .043", .050", .063", .080", .094"

Aluminum

Solid material ideal for spacers and shims.

Available thickness: .010", .016", .020", .025", .032", .040", .050", .063", .080", .100", .125", .188", .250", .313", .375", .500"

Viton coated embossed outer layer

Stainless steel shim layer

Viton coated embossed outer layer

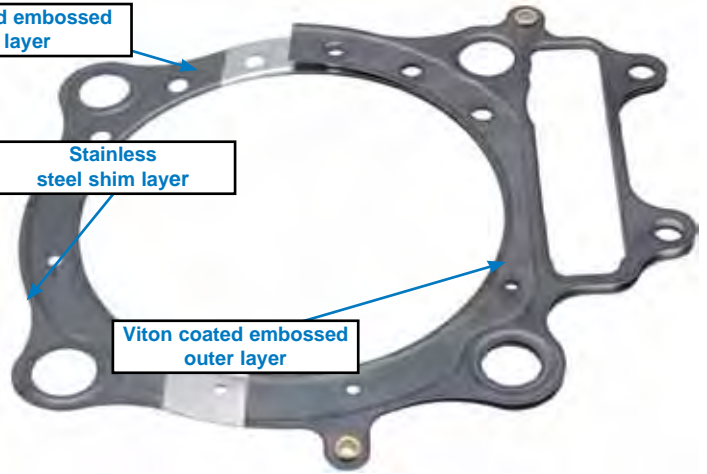

Available thickness:

.027", .030", .036", .040", .045", .051", .060", .066", .070", .075", .080", .086", .092", .098", 120"



The NASCAR Performance® logo and word mark are used under license by the National Association for Stock Car Auto Racing Inc.

Cometic Gasket - An Exclusive NASCAR Performance® Product

Top End Kits

Fit 2-Stroke and 4-Stroke applications and are supplied with the necessary gaskets and seals for a complete top end build. See your specific model for a detailed component listing. All components are also available individually.



Bottom End Kits

Fit 2-Stroke and 4-Stroke applications and are supplied with the necessary gaskets and seals for a complete bottom end build. Some applications will contain our new Oil Seal Kits. See your specific model for a detailed component listing. All components are also available individually.



Oil Seal Kits

Complete Oil Seal Kits fit 2-Stroke and 4-Stroke applications and contain all the required oil seals to rebuild a bottom end. All components are also available individually.



Clutch & Mag Kits

Fit 2-Stroke and 4-Stroke applications and use AFM gaskets and/or O-rings, for when a quick Clutch or Timing Inspection are needed, or just to have a spare for frequently damaged covers. All components are also available individually.



TABLE OF CONTENTS

	Pg.#		Pg.#		Pg.#
Arctic Cat UTV	6	Suzuki	81	EST Big Twin EVO Motor Kits	147
Can-Am Bombardier UTV	6	Yamaha	98	Replacement Gaskets, Seals, O-Rings	
Honda UTV	7	Aprilia	123	Transmission Kits	152
Kawasaki UTV	7	Ducati	123	EST Shovelhead & Panhead Motor Kits	154
Polaris UTV	7	Honda	123	Replacement Gaskets, Seals, O-Rings	
Yamaha UTV	9	Kawasaki	125	EST EVO Sportster Motors Sportster & Buell	157
Arctic Cat	10	KTM	130	Iron Sportster Motor Kits	161
Bombardier	10	Polaris	130	Replacement Gaskets, Seals, O-Rings	
Cobra	11	Suzuki	130	Rotax 600, Rotax 250 Gaskets	164
Gas Gas	13	Triumph	134	Polaris Victory V92C Head & Base Gaskets ...	164
Honda	14	Yamaha	135	HD Gasket Display Boards	165
Husaberg	38	Personal Watercraft	137	Ison Racing Engine Services	173
Husqvarna	39	HARLEY-DAVIDSON GASKETS			
Kawasaki	41	AFM Series Gaskets	138	Cometic Apparel & Promotional Items	176
KTM	62	MLS Head & Base Gaskets	140		
LEM	79	EVO Rocker Cover Gaskets	142		
Polaris	79	EST Twin Cam Hi-Performance Gasket Kits ...	143		
		Replacement Gaskets, Seals, O-Rings			



UTV Gaskets



Cometic Gasket - An Exclusive NASCAR Performance® Product

ARCTIC CAT UTV PROWLER 650



Base Cam Chain Clutch Cover Head

Model	Year	Bore Size	Top End Kit	Component Part#	Component Description	OEM Part #
Prowler	06-12	98 mm	C7220	H1735SP3027S	Head Gasket 98mm Bore	0830-124
650		100 mm	C7022	H1735SP4027S	Head Gasket 100mm Bore	0830-124
				B0647014RC	Base Gasket	0830-084
				EX657	Exhaust Gasket	0412-338
				EC377032AFM	Cam Chain Tens. Gasket	0830-018
				OS020	2 Req.-Cam Chain Tens. O-ring	0830-107
				R22X2.5V	Coolant Line O-ring	0830-007
				R45X3V	Intake O-ring	0830-090
				R54X2V	2 Req.-Valve Cover O-rings	0830-004

Bottom End Gaskets Available Separately

Component Part#	Component Description	OEM Part #
EC1142032AFM	Clutch Cover Gasket	0830-116
EC1143032AFM	Magneto Cover Gasket	0830-128
EC1141032AFM	Primary Cover Gasket	0830-174

PROWLER 700XT LTD

Model	Year	Bore Size	Top End Kit
Prowler	08-15	103.5mm	C3597-EST
700 XT LTD			

Component Part#	Component Description	OEM Part #
H2223SP4027S	Head Gasket	0830-112
B0760014RC	Base Gasket	0830-111
EX657	Exhaust Gasket	0412-338
OS020	Cam Chain Tensioner Gasket	0830-107
EC377032AFM	Cam Chain Tens. Gasket	0830-018
3186V	Valve Seals	0830-186
R22X2.5V	Water Outlet O-ring	0830-007
R124V	Valve Cover O-rings 2 req.	0830-215
R008B	Intake O-ring	0423-182
R124V	Oil Fill Cap O-ring	0830-215
R54X2V	Inspection Cap O-ring	0830-004

Bottom End Gaskets Available Separately

Component Part#	Component Description	OEM Part #
EC1142032AFM	Clutch Cover Gasket	0830-116
EC1143032AFM	Magneto Cover Gasket	0830-128
EC1141032AFM	Primary Cover Gasket	0830-174

CAN-AM/BOMBARDIER UTV COMMANDER 1000



Head Base

Model	Year	Bore Size	Top End Kit	Component Part#	Component Description	OEM Part #
Commander	11-16	92mm	C3459-EST	H2653018S	Head Gasket 92mm 2 Req.	420630195
1000		93mm	C3460-EST	H2653SP1018S	Head Gasket 93mm 2 Req.	
		94mm	C3461-EST	H2653SP2018S	Head Gasket 94mm 2 Req.	
		96mm	C3462-EST	H2653SP5018S	Head Gasket 95mm 2 Req.	

3186V	Valve Stem Seal 8 Req.	420230515
R117V	Cam Chain Tensioner O-ring	420430370
R15X1.5V	Cam Adjuster O-ring	420250890
EX696	Header Gasket 2 Req.	707600317
B0895010RC	Base Gasket 2 Req.	420630210

Bottom End Gaskets Available Separately

Component Part#	Component Description	OEM Part #
EC1142032AFM	Clutch Cover Gasket	0830-116
EC1143032AFM	Magneto Cover Gasket	0830-128
EC1141032AFM	Primary Cover Gasket	0830-174



UTV Gaskets



Cometic Gasket - An Exclusive NASCAR Performance® Product

HONDA UTV

FL250 ODYSSEY

Model	Year	Bore Size	Top End Kit	Component Part#	Component Description	OEM Part #
FL250	73-77	72 mm	C7140	H0182043F	Head Gasket 72mm	12251-358-306
Odyssey				B0137020F	Base Gasket 73-76	12191-357-306
				B0395020F	Base Gasket 77-84	12191-381-306

FL350R ODYSSEY



Model	Year	Bore Size	Top End Kit	Component Part#	Component Description	OEM Part #
FL350R	85	82 mm	C7229	B0204020F	Base Gasket	12191-VM0-772
Odyssey				H0344043F	Head Gasket	12254-VM0-013

PILOT FL-400

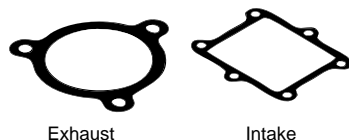

Model	Year	Bore Size	Top End Kit	Component Part#	Component Description	OEM Part #
Pilot	89-91	82 mm	C7024	H0015043F	Head Gasket	12251-HE0-000
FL-400				B0020020F	Base Gasket	12191-HE0 000/010
				EX009042AM	Exhaust Gasket	18291-HE0 000/010
				IR004018AFM	Intake Gasket	14132-KAE- 000/430-000

KAWASAKI UTV

KRF750 Teryx

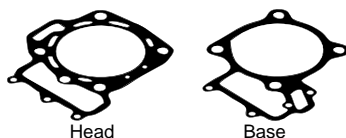

Model	Year	Bore Size	Top End Kit	Component Part#	Component Description	OEM Part #
KRF750	08-14	85mm	C3284-EST	H2624SPA010S	Head Gasket 85mm	11004-0011
Teryx (SXS)		90 mm	C3251-EST	H2624SP1010S	Head Gasket 90mm	11004-0011
				B0951020RC	Base Gasket	11061-0063
				EX361	Exhaust Gasket 2 req	11009-1894
				WA114	Coolant Drain Washer 2 Req	
				R55X2V	Rocker Cap O-Ring 4 Req	92055-0112
				R19X2V	Plug Cover O-Ring 2 Req	92055-1146
				3242V	Valve Stem Seals 8 Req	92049-1218

POLARIS UTV

RZR170

Model	Year	Bore Size	Top End Kit	Component Part#	Component Description	OEM Part #
RZR170	09-16	61mm	C3596-EST	B1318020RC	Cylinder Base Gasket	0454459
				H4194010S	Cylinder Head Gasket	0454365
				IR1308020F	Intake Manifold Gasket	0453451
				R024V	Intake Manifold O-ring	0452459
				R049B	Cylinder Head Cover O-ring	0454363
				EC2131032AFM	Cylinder Head Breather	0454640
				EC2132060AFM	Air Injection Gasket	0452808
				EC2133060AFM	Air Injection Tube Gasket	0454454
				EX886042AM	Exhaust Gasket	0453672
				3234V	Valve Seal	0452390
				EC2134032AFM	Cam Chain Tensioner Gasket	0452417



UTV Gaskets



Cometic Gasket - An Exclusive NASCAR Performance® Product

POLARIS UTV RZR 570



Model	Year	Bore Size	Exhaust Top End Kit	Head	Component Part#	Component Description	OEM Part #
RZR 570	12	99mm	C3528-EST		B1171014RC	Base Gasket	5254903
					H3609021S	Head Gasket 99mm Bore	5813676
					3231V	Valve Seals 4 Req.	3610161
					EX817	Exhaust Gasket	5253989
					EC1654020RC	Cam Chain Tensioner	5813449

RANGER RZR 800

Model	Year	Bore Size	Top End Kit	Component Part#	Component Description	OEM Part #
Ranger	08	80 mm	C3250	H2761030S	Head Gasket 80mm Bore	5247359
RZR 800 (SXS)		82 mm	C3507	H2761SP2030S	Head Gasket 82mm Bore	
				B0940010RC	Base Gasket	5247360
				EX452SP1064AM	Exhaust Gasket	5811511

RANGER RZR 800

Model	Year	Bore Size	Top End Kit	Component Part#	Component Description	OEM Part #
Ranger	11-13	80 mm	C3506	H3657010S	Head Gasket 80mm Bore	5254357
RZR 800 (SXS)		82 mm	C3508	H3657SP2010S	Head Gasket 82mm Bore	
				B0940010RC	Base Gasket	5247360
				EX452SP1064AM	Exhaust Gasket	5811511

XP900

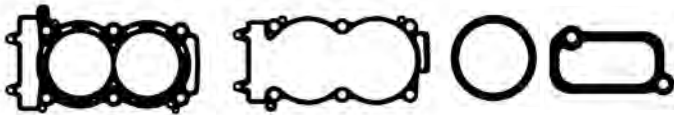

Head Base Cam Chain Tensioner Water Inlet

Model	Year	Bore Size	Top End Kit	Component Part#	Component Description	OEM Part #
XP900	11-14	93.5mm	C3446-EST	H3336018S	Head Gasket 93.5mm Bore	5813439
		96mm	C3447-EST	H3336SP1018S	Head Gasket 93.5mm Bore	
				B1079014RC	Base Gasket	5253037
				EC1654020RC	Cam Chain Tensioner	5813449
				WP383032AFM	Water Inlet Gasket	5813521
				EX817	Exhaust Gasket 2 req.	5253989
				3231V	Valve Seals 8 Req.	3610161

XP1000

Model	Year	Bore Size	Top End Kit	Component Part#	Component Description	OEM Part #
XP1000	14-15	94mm	C3546-EST	H3892018S	Head Gasket 94mm Bore	5813737
		96mm	C3563-EST	H3892SP1018S	Head Gasket 96mm Bore	5813737
				B1079014RC	Base Gasket	5253037
				EC1654020RC	Cam Chain Tensioner Gasket	5813449
				EX1408064AM	Header Gasket	3610184
				3254V	Valve Spring Seat With Seal	3610212
				MR135	Thermostat Seal	5413948
				MR136	Water Outlet O-ring	5813736



UTV Gaskets



Cometic Gasket - An Exclusive NASCAR Performance® Product

YAMAHA UTV RHINO 660

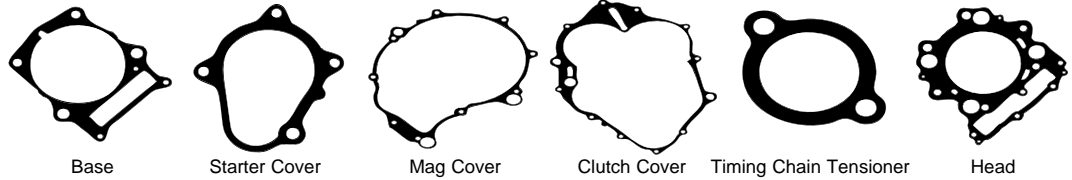

Model	Year	Bore Size	Top End Kit	Component Part#	Component Description	OEM Part #
RHINO 660 (SXS)	04-07	100 mm	C7044-EST	H1481SP2030S	Head Gasket 100mm	3YF-11181-00
		101 mm	C7900-EST	H1481030S	Head Gasket 101mm	
		102 mm	C7798-EST	H1191030S	Head Gasket 102mm	
		103 mm	C3042-EST	H2174030S	Head Gasket 103mm	
		105 mm	C7909-EST	H1191SP1030S	Head Gasket 105mm	
				B0532010RC	Base Gasket	3YF-11351-00
				EX361	Exhaust Gasket 2 Req.	3YF-14613-01-00
				EC584018AFM	Cam Chain Tensioner Gasket	4DW-12213-00
				3187V	Valve Seal 5 Req.	5H0-12119-00-00
				R016B	Radiator Hose O-ring	93210-18417-00
				R113B	Valve Cover Plug O-ring	93210-13657-00
				R114S	Oil Tank O-ring	93210-16629-00
				R116B	Cam Chain Tensioner Cap O-ring	11101/93210-19522-00
				R117B	Dipstick O-ring	93210-21190-00
				R124B	Tappet Cover O-ring	93210-32172-00
			R155S	Cylinder Base O-ring	11256/93211-01467-00	
			R71X2.5B	Intake Valve Adj. Cover O-ring	93210-71360-00	
			WA081080C	Oil Line Washers 4 Req.	90430-08204	
			WA082063C	Oil line Washers 4 Req.	90430-10171	

RHINO 700



Model	Year	Bore Size	Top End Kit	Component Part#	Component Description	OEM Part #
RHINO 700	06-13	103 mm	C3142-EST	H2449027S	Head Gasket	3B4-11181-00-00
		104 mm	C3143-EST	H2449SP2027S	Head Gasket 104mm Bore	3B4-11181-00-00
		105.5 mm	C3144-EST	H2465027S	Head Gasket 105.5mm Bore	3B4-11181-00-00
				B0855010RC	Base Gasket	1S3-11351-00-00
				EX361	Exhaust Gasket 2 Req.	3YF-14613-01-00
				R034V	Throttle Body O-ring	4WV-14147-10-00
				R126V	Water Pump O-ring	93210-33786-00
				R131B	Thermostat O-ring	93210-41042-00
				R240V	Cam Cover O-ring	93210-96601-00
				R79X2.5V	Valve Cover O-rings 2 Req.	93210-78544-00
				3187V	Valve Seal 4 Req.	5H0-12119-00-00
				EC584018AFM	Cam Chain Tensioner Gasket	4DW-12213-00

WOLVERINE R-SPEC YXE700

Model	Year	Bore Size	Top End Kit	Component Part#	Component Description	OEM Part #
Wolverine Spec YXE700	2016	103mm	C3599-EST	EC2098032AFM	Cam Chain Tensioner Gasket	2MB-E2213-00-R-00
				MA0164	Cam Chain Tensioner Crush Gasket	2MB-E21E2-00-00
				B1306010RC	Cylinder Base Gasket	2MB-E1351-00-00
				H4173023S	103mm Bore Head Gasket	2MB-E1181-00-00
				VC362018AFM	Valve Cover Breather Gasket	2MB-E131B-00-00
				EX045	Header Gasket	3EG-14613-00-00
				WA117	Oil Line Banjo Bolt Crush Gaskets	2MB-E1195-00-00
				3187V	Exhaust Valve Seal	2MB-E2129-00-00
				3187V	Intake Valve Seal	2MB-E2119-00-00
				R125V	Water Outlet O-ring	2MB-E2843-00-00



MX/Dirt · Off-Road · ATV Gaskets



Cometic Gasket - An Exclusive NASCAR Performance® Product

ARCTIC CAT



Model	Base Year	Cam Chain Bore Size	EST Top End Kit	Clutch Cover	Head Component Part#	Component Description	OEM Part #
DVX400	03-08	92mm	C7978-EST		H0949027S	Head Gasket 92mm	3402-841
		94mm	C7979-EST		H1045027S	Head Gasket 94mm	
		96mm	C3138-EST		H1045SP2027S	Head Gasket 96mm	
		97mm	C7980-EST		H1046027S	Head Gasket 97mm	
					B0440027S	Base Gasket	3402-844
					EC377032AFM	Cam Tensioner Gasket	3402-137
					EX243	Exhaust Gasket	3512-007
					WA121	Oil Drain Bolt Gasket	3003-290
					3160V	Valve Stem Seals 4 Req	3402-078
					EC1030032AFM	Clutch Cover Gasket	3446-357

Can-Am BOMBARDIER

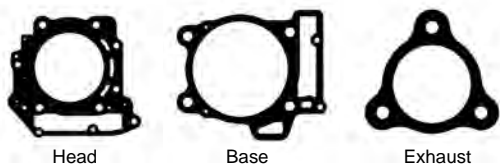

Model	Year	Bore Size	EST Top End Kit	Component Part#	Component Description	OEM Part #	
DS450	10-13	97mm	C3266-EST	H2858027S	Head Gasket 97mm	420650210	
		99mm	C3453-EST	H2858SP4027S	Head Gasket 99mm		
		100mm	C3454-EST	H2858SP3027S	Head Gasket 100mm		
				B0970014RC	Base Gasket	420650390	
				WA117	Temp Sensor Copper Seal ring	420250640	
				3225V	Valve Stem Seals	420230510	
				WA165063A	Cam Chain Tens. Crush Seal	420430622	
				EX1189043F	Exhaust Gasket	707600445	
					Component Part#	List Price	
					H1155030S	Head Gasket 101mm	711650020
			H1830030S	Head Gasket 102mm	711650020		
			H2403040S	Head Gasket 103mm	711650020		
			B0657020F	Base Gasket 101mm	711650010		
			B0657020RC	Base Gasket 102mm			
			B0657SP2031F	Base Gasket 105.5mm			
			Component Part#	Component Description	OEM Part #		
Outlander 400	03-14	92mm	C3489-EST	H2653018S	92mm Head Gasket	420630195	
		93mm	C3490-EST	H2653SP1018S	93mm Head Gasket		
		94mm	C3491-EST	H2653SP2018S	94mm Head Gasket		
		96mm	C3492-EST	H2653SP5018S	95mm Head Gasket		
				3186V	Valve Stem Seal 4 Required	420230515	
				R117V	Cam Chain Tensioner O-ring	420430370	
				R15X1.5V	Cam Adjuster O-ring	420250890	
				EX696	Header Gasket	707600317	
		B0895010RC	Base Gasket	420630210			



MX/Dirt · Off-Road · ATV Gaskets



Cometic Gasket - An Exclusive NASCAR Performance® Product

Can-Am BOMBARDIER

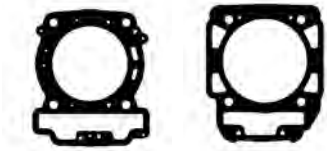

Head

Base

Model	Year	Bore Size	EST Top End Kit	Component Part#	Component Description	OEM Part #
Outlander STD, XT, MAX 1000	12-16	92mm	C3459-EST	H2653018S	92mm Head Gasket 2 Req.	420630195
		93mm	C3460-EST	H2653SP1018S	93mm Head Gasket 2 Req.	
		94mm	C3461-EST	H2653SP2018S	94mm Head Gasket 2 Req.	
		96mm	C3462-EST	H2653SP5018S	95mm Head Gasket Req.	
				3186V	Valve Stem Seal 8 Required	420230515
				R117V	Cam Chain Tensioner O-ring	420430370
				R15X1.5V	Cam Adjuster O-ring	420250890
				EX696	Header Gasket 2 Required	707600317
				B0895010RC	Base Gasket 2 Required	420630210
				Bottom End Gaskets Available Separately		
				EC1652020F	Center Case Gasket	420651225
				EC1651020F	PTO Cover Gasket	420651211
				EC1171032AFM	Magneto Cover Gasket	420651200

COBRA

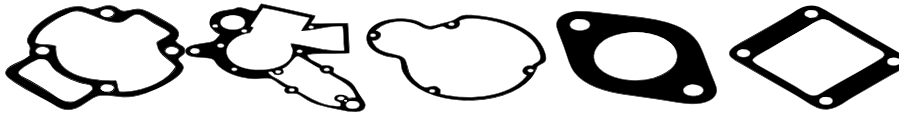

Base

Center Case

Ignition Cover

Exhaust

Intake

Model	Year	Bore Size	Top End Kit	Component Part#	Component Description	OEM Part #		
KING 50	1998	O-RING	C3254	R010V	Head Cover O-rings 4 req.	ZCMUOR03		
				R033B	Inner Head O-ring	ZCMUOR05		
				R105X2B	Outer Head O-ring	ZCMUOR02		
				B0848018AFM	Base Gasket	ZCKG0002		
				B0848012F	High Compression Base			
				EX916059F	Exhaust Gasket	XCKG0001		
					Bottom End Kit w/o crank seals C3307	Component Part#	Component Description	OEM Part #
						EC1220060AFM	Clutch Cover Gasket	ZCMU0030
						EC1301012F	Center Case Gasket	ZCKG0012
						EC1302032AFM	Ignition Cover Gasket	ZCKG0101
		IR715032AFM	Intake Gasket	ECMU0049				
KING 50 W/2PC HEAD	98-03	O-RING	C3255	Component Part#	Component Description	OEM Part #		
				R010V	Head Cover O-rings 8 req.	ECMU0049		
				R033B	Inner Head O-ring	ZCMUOR05		
				R105X2B	Outer Head O-ring	ZCMUOR02		
				R121V	Head Cover Coolant Seal O-ring	ZCMUOR08		
				B0848018AFM	Base Gasket	ZCMU0030		
				B0848012F	High Compression Base	ZCKG9902		
				EX916059F	Exhaust Gasket	ZCKG0101		
					Bottom End Kit w/o crank seals C3308	Component Part#	Component Description	OEM Part #
						EC1220060AFM	Clutch Cover Gasket	ZCMU0030
		EC1301012F	98 Center Case Gasket	ZCKG0012				
		EC1304020F	99-Up Center Case Gasket	ZCKG9902				
		EC1302032AFM	Ignition Cover Gasket	ZCKG0101				
		IR715032AFM	Intake Gasket	ECMU0049				



MX/Dirt · Off-Road · ATV Gaskets



Cometic Gasket - An Exclusive NASCAR Performance® Product

COBRA

Model	Year	Bore Size	Top End Kit	Component Part#	Component Description	OEM Part #			
CX50	13-15	O-Ring	C3602	R105X2B	Outer Head O-ring	ZCMUOR02			
				R033B	Combustion Chamber O-ring	ZCMUOR05			
				R024V	Upper Dome O-ring	ZCMUV024			
				R010V	Stud O-rings 4	ZCMUOR10			
				B0848031F	Base Gasket .031"	ZCMU0708			
				B0848020F	Base Gasket .020"	ZCMU0705			
				B0848015F	Base Gasket .015"	ZCKG0501			
				B0848012F	Base Gasket.012"	ZCMU0703			
				R026V	Exhaust Flange O-ring	ZCMUOR07			
				R125V	Header Flange O-ring 2	ZCMOTE11			
					Bottom End Kit	Component Part#	Description	OEM Part#	
					C3603	EC1982032AFM	Ignition Cover Gasket	ZCCS0002	
						EC1983020F	Crankcase Gasket	ZCCS0005	
						R018V	Sprocket Shaft Spacer O-ring	ZCDCOR01	
						WA116	Drain Plug Gasket	HCWC0000	
					EC1984060AFM	Clutch Cover Gasket	ZCMU0030		
					R12X2V	Kick Shaft O-ring	ZCMUB014		
					R12X2V	Oil Fil Plug O-ring	ZCMUB014		
			CX65	13-14	O-Ring	C3600	Component Part#	Component Description	OEM Part #
							R010V	Cylinder Stud O-ring 5	ZCMUOR03
R020V	Cylinder Dome Plug O-ring	ZCMUOR23							
R033B	Combustion Chamber O-ring	ZCMUOR05							
R88X2B	Outer Chamber O-ring	ZCC60009							
R125V	Expansion Chamber to Flange O-ring 2	ZCMOTE11							
R126V	Pipe to flange O-ring	ZCMUOR11							
R026V	Flange to Head O-ring	ZCMUOR07							
B1106012F	Base Gasket .3mm .011"	ZCC60303							
B1106015F	Base Gasket .4mm .015"	ZCC60304							
B1106020F	Base Gasket .5mm .019"	ZCC60305							
B1106031F	Base Gasket .8mm .031"	ZCC60308							
PV148	Power Valve Cover Gasket	ZCC60012							
R122V	Power Valve Plunger O-ring	ZCMUOR18							
R114V	Power Valve Solenoid Cap O-ring	ZCMU0114							
	Bottom End Kit	Component Part#				Description	OEM Part#		
	C3601	IR747018AFM				Intake Gasket	ZCC60021		
		R020V				Slave Cylinder Seal	ZCMUOR25		
		R105X3.5B				Clutch Cover O-ring	ZCDCOR05		
		R12X2V				Fill Plug O-ring	ZCMUB014		
		EC1985032AFM				Inner Clutch/Kick Cover Gasket	ZCC60007		
		R12X2V				Drain Plug O-ring	ZCMUB014		
		R018V				Output Shaft O-ring	ZCMUOR21		
		EC1673015F				Center Case Gasket	ZCC60008		



MX/Dirt · Off-Road · ATV Gaskets



Cometic Gasket - An Exclusive NASCAR Performance® Product

GAS GAS

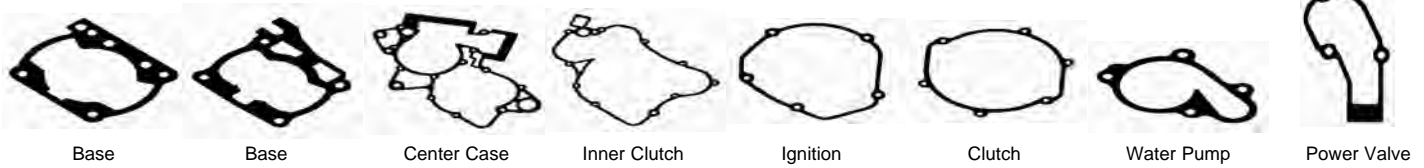

Model	Year	Bore Size	Top End Kit	Component Part#	Component Description	OEM Part #		
125 EC,XC, DE,MC	01-11	O-RING	C3260	B0537020F	Base Gasket	ME120144000		
				IR271020F	Intake Gasket	ME120644005		
				PV106020F	Center Power Valve Gasket	ME120144006		
				PV107039F	Right Side Power Valve Gasket	ME120144007		
				R63X2V	Inner Head O-ring	ME120116065		
				R90X2V	Outer Head O-ring	ME120116060		
				WA135	Head Seal Washers 8 req.	T4008516		
					Bottom End Kit w/o crank seals	OEM Part#		
					C3309			
					EC561020F	Center Case Gasket	ME120144001	
					EC562032AFM	Inner Clutch Cover Gasket	ME120144002	
					EC563020F	Ignition Cover Gasket	ME120144004	
					EC564031F	Clutch Cover Gasket	ME120144004	
	WP125020F	Water Pump Gasket	ME120144008					
	Top End Kit	Component Part#	Component Description	OEM Part#				
200/250/300 EC/MC/SM XC,EC200 XC,EC250 XC,EC300 EC200, DE200, EC200 Hobby, EC250, EC250 Race, DE250, MC250, EC300, DE300	98-UP	O-RING	C3261	R045V	Outer Head O-Ring 200	M01619135		
				B0403020F	Base Gasket	ME25644000		
				IR123032AFM	Intake Gasket	25644005		
				PV089020F	Left Side Power Valve Gasket	ME25644006		
				PV090039F	Right Side Power Valve Gasket	ME25644007		
					Right Power Valve Gasket	ME25610002		
					Base Gasket .38mm	ME25644009		
					B0403015F	Base Gasket .30mm	ME25644010	
					B0403012F	Base Gasket .30mm	ME25644010	
					EX245043F	Exhaust Gasket	ME25644012	
					R046V	Outer Head O-Ring 250-300	ME25916060	
					R040V	Inner Head O-Ring 200-250	ME25916065	
					EC350031F	Thermostat Gasket	ME25944011	
					R041V	Inner Head O-Ring 300	ME30916065	
					WA135	Head Seal Washers 6 req.	T4008516	
					Bottom End Kit w/o crank seals	Component Part#	Component Description	OEM Part#
					C3310			
					EC345039F	Outer Clutch Cover Gasket	ME25644003	
					EC346031F	Mag Cover Gasket	ME25644004	
					EC348020F	Inner Clutch Cover	ME25644002	
	EC349020F	Center Case Gasket	ME25644001					
	EC349031F	Center Case Gasket	ME25644001					
	R44X3S	Crank O-ring	ME250112011					
	WP082020F	Water Pump Gasket	ME25644008					



MX/Dirt · Off-Road · ATV Gaskets



Cometic Gasket - An Exclusive NASCAR Performance® Product

GAS GAS

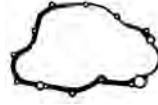
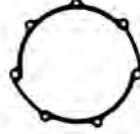

Head		Base	Cam Chain Tensioner	Mag Cover	Outer Clutch Cover	Inner Clutch Cover	
Model	Year	Bore Size	EST Top End Kit	Component Part#	Component Description	OEM Part #	
EC250F Yamaha Motor	10-11	77 mm	C7905-EST	H1168SP3027S	Head Gasket	5NL-11181-00-00	
		79 mm	C3057-EST	H1168SP2027S	Head Gasket 79mm Bore		
		81 mm	C3059-EST	H1271027S	Head Gasket 81mm Bore		
		83 mm	C3061-EST	H1272SP3027S	Head Gasket 84mm Bore		
		84 mm	C3120-EST	B0503020RC	Base Gasket	5NL-11351-00-00	
				EX651	Exhaust Gasket	5NL-14613-00-00	
				EC019032AFM	Cam Chain Tensioner Gasket	4FM-12213-00	
				3179V	Exhaust Valve Seal 2 Req.	4SV-12119-00-00	
				3233	VIntake Valve Seal 3 Req.	4TV-12119-00-00	
			Bottom End Kit w/Oil Seals	Component Part#	Component Description	OEM Part #	
			C3057BE	EC554032AFM	Inner Clutch Cover Gasket	5NL-15462-00-00	
				R011B	Oil Delivery O-ring (SM)	93210-07003-00/07540-00	
				R013B	Oil Pump Seal O-Ring	93210-10197-00*	
				R013B	Clutch Side Oil Feed Line O-Ring	93210-10197-00*	
				R013B	Mag Side Oil Feed Line O-Ring	93210-10197-00*	
				R014B	Oil Delivery Pipe O-Ring (Lg.)	93210-12759-00	
				R016V	Case Dowel O-ring	93210-16772-00	
				R109B	Oil Filter Cover O-Ring (Sm.)	93210-07135-00	
				R10X2V	Centercase Dowel O-ring	93210-10197-00*	
				R113B	Timing Plug O-ring	93210-14369-00	
				R124B	Crank End Plug O-ring	93210-32172-00	
				R134B	Oil Filter O-Ring (LG)	93210-47675-00	
				R19X2V	Oil Fill Plug O-ring	93210-19123-00	
				R903V	Oil Delivery Pipe O-ring (Med.)	93210-09008-00	
				WA080043C	Coolant Drain Bolt Washer	90430-06014-00*	
				WA082063C	Oil Drain Bolt Washer	90430-10188-00*/	
				Component Part#	Component Description	OEM Part#	
				VC103	Valve Cover Gasket		

HONDA CRF50/70



Head		Base	Clutch	Right Engine Cover	Left Engine Cover	Front Engine Cover	Exhaust	Head
Model	Year	Bore Size	EST Top End Kit	Component Part#	Component Description	OEM Part #		
CRF50	04-16	39 mm	C7974-EST	H1820040S	Head Gasket 39mm Bore	12251-GBJ-003		
XR50	88-03	41 mm	C7975-EST	H1821040S	Head Gasket 41mm Bore			
Z50R	82-87			B0659020F	Base Gasket	12191-GW8-681		
				3234V	Valve Stem Seals 2 Req.	12209-GB4-681		
				EC1070018AFM	Right Side Head Cover Gasket	12394-GW8-680		
				EC1071018AFM	Left Side Head Cover Gasket	12395-GW8-680		
				EC1072018AFM	Center Head Cover Gasket	12391-GW8-680		
				EX690064AM	Exhaust Gasket	18291-HB2-900		
				R018B	Intake Runner O-Ring to Carb.	91302-001-020		
				R14X2.5V	Dowel Pin O-Ring	91301-GB0-911		
				R16X2V	Dowel Pin O-Ring	91303-035-000		
				R219V	Valve Adjustment Cap 2 Req.	91302-001-020		
				R27X2V	Intake Runner O-Ring to Head	91301-GK4-871		
				R9X2V	Valve Guide Seals 2 Req.	91305-028-158		
					Component Part#	Component Description	OEM Part#	
			EC901032AFM	Clutch Cover Gasket	11394-GW8-680			



MX/Dirt • Off-Road • ATV Gaskets



Cometic Gasket - An Exclusive NASCAR Performance® Product

HONDA

Model	Year	Bore Size	Top End Kit	Component Part#	Component Description	OEM Part #
ATC70	78-85	49 mm	C7228	H0326043F	Head Gasket	12251-111-505
TRX70	86-87	49 mm		B0193020F	Base Gasket	12191-GW8-681
				Component Part#	Component Description	OEM Part #
				EC901032AFM	Clutch Side Engine Cover	11394-GW8-680
			EST Top End Kit	Component Part#	Component Description	OEM Part #
			C7300-EST	H2712040S	Head Gasket 50mm Bore	12200-GB5-931
XR70R	97-03	50 mm		B0659020F	Base Gasket	12191-GW8-681
CRF70	04-12			3234V	Valve Stem Seals 2 Req.	12209-GB4-681
				EC1070018AFM	Right Side Head Cover Gasket	12394-GW8-680
				EC1071018AFM	Left Side Head Cover Gasket	12395-GW8-680
				EC1072018AFM	Center Head Cover Gasket	12391-GW8-680
				EX690064AM	Exhaust Gasket	18291-HB2-900
				R018B	Intake Runner O-Ring to Carb.	91302-001-020
				R14X2.5V	Dowel Pin O-Ring	91301-GB0-911
				R16X2V	Dowel Pin O-Ring	91303-035-000
				R219V	Valve Adjustment Cap 2 Req.	91302-001-020
				Component Part#	Component Description	OEM Part #
				EC901032AFM	Clutch Side Engine Cover	11394-GW8-680

CR80

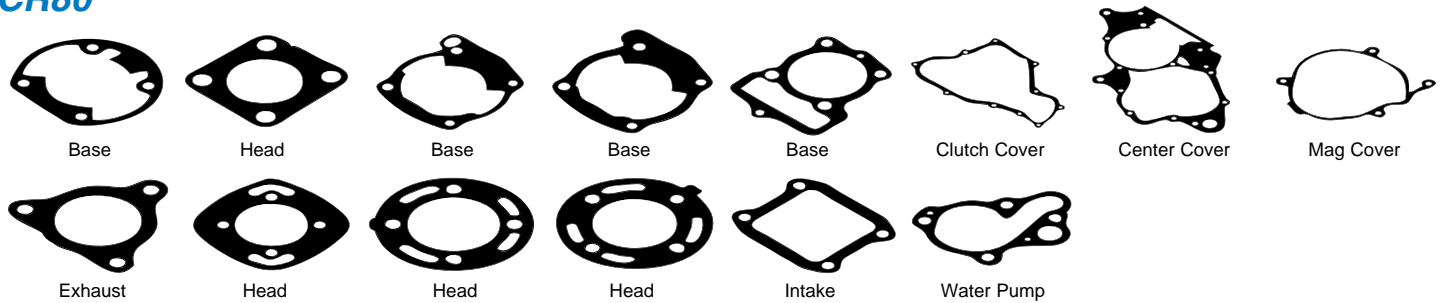

Model	Year	Bore Size	Top End Kit	Component Part#	Component Description	OEM Part #
CR80	80-82	51.5 mm	C7334	H0469020C	Head Gasket	12251-169-000
TC80	70-78			B0277020F	Base Gasket	12191-GC4-306
			Top End Kit	Component Part#	Component Description	OEM Part #
			C7000	H0001020C	Head Gasket	12251-GC4-307
				B0001020F	Base Gasket	12191-GC4-700
			Crank Seal Kit	Kit Components	Component Description	OEM Part#
			C7653	OS103	20X32X7 Left Side Oil Seal	91205-166-004
				OS104	22X40X8 Right Side Oil Seal	91206-GC4-711
			Top End Kit	Component Part#	Component Description	OEM Part #
CR80	84	51.5 mm	C7001	H0001020C	Head Gasket	12251-GC4-307
				B0002020F	Base Gasket	12191-GC4-700
			Crank Seal Kit	Kit Components	Component Description	OEM Part#
			C7653	OS103	20X32X7 Left Side Oil Seal	91205-166-004
				OS104	22X40X8 Right Side Oil Seal	91206-GC4-711
			Top End Kit	Component Part#	Component Description	OEM Part #
CR80	85	49 mm	C7002	H0002043F	Head Gasket	12251-GC4-307
				B0003020F	Base Gasket	12191-GC4-308
			Crank Seal Kit	Kit Components	Component Description	OEM Part#
			C7653	OS103	20X32X7 Left Side Oil Seal	91205-166-004
				OS104	22X40X8 Right Side Oil Seal	91206-GC4-711



MX/Dirt · Off-Road · ATV Gaskets



Cometic Gasket - An Exclusive NASCAR Performance® Product

CR80 86-02 / CR85 03-07

Model	Year	Bore Size	Top End Kit	Component Part#	Component Description	OEM Part #
CR80	86-91	48 mm	C7003	H0003043F	Head Gasket	12251-GS2-781
				B0003020F	Base Gasket	12191-GC4-308
				EX002042AM	Exhaust Gasket	18291-GC4-600
				IR001018AFM	Intake Gasket	14132-904-600
			Crank Seal Kit C7653	Kit Components	Component Description	OEM Part#
				OS103	20X32X7 Left Side Oil Seal	91205-166-004
				OS104	22X40X8 Right Side Oil Seal	91206-GC4-711
			Top End Kit	Component Part#	Component Description	OEM Part #
CR80	92-02	48 mm	C7126	H0266010S	Head Gasket 48mm Bore	12251-GS2-621
CR80Expert	96-02	49 mm	C7305	H0440010S	Head Gasket 49mm Bore	
CR85	03-07	51 mm	C7932	H1698010S	Head Gasket 51mm Bore	
		52 mm	C7315	H0449010S	Head Gasket 52mm Bore	
				B0004018AFM	Base Gasket	12191-GBF-830
				B0004012F	Base Gasket High Compression	12191-GBF-830
				EX002042AM	Exhaust Gasket	18291-GC4-600
				IR001018AFM	Intake Gasket	14132-904-600
				R38X3V	Exhaust O-rings 03-Up	91304-GBF-K41
				WA138	Exhaust Washer 03-Up	18309-GBF-K40
			Bottom End Kit w/Oil Seals C7126BE	Component Part#	Component Description	OEM Part #
				EC183020F	Center Case Gasket	11191-GBF-830
				WP03200032AFM	Water Pump Gasket	19229-GBF-840
				WA133	Water Pump Drain Washer	90543-273-000
				WA137	Drain Plug Washer	90407-259-000
				R12X2.5B	Oil Fill Plug O-ring 11.9x2.2	91370-461-000
			Oil Seal Kit C7126OS	Component Part#	Component Description	OEM Part #
				OS103	Crank Seal 20x32x7	91205-GC4-711
				OS104	Crank Seal 22x40x8	91206-GC4-711
				OS197	Shift Shaft Seal 14x24x6	91202-444-023
				OS203	Output Shaft Seal 17x28x7	91201-415-013
				OS242	Water Pump Shaft Seal 12x25x7	91211-KA3-761
				OS245	Start Shaft Seal 15x25x6	91211-671-003
				OS246	Impeller Shaft Seal 12x21x5	91201-035-015
				OS247	Clutch Actuator Seal 12x18x5	91204-KKO-003
			Clutch & Mag Kit C7126CM	Component Part#	Component Description	OEM Part #
				EC1820032AFM	Clutch Cover Gasket	11393-GBF-830

XL80/100



Base Base Head Head Right Case Cover Head Intake

Model	Year	Bore Size	Top End Kit	Component Part#	Component Description	OEM Part #
XL80	80-85	50 mm	C7230	H0336043F	Head Gasket 50mm Bore	12251-GN1-880
XR80	79-84			B0192020F	Base Gasket	12191-GN1-730
XR80R	85-91					
XR80Z A/B	79-81					
			EST	Component Part#	Component Description	OEM Part #
			Top End Kit C7231-EST			
CRF80F	04-13	54 mm		H2598010S	Head Gasket 50mm Bore	12251-GN1-A41
XR80R	92-03			3231V	Valve Stem Seals 2 req.	12208-413-003
				B0192020RC	Base Gasket	12191-GN1-730
				IR575032AFM	Intake Gasket	16229-GN1-A41
				R10X2V	Valve Guide O-rings 2 req.	91301-200-000
				EX784080C	Exhaust Gasket	18291-KZ1-670
				Component Part#	Component Description	OEM Part #
				EC1074018AFM	Clutch Cover Gasket	11393-KN4-750



MX/Dirt · Off-Road · ATV Gaskets



Cometic Gasket - An Exclusive NASCAR Performance® Product

HONDA TRX90

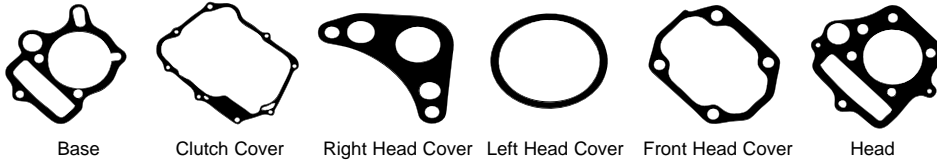

Model	Year	Bore Size	EST Top End Kit	Component Part#	Component Description	OEM Part #
TRX90	93-16	50 mm	C7226-EST	H2710040S	Head Gasket	12251-GB5-811
				B0659020RC	Base Gasket	12191-GW8-681
				3234V	Valve Stem Seals 2 Req.	12209-GB4-681
				EC1070018AFM	Right Head Cover	12394-GW8-680
				EC1071018AFM	Left Head Cover	12395-GW8-680
				EC1072018AFM	Center Head Cover	12391-GW8-680
				R027B	Valve Cap O-rings 2 Req.	91302-001-020
				R14X2.5V	Oil Return O-ring	91301-GF6-003
				R16X2V	Base O-ring	91303-035-000
				R9X2V	Valve Guide O-rings 2 Req.	91305-028-900
				Component Part# EC901032AFM	Component Description Clutch Side Engine Cover	OEM Part # 11394-GW8-680
			Top End Kit C7988	Component Part# H0329040S	Component Description Head Gasket 55mm Bore	OEM Part # 12251-KA8-405
XL100	79-85	55 mm	C7988	H0329040S	Head Gasket 55mm Bore	12251-KA8-405
XR100	81-91	58 mm	C7985	H0329SP1040S	Head Gasket 58mm Bore	12251-KA8-405
				B0194020F	Base Gasket	12191-KN4-750

Model	Year	Bore Size	EST Top End Kit	Component Part#	Component Description	OEM Part #
CRF100	04-13	55 mm	C7989-EST	H0330010S	Head Gasket 55mm Bore	12251-KN4-751
XR100	92-03	58 mm	C7986-EST	H0330SP1010S	Head Gasket 58mm Bore	12208-413-003
				3231V	Valve Stem Seals 2 req.	12191-KN4-750
				B0194020F	Base Gasket	16229-GN1-A41
				IR575032AFM	Intake Gasket	91301-200-000
				R10X2V	Valve Guide O-rings 2 req.	91302-401-000
				R30X3.5B	Intake O-ring	
				Component Part# EC1074018AFM	Component Description Clutch Cover Gasket	OEM Part # 11393-KN4-750

CR125

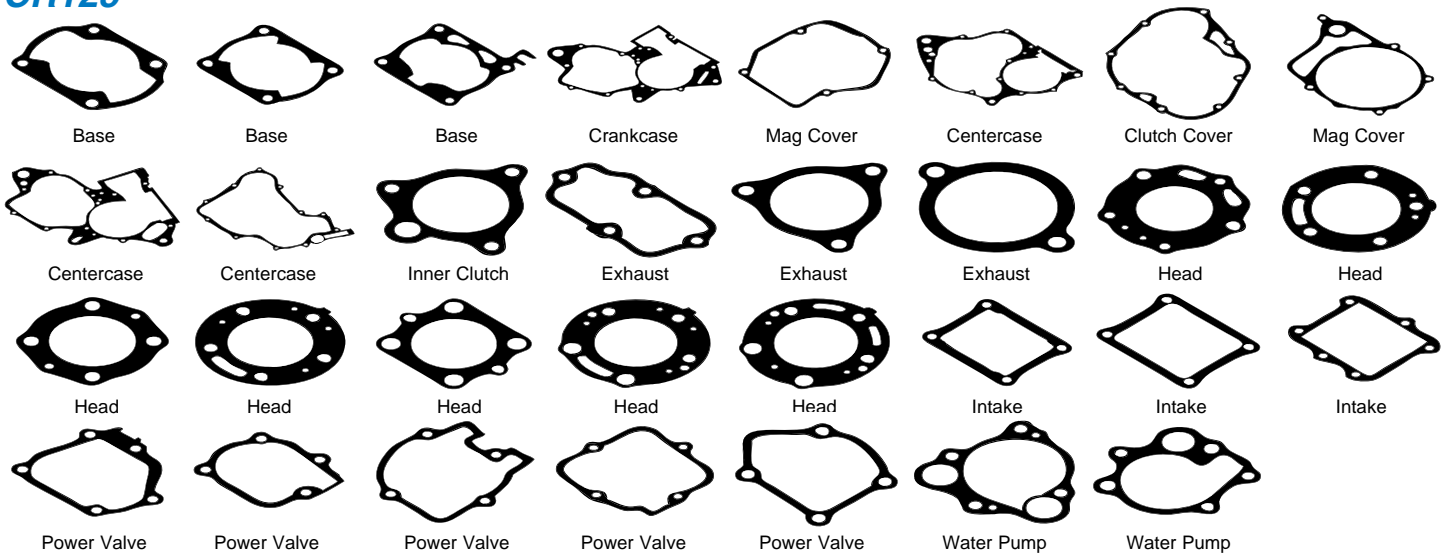



MX/Dirt • Off-Road • ATV Gaskets



Cometic Gasket - An Exclusive NASCAR Performance® Product

HONDA

Model	Year	Bore Size	Top End Kit	Component Part#	Component Description	OEM Part #
CR125 MT125	73-78	58 mm	C7465	H0216020C B0345020F	Head Gasket 58mm Bore Base Gasket	12251-360-000 12191-373-306
CR125	79-80	57.7 mm	Top End Kit C7466	Component Part# H0739020C B0351020F EX419043F IR214060AFM IR215060AFM	Component Description Head Gasket 57.7mm Bore Base Gasket Exhaust Gasket Intake Gasket Reed to Case Intake Gasket Reed to Carb Boot	Component Description OEM Part # 12251-466-000 12191-444-306 18291-444-306 14132-444-306 14131-444-306
			Bottom End Kit w/o crank seals C3312	Component Part# EC533020F EC534020F EC670060AFM	Component Description Center Case Gasket Clutch Cover Gasket Mag Cover Gasket	OEM Part # 11191-444-306 11394-444-306 11395-444-306
CR125	81	56 mm	Top End Kit C3168	Component Part# H1902043F B0351018AFM EX419043F IR214060AFM IR215060AFM	Component Description Head Gasket 56mm Bore Base Gasket Exhaust Gasket Intake Gasket Reed to Case Intake Gasket Reed to Carb Boot	Component Description OEM Part # 12251-KA3-306 12191-444-306 18291-444-306 14132-444-306 14131-444-306
CR125	82	56 mm	Top End Kit C3430	Component Part# H1715043F B0351018AFM EX419043F IR214060AFM IR215060AFM EX419043F	Component Description Head Gasket 56mm Bore Base Gasket Exhaust Gasket Intake Gasket Reed to Case Intake Gasket Reed to Carb Boot Exhaust Gasket	Component Description OEM Part # 12251-KA3-307 12191-444-306 18291-444-306 14132-444-306 14131-444-306 18291-444-306
CR125	83	57 mm	Top End Kit C7118	Component Part# H0004043F B0005020F	Component Description Head Gasket 57mm Bore Base Gasket	Component Description OEM Part # 12251-KA3-308 12191-KA3-306
CR125	84-85	57 mm	Top End Kit C7005	Component Part# H0004043F B0006020F EX003042AM IR002020F IR003018AFM	Component Description Head Gasket 57mm Bore Base Gasket Exhaust Gasket Intake Gasket Reed to Case Intake Gasket Reed to Carb Boot	Component Description OEM Part # 12251-KA3-308 12191-KA3-740 18359-K56-000 14131-KA3-710 14132-K56-701
CR125	86	56 mm	Top End Kit C7006	Component Part# H0005043F B0007020F EX003042AM IR003018AFM	Component Description Head Gasket 56mm Bore Base Gasket Exhaust Gasket Int. Gasket Reed to Carb Boot	Component Description OEM Part # 12251-KS6-405 12191-KA3-307 18359-K56-000 14132-K56-701
CR125	87	56 mm	Top End Kit C7007	Component Part# H0006043F B0008020F EX004042AM EX005031F IR003018AFM	Component Description Head Gasket 56mm Bore Base Gasket Exhaust Gasket Exhaust Gasket Intake Gasket Reed to Carb Boot	Component Description OEM Part # 12251-KZ4-701 12191-KS6-701 18314-K56-701 18339-K56-701 14132-K56-701
			Crank Seal Kit C7654	Component Part# C7491 Kit Components OS103 OS105	Component Description Clutch Cover Gasket Component Description 20X32X7 Left Side Crank Seal 30X45X8 Right Side Crank Seal	Component Description OEM Part# 91311-KS6-700 91205-166-004 91203-KS6-004



MX/Dirt • Off-Road • ATV Gaskets



Cometic Gasket - An Exclusive NASCAR Performance® Product

HONDA

Model	Year	Bore Size	Top End Kit	Component Part#	Component Description	OEM Part #
CR125	88-89	56 mm	C7008	H0355010S	Head Gasket 56mm Bore	12251-KZ4-701
				B0008020F	Base Gasket	12191-KS6-701
				EX004042AM	Exhaust Gasket	18314-K56-701
				EX005031F	Exhaust Gasket	18339-K56-701
				IR003018AFM	Int. Gasket Reed to Carb Boot	14132-K56-701
				Component Part#	Component Description	OEM Part #
				C7491	Clutch Cover Gasket	91311-KS6-700
				Kit Components	Component Description	OEM Part#
				OS103	20X32X7 Left Side Crank Seal	91205-166-004
				OS105	30X45X8 Right Side Crank Seal	91203-KS6-004
CR125	90-91	55 mm	C7010	Component Part#	Component Description	OEM Part #
				H0225010S	Head Gasket 55mm Bore	12251-KZ4-701
				B0009018AFM	Base Gasket	12191-KZ4-860
				EX006042AM	Exhaust Gasket	18291-KZ4-700
				IR003018AFM	Int. Gasket Reed to Carb Boot	14132-K56-701
				PV001018AFM	Right Power Valve Cover Gasket	12108-KZ4-700
				PV002018AFM	Left Power Valve Cover Gasket	12109-KZ4-700
				PV003018AFM	Upper Power Valve Cover Gasket	12112-KZ4-700
				Component Part#	Component Description	OEM Part #
				H0225010S	Head Gasket 55mm Bore	12251-KZ4-701
H0355010S	Head Gasket 56mm Bore	12251-KZ4-701				
H0409010S	Head Gasket 58mm Bore	12251-KZ4-701				
B0009018AFM	Base Gasket	12191-KZ4-860				
B0009012F	High Compression Base Gasket	12191-KZ4-860				
EX006042AM	Exhaust Gasket	18291-KZ4-700				
IR003018AFM	Int. Gasket Reed to Carb Boot	14132-K56-701				
PV001018AFM	Right Power Valve Cover Gasket	12108-KZ4-700				
PV002018AFM	Left Power Valve Cover Gasket	12109-KZ4-700				
PV003018AFM	Upper Power Valve Cover Gasket	12112-KZ4-700				
CR125	92-97	55 mm	C7115	H0225010S	Head Gasket 55mm Bore	12251-KZ4-701
			C7306	H0355010S	Head Gasket 56mm Bore	12251-KZ4-701
			C7299	H0409010S	Head Gasket 58mm Bore	12251-KZ4-701
		56 mm	B0009018AFM	Base Gasket	12191-KZ4-860	
			B0009012F	High Compression Base Gasket	12191-KZ4-860	
			EX006042AM	Exhaust Gasket	18291-KZ4-700	
			IR003018AFM	Int. Gasket Reed to Carb Boot	14132-K56-701	
			PV001018AFM	Right Power Valve Cover Gasket	12108-KZ4-700	
			PV002018AFM	Left Power Valve Cover Gasket	12109-KZ4-700	
			PV003018AFM	Upper Power Valve Cover Gasket	12112-KZ4-700	
Component Part#	Component Description	OEM Part #				
H0225010S	Head Gasket 55mm Bore	12251-KZ4-701				
H0355010S	Head Gasket 56mm Bore	12251-KZ4-701				
H0409010S	Head Gasket 58mm Bore	12251-KZ4-701				
B0314018AFM	Base Gasket	12191-KZ4-J00				
B0314012F	High compression Base Gasket	12191-KZ4-J00				
IR003018AFM	Int. Gasket Reed to Carb Boot	14132-K56-701				
EX006042AM	Exhaust Gasket	18291-KZ4-700				
PV001018AFM	Right Power Valve Cover Gasket	12108-KZ4-700				
PV002018AFM	Left Power Valve Cover Gasket	12109-KZ4-700				
PV003018AFM	Upper Power Valve Cover Gasket	12112-KZ4-700				
CR125	98-99	55 mm	C7394	H0225010S	Head Gasket 55mm Bore	12251-KZ4-701
			C7406	H0355010S	Head Gasket 56mm Bore	12251-KZ4-701
			C7407	H0409010S	Head Gasket 58mm Bore	12251-KZ4-701
		56 mm	B0314018AFM	Base Gasket	12191-KZ4-J00	
			B0314012F	High compression Base Gasket	12191-KZ4-J00	
			IR003018AFM	Int. Gasket Reed to Carb Boot	14132-K56-701	
			EX006042AM	Exhaust Gasket	18291-KZ4-700	
			PV001018AFM	Right Power Valve Cover Gasket	12108-KZ4-700	
			PV002018AFM	Left Power Valve Cover Gasket	12109-KZ4-700	
			PV003018AFM	Upper Power Valve Cover Gasket	12112-KZ4-700	
Component Part#	Component Description	OEM Part #				
H0928010S	Head Gasket 54mm Bore	12251-KZ4-A91				
H0929010S	Head Gasket 56mm Bore	12251-KZ4-A91				
H0930010S	Head Gasket 58mm Bore	12251-KZ4-A91				
B0314018AFM	Base Gasket	12191-KZ4-J00				
B0314012F	High compression Base Gasket	12191-KZ4-J00				
B0314010S	High compression Base Gasket	12191-KZ4-J00				
IR003018AFM	Intake Gasket Reed to Carb Boot	14132-K56-701				
EX006042AM	Exhaust Gasket	18291-KZ4-700				
PV091032AFM	Right Power Valve Cover Gasket	12108-KZ4-A90				
CR125	00	54 mm	C7678	H0928010S	Head Gasket 54mm Bore	12251-KZ4-A91
			C7694	H0929010S	Head Gasket 56mm Bore	12251-KZ4-A91
			C7695	H0930010S	Head Gasket 58mm Bore	12251-KZ4-A91
		56 mm	B0314018AFM	Base Gasket	12191-KZ4-J00	
			B0314012F	High compression Base Gasket	12191-KZ4-J00	
			B0314010S	High compression Base Gasket	12191-KZ4-J00	
			IR003018AFM	Intake Gasket Reed to Carb Boot	14132-K56-701	
			EX006042AM	Exhaust Gasket	18291-KZ4-700	
			PV091032AFM	Right Power Valve Cover Gasket	12108-KZ4-A90	
			Component Part#	Component Description	OEM Part #	
H0928010S	Head Gasket 54mm Bore	12251-KZ4-A91				
B0490018AFM	Base Gasket	12191-KZ4-L10				
B0490012F	High Compression Base Gasket	12191-KZ4-L10				
EX006042AM	Exhaust Gasket	18291-KZ4-700				
IR003018AFM	Intake Gasket Reed to Carb Boot	14132-K56-701				
PV091032AFM	Right Power Valve Cover Gasket	12108-KZ4-A90				
R124S	Expansion Cham O-rings 2 Req.					
R19X3V	Water Outlet O-ring	91312-KE7-003				
CR125	01-02	54 mm	C7757	H0928010S	Head Gasket 54mm Bore	12251-KZ4-A91
			C7758	B0490018AFM	Base Gasket	12191-KZ4-L10
			C7759	B0490012F	High Compression Base Gasket	12191-KZ4-L10
		56mm	EX006042AM	Exhaust Gasket	18291-KZ4-700	
			IR003018AFM	Intake Gasket Reed to Carb Boot	14132-K56-701	
			PV091032AFM	Right Power Valve Cover Gasket	12108-KZ4-A90	
			Component Part#	Component Description	OEM Part #	
			H0928010S	Head Gasket 54mm Bore	12251-KZ4-A91	
			B0490018AFM	Base Gasket	12191-KZ4-L10	
			B0490012F	High Compression Base Gasket	12191-KZ4-L10	
EX006042AM	Exhaust Gasket	18291-KZ4-700				
IR003018AFM	Intake Gasket Reed to Carb Boot	14132-K56-701				
PV091032AFM	Right Power Valve Cover Gasket	12108-KZ4-A90				



MX/Dirt • Off-Road • ATV Gaskets



Cometic Gasket - An Exclusive NASCAR Performance® Product

HONDA

Model	Year			Component Part#	Component Description	OEM Part #	
CR125	90-02		Bottom End Kit w/Oil Seals C7010BE	EC083032AFM	Inner Clutch Cover	11394-KZ4-A90	
				EC185020F	Center Case Gasket	11191-KZ4-620	
				IR003018AFM	Intake Gasket	14132-KY4-970	
				R16X3V	Fill Plug O-ring	91303-800-000	
				R20X2V	Output Shaft O-ring	91351-KA3-711	
				WA117	Drain Plug Gasket	94109-12000	
				WA133	Water Pump Drain Plug Gasket	90543-273-000	
				WP033018AFM	Water Pump Gasket 2 req	19229-KZ4-620	
				Oil Seal Kit C7010OS	OS103	Left Crank Seal	91205-166-004
					OS105	Right Crank Seal	91203-KS6-004
					OS227	Water Pump Shaft Seal	91201-965-000
					OS236	Shift Shaft Seal	91203-KK3-830
					OS242	Outer Water Pump Shaft Seal	91211-KA3-761
					OS243	Start Shaft Seal	91205-KA3-712
OS244	Clutch Pushrod Seal	91206-VA3-J02					
OS363	Output Shaft Seal	91201-KS6-004					
Clutch & Mag Kit C7010CM	EC228	Clutch Cover Gasket	91311-KS6-700				
	EC510060AFM	Mag Cover Gasket	11352-KS6-700				
CR125	03-04	54 mm	Top End Kit C7181 C7184 C3220	H1712010S	Head Gasket 54mm Bore	12251-KZ4-A91	
				H0929010S	Head Gasket 56mm Bore	12251-KZ4-A91	
				H0929SP2010S	Head Gasket 57mm Bore	12251-KZ4-A91	
		B0628018AFM		Base Gasket	12191-KZ4-L30		
		B0628012F		High Compression Base Gasket			
		EX006042AM		Exhaust Gasket	18291-KZ4-700		
		IR394032AFM		Intake Gasket	14132-KZ4-L30		
		PV091032AFM		Rt. Power Valve Cover Gasket 03	12108-KZ4-A90		
		PV110018AFM		Left Power Valve Cover Gasket	12111-KZ3-L20		
		PV127032AFM		Rt. Power Valve Cover Gasket 04	12108-KSR-A00		
		R124S		Exp. Chamber O-rings 2 Req.			
		R19X3V		Water Outlet O-ring	91312-KE7-003		
		Bottom End Kit w/Oil Seals C7181BE		EC709020F	Center Case Gasket	11191-KZ4-L30	
				WA117	Oil Drain Plug Gasket	94109-12000	
				EC083032AFM	Inner Clutch Cover Gasket	11394-KZ4-A90	
R18X3V	Fill Plug O-ring		91307-035-000				
WP033018AFM	Water Pump Cover Gasket		19229-KZ4-620				
WA128	Case Cover Drain		90463-ML7-000				
Plug Crush Washer							
Oil Seal Kit C7181OS	OS105		Right Crank Seal	91203-KS6-004			
	OS227		Water Pump Shaft Seal	91201-965-000			
	OS236		Shift Shaft Seal	91203-KK3-830			
	OS241	Output Shaft Seal	91201-KSR-A01				
	OS242	Impeller Seal	91211-KA3-761				
	OS243	Start Shaft Seal	91205-KA3-712				
	OS244	Clutch Pushrod Seal	91206-VA3-J02				
	Clutch & Mag Kit C7181CM	EC228	Outer Clutch Cover O-ring	91311-KS6-700			
EC510060AFM		Mag Cover Gasket	11352-KZ4-L10				



MX/Dirt · Off-Road · ATV Gaskets



Cometic Gasket - An Exclusive NASCAR Performance® Product

HONDA

Model	Year	Bore Size	Top End Kit	Component Part#	Component Description	OEM Part #
CR125	05-07	54 mm	C3085	H2370010S	Head Gasket 54mm Bore	12251-KSR-731
		56 mm	C3088	H2370SP1010S	Head Gasket 56mm Bore	12251-KSR-731
		57 mm	C3221	H2370SP5010S	Head Gasket 57mm Bore	12251-KSR-731
		58 mm	C3537	H2370SP4010S	Head Gasket 58mm Bore	12251-KSR-731
				B0812014RC	Base Gasket	12191-KSR-731
				B0812010RC	Base Gasket High Compression	12191-KSR-731
				EX644010S	Exhaust Gasket	18291-KSR-730
				PV091032AFM	Right Power Valve Cover Gasket	12108-KZ4-A90
				PV132018AFM	Left Power Valve Cover Gasket	12111-KSR-730
		Bottom End Kit w/Oil Seals				Component Part#
		C3085BE	EC1013020F	Center Case Gasket	11191-KSR-730	
			EC1014032AFM	Inner Clutch cover O-ring	11394-KSR-730	
			IR539032AFM	Intake Gasket	14132-KSR-731	
			MR039	Center Case Coolant Passage O-Ring	91301-KSR-731	
			R18X3V	Fill Plug O-ring	91307-035-000	
			R20X2V	Power Valve Shaft O-ring	91353-KM1-004	
			WA128	Case Cover Drain Plug	90463-ML7-000	
				Crush Washer		
			WA137	Oil Drain Plug Gasket	94109-12000	
			WP395018AFM	Water Pump Cover Gasket	19229-KSR-730	
Oil Seal Kit				Component Part#	Component Description	OEM Part #
		C7181OS	OS105	Right Crank Seal	91203-KS6-004	
			OS227	Water Pump Shaft Seal	91201-965-000	
			OS236	Shift Shaft Seal	91203-KK3-830	
			OS241	Output Shaft Seal	91201-KSR-A01	
			OS242	Impeller Seal	91211-KA3-761	
			OS243	Start Shaft Seal	91205-KA3-712	
			OS244	Clutch Pushrod Seal	91206-VA3-J02	
Clutch & Mag Kit				Component Part#	Component Description	OEM Part #
		C7181CM	EC228	Outer Clutch Cover O-ring	91311-KS6-700	
			EC510060AFM	Mag Cover Gasket	11352-KZ4-L10	
TRX125	85-86	55 mm	Top End Kit C7224	Component Part# H0332020C	Component Description Head Gasket	OEM Part # 12250-VM6-003
				B0195043F	Base Gasket	12191-VM6-306
TRX125	87-88	57 mm	Top End Kit C7223	Component Part# H0331043F	Component Description Head Gasket	OEM Part # 12251-HB6-000/405
				B0021020F	Base Gasket	12191-KT0-710

CRF150F,R

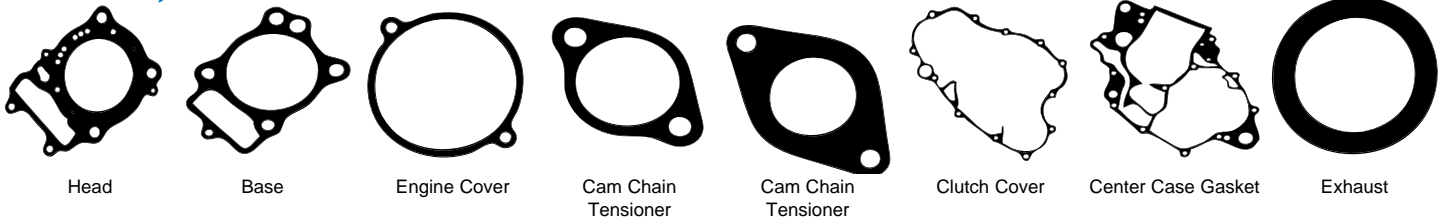

Model	Year	Bore Size	EST Top End Kit	Component Part#	Component Description	OEM Part #
CRF150F	03-05	64.5 mm	C3131-EST	H2490010S	Head Gasket 64.5mm	12251-KBB-901
				H2490SP1010S	Head Gasket 67mm	
		3231V	Valve Stem Seals 2 req.	12208-413-003		
		B0845020F	Base Gasket	12191-KCN-000		
		EC1079018AFM	Cam Chain Tensioner	16214-KPS-900		
		EC681018AFM	Left Cylinder Head Cover	12339-KTO-710		
		R10X2V	Valve Guide O-rings 2 Req.	91301-KW1-900		
		R126V	Intake Gasket	91304-HB3-003		
		R151V	Cam Cover O-ring	12339-KTO-710		
		R35X3V	Valve Adjuster Cap O-rings 2 Req.	91303-KK3-830		
			Component Part#	Component Description	OEM Part #	
			EC1076018AFM	Clutch Cover Gasket	11393-KGA-900	

All Component Parts can be purchased individually.



MX/Dirt • Off-Road • ATV Gaskets



Cometic Gasket - An Exclusive NASCAR Performance® Product

HONDA

Model	Year	Bore Size	EST Top End Kit	Component Part#	Component Description	OEM Part #						
CRF150F	06-14	58mm 62mm	C3499-EST C3500-EST	H2504010S	Head Gasket 58mm	12251-KRM-B41						
				H2504SP6010S	Head Gasket 62mm							
				3234V	Valve Stem Seals 2 req.	12209-GB4-681						
				B0859020F	Base Gasket	12191-KWK-900						
				EC1124018AFM	Cam Chain Tensioner	14560-KRM-840						
				EX691064AM	Exhaust Gasket	18291-MN5-650						
				R126V	Intake Gasket	91304-KRM-840						
CRF150R, 07-16 RB	66 mm 68 mm	C3187-EST C3171-EST	H2612SP1018S H2612018S 3239V B0880014RC EC960018AFM EX784080C	Head Gasket 66mm Bore Head Gasket 68mm Bore Valve Stem Seal 4 Req. Base Gasket Cam Chain Tensioner Gasket Exhaust Gasket	12251-KSE-671 12251-KSE-671 12208-ML0-721 12191-KSE-671 14560-MEN-671 18291-KZ1-670							
						Bottom End Kit w/Oil Seals C3187BE	Component Part#	Component Description	OEM Part #			
										EC1157020RC	Center Case Gasket	11191-KSE-670
										WP205	Water Pump Gasket	19226-KSE-670
										R18X3V	Fill Plug O-ring	91307-035-000
										R27X2V	Crank Plug O-ring	91305-KF0-003
										R113B	Water Pump Inlet Gasket	91303-377-000
										WA118	Water Pump Drain Washer	90463-ML7-000
										R113B	Dip Stick O-ring	91311-PH7-003
										R40X2V	Oil filter O-ring	91302-PA9-003
R18X3V	Timing Plug O-ring	91307-035-003										
R8.5X1.5V	Oil Filter Galley O-ring	90751-GK1-003										
Oil Seal Kit C3187OS	Component Part#	Component Description	OEM Part #									
				OS227	Water Pump Seal 12X22X5	91201-148-003						
				OS236	Shift Shaft Seal 14X22X5	91203-KA4-771						
				OS239	Start Shaft Seal 20X28X5	91204-KF0-003						
				OS262	Crank End Oil Seal 10X21X5	91204-KRN-671						
				OS264	Left Crank Seal 38X52X7	91201-MEB-671						
				OS285	Output Shaft Seal 20X30X7	91202-KCY-761						
				OS303	Right Crank Seal 32X48X7.5	91201-KSE-671						
				OS304	Oil Pump Seal 18X30X5	91203-KSE-671						
Clutch & Mag Kit C3187CM	Component Part#	Component Description	OEM Part #									
				EC1156032AFM	Clutch Cover Gasket	11394-KSE-670						
		EC1155032AFM	Mag Cover Gasket	11395-KSE-670								
ATC185 ATC200 ATC200E ATC200ES ATC200M ATC200S ATC200X TRX200	80-83 81-83 82-83 84 84-85 85-86 83-85 84	67 mm	Top End Kit C7025	Component Part#	Component Description	OEM Part #						
							H0016043F	67mm Bore Head Gasket	12251-4B6-405			
							B0021020F	Base Gasket ATC 185-200	12191-KT0-710			
							B0164020F	Base Gasket ATC 200ES Models				
ATC200X TRX200 TRX200SX	86-87 90-95 86-88	67 mm	Top End Kit C7222	Component Part#	Component Description	OEM Part #						
							H0335SP1043F	Head Gasket 67mm Bore	12251-HB3-003			
							B0168020F	Base Gasket	12191-HFI-910			



MX/Dirt · Off-Road · ATV Gaskets



Cometic Gasket - An Exclusive NASCAR Performance® Product

XR/XL200



Base Base Head

Model	Year	Bore Size	Top End Kit	Component Part#	Component Description	OEM Part #
XL200R	83-84	67 mm	C7234	H0334043F	Head Gasket 67mm	12251-KT0-P00
XR200R	80-83			B0021020F	Base Gasket	12191-KT0-710
XR200	84-85	69 mm	C7235	H0333043F	Head Gasket 69mm	12251-KT0-P00
				B0392020F	Base Gasket	12191-KZ1-920
XR200R	86-91	67 mm	C7236	H0334043F	Head Gasket 67mm	12251-KT0-P00
				B0021020F	Base Gasket	12191-KT0-710
XR200R	92-03	67 mm	C7237	H0334043F	Head Gasket 67mm	12251-KT0-P00
				B0021020F	Base Gasket	12191-KT0-710

CRF230



Base Engine Cover Clutch Cover Cam Chain Tensioner Exhaust Head

Model	Year	Bore Size	Top End Kit	Component Part#	Component Description	OEM Part #
CRF230F	03-16	66 mm	C3132-EST	H2469040S	Head Gasket 66mm	12251-KT0-711
				3231V	Valve Stem Seals 2 req.	12208-413-003
				B0021020F	Base Gasket	12191-KT0-710
				EC1079018AFM	Cam Chain Tensioner	16214-KPS-900
				EC681018AFM	Left Cylinder Head Cover	12339-KTO-710
				EX691064AM	Exhaust Gasket	18291-MN5-650
				R10X2V .	Valve Guide O-rings 2 Req	91301-KW1-900
				R126V	Intake Gasket	91304-HB3-003
				R151V	Cam Cover O-ring	12339-KTO-710
				R35X3V	Valve Adjuster Cap O-rings 2 Req.	91303-KK3-830
				Component Part#	Component Description	OEM Part #
				EC1076018AFM	Clutch Cover	11393-KGA-900

CR250

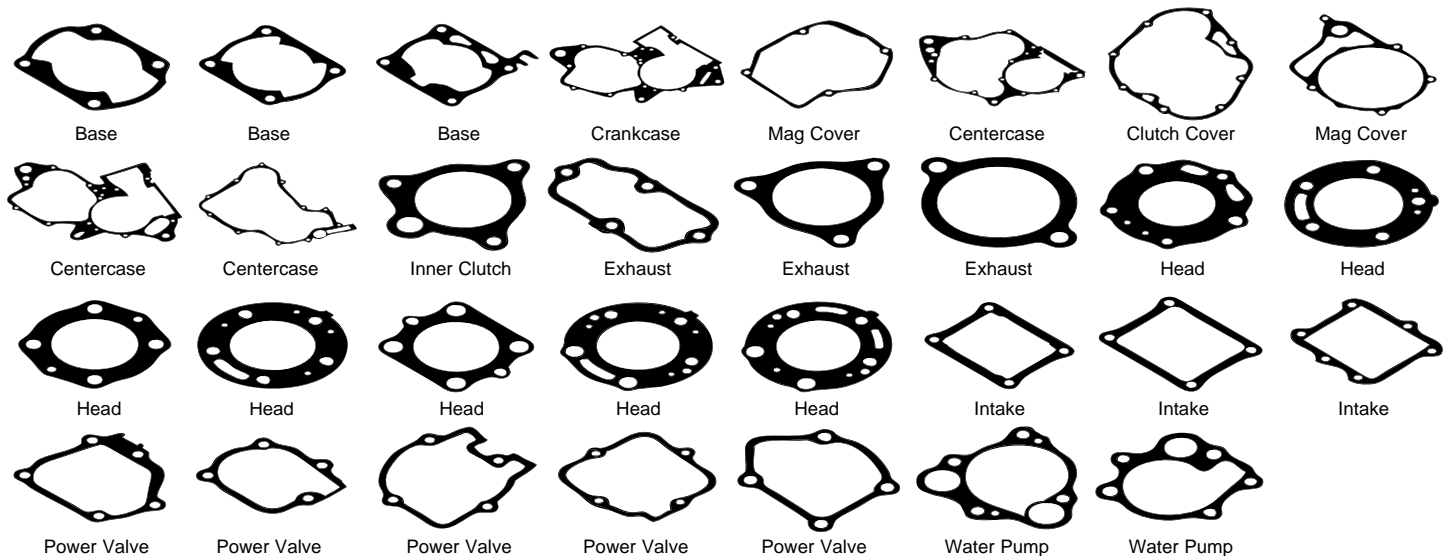

All Component Parts can be purchased individually.



MX/Dirt • Off-Road • ATV Gaskets



Cometic Gasket - An Exclusive NASCAR Performance® Product

HONDA

Model	Year	Bore Size	Top End Kit	Component Part#	Component Description	OEM Part #
ATC250R	81-84	72 mm	C7021	H0014043F	Head Gasket	12254-961-010
				B0018020F	Base Gasket	12191-961-306
				IR004018AFM	Intake Gasket	14132-430-000
ATC250R	85-86	68 mm 69.5 mm 72 mm	Top End Kit C7349 C7350 C7351	Component Part# H0009010S H0195010S H0196010S B0019020F IR004018AFM IR005018AFM	Component Description Head Gasket 68mm Head Gasket 69.5mm Head Gasket 72mm Base Gasket Intake Gasket Cylinder to Reed Intake Gasket Reed Block to Intake Manifold	OEM Part # 12254-KS7-881 12191-HA2-306 14132-430-000 14133-430-000
			Bottom End Kit w/o crank seals C3320	Component Part# C7520 EC312047F EC313020F WP071020F	Component Description Clutch Cover Gasket Mag Cover Gasket Center Case Gasket Water Pump Gasket	OEM Part # 11395-HA2-003 11352-HA2-000 11191-HA2-000 19229-HAZ-000
			Crank Seal Kit C7671	Component Part# OS106 OS108	Component Description 38X58X11 Right Crank Seal 27X50X8 Left Crank Seal	OEM Part # 91201-KA4-004 91202-HA2-771
MR250, MT250,	73-77	72 mm	Top End Kit C7140	Component Part# H0182043F B0137020F B0395020F	Component Description Head Gasket 72mm Base Gasket 73-76 Base Gasket 77-84	OEM Part # 12251-358-306 12191-357-306 12191-381-306
CR250	73-74	71 mm	Top End Kit C7811	Component Part# H0912020C B0137020F EX250020C IR133031F	Component Description Head Gasket 71mm Base Gasket Exhaust Gasket Intake Gasket	OEM Part # 12251-357-020 12191-357-306 18359-357-000 16229-357-010
			Bottom End Kit w/o crank seals C3321	Component Part# EC357031F EC358031F EC394020F	Component Description Center Case Gasket Clutch Cover Gasket Mag Cover Gasket	OEM Part # 11191-357-030 11394-357-040/306 11395-357-020
CR250	78-80	71 mm	Top End Kit C7278	Component Part# H0359020C B0210020F EX293SP1042AM IR004018AFM IR005018AFM	Component Description Head Gasket 71mm Base Gasket Exhaust Gasket Intake Gasket Intake Gasket	OEM Part # 12254-430-000 12191-430-306 18291-430-000 14132-KAE-000 14133-430-000
			Bottom End Kit w/o crank seals C3322	Component Part# EC465031F EC486020F EC487020F	Component Description Inner Clutch Cover Center Case Gasket Mag Cover Gasket	OEM Part # 11191-430-010 11395-430-306
CR250	81-82	68 mm	Top End Kit C7011	Component Part# H0007043F B0010020F IR004018AFM IR005018AFM	Component Description Head Gasket Base Gasket Intake Gasket Intake Gasket	OEM Part # 12254-KA4-004/306 12191-KA4-306 14132-KAE-000 14133-430-000
			Bottom End Kit w/o crank seals C3323	Component Part# EC801032AFM EC802020F EC803060AFM EX397042AM WP157032AFM	Component Description Clutch Cover Gasket Center Case Gasket Mag Cover Gasket Exhaust Gasket Water Pump Gasket	OEM Part # 31129-KA4-000/ 11395-KA4-000/306 11191-KA4-000 11395-KA4-710 18291-430-000/306 19229-KA4-307
CR250	83	68 mm	Top End Kit C7108	Component Part# H0008043F B0010020F EC801032AFM	Component Description Head Gasket Base Gasket Clutch Cover Gasket	OEM Part # 12254-KA4-710 12191-KA4-306 31129-KA4-000/ 11395-KA4-000/306
			Crank Seal Kit C7697	Component Part# OS103 OS106	Component Description Left Side Crank Seal 20X32X7 Right Crank Seal 38X58X11	OEM Part # 91205-166-004 91201-KA4-004



MX/Dirt · Off-Road · ATV Gaskets



Cometic Gasket - An Exclusive NASCAR Performance® Product

HONDA

Model	Year	Bore Size	Top End Kit	Component Part#	Component Description	OEM Part #
CR250	84	68 mm	C7012	H0008043F	Head Gasket	12254-KA4-710
				B0011020F	Base Gasket	12191-KA4-307
CR250	85	68 mm	C7013	Component Part#	Component Description	OEM Part #
				C7490	Clutch Cover Gasket	91311-KS7-701
				H0009043F	Head Gasket	12254-KS7-881
				B0012020F	Base Gasket	12191-KS7-306
				EX007042AM	Exhaust Gasket	18291-KA4-770
				IR004018AFM	Intake Gasket	14132-430-000
				IR005018AFM	Intake Gasket	14133-430-000
				Component Part#	Component Description	OEM Part #
				C7490	Clutch Cover Gasket	91311-KS7-701
				Component Part#	Component Description	OEM Part #
OS103	Left Side Crank Seal 20X32X7	91205-166-004				
OS106	Right Crank Seal 38X58X11	91201-KA4-004				
CR250	86-91	68 mm	C7015	Component Part#	Component Description	OEM Part #
				H0009043F	Head Gasket	12254-KS7-881
				B0013020F	Base Gasket	12191-KS7-306
				B0013012F	High Comp. Base Gasket .012"	
				EX008042AM	Exhaust Gasket	18291-KS7-000
				IR004018AFM	Intake Gasket Cylinder to Reed	14132-430-000
				IR020020F	Intake Gasket Reed to Carb	14133-KS7-000
				PV004018AFM	Side Power Valve Gasket	12108-KS7-000
				PV005020F	Upper Left Power Valve Gasket	12113-KS7-000
				PV006020F	Upper Right Power Valve Gasket	12114-KS7-000
Component Part#	Component Description	OEM Part #				
C7490	Clutch Cover Gasket	91311-KS7-701				
Component Part#	Component Description	OEM Part #				
OS103	Left Side Crank Seal 20X32X7	91205-166-004				
OS106	Right Crank Seal 38X58X11	91201-KA4-004				
CR250	92-01	68.5 mm	C7116	Component Part#	Component Description	OEM Part #
				H0247010S	Head Gasket	12254-KZ3-860
				B0014018AFM	Base Gasket	12191-KZ3-880
				IR004018AFM	Intake Gasket	14132-430-000
				PV007018AFM	Right Side Power Valve Gasket	12108-KZ3-880
				R221V	Exhaust O-rings 2 Req.	91304-KZ3-890
				Component Part#	Component Description	OEM Part #
				MR129	Case Water Galley O-ring	91301-KZ3-861
				EC187020F	Crank Case Gasket	11191-KZ3-J20
				WA137	Drain Plug Gasket	94109-12000
R18X3V	Fill Plug O-ring	91307-035-000				
WA128	Clutch Drain Washer	90463-ML7-000				
WP034018AFM	Water Pump Gasket	19229-KZ3-880				
EC084032AFM	Inner Clutch Cover Gasket	11395-KZ3-880				
Component Part#	Component Description	OEM Part #				
OS107	Left Crank Seal	91205-KZ3-861				
OS106	Right Crank Seal	91201-KA4-004				
OS227	Water Pump Shaft Seal	91201-965-000				
OS236	Shift Shaft Seal	91203-KA4-772				
		91203-KK3-830				
		91203-KA4-771				
OS238	Output Shaft Seal	91207-ML3-871				
OS239	Start Shaft Seal	91204-KF0-003				
OS240	Clutch Pushrod Seal	91201-951-003				
OS242	Impeller Shaft Seal	91211-KA3-761				
Component Part#	Component Description	OEM Part #				
EC196	Outer Clutch O-ring	91311-KS7-701				
EC082063N	Mag Cover Gasket	11352-KA4-771				
Bottom End Kit w/Oil Seals C7116BE						
Oil Seal Kit C7116OS						
Clutch & Mag Kit C7116CM						



MX/Dirt • Off-Road • ATV Gaskets



Cometic Gasket - An Exclusive NASCAR Performance® Product

HONDA

Model	Year	Bore Size	Top End Kit	Component Part#	Component Description	OEM Part #			
CR250	02-04	66.5 mm	C7191	H1288SP1010S	66.5mm Bore Head Gasket	14132-KZ3-L20			
			68.5 mm	C7197	H1288010S	68.5mm Bore Head Gasket	12254-KSK-731		
				B0546018AFM	Base Gasket .018"	12191-KZ3-L20			
				B0546012F	High Comp. Base Gasket .012"				
				IR232018AFM	Intake Gasket	18291-KZ3-L20			
				EX456010S	Exhaust Gasket	12111-KZ3-L20			
				PV110018AFM	Power Valve Gasket	12254-KSK-731			
		Bottom End Kit w/Oil Seals			Component Part#	Component Description	OEM Part #		
				C7191BE	EC5910322AFM	Inner Clutch Cover Gasket	11395-KZ3-L20		
				EC592020F	Center Case Gasket	11191-KSK-670			
		IR232018AFM	Intake Gasket	14132-KZ3-L20					
		MR037	Center Case O-ring	91301-KZ3-L20					
		R18X3V	Fill Plug O-ring	91307-035-000					
		WA128	Case Drain Washer 2 Required	90463-ML7-000					
		WA137	Drain Plug Gasket	94109-12000					
		WP131018AFM	Water Pump Gasket 2 Required	19229-KZ3-L20					
Oil Seal Kit			Component Part#	Component Description	OEM Part #				
		C7191OS	OS107	Left Crank Seal 20x37x7	91205-KZ3-861				
			OS227	Water Pump Shaft Seal 12x22x5	91201-965-000				
			OS236	Shift Shaft Seal 14x22x5	91203-KA4-771				
			OS238	Output Shaft Seal 31x40x7	91207-ML3-871				
			OS239	Start Shaft Seal 20x28x5	91204-KF0-003				
			OS240	Clutch Actuator Seal 12x18x3	91201-951-003				
			OS242	Impeller Seal 12x25x7	91211-KA3-761				
Clutch & Mag Kit			Component Part#	Component Description	OEM Part #				
		C7191CM	EC196	Outer Clutch O-ring	91311-KS7-701				
			EC5900032AFM	Mag Cover Gasket	11352-KZ3-L21				
CR250	05-07	66.5 mm	C3089	H2368010S	Head Gasket	12254-KSK-731			
			68.5 mm	C3092	H2388010S	Head Gasket 68.5mm Bore			
				B0811014RC	Base Gasket	12191-KSK-731			
				PV110018AFM	Power Valve gasket	12111-KZ3-L20			
				R14X2.5V	Exh. Valve Cover O-rings 4 req.	91302-KSK-731			
				R43X3V	Exp. Chamber O-rings 2 req.	91304-KZ3-890			
				WA139	Head Washer 2 Req.	90442-028-000			
				EX456010S	Exhaust Manifold Gasket	18291-KZ3-L20			
				IR232032AFM	Intake Gasket	14132-KZ3-L20			
		Bottom End Kit w/crank seals			Component Part#	Component Description	OEM Part #		
					C3325	EC592020F	Centercase Gasket	11191-KSK-730	
						EC590032AFM	Mag Cover Gasket	11352-KZ3-L20	
						EC591032AFM	Inner Clutch Cover Gasket	11395-K23-L20	
		TRX250R		86-89	68 mm	C7349	H0009010S	Head Gasket 68mm	12254-KS7-881
			69.5 mm			C7350	H0195010S	Head Gasket 69.5mm	
72 mm	C7351				H0196010S	Head Gasket 72mm			
					B0019020F	Base Gasket	12191-HA2-306		
					IR004018AFM	Intake Gasket Cylinder to Reed	14132-430-000		
					IR005018AFM	Int. Gasket Reed Block to Int. Manifold	14133-430-000		
	Bottom End Kit w/crank seals				Component Part#	Component Description	OEM Part #		
						C3220	C7520	Clutch Cover Gasket	11394-HA7-690
							WP071020F	Water Pump Gasket	19229-HAZ-000
							EC312047F	Mag Cover Gasket	11352-HA2-000
							EC313020F	Center Case Gasket	11191-HAZ-000
	Crank Seal Kit				Component Part#	Component Description	OEM Part #		
						C7672	OS108	Left Side Crank Seal 27X50X8	91202-HA2-771
						OS106	Right Crank Seal 38X58X11	91201-KA4-004	



MX/Dirt • Off-Road • ATV Gaskets



Cometic Gasket - An Exclusive NASCAR Performance® Product

CRF250R & CRF250X

Model	Year	Bore Size	EST	Component Part#	Component Description	OEM Part #
			Top End Kit			
CRF250R,	04-09	78 mm	C3133-EST	H2334027S	Head Gasket 78mm Bore	12251-KRN-671/731
CRF250X	04-13	79 mm	C7185-EST	H2145027S	Head Gasket 79mm Bore	12251-KRN-671/731
		81 mm	C7189-EST	H2069027S	Head Gasket 81mm Bore	
				3234V	Int. & Exh. Valve Seals 04-07 4 Req.	12209-GB4-681
				B0694014RC	Base Gasket .014	12191-KRN-731
				EC960018AFM	Cam Chain Tensioner Gasket	14560-MEN-671
				EX169064AM	Exhaust Gasket	18291-MM5-860
				MA0164	Cam Chain Tensioner Bolt Seal	90442-397-000
				R14X2.5V	Head Oil Drain Cap O-ring	91303-377-000
				R19X3V	Water Outlet O-ring	91312-KE7-003
				3239V	Exh. Valve Seals 08-09 2 Req.	12208-ML0-721
				WA110	Air Recirculation Valve Seal	90452-323-000
				Component Part#	Component Description	OEM Part #
				C3069	Valve Cover Gasket	12391-KRN-670

CRF250R, 04-09

Bottom End Kit w/Oil Seals C7185BE	Component Part#	Component Description	OEM Part #
	WP170	Molded Rubber Water Pump	19226-KRN-670
	WA111	Water Pump Imp. Seals 2 Req.	90447-KE1-000
	WA128	Coolant Drain Bolt Washer	90463-ML7-000*
	WA128	Coolant Drain Bolt Washer	90463-ML7-000*
	EC959032AFM	Inner Clutch Cover Gasket	11394-KRN-670
	R16X2.5V	Water Passage Collar O-ring	91304-MJ0-003
	R27x2V	Clutch Cover Cap O-ring	91305-KF0-003
	R12X2V	Trans Oil Fill Cap O-ring	91370-461-000*
	R18X3V	Crank Dipstick O-ring	91307-035-000
	R8.5X2V	Oil Filter Relief Valve O-ring	90751-GK1-003
	R40X2V	Oil Filter Cover O-ring	91302-PA9-003
	R14X2.5V	Mag Side Cap O-ring	91303-377-000
	EC958020F	Case Gasket	111910-KRN-670
Oil Seal Kit C7185OS	Component Part#	Component Description	OEM Part #
	OS243	Start Shaft Seal 16.5x25x5	91205-KA3-712
	OS283	Water Pump Shaft Seal 11x25x7	91211-KRN-671
	OS227	Impeller Shaft Seal 12x22x5	91201-965-000
	OS266	Right Crank Seal 39x52x7	91202-MEB-671
	OS236	Shift Shaft Seal 14x22x5	91203-KA4-771
	OS264	Left Crank Seal 39x52x7	91202-MEB-671
	OS261	Oil Pump Seal 20x33x5	91203-MEB-671
	OS240	Clutch Actuator Seal 12x18x3	91201-951-003
	OS241	Output Shaft Seal 28x37x7	91201-KSR-A01
Clutch & Mag Kit C7185CM	Component Part#	Component Description	OEM Part #
	EC957018AFM	Mag Cover Gasket	11395-KRN-670
	R150X2B	Outer Clutch Cover Gasket	11352-KRN-671



MX/Dirt · Off-Road · ATV Gaskets



Cometic Gasket - An Exclusive NASCAR Performance® Product

HONDA

Model	Year	Bore Size	EST	Component Part#	Component Description	OEM Part #
CRF250R	10-16	78mm 80mm 82mm	Top End Kit			
			C3288-EST	H3017027S	78mm Bore Head Gasket	12251-KRN-A41
			C3289-EST	H3017SP3027S	80mm Bore Head Gasket	
			C3290-EST	H3017SP2027S	82mm Bore Head Gasket	
				B1005014RC	Base Gasket	12191-KRN-A41
				EX169064AM	Exhaust Gasket	18291-MM5-860
				EC960018AFM	Cam Chain Tensioner Gasket	14560-MEN-671
	3239V	Exh. Valve Seals 08-10 2 Req.	12208-ML0-721			
	3234V	Int. Valve Seal 2010 2Req.	12209-GB4-681			
	R19X3V	Water Outlet O-ring	91312-KE7-003			
Bottom End Kit w/Oil Seals				Component Part#	Component Description	OEM Part #
C3288BE				EC1543032AFM	Inner Clutch Cover Gasket	11394-KRN-A40
				EC1544020RC	Center Case Gasket	11191-KRN-A40
				MA0165	Drain Plug Washer	90474-333-000
				R012V	Oil Relief Valve O-ring	90751-GK1-003
				R14X2.5V	Timing Mark Cap O-ring	91303-377-000
				R14X3V	Dipstick O-ring	91307-KRN-A41
				R114V	Inner Clutch Dowel O-ring	91304-MJ0-003
				R18X3V	Trans Fluid Fill Plug O-ring	91307-035-000
				R27X2V	Clutch Cover Drain Plug O-ring	91305-KF0-003
				R40X2V	Oil Filter O-ring	91302-PA9-003
				WP369	Water Pump Gasket	19226-KRN-A40
Oil Seal Kit				Component Part#	Component Description	OEM Part #
C3288OS				OS236	Shift Shaft Seal 14x22x5	91203-KA4-771
				OS240	Clutch Push Rod Oil Seal 12x18x3	91205-MEB-671
				OS241	Output Shaft Oil Seal 28x37x7	91201-KSR-A01
				OS243	Kick Start Shaft Seal 16.5x25x5	91205-KA3-712
				OS262	Left Case Oil Seal 10x21x5	91204-MEN-A31
				OS264	Left Crank Seal 38x52x7	91201-MEB-671
				OS266	Right Crank Seal 39x56x7.5	91202-MEY-671
				OS387	Balancer Shaft Seal 24x36x8	91205-KE1-004
Clutch & Mag Kit				Component Part#	Component Description	OEM Part #
C3288CM				R150x2B	Outer Clutch Cover	11352-KRN-A41
				EC1545032AFM	Mag Cover Gasket	11395-KRN-A40

XR/XL250

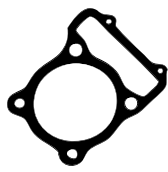

Base

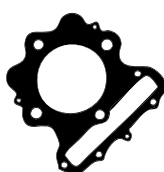

Head

Model	Year	Bore Size	Top End Kit	Component Part#	Component Description	OEM Part #
XL250	86-05	74 mm	C7145	H0238043F	Head Gasket 74mm Bore	12251-KV6-003
XR250R	86-05	78 mm	C7146	H0192043F	Head Gasket 78mm Bore	12251-KV6-003
				B0144020F	Base Gasket	12191-KZ1-920
Top End Kit				Component Part#	Component Description	OEM Part #
XL250	91-96	74 mm	C7821	H0238030S	74mm Head Gasket .030"	12251-KCZ-013
XR250R	86-95	77 mm	C7893	H1401030S	77mm Head Gasket .030"	
XR250R	96-04	78 mm	C7822	H0192030S	78mm Head Gasket .030"	12251-KCZ-013
				B0144020F	Base Gasket	12191-KZ1-920
Bottom End Kit w/o crank seals				Component Part#	Component Description	OEM Part #
C3330				EC424032AFM	Clutch Cover Gasket	11394-KZ1-920
				EC423060AFM	Mag Cover Gasket	11395-KZ1-920
				EC571020F	Center Case Gasket	11191-KZ1-920
				Component Part#	Component Description	OEM Part #
				VC033010S	Valve Cover Gasket	12391-KR6-010



MX/Dirt · Off-Road · ATV Gaskets



Cometic Gasket - An Exclusive NASCAR Performance® Product

TRX250EX



Model	Year	Bore Size	Top End Kit	Component Part#	Component Description	OEM Part #
ATC250ES	85-87	75 mm	C7026	H0017043F	Head Gasket	12251-HA0-004
ATC250SX				B0022020F	Base Gasket	12191-HA7-921
TRX250						
TRX300	85-01					
EST Top End Kit C3153-EST						
TRX250EX	01-16	70mm	C3153-EST	H2473010S	Head Gasket	12251-HN6-000
TRX250TE				3231V	3231V Valve Seals 4 Req.	12209-KL4-005
TRX250TM				B0846020RC	Base Gasket	12191-HM8-000
				EX691064AM	Exhaust Gasket	18291-MN5-650
				R10X2V	Valve Guide O-ring 2 req.	91301-200-000
				R219V	Tappet Cover O-rings 2 Req.	12392-HC4-005
				R8X2V	Rocker Shaft O-rings 2 Req.	91303-428-003
				Component Part#	Component Description	OEM Part #
				VC135018AFM	Valve Cover Gasket	12315-HN6-010
				EC1092032AFM	Clutch Cover Gasket	11394-HM8-000
EST Top End Kit C7143-EST C7906-EST						
TRX250X	87-92	75 mm	C7143-EST	H2475027S	75mm Bore Head Gasket	12251-HC0-013
		78 mm	C7906-EST	H2475SP2027S	78mm Bore Head Gasket	12251-HC0-013
				3231V	Valve Seals 4 Req.	12209-KL4-005
				B0165020F	Base Gasket	12191-HM3-670
				EC036018AFM	Cam Chain Tensioner Gasket	12194-HC5-740
				R10X2V	Valve Guide O-ring 4 req.	91301-200-000
				R35X3V	Intake Manifold O-ring	91305-HA5-000
				R57X2V	Tappet Cover O-ring	12392-HC4-005
				R78X2V	Base O-ring	91302-428-000
				R7X2.5B	Rocker Shaft O-rings 2 Req	91303-428-003
				Component Part#	Component Description	OEM Part #
				C7712	Clutch Cover Gasket	11395-HA2-003
EST Top End Kit C7143-EST C7906-EST C7525-EST C7527-EST						
Fourtrax	92-09	75 mm	C7143-EST	H2475027S	75mm Bore Head Gasket	12251-HC0-013
TRX300EX		78 mm	C7906-EST	H2475SP2027S	78mm Bore Head Gasket	12251-HC0-013
		80 mm	C7525-EST	H2475SP3027S	80mm Bore Head Gasket	12251-HC0-013
		81 mm	C7527-EST	H2475SP5027S	81mm Bore Head Gasket	12251-HC0-013
				B0165020F	Base Gasket	12191-HM3-670
				3231V	Valve Seals 4 Req.	12209-KL4-005
				EC036018AFM	Cam Chain Tensioner Gasket	12194-HC5-740
				R10X2V	Valve Guide O-ring 4 req.	91301-200-000
				R35X3V	Intake Manifold O-ring	91305-HA5-000
				R57X2V	Tappet Cover O-ring	12392-HC4-005
				R78X2V	Base O-ring	91302-428-000
				R7X2.5B	Rocker Shaft O-rings	91303-428-003
				Component Part#	Component Description	OEM Part #
				C7712	Clutch Cover Gasket	11395-HA2-003
				EC309020F	Starter Cover Gasket	11356-HM3-670
				EC310020F	Centercase Gasket	11191-HM3-670
				EC308020F	Mag Cover Gasket	11395-HM3-670
Bottom End Kit w/o crank seals C3332						
				Component Part#	Description	OEM Part#
ATC350X	85-86	82 mm	C7402	H2043027S	Head Gasket 82mm Bore	12251-HA0-003/004/005
TRX350, D	86-89	86 mm	C7405	H2044027S	Head Gasket 86mm Bore	12251-HA0-003/004/005
				B0199020F	Base Gasket	12191-HA7-921
				Component Part#	Description	OEM Part#
				EC650032AFM	Clutch Cover Gasket	11394-HC4-840



MX/Dirt · Off-Road · ATV Gaskets



Cometic Gasket - An Exclusive NASCAR Performance® Product

TRX400EX

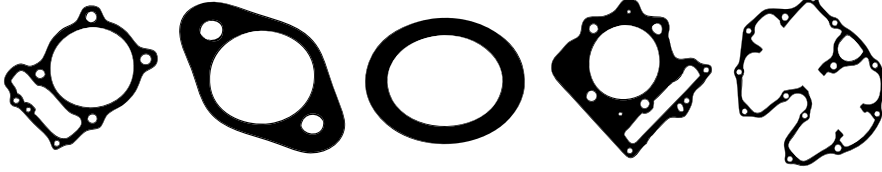

Base Timing Chain Tensioner Exhaust Head Valve Cover

Model	Year	Bore Size	EST Top End Kit	Component Part#	Component Description	OEM Part #		
TRX400 EX	96-04	86 mm	C7825-EST	H0401027S	Head Gasket 86mm .027"	12251-KCY-671		
		87 mm	C7924-EST	H0401SP2027S	Head Gasket 87mm .027"			
		89 mm	C7826-EST	H0402027S	Head Gasket 89mm .027"	12251-KCY-671		
				B0244020RC	Base Gasket .020"	12191-KCY-671		
				R88X2B	Cylinder Base O-ring	91302-356-000		
				EX691064AM	Exhaust Gasket 2 Req.	18291-MN5-650		
				EC578020RC	Cam Chain Tensioner Gasket	14523-KBB-901		
				R10X2V	Valve Guide O-Ring	91301-200-000		
				3231V	Valve Seals 4 Req.	12209-KL4-005		
				R011V	Cam Chain Tensioner O-ring	91306-MG3-000		
				R127V	Valve Adj. Cap O-rings 4 Req.	91301-428-003		
				R132V	Intake Manifold O-ring	91301-679-003		
				R219V	Exhaust O-ring	18291-MN5-650		
		R45.5X2.5V	Intake O-ring	91303-397-000				
TRX400 EX	99-04	Bottom End Kit w/Oil Seals C7825BE			Component Part#	Component Description	OEM Part #	
			EC362020F	Center Case Gasket	11191-HN1-000			
			EC363020F	Starter Cover O-ring	11377-HN1-000			
			WA129	Oil Tank Drain Plug Washer	90441-425-000			
			WA130	Oil Pump Drain Washer	90463-ML7-000			
			R18X3V	Oil Tank Dipstick O-ring	91302-KE8-003			
			R54X2.5	Oil Filter O-ring	91302-KF0-003			
			R114B	Timing Mark O-ring	91303-377-000			
			R214V	Oil Tank Strainer O-ring	91305-384-750			
			R27X2V	Crank End O-ring	91305-KF0-003			
			R013V	Oil line O-ring	91305-PE2-003			
			R214V	Starter Motor O-ring	91312-MG7-003			
			R112V	Oil line O-ring	91314-HN6-000			
			WA137	Drain Plug Washer	94109-12000			
			MR049	Oil Pump Gasket	15152-KCY-670			
			Oil Seal Kit C7825BE			Component Part#	Component Description	OEM Part #
				OS236	Oil Pump Seal	91201-KF0-003		
				OS247	Clutch Pushrod Oil Seal	91204-KK0-003		
				OS254	Shift Shaft Seal	91202-965-003		
				OS257	Output Shaft Seal	91203-KCY-671		
			Clutch & Mag Kit C7825OS			Component Part#	Component Description	OEM Part #
				EC344020F	Clutch Cover Gasket	11394-KCY-671		
				EC361020F	Mag Cover Gasket	11395-KCY-671		
		Component Part#	Component Description	OEM Part #				
		VC032010S	Valve Cover Gasket	12391-KCY-671				



MX/Dirt · Off-Road · ATV Gaskets



Cometic Gasket - An Exclusive NASCAR Performance® Product

HONDA

Model	Year	Bore Size	EST Top End Kit	Component Part#	Component Description	OEM Part #
TRX400	05-08	86 mm	C7825-EST	H0401027S	Head Gasket 86mm .027"	12251-KCY-671
EX		87 mm	C7924-EST	H0401SP2027S	Head Gasket 87mm .027"	
TRX400X	09-14	89 mm	C7826-EST	H0402027S	H0402027S 89mm Bore .027"	12251-KCY-671
				B0244020RC	Base Gasket .020"	12191-KCY-671
				R88X2B	Cylinder Base O-ring	91302-356-000
				EX691064AM	Exhaust Gasket 2 Req.	18291-MN5-650
				EC578020RC	Cam Chain Tensioner Gasket	14523-KBB-901
				R10X2V	Valve Guide O-Ring	91301-200-000
				3231V	Valve Seals 4 Req.	12209-KL4-005
				R011V	Cam Chain Tensioner O-ring	91306-MG3-000
				R127V	Valve Adjuster Cap O-rings 4 Req.	91301-428-003
				R132V	Intake Manifold O-ring	91301-679-003
				R219V	Exhaust O-ring	18291-MN5-650
				R45.5X2.5V	Intake O-ring	91303-397-000
			Bottom End Kit w/crank seals C3342	Component Part#	Component Description	OEM Part #
				EC1222020F	Center Case Gasket	11191-HN1-A40
				C7714	Clutch Cover Gasket	11394-KCY-671
				EC361020F	Mag Cover Gasket	11395-KCY-671
				EC363020F	Starter Cover Gasket	11377-HN1-000
				Component Part#	Description	OEM Part#
				VC032010S	Valve Cover Gasket	12391-KCY-671
				Component Part#	Component Description	OEM Part #
XR400R	96-05	86 mm	EST Top End	H0401027S	Head Gasket 86mm .027"	12251-KCY-671
		89 mm	C7825-EST	H0402027S	Head Gasket 89mm Bore .027"	12251-KCY-671
			C7826-EST	B0244020RC	Base Gasket .020"	12191-KCY-671
				R88X2B	Cylinder Base O-ring	91302-356-000
				EX691064AM	Exhaust Gasket 2 Req.	18291-MN5-650
				EC578020RC	Cam Chain Tensioner Gasket	14523-KBB-901
				R10X2V	Valve Guide O-Ring 4 Req.	91301-200-000
				3231V	Valve Seals 4 Req.	12209-KL4-005
				R011V	Cam Chain Tensioner O-ring	91306-MG3-000
				R127V	Valve Adjuster Cap O-rings 4 Req.	91301-428-003
				R132V	Intake Manifold O-ring	91301-679-003
				R219V	Exhaust O-ring	18291-MN5-650
				R45.5X2.5V	Intake O-ring 2 Req.	91303-397-000
			Bottom End Kit w/crank seals C3327	Component Part#	Component Description	OEM Part #
				EC399060AFM	Clutch Cover Gasket	11394-KCY-671
				EC238020F	Center Case Gasket	11191-KCY-670
				EC361060AFM	Mag Cover Gasket	11395-KCY-671
				Component Part#	Description	OEM Part#
				VC032010S	Valve Cover Gasket	12391-KCY-671

FOREMAN 400



Base



Head

Model	Year	Bore Size	Top End Kit	Component Part#	Component Description	OEM Part #
Fourtrax	95-03	88 mm	C7301	H0434043F	Head Gasket	12251-HM7-004
Foreman 400		95 mm	C7644	H0877043F	95mm Bore Head Gasket	12251-HM7-004
				B0259020F	Base Gasket	12191-HM7-003
				B0401020F	Big Bore Base Gasket	12191-HM7-003
				Component Part#	Description	OEM Part#
				EC611020F	Clutch Cover Gasket	11394-HM7-003



MX/Dirt · Off-Road · ATV Gaskets



Cometic Gasket - An Exclusive NASCAR Performance® Product

CRF450

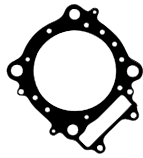
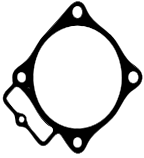
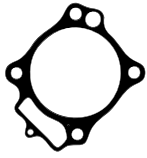

Base Model	Base Year	Base Bore Size	Timing Chain Tensioner EST Top End Kit	Head Component Part#	Head Component Description	OEM Part #		
CRF450R	02-08	96 mm	C3047-EST	H1301027S	Head Gasket 96mm			
			97 mm	C3554-EST	H1301SP6027S	Head Gasket 97mm		
			99 mm	C3049-EST	H1394027S	Head Gasket 99mm		
						B0548014RC	Base Gasket	12191-MEB-671
						EX657	Exhaust Gasket	18291-MEB-670
						EC898018AFM	Cam Chain Tensioner Gasket	14560-KCW-851
						R011V	Cam Chain Tensioner O-ring	91306-M63-000
						3231V	Exhaust Valve Seals 2 Req.	12209-GB4-681
						3234V	Intake Valve Seals 2 Req.	12209-KL4-005
						R19X3V	Water Pipe O-ring	91312-KE7-003
						R9.5X1.5V	Cam Chain Tensioner O-Ring	91306-MG3-000
		Bottom End Kit w/Oil Seals			Component Part#	Component Description	OEM Part #	
		C3047BE			EC585020F	Center Case Gasket	11191-MEN-850	
			EC587020F	Inner Clutch Cover Gasket	11394-MEB-670			
			WP166	Water Pump Cover O-ring	19226-MEB-670			
			WA128	Water Pump Drain Crush Seal	90463-ML7-000			
			WA128	Water Pump Drain Crush Washer	90463-ML7-000			
			WA135	Mag Cover Crush Seal	90474-333-000			
			R8.5X2V	Oil Relief Valve O-ring	90751-GK1-003			
			R110V	Inner Clutch Cover O-ring	91256-383-721			
			R40X2V	Oil Filter O-ring	91302-PA9-003			
			R114B	Timing Mark O-ring	91303-377-000			
			R27X2V	Right Case Plug O-ring 27x2	91305-KF0-003			
			R18X3V	Fill Plug O-ring	91307-035-000			
			R18X3V	Fill Plug O-ring	91307-035-000			
Oil Seal Kit			Component Part#	Component Description	OEM Part #			
C3047OS			OS227	Inner Water Pump Shaft Seal	91201-965-000			
			OS236	Shift Shaft Seal	91203-KA4-771			
			OS238	Output Shaft Seal	91207-ML3-871			
			OS239	Start Shaft Seal	91204-KF0-003			
			OS240	Clutch Pushrod Seal	91205-MEB-671			
			OS261	Balancer Shaft Seal	91203-MEB-671			
			OS262	Mag Seal	91204-HP1-601			
			OS264	Left Crank Seal	91201-MEB-671			
			OS266	Right Crank Seal	91202-MEY-671			
			OS242	Impeller Shaft Seal	91211-MEN-A01			
Clutch & Mag Kit			Component Part#	Component Description	OEM Part #			
C3047CM			EC765060AFM	Clutch Cover Replaces O-ring	11352-MEB-671			
			EC586060AFM	Mag Cover Gasket	11352-MEB-671			
			Component Part#	Description	OEM Part#			
			VC100	Valve Cover Gasket	12391-MEB-670			



MX/Dirt • Off-Road • ATV Gaskets



Cometic Gasket - An Exclusive NASCAR Performance® Product

HONDA

Model	Year	Bore Size	EST	Component Part#	Component Description	OEM Part #		
CRF450R	09-16	96mm	Top End Kit	H2856027S	Head Gasket 97.5mm Stock	12251-MEN-A31		
			C3270-EST	H2856SP1027S	Head Gasket 98.5mm			
			C3275-EST	H2856SP3027S	Head Gasket 100mm			
		98mm	B0969010RC	Base Gasket	12191-MEN-A31			
			EX657	Exhaust Gasket	18291-MEB-670			
			EC960018AFM	Cam Chain Tensioner Gasket	14560-MEN-671			
		100mm	3234V	Valve Seals	12209-GB4-682			
			R19X3V	Water Pipe O-ring	91312-KE7-003			
			R22X2.5V	Cylinder Water Outlet O-ring	91355-759-003			
					EX657	Exhaust Gasket	18291-MEB-670	
		Bottom End Kit w/Oil Seals				Component Part#	Component Description	OEM Part #
					C3270BE	WA135	Drain Plug Washer	90474-333-000
						EC1415020F	Center Crankcase Gasket	11191-MEN-A30
				R16X3V	Neutral Switch O-ring	91305-KC1-850		
				R40X2V	Oil Filter Cover Gasket	91302-035-000/ 91302-PA9-003		
				R14X2.5V	Timing Plug O-ring	91303-377-000		
				R18X3V	Dipstick O-ring	91307-035-000		
				R8.5X1.5V	Oil Pressure Relief Valve O-ring	90751-GK1-003		
				EC1414018AFM	Inner Clutch Cover Gasket	11394-MEN-A30		
					Water Pump Cover Gasket	19226-MEN-A30		
				R27X2V	Right Case Plug O-ring	91305-KF0-003		
				R27X2V	Clutch Oil Fill Plug O-ring	91307-035-000		
Oil Seal Kit				Component Part#	Component Description	OEM Part #		
			C3270OS	OS264	Left Crank Seal 38x52x7	91201-MEB-671		
				OS236	Shift Shaft Oil Seal 14x22x5	91203-KA4-771		
				OS240	Clutch Actuator Oil Seal 12x18x3	91205-MEB-671		
				OS262	Crank End Oil Seal 10x21x5	91204-MEN-A31		
				OS239	Kickstart Shaft Seal 20x28x5	91204-KF0-003		
				OS227	Water Pump Seal 12x22x5	91201-965-000		
				OS238	Output Shaft Seal 31x40x7	91207-ML3-871		
Clutch & Mag Kit				Component Part#	Component Description	OEM Part #		
			C3270CM	EC1416032AFM	Generator Cover Gasket	11395-MEN-A30		
				EC978	Outer Clutch Cover O-ring	11352-MEB-671		



MX/Dirt • Off-Road • ATV Gaskets



Cometic Gasket - An Exclusive NASCAR Performance® Product

HONDA

	EST	Component Part#	Component Description	OEM Part #
CRF450X 05-15	96 mm	H2458027S	Head Gasket 96mm Bore	12251-MEY-671
	98mm	H2458SP1027S	Head Gasket 98mm Bore	
	99mm	H2459027S	Head Gasket 99mm Bore	
		3231V	Exhaust Valve Seals 2 Req.	12209-GB4-681
		3234V	Intake Valve Seals 2 Req.	12209-KL4-005
		B0891020RC	Base Gasket	12191-MEB-671
		EC960018AFM	Cam Chain Tensioner Gasket	14560-MEN-671
		EX657	Exhaust Gasket	18291-MEB-670
		R117B	Water Outlet O-ring	91312-KE7-003
		Component Part#	Description	OEM Part#
	VC100	VC100 Valve Cover Gasket	12391-MEB-670	
Bottom End Kit w/Oil Seals				
	C3134BE	EC1064020F	Center Case Gasket	11191-MEY-671
		R8.5X1.5V	Oil Relief O-Ring	90751-GK1-003
		R40X2V	Oil Filter O-Ring	91302-PA9-003
		R14X2.5V	Timing Mark O-ring	91303-377-000
		R18X3V	Dipstick O-ring	91307-377-000
		WA135	Left Cover Drain Washer	90474-333-000
		EC1065018AFM	Inner Clutch Cover	11394-MEY-671
		R18X3V	Trans Fill Plug O-ring	91307-035-000
		R18X2.5V	Water Galley O-ring	91256-383-721
		WA118	Right Case Drain Seal	90463-ML7-000
		R27X2V	Crank End Plug O-ring	91305-KF0-003
		R22X2.5V	Water Outlet O-ring	91355-759-003
		WP166	Water Pump Gasket	19226-MEB-670
		WA128	Water Pump Drain Gasket	90463-ML7-000
Oil Seal Kit				
	C3134OS	OS266	Right Crank Seal 39X56X7.5	91202-MEY-671
		OS240	Clutch Pushrod Seal 12x18x3	91205-MEB-671
		OS264	Left Crank Seal 38x52x7	91201-MEB-671
		OS261	Balancer Seal 20x33x5	91203-MEB-671
		OS236	Shift Shaft Seal 14x22x5	91203-KA4-771
		OS262	Left Case Cover Oil Seal 10X21X5	91204-KRN-671
		OS239	Start Shaft Oil Seal 20x28x5	91204-KF0-003
		OS238	Output Shaft Seal 31x40x7	91207-ML3-871
		OS227	Water Pump Seal 12X22X5	91201-148-003
Clutch & Mag Kit				
	C3134CM	EC978	Clutch Cover O-ring	11352-MEB-671
		EC586032AFM	Mag Cover Gasket	11352-MEB-671



MX/Dirt • Off-Road • ATV Gaskets



Cometic Gasket - An Exclusive NASCAR Performance® Product

TRX450R

Model	Year	Bore Size	EST	Component Part#	Component Description	OEM Part #	
TRX450R	04-05	94 mm	Top End Kit				
			C7877-EST	H2175027S	94mm Bore Head Gasket	12251-HP1-671	
			C7199-EST	H2084027S	95mm Bore Head Gasket	12251-HP1-671	
			C7878-EST	H2084SP1027S	96mm Bore Head Gasket	12251-HP1-671	
			C7201-EST	H2129027S	97mm Bore Head Gasket	12251-HP1-671	
			C3079-EST	H2131SP2027S	100mm Bore Head Gasket	12251-HP1-671	
			C3076-EST	H2131SP1027S	101mm Bore Head Gasket	12251-HP1-671	
				B0741014RC	Base Gasket	12191-HP1-671	
				B0741SP1014RC	Big Bore Base Gasket 99mm and Larger	12191-HP1-671	
				EX657	Exhaust Gasket	4BE-14613-00-00	
				EC979032AFM	Cam Chain Tensioner Gasket	14523-MAL-A00	
				MA0164	Tensioner Bolt Washer	90442-397-000	
				3231V	Valve Seals 4 Req.	12209-KL4-005	
				R45.5X2.5V	Thermostat Cover O-ring	91373-733-003	
				Bottom End Kit	Component Part#	Description	OEM Part#
				C3331	EC982032AFM	Inner Clutch Cover Gasket	11394-HP1-670
					EC981032AFM	Mag Cover Gasket	11395-HP1-670
					EC980020F	Center Case Gasket	11191-HP1-670
					MA0165	Crankcase Oil Drain Washer	90474-333-000
					R10X2V	Breather Joint O-Ring	91304-HA5-003
					R14X2.5V	Timing Mark Sight Plug O-ring	91303-377-000
					R18X2.5V	Inner Clutch Dowel O-ring	91256-383-721
					R18X3V	Trans./Engine Oil Fill Plug O-rings 2 Req.	91307-035-000
					R27X2V	Inner Clutch Plug O-ring	91305-KF0-003
					R40X2V	Oil Filter Cover O-ring	91302-PA9-003
					R8.5X2V	Relief Valve O-ring	90751-GK1-003
					WA128	Crush Washer Case Oil Seal	90463-ML7-000
					Component Part#	Description	OEM Part#
					VC101	Valve Cover Gasket	12391-HP1-670
			TRX450R, ER	06-14	96 mm	EST	Component Part#
Top End Kit							
C3139-EST	H2458027S	96mm Bore Head Gasket				12251-MEY-671	
C3141-EST	H2458SP1027S	98mm Bore Head Gasket					
C3272-EST	H2459027S	99mm Bore Head Gasket					
C3156-EST	H2460027S	101mm Bore Head Gasket					
	B0856014RC	Base Gasket				12191-HP1-601	
	EX657	Exhaust Gasket				18291-MEB-670	
	EC960018AFM	Cam Chain Tensioner Gasket				14560-MEN-671	
	EC979032AFM	Cam Chain Tensioner Gasket Early				14523-MAL-A00	
	3231V	Exhaust Valve Seals 2 Req.				12209-KL4-005	
	3234V	Intake Valve Seals 2 Req.				12209-GB4-682	
	MA0164	Cam Chain Tensioner Bolt Seal				90442-397-000	
	R45.5X2.5V	Thermostat Housing Gasket				91373-733-003	
	Bottom End Kit	Component Part#				Description	OEM Part#
	C3139BE	WA118				Case Seal Crush Washer 8 Req.	90488-425-000
		EC1134020F				Center Case Gasket	11191-HP1-600
		EC978				Clutch Cover O-ring	11352-HP1-670
		EC1133032AFM				Inner Clutch Cover Gasket	11394-HP1-600
		EC1223032AFM				Mag Cover Gasket	11395-HP1-600
		WA111				Water Pump Crush Washer	90447-KE1-000
		R8X2V				Relief Valve O-ring	90751-GK1-003
		R18X2.5V				Case Dowel O-ring	91256-383-721
		R40X2V				Oil Filter O-ring	91302-PA9-003
		R14X2.5V				Timing Plug O-ring	91303-377-000
		R27X2V				Right Case Plug O-ring	91305-KF0-003
		R18X3V				Fill Plug O-rings 2 Req	91307-035-000
		WA137				Drain Plug Gasket	94109-12000
		Component Part#				Description	OEM Part#
		OS292				Right Crank Seal	91202-HP1-601
		OS262	Balancer Shaft Seal	91204-HP1-601			
		OS264	Left Crank Seal	91201-MEB-671			
		OS227	Shift Shaft Seal	91203-KA4-771			
		OS289	Oil Pump Seal	91203-HP1-601			
		OS239	Start Shaft Seal	91204-KF0-003			
		OS240	Clutch Pushrod Seal	91205-MEB-671			
		OS238	Output Shaft Seal	91207-ML3-871			
		Oil Seal Kit	Component Part#	Description	OEM Part#		
		C3139OS	OS292	Right Crank Seal	91202-HP1-601		
			OS262	Balancer Shaft Seal	91204-HP1-601		
			OS264	Left Crank Seal	91201-MEB-671		
			OS227	Shift Shaft Seal	91203-KA4-771		
			OS289	Oil Pump Seal	91203-HP1-601		
			OS239	Start Shaft Seal	91204-KF0-003		
			OS240	Clutch Pushrod Seal	91205-MEB-671		
			OS238	Output Shaft Seal	91207-ML3-871		

All Component Parts can be purchased individually.



MX/Dirt • Off-Road • ATV Gaskets



Cometic Gasket - An Exclusive NASCAR Performance® Product

CR480

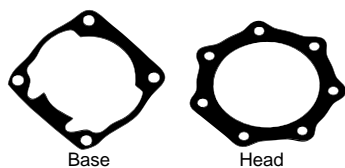

Model	Year	Bore Size	Top End Kit	Component Part#	Component Description	OEM Part #
CR480	82-83	91 mm	C7017	H0011020C	91mm Head Gasket	12254-KA5-770
				B0015020F	Base Gasket	12191-MA0-000
				Component Part#	Component Description	OEM Part #
				EC801032AFM	Clutch Cover Gasket	31129-KA4-000/ 11395-KA4-000/306

XL/XR500

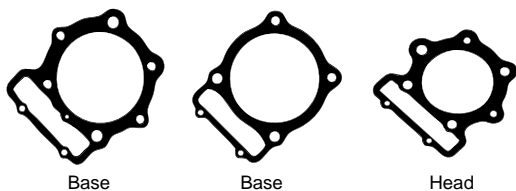

Model	Year	Bore Size	Top End Kit	Component Part#	Component Description	OEM Part #
XL500	79-82	91 mm	C7147	H0265043F	91mm Head Gasket	06130-MC4-000
XR500	79-82	95 mm	C7148	H0260043F	95mm Head Gasket	06130-MC4-000
				B0173020F	Base Gasket	12191-MA0-306
				Component Part#	Component Description	
				EC401032AFM	Clutch Cover Gasket	11394-MN1-700
			Top End Kit	Component Part#	Component Description	OEM Part #
XR500	83-84	93 mm	C7238	B0205020F	Base Gasket	12191-MN1-700
				H0257043F	Head Gasket 93mm Bore	12251-MK4-602
				Component Part#	Component Description	OEM Part #
				EC401032AFM	Clutch Cover Gasket	11394-MN1-700

HONDA CR500

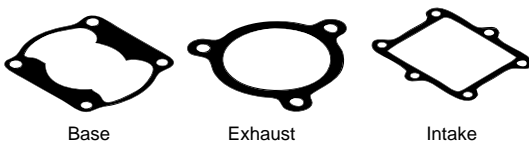

Model	Year	Bore Size	Top End Kit	Component Part#	Component Description	OEM Part #
CR500	84	91 mm	C7018	B0016020F	Base Gasket	12191-ML3-790
				H0011020C	Head Gasket	12254-KA5-770
				IR006018AFM	Intake Gasket	14132-KA5-740
				Component Part#	Component Description	OEM Part #
				C7490	Clutch Cover Gasket	91311-KS7-701
			Top End Kit	Component Part#	Component Description	OEM Part #
CR500	85-88	91 mm	C7019	H0012043F	Head Gasket	12254-ML3-881
				B0016020F	Base Gasket	12191-ML3-790
				IR006018AFM	Intake Gasket	14132-KA5-740
				EX009042AM	Exhaust Gasket	18291-ML3-791
				Component Part#	Component Description	OEM Part #
				C7490	Clutch Cover Gasket	91311-KS7-701
			Top End Kit	Component Part#	Component Description	OEM Part #
CR500	89-01	91 mm	C7020	H0300010S	Head Gasket	12254-ML3-680
				B0017018AFM	Base Gasket	12191-MAC-680
				B0017012F	High Compression Base Gasket .012"	
				IR006018AFM	Intake Gasket	14132-KA5-740
				EX009042AM	Exhaust Gasket	18291-ML3-791
				Component Part#	Component Description	OEM Part #
				C7490	Clutch Cover Gasket	91311-KS7-701
CR500	84-88	Part #	Description			
		C7772	Special 5mm Base Kit for 89-01 Connecting Rod. Includes Shim and 2 Base Gaskets for use with 89-01 Rod in 84-88 Engines.			



MX/Dirt · Off-Road · ATV Gaskets



Cometic Gasket - An Exclusive NASCAR Performance® Product

XL/XR600 XR650R

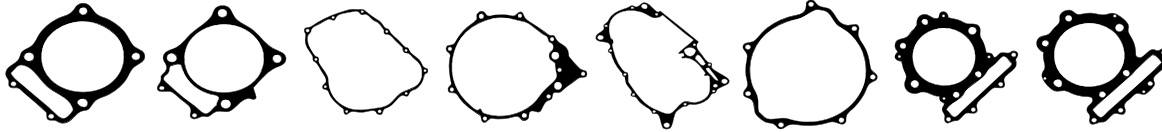

Model	Year	Base Bore Size	Top End Kit	Component Part#	Component Description	OEM Part #
XL600	83-87	103 mm	C7149	H0270SP3040S B0145020F	Head Gasket Base Gasket	12251-MG2-004 12191-MN1-700
				EC401032AFM	Clutch Cover	11394-MN1-700
XR600	88-00	98 mm	C7827	H0239030S	Head Gasket 98mm Bore	12251-MN1-671
		100 mm	C7896	H1407030S	Head Gasket 100mm Bore	12251-MN1-671
		101 mm	C7828	H0317030S	Head Gasket 101mm Bore	12251-MN1-671
		102 mm	C7957	H0317SP2030S	Head Gasket 102mm Bore	12251-MN1-671
		103 mm	C7829	H0221030S	Head Gasket 103mm Bore	12251-MN1-671
					B0145020F	Base Gasket
			C3341	Clutch Cover	11394-MN1-700	
				EC402060AFM	Mag Cover Gasket	11352-MN1-680
				EC403020F	Center Case Gasket	11191-MN1-700
				VC031010S	Valve Cover Gasket	12391-MG2-790
XR650L	93-12	103 mm	C3216	H1675SP3030S	103mm Head Gasket	12251-MN9-742
				B0145020RC	Base Gasket	12191-MN1-700
				EC619032AFM	Clutch Cover Gasket	11394-MY2-621
XR650R	00-07	101 mm	C7681	B0462020F	Base Gasket	12191-MBN-670
		103 mm	C7753	H0983018S	101mm Bore Head Gasket	12251-MBN-671
				H1047018S	103mm Bore Head Gasket	12251-MBN-671
				EC891060AFM	Clutch Cover Gasket	11352-MBN-671

TRX680FA

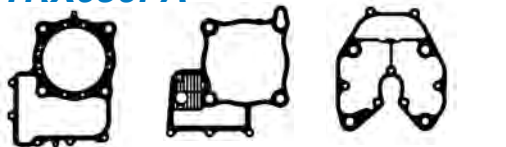

Model	Year	Base Bore Size	EST Top End Kit	Component Part#	Component Description	OEM Part #
TRX680FA	06-16	102 mm	C3475-EST	VC080020RC	Valve Cover Gasket	12315-HN8-000
				R57X2V	Tappet Cover Gasket	91308-500-000
				H1835027S	Cylinder Head Gasket	12251-HN8-A61
				B0665010S	Cylinder Base Gasket	12191-HN8-000
				EX651	Exhaust Gasket	18291-MM5-860
				3231V	Valve Stem Seal	12209-KL4-005
				EC036032AFM	Cam Chain Tensioner	12194-HC5-740
				R9.5X1.5V	Rocker Arm O-rings	91306-MG3-000

TRX700XX



Model	Year	Base Bore Size	EST Top End Kit	Component Part#	Component Description	OEM Part #
TRX700XX	08-09	102 mm	C3420-EST	H3025SP3027S	Head Gasket 102 mm Bore	12251-HP6-A01
		104 mm	C3286-EST	H3025027S	Head Gasket 104 mm Bore	
				R119B	Water Outlet Oring	91356-169-003
				R5.7X1.9B	Dowel Pin O-ring	91305-323-000
				B1012020RC	Base Gasket	12191-HP6-A01
				EC898018AFM	Cam Chain	14560-KCW-851
				3225V	Valve Seals 4 Req.	12209-413-003
				EX657	Exhaust Gasket	18291-MEB-670

All Component Parts can be purchased individually.



MX/Dirt · Off-Road · ATV Gaskets



Cometic Gasket - An Exclusive NASCAR Performance® Product

HUSABERG



Base

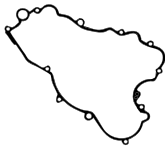

Inner Clutch

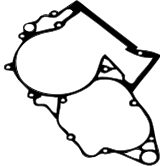

Center Case



Power Valve

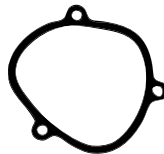

Power Valve

Model	Year	Bore Size	Top End Kit	Component Part#	Component Description	OEM Part #
TE250	11-13	O-Ring	C3222	WA135	Head Seal Crush Washer 6 Req.	56530080000
TE300	11-13			R78X2V	Inner Head O-ring 78,00X2,00	0770078020
				R105X2B	Outer Head O-ring 105,00X2,00	0770105020
				PV136032AFM	Left Side Power Valve Gasket	54837006000
				R11.5X2.5B	Front Power Valve Orings 4 Req.	0770116241
				R44X3S	Exhaust O-rings 44,00X3,00	0770440030
				PV137032AFM	Right Side Power Valve	54837008000
				B0666018AFM	Base Gasket.018" (0,4mm)	54830030004
				R15X1.5V	Power Valve Control O-ring 15x1.5	0770150151
				R16X2V	Control Valve O-ring (300) 16x2	0770160021
				R114V	Power Valve Control Cap O-ring 12,37X2,62	0770021120
				R24X2V	Power Valve Control Guide O-ring 24,00X2,00 NBR70	0770240020
			Bottom End Kit C3539	Component Part#	Component Part#	OEM Part#
				EC779020F	Intake Gasket	54830062200
				EC778032AFM	Center Case Gasket	54830039000
				R19X3V	Clutch Cover Gasket	54830024000
					Clutch Fill Plug O-ring 19,00X3,00 NBR	0770191015
				R0049	Outer Clutch Cover O-ring	54830025000
				WA137	Drain Plug Washer 12X18X1,5	58038022000
				R0050	Water Pump Cover O-ring MR	54835003000
				WA129	Water Pump Drain Crush Washer 10x14x1	0603100141
				R25X1.5V	Crank O-ring 25x1.5	0770250015
				WA129	Copper Crush Gasket Clutch Line 2 Req. 10X14X1	0603100141
				R30X1.5V	Slave Cylinder O-Ring 30,00X1,50	0770300015
				R25X2V	Output Shaft O-ring 25,00X2,00	0770250020
				R027V	Thermostat O-ring 32x2	0770320020
				EC1254032AFM	Ignition Cover Gasket	55130040000
				EC1927018AFM	Outer Ignition Cover (Estart)	55130041100
				R25X3V	Estart O-ring 25,00X3,00	0770250030



MX/Dirt · Off-Road · ATV Gaskets



Cometic Gasket - An Exclusive NASCAR Performance® Product

HUSQVARNA CR/WR125

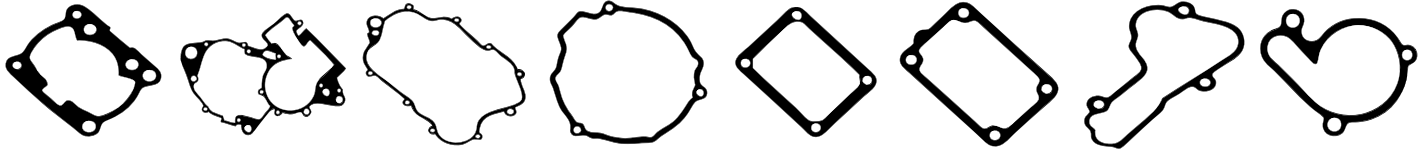

Base

Center Case

Inner Case

Mag Cover

Intake

Power Valve

Power Valve

Water Pump

Model	Year	Bore Size	Top End Kit	Component Part#	Component Description	OEM Part #
CR/WR	97-12	O-Ring	C7734	R038V	Inner Head O-Ring	
WR125	97-12			R044S	Outer Head O-Ring	8000 94652
				B0445018AFM	Base Gasket	8B00 83068
				WA116	Head Crush Washers 5 Req.	8000 39335
				R49X2.5V	Power Valve Cover O-ring	8000 28553
				R019V	Right Side Power Valve	8000 19789
					Housing O-ring	
				R222V	Expansion Chamber Head O-ring	8A00 23186
				IR146032AFM	Intake Gasket	8000 83043
				PV093032AFM	Power Valve	8000 83091
				PV092018AFM	Power Valve	8000 83049
					Component Part# Description	OEM Part#
				WP103018AFM	Water Pump Gasket	8000 65922
				EC430015F	Case Gasket	8000 72889
				IR146032AM	Intake Gasket	8000 83043
				WA120	Drain Plug Washer	62N0 15678
				EC431032AFM	Inner Clutch Cover Gasket	8000 66968
				R0071063N	Fill Plug O-ring	8000 27960
				EC432031F	Mag Cover Gasket	8000 66972
				R109V	Output Shaft O-ring	8000 19789

Bottom End Kit
w/o crank seals
C3373

CR/WR 250

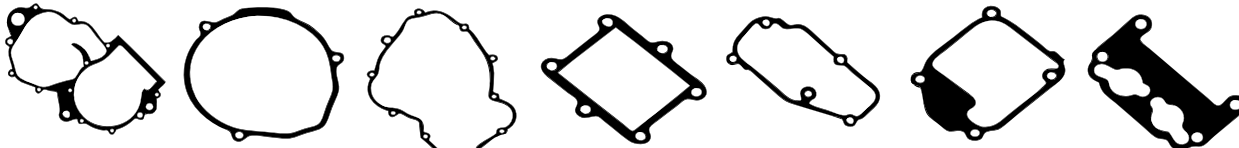

Center Case

Mag Cover

Clutch Cover

Intake

Power Valve

Power Valve

Power Valve

Model	Year	Bore Size	Top End Kit	Component Part#	Component Description	OEM Part #
WR250	99-12	O-Ring	C7743	R041V	Inner Head O-Ring	8A00 44117
CR250	99-12			R157B	Outer Head O-Ring	8A00 63593
				B0464018AFM	Base Gasket	8A00 86902
				PV095018AFM	Left Side Power Valve Cover	8000 86868
				PV094018AFM	Right Side Power Valve Cover	8000 86865
				IR148018AFM	Intake Gasket	8000 89954
				B0464010RC	Base Gasket(0,3 mm)	8000 86902
					.011" Available Separately	
				B0464020RC	Base Gasket (0,5 mm)	8B00 86902
					.019" Available Separately	
				B0464032AFM	Base Gasket (0,8 mm)	8C00 86902
					.031" Available Separately	
				R014V	Power Valve Cover	8A00 23109
					O-rings 4 Req.	
				R017V	Front Power Valve Large O-ring	8000 36380
				R021V	Front Power Valve Large O-ring	8B00 42700
					2002	
				R015V	Exhaust Valve Flap O-ring 2 Req.	8A00 22551
				R45X3.5V	Exp. Chamber Head O-ring	8A00 31970
				EX1311027C	Exp. Chamber Head Washer	8A00 73541
					Component Part# Description	OEM Part#
				R132B	Water Pump Gasket	8000 19965
				EC451020F	Case Gasket	8000 72522
				R165B	Clutch Cover O-ring	8000 86878
				EC453032AFM	Inner Clutch Cover Gasket	8000 34451
				EC452060AFM	Mag Cover Gasket	8000 69372

Bottom End Kit
w/o crank seals
C3374



MX/Dirt • Off-Road • ATV Gaskets



Cometic Gasket - An Exclusive NASCAR Performance® Product

TC250 TE/TXC250

Model	Year	Bore Size	Top End Kit	Component Part#	Component Description	OEM Part #
TC250	10-12	79mm	C3505-EST	R013B	Breather Seal O-ring	8000 01199
TE/TXC250				3239V	Valve Stem Seal 4 Req.	8000 A6356
				R12X1.5V	Cam Gear Shaft O-ring 2 Req.	8000 H6884
				EC1826018AFM	Cam Gear Shaft Gasket	8000 A6627
				WP424018AFM	Water Pump Body Gasket	8000 H6126
				WP416018AFM	Water Pump Body Gasket 2012 TE/TXC Models	8000 A7338
				WP423018AFM	Water Pump Cover Gasket	8000 H6125
				WP417018AFM	Water Pump Cover Gasket 2012 TE/TXC Models	8000 A7346
				R017V	Water Outlet O-ring	8000 36380
				EC1827018AFM	Intermediate Gear Shaft Gasket	8000 A6954
				WA116	Oil Line Crush Washer 2 Req.	8000 45194
				H3702020S	Cylinder Head Gasket (SP= 0,50 mm)	8000 A6576
				H3702027S	Cylinder Head Gasket (SP= 0,70 mm) Not included in kit	8B00A6576
				B1134010RC	Cylinder Base Gasket	8000 A6577
				Component Part#	Description	OEM Part#
				EC1778032AFM	Outer Clutch Cover Gasket	8000 A6999
				EC1777032AFM	Inner Clutch Cover Gasket	8000 A6997
				EC1780018AFM	Bevel Gear Seat Gasket	8000 A6990
				EC1779	Mag Cover Gasket	8000 A7004
				WA116	Oil Line Crush Washer 2 Req.	8000 45194
				R18X2.5V	Oil Fill Plug O-ring	8000 29171
				OP419032AFM	Oil Pump Gasket	8000 A7061
				R013B	Oil Pipe O-ring 2 Req.	8000 01199
				R017V	Kick Starter O-ring	8000 36380

**Bottom End Kit
w/o crank seals
C3512**

WR360



Base

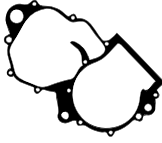

Center Case

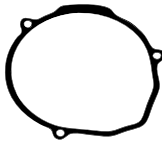

Mag Cover

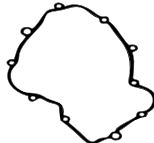

Inner Clutch

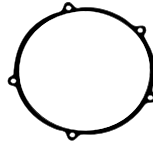

Outer Clutch



Power Valve

Model	Year	Bore Size	Top End Kit	Component Part#	Component Description	OEM Part #
WR 360	99-03	O-Ring	C7745	R043V	Inner Head O-Ring	5410932
CR360	99			R158B	Outer Head O-Ring	
WR360	99			B0465018AFM	Base Gasket	
				PV096018AFM	Power Valve Gasket	8000 73443
				Component Part#	Description	OEM Part#
				R165B	Clutch Cover O-ring	8000 86878
				EC453032AFM	Inner Clutch Gasket	
				EC452060AFM	Mag Cover Gasket	
				EC451020F	Center Case Gasket	8000 72522

**Bottom End Kit
w/o crank seals
C3375**



MX/Dirt · Off-Road · ATV Gaskets



Cometic Gasket - An Exclusive NASCAR Performance® Product

TE410/610

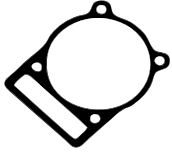

Base

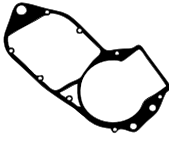

Center Case

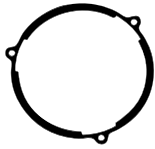

Mag Cover

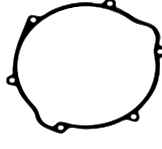

Outer Clutch

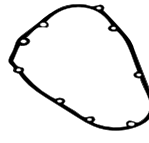

Inner Clutch



Crank Case Upper



Cam Chain
Tensioner



Head



Water Pump

Model	Year	Bore Size	Top End Kit	Component Part#	Component Description	OEM Part #
TE410E	99-01	95 mm	C7730	H0974059F	95mm Head Gasket	161536001
TE/TC 410	99-00			B0431043F	Base gasket	161540702
				EC409012F	Cam Chain Tensioner Gasket	161535801
				EC408015F	Upper Crankcase Gasket	161503601
			Bottom End Kit w/o crank seals C3376	Component Part#	Description	OEM Part#
				EC407032AFM	Left Inner Cover Gasket	161165003
				EC406060AFM	Left Outer Cover Gasket	8000608191
				EC405032AFM	Right Cover Gasket	161527501
				EC1820020F	Center Case Gasket	161501403
				WP093032AFM	Water Pump Gasket	8A00063644
			Top End Kit C7732	Component Part#	Component Description	OEM Part #
TE/TC610	99-01	99 mm	C7732	H0923059F	99mm Head Gasket	800064726
SM610R	00-01			B0431043F	Base Gasket	161540702
TE/TC610	99-00			EC409012F	Cam Chain Tensioner Gasket	161535801
TE610E	99-01			EC408015F	Upper Crankcase Gasket	161503601
			Bottom End Kit w/o crank seals C3376	Component Part#	Description	OEM Part#
				EC407032AFM	Left Inner Cover Gasket	161165003
				EC406060AFM	Left Outer Cover Gasket	8000608191
				EC405032AFM	Right Cover Gasket	161527501

KAWASAKI KDX50



Base



Exhaust

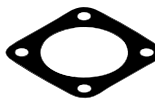

Head



Intake

Model	Year	Bore Size	Top End Kit	Component Part#	Component Description	OEM Part #
KDX50	03-05	43 mm	C7014	H1281020RC	Head Gasket 43mm Bore	11004-S004
				B0543020RC	Base Gasket	11061-S041
				EX349042AM	Exhaust Gasket	11061-S081
				IR417020F	Intake Gasket	11061-S042



MX/Dirt • Off-Road • ATV Gaskets



Cometic Gasket - An Exclusive NASCAR Performance® Product

KX60



Model	Year	Bore Size	Top End Kit	Component Part#	Component Description	OEM Part #		
KX60	85-98	45 mm	C7154	H0262043F	Head Gasket 45mm	11004-1218		
			C7605	H0520043F	Head Gasket 48mm	11004-1218		
			C7606	H0692043F	Head Gasket 53mm	11004-1218		
			B0162018AFM	Base Gasket	11009-1975			
			B0162012F	High Compression Base Gasket				
KX60	99-03	45 mm	Top End Kit C7501	H0262043F	Head Gasket 45mm	11004-1218		
				B0371018AFM	Base Gasket	11060-1873		
				B0371012F	High Compression Base Gasket	11060-1873		
KX60	85-03	Bottom End Kit w/Oil Seals C7154BE		Component Part#	Component Description	OEM Part #		
				R9X2V	Clutch Pushrod O-ring	670B1509		
				WA107	Drain Plug Seal	92065-058		
				WP0500032AFM	Water Elbow Outlet	11009-1952		
				R222V	Water Pump Body O-ring	670B3039		
				WA107	Trans Fluid Drain Plug	92065-058		
				R013B	Output Shaft O-ring	92055-022		
				Oil Seal Kit C7736OS		Component Part#	Component Description	OEM Part #
						OS331	Shift Shaft Seal 13x22x5.5	92051-005
						OS131	Output Shaft Seal 25x37x6	92050-013
						OS110	Crank Seal 20x40x7	92049-1188
						OS366	Start Shaft Seal 16x24x4	92049-002
					OS368	Water Pump Shaft Seal 8x18x10	92049-1366	
Clutch & Mag Kit C7736CM		Component Part#	Component Description	OEM Part #				
		EC275032AFM	Clutch Cover Gasket	11009-1976				
	EC2740032AFM	Mag Cover Gasket	11009-1974					

KX65

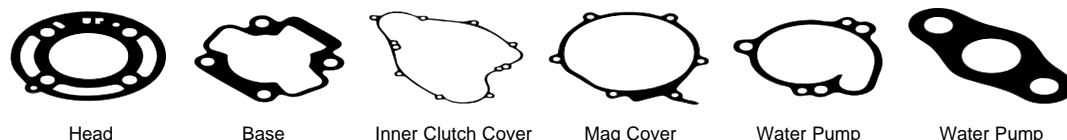

Model	Year	Bore Size	Top End Kit	Component Part#	Component Description	OEM Part #
KX65	00-16	45 mm	C7736	H0970010S	Head Gasket 45mm	11004-1346
		47 mm	C7682	H0971010S	Head Gasket 47mm	11004-1346
		48 mm	C7737	H0972010S	Head Gasket 48mm	11004-1346
				B0444018AFM	Base Gasket	11060-1921
				B0444012F	High Compression Base Gasket	11060-1921
				R218V	Exhaust O-Ring 2 Req	670E3032
			Bottom End Kit w/crank seals C3344	Component Part#	Component Description	OEM Part #
				C3048	Clutch Cover Gasket	11060-1925
				EC274018AFM	Mag Cover Gasket	11009-1974
				WP105018AFM	Water Pipe Gasket	11060-1927
				WP104018AFM	Water Pump Gasket	11060-1924
			Clutch & Mag Kit C7736CM	Component Part#	Component Description	OEM Part #
				3048	Clutch Cover Gasket	11060-1925
				EC274018AFM	Mag Cover Gasket	11009-1974
			Crank Seal Kit C7656	Component Part#	Component Description	OEM Part #
				OS110	20X40X7 Oil Seal 2 Req	92049-1188
				EC274018AFM	Mag Cover Gasket	11009-1974



MX/Dirt • Off-Road • ATV Gaskets



Cometic Gasket - An Exclusive NASCAR Performance® Product

KX80/100

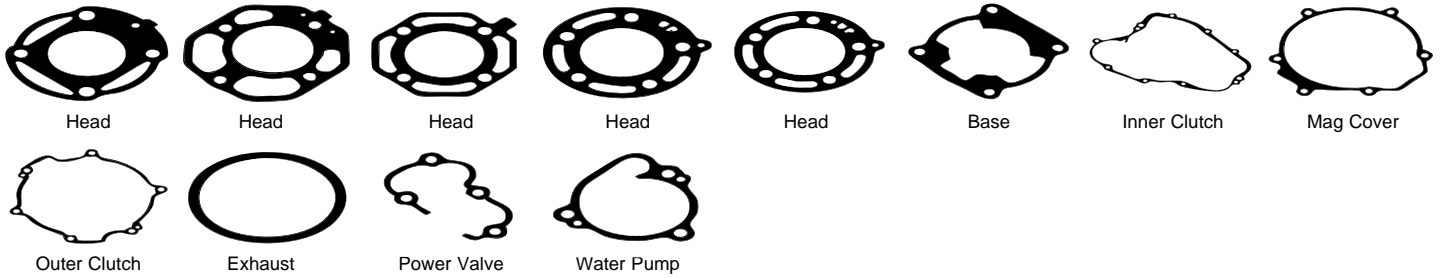

Model	Year	Bore Size	Top End Kit	Component Part#	Component Description	OEM Part #
KX80 EZ	83-84	50 mm	C7027	H0025043F	Head Gasket 50mm	11004-1058
KX80 E3	83-85	50 mm	C7028	B0028020F	Base Gasket	11009-1975
				R221V	Exhaust O-Ring 2 Req	670E3036
			Crank Seal Kit	Component Part#	Component Description	OEM Part #
			C7656	OS110	20X40X7 Oil Seal 2 Req	92049-1188
			Top End Kit	Component Part#	Component Description	OEM Part #
KX80 G1, G2	86-87	50 mm	C7029	H0026043F	Head Gasket 50mm	11004-1138
		53 mm	C7318	H0447043F	Head Gasket 53mm	
				B0029018AFM	Base Gasket	11009-1970
				R221V	Exhaust O-Ring 2 Req	670E3036
			Crank Seal Kit	Component Part#	Component Description	OEM Part #
			C7656	OS110	20X40X7 Oil Seal 2 Req	92049-1188
			Top End Kit	Component Part#	Component Description	OEM Part #
KX80 L1, L2, L3	88-90	50 mm	C7030	H0027043F	Head Gasket 50mm	11004-1168
		53 mm	C7319	H0448043F	Head Gasket 53mm	
				B0029018AFM	Base Gasket	11009-1533
				R221V	Exhaust O-Ring 2 Req	670E3036
			Crank Seal Kit	Component Part#	Component Description	OEM Part #
			C7656	OS110	20X40X7 Oil Seal 2 Req	92049-1188
			Top End Kit	Component Part#	Component Description	OEM Part #
KX80	91-97	49 mm	C7031	H0271010S	Head Gasket 49mm	11004-1213
		50 mm	C7307	H0441010S	Head Gasket 50mm	
				B0029018AFM	Base Gasket	11009-1970
				B0029012F	High Compression Base Gasket	
				R221V	Exhaust O-Ring 2 Req	670E3036
			Bottom End Kit w/crank seals	Component Part#	Component Description	OEM Part #
			C3345	EC191018AFM	Mag Cover Gasket	11009-1973
				C7493	Inner Clutch Cover Gasket	11009-1971
				WP036018AFM	Water Pump Gasket	11009-1972
			Crank Seal Kit	Component Part#	Component Description	OEM Part #
			C7656	OS110 20X40X7	20X40X7 Oil Seal 2 Req	92049-1188
			Top End Kit	Component Part#	Component Description	OEM Part #
KX80	98-00	49 mm	C7391	H0271010S	Head Gasket	11004-1213
				B0311018AFM	Base Gasket	11060-1779
				B0311012F	High Compression Base Gasket	11060-1779
				PV066018AFM	KIPS Cover	11060-1778
				R126V	Exhaust O-Ring 2 Req	671E2535
			Bottom End Kit w/crank seals	Component Part#	Component Description	OEM Part #
			C3345	EC191018AFM	Mag Cover Gasket	11009-1973
				C7493	Inner Clutch Cover Gasket	11009-1971
				WP036018AFM	Water Pump Cover Gasket	11009-1972
			Crank Seal Kit	Component Part#	Component Description	OEM Part #
			C7656	OS110	20X40X7 Oil Seal 2 Req	92049-1188



MX/Dirt • Off-Road • ATV Gaskets



Cometic Gasket - An Exclusive NASCAR Performance® Product

KAWASAKI

Model	Year	Bore Size	Top End Kit	Component Part#	Component Description	OEM Part #
KX85	01-13	48.5 mm 50.5 mm	Top End Kit C3501	H11020SP1010S	Head Gasket 48.5mm	11004-1360
				B0311018AFM	Base Gasket	11060-1779
				B0311012F	High Compression Base Gasket	11060-1779
				EX297063C	Exhaust Gasket	11060-1842
				PV066018AFM	KIPS Cover Gasket	11060-1778
				R126V	Exhaust O-Ring 2 Req	671E2535
			Bottom End Kit w/crank seals C3346	EC191018AFM	Mag Cover Gasket	11009-1973
				EC513018AFM	Outer Clutch Cover	11060-1795
				C7493	Inner Clutch Cover Gasket	11009-1971
				WP036018AFM	Water Pump Gasket	11009-1972
				Component Part#	Component Description	OEM Part #
				EC513018AFM	Outer Clutch Cover	11060-1795
Clutch & Mag Kit C3501CM	EC191018AFM	Mag Cover Gasket	11009-1973			
	Component Part#	Component Description	OEM Part #			
	OS110	20X40X7 Oil Seal 2 Req	92049-1188			
KX85	14-16	48.5 mm	Top End Kit C3541	H3880012S	Head Gasket 48.5mm Bore	11004-0737
				B0311018AFM	Base Gasket	11060-1779
				B0311012F	High Compression Base Gasket	11060-1779
				EX297063C	Exhaust Gasket	11060-1842
				PV145018AFM	Front Power Valve Gasket	11061-0889
				PV066018AFM	KIPS Cover Gasket	11060-1778
			Bottom End Kit w/crank seals C3347	R219V	Exhaust O-Ring 2 Req	670E3034
				Component Part#	Component Description	OEM Part #
				H0342010S	Head Gasket 53mm	11004-1214
				H0490010S	Head Gasket 54.5mm	
				B0029018AFM	Base Gasket	11009-1970
				R221V	Exhaust O-Ring 2 Req	670E3036
KX100	95-97	53 mm 54.5 mm	Top End Kit C7268 C7347	EC191018AFM	Mag Cover Gasket	11009-1973
				C7493	Inner Clutch Cover Gasket	11009-1971
				WP036018AFM	Water Pump Gasket	11009-1972
				Component Part#	Component Description	OEM Part #
				OS110 20X40X7	20X40X7 Oil Seal 2 Req	92049-1188
				Component Part#	Component Description	OEM Part #
			Bottom End Kit w/o crank seals C3347	H0342010S	Head Gasket 53mm	11004-1214
				H0490010S	Head Gasket 54.5mm	
				B0311018AFM	Base Gasket	11060-1779
				B0311012F	High Compression Base Gasket	11060-1779
				EX297063C	Exhaust Gasket	11060-1842
				PV066018AFM	KIPS Cover Gasket	11060-1778
KX100	98-13	53 mm 54.5 mm	Top End Kit C7392 C7413	WA128	Head Bolt Washer 5 Req	92022-304
				R126V	Exhaust O-Ring 2 Req	670E3036
				Component Part#	Component Description	OEM Part #
				EC191018AFM	Mag Cover Gasket	11009-1973
				EC513018AFM	Outer Clutch Cover Gasket	11060-1795
				C7493	Inner Clutch Cover Gasket	11009-1971
			Clutch & Mag Kit C3501CM	WP036018AFM	Water Pump	11009-1972
				Component Part#	Component Description	OEM Part #
				EC513018AFM	Outer Clutch Cover Gasket	11060-1795
				EC191018AFM	Mag Cover Gasket	11009-1973
				Component Part#	Component Description	OEM Part #
				OS110 20X40X7	20X40X7 Oil Seal 2 Req	92049-1188
KX100	14-16	52.5 mm 54.5 mm	Top End Kit C3542 C3543	H3881012S	Cylinder Head Gasket	11004-0739
				H3881SP1012S	Cyl. Head Gasket 112cc MOD	
				PV145018AFM	Power Valve Cover Gasket	11061-0889
				PV066018AFM	Right Power Valve Cover Gasket	11060-1778
				B0311018AFM	Base Gasket	11060-1779
				WA128	Cyl. Head Water Jacket Seal	92022-304
			Bottom End Kit w/o crank seals C3347	R219V	Exhaust Gasket	670E3034



MX/Dirt · Off-Road · ATV Gaskets



Cometic Gasket - An Exclusive NASCAR Performance® Product

KLX110

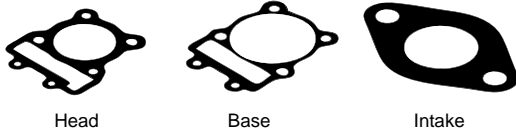

Model	Year	Bore Size	EST Top End Kit	Component Part#	Component Description	OEM Part #
KLX110	03-16	55 mm	C7939-EST	H1891010S	Head Gasket 55mm	11004-1338
		57 mm	C7949-EST	H1917010S	Head Gasket 57mm	11004-1338
				B0678SP2020RC	Base Gasket	11060-1796
				IR431018AFM	Intake Gasket	K1106-01753
				R022B	Intake O-rings 2 Req.	K9205-51527
				EX781	Exhaust Gasket	K1106-11112
				R110B	Cam Chain Tensioner Bolt O-ring	KK670-D2010
				R117B	Cam Chain Tensioner O-ring	KK670-D2021
				3183V	Valve Seals	K9204-91349
				R91X2.5V	Cam Cover O-ring	K9205-51527
				R031B	Tappet Cover O-rings 2 Req.	K9205-51231
				Component Part#	Component Description	OEM Part #
				EC1102018AFM	Clutch Cover Gasket	11061-0131

KLX125



Model	Year	Bore Size	Top End Kit	Component Part#	Component Description	OEM Part #
KLX125	03-06	59 mm	C7835	H1892027S	Head Gasket 59mm	11004-S003
		61 mm	C3109	H1926027S	Head Gasket 57mm	11004-S003
				B0679020F	Base Gasket	11061-S035
				EC824032AFM	Timing Chain Tensioner Gasket	11061-S038
				R216B	Valve Cap Cover O-Ring 2 Req	92055-S036
				R010B	Cam Chain Bolt O-ring	95055-S032

KAWASAKI KX125

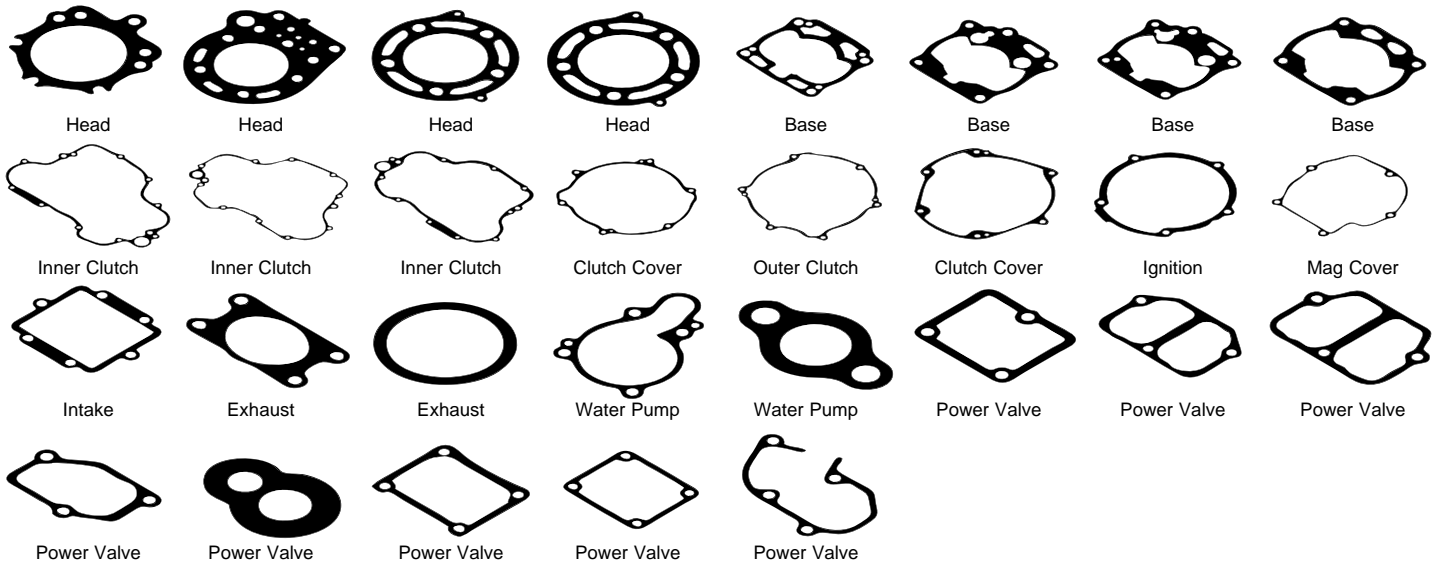



MX/Dirt • Off-Road • ATV Gaskets



Cometic Gasket - An Exclusive NASCAR Performance® Product

KAWASAKI

Model	Year	Bore Size	Top End Kit	Component Part#	Component Description	OEM Part #
KX125	78-79	57 mm	C7130	H0165020C B0108020F	Head Gasket 57mm Base Gasket	11004-1006 11009-1042
KX125	80-81	57 mm	C7131	H0164043F B0108020F	Head Gasket 57mm Base Gasket	11004-1023 11009-1175
KX125	82-83	58 mm	C7109	H0029043F B0024020F	Head Gasket 58mm Base Gasket	11004-1048 11009-1258
KX125	84	58 mm	C7110	H0248043F B0024020F	Head Gasket 58mm Base Gasket	11004-1112 11009-1258
KX125 D1, E1, E2	85-86	58 mm	C7032	H0021043F B0024020F I R007018AFM PV053020F PV054060AFM R224V	Head Gasket 58mm Base Gasket Intake Gasket Left Side Power Valve Right Side Power Valve Exhaust O-Ring 2 Req	11004-1160 11009-1258 11009-1941 11009-1478 11009-1479 670E3045
			Crank Seal Kit C7698	Component Part# OS110 20X40X7	Component Description 20X40X7 Oil Seal 2 Req	OEM Part # 92049-1052
KX125	87	58 mm	C7119	R223V PV054060AFM PV052020F IR007018AFM H0021043F B0024020F	Exhaust O-Ring 2 Req Right Power Valve Gasket Left Power Valve Gasket Intake Gasket Head Gasket 58mm Base Gasket	670E3039 11009-1479 11009-1641 11009-1941 11004-1160 11009-1258
KX125 F1	88	58 mm	C7033	H0030043F B0030020F IR007018AFM PV009018AFM PV010020F R223V	Head Gasket 58mm Base Gasket Intake Gasket Left Power Valve Gasket Right Power Valve Gasket Exhaust O-Ring 2 Req	11004-1188 11009-1940 11009-1941 11009-1938 11009-1934 670E3039
			Crank Seal Kit C7657	Component Part# OS112 OS111	Component Description Right Oil Seal Left Oil Seal	OEM Part # 92049-1301 92049-1300
KX125 G1	89	58 mm	C7034	H0031043F B0030020F IR007018AFM PV009018AFM PV010020F R223V	Head Gasket Base Gasket Intake Gasket Front Power Valve Gasket Left Side Power Valve Exhaust O-Ring 2 Req	11004-1188 11009-1690 11009-1263 11009-1691 11009-1692 670E3039
			Crank Seal Kit C7657	Component Part# OS112 OS111	Component Description Right Oil Seal Left Oil Seal	OEM Part # 92049-1301 92049-1300
KX125 H, H1	90-91	58 mm	C7035	H0032010S B0030020F IR007018AFM PV010020F PV009018AFM R223V	Head Gasket 58mm Base Gasket Intake Gasket Left Side Power Valve Front Power Valve Gasket Exhaust O-Ring 2 Req	11004-1204 11009-1824 11009-1941 11009-1692 11009-1691 670E3039
			Crank Seal Kit C7657	Component Part# OS112 OS111	Component Description Right Oil Seal Left Oil Seal	OEM Part # 92049-1301 92049-1300



MX/Dirt · Off-Road · ATV Gaskets



Cometic Gasket - An Exclusive NASCAR Performance® Product

KAWASAKI

Model	Year	Bore Size	Top End Kit	Component Part#	Component Description	OEM Part #				
KX125	92	56 mm	Top End Kit C7117	H0251010S	Head Gasket 56mm	11004-1231				
				B0031020F	Base Gasket	11060-1188				
				IR007018AFM	Intake Gasket	11009-1941				
				PV009018AFM	Front Power Valve Gasket	11009-1934				
				PV011020F	Right Side Power Valve Gasket	11060-1187				
				R223V	Exhaust O-Ring 2 Req	670E3039				
				Clutch & Mag Kit C7117CM	Component Part#	Component Description	OEM Part #			
					EC198018AFM	Outer Clutch Cover Gasket	11060-1351			
					EC199018AFM	Mag Cover Gasket	11060-1189			
				Crank Seal Kit C7657	Component Part#	Component Description	OEM Part #			
					OS112	Right Oil Seal	92049-1301			
					OS111	Left Oil Seal	92049-1300			
				KX125	93-94	56 mm	Top End Kit C7133	H0251010S	Head Gasket 56mm	11004-1252
								B0031020F	Base Gasket	11060-1188
								IR007018AFM	Intake Gasket	11009-1941
PV067018AFM	Power Valve Rod Gasket	11060-1346								
PV043018AFM	Front Power Valve Gasket	11060-1194								
PV011020F	Right Power Valve Gasket	11060-1187								
WP030018AFM	Water Inlet Gasket	11009-1935								
R223V	Exhaust O-Ring 2 Req	670E3039								
Bottom End Kit w/crank seals C3349	Component Part#	Component Description	OEM Part #							
	EC199018AFM	Mag Cover Gasket	11060-1189							
	EC198018AFM	Outer Clutch Cover Gasket	11060-1351							
Clutch & Mag Kit C7117CM	Component Part#	Component Description	OEM Part #							
	EC197018AFM	Inner Clutch Cover Gasket	11060-1350							
	WP037018AFM	Water Pump Gasket	11009-1936							
Crank Seal Kit C7657	Component Part#	Component Description	OEM Part #							
	EC198018AFM	Outer Clutch Cover Gasket	11060-1351							
	EC199018AFM	Mag Cover Gasket	11060-1189							
KX125	95-97	56 mm 58 mm	Top End Kit C7241 C7297	H0251010S	Head Gasket 56mm	11004-1252				
				H0410010S	Head Gasket 58mm					
				B0181018AFM	Base Gasket	11060-1647				
				B0181012F	High Compression Base Gasket					
				IR007018AFM	Intake Gasket	11009-1941				
				R223V	Exhaust O-Ring 2 Req	670E3039				
				PV043018AFM	Front Power Valve	11060-1690				
				PV044060AFM	Right Power Valve	11060-1686				
				PV067018AFM	Power Valve Rod Gasket	11060-1346				
				Bottom End Kit w/crank seals C3349	Component Part#	Component Description	OEM Part #			
					WP030018AFM	Water Inlet Gasket	11009-1935			
					EC197018AFM	Inner Clutch Cover Gasket	11060-1350			
				Clutch & Mag Kit C7117CM	Component Part#	Component Description	OEM Part #			
					EC198018AFM	Outer Clutch Cover Gasket	11060-1351			
					EC199018AFM	Mag Cover Gasket	11060-1189			
Crank Seal Kit C7657	Component Part#	Component Description	OEM Part #							
	WP037018AFM	Water Pump Gasket	11009-1936							
	EC198018AFM	Outer Clutch Cover Gasket	11060-1351							
Crank Seal Kit C7657	Component Part#	Component Description	OEM Part #							
	EC199018AFM	Mag Cover Gasket	11060-1189							
	OS112	Right Side Oil Seal	92049-1301							
	OS111	Left Side Oil Seal	92049-1300							



MX/Dirt • Off-Road • ATV Gaskets



Cometic Gasket - An Exclusive NASCAR Performance® Product

KAWASAKI

Model	Year	Bore Size	Top End Kit	Component Part#	Component Description	OEM Part #
KX125	98-00	56 mm	C7393	H0251010S	Head Gasket 56mm	11004-1252
		58 mm	C7414	H0410010S	Head Gasket 58mm	
				B0423018AFM	Base Gasket - 2000	11060-1955
				B0181018AFM	Base Gasket	11060-1769
				B0423012F	High Comp. Base Gasket - 2000	
				B0181012F	Big Bore High Comp. Base	
				IR007018AFM	Intake Gasket	11009-1941
				EX292080C	Exhaust Gasket	11060-1370
				EX123020C	Exhaust Manifold Gasket	11060-1790 (1)
				PV108032AFM	Front Power Valve Gasket	11060-1788
				PV067018AFM	Power Valve Rod Gasket	11060-1346
				PV065018AFM	Right Power Valve Cover	11060-1789
				WP030018AFM	Water Inlet Gasket	11009-1935
				R223V	Exhaust O-Ring 2 Req	670E3039
			Bottom End Kit w/crank seals C3349	Component Part#	Component Description	OEM Part #
				EC199018AFM	Mag Cover Gasket	11060-1189
				EC198018AFM	Outer Clutch Cover Gasket	11060-1351
				EC197018AFM	Inner Clutch Cover Gasket	11060-1350
				WP037018AFM	Water Pump Cover Gasket	11009-1936
				WP030018AFM	Water Inlet Pipe	11009-1935
			Clutch & Mag Kit C7117CM	Component Part#	Component Description	OEM Part #
				EC198018AFM	Outer Clutch Cover Gasket	11060-1351
				EC199018AFM	Mag Cover Gasket	11060-1189
			Crank Seal Kit C7657	Component Part#	Component Description	OEM Part #
				OS112	Right Side Oil Seal	92049-1301
				OS111	Left Side Oil Seal	92049-1300
KX125	01-02	56 mm	Top End Kit C7762	Component Part#	Component Description	OEM Part #
		58 mm	C7763	H0251010S	Head Gasket 56mm	11004-1252
				H0410010S	Head Gasket 58mm	
				B0502018AFM	Base Gasket	11060-1998
				B0502012F	High Compression Base Gasket	
				EX292080C	Exhaust Gasket	11060-1370
				EX123020C	Exhaust Manifold Gasket	11060-1790
				IR007018AFM	Intake Gasket	11009-1941
				PV065018AFM	Right Power Valve Cover	11060-1789
				PV067018AFM	Power Valve Rod Gasket	11060-1346
				PV108032AFM	Front Power Valve Gasket	11060-1876
				WP030018AFM	Water Inlet Pipe	11009-1935
				R223V	Exhaust O-Ring 2 Req	670E3042
			Bottom End Kit w/crank seals C3349	Component Part#	Component Description	OEM Part #
				EC199060AFM	Mag Cover Gasket	11060-1189
				EC198018AFM	Outer Clutch Cover Gasket	11060-1351
				EC197018AFM	Inner Clutch Cover Gasket	11060-1350
				WP037018AFM	Water Pump Gasket	11009-1936
			Clutch & Mag Kit C7117CM	Component Part#	Component Description	OEM Part #
				EC198018AFM	Outer Clutch Cover Gasket	11060-1351
				EC199018AFM	Mag Cover Gasket	11060-1189
			Crank Seal Kit C7657	Component Part#	Component Description	OEM Part #
				OS112	Right Oil Seal	92049-1301
				OS111	Left Oil Seal	92049-1300



MX/Dirt · Off-Road · ATV Gaskets



Cometic Gasket - An Exclusive NASCAR Performance® Product

KAWASAKI

Model	Year	Bore Size	Top End Kit	Component Part#	Component Description	OEM Part #								
KX125	03	O-Ring	Top End Kit C7921	R93X2B	Outer O-Ring Head Gasket	92055-1679								
				R62X2V	Inner O-Ring Head Gasket	92055-1679								
				B0604018AFM	Base Gasket	11061-1130								
				B0604012F	High Compression Base Gasket	11061-1130								
				R45X3V	Exhaust O-Ring 2 Req	670E3045								
				PV120018AFM	Right Power Valve Gasket	11061-1132								
				PV119018AFM	Front Power Valve Gasket	11061-1131								
				WA123	Head Bolt Washers 6 Req	11061-1133								
				Bottom End Kit w/crank seals C3350	Component Part#	Component Description	OEM Part #	EC756018AFM	Outer Clutch Cover Gasket	11061-1135				
								EC767018AFM	Inner Clutch Cover Gasket	11061-1134				
								WP151018AFM	Water Pump Gasket	11061-1150				
								WP151018AFM	Water Pump Gasket	11061-1150				
								Clutch & Mag Kit C7921CM	Component Part#	Component Description	OEM Part #	EC756018AFM	Outer Clutch Cover Gasket	11061-1135
												EC199018AFM	Mag Cover Gasket	11060-1189
				Crank Seal Kit C7657	Component Part#	Component Description	OEM Part #	OS112	Right Oil Seal	92049-1301				
OS111	Left Oil Seal	92049-1300												
KX125	04-07	O-Ring	Top End Kit C7203					R93X2B	Outer Head O-Ring	92055-1679				
				R62X2V	Inner Head O-Ring	92053-1678								
				B0692018AFM	Base Gasket	11061-0039								
				B0692012F	High Compression Base Gasket	11061-0039								
				PV120018AFM	Right Power Valve Gasket	11061-1132								
				PV119018AFM	Front Power Valve Gasket	11061-1131								
				R45X3V	Exhaust O-Ring 2 req	670E3045								
				WA123	Head Bolt Washers 6 Req	11061-1133								
				Bottom End Kit w/crank seals C3350	Component Part#	Component Description	OEM Part #	EC756018AFM	Outer Clutch Cover Gasket	11061-1135				
								EC767018AFM	Inner Clutch Cover Gasket	11061-1134				
								WP151018AFM	Water Pump Gasket	11061-1150				
				Clutch & Mag Kit C7921CM	Component Part#	Component Description	OEM Part #	EC756018AFM	Outer Clutch Cover Gasket	11061-1135				
								Crank Seal Kit C7657	Component Part#	Component Description	OEM Part #	OS112	Right Oil Seal	92049-1301
				OS111	Left Oil Seal	92049-1300								

KDX200/220R

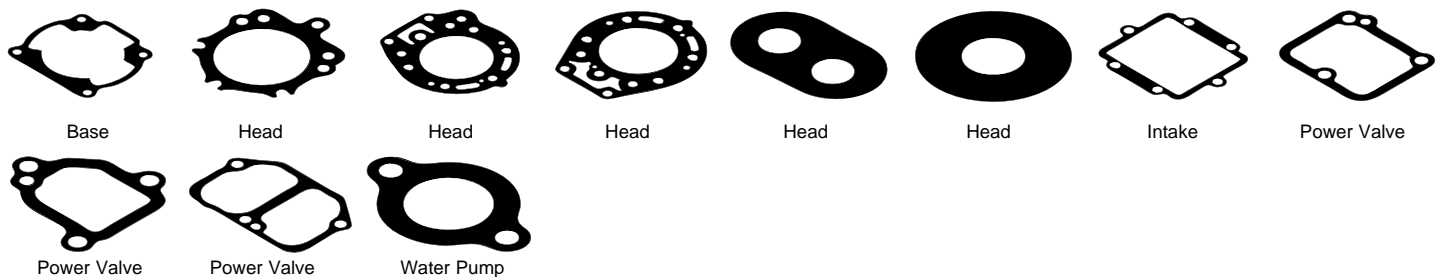

Model	Year	Bore Size	Top End Kit	Component Part#	Component Description	OEM Part #
KDX200	86-88	68 mm	C7042	H0019043F	Head Gasket 68mm	11009-1141
				B0023020F	Base Gasket	11009-1541
				IR007018AFM	Intake Gasket	11009-1263
				PV008020F	Power Valve Gasket	11009-1542

All Component Parts can be purchased individually.



MX/Dirt · Off-Road · ATV Gaskets



Cometic Gasket - An Exclusive NASCAR Performance® Product

KAWASAKI

Model	Year	Bore Size	Top End Kit	Component Part#	Component Description	OEM Part #	
KDX200	89-94	68 mm	C7043	H0299010S	Head Gasket 68mm	11004-1189	
		74 mm	C7321	H0201043F	Head Gasket 74mm		
				H0458020C	Head Insert		
				H0457020C	Head Insert		
				B0023020F	Base Gasket		11004-1659
				IR007018AFM	Intake Gasket		11009-1941
				PV010020F	Right Power Valve Gasket		11009-1934
				PV009018AFM	Left Power Valve Gasket		11009-1968
				WP029018AFM	Water Spigot Gasket		11009-1993
				R222V	Exhaust Gasket 2 Req		670E3039
KDX200	95-06	68 mm	C7242	H0343010S	Head Gasket 68mm	11004-1298	
		73 mm	C7320	H0399043F	Head Gasket 73mm		
				B0203018AFM	Base Gasket		11060-1659
				IR007018AFM	Intake Gasket		11009-1941
				PV060018AFM	Left Power Valve Gasket		11060-1628
				PV047018AFM	Right Power Valve Gasket		11060-1629
				PV046018AFM	Resonator Cover Gasket		11060-1627
				WP029018AFM	Water Spigot Gasket		11009-1993
				R222V	Exhaust Gasket 2 Req		670E3039
				R222V	Exhaust Gasket 2 Req		670E3039
KDX220R	97-05	70 mm	C7298	H0439010S	Head Gasket 70mm	11060-1659	
				B0203018AFM	Base Gasket		11009-1941
				IR007018AFM	Intake Gasket		11060-1628
				PV060018AFM	Left Power Valve Gasket		11060-1629
				PV047018AFM	Right Power Valve Gasket		11060-1627
				PV046018AFM	Resonator Cover Gasket		11009-1993
				R222V	Exhaust Gasket 2 Req		670E3039

KDX250



Head



Base

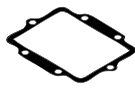

Intake

Model	Year	Bore Size	Top End Kit	Component Part#	Component Description	OEM Part #
KDX250	91-94	69 mm	C7134	H0293010S	Head Gasket 69mm	11004-1240
				B0113018AFM	Base Gasket	11060-1493
				IR008018AFM	Intake Gasket	11009-1950
				PV013018AFM	Front Power Valve Gasket	11060-1289
				PV012020F	Right Power Valve Gasket	11060-1290
KL, KLR250	85-05	77 mm	C7244	H0341010C	Head Gasket 77mm	11004-1121
				B0198020F	Base Gasket	11060-1125
KLX250R	94-14	73 mm	C7214	H0230043F	Head Gasket 73mm	11004-1249
				B0155020RC	Base Gasket	11060-1319



MX/Dirt · Off-Road · ATV Gaskets



Cometic Gasket - An Exclusive NASCAR Performance® Product

KX250

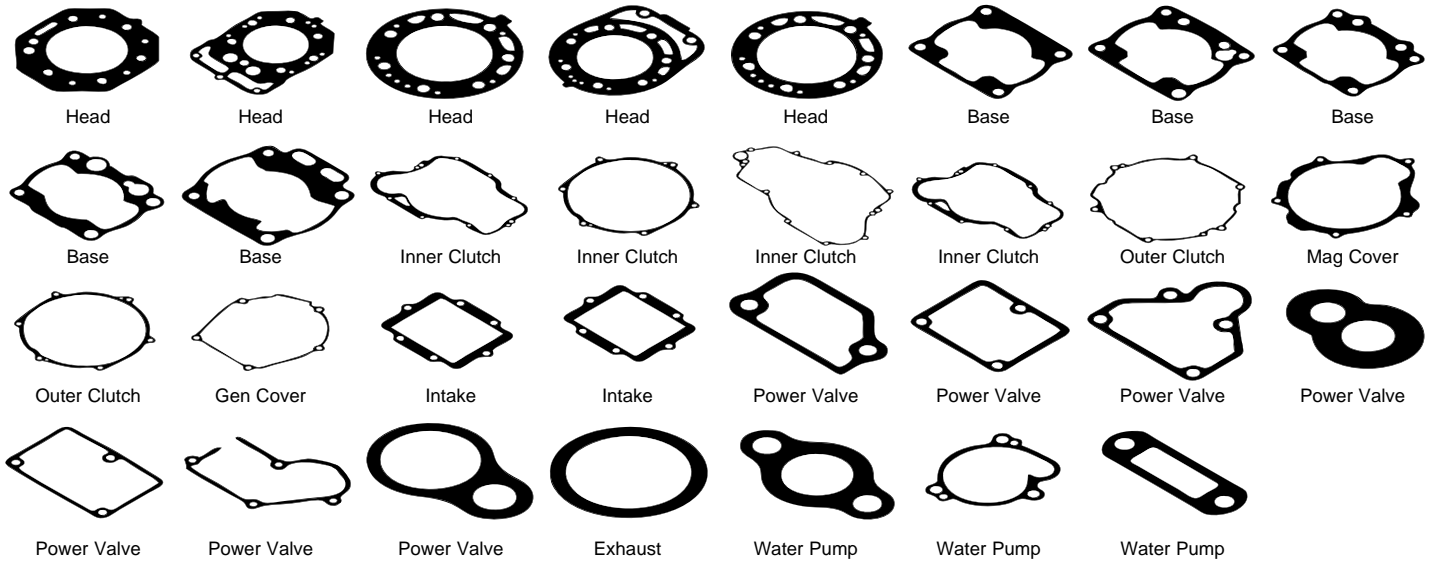

Model	Year	Bore Size	Top End Kit	Component Part#	Component Description	OEM Part #
KX250	83-84	72 mm	Top End Kit C7111	H0022043F	Head Gasket 72mm	11004-1057
				B0025020F	Base Gasket	11009-1318
			Crank Seal Kit C7658	OS110	20X40X7 Left Oil Seal	92049-1052
				OS113	Right Oil Seal	92049-1051
KX250 D1	85	72 mm	Top End Kit C7037	H0023043F	Head Gasket 72mm	11004-1126
				B0025020F	Base Gasket	11004-1462
				IR008018AFM	Intake Gasket	11009-1950
				R136V	Exhaust Gasket 2 Req	671E2550
			Crank Seal Kit C7658	OS110	20X40X7 Left Oil Seal	92049-1052
				OS113	Right Oil Seal	92049-1051
KX250 D2	86	72 mm	Top End Kit C7038	H0023043F	Head Gasket 72mm	11004-1126
				B0026020F	Base Gasket	11009-1546
				IR008018AFM	Intake Gasket	11009-1950
				R136V	Exhaust Gasket 2 Req	671E2550
			Crank Seal Kit C7658	OS110	20X40X7 Left Oil Seal	92049-1052
				OS113	Right Oil Seal	92049-1051
KX250 E1	87	69.5 mm	Top End Kit C7039	H0034043F	Head Gasket 69.5mm	11004-1157
				B0032020F	Base Gasket	11009-1624
				IR008018AFM	Intake Gasket	11004-1950
				PV012020F	Right Power Valve Gasket	11009-1946
				R136V	Exhaust Gasket 2 Req	671E2550
			Crank Seal Kit C7658	OS110	20X40X7 Left Oil Seal	92049-1051
				OS113	Right Oil Seal	92049-1052
KX250 F1, G1, H1	88-90	69 mm	Top End Kit C7040	H0293010S	Head Gasket 69mm	11004-1121
				B0033020F	Base Gasket	11009-1700
				IR008018AFM	Intake Gasket	11009-1252
				PV013018AFM	Front Power Valve Gasket	11009-1701
				PV012020F	Right Power Valve Gasket	11009-1625
				R136V	Exhaust Gasket 2 Req	671E2550
				WP030018AFM	Water Inlet Gasket	11009-1696
			Crank Seal Kit C7658	OS110	20X40X7 Left Oil Seal	92049-1052
				OS113	Right Oil Seal	92049-1051



MX/Dirt • Off-Road • ATV Gaskets



Cometic Gasket - An Exclusive NASCAR Performance® Product

KAWASAKI

Model	Year	Bore Size	Top End Kit	Component Part#	Component Description	OEM Part #				
KX250 H2	91	69mm	Top End Kit C7041	H0293010S	69mm Head Gasket	11004-1217				
				B0034020F	Base Gasket	11009-1947				
				IR008018AFM	Intake Gasket	11009-1251				
				PV013018AFM	Front Power Valve Gasket	11009-1701				
				PV012020F	Right Power Valve Gasket	11009-1625				
				R136V	Exhaust Gasket 2-Req	671E2550				
				WP030018AFM	Water Inlet Gasket	11009-1696				
				Component Part#	Component Description	OEM Part #				
				OS110	20X40X7 Left Oil Seal	92049-1051				
				OS113	Right Oil Seal	92049-1052				
KX250	92	69 mm	Top End Kit C7100	H0293010S	Head Gasket 69mm	11004-1229				
				B0034020F	Base Gasket	11009-1947				
				IR008018AFM	Intake Gasket	11009-1252				
				PV012020F	Right Power Valve Gasket	11009-1625				
				PV013018AFM	Front Power Valve Gasket	11009-1701				
				WP030018AFM	Water Inlet Gasket	11009-1696				
				R136V	Exhaust Gasket 2 Req	671E2550				
				Component Part#	Component Description	OEM Part #				
				C7478	Outer Clutch Cover Gasket	11060-1186				
				EC203018AFM	Mag Cover Gasket	11009-1951				
				Component Part#	Component Description	OEM Part #				
				OS113	Right Oil Seal	92049-1051				
				OS110	20X40X7 Left Oil Seal	92049-1052				
				KX250	88-92	68.5 mm	Top End Kit C7135	H0253010S	Head Gasket 68.5mm	11004-1174
								B0113018AFM	Base Gasket	11009-1700
IR008018AFM	Intake Gasket	11009-1252								
PV014018AFM	Right Power Valve Gasket	11009-1625								
PV039018AFM	Front Power Valve Gasket	11060-1289								
PV040018AFM	Resonator Cover Gasket	11060-1290								
R136V	Exhaust Gasket 2 Req	671E2550								
WP030018AFM	Water Inlet Gasket	11009-1696								
PV067018AFM	Power Valve Rod Gasket	11060-1346								
Component Part#	Component Description	OEM Part #								
C7478	Outer Clutch Cover Gasket	11060-1186								
EC203018AFM	Mag Cover Gasket	11009-1951								
Component Part#	Component Description	OEM Part #								
OS113	Right Oil Seal	92049-1051								
OS110	20X40X7 Left Oil Seal	92049-1052								
KX250	93	68.5 mm	Top End Kit C7135	H0253010S	Head Gasket 68.5mm	11004-1240				
				B0113018AFM	Base Gasket	11060-1147				
				IR008018AFM	Intake Gasket	11009-1252				
				PV067018AFM	Power Valve Rod Gasket	11060-1290				
				PV014018AFM	Right Power Valve Gasket	14090-1226				
				PV039018AFM	Front Power Valve Gasket	11060-1147				
				PV040018AFM	Resonator Cover Gasket	11060-1289				
				R136V	Exhaust Gasket 2 Req	671E2550				
				Component Part#	Component Description	OEM Part #				
				EC200018AFM	Inner Clutch Cover Gasket	11060-1185				
				EC203018AFM	Mag Cover Gasket	11009-1951				
				C7478	Outer Clutch Cover Gasket	11060-1186				
				WP055018AFM	Water Pump Gasket	11060-1184				
				WP030018AFM	Water Inlet Gasket	11009-1935				
				Component Part#	Component Description	OEM Part #				
C7478	Outer Clutch Cover Gasket	11060-1186								
EC203018AFM	Mag Cover Gasket	11009-1951								
Component Part#	Component Part#	OEM Part#								
OS113	Right Oil Seal	92049-1051								
OS110	20X40X7 Left Oil Seal	92049-1052								



MX/Dirt · Off-Road · ATV Gaskets



Cometic Gasket - An Exclusive NASCAR Performance® Product

KAWASAKI

Model	Year	Bore Size	Top End Kit	Component Part#	Component Description	OEM Part #		
KX250	94-00	68.5 mm	C7155	H0253010S	Head Gasket 68.5mm	11004-1240		
				74 mm	C7304	B0113018AFM	Base Gasket	11060-1493
				B0113012F	High Compression Base Gasket	11060-1493		
				IR008018AFM	Intake Gasket	11009-1950		
				PV014018AFM	Right Power Valve Gasket	11009-1960		
				PV039018AFM	Front Power Valve Gasket	11060-1147		
				PV040018AFM	Resonator Cover Gasket	11060-1226		
				PV067018AFM	Power Valve Rod Gasket	11060-1290		
				R136V	Exhaust Gasket 2 Req	92055-1666		
				Bottom End Kit	Component Part#	Component Description	OEM Part #	
				w/crank seals				
				C3351	EC200018AFM	Inner Clutch Cover Gasket	11060-1185	
					C7478	Outer Clutch Cover Gasket	11060-1186	
					EC203018AFM	Mag Cover Gasket	11009-1951	
					WP055018AFM	Water Pump Gasket	11060-1184	
			WP030018AFM	Water Inlet Gasket	11009-1935			
		Clutch & Mag Kit	Component Part#	Component Description	OEM Part #			
		C7135CM	C7478	Outer Clutch Cover Gasket	11060-1186			
			EC203018AFM	Mag Cover Gasket	11009-1951			
		Crank Seal Kit	Component Part#	Component Part#	OEM Part#			
		C7658	OS113	Right Oil Seal	92049-1051			
			OS110	20X40X7 Left Oil Seal	92049-1052			
KX250	01	68.5 mm	Top End Kit	Component Part#	Component Description	OEM Part #		
				C7764	H0253010S	Head Gasket 68.5mm	11004-0014	
		74 mm	C7765	H0417010S	Head Gasket 74mm	11004-0013		
				B0113018AFM	Base Gasket	11060-1493		
				B0113012F	High Compression Base Gasket	11060-1493		
				IR173018AFM	Intake Gasket	11060-1993		
				PV014018AFM	Right Power Valve Gasket	11009-1960		
				PV039018AFM	Front Power Valve Gasket	11060-1289		
				PV040018AFM	Resonator Cover Gasket	11060-1290		
				PV067018AFM	Power Valve Rod Gasket	11060-1346		
					EX290080C	Exhaust Gasket	11060-1689	
					WP030018AFM	Water Inlet Gasket	11009-1935	
					R136V	Exhaust Gasket 2 Req	92055-1666	
		KX250	02-03	68.5 mm	Top End Kit	Component Part#	Component Description	OEM Part #
						C7861	H0253010S	Head Gasket 68.5mm
				B0113012F	High Compression Base Gasket	11060-1493		
				R49.5X3V	Exhaust O-Ring 2 Req	92055-1666		
				B0113018AFM	Base Gasket	11060-1493		
				IR173018AFM	Intake Gasket	11060-1993		
				EX290080C	Exhaust Gasket	11060-1689		
				PV014018AFM	Right Power Valve Gasket	11009-1960		
				PV039018AFM	Front Power Valve Gasket	11060-1289		
				PV040018AFM	Resonator Cover Gasket	11060-1290		
				PV067018AFM	Power Valve Rod Gasket	11060-1346		
KX250	04			68.5 mm	Top End Kit	Component Part#	Component Description	OEM Part #
						C7269	H2155010S	Head Gasket 68.5mm
				70.5 mm	C7284	H2156010S	Head Gasket 70.5mm	
						B0743018AFM	Base Gasket	11061-0040
				B0743012F	High Compression Base Gasket	11061-0040		
				IR173018AFM	Intake Gasket	11060-1993		
				EX290080C	Exhaust Gasket	11060-1689		
				PV014018AFM	Right Power Valve Gasket	11009-1960		
				PV039018AFM	Front Power Valve Gasket	11060-1289		
				PV040018AFM	Resonator Cover Gasket	11060-1290		
				PV067018AFM	Power Valve Rod Gasket	11060-1346		
					R017B	Power Valve O-Ring 2 Req		
					R49.5X3V	Exhaust O-Ring 2 Req	92055-1666	



MX/Dirt • Off-Road • ATV Gaskets



Cometic Gasket - An Exclusive NASCAR Performance® Product

KAWASAKI

Model	Year	Bore Size	Bottom End Kit w/Oil Seals	Component Part#	Component Description	OEM Part #	
KX250	97-04		C7861BE	WA108	Drain Plug Gasket	92065-058	
				EC202020F	Inner Clutch Cover Gasket	11061-1058/ 11060-1749	
				WP165020F	Water Pump Gasket	11061-0057	
				WP117020F	Water Outlet Gasket	11060-1183	
				Oil Seal Kit C7861OS	Component Part#	Component Description	OEM Part #
					OS110	Left Crank Seal 20x40x7	92049-0032/ 92049-1554
					OS187	Right Crank Seal 25x45x7	92049-0031/ 92049-1555
					OS285	Kickstart Shaft Seal 02-07 20x30x7	92049-1594
					OS295	Output Shaft Seal 30x40x7	92049-0030/ 92049-1556
					OS306	Clutch Pushrod Seal 11.5x18x4	92049-1262
			OS307	Kickstart Shaft Seal 83-01 18x30x7	92049-013		
			OS331	Shift Shaft Seal 13x22x5.5	92051-005		
			OS360	Impeller Seal 8x18x3.5	92049-0033		
			OS361	Water Pump Shaft Seal 7x18x9.5	92049-0034		
			OS362	Power Valve Governor Seal 8x14x4	92049-1207		
			OS369	Power Valve Shaft Seal 5.5X11X4	92049-1206		
			Clutch & Mag Kit C3174CM	Component Part#	Component Description	OEM Part #	
				EC203020F	Mag Cover Gasket	11060-1352	
				EC201020F	Outer Clutch Cover Gasket	11060-1494	
				Component Part#	Component Description	OEM Part #	
KX250	05-07	66.6 mm	Top End Kit C3096	R103X2V	Outer Head O-Ring	92055-0050	
				R74X2S	Inner Head O-Ring	92055-0049	
				B0818018AFM	Base Gasket	11061-0091	
				B0818014RC	High Compression Base Gasket	11061-0091	
				R53.5X2V	Exhaust O-Ring 2 Req	92055-0052	
				EX290080C	Exhaust Gasket	11061-0142	
				PV128018AFM	Front Power Valve Gasket	11061-0092	
				PV129018AFM	Left Power Valve Gasket	11061-0093	
				PV130018AFM	Power Valve Gasket 2 Req	11061-0138	
				WA123	Head Bolt Washers 6 Req	11061-1133	
				R8.5X2V	R8.5X2V		
				Component Part#	Component Description	OEM Part #	
				EC1031018AFM	Inner Clutch Cover Gasket	11061-0095	
				EC1032032AFM	Outer Clutch Cover Gasket	11061-0144	
				EC1033032AFM	Mag Cover Gasket	11061-0098	
WP151018AFM	Water Pump Cover Gasket	11061-0097					
Clutch & Mag Kit C3096CM	Component Part#	Component Description	OEM Part #				
	EC1032032AFM	Outer Clutch Cover Gasket	11061-0144				
EC1033032AFM	Mag Cover Gasket	11061-0098					
	Component Part#	Component Description	OEM Part #				
Crank Seal Kit C7773	OS187	Right Oil Seal	92049-0031				
	OS110	20X40X7 Left Oil Seal	92049-0032				



MX/Dirt · Off-Road · ATV Gaskets



Cometic Gasket - An Exclusive NASCAR Performance® Product

KX250F



Head



Head



Head



Base



Exhaust

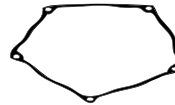

Outer Clutch



Inner Clutch

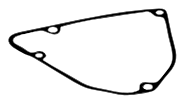

Head

Model	Year	Bore Size	EST	Component Part#	Component Description	OEM Part #
KX250F	04-08	77 mm	Top End Kit			
			C3174-EST	H2169SP1027S	Head Gasket 77mm	11004-0003
			C3054-EST	H2096027S	Head Gasket 78mm	
			C3056-EST	H2169027S	Head Gasket 80mm	
			C7221-EST	H1967027S	Head Gasket 81mm	
			C3135-EST	H2471SP1027S	Head Gasket 83mm	
			C3118-EST	H2471027S	Head Gasket 84mm	
				B0691014RC	Base Gasket	11061-0025
				EX651	Exhaust Gasket	11061-0027
				R018B	Camchain Tensioner O-Ring	92055-086
	3233V	Valve Stem Seal 4 Req	92049-1349			

Bottom End Kit w/Oil Seals	Component Part#	Component Description	OEM Part #
C3174BE	WA108	Crank Case Drain Plug Washer	92065-058
	R118B	Crank End Cap O-Ring	670B2022
	EC903032AFM	Inner Clutch Cover Gasket	11061-0030
	R112B	Timing Mark Plug O-Ring	92055-1141
	R117B	Crank Case Oil Fill O-Ring	92055-1146
	R018B	Output Shaft O-Ring (2)	92055-055
	MR042	Water Pump Cover O-Ring	92055-0010
	R116B	Water Pipe O-Ring	92055-1308
Oil Seal Kit	Component Part#	Component Description	OEM Part #
C3174OS	OS279	Decompression Shaft Seal 10x18x5	92049-1196
	OS295	Crank Seal 30x40x7	92049-1556
	OS305	Shift Shaft Seal 14x22x6	92049-0015
	OS306	Clutch Actuator Shaft Seal 12x18x4	92049-1262
	OS307	Start Shaft Seal 18x30x7	92049-013
	OS308	Impeller Seal 8x22x7x7.5	92049-0021
	OS309	Inner WP Seal 8x22x5	92049-0016
	OS359	Output Shaft Seal 25x40x6	92049-1478
	Clutch & Mag Kit	Component Part#	Component Description
C3174CM	EC847060AFM	Outer Clutch Cover Gasket	11061-0031
	EC904032AFM	Mag Cover Gasket	11061-0032
	VC102	Valve Cover Gasket	11061-0024



MX/Dirt • Off-Road • ATV Gaskets



Cometic Gasket - An Exclusive NASCAR Performance® Product

KAWASAKI

Model	Year	Bore Size	EST Top End Kit	Component Part#	Component Description	OEM Part #	
KX250F	09-16	78mm	C3267-EST	H2848027S	Head Gasket 78mm	11004-0079	
			79mm	C3274-EST	H2848SP3027S	Head Gasket 79mm	
			80mm	C3271-EST	H2848SP1027S	Head Gasket 80mm	
					B0967020RC	Base Gasket	11061-0357
					EX651	Exhaust Gasket	11061-0027
					R018B	Cam Chain Tensioner O-Ring	92055-086
					3183V	Valve Stem Seals 4 Req	92049-1349
					R021V	Cam Tower O-ring	92055-0046
					R013V	Water Temp Sensor O-Ring	92055-0016
					Component Part#	Component Description	OEM Part #
					R014V	Timing Mark Plug O-Ring	92055-1011
					R20X2V	Fill Plug O-ring	92055-1146
					R27.5X2.5V	Crank End Plug O-ring	92055-091
			EC1312032AFM	Outer Clutch Cover Gasket	11061-0362		
			EC1341032AFM	Inner Clutch Cover Gasket	11061-0361		
			EC1340032AFM	Mag Cover Gasket	11061-0363/ 11061-0778		
			WA108	Drain Plug Gasket	92065-058		
			Component Part#	Component Description	OEM Part #		
			EC1312032AFM	Outer Clutch Cover Gasket	11061-0362		
			EC1340032AFM	Mag Cover Gasket	11061-0363/ 11061-0778		
			Clutch & Mag Kit C3267CM				

KXT250

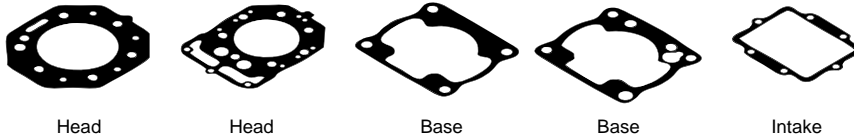

Model	Year	Bore Size	Top End Kit	Component Part#	Component Description	OEM Part #
KXT250 Tecate	83-85	72 mm	C7049	H0022043F	Head Gasket 72mm	11004-1057
		76 mm	C7326	H0022SP1043F	Head Gasket 76mm	
				B0025020F	Base Gasket	11009-1318
KXT250 Tecate	86	72 mm	Top End Kit C7050	Component Part# H0023043F	Component Description Head Gasket 72mm	OEM Part # 11004-1144
		76 mm	C7322	H0197043F	Head Gasket 76mm	
				B0026020F	Base Gasket	11009-1546
				IR008018AFM	Intake Gasket	11009-1050
				R136V	Exhaust O-Ring	671E2550
KFX250 Mojave	87-05	77 mm	Top End Kit C7244	Component Part# B0198020F	Component Description Base Gasket	OEM Part # 11060-1125
				H0341010C	77mm Head Gasket	11004-1121
				Component Part# EC618020F	Component Description Clutch Cover Gasket	OEM Part # 11060-1238
			EST Component Part#	Component Description	OEM Part #	
KLF250 Bayou	88-06	70 mm	Top End Kit C7243-EST	H0261040S	Head Gasket 70mm	11004-1375
				B0169020F	Base Gasket	11061-1104
				EX692064AM	Exhaust Gasket	11009-1866
				R10X2V	Valve Guide O-Ring 2 Req	92055-1177
				R95X2V	Cam Sprocket Cover O-Ring	671B2595
				R70X2S	Cylinder O-Ring	92055-1672
				R32X3V	Intake O-Ring 2 Req	92055-1256
				R118B	Cam Tensioner O-Ring	670B2021
				R227V	Rocker Cap O-Ring 2 Req	92055-112
				3241V	Valve Stem Seals 2 Req	92049-1062
					Component Part# EC1088032AFM	Component Description Clutch Cover Gasket
KXF250 Tecate 4	87-88	69.5 mm	Top End Kit C7039	Component Part# H0034043F	Component Description Head Gasket 69.5	OEM Part # 11004-1157
		74 mm	C7323	H0204043F	Head Gasket 74mm	
				B0032020F	Base Gasket	11009-1624
				IR008018AFM	Intake Gasket	11009-1252
				PV012020F	Power Valve Gasket	11009-1625
			R136V	Exhaust O-Ring	671E2525	



MX/Dirt · Off-Road · ATV Gaskets



Cometic Gasket - An Exclusive NASCAR Performance® Product

KLX300



Model	Year	Bore Size	Top End Kit	Component Part#	Component Description	OEM Part #
KLX300R	97-05	78 mm	C7302	H0252043F	Head Gasket 78mm	11004-1314
		80 mm	C7420	H0521043F	Head Gasket 80mm	
				B0260020RC	Base Gasket	11060-1740

KLF300

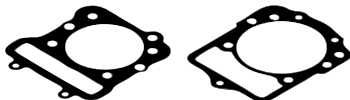

Model	Year	Bore Size	Top End Kit	Component Part#	Component Description	OEM Part #
KLF300	86-87	77 mm	C7245	H0256043F	Head Gasket	11004-1136
				B0163020F	Base Gasket	11060-1221
KEF300	97-03	79 mm	C7248	B0163020F	Base Gasket	11060-1652
Lakota	92-03			H0256020C	Head Gasket 79mm	11004-1183
KLF300				EC598020F	Clutch Cover Gasket 2WD	11060-1655
KLF300 Bayou 4x4	89-05					
			EST			
			Top End Kit			
KLX 400	03-04	92 mm	C7688-EST	H0949027S	Head Gasket 92mm	11004-S006
		94 mm	C7806-EST	H1045027S	Head Gasket 94mm	
		95mm	C7963-EST	H1699027S	Head Gasket 95mm	
		97 mm	C7980-EST	H1046027S	Head Gasket 97mm	
				B0440010RC	Base Gasket	11061-S091
				EX243	Exhaust Gasket	11061-S076
				EC377032AFM	Cam Tensioner Gasket	11061-S073
				WA121	Oil Check Washer	11061-S006
				3160V	Valve Stem Seal 4 Req	92049-S006
				Component Part#	Component Part#	OEM Part#
				EC837032AFM	Clutch Cover	92055-S080
KLF400	93-02	84.5 mm	C7249	Component Part#	Component Description	OEM Part #
Bayou 4x4				H0340010C	Head Gasket	11004-1233
KVF400	99-02			B0201020F	Base Gasket	11060-1205

KFX400

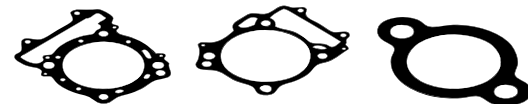

Model	Year	Bore Size	EST	Component Part#	Component Description	OEM Part #
KFX400	03-06	92 mm	Top End Kit	H0949027S	Head Gasket 92mm	11004-S006
		94 mm	C7978-EST	H1045027S	Head Gasket 94mm	
		96 mm	C7979-EST	H1045SP2027S	Head Gasket 96mm	
		97 mm	C3138-EST	H1046027S	Head Gasket 97mm	
				B0440027S	Base Gasket	11061-S070
				EX243	Exhaust Gasket	11061-S076
				EC377032AFM	Cam Tensioner Gasket	11061-S073
				WA121	Oil Drain Bolt Gasket	11061-S005
				3160V	Valve Stem Seals 4 Req	92049-S006
			Clutch & Mag Kit	Component Part#	Component Description	OEM Part #
			C7978CM	EC1030032AFM	Clutch Cover Gasket	11061-S071
				EC1034032AFM	Mag Cover Gasket	11061-S072
				Component Part#	Component Part#	OEM Part#
				EC1030032AFM	Clutch Cover Gasket	11061-S071
				EC1034032AFM	Mag Cover Gasket	11061-S072

All Component Parts can be purchased individually.



MX/Dirt • Off-Road • ATV Gaskets



Cometic Gasket - An Exclusive NASCAR Performance® Product

KX450F



Head



Base



Inner Clutch

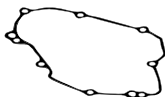

Generator Cover



Exhaust

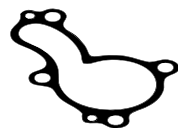

Water Pump



Cam Chain Tensioner



Outer Clutch

Model	Year	Bore Size	EST	Component Part#	Component Description	OEM Part #		
KX450F	06-08	96 mm	C3136-EST	H2466027S	Head Gasket 96.5mm	11004-0045		
			C3146-EST	H2466SP1027S	Head Gasket 98mm	11004-0045		
		98 mm		B0842014RC	Base Gasket	11061-0160		
				EX693064AM	Exhaust Gasket	11061-0082		
				EC1080032AFM	Cam Tensioner Gasket	11061-0260		
				R022B	Spark Plug O-Ring	11061-0079		
				R10X2V	Cam Chain Tensioner O-Ring	670D2010		
				3241V	Valve Stem Seals 4 Req	92049-1062		
		Bottom End Kit w/Oil Seals C3136BE				Component Part#	Component Description	OEM Part #
					R10X2B	Cam Chain O-ring	670D2010	
					R010B	Oil Nozzle O-ring 7mm	670D1507	
					WA108	Drain Plug Washer	92065-058	
					R123V	Crankshaft Timing O-Ring	92055-091	
			R014V	Timing Plug O-ring	92055-1011			
			EC1067032AFM	Outer Clutch Cover Gasket	11061-0145			
			R118B	Crankcase Oil Fill O-Ring	92055-1146			
			EC1068032AFM	Inner Clutch Cover Gasket	11061-0224			
			R123V	Neutral Switch O-Ring	92055-091			
			R138SB	Oil Filter O-Ring 2 Req	92055-1577			
			R10X2B	Oil Pickup O-ring	670D2010			
			WP187032AFM	Water Pump Gasket	11061-0225			
Oil Seal Kit C3136OS				Component Part#	Component Description	OEM Part #		
			OS295	Output Shaft Seal 30x40x7	92049-0030			
			OS339	Clutch Release Oil Seal 12X20X5.5	92049-1475			
			OS331	Shift Shaft Seal 13x22x5.5	92051-005			
			OS227	Inner Water Pump Seal 12x22x5	92049-0041			
			OS277	Outer Water Pump Seal 12x24x7	92049-0040			
			OS285	Kickstart Shaft Seal 20x30x7	92049-1261			
			OS275	Crank End Oil Seal 10x20x5	92049-1542			
Clutch & Mag Kit C3136CM				Component Part#	Component Description	OEM Part #		
			EC1067032AFM	Clutch Cover Gasket	11061-0145			
			EC1081018AFM	Mag Cover Gasket	11061-0084			



MX/Dirt · Off-Road · ATV Gaskets



Cometic Gasket - An Exclusive NASCAR Performance® Product

KAWASAKI

Model	Year	Bore Size	EST	Component Part#	Component Description	OEM Part#				
KX450F	09-15	96mm 98mm	EST Top End Kit C3268-EST C3285-EST	H2466027S	Head Gasket 96.5mm	11004-0045/ 110040088				
				H2466SP1027S	Head Gasket 98mm					
				B0966014RC	Base Gasket	11061-0353/11061-0768				
				EX693064AM	Exhaust Gasket	11061-0082				
				EC1080032AFM	Cam Tensioner Gasket	11061-0211				
				R022B	Spark Plug O-Ring	11061-0079				
				R10X2V	Cam Chain Tensioner O-Ring	670D2010				
				3241V	Valve Stem Seals 4 Req	92045-1062				
				Bottom End Kit w/Oil Seals				Component Part#	Component Description	OEM Part #
				C3268BE	R020V	Output Shaft O-ring	92055-1293			
	R013V	Temp Sensor O-ring	92055-0016							
	R010B	Oil Nozzle O-ring 7mm	670D1507							
	R011B	Oil Nozzle O-ring 8mm	670D1508							
	WA118	Left Case Drain Crush Washer	92022-304							
	WA108	Drain Plug Crush Washer	92065-058							
	EC1338032AFM	Clutch Cover Gasket	11061-0359							
	R010B	Case Dowel O-Ring	92055-0113							
	R123V	Crank End Plug O-ring	92055-091							
	R014V	Timing Plug O-ring	92055-1011							
	R20X2V	Oil Fill Plug O-ring	92055-1146							
	R123V	Neutral Switch O-ring	92055-091							
	R138SB	Oil Filter O-rings	92055-1577							
	R10X2B	Oil Pickup O-ring	670D2010							
	WP187032AFM	Water Pump Gasket	11061-0225							
	WA118	Water Pump Drain Washer	92022-304							
Oil Seal Kit				Component Part#	Component Description	OEM Part #				
C3268OS	OS277	Outer Water Pump Seal 12x24x7	92049-0040							
	OS227	Inner Water Pump Seal 12x22x5	92049-0041							
	OS285	Kickstart Shaft Seal 20x30x7	92049-0134							
	OS275	Crank End Oil Seal 10x20x5	92049-1542							
	OS295	Output Shaft Seal 30x40x7	92049-0030							
	OS339	Clutch Release Oil Seal 12X20X5.5	92049-1475							
	OS331	Shift Shaft Seal 13x22x5.5	92051-005							
Clutch & Mag Kit				Component Part#	Component Description	OEM Part #				
C3268CM	EC1184032AFM	Outer Clutch Cover Gasket	11061-0259							
	EC1339032AFM	Mag Cover Gasket	11061-0358							
KX450F	2016	96mm	EST Top End Kit C3598-EST	H2466027S	Head Gasket	11004-0756				
				B1320014RC	Base Gasket	11061-0984				
				EC1080032AFM	Cam Chain Tensioner Gasket	11061-0260				
				R10X2V	Cam Chain Tensioner O-Ring	670D2010				
				R021V	Cam Tower O-ring	92055-0046				
				EX693064AM	Exhaust Gasket	11061-0082				
				3241V	Valve Stem Seals 4 Req	92045-1062				



MX/Dirt • Off-Road • ATV Gaskets



Cometic Gasket - An Exclusive NASCAR Performance® Product

KAWASAKI

Model	Year	Bore Size	EST	Component Part#	Component Description	OEM Part #				
KFX450R	09-14	96 mm 98 mm	Top End Kit C3201-EST C3202-EST	H2466027S	Head Gasket 96.5mm	11004-0073				
				H2466SP1027S	Head Gasket 98mm					
				B0911020RC	Base Gasket	11061-0234				
				EC1080032AFM	Cam Tensioner Gasket	11061-0260				
				R013B	Water Temp O-Ring	92055-0016				
				R022V	Spark Plug O-Ring	92055-0046				
				R10X2V	Cam Chain Tensioner O-Ring	670D2010				
				3241V	Valve Stem Seals 4 Req	92049-1062				
				Bottom End Kit w/Oil Seals C3201BE				Component Part#	Component Description	OEM Part #
				R011B	Case Oil Feed O-ring	670D1508				
WA108	Drain Plug Seal	92065-097								
R20X2V	Clutch Fill Plug O-ring	92055-1146								
R141SB	Oil Pump Cover O-ring	92055-0110								
R015V	Timing Plug O-ring	92055-1141								
R123V	Crank Plug O-ring	92055-091								
R138SB	Oil Filter O-rings (2)	92055-1577								
R008B	Oil Line O-rings (3)	670D1505								
EC1185032AFM	Inner Clutch Cover Gasket	11061-0236								
R010B	Oil Pipe O-rings (2)	670D1507								
R214B	Starter Motor O-ring	92055-1276								
WP209018AFM	Water Pump Cover	11061-0237								
WA118	Water Pump Bolt Seal	92022-304								
Oil Seal Kit C3201OS				Component Part#	Component Description	OEM Part #				
OS331	Shift Shaft Seal	92051-005								
OS339	Clutch Shaft Seal	92049-1475								
OS295	Out Put Shaft Seal 30x40x7	92049-0030								
OS277	Oil Pump Seal 12x24x7	92049-0040								
OS227	Water Pump Seal 12x22x5	92049-0041								
OS275	Clutch Pushrod Seal 10x20x5	92049-1542								
Clutch & Mag Kit C3201CM				Component Part#	Component Description	OEM Part #				
EC1184032AFM	Clutch Cover	11061-0259								
EC1183032AF	Mag Cover Gasket	11061-0235								

KX500

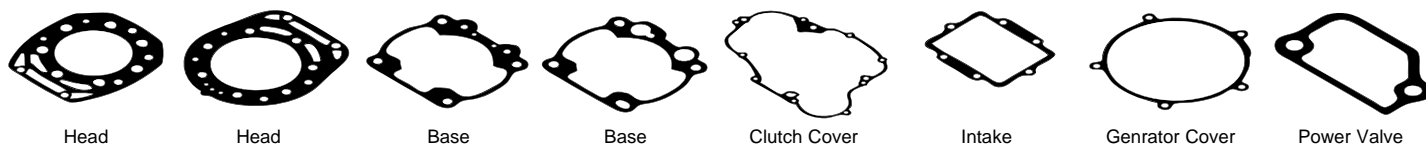

Model	Year	Bore Size	Top End Kit	Component Part#	Component Description	OEM Part #				
KX500 B2, C1	86-88	88 mm	C7045	H0036043F	Head Gasket 88mm	11004-1140				
				B0035020F	Base Gasket	11009-1537				
				IR008018AFM	Intake Gasket	11009-1950				
				PV014018AFM	Right Power Valve Gasket	11009-1960				
				R136V	Exhaust O-Ring 2 Req					
				Bottom End Kit C3356				Component Part#	Component Description	OEM Part#
				C7495	Clutch cover Gasket	11009-1540/1963				
				EC255018AFM	Mag Cover Gasket	11009-1289/1964				
				WP048018AFM	Water Pump Cover Gasket	11009-1466/1962				
				WP050018AFM	Water Pipe Gasket	11009-1446				
Crank Seal Kit C7659				Component Part#	Component Description	OEM Part#				
OS135	Oil Seal 2 Req	92050-057								



MX/Dirt · Off-Road · ATV Gaskets



Cometic Gasket - An Exclusive NASCAR Performance® Product

KAWASAKI

Model	Year	Bore Size	Top End Kit	Component Part#	Component Description	OEM Part #
KX500 E1, E2	89-90	88 mm	Top End Kit C7046	H0037043F	Head Gasket 88mm	11004-1186
				B0036018AFM	Base Gasket	11009-1758
				B0036012F	High Compression Base Gasket	
				IR008018AFM	Intake Gasket	11009-1252
				PV013018AFM	Front Power Valve Gasket	11009-1701
				PV014018AFM	Right Power Valve Gasket	11009-1539
				R136V	Exhaust O-Ring 2 Req	671E2550
			Bottom End Kit C3356	Component Part#	Component Part#	OEM Part#
				C7495	Clutch Cover Gasket	11009-1540
				EC255018AFM	Mag Cover Gasket	11009-1289
				WP048018AFM	Water Pump Cover Gasket	11009-1466
				WP050018AFM	Water Pipe Gasket	11009-1446
				Component Part#	Component Part#	OEM Part#
				OS135	Oil Seal 2 Req	92050-057
KX500 E3, T2, R2	91-04	88 mm	Top End Kit C7047	Component Part#	Component Description	OEM Part #
				H0306010S	Head Gasket 88mm	11004-1209
				B0036018AFM	Base Gasket	11060-1874
				B0036012F	High Compression Base Gasket	
				IR008018AFM	Intake Gasket	11009-1950
				PV013018AFM	Front Power Valve Gasket	11009-1948
				PV014018AFM	Right Power Valve Gasket	11009-1960
			R136V	Exhaust O-Ring 2 Req	671E2550	
			Bottom End Kit C3356	Component Part#	Component Part#	OEM Part#
				C7495	Clutch Cover Gasket	11009-1540/1963
				EC255018AFM	Mag Cover Gasket	11009-1289/1964
				WP048018AFM	Water Pump Cover Gasket	11009-1466/1962
				Component Part#	Component Description	OEM Part #
				C7495	Clutch Cover Gasket	11009-1540/1963
EC255018AFM	Mag Cover Gasket	11009-1289/1964				
Clutch & Mag Kit C7045CM	Component Part#	Component Part#	OEM Part#			
	C7495	Clutch Cover Gasket	11009-1540/1963			
Crank Seal Kit C7659	Component Part#	Component Part#	OEM Part#			
	OS135	Left/Right Oil Seal 2 Req.	92050-057			

KLX650

Model	Year	Bore Size	Top End Kit	Component Part#	Component Description	OEM Part #
KLX650, KLX650R	93-97	100 mm	C7246	H0259043F	Head Gasket 103mm	11004-1158
				B0166020RC	Base Gasket	11060-1110



MX/Dirt • Off-Road • ATV Gaskets



Cometic Gasket - An Exclusive NASCAR Performance® Product

KVF650/KRF750

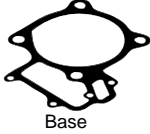
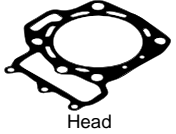

Model	Year	Bore Size	EST Top End Kit	Component Part#	Component Description	OEM Part #
KVF650	01-03	81 mm	C7981-EST	H1893010S	Head Gasket 81mm 2 Req	11004-1373
Prairie 4x4		83 mm	C7982-EST	H1894010S	Head Gasket 83mm 2 Req	11004-1373
KFX700	04-07	84 mm	C3125-EST	H1894SP7010S	Head Gasket 84mm 2 Req	11004-1373
V Force		85 mm	C7173-EST	H1983010S	Head Gasket 85mm 2 Req	11004-1384
KVF700	04-07	87 mm	C3163-EST	H2513SP1010S	Head Gasket 87mm 2 Req	
Prairie		89 mm	C3162-EST	H2513010S	Head Gasket 89mm 2 Req	
		90mm	C3212-EST	H2513SP3010S	Head Gasket 90mm 2 Req	
				B0677020RC	Base Gasket 2 Req	11060-1965
				EX361	Exhaust Gasket 2 Req	11009-1894
				R129B	Intake O-Rings 2 Req	92055-1295
				R140V	Rocker Cap O-Ring 4 Req	92055-1644
				R14X2.5V	Oil Cap O-Ring	670D2014
				R16X2V	Water Pipe O-Ring 2 Req	670B2016
				3242V	Valve Stem Seals 8 Req	92049-1218
Model	Year	Bore Size	EST Top End Kit	Component Part#	Component Description	OEM Part #
KVF750	08-16	85mm	C3284-EST	H2624SPA010S	Head Gasket 85mm	11004-0011
Prairie		90 mm	C3251-EST	H2624SP1010S	Head Gasket 90mm	11004-0011
				B0951020RC	Base Gasket	11061-0063
				EX361	Exhaust Gasket 2 req	11009-1894
				WA114	Coolant Drain Washer 2 Req	
				R55X2V	Rocker Cap O-Ring 4 Req	92055-0112
				R19X2V	Plug Cover O-Ring 2 Req	92055-1146
				3242V	Valve Stem Seals 8 Req	92049-1218

KTM 50 94-01

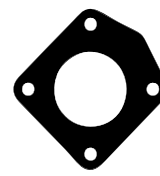
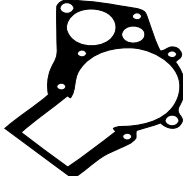

Model	Year	Bore Size	Top End Kit	Component Part#	Component Description	OEM Part #
50 Mini, Junior & Senior Adventure	94-01	41 mm	C7282	H0354010C	Head Gasket .010" Copper	36330036000
				H0354020C	Head Gasket .020" Copper	36330036000
				B0219018AFM	Base Gasket 00-01	45030035800
				B0220018AFM	Base Gasket 94-99	36330030000
				IR054018AFM	Intake Port Small Opening	49130438000
				IR055018AFM	Intake Port Large Opening	49130438000
				EX089039F	Exhaust Gasket	45030046000
Model	Year	Bore Size	Bottom End Kit w/o Crank Seals	Component Part#	Component Description	OEM Part #
			C3381	EC073015F	Center Case Gasket	45030039000
				EC074032AFM	Clutch Cover Gasket	45030025000



MX/Dirt · Off-Road · ATV Gaskets



Cometic Gasket - An Exclusive NASCAR Performance® Product

KTM 50 02-07

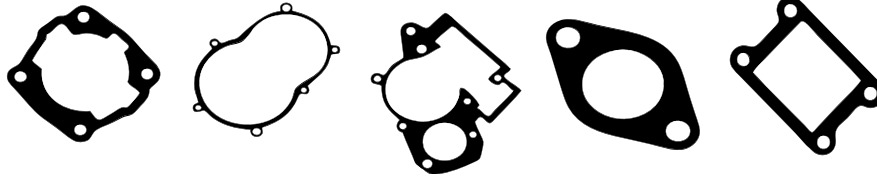

Model	Year	Bore Size	Top End Kit	Component Part#	Component Description	OEM Part #
50 Mini Adventure	02-08	41 mm	C7292	H2287010C	Head Gasket .010" Copper	46030046000
				B0357032AFM	Base Gasket .032" AFM	46030035020
				IR115032AFM	Intake Gasket .032"	46030049000
				R32X3V	Exhaust Pipe O-ring	0770320030
			Bottom End Kit w/o Crank Seals C3382	Component Part#	Component Description	OEM Part #
				EC517018AFM	Clutch Cover Gasket	45130025000
				EC659015F	Center Case Gasket	45130039000
				EC992060AFM	Oil Fill Plug Gasket	45130019000
				WA130	6 req. Head Seal Washers	0125060003

50 SXR

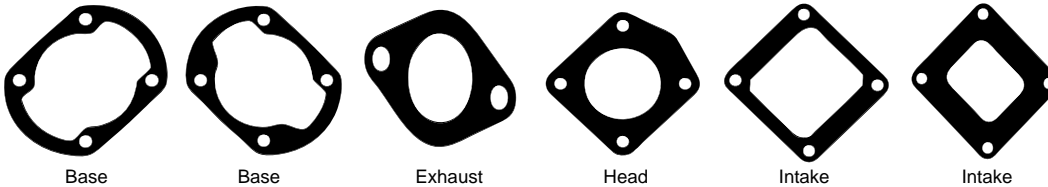

Model	Year	Bore Size	Top End Kit	Component Part#	Component Description	OEM Part #
50 SXR Pro Jr/Sr	97-01	43 mm	C7415	H1197010C	Head Gasket .010	36330036000
				H1197020C	Head Gasket .020	36330036000
				B0219018AFM	Base Gasket 99-01	36330030000
				B0220018AFM	Base Gasket 94-98	45030035800
				IR109018AFM	Intake to Reed Gasket	45030057800
				IR110018AFM	Intake to Case Gasket	45030049900
				EX175060F	Exhaust Gasket	45030046800

50 LC

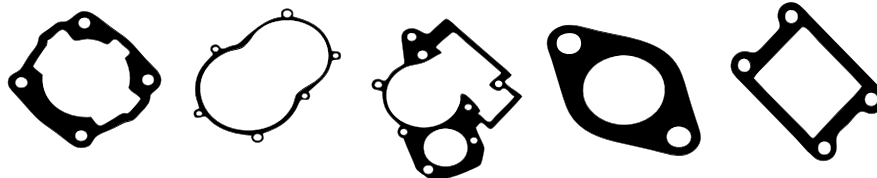

Model	Year	Bore Size	Top End Kit	Component Part#	Component Description	OEM Part #
50 LC Pro Jr/Sr	01-01	O-Ring	C7863	R034V	Inner Head O-ring	46030037000
				R044B	Outer Head O-ring	46030036000
				WA130	6 Req. Head Seal Washers	0125060003
				B0357012F	Base Gasket .012	46030035020
				B0357018AFM	Base Gasket .018	45130025000
				IR115018AFM	Intake Gasket	45130039000
				EX089039F	Exhaust Flange Gasket	46030049000
				R32X3V	Exhaust Pipe O-ring	0770320030
			Bottom End Kit w/o Crank Seals C3383	Component Part#	Component Part#	OEM Part#
				EC517018AFM	Clutch Cover	45130025000
				EC659015F	Center Case Gasket	45130039000
				EC992060AFM	Oil Fill Plug Gasket	45130019000
				WA129	Case Drain Crush Washer 10mm x 14mm x 2mm	0603100141
				WA133	Clutch & Water Pump Drain Crush washers 2 Req.	0603061001



MX/Dirt · Off-Road · ATV Gaskets



Cometic Gasket - An Exclusive NASCAR Performance® Product

KTM 50 PRO SENIOR LC

Model	Year	Bore Size	Top End Kit	Component Part#	Component Description	OEM Part #
50 SX	02-08	O-Ring	C7295	R53.5X2V	Inner Head O-ring	46030036000
Pro Senior LC				R95X2V	Outer Head O-ring	46030037000
				WA130	Head Crush Washer 5 Req.	50230032010
				B0357032AFM	Base Gasket	46030035020
				IR115032AFM	Intake Gasket	46030049000
				EX175060F	Exhaust Gasket	46030046000
			Bottom End Kit w/o Crank Seals	Component Part#	Component Description	OEM Part #
			C3383	EC517018AFM	Clutch Cover	45130025000
				EC659015F	Center Case Gasket	45130039000
				EC992060AFM	Oil Fill Plug Gasket	45130019000
				WA129	Case Drain Crush Washer	0603100141
				WA133	Clutch & Water Pump Drain Crush Washers 2 Req.	0603061001

50 SX LC

Model	Year	Bore Size	Top End Kit	Component Part#	Component Description	OEM Part #
50SX LC	09-16	O-Ring	C3503	R52X2V	Inner Head O-ring	0770052020
				R78X2V	Outer Head O-ring	0770078020
				WA130	Head Crush Washer 5 Req. 7.5mm x 12mm x .5mm	50230032010
				EX14B043F	Exhaust Gasket	45205004000
				B0976018AFM	Base Gasket	46230035040

65 SX

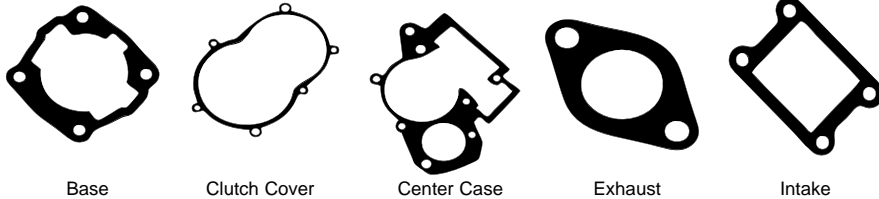

Model	Year	Bore Size	Top End Kit	Component Part#	Component Description	OEM Part #
65 SX	98-01	O-Ring	C7416	R034V	Inner Head O-ring	46030036000
				R044B	Outer Head O-ring	46030037000
				B0357012F	Base Gasket .012"	46030035020
				B0357018AFM	Base Gasket .018"	46030035020
				IR115018AFM	Intake Reed Gasket	46030049000
			Bottom End Kit w/o Crank Seals	Component Part#	Component Description	OEM Part #
			C3384	EC447032AFM	Inner Clutch Cover	46030025000
				EC448020F	Crankcase Gasket	46030039000
				R048B	Mag Cover O-ring	0770020480
				WP106032AFM	Water Pump Gasket	45135053000
65 SX	02-08	O-Ring	C7333	R54X2V	Inner Head O-ring	46030036000
				R95X2V	Outer Head O-ring	46030037000
				WA130	Head Crush Washer 5 Req.	50230032010
				B0357018AFM	Base Gasket .018"	46030035020
				B0357032AFM	Base Gasket .032"	46030035020
				IR115032AFM	Intake Gasket	46030049000
				EX921059F	Exhaust Gasket	46030046000
			Bottom End Kit w/o Crank Seals	Component Part#	Component Description	OEM Part #
			C3385	EC447032AFM	Inner Clutch Cover	46030025000
				EC448020F	Crankcase Gasket	46030039000
				R048B	Mag Cover O-ring	0770020480
				R16X3V	Clutch Fill Plug O-ring	0770160030
				R19X2V	Output Shaft O-ring	46033031000
				R30X1.5V	Clutch Slave Cylinder O-ring	0770300015
				WA129	Case Drain Crush Washer 10mm x 14mm x 2mm	0603101420
				WP106032AFM	Water Pump Gasket	45135053000



MX/Dirt · Off-Road · ATV Gaskets



Cometic Gasket - An Exclusive NASCAR Performance® Product

KTM

Model	Year	Bore Size	Top End Kit	Component Part#	Component Description	OEM Part
65 SX	09-16	O-Ring	C3416	MR106	Cylinder Head Gasket	45230036000
				WA146	Head Crush Washer 4 Req.	50230032010
				B0976018AFM	Cylinder Base Gasket	46230035040
				EX943059F	Header Flange Gasket	46205004000
				R20X2V	Power Valve Control O-ring	770150151
				R005B	Power Valve Base Orings 2 Req.	770030015
				WA133	Power Valve Base Seal Washer	603061001
				WA133	Power Valve Copper Seal	603050901
				IR747018AFM	Reed Valve Gasket	46230049000

KTM 85 SX

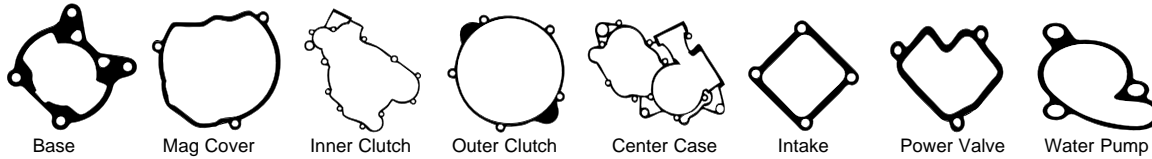

Model	Year	Bore Size	Top End Kit	Component Part#	Component Description	OEM Part #
85 SX	04-12	O-Ring	C7384	R54X2V	Inner Head O-ring	0770 540020
				R82X2V	Outer Head O-ring	0770 820020
				R22X2.5V	Head Insert O-ring	0770 220025
				WA133	Head Seal Crush Washers 6 Req.	0603061001
				B0801032AFM	Base Gasket	47030035000
				WA134	Exhaust Valve Seal Crush Washer	0603040801
				PV126032AFM	Power Valve Side Cover Gasket	47037008000
				R12X2V	Exhaust Control Valve O-ring	0770120020
				R8X1.5V	Exhaust Valve Linkage O-ring	0770008015
				IR530032AFM	Intake Gasket	47030049000
				R22X2V	Exhaust Valve Cover O-ring	0770020200
				R38X3V	Exhaust Pipe Header O-rings 2 req.	0770380030
			Bottom End Kit w/o Crank Seals C3386	Component Part#	Component Description	OEM Part #
				EC986032AFM	Mag Cover Gasket	47030040000
				EC987032AFM	Inner Clutch Cover Gasket	47030025000
				EC988032AFM	Outer Clutch Cover Gasket	47030027000
				EC989020F	Crankcase Gasket	47030039000
				R16X3V	Oil Fill Plug Gasket	0770160030
				R19X2V	Output Shaft O-ring	46033031000
				R30X1.5V	Clutch Slave Cylinder O-ring	0770300015
				WA133	Water Pump Seal Crush Washer	0603061001
				WP174032AFM	Water Pump Gasket	47035053000
			Clutch & Mag Kit C7384CM	Component Part#	Component Description	OEM Part #
				EC988032AFM	Clutch Cover Gasket	47030027000
				EC986032AFM	Mag Cover Gasket	47030040000
85 SX	13-16	O-Ring	Top End Kit C3510	Component Part#	Component Part#	OEM Part#
				R54X2V	Inner Head O-ring 54X2	0770540020
				R80X2S	Outer Head O-ring 80X2	0770800021
				PV143018AFM	Right Power Valve Gasket	47137008000
				WA133	Copper Head Crush Washer	0603061001
				B0801032AFM	Base Gasket .2mm	47030035020
				R12X2V	Power Valve Control O-ring Left 12x2	0770120020
				R8X1.5V	Power Valve Control O-ring Right 8x1.5	0770008015
				R22X2V	Power Valve Control Cover O-ring	0770020200
				R38X3V	Exh. Pipe Header O-rings 2 req	0770380030
			Bottom End Kit C3517	Component Part#	Component Part#	OEM Part#
				EC989020F	Center Case Gasket	47030039000
				EC987032AFM	Inner Clutch Cover Gasket	47030025000
				EC1849032AFM	Outer Clutch Cover Gasket	47030027100
				R16X3V	Oil Fill Plug O-ring	0770160030
				WA129	Drain Plug gasket	0603101420
				WP429018AFM	Water Pump Cover Gasket	47035053000
				WA133	Water Pump Cover Drain	0603061001



MX/Dirt · Off-Road · ATV Gaskets



Cometic Gasket - An Exclusive NASCAR Performance® Product

KTM 105SX

Model	Year	Bore Size	Top End Kit	Component Part#	Component Description	OEM Part
105SX	07-11	O-Ring	C3552	MR124	Inner Head O-ring	47530006000
				R80X2S	Outer Head O-ring 80X2	0770800021
				PV143018AFM	Right Power Valve Gasket	47137008000
				WA133	Copper Head Crush Washer	0603061001
				B0801032AFM	Base Gasket .2mm	47030035020
				R12X2V	Power Valve Control O-ring Left 12x2	0770120020
				R8X1.5V	Power Valve Control O-ring Right 8x1.5	0770008015
				R22X2V	Power Valve Control Cover O-ring	0770020200
				R38X3V	Exhaust Pipe Header O-rings 2 req.	0770380030

125/200 SX

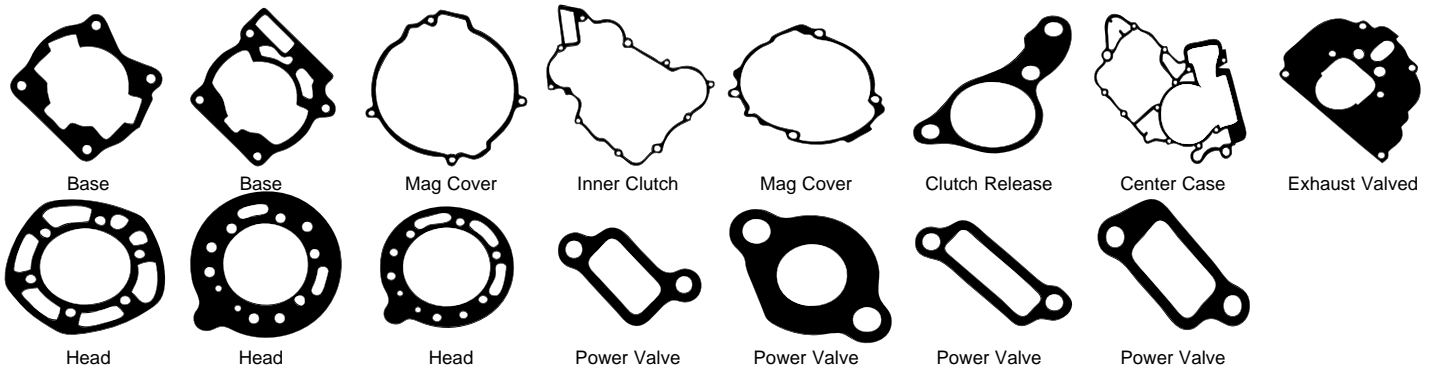

Model	Year	Bore Size	Top End Kit	Component Part#	Component Description	OEM Part #
125 SX, EXC	93-96	O-Ring	C7097	R60X2V	Inner Head O-ring	50230095000
				H0377043F	Head Gasket Outer	50230036500
				B0228018AFM	Base Gasket .018" AFM	50230030020
				B0228032AFM	Base Gasket .032" AFM	50230030030
				PV048018AFM	Power Valve Gasket	50237006000
			Crank Seal Kit C7660	Component Part#	Component Description	OEM Part#
				OS138	29X43X6 Right Side Crank Seal	760304260
				OS139	24X40X7 Left Side Crank Seal	760254070

KTM 125/144/150 SX

Model	Year	Bore Size	Top End Kit	Component Part#	Component Description	OEM Part #
125 SX, EXC	98-01	O-Ring	C7456	H0755043F	Head Gasket Outer	50330037000
				R72X2V	Inner Head O-ring	0770720021
				B0338018AFM	Base Gasket .018"	50330035040
				B0338032AFM	Base Gasket .032"	50330035075
				EC449032AFM	Exh. Intermediate Gasket 00-04	50337046100
				EC544032AFM	Exh. Intermediate Gasket 98-99	50337046000
				PV075032AFM	Rt. Side Power Valve Cover	50337006000
				PV076032AFM	Center Power Valve Cover	50337035050
				PV077032AFM	Left Side Power Valve Cove	50337008000
			Bottom End Kit w/crank seals C3387	Component Part#	Component Description	OEM Part#
				EC236060AFM	Outer Clutch Cover	50330027000
				EC441032AFM	Inner Clutch Cover	50330025000
				EC442060AFM	Mag Cover	50330040000
				EC443012F	Clutch Release Gasket .012"	50332065050
				EC443032AFM	Clutch Release Gasket .032"	50332065050
				EC443060AFM	Clutch Release Gasket .060"	50332065050
				EC446020F	Center Case Gasket	50330039000
			Crank Seal Kit C7661	Component Part#	Component Description	OEM Part#
				OS136	Right Crank Seal 24X35X7	760253570
				OS141	Left Crank Seal 31X45X6	760324564



MX/Dirt · Off-Road · ATV Gaskets



Cometic Gasket - An Exclusive NASCAR Performance® Product

KTM 125/144/150 SX

Model	Year	Bore Size	Top End Kit	Component Part#	Component Description	OEM Part #
125 SX	97-06	O-Ring	C7386	R0047	Outer Head O-ring	50330137000
125 EXC	97-05			R62X2V	Inner Head O-ring	0770062020
				WA130	Head Seal Crush Washers 6 Req.	50230032010
				B0338018AFM	Base Gasket .018"	50330035025
				B0338032AFM	Base Gasket .032"	50330035040
				PV075032AFM	Left Side Power Valve Gasket	50337008000
				PV076032AFM	Right Side Power Valve Gasket	50337006000
				PV077032AFM	Power Valve Cover Gasket	50337035050
				EC449032AFM	Intermediate Exhaust Gasket	50337046100
				R8X2V	Power Valve Axle O-ring	0770008020
				R44X3S	Exp. Chamber O-rings 2 Req.	0770440030
			Bottom End Kit w/crank seals C3388	Component Part#	Component Part#	OEM Part#
				EC236060AFM	Outer Clutch Cover	50330027000
				EC441032AFM	Inner Clutch Cover	50330025000
				EC442060AFM	Mag Cover	50330040000
				EC443032AFM	Clutch Release Gasket	50332065050
				EC446020F	Center Case Gasket	50330039000
				R16X3V	Water Pump O-ring/ Trans Fill Plug O-ring	0770160030
				R23X2V	Transmission Counter Shaft O-ring	0770230020
				R25X2V	Crank O-ring	0770250020
				R49X2.5V	Water Pump O-ring	0770049025
			Clutch & Mag Kit C7386CM	Component Part#	Component Description	OEM Part #
				EC236060AFM	Outer Clutch Cover	50330027000
				EC442060AFM	Mag Cover	50330040000
			Crank Seal Kit C7661	Component Part#	Component Part#	OEM Part#
				OS136	Right Crank Seal 24X35X7	760253570
				OS141	Left Crank Seal 31X45X6	760324564
125 SX	07-14	O-Ring	Top End Kit C3211	Component Part#	Component Part#	OEM Part#
144 SX	07-08			R62X2V	Inner Head O-ring	0770062020
150 SX,XC	09-14			R85X2V	Outer Head O-ring	0770086020
				WA146	Head Seal Crush Washer 6 Req.	50330079000
				B0338018AFM	Base Gasket .018"	50330035025
				EX645032AFM	Intermediate Exhaust Gasket	50337046200
				R44X3S	Exp. Chamber O-rings 2 Req.	0770440030
				PV076032AFM	Left Side Power Valve Gasket	50337006000
				PV077032AFM	Power Valve Cover Gasket	50337035050
				PV135032AFM	Right Side Power Valve Gasket	50337008100
				R014V	Head Power Valve O-ring	0770012021
				R16X3V	Power Valve Bushing O-ring Seal	0770160030
				R8X2V	Power Valve Axle O-ring	0770008020
				WA131	Power Valve Control Shaft Seal	0603262322
				WA133	Power Valve Cover Crush Washer 3 Req.	0603061001
			Bottom End Kit C3518	Component Part#	Component Part#	OEM Part#
				EC236060AFM	Outer Clutch Cover	50330027000
				WA129	Water Pump Seal Washer 2 Req.	0603100141
				WA133	Head Crush Washer -6X10X1	0603061001
				R16X3V	Water Pump O-ring/ Trans Fill Plug O-ring	0770160030
				R19X3V	Fill plug O-ring 19x3	0770191015
				EC441032AFM	Inner Clutch Cover	50330025000
				EC446020F	Center Case Gasket	50330039000
				WA137	Oil Drain Plug Seal 12x18x1.5 2 Req.	58038022000
				R24X2V	Transmission Counter Shaft O-ring	0770250020
				EC443032AFM	Clutch Release Gasket	50332065050
				R23X2V	Transmission Counter Shaft O-ring	0770230020/ 0770049025
			Clutch & Mag Kit C7368CM	Component Part#	Component Description	OEM Part #
				EC236060AFM	Outer Clutch Cover	50330027000
				EC442060AFM	Mag Cover	50330040000



MX/Dirt • Off-Road • ATV Gaskets



Cometic Gasket - An Exclusive NASCAR Performance® Product

KTM 200 SX

Model	Year	Bore Size	Top End Kit	Component Part#	Component Description	OEM Part #	
200 SX, MXC, EXC	98-02	O-Ring	C7738	R72X2V	Inner Head O-ring	0770720021	
				H0985043F	Outer Head Gasket	52330037000	
				B0338018AFM	Base Gasket .018"	50330035040	
				B0338032AFM	Base Gasket .032"	50330035040	
				EC450032AFM	Intermediate Gasket 98-99	52337046000	
				EC545032AFM	Intermediate Gasket 00-01	52337046100	
				PV075032AFM	Right Side Power Valve Gasket	50337008000	
				PV076032AFM	Left Side Power Valve Gasket	50337006000	
				PV077032AFM	Power Valve Cover Gasket	50337035050	
				Bottom End Kit w/crank seals C3389	Component Part#	Component Description	OEM Part #
				EC236060AFM	Outer Clutch Cover	50330027000	
				EC441032AFM	Inner Clutch Cover	50330025000	
				EC442060AFM	Mag Cover	50330040000	
				EC443012F	Clutch Release Gasket	50332065050	
				EC443032AFM	Clutch Release Gasket .032"	50332065050	
EC443060AFM	Clutch Release Gasket .060"	50332065050					
EC446020F	Center Case Gasket	50330039000					
Clutch & Mag Kit C7368CM	Component Part#	Component Description	OEM Part #				
EC236060AFM	Outer Clutch Cover	50330027000					
EC442060AFM	Mag Cover	50330040000					
Crank Seal Kit C7661	Component Part#	Component Part#	OEM Part#				
OS136	Right Crank Seal 24X35X7		760253570				
OS141	Left Crank Seal 31X45X6		760324564				
200 SX, EXC, MXC XC-W	03-14	O-Ring	C7942	Component Part#	Component Part#	OEM Part#	
				R0048	Outer Head O-ring	52330137000	
				R72X2V	Inner Head O-ring	0770720021	
				B0338018AFM	Base Gasket .018"	50330035040	
				B0338032AFM	Base Gasket .032"	50330035040	
				R44X3S	Expansion Chamber O-rings 2 Req.	0770440030	
				EC545032AFM	Intermediate Gasket	52337046100	
				PV075032AFM	Right Side Power Valve Gasket	50337008000	
				PV076032AFM	Left Side Power Valve Gasket	50337006000	
				PV077032AFM	Power Valve Cover Gasket	50337035050	
				WA131	Power Valve Control Shaft Seal	0603262322	
				WA133	Head Crush Washer -6X10X1 3 Req.	0603061001	
				R8X2V	Power Valve Axle O-ring 2 Req.	0770008020	
				Bottom End Kit w/crank seals C3389	Component Part#	Component Description	OEM Part #
				EC236060AFM	Outer Clutch Cover	50330027000	
				EC441032AFM	Inner Clutch Cover	50330025000	
				EC442060AFM	Mag Cover	50330040000	
				EC443012F	Clutch Release Gasket	50332065050	
				EC443032AFM	Clutch Release Gasket .032"	50332065050	
				EC443060AFM	Clutch Release Gasket .060"	50332065050	
				EC446020F	Center Case Gasket	50330039000	
				Clutch & Mag Kit C7368CM	Component Part#	Component Description	OEM Part #
				EC236060AFM	Outer Clutch Cover	50330027000	
				EC442060AFM	Mag Cover	50330040000	
				Crank Seal Kit C7661	Component Part#	Component Part#	OEM Part#
OS136	Right Crank Seal 24X35X7		760253570				
OS141	Left Crank Seal 31X45X6		760324564				



MX/Dirt · Off-Road · ATV Gaskets



Cometic Gasket - An Exclusive NASCAR Performance® Product

250 SX

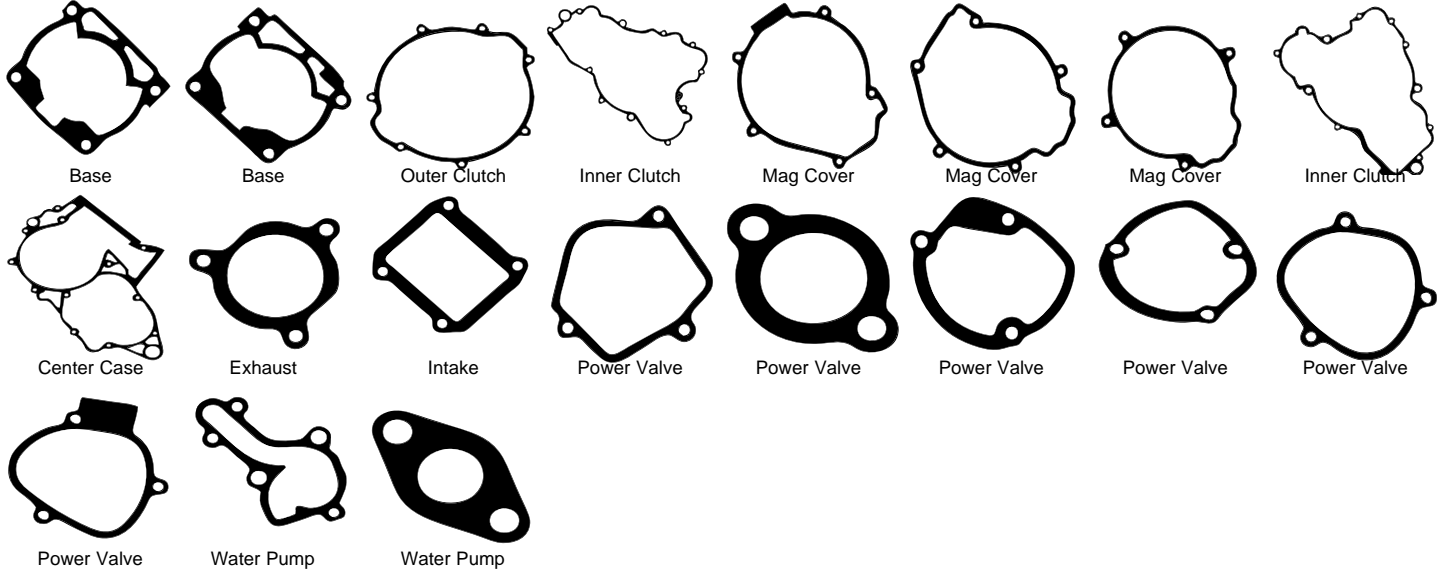

Model	Year	Bore Size	Top End Kit	Component Part#	Component Description	OEM Part #	
250 SX, EXC	90-99	O-Ring	C7098	R114X2B	Outer Head O-ring	0770114020	
				R74X2S	Inner Head O-ring	0770740021	
				B0056018AFM	Base Gasket .018"	54630030005	
				B0056032AFM	Base Gasket .032"	54630030107	
				EX014047F	Exhaust Flange Gasket	54630046000	
				PV028018AFM	Power Valve Timer Gasket	54637006100	
				PV049018AFM	Left Side Power Valve Gasket	54637106000	
				PV088032AFM	Right Side Power Valve Gasket	54637073000	
					Component Part#	OEM Part#	
					EC234060AFM	Outer Clutch Cover Gasket	54630025050
					EC285032AFM	Inner Clutch Cover	54630025200
					EC286020F	Center Case Gasket	54630039200
					EC287060AFM	Mag Cover Gasket	54630040300
					R24X2V	Transmission Counter Shaft O-ring	0770250020
					WP008032AFM	Water Pump Gasket	54635003200
	WP081032AFM	Power Valve Spring Cover	54435037000				
		Component Part#	OEM Part#				
	OS136	Right Crank Seal 24X35X7	760253570				
	OS137	Left Crank Seal 37X53X7	760385273				
		Component Part#	OEM Part #				
		R114X2B	Outer Head O-ring	0770114020			
		R74X2S	Inner Head O-ring	0770720021			
		B0056018AFM	Base Gasket .018"	54630030005			
		B0056032AFM	Base Gasket .032"	54630030107			
		R44X3S	Expansion Chamber O-ring	0770440030			
		EX014042AM	Exhaust Flange Gasket	54630046000			
		PV103032AFM	Left Side Power Valve Gasket	54737006000			
		PV104032AFM	Right Side Power Valve Gasket	54737008000			
			Component Part#	OEM Part#			
		EC234060AFM	Outer Clutch Cover Gasket	54630025050			
		EC285032AFM	Inner Clutch Cover	54630025200			
		EC286020F	Case Gasket	54630039200			
		EC549060AFM	Mag Cover Gasket	54730040100			
		WP008032AFM	Water Pump Gasket	54635003200			
			Component Part#	OEM Part#			
		OS136	Right Crank Seal 24X35X7	760253570			
		OS137	Left Crank Seal 37X53X7	760385273			
			Component Part#	OEM Part #			
		EC234060AFM	Clutch Cover Gasket	54630025050			
		EC549060AFM	Mag Cover Gasket	54730040100			



MX/Dirt · Off-Road · ATV Gaskets



Cometic Gasket - An Exclusive NASCAR Performance® Product

KTM

Model	Year	Bore Size	Top End Kit	Component Part#	Component Description	OEM Part #	
250 SX	03-06	O-Ring	C7943	R114X2B	Outer Head O-ring	0770114020	
				R74X2S	Inner Head O-ring	0770720021	
				B0666018AFM	Base Gasket .018"	54830030004	
				B0666032AFM	Base Gasket .032"	54830030004	
				IR386018AFM	Intake Gasket	548030062000	
				R44X3S	Expansion Chamber O-rings 2 Req.	0770440030	
				PV103032AFM	Left Side Power Valve Gasket	54737006000	
				PV104032AFM	Right Side Power Valve Gasket	54737008000	
				Component Part#	Component Part#	OEM Part#	
				Bottom End Kit w/crank seals	Component Part#	OEM Part#	
				C3392	EC777032AFM	Mag Cover Gasket	54830040000
					EC778032AFM	Inner Clutch Cover Gasket	54830024000
					EC779020F	Center Case Gasket	54830039000
					R0049	Outer Clutch Cover Gasket	54830025000
					R0050	Molded Water Pump Gasket	54835003000
Clutch & Mag Kit	Component Part#	Component Description	OEM Part #				
C7943CM	EC234060AFM	Clutch Cover Gasket	54630025050				
	EC777032AFM	Mag Cover Gasket	54830040000				
Crank Seal Kit	Component Part#	Component Part#	OEM Part#				
C7662	EC778032AFM	Inner Clutch Cover Gasket	54830024000				
	OS137	OS137 Lt. Crank Seal 37x53x7	760385273				
Top End Kit	Component Part#	Component Description	OEM Part #				
C3222	R73X2V	Inner Head O-ring 250 Models	0770730020				
	R78X2V	2008 300 XC Models	0770078020				
	WA135	Head Seal O-rings	56530080000				
	R105X2B	Outer Head O-ring	0770105020				
	B0666018AFM	Base Gasket .018"	54830030004				
	R44X3S	Exhaust Flange O-rings	0770440030				
	PV136032AFM	Left Side Power Valve Gasket	54837006000				
	PV137032AFM	Right Side Power Valve Gasket	54837008000				
	R112V	Power Valve Flap O-rings	0770116241				
	R114V	Power Valve Spring Guide O-ring	0770021120				
	R16X2V	Power Valve Control O-rings 2 Req.	0770160021				
	R24X2V	Power Valve Control Cover O-ring	0770240020				
Bottom End Kit	Component Part#	Component Part#	OEM Part#				
C3539		Intake Gasket	54830062200				
	EC779020F	Center Case Gasket	54830039000				
	EC778032AFM	Clutch Cover Gasket	54830024000				
	R19X3V	Clutch Fill Plug O-ring 19,00x3,00 NBR	0770191015				
	R0049	Outer Clutch Cover O-ring	54830025000				
	WA137	Drain Plug Washer 12x18x1,5	58038022000				
	R0050	Water Pump Cover O-ring MR	54835003000				
	WA129	Water Pump Drain Crush Washer 10x14x1	0603100141				
	R25X1.5V	Crank O-ring 25x1.5	0770250015				
	WA129	Copper Crush Gasket Clutch Line 2 Req. 10X14X1	0603100141				
	R30X1.5V	Slave Cylinder O-Ring	0770300015				
	R25X2V	Output Shaft O-ring 25,00X2,00	0770250020				
	R027V	Thermostat O-ring 32x2	0770320020				
	EC1254032AFM	Ignition Cover Gasket	55130040000				
	EC1927018AFM	Outer Ignition Cover (Estart)	55130041100				
	R25X3V	Estart O-ring 25,00X3,00	0770250030				
Clutch & Mag Kit	Component Part#	Component Description	OEM Part #				
C7943CM	EC234060AFM	Clutch Cover Gasket	54630025050				
	EC777032AFM	Mag Cover Gasket	54830040000				



MX/Dirt · Off-Road · ATV Gaskets



Cometic Gasket - An Exclusive NASCAR Performance® Product

250 EXC

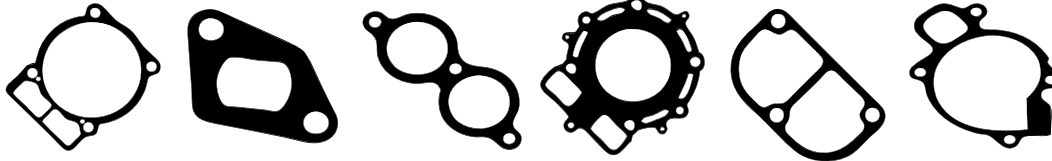

Base		Cam Chain Tensioner	Exhaust	Head	Valve Cover	Water Pump	
Model	Year	Bore Size	Top End Kit	Component Part#	Component Description	OEM Part #	
250 EXC	04	O-Ring	C7417	R74X2S	Inner Head O-ring 2004	0770740021	
250 XC	04-06			R76X2V	Inner Head O-ring 2005	0770760021	
				WA135	Head Seal Crush Washer 6 Req.	56530080000	
				R114X2B	Outer Head O-ring	0770114020	
				B0666018AFM	Base Gasket .018"	54830030004	
				B0666032AFM	Base Gasket .032"	54830030004	
				IR386018AFM	Intake Gasket	548030062000	
				R44X3S	Expansion Chamber O-rings 2 Req.	0770440030	
				R15X1.5V	Power Valve Control O-ring	077015051	
				R11.5X2.5V	Power Valve Cover O-rings 4 Req.	0770116241	
				PV103032AFM	Left Side Power Valve Gasket	54737006000	
				PV104032AFM	Right Side Power Valve Gasket	54737008000	
				Component Part#	Description	OEM Part#	
			Bottom End Kit	EC777032AFM	Mag Cover Gasket	54830040000	
			w/o crank seals	EC778032AFM	Inner Clutch Cover Gasket	54830024000	
			C3393	EC779020F	Center Case Gasket	54830039000	
				R0049	Outer Clutch Cover Gasket	54830025000	
				R0050	Molded Water Pump Gasket	54835003000	
				R12.5X2.5V	Water Pump O-ring	0770021120	
				R19X3V	Clutch Fill Plug O-ring/ Case Seal O-ring	0770191015	
				R24X2V	Water Pump O-ring	0770240020	
				R25X1.5V	Crank O-ring	0770250015	
				R25X2V	Countershaft O-ring	0770250020	
				R30X1.5V	Clutch Push Rod O-ring	0770300015	
				WA133	Water Pump Seal Washer	0603100141	
			Top End Kit	Component Part#	Description	OEM Part#	
250 EXC,	02-05	76 mm	C7169	H1925040S	Head Gasket	59830036000	
RFS		78 mm	C7409	H2099040S	Head Gasket 78mm Bore		
				B0480020F	Base Gasket	59030035050	
				EX281042AM	Exhaust Gasket	59036041000	
				EC495018AFM	Cam Chain Tensioner	59036003050	
				VC027031F	Valve Cover Gasket	58036053000	
				R017B	Oil Screen Plug O-rings	0770020170	
				R12.5X2V	Oil Screen O-rings 2 Req.	0770125015	
				R40X2.5B	Oil Filter O-rings 2 Req.	0770400025	
				WA005063C	Oil Line Washers 4 Req.	0603082121	
				WP114018AFM	Water Pump Gasket	59035053000	



MX/Dirt · Off-Road · ATV Gaskets



Cometic Gasket - An Exclusive NASCAR Performance® Product

KTM 250 SX-F

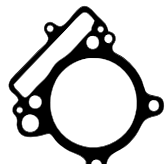

Base



Exhaust

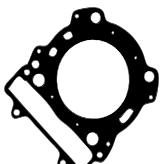

Head

Model	Year	Bore Size	Top End Kit	Component Part#	Component Description	OEM Part #
250 SX-F,	05-12	77 mm	C3164-EST	H2408027S	Head Gasket 77mm Bore	77030036000
EXC-F, XC-F		79 mm	C3184-EST	H2408SP5027S	Head Gasket 79mm Bore	77030036000
				B0748010RC	Base Gasket	77030035000
				EX702064AM	Exhaust Gasket	77036041000
				R018B	Cam Chain Tensioner O-ring	0770180020
				WA145	Cam Chain Tensioner Seal	0603242920
				WA146	Cam Chain Guide Bolt Seal	0603082121
				3186V	Valve Seals 4 Req.	77036027000
				R012SB	Plug Seal O-Ring	0770080020
			Bottom End Kit w/o crank seals C3502	Component Part#	Description	OEM Part#
				EC1035032AFM	Mag Cover Gasket	77030040000
				R40X2.5B	Oil filter O-Ring	0770400025
				R12.5X2V	Oil Screen O-rings 2 Req.	0770125015
				R017B	Oil Screen Plug O-ring	0770020170
				WP427	Water Pump Cover Gasket	77035053000
				WA133	Water Pump Crush Seal	0603061001
				R30X1.5V	Slave Cylinder O-Ring	0770300015
				EC1360018AFM	Slave Cylinder Gasket	59032065000
				WA129	Clutch Bleeder Seal	42013226000
				EC1036032AFM	Inner Clutch Cover Gasket	77030025100
				WA137	Oil Drain Plug Seal 2 Req.	58038022000
				R12X2V	Oil Relief O-Ring	0770120020
250 SX-F, 13-14		78mm	Top End Kit	Component Part#	Component Description	OEM Part #
EXC-F,			C3511-EST	R023V	Plug Well O-ring 2 Req.	0770260015
XC-F			C3516-EST	R9X1.5V	Cam End Plug O-ring 2 Req.	07700900151
				H3698SP2027S	81mm Cylinder Head Gasket	77730036085
				WA145	Cam Chain Tensioner Gasket	0603242920
				R018B	Cam Chain O-Ring	0770180020
				R013V	Cam Chain O-Ring	0770010010
				3186V	Valve Seal 4 Req.	77036027000
				B1026010RC	Base Gasket	77230035000
				R10X2V	Temp Sensor O-ring	0770100020
				EX1333059F	Exhaust Gasket	77236041000
				H3698027S	Stock Cylinder Head Gasket	77730036085
				R40X2V	Intake Cam Decomp. O-Ring	0770400010
			Bottom End Kit C3513	Component Part#	Component Description	OEM Part#
				EC1455032AFM	Mag Cover Gasket	77530040000
				WA137	Magnet Plug Crush Washer	58038022000
				R022V	Output Shaft O-Ring	0770020220
				WA129	Clutch Line Crush Washers	42013226000
				EC1742018AFM	Starter Cover Gasket	77240043000
				R014V	Drain Plug Gasket	0770110015
				R014V	Drain Plug O-Ring 2 Req.	0770110015
				R19X3V	Fill plug O-Ring	0770191015
				R12.5X2V	Oil Screen O-Rings 2 Req.	0770125015
				R031V	Oil Pump Cover O-Ring	0770440020
				R028V	Oil Filter O-Ring	07703305178
				R017V	Oil Screen Plug O-Ring	0770020170
				EC1817018AFM	Clutch Slave Cylinder Gasket	77232062000
				WP427	Water Pump Cover Gasket	77235053000
				EC1816032AFM	Inner Clutch Cover Gasket	77730025000
				MR126	Outer Clutch Cover O-ring	77230027000



MX/Dirt · Off-Road · ATV Gaskets



Cometic Gasket - An Exclusive NASCAR Performance® Product

KTM

Model	Year	Bore Size	Top End Kit	Component Part#	Component Description	OEM Part #
250 SX-F, 15-16 Factory Edition		79mm	C3595-EST	H3698027S	Cylinder Head Gasket	79030036086
				B1301014RC	Cylinder Base Gasket	79230035000
				3186V	Valve Stem Seals 4 Required	77036027000
				R018B	Cam Chain Tensioner O-ring	770180020
				WA145	Cam Chain Tensioner Crush Seal	603242920
				R013V	Cam Chain Tensioner Cap O-ring	770010010
				R023V	Plug Well Cam Tower O-rings	770260015
				EX1333059F	Exhaust Flange Gasket	77236041000

300 SX

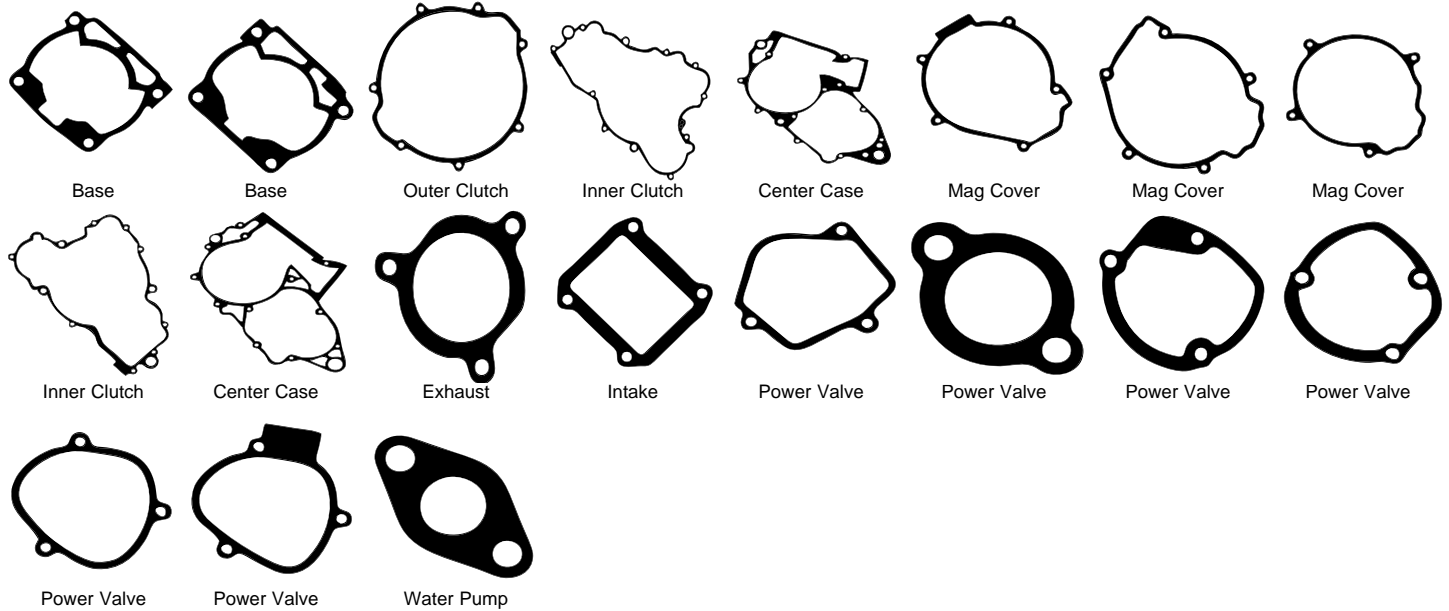

Model	Year	Bore Size	Top End Kit	Component Part#	Component Description	OEM Part #	
300 SX, EXC	90-99	O-Ring	C7099	R78X2V	Inner Head O-ring 300 XC Models	0770078020	
				R114X2B	Outer Head O-ring	0770114020	
				B0056018AFM	Base Gasket .018"	54630030005	
				B0056032AFM	Base Gasket .032"	54630030107	
				EX014047F	Exhaust Flange Gasket	54630046000	
				PV028018AFM	Right Side Power Valve	54637006100	
				PV049018AFM	Left Side Power Valve	54637106000	
				PV088032AFM	Rt. Side Power Valve 90-99	54637073000	
					Bottom End Kit w/crank seals C3390	Component Part#	OEM Part#
						WP081032AFM	Power Valve Spring Cover
		EC234060AFM	Outer Clutch Cover Gasket	54630025050			
		EC285032AFM	Inner Clutch Cover Gasket	54630025200			
		EC286020F	Center Case Gasket	54630039200			
		EC287060AFM	Mag Cover Gasket	546300040300			
		R24X2V	Water Pump O-ring	0770240020			
	Crank Seal Kit C7662	Component Part#	OEM Part#				
		OS136	Right Crank Seal 24X35X7	760253570			
		OS137	Left Crank Seal 37X53X7	760385273			



MX/Dirt • Off-Road • ATV Gaskets



Cometic Gasket - An Exclusive NASCAR Performance® Product

KTM

Model	Year	Bore Size	Top End Kit	Component Part#	Component Description	OEM Part #	
300 SX, EXC, MXC	00-03	O-Ring	Top End Kit C7816	R78X2V	Inner Head O-ring 300 XC Models	0770078020	
				R114X2B	Outer Head O-ring	0770114020	
				B0056018AFM	Base Gasket .018"	54630030005	
				B0056032AFM	Base Gasket .032"	54630030107	
				EX014047F	Exhaust Flange Gasket	54630046000	
				R15X1.5V	Power Valve Control O-rings 2 Req.	0770 15051	
				R16X2V	Power Valve Control O-rings 2 Req.	0770160021	
				PV103032AFM	Left Side Power Valve Gasket	54737006000	
				PV104032AFM	Right Side Power Valve Gasket	54737008000	
				Bottom End Kit w/crank seals C3391	Component Part#	Component Part#	OEM Part#
			EC234060AFM		Outer Clutch Cover Gasket	54630025050	
			EC285032AFM		Inner Clutch Cover Gasket	54630025200	
			EC286020F		Center Case Gasket	54630039200	
			EC549060AFM		Mag Cover Gasket	54730040100	
			WP081032AFM		Power Valve Spring Cover	54435037000	
			Clutch & Mag Kit C7690CM		Component Part#	Component Description	OEM Part #
					EC234060AFM	Clutch Cover Gasket	54630025050
			Crank Seal Kit C7662		Component Part#	Component Part#	OEM Part#
					OS136	Right Crank Seal 24X35X7	760253570
			300 EXC, MXC, XC, XC-W	04-07	O-Ring	Top End Kit C7423	OS137
Component Part#	Component Description	OEM Part #					
R80X2S	Inner Head O-ring	0770800021					
R114X2B	Outer Head O-ring	0770114020					
WA135	Head Seal Crush Washer 6 Req.	56530080000					
B0666018AFM	Base Gasket .018"	54830030004					
B0666032AFM	Base Gasket .032"	54830030004					
IR386018AFM	Intake Gasket	548030062000					
R44X3S	Exp. Chamber O-rings 2 Req.	0770440030					
PV103032AFM	Left Side Power Valve Gasket	54737006000					
PV104032AFM	Right Side Power Valve Gasket	54737008000					
R11.5X2.5V	Power Valve Cover O-rings 4 Req.	0770116241					
R15X1.5V	Power Valve Control O-ring	077015051					
Bottom End Kit w/crank seals C3392	Component Part#	Component Part#				OEM Part#	
	EC777032AFM	Mag Cover Gasket				54830040000	
	EC778032AFM	Inner Clutch Cover Gasket				54830024000	
	EC779020F	Center Case Gasket				54830039000	
	R0049	Outer Clutch Cover Gasket				54830025000	
	R0050	Molded Water Pump Gasket				54835003000	
	R12.5X2.5V	Water Pump O-ring				0770021120	
	R19X3V	Clutch Fill Plug/Case Seal O-ring	0770191015				
	R24X2V	Water Pump O-ring	0770240020				
	R25X1.5V	Crank O-ring	0770250015				
R25X2V	Countershaft O-ring	0770250020					
R30X1.5V	Clutch Push Rod O-ring	0770300015					
WA133	Water Pump Seal Washer	0603100141					
Clutch & Mag Kit C7943CM	Component Part#	Component Description	OEM Part #				
	R0049	Clutch Cover Gasket	54830025000				
Crank Seal Kit C7662	Component Part#	Component Part#	OEM Part#				
	EC777032AFM	Mag Cover Gasket	54830040000				
	OS136	Right Crank Seal 24X35X7	760253570				
	OS137	Left Crank Seal 37X53X7	760385273				



MX/Dirt · Off-Road · ATV Gaskets



Cometic Gasket - An Exclusive NASCAR Performance® Product

KTM

Model	Year	Bore Size	Top End Kit	Component Part#	Component Description	OEM Part #			
300 XC, XC-W	08-10	O-Ring	C3222	R73X2V	Inner Head O-ring 250 Models	0770730020			
				R78X2V	2008 300 XC Models	0770078020			
				R105X2B	Outer Head O-ring	0770105020			
				WA135	Head Seal O-rings	56530080000			
				B0666018AFM	Base Gasket .018"	54830030004			
				R44X3S	Exhaust Flange O-rings	0770440030			
				PV136032AFM	Left Side Power Valve Gasket	54837006000			
				PV137032AFM	Right Side Power Valve Gasket	54837008000			
				R112V	Power Valve Flap O-rings	0770116241			
				R114V	Power Valve Spring Guide O-ring	0770021120			
				R16X2V	Power Valve Control O-rings	0770160021			
					2 Req.				
				R24X2V	Power Valve Control Cover O-ring	0770240020			
					Clutch & Mag Kit				
					C7943CM				
							Component Part#	Component Description	OEM Part #
							EC234060AFM	Clutch Cover Gasket	54630025050
			EC777032AFM	Mag Cover Gasket	54830040000				

350 SX-F

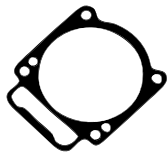

Head



Base

Model	Year	Bore Size	Top End Kit	Component Part#	Component Description	OEM Part #
350SX-F	11-12	88mm	C3428-EST	H3093SP4027S	88mm Cylinder Head Gasket	77230036000
		90mm	C3429-EST	H3093027S	90mm Cylinder Head Gasket	
		91mm	C3458-EST	H3093SP1027S	91mm Cylinder Head Gasket	
				R10X2V	Water Temp Sensor O-ring	0770100020
				R18X2.5V	Cam Chain Tensioner O-ring	0770180020
				R9X2V	Head Seal O-rings	0770090015
				WA145	Cam Chain Tensioner Seal	0603242920
				B1026014RC	Base Gasket	77230035000
				3231V	Valve Seals 4 Req.	77236027000
				R013V	Cam Chain Wear Bushing O-ring	0770010010
				R023V	Plug Shaft O-rings	0770260015
350SX-F, 13-14 XC-F		88mm	C3519-EST	3231V	Valve Seals 4 Req.	77236027000
				R013V	Cam Chain Wear Bushing O-ring	0770010010
				R023V	Plug Shaft O-rings	0770260015
				R10X2V	Water Temp Sensor O-ring	0770100020
				R018B	Cam Chain Tensioner O-ring	0770180020
				R9X2V	Head Seal O-rings	0770090015
				WA145	Cam Chain Tensioner Seal	0603242920
				H3093SP4032S	88mm Cylinder Head Gasket	77230036000
				H3093032S	90mm Cylinder Head Gasket	
				H3093SP1032S	91mm Cylinder Head Gasket	
				B1026014RC	Base Gasket	77230035000
				EX1333059F	Exhaust Gasket	77236041000

350 EXC

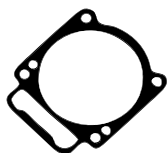

Base



Exhaust



Head



Intake

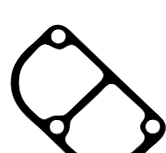

Valve Cover

Model	Year	Bore Size	Top End Kit	Component Part#	Component Description	OEM Part #
350 EXC, RXC	87-90	O-Ring	C7288	H0378040A	Head Gasket	57530036000
				B0230020RC	Base Gasket	58030030000
				IR056032AFM	Intake Gasket	58136043000
				EX088031F	Exhaust Gasket 2 Req.	58036041000
				VC027032AFM	Valve Cover Gasket 2 Req.	58036053000

All Component Parts can be purchased individually.



MX/Dirt • Off-Road • ATV Gaskets



Cometic Gasket - An Exclusive NASCAR Performance® Product

KTM 360/380 SX

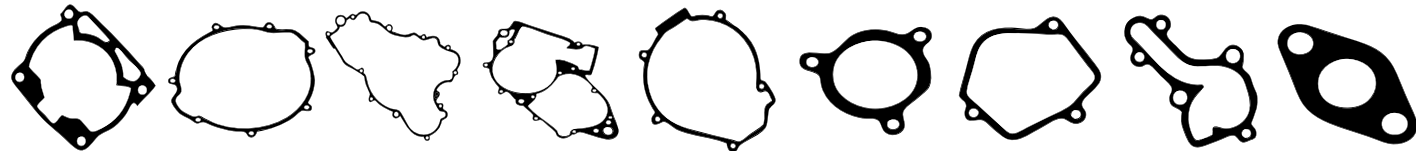

Model	Year	Bore Size	Top End Kit	Component Part#	Component Description	OEM Part #
360 SX, EXC	96-97	O-Ring	C7285	R114X2B	Outer Head O-ring	0770114020
380 SX, EXC	98-01			R84X2V	Inner Head O-ring	077084021
				B0056018AFM	Base Gasket .018"	54630030005
				B0056032AFM	Base Gasket .032"	54630030107
				PV028018AFM	Right Side Power Valve Gasket	54637006100
				PV049018AFM	Left Side Power Valve Gasket	54637106000
				EX014047F	Exhaust Flange Gasket	54630046000
			Bottom End Kit w/crank seals C3390	Component Part#	Component Description	OEM Part#
				EC234060AFM	Outer Clutch Cover Gasket	54630025050
				EC285032AFM	Inner Clutch Cover Gasket	54630025200
				EC286020F	Center Case Gasket	54630039200
				EC287060AFM	Mag Cover Gasket	54630040300
				WP008032AFM	Water Pump Gasket	54635003200
				WP081032AFM	Power Valve Spring Cover	54435037000
			Crank Seal Kit C7662	Component Part#	Component Description	OEM Part#
				OS136	Right Crank Seal 24X35X7	760253570
				OS137	Left Crank Seal 37X53X7	760385273

400 LC4

Model	Year	Bore Size	Top End Kit	Component Part#	Component Description	OEM Part #
400 LC4, MLS Head	88-01	95.5 mm	C7170	H1955040S	95.5mm Head Gasket	58030136200
				B0230020RC	Base Gasket	58030030000

400/450/525 SX



Model	Year	Bore Size	EST Top End Kit	Component Part#	Component Description	OEM Part #
400, 450, 525 SX, EXC, RFS	00-06	91 mm	C7693-EST	H1017040S	Head Gasket 91mm Bore	59030036000
		94 mm	C7885-EST	H1843040S	Head Gasket 94mm Bore	
		95 mm	C7944-EST	H1521040S	Head Gasket 95mm Bore	
		96 mm	C7454-EST	H2081040S	Head Gasket 96mm Bore	
		97 mm	C7691-EST	H1018040S	Head Gasket 97mm Bore	
		98 mm	C7461-EST	H1018SP4040S	Head Gasket 98mm Bore	
		99 mm	C7792-EST	H1018SP2040S	Head Gasket 99mm Bore	
				B0480020F	Base Gasket	59030035050
				EX281042AM	Exhaust Gasket	59036041000
				EC495018AFM	Timing Cover Gasket	59036003050
				3225V	Valve Seals 4 Req.	59036027000
				VC027031F	2 Req. Valve Cover Gasket	58036053000
				R017B	Oil Screen Plug O-rings	0770020170
				R12.5X2V	Oil Screen O-rings 2 Req.	
				R40X2.5B	Oil Filter O-rings 2 Req.	0770400025
				WA005063C	Oil Line Washers 4 Req.	0603082121
			Bottom End Kit w/o crank seals C3394	Component Part#	Component Description	OEM Part#
				WP114018AFM	Water Pump Gasket	59035053000
				EC496032AFM	Clutch Cover Gasket	59030025000
				EC494032AFM	Mag Cover Gasket	59030040000
				EC497012F	Center Case Gasket	59030039000
			Clutch & Mag Kit C7693CM	Component Part#	Component Description	OEM Part #
				EC496032AFM	Clutch Cover Gasket	59030025000
				EC494032AFM	Mag Cover Gasket	59030040000



MX/Dirt • Off-Road • ATV Gaskets



Cometic Gasket - An Exclusive NASCAR Performance® Product

KTM 450SX-F

Model	Year	Bore Size	EST Top End Kit	Component Part#	Component Description	OEM Part #
450SX-F	07-10	97mm	C3412-EST	H2623027S	Head Gasket 97mm Bore	77330036000
450 Rally	14			R010V	Oil Jet O-rings	0770060015
450 SX	07-10			R9X1.5V	Head Oil Plug O-ring	0770090015
ATV				EX873059F	Exhaust Gasket	77336041000
				R014V	Head Coolant Plug Gasket	0770090015
				R25X2V	Cam Tower Plug Well O-ring	0770025020
				3225V	Valve Stem Seals	59036027000
				R013B	Cam Chain Tensioner O-ring	0770010010
				WA145	Cam Chain Tens. Crush Seal	0603242920
				R18X2.5V	Cam Chain Tens. Piston O-ring	0770180020
				R014V	Cam Chain Bushing O-ring	0770012015
				R017B	Cam Axle O-ring	0770015018
				R046V	Base O-ring	0770108018
				B0928	Cam Galley Base O-ring	77330035000

505 SX-F

Model	Year	Bore Size	EST Top End Kit	Component Part#	Component Description	OEM Part #
505SX-F	07-10	100mm	C3413-EST	H2623SP1027S	Head Gasket 100mm Bore	77330036000
505 SX	07-10			R010V	Oil Jet O-rings	0770060015
ATV				R9X1.5V	Head Oil Plug O-ring	0770090015
				EX873059F	Exhaust Gasket	77336041000
				R014V	Head Coolant Plug Gasket	0770090015
				R25X2V	Cam Tower Plug Well O-ring	0770025020
				3225V	Valve Stem Seals	59036027000
				R013B	Cam Chain Tens. O-ring	0770010010
				WA145	Cam Chain Tens. Crush Seal	0603242920
				R18X2.5V	Cam Chain Tens. Piston O-ring	0770180020
				R014V	Cam Chain Bushing O-ring	0770012015
				R017B	Cam Axle O-ring	0770015018
				R046V	Base O-ring	0770108018
				B0928	Cam Galley Base O-ring	77330035000

450/530 EXC-R

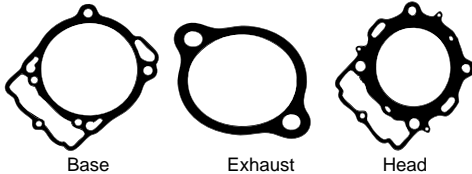

Model	Year	Bore Size	EST Top End Kit	Component Part#	Component Description	OEM Part #
450 EXC-R	08	95 mm	C3241-EST	H2759045S	Head Gasket 95mm Bore	78030036000
530 EXC-R		97 mm	C3242-EST	H2759SP3045S	Head Gasket 97mm Bore	
450 SX-F	12	99 mm	C3243-EST	H2759SP1045S	Head Gasket 99mm Bore	
Factory		101 mm	C3244-EST	H2759SP4045S	Head Gasket 101mm Bore	
Replica				B0933014RC	Base Gasket	78030035000
450 SX-F	13-14			EX873059F	Exhaust Gasket	77336041000
				R019V	Cam Chain Tensioner O-ring	0770180020
				WA145	Cam Chain Tensioner Seal	603242920
				3225V	Intake Valve Seals 4 Req.	59036027000
				3186V	Exhaust Valve Seals 2 Req.	77036027000
				R014V	Rocker Arm O-ring	0770110015
				R10X2V	Temp Sensor O-ring	0770100020



MX/Dirt · Off-Road · ATV Gaskets



Cometic Gasket - An Exclusive NASCAR Performance® Product

450/525 XC

Model	Year	Bore Size	EST Top End Kit	Component Part#	Component Description	OEM Part #			
450 XC ATV	08-10	89 mm	EST Top End Kit C3263-EST C3264-EST	H1017SP2040S	Head Gasket 89mm Bore	59530036000			
				H1017040S	Head Gasket 91mm Bore				
		B0480020RC		Base Gasket	59030035050				
		3225V		Valve Seals 4 Req.	59036027000				
		EC495018AFM		Cam Chain Tensioner Gasket	59036003050				
		EX281042AM		Exhaust Gasket	59036041000				
		R019V		Rocker Arm O-ring	770191016				
		R40X2.5B		Oil Filter O-rings 2 Req.	770400025				
		VC027031F		Valve Cover Gasket 2 Req.	58036053000				
		WA005063C		Crush Washers 4 Req.	603061001				
		WP114018AFM		Water Pump Gasket	59035053000				
					Component Part#	Component Description	OEM Part #		
		525 XC ATV		08-10	95 mm	EST Top End Kit C7944-EST C7454-EST C7691-EST C7461-EST C7792-EST	H1521040S	Head Gasket 95mm Bore	5813169
					96 mm		H2081040S	Head Gasket 96mm Bore	
97 mm	H1018040S		Head Gasket 97mm Bore						
98 mm	H1018SP4040S		Head Gasket 98mm Bore						
99 mm	H1018SP2040S		Head Gasket 99mm Bore						
	B0480020RC		Base Gasket		59030035050				
	EC495018AFM		Timing Chain Tens. Gasket		59036003050				
	EX281042AM		Exhaust Gasket		59036041000				
	R017B		2 Req.-Oil Screen Plug O-ring		5413248				
	R12.5X2V		2 Req.-Oil Screen Plug O-ring		5413249				
	R40X2.5B		2 Req.-Oil Filter O-ring		5413254				
	VC027031F		Valve Cover Gasket 2 Req.		59530036000				
	WA005063C		Crush Washers 4 Req.		603061001				
			Component Part#		Component Description		OEM Part#		
		WP114018AFM	Water Pump Gasket	59035053000					
		EC1377020F	Ignition Cover Gasket	5813170					
		EC494032AFM	Mag. Cover Gasket	5813174					
		EC496032AFM	Clutch Cover Gasket	5413309					
		EC497012F	Center Case Gasket	59030039000					

**Bottom End Kit
w/o crank seals
C3340**

KTM620 LC4

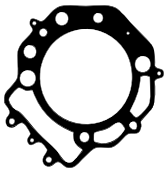

Base

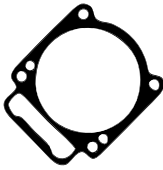

Exhaust

Model	Year	Bore Size	Top End Kit	Component Part#	Component Description	OEM Part #
620 LC	88-01	102 mm	C7171 C7209	H1956040S	Head Gasket 102mm Bore	58330036000
		105 mm		H1957040S	Head Gasket 105mm Bore	
				B0230020RC	Base Gasket	58030030000



MX/Dirt · Off-Road · ATV Gaskets



Cometic Gasket - An Exclusive NASCAR Performance® Product

LEM

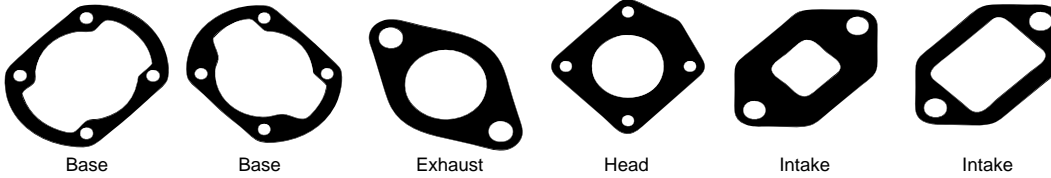

Model	Year	Bore Size	Top End Kit	Component Part#	Component Description	OEM Part #
Cross	96-03	41 mm	C7282	H0354010C	Head Gasket .010" Copper	36330036000
CR-3 USA				H0354020C	Head Gasket .020" Copper	36330036000
LX1, LX2 Factory				B0219018AFM	Base Gasket 00-01	45030035800
LX2, LX2 Sport				B0220018AFM	Base Gasket 94-99	36330030000
LX3				IR054018AFM	Intake Port Small Opening	49130438000
LX3 Sport				IR055018AFM	Intake Port Large Opening	49130438000
				EX089039F	Exhaust Gasket	45030046000

POLARIS PREDATOR 90

Model	Year	Bore Size	Top End Kit	Component Part#	Component Description	OEM Part #
Predator 90	01-06	53mm	C3514	H2381SP1043F	Head Gasket	0450004
				B0774020F	Base Gasket	0450009
				EX650064AM	Exhaust Gasket	0450122

BIG BOSS

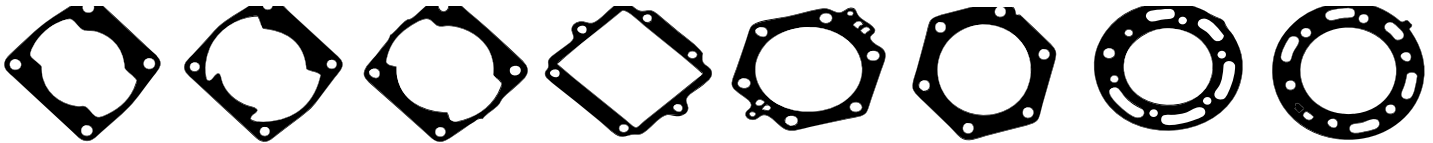

Model	Year	Bore Size	Top End Kit	Component Part#	Component Description	OEM Part #
Big Boss 4x6	89-92	72 mm	C7124	H0018043F	Head Gasket 72mm	3084015
Big Boss 6x6	91-93	73.5 mm	C3485	H0018SP4040S	Head Gasket 73.5mm .040" Steel	3084015
Cyclone	87			B0070018AFM	Base Gasket	3083733/3084016
Trail Blazer	90-06			EX015042AM	Exhaust Gasket	3084026/3084439
Trail Boss 2x4	85-96					
Trail Boss 4x4	87-93					
Trail Boss 6x6	88-93					
2x4 300	94-95	78 mm	Top End Kit C7310	H0451020S	Head Gasket	3085098
4x4 300	94-95			B0265018AFM	Base Gasket	3084795
6x6 300	94-94			EX015042AM	Exhaust Gasket	3084026/3084439
Xplorer 300	96-00					
Xpress 300	96-00					
Sportsman 4x4	93-93	82 mm	Top End Kit C7144	H0212059F	Head Gasket	3084517
Trail Boss 2x4	90-93			B0151020F	Base Gasket	3084140
Trail Boss 4x4	90-93			EX015042AM	Exhaust Gasket	3084026/3084439
Trail Boss 6x6	90-93			IR044018AFM	Intake Gasket	3084148



MX/Dirt · Off-Road · ATV Gaskets



Cometic Gasket - An Exclusive NASCAR Performance® Product

POLARIS

Model	Year	Bore Size	Top End Kit	Component Part#	Component Description	OEM Part #
2x4 400L	94-95	85 mm	C7265	H0345010S	Head Gasket	308415
4x4 400L	94			B0206018AFM	Base Gasket	3084729
6x6 400L,	94-03			EX015042AM	Exhaust Gasket	3084026/3084439
Sportsman 4x4				IR044018AFM	Intake Gasket	3084148
Scrambler	95-00					
4x4						
Sport 400L,	96-00					
Trail Blazer ES						
Xplorer	95-00					
400L 4x4						
Xpress	96-00					
400						
Model	Year	Bore Size	Top End Kit	Component Part#	Component Description	OEM Part #
Magnum	95-00	92 mm	C7311	H0452059F	Head Gasket	3085337
2x4				B0266020F	Base Gasket	3084851
Magnum	95-00			EX038042AM	Exhaust Gasket	3083575/3083023
4x4				R015V	O-ring	3084867
Magnum	96					
6x6						

SCRAMBLER

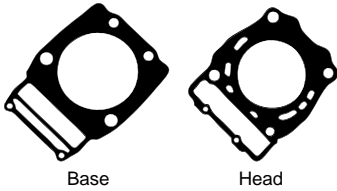

Model	Year	Bore Size	Top End Kit	Component Part#	Component Description	OEM Part #
Scrambler	97-03	94 mm	C7312	H0453059F	Head Gasket	3084865
500				B0267020F	Base Gasket	3084851
Scrambler,	97-05			EX038042AM	Exhaust Gasket	3083575/3083023
Sportsman 500						
Xplorer 500	97					

PREDATOR

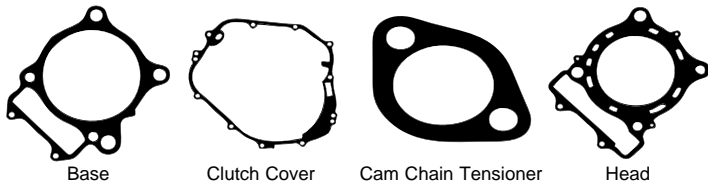

Model	Year	Bore Size	Top End Kit	Price	Component Part#	Component Description	OEM Part #
Predator	03-07	99 mm	C7971-EST		H1818SP1027S	Head Gasket 99mm Bore	3087948
500		100 mm	C7995-EST		H1818030S	Head Gasket 100mm Bore	
Outlaw	06-07	103 mm	C7972-EST		H1818SP4030S	Head Gasket 103mm Bore	
500		105 mm	C3160-EST		H1819030S	Head Gasket 105.5mm Bore	
					B0658010RC	Base Gasket	3089519
					EC996032AFM	Cam Chain Tensioner	3088022
					EX634	Exhaust Gasket/2 Req.	3087957
					WA117	6 Req.-Oil Filter Copper Washer	3088044
					3243V	4 Req. Valve Stem Seals"	3084908
					Component Part#	Component Description	OEM Part #
					VC120	Valve Cover Gasket	3089441



MX/Dirt • Off-Road • ATV Gaskets



Cometic Gasket - An Exclusive NASCAR Performance® Product

OUTLAW (KTM Motor)

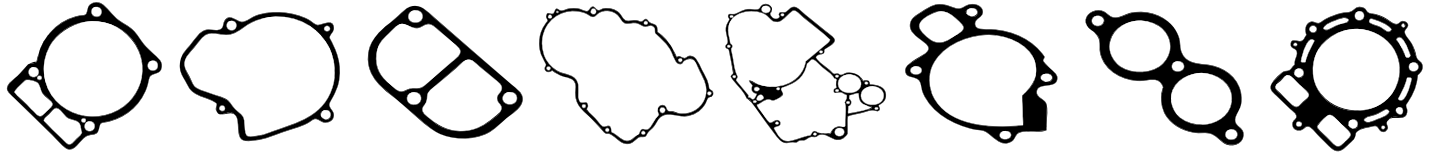

Model	Year	Bore Size	EST	Component Part#	Component Description	OEM Part #	
Outlaw 52506-11 (KTM motor)		95 mm	Top End Kit	H1521040S	Head Gasket 95mm Bore	5813169	
			C7944-EST	H2081040S	Head Gasket 96mm Bore		
			C7454-EST	H1018040S	Head Gasket 97mm Bore		
			C7691-EST	H1018SP4040S	Head Gasket 98mm Bore		
			C7461-EST	H1018SP2040S	Head Gasket 99mm Bore		
			C7792-EST	B0480020F	Base Gasket		5813167
				EC495018AFM	Timing Chain Tens. Gasket		5813173
				EX281042AM	Exhaust Gasket		5813168
				R017B	2 Req.-Oil Screen Plug O-ring		5413248
				R12.5X2V	2 Req.-Oil Screen Plug O-ring		5413249
	R40X2.5B	2 Req.-Oil Filter O-ring	5413254				
	VC027031F	2 Req.-Valve Cover Gasket	5813175				
	WA005063C	4 Req.-Copper Washer	25437-86				
		Bottom End Kit	Component Part#	Component Part#	OEM Part#		
		w/o crank seals					
		C3394	WP114018AFM	Water Pump Gasket	5813172		
			EC1377020F	Ignition Cover Gasket	5813170		
			EC494032AFM	Mag. Cover Gasket	5813174		
			EC496032AFM	Clutch Cover Gasket	5413309		
			EC497012F	Center Case Gasket	59030039000		

SUZUKI JR50

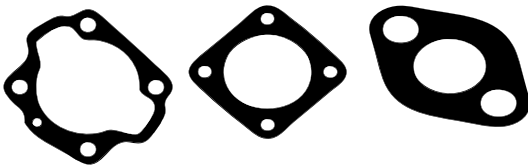

Model	Year	Bore Size	Top End Kit	Component Part#	Component Description	OEM Part #
JR50	78-08	43 mm	C7014	H1281020RC	Head Gasket	11141-04000
				B0543020RC	Base Gasket	11241-04010
				IR417020F	Intake Gasket	13121-04000-H17
				EX349042AM	Exhaust Gasket	14181-04200



MX/Dirt • Off-Road • ATV Gaskets



Cometic Gasket - An Exclusive NASCAR Performance® Product

LT50/RM60

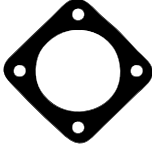
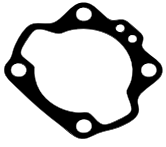

Base Head

Model	Year	Bore Size	Top End Kit	Component Part#	Component Description	OEM Part #		
LT50	84-87	43 mm	C7262	H0263010C	Head Gasket	11141-04000		
				B0161020F	Base Gasket	11241-04010		
RM60	03-04	45 mm	C7501	Component Part#			Component Description	OEM Part #
				H0262043F	Head Gasket	11004-1218		
				B0371018AFM	Base Gasket	11060-1873		
				B0371012	High Comp. Base Gasket .012"	11060-1873		

Bottom End Kit w/Oil Seals	Component Part#	Component Description	OEM Part #
C7154BE	R9X2V	Clutch Pushrod O-ring	670B1509
	WA107	Drain Plug Seal	92065-058
	WP0500032AFM	Water Elbow Outlet	11009-1952
	R222V	Water Pump Body O-ring	670B3039
	WA107	Trans Fluid Drain Plug	92065-058
	R013B	Output Shaft O-ring	92055-022
Oil Seal Kit			
C7736OS	OS331	Shift Shaft Seal 13x22x5.5	92051-005
Crank Seal Kit			
C7656	OS131	Output Shaft Seal 25x37x6	92050-013
	OS110	Crank Seal 20x40x7	92049-1188
	OS366	Start Shaft Seal 16x24x4	92049-002
	OS368	Water Pump Shaft Seal 8x18x10	92049-1366
Clutch & Mag Kit			
C7736CM	EC275032AFM	Clutch Cover Gasket	11009-1976
	EC2740032AFM	Mag Cover Gasket	11009-1974

RM65

Model	Year	Bore Size	Top End Kit	Component Part#	Component Part#	OEM Part#
RM65	03-08	45 mm	C7736	H0970010S	Head Gasket 45mm Bore	11004-1346
		47 mm	C7682	H0971010S	Head Gasket 47mm Bore	
		48 mm	C7737	H0972010S	Head Gasket 48mm Bore	
				B0444018AFM	Base Gasket	11060-1921
				B0444012F	High Comp. Base Gasket .012"	
				R218V	Exhaust O-rings 2 Req.	11060-1925

Bottom End Kit w/Oil Seals	Component Part#	Component Description	OEM Part #
C7736BE	WP104020F	Water Pump Gasket	K1106-01924
	WP105020F	Water Outlet Gasket	K1106-01927
	WA118	Water Pump Drain Crush Washer	KK920-22077
	R013B	Output Shaft O-rings	KK920-55022
	WA108	Drain Plug Gasket	KK920-65058
Oil Seal Kit			
C7736OS	OS360	Water Pump Seal Outer	K9204-91359
Crank Seal Kit			
C7656	OS368	Water Pump Seal Inner	K9204-91366
	OS365	Clutch Actuator Seal	K9204-91414
	OS366	Kickstart Seal	KK920-49002
	OS131	Output Shaft Seal	KK920-50013
	OS331	Shift Shaft Seal	KK920-51005
Clutch & Mag Kit			
C7736CM	EC275032AFM	Clutch Cover Gasket	11009-1976
	EC2740032AFM	Mag Cover Gasket	11009-1974



MX/Dirt · Off-Road · ATV Gaskets



Cometic Gasket - An Exclusive NASCAR Performance® Product

LT80

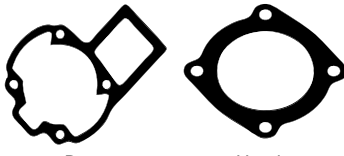

Base

Head

Model	Year	Bore Size	Top End Kit	Component Part#	Component Description	OEM Part #
LT80	87-06	52 mm	C7259	H0314020C	Head Gasket 52mm bore	H11141-07910
		54 mm	C7709	H0899020C	Head Gasket 54mm Bore	
		55 mm	C7931	H0314SP4020C	Head Gasket 55mm Bore	
				B0189020F	Base Gasket	11241-40B10

RM80

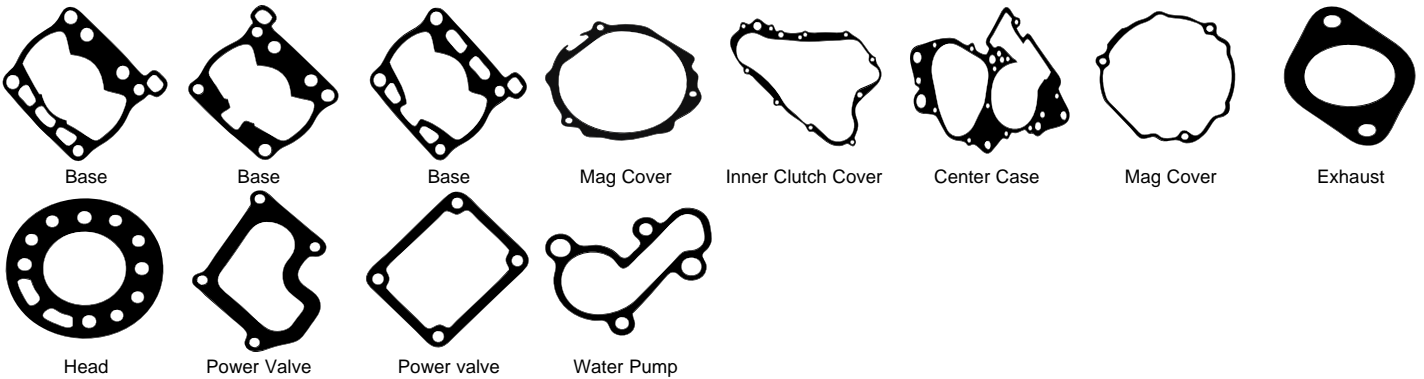

Base

Base

Base

Mag Cover

Inner Clutch Cover

Center Case

Mag Cover

Exhaust

Head

Power Valve

Power valve

Water Pump

Model	Year	Bore Size	Top End Kit	Component Part#	Component Description	OEM Part #
RM80	83-85	51 mm	C7102	H0038043F	Head Gasket 51mm	11141-20931-H17
				B0037020F	Base Gasket	11241-20900-H17
RM80 G, H, J	86-88	50 mm	C7052	H0039043F	Head Gasket	1141-02B60
				B0038020F	Base Gasket	11241-03B01
				IR009020F	Intake Gasket	13156-02B00
				EX010042AM	Exhaust Gasket	14181-02B00
				OS171	31X44X8 Right Crank Seal	09289-32003
				OS172	17X30X8 Left Crank Seal	09283-18004
RM80 K	89-90	50 mm	C7053	H0039043F	Head Gasket	1141-02B60
				B0039020F	Base Gasket	11241-03B01
				IR009020F	Intake Gasket	13156-02B00
				EX010042AM	Exhaust Gasket	14181-02B00
				PV015018AFM	Right Side Power Valve Gasket	11233-02B41
				PV016018AFM	Front Power Valve Cover Gasket	11238-01B30-H17
				R127V	Expansion Chamber O-ring	14171-02B40
				OS132	29X40X7 Right Crank Seal	09283-30061
				OS174	17X30X6 Left Crank Seal	9283-18006
				C7486	Clutch Cover Gasket	11482-27C00



MX/Dirt • Off-Road • ATV Gaskets



Cometic Gasket - An Exclusive NASCAR Performance® Product

SUZUKI

Model	Year	Bore Size	Top End Kit	Component Part#	Component Part#	OEM Part#
RM80	91-01	O-Ring	C7054	R55X2V	Inner Head O-ring	11147-03B00
				R87X2B	Outer Head O-ring	11148-03B00
				B0040018AFM	Base Gasket	11241-03B00
				B0040012F	High Compression Base Gasket	11241-03B00
				EX010042AM	Exhaust Gasket	14181-02B00
				PV015018AFM	Right Side Power Valve Gasket	11233-02B41
				PV016018AFM	Front Power Valve Cover Gasket	11238-01B30-H17
				R127V	Expansion Chamber O-ring	14171-02B40
			Bottom End Kit w/crank seals C3357	Component Part#	Component Part#	OEM Part#
				EC204060AFM	Mag Cover Gasket	11483-02B50
				C7486	Inner Clutch Cover Gasket	11482-27C00
				EC206020F	Crankcase Gasket	11481-02B40
				WP040018AFM	Water Pump Cover Gasket	17431-02B41
			Crank Seal Kit C7663	Component Part#	Component Part#	OEM Part#
				OS132	29X40X7 Right Crank Seal	09283-30061
				OS174	17X30X6 Left Crank Seal	9283-18006

RM85

Model	Year	Bore Size	Top End Kit	Component Part#	Component Description	OEM Part #
RM85	02-12	O-Ring	C7857	R57X2V	inner Head O-ring	11147-03B00
				R88X2B	Outer Head O-ring	11148-03B00
				B0577018AFM	Base Gasket	11241-03B01
				B0577012F	High Compression .012" Base Gasket	
				R127V	Expansion Chamber O-ring	14171-02B40
				PV015018AFM	Right Side Power Valve Cover	11233-02B41
				PV016018AFM	Front Power Valve Cover Gasket	11238-01B30-H17
				R015B	Oil Filler Cap O-ring	NA
			Bottom End Kit w/crank seals C3358	Component Part#	Component Description	OEM Part #
				C7486	Clutch Cover Gasket	11482-27C00
				EC653063N	Mag Cover Gasket	11481-02B41
				EC654020F	Center Case Gasket	11481-03B00
				R115B	Exhaust Valve Cover O-ring	09280-15006
				WP040018AFM	Water Pump Gasket	17431-02B41
			Clutch & Mag Kit C7857CM	Component Part#	Component Description	OEM Part #
				C7486	Clutch Cover Gasket	11482-27C00
				EC653063N	Mag Cover Gasket	11481-02B41
			Crank Seal Kit C7663	Component Part#	Component Part#	OEM Part#
				OS132	29X40X7 Right Crank Seal	09283-30061
				OS174	17X30X6 Left Crank Seal	9283-18006

RM100

Model	Year	Bore Size	Top End Kit	Component Part#	Component Description	OEM Part #
RM100	03-04	53 mm	C7392	H0342010S	Head Gasket 53mm Bore	11004-1214
		54.5 mm	C7413	H0490010S	Head Gasket 54.5mm Bore	
				B0311018AFM	Base Gasket	11060-1779
				B0311012F	High Compression Base Gasket	
				R126V	Expansion Chamber O-ring	NA
				PV066018AFM	Rt. Side Power Valve Cover	11060-1778
			Bottom End Kit w/crank seals C3359	Component Part#	Component Part#	OEM Part#
				EC190018AFM	Clutch Cover Gasket	11009-1971
				EC191018AFM	Mag Cover Gasket	11009-1973
				WP036018AFM	Water Pump Gasket	11009-1972
			Clutch & Mag Kit C3501CM	Component Part#	Component Description	OEM Part #
				EC190018AFM	Clutch Cover Gasket	11009-1971
				EC191018AFM	Mag Cover Gasket	11009-1973



MX/Dirt · Off-Road · ATV Gaskets



Cometic Gasket - An Exclusive NASCAR Performance® Product

DR-Z110

Model	Year	Bore Size	EST Top End Kit	Component Part#	Component Description	OEM Part #
DR-Z110	03-05	55 mm	C7939-EST	H1891010S	Head Gasket 55mm	K1100-41338
		57 mm	C7949-EST	H1917010S	Head Gasket 57mm	
				B0678SP2020RC	Base Gasket	K1106-01796
				IR431018AFM	Intake Gasket	K1106-01753
				R022B	Intake O-rings 2 Req.	K9205-51527
				EX781	Exhaust Gasket	K1106-11112
				R110B	Cam Chain Tensioner Bolt O-ring	KK670-D2010
				R117B	Cam Chain Tensioner O-ring	KK670-D2021
				3183V	Valve Seals	K9204-91349
				R91X2.5V	Cam Cover O-ring	K9205-51527
				R031B	Tappet Cover O-rings 2 Req.	K9205-51231
				Component Part#	Component Description	OEM Part #
				EC1102018AFM	Clutch Cover Gasket	11061-0131

DR-Z125

Model	Year	Bore Size	Top End Kit	Component Part#	Component Description	OEM Part #
DR-Z125	03-13	59 mm	C7835	H1892027S	Head Gasket	11004-S004
		61 mm	C3109	H1926027S	Head Gasket 61mm Bore	
				B0679020F	Base Gasket	11061-S035
				EC824032AFM	Cam Chain Tensioner Gasket	11061-S038
				R010B	Cam Chain Bolt O-ring	09280-06005
				R216B	Tappet Plug O-ring 2 Req.	09280-30001

SUZUKI RM125

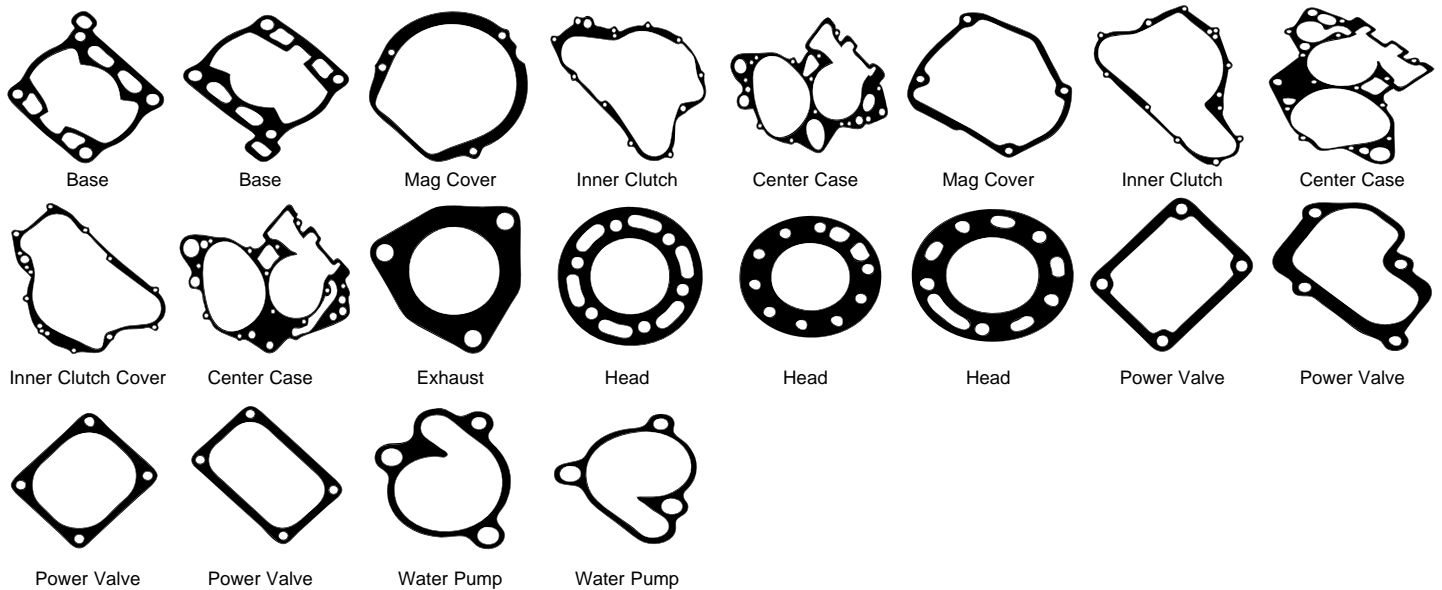

Model	Year	Bore Size	Top End Kit	Component Part#	Component Description	OEM Part #
RM125	83	56 mm	C7103	H0040043F	Head Gasket	1141-14120-H17
				B0041020F	Base Gasket	11241-14110-H17
RM125	84-85	56 mm	C7055	Component Part#	Component Description	OEM Part #
				B0042020F	Base Gasket	11241-14501-H17
				EX011042AM	Exhaust Gasket	14181-40200
				H0041043F	Head Gasket	11141-14500-H17
				IR010020F	Intake Gasket	13156-14500-H17
RM125	86	56 mm	C7056	Component Part#	Component Description	OEM Part #
				B0043020F	Base Gasket	11241-01B00-H17
				EX011042AM	Exhaust Gasket	14181-40200
				H0042043F	Head Gasket	11141-01B01-H17
				IR010020F	Intake Gasket	13156-14500-H17
				PV017020F	Power Valve Gasket	11233-01B00
				Component Part#	Component Description	OEM Part#
OS173	27X40X8 Right Crank Seal	9289-28007				
OS174	17X30X6 Left Crank Seal	9283-18006				

Crank Seal Kit
C7700



MX/Dirt • Off-Road • ATV Gaskets



Cometic Gasket - An Exclusive NASCAR Performance® Product

SUZUKI

Model	Year	Bore Size	Top End Kit	Component Part#	Component Description	OEM Part #
RM125	87-88	56 mm	C7057	B0044020F	Base Gasket	11241-01B00-H17
				H0043043F	Head Gasket	11141-01B01-H17
				IR003018AFM	Intake Gasket	14132-K56-701
				PV016018AFM	Front Power Valve Gasket	11238-01B30-H17
				PV018020F	Right Power Valve Gasket	11233-01B30
				R224V	Power Valve O-ring	09280-28005
				Crank Seal Kit C7700	Component Part#	OEM Part#
				OS173	27X40X8 Right Crank Seal	9289-28007
				OS174	17X30X6 Left Crank Seal	9283-18006
				RM125	89	56 mm
H0044043F	Head Gasket	11141-27C00				
B0045018AFM	Base Gasket	11241-27C10				
PV016018AFM	Front Power Valve Gasket	11238-01B30-H17				
PV019020F	Right Power Valve Gasket	11233-27C10				
R224V	Power Valve O-ring	09280-28005				
Crank Seal Kit C7664	Component Part#	OEM Part#				
OS132	29X40X7 Right Crank Seal	09283-30061				
OS174	17X30X6 Left Crank Seal	9283-18006				
RM125	90	O-Ring	C7120			
				R62X2V	Inner Head O-ring	11147-27C10
				R89X2B	Outer Head O-ring	11148-27C10
				B0045018AFM	Base Gasket	11241-27C10
				PV016018AFM	Front Power Valve Gasket	11238-01B30-H17
				PV019020F	Right Power Valve Gasket	11233-27C10
				R224V	Power Valve O-ring	09280-28005
				Crank Seal Kit C7664	Component Part#	OEM Part#
				OS132	29X40X7 Right Crank Seal	09283-30061
				OS174	17X30X6 Left Crank Seal	9283-18006
RM125	91	O-Ring	C7059	Component Part#	Component Part#	OEM Part#
				R62X2V	Inner Head O-ring	11147-27C10
				R89X2B	Outer Head O-ring	11148-27C10
				B0045018AFM	Base Gasket	11241-27C10
				PV020018AFM	Right Side Power Valve Gasket	11233-27C32
				PV021032AFM	Front Power Valve Gasket	11238-27C31
				Crank Seal Kit C7664	Component Part#	OEM Part#
				OS132	29X40X7 Right Crank Seal	09283-30061
				OS174	17X30X6 Left Crank Seal	9283-18006
				RM125	92	O-Ring
R62X2V	Inner Head O-ring	11147-27C10				
R89X2B	Outer Head O-ring	11148-27C10				
B0045018AFM	Base Gasket	11241-27C10				
PV020018AFM	Right Side Power Valve Gasket	11233-27C32				
PV021032AFM	Front Power Valve Gasket	11238-27C31				
Bottom End Kit C3360	Component Part#	OEM Part#				
EC207060AFM	Mag Cover Gasket	11483-43D00				
EC208032AFM	Inner Clutch Cover Gasket	11482-43D01				
EC210020F	Center Case Gasket	11481-43D00				
C7499	Outer Clutch Cover Gasket	11484-43D00				
WP041018AFM	Water Pump Gasket	17431-43D00				
Crank Seal Kit C7664	Component Part#	OEM Part#				
OS132	29X40X7 Right Crank Seal	09283-30061				
OS174	17X30X6 Left Crank Seal	9283-18006				



MX/Dirt · Off-Road · ATV Gaskets



Cometic Gasket - An Exclusive NASCAR Performance® Product

SUZUKI

Model	Year	Bore Size	Top End Kit	Component Part#	Component Description	OEM Part #		
RM125	93-97	O-Ring	Top End Kit C7136	R62X2V	Inner Head O-ring	11147-27C11		
				R89X2B	Outer Head O-ring	11148-27C11		
				B0045018AFM	Base Gasket	11241-27C10		
				B0045012F	High Comp. Base Gasket .012"			
				PV020018AFM	Right Side Power Valve Gasket	11233-27C32		
				PV021032AFM	Front Power Valve Gasket	11238-27C31		
				PV061018AFM	Front Power Valve Gasket 97-Up	11238-36E00		
			Bottom End Kit w/crank seals C3360	Component Part#	Component Part#	OEM Part#		
				EC207060AFM	Mag Cover Gasket	11483-43D00		
				EC208032AFM	Inner Clutch Cover Gasket	11482-43D00 / 43D01		
				EC210020F	Center Case Gasket	11481-43D00		
				C7499	Outer Clutch Cover Gasket	11484-43D00		
				WP041018AFM	Water Pump Gasket	17431-43D00		
Clutch & Mag Kit C7857CM	Component Part#	Component Description	OEM Part #					
	C7486	Clutch Cover Gasket	11482-27C00					
	EC653063N	Mag Cover Gasket	11481-02B41					
Crank Seal Kit C7664	Component Part#	Component Part#	OEM Part#					
	OS132	29X40X7 Right Crank Seal	09283-30061					
	OS174	17X30X6 Left Crank Seal	9283-18006					
RM125	98-00	O-Ring	Top End Kit C7136	Component Part#	Component Part#	OEM Part#		
				R62X2V	Inner Head O-ring	11147-27C11		
				R89X2B	Outer Head O-ring	11148-27C11		
				B0045018AFM	Base Gasket	11241-27C10		
				B0045012F	High Compression Base Gasket .012"			
				PV020018AFM	Right Side Power Valve Gasket	11233-27C32		
				PV021032AFM	Front Power Valve Gasket	11238-27C31		
			PV061018AFM	Front Power Valve Gasket 97-Up	11238-36E00			
			Bottom End Kit w/o crank seals C3361	Component Part#	Component Part#	OEM Part#		
				EC211018AFM	Mag Cover Gasket	11483-36E10		
				EC212032AFM	Inner Clutch Cover Gasket	11482-36E10		
				C7499	Outer Clutch Cover Gasket	11484-43D00		
				EC214020F	Center Case Gasket	11481-36E10		
WP041018AFM	Water Pump Gasket	17431-43D00						
RM125	01-03	O-Ring	Top End Kit C7778	Component Part#	Component Description	OEM Part #		
				R89X2B	Outer Head O-ring	11148-27C11		
				R63X2V	Inner Head O-ring	11147-27C11		
				B0045018AFM	Base Gasket	11241-27C10		
				PV020018AFM	Right Side Power Valve Gasket	11233-27C32		
				PV061018AFM	Front Power Valve Gasket 97-Up	11238-36E00		
				WA123	Head Crush Washer	09168-08021		
			Bottom End Kit w/Oil Seals C7778BE	Component Part#	Component Description	OEM Part #		
				EC871020F	Center Case Gasket K1-K4	11481-36F20/11481		
				WA125	Drain Plug Gasket	09168-12002		
Oil Seal Kit C7778OS Crank Seal Kit C7784	Component Part#	Component Description	OEM Part #					
	EC502032AFM	Inner Clutch Cover Gasket	11484-36E10					
	R116B	Oil Fill Plug Gasket	09280-17003					
	WP124060AFM	Water Pump Cover Gasket	17431-36F00					
	WA124	Water Pump Drain Gasket	09168-06004					
	R20X2V	Output Shaft O-rings	09280-20006					
	OS364	Impeller Seal K1-K3 12x24x10	17461-03B00					
	OS305	Shift Shaft Seal 14X22X6	09283-14006					
	OS244	Clutch Pushrod Seal 10X17X5.0	09285-10004					
	OS235	Output Shaft Seal K1-K3 28x	09283-28020					
OS215	Start Shaft Seal 15.8X24X5	09283-16004						
OS174	Left Crank Seal 18X30X6	09283-18007						
OS132	Right Crank Seal 30X40X7	09283-30061						
Clutch & Mag Kit C7778CM	Component Part#	Component Description	OEM Part #					
	EC213	Outer Clutch Cover	11482-36F00					
	EC211018AFM	Mag Cover Gasket	11483-36E11					



MX/Dirt · Off-Road · ATV Gaskets



Cometic Gasket - An Exclusive NASCAR Performance® Product

SUZUKI

Model Year Bore Size
RM125 04-07 O-Ring

Model	Year	Bore Size	Top End Kit	Component Part#	Component Description	OEM Part #				
RM125	04-07	O-Ring	C7508	R63X2V	Inner Head O-ring	11147-37F00				
				R89X2B	Outer Head O-ring	11148-37F00				
				B0705018AFM	Base Gasket	11241-36F00				
				B0705012F	High Comp. Base Gasket .012"					
				EX640	Exhaust Gasket	11483-36E10				
				PV020018AFM	Right Side Power Valve	11484-43D00				
				PV061018AFM	Front Power Valve Gasket	11482-36F00				
				WA123	Head Crush Washer	09168-08021				
				Bottom End Kit w/Oil Seals				Component Part#	Component Description	OEM Part #
				C7508BE				EC502032AFM	Inner Clutch(Primary) Cover	11482-36F00
				EC871020F	Center Case Gasket	11481-36F30				
				R116B	Fill Plug Gasket (Trans.)	09280-17003				
				R20X2V	Output Shaft O-ring	09280-20006				
				WA124	Water Pump Drain Crush Washer	09168-06004				
				WA125	Drain Plug Gasket	09168-12002				
				WP124032AFM	Water Pump Cover Gasket	17431-36F00				
Oil Seal Kit				Component Part#	Component Description	OEM Part #				
C7508OS				OS132	Right Crank Seal	09283-30061				
Crank Seal Kit				Component Part#	Component Description	OEM Part #				
C7784				OS174	Left Crank Seal	09283-18007				
				OS215	Kickstart Seal	09283-16004				
				OS216	Water Pump Oil Seal	17461-37F00				
				OS244	Clutch Pushrod Oil Seal	09285-10004				
				OS305	Shift Shaft Seal 14x22x6	09283-14006				
				OS367	Output Shaft Seal	09289-28012				
Clutch & Mag Kit				Component Part#	Component Part#	OEM Part#				
C7508CM				C7499	Clutch Cover O-ring	11484-36E10				
				EC211032AFM	Mag Cover Gasket	11483-36E11				

LT230

Model Year Bore Size
LT230 85-93 67 mm
71 mm

Model	Year	Bore Size	Top End Kit	Component Part#	Component Description	OEM Part #
LT230	85-93	67 mm	C7074	H0056SP1043F	67mm Bore Head Gasket	11141-18A00
				H0425043C	71mm Bore Head Gasket	
				B0055020F	Base Gasket	11241-18A20

LT250R

Model Year Bore Size
LT250R 85-86 72 mm

Model	Year	Bore Size	Top End Kit	Component Part#	Component Description	OEM Part #		
LT250R	85-86	72 mm	C7070	H0051043F	Head Gasket	11141-13A60		
				B0053020F	Base Gasket	11482-19A00-H17		
				IR012020F	Intake Gaskets	13156-13A00		
Bottom End Kit w/crank seals				Component Part#	Component Part#	OEM Part#		
C3363				C7719	Clutch Cover Gasket	11483-13A00		
				EC325020F	Mag Cover Gasket			
Crank Seal Kit				Component Part#	Component Part#	OEM Part#		
C7676				OS147	35X52X8 Left Crank Seal	09289-36003		
				OS148	24X38X7 Right Crank Seal	09283-25078		
LT250R	87-92	69 mm	C7071	Component Part#		Component Description	OEM Part #	
				H0268043F	Head Gasket	11141-01C01-H17		
		74 mm	C7422	Component Part#		Component Description	OEM Part #	
				H2230043F	Head Gasket 74mm Bore			
						B0047020F	Base Gasket	11241-01C10
						IR011018AFM	Intake Gasket	3008-076/13156-01C10
						IR176020F	Intake Gasket	13156-01C10
						PV022018AFM	Right Side Power Valve Gasket	11233-00B00-H17
		Bottom End Kit w/crank seals				Component Part#	Component Part#	OEM Part#
		C3364				C7720	Clutch Cover Gasket	11482-01C10
				EC323020F	Mag Cover Gasket	11483-01C10		
				WP074020F	Water Pump Gasket	17431-14303		
Crank Seal Kit				Component Part#	Component Part#	OEM Part#		
C7675				OS145	35X52X8 Left Side Crank Seal	09283-36004		
				OS146	24X38X7 Right Side Crank Seal	09283-25082		



MX/Dirt • Off-Road • ATV Gaskets



Cometic Gasket - An Exclusive NASCAR Performance® Product

SUZUKI LT250

Model	Year	Bore Size	Top End Kit	Component Part#	Component Description	OEM Part #
LT-F250	88-13	69 mm	C7260	H0364043F	Head Gasket	11141-19B00
LT-4WDX	87-96	71 mm	C7261	H0363043F	Head Gasket 71mm Bore	
King Quad 4 WD	91-00	70.5 mm	C7314	B0055020F	Base Gasket LT250F 87-97 LT-FWDX 87-99	11241-38300
				B0213020F	Base Gasket LT250S 89-90	11241-25C10
				B0214020F	Base Gasket LTF4WDX 87-99 King Quad 99-00	11241-18A20

RM250

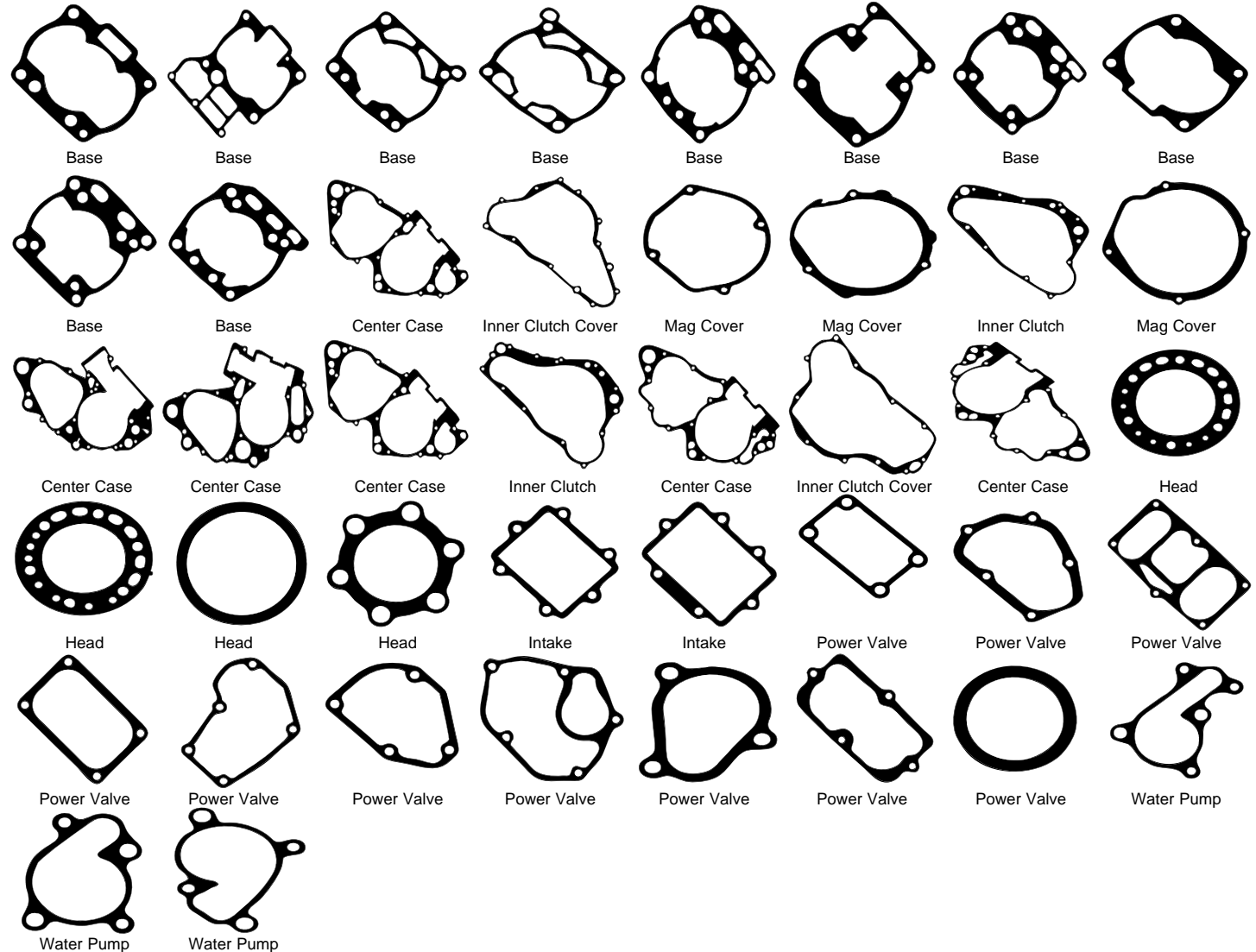

Model	Year	Bore Size	Top End Kit	Component Part#	Component Description	OEM Part #
RM250	77-80	69 mm	C7468	B0350020F	Base Gasket	11241-41100-H17
				H0738016A	Head Gasket	11141-41610
RM250	81	69 mm	Top End Kit C7814	Component Part#	Component Description	OEM Part #
				B0446020F	Base Gasket	11241-14201
				H0966043F	Head Gasket	11141-14202
RM250	83	72 mm	Top End Kit C7104	Component Part#	Component Description	OEM Part #
				B0046020F	Base Gasket	11241-14600-H17
RM250	84-85	72 mm	Top End Kit C7060	Component Part#	Component Description	OEM Part #
				B0046020F	Base Gasket	11241-14600-H17
				EX012031F	Exhaust Gasket	14181-16300
				H0045043F	Head Gasket	11141-13A60

All Component Parts can be purchased individually.



MX/Dirt • Off-Road • ATV Gaskets



Cometic Gasket - An Exclusive NASCAR Performance® Product

SUZUKI

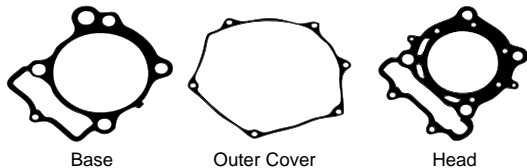

Model	Year	Bore Size	Top End Kit	Component Part#	Component Description	OEM Part #		
RM250	86	69 mm	C7061	B0047020F	Base Gasket	H241-00B20-H17		
				EX012031F	Exhaust Gasket	14181-16300		
				H0046043F	Head Gasket	11141-01C01-H17		
				PV022018AFM	Right Side Power Valve Gasket	11233-00B00-H17		
			Crank Seal Kit C7701	Component Part# OS175	Component Part# 35X52X8 Right Crank Seal	OEM Part# 09283-36003		
				OS176	19X37X6 Left Crank Seal	09283-20046		
RM250	87-88	69 mm	C7062	Component Part#	Component Description	OEM Part #		
				H0046043F	Head Gasket	11141-01C01-H17		
				74 mm	C7327	H0203043F	74mm Bore Head Gasket	
						B0048020F	Base Gasket	11241-00B20-H17
						EX012031F	Exhaust Gasket	14181-16300
						IR004018AFM	Intake Gasket	14132-430
						PV023020F	Center Power Valve Cover	11238-00B20
						PV024020F	Right Side Power Valve Gasket	11233-00B20-H17
					Crank Seal Kit C7701	Component Part# OS175	Component Part# 35X52X8 Right Crank Seal	OEM Part# 09283-36003
						OS176	19X37X6 Left Crank Seal	09283-20046
RM250	89-90	68 mm	C7063	Component Part#	Component Part#	OEM Part#		
				H0047043F	68mm Bore Head Gasket	11141-28C10		
				H0200043F	73.5mm Bore Head Gasket			
				73.5 mm	C7328	B0049020F	Base Gasket	11241-28C11
						B0049012F	High Comp. Base Gasket .012"	
						IR011018AFM	Intake Gasket	3008-076/13156-01C10
						PV025018AFM	Center Power Valve Gasket	11238-28C00
						PV026018AFM	Right Power Valve Gasket	11233-37E00
						R132V	Power Valve O-ring	09280-23002
						EC233020F	Clutch Cover Gasket	11482-28C01
						WP039018AFM	Water Pump Gasket	17431-28C00
					Crank Seal Kit C7701	Component Part# OS175	Component Part# 35X52X8 Right Crank Seal	OEM Part# 09283-20051
						OS176	19X37X6 Left Crank Seal	09283-36007
		RM250	91	O-Ring	C7065	Component Part#	Component Part#	OEM Part#
						R105X2B	Outer Head O-ring	11148-28C20
R75X2V	Inner Head O-ring					11147-28C20		
B0049020F	Base Gasket					11241-28C11		
B0049012F	High Comp. Base Gasket .012"							
IR011018AFM	Intake Gasket					3008-076/13156-01C10		
PV025018AFM	Center Power Valve Gasket					11238-28C00		
PV027018AFM	Right Side Power Valve 93-99					11233-28C01		
R132V	Power Valve O-ring					09280-23002		
C7497	Outer Clutch Cover Gasket					11484-28C10		
	Component Part#					OEM Part#		
	OS178					35X52X8 Right Crank Oil Seal	09283-36007	
	OS179	19X37X6 Left Crank Oil Seal	09283-20051					



MX/Dirt • Off-Road • ATV Gaskets



Cometic Gasket - An Exclusive NASCAR Performance® Product

SUZUKI

Model	Year	Bore Size	Top End Kit	Component Part#	Component Description	OEM Part #	
RM250	92-93	O-Ring	C7123	R105X2B	Outer Head O-ring	11148-28C20	
				R75X2V	Inner Head O-ring	11147-28C20	
				B0050018AFM	Base Gasket	11241-28C11	
				B0050012F	High Comp. Base Gasket .012"		
				IR011018AFM	Intake Gasket	3008-076/13156-01C10	
				PV025018AFM	Center Power Valve Gasket	11238-28C00	
				PV027018AFM	Right Side Power Valve 93-99	11233-28C01	
				R132V	Power Valve O-ring	09280-23002	
				Bottom End Kit w/crank seals C3365	Component Part#	Component Part#	OEM Part#
					EC231039F	Mag Cover Gasket	11483-28C01
					EC233020F	Inner Clutch Cover Gasket	11482-28C01
					EC272020F	Center Case Gasket	11481-28C00
					WP049018AFM	90-95 Water Pump Gasket	17431-28C10
	C7497	Outer Clutch Cover Gasket	11484-28C10				
	Component Part#	Component Part#	OEM Part#				
	OS178	35X52X8 Right Crank Oil Seal	09283-36007				
	OS179	19X37X6 Left Crank Oil Seal	09283-20051				
RM250	94-95	O-Ring	C7156	R105X2B	Outer Head O-ring	11148-28C20	
				R75X2V	Inner Head O-ring	11147-28C20	
				B0050018AFM	Base Gasket	11241-28C11	
				B0050012F	High Comp. Base Gasket .012"		
				IR011018AFM	Intake Gasket	3008-076/13156-01C10	
				PV025018AFM	Center Power Valve Gasket	11238-28C00	
				PV027018AFM	Right Side Power Valve 93-99	11233-28C01	
				R132V	Power Valve O-ring	09280-23002	
				Bottom End Kit w/crank seals C3366	Component Part#	Component Part#	OEM Part#
					C7497	Outer Clutch Cover Gasket	11484-28C10
					EC271060AFM	Mag Cover Gasket	11483-28E10
					EC273020F	Center Case Gasket	11481-28E10
					EC297032AFM	Inner Clutch Cover Gasket	11482-28E10
	WP049018AFM	90-95 Water Pump Gasket	17431-28C10				
	Component Part#	Component Description	OEM Part #				
	C7497	Clutch Cover Gasket	11484-28C10				
	EC271060AFM	Mag Cover Gasket	11483-28E10				
	Component Part#	Component Part#	OEM Part#				
	OS133	37X52X8 Right Crank Oil Seal	09283-38018				
	OS179	19X37X6 Left Crank Oil Seal	09283-20051				
RM250	96-98	O-Ring	C7280	R105X2B	Outer Head O-ring	11148-28C20	
				R75X2V	Inner Head O-ring	11147-28C20	
				B0237018AFM	Base Gasket	11241-37E00	
				B0237012F	Base Gasket High Comp. .012"		
				IR107018AFM	Intake Gasket	13156-37E10	
				PV050018AFM	Right Power Valve Gasket	11233-37E00	
				PV051018AFM	Center Power Valve Cover Gasket	11238-37E00	
				Bottom End Kit w/crank seals C3367	Component Part#	Component Part#	OEM Part#
					EC215020F	Center Case Gasket	11481-37E01
					EC216032AFM	Inner Clutch Cover Gasket	11482-37E01
					C7496	Outer Clutch Cover Gasket	11484-37E00
					EC218060AFM	Mag. Cover Gasket	11483-37E00
					Component Part#	Component Description	OEM Part #
	C7496	Clutch Cover Gasket	11484-37E00				
	EC218060AFM	Mag. Cover Gasket	11483-37E00				
	Component Part#	Component Part#	OEM Part#				
	OS131	24X37X6 Left Crank Oil Seal	09283-25099				
	OS133	37X52X8 Right Crank Oil Seal	09283-38021				



MX/Dirt • Off-Road • ATV Gaskets



Cometic Gasket - An Exclusive NASCAR Performance® Product

SUZUKI

Model	Year	Bore Size	Top End Kit	Component Part#	Component Description	OEM Part #
RM250	99-00	O-Ring	Top End Kit C7505	R105X2B	Outer Head O-ring	11148-28C20
				R75X2V	Inner Head O-ring	11147-28C20
				B0364018AFM	Base Gasket	11241-37E30
				B0364012F	Base Gasket High Comp. .012"	
				IR107018AFM	Intake Gasket	13156-37E10
				PV061018AFM	Center Power Valve Cover	11238-36E00
				PV079018AFM	Rt. Side Power Valve Cover	11233-37E30
				PV081018AFM	Left Side Power Valve Gasket	11234-37E30
					Component Part#	OEM Part#
			Bottom End Kit w/crank seals C3368	EC216032AFM	Inner Clutch Cover Gasket	11482-37E01
				C7496	Outer Clutch Cover Gasket	11484-37E00
				EC218060AFM	Mag Cover Gasket	11483-37E00
			Clutch & Mag Kit C7280CM	EC294020F	Center Case Gasket	11481-37E30
					Component Part#	OEM Part #
				C7496	Clutch Cover Gasket	11484-37E00
Crank Seal Kit C7665	EC218060AFM	Mag. Cover Gasket	11483-37E00			
		Component Part#	OEM Part#			
	OS131	24X37X6 Left Crank Oil Seal	09283-25099			
	OS133	37X52X8 Right Crank Oil Seal	09283-38021			
RM250	01-02	O-Ring	Top End Kit C7779	R100X2B	Outer Head O-ring	11148-37F00
				R73X2V	Inner Head O-ring	11147-37F00
				B0495018AFM	Base Gasket	11241-37F01
				B0495012F	High Comp. Base Gasket .012"	
				IR107018AFM	Intake Gasket	13156-37E10
				PV061018AFM	Center Power Valve Cover	11238-36E00
				PV079018AFM	Right Side Power Valve Cover	11233-37E30
				PV081018AFM	Left Side Power Valve Gasket	11234-37E31
					Component Part#	OEM Part#
			Bottom End Kit w/crank seals C3369	C7496	Outer Clutch Cover Gasket	11484-28C10
				EC218060AFM	Mag Cover Gasket	11483-37E00
				EC500020F	Center Case Gasket	11481-37F00
			Clutch & Mag Kit C7280CM	EC501032AFM	Inner Clutch Cover Gasket	11482-37F00
				WP122032AFM	Water Pump Gasket	17431-37F00
					Component Part#	OEM Part #
Crank Seal Kit C7665	C7496	Clutch Cover Gasket	11484-37E00			
	EC218060AFM	Mag. Cover Gasket	11483-37E00			
		Component Part#	OEM Part#			
	OS131	24X37X6 Left Crank Oil Seal	09283-25099			
	OS133	37X52X8 Right Crank Oil Seal	09283-38021			
RM250	03-04	O-Ring	Top End Kit C7467	R100X2B	Outer Head O-ring	11148-37F00
				R73X2V	Inner Head O-ring	11147-37F00
				B0632018AFM	Base Gasket	11241-37F20
				B0632012F	High Comp. Base Gasket .012"	
				PV116018AFM	Right Side Power Valve Gasket	11233-37F20
				PV117018AFM	Left Side Power Valve Gasket	11234-37F20
				PV118018AFM	Front Power Valve Gasket	11238-37F20
				PV125018AFM	Power Valve Spring Gasket	11279-37F30
				R44X3S	Expansion Chamber O-rings 2 Req.	14171-28C30
				Component Part#	OEM Part#	
			Bottom End Kit w/crank seals C3370	C7496	Outer Clutch Cover Gasket	11484-28C10
				EC218060AFM	Mag Cover Gasket	11483-37E00
				EC501032AFM	Inner Clutch Cover Gasket	11482-37F00
			Clutch & Mag Kit C7280CM	EC738020F	Center Case Gasket	11481-37F20
				WP122032AFM	Water Pump Gasket	17431-37F00
	Component Part#	OEM Part #				
Crank Seal Kit C7665	C7496	Clutch Cover Gasket	11484-37E00			
	EC218060AFM	Mag. Cover Gasket	11483-37E00			
		Component Part#	OEM Part#			
	OS131	24X37X6 Left Crank Oil Seal	09283-25099			
	OS133	37X52X8 Right Crank Oil Seal	09283-38021			



MX/Dirt · Off-Road · ATV Gaskets



Cometic Gasket - An Exclusive NASCAR Performance® Product

SUZUKI

Model	Year	Bore Size	Top End Kit	Component Part#	Component Description	OEM Part #		
RM250	05-08	O-Ring	C3099	R100X2B	Outer Head O-ring	11148-37F00		
				R73X2V	Inner Head O-ring	11147-37F00		
				B0632018AFM	Base Gasket	11241-37F20		
				B0632012F	High Comp. Base Gasket .012"			
				EX640	Exhaust Gasket	14172-28630		
				R44X3S	Exp. O-rings 2 Req.	14171-28C30		
				PV116018AFM	Right Side Power Valve Gasket	11233-37F20		
				PV117018AFM	Left Side Power Valve Gasket	11234-37F20		
				PV118018AFM	Front Power Valve Gasket	11238-37F20		
				PV125018AFM	Power Valve Spring Gasket	11279-37F30		
					Bottom End Kit w/crank seals	Component Part#	Component Description	OEM Part #
					C3371	C7496	Outer Clutch Cover Gasket	11484-28C10
						EC218060AFM	Mag Cover Gasket	11483-37E00
						EC501032AFM	Inner Clutch Cover Gasket	11482-37F00
						EC738020F	Center Case Gasket	11481-37F20
		R116B	Oil Fill Plug O-ring	09280-17003				
		R20X2V	Counter Shaft O-ring	09280-20006				
		WA124	Water Pump Drain/ Trans. Oil Check Plug Washer 2 Req.	09168-06004				
		WA125	Drain Plug Washer	09168-12002				
		WA126	Power Valve Seal Crush Washer	09168-08015				
		WP122032AFM	Water Pump Gasket	17431-37F00				
			Clutch & Mag Kit	Component Description	OEM Part #			
			C7280CM	C7496	Clutch Cover Gasket	11484-37E00		
				EC218060AFM	Mag. Cover Gasket	11483-37E00		
			Crank Seal Kit	Component Description	OEM Part #			
			C3372	OS131	24X37X7 Left Crank Seal	09283-25099		
				OS132	29X40X7 Right Crank Seal	09283-28025		

RMX250

Model	Year	Bore Size	Top End Kit	Component Part#	Component Description	OEM Part #	
RMX250	89-92	68 mm	C7257	B0049020F	Base Gasket	11241-28C11	
				H0313059F	Head Gasket	1141-05D00	
				IR011018AFM	ntake Gasket	3008-076/13156-01C10	
				PV025018AFM	Center Power Valve Gasket	11238-28C00	
				PV026018AFM	Right Power Valve Gasket	11233-37E00	
				R134V	Expansion Chamber O-ring	14171-28C01	
					Component Part#	OEM Part#	
					C7496	Clutch Cover Gasket	11484-28C10
						Component Part#	OEM Part#
						B0050018AFM	Base Gasket
		B0050012F	High Compression Base Gasket	11241-28C11			
		H0313059F	Head Gasket	1141-05D00			
		IR011018AFM	Intake Gasket	3008-076/13156-01C10			
		PV025018AFM	Center Power Valve Gasket	11238-28C00			
		PV026018AFM	Right Power Valve Gasket 93-95	11233-37E00			
		PV027018AFM	96-99 Right Power Valve Gasket	11233-28C01			
		R132V	Power Valve O-ring	09280-23002			
			Component Part#	Component Part#	OEM Part#		
			C7496	Clutch Cover Gasket	11484-28C10		

DR-Z250

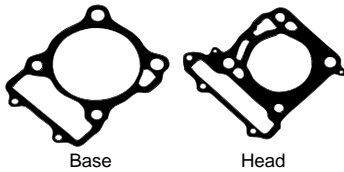

Model	Year	Bore Size	Top End Kit	Component Part#	Component Description	OEM Part #
DR-Z250	03-07	73 mm	C7968	H1694027S	Head Gasket 73mm Bore	11141-13E00
		80 mm		H1552027S	Head Gasket 80mm Bore	
				B0680020F	Base Gasket	11241-13E02



MX/Dirt • Off-Road • ATV Gaskets



Cometic Gasket - An Exclusive NASCAR Performance® Product

RM-Z250

Model	Year	Bore Size	EST	Component Part#	Component Description	OEM Part #		
RM-Z250	04-06	77 mm	Top End Kit					
			C3174-EST	H2169SP1027S	Head Gasket 77mm	K1100-40003		
			C3054-EST	H2096027S	Head Gasket 78mm Bore			
		78 mm	C3056-EST	H2169027S	Head Gasket 80mm Bore			
			C7221-EST	H1967027S	Head Gasket 81mm Bore			
		80 mm	C3135-EST	H2471SP1027S	Head Gasket 83mm Bore			
		81mm	C3118-EST	H2471027S	Head Gasket 84mm Bore			
		83 mm		B0691014RC	Base Gasket	K1106-10025		
		84 mm		3233V	Valve Seals	K9204-91349		
				R018B	Cam Chain Tensioner O-ring	KK920-55086		
				EX651	Exhaust Gasket	14181-49H00		
		Bottom End Kit w/Oil Seals				Component Part#	Component Description	OEM Part #
		C3174BE				WA108	Crank Case Drain Plug Washer	92065-058
				R118B	Crank End Cap O-Ring	670B2022		
				EC903032AFM	Inner Clutch Cover Gasket	11061-0030		
				R112B	Timing Mark Plug O-Ring	92055-1141		
				R117B	Crank Case Oil Fill O-Ring	92055-1146		
				R018B	Output Shaft O-Ring (2)	92055-055		
				MR042	Water Pump Cover O-Ring	92055-0010		
				R116B	Water Pipe O-Ring	92055-1308		
Oil Seal Kit				Component Part#	Component Description	OEM Part #		
C3174OS				OS227	Oil Pump Seal 12x22x5	92049-1519		
				OS279	Decomp. Shaft Seal 10x18x5	92049-1196		
				OS295	Crank Seal 30x40x7	92049-1556/92049-0030		
				OS305	Shift Shaft Seal 14x22x6	92049-0015		
				OS306	Clutch Actuator Shaft Seal 12x18x4	92049-1262		
				OS307	Start Shaft Seal 18x30x7	92049-013/92049-007		
				OS308	Impeller Seal 8x22x7/7.5	92049-0021/92049-0061		
				OS309	Inner WP Seal 8x22x5	92049-0016/92049-0060		
				OS359	Output Shaft Seal 25x40x6	92049-1478		
Clutch & Mag Kit				Component Part#	Component Description	OEM Part #		
C3174CM				EC847060AFM	Clutch Cover Gasket	K1106-10031		
				EC904032AFM	Mag Cover Gasket	K1106-10032		
RM-Z250	07-09	77 mm	Top End Kit					
			C3175-EST	H2617SP2027S	Head Gasket 77mm Bore	11141-10H00		
			C3176-EST	H2617027S	Head Gasket 78mm Bore			
		78 mm	C3177-EST	H2617SP1027S	Head Gasket 79mm Bore			
			C3203-EST	H2617SP7027S	Head Gasket 81mm Bore			
		79 mm	C3278-EST	H2617SP8027S	Head Gasket 83mm Bore			
		81 mm		B0884010RC	Base Gasket	11241-10H00		
		83 mm		EX651	Exhaust Gasket	14181-49H00		
				R018B	Cam Chain Tensioner Gasket	09280-19001		
				WA114	Cam Chain Tensioner Bolt	12837-27F10		
				3251V	Valve Seals	09289-04002		
		Bottom End Kit w/Oil Seals				Component Part#	Component Description	OEM Part #
		C3175BE				EC1148020F	Center Case Gasket	11481-10H00
				WA125	Drain Plug Gasket	09168-12002		
				WA124	Crank Sensor Gasket	09168-06004		
				R116B	Fill Plug O-ring	09280-17003		
				EC1150032AFM	Inner Clutch Cover Gasket	11482-10H00		
				R119B	Crank End Cap O-Ring	09280-22008		
				R10X2V	Timing Mark Plug O-Ring	09280-10016		
				R20X2V	Output Shaft O-rings	09280-20006		
				R029B	Oil Filter O-Ring	09280-39001		
Oil Seal Kit				Component Part#	Component Description	OEM Part #		
C3174OS				WA124	Clutch Drain Plug Gasket	09168-06004		
				R16X2V	Oil Screen O-ring 16x22x2	09168-16003		
				OS132	Right Crank Seal 30x40x7	09283-30061		
				OS218	Shift Shaft Seal 14x22x6	09283-14006		
				OS370	Inner WP Seal	09282-12012		
				OS216	Impeller Seal	17461-37F00		
				OS367	Output Shaft Seal	09289-28012		
				OS172	Start Shaft Seal	09283-18004		
Clutch & Mag Kit				Component Part#	Component Description	OEM Part #		
C3175CM				EC1154032AFM	Mag Cover Gasket	11483-10H00		
				EC1153032AFM	Clutch Cover Gasket	11484-10H00		



MX/Dirt · Off-Road · ATV Gaskets



Cometic Gasket - An Exclusive NASCAR Performance® Product

SUZUKI

Model	Year	Bore Size	EST Top End Kit	Component Part#	Component Description	OEM Part #	
RM-Z250	10-14	77 mm	C3406-EST	H3139027S	Head Gasket 77 mm Bore	11141-49H00	
		79 mm	C3407-EST	H3139SP1027S	Head Gasket 79 mm Bore	11141-49H00	
		80 mm	C3408-EST	H3139SP2027S	Head Gasket 80 mm Bore	11141-49H00	
		82 mm	C3409-EST	H3139SP3027S	Head Gasket 82 mm Bore	11141-49H00	
		84 mm	C3410-EST	H3139SP5027S	Head Gasket 84 mm Bore	11141-49H00	
					3251V	Valve Stem Seals 4 Required	09289-04002
					B1032010RC	Base Gasket	11241-49H00
					EX651	Exhaust Gasket	14181-49H00
					OS020	Head Drain Seal	09168-06023
					R013V	Water Temp Sensor O-ring	13655-14G00
					R019V	Cam Chain Tensioner O-ring	
					R122V	Cam Tower O-ring Seal	09280-26007
					Component Part#	Component Part#	OEM #
				Bottom End Kit w/o crank seals C3443	EC1153032AFM	Clutch Cover Gasket	11484-10H00
					EC1150032AFM	Inner Clutch Cover Gasket	11482-10H00
					EC1633032AFM	Mag Cover Gasket	11483-49H00
					EC1632020F	Center Case Gasket	
			Component Part#	Component Description	OEM Part #		
		Clutch & Mag Kit C3406CM	EC1153032AFM	Clutch Cover Gasket	11484-10H00		
			EC1633032AFM	Mag Cover Gasket	11483-49H00		

DR350



Base



Head

Model	Year	Bore Size	Top End Kit	Component Part#	Component Description	OEM Part #
DR350	90-99	80 mm	C7068	H0244043F	Head Gasket 80mm Bore	11141-14D01
		82 mm	C7157	H0049043F	Head Gasket 82mm Bore	
		88 mm	C7263	H0222043F	Head Gasket 88mm Bore	
		91 mm	C7264	H0229043F	Head Gasket 91mm Bore	
					B0052020F	Base Gasket

DR-Z400

Model	Year	Bore Size	EST Top End Kit	Component Part#	Component Description	OEM Part #	
DR-Z400	00-13	92 mm	C7688-EST	H0949027S	Head Gasket	11141-29F01	
		94 mm	C7806-EST	H1045027S	Head Gasket 94mm Bore		
		95 mm	C7963-EST	H1699027S	Head Gasket 95mm Bore		
		97 mm	C7980-EST	H1046027S	Head Gasket 97mm Bore		
					B0440010RC	Base Gasket	11241-29F00
					EX243	Exhaust Gasket 2 Req.	14181-29E02
					EC377032AFM	Cam Chain Tensioner Gasket	12837-24A10
					WA121	Cam Chain Tensioner Washer	09168-06023
					3160V	Valve Seals	09289-05011
					Component Part#	Component Description	OEM Part#
			EC837032AFM	Clutch Cover Gasket	11484-29F00		

DR-Z400SM

Model	Year	Bore Size	EST Top End Kit	Component Part#	Component Description	OEM Part #	
DRZ400 SM	05-13	92 mm	C7978-EST	H0949027S	Head Gasket 92mm Bore	11141-29F01	
		94 mm	C7979-EST	H1045027S	Head Gasket 94mm Bore		
		97 mm	C7980-EST	H1046027S	Head Gasket 97mm Bore		
					B0440027S	Base Gasket	11241-29F11
					EX243	Exhaust Gasket 2 Req.	14181-29E02
					EC377032AFM	Cam Chain Tensioner Gasket	12837-24A10
					3160V	Valve Seals 4 Req.	09289-05011
					WA121	Cam Chain Tensioner Washer	09168-06023
					Component Part#	Component Description	OEM Part #
					EC837032AFM	Clutch Cover Gasket	11484-29F00



MX/Dirt · Off-Road · ATV Gaskets



Cometic Gasket - An Exclusive NASCAR Performance® Product

LT-R450

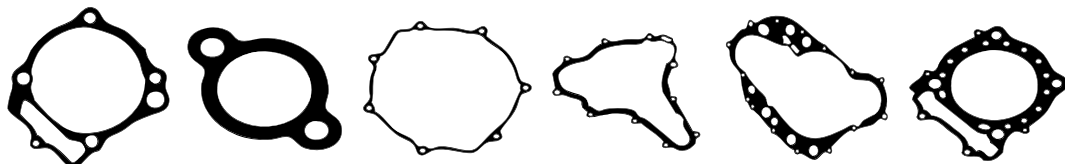

Base Timing Chain Tensioner Outer Clutch Cover Mag Cover Inner Clutch Cover Head

Model	Year	Bore Size	EST	Component Part#	Component Description	OEM Part #
LT-R450	06-09	96mm 97mm 98mm 101mm	Top End Kit			
			C3208-EST	H2499SP5027S	Head Gasket	11141-45G00
			C3150-EST	H2499027S	Head Gasket 97mm Bore	
			C3157-EST	H2499SP2027S	Head Gasket 98mm Bore	
			C3158-EST	H2499SP1027S	Head Gasket 101mm Bore	
				B0857010RC	Base Gasket	11241-45G00
			EX877	Exhaust Gasket	14181-35G00	
			EC377032AFM	Cam Chain Tensioner Gasket	12837-24A10	
			3238V	Valve Seals 4 Req.	09289-05015	
			Bottom End Kit w/o crank seals C3378	Component Part#	Component Description	OEM #
			EC1119018AFM	Clutch Cover	11484-45G00	
			EC1120032AFM	Mag Cover Gasket	11483-45G00	
			EC1121032AFM	Inner Clutch Cover Gasket	11482-45G00	
			R138SB	Oil Filter O-ring	0928-54001	
	R32X3V	Crank End O-ring	09280-33004			
	Clutch & Mag Kit C3408CM	Component Part#	Component Description	OEM Part #		
	EC1119018AFM	Clutch Cover	11484-45G00			
	EC1120032AFM	Mag Cover Gasket	11483-45G00			

RM-Z450

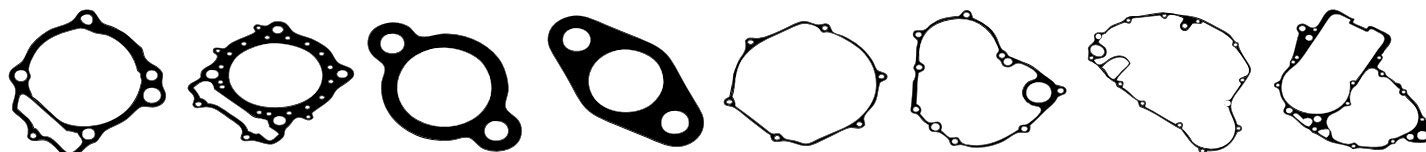

Base Head Cam Chain Tensioner Timing Chain Outer Clutch Cover Mag Cover Inner Clutch Cover Center Case

Model	Year	Bore Size	EST	Component Part#	Component Description	OEM Part #	
RM-Z450	05-07	95.5 mm 97.5 mm 98 mm	Top End Kit				
			C3102-EST	H2393030S	Head Gasket	11141-35G01	
			C3104-EST	H2393SP1030S	97.5mm Bore Head Gasket		
			C3127-EST	H2393SP3030S	98mm Bore Head Gasket		
				B0816010S	Base Gasket	11241-35G00	
				EX877	Exhaust Gasket	14172-28630	
				EC1017032AFM	Cam Chain Tensioner Gasket	12837-32410	
				EC377018AFM	Cam Chain Tensioner Gasket 07	12837-24A10	
				3160V	Valve Seals 4 Req. 05-06 Model	09289-05011	
				3238V	Valve Seals 4 Req. 2007 Model	09289-05015	
				Bottom End Kit w/Oil Seals C3102BE	Component Part#	Component Description	OEM Part #
				WA140	Water Pump Drain Washer	09168-06018	
				R10X2V	Timing Plug O-ring	09280-10016	
				R116B	Fill Plug O-ring	09280-17003	
		R020V	Output Shaft O-ring	09280-21010			
		R119B	Crank End Cap O-Ring	09280-22008			
		R029B	Oil Filter O-Ring	09280-39001			
		EC1021020RC	Center Case Gasket	11481-35G11			
		EC1020032AFM	Inner Clutch Cover Gasket	11482-35G10			
		MR043	Water Pump Cover O-Ring	17431-35G10			
		Oil Seal Kit C3102OS	Component Part#	Component Description	OEM Part #		
		OS370	Inner WP Seal	09282-12012			
		OS218	Shift Shaft Seal 14x22x6	09283-14006			
		OS249	Start Shaft Seal	09283-20031			
		OS132	Right Crank Seal	09283-30061			
		OS219	Clutch Actuator Seal	09285-10004			
		OS338	Output Shaft Seal	09289-31002			
		OS216	Impeller Seal	17461-37F00			
		OS371	Decomp. Shaft Seal 10x17x6	09282-10014			
		Clutch & Mag Kit C3102CM	Component Part#	Component Description	OEM Part #		
		EC1018032AFM	Outer Clutch Cover Gasket	11484-35G10			
		EC1019032AFM	Mag Cover Gasket	11483-35G10			



MX/Dirt · Off-Road · ATV Gaskets



Cometic Gasket - An Exclusive NASCAR Performance® Product

SUZUKI

Model	Year	Bore Size	EST Top End Kit	Component Part#	Component Description	OEM Part #		
RM-Z450	08-15	97mm	C3233-EST	H2784027S	97mm Bore Head Gasket	11141-28H00		
			C3234-EST	H2784SP1027S	99mm Bore Head Gasket			
			C3235-EST	H2784SP2027S	101mm Bore Head Gasket			
					B0943018S	Base Gasket	11241-28H00	
					EX877	Exhaust Gasket	14181-35G00	
					EC440032AFM	Cam Chain Tensioner Gasket	12837-24A10	
					3238V	Valve Seals 4 Req.	09289-05015	
		Bottom End Kit				Component Part#	Component Description	OEM Part #
		w/Oil Seals						
		C3233BE				R116B	Fill Plug O-Ring	09280-17003
				R22X2V	Sprocket Spacer O-ring 1.9, ID:21.8	09280-21010		
				R22X2V	Crank End Plug O-ring	09280-22008		
				WA116	Drain Plug Gasket	09168-08016		
				R029B	Oil Filter Cover O-ring D:2.0, ID:38.5	09280-39001		
				R16X2V	Oil Screen O-ring 16x22x2	09168-16003		
				WP470	Water Pump Cover O-Ring	17431-28H00		
				R122V	Neutral Safety Switch O-ring	09280-26005		
				R9X2V	Oil Pump Dowel O-ring	09280-09005		
				R007V	Oil Pump Nozzle O-ring 4x1.2	09280-05007		
				EC1250020RC	Center Case Gasket	11481-28H00		
				EC1251032AFM	Inner Clutch Cover Gasket	11482-28H00		
Oil Seal Kit				Component Part#	Component Description	OEM Part #		
C3233OS				OS132	Right Crank Seal 30x40x7	09283-30061		
				OS216	Water Pump Oil seal	17461-37F00		
				OS338	Output Shaft Oil Seal 31x4	09289-31003		
				OS249	Start Shaft Oil Seal 20x27x5	09283-20031		
				OS305	Shift Shaft Seal 14x22x6	09283-14006		
				OS370	Water Pump Seal	09282-12012		
				OS372	Left Crank Seal 32x47x6	09283-32037		
Clutch & Mag Kit				Component Part#	Component Description	OEM Part #		
C3233CM				EC1249032AFM	Clutch Cover Gasket	11484-28H00		
				EC1252032AFM	Mag Cover Gasket	11483-28H00		

LT500

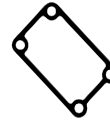
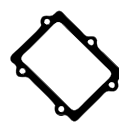
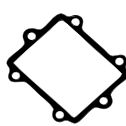
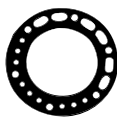
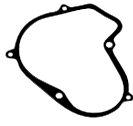
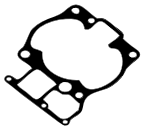

Base

Left Engine Cover

Head

Intake

Intake

Power Valve

Model	Year	Bore Size	Top End Kit	Component Part#	Component Description	OEM Part #		
LT500 H	87	88 mm	C7072	H0052043F	88mm Bore Head Gasket	11141-43B01		
			C7273	H0315043F	89.5mm Bore Head Gasket			
			C7125	H0054043F	91mm Bore Head Gasket			
					B0054020F	Base Gasket	11241-43B00	
					IR176020F	Intake Gasket 87 Model Only		
					PV022018AFM	Right Side Power Valve Cover	11233-00B00-H17	
		Bottom End Kit				Component Part#	Component Part#	OEM #
		w/crank seals						
		C3380				C7718	Clutch Cover Gasket	11482-43B00
						EC321020F	Mag Cover Gasket	11483-43B00
Crank Seal Kit				Component Part#	Component Part#	OEM #		
C7677				OS131	24X37X6 Left Crank Oil Seal	09283-25099		
				OS133	37X52X8 Right Crank Oil Seal	09283-38021		
LT500	88-90	88 mm	C7073	H0053043F	88mm Bore Head Gasket	11111-43B10		
			C7274	H0316043F	89.5mm Bore Head Gasket			
			C7122	H0055043F	91mm Bore Head Gasket			
					B0054020F	Base Gasket	11241-43B10	
					IR011018AFM	Intake Gasket	3008-076/13156-01C10	
					PV022018AFM	Right Side Power Valve Cover	11233-00B00-H17	
		Bottom End Kit				Component Part#	Component Part#	OEM #
		w/crank seals						
		C3380				C7718	Clutch Cover Gasket	11482-43B00
						EC321020F	Mag Cover Gasket	11483-43B00
Crank Seal Kit				Component Part#	Component Part#	OEM Part#		
C7675				OS145	35X52X8 Left Side Crank Seal	09283-36004		
				OS146	24X38X7 Right Side Crank Seal	09283-25082		

All Component Parts can be purchased individually.



MX/Dirt · Off-Road · ATV Gaskets



Cometic Gasket - An Exclusive NASCAR Performance® Product

DR650

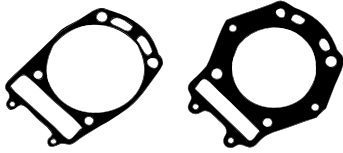

Model	Year	Bore Size	Top End Kit
DR650	95-10	103 mm	C7335

Component Part#	Component Description	OEM Part #
H0460043F	Head Gasket	11141-12D00
B0273020F	Base Gasket	11241-32E00

LTZ-A700



Model	Year	Bore Size	Top End Kit
LTZ-A700 KingQuad	05-07	106mm	C3128-EST

Component Part#	Component Description	OEM Part #
H2424027S	Head Gasket	11141-31G00
B0821010RC	Base Gasket	11241-31G00
EC1044018AFM	Cam Chain Tensioner Gasket	12837-19B10
3238V	Valve Seals 4 Req.	09289-05015
R12.5X2.5V	Thermostat O-ring/Water Line O-ring 2 Req.	09168-12017
R7X2V	Cam Chain Tensioner O-ring	09168-26001

YAMAHA

Model	Year	Bore Size	Top End Kit
PW50	81-05	42 mm	C7266
YSR50	87-92	46 mm	C7075
PW80	83-01	50 mm	C7251

Component Part#	Component Description	OEM Part #
H0309010C	Head Gasket	517-11181-01-00
B0185018AFM	Base Gasket	3PT-11351-00
H0057010C	Head Gasket	5G6-11181-00-00
B0057018AFM	Base Gasket	3T2-11351-00-00
H0310010C	Head Gasket	1W7-11181-00-00
B0186018AFM	BaseGasket	4AW-11351-00

YFM80 RAPTOR



Model	Year	Bore Size	Top End Kit
YFM80 RAPTOR	ALL	48mm	C3457

Component Part#	Component Description	OEM Part #
H1905043F	48mm Head Gasket	55X-11181-00-00
B0721020F	Base Gasket	22F-11351-01-00
EX781	Exhaust Gasket	3DM-14613-00-00

YZ80

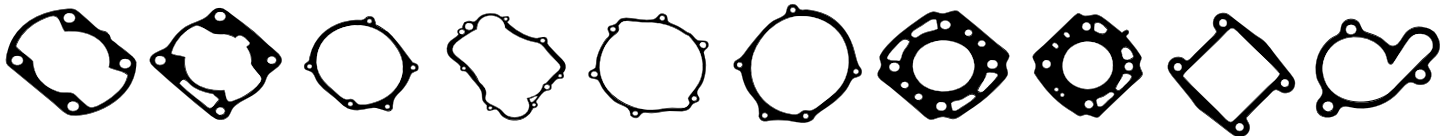

Model	Year	Bore Size	Top End Kit
YZ80	83	49 mm	C7105

Component Part#	Component Description	OEM Part #
H0058043F	Head Gasket	58T-11181-01-00
B0058020F	Base Gasket	4VD-11351-00-00
OS116	Right Crank Seal 27X40X8	93103-28011
OS115	Left Crank Seal 19X40X8	93102-20447



MX/Dirt · Off-Road · ATV Gaskets



Cometic Gasket - An Exclusive NASCAR Performance® Product

YAMAHA

Model	Year	Bore Size	Top End Kit	Component Part#	Component Description	OEM Part #
YZ80	84	50 mm	Top End Kit C7106	H0059043F B0058020F	Head Gasket Base Gasket	58T-11181-01-00 4VD-11351-00-00
			Crank Seal Kit C7666	Component Part# OS116 OS115	Component Description Right Crank Seal 27X40X8 Left Crank Seal 19X40X8	OEM Part # 93103-28011 93102-20447
YZ80 N	85	50 mm	Top End Kit C7076	Component Part# H0059043F B0058020F IR014018AFM	Component Description Head Gasket Base Gasket Intake Gasket	OEM Part # 58T-11181-01-00 4VD-11351-00-00 1LR-13621-00-00
			Crank Seal Kit C7666	Component Part# OS116 OS115	Component Description Right Crank Seal 27X40X8 Left Crank Seal 19X40X8	OEM Part # 93103-28011 93102-20447
YZ80 KR, Z,HF,V, W,B	86-92	50 mm	Top End Kit C7080	Component Part# H0060043F B0058020F IR014018AFM R127V	Component Description Head Gasket Base Gasket Intake Gasket Exhaust O-ring	OEM Part # 1LR-11181-01-00 4VD-11351-00-00 1LR-13621 93210-40745-00
			Crank Seal Kit C7666	Component Part# OS116 OS115	Component Description Right Crank Seal 27X40X8 Left Crank Seal 19X40X8	OEM Part # 93103-28011 93102-20447
YZ80	93-01	O-Ring 54 mm Big Bore	Top End Kit C7137 C7331	Component Part# R85X2V R55X2V H0303043F B0120018AFM B0120012F R127V	Component Description Outer Head O-ring Inner Head O-ring 54mm Big Bore Head Gasket Base Gasket High Comp. Base Gasket .012" Exhaust O-ring	OEM Part # 93210-84724-00 93210-56459-00 4ES-11351-00-00 5PA-14642-00-00
			Bottom End Kit w/Oil Seals C7137BE	Component Part# WP054018AFM WA118 WA116 R116B	Component Description Water Pump Gasket Water Pump Drain Plug Case Drain Crush Washer Fill Plug O-ring	OEM Part # 4BA-12428-00-00 90430-06166-00 90430-08119-00 93210-19123-00
			Oil Seal Kit C7137OS	Component Part# OS354	Component Description Shift Shaft Seal 11.5X21X4	OEM Part # 93101-12173-00
			Crank Seal Kit C7666	OS286	Clutch Pushrod Oil seal 12x18x5	93102-12224-00
				OS232	Start Shaft Seal 17x25x4	93102-17263-00
				OS225	Output Shaft Seal 20X30X5	93102-20143-00
				OS173	Left Crank Seal 27x40x8	93102-20447-00
				OS115	Right Crank Seal 19Xx40x8	93103-28126-00
				OS226	Water Pump Oil Seal 10x31x13.5	93103-10147-00 /93103-10168-00
			Clutch & Mag Kit C7137CM	Component Part# C7500 EC219060AFM	Component Description Clutch Cover Mag Cover	OEM Part # 4ES-15461-00-00 4ES-15451-00-00



MX/Dirt • Off-Road • ATV Gaskets



Cometic Gasket - An Exclusive NASCAR Performance® Product

YAMAHA

Model	Year	Bore Size	Top End Kit	Component Part#	Component Description	OEM Part #
YZ85	02-16	O-Ring	C7851	R85X2V	Outer Head O-ring	93210-84724-00
				R57X2V	Inner Head O-ring	93210-56459-00
				B0120018AFM	Base Gasket	4ES-11351-00-00
				B0120012F	High Comp. Base Gasket .012"	
				R127V	Exhaust O-ring 2 Req.	5PA-14642-00-00
Bottom End Kit w/Oil Seals C7851BE				Component Part#	Component Description	OEM Part #
				WP054020F	Water Pump Gasket	4BA-12428-00-00
				EC220020F	Inner Clutch Cover	4ES-15461-00-00
				WA116	Drain Plug Gasket	90430-08119-00
				R117B	Fill Plug O-ring	93210-19123-00
Oil Seal Kit C7851OS				Component Part#	Component Description	OEM Part #
				OS354	Shift Shaft Seal 11.5X21X4	93101-12173-00
Crank Seal Kit C7666				Component Part#	Component Description	OEM Part #
				OS286	Clutch Pushrod Oil seal 12x18x5	93102-12224-00
				OS227	Water Pump Seal 12x22x5	93102-12321-00
				OS232	Start Shaft Seal 17x25x4	93102-17263-00
				OS173	Left Crank Seal 27x40x8	93102-20447-00
				OS358	Output Shaft Seal 26X38X5	93102-26042-00
				OS115	Right Crank Seal 19Xx40x8	93102-28009-00
				OS283	Impeller Seal 11x25x7	93109-11073-00
Clutch & Mag Kit C7851CM				Component Part#	Component Description	OEM Part #
				EC640060AFM	Mag Cover Gasket	5PA-15451-00-00
				EC632018AFM	Outer Clutch Cover Gasket	93210-12152-00

TTR90



Model	Year	Bore Size	Top End Kit	Component Part#	Component Description	OEM Part #
TT-R90	00-08	48mm	C3249-EST	H2813SP1043F	Head Gasket	4GL-11181-00-00
				B0956010RC	Base Gasket	5HN-11351-00-00
				EC1286018AFM	Cam Chain Tensioner	90430-06014-00
				3179V	Valve Seals 2 Req.	1WG-12119-00-00
				R013V	Valve Guide O-ring 2 Req.	93210-09418-00
				R133B	Valve Cover O-rings 2 Req.	93210-44704-00
				WA114	Cam Chain Washer 2 Req.	90430-06014-00
				R62X2V	Cam Gear Cover	93210-63556-00

YZ125

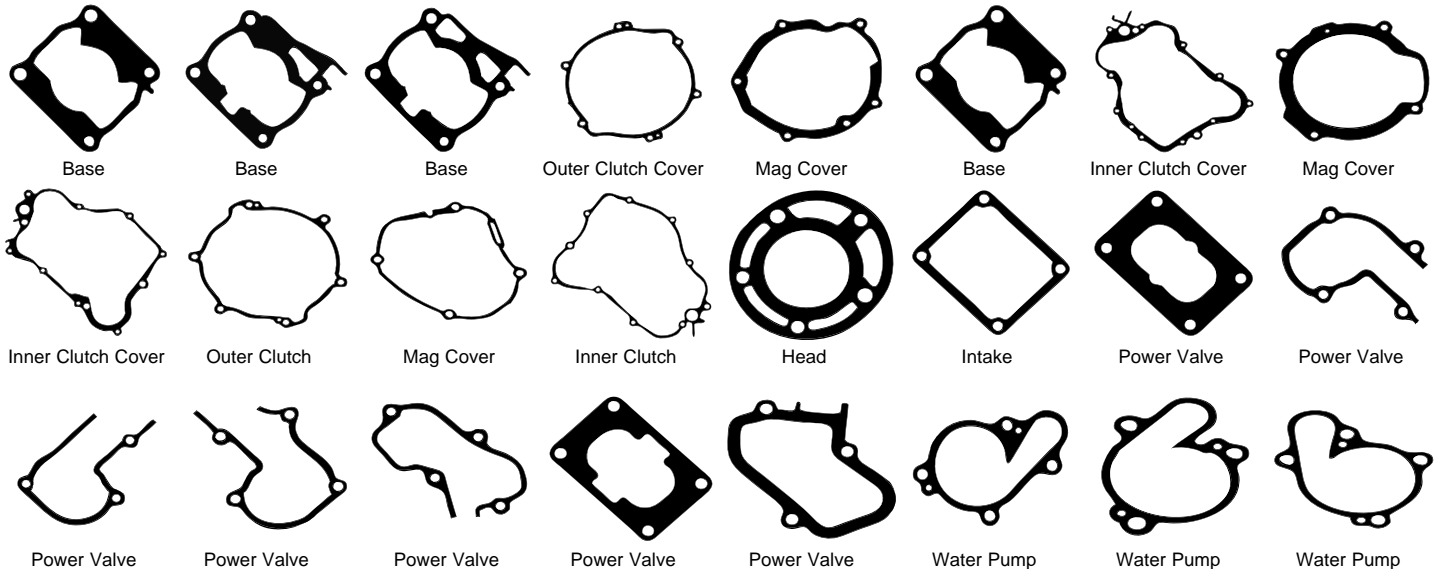



MX/Dirt • Off-Road • ATV Gaskets



Cometic Gasket - An Exclusive NASCAR Performance® Product

YZ125

Model	Year	Bore Size	Top End Kit	Component Part#	Component Description	OEM Part #
YZ125	83-84	58 mm	C7107	H0061043F B0059020F	Head Gasket Base Gasket	55Y-11181-01-00 24X-11351-00-00
YZ125 N	85	58 mm	C7081	H0061043F B0059020F IR015020F PV029020F PV030020F	Head Gasket Base Gasket Intake Gasket Right Side Power Valve Cover Left Side Power Valve Gasket	55Y-11181-01-00 24X-11351-00-00 39W-13621-01-00 5X4-1131N-00-00 5X4-11993-00-00
YZ125 S, T, J	86-88	O-Ring	C7082	R105X2B R63X2V B0060020F PV035020F PV029020F IR016020F	Outer Head O-ring Inner Head O-ring Base Gasket Right Side Power Valve Gasket Left Side Power Valve Cover Intake Gasket	93211-07720-00 93210-65721-00 1LX-11351-00-00 2VM-11993-00-00 5X4-1131N-00-00 3XP-13621-00-00
			C7668	OS118 OS123	Left Crank Seal 21X40X7 Right Crank Seal 30X44X8	93102-22363-00 93103-32171-00
YZ125 W	89	O-Ring	C7083	R105X2B R63X2V B0060020F IR017020F PV035020F PV029020F	Outer Head O-ring Inner Head O-ring Base Gasket Intake Gasket Right Side Power Valve Gasket Left Side Power Valve Cover	93211-07720-00 93210-65721-00 1LX-11351-00-00 80L-13621-01-00 2VM-11993-00-00 5X4-1131N-00-00
			C7668	OS118 OS123	Left Crank Seal 21X40X7 Right Crank Seal 30X44X8	93102-22363-00 93103-32171-00
				C7481	Clutch Cover	3JD-15463-10-00
YZ125	90-91	O-Ring	C7084	R105X2B R63X2V B0060020F IR017020F PV035020F PV029020F	Outer Head O-ring Inner Head O-ring Base Gasket Intake Gasket Right Side Power Valve Gasket Left Side Power Valve Cover	93211-07720-00 93210-65721-00 1LX-11351-00-00 80L-13621-01-00 2VM-11993-00-00 5X4-1131N-00-00
			C7668	OS118 OS123	Left Crank Seal 21X40X7 Right Crank Seal 30X44X8	93102-22363-00 93103-32171-00
				C7481	Clutch Cover	3JD-15463-10-00
YZ125	92-93	O-Ring	C7139	R105X2B R63X2V B0060020F R221V IR017020F PV033020F PV032020F	Outer Head O-ring Inner Head O-ring Base Gasket Exhaust O-ring Intake Gasket Right Side Power Valve Gasket Left Side Power Valve Gasket	93211-07720-00 93210-65721-00 1LX-11351-00-00 93210-45742-00 80L-13621-01-00 4DB-11993-01-00 4DB-1131N-00-00
			C3294	EC284020F EC283020F C7481 WP060020F	Inner Clutch Gasket Mag Cover Gasket Clutch Cover Water Pump Gasket	1LX-15462-10 4DB-15451-00 3JD-15463-10 1LX-12428-01
			C7668	OS118 OS123	Left Crank Seal 21X40X7 Right Crank Seal 30X44X8	93102-22363-00 93103-32171



MX/Dirt • Off-Road • ATV Gaskets



Cometic Gasket - An Exclusive NASCAR Performance® Product

YAMAHA

Model	Year	Bore Size	Top End Kit	Component Part#	Component Description	OEM Part #	
YZ125	94-97	O-Ring	C7158	R90X2B	Outer Head O-ring	93210-90785-00	
				R63X2V	Inner Head O-ring	93210-63442-00	
				B0153018AFM	Base Gasket	4JY-11351-00	
				B0153012F	Base Gasket High Comp. 012"	4JY-11351-00	
				R223V	Exhaust O-ring 2 Req.	93210-42728-00	
				PV059018AFM	Front Power Valve Gasket	4JY-11354-00	
				PV041018AFM	Right Power Valve Gasket	4JY-11993-00-00	
				Bottom End Kit w/crank seals C3295	Component Part#	Component Description	OEM Part #
				EC268032AFM	Inner Clutch Cover Gasket	4JY-15462-00	
				EC224018AFM	Mag Cover Gasket	4JY-15451-00	
				C7489	Clutch Cover	4JY-15463-00	
				WP043018AFM	Water Pump Gasket	4JY-12428-00	
				Clutch & Mag Kit C7158CM	Component Part#	Component Description	OEM Part #
				C7500	Clutch Cover Gasket	4ES-15461-00	
				EC219060AFM	Mag Cover Gasket	4ES-15451-00	
Crank Seal Kit C7705	Component Part#	Component Description	OEM Part #				
OS118	Left Crank Seal 21X40X7	93102-22363-00					
OS123	Right Crank Seal 30X44X8	93103-32171-00					
YZ125	98-00	O-Ring	C7399	Component Part#	Component Description	OEM Part #	
				R90X2B	Outer Head O-ring	93210-90785-00	
				R63X2V	Inner Head O-ring	93210-63442-00	
				B0318018AFM	Base Gasket	5DH-11351-01-00	
				B0318012F	High Compression Base Gasket	5DH-11351-01-00	
				PV059018AFM	Front Power Valve Cover Gasket	4JY-11354-00	
				PV041018AFM	Right Side Power Valve Gasket	4JY-11993-00	
				R224V	Exhaust O-rings 98-00 2 Req	93210-45742-00	
				R223V	Exhaust O-rings 2001 2 Req.	5MV-14642-00-00	
				Bottom End Kit w/Oil Seals C7399BE	Component Part#	Component Description	OEM Part #
				EC268032AFM	Inner Clutch Gasket	4JY-15462-00	
				WP043018AFM	Water Pump Gasket	4JY-12428-00	
				R018V	Case Dowel Pin O-ring	93210-16314-00	
				WA114	Drain Plug Gasket	90430-12207-00	
				R19X2V	Fill Plug O-ring	93210-19123-00	
Oil Seal Kit C7399OS	Component Part#	Component Description	OEM Part #				
OS117	Right Side Crank Seal	93103-32183-00					
Crank Seal Kit C7667	Component Part#	Component Description	OEM Part #				
OS118	Left Side Crank Seal	93102-22363-00					
OS227	Inner Water Pump Oil Seal 12x22x5	93102-12321-00					
OS228	Shift Shaft Seal 12x19x5	93109-12012-00					
OS231	Power Valve Shaft Oil Seal 8x12x3	93104-08040-00					
OS232	Starter Shaft Seal 17x25x4	93102-17263-00					
OS242	Water Pump Oil Seal 12x25x7	93109-11073-00					
OS286	Clutch Pushrod Oil Seal 12x18x5	93102-12224-00					
OS358	Output Shaft Seal 28x38x5	93102-26042-00					
Clutch & Mag Kit C7158CM	Component Part#	Component Description	OEM Part #				
C7500	Clutch Cover Gasket	4ES-15461-00					
EC219060AFM	Mag Cover Gasket	4ES-15451-00					



MX/Dirt • Off-Road • ATV Gaskets



Cometic Gasket - An Exclusive NASCAR Performance® Product

YAMAHA

Model	Year	Bore Size	Top End Kit	Component Part#	Component Description	OEM Part #			
YZ125	01-02	O-Ring	C7853	R90X2B	Outer Head O-ring	93210-90785-00			
				R63X2V	Inner Head O-ring	93210-63442-00			
				B0318018AFM	Base Gasket	5DH-11351-01-00			
				B0318012F	High Compression Base Gasket	5DH-11351-01-00			
				PV059018AFM	Front Power Valve Cover Gasket	4JY-11354-00			
				PV041018AFM	Right Side Power Valve Gasket	4JY-11993-00			
				R223V	Exhaust O-rings 2001 2 Req.	5MV-14642-00-00			
YZ125	03-04	O-Ring	C7936	R90X2B	Outer Head O-ring	93210-90785-00			
				R63X2V	Inner Head O-ring	93210-63442-00			
				B0318032AFM	Base Gasket	5DH-11351-01-00			
				B0318012F	High Compression Base Gasket	5DH-11351-01-00			
				PV114018AFM	Front Power Valve Gasket	4JY-11993-00			
				PV041018AFM	Right Side Power Valve Gasket	4JY-11993-00			
				R223V	Exhaust O-rings 2001 2 Req.	5MV-14642-00-00			
YZ125	01-04	O-Ring	Bottom End Kit w/Oil Seals C7853BE	R018V	Case O-ring	93210-16314-00			
				WA114	Drain Plug Gasket	90430-12207-00			
				EC268020F	Inner Clutch Cover Gasket	4JY-15462-00-00			
				R19X2V	Trans Fill Plug O-ring	93210-19123-00			
				WA114	Clutch Drain Plug Gasket	90430-06014-00			
				WP043018AFM	Water Pump Cover Gasket	4JY-12428-10-00			
				Oil Seal Kit C7853OS	OS110	Left Crank Seal	93102-20485-00		
					OS182	Right Crank Seal	93102-30008-00		
					OS227	Water Pump Shaft Seal	93102-12321-00		
					OS228	Shift Shaft Seal	93109-12012-00		
			OS231		PV Governor Oil Seal	93104-08040-00			
			OS232		Kickstart Shaft Seal	93102-17263-00			
			OS283		Impeller Seal	93109-11073-00			
			Clutch & Mag Kit C7158CM	OS286	Clutch Pushrod Seal	93102-12224-00			
				OS358	Output Shaft Seal	93102-26042-00			
				Component Part#	Component Description	OEM Part #			
			C7500				Clutch Cover Gasket	4ES-15461-00	
			EC219060AFM	Mag Cover Gasket	4ES-15451-00				
			YZ125	05-14	O-Ring	Top End Kit C3105	R90X2B	Outer Head O-ring	93210-90785-00
							R63X2V	Inner Head O-ring	93210-63442-00
B0749032AFM	Base Gasket	1C3-11351-00-00							
B0749018AFM	Base Gasket	1C3-11351-00-00							
R223V	Exhaust O-rings 2001 2 Req.	5MV-14642-00-00							
PV131018AFM	Right Side Power Valve Cover	1C3-11993-00-00							
PV114018AFM	Front Power Valve Gasket	4JY-11354-10-00							
WA136	Head Crush Washers 5 Req.	90201-080L8-00							
Bottom End Kit C3298	Component Part#	Component Description					OEM Part #		
	EC927032AFM	Clutch Cover Gasket					1C3-15463-00		
	EC1006018AFM	Inner Clutch Gasket				1C3-15462-00-00			
	EC1005018AFM	Mag Cover Gasket				1C3-15451-00			
	R19X2V	Clutch Fill Plug O-ring				93210-19123-00			
	WA114	Drain Plug Seal				90430-12207-00			
	WP177032AFM	Water Pump Gasket				1C3-12428-00-00			
Clutch & Mag Kit C3105CM	Component Part#	Component Description				OEM Part #			
	EC927032AFM	Clutch Cover Gasket				1C3-15463-00			
	EC1005018AFM	Mag Cover Gasket				1C3-15451-00			



MX/Dirt • Off-Road • ATV Gaskets



Cometic Gasket - An Exclusive NASCAR Performance® Product

TTR125

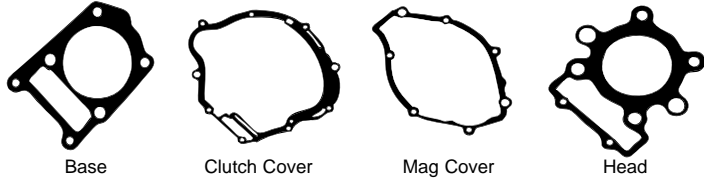

Model	Year	Bore Size	Top End Kit	Component Part#	Component Description	OEM Part #	
TTR125	99-05	55 mm	C7755	H1014010S	Head Gasket	5AP-11181-00	
				H1014SP1010S	Head Gasket 58mm Bore	5AP-11181-00	
		58 mm	C7815	B0478020F	Base Gasket	5HP-11351-00	
				R70X2S	Base O-ring	93210-57897-00	
				C3299	R140V	Cam Cover O-ring	93210-71462-00
					Component Part#	Component Description	OEM Part #
					EC471020F	Mag Cover Gasket	5HP-15451-00
					EC470020F	Clutch Cover Gasket	5HP-15461-00
					R132V	Tappet Cover O-ring 2 Req	93210-44704-00
		YT125	80-83	58 mm	Top End Kit C7127	Component Part#	Component Description
				H0068043F	Head Gasket	3X3-11181-01-00	
				B0069020F	Base Gasket	18G-11351-01-00	
YT175	82-84	68 mm	Top End Kit C7128	Component Part#	Component Description	OEM Part #	
				H0069043F	Head Gasket	5V7-11181-00-00	
				B0069020F	Base Gasket	18G-11351-01-00	

YFS200

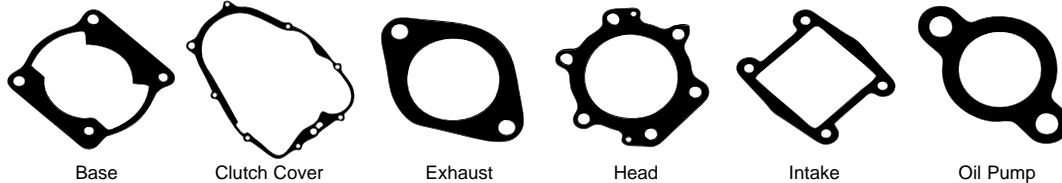

Model	Year	Bore Size	EST	Component Part#	Component Description	OEM Part #		
YFS200 Blaster	88-06	68 mm	C7093-EST	H2532SP1030S	Head Gasket 68mm Steel	2XJ-11181-00-00		
				H2532030S	Head Gasket 72.5mm Steel	2XJ-11181-00-00		
		72.5 mm	C7332-EST	H0064032C	Head Gasket 68mm Copper	2XJ-11181-00-00		
				H0386032C	Head Gasket 72.5mm Copper	2XJ-11181-00-00		
				C7093BE	B0065018AFM	Base Gasket	3JM-11351-01-00	
					Component Part#	Component Description	OEM Part #	
					IR014018AFM	Intake Gasket	1LR-13621	
					EX350064AM	Exhaust Gasket	3PA-14613-10-00	
		YFS200 Blaster	88-05		C7093OS	OP032018AFM	Oil Pump Cover Gasket	126-13116-01-00
						EC316032AFM	Clutch Cover Gasket	3JM-15451-11-00/2XJ-15411-00-00
					R19X2V	Oil Fill Plug O-ring 19X2.4	93210-19123-00	
					WA120	Drain Plug Gasket	90201-12172-00	
					Component Part#	Component Description	OEM Part #	
					OS112	Right Crank Seal 32X44X9	93103-32099-00	
					OS124	Left Crank Seal 25X44X8	93102-25331-00	
					OS225	Output Shaft Seal 20X30X5	93102-20143-00	
					OS262	Oil Pump Seal 10X21X5	93101-10001-00	
					OS354	Shift Shaft Seal 12X21X4	93101-12173-00	
			OS355	Clutch Actuator Seal 14X25X5	93104-14004-00			
			OS356	Start Shaft Seal 20X38X5	93109-20014-00			
YTM200	83-85	71 mm	Top End Kit C7129	Component Part#	Component Description	OEM Part #		
				H0066043F	Head Gasket	1NU-11181-00-00		
				B0067020F	Base Gasket	4BD-11351-00-00		
YFM200	85-89	71 mm	Top End Kit C7095	Component Part#	Component Description	OEM Part #		
				H0066043F	Head Gasket	1NU-11181-00-00		
				B0067020F	Base Gasket	4BD-11351-00-00		
DT/WR200	90-92	68 mm	C7142	H0178043F	Head Gasket	4TP-11181-00-00		
				H0450043F	Head Gasket 72mm			
		72 mm	C7330	B0135020F	Base Gasket	4TP-11351-00-00		
YFM225	86-88	71 mm	Top End Kit C7253	Component Part#	Component Description	OEM Part #		
				H0066043F	Head Gasket	59V-11181-00-00		
				B0067020F	Base Gasket	4BD-11351-00-00		



MX/Dirt • Off-Road • ATV Gaskets



Cometic Gasket - An Exclusive NASCAR Performance® Product

YZ250

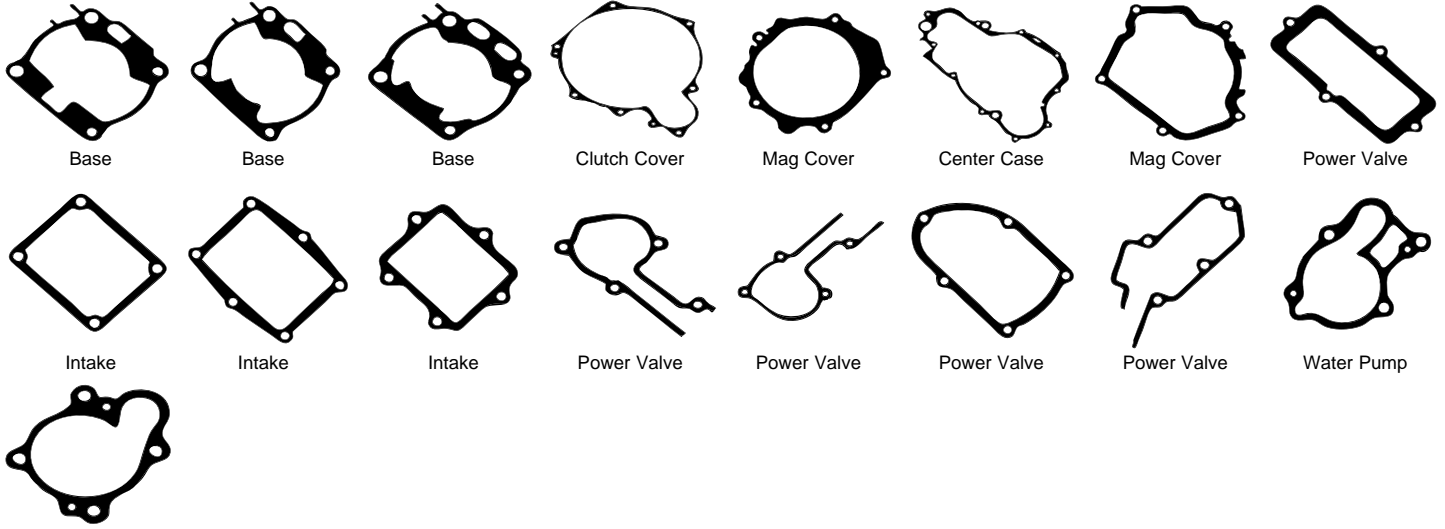

Model	Year	Bore Size	Top End Kit	Component Part#	Component Description	OEM Part #
YZ250	86-87	O-Ring	C7086	R115X2B	Outer Head O-ring	93211-17405-00
				R76X2V	Inner Head O-ring	93210-77363-00
				B0061020F	Base Gasket	1LU-11351-00-00
				IR018018AFM	Intake Gasket	2K7-13621-00-00
				PV034020F	Right Side Power Valve Gasket	1LU-11993-00-00
				PV029020F	Left Side Power Valve Gasket	5X4-1131N-00-00
YZ250	88	O-Ring	C7087	R110X2B	Outer Head O-ring	93211-11770-00
				R76X2V	Inner Head O-ring	93210-77363-00
				B0061020F	Base Gasket	1LU-11351-00-00
				IR018018AFM	Intake Gasket	2K7-13621-00-00
				PV037020F	Right Side Power Valve	2VM-11993-00-00
				PV029020F	Left Side Power Valve Gasket	5X4-1131N-00-00
				R228V	Exhaust O-ring	93210-56743-00
			Crank Seal Kit C7669	OS118	Left Crank Seal 21X40X7	93102-22363-00
				OS119	Right Crank Seal 34X55X10	93103-40091-00
YZ250	89-90	O-Ring	C7088	R110X2B	Outer Head O-ring	93211-11770-00
				R76X2V	Inner Head O-ring	93210-77363-00
				B0062018AFM	Base Gasket	2VM-11351-10
				B0062012F	Base Gasket	2VM-11351-10
				PV037020F	Right Side Power Valve	2VM-11993-00-00
				PV036018AFM	Left Side Power Valve	3JE-1131N-10-00
				IR017020F	Intake Gasket	8CH/8DF-13621-00
				R228V	Exhaust O-ring	93210-56743-00
			Crank Seal Kit C7669	OS118	Left Crank Seal 21X40X7	93102-22363-00
				C7488	Clutch Cover	3SP-15463-11-00



MX/Dirt • Off-Road • ATV Gaskets



Cometic Gasket - An Exclusive NASCAR Performance® Product

YAMAHA

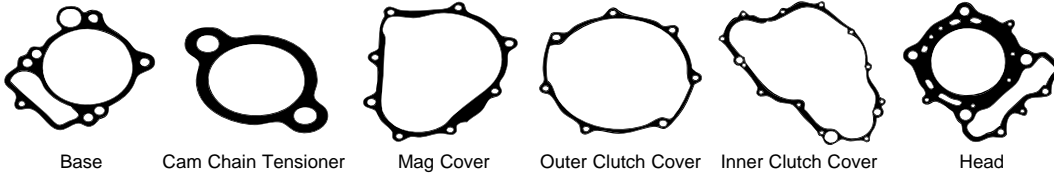

Model	Year	Bore Size	Top End Kit	Component Part#	Component Description	OEM Part #
YZ250, WR250	91	O-Ring	Top End Kit C7089	R110X2B	Outer Head O-ring	93211-11770-00
				R76X2V	Inner Head O-ring	93210-77363-00
				B0062018AFM	Base Gasket	2VM-11351-10-00
				B0062012F	High Compression Base Gasket	2VM-11351-10-00
				IR017020F	Intake Gasket	8CH/8DF-13621-00
				PV036018AFM	Left Side Power Valve	3JE-1131N-10-00
			PV038018AFM	Right Side Power Valve Gasket	3SP-11993-10-00	
			R228V	Exhaust O-ring	93210-56743-00	
			Crank Seal Kit C7669	OS118	Left Crank Seal 21X40X7	93102-22363-00
				OS119	Right Crank Seal 34X55X10	93103-40091-00
				Clutch Cover C7488	Clutch Cover C7488	3SP-15463-11-00
						3SP-15463-11-00
3SP-15463-11-00						
YZ250, WR250	92-94	O-Ring		Top End Kit C7113	R110X2B	Outer Head O-ring
			R76X2V		Inner Head O-ring	93210-77363-00
			B0062018AFM		Base Gasket	2VM-11351-10-00
			B0062012F		High Compression Base Gasket	2VM-11351-10-00
			IR017020F		Intake Gasket	8CH/8DF-13621-00
			PV036018AFM		Left Side Power Valve	3JE-1131N-10-00
			PV038018AFM	Right Side Power Valve Gasket	3SP-11993-10-00	
			R228V	Exhaust O-ring	93210-56743-00	
			Bottom End Kit w/crank seals C3300	C7488	Clutch Cover C7488	3SP-15463-11-00
						2VM-15462-10-00
						2VM-15462-10-00
						2VM-12428-11-00
2VM-15462-10-00						
2VM-15462-10-00						
Clutch & Mag Kit C7113CM	C7488	Clutch Cover C7488	3SP-15463-11-00			
			2VM-15462-10-00			
Crank Seal Kit C7669	OS118	Left Crank Seal 21X40X7	93102-22363-00			
			OS119	Right Crank Seal 34X55X10	93103-40091-00	
YZ250	95-96	O-Ring	Top End Kit C7250	R110X2B	Outer Head O-ring	93211-11770-00
				R76X2V	Inner Head O-ring	93210-77363-00
				B0062018AFM	Base Gasket	2VM-11351-10-00
				B0062012F	High Compression Base Gasket	2VM-11351-10-00
				IR017020F	Intake Gasket	8CH/8DF-13621-00
				PV036018AFM	Left Side Power Valve	3JE-1131N-10-00
			PV038018AFM	Right Side Power Valve Gasket	3SP-11993-10-00	
			PV045018AFM	Left side PV	4MX-11354-00	
			R224V	Exhaust O-ring	93210-472A9-00	
			Bottom End Kit w/crank seals C3300	C7488	Clutch Cover C7488	3SP-15463-11-00
						2VM-15462-10-00
						2VM-15462-10-00
2VM-12428-11-00						
2VM-15462-10-00						
2VM-15462-10-00						
Clutch & Mag Kit C7113CM	C7488	Clutch Cover C7488	3SP-15463-11-00			
			2VM-15462-10-00			
Crank Seal Kit C7669	OS118	Left Crank Seal 21X40X7	93102-22363-00			
			OS119	Right Crank Seal 34X55X10	93103-40091-00	



MX/Dirt · Off-Road · ATV Gaskets



Cometic Gasket - An Exclusive NASCAR Performance® Product

YAMAHA

Model	Year	Bore Size	Top End Kit	Component Part#	Component Description	OEM Part #	
YZ250	97-98	O-Ring	C7337	R110X2B	Outer Head O-ring	93211-11770-00	
				R76X2V	Inner Head O-ring	93210-77363-00	
				B0272018AFM	Base Gasket .018" AFM		
				B0272012F	High Compression Base Gasket		
				IR017020F	Intake Gasket	8CH/8DF-13621-00	
				R224V	Exhaust O-ring	93210-472A9-00	
				PV036018AFM	Left Side Power Valve	3JE-1131N-10-00	
				PV038018AFM	Right Side Power Valve Gasket	3SP-11993-10-00	
				PV045018AFM	Left side PV	4MX-11354-00	
					Component Part#	Component Description	OEM Part #
					C7488	Clutch Cover	3SP-15463-11-00
					EC253060AFM	Mag Cover Gasket	2VM-15462-10-00
					EC254020F	Crankcase Gasket	2VM-15462-10-00
					WP044018AFM	Water Pump	2VM-12428-11-00
						Component Description	OEM Part #
	C7488	Clutch Cover	3SP-15463-11-00				
	EC253060AFM	Mag Cover Gasket	2VM-15462-10-00				
		Component Description	OEM Part #				
	OS118	Left Crank Seal 21X40X7	93102-22363-00				
	OS119	Right Crank Seal 34X55X10	93103-40091-00				
YZ250	99-01	O-Ring	C7507	R101X2B	Outer Head O-ring	93211-02703-00	
				R73X2V	Inner Head O-ring	93210-74316-00	
				B0372032AFM	Base Gasket	5CU-11351-00	
				B0372012F	High Compression Base Gasket		
				PV082018AFM	Right Side Power Valve Gasket	5CU-11993-00	
				PV083018AFM	Front Power Valve Gasket	5CU-11354-00	
				R016B	Power Valve Governor O-ring	93210-15639-00	
				R54X3V	Exhaust Gasket 2-Req.	93210-53638-00	
					Component Part#	Component Description	OEM Part #
					R101X2B	Outer Head O-ring	93211-02703-00
					R73X2V	Inner Head O-ring	93210-74316-00
					B0372032AFM	Base Gasket	5CU-11351-00
					B0372018AFM	High Compression Base Gasket	
					PV082018AFM	Right Side Power Valve Gasket	5CU-11993-00
					PV083018AFM	Front Power Valve Gasket	5CU-11354-00
	R016B	Power Valve Governor O-ring	93210-15639-00				
	R54X3V	Exhaust Gasket 2-Req.	93210-53638-00				
	IR114018AFM	Intake Gasket	5NX-13622-00				
YZ250	02-16	O-Ring	C7855	R101X2B	Outer Head O-ring	93211-02703-00	
				R73X2V	Inner Head O-ring	93210-74316-00	
				B0372032AFM	Base Gasket	5CU-11351-00	
				B0372018AFM	High Compression Base Gasket		
				PV082018AFM	Right Side Power Valve Gasket	5CU-11993-00	
				PV083018AFM	Front Power Valve Gasket	5CU-11354-00	
				R016B	Power Valve Governor O-ring	93210-15639-00	
				R54X3V	Exhaust Gasket 2-Req.	93210-53638-00	
				IR114018AFM	Intake Gasket	5NX-13622-00	
					Component Part#	Component Description	OEM Part #
					H0873SP2020S	Cylinder Head Gasket 72mm Bore	
					B0372032AFM	Base Gasket	5CU-11351-00
					PV082018AFM	Right Side Power Valve Gasket	5CU-11993-00
					PV083018AFM	Front Power Valve Gasket	5CU-11354-00
					R016B	Power Valve Governor O-ring	93210-15639-00
	R54X3V	Exhaust Gasket 2-Req.	93210-53638-00				
	IR114018AFM	Intake Gasket	5NX-13622-00				
YZ250	02-16	72mm	C3592	H0873SP2020S	Cylinder Head Gasket 72mm Bore		
				B0372032AFM	Base Gasket	5CU-11351-00	
				PV082018AFM	Right Side Power Valve Gasket	5CU-11993-00	
				PV083018AFM	Front Power Valve Gasket	5CU-11354-00	
				R016B	Power Valve Governor O-ring	93210-15639-00	
				R54X3V	Exhaust Gasket 2-Req.	93210-53638-00	
				IR114018AFM	Intake Gasket	5NX-13622-00	



MX/Dirt • Off-Road • ATV Gaskets



Cometic Gasket - An Exclusive NASCAR Performance® Product

YAMAHA

Model	Year	Bore Size	Bottom End Kit w/Oil Seals	Component Part#	Component Description	OEM Part #	
YZ250	99-16	O-Ring	C7507BE	R127V	Crank Case Coolant Seal	5CU-15454-00-00	
				EC300032AFM	Inner Clutch Cover	5CU-15462-00-00	
				WP068018AFM	Water Pump Cover Gasket	5XF-12428-00-00	
				WA133	Clutch Pushrod Retainer Seal	90430-05242-00	
				WA080043C	Water Pump Drain Washer	90430-06014-00	
				WA080043C	Water Pump Drain Plug Gasket	90430-06014-00	
				WA114	Drain Plug Gasket	90430-12207-00	
				R117B	Fill Plug O-ring	93210-19123-00	
				R12X2V	Output Shaft O-ring	93210-22298-00	
				Oil Seal Kit	Component Part#	Component Description	OEM Part #
				C7507OS	OS227	Inner Water Pump Seal	93102-12321-00
					OS286	Clutch Pushrod Seal	93102-12224-00
					OS286	Shift Shaft Seal	93102-12224-00
					OS323	Start Shaft Seal	93102-18278-00
					OS110	Left Crank Seal	93102-20485-00
					OS184	Right Crank Seal	93102-28004-00
				OS119	Right Crank Seal 99-00	93103-36182-00	
				OS242	Outer Water Pump Seal	93109-11073-00	
				OS284	Output Shaft Seal	93102-32M07-00	
				Clutch & Mag Kit	Component Part#	Component Description	OEM Part #
	C7507CM	C7528	Clutch Cover Gasket	5CU-15463-00			
		EC299060AFM	Mag Cover Gasket	5CU-15451-00			
YZ250	99-01	O-Ring	Crank Seal Kit	Component Part#	Component Description	OEM Part #	
			C7670	OS119	Right Crank Seal 34X55X10	93103-40091-00	
YZ250	02-14	O-Ring	Crank Seal Kit	Component Part#	Component Description	OEM Part #	
			C7803	OS110	Left Crank Seal 20X40X7	93102-20485-00	
				OS184	Right Crank Seal 26X55X10	93102-28004-00	
				OS110	Left Crank Seal 20X40X7	93102-20485-00	

TTR250

Model	Year	Bore Size	Top End Kit	Component Part#	Component Description	OEM Part #
TTR250	99-06	75 mm	C7726	H0461043F	Head Gasket	4GY-11181-01-00
			C7340	H0461SP1043F	Big Bore Head Gasket 83mm	
		83 mm	B0391020F	Base Gasket	4GY-11351-00-00	
			B0391SP1020F	Big Bore Base Gasket		
			EC353020F	Clutch Cover Gasket	4GY-15461-00-00	



MX/Dirt · Off-Road · ATV Gaskets



Cometic Gasket - An Exclusive NASCAR Performance® Product

WR250F

Model	Year	Bore Size	Top End Kit	Component Part#	Component Description	OEM Part #
WR250F	01-13	77 mm	C7905-EST	H1168SP3027S	Head Gasket	5NL-11181-00-00
		79 mm	C3057-EST	H1168SP2027S	Head Gasket 79mm Bore	
		81 mm	C3059-EST	H1271027S	Head Gasket 81mm Bore	
		83 mm	C3061-EST	H1272SP3027S	Head Gasket 84mm Bore	
		84 mm	C3120-EST	B0503020RC	Base Gasket	5NL-11351-00-00
				EX651	Exhaust Gasket	5NL-14613-00-00
				EC019032AFM	AFM Cam Chain Tens. Gasket	4FM-12213-00
				3179V	Exhaust Valve Seal 2 Req.	4SV-12119-00-00
				3233V	Intake Valve Seal 3 Req.	4TV-12119-00-00

Bottom End Kit w/Oil Seals	Component Part#	Component Description	OEM Part #	
C3561BE	EC554032AFM	Inner Clutch Cover Gasket	5NL-15462-00-00	
	R011B	Oil Delivery Pipe O-Ring (SM)	93210-07003-00/ 07540-00	
	R013B	Oil Delivery Pipe O-Ring (3)	93210-10197-00	
	R014B	Oil Delivery Pipe O-Ring (LG)	93210-12759-00	
	R016B	Base and Case Dowel O-ring	93210-16716-00 / 93210-16772-00	
	R109B	Oil Filter O-Ring (SM) (2)	93210-07135-00	
	R10X2V	Center Case Dowel O-ring	93210-10197-00*	
	R113B	Timing Mark Plug O-Ring	93210-14369-00	
	R120V	Electric Starter O-ring	93210-25711-00	
	R121V	Crank End Plug O-ring	93210-27370-00/ 93210-27778-00	
	R134B	Oil Filter O-Ring	93210-47675-00	
	R19X2V	Oil Fill Plug O-ring	93210-19123-00	
	R141SB	Starter Gear O-ring	93210-60426-00	
	R903B	Oil Delivery Pipe O-Ring (MED)	93210-09008-00	
	WA080043C	Water Pump Drain Washer	90430-06014-00	
	WA082063C	Oil Line Crush Washer (2)	90430-10188-00	
	WA082063C	Oil Drain Bolt Washer	90430-10188-00* / 10171-00	
	WA116	Oil Line Crush Washer (2)	90430-08119-00	
	WP297	Water Pump Cover O-ring	5NL-12439-00-00	
	R116B	Kickstart O-ring	93210-17570-00	
	Oil Seal Kit C3561OS	OS227	Inner Water Pump Seal	93102-12321-00
		OS236	Oil Pump Seal	93101-14164-00
		OS283	Outer Water Pump Seal	93109-11073-00
		OS286	Shift Shaft Seal	93102-12224-00
		OS286	Hot Start Mech Oil Seal	93102-12224-00
		OS323	Start Shaft Seal	93102-18278-00
		OS324	Output Shaft Seal	93102-28010-00
Clutch & Mag Kit C3561CM		EC553032AFM	Outer Clutch Cover Gasket	5NL-15453-10-00
	EC1931032AFM	Mag Cover Gasket	5UM-15451-00-00	



MX/Dirt • Off-Road • ATV Gaskets



Cometic Gasket - An Exclusive NASCAR Performance® Product

YAMAHA

Model	Year	Bore Size	Top End Kit	Component Part#	Component Description	OEM Part #
YZ250F	01-13	77 mm	C7905-EST	H1168SP3027S	Head Gasket	5NL-11181-00-00
		79 mm	C3057-EST	H1168SP2027S	Head Gasket 79mm Bore	
		81 mm	C3059-EST	H1271027S	Head Gasket 81mm Bore	
		83 mm	C3061-EST	H1272SP3027S	Head Gasket 84mm Bore	
		84 mm	C3120-EST	B0503020RC	Base Gasket	5NL-11351-00-00
				EX651	Exhaust Gasket	5NL-14613-00-00
				EC019032AFM	AFM Cam Chain Tens. Gasket	4FM-12213-00
				3179V	Exhaust Valve Seal 2 Req.	4SV-12119-00-00
				3233V	Intake Valve Seal 3 Req.	4TV-12119-00-00
		Bottom End Kit w/Oil Seals				
		C3057BE	Component Part#	Component Description	OEM Part #	
			EC554032AFM	Inner Clutch Cover Gasket	5NL-15462-00-00	
			R011B	Oil Delivery O-ring (SM)	93210-07003-00/07540-00	
			R013B	Oil Pump Seal O-Ring	93210-10197-00*	
			R013B	Clutch Side Oil Feed Line O-Ring	93210-10197-00*	
			R013B	Mag Side Oil Feed Line O-Ring	93210-10197-00*	
			R014B	Oil Delivery Pipe O-Ring (Lg.)	93210-12759-00	
			R016V	Case Dowel O-ring	93210-16772-00	
			R109B	Oil Filter Cover O-Ring (Sm.)	93210-07135-00	
			R10X2V	Centercase Dowel O-ring	93210-10197-00*	
			R113B	Timing Plug O-ring	93210-14369-00	
			R124B	Crank End Plug O-ring	93210-32172-00	
			R134B	Oil Filter O-Ring (LG)	93210-47675-00	
			R19X2V	Oil Fill Plug O-ring	93210-19123-00	
			R903V	Oil Delivery Pipe O-ring (Med.)	93210-09008-00	
			WA080043C	Coolant Drain Bolt Washer	90430-06014-00*	
			WA082063C	Oil Drain Bolt Washer	90430-10188-00*/10171-00	
			WP297	Water Pump O-Ring	5NL-12439-00-00	
Oil Seal Kit						
		C3057OS	Component Part#	Component Description	OEM Part #	
			OS323	Kick Start Shaft Seal	93102-18278-00	
			OS324	Countershaft Oil Seal	93102-28010-00	
			OS283	Outer Water Pump Seal	93109-11073-00	
			OS227	Inner Water Pump Seal	93102-12106-00	
			OS236	Oil Pump Seal	93101-14164-00	
			OS286	Gear Selector Seal	93102-12224-00	
Clutch & Mag Kit						
		C3057CM	Component Part#	Component Description	OEM Part #	
			EC553032AFM	Clutch Cover Gasket	5NL-15453-00-00	
			EC527060AFM	Mag. Cover Gasket	5NL-15451-00-00	
			Component Part#	Component Description	OEM Part #	
			VC103	Valve Cover Gasket		



MX/Dirt • Off-Road • ATV Gaskets



Cometic Gasket - An Exclusive NASCAR Performance® Product

YAMAHA

Model	Year	Bore Size	Top End Kit	Component Part#	Component Description	OEM Part #		
YZ250F	14-16	77mm	C3549-EST	H3885027S	Head Gasket 77mm Bore	1SM-11181-00-00		
			C3550-EST	H3885SP4027S	Head Gasket 80mm Bore			
		80mm	B1236010RC	Base Gasket	1SM-11351-00-00			
			EX651	Exhaust Gasket	5NL-14613-00-00			
		EC019032AFM	Cam Chain Tensioner Gasket	4FM-12213-00-00				
		3239V	Exhaust Valve Stem Seal 2 req.	4TE-12119-00-00				
		3234V	Intake Valve Stem Seal 2 req.	33M-12119-00-00				
		WA114	Cylinder Head Drain Seal	90430-06014-00				
		WA140	Cam Chain Tens. Crush Seal	5EL-12214-00-00				
		R020V	TPS O-ring	1DX-14562-00-00				
		Bottom End Kit w/Oil Seals				Component Part#	Component Description	OEM Part #
		C3549BE				WA082063C	Case Drain Crush Washer	90430-10188-00
						R117B	Fill Plug O-ring	93210-19123-00
				R13.5X2V	Timing Mark O-ring	93210-14369-00		
				R127V	Timing Plug O-ring	93210-357A3-00		
				R115V	Water Pump Coolant Elb. O-ring	93210-16500-00		
				R116B	Kickstart O-ring	93210-17570-00		
				R016V	Case Water Pipe O-ring	93210-16716-00		
						93210-16772-00		
				WA080043C	Water Pump Drain Plug	90430-06014-00		
				EC1935032AFM	Inner Clutch Cover Gasket	1SM-15462-00-00		
				R013V	Oil Filter O-ring	93210-45708-00		
				R014V	Oil Pump O-ring	93210-12010-00		
				R014V	Coolant Elbow O-ring	93210-16275-00		
				WP439032AFM	Water Pump Gasket	33D-12427-00-00		
Oil Seal Kit				Component Part#	Component Description	OEM Part #		
C3549OS				OS236	Water Pump Oil Seal	93101-14164-00		
				OS323	Start Shaft Seal	93102-18278-00		
				OS229	Clutch Actuator Seal	93102-10008-00		
				OS197	Shift Shaft Seal	93109-14010-00		
				OS235	Output Shaft Seal	93102-28012-00		
				OS308	Outer Water Pump Seal	93102-08004-00		
				OS233	Inner Water Pump Seal	93102-08307-00		
Clutch & Mag Kit				Component Part#	Component Description	OEM Part #		
C3549CM				EC1941032AFM	Outer Clutch Cover Gasket	1SM-15453-00-00		
				EC1942032AFM	Mag Cover Gasket	1SM-15451-00-00		

TRiZ250

Model	Year	Bore Size	Top End Kit	Component Part#	Component Description	OEM Part #
TriZ250 Tri Moto	85-86	71 mm	C7153	H0269043F	Head Gasket	38W-11181-00-00
				B0172020F	Base Gasket	39X-11351-01-00
				IR017020F	Intake Gasket	80L-13621-01-00
YFA250 Breeze	89-95	50 mm	Top End Kit C7255	Component Part#	Component Description	OEM Part #
				H0312043F	Head Gasket	3GH-11181-00-00
YFM250 Timberwolf 2WD/4WD	92-03	72 mm	Top End Kit C7254	Component Part#	Component Description	OEM Part #
				B0187020F	Base Gasket	3FA-11351-10-00
YFM250 Moto-4	89-91	71 mm	Top End Kit C7256	Component Part#	Component Description	OEM Part #
				H0066043F	Head Gasket	59V-11181-00-00
				B0067020F	Base Gasket	4BD-11351-00-00



MX/Dirt · Off-Road · ATV Gaskets



Cometic Gasket - An Exclusive NASCAR Performance® Product

YFM250R



Model	Year	Base Bore Size	Head Bore Size	Head Block OffPlate Bore Size	EST	Component Part#	OEM Part #
					Top End Kit		
YFM250R	08-13	74 mm	74 mm	74 mm	C3223-EST	H2760040S Head Gasket	5XT-11181-00-00
Raptor		76 mm	76 mm	76 mm	C3224-EST	H2760SP2040S Head Gasket 76mm	5XT-11181-00-00
		78 mm	78 mm	78 mm	C3225-EST	H2760SP3040S Head Gasket 78mm	5XT-11181-00-00
		80mm	80mm	80mm	C3226-EST	H2760SP1040S Head Gasket 80mm	5XT-11181-00-00
		81mm	81mm	81mm	C3236-EST	H2760SP5040S Head Gasket 81mm	5XT-11181-00-00
						B0936020RC Base Gasket	4D3-11351-00-00
						EX817 Exhaust Gasket	3GD-14613-00
						EC019018AFM Cam Chain Tensioner Gasket	4FM-12213-00
						EC1230032AFM Head Block Off Plate Gasket	5XT-14815-00-00
						R013B Cam O-ring	93210-11453-00
						R046B Cam Gear Cover O-ring	93211-05471-00
						R127V Intake O-Ring Seal	5PA-14642-00-00

XT350

Model	Year	Bore Size	Top End Kit	Component Part#	Component Description	OEM Part #
XT350	85-99	87.5 mm	C7530	H0836043F	Head Gasket	55V-11181-00-00
				B0388020F	Base Gasket	4DR-11351-00

YFZ350

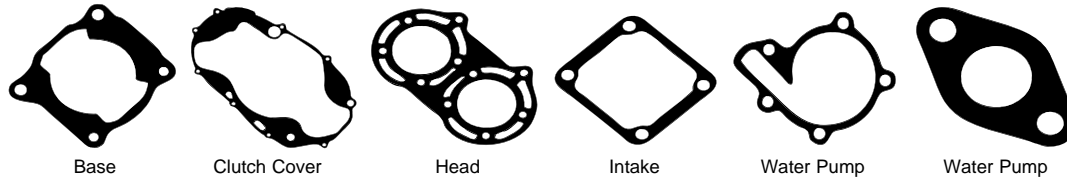

Model	Year	Base Bore Size	Clutch Cover Bore Size	Head Bore Size	Intake Bore Size	Water Pump Bore Size	Water Pump Bore Size	Top End Kit	Component Part#	Component Description	OEM Part #
YFZ350	87-05	65.5 mm	65.5 mm	65.5 mm	65.5 mm	65.5 mm	65.5 mm	C7094	H0275010S	Head Gasket 65.5 mm Bore	2GU-11181-00-00
Banshee		66.5 mm	66.5 mm	66.5 mm	66.5 mm	66.5 mm	66.5 mm	C7275	H0311010S	Head Gasket 66.5mm Bore	2GU-11181-00-00
		68 mm	68 mm	68 mm	68 mm	68 mm	68 mm	C7316	H0442010S	Head Gasket 68mm	2GU-11181-00-00
		69.5 mm	69.5 mm	69.5 mm	69.5 mm	69.5 mm	69.5 mm	C7710	H0745010S	Head Gasket 69.5mm Bore	2GU-11181-00-00
		71 mm	71 mm	71 mm	71 mm	71 mm	71 mm	C7607	H0418010S	Head Gasket 71mm Bore	2GU-11181-00-00
									B0066012F	High Comp. Base Gasket 2 Req.	3GG-11351-00-00
									B0066018AFM	Base Gasket 2 Req.	3GG-11351-00-00
									IR019018AFM	Intake Gasket 2 Req.	55K-13621-00-00
									R224V	Exhaust O-Ring 2 Req.	93210-45742-00
									WP118032AFM	Water Outlet Gasket	3XV-12435-00-00

Bottom End Kit w/Oil Seals	Component Part#	Component Description	OEM Part #
C7094BE	WP072020F	Water Pump Cover Gasket	3GG-12428-01-00
	R19X2V	Oil Fill Plug O-ring	93210-19123-00
	EC318020F	Inner Clutch Cover Gasket	3GG-15461-02-00
	WA120	Drain Plug Gasket	90430-14043-00
Oil Seal Kit	Component Part#	Component Description	OEM Part #
C7094OS	OS126	Right Crank Seal 23x40x10	93103-40077-00
Crank Seal Kit C7673	OS125	Right Crank Seal 38X62X12	93103-40077-00
	OS225	Kickstart Shaft Seal 20x30x5	93102-20484-00
	OS226	Impeller Shaft Seal 10x31x13.5	93103-10147-00
	OS227	Shift Shaft Seal 12x22x5	93102-12106-00/93102-12321-00
	OS268	Output Shaft Seal 35x62x6	93102-35369-00
	OS357	Clutch Actuator Seal 17x28x6	93102-17004-00



MX/Dirt · Off-Road · ATV Gaskets



Cometic Gasket - An Exclusive NASCAR Performance® Product

YFM350 BRUIN



Model	Year	Base	Clutch Cover Bore Size	Mag Cover EST Top End Kit	Timing Chain Tensioner Component Part#	Head Component Description	Head Component Description	Oil Pump OEM Part #
YFM350 Bruin	04-06	84 mm	85 mm	C7096-EST C3159-EST	H0067027S H0067043F	Head Gasket Multi-Layer-Steel Head Gasket Fiber		1UY-11181-01-00 1UY-11181-01-00
YFM350 Raptor Wolverine	04-14				H0067SPA027S B0068020F	Head Gasket 85mm Steel Base Gasket		1UY-11181-01-00 4KB-11351-00-00
YFM350 Warrior	87-04				EC998032AFM 3230V	Cam Chain Tensioner Gasket Valve Seals 2 Req.		3GD-12213-00-00 M01-12129-00-00
YFM350 400 Big Bear, Moto 4	95-06 87-06				R86X3V R57X2V R106X2V R031B R012B	Cam Cover O-ring Tappet Cover O-ring 2 Req. Base O-ring Intake O-ring Base Dowel O-ring		93211-06635-00 93210-57634-00 93210-86509-00 93210-44545-00 93210-18322-00

Bottom End Kit w/Oil Seals C7096BE	Component Part#	Component Description	OEM Part #
	WA080043C	Case Bolt Crush Washer	90430-06014-00
	OP031020F	Oil Pump Gasket	3GD-13329-00-00
	WA080043C	Drain Plug O-ring	93210-35512-00
	WA116	Oil Line Crush Washer	90430-08119-00
	R227V	Oil Pump Cover Gasket	93210-54175-00
	R114V	Shift Shaft O-ring	93210-15566-00
	R020V	Neutral Drum Shift Detent O-ring	90430-14194-00
	R116B	Fill Plug O-ring	93210-19522-00
	R027V	Timing Mark O-ring	93210-14369-00
Oil Seal Kit C7096OS	Component Part#	Component Description	OEM Part #
	OS351	Mag Oil Seal 28x52x8.2	93102-28017-00
	OS347	Shift Shaft Oil Seal 14x26x6	93102-14209-00
	OS352	Neutral Drum Oil Seal 15x25x5	93102-15212-00
	OS348	Output Shaft Oil Seal 35x45x6	93102-35393-00
	OS350	Idler Shaft Oil Seal 20x52x3.5	93104-20068-00
	OS349	Trans Main Shaft Oil Seal 17x40x3.5	93104-17094-00
	OS286	Clutch Actuator Seal 12x18x5	93102-12224-00
Clutch & Mag Kit C7096CM	Component Part#	Component Description	OEM Part #
	EC314032AFM	Clutch Cover Gasket	3GD-15461-00-00
	EC315032AFM	Mag Cover Gasket	3GD-15451-00-00

YFM400



Model	Year	Base	Timing Chain Tensioner Bore Size	Head EST Top End Kit	Component Part#	Component Description	OEM Part #
YFM400 KODIAK/GRIZZLY	00-07	85.5 mm		C3213-EST	H2464027S B0918031F EX130 EC998032AFM R012B R106X2V R116V R141SB R89X2.5V 3230V WA118	Head Gasket Base Gasket Exhaust Gasket Cam Chain Tensioner Gasket Rocker Arm O-ring 2 Req. Cam Cover O-ring Base Dowel O-ring Valve Cover O-ring Base O-ring Valve Seals 2 Req. Head Drain Plug Washer	5GH-11181-00-00 5GH-11351-00 3GD-14613-00-00 3GD-12213-00-00 93210-09165-00 93211-06635-00 93210-18322-00 93210-57634-00 93210-89447-00 M01-12129-00-00 90430-06014-00

All Component Parts can be purchased individually.



MX/Dirt • Off-Road • ATV Gaskets



Cometic Gasket - An Exclusive NASCAR Performance® Product

YZ400F

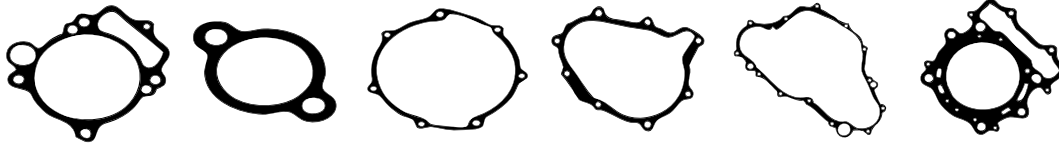

Model	Year	Bore Size	Top End Kit	Component Part#	Component Description	OEM Part #	
YZ400F	98-99	92 mm	C7400	H0707027S	Head Gasket	5BE-11181-00-00	
			C7401	H0709027S	Head Gasket 94mm Bore		
			C7689	H0869027S	Head Gasket 95mm Bore		
		94 mm	C7470	H0725027S	Head Gasket 97mm Bore	5BE-11351-00-00	
			95 mm	B0334020RC	Base Gasket		4FM-12213-00
				EC019018AFM	Cam Chain Tensioner Gasket		
		97 mm	C3303	Bottom End Kit w/o crank seals	Component Part#	Component Description	OEM Part #
					C7487	Outer Clutch Cover Gasket	5BE-15453-00
		Clutch & Mag Kit C7400CM			EC292060AFM	Mag Cover Gasket	5BE-15451-00
					EC293032AFM	Inner Clutch Cover Gasket	5BE-15462-00
Component Part#	Component Description				OEM Part #		
C7487	Outer Clutch Cover Gasket	5BE-15453-00					
EC292060AFM	Mag Cover Gasket	5BE-15451-00					

YZ426F

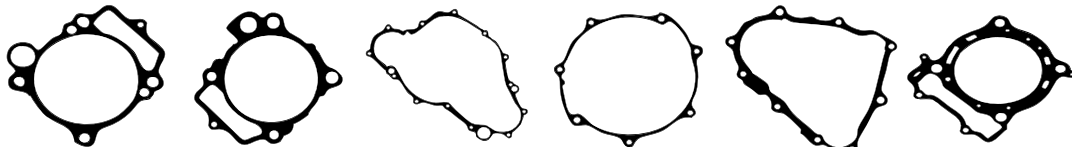

Model	Year	Bore Size	Top End Kit	Component Part#	Component Description	OEM Part #
YZ426F	00-02	95 mm	C7689	H0869027S	Head Gasket 95mm Bore	5JG-11181-00-00
				H0725027S	Head Gasket 97mm Bore	
WR426		97 mm	C7470	B0334020RC	Base Gasket	5BE-11351-00-00
				EC019018AFM	Cam Chain Tensioner Gasket	
Bottom End Kit w/o crank seals		C3304		Component Part#	Component Description	OEM Part #
				EC292060AFM	Mag Cover Gasket	5BE-15451-00
Clutch & Mag Kit C7689CM				EC293032AFM	Inner Clutch Cover Gasket	5BE-15462-00
				EC789032AFM	Clutch Cover Gasket	5JG-15453-00
				Component Part#	Component Description	OEM Part #
EC292060AFM	Mag Cover Gasket	5BE-15451-00				
EC789032AFM	Clutch Cover Gasket	5JG-15453-00				



MX/Dirt · Off-Road · ATV Gaskets



Cometic Gasket - An Exclusive NASCAR Performance® Product

YZ450F

Model	Year	Bore Size	EST	List	Component Part#	Component Description	OEM Part #	
YZ450F	03-05	95 mm	Top End Kit					
			C7947-EST	H1710027S	Head Gasket	5TA-11181-00-00		
			C3147-EST	H2144027S	Head Gasket 96mm Bore			
			C3064-EST	H1711027S	Head Gasket 97mm Bore			
			C3148-EST	H1683027S	Head Gasket 98mm Bore			
			C3149-EST	H1683SP2027S	Head Gasket 99mm Bore			
			C3117-EST	H1683SPB027S	Head Gasket 100mm Bore			
				B0626020RC	Base Gasket	5TA-11351-00-00		
				B0626SP2020RC	Base Gasket 100mm Kits			
				EX641	Exhaust Gasket	3VD-14613-01-00		

Component Part#	Component Description	OEM Part #
EC019018AFM	Cam Chain Tensioner Gasket	4FM-12213-00
EC019020F	Cam Chain Tensioner Gasket	
WA082063C	Oil Line Washers 2 Req.	90430-10171
3179V	Intake Valve Seal 3 Req.	4SV-12119-00-00
3234V	Exhaust Valve Seal 2 Req.	33M-12119-00-00
WA114	Head Drain Washers	90430-06014
WA116	Oil Line Washers 4 Req.	90201-08087-00
Bottom End Kit w/Oil Seals C7947BE		
WP189	Water Pump Cover O-ring	5BE-12439-00-00
EC762032AFM	Inner Clutch Cover	5TA-15462-00-00
WA080043C	Coolant Drain Gasket	90430-06014-00
WA080043C	Water Pump Drain Gasket	90430-06014-00
WA116	Oil Line Crush Washer	90430-08119-00
WA082063C	Drain Plug Gasket	90430-10188-00
WA082063C	Oil Line Crush Washer	90430-10188-00
R109B	Oil Filter Cover O-rings	93210-07135-00
R903V	Oil Pipe O-ring	93210-09008-00
R013B	Case Dowel O-ring	93210-10197-00
R014B	Oil Pipe O-ring	93210-12759-00
R027V	Timing Mark O-ring	93210-14369-00
R114B	Water Pipe O-ring	93210-16500-00
R19X2V	Fill Plug O-ring	93210-19123-00
R018V	Water Outlet O-rings	93210-19758-00
R12X2V	Output Shaft O-ring	93210-22298-00
R124B	Timing Gear O-ring	93210-32172-00
R134B	Oil Filter Cover O-ring	93210-47675-00
Oil Seal Kit C7947OS		
OS236	Oil Pump Seal	93101-14164-00
OS283	Outer Water Pump Oil Seal	93109-11073-00
OS284	Output Shaft Seal	93102-32480-00
OS285	Kick Start Shaft Seal	93102-20108-00
OS286	Hot Start Lever Oil Seal	93102-12224-00
OS286	Clutch Pushrod Seal	93102-12224-00
OS286	Shift Shaft Seal	93102-12224-00
Clutch & Mag Kit C7947CM		
EC761018AFM	Mag Cover Gasket	5TA-15451-00-00
C3129	Outer Clutch Cover Gasket	5TA-15453-00-00
Component Part# Component Description OEM Part #		
VC104	Valve Cover Gasket	



MX/Dirt • Off-Road • ATV Gaskets



Cometic Gasket - An Exclusive NASCAR Performance® Product

YAMAHA

Model	Year	Bore Size	EST	Component Part#	Component Description	OEM Part #		
YZ450F	06-09	95 mm	Top End Kit	H2477027S	Head Gasket 95mm	2S2-11181-00-00		
			C7908-EST	H2477SP1027S	Head Gasket 98mm	2S2-11181-00-00		
		98 mm	C3178-EST	H2477SP4027S	Head Gasket 99mm	2S2-11181-00-00		
			B0849020RC	Base Gasket	2S2-11351-00-00			
		EX696	Exhaust Gasket	3VD-14613-01-00				
		3179V	Intake Valve Seal 3 Req.	4SV-12119-00-00				
		3234V	Exhaust Valve Seal 2 Req.	33M-12119-00-00				
		EC019018AFM	Cam Chain Tensioner Gasket	4FM-12213-00				
		WA082063C	Oil Line Washers 2 Req.	90430-10171				
		WA114	Drain Plug Gasket	90430-06014				
		WA116	Oil Line Washers 4 Req.	90201-08087-00				
		Bottom End Kit w/Oil Seals				Component Part#	Component Description	OEM Part #
		C7908BEF				EC1100031F	Inner Clutch Cover	2S2-15462-10-00
						WP189	Water Pump Cover Gasket	5BE-12439-00-00
						WA080043C	Water Pump Drain Crush Washer	90430-06014-00
				WA080043C	Case Oil Galley Drain Plug	90430-06014-00		
				WA116	Case Water Galley Drain Plug	90430-08119-00		
				WA082063C	Drain Plug Crush Seal	90430-10188-00		
				R109B	Oil Pump O-rings	93210-07135-00		
				R011V	Mag Cover Oil Passage O-ring	93210-08003-00		
				R012B	Case Oil Level Plug O-ring	93210-09350-00		
				R013B	Case Oil Galley O-ring	93210-10197-00		
				R113B	Timing Mark O-ring	93210-14369-00		
				R19X2V	Fill Plug O-Ring	93210-19123-00		
				R018V	Primary Cover Oil Passage O-ring	93210-19758-00		
				R12X2V	Output Shaft O-ring	93210-22298-00		
				R121V	Crank End Plug O-ring	93210-27778-00		
				R134B	Oil Pump Cover O-ring	93210-47675-00		
				R143V	Electric Starter Cover O-ring	93210-58346-00		
Oil Seal Kit				Component Part#	Component Description	OEM Part #		
C7908OS				OS227	Inner Water Pump Oil Seal	93102-12321-00		
				OS236	Oil Pump Seal	93101-14164-00		
				OS283	Outer Water Pump Oil Seal	93109-11073-00		
				OS284	Output Shaft Seal	93102-32480-00		
				OS285	Kick Start Shaft Seal	93102-20108-00		
				OS286	Clutch Pushrod Seal	93102-12224-00		
				OS286	Shift Shaft Seal	93102-12224-00		
Clutch & Mag Kit				Component Part#	Component Description	OEM Part #		
C7908CM				EC763020F	Outer Clutch Cover	5TA-15453-00-00		
				EC1099031F	Mag Cover Gasket	2S2-15451-00-00		
				Component Part#	Component Description	OEM Part #		
				VC104	Valve Cover Gasket			



MX/Dirt · Off-Road · ATV Gaskets



Cometic Gasket - An Exclusive NASCAR Performance® Product

YAMAHA

Model	Year	Bore Size	EST Top End Kit	Component Part#	Component Description	OEM Part #
YZ450F	10-13	97mm	C3395-EST	H3059027S	97mm Bore Head Gasket	33D-11181-00-00
				3238V	Valve Stem Seals 4 Required	51Y-12119-00-00
				B1019010RC	Base Gasket	33D-11351-00-00
				EC019032AFM	Cam Chain Tensioner Gasket	4FM-12213-00-00
				EX1041042AM	Exhaust Gasket	33D-14613-00-00
				Bottom End Kit		
w/Oil Seals						
C3395BE						
Component Part#						
Component Description						
OEM Part #						
EC1569032AFM						
Inner Clutch Gasket						
33D-15462-00-00						
R18X2.5V						
Oil Fill Plug O-ring						
93210-19123-00						
R13.5X2V						
Timing Mark O-ring						
93210-14369-00						
R126B						
Crank Plug O-ring						
93210-357A3-00						
R010V						
Oil Nozzle O-ring						
93210-07001-00						
MR111						
Case Seal Gasket						
90430-08002-00						
WA116						
Right Case Drain Washer						
90201-08087-00						
WA080043C						
Left Case Drain Washer						
90430-06014-00						
R031B						
Oil Filter Cover O-ring						
93210-45708-00						
R24X2V						
Coolant Line Oring						
93210-24253-00						
R114B						
Water Pump O-ring						
93210-16500-00						
R020V						
Output Shaft O-ring						
93210-22298-00						
WP379018AFM						
Water Pump Housing Gasket						
33D-12427-00-00						
WA114						
Water Pump Drain Plug Washer						
90430-06014-00						
R018V						
Water Pipe O-ring						
93210-19758-00						
Oil Seal Kit						
C3395OS						
Component Part#						
Component Description						
OEM Part #						
OS285						
Start Shaft Seal 20x30x7						
93102-20108-00						
OS284						
Output Shaft Seal 32x42x6						
93102-32480-00						
OS286						
Shift Shaft Oil Seal 12x18x5						
93102-12224-00						
OS227						
Water Pump Shaft Seal 12x22x5						
93102-12321-00						
OS236						
Water Pump Oil Seal 14x22x5						
93101-14164-00						
EST						
Top End Kit						
YZ450F	14-16	97mm 99mm	C3540-EST C3547-EST	H3059027S	97mm Bore Head Gasket	33D-11181-00-00
				3238V	Valve Stem Seals 4 Required	51Y-12119-00-00
				B1241010RC	Base Gasket	1SL-11351-00-00
				EC019032AFM	Cam Chain Tensioner Gasket	4FM-12213-00-00
				EX1041042AM	Exhaust Gasket	33D-14613-00-00



MX/Dirt • Off-Road • ATV Gaskets



Cometic Gasket - An Exclusive NASCAR Performance® Product

YFZ450

Model	Year	Bore Size	EST	Component Part#	Component Description	OEM Part #
YFZ450 Carbureted	04-13	96 mm	Top End Kit C3066-EST	H2144027S	96mm Head Gasket	5TA-11181-00-00
		97 mm	C3445-EST	H2144SP1027S	97mm Head Gasket	5TA-11181-00-00
		98 mm	C3068-EST	H1683027S	98mm Head Gasket	5TA-11181-00-00
				B0626020RC	Base Gasket	5TA-11351-00-00
				EX641	Exhaust Gasket	3VD-14613-01-00
				EC019018AFM	Cam Chain Tensioner Gasket	4FM-12213-00
				3179V	Intake Valve Seals 3 Req.	4SV-12119-00-00
				3234V	Exhaust Valve Seals 2 Req.	33M-12119-00-00
				WA082063C	2 Req.	90430-10171-00
				WA114	2 Req.	90430-06014-00
				WA116	4 Req.	90201-08087-00
				R19X2V	Base dowel O-ring	93210-19758-00
			Bottom End Kit w/o crank seals C3338	Component Part#	Component Description	OEM Part #
				EC762032AFM	Inner Clutch Cover Gasket	5TA-15462-00-00
				EC763032AFM	Outer Clutch Cover Gasket	5TA-15453-00-00
				EC899032AFM	Mag Cover Gasket	5TG-15451-10-00
				R10X2V	Center Case Dowel O-ring	93210-10197-00
				R10X2V	Oil Pump Dowel O-ring	93210-10197-00
				R10X2V	Oil Pump Tube O-ring	93210-10197-00
				R12.5X2V	Oil Tube O-ring (Lg)	93210-12759-00
				R13.5X2V	Timing Plug O-ring (Sm)	93210-14369-00
				R19X2V	Inner Clutch O-rings	93210-19758-00
				R22X2V	Counter Shaft O-ring	93210-22164-00/ 22298-00
				R27X2V	Mag Cover Plug O-ring	93210-32172-00
				R47X2.5V	Oil Filter Cover O-ring (Sm)	93210-47675-00
				R60X3B	Water Pump Cover O-ring	93210-60426
				R7X2V	4 Req.-Oil Pump O-rings (Sm)	93210-07003-00/ 07540-00
				R8.5X1.5V	Oil tube O-rings (Med)	93210-09008-00
				WA082063C	Drain Plug Gasket	90430-10171
				Component Part#	Component Description	OEM Part #
				VC104	Valve Cover Gasket	

YFZ450R

Model	Year	Bore Size	EST	Component Part#	Component Description	OEM Part #
YFZ450R	09-16	95mm	Top End Kit C7908-EST	H2477027S	Head Gasket 95mm	2S2-11181-00-00
		98mm	C3178-EST	H2477SP1018S	Head Gasket 98mm	2S2-11181-00-00
		99mm	C3279-EST	H2477SP4018S	Head Gasket 99mm	2S2-11181-00-00
				B0849014RC	Base Gasket	2S2-11351-00-00
				EX696	Exhaust Gasket	3VD-14613-01-00
				EC019018AFM	Cam Chain Tensioner Gasket	4FM-12213-00
				3179V	Intake Valve Seals 3 Req.	4SV-12119-00-00
				3234V	Exhaust Valve Seals 2 Req.	33M-12119-00-00
			Bottom End Kit w/o crank seals C3419	Component Part#	Component Description	OEM Part #
				R013V	Crankcase O-ring	93210-10197-00
				WA082063C	Drain Plug Gasket 2 Req.	90430-10148-00
				WA114	Case Bolt Seal	90430-06014-00
				EC1559032AFM	Outer Clutch Cover	18P-15453-00-00
				R134V	Oil Filter O-ring	93210-47675-00
				R133B	Oil Filter Bolt O-ring 3 Req.	93210-47675-00
				EC1558032AFM	Inner Clutch Cover	18P-15462-00-00
				R117V	Dip Stick O-ring	93210-19026-00
				EC1561032AFM	Mag Cover Gasket	18P-15451-00
				EC1560018AFM	Pinion Cover Gasket	18P-15463-00
				R127V	Crank Plug O-ring	93210-357A3-00
				R114V	Timing Plug O-ring	93210-14369-00
				R214B	Starter Input O-rings	93210-24235
				R022B	Output Shaft O-ring	93210-25001-00
				WP370018AFM	Water Pump Gasket	18P-12428-00-00



MX/Dirt · Off-Road · ATV Gaskets



Cometic Gasket - An Exclusive NASCAR Performance® Product

WR450

Model	Year	Bore Size	EST	Component Part#	Component Description	OEM Part #
WR450	03-06	95 mm	Top End Kit			
			C7947-EST	H1710027S	Head Gasket	5TA-11181-00-00
			C3147-EST	H2144027S	Head Gasket 96mm Bore	
			C3064-EST	H1711027S	Head Gasket 97mm Bore	
			C3148-EST	H1683027S	Head Gasket 98mm Bore	
			C3149-EST	H1683SP2027S	Head Gasket 99mm Bore	
			C3117-EST	H1683SPB027S	Head Gasket 100mm Bore	
				B0626020RC	Base Gasket	5TA-11351-00-00
				B0626SP2020RC	Base Gasket 100mm Kits	
				EX641	Exhaust Gasket	3VD-14613-01-00

Component Part#	Component Description	OEM Part #
EC019018AFM	Cam Chain Tensioner Gasket	4FM-12213-00
EC019020F	Cam Chain Tensioner Gasket	
WA082063C	Oil Line Washers 2 Req.	90430-10171
3179V	Intake Valve Seal 3 Req.	4SV-12119-00-00
3234V	Exhaust Valve Seal 2 Req.	33M-12119-00-00
WA114	Head Drain Washers	90430-06014
WA116	Oil Line Washers 4 Req.	90201-08087-00
Bottom End Kit w/Oil Seals C3560BE	Component Part#	Component Description
	R018V	Water Outlet O-rings
	WP189	Water Pump Cover O-ring
	R12X2V	Output Shaft O-ring
	R114B	Water Pipe O-ring
	R013B	Oil Line O-rings
	EC762032AFM	Inner Clutch Cover
	R19X2V	Fill Plug O-ring
	R143K	Starter O-ring
	R027V	Timing Mark O-ring
	R013B	Case Dowel O-ring
	WA082063C	Drain Plug Gasket
	WA080043C	Coolant Drain Gasket
Oil Seal Kit C3560OS	Component Part#	Component Description
	OS236	Oil Pump Seal
	OS283	Outer Water Pump Oil Seal
	OS284	Output Shaft Seal
	OS285	Kick Start Shaft Seal
	OS286	Shift Shaft Seal
	OS286	Clutch Pushrod Seal
Clutch & Mag Kit C3560CM	Component Part#	Component Description
	EC763018AFM	Outer Clutch Cover Gasket
	EC2003032AFM	Mag Cover Gasket



MX/Dirt • Off-Road • ATV Gaskets



Cometic Gasket - An Exclusive NASCAR Performance® Product

WR450

Model	Year	Bore Size	EST	Component Part#	Component Description	OEM Part #				
WR450	07-14	95 mm 98 mm	Top End Kit C7908-EST C3178-EST	H2477027S	Head Gasket 95mm	2S2-11181-00-00				
				H2477SP1027S	Head Gasket 98mm	2S2-11181-00-00				
				H2477SP4027S	Head Gasket 99mm	2S2-11181-00-00				
				B0849020RC	Base Gasket	2S2-11351-00-00				
				EX696	Exhaust Gasket	3VD-14613-01-00				
				3179V	Intake Valve Seal 3 Req.	4SV-12119-00-00				
				3234V	Exhaust Valve Seal 2 Req.	33M-12119-00-00				
				EC019018AFM	Cam Chain Tensioner Gasket	4FM-12213-00				
				WA082063C	Oil Line Washers 2 Req.	90430-10171				
				WA114	Drain Plug Gasket	90430-06014				
				WA116	Oil Line Washers 4 Req.	90201-08087-00				
				Bottom End Kit w/Oil Seals C7908BE				Component Part#	Component Description	OEM Part #
							EC1100031F	Inner Clutch Cover	2S2-15462-10-00	
			WP189	Water Pump Cover Gasket	5BE-12439-00-00					
			WA080043C	Water Pump Drain Crush Washer	90430-06014-00					
			WA080043C	Case Oil Galley Drain Plug	90430-06014-00					
			WA116	Case Water Galley Drain Plug	90430-08119-00					
			WA082063C	Drain Plug Crush Seal	90430-10188-00					
			R109B	Oil Pump O-rings	93210-07135-00					
			R011V	Mag Cover Oil Passage O-ring	93210-08003-00					
			R012B	Case Oil Level Plug O-ring	93210-09350-00					
			R013B	Case Oil Galley O-ring	93210-10197-00					
			R113B	Timing Mark O-ring	93210-14369-00					
			R19X2V	Fill Plug O-Ring	93210-19123-00					
			R018V	Primary Cover Oil Passage O-ring	93210-19758-00					
			R12X2V	Output Shaft O-ring	93210-22298-00					
			R121V	Crank End Plug O-ring	93210-27778-00					
			R134B	Oil Pump Cover O-ring	93210-47675-00					
				Electric Starter Cover O-ring	93210-58346-00					
Oil Seal Kit C7908OS				Component Part#	Component Description	OEM Part #				
			OS227	Inner Water Pump Oil Seal	93102-12321-00					
			OS236	Oil Pump Seal	93101-14164-00					
			OS283	Outer Water Pump Oil Seal	93109-11073-00					
			OS284	Output Shaft Seal	93102-32480-00					
			OS285	Kick Start Shaft Seal	93102-20108-00					
			OS286	Clutch Pushrod Seal	93102-12224-00					
			OS286	Shift Shaft Seal	93102-12224-00					
Clutch & Mag Kit C7908CM				Component Part#	Component Description	OEM Part #				
			EC763020F	Outer Clutch Cover	5TA-15453-00-00					
			EC1099031F	Mag Cover Gasket	2S2-15451-00-00					
			Component Part#	Component Description	OEM Part #					
			VC104	Valve Cover Gasket						

YZ490

Model	Year	Bore Size	Top End Kit	Component Part#	Component Description	OEM Part #
YZ490	83	89 mm	C7138	H0166043C	Head Gasket	5X6-11181-00-00
				B0063020F	Base Gasket	1LV-11351-00-00
			Top End Kit C7090	Component Part#	Component Description	OEM Part #
YZ490	84-86	89 mm		H0062043C	Head Gasket	40T-11181-00-00
YZ490	87-90			B0063020F	Base Gasket	1LV-11351-00-00
WR500	91-93			IR018018AFM	Intake Gasket	2K7-13621-00-00

XTT500/SR500

Model	Year	Bore Size	Top End Kit	Component Part#	Component Description	OEM Part #
XTT500/ SR500	76-81	90 mm	C7252	H0193043F	Head Gasket	2J2-11181-09-00
				B0188020F	Base Gasket	583-11351-00-00

XTT600XT/SRX

Model	Year	Bore Size	Top End Kit	Component Part#	Component Description	OEM Part #
TT600 XT, SRX	83-87	98 mm	C7114	H0063043F	Head Gasket	1JK-11181-00
				B0064020F	Base Gasket	1VJ-11351-00-00



MX/Dirt · Off-Road · ATV Gaskets



Cometic Gasket - An Exclusive NASCAR Performance® Product

XT600 / YFM600

Model	Year	Bore Size	Top End Kit	Component Part#	Component Description	OEM Part #
YFM600	98-01	97 mm	C7213	H0267043F	Head Gasket 97mm	2KF-11181-01
Grizzly		98 mm	C7276	H0320043F	Head Gasket 98mm	2KF-11181-01
XT600	88-96	101 mm	C7277	H0321043F	Head Gasket 101mm	2KF-11181-01
				B0064020F	Base Gasket	1VJ-11351-00-00
				B1019010RC	Base Gasket	33D-11351-00-00
				EC019032AFM	Cam Chain Tensioner Gasket	4FM-12213-00-00
				EX1041042AM	Exhaust Gasket	33D-14613-00-00

YFM660R

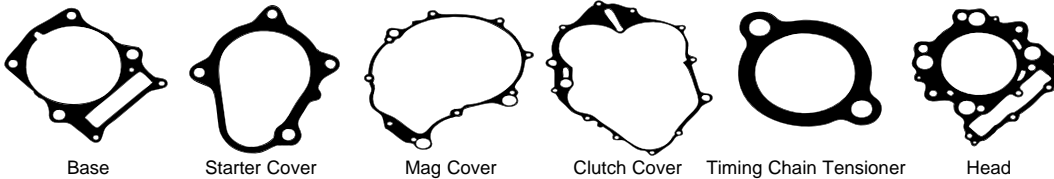

Model	Year	Bore Size	EST Top End Kit	Component Part#	Component Description	OEM Part #
YFM660R	01-05	100mm	C7044-EST	H1481SP2030S	Head Gasket 100mm Bore	3YF-11181-00
Raptor		101mm	C7900-EST	H1481030S	Head Gasket 101mm Bore	
Rhino 660 (SXS)	04-07	102mm	C7798-EST	H1191030S	Head Gasket 102mm Bore	
Fits Top End Only		103mm	C3042-EST	H2174030S	Head Gasket 103mm Bore	
		105mm	C7909-EST	H1191SP1030S	Head Gasket 105mm Bore	
				B0532010RC	Base Gasket	3YF-11351
				EX361	Exhaust Gasket 2 Req.	3YF-14613-01-00
				EC584018AFM	Cam Chain Tensioner Gasket	4DW-12213-00
				3187V	Valve Seal 5 Req.	5H0-12119-00-00
				R016B	Radiator Hose O-ring	93210-18417-00
				R113B	Valve Cover Plug O-ring	93210-13657-00
				R114S	Oil Tank O-ring	93210-16629-00
				R116B	Cam Chain Tens. Cap O-ring	11101/93210
				R117B	Dipstick O-ring	93210-21190-00
				R124B	Tappet Cover O-ring	93210-32172-00
				R155S	Cylinder Base O-ring	11256/93211
				R71X2.5B	Intake Valve Adj. Cover O-ring	93210-71360-00
				WA081080C	Oil Line Washers 4 Req.	90430-08204
				WA082063C	Oil Line Washers 4 Req.	90430-10171
			Bottom End Kit w/o crank seals C3339	Component Part#	Component Description	OEM Part #
				EC580060AFM	Starter Cover Gasket	5LP-15455-00
				EC581060AFM	Cover Gasket	5LP-15451-00
				C7800	Clutch Cover Gasket	5LP-15462-00
				OP092010FB	Oil Pump Cover Gasket	5LP-13329-00
				R027V	Crank Plug O-ring	93210-14369-00
				R031B	Intake O-ring	93210-44545-00
				R109B	Water Pump Impeller O-ring 2 Req.	11171/93210-77363
				R125V	Water Outlet- Oring	93210-33786-00
				R126B	Timing Plug O-ring	93210-357A3-00
				R12X2V	Out Put Shaft O-ring	93210-22298-00
				WA080043C	Drain Plug Washer	90430-06014-00



MX/Dirt • Off-Road • ATV Gaskets



Cometic Gasket - An Exclusive NASCAR Performance® Product

YFM700RV

Model	Year	Bore Size	Top End Kit	Component Part#	Component Description	OEM Part #
YFM700	06-16	103mm	C3142-EST	H2449027S	Head Gasket 103mm	1S3-11181-00-00
YFM700F	07-15	104mm	C3143-EST	H2449SP2027S	Head Gasket 104mm	
Grizzly		105.5mm	C3144-EST	H2465027S	Head Gasket 105.5mm	
				B0855010RC	Base Gasket	1S3-11351-00-00
				EX361	Exhaust Gasket 2 Req.	3YF-14613-01-00
				R034V	Throttle Body O-ring	4WV-14147-10-00
				R0126V	Water Pump O-ring	93210-33786-00
				R131B	Thermostat O-ring	93210-41042-00
				R240V	Cam Cover O-ring	93210-96601-00
				R79X2.5V	Valve Cover O-rings 2 Req.	93210-78544-00
				3187V	Valve Seal 4 Req.	5H0-12119-00-00
				EC584018AFM	Cam Chain Tensioner Gasket	4DW-12213-00
			Bottom End Kit w/o crank seals		Component Description	OEM Part #
			C3581		Inner Crankcase Cover Gasket	3B4-15451-00-00
					Outer Crankcase Cover Gasket	3B4-15453-00-00
					O-ring	93210-14369-00
					Crankcase Seal	3B4-15379-00-00
					Oil Seal	93101-12168-00
					Oil Pump Cover Gasket	3B4-13329-00-00
					Oil Drain Bolt Washer	214-11198-01-00
					Oil Cooler Gasket	1XD-13475-00-00
					Oil Line Washers 4 Req.	90430-14043-00
					Oil Line Washers 4 Req.	90430-08119-00
					Oil Line Washers 2 Req.	90430-10188-00
					Oil Relief O-ring	93210-10096-00

YFM700

Model	Year	Bore Size	Top End Kit	Component Part#	Component Description	OEM Part #
YFM700	2016	103mm	C3599-EST	EC2098032AFM	Cam Chain Tensioner Gasket	2MB-E2213-00-00
Grizzly				MA0164	Cam Chain Tensioner	2MB-YFM700
YFM700					Crush Gasket	E21E2-00-00
Kodiak				B1306010RC	Cylinder Base Gasket	2MB-E1351-00-00
				H4173023S	103mm Bore Cyl. Head Gasket	2MB-E1181-00-00
				VC362018AFM	Valve Cover Breather Gasket	2MB-E131B-00-00
				EX045	Header Gasket	3EG-14613-00-00
				WA117	Oil Line Banjo Bolt	2MB-E1195-00-00
					Crush Gaskets	
				3250V	Exhaust Valve Seal	2MB-E2129-00-00
				3250V	Intake Valve Seal	2MB-E2119-00-00
				R125V	Water Outlet O-ring	2MB-E2843-00-00



STREET·ROAD RACE·STRIP



Cometic Gasket - An Exclusive NASCAR Performance® Product

APRILIA

Model	Year	Type	Bore Size	Displacement / cc	Material	Part #	OEM Part #
RSV1000R Mille	98-06	Head Gaskets	98mm	997cc-1018cc	MLS/C.O.T. .018	C8511-018	
			100mm	1018cc-1060cc	MLS/C.O.T. .018	C8512-018	

DUCATI

Model	Year	Type	Bore Size	Displacement / cc	Material	Part #	OEM Part #
748	94-02	Head Gasket	88mm	748cc	MLS/C.O.T. .030	C8753	786.1053.2A
					Spring Steel .020	C8754	786.1.068.1A
851	87-81	Head Gasket	91mm	858cc	SLS/C.O.T. .017	C8560	
		Head Gasket	96mm	888-955cc	SLS/C.O.T. .017	C8564	
888	91-98	Base Gasket			Spring Steel .020	C8755	
		Head Gasket	96mm	888-955cc	SLS/C.O.T. .017	C8564	
916	91-98	Base Gasket			Spring Steel .020	C8755	
		Head Gasket	96mm	888-955cc	SLS/C.O.T. .017	C8564	
996	99-02	Base Gasket			Spring Steel .020	C8755	
		Head Gasket	98mm	995cc	SLS/C.O.T. .017	C8561	786.1.048.1A
996R	2001	Base Gasket			Spring Steel .014	C8756	
		Head Gasket	100mm		MLS/C.O.T. .027	C8757	786.1.055.1B
1000 DS Super Sport	89-07	Head Gasket	98mm	1025cc	MLS/C.O.T. .027	C8758	
		Head Gasket	98mm	1025cc	SLS/C.O.T. .010	C8700	786.1.064.1A
1098, 1098S	07-08	Base Gasket			Spring Steel .014	C8759	786.1.063.1A
		Head Gasket	104mm		MLS/C.O.T. .027	C8807	786.1.092.2A
1198, 1198S, 1198R	09-11	Base Gasket			Spring Steel .014	C8809	786.1.094.1A
		Head Gasket	106mm		MLS/C.O.T. .027	C8808	786.1.100.1A
Panigale 1199	12-14	Base Gasket			Spring Steel .014	C8809	786.1.094.1A
		Head Gasket	113mm		MLS/C.O.T. .020	C8834	786.1.121.2C
		Head Gasket	116mm		MLS/C.O.T. .020	C8835	

HONDA

Model	Year	Type	Bore Size	Displacement / cc	Material	Part #	OEM Part #
CBR250	11-13	Top End Kit	77mm		MLS/C.O.T. .027	C3522-EST	
CBR250	11-13	Top End Kit	78mm		MLS/C.O.T. .027	C3523-EST	
CBR250	11-13	Top End Kit	80mm		MLS/C.O.T. .027	C3524-EST	
CBR250	11-13	Top End Kit	81mm		MLS/C.O.T. .027	C8832-EST	
CBR250	11-13	Top End Kit	83mm		MLS/C.O.T. .027	C3526-EST	
CB500	13-15	Head Gasket	69mm		MLS/C.O.T. .023	C8887	45584-MGZ-J01
	13-15	Head Gasket	70mm		MLS/C.O.T. .023	C8888	
CB500	72-74	Head Gasket	59mm		MLS/C.O.T. .040	C8824	12251-374-306
CB550	74-78	Head Gasket	60mm		MLS/C.O.T. .040	C8825	12251-374-306
CB650	79-82	Head Gasket	61mm		MLS/C.O.T. .040	C8826	12251-374-306
		Head Gasket	62mm		MLS/C.O.T. .040	C8827	12251-426-306
CBR600F Hurricane	87-90	Head Gasket	65 mm	600cc-637cc	Copper .020	C8000	12251-MN4-003
		Base Gasket		635cc	Copper .010	C8503	12191-MN4-004
		Base Gasket		635cc	Copper .020	C8504	12191-MN4-004
		Head Gasket	67.0 mm	618cc thru 637cc	MLS/C.O.T. .030	C8265	12251-MAL-601
CBR600	91-98	Head Gasket	67.0 mm	618cc thru 637cc	MLS/C.O.T. .018	C8265-018	12251-MAL-601
					MLS/C.O.T. .030	C8265	12251-MAL-601
CBR600 F2	91-94	Head Gasket	67 mm	618cc thru 637cc	MLS/C.O.T. .018	C8265-018	12251-MAL-601
CBR600 F3	95-98	Head Gasket	67 mm	618cc thru 637cc	MLS/C.O.T. .030	C8265	12251-MAL-601
					MLS/C.O.T. .018	C8265-018	12251-MAL-601
CBR600 F4	99-06	Head Gasket	67 mm		MLS/C.O.T. .030	C8572	12251-MBW-013
			67 mm		MLS/C.O.T. .018	C8572-018	12251-MBW-013
			68 mm		MLS/C.O.T. .030	C8636	12251-MBW-013
			69 mm		MLS/C.O.T. .030	C8671	12251-MBW-013
CBR600 RR	03-06	Head Gasket	67 mm	599cc	MLS/C.O.T. .027	C8704-027	12251-MBW-013
					MLS/C.O.T. .018	C8704-018	12251-MBW-013
			69 mm	599-635cc	MLS/C.O.T. .027	C8706-027	12251-MBW-013
					MLS/C.O.T. .018	C8706-018	12251-MBW-013
			70 mm	636-654cc	MLS/C.O.T. .027	C8705-027	12251-MBW-013
					MLS/C.O.T. .018	C8705-018	12251-MBW-013
CBR600 RR	07-15	Head Gasket	68.5mm	599cc-626cc	MLS/C.O.T. .027	C8736	12251-MFJ-D01
					MLS/C.O.T. .018	C8736-018	12251-MFJ-D01
			70mm	627cc-654cc	MLS/C.O.T. .027	C8737	12251-MFJ-D01
				MLS/C.O.T. .018	C8737-018	12251-MFJ-D01	
NT650 Hawk GT	88-91	Head Gasket	82mm	700cc	Stainless .010	C8207	12251-MN8-911
		Base Gasket		700cc	Copper .010	C8520	12191-MN8-003
VFR750	90-94	Head Gasket	72.0 mm	750cc	CFM-20	C8498	12251-MR7-003
CB750 2 Valve	71-78	Head Gasket	65 mm	811cc-836cc	CFM-20	C8001	12251-300-307
			67.5 mm	837cc-915cc	CFM-20	C8002	12251-300-307
		Base Gasket	70.5 mm		Copper .005	C8286	12191-300-020
			70.5 mm		Copper .010	C8287	12191-300-020
			70.5 mm		Copper .020	C8288	12191-300-020
			70.5 mm		Fiber .020	C8289	12191-300-020
CB750K 2V	73-78	Head Gasket	65mm		MLS/C.O.T. .045	C8801	
		Head Gasket	68mm		MLS/C.O.T. .045	C8802	
		Head Gasket	70mm		MLS/C.O.T. .045	C8803	
		Head Gasket	72mm		MLS/C.O.T. .045	C8804	



STREET·ROAD RACE·STRIP



Cometic Gasket - An Exclusive NASCAR Performance® Product

HONDA

Model	Year	Type	Bore Size	Displacement / cc	Material	Part #	OEM Part #
CB750SC 4 Valve	79-83	Head Gasket	65 mm	823cc	CFM-20	C8003	12251-425-000
	79-83		70 mm	890-955cc	CFM-20	C8004	12251-425-000
	79-83	Base Gasket	74 mm		Copper .005	C8451	12191-425-000/010/306
					Copper .010	C8452	12191-425-000/010/306
					Copper .020	C8453	12191-425-000/010/306
CB900C 900 Custom	80-82	Head Gasket	68 mm	985cc	CFM-20 .043	C8005	
	79-83	Base Gasket	74 mm		Copper .005	C8451	
					Copper .010	C8452	
					Copper .020	C8453	
					Fiber .020	C8454	
CB900F Super Sport	81-82	Head Gasket	68 mm	985cc	CFM-20	C8005	
			72 mm	1123cc	Copper .043	C8224	
CBR900 919 (CB900F)	93-99 02-07	Head Gasket	72 mm	945cc	MLS/C.O.T. .040	C8267	12251-MW0/MAS-003
			72 mm		MLS/C.O.T. .018	C8267-018	12251-MW0/MAS-003
			73 mm	970cc	MLS/C.O.T. .040	C8401	12251-MW0/MAS-003
			73 mm		MLS/C.O.T. .018	C8401-018	12251-MW0/MAS-003
			74 mm	997cc	MLS/C.O.T. .040	C8268	12251-MW0/MAS-003
			74 mm		MLS/C.O.T. .018	C8268-018	12251-MW0/MAS-003
			75 mm	1033cc	MLS/C.O.T. .040	C8406	12251-MW0/MAS-003
CBR929	00-01	Head Gasket	76mm	980cc	MLS/C.O.T. .030	C8568	12251-MCJ-003/013
			76mm	980cc	MLS/C.O.T. .018	C8568-018	12251-MCJ-003/013
CBR954	02-03	Head Gasket	76mm	980cc	MLS/C.O.T. .030	C8568	12251-MCJ-003/013
			76mm	980cc	MLS/C.O.T. .018	C8568-018	12251-MCJ-003/013
CBR1000	thru 95	Head Gasket	79.0 mm	1050cc	Stainless .010	C8008	12251-MW7-791
		Base Gasket	84.5 mm		Copper .005	C8410	12191-MS2 611
CBR1000 RR	04-07	Head Gasket	75.0 mm	998cc	MLS/C.O.T. .027	C8702-027	12251-MEL-013
					MLS/C.O.T. .018	C8702-018	12251-MEL-013
			76.0 mm	1025cc	MLS/C.O.T. .027	C8703-027	12251-MEL-013
					MLS/C.O.T. .018	C8703-018	12251-MEL-013
			77 mm	1052cc	MLS/C.O.T. .027	C8727	12251-MEL-013
CBR1000RR	08-14	Head Gasket	77mm	1000-1026cc	MLS/C.O.T. .027	C8727-018	12251-MEL-013
					MLS/C.O.T. .018	C8779	12251-MFL-003
					Spring Steel .010	C8779-018	12251-MFL-003
						C8780	12191-MFL-003
						C8569	12251-MCF-003/12252-MCF-003
RVT1000R/RC51	00-06	Head Gasket	101.5mm	999cc	MLS/C.O.T. .027	C8765	12251-MCF-003/12252-MCF-003
			102.5mm	1030cc	MLS/C.O.T. .027	C8765	12251-MCF-003/12252-MCF-003
			103.5mm	1051cc	MLS/C.O.T. .027	C8766	12251-MCF-003/12252-MCF-003
CBX 6 Cylinder	79-82	Head Gasket	65 mm	1047cc	CFM-20	C8407	12251-422-306
			65 mm	1047cc	Copper .043	C8396	12251-422-306
			67.5 mm	1147cc	Copper .043	C8319	12251-422-306
			68 mm	1147cc	CFM-20	C8341	12251-422-306
			73 mm		Fiber .020	C8342	12191-422-306
CB1100F	83	Head Gasket	72 mm	1123cc	CFM-20	C8006	12251-MG5-670
		Head Gasket	72 mm	1123 cc	Copper .043	C8224	12251-MG5-670
		Head Gasket	74 mm	1186 cc	Copper .043	C8225	12251-MG5-670
CBR1100XX Blackbird	97-03	Head Gasket	75 mm	1219cc	Copper .020	C8007	12251-MG5-670
		Base Gasket	79.5 mm		Copper .020	C8521	12191-MG5-306
CBR1100XX Blackbird	97-03	Head Gasket	81.0 mm	1195cc	MLS/C.O.T. .030	C8499	12251-MAT-003
					MLS/C.O.T. .018	C8499-018	12251-MAT-003
CB900C 900 Custom	80-82	Head Gasket	68 mm	985cc	CFM-20 .043	C8005	
	79-83	Base Gasket	74 mm		Copper .005	C8451	
					Copper .010	C8452	
					Copper .020	C8453	
					Fiber .020	C8454	
CB900F Super Sport	81-82	Head Gasket	68 mm	985cc	CFM-20	C8005	
			72 mm	1123cc	Copper .043	C8224	



Honda Engine Case Rebuild

Model	Year	Part Description	Part #	OEM Part #			
CBR600 F4	99-06	Engine Case Rebuild	C8633	14523-MAL-A00			
		Cam Chain	EC388018AFM				
		Ignition	EC625018AFM				
		Oil Pan	EC626018AFM				
		Generator	EC627018AFM				
CBR600 F2,F3	91-98	Engine Case Rebuild	C8301	11394-MV9-670 11393-MV9-670 11392-MV9-670 11391-MV9-670			
		Oil Pan	EC032020F				
		Clutch Cover	EC033020F				
		Generator	EC034020F				
		Pulse Ignition	EC035020F				
CBR600RR	07-14	Engine Case Rebuild	C8739	14523-MAL-A00			
		Alternator Cover	EC1231032AFM				
		Clutch Cover	EC1232032AFM				
		Cam Chain	EC814018AFM				
		Oil Pan	OP217032AFM				
CB750K 2V	73-78	Engine Case Rebuild Kit	C8863	11397-300-306 14592-300-306 11396-300-306 12391-300-306 11398-300-306 15135-300-010 30372-300-300 31282-300-020 11395-300-306			
		Mag Cover Gasket	EC1024032AFM				
		Cam Chain Tensioner Gasket	EC1023060AFM				
		Clutch Cover Gasket	EC1435SP1060AFM				
		Valve Cover Gasket	VC122060AFM				
		Oil Pan Gasket	OP355032AFM				
		Oil Pump Gasket	EC1699060AFM				
		Points Cover Gasket	EC1968032AFM				
		Starter Motor Cover Gasket	EC1969032AFM				
		Trans Cover Gasket	EC1964032AFM				
		_CBR900 919 (CBR900F)	93-99 02-07		Engine Case Rebuild	C8211	11394-MV9-670 11393-MV9-670 11392-MV9-670 11391-MV9-670 121940HC5-740 18647-MWO-750
					Oil Pan	EC032020F	
Clutch Cover	EC033020F						
Dyno	EC034020F						
Ignition	EC035020F						
Cam Chain	EC036020F						
CA Emission	EC037043F						
CBR929 / 954	00-03			Engine Case Rebuild	C8634	11392-MCJ-000	
		Generator	EC628018AFM				
		Oil Pan	EC629018AFM				
		Ignition / Clutch	EC630018AFM				
		Cam Chain	EC631018AFM				
CBR1100XX Blackbird	97-03	Engine Case Rebuild	C8586	14523-MAL-A00 22862-MW7-650 11392-MAT-000 11393-MAT-000			
		Cam Chain	EC388020F				
		Cam Pulser	EC389020F				
		Pulser Cover	EC390020F				
		Alternator Cover	EC391020F				
		Clutch Cover	EC392020F				

KAWASAKI

Model	Year	Type	Bore Size	Displacement / cc	Material	Part #	OEM Part #	
CB750SC 4 Valve	79-83	Head Gasket	65 mm	823cc	CFM-20	C8003	12251-425-000	
			70 mm	890-955cc	CFM-20	C8004	12251-425-000	
	79-83	Base Gasket	74 mm		Copper .005	C8451	12191-425- 000/010/306	
						Copper .010	C8452	12191-425- 000/010/306
						Copper .020	C8453	12191-425- 000/010/306
EX250 Ninja	86-07	Head Gasket	62mm		Spring Steel .012	C8828	11004-1312	
			64mm		Spring Steel .012	C8829	11004-1312	
	08-12	Head Gasket	62mm	SLS .012"	C8859	11004-0080		
			64mm	SLS .012"	C8860	11004-0080		
			66mm	SLS .012"	C8861	11004-0080		
EX500 Ninja 500, 500R	87-09	Head Gasket	75.5mm	500cc	CFM-20 .043	C8318	11004-1159	
KZ 550 Ltd.	80-83	Head Gasket	61mm	550cc-615cc	CFM-20 .043	C8009	11004-1212/1021	
GP, GPz 550	81-85						11004-1212/1021	
Zeyphr 550	90-91						11004-1212/1021	
ZX600, B1,C1-7	87-94	Head Gasket	62mm	612cc-633cc	.043 CFM-20	C8010	11004-1206	
Ninja 600R		Base Gasket	2.680	600cc-635cc	.005 Copper	C8589	11009-1855	
ZX600 Ninja 600R	95-02	Head Gasket	68 mm	617cc-636cc	MLS/C.O.T. .030	C8270	11004-1303/1348	
Ninja ZX-6R	95-99	Head Gasket	68 mm	617cc-636cc	MLS/C.O.T. .018	C8270-018	11004-1303/1348	
ZZR600			70 mm	636cc-674cc	MLS/C.O.T. .027	C8694	11004-1348	
			70 mm	636cc-674cc	MLS/C.O.T. .018	C8694-018	11004-1348	
Ninja ZX-6R	00-02	Head Gasket	68mm	70mm	.010 Copper	C8354	11060-1844	
					Spring Steel .010	C8698	11060-1844	
					MLS/C.O.T. .027	C8693	11004-1348	
					MLS/C.O.T. .018	C8693-018	11004-1348	
					MLS/C.O.T. .027	C8694	11004-1348	
Base Gasket	MLS/C.O.T. .018	C8694-018	11004-1348					
	Spring Steel .010	C8698	11060-1844					

All Component Parts can be purchased individually.



STREET·ROAD RACE·STRIP



Cometic Gasket - An Exclusive NASCAR Performance® Product

KAWASAKI

Model	Year	Type	Bore Size	Displacement / cc	Material	Part #	OEM Part #	
Ninja ZX-6R	03-06	Head Gasket	68mm	636cc	MLS/C.O.T. .027	C8690	11004-1383	
			69mm	636cc-655cc	MLS/C.O.T. .018	C8690-018	11004-1383	
			70mm	656cc-674cc	M.L.S./C.O.T. .027	C8701	11004-1383	
		Base Gasket				MLS/C.O.T. .018	C8701-018	11004-1383
						Spring Steel .010	C8692	11004-1383
Ninja ZX-6R	07-12	Head Gasket	68mm	636cc	MLS/C.O.T. .027	C8751	11004-0078	
Ninja ZX-6RR	2003	Head Gasket	69mm	600cc-636cc	MLS/C.O.T. .018	C8751-018	11004-0078	
			70mm	618cc-654cc	MLS/C.O.T. .027	C8701	11004-1383	
Ninja ZX-6RR	04-06	Head Gasket	69mm	600cc-617cc	MLS/C.O.T. .018	C8701-018	11004-1383	
			70mm	618cc-654cc	MLS/C.O.T. .027	C8696	11004-1383	
					MLS/C.O.T. .018	C8696-018	11004-1383	
		Base Gasket			Spring Steel .010	C8692	11061-0041	
		Head Gasket	68mm	600cc-617cc	MLS/C.O.T. .027	C8691	11004-0017	
EX-650, KLE650Versys	06-14	Head Gasket	84mm	600cc-617cc	MLS/C.O.T. .018	C8691-018	11004-0017	
			86mm	618cc-654cc	MLS/C.O.T. .027	C8697	11004-0017	
					MLS/C.O.T. .018	C8697-018	11004-0017	
KZ650	77-83	Head Gasket	84mm	600cc-617cc	Spring Steel .010	C8692	11061-0041	
			86mm	618cc-654cc	Spring Steel .010	C8692	11061-0041	
KZ, GPZ750, ZX750 Turbo	84-85	Head Gasket	65mm	700cc-720cc	MLS/C.O.T. .027	C8722	11004-0064	
ZX750 Ninja	87-90	Head Gasket	69.0 mm	810cc	MLS/C.O.T. .027	C8862	11004-0064	
ZX-7	91-95	Head Gasket	72.0 mm	770cc	Spring Steel .010	C8723	11061-0171	
ZX-7R	91-94	Base Gasket	3.210"	750cc - 950cc	MLS/C.O.T. .018	C8274-018	11004-1223	
					Spring Steel .010	C8344	11060-1093	
					Copper .005	C8290	11060-1093	
					Copper .010	C8291	11060-1093	
					Copper .020	C8292	11060-1093	
ZX-7R	96-03	Head Gasket	73.0 mm	750cc	Spring Steel	C8428	11004-1307	
					MLS/C.O.T. .018	C8428-018	11004-1307	
ZX-7RR	96-97	Head Gasket	75.0 mm	795cc	Spring Steel	C8429	11004-1307	
					MLS/C.O.T. .018	C8429-018	11004-1307	
					Copper .010	C8524	11060-1705	
					Copper .020	C8525	11060-1705	
					Base Gasket	750cc	Copper .010	C8524
ZX900/ZX1000 Ninja	84-86	Base Gasket	3.230	900cc - 1000cc	Spring Steel .010	C8346	11009-1505	
					Copper .005	C8355	11009-1505	
ZX-9R	94-97	Head Gasket	75.0 mm	950cc	Spring Steel	C8272	11004-1307	
					Spring Steel .010	C8344	11060-1093	
					Copper .005	C8290	11060-1093	
					Copper .010	C8291	11060-1093	
					Copper .020	C8292	11060-1093	
ZX-9R	98-99	Head Gasket	77 mm	950cc	Spring Steel	C8515	11004-1327	
					Copper .005	C8505	11060-1818	
ZX-9R	00-03	Head Gasket	77 mm	900cc	Spring Steel	C8570	11004-1345	
					MLS/C.O.T. .018	C8570-018	11004-1345	
					Spring Steel	C8609	11004-1345	
					MLS/C.O.T. .018	C8609-018	11004-1345	
					Base Gasket	900cc	Copper .010	C8595
Z1, KZ900, KZ1000	73-81	Head Gasket	71mm	1045cc	Copper .020	C8596	11060-1974	
					MLS/C.O.T. .040	C8839-040	11004-066/11004-1296/11004-052/11004-1269	
Z1, KZ900, KZ1000	73-81	Head Gasket	73mm	1105cc	MLS/C.O.T. .040	C8840-040	11004-066/11004-1296/11004-052/11004-1269	
Z1, KZ900, KZ1000	73-81	Head Gasket	76mm	1197cc	MLS/C.O.T. .040	C8841-040	11004-066/11004-1296/11004-052/11004-1269	
KZ1000, KZ1100, ZX1100, GPZ1100	81-05	Head Gasket	71mm	1045cc	MLS/C.O.T. .040	C8842-040	11004-1222	
					MLS/C.O.T. .040	C8843-040	11004-1222	
KZ1000, KZ1100, ZX1100, GPZ1100	81-05	Head Gasket	73mm	1105cc	MLS/C.O.T. .040	C8844-040	11004-1222	
					MLS/C.O.T. .040	C8844-040	11004-1222	
KZ1000, KZ1100, ZX1100, GPZ1100	81-05	Head Gasket	78mm	1230cc-1260cc	MLS/C.O.T. .040	C8845-040	11004-1222	



STREET·ROAD RACE·STRIP



Cometic Gasket - An Exclusive NASCAR Performance® Product

KAWASAKI

Model	Year	Type	Bore Size	Displacement / cc	Material	Part #	OEM Part #
KZ / GPZ / 10mm Dowel Pin		Head Gasket	70 mm	1015cc	Copper .043	C8152	11004-1222/11004-1296/11004-1104
			71 mm	1045cc	Copper .043	C8153	11004-1222/11004-1296/11004-1104
			72 mm	1075cc	Copper .043	C8154	11004-1222/11004-1296/11004-1104
			73 mm	1105cc	Copper .043	C8181	11004-1222/11004-1296/11004-1104
			75 mm	1166cc	Copper .043	C8182	11004-1222/11004-1296/11004-1104
			76 mm	1197cc	Copper .043	C8156	11004-1222/11004-1296/11004-1104
			77 mm	1229cc	Copper .043	C8183	11004-1222/11004-1296/11004-1104
			78 mm	1261cc	Copper .043	C8157	11004-1222/11004-1296/11004-1104
			80 mm	1327cc	Copper .043	C8158	11004-1222/11004-1296/11004-1104
			82 mm	1393cc	Copper .043	C8159	11004-1222/11004-1296/11004-1104
			83 mm	1428cc	Copper .043	C8160	11004-1222/11004-1296/11004-1104
KZ / GPZ / D Dowel Pin		Head Gasket	82 mm	1393cc	Copper .043	C8432	11004-1222/11004-1296/11004-1104
			83 mm	1428cc	Copper .043	C8433	11004-1222/11004-1296/11004-1104
			84 mm	1463cc	Copper .043	C8161	11004-1222/11004-1296/11004-1104
KZ1000J, GPZ1100, 2 pc	81-83	Head Gasket	72 mm	1075cc	CFM-20	C8324	11004-1222/11004-1296/11004-1104
			74 mm	1135cc	CFM-20	C8325	11004-1222/11004-1296/11004-1104
			76 mm	1197cc	CFM-20	C8326	11004-1222/11004-1296/11004-1104
KZ900-1000, Z1	73-81	Base Gasket	3.210	1000cc-1200cc	Copper .005	C8094	111009-030/11060-1579
					Copper .010	C8095	111009-030/11060-1579
					Copper .020	C8096	111009-030/11060-1579
			3.285	1200cc-1260cc	Fiber .020	C8093	111009-030/11060-1579
					Copper .005	C8098	111009-030/11060-1579
					Copper .010	C8099	111009-030/11060-1579
			3.475	1261cc-1425cc	Copper .020	C8100	111009-030/11060-1579
					Fiber .020	C8097	111009-030/11060-1579
					Copper .005	C8102	111009-030/11060-1579
			3.560	1425cc-1500cc	Copper .010	C8103	111009-030/11060-1579
					Copper .020	C8104	111009-030/11060-1579
					Fiber .020	C8101	111009-030/11060-1579
			Copper .005	C8121	111009-030/11060-1579		
			Copper .010	C8122	111009-030/11060-1579		
			Copper .020	C8123	111009-030/11060-1579		
KZ1000J,K,M,P,R, KZ1000GPz,ZX1100GPZ	81-05	Base Gasket	3.120"	1000cc-1200cc	Fiber .020	C8865	11009-1207/11060-1828/11060-1067
KZ1000J,K,M,P,R, KZ1000GPz,ZX1100GPZ	81-05	Base Gasket	3.285"	1200cc-1260cc	Fiber .020	C8866	11009-1207/11060-1828/11060-1067
KZ1000J,K,M,P,R, KZ1000GPz,ZX1100GPZ	81-05	Base Gasket	3.475"	1261cc-1425cc	Fiber .020	C8867	11009-1207/11060-1828/11060-1067
KZ900- 1000 1pc		Head Gasket	72.0 mm	1075cc	CFM-20	C8018	11004-1222/11004-1296/11004-1104
			75.0 mm	1075cc - 1170cc	CFM-20	C8017	11004-1222/11004-1296/11004-1104



STREET·ROAD RACE·STRIP



Cometic Gasket - An Exclusive NASCAR Performance® Product

KAWASAKI

Model	Year	Type	Bore Size	Displacement / cc	Material	Part #	OEM Part #
KZ900 - 1000 2 pc.		Head Gasket	71.0 mm	1045cc	Copper .043	C8315	11004-1222/11004-1296/11004-1104
			74.0 mm	1135cc	Copper .043	C8244	11004-1222/11004-1296/11004-1104
KZ900 - 1000, GPZ1100	81-84	Head Gasket	74 mm	1060cc - 1135cc	CFM-20	C8019	11004-1222/11004-1296/11004-1104
			76.0 mm	1170cc - 1200cc	CFM-20	C8020	11004-1222/11004-1296/11004-1104
			78.0 mm	1230cc - 1260cc	CFM-20	C8021	11004-1222/11004-1296/11004-1104
			80.0 mm	1290cc - 1325cc	CFM-20	C8022	11004-1222/11004-1296/11004-1104
			83.0 mm	1385cc, 1425cc	CFM-20	C8023	11004-1222/11004-1296/11004-1104
ZR1100	92-95	Head Gasket	82mm	1321cc	CFM-20	C8229	11004-1237
ZX1100 Ninja ZX11C	90-91	Head Gasket	78mm	1109cc	Copper .032	C8483	11004-1248
GPx1100 ZX11E	95-97						
ZRX1100	99						
Ninja 1000R	86-87	Base Gasket	3.210	750cc - 950cc	Spring Steel .010	C8344	11009-1505
		Head Gasket	75.0 mm	972cc	Copper .010	C8291	11009-1505
ZX10 / ZX11	88-01	Head Gasket	78.0 mm	1109cc	CFM-20	C8013	11009-1505
		Head Gasket	78.0 mm	1109cc	Copper .032	C8483	11004-1248
		Head Gasket	82.0 mm	1321cc	CFM-20	C8229	11004-1248
ZX1000 Ninja, ZX10	88-90	Head Gasket	75.5 mm	1040cc	Spring Steel	C8271	11004-1181
		Head Gasket	79 mm	953cc-997cc	MLS/C.O.T. .018	C8708-018	11004-1385
Z1000	03-09	Head Gasket	81 mm	998cc-1049cc	MLS/C.O.T. .018	C8709-018	11004-1385
		Head Gasket	76mm	998cc	MLS/C.O.T. .027	C8680	11004-0032
ZX1000 Ninja ZX-10R	04-05	Head Gasket	78mm	998cc-1051cc	MLS/C.O.T. .018	C8680-018	11004-0032
		Head Gasket	78mm	998cc-1051cc	MLS/C.O.T. .027	C8681	11004-0032
		Head Gasket	78mm	998cc-1051cc	MLS/C.O.T. .018	C8681-018	11004-0032
		Head Gasket	78mm	998cc-1051cc	MLS/C.O.T. .027	C8714	11004-0049
ZX1000 Ninja ZX-10R	06-08	Head Gasket	77mm	998cc	MLS/C.O.T. .018	C8714-018	11004-0049
		Head Gasket	77mm	998cc	MLS/C.O.T. .018	C8848	11004-0094
		Head Gasket	79mm	998cc	MLS/C.O.T. .018	C8849	11004-0094
ZX11 D1, C	90-01	Head Gasket	76 mm	1052cc	Spring Steel	C8740	11004-1248
		Head Gasket	77 mm	1100cc	Spring Steel	C8603	11004-1248
		Head Gasket	77 mm	1100cc	MLS/C.O.T. .018	C8603-018	11004-1248
		Head Gasket	78 mm	1109cc	Spring Steel	C8273	11004-1248
		Head Gasket	78 mm	1109cc	MLS/C.O.T. .018	C8273-018	11004-1248
		Base Gasket	3.290	1052cc-1109cc	Spring Steel .010	C8358	11009-1847
ZRX1200	01-06	Head Gasket	80 mm	1194cc	MLS/C.O.T. .027	C8711	11004-1377
ZX-12R	00-03	Head Gasket	83 mm	1199cc	MLS/C.O.T. .030	C8642	11004-1369
		Head Gasket	84 mm	1228cc	MLS/C.O.T. .018	C8642-018	11004-1369
		Head Gasket	84 mm	1228cc	MLS/C.O.T. .030	C8573	11004-1369
		Head Gasket	85 mm	1257cc	MLS/C.O.T. .018	C8573-018	11004-1369
		Head Gasket	85 mm	1257cc	MLS/C.O.T. .030	C8643	11004-1369
		Head Gasket	86 mm	1287cc	MLS/C.O.T. .018	C8643-018	11004-1369
ZX-14R	06-15	Head Gasket	84 mm	1352cc	MLS/C.O.T. .030	C8641	11004-1369
		Head Gasket	84 mm	1352cc	MLS/C.O.T. .018	C8641-018	11004-1369
		Head Gasket	84 mm	1352cc	Spring Steel .010	C8579	11060-1907
		Head Gasket	84 mm	1352cc	MLS/C.O.T. .018	C8460-018	11004-0059
Concours 08-14		Head Gasket	86 mm	1353cc-1417cc	MLS/C.O.T. .018	C8621	11004-0059
		Head Gasket	87 mm	1418cc-1450cc	MLS/C.O.T. .018	C8622	11004-0059
		Head Gasket	87 mm	1418cc-1450cc	MLS/C.O.T. .018	C8622	11004-0059

Kawasaki Engine Case Rebuild

Model	Year	Part Description	Part #	OEM Part #
Ninja ZX-6R	95-02	Engine Case Rebuild	C8303	
		Oil Pan	EC075020F	11060-1671
		Clutch Cover	EC076020F	11060-1672
		Ignition Cover	EC077020F	11060-1674
		Dyno Cover	EC078020F	11060-1673
Ninja ZX-6R	03-06	Engine Case Rebuild	C8685	
Ninja ZX-6RR	05-08	Cam Pulser	EC948032AFM	11060-1867
		Generator	EC949032AFM	11060-1851
ZZR600	05-08	Clutch Cover	EC950032AFM	11060-1853
		Oil Pan	OP160032AFM	11060-1996
		Engine Case Rebuild	C8750AFM	
Ninja ZX-6R	07-12	Generator Cover Gasket	EC1190032AFM	11061-0249
		Starter Idle Gear Cover	EC1323032AFM	11061-0251
		Small Starter Cover	EC1191032AFM	11061-0250
		Clutch Cover Gasket	EC1324032AFM	11061-0252
		Oil Pan Gasket	OP271060AFM	11061-0253
		Generator Cover Gasket	EC1190032AFM	11061-0249



Kawasaki Engine Case Rebuild

Model	Year	Part Description	Part #	OEM Part #
EX-650 KLE650 Versys	06-14	Engine Case Rebuild	C8721	
		Generator Cover	EC1175032AFM	11061-0165
		Clutch Cover	EC1176032AFM	11061-0164
		Transmission Cover	EC1177032AFM	11061-0166
		Oil Pan	OP203032AFM	11061-0167
ZX7, ZX750	91-95	Engine Case Rebuild	C8304	
		Oil Pan	EC053020F	11060-1355
		Clutch Cover	EC054020F	11060-1623
		Transmission Cover	EC055020F	11060-1660
ZX7	96-03	Engine Case Rebuild	C8619	
		Oil Pan	EC053020F	11060-1355
		Transmission Cover	EC055020F	11060-1660
ZX9R	98-99	Clutch Cover	EC485020F	11060-1704
		Engine Case Rebuild	C8620	
		Generator Cover	EC488020F	11060-1855
KZ900 - 1000	73-78	Engine Case Rebuild	EC489032AFM	11060-1854
		Oil Pan	EC490020F	11061-1143
		Engine Case Rebuild	C8072	
		Valve Cover	C8263	11023-006
		Oil Pan	EC001020F	11060-1074
		Clutch Cover	EC002020F	14046-024
		Dyno Cover	EC003020F	11060-1075
		Transmission Cover	EC004020F	14058-004
		Ignition Cover	EC005020F	11060-1071
		Starter Cover	EC006020F	14046-025
		Cam Chain	EC067031F	11009-1980
Pulser Cover	EC101060F	14050-006		
Clutch Cover	EC392020F			
KZ1000J, GPZ1100 2pc.	81-83	Engine Case Rebuild	C8306	
		Valve Cover 79-80	C8468	11009-1205
		Valve Cover J Models 81-85	C8213	11060-1605
		Oil Pan	EC001020F	11060-1074
		Clutch Cover	EC060047F	11060-1070
		Dyno Cover	EC003020F	11060-1075
		Transmission Cover	EC061020F	11060-1069
		Ignition Cover	EC005020F	11060-1071
		Engine Case Rebuild	C8682	
		Clutch Cover	EC826032AFM	11061-0049
ZX1000 Ninja, ZX-10R	04-05	Starter Idle Gear Cover	EC827032AFM	11061-0048
		Starter Cover	EC828032AFM	11061-0047
		Oil Pan	OP142032AFM	11061-0065
		Engine Case Rebuild	C8715	
ZX1000 Ninja, ZX-10R	06-08	Clutch Cover	EC1165032AFM	11061-0178
		Starter Idle Gear Cover	EC1116032AFM	11061-0177
		Starter Cover	EC1164032AFM	11061-0176
		Oil Pan	OP204032AFM	11061-0180
		Generator Cover	EC1117032AFM	11061-0179
ZX1000 Ninja ZX-10R	11-15	Engine Case Rebuild Kit	C8846	
		Clutch Cover Gasket	EC1905032AFM	11061-0735
		Generator Cover Gasket	EC1903032AFM	11061-0441
		Oil Pan Gasket	OP447032AFM	11061-0747
		Starter Cover Gasket	EC1904032AFM	11061-0442
		Starter Idle Gear Cover Gasket	EC1902032AFM	14092-0153
		Engine Case Rebuild	C8305	
ZX11 D1, C	90-01	Dyno Cover	EC056020F	11009-1863
		Clutch Cover	EC057020F	11061-1154
		Transmission Cover	EC058020F	11009-1982
		Oil Pan	EC059020F	11009-1981
ZX-12R	00-03	Engine Case Rebuild	C8497	
		Generator Cover	EC881032AFM	11060-1911
		Clutch Cover	EC882032AFM	11060-1910
		Breather Cover	EC884032AFM	11061-1087
		Oil Pan	OP149032AFM	11060-1909
Ninja ZX-14 Concours 08-14	06-15	Engine Case Rebuild	C8713	
		Clutch Cover	EC1159032AFM	11061-0198
	06-12	Crank Case Breather	EC1160032AFM	11061-0200
		Generator Cover	EC1161032AFM	11061-0197
		Pulser Cover	EC1162032AFM	92055-0086
		Oil Pan	OP197032AFM	11061-0199
		Clutch Cover	EC392020F	



STREET·ROAD RACE·STRIP



Cometic Gasket - An Exclusive NASCAR Performance® Product

KTM

Model	Year	Type	Bore Size	Displacement / cc	Material	Part #	OEM Part #
RC390, 390 Duke	13	Head Gasket	89mm		MLS/C.O.T. .027"	C8897	9023003600
		Head Gasket	91mm		MLS/C.O.T. .027"	C8898	9023003600
		Base Gasket			Spring Steel .014"	C8899	90230035000

POLARIS

Model	Year	Type	Bore Size	Displacement / cc	Material	Part #	OEM Part #
Victory V92C		Head Gasket	97.0 mm	754cc	Spring Steel	C8652	5244306/5344307
Victory V92C		Head Gasket	101.0 mm	817cc	Spring Steel	C8653	5244306/5344307

SUZUKI

Model	Year	Type	Bore Size	Displacement / cc	Material	Part #	OEM Part #
GS 550 2 Valve	77-86	Head Gasket	60mm	610cc-630cc	CFM-20 .043	C8024	11141-47086-H17
GSX 600 Katana, GSF 600 Bandit	88-04	Head Gasket	66.5mm	606cc-676cc	CFM-20 .043	C8025	11141-19C03
GSX-R600	97-00	Head Gasket		65.5mm 600cc	Spring Steel	C8413	11141-34E01
		Base Gasket		600cc	Spring Steel .010	C8422	11241-33E00
GSXR600	01-03	Head Gasket	68.0 mm		Spring Steel	C8644	11141-39F00
					MLS/C.O.T. .018	C8644-018	11141-39F00
			70.0 mm		Spring Steel	C8646	11141-39F00
			69.0 mm		Spring Steel	C8645	11141-39F00
GSXR600	04-05	Head Gasket	68 mm	600cc-617cc	MLS/C.O.T. .018	C8645-018	11141-39F00
					MLS/C.O.T. .030	C8632	11141-29G00
			70 mm	618cc-654cc	MLS/C.O.T. .018	C8632-018	11141-29G00
					MLS/C.O.T. .030	C8724	11141-29G00
GSXR600	06-15	Head Gasket	68 mm		MLS/C.O.T. .018	C8724-018	11141-29G00
					MLS/C.O.T. .027	C8302	11141-01H00
			70 mm		MLS/C.O.T. .018	C8302-018	11141-01H00
					MLS/C.O.T. .027	C8293	11141-01H00
SV650	99-09	Head Gasket	81.0 mm	635cc	MLS/C.O.T. .018	C8293-018	11141-01H00
					Spring Steel	C8614	11141-20F00
			83.0 mm	650cc	MLS/C.O.T. .018	C8614-018	11141-20F00
					Spring Steel	C8600	11141-20F00
			84.0 mm	694cc	MLS/C.O.T. .018	C8600-018	11141-20F00
					Spring Steel	C8593	11141-20F00
			87.0 mm	744cc	MLS/C.O.T. .018	C8593-018	11141-20F00
					Spring Steel	C8613	11141-20F00
					MLS/C.O.T. .018	C8613-018	11141-20F00
					Base Gasket	650cc	Copper .005
GSXR750	86-87	Head Gasket			Copper .020	C8617	11241-19F00/11242-19F00
					Copper .010	C8616	11241-19F00/11242-19F00
					Spring Steel .020"	C8771	
					Spiral Wound	C8746	
					Spring Steel	C8466	11141-17D10
					Spring Steel	C8464	11141-17D10
					Spring Steel	C8463	11141-27A01
					Spring Steel	C8415	11141-17C02
					Spring Steel	C8466	11141-27A01
					Spring Steel	C8463	11141-17D10
GSXR750	88-89	Head Gasket	74 mm	750cc thru 771cc	Spring Steel	C8464	11141-17D10
					Spring Steel	C8463	11141-17D10
					Spring Steel	C8464	11141-17D10
GSXR750	90-92	Head Gasket	71 mm	756cc thru 771cc	Spring Steel	C8337	11141-17E01
					Spring Steel	C8338	11141-17E01
					Spring Steel	C8387	11141-17E01
GSXR750	93-95	Head Gasket	75 mm	860cc	MLS/C.O.T. .018	C8387-018	11141-33E00-095
					Spring Steel	C8414	11141-33E00-095
			77 mm	907cc	Spring Steel	C8414-018	11141-33E00-095
					Spring Steel	C8445	11141-33E00-095
					MLS/C.O.T. .018	C8445-018	11141-33E00-095
GSXR750	96-99	Head Gasket	72 mm	750cc	.010 Spring Steel	C8421	11141-33E00-095
					Spring Steel	C8663	11141-35F00
			74 mm	791cc	MLS/C.O.T. .018	C8663-018	11141-35F00
					Spring Steel	C8574	11141-35F00
					MLS/C.O.T. .018	C8574-018	11141-35F00
GSXR750	00-05	Head Gasket	73 mm	750-770	Spring Steel	C8214	11141-35F00
					Spring Steel	C8214	11141-35F00
			74 mm	750-791	MLS/C.O.T. .018	C8214-018	11141-35F00
					Spring Steel	C8602	11141-35F00
			75 mm	750-813	MLS/C.O.T. .018	C8602-018	11141-35F00
GSXR750		Head Gasket	76 mm	1000-1071cc	Spring Steel	C8602	11141-35F00
					Spring Steel	C8602	11141-35F00
					MLS/C.O.T. .018	C8602-018	11141-35F00



STREET·ROAD RACE·STRIP



Cometic Gasket - An Exclusive NASCAR Performance® Product

SUZUKI

Model	Year	Type	Bore Size	Displacement / cc	Material	Part #	OEM Part #	
GSXR750	06-14	Head Gasket	70 mm	749cc	MLS/C.O.T. .027	C8717	11141-02H00	
			72 mm	793cc	MLS/C.O.T. .018	C8718	11141-02H00	
					MLS/C.O.T. .027	C8718-018	11141-02H00	
					MLS/C.O.T. .018	C8718-018	11141-02H00	
GSXR750F, Katana	88-97	Head Gasket	74 mm	750cc thru 771cc	Spring Steel	C8415	11141-17C02	
GSXR750W	93-95	Head Gasket	71 mm	750cc thru 771cc	Spring Steel	C8276	11141-17E01	
		Base Gasket	83 mm	771cc-907cc	Copper .020	C8137	11241-17E00	
GS750 2 Valve		Head Gasket	69 mm	844cc	CFM-20	C8028	11141-49410	
GS750 2 Valve, 2.900 Bore		Base Gasket	2.900	750cc	Fiber .020	C8528	11241-45110-H17	
GS750 4 Valve		Head Gasket	70 mm	747cc thru 816cc	CFM-20	C8027	11141-45410	
GS750 4 Valve, 2.953 Bore		Base Gasket	2.953	750cc	Fiber .020	C8549	11241-45401-H17	
RF900	94-98	Head Gasket	75.0 mm	972cc	Spring Steel	C8338	11141-31E00	
		Head Gasket	77.0 mm	1045cc	Spring Steel	C8277	11141-31E00	
TL1000 R/S V-Twin	97-03	Head Gasket	99.0 mm	1000cc	MLS/C.O.T. .030	C8502	11141-02F01	
SV1000S	03-06	Base Gasket	4.450 mm	1000cc	Spring Steel .010	C8509	11241-02F01/11242-02F01	
GS1000 2 Valve	78-81	Head Gasket	73.5mm	749cc	CFM-20 .043	C8030	11141-49410	
					Copper .043	C8408	11141-49410	
					Copper .020	C8364	11241-49000-H17	
GSXR1000	00-04	Head Gasket	73 mm	1000-988cc	MLS/C.O.T. .030	C8663	11141-35F00	
					MLS/C.O.T. .018	C8663-018	11141-35F00	
			74 mm		MLS/C.O.T. .030	C8574	11141-35F00	
					MLS/C.O.T. .018	C8574-018	11141-35F00	
			75 mm	1000-1043cc	MLS/C.O.T. .030	C8214	11141-35F00	
					MLS/C.O.T. .018	C8214-018	11141-35F00	
GSXR1000	05-08	Head Gasket	76 mm	1000-1071cc	MLS/C.O.T. .030	C8602	11141-35F00	
					MLS/C.O.T. .018	C8602-018	11141-35F00	
			75 mm	1000cc-1043cc	MLS/C.O.T. .030	C8214	11141-40F00	
					MLS/C.O.T. .018	C8214-018	11141-40F00	
GSXR1000	09-15	Head Gasket	76 mm	1000cc-1071cc	MLS/C.O.T. .030	C8602	11141-40F00	
					MLS/C.O.T. .018	C8602-018	11141-40F00	
			74.5 mm	1000cc	MLS/C.O.T. .027	C8772	11141-47H01	
GS1100 4 Valve		Head Gasket	75 mm	1133cc, 1168cc	CFM-20 .043	C8031	11141-47H01	
			84 mm	1385cc-1465cc	CFM-20 .043	C8035		
GS1100/1150		Head Gasket	75 mm	1100cc-1166cc	CFM-20 .043	C8031		
			Base Gasket	3.130	1100cc-1168cc	Copper .005	C8110	
						Copper .010	C8111	
						Copper .020	C8112	
						Fiber .020	C8109	
						Copper .005	C8114	
						Copper .010	C8115	
						Copper .020	C8116	
						Fiber .020	C8113	
						Copper .005	C8177	
						Copper .010	C8178	
						Copper .020	C8179	
						Fiber .020	C8180	
						Copper .005	C8118	
						Copper .010	C8119	
				Copper .020	C8120			
				Fiber .020	C8117			
				Copper .005	C8375			
				Copper .010	C8376			
				Copper .020	C8377			
GS1100/1150 / 6mm Dowel Head Gasket		85 mm	1498cc	Copper .043	C8187			
			87 mm	1568cc	Copper .043	C8171		
GS1100/1150 / 8mm Dowel Head Gasket		85 mm	1498cc	Copper .043	C8439			
			87 mm	1568cc	MLS/C.O.T. .045	C8734-045		
GS1100/1150 / D Dowel PinHead Gasket		82 mm	1393cc	Copper .043	C8470			
			83 mm	1428cc	Copper .043	C8471		
			83 mm	1428cc	MLS/C.O.T. .045	C8732-045		
			85 mm	1498cc	Copper .043	C8473		
			85 mm	1498cc	MLS/C.O.T. .045	C8733-045		



STREET·ROAD RACE·STRIP



Cometic Gasket - An Exclusive NASCAR Performance® Product

SUZUKI

Model	Year	Type	Bore Size	Displacement / cc	Material	Part #	OEM Part #		
GS1100/1150 11mm Dowel Head Gasket		72 mm	1100cc	Copper .043	C8163				
			75 mm	1166cc	Copper .043	C8185			
			75mm	1166cc	MLS/C.O.T. .045	C8728-045			
			76 mm	1197cc	Copper .043	C8165			
			76 mm	1197cc	MLS/C.O.T. .045	C8729-045			
			77 mm	1229cc	Copper .043	C8186			
			79 mm	1290cc	Copper .043	C8167			
			79 mm	1290cc	MLS/C.O.T. .045	C8730-045			
			78 mm	1261cc	Copper .043	C8166			
			80 mm	1327cc	Copper .043	C8168			
			80 mm	1327cc	MLS/C.O.T. .045	C8731-045			
			82 mm	1393cc	Copper .043	C8169			
			83 mm	1428cc	Copper .043	C8170			
			84 mm	1465cc	Fiber .043	C8035			
			GS1100/1150 No Dowel Pins		Head Gasket	89 mm	1642cc	MLS/C.O.T. .045	C8735-045
GSXR1100	86-88	Head Gasket	78 mm	1109cc	MLS/C.O.T. .030	C8277			
			81 mm	1196cc		C8321			
			83 mm	1255cc		C8278			
GSXR1100 D Dowel Pins	86-88	Head Gasket	78 mm	1109cc	Copper .032	C8231			
			80 mm	1166cc		C8232			
			83 mm	1255cc		C8234			
			84 mm	1286cc		C8235			
			85 mm	1317cc		C8435			
GSXR1100 6mm Dowel Pins	86-88	Head Gasket	85 mm	1317cc	Copper .032	C8236			
GSXR1100	89-92	Head Gasket	78 mm	1127cc	Spring Steel	C8322			
					Copper .032	C8189			
			80 mm	1186cc	CFM-20	C8037			
					Copper .032	C8190			
					Spring Steel	C8368			
			81 mm	1216cc	Copper .032	C8191			
					Spring Steel	C8279			
82 mm	1245cc	Copper .032	C8243						
83 mm	1276cc	Copper .032	C8192						
				CFM-20	C8036				
GSXR1100 11 mm Dowel Pins	89-92	Head Gasket	82 mm	1246cc	Spring Steel	C8391			
GSXR110 6mm Dowel Pin	89-92	Head Gasket	85 mm	1340cc	Copper .032	C8437			
			86 mm	1377cc	Copper .032	C8195			
GSXR1100 D Dowel Pin	89-92	Head Gasket	83 mm	1276cc	Spring Steel	C8323			
			85 mm	1340cc	Copper .032	C8194			
			85 mm	1340 cc	MLS/C.O.T. .030	C8340			
GSXR1100	86-92	Base Gasket	3.370	1050cc - 1186cc	Copper .005	C8297			
					Copper .020	C8462			
					Spring Steel .010	C8372			
			3.460	1186cc - 1255cc	Copper .010	C8069			
					Fiber .020	C8298			
					Copper .010	C8070			
			3.560	1255cc - 1340cc	Copper .020	C8526			
					Spring Steel .010	C8373			
					Copper .005	C8203			
					Copper .005	C8246			
					Copper .020	C8446			
					Copper .010	C8247			
		Spring Steel .010	C8374						
GSXR1100	93-98	Head Gasket	77 mm	1074cc - 1117cc	MLS/C.O.T. .030	C8280			
			78 mm	1147cc	MLS/C.O.T. .030	C8478			
			78 mm	1147cc	Copper .032	C8479			
			79.5 mm	1192cc	MLS/C.O.T. .030	C8281			
			79.5 mm	1192cc	Copper .032	C8480			
			79.75 mm	1198cc	Copper .032	C8481			
			Base Gasket	3.265	1100cc	Spring Steel .010	C8370		
				3.310	1100cc - 1200cc	Spring Steel .010	C8371		
						Copper.005	C8307		
		GSF1200SX Bandit	98-00	Head Gasket	80 mm	1186cc	Spring Steel	C8368	11141-32F01
					81 mm	1216cc	Spring Steel	C8279	11141-32F01
					82 mm	1246cc	Spring Steel	C8391	11141-32F01
					83 mm	1276cc	Spring Steel	C8323	11141-32F01
GSF1200SX 11 mm Dowel	98-00	Head Gasket	80 mm	1186cc	Spring Steel	C8368	11141-32F01		
			81 mm	1216cc	Spring Steel	C8279	11141-32F01		
GSF1200SX D Dowel Pin	98-00	Head Gasket	83 mm	1276cc	Spring Steel	C8323	11141-32F01		



STREET·ROAD RACE·STRIP



Cometic Gasket - An Exclusive NASCAR Performance® Product

SUZUKI

Model	Year	Type	Bore Size	Displacement / cc	Material	Part #	OEM Part #	
GSX1300R Hayabusa	99-14	Head Gasket	81 mm	1299cc	MLS/C.O.T. .030	C8656	11141-24F00	
			81 mm w/13 mm studs		MLS/C.O.T. .018	C8656-018	11141-24F00	
			82 mm		MLS/C.O.T. .030	C8218	11141-24F00	
			83 mm	1364cc	MLS/C.O.T. .030	C8660	11141-24F00	
			83 mm w/13 mm studs		MLS/C.O.T. .030	C8657	11141-24F00	
			83 mm w/13 mm studs		MLS/C.O.T. .018	C8657-018	11141-24F00	
			84 mm	1396cc	MLS/C.O.T. .030	C8219	11141-24F00	
			84 mm		MLS/C.O.T. .030	C8658	11141-24F00	
			84 mm w/13 mm studs		MLS/C.O.T. .018	C8658-018	11141-24F00	
			84 mm w/13 mm studs		MLS/C.O.T. .030	C8220	11141-24F00	
			85 mm	1428cc	MLS/C.O.T. .030	C8659	11141-24F00	
			85 mm		MLS/C.O.T. .018	C8659-018	11141-24F00	
			Base Gasket	93 mm	1299cc-1428cc	Spring Steel .010	C8585	11141-24F00
			93 mm w/13mm studs	1299cc-1428cc	Spring Steel .010	C8747	11210-24F00	
			93 mm	1299cc-1428cc	Aluminum .080	C7121	11141-24F00	
			Base Shim Kit .060"	93mm	1299cc-1428cc	(1) .040" Alum (2) .010" Steel	C8776	
			Base Shim Kit .100"	93mm	1299cc-1428cc	(1) .080" Alum (2) .010" Steel	C8777	

Suzuki Engine Case Rebuild

Model	Year	Part Description	Part #	OEM Part #
GSX-R600	97-00	Engine Case Rebuild	C8592	
		Magneto Cover	EC090031F	11483-33E01
		Clutch Cover	EC091020F	11482-33E01
		Oil Pan	EC092020F	11489-33E00
		Starter Clutch Cover	EC093031F	11491-33E02
		Starter Cover	EC094031F	11492-33E00
		Starter Clutch Cover	EC410020F	11381-33E02
GSX-R600, GSX-R750	06-15	Engine Case Rebuild	C8742	
		Magneto Cover	EC1278032AFM	11483-01H00
		Clutch Cover	EC1276032AFM	11482-01H00
		Oil Pan	OP235032AFM	11489-01H01
		Cam Chain Tens.(06-07)	EC745032AFM	12837-24F10
		Cam Chain Tens.(08-09)	EC1247018AFM	12837-02H00
		Breather Cover	EC1277032AFM	11484-01H00
GSX-R600, GSX-R750	04-05	Engine Case Rebuild	C8689	
		Starter Idle Gear Cover	EC520032AFM	11492-33E00
		Starter Clutch	EC521032AFM	11491-33E02
		Breather Cover	EC522032AFM	11484-35F00
		Cam Chain	EC945032AFM	12837-18G00
		Magneto Cover	EC946032AFM	11483-18G00
		Clutch Cover	EC947032AFM	12837-24F10
GSX-R600	01-03	Engine Case Rebuild	C8206	
		Starter Idle Gear Cover	EC520032AFM	11492-33E00
		Starter Clutch Cover	EC521032AFM	11491-33E00
		Cam Chain Tensioner	EC523032AFM	12837-35F00
		Magneto Cover	EC519032AFM	11483-35F00
		Clutch Cover Gasket	EC518032AFM	11482-40F00
		Oil Pan Gasket	OP071060AFM	11489-35F00
GSX-R750	96-99	Engine Case Rebuild	C8403	
		Magneto Cover	EC090031F	11483-33E01
		Clutch Cover	EC091020F	11482-33E01
		Oil Pan	EC092020F	11489-33E01
		Starter Clutch Cover	EC093031F	11491-33E02
		Starter Idle Gear Cover	EC094031F	11492-33E00
		Oil Strainer Cover	EC095031F	16527-33E00
		Cam Chain	EC377020F	12837-24A10
GSX-R750 LC	93-95	Engine Case Rebuild	C8143	
		Oil Pan	EC021020F	11489-17E01
GSX-R600	92-93	Clutch Cover	EC022020F	11482-17E00
		Ignition Cover	EC023020F	11491-17E01
		Cam Chain	EC065020F	12837-27A10
GSX-750F	89-96	Engine Case Rebuild	C8423	
KATANA		Oil Pan	EC011020F	11489-27A21
		Clutch Cover	EC012020F	11482-27A20
GSX-R750	86-92	Ignition Cover	EC013020F	11491-27A30
		Dyno Cover	EC014020F	11483-27A20
		Oil Strainer Cover	EC040020F	16528-27A20
		Cam Chain	EC065020F	12837-27A10
		Clutch Cover	EC392020F	

All Component Parts can be purchased individually.



STREET-ROAD RACE-STRIP



Cometic Gasket - An Exclusive NASCAR Performance® Product

Suzuki Engine Case Rebuild

Model	Year	Part Description	Part #	OEM Part #		
GSX-R 1100	86-92	Engine Case Rebuild	C8081			
		AFM Engine Case Rebuild	C8081AFM			
		Cam Chain	EC065020F	12837-27A00		
		Oil Pick Up	EC040020F	16528-27A20		
		Magneto Cover	EC027020F	11483-27A20		
		Ignition Cover	EC013020F	11491-27A20		
		Clutch Cover	EC012020F	11482-27A20		
		Breather Cover	EC085039F	11177-48B00-H17		
		Oil Pan	EC011020F	11489-27A20		
		GSX-R1100	93-98	Engine Case Rebuild	C8144	
Clutch Cover	EC022020F			11482-17E00		
Ignition Cover	EC023020F			11491-17E01		
Oil Pan	EC028020F			11489-17E01		
Cam Chain	EC065020F			12837-27A10		
GS1100/1150	82-84	Engine Case Rebuild	C8073			
		Oil Pan	EC007020F	11482-49201-H17		
		Clutch Cover	EC008020F	11482-49202-H17		
		Generator Cover	EC009020F	11381-00A00		
		Cam Chain	EC062020F	12837-31310		
		Transmission Cover	EC063020F	24762-45000-H17		
		Ignition Cover	EC338020F	11491-45000		
GS1100/1150	82-84	24 Bolt Valve Cover	C8264			
		20 Bolt Valve Cover	C8212			
GSX 1300R Hayabusa	99-14	Engine Case Rebuild	C8587AFM			
		Oil Pan	EC369060AFM	11489-24F01		
		Clutch Cover	EC370060AFM	11482-24F01		
		Starter Idle Gear Cover	EC371032AFM	11492-24F00		
		Gear Shift Cover	EC372032AFM	11485-24F00		
		Breather Cover	EC373032AFM	11318-24F00		
		Magneto Cover	EC374060AFM	11483-24F00		
		Starter Cover	EC375032AFM	11491-24F01		
		Cam Chain	EC377032AFM	12837-24A10		
		Exhaust Gaskets-4 PACK	C8745	14181-22D01		
		Cam Chain Tensioner (08-13)	EC1247018AFM	12837-02H00		
		Valve Stem Seal Kit (99-13)	C8836	09289-05011		
		GSX-R1000	09-15	Engine Case Rebuild Kit	C8893AFM	
				Cam Chain Tensioner Gasket	EC1247018AFM	12837-02H00
Oil Pan Gasket	OP517060AFM			11489-47H00		
Clutch Cover Gasket	EC1579060AFM			11482-47H00		
Mag Cover Gasket	EC1410032AFM			11483-47H00		
GSX-R1000	03-08	Engine Case Rebuild Kit	C8752AFM			
		Mag Cover Gasket	EC946032AFM	11483-18G00		
		Starter Idle Gear Cover	EC521032AFM	11491-33E02		
		Starter Clutch Cover	EC520032AFM	11492-33E00		
		Breather Cover	EC522032AFM	11484-35F00		
		Cam Chain Tensioner Gasket	EC945032AFM	12837-18G00		
		Clutch Cover Gasket	EC947032AFM	11482-40F00		
		Oil Pan Gasket	OP269060AFM	11489-21H00		
GSX-R1000	01-02	Engine Case Rebuild Kit	C8206			
		Mag Cover Gasket	EC519032AFM	11483-35F00		
		Starter Idle Gear Cover	EC521032AFM	11491-33E02		
		Starter Clutch Cover	EC520032AFM	11492-33E00		
		Breather Cover	EC522032AFM	11484-35F00		
		Cam Chain Tensioner Gasket	EC523032AFM	12837-35F00		
		Clutch Cover Gasket	EC947032AFM	11482-40F00		
Oil Pan Gasket	OP071060AFM	11489-35F00				

TRIUMPH

Model	Year	Type	Bore Size	Displacement / cc	Material	Part #	OEM Part #
Bonneville, T100,	02-15	Head Gasket	90mm	865cc	MLS/C.O.T. .030	C8850	T1152915
Scrambler, Thruxton,		Head Gasket	92mm	904cc	MLS/C.O.T. .030	C8851	
America, Speedmaster		Head Gasket	96.5mm	995cc	MLS/C.O.T. .030	C8852	T1160127
		Base Gasket		865cc-904cc	.020 RC Steel	C8853	
		Base Gasket		955cc	.020 RC Steel	C8854	



STREET·ROAD RACE·STRIP



Cometic Gasket - An Exclusive NASCAR Performance® Product

YAMAHA

Model	Year	Type	Bore Size	Displacement / cc	Material	Part #	OEM Part #
RD350	73-75	Head/Base/Reed	66 mm	347cc -370cc	Copper .043	C8331	278-11181-01-00/ 278-11351-01-00/ 87A-13621-00-00
RZ350	84-90	Head/Base/Reed	66 mm	370cc	Spring Steel	C8334	31K-11181-00-00/ 29L-11351-00-00/ 31K-13621-00-00
FZR400	89-90	Head Gasket Base Gasket	58mm	400cc 400cc	.010 Spring Steel Copper .020	C8443 C8427	1WG-11181-00-00 3TJ-11351-00-00
TX, XS 650	74-82	Head Gasket	80.50 mm	744cc - 752cc	CFM-20 .043	C8043	306-11181-09-00
XS750	77-79	Head Gasket	70.0 mm	747cc - 792cc	CFM-20 .043	C8404	2F3-11181-00-00
FZR600	89-99	Head Gasket Base Gasket	60.5 mm 2.565	600cc - 629cc 600cc-618cc	.010 Spring Steel .020 Copper	C8282 C8427	3HE-11181-00-00 3TJ-11351-00-00
YZF600R	95-07	Head Gasket Base Gasket	63 mm 65 mm	599cc-618cc 618cc	.010 Spring Steel Copper .020	C8424 C8427	4JH-11181-00-00 3TJ-11351-00-00
YZF-R6	99-02	Head Gasket	68.0 mm	599cc-646cc	MLS/C.O.T. .030 MLS/C.O.T. .018	C8575 C8575-018	5EB-11181-00-00 5EB-11181-00-00
YZF-R6	03-05		68 mm 70.0 mm	600cc-646cc 647cc-685cc	MLS/C.O.T. .027 MLS/C.O.T. .018 MLS/C.O.T. .027	C8684 C8684-018 C8699	5SL-11181-00-00 5SL-11181-00-00 5SL-11181-00-00
YZF-R6	06-15	Head Gasket	68 mm 70 mm	600cc-617cc 618cc-654cc	MLS/C.O.T. .018 MLS/C.O.T. .027 MLS/C.O.T. .018	C8699-018 C8710 C8710-018	2C0-11181-00-00 2C0-11181-00-00 2C0-11181-00-00
FZ-07	15	Head Gasket Head Gasket	81mm 83mm		MLS/C.O.T. .023 .MLS/C.O.T. .023	C8890 C8891	1WS-11181-00-00 1WS-11181-00-00
TX, XS650	74-82	Head Gasket Head Gasket Head Gasket Head Gasket Head Gasket	75mm 77mm 79mm 81mm 82mm		MLS/C.O.T. .045 MLS/C.O.T. .045 MLS/C.O.T. .045 MLS/C.O.T. .045 MLS/C.O.T. .045	C8810 C8811 C8812 C8813 C8814	306-11181-00-00 306-11181-00-00 306-11181-00-00 306-11181-00-00 306-11181-00-00
FZR1000	89-95	Head Gasket	76.5 mm 78 mm 77 mm	1003cc - 1029cc 1070cc 1040cc	MLS/C.O.T. .030 MLS/C.O.T. .030 MLS/C.O.T. .030	C8384 C8388 C8283	4SV-11181-00-00 4SV-11181-00-00 4SV-11181-00-00
		Base Gasket	3.260	1070cc	Spring Steel .010	C8382	4SV-11181-00-00
YFZ1000	97	Head Gasket	76.5 mm 77 mm 78 mm	1003cc - 1029cc 1040cc 1070cc	MLS/C.O.T. .030 MLS/C.O.T. .030 MLS/C.O.T. .030	C8384 C8283 C8388	3GM-11181-00-00 3GM-11181-00-00 3GM-11181-00-00
		Base Gasket	3.260	1070cc	.010 Spring Steel	C8382	3GM-11351-00-00
YZF-R1	98-03	Head Gasket	75 mm 77 mm	1000cc 1054cc	MLS/C.O.T. .027 MLS/C.O.T. .027	C8562 C8563	4XV-11181-00-00 4XV-11181-00-00
YZF-R1	04-06	Head Gasket	78 mm 79 mm	998cc-1024cc 1025cc-1051cc	MLS/C.O.T. .018 MLS/C.O.T. .018	C8686 C8695	5VY-11181-00-00 5VY-11181-00-00
YZF-R1	07-08	Head Gasket	78mm 79mm	998cc-1024cc 998cc-1024cc	MLS/C.O.T. .018 MLS/C.O.T. .018	C8266 C8767	4C8-11181-00-00 4C8-11181-00-00
		Base Gasket (04-08)			.010" Spring Steel	C8687	5VY-11351-00-00
YZF-R1	09-14	Head Gasket Base Gasket	79mm		MLS/C.O.T. .018" .010" Spring Steel	C8794 C8796	14B-11181-00-00 14B-11351-00-00
YZF-R1	15	Head Gasket Base Gasket	79 mm		MLS/C.O.T. .027 .010" Spring Steel	C8894 C8895	2CR-11181-00-00 2CR-11351-00-00
XS1100		Head Gasket	76 mm	1148cc-1179cc	CFM-20 .043	C8046	2H7-11181-02-00
FJ1100, 1200		Head Gasket	77 mm 78 mm 79 mm 81 mm 83 mm	1157cc - 1188cc 1219cc 1250cc 1314cc 1380cc	MLS/C.O.T. .030 MLS/C.O.T. .030 MLS/C.O.T. .030 MLS/C.O.T. .030 MLS/C.O.T. .030	C8327 C8351 C8330 C8328 C8329	1TX-11181-00-00 1TX-11181-00-00 1TX-11181-00-00 1TX-11181-00-00 1TX-11181-00-00
		Base Gasket	3.285	1157cc - 1260cc	.010 Spring Steel Copper .005 Copper .010 Copper .020	C8597 C8139 C8140 C8141	4CR-11351-00-00 4CR-11351-00-00 4CR-11351-00-00 4CR-11351-00-00
		Base Gasket	3.460	1314cc	.010 Spring Steel Copper .005 Copper .010 Copper .020 Fiber .020	C8598 C8240 C8241 C8242 C8239	4CR-11351-00-00 4CR-11351-00-00 4CR-11351-00-00 4CR-11351-00-00 4CR-11351-00-00
FJ1100, 1200 Legend Approved		Head Gasket	77.5 mm 79.0 mm	1195cc - 1202cc 1250cc	MLS/C.O.T. .030 Copper .032	C8285 C8174	1TX-11181-00-00 1TX-11181-00-00
		Base Gasket	3.285	1157cc - 1260cc	Fiber .020	C8142	1TX-11181-00-00
VMX12 V-Max / XVZ13 Royal Star	83-07	Head Gasket	80.0mm 85.0 mm	1198cc - 1327cc 1394cc - 1498cc	MLS/C.O.T. .030 MLS/C.O.T. .030	C8536 C8535	26H-11181-00-00 26H-11181-00-00
XV1600 Road Star/ Midnight Star	99-03	Head Gaskets (2)	95 mm 97 mm 100 mm 102 mm		MLS/C.O.T. .030 MLS/C.O.T. .030 MLS/C.O.T. .030 MLS/C.O.T. .030	C8673 C8674 C8675 C8676	4WM-11181-00-00 4WM-11181-00-00 4WM-11181-00-00 4WM-11181-00-00
XV1700 Road Star Warrior	02-07	Head Gaskets (2)	97 mm		MLS/C.O.T. .030	C8677	5PX-11181-01-00
XV1700 Road Star	04-07		100 mm 102 mm		MLS/C.O.T. .030 MLS/C.O.T. .030	C8678 C8679	5PX-11181-01-00
XV1900 Raider, Roadliner, Stratoliner	06-14	Head Gaskets (2) Head Gaskets (2)	102 mm 103 mm		MLS/C.O.T. .030" MLS/C.O.T. .030"	C8857 C8858	1D7-11181-00-00

All Component Parts can be purchased individually.



Yamaha Engine Case Rebuild

Model	Year	Part Description	Part #	OEM Part #
YZF-R6	06-15	Engine Case Rebuild	C8720	
		Cam Chain Tensioner	EC1152032AFM	2C0-12213-00-00
		Case Breather	EC1149032AFM	2C0-15462-00-00
		Clutch Cover	EC1151032AFM	2C0-15461-00-00
		Ignition Cover	EC1104018AFM	2C0-15451-00-00
		Oil Pan	OP201032AFM	2C0-13414-01-00
YZF-R6	03-05	Oil Pump Cover	EC1105032AFM	2C0-15456-00-00
		Engine Case Rebuild	C8683	
		Clutch Cover	EC939032AFM	5SL-15461-00
		Ignition Cover	EC355032AFM	5EB-15456-00-00
		Case Breather Cover	EC937032AFM	5SL-15462-00
		Magneto Cover	EC938032AFM	5SL-15451-00-11
YZF-R6	99-02	Engine Case Rebuild	C8612AFM	
		Gear Selector Cover	EC354032AFM	5SL-11181-00-00
		Ignition Cover	EC355032AFM	5EB-15456-00-00
		Clutch Cover	EC356032AFM	5EB-15461-00-00
		Magneto Cover	EC421020F	5EB-15451-00-00
		Oil Pan Gasket	OP246032AFM	5EB-13414-00-00
FZR600	89-99	Engine Case Rebuild	C8402	
		Clutch Cover	EC086020F	3HE-15462-10-00
		Generator Cover	EC087020F	1WG-15455-10-00
		Starter Clutch Cover	EC088020F	3HE-14461-10-00
		Oil Pan	EC089020F	3HE-13414-10-00
		Engine Case Rebuild	C8402	
YZF600R	95-07	Clutch Cover	EC086020F	3HE-15462-10
		Generator Cover	EC087020F	1WG-15455-10
		Starter Clutch Cover	EC088020F	3HE-14461-10
		Oil Pan	EC089020F	3HE-13414-10-00
		Engine Case Rebuild Kit	C8892	
		Oil Pump Cover Gasket	EC2053018AFM	1WS-15456-00
FZ-07	15	Oil Pan Gasket	OP516032AFM	1WS-13414-00-00
		Mag Cover Gasket	EC2025032AFM	1WS-15451-00-00
		Clutch Cover Gasket	EC2024032AFM	1WS-15461-00-00
		Cam Chain Tensioner Gasket	EC2027018AFM	1WS-12213-00-00
		Breather Plate Gasket	EC2026018AFM	1WS-11169-00-00
		Engine Case Rebuild	C8088	
FZR1000	89-95	Oil Pan	EC015020F	4FM-13414-00-00
		Clutch Cover	EC016020F	4FM-15461-00-00
		Engine Case Rebuild	C8588	
		Cam Chain	EC019032AFM	4FM-12213-00
		Clutch Cover	EC383032AFM	4XV-15461-00-00
		Gear Selector Cover	EC384032AFM	4XV-15463-00-00
YZF-R1	98-03	Ignition Cover	EC385018AFM	4XV-15456-00-00
		Oil Strainer Cover	EC387018AFM	4XV-13414-00-00
		Oil Pump Cover	EC940032AFM	5JJ--15456-00
		Engine Case Rebuild	C8688	
		Oil Pump Cover	EC941032AFM	5VY-15456-00
		Breather Cover	EC942032AFM	5VY-15462-00
YZF-R1	04-08	Ignition Cover	EC943032AFM	5VY-15451-00
		Clutch Cover	EC944032AFM	5VY-15461-00
		Oil Pan (04-06)	OP205032AFM	5VY-13414-01
		Oil Pan (10-14)	OP361032AFM	14B-13414-00-00
		Engine Case Rebuild Kit	C8896	
		Clutch Cover Gasket	EC2067032AFM	2CR-15461-00-00
YZF-R1	15	Mag Cover Gasket	EC2068032AFM	2CR-15451-00-00
		Breather Cover Gasket	EC2069018AFM	2CR-15462-00-00
		Oil Pan Gasket	OP519032AFM	2CR-15456-00-00
		Engine Case Rebuild	C8146	
		Oil Pan	EC017032AFM	4CR-13414-00-00
		Clutch Cover(FJ1200)	EC018018AFM	4FM-13414-00-00
FJ1100, 1200 Legend Approved		Cam Chain	EC019018AFM	4FM-12213-00-00
		Oil Strainer Cover	EC020032AFM	4CR-13415-00-00
		Clutch Cover(FJ1100)	EC039032AFM	36Y-15461-00-00



Model	Displ. cc	Bore mm	Top End Kit Part #
ARCTCO			
Barracuda, Daytona 94-95, Montego, Montego Deluxe 94-97, TT640R 98-99, TS640L 98, Tigershark, Tigershark Daytona 93	639	77mm	C6052
Monte Carlo, Daytona 96-97, TS770, TS-L770, TS-R 98-99	770	84mm	C6144
Tigershark 900 95, Monte Carlo 900 96, Daytona 1000 97	900	O-Ring	C6116
TS-11000, TS-R1000 98	999	O-Ring	C6162
KAWASAKI			
JS300, JS300SX 86-94	300	78mm	C6001
JS440, JSX440, JSX440SX 82-92	440	70mm	C6002
JS440, JSX440, JSX440SX 82-92	475	73mm	C6003
JS550 thru 82-88	550	77mm	C6004
JS550, JSX550 89-95	550	78mm	C6015
JS650SC 91-95, JF650X2 86-95, JF650TS 89-96	650	78mm	C6005
JS650SX 87-93, JS650SC 91-95, JF650X2 86-95	701	80mm	C6078
JS750SX 92-95, JS750Sxi 95-97, JH750Xi 93-97, JH750SS 92-97, JH750XiR 94	750	83mm	C6043
JT750STS 95-97, JT750ST 94-95, 750ZXi 95-97, 750SXi 98-02			
750Xi 95-97, SXi Pro 98-02, STX 98	766	81mm	C6215
750ZXi 95-97, SXi Pro 98-02, STX 98, SX800R 03-06	779	83mm	C6126
750ZXi 95-97, SXi Pro 98-02, STX 98, SX800R 03-06	830	84.5mm	C6158
800 SXR 03-11	779	82mm	C6214
900ZXi 95-97, STX 97-06	941	75mm	C6118
1100ZXi 96-03, 1100STX 97-99, STX D. I. 00-03	1097	81mm	C6145
1100Zxi 96-03, 1100STX 97-99, STX D. I. 00-03	1195	84.5mm	C6159
Ultra 150 99-05, 1200STX '02-05	1205	81mm	C6202
Ultra 250/260X 07-10 (Head Gasket Only)	1498	84mm	C6222
POLARIS			
SL650 92-95, SL650STD 92-95	650	67mm	C6044
SLTH 96-03, SLT 700 96-03, SL700DLX 96-03, SLH 96-03, SL700 96-03	700	O-Ring	C6146
SL750 92-96, SLT 92-96	750	71.25mm	C6055
SL750 92-96, SLT 92-96	782	72mm	C6089
SLX780 95-97, SL780 95-96, SLT780 95-96	780	71.5mm	C6143
SLX 785 Pro 97-01	785	72mm	C6181
SL900 96-97	900	O-Ring	C6147
SLTX1050 97-04, SL1050 96-04, SLXH 98-04	1051	O-Ring	C6148
Genesis Ffi 00-04, Pro 1200 00-04, SLX, Virage TX 00-04	1176	86mm	C6212
SEA DOO			
580 Yellow Motor 91, 580XP 91, 580GT 90-91	580	O-Ring	C6010
580 White Motor, 580 SP, XP, SPX, Spi, GTS, GTX 92-96	580	O-Ring	C6095
650XP 93-94, 650XPI 94-95, 650SPX 94-95, GTX650 94-95	657	O-Ring	C6056
GTI750, SPX750, XP750, HX750, GS750, GTS 750 97-01	717	O-Ring	C6119
XP 800, GSX800, GTX800, SPX800, XP800 Ready, RFI800, 97-01 (Lay Down Motor)	787	O-Ring	C6154
GSX950 Limited 97-99, GTX950 Limited 98-00	993	90mm	C6157
XP950 Limited 98-00, GTX950 00, RX950 00, LRV950 00			
GSX950 Limited 97-99, GTX950 Limited 98-00	1017	90mm	C6203
XP950 Limited 98-00, GTX950 00, RX950 00, LRV950 00			
4TEC 02-14 (Head Gasket Only)	1494	101mm	C6223
SUZUKI			
Wet Bike 78-92		86mm	C6163
YAMAHA			
Waverunner III 90-93, VXR 91-95, Waverunner 90-93, Super Jet ALL, LX633 90-96	633	79mm	C6012
Waveblaster 93-95, Super Jet 94-95, Waverunner III 94-97, Pro-VXR 93-94, FX700 94-95, Waveraider 700 96-99 (Kit works with all single carb models)	701	83mm	C6057
Waveblaster 93-95, Super Jet 94-95, Waverunner III 94-97, Pro-VXR 93-94, FX700 94-95, Waveraider 700 96-99 (Kit works with all single carb models)	760	85mm	C6083
Waveblaster 96-97, Super Jet 97-00, Wave Venture 700 95-97, Waveraider 700 93-95, Waveraider Deluxe 93-95, XL700 thru 99-00 (Kit works with all dual carb models)	701	83mm	C6084
Waveblaster 96-97, Super Jet 97-00, Wave Venture 700 95-97, Waveraider 700 93-95, Waveraider Deluxe 93-95, XL700 thru 99-00 (Kit works with all dual carb models)	760	85mm	C6086
Waveraider 760 96-99, Waveblaster II 96-99, Wave Venture 760 97, Waverunner 96-97, Waverunner GP 760 '00	754	85mm	C6149
Waveraider 760 96-99, Waveblaster II 96-99, Wave Venture 760 97, Waverunner 96-97	789	86mm	C6155
800 GP 98-00	800	86mm	C6199
Waveraider 1100 95-97, Wave Venture 1100 96-97	1051	83mm	C6121
1200 GP 97-99, SUV1200 00, XI 1200 00	1131	86mm	C6160
GP1200R 01-10 (with power valve)	1176	82mm	C6220
FZR Waverunner 08-14 (Head Gasket Only)	1812	86mm	C6221



Gaskets for Harley-Davidson®

AFM® Series Gaskets Aluminum Foamet Composite Material

Cometic Part #-C9888 Complete Primary Kit FLT, FLHT, FXR 94-06
Cometic Part #-C9889 Complete Primary Kit FLT, FLHT, FXR 80-93

Cometic Part #-C9261
Starter Shaft Seal 94-06
Dyna 94-05
All B/T Models
Replaces: 12066
Cometic Part #-C9379
Starter Shaft Seal 89-93
All B/T Models
Replaces: 12053

Cometic Part #-C9441
Inner Primary to Motor
Case O-Ring
Dyna L82-05
All Models L82-06
Replaces: 11147
Cometic Part #-C9536
Inner Primary to Motor
Case O-Ring
All Models 70-E82
Replaces: 11125

Cometic Part #-C9261
Starter Shaft Seal
Dyna 94-05, All B/T
Models 94-06 Replaces: 12066
Cometic Part #-C9379
Starter Shaft Seal 89-93 All B/T Models
Replaces: 12053

Cometic Part #-C9260
Wet Clutch Oil Seal All Models L84-UP
Replaces: 12052
Cometic Part #-C9518
Wet Clutch Oil Seal All Models 70-E84
Replaces: 12052

Cometic Part #-C9441
Inner Primary to
Motor Case O-Ring
All Models L82-06,
Dyna L82-05
Replaces: 11147
Cometic Part #-C9536
Inner Primary to
Motor Case O-Ring All
Models 70-E82
Replaces: 11125

Cometic Part #-C9942F1
Primary Spacer Gasket "Pair"
Softail 95-06

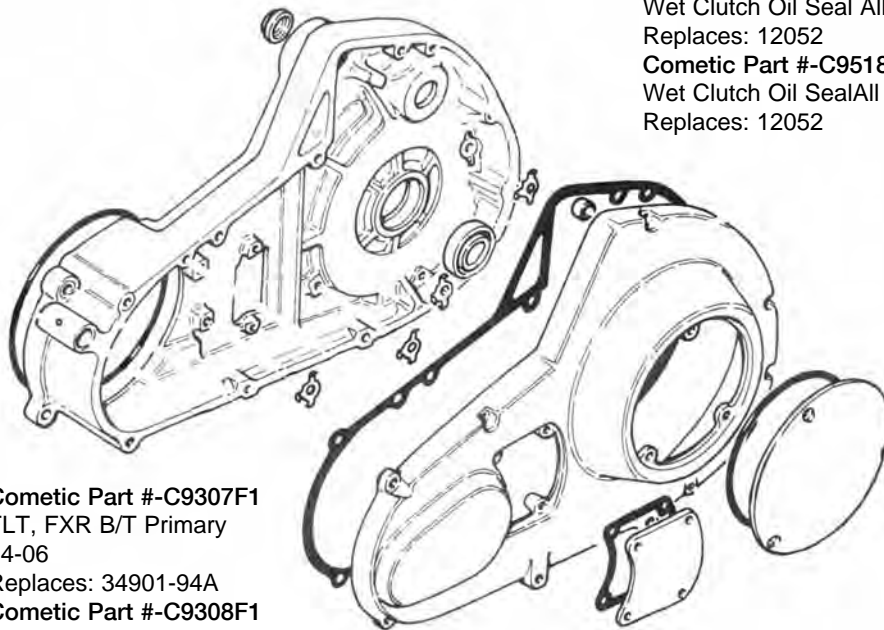

Cometic Part #-C9307F1
FLT, FXR B/T Primary
94-06
Replaces: 34901-94A
Cometic Part #-C9308F1
FLT, FXR B/T Primary
80-93
Replaces: 34901-79A

Cometic Part #-C9305F1
FLT, FXR Inspection Cover 85-06
Replaces: 34906-85A
Cometic Part #-C9303F1
FLT, FXR Inspection Cover 80-84
Replaces: 34906-79A

Cometic Part #-C9260
Wet Clutch Oil Seal All Models L84-UP
Replaces: 12052
Cometic Part #-C9518
Wet Clutch Oil Seal All Models 70-E84
Replaces: 12052

Cometic Part #-C9662
Derby Cover O-Ring
All Big Twin Models
99-06, Dyna 99-05
Replaces: 25416-99

Cometic Part #-C9442
Derby Cover O-Ring
All Big Twin Models
L84-98
Replaces: 25416-84
Cometic Part #-C9997F1
Derby Cover Gasket
Replaces O-Ring
All Big Twin Models
99-UP 5 Hole
Replaces: 25416-99C

Cometic Part #-C9309F1
Primary Gasket Softail 89-06, Dyna 89-05
Replaces: 60539-89
Cometic Part #-C9607F1
Primary Gasket Softail, Superglide 65-88
All Four Speeds
Replaces: 60538-81C
Cometic Part #-C9885
94-06 FXST, 94-05 FXD Primary Kit
Cometic Part #-C9886
89-93 FXST, FXD Primary Kit
Cometic Part #-C9887
65-88 FXST, FX, FL 4-Speed Primary Kit

Cometic Part #-C9338F1
Derby Cover Gasket
All 4 Speed Models 70-83
Replaces: 25416-70
Cometic Part #-C9662
Derby Cover O-Ring
All Big Twin Models
99-06, Dyna 99-05
Replaces: 25416-99
Cometic Part #-C9442
Derby Cover O-Ring
All Big Twin Models
L84-98
Replaces: 25416-84
Cometic Part #-C9997F1
Derby Cover Gasket
Replaces O-Ring
All Big Twin Models
99-UP 5 Hole
Replaces: 25416-99C

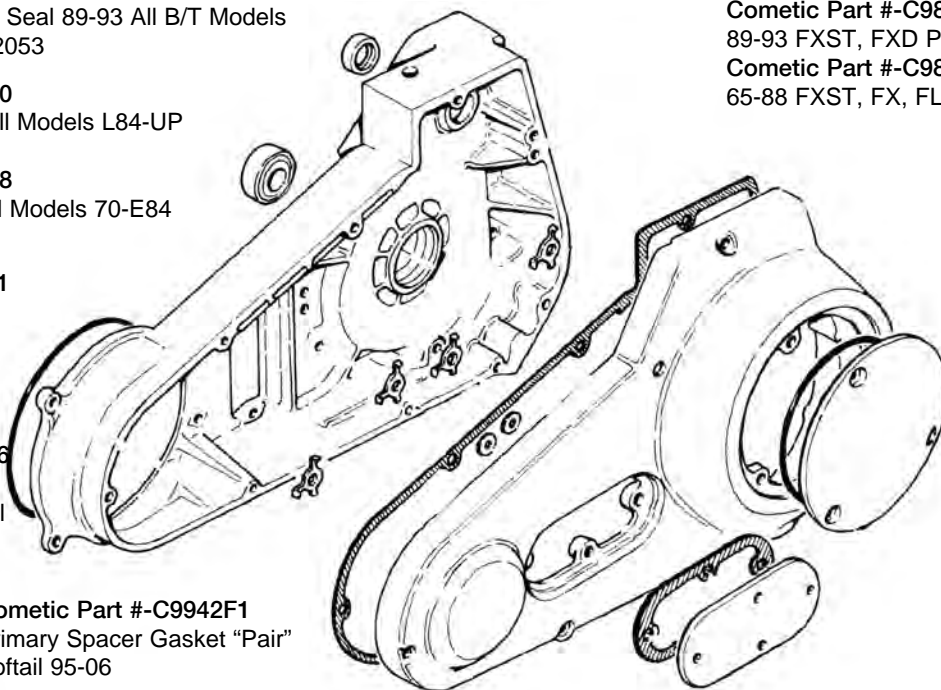

Cometic Part #-C9331F1 Inspection Cover Gasket
Dyna & Softail, 4 & 5 Speed Dyna 65-05 , Softail 65-06



Big Twin Primary Gasket & Seal Kits (All kits contain all Gaskets and Seals needed to R&R Inner & Outer Primary)

Cometic Part #	Description
C9173	07-16 FL Models Primary Kit
C9150	06-16 Dyna Primary Kit, 07-UP Softail
C9885	94-06 FXST, 94-05 FXD Primary Kit
C9888	94-06 FLT, FLHT, FXR Primary Kit
C9886	89-93 FXST, FXD Primary Kit
C9889	80-93 FLT, FLHT, FXR Primary Kit
C9887	65-88 FXST, FX, FL 4-Speed Primary Kit

Primary Gaskets Big Twin, Twin Cam

Cometic Part #	OE#	Description
Single	5 Pack	
C9179F1	C9179F5	34901-07 07-16 FL Models Primary
C9145F1	C9145F5	60547-06 06-16 Dyna, 07-UP Softail
C10122		2007-UP Primary Push Pin 10 Pk.
C9199F1	C9199F5	34934-06 06 Dyna, 07-16 All T/C Inner Primary spacer/seal
C9942F1	C9942F5	63859-95A 95-06 Softail primary spacer gasket (Pair)
C9307F1	C9307F5	34901-94A 94-06 FLT, FXR Big Twin Primary
C9308F1	C9308F5	34901-79A 80-93 Big Twin Primary FLT/FXR
C9309F1	C9309F5	60539-89 89-06 Softail, 89-05 Dyna
C9607F1	C9607F5	60538-81C 65-88 FXST, FX / FL 4 -SPEED
C10125F1	C10125F5	1970-06 Big Twin Case Saver Gasket

Inspection Cover Gaskets Big Twin , Twin Cam

Cometic Part #	OE#	Description
Single	5 Pack	
C9305F1	C9305F5	34906-85A 85-06 FXR, FLT Insp. Cover
C9303F1	C9303F5	34906-79A 80-84 FXR,FLT Insp. Cover
C9326F1	C9326F5	60567-36 36-58-64-69 FL, XLCH Inspection Cover
C9331F1	C9331F5	60567-65B 65-06 Softail 4&5 Speed, 89-05 Dyna Inspection Cover

Derby Cover Gasket Big Twin

Cometic Part #	OE#	Description
Single	5 Pack	
C10140F1	C10140F5	25416-16 2016- T/C All FL Models Except CVO & Low
C9997F1	C9997F5	25416-99C 99-16 Derby Cover Replaces O-ring, 5 Hole
C9183F1	C9183F5	84-98 All Derby Cover Replaces O-Ring , 3 Hole
C9152F1	C9152F5	17369-06 06-16 Dyna, 07-16 All Twin Cam Models O-ring
C9338F1	C9338F5	25416-70 70-83 FL, FXR Derby Cover

Cam Cover Gaskets Big Twin , Twin Cam

Cometic Part #	OE#	Description
Single	5 Pack	
C9575F1	C9575F5	25244-99 99-16 Twin Cam, Cam Cover
C9328F1	C9328F5	25225-93X 93-98 Big Twin Cam Cover
C9302F1	C9302F5	25225-70X 70-92 Big Twin Cam Cover
C9334F1	C9334F5	25225-36C 41-69 Big Twin Cam Cover

Sportster Primary Gasket and Seal Kit

Cometic Part #	Description
C9125	04-16 Sportster Complete Primary Rebuild
C9211	91-03 Sportster Complete Primary Rebuild
C9210	96-90 Sportster Complete Primary Rebuild

Sportster Primary Gasket

Cometic Part #	OE#	Description
Single	5 Pack	
C9943F1	C9943F5	34955-04 04-16 Sportster Primary
C9314F1	C9314F5	34955-89A 91-03 Sporty Primary
C9310F1	C9310F5	34955-75X 77-90 Sporty Primary

Sportster Cam Cover Gasket

Cometic Part #	OE#	Description
Single	5 Pack	
C9944F1	C9944F5	25263-90D 04-16 Sportster Cam Cover
C9313F1	C9313F5	25263-90B 91-03 Sporty Cam Cover
C9311F1	C9311F5	25263-86 86-90 Sporty Cam Cover
C10029F1	C10029F5	25279-08 08-UP XR1200 Cam Cover
C9310F1	C9310F5	34955-75X 77-90 Sporty Primary

Street 500-750 Alternator Cover Gasket

Cometic Part #	OE#	Description
Single	5 Pack	
C10131F1	C10131F5	25700224 2014-16 Street 500/750 Alternator Cvr Gasket

Street 500-750 Primary Cover Gasket

Cometic Part #	OE#	Description
Single	5 Pack	
C10132F1	C10132F5	25700210 2014-16 Street 500/750 Primary Cvr Gasket



Gaskets for Harley-Davidson®

MLS® Multi-Layer Steel

Head & Base Gaskets

Part # Description

V - Rod MLS Head Gaskets (Pairs) 2001-16

- C9895 V-Rod .027" Std Bore Head Gasket
- C9896 V-Rod .030" Std Bore Head Gasket
- C9897 V-Rod .027" 4.250" Bore Head Gasket
- C9898 V-Rod .030" 4.250" Bore Head Gasket

V - Rod EXTREME DUTY Exhaust Gaskets (Pair) 2001-16

- C9928 V-Rod Extreme Performance Exhaust Gasket
- C10060 V-Rod OE Replacement Gasket Pair (Replaces 65109-01)

Twin Cam, Twin Cooled MLS Head Gaskets (Pairs) Select 2014 -16 Touring Models & Trikes

NOTE: TWIN COOLED H/G WILL RETRO TO AIR COOLED HEADS & CYLINDERS

- C10081 3.875", .027"MLS, Twin Cooled
- C10081-030 3.875", .030"MLS, Twin Cooled
- C10081-036 3.875", .036"MLS, Twin Cooled
- C10081-040 3.875", .040"MLS, Twin Cooled
- C10081-045 3.875", .045"MLS, Twin Cooled
- C10083 3.937", .027"MLS, Twin Cooled
- C10083-030 3.937", .030"MLS, Twin Cooled
- C10083-036 3.937", .036"MLS, Twin Cooled
- C10083-040 3.937", .040"MLS, Twin Cooled
- C10083-045 3.937", .045"MLS, Twin Cooled
- C10084 4.000", .027"MLS, Twin Cooled
- C10084-030 4.000", .030"MLS, Twin Cooled
- C10084-036 4.000", .036"MLS, Twin Cooled
- C10084-040 4.000", .040"MLS, Twin Cooled
- C10084-045 4.000", .045"MLS, Twin Cooled
- C10085 4.060", .027"MLS, Twin Cooled
- C10085-030 4.060", .030"MLS, Twin Cooled
- C10085-036 4.060", .036"MLS, Twin Cooled
- C10085-040 4.060", .040"MLS, Twin Cooled
- C10085-045 4.060", .045"MLS, Twin Cooled
- C10086 4.125", .027"MLS, Twin Cooled
- C10086-030 4.125", .030"MLS, Twin Cooled
- C10086-036 4.125", .036"MLS, Twin Cooled
- C10086-040 4.125", .040"MLS, Twin Cooled
- C10086-045 4.125", .045"MLS, Twin Cooled
- C10087 4.160", .027"MLS, Twin Cooled
- C10087-030 4.160", .030"MLS, Twin Cooled
- C10087-036 4.160", .036"MLS, Twin Cooled
- C10087-040 4.160", .040"MLS, Twin Cooled
- C10087-045 4.160", .045"MLS, Twin Cooled
- C10088 4.250", .027"MLS, Twin Cooled
- C10088-030 4.250", .030"MLS, Twin Cooled
- C10088-036 4.250", .036"MLS, Twin Cooled
- C10088-040 4.250", .040"MLS, Twin Cooled
- C10088-045 4.250", .045"MLS, Twin Cooled

Twin Cam MLS Head Gaskets (Pairs)

*2007 Twin Cams 96" displacement increase was made by increasing the stroke to 4.375" std. 96" and big bore 103" are the same bore size as 88" and 95" bores.

- C9790 3.750" Head Gasket .030" MLS All Twin Cam Models Std bore 1999-11
- C9745 3.750" Head Gasket .040" MLS All Twin Cam Models Std bore 1999-11
- C9181 3.750" Head Gasket .045" MLS All Twin Cam Models Std bore 1999-11
- C9157 3.750" Head Gasket .051" MLS All Twin Cam Models Std bore 1999-11
- C9158 3.750" Head Gasket .060" MLS All Twin Cam Models Std bore 1999-11
- C9721 3.875" Head Gasket .030" MLS All Twin Cam Models 95" & 103" 1999-16
- C9721-040 3.875" Head Gasket .040" MLS All Twin Cam Models 95" & 103" 1999-16
- C9721-045 3.875" Head Gasket .045" MLS All Twin Cam Models 95" & 103" 1999-16
- C9721-051 3.875" Head Gasket .051" MLS All Twin Cam Models 95" & 103" 1999-16
- C9721-060 3.875" Head Gasket .060" MLS All Twin Cam Models 95" & 103" 1999-16



Gaskets for Harley-Davidson®

MLS® Multi-Layer Steel

Head & Base Gaskets

Part # Description

Twin Cam MLS Head Gaskets (Pairs) con't.

*2007 Twin Cams 96" displacement increase was made by increasing the stroke to 4.375" std. 96 and big bore 103" are the same bore size as 88" and 95" bores.

C9894 3.937" Head Gasket .030" MLS All Twin Cam Models 97" & 107" 1999-16
 C9894-040 3.937" Head Gasket .040" MLS All Twin Cam Models 97" & 107" 1999-16
 C9894-051 3.937" Head Gasket .051" MLS All Twin Cam Models 97" & 107" 1999-16
 C9725 4.000" Head Gasket .030" MLS All Twin Cam Models 100" & 110" 1999-16
 C9726 4.000" Head Gasket .040" MLS All Twin Cam Models 100" & 110" 1999-16
 C9070-030 4.060" Head Gasket .030" MLS All Twin Cam Models 103" & 113" 1999-16
 C9070-040 4.060" Head Gasket .040" MLS All Twin Cam Models 103" & 113" 1999-16
 C9910 4.125" Head Gasket .030" MLS All Twin Cam Models 107" & 117" 1999-16
 C9743 4.125" Head Gasket .040" MLS All Twin Cam Models 107" & 117" 1999-16
 C9076-030 4.250" Head Gasket .030" MLS All Twin Cam Models 114" & 124" 1999-16
 C9076-040 4.250" Head Gasket .040" MLS All Twin Cam Models 114" & 124" 1999-16

Twin Cam SLS Base Gasket (Pairs) Single Layer Steel 1999-16

C9937 4" Twin Cam Base gasket .010" Pair
 C9738 4" Twin Cam Base gasket .020" Pair
 C10127 4" CV0110 All Twin Cam Models 2007-16, Base Seal Kit
 C9110-010 4.060" Twin Cam Base gasket .010" SLS, Pair
 C9110-020 4.060" Twin Cam Base gasket .020" SLS, Pair
 C10066 4.125" Twin Cam Base gasket .010" SLS, Pair Stock base pattern
 C10066-020 4.125" Twin Cam Base gasket .020" SLS, Pair Stock base pattern
 C9938 4.125" Twin Cam Base gasket .010" Pair
 C9739 4.125" Twin Cam Base gasket .020" Pair
 C9111-010 4.250" Twin Cam Base gasket .010"SLS Pair
 C9111-020 4.250" Twin Cam Base gasket .020"SLS Pair

S&S Head Gaskets

C9930 S&S Super Sidewinder + 4 1/8" H/G Pair .027" MLS
 C9931 S&S Super Sidewinder + 4 1/8" H/G Pair .030" MLS
 C9932 S&S Super Sidewinder + 4 1/8" H/G Pair .036" MLS
 C9933 S&S Super Sidewinder + 4 1/8" H/G Pair .040" MLS
 C9934 S&S Super Sidewinder + 4 1/8" H/G Pair .045" MLS
 C10090 S&S Twin Cam 131"cu 4.250" H&B Kit, .040"MLS H/G & .010" SLS Base
 C10065 S&S Tribute pattern 4 3/8" H/G Pair .040" MLS
 C10065-045 S&S Tribute pattern 4 3/8" H/G Pair .045" MLS

S&S Base Gaskets

C9935 S&S Super Sidewinder + 4 1/8" Base gasket pair .010"
 C9936 S&S Super Sidewinder + 4 1/8" Base gasket pair .020"
 C10009 S&S EVO 1984-99 Fits S&S only .020" Fiber (93-1033)

Street 500 & 750 Head & Base Gaskets 2014-16

C10134 Street 500 H/G 69MM Stock Bore,.036"MLS (Pair)
 C10134-HB Street 500 H/G 69MM Stock Bore,.036"MLS Heaad & Base Kit
 C10135 Street 500 H/G 71MM Big Bore,.036"MLS (Pair)
 C10135-HB Street 500 H/G 71MM Big Bore,.036"MLS Heaad & Base Kit
 C10136 Street 700 H/G 85MM Stock Bore,.036"MLS (Pair)
 C10136-HB Street 700 H/G 85MM Stock Bore,.036"MLS Heaad & Base Kit
 C10137 Street 700 H/G 87MM Big Bore,.036"MLS (Pair)
 C10137-HB Street 700 H/G 87MM Big Bore,.036"MLS Heaad & Base Kit

EVO Big Twin & Sportster MLS Head Gaskets (Pairs)

C10003 XR1200 STD Bore MLS Head gasket .040" 2008-12
 C10004 XR1200 3.812" Bore MLS Head gasket .040" 2008-12
 C10004-030 XR1200 3.812" Bore MLS Head gasket .030" 2008-12
 C10077 XR1200 3.563" Bore Head & Base Kit .030"H/G & .020" Base, 2008-12
 C10057 XR1200 3.875" Bore .030" MLS Head gasket & .020" Base set 2008-12
 C9205 883 XL 3.000" Std bore .040" 1984-16
 C9688 Stock EVO's 3.500" through 3.570" .030" 1984-99 B/T, 1984-16 XL
 C9689 Stock EVO's 3.500" through 3.570" .040" 1984-99 B/T, 1984-16 XL
 C9180 Stock EVO's 3.500" through 3.570" .060" 1984-99 B/T, 1984-16 XL



Gaskets for Harley-Davidson®

MLS® Multi-Layer Steel

Head & Base Gaskets

Part # Description

EVO Big Twin & Sportster MLS Head Gaskets (Pairs) con't

C9690 3 5/8" Big Bore EVO's .030" 1984-99 B/T, 1984-16 XL
 C9691 3 5/8" Big Bore EVO's .040" 1984-99 B/T, 1984-16 XL
 C9694 3 3/4" Big Bore EVO's .030" 1984-99 B/T, 1984-16 XL
 C9695 3 3/4" Big Bore EVO's .040" 1984-99 B/T, 1984-16 XL
 C9692 3 13/16" Big Bore EVO's .030" 1984-99 B/T, 1984-16 XL
 C9693 3 13/16" Big Bore EVO's .040" 1984-99 B/T, 1984-16 XL
 C10120 3.875" Big Bore EVO's .040" 1984-99 B/T, 1984-16 XL
 C9877 4.000" Bore S&S and TP cylinders .027" solid dowels
 C9878 4.000" Bore S&S and TP cylinders .030" solid dowels
 C9879 4.000" Bore S&S and TP cylinders .036" solid dowels
 C9880 4.000" Bore S&S and TP cylinders .040" solid dowels
 C9881 4.125" Bore TP cylinders .027" solid dowels
 C9882 4.125" Bore TP cylinders .030" solid dowels
 C9883 4.125" Bore TP cylinders .036" solid dowels
 C9884 4.125" Bore TP cylinders .040" solid dowels
 C10069 4.250" Bore S&S and TP cylinders head & Base kit .030" head,.020" base

EVO Big Twin SLS Base Gaskets (Pairs) Single Layer Steel

C9101 1340 Evolution B/T STD bore .010" 1984-99
 C9551 1340 Evolution B/T STD bore .020" 1984-99
 C9532 3 5/8" & 3 3/4" Big Bore 1340 B/T EVO's .010" 1984-99
 C9552 3 5/8" & 3 3/4" Big Bore 1340 B/T EVO's .020" 1984-99
 C9869 3 13/16" Evolution B/T .010" 1984-99
 C9870 3 13/16" Evolution B/T .020" 1984-99
 C9871 4.000" S&S and TP cylinder .010"
 C9872 4.000" S&S and TP cylinder .020"
 C9873 4.125" TP cylinder .010"
 C9874 4.125" TP cylinder .020"

EVO Sportster SLS Base Gaskets (Pairs) Single Layer Steel

C9100 883/1200 EVO Sportsters .010" 1984-16
 C9553 883/1200 EVO Sportsters .020" 1984-16
 C9554 3 5/8" Big Bore 883/1200 EVO Sportsters .010" (Also fits Wiseco 3 3/4" Steel Sleeve Big Bore)
 C9555 3 5/8" Big Bore 883/1200 EVO Sportsters .020" (Also fits Wiseco 3 3/4" Steel Sleeve Big Bore)
 C9875 3 3/4" & 3 13/16" Evo Sporty Millenium Cylinders .010" (Either bore utilizes a 4.00" O.D. Spigot Diameter)
 C9876 3 3/4" & 3 13/16" Evo Sporty Millenium Cylinders .020" (Either bore utilizes a 4.00" O.D. Spigot Diameter)

Shovelhead and Panhead MLS Head Gaskets (Pairs)

C9984 Std Bore Head Gasket .040" MLS Shovelhead 74" & 80" 1966-84
 C9985 3 5/8" Head Gasket .040" MLS Shovelhead Big Bore 1966-84
 C10037 3 13/16" Head Gasket .040" MLS Shovelhead Big Bore 1966-84
 C9137 Head Gasket .040" MLS Panhead Std. Bore 1948-65
 C10070 3 5/8" Bore Head Gasket .040" MLS Panhead 1948-65

Shovelhead and Panhead SLS Base Gaskets (Pairs)

C9206 Shovel Only Base Gasket Std bore .020" Viton Front & Rear Pair 1966-84
 C9207 3 5/8" Shovel Only Base Gasket .020" Viton 2 Fronts for S&S Cylinders 1984-99
 C10038 3 13/16" Shovel Only Base Gasket .020" Viton 2 Fronts for S&S Cylinders
 C9987 Panhead Base Front & Rear Set .020" Viton 1948-84
 C9988 Panhead Base 3 5/8" Front & Rear Set .020" Viton 1948-84
 C9989 Panhead Base 3 5/8" 2 Fronts for S&S Cylinders Viton 48-84
 C9893 Panhead Base 3 13/16" .020" Viton 1948-84
 C10116 48-84 Pan/Shovel Pair, No Oil Hole, .020" Fiber STD bore
 C10117 48-84 Pan/Shovel Pair, No Oil Hole, .020" Fiber 3 5/8" bore

EVO Viton Coated Steel Rocker Cover Gaskets

Part#	Description / Qty.	Thickness	Part#	Description / Qty.	Thickness
C9865	84-99 One piece Base All Evo's (2)	.020"	C9560	Right - All 883 thru 1340, '84-99 (5)	.010"
C9866	84-99 One piece Base All Evo's (10)	.020"	C9561	Right - All 883 thru 1340, '84-99 (5)	.020"
C9556	Right - All 883 thru 1340, '84-99 (1)	.010"	C9562	Left - All 883 thru 1340, '84-99 (5)	.010"
C9557	Right - All 883 thru 1340, '84-99 (1)	.020"	C9563	Left - All 883 thru 1340, '84-99 (5)	.020"
C9558	Left - All 883 thru 1340, '84-99 (1)	.010"	C9986	66-84 Shovelhead / OE#17540-69 (2)	.020"
C9559	Left - All 883 thru 1340, '84-99 (1)	.020"	C10008	66-84 Shovelhead / OE#17540-69 (2)	.043"
			C10008-10..	66-84 Shovelhead / OE#17540-69 (10)	.043"

Twin Cam®

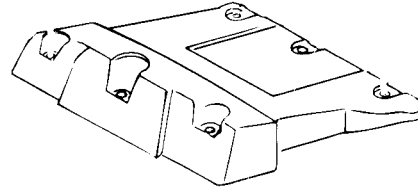

Cometic Part #-C9577
Rocker Cover
All 1999-UP
Replaces: 17286-99

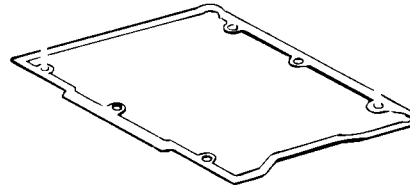

Cometic Part #-C9579
Breather Cover
All 1999-10
Replaces: 17591-99

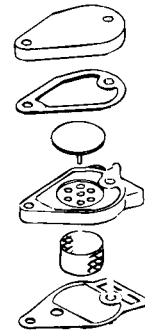

Cometic Part #-C9633
Rocker Umbrella Valve
All 1999-UP
Replaces: 26858-99

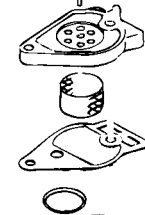

Cometic Part #-C9679
Breather Baffle Element
All 1999-UP
Replaces: 63815-99



Cometic Part #-C9580
Breather Baffle Housing
All 1999-10
Replaces: 17592-99

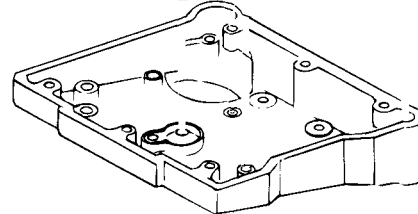

Cometic Part #-C9576
Rocker Housing
All 1999-UP
Replaces: 16719-99

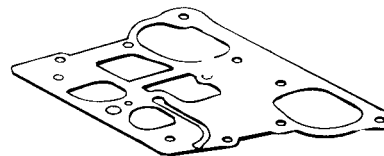

Cometic Part #-C9836
Valve Stem Seal Viton
All 1999-03
Replaces: 18001-83B

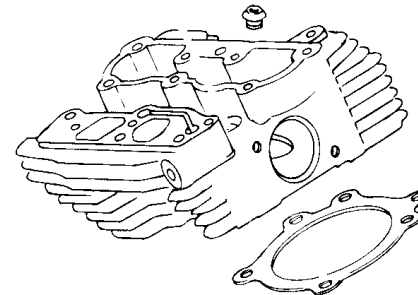

Cometic Part #-C9153
Valve Stem Seal Hat Style Viton
2003-Present
Replaces: 18094-02

Cometic Part #-C9294
Pushrod Cover
O-Ring Upper
Replaces: 11293

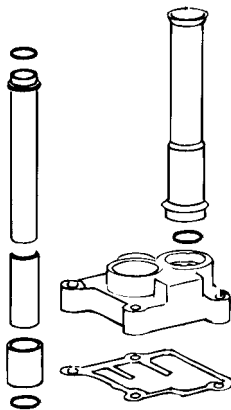

Cometic Part #-C9629
Rocker Arm Support
O-Ring
All 1999-UP
Replaces: 11270

Cometic Part #-C9293
Pushrod Cover
O-Ring Lower
Replaces: 11145

Cometic Part #-C9459
Pushrod Cover
O-Ring Middle
Replaces: 11132

Cometic Part #-C9578
Lifter Cover 1999-UP
Replaces: 18635-99

- Cometic Part #-C9790 Std. Bore Head - MLS .030" - All 1999-UP
- Cometic Part #-C9745 Std. Bore Head - MLS .040" - All 1999-UP
- Cometic Part #-C9721 1550 Big Bore Head - MLS .030" - All 1999-UP
- Cometic Part #-C9722 1550 Big Bore Head - MLS .040" - All 1999-UP



Gaskets for Harley-Davidson®



Complete • Top End • Rocker Box Kits & Individual Replacement Parts

Part # Description

EST TWIN CAM HI-PERFORMANCE KITS

• Complete Gasket Kit (Kits do not contain spacer for 07 models, order seperately)

- C9171 07-16 All Softail, Std. Bore 3.750" .040" Head Gasket
- C9184 07-16 All Softail, 103" Big Bore 3.875", Std bore 2012-Up all Softail
- C10100 07-16 All Softail models 4.125" bore w/.040" H/G
- C10100-030 07-16 All Softail models 4.125" bore w/.030" H/G
- C9172 07-16 All FL Models, Std. Bore 3.750" .040" Head Gasket
- C9185 07-16 All FL Models, 103" Big Bore 3.875", Std bore 2012-Up all FL Models
- C10044 07-16 All FL Models, Big Bore 3.937" .040" Head Gasket
- C10044-030 07-16 All FL Models, Big Bore 3.937" .030" Head Gasket
- C10012 07-16 All FL Models, 113" Big Bore 4.060" .040" Head Gasket & .020" Base Gasket
- C10067 07-16 All FL Models, 117" Big bore 4.125" .030"h/g & .020" Base Gasket
- C9148 06-16 Dyna Models, Std. Bore 3.750" .040" Head Gasket
- C9186 06-16 Dyna Models, 103" Big Bore 3.875", Std bore 2012-Up Dyna Models
- C9149 06-16 Dyna Models, 95" & 103" BB w/.030" Head Gasket,Std bore '12-Up Dyna Models
- C10123 06-14 DYNA Models 107", 3.937" bore w/.040"Head Gasket & Base O-ring
- C10123-030 06-14 DYNA Models 107", 3.937" bore w/.030"Head Gasket & Base O-ring
- C10105 06-14 DYNA Models 110", 4" bore w/.040"Head Gasket & .020" base
- C10113 06-14 DYNA Models 113", 4.060" bore w/.040"Head Gasket & .020" base
- C9777F 99-06 Softails, 99-05 Dyna Std. Bore 3.750" .040" thick head gasket
- C9778F 99-06 FLT's, Road King, Std. Bore 3.750" .040" thick head gasket
- C9920 99-06 All Twin Cam Models, 99-05 Dyna 3.875" Big Bore Kits w/.040" Head Gasket
- C9161 99-06 All Twin Cam Models, 99-05 Dyna 3.875" Big Bore Kits w/.030" Head Gasket
- C10112 99-06 All Twin Cam Models 99-05 Dyna, 3.937" Big Bore Kit w/ .030"H/G
- C10102 99-06 All FL Models 3.937" Big Bore kit w/ .040" Head Gasket
- C10102-030 99-06 All FL Models 3.937" Big Bore kit w/ .030" Head Gasket
- C9807F 99-06 FXST, 99-05 Dyna 4" Big Bore Kits .030" Head Gasket
- C10005 99-06 All FL Models 4" Big Bore kit w/ .030" Head Gasket
- C10118 99-05 4.060" Dyna & 99-06 Softails .030" Head Gasket & .010" Base
- C9221 99-05 4 1/8" Dyna & 99-06 Softails .040" Head Gasket & .010" Base
- C9221-030 99-05 4 1/8" Dyna & 99-06 Softails .030" Head Gasket & .010" Base
- C9222 99-06 4 1/8" FLT/FXR .040" Head Gasket & .010" Base
- C9222-030 99-06 4 1/8" FLT/FXR .030" Head Gasket & .010" Base

• Top End Gasket Kit

- C10041 S&S 4.125" Bore SSW Top End kit .030" Head Gasket
- C10041-030 S&S 4.125" Bore SSW Top End kit .027" Head Gasket
- C9146 03-16 All Twin Cam Std Bore 3.750" W / Hat Style Valve Stem Seal
- C9147 03-16 All Twin Cam 95" & 103" Big Bore Kit 3.875" w/Hat Style Valve Stem Seal
- C9844 03-16 All Twin Cam 95" & 103" Big Bore Kit 3.875" w/ .030" Head Gasket
- C9779 99-02 All Twin Cam 3.750" Bore W / .040" Head Gasket
- C9845 99-02 All Twin Cam 3.750" Bore W / .030" Head Gasket
- C9951-051 99-16 All Twin Cam 3.875" Big Bore Kit W / .051" Head Gasket
- C9951 99-16 All Twin Cam 3.875" Big Bore Kit W / .045" Head Gasket
- C9780 99-16 All Twin Cam 3.875" Big Bore Kit W / .040" Head Gasket
- C9182 99-16 All Twin Cam 3.937" Bore TOP END EST KIT, .040" MLS H/G
- C10034 99-16 All Twin Cam 3.937" Bore TOP END EST KIT, .030" MLS H/G
- C10138 07-16 All Twin Cam CVO110,.4" Bore T/E W/.040"MLS H/G, Air or Twin Cooled
- C10138-030 07-16 All Twin Cam CVO110,.4" Bore T/E W/.030"MLS H/G, Air or Twin Cooled
- C10082 120R Top End Kit 4.060" Bore W/ .040" Head & .020" Base
- C10082-030 120R Top End Kit 4.060" Bore W/ .030" Head & .020" Base
- C9114 99-16 All Twin Cam 4.060" TOP END EST KIT, .040"MLS H/G, .010" Steel Base
- C9114-030 99-16 All Twin Cam 4.060" TOP END EST KIT, .030"MLS H/G, .010" Steel Base
- C9949 99-16 4.00" Bore Twin Cam .040" Head Gasket & .010" Base
- C9976 99-16 4 1/8" Bore Twin Cam .040" Head Gasket & .020" Base
- C9976-030 99-16 4 1/8" Bore Twin Cam .030" Head Gasket & .020" Base
- C9238 99-16 4 1/4" Bore Twin Cam .040" Head Gasket & .010" Base
- C9789 99-16 All Twin Cam FATSO Top End
- C10015 All Twin Cam 3.750" Bore .040" Head Gasket



Gaskets for Harley-Davidson®



Cometic Gasket - An Exclusive NASCAR Performance® Product

Complete • Top End • Rocker Box Kits & Individual Replacement Parts

Part # Description

• Motor Only Gasket Kit

- C9892 All Twin Cam 99-16 with 1550 Big Bore, Motor Only Kit, .040" MLS Head Gaskets
C10071 All Twin Cam 99-16, 3.937" Motor only gasket kit w/.040" MLS H/G & .020" Base
C10071-030 All Twin Cam 99-16, 3.937" Motor only gasket kit w/.030" MLS H/G & .020" Base
C9139 All 4.00" Bore Twin Cam 99-16, Motor Only Kit, .030" MLS Head Gaskets
C9140 All 4.00" Bore Twin Cam 99-16, Motor Only Kit, .040" MLS Head Gaskets
C10079 120R Motor Only Gasket Kit, .040" Head Gasket & .020" Base
C10121 All Twin Cam 99-16 with 4.125" Big Bore, Motor Only Kit, .040" MLS Head Gaskets
C10121-036 All Twin Cam 99-16 with 4.125" Big Bore, Motor Only Kit, .036" MLS Head Gaskets

• Rocker Box Gasket Kit for 88", 95" & 103" Twin Cam

- C9588 99-14 88", 95" & 103" Twin Cam Rocker Box Gasket Kit, inc. gaskets for '11 Breathers
C9167 99-14 Screamin Eagle Heads Rocker Box Rebuild w/seals for .530" O.D. guides
C9840 99-14 Twin Cam FATSO Rocker Box Rebuild Kit
C9155 S&S Rocker Box Rebuild Kit (Die Cast Box)

• Twin Cam Engine & Trans Cover Gasket Kit

- C10099 Twin Cam 96 All FL Models, Engine and Trans Cover Gaskets Only

Table with 4 columns: Cometic Part #, OEM Part #, Description, Pkg. Qty.

TWIN CAM INDIVIDUAL REPLACEMENT GASKETS,SEALS, O-RINGS 1999-UP

• Cam Service Kits for Twin Cam

- C9664 17045-99 Cam Service Kit All T/C Models 99-16KIT

Twin Cooled Coolant Service Parts

- C10139 26064-08X 14-16 Twin Cooled O-Ring KitKIT

• Rocker Box Assembly Gaskets

- C9577 17286-99 Rocker Cover Gasket All Models 99-16 .020" Rubber Coated Steel 10
C9579 17591-99 Breather Cover Gasket All Models 1999 -10 10
C9633 26858-99 Rocker Cover Umbrella Vlv All Models 1999-16 10
C9679 63815-99 Breather Filter Element All Models 1999-16 10
C9580 17592-99 Breather Baffle Gasket All Models 1999 -10 10
C10039 26500002L Breather element gasket All Twin Cam 2011-Up, Lower 10
C10114 26500002U Breather element gasket All Twin Cam 2011-Up, Upper 10
C9576 16719-99 Rocker Housing Gasket All Models 99-16 .020" Rubber Coated Steel 10
C9629 11270 Rocker Arm Support O-ring All Models 1999-16 10

• Pushrod, Tappet Gaskets and Valve Stem Seals

- C9586 Pushrod Seal Kit, All Twin Cam Models 1999-16KIT
C9294 11293 Pushrod Cvr O-ring UPPER all Models 1999-16 10
C9459 11132 Pushrod Cvr O-ring MIDDLE all Models 1999-16 25
C9293 11145 Pushrod Cvr O-ring LOWER all Models 1999-16 25
C9578F 18635-99 Lifter Cvr Gasket All Models 1999-16 10
C9166 Viton Valve Seals for Screamin Eagle Heads or .530" O.D. guides 10
C9836 Valve Stem Oil Seal All Models 1999 -02(Viton) 25
C9153 18094-02 Valve Stem Oil Seal Hat Style All Models 03-16 (Viton) 25

• Head and Base Gaskets

- C9790 16775-99 Head Gasket 3.750" .030" Spring Steel All Models Std Bore '99 -11 2
C9745 Head Gasket 3.750" .040" Spring Steel All Models Std Bore '99 -11 2
C9721 Head Gasket 3.875" .030" Spring Steel All Models 1999-16 2
C9722 Head Gasket 3.875" .040" Spring Steel All Models 1999-16 2
C9894 3.937" Head Gasket .030" MLS All Twin Cam Models 1999-16 2
C9894-040 3.937" Head Gasket .040" MLS All Twin Cam Models 1999-16 2
C9894-051 3.937" Head Gasket .051" MLS All Twin Cam Models 1999-16 2
C9725 4.00" Head Gasket Twin Cam All Models .030" Spring Steel 1999-16 2
C9726 4.00" Head Gasket Twin Cam All Models .040" Spring Steel 1999-16 2
C9070-030 4.060" Bore .030" MLS Head Gasket Twin Cam 1999-16 2
C9070-040 4.060" Bore .040" MLS Head Gasket Twin Cam 1999-16 2
C9910 4.125" Bore .030" MLS All Twin Cam Models 1999-16 2
C9743 4.125" Bore .040" MLS All Twin Cam Models 1999-16 2
C9076-030 4.250" Bore .030" MLS Head Gasket Twin Cam 1999-16 2
C9076-040 4.250" Bore .040" MLS Head Gasket Twin Cam 1999-16 2
C9628 11256 Cylinder Base O-ring All Models 1999-16 10
C9438 11273 Cylinder Locating Dowel O-ring All Models 1999-16 10



Gaskets for Harley-Davidson®



Cometic Gasket - An Exclusive NASCAR Performance® Product

Complete • Top End • Rocker Box Kits & Individual Replacement Parts

Table with 4 columns: Cometic Part #, OEM Part #, Description, and Pkg. Qty. It lists various gasket and seal parts for Harley-Davidson motorcycles, categorized into Motor Case O-rings and Seals, Intake and Exhaust Gaskets, Oil and Oil Pump Gaskets, Primary Housing Gaskets, Cam Housing, and Carb and EFI Gaskets.

Evo Big Twin®

Cometic Part #-C9459
Pushrod O-Ring
Middle 1984-99
Replaces: 11132

Cometic Part #-C9481
Umbrella Valve Seal
1993-99
Replaces: 26856-89

Cometic Part #-C9286
Rocker Cover Washer
1984-99
Replaces: 63858-49

Cometic Part #-C9293
Pushrod O-Ring
Lower 1984-99
Replaces: 11145

Cometic Part #-C9292
Pushrod O-Ring
Upper 1984-99
Replaces: 11157

Cometic Part #-C9278
Upper Rocker Cover
1992-99
Replaces: 17356-92

Cometic Part #-C9297
Rear Tappet Block
Replaces: 18633-48D
Cometic Part #-C9298
Front Tappet Block
Replaces: 18634-48C

Cometic Part #-C9328
Cam Cover 1993-99
Replaces: 25225-93
Cometic Part #-C9302
Cam Cover 1984-92
Replaces: 25225-70B

Cometic Part #-C9282
Lower Rocker Cover
1992-99
Replaces: 17355-92

Cometic Part #-C9283
Inner Rocker Cover
1984-99
Replaces: 17358-84A

Cometic Part #-C9435
Check Valve & Check Ball Cap O-Ring,
All Big Twins Replaces: 11105

Cometic Part #-C9384
Oil Pump Cover 1992-99
Replaces: 26276-92

Cometic Part #-C9382
Oil Pump Cover 1984-91
Replaces: 26276-80A

Cometic Part #-C9350
Cam Seal 1984-99
Replaces: 83162-51DL

Cometic Part #-C9865
One Piece Rocker Base
1984-99
Replaces: 16778-97X &
16779-97X

Cometic Part #-C9836
Valve Stem Seal
1984-99
Replaces: 18001-83A

Cometic Part #-C9383
Oil Pump Body 1992-99
Replaces: 26273-92

Cometic Part #-C9381
Oil Pump Body 1984-91
Replaces: 26273-80B

Cometic Part #-C9383
Oil Pump Body 1992-99
Replaces: 26273-92
Cometic Part #-C9381
Oil Pump Body 1984-91
Replaces: 26273-80B

Cometic Part #-C9290
Intake Manifold Seal
1990-99
Replaces: 26995-86A

Cometic Part #-C9719
Race Style Exhaust
1984-99 "Flat"
Replaces: 65424-83
Cometic Part #-C9288
Std. Exhaust "Tapered"
Replaces: 65324-83A

Cometic Part #-C9349
Oil Pump Drive Gear Seal, 1984-99
Replaces: 26227-58

Cometic Part #-C9684
Oil Pump Lower Cover O-Ring All Big Twins, 1992-98
Replaces: 11241

Cometic Part #-C9688 Std. Bore Head - MLS .030" - 1984-99
Cometic Part #-C9689 Std. Bore Head - MLS .040" - 1984-99



Gaskets for Harley-Davidson®



Cometic Gasket - An Exclusive NASCAR Performance® Product

Complete • Top End • Rocker Box Kits & Individual Replacement Parts

Part # Description

EST BIG TWIN EVOLUTION MOTOR KITS

• Complete Gasket Kit

- C9748F 92-99 EVO Big Twin
- C9846F 92-99 EVO Big Twin W / .030" Head Gasket
- C9751F 89-91 EVO Big Twin Softails & Dyna's
- C9849F 89-91 EVO Big Twin Softails & Dyna's W / .030" Head Gasket
- C9750F 84-91 EVO Big Twin FLT, FXR 5 Spd.
- C9848F 84-91 EVO Big Twin FLT, FXR 5 Spd. M / .030" Head Gasket
- C9749F 84-88 EVO Big Twin 4 & 5 Spd.
- C9847F 84-88 EVO Big Twin 4 & 5 Spd. W / .030" Head Gasket

• Big Bore Complete Gasket Kit

- C9908 92-99 3 5/8" Bore complete motor kit
- C9164 84-91 3 5/8" Bore complete motor kit
- C10013 84-91 3 5/8" Bore FLT-FXR complete motor kit
- C10013-030 84-91 3 5/8" Bore FLT-FXR complete motor kit
- C10064 84-91 3 9/16" Bore complete motor kit, FXR, FL
- C9974 92-99 3 13/16" Bore complete motor kit
- C9940 92-Up 4.00" bore complete motor kit S&S engines, W/S&S Rocker Box Gaskets
- C10103 84-99 S&S V111 4.125" bore complete engine gasket kit

• Top End Gasket Kit

- C9635 92-99 EVO Big Twin
- C9850 92-99 EVO Big Twin W / .030" Head Gasket
- C9130 92-99 EVO Big Twin No Rocker Box Rubber Gaskets
- C9747 84-91 EVO Big Twin
- C9851 84-91 EVO Big Twin W / .030" Head Gasket
- C10130 1984-99 S&S V113, 4" Bore W/.040"H/G

• Evo Big Twin Motor Only Gasket Kit

- C9890 92-99 Evo Big Twin Std bore, Motor Only Kit
- C10119 92-99 Evo Big Twin 3 13/16" bore, Motor Only Kit
- C9891 84-91 Evo Big Twin Std bore, Motor Only Kit

• Big Bore Top End Gasket Kit

- C9766 3 5/8" Bore; 92-99 EVO Big Twin
- C9767 3 5/8" Bore; 84-91 EVO Big Twin
- C9770 3 3/4" Bore; 92-99 EVO Big Twin
- C9771 3 3/4" Bore; 84-91 EVO Big Twin
- C9768 3 13/16" Bore; 92-99 EVO Big Twin
- C9980 3 13/16" Bore; 92-99 EVO Big Twin, with .030" Head Gasket
- C9769 3 13/16" Bore; 84-91 EVO Big Twin
- C9917 4.00" Bore S&S Big Twin, W/S&S Rocker Box Gaskets
- C9917S 4.00" Bore S&S Big Twin, W/O.E. Rocker Box Gaskets
- C9959 4.00" Bore EVO W/Axtell Cylinder Style Head & Base

• Rocker Box Rebuild Gasket Kit

- C9752 92-99 EVO Big Twin
- C9753 84-91 EVO Big Twin



Gaskets for Harley-Davidson®



Cometic Gasket - An Exclusive NASCAR Performance® Product

Complete • Top End • Rocker Box Kits & Individual Replacement Parts

Cometic Part #	OEM Part #	Description	Pkg. Qty.
----------------	------------	-------------	-----------

1984-99 BIG TWIN & EVO INDIVIDUAL REPLACEMENT GASKETS,SEALS, O-RINGS Rocker Box Gaskets

C9481	26856-89	93-99 Umbrella Valve Seal	10
C9400	6114	84-99 Rocker Box Washer copper	10
C9286	63858-49	84-99 Rocker Box Washer paper	10
C9277	17356-84A	84-91 Upper Rocker Cover Gasket rubber	5
C9278	17356-92	92-99 Upper Rocker Cover Gasket rubber	5
C9283	17358-84A	84-99 Inner Rocker Cover Gasket rubber	10
C9281	17355-84A	84-91 Lower Rocker Cover Gasket rubber	5
C9282	17355-92	92-99 Lower Rocker Cover Gasket rubber	5
C9561	16778-97X	84-99 Lower Right Rocker Gasket .020" rubber coated steel	5
C9285	16778-84A	84-99 Lower Right Rocker Gasket fiber	5
C9563	16779-97X	84-99 Lower Left Rocker Gasket .020" rubber coated steel	5
C9284	16779-84A	84-99 Lower Left Rocker Gasket fiber	5
C9865		84-99 One piece Rocker Base all Evo's .020" rubber coated steel	2
C9866		84-99 One piece Rocker Base all Evo's .020" rubber coated steel	10
C9224		S&S Outer Rocker Gasket w/ Breather Flapper	4
C9225		S&S Inner Rocker O-Ring Seal	8
C9226		S&S Rocker Cover Bolt Washer Seal	24

• Pushrod and Tappet Guide Gaskets

C9292	11157	84-99 Upper Pushrod Tube O-ring	25
C9459	11132	84-99 Middle Pushrod Tube O-ring	25
C9293	11145	84-99 Lower Pushrod Tube O-ring	25
C10023		84-99 Tappet Block Pair Front & Rear .060" AFM Pair	2
C9297F	18633-48D	84-99 Rear Tappet Block Gasket AFM	10
C9298F	18634-48C	84-99 Front Tappet Block Gasket AFM	10
C9586		84-99 Evo Pushrod O-ring Set	Kit
C9836		84-99 Valve Guide Seals "Viton"	25

• Head and Base Gaskets

C9688		Stock Bore EVO's 3.500" through 3.570" .030" MLS Design	2
C9689		Stock Bore EVO's 3.500" through 3.570" .040" MLS Design	2
C9690		3 5/8" Big Bore EVO's .030" MLS Design	2
C9691		3 5/8" Big Bore EVO's .040" MLS Design	2
C9694		3 3/4" Big Bore EVO's .030" MLS Design	2
C9695		3 3/4" Big Bore EVO's .040" MLS Design	2
C9692		3 13/16" Big Bore EVO's .030" MLS Design	2
C9693		3 13/16" Big Bore EVO's .040" MLS Design	2
C9287	26432-76A	84-99 Cylinder Stud Insert O-ring	10
C9551		84-99 Stock Sleeve Cylinder Base Gasket .020" Rubber Coated Steel	2
C9009	16774-86	84-99 Stock Sleeve Cylinder Base Gasket .020" Fiber	2
C9615	16777-86S	84-99 3 5/8" Base Gasket .020" Fiber	2
C10009	93-1033	84-99 3 5/8" Base Gasket .020" Fiber fits S&S cylinder only	2
C9552		84-99 3 5/8" Base Gasket .020" Rubber Coated Metal	2
C9615		84-99 3 3/4" Base Gasket .020" Fiber	2
C9082		84-99 3 13/16" Head Gasket .043" Copper	2
C9617		84-99 3 13/16" Base Gasket .020" Fiber	2
C9609		84-99 4" Head Gasket .043" copper w / Axtell Cyl.	2
C9621		84-99 4" Base Gasket w / S&S Cyl. .020" Fiber	2

• EVO Cam Service Kits

C9623		1970-92 All Big Twins	Kit
C9624F		1993-99 All Big Twins	Kit



Gaskets for Harley-Davidson®



Cometic Gasket - An Exclusive NASCAR Performance® Product

Complete • Top End • Rocker Box Kits & Individual Replacement Parts

Cometic Part #	OEM Part #	Description	Pkg. Qty.
• Cam Housing Gaskets			
C9328F5	25225-93	93-99 Cam Cover Gasket AFM	5
C9302F5	25225-70B	84-92 Cam Cover Gasket AFM	5
C9306F	32591-80	84-99 Point Cover Gasket	10
C9350	83162-51DL	84-99 Point Seal double lip	5
• Intake and Exhaust			
C10035	54-0505	Edlebrock rectangle port intake seal Pair	2
C9227		50mm Carb. to Manifold Seal 1999-UP	1
C9131		All EVO Intake Manifold Seal Kit, Head to Manifold and Carb Seal	Kit
C9088	27002-89	89 to Present Carb to Manifold Sealing Ring	1
C9299	29242-83	84-89 Intake to Head Compliance Fitting Gasket	10
C9290	26995-86A	90-99 Intake to Head Compliance Fitting Gasket	10
C9540	01-931	Extreme Performance Exhaust Gasket	10
C9719	65324-83	84-91 Exhaust Port Gasket Race Style	10
C9288	65324-83A	92-99 Exhaust Port Gasket Taper Style	5
C9247		Exhaust Gasket All Models 99 -UP Race Style .240" thick	10
C9223		S&S Big Bore Manifold to Head Seal	4
• Oil Pump Gaskets and Seals			
C10028		81-91 Oil Pump Rebuild Kit	1
C9168		92-99 Oil Pump Rebuild Kit	1
C9435	11105	84-99 Oil Pump Cap O-ring	25
C9684	11241	92-99 Oil Pump Cover O-ring	25
C9349	26227-58	84-99 Oil Pump Drive Gear Seal	5
C9383	26273-92	92-99 Oil Pump Body Gasket paper	10
C9381	26273-80B	84-91 Oil Pump Body Gasket paper	10
C9382	26276-80A	84-91 Oil Pump Cover Gasket paper	10
C9384	26276-92	92-99 Oil Pump Cover Gasket paper	10
C10011	63528-92	HD Oil Line Ferrule 92-98 ALL	5
• Misc. O-ring and Seal			
C9438	11170	95-99 Crankshaft Position Sensor O-ring	25
C9351	12026B	84-99 Sprocket Shaft Seal	5
• Derby Cover Gaskets and O-rings			
C9183F1	25416-70C	84-98 All B/T 3 Hole	1
C9338F5	25416-70C	70-E84 Derby Cover Gasket , AFM60	5
• Inspection Cover Gaskets			
C9442	25416-84	L84-98 Derby Cover O-ring	10
C9363	31433-84A	84-98 Derby Cover Bolt Washer metal	5
C9303F5	34906-79	80-84 FXR, FLT Primary Inspec. Cover Gasket, AFM60	5
C9305F5	34906-85	85-UP FXR, FLT Primary Inspection Cvr. Gasket, AFM60	5
C9326F5	60567-36	36-64 FL, FLTH, 58-69 XLCH Inspection Cover Gasket, AFM60	5
C9331F5	60567-65C	65-UP Inspec. Cover Gasket Dyna & Softails, AFM60	5
• Inner Primary Gaskets, O-rings			
C9536	11125	70-E82 Inner Primary O-ring	10
C10125		70-06 Engine Case Saver Gasket .060" AFM	5
C9441	11147	L82-99 Inner Primary O-ring	10
C9518	12018	70-E84 Inner Primary Bearing Seal	5
C9260	12052	L84-99 Inner Primary Bearing Seal double lip	5
C9343	60629-55	55-64 Chain Housing to Motor Gasket	10



Cometic Part #	OEM Part #	Description	Pkg. Qty.
----------------	------------	-------------	-----------

• Starter Housing Gaskets, O-rings

C9451	11101	L66-82 Starter Oil Deflector O-ring	10
C9433	11116	91-99 Starter Housing O-ring	25
C9436	11171	89-90 Starter Bolt O-ring	10
C9491	12051	L84-88 Starter Shaft Seal	5
C9261	12066	94-99 Starter Shaft Seal	5
C9379	12053	89-93 Starter Shaft Seal	5
C9507F	31320-80	80-86 Starter Housing Gasket	10
C9508F	31321-80	80-86 Starter Cover Gasket	10
C9509	31341-80-DL	80-86 Starter Shaft Seal	5
C9717F	60518-65	65-88 Starter Hole Block Off Gasket	10
C9330F	60559-80	65-85 Starter Housing Gasket	10
C9702	60645-65	65-84 Solenoid Mount Gasket	10

• Shifter Shaft Seals

C9484	11117	L84-99 FXR,DYNA Shifter Sleeve O-ring	25
C9357	11148	82-E84 Shifter Shaft Quad Seal	10
C9661	11191	90-99 FXST, FLST Shift Lever O-ring	25
C9525	60641-74	74-85 Shifter Shaft Seal	5

1936 BIG TWIN & EVO INDIVIDUAL REPLACEMENT GASKETS,SEALS, O-RINGS Seals, O-rings and Washers

C9498	6007	80-98 Drain Plug Washer	10
C9435	11105	90-99 Drain Plug O-ring	10
C9529	11115	65-86 Counter Shaft O-ring	10
C9459	11132	90-99 Dipstick Cover O-ring upper	25
C9667	11140	96-99 Speedometer Sensor O-ring	25
C9495	11162	L84-86 Mainshaft O-ring right end	25
C9361	11165	L84-99 Mainshaft Quad Seal	10
C9530	11166	84-86 Mainshaft Bearing O-ring	25
C9263	11178	87-98 Filler Plug O-ring	10
C9447	11179	87-99 Clutch Cable O-ring	25
C9531	12010	L79-86 Shifter Shaft Seal	5
C9493	12013A	L81-86 Main Drive Gear Seal	5
C9494	12014	65-E84 Clutch Hub Nut Seal	5
C9518	12018	71-E84 Inner Primary Clutch Seal	5
C9506	12022	L66-E81 Main Drive Gear Seal	5
C9351	12026B	70-98 Mainshaft Seal, Engine	5
C9258	12035A	91-99 Main Drive Gear Seal, Transmission	5
C9528	12043	80-86 Starter Shaft Seal	5
C9527	12044DL	80-E84 Main Drive Gear Seal	1
C9259	12045DL	80-06 Shifter Shaft Seal	5
C9359	12050	L84-94 Main Shaft Seal	1
C9260	12052DL	L84-99 Inner Primary Clutch Seal	5
C10110	12052-X	84-14 Inner Primary Clutch seal for use w/ sealed bearing	5
C9262	12067A	95-99 Mainshaft Seal	1
C9632	12068	99-UP Twin Cam, 04-UP Sportster Engine Main Shaft Seal	5
C9497	33043-80	65-95 Neutral Indicator Washer	10
C9374	33076-37	37-86 Starter Crank Seal	10
C9519	34036-36	36-E79 Cam Shaft Seal rubber	10
C9510	34036-80	80-86 Shift Fork Shaft O-ring	10
C9523	35230-39DL	36-79 Mainshaft Seal	5
C9411	35231-36	36-E77 Mainshaft Oil Seal cork washer	10
C9496	37091-80	80-86 Filler Plug Washer	10
C9354	37101-84	84-86 Clutch Release Lever O-ring	1
C9513	37741-67A	L79-81 Mainshaft Seal Double Lip	5
C9514	37741-82DL	82-86 Main Drive Gear Seal Double Lip	5
C9485	62672-90	91-98 Dipstick Cover O-ring	10
C9460	62673-90	91-98 Dipstick O-ring	10
C9403	62702-52	36-86 Drain Plug Washer	10

Complete Transmission Kits & Individual Gaskets

Cometic Part #-C9459
Trans/Clutch Oil Dipstick
O-Ring, All Big Twin
Replaces: 11132

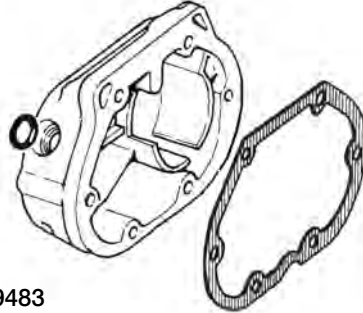

Cometic Part #-C9483
Clutch Release Cover
All Big Twin 88-06
Replaces: 36801-87B

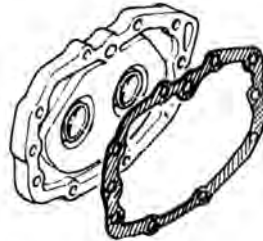

Cometic Part #-C9264
Trans Bearing Cover
All Big Twin 86-98
Replaces: 35652-79B
Cometic Part #-C9644
Trans Bearing Cover
All Big Twin 99-06
Replaces: 35653-98

Cometic Part #-C9459
Oil Tank Filler Cap O-Ring
Top, Dyna 91-98
Replaces: 11132

Cometic Part #-C9485
Oil Tank Filler Cap O-Ring
Bottom, Dyna 91-98
Replaces: 62672-90

Cometic Part #-C9460
Oil Dipstick O-Ring
Dyna 91-UP
Replaces: 62673-90

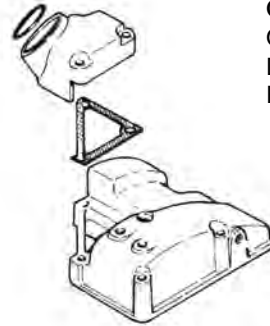

Cometic Part #-C94891F5
Oil Tank Spout
Dyna 91-UP
Replaces: 62423-90

Cometic Part #-C9488
Trans Top Cover
Dyna 91-98
Replaces: 34917-90A

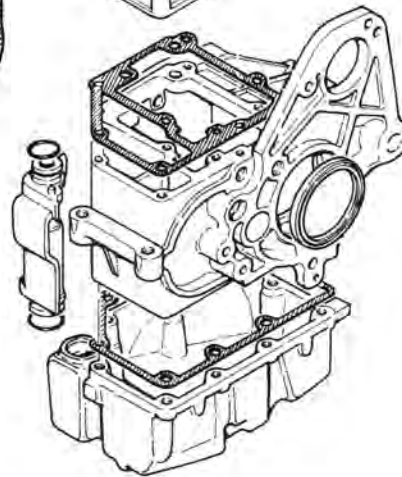

Cometic Part #-C9262
Trans Main Drive Seal
Big Twin L94-06
Replaces: 12067A

Cometic Part #-C9646
Oil Pan, Dyna 99-UP
Replaces: 26072-99
Cometic Part #-C9490
Oil Pan, Dyna 91-98
Replaces: 26072-90A

Cometic Part #	OEM Part #	Description
----------------	------------	-------------

1970-UP BIG TWIN EVO & TWIN CAM INDIVIDUAL REPLACEMENT GASKETS,SEALS, O-RINGS

•Complete Transmission Kits

C9464	33031-70	E70-E 79 Big Twin
C9464F	33031-70	E70-E 79 Big Twin EST Kit
C9465	33031-80	L79-82 Big Twin 4 Speed
C9466	33031-82	80-E84 Big Twin 5 Speed
C9467	33031-85	L84-92 Big Twin Except Dyna 5 Speeds
C9468	33031-91	91-99 Dyna & FXDB-S Evolution Models
C9469	33031-93	93-99 FLT,FLH, FXR, Dyna & Softails Evolution Models w/Fiber
C9469F	93-99	FLT,FLH, FXR, Dyna & Softails Evolution Models w/AFM
C9639	26072-99	99-06 FLT, FLH, Softail 00-06, Twin Cam Models w/Fiber
C9639F	99-06	FLT, FLH, Softail 00-06, Twin Cam Models w/AFM
C9640	26072-99	99-05 Dyna Twin Cam Models
C9151	06-16	Dyna Twin Cam 6 Speed Trans Kit
C9174	07-16	Softail Models Twin Cam 6 Speed Trans Kit
C9175	07-16	FL Models Twin Cam 6 Speed Trans Kit

(Kit contains all of the necessary gaskets, seals, o-rings, end cover, top cover gaskets and all washers needed to completely rebuild the transmission)

Illustrations courtesy: **Clymer® Publications**



Gaskets for Harley-Davidson®



Cometic Gasket - An Exclusive NASCAR Performance® Product

Complete Transmission Kits & Individual Gaskets

Cometic Part #	OEM Part #	Description	Pkg. Qty.	Price
----------------	------------	-------------	-----------	-------

1936-UP BIG TWIN EVO & TWIN CAM INDIVIDUAL REPLACEMENT GASKETS,SEALS, O-RINGS

• Transmission Gaskets

C9434	11201	T/C Mainshaft 5th Gear O-ring 07-16	10	
C9642	11290	Twin Cam Neutral Ind. Switch O-ring All Models 1999 -16	10	
C9215	12074	T/C Mainshaft Oil Seal 07-16 All, 06-16 Dyna	1	
C9200	12077	06 DYNA, All 07-16 Oil Seal Output Gear End Seal	10	
C9490F	26072-90	90-98 Oil Pan Gasket Dyna	10	
C9646F	26072-99	T/C DYNA Oil Pan Gasket 1999-16	10	
C9265F	26077-93	93-98 Oil Pan Gasket FLT	5	
C9647F	26077-99	T/C Oil Pan Gasket FLT's 1999-16	10	
C9517F	33196-79	L79-86 Shifter Cover Gasket	10	
C9515-032AFM33295-36		36-86 End Cover Gasket	10	
C9520F	34552-52	52-E79 Ratchet Cover Gasket	10	
C9521F	34565-52	52-E79 Shifter Adapter Plate Gasket	10	
C9522F	34824-36	36-E79 Top Cover Gasket	10	
C9516-032AFM34824-79		L79-86 Top Cover Gasket	10	
C9499F	34904-79	80-86 Top Cover Gasket	10	
C9983F	34904-86B	87-99 Top Cover Gasket Thin Version	10	
C9267	34904-86XC	T/C Trans Cover Gasket All Models 1999 -16 Wide Version	10	
C9488F	34917-90A	90-98 Top Cover Gasket Dyna	10	
C9645F	34917-99	T/C DYNA Trans. Top Cover Gasket 1999-05	10	
C9189	34917-06	T/C Trans. Top Cover Gasket 07-16 All Models	10	
C9190F5	35607-06	Trans to Eng. Case Gasket Dyna 06-UP & FL 07-16 Models	1	
C9264F	35652-79A	80-98 Bearing Housing Gasket	10	
C9644F	35653-98	T/C Bearing Housing Gasket All Models 1999 -06, 99-05 Dyna	10	
C9187	35654-06	T/C Bearing Housing Gasket All Models 07 -14	10	
C9526F	36801-79	80-86 End Cover Gasket	10	
C9483F	36801-87B	87-05 Dyna, 87-06 All Models Clutch Release Gasket	10	
C9188	36805-06	T/C Trans End Cover All Models 07-16	10	
C9354F5	37101-84	ALL T/C Shift Shaft Seal 09-16	5	
C9489F	62423-90	91-98 Dyna Oil Filler Spout Gasket	10	
C9266F	62432-93	93-06 FLT Oil Filler Spout Gasket	10	
C9512F	67141-36	36-83 Speedometer Drive Gasket	10	

• Carburetor Gaskets

C9452	11107	66-71 XL, 67-70 Big Twin Tillotson Spacer O-ring	10	
C9088	27002-89	88-98 XL, 90-99 Big Twin Keihin CV Seal Ring	1	
C9417	27023-71	72- E76, 79-85 XL; 71-75 Big Twin Bendix Manifold Gasket	10	
C9425	27077-78	78-89 Big Twin Keihin Manifold Gasket	10	
C9300	29058-77	L76-87 XL, 76-89 Big Twin Keihin Air Cleaner Gasket	10	
C9301	29059-88	88-98 XL, 90-99 Big Twin Keihin CV Air Cleaner Gasket	20	

Shovelhead & Panhead®

Cometic Part #-C9365
Oil Line Sleeve Seal
1963-84
Replaces: 63529-57

Cometic Part #-C9986
Rocker Cover Viton Coated Embossed
Shovelhead 1966-84

Cometic Part #-C9336
Rocker Cover 1966-84
Replaces: 17540-69

Cometic Part #-C9451
Upper Pushrod Cover
O-Ring Late 1979-81
Replaces: 11101

Cometic Part #-C9711
Upper Pushrod Cover
O-Ring Late 1981-84
Replaces: 11118

Cometic Part #-C9998
Valve Stem Seal 1980-84
Replaces: 18000-81

Cometic Part #-C9459
Middle Pushrod Cover
O-Ring Late 1979-84
Replaces: 11132

Cometic Part #-C9451
Rocker Shaft O-Ring
1966-84
Replaces: 11101

Cometic Part #-C9346
Rocker Cover Felt Pad
1948-65
Replaces: 17507-48

Cometic Part #-C9342
Rocker Cover 1948-65
Replaces: 17541-48A

Cometic Part #-C9604
Std. Bore Shovelhead
.043" Fire Ring Head
Replaces: 16770-66X

Cometic Part #-C9984
"MLS" Std. Bore
74 & 80 Shovelhead All
Models .040" Head

Cometic Part #-C9460
Lower Pushrod Cover
O-Ring 1979-81
Replaces: 11133

Cometic Part #-C9461
Lower Pushrod Cover
O-Ring Late 1981-84
Replaces: 11133A

Cometic Part #-C9598
Pushrod Cover (Small)
1948-65
Replaces: 17955-36

Cometic Part #-C9613
Head 1948-65
Replaces: 16770-48X

Cometic Part #-C9567
Pan/Shovel Front Cylinder Base
Gasket .031" (Fiber) 1948-84
Replaces: 16776-48

Cometic Part #-C9987
Shovel Front & Rear Pair
Std. 74 & 80 Cylinders
Viton Coated Embossed Base
Gasket

Cometic Part #-C9297
Rear Tappet Block
1948-84
Replaces: 18633-48D

Cometic Part #-C9606
Pushrod Cover (Large)
1948-E79
Replaces: 17955-48

Cometic Part #-C9568
Pan/Shovel Rear Cylinder Base
Gasket .031" (Fiber) 1948-84
Replaces: 16777-48

Cometic Part #-C9298
Front Tappet Block
1948-84
Replaces: 18634-48C



Gaskets for Harley-Davidson®



Cometic Gasket - An Exclusive NASCAR Performance® Product

Complete • Top End • Rocker Box Kits & Individual Replacement Parts

Cometic Part #	OEM Part #	Description
----------------	------------	-------------

EST MOTOR KITS FOR SHOVELHEAD & PANHEAD MOTORS
• Complete EST Gasket Kits for Shovelhead/Panhead

C9900.....	17029-66.....	1966-69 74" Shovelhead FL, FLH
C9964.....	17029-70A.....	1970-84 74" & 80" Shovelhead 4 Spd.
C9154.....		1970-84 3 5/8" Shovelhead 4 Spd.
C9965.....	17029-80.....	1980-84 80" Shovelhead 5 Spd. FLT
C9966.....	17028-48.....	1948-65 Panhead FL, FLH

Motor Only Shovelhead Gasket Kits

C10091.....		1970-84 STD Bore Engine Only Gasket & Seal Kit
-------------	--	--

• Top End EST Gasket Kits for Shovelhead/Panhead

C9967.....	17034-66X.....	1966-84 74" & 80" Shovelhead 4 or 5 Spd.
C9968.....	17034-48.....	1948-65 Panhead FL, FLH

• Big Bore Shovelhead Top End Gasket Kits

C9918.....		3 5/8" Bore 1966-84 All Models
C9969.....		3 13/16" Bore 1966-84 All Models, No Oil Drains in Head Gasket

EST Kits contain MLS head gaskets, steel viton coated base gaskets and AFM material

Cometic Part #	OEM Part #	Description	Pkg. Qty.
----------------	------------	-------------	-----------

1936-84 BIG TWIN PAN & SHOVEL INDIVIDUAL REPLACEMENT GASKETS, SEALS, O-RINGS
• Rocker Housing Gaskets and O-rings

C10030.....	17535-38.....	36-47 Knucklehead Frt Rocker Tin Gasket, .031" Fiber.....	10
C10031.....	18265-37.....	36-47 Knucklehead Valve Guide Gasket.....	10
C10008.....	17540-69.....	66-84 Rocker Cover Gasket .043" CFM20.....	2
C9986.....	17540-69.....	66-84 Rocker Cover Gasket .020" Viton Coated Emb. Steel.....	2
C9336.....	17540-69.....	66-84 Rocker Cover Gasket .031" Fiber.....	10
C9342.....	17541-48A.....	48-65 Rocker Cover Gasket .031" Fiber.....	10
C9346.....	17507-48.....	48-65 Rocker Cover Felt Pad.....	10
C9451.....	11101.....	66-84 Rocker Shaft O-ring.....	25
C9424.....	18000-81.....	L81-84 Valve Guide Seal Teflon.....	25
C9419.....	18196-51.....	51-29 Valve Guide Gasket.....	20
C9998.....		Late Shovelhead & .625" O.D. Guides Viton Seal with garter.....	20

• Pushrod O-rings and Tappet Block Gaskets

C9598.....	17955-36.....	36-E79 Push Rod Cover small cork.....	25
C9606.....	17955-48.....	48-E79 PushRod Cover Large cork.....	25
C9451.....	11101.....	L79-E81 Push Rod Cover O-ring Upper.....	10
C9459.....	11132.....	L79-84 Push Rod Cover O-ring Middle.....	25
C9460.....	11133.....	L79-E81 Push Rod Cover O-ring Lower.....	5
C9711.....	11118.....	L81-84 Push Rod Cover O-ring Upper.....	25
C9461.....	11133.....	L79-E81 Push Rod Cover Quad Seal Lower.....	10
C9297.....	18633-48D.....	48-84 Rear Tappet Block Gasket .020" Fiber.....	10
C9298.....	18634-48C.....	48-84 Front Tappet Block Gasket .020" Fiber.....	10
C9216.....		66-78 All Shovel Push Rod Tube Seal Set.....	Kit
C9584.....		L79-E81 All Shovel Push Rod Tube Seal Set.....	Kit
C9585.....		L81-84 All Shovel Push Rod Tube Seal Set.....	Kit



Gaskets for Harley-Davidson®



Cometic Gasket - An Exclusive NASCAR Performance® Product

Complete • Top End • Rocker Box Kits & Individual Replacement Parts

Cometic Part #	OEM Part #	Description	Pkg. Qty.
• Head and Base Gaskets			
C9984	16770-66X	66-84 Shovelhead MLS Stock Bore Head Gasket 74" & 80" .040"	2
C9985		66-84 Shovelhead MLS 3 5/8 BB Head Gasket .040"	2
C9206		Shovel Only Base Gasket Std bore .020" Viton FR & RR Pair	2
C9207		3 5/8" Shovel Only Base Gasket Std bore .020" Viton 2 Fronts	2
C10116		48-84 Pan/Shovel Std. Bore, No Oil Holes, Pair .020" Fiber	2
C9987		48-65 Panhead Base Front & Rear .020" Viton	2
C10117		48-84 Pan/Shovel 3 5/8" Bore, No Oil Holes, Pair .020" Fiber	2
C9988		48-65 Panhead Base 3 5/8" Front & Rear .020" Viton	2
C9989		48-65 Panhead Base 3 5/8" 2 Fronts for S&S Cylinders Viton	2
C9714		66-84 Shovelhead Stock Bore Head Gasket; .032" Copper	2
C9713		66-84 Shovelhead 3 5/8" Copper Head Gasket: .032"	2
C9618		66-84 Pan/Shovel 3 5/8" Base Gasket: .031" Fiber	2
C9893		66-84 Pan/Shovel 3 13/16" Base Gasket: .020" RC Metal	2
C9567	16776-48	48-84 Pan/Shovel Front Cyl. Std. Bore base Gasket; .031" Fiber	10
C9568	16777-48	48-84 Pan/Shovel Rear Cyl. Std. Bore base Gasket; .031" Fiber	10
C9137	16770-48MLS	48-65 Panhead .040" MLS Head Gasket Pair	2
• Cam / Gear Housing Gaskets and Seals			
C9334F5	25225-36C	41-69 Gear Cover Gasket, AFM60	5
C9302F5	25225-70B	70-84 Cam Cover Gasket, AFM60	5
C9323	32591-70	70-79 Points Cover Gasket	10
C9306	32591-80	80-84 Points Cover Gasket	10
C9350	83162-51DL	70-84 Cam Cover Seal / Double Lip	5
C9337	32521-36	36-64 Timer Base Gasket	10
• Intake and Exhaust Gaskets			
C9453	27060-55	55-E78 Manifold to Head O-ring	10
C9608	27062-78	L78-84 Intake Seal Manifold to Head Rubber Band	10
C9587	65834-68X	66-84 Exhaust Gasket with Fire Ring	10
• Oil Pump and Related Gaskets / Seals			
C9435	1105	L70-84 Oil Screen Pump Plug O-ring	10
C9349	26227-58	68-84 Oil Pump Seal	5
C9715	26231-78	54-80 Oil Pump Relief Plug Gasket	10
C9397	26244-37	37-59 Oil Pump Body Gasket	10
C9393	26245-41	41-67 Oil Pump Gasket Fiber	10
C9391	26246-68D	68-E80 Oil Pump Body Fiber	10
C9394	26257-50A	L50-67 Oil Pump Cover Fiber	10
C9392	26258-68D	68-E80 Oil Pump Cover Gasket Fiber	10
C9382	26276-80A	L80-84 Oil Pump Cover Gasket Fiber	10
C9403	62702-52	66-E70 Oil Screen Plug Gasket	10
C9365	63529-57	63-84 Oil Line Sleeve Seal	10
C9351	12026A	70-84 Motor Main Shaft Seal	5
• Generator Gaskets / Seals			
C9322	30143-30	36-57 Gen. Gasket	10
C9321F	30143-58	58-69 Gen. Gasket	5

Evolution Sportster®

Cometic Part #-C9294
Pushrod Tube O-Ring
Upper 1991-03
Replaces: 11190

Cometic Part #-C9481
Umbrella Valve Seal
1991-03
Replaces: 26856-89

Cometic Part #-C9286
Rocker Cover Washer
1987-03
Replaces: 63858-49

Cometic Part #-C9276
Upper Rocker Box
1991-03
Replaces: 17354-89

Cometic Part #-C9280
Lower Rocker Box
1991-02
Replaces: 17353-89A

Cometic Part #-C9283
Center Rocker Box
Replaces: 17358-84A

Cometic Part #-C9865
One Piece Rocker Base
1986-UP
Replaces: 16778-97X & 16779-97X

Cometic Part #-C9836
Viton Valve Stem Seal
1986-02
Replaces: 18001-83A

Cometic Part #-C9290
Intake Manifold to
Head Seal
Replaces: 26995-86B

Cometic Part #-C9688
Std. Bore Head .040" MLS
1200 1986-UP

Cometic Part #-C9689
Std. Bore Head .030" MLS
1200 1986-UP

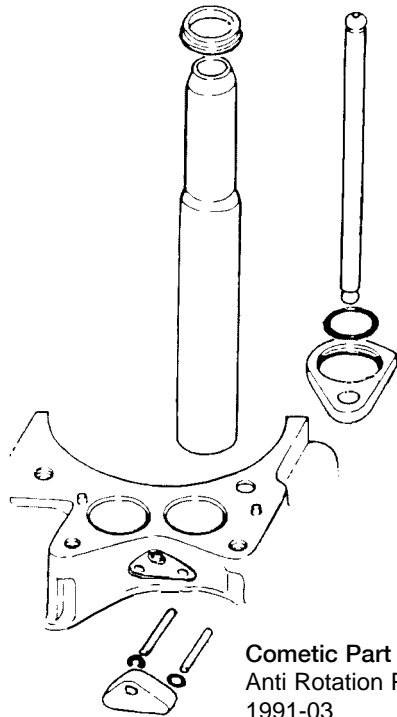

Cometic Part #-C9295
Pushrod Tube O-Ring
Lower 1991-03
Replaces: 17944-89

Cometic Part #-C9296
Anti Rotation Pin O-Ring
1991-03
Replaces: 11176

Cometic Part #-C9355
Cam Seal 1986-03
Replaces: 11124-DL

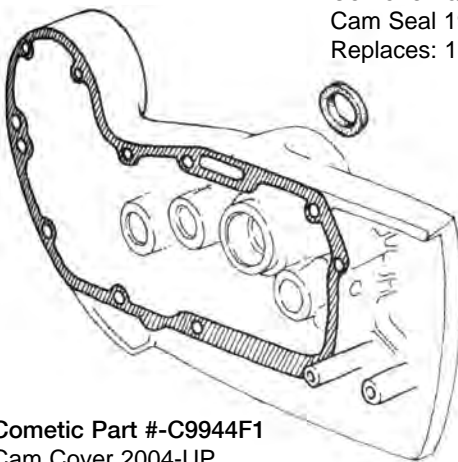

Cometic Part #-C9944F1
Cam Cover 2004-UP
Replaces: 25263-90D AFM
Cometic Part #-C9313F1
Cam Cover 1991-03
Replaces: 25263-90B AFM
Cometic Part #-C9311F1
Cam Cover 1986-90
Replaces: 25263-86 AFM

Cometic Part #-C9719
Race Style Exhaust
Replaces: 65324-83

Cometic Part #-C9288
Std. Exhaust
Replaces: 65324-83

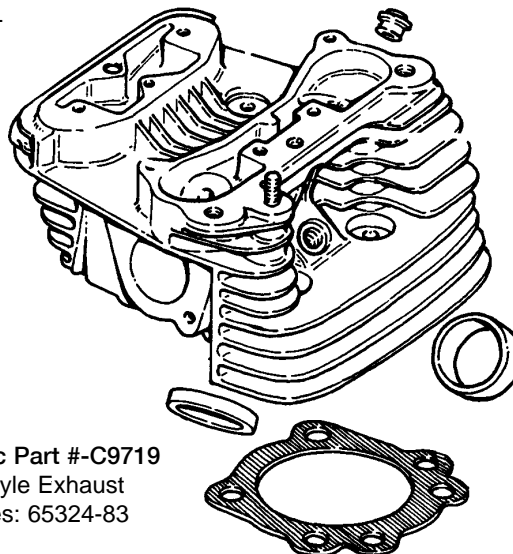
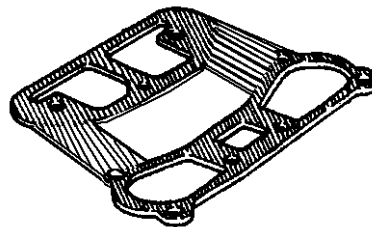
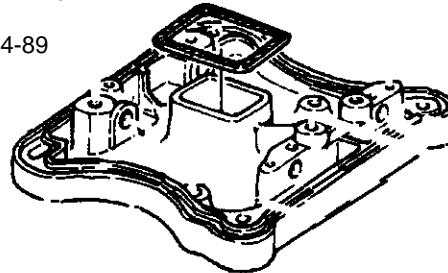
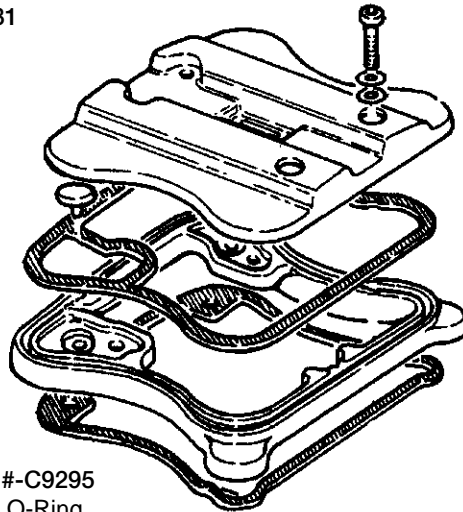



Gaskets for Harley-Davidson®



Cometic Gasket - An Exclusive NASCAR Performance® Product

Complete • Top End • Rocker Box Kits & Individual Replacement Parts

Cometic Description
Part #

EST BUELL FIREBOLT and BLAST
• Top End and Complete Motor Rebuild Gasket Kits

- C10111 Buell XB9, XB12, 2003-10 Top End Rebuild Standard Bore
C10115 Buell XB9, XB12, 2003-10 Top End Rebuild 3.570" Bore
C9204 Buell Firebolt Top End Rebuild Kit Std. Bore 04-06
C9856 Buell Firebolt Top End Rebuild Kit Std. Bore 00-03
C9857 Buell Firebolt CompleteMotor Rebuild Kit Std. Bore 02-03
C9863 Buell Blast Big Bore Top End Rebuild 3 13/16"
C9863-STD..... Buell Blast Big Bore Top End Rebuild STD Bore
C9864 Buell Blast Big Bore Complete Motor Kit 3 13/16"
C9864-STD..... Buell Blast Big Bore Complete Motor Kit STD Bore

• Rocker Box Rebuild Kit

- C9213 Buell XB 9/12 98-02

EST EVO SPORTSTER MOTOR GASKET KITS

• Complete Gasket Kits

- C9754F 86-90 883 EVO Sportster
C9755F 91-03 883 EVO Sportster
C9193 04-06 883 EVO Sportster
C9191 07-16 883 EVO Sportster
C9756F 86-87 1100 EVO Sportster
C9757F 88-90 1200 EVO Sportster
C9758F 91-03 1200 EVO Sportster
C9855F 91-03 1200 EVO Sportster W / .030" Head Gasket
C9133 91-03 1200 EVO Sportster 3 13/16" Big Bore w/.040" Head Gasket
C9124 91-03 1200 EVO Sportster 3 13/16" Big Bore W / .030" Head Gasket
C9952 04-06 1200 EVO Sportster
C9953 04-06 1200 EVO Sportster W / .030" Head Gasket
C9176 07-16 1200 EVO Sportster

• Top End Gasket Kits

- C9759 86-90 883 EVO Sportster
C9760 91-03 883 EVO Sportster
C9194 04-06 883 EVO Sportster
C9192 07-16 883 EVO Sportster
C9761 86-87 1100 EVO Sportster
C9762 88-90 1200 EVO Sportster
C9907 88-90 1200 EVO Sportster W / .030" Head Gasket
C9763 91-03 1200 EVO Sportster
C9854F 91-03 1200 EVO Sportster W / .030" Head Gasket
C9970 04-06 1200 EVO Sportster
C9971 04-06 1200 EVO Sportster W / .030" Head Gasket
C9177 07-16 1200 EVO Sportster

• Big Bore Top End Gasket Kits

- C10096 3.570" Top end kit w/.030" MLS Head Gasket 1991-03
C10095 3.570" Top end kit w/.030" MLS Head Gasket 2004-06
C10094 3.570" Top end kit w/.030" MLS Head Gasket 2007-Up
C10048 3.562" Bore; 91-03 EVO Sportster W / .040" MLS Head Gasket
C10050 3.5/8" Bore; 91-03 EVO Sportster W / .027" MLS Head Gasket
C10050-040 3.5/8" Bore; 91-03 EVO Sportster W / .040" MLS Head Gasket
C9772 3 3/4" Bore; 86-90 883 EVO Sportster
C9773 3 3/4" Bore; 91-UP 883 EVO Sportster
C9774 3 3/4" Bore; 86-87 1100 EVO Sportster
C9775 3 3/4" Bore; 88-90 1200 EVO Sportster
C9776 3 3/4" Bore; 91-03 1200 EVO Sportster
C9138 3 13/16" Bore; 91-03 1200 EVO Sportster W / .040" MLS Head Gasket
C9141 3 13/16" Bore; 91-03 1200 EVO Sportster W / .030" MLS Head Gasket
C9219 3 13/16" Bore; 04-06 1200 EVO Sportster W / .040" MLS Head Gasket
C10057 3.875" XR1200 08-13, .030" Head & .020" Base Kit



Gaskets for Harley-Davidson®



Cometic Gasket - An Exclusive NASCAR Performance® Product

Complete • Top End • Rocker Box Kits & Individual Replacement Parts

Cometic Part #	OEM Part #	Description	Pkg. Qty.
----------------	------------	-------------	-----------

• Rocker Box Rebuild Gasket Kit

C9764	86-90 883, 1100, 1200 EVO Sportster		
C9765	91-03 883, 1200 EVO Sportster		
C9954	04-06 883, 1200 EVO Sportster		
C9195	07-16 All Sportster Models		

EVO SPORTSTER INDIVIDUAL REPLACEMENT GASKETS,SEALS, O-RINGS

• Rocker Cover Gaskets

C9196	17362-07	Outer Rocker Gasket all Sportster Models, 07-16 XL	2
C9197	17695-07	Inner Rocker Gasket all Sportster Models, 07-16 XL	2
C9198	17393-07	Rocker Breather Seal 07-16 XL	2
C9208	17353-89B	Outer Rocker Gasket all Sportster Models 04-06	2
C9400	611486	Rocker Cover Washer copper 87-16	10
C9286	63858-49	87- 05 Rocker Cover Washer Gasket 87-16	10
C9014	17353-86A	87-90 Lower Rocker Cover Gasket rubber	5
C9279	17353-86	86 Lower Rocker Cover cork	5
C9280	17353-89	91-03 Lower Rocker Cover Gasket rubber	5
C9010	17354-86A	87-90 Upper Rocker Cover Gasket rubber	5
C9275	17354-86	86 Upper Rocker Cover cork	5
C9276	17354-89	91-03 Upper Rocker Cover Gasket rubber	5
C9283	17358-84A	86-06 Center Rocker Cover Gasket rubber	10
C9707	17358-84	86-04 Center Rocker Cover Cork	5
C9865	16800-84	86-04 One piece rocker base gasket .020" Rubber Coated Steel 86-16	2
C9561	16778-97X	86-04 Lower Rckr Cover to Head / Right, .020" Rubber Coated Steel	5
C9563	16779-97X	86-04 Lower Rckr Cover to Head / Left, .020" Rubber Coated Steel	5
C9285	16778-84A	86-04 Lower Rckr Cover to Head / Right Gasket	5
C9284	16779-84B	86-04 Lower Rckr Cover to Head / Left Gasket	5
C9481	26856-89	91-03 Umbrella Valve Seal	10
C9224		S&S Outer Rocker Gasket w/ Breather Flapper	4
C9225		S&S Inner Rocker O-Ring Seal	8
C9226		S&S Rocker Cover Bolt Washer Seal	24

2004 SPORTSTER ROCKER BOXES ARE TWO PIECE AND DO NOT USE AN UPPER ROCKER RUBBER GASKET

• Head and Base Gaskets

C10003	XR1200 STD Bore MLS head gasket .040" 08-12	2	
C10004	XR1200 3.812" Bore MLS head gasket .040" 08-12	2	
C10057	XR1200 08-12 3.875" Big Bore Head .030" & Base .020" Kit 08-12	Kit	
C9205	Stock Bore 883 EVO's .040" MLS Design 86-16	2	
C9688	Stock Bore EVO's 3.570" .030" MLS Design 86-16	2	
C9689	Stock Bore EVO's 3.570" .040" MLS Design 86-16	2	
C9690	3 5/8" Big Bore EVO's .030" MLS Design 86-16	2	
C9691	3 5/8" Big Bore EVO's .040" MLS Design 86-16	2	
C9694	3 3/4" Big Bore EVO's .030" MLS Design 86-16	2	
C9695	3 3/4" Big Bore EVO's .040" MLS Design 86-16	2	
C9692	3 13/16" Big Bore EVO's .030" MLS Design 86-16	2	
C9693	3 13/16" Big Bore EVO's .040" MLS Design 86-16	2	
C9287	26432-76A	86-05 Cylinder to Head Dowel O-ring	10
C9214	16774-86E	06-UP Cylinder Base Gasket, All Buell & Sportster .020" Embossed Rubber Coated Steel	2
C9553	16774-96	86-05 Cylinder Base Gasket, .020" Rubber Coated Steel	2
C9008	16774-86D	86-05 Cylinder Base Gasket, .020" Fiber	2
C9836		86-99 Valve Guide Seal Viton	25
C9153	18094-02	02-UP Valve Sterm Oil Seal Hat Style All Models Viton	25



Gaskets for Harley-Davidson®



Cometic Gasket - An Exclusive NASCAR Performance® Product

Complete • Top End • Rocker Box Kits & Individual Replacement Parts

Cometic Part #	OEM Part #	Description	Pkg. Qty.
• Pushrod O-Ring Kit			
C10133		04-16 Sportster Pushrod O-ring Kit	KIT
C9143		91-03 Sportster Pushrod O-ring Kit	KIT
• Pushrod and Tappet Block Gaskets and O-rings			
C9955	17976	04-16 Tappet block gasket	2
C9956	11377	04-16 Lower pushrod tube O-ring	25
C9459	11132	86-90 Pushrod Tube O-ring Middle	25
C9293	11145	86-90 Pushrod Tube O-ring Lower	25
C9292	111157	86-90 Pushrod Tube O-ring Upper	25
C9448	11110	86-90 Tappet Screw O-ring	10
C9443	11167	86-90 Tappet Block O-ring Upper	25
C9444	11168	86-90 Tappet Block O-ring Lower	10
C9294	11190	91-16 Pushrod Tube O-ring Upper	10
C9295	17944-89	91-99 Pushrod Tube O-ring Lower	10
C9296	11176	91-99 Tappet Pin Cover O-ring - Anti Rotation Pin	10
• Intake and Exhaust Gaskets			
C9290	26995-86A	86-16 Intake Manifold to Head / Seal	10
C9088	27002-89	84-04 Intake Seal to Carb	1
C9719	65324-83	84-16 Exhaust Port Gasket Race Style	10
C9288	65324-83A	84-16 Exhaust Port Gasket Tapered Style	10
C9540		84-16 All Models Exhaust Extreme Performance	10
C9223		S&S Big Bore Manifold to Head Seal	4
• Cam Cover Gaskets			
C9355	11124-DL	86-99 Points Cover Seal Double Lip	5
C9306F	32591-80	86-99 Points Cover Gasket	10
C9311F5	25263-86	86-90 Cam Cover Gasket	10
C9313F5	25263-90B	91-03 Cam Cover Gasket	5
C9944F5	25263-90D	04-16 Cam Cover Gasket	5
C10049F1	25262-90D	91-03 Sporty Cam Cover Gasket .060" AFM	1
C10049F5	25262-90D	91-03 Sporty Cam Cover Gasket .060" AFM	5
C10029F1	25279-08	08-12 XR1200 Cam Cover Gasket	1
C10029F5	25279-08	08-12 XR1200 Cam Cover Gasket	5
• Primary Cover Gaskets ,Seals			
C9125		04-16 Sportster Complete Primary Rebuild	Kit
C9211		91-03 Sportster Complete Primary Rebuild	Kit
C9210		86-90 Sportster Complete Primary Rebuild	Kit
C9943F5	34955-04	04-16 Primary Cover Gasket	5
C9957	34986-04	04 -16 Chain Inspection Cover Gasket .060" AFM	5
C9435	11105	04 -16 Primary drain plug O-ring	10
C9436	11171	86-16 Primary Inspection Cover Screw O-ring	10
C9447	11179	88-99 Clutch Cable O-ring	25
C9434	11187	91-93 Clutch Inspection Cover O-ring	10
C9439	11188	91-99 Inspection Cover O-ring	10
C9220	25463-94A	94-UP Clutch Cover O-ring	5
C9363	31433-84A	91-93 Sealing Washer	5
C9401	34624-77	77-90 Footpeg Stud Gasket	10
C9310F5	34955-75	77-90 Primary Cover Gasket, AFM60	5
C9314F5	34955-89A	91-03 Primary Cover Gasket, AFM60	5
C9943F5	34955-04	04-16 Sportster Primary Cover Gasket, AFM60	5
C9354	37101-84	86-UP Shifter Shaft Seal	1
C9353	35151-74	86-99 Motor Sprocket Shaft Seal	5
C9632	12068	04-16 Motor Sprocket Shaft Seal	5
C9667	11289	04-16 Crank Position Sensor O-ring	25
C10104	37101-06	06-14 Shift Shaft Seal All XL	1
C10104F5	37101-06	06-14 Shift Shaft Seal All XL	5

Complete • Top End • Rocker Box Kits & Individual Replacement Parts

Cometic Part #	OEM Part #	Description	Pkg. Qty.
• Oil Pump and Related Gaskets,Seals, and O-rings			
C9376.....	12036A	86-90 Oil Pump Seal metal.....	5
C9449.....	26433-77	86-90 Oil Pump Check Valve O-ring	10
C9439.....	26434-76A.....	86-90 Oil Pump O-ring.....	10
C9437.....	26434-91	91-16 Oil Pump Cover O-ring	10
C9399F.....	26495-75	86-90 Oil Pump Gasket	10
C9315F.....	26495-89B.....	91-16 Oil Pump Gasket	10
C9961.....	11120.....	04-16 Oil dipstick O-ring	5
C9962.....	04-16 Oil jet assembly gasket.....	6
• Starter and Transmission Gaskets,Seals, and O-rings			
C9312F.....	31488-81B.....	86-UP Starter Gasket.....	10
C9362.....	12030.....	91-06 Main Drive Gear Seal	5
C9356.....	12049-DL.....	86-90 Transmission M/S Seal	5
C9359.....	12050.....	91-94 Transmission M/S Seal	1
C9262.....	12067A	95-04 Main Drive Gear Seal	1
C9361.....	11165.....	91-04 Main Shaft Quad Seal 5th Gear	10
C9460.....	11113.....	05-16 Main Shaft O-ring 5th Gear	5
C9215.....	12074.....	07-16 Main Shaft Seal	1

Iron Sportster®

Part #-C9292

Pushrod Cover O-Ring Upper
1984-85
Replaces: 111S7

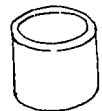
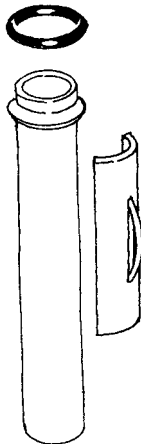

Part #-C9459
Pushrod Cover O-Ring
Middle 1979-85
Replaces: 11132



Part #-C9451
Lower & Top Pushrod O-Ring 1979-85
Replaces: 11101

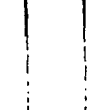

Part #-C9595
Pushrod Cover Seal
Lower, Middle, Top Early 1979 XL, XLCH

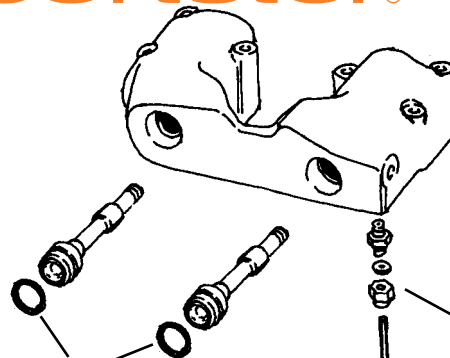

Part #-C9451
Rocker Arm Shaft
O-Ring 1957-85
Replaces: 11101

Part #-C9365
Rubber Sleeve, Oil
Line 1957-85
Replaces 63529-57

Part #-C9602
Rocker Cover Gasket
1957-85
Replaces: 17536-70



Part #-C9566
1000cc Head Gasket
.043" Copper
Late 1973-85
Replaces: 16769-82

Illustrations courtesy: **Clymer® Publications**



Gaskets for Harley-Davidson®



Cometic Gasket - An Exclusive NASCAR Performance® Product

Complete • Top End • Rocker Box Kits & Individual Replacement Parts

Cometic Part #	OEM Part #	Description	Pkg. Qty.
----------------	------------	-------------	-----------

STANDARD MOTOR KITS FOR 900/1000 SPORTSTER

• Complete Gasket Kits for 900/1000 Sportster

C9045F	17026-71	1957-71 900 Sportster XL, XLH, XLCH	
C9047F	17026-72	1972-E73 1000 Sportster XLH, XLCH	
C9049F	17026-73L	1973-76 1000 Sportster XLH, XLCH	
C9051F	17026-79	1977-85 1000 Sportster XLH, XLCH, XLS Hi-Compression	
C9117F	17026-82	1982-85 1000 Sportster XLH, XL, XLS Low Compression, .063" Head Gaskets	

Kit contains .032" copper head gaskets and all of the necessary gaskets, seals and o-rings to rebuild the motor.
Base Gaskets are .031"

• Top End Gasket Kits for 900/1000 Sportster

C9102	17030-57	1957-71 900 Sportster XL, XLH, XLCH	
C9103	17030-72	1972-E73 1000 Sportster XLH, XLCH	
C9104	17030-72AL	1973-76 1000 Sportster XLH, XLCH	
C9052	17030-72B	1977-85 1000 Sportster XLH, XLCH, XLS Hi-Compression	
C9116	17030-82	1982-85 1000 Sportster XLH, XL, XLS Low Compression, .063" Head Gaskets	

Kit contains all of the necessary gaskets, seals and o-rings to rebuild the motor from the cylinder base up.
Head Gaskets are .032" copper except where noted and Base Gaskets are .031"

1957-85 XL IRONHEAD SPORTSTER INDIVIDUAL REPLACEMENT GASKETS,SEALS, O-RINGS

• Rocker Cover Gaskets

C9400	6114	86 Rocker Cover Washer copper	10
C9451	11101	57-85 Rocker Arm Shaft O-ring	10

• Rocker Cover Gaskets,Seals,and O-rings

C9448	11110	83-85 XR1000 Rocker Shaft O-ring	10
C9529	11115	83-85 XR1000 Rocker Arm Shaft O-ring	10
C9602	17536-70	57-85 Rocker Cover Gasket	10
C9365	63529-57	57-85 Rubber Sleeve, Oil Line	10

• Head and Base Gaskets

C9698	16769-72A	72-E73 1000cc Head Gasket , .020" Copper	10
C9565	16769-73	L73-85 1000cc Head Gasket , .032" Copper	10
C9566	16769-82	L73-85 1000cc Head Gasket , .043" Copper	10
C9699	16774-57	57-71 900cc Cylinder Base Gasket, .012" Fiber	10
C9603	16774-72	72-85 1000cc Cylinder Base Gasket, .031" Fiber	10

• Pushrod and Tappet Block Gaskets, O-rings

C10068		57-84 All Iron Sportsters Pushrod seal set	Kit
C9459	11132	79-85 Pushrod Cover O-ring (4) middle	25
C9292	11157	84-85 Pushrod Cover O-ring (4) upper	25
C9369	12023	83-85 XR 1000 Pushrod Cover Seal	5
C9598	17955-36	57-E79 Pushrod Cover Seal / cork	25
C9408	17955-36A	57-E79 Pushrod Cover Seal / rubber	100

• Intake and Exhaust Gaskets

C9608	27062-78	79-85 Intake Manifold to Head O-ring	10
-------	----------	--------------------------------------	----

• Cam and Timer Compartment Gaskets

C9355	11124DL	71-85 Timer Compartment Seal / double lip	5
C9325	32522-37	57-64 XL, XLH Timer Base Gasket	10
C9316F5	25224-52A	57-81 Cam cover Gasket, XR750	5
C9332	25263-81	82-85 Cam Cover Gasket	10
C9323	32591-70	71-78 Point Cover Gasket	10
C9306	32591-80	80-85 Ignition Cover Gasket	10



Gaskets for Harley-Davidson®



Cometic Gasket - An Exclusive NASCAR Performance® Product

Complete • Top End • Rocker Box Kits & Individual Replacement Parts

Cometic Part #	OEM Part #	Description	Pkg. Qty.
• Charging and Starting Gaskets			
C9433	11116	81-85 Starter Housing O-ring	25
C9701	31461-70	70-E79 Starter hole cover plate Gasket	10
C9324	31471-67A	67-80 Starter Housing Gasket	10
C9333	31488-77	67-80 Starter Housing Mount Gasket	10
C9312	31488-81	81-85 Starter Motor Gasket	10
C9702	60645-65	67-80 Solenoid Gasket	10
C9369	12023	68-69 XLCH Magneto Seal	5
C9327	29550-55	58-69 XLCH Magneto Cover Gasket	10
C9374	29603-48	58-E65 Magneto Seal	10
C9321	30143-58	58-E84 Generator Gasket	5
• Oil System Gaskets, O-rings and Seals			
C9376	12036A	77-78 / 83-85 Oil Pump Outer Plate Seal	5
C9404	24978-57	57-76 Oil Strainer Gasket	10
C9349	26227-58	L58-76 Oil Pump Oil Seal	5
C9390	26256-52	57-76 Oil Pump Gasket	10
C9385	26258-52	57-E62, 72-76 Oil Pump Outer Cover Gasket	10
C9389	26258-62	L62-71 Oil Pump Outer Cover Gasket	10
C9388	26259-52	57-E62, 72-76 Oil Pump Inner Cover Gasket	10
C9386	26259-62	L62-71 Oil Pump Inner Cover Gasket	10
C9287	26432-76A	77-85 Oil Pump Body O-ring	10
C9449	26433-77	77-85 Check Valve Oil Pump O-ring	10
C9445	26434-76A	77-85 Oil Pump Cover O-ring	10
C9399	26495-75	77-85 Oil Pump Gasket	10
C9286	63858-49	71-85 Oil Level Screw Gasket	10
• Primary, Clutch, and Transmission Gaskets, Seals, and O-rings			
C9446	11139	L78-85 Primary Filler Cap O-ring	10
C9317F5	34952-52	XR750, 58-69 XLCH Primary Cover Gasket AFM .060"	5
C9318F5	34955-67	67-76 XLH, 70-76 XLCH Primary Cover Gasket AFM .060"	5
C9703	34955-67A	67-76 XLH, 70-76 XLCH Primary Cover Gasket .031"	5
C9326	60567-36	36-64 FL, FLH 58-69 XLCH Inspection/Chain Cover .125" Cork	10
C9326F	60567-36	36-64 FL, FLH 58-69 XLCH Inspection/Chain Cover .125" Cork	5
C9326F1	60567-36	36-64 FL, FLH 58-69 XLCH Inspection/Chain Cover .060" AFM	1
C9326F5	60567-36	36-64 FL, FLH 58-69 XLCH Inspection/Chain Cover .060" AFM	5
C9458	11103	L57-66 XLH, 57-69 XLCH Clutch Gear O-ring	10
C9310F5	34955-75	77-90 Sportster Primary Cover Gasket AFM .060"	5
• Primary, Clutch, and Transmission Gaskets, Seals, and O-rings			
C9455	11119	67-70 XLH, 70 XLCH Clutch Gear O-ring	25
C9367	12021	67-70 XLH, 70 XLCH Clutch Gear Oil Seal	5
C9364	37339-53	57-70 Release Rod Oil Seal	10
C9368	37531-56B	57-66 XLH, 57-69 XLCH Clutch Gear Seal	5
C9371	37740-57	L57-66 XLH, 57-69 XLCH Clutch Shell Seal	5
C9513	37741-67	67-70 XLH, 70 XLCH Clutch Shell Seal	5
C9319	37762-52	57-70 Clutch Cover Gasket	10
C9374	33076-37	57-79 Kicker Shaft Seal	10
C9370	34035-52	57-85 Shifter Shaft Seal	5
C9401	34624-77	77-85 Left Footrest Stud Boss Gasket	10
C9356	12049DL	L84-85 Transmission Mainshaft Seal	5
C9366	35151-52A	57-E84 Trans Mainshaft Seal, 57-E74 Sprocket Shaft	5
C9353	35151-74	L84-85 Trans Mainshaft Seal, L74-85 Motor Sprocket Shaft	5

Rotax 600 Gaskets

Part #	Description
C9500.....	Head and Base, Long Stroke, 3.860" Bore Supplied with .010 and .020 Copper Base Gasket (4.120" Sleeve Dia.)
C9501.....	Head and Base, Long Stroke, 3.908" Bore Supplied with .010 and .020 Copper Base Gasket (4.120" Sleeve Dia.)
C9504.....	.005 Copper Base Gasket
C9502.....	.010 Copper Base Gasket
C9505.....	.016 Copper Base Gasket
C9503.....	.020 Copper Base Gasket
C9589.....	Ignition Cover Gasket
C9590.....	Clutch Cover Gasket

Rotax 250 Gaskets

Part #	Description
C9591.....	Center Case Gasket
C9592.....	Clutch Cover Gasket
C9593.....	Intake Gasket
C9594.....	Base Gasket .020" Kevlar Fiber

Polaris Victory V92C Head & Base Gaskets

Part #	Description
C8652.....	.97mm Head Gasket (1 Pair) / 754cc
C8653.....	.101mm Head Gasket (1 Pair) / 817cc

Cometic MLS Head Gasket Instructions for Harley Davidson Evolution & Twin Cam applications

NOTE: DO NOT USE THE CYLINDER HEAD ALIGNMENT DOWEL O-RING WHEN USING AN MLS GASKET.

NOTE: COMETIC GASKET RECOMMENDS THE HEAD BOLTS BE SET AT A FINAL TORQUE OF 42FT-LBS.

1. Check all gasket surfaces for flatness and imperfections, an excessively rough finish may cause gasket failure. A 50RA surface is recommended.
2. Check all hardware for defects, clean all threads and lubricate with light machine oil. Including the underside flange of the head bolts. (Wipe away any excess.)
3. There are two short and two long head bolts. The short go on the spark plug side while the long go on the pushrod side.
4. Before installing the head, place the head gasket on the cylinder and locate the gasket using the cylinder head alignment dowels (NOTE: The gasket is embossed around the dowel area and the dowel holes are smaller. Do not use dowel alignment o-rings with an MLS gasket.)
5. Once the gasket is located in place make sure the gasket fits your bore. The gasket should not hang in the bore or combustion chamber in any area.
6. If using a head or cylinder other than stock, check brass rivet location to ensure the rivet does not interfere with the sealing surface in any way. Some aftermarket castings are substantially larger than stock castings and may interfere. Simply remove the brass rivets, "side cutters work well".
7. Once proper fitment is established proceed with head installation and torque. (NOTE: See illustration for sequence.)
8. Alternately snug all the head bolts finger tight.
9. In sequence tighten all head bolts to 9 ft-lbs. Then in sequence tighten all head bolts to 14 ft-lbs. Again in sequence tighten all head bolts to 22 ft -lbs. Then in sequence tighten all head bolts to 35 ft-lbs and finally torque all head bolts to a final torque of 42ft-lbs in sequence.

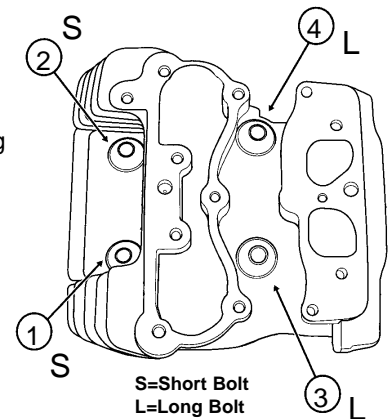

Note: Failure to comply with any or all of these instructions may result in premature failure of the head and or base gasket.

Note: All Panhead, Shovelhead & Iron Sportster models use factory specs when using an MLS head gasket.



V-Twin Hi-Performance Big Bore Display Board Complete with Gaskets, Seals & O-Rings

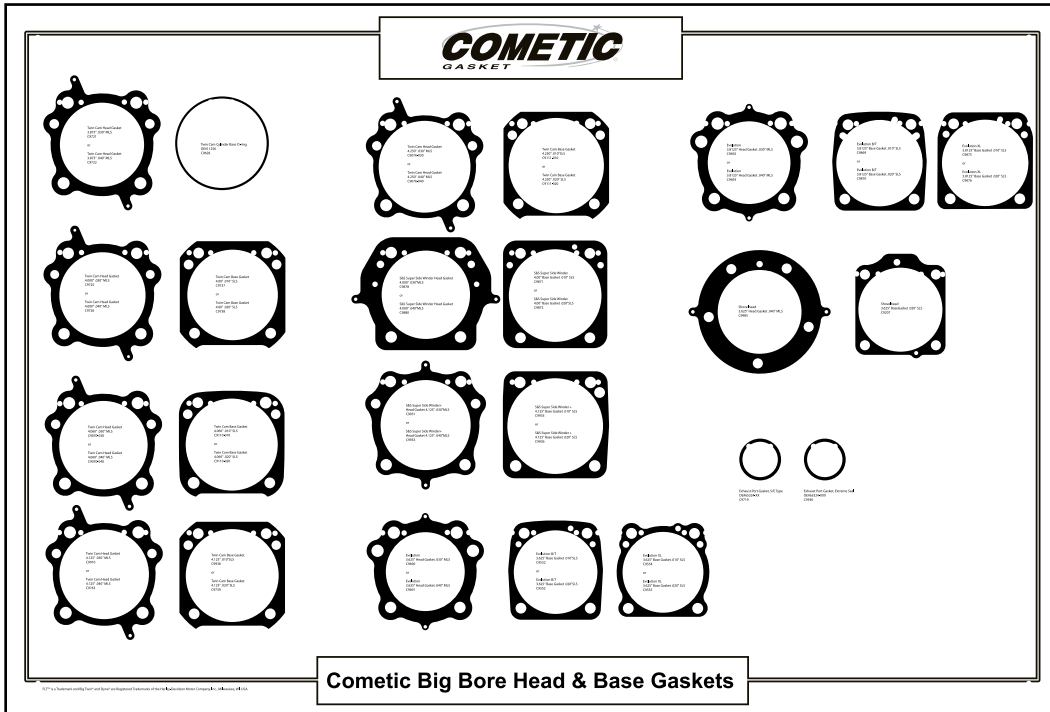

- Sold complete with all Gaskets, Seals & O-Rings and the necessary clamshells, display hooks and xmas treeclips for mounting

- Both Cometic and OE part numbers are printed on boards for easy clarification of parts

- 3 color design, boards measures 48"W x 32"H and are manufactured from 20 mil flexible vinyl and mount easily on 1/8" or 1/4" pegboard

Part#	Description
C9235F-Gas	Gaskets Only
C9235F	Display Board Only

Cometic #	OE#	Qty	Description
Twin Cam			
C9721		2	Head Gasket 3.875" .030" MLS
C9722		2	Head Gasket 3.875" .040" MLS
C9628	11256	10	Cylinder Base O-Ring
C9725		2	Head Gasket 4.000" .030" MLS
C9726		2	Head Gasket 4.000" .040" MLS
C9937		2	Base Gasket 4.00" .010" SLS
C9738		2	Base Gasket 4.00" .020" SLS
C9070-030		2	Head Gasket 4.060" .030" MLS
C9070-040		2	Head Gasket 4.060" .040" MLS
C9110-010		2	Base Gasket 4.060" .010" SLS
C9110-020		2	Base Gasket 4.060" .020" SLS
C9910		2	Head Gasket 4.125" .030" MLS
C9743		2	Head Gasket 4.125" .040" MLS
C9938		2	Base Gasket 4.125" .010" SLS
C9739		2	Base Gasket 4.125" .020" SLS
C9076-030		2	Head Gasket 4.250" .030" MLS
C9076-040		2	Head Gasket 4.250" .040" MLS
C9111-010		2	Base Gasket 4.250" .010" SLS
C9111-020		2	Base Gasket 4.250" .020" SLS
S&S Super Side Winder			
C9878		2	Head Gasket 4.000" .030" MLS
C9880		2	Head Gasket 4.000" .040" MLS
C9871		2	Base Gasket 4.00" .010" SLS
C9872		2	Base Gasket 4.00" .020" SLS

Cometic #	OE#	Qty	Description
S&S Super Side Winder +			
C9931		2	Head Gasket 4.125" .030" MLS
C9933		2	Head Gasket 4.125" .040" MLS
C9935		2	Base Gasket 4.125" .010" SLS
C9936		2	Base Gasket 4.125" .020" SLS
Evolution			
C9690		2	Head Gasket 3.625" .030" MLS
C9691		2	Head Gasket 3.625" .040" MLS
C9532		2	B/T Base Gasket 3.625" .010" SLS
C9552		2	B/T Base Gasket 3.625" .020" SLS
C9554		2	XL Base Gasket 3.625" .010" SLS
C9555		2	XL Base Gasket 3.625" .020" SLS
C9692		2	Head Gasket 3.8125" .030" MLS
C9693		2	Head Gasket 3.8125" .040" MLS
C9869		2	Base Gasket/B/T 3.8125" .010" SLS
C9870		2	Base Gasket B/T 3.8125" .020" SLS
C9875		2	XL Base Gasket 3.8125" .010" SLS
C9876		2	XL Base Gasket 3.8125" .020" SLS
Shovelhead			
C9985		2	Head Gasket 3.625" .040" MLS
C9207		2	Base Gasket 3.625" .020" SLS
Misc.			
C9719	65324-XX	10	Exh. Port Gasket, S/E type
C9540	65324-XXX	10	Exh. Port Gasket, Xtreme Seal



Twin Cam 96

Display Board Complete with Gaskets, Seals & O-Rings

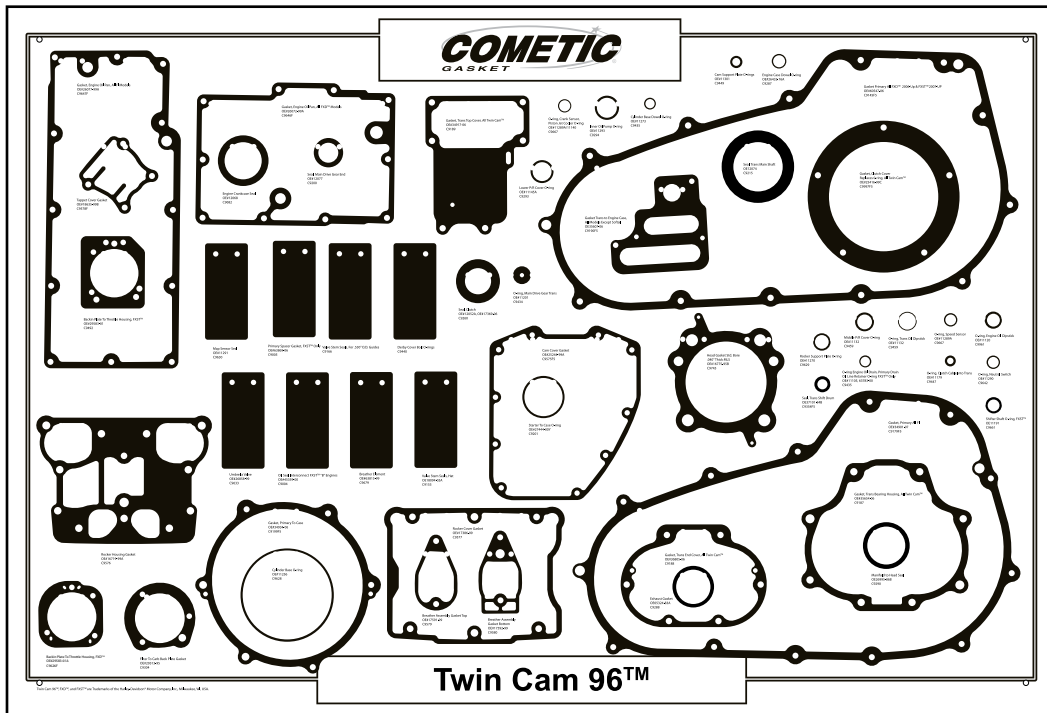

- Sold complete with all Gaskets, Seals & O-Rings and the necessary clamshells, display hooks and xmas treeclips for mounting

- Both Cometic and OE part numbers are printed on boards for easy clarification of parts

- 3 color design, boards measures 48"W x 32"H and are manufactured from 20 mil flexible vinyl and mount easily on 1/8" or 1/4" pegboard

Part#
C9234F-Gas
C9234F

Description
Gaskets Only
Display Board Only

Cometic #	OE#	Qty	Description
C9435	11105	10	O-ring, primary drain
C9961	11120	5	O-ring, engine oil dipstick
C9459	11132	25	O-ring, middle pushrod cvr
C9459	11132	25	O-ring, transmission oil dipstick
C9447	11179	25	O-ring, clutch cable into transmission
C9661	11191	25	O-ring, shifter shaft, FXST
C9434	11201	10	O-ring, main drive gear transmission
C9628	11256	10	O-ring, cylinder base
C9629	11270	10	O-ring, rocker support plate
C9435	11273	10	O-ring cylinder base dowel
C9642	11290	10	O-ring, neutral switch
C9630	11291	10	Map sensor seal
C9686	11292	10	O-ring carb backing plate
C9294	11293	10	O-ring upper pushrod cover
C9294	11293	10	O-ring, inner oil pump
C9449	11301	10	O-ring, cam support plate
C9682	12068	10	Seal, engine crankcase
C9215	12074	1	Seal, transmission mainshaft
C9200	12077	10	Seal, main drive gear end
C9435	11105	10	O-ring, engine oil drain,
	63783-00		oil line retainer FXST only
C9293	11145A	25	O-ring lower pushrod cover
C9667	11289A	25	O-ring, speed sensor
C9667	11289A	25	O-ring, crank sensor, piston cooler jet
	11140		
C9260	12052A	5	Seal, clutch
	17369-06		
C9576	16719-99A	10	Gasket, rocker housing, 020 RC
C9745	16775-95B	2	Std bore head gasket, .040" thick MLS
C9577	17386-99	10	Gasket, rocker cover, 020" RC
C9579	17591-99	10	Gasket, breather assembly, top, .031" fiber
C9580	17592-99	10	Gasket breather assembly, bottom, .031" fiber
C9153	18094-02A	25	Seal, valve stem, hat style
C9578F	18635-99B	10	Gasket, tappet cover, .032" AFM
C9575F5	25244-99	5	Gasket, cam cover, .060" AFM

Cometic #	OE#	Qty	Description
C9997F5	25416-99C	5	Gasket, Clutch cover replces
			O-ring, All Twin Cam
C9646F	26072-99A	10	Gasket, engine oil pan, All FXD models
C9647F	26077-99A	10	Gasket, engine oil pan, All FL models
C9287	26432-76A	10	O-ring, engine case dowel
C9633	26858-99	10	Umbrella valve
C9290	26995-86B	10	Seal, manifold to head
C9201	27444-00Y	5	O-ring, starter to case
C9304	29313-95	10	Gasket, filter to carb backing plate, .060" AFM
C9492	29583-01A	10	Gasket, backing plate to throttle housing, .060" AFM, FXST only
C9626F	29583-01A	10	Gasket, backing plate to throttle housing, .060" AFM, FXD only
C9179F5	34901-07	5	Gasket, primary, .060" AFM, all FL 2007-up
C9189	34917-06	10	Gasket, trans top cover, All Twin Cam, .060" AFM
C9199F5	34934-06	5	Gasket, primary to case, 06-up FXD and all 2007-up Twin Cam
C9190F5	35607-06	5	Gasket, transmission to engine case All 96 Models Except Softail
C9187	35654-06	10	Gasket, bearing housing, All 96 Twin Cam, .060" AFM
C9188	36805-06	10	Gasket, transmission end cover, All 96 Twin Cam .060" AFM
C9354F5	37101-84B	5	Seal, trans shift drum
C9004	45359-00	10	Seal, interconnect, all B Engines
C9145F5	60547-06	5	Gasket, primary, All FXD & FXST
C9679	63815-99	10	Breather element
C9005	63869-06	10	Gasket, primary spacer, FXST only
C9288	65324-83A	10	Gasket, exhaust, OE style
C9166		10	Seal, valve stem, with .530" guide O.D.
C9440		25	Derby cover bolt O-rings



Twin Cam 88

Display Board Complete with Gaskets, Seals & O-Rings

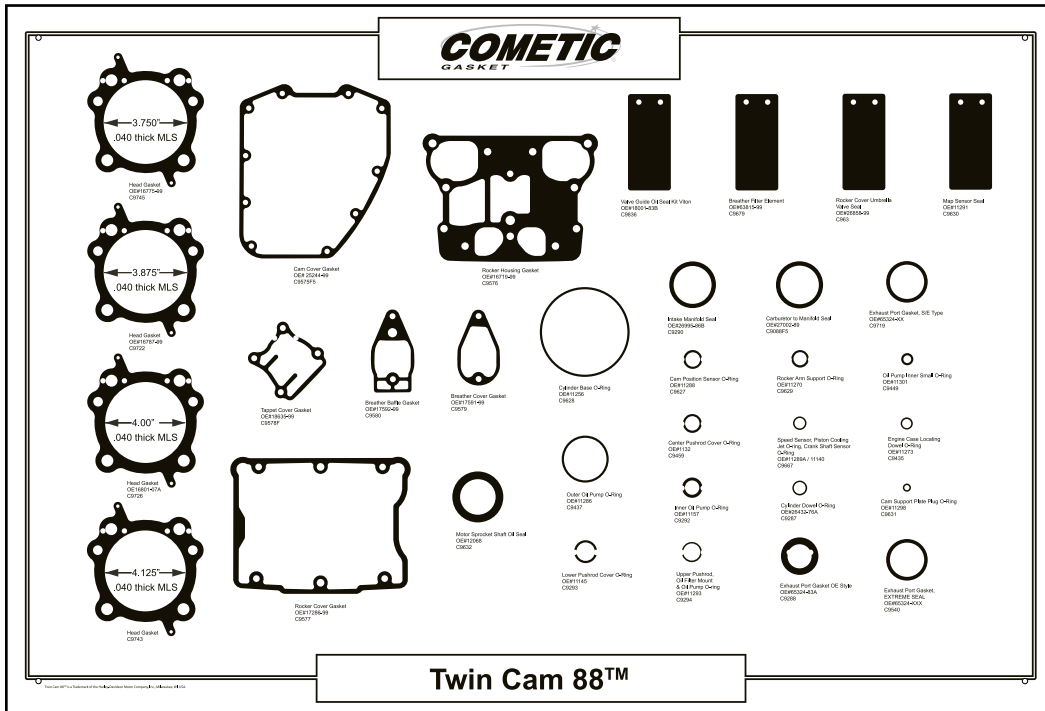

- Sold complete with all Gaskets, Seals & O-Rings and the necessary clamshells, display hooks and xmas treeclips for mounting

- Both Cometic and OE part numbers are printed on boards for easy clarification of parts

- 3 color design, boards measures 48"W x 32"H and are manufactured from 20 mil flexible vinyl and mount easily on 1/8" or 1/4" pegboard

Part#	Description
C9228F-Gas	Gaskets Only
C9228F	Display Board Only

Cometic #	OE#	Qty	Description
C9459	11132	25	Center Pushrod Cover O-ring
C9667	11140	25	Speed Sensor & Piston Cooling O-Ring
C9293	11145	25	Lower Pushrod Cover O-Ring
C9292	11157	25	Inner Oil Pump O-Ring
C9628	11256	10	Cylinder Base O-Ring
C9629	11270	10	Rocker Arm Support O-Ring
C9435	11273	10	Engine Case Locating Dowel O-Ring
C9437	11286	10	Outer Oil Pump O-Ring
C9627	11288	10	Cam Position Sensor O-Ring
C9667	11289A	25	Crank Shaft Sensor O-Ring
C9630	11291	10	Map Sensor Seal
C9294	11293	10	Upper Pushrod, Oil Filter Mount & Oil Pump O-Ring
C9631	11298	10	Cam Support Plate Plug O-Ring
C9449	11301	10	Oil Pump Inner Small O-Ring
C9632	12068	5	Motor Sprocket Shaft Oil Seal
C9576	16719-99	10	Rocker Housing Gasket
C9745	16775-99	2	Twin Cam 3.750" Cylinder Head Gasket (.040")
C9722	16787-99	2	Twin Cam 3.875" Cylinder Head Gasket (.040")

Cometic #	OE#	Qty	Description
C9726	16801-07A	2	Twin Cam 4" Cylinder Head Gasket (.040")
C9743		2	Twin Cam 4.125" Cylinder Head Gasket (.040")
C9577	17286-99	10	Rocker Cover Gasket
C9579	17591-99	10	Breather Cover Gasket
C9580	17592-99	10	Breather Baffle Gasket
C9836	18001-83B	25	Valve Guide Oil Seal Kit 99-04
C9578F	18635-99	10	Tappet Cover Gasket
C9575F5	25244-99	5	Cam Cover Gasket
C9287	26432-76A	10	Cylinder Dowel O-Ring
C9633	26858-99	10	Rocker Cover Umbrella Valve Seal
C9290	26995-86B	10	Intake Manifold Seal
C9088F5	27002-89	5	Carburetor to Manifold Seal
C9288	65324-83A	10	Exhaust Port Gasket, OE type
C9719	65324-XX	10	Exhaust Port Gasket, S/E type
C9540	65324-XXX	10	Exhaust Port Gasket, Xtreme Seal
C9679	63815-99	10	Breather Filter Element

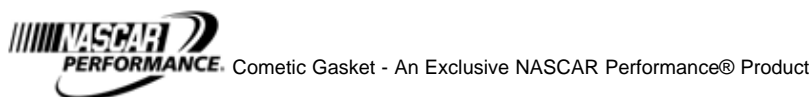



84-99 Big Twin Evolution

Display Board Complete with Gaskets, Seals & O-Rings

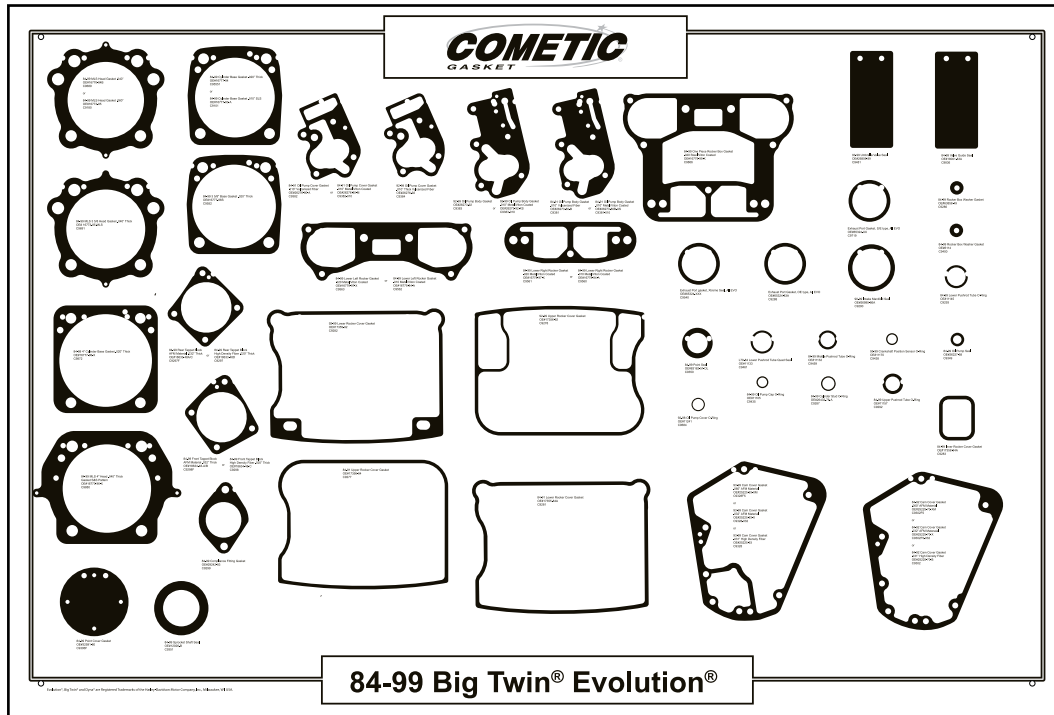

- Sold complete with all Gaskets, Seals & O-Rings and the necessary clamshells, display hooks and xmas treeclips for mounting

- Both Cometic and OE part numbers are printed on boards for easy clarification of parts

- 3 color design, boards measures 48"W x 32"H and are manufactured from 20 mil flexible vinyl and mount easily on 1/8" or 1/4" pegboard

Part#
C9229F-Gas
C9229F

Description
Gaskets Only
Display Board Only

Cometic #	OE#	Qty	Description
C9400.....	6114.....	10.....	84-99 Rocker Box Washer Gasket (Copper)
C9435.....	11105.....	10.....	84-99 Oil Pump Cap O-Ring
C9459.....	11132.....	25.....	84-99 Middle Pushrod Tube O-Ring
C9293.....	11145.....	25.....	84-99 Lower Pushrod Tube O-Ring
C9461.....	11133.....	10.....	L79-84 Lower Pushrod Tube Quad Seal
C9292.....	11157.....	25.....	84-99 Upper Pushrod Tube O-Ring.....
C9438.....	11170.....	10.....	95-99 Crankshaft Position Sensor O-Ring
C9684.....	11241.....	10.....	92-98 Oil Pump Cover O-Ring
C9351.....	12026-B.....	5.....	84-99 Sprocket Shaft Seal
C9180.....	16773-85.....	2.....	84-99 MLS Head Gasket (.060")
C9689.....	16770-84B.....	2.....	84-99 MLS Head Gasket (.040")
C9691.....	16773-85-MLS.....	2.....	84-99 MLS 3 5/8" Head Gasket (.040")
C9880.....	16773-96-X.....	2.....	84-99 MLS 4" Head Gasket S&S Pattern (.040")
C9551.....	16777-94.....	2.....	84-99 Cylinder Base Gasket SLS (Metal/Viton .020")
C9101.....	16777-83-A.....	2.....	84-99 Cylinder Base Gasket SLS (Metal/Viton .010")
C9552.....	16777-86S.....	2.....	84-99 3 5/8" Base Gasket (Paper)
C9872.....	16777-96-X.....	2.....	84-99 4" Cylinder Base Gasket (.020")
C9866.....	16779-99-X.....	10.....	84-99 Lower Left & Right Rocker Box Gasket (One Piece Metal/Viton coated .020")
C9561.....	16778-97-X.....	5.....	84-99 Lower Right Rocker Gasket (Metal/Viton coated .020")
C9560.....	16778-84-A.....	5.....	84-99 Lower Right Rocker Gasket (Metal/Viton coated .010")
C9563.....	16779-97-X.....	5.....	84-99 Lower Left Rocker Gasket (Metal/Viton coated .020")
C9562.....	16779-84-A.....	5.....	84-99 Lower Left Rocker Gasket (Metal/Viton coated .010")
C9281.....	17355-84A.....	5.....	84-91 Lower Rocker Cover Gasket (Rubber)
C9282.....	17355-92.....	5.....	92-99 Lower Rocker Cover Gasket (Rubber)
C9277.....	17356-84.....	5.....	84-91 Upper Rocker Cover Gasket (Rubber)
C9278.....	17356-92.....	5.....	92-99 Upper Rocker Cover Gasket (Rubber)
C9283.....	17358-84A.....	10.....	84-99 Inner Rocker Cover Gasket (Rubber)
C9836.....	18001-83A.....	25.....	84-99 Valve Guide Seal (Viton)

Cometic #	OE#	Qty	Description
C9297.....	18633-48D.....	10.....	84-99 Rear Tappet Block Gasket (High Density Fiber)
C9297F.....	18633-48A/C.....	10.....	84-99 Rear Tappet Block Gasket (AFM)
C9298.....	18634-48-C.....	10.....	84-99 Front Tappet Block Gasket (High Density Fiber)
C9298F.....	18634-48-A/B.....	10.....	84-99 Front Tappet Block Gasket (AFM)
C9328F5.....	25225-93-XM.....	5.....	93-99 Cam Cover Gasket (AFM .060")
C9328F5-032.....	25225-93-X.....	5.....	93-99 Cam Cover Gasket (AFM .032")
C9328.....	25225-93.....	10.....	93-99 Cam Cover Gasket (High Density Fiber .031")
C9302F5.....	25225-70-XM.....	5.....	84-92 Cam Cover Gasket (AFM Material .060")
C9302F5-032.....	25225-70-X.....	5.....	84-92 Cam Cover Gasket (AFM Material .032")
C9302.....	25225-70-B.....	5.....	84-92 Cam Cover Gasket (High Density Fiber .031")
C9349.....	26227-58.....	5.....	84-99 Oil Pump Seal
C9381.....	26273-80-B.....	10.....	84-91 Oil Pump Body Gasket (Vulcanized Fiber)
C9381-010.....	26273-80B-XS.....	10.....	84-91 Oil Pump Body Gasket (Metal/Viton coated .010")
C9383.....	26273-92.....	10.....	92-99 Oil Pump Body Gasket (Vulcanized Fiber .010")
C9383-010.....	26273-92-XS.....	10.....	92-99 Oil Pump Body Gasket (Metal/Viton coated .010")
C9382.....	26276-80-A.....	10.....	84-91 Oil Pump Cover Gasket (Vulcanized Fiber)
C9382-010.....	26276-80-M.....	10.....	84-91 Oil Pump Cover Gasket (Metal/Viton coated .010")
C9384.....	26276-92.....	10.....	92-99 Oil Pump Cover Gasket (Vulcanized Fiber .010")
C9287.....	26432-76-A.....	10.....	84-99 Cylinder Stud O-Ring
C9481.....	26856-89.....	10.....	93-99 Umbrella Valve Seal
C9290.....	26995-86A.....	10.....	90-99 Intake Manifold Seal
C9299.....	29242-83.....	10.....	84-89 Compliance Fitting Gasket
C9306F.....	32591-80.....	10.....	84-99 Point Cover Gasket
C9286.....	63858-49.....	10.....	84-99 Rocker Box Washer Gasket (Vulcanized Fiber)
C9288.....	65324-83A.....	10.....	Exhaust Port Gasket, OE type
C9719.....	65324-XX.....	10.....	Exhaust Port Gasket, S/E type
C9540.....	65324-XXX.....	10.....	Exhaust Port Gasket, XTREME SEAL
C9350.....	83162-51-DL.....	5.....	84-99 Point Seal (Double Lip)



36-84 Big Twin

Display Board Complete with Gaskets, Seals & O-Rings

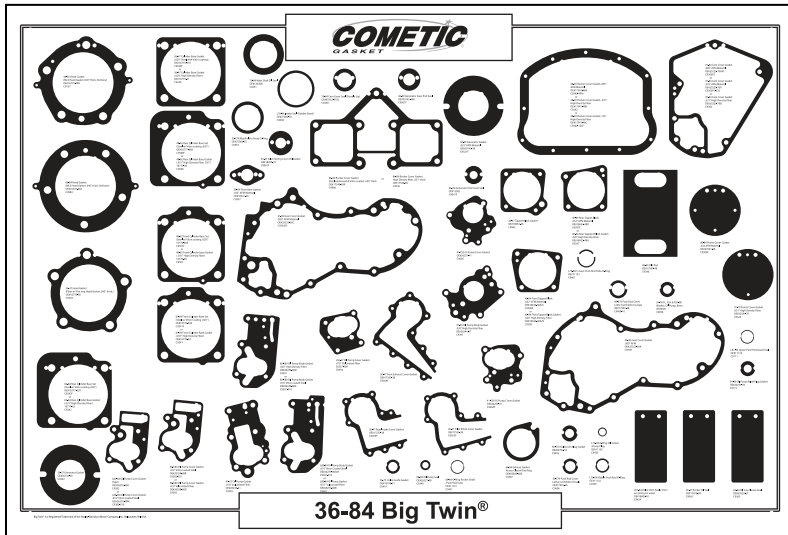

- Sold complete with all Gaskets, Seals & O-Rings and the necessary clamshells, display hooks and xmas treeclips for mounting
- Both Cometic and OE part numbers are printed on boards for easy clarification of parts
- 3 color design, boards measures 48"W x 32"H and are manufactured from 20 mil flexible vinyl and mount easily on 1/8" or 1/4" pegboard

Part#	Description
C9230F-Gas	Gaskets Only
C9230F	Display Board Only

Cometic #	OE#	Qty	Description
C9034	6581	5	54-78 Oil Pump Relief Valve Plug Gasket
C9451	11101	10	66-84 O-Ring Rocker Shaft/Pushrod Tube
C9435	11105	10	L70-84 O-Ring Oil Screen/Pump Plug
C9711	11118	25	L81-84 Upper Pushrod Quad Seal
C9459	11132	25	L79-84 Middle Pushrod O-Ring
C9461	11133	10	L79-E81 Lower Pushrod Tube O-Ring
C9041F	12002	5	61-69 Generator End Cover Seal
C9351	12026B	5	70-84 Main Shaft Oil Seal
C9239	16770-36	2	36-47 Head Gasket (Fiber w/ Fire ring Head Gasket .043")
C9137	16770-48X	2	48-65 Head Gasket (MLS Head Gasket .040" Std bore)
C9984	16770-66X	2	66-84 Head Gasket (MLS Head Gasket .040" Std bore)
C9240F	16774-21X	2	36-47 Cylinder Base Gasket (.020" Steel with Viton coating)
C9240	16774-21	2	36-47 Cylinder Base Gasket (.020" High Density Fiber)
C9567F	16776-48X	2	48-62 Front Cylinder Base Set (Steel w/ Viton coating .020")
C9567	16776-48	10	48-62 Front Cylinder Base Gasket (.031" High Density Fiber)
C9241F	16776-63X	2	63-84 Front Cylinder Base Set (Steel w/ Viton Coating .020")
C9241	16776-63	2	63-84 Front Cylinder Base Gasket (.031" High Density Fiber)
C9568F	16777-48X	2	48-62 Rear Cylinder Base Set (Steel w/ Viton coating .020")
C9568	16777-48	10	48-62 Rear Cylinder Base Gasket (.031" High Density Fiber .031")
C9242F	16777-63X	2	63-84 Rear Cylinder Base Set (Steel w/ Viton coating .020")
C9242	16777-63	10	63-84 Rear Cylinder Base Gasket (.031" High Density Fiber)
C9042	17475-38	5	36-47 Rocker Oil Seal
C9346	17507-48	10	48-65 Felt Pad
C9053F	17535-38	5	36-47 F/Int R/Exh Cover Gasket
C9055F	17537-38	5	36-47 Rear Intake Cover Gasket
C9059F	17539-38	5	36-47 Front Exhaust Cover Gasket
C9986	17540-69X	2	66-84 Rocker Cover Gasket (Steel, embossed & Viton coated, .020")
C9336	17540-69	10	66-84 Rocker Cover Gasket (High Density Fiber)
C9342-AFM	17541-48A	2	48-65 Rocker Cover Gasket, .060"
C9342	17541-48B	10	48-65 Rocker Cover Gasket, (High Density Fiber, .031")
C9342-125F	17541-48C	2	48-65 Rocker Cover Gasket, .125" (High Density Fiber)
C9696	17955-36	10	36-E79 Pushrod Cover Lathe Cut Rubber (Small)
C9409-10	17955-48	10	48-E79 Pushrod Cover Lathe Cut Rubber (Large)
C9424	18000-81	25	L81-84 Valve Stem Seals, Viton w/ spring on wiper
C9419	18196-51	20	51-79 Valve Guide Gasket

Cometic #	OE#	Qty	Description
C9061F	18265-37	10	36-47 Valve Spring Cover Oil Gasket
C9062	18632-36	5	36-47 Tappet Block Gasket
C9297F	18633-48D	10	48-84 Rear Tappet Block (.032" AFM)
C9297	18633-48A	10	48-84 Rear Tappet Block Gasket (.020" High Density Fiber)
C9298F	18634-48A/C	10	48-84 Front Tappet Block (.032" AFM Material)
C9298	18634-48A/B	10	48-84 Front Tappet Block Gasket (.020" High Density Fiber)
C9709	25225-36A	5	36-40 Gear Cover Gasket, .060" AFM
C9334F5	25225-36C	5	41-69 Gear Cover Gasket, .060" AFM
C9302F5	25225-70XM	5	70-84 Cam Cover Gasket, .060" AFM
C9302F5-032	25225-70X	5	70-84 Cam Cover Gasket, .032" AFM
C9302	25225-70B	5	70-84 Cam Cover Gasket (.031" High Density Fiber)
C9349	26227-58	5	68-84 Oil Pump Seal
C9715	26231-78	10	54-80 Oil Pump Relief Plug Gasket
C9397	26244-37	10	37-59 Oil Pump Body Gasket (.020" High Density Fiber)
C9393	26245-41	10	41-67 Oil Pump Gasket (.010" Vulcanized Fiber)
C9391	26246-68D	10	68-E80 Oil Pump Body Gasket (.020" High Density Fiber)
C9391-010	26246-68X	10	68-E80 Oil Pump Body Gasket (.010" Viton Coated Steel)
C9064F	26255-41	5	41-E50 Oil Pump Cover Gasket
C9065	26257-41	5	41-E50 Oil Pump Cover Gasket
C9394	26257-50A	10	L50-67 Oil Pump Cover Gasket (.010" Vulcanized Fiber)
C9392	26258-68D	10	68-E80 Oil Pump Cover Gasket (.010" Vulcanized Fiber)
C9392-010	26258-68B	10	68-E80 Oil Pump Cover Gasket (.010" Viton Coated Steel)
C9381	26273-80B	10	L80-84 Oil Pump Body Gasket (.010" Vulcanized Fiber)
C9381-010	26273-80AM	10	L80-84 Oil Pump Body Gasket (.010" Viton Coated Steel)
C9382	26276-80A	10	L80-84 Oil Pump Cover Gasket (Paper)
C9382-010	26276-80M	10	L80-84 Oil Pump Cover Gasket (.010" Viton coated steel)
C9453	27060-55	10	55-E78 Manifold to Head O-Ring
C9608	27062-78	10	L78-84 Intake Seal (Rubber Band)
C9322	30143-30	10	36-57 Generator Gasket
C9321F	30143-58	5	58-69 Generator Gasket (.032" AFM)
C9067F	30145-46A	5	46-69 Generator Gear End Seal
C9337	32521-36	10	36-64 Timer Base Gasket (.032" AFM)
C9323	32591-70	10	70-79 Points Cover Gasket (.031" High Density Fiber)
C9306F	32591-80	10	80-84 Points Cover Gasket (.032" AFM)
C9403	62702-52	10	66-E70 Oil Screen Plug Gasket
C9365	63529-57	10	63-84 Oil Line Sleeve Seal
C9587	65834-68X	10	66-84 Exhaust Gasket (Armor Clad w/Fire Ring)
C9350	83162-51DL	5	70-84 Cam Cover Seal (Double Lip)



Big Twin Primary

Display Board Complete with Gaskets, Seals & O-Rings

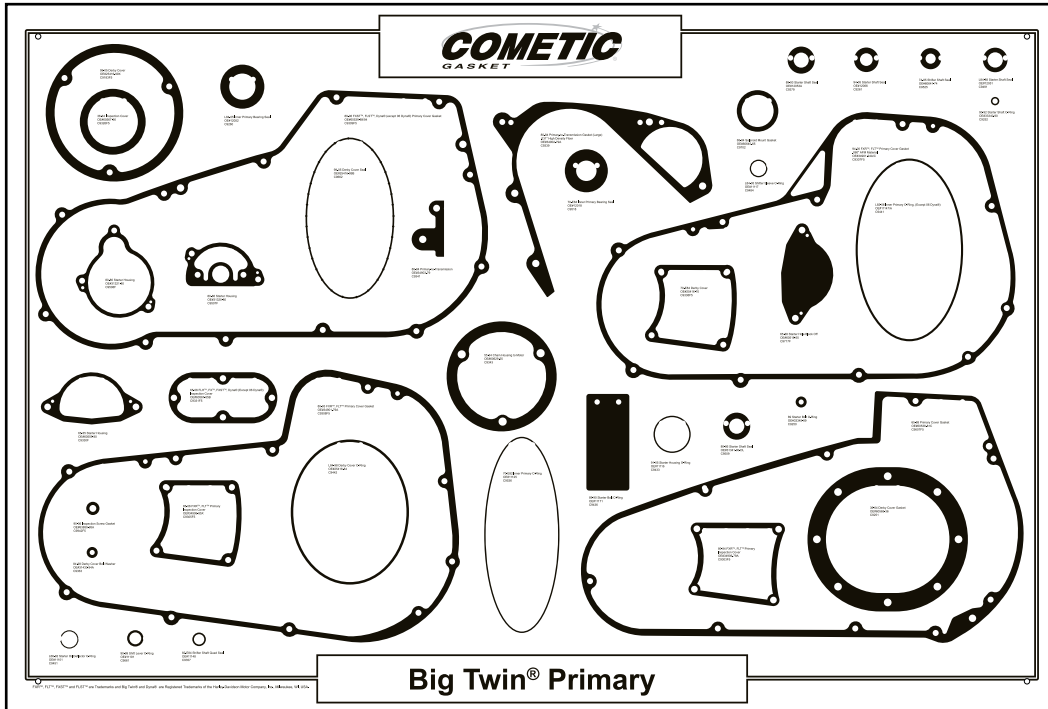

- Sold complete with all Gaskets, Seals & O-Rings and the necessary clamshells, display hooks and xmas treeclips for mounting
- Both Cometic and OE part numbers are printed on boards for easy clarification of parts
- 3 color design, boards measures 48"W x 32"H and are manufactured from 20 mil flexible vinyl and mount easily on 1/8" or 1/4" pegboard

Part#
C9231F-Gas
C9231F

Description
Gaskets Only
Display Board Only

Cometic #	OE#	Qty	Description
C9400.....	6114	10...	84-99 Rocker Box Washer Gasket (Copper)
C9451.....	11101	10...	L66-82 Starter Oil Deflector O-Ring
C9433.....	11116	25...	91-05 Starter Housing O-Ring
C9484.....	11117	25...	L84-05 FXR, Dyna Shifter Sleeve O-Ring
C9536.....	11125	10...	70-E82 Inner Primary O-Ring
C9441.....	11147/A	10...	L82-06 Inner Primary O-Ring, Except 06 DYNA
C9357.....	11148	10...	82-E84 Shifter Shaft Quad Seal
C9436.....	11171	10...	L84-88 Starter Bolt O-Ring
C9661.....	11191	25...	90-99 FXST, FLST Shift Lever O-Ring
C9518.....	12018	5....	70-E84 Inner primary Bearing Seal
C9491.....	12051	5....	L84-88 Starter Shaft Seal
C9260.....	12052	5....	L84-05 Inner Primary Bearing Seal (Double Lip)
C9379.....	12053A	5....	89-93 Starter Shaft Seal
C9261.....	12066	5....	94-05 Starter Shaft Seal
C9338F5.....	25416-70	5....	70-E84 Derby Cover Gasket (.060" AFM Material)
C9442.....	25416-84	10...	L84-98 Derby Cover O-Ring
C9662.....	25416-99B	5....	99-05 Derby Cover Seal
C9183F5.....	25416-99X	5....	99-05 Derby Cover Gasket (.060" AFM Material)
C9507F.....	31320-80	10...	80-86 Starter Housing Gasket (.032"AFM Material)
C9508F.....	31321-80	10...	80-86 Starter Housing Gasket (.032"AFM Material)
C9509.....	31341-80-DL	5....	80-86 Starter Shaft Seal (Double Lip)
C9363.....	31433-84A	5....	84-98 Derby Cover Bolt Washer (Metal)
C9252.....	33340-90	10...	90-92 Starter Shaft O-Ring
C9250.....	33345-89	10...	89 Starter Bolt O-Ring
C9308F5.....	34901-79A	5....	80-93 FXR,FLT Primary Cover Gasket (.060" AFM Material)

Cometic #	OE#	Qty	Description
C9307F5.....	34901-94A/C	5....	94-06 FXR, FLT Primary Cover Gasket (.060" AFM Material)
C9339.....	34902-79A	10...	80-84 Primary-to-Transmission Gasket (Large), .031" High Density Fiber
C9341.....	34903-79	10...	80-84 Primary-to-Transmission Gasket (Small), .039" High Density Fiber
C9303F5.....	34906-79A	5....	80-84 FXR,FLT Primary Inspection Cover Gasket (.060" AFM Material)
C9305F5.....	34906-85X	5....	85-06 FXR,FLT Primary Inspection Cover Gasket (.060" AFM Material)
C9717F.....	60518-65	10...	65-88 Starter Hole Block Off Gasket (.032" AFM Material)
C9607F5.....	60538-81C	5....	65-88 Primary Cover Gasket, Rigid Mount (.060" AFM Material)
C9309F5.....	60539-89/94	5....	89-06 FXST,FLST, Dyna, Except 06 DYNA Primary Cover Gasket (.060" AFM Material)
C9330F.....	60559-80	10...	65-85 Starter Housing Gasket (.032" AFM Material)
C9251.....	60565-36	5....	36-64 Derby Cover Gasket
C9326F5.....	60567-36	10...	36-64 Inspection Cover Gasket (.125" Cork)
C9331F5.....	60567-65B	5....	65-06 FLH, FX, FXST Dyna Inspection Cover Gasket, Except 06 Dyna (.060" AFM Material)
C9343.....	60629-55	10...	55-64 Chain Housing to Motor Gasket (.031" High Density Fiber)
C9525.....	60641-74	5....	74-85 Shifter Shaft Seal
C9702.....	60645-65	10...	65-84 Solenoid Mount Gasket (.190" Closed cell foam)
C9942F5.....	63859-95A	5....	95-06 Inspection Screw Gasket Pair



Big Twin Transmission

Display Board Complete with Gaskets, Seals & O-Rings

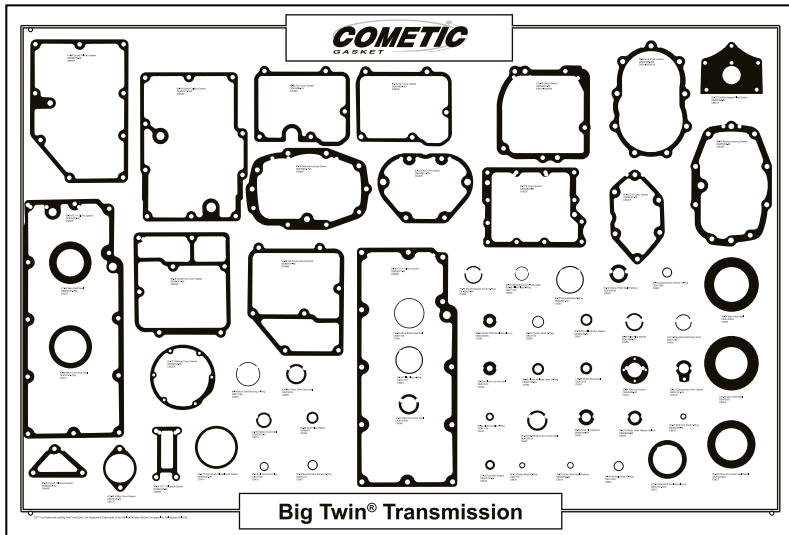

- Sold complete with all Gaskets, Seals & O-Rings and the necessary clamshells, display hooks and xmas treeclips for mounting
- Both Cometic and OE part numbers are printed on boards for easy clarification of parts
- 3 color design, boards measures 48"W x 32"H and are manufactured from 20 mil flexible vinyl and mount easily on 1/8" or 1/4" pegboard

Part#	Description
C9232-Gas	Gaskets Only
C9232F	Display Board Only

Cometic #	OE#	Qty	Description	Cometic #	OE#	Qty	Description
C9498	6007	10	80-98 Drain Plug Washer	C9520F	34552-52	10	52-E79 Ratchet Cover Gasket (.032" AFM Material)
C9435	11105	10	91-04 Oil Pan Drian Plug O-Ring	C9521F	34565-52	10	52-E79 Shifter Adapter Plate Gasket (.032" AFM Material)
C9529	11115	10	65-86 Counter Shaft O-Ring	C9522F	34824-36	10	36-E79 Cover Gasket (.060" AFM Material)
C9459	11132	25	91-04 Dipstick Cover O-Ring	C9516-032AFM	34824-79	10	L79-86 Cover Gasket (.032" AFM Material)
C9667	11140	25	95-04 Speedometer Sensor O-Ring	C9499F	34904-79	10	80-85 Top Cover Gasket (.032" AFM Material)
C9495	11162	25	L84 O-Ring Mainshaft (right end)	C9983F	34904-86	10	86-04 Top Cover Gasket (.032" AFM Material)
C9361	11165	10	L84-04 Main Shaft Quad Seal	C9488F	34917-90	10	91-98 Top Cover Gasket Dyna (.032" AFM Material)
C9530	11166	25	84-86 Main Shaft Bearing O-Ring	C9645F	34917-99	10	99-04 Dyna Top Cover Gasket (.060" AFM Material)
C9436	11171	10	86-91 Starter Motor O-ring	C9523	35230-39DL	5	37-79 Main Shaft Seal
C9263	11178	10	87-04 Filler Plug O-Ring	C9411	35231-36	10	37-E77 Main Shaft Oil Seal Cork Washer
C9447	11179	25	87-04 Clutch Cable O-Ring	C9264F	35652-79X	10	80-98 Bearing Housing Gasket (.032" AFM Material)
C9667	11289	25	99-04 Speedometer Sensor O-Ring	C9644F	35653-98	10	99-05 Bearing Housing Gasket (.032" AFM Material)
C9642	11290	10	99-04 Neutral Switch O-Ring	C9243	36025-36	10	37-64 End Cap Gasket (.020" High Density Fiber)
C9531	12010	5	L79-86 Shifter Shaft Seal	C9526F	36801-79	10	80-86 End Cover Gasket (.032" AFM Material)
C9493	12013A	5	65-E66/L81-90 Main Drive Gear Seal	C9483F	36801-87A	10	87-05 End Cover Gasket (.032" AFM Material)
C9494	12014	5	65-E84 Clutch Hub Nut Seal	C9496	37091-80	10	80-86 Filler Plug Washer (.094" Nylon)
C9506	12022	5	L66-E81 Main Drive gear Seal	C9354	37101-84	1	84-86 Clutch Release Lever O-Ring
C9258	12035B	5	91-04 Main Drive gear Seal	C9249	37337-36	10	37-64 Pushrod Rubber
C9528	12043A	5	80-86 Starter Shaft Seal (Rubber)	C9513	37741-67A	5	L79-81 Mainshaft Seal (Double Lip)
C9527	12044DL	1	80-E84 Main Drive Gear Seal (Metal)	C9514	37741-82DL	5	82-86 Main Drive Gear Seal (Double Lip)
C9259	12045DL	5	80-04 Shifter Shaft Seal (Double lip)	C9489F	62423-90	10	91-98 Dyna Oil Spout Gasket (.032" AFM Material)
C9359	12050	1	L84-94 Main Shaft Seal	C9266F	62432-93	10	93-04 FLT Oil Spout Gasket (.032" AFM Material)
C9262	12067A	1	95-04 Main Shaft Seal	C9485	62672-90	10	91-98 Dyna Dipstick Cover O-Ring
C9490F	26072-90	10	91-98 Dyna Oil Pan Gasket (.032" AFM Material)	C9263	62673-90	10	91-98 Dyna Dipstick O-Ring
C9646F	26072-99A	10	99-09 Dyna Oil Pan Gasket (.060" AFM Material)	C9403	62702-52	10	36-86 Drain Plug Washer
C9265F	26077-93	5	93-98 FLT Oil Pain Gasket (.060" AFM Material)	C9512F	67141-36	10	37-83 Speedometer Drive Gasket (.032" AFM Material)
C9647F	26077-99	10	99-09 FLT Oil Pan Gasket (.060" AFM Material)				
C9497	33043-80	10	80-92 Neutral Indicator Washer (.063" Nylon)				
C9374	33076-37	10	37-86 Starter Crank Seal				
C9517F	33196-79	10	L79-86 Shifter Cover Gasket (.032" AFM Material)				
C9515-032AFM	33295-36X	10	36-86 End Cover Gasket (.032" AFM Material)				
C9519	34036-36	10	36-E79 Cam Shaft Seal (Rubber)				
C9510	34026-80	10	36-84 Shift Fork Shaft O-Ring				
C9248	34459-26	10	36-E79 Shifter Shaft Washer (Nylon)				



86-00 XL Evolution

Display Board Complete with Gaskets, Seals & O-Rings

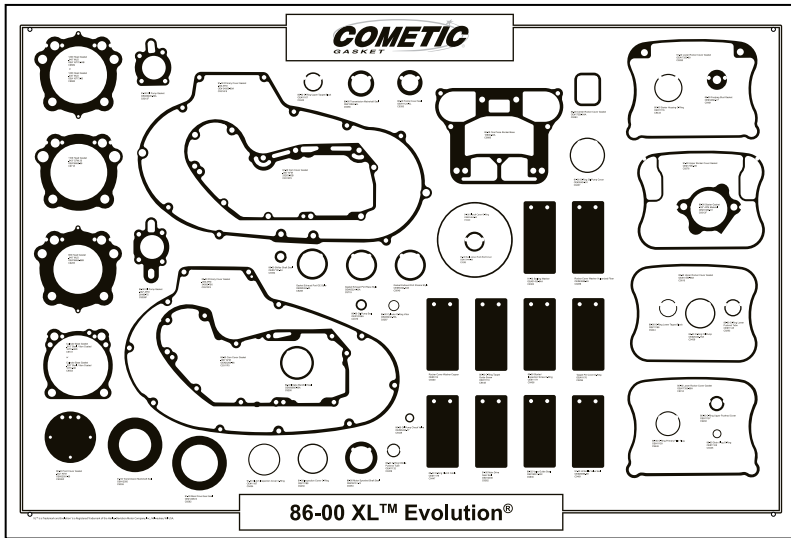

- Sold complete with all Gaskets, Seals & O-Rings and the necessary clamshells, display hooks and xmas treeclips for mounting
- Both Cometic and OE part numbers are printed on boards for easy clarification of parts
- 3 color design, boards measures 48"W x 32"H and are manufactured from 20 mil flexible vinyl and mount easily on 1/8" or 1/4" pegboard

Part#	Description
C9233F-Gas	Gaskets Only
C9233F	Display Board Only

Cometic #	OE#	Qty	Description
C9400	6114	10	86 Rocker Cover Washer (Copper)
C9435	11105	10	86-00 Drain Plug O-Ring
C9448	11110	10	86-90 O-Ring Tappet Guide Screw
C9433	11116	25	86-00 Starter Housing O-Ring
C9355	11124-DL	5	86-00 Points Cover Seal (Double Lip)
C9459	11132	25	86-90 O-Ring Middle Pushrod Tube
C9446	11139	10	86-90 O-Ring Primary Filler Plug
C9293	11145	25	86-90 O-Ring Lower Pushrod Tube
C9292	11157	25	86-90 O-Ring Upper Push Rod Cover
C9443	11167	10	86-90 O-Ring Upper Tappet Block
C9444	11168	10	86-90 O-Ring Lower Tappet Block
C9436	11171	10	86-00 Starter/Inspection Screw O-Ring
C9296	11176	10	Tappet Pin Cover O-Ring
C9447	11179	25	88-00 O-Ring Clutch Cable
C9434	11187	10	91-93 Clutch Inspection Cover O-Ring
C9439	11188	10	91-00 Inspection Cover O-Ring
C9294	11190	10	91-00 O-Ring Upper Pushrod Cover
C9362	12030	5	91-00 Main Drive Gear Seal
C9376	12036A	5	86-90 Oil Pump Seal (Metal)
C9356	12049-DL	5	86-90 Transmission Mainshaft Seal
C9359	12050	1	91-94 Transmission Mainshaft Seal
C9262	12067A	1	91-00 Main Drive Gear Seal
C9205	16664-86B	2	86-00 883 Head Gasket
C9718	16665-86	2	86-87 1100 Head Gasket (.043" CFM20 W/ Fire Ring)
C9689	16770-84B	2	88-08 1200 Head Gasket (.040 MLS)
C9688	16773-85	2	88-08 1200 Head Gasket (.030" MLS)
C9553	16774-96	2	86-00 Cylinder Base Gasket (.020" Steel Viton coated)
C9101	16774-86D	2	86-00 Cylinder Base Gasket (.010" Steel Viton coated)
C9866	16800-84A	10	86-up One piece rocker base (.020" Steel Viton coated)
C9014	17353-86A	5	86-90 Lower Rocker Cover Gasket (Rubber)
C9280	17353-89	5	91-00 Lower Rocker Cover Gasket (Rubber)
C9010	17354-86A	5	86-90 Upper Rocker Cover Gasket (Rubber)

Cometic #	OE#	Qty	Description
C9276	17354-89	5	91-00 Upper Rocker Cover Gasket (Rubber)
C9283	17358-84A	10	86-00 Center Rocker Cover Gasket (Rubber)
C9295	17944-89	10	91-00 Seal, Lower Push Rod Cover
C9836	18001-83X	25	86-00 Valve Guide Seal (Viton w/ spring on wiper)
C9311F5	25263-86	5	86-90 Cam Cover Gasket (.060" AFM Material)
C9313F5	25263-90B	5	91-00 Cam Cover Gasket (.060" AFM Material)
C9220	25463-94	5	94-00 Clutch Cover O-Ring Replaces C9958
C9287	26432-76A	10	86-00 Cylinder O-Ring (Viton)
C9449	26433-77	10	86-90 O-Ring, Oil Pump Check Valve
C9439	26434-76A	10	86-90 O-Ring Oil Pump
C9437	26434-91	0	91-00 O-Ring Oil Pump Cover
C9399F	26495-75	10	86-90 Oil Pump Gasket (.032" AFM Material)
C9315F	26495-89A	10	91-00 Oil Pump Gasket (.032" AFM Material)
C9481	26856-89	10	91-00 Umbrella Valve Seal
C9290	26995-86A	10	86-00 Intake Manifold Seal
C9363	31433-84A	5	91-93 Sealing Washer
C9312F	31488-81	10	86-00 Starter Gasket (.032" AFM Material)
C9306F	32591-80	5	86-00 Point Cover Gasket (.032" AFM Material)
C9401	34624-77	10	86-90 Footpeg Stud Gasket
C9310F5	34955-75X	5	86-90 Primary Cover Gasket (.060" AFM Material)
C9314F5	34955-89A	5	91-00 Primary Cover Gasket (.060" AFM Material)
C9353	35151-74	5	86-00 Motor Sprocket Shaft Seal
C9354	37101-84	1	86-00 Shifter Shaft Seal
C9286	63858-49	10	87-00 Rocker Cover Washer Gasket
C9288	65324-83	10	86-92 Gasket Exhaust Port (OE Style Replacement)
C9719	65324-83A	10	86-00 Gasket, Exhaust Port (S/E Race Style)
C9540	65324-83X	10	86-00 Gasket, Exhaust Port Extreme Performance spiral wound

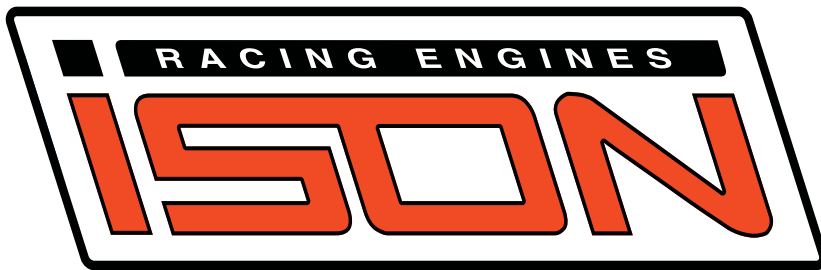

Ison is a full service performance engine builder, serving the powersports and automotive industries.

Ison provides precision workmanship by our experienced staff for everything from complete engine builds and dyno testing, to component machining and assembly.

Outfitted with the finest equipment including Sunnen hones, Kwik-Way boring bars, Serdi seat cutters, and Haas 5-axis CNC mills, close tolerance machining and repeatability can be expected. To complete our expansive list of services, we have added engine dyno testing which is made possible by our new in-house Superflow 902S dyno.

Our extremely clean state-of-the-art facility is a testament to our principles and dedication to quality when working on your power plant.

NEW!

Superflow 902S Engine Dyno



Ison Services

Automotive Services

- Resurfacing and Square Decking
- Align Honing
- Boring and Sleeving
- Diamond Honing
- Dynamic Balancing
- Cylinder Head Reconditioning
- Standard and Radius Valve Job Capability
- Port Machining
- Valve Guide Reconditioning
- Valve Seat Repair
- Complete Engine Builds
- Engine Dyno Testing

Powersports and V-Twin Services

- 2 and 4 Stroke Cylinder Sleeving
- Port Matching
- Boring and Honing
- Case Boring
- Complete Cylinder Head Service