



COMETIC
GASKET

AND
**POWERSPORT
V-TWIN
PERFORMANCE
GASKETS**



Cometic Gasket, Inc. An Exclusive NASCAR® Performance Product



CUSTOM GASKETS



Cometic's custom gaskets can accommodate virtually any engine configuration from naturally aspirated, to the most exotic turbo and nitrous injected engines. Our commitment is to provide innovative, quality gaskets while maximizing your engine's power and performance. When customization is key, Cometic delivers!

Cometic has the ability to customize any gasket to meet your specific application. Need to change the bore size and/or thickness of a gasket? Or do you need a complete gasket design and execution? The process starts with a simple phone call. After Cometic's in-house Technical Sales Team understands your needs, they work directly with our design engineers to insure the gasket is drawn with state-of-the-art software and manufactured with the best materials possible with the most current and efficient manufacturing processes. If special tooling is required, we'll provide a pre-production estimate for approval. Your gasket is then made and shipped. The lead-time on bore and thickness changes is just three days. A complete gasket design takes just two weeks.



The passion for racing runs deep in our Technical Sales and Engineering Teams. We understand the importance of perfection in your next engine build because we are right there with you racing on weekends.





Cometic Gasket - An Exclusive NASCAR Performance. Product

GASKET MATERIALS

MLS Multi Layer Steel Gaskets

Cometic MLS gaskets are comprised of three to five layers of Stainless Steel. Cometic uses Stainless Steel for increased strength, its ability to rebound and corrosion resistance. The outer layers of the gasket are embossed and coated on both sides with a High Performance Polymer coating designed to meet the demands of a variety of harsh sealing environments, load conditions and surface finishes. The coating is heat resistant to 250C or 482F.

The center or shim layer of the gasket is comprised of an uncoated Stainless Steel layer, which can be varied to accommodate multiple thickness requirements. MLS gaskets are ideal for any kind of head and block combination. By design the MLS gasket promotes an even torque load across the sealing surface allowing for measurable reduced bore distortion.

Available thickness: .027", .030", .036", .040", .045", .051", .060", .066", .070", .075", .080", .086", .092", .098", 120"

AFM (Aluminum Foam Material)



A chemically blown, compounded nitrile synthetic rubber bonded to an aluminum core with temperature resistance of over 250F. AFM material has an 85% recovery while maintaining strong torque retention. AFM does not require gasket sealers or re-tightening. **Available thickness:** .018", .032", .060"

Aramid Fiber



A premium hi-temperature, hi-density creep resistant material that requires no re-torquing and is fuel resistant. All Cometic fiber materials are asbestos free and require no additional sealants. **Available thickness:** .012", .015", .020", .031", .039", .047", .060", .094", .125", .188

Aluminum



Solid material ideal for spacers and shims.

Available thickness: .010", .016", .020", .025", .032", .040", .050"

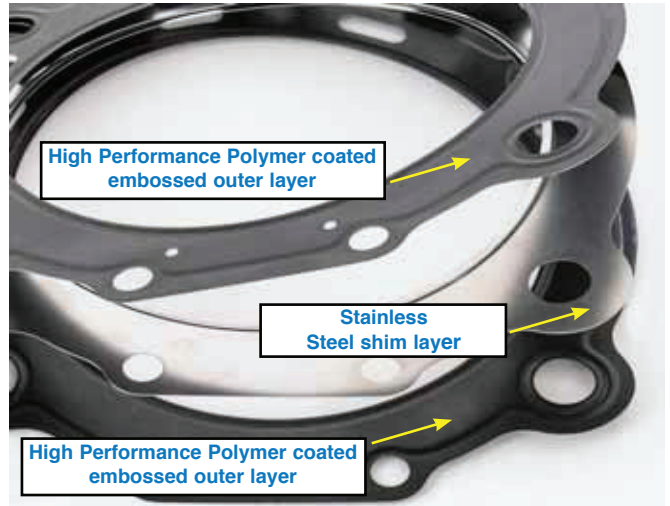

Nitrile Rubber Coated Steel



A steel core with a .001" thick coating of nitrile rubber on both sides. **Available thickness:** .010", .014", .020"

Copper (Dead Soft)



Available thickness: .005", .010", .016", .020", .027", .032", .043", .050", .063", .080", .094"

Valve Guide Seals



Cometic viton steel body (VSB) seals are available for most applications ranging from automotive to motorcycles. Valve stem seals are defined first by the actual measurement of the valve stem OD itself then by the guide OD. Proper seal height and width will be determined by valve spring clearance.

TABLE OF CONTENTS

	Pg.		Pg.		Pg.		Pg.
Arctic Cat UTV	6	Cobra	34	Husqvarna	142	EST Big Twin EVO	190
Can-Am Bombardier UTV	7	Gas Gas	37	Kawasaki	142	Transmission Kits	195
Honda UTV	7	Honda	38	KTM	152	EST Shovelhead & Panhead	197
Kawasaki UTV	8	Husaberg	56	Polaris	152	EST EVO Sportster Motors	200
Polaris UTV	8	Husqvarna	57	Suzuki	152	Sportster & Buell	
Yamaha UTV	9	Kawasaki	62	Triumph	172	Iron Sportster Motor Kits	204
Arctic Cat ATV	11	KTM	82	Yamaha	172	Rotax 250/600, Victory	207
Can-Am/Bombardier ATV	12	LEM	102	Personal Watercraft	176	Karting Kits	208
Honda ATV	12	Suzuki	103	HARLEY-DAVIDSON GASKETS		KLOTZ Synthetic Lubricants	213
Kawasaki ATV	18	Yamaha	118	AFM Series Gaskets	178	Ison Racing Engine Services	215
KTM ATV	21	Water Pump Repair Kits	137	MLS Head & Base Gaskets	179	Cometic Apparel & Promo Items	215
Polaris ATV	22	Aprilia	138	EVO Rocker Cover Gaskets	180		
Outlaw ATV	24	Ducati	138	Milwaukee 8	181		
Suzuki ATV	25	Honda	138	EST Twin Cam	186		
Yamaha ATV	27						

Performance Powersports & V-Twin Products Available for:

Artic Cat
Bombardier
Cobra
Gas Gas

Honda
Husaberg
Husqvarna
Kawasaki

Cometic Products

Dirt | ATV | UTV | PWC

Top-End Kits | Bottom-End Kits | Clutch and Mag Kits | Crank Seals | Individual Gaskets | Engine Seal Kits

Today's lightweight engines are producing more horsepower, higher cylinder pressures, clamp loads and extreme temperatures. Our commitment is to provide innovative, quality gaskets while maximizing your engine's power and performance. Cometic's gaskets are proudly made in the USA with materials manufactured on American soil. We are constantly updating and adding models to our ever growing library of gaskets.

Be sure to check out our NEW Clutch and Mag Kits made from AFM Material. AFM will not stick to the engine case making replacement quick and easy, no more scraping. The aluminum core gives the gasket strength for a superior seal and prevents the gasket from weeping or crawling out. All gasket kits (Top-End, Bottom-End, Clutch and Mag) are sold with the proper amount of gaskets for one application. Need just one gasket, not the entire kit? No problem, we offer individual gaskets.

Cometic is a proud sponsor of Ricky Carmichael, Team Green, The Orange Brigade & Kawasaki Factory Motocross to name a few.

Cycle Street

Head Gaskets | Base Gaskets | Engine Case Kits

For today's hi-horse power streetbikes, Cometic offers MLS head gaskets, base gaskets and engine case rebuild kits utilizing our best materials available! We have a complete line of streetbike applications from new to old.

Cometic is an industry leader in manufacturing processes and committed to pairing the highest possible quality materials with knowledgeable personnel. Cometic stays on the forefront of gasket design technology by utilizing in-house dynamometers and engine assembly rooms to bring its distributors, retailers and ultimately the end-user, the most reliable gaskets available today.



Top-End Kit

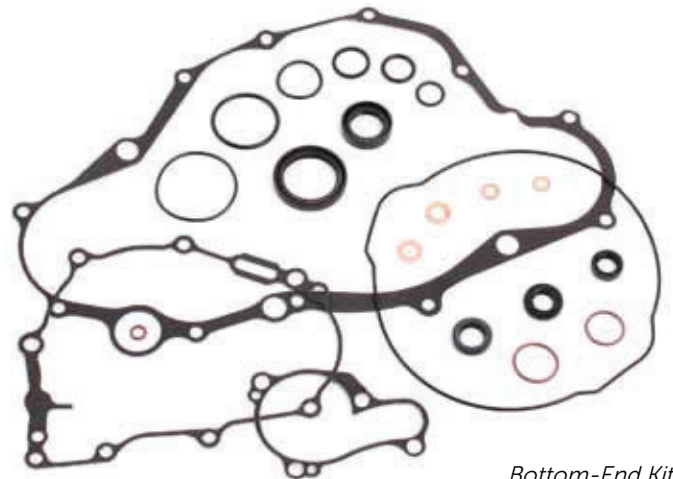

Bottom-End Kit



MLS Head Gasket cross section

KTM
LEM
Polaris
Suzuki

Yamaha
Can-Am Bombardier UTV
Aprilia
Ducati

Triumph
Harley-Davidson
Arctco
Sea Doo

Ski-Doo
John Deere
Rotax

Engine Seal Kits



V-Twin Kit



Clutch and Mag Kit

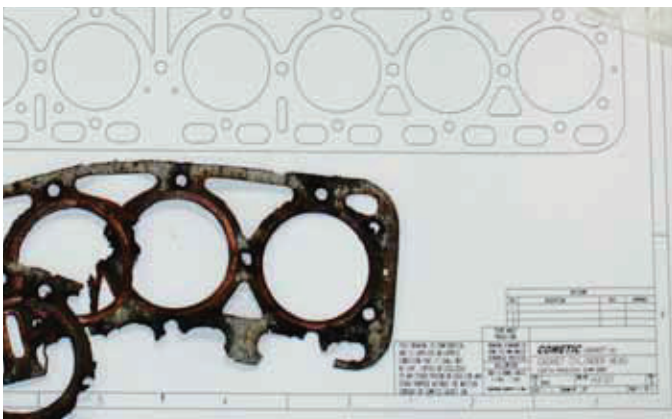
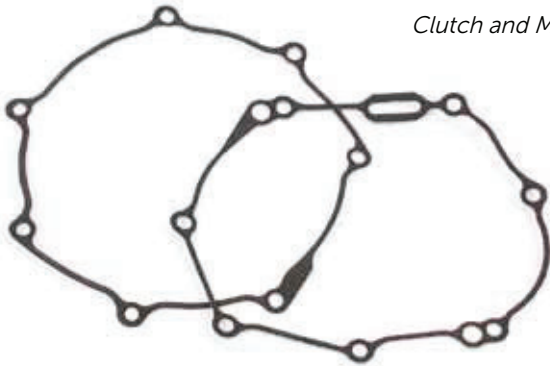

Harley-Davidson® | V-Twin

***Head Gaskets | Base Gaskets | Engine Only Kits | Rocker Box Kits
| Primary Kits | Transmission Kits***

Cometic Gasket has been servicing the American V-Twin Industry for over 25 years. Cometic offers a full line of gaskets for models from 1936 through current day models. Our gaskets can be ordered individually or as complete kits to do the entire job. Cometic also offers full on custom gaskets as well for shelf stock prices. So whether it's a stock bike or a fire breathing all out race machine Cometic has you covered.

All of Cometic's gaskets and seals have been tested on both the street and the track as well as vigorous Dyno shakedown. Rest assured every gasket has been methodically thought out before it is used in any application. Cometic uses it's EST "Extreme Sealing Technology" philosophy while making every gasket. Demand the best, Cometic to seal your engine.

Snowmobile

Complete Kits | Top-End Kits | Exhaust Kits | Intake Kits | Power Valve Kits | Crank Seal Kits

Cometic's Snowmobile gaskets and gasket kits are used by professionals in high-performance machines and as OE replacements worldwide.

Cometic combines advanced materials with the most current manufacturing processes to provide custom-tailored solutions to meet the needs of each individual customer. Engineers analyze the environment in which the gasket will perform, select the proper material, and apply the appropriate technology to offer the best-performing gaskets available in today's ever-changing marketplace.

Custom Gaskets

Need to change the bore size and/or thickness of a gasket? Or do you need a complete gasket design and execution?

The process starts with a simple phone call. After Cometic's in-house Technical Sales Team understands your needs, they work directly with our design engineers to insure the gasket is drawn with state-of-the-art software and manufactured with the best materials possible with the most current and efficient manufacturing processes. If special tooling is required, we'll provide a pre-production estimate for approval. Your gasket is then made and shipped. The lead-time on bore and thickness changes is just three days. A complete gasket design takes just two weeks.



UTV Gaskets



Cometic Gasket - An Exclusive NASCAR Performance® Product

ARCTIC CAT UTV PROWLER 650



Base Cam Chain Clutch Cover Head

Model	Year	Bore Size	Top End Kit	Component Part#	Component Description	OEM Part #
Prowler	06-09	98 mm	C7220	H1735SP3027S	Head Gasket 98mm Bore	0830-124
650		100 mm	C7022	H1735SP4027S	Head Gasket 100mm Bore	0830-124
				B0647014RC	Base Gasket	0830-084
				EX657	Exhaust Gasket	0412-338
				EC377032AFM	Cam Chain Tens. Gasket	0830-018
				OS020	2 Req.-Cam Chain Tens. O-ring	0830-107
				R22X2.5V	Coolant Line O-ring	0830-007
				R45X3V	Intake O-ring	0830-090
				R54X2V	2 Req.-Valve Cover O-rings	0830-004
Bottom End Gaskets Available Separately						
				Component Part#	Component Description	OEM Part #
				EC1142032AFM	Clutch Cover Gasket	0830-116
				EC1143032AFM	Magneto Cover Gasket	0830-128
				EC1141032AFM	Primary Cover Gasket	0830-174

PROWLER 700XT LTD

Model	Year	Bore Size	Top End Kit	Component Part#	Component Description	OEM Part #
Prowler	08-15	103.5mm	C3597-EST	H2223SP4027S	Head Gasket	0830-112
700 XT LTD				B0760014RC	Base Gasket	0830-111
X700	11-17			EX657	Exhaust Gasket	0412-338
				OS020	Cam Chain Tensioner Gasket	0830-107
				EC377032AFM	Cam Chain Tens. Gasket	0830-018
				3186V	Valve Seals	0830-186
				R22X2.5V	Water Outlet O-ring	0830-007
				R124V	Valve Cover O-rings 2 req.	0830-215
				R008B	Intake O-ring	0423-182
				R124V	Oil Fill Cap O-ring	0830-215
				R54X2V	Inspection Cap O-ring	0830-004
Bottom End Gaskets Available Separately						
				Component Part#	Component Description	OEM Part #
				EC1142032AFM	Clutch Cover Gasket	0830-116
				EC1143032AFM	Magneto Cover Gasket	0830-128
				EC1141032AFM	Primary Cover Gasket	0830-174

PROWLER/WILDCAT 1000

Model	Year	Bore Size	Top End Kit	Component Part#	Component Description	OEM Part #
Prowler/	10-17	93.5mm	C3568-EST	H2399SP6027S	Head Gasket	0830-209
Wildcat 1000				B1155014RC	Base Gasket	0830-193
				EX657	Exhaust Gasket	0412-338
				EC2035032AFM	Cam Chain Tensioner Gasket 2 Req.	0830-134
				3186V	Valve Seals 8 Req.	0830-186
				R118V	Water Outlet O-ring	0830-007
				OS384	Water Inlet Seal	0830-120
				R54X2V	Valve Cover O-rings 4 req.	0830-004
				R45X3V	Intake O-ring 2 req.	0830-090

All Component Parts can be purchased individually.



UTV Gaskets



Cometic Gasket - An Exclusive NASCAR Performance® Product

CAN-AM/BOMBARDIER UTV COMMANDER 1000

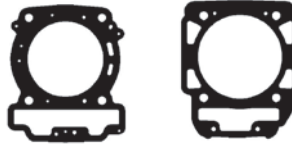

Head

Base

Model	Year	Bore Size	Top End Kit	Component Part#	Component Description	OEM Part #
Commander	11-16	92mm	C3459-EST	H2653018S	Head Gasket 92mm 2 Req.	420630195
1000		93mm	C3460-EST	H2653SP1018S	Head Gasket 93mm 2 Req.	
Maverick	13-15	94mm	C3461-EST	H2653SP2018S	Head Gasket 94mm 2 Req.	
		96mm	C3462-EST	H2653SP5018S	Head Gasket 95mm 2 Req.	
				3186V	Valve Stem Seal 8 Req.	420230515
				R117V	Cam Chain Tensioner O-ring	420430370
				R15X1.5V	Cam Adjuster O-ring	420250890
				EX696	Header Gasket 2 Req.	707600317
				B0895010RC	Base Gasket 2 Req.	420630210

Bottom End Gaskets Available Separately

Component Part#	Component Description	OEM Part #
EC1142032AFM	Clutch Cover Gasket	0830-116
EC1143032AFM	Magneto Cover Gasket	0830-128
EC1141032AFM	Primary Cover Gasket	0830-174

HONDA UTV FL250 ODYSSEY

Model	Year	Bore Size	Top End Kit	Component Part#	Component Description	OEM Part #
FL250	73-77	72 mm	C7140	H0182043F	Head Gasket 72mm	12251-358-306
Odyssey				B0137020F	Base Gasket 73-76	12191-357-306
				B0395020F	Base Gasket 77-84	12191-381-306

FL350R ODYSSEY

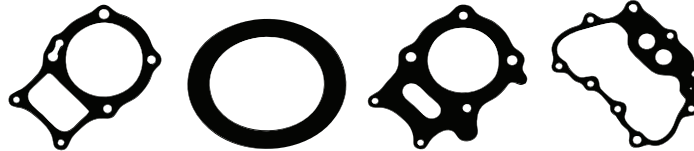

Base

Exhaust

Head

Valve Cover

Model	Year	Bore Size	Top End Kit	Component Part#	Component Description	OEM Part #
FL350R	85	82 mm	C7229	B0204020F	Base Gasket	12191-VMO-772
Odyssey				H0344043F	Head Gasket	12254-VMO-013

PILOT FL-400



Exhaust

Intake

Model	Year	Bore Size	Top End Kit	Component Part#	Component Description	OEM Part #
Pilot	89-91	82 mm	C7024	H0015043F	Head Gasket	12251-HE0-000
FL-400				B0020020F	Base Gasket	12191-HE0-000/010
				EX009042AM	Exhaust Gasket	18291-HE0-000/010
				IR004018AFM	Intake Gasket	14132-KAE-000/430-000

All Component Parts can be purchased individually.



UTV Gaskets



Cometic Gasket - An Exclusive NASCAR Performance® Product

KAWASAKI UTV

KRF750 Teryx



Head



Base

Model	Year	Bore Size	Top End Kit	Component Part#	Component Description	OEM Part #
KRF750 Teryx (SXS)	08-14	85mm	C3284-EST	H2624SPA010S	Head Gasket 85mm	11004-0011
		90 mm	C3251-EST	H2624SP1010S	Head Gasket 90mm	11004-0011
				B0951020RC	Base Gasket	11061-0063
				EX361	Exhaust Gasket 2 req	11009-1894
				WA114	Coolant Drain Washer 2 Req	
				R55X2V	Rocker Cap O-Ring 4 Req	92055-0112
				R19X2V	Plug Cover O-Ring 2 Req	92055-1146
				3242V	Valve Stem Seals 8 Req	92049-1218

POLARIS UTV

RZR170



Exhaust



Model	Year	Bore Size	Top End Kit	Component Part#	Component Description	OEM Part #
RZR170	09-16	61mm	C3596-EST	B1318020RC	Cylinder Base Gasket	0454459
				H4194010S	Cylinder Head Gasket	0454365
				IR1308020F	Intake Manifold Gasket	0453451
				R024V	Intake Manifold O-ring	0452459
				R049B	Cylinder Head Cover O-ring	0454363
				EC2131032AFM	Cylinder Head Breather	0454640
				EC2132060AFM	Air Injection Gasket	0452808
				EC2133060AFM	Air Injection Tube Gasket	0454454
				EX886042AM	Exhaust Gasket	0453672
				3234V	Valve Seal	0452390
				EC2134032AFM	Cam Chain Tensioner Gasket	0452417

RZR 570

Model	Year	Bore Size	Top End Kit	Component Part#	Component Description	OEM Part #
RZR 570	12,14-18	99mm	C3528-EST	B1171014RC	Base Gasket	5254903
				H3609021S	Head Gasket 99mm Bore	5813676
				3231V	Valve Seals 4 Req.	3610161
				EX817	Exhaust Gasket	5253989
				3254V	Valve Spring Seat With Seal	3610212
				EC1654020RC	Cam Chain Tensioner	5813449

RANGER RZR 800 (SXS)

Model	Year	Bore Size	Top End Kit	Component Part#	Component Description	OEM Part #
Ranger	08	80 mm	C3250	H2761030S	Head Gasket 80mm Bore	5247359
RZR 800 (SXS)		82 mm	C3507	H2761SP2030S	Head Gasket 82mm Bore	
				B0940010RC	Base Gasket	5247360
				EX452SP1064AM	Exhaust Gasket	5811511

RANGER RZR 800 (SXS)

Model	Year	Bore Size	Top End Kit	Component Part#	Component Description	OEM Part #
Ranger	11-13	80 mm	C3506	H3657010S	Head Gasket 80mm Bore	5254357
RZR 800 (SXS)		82 mm	C3508	H3657SP2010S	Head Gasket 82mm Bore	
				B0940010RC	Base Gasket	5247360
				EX452SP1064AM	Exhaust Gasket	5811511

All Component Parts can be purchased individually.



UTV Gaskets



Cometic Gasket - An Exclusive NASCAR Performance® Product

POLARIS UTV

XP900

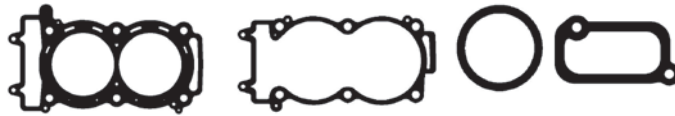

Head Base Cam Chain Tensioner Water Inlet

Model	Year	Bore Size	Top End Kit	Component Part#	Component Description	OEM Part #
XP900	11-14	93.5mm	C3446-EST	H3336018S	Head Gasket 93.5mm Bore	5813439
		96mm	C3447-EST	H3336SP1018S	Head Gasket 93.5mm Bore	
				B1079014RC	Base Gasket	5253037
				EC1654020RC	Cam Chain Tensioner	5813449
				WP383032AFM	Water Inlet Gasket	5813521
				EX817	Exhaust Gasket 2 req.	5253989
				3231V	Valve Seals 8 Req.	3610161

XP1000

Model	Year	Bore Size	Top End Kit	Component Part#	Component Description	OEM Part #
RZR XP1000	14-19	94mm	C3546-EST	H3892018S	Head Gasket 94mm Bore	5813737
RZR XP4 1000		96mm	C3563-EST	H3892SP1018S	Head Gasket 96mm Bore	5813737
900 Ace,	16-19			B1079014RC	Base Gasket	5253037
General 1000				EC1654020RC	Cam Chain Tensioner Gasket	5813449
Ranger 1000	18-19			EX1408064AM	Header Gasket	3610184
RZR 1000	16-19			3254V	Valve Spring Seat With Seal	3610212
RZR XP	16-19			MR135	Thermostat Seal	5413948
Turbo				MR136	Water Outlet O-ring	5813736

YAMAHA UTV

RHINO 660

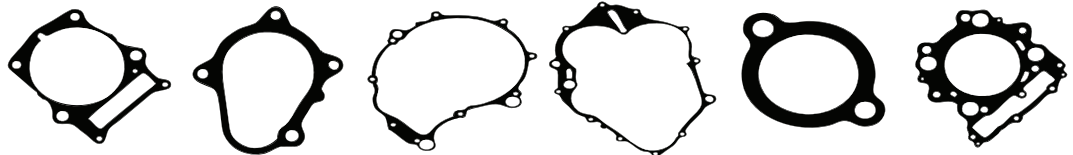

Base Starter Cover Mag Cover Clutch Cover Timing Chain Tensioner Head

Model	Year	Bore Size	Top End Kit	Component Part#	Component Description	OEM Part #
RHINO 660 (SXS)	04-07	100 mm	C7044-EST	H1481SP2030S	Head Gasket 100mm	3YF-11181-00
		101 mm	C7900-EST	H1481030S	Head Gasket 101mm	
		102 mm	C7798-EST	H1191030S	Head Gasket 102mm	
		103 mm	C3042-EST	H2174030S	Head Gasket 103mm	
		105 mm	C7909-EST	H1191SP1030S	Head Gasket 105mm	
				B0532010RC	Base Gasket	3YF-11351-00
				EX361	Exhaust Gasket 2 Req.	3YF-14613-01-00
				EC584018AFM	Cam Chain Tensioner Gasket	4DW-12213-00
				3187V	Valve Seal 5 Req.	5H0-12119-00-00
				R016B	Radiator Hose O-ring	93210-18417-00
				R113B	Valve Cover Plug O-ring	93210-13657-00
				R114S	Oil Tank O-ring	93210-16629-00
				R116B	Cam Chain Tensioner Cap O-ring	11101/93210-19522-00
				R117B	Dipstick O-ring	93210-21190-00
				R124B	Tappet Cover O-ring	93210-32172-00
				R155S	Cylinder Base O-ring	11256/93211-01467-00
				R71X2.5B	Intake Valve Adj. Cover O-ring	93210-71360-00
				WA081080C	Oil Line Washers 4 Req.	90430-08204
				WA082063C	Oil line Washers 4 Req.	90430-10171

All Component Parts can be purchased individually.



UTV Gaskets



Cometic Gasket - An Exclusive NASCAR Performance® Product

YAMAHA UTV



Base Timing Chain Tensioner Head

Model	Year	Bore Size	Top End Kit	Component Part#	Component Description	OEM Part #
RHINO 700	06-13	103 mm	C3142-EST	H2449027S	Head Gasket	3B4-11181-00-00
		104 mm	C3143-EST	H2449SP2027S	Head Gasket 104mm Bore	3B4-11181-00-00
		105.5 mm	C3144-EST	H2465027S	Head Gasket 105.5mm Bore	3B4-11181-00-00
				B0855010RC	Base Gasket	1S3-11351-00-00
				EX361	Exhaust Gasket 2 Req.	3YF-14613-01-00
				R034V	Throttle Body O-ring	4WV-14147-10-00
				R126V	Water Pump O-ring	93210-33786-00
				R131B	Thermostat O-ring	93210-41042-00
				R240V	Cam Cover O-ring	93210-96601-00
				R79X2.5V	Valve Cover O-rings 2 Req.	93210-78544-00
				3187V	Valve Seal 4 Req.	5H0-12119-00-00
				EC584018AFM	Cam Chain Tensioner Gasket	4DW-12213-00

WOLVERINE R-SPEC YXE700

Model	Year	Bore Size	Top End Kit	Component Part#	Component Description	OEM Part #
Wolverine Spec YXE700	2016	103mm	C3599-EST	EC2098032AFM	Cam Chain Tensioner Gasket	2MB-E2213-00-R-00
				MA0164	Cam Chain Tensioner Crush Gasket	2MB-E21E2-00-00
				B1306010RC	Cylinder Base Gasket	2MB-E1351-00-00
				H4173023S	103mm Bore Head Gasket	2MB-E1181-00-00
				VC362018AFM	Valve Cover Breather Gasket	2MB-E131B-00-00
				EX045	Header Gasket	3EG-14613-00-00
				WA117	Oil Line Banjo Bolt Crush Gaskets	2MB-E1195-00-00
				3187V	Exhaust Valve Seal	2MB-E2129-00-00
				3187V	Intake Valve Seal	2MB-E2119-00-00
				R125V	Water Outlet O-ring	2MB-E2843-00-00

YXZ1000R

Model	Year	Bore Size	Top End Kit	Component Part#	Component Description	OEM Part #
YXZ1000R	2016	82.5mm	C3617	EC1152032AFM	Cam Chain Tensioner Gasket	2C0-12213-00-00
				R116B	Fill Plug O-ring	93210-19123-00
				WA116	Cylinder Head Drain Plug Crush Washer	90430-08119-00
				H4270016S	Cylinder Head Gasket	2HC-11181-00-00
				EX651	Exhaust Gasket 3 Req.	4FM-14613-00-00
				3168V	Valve Stem Seal 12 Req.	2HC-12119-00-00

All Component Parts can be purchased individually.



ATV Gaskets



Cometic Gasket - An Exclusive NASCAR Performance® Product

ARCTIC CAT DVX400

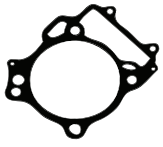

Base



Cam Chain



Clutch Cover

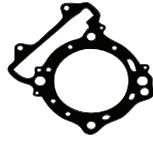

Head

Model	Year	Bore Size	EST Top End Kit	Component Part#	Component Description	OEM Part #
DVX400	03-08	92mm	C7978-EST	H0949027S	Head Gasket 92mm	3402-841
		94mm	C7979-EST	H1045027S	Head Gasket 94mm	
		96mm	C3138-EST	H1045SP2027S	Head Gasket 96mm	
		97mm	C7980-EST	H1046027S	Head Gasket 97mm	
				B0440027S	Base Gasket	3402-844
				EC377032AFM	Cam Tensioner Gasket	3402-137
				EX243	Exhaust Gasket	3512-007
				WA121	Oil Drain Bolt Gasket	3003-290
				3160V	Valve Stem Seals 4 Req	3402-078
				EC1030032AFM	Clutch Cover Gasket	3446-357

Model	Year	Bore Size	EST Top End Kit	Component Part#	Component Description	OEM Part #
650 H1	05-12	98 mm	C7220-EST	H1735SP3027S	Head Gasket 98mm Bore	0830-124
650 TRV	09	100 mm	C7022-EST	H1735SP4027S	Head Gasket 100mm Bore	0830-124
650 TBX	09			B0647014RC	Base Gasket	0830-084
650 4x4	10			EX657	Exhaust Gasket	0412-338
650 Mud Pro	10-11			EC377032AFM	Cam Chain Tens. Gasket	0830-018
				OS020	2 Req.-Cam Chain Tens. O-ring	0830-107
				R22X2.5V	Coolant Line O-ring	0830-007
				R45X3V	Intake O-ring	0830-090
				R54X2V	2 Req.-Valve Cover O-rings	0830-004

Model	Year	Bore Size	EST Top End Kit	Component Part#	Component Description	OEM Part #
Mud Pro	09-17	103.5mm	C3597-EST	H2223SP4027S	Head Gasket	0830-112
700 H1 EFI				B0760014RC	Base Gasket	0830-111
700 EFI	10-11			EX657	Exhaust Gasket	0412-338
TRV 700	09-15			OS020	Cam Chain Tensioner Gasket	0830-107
Alterra 700	2017			EC377032AFM	Cam Chain Tens. Gasket	0830-018
TBX 700	12-17			3186V	Valve Seals	0830-186
XR700	2015			R22X2.5V	Water Outlet O-ring	0830-007
700XT	13-14			R124V	Valve Cover O-rings 2 req.	0830-215
				R008B	Intake O-ring	0423-182
				R124V	Oil Fill Cap O-ring	0830-215
				R54X2V	Inspection Cap O-ring	0830-004

Model	Year	Bore Size	EST Top End Kit	Component Part#	Component Description	OEM Part #
1000 XT	16-17	93.5mm	C3568-EST	H2399SP6027S	Head Gasket 2 req	0830-209
EPS				B1155014RC	Base Gasket 2 req	0830-193
Mud Pro	16-17			EC377032AFM	Cam Chain Tens. Gasket 3 Req	0830-018
1000 Limited				R118V	Water Outlet O-ring	0830-007
EPS				EX657	Exhaust Gasket 2 Req	0412-338
				3186V	Valve Stem Seal 8 Req.	0830-186
				R012B	Head Drain O-ring	0830-213
				R54X2V	Tappet Cover O-ring	0830-004
				OS384	Thermostat Seal	0830-120
				R45X3V	Intake O-ring 2 req.	0830-090

All Component Parts can be purchased individually.



ATV Gaskets



Cometic Gasket - An Exclusive NASCAR Performance® Product

CAN-AM/BOMBARDIER DS450



Head



Base



Exhaust



Head



Base

Model	Year	Bore Size	EST Top End Kit	Component Part#	Component Description	OEM Part #	
DS450	10-13	97mm	C3266-EST	H2858027S	Head Gasket 97mm	420650210	
			C3453-EST	H2858SP4027S	Head Gasket 99mm		
			C3454-EST	H2858SP3027S	Head Gasket 100mm		
					B0970014RC	Base Gasket	420650390
					WA117	Temp Sensor Copper Seal ring	420250640
					3225V	Valve Stem Seals	420230510
					WA165063A	Cam Chain Tens. Crush Seal	420430622
			EX1189043F	Exhaust Gasket	707600445		
DS650	01-04	101 mm	C7711	H1155030S	Head Gasket 101mm	711650020	
			C7721	H1830030S	Head Gasket 102mm	711650020	
			C7722	H2403040S	Head Gasket 105.5mm	711650020	
		102 mm	B0657020F	Base Gasket 101mm	711650010		
			B0657020RC	Base Gasket 102mm			
			B0657SP2031F	Base Gasket 105.5mm			
			Component Part#	Component Description	OEM Part #		
Outlander 03-15 400		92mm	C3489-EST	H2653018S	92mm Head Gasket	420630195	
			C3490-EST	H2653SP1018S	93mm Head Gasket		
			C3491-EST	H2653SP2018S	94mm Head Gasket		
			C3492-EST	H2653SP5018S	95mm Head Gasket		
		93mm	3186V	Valve Stem Seal 4 Required	420230515		
			R117V	Cam Chain Tensioner O-ring	420430370		
			R15X1.5V	Cam Adjuster O-ring	420250890		
			EX696	Header Gasket	707600317		
			B0895010RC	Base Gasket	420630210		
			Component Part#	Component Description	OEM Part #		
Outlander STD, XT, MAX 1000	12-16	92mm	C3459-EST	H2653018S	92mm Head Gasket 2 Req.	420630195	
			C3460-EST	H2653SP1018S	93mm Head Gasket 2 Req.		
			C3461-EST	H2653SP2018S	94mm Head Gasket 2 Req.		
			C3462-EST	H2653SP5018S	95mm Head Gasket Req.		
		93mm	3186V	Valve Stem Seal 8 Required	420230515		
			R117V	Cam Chain Tensioner O-ring	420430370		
			R15X1.5V	Cam Adjuster O-ring	420250890		
			EX696	Header Gasket 2 Required	707600317		
			B0895010RC	Base Gasket 2 Required	420630210		
			Bottom End Gaskets Available Separately				
			EC1652020F	Center Case Gasket	420651225		
			EC1651020F	PTO Cover Gasket	420651211		
			EC1171032AFM	Magneto Cover Gasket	420651200		

HONDA

Model	Year	Bore Size	Top End Kit	Component Part#	Component Description	OEM Part #
ATC70	78-85	49 mm	C7228	H0326043F	Head Gasket	12251-111-505
TRX70	86-87	49 mm		B0193020F	Base Gasket	12191-GW8-681
				Component Part#	Component Description	OEM Part #
				EC901032AFM	Clutch Side Engine Cover	11394-GW8-680

All Component Parts can be purchased individually.



ATV Gaskets



Cometic Gasket - An Exclusive NASCAR Performance® Product

HONDA TRX90

Model	Year	Bore Size	EST Top End Kit	Component Part#	Component Description	OEM Part #					
TRX90	93-16	50 mm	C7226-EST	H2710040S	Head Gasket	12251-GB5-811					
				B0659020RC	Base Gasket	12191-GW8-681					
				3234V	Valve Stem Seals 2 Req.	12209-GB4-681					
				EC1070018AFM	Right Head Cover	12394-GW8-680					
				EC1071018AFM	Left Head Cover	12395-GW8-680					
				EC1072018AFM	Center Head Cover	12391-GW8-680					
				R027B	Valve Cap O-rings 2 Req.	91302-001-020					
				R14X2.5V	Oil Return O-ring	91301-GF6-003					
				R16X2V	Base O-ring	91303-035-000					
				R9X2V	Valve Guide O-rings 2 Req.	91305-028-900					
				Component Part#	Component Description	OEM Part #					
				EC901032AFM	Clutch Side Engine Cover	11394-GW8-680					
				Top End Kit C7224	Component Part# H0332020C	Component Description Head Gasket	OEM Part # 12250-VM6-003				
TRX125	85-86	55 mm	C7224	B0195043F	Base Gasket	12191-VM6-306					
				Component Part# H0331043F	Component Description Head Gasket	OEM Part # 12251-HB6-000/405					
TRX125	87-88	57 mm	C7223	B0021020F	Base Gasket	12191-KT0-710					
				Component Part# H0016043F	Component Description 67mm Bore Head Gasket	OEM Part # 12251-4B6-405					
ATC185	80-83	67 mm	C7025	B0021020F	Base Gasket ATC 185-200	12191-KT0-710					
				B0164020F	Base Gasket ATC 200ES Models						
				Top End Kit C7222	Component Part# H0335SP1043F	Component Description Head Gasket 67mm Bore	OEM Part # 12251-HB3-003				
				ATC200	81-83	67 mm	C7222	B0168020F	Base Gasket	12191-HFI-910	
								Top End Kit C7021	Component Part# H0014043F	Component Description Head Gasket	OEM Part # 12254-961-010
								B0018020F	Base Gasket	12191-961-306	
				ATC200E	82-83	67 mm	C7021	IR004018AFM	Intake Gasket	14132-430-000	
ATC200ES	84	67 mm	C7021	Component Part# H0009010S	Component Description Head Gasket 68mm	OEM Part # 12254-KS7-881					
ATC200M	84-85	67 mm	C7349	H0195010S	Head Gasket 69.5mm						
ATC200S	85-86	67 mm	C7350	H0196010S	Head Gasket 72mm						
ATC200X	83-85	67 mm	C7351	B0019020F	Base Gasket	12191-HA2-306					
TRX200	84	67 mm	C7351	IR004018AFM	Intake Gasket Cylinder to Reed	14132-430-000					
		69.5 mm	C7351	IR005018AFM	Intake Gasket Reed Block to Intake Manifold	14133-430-000					
ATC200X	86-87	67 mm	C7222	Component Part# EC313020F	Component Description Crankcase Gasket	OEM Part # 11191-HA2-306					
TRX200	90-95	67 mm	C7222	WP071018AFM	Water Pump Gasket	19229-HA2-306					
TRX200SX	86-88	67 mm	C7222	WA133	Water Pump Drain Plug	90543-273-000					
		72 mm	C7021	R020V	Output Shaft O-ring	91201-430-003					
ATC250R	81-84	72 mm	C7021	R16X3V	Fill Plug O-ring	91303-800-000					
		72 mm	C7021	R141SB	Balancer Shaft O-ring	91308-500-010					
		72 mm	C7021	WA137	Drain Plug Gasket	94109-12000					
ATC250R	85-86	68 mm	C7349	Component Part# OS106	Component Description Right Crank Seal	OEM Part # 91201-KA4-004					
		69.5 mm	C7350	OS227	Water Pump Seal	91201-965-000					
		72 mm	C7351	OS197	Shift Shaft Seal	91202-444-023					
			C7349BE	OS108	Left Crank Seal	91202-HA2-771					
			C7349BE	OS239	Start Shaft Seal	91204-KF0-003					
			C7349OS	OS244	Clutch Pushrod Seal	91206-VA3-J02					
			C7349OS	OS173	Output Shaft Seal	91207-ML3-003					
			C7349CM	Component Part# EC311032AFM	Component Description Clutch Cover Gasket	OEM Part # 11395-HA2-P00					
			C7349CM	EC312060AFM	Mag Cover Gasket	11352-HA2-306					

All Component Parts can be purchased individually.



ATV Gaskets



Cometic Gasket - An Exclusive NASCAR Performance® Product

HONDA ATC250ES

Model	Year	Bore Size	Top End Kit	Component Part#	Component Description	OEM Part #
ATC250ES	85-87	76 mm	C7026-EST	H4633SP1027S	Head Gasket	12251-HA0-004
ATC250SX	85-87			B0022020F	Base Gasket	12191-HA7-921
TRX250	85-87			EC036018AFM	Cam Chain Tensioner	12194-HC5-740
TRX300	85-01			MA0164	Cam Chain Crush Washer	90442-397-000
				3231V	Valve Stem Seal	12209-KL4-005
				R7X2.5B	Rocker Arm O-rings 7.7x2.5	91303-428-003
				R78X2V	Cylinder Base O-ring 78.3x2	91304-HA0-003
				WA116	Oil line Crush Washer)3(7mm	90441-MC0-000
				R57X2V	Tappet Cover O-ring (2)	12392-HC4-005
				R10X2V	Valve Guide O-ring 10x 1.6 (2)	91301-200-000
				R126V	Intake O-ring 33.7x2.4	91305-HA0-680
				EX651	Header Gasket	18291-MN4-920
			EST Top End Kit	Component Part#	Component Description	OEM Part #
TRX250EX	01-16	70mm	C3153-EST	H2473010S	Head Gasket	12251-HN6-000
TRX250TE	02-17			3231V	3231V Valve Seals 4 Req.	12209-KL4-005
TRX250TM	02-17			B0846020RC	Base Gasket	12191-HM8-000
TRX250X	2016			EX691064AM	Exhaust Gasket	18291-MN5-650
				R10X2V	Valve Guide O-ring 2 req.	91301-200-000
				R219V	Tappet Cover O-rings 2 Req.	12392-HC4-005
				R8X2V	Rocker Shaft O-rings 2 Req.	91303-428-003
				Component Part#	Component Description	OEM Part #
				VC135018AFM	Valve Cover Gasket	12315-HN6-010
				EC1092032AFM	Clutch Cover Gasket	11394-HM8-000
			EST Top End Kit	Component Part#	Component Description	OEM Part #
TRX250X	87-92	75 mm	C7143-EST	H2475027S	75mm Bore Head Gasket	12251-HC0-013
		78 mm	C7906-EST	H2475SP2027S	78mm Bore Head Gasket	12251-HC0-013
				3231V	Valve Seals 4 Req.	12209-KL4-005
				B0165020F	Base Gasket	12191-HM3-670
				EC036018AFM	Cam Chain Tensioner Gasket	12194-HC5-740
				R10X2V	Valve Guide O-ring 4 req.	91301-200-000
				R35X3V	Intake Manifold O-ring	91305-HA5-000
				R57X2V	Tappet Cover O-ring	12392-HC4-005
				R78X2V	Base O-ring	91302-428-000
				R7X2.5B	Rocker Shaft O-rings 2 Req.	91303-428-003
				Component Part#	Component Description	OEM Part #
				C7712	Clutch Cover Gasket	11395-HA2-003
			EST Top End Kit	Component Part#	Component Description	OEM Part #
Fourtrax	92-09	75 mm	C7143-EST	H2475027S	75mm Bore Head Gasket	12251-HC0-013
TRX300EX		78 mm	C7906-EST	H2475SP2027S	78mm Bore Head Gasket	12251-HC0-013
		80 mm	C7525-EST	H2475SP3027S	80mm Bore Head Gasket	12251-HC0-013
		81 mm	C7527-EST	H2475SP5027S	81mm Bore Head Gasket	12251-HC0-013
				B0165020F	Base Gasket	12191-HM3-670
				3231V	Valve Seals 4 Req.	12209-KL4-005
				EC036018AFM	Cam Chain Tensioner Gasket	12194-HC5-740
				R10X2V	Valve Guide O-ring 4 req.	91301-200-000
				R35X3V	Intake Manifold O-ring	91305-HA5-000
				R57X2V	Tappet Cover O-ring	12392-HC4-005
				R78X2V	Base O-ring	91302-428-000
				R7X2.5B	Rocker Shaft O-rings	91303-428-003
			Bottom End Kit w/o crank seals	Component Part#	Component Description	OEM Part #
			C3332	C7712	Clutch Cover Gasket	11395-HA2-003
				EC309020F	Starter Cover Gasket	11356-HM3-670
				EC310020F	Centercase Gasket	11191-HM3-670
				EC308020F	Mag Cover Gasket	11395-HM3-670
			Top End Kit	Component Part#	Description	OEM Part#
ATC350X	85-86	82 mm	C7402	H2043027S	Head Gasket 82mm Bore	12251-HA0-003/004/005
TRX350, D	86-89	86 mm	C7405	H2044027S	Head Gasket 86mm Bore	12251-HA0-003/004/005
				B0199020F	Base Gasket	12191-HA7-921

All Component Parts can be purchased individually.



ATV Gaskets



Cometic Gasket - An Exclusive NASCAR Performance® Product

HONDA TRX350ES

Model	Year	Bore Size	Top End Kit
TRX350ES	00-06	80mm	C3690
TRX350FM			
Fourtrax Rancher			
TRX350TE			
TRX350TM			
Fourtrax Rancher			

Component Part#	Component Description	OEM Part #
VC057018AFM	Valve Cover Gasket	12315-HN5-671
H1187010S	Head Gasket	12251-HN5-671
B0573020F	Base Gasket	12191-HN5-670
EX651	Exhaust Gasket	18291-MN4-920
R126V	Intake Gasket	91305-HN5-671
R8X2V	Cam Tower O-ring	91303-428-003
3231V	Valve Stem Seal	12209-KL4-005
R10X2V	Valve Guide O-rings	91301-200-000

EST			Component Part#	Component Description	OEM Part #
Model	Year	Top End Kit			
TRX400EX	05-08	86 mm	H0401027S	Head Gasket 86mm .027"	12251-KCY-671
TRX400EX	96-04	87 mm	H0401SP2027S	Head Gasket 87mm .027"	
TRX400X	09-14	89 mm	H0402027S	Head Gasket 89mm .027"	12251-KCY-67
			B0244020RC	Base Gasket .020"	12191-KCY-671
			R88X2B	Cylinder Base O-ring	91302-356-000
			EX691064AM	Exhaust Gasket 2 Req.	18291-MN5-650
			EC578020RC	Cam Chain Tensioner Gasket	14523-KBB-901
			R10X2V	Valve Guide O-Ring	91301-200-000
			3231V	Valve Seals 4 Req.	12209-KL4-005
			R011V	Cam Chain Tensioner O-ring	91306-MG3-000
			R127V	Valve Adj. Cap O-rings 4 Req.	91301-428-003
			R132V	Intake Manifold O-ring	91301-679-003
			R219V	Exhaust O-ring	18291-MN5-650
			R45.5X2.5V	Intake O-ring	91303-397-000
		Bottom End Kit	Component Part#	Component Description	OEM Part #
		C3342	EC1222020F	Center Case Gasket	11191-HN1-A40
			C7714	Clutch Cover Gasket	11394-KCY-671
			EC361020F	Mag Cover Gasket	11395-KCY-671
			EC363020F	Clutch Cover Gasket 05-14	11377-HN1-000
		Bottom End Kit	Component Part#	Component Description	OEM Part #
		w/o crank seals	EC362020F	Center Case Gasket	11191-HN1-000
TRX400EX	1999-2004	C7825BE	EC363032AFM	Starter Cover Gasket	11377-HN1-000
			WA129	Oil Tank Drain Plug Washer	90441-425-000
			WA130	Oil Pump Drain Washer	90463-ML7-000
			R18X3V	Oil Tank Dipstick O-ring	91302-KE8-003
			R54X2.5	Oil Filter O-ring	91302-KF0-003
			R114B	Timing Mark O-ring	91303-377-000
			R214V	Oil Tank Strainer O-ring	91305-384-750
			R27X2V	Crank End O-ring	91305-KF0-003
			R013V	Oil line O-ring	91305-PE2-003
			R214V	Starter Motor O-ring	91312-MG7-003
			R112V	Oil line O-ring	91314-HN6-000
			WA137	Drain Plug Washer	94109-12000
			MR049	Oil Pump Gasket	15152-KCY-670
		Oil Seal Kit	Component Part#	Component Description	OEM Part #
		C7825OS	OS286	Clutch Pushrod Oil Seal	91204-KK0-003
			OS254	Shift Shaft Seal	91202-965-003
			OS257	Output Shaft Seal	91203-KCY-671
			OS236	Oil Pump Seal	91201-KF0-00391201-HM3-A61
		Clutch & Mag Kit	Component Part#	Component Description	OEM Part #
		C7825CM	EC344032AFM	Clutch Cover Gasket	11394-KCY-671
			EC361032AFM	Mag Cover Gasket	11395-KCY-671
					11395-KCY-672

HONDA FOURTRAX

Model	Year	Bore Size	Top End Kit
Fourtrax	95-03	88 mm	C7301
Foreman		95 mm	C7644
400			

Component Part#	Component Description	OEM Part #
H0434043F	Head Gasket	12251-HM7-004
H0877043F	95mm Bore Head Gasket	12251-HM7-004
B0259020F	Base Gasket	12191-HM7-003
B0401020F	Big Bore Base Gasket	12191-HM7-003
Component Part#	Description	OEM Part#
EC611020F	Clutch Cover Gasket	11394-HM7-003

All Component Parts can be purchased individually.



ATV Gaskets



Cometic Gasket - An Exclusive NASCAR Performance® Product

HONDA TRX450R

Model	Year	Bore Size	EST	Component Part#	Component Description	OEM Part #	
TRX450R	04-05	94 mm 95 mm 96 mm 97 mm 100 mm 101 mm	Top End Kit				
			C7877-EST	H2175027S	94mm Bore Head Gasket	12251-HP1-671	
			C7199-EST	H2084027S	95mm Bore Head Gasket	12251-HP1-671	
			C7878-EST	H2084SP1027S	96mm Bore Head Gasket	12251-HP1-671	
			C7201-EST	H2129027S	97mm Bore Head Gasket	12251-HP1-671	
			C3079-EST	H2131SP2027S	100mm Bore Head Gasket	12251-HP1-671	
			C3076-EST	H2131SP1027S	101mm Bore Head Gasket	12251-HP1-671	
				B0741014RC	Base Gasket	12191-HP1-671	
				B0741SP1014RC	Big Bore Base Gasket 99mm and Larger	12191-HP1-671	
				EX657	Exhaust Gasket	4BE-14613-00-00	
				EC979032AFM	Cam Chain Tensioner Gasket	14523-MAL-A00	
				MA0164	Tensioner Bolt Washer	90442-397-000	
				3231V	Valve Seals 4 Req.	12209-KL4-005	
				R45.5X2.5V	Thermostat Cover O-ring	91373-733-003	
				Bottom End Kit	Component Part#	Description	OEM Part#
				C3331	EC982032AFM	Inner Clutch Cover Gasket	11394-HP1-670
					EC981032AFM	Mag Cover Gasket	11395-HP1-670
					EC980020F	Center Case Gasket	11191-HP1-670
					MA0165	Crankcase Oil Drain Washer	90474-333-000
					R10X2V	Breather Joint O-Ring	91304-HA5-003
					R14X2.5V	Timing Mark Sight Plug O-ring	91303-377-000
					R18X2.5V	Inner Clutch Dowel O-ring	91256-383-721
					R18X3V	Trans./Engine Oil Fill Plug O-rings 2 Req.	91307-035-000
		R27X2V	Inner Clutch Plug O-ring	91305-KF0-003			
		R40X2V	Oil Filter Cover O-ring	91302-PA9-003			
		R8.5X2V	Relief Valve O-ring	90751-GK1-003			
		WA128	Crush Washer Case Oil Seal	90463-ML7-000			
		Component Part#	Component Description	OEM Part #			
TRX450R, ER	06-14	96 mm 98 mm 99 mm 101 mm	EST				
			Top End Kit				
			C3139-EST	H2458027S	96mm Bore Head Gasket	12251-MEY-671	
			C3141-EST	H2458SP1027S	98mm Bore Head Gasket		
			C3272-EST	H2459027S	99mm Bore Head Gasket		
			C3156-EST	H2460027S	101mm Bore Head Gasket		
				B0856014RC	Base Gasket	12191-HP1-601	
				EX657	Exhaust Gasket	18291-MEB-670	
				EC960018AFM	Cam Chain Tensioner Gasket	14560-MEN-671	
				EC979032AFM	Cam Chain Tensioner Gasket Early	14523-MAL-A00	
				3231V	Exhaust Valve Seals 2 Req.	12209-KL4-005	
				3234V	Intake Valve Seals 2 Req.	12209-GB4-682	
				MA0164	Cam Chain Tensioner Bolt Seal	90442-397-000	
				R45.5X2.5V	Thermostat Housing Gasket	91373-733-003	
				Bottom End Kit	Component Part#	Description	OEM Part#
				C3139BE	WA118	Case Seal Crush Washer 8 Req.	90488-425-000
					EC1134020F	Center Case Gasket	11191-HP1-600
					EC978	Clutch Cover O-ring	11352-HP1-670
					EC1133032AFM	Inner Clutch Cover Gasket	11394-HP1-600
					EC1223032AFM	Mag Cover Gasket	11395-HP1-600
					WA111	Water Pump Crush Washer	90447-KE1-000
					R8X2V	Relief Valve O-ring	90751-GK1-003
					R18X2.5V	Case Dowel O-ring	91256-383-721
		R40X2V	Oil Filter O-ring	91302-PA9-003			
		R14X2.5V	Timing Plug O-ring	91303-377-000			
		R27X2V	Right Case Plug O-ring	91305-KF0-003			
		R18X3V	Fill Plug O-rings 2 Req	91307-035-000			
		WA137	Drain Plug Gasket	94109-12000			
		Component Part#	Description	OEM Part#			
		OS292	Right Crank Seal	91202-HP1-601			
		OS262	Balancer Shaft Seal	91204-HP1-601			
		OS264	Left Crank Seal	91201-MEB-671			
		OS227	Shift Shaft Seal	91203-KA4-771			
		OS289	Oil Pump Seal	91203-HP1-601			
		OS239	Start Shaft Seal	91204-KF0-003			
		OS240	Clutch Pushrod Seal	91205-MEB-671			
		OS238	Output Shaft Seal	91207-ML3-871			

All Component Parts can be purchased individually.



ATV Gaskets



Cometic Gasket - An Exclusive NASCAR Performance® Product

HONDA TRX450S/ES

Model	Year	Bore Size	Top End Kit
TRX450 S/ES	98-01	92mm	C3689
TRX450 FM/FE	02-04		

Component Part#	Component Description	OEM Part #
H2628040S	Head Gasket 92mm bore	12251-HN0-670
B0888020RC	Base Gasket	12191-HM7-013
C415032AFM	Valve Cover Gasket	12315-HM7-005
3231V	Valve Stem Seal	12209-KL4-005
R37X2.4V	Intake O-ring 37x2.4	91305-HN0-A00
R013V	Valve Guide O-rings 10 x 1.6	91306-105-690
EC2383018AFM	Chain Tensioner Gasket	14523-HM7-000
EX651	Header Gasket	18291-MN4-920

HONDA TRX500FA

Model	Year	Bore Size	Top End Kit
TRX500FA Foreman Rubicon	01-14	93mm	C3628

Component Part#	Component Description	OEM Part #
EC036032AFM	Cam Chain Tensioner Gasket	12194-HC5-740
MA0164	Cam Chain Tensioner Crush Washer	90442-397-000
3231V	Valve Stem Seal	12209-KL4-005
R9.5X1.5V	Rocker Arm O-rings	91306-MG3-000
B0564	Cylinder Base gasket	12191-HN2-000
R57X2V	Tappet Cover Gasket	91308-500-000
VC055	Valve Cover Gasket	12315-HN2-003
H1393	Head Gasket	12251-HN2-003
EX651	Header Gasket	18291-MN4-920

TRX680F RINCON

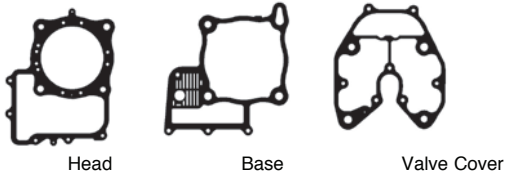

Model	Year	Bore Size	EST Top End Kit
TRX680FA	06-17	102 mm	C3475-EST

Component Part#	Component Description	OEM Part #
VC080020RC	Valve Cover Gasket	12315-HN8-000
R57X2V	Tappet Cover Gasket	91308-500-000
H1835027S	Cylinder Head Gasket	12251-HN8-A61
B0665010S	Cylinder Base Gasket	12191-HN8-000
EX651	Exhaust Gasket	18291-MM5-860
3231V	Valve Stem Seal	12209-KL4-005
EC036032AFM	Cam Chain Tensioner	12194-HC5-740
R9.5X1.5V	Rocker Arm O-rings	91306-MG3-000

TRX700XX

Model	Year	Bore Size	EST Top End Kit
TRX700XX	08-09	102 mm 104 mm	C3420-EST C3286-EST

Component Part#	Component Description	OEM Part #
H3025SP3027S	Head Gasket 102 mm Bore	12251-HP6-A01
H3025027S	Head Gasket 104 mm Bore	
R119B	Water Outlet Oring	91356-169-003
R5.7X1.9B	Dowel Pin O-ring	91305-323-000
B1012020RC	Base Gasket	12191-HP6-A01
EC898018AFM	Cam Chain	14560-KCW-851
3225V	Valve Seals 4 Req.	12209-413-003
EX657	Exhaust Gasket	18291-MEB-670

KAWASAKI KXT250

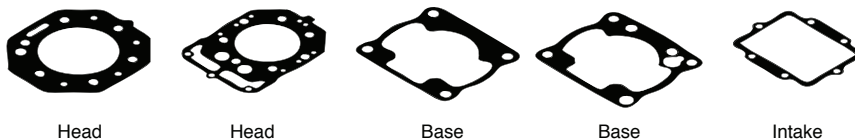

Model	Year	Bore Size	Top End Kit
KXT250 Tecate	83-85	72 mm 76 mm	C7049 C7326

Component Part#	Component Description	OEM Part #
H0022043F	Head Gasket 72mm	11004-1057
H0022SP1043F	Head Gasket 76mm	
B0025020F	Base Gasket	11009-1318
H0023043F	Head Gasket 72mm	11004-1144
H0197043F	Head Gasket 76mm	
B0026020F	Base Gasket	11009-1546
IR008018AFM	Intake Gasket	11009-1050
R136V	Exhaust O-Ring	671E2550

All Component Parts can be purchased individually.



ATV Gaskets



Cometic Gasket - An Exclusive NASCAR Performance® Product

KAWASAKI KFX250



Head



Head



Base



Base

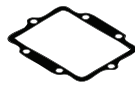

Intake

Model	Year	Bore Size	Top End Kit	Component Part#	Component Description	OEM Part #
KFX250 Mojave	87-05	77 mm	C7244	B0198020F	Base Gasket	11060-1125
				H0341010C	77mm Head Gasket	11004-1121
				Component Part#	Component Description	OEM Part #
				EC618020F	Clutch Cover Gasket	11060-1238
				Component Part#	Component Description	OEM Part #
EST						
Top End Kit						
KLF250 Bayou	88-06	70 mm	C7243-EST	H0261040S	Head Gasket 70mm	11004-1375
				B0169020F	Base Gasket	11061-1104
				EX692064AM	Exhaust Gasket	11009-1866
				R10X2V	Valve Guide O-Ring 2 Req	92055-1177
				R95X2V	Cam Sprocket Cover O-Ring	671B2595
				R70X2S	Cylinder O-Ring	92055-1672
				R32X3V	Intake O-Ring 2 Req	92055-1256
				R118B	Cam Tensioner O-Ring	670B2021
				R227V	Rocker Cap O-Ring 2 Req	92055-112
				3241V	Valve Stem Seals 2 Req	92049-1062
				EC1088032AFM	Clutch Cover Gasket	11060-1648
Top End Kit				Component Part#	Component Description	OEM Part #
KXF250 Tecate 4	87-88	69.5 mm	C7039	H0034043F	Head Gasket 69.5	11004-1157
				H0204043F	Head Gasket 74mm	
		74 mm	C7323	B0032020F	Base Gasket	11009-1624
				IR008018AFM	Intake Gasket	11009-1252
				PV012020F	Power Valve Gasket	11009-1625
R136V	Exhaust O-Ring	671E2525				



Head

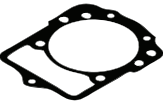

Base

Model	Year	Bore Size	Top End Kit	Component Part#	Component Description	OEM Part #		
KLF300	86-87	77 mm	C7245	H0256043F	Head Gasket	11004-1136		
				B0163020F	Base Gasket	11060-1221		
				Component Part#	Component Description	OEM Part #		
Top End Kit								
KEF300 Lakota	97-03	79 mm	C7248	B0163020F	Base Gasket	11060-1652		
				H0256020C	Head Gasket 79mm	11004-1183		
KLF300	92-03			Component Part#	Component Description	OEM Part #		
KLF300 Bayou 4x4	89-05			EC598020F	Clutch Cover Gasket 2WD	11060-1655		
				Component Part#	Component Description	OEM Part #		
EST								
Top End Kit								
KLX 400	03-04	92 mm	C7688-EST	H0949027S	Head Gasket 92mm	11004-S006		
		94 mm	C7806-EST	H1045027S	Head Gasket 94mm			
		95mm	C7963-EST	H1699027S	Head Gasket 95mm			
		97 mm	C7980-EST	H1046027S	Head Gasket 97mm			
						B0440010RC	Base Gasket	11061-S091
						EX243	Exhaust Gasket	11061-S076
						EC377032AFM	Cam Tensioner Gasket	11061-S073
						WA121	Oil Check Washer	11061-S006
						3160V	Valve Stem Seal 4 Req	92049-S006
						Component Part#	Component Part#	OEM Part#
				EC837032AFM	Clutch Cover	92055-S080		
Top End Kit				Component Part#	Component Description	OEM Part #		
KLF400 Bayou 4x4	93-02	84.5 mm	C7249	H0340010C	Head Gasket	11004-1233		
				B0201020F	Base Gasket	11060-1205		
KVF400	99-02							

All Component Parts can be purchased individually.



ATV Gaskets



Cometic Gasket - An Exclusive NASCAR Performance® Product

KAWASAKI KFX400



Head

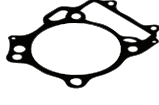

Base



Cam Chain Tensioner

Model	Year	Bore Size	EST Top End Kit	Component Part#	Component Description	OEM Part #	
KFX400	03-06	92 mm	C7978-EST	H0949027S	Head Gasket 92mm	11004-S006	
			94 mm	C7979-EST	H1045027S		Head Gasket 94mm
			96 mm	C3138-EST	H1045SP2027S		Head Gasket 96mm
		97 mm	C7980-EST	H1046027S	Head Gasket 97mm		
					B0440027S	Base Gasket	11061-S070
					EX243	Exhaust Gasket	11061-S076
					EC377032AFM	Cam Tensioner Gasket	11061-S073
					WA121	Oil Drain Bolt Gasket	11061-S005
					3160V	Valve Stem Seals 4 Req	92049-S006
					Component Part#	Component Description	OEM Part #
					EC1030032AFM	Clutch Cover Gasket	11061-S071
					EC1034032AFM	Mag Cover Gasket	11061-S072
					Component Part#	Component Part#	OEM Part#
			EC1030032AFM	Clutch Cover Gasket	11061-S071		
			EC1034032AFM	Mag Cover Gasket	11061-S072		
KFX450R	08-14	96 mm	C3201-EST	H2466027S	Head Gasket 96.5mm	11004-0073	
			98 mm	C3202-EST	H2466SP1027S		Head Gasket 98mm
					B0911020RC	Base Gasket	11061-0234
					EC1080032AFM	Cam Tensioner Gasket	11061-0260
					R013V	Water Temp O-Ring	92055-0016
					R022V	Spark Plug O-Ring	92055-0046
					R10X2V	Cam Chain Tensioner O-Ring	670D2010
					3241V	Valve Stem Seals 4 Req	92049-1062
					Component Part#	Component Description	OEM Part #
					R011B	Case Oil Feed O-ring	670D1508
					WA108	Drain Plug Seal	92065-097
					R20X2V	Clutch Fill Plug O-ring	92055-1146
					R141SB	Oil Pump Cover O-ring	92055-0110
			R015V	Timing Plug O-ring	92055-1141		
			R123V	Crank Plug O-ring	92055-091		
			R138SB	Oil Filter O-rings (2)	92055-1577		
			R008B	Oil Line O-rings (3)	670D1505		
			EC1185032AFM	Inner Clutch Cover Gasket	11061-0236		
			R010B	Oil Pipe O-rings (2)	670D1507		
			R214B	Starter Motor O-ring	92055-1276		
			WP209018AFM	Water Pump Cover	11061-0237		
			WA118	Water Pump Bolt Seal	92022-304		
			Component Part#	Component Description	OEM Part #		
			OS331	Shift Shaft Seal	92051-005		
			OS339	Clutch Shaft Seal	92049-1475		
			OS295	Out Put Shaft Seal 30x40x7	92049-0030		
			OS277	Oil Pump Seal 12x24x7	92049-0040		
			OS227	Water Pump Seal 12x22x5	92049-0041		
			OS275	Clutch Pushrod Seal 10x20x5	92049-1542		
			Component Part#	Component Description	OEM Part #		
			EC1184032AFM	Clutch Cover	11061-0259		
			EC1183032AF	Mag Cover Gasket	11061-0235		

All Component Parts can be purchased individually.



ATV Gaskets



Cometic Gasket - An Exclusive NASCAR Performance® Product

KAWASAKI KV650

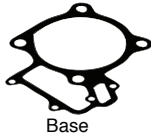
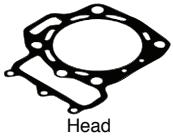

Model	Year	Bore Size	EST Top End Kit	Component Part#	Component Description	OEM Part #
KVF650	01-03	81 mm	C7981-EST	H1893010S	Head Gasket 81mm 2 Req	11004-1373
Prairie 4x4		83 mm	C7982-EST	H1894010S	Head Gasket 83mm 2 Req	11004-1373
KFX700	04-07	84 mm	C3125-EST	H1894SP7010S	Head Gasket 84mm 2 Req	11004-1373
V Force		85 mm	C7173-EST	H1983010S	Head Gasket 85mm 2 Req	11004-1384
KVF700	04-07	87 mm	C3163-EST	H2513SP1010S	Head Gasket 87mm 2 Req	
Prairie		89 mm	C3162-EST	H2513010S	Head Gasket 89mm 2 Req	
		90mm	C3212-EST	H2513SP3010S	Head Gasket 90mm 2 Req	
				B0677020RC	Base Gasket 2 Req	11060-1965
				EX361	Exhaust Gasket 2 Req	11009-1894
				R129B	Intake O-Rings 2 Req	92055-1295
				R140V	Rocker Cap O-Ring 4 Req	92055-1644
				R14X2.5V	Oil Cap O-Ring	670D2014
				R16X2V	Water Pipe O-Ring 2 Req	670B2016
				3242V	Valve Stem Seals 8 Req	92049-1218
			EST Top End Kit	Component Part#	Component Description	OEM Part #
KVF750	08-16	85mm	C3284-EST	H2624SPA010S	Head Gasket 85mm	11004-0011
Brute Force		90 mm	C3251-EST	H2624SP1010S	Head Gasket 90mm	11004-0011
				B0951020RC	Base Gasket	11061-0063
				EX361	Exhaust Gasket 2 req	11009-1894
				WA114	Coolant Drain Washer 2 Req	
				R55X2V	Rocker Cap O-Ring 4 Req	92055-0112
				R19X2V	Plug Cover O-Ring 2 Req	92055-1146
				3242V	Valve Stem Seals 8 Req	92049-1218

KTM 450SX

Model	Year	Bore Size	EST Top End Kit	Component Part#	Component Description	OEM Part #
450 SX ATV	07-10	97mm	C3412-EST	H2623027S	Head Gasket 97mm Bore	77330036000
				R010V	Oil Jet O-rings	0770060015
				R9X1.5V	Head Oil Plug O-ring	0770090015
				EX873059F	Exhaust Gasket	77336041000
				R014V	Head Coolant Plug Gasket	0770090015
				R25X2V	Cam Tower Plug Well O-ring	0770025020
				3225V	Valve Stem Seals	59036027000
				R013B	Cam Chain Tensioner O-ring	0770010010
				WA145	Cam Chain Tens. Crush Seal	0603242920
				R18X2.5V	Cam Chain Tens. Piston O-ring	0770180020
				R014V	Cam Chain Bushing O-ring	0770012015
				R017B	Cam Axle O-ring	0770015018
				R046V	Base O-ring	0770108018
				B0928	Cam Galley Base O-ring	77330035000
			EST Top End Kit	Component Part#	Component Description	OEM Part #
505 SX ATV	07-10	100mm	C3413-EST	H2623SP1027S	Head Gasket 100mm Bore	77330036000
				R010V	Oil Jet O-rings	0770060015
				R9X1.5V	Head Oil Plug O-ring	0770090015
				EX873059F	Exhaust Gasket	77336041000
				R014V	Head Coolant Plug Gasket	0770090015
				R25X2V	Cam Tower Plug Well O-ring	0770025020
				3225V	Valve Stem Seals	59036027000
				R013B	Cam Chain Tens. O-ring	0770010010
				WA145	Cam Chain Tens. Crush Seal	0603242920
				R18X2.5V	Cam Chain Tens. Piston O-ring	0770180020
				R014V	Cam Chain Bushing O-ring	0770012015
				R017B	Cam Axle O-ring	0770015018
				R046V	Base O-ring	0770108018
				B0928	Cam Galley Base O-ring	77330035000

All Component Parts can be purchased individually.



ATV Gaskets



Cometic Gasket - An Exclusive NASCAR Performance® Product

KTM 450 XC

Model	Year	Bore Size	EST Top End Kit	Component Part#	Component Description	OEM Part #	
450 XC ATV	08-10	89 mm	C3263-EST	H1017SP2040S	Head Gasket 89mm Bore	59530036000	
		91mm	C3264-EST	H1017040S	Head Gasket 91mm Bore		
				B0480020RC	Base Gasket	59030035050	
				3225V	Valve Seals 4 Req.	59036027000	
				EC495018AFM	Cam Chain Tensioner Gasket	59036003050	
				EX281042AM	Exhaust Gasket	59036041000	
				R019V	Rocker Arm O-ring	770191016	
				R40X2.5B	Oil Filter O-rings 2 Req.	770400025	
				VC027031F	Valve Cover Gasket 2 Req.	58036053000	
				WA005063C	Crush Washers 4 Req.	603061001	
				WP114018AFM	Water Pump Gasket	59035053000	
			EST Top End Kit	Component Part#	Component Description	OEM Part #	
525 XC ATV	08-10	95 mm	C7944-EST	H1521040S	Head Gasket 95mm Bore	5813169	
		96 mm	C7454-EST	H2081040S	Head Gasket 96mm Bore		
		97 mm	C7691-EST	H1018040S	Head Gasket 97mm Bore		
		98 mm	C7461-EST	H1018SP4040S	Head Gasket 98mm Bore		
		99 mm	C7792-EST	H1018SP2040S	Head Gasket 99mm Bore		
					B0480020RC	Base Gasket	59030035050
					EC495018AFM	Timing Chain Tens. Gasket	59036003050
					EX281042AM	Exhaust Gasket	59036041000
					R017B	2 Req.-Oil Screen Plug O-ring	5413248
					R12.5X2V	2 Req.-Oil Screen Plug O-ring	5413249
					R40X2.5B	2 Req.-Oil Filter O-ring	5413254
					VC027031F	Valve Cover Gasket 2 Req.	59530036000
					WA005063C	Crush Washers 4 Req.	603061001
			Bottom End Kit w/o crank seals C3340	Component Part#	Component Part#	OEM Part#	
				WP114018AFM	Water Pump Gasket	59035053000	
				EC1377020F	Ignition Cover Gasket	5813170	
				EC494032AFM	Mag. Cover Gasket	5813174	
				EC496032AFM	Clutch Cover Gasket	5413309	
				EC497012F	Center Case Gasket	59030039000	

POLARIS PREDATOR 90

Model	Year	Bore Size	Top End Kit	Component Part#	Component Description	OEM Part #
Predator 90	01-06	53mm	C3514	H2381SP1043F	Head Gasket	0450004
				B0774020F	Base Gasket	0450009
				EX650064AM	Exhaust Gasket	0450122

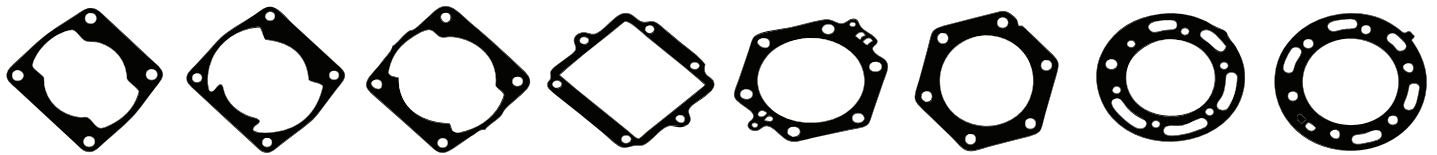

Model	Year	Bore Size	Top End Kit	Component Part#	Component Description	OEM Part #
Big Boss 4x6	89-92	72 mm	C7124	H0018043F	Head Gasket 72mm	3084015
		73.5 mm	C3485	H0018SP4040S	Head Gasket 73.5mm .040" Steel	3084015
Big Boss 6x6	91-93			B0070018AFM	Base Gasket	3083733/3084016
Cyclone Trail Blazer	87 90-06			EX015042AM	Exhaust Gasket	3084026/3084439
Trail Boss 2x4	85-96 87-93					
Trail Boss 4x4	88-93					

All Component Parts can be purchased individually.



ATV Gaskets



Cometic Gasket - An Exclusive NASCAR Performance® Product

POLARIS 2x4 300

Model	Year	Bore Size	Top End Kit	Component Part#	Component Description	OEM Part #
2x4 300	94-95	78 mm	C7310	H0451020S	Head Gasket	3085098
4x4 300	94-95			B0265018AFM	Base Gasket	3084795
6x6 300	94-94			EX015042AM	Exhaust Gasket	3084026/3084439
Xplorer 96-00						
300						
Xpress 96-00						
300						
Sportsman 4x4	93-93	82 mm	C7144	H0212059F	Head Gasket	3084517
Trail Boss 2x4 350L	90-93			B0151020F	Base Gasket	3084140
Trail Boss 4x4 350L	90-93			EX015042AM	Exhaust Gasket	3084026/3084439
Trail Boss 6x6 350L				IR044018AFM	Intake Gasket	3084148
2x4 400L	94-95	85 mm	C7265	H0345010S	Head Gasket	308415
4x4 400L	94			B0206018AFM	Base Gasket	3084729
6x6 400L	94-03			EX015042AM	Exhaust Gasket	3084026/3084439
Sportsman 4x4				IR044018AFM	Intake Gasket	3084148
Scrambler 4x4	95-00					
Sport 400L	96-00					
Trail Blazer ES						
Xplorer 400L 4x4	95-00					
Xpress 400	96-00					
Magnum 2x4	95-00	92 mm	C7311	H0452059F	Head Gasket	3085337
Magnum 4x4	95-00			B0266020F	Base Gasket	3084851
Magnum 6x6	96			EX038042AM	Exhaust Gasket	3083575/3083023
				R015V	O-ring	3084867
Scrambler 500	97-03	94 mm	C7312	H0453059F	Head Gasket	3084865
Scrambler, 97-05				B0267020F	Base Gasket	3084851
Sportsman 500				EX038042AM	Exhaust Gasket	3083575/3083023
Xplorer 500 1997						
Sportsman 550	09-14	98mm	C3610	H4312027S	Head Gasket 98mm Bore	3090104
		101mm	C3611	H4312SP1027S	Head Gasket 101mm Bore	
				WA165063A	Head Plug Gasket	3084861
				WA118	Head Oil Drain Plug Gasket	3088030
				B1362010RC	Base Gasket	3090092
				IR1384	Intake Gasket	3090144
				EX657	Exhaust Gasket	3090004
				3264V	Valve Seal	3090098
				WA117	Oil Line Crush Washers	3088044
				EC2226	Cam Chain Tensioner Gasket	3086448
				R030V	Cam Cover O-ring	3090131

All Component Parts can be purchased individually.



ATV Gaskets



Cometic Gasket - An Exclusive NASCAR Performance® Product

POLARIS PREDATOR 500

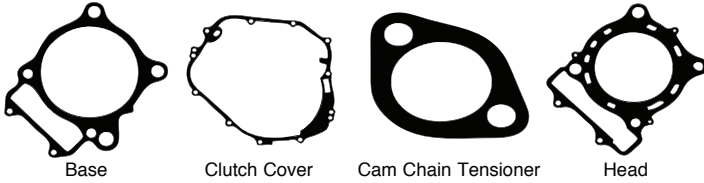

Model	Year	Bore Size	Top End Kit	Component Part#	Component Description	OEM Part #
Predator 500	03-07	99 mm	C7971-EST	H1818SP1027S	Head Gasket 99mm Bore	3087948
		100 mm	C7995-EST	H1818030S	Head Gasket 100mm Bore	
Outlaw 500	06-07	103 mm	C7972-EST	H1818SP4030S	Head Gasket 103mm Bore	
		105 mm	C3160-EST	H1819030S	Head Gasket 105.5mm Bore	
				B0658010RC	Base Gasket	3089519
				EC996032AFM	Cam Chain Tensioner	3088022
				EX634	Exhaust Gasket/2 Req.	3087957
				WA117	6 Req.-Oil Filter Copper Washer	3088044
				3243V	4 Req. Valve Stem Seals	3084908
				Component Part#	Component Description	OEM Part #
				VC120	Valve Cover Gasket	3089441
			EST Top End Kit	Component Part#	Component Description	OEM Part #
XP1000	14-19	94mm	C3546-EST	H3892018S	Cyl. Head Gasket 94mm Bore	5813737
		96mm	C3563-EST	H3892SP1018S	Cyl. Head Gasket 96mm Bore	5813737
				B1079014RC	Base Gasket	5253037
				EC1654020RC	Cam Chain Tensioner Gasket	5813449

OUTLAW (KTM Motor)

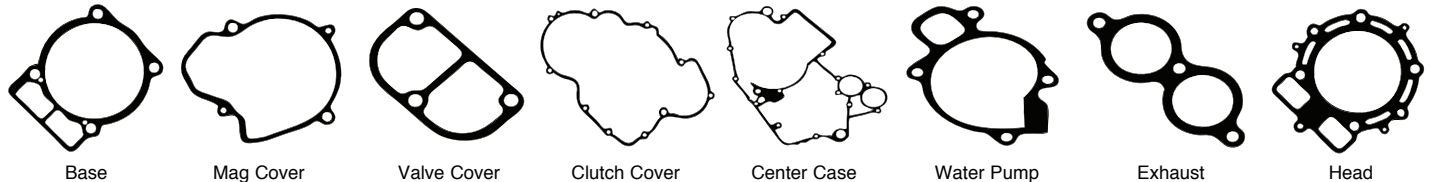

Model	Year	Bore Size	EST Top End Kit	Component Part#	Component Description	OEM Part #
Outlaw 525	06-11 (KTM motor)	95 mm	C7944-EST	H1521040S	Head Gasket 95mm Bore	5813169
		96 mm	C7454-EST	H2081040S	Head Gasket 96mm Bore	
		97 mm	C7691-EST	H1018040S	Head Gasket 97mm Bore	
		98 mm	C7461-EST	H1018SP4040S	Head Gasket 98mm Bore	
		99 mm	C7792-EST	H1018SP2040S	Head Gasket 99mm Bore	
				B0480020F	Base Gasket	5813167
				EC495018AFM	Timing Chain Tens. Gasket	5813173
				EX281042AM	Exhaust Gasket	5813168
				R017B	2 Req.-Oil Screen Plug O-ring	5413248
				R12.5X2V	2 Req.-Oil Screen Plug O-ring	5413249
				R40X2.5B	2 Req.-Oil Filter O-ring	5413254
				VC027031F	2 Req.-Valve Cover Gasket	5813175
				WA005063C	4 Req.-Copper Washer	25437-86
			Bottom End Kit w/o crank seals C3394	Component Part#	Component Description	OEM Part#
				WP114018AFM	Water Pump Gasket	5813172
				EC1377020F	Ignition Cover Gasket	5813170
				EC494032AFM	Mag. Cover Gasket	5813174
				EC496032AFM	Clutch Cover Gasket	5413309
				EC497012F	Center Case Gasket	59030039000

All Component Parts can be purchased individually.



ATV Gaskets



Cometic Gasket - An Exclusive NASCAR Performance® Product

SUZUKI LT50

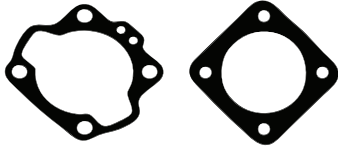

Base Head

Model	Year	Bore Size	Top End Kit	Component Part#	Component Description	OEM Part #
LT50	84-87	43 mm	C7262	H0263010C	Head Gasket	11141-04000
				B0161020F	Base Gasket	11241-04010

SUZUKI LT80

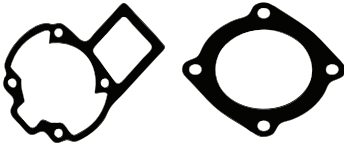

Base Head

Model	Year	Bore Size	Top End Kit	Component Part#	Component Description	OEM Part #	
LT80	87-06	52 mm	C7259	H0314020C	Head Gasket 52mm bore	H11141-07910	
		54 mm	C7709	H0899020C	Head Gasket 54mm Bore		
		55 mm	C7931	H0314SP4020C	Head Gasket 55mm Bore		
			Top End Kit	B0189020F	Base Gasket	11241-40B10	
LT230	85-93	67 mm	C7074	Component Part#	Component Description	OEM Part #	
		71 mm	C7329	H0056SP1043F	67mm Bore Head Gasket	11141-18A00	
				H0425043C	71mm Bore Head Gasket		
				B0055020F	Base Gasket	11241-18A20	
LT250R	85-86	72 mm	Top End Kit	Component Part#	Component Description	OEM Part #	
			C7070	H0051043F	Head Gasket	11141-13A60	
				B0053020F	Base Gasket	11482-19A00-H17	
				IR012020F	Intake Gaskets	13156-13A00	
			Bottom End Kit	Component Part#	Component Part#	OEM Part#	
			w/crank seals	C3363	C7719	Clutch Cover Gasket	11483-13A00
					EC325020F	Mag Cover Gasket	
			Crank Seal Kit	Component Part#	Component Part#	OEM Part#	
			C7676	OS147	35X52X8 Left Crank Seal	09289-36003	
				OS148	24X38X7 Right Crank Seal	09283-25078	
LT250R	87-92	69 mm	Top End Kit	Component Part#	Component Description	OEM Part #	
		74 mm	C7071	H0268043F	Head Gasket	11141-01C01-H17	
			C7422	H2230043F	Head Gasket 74mm Bore		
				B0047020F	Base Gasket	11241-01C10	
				IR011018AFM	Intake Gasket	3008-076/13156-01C10	
				IR176020F	Intake Gasket	13156-01C10	
				PV022018AFM	Right Side Power Valve Gasket	11233-00B00-H17	
			Bottom End Kit	Component Part#	Component Part#	OEM Part#	
			w/crank seals	C3364	C7720	Clutch Cover Gasket	11482-01C10
					EC323020F	Mag Cover Gasket	11483-01C10
					WP074020F	Water Pump Gasket	17431-14303
			Crank Seal Kit	Component Part#	Component Part#	OEM Part#	
			C7675	OS145	35X52X8 Left Side Crank Seal	09283-36004	
				OS146	24X38X7 Right Side Crank Seal	09283-25082	
LT-F250	88-13	69 mm	Top End Kit	Component Part#	Component Description	OEM Part #	
LT-4WDX	87-96	71 mm	C7260	H0364043F	Head Gasket	11141-19B00	
King Quad	91-00	70.5 mm	C7314	H0363043F	Head Gasket 71mm Bore		
4 WD				B0055020F	Base Gasket LT250F 87-97	11241-38300	
					LT-FWDX 87-99		
				B0213020F	Base Gasket LT250S 89-90	11241-25C10	
				B0214020F	Base Gasket LTF4WDX 87-99	11241-18A20	
					King Quad 99-00		

All Component Parts can be purchased individually.



ATV Gaskets



Cometic Gasket - An Exclusive NASCAR Performance® Product

SUZUKI LT-Z400

Model	Year	Bore Size	EST Top End Kit	Component Part#	Component Description	OEM Part #
LT-Z400	03-13	92 mm	C7978-EST	H0949027S	Head Gasket 92mm Bore	11141-29F01
DR-Z400SM All		94 mm	C7979-EST	H1045027S	Head Gasket 94mm Bore	
		97 mm	C7980-EST	H1046027S	Head Gasket 97mm Bore	
				B0440027S	Base Gasket	11241-29F11
				EX243	Exhaust Gasket 2 Req.	14181-29E02
				EC377032AFM	Cam Chain Tensioner Gasket	12837-24A10
				3160V	Valve Seals 4 Req.	09289-05011
				WA121	Cam Chain Tensioner Washer	09168-06023
				Component Part#	OEM Part#	OEM Part#
				EC1030032AFM	Clutch Cover	11482-07G00
				EC1034032AFM	Mag Cover Gasket	11061-S072

SUZUKI LT-Z450

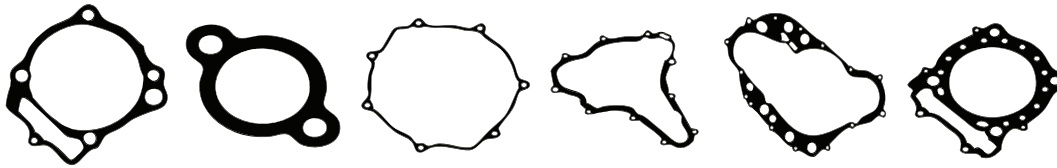

Base Timing Chain Tensioner Outer Clutch Cover Mag Cover Inner Clutch Cover Head

Model	Year	Bore Size	EST Top End Kit	Component Part#	Component Description	OEM Part #
LT-R450	06-09	96mm	C3208-EST	H2499SP5027S	Head Gasket	11141-45G00
		97mm	C3150-EST	H2499027S	Head Gasket 97mm Bore	
		98mm	C3157-EST	H2499SP2027S	Head Gasket 98mm Bore	
		101mm	C3158-EST	H2499SP1027S	Head Gasket 101mm Bore	
				B0857010RC	Base Gasket	11241-45G00
				EX877	Exhaust Gasket	14181-35G00
				EC377032AFM	Cam Chain Tensioner Gasket	12837-24A10
				3238V	Valve Seals 4 Req.	09289-05015
				Component Part#	Component Description	OEM #
			Bottom End Kit w/o crank seals C3378	EC1119018AFM	Clutch Cover	11484-45G00
				EC1120032AFM	Mag Cover Gasket	11483-45G00
				EC1121032AFM	Inner Clutch Cover Gasket	11482-45G00
				R138SB	Oil Filter O-ring	0928-54001
				R32X3V	Crank End O-ring	09280-33004
				Component Part#	Component Description	OEM Part #
			Clutch & Mag Kit C3408CM	EC1119018AFM	Clutch Cover	11484-45G00
				EC1120032AFM	Mag Cover Gasket	11483-45G00

SUZUKI LT-500H

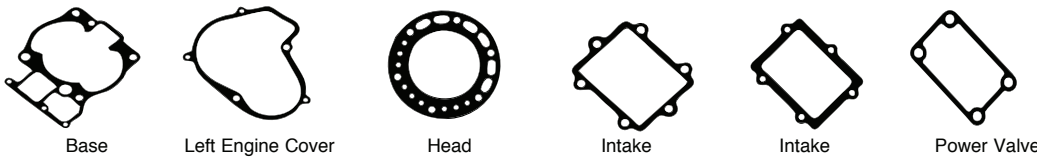

Base Left Engine Cover Head Intake Intake Power Valve

Model	Year	Bore Size	Top End Kit	Component Part#	Component Description	OEM Part #
LT500 H	87	88 mm	C7072	H0052043F	88mm Bore Head Gasket	11141-43B01
		89.5 mm	C7273	H0315043F	89.5mm Bore Head Gasket	
		91 mm	C7125	H0054043F	91mm Bore Head Gasket	
				B0054020F	Base Gasket	11241-43B00
				IR176020F	Intake Gasket 87 Model Only	
				PV022018AFM	Right Side Power Valve Cover	11233-00B00-H17
				Component Part#	Component Description	OEM #
			Bottom End Kit w/crank seals C3380	C7718	Clutch Cover Gasket	11482-43B00
					Mag Cover Gasket	
				Component Part#	Component Part#	OEM #
			Crank Seal Kit C7677	OS131	24X37X6 Left Crank Oil Seal	09283-25099
				OS133	37X52X8 Right Crank Oil Seal	09283-38021

All Component Parts can be purchased individually.



ATV Gaskets



Cometic Gasket - An Exclusive NASCAR Performance® Product

SUZUKI LT500

Model	Year	Bore Size	Top End Kit	Component Part#	Component Description	OEM Part #
LT500	88-90	88 mm	C7073	H0053043F	88mm Bore Head Gasket	11111-43B10
		89.5 mm	C7274	H0316043F	89.5mm Bore Head Gasket	
		91 mm	C7122	H0055043F	91mm Bore Head Gasket	
				B0054020F	Base Gasket	11241-43B10
				IR011018AFM	Intake Gasket	3008-076/13156-01C10
				PV022018AFM	Right Side Power Valve Cover	11233-00B00-H17
				Component Part#	Component Part#	OEM #
			Bottom End Kit w/crank seals	C3380	Clutch Cover Gasket	11482-43B00
				EC321020F	Mag Cover Gasket	11483-43B00
			Crank Seal Kit	C7675	Component Part#	OEM Part#
			OS145	35X52X8 Left Side Crank Seal	09283-36004	
			OS146	24X38X7 Right Side Crank Seal	09283-25082	
		Crank Seal Kit	C7677	Component Part#	OEM Part#	
			OS131	24X37X6 Left Crank Oil Seal	09283-25099	
			OS133	37X52X8 Right Crank Oil Seal	09283-38021	
LTZ-A700 KingQuad	05-07	106mm	Top End Kit	Component Part#	Component Description	OEM Part #
			C3128-EST	H2424027S	Head Gasket	11141-31G00
				B0821010RC	Base Gasket	11241-31G00
				EC1044018AFM	Cam Chain Tensioner Gasket	12837-19B10
				3238V	Valve Seals 4 Req.	09289-05015
				R12.5X2.5V	Thermostat O-ring/Water Line O-ring 2 Req.	09168-12017
				R7X2V	Cam Chain Tensioner O-ring	09168-26001

YAMAHA YFM RAPTOR

Model	Year	Bore Size	Top End Kit	Component Part#	Component Description	OEM Part #		
YFM80 RAPTOR	ALL	48mm	C3457	H1905043F	48mm Head Gasket	55X-11181-00-00		
				B0721020F	Base Gasket	22F-11351-01-00		
				EX781	Exhaust Gasket	3DM-14613-00-00		
YT125	80-83	58 mm	Top End Kit	Component Part#	Component Description	OEM Part #		
			C7127	H0068043F	Head Gasket	3X3-11181-01-00		
				B0069020F	Base Gasket	18G-11351-01-00		
YT175	82-84	68 mm	Top End Kit	Component Part#	Component Description	OEM Part #		
			C7128	H0069043F	Head Gasket	5V7-11181-00-00		
				B0069020F	Base Gasket	18G-11351-01-00		
YTM200	83-85	71 mm	Top End Kit	Component Part#	Component Description	OEM Part #		
			C7129	H0066043F	Head Gasket	1NU-11181-00-00		
				B0067020F	Base Gasket	4BD-11351-00-00		
YFM200	85-89	71 mm	Top End Kit	Component Part#	Component Description	OEM Part #		
			C7095	H0066043F	Head Gasket	1NU-11181-00-00		
				B0067020F	Base Gasket	4BD-11351-00-00		
YFS200 Blaster	88-06	68 mm	EST	Component Part#	Component Description	OEM Part #		
			Top End Kit	H2532SP1030S	Head Gasket 68mm Steel	2XJ-11181-00-00		
			C7093-EST	H2532030S	Head Gasket 72.5mm Steel	2XJ-11181-00-00		
			C7332-EST	H0064032C	Head Gasket 68mm Copper	2XJ-11181-00-00		
				H0386032C	Head Gasket 72.5mm Copper	2XJ-11181-00-00		
			B0065018AFM	Base Gasket	3JM-11351-01-00			
			IR014018AFM	Intake Gasket	1LR-13621			
			EX350064AM	Exhaust Gasket	3PA-14613-10-00			
		YFS200 Blaster	88-05	72.5 mm	Bottom End Kit	Component Part#	Component Description	OEM Part #
					C7093BE	OP032018AFM	Oil Pump Cover Gasket	126-13116-01-00
	EC316032AFM				Clutch Cover Gasket	3JM-15451-11-00/2XJ-15411-00-00		
	R19X2V				Oil Fill Plug O-ring 19X2.4	93210-19123-00		
	WA120				Drain Plug Gasket	90201-12172-00		
	Oil Seal Kit	Component Part#	Component Description	OEM Part #				
	C7093OS	OS112	Right Crank Seal 32X44X9	93103-32099-00				
		OS124	Left Crank Seal 25X44X8	93102-25331-00				
		OS225	Output Shaft Seal 20X30X5	93102-20143-00				
		OS262	Oil Pump Seal 10X21X5	93101-10001-00				
		OS354	Shift Shaft Seal 12X21X4	93101-12173-00				
		OS355	Clutch Actuator Seal 14X25X5	93104-14004-00				
		OS356	Start Shaft Seal 20X38X5	93109-20014-00				
YFM225	86-88	71 mm	Top End Kit	Component Part#	Component Description	OEM Part #		
			C7253	H0066043F	Head Gasket	59V-11181-00-00		
				B0067020F	Base Gasket	4BD-11351-00-00		



ATV Gaskets



Cometic Gasket - An Exclusive NASCAR Performance® Product

YAMAHA YFM225

Model	Year	Bore Size	Top End Kit	Component Part#	Component Description	OEM Part #
YFM225	86-88	71 mm	C7253	H0066043F	Head Gasket	59V-11181-00-00
				B0067020F	Base Gasket	4BD-11351-00-00
TriZ250 Tri Moto	85-86	71 mm	Top End Kit C7153	Component Part#	Component Description	OEM Part #
				H0269043F	Head Gasket	38W-11181-00-00
				B0172020F	Base Gasket	39X-11351-01-00
				IR017020F	Intake Gasket	80L-13621-01-00
YFA250 Breeze	89-95	50 mm	Top End Kit C7255	Component Part#	Component Description	OEM Part #
				H0312043F	Head Gasket	3GH-11181-00-00
				B0187020F	Base Gasket	3FA-11351-10-00
YFM250 Timberwolf 2WD/4WD	92-03	72 mm	Top End Kit C7254	Component Part#	Component Description	OEM Part #
				H0066043F	Head Gasket	59V-11181-00-00
				B0067020F	Base Gasket	4BD-11351-00-00
YFM250 Moto-4	89-91	71 mm	Top End Kit C7256	Component Part#	Component Description	OEM Part #
				H0066043F	Head Gasket	59V-11181-00-00
				B0067020F	Base Gasket	4BD-11351-00-00

YAMAHA YFM225

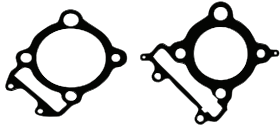

Base Model	Year	Head Bore Size	EST Top End Kit	Component Part#	Component Description	OEM Part #
YFM250R	08-13	74 mm	C3223-EST	H2760040S	Head Gasket	5XT-11181-00-00
Raptor		76 mm	C3224-EST	H2760SP2040S	Head Gasket 76mm	5XT-11181-00-00
		78 mm	C3225-EST	H2760SP3040S	Head Gasket 78mm	5XT-11181-00-00
		80mm	C3226-EST	H2760SP1040S	Head Gasket 80mm	5XT-11181-00-00
		81mm	C3236-EST	H2760SP5040S	Head Gasket 81mm	5XT-11181-00-00
				B0936020RC	Base Gasket	4D3-11351-00-00
				EX817	Exhaust Gasket	3GD-14613-00
				EC019018AFM	Cam Chain Tensioner Gasket	4FM-12213-00
				EC1230032AFM	Head Block Off Plate Gasket	5XT-14815-00-00
				R013B	Cam O-ring	93210-11453-00
				R046B	Cam Gear Cover O-ring	93211-05471-00
				R127V	Intake O-Ring Seal	5PA-14642-00-00
				R228V	Tappet Cover O-Ring	93210-54001-00
				R904V	Rocker Shaft O-ring	93210-09350
				WA114	Head Drain Gasket	90430-06014-00
				3187V	Valve Seals 2 Req.	5H0-12119-00-00
YFZ350 Banshee	87-05	65.5 mm	Top End Kit C7094	Component Part#	Component Description	OEM Part #
		66.5 mm	C7275	H0275010S	Head Gasket 65.5 mm Bore	2GU-11181-00-00
		68 mm	C7316	H0311010S	Head Gasket 66.5mm Bore	2GU-11181-00-00
		69.5 mm	C7710	H0442010S	Head Gasket 68mm	2GU-11181-00-00
		71 mm	C7607	H0745010S	Head Gasket 69.5mm Bore	2GU-11181-00-00
				H0418010S	Head Gasket 71mm Bore	2GU-11181-00-00
				B0066012F	High Comp. Base Gasket 2 Req.	3GG-11351-00-00
				B0066018AFM	Base Gasket 2 Req.	3GG-11351-00-00
				IR019018AFM	Intake Gasket 2 Req.	55K-13621-00-00
				R224V	Exhaust O-Ring 2 Req.	93210-45742-00
				WP118032AFM	Water Outlet Gasket	3XV-12435-00-00
			Bottom End Kit w/Oil Seals C7094BE	Component Part#	Component Description	OEM Part #
				WP072020F	Water Pump Cover Gasket	3GG-12428-01-00
				R19X2V	Oil Fill Plug O-ring	93210-19123-00
				EC318020F	Inner Clutch Cover Gasket	3GG-15461-02-00
				WA120	Drain Plug Gasket	90430-14043-00
			Oil Seal Kit C7094OS	Component Part#	Component Description	OEM Part #
			Crank Seal Kit C7673	OS126	Right Crank Seal 23x40x10	93103-40077-00
				OS125	Right Crank Seal 38X62X12	93103-40077-00
				OS225	Kickstart Shaft Seal 20x30x5	93102-20484-00
				OS226	Impeller Shaft Seal 10x31x13.5	93103-10147-00
				OS227	Shift Shaft Seal 12x22x5	93102-12106-00/
						93102-12321-00
				OS268	Output Shaft Seal 35x62x6	93102-35369-00
				OS357	Clutch Actuator Seal 17x28x6	93102-17004-00



ATV Gaskets



Cometic Gasket - An Exclusive NASCAR Performance® Product

YAMAHA YFM350



Model	Year	Bore Size	EST Top End Kit	Component Part#	Component Description	OEM Part #
YFM350	04-06	84 mm	C7096-EST	H0067027S	Head Gasket Multi-Layer-Steel	1UY-11181-01-00
Bruin		85 mm	C3159-EST	H0067043F	Head Gasket Fiber	1UY-11181-01-00
YFM350	04-14			H0067SPA027S	Head Gasket 85mm Steel	1UY-11181-01-00
Raptor				B0068020F	Base Gasket	4KB-11351-00-00
Wolverine				EC998032AFM	Cam Chain Tensioner Gasket	3GD-12213-00-00
YFM350	87-04			3230V	Valve Seals 2 Req.	M01-12129-00-00
Warrior				R86X3V	Cam Cover O-ring	93211-06635-00
YFM350	95-06			R57X2V	Tappet Cover O-ring 2 Req.	93210-57634-00
YFM350/	87-06			R106X2V	Base O-ring	93210-86509-00
400 Big Bear, Moto 4				R031B	Intake O-ring	93210-44545-00
				R012B	Base Dowel O-ring	93210-18322-00

Bottom End Kit w/Oil Seals C7096BE	Component Part#	Component Description	OEM Part #
	WA080043C	Case Bolt Crush Washer	90430-06014-00
	OP031020F	Oil Pump Gasket	3GD-13329-00-00
	WA080043C	Drain Plug O-ring	93210-35512-00
	WA116	Oil Line Crush Washer	90430-08119-00
	R227V	Oil Pump Cover Gasket	93210-54175-00
	R114V	Shift Shaft O-ring	93210-15566-00
	R020V	Neutral Drum Shift Detent O-ring	90430-14194-00
	R116B	Fill Plug O-ring	93210-19522-00
	R027V	Timing Mark O-ring	93210-14369-00
Oil Seal Kit C7096OS	Component Part#	Component Description	OEM Part #
	OS351	Mag Oil Seal 28x52x8.2	93102-28017-00
	OS347	Shift Shaft Oil Seal 14x26x6	93102-14209-00
	OS352	Neutral Drum Oil Seal 15x25x5	93102-15212-00
	OS348	Output Shaft Oil Seal 35x45x6	93102-35393-00
	OS350	Idler Shaft Oil Seal 20x52x3.5	93104-20068-00
	OS349	Trans Main Shaft Oil Seal 17x40x3.5	93104-17094-00
	OS286	Clutch Actuator Seal 12x18x5	93102-12224-00
Clutch & Mag Kit C7096CM	Component Part#	Component Description	OEM Part #
	EC314032AFM	Clutch Cover Gasket	3GD-15461-00-00
	EC315032AFM	Mag Cover Gasket	3GD-15451-00-00

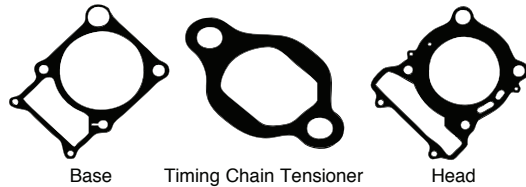

Model	Year	Bore Size	EST Top End Kit	Component Part#	Component Description	OEM Part #
YFM400	00-07	85.5 mm	C3213-EST	H2464027S	Head Gasket	5GH-11181-00-00
KODIAK/GRIZZLY				B0918031F	Base Gasket	5GH-11351-00
				EX130	Exhaust Gasket	3GD-14613-00-00
				EC998032AFM	Cam Chain Tensioner Gasket	3GD-12213-00-00
				R012B	Rocker Arm O-ring 2 Req.	93210-09165-00
				R106X2V	Cam Cover O-ring	93211-06635-00
				R116V	Base Dowel O-ring	93210-18322-00
				R141SB	Valve Cover O-ring	93210-57634-00
				R89X2.5V	Base O-ring	93210-89447-00
				3230V	Valve Seals 2 Req.	M01-12129-00-00
				WA118	Head Drain Plug Washer	90430-06014-00

All Component Parts can be purchased individually.



ATV Gaskets



Cometic Gasket - An Exclusive NASCAR Performance® Product

YAMAHA YFZ450

Model	Year	Bore Size	EST	Component Part#	Component Description	OEM Part #
YFZ450	04-08	96 mm	Top End Kit			
			C3066-EST	H2144027S	96mm Head Gasket	5TA-11181-00-00
			C3445-EST	H2144SP1027S	97mm Head Gasket	5TA-11181-00-00
		97 mm	C3068-EST	H1683027S	98mm Head Gasket	5TA-11181-00-00
				B0626020RC	Base Gasket	5TA-11351-00-00
				EX641	Exhaust Gasket	3VD-14613-01-00
		98 mm		EC019018AFM	Cam Chain Tensioner Gasket	4FM-12213-00
				3179V	ntake Valve Seals 3 Req.	4SV-12119-00-00
				3234V	Exhaust Valve Seals 2 Req.	33M-12119-00-00
				WA082063C	2 Req.	90430-10171-00
				WA114	2 Req.	90430-06014-00
				WA116	4 Req.	90201-08087-00
				R19X2V	Base dowel O-ring	93210-19758-00
				Component Part#	Component Description	OEM Part #
				EC762032AFM	Inner Clutch Cover Gasket	5TA-15462-00-00
				EC763032AFM	Outer Clutch Cover Gasket	5TA-15453-00-00
				EC899032AFM	Mag Cover Gasket	5TG-15451-10-00
				R10X2V	Center Case Dowel O-ring	93210-10197-00
				R10X2V	Oil Pump Dowel O-ring	93210-10197-00
				R10X2V	Oil Pump Tube O-ring	93210-10197-00
			R12.5X2V	Oil Tube O-ring (Lg)	93210-12759-00	
			R13.5X2V	Timing Plug O-ring (Sm)	93210-14369-00	
			R19X2V	Inner Clutch O-rings	93210-19758-00	
			R22X2V	Counter Shaft O-ring	93210-22164-00/22298-00	
			R27X2V	Mag Cover Plug O-ring	93210-32172-00	
			R47X2.5V	Oil Filter Cover O-ring (Sm)	93210-47675-00	
			R60X3B	Water Pump Cover O-ring	93210-60426	
	R7X2V	4 Req.-Oil Pump O-rings (Sm)	93210-07003-00/07540-00			
	R8.5X1.5V	Oil tube O-rings (Med)	93210-09008-00			
	WA082063C	Drain Plug Gasket	90430-10171			
	Component Part#	Component Description	OEM Part #			
	VC104	Valve Cover Gasket				
YFZ450R	09-19	95mm	Top End Kit	Component Part#	Component Description	OEM Part #
			C7908-EST	H2477023S	Head Gasket 95mm	2S2-11181-00-00
			C3178-EST	H2477SP1023S	Head Gasket 98mm	2S2-11181-00-00
		98mm	C3279-EST	H2477SP4023S	Head Gasket 99mm	2S2-11181-00-00
				B0849008S	Base Gasket	2S2-11351-00-00
				3179V	Intake Valve Seal 3 Req.	4SV-12119-00-00
		99 mm		3234V	Exhaust Valve Seal 2 Req.	33M-12119-00-00
				EC019018AFM	Cam Chain Tensioner Gasket	4FM-12213-00
				EX696	Exhaust Gasket	3VD-14613-01-00
			WA082063C	Oil Line Washers 2 Req.	90430-10171	
			WA114	Drain Plug Gasket	90430-06014	
			WA116	Oil Line Washers 4 Req.	90201-08087-00	
			Component Part#	Component Description	OEM Part #	
			EC1558032AFM	Inner Clutch Cover	18P-15462-00-00	
			EC1560018AFM	Stator Cover Gasket	18P-15463-00	
			R013V	Crankcase O-ring	93210-10197-00	
			R022B	Output Shaft O-ring	93210-25001-00	
			R114V	Timing Plug O-ring	93210-14369-00	
	R117V	Dip Stick O-ring	93210-19026-00			
	R127V	Crank Plug O-ring	93210-357A3-00			
	R133B	Oil Filter Bolt O-ring 3 Req.	93210-47675-00			
	R134V	Oil Filter O-ring	93210-47675-00			
	R214B	Starter Input O-rings	93210-24235			
	WA082063C	Drain Plug Gasket 2 Req.	90430-10148-00			
	WA114	Case Bolt Seal	90430-06014-00			
	WP370018AFM	Water Pump Gasket	18P-12428-00-00			
	Component Part#	Component Description	OEM Part #			
	OS348	Output Shaft Seal 34x45x6	93102-35393-00			
	OS305	Crank End Oil Seal 14x22x6	93101-14164-00			
	OS286	Shift Shaft Seal 12x18x5	93102-12224-00			
	OS286	Clutch Pushrod Seal 12x18x5	93102-12224-00			
	OS354	Impeller Oil Seal 12x21x4	93101-12173-00			
	Component Part#	Component Description	OEM Part #			
	EC1561032AFM	Mag Cover Gasket	18P-15451-00			
	EC1559032AFM	Outer Clutch Cover	18P-15453-00-00			



ATV Gaskets



Cometic Gasket - An Exclusive NASCAR Performance® Product

YAMAHA YFM600

Model	Year	Bore Size	Top End Kit	Component Part#	Component Description	OEM Part #
YFM600	98-01	97 mm	C7213	H0267043F	Head Gasket 97mm	2KF-11181-01
Grizzly		98 mm	C7276	H0320043F	Head Gasket 98mm	2KF-11181-01
XT600	88-96	101 mm	C7277	H0321043F	Head Gasket 101mm	2KF-11181-01
				B0064020F	Base Gasket	1VJ-11351-00-00
				B1019010RC	Base Gasket	33D-11351-00-00
				EC019032AFM	Cam Chain Tensioner Gasket	4FM-12213-00-00
				EX1041042AM	Exhaust Gasket	33D-14613-00-00

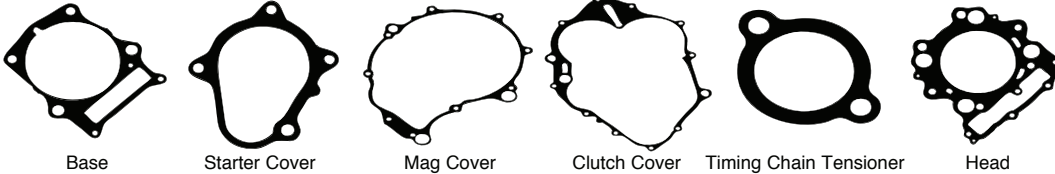

Model	Year	Bore Size	EST Top End Kit	Component Part#	Component Description	OEM Part #
YFM660R	01-05	100mm	C7044-EST	H1481SP2030S	Head Gasket 100mm Bore	3YF-11181-00
Raptor		101mm	C7900-EST	H1481030S	Head Gasket 101mm Bore	
Rhino 660 (SXS)	04-07	102mm	C7798-EST	H1191030S	Head Gasket 102mm Bore	
		103mm	C3042-EST	H2174030S	Head Gasket 103mm Bore	
Fits Top End Only			105mm C7909-EST	H1191SP1030S	Head Gasket 105mm Bore	
				B0532010RC	Base Gasket	3YF-11351
				EX361	Exhaust Gasket 2 Req.	3YF-14613-01-00
				EC584018AFM	Cam Chain Tensioner Gasket	4DW-12213-00
				3187V	Valve Seal 5 Req.	5H0-12119-00-00
				R016B	Radiator Hose O-ring	93210-18417-00
				R113B	Valve Cover Plug O-ring	93210-13657-00
				R114S	Oil Tank O-ring	93210-16629-00
				R116B	Cam Chain Tens. Cap O-ring	11101/93210
				R117B	Dipstick O-ring	93210-21190-00
				R124B	Tappet Cover O-ring	93210-32172-00
				R155S	Cylinder Base O-ring	11256/93211
				R71X2.5B	Intake Valve Adj. Cover O-ring	93210-71360-00
				WA081080C	Oil Line Washers 4 Req.	90430-08204
				WA082063C	Oil Line Washers 4 Req.	90430-10171
			Bottom End Kit w/o crank seals	Component Part#	Component Description	OEM Part #
			C3339	EC580060AFM	Starter Cover Gasket	5LP-15455-00
				EC581060AFM	Cover Gasket	5LP-15451-00
				C7800	Clutch Cover Gasket	5LP-15462-00
				OP092010FB	Oil Pump Cover Gasket	5LP-13329-00
				R027V	Crank Plug O-ring	93210-14369-00
				R031B	Intake O-ring	93210-44545-00
				R109B	Water Pump Impeller O-ring 2 Req.	11171/93210-77363
				R125V	Water Outlet- Oring	93210-33786-00
				R126B	Timing Plug O-ring	93210-357A3-00
				R12X2V	Out Put Shaft O-ring	93210-22298-00
				WA080043C	Drain Plug Washer	90430-06014-00

All Component Parts can be purchased individually.



ATV Gaskets



Cometic Gasket - An Exclusive NASCAR Performance® Product

YAMAHA YFM660R

Model	Year	Bore Size	EST	Component Part#	Component Description	OEM Part #
YFM660R	01-05	100mm	Top End Kit C7044-EST	H1481SP2030S	Head Gasket 100mm Bore	3YF-11181-00
Raptor		101mm	C7900-EST	H1481030S	Head Gasket 101mm Bore	
Rhino 660	04-07	102mm	C7798-EST	H1191030S	Head Gasket 102mm Bore	
(SXS)		103mm	C3042-EST	H2174030S	Head Gasket 103mm Bore	
Fits Top End Only			105mm C7909-EST	H1191SP1030S	Head Gasket 105mm Bore	
				B0532010RC	Base Gasket	3YF-11351
				EX361	Exhaust Gasket 2 Req.	3YF-14613-01-00
				EC584018AFM	Cam Chain Tensioner Gasket	4DW-12213-00
				3187V	Valve Seal 5 Req.	5H0-12119-00-00
				R016B	Radiator Hose O-ring	93210-18417-00
				R113B	Valve Cover Plug O-ring	93210-13657-00
				R114S	Oil Tank O-ring	93210-16629-00
				R116B	Cam Chain Tens. Cap O-ring	11101/93210
				R117B	Dipstick O-ring	93210-21190-00
				R124B	Tappet Cover O-ring	93210-32172-00
				R155S	Cylinder Base O-ring	11256/93211
				R71X2.5B	Intake Valve Adj. Cover O-ring	93210-71360-00
				WA081080C	Oil Line Washers 4 Req.	90430-08204
				WA082063C	Oil Line Washers 4 Req.	90430-10171
			Bottom End Kit w/o crank seals C3339	Component Part#	Component Description	OEM Part #
				EC580060AFM	Starter Cover Gasket	5LP-15455-00
				EC581060AFM	Cover Gasket	5LP-15451-00
				C7800	Clutch Cover Gasket	5LP-15462-00
				OP092010FB	Oil Pump Cover Gasket	5LP-13329-00
				R027V	Crank Plug O-ring	93210-14369-00
				R031B	Intake O-ring	93210-44545-00
				R109B	Water Pump Impeller O-ring 2 Req.	11171/93210-77363
				R125V	Water Outlet- Oring	93210-33786-00
				R126B	Timing Plug O-ring	93210-357A3-00
				R12X2V	Out Put Shaft O-ring	93210-22298-00
				WA080043C	Drain Plug Washer	90430-06014-00
			Top End Kit	Component Part#	Component Description	OEM Part #
YFM700	06-17	103mm	C3142-EST	H2449027S	Head Gasket 103mm	1S3-11181-00-00
YFM700F	07-15	104mm	C3143-EST	H2449SP2027S	Head Gasket 104mm	
Grizzly		105.5mm	C3144-EST	H2465027S	Head Gasket 105.5mm	
				B0855010RC	Base Gasket	1S3-11351-00-00
				EX361	Exhaust Gasket 2 Req.	3YF-14613-01-00
				R034V	Throttle Body O-ring	4WV-14147-10-00
				R0126V	Water Pump O-ring	93210-33786-00
				R131B	Thermostat O-ring	93210-41042-00
				R240V	Cam Cover O-ring	93210-96601-00
				R79X2.5V	Valve Cover O-rings 2 Req.	93210-78544-00
				3187V	Valve Seal 4 Req.	5H0-12119-00-00
				EC584018AFM	Cam Chain Tensioner Gasket	4DW-12213-00

All Component Parts can be purchased individually.



ATV Gaskets



Cometic Gasket - An Exclusive NASCAR Performance® Product

YAMAHA YFM700

Model	Year	Bore Size	Top End Kit	Component Part#	Component Description	OEM Part #
YFM700	16-17	103mm	C3599-EST	EC2098032AFM	Cam Chain Tensioner Gasket	2MB-E2213-00-00
Grizzly				MA0164	Cam Chain Tensionor	2MB-YFM700
YFM700					Crush Gasket	E21E2-00-00
Kodiak				B1306010RC	Cylinder Base Gasket	2MB-E1351-00-00
				H4173023S	103mm Bore Cyl. Head Gasket	2MB-E1181-00-00
				VC362018AFM	Valve Cover Breather Gasket	2MB-E131B-00-00
				EX045	Header Gasket	3EG-14613-00-00
				WA117	Oil Line Banjo Bolt	2MB-E1195-00-00
					Crush Gaskets	
				3250V	Exhaust Valve Seal	2MB-E2129-00-00
				3250V	Intake Valve Seal	2MB-E2119-00-00
				R125V	Water Outlet O-ring	2MB-E2843-00-00



MX/Dirt • Off-Road Gaskets

COBRA KING 50

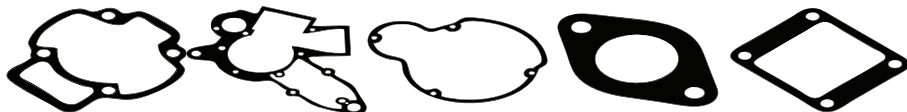

Base Center Case Ignition Cover Exhaust Intake

Model	Year	Bore Size	Top End Kit	Component Part#	Component Description	OEM Part #
KING 50	1998	O-RING	C3254	R010V	Head Cover O-rings 4 req.	ZCMUOR03
				R033B	Inner Head O-ring	ZCMUOR05
				R105X2B	Outer Head O-ring	ZCMUOR02
				B0848018AFM	Base Gasket	ZCKG0002
				B0848012F	High Compression Base	
				EX916059F	Exhaust Gasket	XCKG0001
			Bottom End Kit w/o crank seals C3307	Component Part#	Component Description	OEM Part #
				EC1220060AFM	Clutch Cover Gasket	ZCMU0030
				EC1301012F	Center Case Gasket	ZCKG0012
				EC1302032AFM	Ignition Cover Gasket	ZCKG0101
				IR715032AFM	Intake Gasket	ECMU0049
			Top End Kit C3255	Component Part#	Component Description	OEM Part #
KING 50	98-03	O-RING	C3255	R010V	Head Cover O-rings 8 req.	ECMU0049
W/2PC				R033B	Inner Head O-ring	ZCMUOR05
HEAD				R105X2B	Outer Head O-ring	ZCMUOR02
				R121V	Head Cover Coolant Seal O-ring	ZCMUOR08
				B0848018AFM	Base Gasket	ZCMU0030
				B0848012F	High Compression Base	ZCKG9902
				EX916059F	Exhaust Gasket	ZCKG0101
			Bottom End Kit w/o crank seals C3308	Component Part#	Component Description	OEM Part #
				EC1220060AFM	Clutch Cover Gasket	ZCMU0030
				EC1301012F	98 Center Case Gasket	ZCKG0012
				EC1304020F	99-Up Center Case Gasket	ZCKG9902
				EC1302032AFM	Ignition Cover Gasket	ZCKG0101
				IR715032AFM	Intake Gasket	ECMU0049

All Component Parts can be purchased individually.



MX/Dirt • Off-Road Gaskets



Cometic Gasket - An Exclusive NASCAR Performance® Product

COBRA CX50

Model	Year	Bore Size	Top End Kit	Component Part#	Component Description	OEM Part #
CX50	13-15	O-Ring	Top End Kit C3602	R105X2B	Outer Head O-ring	ZCMUOR02
				R033B	Combustion Chamber O-ring	ZCMUOR05
				R024V	Upper Dome O-ring	ZCMUV024
				R010V	Stud O-rings 4	ZCMUOR10
				B0848031F	Base Gasket .031"	ZCMU0708
				B0848020F	Base Gasket .020"	ZCMU0705
				B0848015F	Base Gasket .015"	ZCKG0501
				B0848012F	Base Gasket.012"	ZCMU0703
				R026V	Exhaust Flange O-ring	ZCMUOR07
				R125V	Header Flange O-ring 2	ZCMOTE11
			Bottom End Kit C3603	EC1982032AFM	Ignition Cover Gasket	ZCCS0002
				EC1983020F	Crankcase Gasket	ZCCS0005
				R018V	Sprocket Shaft Spacer O-ring	ZCDCOR01
				WA116	Drain Plug Gasket	HCWC0000
				EC1984060AFM	Clutch Cover Gasket	ZCMU0030
				R12X2V	Kick Shaft O-ring	ZCMUB014
				R12X2V	Oil Fil Plug O-ring	ZCMUB014
				R88X2B	Outer Chamber O-ring	ZCC60009
				PV148032AFM	Power Valve Cover Gasket	ZCC60012
				B1106012F	Base Gasket .3mm .011"	ZCC60303
B1106015F	Base Gasket .4mm .015"	ZCC60304				
B1106020F	Base Gasket .5mm .019"	ZCC60305				
B1106031F	Base Gasket .8mm .031"	ZCC60308				
R125V	Expansion Chamber to Flange O-ring 2	ZCMOTE11				
R114V	Power Valve Solenoid Cap O-ring	ZCMU0114				
R010V	Cylinder Stud O-ring 5	ZCMUOR03				
R033B	Combustion Chamber O-ring	ZCMUOR05				
R026V	Flange to Head O-ring	ZCMUOR07				
R126V	Pipe to flange O-ring	ZCMUOR11				
R122V	Power Valve Plunger O-ring	ZCMUOR18				
R020V	Cylinder Dome Plug O-ring	ZCMUOR23				
Bottom End Kit w/Oil Seals C3591BE	EC2057018AFM	Inner Clutch Cover Gasket	ZCC60016			
	R12X2V	Drain Plug O-ring	ZCMUB014			
	R020V	Slave Cylinder O-ring	ZCMUOR25			
	R047B	Clutch Cover O-ring	ZCC60013			
	R018V	Output Shaft O-ring	ZCMUOR21			
	EC2056020F	Center Case Gasket	ZCC60014			
	OS366	Kick Start Shaft Seal	ECDC0078			
	OS227	Shift Shaft Seal	ECDC0026			
	OS131	Output Shaft Seal	ECDC0025			
	OS110	Crank Shaft Seals	ECDC0024			
Oil Seal Kit C3591OS	OS308	Water Pump Shaft Seal	ECC60175			

All Component Parts can be purchased individually.



MX/Dirt • Off-Road Gaskets



Cometic Gasket - An Exclusive NASCAR Performance® Product

COBRA CX50

Model	Year	Bore Size	Top End Kit	Component Part#	Component Description	OEM Part #
CX50	13-15	O-Ring	C3602	R105X2B	Outer Head O-ring	ZCMUOR02
				R033B	Combustion Chamber O-ring	ZCMUOR05
				R024V	Upper Dome O-ring	ZCMUV024
				R010V	Stud O-rings 4	ZCMUOR10
				B0848031F	Base Gasket .031"	ZCMU0708
				B0848020F	Base Gasket .020"	ZCMU0705
				B0848015F	Base Gasket .015"	ZCKG0501
				B0848012F	Base Gasket.012"	ZCMU0703
				R026V	Exhaust Flange O-ring	ZCMUOR07
				R125V	Header Flange O-ring 2	ZCMOTE11
					Bottom End Kit	OEM Part#
					C3603	ZCCS0002
					EC1982032AFM	ZCCS0005
					EC1983020F	ZCDCOR01
					R018V	HCWC0000
	WA116	ZCMU0030				
	EC1984060AFM	ZCMUB014				
	R12X2V	ZCMUB014				
	R12X2V	ZCMUB014				
CX65	13-18	O-Ring	C3591	Component Part#	Component Description	OEM Part #
				B1106SP1015F	Base Gasket .4mm .015"	ZCC60304
				B1106SP1020F	Base Gasket .5mm .019"	ZCC60305
				B1106SP1032AFM	Base Gasket .6mm .023" (compressed)	ZCC60306
				B1106SP1031F	Base Gasket .8mm .031"	ZCC60308
				R88X2B	Outer Chamber O-ring	ZCC60009
				R033V	Combustion Chamber O-ring	ZCMUOR05
				R020V	Cylinder Dome Plug O-ring	ZCMUOR23
				R010V	Cylinder Stud O-ring 5	ZCMUOR03
				R026V	Flange to Head O-ring	ZCMUOR07
				R125V	Expansion Chamber to Flange O-ring 2	ZCMOTE11
				R126V	Pipe to flange O-ring	ZCMUOR11
					Bottom End Kit w/Oil Seals	OEM Part #
					C3591BE	ZCC60016
					EC2057018AFM	ZCC60014
					EC2056020F	ZCC60013
					R047B	ZCC60021
					IR1270031F	ZCMUOR07
					R026V	ZCMUOR35
					R12X2V	ZCMUB014
					R018V	ZCMUOR21
					Oil Seal Kit	OEM Part #
					C3591OS	ECD0078
					OS366	ECD0024
					OS110	ECD0025
	OS131	ECD0026				
	OS227	ECC60175				
	OS308					

All Component Parts can be purchased individually.



MX/Dirt • Off-Road Gaskets



Cometic Gasket - An Exclusive NASCAR Performance® Product

GAS GAS 125



Model	Year	Base Bore Size	Top End Kit	Center Case	Inner Clutch	Ignition	Clutch	Water Pump	Power Valve
Model	Year	Bore Size	Top End Kit	Component Part#	Component Description	Component Part#	Component Description	OEM Part #	
125	01-11	O-RING	C3260		B0537020F		Base Gasket	ME120144000	
EC,XC, DE,MC					IR271020F		Intake Gasket	ME120644005	
					PV106020F		Center Power Valve Gasket	ME120144006	
					PV107039F		Right Side Power Valve Gasket	ME120144007	
					R63X2V		Inner Head O-ring	ME120116065	
					R90X2V		Outer Head O-ring	ME120116060	
					WA135		Head Seal Washers 8 req.	T4008516	
			Bottom End Kit w/o crank seals						
			C3309		EC561020F		Center Case Gasket	ME120144001	
					EC562032AFM		Inner Clutch Cover Gasket	ME120144002	
					EC563020F		Ignition Cover Gasket	ME120144004	
					EC564031F		Clutch Cover Gasket	ME120144004	
					WP125020F		Water Pump Gasket	ME120144008	
			Top End Kit						
			C3261						
200/250/300		O-RING							
EC/MC/SM									
XC,EC200	01-03				R045V		Outer Head O-Ring 200	M01619135	
XC,EC250	01-03				B0403020F		Base Gasket	ME25644000	
XC,EC300	01-03				IR123032AFM		Intake Gasket	25644005	
EC200,	04-11				PV089020F		Left Side Power Valve Gasket	ME25644006	
DE200,					PV090039F		Right Side Power Valve Gasket	ME25644007	
EC200 Hobby,							Right Power Valve Gasket	ME25610002	
EC250,					B0403015F		Base Gasket .38mm	ME25644009	
EC250 Race,					B0403012F		Base Gasket .30mm	ME25644010	
DE250, MC250,					EX245043F		Exhaust Gasket	ME25644012	
EC300,	05-06				R046V		Outer Head O-Ring 250-300	ME25916060	
DE300					R040V		Inner Head O-Ring 200-250	ME25916065	
					EC350031F		Thermostat Gasket	ME25944011	
					R041V		Inner Head O-Ring 300	ME30916065	
					WA135		Head Seal Washers 6 req.	T4008516	
			Bottom End Kit w/o crank seals						
			C3310						
					EC345039F		Outer Clutch Cover Gasket	ME25644003	
					EC346031F		Mag Cover Gasket	ME25644004	
					EC348020F		Inner Clutch Cover	ME25644002	
					EC349020F		Center Case Gasket	ME25644001	
					EC349031F		Center Case Gasket	ME25644001	
					R44X3S		Crank O-ring	ME250112011	
					WP082020F		Water Pump Gasket	ME25644008	

All Component Parts can be purchased individually.



MX/Dirt • Off-Road Gaskets



Cometic Gasket - An Exclusive NASCAR Performance® Product

GAS GAS



Head



Base



Cam Chain Tensioner



Mag Cover

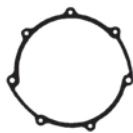

Outer Clutch Cover



Inner Clutch Cover

Model	Year	Bore Size	EST	Component Part#	Component Description	OEM Part #
EC250F Yamaha Motor	10-11	77 mm	Top End Kit	H1168SP3027S	Head Gasket	5NL-11181-00-00
		79 mm	C7905-EST	H1168SP2027S	Head Gasket 79mm Bore	
		81 mm	C3057-EST	H1271027S	Head Gasket 81mm Bore	
		83 mm	C3061-EST	H1272SP3027S	Head Gasket 84mm Bore	
		84 mm	C3120-EST	B0503020RC	Base Gasket	
			EX651	EXHAUST GASKET	5NL-14613-00-00	
			EC019032AFM	CAM CHAIN TENSIONER GASKET	4FM-12213-00	
			3179V	EXHAUST VALVE SEAL 2 REQ.	4SV-12119-00-00	
			3233	INTAKE VALVE SEAL 3 REQ.	4TV-12119-00-00	
			Bottom End Kit w/Oil Seals	Component Part#	Component Description	OEM Part #
			C3057BE	EC554032AFM	Inner Clutch Cover Gasket	5NL-15462-00-00
				R011B	Oil Delivery O-ring (SM)	93210-07003-00/07540-00
				R013B	Oil Pump Seal O-Ring	93210-10197-00*
				R013B	Clutch Side Oil Feed Line O-Ring	93210-10197-00*
				R013B	Mag Side Oil Feed Line O-Ring	93210-10197-00*
				R014B	Oil Delivery Pipe O-Ring (Lg.)	93210-12759-00
				R016V	Case Dowel O-ring	93210-16772-00
				R109B	Oil Filter Cover O-Ring (Sm.)	93210-07135-00
				R10X2V	Centercase Dowel O-ring	93210-10197-00*
				R113B	Timing Plug O-ring	93210-14369-00
				R124B	Crank End Plug O-ring	93210-32172-00
				R134B	Oil Filter O-Ring (LG)	93210-47675-00
				R19X2V	Oil Fill Plug O-ring	93210-19123-00
				R903V	Oil Delivery Pipe O-ring (Med.)	93210-09008-00
				WA080043C	Coolant Drain Bolt Washer	90430-06014-00*
				WA082063C	Oil Drain Bolt Washer	90430-10188-00*/
			Oil Seal Kit	OS323	Kick Start Shaft Seal	93102-18278-00
			C3057OS	OS324	Countershaft Oil Seal	93102-28010-00
				OS242	Outer Water Pump Seal	93109-11073-00
				OS227	Inner Water Pump Seal	93102-12106-00
				OS236	Oil Pump Seal	93101-14164-00
				OS286	Gear Selector Seal	93102-12224-00
			Clutch & Mag Kit	EC527020F	Magneto Cover Gasket	5NL-15451-00-00
			C3057CM	EC553020F	Outer Clutch Cover Gasket	5NL-15453-00-00
				Component Part#	Component Description	OEM Part#
				VC103	Valve Cover Gasket	

HONDA CRF50

Model	Year	Bore Size	EST	Component Part#	Component Description	OEM Part #
CRF50	04-16	39 mm	Top End Kit	H1820040S	Head Gasket 39mm Bore	12251-GBJ-003
			C7974-EST	H1821040S	Head Gasket 41mm Bore	
XR50	88-03	41 mm	C7975-EST	B0659020F	Base Gasket	12191-GW8-681
Z50R	82-87			3234V	Valve Stem Seals 2 Req.	12209-GB4-681
				EC1070018AFM	Right Side Head Cover Gasket	12394-GW8-680
				EC1071018AFM	Left Side Head Cover Gasket	12395-GW8-680
				EC1072018AFM	Center Head Cover Gasket	12391-GW8-680
				EX690064AM	Exhaust Gasket	18291-HB2-900
				R018B	Intake Runner O-Ring to Carb.	91302-001-020
				R14X2.5V	Dowel Pin O-Ring	91301-GB0-911
				R16X2V	Dowel Pin O-Ring	91303-035-000
				R219V	Valve Adjustment Cap 2 Req.	91302-001-020
				R27X2V	Intake Runner O-Ring to Head	91301-GK4-871
				R9X2V	Valve Guide Seals 2 Req.	91305-028-158
				Component Part#	Component Description	OEM Part#
				EC901032AFM	Clutch Cover Gasket	11394-GW8-680

All Component Parts can be purchased individually.



MX/Dirt • Off-Road Gaskets



Cometic Gasket - An Exclusive NASCAR Performance® Product

HONDA XR70R

Model	Year	Bore Size	EST Top End Kit C7300-EST	Component Part#	Component Description	OEM Part #
XR70R	97-03	50 mm		H2712040S	Head Gasket 50mm Bore	12200-GB5-931
CRF70	04-12			B0659020F	Base Gasket	12191-GW8-681
				3234V	Valve Stem Seals 2 Req.	12209-GB4-681
				EC1070018AFM	Right Side Head Cover Gasket	12394-GW8-680
				EC1071018AFM	Left Side Head Cover Gasket	12395-GW8-680
				EC1072018AFM	Center Head Cover Gasket	12391-GW8-680
				EX690064AM	Exhaust Gasket	18291-HB2-900
				R018B	Intake Runner O-Ring to Carb.	91302-001-020
				R14X2.5V	Dowel Pin O-Ring	91301-GB0-911
				R16X2V	Dowel Pin O-Ring	91303-035-000
				R219V	Valve Adjustment Cap 2 Req.	91302-001-020
				Component Part#	Component Description	OEM Part #
				EC901032AFM	Clutch Side Engine Cover	11394-GW8-680

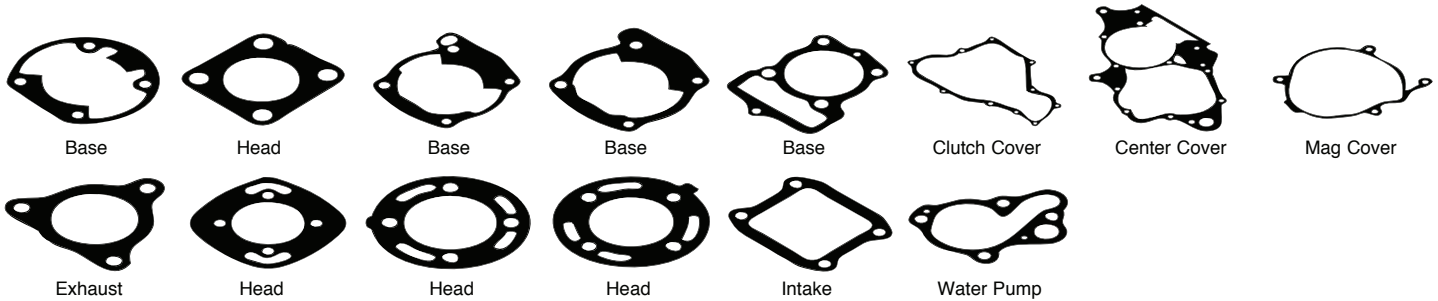

Model	Year	Bore Size	Top End Kit	Component Part#	Component Description	OEM Part #
CR80	80-82	51.5 mm	C7334	H0469020C	Head Gasket	12251-169-000
TC80	70-78			B0277020F	Base Gasket	12191-GC4-306
CR80	83	51.5 mm	Top End Kit C7000	Component Part# H0001020C	Component Description Head Gasket	OEM Part # 12251-GC4-307
				B0001020F	Base Gasket	12191-GC4-700
			Crank Seal Kit C7653	Kit Components	Component Description	OEM Part#
				OS103	20X32X7 Left Side Oil Seal	91205-166-004
				OS104	22X40X8 Right Side Oil Seal	91206-GC4-711
CR80	84	51.5 mm	Top End Kit C7001	Component Part# H0001020C	Component Description Head Gasket	OEM Part # 12251-GC4-307
				B0002020F	Base Gasket	12191-GC4-700
			Crank Seal Kit C7653	Kit Components	Component Description	OEM Part#
				OS103	20X32X7 Left Side Oil Seal	91205-166-004
				OS104	22X40X8 Right Side Oil Seal	91206-GC4-711
CR80	85	49 mm	Top End Kit C7002	Component Part# H0002043F	Component Description Head Gasket	OEM Part # 12251-GC4-307
				B0003020F	Base Gasket	12191-GC4-308
			Crank Seal Kit C7653	Kit Components	Component Description	OEM Part#
				OS103	20X32X7 Left Side Oil Seal	91205-166-004
				OS104	22X40X8 Right Side Oil Seal	91206-GC4-711

All Component Parts can be purchased individually.



MX/Dirt • Off-Road Gaskets



Cometic Gasket - An Exclusive NASCAR Performance® Product

HONDA CR80

Model	Year	Bore Size	Top End Kit	Component Part#	Component Description	OEM Part #
CR80	86-91	48 mm	C7003	H0003043F	Head Gasket	12251-GS2-781
				B0003020F	Base Gasket	12191-GC4-308
				EX002042AM	Exhaust Gasket	18291-GC4-600
				IR001018AFM	Intake Gasket	14132-904-600
			Crank Seal Kit C7653	Kit Components OS103	Component Description 20X32X7 Left Side Oil Seal	OEM Part# 91205-166-004
				OS104	22X40X8 Right Side Oil Seal	91206-GC4-711
			Top End Kit C7126	Component Part# H0266010S	Component Description Head Gasket 48mm Bore	OEM Part # 12251-GS2-621
CR80	92-02	48 mm	C7305	H0440010S	Head Gasket 49mm Bore	
CR80Expert	96-02	49 mm	C7932	H1698010S	Head Gasket 51mm Bore	
CR85	03-07	51 mm	C7315	H0449010S	Head Gasket 52mm Bore	
		52 mm		B0004018AFM	Base Gasket	12191-GBF-830
				B0004012F	Base Gasket High Compression	12191-GBF-830
				EX002042AM	Exhaust Gasket	18291-GC4-600
				IR001018AFM	Intake Gasket	14132-904-600
				R38X3V	Exhaust O-rings 03-Up	91304-GBF-K41
				WA138	Exhaust Washer 03-Up	18309-GBF-K40
			Bottom End Kit w/Oil Seals C7126BE	Component Part# EC183020F	Component Description Center Case Gasket	OEM Part # 11191-GBF-830
				WP03200032AFM	Water Pump Gasket	19229-GBF-840
				WA133	Water Pump Drain Washer	90543-273-000
				WA137	Drain Plug Washer	90407-259-000
				R12X2.5B	Oil Fill Plug O-ring 11.9x2.2	91370-461-000
			Oil Seal Kit C7126OS	Component Part# OS103	Component Description Crank Seal 20x32x7	OEM Part # 91205-GC4-711
				OS104	Crank Seal 22x40x8	91206-GC4-711
				OS197	Shift Shaft Seal 14x24x6	91202-444-023
				OS203	Output Shaft Seal 17x28x7	91201-415-013
				OS242	Water Pump Shaft Seal 12x25x7	91211-KA3-761
				OS245	Start Shaft Seal 15x25x6	91211-671-003
				OS246	Impeller Shaft Seal 12x21x5	91201-035-015
				OS247	Clutch Actuator Seal 12x18x5	91204-KK0-003
			Clutch & Mag Kit C7126CM	Component Part# EC1820032AFM	Component Description Clutch Cover Gasket	OEM Part # 11393-GBF-830
				EC192063N	Mag Cover Gasket	11342-GC4-710

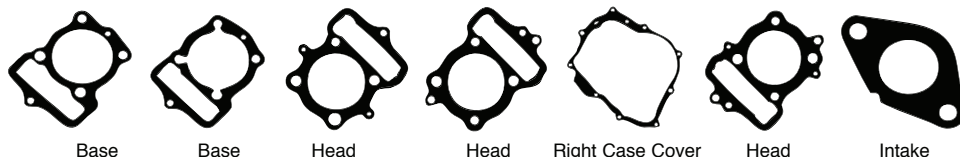

Model	Year	Bore Size	Top End Kit	Component Part#	Component Description	OEM Part #
XL80	80-85	50 mm	C7230	H0336043F	Head Gasket 50mm Bore	12251-GN1-880
XR80	79-84			B0192020F	Base Gasket	12191-GN1-730
XR80R	85-91					
XR80Z A/B	79-81					
			EST Top End Kit C7231-EST	Component Part# H2598010S	Component Description Head Gasket 50mm Bore	OEM Part # 12251-GN1-A41
CRF80F	04-13	54 mm		3231V	Valve Stem Seals 2 req.	12208-413-003
XR80R	92-03			B0192020RC	Base Gasket	12191-GN1-730
				IR575032AFM	Intake Gasket	16229-GN1-A41
				R10X2V	Valve Guide O-rings 2 req.	91301-200-000
				EX784080C	Exhaust Gasket	18291-KZ1-670
				Component Part# EC1074018AFM	Component Description Clutch Cover Gasket	OEM Part # 11393-KN4-750

All Component Parts can be purchased individually.



MX/Dirt • Off-Road Gaskets



Cometic Gasket - An Exclusive NASCAR Performance® Product

HONDA XL100



Model	Year	Bore Size	Top End Kit	Component Part#	Component Description	OEM Part #
XL100	79-85	55 mm	C7988	H0329040S	Head Gasket 55mm Bore	12251-KA8-405
XR100	81-91	58 mm	C7985	H0329SP1040S B0194020F	MLS Head Gasket 58mm Bore Base Gasket	12251-KA8-405 12191-KN4-750

Model	Year	Bore Size	EST Top End Kit	Component Part#	Component Description	OEM Part #
CRF100	04-13	55 mm	C7989-EST	H0330010S	MLS Head Gasket 55mm Bore	12251-KN4-751
XR100	92-03	58 mm	C7986-EST	H0330SP1010S 3231V B0194020F IR575032AFM R10X2V R30X3.5B EC1074018AFM	MLS Head Gasket 58mm Bore Valve Stem Seals 2 req. Base Gasket Intake Gasket Valve Guide O-rings 2 req. Intake O-ring Clutch Cover Gasket	12208-413-003 12191-KN4-750 16229-GN1-A41 91301-200-000 91302-401-000 11393-KN4-750

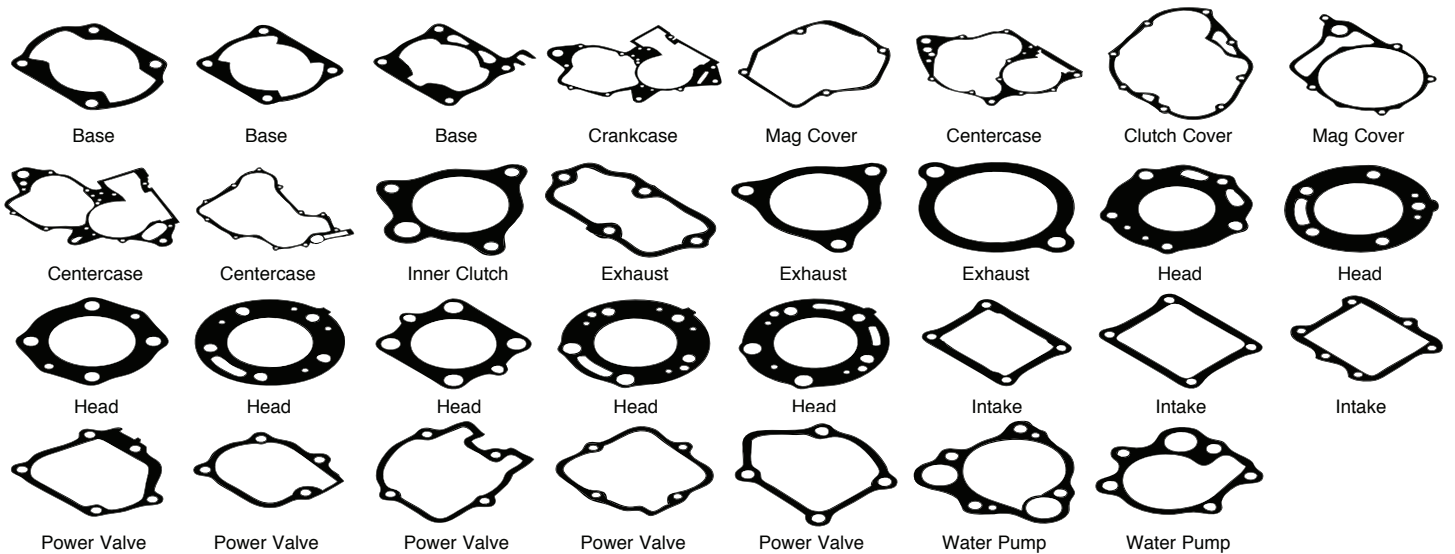

Model	Year	Bore Size	Top End Kit	Component Part#	Component Description	OEM Part #
CR125	73-78	58 mm	C7465	H0216020C	Head Gasket 58mm Bore	12251-360-000
MT125				B0345020F	Base Gasket	12191-373-306
CR125	79-80	57.7 mm	C7466	H0739020C	Head Gasket 57.7mm Bore	12251-466-000
				B0351020F	Base Gasket	12191-444-306
				EX419043F	Exhaust Gasket	18291-444-306
				IR214060AFM	Intake Gasket Reed to Case	14132-444-306
				IR215060AFM	Intake Gasket Reed to Carb Boot	14131-444-306
			Bottom End Kit w/o crank seals C3312	EC533020F	Center Case Gasket	11191-444-306
				EC534020F	Clutch Cover Gasket	11394-444-306
				EC670060AFM	Mag Cover Gasket	11395-444-306
CR125	81	56 mm	C3168	H1902043F	Head Gasket 56mm Bore	12251-KA3-306
				B0351018AFM	Base Gasket	12191-444-306
				EX419043F	Exhaust Gasket	18291-444-306
				IR214060AFM	Intake Gasket Reed to Case	14132-444-306
				IR215060AFM	Intake Gasket Reed to Carb Boot	14131-444-306

All Component Parts can be purchased individually.



MX/Dirt • Off-Road Gaskets



Cometic Gasket - An Exclusive NASCAR Performance® Product

HONDA CR125

Model	Year	Bore Size	Top End Kit	Component Part#	Component Description	OEM Part #
CR125	82	56 mm	C3430	H1715043F B0351018AFM EX419043F IR214060AFM IR215060AFM EX419043F	Head Gasket 56mm Bore Base Gasket Exhaust Gasket Intake Gasket Reed to Case Intake Gasket Reed to Carb Boot Exhaust Gasket	12251-KA3-307 12191-444-306 18291-444-306 14132-444-306 14131-444-306 18291-444-306
CR125	83	57 mm	Top End Kit C7118	Component Part# H0004043F B0005020F	Component Description Head Gasket 57mm Bore Base Gasket	OEM Part # 12251-KA3-308 12191-KA3-306
CR125	84-85	57 mm	Top End Kit C7005	Component Part# H0004043F B0006020F EX003042AM IR002020F IR003018AFM	Component Description Head Gasket 57mm Bore Base Gasket Exhaust Gasket Intake Gasket Reed to Case Intake Gasket Reed to Carb Boot	OEM Part # 12251-KA3-308 12191-KA3-740 18359-K56-000 14131-KA3-710 14132-K56-701
CR125	86	56 mm	Top End Kit C7006	Component Part# H0005043F B0007020F EX003042AM IR003018AFM	Component Description Head Gasket 56mm Bore Base Gasket Exhaust Gasket Int. Gasket Reed to Carb Boot	OEM Part # 12251-KS6-405 12191-KA3-307 18359-K56-000 14132-K56-701
CR125	87	56 mm	Top End Kit C7007	Component Part# H0006043F B0008020F EX004042AM EX005031F IR003018AFM	Component Description Head Gasket 56mm Bore Base Gasket Exhaust Gasket Exhaust Gasket Intake Gasket Reed to Carb Boot	OEM Part # 12251-KZ4-701 12191-KS6-701 18314-K56-701 18339-K56-701 14132-K56-701
			Crank Seal Kit C7654	Component Part# C7491	Component Description Clutch Cover Gasket	OEM Part # 91311-KS6-700
				Kit Components OS103 OS105	Component Description 20X32X7 Left Side Crank Seal 30X45X8 Right Side Crank Seal	OEM Part# 91205-166-004 91203-KS6-004
CR125	88-89	56 mm	Top End Kit C7008	Component Part# H0355010S B0008020F EX004042AM EX005031F IR003018AFM	Component Description Head Gasket 56mm Bore Base Gasket Exhaust Gasket Exhaust Gasket Int. Gasket Reed to Carb Boot	OEM Part # 12251-KZ4-701 12191-KS6-701 18314-K56-701 18339-K56-701 14132-K56-701
			Crank Seal Kit C7654	Component Part# C7491	Component Description Clutch Cover Gasket	OEM Part # 91311-KS6-700
				Kit Components OS103 OS105	Component Description 20X32X7 Left Side Crank Seal 30X45X8 Right Side Crank Seal	OEM Part# 91205-166-004 91203-KS6-004
CR125	90-91	55 mm	Top End Kit C7010	Component Part# H0225010S B0009018AFM EX006042AM IR003018AFM PV001018AFM PV002018AFM PV003018AFM	Component Description Head Gasket 55mm Bore Base Gasket Exhaust Gasket Int. Gasket Reed to Carb Boot Right Power Valve Cover Gasket Left Power Valve Cover Gasket Upper Power Valve Cover Gasket	OEM Part # 12251-KZ4-701 12191-KZ4-860 18291-KZ4-700 14132-K56-701 12108-KZ4-700 12109-KZ4-700 12112-KZ4-700
			See Pg.43 for Bottom End Kit			
CR125	92-97	55 mm 56 mm 58 mm	Top End Kit C7115 C7306 C7299	Component Part# H0225010S H0355010S H0409010S B0009018AFM B0009012F EX006042AM IR003018AFM PV001018AFM PV002018AFM PV003018AFM	Component Description Head Gasket 55mm Bore Head Gasket 56mm Bore Head Gasket 58mm Bore Base Gasket High Compression Base Gasket Exhaust Gasket Int. Gasket Reed to Carb Boot Right Power Valve Cover Gasket Left Power Valve Cover Gasket Upper Power Valve Cover Gasket	OEM Part # 12251-KZ4-701 12251-KZ4-701 12251-KZ4-701 12191-KZ4-860 12191-KZ4-860 18291-KZ4-700 14132-K56-701 12108-KZ4-700 12109-KZ4-700 12112-KZ4-700
			See Pg.39 for Bottom End Kit			

All Component Parts can be purchased individually.



MX/Dirt • Off-Road Gaskets



Cometic Gasket - An Exclusive NASCAR Performance® Product

HONDA 125

Model	Year	Bore Size	Top End Kit	Component Part#	Component Description	OEM Part #		
CR125	98-99	55 mm	C7394	H0225010S	Head Gasket 55mm Bore	12251-KZ4-701		
			C7406	H0355010S	Head Gasket 56mm Bore	12251-KZ4-701		
			C7407	H0409010S	Head Gasket 58mm Bore	12251-KZ4-701		
				56 mm		B0314018AFM	Base Gasket	12191-KZ4-J00
					B0314012F	High compression Base Gasket		
					IR003018AFM	Int. Gasket Reed to Carb Boot	14132-K56-701	
					EX006042AM	Exhaust Gasket	18291-KZ4-700	
					PV001018AFM	Right Power Valve Cover Gasket	12108-KZ4-700	
					PV002018AFM	Left Power Valve Cover Gasket	12109-KZ4-700	
					PV003018AFM	Upper Power Valve Cover Gasket	12112-KZ4-700	
CR125	00	54 mm	Top End Kit	Component Part#	Component Description	OEM Part #		
			C7678	H0928010S	Head Gasket 54mm Bore	12251-KZ4-A91		
			C7694	H0929010S	Head Gasket 56mm Bore	12251-KZ4-A91		
		58 mm	C7695	H0930010S	Head Gasket 58mm Bore	12251-KZ4-A91		
				B0314018AFM	Base Gasket	12191-KZ4-J00		
				B0314012F	High compression Base Gasket	12191-KZ4-J00		
				B0314010S	High compression Base Gasket			
				IR003018AFM	Intake Gasket Reed to Carb Boot	14132-K56-701		
				EX006042AM	Exhaust Gasket	18291-KZ4-700		
				PV091032AFM	Right Power Valve Cover Gasket	12108-KZ4-A90		
CR125	01-02	54 mm	Top End Kit	Component Part#	Component Description	OEM Part #		
			C7757	H0928010S	Head Gasket 54mm Bore	12251-KZ4-A91		
			C7758	B0490018AFM	Base Gasket	12191-KZ4-L10		
		58mm	C7759	B0490012F	High Compression Base Gasket	12191-KZ4-L10		
				EX006042AM	Exhaust Gasket	18291-KZ4-700		
				IR003018AFM	Intake Gasket Reed to Carb Boot	14132-K56-701		
				PV091032AFM	Right Power Valve Cover Gasket	12108-KZ4-A90		
				R124S	Expansion Cham O-rings 2 Req.			
	R19X3V	Water Outlet O-ring	91312-KE7-003					
CR125	90-02		Bottom End Kit w/Oil Seals	Component Part#	Component Description	OEM Part #		
			C7010BE	EC083032AFM	Inner Clutch Cover	11394-KZ4-A90		
				EC185020F	Center Case Gasket	11191-KZ4-620		
				IR003018AFM	Intake Gasket	14132-KY4-970		
				R16X3V	Fill Plug O-ring	91303-800-000		
				R20X2V	Output Shaft O-ring	91351-KA3-711		
				WA117	Drain Plug Gasket	94109-12000		
				WA133	Water Pump Drain Plug Gasket	90543-273-000		
				WP033018AFM	Water Pump Gasket 2 req	19229-KZ4-620		
			Oil Seal Kit	Component Part#	Component Description	OEM Part #		
			C7010OS	OS103	Left Crank Seal	91205-166-004		
				OS105	Right Crank Seal	91203-KS6-004		
				OS227	Water Pump Shaft Seal	91201-965-000		
				OS236	Shift Shaft Seal	91203-KK3-830		
				OS242	Outer Water Pump Shaft Seal	91211-KA3-761		
				OS243	Start Shaft Seal	91205-KA3-712		
				OS244	Clutch Pushrod Seal	91206-VA3-J02		
				OS363	Output Shaft Seal	91201-KS6-004		
			Clutch & Mag Kit	Component Part#	Component Description	OEM Part #		
			C7010CM	EC228	Clutch Cover Gasket	91311-KS6-700		
				EC510060AFM	Mag Cover Gasket	11352-KS6-700		

All Component Parts can be purchased individually.



MX/Dirt • Off-Road Gaskets



Cometic Gasket - An Exclusive NASCAR Performance® Product

HONDA 125

Model	Year	Bore Size	Top End Kit	Component Part#	Component Description	OEM Part #	
CR125	03-04	54 mm	C7181	H1712010S	Head Gasket 54mm Bore	12251-KZ4-A91	
		56 mm	C7184	H0929010S	Head Gasket 56mm Bore	12251-KZ4-A91	
		57 mm	C3220	H0929SP2010S	Head Gasket 57mm Bore	12251-KZ4-A91	
				B0628018AFM	Base Gasket	12191-KZ4-L30	
				B0628012F	High Compression Base Gasket		
				EX006042AM	Exhaust Gasket	18291-KZ4-700	
				IR394032AFM	Intake Gasket	14132-KZ4-L30	
				PV091032AFM	Rt. Power Valve Cover Gasket 03	12108-KZ4-A90	
				PV110018AFM	Left Power Valve Cover Gasket	12111-KZ3-L20	
				PV127032AFM	Rt. Power Valve Cover Gasket 04	12108-KSR-A00	
				R124S	Exp. Chamber O-rings 2 Req.		
				R19X3V	Water Outlet O-ring	91312-KE7-003	
			Bottom End Kit w/Oil Seals	Component Part#	Component Description	OEM Part #	
			C7181BE	EC709020F	Center Case Gasket	11191-KZ4-L30	
				WA117	Oil Drain Plug Gasket	94109-12000	
				EC083032AFM	Inner Clutch Cover Gasket	11394-KZ4-A90	
				R18X3V	Fill Plug O-ring	91307-035-000	
				WP033018AFM	Water Pump Cover Gasket	19229-KZ4-620	
				WA128	Case Cover Drain Plug Crush Washer	90463-ML7-000	
			Oil Seal Kit	Component Part#	Component Description	OEM Part #	
			C7181OS	OS105	Right Crank Seal	91203-KS6-004	
				OS227	Water Pump Shaft Seal	91201-965-000	
				OS236	Shift Shaft Seal	91203-KK3-830	
				OS241	Output Shaft Seal	91201-KSR-A01	
				OS242	Impeller Seal	91211-KA3-761	
				OS243	Start Shaft Seal	91205-KA3-712	
				OS244	Clutch Pushrod Seal	91206-VA3-J02	
			Clutch & Mag Kit	Component Part#	Component Description	OEM Part #	
			C7181CM	EC228	Outer Clutch Cover O-ring	91311-KS6-700	
				EC510060AFM	Mag Cover Gasket	11352-KZ4-L10	
CR125	05-07	54 mm	C3085	H2370010S	Head Gasket 54mm Bore	12251-KSR-731	
		56 mm	C3088	H2370SP1010S	Head Gasket 56mm Bore	12251-KSR-731	
		57 mm	C3221	H2370SP5010S	Head Gasket 57mm Bore	12251-KSR-731	
		58 mm	C3537	H2370SP4010S	Head Gasket 58mm Bore	12251-KSR-731	
					B0812014RC	Base Gasket	12191-KSR-731
				B0812010RC	Base Gasket High Compression	12191-KSR-731	
				EX644010S	Exhaust Gasket	18291-KSR-730	
				PV091032AFM	Right Power Valve Cover Gasket	12108-KZ4-A90	
				PV132018AFM	Left Power Valve Cover Gasket	12111-KSR-730	
				Bottom End Kit w/Oil Seals	Component Part#	Component Description	OEM Part #
				C3085BE	EC1013020F	Center Case Gasket	11191-KSR-730
					EC1014032AFM	Inner Clutch cover O-ring	11394-KSR-730
					IR539032AFM	Intake Gasket	14132-KSR-731
					MR039	Center Case Coolant Passage O-Ring	91301-KSR-731
					R18X3V	Fill Plug O-ring	91307-035-000
					R20X2V	Power Valve Shaft O-ring	91353-KM1-004
					WA128	Case Cover Drain Plug Crush Washer	90463-ML7-000
					WA137	Oil Drain Plug Gasket	94109-12000
					WP395018AFM	Water Pump Cover Gasket	19229-KSR-730
				Oil Seal Kit	Component Part#	Component Description	OEM Part #
				C7181OS	OS105	Right Crank Seal	91203-KS6-004
					OS227	Water Pump Shaft Seal	91201-965-000
					OS236	Shift Shaft Seal	91203-KK3-830
				OS241	Output Shaft Seal	91201-KSR-A01	
				OS242	Impeller Seal	91211-KA3-761	
				OS243	Start Shaft Seal	91205-KA3-712	
				OS244	Clutch Pushrod Seal	91206-VA3-J02	
			Clutch & Mag Kit	Component Part#	Component Description	OEM Part #	
			C7181CM	EC228	Outer Clutch Cover O-ring	91311-KS6-700	
				EC510060AFM	Mag Cover Gasket	11352-KZ4-L10	

All Component Parts can be purchased individually.



MX/Dirt · Off-Road Gaskets



Cometic Gasket - An Exclusive NASCAR Performance® Product

HONDA CRF150F

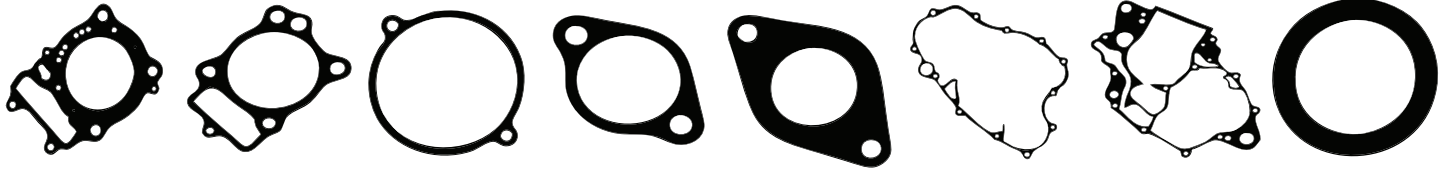

Head

Base

Engine Cover

Cam Chain Tensioner

Cam Chain Tensioner

Clutch Cover

Center Case Gasket

Exhaust

Model	Year	Bore Size	EST Top End Kit	Component Part#	Component Description	OEM Part #
CRF150F	03-05	64.5 mm	C3131-EST	H2490010S	Head Gasket 64.5mm	12251-KBB-901
			C3161-EST	H2490SP1010S	Head Gasket 67mm	
		67 mm	3231V	Valve Stem Seals 2 req.	12208-413-003	
			B0845020F	Base Gasket	12191-KCN-000	
			EC1079018AFM	Cam Chain Tensioner	16214-KPS-900	
			EC681018AFM	Left Cylinder Head Cover	12339-KTO-710	
			R10X2V	Valve Guide O-rings 2 Req.	91301-KW1-900	
			R126V	Intake Gasket	91304-HB3-003	
			R151V	Cam Cover O-ring	12339-KTO-710	
			R35X3V	Valve Adjuster Cap O-rings 2 Req.	91303-KK3-830	
	Component Part#	Component Description	OEM Part #			
	EC1076018AFM	Clutch Cover Gasket	11393-KGA-900			
	Component Part#	Component Description	OEM Part #			
CRF150F	06-14	58mm	C3499-EST	H2504010S	Head Gasket 58mm	12251-KRM-B41
			C3500-EST	H2504SP6010S	Head Gasket 62mm	
		62mm	3234V	Valve Stem Seals 2 req.	12209-GB4-681	
			B0859020F	Base Gasket	12191-KWK-900	
			EC1124018AFM	Cam Chain Tensioner	14560-KRM-840	
			EX691064AM	Exhaust Gasket	18291-MN5-650	
			R126V	Intake Gasket	91304-KRM-840	
				Component Part#	Component Description	OEM Part #
				H2612SP1018S	Head Gasket 66mm Bore	12251-KSE-671
				H2612018S	Head Gasket 68mm Bore	12251-KSE-671
	3239V	Valve Stem Seal 4 Req.	12208-ML0-721			
	B0880014RC	Base Gasket	12191-KSE-671			
	EC960018AFM	Cam Chain Tensioner Gasket	14560-MEN-671			
	EX784080C	Exhaust Gasket	18291-KZ1-670			
	Component Part#	Component Description	OEM Part #			
	EC1157020RC	Center Case Gasket	11191-KSE-670			
	WP205	Water Pump Gasket	19226-KSE-670			
	R18X3V	Fill Plug O-ring	91307-035-000			
	R27X2V	Crank Plug O-ring	91305-KF0-003			
	R113B	Water Pump Inlet Gasket	91303-377-000			
	WA118	Water Pump Drain Washer	90463-ML7-000			
	R113B	Dip Stick O-ring	91311-PH7-003			
	R40X2V	Oil filter O-ring	91302-PA9-003			
	R18X3V	Timing Plug O-ring	91307-035-003			
	R8.5X1.5V	Oil Filter Galley O-ring	90751-GK1-003			
	Component Part#	Component Description	OEM Part #			
	OS227	Water Pump Seal 12X22X5	91201-148-003			
	OS236	Shift Shaft Seal 14X22X5	91203-KA4-771			
	OS239	Start Shaft Seal 20X28X5	91204-KF0-003			
	OS262	Crank End Oil Seal 10X21X5	91204-KRN-671			
	OS264	Left Crank Seal 38X52X7	91201-MEB-671			
	OS285	Output Shaft Seal 20X30X7	91202-KCY-761			
	OS303	Right Crank Seal 32X48X7.5	91201-KSE-671			
	OS304	Oil Pump Seal 18X30X5	91203-KSE-671			
	Component Part#	Component Description	OEM Part #			
	EC1156032AFM	Clutch Cover Gasket	11394-KSE-670			
	EC1155032AFM	Mag Cover Gasket	11395-KSE-670			

All Component Parts can be purchased individually.



MX/Dirt • Off-Road Gaskets



Cometic Gasket - An Exclusive NASCAR Performance® Product

HONDA XL200R/CRF230F

Model	Year	Bore Size	Top End Kit	Component Part#	Component Description	OEM Part #
XL200R	83-84	67 mm	C7234	H0334043F	Head Gasket 67mm	12251-KT0-P00
XR200R	80-83			B0021020F	Base Gasket	12191-KT0-710
XR200	84-85	69 mm	Top End Kit C7235	Component Part# H0333043F	Component Description Head Gasket 69mm	OEM Part # 12251-KT0-P00
				B0392020F	Base Gasket	12191-KZ1-920
XR200R	86-91	67 mm	Top End Kit C7236	Component Part# H0334043F	Component Description Head Gasket 67mm	OEM Part # 12251-KT0-P00
				B0021020F	Base Gasket	12191-KT0-710
XR200R	92-03	67 mm	Top End Kit C7237	Component Part# H0334043F	Component Description Head Gasket 67mm	OEM Part # 12251-KT0-P00
				B0021020F	Base Gasket	12191-KT0-710
CRF230F	03-16	66 mm 68 mm	Top End Kit C3132-EST C3283-EST	Component Part# H2469040S	Component Description Head Gasket 66mm	OEM Part # 12251-KT0-711
				3231V	Valve Stem Seals 2 req.	12208-413-003
				B0021020F	Base Gasket	12191-KT0-710
				EC1079018AFM	Cam Chain Tensioner	16214-KPS-900
				EC681018AFM	Left Cylinder Head Cover	12339-KTO-710
				EX691064AM	Exhaust Gasket	18291-MN5-650
				R10X2V	Valve Guide O-rings 2 Req	91301-KW1-900
				R126V	Intake Gasket	91304-HB3-003
				R151V	Cam Cover O-ring	12339-KTO-710
				R35X3V	Valve Adjuster Cap O-rings 2 Req.	91303-KK3-830
				Component Part#	Component Description	OEM Part #
				EC1076018AFM	Clutch Cover	11393-KGA-900

HONDA MR250

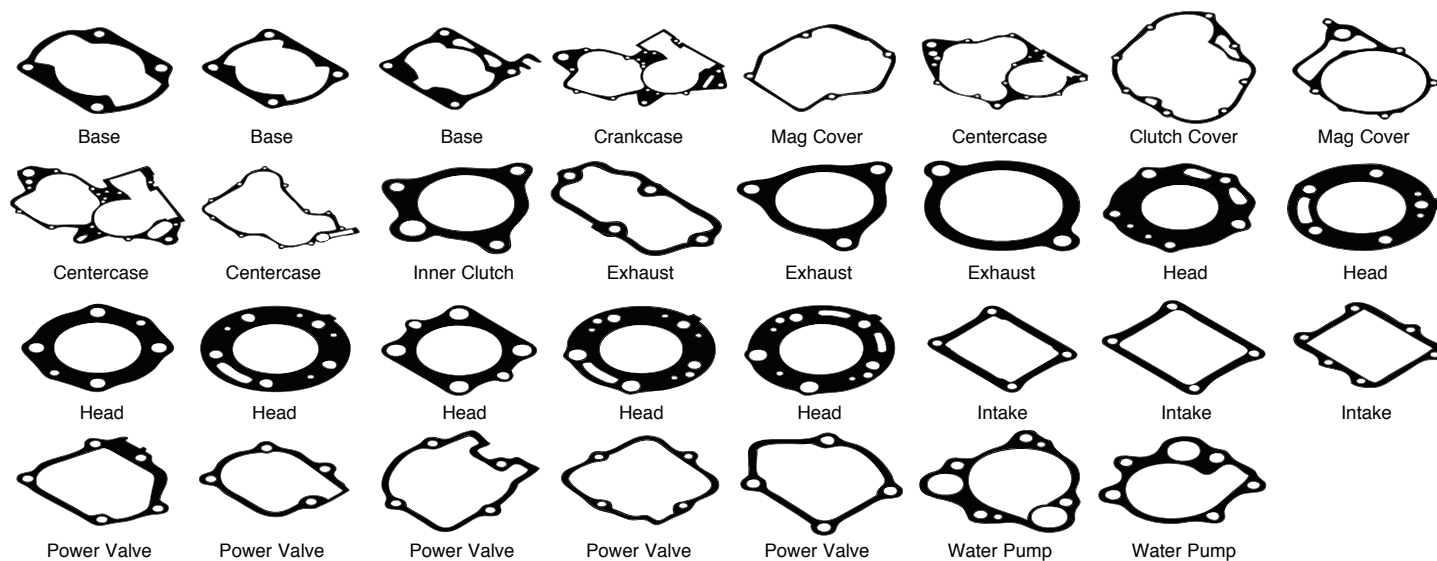

Model	Year	Bore Size	Top End Kit	Component Part#	Component Description	OEM Part #
MR250, MT250,	73-77	72 mm	C7140	H0182043F	Head Gasket 72mm	12251-358-306
				B0137020F	Base Gasket 73-76	12191-357-306
				B0395020F	Base Gasket 77-84	12191-381-306
CR250	73-74	71 mm	Top End Kit C7811	Component Part# H0912020C	Component Description Head Gasket 71mm	OEM Part # 12251-357-020
				B0137020F	Base Gasket	12191-357-306
				EX250020C	Exhaust Gasket	18359-357-000
				IR133031F	Intake Gasket	16229-357-010
			Bottom End Kit w/o crank seals C3321	Component Part#	Component Description	OEM Part #
				EC357031F	Center Case Gasket	11191-357-030
				EC358031F	Clutch Cover Gasket	11394-357-040/306
				EC394020F	Mag Cover Gasket	11395-357-020

All Component Parts can be purchased individually.



MX/Dirt • Off-Road Gaskets



Cometic Gasket - An Exclusive NASCAR Performance® Product

HONDA CR250

Model	Year	Bore Size	Top End Kit	Component Part#	Component Description	OEM Part #
CR250	78-80	71 mm	Top End Kit C7278	H0359020C	Head Gasket 71mm	12254-430-000
				B0210020F	Base Gasket	12191-430-306
				EX293SP1042AM	Exhaust Gasket	18291-430-000
			Bottom End Kit w/o crank seals C3322	IR004018AFM	Intake Gasket	14132-KAE-000
				IR005018AFM	Intake Gasket	14133-430-000
				Component Part#	Component Description	OEM Part #
CR250	81-82	68 mm	Top End Kit C7011	EC465031F	Inner Clutch Cover	
				EC486020F	Center Case Gasket	11191-430-010
				EC487020F	Mag Cover Gasket	11395-430-306
			Bottom End Kit w/o crank seals C3323	Component Part#	Component Description	OEM Part #
				H0007043F	Head Gasket	12254-KA4-004/306
				B0010020F	Base Gasket	12191-KA4-306
CR250	83	68 mm	Top End Kit C7108	IR004018AFM	Intake Gasket	14132-KAE-000
				IR005018AFM	Intake Gasket	14133-430-000
				Component Part#	Component Description	OEM Part #
			Crank Seal Kit C7697	EC801032AFM	Clutch Cover Gasket	31129-KA4-000/ 11395-KA4-000/306
				EC802020F	Center Case Gasket	11191-KA4-000
				EC803060AFM	Mag Cover Gasket	11395-KA4-710
CR250	84	68 mm	Top End Kit C7012	EX397042AM	Exhaust Gasket	18291-430-000/306
				WP157032AFM	Water Pump Gasket	19229-KA4-307
				Component Part#	Component Description	OEM Part #
			Crank Seal Kit C7697	H0008043F	Head Gasket	12254-KA4-710
				B0010020F	Base Gasket	12191-KA4-306
				EC801032AFM	Clutch Cover Gasket	31129-KA4-000/ 11395-KA4-000/306
CR250	85	68 mm	Top End Kit C7013	OS103	Left Side Crank Seal 20X32X7	91205-166-004
				OS106	Right Crank Seal 38X58X11	91201-KA4-004
				Component Part#	Component Description	OEM Part #
			Bottom End Kit C7013BE	H0008043F	Head Gasket	12254-KA4-710
				B0011020F	Base Gasket	12191-KA4-307
				Component Part#	Component Description	OEM Part #
CR250	85-86	68 mm	Oil Seal Kit C7013OS	C7490	Clutch Cover Gasket	91311-KS7-701
				Component Part#	Component Description	OEM Part #
				H0009043F	Head Gasket	12254-KS7-881
			Clutch & Mag Kit C7013CM	B0012020F	Base Gasket	12191-KS7-306
				EX007042AM	Exhaust Gasket	18291-KA4-770
				IR004018AFM	Intake Gasket	14132-430-000
			Bottom End Kit C7013BE	IR005018AFM	Intake Gasket	14133-430-000
				Component Part#	Component Description	OEM Part #
				EC846020F	Center Case Gasket	11191-KA4-770
			Oil Seal Kit C7013OS	WA137	Drain Plug Gasket	94109-12000
				R12X2V	Fill Plug O-ring 11.9x2.2	91370-461-000
				WA133	Clutch Cover Drain Plug	90543-273-000
				Component Part#	Component Description	OEM Part #
				OS103	Left Crank Seal 20x32x7	91205-166-004
				OS106	Right Crank Seal 38x58x11	91201-KA4-004/ 91201-ML3-003
OS236	Shift Shaft Seal 14x22x5	91203-KA4-771/ 91203-KA4-772				
OS240	Clutch Lifter Oil Seal 12x18x3	91201-951-003				
OS443	Output Shaft Seal 28x40x8	91207-ML3-003				
OS239	Start Shaft Seal 20x28x5	91202-KA4-003/ 91204-KF0-003				
Clutch & Mag Kit C7013CM	Component Part#	Component Description	OEM Part #			
	EC082063N	Mag Cover Gasket	11352-KA4-770/ 11352-KA4-771			
	EC041032AFM	Clutch Cover Gasket	11395-KS7-000/ 11395-KS7-306			

All Component Parts can be purchased individually.



MX/Dirt • Off-Road Gaskets



Cometic Gasket - An Exclusive NASCAR Performance® Product

HONDA CR250

Model	Year	Bore Size	Top End Kit	Component Part#	Component Description	OEM Part #		
CR250	86-91	68 mm	C7015	H0009043F	Head Gasket	12254-KS7-881		
				B0013020F	Base Gasket	12191-KS7-306		
				B0013012F	High Comp. Base Gasket .012"			
				EX008042AM	Exhaust Gasket	18291-KS7-000		
				IR004018AFM	Intake Gasket Cylinder to Reed	14132-430-000		
				IR020020F	Intake Gasket Reed to Carb	14133-KS7-000		
				PV004018AFM	Side Power Valve Gasket	12108-KS7-000		
				PV005020F	Upper Left Power Valve Gasket	12113-KS7-000		
				PV006020F	Upper Right Power Valve Gasket	12114-KS7-000		
				Component Part#	Component Description	OEM Part #		
				C7490	Clutch Cover Gasket	91311-KS7-701		
				Component Part#	Component Description	OEM Part #		
				OS103	Left Side Crank Seal 20X32X7	91205-166-004		
				OS106	Right Crank Seal 38X58X11	91201-KA4-004		
				Top End Kit	Component Part#	Component Description	OEM Part #	
CR250	92-01	68.5 mm	C7116	H0247010S	Head Gasket	12254-KZ3-860		
				B0014018AFM	Base Gasket	12191-KZ3-880		
				IR004018AFM	Intake Gasket	14132-430-000		
				PV007018AFM	Right Side Power Valve Gasket	12108-KZ3-880		
				R221V	Exhaust O-rings 2 Req.	91304-KZ3-890		
				Bottom End Kit w/Oil Seals	Component Part#	Component Description	OEM Part #	
				C7116BE	MR129	Case Water Galley O-ring	91301-KZ3-861	
					EC187020F	Crank Case Gasket	11191-KZ3-J20	
					WA137	Drain Plug Gasket	94109-12000	
					R18X3V	Fill Plug O-ring	91307-035-000	
					WA128	Clutch Drain Washer	90463-ML7-000	
					WP034018AFM	Water Pump Gasket	19229-KZ3-880	
					EC084032AFM	Inner Clutch Cover Gasket	11395-KZ3-880	
					Oil Seal Kit	Component Part#	Component Description	OEM Part #
					C7116OS	OS107	Left Crank Seal	91205-KZ3-861
OS106	Right Crank Seal	91201-KA4-004						
OS227	Water Pump Shaft Seal	91201-965-000						
OS236	Shift Shaft Seal	91203-KA4-772						
		91203-KK3-830						
		91203-KA4-771						
OS238	Output Shaft Seal	91207-ML3-871						
OS239	Start Shaft Seal	91204-KF0-003						
OS240	Clutch Pushrod Seal	91201-951-003						
OS242	Impeller Shaft Seal	91211-KA3-761						
Clutch & Mag Kit	Component Part#	Component Description	OEM Part #					
C7116CM	EC196	Outer Clutch O-ring	91311-KS7-701					
	EC082063N	Mag Cover Gasket	11352-KA4-771					
CR250	02-04	66.5 mm	C7191	H1288SP1010S	66.5mm Bore Head Gasket	14132-KZ3-L20		
		68.5 mm	C7197	H1288010S	68.5mm Bore Head Gasket	12254-KSK-731		
				B0546018AFM	Base Gasket .018"	12191-KZ3-L20		
				B0546012F	High Comp. Base Gasket .012"			
				IR232018AFM	Intake Gasket	18291-KZ3-L20		
				EX456010S	Exhaust Gasket	12111-KZ3-L20		
				PV110018AFM	Power Valve Gasket	12254-KSK-731		
	Bottom End Kit w/Oil Seals	Component Part#	Component Description	OEM Part #				
	C7191BE	EC5910322AFM	Inner Clutch Cover Gasket	11395-KZ3-L20				
		EC592020F	Center Case Gasket	11191-KSK-670				
		IR232018AFM	Intake Gasket	14132-KZ3-L20				
		MR037	Center Case O-ring	91301-KZ3-L20				
		R18X3V	Fill Plug O-ring	91307-035-000				
		WA128	Case Drain Washer 2 Required	90463-ML7-000				
		WA137	Drain Plug Gasket	94109-12000				
WP131018AFM		Water Pump Gasket 2 Required	19229-KZ3-L20					
Oil Seal Kit		Component Part#	Component Description	OEM Part #				
C7191OS		OS107	Left Crank Seal 20x37x7	91205-KZ3-861				
	OS227	Water Pump Shaft Seal 12x22x5	91201-965-000					
	OS236	Shift Shaft Seal 14x22x5	91203-KA4-771					
	OS238	Output Shaft Seal 31x40x7	91207-ML3-871					
	OS239	Start Shaft Seal 20x28x5	91204-KF0-003					

All Component Parts can be purchased individually.



MX/Dirt · Off-Road Gaskets



Cometic Gasket - An Exclusive NASCAR Performance® Product

HONDA CR250

Model	Year	Bore Size	Top End Kit	Component Part#	Component Description	OEM Part #
CR250	05-07	66.5 mm	C3089	H2368010S	Head Gasket	12254-KSK-731
		68.5 mm	C3092	H2388010S	Head Gasket 68.5mm Bore	
				B0811014RC	Base Gasket	12191-KSK-731
				PV110018AFM	Power Valve gasket	12111-KZ3-L20
				R14X2.5V	Exh. Valve Cover O-rings 4 req.	91302-KSK-731
				R43X3V	Exp. Chamber O-rings 2 req.	91304-KZ3-890
				WA139	Head Washer 2 Req.	90442-028-000
				EX456010S	Exhaust Manifold Gasket	18291-KZ3-L20
				IR232032AFM	Intake Gasket	14132-KZ3-L20
			Bottom End Kit w/crank seals	Component Part#	Component Description	OEM Part #
			C3325	EC592020F	Centercase Gasket	11191-KSK-730
				EC590032AFM	Mag Cover Gasket	11352-KZ3-L20
				EC591032AFM	Inner Clutch Cover Gasket	11395-K23-L20
			EST Top End Kit	Component Part#	Component Description	OEM Part #
CRF250R,	04-09	78 mm	C3133-EST	H2334027S	Head Gasket 78mm Bore	12251-KRN-671/731
CRF250X	04-13	79 mm	C7185-EST	H2145027S	Head Gasket 79mm Bore	12251-KRN-671/731
		81 mm	C7189-EST	H2069027S	Head Gasket 81mm Bore	
		82 mm	C3232-EST	3234V	Int. & Exh. Valve Seals 04-07 4 Req.	12209-GB4-681
				B0694014RC	Base Gasket .014	12191-KRN-731
				EC960018AFM	Cam Chain Tensioner Gasket	14560-MEN-671
				EX169064AM	Exhaust Gasket	18291-MM5-860
				MA0164	Cam Chain Tensioner Bolt Seal	90442-397-000
				R14X2.5V	Head Oil Drain Cap O-ring	91303-377-000
				R19X3V	Water Outlet O-ring	91312-KE7-003
				3239V	Exh. Valve Seals 08-09 2 Req.	12208-ML0-721
				WA110	Air Recirculation Valve Seal	90452-323-000
				Component Part#	Component Description	OEM Part #
				C3069	Valve Cover Gasket	12391-KRN-670

CRF250R, 04-09

Bottom End Kit w/Oil Seals C7185BE	Component Part#	Component Description	OEM Part #
	WP170	Molded Rubber Water Pump	19226-KRN-670
	WA111	Water Pump Imp. Seals 2 Req.	90447-KE1-000
	WA128	Coolant Drain Bolt Washer	90463-ML7-000*
	WA128	Coolant Drain Bolt Washer	90463-ML7-000*
	EC959032AFM	Inner Clutch Cover Gasket	11394-KRN-670
	R16X2.5V	Water Passage Collar O-ring	91304-MJ0-003
	R27x2V	Clutch Cover Cap O-ring	91305-KF0-003
	R12X2V	Trans Oil Fill Cap O-ring	91370-461-000*
	R18X3V	Crank Dipstick O-ring	91307-035-000
	R8.5X2V	Oil Filter Relief Valve O-ring	90751-GK1-003
	R40X2V	Oil Filter Cover O-ring	91302-PA9-003
	R14X2.5V	Mag Side Cap O-ring	91303-377-000
	EC958020F	Case Gasket	111910-KRN-670
Oil Seal Kit C7185OS	Component Part#	Component Description	OEM Part #
	OS243	Start Shaft Seal 16.5x25x5	91205-KA3-712
	OS242	Water Pump Shaft Seal 11x25x7	91211-KRN-671
	OS227	Impeller Shaft Seal 12x22x5	91201-965-000
	OS266	Right Crank Seal 39x52x7	91202-MEB-671
	OS236	Shift Shaft Seal 14x22x5	91203-KA4-771
	OS264	Left Crank Seal 39x52x7	91202-MEB-671
	OS261	Oil Pump Seal 20x33x5	91203-MEB-671
	OS240	Clutch Actuator Seal 12x18x3	91201-951-003
	OS241	Output Shaft Seal 28x37x7	91201-KSR-A01
Clutch & Mag Kit C7185CM	Component Part#	Component Description	OEM Part #
	EC957018AFM	Mag Cover Gasket	11395-KRN-670
	R150X2B	Outer Clutch Cover Gasket	11352-KRN-671

All Component Parts can be purchased individually.



MX/Dirt • Off-Road Gaskets



Cometic Gasket - An Exclusive NASCAR Performance® Product

HONDA CR250R

Model	Year	Bore Size	EST	Component Part#	Component Description	OEM Part #
CRF250R	10-17	78mm	Top End Kit	H3017027S	78mm Bore Head Gasket	12251-KRN-A41
			C3288-EST	H3017SP3027S	80mm Bore Head Gasket	
			C3289-EST	H3017SP2027S	82mm Bore Head Gasket	
		80mm	C3290-EST	B1005014RC	Base Gasket	12191-KRN-A41
				EX169064AM	Exhaust Gasket	18291-MM5-860
				EC960018AFM	Cam Chain Tensioner Gasket	14560-MEN-671
				3239V	Exh. Valve Seals 08-10 2 Req.	12208-ML0-721
				3234V	Int. Valve Seal 2010 2Req.	12209-GB4-681
				R19X3V	Water Outlet O-ring	91312-KE7-003
				82mm	C3290-EST	Bottom End Kit w/Oil Seals
C3288BE	EC1543032AFM	Inner Clutch Cover Gasket	11394-KRN-A40			
	EC1544020RC	Center Case Gasket	11191-KRN-A40			
	MA0165	Drain Plug Washer	90474-333-000			
	R012V	Oil Relief Valve O-ring	90751-GK1-003			
	R14X2.5V	Timing Mark Cap O-ring	91303-377-000			
	R14X3V	Dipstick O-ring	91307-KRN-A41			
	R114V	Inner Clutch Dowel O-ring	91304-MJ0-003			
	R18X3V	Trans Fluid Fill Plug O-ring	91307-035-000			
	R27X2V	Clutch Cover Drain Plug O-ring	91305-KF0-003			
	R40X2V	Oil Filter O-ring	91302-PA9-003			
	WP369	Water Pump Gasket	19226-KRN-A40			
	Oil Seal Kit	Component Part#	Component Description	OEM Part #		
	C3288OS	OS227	Water Pump Shaft Seal 12x22x5	91201-965-000 (replaces 91201-148-003)		
		OS236	Shift Shaft Seal 14x22x5	91203-KA4-771		
		OS240	Clutch Push Rod Oil Seal 12x18x3	91205-MEB-671		
		OS241	Output Shaft Oil Seal 28x37x7	91201-KSR-A01		
		OS243	Kick Start Shaft Seal 16.5x25x5	91205-KA3-712		
		OS262	Left Case Oil Seal 10x21x5	91204-MEN-A31		
		OS264	Left Crank Seal 38x52x7	91201-MEB-671		
		OS266	Right Crank Seal 39x56x7.5	91202-MEY-671		
		OS387	Balancer Shaft Seal 24x36x8	91205-KE1-004		
	Clutch & Mag Kit	Component Part#	Component Description	OEM Part #		
	C3288CM	R150x2B	Outer Clutch Cover	11352-KRN-A41		
		EC1545032AFM	Mag Cover Gasket	11395-KRN-A40		
	Top End Kit	Component Part#	Component Description	OEM Part #		
CRF250R	2018	79mm	C3635	EX1909	Header Gasket	18291-KSV-J01
				B1409010RC	Cylinder Base Gasket	12191-K95-A20
				WA128	Cylinder Base Crush Seal	90463-ML7-000
				H4584027S	Cylinder Head Gasket 79mm	12251-K95-A21
				EC2384018AFM	Cam Chain Tensioner Gasket	14523-K95-A21
				MA0164	Cam Chain Tensioner Crush Washer	90442-397-000
				3234V	Valve Stem Seal	12209-GB4-681
				WA116	Rocker Arm Seal	90544-439-930
				R19X3V	Water Joint O-ring	91312-KE7-003
				R018B	Cam Tower O-ring	91301-K95-A21
				WA116	Head Drain Plug O-ring	90544-439-930
				WA128	Cam Tower Crush Washer	90463-ML7-000

All Component Parts can be purchased individually.



MX/Dirt · Off-Road Gaskets



Cometic Gasket - An Exclusive NASCAR Performance® Product

HONDA XL250

Model	Year	Bore Size	Top End Kit	Component Part#	Component Description	OEM Part #
XL250	91-96	74 mm	C7821	H0238030S	74mm Head Gasket .030"	12251-KCZ-013
XR250R	86-95	77 mm	C7893	H1401030S	77mm Head Gasket .030"	12251-KCZ-013
XR250R	96-04	78 mm	C7822	H0192030S	78mm Head Gasket .030"	12251-KCZ-013
				B0144020F	Base Gasket	12191-KZ1-920
			Bottom End Kit w/o crank seals	Component Part#	Component Description	OEM Part #
			C3330	EC424032AFM	Clutch Cover Gasket	11394-KZ1-920
			85-87 XL250R	EC423060AFM	Mag Cover Gasket	11395-KZ1-920
			85 XR200R	EC571020F	Center Case Gasket	11191-KZ1-920
			91-96 XR250L	Component Part#	Component Description	OEM Part #
			85-95 XR250R	VC033010S	Valve Cover Gasket	12391-KR6-010

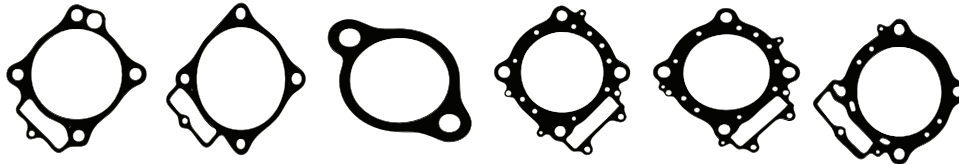

Model	Year	Bore Size	Top End Kit	Component Part#	Component Description	OEM Part #
CRF450R	02-08	96 mm	C3047-EST	H1301027S	Head Gasket 96mm	12191-MEB-671
		97 mm	C3554-EST	H1301SP6027S	Head Gasket 97mm	18291-MEB-670
		99 mm	C3049-EST	H1394027S	Head Gasket 99mm	14560-KCW-851
				B0548014RC	Base Gasket	91306-M63-000
				EX657	Exhaust Gasket	12209-GB4-681
				EC898018AFM	Cam Chain Tensioner Gasket	12209-KL4-005
				R011V	Cam Chain Tensioner O-ring	91312-KE7-003
				3231V	Exhaust Valve Seals 2 Req.	91306-MG3-000
				3234V	Intake Valve Seals 2 Req.	
				R19X3V	Water Pipe O-ring	
				R9.5X1.5V	Cam Chain Tensioner O-Ring	

Component Part#	Component Description	OEM Part #
Bottom End Kit w/Oil Seals	Component Part#	Component Description
C3047BE	EC585020F	Center Case Gasket
	EC587020F	Inner Clutch Cover Gasket
	WP166	Water Pump Cover O-ring
	WA128	Water Pump Drain Crush Seal
	WA128	Water Pump Drain Crush Washer
	WA135	Mag Cover Crush Seal
	R8.5X2V	Oil Relief Valve O-ring
	R110V	Inner Clutch Cover O-ring
	R40X2V	Oil Filter O-ring
	R114B	Timing Mark O-ring
	R27X2V	Right Case Plug O-ring 27x2
	R18X3V	Fill Plug O-ring
	R18X3V	Fill Plug O-ring
Oil Seal Kit	Component Part#	Component Description
C3047OS	OS227	Inner Water Pump Shaft Seal
	OS236	Shift Shaft Seal
	OS238	Output Shaft Seal
	OS239	Start Shaft Seal
	OS240	Clutch Pushrod Seal
	OS261	Balancer Shaft Seal
	OS262	Mag Seal
	OS264	Left Crank Seal
	OS266	Right Crank Seal
	OS242	Impeller Shaft Seal
Clutch & Mag Kit	Component Part#	Component Description
C3047CM	EC765060AFM	Clutch Cover Replaces O-ring
	EC586060AFM	Mag Cover Gasket
	Component Part#	Description
	VC100	Valve Cover Gasket



MX/Dirt • Off-Road Gaskets



Cometic Gasket - An Exclusive NASCAR Performance® Product

HONDA CRF450R

Model	Year	Bore Size	EST	Component Part#	Component Description	OEM Part #
CRF450R	09-16	96mm	Top End Kit			
			C3270-EST	H2856027S	Head Gasket 97.5mm Stock	12251-MEN-A31
			C3275-EST	H2856SP1027S	Head Gasket 98.5mm	
		100mm	C3276-EST	H2856SP3027S	Head Gasket 100mm	
			B0969010RC	Base Gasket	12191-MEN-A31	
			EX657	Exhaust Gasket	18291-MEB-670	
			EC960018AFM	Cam Chain Tensioner Gasket	14560-MEN-671	
			3234V	Valve Seals	12209-GB4-682	
			R19X3V	Water Pipe O-ring	91312-KE7-003	
			R22X2.5V	Cylinder Water Outlet O-ring	91355-759-003	
EX657	Exhaust Gasket	18291-MEB-670				
Bottom End Kit w/Oil Seals C3270BE				Component Part#	Component Description	OEM Part #
			WA135	Drain Plug Washer	90474-333-000	
			EC1415020F	Center Crankcase Gasket	11191-MEN-A30	
			R16X3V	Neutral Switch O-ring	91305-KC1-850	
			R40X2V	Oil Filter Cover Gasket	91302-035-000/ 91302-PA9-003	
			R14X2.5V	Timing Plug O-ring	91303-377-000	
			R18X3V	Dipstick O-ring	91307-035-000	
			R8.5X1.5V	Oil Pressure Relief Valve O-ring	90751-GK1-003	
			EC1414018AFM	Inner Clutch Cover Gasket	11394-MEN-A30	
			WP296	Water Pump Cover Gasket	19226-MEN-A30	
			R27X2V	Right Case Plug O-ring	91305-KF0-003	
			R27X2V	Clutch Oil Fill Plug O-ring	91307-035-000	
Oil Seal Kit C3270OS				Component Part#	Component Description	OEM Part #
			OS266	Right Crank Seal 39x56x7.5	91202-MEY-671	
			OS264	Left Crank Seal 38x52x7	91201-MEB-671	
			OS236	Shift Shaft Oil Seal 14x22x5	91203-KA4-771	
			OS240	Clutch Actuator Oil Seal 12x18x3	91205-MEB-671	
			OS262	Crank End Oil Seal 10x21x5	91204-MEN-A31	
			OS239	Kickstart Shaft Seal 20x28x5	91204-KF0-003	
			OS227	Water Pump Seal 12x22x5	91201-965-000	
			OS238	Output Shaft Seal 31x40x7	91207-ML3-871	
Clutch & Mag Kit C3270CM				Component Part#	Component Description	OEM Part #
			EC1416032AFM	Generator Cover Gasket	11395-MEN-A30	
			EC978	Outer Clutch Cover O-ring	11352-MEB-671	
CRF450	17-18	96mm	Top End Kit			
			C3621	3234V	Valve Seals	18291-MEB-670
				B1366014RC	Base Gasket	12191-MKE-A01
				EC960018AFM	Cam Chain Tensioner Gasket	14560-MEN-671
				EX657	Exhaust Gasket	18291-MEB-670
				H4417023S	Head Gasket 96mm Bore	12251-MKE-A01
				MA0164	Cam Chain Tensioner Washer	90442-397-000
	R19X3V	Water Joint O-ring	91312-KE7-003			

All Component Parts can be purchased individually.



MX/Dirt • Off-Road Gaskets



Cometic Gasket - An Exclusive NASCAR Performance® Product

HONDA CRF450X

Model	Year	Bore Size	EST	Component Part#	Component Description	OEM Part #		
CRF450X	05-15	96mm	Top End Kit	H2458027S	Head Gasket 96mm Bore	12251-MEY-671		
			C3134-EST	H2458SP3027S	Head Gasket 97mm Bore			
			C3555-EST	H2458SP1027S	Head Gasket 98mm Bore			
		97mm	C3556-EST	H2459027S	Head Gasket 99mm Bore			
			C3557-EST	3231V	Exhaust Valve Seals 2 Req.	12209-GB4-681		
		98mm		3234V	Intake Valve Seals 2 Req.	12209-KL4-005		
				B0891020RC	Base Gasket	12191-MEB-671		
		99mm		EC960018AFM	Cam Chain Tensioner Gasket	14560-MEN-671		
				EX657	Exhaust Gasket	18291-MEB-670		
				R117B	Water Outlet O-ring	91312-KE7-003		
				Component Part#	Description	OEM Part#		
				VC100	VC100 Valve Cover Gasket	12391-MEB-670		
		Bottom End Kit w/Oil Seals				Component Part#	Component Description	OEM Part #
		C3134BE				EC1064020F	Center Case Gasket	11191-MEY-671
						R8.5X1.5V	Oil Relief O-Ring	90751-GK1-003
				R40X2V	Oil Filter O-Ring	91302-PA9-003		
				R14X2.5V	Timing Mark O-ring	91303-377-000		
				R18X3V	Dipstick O-ring	91307-377-000		
				WA135	Left Cover Drain Washer	90474-333-000		
				EC1065018AFM	Inner Clutch Cover	11394-MEY-671		
				R18X3V	Trans Fill Plug O-ring	91307-035-000		
				R18X2.5V	Water Galley O-ring	91256-383-721		
				WA118	Right Case Drain Seal	90463-ML7-000		
				R27X2V	Crank End Plug O-ring	91305-KF0-003		
				R22X2.5V	Water Outlet O-ring	91355-759-003		
				WP166	Water Pump Gasket	19226-MEB-670		
				WA128	Water Pump Drain Gasket	90463-ML7-000		
Oil Seal Kit				Component Part#	Component Description	OEM Part #		
C3134OS				OS266	Right Crank Seal 39X56X7.5	91202-MEY-671		
				OS240	Clutch Pushrod Seal 12x18x3	91205-MEB-671		
				OS264	Left Crank Seal 38x52x7	91201-MEB-671		
				OS261	Balancer Seal 20x33x5	91203-MEB-671		
				OS236	Shift Shaft Seal 14x22x5	91203-KA4-771		
				OS262	Left Case Cover Oil Seal 10X21X5	91204-KRN-671		
				OS239	Start Shaft Oil Seal 20x28x5	91204-KF0-003		
				OS238	Output Shaft Seal 31x40x7	91207-ML3-871		
				OS227	Water Pump Seal 12X22X5	91201-148-003		
Clutch & Mag Kit				Component Part#	Component Description	OEM Part #		
C3134CM				EC978	Clutch Cover O-ring	11352-MEB-671		
				EC586032AFM	Mag Cover Gasket	11352-MEB-671		

HONDA CR480

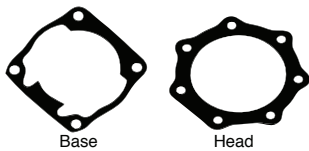

Model	Year	Bore Size	Top End Kit	Component Part#	Component Description	OEM Part #
CR480	82-83	91 mm	C7017	H0011020C	91mm Head Gasket	12254-KA5-770
				B0015020F	Base Gasket	12191-MA0-000
				Component Part#	Component Description	OEM Part #
				EC801032AFM	Clutch Cover Gasket	31129-KA4-000/ 11395-KA4-000/306

All Component Parts can be purchased individually.



MX/Dirt • Off-Road Gaskets



Cometic Gasket - An Exclusive NASCAR Performance® Product

HONDA XR500

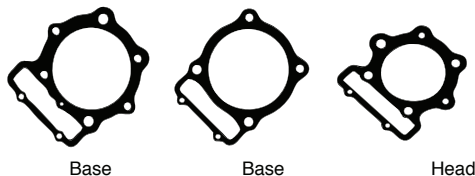

Model	Year	Bore Size	Top End Kit	Component Part#	Component Description	OEM Part #
XL500	79-82	91 mm	C7147	H0265043F	91mm Head Gasket	06130-MC4-000
XR500	79-82	95 mm	C7148	H0260043F	95mm Head Gasket	06130-MC4-000
				B0173020F	Base Gasket	12191-MA0-306
				EC401032AFM	Clutch Cover Gasket	11394-MN1-700
XR500	83-84	93 mm	C7238	B0205020F	Base Gasket	12191-MN1-700
				H0257043F	Head Gasket 93mm Bore	12251-MK4-602
				EC401032AFM	Clutch Cover Gasket	11394-MN1-700

HONDA CR500

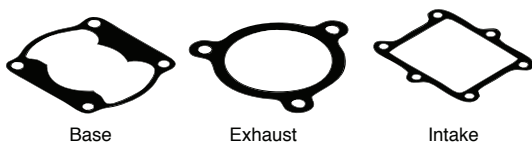

Model	Year	Bore Size	Top End Kit	Component Part#	Component Description	OEM Part #
CR500	84	91 mm	C7018	B0016020F	Base Gasket	12191-ML3-790
				H0011020C	Head Gasket	12254-KA5-770
				IR006018AFM	Intake Gasket	14132-KA5-740
				C7490	Clutch Cover Gasket	91311-KS7-701
CR500	85-88	91 mm	C7019	H0012043F	Head Gasket	12254-ML3-881
				B0016020F	Base Gasket	12191-ML3-790
				IR006018AFM	Intake Gasket	14132-KA5-740
				EX009042AM	Exhaust Gasket	18291-ML3-791
				C7490	Clutch Cover Gasket	91311-KS7-701
CR500	89-01	91 mm	C7020	H0300010S	Head Gasket	12254-ML3-680
				B0017018AFM	Base Gasket	12191-MAC-680
				B0017012F	High Compression Base Gasket .012"	
				IR006018AFM	Intake Gasket	14132-KA5-740
				EX009042AM	Exhaust Gasket	18291-ML3-791
			C7020BE	EC818020F	Center Case Gasket	11191-MAC-680
				WA137	Drain Plug Gasket	94109-12000
				EC602032AFM	Inner Clutch Cover	11395-MAC-680
				R16X3V	Fill Plug O-ring	91303-800-000
				WA128	Right Case Cover Drain Seal	90463-ML7-000
				WP235018AFM	Water Pump Cover Gasket	19229-MAC-680
CR500	84-88		C7772	Special 5mm Base Kit for 89-01 Con. Rod. Includes Shim and 2 Base Gaskets for Use With Late Model (89-01) Rod on Early Model (84-88) Engines		

All Component Parts can be purchased individually.



MX/Dirt · Off-Road Gaskets



Cometic Gasket - An Exclusive NASCAR Performance® Product

HONDA XR500

Model	Year	Bore Size	Oil Seal Kit	Component Part#	Component Description	OEM Part #			
CR500	89-01	91 mm	C7020OS	OS103	Left Crank Seal 20x32x7	91205-166-004			
				OS106	Right Crank Seal 38x58x11	91201-KA4-004			
				OS227	Water Pump Shaft Seal 12x22x5	91201-965-000			
				OS236	Shift Shaft Seal 14x22x5	91203-KK3-830			
				OS238	Output Shaft Seal 31X40X7	91207-ML3-871			
				OS239	Start Shaft Seal 20x28x5	91204-KF0-003			
				OS240	Clutch Pushrod Seal 12x18x3	91201-951-003			
				OS242	Impeller Seal 12x25x7	91211-KA3-761			
							Component Part#	Component Description	OEM Part #
							EC2015032AFM	Mag Cover Gasket	11352-KA5-690
			C7490	Outer Clutch Cover O-ring	91311-KS7-701				
			Clutch & Mag Kit						
			C7020CM						
CR500	84-88		C7772	Special 5mm Base Kit for 89-01 Con. Rod. Includes Shim and 2 Base Gaskets for Use With Late Model (89-01) Rod on Early Model (84-88) Engines					

HONDA XL/XR 600/650

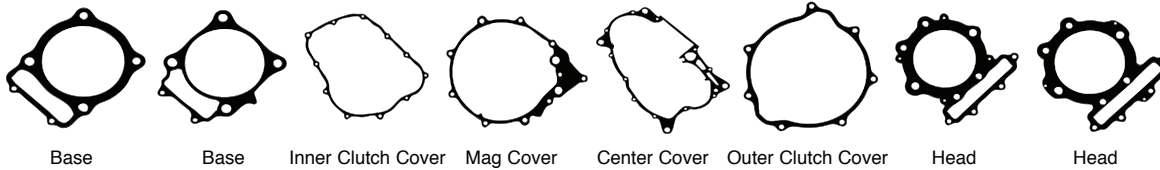

Model	Year	Bore Size	Top End Kit	Component Part#	Component Description	OEM Part #
XL600	83-87	103 mm	C7149	H0270SP3040S	Head Gasket	12251-MG2-004
				B0145020F	Base Gasket	12191-MN1-700
				Component Part#	Component Description	OEM Part #
				EC401032AFM	Clutch Cover	11394-MN1-700
XR600	88-00	98 mm	C7827	Component Part#	Component Description	OEM Part #
				H0239030S	Head Gasket 98mm Bore	12251-MN1-671
				H1407030S	Head Gasket 100mm Bore	12251-MN1-671
				H0317030S	Head Gasket 101mm Bore	12251-MN1-671
				H0317SP2030S	Head Gasket 102mm Bore	12251-MN1-671
				H0221030S	Head Gasket 103mm Bore	12251-MN1-671
				B0145020F	Base Gasket	12191-MN1-700
				Component Part#	Component Part#	OEM Part#
				EC401032AFM	Clutch Cover	11394-MN1-700
				EC402060AFM	Mag Cover Gasket	11352-MN1-680
EC403020F	Center Case Gasket	11191-MN1-700				
			Component Part#	Component Description		
			VC031010S	Valve Cover Gasket	12391-MG2-790	
XR650L	93-12	103 mm	C3216	Component Part#	Component Description	OEM Part #
				H1675SP3030S	103mm Head Gasket	12251-MN9-742
				B0145020RC	Base Gasket	12191-MN1-700
				Component Part#	Component Description	OEM Part #
				EC619032AFM	Clutch Cover Gasket	11394-MY2-621
XR650R	00-07	101 mm	C7681	Component Part#	Component Description	OEM Part #
				B0462020F	Base Gasket	12191-MBN-670
				H0983018S	101mm Bore Head Gasket	12251-MBN-671
				H1047018S	103mm Bore Head Gasket	12251-MBN-671
				Component Part#	Component Part#	OEM Part#
EC891060AFM	Clutch Cover Gasket	11352-MBN-671				

All Component Parts can be purchased individually.



MX/Dirt • Off-Road Gaskets



Cometic Gasket - An Exclusive NASCAR Performance® Product

HUSABERG TE250



Base

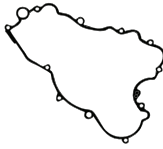

Inner Clutch

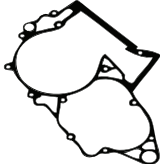

Center Case



Power Valve

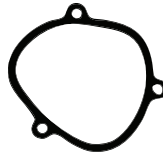

Power Valve

Model	Year	Bore Size	Top End Kit	Component Part#	Component Description	OEM Part #
TE250	11-13	O-Ring	C3222	WA135	Head Seal Crush Washer 6 Req.	56530080000
				R78X2V	Inner Head O-ring 78,00X2,00	0770078020
				R105X2B	Outer Head O-ring 105,00X2,00	0770105020
				PV136032AFM	Left Side Power Valve Gasket	54837006000
				R11.5X2.5B	Front Power Valve Orings 4 Req.	0770116241
				R44X3S	Exhaust O-rings 44,00X3,00	0770440030
				PV137032AFM	Right Side Power Valve	54837008000
				B0666018AFM	Base Gasket.018" (0,4mm)	54830030004
				R15X1.5V	Power Valve Control O-ring 15x1.5	0770150151
				R16X2V	Control Valve O-ring (300) 16x2	0770160021
				R114V	Power Valve Control Cap O-ring 12,37X2,62	0770021120
				R24X2V	Power Valve Control Guide O-ring 24,00X2,00 NBR70	0770240020

Bottom End Kit C7943BE	Component Part#	Component Part#	OEM Part#
	WA133	Clutch Slave Cyl. Crush Washer	0603100141
	R30X1.5V	Clutch Slave Cylinder O-ring	0770300015
	R19X3V	Fill Plug O-ring	0770191015
	WA133	Water Pump Crush Washer	0603100141
	R0050	Water Pump Gasket	54835003000
	WA137	Drain Plug Crush Washer	58038022000
	WA133	Water Pump Cover	0603061001
		Crush Washer	
	R25X1.5V	Crank Backup O-ring	0770250015
	EC778032AFM	Primary Cover Gasket (Inner Clutch)	54830024100
	EC779020F	Center Case Gasket	54830039000
	IR386018AFM	Intake Reed Gasket	54830062200
R25X2V	Output Shaft Backup O-ring	0770250020	
R24X2V	Exhaust Valve Control O-ring	0770240020	
R114V	Spring Guide O-ring	0770021120	
Oil Seal Kit C7943OS	Component Part#	Component Description	OEM Part #
	OS136	Left Crank Seal 25x35x7	760253570
	OS137	Right Crank Seal 38x52x7	760385273
	OS197	Shift Shaft Seal 14x24x6	760142460
	OS202	Water Pump Shaft Seal 8x24x7	760082472
	OS310	Start Shaft Seal 19x30x7	760193070
	OS390	Output Shaft Seal 32x45x7	760324571
Clutch & Mag Kit C7943CM	Component Part#	Component Description	OEM Part #
	R0049	Clutch Cover O-ring	55130027000
	EC777032AFM	Mag Cover Gasket	

All Component Parts can be purchased individually.



MX/Dirt • Off-Road Gaskets



Cometic Gasket - An Exclusive NASCAR Performance® Product

HUSQVARNA TC65

Model	Year	Bore Size	Top End Kit
TC65	09-19	O-Ring	C3416

Component Part#	Component Description	OEM Part #
MR106	Cylinder Head Gasket	45230036000
WA146	Cyl. Head Crush Washer 4 Req.	50230032010
B0976018AFM	Cyl. Base Gasket	46230035040
EX943059F	Header Flange Gasket	46205004000
R15X1.5V	Power Valve Control O-ring	0770150151
R005B	Power Valve Base Orings 2 Req.	0770030015
WA133	Power Valve Base Seal Washer	603061001
WA133	Power Valve Copper Seal	603050901
IR747018AFM	Reed Valve Gasket	46230049000

Bottom End Kit w/o crank seals C3416BE	Component Part#	Description	OEM Part#
	EC1357020F	Center Case Gasket	46230039000
	WA133	Coolant Drain Plug	0603061001
	WA137	Trans Drain Plug Crush Washer	58038022000
	EC2204018AFM	Primary Cover Gasket	46230025100
	R19X3V	Fill Plug O-ring	0770191015
	R16X2V	Crank Back up O-ring	0770160021
	IR747018AFM	Intake Gasket	46230049000
	EC1360018AFM	Slave Cylinder Gasket	59032065000
	R027V	Slave Cylinder O-ring	0770031018
	R20X2	Countershaft Back Up Ring	0770020020
	WP496	Water Pump Gasket	45235053000

Oil Seal Kit C3416OS	Component Part#	Component Description	OEM Part #
	OS294	Right Crank Seal 30x47x7	0760304772
	OS199	Left Crank Seal 20x35x6	47030076100
	OS389	Countershaft Seal 26x35x6	0760263561
	OS357	Start Shaft Seal 17x28x6	0760172860
	OS339	Shift Shaft Seal 12x20x5	0760122050
	OS202	Water Pump Seal 8x24x7	0760082472
	MR162	Clutch Cover O-ring	46230027000

Clutch & Mag Kit C3416CM	Component Part#	Component Description	OEM Part #
	MR162	Clutch Cover O-ring	46230027000
	EC1358032AFM	Mag Cover Gasket	

HUSQVARNA TC85

Model	Year	Bore Size	Top End Kit
TC85	18-19	O-ring	C3636

Component Part#	Component Description	OEM Part #
WA133	Head Crush Washers	603061001
R23X2.5V	Dome O-ring	7702300251
R54X2V	Inner Chamber O-ring	770540020
R80X2S	Outer Chamber O-ring	770800021
PV158018AFM	RT Power Valve Cover Gasket	47237008000
PV157018AFM	LT Power Valve Cover Gasket	47237006000
B1408	Base Gasket	47230035020
B1408010RC	Base Gasket	47230035025
B1408014RC	Base Gasket	47230035040
B1408020RC	Base Gasket	47230035050
B1408031F	Base Gasket	47230035075
WA133	Power Valve Cover Crush Washer	603061001
R8X2V	Power Valve Flap O-ring	770080201
R114V	Power Valve Spring Cover	770021120
R24X2V	Power Valve Spring Cover	770240020

All Component Parts can be purchased individually.



MX/Dirt • Off-Road Gaskets



Cometic Gasket - An Exclusive NASCAR Performance® Product

HUSQVARNA CR/WR 125

Model	Year	Bore Size	Top End Kit	Component Part#	Component Description	OEM Part #
CR/WR	97-12	O-Ring	C7734	R038V	Inner Head O-Ring	
				R044S	Outer Head O-Ring	8000 94652
				B0445018AFM	Base Gasket	8B00 83068
				WA116	Head Crush Washers 5 Req.	8000 39335
				R49X2.5V	Power Valve Cover O-ring	8000 28553
				R019V	Right Side Power Valve Housing O-ring	8000 19789
				R222V	Expansion Chamber Head O-ring	8A00 23186
				IR146032AFM	Intake Gasket	8000 83043
				PV093032AFM	Power Valve	8000 83091
				PV092018AFM	Power Valve	8000 83049
				Component Part#	Description	OEM Part#
			Bottom End Kit w/o crank seals			
			C3373	WP103018AFM	Water Pump Gasket	8000 65922
				EC430015F	Case Gasket	8000 72889
				IR146032AM	Intake Gasket	8000 83043
				WA120	Drain Plug Washer	62N0 15678
				EC431032AFM	Inner Clutch Cover Gasket	8000 66968
				R0071063N	Fill Plug O-ring	8000 27960
				EC432031F	Mag Cover Gasket	8000 66972
				R109V	Output Shaft O-ring	8000 19789

HUSQVARNA TC125

Model	Year	Bore Size	Top End Kit	Component Part#	Component Description	OEM #
TC125	16-19	O-Ring	C3606	B1348010RC	Base Gasket	50430035025
				B1348014RC	Base Gasket	50430035040
				B1348018AFM	Base Gasket	50430035050
				B1348032AFM	Base Gasket	50430035075
				IR1355032AFM	Reed Cage Gasket	50430098050
				MR163	Exhaust Valve Cover Gasket	50437046000
				PV152032AFM	Left Side Exhaust Valve Cover	50437006000
				PV153032AFM	Right Side Exhaust Valve Cover	50437008000
				R14X2V	Power Valve Control O-rings	0770140201
				R23X2.5V	Dome O-ring 23x2.5	07702300251
				R60X2V	Inner Head O-ring 60x2	0770600200
				R89X2V	Outer Head O-ring 89X2	0770890200
				WA133	Head Drain Crush Washer 6X10X1	0603061001
				WA146	Cylinder Head Crush Washer 7.3X12X1 (6)	0603070121
				IR1356032AFM	Intake Gasket	50430098060
				Component Part#	Component Description	OEM Part #
			Bottom End Kit w/Oil Seals			
			C3606BE	EC2182020F	Center Case Gasket	50430039000
				WA137	Copper Drain Plug Crush Washer 12X18X1.5	58038022000
				R19X3V	Fill Plug O-Ring 19x3	0770191015
				WA133	Water Passage Crush Washer	0603061001
				WA133	Clutch Drain Plug Gasket	0603100141
				EC2183032AFM	Inner Clutch Cover Gasket	50430025000
				R25X2V	Primary Gear Back Up Ring 25x2	0770250020
				R30X1.5V	Slave Cylinder O-ring 30x1.5	0770300015
				WA135	Clutch Cable Crush Washer 8x16x1	0603080161
				R23X2V	Output Shaft Back Up O-ring 23x2	0770230020
				WP500	Water Pump Gasket	50435053000
				Component Part#	Component Description	OEM Part #
			Oil Seal Kit			
			C3606OS	OS217	Left Crank Seal 25X35X7	0760253570
				OS141	Right Crank Seal 32X45X6.5	0760324564
				OS141	Output Shaft Seal 32X45X7	0760324571
				OS310	Start Shaft Seal 19X30X7	0760193070
				OS197	Shift Shaft Seal 14X24X6	0760142460
				OS202	Water Pump Seal 8x24x7	0760082472
				Component Part#	Component Part#	OEM Part#
				R0078	Outer Clutch Cover O-ring	50430027000

All Component Parts can be purchased individually.



MX/Dirt · Off-Road Gaskets



Cometic Gasket - An Exclusive NASCAR Performance® Product

HUSQVARNA TE150

Model	Year	Bore Size	Top End Kit
TE150	17-19	O-Ring	C3607

Component Part#	Component Description	OEM #
B1348010RC	Base Gasket	50430035025
B1348014RC	Base Gasket	50430035040
B1348018AFM	Base Gasket	50430035050
B1348032AFM	Base Gasket	50430035075
IR1355032AFM	Reed Cage Gasket	50430098050
MR163	Exhaust Valve Cover Gasket	50437046000
PV152032AFM	Left Side Exhaust Valve Cover	50437006000
PV153032AFM	Right Side Exhaust Valve Cover	50437008000
R14X2V	Power Valve Control O-rings	0770140201
R23X2.5V	Dome O-ring 23x2.5	07702300251
R64X2V	Inner Head O-ring 60x2	0770600200
R89X2V	Outer Head O-ring 89X2	0770890200
WA133	Head Drain Crush Washer 6X10X1	0603061001
WA146	Cylinder Head Crush Washer 7.3X12X1 (6)	0603070121

Bottom End Kit w/Oil Seals C3606OS

Component Part#	Component Description	OEM Part #
IR1356032AFM	Intake Gasket	50430098060
EC2182020F	Center Case Gasket	50430039000
WA137	Copper Drain Plug Crush Washer 12X18X1.5	58038022000
R19X3V	Fill Plug O-Ring 19x3	0770191015
WA133	Water Passage Crush Washer	0603061001
WA133	Clutch Drain Plug Gasket	0603100141
EC2183032AFM	Inner Clutch Cover Gasket	50430025000
R25X2V	Primary Gear Back Up Ring 25x2	0770250020
R30X1.5V	Slave Cylinder O-ring 30x1.5	0770300015
WA135	Clutch Cable Crush Washer 8x16x1	0603080161
R23X2V	Output Shaft Back Up O-ring 23x2	0770230020
WP500	Water Pump Gasket	50435053000
WA133	Water Pump Cover Drain Plug Crush Washer 6X10X1	0603061001
R114V	Power Valve Adjuster O-Ring 12.37X2.62	0770021120

Oil Seal Kit C3606OS

Component Part#	Component Description	OEM Part #
OS217	Left Crank Seal 25X35X7	0760253570
OS141	Right Crank Seal 32X45X6.5	0760324564
OS141	Output Shaft Seal 32X45X7	0760324571
OS310	Start Shaft Seal 19X30X7	0760193070
OS197	Shift Shaft Seal 14X24X6	0760142460
OS202	Water Pump Seal 8x24x7	0760082472
R0078	Outer Clutch Cover O-ring	50430027000

All Component Parts can be purchased individually.



MX/Dirt • Off-Road Gaskets



Cometic Gasket - An Exclusive NASCAR Performance® Product

HUSQVARNA WR250/CR250

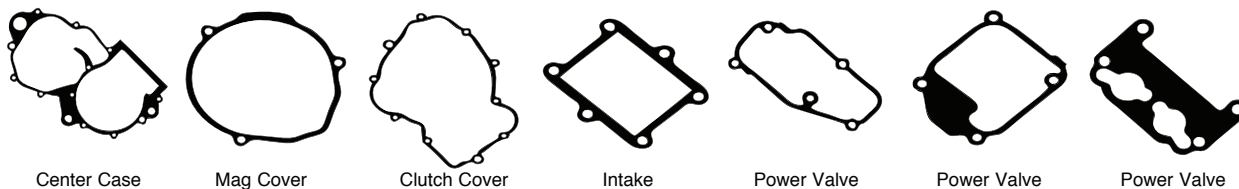

Model	Year	Bore Size	Top End Kit	Component Part#	Component Description	OEM Part #
WR250	99-12	O-Ring	C7743	R041V	Inner Head O-Ring	8A00 44117
CR250	99-12			R157B	Outer Head O-Ring	8A00 63593
				B0464018AFM	Base Gasket	8A00 86902
				PV095018AFM	Left Side Power Valve Cover	8000 86868
				PV094018AFM	Right Side Power Valve Cover	8000 86865
				IR148018AFM	Intake Gasket	8000 89954
				B0464010RC	Base Gasket(0,3 mm)	8000 86902
					.011" Available Separately	
				B0464020RC	Base Gasket (0,5 mm)	8B00 86902
					.019" Available Separately	
				B0464032AFM	Base Gasket (0,8 mm)	8C00 86902
					.031" Available Separately	
				R014V	Power Valve Cover	8A00 23109
					O-rings 4 Req.	
				R017V	Front Power Valve Large O-ring	8000 36380
				R021V	Front Power Valve Large O-ring	8B00 42700
					2002	
				R015V	Exhaust Valve Flap O-ring 2 Req	8A00 22551
				R45X3.5V	Exp. Chamber Head O-ring	8A00 31970
				EX1311027C	Exp. Chamber Head Washer	8A00 73541
				Component Part#	Description	OEM Part#
				R132B	Water Pump Gasket	8000 19965
				EC451020F	Case Gasket	8000 72522
				R165B	Clutch Cover O-ring	8000 86878
				EC453032AFM	Inner Clutch Cover Gasket	8000 34451
				EC452060AFM	Mag Cover Gasket	8000 69372

Bottom End Kit
w/o crank seals
C3374

HUSQVARNA FC250

Model	Year	Bore Size	Top End Kit	Component Part#	Component Description	OEM Part #
TC250	10-12	79mm	C3505-EST	R013B	Breather Seal O-ring	8000 01199
TE/TXC250				3239V	Valve Stem Seal 4 Req.	8000 A6356
				R12X1.5V	Cam Gear Shaft O-ring 2 Req.	8000 H6884
				EC1826018AFM	Cam Gear Shaft Gasket	8000 A6627
				WP424018AFM	Water Pump Body Gasket	8000 H6126
				WP416018AFM	Water Pump Body Gasket 2012	8000 A7338
					TE/TXC Models	
				WP423018AFM	Water Pump Cover Gasket	8000 H6125
				WP417018AFM	Water Pump Cover Gasket 2012	8000 A7346
					TE/TXC Models	
				R017V	Water Outlet O-ring	8000 36380
				EC1827018AFM	Intermediate Gear Shaft Gasket	8000 A6954
				WA116	Oil Line Crush Washer 2 Req.	8000 45194
				H3702020S	Cylinder Head Gasket	8000 A6576
					(SP= 0,50 mm)	
				H3702027S	Cylinder Head Gasket	8B00A6576
					(SP= 0,70 mm) Not included in kit	
				B1134010RC	Cylinder Base Gasket	8000 A6577
				Component Part#	Description	OEM Part#
				EC1778032AFM	Outer Clutch Cover Gasket	8000 A6999
				EC1777032AFM	Inner Clutch Cover Gasket	8000 A6997
				EC1780018AFM	Bevel Gear Seat Gasket	8000 A6990
				EC1779	Mag Cover Gasket	8000 A7004
				WA116	Oil Line Crush Washer 2 Req.	8000 45194
				R18X2.5V	Oil Fill Plug O-ring	8000 29171
				OP419032AFM	Oil Pump Gasket	8000 A7061
				R013B	Oil Pipe O-ring 2 Req.	8000 01199
				R017V	Kick Starter O-ring	8000 36380

Bottom End Kit
w/o crank seals
C3512

All Component Parts can be purchased individually.



MX/Dirt · Off-Road Gaskets



Cometic Gasket - An Exclusive NASCAR Performance® Product

HUSQVARNA WR250/CR250

Model	Year	Bore Size	Top End Kit	Component Part#	Component Description	OEM Part #
TC250, TE250, TE250i, TE300, TX300	17-19		C3623	WA135	Cylinder Head Crush Washer	56530080000
				WA133	Water Jacket Crush Seal	603061001
				R78X2V	Inner Head O-ring 300 Models	770078020
				R73X2V	Inner Head O-ring	770730020
				R105X2B	Outer Head O-ring	770105020
				PV137032AFM	Right Power Valve Cover Gasket	54837008000
				PV136032AFM	Left Power Valve Gasket	54837006000
				R112V	Front Exhaust Cover O-Ring	770116241
				B1384010RC	Cylinder Base Gasket	55430030020
				B1384018AFM	Cylinder Base Gasket	55430030040
				B1384020RC	Cylinder Base Gasket	55430030050
				B1384032AFM	Cylinder Base Gasket	55430030075
				R16X2V	Exhaust Control O-ring	770160021
R15X1.5V	Exhaust Control Flap O-ring	770150151				
R24X2V	PV Actuator Cover O-ring	770240020				
R12.5X2.5V	PV Guide Spring	770021120				
R44X3V	Exhaust O-rings	770440030				
		Oil Seal Kit		Component Part#	Component Description	OEM Part #
		C3623OS		OS141	Output Shaft Seal	0760324571
				OS197	Shift Shaft Seal	0760142460
				OS199	Balance Shaft Seal	47030076100
				OS202	Water Pump Shaft Seal	0760082472
				OS217	Left Crank Seal	0760253570
				OS264	Right Crank Seal	0760385273

HUSQVARNA FC250

Model	Year	Bore Size	Top End Kit	Component Part#	Component Description	OEM Part #
FC250	15-19	79mm	C3595-EST	H3698027S	Cylinder Head Gasket	79030036086
				B1301014RC	Cylinder Base Gasket	79230035000
				3186V	Valve Stem Seals 4 Required	77036027000
				R018B	Cam Chain Tensioner O-ring	770180020
				WA145	Cam Chain Tensioner Crush Seal	603242920
				R013V	Cam Chain Tensioner Cap O-ring	770010010
				R023V	Plug Well Cam Tower O-rings	770260015
				EX1333059F	Exhaust Flange Gasket	77236041000

Bottom End Kit w/Oil Seals	Component Part#	Description	OEM Part#	
C3595BE	WA133	Clutch Cover Crush Seal	0603061001	
	WA133	Water Pump Crush Washer	0603061001	
	WA135	Clutch Banjo Bolt Crush Washer	0603080161	
	R017B	Oil Screen Cover O-ring	0770020170	
	R022V	Output Shaft O-ring	0770020220	
	R3.5X2B	Oil Squirter O-ring	0770035020	
	R014V	Drain Plug O-ring	0770110015	
	R19X3V	Fill Plug O-ring	0770191015	
	R25X3V	Starter O-ring	0770250030	
	R30X1.5V	Slave Cylinder O-Ring	0770300015	
	R031V	Oil Pump Cover O-ring	0770440020	
	R119B	Crank End O-ring	07700240251	
	R9X1.5V	Balance Shaft O-rings	07700900151	
	R12.5X2V	Oil Screen O-ring	07701250151	
	R028V	Oil Filter Cover O-ring	07703305178	
	WA123	RT Case Locating Screw	58030081000	
			Crush Washer	
		WA137	Magnetic Plug Crush Washer	58038022000
		WA137	Oil Check Valve Crush Washer	58038022000
		EC2178032AFM	Inner Clutch Cover	79230025000
	EC2181032AFM	Slave Cylinder Gasket	79232065000	
	WP504	Water Pump Gasket	79235053000	
Oil Seal Kit	Component Part#	Component Description	OEM Part #	
C3595OS	OS269	Oil Pump Seal	0760142450	
	OS197	Shift Shaft Seal	0760142460	
	OS391	Mag Seal	0760304760	
	OS390	Output Shaft Seal	0760324571	
	OS392	Primary Side Oil Seal	0760405561	
	OS393	Balance Shaft/Water Pump Seals	07601530451	
Clutch & Mag Kit	Component Part#	Component Description	OEM Part #	
C3595CM	R0079	Outer Clutch Cover	79230027000	
	EC2177032AFM	Mag Cover Gasket	79230040000	



MX/Dirt • Off-Road Gaskets



Cometic Gasket - An Exclusive NASCAR Performance® Product

HUSQVARNA FC350

Model	Year	Bore Size	Top End Kit	Component Part#	Component Description	OEM Part #				
FC350	15-19	88mm	C3605-EST	H3093SP4032S	Cylinder Head Gasket	79230036086				
				B1301014RC	Cylinder Base Gasket	79230035000				
				3231V	Valve Stem Seals 4 Required	77236027000				
				R018B	Cam Chain Tensioner O-ring	770180020				
				WA145	Cam Chain Tensioner Crush Seal	603242920				
				R013B	Cam Chain Tensioner Cap O-ring	770010010				
				R023V	Plug Well Cam Tower O-rings	770260015				
				R9X1.5V	Oil Galley O-rings 9x1.5	7700900151				
				EX1333059F	Exhaust Flange Gasket	77236041000				
				Bottom End Kit w/Oil Seals C3595BE				Component Part#	Component Description	OEM Part #
							WA133	Clutch Cover Crush Seal	603061001	
							WA133	Water Pump Crush Washer	603061001	
							WA135	Clutch Banjo Bolt Crush Washer	603080161	
							R017B	Oil Screen Cover O-ring	770020170	
			R022V	Output Shaft O-ring	770020220					
			R3.5X2B	Oil Squirter O-ring	770035020					
			R014V	Drain Plug O-ring	770110015					
			R19X3V	Fill Plug O-ring	770191015					
			R25X3V	Starter O-ring	770250030					
			R30X1.5V	Slave Cylinder O-Ring	770300015					
			R031V	Oil Pump Cover O-ring	770440020					
			R119B	Crank End O-ring	7700240251					
			R9X1.5V	Balance Shaft O-rings	7700900151					
			R12.5X2V	Oil Screen O-ring	7701250151					
			R028V	Oil Filter Cover O-ring	7703305178					
			WA123	Right Case Locating Screw	58030081000					
				Crush Washer						
			WA137	Magnetic Plug Crush Washer	58038022000					
			WA137	Oil Check Valve Crush Washer	58038022000					
			EC2178032AFM	Inner Clutch Cover	79230025000					
			EC2181032AFM	Slave Cylinder Gasket	79232065000					
			WP504	Water Pump Gasket	79235053000					
Oil Seal Kit C3595OS				Component Part#	Component Description	OEM Part #				
			OS269	Oil Pump Seal	760142450					
			OS197	Shift Shaft Seal	760142460					
			OS391	Mag Seal	760304760					
			OS390	Output Shaft Seal	760324571					
			OS392	Primary Side Oil Seal	760405561					
			OS393	Balance Shaft Seal/	7601530451					
				Water Pump Seals						
Clutch & Mag Kit C3595CM				Component Part#	Component Description	OEM Part #				
			R0079	Outer Clutch Cover	79230027000					
			EC2177032AFM	Mag Cover Gasket	79230040000					

HUSQVARNA WR/CR 360

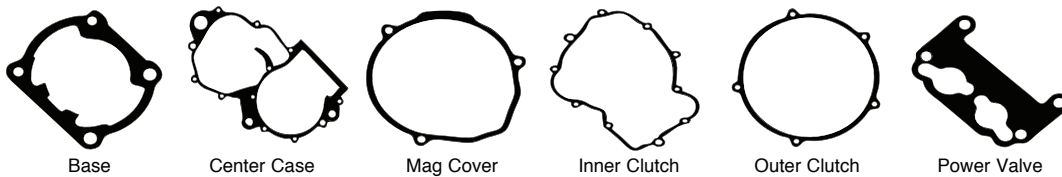

Model	Year	Bore Size	Top End Kit	Component Part#	Component Description	OEM Part #
WR360	99-03	O-Ring	C7745	R043V	Inner Head O-Ring	5410932
CR360	99			R158B	Outer Head O-Ring	
				B0465018AFM	Base Gasket	
				PV096018AFM	Power Valve Gasket	8000 73443
					Description	OEM Part#
			Bottom End Kit w/o crank seals C3375	R165B	Clutch Cover O-ring	8000 86878
				EC453032AFM	Inner Clutch Gasket	
				EC452060AFM	Mag Cover Gasket	
				EC451020F	Center Case Gasket	8000 72522

All Component Parts can be purchased individually.



MX/Dirt • Off-Road Gaskets



Cometic Gasket - An Exclusive NASCAR Performance® Product

HUSQVARNA TE410E

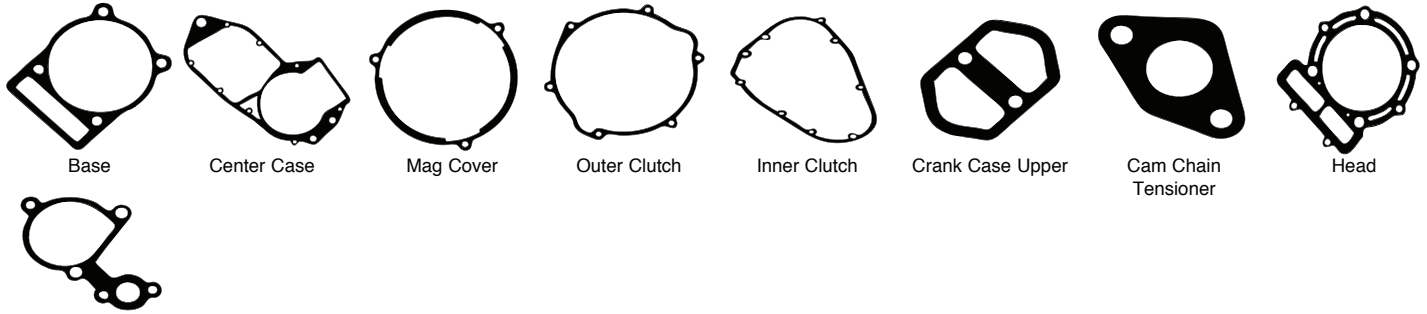

Model	Year	Bore Size	Top End Kit	Component Part#	Component Description	OEM Part #
TE410E	99-01	95 mm	C7730	H0974059F	95mm Head Gasket	161536001
TE/TC 410	99-00			B0431043F	Base gasket	161540702
				EC409012F	Cam Chain Tensioner Gasket	161535801
				EC408015F	Upper Crankcase Gasket	161503601
			Bottom End Kit w/o crank seals C3376	Component Part#	Description	OEM Part#
				EC407032AFM	Left Inner Cover Gasket	161165003
				EC406060AFM	Left Outer Cover Gasket	8000608191
				EC405032AFM	Right Cover Gasket	161527501
				EC1820020F	Center Case Gasket	161501403
				WP093032AFM	Water Pump Gasket	8A00063644
FC450	16	95mm	Top End Kit C3604-EST	Component Part#	Component Description	OEM Part #
FE450	17-18			R10X2V	Temp. Sensor O-ring	770100020
				R017B	Oil Filter Screen O-ring 17x1.78	770020170
				R15X1.5V	Rocker Arm O-rings 15,00X1,50	770150151
				R031V	Oil Pump Cover O-ring	770440020
				3225V	Valve Seal	59036027000
				R9950	EX-C Exhaust Valve Seal Pack	77036027000
				EC495018AFM	Cam Chain Tensioner Gasket	59036003050
				EX1589059F	Exhaust Gasket	78036041000
				H4207036S	Cylinder Head Gasket	79430036010
				B1323014RC	Cylinder Base Gasket	79430035000
TE/TC610	99-08	99 mm	Top End Kit C7732	Component Part#	Component Description	OEM Part #
SM610R	00-08			H0923059F	99mm Head Gasket	800064726
TE/TC610	99-00			B0431043F	Base Gasket	161540702
TE610E	99-04			EC409012F	Cam Chain Tensioner Gasket	161535801
				EC408015F	Upper Crankcase Gasket	161503601
			Bottom End Kit w/o crank seals C3376	Component Part#	Description	OEM Part#
				EC407032AFM	Left Inner Cover Gasket	161165003
				EC406060AFM	Left Outer Cover Gasket	8000608191
				EC405032AFM	Right Cover Gasket	161527501
				EC1820020F	Center Case Gasket	161501403
				WP093032AFM	Water Pump Gasket	8A00063644

KAWASAKI KDX50



Model	Year	Bore Size	Top End Kit	Component Part#	Component Description	OEM Part #
KDX50	03-05	43 mm	C7014	H1281020RC	Head Gasket 43mm Bore	11004-S004
				B0543020RC	Base Gasket	11061-S041
				EX349042AM	Exhaust Gasket	11061-S081
				IR417020F	Intake Gasket	11061-S042

All Component Parts can be purchased individually.



MX/Dirt • Off-Road Gaskets



Cometic Gasket - An Exclusive NASCAR Performance® Product

KAWASAKI KX60

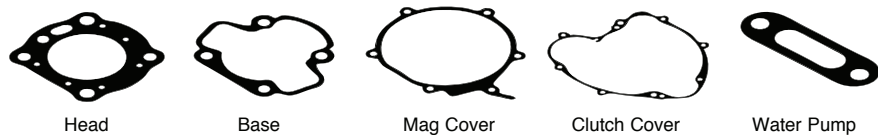

Model	Year	Bore Size	Top End Kit	Component Part#	Component Description	OEM Part #
KX60	85-03	45 mm	C7154	H0262043F	Head Gasket 45mm	11004-1218
		48 mm	C7605	H0520043F	Head Gasket 48mm	11004-1218
		53 mm	C7606	H0692043F	Head Gasket 53mm	11004-1218
				B0162018AFM	Base Gasket	11009-1975
				B0162012F	High Compression Base Gasket	
				R218V	Exhaust Gasket	670E3032
Bottom End Kit w/Oil Seals				Component Part#	Component Description	OEM Part #
		C7154BE	WP0500032AFM	Water Elbow Outlet	11009-1952	
			R222V	Water Pump Body O-ring	670B3039	
			R013B	Output Shaft O-ring	92055-022	
			R9X2V	Clutch Pushrod O-ring	670B1509	
			WA107	Drain Plug Seal	92065-058	
			WA107	Trans Fluid Drain Plug	92065-058	
			OS110	Crank Seal 20x40x7	92049-1188	
Oil Seal Kit				Component Part#	Component Description	OEM Part #
		C7736OS	OS131	Output Shaft Seal 25x37x6	92050-013	
			OS331	Shift Shaft Seal 13x22x5.5	92051-005	
			OS366	Start Shaft Seal 16x24x4	92049-002	
			OS361	Water Pump Shaft Seal 8x18x10	92049-1366	
Clutch & Mag Kit				Component Part#	Component Description	OEM Part #
		C7736CM	C7494	Clutch Cover Gasket	11009-1976	
			EC274032AFM	Mag Cover Gasket	11009-1974	

KAWASAKI KX65

Model	Year	Bore Size	Top End Kit	Component Part#	Component Description	OEM Part #
KX65	00-03	45 mm	C7736	H0970010S	Head Gasket 45mm	11004-1346
		47 mm	C7682	H0971010S	Head Gasket 47mm	11004-1346
		48 mm	C7737	H0972010S	Head Gasket 48mm	11004-1346
				B0444018AFM	Base Gasket	11060-1921
				B0444012F	High Compression Base Gasket	11060-1921
				R218V	Exhaust O-Ring 2 Req	670E3032
Bottom End Kit w/Oil Seals				Component Part#	Component Description	OEM Part #
		C7736BE	WP104018AFM	Water Pump Gasket	K1106-01924	
			WP105018AFM	Water Outlet Gasket	K1106-01927	
			WA118	Water Pump Drain Crush Washer	KK920-22077	
			R013B	Output Shaft O-rings	KK920-55022	
			WA108	Drain Plug Gasket	KK920-65058	
Oil Seal Kit				Component Part#	Component Description	OEM Part #
		C7736OS	OS360	Water Pump Seal Outer	K9204-91359	
			OS361	Water Pump Seal Inner	K9204-91366	
			OS365	Clutch Actuator Seal	K9204-91414	
			OS366	Kickstart Seal	KK920-49002	
			OS131	Output Shaft Seal	KK920-50013	
			OS331	Shift Shaft Seal	KK920-51005	
Clutch & Mag Kit				Component Part#	Component Description	OEM Part #
		C7736CM	EC274018AFM	Mag Cover Gasket	K1100-91974	
			C3078	Inner Clutch (Primary) Gasket	K1106-01925	
					K1106-10121	

All Component Parts can be purchased individually.



MX/Dirt • Off-Road Gaskets



Cometic Gasket - An Exclusive NASCAR Performance® Product

KAWASAKI KX80

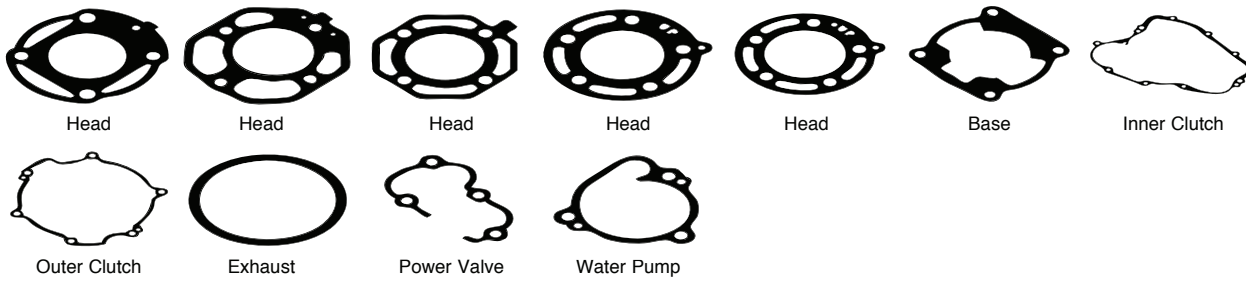

Model	Year	Bore Size	Top End Kit	Component Part#	Component Description	OEM Part #
KX80 EZ	83-85	50 mm	C7027	H0025043F	Head Gasket 50mm	11004-1058
				B0028020F	Base Gasket	11009-1975
				R221V	Exhaust O-Ring 2 Req	670E3036
				Crank Seal Kit C7656	Component Part# OS110	Component Description 20X40X7 Oil Seal 2 Req
KX80 G1, G2	86-87	50 mm	C7029	H0026043F	Head Gasket 50mm	11004-1138
		53 mm	C7318	H0447043F	Head Gasket 53mm	
				B0029018AFM	Base Gasket	11009-1970
				R221V	Exhaust O-Ring 2 Req	670E3036
			Bottom End Kit w/Oil Seals C7029BE	Component Part# R9X2V	Component Description Clutch Linkage O-ring	OEM Part # 670B1509
				WA107	Drain Plug Gasket	92065-058
				WP036018AFM	Water Pump Gasket	11009-1972
				WA118	Drain Plug Gasket	92022-077
				R013B	Output Shaft O-ring	92055-022
			Oil Seal Kit C7029OS	Component Part# OS110	Component Description Left & Right Crank Seals	OEM Part # 92049-1188
				OS131	Output Shaft Seal	92050-013
				OS331	Shift Shaft Seal	92051-005
				OS366	Start Shaft Seal	92049-002
				OS361	Water Pump Oil Seal	92049-1366
			Clutch & Mag Kit C7029CM	Component Part# EC190018AFM	Component Description Clutch Cover Gasket	OEM Part # 11061-0122
				EC274018AFM	Mag Cover Gasket	11009-1974
			Crank Seal Kit C7656	Component Part# OS110	Component Description 20X40X7 Oil Seal 2 Req	OEM Part # 92049-1188
KX80 L1, L2, L3	88-90	50 mm	C7030	H0027043F	Head Gasket 50mm	11004-1168
		53 mm	C7319	H0448043F	Head Gasket 53mm	
				B0029018AFM	Base Gasket	11009-1533
				R221V	Exhaust O-Ring 2 Req	670E3036
			Crank Seal Kit C7656	Component Part# OS110	Component Description 20X40X7 Oil Seal 2 Req	OEM Part # 92049-1188
KX80	91-97	49 mm	C7031	H0271010S	Head Gasket 49mm	11004-1213
		50 mm	C7307	H0441010S	Head Gasket 50mm	
				B0029018AFM	Base Gasket	11009-1970
				B0029012F	High Compression Base Gasket	
				R221V	Exhaust O-Ring 2 Req	670E3036
			Bottom End Kit w/crank seals C3345	Component Part# EC191018AFM	Component Description Mag Cover Gasket	OEM Part # 11009-1973
				C7493	Inner Clutch Cover Gasket	11009-1971
				WP036018AFM	Water Pump Gasket	11009-1972
			Crank Seal Kit C7656	Component Part# OS110	Component Description 20X40X7 Oil Seal 2 Req	OEM Part # 92049-1188

All Component Parts can be purchased individually.



MX/Dirt • Off-Road Gaskets



Cometic Gasket - An Exclusive NASCAR Performance® Product

KAWASAKI KX80/85

Model	Year	Bore Size	Top End Kit	Component Part#	Component Description	OEM Part #			
KX80	98-00	49 mm	C7391	H0271010S	Head Gasket	11004-1213			
				B0311018AFM	Base Gasket	11060-1779			
				B0311012F	High Compression Base Gasket	11060-1779			
				PV066018AFM	KIPS Cover	11060-1778			
				R126V	Exhaust O-Ring 2 Req	671E2535			
				Bottom End Kit w/crank seals			Component Part#	Component Description	OEM Part #
				C3345	EC191018AFM	Mag Cover Gasket	11009-1973		
					C7493	Inner Clutch Cover Gasket	11009-1971		
					WP036018AFM	Water Pump Cover Gasket	11009-1972		
				Crank Seal Kit			Component Part#	Component Description	OEM Part #
C7656	OS110	20X40X7 Oil Seal 2 Req	92049-1188						
KX85	01-13	48.5 mm 50.5 mm	C3501 C7859	Top End Kit					
				H11020SP1010S	Head Gasket 48.5mm	11004-1360			
				B0311018AFM	Base Gasket	11060-1779			
				B0311012F	High Compression Base Gasket	11060-1779			
				EX297063C	Exhaust Gasket	11060-1842			
				PV066018AFM	KIPS Cover Gasket	11060-1778			
				R126V	Exhaust O-Ring 2 Req	671E2535			
				Component Part#			Component Description	OEM Part #	
				C3541	H3880012S	Head Gasket 48.5mm Bore	11004-0737		
				C3634	B0311018AFM	Base Gasket	11060-1779		
	B0311012F	High Compression Base Gasket	11060-1779						
	EX297063C	Exhaust Gasket	11060-1842						
	PV145018AFM	Front Power Valve Gasket	11061-0889						
	PV066018AFM	KIPS Cover Gasket	11060-1778						
	R219V	Exhaust O-Ring 2 Req	670E3034						
KX85	01-19			Bottom End Kit w/Oil Seals					
				C3501BE	EC190018AFM	Inner Clutch Cover Gasket	11061-0122		
					WA124	Drain Plug Gasket	92022-077		
					WA107	Trans Drain Plug	92065-058		
					WP036018AFM	Water Pump Gasket	11061-0184		
					R013B	Output Shaft O-rings 17.5X1.5	92055-022		
				Oil Seal Kit			Component Part#	Component Description	Oem Part #
				C3501OS	OS110	Crank Seals 20x40x7	92049-1188		
					OS131	Output Shaft Seal 25x37x5	92049-1292		
					OS331	Shift Shaft Seal 13x22x5.5	92051-005		
					OS361	Water Pump Shaft Seal 8X18X10	92049-1366		
					OS366	Kickstart Shaft Seal 16x24x4	92049-002		
					OS306	Power Valve Shaft Seal	92049-1262		
					OS365	Clutch Actuator Shaft Seal	92049-1414		
				Clutch & Mag Kit			Component Part#	Component Description	Oem Part #
				C3501CM	EC513018AFM	Clutch Cover Gasket	11061-0869		
					EC191018AFM	Mag Cover Gasket	11061-0194		

KAWASAKI KX100

Model	Year	Bore Size	Top End Kit	Component Part#	Component Description	OEM Part #
KX100	95-97	53 mm 54.5 mm	C7268 C7347	H0342010S	Head Gasket 53mm	11004-1214
				H0490010S	Head Gasket 54.5mm	
				B0029018AFM	Base Gasket	11009-1970
KX100	98-13	53 mm 54.5 mm	C7392 C7413	R221V	Exhaust O-Ring 2 Req	670E3036
				H0342010S	Head Gasket 53mm	11004-1214
				H0490010S	Head Gasket 54.5mm	
				B0311018AFM	Base Gasket	11060-1779
				B0311012F	High Compression Base Gasket	11060-1779
				EX297063C	Exhaust Gasket	11060-1842
				PV066018AFM	KIPS Cover Gasket	11060-1778
				WA128	Head Bolt Washer 5 Req	92022-304
R126V	Exhaust O-Ring 2 Req	670E3036				

All Component Parts can be purchased individually.



MX/Dirt · Off-Road Gaskets



Cometic Gasket - An Exclusive NASCAR Performance® Product

KAWASAKI KX100

Model	Year	Bore Size	Top End Kit	Component Part#	Component Description	OEM Part #			
KX100	14-16	52.5 mm	C3542	H3881012S	Cylinder Head Gasket	11004-0739			
		54.5 mm	C3543	H3881SP1012S	Cylinder Head Gasket 54.5 112cc MOD				
				PV145018AFM	Power Valve Cover Gasket	11061-0889			
				PV066018AFM	Right Power Valve Cover Gasket	11060-1778			
				B0311018AFM	Base Gasket	11060-1779			
	95-16			WA128	WA128	Cyl Head Water Jacket Seal	92022-304		
				R219V	R219V	Exhaust Gasket	670E3034KX100		
						Bottom End Kit w/Oil Seals	Component Part#	Component Description	Oem Part #
					C3501BE	EC190018AFM	Inner Clutch Cover Gasket	11061-0122	
						WA124	Drain Plug Gasket	92022-077	
				WA107	Trans Drain Plug	92065-058			
				WP036018AFM	Water Pump Gasket	11061-0184			
				R013B	Output Shaft O-rings 17.5X1.5	92055-022			
					Oil Seal Kit	Component Part#	Component Description	Oem Part #	
				C3501OS	OS110	Crank Seals 20x40x7	92049-1188		
				OS131	Output Shaft Seal 25x37x5	92049-1292			
				OS331	Shift Shaft Seal 13x22x5.5	92051-005			
				OS361	Water Pump Shaft Seal 8X18X10	92049-1366			
				OS366	Kickstart Shaft Seal 16x24x4	92049-002			
				OS306	Power Valve Shaft Seal	92049-1262			
				OS365	Clutch Actuator Shaft Seal	92049-1414			
				Clutch & Mag Kit	Component Part#	Component Description	Oem Part #		
			C3501CM	EC513018AFM	Clutch Cover Gasket	11061-0869			
				EC191018AFM	Mag Cover Gasket	11061-0194			

KAWASAKI KLX110



Head



Base



Intake

Model	Year	Bore Size	EST Top End Kit	Component Part#	Component Description	OEM Part #	
KLX110	03-19	55 mm	C7939-EST	H1891010S	Head Gasket 55mm	11004-1338	
		57 mm	C7949-EST	H1917010S	Head Gasket 57mm	11004-1338	
				B0678SP2020RC	Base Gasket	11060-1796	
				IR431018AFM	Intake Gasket	K1106-01753	
				R022B	Intake O-rings 2 Req.	K9205-51527	
				EX781	Exhaust Gasket	K1106-11112	
				R110B	Cam Chain Tensioner Bolt O-ring	KK670-D2010	
				R117B	Cam Chain Tensioner O-ring	KK670-D2021	
				3183V	Valve Seals	K9204-91349	
				R91X2.5V	Cam Cover O-ring	K9205-51527	
				R031B	Tappet Cover O-rings 2 Req.	K9205-51231	
					Component Part#	Component Description	OEM Part #
					EC1102018AFM	Clutch Cover Gasket	11061-0131

KAWASAKI KLX125



Head



Cam Chain Tensioner

Model	Year	Bore Size	Top End Kit	Component Part#	Component Description	OEM Part #
KLX125	03-06	59 mm	C7835	H1892027S	Head Gasket 59mm	11004-S003
		61 mm	C3109	H1926027S	Head Gasket 57mm	11004-S003
				B0679020F	Base Gasket	11061-S035
				EC824032AFM	Timing Chain Tensioner Gasket	11061-S038
				R216B	Valve Cap Cover O-Ring 2 Req	92055-S036
				R010B	Cam Chain Bolt O-ring	95055-S032

All Component Parts can be purchased individually.

KAWASAKI KX125

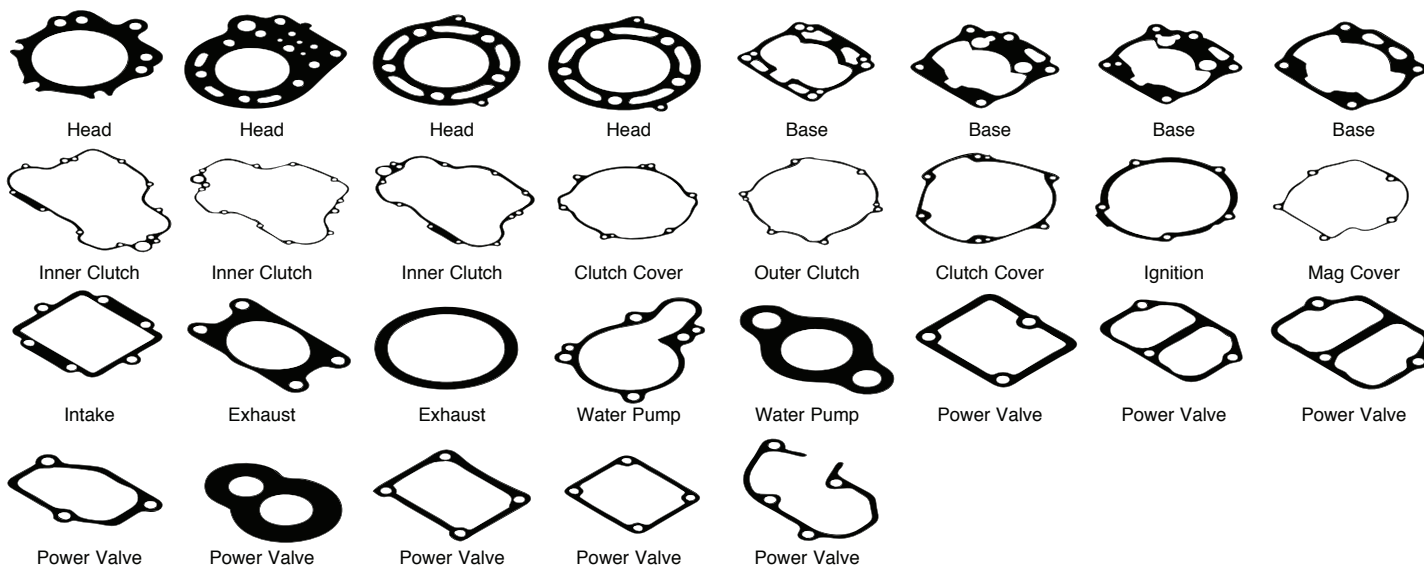

Model	Year	Bore Size	Top End Kit	Component Part#	Component Description	OEM Part #
KX125	78-79	57 mm	C7130	H0165020C B0108020F	Head Gasket 57mm Base Gasket	11004-1006 11009-1042
KX125	80-81	57 mm	C7131	H0164043F B0108020F	Head Gasket 57mm Base Gasket	11004-1023 11009-1175
KX125	82-83	58 mm	C7109	H0029043F B0024020F	Head Gasket 58mm Base Gasket	11004-1048 11009-1258
KX125	84	58 mm	C7110	H0248043F B0024020F	Head Gasket 58mm Base Gasket	11004-1112 11009-1258
KX125 D1, E1, E2	85-86	58 mm	C7032	H0021043F B0024020F I R007018AFM PV053020F PV054060AFM R224V	Head Gasket 58mm Base Gasket Intake Gasket Left Side Power Valve Right Side Power Valve Exhaust O-Ring 2 Req	11004-1160 11009-1258 11009-1941 11009-1478 11009-1479 670E3045
			Crank Seal Kit C7698	OS110 20X40X7	20X40X7 Oil Seal 2 Req	92049-1052
KX125	87	58 mm	C7119	R223V PV054060AFM PV052020F IR007018AFM H0021043F B0024020F	Exhaust O-Ring 2 Req Right Power Valve Gasket Left Power Valve Gasket Intake Gasket Head Gasket 58mm Base Gasket	670E3039 11009-1479 11009-1641 11009-1941 11004-1160 11009-1258
KX125 F1	88	58 mm	C7033	H0030043F B0030020F IR007018AFM PV009018AFM PV010020F R223V	Head Gasket 58mm Base Gasket Intake Gasket Left Power Valve Gasket Right Power Valve Gasket Exhaust O-Ring 2 Req	11004-1188 11009-1940 11009-1941 11009-1938 11009-1934 670E3039
			Crank Seal Kit C7657	OS112 OS111	Right Oil Seal Left Oil Seal	92049-1301 92049-1300

All Component Parts can be purchased individually.



MX/Dirt · Off-Road Gaskets



Cometic Gasket - An Exclusive NASCAR Performance® Product

KAWASAKI KX125 G1

Model	Year	Bore Size	Top End Kit	Component Part#	Component Description	OEM Part #
KX125 G1	89-91	58 mm	C7034	H0031043F	Head Gasket	11004-1188
				B0030020F	Base Gasket	11009-1690
				IR007018AFM	Intake Gasket	11009-1263
				PV009018AFM	Front Power Valve Gasket	11009-1691
				PV010020F	Left Side Power Valve	11009-1692
				R223V	Exhaust O-Ring 2 Req	670E3039
				Component Part#	Component Description	OEM Part #
				OS112	Right Oil Seal	92049-1301
				OS111	Left Oil Seal	92049-1300
				Component Part#	Component Description	OEM Part #
Component Part#	Component Description	OEM Part #				
KX125 H, H1	89-91	58 mm	C7035	H0032010S	Head Gasket 58mm	11004-1204
				B0030020F	Base Gasket	11009-1824
				IR007018AFM	Intake Gasket	11009-1941
				PV010020F	Left Side Power Valve	11009-1692
				PV009018AFM	Front Power Valve Gasket	11009-1691
				R223V	Exhaust O-Ring 2 Req	670E3039
				Component Part#	Component Description	OEM Part #
				OS112	Right Oil Seal	92049-1301
				OS111	Left Oil Seal	92049-1300
				Component Part#	Component Description	OEM Part #
KX125	92	56 mm	C7117	H0251010S	Head Gasket 56mm	11004-1231
				B0031020F	Base Gasket	11060-1188
				IR007018AFM	Intake Gasket	11009-1941
				PV009018AFM	Front Power Valve Gasket	11009-1934
				PV011020F	Right Side Power Valve Gasket	11060-1187
				R223V	Exhaust O-Ring 2 Req	670E3039
				R018B	Case Galley O-ring	92055-086
				WA107	Drain Plug Crush Washer	92065-058
				IR007018AFM	Reed Valve Gasket	11009-1941
				R018B	Primary Gear O-ring	92055-086
				WP030018AFM	Water Pump Elbow Gasket	11009-1935
				WP037018AFM	Water Pump Cover Gasket	11009-1936
				WA118	Water Pump Drain Plug	92022-304
					Crush Washer	
				R5.5X1.5B	Impeller O-ring	92055-1343
				EC270032AFM	Primary Gasket	11060-1190
				R018B	Primary O-ring	92055-086
				R013B	Output Shaft Backup Ring	92055-022
				Component Part#	Component Part#	OEM Part#
				OS111	Left Crank Seal	92049-1300
				OS112	Right Crank Seal	92049-1301
				OS131	Output Shaft Seal 25x37x5	92050-013
				OS306	Clutch Pushrod Seal	92049-1262
				OS308	Start Shaft Seal 16x24x4	92049-002
				OS331	Shift Shaft Seal	92051-005
				OS360	Outer Water Pump Seal	92049-1359
					8x18x3.5	
				OS361	Inner Water Pump Seal 8x18x10	92049-1366
				OS362	Power Valve Governor Seal	92049-1207
					8x14x4	
Component Part#	Component Description	Oem Part #				
EC199018AFM	Mag Cover Gasket	11060-1189				
EC230018AFM	Clutch Cover Gasket	11060-1191				

All Component Parts can be purchased individually.



MX/Dirt • Off-Road Gaskets



Cometic Gasket - An Exclusive NASCAR Performance® Product

KAWASAKI KX125

Model	Year	Bore Size	Top End Kit	Component Part#	Component Description	OEM Part #
KX125	93-94	56 mm	C7133	H0251010S	Head Gasket 56mm	11004-1252
				B0031020F	Base Gasket	11060-1188
				IR007018AFM	Intake Gasket	11009-1941
				PV067018AFM	Power Valve Rod Gasket	11060-1346
				PV043018AFM	Front Power Valve Gasket	11060-1194
				PV011020F	Right Power Valve Gasket	11060-1187
				WP030018AFM	Water Inlet Gasket	11009-1935
				R223V	Exhaust O-Ring 2 Req	670E3039
			Clutch & Mag Kit	Component Part#	Component Description	OEM Part #
			C7117CM	EC198018AFM	Outer Clutch Cover Gasket	11060-1351
				EC199018AFM	Mag Cover Gasket	11060-1189
			Crank Seal Kit	Component Part#	Component Description	OEM Part #
			C7657	OS112	Right Side Oil Seal	92049-1301
				OS111	Left Oil Seal	92049-1300
			Top End Kit	Component Part#	Component Description	OEM Part #
KX125	95-97	56 mm	C7241	H0251010S	Head Gasket 56mm	11004-1252
		58 mm	C7297	H0410010S	Head Gasket 58mm	
				B0181018AFM	Base Gasket	11060-1647
				B0181012F	High Compression Base Gasket	
				IR007018AFM	Intake Gasket	11009-1941
				R223V	Exhaust O-Ring 2 Req	670E3039
				PV043018AFM	Front Power Valve	11060-1690
				PV044060AFM	Right Power Valve	11060-1686
				PV067018AFM	Power Valve Rod Gasket	11060-1346
			Clutch & Mag Kit	Component Part#	Component Description	OEM Part #
			C7117CM	EC198018AFM	Outer Clutch Cover Gasket	11060-1351
				EC199018AFM	Mag Cover Gasket	11060-1189
			Crank Seal Kit	Component Part#	Component Description	OEM Part #
			C7657	OS112	Right Side Oil Seal	92049-1301
				OS111	Left Side Oil Seal	92049-1300
			Top End Kit	Component Part#	Component Description	OEM Part #
KX125	98-00	56 mm	C7393	H0251010S	Head Gasket 56mm	11004-1252
		58 mm	C7414	H0410010S	Head Gasket 58mm	
				B0423018AFM	Base Gasket - 2000	11060-1955
				B0181018AFM	Base Gasket	11060-1769
				B0423012F	High Comp. Base Gasket - 2000	
				B0181012F	Big Bore High Comp. Base	
				IR007018AFM	Intake Gasket	11009-1941
				EX292080C	Exhaust Gasket	11060-1370
				EX123020C	Exhaust Manifold Gasket	11060-1790 (1)
				PV108032AFM	Front Power Valve Gasket	11060-1788
				PV067018AFM	Power Valve Rod Gasket	11060-1346
				PV065018AFM	Right Power Valve Cover	11060-1789
				WP030018AFM	Water Inlet Gasket	11009-1935
				R223V	Exhaust O-Ring 2 Req	670E3039
			Clutch & Mag Kit	Component Part#	Component Description	OEM Part #
			C7117CM	EC198018AFM	Outer Clutch Cover Gasket	11060-1351
				EC199018AFM	Mag Cover Gasket	11060-1189
			Crank Seal Kit	Component Part#	Component Description	OEM Part #
			C7657	OS112	Right Side Oil Seal	92049-1301
				OS111	Left Side Oil Seal	92049-1300

All Component Parts can be purchased individually.



MX/Dirt • Off-Road Gaskets



Cometic Gasket - An Exclusive NASCAR Performance® Product

KAWASAKI KX125

Model	Year	Bore Size	Top End Kit	Component Part#	Component Description	OEM Part #	
KX125	01-02	56 mm	C7762	H0251010S	Head Gasket 56mm	11004-1252	
		58 mm	C7763	H0410010S	Head Gasket 58mm		
				B0502018AFM	Base Gasket	11060-1998	
				B0502012F	High Compression Base Gasket		
				EX292080C	Exhaust Gasket	11060-1370	
				EX123020C	Exhaust Manifold Gasket	11060-1790	
				IR007018AFM	Intake Gasket	11009-1941	
				PV065018AFM	Right Power Valve Cover	11060-1789	
				PV067018AFM	Power Valve Rod Gasket	11060-1346	
				PV108032AFM	Front Power Valve Gasket	11060-1876	
				WP030018AFM	Water Inlet Pipe	11009-1935	
				R223V	Exhaust O-Ring 2 Req	670E3042	
			Clutch & Mag Kit	Component Part#	Component Description	OEM Part #	
			C7117CM	EC198018AFM	Outer Clutch Cover Gasket	11060-1351	
				EC199018AFM	Mag Cover Gasket	11060-1189	
			Crank Seal Kit	Component Part#	Component Description	OEM Part #	
			C7657	OS112	Right Oil Seal	92049-1301	
				OS111	Left Oil Seal	92049-1300	
			Bottom End Kit w/Oil Seals	Component Part#	Component Description	OEM Part #	
KX125	94-02		C7762BE	R018B	Case Galley O-ring	92055-086	
				WA107	Drain Plug Crush Washer	92065-058	
				IR007018AFM	Reed Valve Gasket	11009-1941	
				IR007SP1018AFM	Reed Valve Guide Gasket	11060-1997	
				R018B	Primary Gear O-ring	92055-086	
				EC199018AFM	Mag Cover Gasket	11060-1189	
				WP030018AFM	Water Pump Elbow Gasket	11009-1935	
				WP037018AFM	Water Pump Cover Gasket	11009-1936	
				WA118	Water Pump Drain Plug Crush Washer	92022-304	
				R018B	Primary Gear O-ring	92055-086	
				EC197018AFM	Inner Clutch Cover Gasket	11060-1350	
				EC198018AFM	Clutch Cover Gasket	11060-1351	
				Oil Seal Kit	Component Part#	Component Description	OEM Part #
				C7762OS	OS111	Left Crank Seal	92049-1300
			OS112	Right Crank Seal	92049-1301		
			OS308	Start Shaft Seal 16x24x4	92049-002		
			OS331	Shift Shaft Seal	92051-005		
			OS360	Outer Water Pump Seal 8x18x3.5	92049-1359		
			OS361	Inner Water Pump Seal 8x18x10	92049-1366		
			OS362	Power Valve Governor Seal 8x14x4	92049-1207		
			OS365	Clutch Pushrod Seal	92049-1414		
			OS435	Output Shaft Seal 27x37x7	92049-1413		

All Component Parts can be purchased individually.



MX/Dirt • Off-Road Gaskets



Cometic Gasket - An Exclusive NASCAR Performance® Product

KAWASAKI KX125

Model	Year	Bore Size	Top End Kit	Component Part#	Component Description	OEM Part #	
KX125	03	O-Ring	C7921	R93X2B	Outer O-Ring Head Gasket	92055-1679	
				R62X2V	Inner O-Ring Head Gasket	92055-1679	
				B0604018AFM	Base Gasket	11061-1130	
				B0604012F	High Compression Base Gasket	11061-1130	
				R45X3V	Exhaust O-Ring 2 Req	670E3045	
				PV120018AFM	Right Power Valve Gasket	11061-1132	
				PV119018AFM	Front Power Valve Gasket	11061-1131	
				WA123	Head Bolt Washers 6 Req	11061-1133	
				Clutch & Mag Kit C7921CM	Component Part# EC756018AFM	Component Description Outer Clutch Cover Gasket	OEM Part # 11061-1135
					EC199018AFM	Mag Cover Gasket	11060-1189
				Crank Seal Kit C7657	Component Part# OS112	Component Description Right Oil Seal	OEM Part # 92049-1301
					OS111	Left Oil Seal	92049-1300
KX125	04-07	O-Ring	C7203	Component Part# R93X2B	Component Description Outer Head O-Ring	OEM Part # 92055-1679	
				R62X2V	Inner Head O-Ring	92053-1678	
				B0692018AFM	Base Gasket	11061-0039	
				B0692012F	High Compression Base Gasket	11061-0039	
				PV120018AFM	Right Power Valve Gasket	11061-1132	
				PV119018AFM	Front Power Valve Gasket	11061-1131	
				R45X3V	Exhaust O-Ring 2 req	670E3045	
				WA123	Head Bolt Washers 6 Req	11061-1133	
				Clutch & Mag Kit C7921CM	Component Part# EC756018AFM	Component Description Outer Clutch Cover Gasket	OEM Part # 11061-1135
					Component Part# OS112	Component Description Right Oil Seal	OEM Part # 92049-1301
					OS111	Left Oil Seal	92049-1300
				KX125	03-07		C7921BE
WA108	Drain Plug Crush Washer 10.5x16x1	92065-058					
R018B	Primary Gear O-ring	92055-086					
EC760032AFM	Mag Cover Gasket	11061-0038					
R5.5X1.5B	Power Valve Governor O-ring 5.5x1.5	92055-1343					
WP151018AFM	Water Pump Cover	11061-1150					
EC756032AFM	Clutch Cover Gasket	11061-1135					
EC767018AFM	Primary Cover Gasket	11061-1134					
WA118	Water Pump Drain Plug Crush Washer	92022-304					
	R018V	Output Shaft Backup Ring	92055-055				
Oil Seal Kit C7762OS	Component Part# OS111	Component Description Left Crank Seal	OEM Part # 92049-1300				
	OS123	Right Crank Seal	92049-1301				
	OS308	Start Shaft Seal 16x24x4	92049-002				
	OS331	Shift Shaft Seal	92051-005				
	OS360	Outer Water Pump Seal 8x18x3.5	92049-1359				
	OS361	Inner Water Pump Seal 8x18x10	92049-1366				
	OS362	Power Valve Governor Seal 8x14x4	92049-1207				
	OS365	Clutch Pushrod Seal	92049-1414				
	OS435	Output Shaft Seal 27x37x7	92049-1413				

All Component Parts can be purchased individually.



MX/Dirt · Off-Road Gaskets



Cometic Gasket - An Exclusive NASCAR Performance® Product

KAWASAKI KDX200

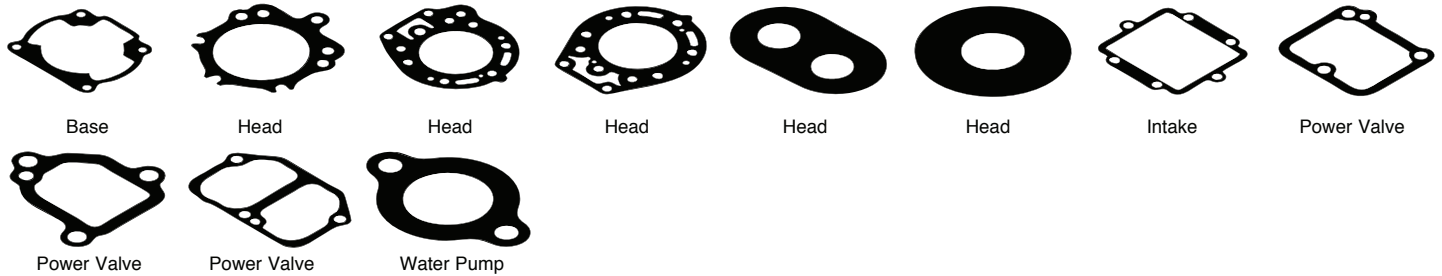

Model	Year	Bore Size	Top End Kit	Component Part#	Component Description	OEM Part #
KDX200	86-88	68 mm	C7042	H0019043F	Head Gasket 68mm	11009-1141
				B0023020F	Base Gasket	11009-1541
				IR007018AFM	Intake Gasket	11009-1263
				PV008020F	Power Valve Gasket	11009-1542
KDX200	89-94	68 mm 74 mm	C7043 C7321	H0299010S	Head Gasket 68mm	11004-1189
				H0201043F	Head Gasket 74mm	
	H0458020C	Head Insert				
	H0457020C	Head Insert				
	B0023020F	Base Gasket	11004-1659			
	IR007018AFM	Intake Gasket	11009-1941			
	PV010020F	Right Power Valve Gasket	11009-1934			
	PV009018AFM	Left Power Valve Gasket	11009-1968			
	WP029018AFM	Water Spigot Gasket	11009-1993			
	KDX200	95-06	68 mm 73 mm	C7242 C7320	H0343010S	Head Gasket 68mm
H0399043F					Head Gasket 73mm	
B0203018AFM		Base Gasket	11060-1659			
IR007018AFM		Intake Gasket	11009-1941			
PV060018AFM		Left Power Valve Gasket	11060-1628			
PV047018AFM		Right Power Valve Gasket	11060-1629			
PV046018AFM		Resonator Cover Gasket	11060-1627			
WP029018AFM		Water Spigot Gasket	11009-1993			
R222V		Exhaust Gasket 2 Req	670E3039			
KDX220R		97-05	70 mm	C7298	H0439010S	Head Gasket 70mm
	B0203018AFM				Base Gasket	11060-1659
	IR007018AFM				Intake Gasket	11009-1941
	PV060018AFM				Left Power Valve Gasket	11060-1628
	PV047018AFM				Right Power Valve Gasket	11060-1629
	PV046018AFM				Resonator Cover Gasket	11060-1627

KAWASAKI KDX250

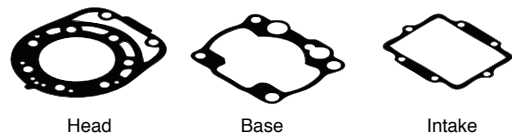

Model	Year	Bore Size	Top End Kit	Component Part#	Component Description	OEM Part #
KDX250	91-94	69 mm	C7134	H0293010S	Head Gasket 69mm	11004-1240
				B0113018AFM	Base Gasket	11060-1493
				IR008018AFM	Intake Gasket	11009-1950
				PV013018AFM	Front Power Valve Gasket	11060-1289
				PV012020F	Right Power Valve Gasket	11060-1290
KL, KLR250	85-05	77 mm	C7244	H0341010C	Head Gasket 77mm	11004-1121
				B0198020F	Base Gasket	11060-1125
KLX250R	94-14	73 mm	C7214	H0230043F	Head Gasket 73mm	11004-1249
				B0155020RC	Base Gasket	11060-1319

All Component Parts can be purchased individually.

KAWASAKI KX250

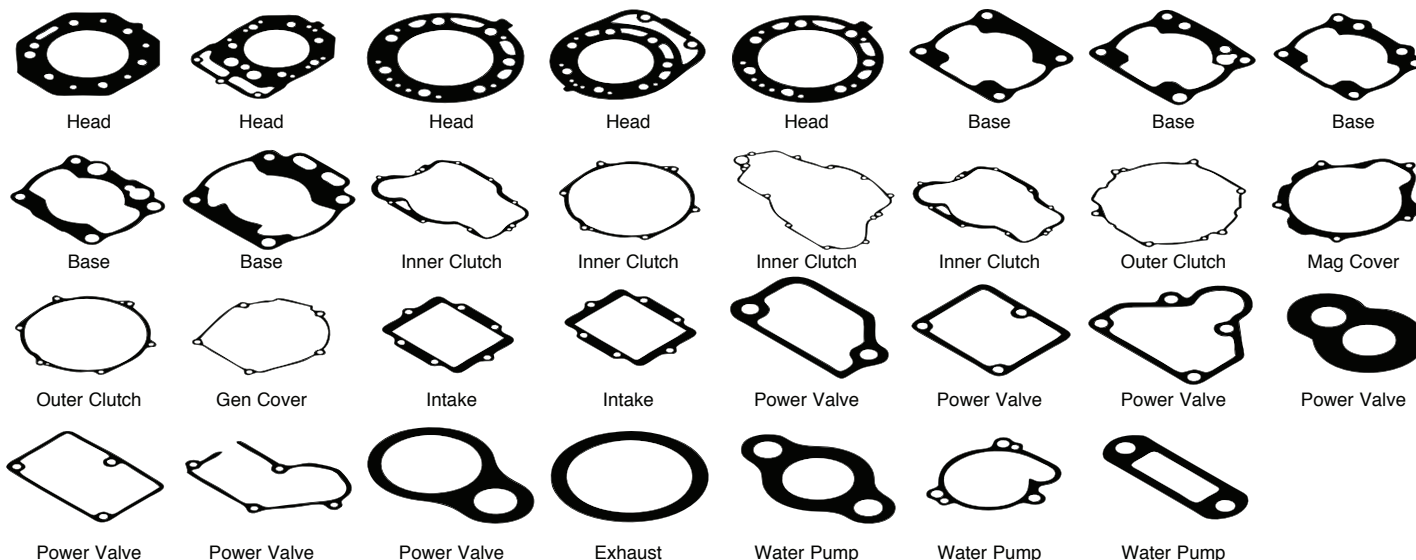

Model	Year	Bore Size	Top End Kit	Component Part#	Component Description	OEM Part #
KX250	83-84	72 mm	Top End Kit C7111	H0022043F	Head Gasket 72mm	11004-1057
				B0025020F	Base Gasket	11009-1318
			Crank Seal Kit C7658	OS110	20X40X7 Left Oil Seal	92049-1052
				OS187	Right Oil Seal	92049-1051
KX250 D1	85	72 mm	Top End Kit C7037	H0023043F	Head Gasket 72mm	11004-1126
				B0025020F	Base Gasket	11004-1462
				IR008018AFM	Intake Gasket	11009-1950
				R136V	Exhaust Gasket 2 Req	671E2550
			Crank Seal Kit C7658	OS110	20X40X7 Left Oil Seal	92049-1052
				OS187	Right Oil Seal	92049-1051
KX250 D2	86	72 mm	Top End Kit C7038	H0023043F	Head Gasket 72mm	11004-1126
				B0026020F	Base Gasket	11009-1546
				IR008018AFM	Intake Gasket	11009-1950
				R136V	Exhaust Gasket 2 Req	671E2550
			Crank Seal Kit C7658	OS110	20X40X7 Left Oil Seal	92049-1052
				OS187	Right Oil Seal	92049-1051
KX250 E1	87	69.5 mm	Top End Kit C7039	H0034043F	Head Gasket 69.5mm	11004-1157
				B0032020F	Base Gasket	11009-1624
				IR008018AFM	Intake Gasket	11004-1950
				PV012020F	Right Power Valve Gasket	11009-1946
				R136V	Exhaust Gasket 2 Req	671E2550
			Crank Seal Kit C7658	OS110	20X40X7 Left Oil Seal	92049-1051
				OS187	Right Oil Seal	92049-1052
KX250 F1, 88-90 G1, H1		69 mm	Top End Kit C7040	H0293010S	Head Gasket 69mm	11004-1121
				B0033020F	Base Gasket	11009-1700
				IR008018AFM	Intake Gasket	11009-1252
				PV013018AFM	Front Power Valve Gasket	11009-1701
				PV012020F	Right Power Valve Gasket	11009-1625
				R136V	Exhaust Gasket 2 Req	671E2550
				WP030018AFM	Water Inlet Gasket	11009-1696
			Crank Seal Kit C7658	OS110	20X40X7 Left Oil Seal	92049-1052
				OS187	Right Oil Seal	92049-1051

All Component Parts can be purchased individually.



MX/Dirt · Off-Road Gaskets



Cometic Gasket - An Exclusive NASCAR Performance® Product

KAWASAKI KX250 H2

Model	Year	Bore Size	Top End Kit	Component Part#	Component Description	OEM Part #				
KX250 H2	91	69mm	C7041	H0293010S	69mm Head Gasket	11004-1217				
				B0034020F	Base Gasket	11009-1947				
				IR008018AFM	Intake Gasket	11009-1251				
				PV013018AFM	Front Power Valve Gasket	11009-1701				
				PV012020F	Right Power Valve Gasket	11009-1625				
				R136V	Exhaust Gasket 2-Req	671E2550				
				WP030018AFM	Water Inlet Gasket	11009-1696				
				Crank Seal Kit C7658	Component Part# OS110	Component Description 20X40X7 Left Oil Seal	OEM Part # 92049-1051			
					OS187	Right Oil Seal	92049-1052			
				KX250	92	69 mm	C7100	Component Part# H0293010S	Component Description Head Gasket 69mm	OEM Part # 11004-1229
B0034020F	Base Gasket	11009-1947								
IR008018AFM	Intake Gasket	11009-1252								
PV012020F	Right Power Valve Gasket	11009-1625								
PV013018AFM	Front Power Valve Gasket	11009-1701								
WP030018AFM	Water Inlet Gasket	11009-1696								
R136V	Exhaust Gasket 2 Req	671E2550								
Clutch & Mag Kit C7135CM	Component Part# C7478	Component Description Outer Clutch Cover Gasket	OEM Part # 11060-1186							
	EC203018AFM	Mag Cover Gasket	11009-1951							
Crank Seal Kit C7658	Component Part# OS113	Component Description Right Oil Seal	OEM Part # 92049-1051							
	OS187	20X40X7 Left Oil Seal	92049-1052							
KX250	88-93	68.5 mm	C7135					H0253010S	Head Gasket 68.5mm	11004-1174
								B0113018AFM	Base Gasket	11009-1700
								IR008018AFM	Intake Gasket	11009-1252
								PV014018AFM	Right Power Valve Gasket	11009-1625
								PV039018AFM	Front Power Valve Gasket	11060-1289
								PV040018AFM	Resonator Cover Gasket	11060-1290
								R136V	Exhaust Gasket 2 Req	671E2550
								WP030018AFM	Water Inlet Gasket	11009-1696
								PV067018AFM	Power Valve Rod Gasket	11060-1346
				Clutch & Mag Kit C7135CM	Component Part# C7478	Component Description Outer Clutch Cover Gasket	OEM Part # 11060-1186			
					EC203018AFM	Mag Cover Gasket	11009-1951			
				Crank Seal Kit C7658	Component Part# OS113	Component Description Right Oil Seal	OEM Part # 92049-1051			
					OS187	20X40X7 Left Oil Seal	92049-1052			
				KX250	93	68.5 mm	C7135	Component Part# H0253010S	Component Description Head Gasket 68.5mm	OEM Part # 11004-1240
								B0113018AFM	Base Gasket	11060-1147
								IR008018AFM	Intake Gasket	11009-1252
								PV067018AFM	Power Valve Rod Gasket	11060-1290
								PV014018AFM	Right Power Valve Gasket	14090-1226
								PV039018AFM	Front Power Valve Gasket	11060-1147
								PV040018AFM	Resonator Cover Gasket	11060-1289
R136V	Exhaust Gasket 2 Req	671E2550								
Bottom End Kit w/crank seals C3351	Component Part# EC200018AFM	Component Description Inner Clutch Cover Gasket	OEM Part # 11060-1185							
	EC203018AFM	Mag Cover Gasket	11009-1951							
	C7478	Outer Clutch Cover Gasket	11060-1186							
	WP055018AFM	Water Pump Gasket	11060-1184							
	WP030018AFM	Water Inlet Gasket	11009-1935							
Clutch & Mag Kit C7135CM	Component Part# C7478	Component Description Outer Clutch Cover Gasket	OEM Part # 11060-1186							
	EC203018AFM	Mag Cover Gasket	11009-1951							
Crank Seal Kit C7658	Component Part# OS113	Component Part# Right Oil Seal	OEM Part# 92049-1051							
	OS187	20X40X7 Left Oil Seal	92049-1052							

All Component Parts can be purchased individually.



MX/Dirt • Off-Road Gaskets



Cometic Gasket - An Exclusive NASCAR Performance® Product

KAWASAKI KX250

Model	Year	Bore Size	Top End Kit	Component Part#	Component Description	OEM Part #		
KX250	94-00	68.5 mm	C7155	B0113012F	High Compression Base Gasket	11060-1493		
		74 mm	C7304	B0113018AFM	Base Gasket	11060-1493		
				H0253010S	Head Gasket 68.5mm	11004-1240		
				H0417010S	Head Gasket 74mm			
				I R008018AFM	Intake Gasket	11009-1950		
				PV014018AFM	Right Power Valve Gasket	11009-1960		
				PV039018AFM	Front Power Valve Gasket	11060-1147		
				PV040018AFM	Resonator Cover Gasket	11060-1226		
				V067018AFM	Power Valve Rod Gasket	11060-1290		
				R136V	Exhaust Gasket 2 Req	92055-1666		
				WP030018AFM	Water Inlet Gasket	11009-1935		
			Bottom End Kit w/crank seals	Component Part#	Component Description	OEM Part #		
			C3351	EC200018AFM	Inner Clutch Cover Gasket	11060-1185		
				EC203018AFM	Mag Cover Gasket	11009-1951		
				C7478	Outer Clutch Cover Gasket	11060-1186		
				WP055018AFM	Water Pump Gasket	11060-1184		
				WP030018AFM	Water Inlet Gasket	11009-1935		
			Clutch & Mag Kit	Component Part#	Component Description	OEM Part #		
			C7135CM	C7478	Outer Clutch Cover Gasket	11060-1186		
				EC203018AFM	Mag Cover Gasket	11009-1951		
			Crank Seal Kit	Component Part#	Component Description	OEM Part #		
			C7658	OS113	Right Oil Seal	92049-1051		
				OS187	20X40X7 Left Oil Seal	92049-1052		
KX250	01	68.5 mm	Top End Kit	Component Part#	Component Description	OEM Part #		
			C7764	H0253010S	Head Gasket 68.5mm	11004-0014		
		74 mm	C7765	H0417010S	Head Gasket 74mm	11004-0013		
				B0113018AFM	Base Gasket	11060-1493		
				B0113012F	High Compression Base Gasket	11060-1493		
				IR173018AFM	Intake Gasket	11060-1993		
				PV014018AFM	Right Power Valve Gasket	11009-1960		
				PV039018AFM	Front Power Valve Gasket	11060-1289		
				PV040018AFM	Resonator Cover Gasket	11060-1290		
				PV067018AFM	Power Valve Rod Gasket	11060-1346		
				EX290080C	Exhaust Gasket	11060-1689		
				WP030018AFM	Water Inlet Gasket	11009-1935		
				R136V	Exhaust Gasket 2 Req	92055-1666		
		KX250	02-03	68.5 mm	Top End Kit	Component Part#	Component Description	OEM Part #
					C7861	H0253010S	Head Gasket 68.5mm	11004-1240
				B0113012F	High Compression Base Gasket	11060-1493		
				R49.5X3V	Exhaust O-Ring 2 Req	92055-1666		
				B0113018AFM	Base Gasket	11060-1493		
				IR173018AFM	Intake Gasket	11060-1993		
				EX290080C	Exhaust Gasket	11060-1689		
				PV014018AFM	Right Power Valve Gasket	11009-1960		
				PV039018AFM	Front Power Valve Gasket	11060-1289		
				PV040018AFM	Resonator Cover Gasket	11060-1290		
				PV067018AFM	Power Valve Rod Gasket	11060-1346		
KX250	04			68.5 mm	Top End Kit	Component Part#	Component Description	OEM Part #
		C7269	H2155010S		Head Gasket 68.5mm	11004-0013		
		70.5 mm	C7284	H2156010S	Head Gasket 70.5mm			
				B0743018AFM	Base Gasket	11061-0040		
				B0743012F	High Compression Base Gasket	11061-0040		
				IR173018AFM	Intake Gasket	11060-1993		
				EX290080C	Exhaust Gasket	11060-1689		
				PV014018AFM	Right Power Valve Gasket	11009-1960		
				PV039018AFM	Front Power Valve Gasket	11060-1289		
				PV040018AFM	Resonator Cover Gasket	11060-1290		
				PV067018AFM	Power Valve Rod Gasket	11060-1346		
				R017B	Power Valve O-Ring 2 Req			
				R49.5X3V	Exhaust O-Ring 2 Req	92055-1666		

All Component Parts can be purchased individually.



MX/Dirt • Off-Road Gaskets



Cometic Gasket - An Exclusive NASCAR Performance® Product

KAWASAKI KX250

Model	Year		Bottom End Kit w/oil seals	Component Part#	Component Description	OEM Part #				
KX250	92-04		C7861BE	EC200018AFM	Primary Gasket 1992-1996	11060-1185				
				EC202018AFM	Primary Gasket 1997-2004	11061-1058				
				R020V	Output Shaft O-Ring	92055-035				
				R5.5X1.5B	Governor O-ring	92055-1343				
				WA107	Drain Plug Gasket	92065-058				
				WA118	Water Pump Drain Crush Washer	92022-304				
				WP055018AFM	Water Pump Gasket	11060-1184				
			C7861OS		WP117018AFM	Water Pump Outlet Gasket	11060-1183			
					OS110	Left Crank Seal	92049-1052			
					OS187	Right Crank Seal	92049-1051			
					OS285	Start Shaft Seal	92049-1594			
					OS295	Output Shaft Seal	92050-033/ 92049-1556			
					OS306	Clutch Actuator Seal	92049-1262			
					OS307	Start Shaft Seal	92049-013			
					OS331	Shift Shaft Seal	92051-005			
					OS360	Water Pump Seal	92049-0033			
					OS361	Water Pump Seal	92049-1366			
					OS362	Governor Shaft Seal	92049-0034 92049-1207			
						C7135CM		C7478	Outer Clutch Cover Gasket	11060-1186
								EC203018AFM	Mag Cover Gasket	11009-1951
KX250	05-07	66.6 mm	C3096	R103X2V	Outer Head O-Ring	92055-0050				
				R74X2S	Inner Head O-Ring	92055-0049				
				B0818018AFM	Base Gasket	11061-0091				
				B0818014RC	High Compression Base Gasket	11061-0091				
				R53.5X2V	Exhaust O-Ring 2 Req	92055-0052				
				EX290080C	Exhaust Gasket	11061-0142				
				PV128018AFM	Front Power Valve Gasket	11061-0092				
				PV129018AFM	Left Power Valve Gasket	11061-0093				
				PV130018AFM	Power Valve Gasket 2 Req	11061-0138				
				WA123	Head Bolt Washers 6 Req	11061-1133				
				R8.5X2V	R8.5X2V					
					C3096BE		MR202	Case Coolant Galley Gasket	92055-0059	
							WA107	Case Drain Plug	92065-058	
							R5.5X1.5B	Centrifugal Power Valve O-ring	92055-1343	
							R116B	Water Pump Elbow O-ring	92055-1308	
							WP151018AFM	Water Pump Gasket	11061-0097	
							WA118	Water Pump Drain Crush Washer	92022-304	
							R117B	Fill Plug O-ring	92055-1146	
							EC1031018AFM	Primary Cover Gasket	11061-0095	
								C3096OS		OS187
				OS285	Start Shaft Seal	92049-1594				
OS295	Output Shaft Seal	92049-0030								
OS306	Clutch Actuator Shaft Seal	92049-1262								
OS331	Shift Shaft Seal	92051-005								
OS360	Impeller Seal	92049-0033								
OS361	Water Pump Shaft Seal	92049-0034								
OS362	Power Valve Governor Seal	92049-1207								
	C3096CM		EC1032032AFM	Clutch Cover Gasket	11061-0144					
			EC1033032AFM	Mag Cover Gasket	11061-0098					

All Component Parts can be purchased individually.



MX/Dirt • Off-Road Gaskets



Cometic Gasket - An Exclusive NASCAR Performance® Product

KAWASAKI KX250F



Head



Head

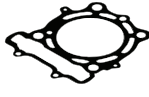

Head



Base



Exhaust



Outer Clutch



Inner Clutch

Model	Year	Bore Size	EST	Component Part#	Component Description	OEM Part #	
KX250F	04-08	77 mm	C3174-EST	H2169SP1027S	Head Gasket 77mm	11004-0003	
		78 mm	C3054-EST	H2096027S	Head Gasket 78mm		
		80 mm	C3056-EST	H2169027S	Head Gasket 80mm		
		81mm	C7221-EST	H1967027S	Head Gasket 81mm		
		83 mm	C3135-EST	H2471SP1027S	Head Gasket 83mm		
		84 mm	C3118-EST	H2471027S	Head Gasket 84mm		
					B0691014RC	Base Gasket	11061-0025
					EX651	Exhaust Gasket	11061-0027
					R018B	Camchain Tensioner O-Ring	92055-086
					3233V	Valve Stem Seal 4 Req	92049-1349

Bottom End Kit w/Oil Seals C3174BE	Component Part#	Component Description	OEM Part #	
	WA108	Crank Case Drain Plug Washer	92065-058	
	R118B	Crank End Cap O-Ring	670B2022	
	EC903032AFM	Inner Clutch Cover Gasket	11061-0030	
	R112B	Timing Mark Plug O-Ring	92055-1141	
	R117B	Crank Case Oil Fill O-Ring	92055-1146	
	R018B	Output Shaft O-Ring (2)	92055-055	
	MR042	Water Pump Cover O-Ring	92055-0010	
	R116B	Water Pipe O-Ring	92055-1308	
	Oil Seal Kit C3174OS	OS279	Decompression Shaft Seal 10x18x5	92049-1196
		OS295	Crank Seal 30x40x7	92049-1556
OS305		Shift Shaft Seal 14x22x6	92049-0015	
OS306		Clutch Actuator Shaft Seal 12x18x4	92049-1262	
OS307		Start Shaft Seal 18x30x7	92049-013	
OS308		Impeller Seal 8x22x7x7.5	92049-0021	
OS309		Inner WP Seal 8x22x5	92049-0016	
OS359		Output Shaft Seal 25x40x6	92049-1478	
Clutch & Mag Kit C3174CM	EC847060AFM	Outer Clutch Cover Gasket	11061-0031	
	EC904032AFM	Mag Cover Gasket	11061-0032	
	VC102	Valve Cover Gasket	11061-0024	

All Component Parts can be purchased individually.



MX/Dirt · Off-Road Gaskets



Cometic Gasket - An Exclusive NASCAR Performance® Product

KAWASAKI KX250F

Model	Year	Bore Size	EST	Component Part#	Component Description	OEM Part #		
KX250F	09-16	78mm 79mm 80mm	Top End Kit					
			C3267-EST	H2848027S	Head Gasket 78mm	11004-0079		
			C3274-EST	H2848SP3027S	Head Gasket 79mm			
				C3271-EST	H2848SP1027S	Head Gasket 80mm		
					B0967020RC	Base Gasket	11061-0357	
					EX651	Exhaust Gasket	11061-0027	
					R018B	Cam Chain Tensioner O-Ring	92055-086	
					3183V	Valve Stem Seals 4 Req	92049-1349	
					R021V	Cam Tower O-ring	92055-0046	
					R013V	Water Temp Sensor O-Ring	92055-0016	
					Bottom End Kit	Component Part#	Component Description	OEM Part #
					C3267BE	R014V	Timing Mark Plug O-Ring	92055-1011
						R20X2V	Fill Plug O-ring	92055-1146
						R27.5X2.5V	Crank End Plug O-ring	92055-091
				EC1341032AFM	Inner Clutch Cover Gasket	11061-0361		
				WA108	Drain Plug Gasket	92065-058		
				R27.5X2.5V	Neutral Switch Indicator	92055-091		
				R018B	Output Shaft O-rings 2	92055-055		
				MR042	Water Pump Cover O-Ring	92055-0010		
				R116B	Water Pipe O-Ring	92055-1308		
				WA118	Water Pump Crush Seal	92022-304		
			Oil Seal Kit	Component Part#	Component Description	OEM Part #		
			C3267OS	OS295	Output Shaft Seal 30x40x7	92049-0030		
				OS295	Primary Shaft Seal	92049-0030		
				OS305	Shift Shaft Seal 14x22x6	92049-0015		
				OS306	Clutch Actuator Shaft Seal 12x18x4	92049-1262		
				OS307	Kickstart Shaft Seal 18x30x7	92049-013		
				OS308	Impeller Seal 8x22x7/7.5	92049-0061		
				OS309	Inner WP Seal 8x22x5	92049-0060		
				OS331	Balance Shaft Seal 13x22x5.5	92049-0762		
			Clutch & Mag Kit	Component Part#	Component Description	OEM Part #		
			C3267CM	EC1312032AFM	Outer Clutch Cover Gasket	11061-0362		
				EC1340032AFM	Mag Cover Gasket	11061-0363/11061-0778		
KX250F	17-19	78mm 80mm	Top End Kit					
			C3619	H4365027S	Head Gasket 78mm	11004-0761		
			C3629	H4365SP2027S	Head Gasket 80mm			
					R018B	Cam Chain O-ring	92055-086	
					R022V	Cam Tower O-ring	92055-0729	
					R031B	Intake Boot O-ring	92055-1401	
					B1353014RC	Cylinder Base Gasket	11061-1198	
					EX651	Header Gasket	11061-0027	
					3183V	Valve Stem Seal	92049-1349	
					Bottom End Kit	Component Part#	Component Description	OEM Part #
					C3619BE	WA107	Drain Plug Gasket	92065-058
						R117B	Fill Plug O-ring	92055-1146
						EC2201032AFM	Inner Clutch Cover Gasket	11061-1199
						R014V	Timing Mark O-Ring	92055-1011
						R123V	Timing Plug O-Ring	92055-091
						R123V	Gear Position Sensor O-ring	92055-091
						R018B	Output Shaft Back-up O-ring	92055-055
						MR042	Water Pump O-ring	92055-0010
						R031B	Water Pump Cover O-ring	92055-520
						R116B	Water Neck O-ring	92055-1308
						WA133	Water Pump Crush Washers	92200-0190
						WA118	Water Pump Crush Washers	92022-304
					Oil Seal Kit	Component Part#	Component Description	OEM Part #
					C3619OS	OS295	Output Shaft Seal	92049-0030
						OS295	Right Crank Seal	92049-0030
						OS306	Clutch Pushrod Oil Seal	92049-1262
						OS307	Start Shaft Seal	92049-013
						OS308	Outer Water Pump Seal	92049-0061
						OS309	Inner Water Pump Oil Seal	92049-0060
						OS331	Shift Shaft Seal	92051-005
						OS331	Oil Pump Seal	92049-0762
					Clutch & Mag Kit	Component Part#	Component Description	OEM Part #
					C3619CM	EC2200032AFM	Outer Clutch Cover Gasket	11061-1201
				EC2202032AFM	Mag Cover Gasket	11061-1200		



Cometic Gasket - An Exclusive NASCAR Performance® Product

KAWASAKI KLX300R

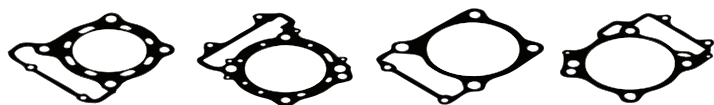

Head Head Base Base

Model	Year	Bore Size	Top End Kit	Component Part#	Component Description	OEM Part #
KLX300R	97-05	78 mm	C7302	H0252043F	Head Gasket 78mm	11004-1314
		80 mm	C7420	H0521043F	Head Gasket 80mm	
				B0260020RC	Base Gasket	11060-1740

KAWASAKI KX450F



Head Base Inner Clutch Generator Cover Exhaust Water Pump Cam Chain Tensioner Outer Clutch

Model	Year	Bore Size	EST Top End Kit	Component Part#	Component Description	OEM Part #
KX450F	06-08	96 mm	C3136-EST	H2466027S	Head Gasket 96.5mm	11004-0045
		98 mm	C3146-EST	H2466SP1027S	Head Gasket 98mm	11004-0045
				B0842014RC	Base Gasket	11061-0160
				EX693064AM	Exhaust Gasket	11061-0082
				EC1080032AFM	Cam Tensioner Gasket	11061-0260
				R022B	Spark Plug O-Ring	11061-0079
				R10X2V	Cam Chain Tensioner O-Ring	670D2010
				3241V	Valve Stem Seals 4 Req	92049-1062

Bottom End Kit w/Oil Seals C3136BE	Component Part#	Component Description	OEM Part #
	R10X2B	Cam Chain O-ring	670D2010
	R010B	Oil Nozzle O-ring 7mm	670D1507
	WA108	Drain Plug Washer	92065-058
	R123V	Crankshaft Timing O-Ring	92055-091
	R014V	Timing Plug O-ring	92055-1011
	EC1067032AFM	Outer Clutch Cover Gasket	11061-0145
	R118B	Crankcase Oil Fill O-Ring	92055-1146
	EC1068032AFM	Inner Clutch Cover Gasket	11061-0224
	R123V	Neutral Switch O-Ring	92055-091
	R138SB	Oil Filter O-Ring 2 Req	92055-1577
	R10X2B	Oil Pickup O-ring	670D2010
	WP187032AFM	Water Pump Gasket	11061-0225
Oil Seal Kit C3136OS	Component Part#	Component Description	OEM Part #
	OS295	Output Shaft Seal 30x40x7	92049-0030
	OS339	Clutch Release Oil Seal 12X20X5.5	92049-1475
	OS331	Shift Shaft Seal 13x22x5.5	92051-005
	OS227	Inner Water Pump Seal 12x22x5	92049-0041
	OS277	Outer Water Pump Seal 12x24x7	92049-0040
	OS285	Kickstart Shaft Seal 20x30x7	92049-1261
	OS275	Crank End Oil Seal 10x20x5	92049-1542
Clutch & Mag Kit C3136CM	Component Part#	Component Description	OEM Part #
	EC1067032AFM	Clutch Cover Gasket	11061-0145
	EC1081018AFM	Mag Cover Gasket	11061-0084

All Component Parts can be purchased individually.



MX/Dirt • Off-Road Gaskets



Cometic Gasket - An Exclusive NASCAR Performance® Product

KAWASAKI KX450F

Model	Year	Bore Size	EST	Component Part#	Component Description	OEM Part#	
KX450F	09-15	96mm 98mm	Top End Kit C3268-EST C3285-EST	H2466027S	Head Gasket 96.5mm	11004-0045/ 110040088	
				H2466SP1027S	Head Gasket 98mm		
				B0966014RC	Base Gasket	11061-0353/11061-0768	
				EX693064AM	Exhaust Gasket	11061-0082	
				EC1080032AFM	Cam Tensioner Gasket	11061-0211	
				R022B	Spark Plug O-Ring	11061-0079	
				R10X2V	Cam Chain Tensioner O-Ring	670D2010	
				3241V	Valve Stem Seals 4 Req	92045-1062	
				Bottom End Kit w/Oil Seals C3268BE	Component Part#	Component Description	OEM Part #
					R020V	Output Shaft O-ring	92055-1293
					R013V	Temp Sensor O-ring	92055-0016
					R010B	Oil Nozzle O-ring 7mm	670D1507
					R011B	Oil Nozzle O-ring 8mm	670D1508
					WA118	Left Case Drain Crush Washer	92022-304
					WA108	Drain Plug Crush Washer	92065-058
					EC1338032AFM	Clutch Cover Gasket	11061-0359
					R010B	Case Dowel O-Ring	92055-0113
					R123V	Crank End Plug O-ring	92055-091
					R014V	Timing Plug O-ring	92055-1011
					R20X2V	Oil Fill Plug O-ring	92055-1146
	R123V	Neutral Switch O-ring	92055-091				
	R138SB	Oil Filter O-rings	92055-1577				
	R10X2B	Oil Pickup O-ring	670D2010				
	WP187032AFM	Water Pump Gasket	11061-0225				
	WA118	Water Pump Drain Washer	92022-304				
	Oil Seal Kit C3268OS	Component Part#	Component Description	OEM Part #			
		OS277	Outer Water Pump Seal 12x24x7	92049-0040			
		OS227	Inner Water Pump Seal 12x22x5	92049-0041			
		OS285	Kickstart Shaft Seal 20x30x7	92049-0134			
		OS275	Crank End Oil Seal 10x20x5	92049-1542			
		OS295	Output Shaft Seal 30x40x7	92049-0030			
		OS339	Clutch Release Oil Seal 12X20X5.5	92049-1475			
		OS331	Shift Shaft Seal 13x22x5.5	92051-005			
	Clutch & Mag Kit C3268CM	Component Part#	Component Description	OEM Part #			
		EC1184032AFM	Outer Clutch Cover Gasket	11061-0259			
		EC1339032AFM	Mag Cover Gasket	11061-0358			
KX450F	16-18	96mm	EST Top End Kit C3598-EST C3626-EST	H2466027S	Head Gasket	11004-0756	
				H2466SP1027S	Head Gasket 98mm		
				B1320014RC	Base Gasket	11061-0984	
				EC1080032AFM	Cam Chain Tensioner Gasket	11061-0260	
				R10X2V	Cam Chain Tensioner O-Ring	670D2010	
				R021V	Cam Tower O-ring	92055-0046	
				EX693064AM	Exhaust Gasket	11061-0082	
				3241V	Valve Stem Seals 4 Req	92045-1062	
				Bottom End Kit w/Oil Seals C3598BE	Component Part#	Component Description	OEM Part #
					R010B	Oil Passage O-ring 7mm	670D1507
					R011B	Oil Nozzle O-ring 8mm	670D1508
					R117B	Fill Plug Gasket	92055-1146
					R27.5X2.5V	Timing Gear O-ring	92055-091
					R27.5X2.5V	Gear Position Sensor O-Ring	92055-091
					WA108	Drain Plug Crush Washer	92065-058
					WA128	Water Pump Crush Washer	92022-304
					R13X2V	Timing Mark O-ring	92055-1021
					R13X2V	Oil Screen Oring Outer	92055-1021
					R10X2V	Oil Elbow O-ring 10mm	670D1510
					EC2194018AFM	Inner Clutch Cover	11061-0981
	R37X2.4V	Oil Filter O-ring	92055-0839				
	R10X2V	Oil Screen O-ring 10mm	670D1510				
	R0077	Oil Pump Cover O-Ring	92055-074				
	WP499032AFM	Water Pump Gasket	11061-0983				

All Component Parts can be purchased individually.



MX/Dirt • Off-Road Gaskets



Cometic Gasket - An Exclusive NASCAR Performance® Product

KAWASAKI KX450F

Model	Year	Bore Size	Top End Kit	Component Part#	Component Description	OEM Part #	
KX450F	16-18		C3598OS	OS227	Inner Water Pump Seal 12x22x5	92049-0783	
				OS277	Water Pump Oil Seal 12x24x7	92049-0782	
				OS295	Output Shaft Seal	92049-0030	
				OS307	Kickstart Shaft Seal 18x30x7	92049-013	
				OS331	Shift Shaft Seal	92051-005	
				OS331	Balance Shaft Seal 13x22x5.5	92049-0762	
				OS339	Clutch Pusrod Oil Seal	92049-1475	
				Clutch & Mag Kit C3598CM	Component Part# R163X2B	Component Description Outer Clutch Cover O-ring	OEM Part # 92055-0833
					EC2193018AFM	Mag Cover	11061-0982
					Component Part# EC2461018AFM	Component Description Cam Chain Tensioner Gasket	OEM Part # 11061-1288
KX450	19		C3696	R021V	Cam Tower O-ring	92055-0046	
				R22X2.5V	Water Elbow O-ring	92055-1081	
				R032V	Intake O-ring	92055-1600	
				H4637027S	Cylinder Head Gasket	11004-0777	
				B1426010RC	Cylinder Base Gasket	11061-1270	
				EX657	Header Gasket	11061-1297	
				3241V	Valve Stem Seal	92049-1062	
				Clutch & Mag Kit C3696CM	Component Part# EC2444018AFM	Component Description Mag Cover	OEM Part #
					R163X2B	163mm x 2mm Buna O-Ring	

KAWASAKI KX450

Model	Year	Bore Size	Top End Kit	Component Part#	Component Description	OEM Part #	
KX500 B2, C1	86-88	88 mm	C7045	H0036043F	Head Gasket 88mm	11004-1140	
				B0035020F	Base Gasket	11009-1537	
				IR008018AFM	Intake Gasket	11009-1950	
				PV014018AFM	Right Power Valve Gasket	11009-1960	
				R136V	Exhaust O-Ring 2 Req		
KX500 E1, E2	89-90	88 mm	C7046	Component Part# H0037043F	Component Description Head Gasket 88mm	OEM Part # 11004-1186	
				B0036018AFM	Base Gasket	11009-1758	
				B0036012F	High Compression Base Gasket		
				IR008018AFM	Intake Gasket	11009-1252	
				PV013018AFM	Front Power Valve Gasket	11009-1701	
				PV014018AFM	Right Power Valve Gasket	11009-1539	
				R136V	Exhaust O-Ring 2 Req	671E2550	
				Crank Seal Kit C7659	Component Part# OS135	Component Part# Left/Right Oil Seal 2 Req.	OEM Part# 92050-057
				Top End Kit C7047	Component Part# H0306010S	Component Description Head Gasket 88mm	OEM Part # 11004-1209
					B0036018AFM	Base Gasket	11060-1874
	B0036012F	High Compression Base Gasket					
	IR008018AFM	Intake Gasket	11009-1950				
	PV013018AFM	Front Power Valve Gasket	11009-1948				
	PV014018AFM	Right Power Valve Gasket	11009-1960				
	R136V	Exhaust O-Ring 2 Req	671E2550				
KX 500	86-04		Bottom End Kit C7046BE	Component Part# WA108	Component Description Drain Plug Crush Washer	OEM Part # 92065-058	
				WP048018AFM	Water Pump Gasket	11009-1962	
				WP050032AFM	Water Pump Outlet Gasket	11009-1952	
				WA128	Water Pump Crush Washer	92022-304	
				R5.5X1.5B	Water Pump Governor O-ring	92055-1343	
				Oil Seal Kit C7046OS	Component Part# OS135	Component Description Crank Seals	OEM Part # 92050-057
					OS239	Starter Oil Seal 20x28x5	92049-012
					OS306	Clutch Actuator Seal	92049-1262
					OS331	Shift Shaft Seal	92051-005
					OS339	Clutch Pushrod Seal 1986	92049-004
				OS361	Water Pump Seal 8x18x10	92049-1366	
				OS362	Power Valve Governor Seal	92049-1207	
				OS390	Output Shaft Seal 32x45x7	92049-1159	
			Clutch & Mag Kit C7045CM	Component Part# EC255018AFM	Component Description Mag Cover Gasket	OEM Part # 11009-1964	



MX/Dirt • Off-Road Gaskets



Cometic Gasket - An Exclusive NASCAR Performance® Product

KAWASAKI KLX650

Model	Year	Bore Size	Top End Kit
KLX650,	93-97	100 mm	C7246
KLX650R			

Component Part#	Component Description
H0259043F	Head Gasket 103mm
B0166020RC	Base Gasket

OEM Part #
11004-1158
11060-1110

KTM 50

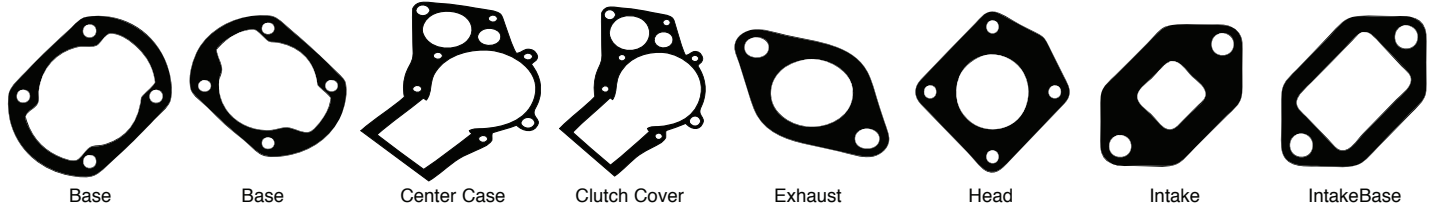

Model	Year	Bore Size	Top End Kit
50 Mini, Junior & Senior Adventure	94-01	41 mm	C7282

Component Part#	Component Description
H0354010C	Head Gasket .010" Copper
H0354020C	Head Gasket .020" Copper
B0219018AFM	Base Gasket 00-01
B0220018AFM	Base Gasket 94-99
IR054018AFM	Intake Port Small Opening
IR055018AFM	Intake Port Large Opening
EX089039F	Exhaust Gasket

OEM Part #
36330036000
36330036000
45030035800
36330030000
49130438000
49130438000
45030046000

Bottom End Kit
w/o Crank Seals
C3381

Component Part#	Component Description
EC073015F	Center Case Gasket
EC074032AFM	Clutch Cover Gasket

OEM Part#
45030039000
45030025000

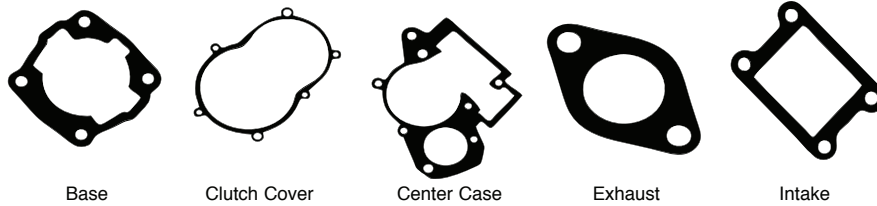

Model	Year	Bore Size	Top End Kit
50 Mini Adventure	02-08	41 mm	C7292

Component Part#	Component Description
H2287010C	Head Gasket .010" Copper
B0357032AFM	Base Gasket .032" AFM
IR115032AFM	Intake Gasket .032"
R32X3V	Exhaust Pipe O-ring

OEM Part #
46030046000
46030035020
46030049000
0770320030

Bottom End Kit
w/o Crank Seals
C3382

Component Part#	Component Description
EC517018AFM	Clutch Cover Gasket
EC659015F	Center Case Gasket
EC992060AFM	Oil Fill Plug Gasket
WA130	6 req. Head Seal Washers

OEM Part #
45130025000
45130039000
45130019000
0125060003

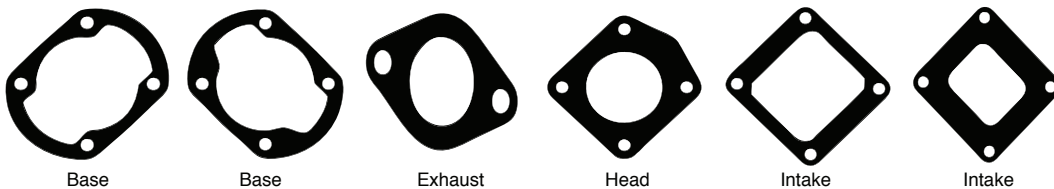

Model	Year	Bore Size	Top End Kit
50 SXR Pro Jr/Sr	97-01	43 mm	C7415

Component Part#	Component Description
H1197010C	Head Gasket .010
H1197020C	Head Gasket .020
B0219018AFM	Base Gasket 99-01
B0220018AFM	Base Gasket 94-98
IR109018AFM	Intake to Reed Gasket
IR110018AFM	Intake to Case Gasket
EX175060F	Exhaust Gasket

OEM Part #
36330036000
36330036000
36330030000
45030035800
45030057800
45030049900
45030046800

All Component Parts can be purchased individually.



MX/Dirt • Off-Road Gaskets



Cometic Gasket - An Exclusive NASCAR Performance® Product

KTM 50LC PROJ/SR

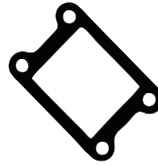
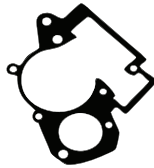
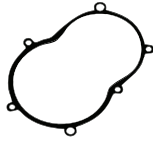
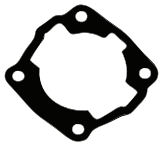

Base

Clutch Cover

Center Case

Exhaust

Intake

Model	Year	Bore Size	Top End Kit	Component Part#	Component Description	OEM Part #	
50 LC Pro Jr/Sr	01-01	O-Ring	C7863	R034V	Inner Head O-ring	46030037000	
				R044B	Outer Head O-ring	46030036000	
				WA130	6 Req. Head Seal Washers	0125060003	
				B0357012F	Base Gasket .012	46030035020	
				B0357018AFM	Base Gasket .018	45130025000	
				IR115018AFM	Intake Gasket	45130039000	
				EX089039F	Exhaust Flange Gasket	46030049000	
				R32X3V	Exhaust Pipe O-ring	0770320030	
					Component Part#	OEM Part#	
					EC517018AFM	Clutch Cover	45130025000
					EC659015F	Center Case Gasket	45130039000
					EC992060AFM	Oil Fill Plug Gasket	45130019000
					WA129	Case Drain Crush Washer 10mm x 14mm x 2mm	0603100141
	WA133	Clutch & Water Pump Drain Crush washers 2 Req.	0603061001				
50 SX Pro Senior LC	02-08	O-Ring	C7295	R53.5X2V	Inner Head O-ring	46030036000	
				R95X2V	Outer Head O-ring	46030037000	
				WA130	Head Crush Washer 5 Req.	50230032010	
				B0357032AFM	Base Gasket	46030035020	
				IR115032AFM	Intake Gasket	46030049000	
				EX175060F	Exhaust Gasket	46030046000	
					Component Part#	OEM Part #	
					EC517018AFM	Clutch Cover	45130025000
					EC659015F	Center Case Gasket	45130039000
					EC992060AFM	Oil Fill Plug Gasket	45130019000
					WA129	Case Drain Crush Washer	0603100141
					WA133	Clutch & Water Pump Drain Crush Washers 2 Req.	0603061001

All Component Parts can be purchased individually.



MX/Dirt • Off-Road Gaskets



Cometic Gasket - An Exclusive NASCAR Performance® Product

KTM 50SX LC

Model	Year	Bore Size	Top End Kit	Component Part#	Component Description	OEM Part #
50SX LC	09-19	O-Ring	C3503	R52X2V	Inner Head O-ring	0770052020
				R78X2V	Outer Head O-ring	0770078020
				WA130	Head Crush Washer 5 Req. 7.5mm x 12mm x .5mm	50230032010
				EX14B043F	Exhaust Gasket	45205004000
				B0976018AFM	Base Gasket	46230035040
			Bottom End Kit w/Oil Seals C3503BE	Component Part#	Component Description	OEM Part #
				EC2180018AFM	Inner Clutch Cover Gasket	4523002500
				EC2179020F	Center Case Gasket	45230039000
				R19X3V	Fill Plug O-ring	0770191015
				IR747018AFM	Intake Gasket	46230049000
				WP496	Water Pump O-ring	45235053000
				WA137	Trans Drain Plug Seal	58038022000
				WA133	Coolant Drain Plug Seal	0603061001
				R017B	Output Shaft O-ring	0770015018
				WA133	Water Pump Drain Seal	0603061001
			Oil Seal Kit C3503OS	Component Part#	Component Description	OEM Part #
				OS202	Outer Water Pump Seal 8x24x7	760082472
				OS206	Left Crank Seal 15x24x7	760152472
				OS209	Kickstart Shaft Seal 16x22x4	760162240
				OS252	Output Shaft Seal 22x32x7	760223270
				OS389	Right Crank Seal 26x35x6	760263561
			Clutch & Mag Kit C3503CM	Component Part#	Component Description	OEM Part#
				R110X2B	Outer Clutch Cover O-ring	45230027000
				EC1572032AFM	Mag Cover Gasket	45230040000

KTM 65SX

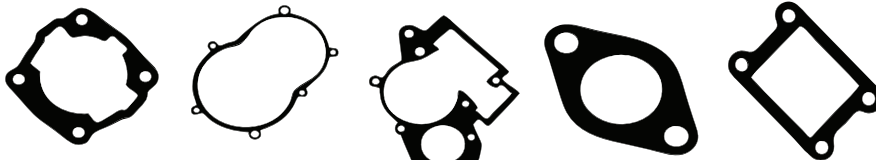

Base

Clutch Cover

Center Case

Exhaust

Intake

Model	Year	Bore Size	Top End Kit	Component Part#	Component Description	OEM Part #
65 SX	98-01	O-Ring	C7416	R034V	Inner Head O-ring	46030036000
				R044B	Outer Head O-ring	46030037000
				B0357012F	Base Gasket .012"	46030035020
				B0357018AFM	Base Gasket .018"	46030035020
				IR115018AFM	Intake Reed Gasket	46030049000
			Bottom End Kit w/o Crank Seals C3384	Component Part#	Component Description	OEM Part #
				EC447032AFM	Inner Clutch Cover	46030025000
				EC448020F	Crankcase Gasket	46030039000
				R048B	Mag Cover O-ring	0770020480
				WP106032AFM	Water Pump Gasket	45135053000

All Component Parts can be purchased individually.



MX/Dirt • Off-Road Gaskets



Cometic Gasket - An Exclusive NASCAR Performance® Product

KTM 65SX

Model	Year	Bore Size	Top End Kit	Component Part#	Component Description	OEM Part #	
65 SX	02-08	O-Ring	Top End Kit C7333	R54X2V	Inner Head O-ring	46030036000	
				R95X2V	Outer Head O-ring	46030037000	
				WA130	Head Crush Washer 5 Req.	50230032010	
				B0357018AFM	Base Gasket .018"	46030035020	
				B0357032AFM	Base Gasket .032"	46030035020	
				IR115032AFM	Intake Gasket	46030049000	
				EX921059F	Exhaust Gasket	46030046000	
				Bottom End Kit C7333BE	Component Part#	Component Description	OEM Part #
					WP106032AFM	Water Pump Gasket	45135053000
					R16X3V	Clutch Fill Plug O-ring	0770160030
			WA129		Case Drain Crush Washer 10mm x 14mm x 2mm	0603101420	
			EC448020F		Crankcase Gasket	46030039000	
			Oil Seal Kit C7333OS	R30X1.5V	Clutch Slave Cylinder O-ring	0770300015	
				Component Part#	Component Description	OEM Part #	
				OS197	Start Shaft Seal 14x24x6	0760142460	
				OS339	Shift Shaft Seal 12x20x5	0760122050	
				OS389	Output Shaft Seal 26x35x6	0760263560	
			Clutch & Mag Kit C7333CM	OS208	Impeller Seal 10X18X4	46035056100	
				OS199	Crank Seals 20x35x6	47030076100	
				Component Part#	Component Description	OEM Part #	
R048B	Mag Cover O-ring 2002	0770020480					
EC447032AFM	Inner Clutch Cover	46030025000					
65 SX	09-19	O-Ring	Top End Kit C3416	Component Part#	Component Description	OEM Part	
				MR106	Cylinder Head Gasket	45230036000	
				WA146	Head Crush Washer 4 Req.	50230032010	
				B0976018AFM	Cylinder Base Gasket	46230035040	
				EX943059F	Header Flange Gasket	46205004000	
			R20X2V	Power Valve Control O-ring	770150151		
			R005B	Power Valve Base Orings 2 Req.	770030015		
			WA133	Power Valve Base Seal Washer	603061001		
			WA133	Power Valve Copper Seal	603050901		
			IR747018AFM	Reed Valve Gasket	46230049000		
			Bottom End Kit C3416BE	Component Part#	Component Description	OEM Part #	
				EC1357020F	Center Case Gasket	46230039000	
				WA133	Coolant Drain Plug	603061001	
				WA137	Trans Drain Plug Crush washer	58038022000	
				EC2204018AFM	Primary Cover Gasket	46230025100	
R19X3V	Fill Plug O-ring	770191015					
R16X2V	Crank Back up O-ring	770160021					
IR747018AFM	Intake Gasket	46230049000					
EC1360018AFM	Slave Cylinder Gasket	59032065000					
R027V	Slave Cylinder O-ring	770031018					
R20X2V	Countershaft Back Up Ring	770020020					
Oil Seal Kit C3416OS	WP496	Water Pump Gasket	45235053000				
	Component Part#	Component Description	OEM Part #				
	OS294	Right Crank Seal 30x47x7	760304772				
	OS199	Left Crank Seal 20x35x6	47030076100				
	OS389	Countershaft Seal 26x35x6	760263561				
	OS357	Start Shaft Seal 17x28x6	760172860				
	OS339	Shift Shaft Seal 12x20x5	760122050				
OS202	Water Pump Seal 8x24x7	760082472					
Clutch & Mag Kit C3416CM	Component Part#	Component Description	OEM Part #				
	MR162	Clutch Cover O-ring	46230027000				
	EC1358032AFM	Mag Cover Gasket					

All Component Parts can be purchased individually.



MX/Dirt · Off-Road Gaskets



Cometic Gasket - An Exclusive NASCAR Performance® Product

KTM 85SX

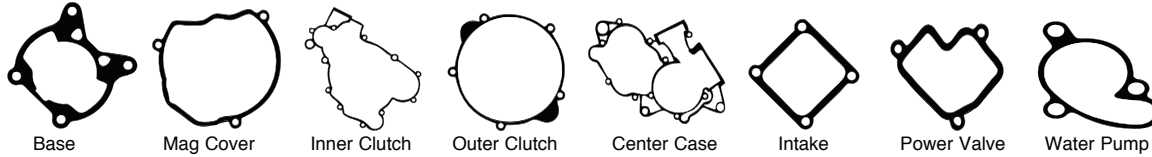

Model	Year	Bore Size	Top End Kit	Component Part#	Component Description	OEM Part #			
85 SX	04-12	O-Ring	C7384	R54X2V	Inner Head O-ring	0770 540020			
				R82X2V	Outer Head O-ring	0770 820020			
				R22X2.5V	Head Insert O-ring	0770 220025			
				WA133	Head Seal Crush Washers 6 Req.	0603061001			
				B0801032AFM	Base Gasket	47030035000			
				WA134	Exhaust Valve Seal Crush Washer	0603040801			
				PV126032AFM	Power Valve Side Cover Gasket	47037008000			
				R12X2V	Exhaust Control Valve O-ring	0770120020			
				R8X1.5V	Exhaust Valve Linkage O-ring	0770008015			
				IR530032AFM	Intake Gasket	47030049000			
				R22X2V	Exhaust Valve Cover O-ring	0770020200			
				R38X3V	Exhaust Pipe Header O-rings 2 req.	0770380030			
					Bottom End Kit w/o Crank Seals C3386		Component Part#	Component Description	OEM Part #
							EC986032AFM	Mag Cover Gasket	47030040000
							EC987032AFM	Inner Clutch Cover Gasket	47030025000
							EC988032AFM	Outer Clutch Cover Gasket	47030027000
							EC989020F	Crankcase Gasket	47030039000
							R16X3V	Oil Fill Plug Gasket	0770160030
							R19X2V	Output Shaft O-ring	46033031000
							R30X1.5V	Clutch Slave Cylinder O-ring	0770300015
			WA133	Water Pump Seal Crush Washer	0603061001				
			WP174032AFM	Water Pump Gasket	47035053000				
			Component Part#	Component Description	OEM Part #				
			EC988032AFM	Clutch Cover Gasket	47030027000				
			EC986032AFM	Mag Cover Gasket	47030040000				
			Component Part#	Component Part#	OEM Part#				
			R54X2V	Inner Head O-ring 54X2	0770540020				
			R80X2S	Outer Head O-ring 80X2	0770800021				
			PV143018AFM	Right Power Valve Gasket	47137008000				
			WA133	Copper Head Crush Washer	0603061001				
			B0801032AFM	Base Gasket .2mm	47030035020				
			R12X2V	Power Valve Control O-ring Left 12x2	0770120020				
			R8X1.5V	Power Valve Control O-ring Right 8x1.5	0770008015				
			R22X2V	Power Valve Control Cover O-ring	0770020200				
			R38X3V	Exh. Pipe Header O-rings 2 req	0770380030				
			Component Part#	Component Part#	OEM Part#				
			EC989020F	Center Case Gasket	47030039000				
			EC987032AFM	Inner Clutch Cover Gasket	47030025000				
			EC1849032AFM	Outer Clutch Cover Gasket	47030027100				
			R16X3V	Oil Fill Plug O-ring	0770160030				
			WA129	Drain Plug gasket	0603101420				
			WP429018AFM	Water Pump Cover Gasket	47035053000				
			WA133	Water Pump Cover Drain Washer	0603061001				
			IR530032AFM	Intake Gasket	47030049000				
			R027V	Slave Cylinder O-ring	0770031018				

All Component Parts can be purchased individually.



MX/Dirt • Off-Road Gaskets



Cometic Gasket - An Exclusive NASCAR Performance® Product

KTM 85SX

Model	Year	Bore Size	Top End Kit	Component Part#	Component Description	OEM Part #
85 SX	18-19	O-ring	C3636	WA133	Head Crush Washers	603061001
				R23X2.5V	Dome O-ring	7702300251
				R54X2V	Inner Chamber O-ring	770540020
				R80X2S	Outer Chamber O-ring	770800021
				PV158018AFM	Right Power Valve Cover Gasket	47237008000
				PV157018AFM	Left Power Valve Cover Gasket	47237006000
				B1408	Base Gasket	47230035020
				B1408010RC	Base Gasket	47230035025
				B1408014RC	Base Gasket	47230035040
				B1408020RC	Base Gasket	47230035050
				B1408031F	Base Gasket	47230035075
				WA133	Power Valve Cover Crush Washer	603061001
				R8X2V	Power Valve Flap O-ring	770080201
				R114V	Power Valve Spring Cover	770021120
				R24X2V	Power Valve Spring Cover	770240020

KTM 105SX

Model	Year	Bore Size	Top End Kit	Component Part#	Component Description	OEM Part #
105 SX	07-11	O-Ring	C3552	MR124	Inner Head O-ring	47530006000
				R80X2S	Outer Head O-ring 80X2	0770800021
				PV143018AFM	Right Power Valve Gasket	47137008000
				WA133	Copper Head Crush Washer	0603061001
				B0801032AFM	Base Gasket .2mm	47030035020
				R12X2V	Power Valve Control O-ring Left 12x2	0770120020
				R8X1.5V	Power Valve Control O-ring Right 8x1.5	0770008015
				R22X2V	Power Valve Control Cover O-ring	0770020200
				R38X3V	Exhaust Pipe Header O-rings 2 req.	0770380030
105 Supermini	18-19	O-ring	C3637	WA133	Head Crush Washers	603061001
				R23X2.5V	Dome O-ring	7702300251
				R60X2V	Inner Chamber O-ring	770600200
				R80X2S	Outer Chamber O-ring	770800021
				PV158018AFM	Right Power Valve Cover Gasket	47237008000
				PV157018AFM	Left Power Valve Cover Gasket	47237006000
				B1408	Base Gasket	47230035020
				B1408010RC	Base Gasket	47230035025
				B1408014RC	Base Gasket	47230035040
				B1408020RC	Base Gasket	47230035050
				B1408031F	Base Gasket	47230035075
				WA133	Power Valve Cover Crush Washer	603061001
				R8X2V	Power Valve Flap O-ring	770080201
				R114V	Power Valve Spring Cover	770021120
				R24X2V	Power Valve Spring Cover	770240020

All Component Parts can be purchased individually.



MX/Dirt · Off-Road Gaskets



Cometic Gasket - An Exclusive NASCAR Performance® Product

KTM 125SX

Model	Year	Bore Size	Top End Kit	Component Part#	Component Description	OEM Part #	
125 SX, EXC	93-96	O-Ring	C7097	R60X2V	Inner Head O-ring	50230095000	
				H0377043F	Head Gasket Outer	50230036500	
				B0228018AFM	Base Gasket .018" AFM	50230030020	
				B0228032AFM	Base Gasket .032" AFM	50230030030	
				PV048018AFM	Power Valve Gasket	50237006000	
				Crank Seal Kit C7660	Component Part# OS138	Component Description 29X43X6 Right Side Crank Seal	OEM Part# 760304260
					OS139	24X40X7 Left Side Crank Seal	760254070
				Top End Kit C7456	Component Part# H0755043F	Component Description Head Gasket Outer	OEM Part # 50330037000
					R72X2V	Inner Head O-ring	0770720021
					B0338018AFM	Base Gasket .018"	50330035040
	B0338032AFM	Base Gasket .032"	50330035075				
	EC449032AFM	Exh. Intermediate Gasket 00-04	50337046100				
	EC544032AFM	Exh. Intermediate Gasket 98-99	50337046000				
	PV075032AFM	Rt. Side Power Valve Cover	50337006000				
	PV076032AFM	Center Power Valve Cover	50337035050				
	PV077032AFM	Left Side Power Valve Cove	50337008000				
125 SX 125 EXC	97-03 02-06	O-Ring	C7386	R0047	Outer Head O-ring	50330137000	
				R62X2V	Inner Head O-ring	0770062020	
				WA130	Head Seal Crush Washers 6 Req.	50230032010	
				B0338018AFM	Base Gasket .018"	50330035025	
				B0338032AFM	Base Gasket .032"	50330035040	
				PV075032AFM	Left Side Power Valve Gasket	50337008000	
				PV076032AFM	Right Side Power Valve Gasket	50337006000	
				PV077032AFM	Power Valve Cover Gasket	50337035050	
				EC449032AFM	Intermediate Exhaust Gasket	50337046100	
				R8X2V	Power Valve Axle O-ring	0770008020	
R44X3S	Exp. Chamber O-rings 2 Req.	0770440030					
125 SX	98-15		Bottom End Kit C7386BE	Component Part# EC446020F	Component Description Center Case Gasket	OEM # 50330039000	
				WA137	Drain Plug Gasket 12X18X1.5	58038022000	
				EC441032AFM	Primary Cover Gasket	50330025000	
				R19X3V	Fill Plug O-ring 19x3	0770191015	
				WA129	Primary Drain Plug Gasket 10x14x1	0603100141	
				WA133	Sight Plug Gasket 6x10x1	0603061001	
				WA129	Water Pump Drain Plug O-ring 10X14X1	0603100141	
				R16X3V	Water Pump Cover O-ring 16x3	0770160030	
				R25X2V	Crank Backup Oring 25x2	0770250020	
				IR1355032AFM	Reed Cage Gasket	50330098050	
				EC443012F	Clutch Release Gasket .3	50332065051	
				EC443032AFM	Clutch Release Gasket .5	50332065052	
				EC443062F	Clutch Release Gasket .75	50332065053	
				WA129	Bleeder Screw Crush Seal 10x16x1	42013226000	
				R23X2V	Output Shaft Backup O-ring 23x2	0770230020	
				R49X2.5V	Water Pump Support Bushing O-ring 49x2.5	0770049025	
				Oil Seal Kit C7386OS	Component Part# OS202	Component Description Water Pump Shaft Seal 8x24x7	OEM # 0760082472
					OS203	Start Shaft Seal 17x28x7	0760172870
					OS197	Shift Shaft Seal 14x24x6	0760142460
					OS390	Output Shaft Seal 32x45x7	0760324571
	OS141	Right Crank Seal 32x45x6.5	0760324564				
	OS217	Left Crank Seal 25x35x7	0760253570				
Clutch & Mag Kit C7386CM	Component Part# EC236060AFM	Component Description Outer Clutch Cover Gasket	OEM # 50330027000				
	EC442060AFM	Mag Cover 98-08	50330040000				

All Component Parts can be purchased individually.



MX/Dirt • Off-Road Gaskets



Cometic Gasket - An Exclusive NASCAR Performance® Product

KTM 125SX

Model	Year	Bore Size	Top End Kit	Component Part#	Component Part#	OEM Part#
125 SX	07-14	O-Ring	C3211	R62X2V	Inner Head O-ring	0770062020
144 SX	07-08			R85X2V	Outer Head O-ring	0770086020
150 SX,XC	09-14			WA146	Head Seal Crush Washer 6 Req.	50330079000
				B0338018AFM	Base Gasket .018"	50330035025
				EX645032AFM	Intermediate Exhaust Gasket	50337046200
				R44X3S	Exp. Chamber O-rings 2 Req.	0770440030
				PV076032AFM	Left Side Power Valve Gasket	50337006000
				PV077032AFM	Power Valve Cover Gasket	50337035050
				PV135032AFM	Right Side Power Valve Gasket	50337008100
				R014V	Head Power Valve O-ring	0770012021
				R16X3V	Power Valve Bushing O-ring Seal	0770160030
				R8X2V	Power Valve Axle O-ring	0770008020
				WA131	Power Valve Control Shaft Seal	0603262322
				WA133	Power Valve Cover Crush Washer 3 Req.	0603061001
125 SX	98-15		Bottom End Kit C7386BE	Component Part# EC446020F	Component Description Center Case Gasket	OEM # 50330039000
				WA137	Drain Plug Gasket 12X18X1.5	58038022000
				EC441032AFM	Primary Cover Gasket	50330025000
				R19X3V	Fill Plug O-ring 19x3	0770191015
				WA129	Primary Drain Plug Gasket 10x14x1	0603100141
				WA133	Sight Plug Gasket 6x10x1	0603061001
				WA129	Water Pump Drain Plug O-ring 10X14X1	0603100141
				R16X3V	Water Pump Cover O-ring 16x3	0770160030
				R25X2V	Crank Backup Oring 25x2	0770250020
				IR1355032AFM	Reed Cage Gasket	50330098050
				EC443012F	Clutch Release Gasket .3	50332065051
				EC443032AFM	Clutch Release Gasket .5	50332065052
				EC443062F	Clutch Release Gasket .75	50332065053
				WA129	Bleeder Screw Crush Seal 10x16x1	42013226000
				R23X2V	Output Shaft Backup O-ring 23x2	0770230020
				R49X2.5V	Water Pump Support Bushing O-ring 49x2.5	0770049025
			Oil Seal Kit C7386OS	Component Part# OS202	Component Description Water Pump Shaft Seal 8x24x7	OEM # 0760082472
				OS203	Start Shaft Seal 17x28x7	0760172870
				OS197	Shift Shaft Seal 14x24x6	0760142460
				OS390	Output Shaft Seal 32x45x7	0760324571
				OS141	Right Crank Seal 32x45x6.5	0760324564
				OS217	Left Crank Seal 25x35x7	0760253570
			Clutch & Mag Kit C7386CM	Component Part# EC236060AFM	Component Description Outer Clutch Cover Gasket	OEM # 50330027000
				EC442060AFM	Mag Cover 98-08	50330040000
125 SX	16-19	O-Ring	Top End Kit C3606	Component Part# B1348010RC	Component Description Base Gasket	OEM Part # 50430035025
				B1348014RC	Base Gasket	50430035040
				B1348018AFM	Base Gasket	50430035050
				B1348032AFM	Base Gasket	50430035075
				IR1355032AFM	Reed Cage Gasket	50430098050
				MR163	Exhaust Valve Cover Gasket	50437046000
				PV152032AFM	Left Side Exhaust Valve Cover	50437006000
				PV153032AFM	Right Side Exhaust Valve Cover	50437008000
				R14X2V	Power Valve Control O-rings	0770140201
				R23X2.5V	Dome O-ring 23x2.5	07702300251
				R60X2V	Inner Head O-ring 60x2	0770600200
				R89X2V	Outer Head O-ring 89X2	0770890200
				WA133	Head Drain Crush Washer 6X10X1	0603061001
				WA146	Cylinder Head Crush Washer 7.3X12X1 (6)	0603070121
				IR1356032AFM	Intake Gasket	50430098060

All Component Parts can be purchased individually.



MX/Dirt · Off-Road Gaskets



Cometic Gasket - An Exclusive NASCAR Performance® Product

KTM 125SX

Model	Year	Bore Size	Bottom End Kit w/Oil Seals	Component Part#	Component Description	OEM Part #		
125 SX	16-19		C3606BE	EC2182020F	Center Case Gasket	50430039000		
				WA137	Copper Drain Plug Crush Washer 12X18X1.5	58038022000		
				R19X3V	Fill Plug O-Ring 19x3	0770191015		
				WA133	Water Passage Crush Washer	0603061001		
				WA133	Clutch Drain Plug Gasket	0603100141		
				EC2183032AFM	Inner Clutch Cover Gasket	50430025000		
				R25X2V	Primary Gear Back Up Ring 25x2	0770250020		
				R30X1.5V	Slave Cylinder O-ring 30x1.5	0770300015		
				WA135	Clutch Cable Crush Washer 8x16x1	0603080161		
				R23X2V	Output Shaft Back Up O-ring 23x2	0770230020		
				WP500	Water Pump Gasket	50435053000		
				WA133	Water Pump Cover Drain Plug Crush Washer 6X10X1	0603061001		
				R114V	Power Valve Adjuster O-Ring 12.37X2.62	0770021120		
					Oil Seal Kit	Component Part#	Component Description	OEM Part #
					C3606OS	OS217	Left Crank Seal 25X35X7	0760253570
						OS141	Right Crank Seal 32X45X6,5	0760324564
						OS141	Output Shaft Seal 32X45X7	0760324571
					OS310	Start Shaft Seal 19X30X7	0760193070	
					OS197	Shift Shaft Seal 14X24X6	0760142460	
					OS202	Water Pump Seal 8x24x7	0760082472	
		Component Part#	Component Description	OEM Part #				
		R0078	Outer Clutch Cover O-ring	50430027000				
150 SX	16-19	O-Ring	Top End Kit C3607	Component Part#	Component Description	OEM Part #		
				B1348010RC	Base Gasket	50430035025		
				B1348014RC	Base Gasket	50430035040		
				B1348018AFM	Base Gasket	50430035050		
				B1348032AFM	Base Gasket	50430035075		
				IR1355032AFM	Reed Cage Gasket	50430098050		
				MR163	Exhaust Valve Cover Gasket	50437046000		
				PV152032AFM	Left Side Exhaust Valve Cover	50437006000		
				PV153032AFM	Right Side Exhaust Valve Cover	50437008000		
				R14X2V	Power Valve Control O-rings	0770140201		
				R23X2.5V	Dome O-ring 23x2.5	07702300251		
				R64X2V	Inner Head O-ring 60x2	0770600200		
				R89X2V	Outer Head O-ring 89X2	0770890200		
				WA133	Head Drain Crush Washer 6X10X1	0603061001		
				WA146	Cylinder Head Crush Washer 7.3X12X1 (6)	0603070121		
					IR1356032AFM	Intake Gasket	50430098060	
					Component Part#	Component Description	OEM Part #	
				EC2182020F	Center Case Gasket	50430039000		
				WA137	Copper Drain Plug Crush Washer 12X18X1.5	58038022000		
				R19X3V	Fill Plug O-Ring 19x3	0770191015		
	WA133	Water Passage Crush Washer	0603061001					
	WA133	Clutch Drain Plug Gasket	0603100141					
	EC2183032AFM	Inner Clutch Cover Gasket	50430025000					
	R25X2V	Primary Gear Back Up Ring 25x2	0770250020					
	R30X1.5V	Slave Cylinder O-ring 30x1.5	0770300015					
	WA135	Clutch Cable Crush Washer 8x16x1	0603080161					
	R23X2V	Output Shaft Back Up O-ring 23x2	0770230020					
	WP500	Water Pump Gasket	50435053000					
	WA133	Water Pump Cover Drain Plug Crush Washer 6X10X1	0603061001					
	R114V	Power Valve Adjuster O-Ring 12.37X2.62	0770021120					

All Component Parts can be purchased individually.



MX/Dirt • Off-Road Gaskets



Cometic Gasket - An Exclusive NASCAR Performance® Product

KTM 150SX

Model	Year	Bore Size	Oil Seal Kit	Component Part#	Component Description	OEM Part #
150 SX	16-19		C3606OS	OS217	Left Crank Seal 25X35X7	0760253570
				OS141	Right Crank Seal 32X45X6,5	0760324564
				OS141	Output Shaft Seal 32X45X7	0760324571
				OS310	Start Shaft Seal 19X30X7	0760193070
				OS197	Shift Shaft Seal 14X24X6	0760142460
				OS202	Water Pump Seal 8x24x7	0760082472
				Component Part#	Component Description	OEM Part #
				R0078	Outer Clutch Cover O-ring	50430027000

KTM 200SX

Model	Year	O-Ring	Kit	Component Part#	Component Description	OEM Part #			
200 SX, MXC, EXC	98-02	O-Ring	Top End Kit C7738	R72X2V	Inner Head O-ring	0770720021			
				H0985043F	Outer Head Gasket	52330037000			
				B0338018AFM	Base Gasket .018"	50330035040			
				B0338032AFM	Base Gasket .032"	50330035040			
				EC450032AFM	Intermediate Gasket 98-99	52337046000			
				EC545032AFM	Intermediate Gasket 00-01	52337046100			
				PV075032AFM	Right Side Power Valve Gasket	50337008000			
				PV076032AFM	Left Side Power Valve Gasket	50337006000			
				PV077032AFM	Power Valve Cover Gasket	50337035050			
			Bottom End Kit w/crank seals C3389	Component Part#	Component Description	OEM Part #			
				EC236060AFM	Outer Clutch Cover	50330027000			
				EC441032AFM	Inner Clutch Cover	50330025000			
				EC442060AFM	Mag Cover	50330040000			
				EC443012F	Clutch Release Gasket	50332065050			
				EC443032AFM	Clutch Release Gasket .032"	50332065050			
				EC443060AFM	Clutch Release Gasket .060"	50332065050			
			EC446020F	Center Case Gasket	50330039000				
			Clutch & Mag Kit C7368CM	Component Part#	Component Description	OEM Part #			
				EC236060AFM	Outer Clutch Cover	50330027000			
				EC442060AFM	Mag Cover	50330040000			
			Crank Seal Kit C7661	Component Part#	Component Part#	OEM Part#			
				OS136	Right Crank Seal 24X35X7	760253570			
				OS141	Left Crank Seal 31X45X6	760324564			
			200 SX, EXC, MXC 03-16 XC-W	03-14	O-Ring	Top End Kit C7942	R0048	Outer Head O-ring	52330137000
							R72X2V	Inner Head O-ring	0770720021
B0338018AFM	Base Gasket .018"	50330035040							
B0338032AFM	Base Gasket .032"	50330035040							
R44X3S	Expansion Chamber O-rings 2 Req.	0770440030							
EC545032AFM	Intermediate Gasket	52337046100							
PV075032AFM	Right Side Power Valve Gasket	50337008000							
PV076032AFM	Left Side Power Valve Gasket	50337006000							
PV077032AFM	Power Valve Cover Gasket	50337035050							
WA131	Power Valve Control Shaft Seal	0603262322							
WA133	Head Crush Washer -6X10X1 3 Req.	0603061001							
R8X2V	Power Valve Axle O-ring 2 Req.	0770008020							
Bottom End Kit w/crank seals C3389	Component Part#	Component Description				OEM Part #			
	EC236060AFM	Outer Clutch Cover				50330027000			
	EC441032AFM	Inner Clutch Cover				50330025000			
	EC442060AFM	Mag Cover				50330040000			
	EC443012F	Clutch Release Gasket				50332065050			
	EC443032AFM	Clutch Release Gasket .032"				50332065050			
	EC443060AFM	Clutch Release Gasket .060"				50332065050			
EC446020F	Center Case Gasket	50330039000							
Clutch & Mag Kit C7368CM	Component Part#	Component Description				OEM Part #			
	EC236060AFM	Outer Clutch Cover				50330027000			
	EC442060AFM	Mag Cover				50330040000			
Crank Seal Kit C7661	Component Part#	Component Part#				OEM Part#			
	OS136	Right Crank Seal 24X35X7				760253570			
	OS141	Left Crank Seal 31X45X6	760324564						

All Component Parts can be purchased individually.



MX/Dirt · Off-Road Gaskets



Cometic Gasket - An Exclusive NASCAR Performance® Product

KTM 250SX

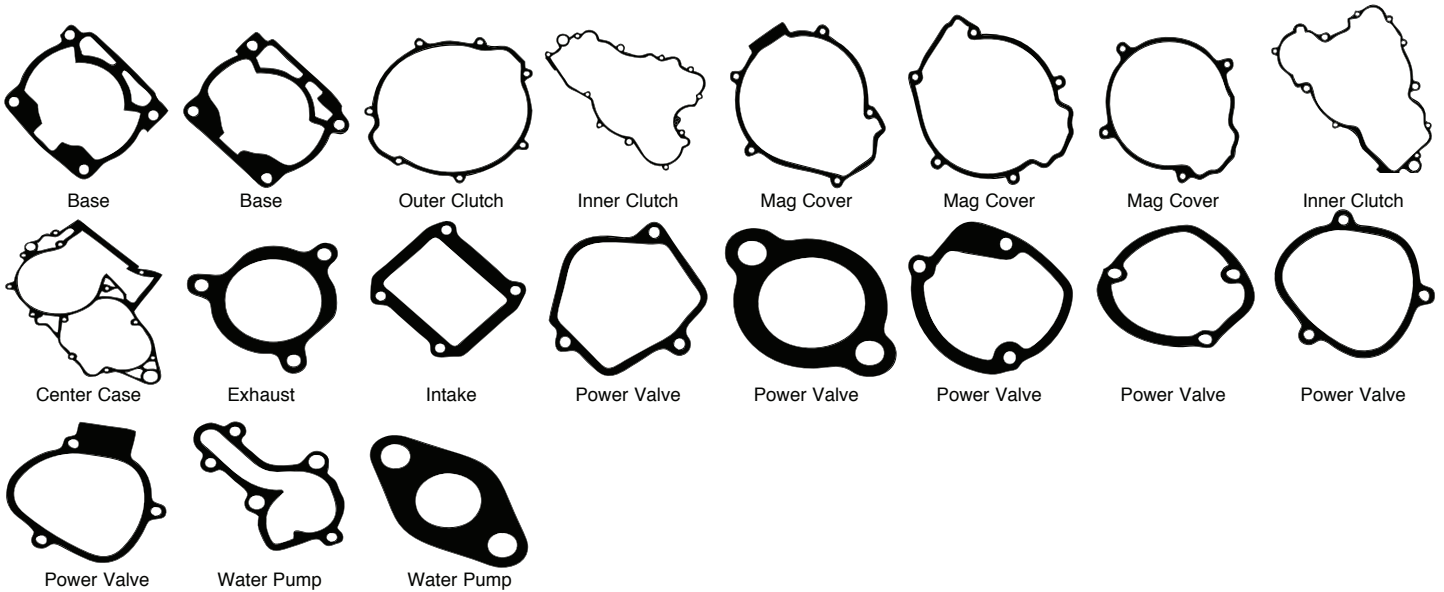

Model Year
250 SX, 90-99
EXC

Bore Size O-Ring
Top End Kit C7098

Bottom End Kit
w/crank seals
C3390

Crank Seal Kit
C7662

Top End Kit
C7690

Bottom End Kit
w/crank seals
C3391

Crank Seal Kit
C7662

Clutch & Mag Kit
C7690CM

Component Part#
R114X2B
R74X2S
B0056018AFM
B0056032AFM
EX014047F
PV028018AFM
PV049018AFM
PV088032AFM
Component Part#

EC234060AFM
EC285032AFM
EC286020F
EC287060AFM
R24X2V
WP008032AFM
WP081032AFM
Component Part#
OS136
OS137

Component Part#
R114X2B
R74X2S
B0056018AFM
B0056032AFM
R44X3S
EX014042AM
PV103032AFM
PV104032AFM
Component Part#

EC234060AFM
EC285032AFM
EC286020F
EC549060AFM
WP008032AFM
Component Part#
OS136
OS137

Component Part#
EC234060AFM
EC549060AFM

Component Description
Outer Head O-ring
Inner Head O-ring
Base Gasket .018"
Base Gasket .032"
Exhaust Flange Gasket
Power Valve Timer Gasket
Left Side Power Valve Gasket
Right Side Power Valve Gasket
Component Part#

Outer Clutch Cover Gasket
Inner Clutch Cover
Center Case Gasket
Mag Cover Gasket
Transmission Counter Shaft O-ring
Water Pump Gasket
Power Valve Spring Cover
Component Part#
OS136
OS137

Component Description
Outer Head O-ring
Inner Head O-ring
Base Gasket .018"
Base Gasket .032"
Expansion Chamber O-ring
Exhaust Flange Gasket
Left Side Power Valve Gasket
Right Side Power Valve Gasket
Component Part#

Outer Clutch Cover Gasket
Inner Clutch Cover
Case Gasket
Mag Cover Gasket
Water Pump Gasket
Component Part#
OS136
OS137

Component Description
Clutch Cover Gasket
Mag Cover Gasket

OEM Part #
0770114020
0770740021
54630030005
54630030107
54630046000
54637006100
54637106000
54637073000
OEM Part#

54630025050
54630025200
54630039200
54630040300
0770250020
54635003200
54435037000
OEM Part#
760253570
760385273

OEM Part #
0770114020
0770720021
54630030005
54630030107
0770440030
54630046000
54737006000
54737008000
OEM Part#

54630025050
54630025200
54630039200
54730040100
54635003200
Component Part#
760253570
760385273

OEM Part #
54630025050
54730040100

All Component Parts can be purchased individually.



MX/Dirt • Off-Road Gaskets



Cometic Gasket - An Exclusive NASCAR Performance® Product

KTM 250SX

Model	Year	Bore Size	Top End Kit	Component Part#	Component Description	OEM Part #
250 SX	03-06	O-Ring	C7943	R114X2B	Outer Head O-ring	0770114020
				R74X2S	Inner Head O-ring	0770720021
				B0666018AFM	Base Gasket .018"	54830030004
				B0666032AFM	Base Gasket .032"	54830030004
				IR386018AFM	Intake Gasket	548030062000
				R44X3S	Exp. Chamber O-rings 2 Req.	0770440030
				PV103032AFM	Left Side Power Valve Gasket	54737006000
				PV104032AFM	Right Side Power Valve Gasket	54737008000
Bottom End Kit C7943BE				Component Part#	Component Description	OEM Part#
				WA133	Clutch Slave Cyl. Crush Washer	0603100141
				R30X1.5V	Clutch slave Cylinder O-ring	0770300015
				R19X3V	Fill Plug O-ring	0770191015
				WA133	Water Pump Crush Washer	0603100141
				R0050	Water Pump Gasket	54835003000
				WA137	Drain Plug Crush Washer	58038022000
				WA133	Water PC Crush Washer	0603061001
				R25X1.5V	Crank Backup O-ring	0770250015
				EC778032AFM	Primary Cover Gasket (Inner Clutch)	54830024100
				EC779020F	Center Case Gasket	54830039000
				IR386018AFM	Intake Reed Gasket	54830062200
				R25X2V	Output Shaft Backup O-ring	0770250020
				R24X2V	Exhaust Valve Control O-ring	0770240020
				R114V	Spring Guide O-ring	0770021120
Oil Seal Kit C7943OS				Component Part#	Component Description	OEM #
				OS136	Left Crank Seal 25x35x7	760253570
				OS137	Right Crank Seal 38x52x7	760385273
				OS197	Shift Shaft Seal 14x24x6	760142460
				OS202	Water Pump Shaft Seal 8x24x7	760082472
				OS310	Start Shaft Seal 19x30x7	760193070
				OS390	Output Shaft Seal 32x45x7	760324571
Clutch & Mag Kit C7943CM				Component Part#	Component Description	OEM #
				EC777032AFM	Mag Cover Gasket	
				R0049	Clutch Cover O-ring	55130027000

All Component Parts can be purchased individually.



MX/Dirt · Off-Road Gaskets



Cometic Gasket - An Exclusive NASCAR Performance® Product

KTM 250SX

Model	Year	Bore Size	Top End Kit	Component Part#	Component Description	OEM Part #
250 EXC	04-06	O-Ring	C7417	R74X2S	Inner Head O-ring 2004	0770740021
250 XC				R76X2V	Inner Head O-ring 2005	0770760021
				WA135	Head Seal Crush Washer 6 Req.	56530080000
				R114X2B	Outer Head O-ring	0770114020
				B0666018AFM	Base Gasket .018"	54830030004
				B0666032AFM	Base Gasket .032"	54830030004
				IR386018AFM	Intake Gasket	548030062000
				R44X3S	Expansion Chamber O-rings 2 Req.	0770440030
				R15X1.5V	Power Valve Control O-ring	077015051
				R11.5X2.5V	Power Valve Cover O-rings 4 Req.	0770116241
				PV103032AFM	Left Side Power Valve Gasket	54737006000
				PV104032AFM	Right Side Power Valve Gasket	54737008000
Bottom End Kit C7417BE				Component Part#	Component Description	OEM Part#
				EC778032AFM	Primary Cover Gasket	54830024000
				EC779020F	Center Case Gasket	54830039000
				EC1927018AFM	Electric Starter Cover Gasket	55130041100
				R25X3V	Electric Starter O-ring 25x3	0770250030
				IR683018AFM	Intake Reed Gasket	
				R25X1.5V	Crank Seal Backup O-ring 25x1.5	0770250015
				R19X3V	Fill Plug O-ring 19x3	0770191015
				R0050	Water Pump Cover Gasket	54835003000
				WA129	Water Pump Drain Crush Washer 10x14x1	0603100141
				WA133	Clutch Cover Water Passage Crush Washer 6x10x1	0603061001
				WA137	Clutch Cover Drain Plug 12x18x1.5	58038022000
				R117B	Breather Element O-ring 18,72X2,62	0770021160
				R30X1.5V	Slave Cylinder O-ring 30x1.5	0770300015
				R25X2V	Output Shaft Backup O-ring 25x2	0770250020
				R24X2V	Power Valve Actuator Cap O-ring 24x2	0770240020
				R49X2.5V	Water Pump Support O-ring 49x2.5	0770049025
				R114V	Power Valve Spring Guide O-ring 12,37X2,62	0770021120
Oil Seal Kit C7417OS				Component Part#	Component Description	OEM #
				OS217	Left Crankcase Seal 25x35x7	0760253570
				OS137	Right Crankcase Seal 38x52x7	0760385273
				OS310	Start Shaft Seal 19x30x7	0760193070
				OS141	Output Shaft Oil Seal 32x45x6.5	0760324565
				OS197	Shift Shaft Seal 14x24x6	0760142460
				OS202	Impeller Seal 8x24x7	0760082472
Clutch & Mag Kit C7417CM				Component Part#	Component Description	OEM #
				R0049	Clutch Cover O-ring	54830025000
				EC777032AFM	Mag Cover Gasket	54830040000
				EC1254032AFM	Mag Cover Gasket 07-16	55130040000/ 55130040100

All Component Parts can be purchased individually.



MX/Dirt • Off-Road Gaskets



Cometic Gasket - An Exclusive NASCAR Performance® Product

KTM 250SX

Model	Year	Bore Size	Top End Kit	Component Part#	Component Description	OEM Part #
250 SX	07-16	O-Ring	C3222	R73X2V	Inner Head O-ring 250 Models	0770730020
250 XC	07-16			R78X2V	2008 300 XC Models	0770078020
				WA135	Head Seal O-rings	56530080000
				R105X2B	Outer Head O-ring	0770105020
				B0666018AFM	Base Gasket .018"	54830030004
				R44X3S	Exhaust Flange O-rings	0770440030
				PV136032AFM	Left Side Power Valve Gasket	54837006000
				PV137032AFM	Right Side Power Valve Gasket	54837008000
				R112V	Power Valve Flap O-rings	0770116241
				R114V	Power Valve Spring Guide O-ring	0770021120
				R16X2V	Power Valve Control O-rings 2 Req.	0770160021
				R24X2V	Power Valve Control Cover O-ring	0770240020
			Bottom End Kit	Component Part#	Component Part#	OEM Part#
			C3539	EC779020F	Intake Gasket	54830062200
				EC778032AFM	Center Case Gasket	54830039000
				R19X3V	Clutch Cover Gasket	54830024000
					Clutch Fill Plug O-ring	0770191015
					19,00x3,00 NBR	
				R0049	Outer Clutch Cover O-ring	54830025000
				WA137	Drain Plug Washer 12x18x1,5	58038022000
				R0050	Water Pump Cover O-ring MR	54835003000
				WA129	Water Pump Drain Crush Washer 10x14x1	0603100141
				R25X1.5V	Crank O-ring 25x1.5	0770250015
				WA129	Copper Crush Gasket Clutch Line 2 Req. 10X14X1	0603100141
				R30X1.5V	Slave Cylinder O-Ring	0770300015
				R25X2V	Output Shaft O-ring 25,00X2,00	0770250020
				R027V	Thermostat O-ring 32x2	0770320020
				EC1254032AFM	Ignition Cover Gasket	55130040000
				EC1927018AFM	Outer Ignition Cover (Estart)	55130041100
				R25X3V	Estart O-ring 25,00X3,00	0770250030
			Clutch & Mag Kit	Component Part#	Component Description	OEM Part #
			C7943CM	EC234060AFM	Clutch Cover Gasket	54630025050
				EC777032AFM	Mag Cover Gasket	54830040000
			Top End Kit	Component Part#	Component Description	OEM Part #
250 SX, XC, 17-18		O-Ring	C3623	WA135	Cylinder Head Crush Washer	56530080000
XC-W				WA133	Water Jacket Crush Seal	603061001
				R78X2V	Inner Head O-ring 300 Models	770078020
				R73X2V	Inner Head O-ring	770730020
				R105X2B	Outer Head O-ring	770105020
				PV137032AFM	Right Power Valve Cover Gasket	54837008000
				PV136032AFM	Left Power Valve Gasket	54837006000
				R112V	Front Exhaust Cover O-Ring	770116241
				B1384010RC	Cylinder Base Gasket	55430030020
				B1384018AFM	Cylinder Base Gasket	55430030040
				B1384020RC	Cylinder Base Gasket	55430030050
				B1384032AFM	Cylinder Base Gasket	55430030075
				R16X2V	Exhaust Control O-ring	770160021
				R15X1.5V	Exhaust Control Flap O-ring	770150151
				R24X2V	PV Actuator Cover O-ring	770240020
				R12.5X2.5V	PV Guide Spring	770021120
				R44X3V	Exhaust O-rings	770440030
			Oil Seal Kit	Component Part#	Component Description	OEM #
			C3623OS	OS141	Output Shaft Seal	0760324571
				OS197	Shift Shaft Seal	0760142460
				OS199	BalancE Shaft Seal	47030076100
				OS202	Water Pump Shaft Seal	0760082472
				OS217	Left Crank Seal	0760253570
				OS264	Right Crank Seal	0760385273
			List Price			
						56.00

All Component Parts can be purchased individually.



MX/Dirt · Off-Road Gaskets



Cometic Gasket - An Exclusive NASCAR Performance® Product

KTM 250SX

Model	Year	Bore Size	Top End Kit	Component Part#	Component Description	OEM Part #				
250 EXC, RFS	02-05	76 mm	C7169	H1925040S	Head Gasket	59830036000				
				H2099040S	Head Gasket 78mm Bore					
250 SX-F, EXC-F, XC-F	05-12	77 mm	C3164-EST	B0480020F	Base Gasket	59030035050				
				EX281042AM	Exhaust Gasket	59036041000				
				EC495018AFM	Cam Chain Tensioner	59036003050				
				VC027031F	Valve Cover Gasket	58036053000				
				R017B	Oil Screen Plug O-rings	0770020170				
				R12.5X2V	Oil Screen O-rings 2 Req.	0770125015				
				R40X2.5B	Oil Filter O-rings 2 Req.	0770400025				
				WA005063C	Oil Line Washers 4 Req.	0603082121				
				WP114018AFM	Water Pump Gasket	59035053000				
				H2408027S	Head Gasket 77mm Bore	77030036000				
				H2408SP5027S	Head Gasket 79mm Bore	77030036000				
				B0748010RC	Base Gasket	77030035000				
				EX702064AM	Exhaust Gasket	77036041000				
				R018B	Cam Chain Tensioner O-ring	0770180020				
				WA145	Cam Chain Tensioner Seal	0603242920				
WA146	Cam Chain Guide Bolt Seal	0603082121								
3186V	Valve Seals 4 Req.	77036027000								
R012SB	Plug Seal O-Ring	0770080020								
			Bottom End Kit w/o crank seals	Component Part#	Description	OEM Part#				
			C3502	EC1035032AFM	Mag Cover Gasket	77030040000				
				R40X2.5B	Oil filter O-Ring	0770400025				
				R12.5X2V	Oil Screen O-rings 2 Req.	0770125015				
				R017B	Oil Screen Plug O-ring	0770020170				
				WP427	Water Pump Cover Gasket	77035053000				
				WA133	Water Pump Crush Seal	0603061001				
				R30X1.5V	Slave Cylinder O-Ring	0770300015				
				EC1360018AFM	Slave Cylinder Gasket	59032065000				
				WA129	Clutch Bleeder Seal	42013226000				
				EC1036032AFM	Inner Clutch Cover Gasket	77030025100				
				WA137	Oil Drain Plug Seal 2 Req.	58038022000				
				R12X2V	Oil Relief O-Ring	0770120020				
250 SX-F, EXC-F, XC-F	13-19	78mm	C3511-EST C3516-EST	Component Part#	Component Description	OEM Part #				
				R023V	Plug Well O-ring 2 Req.	0770260015				
				R9X1.5V	Cam End Plug O-ring 2 Req.	07700900151				
				H3698SP2027S	81mm Cylinder Head Gasket	77730036085				
				WA145	Cam Chain Tensioner Gasket	0603242920				
				R018B	Cam Chain O-Ring	0770180020				
				R013V	Cam Chain O-Ring	0770010010				
				3186V	Valve Seal 4 Req.	77036027000				
				B1026010RC	Base Gasket	77230035000				
				R10X2V	Temp Sensor O-ring	0770100020				
				EX1333059F	Exhaust Gasket	77236041000				
				H3698027S	Stock Cylinder Head Gasket	77730036085				
				R40X2V	Intake Cam Decompr. O-Ring	0770400010				
							Bottom End Kit	Component Part#	Component Description	OEM Part#
							C3513	EC1455032AFM	Mag Cover Gasket	77530040000
				WA137	Magnet Plug Crush Washer	58038022000				
				R022V	Output Shaft O-Ring	0770020220				
				WA129	Clutch Line Crush Washers	42013226000				
				EC1742018AFM	Starter Cover Gasket	77240043000				
				R014V	Drain Plug Gasket	0770110015				
				R014V	Drain Plug O-Ring 2 Req.	0770110015				
				R19X3V	Fill plug O-Ring	0770191015				
				R12.5X2V	Oil Screen O-Rings 2 Req.	0770125015				
				R031V	Oil Pump Cover O-Ring	0770440020				
				R028V	Oil Filter O-Ring	07703305178				
				R017V	Oil Screen Plug O-Ring	0770020170				
				EC1817018AFM	Clutch Slave Cylinder Gasket	77232062000				
				WP427	Water Pump Cover Gasket	77235053000				
				EC1816032AFM	Inner Clutch Cover Gasket	77730025000				
				MR126	Outer Clutch Cover O-ring	77230027000				

All Component Parts can be purchased individually.



MX/Dirt • Off-Road Gaskets



Cometic Gasket - An Exclusive NASCAR Performance® Product

KTM 250 SX-F

Model **Year** **Bore Size** **Top End Kit**
 250 SX-F, 15-19 79mm C3595-EST
 Factory Edition

Component Part#	Component Description	OEM Part #
H3698027S	Cylinder Head Gasket	79030036086
B1301014RC	Cylinder Base Gasket	79230035000
3186V	Valve Stem Seals 4 Required	77036027000
R018B	Cam Chain Tensioner O-ring	770180020
WA145	Cam Chain Tensioner Crush Seal	603242920
R013V	Cam Chain Tensioner Cap O-ring	770010010
R023V	Plug Well Cam Tower O-rings	770260015
EX1333059F	Exhaust Flange Gasket	77236041000

Bottom End Kit w/Oil Seals C3595BE	Component Part#	Component Description	OEM Part #
	WA133	Clutch Cover Crush Seal	0603061001
	WA133	Water Pump Crush Washer	0603061001
	WA135	Clutch Banjo Bolt Crush Washer	0603080161
	R017B	Oil Screen Cover O-ring	0770020170
	R022V	Output Shaft O-ring	0770020220
	R3.5X2B	Oil Squirter O-ring	0770035020
	R014V	Drain Plug O-ring	0770110015
	R19X3V	Fill Plug O-ring	0770191015
	R25X3V	Starter O-ring	0770250030
	R30X1.5V	Slave Cylinder O-Ring	0770300015
	R031V	Oil Pump Cover O-ring	0770440020
	R119B	Crank End O-ring	07700240251
	R9X1.5V	Balance Shaft O-rings	07700900151
	R12.5X2V	Oil Screen O-ring	07701250151
	R028V	Oil Filter Cover O-ring	07703305178
	WA123	Right Case Locating Screw Crush Washer	58030081000
	WA137	Magnetic Plug Crush Washer	58038022000
	WA137	Oil Check Valve Crush Washer	58038022000
	EC2178032AFM	Inner Clutch Cover	79230025000
	EC2181032AFM	Slave Cylinder Gasket	79232065000
	WP504	Water Pump Gasket	79235053000
Oil Seal Kit C3595OS	Component Part#	Component Description	OEM Part #
	OS269	Oil Pump Seal	0760142450
	OS197	Shift Shaft Seal	0760142460
	OS391	Mag Seal	0760304760
	OS390	Output Shaft Seal	0760324571
	OS392	Primary Side Oil Seal	0760405561
	OS393	Balance Shaft Seal/Water Pump Seals	07601530451
Clutch & Mag Kit C3595CM	Component Part#	Component Description	OEM Part #
	R0079	Outer Clutch Cover	79230027000
	EC2177032AFM	Mag Cover Gasket	79230040000

All Component Parts can be purchased individually.



MX/Dirt • Off-Road Gaskets



Cometic Gasket - An Exclusive NASCAR Performance® Product

KTM 300SX

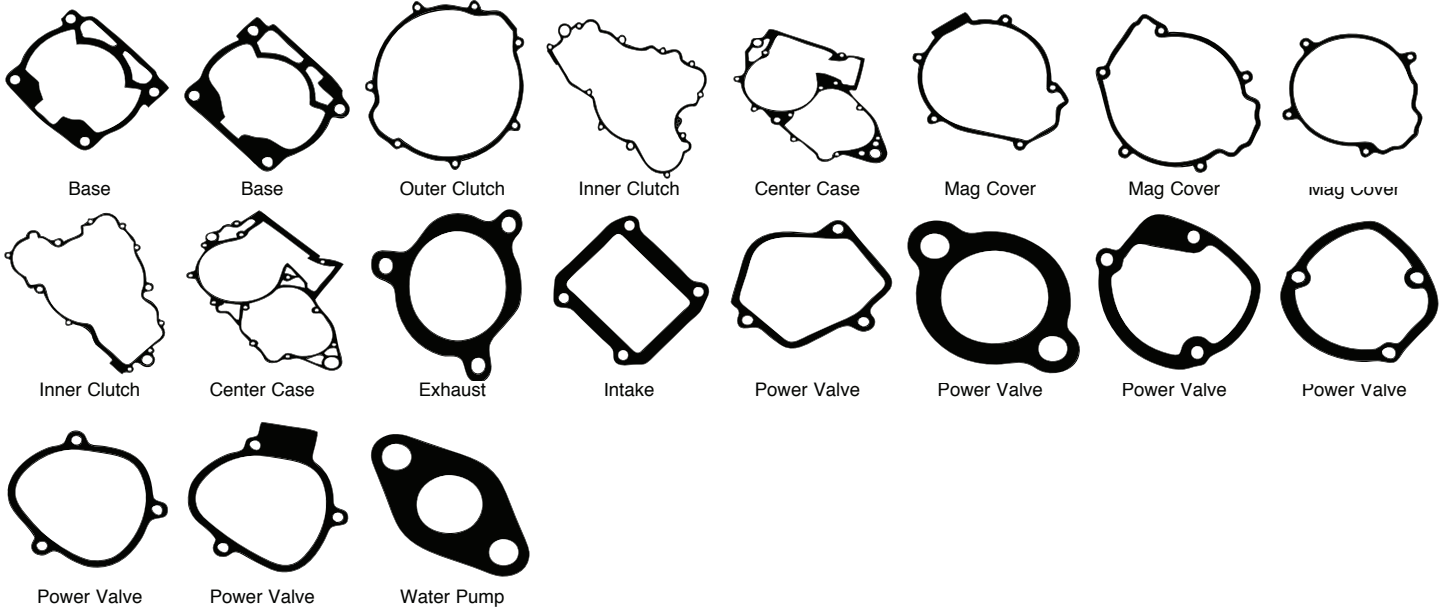

Model	Year	Bore Size	Top End Kit	Component Part#	Component Description	OEM Part #	
300 SX, EXC	90-99	O-Ring	C7099	R78X2V	Inner Head O-ring 300 XC Models	0770078020	
				R114X2B	Outer Head O-ring	0770114020	
				B0056018AFM	Base Gasket .018"	54630030005	
				B0056032AFM	Base Gasket .032"	54630030107	
				EX014047F	Exhaust Flange Gasket	54630046000	
				PV028018AFM	Right Side Power Valve	54637006100	
				PV049018AFM	Left Side Power Valve	54637106000	
				PV088032AFM	Rt. Side Power Valve 90-99	54637073000	
					Component Part#	OEM Part#	
					WP081032AFM	Power Valve Spring Cover	54435037000
					EC234060AFM	Outer Clutch Cover Gasket	54630025050
					EC285032AFM	Inner Clutch Cover Gasket	54630025200
					EC286020F	Center Case Gasket	54630039200
	EC287060AFM	Mag Cover Gasket	54630040300				
	R24X2V	Water Pump O-ring	0770240020				
		Component Part#	OEM Part#				
	OS136	Right Crank Seal 24X35X7	760253570				
	OS137	Left Crank Seal 37X53X7	760385273				
300 SX, EXC, MXC	00-03	O-Ring	C7816	R78X2V	Inner Head O-ring 300 XC Models	0770078020	
				R114X2B	Outer Head O-ring	0770114020	
				B0056018AFM	Base Gasket .018"	54630030005	
				B0056032AFM	Base Gasket .032"	54630030107	
				EX014047F	Exhaust Flange Gasket	54630046000	
				R15X1.5V	Power Valve Control O-rings 2 Req.	0770 15051	
				R16X2V	Power Valve Control O-rings 2 Req.	0770160021	
				PV103032AFM	Left Side Power Valve Gasket	54737006000	
				PV104032AFM	Right Side Power Valve Gasket	54737008000	
					Component Part#	OEM Part#	
					EC234060AFM	Outer Clutch Cover Gasket	54630025050
					EC285032AFM	Inner Clutch Cover Gasket	54630025200
					EC286020F	Center Case Gasket	54630039200
	EC549060AFM	Mag Cover Gasket	54730040100				
	WP081032AFM	Power Valve Spring Cover	54435037000				
		Component Description	OEM Part #				
	EC234060AFM	Clutch Cover Gasket	54630025050				
	EC549060AFM	Mag Cover Gasket	54730040100				
		Component Part#	OEM Part#				
	OS136	Right Crank Seal 24X35X7	760253570				
	OS137	Left Crank Seal 37X53X7	760385273				

All Component Parts can be purchased individually.



MX/Dirt • Off-Road Gaskets



Cometic Gasket - An Exclusive NASCAR Performance® Product

KTM 300EXC

Model	Year	Bore Size	Top End Kit	Component Part#	Component Description	OEM Part #				
300 EXC, MXC, XC, XC-W	04-07	O-Ring	C7423	R80X2S	Inner Head O-ring	0770800021				
				R114X2B	Outer Head O-ring	0770114020				
				WA135	Head Seal Crush Washer 6 Req.	56530080000				
				B0666018AFM	Base Gasket .018"	54830030004				
				B0666032AFM	Base Gasket .032"	54830030004				
				IR386018AFM	Intake Gasket	548030062000				
				R44X3S	Exp. Chamber O-rings 2 Req.	0770440030				
				PV103032AFM	Left Side Power Valve Gasket	54737006000				
				PV104032AFM	Right Side Power Valve Gasket	54737008000				
				R11.5X2.5V	Power Valve Cover O-rings 4 Req.	0770116241				
				R15X1.5V	Power Valve Control O-ring	077015051				
				04-16			Bottom End Kit C7417BE	Component Part#	Component Description	OEM Part#
								EC778032AFM	Primary Cover Gasket	54830024000
								EC779020F	Center Case Gasket	54830039000
								EC1927018AFM	Electric Starter Cover Gasket	55130041100
								R25X3V	Electric Starter O-ring 25x3	0770250030
								IR683018AFM	Intake Reed Gasket	
								R25X1.5V	Crank Seal Backup O-ring 25x1.5	0770250015
								R19X3V	Fill Plug O-ring 19x3	0770191015
								R0050	Water Pump Cover Gasket	54835003000
								WA129	Water Pump Drain Crush Washer 10x14x1	0603100141
								WA133	Clutch Cover Water Passage Crush Washer 6x10x1	0603061001
								WA137	Clutch Cover Drain Plug 12x18x1.5	58038022000
								R117B	Breather Element O-ring 18,72X2,62	0770021160
								R30X1.5V	Slave Cylinder O-ring 30x1.5	0770300015
								R25X2V	Output Shaft Backup O-ring 25x2	0770250020
								R24X2V	Power Valve Actuator Cap O-ring 24x2	0770240020
R49X2.5V	Water Pump Support O-ring 49x2.5	0770049025								
R114V	Power Valve Spring Guide O-ring 12,37X2,62	0770021120								
Oil Seal Kit C7417OS								Component Part#	Component Description	OEM #
								OS217	Left Crankcase Seal 25x35x7	0760253570
								OS137	Right Crankcase Seal 38x52x7	0760385273
								OS310	Start Shaft Seal 19x30x7	0760193070
								OS141	Output Shaft Oil Seal 32x45x6.5	0760324565
								OS197	Shift Shaft Seal 14x24x6	0760142460
								OS202	Impeller Seal 8x24x7	0760082472
								R0049	Clutch Cover O-ring	54830025000
								Clutch & Mag Kit C7417CM		
EC777032AFM	Mag Cover Gasket	54830040000								
EC1254032AFM	Mag Cover Gasket 2007-2016	55130040000/ 55130040100								
300 XC, XC-W	08-17	O-Ring	C3222	Component Part#	Component Description	OEM Part #				
				R73X2V	Inner Head O-ring 250 Models	0770730020				
				R78X2V	2008 300 XC Models	0770078020				
				R105X2B	Outer Head O-ring	0770105020				
				WA135	Head Seal O-rings	56530080000				
				B0666018AFM	Base Gasket .018"	54830030004				
				R44X3S	Exhaust Flange O-rings	0770440030				
				PV136032AFM	Left Side Power Valve Gasket	54837006000				
				PV137032AFM	Right Side Power Valve Gasket	54837008000				
				R112V	Power Valve Flap O-rings	0770116241				
				R114V	Power Valve Spring Guide O-ring	0770021120				
				R16X2V	Power Valve Control O-rings 2 Req.	0770160021				
				R24X2V	Power Valve Control Cover O-ring	0770240020				
				Clutch & Mag Kit C7943CM				Component Part#	Component Description	OEM Part #
								EC234060AFM	Clutch Cover Gasket	54630025050
								EC777032AFM	Mag Cover Gasket	54830040000

All Component Parts can be purchased individually.



MX/Dirt · Off-Road Gaskets



Cometic Gasket - An Exclusive NASCAR Performance® Product

KTM 350SX-F

Model	Year	Bore Size	Top End Kit	Component Part#	Component Description	OEM Part #	
350SX-F	11-12	88mm	C3428-EST	H3093SP4027S	88mm Cylinder Head Gasket	77230036000	
			C3429-EST	H3093027S	90mm Cylinder Head Gasket		
			C3458-EST	H3093SP1027S	91mm Cylinder Head Gasket		
					R10X2V	Water Temp Sensor O-ring	0770100020
					R18X2.5V	Cam Chain Tensioner O-ring	0770180020
					R9X2V	Head Seal O-rings	0770090015
					WA145	Cam Chain Tensioner Seal	0603242920
					B1026014RC	Base Gasket	77230035000
					3231V	Valve Seals 4 Req.	77236027000
					R013V	Cam Chain Wear Bushing O-ring	0770010010
			R023V	Plug Shaft O-rings	0770260015		
350SX-F, XC-F	13-14	88mm	C3519-EST	H3093SP4032S	88mm Cylinder Head Gasket	77230036000	
			C3520-EST	H3093032S	90mm Cylinder Head Gasket		
			C3521-EST	H3093SP1032S	91mm Cylinder Head Gasket		
					B1026014RC	Base Gasket	77230035000
					EX1333059F	Exhaust Gasket	77236041000
					R018B	Cam Chain Tensioner O-ring	0770180020
					R9X2V	Head Seal O-rings	0770090015
					WA145	Cam Chain Tensioner Seal	0603242920
					R013V	Cam Chain Wear Bushing O-ring	0770010010
					R023V	Plug Shaft O-rings	0770260015
350 SX-F, Factory Edition	15-19	88mm	C3605-EST	H3093SP4032S	Cylinder Head Gasket	79230036086	
				B1301014RC	Cylinder Base Gasket	79230035000	
				3231V	Valve Stem Seals 4 Required	77236027000	
				R018B	Cam Chain Tensioner O-ring	0770180020	
				WA145	Cam Chain Tensioner Crush Seal	0603242920	
				R013B	Cam Chain Tensioner Cap O-ring	0770010010	
				R023V	Plug Well Cam Tower O-ring	0770260015	
				R23X1.5V	Plug Shaft Insert O-ring 23x1.5	7702300151	
				R9X1.5V	Oil Galley O-rings 9x1.5	07700900151	
				EX1333059F	Exhaust Flange Gasket	77236041000	
		Bottom End Kit w/Oil Seals C3595BE	Component Part#	Component Description	OEM Part #		
			WA133	Water Pump Crush Washer	0603061001		
			WA135	Clutch Banjo Bolt Crush Washer	0603080161		
			R017B	Oil Screen Cover O-ring	0770020170		
			R022V	Output Shaft O-ring	0770020220		
			R3.5X2B	Oil Squirter O-ring	0770035020		
			R014V	Drain Plug O-ring	0770110015		
			R19X3V	Fill Plug O-ring	0770191015		
			R25X3V	Starter O-ring	0770250030		
			R30X1.5V	Slave Cylinder O-Ring	0770300015		
			R031V	Oil Pump Cover O-ring	0770440020		
			R119B	Crank End O-ring	07700240251		
			R9X1.5V	Balance Shaft O-rings	07700900151		
			R12.5X2V	Oil Screen O-ring	07701250151		
			R028V	Oil Filter Cover O-ring	07703305178		
			WA123	Right Case Locating Screw Crush Washer	58030081000		
			WA137	Magnetic Plug Crush Washer	58038022000		
			WA137	Oil Check Valve Crush Washer	58038022000		
			EC2178032AFM	Inner Clutch Cover	79230025000		
			EC2181032AFM	Slave Cylinder Gasket	79232065000		
			WP504	Water Pump Gasket	79235053000		
		Oil Seal Kit C3595OS	Component Part#	Component Description	OEM Part #		
			OS269	Oil Pump Seal	0760142450		
			OS197	Shift Shaft Seal	0760142460		
			OS391	Mag Seal	0760304760		
			OS390	Output Shaft Seal	0760324571		
			OS392	Primary Side Oil Seal	0760405561		
			OS393	Balance Shaft Seal/Water Pump Seals	07601530451		
		Clutch & Mag Kit C3595CM	Component Part#	Component Description	OEM Part #		
			R0079	Outer Clutch Cover	79230027000		
			EC2177032AFM	Mag Cover Gasket	79230040000		



MX/Dirt • Off-Road Gaskets



Cometic Gasket - An Exclusive NASCAR Performance® Product

KTM 350EXC

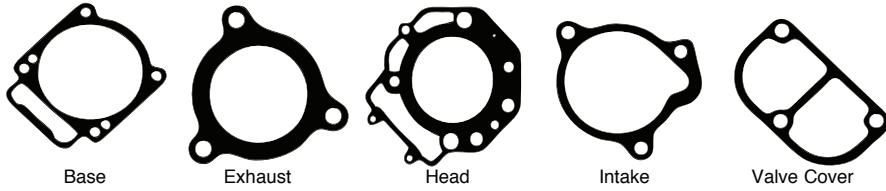

Model	Year	Bore Size	Top End Kit	Component Part#	Component Description	OEM Part #
350 EXC, RXC	87-90	O-Ring	C7288	H0378040A	Head Gasket	57530036000
				B0230020RC	Base Gasket	58030030000
				IR056032AFM	Intake Gasket	58136043000
				EX088031F	Exhaust Gasket 2 Req.	58036041000
				VC027032AFM	Valve Cover Gasket 2 Req.	58036053000

KTM 360/380 SX, EXC

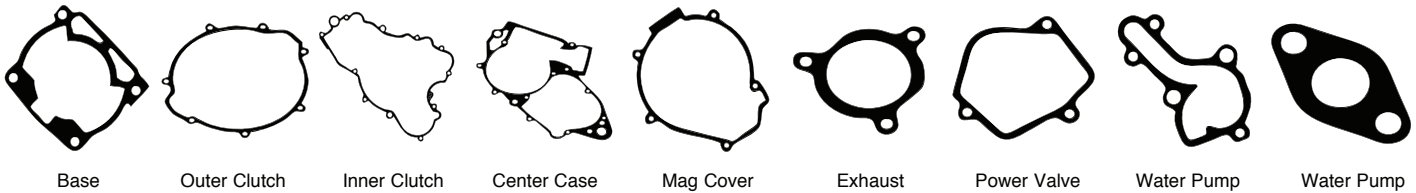

Model	Year	Bore Size	Top End Kit	Component Part#	Component Description	OEM Part #
360 SX, EXC	96-97	O-Ring	C7285	R114X2B	Outer Head O-ring	0770114020
380 SX, EXC	98-01			R84X2V	Inner Head O-ring	077084021
				B0056018AFM	Base Gasket .018"	54630030005
				B0056032AFM	Base Gasket .032"	54630030107
				PV028018AFM	Right Side Power Valve Gasket	54637006100
				PV049018AFM	Left Side Power Valve Gasket	54637106000
				EX014047F	Exhaust Flange Gasket	54630046000
					Component Part#	OEM Part#
			Bottom End Kit w/crank seals C3390	EC234060AFM	Outer Clutch Cover Gasket	54630025050
				EC285032AFM	Inner Clutch Cover Gasket	54630025200
				EC286020F	Center Case Gasket	54630039200
				EC287060AFM	Mag Cover Gasket	54630040300
				WP008032AFM	Water Pump Gasket	54635003200
				WP081032AFM	Power Valve Spring Cover	54435037000
			Crank Seal Kit C7662		Component Part#	OEM Part#
				OS136	Right Crank Seal 24X35X7	760253570
				OS137	Left Crank Seal 37X53X7	760385273

KTM 400LC4

Model	Year	Bore Size	Top End Kit	Component Part#	Component Description	OEM Part #
400 LC4, MLS Head	88-01	95.5 mm	C7170	H1955040S	95.5mm Head Gasket	58030136200
				B0230020RC	Base Gasket	58030030000

All Component Parts can be purchased individually.



MX/Dirt • Off-Road Gaskets



Cometic Gasket - An Exclusive NASCAR Performance® Product

KTM 400

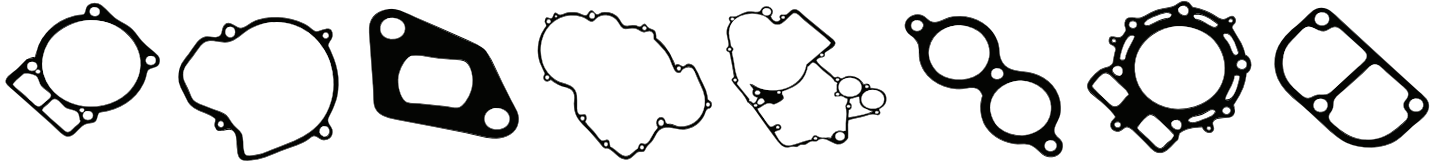

Model	Year	Bore Size	EST Top End Kit	Component Part#	Component Description	OEM Part #
400, 450, 525 SX, EXC, RFS	00-06	91 mm	C7693-EST	H1017040S	Head Gasket 91mm Bore	59030036000
		94 mm	C7885-EST	H1843040S	Head Gasket 94mm Bore	
		95 mm	C7944-EST	H1521040S	Head Gasket 95mm Bore	
		96 mm	C7454-EST	H2081040S	Head Gasket 96mm Bore	
		97 mm	C7691-EST	H1018040S	Head Gasket 97mm Bore	
		98 mm	C7461-EST	H1018SP4040S	Head Gasket 98mm Bore	
		99 mm	C7792-EST	H1018SP2040S	Head Gasket 99mm Bore	
				B0480020F	Base Gasket	59030035050
				EX281042AM	Exhaust Gasket	59036041000
				EC495018AFM	Timing Cover Gasket	59036003050
				3225V	Valve Seals 4 Req.	59036027000
				VC027031F	2 Req. Valve Cover Gasket	58036053000
				R017B	Oil Screen Plug O-rings	0770020170
				R12.5X2V	Oil Screen O-rings 2 Req.	
				R40X2.5B	Oil Filter O-rings 2 Req.	0770400025
				WA005063C	Oil Line Washers 4 Req.	0603082121
			Bottom End Kit w/o crank seals C3394	Component Part#	Component Description	OEM Part#
				WP114018AFM	Water Pump Gasket	59035053000
				EC496032AFM	Clutch Cover Gasket	59030025000
				EC494032AFM	Mag Cover Gasket	59030040000
				EC497012F	Center Case Gasket	59030039000
			Clutch & Mag Kit C7693CM	Component Part#	Component Description	OEM Part #
				EC496032AFM	Clutch Cover Gasket	59030025000
				EC494032AFM	Mag Cover Gasket	59030040000

KTM 450SX-F

Model	Year	Bore Size	EST Top End Kit	Component Part#	Component Description	OEM Part #
450SX-F	07-12	97mm	C3412-EST	H2623027S	Head Gasket 97mm Bore	77330036000
450 Rally	14			R010V	Oil Jet O-rings	0770060015
				R9X1.5V	Head Oil Plug O-ring	0770090015
				EX873059F	Exhaust Gasket	77336041000
				R014V	Head Coolant Plug Gasket	0770090015
				R25X2V	Cam Tower Plug Well O-ring	0770025020
				3225V	Valve Stem Seals	59036027000
				R013B	Cam Chain Tensioner O-ring	0770010010
				WA145	Cam Chain Tens. Crush Seal	0603242920
				R18X2.5V	Cam Chain Tens. Piston O-ring	0770180020
				R014V	Cam Chain Bushing O-ring	0770012015
				R017B	Cam Axle O-ring	0770015018
				R046V	Base O-ring	0770108018
				B0928	Cam Galley Base O-ring	77330035000
			EST Top End Kit C3413-EST	Component Part#	Component Description	OEM Part #
505SX-F	07-10	100mm	C3413-EST	H2623SP1027S	Head Gasket 100mm Bore	77330036000
				R010V	Oil Jet O-rings	0770060015
				R9X1.5V	Head Oil Plug O-ring	0770090015
				EX873059F	Exhaust Gasket	77336041000
				R014V	Head Coolant Plug Gasket	0770090015
				R25X2V	Cam Tower Plug Well O-ring	0770025020
				3225V	Valve Stem Seals	59036027000
				R013B	Cam Chain Tens. O-ring	0770010010
				WA145	Cam Chain Tens. Crush Seal	0603242920
				R18X2.5V	Cam Chain Tens. Piston O-ring	0770180020
				R014V	Cam Chain Bushing O-ring	0770012015
				R017B	Cam Axle O-ring	0770015018
				R046V	Base O-ring	0770108018
				B0928	Cam Galley Base O-ring	77330035000



MX/Dirt • Off-Road Gaskets



Cometic Gasket - An Exclusive NASCAR Performance® Product

KTM 450EXC-R

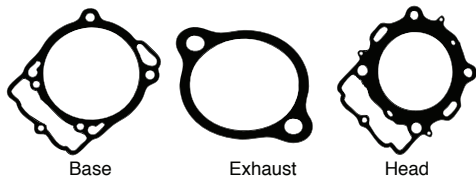

Model	Year	Bore Size	EST Top End Kit	Component Part#	Component Description	OEM Part #
450 EXC-R	08	95 mm	C3241-EST	H2759045S	Head Gasket 95mm Bore	78030036000
530 EXC-R		97 mm	C3242-EST	H2759SP3045S	Head Gasket 97mm Bore	
450 SX-F	12	99 mm	C3243-EST	H2759SP1045S	Head Gasket 99mm Bore	
Factory Replica		101 mm	C3244-EST	H2759SP4045S	Head Gasket 101mm Bore	
450 SX-F	13-15			B0933014RC	Base Gasket	78030035000
				EX873059F	Exhaust Gasket	77336041000
				R019V	Cam Chain Tensioner O-ring	0770180020
				WA145	Cam Chain Tensioner Seal	603242920
				3225V	Intake Valve Seals 4 Req.	59036027000
				3186V	Exhaust Valve Seals 2 Req.	77036027000
				R014V	Rocker Arm O-ring	0770110015
				R10X2V	Temp Sensor O-ring	0770100020
					Component Description	OEM Part #
450SX-F	16	99mm	C3604-EST	R10X2V	Temp. Sensor O-ring	0770100020
Factory Edition				R017B	Oil Filter Screen O-ring 17x1.78	0770020170
EX-C450F	17-19			R15X1.5V	Rocker Arm O-rings 15.00X1.50	0770150151
				R031V	Oil Pump Cover O-ring	0770440020
				3225V	Valve Seal	59036027000
				R9950	EX-C Exhaust Valve Seal Pack	77036027000
				EC495018AFM	Cam Chain Tensioner Gasket	59036003050
				EX1589059F	Exhaust Gasket	78036041000
				H4207036S	Cylinder Head Gasket	79430036010
				B1323014RC	Cylinder Base Gasket	79430035000
					Component Description	OEM Part #
500 EXC	12-16	95mm	C3697	3186V	Exhaust Valve Seal (2)	77036027000
				3225V	Intake Valve Seal	59036027000
				B0933014RC	Cylinder Base Gasket	78030035000
				EC495018AFM	Cam Chain Tensioner Gasket	59036003050
				EX1589059F	Header Gasket	78036041000
				H2759040S	Cylinder Head Gasket 95mm 1mm Thick	78930036010
				R014V	Rocker Arm O-ring 11x1.5	770110015
				R10X2V	Water Temp Sensor O-ring 10x2	770100020
				WA133	Head Crush Washer 6x10x1	603061001
				WA137	Head Crush Washer 12x18x5	58038022000
					Component Description	OEM Part #
620 LC	88-01	102 mm	C7171	H1956040S	Head Gasket 102mm Bore	58330036000
		105 mm	C7209	H1957040S	Head Gasket 105mm Bore	
				B0230020RC	Base Gasket	58030030000

LEM

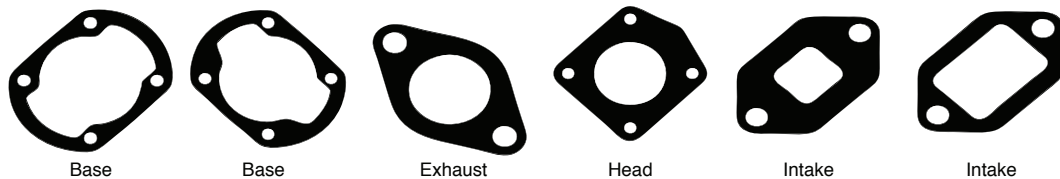

Model	Year	Bore Size	Top End Kit	Component Part#	Component Description	OEM Part #
Cross	96-03	41 mm	C7282	H0354010C	Head Gasket .010" Copper	36330036000
CR-3 USA				H0354020C	Head Gasket .020" Copper	36330036000
LX1, LX2 Factory				B0219018AFM	Base Gasket 00-01	45030035800
LX2, LX2 Sport				B0220018AFM	Base Gasket 94-99	36330030000
LX3				IR054018AFM	Intake Port Small Opening	49130438000
LX3 Sport				IR055018AFM	Intake Port Large Opening	49130438000
				EX089039F	Exhaust Gasket	45030046000

All Component Parts can be purchased individually.



MX/Dirt • Off-Road Gaskets



Cometic Gasket - An Exclusive NASCAR Performance® Product

SUZUKI JR50

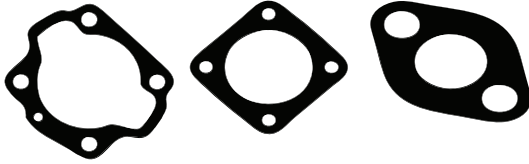

Model	Year	Base Bore Size	Head Bore Size	Top End Kit
JR50	78-08	43 mm		C7014

Component Part#	Component Description	OEM Part #
H1281020RC	Head Gasket	11141-04000
B0543020RC	Base Gasket	11241-04010
IR417020F	Intake Gasket	13121-04000-H17
EX349042AM	Exhaust Gasket	14181-04200

SUZUKI RM60

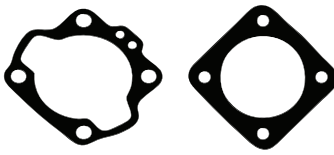

Model	Year	Base Bore Size	Head Bore Size	Top End Kit
RM60	03-04	45 mm		C7501

Component Part#	Component Description	OEM Part #
H0262043F	Head Gasket	11004-1218
B0371018AFM	Base Gasket	11060-1873
B0371012	High Comp. Base Gasket .012"	11060-1873

Bottom End Kit w/Oil Seals	Component Part#	Component Description	OEM Part #
C7154BE	R9X2V	Clutch Pushrod O-ring	670B1509
	WA107	Drain Plug Seal	92065-058
	WP0500032AFM	Water Elbow Outlet	11009-1952
	R222V	Water Pump Body O-ring	670B3039
	WA107	Trans Fluid Drain Plug	92065-058
	R013B	Output Shaft O-ring	92055-022
Oil Seal Kit	Component Part#	Component Description	OEM Part #
C7736OS	OS331	Shift Shaft Seal 13x22x5.5	92051-005
	OS131	Output Shaft Seal 25x37x6	92050-013
Crank Seal Kit	Component Part#	Component Description	OEM Part #
C7656	OS110	Crank Seal 20x40x7	92049-1188
	OS366	Start Shaft Seal 16x24x4	92049-002
	OS368	Water Pump Shaft Seal 8x18x10	92049-1366
Clutch & Mag Kit	Component Part#	Component Description	OEM Part #
C7736CM	EC275032AFM	Clutch Cover Gasket	11009-1976

SUZUKI RM65

Model	Year	Base Bore Size	Head Bore Size	Top End Kit
RM65	03-08	45 mm		C7736
		47 mm		C7682
		48 mm		C7737

Component Part#	Component Description	OEM Part#
H0970010S	Head Gasket 45mm Bore	11004-1346
H0971010S	Head Gasket 47mm Bore	
H0972010S	Head Gasket 48mm Bore	
B0444018AFM	Base Gasket	11060-1921
B0444012F	High Comp. Base Gasket .012"	
R218V	Exhaust O-rings 2 Req.	11060-1925

Bottom End Kit w/Oil Seals	Component Part#	Component Description	OEM Part #
C7736BE	WP104020F	Water Pump Gasket	K1106-01924
	WP105020F	Water Outlet Gasket	K1106-01927
	WA118	Water Pump Drain Crush Washer	KK920-22077
	R013B	Output Shaft O-rings	KK920-55022
	WA108	Drain Plug Gasket	KK920-65058
	Oil Seal Kit	Component Part#	Component Description
C7736OS	OS360	Water Pump Seal Outer	K9204-91359
	OS368	Water Pump Seal Inner	K9204-91366
	OS365	Clutch Actuator Seal	K9204-91414
	OS366	Kickstart Seal	KK920-49002
	OS131	Output Shaft Seal	KK920-50013
	OS331	Shift Shaft Seal	KK920-51005
	Clutch & Mag Kit	Component Part#	Component Description
C7736CM	EC275032AFM	Clutch Cover Gasket	11009-1976
	EC2740032AFM	Mag Cover Gasket	11009-1974



MX/Dirt • Off-Road Gaskets



Cometic Gasket - An Exclusive NASCAR Performance® Product

SUZUKI RM80

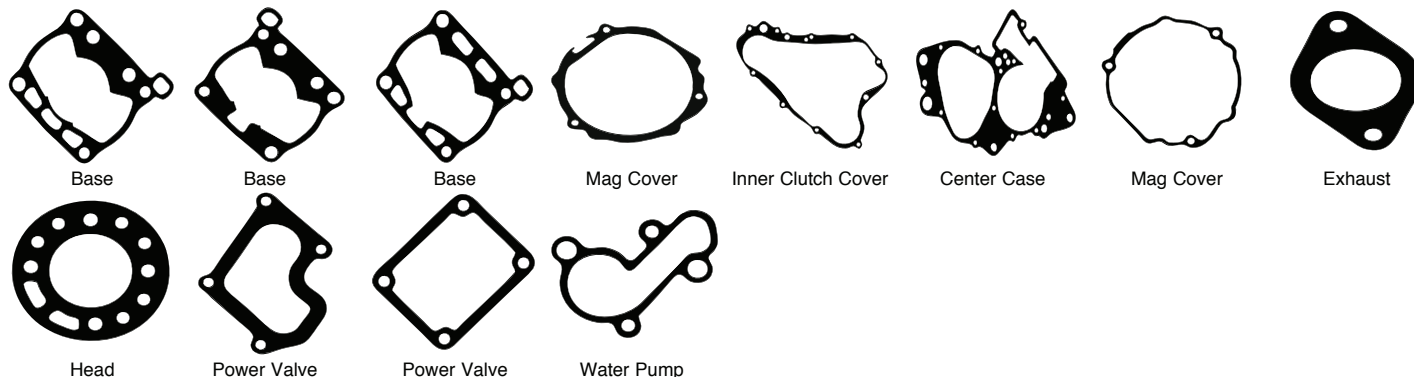

Model	Year	Bore Size	Top End Kit	Component Part#	Component Description	OEM Part #
RM80	83-85	51 mm	C7102	H0038043F B0037020F	Head Gasket 51mm Base Gasket	11141-20931-H17 11241-20900-H17
RM80 G, H, J	86-88	50 mm	Top End Kit C7052	H0039043F B0038020F IR009020F EX010042AM	Head Gasket Base Gasket Intake Gasket Exhaust Gasket	OEM Part # 1141-02B60 11241-03B01 13156-02B00 14181-02B00
			Crank Seal Kit C7699	OS171 OS172	31X44X8 Right Crank Seal 17X30X8 Left Crank Seal	OEM Part# 09289-32003 09283-18004
			Top End Kit C7053	H0039043F B0039020F IR009020F EX010042AM PV015018AFM PV016018AFM R127V	Head Gasket Base Gasket Intake Gasket Exhaust Gasket Right Side Power Valve Gasket Front Power Valve Cover Gasket Expansion Chamber O-ring	OEM Part # 1141-02B60 11241-03B01 13156-02B00 14181-02B00 11233-02B41 11238-01B30-H17 14171-02B40
			Crank Seal Kit C7663	OS132 OS174 C7486	29X40X7 Right Crank Seal 17X30X6 Left Crank Seal Clutch Cover Gasket	OEM Part# 09283-30061 9283-18006 OEM Part# 11482-27C00
RM80	89-90	50 mm	Top End Kit C7053	H0039043F B0039020F IR009020F EX010042AM PV015018AFM PV016018AFM R127V	Head Gasket Base Gasket Intake Gasket Exhaust Gasket Right Side Power Valve Gasket Front Power Valve Cover Gasket Expansion Chamber O-ring	OEM Part # 1141-02B60 11241-03B01 13156-02B00 14181-02B00 11233-02B41 11238-01B30-H17 14171-02B40
RM80	91-01	O-Ring	Top End Kit C7054	R55X2V R87X2B B0040018AFM B0040012F EX010042AM PV015018AFM PV016018AFM R127V	Inner Head O-ring Outer Head O-ring Base Gasket High Compression Base Gasket Exhaust Gasket Right Side Power Valve Gasket Front Power Valve Cover Gasket Expansion Chamber O-ring	OEM Part # 11147-03B00 11148-03B00 11241-03B00 11241-03B00 14181-02B00 11233-02B41 11238-01B30-H17 14171-02B40
			Bottom End Kit w/crank seals C3357	EC204060AFM C7486 EC206020F WP040018AFM	Mag Cover Gasket Inner Clutch Cover Gasket Crankcase Gasket Water Pump Cover Gasket	OEM Part# 11483-02B50 11482-27C00 11481-02B40 17431-02B41
			Crank Seal Kit C7663	OS132 OS174	29X40X7 Right Crank Seal 17X30X6 Left Crank Seal	OEM Part# 09283-30061 9283-18006

All Component Parts can be purchased individually.



MX/Dirt • Off-Road Gaskets



Cometic Gasket - An Exclusive NASCAR Performance® Product

SUZUKI RM85

Model	Year	Bore Size	Top End Kit	Component Part#	Component Description	OEM Part #	
RM85	02-12 18-19	O-Ring	C7857	R57X2V	inner Head O-ring	11147-03B00	
				R88X2B	Outer Head O-ring	11148-03B00	
				B0577018AFM	Base Gasket	11241-03B01	
				B0577012F	High Compression .012" Base Gasket		
				R127V	Expansion Chamber O-ring	14171-02B40	
				PV015018AFM	Right Side Power Valve Cover	11233-02B41	
				PV016018AFM	Front Power Valve Cover Gasket	11238-01B30-H17	
				R015B	Oil Filler Cap O-ring	NA	
			Bottom End Kit C7857BE	Component Part# EC654020F	Component Description Center Case Gasket	OEM Part # 11481-03B00	
	02-19			WA116	Drain Plug Crush Washer 8.2x14x1	09168-08016	
				WP040018AFM	Water Pump Cover Gasket	17431-02B42	
				WA118	Water Pump Crush Washer	17413-28C10	
				WA124	Primary Cover Water Passage Crush Washer 6.2x11x1.2	09168-06004	
			Oil Seal Kit C7857OS	Component Part# OS244	Component Description Clutch Actuator Shaft Seal 10x17x5	OEM Part # 09285-10004	
				OS364	Water Pump Shaft Seal	17461-03B00	
				OS132	Right Crank Seal 30x40x7	09283-30061	
				OS174	Left Crank Seal 18x30x7	09283-18007	
				OS305	Shift Shaft Seal	09283-14006	
				OS197	Starter Seal 14x24x6	09285-14001	
				OS442	Output Shaft Seal 20x35x5	09283-20057	
			Clutch & Mag Kit C7857CM	Component Part# EC653063N	Component Description Mag Cover Gasket	OEM Part # 11483-03B00	
				C7486	Primary Cover Gasket	11482-27C02	
RM100	03-04	53 mm 54.5 mm	Top End Kit C7392	Component Part# H0342010S	Component Description Head Gasket 53mm Bore	OEM Part # 11004-1214	
			C7413	H0490010S	Head Gasket 54.5mm Bore		
					B0311018AFM	Base Gasket	11060-1779
					B0311012F	High Compression Base Gasket	
					R126V	Expansion Chamber O-ring	NA
					PV066018AFM	Rt. Side Power Valve Cover	11060-1778
					Component Part#	Component Part#	OEM Part#
				Bottom End Kit w/crank seals C3359	EC190018AFM	Clutch Cover Gasket	11009-1971
					EC191018AFM	Mag Cover Gasket	11009-1973
					WP036018AFM	Water Pump Gasket	11009-1972
					Component Part#	Component Description	OEM Part #
				Clutch & Mag Kit C3501CM	EC190018AFM	Clutch Cover Gasket	11009-1971
			EC191018AFM	Mag Cover Gasket	11009-1973		
			Component Part#	Component Description	OEM Part #		
			EST Top End Kit	Component Part#	Component Description	OEM Part #	
DR-Z110	03-05	55 mm 57 mm	C7939-EST	H1891010S	Head Gasket 55mm	K1100-41338	
			C7949-EST	H1917010S	Head Gasket 57mm		
				B0678SP2020RC	Base Gasket	K1106-01796	
				IR431018AFM	Intake Gasket	K1106-01753	
				R022B	Intake O-rings 2 Req.	K9205-51527	
				EX781	Exhaust Gasket	K1106-11112	
				R110B	Cam Chain Tensioner Bolt O-ring	KK670-D2010	
				R117B	Cam Chain Tensioner O-ring	KK670-D2021	
				3183V	Valve Seals	K9204-91349	
				R91X2.5V	Cam Cover O-ring	K9205-51527	
				R031B	Tappet Cover O-rings 2 Req.	K9205-51231	
					Component Part#	Component Description	OEM Part #
					EC1102018AFM	Clutch Cover Gasket	11061-0131
					Component Part#	Component Description	OEM Part #
		DR-Z125	03-13	59 mm 61 mm	C7835	H1892027S	Head Gasket
C3109	H1926027S				Head Gasket 61mm Bore		
				B0679020F	Base Gasket	11061-S035	
				EC824032AFM	Cam Chain Tensioner Gasket	11061-S038	
				R010B	Cam Chain Bolt O-ring	09280-06005	
				R216B	Tappet Plug O-ring 2 Req.	09280-30001	

All Component Parts can be purchased individually.



Cometic Gasket - An Exclusive NASCAR Performance® Product

SUZUKI RM125

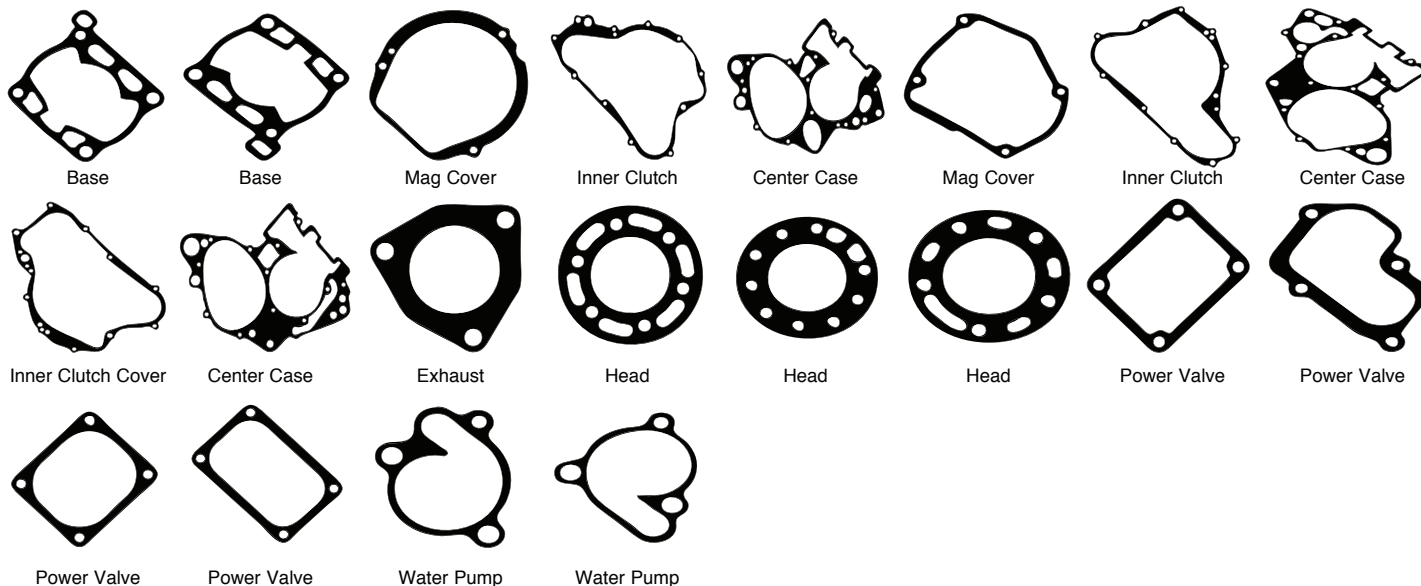

Model	Year	Bore Size	Top End Kit	Component Part#	Component Description	OEM Part #
RM125	83	56 mm	C7103	H0040043F	Head Gasket	1141-14120-H17
				B0041020F	Base Gasket	11241-14110-H17
RM125	84-85	56 mm	C7055	B0042020F	Base Gasket	11241-14501-H17
				EX011042AM	Exhaust Gasket	14181-40200
				H0041043F	Head Gasket	11141-14500-H17
				IR010020F	Intake Gasket	13156-14500-H17
RM125	86	56 mm	C7056	B0043020F	Base Gasket	11241-01B00-H17
				EX011042AM	Exhaust Gasket	14181-40200
				H0042043F	Head Gasket	11141-01B01-H17
				IR010020F	Intake Gasket	13156-14500-H17
				PV017020F	Power Valve Gasket	11233-01B00
			Crank Seal Kit C7700	OS173	27X40X8 Right Crank Seal	9289-28007
				OS174	17X30X6 Left Crank Seal	9283-18006
RM125	87-88	56 mm	C7057	B0044020F	Base Gasket	11241-01B00-H17
				H0043043F	Head Gasket	11141-01B01-H17
				IR003018AFM	Intake Gasket	14132-K56-701
				PV016018AFM	Front Power Valve Gasket	11238-01B30-H17
				PV018020F	Right Power Valve Gasket	11233-01B30
				R224V	Power Valve O-ring	09280-28005
			Crank Seal Kit C7700	OS173	27X40X8 Right Crank Seal	9289-28007
				OS174	17X30X6 Left Crank Seal	9283-18006
RM125	89	56 mm	C7058	H0044043F	Head Gasket	11141-27C00
				B0045018AFM	Base Gasket	11241-27C10
				PV016018AFM	Front Power Valve Gasket	11238-01B30-H17
				PV019020F	Right Power Valve Gasket	11233-27C10
				R224V	Power Valve O-ring	09280-28005
			Crank Seal Kit C7664	OS132	29X40X7 Right Crank Seal	09283-30061
				OS174	17X30X6 Left Crank Seal	9283-18006
RM125	90	O-Ring	C7120	R62X2V	Inner Head O-ring	11147-27C10
				R89X2B	Outer Head O-ring	11148-27C10
				B0045018AFM	Base Gasket	11241-27C10
				PV016018AFM	Front Power Valve Gasket	11238-01B30-H17
				PV019020F	Right Power Valve Gasket	11233-27C10
				R224V	Power Valve O-ring	09280-28005

All Component Parts can be purchased individually.



MX/Dirt • Off-Road Gaskets



Cometic Gasket - An Exclusive NASCAR Performance® Product

SUZUKI RM125

Model	Year	Bore Size	Top End Kit	Component Part#	Component Part#	OEM Part#				
RM125	91	O-Ring	Top End Kit C7059	R62X2V	Inner Head O-ring	11147-27C10				
				R89X2B	Outer Head O-ring	11148-27C10				
				B0045018AFM	Base Gasket	11241-27C10				
				PV020018AFM	Right Side Power Valve Gasket	11233-27C32				
				PV021032AFM	Front Power Valve Gasket	11238-27C31				
				Crank Seal Kit C7664	Component Part#	OEM Part#				
					OS132	29X40X7 Right Crank Seal	09283-30061			
					OS174	17X30X6 Left Crank Seal	9283-18006			
				RM125	92	O-Ring	Top End Kit C7112	R62X2V	Inner Head O-ring	11147-27C10
R89X2B	Outer Head O-ring	11148-27C10								
B0045018AFM	Base Gasket	11241-27C10								
PV020018AFM	Right Side Power Valve Gasket	11233-27C32								
PV021032AFM	Front Power Valve Gasket	11238-27C31								
Bottom End Kit C3360	Component Part#	Component Part#	OEM Part#							
	EC207060AFM	Mag Cover Gasket	11483-43D00							
	EC208032AFM	Inner Clutch Cover Gasket	11482-43D01							
	EC210020F	Center Case Gasket	11481-43D00							
	C7499	Outer Clutch Cover Gasket	11484-43D00							
	WP041018AFM	Water Pump Gasket	17431-43D00							
Crank Seal Kit C7664	Component Part#	OEM Part#								
	OS132	29X40X7 Right Crank Seal	09283-30061							
	OS174	17X30X6 Left Crank Seal	9283-18006							
RM125	93-97	O-Ring	Top End Kit C7136					R62X2V	Inner Head O-ring	11147-27C11
								R89X2B	Outer Head O-ring	11148-27C11
								B0045018AFM	Base Gasket	11241-27C10
								B0045012F	High Comp. Base Gasket .012"	
								PV020018AFM	Right Side Power Valve Gasket	11233-27C32
				PV021032AFM	Front Power Valve Gasket	11238-27C31				
				PV061018AFM	Front Power Valve Gasket 97-Up	11238-36E00				
				Bottom End Kit C7112BE	Component Part#	Component Part#	OEM Part#			
					EC208032AFM	Inner Clutch Cover Gasket	11482-43D01			
					EC210020F	Center Case Gasket	11481-43D00			
					WP041018AFM	Water Pump Gasket	17431-43D00			
					WA125	Drain Plug Gasket	09168-12002			
	WA124	Clutch Drain Plug Gasket	09168-06004							
	WA118	Water Pump Drain Washer	17413-28C10							
	Oil Seal Kit C7112OS	Component Part#	Component Description	OEM Part #						
		OS364	Water Pump Oil Seal	17461-03B00						
		OS132	Left Crank Seal 30x40x7	09283-30061						
		OS174	Right Crank Seal 18x30x6	09283-18006						
		OS305	Shift Shaft Seal 14x22x6	09283-14006						
		OS215	Start Shaft Seal 15.8x24x5	09283-16004						
		OS235	Output Shaft Seal 28x38x6	09283-28020						
		R20X2V	Output Shaft O-ring 2	09280-20006						
Clutch & Mag Kit C7136CM	Component Part#	Component Description	OEM Part #							
	EC207060AFM	Mag Cover Gasket	11483-43D00							
C7499	Outer Clutch Cover Gasket	11484-43D00								
RM125	98-00	O-Ring	Top End Kit C7136	R62X2V	Inner Head O-ring	11147-27C11				
				R89X2B	Outer Head O-ring	11148-27C11				
				B0045018AFM	Base Gasket	11241-27C10				
				B0045012F	High Compression Base Gasket .012"					
				PV020018AFM	Right Side Power Valve Gasket	11233-27C32				
				PV021032AFM	Front Power Valve Gasket	11238-27C31				
				PV061018AFM	Front Power Valve Gasket 97-Up	11238-36E00				
				Bottom End Kit w/o crank seals C3361	Component Part#	Component Part#	OEM Part#			
					EC211018AFM	Mag Cover Gasket	11483-36E10			
					EC212032AFM	Inner Clutch Cover Gasket	11482-36E10			
					C7499	Outer Clutch Cover Gasket	11484-43D00			
					EC214020F	Center Case Gasket	11481-36E10			
					WP041018AFM	Water Pump Gasket	17431-43D00			
					Component Part#	Component Description	OEM Part #			
R89X2B	Outer Head O-ring	11148-27C11								
R63X2V	Inner Head O-ring	11147-27C11								
RM125	01-03	O-Ring	Top End Kit C7778	R89X2B	Outer Head O-ring	11148-27C11				
				R63X2V	Inner Head O-ring	11147-27C11				

All Component Parts can be purchased individually.



MX/Dirt • Off-Road Gaskets



Cometic Gasket - An Exclusive NASCAR Performance® Product

SUZUKI RM125

Model	Year	Bore Size	Top End Kit	Component Part#	Component Description	OEM Part #
RM125	01-03	O-Ring	C7778	R89X2B	Outer Head O-ring	11148-27C11
				R63X2V	Inner Head O-ring	11147-27C11
				B0045018AFM	Base Gasket	11241-27C10
				PV020018AFM	Right Side Power Valve Gasket	11233-27C32
				PV061018AFM	Front Power Valve Gasket 97-Up	11238-36E00
				WA123	Head Crush Washer	09168-08021
			Bottom End Kit w/Oil Seals C7778BE	Component Part#	Component Description	OEM Part #
				EC871020F	Center Case Gasket K1-K4	11481-36F20/11481
				WA125	Drain Plug Gasket	09168-12002
				EC502032AFM	Inner Clutch Cover Gasket	11484-36E10
				R116B	Oil Fill Plug Gasket	09280-17003
				WP124060AFM	Water Pump Cover Gasket	17431-36F00
				WA124	Water Pump Drain Gasket	09168-06004
				R20X2V	Output Shaft O-rings	09280-20006
			Oil Seal Kit C7778OS	Component Part#	Component Description	OEM Part #
				OS364	Impeller Seal K1-K3 12x24x10	17461-03B00
			Crank Seal Kit C7784	Component Part#	Component Description	OEM Part #
				OS305	Shift Shaft Seal 14X22X6	09283-14006
				OS244	Clutch Pushrod Seal 10X17X5.0	09285-10004
				OS235	Output Shaft Seal K1-K3 28x	09283-28020
				OS215	Start Shaft Seal 15.8X24X5	09283-16004
				OS174	Left Crank Seal 18X30X6	09283-18007
				OS132	Right Crank Seal 30X40X7	09283-30061
			Clutch & Mag Kit C7788CM	Component Part#	Component Description	OEM Part #
				EC213	Outer Clutch Cover	11482-36F00
				EC211018AFM	Mag Cover Gasket	11483-36E11
RM125	04-07	O-Ring	C7508	Component Part#	Component Description	OEM Part #
				R63X2V	Inner Head O-ring	11147-37F00
				R89X2B	Outer Head O-ring	11148-37F00
				B0705018AFM	Base Gasket	11241-36F00
				B0705012F	High Comp. Base Gasket .012"	
				EX640	Exhaust Gasket	11483-36E10
				PV020018AFM	Right Side Power Valve	11484-43D00
				PV061018AFM	Front Power Valve Gasket	11482-36F00
				WA123	Head Crush Washer	09168-08021
			Bottom End Kit w/Oil Seals C7508BE	Component Part#	Component Description	OEM Part #
				EC502032AFM	Inner Clutch(Primary) Cover	11482-36F00
				EC871020F	Center Case Gasket	11481-36F30
				R116B	Fill Plug Gasket (Trans.)	09280-17003
				R20X2V	Output Shaft O-ring	09280-20006
				WA124	Water Pump Drain Crush Washer	09168-06004
				WA125	Drain Plug Gasket	09168-12002
				WP124032AFM	Water Pump Cover Gasket	17431-36F00
			Oil Seal Kit C7508OS	Component Part#	Component Description	OEM Part #
				OS132	Right Crank Seal	09283-30061
			Crank Seal Kit C7784	Component Part#	Component Description	OEM Part #
				OS174	Left Crank Seal	09283-18007
				OS215	Kickstart Seal	09283-16004
				OS216	Water Pump Oil Seal	17461-37F00
				OS244	Clutch Pushrod Oil Seal	09285-10004
				OS305	Shift Shaft Seal 14x22x6	09283-14006
				OS367	Output Shaft Seal	09289-28012
			Clutch & Mag Kit C7508CM	Component Part#	Component Part#	OEM Part#
				C7499	Clutch Cover O-ring	11484-36E10
				EC211032AFM	Mag Cover Gasket	11483-36E11

All Component Parts can be purchased individually.



MX/Dirt • Off-Road Gaskets



Cometic Gasket - An Exclusive NASCAR Performance® Product

SUZUKI RM250

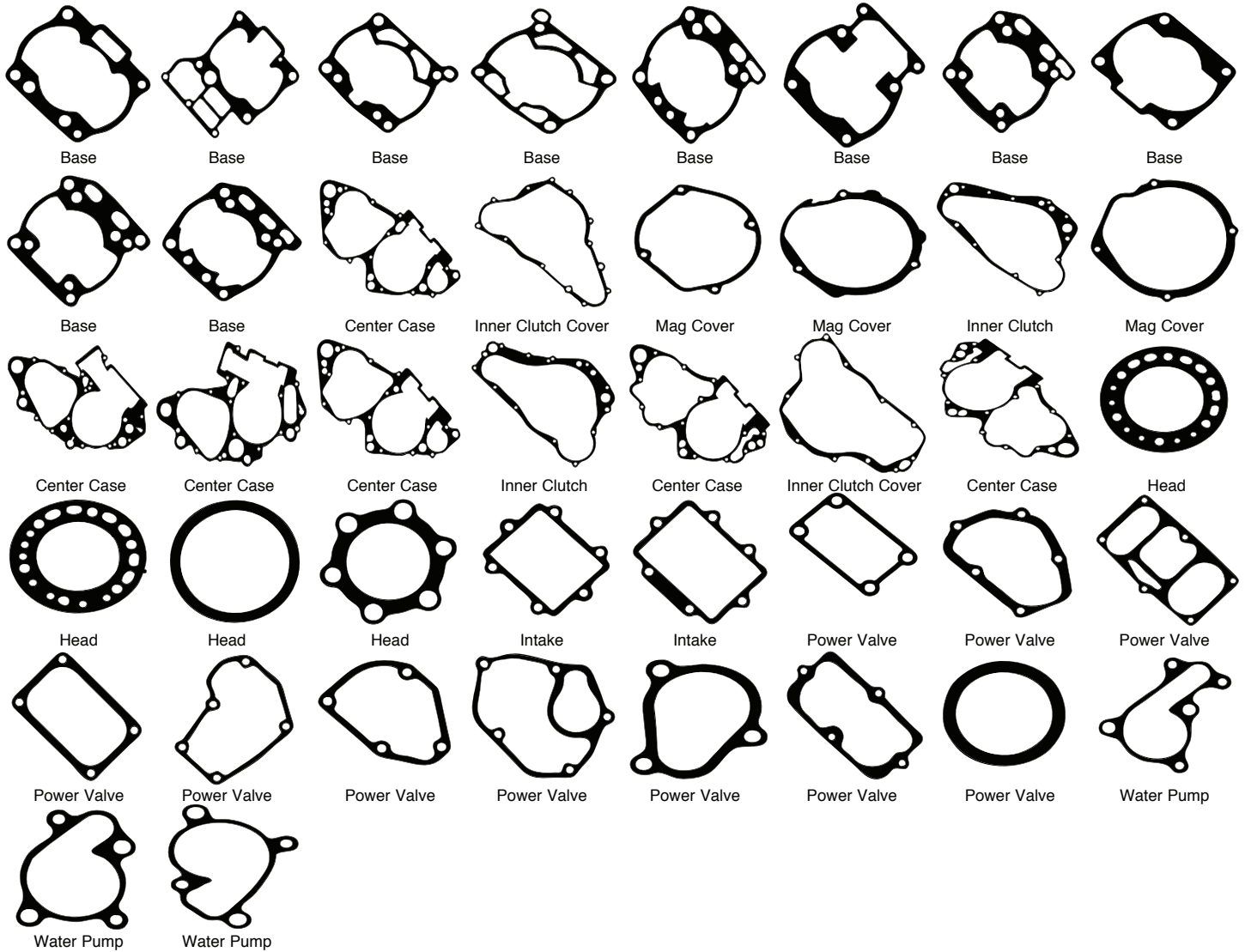

Model	Year	Bore Size	Top End Kit	Component Part#	Component Description	OEM Part #
RM250	77-80	69 mm	C7468	B0350020F	Base Gasket	11241-41100-H17
				H0738016A	Head Gasket	11141-41610
RM250	81	69 mm	C7814	B0446020F	Base Gasket	11241-14201
				H0966043F	Head Gasket	11141-14202
RM250	83	72 mm	C7104	B0046020F	Base Gasket	11241-14600-H17
						11141-13A60
RM250	84-85	72 mm	C7060	B0046020F	Base Gasket	11241-14600-H17
				EX012031F	Exhaust Gasket	14181-16300
				H0045043F	Head Gasket	11141-13A60

All Component Parts can be purchased individually.



MX/Dirt • Off-Road Gaskets



Cometic Gasket - An Exclusive NASCAR Performance® Product

SUZUKI RM250

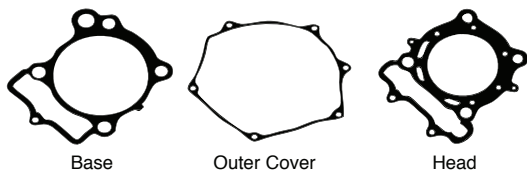

Model	Year	Bore Size	Top End Kit	Component Part#	Component Description	OEM Part #
RM250	86	69 mm	C7061	B0047020F	Base Gasket	H241-00B20-H17
				EX012031F	Exhaust Gasket	14181-16300
				H0046043F	Head Gasket	11141-01C01-H17
				PV022018AFM	Right Side Power Valve Gasket	11233-00B00-H17
			Crank Seal Kit C7701	Component Part# OS175	Component Part# 35X52X8 Right Crank Seal	OEM Part# 09283-36003
				OS176	19X37X6 Left Crank Seal	09283-20046
RM250	87-88	69 mm 74 mm	Top End Kit C7062 C7327	Component Part# H0046043F	Component Description Head Gasket	OEM Part # 11141-01C01-H17
				H0203043F	74mm Bore Head Gasket	
				B0048020F	Base Gasket	11241-00B20-H17
				EX012031F	Exhaust Gasket	14181-16300
				IR004018AFM	Intake Gasket	14132-430
				PV023020F	Center Power Valve Cover	11238-00B20
				PV024020F	Right Side Power Valve Gasket	11233-00B20-H17
			Crank Seal Kit C7701	Component Part# OS175	Component Part# 35X52X8 Right Crank Seal	OEM Part# 09283-36003
				OS176	19X37X6 Left Crank Seal	09283-20046
RM250	89-90	68 mm 73.5 mm	Top End Kit C7063 C7328	Component Part# H0047043F	Component Part# 68mm Bore Head Gasket	OEM Part# 11141-28C10
				H0200043F	73.5mm Bore Head Gasket	
				B0049020F	Base Gasket	11241-28C11
				B0049012F	High Comp. Base Gasket .012"	
				IR011018AFM	Intake Gasket	3008-076/13156-01C10
				PV025018AFM	Center Power Valve Gasket	11238-28C00
				PV026018AFM	Right Power Valve Gasket	11233-37E00
				R132V	Power Valve O-ring	09280-23002
				EC233020F	Clutch Cover Gasket	11482-28C01
				WP039018AFM	Water Pump Gasket	17431-28C00
			Crank Seal Kit C7701	Component Part# OS175	Component Part# 35X52X8 Right Crank Seal	OEM Part# 09283-20051
				OS176	19X37X6 Left Crank Seal	09283-36007
RM250	91	O-Ring	Top End Kit C7065	Component Part# R105X2B	Component Part# Outer Head O-ring	OEM Part# 11148-28C20
				R75X2V	Inner Head O-ring	11147-28C20
				B0049020F	Base Gasket	11241-28C11
				B0049012F	High Comp. Base Gasket .012"	
				IR011018AFM	Intake Gasket	3008-076/13156-01C10
				PV025018AFM	Center Power Valve Gasket	11238-28C00
				PV027018AFM	Right Side Power Valve 93-99	11233-28C01
				R132V	Power Valve O-ring	09280-23002
				C7497	Outer Clutch Cover Gasket	11484-28C10
			Crank Seal Kit C7703	Component Part# OS178	Component Part# 35X52X8 Right Crank Oil Seal	OEM Part# 09283-36007
				OS179	19X37X6 Left Crank Oil Seal	09283-20051

All Component Parts can be purchased individually.



MX/Dirt • Off-Road Gaskets



Cometic Gasket - An Exclusive NASCAR Performance® Product

SUZUKI RM250

Model	Year	Bore Size	Top End Kit	Component Part#	Component Description	OEM Part #												
RM250	92-93	O-Ring	Top End Kit C7123	R105X2B	Outer Head O-ring	11148-28C20												
				R75X2V	Inner Head O-ring	11147-28C20												
				B0050018AFM	Base Gasket	11241-28C11												
				B0050012F	High Comp. Base Gasket .012"													
				IR011018AFM	Intake Gasket	3008-076/13156-01C10												
				PV025018AFM	Center Power Valve Gasket	11238-28C00												
				PV027018AFM	Right Side Power Valve 93-99	11233-28C01												
				R132V	Power Valve O-ring	09280-23002												
				Bottom End Kit w/crank seals C3365	Component Part#	Component Part#	OEM Part#	EC231039F	Mag Cover Gasket	11483-28C01								
								EC233020F	Inner Clutch Cover Gasket	11482-28C01								
								EC272020F	Center Case Gasket	11481-28C00								
								WP049018AFM	90-95 Water Pump Gasket	17431-28C10								
								C7497	Outer Clutch Cover Gasket	11484-28C10								
								Crank Seal Kit C7703	Component Part#	Component Part#	OEM Part#	OS178	35X52X8 Right Crank Oil Seal	09283-36007				
												OS179	19X37X6 Left Crank Oil Seal	09283-20051				
												RM250	94-95	O-Ring	Top End Kit C7156	R105X2B	Outer Head O-ring	11148-28C20
R75X2V	Inner Head O-ring	11147-28C20																
B0050018AFM	Base Gasket	11241-28C11																
B0050012F	High Comp. Base Gasket .012"																	
IR011018AFM	Intake Gasket	3008-076/13156-01C10																
PV025018AFM	Center Power Valve Gasket	11238-28C00																
PV027018AFM	Right Side Power Valve 93-99	11233-28C01																
R132V	Power Valve O-ring	09280-23002																
Bottom End Kit w/crank seals C3366	Component Part#	Component Part#	OEM Part#													C7497	Outer Clutch Cover Gasket	11484-28C10
				EC271060AFM	Mag Cover Gasket	11483-28E10												
				EC273020F	Center Case Gasket	11481-28E10												
				EC297032AFM	Inner Clutch Cover Gasket	11482-28E10												
				WP049018AFM	90-95 Water Pump Gasket	17431-28C10												
				Clutch & Mag Kit C7156CM	Component Part#	Component Description	OEM Part #									C7497	Clutch Cover Gasket	11484-28C10
								EC271060AFM	Mag Cover Gasket	11483-28E10								
								Crank Seal Kit C7704	Component Part#	Component Part#	OEM Part#					OS133	37X52X8 Right Crank Oil Seal	09283-38018
												OS179	19X37X6 Left Crank Oil Seal	09283-20051				
												RM250	96-98	O-Ring	Top End Kit C7280	R105X2B	Outer Head O-ring	11148-28C20
																R75X2V	Inner Head O-ring	11147-28C20
																B0237018AFM	Base Gasket	11241-37E00
																B0237012F	Base Gasket High Comp. .012"	
																IR107018AFM	Intake Gasket	13156-37E10
																PV050018AFM	Right Power Valve Gasket	11233-37E00
																PV051018AFM	Center Power Valve Cover Gasket	11238-37E00
Bottom End Kit w/crank seals C3367	Component Part#	Component Part#	OEM Part#													EC215020F	Center Case Gasket	11481-37E01
																EC216032AFM	Inner Clutch Cover Gasket	11482-37E01
																C7496	Outer Clutch Cover Gasket	11484-37E00
																EC218060AFM	Mag. Cover Gasket	11483-37E00
																Clutch & Mag Kit C7280CM	Component Part#	Component Description
				EC218060AFM	Mag. Cover Gasket	11483-37E00												
				Crank Seal Kit C7665	Component Part#	Component Part#	OEM Part#											
								OS133	37X52X8 Right Crank Oil Seal	09283-38021								

All Component Parts can be purchased individually.



MX/Dirt • Off-Road Gaskets



Cometic Gasket - An Exclusive NASCAR Performance® Product

SUZUKI RM250

Model	Year	Bore Size	Top End Kit	Component Part#	Component Description	OEM Part #	
RM250	99-00	O-Ring	C7505	R105X2B	Outer Head O-ring	11148-28C20	
				R75X2V	Inner Head O-ring	11147-28C20	
				B0364018AFM	Base Gasket	11241-37E30	
				B0364012F	Base Gasket High Comp. .012"		
				IR107018AFM	Intake Gasket	13156-37E10	
				PV061018AFM	Center Power Valve Cover	11238-36E00	
				PV079018AFM	Rt. Side Power Valve Cover	11233-37E30	
				PV081018AFM	Left Side Power Valve Gasket	11234-37E30	
				Bottom End Kit w/crank seals C3368	Component Part#	Component Part#	OEM Part#
					EC216032AFM	Inner Clutch Cover Gasket	11482-37E01
					C7496	Outer Clutch Cover Gasket	11484-37E00
					EC218060AFM	Mag Cover Gasket	11483-37E00
					EC294020F	Center Case Gasket	11481-37E30
				Clutch & Mag Kit C7280CM	Component Part#	Component Description	OEM Part #
	C7496	Clutch Cover Gasket	11484-37E00				
	EC218060AFM	Mag. Cover Gasket	11483-37E00				
Crank Seal Kit C7665	Component Part#	Component Part#	OEM Part#				
	OS131	24X37X6 Left Crank Oil Seal	09283-25099				
	OS133	37X52X8 Right Crank Oil Seal	09283-38021				
RM250	01-02	O-Ring	C7779	Component Part#	Component Description	OEM Part #	
				R100X2B	Outer Head O-ring	11148-37F00	
				R73X2V	Inner Head O-ring	11147-37F00	
				B0495018AFM	Base Gasket	11241-37F01	
				B0495012F	High Comp. Base Gasket .012"		
				IR107018AFM	Intake Gasket	13156-37E10	
				PV061018AFM	Center Power Valve Cover	11238-36E00	
				PV079018AFM	Right Side Power Valve Cover	11233-37E30	
				PV081018AFM	Left Side Power Valve Gasket	11234-37E31	
				C7496	Outer Clutch Cover Gasket	11484-28C10	
				Bottom End Kit w/oil seals C7779BE	Component Part#	Component Part#	OEM Part#
					EC218060AFM	Mag Cover Gasket	11483-37E02
					WA124	Water Pump Cover Crush Washer	09168-06004
					WP122032AFM	Water Pump Cover Gasket	17431-37F00
	EC501032AFM	Primary Cover Gasket	11482-37F01				
	R116B	Fill Plug O-ring	09280-17003				
	C7496	Clutch Cover Gasket	11484-37E00				
	IR107018AFM	Intake Gasket	13156-37E10				
	EC500020F	Center Case Gasket	11481-37F01				
	WA124	Oil Level Screw Crush Washer	09168-06004				
	WA125	Drain Plug Crush Washer	09168-12002				
	OS131	Left Crank Seal 25x37x6	09283-25099				
	OS133	Right Crank Seal 38x52x8	09283-38021				
	OS249	Start Shaft Seal 20x27x5	09283-20031				
	OS228	Clutch Lifter Seal 12x19x5	09285-12004				
	OS235	Output Shaft Seal 28x38x6	09283-28020				
	OS305	Shift Shaft Seal 14x22x6	09283-14006				
	OS364	Water Pump Seal	17461-03B00				
Oil Seal Kit C7779OS	Component Part#	Component Description	OEM Part #				
	OS131	Left Crank Seal 25x37x6	09283-25099				
	OS133	Right Crank Seal 38x52x8	09283-38021				
	OS228	Clutch Lifter Seal 12x19x5	09285-12004				
	OS235	Output Shaft Seal 28x38x6	09283-28020				
	OS249	Start Shaft Seal 20x27x5	09283-20031				
	OS305	Shift Shaft Seal 14x22x6	09283-14006				
	OS364	Water Pump Seal	17461-03B00				
Clutch & Mag Kit C7280CM	Component Part#	Component Description	OEM Part #				
	C7496	Clutch Cover Gasket	11484-37E00				
	EC218060AFM	Mag. Cover Gasket	11483-37E00				

All Component Parts can be purchased individually.



MX/Dirt • Off-Road Gaskets



Cometic Gasket - An Exclusive NASCAR Performance® Product

SUZUKI RM250

Model	Year	Bore Size	Top End Kit	Component Part#	Component Description	OEM Part #	
RM250	03-04	O-Ring	C7467	R100X2B	Outer Head O-ring	11148-37F00	
				R73X2V	Inner Head O-ring	11147-37F00	
				B0632018AFM	Base Gasket	11241-37F20	
				B0632012F	High Comp. Base Gasket .012"		
				PV116018AFM	Right Side Power Valve Gasket	11233-37F20	
				PV117018AFM	Left Side Power Valve Gasket	11234-37F20	
				PV118018AFM	Front Power Valve Gasket	11238-37F20	
				PV125018AFM	Power Valve Spring Gasket	11279-37F30	
				R44X3S	Expansion Chamber O-rings 2 Req.	14171-28C30	
				Bottom End Kit w/oil seals	Component Part#	Component Part#	OEM Part#
				C3370	C7496	Outer Clutch Cover Gasket	11484-28C10
					EC218060AFM	Mag Cover Gasket	11483-37E00
					EC501032AFM	Inner Clutch Cover Gasket	11482-37F00
					EC738020F	Center Case Gasket	11481-37F20
					WP122032AFM	Water Pump Gasket	17431-37F00
Clutch & Mag Kit	Component Part#	Component Description	OEM Part #				
C7280CM	C7496	Clutch Cover Gasket	11484-37E00				
	EC218060AFM	Mag. Cover Gasket	11483-37E00				
Crank Seal Kit	Component Part#	Component Part#	OEM Part#				
C7665	OS131	24X37X6 Left Crank Oil Seal	09283-25099				
	OS133	37X52X8 Right Crank Oil Seal	09283-38021				
RM250	05-08	O-Ring	C3099	R100X2B	Outer Head O-ring	11148-37F00	
				R73X2V	Inner Head O-ring	11147-37F00	
				B0632018AFM	Base Gasket	11241-37F20	
				B0632012F	High Comp. Base Gasket .012"		
				EX640	Exhaust Gasket	14172-28630	
				R44X3S	Exp. O-rings 2 Req.	14171-28C30	
				PV116018AFM	Right Side Power Valve Gasket	11233-37F20	
				PV117018AFM	Left Side Power Valve Gasket	11234-37F20	
				PV118018AFM	Front Power Valve Gasket	11238-37F20	
				PV125018AFM	Power Valve Spring Gasket	11279-37F30	
				Bottom End Kit w/crank seals	Component Part#	Component Description	OEM Part #
				C3371	C7496	Outer Clutch Cover Gasket	11484-28C10
					EC218060AFM	Mag Cover Gasket	11483-37E00
					EC501032AFM	Inner Clutch Cover Gasket	11482-37F00
					EC738020F	Center Case Gasket	11481-37F20
					R116B	Oil Fill Plug O-ring	09280-17003
					R20X2V	Counter Shaft O-ring	09280-20006
					WA124	Water Pump Drain/Trans. Oil Check Plug Washer 2 Req.	09168-06004
					WA125	Drain Plug Washer	09168-12002
					WA126	Power Valve Seal Crush Washer	09168-08015
					WP122032AFM	Water Pump Gasket	17431-37F00
				Clutch & Mag Kit	Component Part#	Component Description	OEM Part #
				C7280CM	C7496	Clutch Cover Gasket	11484-37E00
					EC218060AFM	Mag. Cover Gasket	11483-37E00
				Crank Seal Kit	Component Part#	Component Description	OEM Part #
C3372	OS131	24X37X7 Left Crank Seal	09283-25099				
	OS132	29X40X7 Right Crank Seal	09283-28025				
RMX250	89-92	68 mm	C7257	B0049020F	Base Gasket	11241-28C11	
				H0313059F	Head Gasket	1141-05D00	
				IR011018AFM	ntake Gasket	3008-076/13156-01C10	
				PV025018AFM	Center Power Valve Gasket	11238-28C00	
				PV026018AFM	Right Power Valve Gasket	\$3.80 11233-37E00	
				R134V	Expansion Chamber O-ring	\$3.92 14171-28C01	
				Component Part#	Component Part#	List Price	OEM Part#
				C7496	C7496	\$20.45	11484-28C10

All Component Parts can be purchased individually.



MX/Dirt • Off-Road Gaskets



Cometic Gasket - An Exclusive NASCAR Performance® Product

SUZUKI RMX250

Model	Year	Bore Size	Top End Kit	Component Part#	Component Part#	OEM Part#				
RMX250	93-99	68 mm	C7258	B0050018AFM	Base Gasket	11241-28C11				
				B0050012F	High Compression Base Gasket	11241-28C11				
				H0313059F	Head Gasket	1141-05D00				
				IR011018AFM	Intake Gasket	3008-076/13156-01C10				
				PV025018AFM	Center Power Valve Gasket	11238-28C00				
				PV026018AFM	Right Power Valve Gasket 93-95	11233-37E00				
				PV027018AFM	96-99 Right Power Valve Gasket	11233-28C01				
				R132V	Power Valve O-ring	09280-23002				
				C7496	Clutch Cover Gasket	11484-28C10				
				C7968	Head Gasket 73mm Bore	11141-13E00				
DR-Z250	03-07	73 mm	C7968	H1694027S	Head Gasket 73mm Bore	11141-13E00				
		80 mm	C7969	H1552027S	Head Gasket 80mm Bore					
RM-Z250	04-06	EST	Top End Kit	B0680020F	Base Gasket	11241-13E02				
				C3174-EST	H2169SP1027S	Head Gasket 77mm	K1100-40003			
				C3054-EST	H2096027S	Head Gasket 78mm Bore				
				C3056-EST	H2169027S	Head Gasket 80mm Bore				
				C7221-EST	H1967027S	Head Gasket 81mm Bore				
				C3135-EST	H2471SP1027S	Head Gasket 83mm Bore				
				C3118-EST	H2471027S	Head Gasket 84mm Bore				
				B0691014RC	Base Gasket	K1106-10025				
				3233V	Valve Seals	K9204-91349				
				R018B	Cam Chain Tensioner O-ring	KK920-55086				
				EX651	Exhaust Gasket	14181-49H00				
				Bottom End Kit w/Oil Seals				Component Part#	Component Description	OEM Part #
				C3174BE				WA108	Crank Case Drain Plug Washer	92065-058
								R118B	Crank End Cap O-Ring	670B2022
				EC903032AFM	Inner Clutch Cover Gasket	11061-0030				
				R112B	Timing Mark Plug O-Ring	92055-1141				
				R117B	Crank Case Oil Fill O-Ring	92055-1146				
				R018B	Output Shaft O-Ring (2)	92055-055				
				MR042	Water Pump Cover O-Ring	92055-0010				
				R116B	Water Pipe O-Ring	92055-1308				
Oil Seal Kit				Component Part#	Component Description	OEM Part #				
C3174OS				OS227	Oil Pump Seal 12x22x5	92049-1519				
				OS279	Decomp. Shaft Seal 10x18x5	92049-1196				
				OS295	Crank Seal 30x40x7	92049-1556/92049-0030				
				OS305	Shift Shaft Seal 14x22x6	92049-0015				
				OS306	Clutch Actuator Shaft Seal 12x18x4	92049-1262				
				OS307	Start Shaft Seal 18x30x7	92049-013/92049-007				
				OS308	Impeller Seal 8x22x7/7.5	92049-0021/92049-0061				
				OS309	Inner WP Seal 8x22x5	92049-0016/92049-0060				
				OS359	Output Shaft Seal 25x40x6	92049-1478				
Clutch & Mag Kit				Component Part#	Component Description	OEM Part #				
C3174CM				EC847060AFM	Clutch Cover Gasket	K1106-10031				
				EC904032AFM	Mag Cover Gasket	K1106-10032				

All Component Parts can be purchased individually.



MX/Dirt · Off-Road Gaskets



Cometic Gasket - An Exclusive NASCAR Performance® Product

SUZUKI RM-Z250

Model	Year	Bore Size	EST Top End Kit	Component Part#	Component Description	OEM Part #			
RM-Z250	04-06	77 mm	C3174-EST	H2169SP1027S	Head Gasket 77mm	K1100-40003			
		78 mm	C3054-EST	H2096027S	Head Gasket 78mm Bore				
		80 mm	C3056-EST	H2169027S	Head Gasket 80mm Bore				
		81mm	C7221-EST	H1967027S	Head Gasket 81mm Bore				
		83 mm	C3135-EST	H2471SP1027S	Head Gasket 83mm Bore				
		84 mm	C3118-EST	H2471027S	Head Gasket 84mm Bore				
				B0691014RC	Base Gasket		K1106-10025		
				3233V	Valve Seals		K9204-91349		
				R018B	Cam Chain Tensioner O-ring		KK920-55086		
				EX651	Exhaust Gasket		14181-49H00		
		Bottom End Kit w/Oil Seals C3174BE							
				WA108	Crank Case Drain Plug Washer		92065-058		
		R118B	Crank End Cap O-Ring	670B2022					
		EC903032AFM	Inner Clutch Cover Gasket	11061-0030					
		R112B	Timing Mark Plug O-Ring	92055-1141					
		R117B	Crank Case Oil Fill O-Ring	92055-1146					
		R018B	Output Shaft O-Ring (2)	92055-055					
		MR042	Water Pump Cover O-Ring	92055-0010					
		R116B	Water Pipe O-Ring	92055-1308					
Oil Seal Kit C3174OS									
		OS227	Oil Pump Seal 12x22x5	92049-1519					
		OS279	Decomp. Shaft Seal 10x18x5	92049-1196					
		OS295	Crank Seal 30x40x7	92049-1556/92049-0030					
		OS305	Shift Shaft Seal 14x22x6	92049-0015					
		OS306	Clutch Actuator Shaft Seal 12x18x4	92049-1262					
		OS307	Start Shaft Seal 18x30x7	92049-013/92049-007					
		OS308	Impeller Seal 8x22x7/7.5	92049-0021/92049-0061					
		OS309	Inner WP Seal 8x22x5	92049-0016/92049-0060					
		OS359	Output Shaft Seal 25x40x6	92049-1478					
Clutch & Mag Kit C3174CM									
		EC847060AFM	Clutch Cover Gasket	K1106-10031					
		EC904032AFM	Mag Cover Gasket	K1106-10032					
RM-Z250	07-09	77 mm	C3175-EST	H2617SP2027S	Head Gasket 77mm Bore	11141-10H00			
		78 mm	C3176-EST	H2617027S	Head Gasket 78mm Bore				
		79 mm	C3177-EST	H2617SP1027S	Head Gasket 79mm Bore				
		81 mm	C3203-EST	H2617SP7027S	Head Gasket 81mm Bore				
		83 mm	C3278-EST	H2617SP8027S	Head Gasket 83mm Bore				
				B0884010RC	Base Gasket		11241-10H00		
				EX651	Exhaust Gasket		14181-49H00		
				R018B	Cam Chain Tensioner Gasket		09280-19001		
				WA114	Cam Chain Tensioner Bolt		12837-27F10		
				3251V	Valve Seals		09289-04002		
		Bottom End Kit w/Oil Seals C3175BE							
				EC1148020F	Center Case Gasket		11481-10H00		
		WA125	Drain Plug Gasket	09168-12002					
		WA124	Crank Sensor Gasket	09168-06004					
		R116B	Fill Plug O-ring	09280-17003					
		EC1150032AFM	Inner Clutch Cover Gasket	11482-10H00					
		R119B	Crank End Cap O-Ring	09280-22008					
		R10X2V	Timing Mark Plug O-Ring	09280-10016					
		R20X2V	Output Shaft O-rings	09280-20006					
		R029B	Oil Filter O-Ring	09280-39001					
Oil Seal Kit C3174OS									
		WA124	Clutch Drain Plug Gasket	09168-06004					
		R16X2V	Oil Screen O-ring 16x22x2	09168-16003					
		OS132	Right Crank Seal 30x40x7	09283-30061					
		OS218	Shift Shaft Seal 14x22x6	09283-14006					
		OS370	Inner WP Seal	09282-12012					
		OS216	Impeller Seal	17461-37F00					
		OS367	Output Shaft Seal	09289-28012					
		OS172	Start Shaft Seal	09283-18004					
Clutch & Mag Kit C3175CM									
		EC1154032AFM	Mag Cover Gasket	11483-10H00					
		EC1153032AFM	Clutch Cover Gasket	11484-10H00					



MX/Dirt • Off-Road Gaskets



Cometic Gasket - An Exclusive NASCAR Performance® Product

SUZUKI RM-Z250

Model	Year	Bore Size	EST Top End Kit	Component Part#	Component Description	OEM Part #
RM-Z250	10-19	77 mm	C3406-EST	H3139027S	Head Gasket 77 mm Bore	11141-49H00
		79 mm	C3407-EST	H3139SP1027S	Head Gasket 79 mm Bore	11141-49H00
		80 mm	C3408-EST	H3139SP2027S	Head Gasket 80 mm Bore	11141-49H00
		82 mm	C3409-EST	H3139SP3027S	Head Gasket 82 mm Bore	11141-49H00
		84 mm	C3410-EST	H3139SP5027S	Head Gasket 84 mm Bore	11141-49H00
				3251V	Valve Stem Seals 4 Required	09289-04002
				B1032010RC	Base Gasket	11241-49H00
				EX651	Exhaust Gasket	14181-49H00
				OS020	Head Drain Seal	09168-06023
				R013V	Water Temp Sensor O-ring	13655-14G00
		R019V	Cam Chain Tensioner O-ring			
		R122V	Cam Tower O-ring Seal	09280-26007		
			Bottom End Kit w/o crank seals C3443	Component Part#	Component Description	OEM #
				EC1153032AFM	Clutch Cover Gasket	11484-10H00
				EC1150032AFM	Inner Clutch Cover Gasket	11482-10H00
				EC1633032AFM	Mag Cover Gasket	11483-49H00
				EC1632020F	Center Case Gasket	
			Clutch & Mag Kit C3406CM	Component Part#	Component Description	OEM Part #
				EC1153032AFM	Clutch Cover Gasket	11484-10H00
				EC1633032AFM	Mag Cover Gasket	11483-49H00

SUZUKI DR350, DR-Z400



Base Head

Model	Year	Bore Size	Top End Kit	Component Part#	Component Description	OEM Part #
DR350	90-99	80 mm	C7068	H0244043F	Head Gasket 80mm Bore	11141-14D01
		82 mm	C7157	H0049043F	Head Gasket 82mm Bore	
		88 mm	C7263	H0222043F	Head Gasket 88mm Bore	
		91 mm	C7264	H0229043F	Head Gasket 91mm Bore	
					B0052020F	Base Gasket
			EST Top End Kit	Component Part#	Component Description	OEM Part #
DR-Z400	00-13	92 mm	C7688-EST	H0949027S	Head Gasket	11141-29F01
		94 mm	C7806-EST	H1045027S	Head Gasket 94mm Bore	
		95 mm	C7963-EST	H1699027S	Head Gasket 95mm Bore	
		97 mm	C7980-EST	H1046027S	Head Gasket 97mm Bore	
				B0440010RC	Base Gasket	11241-29F00
				EX243	Exhaust Gasket 2 Req.	14181-29E02
				EC377032AFM	Cam Chain Tensioner Gasket	12837-24A10
				WA121	Cam Chain Tensioner Washer	09168-06023
				3160V	Valve Seals	09289-05011
					Component Part#	Component Description
			EC837032AFM	Clutch Cover Gasket	11484-29F00	
			EST Top End Kit	Component Part#	Component Description	OEM Part #
DRZ400 SM	05-13	92 mm	C7978-EST	H0949027S	Head Gasket 92mm Bore	11141-29F01
		94 mm	C7979-EST	H1045027S	Head Gasket 94mm Bore	
		97 mm	C7980-EST	H1046027S	Head Gasket 97mm Bore	
				B0440027S	Base Gasket	11241-29F11
				EX243	Exhaust Gasket 2 Req.	14181-29E02
		EC377032AFM	Cam Chain Tensioner Gasket	12837-24A10		
		3160V	Valve Seals 4 Req.	09289-05011		
		WA121	Cam Chain Tensioner Washer	09168-06023		
			Component Part#	Component Description	OEM Part #	
			EC837032AFM	Clutch Cover Gasket	11484-29F00	

All Component Parts can be purchased individually.



MX/Dirt • Off-Road Gaskets



Cometic Gasket - An Exclusive NASCAR Performance® Product

SUZUKI RM-Z450

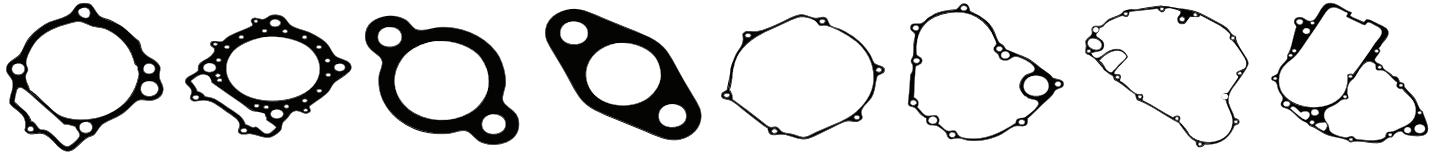

Model	Year	Base Bore Size	Head Bore Size	Cam Chain Tensioner EST	Timing Chain	Outer Clutch Cover	Mag Cover	Inner Clutch Cover	Center Case
RM-Z450	05-07	95.5 mm	97.5 mm	C3102-EST					
		98 mm		C3104-EST					
				C3127-EST					

Bottom End Kit w/Oil Seals	Component Part#	Component Description	OEM Part #
C3102BE	WA140	Water Pump Drain Washer	09168-06018
	R10X2V	Timing Plug O-ring	09280-10016
	R116B	Fill Plug O-ring	09280-17003
	R020V	Output Shaft O-ring	09280-21010
	R119B	Crank End Cap O-Ring	09280-22008
	R029B	Oil Filter O-Ring	09280-39001
	EC1021020RC	Center Case Gasket	11481-35G11
	EC1020032AFM	Inner Clutch Cover Gasket	11482-35G10
	MR043	Water Pump Cover O-Ring	17431-35G10
Oil Seal Kit	Component Part#	Component Description	OEM Part #
C3102OS	OS370	Inner WP Seal	09282-12012
	OS218	Shift Shaft Seal 14x22x6	09283-14006
	OS249	Start Shaft Seal	09283-20031
	OS132	Right Crank Seal	09283-30061
	OS219	Clutch Actuator Seal	09285-10004
	OS338	Output Shaft Seal	09289-31002
	OS216	Impeller Seal	17461-37F00
	OS371	Decomp. Shaft Seal 10x17x6	09282-10014
Clutch & Mag Kit	Component Part#	Component Description	OEM Part #
C3102CM	EC1018032AFM	Outer Clutch Cover Gasket	11484-35G10
	EC1019032AFM	Mag Cover Gasket	11483-35G10

All Component Parts can be purchased individually.



MX/Dirt • Off-Road Gaskets



Cometic Gasket - An Exclusive NASCAR Performance® Product

SUZUKI RM-Z450

Model	Year	Bore Size	EST	Component Part#	Component Description	OEM Part #
RM-Z450	08-19	97mm	Top End Kit	H2784027S	97mm Bore Head Gasket	11141-28H00
			C3233-EST	H2784SP1027S	99mm Bore Head Gasket	
			C3234-EST	H2784SP2027S	101mm Bore Head Gasket	
		101mm	B0943018S	Base Gasket	11241-28H00	
			EX877	Exhaust Gasket	14181-35G00	
			EC440032AFM	Cam Chain Tensioner Gasket	12837-24A10	
			3238V	Valve Seals 4 Req.	09289-05015	
Bottom End Kit w/Oil Seals				Component Part#	Component Description	OEM Part #
C3233BE				R116B	Fill Plug O-Ring	09280-17003
				R22X2V	Sprocket Spacer O-ring 1.9,ID:21.8	09280-21010
				R22X2V	Crank End Plug O-ring	09280-22008
				WA116	Drain Plug Gasket	09168-08016
				R029B	Oil Filter Cover O-ring D:2.0, ID:38.5	09280-39001
				R16X2V	Oil Screen O-ring 16x22x2	09168-16003
				WP470	Water Pump Cover O-Ring	17431-28H00
				R122V	Neutral Safety Switch O-ring	09280-26005
				R9X2V	Oil Pump Dowel O-ring	09280-09005
				R007V	Oil Pump Nozzle O-ring 4x1.2	09280-05007
				EC1250020RC	Center Case Gasket	11481-28H00
				EC1251032AFM	Inner Clutch Cover Gasket	11482-28H00
Oil Seal Kit				Component Part#	Component Description	OEM Part #
C3233OS				OS132	Right Crank Seal 30x40x7	09283-30061
				OS216	Water Pump Oil seal	17461-37F00
				OS338	Output Shaft Oil Seal 31x4	09289-31003
				OS249	Start Shaft Oil Seal 20x27x5	09283-20031
				OS305	Shift Shaft Seal 14x22x6	09283-14006
				OS370	Water Pump Seal	09282-12012
				OS372	Left Crank Seal 32x47x6	09283-32037
Clutch & Mag Kit				Component Part#	Component Description	OEM Part #
C3233CM				EC1249032AFM	Clutch Cover Gasket	11484-28H00
				EC1252032AFM	Mag Cover Gasket	11483-28H00

Model	Year	Bore Size	Top End Kit	Component Part#	Component Description	OEM Part #
DR650	95-15	103 mm	C7335	H0460043F	Head Gasket	11141-12D00
				B0273020F	Base Gasket	11241-32E00

YAMAHA PW50

Model	Year	Bore Size	Top End Kit	Component Part#	Component Description	OEM Part #
PW50	81-05	42 mm	C7266	H0309010C	Head Gasket	517-11181-01-00
				B0185018AFM	Base Gasket	3PT-11351-00
YSR50	87-92	46 mm	C7075	H0057010C	Head Gasket	5G6-11181-00-00
				B0057018AFM	Base Gasket	3T2-11351-00-00

YAMAHA YZ65

Model	Year	Bore Size	Top End Kit	Component Part#	Component Description	OEM Part #				
YZ65	18-19	O-ring	C3694	R032V	Inner Head O-ring	93210-50582-00				
				R041V	Outer Head O-ring	93210-76MF8-00				
				PV160018AFM	Right Power Valve Cover Gasket	BR8-11993-00-00				
				PV159018AFM	Front Power Valve Gasket	BR8-11354-00-00				
				B1427020F	Base Gasket	BR8-11351-00-00				
				R38X3V	Exhaust Gasket	BR8-14642-00-00				
				Oil Seal Kit				Component Part#	Component Description	OEM Part #
				C3694OS				OS231	Power Valve Shaft Seal	93104-08040-00
								OS286	Clutch Actuator Seal	93102-12224-00
								OS110	Crank Seals	93102-20485-00
								OS354	Shift Shaft Seal	93101-12173-00
								OS232	Start Shaft Seal	93102-17263-00
								OS231	Power Valve Shaft Seal	93104-08040-00
				OS358	Output Shaft Seal	93102-26042-00				
				OS242	Impeller Shaft Seal	93109-11073-00				

All Component Parts can be purchased individually.



MX/Dirt • Off-Road Gaskets



Cometic Gasket - An Exclusive NASCAR Performance® Product

YAMAHA PW80

Model	Year	Bore Size	Top End Kit	Component Part#	Component Description	OEM Part #
PW80	83-01	50 mm	C7251	H0310010C	Head Gasket	1W7-11181-00-00
				B0186018AFM	Base Gasket	4AW-11351-00
			Top End Kit	Component Part#	Component Description	OEM Part #
YZ80	84	50 mm	C7106	H0059043F	Head Gasket	58T-11181-01-00
				B0058020F	Base Gasket	4VD-11351-00-00
			Crank Seal Kit	Component Part#	Component Description	OEM Part #
			C7666	OS116	Right Crank Seal 27X40X8	93103-28011
				OS115	Left Crank Seal 19X40X8	93102-20447
YZ80 N	85	50 mm	Top End Kit	Component Part#	Component Description	OEM Part #
			C7076	H0059043F	Head Gasket	58T-11181-01-00
				B0058020F	Base Gasket	4VD-11351-00-00
				IR014018AFM	Intake Gasket	1LR-13621-00-00
			Crank Seal Kit	Component Part#	Component Description	OEM Part #
			C7666	OS116	Right Crank Seal 27X40X8	93103-28011
				OS115	Left Crank Seal 19X40X8	93102-20447
YZ80 KR, Z,HF,V, W,B	86-92	50 mm	Top End Kit	Component Part#	Component Description	OEM Part #
			C7080	H0060043F	Head Gasket	1LR-11181-01-00
				B0058020F	Base Gasket	4VD-11351-00-00
				IR014018AFM	Intake Gasket	1LR-13621
				R127V	Exhaust O-ring	93210-40745-00
			Crank Seal Kit	Component Part#	Component Description	OEM Part #
			C7666	OS116	Right Crank Seal 27X40X8	93103-28011
				OS115	Left Crank Seal 19X40X8	93102-20447
YZ80	93-01	O-Ring 54 mm Big Bore	Top End Kit	Component Part#	Component Description	OEM Part #
			C7137	R85X2V	Outer Head O-ring	93210-84724-00
			C7331	R55X2V	Inner Head O-ring	93210-56459-00
				H0303043F	54mm Big Bore Head Gasket	
				B0120018AFM	Base Gasket	4ES-11351-00-00
				B0120012F	High Comp. Base Gasket .012"	
				R127V	Exhaust O-ring	5PA-14642-00-00
			Bottom End Kit w/Oil Seals	Component Part#	Component Description	OEM Part #
			C7137BE	WP054018AFM	Water Pump Gasket	4BA-12428-00-00
				WA118	Water Pump Drain Plug	90430-06166-00
				WA116	Case Drain Crush Washer	90430-08119-00
				R116B	Fill Plug O-ring	93210-19123-00
			Oil Seal Kit	Component Part#	Component Description	OEM Part #
			C7137OS	OS354	Shift Shaft Seal 11.5X21X4	93101-12173-00
			Crank Seal Kit	Component Part#	Component Description	OEM Part #
			C7666	OS286	Clutch Pushrod Oil seal 12x18x5	93102-12224-00
				OS232	Start Shaft Seal 17x25x4	93102-17263-00
				OS225	Output Shaft Seal 20X30X5	93102-20143-00
				OS173	Left Crank Seal 27x40x8	93102-20447-00
				OS115	Right Crank Seal 19Xx40x8	93103-28126-00
				OS226	Water Pump Oil Seal 10x31x13.5	93103-10147-00 /93103-10168-00
			Clutch & Mag Kit	Component Part#	Component Description	OEM Part #
			C7137CM	C7500	Clutch Cover	4ES-15461-00-00
				EC219060AFM	Mag Cover	4ES-15451-00-00

All Component Parts can be purchased individually.



MX/Dirt • Off-Road Gaskets



Cometic Gasket - An Exclusive NASCAR Performance® Product

YAMAHA YZ85

Model	Year	Bore Size	Top End Kit	Component Part#	Component Description	OEM Part #	
YZ85	02-18	O-Ring	C7851	R85X2V	Outer Head O-ring	93210-84724-00	
				R57X2V	Inner Head O-ring	93210-56459-00	
				B0120018AFM	Base Gasket	4ES-11351-00-00	
				B0120012F	High Comp. Base Gasket .012"		
				R127V	Exhaust O-ring 2 Req.	5PA-14642-00-00	
				Bottom End Kit w/Oil Seals C7851BE	Component Part#	Component Description	OEM Part #
				WP054020F	Water Pump Gasket	4BA-12428-00-00	
				EC220020F	Inner Clutch Cover	4ES-15461-00-00	
				WA116	Drain Plug Gasket	90430-08119-00	
				R117B	Fill Plug O-ring	93210-19123-00	
Oil Seal Kit C7851OS	Component Part#	Component Description	OEM Part #				
OS354	Shift Shaft Seal 11.5X21X4	93101-12173-00					
Crank Seal Kit C7666	Component Part#	Component Description	OEM Part #				
OS286	Clutch Pushrod Oil seal 12x18x5	93102-12224-00					
OS227	Water Pump Seal 12x22x5	93102-12321-00					
OS232	Start Shaft Seal 17x25x4	93102-17263-00					
OS173	Left Crank Seal 27x40x8	93102-20447-00					
OS358	Output Shaft Seal 26X38X5	93102-26042-00					
OS115	Right Crank Seal 19Xx40x8	93102-28009-00					
OS283	Impeller Seal 11x25x7	93109-11073-00					
Clutch & Mag Kit C7851CM	Component Part#	Component Description	OEM Part #				
EC640060AFM	Mag Cover Gasket	5PA-15451-00-00					
EC632018AFM	Outer Clutch Cover Gasket	93210-12152-00					
YZ85	2019	O-Ring	C3731	R55X2V	Inner Cylinder Head O-Ring	93210-56459-00	
				R85X2V	Outer Cylinder Head O-ring	93210-84724-00	
				PV164	Right Power Valve Cover Gasket	B4B-11993-00-00	
				PV163	Front Power Valve Cover Gasket	1C3-11354-00-00	
				B1438018AFM	Cylinder Base Gasket	B4B-11351-00-00	
				WA136	Cylinder Head Crush Washer	90201-080L8-00	
				OS231	Power Valve Axle Oil Seal	93104-08040-00	
				R127V	Exhaust O-rings	93210-40745-00	
				Bottom End Kit C3731BE	Component Part#	Component Description	OEM Part #
				WA118	Water Pump Crush Washer	90430-06166-00	
WP638018AFM	Water Pump Cover Gasket	BR8-12428-00-00					
EC2450018AFM	Primary Cover Gasket	BR8-15461-00-00					
R19X2V	Fill Plug O-ring	93210-19123-00					
WA116	Drain Plug Crush Washer	90430-08119-00					
Oil Seal Kit C3694OS	Component Part#	Component Description	OEM Part #				
OS110	Crank Seals	93102-20485-00					
OS227	Primary Cover Seal (WP)	93102-12106-00					
OS231	Power Valve Actuator Oil Seal	93104-08040-00					
OS232	Start Shaft Seal	93102-17263-00					
OS242	Impeller Shaft Seal	93109-11073-00					
OS286	Clutch Lifter Oil Seal	93102-12224-00					
OS354	Shift Shaft Seal	93101-12173-00					
OS358	Output Shaft Seal	93102-26042-00					
Clutch & Mag Kit C7851CM	Component Part#	Component Description	OEM Part #				
EC640060AFM	Outer Clutch Cover Gasket	5PA-15463-00-00					
EC2449032AFM	Mag Cover Gasket	5PA-15451-00-00					

All Component Parts can be purchased individually.



MX/Dirt • Off-Road Gaskets



Cometic Gasket - An Exclusive NASCAR Performance® Product

YAMAHA TT-R90



Base Cam Chain Tensioner Head

Model	Year	Bore Size	Top End Kit
TT-R90	00-08	48mm	C3249-EST

Component Part#	Component Description
H2813SP1043F	Head Gasket
B0956010RC	Base Gasket
EC1286018AFM	Cam Chain Tensioner
3179V	Valve Seals 2 Req.
R013V	Valve Guide O-ring 2 Req.
R133B	Valve Cover O-rings 2 Req.
WA114	Cam Chain Washer 2 Req.
R62X2V	Cam Gear Cover

OEM Part #
4GL-11181-00-00
5HN-11351-00-00
90430-06014-00
1WG-12119-00-00
93210-09418-00
93210-44704-00
90430-06014-00
93210-63556-00

YAMAHA YZ125

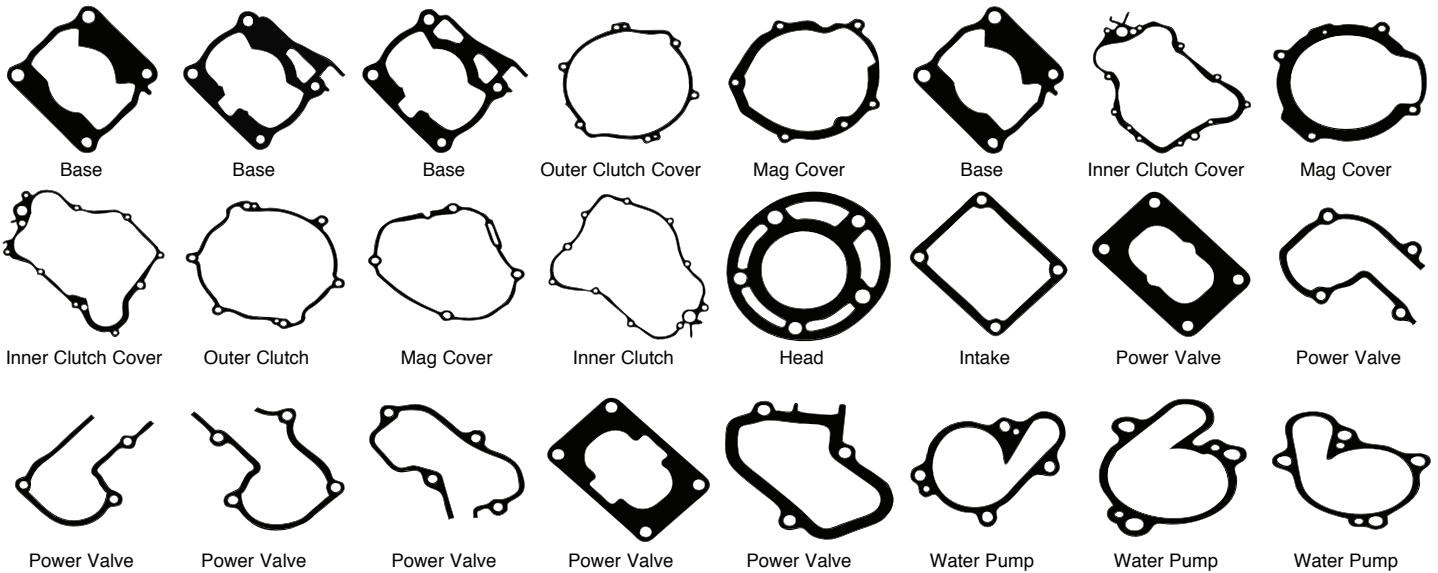

Model	Year	Bore Size	Top End Kit
YZ125	83-84	58 mm	C7107

Component Part#	Component Description
H0061043F	Head Gasket
B0059020F	Base Gasket

OEM Part #
55Y-11181-01-00
24X-11351-00-00

Model	Year	Bore Size	Top End Kit	Component Part#	Component Description	OEM Part #
YZ125 N	85	58 mm	C7081	H0061043F	Head Gasket	55Y-11181-01-00
				B0059020F	Base Gasket	24X-11351-00-00
				IR015020F	Intake Gasket	39W-13621-01-00
				PV029020F	Right Side Power Valve Cover	5X4-1131N-00-00
				PV030020F	Left Side Power Valve Gasket	5X4-11993-00-00

Model	Year	O-Ring	Top End Kit
YZ125 S, T, J	86-88	O-Ring	C7082

Component Part#	Component Description
R105X2B	Outer Head O-ring
R63X2V	Inner Head O-ring
B0060020F	Base Gasket
PV035020F	Right Side Power Valve Gasket
PV029020F	Left Side Power Valve Cover
IR016020F	Intake Gasket

OEM Part #
93211-07720-00
93210-65721-00
1LX-11351-00-00
2VM-11993-00-00
5X4-1131N-00-00
3XP-13621-00-00

Component Part#	Component Description
OS118	Left Crank Seal 21X40X7
OS123	Right Crank Seal 30X44X8

All Component Parts can be purchased individually.



MX/Dirt • Off-Road Gaskets



Cometic Gasket - An Exclusive NASCAR Performance® Product

YAMAHA YZ125 W

Model	Year	Bore Size	Top End Kit	Component Part#	Component Description	OEM Part #	
YZ125 W	89	O-Ring	Top End Kit C7083	R105X2B	Outer Head O-ring	93211-07720-00	
				R63X2V	Inner Head O-ring	93210-65721-00	
				B0060020F	Base Gasket	1LX-11351-00-00	
				IR017020F	Intake Gasket	80L-13621-01-00	
				PV035020F	Right Side Power Valve Gasket	2VM-11993-00-00	
				PV029020F	Left Side Power Valve Cover	5X4-1131N-00-00	
				Crank Seal Kit C7668	Component Part#	Component Description	OEM Part #
					OS118	Left Crank Seal 21X40X7	93102-22363-00
					OS123	Right Crank Seal 30X44X8	93103-32171-00
				YZ125	90-91	O-Ring	Top End Kit C7084
R105X2B	Outer Head O-ring	93211-07720-00					
R63X2V	Inner Head O-ring	93210-65721-00					
B0060020F	Base Gasket	1LX-11351-00-00					
IR017020F	Intake Gasket	80L-13621-01-00					
PV035020F	Right Side Power Valve Gasket	2VM-11993-00-00					
PV029020F	Left Side Power Valve Cover	5X4-1131N-00-00					
Crank Seal Kit C7668	Component Part#	Component Description	OEM Part #				
	OS118	Left Crank Seal 21X40X7	93102-22363-00				
	OS123	Right Crank Seal 30X44X8	93103-32171-00				
YZ125	92-93	O-Ring	Top End Kit C7139	Component Part#	Component Description	OEM Part #	
				R105X2B	Outer Head O-ring	93211-07720-00	
				R63X2V	Inner Head O-ring	93210-65721-00	
				B0060020F	Base Gasket	1LX-11351-00-00	
				R221V	Exhaust O-ring	93210-45742-00	
				IR017020F	Intake Gasket	80L-13621-01-00	
				PV033020F	Right Side Power Valve Gasket	4DB-11993-01-00	
				PV032020F	Left Side Power Valve Gasket	4DB-1131N-00-00	
				Bottom End Kit w/crank seals C3294	Component Part#	Component Description	OEM Part #
					EC284020F	Inner Clutch Gasket	1LX-15462-10
EC283020F	Mag Cover Gasket	4DB-15451-00					
Crank Seal Kit C7668	Component Part#	Component Description	OEM Part #				
	C7481	Clutch Cover	3JD-15463-10				
	WP060020F	Water Pump Gasket	1LX-12428-01				
YZ125	94-97	O-Ring	Top End Kit C7158	Component Part#	Component Description	OEM Part #	
				OS118	Left Crank Seal 21X40X7	93102-22363-00	
				OS123	Right Crank Seal 30X44X8	93103-32171	
				Component Part#	Component Description	OEM Part #	
				R90X2B	Outer Head O-ring	93210-90785-00	
				R63X2V	Inner Head O-ring	93210-63442-00	
				B0153018AFM	Base Gasket	4JY-11351-00	
				B0153012F	Base Gasket High Comp. 012"	4JY-11351-00	
				R223V	Exhaust O-ring 2 Req.	93210-42728-00	
				PV059018AFM	Front Power Valve Gasket	4JY-11354-00	
PV041018AFM	Right Power Valve Gasket	4JY-11993-00-00					
Bottom End Kit w/crank seals C3295	Component Part#	Component Description	OEM Part #				
	EC268032AFM	Inner Clutch Cover Gasket	4JY-15462-00				
	EC224018AFM	Mag Cover Gasket	4JY-15451-00				
Clutch & Mag Kit C7158CM	Component Part#	Component Description	OEM Part #				
	C7489	Clutch Cover	4JY-15463-00				
	WP043018AFM	Water Pump Gasket	4JY-12428-00				
Crank Seal Kit C7705	Component Part#	Component Description	OEM Part #				
	C7489	Clutch Cover Gasket	4JY-15463-01-00				
	EC219060AFM	Mag Cover Gasket	4ES-15451-00				
Crank Seal Kit C7705	Component Part#	Component Description	OEM Part #				
	OS118	Left Crank Seal 21X40X7	93102-22363-00				
				OS123	Right Crank Seal 30X44X8	93103-32171-00	

All Component Parts can be purchased individually.



MX/Dirt • Off-Road Gaskets



Cometic Gasket - An Exclusive NASCAR Performance® Product

YAMAHA YZ125

Model	Year	Bore Size	Top End Kit	Component Part#	Component Description	OEM Part #
YZ125	98-00	O-Ring	C7399	R90X2B	Outer Head O-ring	93210-90785-00
				R63X2V	Inner Head O-ring	93210-63442-00
				B0318018AFM	Base Gasket	5DH-11351-01-00
				B0318012F	High Compression Base Gasket	5DH-11351-01-00
				PV059018AFM	Front Power Valve Cover Gasket	4JY-11354-00
				PV041018AFM	Right Side Power Valve Gasket	4JY-11993-00
				R224V	Exhaust O-rings 98-00 2 Req.	93210-45742-00
				R223V	Exhaust O-rings 2001 2 Req.	5MV-14642-00-00
			Bottom End Kit w/Oil Seals C7399BE	Component Part#	Component Description	OEM Part #
				EC268032AFM	Inner Clutch Gasket	4JY-15462-00
				WP043018AFM	Water Pump Gasket	4JY-12428-00
				R018V	Case Dowel Pin O-ring	93210-16314-00
				WA114	Drain Plug Gasket	90430-12207-00
				R19X2V	Fill Plug O-ring	93210-19123-00
			Oil Seal Kit C7399OS	Component Part#	Component Description	OEM Part #
				OS117	Right Side Crank Seal	93103-32183-00
			Crank Seal Kit C7667	Component Part#	Component Description	OEM Part #
				OS118	Left Side Crank Seal	93102-22363-00
				OS227	Inner Water Pump Oil Seal 12x22x5	93102-12321-00
				OS228	Shift Shaft Seal 12x19x5	93109-12012-00
				OS231	Power Valve Shaft Oil Seal 8x12x3	93104-08040-00
				OS232	Starter Shaft Seal 17x25x4	93102-17263-00
				OS242	Water Pump Oil Seal 12x25x7	93109-11073-00
				OS286	Clutch Pushrod Oil Seal 12x18x5	93102-12224-00
				OS358	Output Shaft Seal 28x38x5	93102-26042-00
			Clutch & Mag Kit C7158CM	Component Part#	Component Description	OEM Part #
				C7489	Clutch Cover Gasket	4JY-15463-01-00
				EC219060AFM	Mag Cover Gasket	4ES-15451-00
YZ125	01-02	O-Ring	Top End Kit C7853	Component Part#	Component Description	OEM Part #
				R90X2B	Outer Head O-ring	93210-90785-00
				R63X2V	Inner Head O-ring	93210-63442-00
				B0318018AFM	Base Gasket	5DH-11351-01-00
				B0318012F	High Compression Base Gasket	5DH-11351-01-00
				PV059018AFM	Front Power Valve Cover Gasket	4JY-11354-00
				PV041018AFM	Right Side Power Valve Gasket	4JY-11993-00
				R223V	Exhaust O-rings 2001 2 Req.	5MV-14642-00-00
YZ125	03-04	O-Ring	Top End Kit C7936	Component Part#	Component Description	OEM Part #
				R90X2B	Outer Head O-ring	93210-90785-00
				R63X2V	Inner Head O-ring	93210-63442-00
				B0318032AFM	Base Gasket	5DH-11351-01-00
				B0318012F	High Compression Base Gasket	5DH-11351-01-00
				PV114018AFM	Front Power Valve Gasket	4JY-11993-00
				PV041018AFM	Right Side Power Valve Gasket	4JY-11993-00
				R223V	Exhaust O-rings 2001 2 Req.	5MV-14642-00-00
YZ125	01-04	O-Ring	Bottom End Kit w/Oil Seals C7853BE	Component Part#	Component Description	OEM Part #
				R018V	Case O-ring	93210-16314-00
				WA114	Drain Plug Gasket	90430-12207-00
				EC268020F	Inner Clutch Cover Gasket	4JY-15462-00-00
				R19X2V	Trans Fill Plug O-ring	93210-19123-00
				WA114	Clutch Drain Plug Gasket	90430-06014-00
				WP043018AFM	Water Pump Cover Gasket	4JY-12428-10-00
			Oil Seal Kit C7853OS	Component Part#	Component Description	OEM Part #
				OS110	Left Crank Seal	93102-20485-00
				OS182	Right Crank Seal	93102-30008-00
				OS227	Water Pump Shaft Seal	93102-12321-00
				OS228	Shift Shaft Seal	93109-12012-00
				OS231	PV Governor Oil Seal	93104-08040-00
				OS232	Kickstart Shaft Seal	93102-17263-00
				OS242	Impeller Seal	93109-11073-00
				OS286	Clutch Pushrod Seal	93102-12224-00
				OS358	Output Shaft Seal	93102-26042-00
			Clutch & Mag Kit C7158CM	Component Part#	Component Description	OEM Part #
				C7489	Clutch Cover Gasket	4JY-15463-01-00
				EC219060AFM	Mag Cover Gasket	4ES-15451-00



MX/Dirt • Off-Road Gaskets



Cometic Gasket - An Exclusive NASCAR Performance® Product

YAMAHA YZ125

Model	Year	Bore Size	Top End Kit	Component Part#	Component Description	OEM Part #
YZ125	05-19	O-Ring	C3105	R90X2B	Outer Head O-ring	93210-90785-00
				R63X2V	Inner Head O-ring	93210-63442-00
				B0749032AFM	Base Gasket	1C3-11351-00-00
				B0749018AFM	Base Gasket	1C3-11351-00-00
				R223V	Exhaust O-rings 2001 2 Req.	5MV-14642-00-00
				PV131018AFM	Right Side Power Valve Cover	1C3-11993-00-00
				PV114018AFM	Front Power Valve Gasket	4JY-11354-10-00
				WA136	Head Crush Washers 5 Req.	90201-080L8-00
Bottom End Kit w/Oil Seals C3105BE				Component Part#	Component Description	OEM Part #
				EC1006018AFM	Primary (Inner Clutch) Cover	1C3-15462-00-00
				R018V	Crankcase Dowel O-ring	93210-16314-00
				R116B	Fill Plug O-ring	93210-19123-00
				WA082063C	Drain Plug Gasket	90430-10188-00
				WA114	Clutch Cover Drain Plug Washer	90430-06014-00
				WP177032AFM	Water Pump Gasket	1C3-12428-00-00
Oil Seal Kit C3105OS				Component Part#	Component Description	OEM Part #
				OS110	Left Crank Seal	93102-20485-00
				OS229	Clutch Pushrod Seal	93102-10008-00
				OS232	Kickstart Shaft Seal	93102-17263-00
				OS233	Inner Water Pump Seal	93102-08307-00
				OS235	Output Shaft Seal	93102-28012-00
				OS308	Outer Water Pump Seal	93102-08004-00
				OS286	Shift Shaft Seal	93102-12224-00
				OS234	Right Crank Seal	93102-22419-00
				OS230	Inner Shift Shaft Seal	93104-12003-00
Clutch & Mag Kit C3105CM				Component Part#	Component Description	OEM Part #
				EC927032AFM	Clutch Cover Gasket	1C3-15463-00
				EC1005018AFM	Mag Cover Gasket	1C3-15451-00

YAMAHA TT125

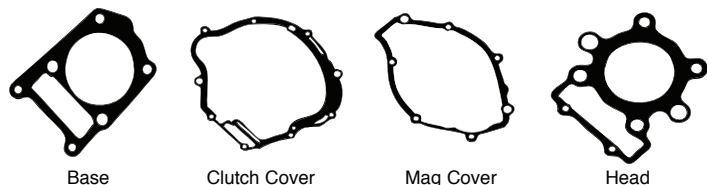

Model	Year	Bore Size	Top End Kit	Component Part#	Component Description	OEM Part #
TTR125	99-05	55 mm	C7755	H1014010S	Head Gasket	5AP-11181-00
		58 mm	C7815	H1014SP1010S	Head Gasket 58mm Bore	5AP-11181-00
				B0478020F	Base Gasket	5HP-11351-00
				R70X2S	Base O-ring	93210-57897-00
				R140V	Cam Cover O-ring	93210-71462-00
Bottom End Kit C3299				Component Part#	Component Description	OEM Part #
				EC471020F	Mag Cover Gasket	5HP-15451-00
				EC470020F	Clutch Cover Gasket	5HP-15461-00
				R132V	Tappet Cover O-ring 2 Req	93210-44704-00

YAMAHA DT/WR200

Model	Year	Bore Size	Top End Kit	Component Part#	Component Description	OEM Part #
DT/WR200	90-92	68 mm	C7142	H0178043F	Head Gasket	4TP-11181-00-00
		72 mm	C7330	H0450043F	Head Gasket 72mm	
				B0135020F	Base Gasket	4TP-11351-00-00

All Component Parts can be purchased individually.



MX/Dirt • Off-Road Gaskets



Cometic Gasket - An Exclusive NASCAR Performance® Product

YAMAHA YZ250

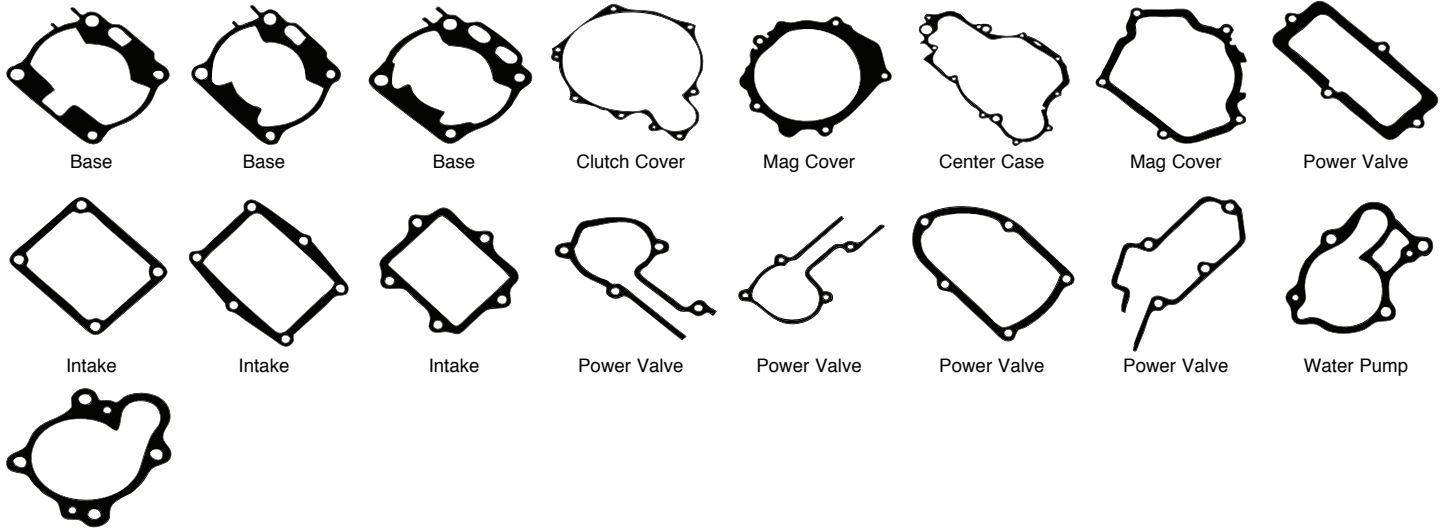

Model	Year	Bore Size	Top End Kit	Component Part#	Component Description	OEM Part #
YZ250	86-87	O-Ring	C7086	R115X2B	Outer Head O-ring	93211-17405-00
				R76X2V	Inner Head O-ring	93210-77363-00
				B0061020F	Base Gasket	1LU-11351-00-00
				IR018018AFM	Intake Gasket	2K7-13621-00-00
				PV034020F	Right Side Power Valve Gasket	1LU-11993-00-00
				PV029020F	Left Side Power Valve Gasket	5X4-1131N-00-00
YZ250	88	O-Ring	Top End Kit C7087	R110X2B	Outer Head O-ring	93211-11770-00
				R76X2V	Inner Head O-ring	93210-77363-00
				B0061020F	Base Gasket	1LU-11351-00-00
				IR018018AFM	Intake Gasket	2K7-13621-00-00
				PV037020F	Right Side Power Valve	2VM-11993-00-00
				PV029020F	Left Side Power Valve Gasket	5X4-1131N-00-00
				R228V	Exhaust O-ring	93210-56743-00
			Crank Seal Kit C7669	OS118	Left Crank Seal 21X40X7	93102-22363-00
				OS119	Right Crank Seal 34X55X10	93103-40091-00
YZ250	89	O-Ring	Top End Kit C7088	R110X2B	Outer Head O-ring	93211-11770-00
				R76X2V	Inner Head O-ring	93210-77363-00
				B0062018AFM	Base Gasket	2VM-11351-10
				B0062012F	Base Gasket	2VM-11351-10
				PV037020F	Right Side Power Valve	2VM-11993-00-00
				PV036018AFM	Left Side Power Valve	3JE-1131N-10-00
				IR017020F	Intake Gasket	8CH/8DF-13621-00
				R228V	Exhaust O-ring	93210-56743-00
			Crank Seal Kit C7669	OS118	Left Crank Seal 21X40X7	93102-22363-00
				C7488	Clutch Cover	3SP-15463-11-00
YZ250, WR250	90-91 92-94	O-Ring	Top End Kit C7089	R110X2B	Outer Head O-ring	93211-11770-00
				R76X2V	Inner Head O-ring	93210-77363-00
				B0062018AFM	Base Gasket	2VM-11351-10-00
				B0062012F	High Compression Base Gasket	2VM-11351-10-00
				IR017020F	Intake Gasket	8CH/8DF-13621-00
				PV036018AFM	Left Side Power Valve	3JE-1131N-10-00
				PV038018AFM	Right Side Power Valve Gasket	3SP-11993-10-00
				R228V	Exhaust O-ring	93210-56743-00
			Crank Seal Kit C7669	OS118	Left Crank Seal 21X40X7	93102-22363-00
				OS119	Right Crank Seal 34X55X10	93103-40091-00
				C7488	Clutch Cover	3SP-15463-11-00

All Component Parts can be purchased individually.



MX/Dirt • Off-Road Gaskets



Cometic Gasket - An Exclusive NASCAR Performance® Product

YAMAHA YZ250

Model	Year	Bore Size	Top End Kit	Component Part#	Component Description	OEM Part #	
YZ250	95-96	O-Ring	Top End Kit C7250	R110X2B	Outer Head O-ring	93211-11770-00	
				R76X2V	Inner Head O-ring	93210-77363-00	
				B0062018AFM	Base Gasket	2VM-11351-10-00	
				B0062012F	High Compression Base Gasket	2VM-11351-10-00	
				IR017020F	Intake Gasket	8CH/8DF-13621-00	
				PV036018AFM	Left Side Power Valve	3JE-1131N-10-00	
				PV038018AFM	Right Side Power Valve Gasket	3SP-11993-10-00	
				PV045018AFM	Left side PV	4MX-11354-00	
				R224V	Exhaust O-ring	93210-472A9-00	
				Component Part#	Component Description	OEM Part #	
				Bottom End Kit w/crank seals C3300	C7488	Clutch Cover	3SP-15463-11-00
					EC253060AFM	Mag Cover Gasket	2VM-15462-10-00
					EC254020F	Crankcase Gasket	2VM-15462-10-00
					WP044018AFM	Water Pump Gasket	2VM-12428-11-00
					Component Part#	Component Description	OEM Part #
Clutch & Mag Kit C7113CM	C7488	Clutch Cover	3SP-15463-11-00				
	EC253060AFM	Mag Cover Gasket	2VM-15462-10-00				
	Component Part#	Component Description	OEM Part #				
Crank Seal Kit C7669	OS118	Left Crank Seal 21X40X7	93102-22363-00				
	OS119	Right Crank Seal 34X55X10	93103-40091-00				
	Component Part#	Component Description	OEM Part #				
YZ250	97-98	O-Ring	Top End Kit C7337	R110X2B	Outer Head O-ring	93211-11770-00	
				R76X2V	Inner Head O-ring	93210-77363-00	
				B0272018AFM	Base Gasket .018" AFM		
				B0272012F	High Compression Base Gasket		
				IR017020F	Intake Gasket	8CH/8DF-13621-00	
				R224V	Exhaust O-ring	93210-472A9-00	
				PV036018AFM	Left Side Power Valve	3JE-1131N-10-00	
				PV038018AFM	Right Side Power Valve Gasket	3SP-11993-10-00	
				PV045018AFM	Left side PV	4MX-11354-00	
				Component Part#	Component Description	OEM Part #	
				Bottom End Kit w/crank seals C3300	C7488	Clutch Cover	3SP-15463-11-00
					EC253060AFM	Mag Cover Gasket	2VM-15462-10-00
					EC254020F	Crankcase Gasket	2VM-15462-10-00
					WP044018AFM	Water Pump	2VM-12428-11-00
					Component Part#	Component Description	OEM Part #
Clutch & Mag Kit C7113CM	C7488	Clutch Cover	3SP-15463-11-00				
	EC253060AFM	Mag Cover Gasket	2VM-15462-10-00				
	Component Part#	Component Description	OEM Part #				
Crank Seal Kit C7669	OS118	Left Crank Seal 21X40X7	93102-22363-00				
	OS119	Right Crank Seal 34X55X10	93103-40091-00				
	Component Part#	Component Description	OEM Part #				
YZ250	99-01	O-Ring	Top End Kit C7507	R101X2B	Outer Head O-ring	93211-02703-00	
				R73X2V	Inner Head O-ring	93210-74316-00	
				B0372032AFM	Base Gasket	5CU-11351-00	
				B0372012F	High Compression Base Gasket		
				PV082018AFM	Right Side Power Valve Gasket	5CU-11993-00	
				PV083018AFM	Front Power Valve Gasket	5CU-11354-00	
				R016B	Power Valve Governor O-ring	93210-15639-00	
				R54X3V	Exhaust Gasket 2-Req.	93210-53638-00	
				Component Part#	Component Description	OEM Part #	
				Bottom End Kit w/crank seals C3300	C7488	Clutch Cover	3SP-15463-11-00
					EC253060AFM	Mag Cover Gasket	2VM-15462-10-00
					EC254020F	Crankcase Gasket	2VM-15462-10-00
					WP044018AFM	Water Pump	2VM-12428-11-00
					Component Part#	Component Description	OEM Part #
					Clutch & Mag Kit C7113CM	C7488	Clutch Cover
EC253060AFM	Mag Cover Gasket	2VM-15462-10-00					
Component Part#	Component Description	OEM Part #					
Crank Seal Kit C7669	OS118	Left Crank Seal 21X40X7	93102-22363-00				
	OS119	Right Crank Seal 34X55X10	93103-40091-00				
	Component Part#	Component Description	OEM Part #				
YZ250	02-19	O-Ring	Top End Kit C7855	R101X2B	Outer Head O-ring	93211-02703-00	
				R73X2V	Inner Head O-ring	93210-74316-00	
				B0372032AFM	Base Gasket	5CU-11351-00	
				B0372018AFM	High Compression Base Gasket		
				PV082018AFM	Right Side Power Valve Gasket	5CU-11993-00	
				PV083018AFM	Front Power Valve Gasket	5CU-11354-00	
				R016B	Power Valve Governor O-ring	93210-15639-00	
				R54X3V	Exhaust Gasket 2-Req.	93210-53638-00	
				IR114018AFM	Intake Gasket	5NX-13622-00	
				Component Part#	Component Description	OEM Part #	

All Component Parts can be purchased individually.



MX/Dirt • Off-Road Gaskets



Cometic Gasket - An Exclusive NASCAR Performance® Product

YAMAHA YZ250

Model	Year	Bore Siz	Top End Kit	Component Part#	Component Description	OEM Part #	
YZ250	02-19	72mm	C3592	H0873SP2020S	Cylinder Head Gasket		
Forward Motion and Cylinder Works				B0372032AFM	Base Gasket	5CU-11351-00	
72mm Bore Kits				PV082018AFM	Right Side Power Valve Gasket	5CU-11993-00	
				PV083018AFM	Front Power Valve Gasket	5CU-11354-00	
				R016B	Power Valve Governor O-ring	93210-15639-00	
				R54X3V	Exhaust Gasket 2-Req.	93210-53638-00	
				IR114018AFM	Intake Gasket	5NX-13622-00	
Bottom End Kit w/Oil Seals							
YZ250	99-19	O-Ring	C7507BE	R127V	Crank Case Coolant Seal	5CU-15454-00-00	
				EC300032AFM	Inner Clutch Cover	5CU-15462-00-00	
				WP068018AFM	Water Pump Cover Gasket	5XF-12428-00-00	
				WA133	Clutch Pushrod Retainer Seal	90430-05242-00	
				WA080043C	Water Pump Drain Washer	90430-06014-00	
				WA080043C	Water Pump Drain Plug Gasket	90430-06014-00	
				WA114	Drain Plug Gasket	90430-12207-00	
				R117B	Fill Plug O-ring	93210-19123-00	
				R12X2V	Output Shaft O-ring	93210-22298-00	
Oil Seal Kit							
				C7507OS	OS227	Inner Water Pump Seal	93102-12321-00
					OS286	Clutch Pushrod Seal	93102-12224-00
					OS286	Shift Shaft Seal	93102-12224-00
					OS323	Start Shaft Seal	93102-18278-00
					OS110	Left Crank Seal	93102-20485-00
					OS184	Right Crank Seal	93102-28004-00
					OS119	Right Crank Seal 99-00	93103-36182-00
					OS242	Outer Water Pump Seal	93109-11073-00
					OS284	Output Shaft Seal	93102-32M07-00
Clutch & Mag Kit							
				C7507CM	C7528	Clutch Cover Gasket	5CU-15463-00
					EC299060AFM	Mag Cover Gasket	5CU-15451-00
Crank Seal Kit							
YZ250	99-01	O-Ring	C7670	OS119	Right Crank Seal 34X55X10	93103-40091-00	
					OS110	Left Crank Seal 20X40X7	93102-20485-00
Crank Seal Kit							
YZ250	02-14	O-Ring	C7803	OS184	Right Crank Seal 26X55X10	93102-28004-00	
					OS110	Left Crank Seal 20X40X7	93102-20485-00
Top End Kit							
TTR250	99-06	75 mm	C7726	H0461043F	Head Gasket	4GY-11181-01-00	
		83 mm	C7340	H0461SP1043F	Big Bore Head Gasket 83mm		
				B0391020F	Base Gasket	4GY-11351-00-00	
				B0391SP1020F	Big Bore Base Gasket		
				EC353020F	Clutch Cover Gasket	4GY-15461-00-00	

All Component Parts can be purchased individually.



MX/Dirt • Off-Road Gaskets



Cometic Gasket - An Exclusive NASCAR Performance® Product

YAMAHA WR250F

Model	Year	Bore Size	Top End Kit	Component Part#	Component Description	OEM Part #
WR250F	01-13	77 mm	C7905-EST	H1168SP3027S	Head Gasket	5NL-11181-00-00
		79 mm	C3057-EST	H1168SP2027S	Head Gasket 79mm Bore	
		81 mm	C3059-EST	H1271027S	Head Gasket 81mm Bore	
		83 mm	C3061-EST	H1272SP3027S	Head Gasket 84mm Bore	
		84 mm	C3120-EST	B0503020RC	Base Gasket	5NL-11351-00-00
				EX651	Exhaust Gasket	5NL-14613-00-00
				EC019032AFM	AFM Cam Chain Tens. Gasket	4FM-12213-00
				3179V	Exhaust Valve Seal 2 Req.	4SV-12119-00-00
				3233V	Intake Valve Seal 3 Req.	4TV-12119-00-00

Bottom End Kit w/Oil Seals	Component Part#	Component Description	OEM Part #	
C3561BE	EC554032AFM	Inner Clutch Cover Gasket	5NL-15462-00-00	
	R011B	Oil Delivery Pipe O-Ring (SM)	93210-07003-00/ 07540-00	
	R013B	Oil Delivery Pipe O-Ring (3)	93210-10197-00	
	R014B	Oil Delivery Pipe O-Ring (LG)	93210-12759-00	
	R016B	Base and Case Dowel O-ring	93210-16716-00 / 93210-16772-00	
	R109B	Oil Filter O-Ring (SM) (2)	93210-07135-00	
	R10X2V	Center Case Dowel O-ring	93210-10197-00*	
	R113B	Timing Mark Plug O-Ring	93210-14369-00	
	R120V	Electric Starter O-ring	93210-25711-00	
	R121V	Crank End Plug O-ring	93210-27370-00/ 93210-27778-00	
	R134B	Oil Filter O-Ring	93210-47675-00	
	R19X2V	Oil Fill Plug O-ring	93210-19123-00	
	R141SB	Starter Gear O-ring	93210-60426-00	
	R903B	Oil Delivery Pipe O-Ring (MED)	93210-09008-00	
	WA080043C	Water Pump Drain Washer	90430-06014-00	
	WA082063C	Oil Line Crush Washer (2)	90430-10188-00	
	WA082063C	Oil Drain Bolt Washer	90430-10188-00*/ 10171-00	
	WA116	Oil Line Crush Washer (2)	90430-08119-00	
	WP297	Water Pump Cover O-ring	5NL-12439-00-00	
	R116B	Kickstart O-ring	93210-17570-00	
	Oil Seal Kit C3561OS	OS227	Inner Water Pump Seal	93102-12321-00
		OS236	Oil Pump Seal	93101-14164-00
		OS283	Outer Water Pump Seal	93109-11073-00
OS286		Shift Shaft Seal	93102-12224-00	
OS286		Hot Start Mech Oil Seal	93102-12224-00	
OS323		Start Shaft Seal	93102-18278-00	
OS324		Output Shaft Seal	93102-28010-00	
Clutch & Mag Kit C3561CM	EC553032AFM	Outer Clutch Cover Gasket	5NL-15453-10-00	
	EC1931032AFM	Mag Cover Gasket	5UM-15451-00-00	

All Component Parts can be purchased individually.



MX/Dirt · Off-Road Gaskets



Cometic Gasket - An Exclusive NASCAR Performance® Product

YAMAHA YZ250F

Model	Year	Bore Size	Top End Kit	Component Part#	Component Description	OEM Part #
YZ250F	01-13	77 mm	C7905-EST	H1168SP3027S	Head Gasket	5NL-11181-00-00
		79 mm	C3057-EST	H1168SP2027S	Head Gasket 79mm Bore	
		81 mm	C3059-EST	H1271027S	Head Gasket 81mm Bore	
		83 mm	C3061-EST	H1272SP3027S	Head Gasket 84mm Bore	
		84 mm	C3120-EST	B0503020RC	Base Gasket	5NL-11351-00-00
				EX651	Exhaust Gasket	5NL-14613-00-00
				EC019032AFM	AFM Cam Chain Tens. Gasket	4FM-12213-00
				3179V	Exhaust Valve Seal 2 Req.	4SV-12119-00-00
				3233V	Intake Valve Seal 3 Req.	4TV-12119-00-00
		Bottom End Kit w/Oil Seals				Component Part#
		C3057BE	EC554032AFM	Inner Clutch Cover Gasket	5NL-15462-00-00	
			R011B	Oil Delivery O-ring (SM)	93210-07003-00/07540-00	
			R013B	Oil Pump Seal O-Ring	93210-10197-00*	
			R013B	Clutch Side Oil Feed Line O-Ring	93210-10197-00*	
			R013B	Mag Side Oil Feed Line O-Ring	93210-10197-00*	
			R014B	Oil Delivery Pipe O-Ring (Lg.)	93210-12759-00	
			R016V	Case Dowel O-ring	93210-16772-00	
			R109B	Oil Filter Cover O-Ring (Sm.)	93210-07135-00	
			R10X2V	Centercase Dowel O-ring	93210-10197-00*	
			R113B	Timing Plug O-ring	93210-14369-00	
			R124B	Crank End Plug O-ring	93210-32172-00	
			R134B	Oil Filter O-Ring (LG)	93210-47675-00	
			R19X2V	Oil Fill Plug O-ring	93210-19123-00	
			R903V	Oil Delivery Pipe O-ring (Med.)	93210-09008-00	
			WA080043C	Coolant Drain Bolt Washer	90430-06014-00*	
			WA082063C	Oil Drain Bolt Washer	90430-10188-00*/10171-00	
			WP297	Water Pump O-Ring	5NL-12439-00-00	
Oil Seal Kit				Component Part#	Component Description	OEM Part #
		C3057OS	OS323	Kick Start Shaft Seal	93102-18278-00	
			OS324	Countershaft Oil Seal	93102-28010-00	
			OS283	Outer Water Pump Seal	93109-11073-00	
			OS227	Inner Water Pump Seal	93102-12106-00	
			OS236	Oil Pump Seal	93101-14164-00	
			OS286	Gear Selector Seal	93102-12224-00	
Clutch & Mag Kit				Component Part#	Component Description	OEM Part #
		C3057CM	EC553032AFM	Clutch Cover Gasket	5NL-15453-00-00	
			EC527060AFM	Mag. Cover Gasket	5NL-15451-00-00	

All Component Parts can be purchased individually.



MX/Dirt • Off-Road Gaskets



Cometic Gasket - An Exclusive NASCAR Performance® Product

YAMAHA YZ250F

Model	Year	Bore Size	Top End Kit	Component Part#	Component Description	OEM Part #
YZ250F	14-18	77mm	C3549-EST	H3885027S	Head Gasket 77mm Bore	1SM-11181-00-00
WR250F	15-18	80mm	C3550-EST	H3885SP4027S	Head Gasket 80mm Bore	
				B1236010RC	Base Gasket	1SM-11351-00-00
				EX651	Exhaust Gasket	5NL-14613-00-00
				EC019032AFM	Cam Chain Tensioner Gasket	4FM-12213-00-00
				3239V	Exhaust Valve Stem Seal 2 req.	4TE-12119-00-00
				3234V	Intake Valve Stem Seal 2 req.	33M-12119-00-00
				WA114	Cylinder Head Drain Seal	90430-06014-00
				WA140	Cam Chain Tens. Crush Seal	5EL-12214-00-00
				R020V	TPS O-ring	1DX-14562-00-00
Bottom End Kit w/Oil Seals						
			C3549BE	WA082063C	Case Drain Crush Washer	90430-10188-00
				R117B	Fill Plug O-ring	93210-19123-00
				R13.5X2V	Timing Mark O-ring	93210-14369-00
				R127V	Timing Plug O-ring	93210-357A3-00
				R115V	Water Pump Coolant Elb. O-ring	93210-16500-00
				R116B	Kickstart O-ring	93210-17570-00
				R016V	Case Water Pipe O-ring	93210-16716-00
						93210-16772-00
				WA080043C	Water Pump Drain Plug	90430-06014-00
				EC1935032AFM	Inner Clutch Cover Gasket	1SM-15462-00-00
				R013V	Oil Filter O-ring	93210-45708-00
				R014V	Oil Pump O-ring	93210-12010-00
				R014V	Coolant Elbow O-ring	93210-16275-00
				WP439032AFM	Water Pump Gasket	33D-12427-00-00
Oil Seal Kit						
			C3549OS	OS236	Water Pump Oil Seal	93101-14164-00
				OS323	Start Shaft Seal	93102-18278-00
				OS229	Clutch Actuator Seal	93102-10008-00
				OS197	Shift Shaft Seal	93109-14010-00
				OS235	Output Shaft Seal	93102-28012-00
				OS308	Outer Water Pump Seal	93102-08004-00
				OS233	Inner Water Pump Seal	93102-08307-00
Clutch & Mag Kit						
			C3549CM	EC1941032AFM	Outer Clutch Cover Gasket	1SM-15453-00-00
				EC1942032AFM	Mag Cover Gasket	1SM-15451-00-00
Top End Kit						
YZ250F	2019	77mm	C3695	EC019018AFM	Cam Chain Tensioner	4FM-12213-00-00
				H4659027S	Cylinder Head Gasket	B7B-11181-00-00
				WA080043C	Water Passage Crush Washer	90430-06014-00
				B1432010RC	Cylinder Base Gasket	B7B-11351-00-00
				EX651	Header Gasket	5NL-14613-00-00
				3239V	Exhaust Valve Seal	4TE-12119-00-00
				3234V	Intake Valve Seal	33M-12119-00-00
Clutch & Mag Kit						
			C3695CM	EC2464032AFM	Outer Clutch Cover Gasket	
				EC2466018AFM	Mag Cover Gasket	

YAMAHA XT350

Model	Year	Bore Size	Top End Kit	Component Part#	Component Description	OEM Part #
XT350	85-99	87.5 mm	C7530	H0836043F	Head Gasket	55V-11181-00-00
				B0388020F	Base Gasket	4DR-11351-00

All Component Parts can be purchased individually.



MX/Dirt • Off-Road Gaskets



Cometic Gasket - An Exclusive NASCAR Performance® Product

YAMAHA YZ400F

Model	Year	Bore Size	Top End Kit	Component Part#	Component Description	OEM Part #
YZ400F	98-99	92 mm	C7400	H0707027S	Head Gasket	5BE-11181-00-00
		94 mm	C7401	H0709027S	Head Gasket 94mm Bore	
		95 mm	C7689	H0869027S	Head Gasket 95mm Bore	
		97 mm	C7470	H0725027S	Head Gasket 97mm Bore	
			B0334020RC	Base Gasket	5BE-11351-00-00	
			EC019018AFM	Cam Chain Tensioner Gasket	4FM-12213-00	
			Bottom End Kit w/o crank seals C3303	Component Part#	Component Description	OEM Part #
				C7487	Outer Clutch Cover Gasket	5BE-15453-00
				EC292060AFM	Mag Cover Gasket	5BE-15451-00
				EC293032AFM	Inner Clutch Cover Gasket	5BE-15462-00
			Clutch & Mag Kit C7400CM	Component Part#	Component Description	OEM Part #
				C7487	Outer Clutch Cover Gasket	5BE-15453-00
				EC292060AFM	Mag Cover Gasket	5BE-15451-00

YAMAHA YZ426F

Model	Year	Bore Size	EST Top End Kit	Component Part#	Component Description	OEM Part #
YZ400	98-99	92 mm	C7400-EST	H0707027S	Head Gasket	5BE-11181-00-00
YZ426F,	00-02	94 mm	C7401-EST	H0709027S	Head Gasket 94mm Bore	
WR426		95 mm	C7689-EST	H0869027S	Head Gasket 95mm Bore	5JG-11181-00-00
		97 mm	C7470-EST	H0725027S	Head Gasket 97mm Bore	
				B0334020RC	Base Gasket	5BE-11351-00-00
				EC019018AFM	Cam Chain Tensioner Gasket	4FM-12213-00
				EX641	Header Gasket	3VD-14613-01-00
				WA082063C	Crush Washers Oil Line	90430-10188-00
				Banjo Bolt (2)		
				3179V	Intake Valve Seal (3)	4SV-12119-00-00
				3234V	Exhaust Valve Seal (2)	33M-12119-00-00
YZ426F,	00-02		Bottom End Kit C7689BE	Component Part#	Component Description	OEM Part #
WR426				EC293032AFM	Primary Cover Gasket	5BE-15462-00-00
				R013B	Case Dowel O-ring	93210-10197-00
				R013B	Oil Pump Dowel O-ring	93210-10197-00
				R013B	Oil Delivery Line O-rings (4)	93210-10197-00
				R014B	Oil Delivery Pipe O-ring Outer	93210-12759-00
				R109B	Oil Filter Cover Passage O-rings (3)	93210-07135-00
				R124B	Timing Gear O-ring	93210-32172-00
				R12X2V	Output Shaft Backup O-ring	93210-22298-00
				R13.5X2V	Timing Mark O-ring	93210-14369-00
				R134B	Oil Filter Cover O-ring	93210-47675-00
				R7X2V	Oil Delivery Pipe O-ring inner	93210-07540-00
				R903V	Oil Delivery Pipe O-ring middle	93210-09008-00
				WA116	Crush Washers Oil Line (4)	90430-08119-00
				WA137	Drain Plug Crush Washer	90430-12213-00
				WP189	Water Pump Cover Gasket	5BE-12439-00-00
				R018V	Oil Passage O-rings	93210-19758-00
			Oil Seal Kit C7689OS	Component Part#	Component Description	OEM Part #
				OS227	Shift Shaft Seal	93102-12321-00
				OS236	Water Pump Seal	93101-14164-00
				OS284	Output Shaft Seal	93102-32480-00
				OS285	Start Shaft Seal	93102-20108-00
				OS286	Clutch Actuator Seal	93102-12224-00
				OS283	Water Pump Impeller Seal	93109-11073-00
				OS227	Inner Water Pump Seal	93102-12321-00
			Clutch & Mag Kit C7689CM	Component Part#	Component Description	OEM Part #
				EC292018AFM	Mag Cover Gasket	5BE-15451-00-00
				EC789032AFM	Clutch Cover Gasket	5JG-15453-00-00

All Component Parts can be purchased individually.



MX/Dirt • Off-Road Gaskets



Cometic Gasket - An Exclusive NASCAR Performance® Product

YAMAHA YZ450F

Model	Year	Bore Size	EST	Component Part#	Component Description	OEM Part #			
YZ450F	03-05	95 mm	Top End Kit						
			C7947-EST	H1710027S	Head Gasket	5TA-11181-00-00			
			C3147-EST	H2144027S	Head Gasket 96mm Bore				
			C3064-EST	H1711027S	Head Gasket 97mm Bore				
			C3148-EST	H1683027S	Head Gasket 98mm Bore				
			C3149-EST	H1683SP2027S	Head Gasket 99mm Bore				
			C3117-EST	H1683SPB027S	Head Gasket 100mm Bore				
				B0626020RC	Base Gasket	5TA-11351-00-00			
				B0626SP2020RC	Base Gasket 100mm Kits				
				EX641	Exhaust Gasket	3VD-14613-01-00			
				EC019018AFM	Cam Chain Tensioner Gasket	4FM-12213-00			
				EC019020F	Cam Chain Tensioner Gasket				
				WA082063C	Oil Line Washers 2 Req.	90430-10171			
				3179V	Intake Valve Seal 3 Req.	4SV-12119-00-00			
				3234V	Exhaust Valve Seal 2 Req.	33M-12119-00-00			
				WA114	Head Drain Washers	90430-06014			
				WA116	Oil Line Washers 4 Req.	90201-08087-00			
			Bottom End Kit w/Oil Seals						
				C7947BE		Component Part#	Component Description	OEM Part #	
						WP189	Water Pump Cover O-ring	5BE-12439-00-00	
			EC762032AFM	Inner Clutch Cover	5TA-15462-00-00				
			WA080043C	Coolant Drain Gasket	90430-06014-00				
			WA080043C	Water Pump Drain Gasket	90430-06014-00				
			WA116	Oil Line Crush Washer	90430-08119-00				
			WA082063C	Drain Plug Gasket	90430-10188-00				
			WA082063C	Oil Line Crush Washer	90430-10188-00				
			R109B	Oil Filter Cover O-rings	93210-07135-00				
			R903V	Oil Pipe O-ring	93210-09008-00				
			R013B	Case Dowel O-ring	93210-10197-00				
			R014B	Oil Pipe O-ring	93210-12759-00				
			R027V	Timing Mark O-ring	93210-14369-00				
			R114B	Water Pipe O-ring	93210-16500-00				
			R19X2V	Fill Plug O-ring	93210-19123-00				
			R018V	Water Outlet O-rings	93210-19758-00				
			R12X2V	Output Shaft O-ring	93210-22298-00				
			R124B	Timing Gear O-ring	93210-32172-00				
			R134B	Oil Filter Cover O-ring	93210-47675-00				
Oil Seal Kit									
	C7947OS		Component Part#	Component Description	OEM Part #				
			OS227	Inner Water Pump Oil Seal	93102-12321-00				
			OS236	Oil Pump Seal	93101-14164-00				
			OS242	Outer Water Pump Oil Seal	93109-11073-00				
			OS284	Output Shaft Seal	93102-32480-00				
			OS285	Kick Start Shaft Seal	93102-20108-00				
			OS286	Hot Start Lever Oil Seal	93102-12224-00				
			OS286	Clutch Pushrod Seal	93102-12224-00				
			OS286	Shift Shaft Seal	93102-12224-00				
Clutch & Mag Kit									
	C7947CM		Component Part#	Component Description	OEM Part #				
			EC761018AFM	Mag Cover Gasket	5TA-15451-00-00				
			C3129	Outer Clutch Cover Gasket	5TA-15453-00-00				
			Component Part#	Component Description	OEM Part #				
			VC104	Valve Cover Gasket					

All Component Parts can be purchased individually.



MX/Dirt • Off-Road Gaskets



Cometic Gasket - An Exclusive NASCAR Performance® Product

YAMAHA YZ450F

Model	Year	Bore Size	EST	Component Part#	Component Description	OEM Part #		
YZ450F	06-09	95 mm	Top End Kit					
			C7908-EST	H2477027S	Head Gasket 95mm	2S2-11181-00-00		
		98 mm	C3178-EST	H2477SP1027S	Head Gasket 98mm	2S2-11181-00-00		
			C3279-EST	H2477SP4027S	Head Gasket 99mm	2S2-11181-00-00		
				B0849020RC	Base Gasket	2S2-11351-00-00		
				EX696	Exhaust Gasket	3VD-14613-01-00		
				3179V	Intake Valve Seal 3 Req.	4SV-12119-00-00		
				3234V	Exhaust Valve Seal 2 Req.	33M-12119-00-00		
				EC019018AFM	Cam Chain Tensioner Gasket	4FM-12213-00		
				WA082063C	Oil Line Washers 2 Req.	90430-10171		
				WA114	Drain Plug Gasket	90430-06014		
				WA116	Oil Line Washers 4 Req.	90201-08087-00		
		Bottom End Kit w/Oil Seals C7908BEF						
					Component Part#	Component Description	OEM Part #	
			EC1100031F	Inner Clutch Cover	2S2-15462-10-00			
			WP189	Water Pump Cover Gasket	5BE-12439-00-00			
			WA080043C	Water Pump Drain Crush Washer	90430-06014-00			
			WA080043C	Case Oil Galley Drain Plug	90430-06014-00			
			WA116	Case Water Galley Drain Plug	90430-08119-00			
			WA082063C	Drain Plug Crush Seal	90430-10188-00			
			R109B	Oil Pump O-rings	93210-07135-00			
			R011V	Mag Cover Oil Passage O-ring	93210-08003-00			
			R012B	Case Oil Level Plug O-ring	93210-09350-00			
			R013B	Case Oil Galley O-ring	93210-10197-00			
			R113B	Timing Mark O-ring	93210-14369-00			
			R19X2V	Fill Plug O-Ring	93210-19123-00			
			R018V	Primary Cover Oil Passage O-ring	93210-19758-00			
			R12X2V	Output Shaft O-ring	93210-22298-00			
			R121V	Crank End Plug O-ring	93210-27778-00			
			R134B	Oil Pump Cover O-ring	93210-47675-00			
			R143V	Electric Starter Cover O-ring	93210-58346-00			
Oil Seal Kit C7908OS								
			Component Part#	Component Description	OEM Part #			
			OS227	Inner Water Pump Oil Seal	93102-12321-00			
			OS236	Oil Pump Seal	93101-14164-00			
			OS242	Outer Water Pump Oil Seal	93109-11073-00			
			OS284	Output Shaft Seal	93102-32480-00			
			OS285	Kick Start Shaft Seal	93102-20108-00			
			OS286	Clutch Pushrod Seal	93102-12224-00			
			OS286	Shift Shaft Seal	93102-12224-00			
Clutch & Mag Kit C7908CM								
			Component Part#	Component Description	OEM Part #			
			EC763020F	Outer Clutch Cover	5TA-15453-00-00			
			EC1099031F	Mag Cover Gasket	2S2-15451-00-00			
			Component Part#	Component Description	OEM Part #			
			VC104	Valve Cover Gasket				

All Component Parts can be purchased individually.



MX/Dirt • Off-Road Gaskets



Cometic Gasket - An Exclusive NASCAR Performance® Product

YAMAHA YZ450F

Model	Year	Bore Size	EST Top End Kit	Component Part#	Component Description	OEM Part #				
YZ450F	10-13	97mm	C3395-EST	H3059027S	97mm Bore Head Gasket	33D-11181-00-00				
				3238V	Valve Stem Seals 4 Required	51Y-12119-00-00				
				B1019010RC	Base Gasket	33D-11351-00-00				
				EC019032AFM	Cam Chain Tensioner Gasket	4FM-12213-00-00				
				EX1041042AM	Exhaust Gasket	33D-14613-00-00				
Bottom End Kit w/Oil Seals C3395BE				Component Part#	Component Description	OEM Part #				
				EC1569032AFM	Inner Clutch Gasket	33D-15462-00-00				
				R18X2.5V	Oil Fill Plug O-ring	93210-19123-00				
				R13.5X2V	Timing Mark O-ring	93210-14369-00				
				R126B	Crank Plug O-ring	93210-357A3-00				
				R010V	Oil Nozzle O-ring	93210-07001-00				
				MR111	Case Seal Gasket	90430-08002-00				
				WA116	Right Case Drain Washer	90201-08087-00				
				WA080043C	Left Case Drain Washer	90430-06014-00				
				R031B	Oil Filter Cover O-ring	93210-45708-00				
				R24X2V	Coolant Line Oring	93210-24253-00				
				R114B	Water Pump O-ring	93210-16500-00				
				R020V	Output Shaft O-ring	93210-22298-00				
				WP379018AFM	Water Pump Housing Gasket	33D-12427-00-00				
				WA114	Water Pump Drain Plug Washer	90430-06014-00				
				R018V	Water Pipe O-ring	93210-19758-00				
Oil Seal Kit C3395OS				Component Part#	Component Description	OEM Part #				
				OS285	Start Shaft Seal 20x30x7	93102-20108-00				
				OS284	Output Shaft Seal 32x42x6	93102-32480-00				
				OS286	Shift Shaft Oil Seal 12x18x5	93102-12224-00				
				OS227	Water Pump Shaft Seal 12x22x5	93102-12321-00				
				OS236	Water Pump Oil Seal 14x22x5	93101-14164-00				
YZ450F	14-17	97mm	EST Top End Kit C3540-EST	H3059027S	97mm Bore Head Gasket	33D-11181-00-00				
				3238V	Valve Stem Seals 4 Required	51Y-12119-00-00				
				B1241010RC	Base Gasket	1SL-11351-00-00				
				EC019032AFM	Cam Chain Tensioner Gasket	4FM-12213-00-00				
				EX1041042AM	Exhaust Gasket	33D-14613-00-00				
				Bottom End Kit w/Oil Seals C3540BE				Component Part#	Component Description	OEM Part #
								WA082063C	Drain Plug Crush Gasket	90430-10188-00
								WA118	Output Shaft Crush Gasket	90430-06166-00
								R19X2V	Fill Plug O-ring	93210-19123-00
								R127V	Timing Gear O-ring	93210-357A3-00
								R027V	Timing Mark O-ring	93210-14369-00
								WA080043C	Mag Crush Washer	90430-06014-00
								R031B	Oil Filter O-ring	93210-45708-00
				R014V	Oil Strainer O-ring	93210-12010-00				
				WP439032AFM	Water Pump Gasket	33D-12427-00-00				
				WA080043C	Water Pump Crush Washer	90430-06014-00				
				R018V	Water Pipe O-ring	93210-19758-00				
				EC2169032AFM	Oil Passage Gasket	1SL-13475-00-00				
				EC2171032AFM	Inner (Primary) Cover	1SL-15462-00-00				
				R22X2V	Output Shaft O-ring	93210-22164-00				
					Oil Pump O-ring	90430-06156-00				
Oil Seal Kit C3540OS				Component Part#	Component Description	OEM Part #				
				OS236	Oil Pump Seal	93101-14164-00				
				OS197	Shift Shaft Seal	93109-14010-00				
				OS285	Kickstart Shaft Seal	93102-20108-00				
				OS284	Output Shaft Seal	93102-32480-00				
				OS308	Outer Water Pump Seal	93102-08004-00				
				OS233	Inner Water Pump Seal	93102-08307-00				
Clutch & Mag Kit C3540CM				Component Part#	Component Description	OEM Part #				
				MR110	Outer Clutch Cover	33D-15453-00-00				
				EC2170032AFM	Mag Cover Gasket	1SL-15451-00-00				

All Component Parts can be purchased individually.



MX/Dirt • Off-Road Gaskets



Cometic Gasket - An Exclusive NASCAR Performance® Product

YAMAHA YZ450F

Model	Year	Bore Size	Top End Kit	Component Part#	Component Description	OEM Part #
YZ450F	18-19	97mm	C3630	H4566023S	97mm Bore Head Gasket	BR9-11181-00-00
				B1400010RC	Cylinder Base Gasket	BR9-11351-00-00
				3238V	Valve Stem Seals	51Y-12119-00-00
				EX1041042AM	Header Gasket	33D-14613-00-00
				WA116	Cam Galley Drain Crush Washer	90430-08119-00
				WA080043C	Cam Galley Drain Crush Washer	90430-06014-00
				WA140	Cam Chain Tensioner Release Washer	5EL-12214-00-00
				WA114	Cam Chain Tensioner Crush Washer	90430-06014-00
				EC019018AFM	Cam Chain Tensioner Gasket	4FM-12213-00-00
			Oil Seal Kit	Component Part#	Component Description	OEM Part #
			C3540OS	OS236	Oil Pump Seal	93101-14164-00
				OS229	Clutch Act Oil Seal	93102-10008-00
				OS197	Shift Shaft Seal	93109-14010-00
				OS284	Output Shaft Seal Oil Seal 32X42	93102-32014-00
				OS308	Outer Water Pump Oil Seal	93102-08004-00
				OS233	Inner Water Pump Oil Seal	93102-08307-00
			Clutch & Mag Kit	Component Part#	Component Description	OEM Part #
			C3630CM	EC2438032AFM	Mag Cover Gasket	
				MR110	Outer Clutch Cover Gasket	
			EST	Component Part#	Component Description	OEM Part #
			Top End Kit			
WR450	03-06	95 mm	C7947-EST	H1710027S	Head Gasket	5TA-11181-00-00
		96 mm	C3147-EST	H2144027S	Head Gasket 96mm Bore	
		97 mm	C3064-EST	H1711027S	Head Gasket 97mm Bore	
		98 mm	C3148-EST	H1683027S	Head Gasket 98mm Bore	
		99 mm	C3149-EST	H1683SP2027S	Head Gasket 99mm Bore	
		100 mm	C3117-EST	H1683SPB027S	Head Gasket 100mm Bore	
				B0626020RC	Base Gasket	5TA-11351-00-00
				B0626SP2020RC	Base Gasket 100mm Kits	
				EX641	Exhaust Gasket	3VD-14613-01-00
				EC019018AFM	Cam Chain Tensioner Gasket	4FM-12213-00
				EC019020F	Cam Chain Tensioner Gasket	
				WA082063C	Oil Line Washers 2 Req.	90430-10171
				3179V	Intake Valve Seal 3 Req.	4SV-12119-00-00
				3234V	Exhaust Valve Seal 2 Req.	33M-12119-00-00
				WA114	Head Drain Washers	90430-06014
				WA116	Oil Line Washers 4 Req.	90201-08087-00
			Bottom End Kit w/Oil Seals	Component Part#	Component Description	OEM Part #
			C3560BE	R018V	Water Outlet O-rings	93210-19758-00
				WP189	Water Pump Cover O-ring	5BE-12439-00-00
				R12X2V	Output Shaft O-ring	93210-22298-00
				R114B	Water Pipe O-ring	93210-16500-00
				R013B	Oil Line O-rings	93210-10197-00
				EC762032AFM	Inner Clutch Cover	5TA-15462-00-00
				R19X2V	Fill Plug O-ring	93210-19123-00
				R143K	Starter O-ring	93210-58346-00
				R027V	Timing Mark O-ring	93210-14369-00
				R013B	Case Dowel O-ring	93210-10197-00
				WA082063C	Drain Plug Gasket	90430-10188-00
				WA080043C	Coolant Drain Gasket	90430-06014-00
			Oil Seal Kit	Component Part#	Component Description	OEM Part #
			C3560OS	OS236	Oil Pump Seal	93101-14164-00
				OS283	Outer Water Pump Oil Seal	93109-11073-00
				OS284	Output Shaft Seal	93102-32480-00
				OS285	Kick Start Shaft Seal	93102-20108-00
				OS286	Shift Shaft Seal	93102-12224-00
				OS286	Clutch Pushrod Seal	93102-12224-00
			Clutch & Mag Kit	Component Part#	Component Description	OEM Part #
			C3560CM	EC763018AFM	Outer Clutch Cover Gasket	5TA-15453-00-00
				EC2003032AFM	Mag Cover Gasket	5TJ-15451-00-00

All Component Parts can be purchased individually.



MX/Dirt • Off-Road Gaskets



Cometic Gasket - An Exclusive NASCAR Performance® Product

YAMAHA WR450

Model	Year	Bore Size	EST	Component Part#	Component Description	OEM Part #		
WR450	07-14	95 mm	Top End Kit	H2477027S	Head Gasket 95mm	2S2-11181-00-00		
			C7908-EST	H2477SP1027S	Head Gasket 98mm	2S2-11181-00-00		
		98 mm	C3178-EST	H2477SP4027S	Head Gasket 99mm	2S2-11181-00-00		
				B0849020RC	Base Gasket	2S2-11351-00-00		
				EX696	Exhaust Gasket	3VD-14613-01-00		
				3179V	Intake Valve Seal 3 Req.	4SV-12119-00-00		
				3234V	Exhaust Valve Seal 2 Req.	33M-12119-00-00		
				EC019018AFM	Cam Chain Tensioner Gasket	4FM-12213-00		
				WA082063C	Oil Line Washers 2 Req.	90430-10171		
				WA114	Drain Plug Gasket	90430-06014		
				WA116	Oil Line Washers 4 Req.	90201-08087-00		
		Bottom End Kit w/Oil Seals C7908BE				Component Part#	Component Description	OEM Part #
					EC1100031F	Inner Clutch Cover	2S2-15462-10-00	
			WP189	Water Pump Cover Gasket	5BE-12439-00-00			
			WA080043C	Water Pump Drain Crush Washer	90430-06014-00			
			WA080043C	Case Oil Galley Drain Plug	90430-06014-00			
			WA116	Case Water Galley Drain Plug	90430-08119-00			
			WA082063C	Drain Plug Crush Seal	90430-10188-00			
			R109B	Oil Pump O-rings	93210-07135-00			
			R011V	Mag Cover Oil Passage O-ring	93210-08003-00			
			R012B	Case Oil Level Plug O-ring	93210-09350-00			
			R013B	Case Oil Galley O-ring	93210-10197-00			
			R113B	Timing Mark O-ring	93210-14369-00			
			R19X2V	Fill Plug O-Ring	93210-19123-00			
			R018V	Primary Cover Oil Passage O-ring	93210-19758-00			
			R12X2V	Output Shaft O-ring	93210-22298-00			
			R121V	Crank End Plug O-ring	93210-27778-00			
			R134B	Oil Pump Cover O-ring	93210-47675-00			
			R141V	Electric Starter Cover O-ring	93210-58346-00			
Oil Seal Kit C7908OS				Component Part#	Component Description	OEM Part #		
			OS227	Inner Water Pump Oil Seal	93102-12321-00			
			OS236	Oil Pump Seal	93101-14164-00			
			OS242	Outer Water Pump Oil Seal	93109-11073-00			
			OS284	Output Shaft Seal	93102-32480-00			
			OS285	Kick Start Shaft Seal	93102-20108-00			
			OS286	Clutch Pushrod Seal	93102-12224-00			
			OS286	Shift Shaft Seal	93102-12224-00			
Clutch & Mag Kit C7908CM				Component Part#	Component Description	OEM Part #		
			EC763020F	Outer Clutch Cover	5TA-15453-00-00			
			EC1099031F	Mag Cover Gasket	2S2-15451-00-00			
			Component Part#	Component Description	OEM Part #			
			VC104	Valve Cover Gasket				

YAMAHA YZ490

Model	Year	Bore Size	Top End Kit	Component Part#	Component Description	OEM Part #
YZ490	83	89 mm	C7138	H0166043C	Head Gasket	5X6-11181-00-00
				B0063020F	Base Gasket	1LV-11351-00-00
			Top End Kit C7090	Component Part#	Component Description	OEM Part #
YZ490	84-86	89 mm	C7090	H0062043C	Head Gasket	40T-11181-00-00
YZ490	87-90			B0063020F	Base Gasket	1LV-11351-00-00
WR500	91-93			IR018018AFM	Intake Gasket	2K7-13621-00-00
			Top End Kit C7252	Component Part#	Component Description	OEM Part #
XTT500/ SR500	76-81	90 mm	C7252	H0193043F	Head Gasket	2J2-11181-09-00
				B0188020F	Base Gasket	583-11351-00-00
			Top End Kit C7114	Component Part#	Component Description	OEM Part #
TT600 XT, SRX	83-87	98 mm	C7114	H0063043F	Head Gasket	1JK-11181-00
			Top End Kit C7213	Component Part#	Component Description	OEM Part #
XT600	88-96	97 mm	C7213	H0267043F	Head Gasket 97mm	2KF-11181-01
		98 mm	C7276	H0320043F	Head Gasket 98mm	2KF-11181-01
		101 mm	C7277	H0321043F	Head Gasket 101mm	2KF-11181-01
				B0064020F	Base Gasket	1VJ-11351-00-00
				B1019010RC	Base Gasket	33D-11351-00-00
				EC019032AFM	Cam Chain Tensioner Gasket	4FM-12213-00-00
				EX1041042AM	Exhaust Gasket	33D-14613-00-00

All Component Parts can be purchased individually.



Water Pump Gaskets



Cometic Gasket - An Exclusive NASCAR Performance® Product

Make/Model	Year	Part#
HONDA		
CR80R/85R	1992-2007C7126WP
CRF150	2007-2019C3187WP
CR125R.....	1990-2004C7757WP
CR125R.....	2005-2007C3085WP
CR250R.....	1992-2001C7116WP
CR250R.....	2002-2007C7191WP
CRF250R.....	2004-2009C7185WP
CRF250X.....	2004-2013C7185WP
CRF250R.....	2010-2017C3288WP
CRF450R.....	2002-2008C3047WP
CRF450R.....	2009-2016C3270WP
CR500R.....	1987-2001C7020WP

HUSQVARNA		
TC125.....	2016-2019C3606WP
TC150.....	2016-2019C3606WP
FC250.....	2016-2019C3595WP
FC350.....	2016-2019C3595WP

KAWASAKI		
KX65.....	2000-2019C7736WP
KX80.....	1986-2000C7029WP
KX85.....	2001-2019C7029WP
KX100.....	1995-2016C7029WP
KX125.....	1994-2002C7241WP
KX125.....	2003-2005C7921WP
KX250F.....	2004-2008C3174WP
KX250F.....	2009-2016C3267WP
KX250F.....	2017-2019C3619WP
KX450F.....	2006-2008C3136WP
KX450F.....	2009-2015C3268WP
KX450F.....	2016-2017C3598WP
KLX450R	2008-2014C3136WP

KTM		
50SX.....	2009-2016C3503WP
65SX.....	2009-2016C3416WP
85SX.....	2003-2016C7384WP
105SX.....	2004-2011.....	C7384WP
150SX.....	2016-2019C3606WP
125SX.....	2016-2019C3606WP
250 SX-F Factory	2016-2019C3595WP
350 SX-F Factory	2016-2019C3595WP

Make/Model	Year	Part#
SUZUKI		
RM65.....	2003-2005C7736WP
RM85.....	2002-2015C7857WP
RM100.....	2003C7029WP
RM125.....	2001-2003C7778WP
RM125.....	2004-2007C7508WP
RM250.....	2001-2002C7799WP
RM250.....	2003-2008C7467WP
RM-Z250.....	2004-2006C3174WP
RM-Z250.....	2007-2015C3175WP
RM-Z450.....	2005-2007C3102WP
RM-Z450.....	2008-2016C3233WP

YAMAHA		
YZ80.....	1993-2001C7137WP
YZ85.....	2002-2015C7851WP
YZ125.....	2005-2016C3105WP
YZ125.....	1998-2004C7399WP
YZ125.....	1994-1997C7158WP
YZ250.....	1999-2016C7507WP
WR250F	2001-2013C3057WP
YZ250F.....	2001-2013C3057WP
YZ250F.....	2014-2017C3549WP
WR400F	1998-2000C7400WP
YZ400F.....	1998-1999C7400WP
YZ426F.....	2000-2002C7689WP
WR426F	2001-2002C7689WP
WR450F	2003-2006C3560WP
WR450F	2007-2015C7908WP
WR450F	2016.....	C3340WP
YZ450F.....	2003-2005C3540WP
YZ450F.....	2006-2009C7908WP
YZ450F.....	2010-2013C3395WP
YZ450F.....	2014-2017C3340WP

All Component Parts can be purchased individually.



STREET-ROAD RACE-STRIP



Cometic Gasket - An Exclusive NASCAR Performance® Product

APRILLA

Model	Year	Head Gasket Part#	Bore	Material/Thickness	Base Gasket Part#	Bore	Material/Thickness	Case Kit Part#
RSV1000R Mille	98-06	C8511-018	98mm	MLS/C.O.T. .018"				
RSV1000R Mille	98-06	C8512-018	100mm	MLS/C.O.T. .018"				

DUCATI

748	94-02	C8753	88mm	MLS/C.O.T. .030"	C8754		.020"	
851	87-81	C8560	91mm	MLS/C.O.T. .018"	C8755		.020"	
851	87-81	C8564	96mm	MLS/C.O.T. .018"	C8755		.020"	
888	91-98	C8564	96mm	MLS/C.O.T. .018"	C8755		.020"	
916	91-98	C8564	96mm	MLS/C.O.T. .018"	C8755		.020"	
996	99-02	C8561	98mm	MLS/C.O.T. .018"	C8756		.014"	
996R	2001	C8757	100mm	MLS/C.O.T. .027"				
996R	2001	C8758	102mm	MLS/C.O.T. .027"				
1000 GS Super Sport	89-07	C8700	98mm	SLS .010"	C8759		.014"	
1098, 1098S	07-08	C8807		MLS/C.O.T. .027"	C8809		.014"	
1198, 1198S, 1198R	09-11	C8808	106mm	MLS/C.O.T. .027"	C8809		.014"	
Panigale 1199	12-13	C8834	113mm	MLS/C.O.T. .020"				
Panigale 1199	12-13	C8835	116mm	MLS/C.O.T. .020"				

HONDA

Model	Year	Bore Size	EST Top End Kit	Component Description
CBR250	11-15	77mm	C3522-EST	MLS/C.O.T. .027" Head, Base, Exhaust, Cam Chain Tensioner Gaskets, and Valve Seals
		78mm	C3523-EST	
		80mm	C3524-EST	
		81mm	C8832-EST	
		83mm	C3526-EST	
Model	Year	Bore Size	Top End Kit	Component Description
MSX125 Grom	14-19	52.4mm	C8915	Head, Base, Exhaust, Cam Chain Tensioner Gaskets, and Valve Seals

HONDA

Model	Year	Head Gasket Part#	Bore	Material/Thickness	Base Gasket Part#	Material/Thickness	Case Kit Part#
CB500	72-74	C8824	59mm	MLS/C.O.T. .040"			
CB500	72-74	C8825	60mm	MLS/C.O.T. .040"			
CB500	72-74	C8826	61mm	MLS/C.O.T. .040"			
CB500	72-74	C8827	62mm	MLS/C.O.T. .040"			
CB500	13-15	C8887	69mm	MLS/C.O.T. .023"			
CB500	13-15	C8888	70mm	MLS/C.O.T. .023"			
CB550	74-78	C8824	59mm	MLS/C.O.T. .040"			
CB550	74-78	C8825	60mm	MLS/C.O.T. .040"			
CB550	74-78	C8826	61mm	MLS/C.O.T. .040"			
CB550	74-78	C8827	62mm	MLS/C.O.T. .040"			
CB650	79-82	C8824	59mm	MLS/C.O.T. .040"			
CB650	79-82	C8825	60mm	MLS/C.O.T. .040"			
CB650	79-82	C8826	61mm	MLS/C.O.T. .040"			
CB650	79-82	C8827	62mm	MLS/C.O.T. .040"			
CBR600	91-98	C8265	67mm	MLS/C.O.T. .030"			C8301
CBR600	91-98	C8265-018	67mm	MLS/C.O.T. .018"			C8301
CBR600 F2	91-94	C8265	67mm	MLS/C.O.T. .030"			
CBR600 F2	91-94	C8265-018	67mm	MLS/C.O.T. .018"			
CBR600 F3	95-98	C8265	67mm	MLS/C.O.T. .030"			
CBR600 F3	95-98	C8265-018	67mm	MLS/C.O.T. .018"			
CBR600 F4	99-06	C8572	67mm	MLS/C.O.T. .030"			C8633
CBR600 F4	99-06	C8572-018	67mm	MLS/C.O.T. .018"			C8633
CBR600 F4	99-06	C8636	68mm	MLS/C.O.T. .030"			C8633
CBR600 F4	99-06	C8671	69mm	MLS/C.O.T. .030"			C8633
CBR600 RR	03-06	C8704-018	67mm	MLS/C.O.T. .018"			
CBR600 RR	03-06	C8704-027	67mm	MLS/C.O.T. .027"			
CBR600 RR	03-06	C8705-018	70mm	MLS/C.O.T. .018"			
CBR600 RR	03-06	C8705-027	70mm	MLS/C.O.T. .027"			



STREET·ROAD RACE·STRIP



Cometic Gasket - An Exclusive NASCAR Performance® Product

<i>Valve Cover Part#</i>	<i>Price</i>	<i>Magneto Cover Part#</i>	<i>Price</i>	<i>Clutch Cover Part#</i>	<i>Price</i>	<i>Exhaust Gasket Part#</i>	<i>Price</i>	<i>Shift Shaft Part#</i>	<i>Price</i>	<i>Output Shaft Part#</i>	<i>Price</i>
--------------------------	--------------	----------------------------	--------------	---------------------------	--------------	-----------------------------	--------------	--------------------------	--------------	---------------------------	--------------

<i>Valve Cover Part#</i>	<i>Price</i>	<i>Magneto Cover Part#</i>	<i>Price</i>	<i>Clutch Cover Part#</i>	<i>Price</i>	<i>Exhaust Gasket Part#</i>	<i>Price</i>	<i>Shift Shaft Part#</i>	<i>Price</i>	<i>Output Shaft Part#</i>	<i>Price</i>
								OS394		OS395	
								OS394		OS395	
								OS394		OS395	
								OS394		OS395	
								OS396		OS395	
								OS396		OS395	
								OS396		OS395	
								OS396		OS395	
								OS396		OS395	
EC034020F		EC033020F						OS236		OS397	
EC034020F		EC033020F						OS236		OS397	
								OS236		OS397	
								OS236		OS397	
								OS236		OS397	
								OS236		OS397	
EC627018AFM		EC625018AFM						OS236		OS397	
EC627018AFM		EC625018AFM						OS236		OS397	
EC627018AFM		EC625018AFM						OS236		OS397	
EC627018AFM		EC625018AFM						OS236		OS397	
								OS236		OS397	
						C8873		OS236		OS397	
						C8873		OS236		OS397	
						C8873		OS236		OS397	
						C8873		OS236		OS397	



STREET·ROAD RACE·STRIP



Cometic Gasket - An Exclusive NASCAR Performance® Product

HONDA

Model	Year	Head Gasket Part#	Bore	Material/Thickness	Price	Base Gasket Part#	Bore	Material/Thickness	Price	Case Kit Part#	Price
CBR600 RR	03-06	C8706-018	69mm	MLS/C.O.T. .018"							
CBR600 RR	03-06	C8706-027	69mm	MLS/C.O.T. .027"							
CBR600 RR	07-18	C8736	68.5mm	MLS/C.O.T. .027"						C8739	
CBR600 RR	07-19	C8736-018	68.5mm	MLS/C.O.T. .018"						C8739	
CBR600 RR	07-19	C8737	70mm	MLS/C.O.T. .027"						C8739	
CBR600 RR	07-19	C8737-018	70mm	MLS/C.O.T. .018"						C8739	
CBR600F Hurricane	87-90	C8000	65mm	.020" Copper		C8503		.010" Copper			
CBR600F Hurricane	87-90					C8504		.020" Copper			
NT650 Hawk GT	88-91	C8207	82mm	SLS .010"		C8520		.010" Copper			
CB750 2 Valve	71-78	C8001	65mm	CFM-20 .043"						C8863	
CB750 2 Valve	71-78	C8002	67.5mm	CFM-20 .043"						C8863	
CB750K 2V	73-78	C8801	65mm	MLS/C.O.T. .045"	C8286			.005" Copper		C8863	
CB750K 2V	73-78	C8801	65mm	MLS/C.O.T. .045"	C8287			.010" Copper		C8863	
CB750K 2V	73-78	C8801	65mm	MLS/C.O.T. .045"	C8288			.020" Copper		C8863	
CB750K 2V	73-78	C8801	65mm	MLS/C.O.T. .045"	C8289			.020" Fiber		C8863	
CB750K 2V	73-78	C8802	68mm	MLS/C.O.T. .045"	C8286			.005" Copper		C8863	
CB750K 2V	73-78	C8802	68mm	MLS/C.O.T. .045"	C8287			.010" Copper		C8863	
CB750K 2V	73-78	C8802	68mm	MLS/C.O.T. .045"	C8288			.020" Copper		C8863	
CB750K 2V	73-78	C8802	68mm	MLS/C.O.T. .045"	C8289			.020" Fiber		C8863	
CB750K 2V	73-78	C8803	70mm	MLS/C.O.T. .045"	C8286			.005" Copper		C8863	
CB750K 2V	73-78	C8803	70mm	MLS/C.O.T. .045"	C8287			.010" Copper		C8863	
CB750K 2V	73-78	C8803	70mm	MLS/C.O.T. .045"	C8288			.020" Copper		C8863	
CB750K 2V	73-78	C8803	70mm	MLS/C.O.T. .045"	C8289			.020" Fiber		C8863	
CB750K 2V	73-78	C8804	72mm	MLS/C.O.T. .045"	C8286			.005" Copper		C8863	
CB750K 2V	73-78	C8804	72mm	MLS/C.O.T. .045"	C8287			.010" Copper		C8863	
CB750K 2V	73-78	C8804	72mm	MLS/C.O.T. .045"	C8288			.020" Copper		C8863	
CB750K 2V	73-78	C8804	72mm	MLS/C.O.T. .045"	C8289			.020" Fiber		C8863	
CB750L,F,K,C,SC 4V DOHC	79-83	C8003	65mm	Fiber .043"		C8451	74mm	.005" Copper			
CB750L,F,K,C,SC 4V DOHC	79-83	C8003	65mm	Fiber .043"		C8452	74mm	.010" Copper			
CB750L,F,K,C,SC 4V DOHC	79-83	C8003	65mm	Fiber .043"		C8453	74mm	.020" Copper			
CB750L,F,K,C,SC 4V DOHC	79-83	C8003	65mm	Fiber .043"		C8454	74mm	.020" Fiber			
CB750L,F,K,C,SC 4V DOHC	79-83	C8004	70mm	Fiber .043"		C8451	74mm	.005" Copper			
CB750L,F,K,C,SC 4V DOHC	79-83	C8004	70mm	Fiber .043"		C8452	74mm	.010" Copper			
CB750L,F,K,C,SC 4V DOHC	79-83	C8004	70mm	Fiber .043"		C8453	74mm	.020" Copper			
CB750L,F,K,C,SC 4V DOHC	79-83	C8004	70mm	Fiber .043"		C8454	74mm	.020" Fiber			
VFR750	90-94	C8498	72mm	Fiber .043"							
CB900F Super Sport	81-82	C8005	68mm	Fiber .043"		C8451	74mm	.005" Copper			
CB900F Super Sport	81-82	C8005	68mm	Fiber .043"		C8452	74mm	.010" Copper			
CB900F Super Sport	81-82	C8005	68mm	Fiber .043"		C8453	74mm	.020" Copper			
CB900F Super Sport	81-82	C8005	68mm	Fiber .043"		C8454	74mm	.020" Fiber			
CB900F Super Sport	81-82	C8224	72mm	Copper .043"		C8451	74mm	.005" Copper			
CB900F Super Sport	81-82	C8224	72mm	Copper .043"		C8452	74mm	.010" Copper			
CB900F Super Sport	81-82	C8224	72mm	Copper .043"		C8453	74mm	.020" Copper			
CB900F Super Sport	81-82	C8224	72mm	Copper .043"		C8454	74mm	.020" Fiber			
CB900C 900 Custom	80-82	C8005	68mm	Fiber .043"		C8451	74mm	.005" Copper			
CB900C 900 Custom	80-82	C8005	68mm	Fiber .043"		C8452	74mm	.010" Copper			
CB900C 900 Custom	80-82	C8005	68mm	Fiber .043"		C8453	74mm	.020" Copper			
CB900C 900 Custom	80-82	C8005	68mm	Fiber .043"		C8454	74mm	.020" Fiber			
CB900C 900 Custom	80-82	C8224	72mm	Copper .043"		C8451	74mm	.005" Copper			
CB900C 900 Custom	80-82	C8224	72mm	Copper .043"		C8452	74mm	.010" Copper			
CB900C 900 Custom	80-82	C8224	72mm	Copper .043"		C8453	74mm	.020" Copper			
CB900C 900 Custom	80-82	C8224	72mm	Copper .043"		C8454	74mm	.020" Fiber			
CBR900	93-99	C8267	72mm	MLS/C.O.T. .040"						C8211	
CBR900	93-99	C8267-018	72mm	MLS/C.O.T. .018"						C8211	
CBR900	93-99	C8268	74mm	MLS/C.O.T. .040"						C8211	
CBR900	93-99	C8268-018	74mm	MLS/C.O.T. .018"						C8211	
CBR900	93-99	C8401	73mm	MLS/C.O.T. .040"						C8211	
CBR900	93-99	C8401-018	73mm	MLS/C.O.T. .018"						C8211	
CBR900	93-99	C8406	75mm	MLS/C.O.T. .040"						C8211	
CBR900	93-99	C8406-018	75mm	MLS/C.O.T. .018"						C8211	
919 (CB900F)	02-07	C8267	72mm	MLS/C.O.T. .040"						C8211	
919 (CB900F)	02-07	C8267-018	72mm	MLS/C.O.T. .018"						C8211	
919 (CB900F)	02-07	C8268	74mm	MLS/C.O.T. .040"						C8211	



STREET-ROAD RACE-STRIP



Cometic Gasket - An Exclusive NASCAR Performance® Product

HONDA

Model	Year	Head Gasket Part#	Bore	Material/Thickness	Price	Base Gasket Part#	Bore	Material/Thickness	Price	Case Kit Part#	Price
919 (CB900F)	02-07	C8268-018	74mm	MLS/C.O.T. .018"						C8211	
919 (CB900F)	02-07	C8401	73mm	MLS/C.O.T. .040"						C8211	
919 (CB900F)	02-07	C8401-018	73mm	MLS/C.O.T. .018"						C8211	
919 (CB900F)	02-07	C8406	75mm	MLS/C.O.T. .040"						C8211	
919 (CB900F)	02-07	C8406-018	75mm	MLS/C.O.T. .018"						C8211	
CBR929	00-01	C8568	76mm	MLS/C.O.T. .030"						C8634	
CBR929	00-01	C8568-018	76mm	MLS/C.O.T. .018"						C8634	
CBR954	02-03	C8568	76mm	MLS/C.O.T. .030"						C8634	
CBR954	02-03	C8568-018	76mm	MLS/C.O.T. .018"						C8634	
CBR1000	87-95	C8008	79mm	Stainless .010"	C8410	84.5mm	.005" Copper				
CBR1000 RR	04-07	C8702-018	75mm	MLS/C.O.T. .018"							
CBR1000 RR	04-07	C8702-027	75mm	MLS/C.O.T. .027"							
CBR1000 RR	04-07	C8703-018	76mm	MLS/C.O.T. .018"							
CBR1000 RR	04-07	C8703-027	76mm	MLS/C.O.T. .027"							
CBR1000 RR	04-07	C8727	77mm	MLS/C.O.T. .027"							
CBR1000 RR	04-07	C8727-018	77mm	MLS/C.O.T. .018"							
CBR1000 RR	08-19	C8779	77mm	MLS/C.O.T. .027"	C8780			.010" RC			
CBR1000 RR	08-19	C8779-018	77mm	MLS/C.O.T. .018"	C8780			.010" RC			
RVT1000R/RC51	00-06	C8766	103.5mm	MLS/C.O.T. .027"							
RVT1000R/RC51	00-06	C8569	101.5mm	MLS/C.O.T. .027"							
RVT1000R/RC51	00-06	C8765	102.5mm	MLS/C.O.T. .027"							
CB1100F	83-83	C8006	72mm	Fiber .043"		C8521	79.5mm	.020" Copper			
CB1100F	83-83	C8007	75mm	.020" Copper		C8521	79.5mm	.020" Copper			
CB1100F	83-83	C8224	72mm	Copper .043"		C8521	79.5mm	.020" Copper			
CB1100F	83-83	C8225	74mm	Copper .043"		C8521	79.5mm	.020" Copper			
CBR1100XX Blackbird	97-03	C8499	81mm	MLS/C.O.T. .030"						C8586	
CBR1100XX Blackbird	97-03	C8499-018	81mm	MLS/C.O.T. .018"						C8586	
CBX 6 Cylinder	79-82	C8319	67.5mm	Copper .043		C8342		.020" Fiber			
CBX 6 Cylinder	79-82	C8341	68mm	Fiber .043"		C8342		.020" Fiber			
CBX 6 Cylinder	79-82	C8396	65mm	Copper .043		C8342		.020" Fiber			
CBX 6 Cylinder	79-82	C8407	65mm	Fiber .043"		C8342		.020" Fiber			

HUSQVARNA

Model	Year	Head Gasket Part#	Bore	Material/Thickness	Price	Base Gasket Part#	Bore	Material/Thickness	Price	Case Kit Part#
Vitpilen 401	18	89mm	MLS/C.O.T. .027"	C8897		C8899		.014" RC Steel		
Vitpilen 401	18	91mm	MLS/C.O.T. .027"	C8898		C8899		.014" RC Steel		
Svartpilen 401	18	89mm	MLS/C.O.T. .027"	C8897		C8899		.014" RC Steel		
Svartpilen 401	18	91mm	MLS/C.O.T. .027"	C8898		C8899		.014" RC Steel		

KAWASAKI

Model	Year	Head Gasket Part#	Bore	Material/Thickness	Price	Base Gasket Part#	Bore	Material/Thickness	Price	Case Kit Part#
919 (CB900F)	02-07	C8406	75mm	MLS/C.O.T. .040"						C8211
EX250 Ninja	86-07	C8828	62mm	SLS .012"						
EX250 Ninja	86-07	C8829	64mm	SLS .012"						
EX250 Ninja	08-12	C8859	62mm	SLS .012"						
EX250 Ninja	08-12	C8860	64mm	SLS .012"						
EX250 Ninja	08-12	C8861	66mm	SLS .012"						
Ninja 400 EX400	18	C8938	70mm	MLS/C.O.T. .018"						
Ninja 500,500R,EX500	87-09	C8318	75.5mm	CFM-20 .043"						
GP, GPz 550	81-85	C8009	61mm	Fiber .043"						
Zeyphr 550	90-91	C8009	61mm	Fiber .043"						
KZ 550 Ltd.	80-83	C8009	61mm	Fiber .043"						
Ninja 600R ZX600	87-94	C8010	62mm	Fiber .043"		C8589	2.680"	.005" Copper		
Ninja ZX-6R	95-02	C8270	68mm	MLS/C.O.T. .030"	C8698			.010" RC		C8303
Ninja ZX-6R	95-02	C8270-018	68mm	MLS/C.O.T. .018"	C8698			.010" RC		C8303
Ninja ZX-6R	00-02	C8693	68mm	MLS/C.O.T. .027"	C8698			.010" RC		C8303
Ninja ZX-6R	00-02	C8693-018	68mm	MLS/C.O.T. .018"	C8698			.010" RC		C8303
Ninja ZX-6R	00-02	C8694	70mm	MLS/C.O.T. .027"	C8698			.010" RC		C8303



STREET·ROAD RACE·STRIP



Cometic Gasket - An Exclusive NASCAR Performance® Product

Valve Cover Part#	Price	Magneto Cover Part#	Clutch Cover Part#	Exhaust Gasket Part#	Shift Shaft Part#	Output Shaft Part#
		EC034020F	EC033020F	C8873	OS236	OS397
		EC034020F	EC033020F	C8873	OS236	OS397
		EC034020F	EC033020F	C8873	OS236	OS397
		EC034020F	EC033020F	C8873	OS236	OS397
		EC034020F	EC033020F	C8873	OS236	OS397
		EC628018AFM	EC630018AFM	C8873	OS236	OS397
		EC628018AFM	EC630018AFM	C8873	OS236	OS397
		EC628018AFM	EC630018AFM	C8873	OS236	OS397
		EC628018AFM	EC630018AFM	C8873	OS236	OS397
				C8873	OS331	OS399
					OS236	OS400
					OS236	OS400
					OS236	OS400
					OS236	OS400
					OS236	OS400
					OS236	OS400
					OS236	OS400
					OS236	OS400
					OS236	OS401
					OS236	OS401
					OS236	OS401
					OS396	OS402
					OS396	OS402
					OS396	OS402
					OS396	OS402
		EC391020F	EC392020F		OS236	OS404
		EC391020F	EC392020F		OS236	OS404
					OS254	OS402
					OS254	OS402
					OS254	OS402
					OS254	OS402
						OS412
					OS331	OS412
					OS331	OS412
					OS331	OS412
					OS331	OS412
						OS405
		EC034020F	EC033020F	C8873	OS236	OS397
			EC1135060AFM	C8875	OS331	OS405
			EC1135060AFM	C8875	OS331	OS405
			EC1135060AFM		OS331	OS405
			EC1135060AFM		OS331	OS405
			EC1135060AFM		OS331	OS405
					OS331	OS405
VC335060AFM				C8879	OS331	OS405
VC335060AFM				C8879	OS331	OS405
				C8879	OS331	OS405
				C8879	OS331	OS405
		EC078020F	EC076020F	C8876	OS331	OS406
		EC078020F	EC076020F	C8876	OS331	OS406
		EC078020F	EC076020F	C8882	OS331	OS406
		EC078020F	EC076020F	C8882	OS331	OS406
		EC078020F	EC076020F	C8882	OS331	OS406



STREET-ROAD RACE-STRIP



Cometic Gasket - An Exclusive NASCAR Performance® Product

KAWASAKI

Model	Year	Head Gasket Part#	Bore	Material/Thickness	Base Gasket Part#	Bore	Material/Thickness	Case Kit Part#
Ninja ZX-6R	00-02	C8694-018	70mm	MLS/C.O.T. .018"	C8698		.010" RC	C8303
Ninja ZX-6R	03-06	C8690	68mm	MLS/C.O.T. .027"	C8692		.010" RC	C8685
Ninja ZX-6R	03-06	C8690-018	68mm	MLS/C.O.T. .018"	C8692		.010" RC	C8685
Ninja ZX-6R	03-06	C8696	70mm	MLS/C.O.T. .027"	C8692		.010" RC	C8685
Ninja ZX-6R	03-06	C8696-018	70mm	MLS/C.O.T. .018"	C8692		.010" RC	C8685
Ninja ZX-6R	03-06	C8701	69mm	MLS/C.O.T. .027"	C8692		.010" RC	C8685
Ninja ZX-6R	03-06	C8701-018	69mm	MLS/C.O.T. .018"	C8692		.010" RC	C8685
Ninja ZX-6R	07-19	C8751	68mm	MLS/C.O.T. .027"				C8750
Ninja ZX-6R	07-19	C8751-018	68mm	MLS/C.O.T. .018"				C8750
Ninja ZX-6RR	03	C8696	70mm	MLS/C.O.T. .027"	C8692		.010" RC	C8685
Ninja ZX-6RR	03	C8696-018	70mm	MLS/C.O.T. .018"	C8692		.010" RC	C8685
Ninja ZX-6RR	03	C8701	69mm	MLS/C.O.T. .027"	C8692		.010" RC	C8685
Ninja ZX-6RR	03	C8701-018	69mm	MLS/C.O.T. .018"	C8692		.010" RC	C8685
Ninja ZX-6RR	04-06	C8691	68mm	MLS/C.O.T. .027"	C8692		.010" RC	C8685
Ninja ZX-6RR	04-06	C8691-018	68mm	MLS/C.O.T. .018"	C8692		.010" RC	C8685
Ninja ZX-6RR	04-06	C8697	70mm	MLS/C.O.T. .027"	C8692		.010" RC	C8685
Ninja ZX-6RR	4-06	C8697-018	70mm	MLS/C.O.T. .018"	C8692		.010" RC	C8685
ZZR600	5-08	C8694	70mm	MLS/C.O.T. .027"	C8698	2.925"	.010" RC	C8685
ZZR600	05-08	C8694-018	70mm	MLS/C.O.T. .018"	C8354	2.925"	.010" Copper	C8685
EX650 Ninja, KLE650 Versys	06-16	C8722	84mm	MLS/C.O.T. .027"	C8723		.010" RC	C8721
EX650 Ninja, KLE650 Versys	06-16	C8862	86mm	MLS/C.O.T. .027"	C8723		.010" RC	C8721
KZ650	77-83	C8011	65mm	Fiber .043"	B1211020F		.020" Fiber	
KZ, GPZ750, ZX750 Turbo	84-85	C8012	69mm	Fiber .043"	B1211020F		.020" Fiber	
ZX750 Ninja	87-90	C8320	69mm	.010" Copper	C8343	3.110"	.020" Fiber	
ZX-7	91-95	C8274	72mm	MLS/C.O.T. .030"	C8290	3.210"	.005" Copper	C8304
ZX-7	91-95	C8274-018	72mm	MLS/C.O.T. .018"	C8291	3.210"	.010" Copper	C8304
ZX-7	91-95				C8292	3.210"	.020" Copper	C8304
ZX-7	91-95				C8344	3.210"	.010" RC	C8304
ZX-7R	96-03	C8428	73mm	MLS/C.O.T. .030"	C8524		.010" Copper	C8619
ZX-7R	96-03	C8428-018	73mm	MLS/C.O.T. .018"	C8525		.020" Copper	C8619
ZX-7R	96-03	C8429	75mm	MLS/C.O.T. .030"				C8619
ZX-7R	96-03	C8429-018	75mm	MLS/C.O.T. .018"				C8619
ZX-7RR	96-97	C8428	73mm	MLS/C.O.T. .030"	C8524		.010" Copper	C8619
ZX-7RR	96-97	C8428-018	73mm	MLS/C.O.T. .018"	C8525		.020" Copper	C8619
ZX-7RR	96-97	C8429	75mm	MLS/C.O.T. .030"				C8619
ZX-7RR	96-97	C8429-018	75mm	MLS/C.O.T. .018"				C8619
ZX-9R	94-97	C8272	75mm	MLS/C.O.T. .030"	C8290	3.210"	.005" Copper	
ZX-9R	94-97				C8291	3.210"	.010" Copper	
ZX-9R	94-97				C8292	3.210"	.020" Copper	
ZX-9R	94-97				C8344	3.210"	.010" RC	
ZX-9R	98-99	C8515	77mm		C8505		.005" Copper	C8620
ZX-9R	00-01	C8570	77mm	MLS/C.O.T. .027"	C8595		.010" Copper	
ZX-9R	00-01	C8570-018	77mm	MLS/C.O.T. .018"	C8596		.020" Copper	
ZX-9R	00-01	C8609	79mm	MLS/C.O.T. .027"				
ZX-9R	00-01	C8609-018	79mm	MLS/C.O.T. .018"				
ZX-9R	02-03	C8570	77mm	MLS/C.O.T. .027"	C8595		.010" Copper	
ZX-9R	02-03	C8570-018	77mm	MLS/C.O.T. .018"	C8596		.020" Copper	
ZX-9R	02-03	C8609	79mm	MLS/C.O.T. .027"				
ZX-9R	02-03	C8609-018	79mm	MLS/C.O.T. .018"				
KZ1000J 10mm Pin	81-83	C8152	70mm	Copper .043"	C8864	3.210"	.020" Fiber	\$13.29 C8306
						70-76mm		
KZ1000J 10mm Pin	81-83	C8153	71mm	Copper .043"				C8306
KZ1000J	81-83	C8842-040	71mm	MLS/C.O.T. .040"				C8306
KZ1000J 10mm Pin	81-83	C8154	72mm	Copper .043"				C8306
KZ1000J	81-83	C8324	72mm 2 pc	Fiber .043"				C8306
KZ1000J	81-83	C8018	72mm	Fiber .043"				C8306
KZ1000J 10mm Pin	81-83	C8181	73mm	Copper .043"				C8306
KZ1000J	81-83	C8843-040	73mm	MLS/C.O.T. .040"				C8306
KZ1000J	81-83	C8325	74mm 2 pc.	Fiber .043"				C8306
KZ1000J	81-83	C8244	74mm	Copper .043"				C8306
KZ1000J 10mm Pin	81-83	C8182	75mm	Copper .043"				C8306
KZ1000J	81-83	C8017	75mm	Fiber .043"				C8306
KZ1000J	81-83	C8326	76mm 2 pc.	Fiber .043"				C8306
KZ1000J 10mm Pin	81-83	C8156	76mm	Copper .043"				C8306
KZ1000J	81-83	C8844-040	76mm	MLS/C.O.T. .040"				C8306



STREET-ROAD RACE-STRIP



Cometic Gasket - An Exclusive NASCAR Performance® Product

KAWASAKI

Model	Year	Head Gasket Part#	Bore	Material/Thickness	Base Gasket Part#	Bore	Material/Thickness	Price	Case Kit Part#
GPZ1100 10mm Pin	81-82	C8183	77mm	Copper .043"	C8865	3.285" 77-79mm	.020" Fiber		C8306
GPZ1100 10mm Pin	81-82	C8157	78mm	Copper .043"					C8306
GPZ1100	81-82	C8845-040	78mm	MLS/C.O.T. .040"					C8306
GPZ1100	81-82								C8306
GPZ1100 10mm Pin	81-82	C8158	80mm n	Copper .043"	C8866	3.475" 80-82mm	.020" Fiber		C8306
GPZ1100 10mm Pin	81-82	C8159	82mm	Copper .043"					C8306
GPZ1100 D Dowel Pin	81-82	C8432	82mm	Copper .043					C8306
GPZ1100	81-82								C8306
GPZ1100 10mm Pin	81-82	C8160	83mm	Copper .043"	C8121	3.560" 83-84mm	.005" Copper		C8306
GPZ1100 D Dowel Pin	81-82	C8433	83mm	Copper .043	C8122	3.560" 83-84mm	.010" Copper		C8306
GPZ1100 D Dowel Pin	81-82	C8161	84mm	Copper .043	C8123	3.560" 83-84mm	.020" Copper		C8306
KZ900 10mm Pin	76-77	C8152	70mm	Copper .043"	C8093	3.210" 70-76mm	.020" Fiber		C8072
KZ900 10mm Pin	76-77	C8153	71mm	Copper .043"	C8094	3.210" 70-76mm	.005" Copper		C8072
KZ900	76-77	C8842-040	71mm	MLS/C.O.T. .040"	C8095	3.210" 70-76mm	.010" Copper		C8072
KZ900 10mm Pin	76-77	C8154	72mm	Copper .043"	C8096	3.210"	.020" Copper		C8072
KZ900	76-77	C8324	72mm 2 pc.	Fiber .043"					C8072
KZ900	76-77	C8018	72mm	Fiber .043"					C8072
KZ900 10mm Pin	76-77	C8181	73mm	Copper .043"					C8072
KZ900	76-77	C8843-040	73mm	MLS/C.O.T. .040"					C8072
KZ900	76-77	C8325	74mm 2 pc.	Fiber .043"					C8072
KZ900	76-77	C8244	74mm	Copper .043"					C8072
KZ900 10mm Pin	76-77	C8182	75mm	Copper .043"					C8072
KZ900	76-77	C8017	75mm	Fiber .043"					C8072
KZ900	76-77	C8326	76mm 2 pc.	Fiber .043"					C8072
KZ900 10mm Pin	76-77	C8156	76mm	Copper .043"					C8072
KZ900	76-77	C8841-040	76mm	MLS/C.O.T. .040"					C8072
KZ900 10mm Pin	76-77	C8183	77mm	Copper .043"	C8097	3.285" 77-79mm	.020" Fiber		C8072
KZ900 10mm Pin	76-77	C8157	78mm	Copper .043"	C8098	3.285" 77-79mm	.005" Copper		C8072
KZ900	76-77	C8845-040	78mm	MLS/C.O.T. .040"	C8099	3.285" 77-79mm	.010" Copper	C8072	
KZ900	76-77				C8100	3.285" 77-79mm	.020" Copper		C8072
KZ900 10mm Pin	76-77	C8158	80mm	Copper .043"	C8101	3.475" 80-82mm	.020" Fiber		C8072
KZ900 10mm Pin	76-77	C8159	82mm	Copper .043"	C8102	3.475" 80-82mm	.005" Copper		C8072
KZ900D Dowel Pin	76-77	C8432	82mm	Copper .043	C8103	3.475" 80-82mm	.010" Copper		C8072
KZ900	76-77				C8104	3.475" 80-82mm	.020" Copper		C8072
KZ900 10mm Pin	76-77	C8160	83mm	Copper .043"	C8121	3.560" 83-84mm	.005" Copper		C8072
KZ900 D Dowel Pin	76-77	C8433	83mm	Copper .043	C8122	3.560"	.010" Copper		C8072
KZ900 D Dowel Pin	76-77	C8161	84mm	Copper .043	C8123	3.560" 83-84mm	.020" Copper		C8072
Z1 10mm Pin	73-75	C8152	70mm	Copper .043"	C8093	3.210" 70-76mm	.020" Fiber		C8072
Z1 10mm Pin	73-75	C815371mm	10mm Pin	Copper .043"	C8094	3.210" 70-76mm	.005" Copper	C8072	
Z1	73-75	C8842-040	71mm	MLS/C.O.T. .040"	C8095	3.210" 70-76mm	.010" Copper	C8072	
Z1 10mm Pin	73-75	C8154	72mm	Copper .043"	C8096	3.210" 70-76mm	.020" Copper	C8072	



STREET-ROAD RACE-STRIP



Cometic Gasket - An Exclusive NASCAR Performance® Product

KAWASAKI

Model	Year	Head Gasket Part#	Bore	Material/Thickness	Base Gasket Part#	Bore	Material/Thickness	Case Kit Part#
KZ1000	79-80	C8324	72mm 2 pc.	Fiber .043"				C8072
KZ1000	79-80	C8018	72mm	Fiber .043"				C8072
KZ1000 10mm Pin	79-80	C8181	73mm	Fiber .043"				C8072
KZ1000	79-80	C8843-040	73mm	MLS/C.O.T. .040"				C8072
KZ1000	79-80	C8325	74mm 2 pc.	Fiber .043"				C8072
KZ1000	79-80	C8244	74mm	Copper .043"				C8072
KZ1000 10mm Pin	79-80	C8182	75mm	Copper .043"				C8072
KZ1000	79-80	C8017	75mm	Fiber .043"				C8072
KZ1000	79-80	C8326	76mm 2 pc.	Fiber .043"				C8072
KZ1000 10mm Pin	79-80	C8156	76mm	Copper .043"				C8072
KZ1000	79-80	C8844-040	76mm	MLS/C.O.T. .040"				C8072
KZ1000 10mm Pin	79-80	C8183	77mm	Copper .043"	C8097	3.285" 77-79mm	.020" Fiber	C8072
KZ1000 10mm Pin	79-80	C8157	78mm	Copper .043"	C8098	3.285" 77-79mm	.005" Copper	C8072
KZ1000	79-80	C8845-040	78mm	MLS/C.O.T. .040"	C8099	3.285" 77-79mm	.010" Copper	C8072
KZ1000	79-80				C8100	3.285" 77-79mm	.020" Copper	C8072
KZ1000 10mm Pin	79-80	C8158	80mm	Copper .043"	C8101	3.475" 80-82mm	.020" Fiber	C8072
KZ1000 10mm Pin	79-80	C8159	82mm	Copper .043"	C8102	3.475" 80-82mm	.005" Copper	C8072
KZ1000 D Dowel Pin	79-80	C8432	82mm	Copper .043"	C8103	3.475" 80-82mm	.010" Copper	C8072
KZ1000	77-78				C8104	3.475" 80-82mm	.020" Copper	C8072
KZ1000 10mm Pin	77-78	C8160	83mm	Copper .043"	C8121	3.560" 83-84mm	.005" Copper	C8072
KZ1000 D Dowel Pin	77-78	C8433	83mm D	Copper .043"	C8122	3.560" 83-84mm	.010" Copper	C8072
KZ1000 D Dowel Pin	77-78	C8161	84mm	Copper .043"	C8123	3.560" 83-84mm	.020" Copper	C8072
KZ1000 10mm Pin	79-80	C8152	70mm	Copper .043"	C8093	3.210" 83-84mm	.020" Fiber	C8072
KZ1000 10mm Pin	79-80	C8153	71mm	Copper .043"	C8094	3.210" 70-76mm	.005" Copper	C8072
KZ1000	79-80	C8842-040	71mm	MLS/C.O.T. .040"	C8095	3.210" 70-76mm	.010" Copper	C8072
KZ1000 10mm Pin	79-80	C8154	72mm	Copper .043"	C8096	3.210" 70-76mm	.020" Copper	C8072
KZ1000	79-80	C8324	72mm 2 pc.	Fiber .043"				C8072
KZ1000	79-80	C8018	72mm	Fiber .043"				C8072
KZ1000 10mm Pin	79-80	C8181	73mm	Fiber .043"				C8072
KZ1000	79-80	C8843-040	73mm	MLS/C.O.T. .040"				C8072
KZ1000	79-80	C8325	74mm 2 pc.	Fiber .043"				C8072
KZ1000	79-80	C8244	74mm	Copper .043"				C8072
KZ1000 10mm Pin	79-80	C8182	75mm	Copper .043"				C8072
KZ1000	79-80	C8017	75mm	Fiber .043"				C8072
KZ1000	79-80	C8326	76mm 2 pc.	Fiber .043"				C8072
KZ1000 10mm Pin	79-80	C8156	76mm	Copper .043"				C8072
KZ1000	79-80	C8844-040	76mm	MLS/C.O.T. .040"				C8072
KZ1000 10mm Pin	79-80	C8183	77mm	Copper .043"	C8097	3.285" 77-79mm	.020" Fiber	C8072
KZ1000 10mm Pin	79-80	C8157	78mm	Copper .043"	C8098	3.285" 77-79mm	.005" Copper	C8072
KZ1000	79-80	C8845-040	78mm	MLS/C.O.T. .040"	C8099	3.285" 77-79mm	.010" Copper	C8072
KZ1000	79-80				C8100	3.285" 77-79mm	.020" Copper	C8072
KZ1000 10mm Pin	79-80	C8158	80mm	Copper .043"	C8101	3.475" 80-82mm	.020" Fiber	C8072
KZ1000 10mm Pin	79-80	C8159	82mm	Copper .043"	C8102	3.475" 80-82mm	.005" Copper	C8072
KZ1000 D Dowel Pin	79-80	C8432	82mm	Copper .043"	C8103	3.475" 80-82mm	.010" Copper	C8072



STREET-ROAD RACE-STRIP



Cometic Gasket - An Exclusive NASCAR Performance® Product

KAWASAKI

Model	Year	Head Gasket Part#	Bore	Material/Thickness	Price	Base Gasket Part#	Bore	Material/Thickness	Case Kit Part#
KZ1000	79-80					C8104	3.475" 80-82mm	.020" Copper	C8072
KZ1000 10mm Pin	79-80	C8160	83mm	Copper .043"		C8121	3.560" 83-84mm	.005" Copper	C8072
KZ1000 D Dowel Pin	79-80	C8433	83mm	Copper .043		C8122	3.560" 83-84mm	.010" Copper	C8072
KZ1000 D Dowel Pin	79-80	C8161	84mm	Copper .043		C8123	3.560" 83m-84mm	.020" Copper	C8072
Ninja 1000R ZX1000	86-87	C8013	75mm	CFM-20		C8346	3.230"	.010"RC	C8305AFM
Z1000 (ZR1000)	03-09	C8708-018	79mm	MLS/C.O.T. .018"					
Z1000 (ZR1000)	03-09	C8709-018	81mm	MLS/C.O.T. .018"					
ZX1000 Ninja, ZX10	88-90	C8271	75.5mm	MLS/C.O.T. .030"					
ZX1000 Ninja ZX-10R	04-05	C8680	76mm	MLS/C.O.T. .027"					C8682
ZX1000 Ninja ZX-10R	04-05	C8680-018	76mm	MLS/C.O.T. .018"					C8682
ZX1000 Ninja ZX-10R	04-05	C8681	78mm	MLS/C.O.T. .027"					C8682
ZX1000 Ninja ZX-10R	04-05	C8681-018	78mm	MLS/C.O.T. .018"					C8682
ZX1000 Ninja ZX-10R	06-07	C8714	76mm	MLS/C.O.T. .027"					C8715
ZX1000 Ninja ZX-10R	06-07	C8714-018	76mm	MLS/C.O.T. .018"					C8715
ZX1000 Ninja ZX-10R	06-07	C8576	78mm	MLS/C.O.T. .027"					C8715
ZX1000 Ninja ZX-10R	06-07	C8576-018	78mm	MLS/C.O.T. .018"					C8715
ZX1000 Ninja ZX-10R	08-10	C8714	76mm	MLS/C.O.T. .027"					C8715
ZX1000 Ninja ZX-10R	08-10	C8714-018	76mm	MLS/C.O.T. .018"					C8715
ZX1000 Ninja ZX-10R	08-10	C8576	78mm	MLS/C.O.T. .027"					C8715
ZX1000 Ninja ZX-10R	08-10	C8576-018	78mm	MLS/C.O.T. .018"					C8715
ZX1000 Ninja ZX-10R	11-15	C8848	77mm	MLS/C.O.T. .018"					C8846
ZX1000 Ninja ZX-10R	11-15	C8849	79mm	MLS/C.O.T. .018"					C8846
ZX1100-C1 (Ninja ZX-11)	90-93	C8740	76mm	MLS/C.O.T. .030"	C8358	3.290"		.010"	
ZX1100-C1 (Ninja ZX-11)	90-93	C8603	77mm	MLS/C.O.T. .030"	C8358	3.290"		.010"	
ZX1100-C1 (Ninja ZX-11)	90-93	C8603-018	77mm	MLS/C.O.T. .018"	C8358	3.290"		.010"	
ZX1100-C1 (Ninja ZX-11)	90-93	C8273	78mm	MLS/C.O.T. .030"	C8358	3.290"		.010"	
ZX1100-C1 (Ninja ZX-11)	90-93	C8273-018	78mm	MLS/C.O.T. .018"	C8358	3.290"		.010"	
ZX1100-C1 (Ninja ZX-11)	90-93	C8483	78mm	Copper .032"	C8358	3.290"		.010"	
ZX1100-E1 (GPZ 1100)	95-97	C8740	76mm	MLS/C.O.T. .030"	C8358	3.290"		.010"	
ZX1100-E1 (GPZ 1100)	95-97	C8603	77mm	MLS/C.O.T. .030"	C8358	3.290"		.010"	
ZX1100-E1 (GPZ 1100)	95-97	C8603-018	77mm	MLS/C.O.T. .018"	C8358	3.290"		.010"	
ZX1100-E1 (GPZ 1100)	95-97	C8273	78mm	MLS/C.O.T. .030"	C8358	3.290"		.010"	
ZX1100-E1 (GPZ 1100)	95-97	C8273-018	78mm	MLS/C.O.T. .018"	C8358	3.290"		.010"	
ZX1100-E1 (GPZ 1100)	95-97	C8483	78mm	Copper .032"	C8358	3.290"		.010"	
ZX1100-F1 (GPZ 1100 ABS)	1996	C8740	76mm	MLS/C.O.T. .030"	C8358	3.290"		.010"	
ZX1100-F1 (GPZ 1100 ABS)	1996	C8603	77mm	MLS/C.O.T. .030"	C8358	3.290"		.010"	
ZX1100-F1 (GPZ 1100 ABS)	1996	C8603-018	77mm	MLS/C.O.T. .018"	C8358	3.290"		.010"	
ZX1100-F1 (GPZ 1100 ABS)	1996	C8273	78mm	MLS/C.O.T. .030"	C8358	3.290"		.010"	
ZX1100-F1 (GPZ 1100 ABS)	1996	C8273-018	78mm	MLS/C.O.T. .018"	C8358	3.290"		.010"	
ZX1100-F1 (GPZ 1100 ABS)	1996	C8483	78mm	Copper .032"	C8358	3.290"		.010"	
ZR1100-C3 (ZRX1100) (99)	99-00	C8740	76mm	MLS/C.O.T. .030"	C8358	3.290"		.010"	
ZR1100-C3 (ZRX1100) (99)	99-00	C8603	77mm	MLS/C.O.T. .030"	C8358	3.290"		.010"	
ZR1100-C3 (ZRX1100) (99)	99-00	C8603-018	77mm	MLS/C.O.T. .018"	C8358	3.290"		.010"	
ZR1100-C3 (ZRX1100) (99)	99-00	C8273	78mm	MLS/C.O.T. .030"	C8358	3.290"		.010"	
ZR1100-C3 (ZRX1100) (99)	99-00	C8273-018	78mm	MLS/C.O.T. .018"	C8358	3.290"		.010"	
ZR1100-C3 (ZRX1100) (99)	99-00	C8483	78mm	Copper .032"	C8358	3.290"		.010"	
ZR1100	92-95	C8229	82mm	CFM-20	C8358	3.290"		.010"	
ZR1200-A (ZRX1200)	1-05	C8711	80mm	MLS/C.O.T. .027"	B0554020RC			.020"	
ZX1200-C (ZZR1200)	2-05	C8711	80mm	MLS/C.O.T. .027"	B0554020RC			.020"	
ZX-12R	00-01	C8642	83mm	MLS/C.O.T. .030"	C8579			.010"	C8497
ZX-12R	00-01	C8642-018	83mm	MLS/C.O.T. .018"	C8579			.010"	C8497
ZX-12R	00-01	C8573	84mm	MLS/C.O.T. .030"	C8579			.010"	C8497
ZX-12R	00-01	C8573-018	84mm	MLS/C.O.T. .018"	C8579			.010"	C8497
ZX-12R	00-01	C8643	85mm	MLS/C.O.T. .030"	C8579			.010"	C8497
ZX-12R	00-01	C8643-018	85mm	MLS/C.O.T. .018"	C8579			.010"	C8497
ZX-12R	00-01	C8641	86mm	MLS/C.O.T. .030"	C8579			.010"	C8497
ZX-12R	00-01	C8641-018	86mm	MLS/C.O.T. .018"	C8579			.010"	C8497
ZX-12R	02-06	C8642	83mm	MLS/C.O.T. .030"	C8579			.010"	C8497
ZX-12R	02-06	C8642-018	83mm	MLS/C.O.T. .018"	C8579			.010"	C8497
ZX-12R	02-06	C8573	84mm	MLS/C.O.T. .030"	C8579			.010"	C8497



STREET-ROAD RACE-STRIP



Cometic Gasket - An Exclusive NASCAR Performance® Product

KAWASAKI

Model	Year	Head Gasket Part#	Bore	Material/Thickness	Base Gasket Part#	Bore	Material/Thickness	Case Kit Part#
ZX-12R	02-06	C8573-018	84mm	MLS/C.O.T. .018"	C8579		.010"	C8497
ZX-12R	02-06	C8643	85mm	MLS/C.O.T. .030"	C8579		.010"	C8497
ZX-12R	02-06	C8643-018	85mm	MLS/C.O.T. .018"	C8579		.010"	C8497
ZX-12R	02-06	C8641	86mm	MLS/C.O.T. .030"	C8579		.010"	C8497
ZX-12R	02-06	C8641-018	86mm	MLS/C.O.T. .018"	C8579		.010"	C8497
Ninja ZX-14	06-19	C8460-018	84mm	MLS/C.O.T. .018"				C8713
Ninja ZX-14	06-19	C8621	86mm	MLS/C.O.T. .018"				C8713
Ninja ZX-14	06-19	C8622	87mm	MLS/C.O.T. .018"				C8713

KTM

Model	Year	Head Gasket Part#	Bore	Material/Thickness	Base Gasket Part#	Bore	Material/Thickness	Case Kit Part#
RC390	13-17	C8897	89mm	MLS/C.O.T. .027"	C8899		.014" RC	
RC390	13-17	C8898	91mm	MLS/C.O.T. .027"	C8899		.014" RC	
390 Duke	13-19	C8897	89mm	MLS/C.O.T. .027"	C8899		.014" RC	
390 Duke	13-19	C8898	91mm	MLS/C.O.T. .027"	C8899		.014" RC	
RC8 1190	09-14	C8939	106mm	MLS/C.O.T. .030"				
1190 Adventure	14-17	C8939	106mm	MLS/C.O.T. .030"				
1290 Super Adventure	14-18	C8940	108mm	MLS/C.O.T. .032"				
1290 Super Duke	14-18	C8940	108mm	MLS/C.O.T. .032"				

VICTORY

Model	Year	Head Gasket Part#	Bore	Material/Thickness	Base Gasket Part#	Bore	Material/Thickness	Case Kit Part#
V92C	99-04	C8652	97mm	MLS/C.O.T. .065"				
V92C	99-04	C8653	101mm	MLS/C.O.T. .065"				

SUZUKI

Model	Year	Head Gasket Part#	Bore	Material/Thickness	Base Gasket Part#	Bore	Material/Thickness	Case Kit Part#
GS550E 2 Valve	77-86	C8024	60mm	CFM-20 .043"				
GSF600S Bandit	96-99	C8025	66.5mm	CFM-20 .043"				
GSF600S Bandit	00-03	C8025	66.5mm	CFM-20 .043"				
GSX600F Katana	98-06	C8025	66.5mm	CFM-20 .043"				
GSX600FT Katana	88-96	C8025	66.5mm	CFM-20 .043"				
GSX600FV	97	C8025	66.5mm	CFM-20 .043"				
GSX600F Katana	93	C8025	66.5mm	CFM-20 .043"				
GSX-R600	97-00	C8413	65.5mm	MLS/C.O.T. .030"	C8422		.010" RC	C8592
GSX-R600	01-03	C8644	68mm	MLS/C.O.T. .027"				C8206
GSX-R600	01-03	C8644-018	68mm	MLS/C.O.T. .018"				C8206
GSX-R600	01-03	C8645	69mm	MLS/C.O.T. .027"				C8206
GSX-R600	01-03	C8645-018	69mm	MLS/C.O.T. .018"				C8206
GSX-R600	01-03	C8646	70mm	MLS/C.O.T. .027"				C8206
GSX-R600	04-05	C8632	68mm	MLS/C.O.T. .030"				C8689
GSX-R600	04-05	C8632-018	68mm	MLS/C.O.T. .018"				C8689
GSX-R600	04-05	C8724	70mm	MLS/C.O.T. .030"				C8689
GSX-R600	04-05	C8724-018	70mm	MLS/C.O.T. .018"				C8689
GSX-R600	06-07							
GSX-R600	08-19	C8293	70mm	MLS/C.O.T. .027"				C8742
GSX-R600	08-19	C8293-018	70mm	MLS/C.O.T. .018"				C8742
GSX-R600	08-19	C8302	68mm	MLS/C.O.T. .027"				C8742
GSX-R600	08-19	C8302-018	68mm	MLS/C.O.T. .018"				C8742
RF600RT	94-96	C8275	67mm	MLS/C.O.T. .030"				C8143
RF600R	95	C8275	67mm	MLS/C.O.T. .030"				C8143
GSX-R600WP	92-93	C8275	67mm	MLS/C.O.T. .030"	C8137	3.265"	.020" Copper	C8143
DL650 V Strom	04-19	C8593	84mm	MLS/C.O.T. .030"	C8771		.020" RC	
DL650 V Strom	04-19	C8593-018	84mm	MLS/C.O.T. .018"	C8615		.005" Copper	
DL650 V Strom	04-19	C8600	83mm	MLS/C.O.T. .030"	C8616		.010" Copper	



STREET·ROAD RACE·STRIP



Cometic Gasket - An Exclusive NASCAR Performance® Product

Valve Cover Part#	Magneto Cover Part#	Clutch Cover Part#	Exhaust Gasket Part#	Shift Shaft Part#	Output Shaft Part#
	EC881032AFM	EC882032AFM	C8745	OS269	OS397
	EC881032AFM	EC882032AFM	C8745	OS269	OS397
	EC881032AFM	EC882032AFM	C8745	OS269	OS397
	EC881032AFM	EC882032AFM	C8745	OS269	OS397
	EC881032AFM	EC882032AFM	C8745	OS269	OS397
	EC1161032AFM	EC1159032AFM	C8873	OS269	OS411
	EC1161032AFM	EC1159032AFM	C8873	OS269	OS411
	EC1161032AFM	EC1159032AFM	C8873	OS269	OS411

Valve Cover Part#	Magneto Cover Part#	Clutch Cover Part#	Exhaust Gasket Part#	Shift Shaft Part#	Output Shaft Part#
				OS331	OS412
				OS331	OS412
				OS331	OS412
				OS331	OS412

Valve Cover Part#	Magneto Cover Part#	Clutch Cover Part#	Exhaust Gasket Part#	Shift Shaft Part#	Output Shaft Part#

Valve Cover Part#	Price	Magneto Cover Part#	Clutch Cover Part#	Exhaust Gasket Part#	Shift Shaft Part#	Output Shaft Part#
		EC014020F	EC012020F	C8884	OS420	OS413
		EC014020F	EC012020F	C8884	OS420	OS414
		EC014020F	EC012020F	C8884	OS420	OS414
		EC014020F	EC012020F	C8884	OS420	OS414
		EC014020F	EC012020F	C8884	OS420	OS414
		EC014020F	EC012020F	C8884	OS420	OS414
		EC090031F	EC091020F	C8886	OS305	OS415
		EC519032AFM	EC518032AFM	C8886	OS305	OS415
		EC519032AFM	EC518032AFM	C8886	OS305	OS415
		EC519032AFM	EC518032AFM	C8886	OS305	OS415
		EC519032AFM	EC518032AFM	C8886	OS305	OS415
		EC519032AFM	EC518032AFM	C8886	OS305	OS415
		EC946032AFM	EC518032AFM	C8886	OS305	OS415
		EC946032AFM	EC518032AFM	C8886	OS305	OS415
		EC946032AFM	EC518032AFM	C8886	OS305	OS415
		EC1278032AFM	EC1276032AFM	C8886	OS305	OS416
		EC1278032AFM	EC1276032AFM	C8886	OS305	OS416
		EC1278032AFM	EC1276032AFM	C8886	OS305	OS416
		EC1278032AFM	EC1276032AFM	C8886	OS305	OS416
			EC022020F		OS305	OS415
			EC022020F		OS305	OS415
			EC022020F		OS305	OS415
				C8746	OS305	OS417
				C8746	OS305	OS417
				C8746	OS305	OS417



STREET-ROAD RACE-STRIP



Cometic Gasket - An Exclusive NASCAR Performance® Product

SUZUKI

Model	Year	Head Gasket Part#	Bore	Material/Thickness	Base Gasket Part#	Bore	Material/Thickness	Case Kit Part#
DL650 V Strom	04-19	C8593-018	84mm	MLS/C.O.T. .018"	C8615		.005" Copper	
DL650 V Strom	04-19	C8600	83mm	MLS/C.O.T. .030"	C8616		.010" Copper	
DL650 V Strom	04-19	C8600-018	83mm	MLS/C.O.T. .018"	C8617		.020" Copper	
DL650 V Strom	04-19	C8613	87mm	MLS/C.O.T. .030"				
DL650 V Strom	04-19	C8613-018	87mm	MLS/C.O.T. .018"				
DL650 V Strom	04-19	C8614	81mm	MLS/C.O.T. .030"				
DL650 V Strom	04-19	C8614-018	81mm	MLS/C.O.T. .018"				
7.99SV650	04-19	C8593	84mm	MLS/C.O.T. .030"	C8771		.020" RC	
SV650	04-19	C8593-018	84mm	MLS/C.O.T. .018"	C8615		.005" Copper	
SV650	04-19	C8600	83mm	MLS/C.O.T. .030"	C8616		.010" Copper	
SV650	04-19	C8600-018	83mm	MLS/C.O.T. .018"	C8617		.020" Copper	
SV650	04-19	C8613	87mm	MLS/C.O.T. .030"				
SV650	04-19	C8613-018	87mm	MLS/C.O.T. .018"				
SV650	04-19	C8614	81mm	MLS/C.O.T. .030"				
SV650	04-19	C8614-018	81mm	MLS/C.O.T. .018"				
GS750 2 Valve	77-79	C8028	69mm	CFM-20 .043"	C8528	2.900"	.020" Fiber	
GS750E 4 Valve	80-82	C8027	70mm	CFM-20 .043"	C8549	2.953"	.020" Fiber	
GSX-R750	86-92	C8466	71mm	MLS/C.O.T. .030"	B0285020F 3.280"		.020" Fiber	
GSX-R750	86-92	C8415	74mm	MLS/C.O.T. .030"	B0285020F 3.280"		.020" Fiber	
GSX-R750	86-92	C8464	77mm	MLS/C.O.T. .030"	B0285020F 3.280"		.020" Fiber	
GSX-R750	86-92	C8463	79mm	MLS/C.O.T. .030"	B0285020F 3.280"		.020" Fiber	
GSXR750W	93-95	C8276	71 mm	MLS/C.O.T. .030"	C8137	83 mm	.020" Copper	C8143
GSXR750W	93-95	C8337	75 mm	MLS/C.O.T. .030"	C8137	83 mm	.020" Copper	C8143
GSXR750W	93-95	C8338	77 mm	MLS/C.O.T. .030"	C8137	83 mm	.020" Copper	C8143
GSX-R750	96-99	C8387	72 mm	MLS/C.O.T. .030"	C8421		.010" RC	C8403
GSX-R750	96-99	C8387-018	72 mm	MLS/C.O.T. .018"	C8421		.010" RC	C8403
GSX-R750	96-99	C8414	74 mm	MLS/C.O.T. .030"	C8421		.010" RC	C8403
GSX-R750	96-99	C8414-018	74 mm	MLS/C.O.T. .018"	C8421		.010" RC	C8403
GSX-R750	96-99	C8445	75 mm	MLS/C.O.T. .030"	C8421		.010" RC	C8403
GSX-R750	96-99	C8445-018	75 mm	MLS/C.O.T. .018"	C8421		.010" RC	C8403
GSX-R750	00-05	C8663	73 mm	MLS/C.O.T. .030"				C8206
GSX-R750	00-05	C8663-018	73 mm	MLS/C.O.T. .018"				C8206
GSX-R750	00-05	C8574	74 mm	MLS/C.O.T. .030"				C8206
GSX-R750	00-05	C8574-018	74 mm	MLS/C.O.T. .018"				C8206
GSX-R750	00-05	C8214	75 mm	MLS/C.O.T. .030"				C8206
GSX-R750	00-05	C8214-018	75 mm	MLS/C.O.T. .018"				C8206
GSX-R750	00-05	C8602	76 mm	MLS/C.O.T. .030"				C8206
GSX-R750	00-05	C8602-018	76 mm	MLS/C.O.T. .018"				C8206
GSX-R750	04-19	C8717	70mm	MLS/C.O.T. .027"				C8742
GSX-R750	04-19	C8717-018	70mm	MLS/C.O.T. .018"				C8742
GSX-R750	04-19	C8718	72mm	MLS/C.O.T. .027"				C8742
GSX-R750	04-19	C8718-018	72mm	MLS/C.O.T. .018"				C8742
GSX-R750	15-18	C8717	70mm	MLS/C.O.T. .027"				C8742
GSX-R750	15-18	C8717-018	70mm	MLS/C.O.T. .018"				C8742
GSX-R750	15-18	C8718	72mm	MLS/C.O.T. .027"				C8742
GSX-R750	15-18	C8718-018	72mm	MLS/C.O.T. .018"				C8742
GSX-750F, Katana	88-97	C8415	74 mm		C8137		.020" Copper	C8423
GS850	79-83	C8028	69mm	CFM-20 .043"				
RF900RV	94-97	C8338	77mm	MLS/C.O.T. .027"	C8138	3.265"	.020" Fiber	C8143
RF900RV	94-97	C8277	78mm	MLS/C.O.T. .027"	C8138	3.265"	.020" Fiber	C8143
DL1000 V-Strom	02-13	C8502	99mm	MLS/C.O.T. .030"	C8509	4.450"	.010" RC	
GS1000 2 Valve	78-80	C8030	73.5mm	CFM-20 .043"	C8364	3.110"	.020" Copper	
GS1000 2 Valve	78-80	C8408	73.5mm	Copper .043"	C8364	3.110"	.020" Copper	
GS1000S 4 valve	82	C8031	75 mm	CFM-20 .043"	C8109	3.130"	.020" Fiber	C8073
GS1000S 4 valve	82	C8031	75 mm	CFM-20 .043"	C8110	3.130"	.005" Copper	C8073
GS1000S 4 valve	82	C8031	75 mm	CFM-20 .043"	C8111	3.130"	.010" Copper	C8073
GS1000S 4 valve	82	C8031	75 mm	CFM-20 .043"	C8112	3.130"	.020" Copper	C8073
GS1000S 4 valve	82	C8035	84 mm	CFM-20 .043"	C8177	3.460"	.005" Copper	C8073
GS1000S 4 valve	1982	C8035	84 mm	CFM-20 .043"	C8178	3.460"	.010" Copper	C8073
GS1000S 4 valve	1982	C8035	84 mm	CFM-20 .043"	C8179	3.460"	.020" Copper	C8073
GS1000S 4 valve	1982	C8035	84 mm	CFM-20 .043"	C8180	3.460"	.020" Fiber	C8073
GSX-R1000	01-02	C8663	73 mm	MLS/C.O.T. .030"				C8582
GSX-R1000	01-02	C8663-018	73 mm	MLS/C.O.T. .018"				C8582
GSX-R1000	01-02	C8574	74 mm	MLS/C.O.T. .030"				C8582
GSX-R1000	01-02	C8574-018	74 mm	MLS/C.O.T. .018"				C8582



STREET-ROAD RACE-STRIP



Cometic Gasket - An Exclusive NASCAR Performance® Product

SUZUKI

Model	Year	Head Gasket Part#	Bore	Material/Thickness	Base Gasket Part#	Bore	Material/Thickness	Price	Case Kit Part#
GSX-R1000	01-02	C8214	75 mm	MLS/C.O.T. .030"					C8582
GSX-R1000	01-02	C8214-018	75 mm	MLS/C.O.T. .018"					C8582
GSX-R1000	01-02	C8602	76 mm	MLS/C.O.T. .030"					C8582
GSX-R1000	01-02	C8602-018	76 mm	MLS/C.O.T. .018"					C8582
GSX-R1000	03-04	C8663	73 mm	MLS/C.O.T. .030"					C8689
GSX-R1000	03-04	C8663-018	73 mm	MLS/C.O.T. .018"					C8689
GSX-R1000	03-04	C8574	74 mm	MLS/C.O.T. .030"					C8689
GSX-R1000	03-04	C8574-018	74 mm	MLS/C.O.T. .018"					C8689
GSX-R1000	03-04	C8214	75 mm	MLS/C.O.T. .030"					C8689
GSX-R1000	03-04	C8214-018	75 mm	MLS/C.O.T. .018"					C8689
GSX-R1000	03-04	C8602	76 mm	MLS/C.O.T. .030"					C8689
GSX-R1000	03-04	C8602-018	76 mm	MLS/C.O.T. .018"					C8689
GSX-R1000	05-06	C8214	75 mm	MLS/C.O.T. .030"					C8689
GSX-R1000	05-06	C8214-018	75 mm	MLS/C.O.T. .018"					C8689
GSX-R1000	05-06	C8602	76 mm	MLS/C.O.T. .030"					C8689
GSX-R1000	05-06	C8602-018	76 mm	MLS/C.O.T. .018"					C8689
GSX-R1000	07-08	C8214	75 mm	MLS/C.O.T. .030"					C8752AFM
GSX-R1000	07-08	C8214-018	75 mm	MLS/C.O.T. .018"					C8752AFM
GSX-R1000	07-08	C8602	76 mm	MLS/C.O.T. .030"					C8752AFM
GSX-R1000	07-08	C8602-018	76 mm	MLS/C.O.T. .018"					C8752AFM
GSX-S1000	17-18	C8214	75 mm	MLS/C.O.T. .030"					C8752AFM
GSX-S1000	17-18	C8214-018	75 mm	MLS/C.O.T. .018"					C8752AFM
GSX-S1000	17-18	C8602	76 mm	MLS/C.O.T. .030"					C8752AFM
GSX-R1000	09-16	C8772	74.5 mm	MLS/C.O.T. .027"					C8893AFM
GSX-R1000	09-16	C8772-018	74.5 mm	MLS/C.O.T. .018"					C8893AFM
GSX-R1000	09-16	C8773	76 mm	MLS/C.O.T. .027"					C8893AFM
GSX-R1000	09-16	C8773-018	76 mm	MLS/C.O.T. .018"					C8893AFM
GSX-R1000	17-18	C8929	76 mm	MLS/C.O.T. .023"					C8893AFM
SV1000S	03-06	C8502	99mm	MLS/C.O.T. .030"	C8509	4.450"	.010" RC		
TL1000 R/S V-Twin	97-03	C8502	99mm	MLS/C.O.T. .030"	C8509	4.450"	.010" RC		
GS1100E 11mm Pin	80-81	C8163	72 mm	Copper .043"	C8109	3.130"	.020" Fiber		C8073
GS1100E 11mm Pin	80-81	C8163	72 mm	Copper .043"	C8110	3.130"	.005" Copper		C8073
GS1100E 11mm Pin	80-81	C8163	72 mm	Copper .043"	C8111	3.130"	.010" Copper		C8073
GS1100E 11mm Pin	80-81	C8163	72 mm	Copper .043"	C8112	3.130"	.020" Copper		C8073
GS1100E 11mm Pin	80-81	C8185	75 mm	Copper .043"	C8109	3.130"	.020" Fiber		C8073
GS1100E 11mm Pin	80-81	C8185	75 mm	Copper .043"	C8110	3.130"	.005" Copper		C8073
GS1100E 11mm Pin	80-81	C8185	75 mm	Copper .043"	C8111	3.130"	.010" Copper		C8073
GS1100E 11mm Pin	80-81	C8185	75 mm	Copper .043"	C8112	3.130"	.020" Copper		C8073
GS1100E 11mm Pin	80-81	C8728-045	75mm	MLS/C.O.T. .045"	C8109	3.130"	.020" Fiber		C8073
GS1100E 11mm Pin	80-81	C8728-045	75mm	MLS/C.O.T. .045"	C8110	3.130"	.005" Copper		C8073
GS1100E 11mm Pin	80-81	C8728-045	75mm	MLS/C.O.T. .045"	C8111	3.130"	.010" Copper		C8073
GS1100E 11mm Pin	80-81	C8728-045	75mm	MLS/C.O.T. .045"	C8112	3.130"	.020" Copper		C8073
GS1100E 11mm Pin	80-81	C8165	76 mm	Copper .043"	C8113	3.290"	.020" Fiber		C8073
GS1100E 11mm Pin	80-81	C8165	76 mm	Copper .043"	C8114	3.290"	.005" Copper		C8073
GS1100E 11mm Pin	80-81	C8165	76 mm	Copper .043"	C8115	3.290"	.010" Copper		C8073
GS1100E 11mm Pin	80-81	C8165	76 mm	Copper .043"	C8116	3.290"	.020" Copper		C8073
GS1100E 11mm Pin	80-81	C8729-045	76 mm	MLS/C.O.T. .045"	C8113	3.290"	.020" Fiber		C8073
GS1100E 11mm Pin	80-81	C8729-045	76 mm	MLS/C.O.T. .045"	C8114	3.290"	.005" Copper		C8073
GS1100E 11mm Pin	80-81	C8729-045	76 mm	MLS/C.O.T. .045"	C8115	3.290"	.010" Copper		C8073
GS1100E 11mm Pin	80-81	C8729-045	76 mm	MLS/C.O.T. .045"	C8116	3.290"	.020" Copper		C8073
GS1100E 11mm Pin	80-81	C8186	77 mm	Copper .043"	C8113	3.290"	.020" Fiber		C8073
GS1100E 11mm Pin	80-81	C8186	77 mm	Copper .043"	C8114	3.290"	.005" Copper		C8073
GS1100E 11mm Pin	80-81	C8186	77 mm	Copper .043"	C8115	3.290"	.010" Copper		C8073
GS1100E 11mm Pin	80-81	C8186	77 mm	Copper .043"	C8116	3.290"	.020" Copper		C8073
GS1100E 11mm Pin	80-81	C8166	78 mm	Copper .043"	C8113	3.290"	.020" Fiber		C8073
GS1100E 11mm Pin	80-81	C8166	78 mm	Copper .043"	C8114	3.290"	.005" Copper		C8073
GS1100E 11mm Pin	80-81	C8166	78 mm	Copper .043"	C8115	3.290"	.010" Copper		C8073
GS1100E 11mm Pin	80-81	C8166	78 mm	Copper .043"	C8116	3.290"	.020" Copper		C8073
GS1100E 11mm Pin	80-81	C8167	79 mm	Copper .043"	C8113	3.290"	.020" Fiber		C8073
GS1100E 11mm Pin	80-81	C8167	79 mm	Copper .043"	C8114	3.290"	.005" Copper		C8073
GS1100E 11mm Pin	80-81	C8167	79 mm	Copper .043"	C8115	3.290"	.010" Copper		C8073
GS1100E 11mm Pin	80-81	C8167	79 mm	Copper .043"	C8116	3.290"	.020" Copper		C8073
GS1100E 11mm Pin	80-81	C8730-045	79 mm	MLS/C.O.T. .045"	C8113	3.290"	.020" Fiber		C8073
GS1100E 11mm Pin	80-81	C8730-045	79 mm	MLS/C.O.T. .045"	C8114	3.290"	.005" Copper		C8073
GS1100E 11mm Pin	80-81	C8730-045	79 mm	MLS/C.O.T. .045"	C8115	3.290"	.010" Copper		C8073



STREET-ROAD RACE-STRIP



Cometic Gasket - An Exclusive NASCAR Performance® Product

SUZUKI

Model	Year	Head Gasket Part#	Bore	Material/Thickness	Base Gasket Part#	Bore	Material/Thickness	Case Kit Part#
GS1100E 11mm Pin	80-81	C8730-045	79 mm	MLS/C.O.T. .045"	C8116	3.290"	.020" Copper	C8073
GS1100E 11mm Pin	80-81	C8168	80 mm	Copper .043"	C8177	3.460"	.005" Copper	C8073
GS1100E 11mm Pin	80-81	C8168	80 mm	Copper .043"	C8178	3.460"	.010" Copper	C8073
GS1100E 11mm Pin	80-81	C8168	80 mm	Copper .043"	C8179	3.460"	.020" Copper	C8073
GS1100E 11mm Pin	80-81	C8168	80 mm	Copper .043"	C8180	3.460"	.020" Fiber	C8073
GS1100E 11mm Pin	80-81	C8731-045	80 mm	MLS/C.O.T. .045"	C8177	3.460"	.005" Copper	C8073
GS1100E 11mm Pin	80-81	C8731-045	80 mm	MLS/C.O.T. .045"	C8178	3.460"	.010" Copper	C8073
GS1100E 11mm Pin	80-81	C8731-045	80 mm	MLS/C.O.T. .045"	C8179	3.460"	.020" Copper	C8073
GS1100E 11mm Pin	80-81	C8731-045	80 mm	MLS/C.O.T. .045"	C8180	3.460"	.020" Fiber	C8073
GS1100E D Pin	80-81	C8470	82 mm	Copper .043"	C8177	3.460"	.005" Copper	C8073
GS1100E D Pin	80-81	C8470	82 mm	Copper .043"	C8178	3.460"	.010" Copper	C8073
GS1100E D Pin	80-81	C8470	82 mm	Copper .043"	C8179	3.460"	.020" Copper	C8073
GS1100E D Pin	80-81	C8470	82 mm	Copper .043"	C8180	3.460"	.020" Fiber	C8073
GS1100E 11mm Pin	80-81	C8169	82 mm	Copper .043"	C8177	3.460"	.005" Copper	C8073
GS1100E 11mm Pin	80-81	C8169	82 mm	Copper .043"	C8178	3.460"	.010" Copper	C8073
GS1100E 11mm Pin	80-81	C8169	82 mm	Copper .043"	C8179	3.460"	.020" Copper	C8073
GS1100E 11mm Pin	80-81	C8169	82 mm	Copper .043"	C8180	3.460"	.020" Fiber	C8073
GS1100E D Pin	80-81	C8471	83 mm	Copper .043"	C8117	3.560"	.020" Fiber	C8073
GS1100E D Pin	80-81	C8471	83 mm	Copper .043"	C8118	3.560"	.005" Copper	C8073
GS1100E D Pin	80-81	C8471	83 mm	Copper .043"	C8119	3.560"	.010" Copper	C8073
GS1100E D Pin	80-81	C8471	83 mm	Copper .043"	C8120	3.560"	.020" Copper	C8073
GS1100E 11mm Pin	80-81	C8170	83 mm	Copper .043"	C8117	3.560"	.020" Fiber	C8073
GS1100E 11mm Pin	80-81	C8170	83 mm	Copper .043"	C8118	3.560"	.005" Copper	C8073
GS1100E 11mm Pin	80-81	C8170	83 mm	Copper .043"	C8119	3.560"	.010" Copper	C8073
GS1100E 11mm Pin	80-81	C8170	83 mm	Copper .043"	C8120	3.560"	.020" Copper	C8073
GS1100E D Pin	80-81	C8732-045	83 mm	MLS/C.O.T. .045"	C8117	3.560"	.020" Fiber	C8073
GS1100E D Pin	80-81	C8732-045	83 mm	MLS/C.O.T. .045"	C8118	3.560"	.005" Copper	C8073
GS1100E D Pin	80-81	C8732-045	83 mm	MLS/C.O.T. .045"	C8119	3.560"	.010" Copper	C8073
GS1100E D Pin	80-81	C8732-045	83 mm	MLS/C.O.T. .045"	C8120	3.560"	.020" Copper	C8073
GS1100E 11mm Pin	80-81	C8035	84 mm	Fiber .043"	C8117	3.560"	.020" Fiber	C8073
GS1100E 11mm Pin	80-81	C8035	84 mm	Fiber .043"	C8118	3.560"	.005" Copper	C8073
GS1100E 11mm Pin	80-81	C8035	84 mm	Fiber .043"	C8119	3.560"	.010" Copper	C8073
GS1100E 11mm Pin	80-81	C8035	84 mm	Fiber .043"	C8120	3.560"	.020" Copper	C8073
GS1100E 6mm Pin	80-81	C8187	85 mm	Copper .043"	C8117	3.560"	.020" Fiber	C8073
GS1100E 6mm Pin	80-81	C8187	85 mm	Copper .043"	C8118	3.560"	.005" Copper	C8073
GS1100E 6mm Pin	80-81	C8187	85 mm	Copper .043"	C8119	3.560"	.010" Copper	C8073
GS1100E 6mm Pin	80-81	C8187	85 mm	Copper .043"	C8120	3.560"	.020" Copper	C8073
GS1100E 8mm Pin	80-81	C8439	85 mm	Copper .043"	C8117	3.560"	.020" Fiber	C8073
GS1100E 8mm Pin	80-81	C8439	85 mm	Copper .043"	C8118	3.560"	.005" Copper	C8073
GS1100E 8mm Pin	80-81	C8439	85 mm	Copper .043"	C8119	3.560"	.010" Copper	C8073
GS1100E 8mm Pin	80-81	C8439	85 mm	Copper .043"	C8120	3.560"	.020" Copper	C8073
GS1100E D Pin	80-81	C8473	85 mm	Copper .043"	C8117	3.560"	.020" Fiber	C8073
GS1100E D Pin	80-81	C8473	85 mm	Copper .043"	C8118	3.560"	.005" Copper	C8073
GS1100E D Pin	80-81	C8473	85 mm	Copper .043"	C8119	3.560"	.010" Copper	C8073
GS1100E D Pin	80-81	C8473	85 mm	Copper .043"	C8120	3.560"	.020" Copper	C8073
GS1100E D Pin	80-81	C8733-045	85 mm	MLS/C.O.T. .045"	C8117	3.560"	.020" Fiber	C8073
GS1100E D Pin	80-81	C8733-045	85 mm	MLS/C.O.T. .045"	C8118	3.560"	.005" Copper	C8073
GS1100E D Pin	80-81	C8733-045	85 mm	MLS/C.O.T. .045"	C8119	3.560"	.010" Copper	C8073
GS1100E D Pin	80-81	C8733-045	85 mm	MLS/C.O.T. .045"	C8120	3.560"	.020" Copper	C8073
GS1100E 6mm Pin	80-81	C8171	87 mm	Copper .043"	C8117	3.560"	.020" Fiber	C8073
GS1100E 6mm Pin	80-81	C8171	87 mm	Copper .043"	C8118	3.560"	.005" Copper	C8073
GS1100E 6mm Pin	80-81	C8171	87 mm	Copper .043"	C8119	3.560"	.010" Copper	C8073
GS1100E 6mm Pin	80-81	C8171	87 mm	Copper .043"	C8120	3.560"	.020" Copper	C8073
GS1100E 6mm Pin	80-81	C8734-045	87 mm	MLS/C.O.T. .045"	C8117	3.560"	.020" Fiber	C8073
GS1100E 6mm Pin	80-81	C8734-045	87 mm	MLS/C.O.T. .045"	C8118	3.560"	.005" Copper	C8073
GS1100E 6mm Pin	80-81	C8734-045	87 mm	MLS/C.O.T. .045"	C8119	3.560"	.010" Copper	C8073
GS1100E 6mm Pin	80-81	C8734-045	87 mm	MLS/C.O.T. .045"	C8120	3.560"	.020" Copper	C8073
GS1100E	80-81	C8735-045	89 mm	MLS/C.O.T. .045"	C8375	3.660"	.005" Copper	C8073
GS1100E	80-81	C8735-045	89 mm	MLS/C.O.T. .045"	C8376	3.660"	.010" Copper	C8073
GS1100E	80-81	C8735-045	89 mm	MLS/C.O.T. .045"	C8377	3.660"	.020" Copper	C8073
GS1100E 11mm Pin	82-83	C8163	72 mm	Copper .043"	C8109	3.130"	.020" Fiber	C8073
GS1100E 11mm Pin	82-83	C8163	72 mm	Copper .043"	C8110	3.130"	.005" Copper	C8073
GS1100E 11mm Pin	82-83	C8163	72 mm	Copper .043"	C8111	3.130"	.010" Copper	C8073
GS1100E 11mm Pin	82-83	C8163	72 mm	Copper .043"	C8112	3.130"	.020" Copper	C8073
GS1100E 11mm Pin	82-83	C8185	75 mm	Copper .043"	C8109	3.130"	.020" Fiber	C8073



STREET-ROAD RACE-STRIP



Cometic Gasket - An Exclusive NASCAR Performance® Product

SUZUKI

Model	Year	Head Gasket Part#	Boze	Material/Thickness	Base Gasket Part#	Boze	Material/Thickness	Case Ktt Part#
GS1100E 11mm Pin	82-83	C8185	75 mm	Copper .043"	C8110	3.130"	.005" Copper	C8073
GS1100E 11mm Pin	82-83	C8185	75 mm	Copper .043"	C8111	3.130"	.010" Copper	C8073
GS1100E 11mm Pin	82-83	C8185	75 mm	Copper .043"	C8112	3.130"	.020" Copper	C8073
GS1100E 11mm Pin	82-83	C8728-045	75mm	MLS/C.O.T. .045"	C8109	3.130"	.020" Fiber	C8073
GS1100E 11mm Pin	82-83	C8728-045	75mm	MLS/C.O.T. .045"	C8110	3.130"	.005" Copper	C8073
GS1100E 11mm Pin	82-83	C8728-045	75mm	MLS/C.O.T. .045"	C8111	3.130"	.010" Copper	C8073
GS1100E 11mm Pin	82-83	C8728-045	75mm	MLS/C.O.T. .045"	C8112	3.130"	.020" Copper	C8073
GS1100E 11mm Pin	82-83	C8165	76 mm	Copper .043"	C8113	3.290"	.020" Fiber	C8073
GS1100E 11mm Pin	82-83	C8165	76 mm	Copper .043"	C8114	3.290"	.005" Copper	C8073
GS1100E 11mm Pin	82-83	C8165	76 mm	Copper .043"	C8115	3.290"	.010" Copper	C8073
GS1100E 11mm Pin	82-83	C8165	76 mm	Copper .043"	C8116	3.290"	.020" Copper	C8073
GS1100E 11mm Pin	82-83	C8729-045	76 mm	MLS/C.O.T. .045"	C8113	3.290"	.020" Fiber	C8073
GS1100E 11mm Pin	82-83	C8729-045	76 mm	MLS/C.O.T. .045"	C8114	3.290"	.005" Copper	C8073
GS1100E 11mm Pin	82-83	C8729-045	76 mm	MLS/C.O.T. .045"	C8115	3.290"	.010" Copper	C8073
GS1100E 11mm Pin	82-83	C8729-045	76 mm	MLS/C.O.T. .045"	C8116	3.290"	.020" Copper	C8073
GS1100E 11mm Pin	82-83	C8186	77 mm	Copper .043"	C8113	3.290"	.020" Fiber	C8073
GS1100E 11mm Pin	82-83	C8186	77 mm	Copper .043"	C8114	3.290"	.005" Copper	C8073
GS1100E 11mm Pin	82-83	C8186	77 mm	Copper .043"	C8115	3.290"	.010" Copper	C8073
GS1100E 11mm Pin	82-83	C8186	77 mm 1	Copper .043"	C8116	3.290"	.020" Copper	C8073
GS1100E 11mm Pin	82-83	C8166	78 mm	Copper .043"	C8113	3.290"	.020" Fiber	C8073
GS1100E 11mm Pin	82-83	C8166	78 mm	Copper .043"	C8114	3.290"	.005" Copper	C8073
GS1100E 11mm Pin	82-83	C8166	78 mm	Copper .043"	C8115	3.290"	.010" Copper	C8073
GS1100E 11mm Pin	82-83	C8166	78 mm	Copper .043"	C8116	3.290"	.020" Copper	C8073
GS1100E 11mm Pin	82-83	C8167	79 mm	Copper .043"	C8113	3.290"	.020" Fiber	C8073
GS1100E 11mm Pin	82-83	C8167	79 mm	Copper .043"	C8114	3.290"	.005" Copper	C8073
GS1100E 11mm Pin	82-83	C8167	79 mm	Copper .043"	C8115	3.290"	.010" Copper	C8073
GS1100E 11mm Pin	82-83	C8167	79 mm	Copper .043"	C8116	3.290"	.020" Copper	C8073
GS1100E 11mm Pin	82-83	C8730-045	79 mm	MLS/C.O.T. .045"	C8113	3.290"	.020" Fiber	C8073
GS1100E 11mm Pin	82-83	C8730-045	79 mm	MLS/C.O.T. .045"	C8114	3.290"	.005" Copper	C8073
GS1100E 11mm Pin	82-83	C8730-045	79 mm	MLS/C.O.T. .045"	C8115	3.290"	.010" Copper	C8073
GS1100E 11mm Pin	82-83	C8730-045	79 mm	MLS/C.O.T. .045"	C8116	3.290"	.020" Copper	C8073
GS1100E 11mm Pin	82-83	C8168	80 mm	Copper .043"	C8177	3.460"	.005" Copper	C8073
GS1100E 11mm Pin	82-83	C8168	80 mm	Copper .043"	C8178	3.460"	.010" Copper	C8073
GS1100E 11mm Pin	82-83	C8168	80 mm	Copper .043"	C8179	3.460"	.020" Copper	C8073
GS1100E 11mm Pin	82-83	C8168	80 mm	Copper .043"	C8180	3.460"	.020" Fiber	C8073
GS1100E 11mm Pin	82-83	C8731-045	80 mm	MLS/C.O.T. .045"	C8177	3.460"	.005" Copper	C8073
GS1100E 11mm Pin	82-83	C8731-045	80 mm	MLS/C.O.T. .045"	C8178	3.460"	.010" Copper	C8073
GS1100E 11mm Pin	82-83	C8731-045	80 mm	MLS/C.O.T. .045"	C8179	3.460"	.020" Copper	C8073
GS1100E 11mm Pin	82-83	C8731-045	80 mm	MLS/C.O.T. .045"	C8180	3.460"	.020" Fiber	C8073
GS1100E D Pin	82-83	C8470	82 mm	Copper .043"	C8177	3.460"	.005" Copper	C8073
GS1100E D Pin	82-83	C8470	82 mm	Copper .043"	C8178	3.460"	.010" Copper	C8073
GS1100E D Pin	82-83	C8470	82 mm	Copper .043"	C8179	3.460"	.020" Copper	C8073
GS1100E D Pin	82-83	C8470	82 mm	Copper .043"	C8180	3.460"	.020" Fiber	C8073
GS1100E 11mm Pin	82-83	C8169	82 mm	Copper .043"	C8177	3.460"	.005" Copper	C8073
GS1100E 11mm Pin	82-83	C8169	82 mm	Copper .043"	C8178	3.460"	.010" Copper	C8073
GS1100E 11mm Pin	82-83	C8169	82 mm	Copper .043"	C8179	3.460"	.020" Copper	C8073
GS1100E 11mm Pin	82-83	C8169	82 mm	Copper .043"	C8180	3.460"	.020" Fiber	C8073
GS1100E D Pin	82-83	C8471	83 mm	Copper .043"	C8117	3.560"	.020" Fiber	C8073
GS1100E D Pin	82-83	C8471	83 mm	Copper .043"	C8118	3.560"	.005" Copper	C8073
GS1100E D Pin	82-83	C8471	83 mm	Copper .043"	C8119	3.560"	.010" Copper	C8073
GS1100E D Pin	82-83	C8471	83 mm	Copper .043"	C8120	3.560"	.020" Copper	C8073
GS1100E 11mm Pin	82-83	C8170	83 mm	Copper .043"	C8117	3.560"	.020" Fiber	C8073
GS1100E 11mm Pin	82-83	C8170	83 mm	Copper .043"	C8118	3.560"	.005" Copper	C8073
GS1100E 11mm Pin	82-83	C8170	83 mm	Copper .043"	C8119	3.560"	.010" Copper	C8073
GS1100E 11mm Pin	82-83	C8170	83 mm	Copper .043"	C8120	3.560"	.020" Copper	C8073
GS1100E 11mm Pin	82-83	C8035	84 mm	Fiber .043"	C8117	3.560"	.020" Fiber	C8073
GS1100E 11mm Pin	82-83	C8035	84 mm	Fiber .043"	C8118	3.560"	.005" Copper	C8073
GS1100E 11mm Pin	82-83	C8035	84 mm	Fiber .043"	C8119	3.560"	.010" Copper	C8073
GS1100E 11mm Pin	82-83	C8035	84 mm	Fiber .043"	C8120	3.560"	.020" Copper	C8073
GS1100E 6mm Pin	82-83	C8187	85 mm	Copper .043"	C8117	3.560"	.020" Fiber	C8073
GS1100E 6mm Pin	82-83	C8187	85 mm	Copper .043"	C8118	3.560"	.005" Copper	C8073



STREET-ROAD RACE-STRIP



Cometic Gasket - An Exclusive NASCAR Performance® Product

SUZUKI

Model	Year	Head Gasket Part#	Bore	Material/Thickness	Base Gasket Part#	Bore	Material/Thickness	Price	Case Ktt Part#
GS1100E 6mm Pin	82-83	C8187	85 mm	Copper .043"	C8119	3.560"	.010" Copper	C8073	
GS1100E 6mm Pin	82-83	C8187	85 mm	Copper .043"	C8120	3.560"	.020" Copper	C8073	
GS1100E 8mm Pin	82-83	C8439	85 mm	Copper .043"	C8117	3.560"	.020" Fiber	C8073	
GS1100E 8mm Pin	82-83	C8439	85 mm	Copper .043"	C8118	3.560"	.005" Copper	C8073	
GS1100E 8mm Pin	82-83	C8439	85 mm	Copper .043"	C8119	3.560"	.010" Copper	C8073	
GS1100E 8mm Pin	82-83	C8439	85 mm	Copper .043"	C8120	3.560"	.020" Copper	C8073	
GS1100E D Pin	82-83	C8473	85 mm	Copper .043"	C8117	3.560"	.020" Fiber	C8073	
GS1100E D Pin	82-83	C8473	85 mm	Copper .043"	C8118	3.560"	.005" Copper	C8073	
GS1100E D Pin	82-83	C8473	85 mm	Copper .043"	C8119	3.560"	.010" Copper	C8073	
GS1100E D Pin	82-83	C8473	85 mm	Copper .043"	C8120	3.560"	.020" Copper	C8073	
GS1100E D Pin	82-83	C8733-045	85 mm	MLS/C.O.T. .045"	C8117	3.560"	.020" Fiber	C8073	
GS1100E D Pin	82-83	C8733-045	85 mm	MLS/C.O.T. .045"	C8118	3.560"	.005" Copper	C8073	
GS1100E D Pin	82-83	C8733-045	85 mm	MLS/C.O.T. .045"	C8119	3.560"	.010" Copper	C8073	
GS1100E D Pin	82-83	C8733-045	85 mm	MLS/C.O.T. .045"	C8120	3.560"	.020" Copper	C8073	
GS1100E 6mm Pin	82-83	C8171	87 mm	Copper .043"	C8117	3.560"	.020" Fiber	C8073	
GS1100E 6mm Pin	82-83	C8171	87 mm	Copper .043"	C8118	3.560"	.005" Copper	C8073	
GS1100E 6mm Pin	82-83	C8171	87 mm	Copper .043"	C8119	3.560"	.010" Copper	C8073	
GS1100E 6mm Pin	82-83	C8171	87 mm	Copper .043"	C8120	3.560"	.020" Copper	C8073	
GS1100E 6mm Pin	82-83	C8734-045	87 mm	MLS/C.O.T. .045"	C8117	3.560"	.020" Fiber	C8073	
GS1100E 6mm Pin	82-83	C8734-045	87 mm	MLS/C.O.T. .045"	C8118	3.560"	.005" Copper	C8073	
GS1100E 6mm Pin	82-83	C8734-045	87 mm	MLS/C.O.T. .045"	C8119	3.560"	.010" Copper	C8073	
GS1100E 6mm Pin	82-83	C8734-045	87 mm	MLS/C.O.T. .045"	C8120	3.560"	.020" Copper	C8073	
GS1100E No Pins	82-83	C8735-045	89 mm	MLS/C.O.T. .045"	C8375	3.660"	Copper	C8073	
GS1100E No Pins	82-83	C8735-045	89 mm	MLS/C.O.T. .045"	C8376	3.660"	.010" Copper	C8073	
GS1100E No Pins	82-83	C8735-045	89 mm	MLS/C.O.T. .045"	C8377	3.660"	.020" Copper	C8073	
GSX-R1100	89-92	C8189	78mm	Copper .032"	C8297	3.370" -	.005" Copper	C8081AFM	
GSX-R1100	89-92	C8189	78mm	Copper .032"	C8069	3.370" -	.010" Copper	C8081AFM	
GSX-R1100	89-92	C8189	78mm	Copper .032"	C8462	3.370" -	.020" Copper	C8081AFM	
GSX-R1100	89-92	C8189	78mm	Copper .032"	C8298	3.370" -	.020" Fiber	C8081AFM	
GSX-R1100	89-92	C8189	78mm	Copper .032"	C8372	3.370" -	.010" RC	C8081AFM	
GSX-R1100	89-92	C8322	78mm	MLS/C.O.T. .030"	C8297	3.370" -	.005" Copper	C8081AFM	
GSX-R1100	89-92	C8322	78mm	MLS/C.O.T. .030"	C8069	3.370" -	.010" Copper	C8081AFM	
GSX-R1100	89-92	C8322	78mm	MLS/C.O.T. .030"	C8462	3.370" -	.020" Copper	C8081AFM	
GSX-R1100	89-92	C8322	78mm	MLS/C.O.T. .030"	C8298	3.370" -	.020" Fiber	C8081AFM	
GSX-R1100	89-92	C8322	78mm	MLS/C.O.T. .030"	C8372	3.370" -	.010" RC	C8081AFM	
GSX-R1100	89-92	C8037	80mm	CFM-20	C8297	3.370" -	.005" Copper	C8081AFM	
GSX-R1100	89-92	C8037	80mm	CFM-20	C8069	3.370" -	.010" Copper	C8081AFM	
GSX-R1100	89-92	C8037	80mm	CFM-20	C8462	3.370" -	.020" Copper	C8081AFM	
GSX-R1100	89-92	C8037	80mm	CFM-20	C8298	3.370" -	.020" Fiber	C8081AFM	
GSX-R1100	89-92	C8037	80mm	CFM-20	C8372	3.370" -	.010" RC	C8081AFM	
GSX-R1100	89-92	C8190	80mm	Copper .032"	C8297	3.370" -	.005" Copper	C8081AFM	
GSX-R1100	89-92	C8190	80mm	Copper .032"	C8069	3.370" -	.010" Copper	C8081AFM	
GSX-R1100	89-92	C8190	80mm	Copper .032"	C8462	3.370" -	.020" Copper	C8081AFM	
GSX-R1100	89-92	C8190	80mm	Copper .032"	C8298	3.370" -	.020" Fiber	C8081AFM	
GSX-R1100	89-92	C8190	80mm	Copper .032"	C8372	3.370" -	.010" RC	C8081AFM	
GSX-R1100	89-92	C8368	80mm	MLS/C.O.T. .030"	C8297	3.370" -	.005" Copper	C8081AFM	
GSX-R1100	89-92	C8368	80mm	MLS/C.O.T. .030"	C8069	3.370" -	.010" Copper	C8081AFM	
GSX-R1100	89-92	C8368	80mm	MLS/C.O.T. .030"	C8462	3.370" -	.020" Copper	C8081AFM	
GSX-R1100	89-92	C8368	80mm	MLS/C.O.T. .030"	C8298	3.370" -	.020" Fiber	C8081AFM	
GSX-R1100	89-92	C8368	80mm	MLS/C.O.T. .030"	C8372	3.370" -	.010" RC	C8081AFM	
GSX-R1100	89-92	C8191	81mm	Copper .032"	C8203	3.460" -	.005" Copper	C8081AFM	
GSX-R1100	89-92	C8191	81mm	Copper .032"	C8070	3.460" -	.010" Copper	C8081AFM	
GSX-R1100	89-92	C8191	81mm	Copper .032"	C8526	3.460" -	.020" Copper	C8081AFM	
GSX-R1100	89-92	C8191	81mm	Copper .032"	C8373	3.460" -	.010" RC	C8081AFM	
GSX-R1100	89-92	C8279	81mm	MLS/C.O.T. .030"	C8203	3.460" -	.005" Copper	C8081AFM	
GSX-R1100	89-92	C8279	81mm	MLS/C.O.T. .030"	C8070	3.460" -	.010" Copper	C8081AFM	
GSX-R1100	89-92	C8279	81mm	MLS/C.O.T. .030"	C8526	3.460" -	.020" Copper	C8081AFM	
GSX-R1100	89-92	C8279	81mm	MLS/C.O.T. .030"	C8373	3.460" -	.010" RC	C8081AFM	
GSX-R1100	89-92	C8243	82mm	Copper .032"	C8203	3.460" -	.005" Copper	C8081AFM	
GSX-R1100	89-92	C8243	82mm	Copper .032"	C8070	3.460" -	.010" Copper	C8081AFM	
GSX-R1100	89-92	C8243	82mm	Copper .032"	C8526	3.460" -	.020" Copper	C8081AFM	
GSX-R1100	89-92	C8243	82mm	Copper .032"	C8373	3.460" -	.010" RC	C8081AFM	
GSX-R1100	89-92	C8391	82mm	MLS/C.O.T. .030"	C8203	3.460" -	.005" Copper	C8081AFM	
GSX-R1100	89-92	C8391	82mm	MLS/C.O.T. .030"	C8070	3.460" -	.010" Copper	C8081AFM	
GSX-R1100	89-92	C8391	82mm	MLS/C.O.T. .030"	C8526	3.460" -	.020" Copper	C8081AFM	



STREET-ROAD RACE-STRIP



Cometic Gasket - An Exclusive NASCAR Performance® Product

SUZUKI

Model	Year	Head Gasket Part#	Bore	Material/Thickness	Base Gasket Part#	Bore	Material/Thickness	Case Kit Part#
GSX-R1100	89-92	C8391	82mm	MLS/C.O.T. .030"	C8373	3.460" - .010" RC		C8081AFM
GSX-R1100	89-92	C8036	83mm	CFM-20	C8246	3.560" - .005" Copper		C8081AFM
GSX-R1100	89-92	C8036	83mm	CFM-20	C8247	3.560" - .010" Copper		C8081AFM
GSX-R1100	89-92	C8036	83mm	CFM-20	C8446	3.560" - .020" Copper		C8081AFM
GSX-R1100	89-92	C8036	83mm	CFM-20	C8374	3.560" - .010" RC		C8081AFM
GSX-R1100	89-92	C8192	83mm	Copper .032"	C8246	3.560" - .005" Copper		C8081AFM
GSX-R1100	89-92	C8192	83mm	Copper .032"	C8247	3.560" - .010" Copper		C8081AFM
GSX-R1100	89-92	C8192	83mm	Copper .032"	C8446	3.560" - .020" Copper		C8081AFM
GSX-R1100	89-92	C8391	82mm	MLS/C.O.T. .030"	C8373	3.460" - .010" RC		C8081AFM
GSX-R1100	89-92	C8036	83mm	CFM-20	C8246	3.560" - .005" Copper		C8081AFM
GSX-R1100	89-92	C8036	83mm	CFM-20	C8247	3.560" - .010" Copper		C8081AFM
GSX-R1100	89-92	C8036	83mm	CFM-20	C8446	3.560" - .020" Copper		C8081AFM
GSX-R1100	89-92	C8036	83mm	CFM-20	C8374	3.560" - .010" RC		C8081AFM
GSX-R1100	89-92	C8192	83mm	Copper .032"	C8246	3.560" - .005" Copper		C8081AFM
GSX-R1100	89-92	C8192	83mm	Copper .032"	C8247	3.560" - .010" Copper		C8081AFM
GSX-R1100	89-92	C8192	83mm	Copper .032"	C8446	3.560" - .020" Copper		C8081AFM
GSX-R1100	89-92	C8192	83mm	Copper .032"	C8374	3.560" - .010" RC		C8081AFM
GSX-R1100	89-92	C8323	83mm	MLS/C.O.T. .030"	C8246	3.560" - .005" Copper		C8081AFM
GSX-R1100	89-92	C8323	83mm	MLS/C.O.T. .030"	C8247	3.560" - .010" Copper		C8081AFM
GSX-R1100	89-92	C8323	83mm	MLS/C.O.T. .030"	C8446	3.560" - .020" Copper		C8081AFM
GSX-R1100	89-92	C8323	83mm	MLS/C.O.T. .030"	C8374	3.560" - .010" RC		C8081AFM
GSX-R1100	89-92	C8340	85mm	MLS/C.O.T. .030"	C8246	3.560" - .005" Copper		C8081AFM
GSX-R1100	89-92	C8340	85mm	MLS/C.O.T. .030"	C8247	3.560" - .010" Copper		C8081AFM
GSX-R1100	89-92	C8340	85mm	MLS/C.O.T. .030"	C8446	3.560" - .020" Copper		C8081AFM
GSX-R1100	89-92	C8340	85mm	MLS/C.O.T. .030"	C8374	3.560" - .010" RC		C8081AFM
GSX-R1100	89-92	C8437	85mm	Copper .032"	C8246	3.560" - .005" Copper		C8081AFM
GSX-R1100	89-92	C8437	85mm	Copper .032"	C8247	3.560" - .010" Copper		C8081AFM
GSX-R1100	89-92	C8437	85mm	Copper .032"	C8446	3.560" - .020" Copper		C8081AFM
GSX-R1100	89-92	C8437	85mm	Copper .032"	C8374	3.560" - .010" RC		C8081AFM
GSX-R1100	89-92	C8194	85mm	Copper .032"	C8246	3.560" - .005" Copper		C8081AFM
GSX-R1100	89-92	C8194	85mm	Copper .032"	C8247	3.560" - .010" Copper		C8081AFM
GSX-R1100	89-92	C8194	85mm	Copper .032"	C8446	3.560" - .020" Copper		C8081AFM
GSX-R1100	89-92	C8194	85mm	Copper .032"	C8374	3.560" - .010" RC		C8081AFM
GSX-R1100	89-92	C8195	86mm	Copper .032"				C8081AFM
GSX-R1100W Water Cooled	93-98	C8280	77 mm	MLS/C.O.T. .030"	C8370	3.265" .010" RC		C8144
GSX-R1100W Water Cooled	93-98	C8280	77 mm	MLS/C.O.T. .030"	C8307	3.310" .005" Copper		C8144
GSX-R1100W Water Cooled	93-98	C8280	77 mm	MLS/C.O.T. .030"	C8308	3.310" .010" Copper		C8144
GSX-R1100W Water Cooled	93-98	C8280	77 mm	MLS/C.O.T. .030"	C8444	3.310" .020" Copper		C8144
GSX-R1100W Water Cooled	93-98	C8280	77 mm	MLS/C.O.T. .030"	C8309	3.310" .020" Fiber		C8144
GSX-R1100W Water Cooled	93-98	C8280	77 mm	MLS/C.O.T. .030"	C8371	3.310" .010" RC		C8144
GSX-R1100W Water Cooled	93-98	C8281	79.5 mm	MLS/C.O.T. .030"	C8307	3.310" .005" Copper		C8144
GSX-R1100W Water Cooled	93-98	C8281	79.5 mm	MLS/C.O.T. .030"	C8308	3.310" .010" Copper		C8144
GSX-R1100W Water Cooled	93-98	C8281	79.5 mm	MLS/C.O.T. .030"	C8444	3.310" .020" Copper		C8144
GSX-R1100W Water Cooled	93-98	C8281	79.5 mm	MLS/C.O.T. .030"	C8309	3.310" .020" Fiber		C8144
GSX-R1100W Water Cooled	93-98	C8281	79.5 mm	MLS/C.O.T. .030"	C8371	3.310" .010" RC		C8144
GSX-R1100W Water Cooled	93-98	C8478	78 mm	MLS/C.O.T. .030"	C8307	3.310" .005" Copper		C8144
GSX-R1100W Water Cooled	93-98	C8478	78 mm	MLS/C.O.T. .030"	C8308	3.310" .010" Copper		C8144
GSX-R1100W Water Cooled	93-98	C8478	78 mm	MLS/C.O.T. .030"	C8444	3.310" .020" Copper		C8144
GSX-R1100W Water Cooled	93-98	C8478	78 mm	MLS/C.O.T. .030"	C8309	3.310" .020" Fiber		C8144
GSX-R1100W Water Cooled	93-98	C8478	78 mm	MLS/C.O.T. .030"	C8371	3.310" .010" RC		C8144
GSX-R1100W Water Cooled	93-98	C8479	78 mm	Copper .032"	C8307	3.310" .005" Copper		C8144
GSX-R1100W Water Cooled	93-98	C8479	78 mm	Copper .032"	C8308	3.310" .010" Copper		C8144
GSX-R1100W Water Cooled	93-98	C8479	78 mm	Copper .032"	C8444	3.310" .020" Copper		C8144
GSX-R1100W Water Cooled	93-98	C8479	78 mm	Copper .032"	C8309	3.310" .020" Fiber		C8144
GSX-R1100W Water Cooled	93-98	C8479	78 mm	Copper .032"	C8371	3.310" .010" RC		C8144
GSX-R1100W Water Cooled	93-98	C8480	79.5 mm	Copper .032"	C8307	3.310" .005" Copper		C8144
GSX-R1100W Water Cooled	93-98	C8480	79.5 mm	Copper .032"	C8308	3.310" .010" Copper		C8144
GSX-R1100W Water Cooled	93-98	C8480	79.5 mm	Copper .032"	C8444	3.310" .020" Copper		C8144
GSX-R1100W Water Cooled	93-98	C8480	79.5 mm	Copper .032"	C8309	3.310" .020" Fiber		C8144
GSX-R1100W Water Cooled	93-98	C8480	79.5 mm	Copper .032"	C8371	3.310" .010" RC		C8144
GSX-R1100W Water Cooled	93-98	C8481	79.75 mm	Copper .032"	C8307	3.310" .005" Copper		C8144
GSX-R1100W Water Cooled	93-98	C8481	79.75 mm	Copper .032"	C8308	3.310" .010" Copper		C8144
GSX-R1100W Water Cooled	93-98	C8481	79.75 mm	Copper .032"	C8444	3.310" .020" Copper		C8144
GSX-R1100W Water Cooled	93-98	C8481	79.75 mm	Copper .032"	C8309	3.310" .020" Fiber		C8144
GSX-R1100W Water Cooled	93-98	C8481	79.75 mm	Copper .032"	C8371	3.310" .010" RC		C8144



STREET·ROAD RACE·STRIP



Cometic Gasket - An Exclusive NASCAR Performance® Product

SUZUKI

Model	Year	Head Gasket Part#	Bore	Material/Thickness	Base Gasket Part#	Bore	Material/Thickness	Case Kit Part#
GSX1100F Katana	88-93	C8189	78mm	Copper .032"	C8297	3.370"	.005" Copper	C8081AFM
GSX1100F Katana	88-93	C8189	78mm	Copper .032"	C8069	3.370"	.010" Copper	C8081AFM
GSX1100F Katana	88-93	C8189	78mm	Copper .032"	C8462	3.370"	.020" Copper	C8081AFM
GSX1100F Katana	88-93	C8189	78mm	Copper .032"	C8298	3.370"	.020" Fiber	C8081AFM
GSX1100F Katana	88-93	C8189	78mm	Copper .032"	C8372	3.370"	.010" RC	C8081AFM
GSX1100F Katana	88-93	C8322	78mm	MLS/C.O.T. .030"	C8297	3.370"	.005" Copper	C8081AFM
GSX1100F Katana	88-93	C8322	78mm	MLS/C.O.T. .030"	C8069	3.370"	.010" Copper	C8081AFM
GSX1100F Katana	88-93	C8322	78mm	MLS/C.O.T. .030"	C8462	3.370"	.020" Copper	C8081AFM
GSX1100F Katana	88-93	C8322	78mm	MLS/C.O.T. .030"	C8298	3.370"	.020" Fiber	C8081AFM
GSX1100F Katana	88-93	C8322	78mm	MLS/C.O.T. .030"	C8372	3.370"	.010" RC	C8081AFM
GSX1100F Katana	88-93	C8037	80mm	CFM-20 .043"	C8297	3.370"	.005" Copper	C8081AFM
GSX1100F Katana	88-93	C8037	80mm	CFM-20 .043"	C8069	3.370"	.010" Copper	C8081AFM
GSX1100F Katana	88-93	C8037	80mm	CFM-20 .043"	C8462	3.370"	.020" Copper	C8081AFM
GSX1100F Katana	88-93	C8037	80mm	CFM-20 .043"	C8298	3.370"	.020" Fiber	C8081AFM
GSX1100F Katana	88-93	C8037	80mm	CFM-20 .043"	C8372	3.370"	.010" RC	C8081AFM
GSX1100F Katana	88-93	C8190	80mm	Copper .032"	C8297	3.370"	.005" Copper	C8081AFM
GSX1100F Katana	88-93	C8190	80mm	Copper .032"	C8069	3.370"	.010" Copper	C8081AFM
GSX1100F Katana	88-93	C8190	80mm	Copper .032"	C8462	3.370"	.020" Copper	C8081AFM
GSX1100F Katana	88-93	C8190	80mm	Copper .032"	C8298	3.370"	.020" Fiber	C8081AFM
GSX1100F Katana	88-93	C8190	80mm	Copper .032"	C8372	3.370"	.010" RC	C8081AFM
GSX1100F Katana	88-93	C8368	80mm	MLS/C.O.T. .030"	C8297	3.370"	.005" Copper	C8081AFM
GSX1100F Katana	88-93	C8368	80mm	MLS/C.O.T. .030"	C8069	3.370"	.010" Copper	C8081AFM
GSX1100F Katana	88-93	C8368	80mm	MLS/C.O.T. .030"	C8462	3.370"	.020" Copper	C8081AFM
GSX1100F Katana	88-93	C8368	80mm	MLS/C.O.T. .030"	C8298	3.370"	.020" Fiber	C8081AFM
GSX1100F Katana	88-93	C8368	80mm	MLS/C.O.T. .030"	C8372	3.370"	.010" RC	C8081AFM
GSX1100F Katana	88-93	C8191	81mm	Copper .032"	C8203	3.460"	.005" Copper	C8081AFM
GSX1100F Katana	88-93	C8191	81mm	Copper .032"	C8070	3.460"	.010" Copper	C8081AFM
GSX1100F Katana	88-93	C8191	81mm	Copper .032"	C8526	3.460"	.020" Copper	C8081AFM
GSX1100F Katana	88-93	C8191	81mm	Copper .032"	C8373	3.460"	.010" RC	C8081AFM
GSX1100F Katana	88-93	C8279	81mm	MLS/C.O.T. .030"	C8203	3.460"	.005" Copper	C8081AFM
GSX1100F Katana	88-93	C8279	81mm	MLS/C.O.T. .030"	C8070	3.460"	.010" Copper	C8081AFM
GSX1100F Katana	88-93	C8279	81mm	MLS/C.O.T. .030"	C8526	3.460"	.020" Copper	C8081AFM
GSX1100F Katana	88-93	C8279	81mm	MLS/C.O.T. .030"	C8373	3.460"	.010" RC	C8081AFM
GSX1100F Katana	88-93	C8243	82mm	Copper .032"	C8203	3.460"	.005" Copper	C8081AFM
GSX1100F Katana	88-93	C8243	82mm	Copper .032"	C8070	3.460"	.010" Copper	C8081AFM
GSX1100F Katana	88-93	C8243	82mm	Copper .032"	C8526	3.460"	.020" Copper	C8081AFM
GSX1100F Katana	88-93	C8243	82mm	Copper .032"	C8373	3.460"	.010" RC	C8081AFM
GSX1100F Katana	88-93	C8036	83mm	CFM-20 .043"	C8246	3.560"	.005" Copper	C8081AFM
GSX1100F Katana	88-93	C8036	83mm	CFM-20 .043"	C8247	3.560"	.010" Copper	C8081AFM
GSX1100F Katana	88-93	C8036	83mm	CFM-20 .043"	C8446	3.560"	.020" Copper	C8081AFM
GSX1100F Katana	88-93	C8036	83mm	CFM-20 .043"	C8374	3.560"	.010" RC	C8081AFM
GSX1100F Katana	88-93	C8192	83mm	Copper .032"	C8246	3.560"	.005" Copper	C8081AFM
GSX1100F Katana	88-93	C8192	83mm	Copper .032"	C8247	3.560"	.010" Copper	C8081AFM
GSX1100F Katana	88-93	C8192	83mm	Copper .032"	C8446	3.560"	.020" Copper	C8081AFM
GSX1100F Katana	88-93	C8192	83mm	Copper .032"	C8374	3.560"	.010" RC	C8081AFM
GSX1100F Katana D Pin	88-93	C8323	83mm	MLS/C.O.T. .030"	C8246	3.560"	.005" Copper	C8081AFM
GSX1100F Katana D Pin	88-93	C8323	83mm	MLS/C.O.T. .030"	C8247	3.560"	.010" Copper	C8081AFM
GSX1100F Katana D Pin	88-93	C8323	83mm	MLS/C.O.T. .030"	C8446	3.560"	.020" Copper	C8081AFM
GSX1100F Katana D Pin	88-93	C8323	83mm	MLS/C.O.T. .030"	C8374	3.560"	.010" RC	C8081AFM
GSX1100F Katana D Pin	88-93	C8340	85mm	MLS/C.O.T. .030"	C8246	3.560"	.005" Copper	C8081AFM
GSX1100F Katana D Pin	88-93	C8340	85mm	MLS/C.O.T. .030"	C8247	3.560"	.010" Copper	C8081AFM
GSX1100F Katana D Pin	88-93	C8340	85mm	MLS/C.O.T. .030"	C8446	3.560"	.020" Copper	C8081AFM
GSX1100F Katana D Pin	88-93	C8340	85mm	MLS/C.O.T. .030"	C8374	3.560"	.010" RC	C8081AFM
GSX1100F Katana 6mm Pin	88-93	C8437	85mm	Copper .032"	C8246	3.560"	.005" Copper	C8081AFM
GSX1100F Katana 6mm Pin	88-93	C8437	85mm	Copper .032"	C8247	3.560"	.010" Copper	C8081AFM
GSX1100F Katana 6mm Pin	88-93	C8437	85mm	Copper .032"	C8446	3.560"	.020" Copper	C8081AFM
GSX1100F Katana 6mm Pin	88-93	C8437	85mm	Copper .032"	C8374	3.560"	.010" RC	C8081AFM
GSX1100F Katana D Pin	88-93	C8194	85mm	Copper .032"	C8246	3.560"	.005" Copper	C8081AFM
GSX1100F Katana D Pin	88-93	C8194	85mm	Copper .032"	C8247	3.560"	.010" Copper	C8081AFM
GSX1100F Katana D Pin	88-93	C8194	85mm	Copper .032"	C8446	3.560"	.020" Copper	C8081AFM
GSX1100F Katana D Pin	88-93	C8194	85mm	Copper .032"	C8374	3.560"	.010" RC	C8081AFM



STREET·ROAD RACE·STRIP



Cometic Gasket - An Exclusive NASCAR Performance® Product

SUZUKI

Model	Year	Head Gasket Part#	Bore	Material/Thickness	Base Gasket Part#	Bore	Material/Thickness	Case Kit Part#
GSX1100F Katana 6mm Pin	88-93	C8195	86mm	Copper .032"				C8081AFM
GS1150E 11mm Pin	84-86	C8185	75 mm	Copper .043"	C8109	3.130"	.020" Fiber	C8073
GS1150E 11mm Pin	84-86	C8185	75 mm	Copper .043"	C8110	3.130"	.005" Copper	C8073
GS1150E 11mm Pin	84-86	C8185	75 mm	Copper .043"	C8111	3.130"	.010" Copper	C8073
GS1150E 11mm Pin	84-86	C8185	75 mm	Copper .043"	C8112	3.130"	.020" Copper	C8073
GS1150E 11mm Pin	84-86	C8728-045	75mm	MLS/C.O.T. .045"	C8109	3.130"	.020" Fiber	C8073
GS1150E 11mm Pin	84-86	C8728-045	75mm	MLS/C.O.T. .045"	C8110	3.130"	.005" Copper	C8073
GS1150E 11mm Pin	84-86	C8728-045	75mm	MLS/C.O.T. .045"	C8111	3.130"	.010" Copper	C8073
GS1150E 11mm Pin	84-86	C8728-045	75mm	MLS/C.O.T. .045"	C8112	3.130"	.020" Copper	C8073
GS1150E 11mm Pin	84-86	C8165	76 mm	Copper .043"	C8113	3.290"	.020" Fiber	C8073
GS1150E 11mm Pin	84-86	C8165	76 mm	Copper .043"	C8114	3.290"	.005" Copper	C8073
GS1150E 11mm Pin	84-86	C8165	76 mm	Copper .043"	C8115	3.290"	.010" Copper	C8073
GS1150E 11mm Pin	84-86	C8165	76 mm	Copper .043"	C8116	3.290"	.020" Copper	C8073
GS1150E 11mm Pin	84-86	C8729-045	76 mm	MLS/C.O.T. .045"	C8113	3.290"	.020" Fiber	C8073
GS1150E 11mm Pin	84-86	C8729-045	76 mm	MLS/C.O.T. .045"	C8114	3.290"	.005" Copper	C8073
GS1150E 11mm Pin	84-86	C8729-045	76 mm	MLS/C.O.T. .045"	C8115	3.290"	.010" Copper	C8073
GS1150E 11mm Pin	84-86	C8729-045	76 mm	MLS/C.O.T. .045"	C8116	3.290"	.020" Copper	C8073
GS1150E 11mm Pin	84-86	C8186	77 mm	Copper .043"	C8113	3.290"	.020" Fiber	C8073
GS1150E 11mm Pin	84-86	C8186	77 mm	Copper .043"	C8114	3.290"	.005" Copper	C8073
GS1150E 11mm Pin	84-86	C8186	77 mm	Copper .043"	C8115	3.290"	.010" Copper	C8073
GS1150E 11mm Pin	84-86	C8186	77 mm	Copper .043"	C8116	3.290"	.020" Copper	C8073
GS1150E 11mm Pin	84-86	C8166	78 mm	Copper .043"	C8113	3.290"	.020" Fiber	C8073
GS1150E 11mm Pin	84-86	C8166	78 mm	Copper .043"	C8114	3.290"	.005" Copper	C8073
GS1150E 11mm Pin	84-86	C8166	78 mm	Copper .043"	C8115	3.290"	.010" Copper	C8073
GS1150E 11mm Pin	84-86	C8166	78 mm	Copper .043"	C8116	3.290"	.020" Copper	C8073
GS1150E 11mm Pin	84-86	C8167	79 mm	Copper .043"	C8113	3.290"	.020" Fiber	C8073
GS1150E 11mm Pin	84-86	C8167	79 mm	Copper .043"	C8114	3.290"	.005" Copper	C8073
GS1150E 11mm Pin	84-86	C8167	79 mm	Copper .043"	C8115	3.290"	.010" Copper	C8073
GS1150E 11mm Pin	84-86	C8167	79 mm	Copper .043"	C8116	3.290"	.020" Copper	C8073
GS1150E 11mm Pin	84-86	C8730-045	79 mm	MLS/C.O.T. .045"	C8113	3.290"	.020" Fiber	C8073
GS1150E 11mm Pin	84-86	C8730-045	79 mm	MLS/C.O.T. .045"	C8114	3.290"	.005" Copper	C8073
GS1150E 11mm Pin	84-86	C8730-045	79 mm	MLS/C.O.T. .045"	C8115	3.290"	.010" Copper	C8073
GS1150E 11mm Pin	84-86	C8730-045	79 mm	MLS/C.O.T. .045"	C8116	3.290"	.020" Copper	C8073
GS1150E 11mm Pin	84-86	C8168	80 mm	Copper .043"	C8177	3.460"	.005" Copper	C8073
GS1150E 11mm Pin	84-86	C8168	80 mm	Copper .043"	C8178	3.460"	.010" Copper	C8073
GS1150E 11mm Pin	84-86	C8168	80 mm	Copper .043"	C8179	3.460"	.020" Copper	C8073
GS1150E 11mm Pin	84-86	C8168	80 mm	Copper .043"	C8180	3.460"	.020" Fiber	C8073
GS1150E 11mm Pin	84-86	C8731-045	80 mm	MLS/C.O.T. .045"	C8177	3.460"	.005" Copper	C8073
GS1150E 11mm Pin	84-86	C8731-045	80 mm	MLS/C.O.T. .045"	C8178	3.460"	.010" Copper	C8073
GS1150E 11mm Pin	84-86	C8731-045	80 mm	MLS/C.O.T. .045"	C8179	3.460"	.020" Copper	C8073
GS1150E 11mm Pin	84-86	C8731-045	80 mm	MLS/C.O.T. .045"	C8180	3.460"	.020" Fiber	C8073
GS1150E D Pin	84-86	C8470	82 mm	Copper .043"	C8177	3.460"	.005" Copper	C8073
GS1150E D Pin	84-86	C8470	82 mm	Copper .043"	C8178	3.460"	.010" Copper	C8073
GS1150E D Pin	84-86	C8470	82 mm	Copper .043"	C8179	3.460"	.020" Copper	C8073
GS1150E D Pin	84-86	C8470	82 mm	Copper .043"	C8180	3.460"	.020" Fiber	C8073
GS1150E 11mm Pin	84-86	C8169	82 mm	Copper .043"	C8177	3.460"	.005" Copper	C8073
GS1150E 11mm Pin	84-86	C8169	82 mm	Copper .043"	C8178	3.460"	.010" Copper	C8073
GS1150E 11mm Pin	84-86	C8169	82 mm	Copper .043"	C8179	3.460"	.020" Copper	C8073
GS1150E 11mm Pin	84-86	C8169	82 mm	Copper .043"	C8180	3.460"	.020" Fiber	C8073
GS1150E D Pin	84-86	C8471	83 mm	Copper .043"	C8117	3.560"	.020" Fiber	C8073
GS1150E D Pin	84-86	C8471	83 mm	Copper .043"	C8118	3.560"	.005" Copper	C8073
GS1150E D Pin	84-86	C8471	83 mm	Copper .043"	C8119	3.560"	.010" Copper	C8073
GS1150E D Pin	84-86	C8471	83 mm	Copper .043"	C8120	3.560"	.020" Copper	C8073
GS1150E 11mm Pin	84-86	C8170	83 mm	Copper .043"	C8117	3.560"	.020" Fiber	C8073
GS1150E 11mm Pin	84-86	C8170	83 mm	Copper .043"	C8118	3.560"	.005" Copper	C8073
GS1150E 11mm Pin	84-86	C8170	83 mm	Copper .043"	C8119	3.560"	.010" Copper	C8073
GS1150E 11mm Pin	84-86	C8170	83 mm	Copper .043"	C8120	3.560"	.020" Copper	C8073
GS1150E D Pin	84-86	C8732-045	83 mm	MLS/C.O.T. .045"	C8117	3.560"	.020" Fiber	C8073
GS1150E D Pin	84-86	C8732-045	83 mm	MLS/C.O.T. .045"	C8118	3.560"	.005" Copper	C8073
GS1150E D Pin	84-86	C8732-045	83 mm	MLS/C.O.T. .045"	C8119	3.560"	.010" Copper	C8073
GS1150E D Pin	84-86	C8732-045	83 mm	MLS/C.O.T. .045"	C8120	3.560"	.020" Copper	C8073
GS1150E 11mm Pin	84-86	C8035	84 mm	Fiber .043"	C8117	3.560"	.020" Fiber	C8073
GS1150E 11mm Pin	84-86	C8035	84 mm	Fiber .043"	C8118	3.560"	.005" Copper	C8073
GS1150E 11mm Pin	84-86	C8035	84 mm	Fiber .043"	C8119	3.560"	.010" Copper	C8073
GS1150E 11mm Pin	84-86	C8035	84 mm	Fiber .043"	C8120	3.560"	.020" Copper	C8073



STREET·ROAD RACE·STRIP



Cometic Gasket - An Exclusive NASCAR Performance® Product

SUZUKI

Model	Year	Head Gasket Part#	Bore	Material/Thickness	Base Gasket Part#	Bore	Material/Thickness	Case Kit Part#
GS1150E 6mm Pin	84-86	C8187	85 mm	Copper .043"	C8117	3.560"	.020" Fiber	C8073
GS1150E 6mm Pin	84-86	C8187	85 mm	Copper .043"	C8118	3.560"	.005" Copper	C8073
GS1150E 6mm Pin	84-86	C8187	85 mm	Copper .043"	C8119	3.560"	.010" Copper	C8073
GS1150E 6mm Pin	84-86	C8187	85 mm	Copper .043"	C8120	3.560"	.020" Copper	C8073
GS1150E 8mm Pin	84-86	C8439	85 mm	Copper .043"	C8117	3.560"	.020" Fiber	C8073
GS1150E 8mm Pin	84-86	C8439	85 mm	Copper .043"	C8118	3.560"	.005" Copper	C8073
GS1150E 8mm Pin	84-86	C8439	85 mm	Copper .043"	C8119	3.560"	.010" Copper	C8073
GS1150E 8mm Pin	84-86	C8439	85 mm	Copper .043"	C8120	3.560"	.020" Copper	C8073
GS1150E D Pin	84-86	C8473	85 mm	Copper .043"	C8117	3.560"	.020" Fiber	C8073
GS1150E D Pin	84-86	C8473	85 mm	Copper .043"	C8118	3.560"	.005" Copper	C8073
GS1150E D Pin	84-86	C8473	85 mm	Copper .043"	C8119	3.560"	.010" Copper	C8073
GS1150E D Pin	84-86	C8473	85 mm	Copper .043"	C8120	3.560"	.020" Copper	C8073
GS1150E D Pin	84-86	C8733-045	85 mm	MLS/C.O.T. .045"	C8117	3.560"	.020" Fiber	C8073
GS1150E D Pin	84-86	C8733-045	85 mm	MLS/C.O.T. .045"	C8118	3.560"	.005" Copper	C8073
GS1150E D Pin	84-86	C8733-045	85 mm	MLS/C.O.T. .045"	C8119	3.560"	.010" Copper	C8073
GS1150E D Pin	84-86	C8733-045	85 mm	MLS/C.O.T. .045"	C8120	3.560"	.020" Copper	C8073
GS1150E 6mm Pin	84-86	C8171	87 mm	Copper .043"	C8117	3.560"	.020" Fiber	C8073
GS1150E 6mm Pin	84-86	C8171	87 mm	Copper .043"	C8118	3.560"	.005" Copper	C8073
GS1150E 6mm Pin	84-86	C8171	87 mm	Copper .043"	C8119	3.560"	.010" Copper	C8073
GS1150E 6mm Pin	84-86	C8171	87 mm	Copper .043"	C8120	3.560"	.020" Copper	C8073
GS1150E 6mm Pin	84-86	C8734-045	87 mm	MLS/C.O.T. .045"	C8117	3.560"	.020" Fiber	C8073
GS1150E 6mm Pin	84-86	C8734-045	87 mm	MLS/C.O.T. .045"	C8118	3.560"	.005" Copper	C8073
GS1150E 6mm Pin	84-86	C8734-045	87 mm	MLS/C.O.T. .045"	C8119	3.560"	.010" Copper	C8073
GS1150E 6mm Pin	84-86	C8734-045	87 mm	MLS/C.O.T. .045"	C8120	3.560"	.020" Copper	C8073
GS1150E	84-86	C8735-045	89 mm	MLS/C.O.T. .045"	C8375	3.660"	.005" Copper	C8073
GS1150E	84-86	C8735-045	89 mm	MLS/C.O.T. .045"	C8376	3.660"	.010" Copper	C8073
GS1150E	84-86	C8735-045	89 mm	MLS/C.O.T. .045"	C8377	3.660"	.020" Copper	C8073
GSF1200SX Bandit	97-05	C8279	81mm	MLS/C.O.T. .030"	B0963010S86mm	.010" RC		C8081AFM
GSF1200SX Bandit	97-05	C8368	80mm	MLS/C.O.T. .030"	B0963010S86mm	.010" RC		C8081AFM
GSF1200SX Bandit 11 mm Pin	97-05	C8391	82mm	MLS/C.O.T. .030"	B0963010S86mm	.010" RC		C8081AFM
GSF1200SX Bandit / D Pin	97-05	C8323	83mm	MLS/C.O.T. .030"	B0963010S86mm	.010" RC		C8081AFM
GSX1300R Hayabusa	99-07	C8656	81mm	MLS/C.O.T. .030"	C8585	93mm	.010" RC	C8587AFM
GSX1300R Hayabusa	99-07	C8656-018	81mm	MLS/C.O.T. .018"	C8585	93mm	.010" RC	C8587AFM
GSX1300R Hayabusa	99-07	C8218	81mm	MLS/C.O.T. .030"	C8747	93mm	.010" RC	C8587AFM
w/13 mm studs								
GSX1300R Hayabusa	99-07	C8660	82mm	MLS/C.O.T. .030"	C8585	93mm	.010" RC	C8587AFM
GSX1300R Hayabusa	99-07	C8657-018	83mm	MLS/C.O.T. .018"	C8585	93mm	.010" RC	C8587AFM
GSX1300R Hayabusa	99-07	C8657	83mm	MLS/C.O.T. .030"	C8585	93mm	.010" RC	C8587AFM
GSX1300R Hayabusa	99-07	C8219	83mm	MLS/C.O.T. .030"	C8747	93mm	.010" RC	C8587AFM
w/13mm studs								
GSX1300R Hayabusa	99-07	C8658	84mm	MLS/C.O.T. .030"	C8585	93mm	.010" RC	C8587AFM
GSX1300R Hayabusa	99-07	C8658-018	84mm	MLS/C.O.T. .018"	C8585	93mm	.010" RC	C8587AFM
GSX1300R Hayabusa	99-07	C8220	84mm	MLS/C.O.T. .030"	C8747	93mm	.010" RC	C8587AFM
w/13mm studs								
GSX1300R Hayabusa	99-07	C8659	85mm	MLS/C.O.T. .030"	C8585	93mm	.010" RC	C8587AFM
GSX1300R Hayabusa	99-07	C8659-018	85mm	MLS/C.O.T. .018"	C8585	93mm	.010" RC	C8587AFM
GSX1300R Hayabusa	99-07	C8913	85mm	MLS/C.O.T. .030"	C8747	93mm	.010" RC	C8587AFM
w/13mm studs								
GSX1300R Hayabusa	99-07	C8913-018	85mm	MLS/C.O.T. .018"	C8747	93mm	.010" RC	C8587AFM
w/13mm studs								
GSX1300R Hayabusa	08-18	C8656	81mm	MLS/C.O.T. .030"	C8585	93mm	.010" RC	C8587AFM
GSX1300R Hayabusa	08-18	C8656-018	81mm	MLS/C.O.T. .018"	C8585	93mm	.010" RC	C8587AFM
GSX1300R Hayabusa	08-18	C8218	81mm	MLS/C.O.T. .030"	C8747	93mm	.010" RC	C8587AFM
w/13mm studs								
GSX1300R Hayabusa	08-18	C8660	82mm	MLS/C.O.T. .030"	C8585	93mm	.010" RC	C8587AFM
GSX1300R Hayabusa	08-18	C8657-018	83mm	MLS/C.O.T. .018"	C8585	93mm	.010" RC	C8587AFM
GSX1300R Hayabusa	08-18	C8657	83mm	MLS/C.O.T. .030"	C8585	93mm	.010" RC	C8587AFM
GSX1300R Hayabusa	08-18	C8219	83mm	MLS/C.O.T. .030"	C8747	93mm	.010" RC	C8587AFM
w/13mm studs								
GSX1300R Hayabusa	08-18	C8658	84mm	MLS/C.O.T. .030"	C8585	93mm	.010" RC	C8587AFM
GSX1300R Hayabusa	08-18	C8658-018	84mm	MLS/C.O.T. .018"	C8585	93mm	.010" RC	C8587AFM

All Component Parts can be purchased individually.



STREET-ROAD RACE-STRIP



Cometic Gasket - An Exclusive NASCAR Performance® Product

SUZUKI

Model	Year	Head Gasket Part#	Bore	Material/Thickness	Base Gasket Part#	Bore	Material/Thickness	Price	Case Kit Part#
GSX1300R Hayabusa	08-18	C8220	84mm	MLS/C.O.T. .030"	C8747	93mm	.010" RC		C8587AFM
			w/13mm studs						
GSX1300R Hayabusa	08-18	C8659	85mm	MLS/C.O.T. .030"	C8585	93mm	.010" RC		C8587AFM
GSX1300R Hayabusa	08-18	C8659-018	85mm	MLS/C.O.T. .018"	C8585	93mm	.010" RC		C8587AFM
GSX1300R Hayabusa	08-18	C8913	85mm	MLS/C.O.T. .030"	C8747	93mm	.010" RC		C8587AFM
			w/13mm studs						
GSX1300R Hayabusa	08-18	C8913-018	85mm	MLS/C.O.T. .018"	C8747	93mm	.010" RC		C8587AFM

TRIUMPH

Model	Year	Head Gasket Part#	Bore	Material/Thickness	Base Gasket Part#	Bore	Material/Thickness	Price	Case Kit Part#
Bonneville T100	06-14	C8850	90mm	MLS/C.O.T. .030"	C8853	105mm	.020" RC		
Scrambler	06-14	C8850	90mm	MLS/C.O.T. .030"	C8853	105mm	.020" RC		
Thrupton	06-14	C8850	90mm	MLS/C.O.T. .030"	C8853	105mm	.020" RC		
Bonneville America	06-14	C8850	90mm	MLS/C.O.T. .030"	C8853	105mm	.020" RC		
Speedmaster	06-14	C8850	90mm	MLS/C.O.T. .030"	C8853	105mm	.020" RC		
Bonneville T100	06-14	C8851	92mm	MLS/C.O.T. .030"	C8853	105mm	.020" RC		
Scrambler	06-14	C8851	92mm	MLS/C.O.T. .030"	C8853	105mm	.020" RC		
Thrupton	06-14	C8851	92mm	MLS/C.O.T. .030"	C8853	105mm	.020" RC		
Bonneville America	06-14	C8851	92mm	MLS/C.O.T. .030"	C8853	105mm	.020" RC		
Speedmaster	06-14	C8851	92mm	MLS/C.O.T. .030"	C8853	105mm	.020" RC		
Bonneville T100	06-14	C8852	96.5mm	MLS/C.O.T. .030"	C8854	106mm	.020" RC		
Scrambler	06-14	C8852	96.5mm	MLS/C.O.T. .030"	C8854	106mm	.020" RC		
Thrupton	06-14	C8852	96.5mm	MLS/C.O.T. .030"	C8854	106mm	.020" RC		
Bonneville America	06-14	C8852	96.5mm	MLS/C.O.T. .030"	C8854	106mm	.020" RC		
Speedmaster	06-19	C8852	96.5mm	MLS/C.O.T. .030"	C8854	106mm	.020" RC		
T100 Bonneville	16-19	C8926	85mm	MLS/C.O.T. .030"	C8928		.010" RC		
T120 Bonneville	16-19	C8927	98mm	MLS/C.O.T. .030"	C8928		.010" RC		
Bonneville Bobber	17-19	C8927	98mm	MLS/C.O.T. .030"	C8928		.010" RC		
Bonneville Speedmaster	18-19	C8927	98mm	MLS/C.O.T. .030"	C8928		.010" RC		
Thrupton 1200	17-19	C8927	8mm	MLS/C.O.T. .030"	C8928		.010" RC		

YAMAHA

Model	Year	Head Gasket Part#	Bore	Material/Thickness	Base Gasket Part#	Bore	Material/Thickness	Price	Case Kit Part#
YZF-R25	15-16	C8910	68mm	MLS/C.O.T. .018"					
YZF-R3	15-19	C8908	68mm	MLS/C.O.T. .018"					
YZF-R3	15-19	C8909	70mm	MLS/C.O.T. .018"					
RD350	73-75	C8871	66mm	Copper.043"	C8872		.020" Fiber		
RZ350	84-90	C8869	66mm	MLS/C.O.T. .030"	C8868		.020" Fiber		
FZR400	89-97	C8443	58mm	SLS .010"	C8427	65 mm			
FZR600	89-99	C8282	60.5 mm	SLS .010"	C8427	65 mm	.020" Copper		C8402
YZF600R	94-98	C8424	63 mm	SLS .010"	C8427	65 mm	.020" Copper		C8402
YZF600R	97-07	C8424	63 mm	SLS .010"	C8427	65 mm	.020" Copper		C8402
YZF-R6	99-02	C8575	68mm	MLS/C.O.T. .030"					C8612AFM
YZF-R6	99-02	C8575-018	68mm	MLS/C.O.T. .018"					C8612AFM
YZF-R6	03-05	C8684	68 mm	MLS/C.O.T. .027"					C8683
YZF-R6	03-05	C8684-018	68 mm	MLS/C.O.T. .018"					C8683
YZF-R6	03-05	C8699	70 mm	MLS/C.O.T. .027"					C8683
YZF-R6	03-05	C8699-018	70 mm	MLS/C.O.T. .018"					C8683
YZF-R6	06-18	C8710	68 mm	MLS/C.O.T. .027"					C8720
YZF-R6	06-18	C8710-018	68 mm	MLS/C.O.T. .018"					C8720
YZF-R6	06-18	C8712	70 mm	MLS/C.O.T. .027"					C8720
YZF-R6	06-18	C8712-018	70 mm	MLS/C.O.T. .018"					C8720
TX,XS650	74-82	C8810	75mm	MLS/C.O.T. .045"	B0377031F3.390"		.031" Fiber		C8820
TX,XS650	74-82	C8811	77mm	MLS/C.O.T. .045"	B0377031F3.390"		.031" Fiber		C8820
TX,XS650	74-82	C8812	79mm	MLS/C.O.T. .045"	B0377031F3.390"		.031" Fiber		C8820
TX,XS650	74-82	C8813	81mm	MLS/C.O.T. .045"	B0377031F3.390"		.031" Fiber		C8820



STREET·ROAD RACE·STRIP



Cometic Gasket - An Exclusive NASCAR Performance® Product

Valve Cover Part#	Price	Magneto Cover Part#	Clutch Cover Part#	Exhaust Gasket Part#	Shift Shaft Part#	Output Shaft Part#
		EC374060AFM	EC370060AFM	C8745	OS305	OS416
		EC374060AFM	EC370060AFM	C8745	OS305	OS416
		EC374060AFM	EC370060AFM	C8745	OS305	OS416
		EC374060AFM	EC370060AFM	C8745	OS305	OS416
		EC374060AFM	EC370060AFM	C8745	OS305	OS416

Valve Cover Part#	Price	Magneto Cover Part#	Clutch Cover Part#	Exhaust Gasket Part#	Shift Shaft Part#	Output Shaft Part#
			EC890060AFM		OS236	OS424
			EC890060AFM		OS236	OS424
			EC890060AFM		OS236	OS424
			EC890060AFM		OS236	OS424
			EC890060AFM		OS236	OS424
			EC890060AFM		OS236	OS424
			EC890060AFM		OS236	OS424
			EC890060AFM		OS236	OS424
			EC890060AFM		OS236	OS424
			EC890060AFM		OS236	OS424
			EC890060AFM		OS236	OS424
			EC890060AFM		OS236	OS424
			EC890060AFM		OS236	OS424
			EC890060AFM		OS236	OS424
			EC890060AFM		OS236	OS424

Valve Cover Part#	Price	Magneto Cover Part#	Clutch Cover Part#	Exhaust Gasket Part#	Shift Shaft Part#	Output Shaft Part#
					OS227	OS431
					OS227	OS431
					OS227	OS268
				C8870	OS227	OS268
				C8876	OS227	OS268
		EC087020F	EC086020F	C8876	OS227	OS268
		EC087020F	EC086020F	C8876	OS227	OS175
		EC087020F	EC086020F	C8876	OS227	OS175
		EC421020F	EC356032AFM	C8876	OS227	OS425
		EC421020F	EC356032AFM	C8876	OS227	OS425
		EC938032AFM	EC939032AFM	C8876	OS227	OS425
		EC938032AFM	EC939032AFM	C8876	OS227	OS425
		EC938032AFM	EC939032AFM	C8876	OS227	OS425
		EC938032AFM	EC939032AFM	C8876	OS227	OS425
		EC1104018AFM	EC1151032AFM	C8873	OS227	OS425
		EC1104018AFM	EC1151032AFM	C8873	OS227	OS425
		EC1104018AFM	EC1151032AFM	C8873	OS227	OS425
		EC1104018AFM	EC1151032AFM	C8873	OS227	OS425
		EC1646032AFM	EC1647032AFM	C8880	OS197	OS426
		EC1646032AFM	EC1647032AFM	C8880	OS197	OS426
		EC1646032AFM	EC1647032AFM	C8880	OS197	OS426
		EC1646032AFM	EC1647032AFM	C8880	OS197	OS426



STREET-ROAD RACE-STRIP



Cometic Gasket - An Exclusive NASCAR Performance® Product

YAMAHA

Model	Year	Head Gasket Part#	Bore	Material/Thickness	Base Gasket Part#	Bore	Material/Thickness	Case Kit Part#
TX, XS650	74-82	C8814	82mm	MLS/C.O.T. .045"				
TX, XS650	74-82	C8043	80.50 mm	CFM-20 .043"	B0377031F3.390"		.031" Fiber	C8820
FZ-07	15-17	C8890	81mm	MLS/C.O.T. .023"	B0377031F3.390"		.031" Fiber	C8820
FZ-07	15-17	C8891	83mm	MLS/C.O.T. .023"				C8892
MT-07	18-19	C8890	81mm	MLS/C.O.T. .023"				C8892
MT-07	18-19	C8891	83mm	MLS/C.O.T. .023"				C8892
FZ-09	14-19	C8918	78mm	MLS/C.O.T. .023"				C8892
FZ-09	14-19	C8919	80mm	MLS/C.O.T. .023"				
FJ-09	15-19	C8918	78mm	MLS/C.O.T. .023"				
FJ-09	15-19	C8919	80mm	MLS/C.O.T. .023"				
Tracer 900	19	C8918	78mm	MLS/C.O.T. .023"				
Tracer 900	19	C8919	80mm	MLS/C.O.T. .023"				
MT-09	18-19	C8918	78mm	MLS/C.O.T. .023"				
MT-09	18-19	C8919	80mm	MLS/C.O.T. .023"				
XSR900	17-19	C8918	78mm	MLS/C.O.T. .023"				
XSR900	17-19	C8919	80mm	MLS/C.O.T. .023"				
XS750	89-19	C8283	77 mm	MLS/C.O.T. .030"	C8382	3.260"	.010" RC	C8088
FZR1000	89-19	C8384	76.5 mm	MLS/C.O.T. .030"	C8382	3.260"	.010" RC	C8088
FZR1000	89-19	C8388	78 mm	MLS/C.O.T. .030"	C8382	3.260"	.010" RC	C8088
YFZ1000R	97-19	C8384	76.5	MLS/C.O.T. .030"	C8382	3.260"	.010" RC	
YFZ1000R	97-19	C8283	77 mm	MLS/C.O.T. .030"	C8382	3.260"	.010" RC	
YFZ1000R	97-19	C8388	78 mm	MLS/C.O.T. .030"	C8382	3.260"	.010" RC	
YZF-R1	98-19	C8562	75 mm	MLS/C.O.T. .027"				C8588
YZF-R1	98-19	C8563	77 mm	MLS/C.O.T. .027"				C8588
YZF-R1	04-19	C8686	78mm	MLS/C.O.T. .018"	C8687		.010" RC	C8688
YZF-R1	04-19	C8695	79mm	MLS/C.O.T. .018"	C8687		.010" RC	C8688
YZF-R1	07-19	C8266	78mm	MLS/C.O.T. .018"	C8687		.010" RC	C8688
YZF-R1	07-19	C8767	79mm	MLS/C.O.T. .018"	C8687		.010" RC	C8688
YZF-R1	09-19	C8794	79mm	MLS/C.O.T. .018"	C8796		.010" RC	
YZF-R1	15-19	C8894	79mm	MLS/C.O.T. .027"	C8895		.010" RC	C8896
FJ1100, 1200	84-96	C8327	77 mm	MLS/C.O.T. .030"	C8139	3.285"	.005" Copper	C8146
FJ1100, 1200	84-96	C8327	77 mm	MLS/C.O.T. .030"	C8140	3.285"	.010" Copper	C8146
FJ1100, 1200	84-96	C8327	77 mm	MLS/C.O.T. .030"	C8597	3.285"	.010" RC	C8146
FJ1100, 1200	84-96	C8327	77 mm	MLS/C.O.T. .030"	C8141	3.285"	.020" Copper	C8146
FJ1100, 1200	84-96	C8327	77 mm	MLS/C.O.T. .030"	C8142	3.285"	.020" Fiber	C8146
FJ1100, 1200 Legend Approved	84-96	C8285	77.5mm	MLS/C.O.T. .030"	C8139	3.285"	.005" Copper	C8146
FJ1100, 1200 Legend Approved	84-96	C8285	77.5mm	MLS/C.O.T. .030"	C8140	3.285"	.010" Copper	C8146
FJ1100, 1200 Legend Approved	84-96	C8285	77.5mm	MLS/C.O.T. .030"	C8597	3.285"	.010" RC	C8146
FJ1100, 1200 Legend Approved	84-96	C8285	77.5mm	MLS/C.O.T. .030"	C8141	3.285"	.020" Copper	C8146
FJ1100, 1200 Legend Approved	84-96	C8285	77.5mm	MLS/C.O.T. .030"	C8142	3.285"	.020" Fiber	C8146
FJ1100, 1200	84-96	C8351	78 mm	MLS/C.O.T. .030"	C8139	3.285"	.005" Copper	C8146
FJ1100, 1200	84-96	C8351	78 mm	MLS/C.O.T. .030"	C8140	3.285"	.010" Copper	C8146
FJ1100, 1200	84-96	C8351	78 mm	MLS/C.O.T. .030"	C8597	3.285"	.010" RC	C8146
FJ1100, 1200	84-96	C8351	78 mm	MLS/C.O.T. .030"	C8141	3.285"	.020" Copper	C8146
FJ1100, 1200	84-96	C8351	78 mm	MLS/C.O.T. .030"	C8142	3.285"	.020" Fiber	C8146
FJ1100, 1200	84-96	C8330	79 mm	MLS/C.O.T. .030"	C8139	3.285"	.005" Copper	C8146
FJ1100, 1200	84-96	C8330	79 mm	MLS/C.O.T. .030"	C8140	3.285"	.010" Copper	C8146
FJ1100, 1200	84-96	C8330	79 mm	MLS/C.O.T. .030"	C8597	3.285"	.010" RC	C8146
FJ1100, 1200	84-96	C8330	79 mm	MLS/C.O.T. .030"	C8141	3.285"	.020" Copper	C8146
FJ1100, 1200	84-96	C8330	79 mm	MLS/C.O.T. .030"	C8142	3.285"	.020" Fiber	C8146
FJ1100, 1200 Legend Approved	84-96	C8174	79mm	.032" Copper	C8139	3.285"	.005" Copper	C8146
FJ1100, 1200 Legend Approved	84-96	C8174	79mm	.032" Copper	C8140	3.285"	.010" Copper	C8146
FJ1100, 1200 Legend Approved	84-96	C8174	79mm	.032" Copper	C8597	3.285"	.010" RC	C8146
FJ1100, 1200 Legend Approved	84-96	C8174	79mm	.032" Copper	C8141	3.285"	.020" Copper	C8146
FJ1100, 1200 Legend Approved	84-96	C8174	79mm	.032" Copper	C8142	3.285"	.020" Fiber	C8146
FJ1100, 1200	84-96	C8328	81 mm	MLS/C.O.T. .030"	C8239	3.460"	.020" Fiber	C8146
FJ1100, 1200	84-96	C8328	81 mm	MLS/C.O.T. .030"	C8240	3.460"	.005" Copper	C8146
FJ1100, 1200	84-96	C8328	81 mm	MLS/C.O.T. .030"	C8241	3.460"	.010" Copper	C8146
FJ1100, 1200	84-96	C8328	81 mm	MLS/C.O.T. .030"	C8242	3.460"	.020" Copper	C8146
FJ1100, 1200	84-96	C8328	81 mm	MLS/C.O.T. .030"	C8598	3.460"	.010" RC	C8146
FJ1100, 1200	84-96	C8329	83 mm	MLS/C.O.T. .030"	C8239	3.460"	.020" Fiber	C8146
FJ1100, 1200	84-96	C8329	83 mm	MLS/C.O.T. .030"	C8240	3.460"	.005" Copper	C8146
FJ1100, 1200	84-96	C8329	83 mm	MLS/C.O.T. .030"	C8241	3.460"	.010" Copper	C8146
FJ1100, 1200	84-96	C8329	83 mm	MLS/C.O.T. .030"	C8242	3.460"	.020" Copper	C8146
FJ1100, 1200	84-96	C8329	83 mm	MLS/C.O.T. .030"	C8598	3.460"	.010" RC	C8146



STREET·ROAD RACE·STRIP



Cometic Gasket - An Exclusive NASCAR Performance® Product

YAMAHA

Model	Year	Head Gasket Part#	Bore	Material/Thickness	Base Gasket Part#	Bore	Material/Thickness	Case Kit Part#
XS1100	78-81	C8046	76 mm	CFM-20 .043"				
VMX12 V-Max / XVZ13 Royal Star	83-07	C8535	85mm	MLS/C.O.T. .030"				
VMX12 V-Max / XVZ13 Royal Star	83-07	C8536	80mm	MLS/C.O.T. .030"				
XV1600 Road Star /Midnight Star	99-03	C8673	95 mm	MLS/C.O.T. .030"				
XV1600 Road Star/ Midnight Star	99-03	C8674	97 mm	MLS/C.O.T. .030"				
XV1600 Road Star/ Midnight Star	99-03	C8675	100 mm	MLS/C.O.T. .030"				
XV1600 Road Star/ Midnight Star	99-03	C8676	102 mm	MLS/C.O.T. .030"				
XV1700 Road Star	04-14	C8678	100 mm	MLS/C.O.T. .030"				
XV1700 Road Star	04-14	C8679	102 mm	MLS/C.O.T. .030"				
XV1700 Road Star Warrior	04-09	C8677	97 mm	MLS/C.O.T. .030"				
XV1900 Raider, Roadliner, Stratoliner	06-14	C8857	102 mm	MLS/C.O.T. .030"				
XV1900 Raider, Roadliner, Stratoliner	06-14	C8858	103 mm	MLS/C.O.T. .030"				



Personal Watercraft

Model Displ. cc Bore mm Top End Kit Part #

ARCTCO

Barracuda, Daytona 94-95, Montego, Montego Deluxe 94-97, TT640R 98-99, TS640L 98, Tigershark, Tigershark Daytona 93	639	77mm	C6052
Monte Carlo, Daytona 96-97, TS770, TS-L770, TS-R 98-99	770	84mm	C6144
Tigershark 900 95, Monte Carlo 900 96, Daytona 1000 97	900	O-Ring	C6116
TS-11000, TS-R1000 98	999	O-Ring	C6162

KAWASAKI

JS300, JS300SX 86-94	300	78mm	C6001
JS440, JSX440, JSX440SX 82-92	440	70mm	C6002
JS440, JSX440, JSX440SX 82-92	475	73mm	C6003
JS550 thru 82-88	550	77mm	C6004
JS550, JSX550 89-95	550	78mm	C6015
JS650SC 91-95, JF650X2 86-95, JF650TS 89-96	650	78mm	C6005
JS650SX 87-93, JS650SC 91-95, JF650X2 86-95	701	80mm	C6078
JS750SX 92-95, JS750Sxi 95-97, JH750Xi 93-97, JH750SS 92-97, JH750XiR 94	750	83mm	C6043
JT750STS 95-97, JT750ST 94-95, 750ZXi 95-97, 750Sxi 98-02			
750Xi 95-97, SXI Pro 98-02, STX 98	766	81mm	C6215
750ZXi 95-97, SXI Pro 98-02, STX 98, SX800R 03-06	779	83mm	C6126
750ZXi 95-97, SXI Pro 98-02, STX 98, SX800R 03-06	830	84.5mm	C6158
800 SXR 03-11	779	82mm	C6214
900ZXi 95-97, STX 97-06	941	75mm	C6118
1100ZXi 96-03, 1100STX 97-99, STX D. I. 00-03	1097	81mm	C6145
1100Zxi 96-03, 1100STX 97-99, STX D. I. 00-03	1195	84.5mm	C6159
Ultra 150 99-05, 1200STX '02-05	1205	81mm	C6202
Ultra 250/260X 07-10 (Head Gasket Only)	1498	84mm	C6222

POLARIS

SL650 92-95, SL650STD 92-95	650	67mm	C6044
SLTH 96-03, SLT 700 96-03, SL700DLX 96-03, SLH 96-03, SL700 96-03	700	O-Ring	C6146
SL750 92-96, SLT 92-96	750	71.25mm	C6055
SL750 92-96, SLT 92-96	782	72mm	C6089
SLX780 95-97, SL780 95-96, SLT780 95-96	780	71.5mm	C6143
SLX 785 Pro 97-01	785	72mm	C6181
SL900 96-97	900	O-Ring	C6147
SLTX1050 97-04, SL1050 96-04, SLXH 98-04	1051	O-Ring	C6148
Genesis Ffi 00-04, Pro 1200 00-04, SLX, Virage TX 00-04	1176	86mm	C6212

All Component Parts can be purchased individually.



STREET·ROAD RACE·STRIP



Cometic Gasket - An Exclusive NASCAR Performance® Product

Valve Cover Part#

Magneto Cover Part#

Clutch Cover Part#

Exhaust Gasket Part#

Shift Shaft Part#

Output Shaft Part#

C8882	OS227	N/A
C8880	OS227	N/A
C8880	OS227	N/A
	OS286	OS429
	OS286	OS429
	OS286	OS429
	OS286	OS429
	OS286	OS429
	OS286	OS429
	OS286	OS429
	OS286	OS429
	OS286	OS430
	OS286	OS430



Personal Watercraft

Model Displ. cc Bore mm Top End Kit Part #

SEA DOO

580 Yellow Motor 91, 580XP 91, 580GT 90-91	580	O-Ring	C6010
580 White Motor, 580 SP, XP, SPX, SPi, GTS, GTX 92-96	580	O-Ring	C6095
650XP 93-94, 650XPI 94-95, 650SPX 94-95, GTX650 94-95	657	O-Ring	C6056
GT1750, SPX750, XP750, HX750, GS750, GTS 750 97-01	717	O-Ring	C6119
XP 800, GSX800, GTX800, SPX800, XP800 Ready, RFI800, 97-01 (Lay Down Motor)	787	O-Ring	C6154
GSX950 Limited 97-99, GTX950 Limited 98-00	993	90mm	C6157
XP950 Limited 98-00, GTX950 00, RX950 00, LRV950 00			
GSX950 Limited 97-99, GTX950 Limited 98-00	1017	90mm	C6203
XP950 Limited 98-00, GTX950 00, RX950 00, LRV950 00			
4TEC 02-14 (Head Gasket Only)	1494	101mm	C6223

SUZUKI

Wet Bike 78-92		86mm	C6163
----------------	--	------	-------

YAMAHA

Waverunner III 90-93, VXR 91-95, Waverunner 90-93, Super Jet ALL, LX633 90-96	633	79mm	C6012
Waveblaster 93-95, Super Jet 94-95, Waverunner III 94-97, Pro-VXR 93-94, FX700 94-95, Waveraider 700 96-99 (Kit works with all single carb models)	701	83mm	C6057
Waveblaster 96-97, Super Jet 97-00, Wave Venture 700 95-97, Waveraider 700 93-95, Waveraider Deluxe 93-95, XL700 thru 99-00 (Kit works with all dual carb models)	701	83mm	C6084
Waveblaster 96-97, Super Jet 97-00, Wave Venture 700 95-97, Waveraider 700 93-95, Waveraider Deluxe 93-95, XL700 thru 99-00 (Kit works with all dual carb models)	760	85mm	C6086
Waveraider 760 96-99, Waveblaster II 96-99, Wave Venture 760 97, Waverunner 96-97, Waverunner GP 760 '00	754	85mm	C6149
Waveraider 760 96-99, Waveblaster II 96-99, Wave Venture 760 97, Waverunner 96-97	789	86mm	C6155
800 GP 98-00	800	86mm	C6199
Waveraider 1100 95-97, Wave Venture 1100 96-97	1051	83mm	C6121
1200 GP 97-99, SUV1200 00, XI 1200 00	1131	86mm	C6160
GP1200R 01-10 (with power valve)	1176	82mm	C6220
FZR Waverunner 08-14 (Head Gasket Only)	1812	86mm	C6221

All Component Parts can be purchased individually.



AFM® Series Gaskets • Aluminum Foamet Composite Material

Cometic Part #-C9888 Complete Primary Kit FLT, FLHT, FXR 94-06

Cometic Part #-C9889 Complete Primary Kit FLT, FLHT, FXR 80-93

Cometic Part #-C9261
Starter Shaft Seal 94-06
Dyna 94-05
All B/T Models
Replaces: 12066
Cometic Part #-C9379
Starter Shaft Seal 89-93
All B/T Models
Replaces: 12053

Cometic Part #-C9441
Inner Primary to Motor
Case O-Ring
Dyna L82-05
All Models L82-06
Replaces: 11147

Cometic Part #-C9536
Inner Primary to Motor
Case O-Ring
All Models 70-E82
Replaces: 11125

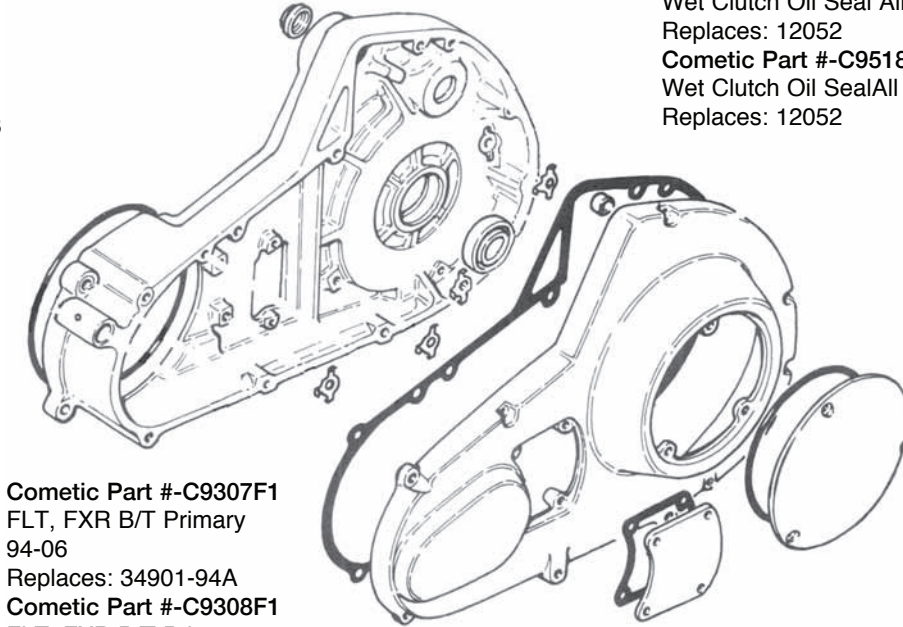

Cometic Part #-C9307F1
FLT, FXR B/T Primary
94-06
Replaces: 34901-94A
Cometic Part #-C9308F1
FLT, FXR B/T Primary
80-93
Replaces: 34901-79A

Cometic Part #-C9305F1
FLT, FXR Inspection Cover 85-06
Replaces: 34906-85A

Cometic Part #-C9303F1
FLT, FXR Inspection Cover 80-84
Replaces: 34906-79A

Cometic Part #-C9261
Starter Shaft Seal
Dyna 94-05, All B/T
Models 94-06 Replaces: 12066

Cometic Part #-C9379
Starter Shaft Seal 89-93 All B/T Models
Replaces: 12053

Cometic Part #-C9260
Wet Clutch Oil Seal All Models L84-UP
Replaces: 12052

Cometic Part #-C9518
Wet Clutch Oil Seal All Models 70-E84
Replaces: 12052

Cometic Part #-C9441
Inner Primary to
Motor Case O-Ring
All Models L82-06,
Dyna L82-05
Replaces: 11147

Cometic Part #-C9536
Inner Primary to
Motor Case O-Ring All
Models 70-E82
Replaces: 11125

Cometic Part #-C9942F1
Primary Spacer Gasket "Pair"
Softail 95-06

Cometic Part #-C9331F1 Inspection Cover Gasket
Dyna & Softail, 4 & 5 Speed Dyna 65-05 , Softail 65-06

Cometic Part #-C9260
Wet Clutch Oil Seal All Models L84-17
Replaces: 12052

Cometic Part #-C9518
Wet Clutch Oil Seal All Models 70-E84
Replaces: 12052

Cometic Part #-C9662
Derby Cover O-Ring
All Big Twin Models
99-06, Dyna 99-05
Replaces: 25416-99

Cometic Part #-C9442
Derby Cover O-Ring
All Big Twin Models
L84-98
Replaces: 25416-84

Cometic Part #-C9997F1
Derby Cover Gasket
Replaces O-Ring
All Big Twin Models
99-15 5 Hole
Replaces: 25416-99C

Cometic Part #-C9309F1
Primary Gasket Softail 89-06, Dyna 89-05
Replaces: 60539-89

Cometic Part #-C9607F1
Primary Gasket Softail, Superglide 65-88
All Four Speeds
Replaces: 60538-81C

Cometic Part #-C9885
94-06 FXST, 94-05 FXD Primary Kit

Cometic Part #-C9886
89-93 FXST, FXD Primary Kit

Cometic Part #-C9887
65-88 FXST, FX, FL 4-Speed Primary Kit

Cometic Part #-C9338F1
Derby Cover Gasket
All 4 Speed Models 70-83
Replaces: 25416-70

Cometic Part #-C9662
Derby Cover O-Ring
All Big Twin Models
99-06, Dyna 99-05
Replaces: 25416-99

Cometic Part #-C9442
Derby Cover O-Ring
All Big Twin Models
L84-98
Replaces: 25416-84

Cometic Part #-C9997F1
Derby Cover Gasket
Replaces O-Ring
All Big Twin Models
99-15 5 Hole
Replaces: 25416-99C

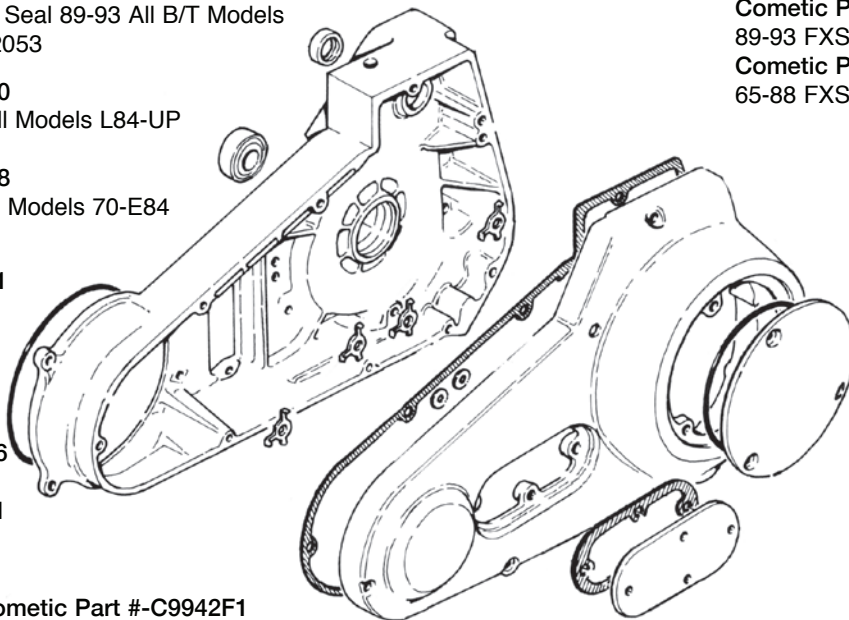



Big Twin Primary Gasket & Seal Kits (All kits contain all Gaskets and Seals needed to R&R Inner & Outer Primary)

Cometic Part #	Description
C10196	2017-19, ALL M8 FL MODELS
C10248	2018-19, ALL M8 FXST MODELS
C9173	07-16 FL Models Primary Kit
C9150	06-14 Dyna Primary Kit, 07-17 Softail
C9885	94-06 FXST, 94-05 FXD Primary Kit
C9888	94-06 FLT, FLHT, FXR Primary Kit
C9886	89-93 FXST, FXD Primary Kit
C9889	80-93 FLT, FLHT, FXR Primary Kit
C9887	65-88 FXST, FX, FL 4-Speed Primary Kit

Primary Gaskets Big Twin, Twin Cam

Cometic Part #	OE#	Description
Single		
5 Pack		
C10198F1	C10198F5	25700378 2017-19 ALL M8 FL MODELS, PRIMARY GASKET
C10241F1	C10241F5	25700564 2018-19 ALL M8 FXST MODELS PRIMARY GASKET
C9179F1	C9179F5	34901-07 07-16 FL Models Primary
C9145F1	C9145F5	60547-06 06-14 Dyna, 07-17 Softail
C9199F1	C9199F5	34934-06 06-17 Dyna, 06-17 ALL FXST, 07-16 ALL FL, Inner Primary Spacer/Seal
C9942F1	C9942F5	63859-95A 95-06 Softail primary spacer gasket (Pair)
C9307F1	C9307F5	34901-94A 94-06 FLT, FXR Big Twin Primary
C9308F1	C9308F5	34901-79A 80-93 Big Twin Primary FLT/FXR
C9309F1	C9309F5	60539-89 89-06 Softail, 89-05 Dyna
C9607F1	C9607F5	60538-81C 65-88 FXST, FX / FL 4 -SPEED

Inspection Cover Gaskets Big Twin , Twin Cam

Cometic Part #	OE#	Description
Single		
5 Pack		
C9305F1	C9305F5	34906-85A 85-06 FXR, FLT Insp. Cover
C9303F1	C9303F5	34906-79A 80-84 FXR,FLT Insp. Cover
C9326F1	C9326F5	60567-36 36-58-64-69 FL, XLCH Inspection Cover
C9331F1	C9331F5	60567-65B 65-06 Softail 4&5 Speed, 89-05 Dyna Inspection Cover

Derby Cover Gasket Big Twin

Cometic Part #	OE#	Description
Single		
5 Pack		
C10140F1	C10140F5	25416-16 2016 FL SLIM, 2017-19 ALL FL, 2018-19 ALL FXST, Derby Cover Gasket
C9997F1	C9997F5	25416-99C 99-16 FL MODELS, 99-17 FXD & FXST Derby Cover Repl. O-ring, 5 Hole
C9997F1-SD	C9997F5-SD	25416-99C 99-16 FL MODELS, 99-17 FXD & FXST Derby Cover Repl. "Solid", 5 Hole
C9183F1	C9183F5	84-98 All Derby Cover Replaces O-Ring , 3 Hole
C9152F1	C9152F5	17369-06 06-14 Dyna, 07-14 All Twin Cam Models O-ring
C9338F1	C9338F5	25416-70 70-83 FL, FXR Derby Cover

Cam Cover Gaskets Big Twin , Twin Cam

Cometic Part #	OE#	Description
Single		
5 Pack		
C10173F1	C10173F5	25700370 17-19 ALL M8 FL MODELS, 2018-19 ALL M8 FXST MODELS Cam Cover
C9575F1	C9575F5	25244-99 99-16 FL MODELS, 2000-17 FXD & FXST Twin Cam, Cam Cover
C9328F1	C9328F5	25225-93X 93-98 Big Twin Cam Cover
C9302F1	C9302F5	25225-70X 70-92 Big Twin Cam Cover
C9334F1	C9334F5	25225-36C 41-69 Big Twin Cam Cover

Sportster Primary Gasket and Seal Kit

Cometic Part #	Description
C9125	04-19 Sportster Complete Primary Rebuild
C9211	91-03 Sportster Complete Primary Rebuild
C9210	96-90 Sportster Complete Primary Rebuild

Sportster Primary Gasket

Cometic Part #	OE#	Description
Single		
5 Pack		
C9943F1	C9943F5	34955-04 04-19 Sportster Primary
C9314F1	C9314F5	34955-89A 91-03 Sporty Primary
C9310F1	C9310F5	34955-75X 77-90 Sporty Primary

Sportster Cam Cover Gasket

Cometic Part #	OE#	Description
Single		
5 Pack		
C9944F1	C9944F5	25263-90D 04-19 Sportster Cam Cover
C9313F1	C9313F5	25263-90B 91-03 Sporty Cam Cover
C9311F1	C9311F5	25263-86 86-90 Sporty Cam Cover
C10029F1	C10029F5	25279-08 08-UP XR1200 Cam Cover

Street 500-750 Alternator Cover Gasket

Cometic Part #	OE#	Description
Single		
5 Pack		
C10131F1	C10131F5	25700224 2014-19 Street 500/750 Alternator Cvr Gasket

Street 500-750 Primary Cover Gasket

Cometic Part #	OE#	Description
Single		
5 Pack		



Gaskets for Harley-Davidson®



Cometic Gasket - An Exclusive NASCAR Performance® Product

MLS® Multi-Layer Steel

Part # Description

V - Rod MLS Head Gaskets (Pairs) 2001-16

- C9895 V-Rod .027" Std Bore Head Gasket
- C9896 V-Rod .030" Std Bore Head Gasket
- C9897 V-Rod .027" 4.250" Bore Head Gasket
- C9898 V-Rod .030" 4.250" Bore Head Gasket

V - Rod EXTREME DUTY Exhaust Gaskets (Pair) 2001-16

- C9928 V-Rod Extreme Performance Exhaust Gasket
- C10060 V-Rod OE Replacement Gasket Pair (Replaces 65109-01)

Twin Cam, Twin Cooled MLS Head Gaskets (Pairs) Select 2014 -16 Touring Models & Trikes

NOTE: TWIN COOLED H/G WILL RETRO TO AIR COOLED HEADS & CYLINDERS

- C10081 3.875", .027"MLS, Twin Cooled 2014-16
- C10081-030 3.875", .030"MLS, Twin Cooled 2014-16
- C10081-036 3.875", .036"MLS, Twin Cooled 2014-16
- C10081-040 3.875", .040"MLS, Twin Cooled 2014-16
- C10081-045 3.875", .045"MLS, Twin Cooled 2014-16
- C10083 3.937", .027"MLS, Twin Cooled 2014-16
- C10083-030 3.937", .030"MLS, Twin Cooled 2014-16
- C10083-036 3.937", .036"MLS, Twin Cooled 2014-16
- C10083-040 3.937", .040"MLS, Twin Cooled 2014-16
- C10083-045 3.937", .045"MLS, Twin Cooled 2014-16
- C10084 4.000", .027"MLS, Twin Cooled 2014-16
- C10084-030 4.000", .030"MLS, Twin Cooled 2014-16
- C10084-036 4.000", .036"MLS, Twin Cooled 2014-16
- C10084-040 4.000", .040"MLS, Twin Cooled 2014-16
- C10084-045 4.000", .045"MLS, Twin Cooled 2014-16
- C10085 4.060", .027"MLS, Twin Cooled 2014-16
- C10085-030 4.060", .030"MLS, Twin Cooled 2014-16
- C10085-036 4.060", .036"MLS, Twin Cooled 2014-16
- C10085-040 4.060", .040"MLS, Twin Cooled 2014-16
- C10085-045 4.060", .045"MLS, Twin Cooled 2014-16
- C10086 4.125", .027"MLS, Twin Cooled 2014-16
- C10086-030 4.125", .030"MLS, Twin Cooled 2014-16
- C10086-036 4.125", .036"MLS, Twin Cooled 2014-16
- C10086-040 4.125", .040"MLS, Twin Cooled 2014-16
- C10086-045 4.125", .045"MLS, Twin Cooled 2014-16
- C10087 4.160", .027"MLS, Twin Cooled 2014-16
- C10087-030 4.160", .030"MLS, Twin Cooled 2014-16
- C10087-036 4.160", .036"MLS, Twin Cooled 2014-16
- C10087-040 4.160", .040"MLS, Twin Cooled 2014-16
- C10087-045 4.160", .045"MLS, Twin Cooled 2014-16
- C10088 4.250", .027"MLS, Twin Cooled 2014-16
- C10088-030 4.250", .030"MLS, Twin Cooled 2014-16
- C10088-036 4.250", .036"MLS, Twin Cooled 2014-16
- C10088-040 4.250", .040"MLS, Twin Cooled 2014-16
- C10088-045 4.250", .045"MLS, Twin Cooled 2014-16

Twin Cam MLS Head Gaskets (Pairs)

*2007 Twin Cams 96" displacement increase was made by increasing the stroke to 4.375" std. 96" and big bore 103" are the same bore size as 88" and 95" bores.

- C9790 3.750" Head Gasket .030" MLS All Twin Cam Models Std bore 1999-17
- C9745 3.750" Head Gasket .040" MLS All Twin Cam Models Std bore 1999-17
- C9181 3.750" Head Gasket .045" MLS All Twin Cam Models Std bore 1999-17
- C9157 3.750" Head Gasket .051" MLS All Twin Cam Models Std bore 1999-17
- C9158 3.750" Head Gasket .060" MLS All Twin Cam Models Std bore 1999-17
- C9721 3.875" Head Gasket .030" MLS All Twin Cam Models 95" & 103" 1999-17
- C9721-040 3.875" Head Gasket .040" MLS All Twin Cam Models 95" & 103" 1999-17
- C9721-045 3.875" Head Gasket .045" MLS All Twin Cam Models 95" & 103" 1999-17
- C9721-051 3.875" Head Gasket .051" MLS All Twin Cam Models 95" & 103" 1999-17
- C9721-060 3.875" Head Gasket .060" MLS All Twin Cam Models 95" & 103" 1999-17



Gaskets for Harley-Davidson®



Cometic Gasket - An Exclusive NASCAR Performance® Product

MLS® Multi-Layer Steel

Part # Description

Twin Cam MLS Head Gaskets (Pairs) con't.

*2007 Twin Cams 96" displacement increase was made by increasing the stroke to 4.375" std. 96 and big bore 103" are the same bore size as 88" and 95" bores.

- C9894 3.937" Head Gasket .030" MLS All Twin Cam Models 97" & 107" 1999-17
- C9894-040 3.937" Head Gasket .040" MLS All Twin Cam Models 97" & 107" 1999-17
- C9894-051 3.937" Head Gasket .051" MLS All Twin Cam Models 97" & 107" 1999-17
- C9725 4.000" Head Gasket .030" MLS All Twin Cam Models 100" & 110" 1999-17
- C9726 4.000" Head Gasket .040" MLS All Twin Cam Models 100" & 110" 1999-17
- C9070-030 4.060" Head Gasket .030" MLS All Twin Cam Models 103" & 113" 1999-17
- C9070-040 4.060" Head Gasket .040" MLS All Twin Cam Models 103" & 113" 1999-17
- C9910 4.125" Head Gasket .030" MLS All Twin Cam Models 107" & 117" 1999 - 17
- C9743 4.125" Head Gasket .040" MLS All Twin Cam Models 107" & 117" 1999 - 17
- C9076-030 4.250" Head Gasket .030" MLS All Twin Cam Models 114" & 124" 1999-17
- C9076-040 4.250" Head Gasket .040" MLS All Twin Cam Models 114" & 124" 1999-17

Twin Cam SLS Base Gasket (Pairs) Single Layer Steel 1999-17

- C9937 4" Twin Cam Base gasket .010" Pair
- C9738 4" Twin Cam Base gasket .020" Pair
- C9110-010 4.060" Twin Cam Base gasket .010" SLS, Pair
- C9110-020 4.060" Twin Cam Base gasket .020" SLS, Pair
- C10066 4.125" Twin Cam Base gasket .010" SLS, Pair Stock base pattern
- C10066-020 4.125" Twin Cam Base gasket .020" SLS, Pair Stock base pattern
- C9938 4.125" Twin Cam Base gasket .010" Pair
- C9739 4.125" Twin Cam Base gasket .020" Pair
- C9111-010 4.250" Twin Cam Base gasket .010" SLS Pair
- C9111-020 4.250" Twin Cam Base gasket .020" SLS Pair

S&S Head Gaskets

- C9930 S&S Super Sidewinder + 4 1/8" H/G Pair .027" MLS
- C9931 S&S Super Sidewinder + 4 1/8" H/G Pair .030" MLS
- C9932 S&S Super Sidewinder + 4 1/8" H/G Pair .036" MLS
- C9933 S&S Super Sidewinder + 4 1/8" H/G Pair .040" MLS
- C9934 S&S Super Sidewinder + 4 1/8" H/G Pair .045" MLS
- C10090 S&S Twin Cam 131"cu 4.250" H&B Kit, .040" MLS H/G & .010" SLS Base
- C10065 S&S Tribute pattern 4 3/8" H/G Pair .040" MLS NEW!
- C10065-045 S&S Tribute pattern 4 3/8" H/G Pair .045" MLS NEW!

S&S Base Gaskets

- C9935 S&S Super Sidewinder + 4 1/8" Base gasket pair .010"
- C9936 S&S Super Sidewinder + 4 1/8" Base gasket pair .020"
- C10009 S&S EVO 1984-99 Fits S&S only .020" Fiber (93-1033)

Street 500 & 750 Head & Base Gaskets 2014-19

- C10134 Street 500 H/G 69MM Stock Bore, .036" MLS (Pair)
- C10134-HB Street 500 H/G 69MM Stock Bore, .036" MLS Head & Base Kit
- C10135 Street 500 H/G 71MM Big Bore, .036" MLS (Pair)
- C10135-HB Street 500 H/G 71MM Big Bore, .036" MLS Head & Base Kit
- C10136 Street 700 H/G 85MM Stock Bore, .036" MLS (Pair)
- C10136-HB Street 700 H/G 85MM Stock Bore, .036" MLS Head & Base Kit
- C10137 Street 700 H/G 87MM Big Bore, .036" MLS (Pair)
- C10137-HB Street 700 H/G 87MM Big Bore, .036" MLS Head & Base Kit

EVO Big Twin & Sportster MLS Head Gaskets (Pairs)

- C10003 XR1200 STD Bore MLS Head gasket .040" 2008-12
- C10004 XR1200 3.812" Bore MLS Head gasket .040" 2008-12
- C10004-030 XR1200 3.812" Bore MLS Head gasket .030" 2008-12
- C10077 XR1200 3.563" Bore Head & Base Kit .030" H/G & .020" Base, 2008-12
- C10057 XR1200 3.875" Bore .030" MLS Head gasket & .020" Base set, 2008-12
- C9205 883 XL 3.000" Std bore .040" 1984-19
- C9688 Stock EVO's 3.500" through 3.570" .030" 1984-99 B/T, 1984-19 XL
- C9689 Stock EVO's 3.500" through 3.570" .040" 1984-99 B/T, 1984-19 XL
- C9180 Stock EVO's 3.500" through 3.570" .060" 1984-99 B/T, 1984-19 XL



Gaskets for Harley-Davidson®



Cometic Gasket - An Exclusive NASCAR Performance® Product

Head & Base Gaskets

Part # Description

EVO Big Twin & Sportster MLS Head Gaskets (Pairs) con't

- C9690 3 5/8" Big Bore EVO's .030", 1984-99 B/T, 1984-19 XL
- C9691 3 5/8" Big Bore EVO's .040" 1984-99 B/T, 1984-19 XL
- C9694 3 3/4" Big Bore EVO's .030" 1984-99 B/T, 1984-19 XL
- C9695 3 3/4" Big Bore EVO's .040" 1984-99 B/T, 1984-19 XL
- C9692 3 13/16" Big Bore EVO's .030" 1984-99 B/T, 1984-19 XL
- C9693 3 13/16" Big Bore EVO's .040" 1984-99 B/T, 1984-19 XL
- C9877 4.000" Bore S&S and TP cylinders .027" solid dowels
- C9878 4.000" Bore S&S and TP cylinders .030" solid dowels
- C9879 4.000" Bore S&S and TP cylinders .036" solid dowels
- C9880 4.000" Bore S&S and TP cylinders .040" solid dowels
- C9881 4.125" Bore TP cylinders .027" solid dowels
- C9882 4.125" Bore TP cylinders .030" solid dowels
- C9883 4.125" Bore TP cylinders .036" solid dowels
- C9884 4.125" Bore TP cylinders .040" solid dowels
- C10069 4.250" Bore S&S and TP cylinders head & Base kit .030" head, .020" base

EVO Big Twin SLS Base Gaskets (Pairs) Single Layer Steel

- C9101 1340 Evolution B/T STD bore .010" 1984-99
- C9551 1340 Evolution B/T STD bore .020" 1984-99
- C9532 3 5/8" & 3 3/4" Big Bore 1340 B/T EVO's .010" 1984-99
- C9552 3 5/8" & 3 3/4" Big Bore 1340 B/T EVO's .020" 1984-99
- C9869 3 13/16" Evolution B/T .010" 1984-99
- C9870 3 13/16" Evolution B/T .020" 1984-99
- C9871 4.000" S&S and TP cylinder .010"
- C9872 4.000" S&S and TP cylinder .020"
- C9873 4.125" TP cylinder .010"
- C9874 4.125" TP cylinder .020"

EVO Sportster SLS Base Gaskets (Pairs) Single Layer Steel

- C9100 883/1200 EVO Sportsters .010" 1984-19
- C9553 883/1200 EVO Sportsters .020" 1984-19
- C9554 3 5/8" Big Bore 883/1200 EVO Sportsters .010" (Also fits Wiseco 3 3/4" Steel Sleeve Big Bore)
- C9555 3 5/8" Big Bore 883/1200 EVO Sportsters .020" (Also fits Wiseco 3 3/4" Steel Sleeve Big Bore)
- C9875 3 3/4" & 3 13/16" Evo Sporty Millenium Cylinders .010" (Either bore utilizes a 4.00" O.D. Spigot Diameter)
- C9876 3 3/4" & 3 13/16" Evo Sporty Millenium Cylinders .020" (Either bore utilizes a 4.00" O.D. Spigot Diameter)

Shovelhead and Panhead MLS Head Gaskets (Pairs)

- C9984 Std Bore Head Gasket .040" MLS Shovelhead 74" & 80" 1966-84
- C9985 3 5/8" Head Gasket .040" MLS Shovelhead Big Bore 1966-84
- C10037 3 13/16" Head Gasket .040" MLS Shovelhead Big Bore 1966-84
- C9137 Head Gasket .040" MLS Panhead Std. Bore 1948-65
- C10070 3 5/8" Bore Head Gasket .040" MLS Panhead 1948-65

Shovelhead and Panhead SLS Base Gaskets (Pairs)

- C9206 Shovel Only Base Gasket Std bore .020" Viton Front & Rear Pair, 1966-84
- C9207 3 5/8" Shovel Only Base Gasket .020" Viton 2 Fronts for S&S Cylinders, 1984-99
- C10038 3 13/16" Shovel Only Base Gasket .020" Viton 2 Fronts for S&S Cylinders
- C9987 Panhead Base Front & Rear Set .020" Viton 1948-84
- C9988 Panhead Base 3 5/8" Front & Rear Set .020" Viton 1948-84
- C9989 Panhead Base 3 5/8" 2 Fronts for S&S Cylinders Viton 48-84
- C9893 Panhead Base 3 13/16" .020" Viton 1948-84

EVO Viton Coated Steel Rocker Cover Gaskets

Part#	Description / Qty.	Thickness	Part#	Description / Qty.	Thickness
C9865	84-99 One piece Base All Evo's (2)	.020"	C9560	Right - All 883 thru 1340, '84-99 (5)	.010"
C9866	84-99 One piece Base All Evo's (10)	.020"	C9561	Right - All 883 thru 1340, '84-99 (5)	.020"
C9556	Right - All 883 thru 1340, '84-99 (1)	.010"	C9562	Left - All 883 thru 1340, '84-99 (5)	.010"
C9557	Right - All 883 thru 1340, '84-99 (1)	.020"	C9563	Left - All 883 thru 1340, '84-99 (5)	.020"
C9558	Left - All 883 thru 1340, '84-99 (1)	.010"	C9986	66-84 Shovelhead / OE#17540-69 (2)	.020"
C9559	Left - All 883 thru 1340, '84-99 (1)	.020"	C10008	66-84 Shovelhead / OE#17540-69 (2)	.043"
			C10008-10	66-84 Shovelhead / OE#17540-69 (10)	.043"



Gaskets for Harley-Davidson®



Cometic Gasket - An Exclusive NASCAR Performance® Product

Milwaukee 8®

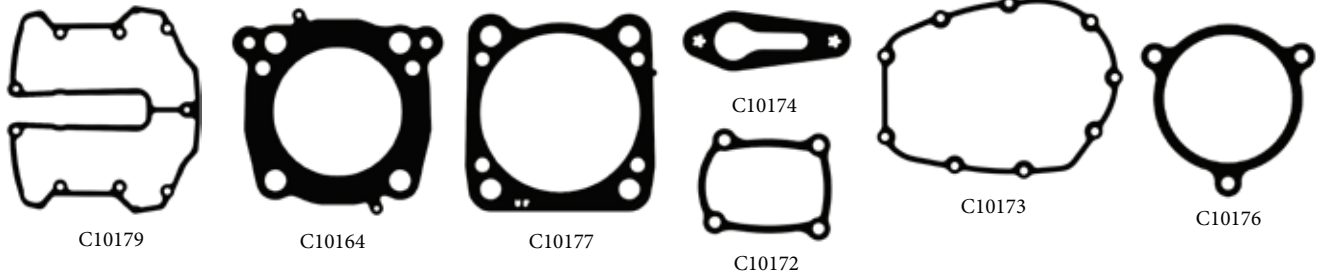

• M8 Rocker Gaskets & Seals, ALL MODELS

Part#	Description	Year Fitment	OEM#
C10226	MILWAUKEE 8, ROCKER BOX REBUILD KIT	17-19	
C10179	MILWAUKEE 8, UPPER ROCKER GASKET, .020"RC, 10PK	17-19	25700372
C10179-2	MILWAUKEE 8, UPPER ROCKER GASKET, .020"RC, 2PK	17-19	25700372
C10183	MILWAUKEE 8 LOWER ROCKER RUBBER, 2PK	17-19	25700425
C10189	MILWAUKEE 8, BREATHER ASSEM O-RING, VITON, 10PK	17-19	11900116
C10202	MILWAUKEE 8, VALVE STEM SEAL, 8PK	17-19	18100044

• M8 Coolant O-rings ALL MODELS

Part#	Description	Year Fitment	OEM#
C10201	MILWAUKEE 8, COOLANT O-RING, 10PK	17-19	11900090

• M8 Push Rod O-rings ALL MODELS

Part#	Description	Year Fitment	OEM#
C9294	MILWAUKEE 8, UPPER PUSH-ROD O-RING, 10PK, VITON	17-19	11293
C9459	MILWAUKEE 8, MIDDLE PUSH-ROD O-RING, 25PK, BUNA	17-19	11132A
C9293	MILWAUKEE 8, LOWER PUSH-ROD O-RING, 25PK, BUNA	17-19	11145A
C9586	MILWAUKEE 8, PUSH-ROD O-RING KIT, ALL M8 MODELS	17-19	11133-M8
C9586-M8	MILWAUKEE 8, PUSH-ROD O-RING KIT w/TAPPET GASKETS	17-19	11133-M8

• M8 Cam Gaskets ALL MODELS

Part#	Description	Year Fitment	OEM#
C10178	MILWAUKEE 8, CAM CHANGE KIT	17-19	25700731
C10178-FP	MILWAUKEE 8, CAM CHANGE KIT w/ROCKER COVER	17-19	25700731
C10173	MILWAUKEE 8, CAM COVER GASKET, .032"AFM, 5PK	17-19	25700370
C10172	MILWAUKEE 8, TAPPET COVER GASKET, .032"AFM, 10PK	17-19	25700362
C10120	MILWAUKEE 8, CAM PLATE TO OIL PUMP, O-RING 10PK	17-19	11900103
C9294	MILWAUKEE 8, OIL PUMP TO ENGINE, O-RING, 10PK	17-19	11293

• M8 Induction Gaskets ALL MODELS

Part#	Description	Year Fitment	OEM#
C10190	MILWAUKEE 8, MAP SENSOR O-RING, VITON, 10 PK	17-19	32700065
C10176	MILWAUKEE 8, AIRBOX TO T/B CVO MODELS, .031"F, 1PK	17-19	29000149
C10200	MILWAUKEE 8, FUEL INJECTOR O-RING KIT	17-19	91800058-X
C10203	MILWAUKEE 8, SEAL INTAKE MANIFOLD TO HEAD, 4PK	17-19	27300087
C10204	MILWAUKEE 8, SEAL MANIFOLD TO THROTTLE BODY, 4PK	17-19	27300082
C10205	MILWAUKEE 8, REPLACES BLACK INJECTOR O-RING, 10PK	17-19	91800058-B
C10206	MILWAUKEE 8, REPLACES ORANG INJECTOR O-RING, 10PK	17-19	91800058-O
C10207	MILWAUKEE 8, AIR CLEANER TO THOTTLE BODY SEAL, 4PK	17-19	29000108
C10247	MILWAUKEE 8, INTAKE MANIFOLD SERVICE KIT	17-19	27200038
	NON-CVO MODELS		
C10247-CVO	MILWAUKEE 8, INTAKE MANIFOLD SERVICE KIT	17-19	27200038-CVO
	CVO MODELS		

• M8 Exhaust Gaskets ALL MODELS

Part#	Description	Year Fitment	OEM#
C9247	EVO, TWIN CAM & M8 EX. RACE STYLE .240" THICK, 10PK	17-19	65324-83X
C9247-2	EVO, TWIN CAM & M8 EX. RACE STYLE .240" THICK, 2PK	17-19	65324-83X
C9540	EVO, T/C, M8. HI PERF.EX GASKET SPIRAL WOUND 10-PK	17-19	65324-83X
C9540-2	EVO, T/C, M8. HI PERF.EX GASKET SPIRAL WOUND 2-PK	17-19	65324-83X
C9719	EVO, T/C, M8 RACE STYLE EX. .110" THICK GASKET; 10PK	17-19	65324-83
C9719-2	EVO, T/C, M8 RACE STYLE EX. .110" THICK GASKET; 2PK	17-19	65324-83
C9288	EVO, T/C, M8, OE REPLACEMENT GASKET 10PK	17-19	65324-83A
C9288-2	EVO, T/C, M8, OE REPLACEMENT GASKET 2PK	17-19	65324-83A
C10232	HD MILWAUKEE 8 FXST MUFFLER GASKET STEEL MESH, 2PK	18-19	65900017



Gaskets for Harley-Davidson®



Cometic Gasket - An Exclusive NASCAR Performance® Product

Milwaukee 8®

• M8 Head Gaskets Oil & Coolant Cooled

Part#	Description	Year Fitment	OEM#
C10164	MILWAUKEE 8 H/G PR 3.937" .040"MLS,STOCK BORE 107CI	17-19	16500326
C10164-030	MILWAUKEE 8 H/G PR 3.937" .030"MLS,STOCK BORE 107CI	17-19	16500326
C10164-HB-030	MILWAUKEE 8 H/G PR 3.937" .030"MLS H/G, .014" BASE	17-19	16500326
C10165	MILWAUKEE 8 H/G PR 4.00" .040"MLS,STOCK BORE 114CI	17-19	16500305
C10165-030	MILWAUKEE 8 H/G PR 4.00" .030"MLS,STOCK BORE 114CI	17-19	16500305
C10166	MILWAUKEE 8 H/G PR 4.075" .040"MLS,GASKET BORE 4.095"	17-19	
C10166-030	MILWAUKEE 8 H/G PR 4.075" .030"MLS,GASKET BORE 4.095"	17-19	
C10166-HB-030	MILWAUKEE 8 H/G PR 4.075" .030"MLS H/G, .014" BASE	17-19	16500326
C10167	MILWAUKEE 8 H/G PR 4.125" .040"MLS,GASKET BORE 4.145"	17-19	
C10167-030	MILWAUKEE 8 H/G PR 4.125" .030"MLS,GASKET BORE 4.145"	17-19	
C10167-036	MILWAUKEE 8 H/G PR 4.125" .036"MLS,GASKET BORE 4.145"	17-19	
C10167-045	MILWAUKEE 8 H/G PR 4.125" .045"MLS,GASKET BORE 4.145"	17-19	
C10167-HB-030	MILWAUKEE 8 H/G PR 4.125" .030"MLS H/G, .014" BASE	17-19	16500326
C10167-HB-040	MILWAUKEE 8 H/G PR 4.125" .040"MLS H/G, .014" BASE	17-19	16500326
C10168	MILWAUKEE 8 H/G PR 4.185" .040"MLS,GASKET BORE 4.205"	17-19	
C10168-030	MILWAUKEE 8 H/G PR 4.185" .030"MLS,GASKET BORE 4.205"	17-19	
C10168-036	MILWAUKEE 8 H/G PR 4.185" .036"MLS,GASKET BORE 4.205"	17-19	
C10169	MILWAUKEE 8 H/G PR 4.200" .040"MLS,GASKET BORE 4.220"	17-19	
C10169-030	MILWAUKEE 8 H/G PR 4.200" .030"MLS,GASKET BORE 4.220"	17-19	
C10181	MILWAUKEE 8 H/G PR 4.250" .040"MLS,PAIR	17-19	
C10181-030	MILWAUKEE 8 H/G PR 4.250" .030"MLS,PAIR	17-19	
C10181-HB	MILWAUKEE 8 H/G PR 4.250" .040"MLS, .014"RC H&B KIT	17-19	
C10181-HB-030-014	MILWAUKEE 8 H/G PR 4.250" .030"MLS, .014"RC H&B KIT	17-19	
C10181-HB-030-020	MILWAUKEE 8 H/G PR 4.250" .030"MLS, .020"RC H&B KIT	17-19	

• M8 Head Gaskets Oil & Coolant Cooled Heads

Note: ALL bores over 4.250" on Oil Cooled Heads must have the Oil Holes Welded

Part#	Description	Year Fitment	Price
C10182	MILWAUKEE 8 H/G PR 4.320" .040"MLS,PAIR, OIL COOLED ONLY	17-19	
C10182-030	MILWAUKEE 8 H/G PR 4.320" .030"MLS,PAIR, OIL COOLED ONLY	17-19	
C10192	MILWAUKEE 8 H/G PR 4.320" .040"MLS,PAIR, COOLANT COOLED ONLY	17-19	
C10192-HB	MILWAUKEE 8 H&B KIT 4.320" .040"HG, .014"BG, COOLANT COOLED ONLY	17-19	
C10193	MILWAUKEE 8 H/G PR 4.500" .040"MLS,PAIR, COOLANT COOLED ONLY	17-19	
C10193-HB	MILWAUKEE 8 H&B KIT 4.500" .040"HG, .014"BG, COOLANT COOLED ONLY	17-19	
C10193-HB-027-014	MILWAUKEE 8 H&B KIT 4.500" .027"HG, .014"BG, COOLANT COOLED ONLY	17-19	

• M8 Base Gaskets ALL MODELS

Part#	Description	Year Fitment	OEM#
C10177	MILWAUKEE 8 BASE GASKET .014" RC, "STOCK THICKNESS" PR	17-19	16500332
C10177-010	MILWAUKEE 8 BASE GASKET .010" RC, PR	17-19	16500332
C10177-020	MILWAUKEE 8 BASE GASKET .020" RC, PR	17-19	16500332
C10177-030	MILWAUKEE 8 BASE GASKET .030" RC, PR	17-19	16500332
C10242	MILWAUKEE 8 BASE GASKET .014" RC,GEN2 EMBOSSING, PR	17-19	16500332
C10242-010	MILWAUKEE 8 BASE GASKET .010" RC,GEN2 EMBOSSING, PR	17-19	16500332
C10242-020	MILWAUKEE 8 BASE GASKET .020" RC,GEN2 EMBOSSING, PR	17-19	16500332
C10242-030	MILWAUKEE 8 BASE GASKET .030" RC,GEN2 EMBOSSING, PR	17-19	16500332
C10194	MILWAUKEE 8 BASE GASKET .014" RC, 4.320" BIG BORE	17-19	16500332
C10195	MILWAUKEE 8 BASE GASKET .014" RC, 4.500" BIG BORE	17-19	16500332

• M8 Engine Case Gaskets & Seals

Part#	Description	Year Fitment	OEM#
C10174	MILWAUKEE 8,PISTON JET COOLER GASKET,.032"AFM, 2PK	17-19	25700433
C10208	MILWAUKEE 8, OIL PRESSURE CHECK VALVE O-RING, 10K	17-19	11900010
C10209	MILWAUKEE 8, SEAL ENGINE CRANK, 4PK	17-19	11000134

All Component Parts can be purchased individually.



Gaskets for Harley-Davidson®



Cometic Gasket - An Exclusive NASCAR Performance® Product

Milwaukee 8®

• M8 Primary Gaskets

Part#	Description	Year Fitment	OEM#
C10196	2017 MILWAUKEE 8 ALL FL PRIMARY & SEAL KIT COMPLETE	17-19	25700746
C10198F1	MILWAUKEE 8 PRIMARY GASKET ALL FL .060"AFM 1PK	17-19	25700378
C10198F5	MILWAUKEE 8 PRIMARY GASKET ALL FL .060"AFM, 5 PK	17-19	25700378
C10248	MILWAUKEE 8, ALL SOFTAIL PRIMARY & SEAL KIT COMPLETE	18-19	25701007
C10241F1	MILWAUKEE 8 PRIMARY GASKET ALL FXST, .032"AFM 1PK	18-19	25700564
C10241F5	MILWAUKEE 8 PRIMARY GASKET ALL FXST, .032"AFM, 5PK	18-19	25700564
C10211	MILWAUKEE 8, PRIMARY TO ENGINE GASKET ALL M8, 1PK	17-19	25700455
C9220	MILWAUKEE 8, SPORT GLIDE, CLUTCH SEAL, 5PK, BUNA	18-19	25463-94A
C9220F1	MILWAUKEE 8, SPORT GLIDE, CLUTCH SEAL, 1PK, BUNA	18-19	25463-94A
C10140F1	DERBY CVR GASKET 5 HOLE ALL FL, 2017,M8, ALL M8 SOFTAIL,2018	17-19	25416-16
C10140F5	DEBRY CVR GASKET 5 HOLE ALL FL, 2017, M8, ALL M8 SOFTAIL,2018	17-19	25416-16
C9152F1	CLUTCH COVER SEAL "RUBBER" ALL FL, 2017, M8, M8 SOFTAIL,2018, 1PK	17-19	17369-06
C9152F5	CLUTCH COVER SEAL "RUBBER" ALL FL, 2017, M8, M8 SOFTAIL,2018, 5PK	17-19	17369-06
C9201	O-RING, STARTER TO CASE ALL M8, 5PK	17-19	27444-00Y

• M8 Top End Gasket Sets for Coolant & Oil Cooled Engines

Part#	Description	Year Fitment	OEM#
C10278	MILWAUKEE 8, T/E, W/OUT HEAD & BASE GASKETS	17-19	
C10217	MILWAUKEE 8, 3.937" 107CU, T/E KIT, .040"H/G	17-19	25700729
C10217-030	MILWAUKEE 8, 3.937" 107CU, T/E KIT, .030"H/G	17-19	25700729
C10218	MILWAUKEE 8, 4.00" 114CU, CVO, T/E KIT, .040"H/G	17-19	25700729
C10218-030	MILWAUKEE 8, 4.00" 114CU, CVO, T/E KIT, .030"H/G	17-19	25700729
C10219	MILWAUKEE 8, 4.075" 114CU, T/E KIT, .040"H/G	17-19	25700729
C10219-030	MILWAUKEE 8, 4.075" 114CU, T/E KIT, .030"H/G	17-19	25700729
C10220	MILWAUKEE 8, 4.125" 117CU, T/E KIT, .040"H/G	17-19	25700729
C10220-030	MILWAUKEE 8, 4.125" 117CU, T/E KIT, .030"H/G	17-19	25700729
C10221	MILWAUKEE 8, 4.185" 120CU, T/E KIT, .040"H/G	17-19	25700729
C10221-030	MILWAUKEE 8, 4.185" 120CU, T/E KIT, .030"H/G	17-19	25700729
C10222	MILWAUKEE 8, 4.200" 121CU, T/E KIT, .040"H/G	17-19	25700729
C10222-030	MILWAUKEE 8, 4.200" 121CU, T/E KIT, .030"H/G	17-19	25700729
C10223	MILWAUKEE 8, 4.250" 124CU, T/E KIT, .040"H/G	17-19	25700729
C10223-030	MILWAUKEE 8, 4.250" 124CU, T/E KIT, .030"H/G	17-19	25700729

• M8 Top End Gasket Sets for Coolant & Oil Cooled Heads

Note: ALL bores over 4.250" on Oil Cooled Heads must have the Oil Holes Welded

Part#	Description	Year Fitment	OEM#
C10224	MILWAUKEE 8, 4.320" 128CU, T/E KIT, .040"H/G	17-19	25700729
C10225	MILWAUKEE 8, 4.500" 139CU, T/E KIT, .040"H/G	17-19	25700729

• M8 Engine only Gasket Sets for Oil & Coolant Cooled Engines

Part#	Description	Year Fitment
C10279	MILWAUKEE 8 ENGINE ONLY, W/OUT HEAD & BASE GASKETS	17-19
C10250	MILWAUKEE 8, ALL MODELS 3.937", 107CU ENGINE GASKET KIT, .040"H/G	17-19
C10250-030	MILWAUKEE 8, ALL MODELS 3.937", 107CU ENGINE GASKET KIT, .030"H/G	17-19
C10251	MILWAUKEE 8, ALL MODELS 4.00", 114CU ENGINE GASKET KIT, .040"H/G	17-19
C1051-030	MILWAUKEE 8, ALL MODELS 4.00", 114CU ENGINE GASKET KIT, .030"H/G	17-19
C10252	MILWAUKEE 8, ALL MODELS 4.075", 117CU ENGINE GASKET KIT, .040"H/G	17-19
C10252-030	MILWAUKEE 8, ALL MODELS 4.075", 117CU ENGINE GASKET KIT, .030"H/G	17-19
C10253	MILWAUKEE 8, ALL MODELS 4.125", 117CU ENGINE GASKET KIT, .040"H/G	17-19
C10253-030	MILWAUKEE 8, ALL MODELS 4.125", 117CU ENGINE GASKET KIT, .030"H/G	17-19
C10254	MILWAUKEE 8, ALL MODELS 4.185", 120CU ENGINE GASKET KIT, .040"H/G	17-19
C10254-030	MILWAUKEE 8, ALL MODELS 4.185", 120CU ENGINE GASKET KIT, .030"H/G	17-19
C10255	MILWAUKEE 8, ALL MODELS 4.200", 124CU ENGINE GASKET KIT, .040"H/G	17-19
10255-030	MILWAUKEE 8, ALL MODELS 4.200", 124CU ENGINE GASKET KIT, .030"H/G	17-19
C10256	MILWAUKEE 8, 4.250" 124CU, ENGINE GASKET KIT, .040"H/G	17-19
C10256-030	MILWAUKEE 8, 4.250" 124CU, ENGINE GASKET KIT, .030"H/G	17-19

All Component Parts can be purchased individually.



Gaskets for Harley-Davidson®



Cometic Gasket - An Exclusive NASCAR Performance® Product

Milwaukee 8®

• M8 Engine only Gasket Sets for Coolant & Oil Cooled engines

Note: ALL bores over 4.250" on Oil Cooled Heads must have the Oil Holes Welded

Part#	Description	Year Fitment
C10257	MILWAUKEE 8, 4.320" 128CU, ENGINE GASKET KIT, .040"H/G	17-19
C10257-030	MILWAUKEE 8, 4.320" 128CU, ENGINE GASKET KIT, .030"H/G	17-19
C10258	MILWAUKEE 8, 4.500" 139CU, ENGINE GASKET KIT, .040"H/G	17-19
C10258-030	MILWAUKEE 8, 4.500" 139CU, ENGINE GASKET KIT, .030"H/G	17-19

• M8 Complete Engine & Primary Gasket Sets All Milwaukee 8 Touring Model, Coolant & Oil Cooled

Part#	Description	Year Fitment
C10280	MILWAUKEE 8, ALL FL W/PRIMARY, NO HEAD & BASE	17-19
C10260	MILWAUKEE 8, ALL FL MODELS 3.937", 107CU, .040"H/G	17-19
C10260-030	MILWAUKEE 8, ALL FL MODELS 3.937", 107CU, .030"H/G	17-19
C10261	MILWAUKEE 8, ALL FL MODELS 4.00", 114CU, .040"H/G	17-19
C10261-030	MILWAUKEE 8, ALL FL MODELS 4.00", 114CU, .030"H/G	17-19
C10262	MILWAUKEE 8, ALL FL MODELS 4.075", 117CU, .040"H/G	17-19
C10262-030	MILWAUKEE 8, ALL FL MODELS 4.075", 117CU, .030"H/G	17-19
C10263	MILWAUKEE 8, ALL FL MODELS 4.125", 117CU, .040"H/G	17-19
C10263-030	MILWAUKEE 8, ALL FL MODELS 4.125", 117CU, .030"H/G	17-19
C10264	MILWAUKEE 8, ALL FL MODELS 4.185", 120CU, .040"H/G	17-19
C10264-030	MILWAUKEE 8, ALL FL MODELS 4.185", 120CU, .030"H/G	17-19
C10265	MILWAUKEE 8, ALL FL MODELS 4.200", 124CU, .040"H/G	17-19
C10265-030	MILWAUKEE 8, ALL FL MODELS 4.200", 124CU, .030"H/G	17-19
C10266	MILWAUKEE 8, ALL FL MODELS 4.250" 124CU, .040"H/G	17-19
C10266-030	MILWAUKEE 8, ALL FL MODELS 4.250" 124CU, .030"H/G	17-19

• M8 Complete Engine & Primary Gasket Sets All M8 Touring Model, Coolant & Oil Cooled

Note: ALL bores over 4.250" on Oil Cooled Heads must have the Oil Holes Welded

Part#	Description	Year Fitment
C10267	MILWAUKEE 8, ALL FL MODELS 4.320" 128CU, .040"H/G	17-19
C10267-030	MILWAUKEE 8, ALL FL MODELS 4.320" 128CU, .030"H/G	17-19
C10268	MILWAUKEE 8, ALL FL MODELS 4.500" 139CU, .040"H/G	17-19
C10268-030	MILWAUKEE 8, ALL FL MODELS 4.500" 139CU, .030"H/G	17-19

• M8 Complete Engine & Primary Gasket Sets All M8 Softail Models

Part#	Description	Year Fitment
C10281	MILWAUKEE 8, ALL FXST W/PRIMARY, NO HEAD & BASE	18-19
C10269	MILWAUKEE 8, ALL SOFTAIL MODELS 3.937", 107CU, .040"H/G	18-19
C10269-030	MILWAUKEE 8, ALL SOFTAIL MODELS 3.937", 107CU, .030"H/G	18-19
C10270	MILWAUKEE 8, ALL SOFTAIL MODELS 4.00", 114CU, .040"H/G	18-19
C10270-030	MILWAUKEE 8, ALL SOFTAIL MODELS 4.00", 114CU, .030"H/G	18-19
C10271	MILWAUKEE 8, ALL SOFTAIL MODELS 4.075", 117CU, .040"H/G	18-19
C10271-030	MILWAUKEE 8, ALL SOFTAIL MODELS 4.075", 117CU, .030"H/G	18-19
C10272	MILWAUKEE 8, ALL SOFTAIL MODELS 4.125", 117CU, .040"H/G	18-19
C10272-030	MILWAUKEE 8, ALL SOFTAIL MODELS 4.125", 117CU, .030"H/G	18-19
C10273	MILWAUKEE 8, ALL SOFTAIL MODELS 4.185", 120CU, .040"H/G	18-19
C10273-030	MILWAUKEE 8, ALL SOFTAIL MODELS 4.185", 120CU, .030"H/G	18-19
C10274	MILWAUKEE 8, ALL SOFTAIL MODELS 4.200", 124CU, .040"H/G	18-19
C10274-030	MILWAUKEE 8, ALL SOFTAIL MODELS 4.200", 124CU, .030"H/G	18-19
C10275	MILWAUKEE 8, ALL SOFTAIL MODELS 4.250" 124CU, .040"H/G	18-19
C10275-030	MILWAUKEE 8, ALL SOFTAIL MODELS 4.250" 124CU, .030"H/G	18-19

• M8 Complete Engine & Primary Gasket Sets All M8 Softail Models

Note: ALL bores over 4.250" on Oil Cooled Heads must have the Oil Holes Welded

Part#	Description	Year Fitment
C10276	MILWAUKEE 8, ALL SOFTAIL MODELS 4.320" 128CU, .040"H/G	18-19
C10276-030	MILWAUKEE 8, ALL SOFTAIL MODELS 4.320" 128CU, .030"H/G	18-19
C10277	MILWAUKEE 8, ALL SOFTAIL MODELS 4.500" 139CU, .040"H/G	18-19
C10277-030	MILWAUKEE 8, ALL SOFTAIL MODELS 4.500" 139CU, .030"H/G	18-19



Milwaukee 8®

• M8 Transmission Gasket Sets

Part#	Description	Year Fitment	OEM#
C10197	MILWAUKEE 8 TRANS. W/ OIL PAN GSKT REBUILD, ALL FL.....	17-19	
C10249	MILWAUKEE 8 TRANS. W OIL PAN GSKT REBUILD, ALL SOFTAIL.....	18-19	
C10212	MILWAUKEE 8, OIL RETURN O-RING,TRANS PLUG, 10PK, OIL COOLED.	17-19.....	11900092
C10213	MILWAUKEE 8, TRANS SHIFT SHAFT SEAL,ALL M8 MODELS, 5PK.....	17-19.....	11000101
C10214	MILWAUKEE 8, ENGINE TO TRAN GASKET,ALL M8 MODELS, 1PK	17-19.....	24400215
C10215	MILWAUKEE 8, OIL PAN GASKET ALL FL MODELS,.032"AFM, 1PK	17-19.....	25700452
C10216	MILWAUKEE 8, TRANS TOP LID ALL FL, .060"AFM GASKET, 1PK	17-19.....	25700453
C9187	BEARING CVR GSKT,.032"AFM ALL M8 MODELS, 10PK	17-19.....	35654-06
C9187F5	BEARING CVR GSKT,.032"AFM ALL M8 MODELS, 5PK	17-19.....	35654-06
C9188	CLUTCH RELEASE CVR.GSKT,.032"AFM ALL M8 MODELS, 10PK	17-19.....	36805-06
C9188F5	CLUTCH RELEASE CVR.GSKT,.032"AFM ALL M8 MODELS, 5PK	17-19.....	36805-06
C9200	TRANS OUTPUT SEAL, ALL M8 MODELS 10PK	17-19.....	12077
C9200F1	TRANS OUTPUT SEAL, ALL M8 MODELS 1PK	17-19.....	12077
C9215	TRANS M/S SEAL, ALL M8 MODELS 1PK.....	17-19.....	12074
C9434	5TH GEAR M/S, ALL M8 MODELS 10PK	17-19.....	11187/11201
C9435	ENGINE,TRANS DRAIN PLUG, ALL M8 MODELS, 10PK	17-19.....	11105/11102/11273
C9459	TRANS OIL FILL O-RING, ALL M8 MODELS, 25PK.....	17-19.....	11132
C9668	SPEED SENSOR O-RING ALL M8 MODELS, 25PK.....	17-19.....	11241/11140/11289
C9961	OIL DIP STICK O-RING, ALL M8 MODELS, 5 PCK.....	17-19.....	11120
C10243	MILWAUKEE 8, OIL PAN GASKET .032", ALL FXST MODELS, 1PK.....	18-19.....	25700593
C10244	MILWAUKEE 8, DIP STICK O-RING ALL FXST MODELS, 10PK.....	18-19.....	62700212
C10245	MILWAUKEE 8, OIL FILL SPOUT SEAL ALL FXST MODELS, 1PK.....	18-19.....	62800053
C10246	MILWAUKEE 8, TRANS TOP COVER GASKET, ALL FXST 1PK.....	18-19.....	34800044

Cometic Installation Procedure for Harley Davidson Milwaukee 8 MLS Head Gaskets

- Check all gasket surfaces for flatness and imperfections, an excessively rough finish may cause gasket failure.
- A surface finish on both the head and cylinder of 50RA or finer is recommended.
- Check all hardware for defects.
 - Bores 3.937" to 4.250" use the triangular shaped embossments on both Oil and Coolant cooled heads.
 - All Oil Cooled heads on larger than 4.250" bores **MUST BE WELDED**. The oil port is exposed to the bore.
 - Coolant Cooled heads require the circular embossments on bores larger than 4.250".
- Clean all threads and lubricate both threads and the underside of the bolt flanges with a light machine oil. Wipe away any excess.
- All surfaces must be clean and dry.
- **No sealants are required when installing a Cometic MLS gasket.**

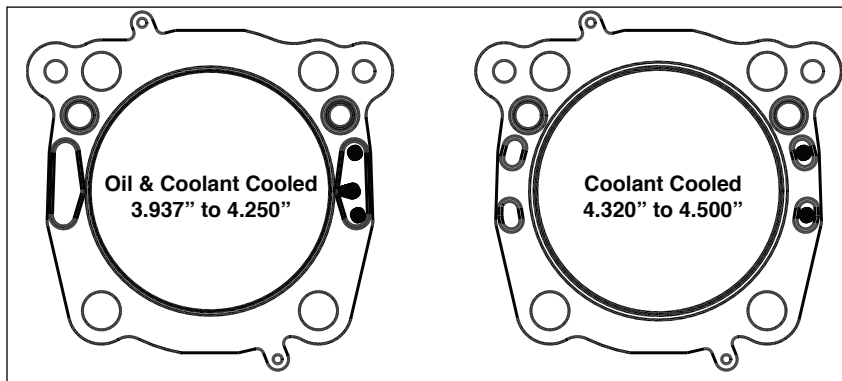

Cometic recommends following all OE Torque Procedures in the service manual.

1. Tighten the head bolts in the recommended X pattern to 20-30ft-lbs.
2. Loosen all head bolts one turn.
3. Tighten all head bolts using recommended X pattern to 9-11ft-lbs.
4. Tighten all head bolts using recommended X pattern to 25-27ft-lbs.
5. Final torque is a 90 degree turn using the recommended X pattern.





Gaskets for Harley-Davidson®



Cometic Gasket - An Exclusive NASCAR Performance® Product

Twin Cam®

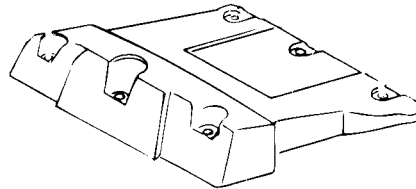

Cometic Part #-C9577
Rocker Cover
All 1999-17
Replaces: 17286-99

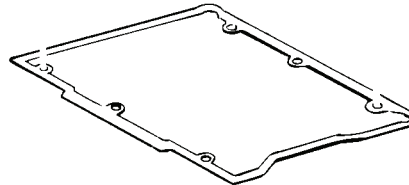

Cometic Part #-C9579
Breather Cover
All 1999-10
Replaces: 17591-99

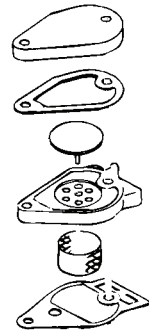

Cometic Part #-C9633
Rocker Umbrella Valve
All 1999-17
Replaces: 26858-99

Cometic Part #-C9294
Pushrod Cover
O-Ring Upper
Replaces: 11293

Cometic Part #-C9629
Rocker Arm Support
O-Ring
All 1999-17
Replaces: 11270

Cometic Part #-C9679
Breather Baffle Element
All 1999-17
Replaces: 63815-99

Cometic Part #-C9580
Breather Baffle Housing
All 1999-10
Replaces: 17592-99

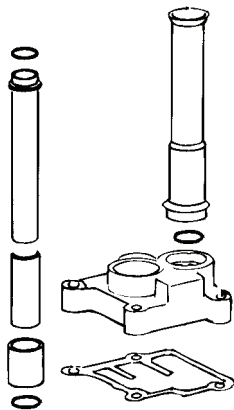

Cometic Part #-C9293
Pushrod Cover
O-Ring Lower
Replaces: 11145

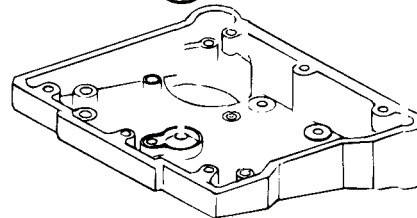

Cometic Part #-C9576
Rocker Housing
All 1999-17
Replaces: 16719-99

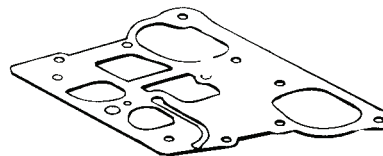

Cometic Part #-C9836
Valve Stem Seal Viton
All 1999-03
Replaces: 18001-83B

Cometic Part #-C9459
Pushrod Cover
O-Ring Middle
Replaces: 11132

Cometic Part #-C9578
Lifter Cover 1999-17
Replaces: 18635-99

Cometic Part #-C9153
Valve Stem Seal Hat Style
Viton
2003-17
Replaces: 18094-02

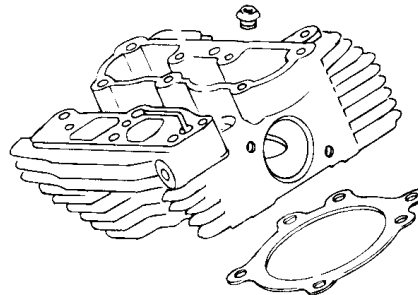

Cometic Part #-C9790 Std. Bore Head - MLS .030" - All 1999-17
Cometic Part #-C9745 Std. Bore Head - MLS .040" - All 1999-17
Cometic Part #-C9721 1550 Big Bore Head - MLS .030" - All 1999-17
Cometic Part #-C9722 1550 Big Bore Head - MLS .040" - All 1999-17



Gaskets for Harley-Davidson®



Cometic Gasket - An Exclusive NASCAR Performance® Product

Complete • Top End • Rocker Box Kits & Individual Replacement Parts

Part # Description

EST TWIN CAM HI-PERFORMANCE KITS

• Complete Gasket Kit (Kits do not contain spacer for 07 models, order seperately)

- C917107-17 All Softail, Std. Bore 3.750" .040" Head Gasket
C918407-17 All Softail, 103" Big Bore 3.875", Std bore 2012-Up all Softail
C1010007-17 All Softail models 4.125" bore w/.040" H/G
C10100-03007-17 All Softail models 4.125" bore w/.030" H/G
C917207-16 All FL Models, Std. Bore 3.750" .040" Head Gasket
C918507-16 All FL Models, 103" Big Bore 3.875", Std bore 2012-Up all FL Models
C1004407-16 All FL Models, Big Bore 3.937" .040" Head Gasket
C10044-03007-16 All FL Models, Big Bore 3.937" .030" Head Gasket
C1001207-16 All FL Models, 113" Big Bore 4.060" .040" Head Gasket & .020" Base
C1006707-16 All FL Models, 117" Big bore 4.125" .030"h/g & .020" base
C914806-17 Dyna Models, Std. Bore 3.750" .040" Head Gasket
C918606-17 Dyna Models, 103" Big Bore 3.875", Std bore 2012-Up Dyna Models
C914906-17 Dyna Models, 95" & 103" BB w/.030" Head Gasket,Std bore '12-Up Dyna Models
C9777F99-06 Softails, 99-05 Dyna Std. Bore 3.750" .040" thick head gasket
C9778F99-06 FLT's, Road King, Std. Bore 3.750" .040" thick head gasket
C992099-06 All Twin Cam Models, 99-05 Dyna 3.875" Big Bore Kits w/.040" Head Gasket
C916199-06 All Twin Cam Models, 99-05 Dyna 3.875" Big Bore Kits w/.030" Head Gasket
C1010299-06 ALL FL Models 3.937" Big Bore kit w/ .040" Head Gasket
C10102-03099-06 ALL FL Models 3.937" Big Bore kit w/ .030" Head Gasket
C9807F99-06 FXST, 99-05 Dyna 4" Big Bore Kits .030" Head Gasket
C1000599-06 ALL FL MODELS 4" Big Bore kit w/ .030" Head Gasket
C922199-05 4 1/8" Dyna & 99-06 Softails .040" Head Gasket & .010" Base
C9221-03099-05 4 1/8" Dyna & 99-06 Softails .030" Head Gasket & .010" Base
C922299-06 4 1/8" FLT/FXR .040" Head Gasket & .010" Base
C9222-03099-06 4 1/8" FLT/FXR .030" Head Gasket & .010" Base

• Top End Gasket Kit

- C10041 S&S 4.125" Bore SSW Top End kit .030" Head Gasket
C10041-030 S&S 4.125" Bore SSW Top End kit .027" Head Gasket
C914603-17 All Twin Cam Std Bore 3.750" W / Hat Style Valve Stem Seal
C914703-17 All Twin Cam 95" & 103" Big Bore Kit 3.875" w/Hat Style Valve Stem Seal
C984403-17 All Twin Cam 95" & 103" Big Bore Kit 3.875" w/ .030" Head Gasket
C977999-02 All Twin Cam Std Bore W / .040" Head Gasket
C984599-02 All Twin Cam Std Bore W / .030" Head Gasket
C9951-05199-17 All Twin Cam 3.875" Big Bore Kit W / .051" Head Gasket
C995199-17 All Twin Cam 3.875" Big Bore Kit W / .045" Head Gasket
C978099-17 All Twin Cam 3.875" Big Bore Kit W / .040" Head Gasket
C918299-17 All Twin Cam 3.937" Bore TOP END EST KIT, .040" MLS H/G
C1003499-17 All Twin Cam 3.937" Bore TOP END EST KIT, .030" MLS H/G
C10082120R Top End Kit 4.060" Bore W/ .040" Head & .020" Base
C10082-030 120R Top End Kit 4.060" Bore W/ .030" Head & .020" Base
C911499-17 All Twin Cam 4.060" TOP END EST KIT, .040"MLS H/G, .010" Steel Base
C9114-03099-17 All Twin Cam 4.060" TOP END EST KIT, .030"MLS H/G, .010" Steel Base
C994999-17, 4.00" Bore Twin Cam .040" Head Gasket & .010" Base
C997699-17, 4 1/8" Bore Twin Cam .040" Head Gasket & .020" Base
C9976-03099-17, 4 1/8" Bore Twin Cam .030" Head Gasket & .020" Base
C923899-17, 4 1/4" Bore Twin Cam .040" Head Gasket & .010" Base
C978999-17 All Twin Cam FATSO Top End

• Motor Only Gasket Kit Air Cooled Only

- C10015 All Twin Cam 3.750" Bore .040" Head Gasket
C9892 All Twin Cam 99-17 with 1550 Big Bore, Motor Only Kit, .040" MLS Head Gaskets
C10071 All Twin Cam 99-17, 3.937" Motor only gasket kit w/.040" MLS H/G & .020" Base
C10071-030 All Twin Cam 99-17, 3.937" Motor only gasket kit w/.030" MLS H/G & .020" Base
C9139 All 4.00" Bore Twin Cam 99-17, Motor Only Kit, .030" MLS Head Gaskets
C9140 All 4.00" Bore Twin Cam 99-17, Motor Only Kit, .040" MLS Head Gaskets
C10079 120R Motor Only Gasket Kit, .040" Head Gasket & .020" Base



Gaskets for Harley-Davidson®



Cometic Gasket - An Exclusive NASCAR Performance® Product

Complete • Top End • Rocker Box Kits & Individual Replacement Parts

Part # Description

• Rocker Box Gasket Kit for 88", 95" & 103" Twin Cam

- C9588 99-17 88", 95" & 103" Twin Cam Rocker Box Gasket Kit, inc. gaskets for '11 Breathers
- C9167 99-17 Screamin Eagle Heads Rocker Box Rebuild w/seals for .530" O.D. guides
- C9840 1999-17 Twin Cam FATSO Rocker Box Rebuild Kit
- C9155 S&S Rocker Box Rebuild Kit (Die Cast Box)

• Twin Cam Engine & Trans Cover Gasket Kit Perfect for covers being chromed or powder coated

- C10099 Twin Cam 96 All FL Models, Engine and Trans Cover Gaskets Only

Cometic Part #	OEM Part #	Description	Pkg. Qty.
----------------	------------	-------------	-----------

TWIN CAM INDIVIDUAL REPLACEMENT GASKETS,SEALS, O-RINGS 1999-17

• Cam Service Kits for Twin Cam

- C9664 17045-99 Cam Service Kit All T/C Models 1999 -17KIT

Twin Cooled Coolant Service Parts

- C10139 26064-08X 14-16 Twin Cooled O-Ring KitKIT

• Rocker Box Assembly Gaskets

- C9577 17286-99 Rocker Cover Gasket All Models 1999 -17 .020" Rubber Coated Steel 10
- C9579 17591-99 Breather Cover Gasket All Models 1999 -10 10
- C9633 26858-99 Rocker Cover Umbrella Vlv All Models 1999 -17 10
- C9679 63815-99 Breather Filter Element All Models 1999 -17 10
- C9580 17592-99 Breather Baffle Gasket All Models 1999 -10 10
- C10039 26500002 Breather element gasket All Twin Cam 2011-17 10
- C9576 16719-99 Rocker Housing Gasket All Models 1999 -17 .020" Rubber Coated Steel .. 10
- C9629 11270 Rocker Arm Support O-ring All Models 1999 -17 10

• Pushrod, Tappet Gaskets and Valve Stem Seals

- C9586 Pushrod Seal Kit, All Twin Cam Models, 1999-17KIT
- C9294 11293 Pushrod Cvr O-ring UPPER all Models 1999 -17 10
- C9459 11132 Pushrod Cvr O-ring MIDDLE all Models 1999 -17 25
- C9293 11145 Pushrod Cvr O-ring LOWER all Models 1999 -17 25
- C9578F 18635-99 Lifter Cvr Gasket All Models 1999 -17 10
- C9166 Viton Valve Seals for Screamin Eagle Heads or .530" O.D. guides 10
- C9836 Valve Stem Oil Seal All Models 1999 -02(Viton) 25
- C9153 18094-02 Valve Stem Oil Seal Hat Style All Models 03-17 (Viton) 25

• Head and Base Gaskets

- C9790 16775-99 Head Gasket 3.750" .030" Spring Steel All Models Std Bore '99 -17 2
- C9745 Head Gasket 3.750" .040" Spring Steel All Models Std Bore'99 -17 2
- C9721 Head Gasket 3.875" .030" Spring Steel All Models 1999-17 2
- C9722 Head Gasket 3.875" .040" Spring Steel All Models 1999-17 2
- C9894 3.937" Head Gasket .030" MLS All Twin Cam Models 99-17 2
- C9894-040 3.937" Head Gasket .040" MLS All Twin Cam Models 99-17 2
- C9894-051 3.937" Head Gasket .051" MLS All Twin Cam Models 99-17 2
- C9725 4.00" Head Gasket Twin Cam All Models .030" Spring Steel '99-17 2
- C9726 4.00" Head Gasket Twin Cam All Models .040" Spring Steel '99-17 2
- C9070-030 4.060" Bore .030" MLS Head Gasket Twin Cam, 99-17 2
- C9070-040 4.060" Bore .040" MLS Head Gasket Twin Cam, 99-17 2
- C9910 4.125" Bore .030" MLS All Twin Cam Models 1999 - 17 2
- C9743 4.125" Bore .040" MLS All Twin Cam Models 1999 - 17 2
- C9076-030 4.250" Bore .030" MLS Head Gasket Twin Cam, 99-17 2
- C9076-040 4.250" Bore .040" MLS Head Gasket Twin Cam, 99-17 2
- C9628 11256 Cylinder Base O-ring All Models 1999 -17 10
- C9438 11273 Cylinder Locating Dowel O-ring All Models 1999 -17 10



Complete • Top End • Rocker Box Kits & Individual Replacement Parts

Cometic Part #	OEM Part #	Description	Pkg. Qty.
• Motor Case O-rings and Seals			
C9287	26432-76A	Engine Case Locating Dowel O-ring 1999 -17	10
C9667	11289	Crankshaft Position Sensor O-ring 1999 -17	25
C9632	12068	Motor Sprocket Shaft Oil Seal 1999 -17	5
C9201	27444-00Y	O-ring Starter to primary case 07-16 All Twin Cam, 06-17 Dyna	5
• Intake and Exhaust Gaskets			
C9247		Exhaust Gasket All Models 99 -17 "Race Style" .240" thick	10
C9540		Exhaust Gasket All Models 99 -17 "Extreme Performance"	10
C9719		Exhaust Gasket All Models 99 - 17 "Race Style"	10
C9288	65324-83A	Exhaust Gasket All Models 99 -17 "Tapered"	10
C9290	26995-86B	Intake Manifold to Head 1999 -17 for Carb & EFI Models	10
C9223		S&S Big Bore Manifold to Head Seal	4
C9131		All Twin Cam Carb Models, Int. Manifold Seal Kit, 1999-02	Kit
C9088	27002-89	Carb.to Intake Manifold Seal All Models 1999-02	1
C9227		50mm Carb. to Manifold Seal 1999-17	1
• Oil and Oil Pump Gaskets			
C10032	17045-99A	99-06 Oil Pump Re-build kit All Twin Cams	1
C10033	17045-99C	07-17 Oil Pump Re-build kit All Twin Cams	1
C9437	11286	Outer Oil Pump O-ring All Models 1999-06, Dyna 05	10
C9449	11301	Cam plate to engine case O-ring All Models 1999-17	10
C9294	11293	Oil Pump to engine case O-ring All Models 1999-17	10
C9294	11293	Oil Filter Mnt Brkt O-ring All Models 1999-17	10
C9667	11140	Piston Cooling Jet O-ring All Models 1999-17	10
C9646F	26072-99	Oil Pan Gasket DYNA 1999-17	10
C9647F	26077-99	Oil Pan Gasket (1) FLT 1999-17	10
• Primary Housing Gaskets			
C9179F1	34901-07	07-16 FL Models Primary Gasket	1
C9145F1	60547-06	06-17 Dyna, 07-17 Softail	1
C9307F5	34901-94	Primary Gasket FLT, FXR 1994-06, AFM .060	5
C9309F5	60539-89	Primary Gasket Softail 1989-06, Dyna 1989-05, AFM .060	5
C9662	25416-99	Derby Cover O-ring All Big Twin Models 99-06, Dyna 99-05	5
C9997F1	25416-99C	99-14 Derby Cover Gasket Replaces O-ring, 5 hole	1
C9183F1		84-98 All Derby Cover Gasket Replaces O-ring, 3 hole	1
C9152F1	17369-06	06-17 Dyna, 07-17 All Twin Cam Models, O-ring Derby Cover	1
C9305F5	34906-85A	Inspection Cover Gasket FLT, FXR Models 1999 -06, AFM .060	5
C9331F5	60567-90A	Ins. Cover Dyna Models '99-05, Softail 00-06 Models, .060" AFM	5
C9441	11147	Inner Primary to Case O-ring All Models 99-06, Dyna 99-05	10
C9199F1	34934-06	06 Dyna, 07-17 All T/C Inner Primary spacer/seal	1
C9260	12052	Wet Clutch Oil Seal All Models 1999-17	5
C9261	12066	Starter Motor Shaft Oil Seal All Models 99-06, Dyna 99-05	5
C9201	27444-00Y	Starter Motor Shaft Oil Seal Dyna 06-17, All Models 07-16	5
• Cam Housing			
C10047		99-17 All Twin Cam, Cam Service kit with Rocker Box kit	1
C9627	11288	Cam Position Sensor O-ring All Models 1999-00	10
C9631	11298	Cam Support Plate Plug O-ring All Models 99-06, Dyna 99-05	10
C9575F5	25244-99	Cam Cover Gasket All Models 1999-17, AFM .060	5
• Carb and EFI Gaskets			
C10007	29645-08	HD All FL Models 08-16, Air Filter Element Gasket	10
C9626F	29062-95	Twin Cam Carb to Backing Plt. Gasket Carb Models 1999-02	10
C9634F	29313-95	Twin Cam Air Filter Mnt. Gasket Carb Models 1999- 02	10
C9641F	29368-99	EFI T/C Ind Module to Bck Plt Gasket 1999-17	10
C9643F	29463-99	EFI T/C Filter Element Gskt EFI Only 1999-17	10
C9630	11291	EFI T/C MAP Sensor Seal EFI Only 1999-17	10
C10072	27270-95	Air Temp Sensor Gasket, 1995-05, .039" Fiber	10
C10073	27635-01B	Induction Module O-ring Kit, 2001-05 Fuel Injected Models	KIT
C10074	27628-01A	Idle Air Control Motor O-Ring, 2001-05 Fuel Injected Models	10
C10075	27655-06	IAFM O-ring Kit, 2006-17 Fuel Injected Models	Kit
C10076	27659-06	TPS Sensor O-Ring, 2006-17 Twin Cams, 2006-07 Touring	10



Gaskets for Harley-Davidson®



Cometic Gasket - An Exclusive NASCAR Performance® Product

Evo Big Twin®

Cometic Part #-C9459
Pushrod O-Ring
Middle 1984-99
Replaces: 11132

Cometic Part #-C9481
Umbrella Valve Seal
1993-99
Replaces: 26856-89

Cometic Part #-C9286
Rocker Cover Washer
1984-99
Replaces: 63858-49

Cometic Part #-C9278
Upper Rocker Cover
1992-99
Replaces: 17356-92

Cometic Part #-C9293
Pushrod O-Ring
Lower 1984-99
Replaces: 11145

Cometic Part #-C9292
Pushrod O-Ring
Upper 1984-99
Replaces: 11157

Cometic Part #-C9282
Lower Rocker Cover
1992-99
Replaces: 17355-92

Cometic Part #-C9297
Rear Tappet Block
Replaces: 18633-48D
Cometic Part #-C9298
Front Tappet Block
Replaces: 18634-48C

Cometic Part #-C9283
Inner Rocker Cover
1984-99
Replaces: 17358-84A

Cometic Part #-C9328
Cam Cover 1993-99
Replaces: 25225-93
Cometic Part #-C9302
Cam Cover 1984-92
Replaces: 25225-70B

Cometic Part #-C9865
One Piece Rocker Base
1984-99
Replaces: 16778-97X & 16779-97X

Cometic Part #-C9435
Check Valve & Check Ball Cap O-Ring,
All Big Twins Replaces: 11105

Cometic Part #-C9350
Cam Seal 1984-99
Replaces: 83162-51DL

Cometic Part #-C9836
Valve Stem Seal
1984-99
Replaces: 18001-83A

Cometic Part #-C9384
Oil Pump Cover 1992-99
Replaces: 26276-92
Cometic Part #-C9382
Oil Pump Cover 1984-91
Replaces: 26276-80A

Cometic Part #-C9383
Oil Pump Body 1992-99
Replaces: 26273-92
Cometic Part #-C9381
Oil Pump Body 1984-91
Replaces: 26273-80B

Cometic Part #-C9290
Intake Manifold Seal
1990-99
Replaces: 26995-86A

Cometic Part #-C9349
Oil Pump Drive Gear Seal, 1984-99
Replaces: 26227-58

Cometic Part #-C9719
Race Style Exhaust
1984-99 "Flat"
Replaces: 65424-83
Cometic Part #-C9288
Std. Exhaust "Tapered"
Replaces: 65324-83A

Cometic Part #-C9684
Oil Pump Lower Cover O-Ring All Big Twins, 1992-98
Replaces: 11241

Cometic Part #-C9688 Std. Bore Head - MLS .030" - 1984-99
Cometic Part #-C9689 Std. Bore Head - MLS .040" - 1984-99



Gaskets for Harley-Davidson®



Cometic Gasket - An Exclusive NASCAR Performance® Product

Complete • Top End • Rocker Box Kits & Individual Replacement Parts

Part # Description

EST BIG TWIN EVOLUTION MOTOR KITS

• Complete Gasket Kit

- C9748F 92-99 EVO Big Twin
C9846F 92-99 EVO Big Twin W / .030" Head Gasket
C9751F 89-91 EVO Big Twin Softails & Dyna's
C9849F 89-91 EVO Big Twin Softails & Dyna's W / .030" Head Gasket
C9750F 84-91 EVO Big Twin FLT, FXR 5 Spd
C9848F 84-91 EVO Big Twin FLT, FXR 5 Spd. M / .030" Head Gasket
C9749F 84-88 EVO Big Twin 4 & 5 Spd.
C9847F 84-88 EVO Big Twin 4 & 5 Spd. W / .030" Head Gasket

• Big Bore Complete Gasket Kit

- C9908 92-99 3 5/8" Bore complete motor kit
C9164 84-91 3 5/8" Bore complete motor kit
C10013 84-91 3 5/8" Bore FLT-FXR complete motor kit
C10013-030 84-91 3 5/8" Bore FLT-FXR complete motor kit
C10064 84-91 3 9/16" Bore complete motor kit, FXR, FL NEW!
C9974 92-99 3 13/16" Bore complete motor kit
C9940 92-Up 4.00" bore complete motor kit S&S engines, W/S&S Rocker Box Gaskets

• Top End Gasket Kit

- C9635 92-99 EVO Big Twin
C9850 92-99 EVO Big Twin W / .030" Head Gasket
C9130 92-99 EVO Big Twin No Rocker Box Rubber Gaskets
C9747 84-91 EVO Big Twin
C9851 84-91 EVO Big Twin W / .030" Head Gasket

• Evo Big Twin Motor Only Gasket Kit

- C9890 92-99 Evo Big Twin Std bore, MOTOR Only Kit
C9891 84-91 Evo Big Twin Std bore, MOTOR Only Kit

• Big Bore Top End Gasket Kit

- C9766 3 5/8" Bore; 92-99 EVO Big Twin
C9767 3 5/8" Bore; 84-91 EVO Big Twin
C9770 3 3/4" Bore: 92-99 EVO Big Twin
C9771 3 3/4" Bore: 84-91 EVO Big Twin
C9768 3 13/16" Bore; 92-99 EVO Big Twin
C9980 3 13/16" Bore: 92-99 EVO Big Twin, with .030" Head Gasket
C9769 3 13/16" Bore: 84-91 EVO Big Twin
C9917 4.00" Bore S&S Big Twin, W/S&S Rocker Box Gaskets
C9917S 4.00" Bore S&S Big Twin, W/O.E. Rocker Box Gaskets
C9959 4.00" Bore EVO W/Axtell Cylinder Style Head & Base

• Rocker Box Rebuild Gasket Kit

- C9752 92-99 EVO Big Twin
C9753 84-91 EVO Big Twin

Complete • Top End • Rocker Box Kits & Individual Replacement Parts

Cometic OEM Description Pkg. Part # Part # Qty.

1984-99 BIG TWIN & EVO INDIVIDUAL REPLACEMENT GASKETS,SEALS, O-RINGS
Rocker Box Gaskets

- C9481 26856-89 93-99 Umbrella Valve Seal 10
C9400 6114 84-99 Rocker Box Washer copper 10
C9286 63858-49 84-99 Rocker Box Washer paper 10
C9277 17356-84A 84-91 Upper Rocker Cover Gasket rubber 5
C9278 17356-92 92-99 Upper Rocker Cover Gasket rubber 5
C9283 17358-84A 84-99 Inner Rocker Cover Gasket rubber 10
C9281 17355-84A 84-91 Lower Rocker Cover Gasket rubber 5
C9282 17355-92 92-99 Lower Rocker Cover Gasket rubber 5



Gaskets for Harley-Davidson®



Cometic Gasket - An Exclusive NASCAR Performance® Product

Complete • Top End • Rocker Box Kits & Individual Replacement Parts

Cometic Part #	OEM Part #	Description	Pkg. Qty.
1984-99 BIG TWIN & EVO INDIVIDUAL REPLACEMENT GASKETS,SEALS, O-RINGS			
Rocker Box Gaskets			
C9561	16778-97X	84-99 Lower Right Rocker Gasket .020" rubber coated steel	5
C9285	16778-84A	84-99 Lower Right Rocker Gasket fiber	5
C9563	16779-97X	84-99 Lower Left Rocker Gasket .020" rubber coated steel	5
C9284	16779-84A	84-99 Lower Left Rocker Gasket fiber	5
C9865		84-99 One piece Rocker Base all Evo's .020" rubber coated steel	2
C9866		84-99 One piece Rocker Base all Evo's .020" rubber coated steel	10
C9224		S&S Outer Rocker Gasket w/ Breather Flapper	4
C9225		S&S Inner Rocker O-Ring Seal	8
C9226		S&S Rocker Cover Bolt Washer Seal	24
• Pushrod and Tappet Guide Gaskets			
C9292	11157	84-99 Upper Pushrod Tube O-ring	25
C9459	11132	84-99 Middle Pushrod Tube O-ring	25
C9293	11145	84-99 Lower Pushrod Tube O-ring	25
C10023		84-99 Tappet Block Pair Front & Rear .060" AFM Pair	2
C9297F	18633-48D	84-99 Rear Tappet Block Gasket AFM	10
C9298F	18634-48C	84-99 Front Tappet Block Gasket AFM	10
C9586		84-99 Evo Pushrod O-ring Set	Kit
C9836		84-99 Valve Guide Seals "Viton"	25
• Head and Base Gaskets			
C9688		Stock Bore EVO's 3.500" through 3.570" .030" MLS Design	2
C9689		Stock Bore EVO's 3.500" through 3.570" .040" MLS Design	2
C9690		3 5/8" Big Bore EVO's .030" MLS Design	2
C9691		3 5/8" Big Bore EVO's .040" MLS Design	2
C9694		3 3/4" Big Bore EVO's .030" MLS Design	2
C9695		3 3/4" Big Bore EVO's .040" MLS Design	2
C9692		3 13/16" Big Bore EVO's .030" MLS Design	2
C9693		3 13/16" Big Bore EVO's .040" MLS Design	2
C9287	26432-76A	84-99 Cylinder Stud Insert O-ring	10
C9551		84-99 Stock Sleeve Cylinder Base Gasket .020" Rubber Coated Steel	2
C9009	16774-86	84-99 Stock Sleeve Cylinder Base Gasket .020" Fiber	2
C9615	16777-86S	84-99 3 5/8" Base Gasket .020" Fiber	2
C10009	93-1033	84-99 3 5/8" Base Gasket .020" Fiber fits S&S cylinder only	2
C9552		84-99 3 5/8" Base Gasket .020" Rubber Coated Metal	2
C9615		84-99 3 3/4" Base Gasket .020" Fiber	2
C9082		84-99 3 13/16" Head Gasket .043" Copper	2
C9617		84-99 3 13/16" Base Gasket .020" Fiber	2
C9609		84-99 4" Head Gasket .043" copper w / Axtell Cyl.	2
C9621		84-99 4" Base Gasket w / S&S Cyl. .020" Fiber	2
• EVO Cam Service Kits			
C9623		1970-92 All Big Twins	Kit
C9624F		1993-99 All Big Twins	Kit
• Cam Housing Gaskets			
C9328F5	25225-93	93-99 Cam Cover Gasket AFM	5
C9302F5	25225-70B	84-92 Cam Cover Gasket AFM	5
C9306F	32591-80	84-99 Point Cover Gasket	10
C9350	83162-51DL	84-99 Point Seal double lip	5



Gaskets for Harley-Davidson®



Cometic Gasket - An Exclusive NASCAR Performance® Product

Complete • Top End • Rocker Box Kits & Individual Replacement Parts

Cometic Part #	OEM Part #	Description	Pkg. Qty.	Price
• Intake and Exhaust				
C10035	54-0505	Edlebrock rectangle port intake seal Pair	2	
C9227		50mm Carb. to Manifold Seal 1999-UP	1	
C9131		All EVO Intake Manifold Seal Kit, Head to Manifold and Carb Seal	Kit	
C9088	27002-89	89 to Present Carb to Manifold Sealing Ring	1	
C9299	29242-83	84-89 Intake to Head Compliance Fitting Gasket	10	
C9290	26995-86A	90-99 Intake to Head Compliance Fitting Gasket	10	
C9540	01-931	Extreme Performance Exhaust Gasket	10	
C9719	65324-83	84-91 Exhaust Port Gasket Race Style	10	
C9288	65324-83A	92-99 Exhaust Port Gasket Taper Style	5	
C9247		Exhaust Gasket All Models 99 -UP Race Style .240" thick	10	
C9223		S&S Big Bore Manifold to Head Seal	4	
• Oil Pump Gaskets and Seals				
C10028		81-91 Oil Pump Rebuild Kit	1	
C9168		92-99 Oil Pump Rebuild Kit	1	
C9435	11105	84-99 Oil Pump Cap O-ring	25	
C9684	11241	92-99 Oil Pump Cover O-ring	25	
C9349	26227-58	84-99 Oil Pump Drive Gear Seal	5	
C9383	26273-92	92-99 Oil Pump Body Gasket paper	10	
C9381	26273-80B	84-91 Oil Pump Body Gasket paper	10	
C9382	26276-80A	84-91 Oil Pump Cover Gasket paper	10	
C9384	26276-92	92-99 Oil Pump Cover Gasket paper	10	
C10011	63528-92	HD Oil Line Ferrule 92-98 ALL	5	
• Misc. O-ring and Seal				
C9438	11170	95-99 Crankshaft Postion Sensor O-ring	25	
C9351	12026B	84-99 Sprocket Shaft Seal	5	
• Derby Cover Gaskets and O-rings				
C9183F1	25416-70C	84-98 All B/T 3 Hole	1	
C9338F5	25416-70C	70-E84 Derby Cover Gasket , AFM60	5	
• Inspection Cover Gaskets				
C9442	25416-84	L84-98 Derby Cover O-ring	10	
C9363	31433-84A	84-98 Derby Cover Bolt Washer metal	5	
C9303F5	34906-79	80-84 FXR, FLT Primary Inspec. Cover Gasket, AFM60	5	
C9305F5	34906-85	85-UP FXR, FLT Primary Inspection Cvr. Gasket, AFM60	5	
C9326F5	60567-36	36-64 FL, FLTH, 58-69 XLCH Inspection Cover Gasket, AFM60	5	
C9331F5	60567-65C	65-UP Inspec. Cover Gasket Dyna & Softails, AFM60	5	
• Inner Primary Gaskets, O-rings				
C9536	11125	70-E82 Inner Primary O-ring	10	
C9441	11147	L82-99 Inner Primary O-ring	10	
C9518	12018	70-E84 Inner Primary Bearing Seal	5	
C9260	12052	L84-99 Inner Primary Bearing Seal double lip	5	
C9343	60629-55	55-64 Chain Housing to Motor Gasket	10	
• Starter Housing Gaskets, O-rings				
C9451	11101	L66-82 Starter Oil Deflector O-ring	10	
C9433	11116	91-99 Starter Housing O-ring	25	
C9436	11171	89-90 Starter Bolt O-ring	10	
C9491	12051	L84-88 Starter Shaft Seal	5	
C9261	12066	94-99 Starter Shaft Seal	5	
C9379	12053	89-93 Starter Shaft Seal	5	
C9507F	31320-80	80-86 Starter Housing Gasket	10	
C9508F	31321-80	80-86 Starter Cover Gasket	10	
C9509	31341-80-DL	80-86 Starter Shaft Seal	5	
C9717F	60518-65	65-88 Starter Hole Block Off Gasket	10	
C9330F	60559-80	65-85 Starter Housing Gasket	10	



Gaskets for Harley-Davidson®



Cometic Gasket - An Exclusive NASCAR Performance® Product

Cometic Part #	OEM Part #	Description	Pkg. Qty.
----------------	------------	-------------	-----------

• Shifter Shaft Seals

C9484	11117	L84-99 FXR,DYNA Shifter Sleeve O-ring	25
C9357	11148	82-E84 Shifter Shaft Quad Seal	10
C9661	11191	90-99 FXST, FLST Shift Lever O-ring	25
C9525	60641-74	74-85 Shifter Shaft Seal	5

**1936 BIG TWIN & EVO INDIVIDUAL REPLACEMENT GASKETS,SEALS, O-RINGS
Seals, O-rings and Washers**

C9498	6007	80-98 Drain Plug Washer	10
C9435	11105	90-99 Drain Plug O-ring	10
C9529	11115	65-86 Counter Shaft O-ring	10
C9459	11132	90-99 Dipstick Cover O-ring upper	25
C9667	11140	96-99 Speedometer Sensor O-ring	25
C9495	11162	L84-86 Mainshaft O-ring right end	25
C9361	11165	L84-99 Mainshaft Quad Seal	10
C9530	11166	84-86 Mainshaft Bearing O-ring	25
C9263	11178	87-98 Filler Plug O-ring	10
C9447	11179	87-99 Clutch Cable O-ring	25
C9531	12010	L79-86 Shifter Shaft Seal	5
C9493	12013A	L81-86 Main Drive Gear Seal	5
C9494	12014	65-E84 Clutch Hub Nut Seal	5
C9518	12018	71-E84 Inner Primary Clutch Seal	5
C9506	12022	L66-E81 Main Drive Gear Seal	5
C9351	12026B	70-98 Mainshaft Seal, Engine	5
C9258	12035A	91-99 Main Drive Gear Seal, Transmission	5
C9528	12043	80-86 Starter Shaft Seal	5
C9527	12044DL	80-E84 Main Drive Gear Seal	1
C9259	12045DL	80-06 Shifter Shaft Seal	5
C9359	12050	L84-94 Main Shaft Seal	1
C9260	12052DL	L84-99 Inner Primary Clutch Seal	5
C9262	12067A	95-99 Mainshaft Seal	1
C9632	12068	99-UP Twin Cam, 04-UP Sportster Engine Main Shaft Seal	5
C9497	33043-80	65-95 Neutral Indicator Washer	10
C9374	33076-37	37-86 Starter Crank Seal	10
C9519	34036-36	36-E79 Cam Shaft Seal rubber	10
C9510	34036-80	80-86 Shift Fork Shaft O-ring	10
C9523	35230-39DL	36-79 Mainshaft Seal	5
C9411	35231-36	36-E77 Mainshaft Oil Seal cork washer	10
C9496	37091-80	80-86 Filler Plug Washer	10
C9354	37101-84	84-86 Clutch Release Lever O-ring	1
C9513	37741-67A	L79-81 Mainshaft Seal Double Lip	5
C9514	37741-82DL	82-86 Main Drive Gear Seal Double Lip	5
C9485	62672-90	91-98 Dipstick Cover O-ring	10
C9460	62673-90	91-98 Dipstick O-ring	10
C9403	62702-52	36-86 Drain Plug Washer	10



Gaskets for Harley-Davidson®



Cometic Gasket - An Exclusive NASCAR Performance® Product

Complete Transmission Kits & Individual Gaskets

Cometic Part #-C9459
Trans/Clutch Oil Dipstick
O-Ring, All Big Twin
Replaces: 11132

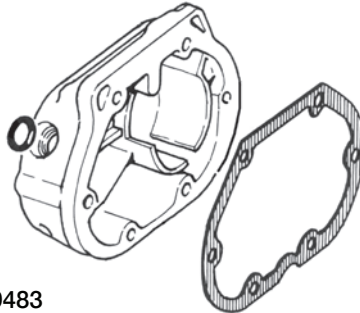

Cometic Part #-C9460
Oil Dipstick O-Ring
Dyna 91-05
Replaces: 62673-90

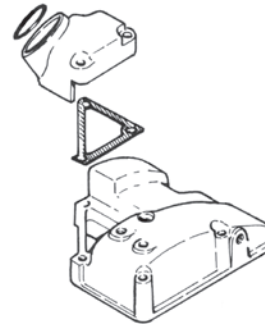

Cometic Part #-C94891F5
Oil Tank Spout
Dyna 91-05
Replaces: 62423-90

Cometic Part #-C9483
Clutch Release Cover
All Big Twin 88-06
Replaces: 36801-87B

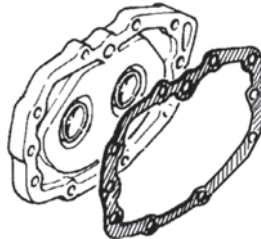

Cometic Part #-C9488
Trans Top Cover
Dyna 91-98
Replaces: 34917-90A

Cometic Part #-C9264
Trans Bearing Cover
All Big Twin 86-98
Replaces: 35652-79B
Cometic Part #-C9644
Trans Bearing Cover
All Big Twin 99-06
Replaces: 35653-98

Cometic Part #-C9459
Oil Tank Filler Cap O-Ring
Top, Dyna 91-98
Replaces: 11132

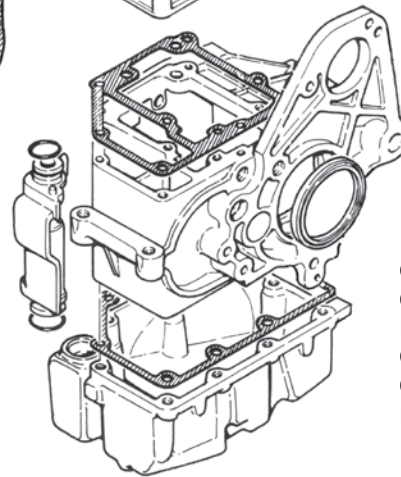

Cometic Part #-C9262
Trans Main Drive Seal
Big Twin L94-06
Replaces: 12067A

Cometic Part #-C9485
Oil Tank Filler Cap O-Ring
Bottom, Dyna 91-98
Replaces: 62672-90

Cometic Part #-C9646
Oil Pan, Dyna 99-UP
Replaces: 26072-99
Cometic Part #-C9490
Oil Pan, Dyna 91-98
Replaces: 26072-90A

Cometic Part #	OEM Part #	Description
----------------	------------	-------------

1970-UP BIG TWIN EVO & TWIN CAM INDIVIDUAL REPLACEMENT GASKETS,SEALS, O-RINGS

•Complete Transmission Kits

C9464	33031-70	E70-E 79 Big Twin
C9464F	33031-70	E70-E 79 Big Twin EST Kit
C9465	33031-80	L79-82 Big Twin 4 Speed
C9466	33031-82	80-E84 Big Twin 5 Speed
C9467	33031-85	L84-92 Big Twin Except Dyna 5 Speeds
C9468	33031-91	91-99 Dyna & FXDB-S Evolution Models
C9469	33031-93	93-99 FLT,FLH, FXR, Dyna & Softails Evolution Models w/Fiber
C9469F	33031-93	93-99 FLT,FLH, FXR, Dyna & Softails Evolution Models w/AFM
C9639	26072-99	99-06 FLT, FLH, Softail 00-06, Twin Cam Models w/Fiber
C9639F	26072-99	99-06 FLT, FLH, Softail 00-06, Twin Cam Models w/AFM
C9640	26072-99	99-05 Dyna Twin Cam Models
C9151	06-17	Dyna Twin Cam 6 Speed Trans Kit
C9174	07-17	Softail Models Twin Cam 6 Speed Trans Kit
C9175	07-16	FL Models Twin Cam 6 Speed Trans Kit

(Kit contains all of the necessary gaskets, seals, o-rings, end cover, top cover gaskets and all washers needed to completely rebuild the transmission)



Gaskets for Harley-Davidson®



Cometic Gasket - An Exclusive NASCAR Performance® Product

Complete Transmission Kits & Individual Gaskets

Cometic Part #	OEM Part #	Description	Pkg. Qty.
----------------	------------	-------------	-----------

1936-UP BIG TWIN EVO & TWIN CAM INDIVIDUAL REPLACEMENT GASKETS,SEALS, O-RINGS

• Transmission Gaskets

C9434	11201	T/C Mainshaft 5th Gear O-ring 07-14	10
C9642	11290	Twin Cam Neutral Ind. Switch O-ring All Models 1999 -14	10
C9215	12074	T/C Mainshaft Oil Seal 07-14 All, 06-14 Dyna	1
C9200	12077	06 DYNA, All 07-17 Oil Seal Output Gear End Seal	10
C9490F	26072-90	90-98 Oil Pan Gasket Dyna	10
C9646F	26072-99	T/C DYNA Oil Pan Gasket 1999-17	10
C9265F	26077-93	93-98 Oil Pan Gasket FLT	5
C9647F	26077-99	T/C Oil Pan Gasket FLT's 1999-16	10
C9517F	33196-79	L79-86 Shifter Cover Gasket	10
C9515-032AFM33295-36	36-86	End Cover Gasket	10
C9520F	34552-52	52-E79 Ratchet Cover Gasket	10
C9521F	34565-52	52-E79 Shifter Adapter Plate Gasket	10
C9522F	34824-36	36-E79 Top Cover Gasket	10
C9516-032AFM34824-79	L79-86	Top Cover Gasket	10
C9499F	34904-79	80-86 Top Cover Gasket	10
C9983F	34904-86B	87-99 Top Cover Gasket Thin Version	10
C9267	34904-86XC	T/C Trans Cover Gasket All Models 1999 -14 Wide Version	10
C9488F	34917-90A	90-98 Top Cover Gasket Dyna	10
C9645F	34917-99	T/C DYNA Trans. Top Cover Gasket 1999-05	10
C9189	34917-06	T/C Trans. Top Cover Gasket 07-17 All Models	10
C9190F5	35607-06	Trans to Eng. Case Gasket Dyna 06-17 & FL 07-16 Models	1
C9264F	35652-79A	80-98 Bearing Housing Gasket	10
C9644F	35653-98	T/C Bearing Housing Gasket All Models 1999 -06, 99-05 Dyna	10
C9187	35654-06	T/C Bearing Housing Gasket All Models 07 -16	10
C9526F	36801-79	80-86 End Cover Gasket	10
C9483F	36801-87B	87-05 Dyna, 87-06 All Models Clutch Release Gasket	10
C9188	36805-06	T/C Trans End Cover All Models 07-17	10
C9489F	62423-90	91-98 Dyna Oil Filler Spout Gasket	10
C9266F	62432-93	93-06 FLT Oil Filler Spout Gasket	10
C9512F	67141-36	36-83 Speedometer Drive Gasket	10

• Carburetor Gaskets

C9452	11107	66-71 XL, 67-70 Big Twin Tillotson Spacer O-ring	10
C9088	27002-89	88-98 XL, 90-99 Big Twin Keihin CV Seal Ring	1
C9417	27023-71	72- E76, 79-85 XL; 71-75 Big Twin Bendix Manifold Gasket	10
C9425	27077-78	78-89 Big Twin Keihin Manifold Gasket	10
C9300	29058-77	L76-87 XL, 76-89 Big Twin Keihin Air Cleaner Gasket	10
C9301	29059-88	88-98 XL, 90-99 Big Twin Keihin CV Air Cleaner Gasket	20



Gaskets for Harley-Davidson®



Cometic Gasket - An Exclusive NASCAR Performance® Product

Shovelhead & Panhead®

Cometic Part #-C9365
Oil Line Sleeve Seal
1963-84
Replaces: 63529-57

Cometic Part #-C9986
Rocker Cover Viton Coated Embossed
Shovelhead 1966-84

Cometic Part #-C9336
Rocker Cover 1966-84
Replaces: 17540-69

Cometic Part #-C9451
Upper Pushrod Cover
O-Ring Late 1979-81
Replaces: 11101

Cometic Part #-C9711
Upper Pushrod Cover
O-Ring Late 1981-84
Replaces: 11118

Cometic Part #-C9998
Valve Stem Seal 1980-84
Replaces: 18000-81

Cometic Part #-C9459
Middle Pushrod Cover
O-Ring Late 1979-84
Replaces: 11132

Cometic Part #-C9451
Rocker Shaft O-Ring
1966-84
Replaces: 11101

Cometic Part #-C9346
Rocker Cover Felt Pad
1948-65
Replaces: 17507-48

Cometic Part #-C9342
Rocker Cover 1948-65
Replaces: 17541-48A

Cometic Part #-C9598
Pushrod Cover (Small)
1948-65
Replaces: 17955-36

Cometic Part #-C9604
Std. Bore Shovelhead
.043" Fire Ring Head
Replaces: 16770-66X

Cometic Part #-C9984
"MLS" Std. Bore
74 & 80 Shovelhead All
Models .040" Head

Cometic Part #-C9460
Lower Pushrod Cover
O-Ring 1979-81
Replaces: 11133

Cometic Part #-C9461
Lower Pushrod Cover
O-Ring Late 1981-84
Replaces: 11133A

Cometic Part #-C9613
Head 1948-65
Replaces: 16770-48X

Cometic Part #-C9567
Pan/Shovel Front Cylinder Base
Gasket .031" (Fiber) 1948-84
Replaces: 16776-48

Cometic Part #-C9568
Pan/Shovel Rear Cylinder Base
Gasket .031" (Fiber) 1948-84
Replaces: 16777-48

Cometic Part #-C9987
Shovel Front & Rear Pair
Std. 74 & 80 Cylinders
Viton Coated Embossed Base
Gasket

Cometic Part #-C9297
Rear Tappet Block
1948-84
Replaces: 18633-48D

Cometic Part #-C9298
Front Tappet Block
1948-84
Replaces: 18634-48C

Cometic Part #-C9606
Pushrod Cover (Large)
1948-E79
Replaces: 17955-48

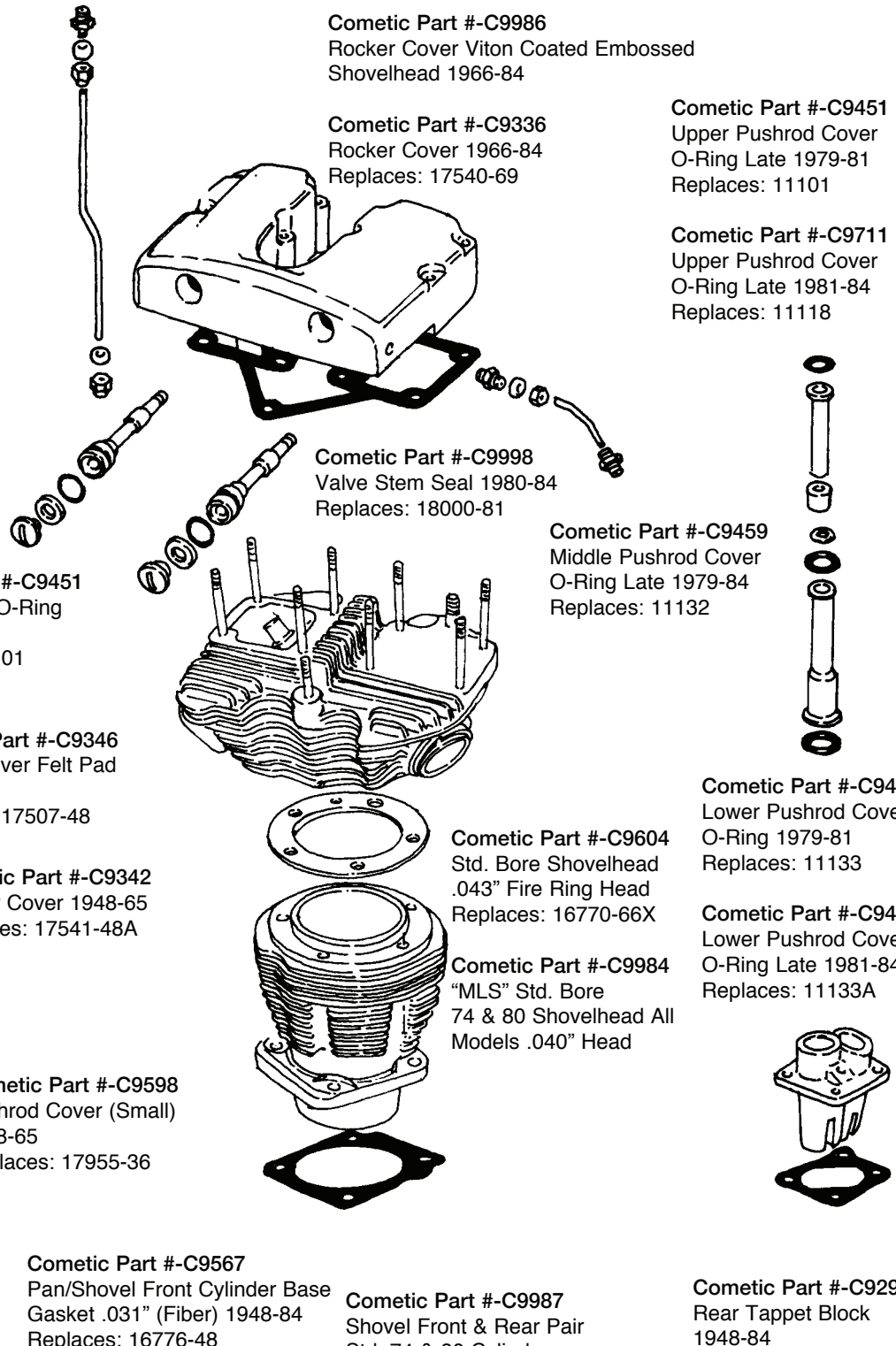



Gaskets for Harley-Davidson®



Cometic Gasket - An Exclusive NASCAR Performance® Product

Complete • Top End • Rocker Box Kits & Individual Replacement Parts

Cometic Part #	OEM Part #	Description
-------------------	---------------	-------------

EST MOTOR KITS FOR SHOVELHEAD & PANHEAD MOTORS

• Complete EST Gasket Kits for Shovelhead/Panhead

C9900.....	17029-66.....	1966-69 74" Shovelhead FL, FLH
C9964.....	17029-70A.....	1970-84 74" & 80" Shovelhead 4 Spd
C9154.....		1970-84 3 5/8" Shovelhead 4 Spd
C9965.....	17029-80.....	1980-84 80" Shovelhead 5 Spd. FLT
C9966.....	17028-48.....	1948-65 Panhead FL, FLH

Motor Only Shovelhead Gasket Kits

C10091.....		1970-84 STD Bore Engine Only Gasket & Seal Kit NEW!
-------------	--	---

• Top End EST Gasket Kits for Shovelhead/Panhead

C9967.....	17034-66X.....	1966-84 74" & 80" Shovelhead 4 or 5 Spd
C9968.....	17034-48.....	1948-65 Panhead FL, FLH

• Big Bore Shovelhead Top End Gasket Kits

C9918.....		3 5/8" Bore 1966-84 All Models
C9969.....		3 13/16" Bore 1966-84 All Models, No Oil Drains in Head Gasket

EST Kits contain MLS head gaskets, steel viton coated base gaskets and AFM material

Cometic Part #	OEM Part #	Description	Pkg. Qty.
-------------------	---------------	-------------	--------------

1936-84 BIG TWIN PAN & SHOVEL INDIVIDUAL REPLACEMENT GASKETS,SEALS, O-RINGS

• Rocker Housing Gaskets and O-rings

C10030.....	17535-38.....	36-47 Knucklehead Frt Rocker Tin Gasket, .031" Fiber	10
C10031.....	18265-37.....	36-47 Knucklehead Valve Guide Gasket.....	10
C10008.....	17540-69.....	66-84 Rocker Cover Gasket .043" CFM20.....	2
C9986.....	17540-69.....	66-84 Rocker Cover Gasket .020" Viton Coated Emb. Steel.....	2
C9336.....	17540-69.....	66-84 Rocker Cover Gasket .031" Fiber.....	10
C9342.....	17541-48A.....	48-65 Rocker Cover Gasket .031" Fiber.....	10
C9346.....	17507-48.....	48-65 Rocker Cover Felt Pad.....	10
C9451.....	11101.....	66-84 Rocker Shaft O-ring.....	25
C9424.....	18000-81.....	L81-84 Valve Guide Seal Teflon.....	25
C9419.....	18196-51.....	51-29 Valve Guide Gasket.....	20
C9998.....		Late Shovelhead & .625" O.D. Guides Viton Seal with garter.....	20

• Pushrod O-rings and Tappet Block Gaskets

C9598.....	17955-36.....	36-E79 Push Rod Cover small cork.....	25
C9606.....	17955-48.....	48-E79 PushRod Cover Large cork.....	25
C9451.....	11101.....	L79-E81 Push Rod Cover O-ring Upper.....	10
C9459.....	11132.....	L79-84 Push Rod Cover O-ring Middle.....	25
C9460.....	11133.....	L79-E81 Push Rod Cover O-ring Lower.....	5
C9711.....	11118.....	L81-84 Push Rod Cover O-ring Upper.....	25
C9461.....	11133.....	L79-E81 Push Rod Cover Quad Seal Lower.....	10
C9297.....	18633-48D.....	48-84 Rear Tappet Block Gasket .020" Fiber.....	10
C9298.....	18634-48C.....	48-84 Front Tappet Block Gasket .020" Fiber.....	10
C9216.....		66-78 All Shovel Push Rod Tube Seal Set.....	Kit
C9584.....		L79-E81 All Shovel Push Rod Tube Seal Set.....	Kit
C9585.....		L81-84 All Shovel Push Rod Tube Seal Set.....	Kit

• Head and Base Gaskets

C9984.....	16770-66X.....	66-84 Shovelhead MLS Stock Bore Head Gasket 74" & 80" .040".....	2
C9985.....		66-84 Shovelhead MLS 3 5/8 BB Head Gasket .040".....	2
C9206.....		Shovel Only Base Gasket Std bore .020" Viton FR & RR Pair.....	2
C9207.....		3 5/8" Shovel Only Base Gasket Std bore .020" Viton 2 Fronts.....	2
C9987.....		48-65 Panhead Base Front & Rear .020" Viton.....	2
C9988.....		48-65 Panhead Base 3 5/8" Front & Rear .020" Viton.....	2
C9989.....		48-65 Panhead Base 3 5/8" 2 Fronts for S&S Cylinders Viton.....	2
C9714.....		66-84 Shovelhead Stock Bore Head Gasket; .032" Copper.....	2



Gaskets for Harley-Davidson®



Cometic Gasket - An Exclusive NASCAR Performance® Product

Complete • Top End • Rocker Box Kits & Individual Replacement Parts

Cometic Part #	OEM Part #	Description	Pkg. Qty.
• Head and Base Gaskets			
C9713		66-84 Shovelhead 3 5/8" Copper Head Gasket: .032"	2
C9618		66-84 Pan/Shovel 3 5/8" Base Gasket: .031" Fiber	2
C9893		66-84 Pan/Shovel 3 13/16" Base Gasket: .020" RC Metal	2
C9567	16776-48	48-84 Pan/Shovel Front Cyl. Std. Bore base Gasket; .031" Fiber	10
C9568	16777-48	48-84 Pan/Shovel Rear Cyl. Std. Bore base Gasket; .031" Fiber	10
C9137	16770-48MLS	48-65 Panhead .040" MLS Head Gasket Pair	2
• Cam / Gear Housing Gaskets and Seals			
C9334F5	25225-36C	41-69 Gear Cover Gasket, AFM60	5
C9302F5	25225-70B	70-84 Cam Cover Gasket, AFM60	5
C9323	32591-70	70-79 Points Cover Gasket	10
C9306	32591-80	80-84 Points Cover Gasket	10
C9350	83162-51DL	70-84 Cam Cover Seal / Double Lip	5
C9337	32521-36	36-64 Timer Base Gasket	10
• Intake and Exhaust Gaskets			
C9453	27060-55	55-E78 Manifold to Head O-ring	10
C9608	27062-78	L78-84 Intake Seal Manifold to Head Rubber Band	10
C9587	65834-68X	66-84 Exhaust Gasket with Fire Ring	10
• Oil Pump and Related Gaskets / Seals			
C9435	1105	L70-84 Oil Screen Pump Plug O-ring	10
C9349	26227-58	68-84 Oil Pump Seal	5
C9715	26231-78	54-80 Oil Pump Relief Plug Gasket	10
C9397	26244-37	37-59 Oil Pump Body Gasket	10
C9393	26245-41	41-67 Oil Pump Gasket Fiber	10
C9391	26246-68D	68-E80 Oil Pump Body Fiber	10
C9394	26257-50A	L50-67 Oil Pump Cover Fiber	10
C9392	26258-68D	68-E80 Oil Pump Cover Gasket Fiber	10
C9382	26276-80A	L80-84 Oil Pump Cover Gasket Fiber	10
C9403	62702-52	66-E70 Oil Screen Plug Gasket	10
C9365	63529-57	63-84 Oil Line Sleeve Seal	10
C9351	12026A	70-84 Motor Main Shaft Seal	5
• Generator Gaskets / Seals			
C9322	30143-30	36-57 Gen. Gasket	10
C9321F	30143-58	58-69 Gen. Gasket	5



Gaskets for Harley-Davidson®



Cometic Gasket - An Exclusive NASCAR Performance® Product

Evolution Sportster®

Cometic Part #-C9294
Pushrod Tube O-Ring
Upper 1991-03
Replaces: 11190

Cometic Part #-C9481
Umbrella Valve Seal
1991-03
Replaces: 26856-89

Cometic Part #-C9286
Rocker Cover Washer
1987-03
Replaces: 63858-49

Cometic Part #-C9276
Upper Rocker Box
1991-03
Replaces: 17354-89

Cometic Part #-C9280
Lower Rocker Box
1991-02
Replaces: 17353-89A

Cometic Part #-C9283
Center Rocker Box
Replaces: 17358-84A

Cometic Part #-C9865
One Piece Rocker Base
1986-19
Replaces: 16778-97X &
16779-97X

Cometic Part #-C9836
Viton Valve Stem Seal
1986-02
Replaces: 18001-83A

Cometic Part #-C9290
Intake Manifold to
Head Seal
Replaces: 26995-86B

Cometic Part #-C9688
Std. Bore Head .040" MLS
1200 1986-19

Cometic Part #-C9689
Std. Bore Head .030" MLS
1200 1986-19

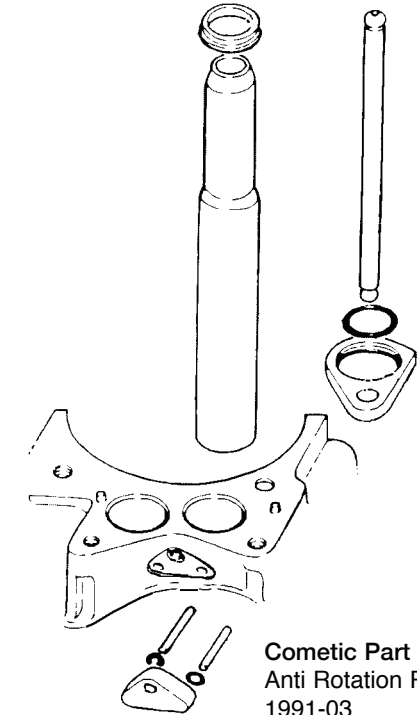

Cometic Part #-C9295
Pushrod Tube O-Ring
Lower 1991-03
Replaces: 17944-89

Cometic Part #-C9296
Anti Rotation Pin O-Ring
1991-03
Replaces: 11176

Cometic Part #-C9355
Cam Seal 1986-03
Replaces: 11124-DL

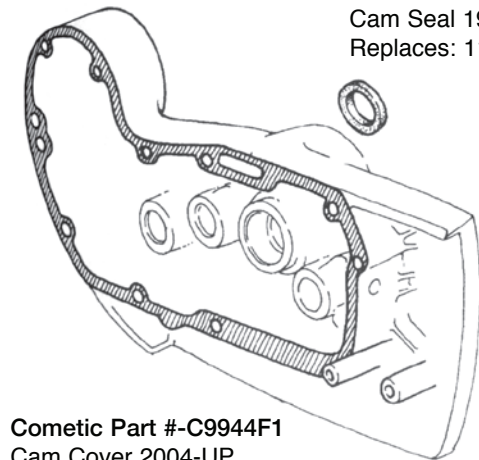

Cometic Part #-C9944F1
Cam Cover 2004-UP
Replaces: 25263-90D AFM
Cometic Part #-C9313F1
Cam Cover 1991-03
Replaces: 25263-90B AFM
Cometic Part #-C9311F1
Cam Cover 1986-90
Replaces: 25263-86 AFM

Cometic Part #-C9719
Race Style Exhaust
Replaces: 65324-83

Cometic Part #-C9288
Std. Exhaust
Replaces: 65324-83

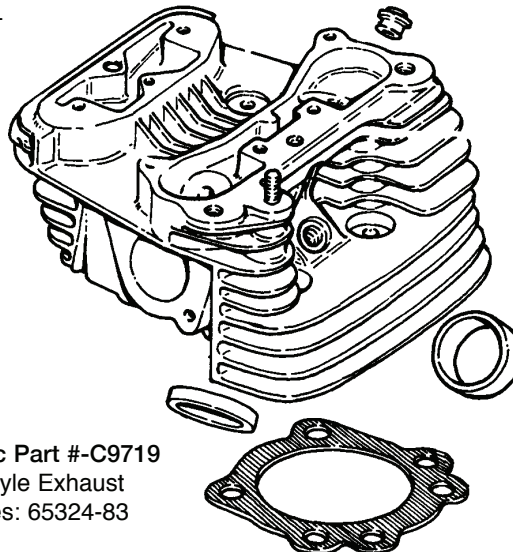
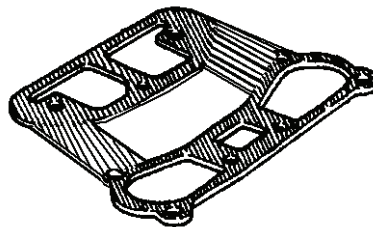
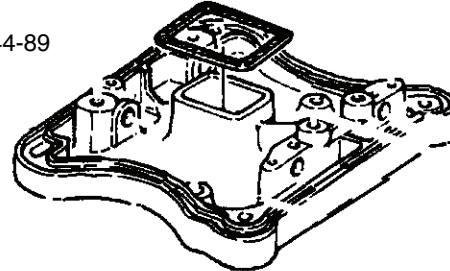
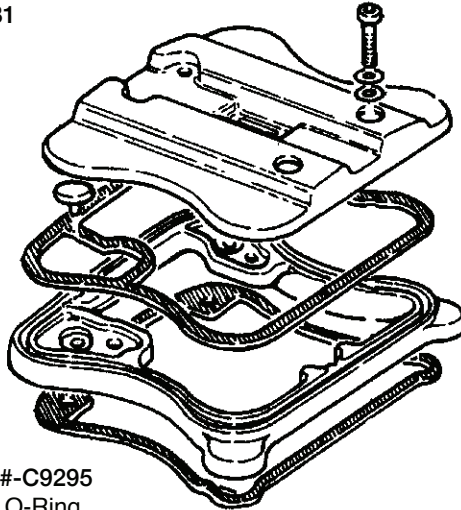



Gaskets for Harley-Davidson®



Cometic Gasket - An Exclusive NASCAR Performance® Product

Complete • Top End • Rocker Box Kits & Individual Replacement Parts

Cometic Description
Part #

EST BUELL FIREBOLT and BLAST

• Top End and Complete Motor Rebuild Gasket Kits

- C9204 Buell Firebolt Top End Rebuild Kit Std. Bore 04-06
- C9856 Buell Firebolt Top End Rebuild Kit Std. Bore 00-03
- C9857 Buell Firebolt Complete Motor Rebuild Kit Std. Bore 02-03
- C9863 Buell Blast Big Bore Top End Rebuild 3 13/16"
- C9863-STD Buell Blast Big Bore Top End Rebuild STD Bore
- C9864 Buell Blast Big Bore Complete Motor Kit 3 13/16"
- C9864-STD Buell Blast Big Bore Complete Motor Kit STD Bore

• Rocker Box Rebuild Kit

- C9213 Buell XB 9/12 98-02

EST EVO SPORTSTER MOTOR GASKET KITS

• Complete Gasket Kits

- C9754F 86-90 883 EVO Sportster
- C9755F 91-03 883 EVO Sportster
- C9193 04-06 883 EVO Sportster
- C9191 07-19 883 EVO Sportster
- C9756F 86-87 1100 EVO Sportster
- C9757F 88-90 1200 EVO Sportster
- C9758F 91-03 1200 EVO Sportster
- C9855F 91-03 1200 EVO Sportster W / .030" Head Gasket
- C9133 91-03 1200 EVO Sportster 3 13/16" Big Bore w/.040" Head Gasket
- C9124 91-03 1200 EVO Sportster 3 13/16" Big Bore W / .030" Head Gasket
- C9952 04-06 1200 EVO Sportster
- C9953 04-06 1200 EVO Sportster W / .030" Head Gasket
- C9176 07-19 1200 EVO Sportster

• Top End Gasket Kits

- C9759 86-90 883 EVO Sportster
- C9760 91-03 883 EVO Sportster
- C9194 04-06 883 EVO Sportster
- C9192 07-19 883 EVO Sportster
- C9761 86-87 1100 EVO Sportster
- C9762 88-90 1200 EVO Sportster
- C9907 88-90 1200 EVO Sportster W / .030" Head Gasket
- C9763 91-03 1200 EVO Sportster
- C9854F 91-03 1200 EVO Sportster W / .030" Head Gasket
- C9970 04-06 1200 EVO Sportster
- C9971 04-06 1200 EVO Sportster W / .030" Head Gasket
- C9177 07-19 1200 EVO Sportster

• Big Bore Top End Gasket Kits

- C10096 3.570" Top end kit w/.030" MLS Head Gasket 1991-03
- C10095 3.570" Top end kit w/.030" MLS Head Gasket 2004-06
- C10094 3.570" Top end kit w/.030" MLS Head Gasket 2007-19
- C10048 3.562" Bore; 91-03 EVO Sportster W / .040" MLS Head Gasket
- C10050 3.5/8" Bore; 91-03 EVO Sportster W / .027" MLS Head Gasket
- C10050-040 3.5/8" Bore; 91-03 EVO Sportster W / .040" MLS Head Gasket
- C9772 3 3/4" Bore; 86-90 883 EVO Sportster
- C9773 3 3/4" Bore; 91-UP 883 EVO Sportster
- C9774 3 3/4" Bore; 86-87 1100 EVO Sportster
- C9775 3 3/4" Bore; 88-90 1200 EVO Sportster
- C9776 3 3/4" Bore; 91-03 1200 EVO Sportster
- C9138 3 13/16" Bore; 91-03 1200 EVO Sportster W / .040" MLS Head Gasket
- C9141 3 13/16" Bore; 91-03 1200 EVO Sportster W / .030" MLS Head Gasket
- C9219 3 13/16" Bore; 04-06 1200 EVO Sportster W / .040" MLS Head Gasket



Gaskets for Harley-Davidson®



Cometic Gasket - An Exclusive NASCAR Performance® Product

Complete • Top End • Rocker Box Kits & Individual Replacement Parts

Cometic Part #	OEM Part #	Description	Pkg. Qty.
----------------	------------	-------------	-----------

• Rocker Box Rebuild Gasket Kit

C9764	86-90 883, 1100, 1200 EVO Sportster
C9765	91-03 883, 1200 EVO Sportster
C9954	04-06 883, 1200 EVO Sportster
C9195	07-19 All Sportster Models

EVO SPORTSTER INDIVIDUAL REPLACEMENT GASKETS,SEALS, O-RINGS

• Rocker Cover Gaskets

C9196	17362-07	Outer Rocker Gasket all Sportster Models, 07-19 XL	2
C9197	17695-07	Inner Rocker Gasket all Sportster Models, 07-19 XL	2
C9198	17393-07	Rocker Breather Seal 07-19 XL	2
C9208	17353-89B	Outer Rocker Gasket all Sportster Models 04-06	2
C9400	611486	Rocker Cover Washer copper	10
C9286	63858-49	87- 05 Rocker Cover Washer Gasket	10
C9014	17353-86A	87-90 Lower Rocker Cover Gasket rubber	5
C9279	17353-86	86 Lower Rocker Cover cork	5
C9280	17353-89	91-03 Lower Rocker Cover Gasket rubber	5
C9010	17354-86A	87-90 Upper Rocker Cover Gasket rubber	5
C9275	17354-86	86 Upper Rocker Cover cork	5
C9276	17354-89	91-03 Upper Rocker Cover Gasket rubber	5
C9283	17358-84A	86-06 Center Rocker Cover Gasket rubber	10
C9707	17358-84	86-04 Center Rocker Cover Cork	5
C9865	16800-84	86-04 One piece rocker base gasket .020" rubber coaed steel	2
C9561	16778-97X	86-04 Lower Rckr Cover to Head / Right, .020" Rubber Coated Steel	5
C9563	16779-97X	86-04 Lower Rckr Cover to Head / Left, .020" Rubber Coated Steel	5
C9285	16778-84A	86-04 Lower Rckr Cover to Head / Right Gasket	5
C9284	16779-84B	86-04 Lower Rckr Cover to Head / Left Gasket	5
C9481	26856-89	91-03 Umbrella Valve Seal	10
C9224		S&S Outer Rocker Gasket w/ Breather Flapper	4
C9225		S&S Inner Rocker O-Ring Seal	8
C9226		S&S Rocker Cover Bolt Washer Seal	24

2004 SPORTSTER ROCKER BOXES ARE TWO PIECE AND DO NOT USE AN UPPER ROCKER RUBBER GASKET

• Head and Base Gaskets

C10003		XR1200 STD Bore MLS head gasket .040" , 2008-12	2
C10004		XR1200 3.812" Bore MLS head gasket .040", 2008-12	2
C10057		XR1200 3.875" Big Bore Head.030" & Base.020" Kit, 2008-12	Kit
C9205		Stock Bore 883 EVO's .040" MLS Design, 1986-19	2
C9688		Stock Bore EVO's 3.570" .030" MLS Design, 1986-19	2
C9689		Stock Bore EVO's 3.570" .040" MLS Design, 1986-19	2
C9690		3 5/8" Big Bore EVO's .030" MLS Design, 1986-19	2
C9691		3 5/8" Big Bore EVO's .040" MLS Design, 1986-19	2
C9694		3 3/4" Big Bore EVO's .030" MLS Design, 1986-19	2
C9695		3 3/4" Big Bore EVO's .040" MLS Design, 1986-19	2
C9692		3 13/16" Big Bore EVO's .030" MLS Design, 1986-19	2
C9693		3 13/16" Big Bore EVO's .040" MLS Design, 1986-19	2
C9287	26432-76A	86-05 Cylinder to Head Dowel O-ring	10
C9214	16774-86E	06-19 Cylinder Base Gasket, All Buell & Sportster .020" Embossed Rubber Coated Steel	2
C9553	16774-96	86-05 Cylinder Base Gasket, .020" Rubber Coated Steel	2
C9008	16774-86D	86-05 Cylinder Base Gasket, .020" Fiber	2
C9836		86-99 Valve Guide Seal Viton	25
C9153	18094-02	02-19 Valve Sterm Oil Seal Hat Style All Models Viton	25



Gaskets for Harley-Davidson®



Cometic Gasket - An Exclusive NASCAR Performance® Product

Complete • Top End • Rocker Box Kits & Individual Replacement Parts

Cometic Part #	OEM Part #	Description	Pkg. Qty.
• Pushrod O-Ring Kit			
C9143	91-03	Sportster Pushrod O-ring Kit	KIT
• Pushrod and Tappet Block Gaskets and O-rings			
C9955	17976	2004-19 Tappet block gasket	2
C9956	11377	2004-19 Lower pushrod tube O-ring	25
C9459	11132	86-90 Pushrod Tube O-ring Middle	25
C9293	11145	86-90 Pushrod Tube O-ring Lower	25
C9292	111157	86-90 Pushrod Tube O-ring Upper	25
C9448	11110	86-90 Tappet Screw O-ring	10
C9443	11167	86-90 Tappet Block O-ring Upper	25
C9444	11168	86-90 Tappet Block O-ring Lower	10
C9294	11190	91-19 Pushrod Tube O-ring Upper	10
C9295	17944-89	91-99 Pushrod Tube O-ring Lower	10
C9296	11176	91-99 Tappet Pin Cover O-ring - Anti Rotation Pin	10
• Intake and Exhaust Gaskets			
C9290	26995-86A	86-19 Intake Manifold to Head / Seal	10
C9088	27002-89	84-04 Intake Seal to Carb	1
C9719	65324-83	84-19 Exhaust Port Gasket Race Style	10
C9288	65324-83A	84-19 Exhaust Port Gasket Tapered Style	10
C9540		84-19 All Models Exhaust Extreme Performance	10
C9223		S&S Big Bore Manifold to Head Seal	4
• Cam Cover Gaskets			
C9355	11124-DL	86-99 Points Cover Seal Double Lip	5
C9306F	32591-80	86-99 Points Cover Gasket	10
C9311F5	25263-86	86-90 Cam Cover Gasket	10
C9313F5	25263-90B	91-03 Cam Cover Gasket	5
C9944F5	25263-90D	2004-19 Cam Cover Gasket	5
C10049F1	25262-90D	91-03 Sporty Cam Cover Gasket .060" AFM	1
C10049F5	25262-90D	91-03 Sporty Cam Cover Gasket .060" AFM	5
C10029F1	25279-08	2008-12 XR1200 Cam Cover Gasket	1
C10029F5	25279-08	2008-12 XR1200 Cam Cover Gasket	5
• Primary Cover Gaskets ,Seals			
C9125		2004-19 Sportster Complete Primary Rebuild	Kit
C9211		91-03 Sportster Complete Primary Rebuild	Kit
C9210		86-90 Sportster Complete Primary Rebuild	Kit
C9943F5	34955-04	2004-19 Primary Cover Gasket	5
C9957	34986-04	2004 -19 Chain Inspection Cover Gasket .060" AFM	5
C9435	11105	2004 -19 Primary drain plug O-ring	10
C9436	11171	86-19 Primary Inspection Cover Screw O-ring	10
C9447	11179	88-99 Clutch Cable O-ring	25
C9434	11187	91-93 Clutch Inspection Cover O-ring	10
C9439	11188	91-99 Inspection Cover O-ring	10
C9220	25463-94A	94-19 Clutch Cover O-ring	5
C9363	31433-84A	91-93 Sealing Washer	5
C9401	34624-77	77-90 Footpeg Stud Gasket	10
C9310F5	34955-75	77-90 Primary Cover Gasket, AFM60	5
C9314F5	34955-89A	91-03 Primary Cover Gasket, AFM60	5
C9943F5	34955-04	04-19 Sportster Primary Cover Gasket, AFM60	5
C9354	37101-84	86-UP Shifter Shaft Seal	1
C9353	35151-74	86-99 Motor Sprocket Shaft Seal	5
C9632	12068	2004-19 Motor Sprocket Shaft Seal	5
C9667	11289	2004-19 Crank Position Sensor O-ring	25



Gaskets for Harley-Davidson®



Cometic Gasket - An Exclusive NASCAR Performance® Product

Complete • Top End • Rocker Box Kits & Individual Replacement Parts

Cometic Part #	OEM Part #	Description	Pkg. Qty.
• Oil Pump and Related Gaskets,Seals, and O-rings			
C9376	12036A	86-90 Oil Pump Seal metal	5
C9449	26433-77	86-90 Oil Pump Check Valve O-ring	10
C9439	26434-76A	86-90 Oil Pump O-ring	10
C9437	26434-91	91-19 Oil Pump Cover O-ring	10
C9399F	26495-75	86-90 Oil Pump Gasket	10
C9315F	26495-89B	91-19 Oil Pump Gasket	10
C9961	11120	2004-19 Oil dipstick O-ring	5
C9962		2004-19 Oil jet assembly gasket	6
• Starter and Transmission Gaskets,Seals, and O-rings			
C9312F	31488-81B	86-UP Starter Gasket	10
C9362	12030	91-06 Main Drive Gear Seal	5
C9356	12049-DL	86-90 Transmission M/S Seal	5
C9359	12050	91-94 Transmission M/S Seal	1
C9262	12067A	95-04 Main Drive Gear Seal	1
C9361	11165	91-04 Main Shaft Quad Seal 5th Gear	10
C9460	11113	05-19 Main Shaft O-ring 5th Gear	5
C9215	12074	07-19 Main Shaft Seal	1

Iron Sportster®

Part #-C9292
Pushrod Cover O-Ring Upper
1984-85
Replaces: 111S7

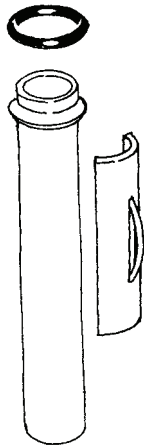

Part #-C9459
Pushrod Cover O-Ring
Middle 1979-85
Replaces: 11132

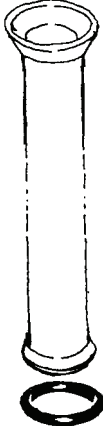

Part #-C9451
Lower & Top Pushrod O-Ring 1979-85
Replaces: 11101

Part #-C9595
Pushrod Cover Seal
Lower, Middle, Top Early 1979 XL, XLCH

Part #-C9451
Rocker Arm Shaft
O-Ring 1957-85
Replaces: 11101

Part #-C9602
Rocker Cover Gasket
1957-85
Replaces: 17536-70

Part #-C9365
Rubber Sleeve, Oil
Line 1957-85
Replaces 63529-57

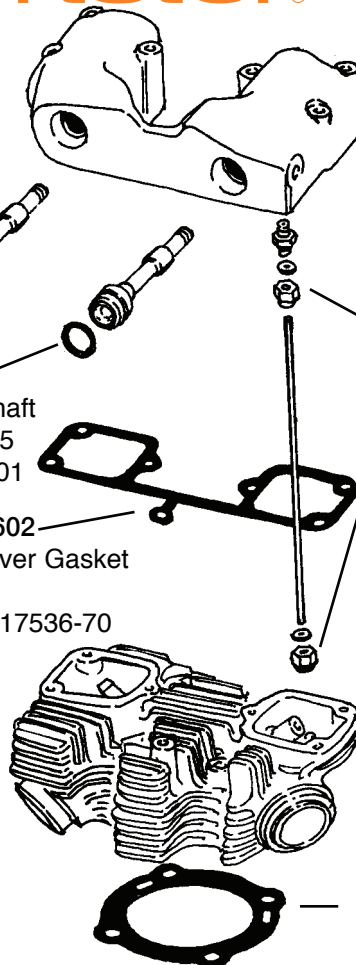

Part #-C9566
1000cc Head Gasket
.043" Copper
Late 1973-85
Replaces: 16769-82



Gaskets for Harley-Davidson®



Cometic Gasket - An Exclusive NASCAR Performance® Product

Complete • Top End • Rocker Box Kits & Individual Replacement Parts

Cometic Part #	OEM Part #	Description	Pkg. Qty.
----------------	------------	-------------	-----------

STANDARD MOTOR KITS FOR 900/1000 SPORTSTER

• Complete Gasket Kits for 900/1000 Sportster

C9045F	17026-71	1957-71 900 Sportster XL, XLH, XLCH	
C9047F	17026-72	1972-E73 1000 Sportster XLH, XLCH	
C9049F	17026-73L	1973-76 1000 Sportster XLH, XLCH	
C9051F	17026-79	1977-85 1000 Sportster XLH, XLCH, XLS Hi-Compression	
C9117F	17026-82	1982-85 1000 Sportster XLH, XL, XLS Low Compression, .063" Head Gaskets	

Kit contains .032" copper head gaskets and all of the necessary gaskets, seals and o-rings to rebuild the motor.
Base Gaskets are .031"

• Top End Gasket Kits for 900/1000 Sportster

C9102	17030-57	1957-71 900 Sportster XL, XLH, XLCH	
C9103	17030-72	1972-E73 1000 Sportster XLH, XLCH	
C9104	17030-72AL	1973-76 1000 Sportster XLH, XLCH	
C9052	17030-72B	1977-85 1000 Sportster XLH, XLCH, XLS Hi-Compression	
C9116	17030-82	1982-85 1000 Sportster XLH, XL, XLS Low Compression, .063" Head Gaskets	

Kit contains all of the necessary gaskets, seals and o-rings to rebuild the motor from the cylinder base up.
Head Gaskets are .032" copper except where noted and Base Gaskets are .031"

1957-85 XL IRONHEAD SPORTSTER INDIVIDUAL REPLACEMENT GASKETS,SEALS, O-RINGS

• Rocker Cover Gaskets

C9400	6114	86 Rocker Cover Washer copper	10
C9451	11101	57-85 Rocker Arm Shaft O-ring	10

• Rocker Cover Gaskets,Seals,and O-rings

C9448	11110	83-85 XR1000 Rocker Shaft O-ring	10
C9529	11115	83-85 XR1000 Rocker Arm Shaft O-ring	10
C9602	17536-70	57-85 Rocker Cover Gasket	10
C9365	63529-57	57-85 Rubber Sleeve, Oil Line	10

• Head and Base Gaskets

C9698	16769-72A	72-E73 1000cc Head Gasket , .020" Copper	10
C9565	16769-73	L73-85 1000cc Head Gasket , .032" Copper	10
C9566	16769-82	L73-85 1000cc Head Gasket , .043" Copper	10
C9699	16774-57	57-71 900cc Cylinder Base Gasket, .012" Fiber	10
C9603	16774-72	72-85 1000cc Cylinder Base Gasket, .031" Fiber	10

• Pushrod and Tappet Block Gaskets, O-rings

C10068		57-84 All Iron Sportsters Pushrod seal set	Kit
C9459	11132	79-85 Pushrod Cover O-ring (4) middle	25
C9292	11157	84-85 Pushrod Cover O-ring (4) upper	25
C9369	12023	83-85 XR 1000 Pushrod Cover Seal	5
C9598	17955-36	57-E79 Pushrod Cover Seal / cork	25
C9408	17955-36A	57-E79 Pushrod Cover Seal / rubber	100

• Intake and Exhaust Gaskets

C9608	27062-78	79-85 Intake Manifold to Head O-ring	10
-------	----------	--------------------------------------	----

• Cam and Timer Compartment Gaskets

C9355	11124DL	71-85 Timer Compartment Seal / double lip	5
C9325	32522-37	57-64 XL, XLH Timer Base Gasket	10
C9316F5	25224-52A	57-81 Cam cover Gasket, XR750	5
C9332	25263-81	82-85 Cam Cover Gasket	10
C9323	32591-70	71-78 Point Cover Gasket	10
C9306	32591-80	80-85 Ignition Cover Gasket	10



Gaskets for Harley-Davidson®



Cometic Gasket - An Exclusive NASCAR Performance® Product

Complete • Top End • Rocker Box Kits & Individual Replacement Parts

Cometic Part #	OEM Part #	Description	Pkg. Qty.
• Charging and Starting Gaskets			
C9433	11116	81-85 Starter Housing O-ring	25
C9701	31461-70	70-E79 Starter hole cover plate Gasket	10
C9324	31471-67A	67-80 Starter Housing Gasket	10
C9333	31488-77	67-80 Starter Housing Mount Gasket	10
C9312	31488-81	81-85 Starter Motor Gasket	10
C9702	60645-65	67-80 Solenoid Gasket	10
C9369	12023	68-69 XLCH Magneto Seal	5
C9327	29550-55	58-69 XLCH Magneto Cover Gasket	10
C9374	29603-48	58-E65 Magneto Seal	10
C9321	30143-58	58-E84 Generator Gasket	5
• Oil System Gaskets, O-rings and Seals			
C9376	12036A	77-78 / 83-85 Oil Pump Outer Plate Seal	5
C9404	24978-57	57-76 Oil Strainer Gasket	10
C9349	26227-58	L58-76 Oil Pump Oil Seal	5
C9390	26256-52	57-76 Oil Pump Gasket	10
C9385	26258-52	57-E62, 72-76 Oil Pump Outer Cover Gasket	10
C9389	26258-62	L62-71 Oil Pump Outer Cover Gasket	10
C9388	26259-52	57-E62, 72-76 Oil Pump Inner Cover Gasket	10
C9386	26259-62	L62-71 Oil Pump Inner Cover Gasket	10
C9287	26432-76A	77-85 Oil Pump Body O-ring	10
C9449	26433-77	77-85 Check Valve Oil Pump O-ring	10
C9445	26434-76A	77-85 Oil Pump Cover O-ring	10
C9399	26495-75	77-85 Oil Pump Gasket	10
C9286	63858-49	71-85 Oil Level Screw Gasket	10
• Primary, Clutch, and Transmission Gaskets, Seals, and O-rings			
C9446	11139	L78-85 Primary Filler Cap O-ring	10
C9317F5	34952-52	XR750, 58-69 XLCH Primary Cover Gasket AFM .060"	5
C9318F5	34955-67	67-76 XLH, 70-76 XLCH Primary Cover Gasket AFM .060"	5
C9703	34955-67A	67-76 XLH, 70-76 XLCH Primary Cover Gasket .031"	5
C9326	60567-36	36-64 FL, FLH 58-69 XLCH Inspection/Chain Cover .125" Cork	10
C9326F	60567-36	36-64 FL, FLH 58-69 XLCH Inspection/Chain Cover .125" Cork	5
C9326F1	60567-36	36-64 FL, FLH 58-69 XLCH Inspection/Chain Cover .060" AFM	1
C9326F5	60567-36	36-64 FL, FLH 58-69 XLCH Inspection/Chain Cover .060" AFM	5
C9458	11103	L57-66 XLH, 57-69 XLCH Clutch Gear O-ring	10
C9310F5	34955-75	77-90 Sportster Primary Cover Gasket AFM .060"	5
C9455	11119	67-70 XLH, 70 XLCH Clutch Gear O-ring	25
C9367	12021	67-70 XLH, 70 XLCH Clutch Gear Oil Seal	5
C9364	37339-53	57-70 Release Rod Oil Seal	10
C9368	37531-56B	57-66 XLH, 57-69 XLCH Clutch Gear Seal	5
C9371	37740-57	L57-66 XLH, 57-69 XLCH Clutch Shell Seal	5
C9513	37741-67	67-70 XLH, 70 XLCH Clutch Shell Seal	5
C9319	37762-52	57-70 Clutch Cover Gasket	10
C9374	33076-37	57-79 Kicker Shaft Seal	10
C9370	34035-52	57-85 Shifter Shaft Seal	5
C9401	34624-77	77-85 Left Footrest Stud Boss Gasket	10
C9356	12049DL	L84-85 Transmission Mainshaft Seal	5
C9366	35151-52A	57-E84 Trans Mainshaft Seal, 57-E74 Sprocket Shaft	5
C9353	35151-74	L84-85 Trans Mainshaft Seal, L74-85 Motor Sprocket Shaft	5



Gaskets for Harley-Davidson®



Cometic Gasket - An Exclusive NASCAR Performance® Product

Rotax 600 Gaskets

Part #	Description
C9500.....	Head and Base Only, Long Stroke, 3.860" Bore Supplied with .010 and .020 Copper Base Gasket (4.120" Sleeve Dia)
C9501.....	Head and Base Only, Long Stroke, 3.908" Bore Supplied with .010 and .020 Copper Base Gasket (4.120" Sleeve Dia)
C9504.....	.005 Copper Base Gasket
C9502.....	.010 Copper Base Gasket
C9505.....	.016 Copper Base Gasket
C9503.....	.020 Copper Base Gasket
C9589.....	Ignition Cover Gasket
C9590.....	Clutch Cover Gasket

Rotax 250 Gaskets

Part #	Description
C9591.....	Center Case Gasket
C9592.....	Clutch Cover Gasket
C9593.....	Intake Gasket
C9594.....	Base Gasket .020" Kevlar Fiber

Polaris Victory V92C Head & Base Gaskets

Part #	Description
C8652.....	97mm Head Gasket (1 Pair) / 754cc
C8653.....	101mm Head Gasket (1 Pair) / 817cc

Cometic MLS Head Gasket Instructions for Harley Davidson Evolution & Twin Cam applications

NOTE: DO NOT USE THE CYLINDER HEAD ALIGNMENT DOWEL O-RING WHEN USING AN MLS GASKET.

NOTE: COMETIC GASKET RECOMMENDS THE HEAD BOLTS BE SET AT A FINAL TORQUE OF 42FT-LBS.

1. Check all gasket surfaces for flatness and imperfections, an excessively rough finish may cause gasket failure. A 50RA surface is recommended.
2. Check all hardware for defects, clean all threads and lubricate with light machine oil. Including the underside flange of the head bolts. (Wipe away any excess.)
3. There are two short and two long head bolts. The short go on the spark plug side while the long go on the pushrod side.
4. Before installing the head, place the head gasket on the cylinder and locate the gasket using the cylinder head alignment dowels (NOTE: The gasket is embossed around the dowel area and the dowel holes are smaller. Do not use dowel alignment o-rings with an MLS gasket.)
5. Once the gasket is located in place make sure the gasket fits your bore. The gasket should not hang in the bore or combustion chamber in any area.
6. If using a head or cylinder other than stock, check brass rivet location to ensure the rivet does not interfere with the sealing surface in any way. Some aftermarket castings are substantially larger than stock castings and may interfere. Simply remove the brass rivets, "side cutters work well".
7. Once proper fitment is established proceed with head installation and torque. (NOTE: See illustration for sequence.)
8. Alternately snug all the head bolts finger tight.
9. In sequence tighten all head bolts to 9 ft-lbs. Then in sequence tighten all head bolts to 14 ft-lbs. Again in sequence tighten all head bolts to 22 ft -lbs. Then in sequence tighten all head bolts to 35 ft-lbs and finally torque all head bolts to a final torque of 42ft-lbs in sequence.

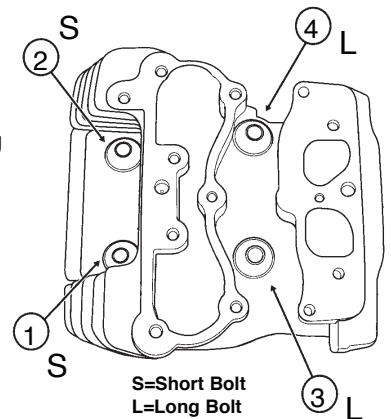

Note: Failure to comply with any or all of these instructions may result in premature failure of the head and or base gasket.

Note: All Panhead, Shovelhead & Iron Sportster models use factory specs when using an MLS head gasket.



Karting Gaskets



Cometic Gasket - An Exclusive NASCAR Performance® Product

BRIGGS & STRATTON

Model	Year	Bore Size	Top End Kit #	List Price	Component #	Component Description	OEM Part #
5HP RAPTOR	All	68.5MM	C104		H0694043F	68.5mm Bore Head Gasket Comp. Fiber	
					IR081047F	Intake Gasket (1.400" Spacing)	
		IR084015F			Carburetor Mount Gasket Tillotson		
		IR085125KF			Intake Gasket (1.800" Spacing)		
		EX113020C			Exhaust Gasket Copper		
		EX113042AM			Exhaust Gasket Fiber		
		CB021060F			Fuel Tank Mounting Gasket		
		CB023015R			Carburetor Diaphragm Gasket		
		EC102047F			Breather Cover Gasket		
		EC103015F			Side Cover Gasket .015"		
EC103020F	Side Cover Gasket .020"						

• Suggested Oil: Klotz KL-870

ANIMAL	All	69.5MM	C187		H3590040S	69.5mm Head Gasket Multi-Layer Steel	555698	
					70.5MM	C200	H3590SP1040S	70.5mm Head Gasket Multi-Layer Steel
		• Suggested Oil: Klotz KL-870			IR786060AFM	Intake Gasket	691885	
					EC1424060AFM	Cylinder Head Plate Gasket	694088	
					EC1426060AFM	Breather Cover Gasket	691890	
					EC1425032AFM	Side Cover Gasket	699485	

LO206	All	69.5MM	C199		H3590SP2060HTS	69.5mm Head Gasket Graphite	555723
					IR786060AFM	Intake Gasket	691885
					EC1424060AFM	Cylinder Head Plate Gasket	694088
					EC1426060AFM	Breather Cover Gasket	691890
					EC1425032AFM	Side Cover Gasket	699485

• Suggested Oil: Klotz KL-870

WORLD FORMULA	All	69.5MM	C188		H3590040S	69.5mm Head Gasket Multi-Layer Steel	555698
					IR1376015F	Intake Gasket	557044
					EX1676059F	Exhaust Gasket	691893
					EC1424060AFM	Cylinder Head Plate Gasket	694088
					EC1426060AFM	Breather Cover Gasket	691890
					EC1425032AFM	Side Cover Gasket	699485

• Suggested Oil: Klotz KL-870

HONDA

Model	Year	Bore Size	Top End Kit #	List Price	Component #	Component Description	OEM Part #
GX200 CLONE	All	68MM	C192		H3096010S	68mm Head Gasket	
					IR836020F	Intake Gasket	
					CB307020F	Carburetor Flange Gasket	
					IR1381094KF	Air Filter Adapter Gasket	
					EX1033042AM	Exhaust Gasket	
					VC207047KF	Valve Cover Gasket	
					EC1453020F	Side Cover Gasket	

• Suggested Oil: Klotz KL-870

STOCK SHIFTER CR125	97-99	55MM	C189		H0225010S	55mm Head Gasket	12251-KZ4-A91
					B0314018AFM	Base Gasket	12191-KZ4-L10
					B0009018AFM	Base Gasket '97 Cylinders Only	2191-KZ4-860
					IR003018AFM	Intake Reed Gasket	14132-K56-701
					EX006042AM	Exhaust Gasket	18291-KZ4-700
					PV001018AFM	Right Power Valve Gasket	12108-KZ4-700
					PV002018AFM	Left Power Valve Gasket	12109-KZ4-700
					PV003018AFM	Upper Power Valve Gasket	12112-KZ4-700
					R19X3V	Water Outlet O-ring	91312-KE7-003

• Suggested Oil: Klotz KL-104

STOCK SHIFTER CR125	00	54MM	C190		H0928010S	54mm Head Gasket	12251-KZ4-A91
					B0314018AFM	Base Gasket	12191-KZ4-L10
					IR003018AFM	Intake Reed Gasket	14132-K56-701
					EX006042AM	Exhaust Gasket	18291-KZ4-700
					PV091032AFM	Power Valve Gasket	12108-KZ4-A90
					R19X3V	Water Outlet O-Ring	91312-KE7-003

• Suggested Oil: Klotz KL-104

STOCK SHIFTER CR125	01-02	54MM	C191		H0928010S	54mm Head Gasket	12251-KZ4-A91
					B0490018AFM	Base Gasket	12191-KZ4-L10
					EX006042AM	Exhaust Gasket	18291-KZ4-700
					IR003018AFM	Intake Gasket Reed To Carb Boot	14132-K56-701
					PV091032AFM	Power Valve Gasket	12108-KZ4-A90
					R124S	Expansion Cham O-Rings (2 Req.)	
					R19X3V	Water Outlet O-Ring	91312-KE7-003

• Suggested Oil: Klotz KL-104



Karting Gaskets



Cometic Gasket - An Exclusive NASCAR Performance® Product

HONDA

Model	Year	Bottom End Kit #	Component #	Component Description	OEM Part#
STOCK SHIFTER CR125	97-02	C189BE	EC083032AFM	Inner Clutch Cover Gasket	11394-KZ4-A90
			EC185020F	Center Case Gasket	11191-KZ4-620
			EC228	Clutch Cover Gasket	91311-KS6-700
			EC510060AFM	Magneto Cover Gasket	11352-KS6-700
			IR003018AFM	Intake Gasket	14132-KY4-970
			WP033018AFM	Water Pump Gasket	19229-KZ-620
			R16X3V	Fill Plus O-Ring	91303-800-000
			R20X2V	Output Shaft O-Ring	94109-12000
			WA133	Water Pump Drain Plug Gasket	90543-273-000
			WA117	Drain Plug Gasket	94109-12000

IAME

Model	Year	Bore Size	Top End Kit #	Component #	Component Description	OEM Part #
MINI SWIFT	All	41.8MM	C193	H4377005C	Head Gasket .005"	A-61049
				B1358015F	Base Gasket	EBP-85045
				IR1380020F	Intake Gasket	A-61822
				EX1684059F	Exhaust Gasket	A-61360
				WA146	Copper Washer	
LEOPARD	08-Later	54MM	C194	R143V	Inner Head O-Ring	DBP-95049
				R249B	Outer Head O-Ring	B-25820
				R8X1.5V	Stud O-Ring (4 Req.)	B-25825
				B1354015F	Base Gasket	BP-25045
				IR1370032AFM	Intake Manifold Gasket	11810
				IR1371031F	Intake Reed Block Gasket	11805-A
				CB456039F	Carburetor Gasket	10360-A
				EX1674059F	Exhaust Gasket	B-85360
				WA082063C	Temp Sensor Washer	B-25845
				LEOPARD MY09	All	54MM
R249B	Outer Head O-Ring	B-25820				
R8X1.5V	Stud O-Ring (4 Req.)	B-25825				
B1213015F	Base Gasket	EBP-125045				
IR1368031F	Intake Manifold Gasket	F-11810				
IR1369031F	Intake Reed Block Gasket	F-11805				
CB456039F	Carburetor Gasket	10360-A				
EX1674059F	Exhaust Gasket	B-85360				
WA082063C	Temp Sensor Washer	B-25845				
X30	All	54MM	C196			
				R246B	Outer Head O-Ring	F-38820
				R8X1.5V	Stud O-Ring (4 Req.)	B-25825
				B1213015F	Base Gasket .015"	EBP-125045
				IR1369031F	Intake Manifold Gasket	F-11805
				IR1368032AFM	Intake Reed Block Gasket	X30125810
				CB456039F	Carburetor Gasket	10360-A
				EX1673059F	Exhaust Gasket	B-75360
				WA213043C	Temp Sensor Washer	B-25845
				WA214050C	Water Pipe Washer	B-25835
				EC2206032AFM	Magneto Cover Gasket	X30125878
				R329B	Magneto Damper O-Ring	X30125853

PRD

Model	Year	Bore Size	Top End Kit #	Component #	Component Description	OEM Part #
PRD FIREBALL	All	54MM	C197	R143V	Inner Head O-Ring	9012555
				R249B	Outer Head O-Ring	9011555
				R015V	Stud O-Ring (4 Req.)	9024555
				B1355012F	Base Gasket	9057555A
				IR1374020F	Intake Manifold Gasket	9101555
				IR1375020F	Intake Reed Block Gasket	9100555
				CB457020F	Carburetor Gasket	9107555
				EX1675064AM	Exhaust Gasket	9021555



Karting Gaskets



Cometic Gasket - An Exclusive NASCAR Performance® Product

ROTAX

Model	Year	Bore Size	Top End Kit #	List Price	Component #	Component Description	OEM Part #
FR125 MAX EVO	All	54MM	C198		R037V	Inner Head O-Ring	250 160
					R155B	Outer Head O-Ring	250 280
					R118B	Spark Plug O-Ring	430 782
					B1356012F	Base Gasket .012"	650 480
					B1356015F	Base Gasket .015"	650 481
					B1356020F	Base Gasket .020"	650 482
					B1356031F	Base Gasket .031"	650 483
					IR1377031F	Intake Manifold Gasket	250 521
					EX1677059F	Exhaust Gasket	250 271
					PV154031F	Power Valve Gasket	250 231

• Suggested Oil: Klotz KL-104

YAMAHA

Model	Year	Bore Size	Top End Kit #	Component #	Component Description	OEM Part #
KT100	All	54MM	C134	H0524032C	Head Gasket	
				B0308015F	Base Gasket	
				CB030015F	Intake Carb Spacer (2 Req.)	
				CB031015F	Intake Manifold to Carb Gasket	
				EX131	Exhaust Gasket	
				EC181012F	Center Case Gasket	

• Suggested Oil: Klotz KL-104

YF200R1	All	71MM	C184	H1795036S	Head Gasket Multi-Layer Steel	F21-304-30
				IR369018AFM	Intake Gasket	F21-310-00
				EX476042AM	Exhaust Gasket	F21-309-00
				EC758018AFM	Tillostson Flange Gasket	F21-318-00
				EC759020RC	Side Cover Gasket	F21-317-00
				VC076060AFM	Valve Cover Gasket	F21-314-00
				VC077032AFM	Valve Cover Baffle	F21-315-00

• Suggested Oil: Klotz KL-870



Karting Gasket Illustrations

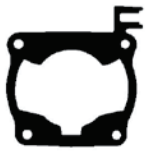

B0009018AFM



B0308015F



B0314018AFM



B0490018AFM



B1213015F



B1354015F



B1355012F



B1356012F



B1358015F



CB021060F

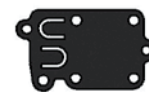

CB023015R



CB030015F



CB031015



CB307020F



CB456039F



CB457020F



EC083032AFM



EC102047F



EC103015F



EC103020F



EC181012F



EC185020F



EC510050AFM

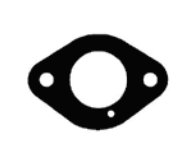

EC758018AFM

Karting Gasket Illustrations



EX1675064AM



EX1676059F



EX1677059F



EX1684059F



H0225010S



H0694043F



H0928010S



H1795036S



H3096010S



H3590040S



H4377005C



IR003018AFM



IR081047F



IR084015F



IR085125KF



IR369018AFM



IR786060AFM



IR836020F



IR836029F



IR1368031F



IR1369031F

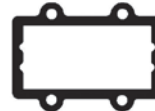

IR1370032AFM



IR1371031F



IR1374020F



IR1375020F



IR1376015F



IR1377031F



IR1380020



IR1381094KF



PV001018AFM



PV002018AFM



PV003018AFM



PV091032AFM



PV154031F



VC076060AFM



VC077032AFM



VC207047KF



EC759020RC



EC1424060AFM



EC1425032AFM



EC1426060AFM

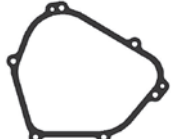

EC1453020F



EC2206032AFM



EX1576SP1



EX006042AM



EX476042AM



EX1033042AM



EX1673059F



EX1674059F



Klotz Synthetic Lubricants are designed and engineered to be the best lubricants in the motorsports industry. Race tested and formulated for all engine types, Klotz offers a full line of Estorlin Synthetic Racing Oils, Power Additives, and Aerosols needed to keep you engine protected and performing at an optimal level. Racers, engine builders, and performance enthusiasts around the world rely on Klotz to get them to the checkered flag. Be Fast, Be First with Klotz Synthetic Lubricants.

2-STROKE LUBRICANTS Available Individually, Case, 30 gal. & 55 gal. drum



SUPER TECHNIPLATE®

Part#	Description
KL-103-1	1 Pint Bottle
KL-100-1	1 Quart Bottle
KL-109-1	1/2 Gallon Bottle
KL-101-1	1 Gallon Bottle

ORIGINAL TECHNIPLATE®

Part#	Description
KL-200-1	1 Quart Bottle
KL-205-1	1 Gallon Bottle

BeNOL® RACING CASTOR LUBRICANT

Part#	Description
BC-175-1	1 Pint Bottle
BC-172-1	1 Quart Bottle
BC-179-1	1/2 Gallon Bottle
BC-171-1	1 Gallon Bottle

MOTORCYCLE TECHNIPLATE® TC-2

Part#	Description
KL-300-1	1 Quart Bottle
KL-301-1	1 Gallon Bottle

R-50® RACING TECHNIPLATE®

Part#	Description
KL-102-1	1 Pint Bottle
KL-104-1	1 Quart Bottle
KL-105-1	1 Gallon Bottle

MOTORCYCLE TECHNIPLATE® TC-W3

Part#	Description
KL-302-1	1 Quart Bottle

50:1 TECHNIPLATE® TC-W3

Part#	Description
KL-305-1	1 Pint Bottle
KL-304-1	1 Quart Bottle

SKICRAFT® TECHNIPLATE®

Part#	Description
KL-306-1	1 Quart Bottle
KL-307-1	1 Gallon Bottle

RACING SYNTHETIC FORK & SHOCK FLUID

Part#	Description
KL-505-1	1 Quart Bottle 5W
KL-515-1	1 Quart Bottle 10W
KL-515-1	1 Quart Bottle 15W

4-STROKE LUBRICANTS Available Individually, Case, 30 gal. & 55 gal. drum



ATV/UTV SYNTHETIC ENGINE LUBRICANT

Part#	Description
ATVUTV-040-1	0W/40 1 Qt. Bottle
ATVUTV-550-1	5W/50 1 Qt. Bottle

ATV/UTV SYNTHETIC ENGINE LUBRICANT WITH INTEGRATED TRANSMISSION

Part#	Description
ATVUTV-1040-1	10W/40 1 Qt. Bottle

MX4® TECHNIPLATE®

Part#	Description
KL-860-1	10W/40 1 Qt. Bottle
KL-870-1	10W/30 1 Qt. Bottle
KL-880-1	15W/50 1 Qt. Bottle

MOTORCYCLE TECHPLATE® WITH INTEGRATED TRANSMISSION

Part#	Description
KL-815-1	15W/50 1 Qt. Bottle
KL-830-1	10W/30 1 Qt. Bottle
KL-840-1	10W/40 1 Qt. Bottle
KL-850-1	20W/50 1 Qt. Bottle

SIDE X SIDE SYNTHETIC ENGINE LUBRICANT

Part#	Description
KL-802	5W/50 1 Qt. Bottle
KL-805	10W/50 1 Qt. Bottle
KL-803	10W/30 1 Qt. Bottle
KL-806	15W/50 1 Qt. Bottle

PURE ESTORLIN® MARINE

Part#	Description
KE-330	10W/30 1 Qt. Bottle
KE-331	10W/30 1 Gallon Bottle
KE-340	25W/40 1 Qt. Bottle
KE-341	25W/30 1 Gallon Bottle
KE-334	10W/40 1 Qt. Bottle
KE-335	10W/30 1 Gallon Bottle

PURE ESTORLIN® KART LUBRICANT

Part#	Description
KE-220-1	1 Quart Bottle 0W/20
KE-230-1	1 Quart Bottle 0W/30
KE-240-1	1 Quart Bottle 0W/40
KE-225-1	1 Quart Bottle 5W/20



TRANSMISSION GEAR LUBE

Part#	Description
KH-GL90-1	80W/90 1 Qt. Bottle
KH-GL140-1	75W/140 1 Qt. Bottle

GEAR AND CHAIN CASE LUBRICANT

Part#	Description
KH-S80-1	1 Qt. Bottle

PRIMARY CASE LUBRICANT

Part#	Description
KH-C80-1	1 Qt. Bottle



MULTI-VISCOSITY SYNTHETIC ENGINE LUBRICANT

Part#	Description
KH-1040-1	10W/40 1 Qt. Bottle
KH-2050-1	20W/50 1 Qt. Bottle
KH-2560-1	25W/60 1 Qt. Bottle
KV-2040-1	20W/40 1 Qt. Bottle
KV-1560-1	5W/60 1 Qt. Bottle

STRAIGHT WEIGHT SYNTHETIC ENGINE LUBRICANT

Part#	Description
KH-50-1	SAE 50 1 Qt. Bottle
KH-60-1	SAE 60 1 Qt. Bottle
KH-70-1	SAE750 1 Qt. Bottle

LUBES

	Part#	Size
ATV/UTV Front/Rear End	ATV/UTV-8090-1	1 qt
Differential Lube		
Flex Drive® 30 Transmission Lubricant.....	KL-506-1	1 qt
Chain Case Lube	KL-500-1	12.oz
Chain Lube Aerosol.....	KL-605-1	15.25oz
KLR® Clean Chain Lube.....	KL-611-1	16oz
Jet Pump Lube.....	KL-511-1	4oz.



ADDITIVES & AEROSOLS

	Part#	Size
Assembly Lube	KL-311-1	12oz
Fogon - Storage & Afterrun Lubricant	KL-610-1	16oz
Foam Air Filter Oil	KL-606-1	15.25oz
Fabric Air Filter Oil	KL-607-1	15.25oz
Filter Cleaner.....	KL-608-1	15.25oz
Plug & Contact Cleaner.....	KL-609-1	12.5oz
Ethanol Gasoline Fazeseparation Treatment	KL-603-1	16oz.
	KL-623-1	1gal.
Storbilizer	KL-613-1	16oz.
	KL-633-1	1gal.
Cometic Engine Block & Head Surface Cleaner.....	C1047-1	15.25oz
Octane Booster.....	KL-602-1	16oz.
	KL-628-1	1gal.



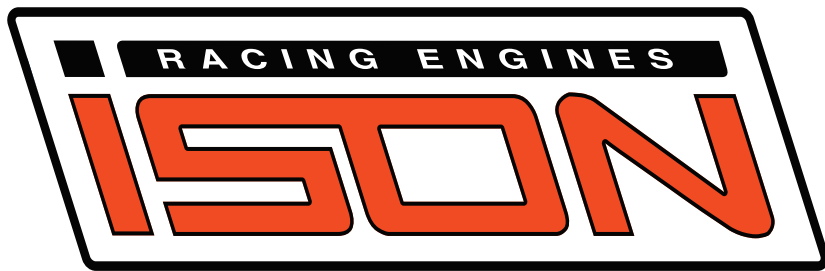

Ison is a full service performance engine builder, serving the powersports and automotive industries.

Ison provides precision workmanship by our experienced staff for everything from complete engine builds and dyno testing, to component machining and assembly.

Outfitted with the finest equipment including Sunnen hones, Kwik-Way boring bars, Serdi seat cutters, and Haas 5-axis CNC mills, close tolerance machining and repeatability can be expected. To complete our expansive list of services, we have added engine dyno testing which is made possible by our new in-house Superflow 902S dyno.

Our extremely clean state-of-the-art facility is a testament to our principles and dedication to quality when working on your power plant.

NEW! Superflow 902S Engine Dyno

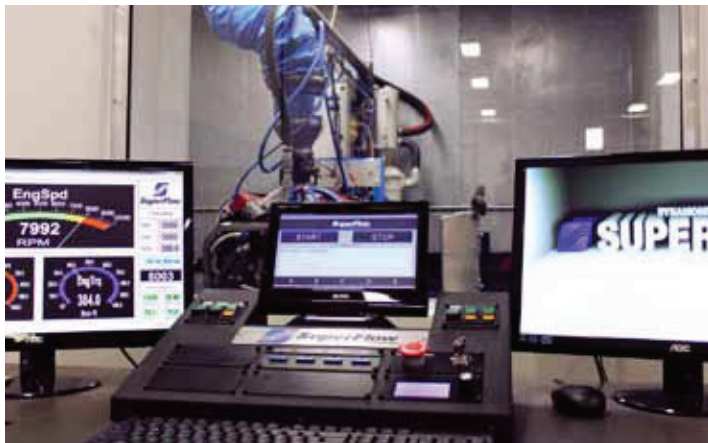

Ison Services

Automotive Services

- Resurfacing and Square Decking
- Align Honing
- Boring and Sleeving
- Diamond Honing
- Dynamic Balancing
- Cylinder Head Reconditioning
- Standard and Radius Valve Job Capability
- Port Machining
- Valve Guide Reconditioning
- Valve Seat Repair
- Complete Engine Builds
- Engine Dyno Testing

Powersports and V-Twin Services

- 2 and 4 Stroke Cylinder Sleeving
- Port Matching
- Boring and Honing
- Case Boring
- Complete Cylinder Head Service



Engine Services

Cylinder Boring & Honing

Part#	Description
CB2	2 Cycle / Per Hole up to 1mm over
CB4	4 Cycle / Per Hole up to 1mm over
CB4SC ..	4 Cycle, Briggs, Kohler per hole
CB4M ...	4 Cycle up to 2mm over
CB4	4 Cycle / Per Hole up to 1mm over

Cylinder Honing

Part#	Description
CH2	2 Cycle / Deglaze Per Hole
CH4	Cycle / Deglaze Per Hole
CH2M ...	2 Cycle Hone Multiple Holes 3 & 4 Cyl. Blocks
CH4M ...	4 Cycle Hone Multiple Holes 3 & 4 Cyl. Blocks

Cylinder Resleeving

Part#	Description
CS2.....	Most 2-Cycle w/o Power Valve (Labor only Sleeve price not included)
CS2V	Most 2-Cycle w/ Power Valve (Labor only Sleeve price not included)
CS4.....	Most 4-Cycle drop in /per hole (Labor only Sleeve price not included)
CS4B	Most 4-Cycle where cylinder must be bored to accept a larger sleeve/ per hole (Labor only Sleeve price not included)
CS4C	4-Cycle where extensive machining is req. 3mm or larger / Liquid cooled Big Bore (Labor only sleeve price not included per hole)
CS2B	2-Cycle big bore resleeve without power valve
PMTS....	Port match thick sleeve 2-Cycle installation TRX,Blaster,Banshee, etc, per cylinder
PMPC ...	Port match 2 stroke sleeve to ported cylinder, starting at

Additional Services

Part#	Description	List
CO4	O-Ring 4-Cycle Block / per hole	
GSKTM..	Gasket Removal Multiple Cylinder	
GSKTS..	Gasket Removal Single Cylinder	
HC	Heli Coil / Per Hole	
SR.....	Remove Cylinder Head Stud	
LH.....	Additional Labor (Per Hour)	
BB	Bead Blast (Single Cylinder)	
PVA	Re-assemble Power Valve Complete	
PVR	Power Valve Removal	
PMRP	Port Match Sleeve to existing ported cylinder	
CHP	2-Cycle cylinder head polish	
CRC.....	2-Cycle chamber recut / squish	

MONO Block

Part#	Description
MBCB4 .	4-Cycle bore and hone per hole
MBJW	Jet wash block * req. with any block
MBCS4..	Sleeve install (labor only) per hole
MBD	Deck block

4-Cycle Head Services

Part#	Description
VJ2VS ..	Valve Job 3 angle - 2 Valve Single Cylinder Head (Disassembly, Inspection, Valve Job, Reassembly complete w/New Valve Stem Seals)
VJ4VS ..	Valve Job 3 angle - 4 Valve Single Cylinder Head (Disassembly, Inspection, Valve Job, Reassembly complete w/New Valve Stem Seals)
VJ5VS ..	Valve Job 3 angle - 5 Valve Single Cylinder Head (Disassembly, Inspection, Valve Job, Reassembly complete w/New Valve Stem Seals)
VJM	Valve 3 angle - Multi Cyl. Head (ea)
VJOR....	Valve Job +1mm/2mm Oversize Radius (ea)
VGRR ...	Valve Guide (removal, replace, resize, (guide not incl.)
VSRR....	Valve Seat removal, replace, recut (seat not incl.)
CDH.....	Deck Cyl. Head/Base Single Head
CHHI.....	Deck Cylinder Inline
VJOHC .	Where camshaft and rockers are integral to the head like Yamaha Rhino, Grizzly,Wolverine and most utility quads. Dissassembly, valve job, cleaning, assembly . and lash to spec
VJ400 ...	Includes everything in a VJ4VS but specs to TRX400EX
SBVL....	Lash shim over bucket cylinder head 4 valve

V-Twin Cylinder Services

Part#	Description
HDHP ...	Hone Pan/Shovelhead (ea.)
HDH	Hone Evo & Twin Cam w/torque plates (ea.)
HDBP ...	Bore & Hone Pan/Shovelhead (ea.)
HDCB ...	Bore & Hone Evo/Twin Cam (ea.) w/torque plates
HDCBB.883 to 1200 Big Bore Conversion (ea.)	
HDDC ...	Deck Cylinder Evo & Twin Cam (ea.)
HDS58 ..	Sleeve Evo & Twin Cam Cyl., labor only (ea.)
HDCBM	Multi pass Bore & Hone Evo & T/C w/torque plates (ea.)

V-Twin Engine Case Services

Part#	Description	List
HDC58...	Bore Cases for Big Bore Cylinders (both holes)	
HDSR	Remove studs Evo & Twin Cam (8 studs)	
HDHT.....	Hot Tank Clean Engine Cases	

V-Twin Engine Head Services

Part#	Description
HDCVJ .	Complete Valve Service (per head)
HDCVS .	Cut Valve & Seat (ea.)
HDIS	Install Seat (ea.)
HDIG.....	Install Guide (ea.)
HDRH ...	Resurface Head (ea.)

4-Cycle Head Services

Part#	Description
VJ2VS ..	Valve Job 3 angle - 2 Valve Single Cylinder Head (Disassembly, Inspection, Valve Job, Reassembly complete w/New Valve Stem Seals)
VJ4VS ..	Valve Job 3 angle - 4 Valve Single Cylinder Head (Disassembly, Inspection, Valve Job, Reassembly complete w/New Valve Stem Seals)
VJ5VS ..	Valve Job 3 angle - 5 Valve Single Cylinder Head (Disassembly, Inspection, Valve Job, Reassembly complete w/New Valve Stem Seals)
VJM	Valve 3 angle - Multi Cyl. Head (ea)
VJOR....	Valve Job +1mm/2mm Oversize Radius (ea)
VGRR ...	Valve Guide (removal, replace, resize, (guide not incl.)
VSRR....	Valve Seat removal, replace, recut (seat not incl.)
CDH.....	Deck Cyl. Head/Base Single Head
CHHI.....	Deck Cylinder Inline
VJOHC .	Where camshaft and rockers are integral to the head like Yamaha Rhino, Grizzly,Wolverine and most utility quads. Dissassembly, valve job, cleaning, assembly . and lash to spec
VJ400 ...	Includes everything in a VJ4VS. but specs to TRX400EX
SBVL....	Lash shim over bucket cylinder head 4 valve

Marine Engine Services

Part#	Description
CS2MPH...	2-Cycle resleeve power head per hole
CS4MPH...	4-Cycle resleeve power head per hole
CH4MPH ..	4-Cycle hone power head per hole
CH2MPH ..	2-Cycle hone power head per hole
CB4MPH ..	4-Cycle bore & hone power head. per hole
CB2MPH	2-Cycle bore, hone, champer power head per hole
DMPHI	Deck inline power head
DMPHV.....	Deck v style power head per side
MPHJW	Jet wash block req. with any block



Product Development



Cometic Gasket - An Exclusive NASCAR Performance® Product

Cometic provides our customers with quality products, born of exhaustive research and development. Cometic's Superflow 902S dynamometer positions us at the forefront of gasket design and technology. Our state-of-the-art testing facilities and processes provide Cometic with the resources necessary to analyze gasket designs and materials in the most extreme conditions, ensuring that your gasket won't fail when you need it the most.

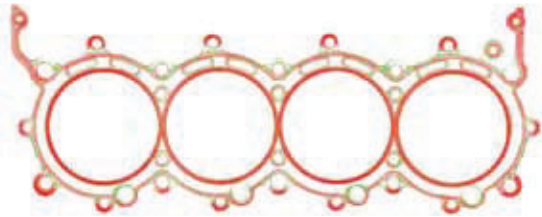

Gasket contact pressure is validated by Fuji film at our in-house research and development center.

Promotional Items



Part #	Description
DC15.....	Package Decal 5.25" x 1.75"
DC06.....	Decal Sheet 5.5" x 8.5"
DC10.....	Embroidered Patch 2" x 5"
DC04.....	Trailer Decal 6" x 19"
DC03.....	Decal 3.125" x 9"
DC11.....	Banner 3' x 8'
DC17.....	StreetPro Decal 1.625" x 9"
DC13.....	Dealer Open House Kit
	(100) DC01, (2) DC04, (2) DC11, (2) DC12,
	(10) 40% Off Retail Certificates, (25) Catalogs
DC12.....	Adjustable Embroidered Hat



Made in the U.S.A.

OEM Production

One Source for Prototyping to Full Production

- Prototyping with economical tooling options.
- Full production Capabilities
- Quick turnaround
- In-house tool & die capabilities
- ISO 9001:2008 Certified
- We can assist in developing a sealing solution for nearly any environment.
- Personal attention by our dedicated staff. We currently supply production to many customers in the automotive, marine, powersports, industrial, and power generator industries.
- Stamping, Laser Cutting, Rubber Injection Molding and 5 Axis Machining

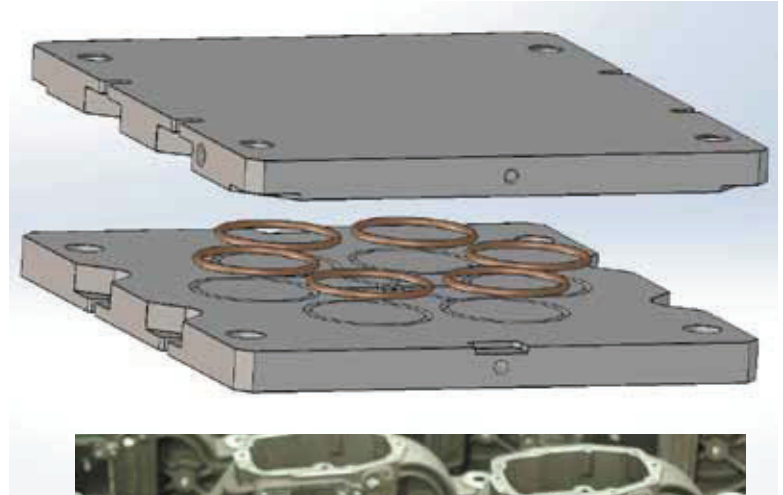

Flexibility is Key

We understand many variables go into determining design, volume, and production forecasts. We are accustomed to working in an ever changing environment.

Maintain knowledge base and part awareness during the transition from the early stages of development all the way through production, without the hassle of changing suppliers.

Inventory turns are important. We can work together for a delivery solution that best fits your inventory level and cash flow needs.

