



2015 CATALOG

ACCESSORIES AND UPGRADES FOR JEEP® ENTHUSIASTS





Crown Automotive Sales Co., Inc. / RT Off-Road is not affiliated with FCA US, LLC. Jeep® is a registered trademark of FCA US, LLC.

Wrangler,™ Cherokee,™ Wagoneer,™ Grand Wagoneer,™ Liberty,™ Commander,™ Comanche,™ Compass,™ Patriot,™ and Grand Cherokee™ are trademarks of FCA US, LLC.

Some part numbers listed in this catalog are used for reference purposes only. No implication is made that the actual products sold are the product of the original equipment manufacturer.

Reference to a manufacturer in the catalog does not indicate that the manufacturer is the source or sponsor of the listed product. All products listed in this catalog are being sold without any sponsorship or approval of any auto manufacturer.

Copyright © 2015 Crown Automotive Sales Company Inc. All rights reserved.

• TABLE OF CONTENTS •

| | |
|--|----------------|
| Soft Tops, Covers & Top/Door Hardware | 6–25 |
| Seat Covers | 26–29 |
| Steel Bumpers & Body Armor | 30–37 |
| Suspension | 38–47 |
| Steering | 48–51 |
| Drivetrain | 52–61 |
| Brakes | 62–67 |
| Lighting | 68–75 |
| Wheel Spacers/Adapters | 76–77 |
| Exterior Accessories | 78–79 |
| Interior Accessories | 80–85 |
| Stainless & Related Accessories | 86–111 |
| Engine | 112–115 |



FEATURED NEW ITEMS

HD DIFFERENTIAL COVERS



More Info on page 54

DOOR SURROUND KITS



More Info on Page 21

HOOD CATCH KITS



More Info on Page 100

FEATURED NEW ITEMS

LED LIGHTS



More Info on Page 72

LED BULBS



More Info on Page 74

QUICK RELEASE MIRROR SETS



More Info on Page 109

COMPLETE TOPS

RT Off-Road's Complete Soft Tops are complete top packages that include everything needed to install them. Kits include: Soft Top, Windows (where applicable), Bow Assembly, and all hardware. Each top also includes soft top disconnects, a soft top storage bag, and storage pockets built into the top itself. The improved frame design and bow assembly increase ease of use and is able to fold down when not in use.



Black Denim



Gray Denim



Spice Denim



Khaki Diamond



Black Diamond



Black Denim

| Model | Year | Tinted Windows | Door Type | Part # |
|-------|-------|----------------|-----------|----------|
| YJ | 88/95 | No | Half | CT20015 |
| YJ | 88/95 | Yes | Half | CT20015T |

Gray Denim

| Model | Year | Tinted Windows | Door Type | Part # |
|-------|-------|----------------|-----------|----------|
| YJ | 88/95 | No | Half | CT20009 |
| YJ | 88/95 | Yes | Half | CT20009T |

Spice Denim

| Model | Year | Tinted Windows | Door Type | Part # |
|-------|-------|----------------|-----------|----------|
| TJ | 97/06 | No | Half | CT20137 |
| TJ | 97/06 | Yes | Half | CT20237T |
| TJ | 97/06 | No | Full | CT20337 |
| TJ | 97/06 | Yes | Full | CT20437T |
| YJ | 88/95 | No | Half | CT20037 |
| YJ | 88/95 | Yes | Half | CT20037T |

Black Diamond

| Model | Year | Tinted Windows | Door Type | Part # |
|-------|-------|----------------|-----------|----------|
| TJ | 97/06 | No | Half | CT20135 |
| TJ | 97/06 | Yes | Half | CT20235T |
| TJ | 97/06 | No | Full | CT20335 |
| TJ | 97/06 | Yes | Full | CT20435T |
| YJ | 87/95 | Yes | Full | CT20035T |
| CJ-7 | 76/86 | Yes | Full | CT20035T |

Khaki Diamond

| Model | Year | Tinted Windows | Door Type | Part # |
|-------|-------|----------------|-----------|----------|
| TJ | 97/06 | No | Half | CT20136 |
| TJ | 97/06 | Yes | Half | CT20236T |
| TJ | 97/06 | No | Full | CT20336 |
| TJ | 97/06 | Yes | Full | CT20436T |

OEM STYLE SOFT TOPS

RT Off-Road's OEM Style Replacement Soft Tops are a perfect way of replacing a worn and drafty top with foggy windows and broken zippers. This direct replacement top includes cloth and either clear or tinted windows. Factory frames and hardware must be reused.

Fabric Top With Half Doors

| Model | Year | Tinted Windows | Color | Part # |
|--------|-------|----------------|---------------|-----------|
| JK 2DR | 07/09 | Yes | Black Diamond | RT10535T |
| JK 4DR | 07/09 | Yes | Black Diamond | RT10635T |
| TJ | 97/06 | Yes | Black Denim | RT10115T |
| TJ | 97/06 | No | Black Denim | RT10315 |
| TJ | 97/06 | Yes | Black Diamond | RT10335T |
| TJ | 97/06 | No | Black Diamond | RT10335 |
| TJ | 97/06 | No | Khaki Diamond | RT10336 |
| TJ | 97/06 | No | Spice | RT10337 |
| TJ | 97/06 | Yes | Spice | RT10337T |
| YJ | 88/95 | No | Spice | RT10037 * |
| YJ | 88/95 | No | Gray | RT10009 |
| YJ | 88/95 | Yes | Black Denim | RT10015T |
| YJ | 88/95 | No | Black Denim | RT10015 |

*1987 YJ Wrangler half door upper door skins are not available.

Fabric Top For Use With Full Steel Doors

| Model | Year | Tinted Windows | Color | Part # |
|-------|-------|----------------|---------------|----------|
| TJ | 97/06 | Yes | Black Denim | RT10215T |
| TJ | 97/06 | Yes | Black Diamond | RT10435T |



SAILCLOTH REPLACEMENT TOPS

RT Off-Road's upgraded Sailcloth Replacement Soft Tops are a direct fit replacement for the factory cloth and windows. The upgraded sailcloth material reduces buffering and noises typical with soft top vehicles. These replacement soft tops are only available with tinted windows. Factory hardware must be reused.

| Model | Year | Color | Part # |
|-------|-------|---------------|-----------|
| TJ | 97/06 | Black Diamond | RTS20035T |
| TJ | 97/06 | Spice | RTS20037T |

BOWLESS SOFT TOPS

RT Off-Road's Bowless Soft Top installs directly over the factory roll bar. It requires no additional supports and still maintains a snug fit. This design allows for larger side windows to improve visibility. When the side and rear windows are removed the top converts into an open air safari top. Each top includes tinted windows and storage pockets.

| Model | Year | Color | Part # |
|--------|-------|---------------|-----------|
| JK 2DR | 07/15 | Black Diamond | BRT20035T |
| JK 4DR | 07/15 | Black Diamond | BRT20135T |
| TJ | 97/06 | Black Diamond | BRT10035 |
| TJ | 97/06 | Spice Diamond | BRT10037 |
| YJ | 92/95 | Black Diamond | BRT10135T |

Note: Requires windshield channel, factory soft door surrounds and tail gate bar which are standard equipment on factory soft top applications. If the soft top is replacing a hard top application, additional parts are required and can be purchased separately.



BRT10135T



BRT10037



BRT10035



BRT20135T

COVER ALL KITS

RT Off-Road's Cover All Kits are a unique way to outfit your vehicle with a weather resistant top system. While not completely weather tight, these Cover All Kits provide protection for vehicles without any top. Each Kit includes a beach topper, a wind breaker, and a tonneau cover. Tire cover and roll bar cover are not included.

| Model | Year | Color | Part # |
|-------|-------|---------------|---------|
| TJ | 97/06 | Black Diamond | CA10335 |
| TJ | 97/06 | Spice | CA10337 |
| YJ | 87/91 | Black Denim | CA10115 |
| YJ | 92/95 | Black Denim | CA10215 |



BEACH TOPPERS

Enjoy the open air feel while staying protected from direct sunlight and an unexpected rain. Windshield channels are sold separately and may be required.

| Model | Year | Color | Part # |
|-------------|-------|---------------|-----------|
| TJ | 97/06 | Black Diamond | BT40035 * |
| TJ | 97/06 | Black | BT40015 * |
| TJ | 97/06 | Spice | BT40037 * |
| YJ | 87/91 | Black | BT20001 |
| YJ | 87/91 | Gray | BT20009 |
| YJ | 87/91 | Black Denim | BT20015 |
| YJ | 92/95 | Gray | BT30009 |
| YJ | 92/95 | Black | BT30015 |
| YJ | 92/95 | Spice | BT30037 |
| CJ-5, M38A1 | 52/75 | Black | BT10001 |
| CJ-5 | 76/83 | Black | BT10101 |
| CJ-7 | 76/86 | Black | BT10201 |

* Also Fits Unlimited Models



COMBO BEACH TOPPERS

RT Off-Road's Combo Beach Toppers allow occupants to enjoy the open air feel while staying protected from direct sunlight and an unexpected rain shower. Each kit is designed to be a versatile system, allowing to partial or full interior coverage. Windshield channels are sold separately and may be required.

| Model | Year | Color | Part # |
|--------|-------|---------------|---------|
| JK 2DR | 07/15 | Black Mesh | CB30011 |
| JK 2DR | 07/15 | Black Diamond | CB30035 |
| JK 2DR | 07/15 | Khaki Diamond | CB30036 |
| JK 4DR | 07/15 | Black Mesh | CB30111 |
| JK 4DR | 07/15 | Black Diamond | CB30135 |
| JK 4DR | 07/15 | Khaki Diamond | CB30136 |
| TJ | 97/06 | Black Denim | CB20015 |
| TJ | 97/06 | Spice | CB20037 |
| TJ | 97/06 | Black Mesh | CB20011 |
| YJ | 92/95 | Black Denim | CB10015 |
| YJ | 92/95 | Spice | CB10037 |
| YJ | 92/95 | Black Mesh | CB10011 |



WINDBREAKERS

RT Off-Road's Windbreakers deflect the air behind the driver and passenger seats, creating an easier environment for conversation and listening to music. They mount behind the front seats to the factory roll bar and extend to the floor, reducing wind, moisture, and dust from entering the passenger compartment.

| Model | Year | Color | Part # |
|------------|-------|---------------|-----------|
| JK | 07/15 | Black Denim | WB20035 * |
| TJ, YJ, CJ | 76/06 | Black Diamond | WB10035 * |
| TJ, YJ, CJ | 76/06 | Spice | WB10037 * |
| TJ, YJ, CJ | 76/06 | Black Denim | WB10015 * |

* Fits Unlimited Models



TAILGATE BAR & TONNEAU COVER KIT

Replace your broken or missing tailgate bar and add a cargo cover for when the top is off the Jeep®. This is a dual function product that can either be used with a soft top or by itself as a tonneau/cargo cover. The bar assembly slides onto a channel for both your top and the cargo cover. The channel allows you to quickly change from a top to the cargo cover. The cargo cover keeps your valuables that you store behind your seat out of sight. The tailgate bar assembly installs in minutes into the factory location.

- Tailgate bar and retainers work with factory and most aftermarket tops.
- Black denim cargo cover encloses space between rear seat and tailgate.
- Includes instructions.
- Includes tailgate bar, retainer mounts, cargo cover, and all necessary hardware.
- Cargo cover can be removed and tailgate bar can be used with standard soft top.

| Model | Year | Color | Part # |
|-------|-------|-------------|---------|
| TJ | 97/06 | Black Denim | TN27015 |
| YJ | 87/95 | Black Denim | TN27015 |



TONNEAU COVERS

Keep gear clean, dry, and away from prying eyes with RT Off-Road's Tonneau Cover. Installs into factory belt rails and extends from the tailgate to the back of the front seats.

| Model | Year | Color | Part # |
|-------|-------|---------------|---------|
| TJ | 97/06 | Black Diamond | TN10135 |
| TJ | 97/06 | Black Denim | TN10115 |
| TJ | 97/06 | Spice | TN10137 |
| YJ | 87/91 | Black Denim | TN10215 |
| YJ | 92/95 | Black Denim | TN10015 |
| YJ | 92/95 | Spice | TN10037 |



FULL COVERS

RT Off-Road's Water Resistant Covers are designed to protect the vehicle from sun, dirt, dust, moisture, and pollution. The cover accomplishes this while also being a breathable enough to reduce moisture and temperature buildup. Includes cover, lock, cable, and storage bag.

| Model | Year | Color | Part # |
|--------------|-------|-------|-----------|
| JK 2DR | 07/15 | Gray | FC10209 |
| JK 4DR | 07/15 | Gray | FC10309 |
| TJ Unlimited | 04/06 | Gray | FC10109 |
| TJ, YJ, CJ-7 | 76/06 | Gray | FC10009 * |

* Will NOT fit on Unlimited Models

CAB ONLY COVERS

RT Off-Road's Cab Covers were designed for a tight fit that will last for years. The elastic bottom and straps will keep the cover tight to the body. The compact design provides easy storage when not being used.

Fits over factory roll bar. Waterproof.

| Model | Year | Color | Part # |
|--------|-------|-------|-----------|
| TJ, YJ | 92/06 | Gray | CC10209 * |
| YJ | 87/91 | Gray | CC10109 |
| CJ-7 | 76/86 | Gray | CC10009 |

Fits over factory soft or hard top. Non-water-resistant.

| Model | Year | Color | Part # |
|--------|-------|-------|-----------|
| TJ, YJ | 92/06 | Gray | CC10309 * |
| JK 2DR | 07/15 | Gray | CC10509 |
| JK 4DR | 07/15 | Gray | CC10609 |

Waterproof with bottom door flaps. Compact design for ease of storage. Secures to body with elastic bottoms and straps.

| Model | Year | Color | Part # |
|--------|-------|-------|---------|
| JK 2DR | 07/15 | Gray | CC10709 |
| JK 4DR | 07/15 | Gray | CC10809 |

* Will NOT work on Unlimited Models



REPLACEMENT DOOR SKINS



Replace worn or damaged factory upper soft door skins with a set from RT Off-Road. Installs directly over factory door frame. Replacement upper door frames available separately. Sold in pairs.

| Model | Year | Color | Part # |
|-------|-------|---------------|---------|
| TJ | 97/06 | Black Denim | DS10115 |
| TJ | 97/06 | Black Diamond | DS10135 |
| TJ | 97/06 | Spice | DS10137 |
| YJ | 87/95 | Black Denim | DS10015 |
| YJ | 87/95 | Spice | DS10037 |

REPLACEMENT UPPER DOOR FRAMES

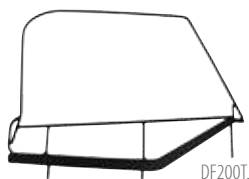

DF200TJ

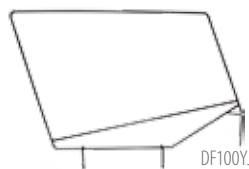

DF100YJ

Replace damaged or missing upper door frames with RT Off-Road's replacement door frame sets. Replacement upper door frames fit all factory half doors and work with our replacement upper door skins. Door frames are only available in pairs.

| Model | Year | Color | Part # |
|-------|-------|-------|---------|
| TJ | 97/06 | Black | DF200TJ |
| YJ | 87/95 | Black | DF100YJ |

DOOR SURROUND KITS

RT Off-Road's Door Surround Kit is a direct fit replacement for the factory door surround. RT Off-Road's door surrounds are able to fit both factory soft tops, replacement tops, and bowless soft tops. Includes all hardware needed for installation and instructions.



| Model | Year | Color | Part # |
|--------|-------|-------|---------|
| JK 2DR | 07/15 | Black | RT25001 |
| JK 4DR | 07/15 | Black | RT25002 |



DOOR PIN INSERTS

Direct replacement for OEM half steel door inserts. These inserts secure the upper window frame to the door. Three are required for each door.



Single

| Model | Year | Color | Replaces Part # |
|--------|-------|---------------------|-----------------|
| TJ, YJ | 87/06 | Charcoal (Lt. Gray) | 5FB63JS1 |
| TJ, YJ | 87/06 | Cinder (Dk. Gray) | 5FB63RXA |
| TJ, YJ | 87/06 | Spice | 5FB63RTB |

Set of Three

| Model | Year | Color | Replaces Part # |
|--------|-------|---------------------|-----------------|
| TJ, YJ | 87/06 | Charcoal (Lt. Gray) | 5FB63JS1K |
| TJ, YJ | 87/06 | Cinder (Dk. Gray) | 5FB63RXAK |
| TJ, YJ | 87/06 | Spice | 5FB63RTBK |



FREEDOM TOP PANEL STORAGE BAG

The Freedom Top Panel Storage Bag is a dual compartment storage system. The outside is constructed out of a durable canvas material while the inside is lined with a soft cloth to protect the panels. Designed to fit behind the rear seat.



| Model | Year | Color | Part # |
|-------|-------|-------|---------|
| JK | 07/15 | Black | SB40001 |

WINDOW STORAGE BAG

Finally a safe and convenient way to store a set of windows and upper doors. One of the most difficult things about taking the top off a Jeep is finding a place to safely store the windows and upper doors. We have solved this problem with our canvas storage bag. Now your windows and doors can be stowed safely and conveniently behind the rear seat. The internal felt separators will ensure their safety while removed from the vehicle. Storage bag works on most Jeep vehicles with a soft top and upper soft doors.

- Heavy duty black canvas material
- Protects windows and upper doors from scratches
- Stores easily behind rear seat
- Felt liners keep windows from rubbing against one another.
- Convenient handle for transporting windows and upper doors

| Model | Year | Color | Part # |
|------------|-------|-------|---------|
| TJ, YJ, CJ | 76/06 | Black | SB40002 |



TIRE COVERS

Protect your spare tire from the elements with a RT Off-Road tire cover. The elastic slip on design allows for easy installation while still maintaining a tight fit. The canvas material protects expensive tire and wheel combinations from corrosive road chemicals, salts, and UV light.

| Tire Size | Color | Part # |
|------------|---------------|----------|
| 27" to 29" | Black | TC272901 |
| 27" to 29" | Gray | TC272909 |
| 27" to 29" | Black Denim | TC272915 |
| 27" to 29" | Spice | TC272937 |
| 30" to 32" | Black | TC303201 |
| 30" to 32" | Gray | TC303209 |
| 30" to 32" | Black Denim | TC303215 |
| 30" to 32" | Spice | TC303237 |
| 33" to 35" | Spice | TC333537 |
| 33" to 35" | Black Diamond | TC333515 |



SOFT TOP STORAGE SLEEVES

Protect your soft top with RT Off-Road's Soft Top Storage Sleeves. Installs quickly and easily on top with no special tools. Available in multiple colors for a direct match to soft top material.

| Model | Year | Color | Part # |
|--------|-------|---------------|---------|
| JK 2DR | 07/15 | Black Diamond | SB20035 |
| JK 2DR | 07/15 | Khaki Diamond | SB20036 |
| JK 4DR | 07/15 | Black Diamond | SB30035 |
| JK 4DR | 07/15 | Khaki Diamond | SB30036 |
| TJ | 97/06 | Gray | SB10009 |
| TJ | 97/06 | Black Denim | SB10015 |
| TJ | 97/06 | Spice | SB10037 |



WINDSHIELD CHANNELS

RT Off-Road's Windshield Channel is designed for aftermarket beach toppers, combo toppers, and bowless replacement tops. Installs to factory windshield frame and includes all hardware needed for installation.

| Model | Year | Comments | Part # |
|--------|-------|----------|---------|
| JK | 07/15 | No Drill | RT26067 |
| TJ | 97/02 | Drill In | RT26065 |
| TJ | 97/06 | No Drill | RT26066 |
| YJ, CJ | 76/95 | Drill In | RT26064 |



SOFT TOP DISCONNECTS

RT Off-Road's Soft Top Disconnect Kit is an upgraded aluminum disconnect kit for the TJ Wrangler. The factory plastic disconnects are known to crack, fracture, and eventually fail. These upgraded aluminum disconnects will install and function just as the factory disconnects.

| Model | Year | Color | Part # |
|-------|-------|----------|---------|
| TJ | 97/06 | Black | RT26063 |
| TJ | 97/06 | Aluminum | RT26062 |

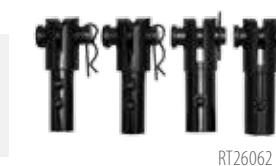

SOFT TOP RETAINERS

A direct replacement for missing, damaged, or stolen tailgate retainers. Sold individually and are specific for driver or passenger side. Connects soft top to tailgate for weather tight seal.

| Model | Year | Position | Replaces Part # |
|-------|-------|----------|-----------------|
| JK | 07/14 | Right | 68041620AA |
| JK | 07/14 | Left | 68041621AA |



SEAT COVERS SETS FOR YJ, TJ WRANGLERS™

These easy to install seat covers are made from durable poly canvas.

The front seat sets include 2 front seat covers, 2 shoulder harness belt pads and a steering wheel cover. The seat covers have adjustable side lace-up draw cords that create a snug fit. Front and side mounted zippered mesh pockets add convenient storage space. Large rear pockets add additional rear access storage space. Included rear carabiner clip is handy for hanging and securing small items. The steering wheel cover installs in seconds without glue or tape. The rubberized interior of the steering wheel cover allows for exceptional grip.

The rear seat sets include one bench seat cover and two shoulder harness belt pads. There is a large storage pocket on the back side of the seat cover.

Both front and rear sets are available in 3 color combinations: Black/Gray, Black/Tan and Black/Red.



Front Seat Cover Sets

| Model | Year | Color | Part # |
|--------|-------|--------------|----------|
| TJ | 03/06 | Black & Gray | SCP20021 |
| TJ | 03/06 | Black & Tan | SCP20024 |
| TJ | 03/06 | Black & Red | SCP20030 |
| TJ, YJ | 87/02 | Black & Gray | SC10021 |
| TJ, YJ | 87/02 | Black & Tan | SC10024 |
| TJ, YJ | 87/02 | Black & Red | SC10030 |

Rear Seat Cover Sets

| Model | Year | Color | Part # |
|--------|-------|--------------|----------|
| TJ | 03/06 | Black & Gray | SCP20221 |
| TJ | 03/06 | Black & Tan | SCP20224 |
| TJ | 03/06 | Black & Red | SCP20230 |
| TJ, YJ | 87/02 | Black & Gray | SCP20121 |
| TJ, YJ | 87/02 | Black & Tan | SCP20124 |
| TJ, YJ | 87/02 | Black & Red | SCP20130 |



SEAT COVERS FOR JK WRANGLERS™

These durable polycanvas seat covers are custom made for a snug fit. The front seat covers have a built-in Side Air Bag pocket for added safety. There are zippered mesh pockets on the front and sides of the seat for convenient storage. Large rear pockets offer additional storage. Custom fit headrest covers are included. Heavy duty straps and clips make installation easy. Available in Black/Gray only.

Front Seat Covers (2)

| Model | Year | Color | Part # |
|-------|-------|--------------|---------|
| JK | 07/10 | Black & Gray | SC30021 |

Rear Seat Covers (2)

| Model | Year | Color | Part # |
|----------|-------|--------------|---------|
| JK - 2DR | 07/11 | Black & Gray | SC30121 |
| JK - 4DR | 07/11 | Black & Gray | SC30221 |



HEAVY DUTY BUMPERS

TJ and YJ Wrangler Bumpers

RT Off-Road's Heavy duty front and rear bumpers are a heavy duty plate steel constructed upgrade over factory bumpers. The 3/16" thick plate steel construction is protected with a durable gloss black powder coat. Bumpers include D-Rings for recover use and mounting holes that are in the same location as the factory. Includes all hardware needed for installation and does not require any drilling or modification.

| Model | Year | Position | Part # |
|-------|-------|----------|---------|
| TJ | 97/06 | Front | RT20001 |
| TJ | 97/06 | Rear | RT20003 |
| YJ | 87/95 | Front | RT20001 |
| YJ | 87/95 | Rear | RT20003 |

This RT Off-Road rear bumper and tire carrier was engineered for severe use on a trail rig as well as standard operation on a daily driver. The bumper's angled profile increases your departure angle without sacrificing overall strength. With this bumper we also recommend also purchasing RT Off-Road's RT33009 2" receiver and d-ring.

- Durable Textured Black Powder Coat Finish
- 3/16" Plate Steel Construction
- 2" Receiver
- Carrier will hold oversized tire and wheel combinations
- Carrier accepts 5 on 4.5" bolt pattern wheels

| Model | Year | Position | Part # |
|-------|-------|----------|---------|
| TJ | 97/06 | Rear | RT20005 |
| YJ | 87/95 | Rear | RT20005 |



RT20001



RT20003



RT20005

JK Wrangler Bumpers

RT Off-Road's Heavy duty Front Bumper is a steel constructed upgrade over the factory bumper. The plate steel and tubular steel construction is protected with a durable textured black powder coat. Bumper includes winch mount, winch fairlead mounting holes, and additional holes for mounting lights. Includes all hardware needed for installation, installs into factory locations, and does not require any drilling or modification.

| Model | Year | Position | Part # |
|-------|-------|----------|---------|
| JK | 07/15 | Front | RT20013 |

RT Off-Road's Rear Bumper is a heavy duty steel constructed upgrade over the factory bumper. The 3/16" plate steel construction is protected with a durable textured black powder coat finish. This rear bumper includes mounting points for d-rings and a large recess for oversized tire clearance. Includes all hardware needed for installation, installs into factory locations, and does not require any drilling or modification.

| Model | Year | Position | Part # |
|-------|-------|----------|---------|
| JK | 07/15 | Rear | RT20014 |



RT20013

ROCKER PANEL GUARDS

RT Off-Road's Heavy Duty Rocker Panel Guard Set is a required upgrade for serious rock crawling off-road enthusiasts. The heavy duty plate steel construction protects the vehicles rocker panels from rocks, trees, and all other obstacles one may encounter on the trail. They are protected with a gloss black powder coated finish that will provide years of protection. Kit includes both driver and passenger side rocker panel guards, all hardware needed to install, and installation instructions.

- 2003-2006 Models require modification to guard or relocation of seat belt mounting bolt
- Drilling required

| Model | Year | Part # |
|-------|-------|---------|
| TJ | 97/06 | RT26046 |



SKID PLATE

Replace the factory plastic brush guard with a heavy duty plate steel skid plate. Keep the electronic sway bar disconnect and steering components safe from rocks, brush, and any potential contact. Direct bolt in design using existing holes. No drilling required. Installs with basic hand tools.

- Black Powder Coat Finish
- 3/16" Plate Steel Construction
- Drilling not required
- Includes all hardware needed for installation



| Model | Year | Part # |
|-------|-------|---------|
| JK | 07/15 | RT20017 |

TUBE BUMPERS

RT Off-Road's Double Tube Bumper design is sure to freshen up the look of your vehicle. All tube bumpers are constructed out of 3" diameter tubing and has a durable powder coated finish. These tube bumpers are designed to install in the factory holes and require no additional drilling or modifications.

Front Bumper

| Model | Year | Part # |
|-------|-------|---------|
| JK | 07/15 | RT20018 |
| TJ | 97/06 | RT20006 |
| TJ | 97/06 | RT20008 |
| YJ | 87/95 | RT20006 |
| YJ | 87/95 | RT20008 |

Rear Bumper

| Model | Year | Part # |
|-------|-------|---------|
| JK | 07/15 | RT20019 |
| TJ | 97/06 | RT20007 |
| TJ | 97/06 | RT20008 |
| YJ | 87/95 | RT20007 |
| YJ | 87/95 | RT20008 |



ROCK CRAWLER BUMPERS

Introducing RT Off-Road's Front Rock Crawler Bumper for YJ, TJ, and JK Wrangler. This heavy duty winch-ready bumper will eliminate any possibility of damage to the grille and fender area of the Jeep as well as function as a recovery point. Installation is as simple as removing the factory bumper cover and bumper before installing the Rock Crawler Bumper. Each kit includes a bumper and all hardware needed to install it.



Front Bumper

| Model | Year | Color | Part # |
|-------|-------|-------|---------|
| TJ | 97/06 | Black | RT20009 |
| YJ | 87/95 | Black | RT20009 |

Durable, textured black powder coat finish. Accepts most winches up to 9,000 lbs. 2 D-Ring Mounts. Full fender to fender protection. Easy No-Drill Installation.

| Model | Year | Color | Part # |
|-------|-------|----------------|---------|
| JK | 07/14 | Black Textured | RT20015 |

Rear Bumper

| Model | Year | Comment | Part # |
|-------|-------|----------------------|---------|
| TJ | 97/06 | With Tire Carrier | RT20004 |
| TJ | 97/06 | Without Tire Carrier | RT20010 |
| YJ | 87/95 | With Tire Carrier | RT20004 |
| YJ | 87/95 | Without Tire Carrier | RT20010 |



RT20004



TUBE SIDE STEPS

RT Off-Road's Side Steps will make entering and exiting the vehicle much easier as well as improving side protection from obstacles. Installation is a breeze, using the factory body mounting bolts to mount the steps to the vehicle. Each kit includes left and right steps, mounting brackets, hardware, and installation instructions.

- Durable, black powder coat finish
- No-Slip flats for entering and exiting the vehicle
- 3" Diameter Tubes
- Works with vehicles with (or without) a body lift
- Easy No-Drill Installation

| Model | Year | Comments | Part # |
|-------|-------|------------------------|-----------|
| JK | 07/14 | 2 Door | RT26059 |
| JK | 07/14 | 4 Door | RT26058 |
| JK | 07/13 | 4 Door; Black Textured | RT26060 |
| JK | 07/13 | 2 Door; Black Textured | RT26061 |
| TJ | 97/06 | Black | RT26015 * |
| TJ | 97/06 | Black Textured | RT26016 * |
| YJ | 87/95 | Black | RT26015 |
| YJ | 87/95 | Black Textured | RT26016 |

* Will NOT work on Unlimited Models



ADJUSTABLE CONTROL ARM KITS

Improve your Jeep's performance with a set of RT Offroad's Heavy Duty Control Arm Sets. The flex ends are utilized to improve the articulation and relieve suspension binding while maintaining a smooth, comfortable ride. The adjustability of these control arms will allow the caster and pinion to be tuned to factory specifications. Each kit includes a pair of fully assembled, zinc plated control arms with greasable bolts for both ends of the control arms.

- Zinc Plated
- Adjustable
- Fits Jeeps with 0-6" of lift
- Includes Greasable Hardware
- Sold in Pairs



| Model | Year | Location | Position | Part # |
|--------|-------|---------------|----------|---------|
| TJ | 97/06 | Front or Rear | Lower | RT21013 |
| TJ | 97/06 | Rear Only | Upper | RT21026 |
| XJ, MJ | 84/01 | Front Only | Lower | RT21013 |
| ZJ | 93/98 | Front Only | Lower | RT21013 |

Front Upper Control Arm Set

| Model | Year | Part # |
|-------|-------|---------|
| TJ | 97/06 | RT21014 |
| XJ | 84/01 | RT21014 |
| MJ | 86/92 | RT21014 |
| ZJ | 93/98 | RT21014 |



RT21013 Rebuild Kit

Small parts kit for RT21013 Adjustable Lower Control Arm Kit.

| Model | Year | Part # |
|-------|-------|---------|
| TJ | 97/06 | RT21016 |
| XJ | 84/01 | RT21016 |
| ZJ | 93/98 | RT21016 |



SPACER LIFT KITS

Improve the look and off-road performance of your vehicle with RT Off-Road's Lift Kit. These kits lift the vehicle 1 3/4", improving ground clearance allowing the use of oversized tires.

- Fits all available models
- 1 3/4" Poly Spacer Kit
- Black Polyurethane construction
- Shocks are not included unless noted



RT21028



RT21035



RT21037



RT21046



RT21050



RT21029

| Model | Year | Comments | Part # |
|--------|-------|-------------|-----------|
| JK | 07/15 | 1 3/4" Lift | RT21035 |
| TJ | 97/06 | 1 3/4" Lift | RT21028 |
| TJ | 97/06 | 1 3/4" Lift | RT21029 * |
| XJ | 84/01 | 1 3/4" Lift | RT21046 |
| KJ | 02/07 | 2" Lift | RT21050 |
| WJ, WG | 99/04 | 1 3/4" Lift | RT21037 |

* Master Kit, Includes HD Shocks

WK and XK

This kit improves ground clearance by lifting the front of the vehicle 2" and the rear 1-3/4" to remove the rake that the vehicle has from the factory. Lifting the vehicle increases ground clearance and allows the use of oversized tires. Each spacer is constructed of MIG welded steel and finished in a rich black powder coat. All necessary hardware is included.

- Lifts & Levels for Improved Stance
- Allows for the use of Oversized Tires
- Includes Front & Rear Spacers and Hardware
- Rich Black Powder Coat Finish

| Model | Year | Comments | Part # |
|-------|-------|----------|---------|
| XK | 06/10 | 2" Lift | RT21038 |
| WK | 05/10 | 2" Lift | RT21038 |



HEAVY DUTY GREASABLE SHACKLE KITS

Improve the performance, durability, and look of your suspension with RT Off-Road's Heavy Duty Shackle Kit. The shackle plates and reinforcement sleeves are finished in a rich black powder coat. Installation is as simple as removing the factory shackle assemblies and installing the supplied shackles.

- Effectively lifts vehicle 3/4"
- Heavy duty plate steel construction
- Includes installation instructions

| Model | Year | Location | Description | Part # |
|-------|-------|----------|---------------|---------|
| YJ | 87/95 | F or R | For 2 Springs | RT21049 |
| YJ | 87/95 | F and R | For 4 Springs | RT21023 |
| CJ | 53/75 | F or R | For 2 Springs | RT21021 |

These Heavy Duty Greasable Shackles are made from 1/4" plate and feature a greasable bushing for a noise-free ride.

| Model | Year | Description | Part # |
|-------|-------|-------------|---------|
| XJ | 84/01 | 1.5" Lift | RT21045 |
| MJ | 86/92 | 0.75" Lift | RT21045 |



PERFORMANCE SWAY BAR LINKS

RT Off-Road's upgraded Sway Bar Links are an affordable upgrade that increases performance and handling. Not only will your vehicle perform better with our upgraded polyurethane bushing and boots, but the product will last longer than the factory rubber pieces it replaces. All sway bar links install in place of the factory link.

- Black powder coated body with blue polyurethane boots and bushings
- Polyurethane bushings Provide long lasting performance and handling
- Installs using factory hardware



Single Link

| Image | Model | Year | Location | Part # |
|-------|--------|-------|----------|---------|
| A | TJ | 97/06 | Front | RT21031 |
| B | TJ | 97/06 | Rear | RT21032 |
| C | YJ | 87/95 | Front | RT21024 |
| D | XJ, MJ | 91/01 | Front | RT21019 |
| E | XJ | 84/01 | Rear | RT21047 |
| D | ZJ | 93/95 | Front | RT21019 |
| F | ZJ | 96/98 | Front | RT21041 |
| G | WJ, WG | 99/04 | Front | RT21039 |
| H | WJ | 99/04 | Rear | RT21040 |
| I | WK | 05/07 | Rear | RT21042 |
| J | WK | 05/10 | Rear | RT21043 |
| I | XK | 06/07 | Rear | RT21042 |
| J | XK | 06/10 | Rear | RT21043 |

Set of 2 Links

| Model | Year | Location | Part # |
|--------|-------|----------|---------|
| TJ | 97/06 | Front | RT21033 |
| TJ | 97/06 | Rear | RT21034 |
| YJ | 87/95 | Front | RT21025 |
| XJ, MJ | 91/01 | Front | RT21020 |
| ZJ | 93/95 | Front | RT21020 |
| ZJ | 96/98 | Front | RT21044 |



DROP PITMAN ARMS

Improve steering performance with RT Off-Road's Drop Pitman Arm. Lifting your Jeep without addressing the steering angles often times results in bump steer and decreased turning radius. Installation of this drop pitman arm will reduce the operating angle of the drag link, resulting in improved steering feel and less wear on steering parts. Each arm is designed to bolt in place of the factory piece with no interference issues.

RT21012



RT21001



RT21036



- Improve Steering Feel
- Reduce Drag Link Angle
- Improve Turning Radius
- Designed to bolt in place of OE arm

| Model | Year | Comments | Part # |
|-------|-------|--------------------|---------|
| JK | 07/15 | LHD, with 6+” Lift | RT21036 |
| TJ | 97/06 | LHD, with 8+” Lift | RT21001 |
| YJ | 87/95 | LHD, with 4+” Lift | RT21012 |
| XJ | 84/01 | LHD, with 4+” Lift | RT21001 |
| ZJ | 93/98 | LHD, with 4+” Lift | RT21001 |

PERFORMANCE SHOCK ABSORBERS

| Model | Year | Comments | Part # |
|--------|-------|--------------------|---------|
| TJ | 97/06 | Rear; For 3” Lift | RT21030 |
| TJ | 97/06 | Front; For 3” Lift | RT21018 |
| XJ, MJ | 84/01 | Front; For 3” Lift | RT21018 |

RT21030



RT21018



BUMP STOP SET

RT Off-Road's Extended Bump Stops prevent expensive body damage to lifted Jeep vehicles. They measure 5" long and install in place of the factory foam bump stops. The polyurethane construction results in a longer product life and improved suspension control. They can be shortened to achieve the perfect amount of suspension articulation while still preventing the tires from contacting the body.



- Polyurethane Construction
- 5" Long
- Simple Installation
- Designed for Vehicles w/ Suspension Lift
- Limits Suspension Travel to Help Clear Oversized Off-Road Tires

| Model | Year | Comments | Part # |
|-------|-------|----------|---------|
| TJ | 97/06 | Front | RT21027 |
| ZJ | 93/98 | Front | RT21027 |

HEAVY DUTY ADJUSTABLE FRONT TRACK BAR

RT Off-Road's adjustable track bar is a heavy-duty, adjustable upgrade over your factory bar. The adjustable assembly allows you to dial in your suspension's alignment to guarantee that the axle is centered under the front of the vehicle. The 1.25" DOM Tubing has a heavy wall thickness that will withstand years of abuse on the trails.

- For vehicles with 0-5" of lift
- 1.25" DOM tubing
- Requires no drop brackets, drilling, or modification. Installs in factory location.
- Black powder coated finish.
- Will not work on Right Hand Drive vehicles

| Model | Year | Comment | Part # |
|--------|-------|--------------------------|---------|
| TJ | 97/06 | With LHD, with 0-5" Lift | RT21017 |
| XJ | 84/01 | With LHD, with 0-5" Lift | RT21017 |
| ZJ, ZG | 93/98 | With LHD, with 0-5" Lift | RT21017 |
| MJ | 86/93 | With LHD, with 0-5" Lift | RT21017 |



HEAVY DUTY STEERING SHAFTS

RT Off-Road's Steering upgrades are an affordable way to regain and improve the vehicle's on road performance. All of our upgraded steering components are engineered to improve upon the factory design to increase responsiveness and handling. We then go a step further and improve the durability and rigidity by increasing material thickness and component construction methods. Even with these upgrades your RT Off-Road product will still install into the factory locations with simple hand tools.

| Model | Year | Comment | Part # |
|-------|-------|-----------------|---------|
| CJ | 72/86 | Manual Steering | RT21010 |
| CJ | 76/86 | Power Steering | RT21011 |



RT21010



EXTREME HEAVY DUTY STEERING BOX BRACKET

- For models with power steering
- Durable black powder coat finish
- Heavy duty plate steel construction
- Includes all hardware needed for installation
- Installation instructions included



| Model | Year | Comments | Part # |
|-------|-------|---------------------|---------|
| CJ | 76/86 | With Power Steering | RT21009 |

HEAVY DUTY STEERING KITS

- Heavy Duty Solid Steel Construction
- No modifications needed to factory mounting components
- Left hand drive models only
- Includes all hardware needed for installation
- Steering Stabilizer included

Steering Stabilizer Included

| Model | Year | Drive Side | Part # |
|-----------|-------|--------------|---------|
| TJ | 97/06 | LHD | RT21005 |
| TJ | 97/04 | RHD | RT21007 |
| XJ, MJ | 91/01 | LHD | RT21005 |
| XJ | 94/01 | RHD | RT21007 |
| ZJ w/4.0L | 93/98 | LHD | RT21005 |
| ZG w/4.0L | 94/98 | RHD (Europe) | RT21007 |

Steering Stabilizer Not Included

| Model | Year | Drive Side | Part # |
|-----------|-------|--------------|---------|
| TJ | 97/06 | LHD | RT21004 |
| TJ | 97/04 | RHD | RT21006 |
| XJ, MJ | 91/01 | LHD | RT21004 |
| XJ | 91/01 | RHD | RT21006 |
| ZJ w/4.0L | 93/98 | LHD | RT21004 |
| ZG w/4.0L | 94/98 | RHD (Europe) | RT21006 |



RT21005

RT21007



HEAVY DUTY BALL JOINT SETS

The "Heavy Duty" description is more than accurate with these ball joints. The newly designed joint is leaps ahead of the OE plastic bushings plagued with premature failure. These HD Ball Joints were manufactured with a sintered metallic bushings. This new bushing is highly resistant to wear and damage. The assembly is greaseable to extend the life of the already durable bushings specifically engineered for vehicles with larger tires, lift kits, and heavier accessories. They install without any fabrication or modification to the factory mounts using tools that can be purchased or rented at a local parts store. The HD Ball Joints are also backed with an industry leading 12 month warranty. Each set includes one upper and one lower Ball Joint with all required hardware needed for installation.

Set includes 1 Upper and 1 Lower Ball Joint with Hardware.

| Model | Year | Part # |
|-------|-------|---------|
| TJ | 97/06 | RT21003 |
| YJ | 87/95 | RT21003 |
| XJ | 84/01 | RT21003 |
| MJ | 86/92 | RT21003 |
| ZJ | 93/98 | RT21003 |



- Heavy Duty Replacement of Factory Ball Joints
- Heavy-Duty Sintered Metallic Bushings
- Greaseable AssemblyHD Ball Joint Set
- Includes All Hardware Needed for Installation
- Sold In Sets (Must Order two sets to complete one front axle)

| Model | Year | Part # |
|-------|-------|---------|
| JK | 07/15 | RT21002 |
| WJ | 99/04 | RT21002 |



HEAVY DUTY CONTROL BRACKET ARM SET

RT Off-Road's Lower Control Arm Bracket Set is a heavy-duty replacement for the failure prone factory mounts. The 3/16" plated steel construction will ensure long lasting performance even with the most rigorous off-road use. The slotted cam bolt design will allow you to dial in the front caster and improve overall ride quality. Cam bolt kits are available separately, replaces part #6504238K. Installation will require cutting, grinding, and welding.

- Brackets are shipped in bare steel
- Welding Required
- Sold in pairs
- Replacement Cam bolt available separately

| Model | Year | Part # |
|-------|-------|---------|
| TJ | 97/06 | RT21015 |
| XJ | 84/01 | RT21015 |
| MJ | 86/92 | RT21015 |
| ZJ | 93/98 | RT21015 |



SECURE DISCONNECT LOCK KITS

A major problem in late 80's and early 90's Jeep Vehicles were the vacuum disconnect front axles. The RT Off-Road Secure Disconnect Lock System removes and replaces that failure prone vacuum disconnect. The factory disconnect assembly is replaced with a reliable cable actuated system. The stainless steel cable is zinc coated to protect the already durable finish. Our aluminum housing replaces the factory vacuum assembly and installs directly in place with a new gasket. Our wiring kit will ensure the factory 4WD light continues to operate as it did originally. Finally, our dash bracket and hardware kit will make installation a snap.

With Disconnect Front Axle; with 0-3" Lift

| Model | Year | Part # |
|-------|-------|---------|
| YJ | 87/95 | RT23002 |
| XJ | 84/93 | RT23002 |
| MJ | 86/92 | RT23002 |

With Disconnect Front Axle; with 3" or Higher Lift

| Model | Year | Part # |
|-------|-------|---------|
| YJ | 87/95 | RT23003 |
| XJ | 84/93 | RT23003 |
| MJ | 86/92 | RT23003 |



Shift Fork Kit

With Dana 30 Front Axle with disconnect; Includes HD Fork, Gasket, Clips, Snap Rings, and Hardware.

| Model | Year | Part # |
|-------|-------|---------|
| YJ | 87/95 | RT23004 |
| XJ | 84/93 | RT23004 |
| MJ | 84/93 | RT23004 |



HD DIFFERENTIAL COVERS

Protect high-dollar differentials with a Heavy Duty Differential Cover from RT Off-Road. These covers are constructed of 3/8" high grade forged steel with a raised fill plug for extra oil capacity. They feature strengthening ribs to ensure a broken or peeled differential cover doesn't cut the day short. The mating surface is machined flat to ensure a leak-free fitment. All covers are finished in a red powder coat and include flanged hex bolts as well as RTV.

- Constructed of 3/8" Forged Steel
- Mating surface machined flat to prevent leaks
- Raised fill plug for increased oil capacity
- Powder Coated Red
- Includes hardware and RTV



| Description | Model | Year | Position | Part # |
|-----------------------------|-----------|-------|---------------|---------|
| D30 HD Differential Cover | Universal | 47/15 | Front or Rear | RT20024 |
| D35 HD Differential Cover | Universal | 84/07 | Rear | RT20025 |
| D44 HD Differential Cover | Universal | 47/15 | Front or Rear | RT20026 |
| 8.25" HD Differential Cover | Universal | 91/12 | Rear | RT20027 |

RT20024



RT20025



RT20026



RT20027



PERFORMANCE AXLE SETS

RT Off-Road continues our tradition of high-quality, heavy-duty, products with Performance Axle Kits. These axles are a direct replacement for the factory shaft but are upgraded to a 4340 alloy steel. This alloy is heat treated to improve both tensile and torsional strength by 30%. The shaft splines are rolled, not cut, into the shaft to further increase overall component strength. Sold in pairs and includes hardware.

DANA 35 PERFORMANCE AXLE KIT
For Vehicles with Rear Drum Brakes

| Model | Year | Part # |
|-------|-------|---------|
| TJ | 97/02 | RT23001 |
| YJ | 93/95 | RT23001 |
| XJ | 92/01 | RT23001 |
| ZJ | 93/96 | RT23001 |
| MJ | 1992 | RT23001 |

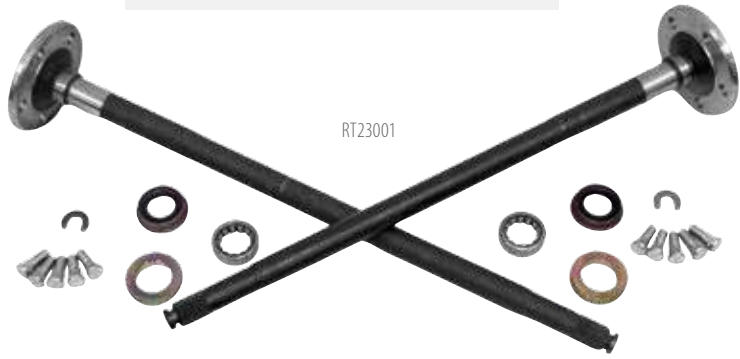

DANA 35 PERFORMANCE AXLE KIT
For Vehicles with Rear Disc Brakes

| Model | Year | Part # |
|-------|-------|---------|
| ZJ | 94/98 | RT23005 |

DANA 44 PERFORMANCE AXLE KIT
Backing plates not included

| Model | Year | Part # |
|-------|-------|---------|
| ZJ | 94/98 | RT23006 |



SLIP YOKE ELIMINATOR KIT

Eliminate drive line vibrations and increase the strength of your NP231 with RT Off-Road's Slip Yoke Eliminator Kit. Each kit includes a replacement output housing, heavy duty Main Shaft, rear output Yoke designed for a double-cardan drive shaft, and all necessary hardware. The Installation can be performed with the transfer case in or out of the vehicle with basic hand tools. Engineered to function with the factory Speedometer sensor/cable and Vacuum Shift Sensor.

- Fits all Jeep NP231 transfer cases
- 1-3/8" 32-Spline Main Shaft and Yoke
- Converts factory rear slip yoke to a CV style output
- Includes installation instructions

| Model | Year | Part # |
|-------|-------|---------|
| TJ | 97/06 | RT24005 |
| YJ | 87/93 | RT24005 |
| XJ | 87/01 | RT24005 |
| MJ | 87/92 | RT24005 |



HEAVY DUTY DRIVE SHAFT

- For Use With RT24005 Slip Yoke Eliminator Kit
- Functional Lengths: Collapsed 16", Extended 18.25", 2-6" Lifts
- Heavy Duty Rear Propeller Shaft
- Include 3 Grease Fittings and Instructions

| Model | Year | Part # |
|-------|-------|-----------|
| TJ | 97/06 | RT24002 |
| YJ | 87/93 | RT24002 |
| YJ | 94/95 | RT24002 * |

* With 1310 (3.219" Width) Series U-Joints. If 94/95 YJ has 1330 Series U-Joint, also purchase Part # D35YOKEUBK.



SLIP YOKE ELIMINATOR & HEAVY DUTY DRIVE SHAFT KIT

This kit contains everything you need to convert the rear output of the NP231 transfer case to a fixed-style yoke. Included in this kit is a heavy duty 32 spline main shaft, a short output housing, a CV-style Yoke, and all the necessary hardware. When paired with the provided Propeller Shaft, these kits will result in an extremely strong, vibration free driveline that will provide you with years of worry free driving.

| Model | Year | Part # |
|-------|-------|-----------|
| TJ | 97/06 | RT24004 |
| YJ | 87/93 | RT24004 |
| YJ | 94/95 | RT24004 * |

*With 1310 (3.219" Width) Series U-Joints. If 94/95 YJ has 1330 Series U-Joint, also purchase Part # D35YOKEUBK.





STAINLESS STEEL BRAKE LINE KITS

RT Off-Road Stainless Steel Brake Lines are designed for modified vehicles requiring additional length and performance. The additional length and stainless construction provides long lasting performance on modified vehicles. All brake lines are D.O.T. approved, 50 state legal. Each kit includes stainless lines to replace the factory soft lines, mounting brackets, junctions blocks (if required), copper washers, and mounting hardware.

- Braided Stainless Steel Construction
- Fits Models with 0-4" of lift
- D.O.T. Approved



RT31016



RT31015



RT31029



| Model | Year | Comment | Part # |
|-------|-------|---------------|---------|
| JK | 07/10 | Up to 6" Lift | RT31029 |
| TJ | 97/02 | Up to 6" Lift | RT31015 |
| YJ | 87/95 | Up to 6" Lift | RT31015 |
| XJ | 84/01 | Up to 6" Lift | RT31015 |
| CJ | 82/86 | Up to 4" Lift | RT31016 |



HIGH PERFORMANCE BRAKE ROTORS

High Performance Brake Rotors from RT Off-Road are designed for the most extreme abuse. These Brake Rotors were tested on: the steep descents in Moab, Utah; stop and go traffic in Boston, Massachusetts; and the long range treks in-between. Each brake rotor is machine slotted and cross drilled to provide maximum cooling. This drastic cooling helps eliminate brake fade and potential warping. The design rapidly expels friction gases, debris, and water from the rotor and pad surface. You can expect greater braking response, increased performance, longer life, and a sporty new look.

| Model | Year | Comments | Location | Part # |
|------------|--------|-------------------------------|----------|---------|
| JK | 07/15 | With 11.89" Diameter Rotor | Front | RT31025 |
| JK | 07/15 | | Rear | RT31026 |
| TJ | 99/06 | With Full Cast Type Rotor | Front | RT31001 |
| TJ | 97/99 | With 2 Piece Composite Rotor | Front | RT31002 |
| TJ | 03/06 | With Rear Disc Brakes | Rear | RT31005 |
| YJ | 90/95 | | Front | RT31002 |
| KJ | 03/07 | | Rear | RT31005 |
| WJ, WG | 99/04 | With Akebono or Teves caliper | Front | RT31032 |
| WJ, WG | 99/04 | | Rear | RT31031 |
| WK, WH | 05/10 | Without SRT 8 Package | Front | RT31003 |
| WK, WH | 05/10 | Without SRT 8 Package | Rear | RT31004 |
| XJ | 99/01 | With Full Cast Type Rotor | Front | RT31001 |
| XJ 2WD | 92½/99 | With 2 Piece Composite Rotor | Front | RT31002 |
| XJ, MJ 4WD | 90/99 | With 2 Piece Composite Rotor | Front | RT31002 |
| XK, XH | 06/10 | | Front | RT31003 |
| XK, XH | 06/10 | | Rear | RT31004 |
| ZJ, ZG | 93/98 | | Front | RT31002 |
| ZJ, ZG | 94/98 | | Rear | RT31030 |



RT31025

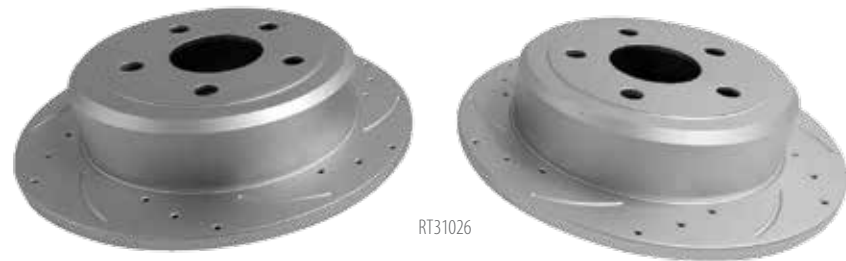

RT31026



RT31001

RT31005



COMPLETE BRAKE KITS WITH DRILLED & SLOTTED ROTORS

High Performance Brake Rotors from RT Off-Road are designed for the most extreme abuse. These brake rotors were tested on: the steep descents in Moab, Utah; stop and go traffic in Boston, Massachusetts; and the long range treks in between. Each brake rotor is machine slotted and cross drilled to provide maximum cooling. This drastic cooling helps eliminate brake fade and potential warping. The design rapidly expels friction gases, debris, and water from the rotor and pad surface. You can expect greater braking response, increased performance, longer life, and a sporty new look.

| Model | Year | Comments | Location | Part # |
|------------|--------|------------------------------|----------|---------|
| JK | 07/15 | With 11.89" Diameter Rotor | Front | RT31027 |
| JK | 07/15 | | Rear | RT31028 |
| TJ | 99/06 | With Full Cast Type Rotor | Front | RT31012 |
| TJ | 97/99 | With 2 Piece Composite Rotor | Front | RT31013 |
| TJ | 03/06 | With Rear Disc Brakes | Rear | RT31014 |
| YJ | 90/95 | With 2 Piece Composite Rotor | Front | RT31013 |
| KJ | 03/07 | | Rear | RT31014 |
| WJ, WG | 99/04 | With Teves caliper | Front | RT31035 |
| WJ, WG | 99/04 | With Akebono caliper | Front | RT31036 |
| WJ, WG | 99/04 | | Rear | RT31034 |
| WK, WH | 05/10 | Without SRT8 Package | Front | RT31008 |
| WK, WH | 05/10 | Without SRT8 Package | Rear | RT31009 |
| XJ | 99/01 | With Full Cast Type Rotor | Front | RT31012 |
| XJ 2WD | 92½/99 | With 2 Piece Composite Rotor | Front | RT31013 |
| XJ 2WD | 99 | With 2 Piece Composite Rotor | Front | RT31013 |
| XJ, MJ 4WD | 90/99 | With 2 Piece Composite Rotor | Front | RT31013 |
| XK, XH | 06/10 | | Front | RT31008 |
| XK, XH | 06/10 | | Rear | RT31009 |
| ZJ, ZG | 93/98 | | Front | RT31013 |
| ZJ, ZG | 94/98 | | Rear | RT31033 |



DRUM TO DISC BRAKE CONVERSION KITS

The RT Off-Road disc brake conversion kits will convert factory Dana 35 or Chrysler 8.25" rear axles from drum to disc brake. This is a must for vehicles with oversized tires and increased accessory weight. These kits are designed for vehicles without ABS and include all hardware, emergency brake cables, and brake hoses needed for installation.

- Dana 35 for Chrysler 8.25" axles only
- Will not work on vehicles equipped with ABS
- Converts Rear Drum Brakes To Disc Brakes
- Incl: Rotors, Pads, Calipers, Backing Plates, Shoes, Brake Hoses, & Hardware

| Model | Year | Part # |
|-------|-------|-----------|
| TJ | 97/06 | RT31006 |
| TJ | 97/06 | RT31007 * |
| YJ | 91/95 | RT31007 * |
| XJ | 91/01 | RT31007 * |
| ZJ | 93/98 | RT31006 |
| ZJ | 93/98 | RT31007 * |

* Emergency brake cables sold separately.



Brake Cables for use with RT31007

RT Off-Road Disc Brake Conversion Cables are designed specifically for our disc brake conversion kits. These Cables are designed to bolt directly in place of the old factory Drum emergency Brake Cable. Their updated design will however operate the new disc brake conversion E-Brake mechanism. Cables are sold individually and may be position specific.

| Model | Years | Length | Position | Part # |
|-------|-------|--------|----------|----------|
| TJ | 97/06 | 44" | Right | 52008904 |
| TJ | 97/06 | 43.80" | Left | 52008905 |
| YJ | 87/90 | 64.75" | Right | RT31019 |
| YJ | 87/90 | 32.75" | Left | RT31020 |
| YJ | 91/95 | 69.75" | Right | RT31021 |
| YJ | 91/95 | 37.5" | Left | RT31022 |
| XJ | 84/96 | 52" | L or R | RT31039 |
| XJ | 97/01 | 70.5" | Right | RT31040 |
| XJ | 97/01 | 34.25" | Left | RT31041 |
| ZJ | 93/98 | 44" | Right | 52008904 |
| ZJ | 93/98 | 43.80" | Left | 52008905 |



HEAVY DUTY DUAL DIAPHRAGM BRAKE BOOSTER & HIGH PRESSURE MASTER CYLINDER KITS

Replace rusty, leaky, and faulty Brake Boosters & Master Cylinders with a HD kit from RT Off-Road. Two performance level kits were designed to specifically cater to the vehicles requirements. The larger bore Master Cylinders are designed for upgrades done to axles with larger brake calipers. The more moderate bore is designed for vehicles with factory brakes, disc brake upgrades, and vehicles that require more braking power. Each kit consists of a zinc-coated Brake Booster, Master Cylinder, bench bleeding kit, and installation instructions. Installation involves replacing the factory brake booster & master cylinder.

- Work on all available models
- Includes mounting bracket and adjustable push rod assembly
- Includes installation instructions

Aftermarket Axles

| Model | Years | MC Bore Size | Comment | Part # |
|--------|-------|--------------|---------------------|---------|
| TJ | 97/06 | 1-1/8" | Without ABS | RT31024 |
| YJ | 87/90 | 1-1/8" | Without ABS | RT31017 |
| YJ | 91/95 | 1-1/8" | Without ABS | RT31010 |
| XJ, MJ | 84/01 | 1-1/8" | With or Without ABS | RT31037 |
| CJ | 76/86 | 1-1/8" | | RT31010 |

Stock Applications

| Model | Years | MC Bore Size | Comment | Part # |
|--------|-------|--------------|---------------------|---------|
| TJ | 97/06 | 1" | Without ABS | RT31023 |
| YJ | 87/90 | 1" | Without ABS | RT31017 |
| YJ | 91/95 | 1" | Without ABS | RT31011 |
| XJ, MJ | 84/01 | 1" | With or Without ABS | RT31038 |
| CJ | 76/86 | 1" | | RT31011 |

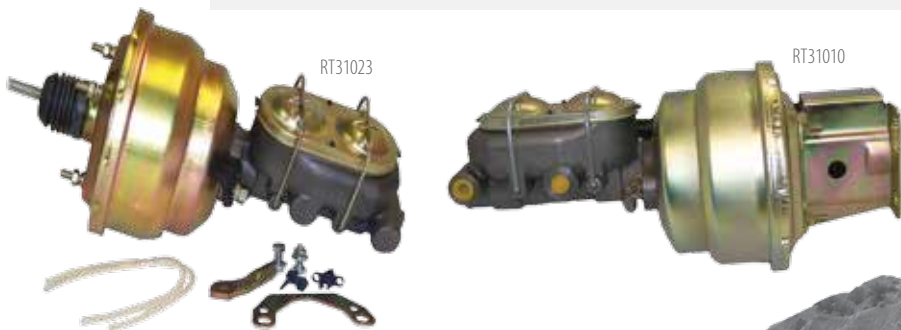

HALOGEN LAMP CONVERSION KITS

The RT Off-Road Lamp conversions are an upgrade for the conventional factory sealed beam headlamps. Included in the Headlight Conversion Kit are two halogen bulbs and two cast housings with clear glass lenses. RT Off-Road's Halogen Light Conversion Kit is DOT and SAE compliant.

- Pair of 7" Round Assemblies
- H4 55/60W Bulbs
- Cast Housing
- Clear Glass Lens
- Meets DOT/SAE



Lamps

| Model | Year | Comment | Part # |
|----------------|-------|------------------------------|---------|
| YJ, XJ, MJ, SJ | 79/01 | 200MM Rectangular Assemblies | RT28005 |
| CJ, TJ | 69/06 | 7" Round Assemblies | RT28006 |



Bulbs

| Model | Year | Comment | Part # |
|-------|-------|-------------------------------------|---------|
| YJ | 87/95 | H4-60W Super White; 2 bulbs; Europe | RT28004 |
| XJ | 84/01 | H4-60W Super White; 2 bulbs; Europe | RT28004 |

Note: Standard Blue Halogen Bulbs also available.



CLEAR PARKING LAMPS & SIDEMARKER LAMPS

The RT Off-Road Crystal Clear lighting packages are a D.O.T. legal way to give the vehicle an all new look. These crystal clear Lenses come complete with amber Bulbs. The bulbs and lenses included in our kit will install directly into the factory wiring harness and body. Installation requires no modifications to the body and can be completed with basic hand tools.

Parking Lamps

Includes: 2 Parking Lamps and 2 Amber Bulbs

| Image | Model | Year | Part # |
|-------|-------|-------|---------|
| A | JK | 07/13 | RT28029 |
| B | TJ | 97/06 | RT28016 |
| C | YJ | 87/95 | RT28012 |

Note: Modifications to Parking Lamp Wiring Required for 94/95 YJ



Sidemarker Lamps

Includes: 2 Sidemarker Lamps and 2 Amber Bulbs

| Image | Model | Year | Part # |
|-------|--------|-------|---------|
| D | JK | 04/15 | RT28028 |
| E | TJ | 97/06 | RT28017 |
| F | YJ | 87/95 | RT28013 |
| G | XJ, MJ | 84/96 | RT28027 |



Parking & Sidemarker Lamp Kits

Includes: 2 Parking Lamps, 2 Sidemarkers, and 4 Amber bulbs

| Model | Year | Part # |
|-------|-------|---------|
| JK | 07/13 | RT28018 |
| TJ | 97/06 | RT28015 |
| YJ | 87/95 | RT28010 |

Note: Modifications to Parking Lamp Wiring Required for 94/95 YJ





HIGH POWER LED ACCESSORIES

LED Block Lamps

- Fully potted to withstand the rigors of outdoor use
- Universal design – Easy to mount anywhere
- 5,000K Color Temperature



| Application | Description | Part # |
|-------------|--|---------|
| Universal | Single 4" Lamp with Wiring Harnesses | RT28030 |
| Universal | Dual Light Wiring Harness for Mounted Lights | RT28031 |
| 07/15 JK | 4" Lamps with Wiring Harness & Windshield Light Mount Brackets | RT28032 |
| 97/06 TJ | 4" Lamps with Wiring Harness & Windshield Light Mount Brackets | RT28073 |
| 87/95 YJ | 4" Lamps with Wiring Harness & Windshield Light Mount Brackets | RT28074 |

LED Light Bars

- 15° focus lenses
- 5,000K Color Temperature
- High quality NICHIA LEDs to accomplish high LUMEN output with 5 watts per LED



| Application | Description | Part # |
|-------------|--|---------|
| 07/15 JK | 20" Bar with #2285 Hood Bracket Kit | RT28033 |
| 07/15 JK | 50" Bar with #2180 Roof Bracket Kit | RT28034 |
| Universal | License Plate Bracket with 10" LED Bar | RT28035 |

LED Fog Lamp Assemblies - PAIR

- Fully compatible OEM harness for plug and play
- Utilizes existing fog lamp housing for an OEM installation; Adjustable design
- Black coated stainless steel hardware and fasteners included
- CNC 6061 aluminum housing

| Application | Comment | Part # |
|--------------------------|------------------|---------|
| 07/15 JK w/ OE Bumper | With H16 Harness | RT28036 |
| 11/15 JK w/ Steel Bumper | With H16 Harness | RT28037 |
| 07/15 JK | With H10 Harness | RT28038 |

LED Grilles

- Cut-to-Fit design to give a Jeep® a true makeover
- With 20" LED Light Bar

| Application | Construction | Part # |
|-------------|------------------------------------|---------|
| 07/15 JK | CNC Billet Aluminum | RT28040 |
| 07/15 JK | Black Powdercoated Stainless Steel | RT28041 |

LED Headlamps - PAIR

- 7" Headlights
- Each pair outputs 12,000LM
- 5,000K color temperature
- CNC 1" 6061 aluminum

| Application | Part # |
|-------------|---------|
| 07/15 JK | RT28039 |

LED Dome Lights

| Application | Part # |
|-----------------|---------|
| 07/15 JK 2-Door | RT28042 |
| 07/10 JK 4-Door | RT28044 |
| 11/15 JK 4-Door | RT28043 |

| Application | Part # |
|-------------|---------|
| 07/15 JK | RT28039 |



Highest Rated LED Bars (certified by an independent lab):

- MIL-STD-810G, method 514.6 – vibration
- MIL-STD-810G, method 511.5 – explosive atmosphere testing
- IP68 – dust and immersion
- ASTMB 117 – salt and fog
- IP69K – dust IP6 and high pressure water spray



LED BULBS



LED Miniature Bulbs - PAIR

| Application | Description | Part # |
|-------------|------------------|---------|
| Universal | 194 - Amber | RT28062 |
| Universal | 194 - Cool White | RT28063 |
| Universal | 194 - Red | RT28064 |
| Universal | 3157 - Amber | RT28065 |
| Universal | 3157 - Red | RT28066 |
| Universal | 3157 - White | RT28067 |
| Universal | 921 - Red | RT28068 |
| Universal | 921 - White | RT28069 |
| Universal | 1157 - Amber | RT28070 |
| Universal | 1157 - Red | RT28071 |
| Universal | 1157 - White | RT28072 |

LED Fog Lamp Bulbs - PAIR

| Application | Description | Part # |
|-------------|-------------|---------|
| Universal | H16 | RT28045 |
| Universal | H3 | RT28046 |
| Universal | H10 | RT28047 |
| Universal | 9006 | RT28048 |
| Universal | PSX24 | RT28049 |

LED Headlight Kits - PAIR

| Application | Description | Part # |
|-------------|-------------|---------|
| Universal | H3 | RT28050 |
| Universal | H4 | RT28051 |
| Universal | H7 | RT28052 |
| Universal | H10 | RT28053 |
| Universal | H16 | RT28054 |
| Universal | H1 | RT28055 |
| Universal | H13 | RT28056 |
| Universal | 9004 | RT28057 |
| Universal | 9005 | RT28058 |
| Universal | 9006 | RT28059 |
| Universal | 9007 | RT28060 |
| Universal | PSX24W | RT28061 |



WHEEL SPACER KITS

Achieve an aggressive look and improved stability with RT Off-Road's Wheel Spacer and Wheel Spacer Adapter kits. These Wheel Spacers and Adapters are an affordable option for additional backsourcing or conversion to a more popular bolt pattern. All of RT Off-Road's Wheel Spacers and Adapters are constructed of 1.5" thick 6061 T6 Aluminum. Each set has a hub-centric and wheel-centric design to ensure proper fitment on applications. All Spacers and Adapters are anodized blue to ensure a long lasting finish. RT Off-Road Spacer and Adapter sets are sold complete with 10 Lug Nuts, grade 8 Studs, and thread locking compound.

| Model | Year | Comments | Part # |
|--------|-------|--|---------|
| JK | 07/15 | 5 on 5" Bolt Pattern | RT32004 |
| TJ | 97/06 | 5 on 4.5" Bolt Pattern | RT32003 |
| YJ | 87/95 | 5 on 4.5" Bolt Pattern | RT32003 |
| XJ | 84/01 | 5 on 4.5" Bolt Pattern | RT32003 |
| MJ | 86/92 | 5 on 4.5" Bolt Pattern | RT32003 |
| KJ | 02/07 | 5 on 4.5" Bolt Pattern | RT32003 |
| KK | 08/10 | 5 on 4.5" Bolt Pattern | RT32003 |
| ZJ | 93/98 | 5 on 4.5" Bolt Pattern | RT32003 |
| WJ, WG | 99/04 | 5 on 5" Bolt Pattern | RT32004 |
| WK, WH | 05/10 | 5 on 5" Bolt Pattern | RT32004 |
| XK, XH | 06/10 | 5 on 5" Bolt Pattern | RT32004 |
| CJ | 76/86 | 5 on 5.5" Bolt Pattern; 4.2" Center Bore | RT32005 |

WHEEL ADAPTERS

RT Off-Road's Wheel Adapter Kits are a perfect solution for anyone wanting to expand their wheel choice. They allow the use of any 5 on 5" wheel to be installed on any vehicle with a 5 on 4.5" bolt pattern (example JK wheels on a TJ). They start as a 1.5" thick piece 6061 T6 aluminum. They are then machined and anodized blue for corrosion resistance. From there, Grade 8 studs are pressed into the Adapters. Each set includes 2 Spacers, 10 Lug Nuts, and thread locking compound.

5 on 4.5" to 5 on 5" Adapters

| Model | Year | Part # |
|--------|-------|---------|
| TJ | 97/06 | RT32001 |
| YJ | 87/95 | RT32001 |
| XJ | 84/01 | RT32001 |
| MJ | 86/92 | RT32001 |
| KJ | 02/07 | RT32001 |
| KK | 08/12 | RT32001 |
| ZJ, ZG | 93/98 | RT32001 |

5 on 4.5" to 5 on 5.5" Adapters

| Model | Year | Part # |
|--------|-------|---------|
| TJ | 97/06 | RT32002 |
| YJ | 87/95 | RT32002 |
| XJ | 84/01 | RT32002 |
| MJ | 86/92 | RT32002 |
| KJ | 02/07 | RT32002 |
| KK | 08/12 | RT32002 |
| ZJ, ZG | 93/98 | RT32002 |



RT32005



RT32001



NUT PLATE KIT

For Skid Plate And/Or Tow Hitch Mounting.
Kit includes 1 left and 1 right reinforcement Nut Plate to mount a Gas Tank Skid Plate or Tow Hitch when factory Nut Plate is missing or damaged.

| Model | Year | Replaces Part # |
|-------|-------|-----------------|
| XJ | 84/01 | 52001174K |



AIR SCOOP

Increase the efficiency of the heater and air conditioner and improve airflow through the vents with this dark smoke acrylic air scoop. No drilling required.

| Model | Year | Part # |
|-------|-------|---------|
| TJ | 97/06 | RT26001 |
| YJ | 87/95 | RT26001 |
| CJ | 76/86 | RT26001 |



JERRY CANS

RT Off-Road's 5.4 gallon metal cans include a plastic pour spout, vent, and a travel cap. The painted steel construction can easily be painted a custom color or used as it is received (Red or Olive colored). UN and Canada Approved. US Forest Service accepted. Universal Mount, Part #D8007 (Zinc Finish and Lockable), Sold Separately.

| Description | Part # |
|-----------------|---------|
| Red Jerry Can | RT26010 |
| Olive Jerry Can | RT26009 |



Replacement Parts for Jerry Cans

| Description | Part # |
|------------------|---------|
| Cap | RT26011 |
| Vent Cap | RT26014 |
| Spout | RT26013 |
| Mounting Bracket | RT26012 |



Blue Water Can

RT Off-Road's Blue Water Can is constructed of powder coated steel with a food-grade liner to prevent contamination of the liquid inside. The top features an o-ring and a lock pin to prevent leakage even in the most intense, off-camber situations.

- Powder Coated Blue
- Food-Grade Liner
- O-Ring Cap w/ Locking Pin
- Will work with traditional Jerry can mounts

| Description | Part # |
|----------------|---------|
| Blue Water Can | RT26020 |



TRAIL CAN UTILITY TOOL BOX



RT Off-Road's Tool Storage can is a great way to uniquely store a vehicle's gear. This Storage Can has the same finish and dimensions as a standard 5 gallon Jerry can (18x13x6.5"). The Storage Can contains two removable drawers and one lift out tray. These trays and drawers are kept safe under the built in lock and key. The all steel construction is kept safe with a durable red powder coated finish.

| Model | Part # |
|--------------|---------|
| All Vehicles | RT26019 |

HOLDERS

For Fire Extinguisher

Handy Fire Extinguisher Holder attaches to any roll bar or sports bar up to 3" diameter. Holds a 3 lb. extinguisher (not included). Attaches with adjustable hook and loop straps. Available in red only.



| Model | Part # |
|--------------|---------|
| All Vehicles | RT27005 |



For Flashlight

Hook and loop straps are used to affix to any roll bar up to 3". Uses a single hook and loop strap to quickly remove any D-Cell flashlight.



| Model | Part # |
|--------------|---------|
| All Vehicles | RT27043 |



For Cups

Includes a pair of insulated drink holders designed to hold a variety of bottles and can sizes. They mount via hook and loop straps to any vehicle with roll bars up to 3"



| Model | Part # |
|--------------|---------|
| All Vehicles | RT27044 |



DOOR GRAB HANDLES

- Fits all models including Rubicon and Unlimited
- Fits both half and full steel doors
- Includes 2 Handles
- Black nylon / rubber construction



| Model | Year | Part # |
|------------|-------|---------|
| JK | 07/15 | RT27046 |
| TJ | 97/06 | RT27017 |
| YJ | 87/95 | RT27004 |
| CJ-5, 7, 8 | 76/86 | RT27004 |



GRAB BAR SETS

These deluxe handles feature molded rubber grips with heavy duty vinyl straps. They have a three loop design with heavy duty hook and loop straps to secure them to a roll bar. Sold in pairs.

These economy handles have a soft vinyl foam grips. They have an adjustable two loop design to secure them to a roll bar. Sold in pairs.

| Model | Part # |
|--------------|---------|
| All Vehicles | RT27007 |



| Model | Part # |
|--------------|---------|
| All Vehicles | RT27006 |



DELUXE LOCKING CENTER CONSOLES

Features: front and rear cup holders, spring action coin organizer, extra large armrest, removable cooler that holds a six-pack, large locking storage area for CD's and valuables, and a concealed sunglasses holder.

| Model | Year | Color | Part # |
|-------|-------|-------|---------|
| YJ | 87/95 | Gray | RT27008 |
| YJ | 87/95 | Spice | RT27010 |
| YJ | 87/95 | Black | RT27009 |
| CJ | 76/86 | Gray | RT27008 |
| CJ | 76/86 | Spice | RT27010 |
| CJ | 76/86 | Black | RT27009 |



ROCK KEY BLANK

These rugged looking keys are licensed replacements for stock Jeep keys. They compliment the Jeep's famous "trail-rated" capabilities.



| Model | Year | Comment | Part # |
|-------|-------|-----------------|---------|
| TJ | 98/05 | Transponder | RT27011 |
| TJ | 97/06 | Non-Transponder | RT27013 |
| YJ | 94/95 | Non-Transponder | RT27013 |
| XJ | 98/01 | Transponder | RT27011 |
| XJ | 94/01 | Non-Transponder | RT27013 |
| ZJ | 94/98 | Non-Transponder | RT27013 |
| WJ | 99/04 | Transponder | RT27011 |
| WJ | 99 | Non-Transponder | RT27013 |
| KJ | 02/04 | Transponder | RT27011 |
| KJ | 02/04 | Non-Transponder | RT27013 |
| XK | 06/07 | Transponder | RT27012 |

LED SUPERBRIGHT UTILITY LIGHT

Universal application. Attaches to roll bar with hook and loop straps. Light also has a magnetic strip that will attach to metal when removed from the hook and loop strap. Takes 3 AAA batteries, not included.

| Model | Part # |
|----------------------------|---------|
| All Vehicles with Rollbars | RT28007 |



STORAGE DASH TRAYS

| Model | Year | Color | Part # |
|-------|-------|-------|---------|
| JK | 07/10 | Black | RT27022 |
| TJ | 97/06 | Black | RT27016 |



RT27016



RT27022

CLINOMETERS

RT Off-Road's new clinometers are an awesome way of ensuring that passengers are safer while off-road. They include a roll gauge which will tell how off-camber the vehicle is at all times, along with a pitch gauge which will show how steep of an incline or decline is being conquered. These clinometers are easy to install and adjust using the included adhesive backed base. Fits all vehicles.

| Description | Part # |
|--|---------|
| Roll and Pitch Gauge with CJ Graphics | RT27003 |
| Roll, Pitch Gauge and Compass with JK Wrangler™ Graphics | RT27045 |



RT27003



RT27045



INTERIOR TRIM PIECES FOR JK WRANGLER™

RT Off-Road's Interior Trim pieces add a distinctive look to the 2007-2010 JK Wranglers. These trim accents install in minutes with double sided tape or by snapping in place. Each piece is constructed out of durable injection molded plastic and finished in either chrome or brushed silver. Trim pieces are available in a complete kit or individually.

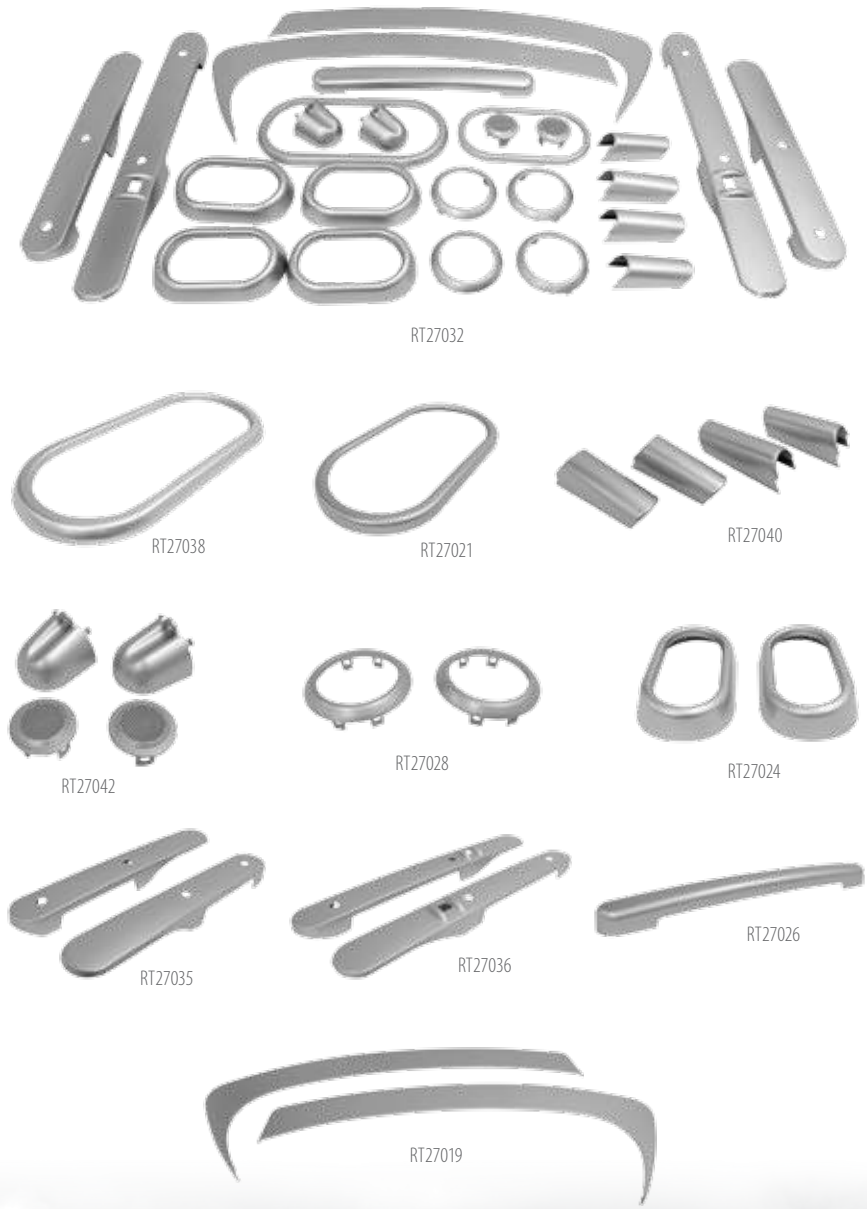

RT27032

RT27038

RT27021

RT27040

RT27042

RT27028

RT27024

RT27035

RT27036

RT27026

RT27019

| Chrome | |
|------------------------------|---------|
| Description | Part # |
| Complete Kit 2 Door | RT27029 |
| Complete Kit 4 Door | RT27032 |
| Shifter Bezel | RT27037 |
| Steering Wheel Spokes | RT27039 |
| A/C Vent Cover (2) | RT27027 |
| Speaker Cover (2) | RT27041 |
| Cup Holder Trim | RT27020 |
| Grab Handle Cover | RT27025 |
| Rear Door Handle Covers (2) | RT27033 |
| Front Door Handle Covers (2) | RT27034 |
| Door Handles (2) | RT27023 |
| Center Console | RT27018 |

| Silver | |
|------------------------------|---------|
| Description | Part # |
| Complete Kit 2 Door | RT27031 |
| Complete Kit 4 Door | RT27032 |
| Shifter Bezel | RT27038 |
| Steering Wheel Spokes | RT27040 |
| A/C Vent Cover (2) | RT27028 |
| Speaker Cover (2) | RT27042 |
| Cup Holder Trim | RT27021 |
| Grab Handle Cover | RT27026 |
| Rear Door Handle Covers (2) | RT27035 |
| Front Door Handle Covers (2) | RT27036 |
| Door Handles (2) | RT27024 |
| Center Console | RT27019 |



FRONT BUMPERS

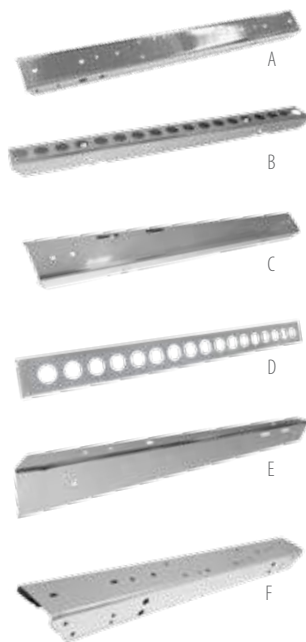

Replace a dented or rusty factory front bumper with an RT Off-Road Stainless Steel Front Bumper. Each bumper is manufactured of stainless steel and then polished to a brilliant finish. Bumper includes all the bolt holes necessary to mount it to the vehicle and requires no drilling. It also includes the same factory hole locations to mount the factory bumper end caps.

Stainless Steel

| Image | Model | Years | Part # |
|-------|-------|-------|-----------|
| A | TJ | 97/06 | RT34051 |
| B | YJ | 87/95 | RT34037 * |
| C | YJ | 87/95 | RT34038 |
| D | CJ | 55/86 | RT34022 * |
| E | CJ | 55/86 | RT34023 |

* 54" Stainless Steel Front Racing Bumper with Holes

Chrome

| Image | Model | Years | Part # |
|-------|-------|-------|-----------|
| F | TJ | 97/06 | RT20011 * |

* USA Only

REAR BUMPERS

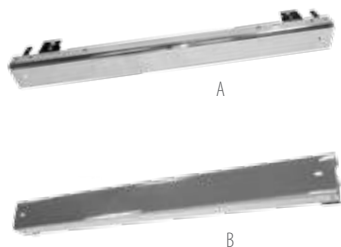

Stainless

| Image | Model | Years | Part # |
|-------|-------|-------|---------|
| A | TJ | 97/06 | RT20022 |

Chrome

| Image | Model | Years | Part # |
|-------|-------|-------|-----------|
| B | TJ | 97/06 | RT20012 * |

* USA Only

CORNER GUARDS



Stainless, Set of Two

| Model | Years | Part # |
|-------|-------|---------|
| YJ | 87/95 | RT34041 |

ROCKER PANEL SIDE PLATE SETS

Stainless; Includes Left and Right Panel.

| Image | Model | Years | Part # |
|-------|-------|-------|-----------|
| A | TJ | 97/06 | RT34062 * |
| B | YJ | 87/95 | RT34046 |

*Without Unlimited

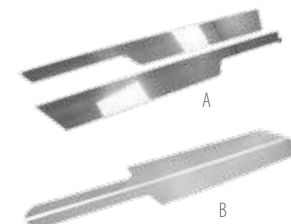

BUMPER OVERLAYS

Cover a dented or rusty factory front bumper with an RT Off-Road Stainless Steel front bumper overlay. Each bumper overlay is manufactured of stainless steel and then polished to a brilliant finish. Bumper overlay includes all the bolt holes necessary to mount it to the vehicle and requires no drilling.

Front

| Image | Model | Years | Part # |
|-------|-------|-------|---------|
| A | TJ | 97/06 | RT34052 |
| B | YJ | 87/95 | RT34039 |
| C | CJ | 76/86 | RT34024 |

Rear

| Image | Model | Years | Part # |
|-------|-------|-------|---------|
| D | YJ | 87/95 | RT34040 |
| E | CJ | 76/86 | RT34025 |

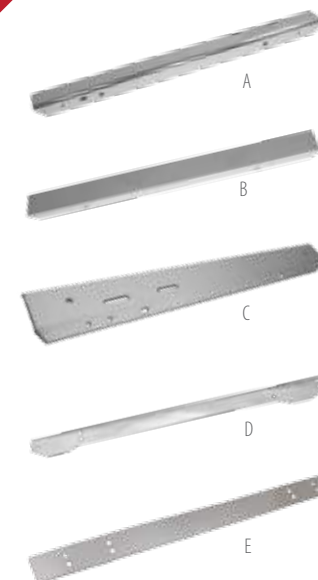

BUMPERETTES

RT Off-Road's Bumperettes are constructed out of a highly polished stainless steel and include stainless steel fasteners. These Bumperettes mount in place of the factory pieces and include all hardware needed for installation. Kit includes driver and passenger side Bumperettes and all hardware needed for installation.

| Model | Years | Color | Part # |
|--------|-------|-----------|---------|
| YJ, CJ | 76/95 | Stainless | RT20020 |



FRONT FRAME COVERS

| Image | Model | Years | Color | Part # |
|-------|-------|-------|-----------|---------|
| A | TJ | 97/06 | Stainless | RT34045 |
| B | YJ | 87/95 | Stainless | RT34043 |
| C | CJ | 76/86 | Stainless | RT34030 |

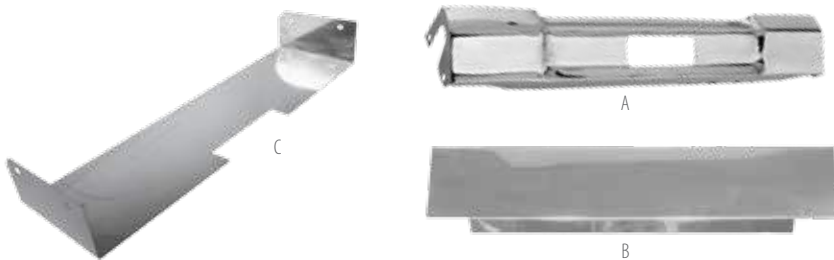

ENTRY GUARDS SETS

| Model | Comment | Color | Years | Part # |
|-----------|---------|-----------|-------|---------|
| JK | 2DR | Stainless | 07/15 | RT34072 |
| JK | 2DR | Black | 07/15 | RT26049 |
| JK | 4DR | Stainless | 07/15 | RT34073 |
| JK | 4DR | Black | 07/15 | RT26050 |
| TJ | | Stainless | 97/06 | RT34053 |
| TJ | | Black | 97/06 | RT26036 |
| YJ & CJ-7 | | Stainless | 76/95 | RT34010 |
| YJ & CJ-7 | | Black | 76/95 | RT34010 |
| CJ-5 | | Stainless | 55/83 | RT34028 |



VEHICLE RECOVERY KIT

The RT Off-Road Vehicle Recovery kit is the most convenient collection of recovery parts available. This kit contains everything needed to complete a complex winching operation as well as individual items that will aid in more simple situations. All items are stowed away in a heavy duty polyester bag. Be prepared and have the right tools ready for vehicle recovery.

- Includes: Recovery Strap, Tree Saver, Snatch Block, Two D-Rings, Winch Line Dampener, Gloves, and a Recovery Bag
- The Recovery Tow Strap is rated for 20,000 lbs. and features leather-wrapped ends.
- The Tree Saver is rated for 30,000 lbs. and is used to guarantee the well-being of trees when recovering with a winch.
- Leather-Palmed Gloves and a winch line dampener are added to ensure the safety of all persons using this kit.
- The Recovery bag is oversized to accommodate for storage of additional accessories.

| Description | Part # |
|-------------------------------|---------|
| Complete Vehicle Recovery Kit | RT33013 |



D-RING AND RECEIVER KITS

RT Off-Road's recovery accessories are a high quality, high value, collection of products. Designed and produced to ensure a strong, safe, and durable point to recover or couple. All metal recovery products are either powder coated black or zinc finished to protect the product for years of use.

All Receivers are 2" and D-Rings are 3/4" unless stated

| Description | Part # |
|-----------------------------|---------|
| Stainless Steel D-Ring | RT33002 |
| Zinc Plated Steel D-Ring | RT33001 |
| 5/8" Stainless Steel D-Ring | RT33003 |
| 1 Receiver and 3 D-Rings | RT33011 |
| 1 Receiver and 2 D-Rings | RT33010 |
| 1 Receiver and 1 D-Ring | RT33009 |
| 2 D-Rings | RT33005 |



Rubber Spacers For D-Rings

Eliminates Rattle

| Description | Part # |
|---------------------------------------|---------|
| 1 Rubber Spacer | RT33007 |
| 2 Rubber Spacers | RT33008 |
| 1 Stainless Steel D-Ring with spacers | RT33004 |
| 1 Receiver and 1 D-Ring with spacers | RT33014 |
| 2 D-Rings with spacers | RT33006 |



TOW HOOK KITS

| Model | Years | Color | Part # |
|---------------|-------|--------|---------|
| CJ-5, 6, 7, 8 | 55/86 | Chrome | RT33014 |
| CJ-5, 6, 7, 8 | 55/86 | Black | RT33015 |



FUEL DOORS

Finish the look of a vehicle with RT Off-Road's Fuel Door. Available in both brushed, polished, or black powder coated aluminum. Available with or without lock mechanism. Includes all hardware needed for installation

| Model | Years | Color | Comment | Part # |
|-------|-------|-------------------|-------------|---------|
| JK | 07/15 | Black | Non-Locking | RT26053 |
| JK | 07/15 | Black | Locking | RT26054 |
| JK | 07/15 | Polished Aluminum | Non-Locking | RT26051 |
| JK | 07/15 | Polished Aluminum | Locking | RT26052 |
| TJ | 97/06 | Black | Non-Locking | RT26037 |
| TJ | 97/06 | Black | Locking | RT26040 |
| TJ | 97/06 | Polished Aluminum | Non-Locking | RT26038 |
| TJ | 97/06 | Polished Aluminum | Locking | RT26039 |



FUEL NECK PROTECTORS

| Image | Model | Years | Color | Part # |
|-------|----------------|-------|-----------|---------|
| A | TJ | 97/06 | Stainless | RT34056 |
| B | YJ, CJ-5, 7, 8 | 78/95 | Stainless | RT34089 |



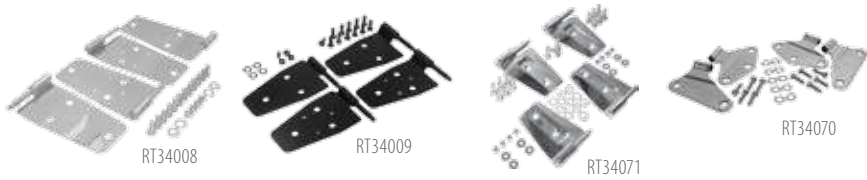

DOOR HINGE SETS

RT Off-Road's Stainless Steel products offer optimal fit and finish while maintaining superior function. All Brackets, Hinges, and hardware are produced from corrosion resistant stainless steel. Each part is available in either a polished stainless steel or a rich black powder coat.

| Model | Color | Comments | Years | Door | Part # |
|------------|-----------|---------------|-------|--------------|-----------|
| JK 2-Door | Stainless | 4 Hinges | 07/15 | Full or Half | RT34071 |
| JK 4-Door | Stainless | 8 Hinges | 07/15 | Full or Half | RT34079 |
| JK 2-Door | Stainless | 4 Body Hinges | 07/15 | Full or Half | RT34070 |
| JK 4-Door | Stainless | 8 Body Hinges | 07/15 | Full or Half | RT34069 |
| TJ | Black | 4 Hinges | 97/06 | Full or Half | RT34094 |
| TJ | Stainless | 4 Hinges | 97/06 | Full or Half | RT34009 |
| YJ | Black | 4 Hinges | 87/95 | Full | RT34093 * |
| YJ | Stainless | 4 Hinges | 87/95 | Full | RT34008 * |
| YJ | Black | 4 Hinges | 87/95 | Half | RT34094 * |
| YJ | Stainless | 4 Hinges | 87/95 | Half | RT34009 * |
| CJ-5, 7, 8 | Black | 4 Hinges | 76/86 | Full or Half | RT34093 |
| CJ-5, 7, 8 | Stainless | 4 Hinges | 76/86 | Full or Half | RT34008 |

* With Provisions for Mirrors

Lower Door Hinge Brackets

| Model | Color | Years | Part # |
|---------------|-----------------|-------|---------|
| TJ | Stainless | 97/06 | RT34007 |
| TJ | Black Stainless | 97/06 | RT34092 |
| YJ | Stainless | 87/95 | RT34007 |
| YJ | Black Stainless | 87/95 | RT34092 |
| CJ-5, 6, 7, 8 | Stainless | 55/86 | RT34007 |
| CJ-5, 6, 7, 8 | Black Stainless | 55/86 | RT34092 |



DOOR HANDLES

- Stainless Steel Construction
- Highly polished finish
- Fits Full or Half Doors on: 07/15 JK Wrangler,™ 08/12 KK Liberty,™ 07/09 KA Dodge Nitro.™ Also fits JK Tailgate.
- Includes all hardware needed for installation.



| Quantity | Comment | Part # |
|----------|----------------------|---------|
| 1 | Individual | RT34002 |
| 2 | 2-Door | RT34003 |
| 3 | 2-Door Plus Tailgate | RT34004 |
| 4 | 4-Door | RT34005 |
| 5 | 4-Door Plus Tailgate | RT34006 |



TAILGATE HINGE SETS

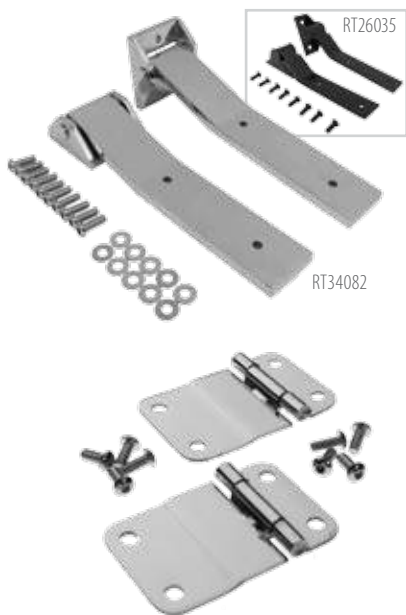

Replace those old, rusty Tailgate Hinges with a set from RT Off-Road. Each set is manufactured out of stainless steel and then polished to a brilliant finish. Stainless steel hardware is included.

| Model | Color | Years | Part # |
|-------|-----------|-------|---------|
| JK | Stainless | 07/15 | RT34082 |
| TJ | Stainless | 97/06 | RT34065 |
| YJ | Stainless | 87/95 | RT34049 |
| YJ | Black | 87/95 | RT26035 |

Lower Tailgate Hinge Sets

RT Off-Road's Tailgate Hinges offer an optimal fit and finish while maintaining superior function. Tailgate Hinges and all hardware are produced from corrosion resistant stainless steel.

| Model | Color | Years | Part # |
|---------|-----------|-------|---------|
| CJ-7, 8 | Stainless | 76/86 | RT34035 |

LIFTGATE HINGE SETS

RT Off-Road's Liftgate Hinges offer an optimal fit and finish while maintaining superior function. Lower Tailgate Hinges and all hardware are produced from corrosion resistant stainless steel.

| Model | Color | Years | Part # |
|-------|-----------|-------|---------|
| CJ-7 | Stainless | 77/86 | RT34032 |



TAILGATE TIRE STOP

Replace that old, rusty Tailgate Tire Stop with one from RT Off-Road. Manufactured out of stainless steel. All hardware included.

| Model | Color | Years | Part # |
|-------------|-----------|-------|---------|
| YJ, CJ-7, 8 | Stainless | 76/95 | RT34015 |
| YJ, CJ-7, 8 | Black | 76/95 | RT26018 |





HOOD VENT COVERS

| Model | Years | Color | Part # |
|----------------|-------|-----------|---------|
| JK | 07/15 | Stainless | RT34078 |
| TJ | 1997 | Stainless | RT34060 |
| TJ | 98/06 | Stainless | RT34061 |
| YJ, CJ-5, 7, 8 | 78/95 | Stainless | RT34014 |
| YJ, CJ-5, 7, 8 | 78/95 | Black | RT26008 |
| CJ-5, 6 | 55/75 | Chrome | RT26024 |



HOOD HINGE SETS

| Model | Color | Years | Part # |
|---------------|-----------|-------|-----------|
| JK | Stainless | 07/15 | RT34076 * |
| JK | Stainless | 07/15 | RT91002 |
| TJ | Stainless | 97/06 | RT34057 |
| TJ | Black | 97/06 | RT34091 |
| YJ | Stainless | 87/95 | RT34012 |
| YJ | Black | 87/95 | RT34095 |
| CJ-5, 6, 7, 8 | Stainless | 55/86 | RT34012 |
| CJ-5, 6, 7, 8 | Black | 55/86 | RT34095 |

* Includes: 1 Footman Loop and 2 Hood Stops

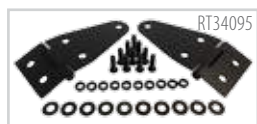

COMPLETE HOOD SETS

| Model | Years | Color | Part # |
|------------|-------|-----------|---------|
| JK | 07/15 | Stainless | RT34077 |
| TJ | 1997 | Stainless | RT34058 |
| TJ | 98/06 | Stainless | RT34059 |
| YJ | 87/95 | Stainless | RT34013 |
| YJ | 87/95 | Black | RT26007 |
| CJ-5, 7, 8 | 78/86 | Stainless | RT34013 |
| CJ-5, 7, 8 | 78/86 | Black | RT26007 |

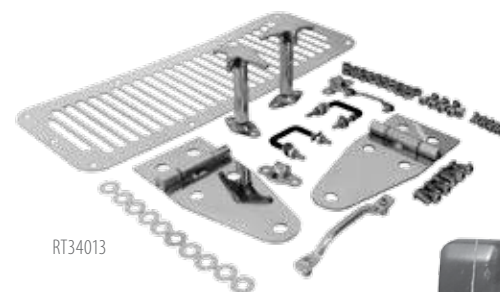
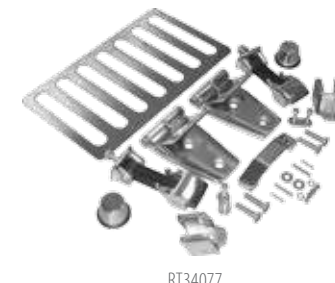

HOOD CATCH KITS

Improve the look of any Jeep with RT Off-Road's Hood Catch Kit. This kit is designed to bolt in place of the OE hood catches. All necessary hardware is included for installation.

Single; fits left or right, Two required.

| Model | Years | Color | Part # |
|--------|-------|-----------|---------|
| YJ, CJ | 41/95 | Chrome | RT26006 |
| YJ, CJ | 41/95 | Stainless | RT26005 |

Pairs; fits left and right.

| Model | Years | Color | Part # |
|--------|-------|-----------|-----------|
| JK | 07/15 | Stainless | RT34075 |
| TJ | 97/06 | Stainless | RT26044 |
| YJ, CJ | 55/95 | Stainless | RT34083 * |
| YJ, CJ | 55/95 | Black | RT34084 * |
| YJ, CJ | 41/95 | Stainless | RT34011 |

* Modern Style

Locking

Bolt on security for the engine compartment and under hood accessories with a Locking Hood Catch Kit from RT Off-Road. Included with each kit is a pair of black powder coated 304 stainless steel Hood Catches, a set of pre-installed lock cylinders with keys, and all necessary hardware. Hood flutter, a very common problem with all Jeep JK's, is eliminated by omitting rubber from the construction of the kit. This kit fits in place of the factory hood catches; a no-drill installation.

| Model | Years | Color | Part # |
|-------|-------|-------|---------|
| JK | 07/15 | Black | RT26057 |

Bolt on security for the engine compartment and under hood accessories with RT Off-Road's Hood Lock. Complete system installs easily to the vehicle's security latch. Lock assembly comes complete with two keys.

| Model | Years | Color | Part # |
|-------|-------|--------|---------|
| TJ | 1997 | Black | RT26070 |
| TJ | 97/06 | Silver | RT26071 |
| YJ | 87/95 | Black | RT26069 |



CHROME GRILLE COVERS

- Stainless Steel Construction.
- Fits all available models.
- Installs directly over factory grille using double face tape and screws.

| Model | Years | Part # |
|-------|-------|-----------|
| YJ | 87/95 | RT34044 |
| YJ | 87/95 | RT34045 * |
| CJ | 72/86 | RT34031 * |
| CJ | 72/86 | RT34086 |

* Includes Chrome Headlight Bezels



GRILLE INSERTS

Complete the factory grille's look with RT Off-Road's Grille Inserts. Every Grille Insert set includes seven primary inserts that either snap or bolt into place. All kits are sold complete and include everything you need for installation.

| Model | Years | Color | Part # |
|-------|-------|----------------|---------|
| JK | 07/15 | Stainless | RT34074 |
| JK | 07/15 | Chrome Plastic | RT26055 |
| JK | 07/15 | Black | RT26056 |
| TJ | 97/06 | Chrome Plastic | RT26042 |
| TJ | 97/06 | Black | RT26043 |
| YJ | 87/95 | Chrome Plastic | RT26030 |
| YJ | 87/95 | Black | RT26031 |



BUG SCREENS



RT34021



RT26023



RT34050



RT34036

| Model | Years | Color | Part # |
|-------|-------|-----------|---------|
| TJ | 97/06 | Stainless | RT34050 |
| TJ | 97/06 | Black | RT34085 |
| YJ | 87/95 | Stainless | RT34036 |
| YJ | 87/95 | Black | RT26029 |
| CJ | 55/86 | Stainless | RT34021 |
| CJ | 55/86 | Black | RT26023 |

STONE GUARD SETS



RT26032



RT334064

| Model | Years | Color | Part # |
|-------|-------|-----------|---------|
| TJ | 97/06 | Stainless | RT34064 |
| TJ | 97/06 | Chrome | RT26047 |
| YJ | 87/95 | Stainless | RT34047 |
| YJ | 87/95 | Chrome | RT26032 |
| YJ | 87/95 | Black | RT26033 |
| CJ | 76/86 | Stainless | RT34034 |
| CJ | 76/86 | Chrome | RT26032 |

BILLET STYLE STONE GUARD SETS

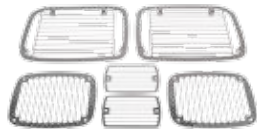

RT34048

| Model | Years | Color | Part # |
|-------|-------|-----------|---------|
| TJ | 97/06 | Stainless | RT34063 |
| TJ | 97/06 | Black | RT26048 |
| YJ | 87/95 | Stainless | RT34048 |
| YJ | 87/95 | Black | RT26034 |

EURO GUARDS

- 6 Piece Kit For Front Lamps
- Includes Guards For: Headlamps, Parking Lamps, And Sidemarkers Lamps

| Model | Years | Color | Part # |
|-------|-------|-----------|---------|
| TJ | 97/06 | Stainless | RT34054 |



TAIL LIGHT GUARDS SETS

Euro Style

| Model | Year | Color | Part # |
|-------|-------|-----------|---------|
| JK | 07/15 | Black | RT28002 |
| TJ | 97/06 | Black | RT26017 |
| TJ | 97/06 | Stainless | RT34090 |
| TJ | 97/06 | Titanium | RT34098 |
| YJ | 87/95 | Black | RT26017 |
| YJ | 87/95 | Stainless | RT34090 |
| YJ | 87/95 | Titanium | RT34098 |
| CJ | 76/86 | Black | RT26017 |
| CJ | 76/86 | Stainless | RT34090 |
| CJ | 76/86 | Titanium | RT34098 |



RT26017



RT34090



RT28002

Traditional Style

| Model | Year | Color | Part # |
|-------|-------|-----------|---------|
| JK | 07/15 | Stainless | RT34080 |
| JK | 07/15 | Stainless | RT34081 |

* Includes Hardware



RT34081



RT34080





WINDSHIELD HINGE SETS

| Model | Color | Years | Part # |
|--------|-----------|-------|---------|
| TJ | Stainless | 97/06 | RT34066 |
| YJ, CJ | Black | 55/95 | RT34096 |
| YJ, CJ | Stainless | 76/95 | RT34017 |

LIGHT BARS



| Model | Years | Color | Part # |
|-------|-------|-----------|---------|
| TJ | 97/06 | Stainless | RT28014 |
| YJ | 87/95 | Stainless | RT28008 |
| YJ | 87/95 | Stainless | RT28009 |
| CJ | 76/86 | Stainless | RT28008 |
| CJ | 76/86 | Stainless | RT28009 |

WINDSHIELD TIE DOWN KITS

- Stainless Steel Construction
- Highly polished, corrosion resistant finish
- Includes all hardware needed for installation

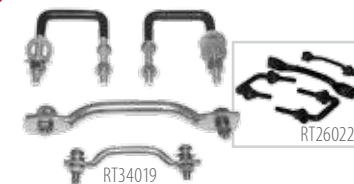

| Model | Years | Color | Part # |
|-------|-------|-----------|------------|
| JK | 07/15 | Stainless | RT34097 ** |
| TJ | 97/06 | Stainless | RT34068 * |
| YJ | 87/95 | Stainless | RT34019 |
| YJ | 87/95 | Black | RT26022 |
| CJ | 55/86 | Stainless | RT34019 |
| CJ | 55/86 | Black | RT26022 |

* Includes two windshield bumper bezels, two wiper nozzle bezels, and one footman loop; Bezels and wiper nozzles attach with double sided tape and are constructed out of plastic

** Includes two windshield bumpers, one hood mounted footman loop, and all hardware needed for install; Will also fit all 1997-2006 TJ Wrangler Models



STAINLESS STEEL FOOTMAN LOOP SETS

| Model | Year | Part # |
|-------|-------|---------|
| CJ | 55/86 | RT34029 |



WINDSHIELD LIGHT MOUNT BRACKET SETS

Easily add auxiliary lights with RT Off-Road's Windshield Light Mount Brackets. Brackets mount to the vehicle using existing holes in the windshield frame. Each set is finished in a rich gloss black powder coat. Kit includes all hardware needed for installation. An antenna bracket and grommet is also included to eliminate any possibility of the antenna contacting the lights.

RT28003



| Model | Color | Years | Part # |
|--------|-----------|-------|---------|
| JK | Black | 07/15 | RT28003 |
| TJ | Stainless | 97/06 | RT34067 |
| TJ | Black | 97/06 | RT28001 |
| YJ, CJ | Stainless | 76/95 | RT34018 |
| YJ, CJ | Black | 76/95 | RT26021 |



MIRROR RELOCATION BRACKET SETS

Remove the doors from a Jeep without removing mirrors with RT Off-Road's Mirror Relocation Brackets. In this kit is a pair of brackets that installs into existing holes in the windshield frame. A pair of door inserts are also included to cover the holes from the moved bracket on JK models. Both the brackets and the inserts are finished in a rich black powder coat.

| Model | Color | Years | Part # |
|-------|-----------|-------|----------|
| JK | Black | 07/15 | RT30016 |
| TJ | Black | 97/02 | RT30013 |
| TJ | Stainless | 97/02 | RT300015 |
| TJ | Black | 03/06 | RT300014 |
| YJ | Black | 87/95 | RT30010 |

RT30016



MIRRORS



Replaces Part # 82200834CK

Door Mounted

| Model | Color | Years | Comments | Replaces Part # |
|--------|--------|-------|------------------|-----------------|
| TJ, YJ | Chrome | 87/06 | Set, 87/02 Style | 82200834CK |



RT30003

Front Windshield Hinge Mounting

| Model | Color | Years | Comment | Part # |
|-------|-----------|-------|---------|---------|
| YJ | Stainless | 87/95 | Set | RT30003 |
| CJ | Stainless | 55/86 | Set | RT30003 |

Side Windshield Hinge Mounting

| Model | Color | Years | Comments | Part # |
|--------|-----------|-------|----------|---------|
| TJ | Stainless | 97/06 | Set | RT30011 |
| TJ | Black | 97/06 | Set | RT30012 |
| YJ, CJ | Stainless | 76/95 | Set | RT30001 |
| YJ, CJ | Black | 76/95 | Set | RT30002 |



RT30011



RT30012

Safari Mirror

RT Off-Road's Safari Mirrors are a great solution for those who want to drive without doors, but require side view Mirrors. These black powder coated Mirrors mount directly to the body side of the door hinge and tighten with the supplied hardware. They are adjustable to change the angle of the Mirror for use on either side of the vehicle. Each kit includes two 8"x6" Mirrors, two Arms, and all hardware needed to mount them to the vehicle.

| Model | Color | Years | Replaces Part # |
|------------|-------|-------|-----------------|
| JK, TJ, YJ | Black | 87/15 | RT30004 * |
| JK, TJ, YJ | Black | 87/15 | RT30005 |
| CJ | Black | 76/86 | RT30004 * |
| CJ | Black | 76/86 | RT30005 |

* Single; One mirror, one arm, and hardware.



Quick Release Mirror Set

RT Off-Road's Quick Release Mirrors are a great solution for those who want to drive without doors, but require side view Mirrors. The gloss black powder coated brackets mount directly to the side of the upper windshield hinge. The included Mirror Arms and Heads attach to the Brackets with a thumb screw to allow for a quick release. Each kit includes two 6" round Mirrors, two Arms, two Brackets, and all hardware needed to mount it to the vehicle.

| Model | Color | Years | Replaces Part # |
|------------|-------|-------|-----------------|
| JK, TJ, YJ | Black | 87/15 | RT30020 |
| CJ | Black | 76/86 | RT30020 |





INTERIOR WINDSHIELD BRACKET SETS

| Model | Years | Color | Part # |
|--------|-------|-----------|---------|
| YJ, CJ | 76/95 | Stainless | RT34016 |
| YJ, CJ | 76/95 | Black | RT27014 |



WINDSHIELD KNOB SET

| Model | Years | Color | Comments | Part # |
|-------|-------|--------|----------|---------|
| CJ | 76/86 | Chrome | Set of 2 | RT26028 |



DASH KNOB SETS

Finish the look of a vehicle's dash with RT Off-Road's Dash Control Knob Set. Available in both polished and powder coated aluminum. Install in place of the factory plastic knobs and are held in place with set screws. Includes all hardware needed for installation.

| Model | Years | Color | Part # |
|-------|-------|----------|---------|
| CJ | 76/86 | Black | RT27002 |
| CJ | 76/86 | Aluminum | RT27001 |

BILLET SHIFT KNOBS

RT Off-Road's polished billet aluminum Shift Knob offer optimal fit and finish while maintaining superior function. All our Shift Knobs and hardware are produced from corrosion resistant aluminum that is polished to a mirror finish. The Aluminum knob installed in place of the factory piece and will include all hardware needed for installation.

| Model | Year | Color | Description | Part # |
|--------|-------|----------|----------------------------------|-----------|
| TJ, YJ | 87/98 | Aluminum | NP231 Shift Pattern, M10 - 1.5 | RT24009 |
| TJ, YJ | 87/98 | Aluminum | 5 Speed Shift Pattern, 3/8" - 16 | RT24008 * |
| TJ, YJ | 94/06 | Aluminum | 5 Speed Shift Pattern, M10 - 1.5 | RT24007 |

* See part 46009 for matching transfer case shift knob for 1987-1995 Wrangler



STAINLESS STEEL DASH GRAB BARS

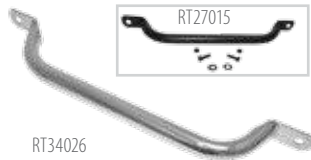

| Model | Years | Color | Part # |
|-------|-------|-----------|---------|
| CJ | 55/86 | Stainless | RT34026 |
| CJ | 55/86 | Black | RT27015 |

STAINLESS STEEL DASH OVERLAYS



| Model | Years | Color | Part # |
|-------|-------|-----------|----------|
| YJ | 87/95 | Stainless | RT34042 |
| CJ | 76/86 | Stainless | RT34027* |

* With Radio Opening

STAINLESS STEEL STEERING COLUMN COVER



| Model | Years | Part # |
|-------|-------|---------|
| CJ | 76/86 | RT34033 |

STAINLESS STEEL BATTERY TRAYS & ACC.



| Model | Years | Description | Part # |
|--------------|-------|-------------|---------|
| CJ | 76/86 | Tray | RT34087 |
| CJ | 76/86 | Clamp | RT34088 |
| CJ | 76/86 | Tray Kit | RT34020 |
| SJ, J-Series | 76/86 | Clamp | RT34088 |

ALUMINUM VALVE COVER KITS

RT Off-Road's Engine Valve Cover Kit's are a direct replacement upgrade for factory valve covers. Each Valve Cover is constructed out of aluminum. Available in an assortment of colors, or in bare aluminum. Increased internal clearance allows for the use of oversized Camshafts and high clearance Rocker Arms. Each kit includes Gasket, Grommets, and additional installation hardware.

- Durable finish with polished fins and engine script
- Includes Valve Cover, Gasket, Oil Cap, Grommets, and Hardware
- Some modification may be required



For all 93/04 Jeep® Vehicles with 4.0L Engine

| Color | Part # |
|--------|---------|
| Red | RT35002 |
| Yellow | RT35003 |
| Black | RT35001 |

Note: Replacement Oil Cap available, Part # 33001016AL



For all 81/86 Jeep® Vehicles with 4.2L Engine

| Color | Part # |
|-------------|-----------|
| Non-Painted | RT35004 * |
| Black | RT35005 * |

* Includes: Bridges



STAINLESS STEEL HEADER KIT

Improve exhaust flow with RT Off-Road's new Stainless Steel Header Kit for 4.0L Jeep vehicles. This manifold starts with a pair of 1/2" thick zinc-coated flanges that will provide a perfect seal to the cylinder head and downpipe. The primaries are manufactured of 1-1/2" diameter polished, mandrel-bent 304 stainless steel tubing. They meet at a 6-to-1 polished 304 stainless steel collector, which improves exhaust flow through the entire operating range of the engine. The primaries are fully welded to the flanges and collector, resulting in an extremely strong and leak-free header. The outlet of the collector is made of polished, mandrel-bent 304 stainless steel; this time with a 2-1/2" diameter, which will mate to the stock downpipe with no issues. These features result in increased horsepower, torque, throttle response, and fuel mileage along with years of worry-free operation. Installation is straight forward with no cutting, grinding, or welding needed.

| Model | Years | Part # |
|--------|-------|-----------|
| TJ, YJ | 91/99 | RT36001 * |
| TJ, YJ | 91/99 | RT36002 |
| XJ, MJ | 91/99 | RT36001 * |
| XJ, MJ | 91/99 | RT36002 |
| ZJ | 93/98 | RT36001 * |
| ZJ | 93/98 | RT36002 |

* Kit

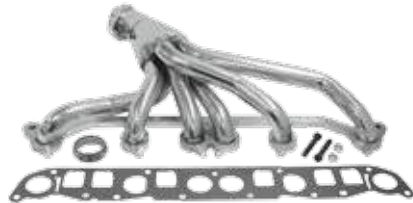

DEEP TRANSMISSION PAN KIT

With A999 Transmission

| Model | Years | Part # |
|---------|-------|-----------|
| YJ | 87/91 | RT24001 |
| XJ, MJ | 84/86 | RT24001 * |
| SJ, J10 | 84/90 | RT24001 |
| CJ | 80/86 | RT24001 * |

* Also with A904 Transmission



HEAVY DUTY TRANSMISSION OIL COOLER KIT

- Direct Bolt In Design
- Tube and Fin Construction
- Clean Factory Look
- Helps Prevent Transmission From Overheating

| Model | Year | Part # |
|-------|-------|---------|
| JK | 07/11 | RT24006 |



