



**2019 CATALOG**  
APPLICATION GUIDES





CURT is the leading manufacturer of USA-made trailer hitches and a complete line of towing and electrical products.



ARIES is a fast-paced marketer and innovator of truck, Jeep, SUV and CUV accessories.



UWS is a leading manufacturer and designer of USA-made truck tool boxes.



LUPERNE is a leading manufacturer of functional aftermarket accessories for pickup trucks, commercial vans and SUVs.



RETRAC is a leading manufacturer of OEM and aftermarket mirrors and front-end protection for heavy-duty and medium-duty trucks.

A leading sales, marketing, engineering and distribution company of towing products and truck accessories for all types of vehicles, from passenger cars to commercial trucks. We stand for EXCELLENCE in our products and our associates. We aspire to be the industry LEADER by recognizing that the customer is KING and our associates are our greatest ASSET.



We are a unified team of more than 1,000 dedicated associates world-wide.



We manufacture products in Wisconsin, South Dakota, Florida and Mexico.



We ship from 12 regional warehouses across the United States and Canada.

Echo™ mobile  
brake control



## FIRST-TO-MARKET. ALWAYS INNOVATING.

CURT strives for continuous improvement. This not only applies to our products but also our people, processes and customer service. We have always approached our work with a first-to-market focus, and as a result, we are able to deliver top quality products, for more vehicle applications, at an industry-leading rate.

This year, we are excited to introduce several new products, including the world's first Bluetooth-enabled brake control. We are also offering a number of new cargo management products, including a cargo carrier with ramp and roof kayak holders.

Each year, we not only develop new, innovative products, but we also put a great deal of effort into our carryover process, expanding the application range of our existing products to cover more and more vehicles.



**INNOVATION IN EVERYTHING WE DO.**

# NEW PRODUCTS



## Custom-Fit Trailer Hitches

Custom hitches are at the heart of our new product efforts. We offer many first-to-market designs, in-house testing and an industry-leading finish. **Page 14**



## Adjustable RV Trailer Hitch

This new hitch has a three-piece design to fit RV frames up to 72" wide. It is tested to 3,500 lbs. GTW and comes with our industry-leading finish. **Page 16**



## Custom Wiring

We continue to advance our plug-and-play, custom wiring line with new technology, like potted housings and many first-to-market applications. **Page 30**



## Echo™ Mobile Brake Control

This is the world's first Bluetooth-enabled brake control! It plugs into the vehicle-trailer 7-way and turns the driver's smartphone into a brake control interface. **Page 133**



## Assure™ Brake Control

This proportional brake control features a high-quality 128 x 64 dot matrix OLED display screen and a pressure-sensitive manual override button. **Page 134**



## Cargo Carrier with Ramp

The built-in ramp of this carrier has a unique, ergonomic double-folding design. We've also added a new aluminum cargo carrier without a ramp. **Page 240**



## Roof Rack Kayak Holders

These universal kayak holders feature a lightweight aluminum build and a 75-lb. capacity. Their rotating arms fit virtually any kayak or paddleboard. **Page 242**



## Roof Rack Crossbars

These universal crossbars are made from lightweight, E-coated aluminum and have a 150-lb. capacity. They attach to virtually any roof side rails. **Page 242**



## Auxiliary LED Indicator Lights

These indicator light strips plug into any standard 4-way flat and stick onto any bike rack, cargo carrier or other accessory for added safety. **Page 240**



### 2-1/2" Forged Pintle Mounts

2-1/2" receivers are ever increasing in popularity. These new pintle mounts are rated for 20,000 lbs. and accept any of our pintle mount attachments. **Page 109**



### 2-1/2" Forged Weight Distribution Shanks

Equip your customers to use any of our WD hitches with their 2-1/2" receiver with these WD shanks. We've also added a deep drop shank for larger trucks. **Page 218**



### 2-1/2" Forged Ball Mounts

These heavy-duty ball mounts are ideal for complementing our Commercial Duty class 5 trailer hitches, featuring a GTW capacity of 21,000 lbs. **Page 99**



### 2" Loaded Ball Mounts

We've added two new loaded ball mounts with a 6" drop. One has a 2" trailer ball and the other a 2-5/16" ball. Both are rated to 7,500 lbs. GTW. **Page 97**



### Channel-Mount Pintle Combinations

Our popular adjustable channel mount line continues to expand with new kitted options for ball and pintle combos, including a 2" and 2-1/2" shank option. **Page 100**



### Channel-Mount Hitch Step

This hitch step attaches to any of our adjustable channel mounts and provides a convenient, hitch-mounted step up on the front or rear of the vehicle. **Page 101**



### ATV / Lawn Tractor Trailer Balls

Uniquely tailored for towing with an ATV or lawn tractor, these trailer balls feature a GTW rating of 2,000 lbs. and are available with a 1-7/8" or 2" ball. **Page 113**



### Clevis Pins

Great for securing accessories or towing with an ATV, UTV or lawn tractor, these clevis pins are heavy-duty and are available in three diameters. **Page 103**



### 3" OEM-Style Gooseneck Ball

Like our existing 2-5/16" ball, this new 3" OEM-style gooseneck ball is compatible with OEM puck systems and our OEM-style goosenecks. **Page 173**

# **UNDERSTANDING TOWING**

Towing basics and electrical guides

## **TRAILER HITCHES**

Rear and front mount, multi-fit and RV hitches

## **TOWING ACCESSORIES**

Ball mounts, trailer balls, locks, pintles and more

## **TOWING ELECTRICAL**

Brake controls, custom wiring, adapters and connectors

## **GOOSENECK HITCHES**

OEM puck system kits, Double Lock EZr™ and more

## **5TH WHEEL HITCHES**

OEM puck system options, A-, Q- and E-series hitches

## **WEIGHT DISTRIBUTION**

TruTrack™ systems, WD hitch kits and sway control

## **TRAILER PARTS & ACCESSORIES**

Jacks, couplers, safety chains, bearing protectors and more

## **CARGO MANAGEMENT**

Cargo carriers, bike racks, cargo straps and tie-downs

## **MARKETING MATERIALS**

Literature, signage and display stands

## **NUMERICAL TRAILER HITCHES**

Numerical listing of front and rear mount trailer hitches

## **NUMERICAL PRODUCTS**

Complete, numerically sorted product listing

## **NUMERICAL CUSTOM WIRING**

Custom wiring listed numerically

**TESTED. PROVEN. SAFE.**



# UNDERSTANDING TOWING

## CONFIDENCE TO BRING IT®

It is CURT's goal, first and foremost, to provide you with a complete line of quality towing products. However, we also strive to give you the resources needed to educate your customers, so they can Bring It® safely and confidently. Understanding Towing offers information on towing components, weight capacities, vehicle-trailer wiring and much more.

# THE BASICS OF TOWING A TRAILER

## Gross trailer weight (GTW)

The gross trailer weight is the total weight of a trailer and its cargo. For example, GTW = boat + trailer + cooler + fishing gear. It is vitally important to know the GTW to ensure safe towing. It can be measured by putting the fully loaded trailer on a vehicle scale.

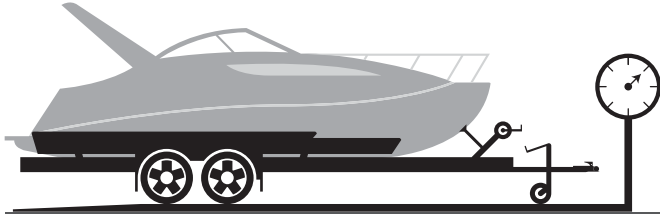

## Weight carrying capacity (WC)

The weight carrying capacity is the total weight a trailer hitch is safely rated to tow without the assistance of a weight distribution system. When towing, always use the lowest weight capacity rating of the towing system.

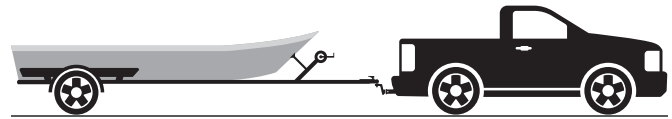

## Tongue weight (TW)

Tongue weight is the downward force of the trailer at the coupling point. Proper TW should be about 10% to 15% of the GTW. To measure TW, use a commercial scale or a bathroom scale. In the method shown below, multiply the scale reading by three.

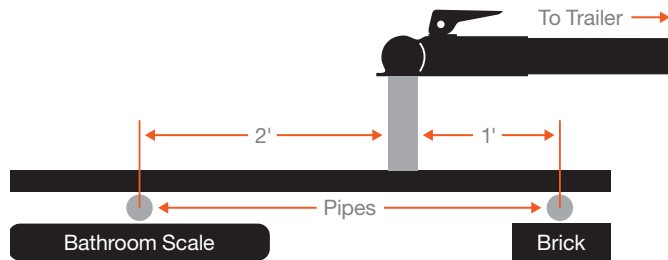

## Weight distribution capacity (WD)

The weight distribution capacity is the maximum amount of weight a trailer hitch can safely tow with a weight distribution hitch installed. A weight distribution hitch distributes a portion of the TW across the vehicle and trailer. See page 210 for WD products.

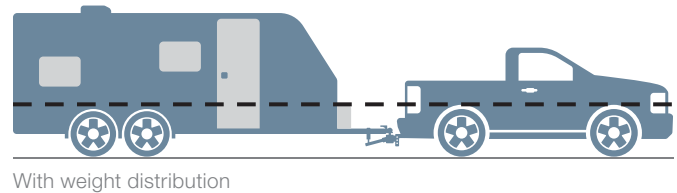

## Measuring ball mount drop & rise

When selecting a ball mount, it is important to determine drop / rise for leveling the trailer. Use the diagram below to find this value. B minus A equals C. If C is negative, this indicates the amount of drop needed. If positive, it indicates rise.

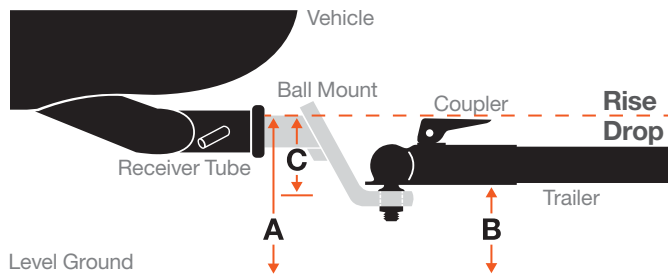

## Level towing

Using a ball mount with the proper amount of drop or rise will allow for level towing across both trailer and vehicle. Without a level vehicle-trailer combination, the trailer can tend to wander and can even impair the driver's control over the vehicle.

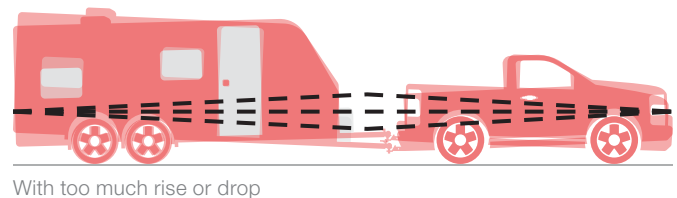



# TOWING ELECTRICAL SUBCATEGORY COLOR GUIDE

## Towing Electrical

CURT has identified seven subcategories within the Towing Electrical category to make it easier for retail customers to find the correct products. Each sub category is given a unique color that we apply in our literature and retail packaging for easy visibility.

### Brake controls

Many trailers are equipped with electric trailer brakes, and to properly use them, a brake control is needed. A brake control regulates the trailer brakes from the dash of the vehicle and serves as an interface for the driver. There are two basic types: inertia-based and time-based. For more information, see page 131.

### RV harnesses

When dinghy towing a vehicle behind an RV, syncing the taillights is essential. This requires an electrical connection from the vehicle to the RV. CURT RV harnesses plug into the vehicle, using vehicle-specific plugs, and provide a standard 4-way flat to plug into the RV socket. See page 150 for a complete listing.

### Plugs & sockets

A plug and socket are the basic components that allow a vehicle wiring system to connect to a trailer. Plugs and sockets can use anywhere from two to seven wires. When preparing to tow, the plug is inserted into the socket and supplies power to the trailer lights and other electronics. See page 157 for our plugs & sockets.

### Accessories & testers

When installing CURT electrical products, certain electrical components may be required. For splicing, snap locks, wire nuts, terminals and butt connectors provide a reliable connection. When installing a trailer wiring connector or experiencing electrical problems, be sure to test the connection with an electrical tester.

### Custom wiring

If your customer's vehicle is not equipped with a factory-installed connector, custom wiring is the ideal solution. Custom wiring (or a 'T-connector') plugs into the vehicle's electrical system, using the taillights or an OEM socket, and provides a trailer wiring connector. See the application guide, starting on page 30.

### Electrical converters

If a custom wiring harness is not available for a certain vehicle, an electrical converter may be required. A converter is designed to splice into a vehicle's wiring and convert the signals to be compatible with the trailer wiring, providing a standard 4-way flat socket. Start on page 141 for a listing of CURT converters.

### Electrical adapters

An adapter allows a connection to be made between a mismatched trailer plug and vehicle socket. For example, a vehicle may be equipped with a 7-way, while the trailer may have a 4-way. An adapter can easily be installed to bridge the connection. For our full selection of adapters, see page 152.

# ELECTRICAL WIRING SYSTEMS

Vehicles today use different wiring systems to carry out electrical functions, specifically for taillights, stop or brake lights and turn signals. As vehicles have advanced, these wiring systems have changed. To provide a proper wiring connection for towing a trailer, oftentimes an electrical converter is needed. Below are the common wiring systems used in vehicles today, as well as the types of converters used.

## Two-Wire System

The two-wire system is the simplest form of vehicle and trailer wiring and is still used by some vehicles today. This system sends the stop and turn signals along one wire, and the taillight signal along a second wire.



## Three-Wire System

The three-wire system is the most common in the automotive industry. It sends the stop, taillight and turn signals along three separate wires. Vehicles with a this system usually require a converter.

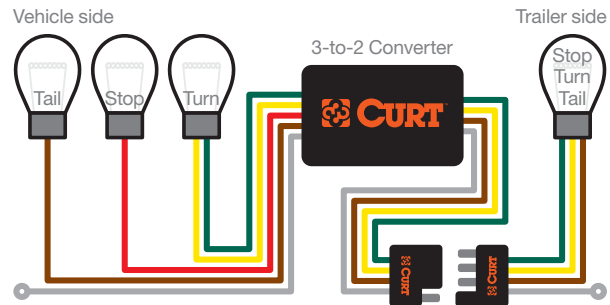

## PWM Systems

More and more vehicles today use a PWM (pulse width modulation) system. Sometimes called a 'multiplex', this type of wiring is able to control multiple lighting functions through a single wire by varying the signal intensity. PWM systems can use incandescent or LED lights. There are generally two types: ST systems and STT systems. See the application guide starting on page 30 for a detailed listing of vehicles with ST and STT systems

### ST system

The ST system (stop / tail) uses a single wire to control the stop and taillight signals. Separate wires are used to control the left and right turn signals.

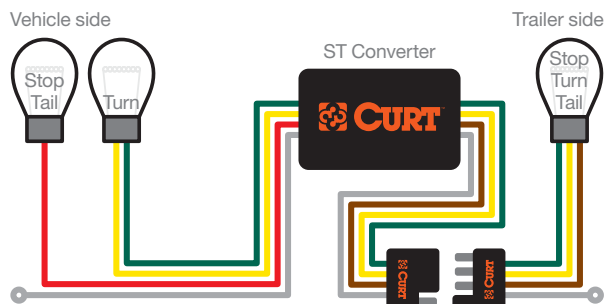

### STT system

The STT system (stop / turn / tail) uses a single wire to control all three lighting functions: the stop or brake lights, turn signals and taillights.

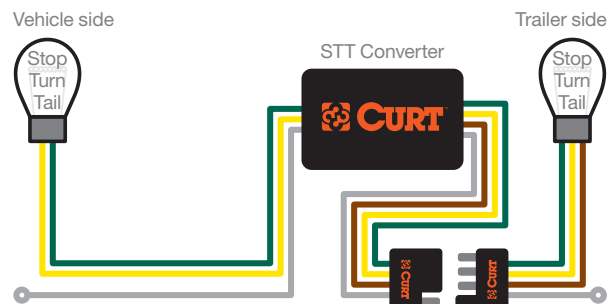

# ELECTRICAL CONNECTOR WIRING GUIDE

There are several formats used for connecting trailer wiring, and each offers slightly different electrical functions. 'Socket' refers to the vehicle-side connection, and 'plug' is used to refer to the trailer side. While most plugs and sockets come with standard color-coded wires, the colors illustrated below may not reflect all vehicles and trailers.

## 7-way RV blade traditional configuration

Vehicle side      Trailer side

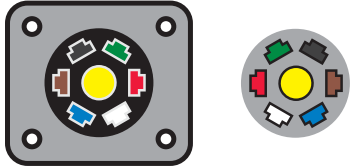

Function	Color
+12 volt	Black
Electric brakes	Blue
Reverse lights	Yellow
Left turn / brakes	Red
Right turn / brakes	Brown
Taillights	Green
Ground	White

## 7-way RV blade SAE J2863 configuration

Vehicle side      Trailer side

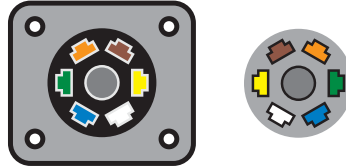

Function	Color
+12 volt	Orange
Electric brakes	Blue
Reverse lights	Grey
Left turn / brakes	Yellow
Right turn / brakes	Green
Taillights	Brown
Ground	White

## The difference in configurations

### Traditional configuration

The traditional 7-way RV blade format is typically used on 5th wheel trailers, travel trailers and campers.

### SAE J2863 configuration

The SAE J2863 7-way RV blade format is typically used on gooseneck trailers, utility trailers, cargo trailers and equipment trailers.

## 7-way round

Vehicle side      Trailer side

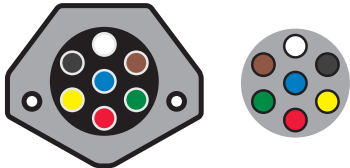

Function	Color
Auxiliary power	Red
Electric brakes	Blue
Reverse lights	Black
Left turn / brakes	Yellow
Right turn / brakes	Green
Taillights	Brown
Ground	White

## 6-way round

Vehicle side      Trailer side

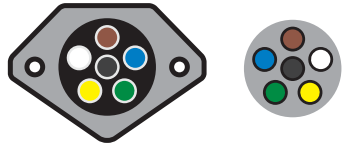

Function	Color
+12 volt	Black
Electric brakes	Blue
Left turn / brakes	Yellow
Right turn / brakes	Green
Taillights	Brown
Ground	White

## 6-way square

Vehicle side      Trailer side

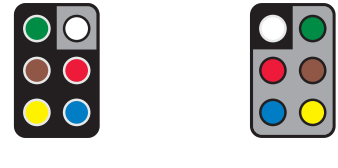

Function	Color
+12 volt	Red
Electric brakes	Blue
Left turn / brakes	Yellow
Right turn / brakes	Green
Taillights	Brown
Ground	White

## 5-way flat

Vehicle side      Trailer side



Function	Color
Reverse lights	Blue
Left turn / brakes	Yellow
Right turn / brakes	Green
Taillights	Brown
Ground	White

## 4-way flat

Vehicle side      Trailer side

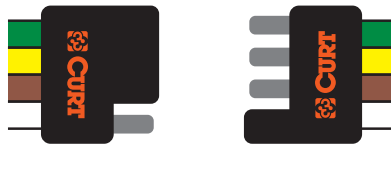

Function	Color
Left turn / brakes	Yellow
Right turn / brakes	Green
Taillights	Brown
Ground	White

## 4-way round

Vehicle side      Trailer side

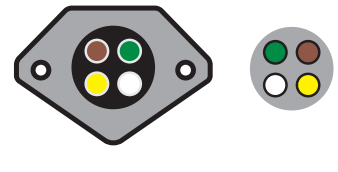

Function	Color
Left turn / brakes	Yellow
Right turn / brakes	Green
Taillights	Brown
Ground	White

**TESTED. PROVEN. SAFE.**



# TRAILER HITCHES

**THOROUGHLY TESTED. PROVEN SAFE.**

CURT manufactures over 1,000 unique hitch models to provide a custom fit for nearly every vehicle on the road today. We engineer and rigorously test each one to SAE J684 protocols for safety. We protect each hitch, inside and out, with an industry-leading, rust-resistant finish, and we do all of this in the USA. CURT hitches are available in five classes with a range of weight capacities and receiver tube sizes. We also offer front mount, RV and multi-fit hitches for a complete range of towing options.



# FEATURED PRODUCTS



## Rear mount hitches

CURT is the industry leader in first-to-market hitch designs, and each one is engineered and tested to the highest safety standards.



## Multi-fit hitches

Perfect for the retail setting, multi-fit hitches fit a wide range of applications and are available in several different weight capacities.



## Front mount hitches

CURT front mount hitches are vehicle-specific and provide a useful receiver for a cargo carrier, snow plow or even for parking a trailer.

# PRODUCT INDEX



15

Class 1 & 2  
Trailer Hitches

Made in USA



15

Class 3 & 4  
Trailer Hitches

Made in USA



15

Class 5  
Trailer Hitches

Made in USA



16

Adjustable  
RV Hitches

Made in USA



16

Multi-Fit  
Trailer Hitches



22

Weld-On  
Trailer Hitches

Made in USA



22

Bumper  
Hitches

Made in USA



23

RV Towing  
Products

Made in USA



24

Front Mount  
Hitches

Made in USA



## CUSTOM-FIT TRAILER HITCHES

CURT custom hitches are broken out into five distinct classes, based on their receiver tube size and weight ratings. Despite these classes, weight ratings vary by part number. Each hitch is made for vehicle-specific application and is always limited by the lowest-rated towing component.

### Product Details

- Made with a vehicle-specific design for a custom fit
- Tested for safety in accordance with SAE J684
- Precisely welded for superior strength and fit
- Protected by a durable black powder coat finish
- Co-cured in a rust-resistant liquid Bonderite® coating
- Equipped with an open-back receiver for easy cleaning
- Limited lifetime warranty (see last page for details)



### Advantages of CURT trailer hitches



Proud to manufacture all of our custom hitches in the USA



Precision robotic welding for superior strength and fit



Liquid Bonderite® applied inside and out for max rust resistance



Industry-leading safety and performance testing



# CUSTOM-FIT TRAILER HITCHES

Below is a quick comparison of the five different hitch classes as well as front mount hitches.

For a complete vehicle application guide, see page 30.

## 1 1/4 INCH CLASS 1 & 2 HITCHES

- Available with included ball mount (see page 31 for ordering options)



## 2 INCH CLASS 3 & 4 HITCHES

- Many models feature a concealed main body for an OE look



## 2 INCH & 2 1/2 INCH CLASS 5 HITCHES

- Constructed with a large, powerful main body
- Features wide safety chain openings for heavy-duty hooks
- Includes strong, grade-8 installation hardware



## 2 INCH FRONT MOUNT HITCHES

- Ideal for attaching a snow plow, cargo carrier or other front hitch mount
- Allows for easy maneuvering of a trailer into a tight spot
- See page 24 for application information



## QUICK COMPARISON

Hitch Class	Rec. Size	GTW (lbs.)	TW (lbs.)	WD (lbs.)	WDTW (lbs.)	Finish
Class 1	1-1/4"	Up to 2,000	Up to 200	--	--	Gloss black
Class 2	2"	Up to 3,500	Up to 350	--	--	Gloss black
Class 3	2"	Up to 8,000	Up to 800	Up to 12,000	Up to 1,200	Gloss black
Class 4	2"	Up to 10,000	Up to 1,000	Up to 12,000	Up to 1,200	Gloss black
Class 5 - Xtra Duty	2"	16,000 to 17,000	2,400 to 2,550	17,000	2,400 to 2,550	Carbide black
Class 5 - Commercial Duty	2-1/2"	18,000 to 20,000	2,700	18,000 to 20,000	2,700	Carbide black
Front Mount	2"	Up to 5,000	Up to 500	--	--	Gloss black

Trailer hitch weight ratings vary by part number and are limited to vehicle manufacturer's stated capacities.



2  
INCH

# ADJUSTABLE RV TRAILER HITCHES

- Three-piece, adjustable design fits multiple frame sizes
- Designed for towing a trailer or small vehicle behind an RV
- Co-cured in a rust-resistant liquid Bonderite® coating and protected by a durable gloss black powder coat finish
- Limited lifetime warranty (see last page for details)



Designed for dinghy towing behind an RV

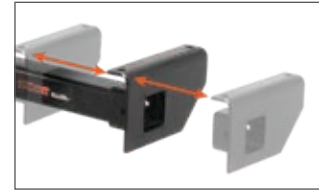

Adjustable design fits multiple frame sizes



Part#	GTW / TW	WD / WDTW	Frame	Drop
13701	5,000 / 500 lbs.	6,000 / 600 lbs.	Fits box frames up to 51" wide	2"
13702	5,000 / 500 lbs.	6,000 / 600 lbs.	Fits box frames up to 51" wide	--
13703	3,500 / 350 lbs.	--	Fits box, C-channel and I-beam frames up to 72" wide	--
13704 <b>NEW</b>	5,000 / 500 lbs.	--	Fits box frames up to 68-1/2" wide	--

## MULTI-FIT TRAILER HITCHES

For multi-fit hitch application guide go to page 17

For retail settings or if a CURT custom hitch is not available for a particular vehicle, a multi-fit hitch is a dependable alternative. These hitches are made to fit a wide variety of vehicle applications, and most require little or no drilling for installation.

### Product Details

- Versatile frame design to fit a variety of vehicles
- Available with 1-1/4" or 2" receiver tube
- Gross trailer weight ratings ranging from 3,500 lbs. up to 15,000 lbs.
- Select models compatible with weight distribution hitch
- Requires little or no drilling on most models
- Robotically welded for superior strength and fit
- #13902 and #13903 provide a comprehensive retail option for pickups
- Includes mounting hardware (grade-8 on #15510, #15511)
- Protected by a durable black powder coat finish
- Informative, full-color retail box (excluding #15510, #15511)
- Limited lifetime warranty (see last page for details)



Multi-fit hitches are designed to perfectly balance a wide range of fitment and an integrated look, providing a safe, secure towing solution



## Multi-Fit Trailer Hitches

Make / Model	Style	Years	Rec. Size	Part#	Foot Notes	GTW / TW (lbs.)	WD / WDTW (lbs.)
<b>Chevrolet</b>							
Astro	Extended chassis	85 - 05	1.25	12923	4, 5	3.5 / 350	--
			2	13900	4, 5	5.0 / 500	--
Blazer	--	92 - 94	2	13900	4	5.0 / 500	--
		83 - 94	1.25	12923	4	3.5 / 350	--
	Full-size	80 - 91	2	13900	4	5.0 / 500	--
C/K 1500	Excluding stepside and king cab	62 - 99	1.25	12923	4	3.5 / 350	--
	8' bed	88 - 99	2	13900	4	5.0 / 500	--
	8' bed, excluding stepside	62 - 87	2	13900	4	5.0 / 500	--
			2	15511	2	15 / 1500	16 / 1600
			2	15510	1	15 / 1500	16 / 1600
C/K 2500	Excluding stepside and king cab	62 - 99	1.25	12923	4	3.5 / 350	--
	8' bed	88 - 99	2	13900	4	5.0 / 500	--
	8' bed, excluding stepside	62 - 87	2	13900	4	5.0 / 500	--
			2	15511	2	15 / 1500	16 / 1600
			2	15510	1	15 / 1500	16 / 1600
	Cab & chassis	88 - 99	2	15510	1	15 / 1500	16 / 1600
			2	15511	2	15 / 1500	16 / 1600
C/K 3500	8' bed	62 - 87	2	15510	1	15 / 1500	16 / 1600
			2	15511	2	15 / 1500	16 / 1600
	Cab & chassis	88 - 99	2	15510	1	15 / 1500	16 / 1600
			2	15511	2	15 / 1500	16 / 1600
Express	Full-size van	96 - 17	2	13900	4	5.0 / 500	--
G-Series	Full-size van	78 - 96	2	13900	4	5.0 / 500	--
S10	4WD, short bed	98 - 04	2	13900	4	5.0 / 500	--
	Long bed, excluding Baja	83 - 04	1.25	12923	4	3.5 / 350	--
			2	13900	4	5.0 / 500	--
Silverado 1500	--	99 - 18	2	13901	--	5.0 / 500	7.5 / 750
		99 - 18	2	13902	--	8.0 / 800	12 / 1200
	8' bed	99 - 06	2	13900	4	5.0 / 500	--
Silverado 1500 Classic	--	07 - 07	2	13901	--	5.0 / 500	7.5 / 750
	2		13902	--	8.0 / 800	12 / 1200	
	8' bed	07 - 07	2	13900	4	5.0 / 500	--
Silverado 1500 HD	--	05 - 06	2	13901	--	5.0 / 500	7.5 / 750
		01 - 03	2	13901	--	5.0 / 500	7.5 / 750
Silverado 1500 HD Classic	--	07 - 07	2	13901	--	5.0 / 500	7.5 / 750
Silverado 2500	--	99 - 04	2	13901	--	5.0 / 500	7.5 / 750
	2		13902	--	8.0 / 800	12 / 1200	
	8' bed	99 - 04	2	13900	4	5.0 / 500	--
Silverado 2500 HD	--	01 - 19	2	13902	--	8.0 / 800	12 / 1200
		01 - 14	2	13901	--	5.0 / 500	7.5 / 750
	8' bed	01 - 06	2	13900	4	5.0 / 500	--
Silverado 2500 HD Classic	--	07 - 07	2	13901	--	5.0 / 500	7.5 / 750
	2		13902	--	8.0 / 800	12 / 1200	
	8' bed	07 - 07	2	13900	4	5.0 / 500	--
Silverado 3500	--	01 - 06	2	13901	--	5.0 / 500	7.5 / 750
	2		13902	--	8.0 / 800	12 / 1200	
	8' bed	01 - 06	2	13900	4	5.0 / 500	--

1. Receiver tube drops 5-1/2" on the rear of the vehicle
2. Receiver tube drops 7-1/2" on the rear of the vehicle
3. Two sets of mounting brackets included, only one set will be used based on application

4. Adjustable frame
5. Spare tire may need relocating
6. Excluding 20" spare tire

**Applications continued on the following page**

## Multi-Fit Trailer Hitches

Make / Model	Style	Years	Rec. Size	Part#	Foot Notes	GTW / TW (lbs.)	WD / WDTW (lbs.)
<b>Chevrolet (continued)</b>							
Silverado 3500 Classic	--	07 - 07	2	13901	--	5.0 / 500	7.5 / 750
			2	13902	--	8.0 / 800	12 / 1200
	8' bed	01 - 07	2	13900	4	5.0 / 500	--
Silverado 3500 HD	--	07 - 19	2	13902	--	8.0 / 800	12 / 1200
		07 - 14	2	13901	--	5.0 / 500	7.5 / 750
Suburban	--	92 - 06	1.25	12923	4	3.5 / 350	--
			2	13900	4	5.0 / 500	--
Tahoe	--	95 - 06	2	13900	4	5.0 / 500	--
Venture	--	97 - 04	1.25	12923	4	3.5 / 350	--
			2	13900	4	5.0 / 500	--
<b>Chrysler</b>							
Town & Country	Excl. Stow-n-Go	88 - 07	1.25	12923	4	3.5 / 350	--
			2	13900	4	5.0 / 500	--
Voyager	--	00 - 03	2	13900	4	5.0 / 500	--
<b>Dodge</b>							
Caravan	Excl. Stow-n-Go	88 - 07	1.25	12923	4	3.5 / 350	--
			2	13900	4	5.0 / 500	--
Dakota	--	86 - 04	1.25	12923	4	3.5 / 350	--
			2	13900	4	5.0 / 500	--
D/W Series Pickups	Excluding 1-ton	62 - 87	2	13900	4	5.0 / 500	--
	--	72 - 93	2	15510	1	15 / 1500	16 / 1600
			2	15511	2	15 / 1500	16 / 1600
Ram 1500	--	02 - 10	2	13902	--	8.0 / 800	12 / 1200
		94 - 01	1.25	12923	4	3.5 / 350	--
Ram 2500	--	03 - 10	2	13902	--	8.0 / 800	12 / 1200
		94 - 01	1.25	12923	4	3.5 / 350	--
Ram 3500	--	03 - 10	2	13902	--	8.0 / 800	12 / 1200
		94 - 01	1.25	12923	4	3.5 / 350	--
Ramcharger	--	78 - 93	1.25	12923	4	3.5 / 350	--
			2	13900	4	5.0 / 500	--
<b>Ford</b>							
Aerostar	Extended chassis	86 - 97	2	13900	4	5.0 / 500	--
Bronco	--	78 - 97	1.25	12923	4	3.5 / 350	--
			2	13900	4	5.0 / 500	--
Bronco II	--	84 - 90	1.25	12923	4	3.5 / 350	--
			2	13900	4	5.0 / 500	--
Escape	--	01 - 04	2	13900	4	5.0 / 500	--
E-150	--	03 - 14	2	13900	4	5.0 / 500	--
E-150 Econoline	--	80 - 98	1.25	12923	4	3.5 / 350	--
		80 - 02	2	13900	4	5.0 / 500	--
E-250	--	03 - 14	2	13900	4	5.0 / 500	--
E-250 Econoline	--	80 - 98	1.25	12923	4	3.5 / 350	--
		80 - 02	2	13900	4	5.0 / 500	--
F-100	--	67 - 83	2	15510	1	15 / 1500	16 / 1600
			2	15511	2	15 / 1500	16 / 1600
	Excluding flareside	67 - 83	1.25	12923	4	3.5 / 350	--
			2	13900	4	5.0 / 500	--

1. Receiver tube drops 5-1/2" on the rear of the vehicle
2. Receiver tube drops 7-1/2" on the rear of the vehicle
3. Two sets of mounting brackets included, only one set will be used based on application

4. Adjustable frame
5. Spare tire may need relocating
6. Excluding 20" spare tire

**Applications continued on the following page**

**Multi-Fit Trailer Hitches**

Make / Model	Style	Years	Rec. Size	Part#	Foot Notes	GTW / TW (lbs.)	WD / WDTW (lbs.)			
<b>Ford (continued)</b>										
F-150	--	06 - 19	2	13903	3	8.0 / 800	12 / 1200			
		97 - 05	2	13901	--	5.0 / 500	7.5 / 750			
			2	13902	--	8.0 / 800	12 / 1200			
	6' flareside bed	97 - 03	2	13900	4, 5	5.0 / 500	--			
	8' bed	99 - 03	2	13900	4	5.0 / 500	--			
	--	75 - 96	2	15510	1	15 / 1500	16 / 1600			
			2	15511	2	15 / 1500	16 / 1600			
		Excluding flareside	75 - 96	1.25	12923	4	3.5 / 350	--		
2	13900			4	5.0 / 500	--				
F-150 Heritage	--	04 - 04	2	13901	--	5.0 / 500	7.5 / 750			
			2	13902	--	8.0 / 800	12 / 1200			
F-250	--	97 - 99	2	13901	--	5.0 / 500	7.5 / 750			
		67 - 99	2	15510	1	15 / 1500	16 / 1600			
			2	15511	2	15 / 1500	16 / 1600			
	Excluding flareside	74 - 99	1.25	12923	4	3.5 / 350	--			
2			13900	4	5.0 / 500	--				
F-250 Super Duty	--	99 - 16	2	13901	--	5.0 / 500	7.5 / 750			
			2	13902	--	8.0 / 800	12 / 1200			
	8' bed	99 - 16	2	13900	4, 6	5.0 / 500	--			
F-350	--	67 - 97	2	15510	1	15 / 1500	16 / 1600			
			2	15511	2	15 / 1500	16 / 1600			
F-350 Super Duty	8' bed	99 - 16	2	13900	4, 6	5.0 / 500	--			
			2	13901	--	5.0 / 500	7.5 / 750			
			2	13902	--	8.0 / 800	12 / 1200			
F-450 Super Duty	Crew cab	08 - 16	2	13901	--	5.0 / 500	7.5 / 750			
			2	13902	--	8.0 / 800	12 / 1200			
	2WD, cab & chassis	99 - 07	2	15510	1	15 / 1500	16 / 1600			
			2	15511	2	15 / 1500	16 / 1600			
Ranger	--	83 - 11	1.25	12923	4	3.5 / 350	--			
	Short bed, excluding flareside	83 - 06	2	13900	4	5.0 / 500	--			
	Long bed	83 - 11	2	13900	4, 5	5.0 / 500	--			
Windstar	--	99 - 03	2	13900	4	5.0 / 500	--			
<b>GMC</b>										
C/K 1500	Excluding stepside and king cab	62 - 99	1.25	12923	4	3.5 / 350	--			
			8' bed	88 - 99	2	13900	4	5.0 / 500		
					8' bed, excluding stepside	62 - 87	2	13900	4	5.0 / 500
							2	15511	2	15 / 1500
							2	15510	1	15 / 1500
C/K 2500	Excluding stepside and king cab	62 - 99	1.25	12923	4	3.5 / 350	--			
			8' bed	88 - 99	2	13900	4	5.0 / 500		
					8' bed, excluding stepside	62 - 87	2	13900	4	5.0 / 500
							2	15511	2	15 / 1500
							2	15510	1	15 / 1500
			Cab & chassis	88 - 99	2	15510	1	15 / 1500	16 / 1600	
					2	15511	2	15 / 1500	16 / 1600	

- Receiver tube drops 5-1/2" on the rear of the vehicle
- Receiver tube drops 7-1/2" on the rear of the vehicle
- Two sets of mounting brackets included, only one set will be used based on application

- Adjustable frame
- Spare tire may need relocating
- Excluding 20" spare tire

**Applications continued on the following page**

## Multi-Fit Trailer Hitches

Make / Model	Style	Years	Rec. Size	Part#	Foot Notes	GTW / TW (lbs.)	WD / WDTW (lbs.)
<b>GMC (continued)</b>							
C/K 3500	8' bed	62 - 87	2	15510	1	15 / 1500	16 / 1600
			2	15511	2	15 / 1500	16 / 1600
	Cab & chassis	88 - 99	2	15510	1	15 / 1500	16 / 1600
			2	15511	2	15 / 1500	16 / 1600
G-Series	Full-size van	78 - 96	2	13900	4	5.0 / 500	--
Jimmy	--	92 - 94	2	13900	4	5.0 / 500	--
			1.25	12923	4	3.5 / 350	--
	Full-size	80 - 91	2	13900	4	5.0 / 500	--
Safari	Extended chassis	85 - 05	1.25	12923	4, 5	3.5 / 350	--
			2	13900	4, 5	5.0 / 500	--
Savana	Full-size van	96 - 17	2	13900	4	5.0 / 500	--
Sierra 1500	--	99 - 18	2	13901	--	5.0 / 500	7.5 / 750
			2	13902	--	8.0 / 800	12 / 1200
	8' bed	99 - 06	2	13900	4	5.0 / 500	--
Sierra 1500 Classic	--	07 - 07	2	13901	--	5.0 / 500	7.5 / 750
			2	13902	--	8.0 / 800	12 / 1200
	8' bed	07 - 07	2	13900	4	5.0 / 500	--
Sierra 1500 HD	--	05 - 06	2	13901	--	5.0 / 500	7.5 / 750
		01 - 03	2	13901	--	5.0 / 500	7.5 / 750
Sierra 1500 HD Classic	--	07 - 07	2	13901	--	5.0 / 500	7.5 / 750
Sierra 2500	--	99 - 04	2	13901	--	5.0 / 500	7.5 / 750
			2	13902	--	8.0 / 800	12 / 1200
	8' bed	99 - 04	2	13900	4	5.0 / 500	--
Sierra 2500 HD	--	01 - 18	2	13902	--	8.0 / 800	12 / 1200
			2	13901	--	5.0 / 500	7.5 / 750
	8' bed	01 - 06	2	13900	4	5.0 / 500	--
Sierra 2500 HD Classic	--	07 - 07	2	13901	--	5.0 / 500	7.5 / 750
			2	13902	--	8.0 / 800	12 / 1200
	8' bed	07 - 07	2	13900	4	5.0 / 500	--
Sierra 3500	--	01 - 06	2	13901	--	5.0 / 500	7.5 / 750
			2	13902	--	8.0 / 800	12 / 1200
	8' bed	01 - 06	2	13900	4	5.0 / 500	--
Sierra 3500 Classic	--	07 - 07	2	13901	--	5.0 / 500	7.5 / 750
			2	13902	--	8.0 / 800	12 / 1200
	8' bed	01 - 07	2	13900	4	5.0 / 500	--
Sierra 3500 HD	--	07 - 14	2	13901	--	5.0 / 500	7.5 / 750
			2	13902	--	8.0 / 800	12 / 1200
Sonoma	4WD, short bed	98 - 04	2	13900	4	5.0 / 500	--
			1.25	12923	4	3.5 / 350	--
	Long bed	83 - 04	2	13900	4	5.0 / 500	--
Suburban	--	92 - 99	1.25	12923	4	3.5 / 350	--
			2	13900	4	5.0 / 500	--
Yukon	--	92 - 06	2	13900	4	5.0 / 500	--
Yukon XL 1500	--	00 - 06	2	13900	4	5.0 / 500	--
Yukon XL 2500	--	00 - 06	2	13900	4	5.0 / 500	--

1. Receiver tube drops 5-1/2" on the rear of the vehicle
2. Receiver tube drops 7-1/2" on the rear of the vehicle
3. Two sets of mounting brackets included, only one set will be used based on application

4. Adjustable frame
5. Spare tire may need relocating
6. Excluding 20" spare tire

**Applications continued on the following page**

## Multi-Fit Trailer Hitches

Make / Model	Style	Years	Rec. Size	Part#	Foot Notes	GTW / TW (lbs.)	WD / WDTW (lbs.)
<b>Isuzu</b>							
Hombre	4WD	98 - 00	2	13900	4	5.0 / 500	--
<b>Jeep</b>							
Cherokee XJ	--	84 - 01	2	13900	4	5.0 / 500	--
Grand Cherokee	--	93 - 98	2	13900	4	5.0 / 500	--
Liberty	--	02 - 06	2	13900	4	5.0 / 500	--
Wagoneer	--	87 - 90	1.25	12923	4	3.5 / 350	--
<b>Mazda</b>							
Pickup	--	90 - 06	2	13900	4	5.0 / 500	--
Tribute	--	01 - 04	2	13900	4	5.0 / 500	--
<b>Nissan</b>							
Frontier	4.5' or 6.25' bed	87 - 04	2	13900	4	5.0 / 500	--
Pickup	4.5' bed	87 - 04	2	13900	4	5.0 / 500	--
	6' bed	87 - 94	1.25	12923	4	3.5 / 350	--
		87 - 04	2	13900	4	5.0 / 500	--
<b>Oldsmobile</b>							
Bravada	--	91 - 94	1.25	12923	4	3.5 / 350	--
Silhouette	--	97 - 05	1.25	12923	4	3.5 / 350	--
<b>Plymouth</b>							
Trail Duster	--	74 - 91	1.25	12923	4	3.5 / 350	--
			2	13900	4	5.0 / 500	--
Voyager	--	88 - 98	1.25	12923	4	3.5 / 350	--
			84 - 03	2	13900	4	5.0 / 500
<b>Pontiac</b>							
6000	--	82 - 84	1.25	12923	4	3.5 / 350	--
Montana	--	99 - 06	1.25	12923	4	3.5 / 350	--
Trans Sport	--	97 - 98	1.25	12923	4	3.5 / 350	--
<b>Ram</b>							
1500	--	11 - 18	2	13902	--	8.0 / 800	12 / 1200
2500	--	11 - 18	2	13902	--	8.0 / 800	12 / 1200
3500	--	11 - 18	2	13902	--	8.0 / 800	12 / 1200
<b>Toyota</b>							
Pickup	6' bed, excluding T100	87 - 95	1.25	12923	4	3.5 / 350	--
	8' bed, excluding T100	87 - 94	2	13900	4	5.0 / 500	--
Tundra	--	00 - 06	2	13900	4	5.0 / 500	--

1. Receiver tube drops 5-1/2" on the rear of the vehicle
2. Receiver tube drops 7-1/2" on the rear of the vehicle
3. Two sets of mounting brackets included, only one set will be used based on application

4. Adjustable frame
5. Spare tire may need relocating
6. Excluding 20" spare tire



2  
INCH

## UNIVERSAL WELD-ON TRAILER HITCHES

- Adjustable frame fits a variety of vehicles (side plates do not come pre-welded)
- Great for use with utility boxes
- Co-cured in a rust-resistant liquid Bonderite® coating and protected by a durable carbide powder coat finish
- Limited lifetime warranty (see last page for details)



15901



15903

Part#	GTW / TW	Drop	Maximum Width	Minimum Width
15901	15,000 / 1,500 lbs.	3-1/8"	43"	18"
15902	15,000 / 1,500 lbs.	11-1/2"	43"	18"
15903	15,000 / 1,500 lbs.	11-1/2"	60"	18"

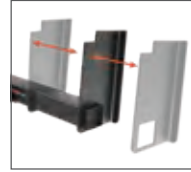

Side plates unattached to allow for easy adjustment



2  
INCH

## BUMPER HITCHES

- Bolts onto the bottom of the truck's step bumper (#19030 and #19031)
- Fits flush to factory bumpers on 1994 to 2002 Dodge trucks (#19050)
- Includes safety chain hookups and mounting hardware
- Limited lifetime warranty (see last page for details)



19030



19031



19050

Pkg#	GTW / TW	Bolt Pattern	Years	Fits
19030	5,000 / 500 lbs.	8-1/2" width on center	--	Most factory steel bumpers
19031	5,000 / 500 lbs.	10-1/2" width on center	--	Westin and DMI bumpers
19050	4,000 / 400 lbs.	8" width on center	94 - 02	Dodge pickups with one-piece factory-formed steel step bumper



2  
INCH

## RV BUMPER HITCHES

- Includes safety chain hookups and mounting hardware
- Limited lifetime warranty (see last page for details)

Pkg#	GTW / TW	Fits
19100	3,500 / 350 lbs.	4" x 4" channel bumpers
19101	3,500 / 350 lbs.	2" x 4" channel bumpers



19100



19101

# ADJUSTABLE TOW BAR

- Ideal for dingy towing a small vehicle behind an RV
- Adjusts in width from 26" to 41"
- Features a 2" heavy-duty coupler
- Lightweight design only weighs 31 lbs.
- Brackets mount to the frame of the vehicle (trimming may be required)
- Includes universal frame brackets and mounting hardware



19745



19746



21500



19748



Tow bars adjust to fit different vehicles

Bulk#	Pkg#	Capacity	Ball Diameter	Finish	Dimensions	Description
--	19745	5,000 lbs.	2"	Gloss black	Adjusts from 26" to 41" in width	Adjustable tow bar
19746	--	--	--	Zinc-plated	1/2" diameter x 3" length	Replacement safety pin (new style)
21500	21501	--	--	Zinc-plated	5/8" diameter	Replacement pin & clip (old style)
19748	--	--	--	Gloss black	--	Bumper brackets (new style)

# RV HARNESES

- Connects a towed vehicle to an RV using a standard 4-way flat trailer plug
- Simple plug-and-play design eliminates the need for cutting or splicing
- Integrated block diodes isolate sensitive vehicle electronics from RV signals
- Uses towed vehicle's existing taillights, brake lights and turn signals
- Includes harness, 4-flat extension, mounting bracket and hardware
- See page 150 for application guide



58902



Provides a simple, plug-and-play connection for dinghy towing

# TOWING LIGHTS

- Easily adds tow lights to a dinghy-towed vehicle or trailer without lights
- Non-scratch magnetic base protects vehicle finish
- See page 164 for more information

Bulk#	Pkg#	Length	Plug	Description
53200	53204	20'	4-way flat	Auxiliary towing lights



53200



Magnetically mounts as needed on the towed vehicle

## 2

INCH

# FRONT MOUNT ACCESSORIES

- Fits any 2" x 2" receiver tube opening
- Designed for use with front mount hitches
- Can also be used with rear mount hitches when not towing a trailer
- Also see cargo carriers on pages 238 through 241



Part#	Description
31006	Spare tire mount (mounting hardware not included)
31001	Step pad with anti-skid surface
31002	License plate holder
31007	Skid shield
31010	Winch mount
31005	Winch mount handles
31009	Winch mount with handles



Step pad provides easy under-the-hood access (31001)



Provides protection for the front end and hitch (31007)



Allows a winch to be easily attached to a receiver (31009)



24" height accepts multiple tire sizes (31006)



## 2

INCH

# FRONT MOUNT HITCHES

- 2" x 2" receiver tube opening
- Up to 5,000 lbs. GTW and 500 lbs. TW / 9,000 lbs. straight line pull
- Ideal for attaching a snow plow, cargo carrier or other front hitch mount
- Allows for easy maneuvering of a trailer into a tight spot
- Tested for safety in accordance with SAE J684
- Limited lifetime warranty (see last page for details)



### Front Mount Hitches

Make / Model	Style	Years	Part#	Foot Notes	GTW / TW (lbs.)	Price Code	Install Time	Main Body
<b>Buick</b>								
Enclave	--	08 - 12	31045	D, ●	3,500 / 350	53	30	Exposed
Rainier	--	04 - 07	31055	D, ●	3,500 / 350	71	45	Exposed
<b>Cadillac</b>								
Escalade	Excluding hybrid	07 - 18	31012	D	5,000 / 500	37	45	Concealed
	--	00 - 06	31302	D, ●	5,000 / 500	55	60	Concealed
<b>Chevrolet</b>								
Avalanche	Excluding Z71	07 - 13	31012	D	5,000 / 500	37	45	Concealed
Avalanche 1500	--	02 - 06	31302	D, ●	5,000 / 500	55	60	Concealed
Avalanche 2500	--	02 - 06	31302	D, ●	5,000 / 500	55	60	Concealed
Blazer	4WD, excluding ZR2	96 - 04	31021	●	3,500 / 350	29	30	Exposed
	Full-size	92 - 94	31042	●	5,000 / 500	41	30	Concealed

D = Minor fascia trim

N = Continued while supplies last

● = No drilling required

Applications continued on the following page



## Front Mount Hitches

Make / Model	Style	Years	Part#	Foot Notes	GTW / TW (lbs.)	Price Code	Install Time	Main Body
<b>Chevrolet (continued)</b>								
C1500	--	88 - 99	31042	●	5,000 / 500	41	30	Concealed
C1500 Suburban	--	92 - 99	31043	--	5,000 / 500	47	30	Exposed
C2500	--	88 - 00	31043	--	5,000 / 500	47	30	Exposed
C2500 Suburban	--	92 - 99	31043	--	5,000 / 500	47	30	Exposed
C3500	--	88 - 00	31043	--	5,000 / 500	47	30	Exposed
Colorado	--	15 - 19	31074	D, ●	5,000 / 500	41	45	Concealed
	Z71 with front stabilizer bar	10 - 12	31030	D, ●	5,000 / 500	29	20	Exposed
	Z71 without front stabilizer bar	10 - 12	31221	D, ●	5,000 / 500	45	20	Concealed
	--	04 - 09	31221	D, ●	5,000 / 500	45	20	Concealed
Equinox	--	10 - 13	31032	D	3,500 / 350	55	45	Concealed
Express 1500	--	96 - 03	31016	--	5,000 / 500	25	35	Exposed
Express 2500	--	96 - 03	31016	--	5,000 / 500	25	35	Exposed
Express 3500	--	96 - 03	31016	--	5,000 / 500	25	35	Exposed
K1500	--	88 - 99	31042	●	5,000 / 500	41	30	Concealed
K1500 Suburban	--	92 - 99	31042	●	5,000 / 500	41	30	Concealed
K2500	--	88 - 00	31042	●	5,000 / 500	41	30	Concealed
K2500 Suburban	--	92 - 99	31042	●	5,000 / 500	41	30	Concealed
K3500	--	88 - 00	31042	●	5,000 / 500	41	30	Concealed
S10	4WD, excluding ZR2	94 - 04	31021	●	3,500 / 350	29	30	Exposed
Silverado 1500	--	14 - 18	31012	D	5,000 / 500	37	45	Concealed
			31069	D	5,000 / 500	37	45	Concealed
		07 - 13	31322	D, ●	5,000 / 500	47	30	Concealed
		99 - 06	31302	D, ●	5,000 / 500	55	60	Concealed
Silverado 1500 Classic	--	07 - 07	31302	D, ●	5,000 / 500	55	60	Concealed
Silverado 1500 HD	--	01 - 06	31108	D, ●	5,000 / 500	47	30	Concealed
Silverado 1500 HD Classic	--	07 - 07	31108	D, ●	5,000 / 500	47	30	Concealed
Silverado 1500 Legacy	--	19 - 19	31069	D	5,000 / 500	37	45	Concealed
			31012	D	5,000 / 500	37	45	Concealed
Silverado 2500	--	99 - 04	31108	D, ●	5,000 / 500	47	30	Concealed
Silverado 2500 HD	--	15 - 19	31071	●	5,000 / 500	37	25	Concealed
		11 - 14	31023	D, ●	5,000 / 500	17	30	Concealed
		07 - 10	31109	●	5,000 / 500	41	20	Concealed
		01 - 06	31108	D, ●	5,000 / 500	47	30	Concealed
Silverado 2500 HD Classic	--	07 - 07	31108	D, ●	5,000 / 500	47	30	Concealed
Silverado 3500	--	01 - 06	31108	D, ●	5,000 / 500	47	30	Concealed
Silverado 3500 Classic	--	07 - 07	31108	D, ●	5,000 / 500	47	30	Concealed
Silverado 3500 HD	--	15 - 19	31071	●	5,000 / 500	37	25	Concealed
		11 - 14	31023	D, ●	5,000 / 500	17	30	Concealed
		07 - 10	31109	●	5,000 / 500	41	20	Concealed
Suburban	--	15 - 19	31073	D	5,000 / 500	37	45	Concealed
Suburban 1500	--	07 - 14	31012	D	5,000 / 500	37	45	Concealed
		00 - 06	31302	D, ●	5,000 / 500	55	60	Concealed
Suburban 2500	--	01 - 06	31108	D, ●	5,000 / 500	47	30	Concealed
Suburban 3500 HD	--	18 - 18	31071	●	5,000 / 500	37	25	Concealed
Tahoe	Excluding PPV or SSV	15 - 18	31073	D	5,000 / 500	37	45	Concealed
	Excluding Hybrid	07 - 14	31012	D	5,000 / 500	37	45	Concealed
	--	00 - 06	31302	D, ●	5,000 / 500	55	60	Concealed
	--	95 - 99	31042	●	5,000 / 500	41	30	Concealed
Trailblazer	--	02 - 09	31055	D, ●	3,500 / 350	71	45	Exposed
Traverse	--	09 - 12	31045	D, ●	3,500 / 350	53	30	Exposed

D = Minor fascia trim

N = Continued while supplies last

● = No drilling required

Applications continued on the following page

## Front Mount Hitches

Make / Model	Style	Years	Part#	Foot Notes	GTW / TW (lbs.)	Price Code	Install Time	Main Body
<b>Chrysler</b>								
Aspen	--	07 - 09	31297	D, ●	5,000 / 500	69	30	Exposed
<b>Dodge</b>								
Dakota	--	08 - 10	31230	D, ●	3,500 / 350	75	20	Exposed
		05 - 07	31228	D, ●	3,500 / 350	91	30	Exposed
	4WD	00 - 04	31080	●	3,500 / 350	63	40	Concealed
	--	98 - 99	31097	D, ●	3,500 / 350	55	20	Exposed
Durango	Excluding SRT	11 - 19	31033	D	3,000 / 300	57	35	Concealed
	--	98 - 99	31097	D, ●	3,500 / 350	55	20	Exposed
		04 - 09	31297	D, ●	5,000 / 500	69	30	Exposed
		00 - 03	31080	●	3,500 / 350	63	40	Concealed
Ram 1500	4WD	09 - 10	31374	D	5,000 / 500	41	30	Concealed
	Excluding Mega cab	06 - 08	31320	D, ●	5,000 / 500	47	30	Concealed
	Mega cab	06 - 08	31017	D	3,500 / 350	53	30	Exposed
	Sport only	06 - 07	31321	--	5,000 / 500	61	30	Concealed
	--	02 - 05	31320	D, ●	5,000 / 500	47	30	Concealed
	Excluding Sport	94 - 01	31604	--	5,000 / 500	63	45	Concealed
Ram 2500	4WD	10 - 10	31015	D, ●	5,000 / 500	49	30	Concealed
	--	03 - 09	31017	D	3,500 / 350	53	30	Exposed
		94 - 02	31604	--	5,000 / 500	63	45	Concealed
Ram 3500	--	10 - 10	31065	D	3,500 / 350	45	45	Exposed
	Excluding Laramie	03 - 09	31017	D	3,500 / 350	53	30	Exposed
	--	94 - 02	31604	--	5,000 / 500	63	45	Concealed
<b>Ford</b>								
E-150	--	08 - 14	31053	D	5,000 / 500	35	30	Exposed
		03 - 07	33055	--	5,000 / 500	35	20	Concealed
E-150 Econoline	--	91 - 02	33055	--	5,000 / 500	35	20	Concealed
E-250	--	08 - 14	31053	D	5,000 / 500	35	30	Exposed
		03 - 07	33055	--	5,000 / 500	35	20	Concealed
E-250 Econoline	--	91 - 02	33055	--	5,000 / 500	35	20	Concealed
E-350 Econoline	--	91 - 98	33055	--	5,000 / 500	35	20	Concealed
E-350 Super Duty	--	08 - 14	31053	D	5,000 / 500	35	30	Exposed
		99 - 07	33055	--	5,000 / 500	35	20	Concealed
Edge	--	11 - 13	31050	D	3,500 / 350	53	30	Concealed
Escape	--	11 - 12	31025	D	3,500 / 350	41	40	Exposed
		05 - 10	31650	D	3,500 / 350	55	90	Exposed
Excursion	--	00 - 05	31114	●	5,000 / 500	75	60	Concealed
Expedition	--	15 - 18	31083	●	5,000 / 500	67	30	Concealed
		09 - 14	31068	D, ●	5,000 / 500	45	30	Exposed
	4WD	07 - 08	31368	D, ●	5,000 / 500	45	30	Concealed
	4WD with factory tow hooks	03 - 06	31352	D, ●	5,000 / 500	45	30	Concealed
		99 - 02	31038	●	5,000 / 500	49	45	Concealed
		97 - 98	31049	●	5,000 / 500	47	30	Concealed
Explorer	Excluding 2.0L EcoBoost	11 - 16	31052	D	3,500 / 350	55	30	Exposed
	--	07 - 10	31545	●	5,000 / 500	59	30	Concealed
	Excluding Sport	02 - 06	31540	D	5,000 / 500	37	30	Concealed
	--	97 - 01	31051	--	3,500 / 350	53	30	Concealed
Explorer Sport Trac	--	07 - 10	31545	●	5,000 / 500	59	30	Concealed
		01 - 05	31407	●	3,500 / 350	33	20	Exposed
		01 - 05	31029	--	5,000 / 500	41	30	Exposed

D = Minor fascia trim

N = Continued while supplies last

● = No drilling required

Applications continued on the following page

## Front Mount Hitches

Make / Model	Style	Years	Part#	Foot Notes	GTW / TW (lbs.)	Price Code	Install Time	Main Body	
<b>Ford (continued)</b>									
F-150	--	15 - 18	31083	●	5,000 / 500	67	30	Concealed	
		09 - 14	31068	D, ●	5,000 / 500	45	30	Exposed	
		04 - 08	31352	D, ●	5,000 / 500	45	30	Concealed	
	4WD with factory tow hooks	99 - 03	31038	●	5,000 / 500	49	45	Concealed	
		97 - 98	31049	●	5,000 / 500	47	30	Concealed	
	--	92 - 96	31026	--	5,000 / 500	53	30	Concealed	
F-150 Heritage	4WD	04 - 04	31038	●	5,000 / 500	49	45	Concealed	
F-250	4WD with factory tow hooks	99 - 99	31038	●	5,000 / 500	49	45	Concealed	
		97 - 98	31049	●	5,000 / 500	47	30	Concealed	
	2WD	92 - 96	31311	●	5,000 / 500	45	25	Exposed	
	4WD	92 - 97	31310	●	5,000 / 500	41	30	Concealed	
F-250 HD	2WD	97 - 97	31311	●	5,000 / 500	45	25	Exposed	
F-250 / F-350 Super Duty	--	17 - 19	31078	D, ●	5,000 / 500	53	30	Concealed	
	4WD	11 - 16	31018	D, ●	5,000 / 500	57	45	Concealed	
	--	08 - 10	31008	D, ●	5,000 / 500	37	20	Concealed	
		04 - 07	31114	●	5,000 / 500	75	60	Concealed	
	With blocker beam	99 - 03	31014	--	5,000 / 500	75	45	Concealed	
	Without blocker beam	99 - 03	31114	●	5,000 / 500	75	60	Concealed	
F-350	2WD diesel	97 - 97	31311	●	5,000 / 500	45	25	Exposed	
	2WD	92 - 96	31311	●	5,000 / 500	45	25	Exposed	
	4WD	92 - 97	31310	●	5,000 / 500	41	30	Concealed	
F-450 Super Duty	--	17 - 18	31078	D, ●	5,000 / 500	53	30	Concealed	
		08 - 10	31008	D, ●	5,000 / 500	37	20	Concealed	
		99 - 07	31114	●	5,000 / 500	75	60	Concealed	
F-550 Super Duty	Cab & chassis	08 - 10	31008	D, ●	5,000 / 500	37	20	Concealed	
		99 - 07	31114	●	5,000 / 500	75	60	Concealed	
Ranger	Excl. models with front cross member & Canadian 2WD models	92 - 11	31063	D	3,500 / 350	53	30	Concealed	
<b>GMC</b>									
Acadia	--	09 - 11	31045	D, ●	3,500 / 350	53	30	Exposed	
C1500	--	88 - 99	31042	●	5,000 / 500	41	30	Concealed	
C1500 / C2500 Suburban	--	92 - 99	31043	--	5,000 / 500	47	30	Exposed	
C2500 / C3500	--	88 - 00	31043	--	5,000 / 500	47	30	Exposed	
Canyon	--	15 - 19	31074	D, ●	5,000 / 500	41	45	Concealed	
		Z71 with front stabilizer bar	10 - 12	31030	D, ●	5,000 / 500	29	20	Exposed
		Z71 without front stabilizer bar	10 - 12	31221	D, ●	5,000 / 500	45	20	Concealed
		--	04 - 09	31221	D, ●	5,000 / 500	45	20	Concealed
Envoy	--	02 - 09	31055	D, ●	3,500 / 350	71	45	Exposed	
Jimmy	4WD	94 - 01	31021	●	3,500 / 350	29	30	Exposed	
K1500	--	88 - 99	31042	●	5,000 / 500	41	30	Concealed	
K1500 / K2500 Suburban	--	92 - 99	31042	●	5,000 / 500	41	30	Concealed	
K2500 / K3500	--	88 - 00	31042	●	5,000 / 500	41	30	Concealed	
Savana 1500 / 2500 / 3500	--	96 - 03	31016	--	5,000 / 500	25	35	Exposed	
Sierra 1500	--	14 - 18	31012	D	5,000 / 500	37	45	Concealed	
			31069	D	5,000 / 500	37	45	Concealed	
		07 - 13	31322	D, ●	5,000 / 500	47	30	Concealed	
		99 - 06	31302	D, ●	5,000 / 500	55	60	Concealed	
Sierra 1500 Classic	--	07 - 07	31302	D, ●	5,000 / 500	55	60	Concealed	
Sierra 1500 HD	--	01 - 06	31108	D, ●	5,000 / 500	47	30	Concealed	
Sierra 1500 HD Classic	--	07 - 07	31108	D, ●	5,000 / 500	47	30	Concealed	

D = Minor fascia trim

N = Continued while supplies last

● = No drilling required

Applications continued on the following page

## Front Mount Hitches

Make / Model	Style	Years	Part#	Foot Notes	GTW / TW (lbs.)	Price Code	Install Time	Main Body	
<b>GMC (continued)</b>									
Sierra 1500 Limited	--	19 - 19	31069	D	5,000 / 500	37	45	Concealed	
			31012	D	5,000 / 500	37	45	Concealed	
Sierra 2500	--	99 - 04	31108	D, ●	5,000 / 500	47	30	Concealed	
Sierra 2500 HD	--	15 - 19	31071	●	5,000 / 500	37	25	Concealed	
		11 - 14	31023	D, ●	5,000 / 500	17	30	Concealed	
		07 - 10	31109	●	5,000 / 500	41	20	Concealed	
		01 - 06	31108	D, ●	5,000 / 500	47	30	Concealed	
Sierra 2500 HD Classic	--	07 - 07	31108	D, ●	5,000 / 500	47	30	Concealed	
Sierra 3500	--	01 - 06	31108	D, ●	5,000 / 500	47	30	Concealed	
Sierra 3500 Classic	--	07 - 07	31108	D, ●	5,000 / 500	47	30	Concealed	
Sierra 3500 HD	--	15 - 19	31071	●	5,000 / 500	37	25	Concealed	
		11 - 14	31023	D, ●	5,000 / 500	17	30	Concealed	
		07 - 10	31109	●	5,000 / 500	41	20	Concealed	
Sonoma	4WD	94 - 04	31021	●	3,500 / 350	29	30	Exposed	
Terrain	--	10 - 13	31032	D	3,500 / 350	55	45	Concealed	
Yukon	--	15 - 18	31073	D	5,000 / 500	37	45	Concealed	
		Excluding hybrid	07 - 14	31012	D	5,000 / 500	37	45	Concealed
	--	00 - 06	31302	D, ●	5,000 / 500	55	60	Concealed	
		92 - 99	31042	●	5,000 / 500	41	30	Concealed	
Yukon XL	--	15 - 18	31073	D	5,000 / 500	37	45	Concealed	
Yukon XL 1500	--	00 - 06	31302	D, ●	5,000 / 500	55	60	Concealed	
Yukon XL 2500	--	01 - 06	31108	D, ●	5,000 / 500	47	30	Concealed	
<b>Honda</b>									
Pilot	--	12 - 15	31064	--	3,500 / 350	37	60	Exposed	
		09 - 11	31024	D	3,500 / 350	33	60	Exposed	
		03 - 08	33328	D, ●	3,500 / 350	55	35	Exposed	
Ridgeline	--	17 - 19	31082	D	5,000 / 500	55	30	Exposed	
		06 - 14	33328	D, ●	3,500 / 350	55	35	Exposed	
<b>Hummer</b>									
H3	--	06 - 10	31270	●	3,000 / 300	45	30	Exposed	
<b>Jeep</b>									
Cherokee	--	84 - 01	31084	D	3,000 / 300	25	30	Exposed	
Comanche	--	86 - 92	31084	D	3,000 / 300	25	30	Exposed	
Commander	4WD	06 - 10	31056	--	3,500 / 350	53	45	Exposed	
Grand Cherokee	Excluding SRT, SRT8, Trailhawk, & models with factory tow hooks	11 - 17	31033	D	3,000 / 300	57	35	Concealed	
		--	05 - 10	31047	--	3,000 / 300	49	90	Exposed
			02 - 04	31048	--	3,500 / 350	49	45	Concealed
Liberty	--	08 - 13	31020	D	3,000 / 300	57	20	Concealed	
		03 - 07	31022	--	3,500 / 350	35	30	Exposed	
Wagoneer	Excluding Grand Wagoneer	84 - 90	31084	D	3,000 / 300	25	30	Exposed	
Wrangler	JL	18 - 18	31086	AA,B, HG, ●	3,500 / 350	45	45	Concealed	
	JK, excluding Hard Rock and 75th Anniversary bumpers	07 - 18	31432	D, ●	3,500 / 350	47	45	Concealed	
	JK, with Hard Rock bumper only	07 - 18	31433	●	3,500 / 525	47	20	Exposed	
	--	97 - 06	31028	--	3,500 / 350	45	30	Exposed	
		87 - 06	31408	D, ●	3,500 / 350	25	30	Exposed	

D = Minor fascia trim

N = Continued while supplies last

● = No drilling required

Applications continued on the following page

## Front Mount Hitches

Make / Model	Style	Years	Part#	Foot Notes	GTW / TW (lbs.)	Price Code	Install Time	Main Body
<b>Lincoln</b>								
Mark LT	--	06 - 08	31352	D, ●	5,000 / 500	45	30	Concealed
Navigator	--	09 - 15	31068	D, ●	5,000 / 500	45	30	Exposed
	4WD	07 - 08	31368	D, ●	5,000 / 500	45	30	Concealed
<b>Mazda</b>								
Tribute	--	05 - 11	31650	D	3,500 / 350	55	90	Exposed
<b>Mercury</b>								
Mariner	--	11 - 11	31025	D	3,500 / 350	41	40	Exposed
		05 - 10	31650	D	3,500 / 350	55	90	Exposed
Mountaineer	--	07 - 10	31545	●	5,000 / 500	59	30	Concealed
<b>Mitsubishi</b>								
Raider	--	08 - 09	31230	D, ●	3,500 / 350	75	20	Exposed
<b>Nissan</b>								
Armada	--	17 - 18	31081	●	5,000 / 500	55	30	Exposed
Frontier	--	15 - 19	31241	●	3,500 / 350	37	35	Exposed
Pathfinder	--	05 - 12	31241	●	3,500 / 350	37	35	Exposed
Titan	4WD	09 - 15	31061	--	5,000 / 500	69	45	Exposed
	--	04 - 08	31199	--	5,000 / 500	49	45	Exposed
Titan XD	--	16 - 17	31077	●	5,000 / 500	45	20	Exposed
Xterra	--	05 - 15	31514	●	3,500 / 350	59	35	Exposed
<b>Ram</b>								
1500	--	19 - 19	31087	D, ●	5,000 / 500	53	30	Concealed
	4WD	11 - 18	31374	D	5,000 / 500	41	30	Concealed
1500 Classic	4WD	19 - 19	31374	D	5,000 / 500	41	30	Concealed
2500	4WD	11 - 18	31015	D, ●	5,000 / 500	49	30	Concealed
3500	--	13 - 18	31067	D, ●	5,000 / 500	61	30	Concealed
		11 - 12	31065	D	3,500 / 350	45	45	Exposed
<b>Suzuki</b>								
Equator	4WD	09 - 12	31241	●	3,500 / 350	37	35	Exposed
<b>Toyota</b>								
4Runner	Limited	10 - 18	31054	●	3,500 / 350	61	30	Exposed
	SR5	14 - 19	31076	●	3,500 / 350	63	20	Exposed
		10 - 19	31054	●	3,500 / 350	61	30	Exposed
		14 - 16	31076	●	3,500 / 350	63	20	Exposed
	Trail	10 - 13	31367	●	3,500 / 350	61	30	Exposed
		17 - 18	31076	●	3,500 / 350	63	20	Exposed
	--	07 - 09	31367	●	3,500 / 350	61	30	Exposed
FJ Cruiser	--	07 - 14	31367	●	3,500 / 350	61	30	Exposed
Land Cruiser	--	08 - 18	31198	●	5,000 / 500	17	20	Exposed
Sequoia	--	08 - 18	31198	●	5,000 / 500	17	20	Exposed
		01 - 07	31180	--	5,000 / 500	49	40	Exposed
Tacoma	--	16 - 19	31075	D, ●	3,500 / 350	47	30	Exposed
		05 - 15	31313	●	3,500 / 350	75	35	Exposed
		01 - 04	31013	--	5,000 / 500	45	45	Exposed
Tundra	--	07 - 19	31198	●	5,000 / 500	17	20	Exposed
		00 - 06	31180	--	5,000 / 500	49	40	Exposed

D = Minor fascia trim

N = Continued while supplies last

● = No drilling required

**TESTED. PROVEN. SAFE.**



# APPLICATION GUIDE

## TRAILER HITCHES & CUSTOM WIRING

With over 1,000 different custom-fit hitch designs and over 400 custom wiring products, CURT has an application for virtually every vehicle on the road today. Our Application Guide makes it easy to locate the correct part for your customer's vehicle, simply using the make, model, style and year. For 2019, we have greatly improved our App Guide, streamlining the data into a single-page format for easier reading and navigation.

# CLASS 1 & 2 TRAILER HITCH ORDERING OPTIONS

Hitch only



Hitch with ball mount



Ordering Option	Add-On#	Example Order#
Hitch only	None	12226
Hitch with ball mount	3	122263



## HOW TO CONFIRM VEHICLE MODEL YEAR

Each VIN (vehicle identification number) is unique and has become standard in all vehicles manufactured since 1981. Of this 17-digit number, the 10th digit represents the model year. Use the table below to find the year that corresponds with each letter or number. **Note:** A VIN will never contain the letters I (i), O (o), Q (q), U (u) or Z (z).

### Example VIN tag

DATE: 06/19	GVWR 7200LB / 3266KG
FRONT GAWR: 3750LB	REAR GAWR: 3850LB
1701 KB WITH 1745KG WITH	
P275 / 65R18 TIRES P275/65R18 TIRES	
18X7.5J RIMS 18X7.5J RIMS	
AT 240 KPO/35PSI COLD AT 240 KPO/35PSI COLD	
THIS VEHICLE CONFORMS TO ALL APPLICABLE FEDERAL MOTOR VEHICLE SAFETY STANDARDS IN EFFECT ON THE DATE OF MANUFACTURE SHOWN ABOVE.	
VIN: XXXXXXXXX <b>K</b> XXXXXXXX	
TYPE: TRUCK	

**K** indicates a 2019 model year

### VIN-to-year chart

Code	Year	Code	Year	Code	Year	Code	Year
A	1980	R	1994	8	2008	N	2022
B	1981	S	1995	9	2009	P	2023
C	1982	T	1996	A	2010	R	2024
D	1983	V	1997	B	2011	S	2025
E	1984	W	1998	C	2012	T	2026
F	1985	X	1999	D	2013	V	2027
G	1986	Y	2000	E	2014	W	2028
H	1987	1	2001	F	2015	X	2029
J	1988	2	2002	G	2016	Y	2030
K	1989	3	2003	H	2017	1	2031
L	1990	4	2004	J	2018	2	2032
M	1991	5	2005	K	2019	3	2033
N	1992	6	2006	L	2020	4	2034
P	1993	7	2007	M	2021	5	2035

## APPLICATION GUIDE ELECTRICAL SYSTEM NOTES

### Electrical System Notes & Abbreviations

1	2-wire system - No converter needed, 20-minute install See page 157 and 159 for suggested splice-in plugs	5	3-wire system - Use powered converter, 45-minute install
2	2-wire system - Use powered converter, 45-minute install See page 141 for suggested splice-in converter	6	3-wire system - Use HD powered converter, 45-minute install
3	2-wire system - Use multi-function converter, 45-minute install See page 142 for suggested splice-in converter	7	System requires PWM-ST converter, 45-minute install
4	3-wire system - Use non-powered converter, 20-minute install	8	System requires PWM-STT converter, 45-minute install
		9	System requires low-side switching converter, 45-minute install
		10	System type to be determined at time of install
		11	Vehicle plug may require dealer activation

**PULSE WIDTH MODULATION (PWM) SYSTEM TYPES: ST** - Stop, Tail and **STT** - Stop, Tail, Turn

TESTED. PROVEN. SAFE.



# TOWING ACCESSORIES

## EQUIPPED FOR THE ROAD AHEAD

CURT offers a complete line of towing accessories to give your customers a safe, successful journey every time. New for 2019, we have added more options for our adjustable channel mounts. These versatile ball mounts are highly adjustable and offer multiple coupling options. This year, we are introducing a hitch step accessory that fits any of our channel mounts. We are also now offering kitted options for our channel mount ball and pintle combinations, as well as a number of new heavy-duty ball mounts.





## FEATURED PRODUCTS



### Deep drop pintle mount

This new 2-1/2" pintle mount has a 12-1/2" long plate with six height adjustment positions, allowing for level towing with larger, lifted trucks.



### Channel mount step

This new accessory for our adjustable channel mounts provides a 16" wide, non-skid step. It is hitch-mounted and foldable.



### D-ring shackle mounts

These high-strength shackle mounts are available to fit 2" or 2-1/2" receivers, and they are rated for 13,000 lbs. straight-line pull.

## PRODUCT INDEX



**93**  
Ball  
Mounts



**99**  
Forged Ball  
Mounts



**100**  
Adjustable  
Channel Mounts



**104**  
Tow Hook  
Mounts



**106**  
Extenders  
& Adapters



**108**  
Pintles &  
Lunette Eyes



**112**  
Trailer  
Balls



**116**  
Hitch & Coupler  
Lock Sets



**121**  
Hitch  
Pins & Clips



**123**  
Fab  
Components



**124**  
Trailer Hitch  
Accessories



**126**  
RV Towing  
Products

# ACCESSORIES OVERVIEW

## Ball Mounts

The majority of our ball mounts are made in the USA. We use CNC-forming and robotic welding for the utmost accuracy, and each is protected with a durable powder coat finish.

- 1-1/4", 2", 2-1/2" and 3" shank options
- GTW capacities ranging from 2,000 up to 21,000 lbs.
- [See page 93 for ball mounts](#)



## Pintles & Lunette Eyes

Pintle hitches are widely used in agriculture, construction and the military. We offer standard pintle hooks and mounts, ball and pintle combinations and receiver-mount pintles.

- GTW capacities up to 60,000 lbs.
- 2" and 2-1/2" shank options available
- [See page 108 for pintle products](#)

## Towing Security

CURT carries several styles of hitch locks and coupler locks to fit any receiver tube or coupler latch. We also offer a number of specialty locks, including 5th wheel hitch locks.

- Pins available to fit 1-1/4", 2", 2-1/2" and 3" receivers
- Convenient 1/4-turn lock activation on most models
- [See page 116 for towing security products](#)

## Hitch Accessories

Some of the other trailer hitch accessories we offer include front mount accessories, hitch tube covers, fish wire and a finishing pack for trailer hitch and electrical installations.

- Front accessories include winch and skid plates
- Hitch tube covers for 1-1/4", 2" and 2-1/2"
- [See page 124 for hitch accessories](#)

## Trailer Balls

We offer trailer balls for any and every job. They are available in three different finish options, including stainless steel, and all are tested to meet U.S. VESC specifications for safety.

- Standard diameters of 1-7/8", 2" 2-5/16" and 3"
- GTW capacities ranging from 2,000 up to 30,000 lbs.
- [See page 112 for trailer balls](#)

## Fab Components

CURT fabrication components are the perfect building blocks for a variety of DIY welding projects. Most components are made in the USA and come with a raw finish for ready welding.

- Hitch bars ranging from 8" to 24" long
- Receiver tubing available in 1-1/4", 2", 2-1/2" and 3"
- [See page 123 for fabrication components](#)

## RV Towing

CURT has what your customers need to outfit their RV for the ultimate road trip. Our hitches, tow bar and electrical products make it easy to tow a trailer or dinghy tow a vehicle.

- Adjustable RV and bumper hitches with 2" receiver
- RV harnesses offer a custom fit for dinghy towing
- [See page 126 for RV towing products](#)

# BALL MOUNTS

## 1 1/4 INCH EURO MOUNT® BALL MOUNTS

If your customer is looking for a simple, maintenance-free 1-1/4" ball mount option, the Euro Mount® is the perfect choice. With the Euro Mount®, there are fewer installation requirements, and it is easy to choose the right fit. Take a look below to find the Euro Mount® that works best for your customer's towing needs.

### Product Details

- Fits any 1-1/4" receiver tube opening
- Installs easily with no tools or torque specifications required
- Permanently attached trailer ball cannot be loosened or stolen
- Highly durable carbide powder coat finish
- Patents: #D610,051 S; #D610,492 S; #D610,493 S; #D610,494 S; #D610,954 S



No tools or torque specs required



Permanently attached trailer ball



Engineered with a sleek, modern look

### Each Euro Mount® was designed to replace a common, old-style ball mount, making trailer ball installation unnecessary

The comparisons below illustrate which Euro Mount® replaces a common, old-style ball mount



45551 Euro Mount® vs 45518 old-style



45571 Euro Mount® vs 45521 old-style



45561 Euro Mount® vs 45520 old-style



45591 Euro Mount® vs 45522 old-style



45581 Euro Mount® vs 45521 old-style



45551 (1-7/8" ball)  
45552 (2" ball)



45571 (1-7/8" ball)  
45572 (2" ball)



45561 (1-7/8" ball)  
45562 (2" ball)



45591 (1-7/8" ball)  
45592 (2" ball)



45581 (1-7/8" ball)  
45582 (2" ball)

Part#	GTW / TW	Ball Diam.	Ball Height	Length
45551	3,500 / 350 lbs.	1-7/8"	2-3/4"	10"
45571	3,500 / 350 lbs.	1-7/8"	4-5/8"	7-1/4"
45561	3,500 / 350 lbs.	1-7/8"	5-1/8"	9-3/4"
45591	3,500 / 350 lbs.	1-7/8"	5-1/8"	11-1/4"
45581	3,500 / 350 lbs.	1-7/8"	Negative 3/4"	8-3/4"
45552	3,500 / 350 lbs.	2"	2-3/4"	10"
45572	3,500 / 350 lbs.	2"	4-5/8"	7-1/4"
45562	3,500 / 350 lbs.	2"	5-1/8"	9-3/4"
45592	3,500 / 350 lbs.	2"	5-1/8"	11-1/4"
45582	3,500 / 350 lbs.	2"	Negative 3/4"	8-3/4"

### Required Ball Height = A - B

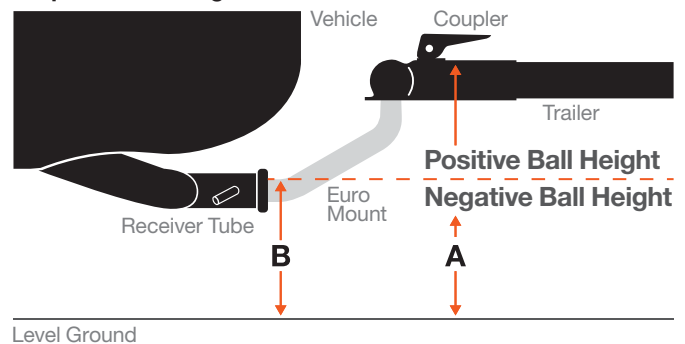

# MEASURING A BALL MOUNT

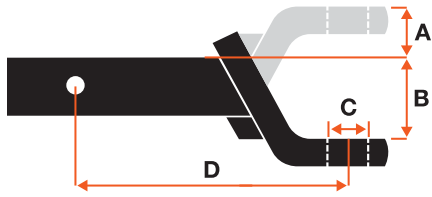

## A: Rise

Distance the ball platform is set above the top of the shank.

## B: Drop

Distance the ball platform is set below the top of the shank.

## C: Hole Size

Size of trailer ball shank that is required to fit the ball mount.

## D: Length

Distance from the pin hole center to the ball hole center.

1 1/4

INCH

## CLASS 1 & 2 BALL MOUNTS

- Fits any 1-1/4" x 1-1/4" receiver tube opening
- Multiple drop and rise options to accommodate various vehicle-trailer combinations
- Anti-rattle kits can be used with hollow shank mounts, see page 120



Part#	GTW / TW	Drop	Rise	Length	Ball Hole Size	Shank Type	Finish
<b>Class 1 Ball Mounts</b>							
45018	2,000 / 200 lbs.	1-1/4"	5/8"	6-3/4"	3/4"	Hollow	Gloss black
45019	2,000 / 200 lbs.	1-1/4"	5/8"	9-3/4"	3/4"	Hollow	Gloss black
45027	2,000 / 200 lbs.	3-1/4"	2-5/8"	6-1/4"	3/4"	Hollow	Gloss black
45022	2,000 / 200 lbs.	3-1/4"	2-5/8"	7-1/4"	3/4"	Hollow	Gloss black
45026	2,000 / 200 lbs.	3-1/4"	2-5/8"	9-3/8"	3/4"	Hollow	Gloss black
45028	2,000 / 200 lbs.	6"	4-5/8"	5-9/16"	3/4"	Solid	Gloss black
45021	2,000 / 200 lbs.	--	3-3/4"	9-1/2"	3/4"	Solid	Gloss black
45023	2,000 / 200 lbs.	--	3-3/4"	11-1/2"	3/4"	Solid	Gloss black
45024	2,000 / 200 lbs.	--	5"	9-9/16"	3/4"	Solid	Gloss black
45025	2,000 / 200 lbs.	--	5"	11-9/16"	3/4"	Solid	Gloss black



<b>Class 2 Ball Mounts</b>							
45503	3,500 / 350 lbs.	1"	3/8"	7-13/16"	3/4"	Solid	Gloss black
45518	3,500 / 350 lbs.	1-1/4"	3/4"	6-3/4"	3/4"	Solid	Gloss black
45519	3,500 / 350 lbs.	1-1/4"	3/4"	9-3/4"	3/4"	Solid	Gloss black
45017	3,500 / 350 lbs.	3-1/4"	2-5/8"	6-1/4"	3/4"	Solid	Gloss black
45521	3,500 / 350 lbs.	3-1/4"	2-5/8"	7-1/4"	3/4"	Solid	Gloss black
45016	3,500 / 350 lbs.	3-1/4"	2-5/8"	9-3/8"	3/4"	Solid	Gloss black
45520	3,500 / 350 lbs.	--	3-1/8"	9-3/4"	3/4"	Solid	Gloss black
45510	3,500 / 350 lbs.	--	3-1/8"	10-5/16"	3/4"	Solid	Gloss black
45522	3,500 / 350 lbs.	--	3-1/8"	11-1/4"	3/4"	Solid	Gloss black
45000	3,500 / 350 lbs.	--	3-7/8"	13-1/2"	3/4"	Solid	Gloss black
45014	3,500 / 350 lbs.	--	5"	9-5/8"	3/4"	Solid	Gloss black
45015	3,500 / 350 lbs.	--	5"	11-5/8"	3/4"	Solid	Gloss black



## 2 CLASS 3 BALL MOUNTS

INCH

- Fits any 2" x 2" receiver tube opening
- Multiple drop and rise options to accommodate various vehicle-trailer combinations
- Increased drop on select models allows for level towing with lifted vehicles
- Anti-rattle kits can be used with hollow shank mounts, see page 120
- White box kits include a pin & clip



Black Bulk#	Chrome Bulk#	White Box Kit#	With Pin & Clip Poly Bag#	GTW / TW	Drop	Rise	Length	Ball Hole Size	Shank Type
45030	45290	45032	45033	7,500 / 750 lbs.	2"	3/4"	7-1/2"	1"	Hollow
45010	--	45012	--	7,500 / 750 lbs.	2"	3/4"	8-1/4"	1"	Hollow
45040	--	--	--	7,500 / 750 lbs.	2"	3/4"	10-1/4"	1"	Hollow
45020	--	--	--	7,500 / 750 lbs.	2"	3/4"	10-1/4"	1"	Hollow
45260	--	--	--	7,500 / 750 lbs.	2"	3/4"	12-1/4"	1"	Hollow
45250	--	--	--	7,500 / 750 lbs.	2"	3/4"	12-1/4"	1"	Hollow
45050	45296	45052	--	7,500 / 750 lbs.	4"	2"	8-1/4"	1"	Hollow
45060	--	--	--	7,500 / 750 lbs.	4"	2"	10-1/4"	1"	Hollow
45270	--	--	--	7,500 / 750 lbs.	4"	2"	13"	1"	Hollow
45070	45297	--	--	7,500 / 750 lbs. drop 6,000 / 600 lbs. rise	6"	4"	9-1/4"	1"	Hollow
45080	--	--	--	7,500 / 750 lbs. drop 6,000 / 600 lbs. rise	6"	4"	12-1/4"	1"	Hollow
45280	--	--	--	7,500 / 750 lbs. drop 6,000 / 600 lbs. rise	6"	4"	14-1/4"	1"	Hollow
45090	--	--	--	5,000 / 500 lbs. drop 3,500 / 350 lbs. rise	8"	6"	11-1/2"	1"	Hollow
45100	--	--	--	5,000 / 500 lbs. drop 3,500 / 350 lbs. rise	8"	6"	13"	1"	Hollow
45110	--	--	--	5,000 / 500 lbs. drop 3,500 / 350 lbs. rise	10"	8"	13"	1"	Hollow
45112	--	--	--	5,000 / 500 lbs. drop 3,500 / 350 lbs. rise	10"	8"	14"	1"	Hollow

# 1 1/4 INCH & 2 INCH TOWING STARTER KITS

- Includes all the accessories needed to complement a trailer hitch in one kit
- Reusable case is able to be shelved or hung on pegs (#45534, #45554)
- Anti-rattle kits can be used with hollow shank mounts, see page 120



Part#	Shank Size	GTW / TW	Ball Diameter	Drop	Rise	Length	Included Parts
45141	2"	7,500 / 750 lbs.	2"	2"	--	7-1/2"	45134 Fusion ball mount, 23021 hitch lock
45142	2"	7,500 / 750 lbs.	2"	4"	--	8-1/8"	45154 Fusion ball mount, 23021 hitch lock
45148	1-1/4"	3,500 / 350 lbs.	2"	3-1/4"	2-5/8"	7-1/4"	45521 ball mount, 40003 trailer ball, 21403 pin & clip
45147	1-1/4"	3,500 / 350 lbs.	2"	1-1/4"	3/4"	9-3/4"	45519 ball mount, 40003 trailer ball, 21403 pin & clip
45534*	2"	7,500 / 750 lbs.	2"	2"	3/4"	8-1/4"	45030 ball mount, 40037 trailer ball, 23515 hitch lock, 22272 hitch tube cover, 21500 pin & clip, case
45554*	2"	7,500 / 750 lbs.	2"	4"	2"	8-1/4"	45050 ball mount, 40037 trailer ball, 23515 hitch lock, 22272 hitch tube cover, 21500 pin & clip, case

\* Sturdy, reusable case included

# ATV 2 INCH ATV TOWING STARTER KITS

- Includes 3-in-1 ATV ball mount, bolt-on ATV adapter and pin & clip
- Never exceed the ATV's maximum tow rating
- Ball mount features a trailer ball, 5/8" hole and a clevis pin
- Adapter bolts onto ATV tongue to provide a 2" x 2" receiver tube
- Welded D-ring accepts tow straps or hooks
- Patent #8,915,514 and #8,276,932

Pkg#	Ball Diameter	Rise	Length	Hole Size	Finish
<b>Starter Kits</b>					
45029	1-7/8"	1/4"	6"	5/8"	Gloss black
45038	2"	1/4"	6"	5/8"	Gloss black
<b>Ball Mounts</b>					
45005	1-7/8"	1/4"	6"	5/8"	Gloss black
45009	2"	1/4"	6"	5/8"	Gloss black
<b>Bolt-On Adapter</b>					
45006	--	--	--	--	Gloss black



45029



Installs on ATV and provides a variety of hook-up options



45005



Clevis pin accepts hook or strap for straight-line pull



45006



No-swivel design



Converts an ATV platform into a 2" receiver tube

## 2 INCH LOADED BALL MOUNTS

- Fits any 2" x 2" receiver tube opening
- Includes a factory-torqued trailer ball and pin & clip
- Three-packs include an informative point-of-purchase tray
- Anti-rattle kits can be used with hollow shank mounts, see page 120

**NEW**



45037  
multi-pack



45064 (2" ball)  
45065 (2-5/16" ball)



45034 (1-7/8" ball)  
45036 (2" ball)  
45041 (2-5/16" ball)



45293 (1-7/8" ball)  
45295 (2" ball)



45055 (1-7/8" ball)  
45056 (2" ball)  
45042 (2-5/16" ball)



45331



45332

Part#	White Box#	Three-Pack#	GTW / TW	Ball Diameter	Drop	Length	Shank Type	Finish
45034	--	45035*	3,500 / 350 lbs.	1-7/8" (40002)	2"	8-1/4"	Hollow	Gloss black
--	45293	--	3,500 / 350 lbs.	1-7/8" (40002)	2"	8-1/4"	Hollow	Chrome
45036	--	45037	7,500 / 750 lbs.	2" (40037)	2"	8-1/4"	Hollow	Gloss black
--	45295	--	7,500 / 750 lbs.	2" (40037)	2"	8-1/4"	Hollow	Chrome
45041	--	--	7,500 / 750 lbs.	2-5/16" (40005)	2"	8-1/4"	Hollow	Gloss black
45331	--	--	15,000 / 1,500 lbs.	2-5/16" (40030)	2"	8-1/2"	Solid	Carbide
45055	--	--	3,500 / 350 lbs.	1-7/8" (40002)	4"	8-1/4"	Hollow	Gloss black
45056	--	45057	7,500 / 750 lbs.	2" (40037)	4"	8-1/4"	Hollow	Gloss black
45042	--	--	7,500 / 750 lbs.	2-5/16" (40005)	4"	8-1/4"	Hollow	Gloss black
45332	--	--	15,000 / 1,500 lbs.	2-5/16" (40030)	4"	8-1/2"	Solid	Carbide
45064 <b>NEW</b>	--	--	7,500 / 750 lbs.	2" (40037)	6"	9-1/4"	Hollow	Gloss black
45065 <b>NEW</b>	--	--	7,500 / 750 lbs.	2-5/16" (40005)	6"	9-1/4"	Hollow	Gloss black

\* Continued while supplies last

## 2 INCH FUSION BALL MOUNTS

- Fits any 2" x 2" receiver tube opening
- Includes a welded trailer ball and pin & clip
- Permanently attached trailer ball cannot be loosened or stolen
- Anti-rattle kits can be used with hollow shank mounts, see page 120



45131 (1-7/8" ball)  
45134 (2" ball)



45151 (1-7/8" ball)  
45154 (2" ball)



45152 (1-7/8" ball)  
45155 (2" ball)

Part#	GTW / TW	Ball Diameter	Drop	Rise	Length	Finish
45131	5,000 / 500 lbs.	1-7/8"	2"	--	7-1/2"	Gloss black
45134	7,500 / 750 lbs.	2"	2"	--	7-1/2"	Gloss black
45151	5,000 / 500 lbs.	1-7/8"	4"	--	8-1/8"	Gloss black
45154	7,500 / 750 lbs.	2"	4"	--	8-1/8"	Gloss black
45152	5,000 / 500 lbs.	1-7/8"	--	2"	8-1/8"	Gloss black
45155	7,500 / 750 lbs.	2"	--	2"	8-1/8"	Gloss black

**2**

INCH

## DUAL-LENGTH BALL MOUNTS

- Fits any 2" x 2" receiver tube opening
- Two hitch pin holes for varying length
- Anti-rattle kits can be used with hollow shank mounts, see page 120



Part#	GTW / TW	Drop	Rise	Length	Hole Size	Finish
45220	7,500 / 750 lbs.	2"	3/4"	7-1/2" or 10-1/2"	1"	Gloss black
45230	7,500 / 750 lbs.	4"	2"	8-1/8" or 11-1/8"	1"	Gloss black
45240	7,500 / 750 lbs. drop 6,000 / 600 lbs. rise	6"	4"	9-1/4" or 12-1/4"	1"	Gloss black



Two pin holes  
for varying length

**2**

INCH

## CLASS 4 BALL MOUNTS

- Fits any 2" x 2" receiver tube opening
- Increased drop allows for level towing with lifted vehicles
- Anti-rattle kits can be used with hollow shank mounts, see page 120



Part#	GTW / TW	Drop	Rise	Length	Ball Hole Size	Shank Type	Finish
45310	10,000 / 1,000 lbs.	2"	1"	9-3/8"	1-1/4"	Hollow	Gloss black
45311	10,000 / 1,000 lbs.	4"	2-3/4"	9-3/8"	1-1/4"	Hollow	Gloss black
45336	10,000 / 1,000 lbs.	6"	4-3/4"	9-3/8"	1-1/4"	Hollow	Gloss black
45338	10,000 / 1,000 lbs.	8"	6-3/4"	9-3/8"	1-1/4"	Hollow	Gloss black
45312	12,000 / 1,200 lbs.	2"	1"	9-3/8"	1-1/4"	Solid	Gloss black
45313	12,000 / 1,200 lbs.	4"	3"	9-3/8"	1-1/4"	Solid	Gloss black
45446	12,000 / 1,200 lbs.	6"	5"	9-3/8"	1-1/4"	Solid	Gloss black
45448	12,000 / 1,200 lbs.	8"	7"	9-3/8"	1-1/4"	Solid	Gloss black



# 2 INCH & 2½ INCH & 3 INCH FORGED BALL MOUNTS

- Fits 2", 2-1/2" or 3" receiver tube openings
- Constructed from solid, forged steel for superior strength



Ideal for CURT class 5 Xtra Duty and Commercial Duty trailer hitches (page 15)



Part#	Shank Size	GTW / TW	Drop	Rise	Length	Ball Hole Size	Finish
<b>2" x 2" Xtra Duty Forged Ball Mounts</b>							
45340	2" x 2"	17,000 / 2,550 lbs.	2"	1"	8-1/2"	1-1/4"	Carbide
45341	2" x 2"	17,000 / 2,550 lbs.	4"	3"	8-1/2"	1-1/4"	Carbide
45342	2" x 2"	17,000 / 2,550 lbs.	6"	5"	9-1/2"	1-1/4"	Carbide
<b>2-1/2" x 2-1/2" Commercial Duty Forged Ball Mounts</b>							
45456	2-1/2" x 2-1/2"	20,000 / 2,700 lbs.	2"	1/2"	8-1/2"	1-1/4"	Carbide
45458	2-1/2" x 2-1/2"	20,000 / 2,700 lbs.	4"	2-1/2"	8-1/2"	1-1/4"	Carbide
45459 <b>NEW</b>	2-1/2" x 2-1/2"	20,000 / 2,700 lbs.	6"	4-1/2"	9"	1-1/4"	Carbide
45460 <b>NEW</b>	2-1/2" x 2-1/2"	20,000 / 2,700 lbs. drop 16,000 / 2,160 lbs. rise	8"	6-1/2"	10"	1-1/4"	Carbide
<b>3" x 3" Industrial Duty Forged Ball Mounts</b>							
45430	3" x 3"	21,000 / 2,800 lbs.	4"	2"	9"	1-1/4"	Carbide
45431	3" x 3"	21,000 / 2,800 lbs.	6"	4"	10"	1-1/4"	Carbide
45432	3" x 3"	21,000 / 2,800 lbs.	8"	6"	10-1/2"	1-1/4"	Carbide



## 2 INCH & 2½ INCH ADJUSTABLE CHANNEL MOUNTS

**⚠️ Weight capacities limited to the lowest rated towing component**

- Adjustable channel mount allows for precise trailer leveling
- Shank can be flipped to maximize rise or drop
- Built-in anti-rattle helps promote quiet towing
- Channels measure 3" wide (I.D.) with holes spaced 1" on center

- Pintle mounts include safety pin (#25012)
- Protected by a durable carbide powder coat finish
- Includes pins & clips
- Patent #8,033,563 (#45900, #45901, #45902)
- [See page 101 for replacement parts](#)



Built-in anti-rattle prevents shaking (45902 and 45908)



Built-in anti-rattle prevents shaking (45900, 45901, 45907)



Pins & clips secure channel accessory into place



45901



45900



45902



45907



45908

Pkg#	Shank Size	Ball Mount GTW / TW (lbs.)	2" Ball GTW / TW (lbs.)	2-5/16" Ball GTW / TW (lbs.)	Max Drop	Max Rise	Length	Hole Size	Ball Finish
45901	2"	6,000 / 600	--	--	6-3/4"	5-1/4"	11" or 12"	1"	--
45900	2"	--	10,000 / 1,000	14,000 / 1,400	6"	5-1/4"	11" or 12"	--	Yellow zinc-plated
45902	2-1/2"	--	10,000 / 1,000	20,000 / 2,000	6"	5-1/4"	11" or 12"	--	Yellow zinc-plated
45907 <b>NEW</b>	2"	--	13,000	--	6"	5-1/4"	11" or 12"	1-1/4"	Chrome-plated
45908 <b>NEW</b>	2-1/2"	--	--	20,000	6"	5-1/4"	11" or 12"	1-1/4"	Chrome-plated

# CHANNEL MOUNT HITCH STEP

- Provides a convenient 16" step on the front or rear of the vehicle
- Attaches to any CURT adjustable channel mount
- Channel mount attachment allows for versatile height adjustment
- Folds up and out of the way when not in use
- Cast steel construction with a highly durable powder coat finish
- Includes hitch step only (channel mount, pins and clips must be purchased separately)



45909



Versatile height adjustment



Tilts up when not in use

Pkg#	Tongue Weight	Step Width
45909 <b>NEW</b>	500 lbs.	16"

# CHANNEL MOUNT LOCK SET

- Replaces adjustable channel-mount pins for increased security
- Locks keyed alike for convenient one-key operation
- Watertight dust caps prevent internal corrosion



Locks secure the mount from theft



23556

Pkg#	Diameter	Fits
23556	5/8"	2" and 2-1/2" receiver tubes and channel mounts

# CHANNEL MOUNT REPLACEMENT PARTS

Part#	Description	Replacement For
45910	Replacement shank	45900 and 45907
45911	Replacement shank	45901
45917	Replacement shank	45902 and 45908
45912	Replacement dual-ball	45900
45923	Replacement dual-ball	45902
45925	Replacement pins, 5/8" diameter	All channel mounts
45916	Replacement anti-rattle set screw	45902 and 45908
45921 <b>NEW</b>	Replacement anti-rattle rubber bumper	45900, 45901, 45907
45919	Replacement ball and pintle combo, 2" ball with 10,000 lbs. GTW	All channel mounts
45920	Replacement ball and pintle combo, 2-5/16" ball with 13,000 lbs. GTW	45907
45922	Replacement ball and pintle combo, 2-5/16" ball with 20,000 lbs. GTW	45908



45919  
45920  
45922



45925



45916



45921

2

INCH

## ADJUSTABLE TRI-BALL MOUNT

- Fits any 2" x 2" receiver tube opening
- Adjustable height allows for precise trailer leveling
- Includes three 5/8" diameter pins & clips



Bulk#	Pkg#	Description	GTW	Ball Diameter	Max Drop	Max Rise	Length
--	45799	Complete tri-ball assembly	6,000 / 7,500 / 10,000 lbs.	1-7/8", 2", 2-5/16"	5-3/4"	5-3/4"	16"
45800	--	Replacement tri-ball head for 45799	6,000 / 7,500 / 10,000 lbs.	1-7/8", 2", 2-5/16"	--	--	--
45059	--	Adjustable shank for 45799 or 45008	10,000 lbs.	--	5-3/4"	5-3/4"	8-3/4"
45802	--	Replacement tube mount for 45799	10,000 lbs.	--	--	--	--

2

INCH

## ADJUSTABLE MULTI-PURPOSE BALL MOUNT

- Fits any 2" x 2" receiver tube opening
- Features two welded trailer balls and removable clevis bar for lunette eyes
- Adjustable height allows for precise trailer leveling
- Includes three 5/8" diameter pins & clips (#45049)
- Patent #8,534,695



Bulk#	Pkg#	Description	Ball Diameter and Maximum GTW / TW		Max Drop	Max Rise	Length
			2"	2-5/16"			
--	45049	Complete mount and shank assembly	7,500 / 750 lbs.	10,000 / 1,000 lbs.	4-1/2"	6-1/2"	14-3/16"
--	45008	Replacement head for 45049	7,500 / 750 lbs.	10,000 / 1,000 lbs.	--	--	--
45059	--	Adjustable shank for 45008 or 45799	10,000 / 1,000 lbs. - no ball included		--	--	--

2

INCH

## ADJUSTABLE BALL MOUNT

- Fits any 2" x 2" receiver tube opening
- Adjusts in 1-1/2" increments for precise trailer leveling
- Anti-rattle kits can be used with hollow shank mounts, see page 120
- Includes pin & clip (#21500)



Part#	GTW / TW	Max Drop	Max Rise	Length	Ball Hole Size	Finish
45812	5,000 / 500 lbs.	7-1/2"	6-1/4"	12-1/2"	1"	Gloss black

## 2 INCH MULTI-BALL MOUNTS

- Fits any 2" x 2" receiver tube opening
- Allows for quick switching between trailer ball sizes
- Permanently attached trailer balls cannot be loosened or stolen
- Anti-rattle kits can be used with hollow shank mounts, see page 120



Part#	Trailer Balls	Ball Diameter and Maximum GTW / TW			Length	Shank Type	Ball Finish	Shank Finish
		1-7/8"	2"	2-5/16"				
45660	2	--	7,500 / 750 lbs.	10,000 / 1,000 lbs.	8-1/2"	Solid	Black	Gloss black
45665	2	--	7,500 / 750 lbs.	10,000 / 1,000 lbs.	8-1/2"	Solid	Chrome	Gloss black
45002	2	--	7,500 / 750 lbs.	10,000 / 1,000 lbs.	8-1/2"	Hollow	Chrome	Gloss black
45675*	3	3,500 / 350 lbs.	5,000 / 500 lbs.	10,000 / 1,000 lbs.	7" and 8-1/2"	Solid	Chrome	Gloss black
45650	3	5,000 / 500 lbs.	7,500 / 750 lbs.	10,000 / 1,000 lbs.	7" and 8-1/2"	Solid	Black	Gloss black
45655	3	5,000 / 500 lbs.	7,500 / 750 lbs.	10,000 / 1,000 lbs.	7" and 8-1/2"	Solid	Chrome	Gloss black
45001	3	5,000 / 500 lbs.	7,500 / 750 lbs.	10,000 / 1,000 lbs.	7" and 8-1/2"	Hollow	Chrome	Gloss black

\*Tow hook limited to trailer hitch capacity

## CLEVIS PINS

- Heavy-duty hitch pin for hitch accessories or towing with a UTV or lawn tractor
- Extra-wide, rubber-coated handle for better grip
- Welded steel construction for reliable strength
- Black powder-coated pin for enhanced protection
- Includes clevis pin and cotter pin



Part#	Pin Diameter	Pin Length	Pin Finish
45803 <b>NEW</b>	1"	5-1/2"	Black powder coat
45804 <b>NEW</b>	5/8"	4"	Black powder coat
45805 <b>NEW</b>	1/2"	3-5/8"	Black powder coat

## 2 INCH CLEVIS PIN BALL MOUNT

- Fits any 2" x 2" receiver tube opening
- Clevis pin accepts a tow hook or strap
- Can also be used as a standard ball mount
- Includes clevis pin (trailer ball sold separately)
- Solid steel shank for optimum strength



Part#	GTW / TW	Length	Ball Hole Size	Finish
45821	6,000 / 600 lbs.	8-3/4"	1"	Gloss black

**2**

INCH

## SWAY TAB BALL MOUNT

- Fits any 2" x 2" receiver tube opening
- Provides a mounting tab for a sway control trailer ball (ball sold separately)
- Anti-rattle kits can be used with hollow shank mounts, see page 120
- [See page 214 for sway control units and balls](#)



Part#	GTW / TW	Drop	Rise	Length	Ball Hole Size
45820	7,500 / 750 lbs.	2"	3/4"	7-1/2"	1"

**1 1/4**

INCH

**&****2**

INCH

## VERTICAL RECEIVER TUBE BALL MOUNTS

- Converts a vertical receiver tube into a ball mount tongue (#45507, #45003)
- Adapts a 2" vertical receiver into a 2" standard receiver (#45013)



Part#	Shank Size	GTW / TW	Hole Size	Adapts From	Adapts To	Length	Finish
45507	1-1/4"	3,500 / 300 lbs.	3/4"	Vertical 1-1/4"	Ball mount tongue	9-3/4"	Gloss black
45003	2"	4,000 / 400 lbs.	1"	Vertical 2"	Ball mount tongue	9"	Gloss black
45013	2"	5,000 / 500 lbs.	--	Vertical 2"	Standard 2"	4-1/4"	Gloss black

**2**

INCH

**&****2 1/2**

INCH

## D-RING SHACKLE AND TOW HOOK MOUNTS

- Fits 2" or 2-1/2" receiver tube openings
- GTW and TW are limited to trailer hitch capacity



Part#	Shank Size	Description	Length	Finish
45831	2-1/2"	Use with tow straps, complete with shackle and solid shank	7-1/2"	Carbide
45832	2"	Use with tow straps, complete with shackle and solid shank	7-1/2"	Carbide
45825	2"	Use with 83066 vehicle recovery strap or similar	7-1/2"	Gloss black
45500	2"	Use with 83066 vehicle recovery strap or similar	10"	Carbide

# TOW HOOKS & TOW STRAP

See page 227 for chain options

- Commonly used on 4WD pickups, SUVs and vans
- Constructed from forged, heat-treated steel
- Spring clip provides added security for rope or strap attachment



83066



22420



22430



22401



22411

Bulk#	Pkg#	Capacity	Break Strength	Finish	Description
--	22401	10,000 lbs.	--	Chrome-plated	Tow hook with hardware
--	22411	10,000 lbs.	--	Black	Tow hook with hardware
22420	--	10,000 lbs.	--	Chrome-plated	Tow hook
22430	--	10,000 lbs.	--	Black	Tow hook
83066	--	9,000 lbs. GVW	18,000 lbs.	Nylon	Tow strap, 2" wide by 30' long

## 2 INCH SPECIALTY MOUNTS

Weight capacities limited to the lowest rated towing component

- Fits any 2" x 2" receiver tube opening
- Top receiver increases ground clearance for a cargo carrier or other hitch-mounted accessories
- Top receiver not for towing use
- Provides two receiver tubes for multiple accessories, such as a cargo carrier and a ball mount (#45792)
- Ideal for carrying a bike rack while towing a trailer (#45810)



45794



45792



45794 gives added ground clearance



45792 provides two receiver tubes



45810 provides a ball mount and receiver tube to tow a trailer and an additional accessory



45810

Part#	Description	GTW / TW	Drop	Rise	Length	Ball Hole Size	Finish
45794	Raised receiver adapter	Not for towing use / 350 lbs.	--	4-1/4"	5-1/4"	--	Gloss black
45792	Dual receiver extender with pin & clip	3,500 / 350 lbs.	--	5-13/16"	8"	--	Gloss black
45810	Multi-use ball mount with pin & clip	7,500 / 750 lbs.	2"	5-13/16"	12-1/4"	1"	Gloss black

**1 1/4**  
INCH**&****2**  
INCH

# TRAILER HITCH RECEIVER TUBE EXTENDERS

- Provides added clearance for a trailer or hitch-mounted accessory
- Shank constructed from solid steel for optimum strength
- Protected by a durable powder coat finish



Part#	Extends	Shank Size	GTW / TW
45789	7"	1-1/4"	Not for towing use / 350 lbs.
45791	8"	2"	3,500 / 350 lbs.
45795	14"	2"	3,500 / 350 lbs.
45796	18"	2"	3,500 / 350 lbs.

## Measuring extenders and adapters

Length is measured between pin-holes, from center to center

**1 1/4**  
INCH**→****2**  
INCH**←****2 1/2**  
INCH

# TRAILER HITCH RECEIVER TUBE ADAPTERS

- Adapts a receiver tube opening to a different size
- #45048 can be cut down from 34" to 24" and has integrated safety chain loops and an electrical bracket
- Protected by a durable powder coat finish



Part#	Adapts From	Adapts To	GTW / TW	Weight Dist. GTW / TW	Length	Finish
45785	1-1/4"	2"	Not for towing use / 350 lbs.	--	6-1/4"	Gloss black
45790	1-1/4"	2"	Not for towing use / 350 lbs.	--	10"	Gloss black
45770	2"	1-1/4"	3,500 / 350 lbs.	--	4"	Gloss black
45775	2"	1-1/4"	3,500 / 350 lbs.	--	9-1/2"	Gloss black
45780	2"	1-1/4"	3,500 / 350 lbs.	--	15"	Gloss black
45013	Vertical 2"	Standard 2"	5,000 / 500 lbs.	--	4-1/4"	Gloss black
45048	2-1/2"	2"	4,500 / 450 lbs.	6,000 / 600 lbs.	34"	Gloss black
			6,000 / 600 lbs.	8,000 / 800 lbs.	24"	



**3** INCH → **2½** INCH → **2** INCH **REDUCER SLEEVES**

- #45405 reduces a 2-1/2" x 2-1/2" receiver tube opening to fit a 2" x 2" shank
- #45408 two-piece set reduces a 3" receiver tube opening to fit a 2-1/2" shank or 2" shank
- GTW and TW are limited to trailer hitch capacity

Part#	Reduces From	Reduces To	Length	Finish
45405	2-1/2"	2"	5-1/2"	Carbide
45408	3"	2-1/2"	6-1/4"	Carbide
	2-1/2"	2"		

**How to use a reducer sleeve**

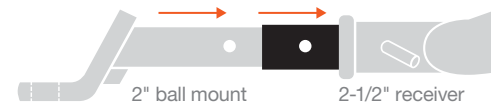

**REDUCER BUSHINGS**

- Reduces hole size, allowing use of trailer balls with smaller shank diameters

Bulk/#	Pkg#	Reduces From	Reduces To	Finish
21100	21101	1"	3/4"	Yellow zinc-plated
21200	21201	1-1/4"	1"	Yellow zinc-plated
21300	21301	1-3/8"	1-1/4"	Yellow zinc-plated



**BALL MOUNT TONGUE SLEEVE**

- Allows for single-wrench trailer ball torquing
- For use with CURT and other 'wrench flat' trailer balls
- See our trailer ball hex-end wrench on page 113
- Patent #8,376,387

Pkg#	Fits	Ball Hole Size	Finish
45007	2-1/2" tongue width	1"	Gloss black



**TOW POUCH**

- Stores ball mount, trailer balls, hitch pins and other accessories
- Keeps hands and vehicle interior clean

Part#	Width	Length
22200	11-1/2"	17-1/2"



# PINTLES & LUNETTE EYES

## FORGED PINTLE HOOKS & COMBINATIONS

For pintle mount options go to page 109

- Mounts on any CURT adjustable pintle mount
- Spring-loaded locking arm for secure coupling
- Constructed from solid, forged steel for superior strength
- Changeable trailer ball features a hard chrome finish
- Includes safety pin and bolt kit



48180



48190



48200



Pintle hook coupled to a lunette eye



Ball & pintle combo attached to coupler



48205



48210



48215



48231

Bulk#	Pkg#	Pintle GTW	Vertical Load	Ball GTW	Ball Diameter	Fits Lunette Eye	Finish
<b>Ball &amp; Pintle Combinations</b>							
--	48180	16,000 lbs.	1,600 lbs.	6,000 lbs.	1-7/8"	2-1/2" or 3" I.D.	Black
--	48190	16,000 lbs.	1,600 lbs.	10,000 lbs.	2"	2-1/2" or 3" I.D.	Black
--	48200	16,000 lbs.	1,600 lbs.	16,000 lbs.	2-5/16"	2-1/2" or 3" I.D.	Black
<b>Pintle Hooks</b>							
--	48205	10,000 lbs.	2,000 lbs.	--	--	2-1/2" or 3" I.D.	Black
--	48210	20,000 lbs.	4,000 lbs.	--	--	2-1/2" or 3" I.D.	Black
--	48215	30,000 lbs.	8,000 lbs.	--	--	2-1/2" or 3" I.D.	Black
--	48231*	60,000 lbs.	12,000 lbs.	--	--	2-1/2" or 3" I.D.	Black
<b>Replacement Bolt Kits</b>							
48330	-Four 12mm x 50mm hex bolts (class 10.9) -Four 12mm hex nuts (class 8) -Four 12mm lock washers						Yellow zinc-plated
48332*	Replacement hardware for #48231 (required to reach 60,000 lbs. gross trailer weight)						Black oxide



48330



48332  
(for part# 48231)

# 2 INCH & 2½ INCH ADJUSTABLE PINTLE MOUNTS

- Mounts any CURT adjustable pintle hook or ball & pintle combination
- Height adjustment allows for precise trailer leveling
- Bent face plate and solid shank provides superior strength (#48343)
- 2-1/2" shank is ideal for class 5 Commercial Duty hitches (page 15)
- Protected by a highly durable carbide powder coat finish
- Protective cardboard sleeve and full-color retail label

## Measuring a pintle mount

See table for corresponding measurements

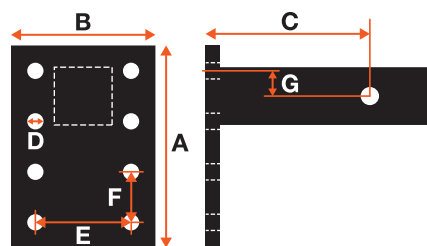

48326  
48327



48323  
48324  
48328  
48325



48343



48341  
48342



48340



48329



48348

**NEW**



48349

**NEW**



48330

Part#	GTW	Pintle Positions	Plate Height (A)	Plate Width (B)	Shank Length (C)	Hole Size (D)	Hole Space Width (E)	Hole Space Height (F)	Top Hole Height (G)
<b>For 2" x 2" Receiver Tube Openings</b>									
48326	20,000 lbs.	1-position	3-1/2"	5"	6"	9/16"	3-5/16"	1-3/4"	7/8"
48327	20,000 lbs.	1-position	3-1/2"	5"	8"	9/16"	3-5/16"	1-3/4"	7/8"
48323	10,000 lbs.	3-position	7"	5"	6"	9/16"	3-5/16"	1-3/4"	7/8"
48324	10,000 lbs.	3-position	7"	5"	8"	9/16"	3-5/16"	1-3/4"	7/8"
48328	15,000 lbs.	3-position	7"	5"	6"	9/16"	3-5/16"	1-3/4"	7/8"
48325	15,000 lbs.	3-position	7"	5"	8"	9/16"	3-5/16"	1-3/4"	7/8"
48343	17,000 lbs.	3-position	7-1/4"	6-1/2"	6"	9/16"	3-5/16"	1-3/4"	7/8"
48341	10,000 lbs.	6-position	13"	5"	10"	9/16"	3-5/16"	1-3/4"	7/8"
48342	10,000 lbs.	6-position	13"	5"	12"	9/16"	3-5/16"	1-3/4"	7/8"
<b>For 2-1/2" x 2-1/2" Receiver Tube Openings</b>									
48340	20,000 lbs.	1-position	3-1/2"	5"	8"	9/16"	3-5/16"	1-3/4"	7/8"
48329	18,000 lbs.	3-position	7"	5"	8"	9/16"	3-5/16"	1-3/4"	7/8"
48348 <b>NEW</b>	20,000 lbs.	3-position	7-1/4"	5"	10-3/4"	9/16"	3-5/16"	1-3/4"	7/8"
48349 <b>NEW</b>	20,000 lbs.	6-position	12-1/2"	5"	10-3/4"	9/16"	3-5/16"	1-3/4"	7/8"
<b>Replacement Bolt Kit</b>									
48330	Four 12mm x 50mm hex bolts (class 10.9) / Four 12mm hex nuts (class 8) / Four 12mm lock washers								

**2** INCH & **2½** INCH

# FORGED RECEIVER-MOUNT PINTLE HOOKS & COMBINATIONS

- Fits 2" or 2-1/2" receiver tube openings
- Spring-loaded locking arm for secure coupling
- Constructed from solid, forged steel for superior strength
- 2-1/2" shank ideal for class 5 Commercial Duty hitches (#48010, #48012)
- Protected by a durable powder coat finish
- Changeable trailer ball features a hard chrome finish
- Includes safety pin with chain or cable



Part#	GTW	Ball Capacity	Fits Receiver Tube Size	Ball Size	Overall Length	Ball Length	Hook Length	Fits Lunette Eye
<b>Receiver-Mount Ball &amp; Pintle Combinations</b>								
48006	16,000 lbs.	12,000 lbs.	2"	2-5/16"	15-1/4"	11-1/4"	9-1/2"	2-1/2" or 3" I.D.
48007	16,000 lbs.	10,000 lbs.	2"	2"	15-1/4"	11-1/4"	9-1/2"	2-1/2" or 3" I.D.
48012	20,000 lbs.	20,000 lbs.	2-1/2"	2-5/16"	15"	11"	9-1/2"	2-1/2" or 3" I.D.
<b>Receiver-Mount Pintle Hooks</b>								
48005	10,000 lbs.	--	2"	--	14-1/2"	--	9-1/2"	2-1/2" I.D.
48004	20,000 lbs.	--	2"	--	14-1/2"	--	9-1/2"	2-1/2" I.D.
48010	20,000 lbs.	--	2-1/2"	--	14-3/4"	--	9-1/2"	2-1/2" I.D.

## FORGED LUNETTE EYES

- Smooth back plate for flush mounting
- Four-bolt pattern for simple, secure attachment
- Constructed from forged steel alloy for superior strength



Pkg#	GTW	Eye Hole Size	Ring Thickness	Bolt Hole Spacing	Base Size	Finish
48550	35,000 lbs.	2-1/2" I.D.	1-1/2"	4-1/2" center to center	6" square	Black
48560	60,000 lbs.	3" I.D.	1-1/2"	4-1/2" center to center	6" square	Black

# FORGED LUNETTE EYES

- Single stud eliminates need for a swivel-type pintle hook (#48520, #48530)
- Threaded shank and castle nut for secure attachment to trailer (#48520, #48530)
- Flat design allows drawbar to bolt quickly and easily to a trailer tongue (#48510)
- Constructed from forged steel alloy for superior strength



48520



48530



48510



Using pintle hook



Using clevis bar

Part#	GTW	Eye Hole Size	Bar Width	Bar Length	Bar Thickness	Finish	Description
48520	15,000 lbs.	2-1/2" I.D.	--	--	--	Black	Lunette eye with 39mm castle nut
48530	45,000 lbs.	3" I.D.	--	--	--	Black	Lunette eye with 48mm castle nut
48510	22,000 lbs.	3" I.D.	3"	13"	1-5/8"	Black	Lunette eye drawbar, seven-bolt

# CHANNELS & FORGED LUNETTE EYES

- Height adjustment allows for precise trailer leveling
- 2" bolt pattern spread for simple, secure attachment
- Constructed from forged steel for superior strength
- Channel brackets feature one-piece, formed steel construction



48601



48660



48610



48650



48630



48631



48640



48620

Bulk#	Pkg#	GTW	Number of Positions	Eye Hole Size	Bolt Hole Spacing	Channel Width	Channel Height	Description
48600	--	12,000 lbs.	--	3" I.D.	--	--	--	Forged lunette eye
48601	--	12,000 lbs.	--	3" I.D.	--	--	--	Forged lunette eye, black
48660	--	24,000 lbs.	--	3" I.D.	--	--	--	Forged lunette eye
48631	48630	12,000 lbs.	3-position	3" I.D.	2" on center	3-1/2" I.D.	7-1/2"	Forged lunette eye with channel
48610	--	--	3-position	--	2" on center	3-1/2" I.D.	7-1/2"	Formed channel
48650	--	--	5-position	--	2" on center	3-1/2" I.D.	11-3/4"	Formed channel
48640	--	12,000 lbs.	5-position	3" I.D.	2" on center	3-1/2" I.D.	11-3/4"	Forged lunette eye with channel
48620	Grade-8 bolt kit includes two of each of the following: hex bolts (5/8" x 5-1/2"), hex bolts (1/2" x 1-1/2"), nylock hex nuts (5/8"), flat washers (1/2") and flat washers (5/8")							

# TRAILER BALLS

- Chrome-plated, stainless steel and raw trailer balls available
- Fine threads provide superior holding strength
- Tested for safety to meet U.S. VESC specifications

## Chrome-plated



## Stainless steel



## Raw



## Measuring a trailer ball

- A: Ball diameter
- B: Shank length
- C: Shank diameter
- D: Rise

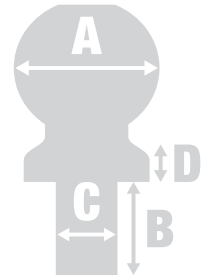

Shank Diameter (C)	Shank Length (B)	Rise (D)	GTW	Chrome Bulk#	Chrome Pkg#	Stainless Bulk#	Stainless Pkg#	Raw Bulk#
<b>1-7/8" Ball Diameter (A)</b>								
3/4"	1-5/8"	0"	2,000 lbs.	40001	40061	--	--	--
3/4"	2-1/8"	0"	2,000 lbs.	40015	40063	40050	40080	--
3/4"	3"	0"	2,000 lbs.	40016	40071	--	--	--
1"	2-1/8"	0"	3,500 lbs.	40002	40062	40051	40081	--
1"	2-1/8"	2"	3,500 lbs.	40032	--	--	--	--
1"	2-3/16"	1"	3,500 lbs.	40031	--	--	--	--
1"	3"	0"	3,500 lbs.	40017	40072	--	--	--
<b>2" Ball Diameter (A)</b>								
3/4"	1-3/4"	0"	3,500 lbs.	40003	40064	--	--	--
3/4"	2-1/8"	0"	3,500 lbs.	40018	40065	40052	40082	--
3/4"	3"	0"	3,500 lbs.	40019	40073	--	--	--
1"	2-1/8"	0"	6,000 lbs.	40004	40066	40053	40083	--
1"	2-1/8"	0"	7,500 lbs.	40037	--	--	--	--
1"	2-1/8"	1"	6,000 lbs.	40033	--	--	--	--
1"	2-1/8"	2"	6,000 lbs.	40034	--	--	--	--
1"	2-1/4"	0"	12,000 lbs.	40038*	--	--	--	--
1"	3"	0"	6,000 lbs.	40020	40074	--	--	--
1-1/4"	2-5/8"	0"	10,000 lbs.	40090	40069	--	--	--
<b>2-5/16" Ball Diameter (A)</b>								
1"	2-1/8"	0"	7,500 lbs.	40005	40067	40054	40084	--
1"	2-1/4"	0"	10,000 lbs.	40007	--	--	--	--
1"	2-1/4"	0"	12,000 lbs.	40039*	--	--	--	40042*
1"	3"	0"	6,000 lbs.	40021	40075	--	--	--
1-1/4"	2-5/8"	0"	10,000 lbs.	40006	40068	--	--	--
1-1/4"	2-5/8"	0"	15,000 lbs.	40030*	--	--	--	--
1-1/4"	2-5/8"	0"	30,000 lbs.	--	--	--	--	40085*
1-1/4"	2-5/8"	1"	10,000 lbs.	40035	--	--	--	--
1-1/4"	2-5/8"	1"	25,000 lbs.	--	--	--	--	40086*
1-1/4"	2-5/8"	2"	10,000 lbs.	40036	--	--	--	--
1-1/4"	2-5/8"	2"	25,000 lbs.	--	--	--	--	40087*
1-1/4"	2-3/4"	0"	20,000 lbs.	40008*	--	--	--	--
1-1/4"	3"	0"	6,000 lbs.	40022	40076	--	--	--
1-1/4"	2-3/4"	0"	20,000 lbs.	--	40009 <b>NEW</b>	--	--	--
2"	3-1/2"	0"	30,000 lbs.	--	--	--	--	40088**
<b>3" Ball Diameter (A)</b>								
2"	3-1/4"	0"	30,000 lbs.	--	--	--	--	40089**
<b>50mm Ball Diameter (A)</b>								
3/4"	50mm	0"	1,600 kg.	40099 <b>NEW</b>	--	--	--	--

\*Heat-treated

\*\*Heat-treated, coarse-threaded

# ATV-LAWN TRACTOR TRAILER BALLS

**NEW**

- Fits ATVs, UTVs or lawn tractors with 5/8" ball hole
- Available in 1-7/8" and 2" diameter
- Rated for up to 2,000 lbs. GTW
- Constructed from high-strength, hot-forged steel
- Enhanced durability with chrome-plated finish
- Fine threading for superior holding strength
- Tested for safety to meet U.S. VESC V-5 specifications



Ball Diameter	Shank Diameter	Shank Length	Rise	GTW	Torque Specification	Bulk#	Pkg#
1-7/8"	5/8"	1-3/4"	0"	2,000 lbs.	90 ft. lbs.	40095 <b>NEW</b>	40096 <b>NEW</b>
2"	5/8"	1-3/4"	0"	2,000 lbs.	90 ft. lbs.	40097 <b>NEW</b>	40098 <b>NEW</b>

# TRAILER BALL COVERS

- Protects trailer ball when not in use

Bulk#	Pkg#	Finish	Fits
21800	21801	Black rubber	1-7/8" and 2" trailer balls
21810	21811	Black rubber	2-5/16" trailer balls



# REPLACEMENT NUTS & WASHERS

- Fits trailer ball shanks with fine threads
- Helical lock washer ensures a secure mount
- Constructed from zinc-plated steel
- Tested for safety to meet U.S. VESC V-5 specifications



Pkg#	Torque Specification	Description
40103	160 ft. lbs.	3/4" nut and lock washer
40104	250 ft. lbs.	1" nut and lock washer
40105	450 ft. lbs.	1-1/4" nut and lock washer

# TRAILER BALL BOX-END WRENCH

- Six-point design ensures the best grip and protects against rounding of the nut
- Forged, hardened steel construction with a durable chrome plating



Shown with 45007



20001



Part#	Length	Wrench Sizes	Fits
20001	15-1/2"	1-1/8" and 1-1/2"	3/4" and 1" shanks

# SWITCH BALL™ TRAILER BALLS

- Exclusive 'J' groove design for secure attachment to the shank
- No tools, coins or pins required for trailer ball install or removal
- Shank bears the weight, freeing the coupler from binding
- Built from high-strength steel
- Protected by a premium grade, nickel chrome-plated finish
- Neck covers protect the Switch Ball™ neck from the elements when not in use
- Tested for safety in accordance with SAE J684
- U.S. patent #5,169,168; Canadian patent #1,325,445

## Features

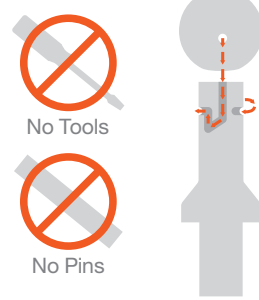

## Measuring a Switch Ball™

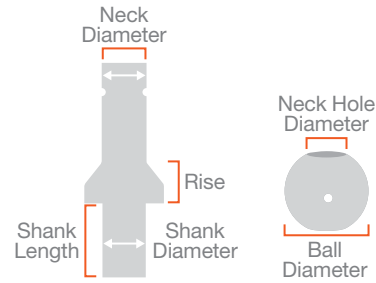

Place the ball on the shank



Twist the ball down onto the shank to lock



42178



42280



42225



41352

41353

Bulk#	Pkg#	Ball Diameter and GTW			Shank GTW	Shank Length	Shank Diameter	Neck Diameter	Neck Hole Diameter	Rise	Finish
		1-7/8"	2"	2-5/16"							
<b>Switch Ball™ Trailer Ball Sets</b>											
--	42178	3,500 lbs.	6,000 lbs.	--	--	2-1/4"	1"	1"	--	0"	Chrome-plated
--	42225	3,500 lbs.	6,000 lbs.	8,000 lbs.	--	2-1/4"	1"	1-1/8"	--	3/4"	Chrome-plated
--	42280	--	6,000 lbs.	8,000 lbs.	--	2-1/4"	1"	1-1/8"	--	3/4"	Chrome-plated
--	41782	3,500 lbs.	6,000 lbs.	--	--	1-5/8"	3/4"	1"	--	0"	Chrome-plated
--	41783*	3,500 lbs.	6,000 lbs.	--	--	2-1/4"	3/4"	1"	--	0"	Chrome-plated
<b>Switch Ball™ Neck Covers</b>											
--	41352*	--	--	--	--	--	--	1"	--	--	Black rubber
--	41353*	--	--	--	--	--	--	1"	--	--	Red rubber
--	41355*	--	--	--	--	--	--	1-1/8"	--	--	Red rubber
<b>Replacement Trailer Balls</b>											
41780*	--	6,000 lbs.	--	--	--	--	--	--	1"	--	Chrome-plated
42780*	--	8,000 lbs.	--	--	--	--	--	--	1-1/8"	--	Chrome-plated
41200*	--	--	6,000 lbs.	--	--	--	--	--	1"	--	Chrome-plated
42200*	--	--	8,000 lbs.	--	--	--	--	--	1-1/8"	--	Chrome-plated
42203*	--	--	--	8,000 lbs.	--	--	--	--	1-1/8"	--	Chrome-plated
<b>Replacement Shanks</b>											
41340*	--	--	--	--	3,500 lbs.	1-5/8"	3/4"	1"	--	0"	Chrome-plated
41341*	--	--	--	--	3,500 lbs.	2-1/4"	3/4"	1"	--	0"	Chrome-plated
42100*	--	--	--	--	6,000 lbs.	2-1/4"	1"	1"	--	0"	Chrome-plated

\* Continued while supplies last



# REPLACEMENT PINTLE BALLS

- Fits lunette eyes with a 2-1/2" or 3" inside diameter
- Fine threads and self-securing nylock nut
- Constructed from high-strength, drop-forged steel
- Protected by a hard chrome-plated finish



Shown with 48215



48810



48820



48830

Bulk#	Ball Diameter	Shank Diameter	GTW
48810	1-7/8"	1-1/4"	6,000 lbs.
48820	2"	1-1/4"	10,000 lbs.
48830	2-5/16"	1-1/4"	16,000 lbs.

# REPLACEMENT SWAY CONTROL BALL

- Fits the sway control unit #17200, sway tab ball mount #45820 or weld-on sway tab #45822
- Sway control helps reduce lateral trailer movement
- Constructed from chrome-plated steel



Shown with 45822



Shown with 45820



40093

Bulk#	Ball Diameter	Shank Diameter	Shank Length
40093	1-1/4"	5/8"	1-3/4"

# REPLACEMENT GOOSENECK BALLS

## Double Lock Goosenecks

- Trailer balls fit all original Double Lock gooseneck hitches
- #60616 also fits Double Lock EZr™ gooseneck hitches

## OEM Puck System

- Installs easily with quarter-turn latch locking system
- Tested for safety to meet U.S. VESC V-19 specifications
- Patent #8,955,866

## Weld-On

- Heat-treated for optimum strength and durability
- Tested for safety to meet U.S. VESC V-5 specifications



60616



60602



60603



60629



60628



40094

**NEW**

Bulk#	Pkg#	Description	Ball Size	GTW / Vertical Load	Finish
<b>For Double Lock Goosenecks</b>					
60616	--	Fits Double Lock EZr™ and Original Double Lock goosenecks	2-5/16"	30,000 / 7,500 lbs.	Chrome-plated
--	60602	Moves pivot point 4" rearward for added cab clearance (Fits Original Double Lock only)	2-5/16"	20,000 / 5,000 lbs.	Black powder coat
--	60603	Adds 1" clearance for trucks with plastic or rubber bed liners (Fits Original Double Lock only)	2-5/16"	30,000 / 7,500 lbs.	Chrome-plated
<b>For Puck Systems and OEM-Style Goosenecks</b>					
60629	--	Fits Chevrolet, Ford, GMC, Nissan and Ram puck systems	2-5/16"	30,000 / 7,500 lbs.	Chrome-plated
60628	<b>NEW</b>	Fits Chevrolet, Ford, GMC, Nissan and Ram puck systems	3"	30,000 / 7,500 lbs.	Chrome-plated
<b>For Weld-On Applications</b>					
40094	--	High-strength, ready-to-weld steel alloy	2-5/16"	30,000 lbs	Raw

# TOWING SECURITY

## HITCH & COUPLER LOCK SETS

- Locks keyed alike for convenient one-key operation
- Easy-to-operate, 1/4-turn lock activation
- Watertight dust caps prevent internal corrosion
- Four keys included for added convenience
- Space-saving, retail packaging



Pkg#	Fits Receiver Tube Opening	Fits Latch Span	Fits Coupler	Lock Pin Diameter	Coupler Pin Diameter	Finish	Description
23526	2" x 2"	7/8"	--	5/8"	1/4"	Chrome-plated	Hitch lock (23515) & coupler lock (23520)
23527	2" x 2"	2-1/2"	--	5/8"	1/4"	Chrome-plated	Hitch lock (23515) & coupler lock (23522)
23505	2" x 2"	Adjustable from 1" to 3"	--	5/8"	1/4"	Chrome-plated	Hitch lock & coupler lock (23503)
23086	2" x 2"	Adjustable from 1/2" to 2-1/2"	1-7/8" & 2" flat lip couplers	5/8"	1/4"	Chrome-plated (hitch & coupler lock) Grey powder coat (trailer coupler lock)	Hitch lock, coupler lock & trailer coupler lock (23079)
23088	2" x 2"	Adjustable from 1/2" to 2-1/2"	2" & 2-1/2" flat lip couplers	5/8"	1/4"	Chrome-plated (hitch & coupler lock) Grey powder coat (trailer coupler lock)	Hitch lock, coupler lock & trailer coupler lock (23081)

# HITCH LOCKS

- Easy-to-operate, 1/4-turn lock activation
- Watertight dust cap prevents internal corrosion
- Two keys included for added convenience
- Space-saving, full-color retail packaging



Pkg#	Fits Receiver Tube Opening	Pin Diameter	Finish	Lock Style
23020	1-1/4" x 1-1/4"	1/2"	Chrome-plated	Dead bolt
23501	1-1/4" x 1-1/4"	1/2"	Chrome-plated	Barbell
23024	1-1/4" x 1-1/4"	1/2"	Chrome-plated	Dead bolt with adapter sleeve
	2" x 2"	5/8"		
23517	1-1/4" x 1-1/4"	1/2"	Stainless steel with blue anodized aluminum	Barbell with adapter sleeve
	2" x 2"	5/8"		
23506	1-1/4" x 1-1/4"	1/2"	Chrome-plated	Barbell, right angle with adapter sleeve
	2" x 2"	5/8"		
23515	2" x 2"	5/8"	Chrome-plated	Barbell
23530*	2" x 2"	5/8"	Chrome-plated	Barbell with anti-rattle
23516	2" x 2"	5/8"	Stainless steel	Barbell
23518	2" x 2"	5/8"	Black	Barbell
23502	2" x 2"	5/8"	Stainless steel with blue anodized aluminum	Barbell, right angle
23510	2" x 2"	5/8"	Chrome-plated	Barbell, right angle
23528	Up to 2-1/2"	5/8"	Chrome-plated	Barbell
23519	Up to 2-1/2"	5/8"	Stainless steel	Barbell
23504	Up to 2-1/2"	5/8"	Chrome-plated with blue anodized aluminum	Barbell, right angle
23021	Up to 3"	5/8"	Chrome-plated	Dead bolt
23025 <b>NEW</b>	Up to 3"	5/8"	Chrome-plated	Barbell

\* Continued while supplies last



**NEW**



# COUPLER LATCH LOCKS

- Easy-to-operate, 1/4-turn lock activation
- Watertight dust cap prevents internal corrosion
- Two keys included for added convenience
- Space-saving, full-color retail packaging



23521



23520



23522



23523



23503



23546



23022

Pkg#	Fits Latch Span	Pin Diameter	Finish	Lock Style
23546	3/4"	1/4"	Solid brass	Padlock
23022	3/4"	1/4"	Brass-plated	Padlock
23521	3/4"	1/4"	Black	Padlock
23520	7/8"	1/4"	Chrome-plated	Barbell
23522	2-1/2"	1/4"	Chrome-plated	Barbell
23523	3-3/8"	1/4"	Chrome-plated	Barbell
23503	Adjustable from 1" to 3"	1/4"	Chrome with blue anodized aluminum	Barbell, right angle



23503 coupler lock shown in trailer coupler

# TRAILER COUPLER LOCKS

- Designed to deter trailer theft by preventing a trailer ball from being inserted into the coupler
- Two keys included for added convenience



Two different designs fit multiple coupler sizes to secure unattended trailers



23079



23081



23659



23179

Pkg#	Fits	Finish	Description
23079	1-7/8" and 2" couplers	Grey powder coat	Aluminum lock for flat lip couplers
23081	2" and 2-5/16" couplers	Grey powder coat	Aluminum lock for flat lip couplers
23659	Universal	Hammer-tone epoxy	Die-cast trailer lock with dual-ratchet locking system
23179	Universal	Ballistic grade nylon	Solid, hardened steel trailer lock with dual-ratchet locking system

# 5TH WHEEL HITCH LOCK

- Locks a 5th wheel hitch into the rails, taking the place of a pin & clip
- Installs tight against the lip of the base rail for enhanced security
- Extra-long 1/2" diameter pin fits all industry-standard base rails
- Rust-free aluminum housing with a durable black powder coat finish
- Weather-resistant dust cap helps prevent internal corrosion
- Easy-to-access, 1/8-turn lock activation
- Includes two keys for added convenience

Pkg#	Pin Diameter	Finish
23256	1/2"	Black powder-coated aluminum



23256



Locks a 5th wheel hitch to industry-standard base rails



Flush-mount on the base rail for enhanced security



Key slot angled upward for easier ergonomic access

# KINGPIN LOCK

- Locks on to 5th wheel kingpin to deter theft of 5th wheel trailer
- Universal design fits most 5th wheel trailer kingpins
- Built with an aluminum body for excellent corrosion resistance
- Two keys included for added convenience
- Space-saving, full-color retail packaging

Pkg#	Description	Finish
23255	5th wheel trailer kingpin lock	Chrome-plated



23255



Universal design fits most kingpins



Prevents coupling to deter theft

# SPARE TIRE LOCK

- Secures spare tires to prevent theft
- Protected by a durable chrome-plated finish
- Two keys included for added convenience

Pkg#	Fits	Finish
23562	Side-mount spare tires	Chrome-plated



23562 exploded



23562

## WHEEL CHOCK LOCK

- Secures unattended trailers, RVs or vehicles by clamping onto the wheel
- Chocks and locks the wheel to prevent roll-away
- Expandable width fits most tire sizes
- Red rubber-coated arms protect the wheel's finish
- Three keys included for added convenience



23175 in use



23175

Pkg#	Fits Tire Sizes		Finish
23175	4.8" - R12	215 / 70R15	Yellow powder coat with red rubber-coated arms
	7.5" - R16	225 / 75R15	
	195 / 75R14	235 / 75R15	
	205 / 60R16	235 / 80R16	
	205 / 70R15	33" x 12.5" - R15	

## MULTI-USE CABLE LOCK

- Secures bike racks, cargo and other belongings to deter theft
- Features versatile locking and cinching capabilities
- 6' length allows for great use as a bike lock
- Constructed from 3/8" high-strength braided steel cable
- Protected by a vinyl coating for rust resistance
- Two keys included for added convenience



23666 on bike frame



23666

Pkg#	Length	Cable	Finish
23666	6'	3/8" diameter	Vinyl-coated, braided steel

## WHEEL CHOCK SET

- Ideal for chocking wheels on a parked trailer
- Perfect for adding safety during vehicle maintenance
- Raised tread offers a better grip on the wheel
- Saw-tooth edges on the base provide solid traction on the ground
- Always to be used with vehicle brake
- Not for commercial use



22800 in use



22800

Part#	Description
22800	For use with wheels up to 17" wide

## ANTI-RATTLE HITCH PINS

- Stops rattling and prevents swaying of load when using a hollow shank
- Compatible with CURT cargo carriers and other hollow-shank accessories
- Threaded pin allows bracket to be tightly installed



22321 in use

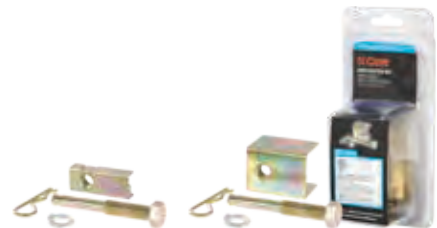

22315

22321

Pkg#	Fits Receiver Tube Opening	Finish
22315	1-1/4" x 1-1/4"	Yellow zinc-plated
22321	2" x 2"	Yellow zinc-plated

# HITCH PINS & CLIPS

- Secures ball mounts and other receiver tube inserts
- Bent handle for an easier grip



Bulk#	Pkg#	Three-Pack#	Fits Receiver Tube Opening	Pin Diameter	Finish	Clip Attachment
21400	21401	--	1-1/4" x 1-1/4"	1/2"	Zinc-plated	Hole
21403	21404	--	1-1/4" x 1-1/4"	1/2"	Zinc-plated	Groove
21410	21411	--	1-1/4" x 1-1/4"	1/2"	Zinc-plated, coated grip	Hole
--	21502	--	1-1/4" x 1-1/4"	1/2"	Zinc-plated	Hole
			2" x 2"	5/8" adapter		
21500	21501	--	2" x 2"	5/8"	Zinc-plated	Hole
21504	21505	--	2" x 2"	5/8"	Zinc-plated	Groove
21510	21511	--	2" x 2"	5/8"	Zinc-plated, coated grip	Hole
21578	21579	--	2" x 2"	5/8"	Black zinc-plated	Hole
21580	21581	--	2" x 2"	5/8"	Zinc-plated	Hole
			2-1/2" x 2-1/2"			
21582	21583	--	2" x 2"	5/8"	Zinc-plated	Groove
			2-1/2" x 2-1/2"			
21507	21506	--	2-1/2" x 2-1/2"	5/8"	Zinc-plated	Groove
			3" x 3"			
21600	21601	21602	--	Fits 1/2" or 5/8"	Zinc-plated	--

# SWIVEL HITCH PINS

- Quickly secures ball mounts and other receiver tube inserts with no clip needed
- Permanently attached swivel clip cannot be lost
- Bent handle for an easier grip



Pkg#	Fits Receiver Tube Opening	Pin Diameter	Finish	Description
21541	1-1/4" x 1-1/4"	1/2"	Chrome-plated	Swivel pin
23581	1-1/4" x 1-1/4"	1/2"	Stainless steel	Swivel pin
21551	2" x 2"	5/8"	Chrome-plated	Swivel pin
23582	2" x 2"	5/8"	Stainless steel	Swivel pin
21561	1-1/4" x 1-1/4"	1/2"	Zinc-plated	Swivel pin with adapter sleeve
	2" x 2"	5/8"		

# SAFETY PINS

- Quickly secures coupler latches, pintle hooks, jack legs or caster wheels
- Square retainer wire clip provides added clearance
- Protected by a durable zinc-plated finish



Bulk#	Pkg#	Pin Diameter	Pin Length	Chain Length
25080	25081	1/4"	2-3/4"	--
25012	25013	1/4"	2-3/4"	12"
25010	25011	5/16"	3"	--
25034	25035	5/16"	3"	12"
28278	28279	3/8"	2-3/4"	--
28000	28001	3/8"	3"	12"



Securing a coupler latch (25034)

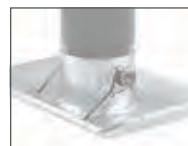

Securing a jack foot (28278)



# FAB COMPONENTS



## RAW STEEL RECEIVER TUBING

- Raw finish allows for immediate welding
- 1/2" reinforcing collar for increased strength
- Features a pre-drilled hitch pin hole



Part#	Finish	Receiver Tube Size	Tube Length
49506	Raw	1-1/4" x 1-1/4"	6"
49512	Raw	1-1/4" x 1-1/4"	12"
49524	Raw	1-1/4" x 1-1/4"	24"
49060	Raw	2" x 2"	6"
49090	Raw	2" x 2"	9"
49120	Raw	2" x 2"	12"
49180	Raw	2" x 2"	18"
49240	Raw	2" x 2"	24"
49360	Raw	2" x 2"	36"
49480	Raw	2" x 2"	48"
49510	Raw	2-1/2" x 2-1/2"	10"
45916	<b>NEW</b> Raw	2-1/2" x 2-1/2"	6"
49511	<b>NEW</b> Raw	2-1/2" x 2-1/2"	18"
49513	<b>NEW</b> Raw	3" x 3"	12"
49515	<b>NEW</b> Raw	3" x 3"	18"



**2**  
INCH

## RAW STEEL HITCH BARS

- Raw finish allows for immediate welding
- Rounded corners for easier insertion into the receiver
- Constructed from high-strength, hot-rolled steel
- Features a pre-drilled hitch pin hole



Part#	Finish	Bar Length	Shank Size
49537	Raw	8"	2" x 2"
49529	Raw	10"	2" x 2"
49530	Raw	12"	2" x 2"
49531	Raw	14"	2" x 2"
49532	Raw	16"	2" x 2"
49533	Raw	18"	2" x 2"
49534	Raw	20"	2" x 2"
49535	Raw	22"	2" x 2"
49536	Raw	24"	2" x 2"

## WELD-ON ACCESSORIES

- Features a pre-drilled trailer hitch pin hole (#49717)
- Reinforcing collar provides added strength (#49770)
- Accepts 2x4 studs or adds a tie-down for straps and chains (#83072)
- Provides a safety chain attachment point (#49950)

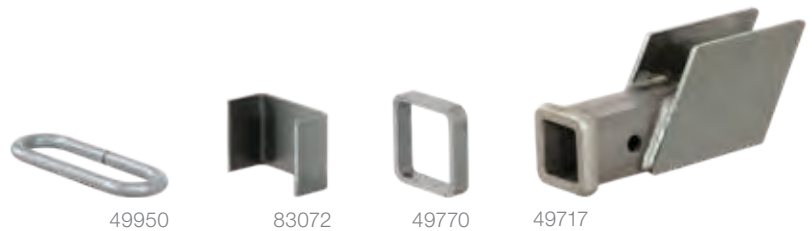

Part#	Description	GTW / TW	Receiver Tube Size	Inside Width	Inside Depth	Finish
49717	Hitch box	5,000 / 500 lbs.	2" x 2"	--	--	Raw
49770	Reinforcement collar	--	2" x 2"	--	--	Raw
83072	Stake pocket	--	--	3-1/2"	1-5/8"	Raw
49950	Safety chain loop	10,000 lbs.	--	--	--	Raw

# HITCH ACCESSORIES

2

INCH

## FRONT MOUNT ACCESSORIES

- Fits any 2" x 2" receiver tube opening
- Designed for use with front mount hitches
- Can also be used with rear mount hitches when not towing a trailer



Part#	Description
31006	Spare tire mount (mounting hardware not included)
31001	Step pad with anti-skid surface
31002	License plate holder
31007	Skid shield
31010	Winch mount
31005	Winch mount handles
31009	Winch mount with handles



Step pad provides easy under-the-hood access (31001)



Provides protection for the front end and hitch (31007)



Allows a winch to be easily mounted to a receiver (31009)



24" height accepts multiple tire sizes (31006)

## FISH WIRE

- Makes it easier to lead bolts through tough-to-reach holes
- Ideal for installing a trailer hitch on a vehicle with a hollow frame
- Coiled end accepts threaded bolts
- Constructed from spring steel for versatile twisting and bending
- Includes one per poly bag



58430



58390



58410



58400

Part#	Length	Coil Diameter	Material
58390	18"	3/8"	Spring steel
58410	18"	7/16"	Spring steel
58400	18"	1/2"	Spring steel
58430	18"	5/8"	Spring steel

## PROFESSIONAL FINISHING PACK

- Great for hitch and wiring installations
- Features 11 commonly used automotive trim panel retainers and frame hole plugs
- Contains 50 total pieces in a poly bag



22322

Pkg#	Description
22322	50 automotive finishing pieces

**1 1/4 INCH & 2 INCH & 2 1/2 INCH RUBBER HITCH TUBE COVERS**

- Protects 1-1/4", 2" or 2-1/2" receiver tube opening when not in use
- Adds a clean, finished look and keeps debris out
- Friction fit does not require a pin & clip to hold in place
- Features a convenient holder to mount a 4-way flat connector (#21728)



21728 in use



21728

Bulk#	Pkg#	Fits Receiver Tube Size	Finish
<b>Rubber Hitch Tube Covers</b>			
22271	22275	1-1/4" x 1-1/4"	Black rubber
22272	22276	2" x 2"	Black rubber
22277	22278	2-1/2" x 2-1/2"	Black rubber
<b>Rubber Hitch Tube Cover with 4-Way Flat Holder</b>			
--	21728	2" x 2"	Black rubber



22271 friction fit



22275

22276

22278

**1 1/4 INCH & 2 INCH STEEL & PLASTIC HITCH TUBE COVERS**

- Protects 1-1/4" or 2" receiver tube opening when not in use
- Adds a clean, finished look and keeps debris out
- Available in high-strength steel or rust-free plastic
- Securely mounts using a pin and clip (not included)



22750 in use



21900



21901



22101



22111



22751



22171

22181

Bulk#	Pkg#	Fits Receiver Tube Size	Finish
<b>Steel Hitch Tube Covers</b>			
21900	21901	1-1/4" x 1-1/4"	Chrome-plated
22100	22101	2" x 2"	Chrome-plated
22110	22111	2" x 2"	Chrome-plated
22750	22751	2" x 2"	Black
<b>Plastic Hitch Tube Covers</b>			
22170	22171	2" x 2"	Chrome-plated
22180	22181	2" x 2"	Black

# RV TOWING



## 2 INCH ADJUSTABLE RV TRAILER HITCHES

- Three-piece, adjustable design fits multiple frame sizes
- Designed for towing a trailer or small vehicle behind an RV
- Limited lifetime warranty (see back page for details)

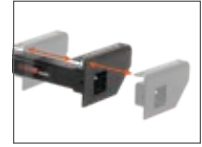

Part#	GTW / TW	WD / WDTW	Frame	Drop
13701	5,000 / 500 lbs.	6,000 / 600 lbs.	Fits box frames up to 51" wide	2"
13702	5,000 / 500 lbs.	6,000 / 600 lbs.	Fits box frames up to 51" wide	--
13703	3,500 / 350 lbs.	--	Fits box, C-channel and I-beam frames up to 72" wide	--
13704 <b>NEW</b>	5,000 / 500 lbs.	--	Fits box frames up to 68-1/2" wide	--

## ADJUSTABLE TOW BAR

- Ideal for dingy towing a small vehicle behind an RV
- Adjusts in width from 26" to 41"
- Features a 2" heavy-duty coupler
- Lightweight design only weighs 31 lbs.
- Brackets mount to the frame of the vehicle (trimming may be required)
- Includes universal frame brackets and mounting hardware



Tow bars adjust to fit different vehicles

Bulk#	Pkg#	Capacity	Ball Diameter	Finish	Dimensions	Description
--	19745	5,000 lbs.	2"	Gloss black	Adjusts from 26" to 41" in width	Adjustable tow bar
19746	--	--	--	Zinc-plated	1/2" diameter / 3" length	Replacement safety pin (new style)
21500	21501	--	--	Zinc-plated	5/8" diameter	Replacement pin & clip (old style)
19748	--	--	--	Gloss black	--	Bumper brackets

# RV HARNESES

- Connects a towed vehicle to an RV using a standard 4-way flat trailer plug
- Simple plug-and-play design eliminates the need for cutting or splicing
- Integrated block diodes isolate sensitive vehicle electronics from RV signals
- Uses towed vehicle's existing taillights, brake lights and turn signals
- Includes harness, 4-flat extension, mounting bracket and hardware



# TOWING LIGHTS

- Easily adds tow lights to a dinghy-towed vehicle or trailer without lights
- Non-scratch magnetic base protects vehicle finish
- Perfect for boats, RVs and flat towing applications
- 20' cord with 4-way flat plug allows for plug-and-play convenience
- Snap locks included for simple, secure splice-in connection
- Patent #D355,270



Bulk#	Pkg#	Length	Plug	Description
53200	53204*	20'	4-way flat	Auxiliary towing lights

\* Includes a sturdy, reusable case

# EXTENDED VIEW TOW MIRROR

- Attaches to side mirror to expand view with a trailer
- Compatible with pickup or SUV left or right side mirror
- Fully adjustable design can be used in horizontal or vertical position
- Articulating head allows precise angling
- Hinging arm and elastic straps provide easy and secure installation



Pkg#	Mirror Dimensions	Description
20002	Extends from 5" to 7-1/2"	Tow mirror for trucks and SUVs

TESTED. PROVEN. SAFE.



# TOWING ELECTRICAL

## EMPOWERING THEIR PASSIONS

Get your customers plugged in with CURT electrical. Last year, we introduced the revolutionary Spectrum™ brake control – a simple, rotary knob with a separate module for unparalleled integration into the vehicle's dash. For 2019, we are upping the ante with the industry's first wireless, Bluetooth-enabled brake control. The Echo™ connects to any Apple or Android device to control all trailer brake activity right from the driver's smartphone. It is easily portable, plug-and-play and weather-resistant.



# FEATURED PRODUCTS



## Echo™ mobile brake control

Wireless, portable and an industry-first — Echo™ plugs into any 7-way and turns the driver's smartphone into a brake control interface.



## Spectrum™ brake control

This innovative brake control integrates unlike any other for an OE look and feel, featuring a simple rotary knob with multi-color LEDs.



## RV towing harnesses

Designed for vehicle-specific application, RV harnesses make dinghy towing easy, synchronizing the vehicle's lights with the RV's.

# PRODUCT INDEX



Brake Controls



Brake Control Harnesses



Breakaway Kits



Taillight Converters



Custom Wiring



USCAR Products



Wiring Harness Extensions



RV Harnesses



Electrical Adapters



Plugs, Sockets & Brackets



Towing Lights

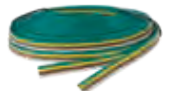

Accessories & Testers

# TOWING ELECTRICAL SUBCATEGORY COLOR GUIDE

CURT has identified seven subcategories within the Towing Electrical category to make it easier for retail customers to find the correct products. Each subcategory is given a unique color that we apply in our literature and retail packaging for easy visibility.



## ELECTRICAL CONNECTOR WIRING GUIDE

- Rear views of plugs & sockets shown in the representative illustrations below
- Colors illustrated may not correspond with wiring found on the tow vehicle or trailer
- For more information on connector types see page 11

### 7-way RV blade traditional configuration

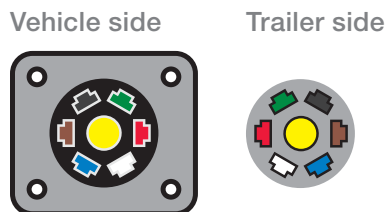

Function	Color
+12 volt	Black
Electric brakes	Blue
Reverse lights	Yellow
Left turn / brakes	Red
Right turn / brakes	Brown
Taillights	Green
Ground	White

### 6-way round

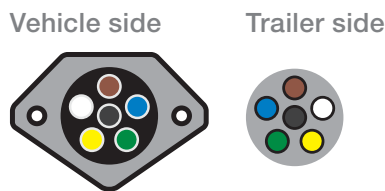

Function	Color
+12 volt	Black
Electric brakes	Blue
Left turn / brakes	Yellow
Right turn / brakes	Green
Taillights	Brown
Ground	White

### 4-way flat



Function	Color
Left turn / brakes	Yellow
Right turn / brakes	Green
Taillights	Brown
Ground	White

## WIRING SYSTEMS

### Two-wire system

The two-wire system is the simplest form of vehicle and trailer wiring and is still used by some vehicles today. This system sends the stop and turn signals along one wire, and the taillight signal along a second wire.

### Three-wire system

The three-wire system is the most common in the automotive industry. It sends the stop, taillight and turn signals along three separate wires. Vehicles with a this system usually require a converter.

### PWM system

More and more vehicles today use a PWM (pulse width modulation) system. Sometimes called a 'multiplex', this type of wiring is able to control multiple lighting functions through a single wire by varying the signal intensity. PWM systems can use incandescent or LED lights. There are generally two types: ST systems and STT systems.

See page 10 for more details

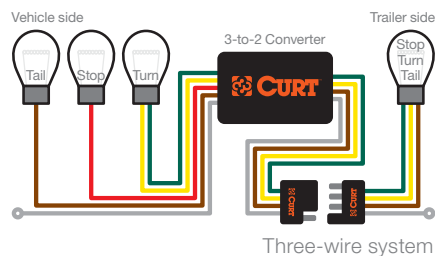

Three-wire system





# THE INNOVATION LEADER IN BRAKE CONTROLS

## BRAKE CONTROLS

## HOW TO SELECT A BRAKE CONTROL

There are two basic types of brake controls. Inertia-based brake controls use accelerometers to measure the change in velocity or inertia of the tow vehicle when braking. Time-based brake controls apply a steadily increasing amount of brake power, based on the gain setting and sensitivity adjustment specified by the driver.

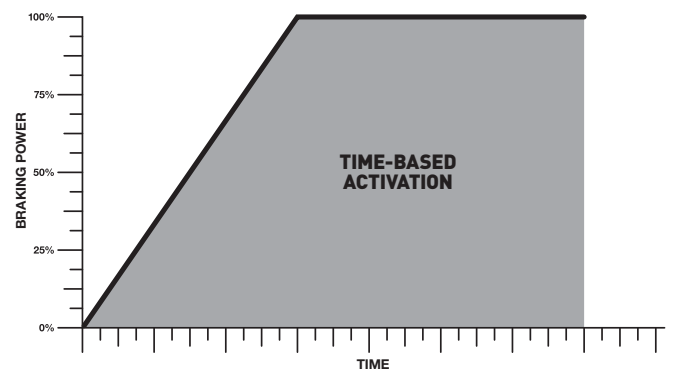
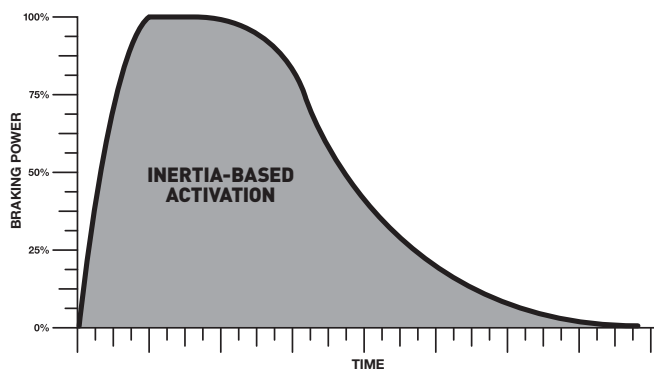

Answer the following questions to help determine which brake control is the best fit for your customer.

### What are they towing?

#### Heavy-duty

An inertia-based brake control is ideal for towing heavy or fragile cargo. It will perform much smoother stops, resulting in less stress on the cargo and on the vehicle.

#### Light-duty

If your customer is planning to tow a relatively lightweight trailer, a time-based brake control may be sufficient. CURT's time-based controls are more budget-friendly and perform well with lighter loads.

### How often do they tow?

#### Frequently

If your customer is planning to tow more than twice a year, the precision of an inertia-based brake control will help protect the life of the vehicle and trailer.

#### Occasionally

If your customer will only tow once or twice a year, they may prefer the simplicity and relatively lower cost of a time-based control. Time-based controls also require very little effort to set up.

## BRAKE CONTROLS

# BRAKE CONTROLS

- Easily calibrated for all towing needs
- Compatible with anti-lock brakes and cruise control
- Includes mounting hardware, if necessary
- Optional spare bracket allows for convenient use of the same brake control in multiple vehicles (select models)
- Informative, full-color retail packaging
- Limited lifetime warranty (see last page for details)

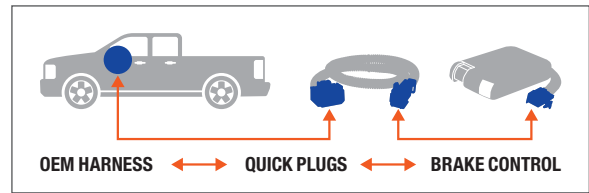

Quick plug equipped for fast, easy installation (excluding Echo™)

**NEW**



**Echo™**  
Bluetooth-enabled  
Smartphone-ready  
Portable design



**Spectrum™**  
Integrated OE look  
Hidden main module  
Tri-color LED display



**Assure™**  
Full text readout  
Adjustable screen  
Slim-profile design



**TriFlex™**  
Tri-axis sensitivity  
Auto adjustment  
Digital display



**Reflex™**  
Dual-axis sensitivity  
Auto adjustment  
Digital display



**Discovery™**  
Adjustable output  
No leveling required  
Digital display



**Venturer™**  
Adjustable output  
No leveling required  
Ramp-up LED display

## Dynamic power adjustment

Applies to Echo™, Spectrum™, Assure™, TriFlex™ and Reflex™



**4.0** User input power adjustment setting



**4.0** ▶ **3.2** Automatic power reduction for incline

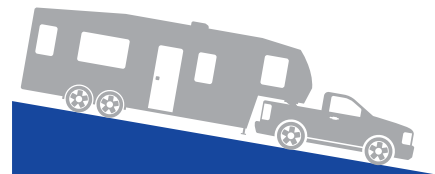

**4.0** ▶ **5.3** Automatic power increase for decline

Note: Values represented are for illustration only. The actual preset and adaptive values may differ from those shown here.

Name	Pkg#	Six-Pack#	Repl. Bracket#	Axles	Brakes	Activation Method	Display	Vertical Mount Angle	Level Adjust	Warranty
Echo™	51180 <b>NEW</b>	--	--	1 - 2	2 - 4	Tri-axis inertia	Phone app	N/A	Auto	Ltd lifetime
Spectrum™	51170	--	--	1 - 4	2 - 8	Tri-axis inertia	Tri-color LED	Any	Auto	Ltd lifetime
Assure™	51160	--	--	1 - 4	2 - 8	Tri-axis inertia	OLED screen	Any	Auto	Ltd lifetime
TriFlex™	51140	51142	51144	1 - 4	2 - 8	Tri-axis inertia	Digital	-20° to +70°	Auto	Ltd lifetime
Reflex™	51130	51132	--	1 - 4	2 - 8	Dual-axis inertia	Digital	Any	Auto	Ltd lifetime
Discovery™	51120	51122	51124	1 - 4	2 - 8	Time-based	Digital	Any	Auto	Ltd lifetime
Venturer™	51110	--	51114	1 - 3	2 - 6	Time-based	LED	Any	Auto	Ltd lifetime



**BRAKE  
CONTROLS**

# ECHO™ MOBILE BRAKE CONTROL

**NEW**

- Wireless, portable design allows for easy transfer from one vehicle to another
- Bluetooth connection to control all brake settings from a smartphone
- Non-invasive, plug-and-play setup installs between vehicle-trailer 7-way connectors
- Triple-axis, motion-sensing accelerometer for highly responsive, smooth stops
- Stores multiple user and vehicle-trailer profiles
- Allows incoming calls to be received while the app is running
- Potted enclosure seals off electronics from the elements for lasting durability
- Soft locking tab reduces vibration and improves connection
- Operates 2-4 trailer brakes at a time (1-2 axles)
- Compatible with low-voltage systems, PWM systems, ABS and cruise control



## Easy, plug-and-play install



Insert Echo™ between the vehicle and trailer



Download the app on your smartphone



Configure settings in the app and tow

**BRAKE  
CONTROLS**

# SPECTRUM™ BRAKE CONTROL

- Triple-axis, motion-sensing accelerometer for highly responsive, smooth stops
- Easily accessible manual override with the press of a button
- Features two installation options: drill mount or surface adhesive mount
- Equipped with a quick plug for easy, plug-and-play installation
- User-selectable power output and trailer brake light activation
- Automatic calibration reduces setup requirements



51170  
actual size  
(module not shown)



Controls all brake settings with a simple push-button rotary knob



Clean, dash-mounted, OEM-style user interface with 10 tri-color LEDs



Main module can be mounted out of sight to maintain a consistent, original equipment look

**BRAKE  
CONTROLS**

**ASSURE™  
#51160**

- Pressure-sensitive manual override button for precise braking power
- High-quality 128 x 64 dot matrix OLED screen display
- Display can be tilted for different mounting options, above or below the dash
- Triple-axis, motion-sensing accelerometer for highly responsive, smooth stops
- Sleek, low-profile design with tactile buttons
- User-selectable power output and trailer brake light activation
- Nine levels of sensitivity adjustment for varying loads or driving conditions
- Auto sleep mode prevents battery drain
- Built-in reverse-polarity and short-circuit protection
- Compatible with low-voltage systems, PWM systems, ABS and cruise control



**BRAKE  
CONTROLS**

**TRIFLEX™  
#51140**

- Triple-axis, motion-sensing accelerometer for highly responsive, smooth stops
- Nine levels of sensitivity adjustment for varying loads or driving conditions
- User-selectable power output and trailer brake light activation
- Digital display with 0.1 increments
- Built-in reverse-polarity and short-circuit protection
- Tow vehicle 'low voltage' and trailer disconnect indicators
- Compatible with low-voltage systems, PWM systems, ABS and cruise control
- Compact size: 3-1/4" wide, 4" deep, 7/8" tall



**BRAKE  
CONTROLS**

**REFLEX™  
#51130**

- Dual-axis, motion-sensing accelerometer for smooth stops
- Automatically adjusts brake output when going up or down a hill
- Adjustable power output allows use with multiple load sizes
- Digital display with 0.1 increments



**BRAKE  
CONTROLS**

**DISCOVERY™ #51120  
VENTURER™ #51110**

- Increases brake power based on gain setting and sensitivity adjustment
- Features adjustable power and ramp time
- No internal moving parts and no leveling required
- Digital display with 0.1 increments (#51120)
- LED indicator lengthens as power is applied (#51110)



**BRAKE  
CONTROLS**

## COMPETITOR-TO-CURT ADAPTER

- Allows CURT brake controls to be used with Tekonsha, Reese, Draw-Tite or Pro Series vehicle-specific brake control harnesses (Brands are registered trademarks of Horizon Global™)



Pkg#	Description
51520	Connects CURT brake controls to competitor harnesses

**BRAKE  
CONTROLS**

## QUICK PLUG WITH PIGTAILS

- For vehicles not equipped with factory tow package wiring
- Splices into a vehicle for a quick plug brake control connection
- Compatible with any CURT brake control



Bulk#	Pkg#	Description
51515	51516	Quick plug with 24" pigtails

**BRAKE  
CONTROLS**

## BRAKE CONTROL WIRING KITS

### Adapter with brake control wiring kit

- Adapts a 4-way flat vehicle socket to fit 7-way RV blade trailer plugs
- Includes wiring and components to splice in a brake control connection



Pkg#	Includes	Size	Qty
57186	Adapter (4-way to 7-way)	4-way flat to 7-way RV blade	1
	Cross-linked wire	10-gauge	25 feet
	Snap lock	12-10 gauge	1
	Flasher	--	1
	Circuit breaker	30-amp	1
	Circuit breaker	40-amp	1
	3/8" ring terminals	12-10 gauge	2
	#10 ring terminals	12-10 gauge	5
	Butt connectors	12-10 gauge	4
	Hex head screws	#10 - 3/4"	8
	Cable ties	8-1/2"	6

### Universal brake control wiring kit

- For tow vehicles not equipped with factory tow package wiring
- Compatible with 2, 4, 6 or 8-brake systems (1-4 axles)
- Designed for use with CURT quick plugs #51515 or #51516
- Brake control and trailer connector are not included



Pkg#	Includes	Size	Qty
51500	Duplex wire	10-gauge	10 feet
	Cross-linked wire	10-gauge	20 feet
	Circuit breaker	30-amp	1
	3/8" ring terminals	12-10 gauge	2
	#10 ring terminals	12-10 gauge	2
	1/2" ring terminals	12-10 gauge	2
	Butt connectors	12-10 gauge	3
	Cable ties	8-1/2"	8

# BRAKE CONTROL HARNESS APPLICATION GUIDE

- Quick plug harness installs in less than ten minutes
- Connects any CURT brake control to specific vehicle applications
- Includes 24" of wire for flexible installation
- Slit-loom sleeve keeps wires contained and protected



## Brake control harness locations

**BH1** - Under dash, left of steering column, near emergency brake pedal

**BH2** - Under dash, near center console

**BH3** - Under dash, in junction box left of steering column

**BH4** - Behind storage pocket, above ashtray

**BH5** - Under dash, behind center access panel on passenger side

**BH6** - Under dash, near brake pedal

**BH7** - Behind storage pocket in center of dash

**BH8** - Under dash, to right of emergency brake pedal

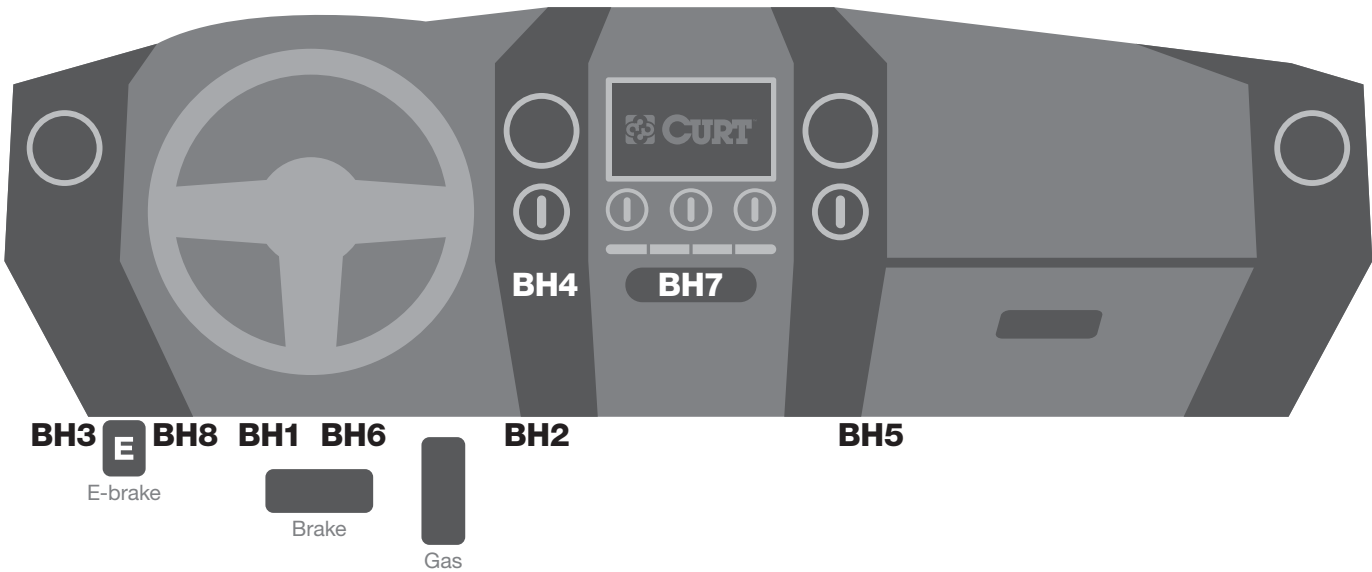

Brake Control Harnesses				
Make / Model (Style)	Years	Bulk#	Pkg#	Location
<b>Acura</b>				
MDX	14 - 17	--	51523	BH1
<b>Audi</b>				
SQ5	14 - 17	--	51522	BH2
Q5	09 - 17	--	51522	BH2
Q7	07 - 17	--	51522	BH2
<b>Buick</b>				
Enclave	08 - 17	51422	51423	BH1
<b>Cadillac</b>				
Escalade	14 - 19	51451	51452	BH3, BH1
	03 - 06	51352	51353	BH3
	02 - 02	51342	51343	BH3
Escalade ESV	14 - 19	51451	51452	BH3, BH1
	03 - 06	51352	51353	BH3
Escalade EXT	03 - 06	51352	51353	BH3
	02 - 02	51342	51343	BH3

See page 136 for installation location designators  
**Applications continued on the following page**

Brake Control Harnesses				
Make / Model (Style)	Years	Bulk#	Pkg#	Location
<b>Chevrolet</b>				
Avalanche 1500	03 - 06	51352	51353	BH3
	02 - 02	51342	51343	BH3
Avalanche 2500	03 - 06	51352	51353	BH3
	02 - 02	51342	51343	BH3
Silverado 1500	14 - 18	51451	51452	BH3, BH1
	03 - 06	51352	51353	BH3
	99 - 02	51342	51343	BH3
Silverado 1500 Classic	07 - 07	51352	51353	BH3
Silverado 1500 HD	03 - 06	51352	51353	BH3
	01 - 02	51342	51343	BH3
Silverado 1500 HD Classic	07 - 07	51352	51353	BH3
Silverado 1500 Legacy	19 - 19	51451	51452	BH3, BH1
Silverado 2500	03 - 04	51352	51353	BH3
	99 - 02	51342	51343	BH3

See page 136 for installation location designators  
**Applications continued on the following page**

### Brake Control Harnesses

Make / Model (Style)	Years	Bulk#	Pkg#	Location
<b>Chevrolet (continued)</b>				
Silverado 2500 HD	14 - 19	51451	51452	BH3, BH1
	03 - 06	51352	51353	BH3
	01 - 02	51342	51343	BH3
Silverado 2500 HD Classic	07 - 07	51352	51353	BH3
Silverado 3500	03 - 06	51352	51353	BH3
	01 - 02	51342	51343	BH3
Silverado 3500 Classic	07 - 07	51352	51353	BH3
Silverado 3500 HD	15 - 19	51451	51452	BH3, BH1
Suburban	15 - 19	51451	51452	BH3, BH1
Suburban 1500	14 - 14	51451	51452	BH3, BH1
	03 - 06	51352	51353	BH3
	00 - 02	51342	51343	BH3
Suburban 2500	03 - 06	51352	51353	BH3
	00 - 02	51342	51343	BH3
Suburban 3500 HD	16 - 18	51451	51452	BH3, BH1
Tahoe	15 - 19	51451	51452	BH3, BH1
	03 - 06	51352	51353	BH3
	00 - 02	51342	51343	BH3
Traverse	09 - 17	51422	51423	BH1
<b>Chrysler</b>				
Aspen	07 - 09	51332	51333	BH1
<b>Dodge</b>				
Dakota	97 - 10	51332	51333	BH1
Durango	11 - 18	51446	51447	BH8
	98 - 09	51332	51333	BH1
Ram 1500	10 - 10	51438	51439	BH8
	95 - 09	51332	51333	BH1
Ram 2500	10 - 10	51438	51439	BH8
	95 - 09	51332	51333	BH1
Ram 3500	10 - 10	51438	51439	BH8
	95 - 09	51332	51333	BH1
<b>Ford</b>				
Bronco	94 - 96	51322	51323	BH2, BH1
	92 - 93	51312	51313	BH1
E-150	03 - 08	51322	51323	BH2, BH1
	09 - 14	51432	51433	BH5
E-150 Club Wagon	03 - 05	51322	51323	BH2, BH1
E-150 Econoline	92 - 02	51322	51323	BH2, BH1
E-150 Econoline Club Wagon	92 - 02	51322	51323	BH2, BH1
E-250	09 - 14	51432	51433	BH5
E-250 Econoline	92 - 02	51322	51323	BH2, BH1
E-350 Econoline	92 - 98	51322	51323	BH2, BH1
E-350 Econoline Club Wagon	92 - 02	51322	51323	BH2, BH1
E-350 Super Duty	09 - 14	51432	51433	BH5
E-450 Econoline Super Duty	00 - 02	51322	51323	BH2, BH1
E-450 Super Duty	09 - 14	51432	51433	BH5
Excursion	00 - 05	51322	51323	BH2, BH1

See page 136 for installation location designators  
**Applications continued on the following page**

### Brake Control Harnesses

Make / Model (Style)	Years	Bulk#	Pkg#	Location
<b>Ford (continued)</b>				
Expedition	15 - 17	51436	51437	BH7
	13 - 14	51432	51433	BH5
	97 - 12	51322	51323	BH2, BH1
Explorer	02 - 19	51322	51323	BH2, BH1
F-150	09 - 18	51436	51437	BH7
	94 - 08	51322	51323	BH2, BH1
	92 - 93	51312	51313	BH1
F-150 Heritage	04 - 04	51322	51323	BH2, BH1
F-250	94 - 97	51322	51323	BH2, BH1
F-250 Super Duty	17 - 19	51436	51437	BH7
	08 - 16	51432	51433	BH5
	05 - 07	51372	51373	BH4
	99 - 04	51322	51323	BH2, BH1
F-350	94 - 96	51322	51323	BH2, BH1
F-350 Super Duty	17 - 19	51436	51437	BH7
	08 - 16	51432	51433	BH5
	05 - 07	51372	51373	BH4
	99 - 04	51322	51323	BH2, BH1
F-450 Super Duty	17 - 18	51436	51437	BH7
	08 - 16	51432	51433	BH5
	05 - 07	51372	51373	BH4
F-550 Super Duty	17 - 18	51436	51437	BH7
	11 - 16	51432	51433	BH5
Flex	12 - 16	51436	51437	BH7
	09 - 11	51322	51323	BH2, BH1
Police Interceptor Utility	13 - 18	51322	51323	BH2, BH1
Windstar	95 - 03	51322	51323	BH2, BH1
<b>GMC</b>				
Acadia	07 - 18	51422	51423	BH1
Acadia Limited	17 - 17	51422	51423	BH1
Sierra 1500	14 - 18	51451	51452	BH3, BH1
	03 - 06	51352	51353	BH3
	99 - 02	51342	51343	BH3
Sierra 1500 Classic	07 - 07	51352	51353	BH3
Sierra 1500 HD	03 - 06	51352	51353	BH3
	01 - 02	51342	51343	BH3
Sierra 1500 HD Classic	07 - 07	51352	51353	BH3
Sierra 1500 Limited	19 - 19	51451	51452	BH3, BH1
Sierra 2500	03 - 04	51352	51353	BH3
	99 - 02	51342	51343	BH3
Sierra 2500 HD	14 - 19	51451	51452	BH3, BH1
	03 - 06	51352	51353	BH3
	01 - 02	51342	51343	BH3
Sierra 2500 HD Classic	07 - 07	51352	51353	BH3
Sierra 3500	03 - 06	51352	51353	BH3
	01 - 02	51342	51343	BH3
Sierra 3500 Classic	07 - 07	51352	51353	BH3
Sierra 3500 HD	15 - 19	51451	51452	BH3, BH1

See page 136 for installation location designators  
**Applications continued on the following page**

Brake Control Harnesses				
Make / Model (Style)	Years	Bulk#	Pkg#	Location
<b>GMC (continued)</b>				
Yukon	15 - 19	51451	51452	BH3, BH1
	03 - 06	51352	51353	BH3
	00 - 02	51342	51343	BH3
Yukon XL	15 - 18	51451	51452	BH3, BH1
Yukon XL 1500	03 - 06	51352	51353	BH3
	00 - 02	51342	51343	BH3
Yukon XL 2500	03 - 06	51352	51353	BH3
	00 - 02	51342	51343	BH3
<b>Honda</b>				
Pilot	09 - 19	51392	51393	BH1
Ridgeline	06 - 19	51392	51393	BH1
<b>Hummer</b>				
H2	03 - 07	51352	51353	BH3
<b>Infiniti</b>				
QX56	04 - 13	51382	51383	BH1
QX60	14 - 18	51382	51383	BH1
QX80	14 - 18	51382	51383	BH1
<b>Jeep</b>				
Cherokee	14 - 19	51459	51460	BH1
Grand Cherokee	11 - 18	51446	51447	BH8
Wrangler (JL, Unlimited)	18 - 18	51457	51458	BH2
<b>Kia</b>				
Borrego	09 - 11	51442	51443	BH1
<b>Land Rover</b>				
LR3	05 - 09	51322	51323	BH2, BH1
LR4	10 - 15	51322	51323	BH2, BH1
Range Rover	05 - 15	51322	51323	BH2, BH1
Range Rover Evoque	12 - 17	51322	51323	BH2, BH1
Range Rover Sport	06 - 15	51322	51323	BH2, BH1
<b>Lexus</b>				
GX460	10 - 15	51362	51363	BH1
GX470	03 - 09	51362	51363	BH1
LX470	03 - 07	51362	51363	BH1
LX570	08 - 15	51362	51363	BH1
<b>Lincoln</b>				
Mark LT	06 - 08	51322	51323	BH2, BH1
MKT	12 - 15	51436	51437	BH7
	10 - 11	51322	51323	BH2, BH1
Navigator	15 - 17	51436	51437	BH7
	13 - 14	51432	51433	BH5
	98 - 12	51322	51323	BH2, BH1

See page 136 for installation location designators

Brake Control Harnesses				
Make / Model (Style)	Years	Bulk#	Pkg#	Location
<b>Mercury</b>				
Mountaineer	02 - 10	51322	51323	BH2, BH1
<b>Nissan</b>				
Armada	05 - 18	51382	51383	BH1
Frontier	05 - 19	51382	51383	BH1
NV1500	12 - 18	51382	51383	BH1
NV200	13 - 18	51382	51383	BH1
NV2500	12 - 18	51382	51383	BH1
NV3500	12 - 18	51382	51383	BH1
Pathfinder	05 - 19	51382	51383	BH1
Pathfinder Armada	04 - 04	51382	51383	BH1
Titan	04 - 19	51382	51383	BH1
Titan XD	16 - 19	51382	51383	BH1
Xterra	05 - 15	51382	51383	BH1
<b>Ram</b>				
1500 (Excl. factory integrated brake ctrl - ITBC)	15 - 19	51457	51458	BH2
1500	13 - 14	--	51453	BH8
	11 - 12	51438	51439	BH8
1500 Classic (Excl. factory integrated brake ctrl - ITBC)	19 - 19	51457	51458	BH2
2500 (Excl. factory integrated brake ctrl - ITBC)	15 - 19	51457	51458	BH2
2500	13 - 14	--	51453	BH8
	11 - 12	51438	51439	BH8
3500 (Excl. factory integrated brake ctrl - ITBC)	15 - 19	51457	51458	BH2
3500	13 - 14	--	51453	BH8
	11 - 12	51438	51439	BH8
4500 (Excl. factory integrated brake ctrl - ITBC)	16 - 18	51457	51458	BH2
5500 (Excl. factory integrated brake ctrl - ITBC)	16 - 18	51457	51458	BH2
<b>Saturn</b>				
Outlook	07 - 09	51422	51423	BH1
<b>Toyota</b>				
4Runner	03 - 18	51362	51363	BH1
Land Cruiser	03 - 17	51362	51363	BH1
Sequoia	03 - 17	51362	51363	BH1
Tacoma	16 - 19	51455	51456	BH4
	07 - 15	51362	51363	BH1
Tundra	15 - 18	51455	51456	BH4
	03 - 14	51362	51363	BH1

See page 136 for installation location designators



**BRAKE  
CONTROLS**

# BREAKAWAY KITS

Check to ensure battery is charged before towing

- Activates electric trailer brakes in the event of a breakaway
- Meets DOT requirements for holding / breakaway situations
- Compatible on trailers with up to three axles
- LED lights indicate a good charge, battery charging or low battery (#52042, #52044)
- Bolt-on mounting system for secure installation on the trailer
- Required in most states



52044



52042



52040



52028

Pkg#	Loads From	Includes	Replacement Part#
<b>Push-to-Test Breakaway Kits</b>			
52044	Top	Push-to-test battery case	--
		12-volt 5-amp rechargeable battery	52023
		Built-in battery charger	52025
		Nylon breakaway switch	52010
		Mounting hardware	--
52042	Side	Includes the same parts as 52044	--
<b>Soft-Trac 1 Breakaway Kits</b>			
52040	Side	Lockable battery case	52027
		12-volt 5-amp rechargeable battery	52023
		Nylon breakaway switch	52010
		Battery charger	52025
		Mounting hardware	--
52041	Side	Includes the same parts as 52040 Battery charger not included	--
<b>Soft-Trac 2 Breakaway Kits</b>			
52028	Top	Battery case with mounting bracket	52029
		12-volt 5-amp rechargeable battery	52023
		Nylon breakaway switch	52010
		Battery charger	52025
52026	Top	Includes the same parts as 52028 Battery charger not included	--



52042 push-to-test, side load



52044 push-to-test, top load

**BRAKE  
CONTROLS**

# REPLACEMENT BATTERY CASES

- Protects battery and charger from the elements and corrosion
- Constructed from durable polyethylene plastic



52022



52090



52029



52027



52030

Bulk#	Width	Height	Depth	Description	Loads From	Includes
52029	5"	3-1/4"	3-7/8"	3-1/8" inside bracket depth	Top	Weldable metal bracket for easy mounting on A-frame or jack posts
52030	5"	3-1/4"	3-7/8"	--	Side	--
52027	5"	3-3/8"	3-3/4"	Watertight case with rubber gaskets and screw-tight lid	Top	Four-screw lid
52022	6"	5-1/2"	3-1/4"	--	Top	Lockable tab and a bolt-on mount
52090	5-7/8"	5-3/8"	3-1/2"	--	Top	Metal bracket and locking bar for security

**BRAKE  
CONTROLS**

# BREAKAWAY KIT REPLACEMENT PARTS

- For use with trailer breakaway systems
- Connects tow vehicle to trailer breakaway battery (#52010, #52011)
- Features a high-temp metal mounting tab and nylon pull-pin (#52020)



52023



52025



52010



52011



52020

Bulk#	Pkg#	Width	Height	Depth	Description	Includes
52010	52011	--	--	--	Breakaway switch with 10' leads	Nylon case with weldable high-temp, metal tab and silver contact points
52020	--	--	--	--	48" lanyard	--
52023	--	3-1/2"	4"	2-3/4"	Sealed lead acid battery for 1-3 axle trailers (12-volt, 5 amps per hour)	--
52025	--	--	--	--	12-volt battery charger plug	--



On vehicles with two-wire electrical systems that require a powered converter, the converter's red wire is not used as a stoplight connection and needs to be grounded.

**ELECTRICAL  
CONVERTERS**

## TAILLIGHT CONVERTERS

For vehicles that are not compatible with CURT custom wiring options, a taillight converter provides a reliable alternative. CURT taillight converters splice into the vehicle's wiring system and provide a standard 4-way flat trailer connector. **Use the Application Guide on page 30 to find the right wiring solution for your customer.**

**ELECTRICAL  
CONVERTERS**

## 3-TO-2-WIRE CONVERTERS

- Most constructed with surface mount technology for better performance and durability
- No heavy-duty flasher required
- Kits contain powered wiring converter kit #55151
- Four snap locks included for fast, secure splicing (excluding #58240)
- Includes converter, 4-way flat loop, four snap locks and four wire connectors (#55179)



56130

Bulk#	30-Pack#	Kit#	Pkg#	Powered	Circuit- Protected	Signal Circuit	Taillight Circuit
--	56146030	59146	56146	Yes	Yes	3.0 amps	6.0 amps
55177*	--	55179*	55178*	--	--	2.1 amps	5.0 amps
--	56132	--	56130	--	--	3.0 amps	5.0 amps
--	--	--	56175	--	Yes	3.0 amps	5.0 amps
--	--	59187	56187	Yes	--	3.0 amps	5.0 amps
--	--	59190	56190	Yes	Yes	7.5 amps	7.5 amps
58240**	--	--	--	--	--	2.1 amps	5.0 amps

\* Does not use surface mount technology (SMT)

\*\* Comes with blunt-cut wires instead of 4-way flat output

**ELECTRICAL  
CONVERTERS**

## 3-TO-2-WIRE POTTED CONVERTER

- Potted enclosure significantly increases resistance to water and vibration allowing the converter to be mounted on the exterior of the vehicle
- Provides improved overvolt, ESD and short-circuit protection
- Four snap locks included for fast, secure splicing
- No heavy-duty flasher required
- #59496 contains 10-amp powered converter wiring kit #55151



59496

Kit#	Pkg#	Powered	Circuit- Protected	Signal Circuit	Taillight Circuit
59496	56496	Yes	Yes	3.0 amps	6.0 amps

**ELECTRICAL  
CONVERTERS****MULTI-FUNCTION  
CONVERTER**

- Converts 2-wire, 3-wire or PWM ST / PWM STT systems to 2-wire trailer light wiring
- Potted enclosure significantly increases resistance to water and vibration
- Constructed with SMT circuitry for better performance and durability
- Microcontroller senses current to rapidly react to overload
- Provides improved overload, short-circuit and thermal protection
- Low-voltage operation allows function down to seven volts
- Four snap locks included for fast, secure splicing
- #59236 contains 15-amp powered converter wiring kit #55152



56236

Kit#	Pkg#	Powered	Circuit- Protected	Signal Circuit	Taillight Circuit
59236	56236	Yes	Yes	3.0 amps	6.0 amps

**ELECTRICAL  
CONVERTERS****2-TO-3-WIRE  
CONVERTER**

- Used for dinghy towing
- Constructed with SMT circuitry for better performance and durability
- No heavy-duty flasher or direct battery connection required
- Not compatible with LED trailer lighting systems



56196

Pkg#	Powered	Signal Circuit	Taillight Circuit
56196	No	2.1 amps	5.0 amps

Comes with blunt-cut wires instead of 4-way flat output

**ELECTRICAL  
CONVERTERS****LOW-SIDE SWITCHING  
CONVERTER**

- Constructed with SMT circuitry for better performance and durability
- Snap locks included for fast, secure splicing
- No heavy-duty flasher required



56195

Pkg#	Powered	Signal Circuit	Taillight Circuit
56195	Yes	2.1 amps	4.2 amps

**ELECTRICAL CONVERTERS**

## 24-VOLT TAILLIGHT CONVERTER

- Primarily used for 24V automotive systems, buses, trucks and cab and chassis wiring
- 3-wire to 2-wire converter compatible with incandescent and LED trailer lighting systems
- 26" color-coded, 16-gauge wires
- No heavy-duty flasher or direct battery connection required
- Does not reduce output to 12 volts



56424

Pkg#	Powered	Signal Circuit	Taillight Circuit
56424	No	2.1 amps	7.5 amps

**ELECTRICAL CONVERTERS**

## POWERED CONVERTER WIRING KITS

- Routes power from vehicle battery to powered converter
- Designed for use with battery-powered converters



55151



55152

Pkg#	Amps	Includes
55151	10	Cross-linked wire, 12-gauge Length: 20 feet In-line fuse holder, 10-amp (red) ATC10 fuse, 10-amp (red) 3/8" ring terminal Butt connector, 12-15 gauge Cable tie, 14-1/2" Cable ties, 6" Qty: 8
55152*	15	Cross-linked wire, 12-gauge Length: 20 feet In-line fuse holder, 15-amp (yellow) ATC10 fuse, 15-amp (blue) 3/8" ring terminal Butt connector, 12-15 gauge Cable tie, 14-1/2" Cable ties, 6" Qty: 8

\* Use with converter part number 56236, see page 142

**CUSTOM WIRING**

# CUSTOM WIRING & T-CONNECTORS

For custom wiring application guide go to page 30

Custom wiring is the easiest way to equip a vehicle with a trailer wiring connection. There are two types: harnesses and connectors. Both are made vehicle-specific and install with no cutting or splicing.

- Provides a standard 4-way flat connector on the vehicle for plugging in trailer wiring
- Simple plug-and-play design eliminates the need for cutting or splicing
- Equipped with a taillight converter if needed
- Dust cover included to keep 4-way flat clean when not in use



## Harnesses

Custom wiring harnesses use multiple plugs to 'T' into the taillight assembly



## Connectors

Custom wiring connectors use a single plug to plug into a specific OEM socket



**CUSTOM WIRING**

# DODGE FACTORY HARNESS ADAPTER

- #57300 adapts Dodge harness applications to fit USCAR replacement plugs (pictured right)
- Simple plug-and-play design eliminates the need for cutting or splicing
- Slit loom keeps wires contained and well protected



Provides this USCAR socket



57300

Dodge Factory Harness Adapter	
Make / Model	Years
<b>Chrysler</b>	
Aspen	07 - 08
Pacifica	04 - 08
<b>Dodge</b>	
Dakota	00 - 09
Durango	00 - 08
Ram 1500	00 - 08
Ram 1500 Van	01 - 03
Ram 2500	00 - 09

Dodge Factory Harness Adapter	
Make / Model	Years
<b>Dodge (continued)</b>	
Ram 2500 Van	01 - 03
Ram 3500	00 - 09
Ram 3500 Van	01 - 03
Sprinter 2500	03 - 09
Sprinter 3500	03 - 09
<b>Freightliner</b>	
Sprinter 2500	03 - 09
Sprinter 3500	03 - 09

Dodge Factory Harness Adapter	
Make / Model	Years
<b>Jeep</b>	
Commander	06 - 10
Grand Cherokee	00 - 10
Liberty	05 - 08
<b>Mitsubishi</b>	
Raider	06 - 09

#57300 fits all applications listed in this table

**CUSTOM WIRING**

# REPLACEMENT USCAR SOCKET

- Replaces damaged or missing USCAR vehicle harnesses
- Retrofits weatherproof USCAR-type 7-way to vehicles not equipped by using CURT part numbers 55415, 55515, 55664, 55774, 56514, 56515 or 57101

Pkg#	Length	Replaces	Provides
56229	24" wires	Existing vehicle harness connector	USCAR connector end



**CUSTOM WIRING**

**ELECTRICAL ADAPTERS**

# DUAL-OUTPUT ADAPTERS WITH BACKUP ALARM

- Integrated backup alarm sounds when vehicle is in reverse (97 decibels)
- Provides a 7-way RV blade and 4-way flat socket
- Dust covers included to keep connectors clean when not in use
- Metal bracket securely mounts wiring to the vehicle or trailer hitch



57100 8-prong plug



57101 USCAR plug



Pkg#	Fits	Plugs Into	Output
<b>Custom Wiring</b>			
57100	Dodge, Chrysler, Jeep	Factory rectangular 8-prong	7-way RV blade and 4-way flat
57101	See USCAR replacement products on page 146	USCAR socket	7-way RV blade and 4-way flat
<b>Adapter</b>			
57102	Universal adapter	4-way flat, manual wiring needed	7-way RV blade and 4-way flat

**CUSTOM WIRING**

# USCAR CUSTOM WIRING HARNESSES & CONNECTORS



All plug into this USCAR socket

- Products listed fit the applications in the table below
- Fits USCAR-equipped vehicles with factory tow plugs (shown below)
- See page 163 for USCAR mounting bracket #58520
- Weather-resistant dust cover features a rubber insert to seal out moisture (#55416)



55416



55415



56415



55515



55384



55664

Pkg#	Plugs Into	Provides	Output
55664	USCAR socket	Two output connections	6-way round and 4-way flat
55774	USCAR socket	Two output connections	7-way RV blade and 4-way flat
55515	USCAR socket	Replacement end	4-way flat
56515	USCAR socket	Replacement end	5-way flat
55384	T's into USCAR socket	Additional connection	4-way flat
56584	T's into USCAR socket	Additional connection	5-way flat
57101	USCAR socket	Two output connections and backup alarm (97 decibels)	7-way RV blade and 4-way flat
55416	USCAR socket	Heavy-duty replacement for Ford, GM and Nissan vehicles	7-way RV blade
55415	USCAR socket	Replacement for Ford, GM and Nissan vehicles	7-way RV blade
56415	USCAR socket	Replacement for twist-lock brackets	7-way RV blade

USCAR Custom Wiring		
Make / Model	Style	Years
<b>Audi</b>		
Q7	--	17 - 17
<b>Buick</b>		
Enclave	--	08 - 19
Rainier	--	04 - 07
<b>Cadillac</b>		
Escalade	--	02 - 19
Escalade ESV	--	03 - 19
Escalade EXT	--	02 - 13
XT5	--	18 - 19
<b>Chevrolet</b>		
Avalanche	--	07 - 12
Avalanche 1500	--	02 - 06
Avalanche 2500	--	02 - 06
Colorado	--	15 - 18 04 - 12
Equinox	With factory tow package	18 - 18
Express 1500	--	09 - 09
Express 2500	--	09 - 09
Express 3500	--	09 - 09
	Cutaway van	17 - 17
Express 4500	--	09 - 09

USCAR Custom Wiring		
Make / Model	Style	Years
<b>Chevrolet (continued)</b>		
Silverado 1500	--	99 - 18
Silverado 1500 Classic	--	07 - 07
Silverado 1500 HD	--	01 - 06
Silverado 1500 HD Classic	--	07 - 07
Silverado 2500	--	99 - 04
Silverado 2500 HD	--	01 - 18
Silverado 2500 HD Classic	--	07 - 07
Silverado 3500	--	01 - 06
Silverado 3500 Classic	--	07 - 07
Silverado 3500 HD	--	07 - 18
Suburban	--	15 - 19
Suburban 1500	--	00 - 14
Suburban 2500	--	00 - 13
Suburban 3500 HD	--	16 - 18
Tahoe	--	00 - 19
Trailblazer	--	02 - 08
Trailblazer EXT	--	02 - 06
Traverse	--	09 - 19



USCAR Custom Wiring		
Make / Model	Style	Years
<b>Chrysler</b>		
Aspen	--	07 - 09
<b>Dodge</b>		
Durango	Excluding #55384	07 - 18
Ram 1500	--	09 - 10
Ram 2500	--	10 - 10
Ram 3500	--	10 - 10
<b>Ford</b>		
Excursion	--	00 - 05
Expedition	--	97 - 18
Explorer	--	00 - 19
Explorer Sport Trac	--	09 - 09
F-150	--	97 - 18
F-150 Heritage	--	04 - 04
F-250	--	97 - 99
F-250 Super Duty	--	99 - 19
F-350 Super Duty	--	99 - 18
F-450 Super Duty	--	99 - 18
F-550 Super Duty	--	99 - 17
Flex	--	09 - 16
Police Interceptor Utility	--	18 - 18
Ranger	--	00 - 11
Transit-150	--	15 - 18
Transit-250 / Transit-350	--	15 - 18
<b>GMC</b>		
Acadia	--	07 - 19
Acadia Limited	--	17 - 17
Canyon	--	15 - 18 04 - 12
Envoy	--	02 - 09
Envoy XL	--	02 - 06
Envoy XUV	--	04 - 05
Savana 1500	--	09 - 09
Savana 2500	--	09 - 09
Savana 3500	-- Cutaway van	09 - 09 17 - 17
Savana 4500	--	09 - 09
Sierra 1500	--	99 - 18
Sierra 1500 Classic	--	07 - 07
Sierra 2500 HD	--	01 - 18
Sierra 2500 HD Classic	--	07 - 07
Sierra 3500	--	01 - 06
Sierra 3500 Classic	--	07 - 07
Sierra 3500 HD	--	07 - 18
Terrain	With factory tow package	18 - 18
Yukon	--	00 - 19
Yukon XL	--	15 - 19
Yukon XL 1500	--	00 - 14
Yukon XL 2500	--	00 - 13
<b>Honda</b>		
Pilot	--	09 - 19
Ridgeline	--	18 - 19

USCAR Custom Wiring		
Make / Model	Style	Years
<b>Hummer</b>		
H2	--	03 - 09
H3	--	06 - 10
H3T	--	09 - 10
<b>Infiniti</b>		
JX35	--	13 - 13
QX56	--	04 - 13
QX60	--	14 - 18
QX80	--	14 - 18
<b>Isuzu</b>		
Ascender	--	03 - 08
<b>Jeep</b>		
Cherokee	With factory tow package	14 - 19
Grand Cherokee	Excluding #55384	11 - 17
Wrangler	With factory tow package	07 - 18
<b>Kia</b>		
Borrego	--	09 - 09
<b>Lincoln</b>		
Aviator	--	03 - 05
Mark LT	--	06 - 08
Navigator	--	98 - 17
<b>Mercury</b>		
Mountaineer	--	02 - 10
<b>Nissan</b>		
Armada	--	05 - 18
Frontier	--	09 - 19
Pathfinder	--	05 - 18
Pathfinder Armada	--	04 - 04
Titan	--	04 - 18
Titan XD	--	16 - 17
<b>Oldsmobile</b>		
Bravada	--	02 - 04
<b>Ram</b>		
1500	--	11 - 19
1500 Classic	--	19 - 19
2500	--	11 - 18
3500	--	11 - 18
4500	--	11 - 18
5500	--	11 - 18
ProMaster 1500	--	14 - 18
ProMaster 2500 / 3500	--	14 - 17
<b>Saab</b>		
9-7x	--	05 - 09
<b>Saturn</b>		
Outlook	--	07 - 10
<b>Toyota</b>		
4Runner	--	15 - 18
Land Cruiser	--	18 - 18
Sequoia	--	12 - 18
Tacoma	--	07 - 19
Tundra	--	10 - 19

**CUSTOM WIRING**

# CUSTOM WIRING HARNESS EXTENSIONS

- Routes a 7-way RV blade socket into truck bed while retaining use of rear socket
- Simple plug-and-play design eliminates the need for cutting or splicing
- Allows for easy connection of 5th wheel or gooseneck wiring
- Spring-loaded dust cover keeps connector clean when not in use
- Slit loom protects and contains wires
- Requires 2-1/8" hole saw for installation



56070 (7')  
56000 (10')



Right-angle plug for easy installation

## Custom Wiring Harness Extensions

Make / Model	Style	Years	7' Pkg#	7' Bulk 10-Pack#	10' Pkg#	10' Bulk 10-Pack#
<b>Chevrolet / GMC</b>						
Silverado / Sierra 1500	--	99 - 19	56070	56070010	56000	56000010
Silverado / Sierra 1500 Classic	--	07 - 07	56070	56070010	56000	56000010
Silverado / Sierra 1500 HD	--	05 - 06	56070	56070010	56000	56000010
		01 - 03	56070	56070010	56000	56000010
Silverado / Sierra 1500 HD Classic	--	07 - 07	56070	56070010	56000	56000010
Silverado / Sierra 1500 Legacy	--	19 - 19	56070	56070010	56000	56000010
Silverado / Sierra 2500	--	99 - 04	56070	56070010	56000	56000010
Silverado / Sierra 2500 HD	--	01 - 18	56070	56070010	56000	56000010
Silverado / Sierra 2500 HD Classic	--	07 - 07	56070	56070010	56000	56000010
Silverado / Sierra 3500	--	01 - 06	56070	56070010	56000	56000010
Silverado / Sierra 3500 Classic	--	07 - 07	56070	56070010	56000	56000010
Silverado / Sierra 3500 HD	--	07 - 18	56070	56070010	56000	56000010
<b>Dodge</b>						
Dakota	--	95 - 10	56071	--	56001	--
Ram 1500 / 2500 / 3500	--	09 - 10	56070	56070010	56000	56000010
		95 - 09	56071	--	56001	--
<b>Ford</b>						
F-150	--	15 - 18	57008*	--	57010*	--
		97 - 14	56070	56070010	56000	56000010
F-150 Heritage	--	04 - 04	56070	56070010	56000	56000010
F-250	--	97 - 99	56070	56070010	56000	56000010
F-250 HD	--	97 - 97	56070	56070010	56000	56000010
F-250 / F-350 Super Duty	--	17 - 17	57008*	--	57010*	--
		99 - 16	56070	56070010	56000	56000010
F-450 Super Duty	--	99 - 17	56070	56070010	56000	56000010
F-550 Super Duty	--	99 - 14	56070	56070010	56000	56000010
<b>Nissan</b>						
Titan	--	17 - 17	56070	56070010	56000	56000010
		04 - 15	56070	56070010	56000	56000010
Titan XD	--	16 - 17	56070	56070010	56000	56000010
<b>Ram</b>						
1500 / 2500 / 3500	--	11 - 18	56070	56070010	56000	56000010
1500 Classic	--	19 - 19	56070	56070010	56000	56000010
<b>Toyota</b>						
Tundra	--	10 - 19	56070	56070010	56000	56000010

\* Includes 57007 isolator kit to prevent corrosion of aluminum bodies



7' routes socket into rear of the truck bed



10' routes socket closer to truck cab

**CUSTOM WIRING**

# CUSTOM WIRING HARNESS EXTENSION ISOLATOR KIT

- Neoprene well nuts isolate steel bolts from aluminum surfaces
- Securely mounts a 7-way RV blade extension harness in the truck bed
- Designed for specific Ford applications

**Custom Wiring Harness Extension Isolator Kit**

Make / Model	Years	Part#
<b>Ford</b>		
F-150	15 - 19	57007
F-250 / F-350 Super Duty	17 - 19	57007



**PLUGS & SOCKETS**

## 7-WAY RV BLADE EXTENSION

- Routes existing 7-way RV blade socket into full-size pickup truck bed
- Universal size fits any 7-way RV blade socket
- Allows for easy connection of 5th wheel or gooseneck wiring
- 7' extension length accommodates virtually any size truck bed
- Spring-loaded dust cover keeps connector clean when not in use

Pkg#	Length	Fits
56080	7'	7-way RV blade socket



**PLUGS & SOCKETS**

## 7-WAY RV BLADE REPLACEMENT HARNESSES

- Replaces the trailer-end plug of any 7-way harness
- Wires protected by heavy-duty, weather-resistant cable
- Cold-weather harnesses feature soft thermoplastic elastomer casing to remain flexible in cold temperatures (temperature rating from -40°F up to 221°F)
- Double-sided blades for improved connectivity

Bulk#	Pkg#	Length	Description
56601	56621	6'	Replacement harness
56602	56622	8'	Replacement harness
56603	56623	10'	Replacement harness
56611	--	6'	Cold-weather replacement harness
56612	--	8'	Cold-weather replacement harness
56613	--	10'	Cold-weather replacement harness





## RV HARNESSES

# RV HARNESSES

- Connects a towed vehicle to an RV using a standard 4-way flat trailer plug
- Simple plug-and-play design eliminates the need for cutting or splicing
- Integrated block diodes isolate sensitive vehicle electronics from RV signals
- Uses towed vehicle's existing taillights, brake lights and turn signals
- Includes harness, 4-flat extension, mounting bracket and hardware
- Optional harness add-on equips vehicle with standard 4-way flat for towing a trailer (not available for all RV harnesses; see table)



58946



58948

RV Harnesses				
Make / Model	Style	Years	Harness#	Add-On#
<b>Acura</b>				
CL	--	97 - 03	58949	--
Integra	--	94 - 01	58949	--
MDX	--	01 - 07	58949	--
RL	--	96 - 01	58949	--
TL	--	96 - 03	58949	--
<b>Buick</b>				
Enclave	--	13 - 17	58908	58920
		08 - 12	58932	58918
Rainier	--	04 - 07	58925	--
<b>Cadillac</b>				
Escalade	--	07 - 12	58927	--
<b>Chevrolet</b>				
Avalanche	--	07 - 12	58924	58918
Captiva Sport	--	12 - 12	58933	58920
Cobalt	Coupe, excl. SS	05 - 10	58929	58918
	Sedan, excl. SS	05 - 10	58931	58918
Colorado	4WD	15 - 18	58910	--
		04 - 12	58926	58919

RV Harnesses				
Make / Model	Style	Years	Harness#	Add-On#
<b>Chevrolet (continued)</b>				
Cruze	--	11 - 15	58935	--
Cruze Limited	--	16 - 16	58935	--
Equinox	--	10 - 17	58900	58918
HHR	Excl. SS	06 - 11	58929	58918
Malibu	Excl. LTZ	13 - 15	58934	--
		08 - 12	58932	58918
Malibu Limited	Excl. LTZ	16 - 16	58934	--
Silverado 1500	--	07 - 13	58923	58918
Sonic	--	12 - 16	58936	--
Suburban 1500	--	07 - 13	58927	--
Tahoe	Excl. hybrid	07 - 12	58927	--
Trailblazer	--	02 - 08	58925	--
Traverse	--	13 - 17	58922	58920
		09 - 12	58932	58918
<b>Dodge</b>				
Nitro	--	07 - 11	58937	58919
Ram 1500	--	09 - 10	58916	--

58918 - non-converter add-on compatible  
58919 - non-powered converter add-on compatible  
58920 - powered converter add-on compatible

RV Harnesses				
Make / Model	Style	Years	Harness#	Add-On#
<b>Fiat</b>				
500	--	12 - 18	58911	--
<b>Ford</b>				
Edge	Excl. Sport or Titanium	15 - 17	58953	58920
	--	11 - 14	58914	58920
		07 - 10	58952	58920
Escape	--	13 - 16	58943	58920
		05 - 12	58952	58920
F-150	--	09 - 14	58912	--
Fiesta	Hatchback	11 - 13	58946	--
Flex	--	09 - 19	58941	58918
Focus	Hatchback	12 - 14	58905	--
	Sedan	12 - 18	58944	58920
Freestar	--	04 - 07	58952	58920
Fusion	--	13 - 18	58945	58920
		06 - 12	58942	58920
<b>GMC</b>				
Acadia	--	13 - 16	58908	58920
		07 - 12	58921	58918
Acadia Limited	--	17 - 17	58908	58920
Canyon	4WD	15 - 18	58910	--
		04 - 12	58926	58919
Envoy	--	02 - 09	58925	--
Sierra 1500	--	07 - 13	58923	58918
Terrain	--	10 - 17	58900	58918
Yukon	--	07 - 14	58927	--
Yukon XL 1500	--	07 - 14	58927	--
<b>Honda</b>				
Accord	--	94 - 02	58949	--
CR-V	--	12 - 16	58904	--
		07 - 11	58901	--
		97 - 06	58949	--
Element	--	07 - 11	58947	--
		03 - 04	58949	--
Fit	--	07 - 13	58948	58919
Odyssey	--	95 - 04	58949	--
Pilot	--	03 - 08	58949	--
Prelude	--	01 - 01	58949	--
<b>Isuzu</b>				
i-280	--	06 - 06	58926	58919
i-290	--	07 - 08	58926	58919
i-350	--	06 - 06	58926	58919
i-370	--	07 - 08	58926	58919
Oasis	--	96 - 99	58949	--

RV Harnesses					
Make / Model	Style	Years	Harness#	Add-On#	
<b>Jeep</b>					
Cherokee	--	14 - 18	58909	58920	
Compass	--	11 - 16	58938	58920	
Grand Cherokee	Excl. SRT-8	14 - 18	58907	--	
	--	07 - 13	58940	58918	
	Excl. SRT	05 - 06	58939	58919	
	--	99 - 04	58915	58919	
Liberty	--	08 - 12	58937	58919	
		02 - 07	58917	58919	
TJ	--	98 - 06	58902	58918	
Wrangler	JK, excl. right hand drive	07 - 18	58903	58918	
		98 - 06	58902	58918	
<b>Lincoln</b>					
MKX	--	11 - 15	58930	58920	
		07 - 10	58952	58920	
<b>Mazda</b>					
Tribute	--	08 - 11	58952	58920	
<b>Mercury</b>					
Mariner	--	05 - 11	58952	58920	
<b>Oldsmobile</b>					
Bravada	--	02 - 04	58925	--	
<b>Pontiac</b>					
G5	Coupe	07 - 09	58929	58918	
	Sedan	07 - 09	58931	58918	
Pursuit	Coupe	05 - 06	58929	58918	
	Sedan	05 - 06	58931	58918	
<b>Ram</b>					
1500	4WD, with LED taillights	13 - 15	58906	--	
		Without LED taillights	13 - 13	58916	--
		--	11 - 12	58916	--
<b>Saturn</b>					
Vue	--	08 - 10	58933	58920	
	Excl. CVT transmission	02 - 07	58928	58919	
<b>Suzuki</b>					
Grand Vitara	--	06 - 12	58950	58919	
SX4	--	07 - 11	58950	58919	
<b>Toyota</b>					
RAV4	--	06 - 12	58913	58920	

58918 - non-converter add-on compatible  
58919 - non-powered converter add-on compatible  
58920 - powered converter add-on compatible

# 4-WAY FLAT

- Single-output adapters adapt a 4-way flat vehicle socket to fit 5-way flat, 6-way round or 7-way RV blade trailer plugs
- Dual-output adapters add a 6-way round or 7-way RV blade to an existing 4-way flat vehicle socket
- Informative, full-color retail packaging



57186



57185



57187



57184



57183



57626



57676



57604



57624



57672



57674



57102

Pkg#	From Vehicle	To Trailer	Notes	Material
<b>Single Output</b>				
57184	4-way flat	7-way RV blade	See mounting brackets on page 162 and page 163	Plastic
57183	4-way flat	6-way round	See mounting brackets on page 162 and page 163	Die-cast
57185	4-way flat	7-way RV blade	Includes mounting bracket	Steel
57186	4-way flat	7-way RV blade	Includes wiring and components to splice in a brake control connection	Plastic
57187	4-way flat	5-way flat	--	Plastic
57626*	4-way flat	6-way round	Integrated test lamps display proper connections	Plastic
57676*	4-way flat	7-way RV blade	Integrated test lamps display proper connections	Plastic
<b>Dual Output</b>				
57604*	4-way flat	4-way flat 6-way round	--	Plastic
57624*	4-way flat	4-way flat 6-way round	Integrated test lamps display proper connections	Plastic
57672*	4-way flat	4-way flat 7-way RV blade	--	Plastic
57674*	4-way flat	4-way flat 7-way RV blade	Integrated test lamps display proper connections	Plastic
57102*	4-way flat	4-way flat 7-way RV blade	Audible back-up alarm when vehicle in reverse (97 decibels)	Plastic

\* Includes mounting bracket and hardware

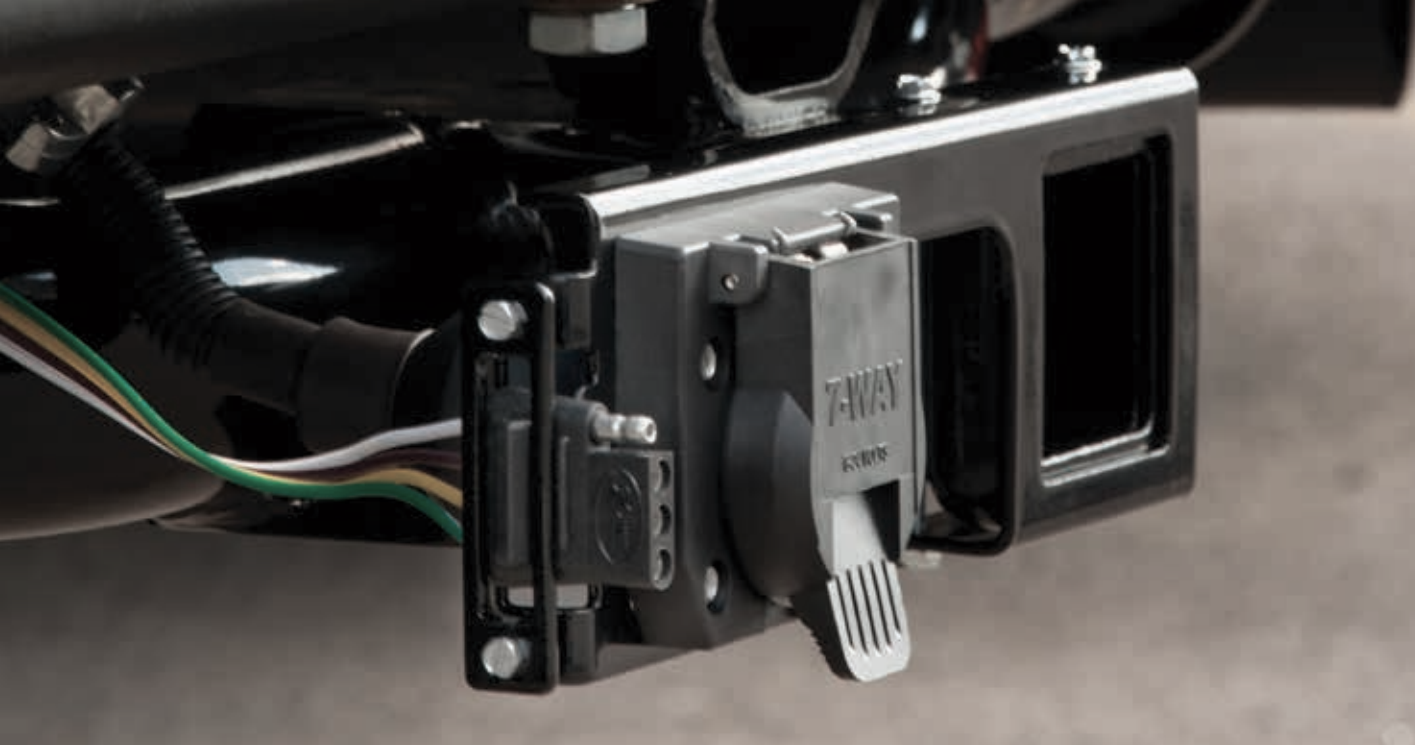

**ELECTRICAL ADAPTERS**

## ACCESSORY SOCKET

- Powers accessories with the vehicle's 2-, 4- or 5-way flat connector
- Provides a cigarette lighter type socket

Bulk#	Pkg#	From Vehicle	To Trailer	Material
58312	58313*	2-way flat	Accessory socket power adapter	Plastic
		4-way flat		
		5-way flat		

\* Continued while supplies last



**ELECTRICAL ADAPTERS**

## 4-WAY ROUND

- Adapts a 4-way round vehicle socket to fit 4-way flat trailer plugs
- Simple plug-and-play design eliminates the need for cutting or splicing



Bulk#	Pkg#	From Vehicle	To Trailer	Material
58414	--	4-way round	4-way flat	Plastic
57224	57225	4-way round	4-way flat	Plastic
57444	--	4-way round	4-way flat	Die-cast

**ELECTRICAL ADAPTERS**

# 6-WAY ROUND

- Adapts a 6-way round vehicle socket to fit 4-way flat or 7-way RV blade trailer plugs
- Simple plug-and-play design eliminates the need for cutting or splicing



Bulk#	Pkg#	From Vehicle	To Trailer	Material
57620	57621	6-way round	4-way flat	Plastic
--	57667	6-way round	7-way RV blade	Die-cast and plastic

**ELECTRICAL ADAPTERS**

# 6- OR 7-WAY WITH LED DUST COVERS

- Adapts a 6-way round or 7-way RV blade vehicle socket to fit 4-way flat or 6-way round trailer plugs
- LED tester confirms proper function of vehicle-side wiring connector
- Dust cover keeps connector clean when not in use
- Simple plug-and-play design eliminates the need for cutting or splicing



Pkg#	From Vehicle	To Trailer	Center Pin Function
57627	6-way round	4-way flat	--
57245	7-way RV blade	4-way flat	--
57255	7-way RV blade	6-way round	Auxiliary power
57265	7-way RV blade	6-way round	Brake lights



57265 LED cover



**ELECTRICAL ADAPTERS**

## 7-WAY RV BLADE ADAPTER HARNESSES

- Adapts 7-way RV blade vehicle socket to fit 4- or 5-way flat trailer plugs
- UV-resistant coiled cable extends up to 5' without scraping the ground
- Simple plug-and-play design eliminates the need for cutting or splicing
- Durable molded plastic housing resists corrosion



57271



57281

Pkg#	From Vehicle	To Trailer	Extends	Material
57271	7-way RV blade	4-way flat	5 feet	Plastic
57281	7-way RV blade	5-way flat	5 feet	Plastic

**ELECTRICAL ADAPTERS**

## 7-WAY RV BLADE FOR LED TRAILER LIGHTS

- Adapts a 7-way RV blade vehicle socket to fit 4- or 5-way flat, 6-way round or 7-way RV blade trailer plugs
- Enables vehicles with a 7-way RV blade socket to recognize LED trailer lights
- Built-in, integrated resistors for computers that do not recognize LED lights
- Simple plug-and-play design eliminates the need for cutting or splicing



57004



57005



57003

Pkg#	From Vehicle	To Trailer	Material
57003	7-way RV blade	7-way RV blade	Plastic
57004	7-way RV blade	4-way flat	Plastic
		5-way flat	
57005	7-way RV blade	6-way round	Plastic

**ELECTRICAL ADAPTERS**

# 7-WAY ROUND AND RV BLADE

- Adapts a 7-way vehicle socket to fit 4- or 5-way flat or 6-way round trailer plugs
- Simple plug-and-play design eliminates the need for cutting or splicing



57240 57241



57250 57251



57260 57261



57660 57661

Bulk#	Pkg#	From Vehicle	To Trailer	Center Pin Function
57240	57241	7-way RV blade	4-way flat	--
57250	57251	7-way RV blade	5-way flat	--
57260	57261	7-way RV blade	6-way round	Auxiliary power
57660	57661	7-way RV blade	6-way round	Brake lights
57040	57041	7-way round	4-way flat	--



57040 57041

**ELECTRICAL ADAPTERS**

# 7-WAY RV BLADE WITH BACKUP ALARM OPTION

- Adapts a 7-way vehicle socket to fit 4- or 5-way flat or 6-way round trailer plugs
- Integrated backup alarm sounds when vehicle is in reverse (97 decibels)
- Simple plug-and-play design eliminates the need for cutting or splicing



57724



57725



57720



57726

Pkg#	From Vehicle	To Trailer	Center Pin Function
57724	7-way RV blade	4-way flat	--
57725	7-way RV blade	5-way flat	--
57720	7-way RV blade	6-way round	Brake lights
57726	7-way RV blade	6-way round	Auxiliary power
57727	7-way RV blade	7-way RV blade (extender)	--



57727

**PLUGS & SOCKETS**

# 2-WAY FLAT

- Splices into existing wiring to supply power to an electrical accessory
- 18-gauge looped wire can also be used as an extension for an existing connector
- Constructed with bonded wires and durable molded rubber

Bulk#	Pkg#	Location	Wire Length	Description
58020	58021	Vehicle	12"	Socket with bonded loop
		Trailer		Plug with bonded loop



**PLUGS & SOCKETS**

# 4-WAY FLAT

- Splices into existing wiring to supply power from the vehicle to the trailer
- Looped wires can also be used as a wire extension for an existing connector
- Constructed with bonded wires and durable molded rubber
- Designed for use on vehicles and trailers with two-wire systems



Bulk#	Pkg#	Pkg Kit#	Location	Wire Length	Description
58030	58031	58033*	Trailer	12"	Plug with bonded wire
--	58348	58349*	Trailer	48"	Plug with bonded wire
58040	58041	58044*	Vehicle	60"	Socket with bonded wire
--	58304	58344*	Vehicle	12"	Socket with bonded wire
			Trailer	12"	Plug with bonded wire
--	58355	58305*	Vehicle	48"	Socket with bonded wire
			Trailer	12"	Plug with bonded wire
58050	58051	--	Vehicle	72"	Socket with bonded loop
			Trailer		Plug with bonded loop
58380	58381	--	Vehicle	12"	Socket with bonded loop
			Trailer		Plug with bonded loop
--	57220	--	Trailer	240"	Plug with bonded wire

\*Includes four snap locks



**PLUGS & SOCKETS**

# 4-WAY FLAT LICENSE PLATE LIGHT PLUGS

- 1-1/4" plug fits a typical license plate light hole
- Dust cover keeps connector clean when not in use



Bulk#	Pkg#	Location	Wire Length	Description
58404	57404	Vehicle	--	Adapter, dust cap included
		Trailer		
58405	57405	Vehicle	36"	Socket with bonded wire, dust cap included
58406*	57406	Vehicle	60"	Socket with bonded wire, dust cap included

\* Continued while supplies last

**PLUGS & SOCKETS**

# 4-WAY ROUND

- Splices into existing wiring to supply power from the vehicle to the trailer
- Concealed terminals help ensure a reliable connection
- Constructed from strong die-cast metal
- Dust- and water-resistant design to withstand the elements



Bulk#	Pkg#	Pkg Kit#	Location	Material	Description
58060	58061	--	Trailer	Die-cast	Round plug
58070	58071	--	Vehicle	Die-cast	Round socket
--	58671	58677*	Trailer	Die-cast	Round plug (58060)
			Vehicle	Die-cast	Round socket (58070)

\* Includes mounting bracket, wiring and hardware

**PLUGS & SOCKETS**

# 4- & 5-WAY FLAT DUST COVERS

- Protects connector from water, dust and road grime when not in use
- Helps prevent internal corrosion for a long operating life
- Attachment loop allows for fast, easy installation
- Constructed from durable molded rubber



58200



58201



58202



58750



58761

Bulk#	Pkg#	Location	Material	Fits
58200	58201	Vehicle	Rubber	4-way flat
58750	--	Trailer	Rubber	4-way flat
--	58761	Vehicle	Rubber	4-way flat
		Trailer		
58202	58203	Vehicle	Rubber	5-way flat

**PLUGS & SOCKETS**

# 5-WAY FLAT

- Ideal for trailers with surge brakes, commonly found on larger boat trailers
- Splices into existing wiring to supply power from the vehicle to the trailer
- Looped wires can also be used as a wire extension for an existing connector



58530



58540



58550

Bulk#	Pkg#	Location	Wire Length	Description
58530	58531	Vehicle	60"	Socket with wire
58540	58541	Trailer	48"	Plug with wire
58550	58551	Vehicle	72"	Socket with loop
		Trailer		Plug with loop

**PLUGS & SOCKETS**

# 6-WAY ROUND

- Splices into existing wiring to supply power from the vehicle to the trailer
- Concealed terminals help ensure a reliable connection
- Spring-loaded dust covers keep connectors clean when not in use



58120



58082



58083



58093



58130



58080



58081



58092



58090



58091

Bulk#	Pkg#	Pkg Kit#	Location	Material	Description
58080	58081	--	Trailer	Die-cast	Round plug
58120	--	--	Trailer	Plastic chrome	Round plug
58082	58083	--	Trailer	Die-cast	Round plug with spring
58090	58091	--	Vehicle	Die-cast	Round socket
58130	--	--	Vehicle	Plastic	Round socket
--	58092	58093*	Trailer	Die-cast	Round plug (58080)
			Vehicle	Die-cast	Round socket (58090)

\* Includes electrical connectors, mounting bracket and hardware

**PLUGS & SOCKETS**

# 6-WAY SQUARE

- 6-way square connectors are commonly used on popup campers
- Splices into existing wiring to supply power from the vehicle to the trailer
- Looped wires can also be used as a wire extension for an existing connector



58034

Pkg#	Location	Wire Length	Description
58034	Vehicle	12"	Square socket with loop
	Trailer		Square plug with loop
58035	Vehicle	12"	Square socket with wire
58037	Trailer	12"	Square plug with wire



58035



58037

**PLUGS & SOCKETS**

# 7-WAY ROUND

- 7-way round connectors are commonly used on semi- and utility trailers
- Splices into existing wiring to supply power from the vehicle to the trailer
- Constructed from strong die-cast metal



58170



58160



58161



58180



58181

Bulk#	Pkg#	Location	Material	Description
58170	--	Vehicle	Die-cast	Round socket
58160	58161	Trailer	Die-cast	Round plug
58180	58181	Trailer	Die-cast	Round plug with spring

**PLUGS & SOCKETS**

# 7-WAY RV BLADE

- Concealed terminals help ensure a reliable connection
- Ergonomic design offers a comfortable, more secure grip (#58145)
- Weather-resistant dust cover features a rubber insert to seal out moisture (#58155)



58140



58141



58145



58155



58190



58220



58150



58151



58417



58152

Bulk#	Pkg#	Pkg Kit#	Location	Material	Description
58140	58141	--	Trailer	Plastic	RV blade plug
--	58145	--	Trailer	Plastic	Heavy-duty RV blade plug
58150	58151	--	Vehicle	Plastic	RV blade socket
--	58155	--	Vehicle	Plastic	Heavy-duty RV blade socket
58190	--	--	Trailer	Die-cast	RV blade plug
58220	--	--	Vehicle	Steel	RV blade socket
--	58417	--	Vehicle	Plastic	RV blade socket with mounting bracket
--	--	58152*	Trailer	Plastic	RV blade plug
--	--	58152*	Vehicle	Plastic	RV blade socket

\*Includes electrical connectors, mounting bracket and hardware

# EASY-MOUNT ELECTRICAL BRACKETS

- Allows connectors to be hitch-mounted with no drilling or clamping required
- Two threaded stainless steel bolts provide secure attachment to the hitch
- Notched design allows convenient access to pin & clip
- Steel body will not break like competitive plastic products
- Protected by a durable powder coat finish
- Bulk retail boxes contain 10 poly-bagged units
- Patent #5,664,304



Patented, no-drill, hitch-mounted design provides a secure mount for the connector

**Fits 1-1/4" receiver tubes and holds 4-way or 5-way flats**

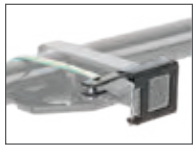

58002

**Fits 2" receiver tubes and holds 4-way or 5-way flats**

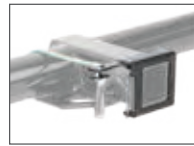

58001

**Fits 2" receiver tubes and holds 4- or 5-way flats and 6- or 7-way sockets**



58000

**Fits 2-1/2" receiver tubes and holds 4- or 5-way flats and 6- or 7-way sockets**



58003

Pkg#	Bulk Retail 10-Pack#	Receiver Tube Opening	Fits
58002	58002010	1-1/4" x 1-1/4"	4- or 5-way flat sockets
58001	58001010	2" x 2"	4- or 5-way flat sockets
58000	58000010	2" x 2"	4- or 5-way flat and 6- or 7-way sockets
58003	--	2-1/2" x 2-1/2"	4- or 5-way flat and 6- or 7-way sockets

58001010  
10-pack





**PLUGS & SOCKETS**

# ELECTRICAL SOCKET MOUNTING BRACKETS

- Allows for secure connector attachment to the vehicle or trailer hitch
- Steel body will not break like competitive plastic products
- Mounting hardware not included



Bulk#	Bulk 12-Pack#	Pkg#	Fits	Description	Finish
<b>For 4-Way Flat, 5-Way Flat and 6-Way Round Connectors</b>					
58300	--	58301	4-way flat	--	Gloss black
--	57207	57208	4- or 6-way round sockets	--	Gloss black
58210	--	--	4- or 6-way round sockets	--	Zinc-plated
<b>For 7-Way Round and 7-Way RV Blade Connectors</b>					
58222	--	--	7-way round socket #58170	--	Zinc-plated
--	57205	57206	7-way RV blade socket #55415	Increased strength, slotted screw holes	Gloss black
58230	--	58231	7-way RV blade sockets #58150 and #58220	--	Zinc-plated
58290	--	58291	7-way RV blade sockets #58150 and #58220	--	Gloss black
58510	--	--	7-way RV blade sockets #58150 and #58220	Increased strength	Gloss black
58520	--	--	7-way USCAR factory Ford, GM and Nissan sockets	--	Gloss black
<b>For Mounting Connector Brackets to Trailer Hitches</b>					
--	57203	57204	4- or 5-way flat and 6-way round brackets	Short, universal clamp-on mount	Gloss black
--	57201	57202	7-way round or RV blade sockets	Long, universal clamp-on mount	Gloss black

**ACCESSORIES & TESTERS**

## LENSES & COMBO LIGHTS

- Exceeds DOT requirements for stop, tail, rear and side reflectors, side markers and license plate illumination
- Two extra connections provide hookups for other lights
- Features a molded housing with standard red lenses
- Phosphor-bronze contacts for good connection in any weather
- Bolt-on mounting system for secure installation on the trailer



Pkg#	Vehicle Side	Lens Color	License Plate Illumination
53440	Passenger	Red	No
53441	Driver	Red	Yes
53445	Rear replacement lens		
53515	Side replacement lens		

**ACCESSORIES & TESTERS**

## SUBMERSIBLE COMBO LIGHTS

- Exceeds DOT requirements for stop, tail, rear and side reflectors, clearance and license plate illumination
- Watertight design allows for full water immersion
- Great for replacing lights on a boat trailer
- Bolt-on mounting system for secure installation on the trailer
- Legal for trailers over 80" wide



Pkg#	Vehicle Side	Lens Color	License Plate Illumination
53452	Passenger	Red	No
53453	Driver	Red	Yes

**ACCESSORIES & TESTERS**

## TRAILER LIGHT KIT

- Exceeds DOT highway standards
- Designed to replace all necessary trailer lights on most trailers
- Easily connects to any standard automobile lighting system
- Frame mounting clips keep wires contained and protected
- Ideal for trailers up to 80" wide



Pkg#	Length	Plug	Includes
53540	20'	4-way flat	Two combination lights, two marker lights, license plate bracket and frame mounting clips

**ACCESSORIES & TESTERS**

## TOWING LIGHTS

- Easily adds tow lights to a dinghy-towed vehicle or trailer without lights
- Non-scratch magnetic base protects vehicle finish
- Perfect for boats, RVs and flat towing applications
- 20' cord with 4-way flat plug allows for plug-and-go convenience
- Snap locks included for simple, secure splice-in connection
- Patent# D355,270



Bulk#	Pkg#	Length	Plug	Description	
	53200	53204*	20'	4-way flat	Auxiliary towing lights

\* Includes a sturdy, reusable case

**ACCESSORIES  
& TESTERS**

# CONNECTOR TESTERS

- Confirms proper function of vehicle-side wiring connector
- Constructed with LED lights for long-lasting use



Bulk#	Pkg#	Description	Material
58260	58261	LED 4-way flat	Plastic
57505	--	LED 5-way flat	Plastic
58650	--	LED 6-way round	Plastic
58270	58271	LED 7-way RV blade	Plastic

**ACCESSORIES  
& TESTERS**

# BRAKE CONTROL TESTERS

- Tests vehicle wiring for battery voltage, brake voltage and signal circuits (#51498)
- Designed to bench test a brake control for proper function (#51521)
- Tests brake voltage, pedal activation, short-circuit / overload and disconnect (#51521)



Bulk#	Tests	Plug	Socket
51498	Vehicle-side wiring functions	7-way RV blade	--
51521	Brake control unit	--	Quick plug

**ACCESSORIES  
& TESTERS**

# BONDED 4-WIRE SPOOL

- Standard 4-way wire for rewiring a trailer or a similar application



Pkg#	Gauge	Length	Description
57001	16	25'	Bonded four-wire spool (green, yellow, brown, white)

ACCESSORIES & TESTERS

# SNAP LOCKS & WIRE NUT

- Instantly splices two wires together using only a pliers
- Aluminum blade pierces both channels to eliminate any stripping or soldering
- Latching safety lock ensures a reliable connection
- Side gap allows for easy insertion of existing wire
- Constructed from high-impact plastic to protect against corrosion



Bulk#	Gauge	Description	Quantity
58280	18-14	Tap connector	100
59906	18-14	Double-run tap connector	100
59956	18-14	Tap connector with gel sealant	100
59905	12-10	Tap connector	100
59901	18-10	Wire nut	100

ACCESSORIES & TESTERS

# RING & SPADE TERMINALS

- Allows wires to be fastened down for a firm connection
- Perfect for installing towing electrical components or similar applications
- Vinyl-insulated to ensure a long-lasting connection
- Flared opening allows for easy wire insertion



Bulk#	Gauge	Stud Size	Color	Quantity
<b>Ring Terminals</b>				
59521	16-14	#10	Blue	100
59522	16-14	1/4"	Blue	100
59525	16-14	5/16"	Blue	100
59523	16-14	3/8"	Blue	100
59531	12-10	#10	Yellow	100
59534	12-10	1/4"	Yellow	100
59556	12-10	5/16"	Yellow	100
59538	12-10	3/8"	Yellow	100
<b>Spade Terminals</b>				
59611	22-18	#10	Red	100
59621	16-14	#10	Blue	100
59631	12-10	#10	Yellow	100

ACCESSORIES & TESTERS

# BUTT & QUICK CONNECTORS

- Quick connectors provide a firm wire connection with the option to disconnect later
- Butt connectors splice wires together with no taping required
- Perfect for installing towing electrical components or similar applications
- Vinyl-insulated to ensure a long-lasting connection
- Flared opening allows for easy wire insertion

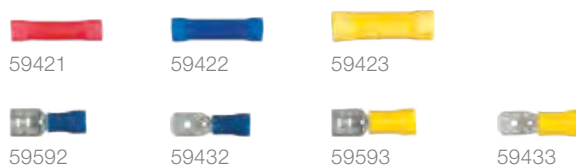

Bulk#	End	Gauge	Color	Quantity
<b>Butt Connectors</b>				
59421	--	22-18	Red	100
59422	--	16-14	Blue	100
59423	--	12-10	Yellow	100
<b>Quick Connectors</b>				
59592	Female	16-14	Blue	100
59432	Male	16-14	Blue	100
59593	Female	12-10	Yellow	100
59433	Male	12-10	Yellow	100

**ACCESSORIES  
& TESTERS**

# HEAVY-DUTY FLASHERS, CIRCUIT BREAKERS & FUSES

- Recommended for applications where over-current protection is required
- Turn signal flashers are 12-volt, two-terminal flashers



Bulk#	Amps	Description	Qty
<b>Fuses and Holder</b>			
58440	10 amps	ATC fuse	100
58450	15 amps	ATC fuse	100
58460	20 amps	ATC fuse	100
58470	10 amps	In-line fuse holder	12
<b>Relays</b>			
58480	35 amps	Relay, SPNO, 4-terminal, 12-volt DC	12
57000	--	Nissan '04 to present Armada and Titan without factory tow package	1

Bulk#	Amps	Description	Qty
<b>Flashers</b>			
58310	14 amps	Flasher 1-4 lamps or 2-8 hazard	1
58320	14 amps	Flasher 2-3 lamps or 2-6 hazard	1
<b>Circuit Breaker</b>			
58341	15 amps	Universal circuit breaker	1
58351	20 amps	Universal circuit breaker	1
58361	30 amps	Universal circuit breaker	1
58371	40 amps	Universal circuit breaker	1

**ACCESSORIES  
& TESTERS**

# SLIT LOOM & CLAMP

- Protects loose wires against vibration and damage
- Keeps multiple wires contained in a single channel
- Slit lengthwise for easy application to wires
- Stronger and easier to use than a braided sleeve or wire spiral wrap



Bulk#	Pkg#	Description	Amount
58823	--	1/4" convoluted slit loom	Per foot
59824	59825	3/8" convoluted slit loom	Per foot / 25'
59826	59827	1/2" convoluted slit loom	Per foot / 25'
--	59828	3/8" ID nylon loom clamp	25 per bag

**ACCESSORIES  
& TESTERS**

# ELECTRICAL TAPE & NYLON TIES

- Self-locking ties for securing wires and cables
- Zip tie mechanism allows for tight bundling
- Tapered end for easier insertion into lock



Bulk#	Length	Quantity	Specifications	Description
59728	7-1/4"	100	--	Nylon ties
59732	14-1/4"	100	--	Nylon ties
59740	60'	10-pack	7 mil x 3/4"	Electrical tape

**TESTED. PROVEN. SAFE.**



# GOOSENECK HITCHES

## TESTING THE LIMITS

CURT gooseneck hitches are engineered and tested to keep up with your hardworking customers. New for 2019, we have added an OEM-style 3" gooseneck ball. This ball easily drops into any puck system on Ford, GM, Nissan or Ram trucks and features our patented quarter-turn latch system. It also fits our OEM-style gooseneck hitches for Ford and Ram. We continue to offer our easy-to-install, easy-to-operate Double Lock EZr™ and a complete line of gooseneck products.



# FEATURED PRODUCTS



## OEM puck system kits

If your customer has a puck system, this simple kit fully equips them for gooseneck towing. Available for Ford, GM, Nissan and Ram.



## 3" gooseneck ball

Compatible with Ford, GM, Nissan and Ram puck systems, this new gooseneck ball fits 3" couplers and has a simple drop-in installation.



## OEM-style hitch for Ford

The #60700 offers a unique fit for Ford Super Duty trucks and features an easy, one-person install. Best of all, it's made in the USA.

# PRODUCT INDEX

**A B C**



Selecting a Gooseneck

OEM Puck System Kits



OEM-Style Hitches



Double Lock EZr™ Hitches



Original Double Lock Hitches



X5 5th Wheel Adapter Plates



Quick Goose II Hitches



Over-Bed Hitches



5th Wheel Rail Hitches



Gooseneck Electrical

# SELECTING A GOOSENECK HITCH

There are three basic methods for installing a gooseneck hitch in your customer's pickup truck:



**A** Using an OEM puck system, if equipped



**B** Using a gooseneck hitch and brackets



**C** Using pre-existing 5th wheel base rails

## A | OEM PUCK SYSTEM OPTIONS

Many pickups today, specifically models from Ford, GM, Nissan and Ram, are factory-equipped with a truck bed puck system. A puck system provides attachment points for both gooseneck and 5th wheel towing.

For trucks with a puck system, an OEM puck system gooseneck kit is the easiest way to tow a gooseneck trailer. The components can be installed or removed quickly as necessary.

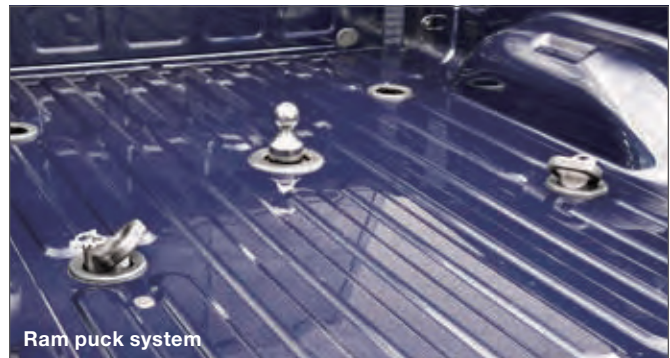

Ram puck system

### Quarter-turn anchoring system



**Step 1** - Lift and twist latch to release the retention balls



**Step 2** - Drop the ball into OEM puck system hole



**Step 3** - Return latch to lock the ball in place for towing



Large safety chain openings accept heavy-duty hooks



## B | CUSTOM APPLICATION OPTIONS

For trucks without a puck system, the traditional method for installing a gooseneck hitch is vehicle-specific brackets.

CURT OEM-style gooseneck hitches are a unique vehicle-specific option, featuring a custom design that quickly and easily bolts to the truck frame without any additional brackets required. These hitches are available for select Ford and Ram trucks.

We also offer a variety of other traditional gooseneck hitch options that mount with vehicle-specific brackets. Options include our Double Lock EZr™, original Double Lock, Quick Goose II and more. Many of these hitches are available as a complete kit with the brackets included.



## C | EXISTING 5TH WHEEL BASE RAIL OPTIONS

For trucks with 5th wheel rails already installed, CURT offers 5th wheel rail gooseneck hitches. These 5th-wheel-to-gooseneck adapters feature a four-point mounting system to easily drop into any set of industry-standard 5th wheel base rails.

A 5th wheel rail gooseneck hitch provides a ball ready for towing a gooseneck trailer, and the hitch can easily be removed from the base rails whenever necessary to allow for 5th wheel towing.

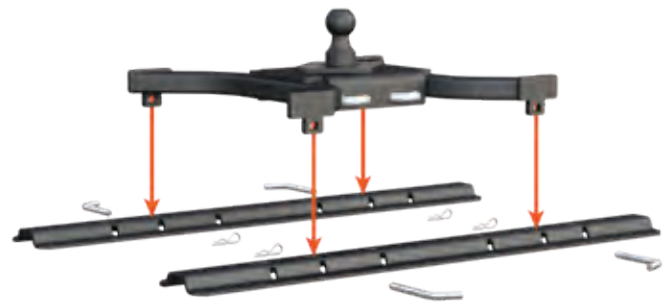

### 5th wheel rail gooseneck hitch.



# OEM PUCK SYSTEMS

30k

GTW

## OEM PUCK SYSTEM GOOSENECK KITS

Available for Ford, GM, Nissan and Ram, these kits utilize the truck bed puck system built into select pickups with the towing prep package. The ball and anchors easily drop into the pucks, lock into place and are immediately ready to couple to a gooseneck trailer.

See page 170 for a helpful gooseneck hitch selection guide.

### Each kit includes:

- Gooseneck ball
- Two safety chain anchors
- Rubber hole cover
- Durable storage case



60692

### Quarter-turn anchoring system



**Step 1** - Lift and twist latch to release the retention balls



**Step 2** - Drop the ball into OEM puck system hole



**Step 3** - Return latch to lock the ball in place for towing



Large safety chain openings accept heavy-duty hooks

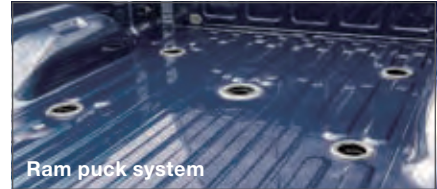

Installation of these products requires an OEM truck bed puck system (example above)

## Product Details

### Gooseneck ball

- Up to 30,000 lbs. GTW and 7,500 lbs. vertical load
- Weight ratings are limited to vehicle manufacturer's stated capacities
- Installs easily with quarter-turn latch locking system
- Kits include 2-5/16" (3" ball sold separately)
- Retention balls keep shank fully locked into the hitch
- Constructed from strong, machine-forged steel alloy
- Protected by a polished chrome-plated mirror finish
- Tested for safety to U.S. VESC V-19 specifications
- Patent# 8,955,866

### Safety chain anchors

- Provides a reliable connection for gooseneck trailer safety chains
- Simple, drop-in install eliminates the need for tools
- Wide openings accept large safety chain hooks
- Constructed from heavy-duty, forged steel
- Durable carbide black powder coat finish
- Patent# 9,452,647

**30k**  
GTW

# OEM PUCK SYSTEM GOOSENECK KITS



60618



60692

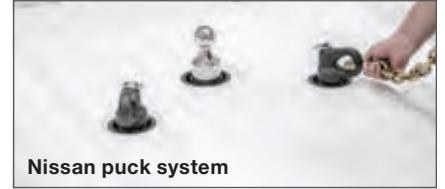

**Nissan puck system**

OEM puck system gooseneck components are easy to install whenever needed

Pkg#	Make	Ball GTW / Vertical Load	Ball Size	Ball Finish	Anchor Finish
60618	Ram	30,000 / 7,500 lbs.	2-5/16"	Chrome-plated	Carbide
60692	Chevrolet / GMC, Ford and Nissan	30,000 / 7,500 lbs.	2-5/16"	Chrome-plated	Carbide

## OEM PUCK SYSTEM COMPONENT PARTS



60617



60691



60629



60628

**NEW**



66155



66155 installed

Part#	Make	Ball Size	Description	Ball GTW / Vertical Load	Finish
60617	Ram	--	Two safety chain anchors	--	Carbide
60691	Chevrolet / GMC, Ford and Nissan	--	Two safety chain anchors	--	Carbide
60629	Chevrolet / GMC, Ford, Nissan, Ram	2-5/16"	OEM-style gooseneck ball	30,000 / 7,500 lbs.	Chrome-plated
60628	<b>NEW</b> Chevrolet / GMC, Ford, Nissan, Ram	3"	OEM-style gooseneck ball	30,000 / 7,500 lbs.	Chrome-plated
66155	--	--	Replacement rubber hole cover	--	Black rubber



# CUSTOM APPLICATIONS



**30k**  
GTW

## OEM-STYLE GOOSENECK HITCHES

OEM-style gooseneck hitches are designed for a unique, vehicle-specific fit. They quickly and securely bolt onto the truck's frame with no drilling or installation brackets required.

### Product Details

- Up to 30,000 lbs. GTW and 7,500 lbs. vertical load
- Weight ratings are limited to vehicle manufacturer's stated capacities
- Quickly bolts on underneath the truck bed in 45 minutes or less (#60614, #60626)
- Easy, one-person installation requires no lowering of exhaust or spare tire (#60700)
- Requires no additional hardware and no drilling necessary except the truck bed holes
- Installation also requires no welding, bed flange trimming or bed removal
- Included patented 2-5/16" ball eliminates the need for a side handle
- Heavy-duty 5/8" safety chain loops for a reliable connection
- Tested for safety in accordance with SAE J2638
- Not compatible with X5 adapters
- Protected by a highly durable, rust-resistant, liquid A-coat



60626



60614



60700

#### OEM-Style Gooseneck Hitches

Make / Model	Style	Years	Part#
<b>Ford</b>			
F-250 Super Duty	--	17 - 19	60700
F-350 Super Duty	--	17 - 19	60700
F-450 Super Duty	Excluding cab & chassis	17 - 17	60700
<b>Ram</b>			
2500	Excluding 5th wheel prep package	14 - 18	60614
3500	Excluding cab & chassis	13 - 18	60626
<b>Replacement Parts</b>			
Replacement OEM-style ball, 2-5/16"			60629
Replacement rubber hole cover			66155

#### Quarter-turn gooseneck ball



Factory-style gooseneck ball operates with a simple, 1/4-turn latch-locking system



30k

GTW

# DOUBLE LOCK EZr™ GOOSENECK HITCH SYSTEM



60611

## What makes the EZr™ different?

### One-person installation



Easy-to-install clips eliminate the need for a second person to hold up the center section

- Retainer clips secure the bolts supporting the center section while attaching the installation kit
- Uses carriage bolts when possible for one-wrench tightening
- No need to lower exhaust on Ford, GM and most Dodge / Ram models
- No need to relocate cable hanger and ground wire on Dodge / Ram models

### No measuring required



Exclusive Center Locator saves time



Simply drill up from under the bed

- Exclusive Center Locator eliminates the need to measure where the ball hole should be
- Safety chain loop holes are drilled from the underside of the truck bed
- No welding or truck bed removal required
- Center Locator covered by patent# D685,299 S

## How is the EZr™ installed without measuring?



**Step 1** - Place the Center Locator into the gooseneck hitch ball hole



**Step 2** - Bolt the installation brackets and hitch to the vehicle frame



**Step 3** - Drill a pilot hole up from under the bed, using the Center Locator



**Step 4** - Use the pilot hole to drill down with no measuring required

# Product Details & Operation

- Up to 30,000 lbs. GTW and 7,500 lbs. vertical load
- Weight ratings are limited to vehicle manufacturer's stated capacities
- Includes 2-5/16" ball, 5/8" safety chain loops and grade-8 hardware
- Protected by a durable carbide powder coat finish
- Tested for safety in accordance with SAE J2638
- Informative, full-color retail box



Engage the double locking pins for superior pin strength



Retract the sturdy 3/8" handle and drop the ball into the hole



After towing, flip the ball over to eliminate obstructions



Install the hole cover to protect the ball from the elements



Replacement rubber hole cover available



Replacement gooseneck ball available

If a particular application is not listed in the table below, see the original Double Lock gooseneck hitch application guide

Double Lock EZr™ Gooseneck Hitches						
Make / Model	Style	Years	EZr™ Kit#	Footnotes	Hitch#	Bracket#
<b>Chevrolet</b>						
Silverado 2500 HD / 3500 HD	--	11 - 19	60680	1, ●	60611	60624
		01 - 10	60681	●	60619	60648
<b>Dodge</b>						
Ram 2500	--	03 - 10	60682	1, 2, 3, ●	60619	60660
Ram 3500	--	03 - 10	60682	1, 2, 3, ●	60619	60660
<b>Ford</b>						
F-250	--	99 - 99	60685	●	60619	60647
F-250 Super Duty	--	11 - 16	60683	●	60619	60645
		99 - 10	60685	●	60619	60647
		17 - 19	See page 174 for OEM-style gooseneck hitch			
F-350 Super Duty	--	11 - 16	60683	●	60619	60645
		99 - 10	60685	●	60619	60647
		17 - 19	See page 174 for OEM-style gooseneck hitch			
F-450 Super Duty	--	17 - 17	See page 174 for OEM-style gooseneck hitch			
<b>GMC</b>						
Sierra 2500 HD / 3500 HD	--	11 - 19	60680	1, ●	60611	60624
		01 - 10	60681	●	60619	60648
<b>Ram</b>						
2500	--	11 - 13	60682	1, 2, 3, ●	60619	60660
		14 - 18	See page 174 for OEM-style gooseneck hitch			
3500	--	11 - 13	60682	1, 2, 3, ●	60619	60660
		13 - 18	See page 174 for OEM-style gooseneck hitch			

1. Passenger-side wheel well flange must be bent for frame rail access
  2. Check inverted ball clearance with heavy loads on two-wheel drive
  3. Exhaust may have to be permanently lowered on power wagon and Mega cab applications
- = No frame drilling required

**30k**

GTW

# ORIGINAL DOUBLE LOCK GOOSENECK HITCHES

- Double locking pins for superior trailer and trailer ball security
- Flip-and-store ball keeps truck bed free of obstructions
- Installation requires no welding or truck bed removal
- Heavy-duty handle can be positioned on either side of the vehicle
- Rubber hole cover helps prevent corrosion in trailer ball hole
- Includes spring-loaded safety chain loops and grade-8 hardware
- Protected by a highly durable carbide powder coat finish
- Informative, full-color retail box (#60607)



60607



Engage the double locking pins for superior pin strength



Retract the sturdy 3/8" handle and drop the ball into the hole



Chrome trim ring for a clean, professional finish

Part#	Make / Model	Years	Ball Size	Finish	GTW / Vertical Load
60607	Multiple applications for Ford, GM, Nissan and Ram See page 180 for full application listing	--	2-5/16"	Carbide	30,000 / 7,500 lbs.
60615	Chevrolet Silverado 1500 & GMC Sierra 1500	07 - 18	2-5/16"	Carbide	30,000 / 7,500 lbs.
	Chevrolet Silverado 1500 Legacy & GMC Sierra 1500 Limited	19 - 19			
60620	Nissan Titan	04 - 17	2-5/16"	Carbide	30,000 / 7,500 lbs.
60625*	Toyota Tundra	00 - 06	2-5/16"	Carbide	30,000 / 7,500 lbs.

\* Continued while supplies last

## ORIGINAL DOUBLE LOCK GOOSENECK HITCH ACCESSORIES

- 2-5/16" gooseneck balls rated up to 30,000 lbs. GTW and 7,500 lbs. vertical load



60616



60602



60603



60606



66165

Bulk#	Pkg#	Description	For Use With
60616	--	2-5/16" gooseneck replacement ball	EZr™ and original Double Lock goosenecks
--	60602	2-5/16" offset ball pivot point 4" rearward for added cab clearance	Original Double Lock goosenecks only
--	60603	2-5/16" riser ball adds 1" clearance for trucks with plastic or rubber bed liners	Original Double Lock goosenecks only
60606	--	Installation tool supports the gooseneck hitch for one-person install	--
66165	--	Replacement rubber hole cover	EZr™ and original Double Lock goosenecks





**20K**  
GTW

## X5 GOOSENECK TO 5TH WHEEL ADAPTER PLATES

The X5 adapter plate allows a gooseneck hitch to become a mounting platform for a 5th wheel hitch. The X5 shank simply drops into the gooseneck ball hole and instantly provides a set of industry-standard 5th wheel base rails. See the table below for gooseneck hitch compatibility.

### Product Details

- Converts a gooseneck hitch into a set of standard 5th wheel base rails
- Simple, secure design allows for fast installation and removal as needed
- For use with CURT and competitive 5th wheels up to 20,000 lbs.
- Capacity limited to lowest-rated towing component
- Accepts any standard CURT 5th wheel legs or roller (excludes OEM puck system)
- Protected by a durable carbide powder coat finish
- Co-cured in a rust-resistant liquid Bonderite® coating
- **Not compatible with OEM-style gooseneck hitches**
- **Not compatible with Sidewinder™ pin boxes**  
(Trademark of Horizon Global™)



16210 - Fits CURT original Double Lock



16220 - Fits CURT Double Lock EZr™



16310 - Fits B&W Turnoverball®

Part#	Fits	Capacity	Shank Style
16210	CURT Double Lock 60607, 60615, 60620, 60625	20,000 lbs.	Round shank
16220	CURT Double Lock EZr™ 60611 and 60619	20,000 lbs.	Round shank
16310	B&W Turnoverball® gooseneck hitch (does not work with shallow models)	20,000 lbs.	Square shank



On two-wheel drive trucks, a clearance check must be performed when truck is loaded and unloaded to verify the inverted ball will not interfere with the top of the differential. See footnote 6 for more details.

**30k**  
GTW

# ORIGINAL DOUBLE LOCK GOOSENECK HITCHES

## Original Double Lock Gooseneck Hitches

Make / Model	Style	Years	Footnotes	Kit# (Hitch and Brackets)	Hitch#	Bracket#
<b>Chevrolet</b>						
C/K Series Pickups	Excluding cab & chassis	88 - 00	●	60713	60607	60631
Silverado 1500	--	07 - 18	●	60711	60615	60632
		99 - 06	●	60712	60607	60652
Silverado 1500 Classic	--	07 - 07	●	60712	60607	60652
Silverado 1500 Legacy	--	19 - 19	●	60711	60615	60632
Silverado 2500	--	99 - 04	●	60712	60607	60652
Silverado 2500 HD	--	11 - 18	●	60710	60607	60604
		01 - 10	4, ●	60712	60607	60652
Silverado 2500 HD Classic	--	07 - 07	4, ●	60712	60607	60652
Silverado 3500	--	01 - 06	4, ●	60712	60607	60652
Silverado 3500 Classic	--	07 - 07	4, ●	60712	60607	60652
Silverado 3500 HD	--	11 - 18	●	60710	60607	60604
		07 - 10	4, ●	60712	60607	60652
<b>Dodge</b>						
Ram 1500	--	09 - 10	●	60730	60607	60657
		02 - 08	1, 2	60733	60607	60659
		94 - 01	●	60734	60607	60635
Ram 2500	--	03 - 10	1, 2, 6, ●	60732	60607	60661
		94 - 02	6, ●	60734	60607	60635
Ram 3500	--	03 - 10	1, 2, 6, ●	60732	60607	60661
		94 - 02	6, ●	60734	60607	60635
<b>Ford</b>						
F-150	Excluding Police Responder	15 - 18	●	60724	60607	60649
	--	04 - 14	●	60721	60607	60641
		97 - 03	●	60722	60607	60637
		80 - 96	1, ●	60723	60607	60636
F-150 Heritage	--	04 - 04	●	60722	60607	60637
F-250	New body	97 - 03	●	60722	60607	60637
	Old body	80 - 98	--	60723	60607	60636
F-250 Super Duty	--	11 - 16	3, ●	60720	60607	60644
		99 - 10	3, ●	60720	60607	60644
		99 - 10	3, ●	--	60607	60643*
F-350	Excluding overload springs	80 - 98	●	60723	60607	60636
F-350 Super Duty	Excluding cab & chassis	11 - 16	3, ●	60720	60607	60644
F-450 Super Duty	Excluding cab & chassis	08 - 12	3, ●	60720	60607	60644
		08 - 10	3, ●	--	60607	60643*

\* Continued while supplies last

All models: Brake, fuel and electrical lines may need to be loosened or repositioned. Heat shield requires modification or removal.

- |  |   |
|--|---|
| 1. Passenger-side wheel well must be notched for frame rail access     | 4. Vacuum canister requires relocation (kit included)                         |
| 2. Parking brake cable bracket may require relocation                  | 5. Ball cannot be turned over. Brake lines must be cable-tied (ties included) |
| 3. Exhaust may have to be permanently lowered on 2005 and newer models | 6. Do not invert ball with heavy loads on two-wheel drive models              |
|  | ● = No frame drilling required  |



### Original Double Lock Gooseneck Hitches

Make / Model	Style	Years	Footnotes	Kit# (Hitch and Brackets)	Hitch#	Bracket#
<b>GMC</b>						
C/K Series Pickups	Excluding cab & chassis	88 - 00	●	60713	60607	60631
Sierra 1500	--	07 - 18	●	60711	60615	60632
		99 - 06	●	60712	60607	60652
Sierra 1500 Classic	--	07 - 07	●	60712	60607	60652
Sierra 1500 Limited	--	19 - 19	●	60711	60615	60632
Sierra 2500	--	99 - 04	●	60712	60607	60652
Sierra 2500 HD	--	11 - 18	●	60710	60607	60604
		01 - 10	4, ●	60712	60607	60652
Sierra 2500 HD Classic	--	07 - 07	4, ●	60712	60607	60652
Sierra 3500	--	01 - 06	4, ●	60712	60607	60652
Sierra 3500 Classic	--	07 - 07	4, ●	60712	60607	60652
Sierra 3500 HD	--	11 - 18	●	60710	60607	60604
		07 - 10	4, ●	60712	60607	60652
<b>Nissan</b>						
Titan	--	17 - 17	1, ●	60740	60620	60664
		04 - 15	1, ●	60740	60620	60664
<b>Ram</b>						
1500	Air suspension	13 - 16	●	60731	60607	60658
	Coil springs	11 - 17	●	60730	60607	60657
2500	--	11 - 13	1, 2, 6, ●	60732	60607	60661
3500	--	11 - 12	1, 2, 6, ●	60732	60607	60661
<b>Toyota</b>						
Tundra	6.5' bed	07 - 19	5, ●	60751	60607	60667
	--	00 - 06	6, ●	60750*	60625*	60665*

\* Continued while supplies last

All models: Brake, fuel and electrical lines may need to be loosened or repositioned. Heat shield requires modification or removal.

- |  |   |
|--|---|
| 1. Passenger-side wheel well must be notched for frame rail access     | 4. Vacuum canister requires relocation (kit included)                         |
| 2. Parking brake cable bracket may require relocation                  | 5. Ball cannot be turned over. Brake lines must be cable-tied (ties included) |
| 3. Exhaust may have to be permanently lowered on 2005 and newer models | 6. Do not invert ball with heavy loads on two-wheel drive models              |
|  | ● = No frame drilling required  |

30k

GTW

## UNDER-BED QUICK GOOSE II GOOSENECK HITCHES

- Two-handle operation for raising and lowering the gooseneck ball
- Dual handles eliminate the need to climb in and out of the truck bed
- Drop-ball storage keeps the truck bed free of obstructions
- Installation requires no welding or truck bed removal
- Heavy-duty handles can be positioned on either side of the truck
- Chrome-plated trim ring provides a finished look
- Rubber hole cover #66145 helps prevent corrosion in trailer ball hole
- Includes spring-loaded safety chain loops and grade-8 hardware
- Protected by a highly durable carbide powder coat finish
- Informative, full-color retail box



60630



66145



Raise / lower the trailer ball without climbing in truck bed



Ball up, ready for coupling



Ball stored, without included rubber cover

Bulk#	Pkg#	Description	Make	Ball Size	Finish	GTW / Vertical Load
--	60630	Quick Goose II gooseneck hitch	Chevrolet / GMC and Ford	2-5/16"	Carbide	30,000 / 7,500 lbs.
--	60640	Quick Goose II gooseneck hitch	Dodge / Ram and Ford	2-5/16"	Carbide	30,000 / 7,500 lbs.
66145	--	Replacement rubber hole cover	--	--	Black rubber	--

30k

GTW

## UNDER-BED FOLDING BALL GOOSENECK HITCH

- Folding ball design keeps truck bed free of obstructions
- Permanently attached gooseneck ball cannot be loosened or stolen
- Chrome-plated 2-5/16" trailer ball fits all standard gooseneck trailers
- Includes spring-loaded safety chain loops and grade-8 hardware
- Protected by a highly durable carbide powder coat finish
- Patents #656,437 and #664,076
- Informative, full-color retail box



61652



Pull ball pin, raise cover



Lower ball, close cover



Ball stored

Pkg#	Ball Size	Finish	GTW / Vertical Load
61652	2-5/16"	Carbide	30,000 / 7,500 lbs.



On two-wheel drive trucks, a clearance check must be performed when truck is loaded and unloaded to verify the inverted ball will not interfere with the top of the differential. See footnote 6 for more details.

# QUICK GOOSE II & FOLDING BALL APPLICATION GUIDE

- Weight ratings are limited to vehicle manufacturer's stated capacities
- Vehicle-specific design optimizes strength and installation time
- Protected by a rust-resistant liquid Bonderite® coating
- Includes grade-8 mounting hardware



60667

## Quick Goose II & Folding Ball Gooseneck Hitches

Make / Model	Style	Years	Footnotes	Quick Goose II Hitch#	Folding Ball Hitch#	Bracket#
<b>Chevrolet / GMC</b>						
C/K Series Pickups	Excluding cab & chassis	88 - 00	●	60630	61652	60631
Silverado / Sierra 1500	--	99 - 06	●	60630	61652	60652
Silverado / Sierra 1500 Classic	--	07 - 07	●	60630	61652	60652
Silverado / Sierra 2500	--	99 - 04	●	60630	61652	60652
Silverado / Sierra 2500 HD	--	01 - 10	4, ●	60630	61652	60652
Silverado / Sierra 2500 HD Classic	--	07 - 07	4, ●	60630	61652	60652
Silverado / Sierra 3500	--	01 - 06	4, ●	60630	61652	60652
Silverado / Sierra 3500 Classic	--	07 - 07	4, ●	60630	61652	60652
Silverado / Sierra 3500 HD	--	07 - 10	4, ●	60630	61652	60652
<b>Dodge</b>						
Ram 1500	--	02 - 08	1, 2	60640	--	60659
		94 - 01	●	60640	--	60635
Ram 2500 / 3500	--	03 - 10	1, 2, 5, ●	--	61652	60661
		94 - 02	5, ●	60640	--	60635
<b>Ford</b>						
F-150	--	04 - 14	●	60630	61652	60641
		97 - 03	●	60630	61652	60637
		80 - 96	1, ●	60630	61652	60636
F-150 Heritage	--	04 - 04	●	60630	61652	60637
F-250	New body	97 - 03	●	60630	61652	60637
	Old body	80 - 98	--	60630	61652	60636
F-250 / F-350 Super Duty	--	11 - 16	3, ●	60630	61652	60644
		99 - 10	3, ●	60640	--	60644
		99 - 10	3, ●	60640	--	60643*
F-350	Excluding overload springs	80 - 98	●	60630	61652	60636
F-450 Super Duty	Excluding cab & chassis	08 - 12	3, ●	60640	--	60644
		08 - 10	3, ●	60640	--	60643*
<b>Ram</b>						
2500	--	11 - 13	1, 2, 5, ●	--	61652	60661
3500	--	11 - 12	1, 2, 5, ●	--	61652	60661

\* Continued while supplies last

All models: Brake, fuel and electrical lines may need to be loosened or repositioned. Heat shield requires modification or removal.

1. Passenger-side wheel well must be notched for frame rail access
  2. Parking brake cable bracket may require relocation
  3. Exhaust may have to be permanently lowered on 2005 and newer models
  4. Vacuum canister requires relocation (kit included)
  5. Do not invert ball with heavy loads on two-wheel drive models
- = No frame drilling required

**30k**

GTW

## OVER-BED FOLDING BALL GOOSENECK HITCH

- Folding ball design keeps truck bed free of obstructions
- Stainless steel safety pin and pivot spring prevent binding
- Permanently attached gooseneck ball
- Includes safety chain loops and grade-8 hardware
- Patent#: 5,571,270; 5,755,452; 5,435,585
- Informative, full-color retail packaging

Pkg#	Plate Size	Ball Size	Finish	GTW / Vertical Load
61052	12" x 14"	2-5/16"	Carbide	30,000 / 7,500 lbs.



61052

**30k**

GTW

## OVER-BED FIXED BALL GOOSENECK HITCHES

- Reinforcement required to reach max gross trailer weight rating



65500



61100

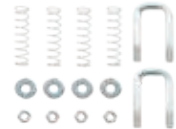

66113

Part#	Description	Plate Size	Ball Size	Finish	GTW / Vertical Load
65500	Flat plate with fixed trailer ball and two 1/2" forged D-rings	13" x 48"	2-5/16"	Carbide	30,000 / 7,500 lbs.
61100	Flat plate with fixed trailer ball (safety chain hook-ups sold separately)	12" x 12"	2-5/16"	Carbide	30,000 / 7,500 lbs.
66113	Safety chain U-bolt kit	--	--	--	--

## UNIVERSAL OVER-BED GOOSENECK BRACKETS

- Universal design fits multiple vehicles and hitches
- High-strength, laser-cut steel
- Includes grade-8 mounting hardware



61502

## WELD-ON GOOSENECK BALL

- High-strength, ready-to-weld steel alloy
- Heat-treated for optimum durability
- Tested to U.S. VESC V-5 specifications



40094

Part#	GTW	Fit	Finish
61502	30,000 lbs	Universal	Raw

Part#	GTW	Ball Size	Finish
40094	30,000 lbs	2-5/16"	Raw

**30k**  
GTW

# OVER-BED GOOSENECK APPLICATION GUIDE

- Up to 30,000 lbs. GTW (limited to vehicle capacities)
- Vehicle-specific design optimizes strength and installation time
- Constructed from high-strength, laser-cut steel for a precise fit
- Protected by a rust-resistant liquid Bonderite® coating
- Includes grade-8 mounting hardware



61301

## Over-Bed Gooseneck Hitches

Make / Model	Style	Years	Footnotes	Folding Ball Hitch#	Fixed Ball Hitch#	Flat Plate Hitch#	Bracket#
<b>Chevrolet / GMC</b>							
C1500 / C2500	6' bed	88 - 99	--	61052	61100	65500	61504
	8' bed	88 - 99	--	61052	61100	65500	61503
C3500	--	88 - 99	--	61052	61100	65500	61503
K1500 / K2500	6' bed	88 - 99	--	61052	61100	65500	61504
	8' bed	88 - 99	--	61052	61100	65500	61503
K3500	--	88 - 99	--	61052	61100	65500	61503
Silverado / Sierra 1500	--	07 - 18	--	61052	61100	65500	61331
		99 - 06	●	61052	61100	65500	61341
Silverado / Sierra 1500 Classic	--	07 - 07	●	61052	61100	65500	61341
Silverado / Sierra 1500 Legacy	--	19 - 19	--	61052	61100	65500	61331
Silverado / Sierra 2500	Excluding cab & chassis	99 - 04	●	61052	61100	65500	61341
Silverado / Sierra 2500 HD	Excluding cab & chassis	11 - 15	●	61052	61100	65500	61301
		01 - 10	●	61052	61100	65500	61341
Silverado / Sierra 2500 HD Classic	Excluding cab & chassis	07 - 07	●	61052	61100	65500	61341
Silverado / Sierra 3500	Excluding cab & chassis	01 - 06	●	61052	61100	65500	61341
Silverado / Sierra 3500 Classic	Excluding cab & chassis	07 - 07	●	61052	61100	65500	61341
Silverado / Sierra 3500 HD	Excluding cab & chassis	11 - 16	●	61052	61100	65500	61301
		07 - 10	●	61052	61100	65500	61341
<b>Dodge</b>							
Ram 1500	--	02 - 08	●	61052	61100	65500	61319
		94 - 01	--	61052	61100	65500	61509
Ram 2500	--	03 - 10	--	61052	61100	65500	61529
		94 - 02	--	61052	61100	65500	61509
Ram 3500	--	03 - 10	--	61052	61100	65500	61529
		94 - 02	--	61052	61100	65500	61509
<b>Ford</b>							
F-150	--	04 - 13	●	61052	61100	65500	61321
		97 - 03	--	61052	61100	65500	61506
		80 - 96	--	61052	61100	65500	61505
F-150 Heritage	--	04 - 04	--	61052	61100	65500	61506
F-250	--	80 - 99	--	61052	61100	65500	61505
F-250 Super Duty	--	99 - 15	●	61052	61100	65500	61332
F-350 Super Duty	Excluding cab & chassis	99 - 15	●	61052	61100	65500	61332
F-450 Super Duty	Excluding cab & chassis	08 - 11	●	61052	61100	65500	61332
<b>Ram</b>							
2500	--	11 - 12	--	61052	61100	65500	61529
3500	--	11 - 12	--	61052	61100	65500	61529

● = No frame drilling required

# 5TH WHEEL RAIL OPTIONS

25k

GTW

## 5TH WHEEL RAIL GOOSENECK HITCHES

- Allows pickup trucks equipped with 5th wheel rails to tow gooseneck trailers
- Mounts to all industry-standard 5th wheel rails
- Four-pin installation and removal for easy truck bed access
- Features a welded 2-5/16" trailer ball
- #16055 can be positioned over the axle or flipped to provide a 3" rearward offset
- Includes safety chain hookups, pins & clips
- Protected by a durable carbide powder coat finish
- Tested for safety in accordance with SAE J2638
- Informative, full-color retail box

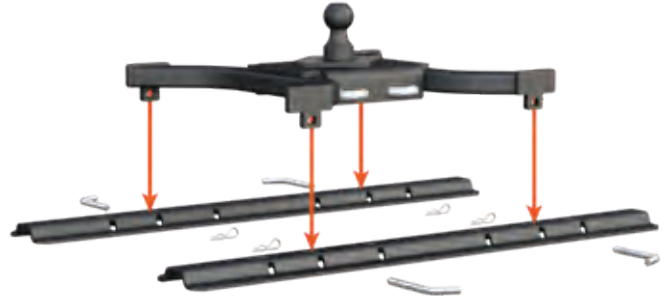

16085



16055

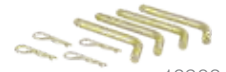

16902

Pkg#	Description	Ball Size	Finish	GTW
16085	Spyder gooseneck hitch	2-5/16"	Carbide	25,000 lbs.
16055	Bent plate gooseneck hitch with 3" offset	2-5/16"	Carbide	25,000 lbs.
16902	Replacement rail pins & clips	--	Yellow zinc	--



## CUSTOM 5TH WHEEL BRACKETS

CURT custom brackets are designed to bolt onto the truck's frame and provide a set of permanent base rails in the truck bed to mount a 5th wheel hitch. Each set of brackets is designed to fit a specific truck application.

- Provides a solid mounting point for 5th wheel base rails and a 5th wheel hitch
- Brackets designed to be used in combination with CURT base rails #16104 or #16204
- Vehicle-specific application reduces or eliminates drilling to cut installation time in half
- Protected by a rust-resistant liquid Bonderite® coating
- Includes mounting hardware





# GOOSENECK ELECTRICAL

## CUSTOM WIRING HARNESS EXTENSIONS

- Routes a 7-way RV blade socket into truck bed while retaining use of rear socket
- Simple plug-and-play design eliminates the need for cutting or splicing
- Neoprene well nuts isolate steel bolts from aluminum surfaces (#57007)



Right-angle plug for easy installation

## 7-WAY RV BLADE EXTENSION

- Routes existing 7-way RV blade socket into full-size pickup truck bed (7' length)
- Universal size fits any 7-way RV blade socket
- Allows for easy connection of 5th wheel or gooseneck wiring



## REPLACEMENT 7-WAY RV BLADE HARNESSES

- Replaces the trailer-end plug of any 7-way harness
- Wires protected by heavy-duty, weather-resistant cable
- Cold-weather harnesses feature soft thermoplastic elastomer casing to remain flexible in cold temperatures (temperature rating from -40°F up to 221°F)



## BRAKE CONTROLS

- Easily calibrated for all towing needs
- Compatible with anti-lock brakes and cruise control



Name	Retail Pkg#	Six-Pack#	Repl. Bracket#	Axles	Brakes	Activation Method	Display	Vertical Mount Angle	Level Adjust	Warranty
Echo™	51180 <b>NEW</b>	--	--	1 - 2	2 - 4	Tri-axis inertia	Phone app	N/A	Auto	Ltd lifetime
Spectrum™	51170	--	--	1 - 4	2 - 8	Tri-axis inertia	Tri-color LED	Any	Auto	Ltd lifetime
Assure™	51160	--	--	1 - 4	2 - 8	Tri-axis inertia	OLED screen	Any	Auto	Ltd lifetime
TriFlex™	51140	51142	51144	1 - 4	2 - 8	Tri-axis inertia	Digital	-20° to +70°	Auto	Ltd lifetime
Reflex™	51130	51132	--	1 - 4	2 - 8	Dual-axis inertia	Digital	Any	Auto	Ltd lifetime
Discovery™	51120	51122	51124	1 - 4	2 - 8	Time-based	Digital	Any	Auto	Ltd lifetime
Venturer™	51110	--	51114	1 - 3	2 - 6	Time-based	LED	Any	Auto	Ltd lifetime

**TESTED. PROVEN. SAFE.**



# 5TH WHEEL HITCHES

## TESTED FOR ADVENTURE

CURT 5th wheel towing products offer the superior towing power and stable ride your customers need to Bring It®. CURT 5th wheel hitches are available in capacities of 16K to 25K and with a range of mounting options. We offer three distinct series, including our articulating A-series, quiet Q-series and economical E-series. See page 190 for a helpful hitch selection guide. We also continue to offer a wide variety of 5th wheel accessories, including our innovative 5th wheel hitch lock.



# FEATURED PRODUCTS



## A25 hitch

The A25 is our best 5th wheel yet, featuring a 25K rating, a patented head design, a self-resetting handle and an easier-than-ever setup.



## Hitch lock

Designed to maximize 5th wheel hitch security, this lock inserts at the base rail connection and features a unique, flush-mount design.



## OEM puck systems

OEM puck system legs and rollers streamline 5th wheel towing with a simple drop-in installation. Available for Ford, GM, Nissan and Ram.

# PRODUCT INDEX



Mounting a 5th Wheel Hitch



Puck System Legs



Puck System Roller Products



Roller Units



Brackets & Base Rails



X5 Adapter Plate



A-Series 5th Wheels



Q-Series 5th Wheels



E-Series 5th Wheel



5th Wheel Accessories



5th Wheel Electrical

# 5TH WHEEL HITCHES

CURT 5th wheel hitches are designed for versatile application and are available in three distinct series. Each one is compatible with a variety of mounting options. See below for an overview of the features and benefits of our different 5th wheel hitches.



## A-SERIES

The A-series is named for its articulating head design. The head is built on a patented cast yoke that offers a stable, quiet ride, even with large 5th wheel trailers. This cast yoke also features torsion springs and poly-torsion inserts to support the head and add even more stability to the connection.

- Lockable, self-resetting handle for fewer steps while coupling
- One-pin head attachment for easy removal and relocation
- High-strength interlocking jaws to add security and reduce noise
- Compatible with Sidewinder™ pin boxes (see page 207)



## Q-SERIES

The Q-series is designed to offer the quietest towing possible. It features a spherical axial bearing that allows the head to tilt in any direction needed to ensure a smooth ride. The head is also equipped with three grease fittings for continuous lubrication and thick rubber stoppers to cushion the head.

- Lockable, short-throw, single-handle operation
- Self-aligning head offers a wide opening for easy coupling
- Dual jaws provide 360° kingpin contact to resist chucking noises
- Not compatible with Sidewinder™ pin boxes



## E-SERIES

The E-series is designed to be a more economical option for our budget-conscious customers. The E-series operates on a dual-pivoting head that provides 10° of lateral movement for smooth towing. The head also features an anti-rattle skid plate with rubber stoppers to help promote a quiet ride.

- Easy, single-handle operation
- Automatic locking mechanism for simple, secure coupling
- Four height adjustment positions to adapt to each unique truck bed
- Compatible with Sidewinder™ pin boxes (see page 207)

## QUICK COMPARISON

Feature	A-Series	Q-Series	E-Series
Pivoting Mechanism	Cast yoke with two pivot points	Spherical axial bearing	10° dual-pivoting head
Handle Operation	Single-throw, self-resetting handle	Short-throw, single handle	Single handle
Head Opening	Extra wide, self-aligning	Extra wide, self-aligning	Self-aligning
Jaw Type	Dual, interlocking	Dual	Locking bar
Coupling Indicator	Yes	Yes	No
Head Removal	One-pin	Two-pin	Two-pin
Sidewinder™ Compatible	Yes (wedge required)	No	Yes (wedge required)
GTW Options	16K, 20K, 25K	20K, 24K, 25K	16K
Warranty	Limited lifetime	Limited lifetime	Limited lifetime

# 5TH WHEEL MOUNTING OPTIONS

## OEM Puck System Products

Puck system legs and roller products use a simple quarter-turn anchor system to easily and securely drop into the truck bed pucks built into many pickups today.

- Options available for Ford, GM, Nissan and Ram
- Compatible with most CURT 5th wheel hitches



## 5th Wheel Rollers

CURT 5th wheel rollers are true rolling units, operating on solid rods and wheels to resist binding. They add 12" of clearance when making tight turns.

- Adds turning clearance for short-bed trucks
- Available in 16K, 20K and 24K capacities



## Custom Under-Bed Brackets

Each designed to fit a specific truck application, our custom brackets install in less time and provide a solid mount for our industry-standard base rails.

- Vehicle-specific fit reduces or eliminates drilling
- Protected by a rust-resistant liquid Bonderite® coating



## Industry-Standard Base Rails

CURT industry-standard base rails accept any CURT 5th wheel legs or roller, as well as any competitor 5th wheel with industry-standard mounting points.

- Gloss black or carbide black powder coat finish
- Co-cured in a rust-resistant liquid Bonderite® coating



## X5 Adapter Plates

X5 adapter plates allow a gooseneck hitch to become a 5th wheel mount. They drop into the gooseneck hole and provide a set of industry-standard base rails.

- Available for EZr™, Double Lock and competitor models
- Compatible with CURT 5th wheels up to 20,000 lbs.



## 5th Wheel Accessories

We offer a number of accessories to help improve 5th wheel operation and safety while towing, including 5th wheel wedges, locks, noise dampeners and more.

- Lube plates and sound pads for smooth operation
- Safety chain loops and locks for improved safety



# MOUNTING A 5TH WHEEL HITCH

There are several components that make up a 5th wheel hitch, and these components are determined by truck type and customer preferences. Answer the following questions to help choose the right hitch for your customer.

## What size is the truck bed?

The length of the truck bed will determine which type of mounting platform the 5th wheel hitch requires: legs or a roller. **Note: A roller may be required for long-bed trucks. Review each configuration before purchase.**



### LONG-BED

5th wheel legs are the standard 5th wheel mounting method. A long-bed truck will provide the necessary room for this option.

For long-bed trucks, follow the orange path.



### SHORT-BED

A 5th wheel roller is recommended on short-bed trucks. A roller adds clearance between the cab and the trailer when turning.

For short-bed trucks, follow the blue path.

## A | OEM PUCK SYSTEM OPTIONS

Many trucks today, specifically from Ford, GM, Nissan and Ram, come with a built-in mounting platform in the bed called a puck system. A puck system makes installing a CURT 5th wheel hitch very easy.

If the truck does not have a puck system, continue to page 198 for rail system options.

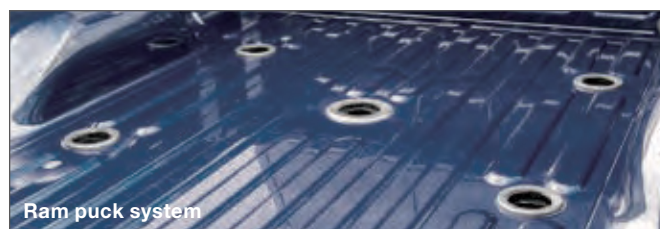

Ram puck system



### LONG-BED WITH OEM PUCK SYSTEM

If the long bed has a puck system, select a 5th wheel hitch with OEM puck system legs.

See page 195 for our complete kits.



### SHORT-BED WITH OEM PUCK SYSTEM

If the short bed has a puck system, select an OEM puck system roller to mount the 5th wheel hitch.

See page 197 for our complete kits.

## B | PERMANENT RAIL SYSTEMS

If your customer prefers fixed rails in the truck bed, select a vehicle-specific, under-bed bracket kit and corresponding base rails to mount the 5th wheel hitch.

### LONG-BED

1. See page 199 for available bracket applications.
2. See page 198 for corresponding base rails.
3. Select a 5th wheel hitch from the 'Long-Bed Options' starting on page 203.

3. 5th wheel with legs



2. Above-bed base rails



1. Custom under-bed brackets



### SHORT-BED

1. See page 199 for available bracket applications.
2. See page 198 for corresponding base rails.
3. Select a 5th wheel hitch from the 'Short-Bed Options' starting on page 203.

3. 5th wheel with roller



2. Above-bed base rails



1. Custom under-bed brackets



## C | REMOVABLE RAIL SYSTEMS

If your customer prefers the option of easily removing the base rails for an unobstructed truck bed, select a gooseneck hitch kit and an X5 adapter plate to mount the 5th wheel hitch.

### LONG-BED

1. See page 169 for available gooseneck hitches.
2. See page 201 for a corresponding X5 adapter.
3. Select a 5th wheel hitch from the 'Long-Bed Options' starting on page 203.

3. 5th wheel with legs



2. Above-bed X5 adapter



1. Under-bed gooseneck hitch kit



### SHORT-BED

1. See page 169 for available gooseneck hitches.
2. See page 201 for a corresponding X5 adapter.
3. Select a 5th wheel hitch from the 'Short-Bed Options' starting on page 203.

3. 5th wheel with roller



2. Above-bed X5 adapter



1. Under-bed gooseneck hitch kit



# PUCK SYSTEMS FOR LONG-BED

## OEM PUCK SYSTEM 5TH WHEEL HITCH LEG KITS

5th wheel kits are available for Ford, GM, Nissan Titan XD and Ram trucks with the OEM puck system. These kits come with puck system legs and are designed to fit long-bed trucks. For short-bed trucks with the puck system, a 5th wheel roller will be needed.

**See page 196 for our OEM puck system 5th wheel roller products.**

### How OEM puck system legs work



**Step 1** - Drop legs into the truck bed puck system



**Step 2** - Close the anchor levers to lock legs into place



**Step 3** - Secure levers with attached safety pins



Ram legs installed in a long-bed truck with Q20 head (16045)

### Product Details

- Legs allow CURT 5th wheel hitches to fit an OEM puck system
- Quarter-turn anchors allow for quick installation and removal
- Anchors can be adjusted to eliminate chocking between the legs and under-bed platform
- Protected by a highly durable carbide powder coat finish



16069 - GM legs with Q25 head

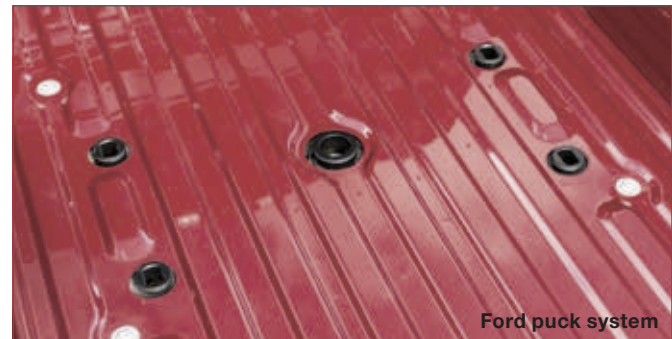

Ford puck system

Installation of these products requires an OEM truck bed puck system



16034 - Ford legs with A20 head



16049 - Ram legs with Q25 head



16074 - Nissan legs with A20 head



Step 1 - Verify vehicle make and puck system compatibility

Step 2 - Determine the weight capacity required

Step 3 - Select a 5th wheel kit. See comparison on page 190

Kit#	GTW / Vertical Load	5th Wheel Head	OEM Puck System Legs	Height
<b>Chevrolet / GMC</b>				
16063	16,000 / 4,000 lbs.	A16 head (16520)	Chevrolet / GMC legs (16025)	13" - 17"
16061	16,000 / 4,000 lbs.	E16 head (16515)	Chevrolet / GMC legs (16025)	11-1/2" - 13-1/2"
16064	20,000 / 5,000 lbs.	A20 head (16540)	Chevrolet / GMC legs (16025)	13" - 17"
16065	20,000 / 5,000 lbs.	Q20 head (16530)	Chevrolet / GMC legs (16025)	13" - 17"
16067	24,000 / 6,000 lbs.	Q24 head (16545)	Chevrolet / GMC legs (16025)	13" - 17"
16066	25,000 / 6,250 lbs.	A25 head (16580)	Chevrolet / GMC legs (16025)	13" - 17"
16069	25,000 / 6,250 lbs.	Q25 head (16565)	Chevrolet / GMC legs (16025)	13" - 17"
<b>Ford</b>				
16033	16,000 / 4,000 lbs.	A16 head (16520)	Ford legs (16017)	13" - 17"
16031	16,000 / 4,000 lbs.	E16 head (16515)	Ford legs (16017)	11-1/2" - 13-1/2"
16034	20,000 / 5,000 lbs.	A20 head (16540)	Ford legs (16017)	13" - 17"
16035	20,000 / 5,000 lbs.	Q20 head (16530)	Ford legs (16017)	13" - 17"
16037	24,000 / 6,000 lbs.	Q24 head (16545)	Ford legs (16017)	13" - 17"
16036	24,000 / 6,000 lbs.	A25 head (16580)	Ford legs (16017)	13" - 17"
16039	24,000 / 6,000 lbs.	Q25 head (16565)	Ford legs (16017)	13" - 17"
<b>Nissan Titan XD</b>				
16073	16,000 / 4,000 lbs.	A16 head (16520)	Nissan Titan XD legs (16026)	13" - 17"
16071	16,000 / 4,000 lbs.	E16 head (16515)	Nissan Titan XD legs (16026)	11-1/2" - 13-1/2"
16074	20,000 / 5,000 lbs.	A20 head (16540)	Nissan Titan XD legs (16026)	13" - 17"
16075	20,000 / 5,000 lbs.	Q20 head (16530)	Nissan Titan XD legs (16026)	13" - 17"
<b>Ram</b>				
16043	16,000 / 4,000 lbs.	A16 head (16520)	Ram legs (16021)	14" - 18"
16041	16,000 / 4,000 lbs.	E16 head (16515)	Ram legs (16021)	12-1/2" - 15-1/2"
16044	20,000 / 5,000 lbs.	A20 head (16540)	Ram legs (16021)	14" - 18"
16045	20,000 / 5,000 lbs.	Q20 head (16530)	Ram legs (16021)	14" - 18"
16047	24,000 / 6,000 lbs.	Q24 head (16545)	Ram legs (16021)	14" - 18"
16046	25,000 / 6,250 lbs.	A25 head (16580)	Ram legs (16021)	14" - 18"
16049	25,000 / 6,250 lbs.	Q25 head (16565)	Ram legs (16021)	14" - 18"

## OEM PUCK SYSTEM 5TH WHEEL LEGS ONLY



16017  
Ford legs



16025  
GM legs



16021  
Ram legs

Part#	Fits	GTW
16017	Ford	Up to 24,000 lbs.
16021	Ram	Up to 25,000 lbs.
16025	Chevrolet / GMC	Up to 25,000 lbs.
16026	Nissan Titan XD	Up to 20,000 lbs.



16026  
Nissan legs

# PUCK SYSTEMS FOR SHORT-BED

24K

GTW

## OEM PUCK SYSTEM 5TH WHEEL ROLLER PRODUCTS

The 5th wheel roller products below are for short-bed trucks with the OEM puck system. The Ford option has a built-in roller unit and is designed to accept a CURT 5th wheel head. The GM and Ram options are designed to accept a CURT 5th wheel roller.

### How OEM puck system rollers work



**Step 1** - Drop OEM product into the truck bed puck system



**Step 2** - Close the anchor levers to lock the roller into place



**Step 3** - Secure levers with attached safety pins



Chevrolet / GMC roller adapter installed in a short-bed truck with A20 head and R20 roller kit (16669)

## Product Details

### Ford roller system

- Adapts any CURT 5th wheel head unit to fit the Ford puck system
- Features integrated roller to provide added clearance for short-bed trucks

### Chevrolet / GMC & Ram roller adapters

- Adapts any CURT 5th wheel roller to fit the OEM puck system
- Requires a 5th wheel roller unit to mount the 5th wheel hitch

### All roller products

- Quarter-turn anchors allow for quick installation and removal
- Anchors can be adjusted to eliminate chocking between the roller and under-bed platform
- Tested for safety in accordance with SAE J2638
- Protected by a durable carbide powder coat finish
- Capacity limited to lowest-rated towing component



16020



16022



16023

Part#	Make	GTW	Description	Notes	Finish
16020	Ford	Up to 24,000 lbs.	OEM roller system (roller built in)	Hitch head sold separately	Carbide
16022	Ram	Up to 24,000 lbs.	OEM roller adapter	Hitch head and roller sold separately	Carbide
16023	Chevrolet / GMC	Up to 20,000 lbs.	OEM roller adapter	Hitch head and roller sold separately	Carbide

Step 1 - Verify vehicle make and puck system compatibility

Step 2 - Determine the weight capacity required

Step 3 - Select a 5th wheel kit.

Kit#	GTW / Vertical Load	5th Wheel Head	5th Wheel Roller	OEM Puck System Product	Height
<b>Chevrolet / GMC</b>					
16667	16,000 / 4,000 lbs.	E16 head (16515)	R16 roller (16560)	Chevrolet / GMC roller adapter (16023)	16" - 19"
16668	16,000 / 4,000 lbs.	A16 head (16520)	R16 roller (16560)	Chevrolet / GMC roller adapter (16023)	19" - 23"
16669	20,000 / 5,000 lbs.	A20 head (16540)	R20 roller (16550)	Chevrolet / GMC roller adapter (16023)	19" - 23"
16671	20,000 / 5,000 lbs.	Q20 head (16530)	R20 roller (16550)	Chevrolet / GMC roller adapter (16023)	19" - 23"
<b>Ford</b>					
16674	16,000 / 4,000 lbs.	E16 head (16515)	--	Ford roller (16020)	14" - 18"
16675	16,000 / 4,000 lbs.	A16 head (16520)	--	Ford roller (16020)	17-1/2" - 21-1/2"
16676	20,000 / 5,000 lbs.	A20 head (16540)	--	Ford roller (16020)	17-1/2" - 21-1/2"
16677	20,000 / 5,000 lbs.	Q20 head (16530)	--	Ford roller (16020)	17-1/2" - 21-1/2"
16678	24,000 / 6,000 lbs.	Q24 head (16545)	--	Ford roller (16020)	17-1/2" - 21-1/2"
<b>Ram</b>					
16684	16,000 / 4,000 lbs.	E16 head (16515)	R16 roller (16560)	Ram roller adapter (16022)	16" - 19"
16685	16,000 / 4,000 lbs.	A16 head (16520)	R16 roller (16560)	Ram roller adapter (16022)	19" - 23"
16686	20,000 / 5,000 lbs.	A20 head (16540)	R20 roller (16550)	Ram roller adapter (16022)	19" - 23"
16687	20,000 / 5,000 lbs.	Q20 head (16530)	R20 roller (16550)	Ram roller adapter (16022)	19" - 23"
16688	24,000 / 6,000 lbs.	Q24 head (16545)	R24 roller (16570)	Ram roller adapter (16022)	19" - 23"

## 5TH WHEEL ROLLERS ONLY

For short-bed trucks, a 5th wheel roller is used in place of fixed 5th wheel legs to provide the extra clearance needed to make tight turns. A roller allows the hitch to slide backward towards the tailgate several inches, allowing the truck and trailer to turn without obstruction.

See our complete roller and hitch head kits under the 'Short-Bed Options' section in the table starting on page 203.

### Product Details

- Constructed with solid, non-binding rods that lock the hitch into position
- Designed to be a true rolling unit, not just a slider
- Provides 12" of travel
- Uses wheels to bear the weight
- Protected by a highly durable carbide powder coat finish

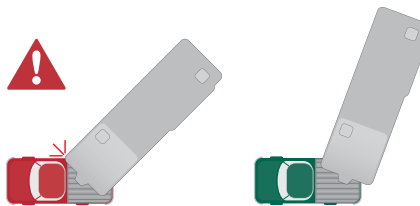

16560



16550



16570

Pkg#	Description	GTW	Finish
16560	R16 5th wheel roller unit	16,000 lbs.	Carbide
16550	R20 5th wheel roller unit	20,000 lbs.	Carbide
16570	R24 5th wheel roller unit	24,000 lbs.	Carbide

# PERMANENT RAIL SYSTEMS

## CUSTOM UNDER-BED BRACKETS & INDUSTRY-STANDARD BASE RAILS

Custom brackets provide a set of permanent 5th wheel base rails in the truck bed. If your customer prefers removable rails for no obstructions in the truck bed.

### Custom brackets

- Designed to be used in combination with CURT base rails #16104 or #16204
- Vehicle-specific applications reduce or eliminate drilling, cutting installation time in half
- Protected by a rust-resistant liquid Bonderite® coating
- Includes mounting hardware



16400 brackets shown with 16204 base rails

### Semi-custom brackets

- Designed to be used in combination with CURT universal brackets and base rails #16100 or #16200
- All semi-custom brackets require drilling to be installed

Step 1 - Pick vehicle-specific brackets starting

Step 2 - Select the base rails by finish preference

Step 3 - Start to select a 5th wheel hitch

## UNIVERSAL UNDER-BED BRACKETS & INDUSTRY-STANDARD BASE RAILS

- Intended for vehicle applications not covered by CURT custom brackets
- Compatible with CURT and most competitive 5th wheel hitches, rollers and gooseneck adapters
- All universal brackets require drilling or welding to be installed



16104 gloss rails  
16204 carbide rails  
16101 brackets

Part#	Multi-Pack#	Finish	Description	Includes
<b>5th Wheel Brackets and Base Rails</b>				
16150	--	Gloss black	Two 5th wheel base rails, four-bolt	Brackets and hardware
16100	--	Gloss black	Two 5th wheel base rails, 10-bolt	Brackets and hardware (16101)
16200	--	Carbide	Two 5th wheel base rails, 10-bolt	Brackets and hardware (16101)
<b>5th Wheel Base Rails Only</b>				
16104	--	Gloss black	Two 5th wheel base rails, 10-bolt	--
16204	--	Carbide	Two 5th wheel base rails, 10-bolt	--
<b>Replacement Parts</b>				
16101	--	Zinc-plated	Installation brackets and hardware	--
16111	--	Zinc-plated	Replacement installation hardware kit	--
16103	16103010	Zinc-plated	Replacement bracket bolts, needed when installing new brackets	16103 - eight bolts 16103010 - 10 sets of eight bolts

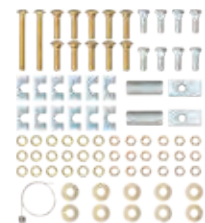

16111



16103



# APPLICATION GUIDE

## Custom 5th Wheel Under-Bed Brackets & Base Rails

Make / Model	Style	Years	Bracket Type	Bracket#	Drilling	Base Rails	
						Carbide#	Gloss#
<b>Chevrolet</b>							
Silverado 1500	--	07 - 18	Custom	16400	No	16204	16104
		99 - 06	Custom	16418	Yes	16204	16104
Silverado 1500 Classic	--	07 - 07	Custom	16418	Yes	16204	16104
Silverado 1500 Legacy	--	19 - 19	Custom	16400	No	16204	16104
Silverado 2500	--	99 - 04	Custom	16418	Yes	16204	16104
Silverado 2500 HD	--	11 - 19	Custom	16411	No	16204	16104
		01 - 10	Custom	16418	Yes	16204	16104
Silverado 2500 HD Classic	--	07 - 07	Custom	16418	Yes	16204	16104
Silverado 3500	--	01 - 06	Custom	16418	Yes	16204	16104
Silverado 3500 Classic	--	07 - 07	Custom	16418	Yes	16204	16104
Silverado 3500 HD	--	11 - 19	Custom	16411	No	16204	16104
		07 - 10	Custom	16418	Yes	16204	16104
<b>Dodge</b>							
Ram 1500	Excluding crew cab	09 - 10	Custom	16422	Yes	16204	16104
	--	09 - 10	Semi-custom	16306	Yes	16204	16104
	Extended crew cab only	06 - 08	Custom	16420	No	16204	16104
	Excluding extended crew cab	06 - 08	Custom	16419	No	16204	16104
	--	02 - 05	Custom	16419	No	16204	16104
	--	02 - 08	Semi-custom	16303	Yes	16200	16100
Ram 2500	--	03 - 10	Custom	16420	No	16204	16104
		03 - 09	Semi-custom	16301	Yes	16200	16100
Ram 3500	--	03 - 10	Custom	16420	No	16204	16104
		03 - 09	Semi-custom	16301	Yes	16200	16100

Applications continued on the following page

## Custom 5th Wheel Under-Bed Brackets & Base Rails

Make / Model	Style	Years	Bracket Type	Bracket#	Drilling	Base Rails	
						Carbide#	Gloss#
<b>Ford</b>							
F-150	Excluding Police Responder	15 - 18	Custom	16442	No	16204	16104
	Excluding 5.5' bed	04 - 14	Custom	16441	No	16204	16104
	--	04 - 11	Semi-custom	16300	Yes	16204	16104
		97 - 03	Custom	16437	No	16204	16104
F-150 Heritage	--	04 - 04	Custom	16437	No	16204	16104
F-250	--	97 - 99	Custom	16437	No	16204	16104
F-250 Super Duty	--	17 - 19	Custom	16428	No	16204	16104
		11 - 16	Custom	16424	No	16204	16104
		05 - 10	Custom	16448	Yes	16204	16104
		99 - 04	Custom	16443	Yes	16204	16104
F-350 Super Duty	Excluding cab & chassis	17 - 19	Custom	16428	No	16204	16104
		11 - 16	Custom	16424	No	16204	16104
		05 - 10	Custom	16448	Yes	16204	16104
	--	99 - 04	Custom	16443	Yes	16204	16104
F-450 Super Duty	Excluding cab & chassis	17 - 18	Custom	16428	No	16204	16104
		11 - 16	Custom	16424	No	16204	16104
		08 - 10	Custom	16448	Yes	16204	16104
<b>GMC</b>							
Sierra 1500	--	07 - 18	Custom	16400	No	16204	16104
		99 - 06	Custom	16418	Yes	16204	16104
Sierra 1500 Classic	--	07 - 07	Custom	16418	Yes	16204	16104
Sierra 1500 Limited	--	19 - 19	Custom	16400	No	16204	16104
Sierra 2500	--	99 - 04	Custom	16418	Yes	16204	16104
Sierra 2500 HD	--	11 - 19	Custom	16411	No	16204	16104
		01 - 10	Custom	16418	Yes	16204	16104
Sierra 2500 HD Classic	--	07 - 07	Custom	16418	Yes	16204	16104
Sierra 3500	--	01 - 06	Custom	16418	Yes	16204	16104
Sierra 3500 Classic	--	07 - 07	Custom	16418	Yes	16204	16104
Sierra 3500 HD	--	11 - 19	Custom	16411	No	16204	16104
		07 - 10	Custom	16418	Yes	16204	16104
<b>Nissan</b>							
Titan	--	17 - 18	Custom	16470	Yes	16204	16104
		04 - 15	Custom	16470	Yes	16204	16104
<b>Ram</b>							
1500	Coil springs, excluding Limited	11 - 18	Semi-custom	16306	Yes	16204	16104
	With factory air suspension	13 - 17	Custom	16444	Yes	16204	16104
1500 Classic	--	19 - 19	Semi-custom	16306	Yes	16204	16104
2500	Without 5th wheel prep pkg	14 - 18	Custom	16427	No	16204	16104
	--	13 - 13	Custom	16426	Yes	16204	16104
		11 - 12	Custom	16420	No	16204	16104
3500	--	13 - 18	Custom	16426	Yes	16204	16104
		11 - 12	Custom	16420	No	16204	16104
<b>Toyota</b>							
Tundra	6.5' bed, excl. extended crew cab	07 - 19	Custom	16468	Yes	16204	16104
	Excluding extended crew cab	07 - 19	Semi-custom	16304	Yes	16200	16100
	8' bed, standard cab	00 - 06	Custom	16465	No	16204	16104
		00 - 06	Semi-custom	16302	Yes	16200	16100

# REMOVABLE RAIL SYSTEMS

**20k**  
GTW

## X5 GOOSENECK TO 5TH WHEEL ADAPTER PLATES

The X5 adapter plate allows a gooseneck hitch to become a mounting platform for a 5th wheel hitch. The X5 shank simply drops into the gooseneck ball hole and instantly provides a set of industry-standard 5th wheel base rails.

See the table below for gooseneck hitch compatibility.

### Product Details

- Converts a gooseneck hitch into a set of standard 5th wheel base rails
- Simple, secure design allows for fast installation and removal as needed
- For use with CURT and competitive 5th wheels up to 20,000 lbs.
- Capacity limited to lowest-rated towing component
- Accepts any standard CURT 5th wheel legs or roller (excludes OEM puck system)
- Protected by a durable carbide powder coat finish
- Co-cured in a rust-resistant liquid Bonderite® coating
- **Not compatible with OEM-style gooseneck hitches**
- **Not compatible with Sidewinder™ pin boxes**  
(Trademark of Horizon Global™)



**Step 1 - Pick a gooseneck hitch. If your customer has a gooseneck hitch, see step 2**

**Step 2 - Select the corresponding X5 adapter plate to match the gooseneck**

**Step 3 - See page 190 for our 5th wheel hitch selection guide**



Part#	Fits	Capacity	Shank Style
16210	CURT Double Lock 60607, 60615, 60620, 60625	20,000 lbs.	Round shank
16220	CURT Double Lock EZr™ 60611 and 60619	20,000 lbs.	Round shank
16310	B&W Turnoverball® gooseneck hitch (does not work with shallow models)	20,000 lbs.	Square shank

See page 178 for original Double Lock gooseneck hitches. See page 176 for Double Lock EZr™ gooseneck hitches

# A-SERIES HITCHES

## 16k GTW A16 HITCH



16120

## 20k GTW A20 HITCH



16140

## 25k GTW A25 HITCH



16180

### Product Details

- GTW capacities up to 16,000, 20,000 and 25,000 lbs.
- Weight ratings are limited to vehicle manufacturer's stated capacities
- High-strength, interlocking jaws fully wrap the kingpin to minimize noise
- Extra wide head opening for easier coupling
- Fast, one-pin head removal makes moving easy with smaller, lighter pieces
- Constructed with a cast steel main body for a more precise build (A25 only)
- Offers three height adjustment positions to adapt to each unique truck bed
- Compatible with kingpin extension boxes, including common pivoting pin boxes (see below for 5th wheel wedge)
- Includes a polyethylene lube plate to eliminate messy grease deposits
- Protected by a highly durable carbide powder coat finish
- Tested for safety in accordance with SAE J2638
- Patent# 8,827,298

### Product Features



Lockable handle self-resets to the ready-to-couple position after the hitch is uncoupled



Fully articulating torsion head for controlled coupling and stable towing



Alignment pegs and easy-access mounting bolts for simple leg-to-body attachment (A20 & A25 only)



Cast yoke and poly-torsion inserts suppress shock loads and reduce noise

### Three-position coupling indicator



- UNCOUPLE** Jaws unlocked, ready to uncouple
- △ COUPLE** Jaws open, ready to couple
- TOW** Jaws locked, ready to tow

### A-Series Wedge

- Helps restrict movement between A-series hitch and Sidewinder™ pin boxes (Trademark of Horizon Global™)



16992



# A-SERIES 5TH WHEEL HITCH OPTIONS



16064



16669



16641

Part#	Description	GTW / Vertical Load	Height Range
<b>Long-Bed Options</b>			
16120	A16 5th wheel hitch	16,000 / 4,000 lbs.	13" - 17"
16121	A16 5th wheel hitch (16120) with base rails (16200)	16,000 / 4,000 lbs.	13" - 17"
16063	A16 head (16520) with Chevrolet / GMC puck system legs (16025)	16,000 / 4,000 lbs.	13" - 17"
16033	A16 head (16520) with Ford puck system legs (16017)	16,000 / 4,000 lbs.	13" - 17"
16073	A16 head (16520) with Nissan Titan XD puck system legs (16026)	16,000 / 4,000 lbs.	13" - 17"
16043	A16 head (16520) with Ram puck system legs (16021)	16,000 / 4,000 lbs.	14" - 18"
16140	A20 5th wheel hitch	20,000 / 5,000 lbs.	13" - 17"
16141	A20 5th wheel hitch (16140) with base rails (16200)	20,000 / 5,000 lbs.	13" - 17"
16064	A20 head (16540) with Chevrolet / GMC puck system legs (16025)	20,000 / 5,000 lbs.	13" - 17"
16034	A20 head (16540) with Ford puck system legs (16017)	20,000 / 5,000 lbs.	13" - 17"
16074	A20 head (16540) with Nissan Titan XD puck system legs (16026)	20,000 / 5,000 lbs.	13" - 17"
16044	A20 head (16540) with Ram puck system legs (16021)	20,000 / 5,000 lbs.	14" - 18"
16180	A25 5th wheel hitch	25,000 / 6,250 lbs.	13" - 17"
16181	A25 5th wheel hitch (16180) with base rails (16200)	25,000 / 6,250 lbs.	13" - 17"
16066	A25 head (16580) with Chevrolet / GMC puck system legs (16025)	25,000 / 6,250 lbs.	13" - 17"
16036	A25 head (16580) with Ford puck system legs (16017)	24,000 / 6,000 lbs.	13" - 17"
16046	A25 head (16580) with Ram puck system legs (16021)	25,000 / 6,250 lbs.	14" - 18"
<b>Short-Bed Options</b>			
16521	A16 head (16520) with R16 roller (16560)	16,000 / 4,000 lbs.	17-1/2" - 21-1/2"
16621	A16 head with R16 roller (16521) and base rails (16200)	16,000 / 4,000 lbs.	17-1/2" - 21-1/2"
16668	A16 head with R16 roller (16521) & Chevrolet / GMC puck system roller adapter (16023)	16,000 / 4,000 lbs.	19" - 23"
16675	A16 head (16520) & Ford puck system roller (16020)	16,000 / 4,000 lbs.	17-1/2" - 21-1/2"
16685	A16 head with R16 roller (16521) & Ram puck system roller adapter (16022)	16,000 / 4,000 lbs.	19" - 23"
16541	A20 head (16540) with R20 roller (16550)	20,000 / 5,000 lbs.	17-1/2" - 21-1/2"
16641	A20 head with R20 roller (16541) and base rails (16200)	20,000 / 5,000 lbs.	17-1/2" - 21-1/2"
16669	A20 head with R20 roller (16541) & Chevrolet / GMC puck system roller adapter (16023)	20,000 / 5,000 lbs.	19" - 23"
16676	A20 head (16540) & Ford puck system roller (16020)	20,000 / 5,000 lbs.	17-1/2" - 21-1/2"
16686	A20 head with R20 roller (16541) & Ram puck system roller adapter (16022)	20,000 / 5,000 lbs.	19" - 23"
<b>Individual Components</b>			
16520	A16 head only	16,000 / 4,000 lbs.	--
16920	A16 replacement leg kit and hardware	--	--
16540	A20 head only	20,000 / 5,000 lbs.	--
16906	A20 replacement leg kit and hardware	--	--
16580	A25 head only	25,000 / 6,250 lbs.	--
16907	A25 replacement leg kit and hardware	--	--
16902	Replacement rail pins & clips	--	--

For a guide in selecting the right 5th wheel for your customer's truck, see page 192

# Q-SERIES HITCHES

**20k**  
GTW

## Q20 HITCH



16130

**24k**  
GTW

## Q24 HITCH



16245

**25k**  
GTW

## Q25 HITCH



16265

### Product Details

- GTW capacities up to 20,000, 24,000 and 25,000 lbs.
- Weight ratings are limited to vehicle manufacturer's stated capacities
- Three easy-access grease fittings for lubrication
- Offers three height adjustment positions to adapt to each unique truck bed
- Includes a polyethylene lube plate to eliminate messy grease deposits
- Protected by a highly durable carbide powder coat finish
- Tested for safety in accordance with SAE J2638

### Product Features



Spherical axial bearing tilts head in any direction for a smooth, quiet ride



Dual jaws fully wrap the kingpin to reduce chucking noises and increase towing security



Wide, self-aligning head helps eliminate errors when backing up to the trailer for easier coupling



Lockable, short-throw handle automatically engages with the kingpin to simplify operation

### Three-position coupling indicator



- UNCOUPLE** Jaws unlocked, ready to uncouple
- △ COUPLE** Jaws open, ready to couple
- TOW** Jaws locked, ready to tow

# Q-SERIES 5TH WHEEL HITCH OPTIONS



16037



16677



16646

Part#	Description	GTW / Vertical Load	Height Range
<b>Long-Bed Options</b>			
16130	Q20 5th wheel hitch	20,000 / 5,000 lbs.	13" - 17"
16131	Q20 5th wheel hitch (16130) with base rails (16200)	20,000 / 5,000 lbs.	13" - 17"
16065	Q20 head (16530) with Chevrolet / GMC puck system legs (16025)	20,000 / 5,000 lbs.	13" - 17"
16035	Q20 head (16530) with Ford puck system legs (16017)	20,000 / 5,000 lbs.	13" - 17"
16075	Q20 head (16530) with Nissan Titan XD puck system legs (16026)	20,000 / 5,000 lbs.	13" - 17"
16045	Q20 head (16530) with Ram puck system legs (16021)	20,000 / 5,000 lbs.	14" - 18"
16245	Q24 5th wheel hitch	24,000 / 6,000 lbs.	13" - 17"
16246	Q24 5th wheel hitch (16245) with base rails (16200)	24,000 / 6,000 lbs.	13" - 17"
16067	Q24 head (16545) with Chevrolet / GMC puck system legs (16025)	24,000 / 6,000 lbs.	13" - 17"
16037	Q24 head (16545) with Ford puck system legs (16017)	24,000 / 6,000 lbs.	13" - 17"
16047	Q24 head (16545) with Ram puck system legs (16021)	24,000 / 6,000 lbs.	14" - 18"
16265	Q25 5th wheel hitch	25,000 / 6,250 lbs.	13" - 17"
16266	Q25 5th wheel hitch (16265) with base rails (16200)	25,000 / 6,250 lbs.	13" - 17"
16069	Q25 head (16565) with Chevrolet / GMC puck system legs (16025)	25,000 / 6,250 lbs.	13" - 17"
16039	Q25 head (16565) with Ford puck system legs (16017)	24,000 / 6,000 lbs.	13" - 17"
16049	Q25 head (16565) with Ram puck system legs (16021)	25,000 / 6,250 lbs.	14" - 18"
<b>Short-Bed Options</b>			
16536	Q20 head (16530) with R20 roller (16550)	20,000 / 5,000 lbs.	17-1/2" - 21-1/2"
16636	Q20 head with R20 roller (16536) and base rails (16200)	20,000 / 5,000 lbs.	17-1/2" - 21-1/2"
16671	Q20 head with R20 roller (16536) & Chevrolet / GMC puck system roller adapter (16023)	20,000 / 5,000 lbs.	19" - 23"
16677	Q20 head (16530) & Ford puck system roller (16020)	20,000 / 5,000 lbs.	17-1/2" - 21-1/2"
16687	Q20 head with R20 roller (16536) & Ram puck system roller adapter (16022)	20,000 / 5,000 lbs.	19" - 23"
16546	Q24 head (16545) with R24 roller (16570)	24,000 / 6,000 lbs.	17-1/2" - 21-1/2"
16646	Q24 head with R24 roller (16546) and base rails (16200)	24,000 / 6,000 lbs.	17-1/2" - 21-1/2"
16678	Q24 head (16545) & Ford puck system roller (16020)	24,000 / 6,000 lbs.	17-1/2" - 21-1/2"
16688	Q24 head with R24 roller (16546) & Ram puck system roller adapter (16022)	24,000 / 6,000 lbs.	19" - 23"
<b>Individual Components</b>			
16530	Q20 head only	20,000 / 5,000 lbs.	--
16904	Q20 replacement leg kit and hardware	--	--
16545	Q24 head only	24,000 / 6,000 lbs.	--
16913	Q24 replacement leg kit and hardware	--	--
16565	Q25 head only	25,000 / 6,250 lbs.	--
16963	Q25 replacement leg kit and hardware	--	--
16902	Replacement rail pins & clips	--	--

For a guide in selecting the right 5th wheel for your customer's truck, see page 192

**16k**

GTW

# E16 5TH WHEEL HITCH

## Product Details

- Up to 16,000 lbs. GTW / 4,000 lbs. vertical load
- Weight ratings are limited to vehicle manufacturer's stated capacities
- Pivots on dual axes for 10° of lateral movement
- Automatically locks for easy, secure coupling
- Operates using a single handle
- Features an anti-rattle skid plate for a quiet ride
- Mounts to all industry-standard base rails
- Offers four height adjustment positions to adapt to each unique truck bed
- Compatible with kingpin extension boxes, including common pivoting pin boxes (see page 207 for 5th wheel wedges)
- Protected by a highly durable steel carbide powder coat finish



Part#	Description	GTW / Vertical Load	Height Range
<b>Long-Bed Options</b>			
16115	E16 5th wheel hitch	16,000 / 4,000 lbs.	13" - 17"
16116	E16 5th wheel hitch (16115) with base rails (16200)	16,000 / 4,000 lbs.	13" - 17"
16061	E16 head (16515) with Chevrolet / GMC puck system legs (16025)	16,000 / 4,000 lbs.	11-1/2" - 13-1/2"
16031	E16 head (16515) with Ford puck system legs (16017)	16,000 / 4,000 lbs.	11-1/2" - 13-1/2"
16071	E16 head (16515) with Nissan Titan XD puck system legs (16026)	16,000 / 4,000 lbs.	11-1/2" - 13-1/2"
16041	E16 head (16515) with Ram puck system legs (16021)	16,000 / 4,000 lbs.	12-1/2" - 15-1/2"
<b>Short-Bed Options (*16505 adapter included)</b>			
16516*	E16 head (16515) with R16 roller (16560)	16,000 / 4,000 lbs.	14" - 17"
16616*	E16 head (16515) with R16 roller (16560) and base rails (16200)	16,000 / 4,000 lbs.	14" - 17"
16667*	E16 head with R16 roller (16516) & Chevrolet / GMC puck system roller adapter (16023)	16,000 / 4,000 lbs.	16" - 19"
16674	E16 head (16515) & Ford puck system roller (16020)	16,000 / 4,000 lbs.	14" - 18"
16684*	E16 head with R16 roller (16516) & Ram puck system roller adapter (16022)	16,000 / 4,000 lbs.	16" - 19"
<b>Individual Components</b>			
16515*	E16 head only (16505 adapter included)	16,000 / 4,000 lbs.	--
16903	E16 replacement leg kit and hardware	--	--
16505	E16 head adapter (required for use with a roller)	--	--
16902	Replacement rail pins & clips	--	--

# 5TH WHEEL ACCESSORIES

## 5TH WHEEL HITCH LOCK

- Locks a 5th wheel hitch into the rails, taking the place of a pin & clip
- Installs tight against the lip of the base rail for enhanced security
- Extra-long 1/2" diameter pin fits all industry-standard base rails
- Rust-free aluminum housing with a durable black powder coat finish
- Weather-resistant dust cap helps prevent internal corrosion
- Easy-to-access, 1/8-turn lock activation
- Includes two keys for added convenience



23256

Pkg#	Pin Diameter	Finish
23256	1/2"	Black powder-coated aluminum



Locks a 5th wheel hitch to industry-standard base rails



Flush-mount on the base rail for enhanced security



Key slot angled upward for easier ergonomic access

## KINGPIN LOCK

- Locks on to 5th wheel kingpin to deter theft
- Universal design fits most 5th wheel trailer kingpins
- Built with an aluminum body for corrosion resistance
- Two keys included for added convenience
- Space-saving, full-color retail packaging



23255 on kingpin



23255

Pkg#	Description	Finish
23255	5th wheel trailer kingpin lock	Chrome-plated



## 5TH WHEEL WEDGES

A rotating 5th wheel pin box creates an alternative pivot point for the 5th wheel connection, providing the 5th wheel trailer with a wider turn radius. However, because of this secondary pivot point, the primary pivot point must be fixed to keep the trailer from wandering. A 5th wheel wedge bolts onto the pin box, locks up the kingpin and keeps it from swiveling.

- Allows CURT A25, A20, A16 or E16 to be used with Sidewinder™ pin boxes (Trademark of Horizon Global™)
- Helps restrict movement between 5th wheel hitch and pin box
- Permanently attaches behind the kingpin of the pin box
- Protected by a durable carbide powder coat finish

Part#	Fits
16991	E-series 5th wheel hitch (page 206)
16992	A-series 5th wheel hitches (page 202)



16991



16992

## 5TH WHEEL LUBE PLATES

- Provides a buffer between 5th wheel hitch head plate and kingpin pin box
- Reduces normal wear and tear when towing
- Eliminates messy grease deposits on hitch head plate
- 12" plate features self-cleaning grooves to maintain good lubrication
- Easily fits on any standard kingpin
- Constructed from tough polyethylene

Bulk#	25-Pack Tray#	Description
16721	16721025	10" 5th wheel lube plate
16722	--	12" 5th wheel lube plate



16721 installation



16722



16721



16721025

## 5TH WHEEL SAFETY CHAIN LOOPS

- Provides a solid attachment point for 5th wheel safety chains in your truck bed
- Installs easily onto 5th wheel rails with pins & clips
- Constructed with a universal design to fit all industry-standard 5th wheel rails
- Features wide openings to accept heavy-duty hooks and chains
- Protected by a durable carbide powder coat finish



16000 on base rails



16000

Pkg#	GTW	Description
16000	20,000 lbs.	5th wheel safety chain loops

## 5TH WHEEL RAIL SOUND-DAMPENING PADS

- Designed to be placed between a 5th wheel hitch and base rails to dampen sound
- Helps eliminate clanking and rattling common in 5th wheel towing
- Compatible with all CURT 5th wheel legs, rollers and base rails (except OEM puck system products)
- Constructed from tough neoprene rubber



16900 installed



16901

16900

Bulk#	Pkg#	Description
16900	16901	Four 5th wheel sound-dampening pads

# 5TH WHEEL ELECTRICAL

## CUSTOM WIRING HARNESS EXTENSIONS

- Routes a 7-way RV blade socket into truck bed while retaining use of rear socket
- Simple plug-and-play design eliminates the need for cutting or splicing
- Neoprene well nuts isolate steel bolts from aluminum surfaces (#57007)



Right-angle plug for easy installation

## 7-WAY RV BLADE EXTENSION

- Routes existing 7-way RV blade socket into full-size pickup truck bed (7' length)
- Universal size fits any 7-way RV blade socket
- Allows for easy connection of 5th wheel or gooseneck wiring



## REPLACEMENT 7-WAY RV BLADE HARNESSES

- Replaces the trailer-end plug of any 7-way harness
- Wires protected by heavy-duty, weather-resistant cable
- Cold-weather harnesses feature soft thermoplastic elastomer casing to remain flexible in cold temperatures (temperature rating from -40°F up to 221°F)



## BRAKE CONTROLS

- Easily calibrated for all towing needs
- Compatible with anti-lock brakes and cruise control



Name	Retail Pkg#	Six-Pack#	Repl. Bracket#	Axles	Brakes	Activation Method	Display	Vertical Mount Angle	Level Adjust	Warranty
Echo™	51180 <b>NEW</b>	--	--	1 - 2	2 - 4	Tri-axis inertia	Phone app	N/A	Auto	Ltd lifetime
Spectrum™	51170	--	--	1 - 4	2 - 8	Tri-axis inertia	Tri-color LED	Any	Auto	Ltd lifetime
Assure™	51160	--	--	1 - 4	2 - 8	Tri-axis inertia	OLED screen	Any	Auto	Ltd lifetime
TriFlex™	51140	51142	51144	1 - 4	2 - 8	Tri-axis inertia	Digital	-20° to +70°	Auto	Ltd lifetime
Reflex™	51130	51132	--	1 - 4	2 - 8	Dual-axis inertia	Digital	Any	Auto	Ltd lifetime
Discovery™	51120	51122	51124	1 - 4	2 - 8	Time-based	Digital	Any	Auto	Ltd lifetime
Venturer™	51110	--	51114	1 - 3	2 - 6	Time-based	LED	Any	Auto	Ltd lifetime

**TESTED. PROVEN. SAFE.**



# WEIGHT DISTRIBUTION

## A PROVEN LINK TO THEIR LIFESTYLE

Towing equipment should never be the limiting factor for your customers. That is why CURT has developed a robust line of weight distribution hitches. New for 2019, we have added a deep drop WD replacement shank with up to 8" of drop for larger, lifted vehicles. The shank is designed for 2-1/2" receivers, including all CURT Commercial Duty class 5 hitches. This new shank fits our TruTrack™ WD system with integrated sway control as well as our trunnion bar and round bar WD hitches.





## FEATURED PRODUCTS



### TruTrack™ system

With integrated sway control and weight distribution, TruTrack™ offers smooth, safe towing and is available in 8K, 10K and 15K options.



### TruTrack™ 8" & 10" brackets

Replacement support brackets for the TruTrack™ weight distribution hitch are available to fit 8" and 10" trailer frames.



### Deep drop shank

The new #17132 replacement WD shank offers a drop of up to 8", and it fits 2-1/2" receivers – perfect for CURT Commercial Duty hitches.

## PRODUCT INDEX



TruTrack™  
WD Systems



Sway  
Control



Trunnion Bar  
WD Hitches



Round Bar  
WD Hitches



Replacement  
Shanks



Brackets  
& Chains

# TRUTRACK™ WEIGHT DISTRIBUTION SYSTEMS

The CURT TruTrack™ weight distribution system is one of the most advanced weight distribution hitches in the industry. It combines precise weight distribution with integrated sway control to deliver the smoothest, safest ride possible. By integrating both features, the TruTrack™ eliminates the need to purchase a separate sway control unit.

## Product Details

- Integrated sway control actively resists sway and levels the vehicle and trailer
- Uses spring & cam system with hardened components, instead of metal friction
- Adjustable brackets provide fixed support unlike spring bar chain models
- Weight capacities available up to 15,000 lbs.
- 2" shank can be flipped to provide necessary drop or rise
- 2-1/2" replacement shanks available (page 218)
- Highly durable carbide powder coat finish
- Informative, full-color retail box



## True integrated sway control

The spring & cam system and fixed support brackets offer true four-point sway control and weight distribution.



## Long-lasting construction

The hardened spring & cam components and cast head are less subject to wear than competitor models.



## Quiet operation

Each TruTrack™ hitch is equipped with grease zerk fittings for continuous lubrication and a quiet ride.



## Easy, versatile setup

The TruTrack™ has two neutral bar settings and adjustable castle nuts to accommodate different trailer sizes.





## TRUTRACK™ WEIGHT DISTRIBUTION SYSTEMS & REPLACEMENT PARTS



Bulk#	Pkg#	GTW	TW	Bars	Description
<b>TruTrack™ Weight Distribution Systems</b>					
--	17499	5,000 - 8,000 lbs.	500 - 800 lbs.	35-9/16"	WD system only
--	17500	8,000 - 10,000 lbs.	800 - 1,000 lbs.	35-9/16"	WD system (17500) and pre-torqued 2-5/16" trailer ball (40006)
--	17501	10,000 - 15,000 lbs.	1,000 - 1,500 lbs.	35-9/16"	WD system (17501) and pre-torqued 2-5/16" trailer ball (40030)
<b>TruTrack™ Replacement Parts</b>					
17535	--	5,000 - 8,000 lbs.	500 - 800 lbs.	35-9/16"	Replacement spring bar for 17499
17536	--	8,000 - 10,000 lbs.	800 - 1,000 lbs.	35-9/16"	Replacement spring bar for 17500
17537	--	10,000 - 15,000 lbs.	1,000 - 1,500 lbs.	35-9/16"	Replacement spring bar for 17501
17506	--	8,000 lbs.	800 lbs.	--	Replacement head for 17499
17507	--	10,000 lbs.	1,000 lbs.	--	Replacement head for 17500
17509	--	15,000 lbs.	1,500 lbs.	--	Replacement head for 17501
17512	--	--	--	--	Replacement lift handle
17508	--	--	--	--	Replacement support brackets, up to 6" (two brackets)
17515	--	--	--	--	Replacement support brackets, 8" (two brackets)
17516	--	--	--	--	Replacement support brackets, 10" (two brackets)
17513	--	--	--	--	Replacement L-pins & clips
17550	--	--	--	--	Replacement bolt kit for 17500 and 17499
17554	--	--	--	--	Replacement bolt kit for 17501
17100	--	Shanks do not have individual ratings	--	--	Replacement shank

# WEIGHT DISTRIBUTION HITCH FEATURES

CURT weight distribution hitches are designed to distribute the tongue weight of a trailer across all axles of the vehicle-trailer combination, allowing for more control and safer towing. Our TruTrack™ weight distribution system is one of the most advanced weight distribution hitches in the industry. It combines precise weight distribution with integrated sway control to deliver the smoothest, safest ride possible.

- Heavy-duty head and forged steel spring bars
- 2" adjustable shank with 2-1/2" replacement option
- Protected by a durable black powder coat finish
- Kits include a pre-torqued 2-5/16" trailer ball and sway control unit

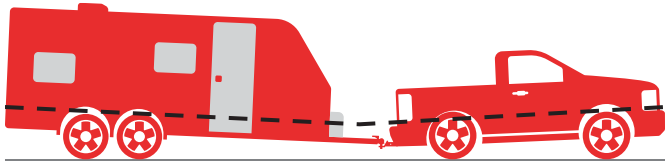

Without weight distribution

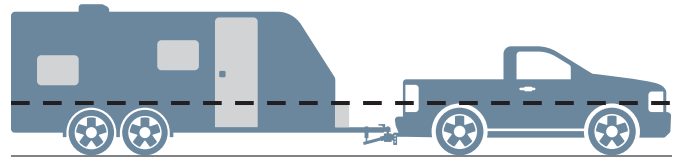

With weight distribution

# SWAY CONTROL & REPLACEMENT PARTS

Sway control units reduce lateral movement, commonly caused by the wind, while pulling a trailer. The diagrams below illustrate the effectiveness of using sway control units. Two sway control units should be used for maximum control and stability.

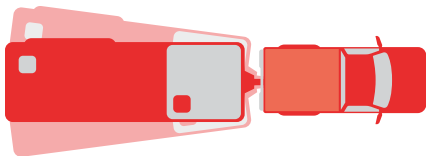

Without sway control



With sway control

Bulk#	Pkg#	Description
<b>Sway Control Kit</b>		
--	17200	Kit includes: - Sway control unit - Trailer-mounted attachment ball and bolts (17201) - Hitch-mounted attachment ball (40093) - Weld-on tab (45822) - Mount reinforcement plate - Spring clips
<b>Sway Tab Ball Mount</b>		
45820	--	See page 104 for more information
<b>Sway Control Replacement Parts</b>		
17201	--	Trailer-mounted attachment ball with four self-tapping bolts and two spring clips
40093	--	Sway control attachment ball
45822	--	Weld-on sway tab



45820 with 40093 ball (sold separately)



45822



17201



40093

2

INCH

## TRUNNION BAR KITS & WD HITCHES

- Up to 15,000 lbs. GTW / 1,500 lbs. TW
- Weight ratings are limited to vehicle manufacturer's stated capacities
- Equipped with trunnion-style, forged steel spring bars
- Heavy-duty, formed head can be adjusted for precise leveling
- Features built-in sway control attachment tabs
- 2" shank can be flipped to provide necessary drop or rise
- 2-1/2" replacement shanks available (page 218)
- Snap-up brackets and lift handle allow for easy leveraging of spring bars
- Highly durable carbide powder coat finish
- Informative, full-color retail box



Formed head

Bulk#	Pkg#	GTW	TW	Bars	Description
<b>Trunnion Bar Weight Distribution Kits</b>					
--	17322	8,000 - 10,000 lbs.	800 - 1,000 lbs.	28-3/8"	WD hitch (17332), sway control (17200), pre-torqued 2-5/16" trailer ball (40006) and chains pre-assembled to spring bars
--	17422	10,000 - 15,000 lbs.	1,000 - 1,500 lbs.	28-3/8"	WD hitch (17333), sway control (17200), pre-torqued 2-5/16" trailer ball (40030) and chains pre-assembled to spring bars
<b>Trunnion Bar Weight Distribution Hitches</b>					
--	17300	5,000 - 6,000 lbs.	500 - 600 lbs.	30-5/8"	Weight distribution hitch only
--	17301	6,000 - 8,000 lbs.	600 - 800 lbs.	30-5/8"	Weight distribution hitch only
--	17302	8,000 - 10,000 lbs.	800 - 1,000 lbs.	30-5/8"	Weight distribution hitch only
--	17330	5,000 - 6,000 lbs.	500 - 600 lbs.	28-3/8"	Weight distribution hitch only
--	17331	6,000 - 8,000 lbs.	600 - 800 lbs.	28-3/8"	Weight distribution hitch only
--	17332	8,000 - 10,000 lbs.	800 - 1,000 lbs.	28-3/8"	Weight distribution hitch only
--	17333	10,000 - 15,000 lbs.	1,000 - 1,500 lbs.	28-3/8"	Weight distribution hitch only
<b>Trunnion Bar Replacement Parts</b>					
17309	--	5,000 - 6,000 lbs.	500 - 600 lbs.	30-5/8"	Replacement spring bar with pre-assembled chain
17308	--	6,000 - 8,000 lbs.	600 - 800 lbs.	30-5/8"	Replacement spring bar with pre-assembled chain
17303	--	8,000 - 10,000 lbs.	800 - 1,000 lbs.	30-5/8"	Replacement spring bar with pre-assembled chain
17334	--	5,000 - 6,000 lbs.	500 - 600 lbs.	28-3/8"	Replacement spring bar with pre-assembled chain
17335	--	6,000 - 8,000 lbs.	600 - 800 lbs.	28-3/8"	Replacement spring bar with pre-assembled chain
17336	--	8,000 - 10,000 lbs.	800 - 1,000 lbs.	28-3/8"	Replacement spring bar with pre-assembled chain
17337	--	10,000 - 15,000 lbs.	1,000 - 1,500 lbs.	28-3/8"	Replacement spring bar with pre-assembled chain
17307	--	15,000 lbs.	1,500 lbs.	--	Replacement head
17008	--	--	--	--	Replacement hookup bracket (single)
17112	--	--	--	--	Replacement lift handle
17312	--	--	--	--	Head angle adjustment rod kit
17314	--	--	--	--	Conical washers (set of four)
17350	--	--	--	--	Replacement bolt kit
17100	--	Shanks do not have individual ratings	--	--	Replacement shank (additional shanks found on page 218)

# 2

INCH

## MV ROUND BAR WD HITCHES & KITS

- Up to 14,000 lbs. GTW / 1,400 lbs. TW
- Weight ratings are limited to vehicle manufacturer's stated capacities
- Grease zerk fitting provides easy, continuous lubrication
- Equipped with round, forged steel spring bars for reliable strength
- Heavy-duty, fabricated head can be adjusted for precise leveling
- Features built-in sway control attachment tabs
- 2" shank can be flipped to provide necessary drop or rise
- 2-1/2" replacement shanks available (page 218)
- Snap-up brackets and lift handle allow for easy leveraging of spring bars
- Highly durable carbide powder coat finish



17063



Easily-access grease zerk fittings



Fabricated head



17071



17075



17112



17076



17100

Bulk#	Pkg#	GTW	TW	Bars	Description
<b>MV Round Bar Weight Distribution Kits</b>					
--	17062	8,000 - 10,000 lbs.	800 - 1,000 lbs.	31-3/16"	WD hitch (17052), sway control (17200), pre-torqued 2-5/16" trailer ball (40006) and chains pre-assembled to spring bars
--	17063	10,000 - 14,000 lbs.	1,000 - 1,400 lbs.	31-3/16"	WD hitch (17057), sway control (17200), pre-torqued 2-5/16" trailer ball (40030) and chains pre-assembled to spring bars
<b>MV Round Bar Weight Distribution Hitches</b>					
--	17050	5,000 - 6,000 lbs.	500 - 600 lbs.	31-3/16"	Round bar weight distribution hitch
--	17051	6,000 - 8,000 lbs.	600 - 800 lbs.	31-3/16"	Round bar weight distribution hitch
--	17052	8,000 - 10,000 lbs.	800 - 1,000 lbs.	31-3/16"	Round bar weight distribution hitch
--	17057	10,000 - 14,000 lbs.	1,000 - 1,400 lbs.	31-3/16"	Round bar weight distribution hitch
<b>MV Round Bar Replacement Parts</b>					
17071	--	5,000 - 6,000 lbs.	500 - 600 lbs.	31-3/16"	Replacement spring bar with pre-assembled chain
17072	--	6,000 - 8,000 lbs.	600 - 800 lbs.	31-3/16"	Replacement spring bar with pre-assembled chain
17073	--	8,000 - 10,000 lbs.	800 - 1,000 lbs.	31-3/16"	Replacement spring bar with pre-assembled chain
17074	--	10,000 - 14,000 lbs.	1,000 - 1,400 lbs.	31-3/16"	Replacement spring bar with pre-assembled chain
17075	--	14,000 lbs.	1,400 lbs.	--	Replacement head
17008	--	--	--	--	Replacement hookup bracket (single)
17112	--	--	--	--	Replacement lift handle
17076	--	--	--	--	Replacement bolt kit
17100	--	Shanks do not have individual ratings	--	--	Replacement shank (additional shanks found on page 218)

**2**  
INCH

# ROUND BAR WD HITCHES & KITS

- Up to 14,000 lbs. GTW / 1,400 lbs. TW
- Weight ratings are limited to vehicle manufacturer's stated capacities
- Equipped with round, forged steel spring bars for reliable strength
- Heavy-duty, formed head can be adjusted for precise leveling
- Features built-in sway control attachment tabs
- 2" shank can be flipped to provide necessary drop or rise
- 2-1/2" replacement shanks available (page 218)
- Snap-up brackets and lift handle allow for easy leveraging of spring bars
- Highly durable carbide powder coat finish
- Informative, full-color retail box



Formed head



17101



17107



17109



17114



17312



17150

Bulk#	Pkg#	GTW	TW	Bars	Description
<b>Round Bar Weight Distribution Kits</b>					
--	17022	8,000 - 10,000 lbs.	800 - 1,000 lbs.	31-5/8"	WD hitch (17002), sway control (17200), pre-torqued 2-5/16" trailer ball (40006) and chains pre-assembled to spring bars
--	17222	10,000 - 14,000 lbs.	1,000 - 1,400 lbs.	31-5/8"	WD hitch (17007), sway control (17200), pre-torqued 2-5/16" trailer ball (40030) and chains pre-assembled to spring bars
<b>Round Bar Weight Distribution Hitches</b>					
--	17000	5,000 - 6,000 lbs.	500 - 600 lbs.	31-5/8"	Round bar weight distribution hitch
--	17001	6,000 - 8,000 lbs.	600 - 800 lbs.	31-5/8"	Round bar weight distribution hitch
--	17002	8,000 - 10,000 lbs.	800 - 1,000 lbs.	31-5/8"	Round bar weight distribution hitch
--	17007	10,000 - 14,000 lbs.	1,000 - 1,400 lbs.	31-5/8"	Round bar weight distribution hitch
<b>Round Bar Replacement Parts</b>					
17101	--	5,000 - 6,000 lbs.	500 - 600 lbs.	31-5/8"	Replacement spring bar with pre-assembled chain
17113	--	6,000 - 8,000 lbs.	600 - 800 lbs.	31-5/8"	Replacement spring bar with pre-assembled chain
17115	--	8,000 - 10,000 lbs.	800 - 1,000 lbs.	31-5/8"	Replacement spring bar with pre-assembled chain
17117	--	10,000 - 14,000 lbs.	1,000 - 1,400 lbs.	31-5/8"	Replacement spring bar with pre-assembled chain
17107	--	14,000 lbs.	1,400 lbs.	--	Replacement head
17008	--	--	--	--	Replacement hookup bracket (single)
17112	--	--	--	--	Replacement lift handle
17109	--	--	--	--	Retainer package (two clips, two pins, two screws)
17114	--	--	--	--	Head adjustment spacer kit
17312	--	--	--	--	Head angle adjustment rod kit
17314	--	--	--	--	Conical washers (set of four)
17150	--	--	--	--	Replacement bolt kit
17100	--	Shanks do not have individual ratings	--	--	Replacement shank (additional shanks found on page 218)

**2** INCH & **2½** INCH

# REPLACEMENT WD SHANKS

- Provides an adjustable mount for most weight distribution hitches
- Features multiple holes for adjustable head height
- Can be flipped to provide necessary drop or rise
- 2-1/2" shank ideal for class 5 Commercial Duty hitches (page 15)
- 3/4" diameter holes are spaced 1-1/4" from center to center
- Constructed from solid steel for reliable strength
- Protected by a durable powder coat finish
- Limited to spring bar capacity



## Measuring a WD shank

See table for corresponding measurements

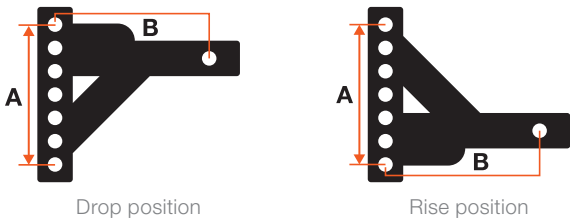

## Measuring a WD shank with WD hitch head

See table for corresponding measurements

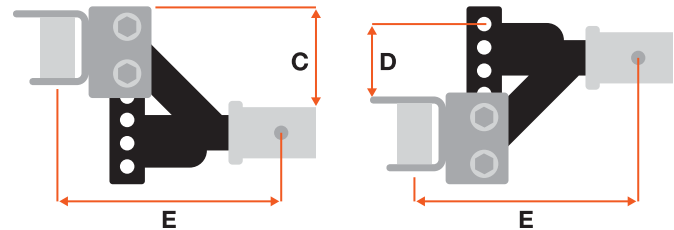

Part#	Measuring a WD Shank		Measuring a WD Shank with WD Hitch Head		
	Height (A)	Length (B)	Rise (C)	Drop (D)	Length (E)
<b>For 2" x 2" Receiver Tube Openings</b>					
17100	7-1/2"	8"	6"	2"	12"
17102	7-1/2"	12"	6"	2"	14"
17103	7-1/2"	14"	6"	2"	16"
17120	8-3/4"	10"	8-7/8"	5-5/8"	12"
17121	10"	12"	10-1/4"	6"	14"
17122	10"	14"	10-1/4"	6"	16"
17123	11-1/4"	7"	10-1/2"	7"	9"
17124	6-1/4"	9"	N/A	8-3/4"	11"
17125	6-1/4"	8"	N/A	14-1/2"	10"
<b>For 2-1/2" x 2-1/2" Receiver Tube Openings</b>					
17131 <b>NEW</b>	7-1/2"	8"	6"	2"	12"
17132 <b>NEW</b>	12-1/2"	8"	N/A	7-1/2"	12"





## HOOKUP BRACKETS & ACCESSORIES

- Replaces original brackets
- Hardware included



17109



17112



17111



17003



17005



17208



17008

Bulk#	Pkg#	Description	Finish
--	17003	Clamp-on chain hangers	Carbide
--	17005	Bolt-on chain hangers	Carbide
17008	--	Replacement hookup bracket (single)	Carbide
17208*	--	Replacement hookup brackets (pair)	Carbide
17111	--	Chain kit (includes four 3/8" - 16 lock nuts, four 3/8" flat washers, two chains and two U-bolts)	Zinc-plated
17112	--	Replacement lift handle	Carbide
17109	--	Retainer package for round bar WDs (page 217) (includes two clips, two pins, two screws)	Carbide

\*For use on trailers with LP tanks or other obstructions

**TESTED. PROVEN. SAFE.**



# TRAILER PARTS & ACCESSORIES

## FREE TO TOW WITH CONFIDENCE

CURT has everything your customers need to keep their trailer towing in optimal condition. We offer jacks, safety chains and couplers in a variety of styles and capacities to accommodate virtually any type of trailer – everything from utility haulers and popup campers to horse trailers and 5th wheel RVs. We also offer a number of accessories to fully equip your customers for the road ahead, including hand winches, wheel bearings, snap hooks and wheel chocks.



## FEATURED PRODUCTS



### Channel-mount couplers

Mounted on a CURT channel, channel mount couplers make it easy to adjust the tongue height of a trailer and level the load.



### Marine jacks

Ideal for boat trailers and other watercraft haulers, marine jacks are water-resistant and have a wheel for convenient mobility.



### Cargo straps

Cargo straps are perfect for securing any load – big, small, heavy-duty or fragile. We offer a variety of capacities, lengths and hook types.

## PRODUCT INDEX



Couplers & Accessories



Jacks & Accessories



Safety Chains & Cables



Hooks & Links



Hand Winches & Straps



Wheel Bearing Components



Cargo Straps

# STRAIGHT-TONGUE & A-FRAME COUPLERS

- Sleeve-lock latch system for optimum security (#25217, #25227)
- Spring and nut posi-lock mechanism allows for easy adjustment (select models)
- Features holes to accept a safety pin or coupler lock
- Constructed from high-strength steel
- Protected by a durable zinc-plated or gloss black powder coat finish
- Tested for safety in accordance with SAEJ684



25200



25105



25128



25131



25153



25135



25138



25100



25227



25217



25210



25101

Part#	Class	GTW / TW	Ball Diameter	Latch Style	Channel Width	Finish
<b>Straight-Tongue Couplers</b>						
25105	1	2,000 / 200 lbs.	1-7/8"	Posi-lock	2-1/2"	Zinc-plated
25128	1	2,000 / 200 lbs.	1-7/8"	Posi-lock	2"	Zinc-plated
25131	1	2,000 / 200 lbs.	1-7/8"	Posi-lock	3"	Zinc-plated
25153	2	3,500 / 500 lbs.	2"	Posi-lock	2"	Zinc-plated
25135	2	3,500 / 500 lbs.	2"	Posi-lock	2-1/2"	Zinc-plated
25138	2	3,500 / 500 lbs.	2"	Posi-lock	3"	Zinc-plated
25100	3	5,000 / 700 lbs.	2"	Posi-lock	3"	Zinc-plated
<b>A-Frame Couplers</b>						
25101	3	5,000 / 700 lbs.	2"	Posi-lock	--	Zinc-plated
25210	3	5,000 / 700 lbs.	2"	Posi-lock	--	Gloss black
25217*	4	7,000 / 1,050 lbs.	2"	Sleeve-lock	--	Gloss black
25200	4	10,000 / 1,500 lbs.	2-5/16"	Easy-lock	--	Gloss black
25227*	4	12,500 / 1,875 lbs.	2-5/16"	Sleeve-lock	--	Gloss black
<b>Replacement Part for #25101 and #25210 A-Frame Couplers</b>						
25294	3	5,000 / 700 lbs.	2"	Posi-lock	--	Zinc-plated
<b>Replacement Parts for Straight-Tongue Couplers</b>						
25094	1	2,000 / 200 lbs.	1-7/8"	Posi-lock	--	Zinc-plated
25194	2	3,500 / 500 lbs.	2"	Posi-lock	--	Zinc-plated



25094



25194



25294

# CHANNEL-MOUNT COUPLERS

- Compatible with CURT channels #48610 and #48650, see page 111
- Secured by a dual-bolt mounting system
- Channel-mount allows for easy height adjustment
- Safety pin hole can also accept a coupler lock
- Constructed from heavy-duty cast steel
- Protected by a durable black powder coat finish



Part#	GTW / TW	Ball Diameter	Description
25319*	7,000 / 1,050 lbs.	2"	Sleeve-lock coupler
25329*	12,500 / 1,875 lbs.	2-5/16"	Sleeve-lock coupler
25330	14,000 / 2,100 lbs.	2-5/16"	Easy-lock coupler
25328	15,000 / 2,250 lbs.	2-5/16"	Easy-lock coupler
25388	--	--	Bolt kit includes: -Two 5/8" x 4-3/4" hex bolts (grade 8) -Two 5/8" nylock hex nuts (grade 5) -Four 5/8" flat washers (grade 5)

\*Solid neck for increased strength and greater corrosion resistance

## SAFETY PINS

- Quickly secures coupler latches, pintle hooks, jack legs or caster wheels
- Square retainer wire clip provides added clearance
- Protected by a durable zinc-plated finish



Bulk#	Pkg#	Pin Diameter	Pin Length	Chain Length
25080	25081	1/4"	2-3/4"	--
25012	25013	1/4"	2-3/4"	12" chain
25010	25011	5/16"	3"	--
25034	25035	5/16"	3"	12" chain
28278	28279	3/8"	2-3/4"	--
28000	28001	3/8"	3"	12" chain



#25034 securing a coupler latch



#28278 securing a jack foot

2

INCH

## MARINE JACKS

- Caster wheel for trailer mobility and coupling
- Side-wind handle raises or lowers trailer coupler
- Swivel bracket allows jack to fully swing up and out of the way for travel
- Heavy-duty pull-pin locks jack securely in place
- Bolt-on hardware included for secure mounting
- Protected by a durable zinc-plated finish



28100



28101



Mounting bracket



Single wheel



Dual wheel (#28155)

Bulk#	Pkg#	Lift Capacity	Wind	Travel	Bracket Ht.	Wheel Size	Retracted Ht.	Extended Ht.	Finish
28100	28101	1,000 lbs.	Side	10-1/2"	12-11/16"	6"	12-5/8"	23-1/4"	Zinc-plated
28112	28113	1,200 lbs.	Side	11"	12-11/16"	6"	12-1/2"	23-1/2"	Zinc-plated
28115	28116	1,500 lbs.	Side	11"	12-11/16"	8"	13"	24"	Zinc-plated
28155	28156	1,500 lbs.	Side	10-3/8"	12-1/2"	Dual 6"	12-5/8"	23"	Zinc-plated

2

INCH

## A-FRAME JACKS

- Designed to be mounted on an A-frame trailer tongue
- Can bolted or welded on (hardware not included)

28204  
side-wind28255  
top-wind28203  
top-wind

Mounting bracket



Straight handle



Claw handle

Bulk#	Pkg#	Lift Capacity	Wind	Travel	Bracket Ht.	Handle Type	Retracted Ht.	Extended Ht.	Finish
28200	--	2,000 lbs.	Top	14-1/4"	8"	Straight	8-1/4"	22-1/2"	Gloss black
28202	28203	2,000 lbs.	Top	14-3/4"	9"	Straight	9-1/4"	24"	Gloss black
28204	--	2,000 lbs.	Side	15"	9"	Straight	9-1/4"	24-1/4"	Gloss black
28250	--	5,000 lbs.	Top	14-1/8"	10-1/2"	Straight	10-3/8"	24-1/2"	Gloss black
28255	--	5,000 lbs.	Top	15"	10-1/2"	Claw	10"	25"	Gloss black

## 2 SWIVEL JACKS

INCH

- Swivel bracket allows jack to fully swing up and out of the way during travel
- Pull-pin keeps jack securely locked in place



28302  
bracket-mount



28354  
pipe-mount



28351  
pipe-mount



Bracket mount



Pipe mount



Straight handle

Bulk#	Pkg#	Lift Capacity	Wind	Travel	Hole Size	Handle Type	Style	Retracted Ht.	Extended Ht.
28320*	--	2,000 lbs.	Top	10-3/4"	9/16"	Claw	Pipe-mount	11"	21-3/4"
28350*	28351*	5,000 lbs.	Top	10-3/4"	9/16"	Claw	Pipe-mount	11-1/2"	21-1/2"
28356*	--	5,000 lbs.	Top	15"	5/8"	Claw	Pipe-mount	16-1/2"	31-1/2"
28322*	28323*	2,000 lbs.	Top	15"	9/16"	Claw	Pipe-mount	16"	31"
28321	--	2,000 lbs.	Side	10"	9/16"	Straight	Pipe-mount	17-1/2"	28-1/2"
28354	--	5,000 lbs.	Side	10"	5/8"	Straight	Pipe-mount	10-1/4"	20-1/4"
28358	--	5,000 lbs.	Side	15-1/2"	5/8"	Straight	Pipe-mount	15-5/8"	31-1/4"
28324	--	2,000 lbs.	Side	15"	9/16"	Straight	Pipe-mount	15-1/4"	30-1/8"
28300*	28301*	2,000 lbs.	Top	10-1/2"	--	Claw	Bracket-mount	11-1/2"	21-1/2"
28302	--	2,000 lbs.	Side	10"	--	Straight	Bracket-mount	10"	20-1/2"
28304*	28305*	2,000 lbs.	Top	15-1/4"	--	Claw	Bracket-mount	16"	31-1/4"
28306	--	2,000 lbs.	Side	14-1/2"	--	Straight	Bracket-mount	15-1/2"	30"

\*Use replacement handle, bulk# 28937

## DIRECT-WELD SQUARE JACKS

- Designed to weld directly to the trailer frame
- Drop leg with spring return for fast retraction (#28512)
- Pull-pin keeps jack leg securely locked in place



28512



28570



28575



28359



#28512 drop leg

Part#	Lift Capacity	Support	Wind	Travel	Handle Type	Inner Tube	Retracted Ht.	Extended Ht.	Incl. Jack Foot
28512	10,000 lbs.	12,000 lbs.	Side	12-3/8"	Straight	3-1/2"	28"	40-1/4"	Yes
28570	7,000 lbs.	8,000 lbs.	Top	15-1/4"	Claw	2-1/4"	24-1/4"	39-1/2"	Yes
28575	7,000 lbs.	8,000 lbs.	Side	15"	Straight	2-1/4"	24-3/4"	40-1/8"	Yes
28359	3,000 lbs.	5,000 lbs.	Side	15-1/4"	Straight	2"	15-3/4"	31"	No

# JACK ACCESSORIES

- Caster assemblies #28276 and #28277 are not designed as repair parts for marine jacks; use jack repair part number #28912



28270 28271



28273 28272



28275 28274



28277 28276



28278 28279

Bulk#	Pkg#	Description	Capacity	Fits Tube	Height	Wheel Size	Diameter
28270	28271	Jack foot, bolt-on	2,000 lbs.	2"	--	--	--
28272	28273	Jack foot	2,000 lbs.	2"	1-11/16"	--	--
28274	28275	Jack foot	2,000 lbs.	2"	8-1/2"	--	--
28276	28277	Caster assembly with poly wheel	1,200 lbs.	2"	--	6" x 2"	--
28278	28279	Safety pin	--	--	--	--	3/8"

## JACK REPAIR PARTS



28913



28964



28951



28938



28940



28912

Part#	Description
<b>Marine Jacks</b>	
28910	Bolt-through jack mounting bracket
28911	Bolt-through jack mounting bars (two) and bolts (four)
28912	Replacement caster wheel with bolt and bushing
28913	Replacement handle for marine jacks (excluding continue-while-supplies-last jacks)
28914	Gear kit with shear pins
<b>A-Frame Jacks</b>	
28921	Handle for 28200, 28202, 28203, 28250
<b>Swivel Jacks</b>	
28922	Bearing for 2,000 lbs. and 5,000 lbs. top-wind jacks
28923	Handle for 2,000 lbs. and 5,000 lbs. side-wind jacks
28924	Gear kit with shear pins for 2,000 lbs. and 5,000 lbs. side-wind jacks
28930	Female pipe weld-on for 2,000 lbs. and 5,000 lbs. pipe-mounted swivel jacks
28931	Male pipe weld-on for 2,000 lbs. and 5,000 lbs. pipe-mounted swivel jacks, 9/16" pin hole
28932	Male pipe weld-on for 2,000 lbs. and 5,000 lbs. pipe-mounted swivel jacks, 5/8" pin hole
28934	9/16" pin with 3-1/2" long chain
28935	5/8" pin with 3-1/2" long chain
28938	Mounting bracket for bracket-mounted swivel jacks

Part#	Description
<b>Direct-Weld Square Jacks</b>	
28950	Gear kit with shear pins for 28512
28951	Handle for 28512
28952	Cap for 28512
28953	Handle clip for 28512
28954	Bearing for 28512
28955	Pull-pin assembly designed for 28512 (3/4" pull-pin, spring, washer and cotter pin)
28956	Threaded lift nut with grease retaining structure for 28512
28957	Inner pipes with drop leg, foot and pull-pin for 28512
28958	Gear kit with shear pins for 28575
28959	Side-wind handle with pins and bushings for 28575
28960	Side-wind handle with pins, bushings and gears for 28575
28961	Cap and screws for 28575
28962	Drop leg with foot for 28570 and 28575
28963	Drop leg foot pin for 28570 and 28575
28964	Handle kit for 28570
28965	Bearing for 28570
<b>Miscellaneous Repair Parts</b>	
28925	Plastic cap for 2,000 lbs. side-wind jacks
28926	Black handle knob and cap nut
28927	Black handle knob and cap nut for top-wind jacks
28937	Solid handle for top-wind jacks
28939	2" snap ring for 28100, 28304, 28302, 28300
28940	1/2" pull-pin for bracket-mounted swivel and marine jacks



# BULK CHAIN

- High-test chain for wear and abrasion resistance
- Transport chain for binding applications
- Alloy chain for high work load limits
- All bulk chain is sold by the foot

Bulk#	Break Strength	Link Diameter	Grade	Finish
<b>Proof Coil</b>				
82116	3,200 lbs.	3/16"	30	Zinc-plated
82165	3,700 lbs.	5/0	30	Zinc-plated
82105	5,200 lbs.	1/4"	30	Zinc-plated
82170	7,600 lbs.	8/0	30	Zinc-plated
82110	7,600 lbs.	5/16"	30	Zinc-plated
82115	10,600 lbs.	3/8"	30	Zinc-plated
<b>High-test</b>				
82120	7,800 lbs.	1/4"	43	Zinc-plated
82125	11,700 lbs.	5/16"	43	Zinc-plated
82130	16,200 lbs.	3/8"	43	Zinc-plated
<b>Transport</b>				
82135	12,600 lbs.	1/4"	70	Yellow zinc-plated
82140	18,800 lbs.	5/16"	70	Yellow zinc-plated
82145	26,400 lbs.	3/8"	70	Yellow zinc-plated
82155	45,200 lbs.	1/2"	70	Yellow zinc-plated
<b>Alloy</b>				
82158	48,000 lbs.	1/2"	80	Raw
82160	72,400 lbs.	5/8"	80	Yellow zinc-plated



# CUSTOM SAFETY CHAIN

Safety chains are required by law and should be crossed under the tongue of the trailer so that the tongue will not drop to the road if it becomes separated from the hitch. Always leave enough slack so the vehicle can safely turn. Never allow the safety chains to drag on the ground and never attach the chains to the bumper.

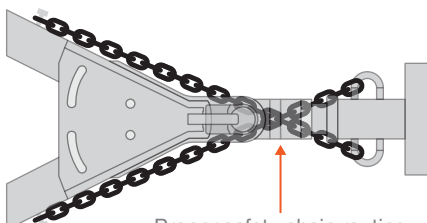

Proper safety chain routing crosses under the coupler

## How to order custom safety chain:

- Step 1 - Determine the gross weight of the trailer  
Example: 7,000 lbs. GTW
- Step 2 - Select chain required  
Example: #82120 zinc-plated (7,800 lbs.)  
Note: By law each individual chain must meet or exceed the GTW
- Step 3 - Determine the required length of chain  
Note: The chains must be long enough to cross one over the other under the coupling point (see illustration to the left)
- Step 4 - Select hook(s) according to capacity and design  
Example: #81900 clevis hook (7,800 lbs.)
- Step 5 - Contact your CURT sales rep for a quote



Federal law requires safety chains to be secured while towing.  
Each individual chain or cable must meet or exceed the trailer weight.

## SAFETY CHAIN WITH S-HOOKS

- Protected by a durable zinc-plated finish



S-hook



Safety chains in use



Bulk#	Pkg#	Break Strength	Number of Chains	Total Length	Link Diameter	Hooks Per Chain	Hook Size	Chain Length	Grade	Finish
80020	--	2,000 lbs.	1	27"	3/16"	1 (81260)	3/8"	23"	30	Zinc-plated
80010	80011	2,000 lbs.	1	48"	3/16"	2 (81260)	3/8"	40"	30	Zinc-plated
80040	--	5,000 lbs.	1	27"	1/4"	1 (81270)	7/16"	23"	30	Zinc-plated
80030	80031	5,000 lbs.	1	48"	1/4"	2 (81270)	7/16"	40"	30	Zinc-plated
80300	--	7,000 lbs.	1	27"	8/0	1 (81620)	17/32"	23"	30	Zinc-plated
80301	--	7,000 lbs.	1	48"	8/0	2 (81620)	17/32"	40"	30	Zinc-plated

## SAFETY CHAIN WITH SNAP HOOKS

- Spring-loaded safety latch helps ensure secure attachment
- Protected by a durable zinc-plated finish
- Vinyl coating protects chains from rust and allows for easier handling (#19749)



19749



80312



80313



Snap hook

Bulk#	Pkg#	Break Strength	Number of Chains	Total Length	Link Diameter	Hooks Per Chain	Hook Size	Chain Length	Grade	Finish
80312	--	2,000 lbs.	One	27"	3/16"	1 (81266)	3/8"	24"	30	Zinc-plated
80313	--	5,000 lbs.	One	27"	1/4"	1 (81277)	7/16"	24"	30	Zinc-plated
--	19749	5,000 lbs.	Two	65"	1/4"	2 (81260)	7/16"	60"	30	Zinc-plated with rubber coating

# SAFETY CABLES WITH SAFETY LATCH HOOKS

- Coiled design keeps cables from dragging on the ground
- Nylon coating protects cables from rust and allows for easier handling
- Assembled with two safety latch hooks for secure attachment



Safety latch S-hook



Safety cables in use



80136



80151



80176

Pkg#	Break Strength	Number of Cables	Total Length	Cable Diameter	Hooks Per Cable	Hook Size	Cable Length	Cable Finish	Hook Finish
80136	3,500 lbs.	2	43-7/8"	1/4"	2 (81810)	3/8"	40-1/2"	Nylon-coated	Zinc-plated
80151	5,000 lbs.	2	44-1/2"	5/16"	2 (81820)	7/16"	40-1/2"	Nylon-coated	Zinc-plated
80176	7,500 lbs.	2	44"	3/8"	2 (81830)	17/32"	39-3/4"	Nylon-coated	Zinc-plated

# SAFETY CHAIN WITH SAFETY LATCH CLEVIS HOOKS

- Exclusive clevis design and spring-loaded safety latch help ensure secure attachment
- Hook pin and cotter pin provide an easy, secure attachment to safety chain
- Hooks constructed from high-strength, heat-treated, forged steel
- Protected by a durable zinc-plated finish



Safety latch clevis hooks



80315 with 45500



Zinc-plated



Yellow zinc-plated

Part#	Break Strength	Number of Chains	Total Length	Link Diameter	Hooks Per Chain	Hook Size	Chain Length	Grade	Chain Finish	Hook Finish
80302	7,800 lbs.	1	35"	1/4"	1 (81900)	1/4"	32"	43	Zinc-plated	Yellow zinc-plated
80314	11,700 lbs.	1	35"	5/16"	1 (81550)	5/16"	32"	43	Zinc-plated	Yellow zinc-plated
80303	12,600 lbs.	1	35"	1/4"	1 (81940)	1/4"	32"	70	Yellow zinc-plated	Yellow zinc-plated
80315	16,200 lbs.	1	35"	3/8"	1 (81560)	3/8"	31"	43	Zinc-plated	Yellow zinc-plated
80304	18,800 lbs.	1	35"	5/16"	1 (81950)	5/16"	32"	70	Yellow zinc-plated	Yellow zinc-plated
80316	24,000 lbs.	1	35"	3/8"	1 (81960)	3/8"	31"	70	Yellow zinc-plated	Yellow zinc-plated



Federal law requires safety chains to be secured while towing.  
Each individual chain or cable must meet or exceed the trailer weight.

## TRANSPORT BINDER SAFETY CHAIN

- Designed for tying down and binding heavy-duty cargo
- Grade-70 rating for superior tensile strength and abrasion resistance
- Assembled with two clevis grab hooks for secure attachment
- Protected by a durable yellow zinc-plated finish
- Do not exceed work load limit



80306



80308

Part#	Work Load	Break Strength	Total Length	Link Diameter	Hooks Per Chain	Hook Size	Chain Length	Grade	Finish
80305	4,700 lbs.	18,800 lbs.	14'	5/16"	2 (81503)	5/16"	162"	70	Yellow zinc
80306	4,700 lbs.	18,800 lbs.	16'	5/16"	2 (81503)	5/16"	186"	70	Yellow zinc
80307	4,700 lbs.	18,800 lbs.	20'	5/16"	2 (81503)	5/16"	234"	70	Yellow zinc
80308	4,700 lbs.	18,800 lbs.	25'	5/16"	2 (81503)	5/16"	294"	70	Yellow zinc
80309	6,600 lbs.	26,400 lbs.	14'	3/8"	2 (81438)	3/8"	162"	70	Yellow zinc
80310	6,600 lbs.	26,400 lbs.	16'	3/8"	2 (81438)	3/8"	186"	70	Yellow zinc
80311	6,600 lbs.	26,400 lbs.	20'	3/8"	2 (81438)	3/8"	234"	70	Yellow zinc

## CLEVIS GRAB HOOKS

- Designed for use on transport binder safety chain to tie down heavy cargo
- Can also be used to connect safety chains from trailer to tow vehicle
- Meets requirements for high-test chain
- Hook pin and cotter pin provide an easy, secure attachment to safety chain
- Constructed from high-strength, forged steel
- Protected by a durable zinc-plated finish



81330



81502



81340



81503



81350



81438

Part#	GTW	Hook Size	Grade	Finish
81330	2,600 lbs.	1/4"	43	Zinc-plated
81502	3,150 lbs.	1/4"	70	Yellow zinc-plated
81340	3,900 lbs.	5/16"	43	Zinc-plated
81503	4,700 lbs.	5/16"	70	Yellow zinc-plated
81350	5,400 lbs.	3/8"	43	Zinc-plated
81438	6,600 lbs.	3/8"	70	Yellow zinc-plated

# SAFETY LATCH CLEVIS HOOKS

- Quickly and easily connects safety chains from trailer to tow vehicle
- Exclusive design and spring-loaded safety latch help ensure secure attachment
- Meets requirements for high-test, transport and alloy chain
- Hook pin and cotter pin provide an easy, secure attachment to safety chain
- Built from high-strength, heat-treated, forged steel
- Protected by a durable yellow zinc-plated finish

Part#	GTW	Hook Size	Grade	Hook Size
<b>Clevis Hooks</b>				
81900	7,800 lbs.	1/2"	43	1/4"
81940	12,600 lbs.	1/2"	70	1/4"
81550	14,000 lbs.	3/4"	43	5/16"
81950	18,000 lbs.	3/4"	70	5/16"
81560	18,000 lbs.	1"	43	3/8"
81960	24,000 lbs.	1"	70	3/8"
81970	40,000 lbs.	1-1/3"	80	7/16"
81910	35,000 lbs.	1-1/4"	43	1/2"
81980	48,000 lbs.	1-1/4"	80	1/2"
81920	65,000 lbs.	1-1/4"	80	5/8"
<b>Replacement Latch</b>				
81999	Fits 81950 and 81960			



# CERTIFIED & SAFETY LATCH S-HOOKS

- Quickly and easily connects safety chains from trailer to tow vehicle
- Tested for safety in accordance with SAEJ684
- Wire safety latch helps ensure secure attachment
- Constructed from high-strength, heat-treated steel
- Protected by a durable zinc-plated finish

Part#	GTW	Hook Size	Safety Latch
81260	2,000 lbs.	3/8"	No
81810	2,000 lbs.	3/8"	Yes
81640	3,500 lbs.	13/32"	No
81840	3,500 lbs.	13/32"	Yes
81270	5,000 lbs.	7/16"	No
81820	5,000 lbs.	7/16"	Yes
81620	7,600 lbs.	17/32"	No
81830	7,600 lbs.	17/32"	Yes





Federal law requires safety chains to be secured while towing.  
Each individual chain or cable must meet or exceed the trailer weight.

## SNAP HOOKS

- Quickly and easily connects safety chains from trailer to tow vehicle
- Spring-loaded safety latch helps ensure secure attachment
- Patent# 5,664,304

Bulk#	Pkg#	GTW	Diameter
81266	81261	2,000 lbs.	3/8"
81277	81271	5,000 lbs.	7/16"
81288	81281	5,000 lbs.	9/16"
81360	--	3,500 lbs.	5/8" eye



## QUICK LINKS

- Provides a quick connection for chains, cables, ropes or straps
- Threaded link ensures secure attachment with the option to disconnect later
- Requires no tools for installation
- Do not exceed work load limit

Bulk#	Pkg#	Two-Pack#	Work Load	Diameter	Finish
82610	82611	--	880 lbs.	1/4"	Zinc
82900	82901	82903	1,760 lbs.	5/16"	Zinc
82930	82933	--	2,200 lbs.	3/8"	Zinc
82931	--	--	2,640 lbs.	7/16"	Zinc
82932	--	--	3,300 lbs.	1/2"	Zinc



## JOINING LINKS

- Constructed from 1038 steel
- Do not use for lifting
- Welding required

Part#	Finish	Size
82940	Raw	9/0
82942	Raw	7/16"
82943	Zinc-plated	9/0
82944	Zinc-plated	7/16"



# HAND WINCHES

- Crank-style winch for boat trailers or hoisting applications
- Constructed from high-strength, cold-forged steel
- Equipped with a locking lever for increased safety
- Strong pinions eliminate gear-to-shaft bonding failures
- Broached pinion shaft securely engages the pinion gear
- Handle with plastic grip cover for easy, comfortable operation
- Base features slotted screw holes for flexible mounting
- Straps made from 2" wide, no-stretch nylon web
- Zinc-plated snap hook for easy, secure hookup



23423 pinion gear



23424 pinion gear



23427 crank handle



23438 locking lever



Pkg#	Capacity	Gear Ratio	Hub Diameter	Handle Length	Strap Included
29423	900 lbs.	3.25:1	3/4"	6-1/2"	No
29433	900 lbs.	3.25:1	3/4"	6-1/2"	Yes, 15' (29450)
29424	1,200 lbs.	4.2:1	3/4"	7-1/2"	No
29425	1,400 lbs.	4.2:1	3/4"	7-1/2"	No
29435	1,400 lbs.	4.2:1	3/4"	7-1/2"	Yes, 20' (29451)
29427	1,700 lbs.	5.1:1	1"	8"	No
29428	1,900 lbs.	5.1:1	1"	8"	No
29438	1,900 lbs.	5.1:1	1"	8"	Yes, 20' (29451)
29429	2,100 lbs.	5.1:1	1"	9-3/4"	No

# WINCH STRAPS

- Made from 2" wide, no-stretch nylon web
- Zinc-plated snap hook for easy, secure hookup



Bulk#	Pkg#	Work Load	Break Strength	Strap Width	Strap Length
29007	--	1,333 lbs.	4,000 lbs.	2"	20'
--	29450	1,100 lbs.	3,300 lbs.	2"	15'
--	29451	1,100 lbs.	3,300 lbs.	2"	20'

# WHEEL BEARING KITS

- Automatically maintains the correct internal pressure to avoid seal damage
- Includes two bearing cones, two bearing cups, a grease seal and cotter pin

Pkg#	Spindle O.D.	Kit Includes
23209	3/4"	(2) LM11910, (2) LM11949, seal, cotter pin
23210	1"	(2) L44643, (2) L44610, seal, cotter pin
23211	1-1/16"	(2) L44649, (2) L44610, seal, cotter pin



# BEARING PROTECTORS & REPLACEMENT DUST COVERS

- Protects wheel bearings from dirt, water and road grime
- Maintains pressure and keeps bearing greased
- Features a small reservoir to keep bearings well-lubricated
- Covers prevent dust and debris from entering the bearing protector
- Includes two protectors and two dust covers



Bearing Protector#	Replacement Cover Two-Pack#	Hub Bore Size
22178	23178	1.78" diameter
22198	23198	1.98" diameter
22232	23232	2.32" diameter
22244	23244	2.44" diameter

# WHEEL CHOCK SET

- Perfect for chocking wheels on a parked trailer or adding safety during vehicle maintenance
- Raised tread offers a better grip on the wheel
- Saw-tooth edges on the base provide solid traction on the ground
- Always to be used with vehicle brake
- Not for commercial use



Part#	Description
22800	For use with wheels up to 17" wide



# CARGO STRAPS

- Perfect for securing cargo in trailers, truck beds and more
- Offers a superior tie-down method compared to bungee cords and rope
- Cambuckle mechanism allows for quick, direct tension on lighter loads
- Ratchet mechanism allows for greater tension on heavy loads
- Straps constructed from high-strength, woven nylon
- Cinching components protected by a durable yellow zinc-plated finish



Secures cargo better than bungee cords or rope



Pkg#	Work Load	Break Strength	Strap Color	Strap Length	Strap Width	Hook Style	Hook Finish	Strap Quantity	Mechanism
83015	300 lbs.	900 lbs.	Dark green	15'	1"	S-hook	Rubber-coated	2	Cambuckle
83016	300 lbs.	900 lbs.	Dark green	16'	1"	S-hook	Rubber-coated	4	Cambuckle
83001	500 lbs.	1,500 lbs.	Red	10'	1"	S-hook	Rubber-coated	2	Ratchet
83002	500 lbs.	1,500 lbs.	Red	16'	1"	S-hook	Rubber-coated	4	Ratchet
83009	500 lbs.	1,500 lbs.	Black	10'	1"	S-hook	Rubber-coated	2	Ratchet
83010	500 lbs.	1,500 lbs.	Black	16'	1"	S-hook	Rubber-coated	4	Ratchet
83019	733 lbs.	2,200 lbs.	Blue	16'	1"	J-hook	Rubber-coated	1	Ratchet
83020	733 lbs.	2,200 lbs.	Blue	16'	1"	J-hook	Rubber-coated	2	Ratchet
83025	1,100 lbs.	3,300 lbs.	Orange	16'	1"	J-hook	Rubber-coated	1	Ratchet
83026	1,100 lbs.	3,300 lbs.	Orange	16'	1"	J-hook	Rubber-coated	2	Ratchet
83027	1,100 lbs.	3,300 lbs.	Lime green	16'	1"	S-hook	Rubber-coated	1	Ratchet
83028	1,100 lbs.	3,300 lbs.	Lime green	16'	1"	S-hook	Rubber-coated	2	Ratchet
83036	1,667 lbs.	5,000 lbs.	Yellow	14'	1-1/2"	J-hook	Yellow zinc-plated	1	Ratchet
83047	3,333 lbs.	10,000 lbs.	Yellow	27'	2"	J-hook	Yellow zinc-plated	1	Ratchet
83048	3,333 lbs.	10,000 lbs.	Yellow	27'	2"	Flat hook	Yellow zinc-plated	1	Ratchet

**TESTED. PROVEN. SAFE.**



# CARGO MANAGEMENT

## PACK IT UP AND LOCK IT DOWN

From weekend getaways to week-long excursions, CURT gives your customers the extra space and security to pack what they want. For 2019, we have added several new products to the line, including two new aluminum cargo carriers. One has a double-folding ramp for ergonomic operation and reduced wind resistance while travelling. The other has a uniquely lightweight design. We are also now offering universal roof rack crossbars and kayak holders, as well as auxiliary LED taillights for cargo carriers.



# FEATURED PRODUCTS



## Cargo carrier with ramp

For powered chairs, snowblowers and more, this cargo carrier has a unique, three-position ramp for versatile use and transportation.



## Roof rack crossbars

These new universal crossbars are rated for up to 150 lbs. and feature a lightweight, aluminum design. They easily install on most side rails.



## Roof rack kayak holders

Our new aluminum kayak holders are strong, lightweight and feature pivoting arms to fit virtually any size kayak or paddleboard.

# PRODUCT INDEX



Hitch-Mounted Cargo Carriers



Roof Rack Accessories



Cargo Bags & Nets



Tray-Style Bike Racks



Hitch-Mounted Bike Racks



Clamp-on Bike Rack



Bike Rack Accessories



Extenders & Adapters



Specialty Mounts



Reducer Sleeves



Cargo Straps



Rings & Tie-Down Anchors



## 1 1/4 INCH & 2 INCH TRAY-STYLE CARGO CARRIERS

- Frees up space inside the vehicle for passengers and cargo
- Easily bolts together for quick assembly
- Folding design allows carrier to be tilted up when not in use (select models)
- Mesh base for easy cleanup
- Features mounting holes for a cargo net or bungees
- #18100 is constructed from lightweight aluminum (shank made from powder-coated steel)
- Protected by a highly durable E-coat and carbide black powder coat finish



Easy-to-store fold-away design (select mods)



Frees up space inside the vehicle



18110



18100



18108



18109

Pkg#	Capacity	Dimensions	Shank	Shank	Finish and Material
18110	300 lbs.	47-3/4" (L) x 19-1/2" (W) x 2-1/2" (H)	1-1/4" x 1-1/4" 2" x 2" adapter	Fixed	Carbide powder coat over steel
18100*	500 lbs.	60" (L) x 19" (W) x 2-3/4" (H)	2" x 2"	Folding	Raw aluminum basket with a powder-coated steel shank
18108	500 lbs.	60" (L) x 19-1/4" (W) x 2-1/2" (H)	2" x 2"	Fixed	Carbide powder coat over steel
18109*	500 lbs.	60" (L) x 19-1/4" (W) x 2-1/2" (H)	2" x 2"	Folding	Carbide powder coat over steel

\*Rear-mounted spare tire may interfere with the folding feature

1 1/4  
INCH

&

2  
INCH

# BASKET-STYLE CARGO CARRIERS

- 6" tall sides keep items more secure during travel
- Frees up space inside the vehicle for passengers and cargo
- Constructed from heavy-duty, tubular steel
- Folding shank allows carrier to be tilted up when not in use (select models)
- Angled shank elevates carrier for more ground clearance (select models)
- Mesh base for easy cleanup
- Built-in reflectors add visibility for increased safety
- Easily accepts a cargo bag, cargo net or bungees
- Protected by a highly durable E-coat and carbide black powder coat finish



Easy-to-store fold-away design (select mods)



Frees up space inside the vehicle



18150



18151



18145



18152



18153

Pkg#	Capacity	Dimensions	Shank Size	Shank	Finish	Material
18150	500 lbs.	59-1/2" (L) x 20-1/4" (W) x 5-12" (H)	2" x 2"	Fixed	Carbide	Steel
18151*	500 lbs.	58" (L) x 20" (W) x 5-1/2" (H)	2" x 2"	Folding	Carbide	Steel
18152	500 lbs.	60" (L) x 24" (W) x 6" (H)	2" x 2"	Fixed	Carbide	Steel
18153*	500 lbs.	60" (L) x 23-3/4" (W) x 5-1/2" (H)	2" x 2"	Folding	Carbide	Steel
18145	500 lbs.	46-1/2" (L) x 17-1/2" (W) x 5-1/2" (H)	1-1/4" x 1-1/4"	Fixed	Carbide	Steel
			2" x 2" adapter			

\*Rear-mounted spare tire may interfere with the folding feature

# ALUMINUM CARGO CARRIER WITH RAMP

**NEW**

- Built-in ramp for easy loading of scooters, push mowers, snow blowers and more
- Three-position ramp can be extended, folded vertically or stowed in the carrier
- Double-folding ramp for ergonomic operation and less wind resistance
- Threaded anti-rattle shank to resist sway and suppress noise
- Ramp folds flat into the carrier for compact storage and rear vehicle access
- Non-skid ridges provide enhanced traction when moving up or down the ramp
- Built-in reflectors add visibility for increased safety
- 8-bolt assembly for fast, easy installation
- Mounts onto any 2" x 2" receiver tube opening
- Fully welded aluminum construction with durable carbide powder coat finish



18112



Built-in ramp for easy loading of cargo



Double-folding ramp for ergonomic operation



Folding shank for easy parking and storage

Pkg#	Capacity	Dimensions	Shank Size	Shank	Finish	Material
18112 <b>NEW</b>	500 lbs.	50" (L) x 30-1/2" (W) x 4" (H)	2" x 2"	Folding	Carbide black	Aluminum

# AUXILIARY LED INDICATOR LIGHTS

**NEW**

- Auxiliary indicator lights for increased safety on cargo carriers or bike racks
- Double row of LEDs in each strip correspond with brake, turn and running lights
- Industry-standard 4-way flat connector for quick installation
- 3M adhesive backing for secure, convenient mounting
- Durable, waterproof construction for lasting weather resistance



53201



Increases safety on cargo carriers



Adhesive backing for easy installation anywhere

Pkg#	Includes
53201 <b>NEW</b>	Two LED light strips, adhesive backing and wiring harnesses

# ALUMINUM BASKET-STYLE CARGO CARRIER

- One-piece welded aluminum basket with durable E-coat finish
- Spacious design provides ample room for cargo
- Built-in reflectors add visibility for increased safety
- 4-bolt assembly for fast, easy installation
- Weighs only 25 lbs. for easy moving and handling
- Mounts onto any 2" x 2" receiver tube opening

**NEW**



18113



4" tall sides help keep cargo more secure



Rated to carry loads up to 500 lbs.



Built-in reflectors for added safety

Pkg#	Capacity	Dimensions	Shank Size	Shank	Finish	Material
18113 <b>NEW</b>	500 lbs.	49" (L) x 22-1/2" (W) x 4" (H)	2" x 2"	Fixed	Carbide black	Aluminum

# UNIVERSAL ATV CARGO CARRIER

- Universal design fits most ATV cargo racks
- 6" tall sides keep items more secure during travel
- Lightweight for easy installation and use
- Mesh base for easy cleanup
- Constructed from heavy-duty, tubular steel
- Protected by a highly durable E-coat and carbide black powder coat finish
- Includes universal mounting hardware
- White box with full-color retail label



18101



Quickly and easily installs to ATV racks



Adds extra space for securing cargo



6" tall sides keep items more secure

Pkg#	Capacity	Finish	Material	Dimensions
18101	Limited to ATV	Carbide	Steel	41" (L) x 26" (W) x 6-1/4" (H)

# ROOF RACK CROSSBARS

- Lightweight, E-coated aluminum construction
- Adjustable, universal design mounts to roof side rails with up to 50" span
- Rubber-coated clamps quickly secure with no tools required
- Integrated rubber strip on top of bars to protect and help secure cargo
- Sleek, oval-shaped cross bars to match the OE style of modern vehicles
- Compatible with CURT roof rack cargo carrier and kayak racks



18118



Key-operated twist knobs for added security



Adjustable design mounts various accessories



Sleek, oval shape matches modern vehicles

Pkg#	Capacity	Length	Width	Height	Includes
18118 <b>NEW</b>	150 lbs.	53-3/8"	2-1/8"	7/8" (2" installed)	Two crossbars and mounting hardware

# ROOF RACK KAYAK HOLDERS

- Lightweight aluminum construction with 75-lb. capacity
- Rotating arms pivot to fit virtually any size kayak
- Notched pivot points for precise positioning and locking
- Universal brackets mount on any roof rack crossbars with no tools required
- Foam padding protects kayak from scuffs and scratches
- Straps loop around the kayak for secure travel
- Arms fold up in seconds for convenient, compact storage



18320



Rotating arms pivot to fit any size kayak



Foam padding protects kayak from scratches



Arms fold down for convenience storage

Pkg#	Capacity	Includes
18320 <b>NEW</b>	75 lbs.	Two holders, straps and mounting hardware





## ROOF RACK CARGO CARRIER

- Frees up space inside the vehicle for passengers and cargo
- Mounts to most roof rack crossbars
- Easily accepts a CURT cargo bag or cargo net
- Lightweight and easy to install with included mounting brackets
- Two-piece design easily bolts together for quick assembly
- Protected by a durable E-coat and carbide black powder coat finish



Mounts to most roof rack base rails



Frees up space inside the vehicle



18115

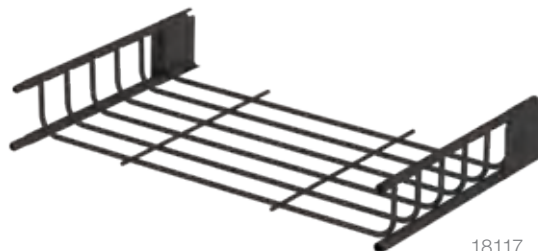

18117

Pkg#	Capacity	Inside Dimensions	Storage Area	Finish	Material	Description
18115	Limited to vehicle	41-1/2" (L) x 37" (W) x 4" (H)	10-5/8 square feet	Carbide	Steel	Roof basket
18117	Limited to vehicle	21" (L) x 37" (W) x 4" (H)	Adds 5-3/8 square feet	Carbide	Steel	Extension

# CARGO BAGS

- Keeps cargo protected from water, dirt, wind damage and more
- Made from thick, 500 x 500 denier, UV-resistant vinyl
- Features welded seams to be highly weather-resistant
- Zip closure with hook-and-loop flap helps keep the inside dry
- Zippers feature large holes to accept a padlock
- Tie-down straps securely attach to cargo carrier frame
- Easily folds up for compact storage



18210



18211



18220



18221



Vinyl exterior helps keeps cargo dry



Secure zip closure, hook-and-loop flap



Easily folds up for compact storage



Fits into CURT roof rack cargo carriers



Fits into most CURT cargo carriers



Pkg#	Dimensions	Storage	Straps	Description	Yarn Count	Weight	Thickness
18210	56" x 18" x 21"	12.25 cubic feet	6	Cargo carrier bag	500 denier	600 grams per square meter	0.45mm - 0.55mm
18211	56" x 22" x 21"	15.00 cubic feet	6	Cargo carrier bag			
18220	38" x 34" x 18"	13.50 cubic feet	4	Roof rack cargo carrier cargo bag			
18221	59" x 34" x 18"	21 cubic feet	6	Roof rack cargo carrier cargo bag			

# CARGO NETS

- Secures cargo from dislodging during travel
- Provides more reliable security compared to bungee cords
- Attachment hooks feature holes for easy handling
- Elastic netting fits over a variety of cargo
- Includes durable, netted storage bag



Secures cargo from dislodging during travel



Hook holes for easy handling



18202



18200

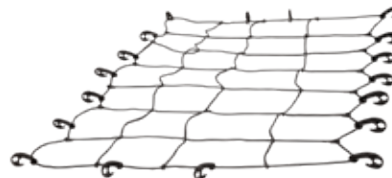

18201



Pkg#	Dimensions	Fits
18202	43" x 24"	60" wide carriers
18200	44" x 38"	Roof rack cargo carrier
18201	65" x 38"	Extended roof rack cargo carrier





Any bike rack used with a 1-1/4" receiver tube requires the use of a support strap (CURT #18050). Failure to use a support strap may void the warranty of the trailer hitch and / or bike rack.

**1 1/4**  
INCH

**&**

**2**  
INCH

## TRAY-STYLE HITCH-MOUNTED BIKE RACKS

- Tray-style cradles provide three points of contact to keep bikes fully secure
- Ratcheting arms lock down onto the frames and will not loosen during travel
- Key-operated ratchets also deter theft while the vehicle is left unattended
- Highly adjustable cradles easily accommodate various bike sizes and styles
- Padded arms protect the bike frames from nicks and scratches
- Tray-style design allows for easy loading and unloading of bikes
- Threaded anti-wobble shank prevents bikes from swaying during travel
- Tilts away for convenient rear vehicle access
- Sides fold up when not in use for compact storage
- Protected by a durable black powder coat finish
- **Do not install on a trailer or other towed vehicle**



Tilts away for rear vehicle access



Lockable, ratcheting arms will not loosen



Sides fold up for compact storage



Threaded shank prevents wobble

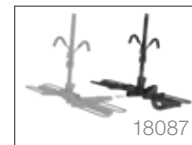

Removable 2-bike extension



Included adapter fits 2" receiver

Pkg#	Number of Bikes	Max Load	Shank Size	Extendable
18085	2	90 lbs.	1-1/4" x 1-1/4" 2" x 2"	No
18087	4	180 lbs.	2" x 2"	Yes

## TRAY-STYLE BIKE RACK CRADLES FOR FAT TIRES

- 4-7/8" inside width accepts most types of fat bike tires
- Add-on cradles are designed to replace existing cradles
- Durable black powder coat finish
- Includes two cradles for holding one bike



Designed to replace existing cradles



18091

Pkg#	Fits	Inside width
18091	CURT tray-style bike racks	4-7/8"

## 2 INCH PREMIUM HITCH-MOUNTED BIKE RACKS

- Tapered arms accommodate multiple bike sizes, including kids' bikes
- Adjustable rubber cradles will not scratch bike frames
- Tilts away for convenient rear vehicle access
- Arms fold down when not in use for compact storage
- Threaded anti-wobble shank prevents bikes from swaying during travel
- Built-in reflectors for added safety
- Protected by a durable black powder coat finish
- **Do not install on a trailer or other towed vehicle**



Tilts away for rear vehicle access



Threaded shank prevents wobble

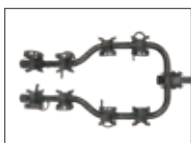

Tapered arms fit a range of bike sizes



Adjustable rubber cradles



Towable shank allows use of the bike rack while towing a trailer, see page 248 for details



18063



18064



18065

Pkg#	Number of Bikes	Max Bike Capacity	Shank Size	Towable Shank
18063*	3	135 lbs.	2" x 2"	Compatible, not included
18064	4	180 lbs.	2" x 2"	Compatible, not included
18065	5	225 lbs.	2" x 2"	Not compatible

\*Continued while supplies last

## BIKE RACK REPLACEMENT STRAPS

- Fastens to the bike rack cradles to secure bikes for travel
- Multiple holes allows for easy adjustment for different bike frame tube sizes
- Rubber construction will not scratch bike frames

Part#	Fits
18007	CURT standard and premium hitch-mount bike racks



18007 installed



18007



## 1 1/4 INCH & 2 INCH HITCH-MOUNTED BIKE RACKS

- Adapter sleeve allows mounting on either 1-1/4" or 2" receiver tube (#18029, #18030, #18033, #18034)
- Towable shank allows use of the bike rack while towing a trailer (#18031 and #18035)
- 3/4" trailer ball hole accepts any trailer ball with a 3" shank (CURT #40016 recommended)
- Adjustable rubber cradles will not scratch bike frames
- Tilts away for convenient rear vehicle access
- Arms fold down when not in use for compact storage
- Threaded anti-wobble shank helps prevent bikes from swaying during travel
- Bolt-together post can be disconnected for compact storage
- Protected by a durable black powder coat finish
- Compact package makes part numbers #18029 and #18030 retail-friendly
- **Do not install on a trailer or other towed vehicle**



Tilts away for rear vehicle access



Adjustable rubber cradles



Threaded shank prevents wobble



Support strap included



Removable arm extenders save space

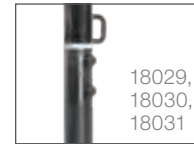

Bolt-together post for compact storage

## 2 INCH TOWABLE BIKE RACK SHANK

- Allows for easy towing of a trailer while using a bike rack
- Fits trailer hitches with a 2" x 2" receiver tube opening
- Bike rack tilts away for rear vehicle access
- 3/4" trailer ball hole accepts any trailer ball with a 3" shank (CURT #40016 recommended)
- Hollow shank accepts an anti-rattle kit to prevent wobble
- Constructed from high-strength steel
- Bike rack and trailer ball not included



Tow a trailer while using the bike rack



18008

Part#	Shank Size	GTW / TW	Finish
18008*	2" x 2"	2,000 / 200 lbs.	Gloss black

\* Continued while supplies last



Any bike rack used with a 1-1/4" receiver tube requires the use of a support strap (CURT #18050). Failure to use a support strap may void the warranty of the trailer hitch and / or bike rack.

**1 1/4**  
INCH

**&**

**2**  
INCH

## HITCH-MOUNTED BIKE RACKS



Towable shank allows use of the bike rack while towing a trailer



Pkg#	Number of Bikes	Max Bike Capacity	Shank Size	Towable Shank	Towable GTW / TW	Extendable
<b>Hitch-Mounted Bike Racks</b>						
18029	2	90 lbs.	1-1/4" x 1-1/4" 2" x 2"	Compatible, not included	--	No
18030	2 or 4	90 / 180 lbs.	1-1/4" x 1-1/4" 2" x 2"	Compatible, not included	--	Yes
18033*	3	135 lbs.	1-1/4" x 1-1/4" 2" x 2"	Compatible, not included	--	No
18034*	4	180 lbs.	1-1/4" x 1-1/4" 2" x 2"	Compatible, not included	--	No
<b>Towable Hitch-Mounted Bike Racks</b>						
18031*	2 or 4	90 / 180 lbs.	2" x 2"	Included	2,000 / 200 lbs.	Yes
18035*	4	180 lbs.	2" x 2"	Included	2,000 / 200 lbs.	No

\* Continued while supplies last



Any bike rack used with a 1-1/4" receiver tube requires the use of a support strap (CURT #18050). Failure to use a support strap may void the warranty of the trailer hitch and / or bike rack.

**2**

INCH

## CLAMP-ON BIKE RACK

- Clamps onto any 2" x 2" ball mount shank (ball mount not included)
- Adjustable rubber cradles will not scratch bike frames
- Easily accessible release handle allows for fast installation and removal
- Arms fold down when not in use for compact storage
- Built-in reflectors for added safety
- Protected by a durable black powder coat finish
- Includes support straps
- **Do not install on a trailer or other towed vehicle**



Fits 2" x 2" ball mount shank



Adjustable rubber cradle



Support strap included



Easily accessible release handle



18013

Pkg#	Clamp Size	Number of Bikes	Max Load
18013	2" x 2"	3	135 lbs.

## BOLT-ON BIKE RACK

- Bolts onto any ball mount or step bumper with a 3/4" hole
- Tilts away for convenient rear vehicle access
- Rubber-coated arms will not scratch bike frames
- Features a lockable arm for added security
- Protected by a durable black powder coat finish
- **Do not install on a trailer or other towed vehicle**



18011

Pkg#	Number of Bikes	Max Load	Bolt Size
18011	2	70 lbs.	3/4"

## BIKE BEAM

- Allows bike with angled frame to be used on bike rack
- Extends from 22-1/2" to 31" to accommodate multiple bike sizes
- Made with high-strength steel construction



Helps mount angled-frame bikes



18016

Pkg#	Length	Finish
18016	Extends from 22-1/2" to 31"	Black



## MULTI-USE CABLE LOCK

- Secures bike racks and cargo to deter theft
- Features versatile locking and cinching capabilities
- 6' length allows for great use as a bike lock
- Constructed from 3/8" high-strength braided steel cable
- Protected by a vinyl coating for rust resistance
- Includes two keys for added convenience



Locks bikes to deter theft



23666

Pkg#	Length	Cable	Finish
23666	6'	3/8" diameter	Vinyl-coated, braided steel

## BIKE RACK SUPPORT STRAP

- Provides added stability and support for a hitch-mounted bike rack
- Vinyl-coated hook prevents scratches on painted surfaces
- Required for all 1-1/4" hitch-mounted bike racks (Recommended for all hitch-mounted bike racks)
- Failure to use a support strap with a 1-1/4" bike rack may void the warranty of the trailer hitch and bike rack



Supports 1-1/4" hitch-mounted racks



18050

Pkg#	Dimensions
18050	1" wide by 61" long

## ANTI-RATTLE HITCH PINS

- Stops rattling and prevents swaying of load when using a hollow shank
- Compatible with CURT cargo carriers and other hollow-shank accessories
- Threaded pin allows bracket to be tightly installed



22315



22321

Pkg#	Fits Receiver Tube Opening	Finish
22315	1-1/4" x 1-1/4"	Yellow zinc-plated
22321	2" x 2"	Yellow zinc-plated

## TRAY-STYLE BIKE RACK LOCKING KNOBS

- Locking knobs are designed to replace existing knobs
- Includes two keys for added convenience
- Compatible with CURT #18084 and #18086 only
- Includes two knobs per package



18090

Pkg#	Fits
18090*	18084 and 18086 tray-style bike racks

\* Continued while supplies last

# 1 1/4 INCH & 2 INCH TRAILER HITCH RECEIVER TUBE EXTENDERS

- Provides added clearance for a trailer or hitch-mounted accessory
- Shank constructed from solid steel for optimum strength
- Protected by a durable powder coat finish



Part#	Extends	Shank Size	GTW / TW
45789	7"	1-1/4"	Not for towing use / 350 lbs.
45791	8"	2"	3,500 / 350 lbs.
45795	14"	2"	3,500 / 350 lbs.
45796	18"	2"	3,500 / 350 lbs.

## Measuring extenders and adapters

Length is measured between pin-holes, from center to center



# 1 1/4 INCH → 2 INCH ← 2 1/2 INCH TRAILER HITCH RECEIVER TUBE ADAPTERS

- Adapts a receiver tube opening to a different size
- #45048 can be cut down from 34" to 24" and has integrated safety chain loops and an electrical bracket
- Protected by a durable powder coat finish



Part#	Adapts From	Adapts To	GTW / TW	Weight Dist. GTW / TW	Length	Finish
45785	1-1/4"	2"	Not for towing use / 350 lbs.	--	6-1/4"	Gloss black
45790	1-1/4"	2"	Not for towing use / 350 lbs.	--	10"	Gloss black
45770	2"	1-1/4"	3,500 / 350 lbs.	--	4"	Gloss black
45775	2"	1-1/4"	3,500 / 350 lbs.	--	9-1/2"	Gloss black
45780	2"	1-1/4"	3,500 / 350 lbs.	--	15"	Gloss black
45013	Vertical 2"	Standard 2"	5,000 / 500 lbs.	--	4-1/4"	Gloss black
45048	2-1/2"	2"	4,500 / 450 lbs.	6,000 / 600 lbs.	34"	Gloss black
			6,000 / 600 lbs.	8,000 / 800 lbs.	24"	

## 2 INCH SPECIALTY MOUNTS

 Weight capacities limited to the lowest rated towing component

- Fits any 2" x 2" receiver tube opening
- Top receiver increases ground clearance for a cargo carrier or other hitch-mounted accessories
- Top receiver not for towing use
- Provides two receiver tubes for multiple accessories, such as a cargo carrier and a ball mount (#45792)
- Ideal for carrying a bike rack while towing a trailer (#45810)



45794 gives added ground clearance



45792 provides two receiver tubes



45810 provides a ball mount and receiver tube to tow a trailer and an additional accessory



Part#	Description	GTW / TW	Drop	Rise	Length	Hole Size	Finish
45794	Raised receiver adapter	Not for towing use / 350 lbs.	--	4-1/4"	5-1/4"	--	Gloss black
45792	Dual receiver extender with pin & clip	3,500 / 350 lbs.	--	5-13/16"	8"	--	Gloss black
45810	Multi-use ball mount with pin & clip	7,500 / 750 lbs.	2"	5-13/16"	12-1/4"	1"	Gloss black

## 3 INCH → 2 1/2 INCH → 2 INCH REDUCER SLEEVES

- #45405 reduces a 2-1/2" x 2-1/2" receiver tube opening to fit a 2" x 2" shank
- #45408 set reduces a 3" x 3" receiver tube opening to fit a 2-1/2" x 2-1/2" shank or 2" x 2" shank
- Protected by a durable carbide powder coat finish
- GTW and TW are limited to trailer hitch capacity

### How to use a reducer sleeve



Part#	Reduces From	Reduces To	Length	Finish
45405	2-1/2"	2"	5-1/2"	Carbide
45408	3"	2-1/2"	6-1/4"	Carbide
	2-1/2"	2"		



45405



45408



45408 is two reducer sleeves in one set

# CARGO STRAPS

- Perfect for securing cargo in trailers, truck beds and more
- Offers a superior tie-down method compared to bungee cords and rope
- Cambuckle mechanism allows for direct tension on lighter loads
- Ratchet mechanism allows for greater tension on heavy loads
- Straps constructed from high-strength, woven nylon
- Cinching components protected by a durable yellow zinc-plated finish



Secures cargo better than bungee cords or rope



Pkg#	Work Load	Break Strength	Strap Color	Strap Length	Strap Width	Hook Style	Hook Finish	Strap Quantity	Mechanism
83015	300 lbs.	900 lbs.	Dark green	15'	1"	S-hook	Rubber-coated	2	Cambuckle
83016	300 lbs.	900 lbs.	Dark green	16'	1"	S-hook	Rubber-coated	4	Cambuckle
83001	500 lbs.	1,500 lbs.	Red	10'	1"	S-hook	Rubber-coated	2	Ratchet
83002	500 lbs.	1,500 lbs.	Red	16'	1"	S-hook	Rubber-coated	4	Ratchet
83009	500 lbs.	1,500 lbs.	Black	10'	1"	S-hook	Rubber-coated	2	Ratchet
83010	500 lbs.	1,500 lbs.	Black	16'	1"	S-hook	Rubber-coated	4	Ratchet
83019	733 lbs.	2,200 lbs.	Blue	16'	1"	J-hook	Rubber-coated	1	Ratchet
83020	733 lbs.	2,200 lbs.	Blue	16'	1"	J-hook	Rubber-coated	2	Ratchet
83025	1,100 lbs.	3,300 lbs.	Orange	16'	1"	J-hook	Rubber-coated	1	Ratchet
83026	1,100 lbs.	3,300 lbs.	Orange	16'	1"	J-hook	Rubber-coated	2	Ratchet
83027	1,100 lbs.	3,300 lbs.	Lime green	16'	1"	S-hook	Rubber-coated	1	Ratchet
83028	1,100 lbs.	3,300 lbs.	Lime green	16'	1"	S-hook	Rubber-coated	2	Ratchet
83036	1,667 lbs.	5,000 lbs.	Yellow	14'	1-1/2"	J-hook	Yellow zinc-plated	1	Ratchet
83047	3,333 lbs.	10,000 lbs.	Yellow	27'	2"	J-hook	Yellow zinc-plated	1	Ratchet
83048	3,333 lbs.	10,000 lbs.	Yellow	27'	2"	Flat hook	Yellow zinc-plated	1	Ratchet

# FOLD-AWAY ROPE HOOK

- Adds a convenient anchor point for ropes, bungee cords or straps
- Perfect for cargo management in trailers, trucks and vans
- Fold-away design eliminates obstruction and provides a finished look
- Protected by a durable chrome-plated finish
- Includes mounting hardware



Folds out as needed and folds away to be completely unobtrusive

83060

83061

Bulk#	Pkg#	Capacity	Finish
83060	83061	1,200 lbs.	Chrome-plated

# WELD-ON STAKE POCKET

- Adds a tie-down point for cargo straps and transport binder chains
- Perfectly sized to accept a 2x4 wood or metal stud
- Raw finish allows for ready welding
- Made in the USA

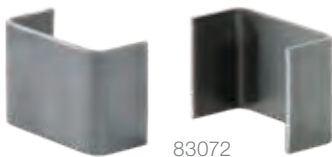

83072

Part#	Finish	Inside Width	Inside Depth
83072	Raw	3-1/2"	1-5/8"

# RINGS & TIE-DOWN ANCHORS

See page 257 for  
part number table

## Recessed rope rings

- Recessed design eliminates obstruction and provides a finished look
- Adds a convenient anchor point for ropes, bungee cords or straps
- Perfect for cargo management in trailers, trucks and vans
- Constructed from high-strength steel
- Protected by a durable zinc-plated finish
- Mounting screws not included



83601



83710



83600

## D-rings

- Square holes accept 3/8" carriage bolts (#83740 and #83742)
- Round holes accept 1/4" bolts (#83730 and #83732)
- Adds a convenient anchor point for ropes, bungee cords or straps
- Perfect for cargo management in trailers, trucks and vans
- Constructed from high-strength steel
- Mounting screws not included



83740



83742



83730



83732



83731

## Lashing rings

- Adds a heavy-duty anchor point for ropes, cables, straps or chains
- Perfect for heavyweight cargo management in trailers and trucks
- Raw finish allows for ready welding of mounting bracket
- Large opening offers a reliable anchoring point
- Constructed from high-strength, forged steel



83750



83760



83770



83780



Adds attachment point to a trailer

## Backing plate

- Allows for more secure attachment of tie-down anchors
- Constructed from high-strength steel
- Compatible with #83600, #83740 and #83742
- Mounting screws not included



83607



83740 & 83607

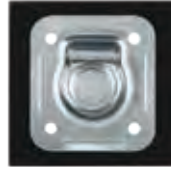

83600 & 83607

## Trim ring

- Provides a clean, finished look for recessed plate #83710
- Helps protect plate edges from damage and corrosion
- Constructed from durable black plastic



83720



83710 in 83720

# RINGS & TIE-DOWN ANCHORS

Part#	Capacity	Break Strength	Finish	Base Size	Mount Hole Size	Mounting Hole Pattern	Ring I.D.	Ring Thickness
<b>Recessed Rope Rings</b>								
83710	1,000 lbs.	1,000 lbs.	Zinc-plated	3-1/2" x 3-1/2"	1/4"	1-3/16"	1-1/8" x 1-5/8"	1/4"
83601	1,200 lbs.	1,200 lbs.	Zinc-plated	5" x 3-1/2"	1/4"	4-1/16" x 1/4"	1-3/8" x 1-7/8"	1/4"
83600	5,000 lbs.	5,000 lbs.	Zinc-plated	4-7/8" x 4-1/2"	3/8"	3-3/8" x 2-7/8"	1-1/2" x 1-1/2"	1/2"
<b>D-Rings</b>								
83730	1,200 lbs.	1,200 lbs.	Zinc-plated	2-1/4" x 13/16"	1/4"	1-1/2"	1" x 1-1/4"	1/4"
83731*	1,200 lbs.	1,200 lbs.	Zinc-plated	2-1/4" x 13/16"	1/4"	1-1/2"	1" x 1-1/4"	1/4"
83732	1,200 lbs.	1,200 lbs.	Stainless	2-1/4" x 13/16"	1/4"	1-1/2"	1" x 1-1/4"	1/4"
83740	3,600 lbs.	11,000 lbs.	Yellow zinc-plated	1-3/4" x 3-11/16" x 7/8"	7/16"	2"	3" x 3"	1/2"
83742	3,600 lbs.	11,000 lbs.	Zinc-plated	1-3/4" x 3-11/16" x 7/8"	7/16"	2"	3" x 3"	1/2"
<b>Lashing Rings</b>								
83750	6,100 lbs.	18,000 lbs.	Raw steel	2-1/4" x 1-5/8" x 1-1/4"	--	--	3" x 3"	5/8"
83760	8,833 lbs.	26,500 lbs.	Raw steel	2-1/4" x 1-5/8" x 1-1/4"	--	--	3" x 3"	3/4"
83770	15,587 lbs.	46,760 lbs.	Raw steel	2-1/4" x 2-1/8" x 1-3/4"	--	--	3" x 3"	1"
83780	15,587 lbs.	46,760 lbs.	Raw steel	2-1/4" x 2-1/8" x 1-3/4"	--	--	3" x 4"	1"
<b>Backing Plate and Trim Ring</b>								
83607	--	--	Gloss black	6" x 6"	7/16"	3" x 3-1/4" (2" center)	--	--
83720	--	--	Plastic	--	--	--	3" x 3"	3/8"

\* Packaged two-pack



# MARKETING MATERIALS

## FULLY SUPPORTING YOUR BUSINESS

We believe in providing our customers with the highest quality products and fully supporting the sale of those products in-store and online. For in-store sales, we offer signage, display stands and literature to draw in more traffic and help your customers make an informed buying decision. We also have a large selection of planogram options. For online sales, we offer extensive image, video and content libraries available for your use. To use these resources on your website, please speak to your sales representative.



Contact your sales representative for a complete list of available items.

# POINT-OF-PURCHASE

## LITERATURE & CATALOG

- Tri-fold literature focuses on educating the consumer about the advantages of CURT product lines
- Tri-fold: 8-1/2" x 3-1/2" finished size
- The catalog provides a complete listing of CURT products and vehicle-specific applications (#99272)
- Clear plastic stands available for displaying literature

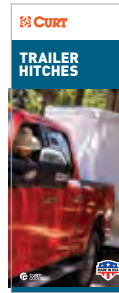

99067



99275



99272

## BANNERS & POSTERS

- Bold graphics and clear lifestyle messaging to draw attention to your store
- Various options designed to promote your CURT product offering while educating your customers



99042



99132

## RETAIL SIGNAGE

- Window stickers, indoor / outdoor signage and counter mats to help promote CURT products
- Header cards also available, see page 263



99133



99191



99141 & 99269



99266



99267

# DISPLAY STANDS

## TRAILER HITCHES

- Contact your CURT sales representative to determine the hitch lineup best tailored to your needs
- Accepts trailer hitches with 2" receiver tubes
- Quickly adapt the CURT #99143 trailer hitch stand to accept 1-1/4" or 2-1/2" receiver tube trailer hitches



99157



99095

Part#	Description / Requirements for a Free Display
99143	Buy five hitches, five ball mounts and five pins & clips
99157	Adapts 1-1/4" receiver tube openings to fit 2" (ball mount and pin & clip included)
99095	2-1/2" receiver tube openings to fit 2" (designed for Commercial Duty trailer hitches)



99145 sign



99143

## 5TH WHEEL HITCHES & ROLLERS

- For use with CURT A-series and Q-series hitches (#99156)
- Adapters required for A-series hitches
- For use with CURT E16 5th wheel hitch (#99160)
- For use with all CURT R-series rollers (#99158)



99183



99257

Part#	Description / Requirements for a Free Display
99160	Buy four E16 5th wheels with rails (one for display, three for stock)
99156	Buy three Q- or A-series 5th wheel hitches with rails (one for display, two for stock)
99183	A16 display adapter plate (Required to mount A16 5th wheel hitch to 99156 display)
99257	A20 and A25 display adapter plate (Required to mount A20 and A25 5th wheel hitches to 99156 display)
99158	Buy any two 5th wheel rollers (one for display, one for stock)



99022 display box



99158 stand, displaying 16646

Receive free display stands by fulfilling the purchase requirements listed.  
Contact your sales representative for ordering information. Signage must be ordered separately.

## GOOSENECK HITCHES

- For use with select CURT gooseneck hitches
- See the table below for compatible gooseneck part numbers (#99180)
- Shows both the CURT Spyder and bent plate 5th wheel rail gooseneck hitches at the same time (#99159)

Part#	Description / Requirements for a Free Display
99180*	Buy four gooseneck hitches (one for display, three for stock) Compatible parts: 60607, 60611, 60619, 60630
99159	Buy three 16055 and three 16085 (one each for display, two each for stock)

\* 60615, 60620, 60625 and 60640 do not fit the 99180 display stand



## WEIGHT DISTRIBUTION

- Double-stack design allows for easy comparison between models (#99254)
- For use with all CURT weight distribution hitches
- Coupler accepts a 2-5/16" trailer ball (#99254)
- Receiver tube accepts 2" x 2" shanks (#99246)
- #99255 sign is included



Part#	Description / Requirements for a Free Display
99254	Double-stack display with header card Buy any four WD units, two for display, two for stock
99246*	Low-rise weight distribution display stand

\* Continued while supplies last



Receive free display stands by fulfilling the purchase requirements listed.  
Contact your sales representative for ordering information. Signage must be ordered separately.

## BIKE RACKS

- For use with all CURT bike racks
- Includes five receiver tubes on each side of the display for multiple bike rack configurations (#99154)



Part#	Requirements for a Free Display
99039	Single-sided display Buy any three bike racks with a shank
99154*	Double-sided display Buy any five bike racks with a shank

\* Continued while supplies last

## CARGO CARRIERS

- For use with CURT cargo carriers
- Double-sided display



Part#	Requirements for a Free Display
99152	Buy any eight 2" shank cargo carriers (four for display, four for stock)

## CARGO STRAPS

- For use with CURT cargo straps
- Includes display stand and peg hooks
- See page 254 for cargo straps



Part#	Description
99193	Cargo strap display stand and peg hooks (cargo straps sold separately)



# PLANOGRAM SUPPORT

## IN-STORE PLANOGRAMS

CURT offers custom planogram services tailored to your needs. Whether pre-designed or custom, we can help provide a convenient retail solution for your store.

Please contact your sales representative for more information about sizes and options or to discuss custom planogram options.



## GONDOLA DISPLAYS

- Fit 4' wide Lozier gondola displays
- Use with retail header cards listed below



99028 loaded



99015 loaded



99029 loaded



99162 loaded

Part#	Holds	Description / Requirements for a Free Display	Notes
99028	Trailer balls	Buy any 30 bulk trailer balls	Holds up to 45 trailer balls
99015	Ball mounts	Buy any 20 ball mounts	Holds up to 32 ball mounts
99029	Ball mounts and trailer balls	Buy any 15 bulk trailer balls and any 10 ball mounts	Holds up to 21 trailer balls and 18 ball mounts
99162	Ball mounts	Buy any 45 ball mounts	15 pegs display various ball mounts

## RETAIL HEADER CARDS

- Help your customers identify CURT product categories and connect them to towing lifestyles



99040

## OUT-OF-STOCK PEG TAGS

- Place behind your product to easily identify where CURT product should be restocked
- Ships as a perforated sheet of 16 tags



Individual tag

# TRAILER HITCHES LISTED NUMERICALLY

Part#	Years	Make	Model
11000	10-14	VOLKSWAGEN	GOLF
11000	10-14	VOLKSWAGEN	GTI
11001	10-16	MERCEDES-BENZ	E350
11002	10-11	HONDA	ACCORD CROSSTOUR
11002	12-15	HONDA	CROSSTOUR
11005	91-92	SATURN	SC
11005	93-02	SATURN	SC1
11005	93-02	SATURN	SC2
11005	91-02	SATURN	SL
11005	91-02	SATURN	SL1
11005	91-02	SATURN	SL2
11005	93-99	SATURN	SW1
11005	93-01	SATURN	SW2
11006	07-11	DODGE	CALIBER
11008	92-96	MITSUBISHI	DIAMANTE
11010	93-99	VOLKSWAGEN	JETTA
11011	97-99	VOLKSWAGEN	CABRIO
11011	93-99	VOLKSWAGEN	GOLF
11012	94-98	MITSUBISHI	GALANT
11013	10-14	CADILLAC	CTS
11014	97-01	HONDA	CR-V
11017	10-12	LEXUS	HS250H
11019	10-13	KIA	FORTE KOUP
11020	08-15	SMART	FORTWO
11022	10-12	SUZUKI	KIZASHI
11023	10-13	ACURA	ZDX
11024	99-04	CHEVROLET	TRACKER
11024	99-05	SUZUKI	GRAND VITARA
11024	91-98	SUZUKI	SIDEKICK
11025	11-14	HYUNDAI	SONATA
11025	11-15	KIA	OPTIMA
11027	95-00	CHRYSLER	CIRRUS
11027	95-06	DODGE	STRATUS
11027	96-00	PLYMOUTH	BREEZE
11028	06-15	MAZDA	MX-5 MIATA
11030	12-13	MERCEDES-BENZ	C250
11030	08-13	MERCEDES-BENZ	C300
11030	08-13	MERCEDES-BENZ	C350
11030	08-13	MERCEDES-BENZ	C63 AMG
11031	07-10	KIA	RONDO
11033	07-08	BMW	328XI
11033	07-08	BMW	335XI
11034	97-04	CHEVROLET	CORVETTE
11036	98-00	CHEVROLET	METRO
11036	95-97	GEO	METRO
11036	95-01	SUZUKI	SWIFT
11037	08-16	AUDI	A5
11038	95-97	DODGE	NEON
11038	95-97	PLYMOUTH	NEON
11039	00-05	DODGE	NEON
11039	00-01	PLYMOUTH	NEON
11041	94-04	FORD	MUSTANG
11047	10-13	LEXUS	IS250
11048	10-11	FORD	MUSTANG
11051	10-14	HONDA	INSIGHT
11054	98-05	VOLKSWAGEN	PASSAT
11055	11-12	FORD	FIESTA
11057	87-95	JEEP	WRANGLER
11058	07-08	HONDA	FIT
11060	07-11	TOYOTA	YARIS
11061	11-11	FORD	MUSTANG
11064	09-13	HONDA	FIT
11065	11-13	VOLVO	C70
11066	98-10	VOLKSWAGEN	BETLE
11066	99-06	VOLKSWAGEN	GOLF
11066	07-09	VOLKSWAGEN	GOLF CITY
11067	11-18	FORD	FIESTA
11068	09-13	INFINITI	G37
11068	14-14	INFINITI	Q60
11070	99-05	VOLKSWAGEN	JETTA

Part#	Years	Make	Model
11073	11-14	MAZDA	2
11074	06-09	VOLKSWAGEN	GTI
11074	06-09	VOLKSWAGEN	RABBIT
11076	00-05	VOLKSWAGEN	PASSAT
11077	11-16	HONDA	CR-Z
11079	00-02	VOLKSWAGEN	CABRIO
11080	06-11	HYUNDAI	AZERA
11081	07-10	CHRYSLER	SEBRING
11081	08-10	DODGE	AVENGER
11083	01-05	VOLKSWAGEN	JETTA
11085	11-14	ACURA	TSX
11085	08-12	HONDA	ACCORD
11086	10-16	HYUNDAI	GENESIS COUPE
11087	11-13	SCION	TC
11088	11-17	NISSAN	JUKE
11090	07-16	VOLKSWAGEN	EOS
11091	09-17	VOLKSWAGEN	CC
11091	06-10	VOLKSWAGEN	PASSAT
11092	06-11	HYUNDAI	ACCENT
11092	06-11	KIA	RIO5
11094	06-11	HYUNDAI	ACCENT
11094	06-11	KIA	RIO
11096	07-10	VOLKSWAGEN	PASSAT
11103	07-10	JEEP	GRAND CHEROKEE
11105	91-02	FORD	ESCORT
11105	91-99	MERCURY	TRACER
11106	01-04	FORD	ESCAPE
11106	01-04	MAZDA	TRIBUTE
11108	91-94	CHEVROLET	CAVALIER
11109	95-05	CHEVROLET	CAVALIER
11109	95-05	PONTIAC	SUNFIRE
11110	10-13	KIA	SOUL
11111	11-13	INFINITI	M37
11111	11-13	INFINITI	M56
11111	14-19	INFINITI	Q70
11112	08-08	SATURN	ASTRA
11113	95-00	FORD	CONTOUR
11113	95-00	MERCURY	MYSTIQUE
11114	07-09	SATURN	SKY
11115	03-07	SATURN	ION
11117	82-02	CHEVROLET	CAMARO
11117	82-01	PONTIAC	FIREBIRD
11119	06-09	PONTIAC	SOLSTICE
11119	07-10	SATURN	SKY
11120	09-14	SUBARU	IMPREZA
11122	10-13	CHEVROLET	CAMARO
11124	11-13	KIA	FORTE
11126	02-08	MINI	COOPER
11127	12-15	MAZDA	5
11128	98-98	CHEVROLET	TRACKER
11128	89-97	GEO	TRACKER
11128	89-98	SUZUKI	SIDEKICK
11129	89-96	BUICK	CENTURY
11130	07-10	MINI	COOPER
11132	01-10	CHRYSLER	PT CRUISER
11133	11-14	CHRYSLER	200
11133	11-14	DODGE	AVENGER
11134	11-14	SCION	XD
11138	12-15	CHEVROLET	CAPRICE
11138	14-17	CHEVROLET	SS
11138	08-09	PONTIAC	G8
11140	06-11	SAAB	9-3
11141	96-05	TOYOTA	RAV4
11143	90-93	ACURA	INTEGRA
11145	92-93	ACURA	INTEGRA
11146	91-97	TOYOTA	PREVIA
11147	94-01	ACURA	INTEGRA
11148	96-00	HYUNDAI	ELANTRA
11150	89-95	MAZDA	MPV
11153	91-95	ACURA	LEGEND

Part#	Years	Make	Model
11154	02-04	ACURA	RSX
11155	96-98	ACURA	TL
11158	12-18	FORD	FOCUS
11159	96-04	ACURA	RL
11160	07-11	MINI	COOPER
11164	02-08	AUDI	A4
11164	02-08	AUDI	A4 QUATTRO
11164	04-08	AUDI	S4
11164	03-04	VOLKSWAGEN	PASSAT
11166	98-04	AUDI	A6
11166	98-04	AUDI	A6 QUATTRO
11166	01-05	AUDI	ALLROAD QUATTRO
11167	92-94	AUDI	100
11167	92-94	AUDI	100 QUATTRO
11167	95-97	AUDI	A6
11167	95-98	AUDI	A6 QUATTRO
11169	96-01	AUDI	A4
11169	96-01	AUDI	A4 QUATTRO
11169	00-02	AUDI	S4
11172	97-98	BMW	528I
11172	97-98	BMW	540I
11174	00-00	BMW	325CI
11174	99-00	BMW	323I
11174	99-99	BMW	323IS
11174	01-05	BMW	325CI
11174	01-05	BMW	325I
11174	01-05	BMW	325XI
11174	00-00	BMW	328CI
11174	99-00	BMW	328I
11174	99-99	BMW	328IS
11174	01-05	BMW	330CI
11174	01-05	BMW	330I
11174	01-05	BMW	330XI
11177	92-98	BMW	318I
11177	92-97	BMW	318IS
11177	98-99	BMW	323I
11177	98-99	BMW	323IS
11177	92-95	BMW	325I
11177	92-95	BMW	325IS
11177	96-99	BMW	328I
11177	96-99	BMW	328IS
11177	95-99	BMW	M3
11178	00-00	BMW	323CI
11178	00-00	BMW	323I
11178	01-04	BMW	325CI
11178	01-04	BMW	325I
11178	01-04	BMW	325XI
11178	00-00	BMW	328CI
11178	00-00	BMW	328I
11178	01-04	BMW	330CI
11178	01-04	BMW	330I
11178	01-04	BMW	330XI
11179	01-03	BMW	525I
11179	99-00	BMW	528I
11179	01-03	BMW	530I
11179	99-03	BMW	540I
11180	07-08	AUDI	A4 QUATTRO
11181	98-02	CHEVROLET	PRIZM
11181	93-97	GEO	PRIZM
11181	93-02	TOYOTA	COROLLA
11182	06-07	BMW	530XI
11184	11-11	BMW	1 SERIES M
11184	08-11	BMW	128I
11184	08-11	BMW	135I
11185	96-00	CHRYSLER	SEBRING
11186	99-16	AUDI	A4
11186	09-16	AUDI	A4 QUATTRO
11187	95-02	CHRYSLER	SEBRING
11187	95-00	DODGE	AVENGER
11187	95-02	DODGE	STRATUS

Part#	Years	Make	Model
11188	08-16	AUDI	A5
11189	11-13	MERCEDES-BENZ	E350
11190	01-06	CHRYSLER	SEBRING
11191	90-94	EAGLE	TALON
11191	90-94	MITSUBISHI	ECLIPSE
11191	90-94	PLYMOUTH	LASER
11192	06-13	AUDI	A3
11193	95-98	EAGLE	TALON
11193	95-99	MITSUBISHI	ECLIPSE
11194	09-10	BMW	535I XDRIVE
11194	08-08	BMW	535XI
11195	09-13	AUDI	A4 QUATTRO
11195	13-16	AUDI	ALLROAD
11196	11-15	CADILLAC	CTS
11197	12-16	AUDI	A7 QUATTRO
11198	04-09	HONDA	S2000
11199	04-09	AUDI	A8 QUATTRO
11200	11-17	LEXUS	CT200H
11201	90-93	HONDA	ACCORD
11202	09-14	NISSAN	CUBE
11203	94-97	HONDA	ACCORD
11204	01-05	HONDA	CIVIC
11205	94-97	HONDA	ACCORD
11206	02-04	HONDA	CIVIC
11207	97-01	ACURA	EL
11207	92-00	HONDA	CIVIC
11208	92-01	HONDA	PRELUDE
11209	92-00	HONDA	CIVIC
11210	11-14	FORD	MUSTANG
11211	95-98	HONDA	ODYSSEY
11211	96-99	ISUZU	OASIS
11212	00-03	HONDA	S2000
11214	95-05	HYUNDAI	ACCENT
11215	90-94	HYUNDAI	EXCEL
11215	91-95	HYUNDAI	SCOUPE
11215	90-93	MITSUBISHI	PRECIS
11216	99-01	HYUNDAI	SONATA
11216	01-05	KIA	OPTIMA
11217	89-94	HYUNDAI	SONATA
11218	97-01	HYUNDAI	TIBURON
11219	95-98	HYUNDAI	SONATA
11220	01-06	HYUNDAI	ELANTRA
11221	11-15	CHEVROLET	VOLT
11222	11-15	CHEVROLET	CAMARO
11223	90-91	LEXUS	ES250
11223	86-91	TOYOTA	CAMRY
11223	86-89	TOYOTA	CELICA
11223	89-92	TOYOTA	COROLLA
11223	90-92	TOYOTA	SUPRA
11224	99-02	INFINITI	G20
11225	92-96	LEXUS	ES300
11225	92-96	TOYOTA	CAMRY
11227	89-92	GEO	PRIZM
11227	90-94	LEXUS	LS400
11227	90-99	TOYOTA	CELICA
11227	87-92	TOYOTA	COROLLA
11227	87-90	TOYOTA	TERCEL
11228	01-01	HYUNDAI	XG300
11228	02-05	HYUNDAI	XG350
11232	12-15	VOLKSWAGEN	PASSAT
11233	92-00	LEXUS	SC300
11233	92-00	LEXUS	SC400
11234	12-18	VOLKSWAGEN	PASSAT
11235	91-94	MAZDA	PROTEGE
11237	95-98	MAZDA	PROTEGE
11238	98-05	LEXUS	GS300
11238	98-00	LEXUS	GS400
11238	01-05	LEXUS	GS430
11239	83-92	MAZDA	626
11240	12-17	CHEVROLET	SONIC
11241	93-02	MAZDA	626
11241	93-97	MAZDA	MX-6
11242	98-01	KIA	SEPHIA
11242	00-04	KIA	SPECTRA
11243	92-95	MAZDA	929

Part#	Years	Make	Model
11244	97-02	MITSUBISHI	DIAMANTE
11245	92-96	EAGLE	SUMMIT
11245	92-95	MITSUBISHI	EXPO
11245	92-94	MITSUBISHI	EXPO LRV
11245	92-94	PLYMOUTH	COLT
11246	00-05	MITSUBISHI	ECLIPSE
11248	99-03	MITSUBISHI	GALANT
11249	02-03	MAZDA	PROTEGE
11250	12-17	HYUNDAI	ACCENT
11250	12-17	KIA	RIO
11251	93-01	NISSAN	ALTIMA
11253	89-94	NISSAN	MAXIMA
11254	12-16	HYUNDAI	VELOSTER
11255	95-96	NISSAN	MAXIMA
11256	12-18	NISSAN	VERSA
11257	91-94	NISSAN	SENTRA
11258	12-16	CHEVROLET	SONIC
11259	95-96	NISSAN	200SX
11259	95-96	NISSAN	SENTRA
11260	12-15	VOLKSWAGEN	BEETLE
11261	97-98	NISSAN	200SX
11261	97-99	NISSAN	SENTRA
11262	12-17	KIA	RIO
11263	00-06	NISSAN	SENTRA
11264	02-06	NISSAN	ALTIMA
11264	04-08	NISSAN	MAXIMA
11265	03-19	TOYOTA	COROLLA
11267	06-08	BMW	750I
11267	06-06	BMW	760I
11270	12-12	VOLKSWAGEN	BEETLE
11272	12-13	MINI	COOPER
11275	87-89	SUBARU	DL
11275	87-89	SUBARU	GL
11275	87-89	SUBARU	GL-10
11275	93-94	SUBARU	IMPREZA
11275	90-94	SUBARU	LEGACY
11275	90-94	SUBARU	LOYALE
11276	10-15	TOYOTA	PRIUS
11276	12-15	TOYOTA	PRIUS PLUG-IN
11276	12-17	TOYOTA	PRIUS V
11277	86-95	SUZUKI	SAMURAI
11278	12-14	CHEVROLET	ORLANDO
11280	03-06	SUBARU	BAJA
11281	13-16	DODGE	DART
11282	12-17	BUICK	VERANO
11282	11-15	CHEVROLET	CRUZE
11283	93-96	TOYOTA	COROLLA
11285	92-95	TOYOTA	PASEO
11286	12-16	SUBARU	IMPREZA
11286	13-15	SUBARU	XV CROSSTREK
11287	91-98	TOYOTA	TERCEL
11289	00-05	TOYOTA	CELICA
11289	00-05	TOYOTA	ECHO
11290	01-03	ACURA	CL
11290	99-03	ACURA	TL
11290	98-07	HONDA	ACCORD
11291	12-15	SCION	IQ
11292	01-05	KIA	RIO
11293	06-12	MITSUBISHI	ECLIPSE
11294	00-07	FORD	FOCUS
11296	01-07	FORD	FOCUS
11298	01-02	SATURN	L100
11298	01-03	SATURN	L200
11298	01-05	SATURN	L300
11298	00-00	SATURN	LW1
11298	00-00	SATURN	LW2
11298	01-03	SATURN	LW200
11298	01-03	SATURN	LW300
11300	03-03	MAZDA	PROTEGE
11301	04-06	CHEVROLET	AVEO
11302	11-17	NISSAN	JUKE
11303	11-16	HYUNDAI	ELANTRA
11303	13-14	HYUNDAI	ELANTRA COUPE
11304	12-17	HYUNDAI	AZERA
11306	07-11	CHEVROLET	AVEO5

Part#	Years	Make	Model
11306	09-10	PONTIAC	G3
11307	03-13	CADILLAC	CTS
11307	05-11	CADILLAC	STS
11308	03-05	MAZDA	6
11310	02-05	HYUNDAI	SONATA
11311	13-18	CADILLAC	ATS
11312	05-08	FORD	MUSTANG
11315	08-11	SUBARU	IMPREZA
11316	13-15	CHEVROLET	SPARK
11317	08-14	SUBARU	IMPREZA
11318	05-06	SAAB	9-2X
11318	93-07	SUBARU	IMPREZA
11319	08-11	FORD	FOCUS
11320	04-06	SUZUKI	VERONA
11321	04-08	ACURA	TL
11325	06-10	HYUNDAI	SONATA
11326	03-11	SAAB	9-3
11327	03-07	HONDA	ACCORD
11328	13-15	MITSUBISHI	LANGER
11329	06-09	FORD	FUSION
11329	07-09	LINCOLN	MKZ
11329	06-06	LINCOLN	ZEPHYR
11329	06-08	MAZDA	6
11329	06-09	MERCURY	MILAN
11330	05-10	SCION	TC
11331	07-11	CHEVROLET	AVEO
11333	11-16	MINI	COOPER CTRYMAN
11334	13-15	CHEVROLET	SPARK
11336	05-12	ACURA	RL
11337	11-13	VOLVO	C30
11338	06-10	MAZDA	5
11339	02-08	JAGUAR	X-TYPE
11340	11-15	MERCEDES-BENZ	E550
11344	06-11	AUDI	A6
11344	05-11	AUDI	A6 QUATTRO
11347	12-16	FIAT	500
11348	07-12	NISSAN	VERSA
11349	13-18	NISSAN	SENTRA
11351	06-08	KIA	MAGENTIS
11351	06-10	KIA	OPTIMA
11352	07-18	NISSAN	ALTIMA
11352	09-18	NISSAN	MAXIMA
11353	06-09	MERCEDES-BENZ	CLK350
11354	12-18	VOLKSWAGEN	BEETLE
11356	14-18	MAZDA	6
11357	08-13	NISSAN	ALTIMA
11359	09-13	MAZDA	6
11362	13-18	LEXUS	ES350
11363	12-18	FIAT	500
11364	14-17	FIAT	500L
11365	09-13	JAGUAR	XF
11366	13-18	LEXUS	GS350
11367	14-16	BMW	228I
11367	15-16	BMW	228I XDRIVE
11367	13-17	BMW	320I
11367	13-17	BMW	320I XDRIVE
11367	14-17	BMW	328D
11367	14-17	BMW	328D XDRIVE
11367	11-16	BMW	328I
11367	11-16	BMW	328I XDRIVE
11367	14-16	BMW	335I GT XDRIVE
11367	13-15	BMW	335I XDRIVE
11367	16-16	BMW	340I
11367	17-17	BMW	340I XDRIVE
11367	14-16	BMW	428I
11367	15-15	BMW	428I GRAN COUPE
11367	14-16	BMW	428I XDRIVE
11367	15-16	BMW	428I XDRIVE GRAN CP
11367	14-16	BMW	435I
11367	15-16	BMW	435I GRAN COUPE
11367	14-16	BMW	435I XDRIVE
11367	15-16	BMW	435I XDRIVE GRAN CP
11367	17-18	BMW	440I
11367	17-18	BMW	440I GRAN COUPE
11367	17-18	BMW	440I XDRIVE

Part#	Years	Make	Model
11367	17-18	BMW	440iXDRIVE GRAN CP
11368	14-18	KIA	FORTE
11369	13-16	FORD	FIESTA
11370	07-12	NISSAN	SENTRA
11371	14-15	CHEVROLET	CRUZE
11372	06-06	LEXUS	GS300
11372	07-11	LEXUS	GS350
11372	06-06	LEXUS	GS430
11372	06-13	LEXUS	IS250
11372	06-12	LEXUS	IS350
11373	14-15	CHEVROLET	CAMARO
11375	14-15	SCION	TC
11376	14-14	MERCEDES-BENZ	SLK250
11377	14-18	MAZDA	3
11378	14-17	NISSAN	VERSA NOTE
11379	13-16	SCION	FR-S
11379	13-17	SUBARU	BRZ
11379	17-17	TOYOTA	86
11380	05-13	CHEVROLET	CORVETTE
11381	11-16	BMW	535i
11381	11-16	BMW	535iXDRIVE
11381	11-16	BMW	550i
11381	11-14	BMW	550iXDRIVE
11382	14-15	CADILLAC	CTS
11383	10-13	MAZDA	3
11386	04-09	MAZDA	3
11387	08-14	MINI	COOPER
11389	17-17	LEXUS	IS TURBO
11389	16-16	LEXUS	IS200T
11389	14-15	LEXUS	IS250
11389	16-18	LEXUS	IS300
11389	14-18	LEXUS	IS350
11390	10-12	FORD	FUSION
11390	10-12	LINCOLN	MKZ
11390	10-11	MERCURY	MILAN
11391	06-11	ACURA	CSX
11391	13-19	ACURA	ILX
11391	06-15	HONDA	CIVIC
11392	14-16	KIA	FORTE KOUP
11393	10-13	MAZDA	3
11394	14-18	MITSUBISHI	MIRAGE
11395	14-18	KIA	FORTE5
11396	11-17	NISSAN	LEAF
11397	97-99	ACURA	CL
11398	13-16	CHEVROLET	SONIC
11399	15-19	AUDI	A3
11399	15-19	AUDI	A3 QUATTRO
11400	13-17	HYUNDAI	ELANTRA GT
11402	15-18	HYUNDAI	SONATA
11402	16-18	KIA	OPTIMA
11403	15-17	CHRYSLER	200
11404	14-16	MERCEDES-BENZ	E350
11405	15-17	FORD	MUSTANG
11406	15-19	HONDA	FIT
11407	14-18	INFINITI	Q50
11408	12-16	SUBARU	IMPREZA
11408	15-18	SUBARU	WRX
11408	15-18	SUBARU	WRX STI
11410	15-15	VOLKSWAGEN	JETTA
11411	15-15	VOLKSWAGEN	GOLF
11412	15-18	VOLKSWAGEN	GOLF
11412	15-18	VOLKSWAGEN	GTI
11413	16-16	MERCEDES-BENZ	E350
11415	06-11	SAAB	9-3
11416	16-19	HONDA	HR-V
11417	14-15	MINI	COOPER
11418	16-19	MAZDA	CX-3
11419	14-19	KIA	SOUL
11420	16-16	SCION	IM
11420	17-18	TOYOTA	COROLLA IM
11421	16-16	SCION	IA
11421	17-18	TOYOTA	YARIS IA
11422	17-18	VOLKSWAGEN	GOLF ALLTRACK
11422	15-18	VOLKSWAGEN	GOLF SPORTWAGEN
11423	12-16	AUDI	A6

Part#	Years	Make	Model
11423	12-16	AUDI	A6 QUATTRO
11424	17-18	HYUNDAI	ELANTRA
11425	15-15	CHEVROLET	CRUZE
11425	16-16	CHEVROLET	CRUZE LIMITED
11427	05-12	TOYOTA	AVALON
11428	05-06	KIA	SPECTRA5
11429	07-08	KIA	SPECTRA5
11430	05-10	CHEVROLET	COBALT
11430	05-06	PONTIAC	PURSUIT
11431	13-18	FORD	FOCUS
11432	05-05	TOYOTA	ECHO
11433	16-18	CHEVROLET	SPARK
11434	10-13	KIA	FORTE
11435	16-18	MAZDA	MX-5 MIATA
11436	16-18	CHEVROLET	VOLT
11438	04-11	VOLVO	S40
11438	05-11	VOLVO	V50
11439	16-18	CHEVROLET	CRUZE
11440	02-06	SUZUKI	AERIO
11441	16-18	BUICK	CASCADA
11442	05-08	SUZUKI	RENO
11443	10-13	SUZUKI	SX4
11444	05-06	NISSAN	X-TRAIL
11445	16-17	HONDA	CIVIC
11446	08-13	SUZUKI	SX4
11447	05-10	CHEVROLET	COBALT
11447	06-11	CHEVROLET	HHR
11447	07-09	PONTIAC	G5
11447	05-06	PONTIAC	PURSUIT
11447	04-07	SATURN	ION
11448	17-18	AUDI	A4
11448	17-18	AUDI	A4 ALLROAD
11448	17-18	AUDI	A4 QUATTRO
11448	18-18	AUDI	A5 QUATTRO
11448	18-18	AUDI	A5 SPORTBACK
11448	18-18	AUDI	S5
11448	18-18	AUDI	S5 SPORTBACK
11449	17-19	MITSUBISHI	MIRAGE G4
11450	04-06	KIA	AMANTI
11452	87-96	CHEVROLET	BERETTA
11452	91-96	CHEVROLET	CORSICA
11453	15-17	NISSAN	MICRA
11454	17-17	MERCEDES-BENZ	E300
11455	04-08	ACURA	TSX
11457	17-19	CHEVROLET	BOLT EV
11458	17-18	CHEVROLET	CRUZE
11460	04-06	MITSUBISHI	GALANT
11462	07-12	MITSUBISHI	GALANT
11463	16-18	HONDA	CIVIC
11464	17-18	CHEVROLET	SONIC
11465	17-17	SUBARU	IMPREZA
11466	17-18	SUBARU	IMPREZA
11467	07-10	HYUNDAI	ELANTRA
11468	04-09	TOYOTA	PRIUS
11471	09-12	HYUNDAI	ELANTRA
11472	04-08	MAZDA	RX-8
11473	16-18	TOYOTA	PRIUS
11473	17-18	TOYOTA	PRIUS PRIME
11474	10-14	VOLKSWAGEN	GOLF
11474	05-18	VOLKSWAGEN	JETTA
11475	17-17	VOLKSWAGEN	GOLF R
11476	02-06	MITSUBISHI	LANCER
11477	03-08	HYUNDAI	TIBURON
11478	17-18	BMW	530i
11478	17-18	BMW	530iXDRIVE
11478	17-18	BMW	540i
11478	17-18	BMW	540iXDRIVE
11479	08-17	MITSUBISHI	LANCER
11480	07-17	TOYOTA	YARIS
11481	04-05	CHEVROLET	OPTRA
11481	04-08	SUZUKI	FORENZA
11482	03-06	INFINITI	G35
11483	03-06	INFINITI	G35
11483	04-05	NISSAN	350Z
11484	12-17	TOYOTA	PRIUS C

Part#	Years	Make	Model
11485	15-18	MERCEDES-BENZ	C300
11486	17-18	HYUNDAI	IONIQ
11487	04-06	SCION	XB
11488	05-06	SCION	XA
11489	16-18	FORD	FOCUS
11490	18-18	TOYOTA	C-HR
11491	08-10	SCION	XD
11492	17-18	CHEVROLET	CRUZE
11493	08-13	INFINITI	G37
11493	14-14	INFINITI	Q60
11493	06-06	NISSAN	350Z
11496	09-14	ACURA	TL
11496	09-14	ACURA	TSX
11496	08-10	HONDA	ACCORD
11497	05-06	SAAB	9-2X
11497	93-07	SUBARU	IMPREZA
11498	04-07	BMW	525i
11498	06-07	BMW	525Xi
11498	08-10	BMW	528i
11498	09-10	BMW	528iXDRIVE
11498	08-08	BMW	528Xi
11498	04-07	BMW	530i
11498	06-07	BMW	530Xi
11498	08-10	BMW	535i
11498	10-10	BMW	535i GT
11498	09-10	BMW	535iXDRIVE
11498	08-08	BMW	535Xi
11498	04-05	BMW	545i
11498	06-10	BMW	550i
11498	10-10	BMW	550i GT
11498	10-10	BMW	550i GT XDRIVE
11499	11-12	INFINITI	G25
11499	07-08	INFINITI	G35
11499	09-13	INFINITI	G37
11501	86-88	ACURA	LEGEND
11502	89-90	ACURA	LEGEND
11503	86-89	ACURA	INTEGRA
11504	87-90	ACURA	LEGEND
11507	85-87	AUDI	4000 QUATTRO
11508	78-83	AUDI	5000
11509	18-18	HYUNDAI	ELANTRA GT
11510	08-12	INFINITI	EX35
11510	13-13	INFINITI	EX37
11510	14-17	INFINITI	QX50
11511	89-95	BMW	525i
11511	93-93	BMW	525iT
11511	94-95	BMW	530i
11511	89-93	BMW	535i
11511	94-95	BMW	540i
11512	77-83	BMW	320i
11513	04-05	BMW	645Ci
11514	91-93	BMW	325i
11514	91-93	BMW	325iS
11514	91-91	BMW	325iX
11515	78-84	BMW	733i
11515	85-86	BMW	735i
11516	87-92	BMW	735i
11516	88-92	BMW	735iL
11516	93-94	BMW	740i
11516	88-94	BMW	750iL
11517	77-78	BMW	630CSI
11517	78-84	BMW	633CSI
11517	85-89	BMW	635CSI
11520	85-88	DODGE	COLT
11520	85-88	MITSUBISHI	MIRAGE
11521	89-92	DODGE	COLT
11521	89-92	MITSUBISHI	MIRAGE
11522	17-18	MINI	COOPER CTRYMAN
11523	18-19	TOYOTA	PRIUS C
11524	16-18	MINI	COOPER CLUBMAN
11525	18-18	HONDA	ACCORD
11526	86-88	DODGE	COLT
11526	86-88	MITSUBISHI	MIRAGE
11527	13-19	BUICK	ENCORE
11527	15-19	CHEVROLET	TRAX



Part#	Years	Make	Model
11528	89-91	DODGE	COLT
11528	89-92	EAGLE	SUMMIT
11528	89-92	MITSUBISHI	MIRAGE
11528	89-91	PLYMOUTH	COLT
11529	18-18	HYUNDAI	KONA
11530	18-19	BMW	X2
11531	90-91	GEO	STORM
11532	91-93	GEO	STORM
11534	85-88	NISSAN	MAXIMA
11534	87-89	NISSAN	STANZA
11535	15-19	ACURA	TLX
11536	85-88	NISSAN	MAXIMA
11537	84-86	NISSAN	200SX
11539	89-94	NISSAN	240SX
11540	19-19	VOLKSWAGEN	JETTA
11541	90-92	NISSAN	STANZA
11542	83-83	NISSAN	PULSAR
11542	83-86	NISSAN	PULSAR NX
11543	87-90	NISSAN	PULSAR NX
11544	91-93	NISSAN	NX
11546	86-89	NISSAN	STANZA
11548	18-18	HYUNDAI	ACCENT
11549	89-93	NISSAN	240SX
11550	19-19	HYUNDAI	VELOSTER
11551	82-86	NISSAN	SENTRA
11552	87-90	NISSAN	SENTRA
11553	82-86	NISSAN	SENTRA
11555	07-16	HONDA	CR-V
11557	79-83	NISSAN	280ZX
11558	84-86	NISSAN	300ZX
11559	87-89	NISSAN	300ZX
11560	82-88	VOLKSWAGEN	QUANTUM
11561	86-88	VOLKSWAGEN	QUANTUM
11562	90-92	DAIHATSU	ROCKY
11563	18-18	NISSAN	KICKS
11565	81-90	FORD	ESCORT
11565	87-94	FORD	TEMPO
11565	81-87	MERCURY	LYNX
11565	87-94	MERCURY	TOPAZ
11566	88-93	FORD	FESTIVA
11568	88-89	MERCURY	TRACER
11570	84-87	PONTIAC	FIERO
11574	84-87	HONDA	CIVIC
11577	84-85	HONDA	ACCORD
11579	84-85	HONDA	ACCORD
11582	83-87	HONDA	PRELUDE
11583	85-87	HONDA	PRELUDE
11584	88-89	HONDA	PRELUDE
11585	84-86	HONDA	CIVIC
11586	87-87	HONDA	CIVIC
11587	88-91	HONDA	CIVIC
11588	84-87	HONDA	CIVIC
11589	84-87	HONDA	CIVIC
11590	88-91	HONDA	CIVIC
11592	88-91	HONDA	CIVIC
11595	91-93	ISUZU	STYLUS
11597	86-89	MAZDA	323
11598	90-94	MAZDA	323
11600	86-89	MAZDA	323
11602	81-85	MAZDA	RX-7
11604	16-17	HONDA	CIVIC
11605	90-90	MAZDA	PROTEGE
11610	89-90	MITSUBISHI	SIGMA
11611	87-90	MITSUBISHI	VAN
11613	75-76	MERCEDES-BENZ	230
11613	75-76	MERCEDES-BENZ	240D
11613	75-76	MERCEDES-BENZ	280
11613	75-76	MERCEDES-BENZ	280C
11613	75-76	MERCEDES-BENZ	300D
11614	77-78	MERCEDES-BENZ	230
11614	77-83	MERCEDES-BENZ	240D
11614	78-81	MERCEDES-BENZ	280CE
11614	77-81	MERCEDES-BENZ	280E
11614	78-85	MERCEDES-BENZ	300CD
11614	77-85	MERCEDES-BENZ	300D

Part#	Years	Make	Model
11616	75-76	MERCEDES-BENZ	280S
11616	77-80	MERCEDES-BENZ	280SE
11616	78-80	MERCEDES-BENZ	300SD
11616	74-76	MERCEDES-BENZ	450SE
11616	74-80	MERCEDES-BENZ	450SEL
11617	81-85	MERCEDES-BENZ	380SL
11617	74-80	MERCEDES-BENZ	450SL
11617	86-89	MERCEDES-BENZ	560SL
11618	80-88	PEUGEOT	505
11624	87-88	STERLING	825
11624	89-91	STERLING	827
11626	89-94	GEO	METRO
11626	89-94	SUZUKI	SWIFT
11628	87-88	SUBARU	JUSTY
11629	89-94	SUBARU	JUSTY
11631	85-86	SUBARU	DL
11631	85-86	SUBARU	GL
11631	85-86	SUBARU	GL-10
11631	85-86	SUBARU	RX
11632	87-89	SUBARU	DL
11632	87-89	SUBARU	GL
11632	87-89	SUBARU	GL-10
11632	93-93	SUBARU	IMPREZA
11632	90-93	SUBARU	LEGACY
11632	90-93	SUBARU	LOYALE
11632	87-89	SUBARU	RX
11634	85-86	SUBARU	DL
11634	85-86	SUBARU	GL
11634	85-86	SUBARU	GL-10
11635	87-89	SUBARU	DL
11635	87-89	SUBARU	GL
11635	87-89	SUBARU	GL-10
11635	90-94	SUBARU	LOYALE
11639	87-91	SUBARU	XT
11641	82-85	TOYOTA	CELICA
11642	81-84	TOYOTA	CRESSIDA
11643	84-89	TOYOTA	VAN
11643	88-88	TOYOTA	VAN WAGON
11645	87-92	TOYOTA	COROLLA
11646	87-91	TOYOTA	CAMRY
11646	86-89	TOYOTA	CELICA
11646	87-88	TOYOTA	CRESSIDA
11646	86-89	TOYOTA	SUPRA
11647	86-89	TOYOTA	CELICA
11649	79-83	TOYOTA	COROLLA
11649	79-82	TOYOTA	CORONA
11649	81-84	TOYOTA	STARLET
11649	83-86	TOYOTA	TERCEL
11651	82-85	TOYOTA	CELICA
11652	68-79	VOLKSWAGEN	BEETLE
11652	71-79	VOLKSWAGEN	SUPER BEETLE
11653	75-84	VOLKSWAGEN	RABBIT
11653	75-81	VOLKSWAGEN	SCIROCCO
11654	85-90	VOLKSWAGEN	GOLF
11655	73-79	VOLKSWAGEN	TRANSPORTER
11656	80-91	VOLKSWAGEN	VANAGON
11657	87-91	VOLKSWAGEN	VANAGON
11658	80-84	VOLKSWAGEN	JETTA
11659	85-90	VOLKSWAGEN	JETTA
11660	82-88	VOLKSWAGEN	SCIROCCO
11661	85-93	VOLKSWAGEN	CABRIOLET
11662	87-93	VOLKSWAGEN	FOX
11664	90-93	VOLVO	240
11664	86-89	VOLVO	244
11664	86-89	VOLVO	245
11666	84-87	MERCEDES-BENZ	190D
11666	84-87	MERCEDES-BENZ	190E
11667	95-99	DODGE	NEON
11667	95-99	PLYMOUTH	NEON
11668	94-97	FORD	ASPIRE
11674	95-98	PORSCHE	911
11679	05-09	KIA	SPECTRA
11680	05-05	MERCEDES-BENZ	C240
11681	13-17	HONDA	ACCORD
11699	07-10	HONDA	ELEMENT

Part#	Years	Make	Model
11700	03-11	HONDA	ELEMENT
11701	03-09	MERCEDES-BENZ	E320
11701	06-09	MERCEDES-BENZ	E350
11701	03-06	MERCEDES-BENZ	E500
11701	03-06	MERCEDES-BENZ	E55 AMG
11701	07-09	MERCEDES-BENZ	E550
11701	07-09	MERCEDES-BENZ	E63 AMG
11702	84-85	BMW	318i
11702	86-88	BMW	325i
11702	84-87	BMW	325E
11702	86-87	BMW	325ES
11702	87-90	BMW	325i
11702	87-88	BMW	325iS
11702	88-88	BMW	325iX
11703	90-96	NISSAN	300ZX
11704	89-92	FORD	PROBE
11705	84-96	CHEVROLET	CORVETTE
11706	90-92	INFINITI	M30
11707	91-96	INFINITI	G20
11708	92-95	MAZDA	MX-3
11710	91-96	DODGE	STEALTH
11710	91-99	MITSUBISHI	3000GT
11711	81-85	MERCEDES-BENZ	300SD
11711	86-87	MERCEDES-BENZ	300SDL
11711	88-91	MERCEDES-BENZ	300SE
11711	88-91	MERCEDES-BENZ	300SEL
11711	91-91	MERCEDES-BENZ	350SD
11711	90-91	MERCEDES-BENZ	350SDL
11711	84-85	MERCEDES-BENZ	380SE
11711	82-83	MERCEDES-BENZ	380SEC
11711	81-83	MERCEDES-BENZ	380SEL
11711	86-91	MERCEDES-BENZ	420SEL
11711	84-85	MERCEDES-BENZ	500SEC
11711	84-85	MERCEDES-BENZ	500SEL
11711	86-91	MERCEDES-BENZ	560SEC
11711	86-91	MERCEDES-BENZ	560SEL
11712	77-88	PORSCHE	924
11712	83-91	PORSCHE	944
11713	91-95	TOYOTA	MR2
11714	90-92	VOLKSWAGEN	GOLF
11715	91-92	VOLKSWAGEN	JETTA
11716	90-94	VOLKSWAGEN	CORRADO
11717	90-94	VOLKSWAGEN	PASSAT
11718	90-94	VOLKSWAGEN	PASSAT
11720	93-97	FORD	PROBE
11721	88-89	MERCEDES-BENZ	190D
11721	88-93	MERCEDES-BENZ	190E
11722	85-90	VOLKSWAGEN	JETTA
11724	93-97	HONDA	CIVIC
11725	90-91	HONDA	PRELUDE
11726	86-89	HONDA	ACCORD
11727	93-97	INFINITI	J30
11728	93-95	MITSUBISHI	DIAMANTE
11729	90-97	MAZDA	MIATA
11730	94-98	SAAB	900
11731	95-98	NISSAN	240SX
11732	95-96	VOLKSWAGEN	CABRIO
11733	75-79	JAGUAR	XJ12
11733	75-87	JAGUAR	XJ6
11733	76-93	JAGUAR	XJS
11734	94-94	JAGUAR	XJ12
11734	88-94	JAGUAR	XJ6
11735	95-97	VOLKSWAGEN	PASSAT
11736	95-97	VOLKSWAGEN	PASSAT
11742	90-93	MERCEDES-BENZ	300SL
11742	94-97	MERCEDES-BENZ	SL320
11742	94-02	MERCEDES-BENZ	SL500
11742	94-02	MERCEDES-BENZ	SL600
11744	96-99	MERCEDES-BENZ	E300
11744	96-02	MERCEDES-BENZ	E320
11744	97-97	MERCEDES-BENZ	E420
11744	98-02	MERCEDES-BENZ	E430
11744	99-02	MERCEDES-BENZ	E55 AMG
11745	95-98	VOLKSWAGEN	GOLF
11746	90-97	MAZDA	MIATA

Part#	Years	Make	Model
11747	95-01	BMW	740I
11747	95-01	BMW	740IL
11747	95-01	BMW	750IL
11748	96-02	BMW	Z3
11749	99-05	MAZDA	MIATA
11750	97-00	JAGUAR	XK8
11750	00-00	JAGUAR	XKR
11751	98-04	MERCEDES-BENZ	SLK230
11751	02-04	MERCEDES-BENZ	SLK32 AMG
11751	01-04	MERCEDES-BENZ	SLK320
11754	99-02	SAAB	9-3
11755	99-05	MAZDA	MIATA
11756	07-10	BMW	335I
11756	07-08	BMW	335XI
11758	75-79	CHEVROLET	CORVETTE
11760	80-82	CHEVROLET	CORVETTE
11762	01-05	LEXUS	IS300
11764	00-02	DAEWOO	NUBIRA
11765	00-06	AUDI	TT QUATTRO
11767	93-94	DODGE	COLT
11767	93-96	EAGLE	SUMMIT
11767	93-02	MITSUBISHI	MIRAGE
11767	93-94	PLYMOUTH	COLT
11768	02-06	HONDA	CR-V
11771	06-06	BMW	325XI
11771	07-11	BMW	328I
11771	09-11	BMW	328I XDRIVE
11771	07-08	BMW	328XI
11772	96-99	INFINITI	I30
11772	97-99	NISSAN	MAXIMA
11773	01-03	ACURA	MDX
11773	03-03	HONDA	PILOT
11775	09-10	AUDI	TT QUATTRO
11800	91-93	HONDA	ACCORD
11801	90-96	INFINITI	Q45
11804	88-91	MAZDA	929
11805	79-85	MERCEDES-BENZ	300TD
11806	87-87	MERCEDES-BENZ	300TD
11806	88-93	MERCEDES-BENZ	300TE
11806	94-95	MERCEDES-BENZ	E320
11807	81-86	SAAB	900
11808	86-94	SAAB	900
11809	86-88	SAAB	9000
11810	89-92	SAAB	9000
11811	89-98	SAAB	9000
11812	82-90	TOYOTA	LAND CRUISER
11814	92-93	MERCEDES-BENZ	300SD
11814	92-93	MERCEDES-BENZ	300SE
11814	92-92	MERCEDES-BENZ	400SE
11814	93-93	MERCEDES-BENZ	400SEL
11814	93-93	MERCEDES-BENZ	500SEC
11814	92-93	MERCEDES-BENZ	500SEL
11814	93-93	MERCEDES-BENZ	600SEC
11814	92-93	MERCEDES-BENZ	600SEL
11814	98-99	MERCEDES-BENZ	CL500
11814	98-99	MERCEDES-BENZ	CL600
11814	94-99	MERCEDES-BENZ	S320
11814	94-95	MERCEDES-BENZ	S350
11814	94-95	MERCEDES-BENZ	S420
11814	94-99	MERCEDES-BENZ	S500
11814	94-99	MERCEDES-BENZ	S600
11815	94-96	MERCEDES-BENZ	C220
11815	97-00	MERCEDES-BENZ	C230
11815	94-00	MERCEDES-BENZ	C280
11815	95-97	MERCEDES-BENZ	C36 AMG
11815	98-00	MERCEDES-BENZ	C43 AMG
11815	98-03	MERCEDES-BENZ	CLK320
11815	99-03	MERCEDES-BENZ	CLK430
11815	03-03	MERCEDES-BENZ	CLK500
11815	01-03	MERCEDES-BENZ	CLK55 AMG
11816	88-93	MERCEDES-BENZ	300CE
11816	87-93	MERCEDES-BENZ	300D
11816	86-93	MERCEDES-BENZ	300E
11816	92-93	MERCEDES-BENZ	400E
11818	95-96	JAGUAR	XJ12

Part#	Years	Make	Model
11818	95-97	JAGUAR	XJ6
11818	98-03	JAGUAR	XJ8
11818	95-03	JAGUAR	XJR
11820	04-05	MERCEDES-BENZ	E320
11820	04-06	MERCEDES-BENZ	E500
11821	99-08	SAAB	9-5
11822	00-04	VOLVO	S40
11822	00-04	VOLVO	V40
11823	06-06	MERCEDES-BENZ	S350
11823	00-06	MERCEDES-BENZ	S430
11823	00-06	MERCEDES-BENZ	S500
11823	01-06	MERCEDES-BENZ	S600
11824	03-07	MERCEDES-BENZ	C230
11824	01-05	MERCEDES-BENZ	C240
11824	06-07	MERCEDES-BENZ	C280
11824	02-04	MERCEDES-BENZ	C32 AMG
11824	01-05	MERCEDES-BENZ	C320
11824	06-07	MERCEDES-BENZ	C350
11824	05-06	MERCEDES-BENZ	C55 AMG
11824	06-06	MERCEDES-BENZ	CLS500
11824	06-06	MERCEDES-BENZ	CLS55 AMG
11824	07-07	MERCEDES-BENZ	CLS550
11824	07-07	MERCEDES-BENZ	CLS63 AMG
11828	07-11	MERCEDES-BENZ	S550
11829	08-10	VOLVO	C30
11830	98-03	MERCEDES-BENZ	E320
11831	99-09	SAAB	9-5
11900	14-19	CADILLAC	CTS
11900	16-18	CHEVROLET	CAMARO
11901	16-17	CADILLAC	CTS
12002	06-13	SUZUKI	GRAND VITARA
12003	96-98	MAZDA	MPV
12004	07-09	ACURA	RDX
12005	78-81	BUICK	CENTURY
12005	78-87	BUICK	REGAL
12005	78-87	CHEVROLET	EL CAMINO
12005	77-88	CHEVROLET	MONTE CARLO
12005	82-83	OLDSMOBILE	CUTLASS CIERA
12005	78-88	OLDSMOBILE	CUTLASS SUPREME
12005	82-86	PONTIAC	BONNEVILLE
12005	78-87	PONTIAC	GRAND PRIX
12005	78-81	PONTIAC	LEMANS
12006	98-04	DODGE	INTREPID
12008	88-96	OLDSMOBILE	CUTLASS CIERA
12008	85-91	PONTIAC	6000
12009	71-73	BUICK	CENTURION
12009	77-84	BUICK	ELECTRA
12009	77-85	BUICK	LESABRE
12009	92-96	BUICK	ROADMASTER
12009	77-96	CHEVROLET	CAPRICE
12009	80-80	OLDSMOBILE	98
12009	80-80	OLDSMOBILE	DELTA 88
12009	83-86	PONTIAC	PARISIENNE
12010	10-16	LINCOLN	MKT
12011	83-04	CHEVROLET	S10
12011	83-90	GMC	S15
12011	91-04	GMC	SONOMA
12012	83-11	FORD	RANGER
12012	94-09	MAZDA	B2300
12012	94-07	MAZDA	B3000
12012	94-09	MAZDA	B4000
12013	03-08	TOYOTA	MATRIX
12021	94-97	HONDA	PASSPORT
12021	91-97	ISUZU	RODEO
12022	10-11	BUICK	LUCERNE
12025	90-93	CHRYSLER	IMPERIAL
12025	89-94	CHRYSLER	LEBARON
12025	86-93	CHRYSLER	NEW YORKER
12025	88-93	DODGE	DYNASTY
12025	89-95	DODGE	SPIRIT
12025	89-95	PLYMOUTH	ACCLAIM
12027	04-05	CHEVROLET	CLASSIC
12027	97-03	CHEVROLET	MALIBU
12027	97-99	OLDSMOBILE	CUTLASS
12028	00-07	CHEVROLET	MONTE CARLO

Part#	Years	Make	Model
12030	10-15	HYUNDAI	TUCSON
12030	11-15	KIA	SPORTAGE
12031	99-17	HONDA	ODYSSEY
12032	98-01	CHRYSLER	CONCORDE
12034	99-04	CHRYSLER	300M
12035	02-04	CHRYSLER	CONCORDE
12035	99-01	CHRYSLER	LHS
12036	07-14	FORD	EDGE
12036	07-15	LINCOLN	MKX
12037	83-94	CHEVROLET	S10 BLAZER
12037	92-94	GMC	JIMMY
12037	83-91	GMC	S15 JIMMY
12037	91-94	OLDSMOBILE	BRAVADA
12038	98-08	SUBARU	FORESTER
12040	99-04	OLDSMOBILE	ALERO
12040	99-05	PONTIAC	GRAND AM
12041	77-83	BUICK	ESTATE WAGON
12041	85-90	BUICK	LESABRE
12041	91-96	BUICK	ROADMASTER
12041	77-96	CHEVROLET	CAPRICE
12041	77-92	OLDSMOBILE	CUSTOM CRUISER
12041	83-86	PONTIAC	PARISIENNE
12044	00-05	BUICK	LESABRE
12044	06-09	BUICK	LUCERNE
12044	01-03	OLDSMOBILE	AURORA
12044	00-05	PONTIAC	BONNEVILLE
12045	85-05	CHEVROLET	ASTRO
12045	85-05	GMC	SAFARI
12047	09-13	SUBARU	FORESTER
12048	11-19	MITSUBISHI	OUTLANDER SPORT
12048	11-15	MITSUBISHI	RVR
12049	91-96	BUICK	PARK AVENUE
12049	91-96	OLDSMOBILE	98
12049	97-97	OLDSMOBILE	REGENCY
12050	11-14	SUBARU	TRIBECA
12051	08-12	CHEVROLET	MALIBU
12051	07-09	SATURN	AURA
12052	94-96	CADILLAC	DEVILLE
12053	89-97	FORD	THUNDERBIRD
12053	93-98	LINCOLN	MARK VIII
12053	89-97	MERCURY	COUGAR
12054	92-94	CADILLAC	ELDORADO
12054	92-97	CADILLAC	SEVILLE
12055	97-99	CADILLAC	DEVILLE
12056	06-10	MERCEDES-BENZ	R350
12056	06-08	MERCEDES-BENZ	R500
12057	11-17	JEEP	COMPASS
12057	11-17	JEEP	PATRIOT
12058	00-05	CADILLAC	DEVILLE
12058	06-11	CADILLAC	DTS
12060	05-12	FORD	ESCAPE
12060	05-11	MAZDA	TRIBUTE
12060	05-11	MERCURY	MARINER
12061	11-17	NISSAN	QUEST
12064	11-15	CHRYSLER	300
12064	11-15	DODGE	CHALLENGER
12064	11-15	DODGE	CHARGER
12065	04-19	TOYOTA	SIENNA
12066	11-16	VOLVO	S60
12066	15-18	VOLVO	V60
12066	15-18	VOLVO	V60 CROSS CTRY
12066	08-10	VOLVO	V70
12066	09-16	VOLVO	XC70
12068	95-02	CADILLAC	ELDORADO
12069	88-96	BUICK	REGAL
12069	90-94	CHEVROLET	LUMINA
12069	88-97	OLDSMOBILE	CUTLASS SUPREME
12069	88-96	PONTIAC	GRAND PRIX
12070	10-16	CADILLAC	SRX
12073	92-98	BUICK	SKYLARK
12073	92-98	OLDSMOBILE	ACHIEVA
12073	92-98	PONTIAC	GRAND AM
12074	10-12	ACURA	RDX
12076	10-13	FORD	TRANSIT CONNECT
12083	13-18	ACURA	RDX

Part#	Years	Make	Model
12086	09-16	HYUNDAI	GENESIS
12088	09-16	LINCOLN	MKS
12089	86-97	FORD	AEROSTAR
12091	13-19	FORD	FUSION
12091	13-19	LINCOLN	MKZ
12092	13-18	FORD	C-MAX
12093	07-12	MAZDA	CX-7
12094	96-07	CHRYSLER	TOWN & COUNTRY
12094	96-07	DODGE	CARAVAN
12094	96-00	PLYMOUTH	VOYAGER
12095	12-15	CHEVROLET	CAPTIVA SPORT
12095	08-10	SATURN	VUE
12096	15-19	LINCOLN	MKC
12097	09-17	VOLKSWAGEN	TIGUAN
12098	90-93	CHEVROLET	LUMINA APV
12098	90-96	OLDSMOBILE	SILHOUETTE
12098	90-93	PONTIAC	TRANS SPORT
12100	14-18	SUBARU	FORESTER
12101	93-97	CHRYSLER	CONCORDE
12101	94-97	CHRYSLER	LHS
12101	94-96	CHRYSLER	NEW YORKER
12101	93-97	DODGE	INTREPID
12101	93-97	EAGLE	VISION
12102	99-02	MERCURY	VILLAGER
12102	99-02	NISSAN	QUEST
12103	95-99	BUICK	RIVIERA
12103	95-99	OLDSMOBILE	AURORA
12105	95-98	MERCURY	VILLAGER
12105	93-98	NISSAN	QUEST
12106	04-09	CADILLAC	SRX
12107	13-18	TOYOTA	AVALON
12107	12-17	TOYOTA	CAMRY
12108	06-18	TOYOTA	RAV4
12110	04-08	TOYOTA	SOLARA
12111	13-19	FORD	ESCAPE
12112	07-15	MAZDA	CX-9
12113	13-18	HYUNDAI	SANTA FE SPORT
12113	14-15	KIA	SORENTO
12114	12-17	LEXUS	LS460
12115	10-16	BUICK	LACROSSE
12115	11-17	BUICK	REGAL
12115	13-18	CADILLAC	XTS
12115	14-18	CHEVROLET	IMPALA
12115	13-15	CHEVROLET	MALIBU
12115	16-16	CHEVROLET	MALIBU LIMITED
12116	14-16	KIA	RONDO
12117	94-96	CHEVROLET	LUMINA APV
12117	94-96	PONTIAC	TRANS SPORT
12118	14-19	KIA	CADENZA
12120	14-19	ACURA	RLX
12121	95-03	FORD	WINDSTAR
12122	08-18	NISSAN	ROGUE
12122	14-15	NISSAN	ROGUE SELECT
12123	14-19	FORD	TRANSIT CONNECT
12125	95-00	CHEVROLET	LUMINA
12125	95-99	CHEVROLET	MONTE CARLO
12126	05-09	HYUNDAI	TUCSON
12126	05-10	KIA	SPORTAGE
12127	96-99	OLDSMOBILE	88
12127	96-99	PONTIAC	BONNEVILLE
12128	92-99	PONTIAC	BONNEVILLE
12130	87-91	FORD	COUNTRY SQUIRE
12130	92-11	FORD	CROWN VICTORIA
12130	80-83	LINCOLN	MARK VI
12130	81-11	LINCOLN	TOWN CAR
12130	87-91	MERCURY	COLONY PARK
12130	80-09	MERCURY	GRAND MARQUIS
12130	03-04	MERCURY	MARAUDER
12134	09-18	DODGE	JOURNEY
12136	14-18	SUBARU	OUTBACK
12137	84-01	JEEP	CHEROKEE
12138	15-15	JEEP	RENEGADE
12139	15-15	LEXUS	NX200T
12139	15-15	LEXUS	NX300H
12140	15-18	FORD	EDGE

Part#	Years	Make	Model
12141	88-95	CHRYSLER	TOWN & COUNTRY
12141	88-95	DODGE	CARAVAN
12141	90-93	PLYMOUTH	VOYAGER
12142	15-18	JEEP	RENEGADE
12143	15-16	LEXUS	NX200T
12143	15-16	LEXUS	NX300H
12148	15-18	AUDI	Q3
12148	15-18	AUDI	Q3 QUATTRO
12152	16-18	CHEVROLET	MALIBU
12154	18-19	MITSUBISHI	ECLIPSE CROSS
12156	16-19	MAZDA	CX-9
12157	97-05	BUICK	PARK AVENUE
12158	17-19	KIA	SPORTAGE
12159	17-18	CHRYSLER	PACIFICA
12160	16-18	CADILLAC	CT6
12163	16-18	MERCEDES-BENZ	CLA250
12164	17-19	FORD	FUSION
12164	17-17	LINCOLN	MKZ
12165	17-18	GENESIS	G80
12165	17-18	GENESIS	G90
12165	12-16	HYUNDAI	GENESIS
12166	17-18	BUICK	LACROSSE
12169	17-19	HONDA	CR-V
12170	13-18	MAZDA	CX-5
12171	17-19	KIA	NIRO
12172	17-17	LEXUS	NX200T
12172	18-18	LEXUS	NX300
12172	17-18	LEXUS	NX300H
12173	18-19	BUICK	REGAL TOURX
12174	17-19	JEEP	COMPASS
12175	18-19	HONDA	ODYSSEY
12176	18-18	TOYOTA	CAMRY
12177	18-18	VOLKSWAGEN	TIGUAN
12180	17-18	CHRYSLER	PACIFICA
12181	87-89	DODGE	RAIDER
12181	89-94	ISUZU	AMIGO
12181	88-91	ISUZU	TROOPER
12181	83-00	MITSUBISHI	MONTERO
12181	91-97	TOYOTA	LAND CRUISER
12182	17-19	LINCOLN	CONTINENTAL
12184	18-19	SUBARU	CROSSTREK
12185	18-19	BUICK	REGAL SPORTBACK
12185	16-18	CHEVROLET	MALIBU
12186	01-06	CHRYSLER	SEBRING
12187	04-07	FORD	FREESTAR
12187	04-07	MERCURY	MONTEREY
12188	18-19	FORD	ECOSPORT
12189	07-10	CHRYSLER	SEBRING
12189	08-10	DODGE	AVENGER
12190	08-10	CHRYSLER	SEBRING
12199	97-03	PONTIAC	GRAND PRIX
12207	74-74	VOLVO	142
12207	74-74	VOLVO	144
12207	74-74	VOLVO	145
12207	74-75	VOLVO	164
12207	90-93	VOLVO	240
12207	75-84	VOLVO	242
12207	75-89	VOLVO	244
12207	75-89	VOLVO	245
12207	76-81	VOLVO	262
12207	76-82	VOLVO	264
12207	76-81	VOLVO	265
12209	85-92	VOLVO	740
12209	83-90	VOLVO	760
12209	88-90	VOLVO	780
12209	91-95	VOLVO	940
12209	92-94	VOLVO	960
12211	93-97	VOLVO	850
12211	98-02	VOLVO	C70
12211	98-00	VOLVO	S70
12211	98-00	VOLVO	V70
12213	95-97	VOLVO	960
12213	98-98	VOLVO	S90
12213	98-98	VOLVO	V90
12217	93-03	VOLKSWAGEN	EUROVAN

Part#	Years	Make	Model
12217	93-94	VOLKSWAGEN	TRANSPORTER
12220	97-01	INFINITI	Q45
12221	03-10	PONTIAC	VIBE
12221	03-13	TOYOTA	MATRIX
12224	00-01	INFINITI	I30
12224	02-04	INFINITI	I35
12224	00-03	NISSAN	MAXIMA
12225	97-04	BUICK	REGAL
12225	97-08	PONTIAC	GRAND PRIX
12228	09-10	PONTIAC	VIBE
12228	09-13	TOYOTA	MATRIX
12230	95-00	LEXUS	LS400
12231	01-06	LEXUS	LS430
12232	86-07	FORD	TAURUS
12232	88-94	LINCOLN	CONTINENTAL
12232	86-05	MERCURY	SABLE
12233	92-99	BUICK	LESABRE
12233	92-95	OLDSMOBILE	88
12233	92-95	PONTIAC	BONNEVILLE
12234	03-08	PONTIAC	VIBE
12237	95-02	KIA	SPORTAGE
12239	05-09	BUICK	ALLURE
12239	97-05	BUICK	CENTURY
12239	95-09	BUICK	LACROSSE
12239	98-02	OLDSMOBILE	INTRIGUE
12240	05-10	CHRYSLER	300
12240	08-10	DODGE	CHALLENGER
12240	06-10	DODGE	CHARGER
12240	05-08	DODGE	MAGNUM
12241	16-18	HYUNDAI	TUCSON
12242	05-07	FORD	FIVE HUNDRED
12242	05-07	FORD	FREESTYLE
12242	08-09	FORD	TAURUS
12242	08-08	FORD	TAURUS X
12242	05-07	MERCURY	MONTEGO
12242	08-08	MERCURY	SABLE
12243	95-02	LINCOLN	CONTINENTAL
12244	05-07	BUICK	TERRAZA
12244	05-09	CHEVROLET	UPLANDER
12244	97-05	CHEVROLET	VENTURE
12244	97-04	OLDSMOBILE	SILHOUETTE
12244	99-09	PONTIAC	MONTANA
12244	97-99	PONTIAC	TRANS SPORT
12245	08-12	JEEP	LIBERTY
12246	04-06	PONTIAC	GTO
12252	00-13	CHEVROLET	IMPALA
12252	14-16	CHEVROLET	IMPALA LIMITED
12253	00-06	LINCOLN	LS
12255	07-10	JEEP	COMPASS
12255	07-10	JEEP	PATRIOT
12259	07-09	KIA	AMANTI
12262	04-06	CHRYSLER	PACIFICA
12264	08-16	CHRYSLER	TOWN & COUNTRY
12264	08-19	DODGE	GRAND CARAVAN
12264	12-15	RAM	C/V
12264	09-14	VOLKSWAGEN	ROUTAN
12265	98-04	CADILLAC	SEVILLE
12270	90-04	SUBARU	LEGACY
12270	00-04	SUBARU	OUTBACK
12272	04-07	CHEVROLET	MALIBU
12280	04-07	CHEVROLET	MALIBU
12284	05-09	SUBARU	LEGACY
12284	05-09	SUBARU	OUTBACK
12285	99-06	VOLVO	S80
12287	07-14	VOLVO	S80
12288	00-06	MAZDA	MPV
12289	04-07	CHRYSLER	TOWN & COUNTRY
12289	04-07	DODGE	CARAVAN
12289	04-07	DODGE	GRAND CARAVAN
12290	15-17	SUBARU	LEGACY
12290	10-13	SUBARU	OUTBACK
12291	05-17	CHEVROLET	EQUINOX
12291	10-17	GMC	TERRAIN
12291	06-09	PONTIAC	TORRENT
12291	02-07	SATURN	VUE

Part#	Years	Make	Model
12292	08-09	FORD	TAURUS X
12293	03-06	MITSUBISHI	OUTLANDER
12296	10-19	FORD	TAURUS
12298	10-14	SUBARU	LEGACY
12303	87-87	MAZDA	B2000
12303	87-93	MAZDA	B2200
12303	87-93	MAZDA	B2600
12304	91-97	TOYOTA	PREVIA
12312	98-99	NISSAN	FRONTIER
12314	00-04	JAGUAR	S-TYPE
12318	01-09	VOLVO	S60
12318	01-07	VOLVO	V70
12318	03-07	VOLVO	XC70
12333	05-10	PONTIAC	G6
12336	05-07	BUICK	TERRAZA
12336	05-09	CHEVROLET	UPLANDER
12336	05-09	PONTIAC	MONTANA
12336	05-07	SATURN	RELAY
12339	97-03	LEXUS	ES300
12339	04-06	LEXUS	ES330
12339	95-04	TOYOTA	AVALON
12339	97-06	TOYOTA	CAMRY
12339	99-03	TOYOTA	SOLARA
12341	09-15	TOYOTA	VENZA
12343	07-12	LEXUS	ES350
12343	07-11	TOYOTA	CAMRY
12362	96-07	CHRYSLER	TOWN & COUNTRY
12362	04-07	DODGE	CARAVAN
12362	96-00	PLYMOUTH	VOYAGER
12490	08-15	SCION	XB
13000	10-16	LINCOLN	MKT
13001	06-13	SUZUKI	GRAND VITARA
13002	10-16	CADILLAC	SRX
13005	09-10	KIA	BORREGO
13007	09-10	HUMMER	H3T
13008	01-06	CHEVROLET	SILVER. 2500 HD
13008	07-07	CHEVROLET	SILV. 2500 HD CLA.
13008	01-06	CHEVROLET	SILVERADO 3500
13008	07-07	CHEVROLET	SILV. 3500 CLA.
13008	01-06	GMC	SIERRA 2500 HD
13008	07-07	GMC	SIER. 2500 HD CLA.
13008	01-06	GMC	SIERRA 3500
13008	07-07	GMC	SIERRA 3500 CLA.
13010	10-15	MERCEDES-BENZ	G550
13011	84-90	FORD	BRONCO II
13013	95-04	TOYOTA	TACOMA
13014	99-16	FORD	F-250 SUPER DUTY
13014	99-16	FORD	F-350 SUPER DUTY
13015	99-03	DODGE	RAM 1500 VAN
13015	99-03	DODGE	RAM 2500 VAN
13015	99-99	DODGE	RAM 3500 VAN
13016	78-95	CHEVROLET	G10
13016	78-95	CHEVROLET	G20
13016	78-96	CHEVROLET	G30
13016	78-78	GMC	G15
13016	79-95	GMC	G1500
13016	78-78	GMC	G25
13016	79-95	GMC	G2500
13016	78-78	GMC	G35
13016	79-96	GMC	G3500
13017	73-86	CHEVROLET	C10 SUBURBAN
13017	73-86	CHEVROLET	C20 SUBURBAN
13017	88-91	CHEVROLET	C2500
13017	73-86	CHEVROLET	K20 SUBURBAN
13017	87-88	CHEVROLET	R10 SUBURBAN
13017	89-91	CHEVROLET	R1500 SUBURBAN
13017	87-88	CHEVROLET	R20 SUBURBAN
13017	89-91	CHEVROLET	R2500 SUBURBAN
13017	75-78	GMC	C15 SUBURBAN
13017	73-74	GMC	C15/C1500 SUB.
13017	79-86	GMC	C1500 SUBURBAN
13017	75-78	GMC	C25 SUBURBAN
13017	73-74	GMC	C25/C2500 SUB.
13017	79-91	GMC	C2500
13017	79-86	GMC	C2500 SUBURBAN

Part#	Years	Make	Model
13017	75-78	GMC	K15 SUBURBAN
13017	79-86	GMC	K1500 SUBURBAN
13017	75-78	GMC	K25 SUBURBAN
13017	73-74	GMC	K25/K2500 SUB.
13017	79-86	GMC	K2500 SUBURBAN
13017	87-91	GMC	R1500 SUBURBAN
13017	87-91	GMC	R2500 SUBURBAN
13018	98-02	MERCEDES-BENZ	ML320
13018	03-05	MERCEDES-BENZ	ML350
13018	99-01	MERCEDES-BENZ	ML430
13018	02-05	MERCEDES-BENZ	ML500
13019	83-11	FORD	RANGER
13019	94-09	MAZDA	B2300
13019	94-07	MAZDA	B3000
13019	94-09	MAZDA	B4000
13020	95-04	CHEVROLET	BLAZER
13020	95-01	GMC	JIMMY
13020	96-04	OLDSMOBILE	BRAVADA
13021	83-04	CHEVROLET	S10
13021	83-90	GMC	S15
13021	91-04	GMC	SONOMA
13021	96-00	ISUZU	HOMBRE
13024	87-91	TOYOTA	4RUNNER
13028	80-86	CHEVROLET	C30
13028	88-00	CHEVROLET	C3500
13028	91-02	CHEVROLET	C3500HD
13028	01-06	CHEVROLET	SILVERADO 3500
13028	88-97	FORD	F SUPER DUTY
13028	80-87	FORD	F-350
13028	99-06	FORD	F-350 SUPER DUTY
13028	99-06	FORD	F-450 SUPER DUTY
13028	99-06	FORD	F-550 SUPER DUTY
13028	80-95	GMC	C3500
13028	91-94	GMC	C3500HD
13028	80-95	GMC	K3500
13029	99-00	CADILLAC	ESCALADE
13029	92-94	CHEVROLET	BLAZER
13029	92-99	CHEVROLET	C1500 SUBURBAN
13029	92-99	CHEVROLET	C2500 SUBURBAN
13029	92-99	CHEVROLET	K1500 SUBURBAN
13029	92-99	CHEVROLET	K2500 SUBURBAN
13029	00-00	CHEVROLET	SUBURBAN 1500
13029	00-00	CHEVROLET	SUBURBAN 2500
13029	95-00	CHEVROLET	TAHOE
13029	92-00	GMC	YUKON
13029	00-00	GMC	YUKON XL 1500
13029	00-00	GMC	YUKON XL 2500
13032	86-97	FORD	AEROSTAR
13033	91-01	FORD	EXPLORER
13033	01-03	FORD	EXPLORER SPORT
13033	91-94	MAZDA	NAVAJO
13033	97-01	MERCURY	MOUNTAINEER
13035	85-05	CHEVROLET	ASTRO
13035	85-05	GMC	SAFARI
13037	91-95	CHRYSLER	TOWN & COUNTRY
13037	91-95	DODGE	CARAVAN
13037	91-95	PLYMOUTH	VOYAGER
13038	97-04	FORD	F-150
13038	04-04	FORD	F-150 HERITAGE
13038	97-99	FORD	F-250
13040	96-14	CHEVROLET	EXPRESS 1500
13040	96-18	CHEVROLET	EXPRESS 2500
13040	96-18	CHEVROLET	EXPRESS 3500
13040	96-14	GMC	SAVANA 1500
13040	96-18	GMC	SAVANA 2500
13040	96-18	GMC	SAVANA 3500
13041	78-80	DODGE	B100
13041	81-94	DODGE	B150
13041	95-97	DODGE	B1500
13041	78-80	DODGE	B200
13041	81-94	DODGE	B250
13041	95-97	DODGE	B2500
13041	78-80	DODGE	B300
13041	93-94	DODGE	B350
13041	95-97	DODGE	B3500

Part#	Years	Make	Model
13042	88-98	CHEVROLET	C1500
13042	88-00	CHEVROLET	C2500
13042	88-00	CHEVROLET	C3500
13042	91-00	CHEVROLET	C3500HD
13042	99-00	CHEVROLET	SILVERADO 2500
13042	88-98	GMC	C1500
13042	88-00	GMC	C2500
13042	88-00	GMC	C3500
13042	91-00	GMC	C3500HD
13042	99-00	GMC	SIERRA 2500
13043	10-18	LEXUS	GX460
13044	02-07	JEEP	LIBERTY
13045	93-98	TOYOTA	T100
13046	06-07	SUBARU	B9 TRIBECA
13046	08-10	SUBARU	TRIBECA
13048	93-98	JEEP	GRAND CHEROKEE
13049	97-02	FORD	EXPEDITION
13049	98-02	LINCOLN	NAVIGATOR
13050	04-09	CADILLAC	SRX
13051	99-04	JEEP	GRAND CHEROKEE
13052	08-15	LAND ROVER	LR2
13053	03-06	FORD	E-150
13053	75-02	FORD	E-150 ECONOLINE
13053	03-06	FORD	E-250
13053	75-02	FORD	E-250 ECONOLINE
13053	75-98	FORD	E-350 ECONOLINE
13053	99-06	FORD	E-350 SUPER DUTY
13055	03-14	FORD	E-150
13055	00-02	FORD	E-150 ECONOLINE
13055	03-14	FORD	E-250
13055	00-02	FORD	E-250 ECONOLINE
13055	00-14	FORD	E-350 SUPER DUTY
13056	98-03	DODGE	DURANGO
13057	09-12	AUDI	Q5
13061	11-14	CHEVROLET	SILV. 2500 HD
13061	11-14	CHEVROLET	SILV. 3500 HD
13061	11-14	GMC	SIERRA 2500 HD
13061	11-14	GMC	SIERRA 3500 HD
13062	11-14	CHEVROLET	SILV. 2500 HD
13062	11-14	CHEVROLET	SILV. 3500 HD
13062	11-14	GMC	SIERRA 2500 HD
13062	11-14	GMC	SIERRA 3500 HD
13063	11-14	CHEVROLET	SILV. 2500 HD
13063	11-14	CHEVROLET	SILV. 3500 HD
13063	11-14	GMC	SIERRA 2500 HD
13063	11-14	GMC	SIERRA 3500 HD
13064	98-99	NISSAN	FRONTIER
13065	11-17	JEEP	GRAND CHEROKEE
13066	10-15	HYUNDAI	TUCSON
13066	11-15	KIA	SPORTAGE
13067	07-14	FORD	EDGE
13067	07-15	LINCOLN	MKX
13068	99-17	HONDA	ODYSSEY
13069	11-14	SUBARU	TRIBECA
13071	11-14	CHEVROLET	SILV. 2500 HD
13071	11-14	CHEVROLET	SILV. 3500 HD
13071	11-14	GMC	SIERRA 2500 HD
13071	11-14	GMC	SIERRA 3500 HD
13072	07-09	CHRYSLER	ASPEN
13072	04-09	DODGE	DURANGO
13073	10-12	HYUNDAI	SANTA FE
13073	11-13	KIA	SORENTO
13076	10-13	FORD	TRANSIT CONNECT
13077	07-18	BMW	X5
13077	14-19	BMW	X6
13078	11-17	NISSAN	QUEST
13079	11-19	MITSUBISHI	OUTLANDER SPORT
13079	11-15	MITSUBISHI	RVR
13081	11-17	JEEP	COMPASS
13081	11-17	JEEP	PATRIOT
13082	88-99	CHEVROLET	C1500
13082	88-00	CHEVROLET	C2500
13082	88-00	CHEVROLET	C3500
13082	88-99	CHEVROLET	K1500
13082	88-00	CHEVROLET	K2500

Part#	Years	Make	Model
13082	88-00	CHEVROLET	K3500
13082	99-00	CHEVROLET	SILVERADO 1500
13082	99-00	CHEVROLET	SILVERADO 2500
13082	88-99	GMC	C1500
13082	88-00	GMC	C2500
13082	88-00	GMC	C3500
13082	88-99	GMC	K1500
13082	88-00	GMC	K2500
13082	88-00	GMC	K3500
13082	99-00	GMC	SIERRA 1500
13082	99-00	GMC	SIERRA 2500
13083	83-94	CHEVROLET	S10 BLAZER
13083	92-94	GMC	JIMMY
13083	83-91	GMC	S15 JIMMY
13083	91-94	OLDSMOBILE	BRAVADA
13084	84-01	JEEP	CHEROKEE
13085	95-03	FORD	WINDSTAR
13086	84-95	TOYOTA	PICKUP
13087	96-02	TOYOTA	4RUNNER
13088	97-03	INFINITI	QX4
13088	96-04	NISSAN	PATHFINDER
13089	96-97	LEXUS	LX450
13089	91-97	TOYOTA	LAND CRUISER
13091	92-00	NISSAN	MONTERO
13092	86-94	NISSAN	D21
13093	11-15	CHRYSLER	300
13093	15-16	DODGE	CHALLENGER
13093	12-16	DODGE	CHARGER
13094	92-95	TOYOTA	4RUNNER
13095	87-95	NISSAN	PATHFINDER
13096	94-94	HONDA	PASSPORT
13096	91-97	ISUZU	RODEO
13097	98-03	DODGE	DURANGO
13098	96-99	ACURA	SLX
13098	92-02	ISUZU	TROOPER
13099	75-86	CHEVROLET	C10
13099	70-74	CHEVROLET	C10 PICKUP
13099	88-98	CHEVROLET	C1500
13099	75-86	CHEVROLET	C20
13099	70-74	CHEVROLET	C20 PICKUP
13099	88-00	CHEVROLET	C2500
13099	88-00	CHEVROLET	C3500
13099	91-00	CHEVROLET	C3500HD
13099	70-74	CHEVROLET	K10 PICKUP
13099	88-98	CHEVROLET	K1500
13099	88-00	CHEVROLET	K2500
13099	88-00	CHEVROLET	K3500
13099	88-96	FORD	F SUPER DUTY
13099	63-83	FORD	F-100
13099	75-96	FORD	F-150
13099	63-96	FORD	F-250
13099	63-96	FORD	F-350
13099	70-74	GMC	C15/C1500 PICKUP
13099	79-98	GMC	C1500
13099	75-78	GMC	C25
13099	70-74	GMC	C25/C2500 PICKUP
13099	79-00	GMC	C2500
13099	70-74	GMC	C35/C3500 PICKUP
13099	79-00	GMC	C3500
13099	91-00	GMC	C3500HD
13099	75-78	GMC	K15
13099	79-98	GMC	K1500
13099	79-00	GMC	K2500
13099	79-00	GMC	K3500
13102	10-13	MERCEDES-BENZ	GL350
13102	07-13	MERCEDES-BENZ	GL450
13102	08-13	MERCEDES-BENZ	GL550
13102	11-11	MERCEDES-BENZ	ML350
13103	07-09	MERCEDES-BENZ	R320
13103	06-12	MERCEDES-BENZ	R350
13103	06-07	MERCEDES-BENZ	R500
13105	04-19	TOYOTA	SIENNA
13106	91-03	FORD	EXPLORER
13106	97-01	MERCURY	MOUNTAINEER
13108	01-06	CHEVROLET	SILVER. 2500 HD

Part#	Years	Make	Model
13108	07-07	CHEVROLET	SILV. 2500 HD CLA.
13108	01-06	GMC	SIERRA 2500 HD
13108	07-07	GMC	SIER.2500 HD CLA.
13109	12-17	NISSAN	NV1500
13109	12-17	NISSAN	NV2500
13109	12-17	NISSAN	NV3500
13110	09-18	FORD	FLEX
13110	10-17	LINCOLN	MKT
13112	06-10	FORD	EXPLORER
13112	06-10	MERCURY	MOUNTAINEER
13113	06-11	NISSAN	ENDEAVOR
13114	08-13	BMW	X6
13115	15-18	KIA	SEDONA
13116	11-18	PORSCHE	CAYENNE
13116	11-17	VOLKSWAGEN	TUAREG
13117	16-16	MERCEDES-BENZ	GLE350
13117	12-15	MERCEDES-BENZ	ML350
13118	15-18	FORD	F-150
13119	12-16	HONDA	CR-V
13120	10-14	HYUNDAI	TUCSON
13120	10-16	KIA	SPORTAGE
13121	99-00	CADILLAC	ESCALADE
13121	92-96	CHEVROLET	BLAZER
13121	92-99	CHEVROLET	C1500 SUBURBAN
13121	92-99	CHEVROLET	C2500 SUBURBAN
13121	92-99	CHEVROLET	K1500 SUBURBAN
13121	92-99	CHEVROLET	K2500 SUBURBAN
13121	00-00	CHEVROLET	SUBURBAN 1500
13121	00-00	CHEVROLET	SUBURBAN 2500
13121	95-00	CHEVROLET	TAHOE
13121	92-99	GMC	C1500 SUBURBAN
13121	92-99	GMC	C2500 SUBURBAN
13121	92-99	GMC	K1500 SUBURBAN
13121	92-99	GMC	K2500 SUBURBAN
13121	92-00	GMC	YUKON
13121	00-00	GMC	YUKON XL 1500
13121	00-00	GMC	YUKON XL 2500
13122	14-16	MOBILITYVENTURES	MV-1
13122	11-12	VPG	MV-1
13125	97-02	FORD	EXPEDITION
13125	98-02	LINCOLN	NAVIGATOR
13126	14-19	INFINITI	QX60
13126	13-16	NISSAN	PATHFINDER
13128	12-18	LAND ROVER	RANGE RVR EVOQUE
13130	13-18	ACURA	RDX
13131	13-19	FORD	ESCAPE
13132	83-04	CHEVROLET	S10
13132	83-90	GMC	S15
13132	91-04	GMC	SONOMA
13133	09-17	VOLKSWAGEN	TIGUAN
13135	16-17	SUBARU	CROSSTREK
13135	13-15	SUBARU	XV CROSSTREK
13136	09-17	AUDI	Q5
13136	15-18	PORSCHE	MACAN
13138	83-11	FORD	RANGER
13138	94-09	MAZDA	B2300
13138	94-07	MAZDA	B3000
13138	94-09	MAZDA	B4000
13140	13-15	BMW	X1
13142	10-12	MERCEDES-BENZ	GLK350
13143	10-15	LEXUS	RX350
13143	10-15	LEXUS	RX450H
13144	14-18	SUBARU	FORESTER
13145	87-04	DODGE	DAKOTA
13146	14-17	ACURA	MDX
13146	16-19	HONDA	PILOT
13147	09-13	SUBARU	FORESTER
13149	06-18	TOYOTA	RAV4
13151	93-98	JEEP	GRAND CHEROKEE
13152	13-18	HYUNDAI	SANTA FE SPORT
13152	14-15	KIA	SORENTO
13153	13-18	HYUNDAI	SANTA FE
13153	19-19	HYUNDAI	SANTA FE XL
13154	10-12	ACURA	RDX
13155	13-15	MERCEDES-BENZ	GLK250

Part#	Years	Make	Model
13156	97-03	INFINITI	QX4
13156	96-04	NISSAN	PATHFINDER
13157	96-02	TOYOTA	4RUNNER
13158	10-14	SUBARU	LEGACY
13160	84-01	JEEP	CHEROKEE
13161	07-14	CHEVROLET	TAHOE
13162	00-06	BMW	X5
13163	14-18	MITSUBISHI	OUTLANDER
13165	15-18	CHEVROLET	CITY EXPRESS
13165	13-17	NISSAN	NV200
13167	14-19	FORD	TRANSIT CONNECT
13171	14-19	JEEP	CHEROKEE
13172	14-18	JEEP	CHEROKEE
13173	14-14	MERCEDES-BENZ	GL350
13175	14-18	CHEVROLET	SILVERADO 1500
13175	19-19	CHEVROLET	SILV. 1500 LEGACY
13175	14-18	GMC	SIERRA 1500
13175	19-19	GMC	SIERRA 1500 LTD
13176	15-19	CHEVROLET	COLORADO
13176	15-19	GMC	CANYON
13177	13-14	MERCEDES-BENZ	GLK350
13178	15-19	CHEVROLET	SILV. 2500 HD
13178	15-19	CHEVROLET	SILV. 3500 HD
13178	15-19	GMC	SIERRA 2500 HD
13178	15-19	GMC	SIERRA 3500 HD
13180	00-06	TOYOTA	TUNDRA
13182	11-19	DODGE	DURANGO
13182	12-18	JEEP	GRAND CHEROKEE
13183	00-04	NISSAN	XTERRA
13184	00-06	TOYOTA	TUNDRA
13186	13-19	FORD	ESCAPE
13187	15-16	CHEVROLET	SILV. 2500 HD
13187	15-16	CHEVROLET	SILV. 3500 HD
13187	15-16	GMC	SIERRA 2500 HD
13187	15-16	GMC	SIERRA 3500 HD
13188	04-10	INFINITI	QX56
13188	05-15	NISSAN	ARMADA
13188	04-04	NISSAN	PATHFIND. ARMADA
13190	14-16	MERCEDES-BENZ	GL450
13190	14-16	MERCEDES-BENZ	GL550
13190	17-17	MERCEDES-BENZ	GLS450
13190	17-17	MERCEDES-BENZ	GLS550
13193	15-18	FORD	TRANSIT-150
13193	15-18	FORD	TRANSIT-250
13193	15-18	FORD	TRANSIT-350
13194	15-19	LINCOLN	MKC
13195	19-19	HYUNDAI	SANTA FE
13195	16-19	KIA	SORENTO
13196	93-98	TOYOTA	T100
13197	17-19	INFINITI	QX30
13197	15-18	MERCEDES-BENZ	GLA250
13197	15-18	MERCEDES-BENZ	GLA45 AMG
13198	07-19	TOYOTA	TUNDRA
13199	04-15	NISSAN	TITAN
13200	14-18	TOYOTA	HIGHLANDER
13201	09-18	DODGE	JOURNEY
13203	15-19	CHEVROLET	COLORADO
13203	15-19	GMC	CANYON
13204	08-18	NISSAN	ROGUE
13204	14-15	NISSAN	ROGUE SELECT
13205	15-18	NISSAN	MURANO
13206	14-18	SUBARU	OUTBACK
13207	14-18	RAM	PROMASTER 1500
13207	14-18	RAM	PROMASTER 2500
13207	14-18	RAM	PROMASTER 3500
13208	01-10	CHEVROLET	SILV. 2500 HD
13208	07-07	CHEVROLET	SILV. 2500 HD CLA.
13208	01-06	CHEVROLET	SILVERADO 3500
13208	07-07	CHEVROLET	SILV. 3500 CLA.
13208	07-10	CHEVROLET	SILV. 3500 HD
13208	01-10	GMC	SIERRA 2500 HD
13208	07-07	GMC	SIER. 2500 HD CLA.
13208	01-06	GMC	SIERRA 3500
13208	07-07	GMC	SIERRA 3500 CLA.
13208	07-10	GMC	SIERRA 3500 HD

Part#	Years	Make	Model
13209	15-16	AUDI	Q3
13210	01-10	CHEVROLET	SILV. 2500 HD
13210	07-07	CHEVROLET	SILV. 2500 HD CLA.
13210	01-06	CHEVROLET	SILVERADO 3500
13210	07-07	CHEVROLET	SILV. 3500 CLA.
13210	07-10	CHEVROLET	SILV. 3500 HD
13210	01-10	GMC	SIERRA 2500 HD
13210	07-07	GMC	SIER. 2500 HD CLA.
13210	01-06	GMC	SIERRA 3500
13210	07-07	GMC	SIERRA 3500 CLA.
13210	07-10	GMC	SIERRA 3500 HD
13211	01-10	CHEVROLET	SILV. 2500 HD
13211	07-07	CHEVROLET	SILV. 2500 HD CLA.
13211	01-06	CHEVROLET	SILVERADO 3500
13211	07-07	CHEVROLET	SILV. 3500 CLA.
13211	07-10	CHEVROLET	SILV. 3500 HD
13211	01-10	GMC	SIERRA 2500 HD
13211	07-07	GMC	SIER. 2500 HD CLA.
13211	01-06	GMC	SIERRA 3500
13211	07-07	GMC	SIERRA 3500 CLA.
13211	07-10	GMC	SIERRA 3500 HD
13212	01-04	CHEVROLET	SILVERADO 2500
13212	01-10	CHEVROLET	SILV. 2500 HD
13212	07-07	CHEVROLET	SILV. 2500 HD CLA.
13212	01-04	GMC	SIERRA 2500
13212	01-10	GMC	SIERRA 2500 HD
13212	07-07	GMC	SIER. 2500 HD CLA.
13213	01-10	CHEVROLET	SILV. 2500 HD
13213	07-07	CHEVROLET	SILV. 2500 HD CLA.
13213	01-06	CHEVROLET	SILVERADO 3500
13213	07-07	CHEVROLET	SILV. 3500 CLA.
13213	07-10	CHEVROLET	SILV. 3500 HD
13213	01-10	GMC	SIERRA 2500 HD
13213	07-07	GMC	SIER. 2500 HD CLA.
13213	01-06	GMC	SIERRA 3500
13213	07-07	GMC	SIERRA 3500 CLA.
13213	07-10	GMC	SIERRA 3500 HD
13215	15-18	RAM	PROMASTER CITY
13217	93-03	VOLKSWAGEN	EUROVAN
13219	15-15	JEEP	RENEGADE
13220	07-15	AUDI	Q7
13220	04-10	PORSCHE	CAYENNE
13220	04-10	VOLKSWAGEN	TOUAREG
13222	98-02	HONDA	PASSPORT
13222	02-03	ISUZU	AXIOM
13222	98-04	ISUZU	RODEO
13223	97-04	MINI	MONTERO
13229	05-10	DODGE	DAKOTA
13229	06-09	MINI	RAIDER
13230	05-10	DODGE	DAKOTA
13233	16-18	VOLVO	XC90
13234	15-18	FORD	EDGE
13235	98-02	HONDA	PASSPORT
13235	89-00	ISUZU	AMIGO
13235	98-04	ISUZU	RODEO
13236	15-18	CHRYSLER	300
13236	11-18	DODGE	CHALLENGER
13236	15-18	DODGE	CHARGER
13238	15-18	AUDI	Q3
13238	15-18	AUDI	Q3 QUATTRO
13240	16-18	HYUNDAI	TUCSON
13241	05-19	NISSAN	FRONTIER
13241	09-12	SUZUKI	EQUATOR
13243	14-18	LAND ROVER	RANGE RVR SPORT
13244	02-07	JEEP	LIBERTY
13245	08-12	JEEP	LIBERTY
13250	03-06	DODGE	SPRINTER 2500
13250	03-06	DODGE	SPRINTER 3500
13251	05-10	JEEP	GRAND CHEROKEE
13252	04-12	CHEVROLET	COLORADO
13252	04-12	GMC	CANYON
13252	06-06	ISUZU	I-280
13252	07-08	ISUZU	I-290
13252	06-06	ISUZU	I-350
13252	07-08	ISUZU	I-370

Part#	Years	Make	Model
13255	07-09	DODGE	SPRINTER 2500
13255	07-09	DODGE	SPRINTER 3500
13255	07-16	FREIGHTLINER	SPRINTER 2500
13255	07-16	FREIGHTLINER	SPRINTER 3500
13255	10-16	MERCEDES-BENZ	SPRINTER 2500
13255	10-16	MERCEDES-BENZ	SPRINTER 3500
13262	16-18	LINCOLN	MKX
13264	16-18	TOYOTA	TACOMA
13265	03-06	DODGE	SPRINTER 2500
13265	03-06	DODGE	SPRINTER 3500
13266	11-16	VOLVO	S60
13266	15-18	VOLVO	V60
13266	08-10	VOLVO	V70
13266	09-16	VOLVO	XC70
13268	10-17	VOLVO	XC60
13269	15-18	JEEP	RENEGADE
13270	06-10	HUMMER	H3
13271	16-18	FIAT	500X
13272	16-19	LEXUS	RX350
13273	18-19	MINI	ECLIPSE CROSS
13275	07-09	DODGE	SPRINTER 2500
13275	07-09	DODGE	SPRINTER 3500
13275	07-09	FREIGHTLINER	SPRINTER 2500
13275	07-11	FREIGHTLINER	SPRINTER 3500
13275	10-11	MERCEDES-BENZ	SPRINTER 3500
13276	16-18	MERCEDES-BENZ	METRIS
13277	17-19	AUDI	Q7
13280	87-04	DODGE	DAKOTA
13281	17-19	KIA	SPORTAGE
13282	16-18	LEXUS	RX450H
13284	16-19	MAZDA	CX-9
13285	17-19	CADILLAC	XT5
13287	11-16	FORD	RANGER
13290	16-18	MERCEDES-BENZ	GLC300
13291	17-18	JAGUAR	F-PACE
13292	16-18	BUICK	ENVISION
13293	17-19	GMC	ACADIA
13294	16-18	MERCEDES-BENZ	GLE350
13295	14-18	RAM	PROMASTER 1500
13295	14-18	RAM	PROMASTER 2500
13295	14-18	RAM	PROMASTER 3500
13296	07-09	CHRYSLER	ASPEN
13296	07-09	DODGE	DURANGO
13297	04-06	DODGE	DURANGO
13300	95-04	CHEVROLET	BLAZER
13300	95-01	GMC	JIMMY
13300	96-04	OLDSMOBILE	BRAVADA
13301	07-18	CHEVROLET	SILVERADO 1500
13301	19-19	CHEVROLET	SILV. 1500 LEGACY
13301	07-18	GMC	SIERRA 1500
13301	19-19	GMC	SIERRA 1500 LTD
13303	16-18	BMW	X1
13304	17-18	NISSAN	TITAN
13305	17-18	VOLVO	S90
13307	18-19	CHEVROLET	EQUINOX
13307	18-19	GMC	TERRAIN
13309	17-18	NISSAN	PATHFINDER
13310	68-74	DODGE	D100 PICKUP
13310	77-93	DODGE	D150
13310	68-74	DODGE	D200 PICKUP
13310	81-93	DODGE	D250
13310	68-74	DODGE	D300 PICKUP
13310	81-93	DODGE	D350
13310	80-96	FORD	BRONCO
13310	74-83	FORD	F-100
13310	75-97	FORD	F-150
13310	73-97	FORD	F-250
13310	73-97	FORD	F-350
13314	97-01	HONDA	CR-V
13315	13-18	MAZDA	CX-5
13316	11-17	BMW	X3
13316	15-18	BMW	X4
13317	16-17	NISSAN	TITAN XD
13318	02-08	MERCEDES-BENZ	G500
13320	02-02	DODGE	RAM 1500

Part#	Years	Make	Model
13322	99-13	CHEVROLET	SILVERADO 1500
13322	07-07	CHEVROLET	SILV. 1500 CLA.
13322	01-06	CHEVROLET	SILV. 1500 HD
13322	07-07	CHEVROLET	SILV. 1500 HD CLA.
13322	99-04	CHEVROLET	SILVERADO 2500
13322	99-13	GMC	SIERRA 1500
13322	07-07	GMC	SIERRA 1500 CLA.
13322	01-06	GMC	SIERRA 1500 HD
13322	07-07	GMC	SIER. 1500 HD CLA.
13322	99-04	GMC	SIERRA 2500
13323	05-15	TOYOTA	TACOMA
13326	02-02	DODGE	RAM 1500
13328	01-06	ACURA	MDX
13328	03-08	HONDA	PILOT
13329	17-19	KIA	NIRO
13331	18-19	AUDI	Q5
13332	99-06	CHEVROLET	SILVERADO 1500
13332	07-07	CHEVROLET	SILV. 1500 CLA.
13332	01-06	CHEVROLET	SILV. 1500 HD
13332	07-07	CHEVROLET	SILV. 1500 HD CLA.
13332	99-04	CHEVROLET	SILVERADO 2500
13332	99-06	GMC	SIERRA 1500
13332	07-07	GMC	SIERRA 1500 CLA.
13332	01-06	GMC	SIERRA 1500 HD
13332	07-07	GMC	SIER 1500 HD CLA.
13333	03-10	DODGE	RAM 1500
13333	03-10	DODGE	RAM 2500
13333	03-10	DODGE	RAM 3500
13333	11-18	RAM	1500
13333	19-19	RAM	1500 CLASSIC
13333	11-13	RAM	2500
13333	11-13	RAM	3500
13334	07-11	DODGE	NITRO
13336	05-07	BUICK	TERRAZA
13336	05-09	CHEVROLET	UPLANDER
13336	05-09	PONTIAC	MONTANA
13336	05-07	SATURN	RELAY
13337	15-17	LEXUS	NX200T
13337	18-18	LEXUS	NX300
13337	15-18	LEXUS	NX300H
13339	99-12	CHEVROLET	SILVERADO 1500
13339	07-07	CHEVROLET	SILV. 1500 CLA.
13339	01-06	CHEVROLET	SILV. 1500 HD
13339	07-07	CHEVROLET	SILV. 1500 HD CLA.
13339	99-04	CHEVROLET	SILVERADO 2500
13339	99-12	GMC	SIERRA 1500
13339	07-07	GMC	SIERRA 1500 CLA.
13339	01-06	GMC	SIERRA 1500 HD
13339	07-07	GMC	SIER.1500 HD CLA.
13339	99-04	GMC	SIERRA 2500
13340	02-05	KIA	SEDONA
13342	07-08	MERCEDES-BENZ	ML320
13342	06-11	MERCEDES-BENZ	ML350
13342	06-07	MERCEDES-BENZ	ML500
13342	08-09	MERCEDES-BENZ	ML550
13343	11-17	TOYOTA	SIENNA
13344	05-07	BUICK	TERRAZA
13344	05-09	CHEVROLET	UPLANDER
13344	97-05	CHEVROLET	VENTURE
13344	97-04	OLDSMOBILE	SILHOUETTE
13344	99-09	PONTIAC	MONTANA
13344	97-98	PONTIAC	TRANS SPORT
13345	07-09	HYUNDAI	ENTOURAGE
13345	06-14	KIA	SEDONA
13349	07-10	KIA	SEDONA
13352	04-05	FORD	F-150
13354	07-13	ACURA	MDX
13355	97-03	FORD	F-150
13355	04-04	FORD	F-150 HERITAGE
13355	97-99	FORD	F-250
13355	99-16	FORD	F-250 SUPER DUTY
13355	99-16	FORD	F-350 SUPER DUTY
13355	08-16	FORD	F-450 SUPER DUTY
13356	09-16	TOYOTA	VENZA
13357	04-05	FORD	F-150

Part#	Years	Make	Model
13358	07-09	DODGE	SPRINTER 2500
13358	07-09	DODGE	SPRINTER 3500
13358	07-16	FREIGHTLINER	SPRINTER 2500
13358	07-16	FREIGHTLINER	SPRINTER 3500
13358	10-16	MERCEDES-BENZ	SPRINTER 2500
13358	10-16	MERCEDES-BENZ	SPRINTER 3500
13359	97-03	FORD	F-150
13359	04-04	FORD	F-150 HERITAGE
13359	97-99	FORD	F-250
13359	99-15	FORD	F-250 SUPER DUTY
13359	99-15	FORD	F-350 SUPER DUTY
13360	06-08	FORD	F-150
13360	06-08	LINCOLN	MARK LT
13361	02-08	DODGE	RAM 1500
13361	03-10	DODGE	RAM 2500
13361	03-10	DODGE	RAM 3500
13361	11-18	RAM	2500
13361	11-18	RAM	3500
13362	96-07	CHRYSLER	TOWN & COUNTRY
13362	00-03	CHRYSLER	VOYAGER
13362	96-07	DODGE	CARAVAN
13362	04-07	DODGE	GRAND CARAVAN
13362	96-00	PLYMOUTH	VOYAGER
13363	17-19	JEEP	COMPASS
13364	08-16	CHRYSLER	TOWN & COUNTRY
13364	08-19	DODGE	GRAND CARAVAN
13364	12-15	RAM	C/V
13364	09-14	VOLKSWAGEN	ROUTAN
13365	06-08	FORD	F-150
13365	06-08	LINCOLN	MARK LT
13366	18-19	VOLKSWAGEN	ATLAS
13367	07-14	TOYOTA	FJ CRUISER
13368	09-14	FORD	F-150
13370	18-19	HONDA	ODYSSEY
13371	09-14	FORD	F-150
13372	06-08	FORD	F-150
13373	04-05	FORD	F-150
13374	09-10	DODGE	RAM 1500
13374	11-18	RAM	1500
13374	19-19	RAM	1500 CLASSIC
13375	07-09	DODGE	SPRINTER 3500
13375	07-16	FREIGHTLINER	SPRINTER 3500
13375	10-16	MERCEDES-BENZ	SPRINTER 3500
13377	17-18	NISSAN	QASHQAI
13377	17-18	NISSAN	ROGUE SPORT
13379	10-19	FORD	TAURUS
13380	18-19	CHEVROLET	TRAVERSE
13381	18-18	VOLKSWAGEN	TIGUAN
13382	18-19	SUBARU	CROSSTREK
13383	17-18	CHRYSLER	PACIFICA
13384	18-19	BUICK	ENCLAVE
13385	06-14	HONDA	RIDGELINE
13386	11-19	FORD	EXPLORER
13386	13-18	FORD	POLICE INTER.UTLTY
13387	18-19	BMW	X3
13388	07-09	DODGE	SPRINTER 2500
13388	07-09	DODGE	SPRINTER 3500
13388	07-17	FREIGHTLINER	SPRINTER 2500
13388	07-17	FREIGHTLINER	SPRINTER 3500
13388	10-17	MERCEDES-BENZ	SPRINTER 2500
13388	10-17	MERCEDES-BENZ	SPRINTER 3500
13389	04-07	CHRYSLER	TOWN & COUNTRY
13389	04-07	DODGE	CARAVAN
13389	04-07	DODGE	GRAND CARAVAN
13390	15-18	SUBARU	LEGACY
13390	10-13	SUBARU	OUTBACK
13391	18-18	ALFA ROMEO	STELVIO
13392	18-18	JEEP	WRANGLER
13395	19-19	JEEP	CHEROKEE
13396	15-18	LAND ROVER	DISCOVERY SPORT
13397	17-19	HONDA	CR-V
13398	18-18	NISSAN	OUTLANDER PHEV
13401	73-91	CHEVROLET	BLAZER
13401	75-86	CHEVROLET	K5 BLAZER
13401	73-91	GMC	JIMMY

Part#	Years	Make	Model
13402	00-02	CADILLAC	ESCALADE
13402	02-02	CHEVROLET	AVALANCHE 1500
13402	02-02	CHEVROLET	AVALANCHE 2500
13402	00-02	CHEVROLET	SUBURBAN 1500
13402	00-02	CHEVROLET	SUBURBAN 2500
13402	00-02	CHEVROLET	TAHOE
13402	00-02	GMC	YUKON
13402	00-02	GMC	YUKON XL 1500
13402	00-02	GMC	YUKON XL 2500
13407	01-05	FORD	EXPL. SPORT TRAC
13408	97-06	JEEP	WRANGLER
13412	78-83	JEEP	CJ5
13412	78-86	JEEP	CJ7
13414	06-10	JEEP	COMMANDER
13422	03-06	CADILLAC	ESCALADE
13422	03-06	CADILLAC	ESCALADE ESV
13422	03-06	CADILLAC	ESCALADE EXT
13422	03-06	CHEVROLET	AVALANCHE 1500
13422	03-06	CHEVROLET	AVALANCHE 2500
13422	03-06	CHEVROLET	SUBURBAN 1500
13422	03-06	CHEVROLET	SUBURBAN 2500
13422	03-06	CHEVROLET	TAHOE
13422	03-06	GMC	YUKON
13424	08-17	BUICK	ENCLAVE
13424	09-17	CHEVROLET	TRAVERSE
13424	07-16	GMC	ACADIA
13424	17-17	GMC	ACADIA LIMITED
13424	07-10	SATURN	OUTLOOK
13429	99-03	LEXUS	RX300
13429	01-03	TOYOTA	HIGHLANDER
13430	97-06	JEEP	WRANGLER
13432	07-17	JEEP	WRANGLER
13432	18-18	JEEP	WRANGLER JK
13440	01-07	TOYOTA	SEQUOIA
13442	08-11	TOYOTA	SEQUOIA
13443	98-07	LEXUS	LX470
13443	98-07	TOYOTA	LAND CRUISER
13445	03-09	LEXUS	GX470
13445	03-09	TOYOTA	4RUNNER
13450	02-05	LAND ROVER	FREELANDER
13455	98-04	LAND ROVER	DISCOVERY
13456	05-09	LAND ROVER	LR3
13456	10-16	LAND ROVER	LR4
13456	06-13	LAND ROVER	RANGE ROVER
13465	05-10	CHRYSLER	300
13465	08-10	DODGE	CHALLENGER
13465	06-10	DODGE	CHARGER
13465	05-08	DODGE	MAGNUM
13469	02-07	BUICK	RENDEZVOUS
13469	01-05	PONTIAC	AZTEK
13505	01-06	HYUNDAI	SANTA FE
13506	01-04	FORD	ESCAPE
13506	01-04	MAZDA	TRIBUTE
13511	98-03	TOYOTA	SIENNA
13513	03-09	KIA	SORENTO
13514	05-15	NISSAN	XTERRA
13517	99-04	CHEVROLET	TRACKER
13517	99-06	SUZUKI	GRAND VITARA
13517	99-04	SUZUKI	VITARA
13517	02-06	SUZUKI	XL-7
13518	07-09	SUZUKI	GRAND VITARA
13518	07-09	SUZUKI	XL-7
13524	96-05	TOYOTA	RAV4
13526	05-09	HYUNDAI	TUCSON
13526	05-10	KIA	SPORTAGE
13529	04-08	CHRYSLER	PACIFICA
13530	04-06	LEXUS	RX330
13530	07-09	LEXUS	RX350
13530	06-08	LEXUS	RX400H
13530	04-07	TOYOTA	HIGHLANDER
13534	08-13	TOYOTA	HIGHLANDER
13535	02-06	HONDA	CR-V
13536	07-09	ACURA	RDX
13537	95-02	KIA	SPORTAGE
13538	07-09	HYUNDAI	SANTA FE

Part#	Years	Make	Model
13540	91-03	FORD	EXPLORER
13540	91-94	MAZDA	NAVAJO
13540	97-01	MERCURY	MOUNTAINEER
13542	05-07	FORD	FIVE HUNDRED
13542	05-07	FORD	FREESTYLE
13542	08-08	FORD	TAURUS
13542	08-09	FORD	TAURUS X
13542	05-07	MERCURY	MONTEGO
13542	08-08	MERCURY	SABLE
13545	07-12	HYUNDAI	VERACRUZ
13548	07-10	JEEP	COMPASS
13548	07-10	JEEP	PATRIOT
13550	02-05	FORD	EXPLORER
13550	03-05	LINCOLN	AVIATOR
13550	02-05	MERCURY	MOUNTAINEER
13551	09-18	FORD	FLEX
13554	09-12	INFINITI	FX35
13554	13-13	INFINITI	FX37
13554	09-13	INFINITI	FX50
13554	14-17	INFINITI	QX70
13555	07-11	HONDA	CR-V
13556	99-01	ISUZU	VEHICROSS
13558	03-08	INFINITI	FX35
13558	03-08	INFINITI	FX45
13559	03-14	VOLVO	XC90
13563	04-09	NISSAN	QUEST
13569	04-05	NISSAN	ENDEAVOR
13571	03-07	NISSAN	MURANO
13572	99-02	MERCURY	VILLAGER
13572	99-02	NISSAN	QUEST
13573	04-10	BMW	X3
13574	03-11	HONDA	ELEMENT
13575	07-15	MAZDA	CX-9
13577	09-14	NISSAN	MURANO
13580	71-80	INTERNATIONAL	SCOUT II
13581	07-13	NISSAN	OUTLANDER
13587	04-07	FORD	FREESTAR
13587	04-07	MERCURY	MONTEREY
13590	99-03	DODGE	RAM 1500 VAN
13590	99-03	DODGE	RAM 2500 VAN
13590	99-03	DODGE	RAM 3500 VAN
13591	05-17	CHEVROLET	EQUINOX
13591	10-17	GMC	TERRAIN
13591	06-09	PONTIAC	TORRENT
13591	02-07	SATURN	VUE
13593	07-12	MAZDA	CX-7
13594	12-15	CHEVROLET	CAPTIVA SPORT
13594	08-10	SATURN	VUE
13650	05-12	FORD	ESCAPE
13650	05-11	MAZDA	TRIBUTE
13650	05-11	MERCURY	MARINER
13651	05-11	FORD	ESCAPE
13651	05-11	MAZDA	TRIBUTE
13651	05-11	MERCURY	MARINER
13657	87-95	JEEP	WRANGLER
13707	87-91	FORD	COUNTRY SQUIRE
13707	92-11	FORD	CROWN VICTORIA
13707	80-83	LINCOLN	MARK VI
13707	81-11	LINCOLN	TOWN CAR
13707	79-09	MERCURY	GRAND MARQUIS
13707	03-04	MERCURY	MARAUDER
13800	01-06	NISSAN	MONTERO
13831	00-04	NISSAN	FRONTIER
13841	00-04	NISSAN	FRONTIER
13842	03-04	NISSAN	FRONTIER
13902	99-18	CHEVROLET	SILVERADO 1500
13902	07-07	CHEVROLET	SILV. 1500 CLA.
13902	01-06	CHEVROLET	SILV. 1500 HD
13902	07-07	CHEVROLET	SILV. 1500 HD CLA.
13902	99-04	CHEVROLET	SILVERADO 2500
13902	01-18	CHEVROLET	SILV. 2500 HD
13902	07-07	CHEVROLET	SILV. 2500 HD CLA.
13902	01-06	CHEVROLET	SILVERADO 3500
13902	07-07	CHEVROLET	SILV. 3500 CLA.
13902	07-18	CHEVROLET	SILV. 3500 HD

Part#	Years	Make	Model
13902	02-10	DODGE	RAM 1500
13902	03-10	DODGE	RAM 2500
13902	03-10	DODGE	RAM 3500
13902	98-05	FORD	F-150
13902	04-04	FORD	F-150 HERITAGE
13902	00-16	FORD	F-250 SUPER DUTY
13902	00-16	FORD	F-350 SUPER DUTY
13902	99-16	FORD	F-450 SUPER DUTY
13902	99-18	GMC	SIERRA 1500
13902	07-07	GMC	SIERRA 1500 CLA.
13902	01-06	GMC	SIERRA 1500 HD
13902	07-07	GMC	SIER.1500 HD CLA.
13902	99-04	GMC	SIERRA 2500
13902	01-18	GMC	SIERRA 2500 HD
13902	07-07	GMC	SIER. 2500 HD CLA.
13902	01-06	GMC	SIERRA 3500
13902	07-07	GMC	SIERRA 3500 CLA.
13902	07-18	GMC	SIERRA 3500 HD
13902	11-18	RAM	1500
13902	11-18	RAM	2500
13902	11-18	RAM	3500
13903	06-18	FORD	F-150
13920	82-04	CHEVROLET	S10
13920	82-90	GMC	S15
13920	91-04	GMC	SONOMA
13932	99-06	CHEVROLET	SILVERADO 1500
13932	07-07	CHEVROLET	SILV. 1500 CLA.
13932	99-06	GMC	SIERRA 1500
13932	07-07	GMC	SIERRA 1500 CLA.
13942	88-99	CHEVROLET	C1500
13942	88-99	CHEVROLET	K1500
13942	88-99	GMC	C1500
13942	88-99	GMC	K1500
14000	12-17	NISSAN	NV1500
14000	12-17	NISSAN	NV2500
14000	12-17	NISSAN	NV3500
14001	75-89	DODGE	D100
14001	68-74	DODGE	D100 PICKUP
14001	77-93	DODGE	D150
14001	68-74	DODGE	D200 PICKUP
14001	81-93	DODGE	D250
14001	68-74	DODGE	D300 PICKUP
14001	81-93	DODGE	D350
14001	94-02	DODGE	RAM 1500
14001	94-02	DODGE	RAM 2500
14001	94-02	DODGE	RAM 3500
14001	89-96	FORD	BRONCO
14001	73-83	FORD	F-100
14001	75-96	FORD	F-150
14001	73-97	FORD	F-250
14001	97-97	FORD	F-250 HD
14001	73-97	FORD	F-350
14002	09-14	FORD	F-150
14006	14-18	CHEVROLET	SILVERADO 1500
14006	19-19	CHEVROLET	SILV. 1500 LEGACY
14006	14-18	GMC	SIERRA 1500
14006	19-19	GMC	SIERRA 1500 LTD
14008	01-06	CHEVROLET	SILV. 2500 HD
14008	07-07	CHEVROLET	SILV. 2500 HD CLA.
14008	01-06	CHEVROLET	SILVERADO 3500
14008	07-07	CHEVROLET	SILV. 3500 CLA.
14008	01-06	GMC	SIERRA 2500 HD
14008	07-07	GMC	SIER. 2500 HD CLA.
14008	01-06	GMC	SIERRA 3500
14008	07-07	GMC	SIERRA 3500 CLA.
14009	15-19	CHEVROLET	SILVE. 2500 HD
14009	15-19	CHEVROLET	SILV. 3500 HD
14009	15-19	GMC	SIERRA 2500 HD
14009	15-19	GMC	SIERRA 3500 HD
14010	15-17	CHEVROLET	SILV. 2500 HD
14010	15-17	CHEVROLET	SILV. 3500 HD
14010	15-17	GMC	SIERRA 2500 HD
14010	15-17	GMC	SIERRA 3500 HD
14011	00-05	FORD	EXCURSION
14012	15-18	FORD	TRANSIT-150

Part#	Years	Make	Model
14012	15-18	FORD	TRANSIT-250
14012	15-18	FORD	TRANSIT-350
14016	15-18	FORD	F-150
14017	15-18	FORD	F-150
14020	02-02	DODGE	RAM 1500
14029	99-00	CADILLAC	ESCALADE
14029	92-94	CHEVROLET	BLAZER
14029	92-99	CHEVROLET	C1500 SUBURBAN
14029	92-99	CHEVROLET	C2500 SUBURBAN
14029	92-99	CHEVROLET	K1500 SUBURBAN
14029	92-99	CHEVROLET	K2500 SUBURBAN
14029	00-00	CHEVROLET	SUBURBAN 1500
14029	00-00	CHEVROLET	SUBURBAN 2500
14029	95-00	CHEVROLET	TAHOE
14029	92-00	GMC	YUKON
14029	00-00	GMC	YUKON XL 1500
14029	00-00	GMC	YUKON XL 2500
14048	99-17	FORD	F-350 SUPER DUTY
14048	99-17	FORD	F-450 SUPER DUTY
14048	99-17	FORD	F-550 SUPER DUTY
14048	00-16	FORD	F-650
14053	03-06	FORD	E-150
14053	75-02	FORD	E-150 ECONOLINE
14053	03-06	FORD	E-250
14053	75-02	FORD	E-250 ECONOLINE
14053	75-98	FORD	E-350 ECONOLINE
14053	99-06	FORD	E-350 SUPER DUTY
14055	03-14	FORD	E-150
14055	03-14	FORD	E-250
14055	00-14	FORD	E-350 SUPER DUTY
14061	11-14	CHEVROLET	SILV. 2500 HD
14061	11-14	CHEVROLET	SILV. 3500 HD
14061	11-14	GMC	SIERRA 2500 HD
14061	11-14	GMC	SIERRA 3500 HD
14062	11-14	CHEVROLET	SILV. 2500 HD
14062	11-14	CHEVROLET	SILV. 3500 HD
14062	11-14	GMC	SIERRA 2500 HD
14062	11-11	GMC	SIERRA 3500 HD
14070	07-10	DODGE	RAM 3500
14070	08-10	DODGE	RAM 4500
14070	08-10	DODGE	RAM 5500
14070	11-18	RAM	3500
14070	11-18	RAM	4500
14070	11-18	RAM	5500
14080	02-02	CADILLAC	ESCALADE
14080	02-02	CADILLAC	ESCALADE EXT
14080	02-02	CHEVROLET	AVALANCHE 1500
14080	02-02	CHEVROLET	AVALANCHE 2500
14080	00-02	CHEVROLET	SUBURBAN 1500
14080	00-02	CHEVROLET	SUBURBAN 2500
14080	00-02	CHEVROLET	TAHOE
14080	00-02	GMC	YUKON
14081	90-99	CHEVROLET	C1500
14081	88-00	CHEVROLET	C2500
14081	88-00	CHEVROLET	C3500
14081	88-99	CHEVROLET	K1500
14081	88-00	CHEVROLET	K2500
14081	88-00	CHEVROLET	K3500
14081	99-00	CHEVROLET	SILVERADO 1500
14081	99-00	CHEVROLET	SILVERADO 2500
14081	88-99	GMC	C1500
14081	88-00	GMC	C2500
14081	88-00	GMC	C3500
14081	88-99	GMC	K1500
14081	88-00	GMC	K2500
14081	88-00	GMC	K3500
14081	99-00	GMC	SIERRA 1500
14081	99-00	GMC	SIERRA 2500
14082	80-86	CHEVROLET	C30
14082	88-00	CHEVROLET	C3500
14082	91-02	CHEVROLET	C3500HD
14082	01-06	CHEVROLET	SILVERADO 3500
14082	88-97	FORD	F SUPER DUTY
14082	80-97	FORD	F-350
14082	99-06	FORD	F-350 SUPER DUTY

Part#	Years	Make	Model
14082	99-06	FORD	F-450 SUPER DUTY
14082	99-06	FORD	F-550 SUPER DUTY
14082	80-95	GMC	C3500
14082	91-94	GMC	C3500HD
14082	80-95	GMC	K3500
14090	96-14	CHEVROLET	EXPRESS 1500
14090	96-18	CHEVROLET	EXPRESS 2500
14090	96-18	CHEVROLET	EXPRESS 3500
14090	96-14	GMC	SAVANA 1500
14090	96-18	GMC	SAVANA 2500
14090	96-18	GMC	SAVANA 3500
14108	01-06	CHEVROLET	SILV. 2500 HD
14108	07-07	CHEVROLET	SILV. 2500 HD CLA.
14108	06-06	CHEVROLET	SILVERADO 3500
14108	01-06	GMC	SIERRA 2500 HD
14108	07-07	GMC	SIER. 2500 HD CLA.
14211	01-10	CHEVROLET	SILV. 2500 HD
14211	07-07	CHEVROLET	SILV. 2500 HD CLA.
14211	01-06	CHEVROLET	SILVERADO 3500
14211	07-07	CHEVROLET	SILV. 3500 CLA.
14211	07-10	CHEVROLET	SILV. 3500 HD
14211	01-10	GMC	SIERRA 2500 HD
14211	07-07	GMC	SIER. 2500 HD CLA.
14211	01-06	GMC	SIERRA 3500
14211	07-07	GMC	SIERRA 3500 CLA.
14211	07-10	GMC	SIERRA 3500 HD
14250	03-06	DODGE	SPRINTER 2500
14250	03-06	DODGE	SPRINTER 3500
14258	16-18	RAM	2500
14258	16-18	RAM	3500
14301	07-18	CHEVROLET	SILVERADO 1500
14301	07-07	CHEVROLET	SILV. 1500 CLA.
14301	07-07	CHEVROLET	SILV. 1500 HD CLA.
14301	19-19	CHEVROLET	SILV. 1500 LEGACY
14301	07-18	GMC	SIERRA 1500
14301	07-07	GMC	SIER.1500 CLA.
14301	07-07	GMC	SIER. 1500 HD CLA.
14301	19-19	GMC	SIERRA 1500 LTD
14332	99-07	CHEVROLET	SILVERADO 1500
14332	07-07	CHEVROLET	SILV. 1500 CL.
14332	01-06	CHEVROLET	SILV. 1500 HD
14332	07-07	CHEVROLET	SILV. 1500 HD CLA.
14332	99-04	CHEVROLET	SILVERADO 2500
14332	99-07	GMC	SIERRA 1500
14332	07-07	GMC	SIERRA 1500 CLA.
14332	01-06	GMC	SIERRA 1500 HD
14332	07-07	GMC	SIER. 1500 HD CLA.
14332	99-04	GMC	SIERRA 2500
14355	97-03	FORD	F-150
14355	04-04	FORD	F-150 HERITAGE
14355	97-99	FORD	F-250
14355	99-15	FORD	F-250 SUPER DUTY
14355	99-15	FORD	F-350 SUPER DUTY
14355	08-16	FORD	F-450 SUPER DUTY
14357	04-05	FORD	F-150
14360	06-08	FORD	F-150
14360	06-08	LINCOLN	MARK LT
14361	02-08	DODGE	RAM 1500
14361	03-10	DODGE	RAM 2500
14361	03-10	DODGE	RAM 3500
14361	11-18	RAM	2500
14361	11-15	RAM	3500
14374	09-10	DODGE	RAM 1500
14374	11-18	RAM	1500
14374	19-19	RAM	1500 CLASSIC
15300	75-89	DODGE	D100
15300	68-74	DODGE	D100 PICKUP
15300	77-93	DODGE	D150
15300	68-74	DODGE	D200 PICKUP
15300	81-93	DODGE	D250
15300	68-74	DODGE	D300 PICKUP
15300	81-93	DODGE	D350
15300	94-02	DODGE	RAM 1500
15300	94-02	DODGE	RAM 2500
15300	94-02	DODGE	RAM 3500



Part#	Years	Make	Model
15300	78-96	FORD	BRONCO
15300	73-83	FORD	F-100
15300	75-96	FORD	F-150
15300	73-97	FORD	F-250
15300	97-97	FORD	F-250 HD
15300	73-97	FORD	F-350
15302	01-04	CHEVROLET	SILVERADO 2500
15302	01-10	CHEVROLET	SILV. 2500 HD
15302	07-07	CHEVROLET	SILV. 2500 HD CLA.
15302	01-04	GMC	SIERRA 2500
15302	01-10	GMC	SIERRA 2500 HD
15302	07-07	GMC	SIER. 2500 HD CLA.
15303	97-03	FORD	F-150
15303	97-99	FORD	F-250
15306	16-17	NISSAN	TITAN XD
15312	01-04	CHEVROLET	SILVERADO 2500
15312	01-10	CHEVROLET	SILV. 2500 HD
15312	07-07	CHEVROLET	SILV. 2500 HD CLA.
15312	01-06	CHEVROLET	SILVERADO 3500
15312	07-07	CHEVROLET	SILV. 3500 CLA.
15312	07-10	CHEVROLET	SILV. 3500 HD
15312	01-04	GMC	SIERRA 2500
15312	01-10	GMC	SIERRA 2500 HD
15312	07-07	GMC	SIER. 2500 HD CLA.
15312	01-06	GMC	SIERRA 3500
15312	07-07	GMC	SIERRA 3500 CLA.
15312	07-10	GMC	SIERRA 3500 HD
15313	01-04	CHEVROLET	SILVERADO 2500
15313	01-10	CHEVROLET	SILV. 2500 HD
15313	07-07	CHEVROLET	SILV. 2500 HD CLA.
15313	01-06	CHEVROLET	SILVERADO 3500
15313	07-07	CHEVROLET	SILV. 3500 CLA.
15313	07-10	CHEVROLET	SILV. 3500 HD
15313	01-04	GMC	SIERRA 2500
15313	01-10	GMC	SIERRA 2500 HD
15313	07-07	GMC	SIER. 2500 HD CLA.
15313	01-06	GMC	SIERRA 3500
15313	07-07	GMC	SIERRA 3500 CLA.
15313	08-10	GMC	SIERRA 3500 HD
15316	99-99	FORD	F-250 SUPER DUTY
15316	99-03	FORD	F-350 SUPER DUTY
15317	88-99	CHEVROLET	C1500
15317	88-00	CHEVROLET	C2500
15317	88-00	CHEVROLET	C3500
15317	91-00	CHEVROLET	C3500HD
15317	88-99	CHEVROLET	K1500
15317	88-00	CHEVROLET	K2500
15317	88-00	CHEVROLET	K3500
15317	88-99	GMC	C1500
15317	88-00	GMC	C2500
15317	88-00	GMC	C3500
15317	88-99	GMC	K1500
15317	88-00	GMC	K2500
15317	88-00	GMC	K3500
15318	94-02	DODGE	RAM 2500
15318	94-98	DODGE	RAM 3500
15319	94-02	DODGE	RAM 2500
15319	94-02	DODGE	RAM 3500
15320	96-14	CHEVROLET	EXPRESS 1500
15320	96-18	CHEVROLET	EXPRESS 2500
15320	96-18	CHEVROLET	EXPRESS 3500
15320	96-14	GMC	SAVANA 1500
15320	96-18	GMC	SAVANA 2500
15320	96-18	GMC	SAVANA 3500
15323	99-14	CHEVROLET	SILVERADO 1500
15323	07-07	CHEVROLET	SILV. 1500 CLA.
15323	01-06	CHEVROLET	SILV. 1500 HD
15323	07-07	CHEVROLET	SILV. 1500 HD CLA.
15323	99-04	CHEVROLET	SILVERADO 2500
15323	99-14	GMC	SIERRA 1500
15323	07-07	GMC	SIERRA 1500 CLA.
15323	01-06	GMC	SIERRA 1500 HD
15323	07-07	GMC	SIER. 1500 HD CLA.
15323	99-04	GMC	SIERRA 2500
15324	03-06	CADILLAC	ESCALADE

Part#	Years	Make	Model
15324	03-06	CADILLAC	ESCALADE ESV
15324	03-06	CADILLAC	ESCALADE EXT
15324	03-06	CHEVROLET	AVALANCHE 1500
15324	03-06	CHEVROLET	AVALANCHE 2500
15324	03-06	CHEVROLET	SUBURBAN 1500
15324	03-06	CHEVROLET	SUBURBAN 2500
15324	03-06	CHEVROLET	TAHOE
15324	03-06	GMC	YUKON
15325	98-99	CHEVROLET	C1500
15325	98-00	CHEVROLET	C2500
15325	98-00	CHEVROLET	C3500
15325	98-00	CHEVROLET	K2500
15325	98-00	CHEVROLET	K3500
15325	98-00	GMC	C2500
15325	98-00	GMC	C3500
15325	98-00	GMC	K2500
15325	98-00	GMC	K3500
15363	11-12	CHEVROLET	SILV. 2500 HD
15363	11-12	CHEVROLET	SILV. 3500 HD
15363	11-12	GMC	SIERRA 2500 HD
15363	11-12	GMC	SIERRA 3500 HD
15398	07-19	TOYOTA	TUNDRA
15400	01-06	CHEVROLET	SILVERADO 3500
15400	07-07	CHEVROLET	SILV. 3500 CLA.
15400	07-16	CHEVROLET	SILV. 3500 HD
15400	07-10	DODGE	RAM 3500
15400	08-10	DODGE	RAM 4500
15400	08-10	DODGE	RAM 5500
15400	01-06	GMC	SIERRA 3500
15400	07-07	GMC	SIERRA 3500 CLA.
15400	07-16	GMC	SIERRA 3500 HD
15400	11-18	RAM	3500
15400	11-18	RAM	4500
15400	11-18	RAM	5500
15401	16-18	RAM	2500
15401	16-16	RAM	3500
15409	03-08	DODGE	RAM 1500
15409	03-10	DODGE	RAM 2500
15409	03-10	DODGE	RAM 3500
15409	16-18	RAM	2500
15409	11-13	RAM	3500
15410	99-16	FORD	F-250 SUPER DUTY
15410	99-16	FORD	F-350 SUPER DUTY
15410	08-15	FORD	F-450 SUPER DUTY
15445	99-17	FORD	F-350 SUPER DUTY
15445	99-17	FORD	F-450 SUPER DUTY
15445	99-17	FORD	F-550 SUPER DUTY
15460	11-19	CHEVROLET	SILV. 2500 HD
15460	11-19	CHEVROLET	SILV. 3500 HD
15460	11-19	GMC	SIERRA 2500 HD
15460	11-19	GMC	SIERRA 3500 HD
15572	09-10	DODGE	RAM 1500
15572	11-18	RAM	1500
15572	19-19	RAM	1500 CLASSIC
15703	01-04	CHEVROLET	SILVERADO 2500
15703	01-10	CHEVROLET	SILV. 2500 HD
15703	07-07	CHEVROLET	SILV. 2500 HD CLA.
15703	01-06	CHEVROLET	SILVERADO 3500
15703	07-07	CHEVROLET	SILV. 3500 CLA.
15703	07-10	CHEVROLET	SILV. 3500 HD
15703	01-04	GMC	SIERRA 2500
15703	01-10	GMC	SIERRA 2500 HD
15703	07-07	GMC	SIER. 2500 HD CLA.
15703	01-06	GMC	SIERRA 3500
15703	07-07	GMC	SIER. 3500 CLA.
15703	07-10	GMC	SIERRA 3500 HD
15704	03-08	DODGE	RAM 1500
15704	03-10	DODGE	RAM 2500
15704	03-10	DODGE	RAM 3500
15800	01-06	CHEVROLET	SILVERADO 3500
15800	07-07	CHEVROLET	SILV. 3500 CLA.
15800	07-16	CHEVROLET	SILV. 3500 HD
15800	07-10	DODGE	RAM 3500
15800	08-10	DODGE	RAM 4500
15800	08-10	DODGE	RAM 5500

Part#	Years	Make	Model
15800	01-06	GMC	SIERRA 3500
15800	07-07	GMC	SIER. 3500 CLA.
15800	07-16	GMC	SIERRA 3500 HD
15800	11-18	RAM	3500
15800	11-17	RAM	4500
15800	11-17	RAM	5500
15801	16-18	RAM	2500
15801	16-16	RAM	3500
15802	17-19	FORD	F-250 SUPER DUTY
15802	17-19	FORD	F-350 SUPER DUTY
15802	17-18	FORD	F-450 SUPER DUTY
15803	14-17	RAM	3500
15808	14-16	RAM	3500
15809	03-08	DODGE	RAM 1500
15809	03-10	DODGE	RAM 2500
15809	03-10	DODGE	RAM 3500
15809	11-18	RAM	2500
15809	11-13	RAM	3500
15810	00-16	FORD	F-250 SUPER DUTY
15810	00-16	FORD	F-350 SUPER DUTY
15810	08-15	FORD	F-450 SUPER DUTY
15845	99-17	FORD	F-350 SUPER DUTY
15845	99-17	FORD	F-450 SUPER DUTY
15845	99-17	FORD	F-550 SUPER DUTY
15845	00-16	FORD	F650
15860	11-19	CHEVROLET	SILV. 2500 HD
15860	11-19	CHEVROLET	SILV. 3500 HD
15860	11-19	GMC	SIERRA 2500 HD
15860	11-19	GMC	SIERRA 3500 HD
31008	08-10	FORD	F-250 SUPER DUTY
31008	08-10	FORD	F-350 SUPER DUTY
31008	08-10	FORD	F-450 SUPER DUTY
31008	08-10	FORD	F-550 SUPER DUTY
31012	07-18	CADILLAC	ESCALADE
31012	07-13	CHEVROLET	AVALANCHE
31012	14-18	CHEVROLET	SILVERADO 1500
31012	19-19	CHEVROLET	SILV. 1500 LEGACY
31012	07-14	CHEVROLET	SUBURBAN 1500
31012	07-14	CHEVROLET	TAHOE
31012	14-18	GMC	SIERRA 1500
31012	19-19	GMC	SIERRA 1500 LTD
31012	07-14	GMC	YUKON
31013	01-04	TOYOTA	TACOMA
31014	99-03	FORD	F-250 SUPER DUTY
31014	99-03	FORD	F-350 SUPER DUTY
31015	10-10	DODGE	RAM 2500
31015	11-18	RAM	2500
31016	96-03	CHEVROLET	EXPRESS 1500
31016	96-03	CHEVROLET	EXPRESS 2500
31016	96-03	CHEVROLET	EXPRESS 3500
31016	96-03	GMC	SAVANA 1500
31016	96-03	GMC	SAVANA 2500
31016	96-03	GMC	SAVANA 3500
31016	96-08	DODGE	RAM 1500
31017	03-09	DODGE	RAM 2500
31017	03-09	DODGE	RAM 3500
31018	11-16	FORD	F-250 SUPER DUTY
31018	11-16	FORD	F-350 SUPER DUTY
31020	08-13	JEEP	LIBERTY
31021	96-04	CHEVROLET	BLAZER
31021	94-04	CHEVROLET	S10
31021	94-01	GMC	JIMMY
31021	94-04	GMC	SONOMA
31022	03-07	JEEP	LIBERTY
31023	11-14	CHEVROLET	SILV. 2500 HD
31023	11-14	CHEVROLET	SILV. 3500 HD
31023	11-14	GMC	SIERRA 2500 HD
31023	11-14	GMC	SIERRA 3500 HD
31024	09-11	HONDA	PILOT
31025	11-12	FORD	ESCAPE
31025	11-11	MERCURY	MARINER
31026	92-96	FORD	F-150
31028	97-06	JEEP	WRANGLER
31029	01-05	FORD	EXPL. SPORT TRAC
31030	10-12	CHEVROLET	COLORADO

Part#	Years	Make	Model
31030	10-12	GMC	CANYON
31032	10-13	CHEVROLET	EQUINOX
31032	10-13	GMC	TERRAIN
31033	11-19	DODGE	DURANGO
31033	11-17	JEEP	GRAND CHEROKEE
31034	10-11	HYUNDAI	SANTA FE
31035	07-09	HYUNDAI	SANTA FE
31038	99-02	FORD	EXPEDITION
31038	99-04	FORD	F-150
31038	99-99	FORD	F-250
31042	92-94	CHEVROLET	BLAZER
31042	88-99	CHEVROLET	C1500
31042	88-99	CHEVROLET	K1500
31042	92-99	CHEVROLET	K1500 SUBURBAN
31042	88-00	CHEVROLET	K2500
31042	92-99	CHEVROLET	K2500 SUBURBAN
31042	88-00	CHEVROLET	K3500
31042	95-99	CHEVROLET	TAHOE
31042	88-99	GMC	C1500
31042	88-99	GMC	K1500
31042	92-99	GMC	K1500 SUBURBAN
31042	88-00	GMC	K2500
31042	92-99	GMC	K2500 SUBURBAN
31042	88-00	GMC	K3500
31042	92-99	GMC	YUKON
31043	92-99	CHEVROLET	C1500 SUBURBAN
31043	88-00	CHEVROLET	C2500
31043	92-99	CHEVROLET	C2500 SUBURBAN
31043	88-00	CHEVROLET	C3500
31043	92-99	GMC	C1500 SUBURBAN
31043	88-00	GMC	C2500
31043	92-99	GMC	C2500 SUBURBAN
31043	88-00	GMC	C3500
31045	08-12	BUICK	ENCLAVE
31045	09-12	CHEVROLET	TRAVERSE
31045	09-11	GMC	ACADIA
31047	05-10	JEEP	GRAND CHEROKEE
31048	02-04	JEEP	GRAND CHEROKEE
31049	97-98	FORD	EXPEDITION
31049	97-98	FORD	F-150
31049	97-98	FORD	F-250
31050	11-13	FORD	EDGE
31051	97-01	FORD	EXPLORER
31052	11-16	FORD	EXPLORER
31053	08-14	FORD	E-150
31053	08-14	FORD	E-250
31053	08-14	FORD	E-350 SUPER DUTY
31054	10-18	TOYOTA	4RUNNER
31055	04-07	BUICK	RAINIER
31055	02-09	CHEVROLET	TRAILBLAZER
31055	02-09	GMC	ENVOY
31056	06-10	JEEP	COMMANDER
31061	09-15	NISSAN	TITAN
31063	92-11	FORD	RANGER
31064	12-15	HONDA	PILOT
31065	10-10	DODGE	RAM 3500
31065	11-12	RAM	3500
31067	13-18	RAM	3500
31068	09-17	FORD	EXPEDITION
31068	09-14	FORD	F-150
31068	09-17	LINCOLN	NAVIGATOR
31069	14-18	CHEVROLET	SILVERADO 1500
31069	19-19	CHEVROLET	SILV. 1500 LEGACY
31069	14-18	GMC	SIERRA 1500
31069	19-19	GMC	SIERRA 1500 LTD
31071	15-19	CHEVROLET	SILV. 2500 HD
31071	15-19	CHEVROLET	SILV. 3500 HD
31071	18-18	CHEVROLET	SUBUR.3500 HD
31071	15-19	GMC	SIERRA 2500 HD
31071	15-19	GMC	SIERRA 3500 HD
31073	15-19	CHEVROLET	SUBURBAN
31073	15-18	CHEVROLET	TAHOE
31073	15-18	GMC	YUKON
31073	15-18	GMC	YUKON XL
31074	15-19	CHEVROLET	COLORADO

Part#	Years	Make	Model
31074	15-19	GMC	CANYON
31075	16-18	TOYOTA	TACOMA
31076	14-18	TOYOTA	4RUNNER
31077	16-17	NISSAN	TITAN XD
31078	17-19	FORD	F-250 SUPER DUTY
31078	17-19	FORD	F-350 SUPER DUTY
31078	17-18	FORD	F-450 SUPER DUTY
31080	00-04	DODGE	DAKOTA
31080	00-03	DODGE	DURANGO
31081	17-18	NISSAN	ARMADA
31082	17-19	HONDA	RIDGELINE
31083	15-18	FORD	EXPEDITION
31083	15-18	FORD	F-150
31084	84-01	JEEP	CHEROKEE
31084	86-92	JEEP	COMANCHE
31084	84-90	JEEP	WAGONEER
31086	18-18	JEEP	WRANGLER
31087	19-19	RAM	1500
31097	98-99	DODGE	DAKOTA
31097	98-99	DODGE	DURANGO
31108	01-06	CHEVROLET	SILV. 1500 HD
31108	07-07	CHEVROLET	SILV. 1500 HD CLA.
31108	99-04	CHEVROLET	SILVERADO 2500
31108	01-07	CHEVROLET	SILV. 2500 HD
31108	07-07	CHEVROLET	SILV. 2500 HD CLA.
31108	01-06	CHEVROLET	SILVERADO 3500
31108	07-07	CHEVROLET	SILV. 3500 CLA.
31108	01-06	CHEVROLET	SUBURBAN 2500
31108	01-06	GMC	SIERRA 1500 HD
31108	07-07	GMC	SIER. 1500 HD CLA.
31108	99-04	GMC	SIERRA 2500
31108	01-07	GMC	SIERRA 2500 HD
31108	07-07	GMC	SIERRA 3500
31108	07-07	GMC	SIERRA 3500 CLA.
31108	01-06	GMC	YUKON XL 2500
31109	07-10	CHEVROLET	SILV. 2500 HD
31109	07-10	CHEVROLET	SILV. 3500 HD
31109	07-10	GMC	SIERRA 2500 HD
31109	07-10	GMC	SIERRA 3500 HD
31114	00-05	FORD	EXCURSION
31114	99-07	FORD	F-250 SUPER DUTY
31114	99-07	FORD	F-350 SUPER DUTY
31114	99-07	FORD	F-450 SUPER DUTY
31114	99-07	FORD	F-550 SUPER DUTY
31180	01-07	TOYOTA	SEQUOIA
31180	00-06	TOYOTA	TUNDRA
31198	08-18	TOYOTA	LAND CRUISER
31198	08-18	TOYOTA	SEQUOIA
31198	07-19	TOYOTA	TUNDRA
31199	04-08	NISSAN	TITAN
31221	04-12	CHEVROLET	COLORADO
31221	04-12	GMC	CANYON
31228	05-07	DODGE	DAKOTA
31230	08-10	DODGE	DAKOTA
31230	08-09	MITSUBISHI	RAIDER
31241	05-19	NISSAN	FRONTIER
31241	05-12	NISSAN	PATHFINDER
31241	09-12	SUZUKI	EQUATOR
31270	06-10	HUMMER	H3
31297	07-09	CHRYSLER	ASPEN
31297	04-09	DODGE	DURANGO
31302	00-06	CADILLAC	ESCALADE
31302	02-06	CHEVROLET	AVALANCHE 1500
31302	02-06	CHEVROLET	AVALANCHE 2500
31302	99-07	CHEVROLET	SILVERADO 1500
31302	07-07	CHEVROLET	SILV. 1500 CLA.
31302	01-06	CHEVROLET	SILV.1500 HD
31302	00-06	CHEVROLET	SUBURBAN 1500
31302	00-06	CHEVROLET	TAHOE
31302	99-07	GMC	SIERRA 1500
31302	07-07	GMC	SIERRA 1500 CLA.
31302	01-06	GMC	SIERRA 1500 HD
31302	07-07	GMC	SIER. 1500 HD CLA.
31302	99-04	GMC	SIERRA 2500

Part#	Years	Make	Model
31302	00-06	GMC	YUKON
31302	00-06	GMC	YUKON XL 1500
31310	92-97	FORD	F-250
31310	92-97	FORD	F-350
31311	92-97	FORD	F-250
31311	92-97	FORD	F-350
31313	05-15	TOYOTA	TACOMA
31320	02-08	DODGE	RAM 1500
31321	06-07	DODGE	RAM 1500
31322	07-13	CHEVROLET	SILVERADO 1500
31322	07-13	GMC	SIERRA 1500
31352	03-06	FORD	EXPEDITION
31352	04-08	FORD	F-150
31352	06-08	LINCOLN	MARK LT
31367	07-13	TOYOTA	4RUNNER
31367	07-14	TOYOTA	FJ CRUISER
31368	07-08	FORD	EXPEDITION
31368	07-08	LINCOLN	NAVIGATOR
31374	09-10	DODGE	RAM 1500
31374	11-18	RAM	1500
31374	19-19	RAM	1500 CLASSIC
31407	01-05	FORD	EXPL. SPORT TRAC
31408	87-06	JEEP	WRANGLER
31432	07-17	JEEP	WRANGLER
31432	18-18	JEEP	WRANGLER JK
31433	07-17	JEEP	WRANGLER
31433	18-18	JEEP	WRANGLER JK
31514	05-15	NISSAN	XTERRA
31540	02-06	FORD	EXPLORER
31545	07-10	FORD	EXPLORER
31545	07-10	FORD	EXPL. SPORT TRAC
31545	07-10	MERCURY	MOUNTAINEER
31604	94-01	DODGE	RAM 1500
31604	94-02	DODGE	RAM 2500
31604	94-02	DODGE	RAM 3500
31650	05-10	FORD	ESCAPE
31650	05-11	MAZDA	TRIBUTE
31650	05-10	MERCURY	MARINER
33055	03-07	FORD	E-150
33055	91-02	FORD	E-150 ECONOLINE
33055	03-07	FORD	E-250
33055	91-02	FORD	E-250 ECONOLINE
33055	91-98	FORD	E-350 ECONOLINE
33055	99-07	FORD	E-350 SUPER DUTY
33328	03-08	HONDA	PILOT
33328	06-14	HONDA	RIDGELINE

# ALL PRODUCTS LISTED NUMERICALLY

Part#	Description
16000	LOOP,SAFETY CHAIN,5TH WHEEL
16017	FORD OEM 5TH WHEEL LEGS
16020	ROLLER,FORD PUCK
16021	OEM 5TH WHEEL LEG KIT-CHRYSLER
16022	RAM OE ROLLER MOUNT
16023	GM OE ROLLER ADAPTER
16025	GM OEM 5TH WHEEL LEGS
16026	NISSAN TITAN XD 5TH WHEEL
16031	KIT, 16017 & 16515
16033	KIT, 16017 & 16520
16034	KIT, 16017 & 16540
16035	KIT, 16017 & 16530
16036	KIT, 16017 & 16580
16037	KIT, 16017 & 16545
16039	KIT, 16017 & 16565
16041	KIT, 16021 & 16515
16043	KIT, 16021 & 16520
16044	KIT, 16021 & 16540
16045	KIT, 16021 & 16530
16046	KIT, 16021 & 16580
16047	KIT, 16021 & 16545
16049	KIT, 16021 & 16565
16055	RAIL MOUNTED GOOSENECK HITCH
16061	KIT, 16025 & 16515
16063	KIT, 16025 & 16520
16064	KIT, 16025 & 16540
16065	KIT, 16025 & 16530
16066	KIT, 16025 & 16580
16067	KIT, 16025 & 16545
16069	KIT, 16025 & 16565
16071	KIT, 16026 & 16515
16073	KIT, 16026 & 16520
16074	KIT, 16026 & 16540
16075	KIT, 16026 & 16530
16085	RAIL MOUNTED GOOSENECK HITCH
16100	5TH WHEEL MOUNTING RAIL KIT
16101	INSTALLATION HARDWARE KIT FOR
16103	BOLT KIT,FIFTH WHEEL, 8PC
16104	5TH WHEEL RAIL KIT,NO HARDWARE
16111	UNIVERSAL RAIL HARDWARE KIT
16115	16K 5TH WHEEL UNIT
16116	KIT, 16115 & 16200
16120	A16 5TH WHEEL
16121	A16 5TH WHEEL WITH BASE RAILS
16130	CURT Q20 20K 5TH WHEEL HITCH
16131	KIT, 16130 & 16200
16140	A20 5TH WHEEL HITCH
16141	A20 5TH WHEEL WITH BASE RAILS
16150	RAILS,5TH WHL,W/CNTR HOLES,CB
16180	A25 5TH WHEEL HITCH
16181	A25 5TH WHEEL WITH BASE RAILS*
16200	CARBIDE BLACK 5TH WHEEL RAIL K
16204	CARBIDE 5TH WHEEL RAILS
16210	X5 ADAPTER PLATE
16220	X5 ADAPTER PLATE
16245	FIFTH WHEEL, Q24
16246	KIT,16245 & 16200
16265	FIFTH WHEEL, Q25
16266	KIT,16265 & 16200
16300	CUSTOM 5TH WHEEL INSTALL KIT
16301	CUSTOM 5TH WHEEL INSTALL KIT
16302	CUSTOM 5TH WHEEL INSTALL KIT
16303	CUSTOM 5TH WHEEL INSTALL KIT
16304	TUNDRA UNIVERSAL RAIL BOLT KIT
16306	DODGE 5TH WHEEL UNDERBED KIT
16310	X5 B & W ADAPTER PLATE
16400	GM 5TH WHL UNDERBED KIT
16411	CHEVY/GMC UNDERBED 5TH WHL KIT
16418	CHEVY/GMC UNDERBED 5TH WHL KIT
16419	DODGE 5TH WHEEL UNDERBED KIT
16420	DODGE UNDERBED FIFTH WHEEL KIT
16422	DODGE UNDERBED FIFTH WHEEL KIT
16424	FORD 5TH WHEEL UNDERBED KIT
16426	RAM UNDERBED FIFTH WHEEL KIT
16427	RAM UNDERBED FIFTH WHEEL KIT
16428	FORD SUPER DTY FIFTH WHEEL KIT

Part#	Description
16437	FORD 5TH WHEEL UNDERBED KIT
16441	FORD F150 UNDERBED 5TH WHL KIT
16442	FORD F-150 5TH WHEEL KIT
16443	FORD UNDERBED 5TH WHEEL KIT
16444	RAM UNDERBED 5TH WHEEL KIT
16448	FORD SD UNDERBED 5TH WHEEL KIT
16465	TOYOTA TUNDRA UNDERBED 5TH WHL
16468	TOYOTA 5TH WHEEL UNDERBED KIT
16470	NISSAN TITAN FIFTH WHEEL KIT
16505	16115 E5 ADAPTER KIT
16515	16515 E5 FIFTH WHEEL HEAD ONLY
16516	KIT, 16515 & 16560
16520	A16 5TH WHEEL HEAD UNIT
16521	A16 5TH WHEEL WITH R16 ROLLER
16530	HEAD, FIFTH WHEEL, Q20
16536	KIT,16530 & 16550
16540	A20 5TH WHEEL HEAD UNIT
16541	A20 5TH WHEEL WITH R20 ROLLER
16545	HEAD,FIFTH WHEEL, Q24
16546	KIT,16545 & 16570
16550	ROLLER,FIFTH WHEEL, R20
16560	ROLLER,FIFTH WHEEL, R16
16565	HEAD,FIFTH WHEEL, Q25
16570	ROLLER, FIFTH WHEEL, R24
16580	A25 5TH WHEEL HEAD UNIT
16616	KIT, 16515, 16560 & 16200
16621	A16 5TH WHEEL R16 ROLLER/RAILS
16636	KIT,16530,16550 & 16200
16641	A20 5TH WHEEL R20 ROLLER/RAILS
16646	KIT,16545,16570 & 16200
16667	KIT, 16023 & 16560 & 16515
16668	KIT, 16023 & 16560 & 16520
16669	KIT, 16023 & 16550 & 16540
16671	KIT, 16023 & 16550 & 16530
16674	KIT, 16515 & 16020
16675	KIT, 16520 & 16020
16676	KIT, 16540 & 16020
16677	KIT, 16530 & 16020
16678	KIT, 16545 & 16020
16684	KIT, 16022 & 16560 & 16515
16685	KIT, 16022 & 16560 & 16520
16686	KIT, 16022 & 16550 & 16540
16687	KIT, 16022 & 16550 & 16530
16688	KIT, 16022 & 16545 & 16570
16721	10 IN 5TH WHEEL LUBE PLATE
16722	LUBE PLATE,5TH WHEEL, 12 INCH
16900	SPACER KIT,5TH WHL TAB MT
16901	SPACER KIT,5TH WHL TAB MT,CLAM
16902	5TH WHEEL REPL PINS AND CLIPS
16904	16130 SERVICE KIT,LEGS (PAIR)
16906	16140 A20 LEG KIT
16907	5TH WHEEL LEG KIT *
16913	Q24 LEG KIT
16920	16120 - LEG KIT
16963	Q25 LEG KIT
16991	E16 WEDGE KIT
16992	Q16 WEDGE KIT
17000	600 TW ROUND BAR KIT 600 LBS M
17001	800 TW ROUND BAR KIT 800 LB MA
17002	1000 TW ROUND BAR KIT 1000 LB
17003	SNAP-UP BRACKET WD BARS CLAMP
17005	SNAP-UP BRACKET WD BAR BOLTON
17007	WD,ROUND BAR,1400 LB
17008	WD,HOOK-UP BRKT,SINGLE LP
17022	WD,ROUND BAR,1000 LB,KIT
17050	600 TW ROUND BAR WD
17051	800 TW ROUND BAR WD
17052	1000 TW ROUND BAR WD
17057	1400 TW ROUND BAR WD
17062	1000 TW ROUND BAR WD W/SWAY
17063	1400 TW ROUND BAR WD W/SWAY
17071	600 TW REPLACEMENT ROUND BAR
17072	800 TW REPLACEMENT ROUND BAR
17073	1000 TW REPLACEMENT ROUND BAR
17074	1400 TW REPLACEMENT ROUND BAR
17075	WD REPLACEMENT HEAD

Part#	Description
17076	BOLT KIT
17100	ADJ HITCH BAR 12 IN LENGTH
17101	WD,600# RND BAR REPL W/CHAIN
17102	ADJ HITCH BAR 14 IN LENGTH
17103	ADJ HITCH BAR 16 IN LENGTH
17107	ROUND BAR WD REPLACEMENT HEAD
17109	RETAINER PACKAGE
17111	SPRING BAR CHAIN & U-BOLT KIT
17112	LIFT HANDLE
17113	WD,800# RND BAR REPL W/CHAIN
17114	REPLACEMENT 1 IN RIVET
17115	WD,1000# RND BAR REPL W/CHAIN
17117	1400# SPRING BAR W/CHAIN
17120	ADJ HITCH BAR 12 IN X 5 625 IN
17121	ADJ HITCH BAR 14 IN X 6 IN WIT
17122	ADJ HITCH BAR 16 IN X 6 IN WIT
17123	ADJ HITCH BAR 9 IN X 7 IN WITH
17124	ADJ HITCH BAR 11 IN X 8 3/4 IN
17125	ADJ HITCH BAR 10 IN X 14 1/2 I
17131	2.5" FORGED WD SHANK, 7 HOLE
17132	2.5" FORGED WD SHANK, 11 HOLE
17150	BOLT KIT FOR ROUND BAR WEIGHT
17200	SWAY CONTROL KIT
17201	SWAY CONTROL A-FRAME BALL
17208	OPTIONAL SNAP UP BRACKETS
17222	WD,ROUND BAR,1400 LB,KIT
17300	WEIGHT DISTRIBUTION TRUNNION S
17301	WEIGHT DISTRIBUTION TRUNNION S
17302	WEIGHT DISTRIBUTION TRUNNION S
17303	WD,1000#LONG TBAR REPL W/CHAIN
17307	WEIGHT DISTRIBUTION HITCH HEAD
17308	WD,800#LONG TBAR REPL W/CHAIN
17309	WD,600#LONG TBAR REPL W/CHAIN
17312	WD ADJUSTMENT ROD KIT
17314	WD WASHER SERVICE KIT
17322	WD,TRUNNION,SHORT BAR,1K KIT
17330	WD,TRUNNION,SHORT BAR,600 LB
17331	WD,TRUNNION,SHORT BAR,800 LB
17332	WD,TRUNNION,SHORT BAR,1000 LB
17333	WD,TRUNNION,1500 LB
17334	WD,600#SHORT TBAR REPL W/CHAIN
17335	WD,800#SHORT TBAR REPL W/CHAIN
17336	WD,1000#SHORT TBAR REP W/CHAIN
17337	1500# SHORT SPRING BAR W/CHAIN
17350	BOLT KIT FOR TRUNNION BAR WEIG
17422	WD,TRUNNION,1500 LB KIT
17499	WD, 800# W/INTEGRATED SWAY
17500	WD,1000# W/INTEGRATED SWAY
17501	WD 1500# W/INTEGRATED SWAY
17506	WD REPLACEMENT HEAD, 17499
17507	WD REPLACEMENT HEAD, 17500
17508	REPLACEMENT INT-WD BRACKET
17509	1500# REPLACEMENT HEAD
17512	TRU-TRACK TENSION RAIL
17513	REPLACEMENT L-PINS & CLIPS
17515	REPLACEMENT BRACKET KIT, 8"
17516	REPLACEMENT BRACKET KIT, 10"
17535	800# REPLACEMENT SPRING BAR
17536	1000# REPLACEMENT SPRING BAR
17537	1500# REPLACEMENT SPRING BAR
17550	BOLT KIT FOR INT-WD
17554	BOLT KIT FOR INT-WD, 17501
18007	STRAP,REPLACEMENT,QTY 2
18008	BIKE RACK TOWABLE SHANK
18011	BOLT ON BIKE RACK 2 BIKE CARRI
18013	BIKE RACK,CLAMP-ON
18016	BIKE BEAM
18029	RACK,2-BIKE,DUAL ARM
18030	RACK,2-BIKE,DUAL ARM W/EXT
18031	BIKE RACK 2/4 W/TBL SHANK
18033	RACK,3-BIKE,DUAL ARM
18034	RACK,4-BIKE
18035	BIKE RACK 4 W/TBL SHANK
18050	STRAP, BIKE RACK
18063	RACK,3-BIKE,TAPERED DUAL ARM
18064	RACK,4-BIKE,TAPERED DUAL ARM

Part#	Description
18065	RACK,5-BIKE,TAPERED DUAL ARM
18085	BIKE RACK, 2-BIKE, TRAY STYLE
18087	BIKE RACK, 4-BIKE, TRAY STYLE
18090	LOCKING KNOBS TRAY STYLE RACK
18091	FAT TIRE BIKE RACK TRAYS
18092	BED RAIL BIKE RACK
18100	CARRIER,CARGO,ALUMINUM
18101	CARRIER,CARGO,ATV
18108	CARGO CARRIER 2IN FIXED 60X20
18109	CARGO CARRIER FOLDING 60X20
18110	CARGO CARRIER,48"X20" FIXED
18112	ALUMINUM CARGO CARRIER W/RAMP
18113	ALUMINUM CARGO CARRIER
18115	ROOF RACK,EXPANDABLE,43.5X37X4
18117	ROOF RACK,EXTENSION,43.5X20X4
18118	ALUMINUM CROSSBARS
18145	CARGO CARRIER,KNOCK DN,48X20X6
18150	CARGO CARRIER BASKET FIXED SHA
18151	CARGO CARRIER BASKET FOLDING S
18152	CARGO CARRIER,60X24 FIXED
18153	CARGO CARRIER,60X24 FOLDING
18200	CARGO NET,ROOF RACK
18201	CARGO NET,EXTENDED ROOF RACK
18202	CARGO NET
18210	CARGO CARRIER BAG 18"
18211	CARGO CARRIER BAG 22"
18220	ROOF RACK BAG 38"
18221	ROOF RACK BAG 59"
18320	ALUMINUM KAYAK RACK
19745	ADJUSTABLE TOW BAR
19746	REPLACEMENT SAFETY PIN
19748	BUMPER BRACKET KIT
19749	TOW BAR BLACK VINYL COATED CHA
20001	WRENCH,BOX END,1.125/1.50,6 PT
20002	MIRROR
21100	REDUCER BUSHING 1 IN TO 3/4 IN
21101	REDUCER BUSHING 1 IN TO 3/4 IN
21200	REDUCER BUSHING 1 1/4 IN TO 1
21201	REDUCER BUSHING 1 1/4 IN TO 1
21300	REDUCER BUSHING 1 3/8 TO 1 1/4
21301	REDUCER BUSHING 1 3/8" - 1 1/4
21400	1/2 IN HITCH PIN WITH CLIP POL
21401	1/2 IN HITCH PIN WITH CLIP PAC
21403	1/2" GROOVED HITCH PIN & CLIP
21404	1/2" GROOVED PIN&CLIP PACKAGED
21410	1/2" PIN & CLIP, COATED GRIP
21411	1/2" PIN & CLIP, COATED GRIP
21500	5/8 IN HITCH PIN WITH CLIP POL
21501	5/8 IN HITCH PIN WITH CLIP PAC
21502	UNIVERSAL RECEIVER PIN & CLIP
21504	5/8" GROOVED HITCH PIN & CLIP
21505	5/8" GROOVED PIN&CLIP PACKAGED
21506	5/8" GROOVED PIN & CLIP; CARD
21507	5/8" GROOVED PIN & CLIP; BULK
21510	5/8" PIN & CLIP, COATED GRIP
21511	5/8" PIN & CLIP, COATED GRIP
21541	HITCH PIN,CHRM,1/2" PIVOT LK
21551	5/8 IN CHROME SWIVEL HITCH PIN
21561	1/2 IN SWIVEL HITCH PIN W/SLEEVE
21578	5/8 IN HITCH PIN & CLIP BLACK
21579	5/8 IN HITCH PIN WITH CLIP BLA
21580	5/8" HITCH PIN FOR SUPER DUTY
21581	5/8" HITCH PIN SUPER DUTY PKG
21582	5/8" CD GROOVED PIN & CLIP
21583	5/8" CD GROOVED PIN&CLIP PACK
21600	CLIP FOR HITCH PIN, BULK
21601	CLIP FOR HITCH PIN PKG
21602	HITCH PIN CLIP, 3 PACK
21728	PROTECTIVE RUBBER CAP 2 IN X 2
21800	PLASTIC HITCH BALL COVER
21801	PLASTIC HITCH BALL COVER/PKGD
21810	BALL COVER,2 5/16" BLACK,BULK
21811	BALL COVER,2 5/16" BLACK,PKG
21900	CHROME TUBE COVER
21901	CHROME TUBE COVER/PKGD
22100	2 IN X 2 IN TUBE COVER CHROME
22101	2 IN X 2 IN TUBE COVER CHROME
22110	2 IN X 2 IN TUBE COVER CHROME
22111	2 IN X 2 IN TUBE COVER CHROME
22170	2 IN X 2 IN TUBE COVER CHROME
22171	2 IN X 2 IN TUBE COVER CHROME

Part#	Description
22178	BEARING PROTECTOR 2 QTY FITS 1
22180	2 IN X 2 IN TUBE COVER PLASTIC
22181	2 IN X 2 IN TUBE COVER PLASTIC
22198	BEARING PROTECTOR 2 QTY FITS 1
22200	HITCH BAG IN A CLEAR TUBE
22232	DUST COVER, BEARING 2.328
22244	BEARING PROT,2.44" 2 PAK W/COV
22271	1 1/4" RECVR TUBE COVER
22272	COVER,RCVR TUBE,2" CURT
22275	1 1/4" RECVR TUBE COVER PKG
22276	COVER,RCVR TUBE,2" CURT,PKG
22277	COVER RECVR TUBE,2-1/2" BULK
22278	COVER, RCVR TUBE, 2-1/2" PKGD
22315	ANTI-RATTLE FOR 1 1/4 IN HOLLO
22321	ANTI-RATTLE FOR 2 IN HOLLOW SH
22322	PRO-FINISHING PACK (BAGGED)
22401	TOW HOOK W/HARDWARE CHROME 100
22411	TOW HOOK W/HARDWARE 10000 LB B
22420	TOW HOOK CHROME 10000 GTW BULK
22430	TOW HOOK BLACK 10000 QTW BULK
22750	TUBE COVER 2 IN X 2 IN BLACK B
22751	STEEL TUBE COVER/PKGD
22800	CHOCKS,WHEEL,PAIR
23020	1/2 IN HITCH LOCK 15000 LB PAC
23021	5/8 IN HITCH LOCK 30000 LB PAC
23022	COUPLER LOCK BRASS 2 KEYS INCL
23024	1/2" HITCH PIN LOCK W/SLEEVE
23025	3 IN HITCH LOCK 3000 LB PAC
23079	LOCK,COUPLER,ROLLED LIP
23081	LOCK,BLOCK HEAD *
23086	KEYED ALIKE LOCK COMBINATION
23088	KEYED ALIKE LOCK COMBINATION
23175	WHEEL CHOCK LK
23178	DUST COVER,BEARING,1.78" 2 PAK
23179	TRAILER LOCK
23198	DUST COVER,BEARING,1.98" 2 PAK
23209	3/4" WHEEL BEARING KIT
23210	1" WHEEL BEARING KIT
23211	1-1/16" WHEEL BEARING KIT
23232	DUST COVER,BEARING,2.32" 2 PAK
23244	DUST COVER,BEARING,2.44" 2 PAK
23255	LOCK,KING PIN,DUMBELL STYLE
23256	LOCK, FIFTH WHEEL
23501	1/2" DOGBONE LOCK, CHROME
23502	5/8 IN RIGHT ANGLE LOCK
23503	ADJUSTABLE LOCK COUPLER
23504	5/8 IN RIGHT ANGLE LOCK, 2-1/2
23505	LOCK SET, HITCH & COUPLER
23506	1/2" W/ 5/8" SLEEVE, BLUE ALUM
23510	5/8 IN PUSH BUTTON 90 DEG LOCK
23515	5/8 IN DOGBONE LOCK CHROME
23516	5/8 IN DOGBONE LOCK SS
23517	5/8" DOGBONE LOCK,SS**
23518	5/8 IN DOGBONE LOCK BLACK
23519	5/8 IN DOGBONE LOCK,SS**
23520	7/8IN SPAN COUPLER LOCK CHROME
23521	7/8 IN SPAN COUPLER LOCK BLACK
23522	2-1/2" SPAN COUPLER LOCK, CHRM
23523	3-3/8" SPAN COUPLER LOCK, CHRM
23526	5/8 DOGBONE WITH 7/8 SPAN LOCK
23527	5/8 IN DOGBONE LOCK WITH**
23528	5/8 IN DOGBONE LOCK CHROME**
23546	COUPLER LOCK, SOLID BRASS
23556	LOCK SET,KEYED ALIKE,ONE MOUNT
23562	SPARE TIRE LOCK PACKAGED
23581	HITCH PIN,1/2" PIVOT LK,SS
23582	SS PIVOT LOCK HITCH PIN
23659	1 7/8 IN 2 IN AND 2 5/16 IN TR
23666	CABLE LOCK
25010	5/16 IN COUPLER SAFETY PIN
25011	5/16 IN COUPLER SAFETY PIN PAC
25012	K-8 1/4 IN COUPLER PIN WITH 12
25013	PIN,COUPLER,,25" W/12"CHAIN,PK
25034	5/16" SAFETY PIN W/CHAIN BULK
25035	5/16" SAFETY PIN W/CHAIN PACK
25080	COUPLER SAFETY PIN 1/4 IN DIA
25081	COUPLER SAFETY PIN 1/4 IN DIA
25094	REPAIR KIT, 1.875" COUPLER
25100	COUPLER, 2 X 3" STRAIGHT 5000#
25101	COUPLER,2",A-FRAME,5000#
25105	COUPLER, 1.875 X 2.5" 2000#

Part#	Description
25128	COUPLER, 1.875 X 2" 2000#
25131	COUPLER, 1.875 X 3" 2000#
25135	COUPLER, 2 5/2.5" 3500#
25138	COUPLER, 2 X 3" 3500#
25153	COUPLER, 2 X 2" 3500#
25194	REPAIR KIT, 2" COUPLER
25200	COUPLER, 2 5/16",A-FRAME,10000#
25210	COUPLER,2",A-FRAME,5000#
25217	COUPLER,2",A-FRAME,7000#
25227	COUPLER,2 5/16",A-FRAME,12500#
25294	REPAIR KIT,2" COUPLER A-FRAME
25319	COUPLER,2",ADJST,7000#, COLLAR
25328	COUPLER, 2 5/16",AJUSTBL,15000#
25329	COUPLER, 2 5/16",AJUSTBL,12500#
25330	COUPLER, 2 5/16" ADJ LT,14000#
25388	BOLT KIT, ADJUST CPLR CHANNEL
28000	SAFETY PIN 3/8" W/ CHAIN, BULK
28001	SAFETY PIN 3/8" W/ CHAIN, PKGD
28100	JACK,BOLT ON SNAP RING 1000#
28101	JACK,BOLT SNAP RING 1000# PKGD
28112	JACK,BOLT ON SWIVEL 1200#
28113	JACK,BOLT ON SWIVEL 1200# PKGD
28115	JACK,BOLT ON SWIVEL 1500#
28116	JACK,BOLT ON SWIVEL 1500# PKGD
28155	JACK,BOLT,SWIVEL,2 WHEEL
28156	JACK,BOLT,SWIVEL,2 WHEEL PKGD
28200	JACK,A FRAME TOP WIND 2000#
28202	JACK,A FRAME TOP WIND 2K TL
28203	JACK,A FRAME TOPWIND 2K TL PKG
28204	JACK,A FRAME SIDE WIND 2000#
28250	JACK,A FRAME TOP WIND 5000#
28255	JACK,AFRAME TOPWIND 5K BLK HDL
28270	FOOT, JACK WITH HARDWARE
28271	FOOT, JACK WITH HARDWARE, PKGD
28272	FOOT, JACK 1.7", ZINC
28273	FOOT, JACK 1.7", ZINC, PKG
28274	FOOT, JACK 8.5", ZINC,
28275	FOOT, JACK 8.5", ZINC, PKG
28276	WHEEL, JACK CASTER, 1200#
28277	WHEEL, JACK CASTER, 1200#, PKG
28278	PIN, SAFETY FOR JACK FOOT
28279	PIN, SAFETY FOR JACK FOOT, PKG
28300	JACK,WELD,TOP WIND,2K,10"
28301	JACK,WELD,TOP WIND,2K,10" PKG
28302	JACK,WELD ON,SIDE WIND,2000#
28304	JACK,WELD,TOP WIND,2K, 15"
28305	JACK,WELD,TOP WIND,2K,15", PKG
28306	JACK,WELD ON,2000 LB,SIDE WIND
28320	JACK,PIPE MNT,TOPWIND,2K 10"
28321	JACK,PIPE MNT,SIDEWIND,2000#,
28322	JACK,PIPE MNT,TOP WIND,2000#,
28323	JACK,PIPE MNT,TOPWIND,2000#,PK
28324	JACK,PIPE MNT,SIDE WIND,2000#
28350	JACK,PIPE MNT,TOPWIND,5K,10"
28351	JACK,PIPEMNT,TOPWIND,5K,10" PK
28354	JACK,PIPE MNT,SIDEWIND,5K, 10"
28356	JACK,PIPE MNT,TOPWIND,5K 15"
28358	JACK,PIPE MNT,SIDEWIND,5K,15"
28359	JACK, 5000 LB., SQ., WELD ON
28512	JACK, HD SQUARE 10K/12K ASSY
28570	JACK, HD SQUARE TOP WIND 7K/8K
28575	JACK, HD SQUARE SIDE WIND 7K/8K
28910	PART, JACK MARINE MNT BRKT
28911	PART, JACK MNT BARS & BOLTS
28912	PART, JACK CASTER WHEEL & BOLT
28913	PART, JACK FULL MARINE TOP HNDL
28914	PART, JACK GEAR KIT, MARINE
28921	PART, JACK TOP WIND HANDLE
28922	PART, JACK BEARING 2K/5K TW
28923	PART, JACK SIDE WIND HANDLE
28924	PART, JACK GEAR KIT 2K/5K SW
28925	PART, JACK CAP 2K SIDE WIND
28926	PART, JACK BLACK HANDLE KNOB
28927	PART, JACK BLACK HANDLE KNOB
28930	PART, JACK FEMALE PIPE, WELD
28931	PART, JACK MALE PIPE, WELD
28932	PART, JACK MALE PIPE, PIN TYPE
28934	PART, JACK 9/16" PIN W/ CHAIN
28935	PART, JACK 5/8" PIN W/ CHAIN
28937	PART, JACK 2K/5K FULL BLCK HNDL
28938	PART, JACK RND TB WELD MNT BRKT

Part#	Description
28939	PART,JACK 2" SNAP RING
28940	PART,JACK 1/2" PLUNGER PIN
28950	PART,JACK GEAR KIT 12K
28951	PART,JACK FULL 12K HANDLE
28952	PART,JACK CAP 12K
28953	PART,JACK HANDLE CLIP
28954	PART,JACK 12K BEARING
28955	PART,JACK 12K PLUNGER PIN ASBL
28956	PART,JACK THREADED LIFTING NUT
28957	PART,JACK INNER PIPES W/ FOOT
28958	PART,JACK GEAR KIT 7K
28959	PART,JACK FULL 7K HANDLE SW
28960	PART,JACK 7K GEAR HNDL BUSHING
28961	PART,JACK CAP 7K
28962	PART,JACK 7K DROP LEG & FOOT
28963	PART,JACK 7K DROP LEG PIN
28964	PART,JACK FULL 7K BLCK HNDL TW
28965	PART,JACK 7K BEARING
29007	2 IN 20 FT NYLON WINCH STRAP *
29423	900 LB WINCH
29424	1200 LB WINCH
29425	1400 LB WINCH
29427	1700 LB WINCH
29428	1900 LB WINCH
29429	2100 LB WINCH
29433	900 LB WINCH W/15' STRAP
29435	1400 LB WINCH W/20' STRAP
29438	1900 LB WINCH W/20' STRAP
29450	15' WINCH STRAP
29451	20' WINCH STRAP
31001	STEP PAD
31002	LICENSE PLATE HOLDER
31005	WINCH MOUNT HANDLES
31006	SPARE TIRE MOUNT
31007	SKID SHIELD
31009	WINCH PLATE AND HANDLE ASSY
31010	WINCH MOUNT
40001	1 7/8 X 3/4 X 1 5/8 HITCH BALL
40002	1 7/8 X 1 X 2 1/8 HITCH BALL
40003	2 X 3/4 X 1 3/4 HITCH BALL
40004	2 X 1 X 2 1/8 HITCH BALL
40005	2 5/16 X 1 X 2 1/8 HITCH BALL
40006	2 5/16X1 1/4X2 5/8 HITCH BALL
40007	2-5/16 X 1 X 2-1/4 HITCH BALL
40008	BALL,HITCH,2.31X1.25,2.75,20K
40009	2.31X1.25,2.75,20K HITCH BALL
40015	1 7/8 X 3/4 X 2 1/8 HITCH BALL
40016	1 7/8 X 3/4 X 3 HITCH BALL
40017	1 7/8 X 1 X 3 HITCH BALL
40018	2 X 3/4 X 2 1/8 HITCH BALL
40019	2 X 3/4 X 3 HITCH BALL
40020	2 X 1 X 3 HITCH BALL
40021	2 5/16 X 1 X 3 HITCH BALL
40022	2 5/16 X 1 1/4 X 3 HITCH BALL
40030	2-5/16 X 1-1/4 X 2-5/8 H. BALL
40031	1 7/8 X1X2 3/16 X1 HITCH BALL
40032	1 7/8X1X2 1/8X2 HITCH BALL
40033	2 X 1 X 2 1/8 X 1 HITCH BALL
40034	2X1X2 1/8X2 HITCH BALL
40035	2 5/16X1 1/4X2 5/8 HITCH BALL
40036	2 5/16X1 1/4X2 5/8 HITCH BALL
40037	2 X 1 X 2 1/8 HITCH BALL
40038	2 X 1 X 2 1/4 HITCH BALL
40039	2 5/16 X 1 X 2 1/4 HITCH BALL
40042	2 5/16X1X2 1/4 HITCH BALL
40050	1 7/8X3/4 X2 1/8 HITCH BALL
40051	1 7/8X1X2 1/8 HITCH BALL
40052	2X3/4X2 1/8 HITCH BALL
40053	2 X 1 X 2 1/8 HITCH BALL
40054	2 5/16X1X2 1/8 HITCH BALL
40061	1 7/8 X 3/4 X 1 5/8 HITCH BALL
40062	1 7/8 X 1 X 2 1/8 HITCH BALL
40063	1 7/8X3/4X2 1/8 HITCH BALL
40064	2 X 3/4 X 1 3/4 HITCH BALL
40065	2 X 3/4 X 2 1/8 HITCH BALL
40066	2 X 1 X 2 1/8 HITCH BALL
40067	2 5/16 X 1 X 2 1/8 HITCH BALL
40068	2 5/16X1 1/4X2 5/8 HITCH BALL
40069	BALL,HITCH 2X1.25X2.625,PKG
40071	1 7/8 X 3/4 X 3 HITCH BALL
40072	1 7/8 X 1 X 3 HITCH BALL

Part#	Description
40073	2 X 3/4 X 3 HITCH BALL
40074	2 X 1 X 3 HITCH BALL
40075	2 5/16 X 1 X 3 HITCH BALL
40076	2 5/16 X 1 1/4 X 3 HITCH BALL
40080	1 7/8X3/4X2 1/8 HITCH BALL
40081	1 7/8X1X2 1/8 HITCH BALL
40082	2X3/4X2 1/8 HITCH BALL
40083	2X1X2 1/8 HITCH BALL
40084	2 5/16X1X2 1/8 HITCH BALL
40085	2-5/16 X 1-1/4 X 2-3/4 RAW BAL
40086	2-5/16 X 1"RISE X1-1/4 X 2-5/8
40087	2 5/16 X 1 1/4 RAW HITCH BALL
40088	2 5/16 X 2 X 3 1/2 HITCH BALL
40089	3 X 2 X 3 1/4 HITCH BALL
40090	2 X 1 1/4 X 2 5/8 HITCH BALL
40093	SWAY CONTROL HITCH BALL
40094	2 5/16 GOOSE NECK WELD ON BALL
40095	1-7/8" ATV BALL, BULK
40096	1-7/8" ATV BALL, PACKAGED
40097	2" ATV BALL, BULK
40098	2" ATV BALL, PACKAGED
40099	50MM HITCH BALL, BULK
40103	PKG 3/4 IN REPLACEMENT NUT & W
40104	PKG 1 IN REPLACEMENT NUT & WAS
40105	PKG 1 1/4 IN REPLACEMENT NUT &
41200	2 IN REPLACEMENT BALL 6,000 LB
41340	3/4 IN REPLACEMENT SHANK, 3,50
41341	3/4 IN REPLACEMENT SHANK LONG,
41352	SHANK COVER FOR 3/4 IN SHANK,B
41353	SHANK COVER FOR 3/4 IN SHANK,
41355	SHANK COVER FOR 1 IN SHANK, RE
41780	1 7/8 IN REPLACEMENT BALL
41782	SWITCH BALL SET 3/4 IN SHANK W
41783	3/4 IN LONG SHANK W/ 1 7/8 IN
42100	1 INCH REPLACEMENT SHANK 6000
42178	1 IN SHANK WITH 1 7/8 IN & 2 I
42200	2 IN REPLACEMENT BALL 8,000 LB
42203	2 5/16 IN REPLACEMENT BALL 8,0
42225	SWITCH BALL SET 1 IN SHANK WIT
42280	SWITCH BALL SET 1 IN SHANK WIT
42780	1 7/8 IN REPLACEMENT BALL
45000	BALL MOUNT,4" R X 13.50
45001	BALL MOUNT,TRIBALL,HOLLOW SH
45002	BALL MOUNT,DBL BALL,HOLLOW SH
45003	BALL MOUNT,VER SHANK,3.50"R
45005	BALL MOUNT,ATV,1.88" BALL W/T
45006	ADAPTER,ATV RECEIVER TUBE
45007	ADAPTER,BALL MNT TONGUE SLEEVE
45008	BALL MOUNT,ADJ DUAL BALL
45009	BALL MOUNT,ATV,2.00" BALL W/T
45010	STRAIGHT BALL MOUNT 8 1/4 IN B
45012	PACKAGED BALL MOUNT W/PIN AND
45013	ADAPTER,RECEIVER,VERTICAL
45014	BALL MOUNT 5 IN. RISE
45015	BALL MOUNT 5 IN. RISE
45016	BALL MOUNT 3.25 DROP 2.63 RISE
45017	BALL MOUNT 2 3/4 IN DROP 2 1/8
45018	BALL MOUNT, 1 1/4" D, 2000/200
45019	BALL MOUNT, 1 1/4" D,2000/200
45020	STRAIGHT BALL MOUNT 10 1/4 IN
45021	BALL MOUNT,3 1/8 R,2000/200
45022	BALL MOUNT,3 3/4D,2000/200
45023	BALL MOUNT, 4" R, 2000/200
45024	BALL MOUNT, 5" R, 2000/200
45025	BALL MOUNT, 5" R, 2000/200
45026	BALL MOUNT, 3.25" D, 2000/200
45027	BALL MOUNT, 3.25" D, 2000/200
45028	BALL MOUNT 6 IN DROP 5 1/16 IN
45029	BALL MOUNT,KIT 45005 + 45006
45030	2 IN DROP BALL MOUNT W/ 8 1/4
45032	PACKAGED BALL MOUNT W/PIN AND
45033	D-3 W/ PIN, CLIP AND BAG
45034	2 IN DROP LOADED BALL MOUNT W/
45035	D-532 MASTER PACK OF 3
45036	2 IN DROP LOADED BALL MOUNT W/
45037	2 IN DROP LOADED BALL MOUNT W/
45038	BALL MOUNT,KIT 45006 + 45009
45040	2 IN X 3/4 IN X 10 1/4 IN BALL
45041	BALL MOUNT,2"D,7500/750,LOADED
45042	BALL MOUNT,4"D,7500/750,LOADED
45048	RECEIVER EXTENSION 24"

Part#	Description
45049	DUAL BALL & CLEVIS W/SHANK
45050	4X2X8 1/4 IN BALL MOUNT
45052	PACKAGED BALL MOUNT W/PIN AND
45055	4 IN DROP LOADED BALL MOUNT W/
45056	4 IN DROP LOADED BALL MOUNT W/
45057	MASTER PACK OF 3 D-554 BALL MOUNT
45059	SHANK,ADJ BALL & CLEVIS,45008
45060	4 IN X 2 IN X 10 1/4 IN BALL M
45064	6" DROP LOADED W/ 2" BALL
45065	6" DROP LOADED W/ 2-5/16" BALL
45070	6 IN X 4 IN X 8 1/4 IN BALL MO
45080	6 IN X 4 IN X 12 1/4 IN BALL M
45090	8 IN X 6 IN X 8 1/4 IN BALL MO
45100	BALL MOUNT
45110	BALL MOUNT
45112	BALL MOUNT
45131	2" DROP WELDED BM 5000
45134	2" DROP WELDED BM 7500
45141	2" X 2" STARTER KIT 2" DROP
45142	2" X 2" STARTER KIT 4" DROP
45147	1-1/4" X 1-1/4" STARTER KIT
45148	1 1/4" X 1 1/4" STARTER KIT
45151	4" DROP WELDED BM 5000
45152	2" RISE WELDED BM 5000
45154	4" DROP WELDED BM 7500
45155	2" RISE WELDED BM 7500
45220	2 IN DROP W/8 1/4 IN & 10 1/4
45230	4 IN DROP W/8 1/4 IN & 10 1/4
45240	6 IN DROP W/8 1/4 IN & 10 1/4
45250	STRAIGHT BALL MOUNT 12 1/4 IN
45260	2 IN X 3/4 IN X 12 1/4 IN BALL
45270	4 IN X 2 IN X 12 1/4 IN BALL M
45280	BALL MOUNT,6"X4"X14.25"
45290	7500 GWT 2 IN DROP WITH 8 1/4
45293	2" DROP CHROME BALL MOUNT WITH
45295	2" DROP CHROME BALL MOUNT WITH
45296	7500 GWT - 4 IN DROP WITH 8 1/
45297	7500 GWT 6 IN DROP WITH 8 1/4
45310	BALL MOUNT 2" DROP HOLLOW *
45311	BALL MOUNT 4" DROP HOLLOW *
45312	BALL MOUNT 2" DROP SOLID *
45313	BALL MOUNT 4" DROP SOLID *
45331	BALL MOUNT,FORGED,2"D,15K,LOAD
45332	BALL MOUNT,FORGED,4"D,15K,LOAD
45336	BALL MOUNT, 10000 LB, 6" DROP
45338	BALL MOUNT, 10000 LB, 8" DROP
45340	FORGED BALL MOUNT 17K, 2" DROP
45341	FORGED BALL MOUNT 17K, 4" DROP
45342	FORGED BALL MOUNT 17K, 6" DROP
45405	BALL MOUNT REDUCER 2 1/2
45408	REDUCER SLEEVE SET 3" TO 2"
45430	FORGED BALL MOUNT 21K, 4" DROP
45431	FORGED BALL MOUNT 21K, 6" DROP
45432	FORGED BALL MOUNT 21K, 8" DROP
45446	BALL MOUNT, 12000 LB, 6" DROP
45448	BALL MOUNT, 12000 LB, 8" DROP
45456	FORGED BALL MOUNT 20K, 2" DROP
45458	FORGED BALL MOUNT 20K, 4" DROP
45459	FORGED BALL MOUNT 20K 6" DROP
45460	FORGED BALL MOUNT 20K, 8" DROP
45500	HOOK,TOW,FORGED RCVR MNNT,10K
45503	BALL MOUNT,1.0"D,.38R,3500
45507	VERTICAL MOUNT BALL MOUNT
45510	CLASS I BALL MOUNT
45518	1 1/4 IN DROP W/ 6 3/4 IN CLAS
45519	1 1/4 IN DROP W/ 9 3/4 IN CLAS
45520	12 IN CLASS I & II BALL MOUNT
45521	3 1/4 DROP W/ 7 1/8 IN BAR CLA
45522	1 1/8 IN RISE X 14 IN CLASS I/
45534	TOWING STARTER KIT, 2" DROP
45551	BALL MOUNT,EURO,.75"R,1.875"B
45552	BALL MOUNT,EURO,.75"R,2"B
45554	TOWING STARTER KIT, 4" DROP
45561	BALL MOUNT,EURO,3.13"R,1.875"B
45562	BALL MOUNT,EURO,3.13"R,2"B
45571	BALL MOUNT,EURO,2.63"R,1.88"B
45572	BALL MOUNT,EURO,2.63"R,2"B
45581	BALL MOUNT,EURO,3.25"D,1.88"B
45582	BALL MOUNT,EURO,3.25"D,2"B
45591	BALL MOUNT,EURO,3.13"R,1.88"B
45592	BALL MOUNT,EURO,3.13"R,2"B

Part#	Description
45650	TRIPLE TOW BAR 1 7/8 IN 2 IN 2
45655	TRIPLE TOW BAR 1 7/8 X 2 X 2 5
45660	DOUBLE TOW BAR 2 IN X 2 5/16 I
45665	DOUBLE TOW BAR 2 IN X 2 5/16 I
45675	TRIBALL W/HOOK 1-7/8X2X2-5/16
45770	ADAPTABLE HITCH EXTENDER 2 IN
45775	ADAPTABLE HITCH EXTENDER 2 IN
45780	ADAPTABLE HITCH EXTENDER 2 X 1
45785	RECEIVER TUBE ADAPTER
45789	RECEIVER TUBE EXTENSION
45790	ADAPTABLE HITCH EXTENDER 1 1/4
45791	ADAPTABLE HITCH EXTENDER 2 IN
45792	MULTI-USE RECEIVER EXTENDER
45794	ADAPTER, RECEIVER TUBE, VERTICAL
45795	ADAPTABLE HITCH EXTENDER 2 IN
45796	ADAPTABLE HITCH EXTENDER 2 IN
45799	ADJUSTABLE MULTI-BALL MOUNT
45800	BALL MOUNT, MB, ADJ, REPL. MOUNT
45802	REPL ADJ TUBE MNT, FOR 45799
45803	1" CLEVIS PIN
45804	5/8" CLEVIS PIN
45805	1/2" CLEVIS PIN
45810	MULTI-USE BALL MOUNT
45812	ADJUSTABLE BALL MOUNT
45820	SWAY CONTROL BALL MOUNT
45821	CLEVIS PIN BALL MOUNT
45822	MOUNT, WELD ON SWAY CONTROL
45825	MOUNT, TOW HOOK, CHROME
45831	TOW HOOK MOUNT 2-1/2"
45832	TOW HOOK MOUNT 2"
45900	BALL MOUNT, FORGED, DUAL, 2/2.313
45901	BALL MOUNT, FORGED, DUAL
45902	BALL MOUNT, FR, DL 2/2.313 X 2.5
45907	13K CHANNEL MOUNT W/PINTLE
45908	20K CHANNEL MOUNT W/PINTLE
45909	CHANNEL MOUNT STEP
45910	SHANK, BM, FORGED, REPL 45900
45911	SHANK, BM, ADJ, REPL 45901
45912	BALL, ADJ DUAL, REPL 45900
45916	ANTI-RATTLE SET SCREW W/WRENCH
45917	SHANK, BM, FRG, REPL 45902 X 2.5
45919	PINTLE, COMBO, ADJUSTABLE, 2.00
45920	PINTLE, COMBO, ADJUSTABLE, 2.313
45921	ANTI-RATTLE RUBBER BUMPER *
45922	PINTLE, COMBO, ADJ, 2.313, 20K
45923	BALL, ADJ DUAL, REPL 45902
45925	ONE MNT PIN&CLIP RPL. KIT, 20K
48004	PINTLE, RCVR MNT, 10 TON
48005	PINTLE, RCVR MNT, 5 TON
48006	PINTLE, COMB, RCVR MNT, 2.31 BALL
48007	PINTLE, COMB, RCVR MNT, 2.00 BALL
48010	2.5" REC MOUNT PINTLE 20K ****
48012	2.5" REC MNT PINTLE COMBO 20K*
48180	1 7/8 IN BALL & PINTLE COMBINA
48190	2 IN BALL & PINTLE COMBINATION
48200	8 TON COMBO BALL & PINTLE - 2
48205	5 TON GTW - REGULAR PINTLE FOR
48210	10 TON GTW - REGULAR PINTLE FO
48215	15 TON GTW - REGULAR PINTLE FO
48231	30 TON GTW - REGULAR PINTLE
48323	7 IN PLATE 8 1/2 IN SHANK PINT
48324	7 IN PLATE 10 1/2 IN SHANK PIN
48325	10 1/2" ADJUSTABLE PINTLE MT
48326	8 1/2" PINTLE MOUNT
48327	10 1/2" PINTLE MOUNT
48328	8 1/2" ADJUSTABLE PINTLE MOUNT
48329	2.5" ADJUSTABLE PINTLE MOUNT
48330	BOLT KIT FOR PINTLE MOUNT
48332	BOLT KIT FOR PINTLE MOUNT
48340	2.5" PINTLE MOUNT
48341	13 IN PLATE 12 1/2 IN SHANK
48342	13 IN PLATE 14 1/2 IN SHANK
48343	2" PINTLE MOUNT, 17K, 4 HOLE
48348	2.5" FORGED PINTLE MNT, 4 HOLE
48349	2.5" FORGED PINTLE MNT, 7 HOLE
48510	22000 GTW - ALLOY STEEL DRAWBA
48520	15000 GTW - ALLOY STEEL DRAWBA
48530	45000 GTW - ALLOY STEEL DRAWBA
48550	35000 GTW - ALLOY STEEL DRAWBA
48560	60000 GTW - FORGED DRAWBAR WIT
48600	12000 GTW - 3 IN ADJUSTABLE EY

Part#	Description
48601	12000 GTW - 3 IN ADJ EYE BLACK
48610	3 POSITION CHANNEL
48620	E-62 BOLT KIT, FOR E-63 & E-64
48630	3 IN ID EYE KIT W/3 POS CHANNEL
48631	3 IN ID EYE KIT W/3 POS CHANNEL
48640	3 IN ID EYE KIT W/5 POS CHANNEL
48650	5 POSITION CHANNEL
48660	12 TON FORGED 3 IN ID EYE ADJU
48810	1 7/8 IN REPLACEMENT BALL FOR
48820	2 IN REPLACEMENT BALL
48830	2 5/16 IN REPLACEMENT BALL
49060	6 IN RECEIVER TUBE 2 IN X 2 IN
49090	9 IN RECEIVER TUBE 2 IN X 2 IN
49120	12 IN RECEIVER TUBE 2 IN X 2 I
49180	18 IN RECEIVER TUBE 2 IN X 2 I
49240	24 IN RECEIVER TUBE 2 IN X 2 I
49360	36 IN RECEIVER TUBE 2 IN X 2 I
49480	48 IN RECEIVER TUBE
49506	6 IN RECEIVER TUBE 1 1/4 IN X
49510	2.5" RECEIVER TUBE 10" LONG
49511	2.5" RECEIVER TUBE 18" LONG
49512	12 IN RECEIVER TUBE 1 1/4 IN X
49513	3" RECEIVER TUBE 12" LONG
49515	3" RECEIVER TUBE 18" LONG
49524	24 IN RECEIVER TUBE 1 1/4 IN X
49529	10 IN SOLID STEEL HITCH BAR
49530	12 IN SOLID STEEL HITCH BAR
49531	14 IN SOLID STEEL HITCH BAR
49532	16 IN SOLID STEEL HITCH BAR
49533	18 IN SOLID STEEL HITCH BAR
49534	20 IN SOLID STEEL HITCH BAR
49535	22 IN SOLID STEEL HITCH BAR
49536	24 IN SOLID STEEL HITCH BAR
49537	8 IN SOLID STEEL HITCH BAR
49717	WELD ON HITCH BOX 5000 GTW RAW
49770	3 IN X 3 IN X 1 IN COLLAR
49950	10000 LB WELD-ON SAFETY CHAIN
51110	BRK CNTRLR, VENTURER, PKGD
51114	KIT, REPLACE BRK HDWRE, VENTURER
51120	BRK CNTRLR, DISCOVERY, PKGD
51122	BRK CNTRLR, DISCOVERY, BULK(6)
51124	KIT, REPLACE BRK HDWRE, DISCOVER
51130	BRK CNTRLR, REFLEX, PKGD
51140	BRK CNTRLR, TRIFLEX, PKGD
51142	BRK CNTRLR, TRIFLEX, BULK
51144	KIT, REPLACE BRK HDWRE, TRIFLEX
51170	BRAKE CONTROL - SPECTRUM
51180	BRK, CNTRLR, PORTABLE, PKGD
51312	HARNESS WITH QUICK PLUG, BULK
51313	HARNESS WITH QUICK PLUG, PKGD
51322	HARNESS WITH QUICK PLUG, BULK
51323	HARNESS WITH QUICK PLUG, PKGD
51332	HARNESS WITH QUICK PLUG, BULK
51333	HARNESS WITH QUICK PLUG, PKGD
51342	HARNESS WITH QUICK PLUG, BULK
51343	HARNESS WITH QUICK PLUG, PKGD
51352	HARNESS WITH QUICK PLUG, BULK
51353	HARNESS WITH QUICK PLUG, PKGD
51362	HARNESS WITH QUICK PLUG, BULK
51363	HARNESS WITH QUICK PLUG, PKGD
51372	HARNESS WITH QUICK PLUG, BULK
51373	HARNESS WITH QUICK PLUG, PKGD
51382	HARNESS WITH QUICK PLUG, BULK
51383	HARNESS WITH QUICK PLUG, PKGD
51392	HARNESS WITH QUICK PLUG, BULK
51393	HARNESS WITH QUICK PLUG, PKGD
51422	HARNESS WITH QUICK PLUG, BULK
51423	HARNESS WITH QUICK PLUG, PKGD
51432	HARNESS WITH QUICK PLUG, BULK
51433	HARNESS WITH QUICK PLUG, PKGD
51436	HARN, BKCTRL, QP, FORD F-150, BULK
51437	HARN, BKCTRL, QP, FORD F-150, PKGD
51438	HARN, BKCTRL, QP, DODGE RAM, BULK
51439	HARN, BKCTRL, QP, DODGE RAM, PKGD
51442	HARN, BK CTRL, KIA BORRE, QP, BULK
51443	HARN, BK CTRL, KIA BORREGO, QP, PK
51446	HARN, BK CTRL, JEEP GR CHER, QP, B
51447	HARN, BK CTRL, JEEP GR CHER, QP, P
51451	HARN, BKCTRL, QP, SILVERADO 1500*
51452	HARN, BKCTRL, QP, SILVERADO, PKGD
51453	HARN, BKCTRL, QP, RAM, PKGD

Part#	Description
51455	HARN, BKCTRL, QP, TOYOTA TUNDRA*
51456	HARN, BKCTRL, QP, TUNDRA, PKGD
51457	HARN, BKCTRL, QP, DODGE RAM, BULK
51458	HARN, BKCTRL, QP, DODGE RAM, PKGD
51459	HARN, BKCTRL, QP, JEEP, BULK *
51460	HARN, BKCTRL, QP, JEEP, PKGD
51498	TEST BOX, 7 WAY FUNCTION
51500	KIT, BRK CNTRL WIRING, UNIVERSAL
51515	HARN, BK CTRL, QP W/PIGTAILS
51516	HARN, BK CTRL, QP W/PIGTAILS, PKG
51520	HARN, BRK CTRL, D-T TO CURT, PKGD
51521	TEST BOX, BRAKE CONTROL
51522	HARN, BKCTRL, AUDI Q5, Q7, PKGD
51523	HARN, BKCTRL, ACURA MDX, PKGD
52010	NYLON BREAKAWAY SWITCH WITH SW
52011	NYLON BREAKAWAY SWITCH PACKAGED
52020	REPLACEMENT LANYARD WITH PULL
52022	CURT BATTERY BOX
52023	CURT 12V 5.4 AMP RECHARGEABLE B
52025	CURT 12V BATTERY CHARGER
52027	CURT BATTERY CASE
52029	CURT BATTERY BOX
52030	CURT BATTERY BOX
52090	CURT BATTERY BOX
53200	TOWING LIGHTS, 20', KIT
53201	LED CARGO LIGHTS
53204	4-WAY FLAT MAGNETIC TOW LIGHT
53440	RED COMBINATION LIGHT, W/OUT L
53441	RED COMBINATION LIGHT, W/OUT L
53445	RED REAR REPLACEMENT LENS COMB
53452	RED SUBMERSIBLE COMBO LIGHT, RI
53453	RED SUBMERSIBLE COMBO LIGHT, W
53515	RED SIDE REPLACEMENT LIGHT COM
53540	STOP TAIL AND SIDE LIGHTS W WI
55151	WIRING KIT, T-CONN, 10 AMP
55152	WIRING KIT, T-CONN, 15 AMP
55177	3 WIRE TO 2 WIRE CONVERTER
55178	3 TO 2 CONVERTER PACKAGED
55179	4 FLAT 3 TO 2 CONVERTER 12 IN
55415	OEM 7-WAY CONNECTOR
55416	HD 7-WAY USCAR 75035 CONNECTOR
55515	ROEM, CHEVY SILVERADO
55664	US CAR TO 6 ROUND AND 4 FLAT
55774	US CAR TO 7 RV AND 4 FLAT
56000	CUSTOM WIRING EXT HARNESS
56001	CUSTOM WIRING EXT HARNESS
56070	CUSTOM WIRING EXT HARNESS
56071	CUSTOM WIRING EXT HARNESS
56080	EXTENSION, 5TH WHEEL, 7-WAY
56130	CONVERTER, BASIC, PACKAGED(SM)
56132	CONV, BASIC, MASTERPACK(30)(SM)
56146	CONVERTER, CP, PWRD, PACKAGED(SM)
56175	CONVERTER, CP, PACKAGED(SM)
56187	CONVERTER, BASIC, PWRD, PKGD(SM)
56190	CONVERTER, HD W/SMART BOARD
56195	CONVERTER, CP, LSS, PACKAGED
56196	CONVERTER, 2-WIRE TO 3-WIRE, PKG
56229	7 PIN USCAR VEHICLE CONNECTOR
56236	CONVERTER, MULTI-FUNCTION, PKGD
56415	OEM 7-WAY TWIST-LOCK CONNECTOR
56424	BOARD, CONVERTER 24 VOLT
56496	POTTED TAILLIGHT CONVERTER
56515	OEM RPL, 5-FLAT TO USCAR
56584	T-CONN, 5-FLAT TO US CAR
56601	7 WAY MOLDED TRLR END 6' BULK
56602	7 WAY MOLDED TRLR END 8' BULK
56603	7 WAY MOLDED TRLR END 10' BULK
56611	7 WAY COLD WEATHER 6' BULK
56612	7 WAY COLD WEATHER 8' BULK
56613	7 WAY COLD WEATHER 10' BULK
56621	7 WAY MOLDED TRLR END 6' PKG
56622	7 WAY MOLDED TRLR END 8' PKG
56623	7 WAY MOLDED TRLR END 10' PKG
57000	KIT, RELAY, NISSAN
57001	WIRE, 16-4, WT/BN/YL/GN, 25 FT
57003	VW 7-WAY ADAPTOR
57004	ADAPTOR, 7 TO 4/5, LED
57005	ADAPTOR, 7 TO 6, LED
57007	KIT, 7-WAY EXT, ISOLATION
57008	CUSTOM WIRING HARNESS EXT
57010	CUSTOM WIRING HARNESS EXT

Part#	Description
57040	7-POLE ROUND TO 4 FLAT ADAPTER
57041	7-POLE ROUND TO 4 FLAT ADAPTER
57100	SOCKET,MFUNC,7WBLD,4W,BUA,DODG
57101	SOCKET,MFUNC,7WBLD,4W,BUA,FDGM
57102	SOCKET,MFUNC,7WBLD,4W,BUA,UNIV
57183	4-WAY FLAT TO 6-WAY ROUND CAR
57184	4-WAY FLAT TO 7-WAY RV ROUND C
57185	4-WAY FLAT TO 7-WAY ROUND CAR
57186	4-FLAT TO 7-WAY W/BC WIRNG KIT
57187	5-WAY FLAT TO 4-WAY FLAT 75136
57201	BRKT,MNT,7WAY,UNV,LG, 12 PK
57202	MOUNTING BRKT, LONG W/CLAMP PKG
57203	BRKT,MNT,7WAY,UNV,SHORT,12 PK
57204	MOUNTING BRKT,SHORT W/CLAMP PK
57205	BRKT,MNT,7WAY,HD,12 PACK
57206	BRKT,MNT,7WAY,HD,PKG
57207	BRKT,MNT,456 WAY RND,12 PACK
57208	BRKT,MNT,456 WAY RND,PKG
57220	1-420 4-FLAT 20' TRAILER END
57224	4 POLE ROUND TO 4 FLAT ADAPTER
57225	4 POLE ROUND TO 4 FLAT ADAPTER
57240	7-WAY RV ROUND TO 4-WAY FLAT,
57241	7-WAY RV ROUND TO 4-WAY FLAT,
57245	7 TO 4 W/LED DUST COVER
57250	7-WAY RV (FLAT CONNECTORS) TO
57251	7-WAY RV (FLAT CONNECTORS) TO
57255	7 TO 6 AUX W/LED DUST COVER
57260	7-WAY RV ROUND TO 6-WAY ROUND,
57261	7-WAY RV STYLE (FLAT CONNECTOR
57265	7 TO 6 BRAKE W/LED DUST COVER
57271	7-WAY TO 4-WAY 75065
57281	7-WAY ADAPTOR 75065
57300	ADAPTER,USCAR GM/FORD TO DODGE
57404	4 FLAT TO 4 FLAT 1.25 IN DIAME
57405	4-FLAT TO 4-FLAT 1.25 DIAMETER
57406	4-FLAT TO 4-FLAT 1.25 IN DIAME
57444	4 WAY ROUND TO 4 WAY FLAT ADAP
57505	12 VOLT CIRCUIT TESTER 5 WAY F
57604	4-WAY FLAT TO BOTH 6-WAY ROUND
57620	6-WAY ROUND TO 4-WAY FLAT, BUL
57621	6-WAY ROUND TO 4-WAY FLAT, PKG
57624	4 WAY FLAT TO BOTH 6 WAY ROUND
57626	6 WAY ROUND TO 4 WAY FLAT WITH
57627	6 TO 4 W/LED DUST COVER
57660	7-WAY RV TO 6 ROUND ADAPTER
57661	7-WAY RV TO 6 ROUND ADAPTER PK
57667	6-WAY ROUND TO 7-WAY RV, PKG
57672	4 WAY FLAT TO BOTH 7 WAY ROUND
57674	4 WAY FLAT TO BOTH 7 WAY ROUND
57676	7 WAY ROUND TO 4 WAY FLAT WITH
57720	7 TO 6 ADPTR W/BKUP ALM(CPB)
57724	7 TO 4 ADPTR W/BKUP ALM
57725	7 TO 5 ADPTR W/BKUP ALM
57726	7 TO 6 ADPTR W/BKUP ALM(CPA)
57727	7 TO 7 ADPTR W/BKUP ALM
58000	BRACKET,ELEC,7WAY/4FLAT 2.00"
58001	BRACKET,ELEC,4FLAT 2.00"
58002	BRACKET,ELEC,4FLAT 1.25"
58003	BRACKET,ELEC,7WAY/4FLAT 2.50"
58020	2-FLAT LOOP 12 IN BULK
58021	2-FLAT LOOP 12 IN PACKAGED
58030	4 WAY FLAT 12 IN TRAILER BONDE
58031	4 WAY FLAT 12 IN TRAILER BONDE
58033	I-3 4-FLAT TRAILER END 12 IN K
58034	6 WAY SQUARE W/12" LOOP
58035	6 WAY SQUARE CAR END BULK PKGD
58037	6 WAY SQUARE TRLR END PKG
58040	4 WAY FLAT 60 IN CAR BONDED BU
58041	4 WAY FLAT 60 IN CAR BONDED PA
58044	I-4 4-FLAT CAR END 60 IN KIT P
58050	4 WAY BONDED 72 IN LOOP CAR &
58051	4-WAY BONDED 72 IN LOOP CAR &
58060	4 POLE DIE CAST CONNECTOR TRAI
58061	PKG-4-WAY DIE CAST
58070	4 POLE DIE CAST CONNECTOR CAR
58071	PKG-7-WAY DIE CAST
58080	6 POLE DIE CAST CONNECTOR, TRA
58081	6 POLE DIE CAST CONNECTOR, TRA
58082	6-POLE DIE CAST CONNECTOR WITH
58083	CONN,6-POLE DIECAST W/SPRG,PKG
58090	6 POLE DIE CAST CONNECTOR, CAR

Part#	Description
58091	6 POLE DIE CAST CONNECTOR CAR
58092	I-8/1-9 6-POLE DIE CAST CONNEC
58093	I-8/1-9/1-21 6-POLE DIE CAST C
58120	6 POLE PL CONN, TRAILER END
58130	6-POLE CONNECTOR, CAR END
58140	7 POLE PLASTIC CONNECTOR, TRAI
58141	7 POLE PLASTIC CONNECTOR, TRAI
58145	HD 7-WAY TRAILER-SIDE 75040
58150	7 POLE PLASTIC CONNECTOR, CAR
58151	7-POLE PLASTIC CONNECTOR, CAR
58152	PKG I-14/1-15/1-51 7 POLE CONN
58155	HD 7-WAY RV-STYLE 75310
58160	7-POLE DIE-CAST CONNECTOR, TRA
58161	CONN,7-POLE DIECAST,PKG
58170	7-POLE DIE-CAST CONNECTOR, CAR
58180	7-POLE DIE CAST CONNECTOR TRAI
58181	CONN,7-POLE DIECAST W/SPRG,PKG
58190	7-POLE METAL CONNECTOR TRAILER
58200	4-FLAT CAP,CAR,SIDE
58201	4-FLAT CAP,CAR,SIDE,PKG
58202	COVER, 5-FLAT, CAR,SIDE
58203	COVER, 5-FLAT, CAR,SIDE, PKGD
58210	BRACKET FOR CONNECTOR I-7 I-9
58220	7-POLE METAL CONNECTOR CAR END
58222	BRACKET FOR CONNECTOR I-17
58230	BRACKET FOR CONNECTOR I-15 & I
58231	BRACKET FOR CONNECTOR I-15 & I
58240	TAIL LIGHT CONVERTER 3 TO 2 WI
58260	LED 4-FLAT TESTER
58261	LED 4-FLAT TESTER,PKG
58270	12V 7-WAY RV ROUND CIRCUIT TES
58271	12V 7-WAY RV ROUND CIRCUIT TES
58280	14-18 GAUGE WIRE CONN- 100 PK
58290	BLACK BRACKET FOR CONNECTOR I-
58291	PKG BLACK ZINC CONN BRACKET FO
58300	BRACKET,4-FLAT,BULK
58301	BRACKET,4-FLAT,PKG
58304	12 CAR END/12 TRAILER END
58305	48 CAR END/12 TRAILER END KIT
58310	FLASHES 1-4 32 CP TURN SIGNAL
58312	2-FLAT POWER ADAPTER TO CIG. L
58313	2-FLAT POWER ADAPTER TO CIG. L
58320	FLASHES 2-3 32 CP TURN SIGNAL
58341	15 AMP CIRCUIT BREAKER BAG KIT
58344	12 CAR END/12 TRAILER END KIT
58348	48 TRAILER END
58349	48 TRAILER END KIT
58351	20 AMP CIRCUIT BREAKER BAG KIT
58355	48 CAR END/12 TRAILER END
58361	30 AMP CIRCUIT BREAKER BAG KIT
58371	40 AMP CIRCUIT BREAKER BAG KIT
58380	4-WAY BONDED 12 BONDED LOOP, C
58381	4-WAY BONDED 12 BONDED LOOP, C
58390	PULL WIRE 3/8 IN
58400	PULL WIRE 1/2 IN
58404	4 FLAT TO 4 FLAT 1.25 IN DIAME
58405	4-FLAT TO 4-FLAT 1.25 IN DIAME
58406	4-FLAT TO 4-FLAT 1.25 IN DIAME
58410	PULL WIRE 7/16 IN
58414	4 WAY ROUND TO 4 WAY FLAT ADAP
58417	7 WAY RV SOCKET WITH MOUNTING
58430	PULL WIRE 5/8 IN
58440	FUSE,10 AMP ATC,BULK 100 PACK
58450	FUSE,15 AMP ATC,BULK 100 PACK
58460	FUSE,20 AMP ATC,BULK 100 PACK
58470	HOLDER, IN-LINE FUSE, BULK 12
58480	RELAY, BULK 12 PACK
58510	BRACKET FOR I-15/1-20 14 (BLAC
58520	BRACKET,U.S. CAR 7 WAY RV PLUG
58530	5-FLAT CAR END 60 IN BULK
58531	5-FLAT CAR END 60 IN PACK
58540	5-FLAT TRAILER END 48 IN BULK
58541	5-FLAT TRAILER END 48 IN PACKA
58550	5-FLAT LOOP 72 IN BULK
58551	5-FLAT LOOP 72 IN PACKAGED
58650	12 VOLT CIRCUIT TESTER 6 WAY R
58671	I-6/1-7, 4 POLE DIE CAST CONNE
58677	I-6/1-7/1-21 PKG.
58750	DUST COVER TRAILER SIDE
58761	DUST COVER SET
58823	1/4 IN CONVOLUTED SLIT LOOM PE

Part#	Description
58900	RV HARNESS, CHEV EQUINOX
58901	RV HARNESS, HONDA CRV
58902	RV HARNESS, JEEP WRANGLER
58903	RV HARNESS, JEEP WRANGLER
58904	RV HARNESS, HONDA CRV
58905	RV HARNESS, FORD FOCUS HATCH
58906	RV HARNESS, DODGE RAM 1500
58907	RV HARNESS, JEEP GRD CHEROKEE
58908	RV HARNESS, BUICK ENCLAVE
58909	RV HARNESS, JEEP CHEROKEE
58910	RV HARNESS, CHEV COLORADO
58911	RV HARNESS, FIAT 500
58912	RV HARNESS, FORD F-150
58913	RV HARNESS, TOYOTA RAV4
58914	RV HARNESS, FORD EDGE
58915	RV HARNESS, JEEP GRD CHEROKEE
58916	RV HARNESS, RAM 1500
58917	RV HARNESS, JEEP LIBERTY
58918	RV HARNESS, 4 FLAT ADD-ON
58919	RV HARNESS, NPWR CONVER ADD-ON
58920	RV HARNESS, PWR CONVER ADD-ON
58921	RV HARNESS, GMC ACADIA
58922	RV HARNESS, CHEVY TRAVERSE
58923	RV HARNESS, CHEVY 1500
58924	RV HARNESS, CHEVY AVALANCHE
58925	RV HARNESS, CHEVY TRAILBLAZER
58926	RV HARNESS, CHEVY COLORADO
58927	RV HARNESS, CADILLAC ESCALADE
58928	RV HARNESS, SATURN VUE
58929	RV HARNESS, CHEVY HHR
58930	RV HARNESS, LINCOLN MKX
58931	RV HARNESS, CHEVY COBALT
58932	RV HARNESS, BUICK ENCLAVE
58933	RV HARNESS, SATURN VUE
58934	RV HARNESS, CHEVY MALIBU
58935	RV HARNESS, CHEVY CRUZE
58936	RV HARNESS, CHEVY SONIC
58937	RV HARNESS, DODGE NITRO
58938	RV HARNESS, JEEP COMPASS
58939	RV HARNESS, JEEP GRD CHEROKEE
58940	RV HARNESS, JEEP GRD CHEROKEE
58941	RV HARNESS, FORD FLEX
58942	RV HARNESS, FORD FUSION
58943	RV HARNESS, FORD ESCAPE
58944	RV HARNESS, FORD FOCUS
58945	RV HARNESS, FORD FUSION
58946	RV HARNESS, FORD FIESTA
58947	RV HARNESS, HONDA ELEMENT
58948	RV HARNESS, HONDA FIT
58949	RV HARNESS, HONDA CRV
58950	RV HARNESS, SUZUKI GRND VITARA
58952	RV HARNESS, FORD EDGE
58953	RV HARNESS, FORD EDGE
59146	CONVERTER,CP,PWR KIT,PKG(D/SM)
59187	CONVERTER,BASIC,PWRKIT,PKD(SM)
59190	CONVERTER,HD,PWRKIT,SMRT BRD
59236	CONVERTER,MULTI-FUNCTION,PKG*
59421	22-18 G BUTT CONNECTORS 100 PE
59422	16-14 G BUTT CONNECTORS - 100
59423	12-10 G BUTT CONNECTORS - 100
59432	16-14 G MALE QUICK CONNECTOR
59433	12-10 G MALE QUICK CONNECTOR
59496	POTTED CONVERTER W/ WIRE KIT
59521	16-14 G 10 RING TERM - 100 PER
59522	16-14 G 1/4 IN RING TERM 100 P
59523	16-14 G 3/8 IN RING TERM 100 P
59525	16-14 G 5/16 IN RING TERM 100
59531	12-10 G 10 RING TERM 100 PER B
59534	12-10 G 1/4 IN RING TERM 100 P
59538	12-10 G 3/8 IN RING TERM 100 P
59556	12-10 G 5/16 IN RING TERM 100
59592	16-14 G FEMALE QUICK CONNECTOR
59593	12-10 G FEMALE QUICK CONNECTOR
59611	22-18 G SPADE TERMINALS - 100
59621	16-14 G SPADE TERMINALS - 100
59631	12-10 G SPADE TERMINALS - 100
59728	7 1/4 IN NYLON WIRE TIES 100 P
59732	14 1/4 IN NYLON WIRE TIES 100
59740	3/4 IN X 60 FT 10 PACK ELECTRI
59824	3/8 IN CONVOLUTED SLIT LOOM PE
59825	3/8 X 25 IN SLIT LOOM PACKAGED

Part#	Description
59826	1/2 IN BLACK CONVOLUTED SLIT L
59827	1/2 X 25 IN SLIT LOOM PACKAGED
59828	3/8 IN ID NYLON LOOM/PACKS 25
59901	WIRE NUTS - 100 PER BAG
59905	12-10 GAUGE QUICK SPLICES 100
59906	14-18 GAUGE QUICK SPLICES 100
59956	18-14 GAUGE TAP CONNECTOR 100
60602	ROUND SHANK BALL EXTENSION
60603	ROUND SHANK HIGH RISE BALL
60604	CHEV/GMC 2500/3500 INSTALL KIT
60606	GOOSENECK INSTALL KIT
60607	DOUBLE LOCK GOOSENECK W/NOTCH
60611	DOUBLE LOCK EZR GOOSENECK
60614	RAM 2500 GOOSENECK HITCH
60615	CHEVY 1500 GOOSENECK CENTER
60616	600 SERIES REPLACEMENT BALL
60617	60617 RAM SAFETY CHAIN LOOPS
60618	60618 RAM SAFETY CHAIN KIT
60619	DOUBLE LOCK EZR GOOSENECK
60620	NISSAN TITAN GOOSENECK CENTER
60624	GM GOOSENECK SUB KIT
60625	TOYOTA TUNDRA GOOSENECK HITCH
60626	GOOSENECK CENTER
60628	60628 3" OE GOOSEBALL
60629	60629 OE GOOSEBALL
60630	QUICKGOOSE II
60631	GOOSENECK INSTALL KIT 1988-200
60632	NEW BODY CHEVY SUBKIT
60635	GOOSENECK INSTALL KIT 1994-200
60636	GOOSENECK INSTALL KIT OLD BODY
60637	GOOSENECK INSTALL KIT 1997-200
60640	QUICKGOOSE II
60641	GOOSENECK INSTALL KIT NEW BODY
60643	FORD SUPER DUTY SUB-KIT
60644	SUB-KIT,600 SERIES,FORD SD
60645	SUB-KIT, FORD SD
60647	SUB-KIT, EZR, FORD SD
60648	SUB-KIT, EZR, CHEV HD
60649	SUB-KIT, FORD F-150
60652	GOOSENECK INSTALL KIT, CHEVY
60657	DODGE RAM INSTALL KIT
60658	RAM 1500 INSTALL KIT
60659	SUBKIT,C-600,30K
60660	DODGE 2500/3500 INSTALL KIT
60661	DODGE 2500/3500 INSTALL KIT
60664	NISSAN TITAN GOOSENECK INSTAL
60665	00-06 TOYOTA TUNDRA SUB-KIT
60667	07 TOYOTA TUNDRA SUB-KIT
60680	KIT, 60624 & 60611
60681	KIT, 60648 & 60619
60682	KIT, 60660 & 60619
60683	KIT, 60645 & 60619
60685	KIT, 60647 & 60619
60691	GM SAFETY CHAIN LOOPS
60692	GM SAFETY CHAIN KIT
60700	KIT, 60610 & 60651
60710	KIT, 60607 & 60604
60711	KIT, 60615 & 60632
60712	KIT, 60607 & 60652
60713	KIT, 60607 & 60631
60720	KIT, 60607 & 60644
60721	KIT, 60607 & 60641
60722	KIT, 60607 & 60637
60723	KIT, 60607 & 60636
60724	KIT, 60607 & 60649
60730	KIT, 60607 & 60657
60731	KIT, 60607 & 60658
60732	KIT, 60607 & 60661
60734	KIT, 60607 & 60635
60740	KIT, 60620 & 60664
60750	KIT, 60625 & 60665
60751	KIT, 60607 & 60667
61052	FOLDING BALL GOOSENECK HITCH A
61100	HITCH PLATE WITH BALL
61301	30K CHEV/GMC HD INSTALL KIT
61319	FOLDING BALL HITCH ASSEMBLY
61321	FOLDING BALL HITCH ASSEMBLY KI
61331	CHEVY 1500 C-52 KIT, 30K
61332	30K SUPER DUTY INSTALL KIT
61341	FOLDING HITCH BALL ASSEMBLY KI
61502	C-52 INSTALL KIT UNIVERSAL 30K

Part#	Description
61503	C-52 INSTALL KIT 30K GTW
61504	C-52 INSTALL KIT 30K GTW
61505	C-52 INSTALL KIT 30K GTW
61506	C-52 INSTALL KIT 30K GTW
61509	C-52 INSTALL KIT 30K GTW
61529	SUBKIT,C-52,30K
61652	GOOSENECK,FOLDING BALL
65500	FLAT HITCH PLATE 13 IN X 48 IN
66113	SAFETY CHAIN U-BOLT KIT
66145	RUBBER COVER FOR QUICKGOOSE
66155	REPLACEMENT CAP FOR 60613
66165	REPLACEMENT CAP FOR 600 SERIES
80136	CABLE, TRAILER SAFETY 3500LB
80151	CABLE, TRAILER SAFETY 5000LB
80176	CABLE, TRAILER SAFETY 7600LB
81360	SNAP HOOK WITH 5/8 IN EYE
81999	YELLOW ZINC LATCH KIT IN P
82610	1/4 IN THREADED LINK 880 LB CA
82611	1/4 IN THREADED LINK 880LB CAP
82900	5/16 IN THREADED LINK 1760LB C
82901	5/16 IN THREADED LINK 1760LB C
82903	5/16" QUICK LINK 2 PACK
82930	3/8 IN THREADED LINK 2200LB CA
82931	7/16 IN THREADED LINK 2640LB C
82932	1/2 IN THREADED LINK 3300LB CA
82933	3/8 IN THD LINK 2200LB PKG
82940	9/0 JOINING LINK RAW FINISH 10
82942	7/16 IN JOINING LINK RAW FINIS
82943	9/0 JOINING LINK ZINC
82944	7/16 IN JOINING LINK ZINC
83001	RATCHET, 1" X 10', 1500#
83002	RATCHET, 1" X 16', 1500#
83009	RATCHET, 1" X 10', 1500#
83010	RATCHET, 1" X 16', 1500#
83015	CAM TIE DOWN, 1" X 15', 900#
83016	CAM TIE DOWN, 1" X 16', 900#
83019	RATCHET, 1" X 16', 2200#
83020	RATCHET, 1" X 16', 2200#
83025	RATCHET, 1-1/16" X 16', 3300#
83026	RATCHET, 1-1/16" X 16', 3300#
83027	RATCHET, 1-1/16" X 16', 3300#
83028	RATCHET, 1-1/16" X 16', 3300#
83036	RATCHET, 1-1/2" X 14', 5000#
83047	RATCHET, 2" X 27', 10000#
83048	RATCHET, 2" X 27', 10000#
83060	HIDE-A-TIE ROPE HOOK, BULK
83061	HIDE-A-TIE ROPE HOOK - PKG.
83066	2 IN X 30 FT VEHICLE RECOVERY
83072	WELD ON ANCHOR 1 5/8 IN X 3 1/
83600	5000 GTW RECESSED FLOOR/WALL T
83601	1200 GTW FOR USE WITH 3/8 IN P
83607	BACKING PLATE FOR J-600 AND J-
83710	1000 LB CAPACITY 1/4 IN DIAMET
83720	BLACK PLASTIC TRIM RING FOR J-
83730	1200 LB CAP 10 GA STL D-RING .
83731	1,200 LB CAP, 10 GA STL D-RING
83732	1200 LB CAP 10 GA STL DRING 22
83740	11000 LB CAPACITY 1/2 IN FORGE
83742	WHITE ZINC D-RING ASSEMBLY
83750	18800 LB CAP 5/8 IN FORGED D-R
83760	26500 LB CAP 3/4 IN FORGED D-R
83770	46760 LB CAP 1 IN FORGED D-RIN
83780	46760 LB CAP 1 IN X 5 IN X 6 I
16103010	BOLT KIT,FIFTH WHEEL, 80PC
16721025	LUBE PLATE,5TH WHEEL,25 PACK
56070010	7" 7-WAY OEM EXT ASSY 10 PACK
56146030	56146 30 PACK
58000010	BRACKET,ELEC,7WAY/4FLAT 2.00"
58001010	BRACKET,ELEC,4FLAT 2.00"
58002010	BRACKET,ELEC,4FLAT 1.25"



# CUSTOM WIRING PRODUCTS LISTED NUMERICALLY

Part#	Make	Model	Years	INS
55028	FREIGHTLINER	F-150	97-03	5
	FORD	F-150 HERITAGE	04-04	5
55029	FORD	F-250 SUPER DUTY	99-01	5
	FORD	F-350 SUPER DUTY	99-01	5
55050	DODGE	CALIBER	07-07	30
	JEEP	COMPASS	07-10	30
	JEEP	PATRIOT	07-07	30
55057	PONTIAC	VIBE	03-08	25
55106	HONDA	CR-V	07-11	30
55124	JEEP	WRANGLER	07-17	10
	JEEP	WRANGLER JK	18-18	10
55240	CHEVROLET	EXPRESS 1500	96-03	5
	CHEVROLET	EXPRESS 2500	96-03	5
	CHEVROLET	EXPRESS 3500	96-03	5
	GMC	SAVANA 1500	96-03	5
	GMC	SAVANA 2500	96-03	5
	GMC	SAVANA 3500	96-03	5
55241	FORD	EXPLORER	95-01	5
	FORD	RANGER	98-99	5
	MAZDA	B2500	98-01	5
	MAZDA	B3000	98-01	5
	MAZDA	B4000	98-01	5
	MERCURY	MOUNTAINEER	97-01	5
55242	FORD	F-150	97-03	5
	FORD	F-150 HERITAGE	04-04	5
	FORD	F-250	97-99	5
55243	FORD	F-250 SUPER DUTY	99-01	5
	FORD	F-350 SUPER DUTY	99-01	5
	FORD	F-450 SUPER DUTY	99-01	5
	FORD	F-550 SUPER DUTY	99-01	5
55244	NISSAN	XTERRA	00-04	5
55245	LEXUS	LX470	01-07	5
	LEXUS	LX570	08-11	5
	LEXUS	RX300	01-03	5
	TOYOTA	4RUNNER	01-02	5
	TOYOTA	HIGHLANDER	01-03	5
	TOYOTA	LAND CRUISER	01-02	5
55246	TOYOTA	SEQUOIA	01-02	5
55247	FORD	F-250 SUPER DUTY	99-01	5
	FORD	F-350 SUPER DUTY	99-01	5
55249	FORD	EXPEDITION	97-99	5
	LINCOLN	NAVIGATOR	98-99	5
55250	FORD	EXPEDITION	00-02	5
55251	FORD	EXPLORER	02-05	5
	LINCOLN	NAVIGATOR	03-05	5
	MERCURY	MOUNTAINEER	02-05	5
55255	FORD	ESCAPE	01-04	5
	MAZDA	TRIBUTE	01-04	5
55256	FORD	F-150	97-04	5
	FORD	F-250	97-99	5
55260	JEEP	GRAND CHEROKEE	95-98	25
55265	FORD	F-250 SUPER DUTY	02-04	5
	FORD	F-350 SUPER DUTY	02-04	5
55301	FORD	F-150	73-79	5
	FORD	F-250	73-79	5
	FORD	F-350	73-79	5
55302	FORD	BRONCO	87-88	5
55303	FORD	BRONCO	89-91	5
55304	MAZDA	B2000	86-87	5
	MAZDA	B2200	87-93	5
	MAZDA	B2600	87-93	5
55307	TOYOTA	RAV4	01-05	10
55308	TOYOTA	CAMRY	02-06	5

Part#	Make	Model	Years	INS
55309	KIA	SEDONA	02-05	25
55310	HYUNDAI	ELANTRA	09-12	20
	HYUNDAI	SANTA FE	01-06	20
	KIA	RI05	06-11	20
55311	CHEVROLET	BLAZER	73-74	5
	CHEVROLET	C10	75-84	5
	CHEVROLET	C10 PICKUP	73-74	5
	CHEVROLET	C10 SUBURBAN	73-84	5
	CHEVROLET	C20	75-84	5
	CHEVROLET	C20 PICKUP	73-74	5
	CHEVROLET	C20 SUBURBAN	73-84	5
	CHEVROLET	C30	75-84	5
	CHEVROLET	C30 PICKUP	73-74	5
	CHEVROLET	K10	75-84	5
	CHEVROLET	K10 PICKUP	73-74	5
	CHEVROLET	K10 SUBURBAN	73-84	5
	CHEVROLET	K20	75-84	5
	CHEVROLET	K20 PICKUP	73-74	5
	CHEVROLET	K20 SUBURBAN	73-84	5
	CHEVROLET	K30	77-84	5
	CHEVROLET	K30 PICKUP	73-74	5
	CHEVROLET	K5 BLAZER	75-84	5
	GMC	C15	75-78	5
	GMC	C15 SUBURBAN	75-78	5
	GMC	C15/C1500 PICKUP	73-74	5
	GMC	C15/C1500 SUBURBAN	73-74	5
	GMC	C1500	79-84	5
	GMC	C1500 SUBURBAN	79-84	5
	GMC	C25	75-78	5
	GMC	C25 SUBURBAN	75-78	5
	GMC	C25/C2500 PICKUP	73-74	5
	GMC	C25/C2500 SUBURBAN	73-74	5
	GMC	C2500	79-84	5
	GMC	C2500 SUBURBAN	79-84	5
	GMC	C35	75-78	5
	GMC	C35/C3500 PICKUP	73-74	5
	GMC	C3500	79-84	5
	GMC	K15	75-78	5
	GMC	K15 SUBURBAN	75-78	5
	GMC	K15/K1500 PICKUP	73-74	5
	GMC	K15/K1500 SUBURBAN	73-74	5
	GMC	K1500	79-84	5
	GMC	K1500 SUBURBAN	79-84	5
	GMC	K25	75-78	5
	GMC	K25 SUBURBAN	75-78	5
	GMC	K25/K2500 PICKUP	73-74	5
	GMC	K25/K2500 SUBURBAN	73-74	5
	GMC	K2500	79-84	5
	GMC	K2500 SUBURBAN	79-84	5
	GMC	K35	77-78	5
	GMC	K35/K3500 PICKUP	73-74	5
	GMC	K3500	79-84	5
55312	CHEVROLET	C10	85-86	5
	CHEVROLET	C10 SUBURBAN	85-86	5
	CHEVROLET	C1500	94-94	5
	CHEVROLET	C20	85-86	5
	CHEVROLET	C20 SUBURBAN	85-86	5
	CHEVROLET	C30	85-86	5
	CHEVROLET	K10	85-86	5
	CHEVROLET	K10 SUBURBAN	85-86	5
	CHEVROLET	K20	85-86	5
	CHEVROLET	K20 SUBURBAN	85-86	5
	CHEVROLET	K30	85-86	5

Part#	Make	Model	Years	INS
55312	CHEVROLET	S10	85-97	5
	GMC	C1500	85-86	5
	GMC	C1500 SUBURBAN	85-86	5
	GMC	C2500	85-86	5
	GMC	C2500 SUBURBAN	85-86	5
	GMC	C3500	85-86	5
	GMC	K1500	85-86	5
	GMC	K1500 SUBURBAN	85-86	5
	GMC	K2500	85-86	5
	GMC	K2500 SUBURBAN	85-86	5
	GMC	K3500	85-86	5
	GMC	SONOMA	91-97	5
	GMC	SYCLONE	91-91	5
	ISUZU	HOMBRE	96-97	5
55313	FORD	BRONCO	80-86	5
	FORD	F-100	80-83	5
	FORD	F-150	80-86	5
	FORD	F-250	80-86	5
	FORD	F-350	80-86	5
55314	FORD	RANGER	86-92	5
55315	GMC	C1500	88-99	5
	GMC	C2500	88-00	5
	GMC	C3500	88-00	5
	GMC	K1500	88-99	5
	GMC	K2500	88-00	5
	GMC	K3500	88-00	5
55316	FORD	F-150	87-96	5
	FORD	F-250	87-96	5
	FORD	F-250 HD	97-97	5
	FORD	F-350	87-97	5
55317	DODGE	B250	94-94	5
	DODGE	D100	86-89	5
	DODGE	D150	86-89	5
	DODGE	D250	86-93	5
	DODGE	D350	86-93	5
	DODGE	DAKOTA	87-94	5
	DODGE	RAM 1500	94-94	5
	DODGE	RAM 2500	94-94	5
	DODGE	RAM 3500	94-94	5
	DODGE	RAM 50	86-93	5
	DODGE	RAMCHARGER	86-93	5
	DODGE	W100	86-89	5
	DODGE	W150	86-93	5
	DODGE	W250	86-93	5
	DODGE	W350	86-93	5
55318	CHEVROLET	S10 BLAZER	84-91	20
55319	CADILLAC	ESCALADE	99-00	5
	CHEVROLET	BLAZER	92-94	5
	CHEVROLET	C1500 SUBURBAN	92-99	5
	CHEVROLET	C2500 SUBURBAN	92-99	5
	CHEVROLET	K1500 SUBURBAN	92-99	5
	CHEVROLET	K2500 SUBURBAN	92-99	5
	CHEVROLET	TAHOE	95-00	5
	GMC	C1500 SUBURBAN	92-99	5
	GMC	C2500 SUBURBAN	92-99	5
	GMC	K1500 SUBURBAN	92-99	5
	GMC	K2500 SUBURBAN	92-99	5
	GMC	YUKON	92-00	5
	GMC	YUKON XL 1500	00-00	5
	GMC	YUKON XL 2500	00-00	5

Part#	Make	Model	Years	INS
55323	CHRYSLER	TOWN & COUNTRY	91-95	10
	DODGE	CARAVAN	91-95	10
	DODGE	DAKOTA	04-10	10
	DODGE	GRAND CARAVAN	91-95	10
	MITSUBISHI	RAIDER	06-09	10
	PLYMOUTH	GRAND VOYAGER	91-95	10
55324	FORD	EXPLORER	91-94	20
	MAZDA	NAVAJO	91-94	20
55325	FORD	RANGER	93-99	5
	MAZDA	B2300	94-08	5
	MAZDA	B2500	98-01	5
	MAZDA	B3000	94-07	5
	MAZDA	B4000	94-08	5
55326	FORD	CROWN VICTORIA	92-97	20
	FORD	MUSTANG	94-04	20
	MERCURY	GRAND MARQUIS	92-97	20
55327	FORD	TAURUS	92-95	10
55328	DODGE	B150	93-94	5
	DODGE	B1500	95-98	5
	DODGE	B250	93-94	5
	DODGE	B2500	95-98	5
	DODGE	B350	93-94	5
	DODGE	B3500	95-98	5
	55329	DODGE	DAKOTA	95-03
DODGE		RAM 1500	95-01	5
DODGE		RAM 2500	95-02	5
DODGE		RAM 3500	95-02	5
55331	HONDA	PASSPORT	94-97	5
	ISUZU	RODEO	92-97	5
55333	FORD	TAURUS	96-99	10
	MERCURY	SABLE	96-99	10
55334	CHRYSLER	TOWN & COUNTRY	96-00	20
	DODGE	CARAVAN	96-00	20
	DODGE	DURANGO	98-03	20
	DODGE	GRAND CARAVAN	96-00	20
	PLYMOUTH	GRAND VOYAGER	96-00	20
	PLYMOUTH	VOYAGER	96-00	20
55335	CHEVROLET	EXPRESS 1500	96-99	20
	CHEVROLET	EXPRESS 2500	96-99	20
	CHEVROLET	EXPRESS 3500	96-99	20
	GMC	SAVANA 1500	96-99	20
	GMC	SAVANA 2500	96-99	20
	GMC	SAVANA 3500	96-99	20
55336	ACURA	CL	97-03	10
	ACURA	INTEGRA	94-01	10
	ACURA	MDX	01-06	10
	ACURA	RL	96-01	10
	ACURA	TL	96-03	10
	HONDA	ACCORD	94-02	10
	HONDA	CR-V	97-06	10
	HONDA	ELEMENT	03-04	10
	HONDA	ODYSSEY	95-04	10
	HONDA	PILOT	03-08	10
	HONDA	PRELUDE	01-01	10
	ISUZU	OASIS	96-99	10
	55337	CHEVROLET	LUMINA APV	93-96
OLDSMOBILE		SILHOUETTE	93-96	20
PONTIAC		TRANS SPORT	93-96	20
55338	CHEVROLET	G10	87-95	10
	CHEVROLET	G20	87-95	10
	CHEVROLET	G30	87-95	10
	GMC	G1500	87-95	10
	GMC	G2500	87-95	10
	GMC	G3500	87-95	10
55339	ACURA	SLX	96-99	10
	ISUZU	TROOPER	92-02	10
55341	TOYOTA	4RUNNER	96-02	20

Part#	Make	Model	Years	INS	
55343	FORD	E-150 ECONOLINE	92-94	10	
	FORD	E-150 ECONO. CLUB WAG.	92-94	10	
	FORD	E-250 ECONOLINE	92-94	10	
	FORD	E-350 ECONOLINE	92-94	10	
	FORD	E-350 ECONO.CLUB WAG.	92-94	10	
	FORD	ESCAPE	01-03	10	
	MAZDA	TRIBUTE	01-03	10	
	MERCURY	SABLE	96-05	10	
	55344	FORD	E-150	03-03	10
		FORD	E-150 CLUB WAGON	03-03	10
		FORD	E-150 ECONOLINE	95-02	10
FORD		E-150 ECONO. CLUB WAG.	95-02	10	
FORD		E-250	03-03	10	
FORD		E-250 ECONOLINE	95-02	10	
FORD		E-350 CLUB WAGON	03-03	10	
FORD		E-350 ECONOLINE	95-98	10	
FORD		E-350 ECONO. CLUB WAG.	95-02	10	
FORD		E-350 SUPER DUTY	99-03	10	
FORD		E-450 ECONO. SUP. DTY	00-02	10	
FORD		E-450 SUPER DUTY	03-03	10	
FORD		E-550 ECONO. SUP. DTY	02-02	10	
FORD		E-550 SUPER DUTY	03-03	10	
FORD		ECONO. SUPER DUTY	96-99	10	
FORD		ESCORT	97-99	10	
FORD		EXCURSION	00-03	10	
FORD		EXPEDITION	97-03	10	
FORD		EXPLORER	01-03	10	
FORD		EXPLORER SPORT TRAC	02-03	10	
FORD		F-150	95-03	10	
FORD	F-150 HERITAGE	04-04	10		
FORD	FOCUS	00-03	10		
FORD	RANGER	00-03	10		
LINCOLN	AVIATOR	03-04	10		
LINCOLN	NAVIGATOR	98-03	10		
MERCURY	MOUNTAINEER	02-03	10		
MERCURY	TRACER	97-99	10		
55345	FORD	EXPLORER	95-01	40	
MERCURY	MOUNTAINEER	97-01	40		
55346	FORD	WINDSTAR	95-98	20	
55347	BUICK	ROADMASTER	91-96	10	
	CHEVROLET	CAPRICE	91-96	10	
	CHEVROLET	IMPALA	94-96	10	
55349	JEEP	GRAND CHEROKEE	94-98	25	
55350	FORD	BRONCO	92-96	5	
55351	MERCURY	SABLE	92-95	10	
55352	BUICK	ROADMASTER	91-96	10	
	CHEVROLET	CAPRICE	91-96	10	
	OLDSMOBILE	CUSTOM CRUISER	91-92	10	
55353	NISSAN	PATHFINDER	87-95	10	
NISSAN	PICKUP	95-97	10		
55354	JEEP	CHEROKEE	97-01	20	
55355	CHEVROLET	VENTURE	97-05	10	
	OLDSMOBILE	SILHOUETTE	97-04	10	
	PONTIAC	MONTANA	99-09	10	
	PONTIAC	TRANS SPORT	97-98	10	
	JEEP	TJ	97-97	10	
JEEP	WRANGLER	91-97	10		
55358	TOYOTA	CAMRY	97-01	5	
55359	CHEVROLET	S10	98-04	5	
	GMC	SONOMA	98-04	5	
	ISUZU	HOMBRE	98-00	5	
55360	HONDA	PASSPORT	98-02	15	
	ISUZU	AMIGO	98-00	15	
	ISUZU	RODEO	98-04	15	
55361	INFINITI	QX4	97-03	20	
	NISSAN	ALTIMA	98-01	20	
	NISSAN	PATHFINDER	96-04	20	

Part#	Make	Model	Years	INS
55362	MERCURY	VILLAGER	98-98	20
	NISSAN	FRONTIER	98-03	20
	NISSAN	QUEST	98-98	20
55363	JEEP	TJ	98-06	10
	JEEP	WRANGLER	98-06	10
55364	CHRYSLER	300M	99-04	15
	CHRYSLER	CONCORDE	98-02	15
	CHRYSLER	LHS	99-99	15
	DODGE	INTREPID	98-04	15
55365	LEXUS	LX470	98-99	5
	TOYOTA	LAND CRUISER	98-99	5
55366	FORD	WINDSTAR	99-03	25
55367	TOYOTA	TUNDRA	00-00	10
55368	DODGE	RAM 1500 VAN	99-00	5
	DODGE	RAM 2500 VAN	99-00	5
	DODGE	RAM 3500 VAN	99-00	5
55369	JEEP	GRAND CHEROKEE	99-04	10
55370	SUBARU	B9 TRIBECA	06-07	10
	SUBARU	FORESTER	98-08	10
	SUBARU	IMPREZA	04-04	10
	SUBARU	LEGACY	96-99	10
	SUBARU	OUTBACK	00-09	10
	SUBARU	TRIBECA	08-14	10
	55371	KIA	SPORTAGE	98-02
55372	CHEVROLET	TRACKER	98-04	5
	SUZUKI	GRAND VITARA	99-05	5
	SUZUKI	SIDEKICK	89-98	5
	SUZUKI	VITARA	99-04	5
	SUZUKI	XL-7	02-06	5
55373	LINCOLN	LS	00-06	20
55375	FORD	TAURUS	00-03	10
	MERCURY	SABLE	00-03	10
55376	CHRYSLER	TOWN & COUNTRY	01-03	15
	CHRYSLER	VOYAGER	01-03	15
	DODGE	CARAVAN	01-03	15
	DODGE	GRAND CARAVAN	01-03	15
	CHEVROLET	EXPRESS 1500	00-02	10
55377	CHEVROLET	EXPRESS 2500	00-02	10
	CHEVROLET	EXPRESS 3500	00-02	10
	GMC	SAVANA 1500	00-02	10
	GMC	SAVANA 2500	00-02	10
	GMC	SAVANA 3500	00-02	10
	55378	TOYOTA	TUNDRA	01-02
55379	TOYOTA	PICKUP	89-95	10
	TOYOTA	TACOMA	95-04	10
55380	MITSUBISHI	MONTERO	01-06	20
55381	CHRYSLER	ASPEN	07-08	5
	CHRYSLER	PACIFICA	04-08	5
	DODGE	DAKOTA	00-09	5
	DODGE	DURANGO	00-08	5
	DODGE	RAM 1500	00-08	5
	DODGE	RAM 1500 VAN	01-03	5
	DODGE	RAM 2500	00-09	5
	DODGE	RAM 2500 VAN	01-03	5
	DODGE	RAM 3500	00-09	5
	DODGE	RAM 3500 VAN	01-03	5
	DODGE	SPRINTER 2500	03-09	5
	DODGE	SPRINTER 3500	03-09	5
	FREIGHTLINER	SPRINTER 2500	03-09	5
	FREIGHTLINER	SPRINTER 3500	03-09	5
JEEP	COMMANDER	06-10	5	
JEEP	GRAND CHEROKEE	00-10	5	
JEEP	LIBERTY	05-08	5	
MITSUBISHI	RAIDER	06-09	5	
55382	JEEP	LIBERTY	02-07	10
55383	BUICK	RENDEZVOUS	02-07	20
	PONTIAC	AZTEK	01-05	20

Part#	Make	Model	Years	INS
55400	HYUNDAI	AZERA	06-11	20
	TOYOTA	HIGHLANDER	01-07	20
55411	CHEVROLET	ASTRO	95-05	15
	CHEVROLET	BLAZER	95-02	15
	GMC	JIMMY	95-01	15
	GMC	SAFARI	95-05	15
	OLDSMOBILE	BRAVADA	96-01	15
55414	JEEP	COMMANDER	06-10	15
55418	TOYOTA	SIENNA	98-03	10
55432	CHEVROLET	COBALT	05-10	15
	CHEVROLET	HHR	06-11	15
	PONTIAC	G5	07-09	15
	PONTIAC	PURSUIT	05-06	15
55434	CHEVROLET	COBALT	05-10	10
	PONTIAC	G5	07-09	10
	PONTIAC	PURSUIT	05-06	10
55441	NISSAN	FRONTIER	05-18	5
	NISSAN	PATHFINDER	05-10	5
	NISSAN	XTERRA	05-15	5
	SUZUKI	EQUATOR	09-12	5
55451	JEEP	GRAND CHEROKEE	05-06	20
55486	TOYOTA	RAV4	96-00	20
55493	CHRYSLER	TOWN & COUNTRY	90-90	10
	DODGE	CARAVAN	89-90	10
	PLYMOUTH	VOYAGER	89-90	10
55495	JEEP	CHEROKEE	76-82	10
55502	ACURA	TSX	06-14	10
	HONDA	ACCORD	03-12	10
55503	HYUNDAI	ENTOURAGE	07-08	25
	KIA	SEDONA	06-14	25
55504	DODGE	RAM 1500	02-05	10
	DODGE	RAM 2500	03-05	10
	DODGE	RAM 3500	03-05	10
55510	CHEVROLET	COLORADO	04-12	10
	GMC	CANYON	04-12	10
	ISUZU	I-280	06-06	10
	ISUZU	I-290	07-08	10
	ISUZU	I-350	06-06	10
	ISUZU	I-370	07-08	10
55513	TOYOTA	HILUX	08-12	10
	TOYOTA	T100	93-98	10
	TOYOTA	TACOMA	05-15	10
55522	TOYOTA	ECHO	00-02	20
	TOYOTA	MATRIX	03-08	20
55525	FORD	WINDSTAR	03-03	25
55528	HYUNDAI	TUCSON	05-09	20
55529	KIA	SPORTAGE	05-10	5
55530	CHRYSLER	PACIFICA	04-08	25
55532	CHRYSLER	PT CRUISER	01-10	20
55534	CHRYSLER	300	05-07	10
	DODGE	CHALLENGER	08-14	10
	DODGE	CHARGER	06-10	10
55537	CHRYSLER	TOWN & COUNTRY	04-07	20
	DODGE	CARAVAN	04-07	20
	DODGE	GRAND CARAVAN	04-07	20
55540	CHEVROLET	EXPRESS 1500	03-14	20
	CHEVROLET	EXPRESS 2500	03-18	20
	CHEVROLET	EXPRESS 3500	03-18	20
	CHEVROLET	EXPRESS 4500	09-17	20
	GMC	SAVANA 1500	03-14	20
	GMC	SAVANA 2500	03-18	20
	GMC	SAVANA 3500	03-18	20
	GMC	SAVANA 4500	09-16	20
55542	TOYOTA	COROLLA	03-13	15
55546	CHRYSLER	300	05-10	15
55550	KIA	SORENTO	03-06	5

Part#	Make	Model	Years	INS
55551	FORD	F-150	04-04	10
	FORD	F-150 HERITAGE	04-04	10
55560	CHEVROLET	EQUINOX	05-06	5
	PONTIAC	TORRENT	06-06	5
55562	DODGE	MAGNUM	05-08	30
55563	LEXUS	RX330	04-06	20
	LEXUS	RX350	07-12	20
55565	NISSAN	OUTLANDER	03-06	25
55567	MAZDA	3	14-18	25
	MAZDA	6	03-08	25
	TOYOTA	CAMRY	07-17	25
	TOYOTA	COROLLA	14-19	25
	TOYOTA	FJ CRUISER	07-14	25
55570	NISSAN	QUEST	04-09	10
55571	NISSAN	MURANO	03-14	25
55580	TOYOTA	SIENNA	04-10	10
55585	HONDA	RIDGELINE	06-14	10
55587	FORD	FIVE HUNDRED	05-07	10
	FORD	FREESTYLE	05-07	10
55593	MAZDA	CX-7	07-12	25
55597	CHRYSLER	ASPEN	07-09	25
	DODGE	DURANGO	04-09	25
56002	SUZUKI	GRAND VITARA	06-12	20
	SUZUKI	SX4	07-11	20
56008	ACURA	RDZ	07-18	30
	HONDA	ACCORD CROSSTOUR	10-11	30
56009	JEEP	GRAND CHEROKEE	07-13	15
56010	MAZDA	MPV	00-06	20
56011	HONDA	ACCORD	11-15	20
	HONDA	CIVIC	06-15	20
	HONDA	FIT	07-13	20
	MAZDA	3	04-13	20
	MAZDA	CX-5	13-15	20
	NISSAN	GALANT	09-12	20
56012	CHEVROLET	EQUINOX	07-09	15
	PONTIAC	TORRENT	07-09	15
	SUZUKI	XL-7	07-08	15
56013	CHEVROLET	MALIBU	04-07	20
	PONTIAC	G6	05-09	20
56014	CHEVROLET	CORVETTE	05-11	20
	FORD	FOCUS	07-11	20
	FORD	RANGER	11-11	20
56015	FORD	TAURUS	08-09	20
	MERCURY	SABLE	08-09	20
56016	MAZDA	2	11-14	30
	MAZDA	5	06-15	30
	MAZDA	CX-9	07-15	30
56017	SATURN	AURA	07-09	20
56018	SATURN	VUE	02-07	15
56020	FORD	E-150	04-14	15
	FORD	E-250	04-14	15
	FORD	E-350 SUPER DUTY	04-18	15
56021	NISSAN	VERSA	07-12	30
56022	NISSAN	ALTIMA	07-15	30
	NISSAN	MAXIMA	07-14	30
	NISSAN	SENTRA	07-12	30
56025	SATURN	OUTLOOK	07-10	15
56026	CHEVROLET	CAPTIVA SPORT	12-12	30
	SATURN	VUE	08-10	30
56027	BUICK	ENCLAVE	08-12	10
	CHEVROLET	MALIBU	08-12	10
	CHEVROLET	TRAVESE	09-12	10
56028	DODGE	AVENGER	08-10	30
56029	HONDA	ELEMENT	07-11	20
56030	SCION	XB	04-06	20
56031	FORD	F-150	97-07	10
	FORD	F-150 HERITAGE	04-04	10

Part#	Make	Model	Years	INS
56032	FORD	F-250 SUPER DUTY	03-07	10
	FORD	F-350 SUPER DUTY	03-07	10
56033	INFINITI	G25	11-12	30
	INFINITI	G35	07-08	30
	INFINITI	G37	09-13	30
	INFINITI	Q60	14-15	30
	NISSAN	ROGUE	08-18	30
56035	PONTIAC	VIBE	09-10	30
	SCION	XB	11-15	30
	TOYOTA	MATRIX	09-13	30
56036	SATURN	ION	03-07	10
56037	DODGE	JOURNEY	09-09	30
56038	ACURA	MDX	07-13	30
56039	NISSAN	ENDEAVOR	04-11	15
56040	SUBARU	ASCENT	19-19	10
	SUBARU	CROSSTREK	16-19	10
	SUBARU	FORESTER	09-18	10
	SUBARU	OUTBACK	10-19	10
	SUBARU	XV CROSSTREK	13-15	10
56041	HYUNDAI	GENESIS	09-14	20
56042	TOYOTA	HIGHLANDER	08-18	20
56043	CADILLAC	CTS	03-07	45
56044	CADILLAC	CTS	08-15	20
56045	VOLVO	XC90	05-14	20
56046	CHEVROLET	IMPALA	06-13	10
	CHEVROLET	IMPALA LIMITED	14-16	10
56047	BUICK	LUCERNE	06-11	10
	FORD	FIESTA	11-18	10
56048	FORD	FUSION	06-12	30
56049	HYUNDAI	ELANTRA	07-10	10
	HYUNDAI	SONATA	06-14	10
	KIA	OPTIMA	09-09	10
56050	HONDA	ACCORD	06-07	10
56051	HONDA	CIVIC	06-15	10
56053	HONDA	ACCORD	03-05	10
56054	CHRYSLER	SEBRING	07-10	45
56055	FORD	TAURUS X	08-09	15
56056	GMC	ACADIA	07-12	15
56057	KIA	OPTIMA	07-08	10
56058	KIA	AMANTI	07-09	45
	KIA	OPTIMA	11-15	45
56059	VOLVO	S80	07-16	45
56060	VOLVO	V70	08-10	45
56061	SUBARU	IMPREZA	08-14	45
56062	SCION	XB	08-10	45
56064	FORD	FIESTA	11-13	40
	LINCOLN	MKS	09-10	40
56066	SUZUKI	SX4	08-09	20
56069	VOLVO	S40	08-11	45
56073	FORD	FREESTAR	04-07	5
	MERCURY	MONTEREY	04-07	5
56074	INFINITI	FX35	09-12	30
	INFINITI	FX37	13-13	30
	INFINITI	FX50	09-13	30
56076	PONTIAC	GRAND PRIX	04-08	15
56077	BUICK	TERRAZA	05-07	15
	CHEVROLET	UPLANDER	05-08	15
	PONTIAC	MONTANA	06-06	15
	SATURN	RELAY	05-07	15
56078	HYUNDAI	SANTA FE	07-12	20
	KIA	FORTE	10-14	20
56079	TOYOTA	AVALON	11-12	45
	TOYOTA	CAMRY	07-11	45
	TOYOTA	VENZA	09-16	45
56081	CHEVROLET	AVEO	04-06	20
	CHEVROLET	AVEO5	07-11	20
	PONTIAC	G3	09-09	20

Part#	Make	Model	Years	INS
56082	MAZDA	MX-5 MIATA	06-15	20
56083	LEXUS	RX350	10-18	5
	LEXUS	RX450H	10-18	5
56084	NISSAN	CUBE	09-14	20
56085	HYUNDAI	GENESIS COUPE	10-16	45
56087	SUZUKI	EQUATOR	09-11	5
56088	FORD	MUSTANG	10-18	40
56089	CHEVROLET	CAMARO	10-11	15
56090	FORD	TRANSIT CONNECT	10-13	45
56091	SUBARU	LEGACY	10-14	20
56092	CHEVROLET	AVEO	07-11	15
56093	FORD	EXPLORER	11-13	45
	FORD	TAURUS	10-18	45
	LINCOLN	MKS	13-16	45
56094	CHEVROLET	EQUINOX	10-17	20
	GMC	TERRAIN	10-17	20
56095	LINCOLN	MKT	10-19	45
56096	CADILLAC	SRX	10-16	5
56098	BUICK	LACROSSE	10-16	45
56099	LEXUS	CT200H	11-16	20
	LEXUS	HS250H	10-12	20
56102	MITSUBISHI	OUTLANDER	07-13	25
56103	SUZUKI	KIZASHI	10-11	20
56104	KIA	BORREGO	09-09	45
56106	TOYOTA	SIENNA	11-17	45
56107	TOYOTA	HIGHLANDER	04-07	20
56108	ACURA	ZDX	10-13	45
56109	DODGE	JOURNEY	12-18	15
56110	FORD	F-150	10-18	10
56111	SUBARU	IMPREZA	08-12	45
56113	BUICK	REGAL	11-13	10
56114	FORD	FIESTA	11-13	10
56116	CHEVROLET	IMPALA	00-05	10
56117	INFINITI	G37	10-10	30
56119	VOLVO	C70	11-13	45
56120	FORD	EDGE	11-14	45
56121	LINCOLN	MKX	11-15	45
56123	HONDA	CR-Z	11-16	45
56124	NISSAN	JUKE	11-16	20
56126	HYUNDAI	ELANTRA	11-16	20
56127	MITSUBISHI	LANCER	10-17	45
	MITSUBISHI	OUTLANDER SPORT	11-18	45
	MITSUBISHI	RVR	11-12	45
56131	KIA	FORTE	11-13	20
56133	DODGE	DURANGO	11-13	10
56135	DODGE	CHARGER	11-14	25
56136	SCION	XD	08-14	20
56137	NISSAN	QUEST	11-18	45
56138	FORD	FOCUS	12-18	45
56139	MAZDA	6	09-13	25
56140	FORD	FOCUS	00-16	45
56141	NISSAN	PATHFINDER	11-11	5
56142	LEXUS	IS250	09-15	40
	LEXUS	IS350	09-16	40
56145	CHRYSLER	300	11-14	15
56147	TOYOTA	PRIUS	04-15	30
56148	NISSAN	NV1500	12-18	45
	NISSAN	NV2500	12-18	45
	NISSAN	NV3500	12-18	45
56149	HYUNDAI	ACCENT	12-17	20
56153	HYUNDAI	VELOSTER	12-17	45
56155	CHEVROLET	SONIC	12-16	45
56156	TOYOTA	PRIUS V	12-17	45
56157	KIA	RIO	12-17	20
56158	HONDA	CR-V	12-16	30
56159	LAND ROVER	RANGE ROVER EVOQUE	12-14	5
56161	HONDA	ODYSSEY	05-10	15

Part#	Make	Model	Years	INS
56163	KIA	SORENTO	11-13	45
56165	TOYOTA	RAV4	06-12	45
56170	HONDA	PILOT	12-15	20
56171	HYUNDAI	AZERA	12-17	45
56172	FORD	EXPLORER	11-18	10
	FORD	POLICE INTER. UTILITY	13-18	10
56173	HONDA	ACCORD	13-17	45
56174	FIAT	500	12-18	45
56176	CHEVROLET	MALIBU	13-15	45
	CHEVROLET	MALIBU LIMITED	16-16	45
56177	CHEVROLET	MALIBU	13-15	45
	CHEVROLET	MALIBU LIMITED	16-16	45
56179	DODGE	DART	13-16	45
56180	CADILLAC	ATS	13-18	45
56181	CHEVROLET	TRaverse	13-17	45
56182	LEXUS	LS460	12-12	40
56184	HYUNDAI	SANTA FE	13-18	45
	KIA	BORREGO	09-09	45
56185	NISSAN	VERSA	14-18	20
56186	KIA	FORTE	14-18	20
	KIA	FORTE KOUP	14-16	20
56188	CHEVROLET	IMPALA	14-18	45
56189	MITSUBISHI	OUTLANDER	14-18	45
56191	FORD	FIESTA	14-18	20
56192	ACURA	MDX	14-18	15
56193	FIAT	500L	14-17	45
56197	CHEVROLET	CAMARO	14-15	15
56199	KIA	CADENZA	14-16	30
56204	MAZDA	3	14-18	45
56205	NISSAN	SENTRA	13-19	45
56206	NISSAN	VERSA NOTE	14-18	30
56207	CADILLAC	CTS	14-18	45
56208	JEEP	CHEROKEE	14-18	45
56209	RAM	PROMASTER 1500	14-18	45
	RAM	PROMASTER 2500	14-18	45
	RAM	PROMASTER 3500	14-18	45
56210	CHEVROLET	EQUINOX	10-17	20
	GMC	TERRAIN	10-17	20
56211	CHRYSLER	200	11-14	45
	DODGE	AVENGER	11-14	45
56212	SCION	FR-S	13-16	45
	SUBARU	BRZ	13-18	45
	SUBARU	IMPREZA	17-18	45
56213	ACURA	RLX	14-17	45
56214	CHEVROLET	CRUZE	11-15	20
	CHEVROLET	CRUZE LIMITED	16-16	20
56215	HONDA	CROSSTOUR	13-15	30
56216	BUICK	ENCORE	13-16	45
56217	TOYOTA	HIGHLANDER	08-18	30
56218	FORD	TRANSIT CONNECT	14-18	45
56219	HONDA	CIVIC	13-15	45
56220	KIA	RONDO	07-12	30
	KIA	SOUL	10-19	30
56222	KIA	RONDO	07-12	15
	KIA	SOUL	10-18	15
56223	MITSUBISHI	MIRAGE	14-17	20
	MITSUBISHI	MIRAGE G4	17-17	20
56224	VOLVO	S60	11-18	45
	VOLVO	S60 CROSS COUNTRY	16-18	45
56225	NISSAN	FRONTIER	05-18	30
	NISSAN	PATHFINDER	05-12	30
	NISSAN	XTERRA	05-15	30
	SUZUKI	EQUATOR	09-12	30
56226	NISSAN	FRONTIER	05-18	30
	NISSAN	PATHFINDER	05-12	30
	NISSAN	XTERRA	05-15	30
	SUZUKI	EQUATOR	09-12	30

Part#	Make	Model	Years	INS
56227	NISSAN	LEAF	11-19	45
56228	KIA	FORTE5	14-18	20
56230	DODGE	CHALLENGER	15-18	45
56231	ACURA	TL	04-08	10
56233	HYUNDAI	ELANTRA	14-18	45
	HYUNDAI	ELANTRA GT	14-17	45
	HYUNDAI	IONIQ	17-18	45
56234	DODGE	CHARGER	15-18	45
56235	CHRYSLER	300	15-18	45
56241	HYUNDAI	SONATA	11-15	30
56242	CHRYSLER	200	15-17	45
56243	SUBARU	CROSSTREK	16-16	45
	SUBARU	XV CROSSTREK	14-15	45
56245	BUICK	ENCLAVE	13-17	20
	CHEVROLET	TRaverse	13-17	20
	GMC	ACADIA	13-16	20
	GMC	ACADIA LIMITED	17-17	20
56246	SUBARU	LEGACY	15-18	45
56247	HYUNDAI	SONATA	15-17	20
56248	INFINITI	Q50	14-19	45
56250	BUICK	VERANO	12-15	20
56251	KIA	SPORTAGE	11-16	45
56252	HYUNDAI	ACCENT	18-18	45
	HYUNDAI	ELANTRA	13-15	45
56253	CHEVROLET	CAMARO	12-13	45
56254	HYUNDAI	ACCENT	13-17	20
56255	BUICK	REGAL	14-17	45
56256	KIA	SORENTO	14-18	45
56257	CHEVROLET	CAPTIVA SPORT	12-15	45
56258	LINCOLN	MKZ	13-19	30
56259	SUBARU	IMPREZA	12-16	45
	SUBARU	WRX	15-19	45
	SUBARU	WRX STI	19-19	45
56261	TOYOTA	SIENNA	15-19	45
56262	LINCOLN	MKC	15-19	40
56263	LEXUS	GS TURBO	17-17	45
	LEXUS	GS200T	16-16	45
	LEXUS	GS300	18-18	45
	LEXUS	GS350	13-18	45
	LEXUS	GS450H	13-18	45
56264	GENESIS	G80	17-17	45
	HYUNDAI	GENESIS	15-16	45
56267	NISSAN	MURANO	15-18	30
56268	LEXUS	NX200T	15-17	45
	LEXUS	NX300H	15-17	45
56269	ACURA	ILX	13-18	45
56270	RAM	PROMASTER CITY	15-18	45
56272	FORD	EDGE	15-18	45
56273	FORD	FOCUS	15-18	45
56274	JEEP	RENEGADE	15-18	45
56275	TOYOTA	PRIUS C	12-18	45
56277	HYUNDAI	TUCSON	10-17	45
56278	FORD	EXPLORER	11-15	20
56279	CHEVROLET	CITY EXPRESS	15-18	45
	NISSAN	NV200	13-19	45
56280	MAZDA	6	14-17	45
56281	INFINITI	JX35	13-13	30
	INFINITI	QX60	14-18	30
	NISSAN	PATHFINDER	13-18	30
56282	TOYOTA	TACOMA	16-18	45
56283	HYUNDAI	ELANTRA	16-16	45
56284	HONDA	HR-V	16-19	45
56285	VOLVO	S90	17-18	30
	VOLVO	XC90	16-18	30
56287	VOLVO	V60	15-18	45
	VOLVO	V60 CROSS COUNTRY	15-18	45
56288	BUICK	VERANO	12-17	45

Part#	Make	Model	Years	INS
56291	HONDA	PILOT	16-19	20
56292	FORD	EDGE	15-18	45
56293	LAND ROVER	RANGE ROVER SPORT	15-17	5
56294	NISSAN	MAXIMA	16-18	45
56295	KIA	RIO	12-16	25
56296	MITSUBISHI	ECLIPSE CROSS	18-18	25
	MITSUBISHI	OUTLANDER	14-18	25
56297	LAND ROVER	DISCOVERY SPORT	15-18	45
56298	LINCOLN	MKX	16-18	45
56299	HONDA	ACCORD	16-17	45
56300	MAZDA	6	18-18	45
	MAZDA	CX-3	16-18	45
	MAZDA	MX-5 MIATA	16-18	45
56301	HONDA	ACCORD	16-17	45
56302	FORD	FUSION	16-18	45
56303	CHEVROLET	SONIC	12-16	45
56305	NISSAN	MURANO	06-07	45
56306	FORD	EXPLORER	11-18	20
	FORD	POLICE INTER. UTILITY	13-18	20
56307	FORD	F-150	15-18	20
56308	FIAT	500X	16-18	45
56309	SCION	IM	16-16	45
	TOYOTA	COROLLA	19-19	45
	TOYOTA	COROLLA IM	17-18	45
56310	MAZDA	CX-5	16-16	45
56311	SCION	IA	16-16	45
	TOYOTA	YARIS IA	17-18	45
56313	CHEVROLET	MALIBU	16-18	45
56314	KIA	OPTIMA	11-18	45
56315	CHEVROLET	VOLT	16-18	45
56316	HYUNDAI	ELANTRA	17-18	45
56317	TOYOTA	PRIUS	16-16	45
56318	CHEVROLET	CAMARO	16-18	45
56319	CHEVROLET	CRUZE	16-18	45
56320	FORD	ESCAPE	17-18	60
56321	KIA	SPORTAGE	17-18	60
56322	CHRYSLER	PACIFICA	17-18	45
56323	CADILLAC	CT6	16-18	45
56324	HONDA	CIVIC	16-18	10
56325	CADILLAC	XT5	17-19	10
	GMC	ACADIA	17-19	10
56326	CADILLAC	XT5	17-19	10
	GMC	ACADIA	17-19	10
56327	FORD	TRANSIT-150	15-18	45
	FORD	TRANSIT-250	15-18	45
	FORD	TRANSIT-350	15-18	45
	FORD	TRANSIT-350 HD	15-18	45
56328	KIA	SORENTO	11-13	45
56329	FORD	EDGE	07-10	45
	FORD	ESCAPE	08-12	45
	FORD	FREESTAR	04-07	45
	LINCOLN	MKX	07-10	45
	MAZDA	TRIBUTE	08-11	45
	MERCURY	MARINER	05-11	45
56330	DODGE	JOURNEY	11-18	45
56331	CHRYSLER	TOWN & COUNTRY	11-16	45
	DODGE	GRAND CARAVAN	11-18	45
56332	HYUNDAI	SANTA FE	13-18	20
	HYUNDAI	SANTA FE XL	19-19	20
	HYUNDAI	VERACRUZ	07-12	20
	KIA	SEDONA	15-16	20
	KIA	SORENTO	07-19	20
56333	CHRYSLER	TOWN & COUNTRY	08-10	30
	DODGE	CALIBER	08-12	30
	DODGE	DURANGO	11-13	30
	DODGE	GRAND CARAVAN	08-10	30
	JEEP	PATRIOT	08-17	30

Part#	Make	Model	Years	INS
56334	DODGE	NITRO	07-12	15
	JEEP	LIBERTY	08-12	15
56335	FORD	ESCAPE	13-16	45
56336	DODGE	DURANGO	14-18	30
56338	MAZDA	CX-9	16-19	45
56339	NISSAN	ALTIMA	16-18	45
56340	BUICK	LACROSSE	05-09	10
56341	HONDA	CIVIC	01-05	45
56342	NISSAN	QUEST	11-17	45
56343	FORD	FLEX	09-19	45
56344	JEEP	COMPASS	11-16	45
56345	FORD	ESCAPE	05-07	45
56345	MAZDA	TRIBUTE	05-06	45
56346	HYUNDAI	SANTA FE	07-12	20
56347	HYUNDAI	ENTOURAGE	07-09	45
	KIA	SEDONA	06-14	45
56348	HYUNDAI	TUCSON	10-18	45
56349	TOYOTA	TACOMA	16-18	45
56350	TOYOTA	AVALON	13-18	45
	TOYOTA	RAV4	13-18	45
56351	FORD	FUSION	13-18	45
56352	FIAT	500X	16-18	45
56353	TOYOTA	PRIUS	16-18	45
56354	CHEVROLET	CRUZE	17-18	45
56355	VOLVO	XC60	10-17	45
56356	BUICK	LACROSSE	17-17	45
56357	INFINITI	JX35	13-13	30
	INFINITI	QX60	14-18	30
	NISSAN	PATHFINDER	13-17	30
56358	VOLKSWAGEN	TIGUAN	12-16	45
56359	LINCOLN	CONTINENTAL	17-18	45
56360	VOLKSWAGEN	GOLF ALLTRACK	17-17	45
56361	BUICK	ENVISION	16-18	45
56362	HYUNDAI	SONATA	16-17	30
56363	BUICK	ENCORE	17-19	45
56364	BUICK	ENVISION	16-19	10
56365	HONDA	PILOT	09-11	20
	HONDA	RIDGELINE	17-19	20
56366	HONDA	PILOT	09-11	20
	HONDA	RIDGELINE	17-19	20
56367	SUBARU	IMPREZA	17-18	45
56368	SUBARU	IMPREZA	12-16	45
56369	JEEP	COMPASS	17-18	45
56370	HONDA	CR-V	17-18	45
56371	TOYOTA	PRIUS PRIME	17-18	45
56372	CHEVROLET	SONIC	17-18	45
56374	VOLKSWAGEN	GOLF R	17-17	45
	VOLKSWAGEN	PASSAT	12-15	45
56375	CHEVROLET	EQUINOX	18-18	20
	GMC	TERRAIN	18-18	20
56376	KIA	NIRO	17-18	45
56377	MAZDA	CX-5	17-18	45
56378	HONDA	ODYSSEY	11-17	20
56379	INFINITI	QX30	17-19	45
56380	VOLKSWAGEN	BEETLE	12-18	45
56381	HYUNDAI	IONIQ	17-18	45
56382	HONDA	ODYSSEY	18-19	20
56383	VOLKSWAGEN	ATLAS	18-18	45
56384	TOYOTA	C-HR	18-18	45
56385	TOYOTA	YARIS	15-18	45
56386	VOLVO	XC70	08-16	45
56387	CHEVROLET	MALIBU	16-18	45
56388	VOLKSWAGEN	PASSAT	16-18	45
56389	BUICK	REGAL TOURX	18-18	45
56390	HYUNDAI	SONATA	16-18	30
56391	VOLKSWAGEN	GOLF ALLTRACK	17-17	45

Part#	Make	Model	Years	INS
56393	BUICK	ENCLAVE	18-19	20
	CHEVROLET	TRAVERSE	18-19	20
56394	BUICK	ENCLAVE	18-19	20
	CHEVROLET	TRAVERSE	18-19	20
56395	HONDA	FIT	15-19	45
56396	HONDA	CIVIC	16-18	45
56397	NISSAN	ROGUE SPORT	17-19	45
56398	VOLVO	V70	08-10	45
56399	CHRYSLER	PACIFICA	17-18	45
56400	NISSAN	VERSA	13-18	45
56401	NISSAN	PATHFINDER	18-18	30
56402	HONDA	ACCORD	18-18	45
56403	VOLKSWAGEN	TIGUAN	18-18	45
56405	VOLKSWAGEN	GTI	18-18	45
56406	JEEP	CHEROKEE	19-19	45
56407	JEEP	WRANGLER	18-18	25
56510	CHEVROLET	COLORADO	04-12	10
	GMC	CANYON	04-12	10
	ISUZU	I-280	06-06	10
	ISUZU	I-290	07-08	10
	ISUZU	I-350	06-06	10
	ISUZU	I-370	07-08	10
56513	TOYOTA	HILUX	08-12	10
	TOYOTA	T100	93-98	10
	TOYOTA	TACOMA	05-15	10
56594	CHEVROLET	EQUINOX	10-17	20
	GMC	TERRAIN	10-17	20
56673	FORD	FREESTAR	04-07	5
	MERCURY	MONTEREY	04-07	5



**TESTED.  
PROVEN.  
SAFE.**

CURT products are thoroughly tested and proven safe to give your customers confidence for the road ahead. That is why we continue to uphold the value of American manufacturing and why we maintain dedicated testing and engineering teams for continuous improvement.

Our goal isn't just to produce a stronger hitch or a more dependable wiring harness. We want to give our consumers the means to enjoy their lifestyle. We want to give hardworking contractors a solid foundation to grow their business, diehard sportsmen a shot at that next big adventure and ordinary families an unforgettable vacation.

Whether they're towing 30,000 pounds or packing up for a weekend getaway, CURT offers your customers the freedom to pursue their passion and the peace of mind to enjoy every mile of it.



If you're looking for quality trailer hitches and towing, visit our website.