

DORMAN[®]



MEDIUM DUTY PRODUCT GUIDE

FREIGHTLINER & INTERNATIONAL



FREIGHTLINER COVERAGE

DORMAN HAS LEADING COVERAGE FOR FREIGHTLINER MEDIUM DUTY VEHICLES WITH OVER 35 SKUS TO REPAIR UNDERHOOD ENGINE COMPONENTS, EXTERIOR AND INTERIOR BODY PARTS, FUEL AND EMISSIONS, LIGHTING AND MORE...

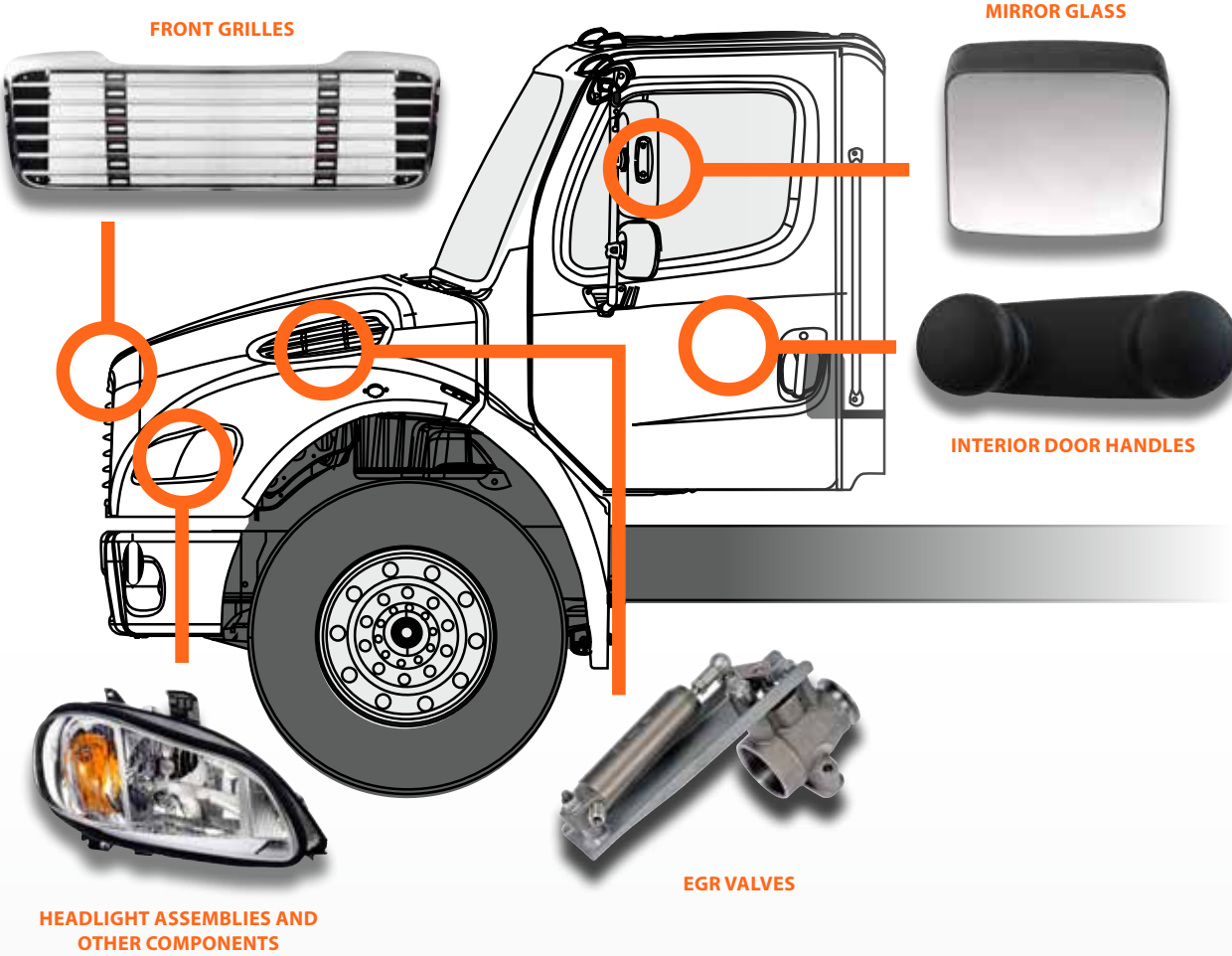

LOOK FOR ALL THESE FREIGHTLINER MEDIUM DUTY STYLE VEHICLES:



SCHOOL BUSES



BOX TRUCKS



STRAIGHT TRUCKS



FLATBED TRUCKS



BUCKET TRUCKS



UTILITY TRUCKS

FREIGHTLINER

Body - Exterior	
Bumper End, Left Hand, Steel	242-5288
	
Applications:	M2
Years:	2009 - 2012
Position:	Left
Notes:	
OE Number:	A21-27811-016

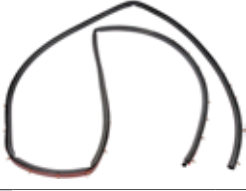
Body - Exterior	
Cab Door Weather Strip	750-5203
	
Applications:	M2
Years:	2002 - 2015
Position:	Driver side
Notes:	
OE Number:	A1845220000

Body - Exterior	
Cab Door Weather Strip	750-5206
	
Applications:	M2
Years:	2002 - 2015
Position:	Passenger Side
Notes:	
OE Number:	A1845220001

Body - Exterior	
Grille	242-5208
	
Applications:	M2
Years:	2003 - 2015
Position:	
Notes:	Chrome, Includes Mounting Hardware and Bug Screen
OE Number:	A1714787001

Body - Exterior	
Handle - Exterior Door	760-5207
	
Applications:	M2 & Cascadia
Years:	2008 - 2011
Position:	Front Right
Notes:	Black
OE Number:	A18-47729-003, A18-53241-001

Body - Exterior	
Handle - Exterior Door	760-5208
	
Applications:	M2 & Cascadia
Years:	2008 - 2011
Position:	Front Left
Notes:	Black
OE Number:	A1847729000, A1847729002, A18-53241-000

Body - Exterior	
Heavy Duty Rear Differential Breather Kit	924-5213
	
Applications:	Rockwell and Meritor Differentials
Years:	1981 - 2014
Position:	Rear
Notes:	
OE Number:	KIT2902

Body - Exterior	
Mirror Glass - Door	955-5201
	
Applications:	M2 & Columbia
Years:	2002 - 2011
Position:	Left, Right
Notes:	w/Two Piece Power Mirror Assembly, Heated Spot Mirror
OE Number:	A2259713001

Body - Exterior	
Truck Cab Side Step	157-5202
	
Applications:	M2 & Cascadia
Years:	2003 - 2015
Position:	
Notes:	w/60 Gallon Tank (23 In. Diameter)
OE Number:	A2257757090

Body - Exterior	
Truck Cab Side Step	157-5203
	
Applications:	M2, FLD & Cascadia
Years:	1998 - 2015
Position:	
Notes:	w/100 Gallon Tank (25 In. Diameter)
OE Number:	A2257757150

Brake	
Brake Hydraulic Hose	H622114-BX
	
Applications:	4000 series
Years:	2002 - 2010
Position:	Rear Left; Rear Right
Notes:	38 In. Length
OE Number:	A12-18220-000

EGR & Underhood	
Air Inlet Manifold Pressure Sensor	904-7033
	
Applications:	M2, Argosy, FL series, Century, Columbia, Coronado & Cascadia
Years:	1999 - 2001
Position:	
Notes:	Caterpillar C12 engines
OE Number:	1619929, 1946724

FREIGHTLINER

EGR & Underhood	
Air Inlet Manifold Pressure Sensor	904-7037
	
Applications:	M2
Years:	2003 - 2011
Position:	
Notes:	Caterpillar C11 engines
OE Number:	2393478

EGR & Underhood	
Ambient Air Pressure Sensor	904-7126
	
Applications:	M2
Years:	2010 - 2014
Position:	
Notes:	Cummins L10, C11 engines
OE Number:	4902720

EGR & Underhood	
Boost Pressure Sensor	904-7244
	
Applications:	M2, Argosy, FL series, Century, Columbia, Coronado & Cascadia
Years:	1999 - 2003
Position:	
Notes:	Detroit Diesel Series 60 engines
OE Number:	23522322

EGR & Underhood	
Boost Pressure Sensor	904-7256
	
Applications:	M2, Centry, Classic & Columbia
Years:	2002 - 2007
Position:	
Notes:	Mercedes-Benz MBE 4000 series engines
OE Number:	A0041537028

EGR & Underhood	
Camshaft Timing Sensor	904-7017
	
Applications:	M2, Argosy, FL series, Century, Columbia, Coronado & Cascadia
Years:	2004 - 2005
Position:	
Notes:	Caterpillar C15 engines
OE Number:	2016617

EGR & Underhood	
Camshaft Timing Sensor	904-7038
	
Applications:	M2, Argosy, FL series, Century, Columbia, Coronado & Cascadia
Years:	2000 - 2001
Position:	
Notes:	Caterpillar C12 engines
OE Number:	1918304

EGR & Underhood	
Camshaft Timing Sensor	904-7251
	
Applications:	M2, Argosy, FL series, Century, Columbia, Coronado & Cascadia
Years:	1986 - 2003
Position:	
Notes:	Detroit Diesel Series 60 engines
OE Number:	08929388, A9042031202

EGR & Underhood	
Copper Drain Plug Gasket	095-5002CD
	
Applications:	Columbia, FLD, M2
Years:	1981 - 2010
Position:	
Notes:	Cummins N14, L10 engines
OE Number:	67946

EGR & Underhood	
Crank Case Pressure Sensor	904-7119
	
Applications:	M2
Years:	2007 - 2016
Position:	
Notes:	Cummins ISB, ISC engines
OE Number:	4984575

EGR & Underhood	
EGR Cooler Gasket Kit	904-5013
	
Applications:	M2 & MT
Years:	2007 - 2010
Position:	
Notes:	Cummins ISB Engine
OE Number:	4955518NX

EGR & Underhood	
EGR Valve	904-5073
	
Applications:	M2, Centry, Classic & Columbia
Years:	2003 - 2006
Position:	
Notes:	MBE 4000 Mercedes Engine
OE Number:	RA4601420419

EGR & Underhood	
Engine Coolant Temperature Sensor	904-7039
	
Applications:	M2, Argosy, FL series, Century, Columbia, Coronado & Cascadia
Years:	1994 - 1999
Position:	
Notes:	Caterpillar 3406 engines
OE Number:	1022240

EGR & Underhood	
Engine Crankshaft Position Sensor	904-7020
	
Applications:	M2, Argosy, FL series, Century, Columbia, Coronado & Cascadia
Years:	2000 - 2004
Position:	Rear Left
Notes:	Caterpillar 3126 engines
OE Number:	1194142, 1693300, 2454630

EGR & Underhood	
Engine Crankshaft Position Sensor	904-7021
	
Applications:	Columbia, Condor, M2
Years:	2004 - 2006
Position:	
Notes:	Caterpillar C11 engines
OE Number:	2016615

EGR & Underhood	
Engine Crankshaft Position Sensor	904-7024
	
Applications:	M2, Argosy, FL series, Century, Columbia, Coronado & Cascadia
Years:	2003 - 2004
Position:	
Notes:	Caterpillar C15 engines
OE Number:	1918303

EGR & Underhood	
Engine Oil Pressure Sensor	904-7027
	
Applications:	M2, Argosy, FL series, Century, Columbia, Coronado & Cascadia
Years:	2004 - 2005
Position:	
Notes:	Caterpillar C15 engines
OE Number:	1946725

EGR & Underhood	
Engine Oil Pressure Sensor	904-7031
	
Applications:	M2, Argosy, FL series, Century, Columbia, Coronado & Cascadia
Years:	2003 - 2006
Position:	
Notes:	Caterpillar C15 engines
OE Number:	2244535

EGR & Underhood	
Exhaust Manifold Kit	674-5002
	
<i>Includes Required Gaskets And Hardware</i>	
Applications:	M2, Argosy, FL series, Century, Columbia, Coronado & Cascadia
Years:	2000 - 2004
Position:	
Notes:	Caterpillar C15 engines
OE Number:	1501914, CT1333359

EGR & Underhood	
Fuel Pressure Sensor	904-7018
	
Applications:	M2, Argosy, FL series, Century, Columbia, Coronado & Cascadia
Years:	2006 - 2008
Position:	
Notes:	Caterpillar C15 engines
OE Number:	2482168, 2842728

EGR & Underhood	
Fuel Pressure Sensor	904-7029
	
Applications:	M2
Years:	2005 - 2007
Position:	
Notes:	Caterpillar C7 engines
OE Number:	2482169

EGR & Underhood	
Heavy Duty Power Steering Reservoir	603-5206
	
Applications:	M2
Years:	2008 - 2014
Position:	
Notes:	2 Quart Capacity
OE Number:	A1414796003, A1419133000

EGR & Underhood	
Throttle Body Motor	341-5001
	
Applications:	M2, Argosy, FL series, Century, Columbia, Coronado & Cascadia
Years:	1987 - 2015
Position:	
Notes:	Remanufactured
OE Number:	A4600980210, A4600980310, RA4600900065

EGR & Underhood	
Transmission Speed Sensor	904-7026
	
Applications:	Columbia, Condor, M2
Years:	2004 - 2006
Position:	
Notes:	Caterpillar C11 engines
OE Number:	2016616

EGR & Underhood	
Turbocharger Compressor Outlet Temp Sensor	904-7255
	
Applications:	M2, Argosy, FL series, Century, Columbia, Coronado & Cascadia
Years:	1996 - 2014
Position:	
Notes:	Detroit Diesel Series 60 engines
OE Number:	23527813

FREIGHTLINER

Fluid Reservoirs & Caps	
Coolant Reservoir	603-5202
	
Applications:	M2
Years:	2005 - 2011
Position:	
Notes:	Includes caps, pump, and level sensors (where applicable)
OE Number:	05-21178-000, 05-23195-000, 05-23195-001, Z05-30740-000, Z05-30740-001

Fluid Reservoirs & Caps	
Coolant Reservoir	603-5207
	
Applications:	M2
Years:	2012 - 2016
Position:	
Notes:	Includes caps, pump, and level sensors (where applicable)
OE Number:	A0528531000, A0528531001, A0528531002

Fluid Reservoirs & Caps	
Coolant Reservoir Cap	902-5202
	
Applications:	M2
Years:	2005 - 2011
Position:	
Notes:	20 PSI
OE Number:	05-17223-002

Fluid Reservoirs & Caps	
DEF Filler Cap	904-5201
	
Applications:	M2, Argosy, FL series, Century, Columbia, Coronado & Cascadia
Years:	2010 - 2012
Position:	
Notes:	
OE Number:	04-27757-000

Fluid Reservoirs & Caps	
Windshield Washer Reservoir	603-5214
	
Applications:	M2
Years:	2004 - 2010
Position:	
Notes:	Includes caps, pump, and level sensors (where applicable)
OE Number:	A22-58778-000, A2262487000

Fuel	
Fuel Tank Sending Unit	285-5207
	
Applications:	M2, Cascadia, Century, Columbia & Coronado
Years:	2002 - 2012
Position:	Front
Notes:	
OE Number:	A22-43065-003

Fuel	
Fuel Tank Strap	578-5201
	
Applications:	M2, Argosy, FL series, Century, Columbia, Coronado & Cascadia
Years:	2000 - 2011
Position:	
Notes:	23" diameter round tanks
OE Number:	A0338910000

Interior & Door	
Door Check	924-5215
	
Applications:	M2
Years:	2008 - 2012
Position:	
Notes:	
OE Number:	A18-43533-000

Interior & Door	
Door Seal	750-5207
	
Applications:	M2
Years:	2004 - 2015
Position:	Inner
Notes:	Secondary Seal
OE Number:	1848637000, 1863922000

Interior & Door	
Door Seal	750-5208
	
Applications:	M2
Years:	2002 - 2015
Position:	Left, Right
Notes:	Rain Gutter Seal
OE Number:	1845727001, 1863286000

Interior & Door	
Handle - Interior Door	761-5204
	
Applications:	M2, Cascadia & Coronado
Years:	2003 - 2013
Position:	Front Right
Notes:	Black
OE Number:	18-41717-001, 18-48225-001, A18-46490-001

Interior & Door	
Handle - Interior Door	761-5215
	
Applications:	M2, Cascadia & Coronado
Years:	2003 - 2013
Position:	Front Left
Notes:	Chrome
OE Number:	A18-46490-000

FREIGHTLINER

Interior & Door	
Handle - Interior Door	761-5216
	
Applications:	M2, Cascadia & Coronado
Years:	2003 - 2013
Position:	Front Right
Notes:	Chrome
OE Number:	A18-46490-001

Interior & Door	
Handle - Window Crank	775-5202
	
Applications:	M2
Years:	2002 - 2015
Position:	Left, Right
Notes:	Black
OE Number:	A18-43563-000

Lighting	
Headlight Assembly	888-5203
	
Applications:	M2
Years:	2002 - 2014
Position:	Right
Notes:	Bulbs included
OE Number:	A06-35853-001, A06-51039-001, A06-51039-003, A06-75732-001, A06-75732-003, A06-75732-005

Lighting	
Headlight Assembly	888-5204
	
Applications:	M2
Years:	2003 - 2014
Position:	Left
Notes:	Bulbs included
OE Number:	A06-35853-000, A06-51039-000, A06-51039-002, A06-75732-002, A06-75732-004

Lighting	
Headlight Bezel	889-5203
	
Applications:	M2
Years:	2002 - 2016
Position:	Right
Notes:	Chrome
OE Number:	A1714930001

Lighting	
Headlight Bezel	889-5204
	
Applications:	M2
Years:	2002 - 2016
Position:	Left
Notes:	Chrome
OE Number:	A1714930000

Sensors & Switches	
Diesel Particulate Filter Pressure Sensor	904-7127
	
Applications:	M2, Argosy, FL series, Century, Columbia, Coronado & Cascadia
Years:	2010 - 2016
Position:	
Notes:	Cummins ISB, ISX & ISL Engines
OE Number:	2871960

Sensors & Switches	
EGR Pressure Sensor	904-5052
	
Applications:	M2
Years:	2007 - 2014
Position:	
Notes:	Cummins ISB Engine
OE Number:	4921746, 4928594

Sensors & Switches	
Engine Oil Pressure Sensor	904-7013
	
Applications:	M2
Years:	2005 - 2007
Position:	
Notes:	Caterpillar Engine
OE Number:	2482167, 2746719

Sensors & Switches	
Engine Oil Pressure Sensor	904-7135
	
Applications:	M2
Years:	2009 - 2016
Position:	
Notes:	Cummins ISL-G Engine
OE Number:	4921511

Sensors & Switches	
Exhaust Backpressure Sensor	904-7105
	
Applications:	M2 & Cascadia
Years:	2007 - 2017
Position:	
Notes:	Cummins ISB Engine
OE Number:	4921746, 4928594

Sensors & Switches	
Multi Function Switch	978-5201
	
Applications:	M2
Years:	2003 - 2011
Position:	
Notes:	Black
OE Number:	A06-36956-002, A0636956003

FREIGHTLINER

Sensors & Switches	
Sensor - Vehicle Speed	505-5201
	
Applications:	M2, Argosy, FL series, Century, Columbia, Coronado & Cascadia
Years:	1989 - 2011
Position:	
Notes:	w/Merritor Transmission, Screw In Style, w/Internal Tone Ring
OE Number:	SAA85920008

Sensors & Switches	
Turbocharger Speed Sensor	904-7139
	
Applications:	M2
Years:	2009 - 2010
Position:	
Notes:	Cummins ISB Engine
OE Number:	4032315

Sensors & Switches	
Turbocharger Speed Sensor	904-7146
	
Applications:	M2
Years:	2011 - 2016
Position:	
Notes:	Cummins ISB Engine
OE Number:	4032806

Sensors & Switches	
Turbocharger Speed Sensor	904-7240
	
Applications:	M2, Argosy, FL series, Century, Columbia, Coronado & Cascadia
Years:	2003 - 2009
Position:	
Notes:	Cummins ISX Engine
OE Number:	4032068

FEATURED PARTS: FLUID RESERVOIRS



Avoid CSA points by easily replacing cracked or leaking reservoirs.

DORMAN FLUID RESERVOIRS FEATURE THE FOLLOWING BENEFITS:

- #1 IN AFTERMARKET COVERAGE, OFFERING THE MOST EXCLUSIVE SKUS
- ALL RESERVOIRS INCLUDE CAPS AND SENSORS (WHERE APPLICABLE)



CLEAR DESIGN ELIMINATES NEED FOR LEAK PRONE SIGHT GAUGES

PROBLEM

RESERVOIRS TEND TO LEAK FROM THE SIGHT HOLES



SOLUTION

CLEAR DESIGN EASILY MAKES FLUID VIEWABLE



INTERNATIONAL COVERAGE

DORMAN'S COMPREHENSIVE COVERAGE FOR INTERNATIONAL MEDIUM DUTY VEHICLES INCLUDES OVER 80 SKUS TO REPAIR VIRTUALLY ANYTHING THAT BREAKS ON YOUR TRUCK

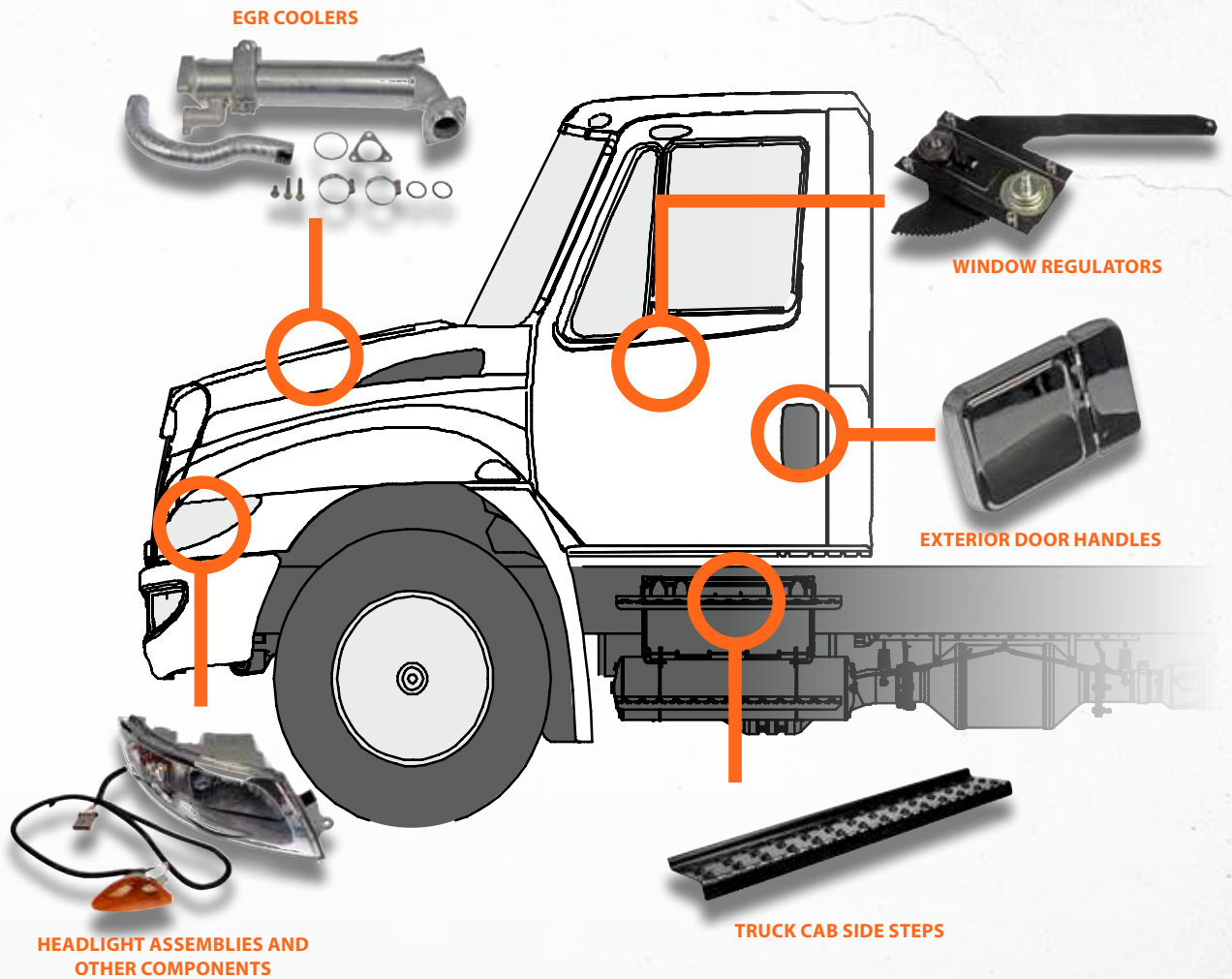

LOOK FOR ALL THESE INTERNATIONAL MEDIUM DUTY STYLE VEHICLES:



INTERNATIONAL

Body - Exterior	
Battery Box Cover	242-5103
	
Applications:	4000 series
Years:	2006 - 2016
Position:	Left
Notes:	
OE Number:	3535374C2

Body - Exterior	
Door Mirror Bracket	924-5105
	
Applications:	3000, 4000, 8000 , LoneStar & ProStar Series
Years:	2002 - 2011
Position:	Left
Notes:	Lower
OE Number:	2597071C91

Body - Exterior	
Door Mirror Bracket	924-5106
	
Applications:	3000, 4000, 8000 , LoneStar & ProStar Series
Years:	2002 - 2012
Position:	Right
Notes:	Lower
OE Number:	2597075C91

Body - Exterior	
Grille	242-5107
	
Applications:	3000, 4000, 7000 & 8000 Series
Years:	1990 - 2016
Position:	Front
Notes:	Chrome, Includes mounting clips
OE Number:	3551015C91, 3551015C92, 3551015C93, 3551015C94, 3551015C95, 3551015C96, 3551015C97, 3551015C98, 3551015C99

Body - Exterior	
Handle - Exterior Door	760-5107
	
Applications:	4000, 7000, 8000 & ProStar Series
Years:	2003 - 2014
Position:	Front Left
Notes:	Black Handle
OE Number:	2511119C91, 2587515C1, 3747735C1

Body - Exterior	
Handle - Exterior Door	760-5108
	
Applications:	4000, 7000, 8000 & ProStar Series
Years:	2003 - 2014
Position:	Front Right
Notes:	Black Handle
OE Number:	2505423C1, 2511120C91, 3747736C1

Body - Exterior	
Headlight Adjusting Screw	924-5104
	
Applications:	3000 Series
Years:	1989 - 2004
Position:	
Notes:	
OE Number:	500565C91

Body - Exterior	
Heavy Duty Fuel Level Sensor / Fuel Sender	285-5107
	
Applications:	4000, 7000, Workstar
Years:	2001 - 2016
Position:	
Notes:	19" Length; 33-240 OHM
OE Number:	2585994C91, 3864393C91, 3864393C92

Body - Exterior	
Heavy Duty Fuel Level Sensor / Fuel Sender	285-5108
	
Applications:	3000, 4000 series
Years:	2002 - 2016
Position:	
Notes:	w/13" Length; 33-240 OHM
OE Number:	2609658C91, 3864394C91, 3864394C92

Body - Exterior	
Hood Hinge Spring	938-5101
	
Applications:	1000, 2000, 3000 & 4000 Series
Years:	1989 - 2001
Position:	
Notes:	Gold
OE Number:	1675762C3

Body - Exterior	
Hood Hinge Spring	938-5102
	
Applications:	2000, 8000 & 9000 Series
Years:	1986 - 2011
Position:	
Notes:	Gold, Long hook
OE Number:	3588532C2

Body - Exterior	
Hood Latch Assembly	315-5101
	
Applications:	1000, 2000, 4000, 7000 & 8000 Series
Years:	1980 - 2011
Position:	Left; Right
Notes:	Contains all brackets and hardware
OE Number:	1689930C91, 1689930C91, 1699929C9, 1699929C91, 1699930C92, 499523C3, 500269A, 500269C1, 500270C1, 500271C1, 500273C1, 500273C2, 500274C1

INTERNATIONAL

Body - Exterior	
Truck Cab Side Step	157-5101
	
Applications:	1000, 3000, 4000, 7000 & 8000 Series
Years:	1966 - 2014
Position:	
Notes:	32.75 In. Long x 8 In. Wide, Direct fit, matching finish
OE Number:	3536371C1, 3536371C2, 4C4Z-9B098-AA

Body - Exterior	
Truck Cab Side Step	157-5102
	
Applications:	3000, 4000, 7000 & 8000 Series
Years:	2001 - 2013
Position:	
Notes:	35.25 In. Long x 6 In. Wide, Direct fit, matching finish
OE Number:	3571060C1

Body - Exterior	
Truck Cab Side Step	157-5104
	
Applications:	1000, 3000, 7000 & 8000 Series
Years:	1997 - 2014
Position:	
Notes:	Lower, Direct fit, matching finish
OE Number:	3578201C1

Body - Exterior	
Truck Cab Side Step	157-5106
	
Applications:	1000, 3000, 4000, 7000 & 8000 Series
Years:	1997 - 2014
Position:	
Notes:	Upper, Direct fit, matching finish
OE Number:	3578200C1

Body - Exterior	
Truck Cab Side Step	157-5111
	
Applications:	3000, 4000, 7000 & 8000 Series
Years:	2001 - 2014
Position:	
Notes:	448mm/17.64 inches, matching finish
OE Number:	3589481C1

Body - Exterior	
Windshield Washer Nozzle	924-5101
	
Applications:	3000, 4000, 7000, 8000 & 9000 Series
Years:	2001 - 2015
Position:	Front
Notes:	Includes washer hose and nozzle
OE Number:	1696499C1

Brake	
ABS Sensor Bracket Assembly	924-5209
	
Applications:	4000 series
Years:	1999 - 2009
Position:	
Notes:	Hydraulic Brakes
OE Number:	1013536000, 3527646C1, 3527646C2, 4C4Z-2A155-AA

Brake	
Brake Hydraulic Hose	H621929-BX
	
Applications:	4000 series
Years:	2002 - 2009
Position:	Rear Left; Rear Right
Notes:	Dual Piston Caliper
OE Number:	3554192C3, 3554192C4, 3870897C4, 4C4Z 2282-CB, 4C4Z-2282-A, 4C4Z-2282-CA, BC4Z-2282-A

Brake	
Brake Hydraulic Hose	H621951-BX
	
Applications:	4000 series
Years:	2000 - 2009
Position:	Front Left; Front Right
Notes:	66 mm Dual Piston Caliper; 33.5 In. Length
OE Number:	3523112C2, 3523112C3, 3AA 611 701A, 4C4Z 2078-BA

Brake	
Brake Hydraulic Hose	H622113-BX
	
Applications:	4000 series
Years:	1999 - 2009
Position:	Front Left; Front Right
Notes:	66 mm Dual Piston Caliper; 33 In. Length
OE Number:	3870750C2, 3870750C3, 4C4Z 2078-F, 4C4Z-2078-D

Brake	
Brake Hydraulic Hose	H622115-BX
	
Applications:	4000 series
Years:	2000 - 2004
Position:	Front Left; Front Right
Notes:	73 mm Dual Piston Caliper
OE Number:	3523113C2, 3523113C3

Brake	
Brake Hydraulic Hose	H622116-BX
	
Applications:	4000 series
Years:	1999 - 2007
Position:	Rear Left; Rear Right
Notes:	Dual Piston Caliper; 40.4 In. Length
OE Number:	3870888C91, 3870888C92

INTERNATIONAL

Brake	
Brake Hydraulic Hose	H622128-BX
	
Applications:	4000 series
Years:	2005 - 2009
Position:	Front Left; Front Right
Notes:	73 mm Dual Piston Caliper
OE Number:	3870751C1, 3870751C2, 3870751C3, 4C4Z 2078-C, 4C4Z 2078-E

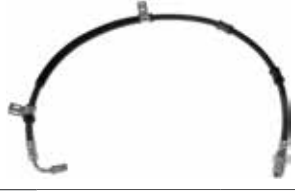
Brake	
Brake Hydraulic Hose	H622129-BX
	
Applications:	4000 series
Years:	2009 - 2016
Position:	Front Left; Front Right
Notes:	4-Piston Caliper
OE Number:	3870758C1, 3870758C2, 9C4Z 2282-E, 9C4Z 2282-J

Brake	
Brake Hydraulic Hose	H622132-BX
	
Applications:	4000 series
Years:	2009 - 2016
Position:	Rear Left; Rear Right
Notes:	4-Piston Caliper
OE Number:	3823326C2, 3870902C1, 3870902C4, 9C4Z 2C245-F, 9C4Z-2C245-G

Brake	
HD ABS Sensor Bracket	970-5600
	
Applications:	4000 series
Years:	1997 - 2016
Position:	
Notes:	U/K Brakes, Air Brakes
OE Number:	15108406, 2037413C2, 3591877C1, 4C4Z-2C218-AA, 745-801534, 801534, 8235-R955458, 8235-R955459, 8235-S8997598154, 8997598154, 8997605104, ATIS8997598154, BAN801534, BW801534, BX801534, R955458, R955459, RWS8997605104, RWS8997598154, S8997598154, S89975981

EGR & Underhood	
Automatic Belt Tensioner (Tensioner Only)	419-001
	
Applications:	VT275, VT365 engines
Years:	2002 - 2012
Position:	
Notes:	Main Belt
OE Number:	1844538C1, 3C2E6B209AB, 3C2E6B209AC, 3C2E6B209DA, 3C2Z6B209A, 3C2Z6B209AA, 3C2Z6B209CA

EGR & Underhood	
Balancer/Pulley Assembly	594-124
	
Applications:	1000, 2000, 3000, 4000 series trucks
Years:	1994 - 2004
Position:	
Notes:	w/8 Rib Serpentine Belt
OE Number:	1826762C92, F5T26316AA, F81Z 6316-AA

EGR & Underhood	
Battery Cover	242-5106
	
Applications:	2000, 3000 & 4000 Series
Years:	1997 - 2005
Position:	
Notes:	
OE Number:	2029260C2

EGR & Underhood	
Cast Iron - Includes Hardware And Gaskets	674-942
	
Applications:	1000, 2000, 3000, 4000 series trucks
Years:	2003 - 2009
Position:	
Notes:	VT365 engines
OE Number:	1840770C1, 3C3Z9430AB

EGR & Underhood	
Cast Iron - Includes Hardware And Gaskets	674-943
	
Applications:	1000, 2000, 3000, 4000 series trucks
Years:	2003 - 2009
Position:	
Notes:	VT365 engines
OE Number:	1840994C1, 3C3Z9431AB

EGR & Underhood	
Clutch Switch With Integral Wiring Harness And Connector	901-5103
	
Applications:	4000, 7000, Workstar
Years:	2001 - 2016
Position:	
Notes:	
OE Number:	2505658C91

EGR & Underhood	
Crankshaft Position Sensor	917-710
	
Applications:	4000, 5000, 7000, 8000 series trucks
Years:	2003 - 2012
Position:	
Notes:	DT466, MaxxForceDT, 9, DT570 engines
OE Number:	1835985C92, 1835985C92, 8C3Z12K073A, 8C3Z12K073A

EGR & Underhood	
Diesel EGR Cooler	904-218
	
Applications:	1000, 2000, 3000, 4000 series trucks
Years:	2005 - 2012
Position:	
Notes:	VT365 engines
OE Number:	1845145C96, 1845145C97, 1845145C99, 4C3Z 9P456-AA, 4C3Z 9P456-AC, 4C3Z 9P456-AH, 4C3Z-9P456-AF, 4C3Z9P456AJ

INTERNATIONAL

EGR & Underhood	
Diesel Fuel Filter Cap and Gasket	904-203
	
Applications:	1000, 2000, 3000, 4000 series trucks
Years:	2003 - 2009
Position:	
Notes:	VT365 engines
OE Number:	1831193C91, F81Z 9G270-BA

EGR & Underhood	
Diesel Fuel Injector O-ring Kit	904-206
	
Applications:	4000, 5000, 7000, 8000 series trucks
Years:	1994 - 2006
Position:	
Notes:	DT466 engines
OE Number:	1833564C91, 1833564C92, XC3A-9229-AB, XC3Z 9229-AB

EGR & Underhood	
Diesel Fuel Injector O-ring Kit	904-207
	
Applications:	1000, 2000, 3000, 4000 series trucks
Years:	2003 - 2009
Position:	
Notes:	VT365 engines
OE Number:	1843682C91, 3C3Z 9229-AA

EGR & Underhood	
Diesel Valve Cover Gasket Kit	615-201
	
Applications:	1000, 2000, 3000, 4000 series trucks
Years:	1998 - 2002
Position:	
Notes:	T444E engines
OE Number:	1379998, 1826703C1, F81Z 9D930-AB, F81Z-6584-AA

EGR & Underhood	
Diesel Valve Cover Gasket Kit	615-202
	
Applications:	1000, 2000, 3000, 4000 series trucks
Years:	1994 - 2000
Position:	
Notes:	T444E engines
OE Number:	1379999, 1818350C2, F4TZ 9D930-K, F4TZ-6584-A

EGR & Underhood	
EGR Cooler	904-5020
	
Applications:	International DT466, DT570, HT570
Years:	2004 - 2009
Position:	
Notes:	Round Cooler; 11.5 Inches Long. Includes all gaskets and hardware
OE Number:	1871733C92, 1871733C93, 1871733C95

EGR & Underhood	
EGR Cooler	904-5023
	
Applications:	International DT466, DT570, HT570
Years:	2004 - 2009
Position:	
Notes:	Square Cooler; 21 Inches Long. Includes all gaskets and hardware
OE Number:	1832542C91, 1832542C92, 1832542C93, 1832542C94

EGR & Underhood	
EGR Cooler Water Outlet	904-199
<i>from Oil Cooler Water Outlet Adaptor Hose</i>	
	
Applications:	1000, 2000, 3000, 4000 series trucks
Years:	2003 - 2012
Position:	
Notes:	VT365 engines
OE Number:	1837845C2, 4C4Z 8592-AA

EGR & Underhood	
EGR Cooler/Intake Gasket Kit	904-265
	
Applications:	1000, 2000, 3000, 4000 series trucks
Years:	2002 - 2010
Position:	
Notes:	VT365 engines
OE Number:	1836542C1, 1840701C92, 3C3Z-9433-BJ, 3C3Z-9439-AA, 3C3Z-9T514-AG

EGR & Underhood	
EGR Valve	904-5056
	
Applications:	DT466 Maxforce 9 & 10 Engine
Years:	2007 - 2010
Position:	
Notes:	2003 EPA Standard. Includes gaskets and hardware
OE Number:	1873842C92, 1875808C1, 1878918C1, 1878918C2

EGR & Underhood	
EGR Valve	904-5062
	
Applications:	DT466 Engine
Years:	2003 - 2006
Position:	
Notes:	Exc. 2003 EPA Standard. Includes gaskets and hardware
OE Number:	1842593C91, 1842593C92

EGR & Underhood	
Engine Heater Hose Assembly	626-230
	
Applications:	1000, 2000, 3000, 4000 series trucks
Years:	2003 - 2009
Position:	
Notes:	VT365 engines
OE Number:	1840603C93, 3C3Z8592AB

INTERNATIONAL

EGR & Underhood	
Engine Mount	917-5101
	
Applications:	1000 & 4000 Series
Years:	1999 - 2004
Position:	Front Left; Front Right; Rear Left; Rear Right
Notes:	
OE Number:	479237C1

EGR & Underhood	
Engine Oil Pressure Sensor	904-7512
	
Applications:	1000, 2000, 3000, 4000 series trucks
Years:	2002 - 2012
Position:	
Notes:	VT365 engines
OE Number:	1834538C91, 1839415C91, 1872556C91

EGR & Underhood	
Exhaust Gas Recirculation Cooler	904-5031
	
Applications:	4000, 5000, 7000, 8000 series trucks
Years:	2008 - 2010
Position:	
Notes:	MaxxForce DT engines
OE Number:	1872759C1, 1876262C91, 1876262C92, 1876262C93, 1876262C94, 1876262C95, 1876262C96, 1876262C97, 1876445C94, 4307362R91, 7090545C91

EGR & Underhood	
Exhaust Gas Recirculation Cooler	904-5032
	
Applications:	4000, 5000, 7000, 8000 series trucks
Years:	2008 - 2010
Position:	
Notes:	MaxxForce DT engines
OE Number:	1876261C98, 1876261C99, 1878616C1, 7090595C91

EGR & Underhood	
Exhaust Manifold Kit	674-383
	
Applications:	1000, 2000, 3000, 4000 series trucks
Years:	1998 - 2004
Position:	
Notes:	T444E engines
OE Number:	1820503C1, FSUZ 9431-A

EGR & Underhood	
Exhaust Manifold Kit	674-745
	
Applications:	1000, 2000, 3000, 4000 series trucks
Years:	1996 - 2004
Position:	
Notes:	T444E engines
OE Number:	1831025C1, F81Z 9430-AA

EGR & Underhood	
Exhaust Manifold Kit	674-5006
<i>Includes Required Gaskets And Hardware</i>	
	
Applications:	4000, 5000, 7000, 8000 series trucks
Years:	1995 - 2002
Position:	
Notes:	DT466 engines
OE Number:	1814149C2, 1818561C3, 1818561C4

EGR & Underhood	
Exhaust Up Pipe - Right Hand Side	679-009
	
Applications:	1000, 2000, 3000, 4000 series trucks
Years:	2003 - 2004
Position:	
Notes:	VT365 engines
OE Number:	1839135C1, 3C3Z 6K854-AA

EGR & Underhood	
Exhaust Up Pipe - Right Hand Side	679-010
	
Applications:	1000, 2000, 3000, 4000 series trucks
Years:	2004 - 2005
Position:	
Notes:	VT365 engines
OE Number:	1843175C1, 4C3Z 6K854-BA

EGR & Underhood	
Fuel Filter Cap and Gasket	904-208
	
Applications:	1000, 2000, 3000, 4000 series trucks
Years:	1996 - 2004
Position:	
Notes:	T444E engines
OE Number:	1825190C91, FSTZ-9G270-A

EGR & Underhood	
Fuel Injection Control Module Repair Kit - No Flash Required	904-229
	
Applications:	CE, 1000, 2000, 4000, 5000, 7000 & 8000 Series
Years:	2004 - 2009
Position:	
Notes:	VT275, DT466, DT570, HT570 engines
OE Number:	1845117C2, 1845117C2, 1845117C6, 1845117C6, 3C3Z12B599AARM, 3C3Z12B599AARM, 4C3Z12B599AARM, 4C3Z12B599AARM, 4C3Z12B599AARM, 4C3Z12B599AARM, 4C3Z12B599AARM, 5010121R94, 5010121R94

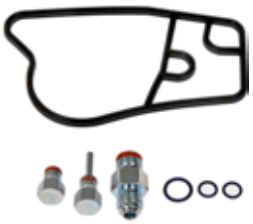
EGR & Underhood	
Fuel Pump Repair Kit	285-5102
	
Applications:	4000, 5000, 7000, 8000 series trucks
Years:	1994 - 2013
Position:	
Notes:	DT466 engines
OE Number:	1825685C1, 1842906C92

INTERNATIONAL

EGR & Underhood	
Heavy Duty Coolant Tank Cap	902-5102
	
Applications:	International trucks w/ 15 psi
Years:	2003 - 2016
Position:	
Notes:	
OE Number:	3578833C2, 3578833C3, 4C4Z-8100-B

EGR & Underhood	
Heavy Duty Diesel Engine Oil Cooler	904-5101
	
Applications:	4000, 5000, 7000, 8000 series trucks
Years:	2006 - 2009
Position:	
Notes:	DT466 engines
OE Number:	1842417C91, 1842417C92, 1842417C93, 1842417C94, 1842418C3, 1842530C93

EGR & Underhood	
Hpop Reservoir Gasket	635-128
	
Applications:	1000, 2000, 3000, 4000 series trucks
Years:	1996 - 2004
Position:	
Notes:	T444E engines
OE Number:	1831316C2, YC3Z 6619 BA

EGR & Underhood	
Injection Control Pressure Sensor	904-500
	
Applications:	1000, 2000, 3000, 4000 series trucks
Years:	1998 - 2004
Position:	
Notes:	T444E engines
OE Number:	1807329C92, F6T29F838A

EGR & Underhood	
Injection Pressure Regulator Seal Kit	904-232
	
Applications:	4000, 5000, 7000, 8000 series trucks
Years:	1994 - 2005
Position:	
Notes:	DT466 engines
OE Number:	1825806C91, 1825806C92, 4C3Z-9C977-AA

EGR & Underhood	
Magnet Camshaft Position Sensor	917-732
	
Applications:	1000, 2000, 3000, 4000 series trucks
Years:	1994 - 2003
Position:	
Notes:	T444E engines
OE Number:	1821720C99, 1876735C91, 1876736C91, F4TZ 12K073-C

EGR & Underhood	
Magnet Camshaft Position Sensor	917-780
	
Applications:	4000, 5000, 7000, 8000 series trucks
Years:	2004 - 2013
Position:	
Notes:	DT466, MaxxForce DT, HT570 engines; Caterpillar C13 engines
OE Number:	1828345C91, 1828345C91, 3C3Z 6C315-AA, 3C3Z 6C315-AA, DY-985, DY-985

EGR & Underhood	
Oil Cooler Gasket Kit Includes Gaskets and O-rings	904-224
	
Applications:	1000, 2000, 3000, 4000 series trucks
Years:	1994 - 2003
Position:	
Notes:	T444E engines
OE Number:	1824735C1, 1824736C1, 1831665C1, 1831666C1, 1C3Z 6C610-BA, 1C3Z 6K649-BA, F4TZ 6A636-A, F7TZ 6A636-AAA

EGR & Underhood	
Oil Cooler Kit Includes Required Gaskets and O-rings	904-225
	
Applications:	1000, 2000, 3000, 4000 series trucks
Years:	1994 - 2003
Position:	
Notes:	T444E engines
OE Number:	1804378C2, 1804414C1, 1807563C1, 1815904C1, 1815904C2, 1836542C1, 1840053C96, 1C3Z 6A642-AA, 1C3Z 6C610-BA, 1C3Z 6K649-BA, F4TZ 6A636-A, F7TZ 6A636-AAA

EGR & Underhood	
Oil Pan Dipstick Flange Kit	904-256
	
Applications:	1000, 2000, 3000, 4000 series trucks
Years:	1994 - 2004
Position:	
Notes:	T444E engines
OE Number:	3C3Z-6753-AA, F4TZ-6751-A, F4TZ-6751-B, F4TZ-6753-A

EGR & Underhood	
Oil Temperature Sensor	904-7526
	
Applications:	1000, 2000, 3000, 4000 series trucks
Years:	1995 - 2011
Position:	
Notes:	DT466, MaxxForce DT engines
OE Number:	1889995C91

EGR & Underhood	
Oil/Fuel Filter Cap And Gasket	904-204
	
Applications:	4000, 5000, 7000, 8000 series trucks
Years:	2003 - 2011
Position:	
Notes:	MaxxForce 9, 10, DT engines
OE Number:	1837497C1, 1837497C1, 1840754C91, 1840754C91, 3C3Z 9G270BA, 3C3Z 9G270BA, 3C3Z-6766-CA, 3C3Z-6766-CA, 3C3Z-9G270-A, 3C3Z-9G270-A

INTERNATIONAL

EGR & Underhood	
Oil/Fuel Filter Cap And Gasket	904-204
	
Applications:	1000, 2000, 3000, 4000 series trucks
Years:	2008 - 2013
Position:	
Notes:	VT365 engines
OE Number:	1837497C1, 1837497C1, 1840754C91, 1840754C91, 3C3Z 9G270BA, 3C3Z 9G270BA, 3C3Z-6766-CA, 3C3Z-6766-CA, 3C3Z-9G270-A, 3C3Z-9G270-A

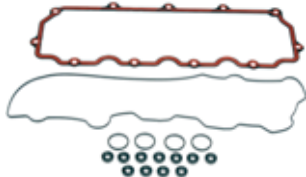
EGR & Underhood	
Rocker Box And Valve Cover Gasket Kit	904-401
	
Applications:	1000, 2000, 3000, 4000 series trucks
Years:	2002 - 2009
Position:	
Notes:	VT365 engines
OE Number:	1836517C1, 3C3Z-6584-AA

EGR & Underhood	
Turbocharger Installation Gasket Kit	904-234
	
Applications:	1000, 2000, 3000, 4000 series trucks
Years:	2002 - 2010
Position:	
Notes:	VT365 engines
OE Number:	1840053C96, 3C3Z-9T514-AD

EGR & Underhood	
Turbocharger Installation Gasket Kit	904-270
	
Applications:	1000, 2000, 3000, 4000 series trucks
Years:	1999 - 2004
Position:	
Notes:	T444E engines
OE Number:	1831658C91, F81Z-6N653-BA

EGR & Underhood	
Turbocharger Oil Feed Line	625-210
	
Applications:	1000, 2000, 3000, 4000 series trucks
Years:	2003 - 2009
Position:	
Notes:	VT365 engines
OE Number:	1845287C95, 3C3Z9T516-A, 3C3Z9T516BA

EGR & Underhood	
Turbocharger Up-Pipe Kit	679-014
	
Applications:	1000, 2000, 3000, 4000 series trucks
Years:	1994 - 2002
Position:	
Notes:	T444E engines
OE Number:	1816124C1, 1824434C1, F4T26K854D, F5T26K854A, F6T26K854A

EGR & Underhood	
Turbocharger Up-Pipe Kit	679-005
<i>Includes Hardware And Gaskets</i>	
	
Applications:	1000, 2000, 3000, 4000 series trucks
Years:	1996 - 2004
Position:	
Notes:	T444E engines
OE Number:	1816103C1, 1820747C1, 1827228C1, 1827268C1, 1827410C1, 1827597C91, F4T26K854C, F4T26K854F, F81Z-6K854EA, F81Z6K854FA, F81Z6N632AA, F81Z6K854AA

Fluid Reservoirs & Caps	
Coolant Reservoir	603-5101
	
Applications:	3000 & 4000 Series
Years:	1995 - 2004
Position:	
Notes:	Includes caps, pump, and level sensors (where applicable)
OE Number:	2002105C2, 2002105C3, 5C4Z8A080AA

Fluid Reservoirs & Caps	
Coolant Reservoir	603-5104
	
Applications:	3000, 4000, 7000 & 8000 Series
Years:	1990 - 2016
Position:	
Notes:	Includes caps, pump, and level sensors (where applicable), w/ dual vacuum ports
OE Number:	2602943C91

Fluid Reservoirs & Caps	
Coolant Reservoir	603-5110
	
Applications:	1000, 4000 & 8000 Series
Years:	1990 - 2016
Position:	Front
Notes:	1 port, Includes caps, pump, and level sensors (where applicable)
OE Number:	2039390C3, 2587324C1, 2591625C92, 2599039C91, 2602872C91, 2602935C91, 3578833C3, 4C4Z8B379A, BC4Z8A080A

Fluid Reservoirs & Caps	
Coolant Reservoir Cap	902-5101
	
Applications:	2000 & 4000 Series
Years:	2002 - 2008
Position:	
Notes:	10 PSI
OE Number:	2039390C3, 4C4Z8100A

Fluid Reservoirs & Caps	
Windshield Washer Reservoir	603-5102
	
Applications:	3000 & 4000 Series
Years:	1997 - 2007
Position:	
Notes:	Includes caps, pump, and level sensors (where applicable)
OE Number:	2033902C91, 2033902C92, 2033903C92

INTERNATIONAL

Fuel	
Fuel Tank Sending Unit	285-5101
	
Applications:	3000, 4000, & 7000 Series
Years:	2001 - 2011
Position:	
Notes:	w/16in Diameter Tank
OE Number:	2585993C91, 3591593C1, 3864392C91, 3864392C92

Fuel	
Fuel Tank Sending Unit	285-5104
	
Applications:	1000, 2000, 3000, 4000, 5000, 7000, 8000, 9000 & ProStar Series
Years:	1997 - 2015
Position:	
Notes:	w/15 In. Deep Tank
OE Number:	476846C1, 476846C2

Fuel	
Fuel Tank Sending Unit	285-5105
	
Applications:	1000, 2000, 3000, 4000, 7000, 8000 & 9000 Series
Years:	1985 - 1991
Position:	
Notes:	Direct fit
OE Number:	497840C94, 497840C95, 497840C96

Fuel	
Fuel Tank Strap	578-5102
	
Applications:	1000, 2000, 3000, 4000, 5000, 7000, 8000, 9000 & ProStar Series
Years:	1997 - 2011
Position:	
Notes:	50 and 60 gallon square tanks
OE Number:	471453C2

Interior & Door	
Accelerator Pedal Assembly	699-5103
	
Applications:	4000, 5000, 7000, 8000 series trucks
Years:	2002 - 2016
Position:	
Notes:	DT466 engines
OE Number:	2606578C91

Interior & Door	
Accelerator Pedal Position Assembly With Sensor	699-5104
	
Applications:	4000, 5000, 7000, 8000 series trucks
Years:	1997 - 2005
Position:	
Notes:	DT466 engines
OE Number:	2608079C91

Interior & Door	
Air Door Actuator	604-5101
	
Applications:	4000, 7000, 8000, LoneStar & ProStar Series
Years:	2001 - 2012
Position:	
Notes:	For Main Cab Unit; Located Inside Cab; w/BEHR HVAC Unit, Mode; Located Inside Cab
OE Number:	2611234C1, 3542606C1

Interior & Door	
Air Door Actuator	604-5106
	
Applications:	4000, 7000, 8000, LoneStar & ProStar Series
Years:	2001 - 2012
Position:	
Notes:	Fresh/Recirculating Air; 2 Pin Connector, Fresh/Recirculating Air; For Main Cab Unit; 2 Pin Connector, Fresh/Recirculating Air; For Main Cab Unit; Located Outside Cab; 2 Pin Connector, Fresh/Recirculating Air; Located Outside Cab; 2 Pin Connector
OE Number:	10-0833, 2113005, 2386, 3542575-C1, 3542575-C2, 640059, MA1710, RD-5-14610-0P

Interior & Door	
Auto / Manual Trans Shift Boot	924-5111
	
Applications:	4000 Series
Years:	1990 - 2004
Position:	
Notes:	
OE Number:	291068C2

Interior & Door	
Blower Motor Speed Resistor	973-5089
	
Applications:	4000 series
Years:	2002 - 2017
Position:	
Notes:	Rectangular; 5 Terminal and 2 Terminal Connectors; I.D. No. 351321621
OE Number:	3626414C1

Interior & Door	
Cruise Control/Horn Button	901-0008
	
Applications:	4000, 7000, Workstar
Years:	2001 - 2016
Position:	Left
Notes:	
OE Number:	2590922C1

Interior & Door	
Dash Board Air Vent	216-5101
	
Applications:	4000, 5000, 7000, 8000 & 9000 Series
Years:	2001 - 2011
Position:	Center; Left; Right
Notes:	Black
OE Number:	3529263C1

INTERNATIONAL

Interior & Door	
Door Hinge Assembly	924-5103
	
Applications:	4000, 8000 & ProStar Series
Years:	2002 - 2016
Position:	Front
Notes:	
OE Number:	3549259C1, 3549259C2

Interior & Door	
Door Seal	750-5102
	
Applications:	3000, 4000, 7000, 8000, LoneStar & ProStar Series
Years:	1990 - 2014
Position:	
Notes:	Primary Door Seal
OE Number:	3508972C6

Interior & Door	
Door Seal	750-5103
	
Applications:	3000, 4000, 7000, 8000, LoneStar & ProStar Series
Years:	1990 - 2014
Position:	Left
Notes:	Secondary Door Seal
OE Number:	3508975C7

Interior & Door	
Door Seal	750-5104
	
Applications:	3000, 4000, 7000, 8000, LoneStar & ProStar Series
Years:	1990 - 2014
Position:	Right
Notes:	Secondary Door Seal
OE Number:	3508976C7

Interior & Door	
Handle - Exterior Door	760-5101
	
Applications:	2000, 3000 & 4000 Series
Years:	1997 - 2006
Position:	Front Left; Front Right
Notes:	Black and Chrome
OE Number:	1680789C91, 3550925C91, 3550931C91

Interior & Door	
Handle - Interior Door	761-5103
	
Applications:	Durastar
Years:	2010 - 2011
Position:	Front Right
Notes:	Black
OE Number:	2505425C1

Interior & Door	
Handle - Interior Door	761-5104
	
Applications:	Durastar
Years:	2010 - 2011
Position:	Front Left
Notes:	Black
OE Number:	2505424C1

Interior & Door	
Handle - Interior Door Pull	761-5105
	
Applications:	3000, 4000 & 7000 Series
Years:	2005 - 2011
Position:	Front Left; Front Right
Notes:	Gray
OE Number:	2505201C1

Interior & Door	
Handle - Window Crank	775-5101
	
Applications:	4000 & DuraStar Series
Years:	2002 - 2009
Position:	Left; Right
Notes:	Black Handle; w/Black Knob
OE Number:	3508990C4

Interior & Door	
Handle - Window Crank	775-5102
	
Applications:	1000, 2000, 3000, 4000, 5000, 7000, 8000 & 9000 Series
Years:	1984 - 2005
Position:	
Notes:	Black
OE Number:	1649776C1

Interior & Door	
Handle - Window Crank	775-5104
	
Applications:	1000, 2000 & 3000
Years:	1962 - 2014
Position:	
Notes:	Chrome
OE Number:	1649776C1

Interior & Door	
Instrument Panel Circuit Board	599-5103
	
Applications:	2000, 3000, 4000 & 8000 Series
Years:	1992 - 2002
Position:	
Notes:	New not remanufactured, fits both electric and mechanical oil pressure gauges
OE Number:	1689995C93, 1689996C93, 2512565C91, 3525074C91, 3525078C91, 3525091C91, 3595124C1, 3595124C2

INTERNATIONAL

Interior & Door	
Seat Cushion Pad	641-5101
	
Applications:	3000, 4000, 7000 & 8000 Series
Years:	2001 - 2016
Position:	
Notes:	Charcoal; Cloth/Vinyl; w/National Seats
OE Number:	2595485C92

Interior & Door	
Seat Cushion Pad	641-5102
	
Applications:	3000, 4000, 7000 & 8000 Series
Years:	2001 - 2016
Position:	
Notes:	Gray; Vinyl; w/National Seats
OE Number:	2505891C92

Interior & Door	
Seat Cushion Pad	641-5104
	
Applications:	4000, 7000 & 8000 Series
Years:	1990 - 2016
Position:	
Notes:	Gray; Cloth/Vinyl; w/National Seats
OE Number:	2505895C92

Interior & Door	
Seat Cushion Pad	641-5106
	
Applications:	3000, 4000, 7000 & 8000 Series
Years:	2001 - 2016
Position:	
Notes:	Charcoal; Vinyl; w/National Seats
OE Number:	2594999C92

Interior & Door	
Steering Wheel Mounted Cruise Control Switch	901-5129
	
Applications:	4000, 7000, 8000, Terrastar
Years:	1990 - 2017
Position:	Right
Notes:	
OE Number:	2598851C1

Interior & Door	
Window Regulator	740-5103
	
Applications:	1000, 2000, 3000, 4000, 7000, 8000 & 9000 Series
Years:	1989 - 2002
Position:	Front Right
Notes:	Manual
OE Number:	1686705C91

Interior & Door	
Window Regulator	740-5104
	
Applications:	1000, 2000, 4000, 7000, 8000 & 9000 Series
Years:	1989 - 2002
Position:	Front Left
Notes:	Manual
OE Number:	1686704C91

Interior & Door	
Window Regulator and Lift Motor Assembly	741-5101
	
Applications:	4000, 7000, 8000 & 9000 Series
Years:	2003 - 2011
Position:	Front Right
Notes:	Power Window Regulator w/Motor, Power Window Regulator w/Motor; Exc. School Bus
OE Number:	3515113C92

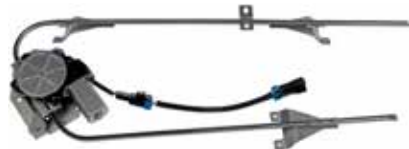
Interior & Door	
Window Regulator and Lift Motor Assembly	741-5102
	
Applications:	4000, 7000, 8000 & 9000 Series
Years:	2003 - 2011
Position:	Front Left
Notes:	Power Window Regulator w/Motor, Power Window Regulator w/Motor; Exc. School Bus
OE Number:	3515112C92

Lighting	
Headlight Assembly	888-5105
	
Applications:	CE, 4000 & 8000 Series
Years:	2002 - 2015
Position:	Right
Notes:	Includes Bulbs; w/Marker Light
OE Number:	3574388C91, 3574388C92, 3574388C93, 3574388C94, 3765681C92, 4020384C91, S-19900

Lighting	
Headlight Assembly	888-5106
	
Applications:	CE, 4000 & 8000 Series
Years:	2002 - 2015
Position:	Left
Notes:	Includes Bulbs; w/Marker Light
OE Number:	3574387C91, 3574387C92, 3574387C93, 3574387C94, 3765692C92, 4020383C91

Lighting	
Headlight Assembly	888-5109
	
Applications:	3000, 4000 & 8000 Series
Years:	2007 - 2011
Position:	Right
Notes:	Includes Bulbs; wo/Marker Light
OE Number:	3565430C91, 3565430C92, 3565430C93, 4020417C91

INTERNATIONAL

Lighting	
Headlight Assembly	888-5110
	
Applications:	3000, 4000 & 8000 Series
Years:	2007 - 2011
Position:	Left
Notes:	Includes Bulbs; wo/Marker Light
OE Number:	3565429C91, 3565429C92, 3565429C93, 4020416C91

Lighting	
Headlight Bezel	889-5101
	
Applications:	3000, 4000 & 8000 Series
Years:	1990 - 2004
Position:	Left
Notes:	Gray
OE Number:	1654293C1, 1661763C1, 3000077C1, 34004277, EE02004024

Lighting	
Headlight Bezel	889-5102
	
Applications:	3000, 4000 & 8000 Series
Years:	1990 - 2004
Position:	Right
Notes:	Gray
OE Number:	1654294C1, 1661764C1, 3000078C1, 34004274, EE02004023

Lighting	
Roof Marker Light	888-5125
	
Applications:	4000, 5000, 7000, 8000, 9000, LoneStar & ProStar Series
Years:	1986 - 2016
Position:	
Notes:	Amber
OE Number:	3529900C97

Lighting	
Turn Signal and Side Marker - Light	888-5112
	
Applications:	3000, 4000 & 8000 Series
Years:	1990 - 2002
Position:	Front Left
Notes:	Amber
OE Number:	1661761C93

Lighting	
Turn Signal and Side Marker - Light	888-5113
	
Applications:	3000, 4000 & 8000 Series
Years:	1990 - 2002
Position:	Front Right
Notes:	Amber
OE Number:	1661762C93

Lighting	
Turn Signal and Side Marker - Light	888-5122
	
Applications:	3000, 4000, 7000, 8000 & DuraStar
Years:	2001 - 2014
Position:	Front Right
Notes:	Hood Mounted
OE Number:	3561966C1

Lighting	
Turn Signal and Side Marker - Light	888-5123
	
Applications:	3000, 4000, 7000, 8000 & DuraStar
Years:	2001 - 2014
Position:	Front Left
Notes:	Hood Mounted
OE Number:	3561965C1

Sensors & Switches	
Brake Light Switch	901-0001
	
Applications:	3000 & 4000 Series
Years:	2001 - 2016
Position:	
Notes:	
OE Number:	2505677C91, 5005836

Sensors & Switches	
Diesel Particulate Filter Pressure Sensor	904-7127
	
Applications:	4000, 5000, 8000 & ProStar
Years:	2010 - 2016
Position:	
Notes:	Cummins ISB, ISC, ISL, ISX
OE Number:	2871960

Sensors & Switches	
Engine Camshaft Position Sensor	505-5110
	
Applications:	2000, 3000, 4000, 5000, 7000 & 8000 Series
Years:	1997 - 2004
Position:	
Notes:	Includes Shims; DT466, DT530, 444E
OE Number:	1807339C92, 1807339C93, 1825899C93, 1885812C91, F7TZ 12K073-B

Sensors & Switches	
Engine Crankshaft Position Sensor	904-7516
	
Applications:	CE, 2000, 4000, 8000 & ProStar Series
Years:	2005 - 2015
Position:	
Notes:	Maxforce 7
OE Number:	1828345C91, 1828345C91, 3C3Z 6C315-AA, 3C3Z 6C315-AA, DY-985, DY-985

INTERNATIONAL

Sensors & Switches	
Multi Function Switch	978-5201
	
Applications:	3000 Series
Years:	2005 - 2015
Position:	
Notes:	
OE Number:	A06-36956-002, A0636956003

Sensors & Switches	
Sensor - Vehicle Speed	505-5105
	
Applications:	1000, 4000, 5000, 7000, 8000 & 9000 Series
Years:	1997 - 2007
Position:	
Notes:	
OE Number:	3528003C1

Sensors & Switches	
Turbocharger Boost Sensor	904-7113
	
Applications:	2000, 5000, 8000, 9000 Series
Years:	1994 - 2003
Position:	
Notes:	
OE Number:	3084521, 4921501

Sensors & Switches	
Turbocharger Speed Sensor	904-7146
	
Applications:	4000 Series
Years:	2014 - 2016
Position:	
Notes:	
OE Number:	4032806

FEATURED PARTS: HEADLIGHT ASSEMBLIES

CSA COMPLIANCE * * * * * **COVERAGE** Avoid CSA points by easily replacing cracked or hazed lighting assemblies.

DORMAN LIGHTING PRODUCTS FEATURE THE FOLLOWING BENEFITS:

- ALL DORMAN HEADLIGHTS ARE COATED WITH A TWO-COMPONENT, THERMALLY CURED SILICONE HARD COATING, WHICH IS RECOMMENDED BY TMC*

– COATING HELPS PREVENT HEADLIGHT'S SURFACE FROM HAZING



*TECHNOLOGY & MAINTENANCE COUNCIL



Growing the HEAVY DUTY Aftermarket

HD LIGHTING

Lighting Solutions for Today's Most Popular Applications

- Avoid CSA points by easily replacing cracked or hazed lighting assemblies
- All HD headlights are coated with a two-component, thermally cured silicone hard coating



NEW!

888-5200
Freightliner Cascadia 2015-08



888-5505 (R)
888-5506 (L)
Volvo VNL 2015-05



888-5107 (R)
888-5108 (L)
International Prostar 2015-08



888-5205 (R)
888-5206 (L)
Freightliner Cascadia 2015-08

HD EGR VALVE & COOLERS

Heavy Duty Exhaust Gas Recirculation Coolers

- Dorman HD Solutions' EGR Coolers are quality-engineered to cool exhaust gas and recirculate it back to engine
- Complete Kits include all gaskets and hardware allowing for a complete repair



904-5001
Cummins ISX 6007-03



904-5035
Cummins ISX 6007-03



904-5021
Volvo D12 2007-03

HD RESERVOIRS

The Aftermarket's Most Comprehensive Fluid Reservoir Coverage

- Avoid CSA points by replacing cracked or leaking reservoirs
- Dorman HD Reservoirs are engineered to a clear design eliminating need for leak prone sight gauges



803-5505
Volvo D12 2015-08



803-5104
International 4300, 4300C, 4400 2011-03



803-5504
Volvo D12 2007-07

HD CAB REPAIR

A Broad Range of Commonly Replaced Interior Cab Components

REPAIR COMPONENTS INCLUDE:

- Air Door Actuators
- Door Hinge Assemblies
- Hood Control Cables
- Hood Latch Assemblies
- HVAC Knob Kits
- Multi-Function Switches
- Window Channels
- Wiper Nozzle Kits
- **AND MORE!**



804-5103
Fits over 30 Different models!



315-5401
Ford Super Duty 2015-07



978-5201
Freightliner MD, Thomas C2 2015-03

HD ABS SENSORS

Restore the Anti-lock Brake to Safe and Proper Operation

- Engineered from high-quality materials for years of service
- Direct replacement for a proper fit every time
- Easy to install
- Quality tested to ensure long-lasting performance



970-5136
Hudon, Midland



970-5109
Bentley



970-5602
Chevrolet 2000-05, GMC 2000-05

ADDITIONAL COVERAGE AVAILABLE:



DORMAN MEDIUM DUTY: A GROWING CATEGORY OF OVER 1,600 SKUS IDEAL FOR:

Tow Trucks Landscapers Cable / TV Service Utility Companies Municipalities Refuse Trucks

FORD F-450, F-550, F-650

OVER 550 SKUS



CHEVROLET TOP KICK KODIAK

OVER 700 SKUS



ISUZU NPR

OVER 240 SKUS



HINO

OVER 55 SKUS

