

Table of Contents

<i>Alphabetical Index</i>	<i>i-ii</i>	<i>Hydraulic Clutch Lines</i>	<i>257-260</i>
<i>Air Door Actuators</i>	<i>1-4</i>	<i>Ignition Distributor Assemblies</i>	<i>261-272</i>
<i>Air Filter Boxes</i>	<i>5-6</i>	<i>Intake Manifold Kits</i>	<i>273-276</i>
<i>Air Intake Hoses</i>	<i>7-10</i>	<i>Latches</i>	<i>277-280</i>
<i>Brake Caliper Assemblies, First Stop</i>	<i>11-12</i>	<i>Oil Cooler Line Assemblies</i>	<i>281-302</i>
<i>Brake Caliper Bracket Assemblies</i>	<i>13-16</i>	<i>Oil Pans</i>	<i>303-316</i>
<i>Camshaft Synchronizers</i>	<i>17-20</i>	<i>Power Steering Pulleys</i>	<i>317-326</i>
<i>Clock Springs</i>	<i>21-24</i>	<i>Quick Disconnect™</i>	<i>327-396</i>
<i>Control Arms</i>	<i>25-54</i>	<i>Radiator Fan Assemblies</i>	<i>397-430</i>
<i>CV Joint Boots & Accessories</i>	<i>55-66</i>	<i>Rear Axle Shaft Kits</i>	<i>431-434</i>
<i>Door Lock Actuators</i>	<i>67-72</i>	<i>Side View Mirror Assemblies</i>	<i>435-468</i>
<i>Exhaust Manifold Kits</i>	<i>73-134</i>	<i>Smog Pump Pulleys</i>	<i>469-472</i>
<i>Fan Clutch</i>	<i>135-136</i>	<i>Timing Cover Kits</i>	<i>473-484</i>
<i>Fan Pulley Brackets</i>	<i>137-138</i>	<i>Transmission Line Assemblies</i>	<i>485-532</i>
<i>Fluid Reservoirs</i>	<i>139-142</i>	<i>Transmission Shift Solenoid Pack</i>	<i>533-534</i>
<i>Four Wheel Drive Components</i>	<i>143-148</i>	<i>Window Lift Motors</i>	<i>535-554</i>
<i>Fuel Lines</i>	<i>149-154</i>	<i>Window Regulators</i>	<i>555-566</i>
<i>Fuel Sending Units</i>	<i>155-176</i>	<i>Wiper Motors</i>	<i>567-572</i>
<i>Fuel Tanks</i>	<i>177-228</i>	<i>Wiper Transmission Linkages</i>	<i>573-576</i>
<i>Harmonic Balancers</i>	<i>229-254</i>	<i>OE Interchange</i>	<i>577-591</i>
<i>Heater Hose Assemblies</i>	<i>255-256</i>	<i>Numerical Index</i>	<i>592-598</i>



Product Name	Page #	Product Name	Page #	Product Name	Page #
4WD Components	143-148	Engine Oil Pans	303-316	Oil Pump Drives	17-20
Actuator, Four Wheel Drive	143-148	Engine Timing Covers	473-484	Overflow Reservoirs	139-142
Actuators, Door Lock	67-72	Exhaust Manifold Kits	73-134	Plenum	273-276
Air Bag Clock Springs	21-24	Exhaust Manifolds	73-134	Power Steering Pulleys	317-326
Air Bag Coils	21-24	Fan Assemblies, Radiator	397-430	Power Steering Pump Drive Pulley	317-326
Air Cleaner Assemblies	5-6	Fan Clutches	135-136	Power Steering Pump Pulleys	317-326
Air Door Actuators	1-4	Fan Idler Pulley Bracket Assemblies	137-138	Pulley, Power Steering	317-326
Air Filter Boxes	5-6	Fan Pulley Brackets	137-138	Pulleys	229-254
Air Inlet Hoses	7-10	Fluid Lines	149-154	QD Fittings	327-396
Air Intake Hoses	7-10	Fluid Reservoirs	139-142	Quick Disconnect	327-396
A.I.R. Pump Pulleys	469-472	Four Wheel Drive Actuators	143-148	Quick Disconnect Fittings/Connectors	327-396
Air Tool, CV Boot	55-66	Four Wheel Drive Components	143-148	Radiator Fan Assemblies	397-430
Axle Shift Actuators	143-148	Four Wheel Drive Transfer		Radiator Motor Fan Assemblies	397-430
Balancer	229-254	Case Motors	143-148	Radius Arm	25-54
Blend Door Actuators	1-4	Fuel Level Indicators	155-176	Rear Axle Shafts	431-434
Boots, CV	55-66	Fuel Line Couplers	327-396	Rear Drive Axle Shafts	431-434
Boxes, Air Filter	5-6	Fuel Lines	149-154	Rear Drive Axles	431-434
Brake Caliper Bracket Assemblies	13-16	Fuel Quick Disconnects	327-396	Regulators, Window	555-566
Brake Caliper Mounting Brackets	13-16	Fuel Sending Units	155-176	Reservoirs, Coolant	139-142
Caliper Mounting Brackets	13-16	Fuel Tank Sending Unit	155-176	Shift Solenoid	533-534
Camshaft Position Sensors	17-20	Fuel Tank Unit	155-176	Side View Mirrors	435-468
Camshaft Synchronizers	17-20	Fuel Tanks	177-228	Smog Pump Pulleys	469-472
Clamp Banding Tool	55-66	Fuel Tubes	149-154	Solenoid Pack	533-534
Clamps, CV Joint Boot	55-66	Gas Tanks	177-228	Solenoids	533-534
Clock Springs	21-24	Grease, CV Joint	55-66	Steering	21-24
Clutch Lines	257-260	Harmonic Balancer Kits	229-254	Steering Pulleys, Power	317-326
Computer Controlled Electronic		Harmonic Balancers	229-254	Temperature Actuators	1-4
Fan Clutch	135-136	Harmonic Dampeners	229-254	Throttle Body Hoses	7-10
Control Arm	25-54	Heater Couplers	327-396	Thrust Arms	25-54
Coolant Reservoir	139-142	Heater Door Actuators	1-4	Timing Case Cover	473-484
Cooler Line Couplers	327-396	Heater Hose Assemblies	255-256	Timing Cover Kits	473-484
Cooler Lines, Oil	281-302	Heater Supply Hose/Pipe Assembly	255-256	Timing Covers	473-484
Cooling Quick Disconnects	327-396	Hood Latches	277-280	Tool, Clamp Banding	55-66
Covers, Timing	473-484	Hoses, Air Intake	7-10	Tool, CV Boot Air	55-66
Crankshaft Balancers	229-254	Hydraulic Clutch Feed Lines	257-260	Tool, CV Joint Clamp Banding Tool	55-66
Crankshaft Pulley Assemblies	229-254	Hydraulic Clutch Lines	257-260	Transfer Case Actuators	143-148
Crankshaft Pulleys	229-254	Hydraulic Clutch Supply Lines	257-260	Transfer Case Motors	143-148
CV Boot Air Tool	55-66	Idler Pulley Brackets	137-138	Transfer Case Parts	143-148
CV Boots	55-66	Ignition Distributor Assemblies	261-272	Transmission Feed and Return Lines	485-532
CV Joint Boot Clamps	55-66	Ignition Distributors	261-272	Transmission Line Assemblies	485-532
CV Joint Boot Kits	55-66	Intakes	273-276	Transmission Quick Disconnects	327-396
CV Joint Boots	55-66	Intake Manifold Kits	273-276	Transmission Shift Solenoid Pack	533-534
CV Joint Clamp Banding Tool	55-66	Intake Manifolds	273-276	Transmission Solenoid Pack	533-534
CV Joint Grease	55-66	Latches	277-280	Upper Control Arms	25-54
Cylinder, Electric Door Lock	67-72	Lateral Arm	25-54	Upper Plenum	273-276
Dampers; Crankshaft	229-254	Lateral Link	25-54	Vibration Dampener	229-254
Distributors	261-272	Lifts, Window	535-554, 555-566	Water Pump Bracket	137-138
Distributors, Ignition	261-272	Lines, Oil Cooler	281-302	Window Lift Motors	535-554
Door Latches	277-280	Linkage, Wiper	573-576	Window Lifts	535-554
Door Lock Actuators	67-72	Lower Control Arm	25-54	Window Regulators	555-566
Drive Pulleys	317-326	Manifolds, Exhaust	73-134	Window Regulators and Assemblies	555-566
Electric Door Lock Actuators	67-72	Manifolds, Intake	273-276	Windshield Washer Fluid Reservoir	139-142
Electric Fan Motor Assemblies	363-396	Mirror Assemblies	435-468	Wiper Arm Linkages	573-576
Electronic Cooling Fan Clutches	135-136	Motors, Transfer Case	143-148	Wiper Drive Linkages	573-576
Electronic Fan Clutches	135-136	Motors, Wiper	567-572	Wiper Linkages	573-576
Electronically Controlled Cooling		Oil Cooler Line Assemblies	281-302	Wiper Motors	567-572
Fan Clutch	135-136	Oil Cooler Lines	281-302	Wiper Transmission Linkages	573-576
Engines	273-276	Oil Lines	281-302		
Engine Oil Cooler Lines	281-302	Oil Pans	303-316		

Air Door Actuators



Don't Get Left in the Cold!



- Redesigned housing lasts longer and prevents comebacks
- Controls the flow and temperature of air into the interior of the vehicle
- 9 SKUs cover over 25 million Ford, GM, and Jeep vehicles

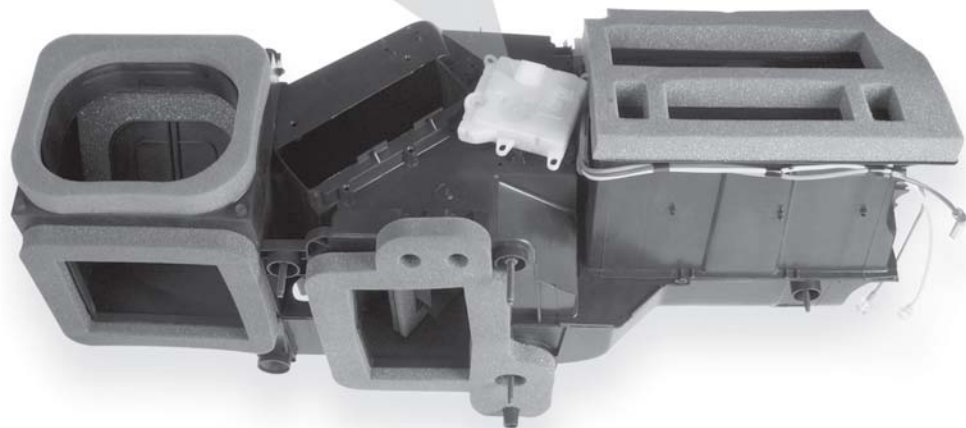

Common Symptoms of Failed Actuators

- Heat or air conditioning will only work on one side of vehicle
- Defrost function may not work at all

Activant Path

*Heating System/Heater
Valves, Cores & Blowers*

Activant Code

DOE

**Applications begin
on page 2.**

Air Door Actuators



604-001
Jeep Grand Cherokee 2004-99.

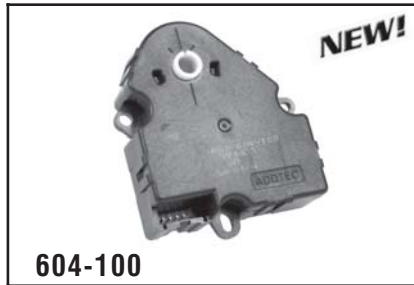

604-100
GM C/K, S-Series Trucks 2006-93.



604-101
GM SUVs and C/K-Series Trucks 2002-99.



604-102
GM SUVs and C/K-Series Trucks 2002-88.



604-103
GM SUVs and C/K-Series Trucks 2002-91.



604-200
Ford E-Series Vans, Windstar 2004-96.



604-201
Ford Explorer, Ranger w/Automatic A/C Control 2003-98.



604-202
Ford Explorer, Ranger w/Manual A/C Control 2006-98.



604-203
Ford Windstar 2003-99.

Air Door Actuator Applications

Make/Model/Years	Description	Dorman #
BUICK		
SKYLARK 1991	-	604-100
CADILLAC		
ESCALADE 2006-03	Rear A/C Controls, Exc. EXT Series	604-100
2002-00	-	604-101
CHEVROLET		
BERETTA 1996-91	-	604-100
CORSICA 1996-91	-	604-100
LUMINA APV 1996-93	-	604-100
CHEVROLET TRUCK		
ASTRO 2005-96	-	604-100
AVALANCHE 2002	-	604-101

Make/Model/Years	Description	Dorman #
CHEVROLET TRUCK (continued)		
BLAZER		
1994-92	Manual A/C Controls (Air Circulator)	604-103
1994-92	Manual A/C Controls (Mode Valve)	604-102
C/K SERIES PICKUP		
1994-92	Manual A/C Controls (Air Circulator)	604-103
1994-92	Manual A/C Controls (Mode Valve)	604-102
1990-88	Manual A/C Controls	604-102
EXPRESS VAN		
2006-03	Rear A/C Controls	604-100
2002-96	-	604-100
S10 BLAZER		
2005-04	Manual A/C Controls	604-100
2003-98	Manual A/C Controls, w/HD Heater	604-100
1997-95	Manual A/C Controls, w/HD Heater	604-100
1997-95	Manual A/C Controls, wo/HD Heater	604-104
S10 PICKUP		
2004	Manual A/C Controls	604-100
2003-98	Manual A/C Controls, w/HD Heater	604-100

Air Door Actuator Applications

Make/ Model/Years	Description	Dorman #
CHEVROLET TRUCK (continued)		
S10 PICKUP (continued)		
1997-95	Manual A/C Controls, w/HD Heater	604-100
1997-95	Manual A/C Controls, wo/HD Heater	604-104
1994	-	604-100
SILVERADO		
2002-99	-	604-101
SUBURBAN		
2006-03	Rear A/C Controls	604-100
2002-00	-	604-101
2002-00	Rear A/C Controls	604-100
1999-98	Rear A/C Controls	604-100
1999-98	RHD, 4WD, Manual A/C Controls	604-104
1997-95	Rear A/C Controls	604-100
1994-92	Manual A/C Controls (Air Circulator)	604-103
1994-92	Manual A/C Controls (Mode Valve)	604-102
1994-92	Rear A/C Controls	604-100
TAHOE		
2006-03	4-Door, Rear A/C Controls	604-100
2002-00	-	604-101
2002-00	4-Door, Rear A/C Controls	604-100
1999-98	4-Door, Rear A/C Controls	604-100
1999-98	RHD, 4WD, Manual A/C Controls	604-104
1997-95	4-Door, Rear A/C Controls	604-100
TOPKICK, KODIAK		
2003	Label No 52479669	604-100
2002-96	Air Circulator	604-103
2002-96	Mode Valve	604-102
1995-91	Dealer Installed Air Conditioning Condenser, (Air Circulator)	604-103
1995-90	Exc. Dealer Installed Air Conditioning Condenser, (Mode Valve)	604-102
FORD TRUCK		
E-SERIES VAN		
2004	To 1/13/04	604-200
2003-97	-	604-200
E-SUPER DUTY		
2001-97	-	604-200
EXPEDITION		
2004-02	Auxiliary Unit, Blend Door	604-202
EXPLORER		
2006-03	Sport & Sport Trac	604-202
2002	Auxiliary Unit, Blend Door, Exc. Sport & Sport Trac, To 10/29/01	604-202
2002	Sport & Sport Trac	604-202
2001	Automatic A/C Control	604-201
2001	Manual A/C Control, Exc. Sport & Sport Trac	604-202
2001	Sport & Sport Trac	604-202
2000-98	Automatic A/C Control	604-201
2000-98	Manual A/C Control	604-202
RANGER		
2006-04	-	604-202
2003-01	Automatic A/C Control	604-201
2000	Automatic A/C Control	604-201
2000	Manual A/C Control, To 3/1/00	604-202
1999-98	Automatic A/C Control	604-201
1999-98	Manual A/C Control	604-202
WINDSTAR		
2003-99	Front Air Conditioning Unit	604-203
1998-96	-	604-200
GMC TRUCK		
C/K SERIES PICKUP		
1994-92	Manual A/C Controls (Air Circulator)	604-103
1994-92	Manual A/C Controls (Mode Valve)	604-102
1990-88	Manual A/C Controls	604-102
DENALI		
2002-01	-	604-101
DENALI XL		
2002-01	-	604-101
S15 JIMMY		
2001-98	Manual A/C Controls, w/HD Heater	604-100

Make/ Model/Years	Description	Dorman #
GMC TRUCK (continued)		
S15 JIMMY (continued)		
1997-95	Manual A/C Controls, w/HD Heater	604-100
1997-95	Manual A/C Controls, wo/HD Heater	604-104
S15 SONOMA		
2004	Manual A/C Controls	604-100
2003-98	Manual A/C Controls, w/HD Heater	604-100
1997-95	Manual A/C Controls, w/HD Heater	604-100
1997-95	Manual A/C Controls, wo/HD Heater	604-104
1994	-	604-100
SAFARI		
2005-96	-	604-100
SAVANA VAN		
2006-03	Rear A/C Controls	604-100
2002-96	-	604-100
SIERRA		
2002-99	-	604-101
SUBURBAN		
1999-98	Rear A/C Controls	604-100
1999-98	RHD, 4WD, Manual A/C Controls	604-104
1997-95	Rear A/C Controls	604-100
1994-92	Manual A/C Controls (Air Circulator)	604-103
1994-92	Manual A/C Controls (Mode Valve)	604-102
1994-92	Rear A/C Controls	604-100
TOPKICK, KODIAK		
2003	Label No 52479669	604-100
2002-96	Air Circulator	604-103
2002-96	Mode Valve	604-102
1995-91	Dealer Installed Air Conditioning Condenser, (Air Circulator)	604-103
1995-90	Exc. Dealer Installed Air Conditioning Condenser, (Mode Valve)	604-102
YUKON		
2006-03	4-Door, Rear A/C Controls	604-100
2002-00	-	604-101
2002-00	4-Door, Rear A/C Controls	604-100
1999-98	4-Door, Rear A/C Controls	604-100
1999-98	RHD, 4WD, Manual A/C Controls	604-104
1994-92	4-Door, Rear A/C Controls	604-100
1994-92	Manual A/C Controls (Air Circulator)	604-103
1994-92	Manual A/C Controls (Mode Valve)	604-102
YUKON XL		
2006-03	Rear A/C Controls	604-100
2002-01	-	604-101
2002-01	Rear A/C Controls	604-100
JEEP		
GRAND CHEROKEE		
2004-99	Automatic A/C Controls	604-001
LINCOLN		
NAVIGATOR		
2004-02	Auxiliary Unit, Blend Door	604-202
MERCURY		
MOUNTAINEER		
2002	Auxiliary Unit, Blend Door, To 10/29/01	604-202
2001-98	Automatic A/C Control	604-201
2001-98	Manual A/C Control	604-202
OLDSMOBILE		
BRAVADA		
2001-98	Manual A/C Controls, w/HD Heater	604-100
1997-96	Manual A/C Controls, w/HD Heater	604-100
1997-96	Manual A/C Controls, wo/HD Heater	604-104
SILHOUETTE		
1996-93	-	604-100
PONTIAC		
BONNEVILLE		
1999-96	Automatic A/C Controls	604-104
TRANSPORT		
1996-93	-	604-100

Related Sales - Heater Blend Door Kit



The Heater Blend Door, located in the vehicle's heater case, allows airflow temperatures to be adjusted by varying the position of the blend door.

The 2004-97 Ford Taurus/Explorer, Mercury Sable, Mercury Mountaineer, 2004-00 Lincoln Aviator and Ford Ranger can develop problems with the Blend Door. The Blend Door pivot pins (located at the top and bottom of the door) have a tendency to break, causing the door to fall apart, hang up and jam. Up until now the only repair was to replace the entire heater case assembly.

The original heater case is glued together and difficult to separate for a repair.

The **Heater Blend Door Repair Kit, part number 76807**, provides a much more cost-efficient way to repair the heater door/case assembly. This kit has been engineered to replace just the broken door and avoids the costly replacement of the whole heater case assembly. The kit includes a template for cutting the case, retaining screws for the guide plate, 2 replacement doors (pick the one that matches the vehicle's defective one), and an upper plate with sealing gasket. Below is a copy of the instruction sheet that has been developed to aid the service dealer in a trouble free repair.



76807

2006-96 Ford Taurus/Sable; 2005-95 Explorer; 2006-95 Ranger; 2005-03 Aviator; 2005-97 Mountaineer



76809

2005-97 Ford E Series Van, 2001-97 E Super Duty

Read and Follow All Instructions Carefully!

- Remove the heater case assembly according to the procedure outlined in the shop manual.
- Locate the guide plate in the package and place on the top of the heater case above the broken blend door.

HINT: All 4 holes on the heater case will line up with the holes in the guide plate.

- Secure the guide plate to the heater case with 4 screws provided.
- Using the plate opening as a guide, position the cutting tool vertically against the guide plate outline and begin cutting the case straight down. Continue to follow the outline of the guide plate as you are cutting until the section on the heater case is loose.
- Remove the cutaway section from the heater case and discard.
- Remove and discard the broken blend door. Be sure to remove all broken parts from the case to prevent the replacement door from binding.
- Select the appropriate matching door and insert into the heater case (use only 1 door).
- Remove the protective backing from the new retaining plate.
- Press the retaining plate down firmly making sure the blend door pivot is in place.
- Reinstall the heater case per the procedure outlined in the shop manual.



Air Filter Boxes



NEW! to the Aftermarket!

- Direct OE Replacement
- Expands your customer base in the crash market



258-500
Toyota Tacoma
4 cyl 2.7L 2694cc
2004-95



258-504
Toyota Tacoma
V6-3.4L
2004-99

DOES NOT INCLUDE FILTER

Common Failure Symptoms

- Easily damaged due to a crash or during underhood repairs
- Commonly cracks or hinges break during filter replacement



2006 Quick Ship Program

Air Filter Boxes are also available as part of the Dorman® OE Solutions Quick Ship Program.

Activant Path

FILTERS, ENGINE & TRANSMISSION/
ENG FILTERS & PCV

Activant Code

MTL

Applications begin
on page 6.

Air Filter Boxes



258-500

Toyota
2004-95 Tacoma; 2000-96 4 Runner;
4 cyl 2.7L 2694cc



258-501

Toyota
1998-95 Toyota Tacoma V6 3.4L



258-504

Toyota
2004-99 Toyota Tacoma V6 3.4L

Air Filter Box Applications

Make/Model/Engine	Years	Dorman #
TOYOTA TRUCK		
4 RUNNER		
L4 - 2.7L (2694 cc)	2000-96	258-500
TACOMA		
L4 - 2.7L (2694 cc)	2004-95	258-500
V6 - 3.4L (3378 cc)	2004-99	258-504
V6 - 3.4L (3378 cc)	1998-95	258-501

Air Filter Boxes

Related Sales

Air Cleaner Screw & Clip

41071 (2)



- Screw inserts fail when changing air filter
- HELP!'s screw & clip fixes the job
- No need to replace entire air cleaner box

Ford/Mercury models with EFI 1996-87.
Simple repair for stripped out air boxes.
Secures air intake box. 1/4".

Also Available - Air Filter-Tite! # 41255 (1)

41101 (3)



Air Cleaner Hold-Down Clamp Assortment

Assortment contains 3 clamps (**41104, 41105, 41109**) that fit Ford Contour, Mercury Mystique 1997-95, Ford Escort, Mercury Tracer with 1.8L, 1.9L 1996-91.

BETTER VALUE

Air Intake Hoses



Coverage for the Most Failure-Prone Applications

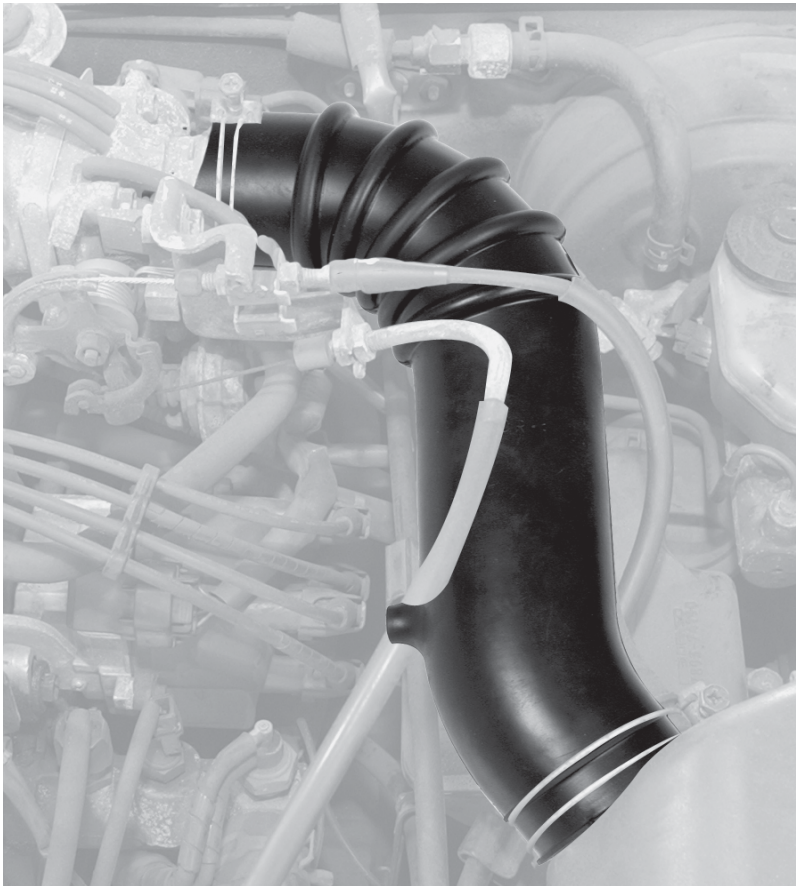

Cracked or Worn Air Intake Hoses Allow Unmetered Air into the Engine Causing:



- Engine to Stall Out
- Poor Gas Mileage
- Rough Idle
- Sluggish Acceleration

Get Your Customers Back on the Road

- Keep Dirt and Debris Out of the Engine
- Direct OE Replacement
- 16 SKUs Cover Over 8.5 Million Registered Vehicles

Activant Path Emissions/Emission Parts **Activant Code** DAI

Applications begin on page 9.

Air Intake Hoses

- Brings air from the Air Cleaner Box into the Throttle Body and then into the Engine Cylinders.
- Cracks or damage to the Air Intake Hose can cause improper air mixture, as well as allow debris and contaminants that damage the engine.
- Original Equipment Construction



696-100

GM
S10 Blazer/Pickups, Jimmy/Sonoma 4.3L
1995-92



696-101

GM
Chevrolet Cavalier, Pontiac Sunfire 2.2L
w/o DOHC 1997-95



696-200

Ford/Mazda
Escort, Tracer / 323, Protégé 1.8L/DOHC
1996-91



696-201

Ford/Mazda
Probe / 626, MX-6 2.2L w/o turbo
1992-90



696-202

Ford
Ford Excursion, Ford F-Series Pickups
7.3L Diesel 2003-99



696-203

Ford
Ford Probe 2.5L 1997-93



696-204

Ford
Ford Probe 2.0L 1997-93



696-300

Chrysler/Dodge/Plymouth
Chrysler Town & Country, Voyager, Grand
Voyager; Dodge Caravan, Grand Caravan;
Plymouth Voyager, Grand Voyager 3.3L,
3.8L 2000-97



696-600

Mazda
Protégé 1.5L 1996-95



696-602

Mazda
626 & MX-6 2.5L 1997-93



696-603

Mazda
MPV 3.0L 1995-93



696-605

Mazda
Millenia 2.5L 2002-95

Air Intake Hoses



696-700

Toyota
Camry 2.2L 1995-92



696-701

Lexus/Toyota
Lexus ES300; Toyota Camry 3.0L 1993-92



696-702

Toyota
Toyota Camry 2.2L 1996



696-703

Toyota
4 Runner/Pickups 6 Cyl. 1995-89

Air Intake Hose Applications

Make/Model/Years	Description	Dorman #
CHEVROLET		
CAVALIER		
1997-95	2.2L Eng	696-101
CHEVROLET TRUCK		
S10 BLAZER		
1995-92	4.3L Eng	696-100
S10 PICKUP		
1995-92	4.3L Eng	696-100
CHRYSLER		
TOWN & COUNTRY VAN		
2000-97	3.3L, 3.8L Eng	696-300
VOYAGER, GRAND VOYAGER		
2000	3.3L, 3.8L Eng	696-300
DODGE		
CARAVAN, GRAND CARAVAN		
2000-97	3.3L, 3.8L Eng	696-300
FORD		
ESCORT		
1996-91	1.8L Eng	696-200
PROBE		
1997-93	2.0L Eng	696-204
1997-93	2.5L Eng	696-203
1992-90	2.2L Eng, wo/Turbo	696-201
FORD TRUCK		
EXCURSION		
2003-00	7.3L Eng	696-202
F-SERIES PICKUP		
2003-99	7.3L Eng	696-202
GMC TRUCK		
S15 JIMMY		
1995-92	4.3L Eng	696-100
S15 SONOMA		
1995-92	4.3L Eng	696-100
LEXUS		
ES300		
1993-92	3.0L Eng	696-701
MAZDA		
323		
1994-90	DOHC	696-200

Make/Model/Years	Description	Dorman #
MAZDA (continued)		
626		
1997-93	2.5L Eng	696-602
1992-90	wo/Turbo	696-201
MILLENNIA		
2002-95	2.5L Eng	696-605
MPV		
1995-93	3.0L Eng	696-603
MX-6		
1997-93	2.5L Eng	696-602
1992-90	wo/Turbo	696-201
PROTEGE		
1996-95	1.5L Eng	696-600
1995	DOHC	696-200
1994-90	DOHC	696-200
MERCURY		
TRACER		
1996-91	1.8L Eng	696-200
OLDSMOBILE		
BRAVADA		
1994-92	4.3L Eng	696-100
PLYMOUTH		
VOYAGER, GRAND VOYAGER		
2000-97	3.3L, 3.8L Eng	696-300
PONTIAC		
SUNFIRE		
1997-95	2.2L Eng	696-101
TOYOTA		
4RUNNER		
1995-89	3.0L Eng	696-703
CAMRY		
1996	2.2L Eng, Exc. Calif	696-702
1995-92	2.2L Eng	696-700
1993-92	3.0L Eng	696-701
PICKUP		
1995-89	3.0L Eng	696-703

Air Intake Hoses



2006 Quick Ship Program

Don't Lose the Sale...
 It's Quick...
 It's Easy...
 It's at Your Door Tomorrow.*

Listed below are the categories now available:

 Air Door Actuators	 Air Filter Boxes	 Air Intake Hoses	 Caliper Brackets	 Camshaft Synchronizers	 Clock Springs	 CV Boots	 Door Lock Actuators
 Electronic Fan Clutches	 Exhaust Manifold Kits	 Fan Pulley Brackets	 Fluid Lines	 Fluid Reservoirs	 Four Wheel Drive Actuators	 Fuel Sending Units	 Fuel Tanks
 Harmonic Balancers	 New Ignition Distributor Assemblies	 Intake Manifold Kits	 Latches	 Mirror Assemblies	 Oil Pans	 Power Steering Pulleys	 Quick Disconnect
 Radiator Fan Assemblies	 Rear Axle Shaft Kits	 Side View Mirrors	 Smog Pump Pulleys	 Timing Cover Kits	 Transfer Case Motors	 New Window Lift Motors	 New Window Regulators
 New Wiper Motors	 Wiper Transmissions Linkages						

Now you can have the parts your customers need, when they need them!

It's that easy...
 call your servicing distribution center!

* Additional Charges Apply

Air Intake Hoses

**100%
NEW**

Brake Caliper Assemblies



100% NEW and Complete:

- All calipers, components and castings are 100% NEW
- Includes all hardware to install the caliper

Zinc Chromate Plating

- Resists rust and corrosion
- Provides visual confirmation of improved quality

Dorman Engineered:

- Engineered to Dorman Quality Standards
- Improvements made to OE Failure-Prone Applications

NO CORES!



**Dorman 100% NEW
Brake Calipers are now**



Dorman 100% NEW Brake Calipers have moved from the OE Solutions catalog and will

now be included in the new



brake catalog coming soon.

Activant Path

N/A

Activant Code

DML

100% NEW BRAKE CALIPERS



Brake Caliper Assemblies

Dorman® Engineered Casting to Exacting Dimensions and Tolerances

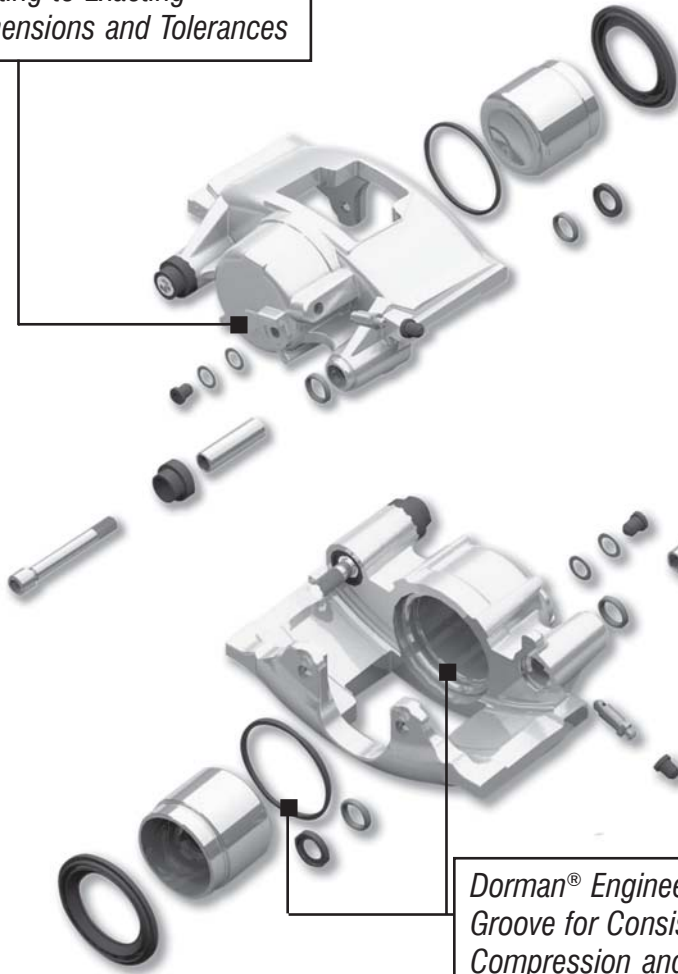

Save bay time,
all necessary
hardware included



Dorman® Engineered Seal and Groove for Consistent Seal Compression and Function

- OE and Remanufactured GM “W-Body” Calipers Use Steel Guide Sleeves, Which Cause Corrosion and Seizing
- Dorman® Units Prevent Corrosion and Seizing by Utilizing an Anodized Aluminum Guide Sleeve
- All Dorman® Calipers are Fully Assembled and Friction Ready
- Zinc Chromate Plating Extends Part Life and Reduces Corrosion

Application-specific instruction sheets included



Brake Caliper Bracket Assemblies



New Brake Caliper Bracket Assemblies deliver smoother stops, promote even pad wear and reduce steering wheel pull and brake pedal pulsation.

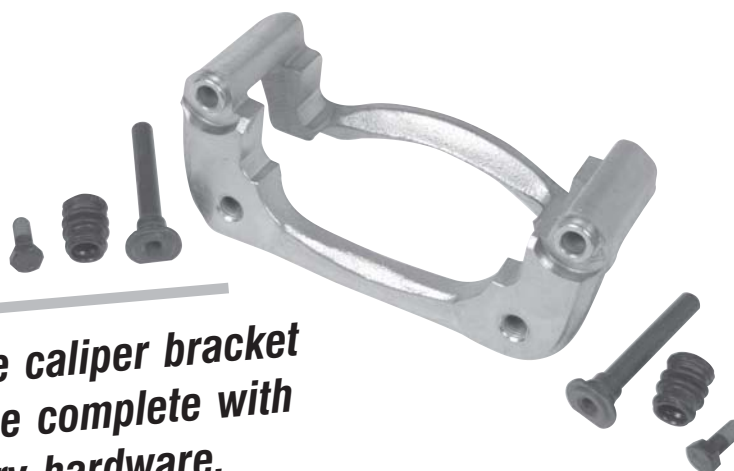

All Dorman brake caliper bracket assemblies come complete with all necessary hardware.

Typical Failures

- Loose slide pins caused by excessive wear to the bracket
- Slide pins seize in the bracket due to corrosion

Dorman® OE Solutions™ Brake Caliper Bracket Assemblies offer you:

- Direct OE Replacement
- The ability to replace just the bracket
- Fewer comebacks due to corrosion and wear in the old bracket.
- Ensures you have everything needed to complete the repair.

32 Available SKUs...

cover the most failure-prone applications

Activant Path Brake Hardware & Cables **Activant Code** DBK

Applications begin on page 16.

Brake Caliper Bracket Assemblies

Brake Caliper Bracket Assemblies



619-001

Rear
Chevrolet Caprice 1996-94



619-002

Rear
Chevrolet Camaro, Pontiac Firebird 2002-98

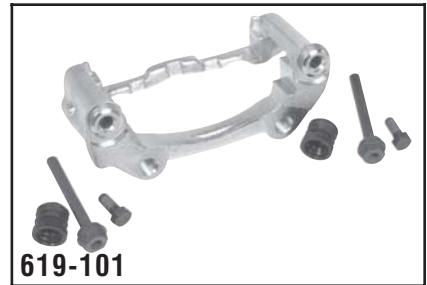

619-101

Rear RH
Ford Taurus, Thunderbird, Mercury Sable, Cougar, Lincoln Continental, Mark Series 1993-90

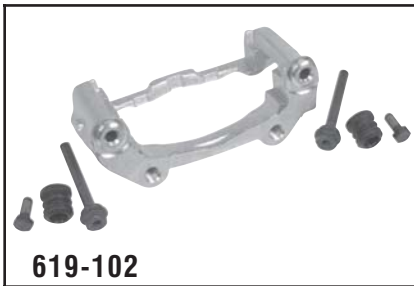

619-102

Rear LH
Ford Taurus, Mercury Sable, Lincoln Continental 1993-90



619-103

Rear
Ford Taurus, Mercury Sable, Lincoln Continental 2002-93



619-104

Front
Ford Taurus, Mercury Sable 2006-93



619-105

Rear
Ford Mustang Exc. Cobra 2004-94



619-106

Front
Ford Mustang Exc. Cobra 1998-94

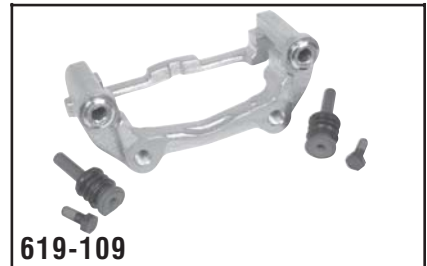

619-109

Rear
Ford Thunderbird, Mercury Cougar 1997-94



619-110

Front
Ford Crown Victoria, Lincoln Town Car, Mercury Grand Marquis 1997-95



619-111

Front
Ford Ranger 1997-95



619-112

Front RH
Ford F150 2 & 4 WD 2004-97



619-113

Front LH
Ford F150 2 & 4 WD 2004-97



619-301

Rear
Honda Accord Exc. SW 1997-90



619-302

Rear
Honda Civic 1995-92

Brake Caliper Bracket Assemblies

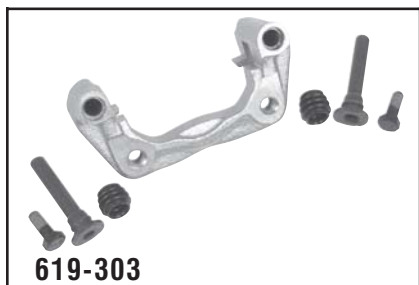

619-303

Rear
Honda Accord 1989-86



619-304

Front
Honda Accord 1989-88



619-305

Front
Honda Accord 1997-90



619-306

Front
Honda Accord 6 Cyl. 2001-94



619-307

Front RH
Honda Civic DX, LX 1995

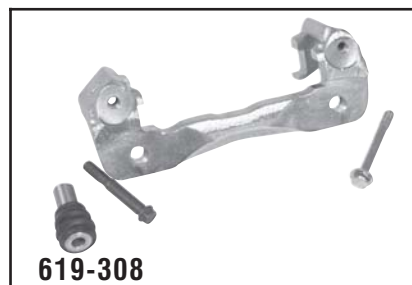

619-308

Front LH
Honda Civic DX, LX 1995



619-401

Rear
Toyota Camry 1999-87



619-402

Front RH
Toyota Camry 6 Cyl. w/o ABS 1996-92

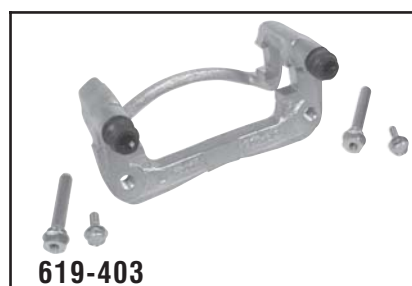

619-403

Front LH
Toyota Camry 6 Cyl. w/o ABS 1996-92



619-404

Front RH
Toyota Camry 4 Cyl. 1996-92



619-405

Front LH
Toyota Camry 4 Cyl. 1996-92



619-406

Front
Toyota Camry 6 Cyl. 2001-97



619-501

Rear
Nissan Altima 2001-93, Nissan Maxima
1994-91



619-502

Rear
Nissan Sentra 2001-95



619-503

Rear
Nissan Maxima 2001-95

Brake Caliper Bracket Assemblies

*Window
Lift Motors*
pg. 535-554

*Window
Regulators*
pg. 555-566

*Wiper
Motors*
pg. 567-572

*Wiper Transmission
Linkages*
pg. 573-576

**Save Time, Replace Bracket
Instead of Rebuilding**

Brake Caliper Bracket Assemblies

Brake Caliper Bracket Assemblies



619-504

Front
Nissan Altima 2001-93, Nissan Maxima
1999-91

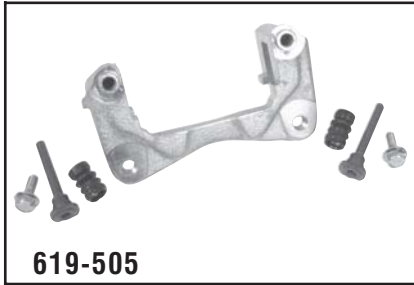

619-505

Front
Nissan Sentra w/2.4L 1999-95, 200SX
w/2.4L 1999-98

Brake Caliper Bracket Assembly Applications

Brake Caliper Bracket Assemblies

Make/Model/Years	Description	Dorman #
ACURA		
INTEGRA		
2001-97	Front-LH & RH, Type R Series	619-306
CHEVROLET		
CAMARO		
2002-98	Rear LH & RH	619-002
CAPRICE, IMPALA SS		
1996-94	Rear LH & RH, Heavy Duty Brakes	619-001
FORD		
CROWN VICTORIA		
1997-95	Front RH	619-110
MUSTANG		
2004-99	Rear LH & RH, Exc.Cobra	619-105
1998-94	Front LH & RH, Exc.Cobra	619-106
1998-94	Rear LH & RH, Exc.Cobra	619-105
TAURUS		
2006-02	Front LH & RH	619-104
2001-93	Front LH & RH, Exc. SHO	619-104
2001-93	Rear LH & RH	619-103
1992-90	Rear LH	619-102
1992-90	Rear RH	619-101
THUNDERBIRD		
1997-94	Rear LH & RH	619-109
1993-90	Rear LH	619-102
1993-90	Rear RH	619-101
FORD TRUCK		
F150 PICKUP		
2004	Front LH, Heritage	619-113
2004	Front RH, Heritage	619-112
2003-97	Front LH	619-113
2003-97	Front RH	619-112
RANGER		
1997-95	Front LH & RH, 2WD	619-111
HONDA		
ACCORD		
1997-94	Front LH & RH, Coupe	619-305
1997-94	Front LH & RH, Sedan, w/4-Cyl Eng	619-305
1997-94	Front LH & RH, Sedan, w/6-Cyl Eng	619-306
1997-94	Front LH & RH, Wagon	619-306
1997-94	Rear LH & RH, Exc.Wagon	619-301
1993	Front LH & RH, 2-Door	619-305
1993	Front LH & RH, 4-Door, Vendor-Akebono	619-305
1993	Rear LH & RH, Exc.Wagon	619-301
1992-90	Front LH & RH, 4-Door, Vendor-Akebono	619-305
1992-90	Rear LH & RH, Exc.Wagon	619-301
1989-88	Front LH & RH, DX,LX Series	619-304
1989-88	Rear LH & RH	619-303
1987-86	Rear LH & RH	619-303
CIVIC		
1995	Front LH, 4-Door, LX Series, wo/ABS, USA Built	619-308
1995	Front LH, 4-Door, DX Series, USA Built	619-308
1995	Front RH, 4-Door, LX Series, wo/ABS, USA Built	619-307
1995	Front RH, 4-Door, DX Series, USA Built	619-307
1995	Rear LH & RH	619-302
1994-92	Rear LH & RH	619-302

Make/Model/Years	Description	Dorman #
LINCOLN		
CONTINENTAL		
2002-93	Rear LH & RH	619-103
1992-90	Rear LH	619-102
1992-90	Rear RH	619-101
MARK SERIES		
1992-90	Rear LH	619-102
1992-90	Rear RH	619-101
TOWN CAR		
1997-95	Front RH	619-110
MERCURY		
COUGAR		
1997-94	Rear LH & RH	619-109
1993-90	Rear LH	619-102
1993-90	Rear RH	619-101
GRAND MARQUIS		
1997-95	Front RH	619-110
SABLE		
2006-02	Front LH & RH	619-104
2001-93	Front LH & RH	619-104
2001-93	Rear LH & RH	619-103
1992-90	Rear LH	619-102
1992-90	Rear RH	619-101
NISSAN		
200SX		
1999-98	Front LH & RH	619-505
ALTIMA		
2001-93	Front LH & RH	619-504
2001-93	Rear LH & RH	619-501
MAXIMA		
2001-00	Rear LH & RH	619-503
1999-95	Front LH & RH	619-504
1999-95	Rear LH & RH	619-503
1994-91	Front LH & RH	619-504
1994-91	Rear LH & RH	619-501
SENTRA		
2001-95	Rear LH & RH	619-502
1999	Front LH & RH (Mexico Built, Exc. GXE)	619-505
1999	Front LH & RH (USA Built)	619-505
1998-97	Front LH & RH	619-505
1996-95	Front LH & RH (USA Built)	619-505
PONTIAC		
FIREBIRD		
2002-98	Rear LH & RH	619-002
TOYOTA		
CAMRY		
2001-00	Front LH & RH, 6-Cyl Eng	619-406
1999-97	Front LH & RH, 6-Cyl Eng	619-406
1999-97	Rear LH & RH	619-401
1996-92	Front LH, 4-Cyl Eng	619-405
1996-92	Front LH, 6-Cyl Eng, wo/ABS	619-403
1996-92	Front RH, 4-Cyl Eng	619-404
1996-92	Front RH, 6-Cyl Eng, wo/ABS	619-402
1996-92	Rear LH & RH	619-401
1991-87	Rear LH & RH	619-401

Camshaft Synchronizers

100% New No Core Charges!



• Kit Includes:

NEW Camshaft Position Sensor

NEW Camshaft Synchronizer

NEW Gear



INCLUDES:

**NEW Alignment Tool
for Easy Installation***



*Where Applicable

Aftermarket Exclusive Category

- Present on new distributorless engines
- Indicates camshaft position to computer
- 21 SKUs cover approximately 12 million vehicles

Activant Path

Emission/Emission Parts

Activant Code

DOI

**Applications begin
on page 19.**

**Clock
Springs**
pg. 21-24

**Control
Arms**
pg. 25-54

**CV Joint Boots
& Accessories**
pg. 55-66

**Door Lock
Actuators**
pg. 67-72

**Exhaust
Manifold Kits**
pg. 73-134

**All New Synchronizers,
All New Sensor
Free Alignment Tool (where applicable)**

Camshaft Synchronizers

Camshaft Synchronizers



NEW!

689-100

Ford/Mercury
3.8L, 2006-99 Mustang, Freestar,
Windstar. Includes Alignment Tool.



NEW!

689-101

Ford/Mercury
5.0L, 2001-99 Explorer, Mountaineer.
Includes Alignment Tool.



NEW!

689-102

Ford/Mercury
3.8L & 4.2L, 1997-96 Thunderbird 3.8L;
1998-96 Mustang, Windstar 3.8L; 2006-
97 Econoline, F-Series 4.2L. Includes
Alignment Tool.



NEW!

689-103

Ford/Mercury
5.0L, 1998-96 Explorer, Mountaineer.
Includes Alignment Tool.



NEW!

689-104

Ford/Mercury
3.0L, 1998-96 Aerostar, Ranger, Windstar;
1997-96 Taurus, Sable 12V. Includes
Alignment Tool.



NEW!

689-105

Ford
4.0L (123mm shaft), 1997-96 Aerostar,
Explorer, Ranger. Includes Alignment
Tool.



NEW!

689-106

Ford
4.0L (132mm shaft), 1999-96 Aerostar,
Explorer, Ranger. Includes Alignment
Tool.



NEW!

689-107

Ford/Mercury
3.0L, 2006-98 Taurus, 24V, Sable,
Ranger, Windstar. Includes Alignment
Tool.



NEW!

689-108

Ford
2.3L, 1997-94 Ranger. Includes
Alignment Tool.



NEW!

689-109

Ford
4.0L, 2000-99 Explorer, Ranger. Includes
Alignment Tool.



NEW!

689-200

Jeep
4.0L, 2004-02 Grand Cherokee, Wrangler.



NEW!

689-300

Suzuki
1.8L, 2.0L & 2.3L, 2005-99 Suzuki
Models.



NEW!

689-301

Mazda
2.3L, 2002-95 Millenia.



NEW!

689-302

Mitsubishi
2.0L w/o Turbo, 1994-89 Eclipse/Galant.



NEW!

689-303

Hyundai
1.6L, 1995-92 Elantra.



NEW!

689-304

Mitsubishi
2.0L, 1994-89 Eclipse.



NEW!

689-305

Infiniti/Nissan
3.0L, 1997-90 J30, 300ZX.



NEW!

689-306

Nissan
3.0L, 1994-92 Maxima.

Camshaft Synchronizers



689-307

Infiniti
4.5L, 1993-90 Q45.



689-308

Infiniti
4.5L, 1996-94 Q45.



689-309

Geo
2.0L, 2004-99 Tracker.

Camshaft Synchronizer Applications

Make/Model/Engine	Years	Description	Dorman #
CHEVROLET TRUCK			
TRACKER			
L4 - 2.0L (122 CID)	2004-99	-	689-309
FORD			
MUSTANG			
V6 - 3.8L (232 CID)	2004-99	-	689-100
V6 - 3.8L (232 CID)	1998-96	-	689-102
TAURUS			
V6 - 3.0L (182 CID)	2006-98	w/12 Valve Eng	689-107
V6 - 3.0L (182 CID)	1997-96	w/12 Valve Eng	689-104
THUNDERBIRD			
V6 - 3.8L (232 CID)	1997-96	-	689-102
FORD TRUCK			
AEROSTAR			
V6 - 3.0L (182 CID)	1997-96	-	689-104
V6 - 4.0L (245 CID)	1997-96	123mm Shaft	689-105
V6 - 4.0L (245 CID)	1997-96	132mm Shaft	689-106
E-SERIES VAN			
V6 - 4.2L (256 CID)	2006-97	-	689-102
EXPLORER			
V6 - 4.0L (245 CID)	2000	VIN Code X, OHV	689-109
V6 - 4.0L (245 CID)	1999	VIN Code X, OHV; w/2 Pin Stator	689-109
V6 - 4.0L (245 CID)	1999	VIN Code X, OHV; w/3 Pin Stator	689-106
V6 - 4.0L (245 CID)	1998	VIN Code X, OHV	689-106
V6 - 4.0L (245 CID)	1997	VIN Code X, OHV; 123mm Shaft	689-105
V6 - 4.0L (245 CID)	1997	VIN Code X, OHV; 132mm Shaft	689-106
V6 - 4.0L (245 CID)	1996	-	689-105
V8 - 5.0L (302 CID)	2001-99	-	689-101
V8 - 5.0L (302 CID)	1998-96	-	689-103
F-SERIES PICKUP			
V6 - 4.2L (256 CID)	2006-97	-	689-102
FREESTAR			
V6 - 3.9L (238 CID)	2006-04	-	689-100
V6 - 4.2L (256 CID)	2006-04	-	689-100
RANGER			
L4 - 2.3L (140 CID)	1997-94	-	689-108
V6 - 3.0L (182 CID)	2006-98	-	689-107
V6 - 3.0L (182 CID)	1997-96	-	689-104
V6 - 4.0L (245 CID)	2000	-	689-109
V6 - 4.0L (245 CID)	1999	w/2 Pin Stator	689-109
V6 - 4.0L (245 CID)	1999	w/3 Pin Stator	689-106
V6 - 4.0L (245 CID)	1998	-	689-106
V6 - 4.0L (245 CID)	1997	123mm Shaft	689-105
V6 - 4.0L (245 CID)	1997	132mm Shaft	689-106
V6 - 4.0L (245 CID)	1996	-	689-105
WINDSTAR			
V6 - 3.0L (182 CID)	1999	-	689-107
V6 - 3.0L (182 CID)	1998	w/Thick Stator	689-107
V6 - 3.0L (182 CID)	1998	w/Thin Stator	689-104
V6 - 3.0L (182 CID)	1997-96	-	689-104
V6 - 3.8L (232 CID)	2003-99	-	689-100
V6 - 3.8L (232 CID)	1998-96	-	689-102

Make/Model/Engine	Years	Description	Dorman #
HYUNDAI			
ELANTRA			
L4 - 1.6L (1596 cc)	1995-92	-	689-303
L4 - 1.8L (1836 cc)	1995-93	-	689-303
INFINITI			
J30			
V6 - 3.0L (2960 cc)	1997-93	-	689-305
Q45			
V8 - 4.5L (4494 cc)	1996-93	From 2/93	689-308
V8 - 4.5L (4494 cc)	1993-90	To 2/93	689-307
JEEP			
GRAND CHEROKEE			
L6 - 4.0L (242 CID)	2004-02	Oil Pump Drive only	689-200
WRANGLER			
L6 - 4.0L (242 CID)	2004-02	Oil Pump Drive only	689-200
MAZDA			
MILLENNIA			
V6 - 2.3L (2254 cc)	2002-95	Sensor #1	689-301
MERCURY			
COUGAR			
V6 - 3.8L (232 CID)	1997-96	-	689-102
MONTEREY			
V6 - 4.2L (256 CID)	2006-04	-	689-100
MOUNTAINEER			
V8 - 5.0L (302 CID)	2001-99	-	689-101
V8 - 5.0L (302 CID)	1998-97	-	689-103
SABLE			
V6 - 3.0L (182 CID)	2005-98	w/12 Valve Eng	689-107
V6 - 3.0L (182 CID)	1997-96	w/12 Valve Eng	689-104
MITSUBISHI			
ECLIPSE			
L4 - 2.0L (1997 cc)	1994-89	2WD	689-304
L4 - 2.0L (1997 cc)	1994-89	4WD	689-302
GALANT			
L4 - 2.0L (1997 cc)	1993-89	2WD; DOHC	689-304
L4 - 2.0L (1997 cc)	1993-89	4WD; DOHC	689-302
NISSAN			
300ZX			
V6 - 3.0L (2960 cc)	1996-90	-	689-305
MAXIMA			
V6 - 3.0L (2960 cc)	1994-92	DOHC, VE30DE Eng	689-306
SUZUKI			
AERIO			
L4 - 2.3L (2300 cc)	2005-02	-	689-300
AERIO SX			
L4 - 2.0L (2000 cc)	2003	-	689-300
ESTEEM			
L4 - 1.8L (1790 cc)	2002-99	-	689-300
SIDEKICK			
L4 - 1.8L (1840 cc)	1998-96	-	689-300

Camshaft Synchronizers

Related Sales - Quick Disconnect™ Tech Trays

Quick Disconnect™ Connectors & Clips



800-094 44 pcs, 7 SKUs

Quick Disconnect™ Connectors Assortment



800-095 12 pcs, 12 SKUs

Quick Disconnect™ Retaining Clips



800-096 26 pcs, 6 SKUs

Quick Disconnect™ Transmission Connector Service Tray



800-101 28 pcs, 16 SKUs

Quick Disconnect™ Oil Cooler Connector Service Tray



800-102 32 pcs, 10 SKUs

Quick Disconnect™ Master Technician Tray



800-103 54 pcs, 19 SKUs

Quick Disconnect™ Fuel Line and Sending Unit Repair



800-299 8 pcs, 6 SKUs



800-300 Nylon Fuel Line Repair Kit



800-500 Steel Fuel Line Repair Kit

See the Quick Disconnect section on pages 327-396 for more details

Camshaft Synchronizers

Air Bag Clock Springs



It's not IF it goes bad . . . it's WHEN it goes bad

- Clock Springs transfer the current from the steering column to the steering wheel.
- Clock springs fail when wire breaks or separates from connector
- Clock spring failure renders steering wheel mounted accessories inoperable

525-601
Honda Accord,
Prelude
2001-98



525-213
Ford F-Series,
Expedition, Excursion
2004-99



When wire controlling air bag fails, warning light illuminates.



Now Available In the Aftermarket

- Simple and safe installation
- System performs self check every time vehicle is started
- One on every car since 1994
- 21 SKUs fit the most failure-prone applications
- Coverage for 28 million registered vehicles



Activant Path

*Lamps, Bulbs, Flashers
& Switch; Accessories/
Body, Switches & Relays*

Activant Code

DOK

**Applications begin
on page 23.**

Clock Springs

Clock Springs



525-003

1999-94 GM w/o Electronic Accessory Control System



525-005

2005-00 Chevrolet Malibu



525-006

2000-95 GM Trucks



525-100

2000-96 Chrysler Minivans w/cruise



525-101

2005-01 Chrysler Minivans



525-103

2001-97 Dodge Ram Pickups w/cruise



525-104

2002 Dodge Ram Trucks



525-106

2000-96 Chrysler Minivans w/o cruise



525-200

1994 Ford Bronco, F-Series Pickups



525-201

1992-90 Ford Crown Victoria



525-205

1996-95 Ford E-Series Vans



525-206

1997-96 Ford Taurus, Mercury, Sable, 1998-95 Ford Mustang



525-212

2001-00 Ford Focus



525-213

2004-99 Ford F-Series, Expedition, Excursion



525-600

1997-96 Honda Accord LX, EX and SE Series

Clock Springs



525-601

2001-98 Honda Accord LX, EX & 4 Door SE Series, Prelude



525-602

2002-01 Honda Accord LX, EX & SE series



525-604

2004-02 Honda CRV



525-605

2001-98 Honda CRV



525-700

2002-90 VW Cabrio, Eurovan, Golf, Jetta & Passat



525-701

2006-98 VW Beetle, Golf, Jetta & Passat

Clock Springs

Clock Spring Applications

Make/Model/Years	Description	Dorman #
ACURA		
CL		
1997	-	525-600
AUDI		
A4		
2002-99	-	525-701
A4 QUATTRO		
2002-99	wo/Tiptronic	525-701
A6		
2004-98	Non Heated Steering Wheel	525-701
A6 QUATTRO		
2004-99	Non Heated Steering Wheel	525-701
A8		
2003-98	Non Heated, wo/Multi-Function Control Steering Wheel	525-701
A8 QUATTRO		
2003-98	Non Heated, wo/Multi-Function Control Steering Wheel	525-701
ALLROAD QUATTRO		
2005-04	Non Heated Steering Wheel	525-701
S4		
2002-99	-	525-701
S6		
2004-98	Non Heated Steering Wheel	525-701
S8		
2003-98	Non Heated, wo/Multi-Function Control Steering Wheel	525-701
TT		
2002-00	wo/Electronic Stability Program	525-701
TT QUATTRO		
2002-00	wo/Electronic Stability Program	525-701
BUICK		
RIVIERA		
1999-95	Exc. Electronic Accessory Control System	525-003
SKYLARK		
1998-94	Exc. Electronic Accessory Control System	525-003
CADILLAC		
ESCALADE		
1999	-	525-006
CHEVROLET		
CAVALIER		
1999-95	-	525-003
MALIBU		
2003-00	w/Speed Control	525-005
MALIBU CLASSIC		
2005-04	-	525-005
VENTURE VAN		
1999-97	-	525-006

Make/Model/Years	Description	Dorman #
CHEVROLET TRUCK		
ASTRO		
1998	Exc. Interim Control, w/Code CTF In Glove Box	525-006
1997-96	-	525-006
C1500 PICKUP		
1997-95	-	525-006
C2500 PICKUP		
1997-95	-	525-006
C3500 PICKUP		
1997-95	-	525-006
EXPRESS		
1997-96	-	525-006
K1500 PICKUP		
1997-95	-	525-006
K2500 PICKUP		
1997-95	-	525-006
K3500 PICKUP		
1997-95	-	525-006
S10 BLAZER		
1998	Exc. Extended Build, w/Code ZN4 In Glove Box	525-006
1997-95	-	525-006
S10 PICKUP		
1998	Exc. Extended Build, w/Code ZN4 In Glove Box	525-006
1997-95	-	525-006
SUBURBAN		
1999-95	-	525-006
TAHOE		
2000-95	-	525-006
CHRYSLER		
TOWN & COUNTRY VAN		
2005-01	-	525-101
2000-96	w/Speed Control (6 Circuit)	525-100
2000-96	wo/Speed Control (3 Circuit)	525-106
VOYAGER		
2004-01	-	525-101
DODGE		
CARAVAN		
2005-01	-	525-101
2000-96	w/Speed Control (6 Circuit)	525-100
2000-96	wo/Speed Control (3 Circuit)	525-106
GRAND CARAVAN		
2005-01	-	525-101
2000-96	w/Speed Control (6 Circuit)	525-100
2000-96	wo/Speed Control (3 Circuit)	525-106

Window
Lift Motors
pg. 535-554

Window
Regulators
pg. 555-566

Wiper
Motors
pg. 567-572

Wiper Transmission
Linkages
pg. 573-576

Clock Springs

Clock Spring Applications

Make/ Model/Years	Description	Dorman #
DODGE TRUCK		
RAM 1500 PICKUP		
2002	w/Speed Control, w/Radio Controls	525-104
2001-99	w/Speed Control, wo/Radio Controls	525-103
1998-97	w/Speed Control	525-103
RAM 2500 PICKUP		
2002	w/Speed Control, w/Radio Controls	525-104
2001-99	w/Speed Control, wo/Radio Controls	525-103
1998-97	w/Speed Control	525-103
RAM 3500 PICKUP		
2002	w/Speed Control, w/Radio Controls	525-104
2001-99	w/Speed Control, wo/Radio Controls	525-103
1998-97	w/Speed Control	525-103
FORD		
COUNTRY SQUIRE		
1992-90	-	525-201
CROWN VICTORIA		
1992-90	-	525-201
FOCUS		
2001-00	-	525-212
MUSTANG		
1998-95	-	525-206
TAURUS		
1997-96	-	525-206
FORD TRUCK		
BRONCO		
1994	-	525-200
E SUPER DUTY		
1996-95	wo/Speed Control wo/Remote Keyless Entry	525-205
E-150 ECONOLINE		
1996-95	wo/Speed Control wo/Remote Keyless Entry	525-205
E-250 ECONOLINE		
1996-95	wo/Speed Control wo/Remote Keyless Entry	525-205
E-350 ECONOLINE		
1996-95	wo/Speed Control wo/Remote Keyless Entry	525-205
EXCURSION		
2001-00	-	525-213
EXPEDITION		
2002-99	w/Speed Control	525-213
F-150 PICKUP		
2004	w/Speed Control, Lightning, Heritage	525-213
2003-99	w/Speed Control	525-213
1994	-	525-200
F-250 PICKUP		
2004-99	w/Speed Control	525-213
1994	-	525-200
F-250 SUPER DUTY PICKUP		
2001-99	w/Speed Control	525-213
F-350 PICKUP		
1994	-	525-200
F-350 SUPER DUTY PICKUP		
2001-99	w/Speed Control	525-213
F-450 SUPER DUTY		
1994	-	525-200
F-450 SUPER DUTY PICKUP		
2001-99	w/Speed Control	525-213
F-550 SUPER DUTY PICKUP		
2001-99	w/Speed Control	525-213
GMC TRUCK		
C1500 PICKUP		
1997-95	-	525-006
C2500 PICKUP		
1997-95	-	525-006
C3500 PICKUP		
1997-95	-	525-006
K1500 PICKUP		
1997-95	-	525-006
K2500 PICKUP		
1997-95	-	525-006
K3500 PICKUP		
1997-95	-	525-006
S15 JIMMY		
1998	Exc. Extended Build, w/Code ZN4 In Glove Box	525-006
1997-95	-	525-006
S15 SONOMA		
1998	Exc. Extended Build, w/Code ZN4 In Glove Box	525-006
1997-95	-	525-006
SAFARI		
1998	Exc. Interim Control, w/Code CTF In Glove Box	525-006
1997-96	-	525-006

Make/ Model/Years	Description	Dorman #
GMC TRUCK (continued)		
SAVANA		
1997-96	-	525-006
SUBURBAN		
1999-95	-	525-006
YUKON		
2000-95	-	525-006
HONDA		
ACCORD		
2002-01	LX, EX, SE Series (Sumitomo)	525-602
2000-98	LX, EX & 4-Door SE Series	525-601
1997-96	LX, EX, SE Series	525-600
CR-V		
2004-02	Sumitomo	525-604
2001-98	-	525-605
PRELUDE		
2001-99	-	525-601
LINCOLN		
MARK VII		
1992-90	-	525-201
TOWN CAR		
1992-90	-	525-201
MERCURY		
GRAND MARQUIS		
1992-90	-	525-201
SABLE		
1997-96	-	525-206
OLDSMOBILE		
ACHIEVA		
1998-94	-	525-003
BRAVADA		
1998	Exc. Extended Build, w/Code ZN4 In Glove Box	525-006
1997-96	-	525-006
SILHOUETTE		
1999-97	Exc. Electronic Accessory Control System	525-006
PLYMOUTH		
GRAND VOYAGER		
2000-96	w/Speed Control (6 Circuit)	525-100
2000-96	wo/Speed Control (3 Circuit)	525-106
VOYAGER		
2000-96	w/Speed Control (6 Circuit)	525-100
2000-96	wo/Speed Control (3 Circuit)	525-106
PONTIAC		
GRAND AM		
1998-96	Exc. Electronic Accessory Control System	525-003
1995-94	-	525-003
GRAND PRIX		
1997	Exc. Electronic Accessory Control System	525-006
SUNFIRE		
1999-95	Exc. Electronic Accessory Control System	525-003
TRANS SPORT		
1997	Exc. Electronic Accessory Control System	525-006
VOLKSWAGEN		
BETLE		
2006-04	wo/Electronic Stability Program, wo/Airbag Deactivation Switch	525-701
2003-98	wo/Electronic Stability Program	525-701
CABRIO		
2002-95	-	525-700
CABRIOLET		
1994-93	-	525-700
CORRADO		
1994-90	-	525-700
EUROVAN		
1999	To VIN XH051759	525-700
1998-97	-	525-700
GOLF		
2005-02	Made in Brazil, wo/Electronic Stability Program	525-701
2001-99	Made in Germany, wo/Electronic Stability Program	525-701
2001-00	Made in Brazil	525-701
1999-93	-	525-700
JETTA		
2005-00	-	525-701
1999-93	-	525-700
PASSAT		
2005-01	wo/Electronic Stability Program	525-701
2000-98	-	525-701
1997-90	-	525-700

Control Arms



The Most Comprehensive, All-Inclusive Control Arm Program in the Aftermarket

- Coverage for the most failure-prone applications
- Late-model coverage not offered elsewhere in the aftermarket
- Best OE stocking SKUs
- Coverage includes: Asian, Domestic and European Makes, Popular Light Trucks and SUVs



520-301
Chrysler Cirrus,
Dodge Stratus
2000-96



520-767
Volkswagen Passat
2005-98



520-202
Ford Contour, Cougar
Mercury Mystique
2000-99

Features and Benefits

- Direct OE Replacement
- Complete assemblies including ball joint, bushings, and new hardware

Kit Contents

*New Dorman Hardware included
(where applicable)*

Typical Failures

- Cracked or torn ball joint boots allow grease to escape, causing corrosion, wear and failure.
- Loose ball joints and bushings create noise, vibration, drivability and safety issues.
- Control arms bend due to curb impact.

Activant Path

**CHASSIS & STEERING/
SUSPENSION PARTS**

Activant Code DCO

**Applications begin
on page 40.**

Control Arms

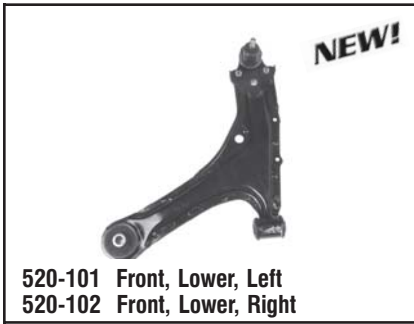

520-101 Front, Lower, Left
520-102 Front, Lower, Right

GM
2005-95 GM Cavalier, Sunfire and Metro



520-107 Rear, Lower, Left
520-108 Rear, Lower, Right

GM
1994-92 Suzuki Swift



520-111 Front, Lower, Left
520-112 Front, Lower, Right

GM
1997-95 Geo Metro



520-113 Front, Lower, Left
520-114 Front, Lower, Right

GM
1984-73 GM 2WD Pickups, Vans, and Suburban



520-116 Front, Upper, Left and Right

GM
2006-99 GM Pickups, Express, Savana, and Yukon



520-119 Front, Upper, Left
520-120 Front, Upper, Right

GM
1996-77 GM Caprice, LeSabre, and Bonneville

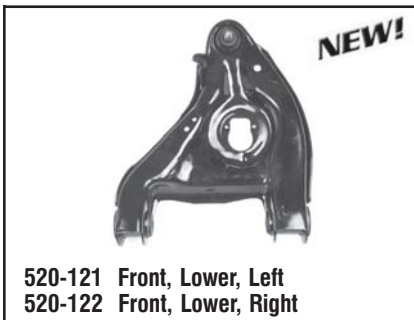

520-121 Front, Lower, Left
520-122 Front, Lower, Right

GM
2000-88 GM Pickups, Express, Savana, and Yukon

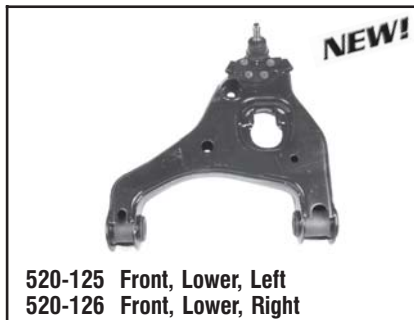

520-125 Front, Lower, Left
520-126 Front, Lower, Right

GM
2006-00 GM Sierra and Silverado 1500



520-127 Front, Lower, Left
520-128 Front, Lower, Right

GM
2006-99 GM Pickups, Express, Savana, and Yukon



520-129 Front, Upper, Left
520-130 Front, Upper, Right

GM
2002-92 GM C/K Pickups, Express, Yukon, Suburban



520-131 Front, Lower, Left
520-132 Front, Lower, Right

GM
1998-95 GM Grand Am, Corsica, and Beretta



520-133 Front, Lower, Left
520-134 Front, Lower, Right

GM
2004-97 GM Grand Am, Cutlass, Malibu and Alero

Control Arms



GM
2004-97 GM S10 and S15

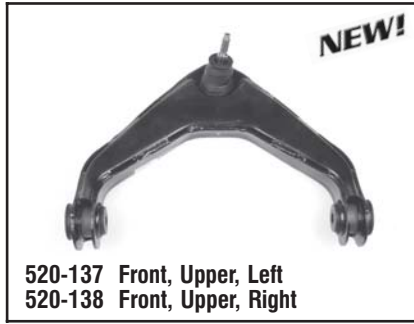

GM
2005-82 GM S10 and S15



GM
2004-84 GM 4WD S10 and S15



GM
2000-83 GM 4WD S10 and S15



GM
2006-02 GM S10 Trailblazer, S15 Envoy, Rainier, and Bravada

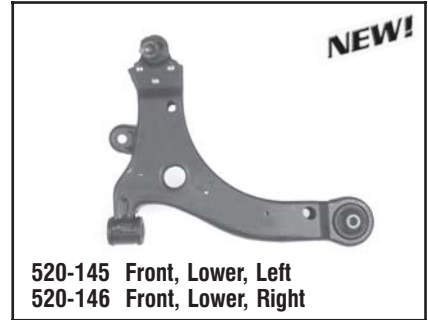

GM
2005-97 GM Venture Vans, Silhouette, and Montana



GM
2006-99 GM Pickups, Suburban, H2 and Yukon



GM
2002-91 Saturn SW, SL and SC

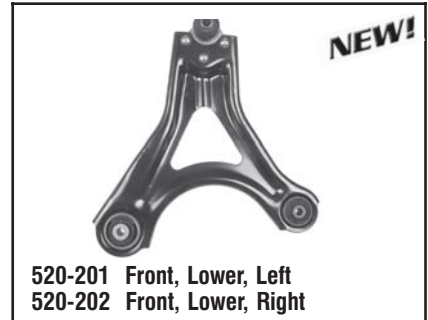

Ford
2000-99 Ford Cougar, Contour and Mystique



Ford
2002-95 Ford Cougar, Contour and Mystique

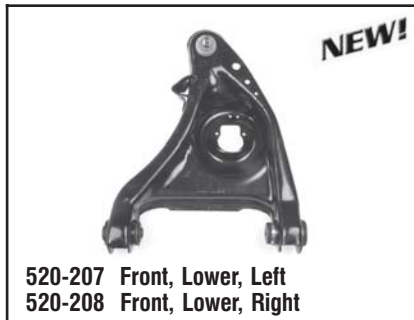

Ford
2002-95 Ford Town Car, Grand Marquis and Crown Victoria



Ford
1996-91 Ford Escort and Tracer

Control Arms



Ford
1983-81 Ford Escort, LN7, Lynx, and EXP



Ford
1994-84 Ford Escort, LN7, Lynx, and EXP



Ford
2004-97 Ford 4WD F150, Expedition, Navigator



Ford
2004-97 Ford 2WD F150, Expedition, Navigator



Ford
2004-97 Ford 2WD F150, Expedition, Navigator



Ford
2005-96 Ford Explorer, Ranger, and Mountaineer



Ford
2006-95 Ford Explorer, Ranger, and Mountaineer



Ford
1993-88 Ford Festiva



Ford
2004-00 Ford Focus



Ford
2006-98 Ford Ranger



Ford
1995-86 Ford Taurus and Sable



Ford
1997-89 Ford Cougar and Thunderbird

Control Arms



Ford
1998-95 Ford Windstar



Ford
1994-88 Ford Continental



Ford/Mazda
1992-88 Ford Probe, Mazda 626 and MX-6



Ford/Mazda
1997-93 Ford Probe, Mazda 626 and MX-6



Ford
1992-90 Ford Probe



Mercury
1989-85 Mercury XR4Ti



Mercury/Nissan
2002-99 Mercury Villager, Nissan Quest



Nissan
1998-93 Nissan Quest



Chrysler
2000-96 Chrysler Sebring, Stratus, Cirrus and Breeze



Chrysler
2004-93 Chrysler Intrepid, Concord, LHS, and 300M



Chrysler
2004-00 Dodge 4WD Dakota and Durango



Chrysler
1999-97 Dodge 4WD Dakota and Durango

Control Arms

Control Arms



Chrysler
2004-00 Dodge 4WD Dakota



Chrysler
1999-97 Dodge 4WD Dakota and Durango



Chrysler
2005-04 Dodge Durango



Chrysler
2003-79 Dodge Full-Size Vans



Chrysler
2003-79 Dodge Full-Size Vans



Chrysler
2005-00 Chrysler Neon

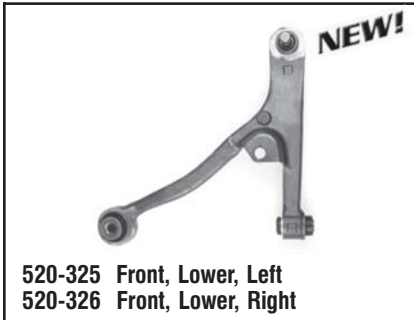

Chrysler
1999-95 Chrysler Neon



Chrysler
2006-01 Chrysler Neon and PT Cruiser



Chrysler
1996-79 Chrysler B and P Vans



Chrysler
1997-79 Chrysler B and P Vans



Chrysler
2006-01 Chrysler Minivans



Chrysler
2000-96 Chrysler Minivans

Control Arms



Chrysler
1995-91 Chrysler Minivans



Chrysler/Mitsubishi
1993 Mitsubishi Galant



Chrysler
2004-00 Dodge Durango and Dakota



Chrysler
1986-85 Chrysler Colt



Chrysler/Mitsubishi
2000-93 Chrysler Sebring, Mitsubishi Galant and Eclipse



Toyota
2006-02 Toyota Camry



Toyota
2001-97 Toyota Camry

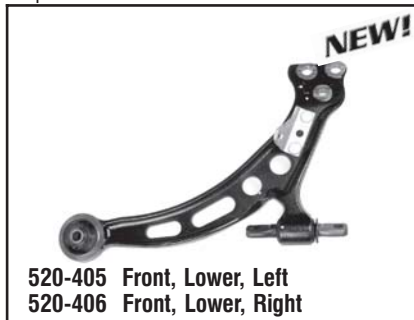

Toyota
1996-92 Toyota Camry



Toyota
1991-87 Toyota Camry



Toyota
1987-86 Toyota Celica



Toyota
1985-82 Toyota Celica



Toyota
1981-76 Toyota Celica and Supra

Control Arms



Toyota
2002-97 Toyota Corolla



Toyota
1995-94 Toyota Corolla



Toyota
1993-88 Toyota Corolla



Toyota
1987-84 Toyota Corolla



Toyota
1992-89 Toyota Cressida



Toyota
1988-85 Toyota Cressida



Toyota
1984-81 Toyota Cressida



Toyota
1994-91 Toyota Tercel and Paseo



Toyota
2000-96 Toyota RAV 4



Toyota
1984-81 Toyota Starlet



Toyota
1996-93 Toyota Supra



Infiniti/Nissan
2003-96 Nissan Pathfinder and Infiniti QX4

Control Arms



Nissan
1988-81 Nissan 200SX and 810



Nissan
1993-89 Nissan 240SX



Nissan
1985-80 Nissan 720 Pickups



Nissan
2005-02 Nissan Altima



Nissan
1997-93 Nissan Altima



Nissan
2002-99 Nissan Maxima



Nissan
1999-95 Nissan Maxima



Nissan
1991-89 Nissan Maxima



Nissan
2000-95 Nissan Sentra



Nissan
1994-91 Nissan Sentra



Nissan
1990-87 Nissan Sentra



Acura
1993-90 Acura Integra

Control Arms



Acura
1995-91 Acura Legend



Honda/Acura
1991-87 Honda Civic and Acura Legend



Honda
2002-98 Honda Accord



Honda
2002-98 Honda Accord



Honda/Acura
1999-94 Honda Accord and Acura CL



Honda/Acura
1999-94 Honda Accord and Acura CL



Honda
1995 Honda Accord



Honda
1993-90 Honda Accord

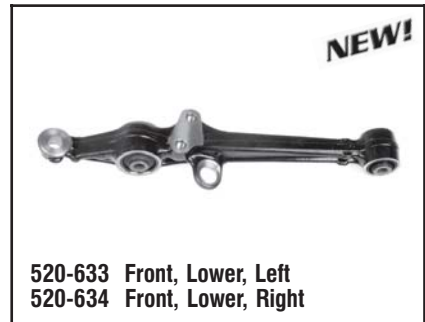

Honda
1993-90 Honda Accord



Honda
1993-90 Honda Accord



Honda
1993-90 Honda Accord



Honda
1989-86 Honda Accord

Control Arms



Honda
1989-86 Honda Accord



Honda
1989-87 Honda Accord



Honda
2001-97 Honda CR-V



Honda
2001-97 Honda CR-V



Honda
1982-79 Honda Prelude



Honda
1985-84 Honda Accord



Honda
1983-82 Honda Accord



Honda
1981-76 Honda Accord



Honda
2000-96 Honda Civic



Honda
2000-96 Honda Civic



Honda
2000-92 Honda Civic and Del Sol



Honda
1995-92 Honda Civic

Control Arms



520-675 Front, Upper, Left
520-676 Front, Upper, Right

Honda
1995-92 Honda Civic and Del Sol



520-677 Front, Lower, Left
520-678 Front, Lower, Right

Honda/Acura
1993-88 Honda Civic and Acura Integra



520-683 Front, Lower, Left
520-684 Front, Lower, Right

Honda
1987-84 Honda Civic and CRX



520-688 Front, Lower, Left and Right
520-690 Front, Lower, Left and Right

Honda
1983-80 Honda Civic



520-709 Front, Lower, Left
520-710 Front, Lower, Right

Audi
1991-80 Audi 100/200



520-717 Front, Lower, Left
520-718 Front, Lower, Right

Audi
1996-92 Audi 100, S4 and A6 Quattro



520-721 Front, Lower, Left
520-722 Front, Lower, Right

BMW
1981-77 BMW 528i, 530i, 630CSi and 633CSi



520-725 Front, Lower, Left
520-726 Front, Lower, Right

BMW
1983-78 BMW 320i



520-727 Front, Lower, Left
520-728 Front, Lower, Right

BMW
1983-78 BMW 733i



520-729 Front, Upper, Left
520-730 Front, Upper, Right

BMW
1988-87 BMW M6



520-731 Front, Lower, Left
520-732 Front, Lower, Right

BMW
1991-84 BMW 3 Series



520-733 Front, Lower, Left
520-734 Front, Lower, Right

BMW
1995-89 BMW 5 Series

Control Arms



BMW
1995-89 BMW 5 Series



BMW
2003-97 BMW 540i and M5



BMW
2002-92 BMW 3 Series

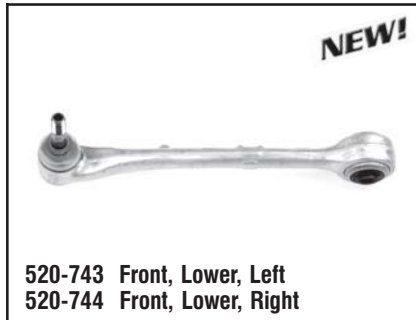

BMW
2001-95 BMW 7 Series



Mercedes
1983-75 Mercedes-Benz 240, 280, 300,
and 450



Mercedes
1991-82 Mercedes-Benz 300, 350, 420 and 560



VW
2006-98 Volkswagen Jetta, Beetle, and Golf



Audi
2002-96 Audi A4 and A4 Quattro



VW
2003-98 Volkswagen Passat and Audi A4 and A8



VW/Audi
2005-01 Volkswagen Passat and Audi A4
and RS6



VW/Audi
2005-96 Volkswagen Passat and Audi A4, A6
and A8



Hyundai/Mitsubishi
1994-90 Hyundai Excel and Mitsubishi Precis

Control Arms



520-811 Front, Lower, Left
520-812 Front, Lower, Right

Mazda
1989-86 Mazda 323



520-813 Rear, Front Lat Link, Left
520-814 Rear, Front Lat Link, Right

Mazda
1995-90 Mazda 323 and Protege



520-816 Rear, Rear Lat Link, Left and Right

Mazda
1995-90 Mazda 323 and Protege



520-817 Front, Lower, Left
520-818 Front, Lower, Right

Mazda
1995-90 Mazda 323 and Protege



520-819 Front, Lower, Left
520-820 Front, Lower, Right

Mazda
1987-83 Mazda 626



520-821 Front, Lower, Left
520-822 Front, Lower, Right

Mazda
1995-92 Mazda 929



520-824 Front, Lower, Right

Mazda
1991-90 Mazda 929



520-825 Front, Lower, Left
520-826 Front, Lower, Right

Mazda
1993-86 Mazda B2200 and B2600



520-830 Front, Lower, Left and Right

Mazda
1996-89 Mazda MPV



520-835 Front, Upper, Left
520-836 Front, Upper, Right

Mitsubishi
1994-93 Mitsubishi Galant



520-837 Front, Lower, Left
520-838 Front, Lower, Right

Mitsubishi
1993-89 Mitsubishi Galant



520-839 Front, Lower, Left
520-840 Front, Lower, Right

Mitsubishi
1996-93 Mitsubishi Mirage

Control Arms



Mitsubishi
2002-93 Mitsubishi Mirage



Mitsubishi
2002-93 Mitsubishi Mirage



Suzuki
1998-89 Suzuki Sidekick and X-90



Suzuki
2001-89 Suzuki Swift

CONTROL ARMS

First True Control Arm Program to the Aftermarket!

- Direct OE Replacement
- Over 300 SKUs
- Control Arms Fail and Are Stocked at OE Dealerships

FAILURE MODES:

Wear

- Worn Ball Joint Deforms Control Arm Seat
- Damaged When Pressing Out / In Ball Joint
- Worn Bushings Can Damage the Arm

Crash / Road Hazard

- Control Arms Bend / Deform Due to Minor Impacts
- Control Arms Can Bend from Pot Holes, Curbs, and Speed Bumps

Component Wear on Integrated Assemblies

- Ball Joint or Bushings Cannot Be Replaced Separately on Some Units



Control Arm Applications

Make Model/Years	Location	Description	Dorman LH	Dorman RH
ACURA				
CL				
1999-97	Front, Lower	4 Cyl Eng	520-625	520-626
1999-97	Front, Upper	-	520-627	520-628
INTEGRA				
1994	Front, Upper	RS Model, To Serial #RS016006	520-675	520-676
1993-90	Front, Lower	-	520-677	520-678
1993-90	Front, Upper	-	520-607	520-608
LEGEND				
1995-91	Front, Upper	-	520-609	520-610
1990-88	Front, Upper	-	520-611	520-612
1987	Front, Upper	Coupe	520-611	520-612
AUDI				
100				
1994-92	Front, Lower	-	520-717	520-718
1991-89	Front, Lower	-	520-709	520-710
100 QUATTRO				
1994-92	Front, Lower	-	520-717	520-718
1991-89	Front, Lower	-	520-709	520-710
200				
1991-89	Front, Lower	-	520-709	520-710
200 QUATTRO				
1991-89	Front, Lower	-	520-709	520-710
5000				
1982-80	Front, Lower	-	520-709	520-710
A4				
2005-03	Front, Lower	Rear Link Assy, Convertible	520-765	520-766
2005-03	Front, Upper	Front Link Assy, w/Comfort Suspension & Convertible	520-767	520-768
2005-03	Front, Upper	Rear Link Assy, w/Comfort Suspension & Convertible	520-767	520-768
2002-00	Front, Lower	Rear Link Assy	520-762	520-762
2002-00	Front, Upper	Front Link Assy	520-767	520-768
2002-00	Front, Upper	Rear Link Assy	520-767	520-768
1999	Front, Lower	Rear Link Assy	520-762	520-762
1999	Front, Upper	Front Link Assy	520-767	520-768
1999	Front, Upper	Rear Link Assy, From VIN #X200001	520-767	520-768
1999	Front, Upper	Rear Link Assy, To VIN #X199999	520-763	520-764
1998	Front, Lower	Rear Link Assy	520-762	520-762
1998	Front, Upper	Front Link Assy	520-767	520-768
1998	Front, Upper	Rear Link Assy	520-763	520-764
1997-96	Front, Lower	Rear Link Assy	520-762	520-762
1997-96	Front, Upper	Front Link Assy	520-767	520-768
1997-96	Front, Upper	Rear Link Assy	520-767	520-768
A4 QUATTRO				
2005-03	Front, Lower	Rear Link Assy, Convertible	520-765	520-766
2005-03	Front, Upper	Front Link Assy, w/Comfort Suspension & Convertible	520-767	520-768
2005-03	Front, Upper	Rear Link Assy, w/Comfort Suspension & Convertible	520-767	520-768
2002-00	Front, Lower	Rear Link Assy	520-762	520-762
2002-00	Front, Upper	Front Link Assy	520-767	520-768
2002-00	Front, Upper	Rear Link Assy	520-767	520-768
1999	Front, Lower	Rear Link Assy	520-762	520-762
1999	Front, Upper	Front Link Assy	520-767	520-768
1999	Front, Upper	Rear Link Assy, From VIN #X200001	520-767	520-768
1999	Front, Upper	Rear Link Assy, To VIN #X199999	520-763	520-764
1998	Front, Lower	Rear Link Assy	520-762	520-762
1998	Front, Upper	Front Link Assy	520-767	520-768
1998	Front, Upper	Rear Link Assy	520-763	520-764
1997-96	Front, Lower	Rear Link Assy	520-762	520-762
1997-96	Front, Upper	Front Link Assy	520-767	520-768
1997-96	Front, Upper	Rear Link Assy	520-767	520-768
A6				
2004-98	Front, Upper	Front Link Assy	520-767	520-768
2004-98	Front, Upper	Rear Link Assy	520-767	520-768
1996-95	Front, Lower	-	520-717	520-718
A6 QUATTRO				
2005-98	Front, Upper	Front Link Assy	520-767	520-768
2005-98	Front, Upper	Rear Link Assy	520-767	520-768
1996-95	Front, Lower	-	520-717	520-718
A8				
1999-98	Front, Upper	Rear Link Assy	520-763	520-764
1997	Front, Upper	Rear Link Assy, From VIN #V004001	520-763	520-764
1997	Front, Upper	Rear Link Assy, To VIN #V004000	520-767	520-768
A8 QUATTRO				
2003-98	Front, Upper	Rear Link Assy	520-763	520-764
1997	Front, Upper	Rear Link Assy, From VIN #V004001	520-763	520-764
1997	Front, Upper	Rear Link Assy, To VIN #V004000	520-767	520-768
ALLROAD QUATTRO				
2005-01	Front, Upper	Front Link Assy	520-767	520-768
2005-01	Front, Upper	Rear Link Assy	520-767	520-768
RS6				
2004-03	Front, Lower	Rear Link Assy	520-765	520-766

Control Arm Applications

Make Model/Years	Location	Description	Dorman LH	Dorman RH
AUDI (continued)				
S4				
2005-04	Front, Upper	Front Link Assy, w/Comfort Suspension	520-767	520-768
1994-92	Front, Lower	-	520-717	520-718
S6				
2003-02	Front, Upper	Front Link Assy	520-767	520-768
2003-02	Front, Upper	Rear Link Assy	520-767	520-768
S8				
2003-01	Front, Upper	Rear Link Assy	520-767	520-768
BMW				
318i				
1998-92	Front, Lower	-	520-740	520-740
318iC				
1997-92	Front, Lower	-	520-740	520-740
318iS				
1997-92	Front, Lower	-	520-740	520-740
318Ti				
1998-95	Front, Lower	-	520-740	520-740
320i				
1983-78	Front, Lower	-	520-725	520-726
323iC				
1998	Front, Lower	-	520-740	520-740
323iS				
1998	Front, Lower	-	520-740	520-740
325				
1988-87	Front, Lower	2WD	520-731	520-732
325e				
1987-84	Front, Lower	2WD	520-731	520-732
325i				
1995-92	Front, Lower	-	520-740	520-740
1991-87	Front, Lower	2WD	520-731	520-732
325iC				
1995-92	Front, Lower	-	520-740	520-740
1991-87	Front, Lower	2WD	520-731	520-732
325iS				
1995-92	Front, Lower	-	520-740	520-740
1991-87	Front, Lower	2WD	520-731	520-732
325iX				
1991-88	Front, Lower	2WD	520-731	520-732
328i				
1998-96	Front, Lower	-	520-740	520-740
328iC				
1998-96	Front, Lower	-	520-740	520-740
328iS				
1998-96	Front, Lower	-	520-740	520-740
525i				
1995-89	Front, Lower	-	520-733	520-734
1995-89	Front, Upper	Thrust Arm	520-735	520-736
525iT				
1995-93	Front, Lower	-	520-733	520-734
1995-93	Front, Upper	Thrust Arm	520-735	520-736
528i				
1981-79	Front, Lower	-	520-721	520-722
530i				
1995-94	Front, Lower	-	520-733	520-734
1995-94	Front, Upper	Thrust Arm	520-735	520-736
1978-77	Front, Lower	-	520-721	520-722
530iT				
1995-94	Front, Lower	-	520-733	520-734
1995-94	Front, Upper	Thrust Arm	520-735	520-736
535i				
1993-89	Front, Lower	-	520-733	520-734
1993-89	Front, Upper	Thrust Arm	520-735	520-736
540i				
2003-97	Front, Lower	Thrust Arm	520-737	520-738
1995-94	Front, Lower	-	520-733	520-734
1995-94	Front, Upper	Thrust Arm	520-735	520-736
540iT				
2000-99	Front, Lower	Thrust Arm	520-737	520-738
630CSi				
1977	Front, Lower	-	520-721	520-722
633CSi				
1981-78	Front, Lower	-	520-721	520-722
733i				
1983-78	Front, Lower	-	520-727	520-728
740i				
2001-95	Front, Lower	-	520-743	520-744
740iL				
2001-95	Front, Lower	-	520-743	520-744
750iL				
2001-95	Front, Lower	-	520-743	520-744

Control Arm Applications

Make Model/Years	Location	Description	Dorman LH	Dorman RH
BMW (continued)				
M5				
2003-00	Front, Lower	Thrust Arm	520-737	520-738
M6				
1988-87	Front, Upper	-	520-729	520-730
Z3				
2002-96	Front, Lower	-	520-740	520-740
BUICK				
ELECTRA				
1984-77	Front, Upper	-	520-119	520-120
ESTATE WAGON				
1990-77	Front, Upper	-	520-119	520-120
LESABRE				
1985-77	Front, Upper	-	520-119	520-120
RAINIER				
2006-04	Front, Upper	-	520-143	520-144
REGAL				
1987-82	Front, Upper	-	520-137	520-138
RIVIERA				
1978-77	Front, Upper	-	520-119	520-120
ROADMASTER				
1996-91	Front, Upper	-	520-119	520-120
CADILLAC				
DEVILLE				
1984-77	Front, Upper	-	520-119	520-120
ESCALADE				
2006-04	Front, Lower	-	520-127	520-128
2006-04	Front, Upper	-	520-150	520-150
2003-00	Front, Lower	2WD	520-127	520-128
2003-00	Front, Lower	4WD	520-127	520-128
2003-00	Front, Upper	-	520-150	520-150
1999	Front, Lower	2WD	520-121	520-122
FLEETWOOD				
1996-85	Front, Upper	RWD	520-119	520-120
1984-77	Front, Upper	-	520-119	520-120
FLEETWOOD COMMERCIAL CHASSIS				
1996-77	Front, Upper	-	520-119	520-120
SEVILLE				
1984	Front, Upper	-	—	520-120
1979-77	Front, Upper	-	520-119	—
CHEVROLET				
BERETTA				
1995	Front, Lower	Sport Suspension	520-131	520-132
CAPRICE				
1996-93	Front, Upper	-	520-119	520-120
1992-91	Front, Upper	Exc. Police	520-119	520-120
1990-87	Front, Upper	Exc. Police	520-119	520-120
1990-87	Front, Upper	Police	520-137	520-138
CAVALIER				
2005-95	Front, Lower	Soft Ride Suspension	520-101	520-102
CORSICA				
1995	Front, Lower	Sport Suspension	520-131	520-132
EL CAMINO				
1987-82	Front, Upper	-	520-137	520-138
IMPALA				
1985-77	Front, Upper	-	520-119	520-120
IMPALA SS				
1996-94	Front, Upper	-	520-119	520-120
MALIBU				
2003-00	Front, Lower	-	520-133	520-134
1999	Front, Lower	Stamped Steel	520-133	520-134
1998-97	Front, Lower	-	520-133	520-134
1983-82	Front, Upper	-	520-137	520-138
MALIBU CLASSIC				
2004	Front, Lower	To VIN #4M631462	520-133	520-134
METRO				
2001-98	Front, Lower	-	520-111	520-112
MONTE CARLO				
1988-82	Front, Upper	-	520-137	520-138
VENTURE VAN				
2005-97	Front, Lower	-	520-145	520-146
CHEVROLET TRUCK				
ASTRO				
1989-85	Front, Upper	-	—	520-120
AVALANCHE 1500				
2006-02	Front, Lower	-	520-127	520-128
2006-02	Front, Upper	-	520-116	520-116
AVALANCHE 2500				
2006-02	Front, Upper	-	520-150	520-150
BLAZER				
1994-92	Front, Lower	2WD	520-121	520-122

Control Arm Applications

Make Model/Years	Location	Description	Dorman LH	Dorman RH
CHEVROLET TRUCK (continued)				
BLAZER (continued)				
1994	Front, Upper	5.7L Eng	520-129	520-130
1993-92	Front, Upper	4-Door	520-129	520-130
C1500 PICKUP				
1999-88	Front, Lower	2WD	520-121	520-122
1999-88	Front, Upper	-	520-129	520-130
C1500 SUBURBAN				
1999-94	Front, Upper	5.7L Eng	520-129	520-130
1999-92	Front, Lower	2WD	520-121	520-122
1993-92	Front, Upper	-	520-129	520-130
C20 PICKUP				
1984-73	Front, Lower	2WD	520-113	520-114
C20 SUBURBAN				
1984-73	Front, Lower	2WD	520-113	520-114
C2500 PICKUP				
2000-88	Front, Lower	2WD	520-121	520-122
1999-88	Front, Upper	7200 Lb GVW	520-129	520-130
C2500 SUBURBAN				
1999-94	Front, Upper	5.7L Eng	520-129	520-130
1999-92	Front, Lower	2WD	520-121	520-122
1993-92	Front, Upper	-	520-129	520-130
C30 PICKUP				
1984-82	Front, Lower	2WD, Exc. Heavy Duty Suspension	520-113	520-114
1981-73	Front, Lower	2WD	520-113	520-114
C3500 PICKUP				
2000-88	Front, Lower	2WD	520-121	520-122
EXPRESS				
2002-96	Front, Lower	-	520-121	520-122
EXPRESS 1500				
2005-04	Front, Lower	4WD	520-127	520-128
2002-96	Front, Upper	-	520-129	520-130
EXPRESS 2500				
2006-03	Front, Upper	7300 Lb GVW	520-116	520-116
2002-96	Front, Upper	7300 Lb GVW	520-129	520-130
EXPRESS 3500				
2006-03	Front, Upper	-	520-116	520-116
G20 VAN				
1997-96	Front, Upper	7300 Lb GVW	520-129	520-130
G30 VAN				
1978-73	Front, Lower	-	520-113	520-114
K1500 SUBURBAN				
1999-94	Front, Upper	5.7L Eng	520-129	520-130
1993-92	Front, Upper	-	520-129	520-130
K2500 SUBURBAN				
1999-94	Front, Upper	5.7L Eng	520-129	520-130
1993-92	Front, Upper	-	520-129	520-130
LLV (POSTAL VEHICLE)				
1994-87	Front, Upper	4WD	520-139	—
P20 VAN				
1984-78	Front, Lower	2WD	520-113	520-114
1977-73	Front, Lower	2WD, Exc. 11,000 Lb Axle	520-113	520-114
P30 VAN				
1978	Front, Lower	2WD, w/Power Brakes	520-113	520-114
1977-73	Front, Lower	2WD, Exc. 11,000 Lb Axle	520-113	520-114
POSTAL SERVICE VAN				
1995-87	Front, Upper	-	520-137	520-138
S10 BLAZER				
2005-84	Front, Upper	4WD	520-139	—
2005-04	Front, Lower	2WD, Exc. High Wider Pkg	520-135	520-136
2005-04	Front, Upper	2WD, Low Rider Pkg	520-137	520-138
2005-03	Front, Upper	2WD; w/High Wider Pkg	520-139	—
2003-95	Front, Lower	2WD	520-135	520-136
2003-83	Front, Upper	2WD	520-137	520-138
2000	Front, Lower	4WD	520-141	520-142
1999-94	Front, Lower	4WD, Exc. High Wider Pkg	520-141	520-142
1993-83	Front, Lower	4WD	520-141	520-142
S10 PICKUP				
2004-84	Front, Upper	4WD	520-139	—
2004	Front, Lower	2WD, Exc. High Wider Pkg	520-135	520-136
2004	Front, Upper	2WD, Low Rider Pkg Or Chassis Cab	520-137	520-138
2003-97	Front, Lower	2WD, w/Sport Suspension	520-135	520-136
2003-82	Front, Upper	2WD	520-137	520-138
2000	Front, Lower	4WD	520-141	520-142
1999-94	Front, Lower	4WD, Exc. High Wider Pkg	520-141	520-142
1993-83	Front, Lower	4WD	520-141	520-142
S10 TRAILBLAZER				
2006-02	Front, Upper	-	520-143	520-144
SILVERADO 1500				
2006-04	Front, Lower	2WD, Extended Cab, w/High Performance Pkg	520-127	520-128
2006-04	Front, Lower	4WD, Exc. Extended Cab	520-127	520-128

Control Arm Applications

Make Model/Years	Location	Description	Dorman LH	Dorman RH
CHEVROLET TRUCK (continued)				
SILVERADO 1500 (continued)				
2006-01	Front, Lower	2WD	520-125	520-126
2006-01	Front, Upper	Exc. Crew Cab	520-116	520-116
2003-99	Front, Lower	4WD	520-127	520-128
2003-01	Front, Upper	Crew Cab	520-150	520-150
2000-99	Front, Upper	-	520-116	520-116
2000	Front, Lower	2WD, w/Triangular Reinforcement Welded to Crossmember	520-125	520-126
SILVERADO 2500				
2004-01	Front, Upper	-	520-150	520-150
2000-99	Front, Upper	4WD	520-150	520-150
SILVERADO 3500				
2006-01	Front, Upper	-	520-150	520-150
SUBURBAN 1500				
2006-00	Front, Lower	-	520-127	520-128
2006-00	Front, Upper	-	520-116	520-116
SUBURBAN 2500				
2006-01	Front, Upper	-	520-150	520-150
2000	Front, Upper	4WD	520-150	520-150
TAHOE				
2006-00	Front, Lower	-	520-127	520-128
2000-95	Front, Lower	2WD	520-121	520-122
2000-95	Front, Upper	5.7L Eng	520-129	—
2000-94	Front, Upper	5.7L Eng	—	520-130
CHRYSLER				
300M				
2004-99	Front, Lower	-	520-303	520-304
CIRRUS				
2000-95	Front, Lower	-	520-301	520-302
CONCORDE				
2004-93	Front, Lower	-	520-303	520-304
LHS				
2001-94	Front, Lower	-	520-303	520-304
NEW YORKER				
1996-94	Front, Lower	-	520-303	520-304
PT CRUISER				
2006-01	Front, Lower	-	520-327	520-328
SEBRING				
2000-96	Front, Lower	Convertible	520-301	520-302
2000-96	Front, Lower	Coupe, Lateral Arm	520-357	520-358
1995	Front, Lower	Lateral Arm	520-357	520-358
TOWN & COUNTRY VAN				
2006	Front, Lower	-	520-341	520-342
2005-04	Front, Lower	-	520-341	520-342
2003	Front, Lower	Heavy Duty Suspension	520-341	520-342
2002-01	Front, Lower	Base & SE	520-341	520-342
2000-96	Front, Lower	-	520-343	520-344
1995-91	Front, Lower	-	520-345	520-346
VOYAGER, GRAND VOYAGER				
2003	Front, Lower	Heavy Duty Suspension	520-341	520-342
2002-01	Front, Lower	Base & SE	520-341	520-342
2000	Front, Lower	-	520-343	520-344
DODGE				
AVENGER				
2000-95	Front, Lower	Lateral Arm	520-357	520-358
CARAVAN, GRAND CARAVAN				
2006-04	Front, Lower	6 Cyl Eng	520-341	520-342
2003	Front, Lower	Heavy Duty Suspension	520-341	520-342
2002-01	Front, Lower	Base & SE	520-341	520-342
2000-96	Front, Lower	-	520-343	520-344
1995-91	Front, Lower	-	520-345	520-346
COLT				
1986-85	Front, Lower	-	520-355	520-356
INTREPID				
2004-93	Front, Lower	-	520-303	520-304
NEON				
2005-03	Front, Lower	2.0L Eng	520-323	520-324
2005-03	Front, Lower	2.4L Eng	520-327	520-328
2002-00	Front, Lower	-	520-323	520-324
1999-95	Front, Lower	-	520-325	520-326
STRATUS				
2000-95	Front, Lower	-	520-301	520-302
DODGE TRUCK				
B100/150/1500 VAN				
1998	Front, Upper	3500 Lb Axle	520-315	520-316
1998	Front, Upper	4000 Lb Axle	520-317	520-318
1997	Front, Lower	3500 Lb Axle	520-333	520-334
1997	Front, Lower	3600 Lb Axle	520-335	520-336
1997	Front, Upper	3500 Lb Axle	520-315	520-316
1997	Front, Upper	3600 Lb Axle	—	520-316
1997	Front, Upper	4000 Lb Axle	520-317	520-318

Control Arm Applications

Make Model/Years	Location	Description	Dorman LH	Dorman RH
DODGE TRUCK (continued)				
B100/150/1500 VAN (continued)				
1996-88	Front, Lower	-	520-333	520-334
1996-88	Front, Upper	-	520-315	520-316
1987-80	Front, Lower	3300 Lb Axle	520-333	520-334
1987-80	Front, Lower	3600 Lb Axle	520-335	520-336
1987-80	Front, Upper	3300 Lb Axle	520-315	520-316
1987-80	Front, Upper	3600 Lb Axle	520-315	520-316
1987-80	Front, Upper	4000 Lb Axle	520-317	520-318
1979	Front, Lower	3300 Lb Axle, From 5/21/79	520-333	520-334
1979	Front, Lower	3600 Lb Axle	520-335	520-336
1979	Front, Upper	3300 Lb Axle	520-315	520-316
1979	Front, Upper	3600 Lb Axle	520-315	520-316
1979	Front, Upper	4000 Lb Axle	520-317	520-318
B200/250/2500 VAN				
1998	Front, Upper	3500 Lb Axle	520-315	520-316
1998	Front, Upper	4000 Lb Axle	520-317	520-318
1997	Front, Lower	3500 Lb Axle	520-333	520-334
1997	Front, Lower	3600 Lb Axle	520-335	520-336
1997	Front, Upper	3500 Lb Axle	520-315	520-316
1997	Front, Upper	3600 Lb Axle	—	520-316
1997	Front, Upper	4000 Lb Axle	520-317	520-318
1996-88	Front, Lower	-	520-333	520-334
1996-88	Front, Upper	-	520-315	520-316
1987-80	Front, Lower	3300 Lb Axle	520-333	520-334
1987-80	Front, Lower	3600 Lb Axle	520-335	520-336
1987-80	Front, Upper	3300 Lb Axle	520-315	520-316
1987-80	Front, Upper	3600 Lb Axle	520-315	520-316
1987-80	Front, Upper	4000 Lb Axle	520-317	520-318
1979	Front, Lower	3300 Lb Axle, From 5/21/79	520-333	520-334
1979	Front, Lower	3600 Lb Axle	520-335	520-336
1979	Front, Upper	3300 Lb Axle	520-315	520-316
1979	Front, Upper	3600 Lb Axle	520-315	520-316
1979	Front, Upper	4000 Lb Axle	520-317	520-318
B300/350/3500 VAN				
1998	Front, Upper	3500 Lb Axle	520-315	520-316
1998	Front, Upper	4000 Lb Axle	520-317	520-318
1997	Front, Lower	3500 Lb Axle	520-333	520-334
1997	Front, Lower	3600 Lb Axle	520-335	520-336
1997	Front, Upper	3500 Lb Axle	520-315	520-316
1997	Front, Upper	3600 Lb Axle	—	520-316
1997	Front, Upper	4000 Lb Axle	520-317	520-318
1996-88	Front, Lower	3600 Lb Axle	520-335	520-336
1996-88	Front, Upper	3600 Lb Axle	—	520-316
1996-88	Front, Upper	4000 Lb Axle	520-317	520-318
1987-80	Front, Lower	3300 Lb Axle	520-333	520-334
1987-80	Front, Lower	3600 Lb Axle	520-335	520-336
1987-80	Front, Upper	3300 Lb Axle	520-315	520-316
1987-80	Front, Upper	3600 Lb Axle	520-315	520-316
1987-80	Front, Upper	4000 Lb Axle	520-317	520-318
1979	Front, Lower	3300 Lb Axle, From 5/21/79	520-333	520-334
1979	Front, Lower	3600 Lb Axle	520-335	520-336
1979	Front, Upper	3300 Lb Axle	520-315	520-316
1979	Front, Upper	3600 Lb Axle	520-315	520-316
1979	Front, Upper	4000 Lb Axle	520-317	520-318
CB300				
1980	Front, Lower	3300 Lb Axle	520-333	520-334
1980	Front, Lower	3600 Lb Axle	520-335	520-336
1980	Front, Upper	3300 Lb Axle	520-315	520-316
1980	Front, Upper	3600 Lb Axle	520-315	520-316
1980	Front, Upper	4000 Lb Axle	520-317	520-318
1979	Front, Lower	3300 Lb Axle, From 5/21/79	520-333	520-334
1979	Front, Lower	3600 Lb Axle	520-335	520-336
1979	Front, Upper	3300 Lb Axle	520-315	520-316
1979	Front, Upper	3600 Lb Axle	520-315	520-316
1979	Front, Upper	4000 Lb Axle	520-317	520-318
DAKOTA				
2004-00	Front, Lower	2WD	—	520-350
2004-00	Front, Lower	4WD	520-305	520-306
2004-00	Front, Upper	4WD	520-309	520-310
1999-97	Front, Lower	4WD	520-307	520-308
1999-97	Front, Upper	4WD	520-311	520-312
DURANGO				
2005-04	Front, Lower	-	520-314	520-314
2003-00	Front, Lower	2WD	—	520-350
2003-00	Front, Lower	4WD	520-305	520-306
1999-98	Front, Lower	4WD	520-307	520-308
1999-98	Front, Upper	4WD	520-311	520-312
RAM 1500 VAN				
2003-01	Front, Upper	3500 Lb Axle	520-315	520-316
2003-01	Front, Upper	4000 Lb Axle	520-317	520-318

Control Arms

Power Steering Pulleys
pg. 317-326

Quick Disconnect™
pg. 327-396

Radiator Fan Assemblies
pg. 397-430

Rear Axle Shaft Kits
pg. 431-434

Side View Mirror Assemblies
pg. 435-468

Complete assemblies including ball joint, bushings and new hardware.

Control Arms

Control Arm Applications

Make Model/Years	Location	Description	Dorman LH	Dorman RH
DODGE TRUCK (continued)				
RAM 1500 VAN (continued)				
2000-99	Front, Upper	3500 Lb Axle	520-315	520-316
2000-99	Front, Upper	4000 Lb Axle	520-317	520-318
RAM 2500 VAN				
2003-01	Front, Upper	3500 Lb Axle	520-315	520-316
2003-01	Front, Upper	4000 Lb Axle	520-317	520-318
2000	Front, Upper	3500 Lb Axle	520-315	520-316
2000	Front, Upper	4000 Lb Axle	520-317	520-318
1999	Front, Upper	3500 Lb Axle	520-315	520-316
RAM 3500 VAN				
2003-00	Front, Upper	3500 Lb Axle	520-315	520-316
2003-00	Front, Upper	4000 Lb Axle	520-317	520-318
1999	Front, Upper	3500 Lb Axle	520-315	520-316
EAGLE				
TALON				
1998-95	Front, Lower	Lateral Arm	520-357	520-358
VISION				
1997-93	Front, Lower	-	520-303	520-304
FORD				
CONTOUR				
2000-99	Front Lower	-	520-201	520-202
1998	Front Lower	2 Bolt Hole Attachment	520-201	520-202
1998	Front Lower	4 Bolt Hole Attachment	520-203	520-204
1997-95	Front Lower	-	520-203	520-204
CROWN VICTORIA				
2002-95	Front Lower	-	520-207	520-208
ESCORT				
1996-91	Front Lower	1.9L Eng	520-209	520-210
1990-84	Front Lower	-	520-213	520-214
1983-81	Front Lower	-	520-211	520-212
EXP				
1985-84	Front Lower	-	520-213	520-214
1983-82	Front Lower	-	520-211	520-212
FESTIVA				
1993-88	Front Lower	-	520-230	520-230
FOCUS				
2004-00	Front Lower	-	520-231	520-232
PROBE				
1997-93	Front Lower	2.0L Eng	520-265	520-266
1992-90	Front Lower	2.2L Eng, wo/Turbo	520-267	520-268
1992-90	Front Lower	3.0L Eng	520-267	520-268
1989	Front Lower	wo/Turbo	520-263	520-264
TAURUS				
1995-90	Front Lower	Exc. SHO or Police	520-247	520-248
1989	Front Lower	Exc. SHO	520-247	520-248
1988-86	Front Lower	-	520-247	520-248
TEMPO				
1994-92	Front Lower	wo/Special Handling Package	520-213	520-214
1991-85	Front Lower	-	520-213	520-214
1984	Front Lower	From 8/83	520-213	520-214
THUNDERBIRD				
1997-89	Front Upper	-	520-249	520-250
FORD TRUCK				
EXPEDITION				
2002-97	Front Lower	2WD	520-219	520-220
2002-97	Front Upper	2WD	520-217	520-218
2002-97	Front Upper	4WD	520-215	520-216
EXPLORER				
2003-02	Front Lower	Sport	520-223	520-224
2003-02	Front Upper	Sport	520-221	520-222
2001-95	Front Lower	-	520-223	520-224
2001-95	Front Upper	-	520-221	520-222
EXPLORER SPORT TRAC				
2005-01	Front Lower	-	520-223	520-224
2005-01	Front Upper	-	520-221	520-222
F-150 PICKUP				
2004	Front Lower	2WD, Heritage	520-219	520-220
2004	Front Upper	2WD, Heritage	520-217	520-218
2004	Front Upper	2WD, Lightning	520-217	520-218
2004	Front Upper	4WD, Heritage	520-215	520-216
2004	Front Upper	4WD, Lightning	520-215	520-216
2003-99	Front Lower	2WD, Exc. Lightning	520-219	520-220
2003-97	Front Upper	2WD	520-217	520-218
2003-97	Front Upper	4WD	520-215	520-216
1998-97	Front Lower	2WD	520-219	520-220
F-250 PICKUP				
1999-97	Front Lower	2WD, Under 8500 Lb GVW	520-219	520-220
1999-97	Front Upper	2WD, Under 8500 Lb GVW	520-217	520-218
1999-97	Front Upper	4WD, Under 8500 Lb GVW	520-215	520-216

Control Arm Applications

Make Model/Years	Location	Description	Dorman LH	Dorman RH
FORD TRUCK (continued)				
RANGER				
2006-98	Front Lower	w/Torsion Bar Suspension	520-223	520-224
2006-98	Front Upper	w/Torsion Bar Suspension	520-221	520-222
2006-98	Front, Lower	2WD; w/Standard Duty Coil Suspension	520-239	520-240
WINDSTAR				
1998-95	Front Lower	-	520-255	520-256
GEO				
METRO				
1997-95	Front, Lower	-	520-111	520-112
GMC TRUCK				
C1500 PICKUP				
1999-88	Front, Lower	2WD	520-121	520-122
1999-88	Front, Upper	-	520-129	520-130
C1500 SUBURBAN				
1999-94	Front, Upper	5.7L Eng	520-129	520-130
1999-92	Front, Lower	2WD	520-121	520-122
1993-92	Front, Upper	-	520-129	520-130
C25/C2500 PICKUP				
1984-73	Front, Lower	2WD	520-113	520-114
C25/C2500 SUBURBAN				
1984-73	Front, Lower	2WD	520-113	520-114
C2500 PICKUP				
2000-88	Front, Lower	2WD	520-121	520-122
1999-88	Front, Upper	7200 Lb GVW	520-129	520-130
C2500 SUBURBAN				
1999-94	Front, Upper	5.7L Eng	520-129	520-130
1999-92	Front, Lower	2WD	520-121	520-122
1993-92	Front, Upper	-	520-129	520-130
C35/C3500 PICKUP				
1984-82	Front, Lower	2WD, Exc. Heavy Duty Suspension	520-113	520-114
1981-73	Front, Lower	2WD	520-113	520-114
C3500 PICKUP				
2000-88	Front, Lower	2WD	520-121	520-122
G25/G2500 VAN				
1997-96	Front, Upper	7300 Lb GVW	520-129	520-130
G35/G3500 VAN				
1978-73	Front, Lower	-	520-113	520-114
K1500 SUBURBAN				
1999-94	Front, Upper	5.7L Eng	520-129	520-130
1993-92	Front, Upper	-	520-129	520-130
K2500 SUBURBAN				
1999-94	Front, Upper	5.7L Eng	520-129	520-130
1993-92	Front, Upper	-	520-129	520-130
P25/P2500 VAN				
1984-78	Front, Lower	2WD	520-113	520-114
1977-73	Front, Lower	2WD, Exc. 11,000 Lb Axle	520-113	520-114
P35/P3500 VAN				
1978	Front, Lower	2WD, w/Power Brakes	520-113	520-114
1977-73	Front, Lower	2WD, Exc. 11,000 Lb Axle	520-113	520-114
S15 ENVOY				
2006-02	Front, Upper	-	520-143	520-144
S15 JIMMY				
2001-95	Front, Lower	2WD	520-135	520-136
2001-84	Front, Upper	4WD	520-139	—
2001-83	Front, Upper	2WD	520-137	520-138
2000	Front, Lower	4WD	520-141	520-142
1999-94	Front, Lower	4WD, Exc. High Wider Pkg	520-141	520-142
1993-83	Front, Lower	4WD	520-141	520-142
S15 PICKUP				
1990-84	Front, Upper	4WD	520-139	—
1990-83	Front, Lower	4WD	520-141	520-142
1990-82	Front, Upper	2WD	520-137	520-138
S15 SONOMA				
2004-91	Front, Upper	4WD	520-139	—
2004	Front, Lower	2WD, Exc. High Wider Pkg	520-135	520-136
2004	Front, Upper	2WD, Low Rider Pkg Or Chassis Cab	520-137	520-138
2003-97	Front, Lower	2WD, w/Sport Suspension	520-135	520-136
2003-91	Front, Upper	2WD	520-137	520-138
2000	Front, Lower	4WD	520-141	520-142
1999-94	Front, Lower	4WD, Exc. High Wider Pkg	520-141	520-142
1993-91	Front, Lower	4WD	520-141	520-142
S15 SYCLONE				
1991	Front, Lower	4WD	520-141	520-142
1991	Front, Upper	2WD	520-137	520-138
1991	Front, Upper	4WD	520-139	—
S15 TYPHOON				
1993-92	Front, Lower	4WD	520-141	520-142
1993-92	Front, Upper	2WD	520-137	520-138
1993-92	Front, Upper	4WD	520-139	—

Control Arm Applications

Make Model/Years	Location	Description	Dorman LH	Dorman RH
GMC TRUCK (continued)				
SAFARI				
1989-85	Front, Upper	-	—	520-120
SAVANA				
2002-96	Front, Lower	-	520-121	520-122
SAVANA 1500				
2005-04	Front, Lower	4WD	520-127	520-128
2002-96	Front, Upper	-	520-129	520-130
SAVANA 2500				
2006-03	Front, Upper	7300 Lb GVW	520-116	520-116
2002-96	Front, Upper	7300 Lb GVW	520-129	520-130
SAVANA 3500				
2006-03	Front, Upper	-	520-116	520-116
SIERRA 1500				
2006-04	Front, Lower	2WD, Extended Cab, w/High Performance Pkg	520-127	520-128
2006-04	Front, Lower	4WD, Exc. Extended Cab	520-127	520-128
2006-01	Front, Lower	2WD	520-125	520-126
2006-01	Front, Upper	Exc. Crew Cab	520-116	520-116
2003-99	Front, Lower	4WD	520-127	520-128
2003-01	Front, Upper	Crew Cab	520-150	520-150
2000-99	Front, Upper	-	520-116	520-116
2000	Front, Lower	2WD, w/Triangular Reinforcement Welded to Crossmember	520-125	520-126
SIERRA 2500				
2004-01	Front, Upper	-	520-150	520-150
2000-99	Front, Upper	4WD	520-150	520-150
SIERRA 3500				
2006-01	Front, Upper	-	520-150	520-150
SIERRA C3				
2001	Front, Upper	-	520-150	520-150
YUKON				
2006-00	Front, Lower	-	520-127	520-128
2000-94	Front, Upper	5.7L Eng	520-129	520-130
2000-92	Front, Lower	2WD	520-121	520-122
1993-92	Front, Upper	4-Door	520-129	520-130
YUKON DENALI				
2006-05	Front, Lower	-	520-127	520-128
YUKON DENALI XL				
2006-05	Front, Lower	-	520-127	520-128
YUKON XL 1500				
2006-01	Front, Lower	-	520-127	520-128
2006-01	Front, Upper	-	520-116	520-116
YUKON XL 2500				
2006-01	Front, Upper	-	520-150	520-150
HONDA				
ACCORD				
2002-98	Front, Lower	-	520-623	520-624
2002-98	Front, Upper	-	520-621	520-622
1997-96	Front, Lower	Coupe or Sedan, 4 Cyl Eng	520-625	520-626
1997-96	Front, Lower	Wagon	520-625	520-626
1997-96	Front, Upper	Sedan or Coupe	520-627	520-628
1997-96	Front, Upper	Wagon	520-627	520-628
1995	Front, Lower	Coupe or Sedan, 4 Cyl Eng	520-625	520-626
1995	Front, Lower	Wagon	520-625	520-626
1995	Front, Upper	Sedan or Coupe	520-627	520-628
1995	Front, Upper	Wagon	520-627	520-628
1995	Rear, Upper	LX or EX Sedan, Made in Japan	520-629	520-630
1994	Front, Lower	Coupe or Sedan, 4 Cyl Eng	520-625	520-626
1994	Front, Lower	Wagon	520-625	520-626
1994	Front, Upper	Wagon	520-627	520-628
1993-91	Front, Lower	Coupe or Sedan	520-633	520-634
1993-91	Front, Lower	Wagon	520-633	520-634
1993-91	Front, Upper	Sedan or Coupe	520-639	520-640
1993-91	Front, Upper	Wagon	520-639	520-640
1993-91	Rear, Lower	Coupe	520-631	520-632
1993-91	Rear, Lower	DX or LX Sedan	520-631	520-632
1993-91	Rear, Upper	Sedan or Coupe	520-637	520-638
1990	Front, Lower	Coupe or Sedan	520-633	520-634
1990	Front, Upper	Sedan or Coupe	520-639	520-640
1990	Rear, Lower	Coupe	520-631	520-632
1990	Rear, Lower	DX or LX Sedan	520-631	520-632
1990	Rear, Upper	Sedan or Coupe	520-637	520-638
1989-88	Front, Lower	Coupe	520-643	520-644
1989-88	Front, Lower	Hatchback or Sedan	520-643	520-644
1989-88	Front, Upper	Coupe	520-641	520-642
1989-88	Front, Upper	Hatchback or Sedan	520-641	520-642
1989-88	Rear, Upper	Coupe	520-646	520-646
1989-88	Rear, Upper	Hatchback or Sedan	520-646	520-646
1987-86	Front, Lower	Hatchback or Sedan	520-643	520-644
1987-86	Front, Upper	Hatchback or Sedan	520-641	520-642
1987-86	Rear, Upper	Hatchback or Sedan	520-646	520-646
1985-84	Front, Lower	-	520-661	520-662

Control Arm Applications

Make Model/Years	Location	Description	Dorman LH	Dorman RH
HONDA (continued)				
ACCORD (continued)				
1983-82	Front, Lower	-	520-663	520-664
1981-76	Front, Lower	-	520-665	520-666
CIVIC				
2000-96	Front, Lower	DX Sedan	520-667	520-668
2000-96	Front, Lower	Hatchback or Coupe	520-667	520-668
2000-96	Front, Upper	Hatchback or Coupe	520-669	520-670
2000-96	Front, Upper	Sedan, Made in USA or Canada	520-669	520-670
2000-96	Rear, Upper	Hatchback or Coupe	520-671	520-672
2000-96	Rear, Upper	Sedan, Made in USA or Canada	520-671	520-672
1995	Front, Lower	EX Coupe	520-673	520-674
1995	Front, Lower	EX Sedan	520-673	520-674
1995	Front, Lower	LX Sedan	520-673	520-674
1995	Front, Lower	SI Hatchback	520-673	520-674
1995	Front, Upper	Coupe	520-675	520-676
1995	Front, Upper	Hatchback	520-675	520-676
1995	Rear, Upper	-	520-671	520-672
1994-93	Front, Lower	EX Coupe	520-673	520-674
1994-93	Front, Lower	EX Sedan	520-673	520-674
1994-93	Front, Lower	LX Sedan	520-673	520-674
1994-93	Front, Lower	SI Hatchback	520-673	520-674
1994-93	Front, Upper	Coupe	520-675	520-676
1994-93	Front, Upper	DX or LX Sedan	520-675	520-676
1994-93	Front, Upper	EX Sedan	520-675	520-676
1994-93	Front, Upper	Hatchback	520-675	520-676
1994-93	Rear, Upper	-	520-671	520-672
1992	Front, Lower	EX Sedan	520-673	520-674
1992	Front, Lower	LX Sedan	520-673	520-674
1992	Front, Lower	SI Hatchback	520-673	520-674
1992	Front, Upper	DX or LX Sedan, To Serial #RS001831	520-675	520-676
1992	Front, Upper	EX Sedan, To Serial #RS001212	520-675	520-676
1992	Front, Upper	Hatchback	520-675	520-676
1992	Rear, Upper	-	520-671	520-672
1991-90	Front, Upper	Hatchback, Canada Built	520-611	520-612
1991-90	Front, Upper	Sedan	520-611	520-612
1989-88	Front, Lower	DX or LX Sedan	520-677	520-678
1989-88	Front, Lower	Hatchback	520-677	520-678
1989-88	Front, Lower	Wagon or Wagovan	520-677	520-678
1989-88	Front, Upper	Hatchback	520-611	520-612
1989-88	Front, Upper	Sedan	520-611	520-612
1987-85	Front, Lower	Radius Arm, 4WD Wagon	520-683	520-684
1987-85	Front, Lower	Radius Arm, Sedan or Hatchback	520-683	520-684
1984	Front, Lower	Radius Arm, 2WD Wagon	520-683	520-684
1984	Front, Lower	Radius Arm, Sedan or Hatchback	520-683	520-684
1983-81	Front, Lower	-	520-688	520-688
1980	Front, Lower	Hatchback or Wagon	520-688	520-688
1979-78	Front, Lower	1200 Series	520-690	520-690
1979-78	Front, Lower	Sedan or Wagon	520-690	520-690
1977-76	Front, Lower	Wagon	520-690	520-690
CIVIC DEL SOL				
1997-95	Rear, Upper	-	520-671	520-672
1994-93	Front, Upper	To Serial #RS000749	520-675	520-676
1994-93	Rear, Upper	-	520-671	520-672
CR-V				
2001-97	Front, Lower	-	520-649	520-650
2001-97	Front, Upper	-	520-647	520-648
CRX				
1991-88	Front, Upper	-	520-611	520-612
1987-84	Front, Lower	Radius Arm	520-683	520-684
PRELUDE				
1982-79	Front, Lower	-	520-660	520-660
HUMMER				
H2				
2006-03	Front, Upper	-	520-150	520-150
HYUNDAI				
EXCEL				
1994-90	Front, Lower	-	520-803	520-804
INFINITI				
QX4				
2003-97	Front, Lower	-	520-501	520-502
LINCOLN				
CONTINENTAL				
1994-88	Front Lower	-	520-257	520-258
NAVIGATOR				
2002-98	Front Lower	2WD	520-219	520-220
2002-98	Front Upper	2WD	520-217	520-218
2002-98	Front Upper	4WD	520-215	520-216
TOWN CAR				
2002-95	Front Lower	-	520-207	520-208

Control Arms

Control Arm Applications

Make Model/Years	Location	Description	Dorman LH	Dorman RH
MAZDA				
323				
1994-92	Front, Lower	Normal Suspension	520-817	520-818
1994-92	Rear, Lower	Lateral Link, Forward Position	520-813	520-814
1994-92	Rear, Lower	Lateral Link, Rearward Position	520-816	520-816
1991-90	Front, Lower	2WD	520-817	520-818
1991-90	Rear, Lower	Lateral Link, Forward Position, 2WD	520-813	520-814
1991-90	Rear, Lower	Lateral Link, Rearward Position	520-816	520-816
1989-88	Front, Lower	w/Turbo, 2WD	520-811	520-812
1989-88	Front, Lower	wo/Turbo	520-811	520-812
1987-86	Front, Lower	-	520-811	520-812
626				
1997-93	Front Lower	2.0L Eng	520-265	520-266
1997-93	Front, Lower	-	520-265	520-266
1992-90	Front, Lower	2 Wheel Steering, Japan Built	520-263	520-264
1989-88	Front, Lower	2 Wheel Steering	520-263	520-264
1987-83	Front, Lower	-	520-819	520-820
929				
1995-92	Front, Lower	-	520-821	520-822
1991-90	Front, Lower	-	—	520-824
MPV				
1996-91	Front, Lower	2WD	520-830	520-830
1990-89	Front, Lower	-	520-830	520-830
MX-6				
1997-93	Front Lower	2.0L Eng	520-265	520-266
1997-93	Front, Lower	-	520-265	520-266
1992-90	Front, Lower	2 Wheel Steering, Japan Built	520-263	520-264
1989-88	Front, Lower	2 Wheel Steering	520-263	520-264
PROTEGE				
1995-92	Front, Lower	Normal Suspension	520-817	520-818
1995-92	Rear, Lower	Lateral Link, Forward Position	520-813	520-814
1995-92	Rear, Lower	Lateral Link, Rearward Position	520-816	520-816
1991-90	Front, Lower	2WD	520-817	520-818
1991-90	Rear, Lower	Lateral Link, Forward Position, 2WD	520-813	520-814
1991-90	Rear, Lower	Lateral Link, Rearward Position	520-816	520-816
MAZDA TRUCK				
B2000				
1987-86	Front, Lower	2WD	520-825	520-826
B2200				
1993-87	Front, Lower	2WD	520-825	520-826
B2600				
1993-87	Front, Lower	2WD	520-825	520-826
MERCEDES-BENZ				
230				
1978-75	Front, Upper	-	520-755	520-756
240D				
1983-75	Front, Upper	-	520-755	520-756
280CE				
1981-78	Front, Upper	-	520-755	520-756
280E				
1981-77	Front, Upper	-	520-755	520-756
280SE				
1980-77	Front, Upper	-	520-755	520-756
300CD				
1980-78	Front, Upper	-	520-755	520-756
300CDT				
1985-82	Front, Upper	-	520-757	520-758
300CE				
1991-88	Front, Upper	-	520-757	520-758
300D				
1991-87	Front, Upper	-	520-757	520-758
1980-75	Front, Upper	-	520-755	520-756
300DT				
1987-82	Front, Upper	-	520-757	520-758
300E				
1991-86	Front, Upper	-	520-757	520-758
300SD				
1985-82	Front, Upper	-	520-757	520-758
1980-78	Front, Upper	-	520-755	520-756
300SDL				
1987-86	Front, Upper	-	520-757	520-758
300SE				
1991-88	Front, Upper	-	520-757	520-758
300SEL				
1991-88	Front, Upper	-	520-757	520-758
300SL				
1991-90	Front, Upper	-	520-757	520-758
300TD				
1980-79	Front, Upper	-	520-755	520-756
300TDT				
1987-82	Front, Upper	-	520-757	520-758

Control Arm Applications

Make Model/Years	Location	Description	Dorman LH	Dorman RH
MERCEDES-BENZ (continued)				
300TE				
1991-88	Front, Upper	-	520-757	520-758
350SD				
1991	Front, Upper	-	520-757	520-758
350SDL				
1991-90	Front, Upper	-	520-757	520-758
420SEL				
1991-86	Front, Upper	-	520-757	520-758
450SE				
1976-75	Front, Upper	-	520-755	520-756
450SEL				
1980-75	Front, Upper	-	520-755	520-756
450SEL 6.9				
1979-77	Front, Upper	-	520-755	520-756
450SL				
1980-75	Front, Upper	-	520-755	520-756
450SLC				
1980-75	Front, Upper	-	520-755	520-756
560SEC				
1991-86	Front, Upper	-	520-757	520-758
560SEL				
1991-86	Front, Upper	-	520-757	520-758
560SL				
1989-86	Front, Upper	-	520-757	520-758
MERCURY				
COUGAR				
2002-99	Front Lower	2 Bolt Hole Attachment	520-201	520-202
2002-99	Front Lower	4 Bolt Hole Attachment	520-203	520-204
1997-89	Front Upper	-	520-249	520-250
GRAND MARQUIS				
2002-95	Front Lower	-	520-207	520-208
LN7				
1983-82	Front Lower	-	520-211	520-212
LYNX				
1987-84	Front Lower	-	520-213	520-214
1983-81	Front Lower	-	520-211	520-212
MOUNTAINEER				
2001-97	Front Lower	-	520-223	520-224
2001-97	Front Upper	-	520-221	520-222
MYSTIQUE				
2000-99	Front Lower	-	520-201	520-202
1998	Front Lower	2 Bolt Hole Attachment	520-201	520-202
1998	Front Lower	4 Bolt Hole Attachment	520-203	520-204
1997-95	Front Lower	-	520-203	520-204
SABLE				
1995-86	Front Lower	-	520-247	520-248
TOPAZ				
1994-92	Front Lower	wo/Special Handling Package	520-213	520-214
1991-85	Front Lower	-	520-213	520-214
1984	Front Lower	From 8/83	520-213	520-214
TRACER				
1996-91	Front Lower	1.9L Eng	520-209	520-210
VILLAGER				
2002-99	Front Lower	-	520-273	520-274
MERKUR				
XR4TI				
1989-85	Front Lower	-	520-271	520-272
MITSUBISHI				
ECLIPSE				
1999-95	Front, Lower	Lateral Arm	520-357	520-358
ECLIPSE SPYDER				
1999-96	Front, Lower	Lateral Arm	520-357	520-358
GALANT				
1998-95	Front, Lower	Lateral Arm	520-357	520-358
1994	Front, Lower	Lateral Arm	520-357	520-358
1994	Front, Upper	Control Arm, To 12/93	520-835	520-836
1993	Front, Lower	Control Arm, From 2/93	520-347	520-348
1993	Front, Lower	Control Arm, To 2/93	520-837	520-838
1993	Front, Lower	Lateral Arm	520-357	520-358
1993	Front, Upper	-	520-835	520-836
1992-90	Front, Lower	-	520-837	520-838
1989	Front, Lower	From 5/89	520-837	520-838
MIRAGE				
2002-97	Rear	Assist Link	520-841	520-842
2002-97	Rear, Upper	Control Arm	520-843	520-844
1996-93	Front, Lower	-	520-839	520-840
1996-93	Rear	Assist Link	520-841	520-842
1996-93	Rear, Upper	Control Arm	520-843	520-844
PRECIS				
1994-90	Front, Lower	-	520-803	520-804

Control Arm Applications

Make Model/Years	Location	Description	Dorman LH	Dorman RH
NISSAN				
200SX				
1988-84	Front, Lower	-	520-503	520-504
240SX				
1993-89	Front, Lower	-	520-505	520-506
810				
1981	Front, Lower	-	520-503	520-504
ALTIMA				
2005-02	Front, Lower	-	520-511	520-512
1997-93	Front, Lower	-	520-513	520-514
MAXIMA				
2002-00	Front, Lower	-	520-517	520-518
1999	Front, Lower	From 4/99	520-517	520-518
1999	Front, Lower	To 3/99	520-519	520-520
1998-96	Front, Lower	-	520-519	520-520
1995	Front, Lower	From 5/95	520-519	520-520
1995	Front, Lower	To 5/95, Exc. GLE Series	520-519	520-520
1994	Front, Lower	GXE & SE Series, From 2/94	520-519	520-520
1991-89	Front, Lower	GXE Series, w/AT	520-521	520-522
QUEST				
2002-99	Front, Lower	-	520-273	520-274
1998-93	Front, Lower	-	520-275	520-276
SENTRA				
2000	Front, Lower	To 12/99	520-523	—
1999-95	Front, Lower	-	520-523	—
1994-91	Front, Lower	-	520-525	520-526
1990-87	Front, Lower	-	520-527	520-528
NISSAN TRUCK				
620 PICKUP				
1977-72	Front, Lower	-	—	520-510
720 PICKUP				
1985-80	Front, Lower	2WD	520-509	520-510
PATHFINDER				
2004	Front, Lower	3.5L Eng	520-501	520-502
2003-96	Front, Lower	-	520-501	520-502
OLDSMOBILE				
98				
1984-77	Front, Upper	-	520-119	520-120
ACHIEVA				
1996-95	Front, Lower	-	520-131	520-132
ALERO				
2004-00	Front, Lower	Ride & Handling Suspension	520-133	520-134
1999	Front, Lower	Ride & Handling Suspension, Stamped Steel	520-133	520-134
BRAVADA				
2004-02	Front, Upper	-	520-143	520-144
2000-91	Front, Lower	4WD	520-141	520-142
1994-91	Front, Upper	4WD	520-139	—
CUSTOM CRUISER				
1992-77	Front, Upper	-	520-119	520-120
CUTLASS				
1999	Front, Lower	Stamped Steel	520-133	520-134
1998-97	Front, Lower	-	520-133	520-134
1987-85	Front, Upper	-	520-137	520-138
CUTLASS SUPREME				
1988-82	Front, Upper	-	520-137	520-138
1988	Front, Upper	-	520-137	520-138
DELTA 88				
1985-77	Front, Upper	-	520-119	520-120
SILHOUETTE				
2004-97	Front, Lower	-	520-145	520-146
PLYMOUTH				
BREEZE				
2000-96	Front, Lower	-	520-301	520-302
COLT				
1986-85	Front, Lower	-	520-355	520-356
NEON				
2001-00	Front, Lower	-	520-323	520-324
1999-95	Front, Lower	-	520-325	520-326
VOYAGER, GRAND VOYAGER				
2000-96	Front, Lower	-	520-343	520-344
1995-91	Front, Lower	-	520-345	520-346
PLYMOUTH TRUCK				
PB100/150 VAN				
1983-80	Front, Lower	3300 Lb Axle	520-333	520-334
1983-80	Front, Lower	3600 Lb Axle	520-335	520-336
1983-80	Front, Upper	3300 Lb Axle	520-315	520-316
1983-80	Front, Upper	3600 Lb Axle	520-315	520-316
1983-80	Front, Upper	4000 Lb Axle	520-317	520-318
1979	Front, Lower	3300 Lb Axle, From 5/21/79	520-333	520-334
1979	Front, Lower	3600 Lb Axle	520-335	520-336

Control Arm Applications

Make Model/Years	Location	Description	Dorman LH	Dorman RH
PLYMOUTH TRUCK (continued)				
PB100/150 VAN (continued)				
1979	Front, Upper	3300 Lb Axle	520-315	520-316
1979	Front, Upper	3600 Lb Axle	520-315	520-316
1979	Front, Upper	4000 Lb Axle	520-317	520-318
PB200/250 VAN				
1983-80	Front, Lower	3300 Lb Axle	520-333	520-334
1983-80	Front, Lower	3600 Lb Axle	520-335	520-336
1983-80	Front, Upper	3300 Lb Axle	520-315	520-316
1983-80	Front, Upper	3600 Lb Axle	520-315	520-316
1983-80	Front, Upper	4000 Lb Axle	520-317	520-318
1979	Front, Lower	3300 Lb Axle, From 5/21/79	520-333	520-334
1979	Front, Lower	3600 Lb Axle	520-335	520-336
1979	Front, Upper	3300 Lb Axle	520-315	520-316
1979	Front, Upper	3600 Lb Axle	520-315	520-316
1979	Front, Upper	4000 Lb Axle	520-317	520-318
PB300/350 VAN				
1983-80	Front, Lower	3300 Lb Axle	520-333	520-334
1983-80	Front, Lower	3600 Lb Axle	520-335	520-336
1983-80	Front, Upper	3300 Lb Axle	520-315	520-316
1983-80	Front, Upper	3600 Lb Axle	520-315	520-316
1983-80	Front, Upper	4000 Lb Axle	520-317	520-318
1979	Front, Lower	3300 Lb Axle, From 5/21/79	520-333	520-334
1979	Front, Lower	3600 Lb Axle	520-335	520-336
1979	Front, Upper	3300 Lb Axle	520-315	520-316
1979	Front, Upper	3600 Lb Axle	520-315	520-316
1979	Front, Upper	4000 Lb Axle	520-317	520-318
PONTIAC				
BONNEVILLE				
1986-82	Front, Upper	-	520-137	520-138
1981-77	Front, Upper	-	520-119	520-120
CATALINA				
1981-77	Front, Upper	-	520-119	520-120
GRAND AM				
2004-00	Front, Lower	Ride & Handling Suspension	520-133	520-134
1999	Front, Lower	Ride & Handling Suspension, Stamped Steel	520-133	520-134
1998-97	Front, Lower	Sport Suspension	520-131	520-132
1996-95	Front, Lower	-	520-131	520-132
GRAND PRIX				
1987-82	Front, Upper	-	520-137	520-138
GRAND SAFARI				
1978-77	Front, Upper	-	520-119	520-120
MONTANA				
2005-99	Front, Lower	-	520-145	520-146
PARISIENNE				
1986-83	Front, Upper	-	520-119	520-120
SUNFIRE				
2005-95	Front, Lower	Soft Ride Suspension	520-101	520-102
TRANS SPORT				
1998-97	Front, Lower	-	520-145	520-146
SATURN				
SC SERIES				
2002-91	Front, Lower	-	520-151	520-152
SL SERIES				
2002-91	Front, Lower	-	520-151	520-152
SW SERIES				
2001-93	Front, Lower	-	520-151	520-152
SUZUKI				
SIDEKICK				
1998-90	Front, Lower	-	520-845	520-846
1989	Front, Lower	1.6L Eng	520-845	520-846
SWIFT				
2001-95	Rear	Lateral Link	520-848	520-848
1994-92	Rear	Lateral Link	520-850	520-850
1994-92	Rear, Lower	3-Door GT Series	520-107	520-108
1991-89	Rear	Lateral Link	520-850	520-850
X-90				
1998-96	Front, Lower	-	520-845	520-846
TOYOTA				
CAMRY				
2006-02	Front, Lower	2.4L Eng, AT, USA Built	520-401	520-402
2006-02	Front, Lower	3.0L Eng, LE Series, USA Built	520-401	520-402
2001-97	Front, Lower	-	520-403	520-404
1996-92	Front, Lower	-	520-405	520-406
1991-87	Front, Lower	-	520-407	520-408
CELICA				
1987-86	Front, Lower	-	520-409	520-410
1985-82	Front, Lower	-	520-411	520-412
1981-76	Front, Lower	-	—	520-414
COROLLA				
2002	Front, Lower	w/Front Stabilizer, To 1/02	520-417	520-418

Control Arms

Power Steering Pulleys
pg. 317-326

Quick Disconnect™
pg. 327-396

Radiator Fan Assemblies
pg. 397-430

Rear Axle Shaft Kits
pg. 431-434

Side View Mirror Assemblies
pg. 435-468

Complete assemblies including ball joint, bushings and new hardware.

Control Arms

Control Arm Applications

Make Model/Years	Location	Description	Dorman LH	Dorman RH
TOYOTA (continued)				
COROLLA (continued)				
2001-97	Front, Lower	w/Front Stabilizer	520-417	520-418
1995	Front, Lower	Sedan 1.6L Eng, To 8/95	520-419	520-420
1994	Front, Lower	Sedan 1.6L Eng	520-419	520-420
1993	Front, Lower	Sedan & Wagon 1.6L Eng	520-421	520-422
1992	Front, Lower	Sedan & Wagon	520-421	520-422
1991-88	Front, Lower	-	520-421	520-422
1987-84	Front, Lower	Sedan & Liftback	520-423	520-424
CRESSIDA				
1992-89	Front, Lower	-	520-425	520-426
1988-85	Front, Lower	-	520-427	520-428
1984-81	Front, Lower	-	520-429	520-430
PASEO				
1994-92	Front, Lower	-	520-433	520-434
STARLET				
1984-81	Front, Lower	-	520-442	520-442
SUPRA				
1996-93	Front, Upper	-	520-443	520-444
1981-79	Front, Lower	-	—	520-414
TERCEL				
1994-91	Front, Lower	-	520-433	520-434
TOYOTA TRUCK				
RAV4				
2000-96	Front, Lower	2 Door, w/Steel Wheels	520-437	520-438
VOLKSWAGEN				
BEETLE				
2006-98	Front, Lower	Front Link Assy	520-760	520-760
GOLF				
2005-99	Front, Lower	Front Link Assy	520-760	520-760
JETTA				
2005-99	Front, Lower	Front Link Assy	520-760	520-760
PASSAT				
2005-01	Front, Lower	Rear Link Assy	520-765	520-766
2005-01	Front, Upper	Front Link Assy	520-767	520-768
2005-01	Front, Upper	Rear Link Assy	520-767	520-768
2000	Front, Upper	Front Link Assy	520-767	520-768
2000	Front, Upper	Rear Link Assy	520-767	520-768
1999	Front, Upper	Front Link Assy	520-767	520-768
1999	Front, Upper	Rear Link Assy, From VIN #X113735	520-767	520-768
1999	Front, Upper	Rear Link Assy, To VIN #X113734	520-763	520-764
1998	Front, Upper	Front Link Assy	520-767	520-768
1998	Front, Upper	Rear Link Assy	520-763	520-764

Control Arm Bumpers



31052 (1) For Better Value, Order 31054



Lower

Chrysler 1994-66.

31053 (1) For Better Value, Order 31054



Upper

Chrysler 1994-66.

31054 (2)



Upper & Lower

Chrysler 1994-66. Kit contains upper and lower bumpers. **Kit contains 31052 and 31053.**

31061 (1)



Lower

GM 2003-1953.



Worn shocks can cause Control Arm Bumpers to wear or crack. Inspect when replacing shocks.

CV Joint Boot Kits



UNI-FIT™

Guaranteed to always have the right boot on hand.



- Two Uni-Fit™ CV Boot Kits can be installed with one tool on 95% of all vehicles
- Uni-Fit™ CV Boot Kits include grease, clamps and boots - all which are needed to do the job right the first time
- Air powered “On-the-Car” Installation Tool **saves up to 40 minutes** over conventional CV Boot installation
- No need to remove the half-shaft or disassemble the joint to replace the CV Boot



Prevent a Breakdown: Failed CV Boots can lead to a failed axle.



Tech Tip

- Inspect all suspension components including CV Boots every time the vehicle is in for service.
- Grease on the suspension, spindle and caliper indicates a ruptured boot.
- Replace the torn CV Boot as soon as possible to prevent contaminants from entering the joint and ruining it.
- Do not leave a kink in the boot bellows after installation. The boot will fail prematurely.
- Always use the proper tools when removing and installing CV Boots.
- DO NOT use an impact gun to install the retaining nut on the axle. Damage to the joint and/or bearing may occur.

Activant Path

*C.V. JOINTS & U JOINTS/
U & CV JOINTS, &
DRIVESHAFT*

Activant Code

*DDW/
DQB/
DQC*

**Applications begin
on page 59.**

UNI-FIT™ CV Joint Boot Installation Tools

- Stretch our Uni-Fit CV Joint Boots to a diameter of up to 4.5" to slide the boot over the CV joint
- No need to remove the half-shaft or disassemble the joint to replace the CV Boot
- Boost profits by reducing labor time—Saves up to 40 minutes over conventional CV Boot installation

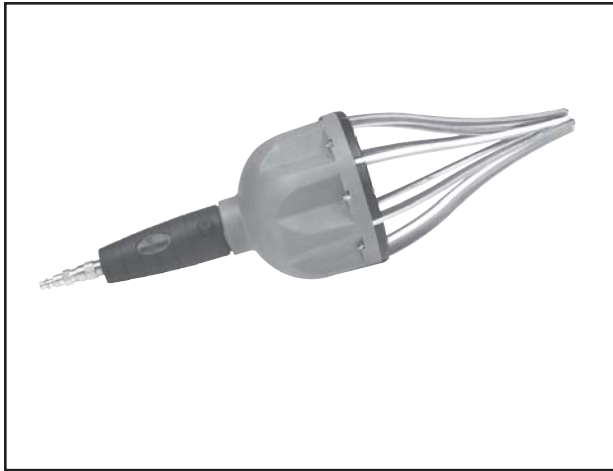

614-030 Uni-Fit™ CV Boot Air Tool

- Air powered “On-the-Car” Installation Tool works exclusively with **Neoprene** Uni-Fit CV Boots for installation on 90% of all applications.
- Simple single-button operation expands the CV boot in seconds to fit over the CV joint.
- Air compressor required; tool fits a 1/4" NPT air hose nipple.
- Each tool supplied with an Industrial Milton 1/4" body 1/4" NPT air hose nipple and an instruction sheet.
- Dorman Two Year Limited Warranty



614-050 Uni-Fit™ “On-The-Car” Installation Tool Kit

- Economical “On-the-Car” Installation Tool works exclusively with Neoprene and Silicone Uni-Fit CV Boots.
- No air compressor needed.
- Each Kit includes: Installation Tool, 4" & 5" Mounting Cones, Deluxe Banding Tool, Cutting Knife, Lubrication Spray and Instructions. Packaged in a durable utility box.
- Dorman Limited Lifetime Warranty

CV Joint Boot Kits

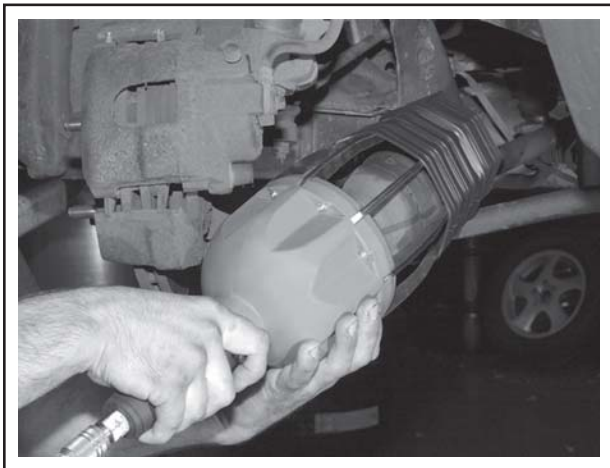

UNI-FIT™ CV Joint Boot Kits

- Each Kit Includes: CV Boot, 3 oz. Pack of Grease, 2 Clamps and Instructions.
- Reduce stocking inventory - Four SKUs replace over 350 OEM style replacement boots - 95% of all front, rear, or all wheel drive applications for both outer and inner CV joints.
- Eliminate missed applications - Coverage where no Aftermarket boot is available.
- Correct boot always on hand - No waiting for parts delivery or being sent the wrong boot kits.
- Stretch to fit most applications - Only CV Boot that can be installed over the CV joint and retain its original durometer and shape. Can also be installed in the traditional method with joint disassembly or shaft removal.
- Proprietary rubber blend and patented design offer maximum durability and life. Boots stay flexible in winter and are resistant to cuts and abrasions.

Neoprene Rubber CV Joint Boot Kits

- For installation using the traditional method, the Dorman Uni-Fit “On-the-Car” Installation Tool Kit, or the Dorman Uni-Fit CV Boot Air Tool.



614-001

Uni-Fit™ CV Boot Kit

This Neoprene Boot provides coverage for outer joints up to 3.58" in diameter.



614-003

Uni-Fit™ CV Boot Kit

This Neoprene Boot provides coverage for outer joints larger than 3.58" in diameter commonly found on pickups, SUVs, luxury, and sport vehicles.



614-012

Uni-Fit™ CV Boot Kit Bulk Pack

Box of supplies to complete 12 CV Boot installations. Contains 12 **614-001** Neoprene Boots that fit outer joints up to 3.58", 12 (3 oz.) Packs of Grease, 24 Clamps, and Instruction Sheet.

Silicone Rubber CV Joint Boot Kits

- For installation using the traditional method.
- Designed specifically for inner joints where the CV Boot is exposed to high temperatures.



614-002

Uni-Fit™ CV Boot Kit

This Silicone Boot provides coverage for inner joints up to 3.58" in diameter where the CV boot is exposed to high temperatures.



614-004

Uni-Fit™ CV Boot Kit

This Silicone Boot provides coverage for inner joints larger than 3.58" in diameter where the CV boot is exposed to high temperatures.

UNI-FIT™ CV Joint Accessories & Hardware

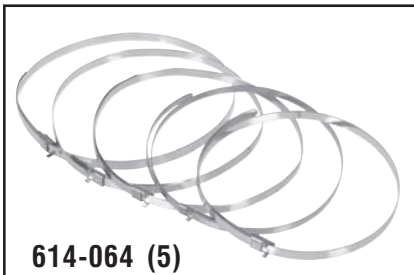

614-064 (5)

Heavy-Duty Stainless Steel Clamps

- OE quality, "free-end" style
- Ideal for clamping Uni-Fit™ CV Joint Boots
- Rounded edges and smooth surfaces
- 450 pound loop tensile strength
- HD 1/4" x 19"
- Same clamp that is used in Uni-Fit CV Joint Boot Kits. Carded, 5 per.



614-072

Uni-Fit™ Deluxe Banding Tool

- High strength construction
- Convenient tensioning ratchet with integrated band cutter
- Ideal professional quality tool for tightening Heavy Duty clamps used for Uni-Fit CV Joint Boots.



03618

CV Joint Grease

- Fortified with anti-wear agent molybdenum disulfide.
- One joint supply (3 oz) in a squeezable tube.
- Can be used for wheel bearings, ball joints, U-joints, hinged parts, cables, chassis parts, and general automotive applications.
- Excellent mechanical stability, heat resistance, and high compatibility with other grease.



Tech Tip

- Inspect all suspension components including CV Boots every time the vehicle is in for service.
- Grease on the suspension, spindle and caliper indicates a ruptured boot.
- Replace the torn CV Boot as soon as possible to prevent contaminants from entering the joint and ruining it.
- Do not leave a kink the boot bellows after installation. The boot will fail prematurely.
- Always use the proper tools when removing and installing CV Boots.
- DO NOT use an impact gun to install the retaining nut on the axle. Damage to the joint and/or bearing may occur.

Increase Customer Satisfaction and Loyalty!

CV Joint Boot Kits



Maintenance Checklist

- Change Oil
- Inspect CV Boot
- Check Belts
- Check Hoses
- Grease Chassis



Sales Tip

Ask the customer about the condition of the axle/spindle nuts whenever selling CV Joint Boot Kits. This is an ideal time to inspect and replace these parts. Refer to Dorman® AutoGrade™ Hardware Catalog, DAG2006.

Save Your Customers Money on Repairs...
REPLACE THE CV BOOT ONLY!

CV Joint Boot Kit Applications

Make/ Model/Years	Description	Dorman Uni-Fit Outer	Dorman Uni-Fit Inner
ACURA			
CL			
2003-97	-	614-003	614-004
INTEGRA			
2001-86	-	614-001	614-002
LEGEND			
1995-86	-	614-003	614-004
NSX			
2003-91	-	614-003	614-004
RL			
2003-96	-	614-003	614-004
RSX			
2003-02	-	614-001	614-002
TL			
2005-04	AT, RH	614-003	-
2003-95	-	614-003	614-004
VIGOR			
1994-92	-	614-003	614-004
AM GENERAL			
HUMMER			
1999-95	-	614-003	614-002
AMERICAN MOTORS			
EAGLE			
1988-85	Exc. Limited Series	614-001	614-004
1988-85	Limited Series	614-003	614-002
1984-83	4-Cyl Eng	614-001	614-004
1984-83	6-Cyl Eng	614-003	614-002
1982-80	-	614-001	614-004
SPIRIT			
1983	-	614-003	614-002
1982-80	-	614-001	614-004
ASUNA			
SE, GT			
1994-92	-	614-001	614-002
SUNFIRE			
1995-93	-	614-001	614-002
SUNRUNNER			
1995-93	-	614-001	614-002
AUDI			
80, 90			
1992-88	Front	614-001	614-002
1992-88	Rear	614-001	614-002
100			
1995	Front	614-003	614-004
1994-92	Front	614-003	614-004
1994-92	Rear	614-001	614-002
1991-89	Front, AT, 3-Speed	614-001	614-002
1991-89	Front, Exc. AT, 3-Speed	614-001	614-002
1991-89	Rear	614-001	614-002
1977-68	-	614-001	614-002
200			
1991-88	Front	614-003	614-004
1991-88	Rear	614-001	614-002
4000			
1983-80	From VIN 81D077974	614-001	614-002
4000CS QUATTRO			
1987-86	Front	614-001	614-002
1987-86	Rear	614-003	614-004
4000S			
1987-83	-	614-001	614-002
4000S QUATTRO			
1985-84	Front	614-001	614-002
1985-84	Rear	614-003	614-004
5000			
1985-84	-	614-001	614-002
1983-82	w/Turbo	614-003	614-004
1983-82	wo/Turbo	614-001	614-002
1981-75	-	614-001	614-002
5000CS			
1988-86	AT	614-001	614-002
5000CS QUATTRO			
1988-86	Front	614-003	614-004
1988-86	Rear	614-003	614-004
5000S QUATTRO			
1988-87	Front	614-003	614-004
1988-87	Rear	614-003	614-004
5000S TURBO			
1985-84	-	614-003	614-004
A4, A6, A8			
2003-96	-	614-001	614-002
CABRIOLET			
1999-94	-	614-001	614-002

Make/ Model/Years	Description	Dorman Uni-Fit Outer	Dorman Uni-Fit Inner
AUDI (continued)			
COUPE QUATTRO			
1987-85	Front	614-001	614-002
1984-82	Front	614-001	614-002
1984-82	Rear	614-001	614-002
COUPE, GT			
1987-81	From VIN 85H026077	614-001	614-002
FOX			
1979-73	-	614-001	614-002
QUATTRO			
1985-83	Front	614-001	614-002
1985-83	Rear	614-003	614-004
S4, S6			
1996-92	-	614-001	614-002
V8 QUATTRO			
1994-90	-	614-001	614-002
BMW			
318i			
1985-83	-	614-001	614-001
318i, 318iC, 318iS			
1993-90	-	614-001	614-001
325, 325e, 325i, 325iC, 325iS			
1988-83	-	614-001	614-001
325iX			
1990-89	Rear	614-001	614-001
524td			
1991-82	-	614-001	614-001
528e			
1988-82	-	614-001	614-001
528i			
1991-82	-	614-001	614-001
530i			
1991-82	-	614-001	614-001
533i			
1984-82	-	614-001	614-001
535i			
1990-85	-	614-001	614-001
633CSi			
1984-83	-	614-001	614-001
635CSi			
1988-85	-	614-001	614-001
733i			
1984-82	-	614-001	614-001
735i, 735iL			
1993-85	-	614-001	614-001
740i, 740iL			
1993	-	614-001	614-001
750iL			
1993-88	-	614-001	614-001
M3			
1991-87	w/ABS	614-001	614-001
M5			
1991-88	-	614-001	614-001
M6			
1988-87	-	614-001	614-001
BUICK			
CENTURY			
2005-97	-	614-003	614-004
1996-95	-	614-003	614-004
1994	-	614-003	614-004
1993-89	4-Cyl Eng	614-001	614-002
1993-89	6-Cyl Eng	614-003	614-004
1988	4-Cyl Eng, Exc. Heavy Duty Brakes	614-001	614-002
1988	4-Cyl Eng, Heavy Duty Brakes	614-003	614-004
1988	6-Cyl Eng	614-003	614-004
1987-85	Exc. Heavy Duty Brakes	614-001	614-002
1987-85	Heavy Duty Brakes	614-003	614-004
1984-83	Exc. Heavy Duty Brakes	614-001	614-004
1984-83	Heavy Duty Brakes	614-003	614-004
1982	-	614-001	614-004
ELECTRA			
1990-85	-	614-003	614-004
LACROSSE			
2006-05	3.8L Eng	614-003	614-004
LESABRE			
2005-86	-	614-003	614-004
PARK AVENUE			
2005-91	-	614-003	614-004
RAINIER			
2006-04	4WD	614-003	614-004
REATA			
1991-88	-	614-003	614-004

CV Joint Boot Kits

Fuel Sending Units
pg. 155-176

Fuel Tanks
pg. 177-228

Harmonic Balancers
pg. 229-254

Heater Hose Assemblies
pg. 255-256

Hydraulic Clutch Lines
pg. 257-260

Uni-Fit™ CV Boot System reduces labor time and boosts profits!

CV Joint Boot Kits

CV Joint Boot Kit Applications

Make/ Model/Years	Description	Dorman Uni-Fit Outer	Dorman Uni-Fit Inner
BUICK (continued)			
REGAL			
2004-88	-	614-003	614-004
RENDEZVOUS			
2006-02	-	614-003	614-004
RIVIERA			
1999-79	-	614-003	614-004
SKYHAWK			
1989-87	-	614-001	614-002
1986	AT	614-001	614-002
1986	MT, w/Turbo	614-003	614-004
1986	MT, wo/Turbo	614-001	614-002
1985	AT	614-001	614-002
1985	MT, w/Turbo, 4-Speed	614-003	614-004
1985	MT, wo/Turbo, 4-Speed	614-001	614-002
1984	AT	614-001	614-004
1984	MT, w/Turbo	614-003	614-004
1984	MT, wo/Turbo	614-001	614-004
1983-82	-	614-001	614-004
SKYLARK			
1999-96	-	614-003	614-004
1995-94	AT	614-001	614-002
1993-92	w/16" Wheels	614-003	614-004
1993-92	wo/16" Wheels	614-001	614-002
1991-88	-	614-001	614-002
1987-86	AT	614-001	614-002
1987-86	MT	614-003	614-004
1985	-	614-001	614-002
1984	4-Cyl Eng	614-001	614-004
1984	6-Cyl Eng	614-001	614-002
1983-80	-	614-001	614-004
SOMERSET			
1987-85	AT	614-001	614-002
1987-85	MT	614-003	614-004
CADILLAC			
ALLANTE			
1993-87	-	614-003	614-004
CIMARRON			
1988-87	AT	614-001	614-002
1988-87	MT	614-003	614-004
1986	AT	614-001	614-002
1986	MT, 4-Speed	614-003	614-004
1986	MT, 5-Speed	614-001	614-002
1985	-	614-001	614-002
1984	Hard Plastic Joint Seals	614-001	614-002
1984	Soft Rubber Joint Seals	614-001	614-004
1983-82	-	614-001	614-004
COMMERCIAL CHASSIS			
2001-91	-	614-003	614-004
CONCOURS			
1999-94	-	614-003	614-004
DEVILLE			
2005-85	-	614-003	614-004
ELDORADO			
2002-67	-	614-003	614-004
ESCALADE			
2006-99	-	614-003	614-004
FLEETWOOD			
1991-85	-	614-003	614-004
SEVILLE			
2005-80	-	614-003	614-004
CHEVROLET			
BERETTA			
1996-95	4-Cyl Eng	614-001	614-002
1996-95	6-Cyl Eng	614-003	614-004
1994	4-Cyl Eng, 2.2L	614-001	614-002
1994	4-Cyl Eng, 2.3L	614-003	614-004
1994	6-Cyl Eng	614-003	614-004
1993-92	4-Cyl Eng, 2.2L	614-001	614-002
1993-92	4-Cyl Eng, 2.3L	614-003	614-004
1993-92	6-Cyl Eng, w/AT	614-001	614-002
1993-92	6-Cyl Eng, w/MT	614-003	614-004
1991-90	4-Cyl Eng, 2.2L	614-001	614-002
1991-90	4-Cyl Eng, 2.3L	614-003	614-004
1991-90	6-Cyl Eng, w/Soft & Firm Ride Suspension FE1, F41	614-003	614-004
1991-90	6-Cyl Eng, w/Sport & Heavy Duty Suspension FE3, FE7, AT	614-001	614-002
1991-90	6-Cyl Eng, w/Sport & Heavy Duty Suspension FE3, FE7, MT	614-003	614-004
1989-87	-	614-003	614-004
CAVALIER			
2002-97	-	614-001	614-002

Make/ Model/Years	Description	Dorman Uni-Fit Outer	Dorman Uni-Fit Inner
CHEVROLET (continued)			
BERETTA (continued)			
1996	AT, 4-Speed	614-003	614-004
1996	MT, 2.4L Eng	614-003	614-004
1995	AT, 3-Speed	614-001	614-002
1995	AT, 4-Speed	614-003	614-004
1995	MT	614-003	614-004
1994-85	AT	614-001	614-002
1994-85	MT, 4-Cyl Eng	614-001	614-002
1994-85	MT, 6-Cyl Eng	614-003	614-004
1984	Hard Plastic Joint Seals	614-001	614-002
1984	Soft Rubber Joint Seals	614-001	614-004
1983-82	-	614-001	614-004
CELEBRITY			
1990-89	4-Cyl Eng	614-001	614-002
1990-89	6-Cyl Eng	614-003	614-004
1988	4-Cyl Eng, Exc. Heavy Duty Brakes	614-001	614-002
1988	4-Cyl Eng, Heavy Duty Brakes	614-003	614-004
1988	6-Cyl Eng	614-003	614-004
1987-85	Exc. Heavy Duty Brakes	614-001	614-002
1987-85	Heavy Duty Brakes	614-003	614-004
1984-83	Exc. Heavy Duty Brakes	614-001	614-004
1984-83	Heavy Duty Brakes	614-003	614-004
1982	-	614-001	614-004
CITATION			
1985	-	614-001	614-002
1984	Hard Plastic Joint Seals	614-001	614-002
1984	Soft Rubber Joint Seals	614-001	614-004
1983-80	-	614-001	614-004
CORSICA			
1996-94	4-Cyl Eng	614-001	614-002
1996-94	6-Cyl Eng	614-003	614-004
1993-92	4-Cyl Eng	614-001	614-002
1993-92	6-Cyl Eng, w/AT	614-001	614-002
1993-92	6-Cyl Eng, w/MT	614-003	614-004
1991-90	4-Cyl Eng	614-001	614-002
1991-90	6-Cyl Eng, w/Soft & Firm Ride Suspension FE1, F41	614-003	614-004
1991-90	6-Cyl Eng, w/Sport & Heavy Duty Suspension FE3, FE7, AT	614-001	614-002
1991-90	6-Cyl Eng, w/Sport & Heavy Duty Suspension FE3, FE7, MT	614-003	614-004
1989-87	-	614-003	614-004
IMPALA			
2006-00	-	614-003	614-004
LUMINA			
2001-94	-	614-003	614-004
1993-92	AT, 3-Speed	614-001	614-002
1993-92	AT, 4-Speed	614-003	614-004
1993-92	MT	614-003	614-004
1991-90	4-Cyl Eng	614-001	614-002
1991-90	6-Cyl Eng	614-003	614-004
LUMINA APV			
1996-90	-	614-003	614-004
MALIBU			
2004-97	-	614-003	614-004
METRO			
2001-98	-	614-001	614-002
MONTE CARLO			
2006-95	-	614-003	614-004
NOVA			
1988-85	-	614-001	614-002
PRIZM			
2002-98	-	614-001	614-002
SPECTRUM			
1988-85	-	614-001	614-002
SPRINT			
1988-85	-	614-001	614-002
TRACKER			
2003-98	4WD	614-001	614-002
VENTURE			
2005-97	-	614-003	614-004
CHEVROLET/GMC TRUCK			
ASTRO, SAFARI			
2005-90	-	614-003	614-004
AVALANCHE			
2006-02	4WD, 1/2 Ton	614-003	614-004
BLAZER, TAHOE, JIMMY, YUKON			
2006-92	-	614-003	614-004
DENALI			
2006-02	-	614-003	614-004
ENVOY, TRAILBLAZER			
2006-02	4WD	614-003	614-004

CV Joint Boot Kit Applications

Make/ Model/Years	Description	Dorman Uni-Fit Outer	Dorman Uni-Fit Inner
CHEVROLET/GMC TRUCK (continued)			
K1500 PICKUP			
2000-88	-	614-003	614-004
K2500, K3500 PICKUP			
2000-98	-	614-003	614-004
1997-88	-	614-003	614-004
LUV PICKUP			
1982-79	-	614-001	614-002
MOTORHOME			
1979-73	-	614-003	614-004
S SERIES BLAZER, ENVOY, JIMMY, TYPHOON			
1996-83	4WD	614-003	614-004
S SERIES BLAZER, JIMMY, TYPHOON			
2005-97	4WD	614-003	614-004
S SERIES PICKUP, SONOMA, SYCLONE			
2004-97	4WD	614-003	614-004
1996-83	4WD	614-003	614-004
SILVERADO, SIERRA			
2006-99	4WD, 1/2 Ton	614-003	614-004
SUBURBAN			
2006-92	4WD, 1/2 Ton	614-003	614-004
YUKON XL			
2006-01	4WD, 1/2 Ton	614-003	614-004
CHRYSLER			
300M			
2002	Exc. Special Series	614-001	614-002
2001-99	-	614-001	614-002
CIRRUS			
2000-95	-	614-001	614-002
CONCORDE			
2002-93	-	614-001	614-002
CONQUEST			
1989-87	-	614-001	614-002
E CLASS			
1984-83	-	614-001	614-002
EXECUTIVE SEDAN			
1984-83	-	614-001	614-002
IMPERIAL			
1993-91	-	614-003	614-002
1990	Axle-GKN	614-003	614-002
1990	Axle-Saginaw	614-001	614-002
LASER			
1986-84	-	614-001	614-002
LEBARON			
1995-94	-	614-003	614-002
1993-91	AT, w/Turbo	614-003	614-002
1993-91	AT, wo/Turbo	614-001	614-002
1993-91	MT, Axle-Saginaw	614-003	614-002
1990	-	614-001	614-002
1989-88	w/Turbo	614-001	614-002
1989-88	wo/Turbo	614-003	614-002
1987-82	-	614-001	614-002
LEBARON GTS			
1989-85	-	614-001	614-002
LHS			
2001-94	-	614-003	614-002
NEW YORKER			
1997-91	-	614-003	614-002
1990-83	-	614-001	614-002
PT CRUISER			
2005-00	-	614-001	614-002
SEBRING			
2003-95	-	614-003	614-002
TC MASERATI			
1991-89	-	614-001	614-002
TOWN & COUNTRY			
1988	w/Turbo	614-001	614-002
1988	wo/Turbo	614-003	614-002
1987-82	-	614-001	614-002
TOWN & COUNTRY VAN			
2003-00	-	614-003	614-002
1999-91	Front	614-003	614-002
1999-91	Rear	614-001	614-001
1990	-	614-001	614-002
VOYAGER			
2003-00	-	614-003	614-002
DAEWOO			
LANOS			
2002-99	-	614-001	614-002
LEGANZA			
2002-99	-	614-001	614-002
NUBIRA			
2002-99	-	614-001	614-002

Make/ Model/Years	Description	Dorman Uni-Fit Outer	Dorman Uni-Fit Inner
DAIHATSU			
CHARADE			
1992-88	-	614-001	614-002
ROCKY			
1992-90	-	614-001	614-002
DODGE			
400			
1983-82	-	614-001	614-002
600			
1988-83	-	614-001	614-002
ARIES			
1989-81	-	614-001	614-002
AVENGER			
2000-95	-	614-003	614-002
CARAVAN, GRAND CARAVAN, MINI RAM VAN			
2003-00	-	614-003	614-002
1999-91	Front	614-003	614-002
1999-91	Rear	614-001	614-001
1990-84	-	614-001	614-002
CHARGER			
1987-83	-	614-001	614-002
COLT			
1992-79	-	614-001	614-002
COLT VISTA			
1990-84	-	614-001	614-002
CONQUEST			
1986-83	-	614-001	614-002
DAYTONA			
1993	w/Turbo	614-003	614-002
1993	wo/Turbo, AT	614-001	614-002
1993	wo/Turbo, MT	614-003	614-002
1992	2.2L Eng	614-003	614-002
1992	2.5L Eng, w/Turbo	614-003	614-002
1992	2.5L Eng, wo/Turbo, AT	614-001	614-002
1992	2.5L Eng, wo/Turbo, MT	614-003	614-002
1992	3.0L Eng	614-003	614-002
1991	Axle-Saginaw, w/AT, 4-Cyl Eng, w/Turbo	614-003	614-002
1991	Axle-Saginaw, w/AT, 4-Cyl Eng, wo/Turbo	614-001	614-002
1991	Axle-Saginaw, w/AT, 6-Cyl Eng	614-003	614-002
1991	Axle-Saginaw, w/MT & w/ABS, 4-Cyl Eng, w/Turbo	614-003	614-002
1991	Axle-Saginaw, w/MT & wo/ABS, Left	614-003	614-002
1990-84	Axle-Saginaw	614-001	614-002
DYNASTY			
1993-91	4-Cyl Eng	614-001	614-002
1993-91	6-Cyl Eng	614-003	614-002
1990-88	-	614-001	614-002
INTREPID			
2002-98	-	614-003	614-002
1997-93	-	614-003	614-002
LANCER			
1989-85	-	614-001	614-002
MONACO			
1992-90	-	614-001	614-002
NEON			
2002-95	-	614-001	614-002
OMNI, O24			
1990-78	-	614-001	614-002
SHADOW			
1994	4-Cyl Eng, w/ABS	614-003	614-002
1994	4-Cyl Eng, wo/ABS, AT	614-001	614-002
1994	4-Cyl Eng, wo/ABS, MT	614-003	614-002
1994	6-Cyl Eng	614-003	614-002
1993	4-Cyl Eng, w/AT	614-001	614-002
1993	4-Cyl Eng, w/MT	614-003	614-002
1993	6-Cyl Eng	614-003	614-002
1992-91	AT, w/Turbo	614-003	614-002
1992-91	AT, wo/Turbo	614-001	614-002
1992-91	MT	614-003	614-002
1990-87	-	614-001	614-002
SPIRIT			
1995-94	2.5L Eng, w/AT, wo/Turbo	614-001	614-002
1993	2.5L Eng, ABS, wo/Turbo	614-001	614-002
1993	2.5L Eng, w/MT, Axle-Saginaw	614-003	614-002
1992-91	4-Cyl Eng, w/ABS	614-003	614-002
1990-89	-	614-001	614-002
STEALTH			
1996-91	Front	614-003	614-004
STRATUS			
2003-95	-	614-001	614-002

CV Joint Boot Kits

Power Steering
Pulleys
pg. 317-326

Quick
Disconnect™
pg. 327-396

Radiator Fan
Assemblies
pg. 397-430

Rear Axle
Shaft Kits
pg. 431-434

Side View Mirror
Assemblies
pg. 435-468

Uni-Fit™ CV Boot System reduces
labor time and boosts profits!

CV Joint Boot Kits

CV Joint Boot Kit Applications

Make/ Model/Years	Description	Dorman Uni-Fit Outer	Dorman Uni-Fit Inner
DODGE (continued)			
VIPER			
1997-92	-	614-001	614-002
DODGE TRUCK			
DAKOTA			
2003-87	4WD	614-003	614-004
DURANGO			
2003-98	-	614-003	614-002
RAIDER			
1989-87	4WD	614-001	614-002
RAM 1500 PICKUP			
2003-02	4WD	614-003	614-004
RAM 50			
1993-83	4WD	614-001	614-002
RAMPAGE			
1984-82	-	614-001	614-002
EAGLE			
2000 GTX			
1993-91	-	614-001	614-002
MEDALLION			
1989-88	-	614-001	614-002
PREMIER			
1992-88	-	614-001	614-002
SUMMIT			
1996-93	-	614-001	614-002
1992	Sedan, Axle-MMC	614-001	614-002
1991-89	-	614-001	614-002
TALON			
1998-90	-	614-001	614-002
VISION			
1997-93	-	614-003	614-002
FIAT			
124, 128			
1979-69	-	614-001	614-002
BERTONE X 1/9			
1985-74	-	614-001	614-002
STRADA			
1982-78	-	614-001	614-002
FORD			
ASPIRE			
1997-94	-	614-001	614-002
CONTOUR			
2000-95	-	614-001	614-002
ESCORT			
2002-81	-	614-001	614-002
EXP			
1985-81	-	614-001	614-002
FESTIVA			
1993-88	-	614-001	614-002
FIESTA			
1980-78	-	614-001	614-002
FOCUS			
2006-00	-	614-001	614-002
PROBE			
1997-90	-	614-001	614-002
1989-88	w/Turbo	614-003	614-004
1989-88	wo/Turbo	614-001	614-002
TAURUS			
2006-86	-	614-001	614-002
TEMPO			
1994-84	-	614-001	614-002
THUNDERBIRD			
1997-89	-	614-001	614-001
ZX2			
2003-98	AT	614-001	614-002
FORD TRUCK			
AEROSTAR			
1997-86	-	614-001	614-002
ESCAPE			
2006-01	-	614-001	614-002
EXPEDITION			
2006-97	-	614-003	614-004
EXPLORER			
2006-02	Front	614-003	614-004
2006-02	Rear, Exc. Sport or Sport Trac	614-003	614-003
2001-95	-	614-003	614-004
F150 PICKUP			
2006-97	4WD	614-003	614-004
F250 PICKUP			
1999-97	4WD	614-003	614-004
RANGER			
2006-98	4WD	614-003	614-004

Make/ Model/Years	Description	Dorman Uni-Fit Outer	Dorman Uni-Fit Inner
FORD TRUCK (continued)			
WINDSTAR			
2003-95	-	614-001	614-001
GEO			
METRO			
1997-88	-	614-001	614-002
PRIZM			
1997-89	-	614-001	614-002
SPECTRUM			
1989	-	614-001	614-002
STORM			
1993-90	-	614-001	614-002
TRACKER			
1997-88	-	614-001	614-002
GMC TRUCK (SEE CHEVROLET/GMC TRUCK)			
HONDA			
ACCORD			
2005-03	4-Cyl Eng, 2-Door, MT	614-003	—
2005-03	4-Cyl Eng, 4-Door, MT, USA Built	614-003	—
2005-03	6-Cyl Eng, RH, Exc. Hybrid	614-003	—
2002-86	-	614-003	614-002
1985-76	-	614-001	614-002
CIVIC			
2005-92	-	614-001	614-002
1991-88	Front	614-001	614-002
1991-88	Rear	614-001	614-001
1987-73	-	614-001	614-002
CIVIC DEL SOL			
1997-93	-	614-001	614-002
CRV			
2002-98	-	614-001	614-002
CRX			
1991-84	-	614-001	614-002
ELEMENT			
2005-04	-	614-003	—
ODYSSEY			
2001-95	-	614-001	614-002
PASSPORT			
2002-94	-	614-001	614-002
PRELUDE			
2001-90	-	614-003	614-002
1989-79	-	614-001	614-002
WAGOVAN			
1989-82	-	614-001	614-002
HYUNDAI			
ACCENT			
2005-95	-	614-001	614-002
ELANTRA			
2005-92	-	614-001	614-002
EXCEL			
1994-86	-	614-001	614-002
SANTA FE			
2004-01	-	614-001	614-002
SCOUPE			
1995-91	-	614-001	614-002
SONATA			
2005-95	-	614-001	614-002
1994-90	4-Cyl Eng	614-001	614-002
1994-90	6-Cyl Eng	614-003	614-004
1989	-	614-001	614-002
TIBURON			
2001-97	-	614-001	614-002
INFINITI			
G20			
2002-99	-	614-001	614-002
1996-90	-	614-001	614-002
I30			
2001-96	-	614-003	614-004
I35			
2004-02	-	614-003	614-004
J30			
1997-93	-	614-003	614-003
M30			
1993-90	-	614-003	614-003
Q45			
1997-90	-	614-003	614-003
QX4			
2003-97	-	614-003	614-003
ISUZU			
AMIGO			
2000-89	4WD	614-001	614-002
AXIOM			
2002	-	614-001	614-002

CV Joint Boot Kit Applications

Make/ Model/Years	Description	Dorman Uni-Fit Outer	Dorman Uni-Fit Inner
ISUZU (continued)			
HOMBRE 2000-96	4WD	614-001	614-002
I-MARK 1989-85	-	614-001	614-002
OASIS 1998-96	-	614-001	614-002
PICKUP 1997-81	-	614-001	614-002
RODEO 2004-91	4WD	614-001	614-002
TROOPER 2001-84	4WD	614-001	614-002
VEHICROSS 2001-99	4WD	614-001	614-002
JEEP			
CHEROKEE 2001-84	-	614-001	—
COMANCHE 1992-86	-	614-001	—
GRAND CHEROKEE 2001-93	-	614-001	—
WAGONEER 1990-84	-	614-001	—
KIA			
SEDONA 2004-02	-	614-001	614-002
SEPHIA 2001-94	-	614-001	614-002
SPECTRA 2004-00	-	614-001	614-002
SPORTAGE 2002-95	-	614-001	614-002
LEXUS			
ES250 1991-90	-	614-003	614-004
ES300 2003-92	-	614-001	614-002
LX450 1999-96	-	614-001	614-002
RX300 2003-99	Front	614-003	614-004
	Rear	614-003	614-003
LINCOLN			
CONTINENTAL 2002-88	-	614-001	614-001
NAVIGATOR 2006-97	-	614-003	614-004
MAZDA			
323 1994-86	-	614-001	614-002
626 2002-83	-	614-001	614-002
929 1995-88	-	614-001	614-002
B SERIES PICKUP 2002-98	-	614-003	614-004
	1993-86	614-001	614-002
GLC 1985-81	-	614-001	614-002
MIATA 2003-90	-	614-001	614-002
MILLENNIA 2002-95	-	614-001	614-002
MPV 2003-89	-	614-001	614-002
MX-3 1995-92	-	614-001	614-002
MX-6 1997-93	-	614-001	614-002
	1992-88 w/Turbo	614-003	614-004
	1992-88 wo/Turbo	614-001	614-002
PROTEGE 2002-90	FWD	614-001	614-002
RX-7 1996-86	-	614-001	614-002
MERCEDES BENZ			
190D 1982-73	-	614-001	614-001
220 SERIES 1973	-	614-001	614-001
230 1978-73	-	614-001	614-001

Make/ Model/Years	Description	Dorman Uni-Fit Outer	Dorman Uni-Fit Inner
MERCEDES BENZ (continued)			
240D 1982-74	-	614-001	614-001
280 SERIES 1981-73	-	614-001	614-001
300 SERIES 1996-83	-	614-003	614-001
	1982-73	614-001	614-001
380 SERIES 1982-81	-	614-001	614-001
450 SERIES 1980-73	-	614-001	614-001
560 SERIES 1991-86	-	614-003	614-001
ML320 2001-98	Front	614-003	614-004
	2001-98 Rear	614-003	614-003
ML430 2001-99	Front	614-003	614-004
	2001-99 Rear	614-003	614-003
MERCURY			
COUGAR 2002-89	-	614-001	614-001
LN7 1983-81	-	614-001	614-002
LYNX 1987-81	-	614-001	614-002
MOUNTAINEER 2006-02	Front	614-003	614-004
	2006-02 Rear	614-003	614-003
	2001-97	614-003	614-004
MYSTIQUE 2000-95	-	614-001	614-002
SABLE 2005-86	-	614-001	614-002
TOPAZ 1994-84	-	614-001	614-002
TRACER 1999-97	-	614-001	614-002
	1996-91	614-001	614-002
VILLAGER 2002-93	-	614-001	614-002
MERKUR			
SCORPIO 1989-88	-	614-001	614-002
XR4TI 1989-85	-	614-001	614-002
MITSUBISHI			
3000GT 1999-91	Front	614-003	614-004
CORDIA 1988-83	-	614-001	614-002
DIAMANTE 2004-92	-	614-001	614-002
ECLIPSE 2005-90	-	614-001	614-002
ECLIPSE SPYDER 2005-00	-	614-001	614-002
EXPO, EXPO LRV 1995-92	-	614-001	614-002
GALANT 2003-89	-	614-001	614-002
LANCER 2002	-	614-001	614-002
MIGHTY MAX PICKUP 1995-83	-	614-003	614-002
MIRAGE 2002-85	-	614-001	614-002
MONTERO 2005-83	-	614-001	614-002
MONTERO SPORT 2004-97	-	614-001	614-002
PRECIS 1993-86	-	614-001	614-002
SIGMA 1990-88	-	614-003	614-002
STARION 1989-83	-	614-001	614-002
TREDIA 1988-83	-	614-001	614-002
NISSAN			
200SX 1998-95	-	614-001	614-002

CV Joint Boot Kits

Window
Lift Motors
pg. 535-554

Window
Regulators
pg. 555-566

Wiper
Motors
pg. 567-572

Wiper Transmission
Linkages
pg. 573-576

Uni-Fit™ CV Boot System reduces
labor time and boosts profits!

CV Joint Boot Kits

CV Joint Boot Kit Applications

Make/ Model/Years	Description	Dorman Uni-Fit Outer	Dorman Uni-Fit Inner
NISSAN (continued)			
200SX (continued)			
1988-84	Rear	614-001	614-002
240SX			
1998-92	-	614-001	614-002
1991-89	Rear	614-001	614-002
240Z			
1973-71	Rear	614-001	614-002
260Z			
1975-74	Rear	614-001	614-002
280Z			
1978-75	Rear	614-001	614-002
280ZX			
1983-79	Rear	614-001	614-002
300ZX			
1997-84	Rear	614-001	614-002
310			
1982-79	-	614-001	614-002
720 PICKUP			
1986-80	-	614-001	—
ALTIMA			
2001-93	-	614-001	614-002
AXXESS			
1990-89	-	614-001	614-002
F10			
1978-76	-	614-001	614-002
FRONTIER			
2003-98	4WD	614-003	614-004
MAXIMA			
2001-85	-	614-003	614-002
1984	Rear, Sedan	614-001	614-002
NX COUPE			
1995-91	-	614-001	614-002
PATHFINDER			
2003-87	-	614-003	614-004
PICKUP, D21 PICKUP			
1997-96	-	614-003	614-004
1995-94	4-Cyl Eng	614-003	614-004
1993	To 11/92	614-003	614-004
1992-86	-	614-003	614-004
1985-80	4WD	614-003	614-004
PULSAR			
1990-83	-	614-001	614-002
QUEST			
2002-93	-	614-001	614-002
SENTRA			
2001-95	-	614-001	614-002
1994-91	wo/ABS	614-001	614-002
1990-88	Front, 2WD, Sedan & Wagon	614-001	614-002
1990-88	Front, Coupe	614-001	614-002
1990-88	Rear	614-001	614-002
1987	2WD, Sedan & Wagon	614-001	614-002
1987	Coupe	614-001	614-002
1986-82	-	614-001	614-002
STANZA			
1992-87	-	614-003	614-004
1986-82	-	614-001	614-002
XTERRA			
2003-00	-	614-003	614-004
OLDSMOBILE			
98, 98 REGENCY			
1996-85	-	614-003	614-004
ACHIEVA			
1998-96	-	614-003	614-004
1995-94	AT, 3-Speed	614-001	614-002
1995-94	AT, 4-Speed	614-003	614-004
1995-94	MT	614-003	614-004
1993-92	w/16" Wheels	614-003	614-004
1993-92	wo/16" Wheels, AT	614-001	614-002
1993-92	wo/16" Wheels, MT	614-003	614-004
ALERO			
2004-99	-	614-001	614-002
AURORA			
2003-95	-	614-003	614-004
BRAVADA			
2004-91	-	614-003	614-004
CALAIS, CUTLASS CALAIS			
1991	w/ABS	614-003	614-004
1991	wo/ABS, AT	614-001	614-002
1991	wo/ABS, MT	614-003	614-004
1990-85	AT	614-001	614-002
1990-85	MT	614-003	614-004

Make/ Model/Years	Description	Dorman Uni-Fit Outer	Dorman Uni-Fit Inner
OLDSMOBILE (continued)			
CIERA, CUTLASS CIERA			
1996-94	-	614-003	614-004
1993-89	4-Cyl Eng	614-001	614-002
1993-89	6-Cyl Eng	614-003	614-004
1988	4-Cyl Eng, Exc. Heavy Duty Brakes	614-001	614-002
1988	4-Cyl Eng, Heavy Duty Brakes	614-003	614-004
1988	6-Cyl Eng	614-003	614-004
1987-85	Exc. Heavy Duty Brakes	614-001	614-002
1987-85	Heavy Duty Brakes	614-003	614-004
1984-83	Exc. Heavy Duty Brakes	614-001	614-004
1984-83	Heavy Duty Brakes	614-003	614-004
1982	-	614-001	614-004
CUTLASS, CUTLASS SUPREME			
1999-97	-	614-001	614-002
1996-95	-	614-003	614-004
1994	-	614-003	614-004
1993	AT, 3-Speed	614-001	614-002
1993	AT, 4-Speed	614-003	614-004
1992	AT, 3-Speed	614-001	614-002
1992	AT, 4-Speed	614-003	614-004
1992	MT	614-003	614-004
1991-88	-	614-003	614-004
DELTA 88, 88 ROYALE, LSS			
1999-86	-	614-003	614-004
FIRENZA			
1988	-	614-001	614-002
1987	AT	614-001	614-002
1987	MT, Exc. Getrag Trans	614-001	614-002
1987	MT, Getrag Trans	614-003	614-004
1986-85	AT	614-001	614-002
1986-85	MT, w/4-Cyl Eng	614-001	614-002
1986-85	MT, w/6-Cyl Eng	614-003	614-004
1984	Hard Plastic Joint Seals	614-001	614-002
1984	Soft Rubber Joint Seals	614-001	614-004
1983-82	-	614-001	614-004
INTRIGUE			
2002-98	-	614-003	614-004
OMEGA			
1984	Hard Plastic Joint Seals	614-001	614-002
1984	Soft Rubber Joint Seals	614-001	614-004
1983-80	-	614-001	614-004
SILHOUETTE			
2004-97	-	614-003	614-004
1994-90	-	614-003	614-004
TORONADO, TROFEO			
1992-67	-	614-003	614-004
PLYMOUTH			
ACCLAIM			
1995-94	2.5L Eng, w/AT, wo/Turbo	614-001	614-002
1993	2.5L Eng, w/AT, wo/Turbo	614-001	614-002
1993	2.5L Eng, w/MT, Axle-Saginaw	614-003	614-002
1992-91	2.2L Eng, w/ABS	614-003	614-002
1992-91	2.5L Eng, w/ABS, MT	614-003	614-002
1990-89	-	614-001	614-002
BREEZE			
2000-94	-	614-001	614-002
CARAVELLE			
1988-85	-	614-001	614-002
CHAMP			
1982-79	-	614-001	614-002
COLT			
1992-90	Axle-MMC	614-001	614-002
1989	w/Turbo	614-001	614-002
1989	wo/Turbo, Axle-MMC	614-001	614-002
1988-84	-	614-001	614-002
COLT VISTA			
1994-84	-	614-001	614-002
CONQUEST			
1986-83	-	614-001	614-002
HORIZON, TC3, TURSIMO			
1990-78	-	614-001	614-002
LASER			
1994-90	-	614-001	614-002
NEON			
2001-95	-	614-001	614-002
RELIANT			
1989-81	-	614-001	614-002
SCAMP			
1983	-	614-001	614-002
SUNDANCE			
1994	4-Cyl Eng, w/ABS	614-003	614-002
1994	4-Cyl Eng, wo/ABS, AT	614-001	614-002

CV Joint Boot Kit Applications

Make/ Model/Years	Description	Dorman Uni-Fit Outer	Dorman Uni-Fit Inner
PLYMOUTH (continued)			
SUNDANCE (continued)			
1994	4-Cyl Eng, wo/ABS, MT	614-003	614-002
1994	6-Cyl Eng	614-003	614-002
1993	4-Cyl Eng, w/AT	614-001	614-002
1993	4-Cyl Eng, w/MT	614-003	614-002
1993	6-Cyl Eng	614-003	614-002
1992-91	AT, w/Turbo	614-003	614-002
1992-91	AT, wo/Turbo	614-001	614-002
1992-91	MT	614-003	614-002
1990-87	-	614-001	614-002
VOYAGER, GRAND VOYAGER			
2000	-	614-003	614-002
1999-91	Front	614-003	614-002
1999-91	Rear	614-001	614-001
1990-84	-	614-001	614-002
PONTIAC			
6000			
1991-89	4-Cyl Eng	614-001	614-002
1991-89	6-Cyl Eng	614-003	614-004
1988	4-Cyl Eng, Exc. Heavy Duty Brakes	614-001	614-002
1988	4-Cyl Eng, Heavy Duty Brakes	614-003	614-004
1988	6-Cyl Eng	614-003	614-004
1987-83	Exc. Heavy Duty Brakes	614-001	614-002
1987-83	Heavy Duty Brakes	614-003	614-004
1982	-	614-001	614-004
AZTEK			
2005-01	-	614-003	614-004
BONNEVILLE			
2005-87	-	614-003	614-004
FIERO			
1988-85	AT	614-001	614-002
1988-85	MT	614-003	614-004
1984	Hard Plastic Joint Seals, AT	614-001	614-002
1984	Hard Plastic Joint Seals, MT	614-003	614-004
1984	Soft Rubber Joint Seals, AT	614-001	614-004
1984	Soft Rubber Joint Seals, MT	614-003	614-004
GRAND AM			
2005-97	-	614-003	614-004
1994	AT, 3-Speed	614-001	614-002
1994	AT, 4-Speed	614-003	614-004
1994	MT	614-003	614-004
1993-92	w/16" Wheels	614-003	614-004
1993-92	wo/16" Wheels, AT	614-001	614-002
1993-92	wo/16" Wheels, MT	614-003	614-004
1991	w/ABS	614-003	614-004
1991	wo/ABS, AT	614-001	614-002
1991	wo/ABS, MT	614-003	614-004
1990	AT	614-001	614-002
1990	MT	614-003	614-004
1989	AT, w/Aluminum Wheels	614-001	614-002
1989	AT, wo/Aluminum Wheels	614-003	614-004
1989	MT	614-003	614-004
1988-85	AT	614-001	614-002
1988-85	MT	614-003	614-004
GRAND PRIX			
2006-94	-	614-003	614-004
1993-92	AT, 3-Speed	614-001	614-002
1993-92	AT, 4-Speed	614-003	614-004
1993-92	MT	614-003	614-004
1991-88	-	614-003	614-004
J2000			
1985-84	AT	614-001	614-002
1985-84	MT, w/Turbo	614-003	614-004
1985-84	MT, wo/Turbo	614-001	614-002
1983-82	-	614-001	614-004
LEMANS			
1993-88	-	614-001	614-002
MONTANA			
2005-99	-	614-003	614-004
PHOENIX			
1984	Hard Plastic Joint Seals	614-001	614-002
1984	Soft Rubber Joint Seals	614-001	614-004
1983-80	-	614-001	614-004
SUNBIRD			
1994-91	4-Cyl Eng	614-001	614-002
1994-91	6-Cyl Eng, w/AT	614-001	614-002
1994-91	6-Cyl Eng, w/MT	614-003	614-004
1990-85	AT	614-001	614-002
1990-85	MT, w/Turbo	614-003	614-004
1990-85	MT, wo/Turbo	614-001	614-002
SUNFIRE			
2002-97	-	614-001	614-002

Make/ Model/Years	Description	Dorman Uni-Fit Outer	Dorman Uni-Fit Inner
PONTIAC (continued)			
SUNFIRE (continued)			
1996	AT, 4-Speed	614-003	614-004
1996	MT, 2.4L Eng	614-003	614-004
1995	AT, 3-Speed	614-001	614-002
1995	AT, 4-Speed	614-003	614-004
1995	MT	614-003	614-004
TRANS SPORT			
1994-90	-	614-003	614-004
PORSCHE			
924			
1988-79	-	614-001	614-002
944			
1991-82	-	614-001	614-002
RENAULT			
181			
1986-80	-	614-001	614-002
ALLIANCE			
1987-83	-	614-001	614-002
ENCORE			
1986-84	-	614-001	614-002
FUEGO			
1985-82	-	614-001	614-002
LECAR, R5			
1984-76	-	614-001	614-002
SPORTWAGON			
1987-85	-	614-001	614-002
SAAB			
900			
1993-78	-	614-001	614-002
9000			
1995-90	w/Turbo	614-003	614-004
1995-90	wo/Turbo	614-001	614-002
1989-85	-	614-001	614-002
99			
1984-75	-	614-001	614-002
SATURN			
L SERIES			
2005-00	-	614-001	614-002
SC, SL, SW SERIES			
2002-91	-	614-001	614-002
STERLING			
825, 827 SERIES			
1990-87	-	614-003	614-002
SUBARU			
BRAT			
1987-78	Front	614-001	614-002
DL			
1989-75	-	614-001	614-002
FE			
1979	-	614-001	614-002
FORESTER			
2001-98	-	614-001	614-002
GF			
1979-75	-	614-001	614-002
GL			
1989-75	-	614-001	614-002
GL-10			
1989-86	-	614-001	614-002
GLF			
1982-80	-	614-001	614-002
IMPREZA			
2001-97	-	614-001	614-002
1996-93	1.8L Eng, Front	614-001	614-002
JUSTY			
1994-87	-	614-001	614-002
LEGACY			
2004-96	Front	614-001	614-002
1995-90	Front	614-001	614-001
LEGACY OUTBACK			
2004-96	Front	614-001	614-002
LOYALE			
1994-90	-	614-001	614-002
RX			
1989-86	-	614-001	614-002
STANDARD			
1987-76	-	614-001	614-002
SVX			
1997-92	-	614-001	614-002
XT			
1991-85	-	614-001	614-002
XT6			
1991-88	4WD	614-001	614-002

Clock Springs
pg. 21-24

Control Arms
pg. 25-54

CV Joint Boots & Accessories
pg. 55-66

Door Lock Actuators
pg. 67-72

Exhaust Manifold Kits
pg. 73-134

Uni-Fit™ CV Boot System reduces labor time and boosts profits!

CV Joint Boot Kits

CV Joint Boot Kit Applications

Make/ Model/Years	Description	Dorman Uni-Fit Outer	Dorman Uni-Fit Inner
SUZUKI			
ESTEEM			
2002-95	-	614-001	614-002
GRAND VITARA			
2004-99	-	614-001	614-002
SAMURAI			
1995-86	-	614-001	614-002
SIDEKICK			
1998-89	-	614-001	614-002
SWIFT			
2001-89	-	614-001	614-002
VITARA			
2004-99	-	614-001	614-002
X-90			
1998-96	-	614-001	614-002
TOYOTA			
4-RUNNER			
2002-96	4WD	614-003	614-004
1995-86	-	614-003	614-004
AVALON			
2004-95	-	614-001	614-002
CAMRY			
2002-97	-	614-003	614-004
1996-92	4-Cyl Eng, Axle-GKN	614-003	614-004
1996-92	4-Cyl Eng, Axle-Toyota	614-001	614-002
1991-89	4-Cyl Eng, 2WD	614-001	614-002
1991-89	4-Cyl Eng, 4WD, w/AT	614-001	614-002
1991-89	6-Cyl Eng	614-003	614-004
1988	4-Cyl Eng, 2WD	614-001	614-002
1988	4-Cyl Eng, 4WD, w/ABS	614-003	614-004
1988	6-Cyl Eng	614-003	614-004
1987-83	-	614-001	614-002
CELICA			
2002-98	-	614-001	614-002
1997-94	1.8L Eng	614-001	614-002
1997-94	2.2L Eng, w/AT	614-001	614-002
1993-90	Front, All Trac	614-003	614-004
1993-90	Front, GT, GTS & ST	614-001	614-002
1993-90	Rear	614-001	614-001
1989-88	Front, 2WD	614-001	614-002
1989-88	Front, 4WD	614-003	614-004
1989-88	Rear	614-001	614-001
1987-86	-	614-001	614-002
COROLLA			
2002-98	-	614-001	614-002
1997-93	Axle-Toyota	614-001	614-002
1992	2WD, Japan Built	614-001	614-002
1991	Coupe, Exc. GTS	614-001	614-002
1991	Sedan & Wagon, 2WD, Japan Built	614-001	614-002
1990-89	Coupe	614-001	614-002
1990-89	Sedan & Wagon, 2WD, Japan Built	614-001	614-002
1988	Coupe	614-001	614-002
1988	Sedan & Wagon, 2WD	614-001	614-002
1987	1.6L Eng	614-001	614-002
1986-84	-	614-001	614-002
COROLLA FX, FX16, FX16GTS			
1988-86	-	614-001	614-002
CRESSIDA			
1991-89	-	614-003	614-003
1988-85	-	614-001	614-001
ECHO			
2003-00	-	614-001	614-002
HIGHLANDER			
2003-01	4WD	614-003	614-004
MR2			
1995-85	Rear	614-001	614-002
PASEO			
1998-92	-	614-001	614-002
PICKUP			
1996-95	4WD	614-003	614-004
1994-86	-	614-003	614-004
PREVIA			
1997-91	-	614-003	614-004
RAV4			
2003-01	Front	614-003	614-004
2003-01	Rear	614-003	614-003
2000-96	Front, 4WD	614-003	614-004
2000-96	Rear	614-003	614-003

Make/ Model/Years	Description	Dorman Uni-Fit Outer	Dorman Uni-Fit Inner
TOYOTA (continued)			
SEQUOIA			
2003-01	4WD	614-003	614-004
SIENNA			
2002-97	FWD	614-001	614-002
SOLARA			
2003-99	-	614-003	614-004
SUPRA			
1999-98	-	614-001	614-001
1997	Rear, wo/Turbo	614-001	614-001
1996-79	-	614-001	614-001
T100 PICKUP			
1998-93	4WD	614-003	614-004
TACOMA			
2004-95	4WD	614-003	614-004
TERCEL			
1998-80	-	614-001	614-002
TUNDRA			
2003-00	4WD	614-003	614-004
VOLKSWAGEN			
BEETLE			
2003-98	-	614-001	614-002
CABRIO			
2002-95	-	614-001	614-002
CABRIOLET			
1993-85	-	614-001	614-002
CORRADO			
1994-90	-	614-001	614-002
DASHER			
1981-74	-	614-001	614-002
EUROVAN			
2003-99	-	614-001	614-002
1993	-	614-001	614-002
FOX			
1993-87	-	614-001	614-002
GOLF			
2005-85	-	614-001	614-002
JETTA			
2005-80	-	614-001	614-002
PASSAT			
2002-90	-	614-001	614-002
QUANTUM			
1988-86	Front	614-001	614-002
1988-86	Rear	614-001	614-002
1985-82	-	614-001	614-002
RABBIT			
1984-75	-	614-001	614-002
RABBIT PICKUP			
1984-80	-	614-001	614-002
SCIROCCO			
1988-75	-	614-001	614-002
VOLVO			
780			
1989-88	Coupe & Sedan	614-001	614-002
850			
1997-93	Non Turbo	614-001	614-002
C70			
2004-98	-	614-001	614-002
S40			
2004-00	-	614-003	614-004
S60			
2005-01	-	614-003	614-004
S70			
2000-98	-	614-001	614-002
S80			
2005-99	-	614-001	614-002
V40			
2004-00	-	614-003	614-004
V70			
2005-98	-	614-001	614-002
WINNEBAGO			
CENTAURI			
1985-83	-	614-001	614-002
LASHARO			
1992-83	-	614-001	614-002
YUGO			
GV SERIES			
1991-86	-	614-001	614-002

Door Lock Actuators



100% NEW Actuators

The door lock actuator is the mechanism used to lock or unlock the vehicle's power door locks.



746-014
Fits 90% of GM
Models 2005-77



746-145
Fits 95% of Ford
Models 1994-80



746-253
Fits All Chrysler
Minivan Sliding Doors
2003-96



746-360
Fits Honda Accord
1997-94

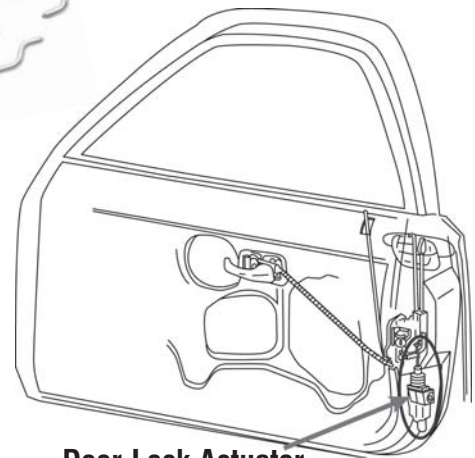

Door Lock Actuator

Typical Failure

- 83% of Power Door Locks Fail Due to the Actuator – Not the Switch, Fuse, or Wiring
- 7 SKUs Cover 22 OE Part Numbers and Over 2500 Vehicle Applications

Symptoms of Failure

- Stiff or jammed door lock
- Power door lock switch inoperable
- Humming noise during operation

Activant Path *Fuel Caps, Hitches & Misc.* **Activant Code** MWX

**Applications begin
on page 68.**

Door Lock Actuators

- Dorman Door Lock Actuators are manufactured from 100% new components.

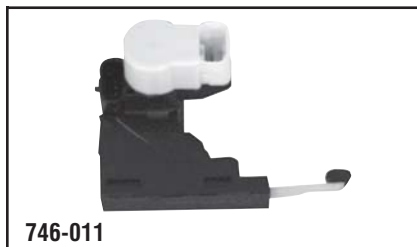

746-011
GM
 2006-91 Various Models, Right Side.



746-014
GM
 2005-77 Various Models, Left or Right.



746-017
GM
 2006-91 Various Models, Left Side



746-145
Ford
 1994-80 Ford/Lincoln/Mercury Various Models, Left and Right Sides.



746-147
Ford
 1994-80 Various Models, Left and Right Side



746-253
Chrysler
 2003-96 Minivans, Sliding Door



746-360
Honda
 1997-94 Accord.

Related Sales Dorman HELP!®



75450 (6)
 Assortment of popular door lock rod clips. Covers GM 2004-59, Ford 2000-80, Chrysler 2000-71. Applications include both cars and trucks. **Kit contains 75451, 75452, 75453, 75454, 75455, 75459 and 75460.**

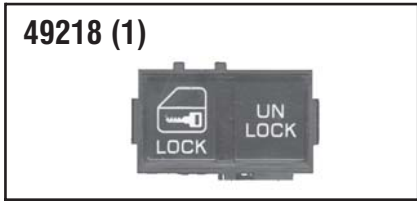

49218 (1)
 On trim panel. Left & right hand side. Century 1989-85, Skyhawk 1989-83, Cimarron 1988-83, Camaro 1989-82, Cavalier 1990-83, Celebrity 1989-85, Citation 1985, Corvette 1985-84, Cutlass 1995-91, Firenza 1988-82.

Door Lock Actuator Applications

Make/Model/Years	Description	Dorman #
BUICK		
CENTURY		
2005-97	Front & Rear Driver Side	746-017
2005-97	Front & Rear Passenger Side	746-011
1996-90	Rear Driver & Passenger Side	746-014
1989-77	Front & Rear Driver & Passenger Side	746-014
ELECTRA, PARK AVENUE		
1998-91	Front & Rear Driver Side	746-017
1998-91	Front & Rear Passenger Side	746-011
1990-77	Front & Rear Driver & Passenger Side	746-014
ESTATE WAGON		
1990-82	Tailgate	746-014
1990-77	Front & Rear Driver & Passenger Side	746-014
LESABRE		
2005-92	Front & Rear Driver Side	746-017
2005-92	Front & Rear Passenger Side	746-011
1990	Rear Driver & Passenger Side	746-014
1989-86	Front & Rear Driver & Passenger Side	746-014
1985-82	Rear Driver & Passenger Side	746-014
1981-77	Front & Rear Driver & Passenger Side	746-014
PARK AVENUE		
2005-99	Front Driver Side	746-017
2005-99	Front Passenger Side	746-011

Make/Model/Years	Description	Dorman #
BUICK (continued)		
RAINIER		
2006-04	Front & Rear Driver Side	746-017
2006-04	Front & Rear Passenger Side	746-011
REGAL		
2005-97	Front & Rear Driver Side	746-017
2005-97	Front & Rear Passenger Side	746-011
1992-88	Front & Rear Driver & Passenger Side	746-014
1987-77	Front & Rear Driver & Passenger Side	746-014
RENDEZVOUS		
2006-02	Front & Rear Driver Side	746-017
2006-02	Front & Rear Passenger Side	746-011
RIVIERA, REATTA		
1999-95	Driver Side	746-017
1999-95	Passenger Side	746-011
1991-77	Driver & Passenger Side	746-014
SKYHAWK		
1989-82	Front & Rear Driver & Passenger Side	746-014
SKYLARK, SOMERSET		
1995-92	Rear Driver Side	746-017
1995-92	Rear Passenger Side	746-011
1991-82	Front & Rear Driver & Passenger Side	746-014

Door Lock Actuator Applications

Make/ Model/Years	Description	Dorman #
BUICK (continued)		
TERRAZA		
2006-05	Front Driver Side	746-017
2006-05	Front Passenger Side	746-011
CADILLAC		
ALLANTE		
1993	Driver Side	746-017
1993	Passenger Side	746-011
CIMARRON		
1988-82	Front & Rear Driver & Passenger Side	746-014
CONCOURS		
1999-94	Front & Rear Driver Side	746-017
1999-94	Front & Rear Passenger Side	746-011
DEVILLE		
2005-94	Front & Rear Driver Side	746-017
2005-94	Front & Rear Passenger Side	746-011
1990-77	Front & Rear Driver & Passenger Side	746-014
DTS		
2006	Front & Rear Driver Side	746-017
2006	Front & Rear Passenger Side	746-011
ELDORADO		
2002-92	Driver Side	746-017
2002-92	Passenger Side	746-011
1991-77	Driver & Passenger Side	746-014
ESCALADE		
2006-02	Front & Rear Driver Side	746-017
2006-02	Front & Rear Passenger Side	746-011
2000-99	Back Door	746-014
2000-99	Front Driver & Passenger Side	746-014
2000-99	Rear Passenger Side	746-011
FLEETWOOD, FLEETWOOD BROUGHAM		
1990-77	Front & Rear Driver & Passenger Side	746-014
SEVILLE		
2003-92	Front & Rear Driver Side	746-017
2003-92	Front & Rear Passenger Side	746-011
1991-77	Front & Rear Driver & Passenger Side	746-014
CHEVROLET		
BERETTA		
1993-87	Driver & Passenger Side	746-014
CAMARO		
2002-93	Driver Side	746-017
2002-93	Passenger Side	746-011
1992-82	Driver & Passenger Side	746-014
CAPRICE		
1990-82	Front & Rear Driver & Passenger Side	746-014
1990-82	Tailgate	746-014
CAVALIER		
2005-97	Front & Rear Driver Side	746-017
2005-97	Front & Rear Passenger Side	746-011
1996-95	Front & Rear Driver Side	746-017
1996-95	Front & Rear Passenger Side	746-011
1990-82	Front & Rear Driver & Passenger Side	746-014
CELEBRITY		
1990-82	Front & Rear Driver & Passenger Side	746-014
CITATION		
1985-82	Front & Rear Driver & Passenger Side	746-014
CORSICA		
1993-87	Front & Rear Driver & Passenger Side	746-014
CORVETTE		
2004-97	Passenger Side	746-011
1984-78	Driver & Passenger Side	746-014
EL CAMINO		
1987-82	Driver & Passenger Side	746-014
IMPALA, IMPALA SS		
2006	Front Driver Side	746-017
2006	Front Passenger Side	746-011
2005-00	Front & Rear Driver Side	746-017
2005-00	Front & Rear Passenger Side	746-011
1985-82	Front & Rear Driver & Passenger Side	746-014
1985-82	Tailgate	746-014
LUMINA		
2001-95	Front & Rear Driver Side	746-017
2001-95	Front & Rear Passenger Side	746-011
LUMINA APV		
1993-90	Front Driver & Passenger Side	746-014
1993-90	Passenger Side Sliding Door	746-014

Make/ Model/Years	Description	Dorman #
CHEVROLET (continued)		
MALIBU		
2003-97	Front & Rear Driver Side	746-017
2003-97	Front & Rear Passenger Side	746-011
1983-82	Front & Rear Driver & Passenger Side	746-014
MALIBU CLASSIC		
2005-04	Front & Rear Driver Side	746-017
2005-04	Front & Rear Passenger Side	746-011
MONTE CARLO		
2006-95	Driver Side	746-017
2006-95	Passenger Side	746-011
1988-82	Driver & Passenger Side	746-014
UPLANDER		
2006-05	Front Driver Side	746-017
2006-05	Front Passenger Side	746-011
VENTURE		
2005-97	Front Driver Side	746-017
2005-97	Front Passenger Side	746-011
CHEVROLET/GMC TRUCK		
ASTRO, SAFARI VAN		
2005-92	Front Driver & Passenger Side	746-014
2005-92	Passenger Side Sliding Door	746-014
2005-92	Tailgate (Back Swing-Out Door)	746-014
2004-92	Liftgate	746-011
1991-90	Front Driver & Passenger Side	746-014
1991-90	Passenger Side Sliding Door	746-014
1991-90	Tailgate (Back Swing-Out Door)	746-014
1989-85	Front Driver & Passenger Side	746-014
1989-85	Passenger Side Sliding Door	746-014
AVALANCHE		
2006-02	Front & Rear Driver Side	746-017
2006-02	Front & Rear Passenger Side	746-011
BLAZER		
1994-92	Driver & Passenger Side	746-014
1994-92	Tailgate (Back Swing-Out Door)	746-014
1991-77	Front & Rear Driver & Passenger Side	746-014
C,K SERIES PICKUP		
2002-97	Front & Rear Driver & Passenger Side	746-014
1996	Front & Rear Driver Side	746-017
1996	Front & Rear Passenger Side	746-011
1995-88	Front & Rear Driver & Passenger Side	746-014
1986-77	Front & Rear Driver & Passenger Side	746-014
CABALLERO		
1987-78	Driver & Passenger Side	746-014
DENALI		
2006-01	Front & Rear Driver Side	746-017
2006-01	Front & Rear Passenger Side	746-011
EXPRESS VAN		
2006-96	Rear Passenger Side Hinged Door	746-011
2006-96	Tailgate	746-011
2002-96	Front Driver Side	746-017
2002-96	Front Passenger Side	746-011
G SERIES VAN		
1996	Front Driver Side	746-014
1996	Front Passenger Side	746-014
1996	Rear Passenger Side Hinged Door	746-011
1996	Tailgate	746-011
1995-92	Rear (Side Swing-Out Door)	746-014
1991-85	Driver & Passenger Side	746-014
1991-85	Rear (Side Swing-Out Door)	746-014
1984-78	Driver & Passenger Side	746-014
JIMMY		
1991-77	Front & Rear Driver & Passenger Side	746-014
P SERIES VAN		
1996-93	Driver & Passenger Side	746-014
R,V SERIES PICKUP		
1991-87	Front & Rear Driver & Passenger Side	746-014
S SERIES BLAZER, JIMMY		
2001-97	Liftgate	746-017
1994-83	Front & Rear Driver & Passenger Side	746-014
S SERIES PICKUP, SONOMA, SYCLONE, TYPHOON		
2005-94	Front & Rear Driver Side	746-017
2005-94	Front & Rear Passenger Side	746-011
1993-82	Front & Rear Driver & Passenger Side	746-014
S SERIES TRAILBLAZER, ENVOY		
2006-02	Front & Rear Driver Side	746-017

Door Lock Actuators

**Power Steering
Pulleys**
pg. 317-326

**Quick
Disconnect™**
pg. 327-396

**Radiator Fan
Assemblies**
pg. 397-430

**Rear Axle
Shaft Kits**
pg. 431-434

**Side View Mirror
Assemblies**
pg. 435-468

**Don't Forget
Door Panel Clips**

Door Lock Actuators

Door Lock Actuator Applications

Make/ Model/Years	Description	Dorman #
CHEVROLET/GMC TRUCK (continued)		
S SERIES TRAILBLAZER, ENVOY (continued)		
2006-02	Front & Rear Passenger Side	746-011
SAVANA VAN		
2006-96	Rear Passenger Side Hinged Door	746-011
2006-96	Tailgate	746-011
2002-96	Front Driver Side	746-017
2002-96	Front Passenger Side	746-011
SIERRA		
2006-99	Front & Rear Driver Side	746-017
2006-99	Front & Rear Passenger Side	746-011
SILVERADO		
2006-99	Front & Rear Driver Side	746-017
2006-99	Front & Rear Passenger Side	746-011
SUBURBAN		
2006-00	Front & Rear Driver Side	746-017
2006-00	Front & Rear Passenger Side	746-011
1999-97	Front & Rear Driver & Passenger Side	746-014
1999-97	Tailgate (Back Swing-Out Door)	746-014
1996	Front & Rear Driver Side	746-017
1996	Front & Rear Passenger Side	746-011
1996	Tailgate (Back Swing-Out Door)	746-014
1995-92	Front & Rear Driver & Passenger Side	746-014
1995-92	Tailgate (Back Swing-Out Door)	746-014
1991-77	Front & Rear Driver & Passenger Side	746-014
TAHOE		
2006-00	Front & Rear Driver Side	746-017
2006-00	Front & Rear Passenger Side	746-011
2000	Tailgate (Back Swing-Out Door)	746-014
1999-97	Front & Rear Driver & Passenger Side	746-014
1999-97	Rear Driver Side	746-017
1999-97	Rear Passenger Side	746-011
1999-97	Tailgate (Back Swing-Out Door)	746-014
1996-95	Front & Rear Driver Side	746-017
1996-95	Front & Rear Passenger Side	746-011
1996-95	Tailgate (Back Swing-Out Door)	746-014
YUKON		
2006-00	Front & Rear Driver Side	746-017
2006-00	Front & Rear Passenger Side	746-011
2000	Tailgate (Back Swing-Out Door)	746-014
1999-97	Front & Rear Driver & Passenger Side	746-014
1999-97	Rear Driver Side	746-017
1999-97	Rear Passenger Side	746-011
1999-97	Tailgate (Back Swing-Out Door)	746-014
1996-95	Front & Rear Driver Side	746-017
1996-95	Front & Rear Passenger Side	746-011
1996-95	Tailgate (Back Swing-Out Door)	746-014
1994-92	Driver & Passenger Side	746-014
1994-92	Tailgate (Back Swing-Out Door)	746-014
CHRYSLER		
PT CRUISER		
2003-02	Rear Driver & Passenger Side	746-253
TOWN & COUNTRY VAN, VOYAGER, GRAND VOYAGER		
2003-97	Passenger Side Sliding Door	746-253
1996	Driver & Passenger Side Sliding Door	746-253
DODGE		
CARAVAN, GRAND CARAVAN		
2003-97	Passenger Side Sliding Door	746-253
1996	Driver & Passenger Side Sliding Door	746-253
FORD		
COUNTRY SQUIRE		
1991-80	Front & Rear Driver & Passenger Side	746-147
1991-80	Tailgate	746-147
CROWN VICTORIA		
1991-88	Front Driver & Passenger Side	746-147
1991-88	Tailgate (Wagon)	746-147
1987-80	Front Driver & Passenger Side (2-Door)	746-145
1987-80	Front Driver & Passenger Side (4-Door & Wagon)	746-147
1987-80	Tailgate (Wagon)	746-147
FAIRMONT		
1983-80	Front Driver & Passenger Side (4-Door & Wagon)	746-147
GRANADA		
1982-81	Front Driver & Passenger Side (4-Door & Wagon)	746-147
LTD		
1986-80	Front Driver & Passenger Side (2-Door)	746-145
1986-80	Front Driver & Passenger Side (4-Door & Wagon)	746-147

Make/ Model/Years	Description	Dorman #
FORD (continued)		
LTD (continued)		
1986-80	Tailgate (Wagon)	746-147
MUSTANG		
1993-80	Driver & Passenger Side	746-147
TAURUS		
1994-89	Rear Driver & Passenger Side	746-145
1988-86	Rear Driver & Passenger Side	746-147
TEMPO		
1994-84	Rear Driver & Passenger Side	746-147
FORD TRUCK		
AEROSTAR		
1991-86	Passenger Side Sliding Door	746-147
BRONCO		
1991-89	Front Driver & Passenger Side	746-147
BRONCO II		
1990-88	Front Driver & Passenger Side	746-147
E-SERIES ECONOLINE VAN		
1991-80	Front Driver & Passenger Side	746-147
F-SERIES PICKUP		
1991-89	Front Driver & Passenger Side	746-147
RANGER		
1992-88	Front Driver & Passenger Side	746-147
HONDA		
ACCORD		
1997-94	Front Driver Side, Sedan & Wagon	746-360
LINCOLN		
CONTINENTAL		
1987-82	Front & Rear Driver & Passenger Side	746-147
MARK VI		
1983-80	Driver & Passenger Side	746-145
MERCURY		
COLONY PARK		
1991-81	Front & Rear Driver & Passenger Side	746-147
1991-81	Tailgate	746-147
COUGAR		
1982-81	Front Driver & Passenger Side (4-Door & Wagon)	746-147
GRAND MARQUIS		
1991-88	Front Driver & Passenger Side	746-147
1991-88	Tailgate	746-147
1987-80	Front Driver & Passenger Side (2-Door)	746-145
1987-80	Front Driver & Passenger Side (4-Door & Wagon)	746-147
1987-80	Tailgate (Wagon)	746-147
MARQUIS		
1986-80	Front Driver & Passenger Side (2-Door)	746-145
1986-80	Front Driver & Passenger Side (4-Door & Wagon)	746-147
1986-80	Tailgate (Wagon)	746-147
SABLE		
1994-89	Rear Driver & Passenger Side	746-145
1988-86	Rear Driver & Passenger Side	746-147
TOPAZ		
1994-84	Rear Driver & Passenger Side	746-147
ZEPHYR		
1983-80	Front Driver & Passenger Side (4-Door & Wagon)	746-147
OLDSMOBILE		
98 REGENCY		
1996-91	Front & Rear Driver Side	746-017
1996-91	Front & Rear Passenger Side	746-011
1990	Front & Rear Driver & Passenger Side; w/Metal Motor	746-014
1989-77	Front & Rear Driver & Passenger Side	746-014
ACHIEVA		
1998-92	Rear Driver Side	746-017
1998-92	Rear Passenger Side	746-011
ALERO		
2004-99	Front & Rear Driver Side	746-017
2004-99	Front & Rear Passenger Side	746-011
AURORA		
2003-95	Front & Rear Driver Side	746-017
2003-95	Front & Rear Passenger Side	746-011
BRAVADA		
2004-02	Front & Rear Driver Side	746-017
2004-02	Front & Rear Passenger Side	746-011
2001-97	Liftgate	746-017
1994-91	Driver & Passenger Side	746-014
CALAIS, CUTLASS CALAIS		
1991-78	Front & Rear Driver & Passenger Side	746-014

Door Lock Actuator Applications

Make/ Model/Years	Description	Dorman #
OLDSMOBILE (continued)		
CIERA, CUTLASS CIERA		
1996-82	Front & Rear Driver & Passenger Side	746-014
CUSTOM CRUISER		
1990-82	Front & Rear Driver & Passenger Side	746-014
1990-82	Tailgate	746-014
1981-77	Front & Rear Driver & Passenger Side	746-014
CUTLASS		
1999-97	Driver Side	746-017
1999-97	Passenger Side	746-011
CUTLASS SUPREME, CUTLASS CRUISER		
1992-91	Driver & Passenger Side; 2-Door	746-014
1990	Driver & Passenger Side; 2-Door	746-014
1990	Rear Driver & Passenger Side; w/Metal Motor	746-014
1989	Driver & Passenger Side	746-014
1988	Driver & Passenger Side (FWD)	746-014
1988	Front & Rear Driver & Passenger Side (RWD)	746-014
1987-77	Front & Rear Driver & Passenger Side	746-014
DELTA 88, 88 ROYALE		
1999-92	Front & Rear Driver Side	746-017
1999-92	Front & Rear Passenger Side	746-011
1990-77	Front & Rear Driver & Passenger Side	746-014
FIRENZA		
1988-82	Front & Rear Driver & Passenger Side	746-014
INTRIGUE		
2002-98	Front & Rear Driver Side	746-017
2002-98	Front & Rear Passenger Side	746-011
LSS		
1999-96	Front & Rear Driver Side	746-017
1999-96	Front & Rear Passenger Side	746-011
OMEGA		
1984-82	Front & Rear Driver & Passenger Side	746-014
SILHOUETTE		
2004-97	Front Driver Side	746-017
2004-97	Front Passenger Side	746-011
1993-90	Front Driver & Passenger Side	746-014
1993-90	Passenger Side Sliding Door	746-014
TORONADO, TROFEO		
1991	Driver & Passenger Side; w/Metal Motor	746-014
1990-77	Front & Rear Driver & Passenger Side	746-014
VISTA CRUISER		
1977	Front & Rear Driver & Passenger Side	746-014
PLYMOUTH		
VOYAGER, GRAND VOYAGER		
2003-97	Passenger Side Sliding Door	746-253
1996	Driver & Passenger Side Sliding Door	746-253
PONTIAC		
6000		
1991-82	Front & Rear Driver & Passenger Side	746-014
AZTEK		
2005-01	Front & Rear Driver Side	746-017
2005-01	Front & Rear Passenger Side	746-011
BONNEVILLE		
2005-92	Front & Rear Driver Side	746-017
2005-92	Front & Rear Passenger Side	746-011
1989-77	Front & Rear Driver & Passenger Side	746-014
CATALINA		
1981-77	Front & Rear Driver & Passenger Side	746-014

Make/ Model/Years	Description	Dorman #
PONTIAC (continued)		
FIRO		
1988-84	Driver & Passenger Side	746-014
FIREBIRD		
2002-93	Driver Side	746-017
2002-93	Passenger Side	746-011
1992-78	Driver & Passenger Side	746-014
GRAND AM		
2005-98	Front & Rear Driver Side	746-017
2005-98	Front & Rear Passenger Side	746-011
1998-92	Rear Driver Side	746-017
1998-92	Rear Passenger Side	746-011
1991-85	Front & Rear Driver & Passenger Side	746-014
1980-78	Front & Rear Driver & Passenger Side	746-014
GRAND LEMANS		
1981-77	Front & Rear Driver & Passenger Side	746-014
GRAND PRIX		
2006-04	Rear Driver Side	746-017
2006-04	Rear Passenger Side	746-011
2003-97	Front & Rear Driver Side	746-017
2003-97	Front & Rear Passenger Side	746-011
1992-90	Driver & Passenger Side; 2-Door	746-014
1989-88	Front & Rear Driver & Passenger Side	746-014
1987-77	Front & Rear Driver & Passenger Side	746-014
GRAND SAFARI		
1978-77	Front & Rear Driver & Passenger Side	746-014
J2000		
1986-82	Front & Rear Driver & Passenger Side	746-014
LEMANS		
1981-77	Front & Rear Driver & Passenger Side	746-014
MONTANA		
2005-99	Front Driver Side	746-017
2005-99	Front Passenger Side	746-011
PARISIENNE		
1986-83	Front & Rear Driver & Passenger Side	746-014
1986-83	Tailgate	746-014
PHOENIX		
1984-80	Front & Rear Driver & Passenger Side	746-014
SAFARI		
1989-87	Front & Rear Driver & Passenger Side	746-014
1989-87	Tailgate	746-014
SUNBIRD		
1990-85	Front & Rear Driver & Passenger Side	746-014
SUNFIRE		
2005-97	Front & Rear Driver Side	746-017
2005-97	Front & Rear Passenger Side	746-011
1996-95	Front & Rear Driver Side	746-017
1996-95	Front & Rear Passenger Side	746-011
SV6		
2006-05	Front Driver Side	746-017
2006-05	Front Passenger Side	746-011
TRANS SPORT		
1998-97	Front Driver Side	746-017
1998-97	Front Passenger Side	746-011
1993-90	Front & Rear Driver & Passenger Side	746-014
1993-90	Passenger Side Sliding Door	746-014

Door Lock Actuators



2006 Quick Ship Program

Door Lock Actuators

**Don't Lose the Sale...
It's Quick...
It's Easy...
It's at Your Door Tomorrow.***

Listed below are the categories now available:

 Air Door Actuators	 Air Filter Boxes	 Air Intake Hoses	 Caliper Brackets	 Camshaft Synchronizers	 Clock Springs	 CV Boots	 Door Lock Actuators
 Electronic Fan Clutches	 Exhaust Manifold Kits	 Fan Pulley Brackets	 Fluid Lines	 Fluid Reservoirs	 Four Wheel Drive Actuators	 Fuel Sending Units	 Fuel Tanks
 Harmonic Balancers	 New Ignition Distributor Assemblies	 Intake Manifold Kits	 Latches	 Mirror Assemblies	 Oil Pans	 Power Steering Pulleys	 Quick Disconnect
 Radiator Fan Assemblies	 Rear Axle Shaft Kits	 Side View Mirrors	 Smog Pump Pulleys	 Timing Cover Kits	 Transfer Case Motors	 New Window Lift Motors	 New Window Regulators
 New Wiper Motors	 Wiper Transmissions Linkages						

Now you can have the parts your customers need, when they need them!

**It's that easy...
call your servicing distribution center!**

*Additional Charges Apply

Exhaust Manifold Kits

270 Manifolds Covering Over 90 Million Registered Vehicles on the Road



Dorman Is the Leader in Aftermarket Coverage

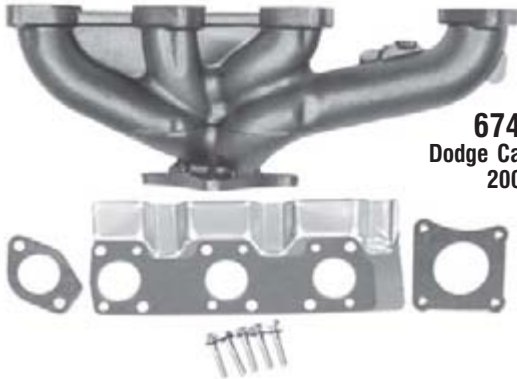

674-510
Dodge Caravan 3.0L
2000-96



674-573
GM 5.7L
C&K Series Trucks
2002-95



674-557
Ford 8 cyl. 4.6L (281 CID) LH
Crown Victoria
2002-95

New Manifold with Integral Converter Assembly Coverage

Dorman Engineered

Reinforced Manifold Casting for Greater Durability

674-439
Honda Civic
2000-96
(Not for use in CA)



Related Sales

Exhaust Manifold to Head Hardware

03400

Stud Kit

Includes 3 studs, 2 bolts, 3 nuts. GM/Toyota 1997-88.

03405

Stud Kit

Ford 1996-86, 8 cyl. 5.0L;
Ford 1996-80, 8 cyl. 4.2L,
5.0L, 5.8L.

03410

Exhaust Manifold Mounting Hardware

Fits 1996-87 Ford E, F Series w/7.5L Engine (RH & LH). Size 3/8-16.

Activant Path

Exhaust System Parts

Activant Code

DMN

Applications begin on page 119.

Exhaust Manifold Kits



674-100

Chevrolet/GMC Truck
 1993-85 S10/S15 Pickups, Sonoma 2.5L; 1988-85 S10/S15 Blazer, Jimmy 2.5L; Tubular w/Heat Shield 2 Bolts, 2 Nuts, 2 Springs, 1 Flange & 2 Manifold.



674-101

GM
 1987-85 Grand Am, Century, Skylark, Somerset, Celebrity, Calais, Cierra, 6000 2.5L; 1985 Citation 2.5L; 1987 Fiero 2.5L; Tubular w/Heat Shield, 2 Bolts, 2 Springs, 1 Flange & 1 Manifold.



674-102

Buick/Pontiac
 1987 Skyhawk, 1990-87 Sunbird, 1989-87 Grand Am 2.0L w/Turbo, 4 Studs, 4 Nuts, 1 Flange & 1 Manifold.



674-102T

GM
 1986-85 Cavalier, Cimarron, Firenza, Skyhawk, Sunbird 2.0L w/Heat Shield, 2 Studs, 2 Bolts, 2 Nuts, 2 Springs, 1 Flange.



674-150

Ford/Mercury
 1994-85 Tempo, Topaz 2.3L, 3 Studs, 3 Nuts, 1 Flange.



674-151

Ford/Mercury
 1991-86 Taurus, Sable 2.5L, 3 Studs, 3 Nuts,

Exhaust Manifold Kits

Exhaust Manifold Kits



674-152

Ford Truck
1996-80 Bronco, F-Series Pickups, E Series Van, 5.0L (302 CID) and 5.8L (351 CID) Windsor; LH, 2 Studs, 4 Nuts,



674-153

Ford
1996-86 Bronco, E-Series Econoline, F-Series Pickups; 5.0L, 1991-90 Full Size Car 5.0L; RH, 2 Studs, 4 Nuts,



674-155

Ford Truck
1987-83 Bronco, E-Series Econoline, F-Series Pickups 5.0L, 5.8L; LH, w/Heat Riser, 2 Studs, 4 Nuts,



674-156

Chevrolet/GMC Truck
1995-88 C,K,R,V Pickups, G-Series Vans, Blazer, Jimmy, Suburban, Tahoe, Yukon 5.0L, 5.7L; RH, w/Heat Shield, 3 Studs, 3 Nuts, 3 Springs, 1 Flange.



674-157

Chevrolet/GMC Truck
1995-88 C,K,R,V Pickups, G-Series Vans, Blazer, Jimmy, Suburban, Tahoe, Yukon 5.0L, 5.7L; LH, w/Heat Shield, 3 Studs, 3 Nuts, 3 Springs, 1 Flange.



674-158

Chevrolet/GMC Truck
1991-87 C,K,R,V Pickups, G-Series Vans, Blazer, Jimmy, Suburban, Tahoe, Yukon 5.0L, 5.7L; RH, w/EGR w/Heat Shield, 3 Studs, 3 Nuts, 3 Springs, 3 Washers, 1 Flange.

Exhaust Manifold Kits

Exhaust Manifold Kits



674-159

Chevrolet/GMC Truck

1997-73 C,K,R,V Pickups, G-Series Vans, P-Series Vans, Suburban 7.4L; LH, with A.I.R. & O2 Holes, 6 Studs, 3 Nuts, 3 Springs, 3 Washers, 1 Flange & 1 Manifold.



674-160

Suzuki

1994-89 Swift 1.3L w/DOHC eng; 3 Bolts, 3 Nuts, 3 Washers, 1 Flange & 1 Manifold.



674-161

Chevrolet/GMC Truck

1997-85 C,K,R,V Pickups, G-Series Vans, P-Series Vans, Suburban 7.4L; RH, w/Heat Shield, 6 Studs, 3 Nuts, 3 Springs, 3 Washers, 1 Flange & 1 Manifold.



674-162

Chevrolet/GMC Truck

1990-83 Medium Duty, School Bus 6.0L, 7.0L; LH 1/4"-18 A.I.R. Holes; 3 Studs, 3 Nuts, 3 Springs, 1 Flange & 1 Manifold.



674-163

Chevrolet/GMC Truck

1990-83 Medium Duty, School Bus 6.0L, 7.0L; RH, 1/4"-18 A.I.R. Holes; 3 Studs, 3 Nuts, 3 Springs, 1 Flange & 1 Manifold.



674-164

Chevrolet/Geo/Toyota

1997-88 Nova 1.6L, Prizm 1.6L, 1.8L, Corolla 1.6L, 1.8L, Celica 1.6L, 1.8L; w/Heat Shield, 1 Hole for exh pipe; 2 Studs, 2 Nuts, 1 Flange & 1 Manifold.

Exhaust Manifold Kits



674-165

Ford Truck
1997-88 Bronco, E-Series Econoline, F-Series Pickups 5.8L; RH w/ EGR, 2 Studs, 2 Nuts.



674-166

Ford
1987-81 Bronco, E-Series Econoline & F-Series Pickups w/5.8L; 1991-83 Full Size Car; RH with oxygen sensor, w/Heat Shield (not shown), 2 Studs, 2 Nuts.



674-168

Ford Truck
1991-79 Medium Duty 6.1L, 7.0L; LH & RH, with A.I.R. Carb., 1 Manifold.



674-169

Ford Truck
1997-88 Bronco, E-Series Econoline, F-Series Pickups 5.8L; LH, 2 Studs, 2 Nuts.



674-170

Jeep
1990-87 Cherokee, Comanche, Wagoneer 4.0L; Tubular Design w/Heat Stove, 2 Bolts, 2 Nuts, 1 Flange & 1 Manifold.



674-172

Hyundai/Mitsubishi
1989 Excel, Precis 1.5L, 5 Bolts, 1 Flange & 1 Manifold.

Exhaust Manifold Kits

Exhaust Manifold Kits

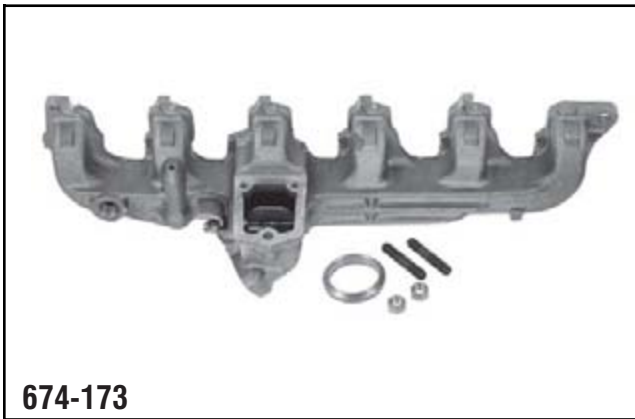

674-173

Ford
1983-65 All Light & Medium Duty 3.9L, 4.9L, 1972-65 Full Size Car 3.9L; 2 Studs, 2 Nuts, 1 Flange.

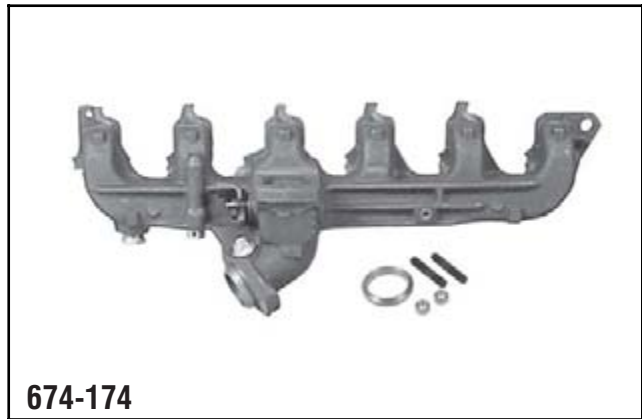

674-174

Ford Truck
1986-81 Bronco, E-Series Econoline, F-Series Pickups 4.9L, 2 Studs, 2 Nuts, 1 Heat Riser Spring, 1 Flange.



674-175

Chevrolet/Geo/Isuzu
1989-87 Spectrum, I-Mark 1.5L; 5 Studs, 1 Flange & 1 Manifold.



674-176

Dodge/Plymouth Truck
1978-72 Motorhome, Pickups, Ramcharger, Trailduster 6.6L, 7.2L, LH & RH, w/o Heat Tube 2 Bolts, 2 Nuts, 1 Flange & 1 Manifold.



674-178

Ford/Mercury
1993-86 Sable, Taurus 3.0L; Rear, 4 Studs, 2 Nuts.



674-179

Ford/Mercury
1993-86 Sable, Taurus 3.0L; Front, 4 Studs, 2 Nuts.

Exhaust Manifold Kits



674-180

Geo/Isuzu
1993-90 Storm, Stylus 1.6L; 3 Studs, 3 Nuts, 1 Flange & 1 Manifold.



674-181

Nissan
1987 Sentra 1.6L; w/Federal Emissions; 3 Studs, 3 Nuts, 1 Flange & 1 Manifold.



674-182

Ford Truck
1982-80 Bronco, E-Series Econoline, F-Series Pickups 5.8L, 6.6L; RH, 4 Studs, 2 Nuts.



674-183

International
1983-75 All Models 6.6L, 7.3L; LH & RH, 2 Bolts, 2 Nuts, 2 Lock Washers, 1 Manifold.



674-184

Ford/Lincoln/Mercury
1991-86 Full Size 5.0L, 1988-86 Cougar, LTD, Thunderbird 5.0L, 1990-86 Continental, Town Car 5.0L, 1997-86 Mark VII 5.0L; LH., 2 Studs, 2 Nuts.



674-185

Ford Truck
1996-90 Bronco, E-Series Econoline, F-Series Pickups 4.9L; Front, 4 Studs, 2 Nuts.

Exhaust Manifold Kits

Exhaust Manifold Kits



674-186

Ford Truck
 1995-90 Bronco, E-Series Econoline, F-Series Pickups 4.9L; Rear, 4 Studs, 2 Nuts.



674-187

International
 1983-68 All Models w/6.4L (392); LH & RH, Center Dump 3-Bolt Flange, 3 Bolts, 3 Nuts, 3 Lock Washers, 1 Flange & 1 Manifold.



674-188

International
 1983-68 All Models w/5.6L (345); LH & RH, Center Dump 2-Bolt Flange, 2 Bolts, 2 Nuts, 2 Lock Washers, 1 Flange & 1 Manifold.



674-189

Dodge Truck
 1975-63 Medium Duty, Motorhome 5.9L, 6.8L; LH & RH, 4 Studs, 4 Nuts, 1 Flange & 1 Manifold.



674-190

Ford/Lincoln
 1993-86 Mustang 5.0L, 1992-87 Mark VII, Capri 5.0L; LH., 2 Studs, 4 Nuts, 1 Manifold.



674-191

Ford/Lincoln/Mercury
 1993-86 Mustang, Mark VII, Capri 5.0L; RH, 2 Studs, 4 Nuts, 1 Manifold.

Exhaust Manifold Kits



674-193

Ford/Lincoln/Mercury

1982-77 Bronco, E-Series Econoline, F-Series Pickups 5.8L, 6.6L, 1979-75 Full Size Cars 5.8L, 6.6L; LH, 4 Studs, 2 Nuts.



674-194

Ford/Lincoln/Mercury

1995-88 Taurus, Windstar, Continental, Sable 3.8L; Rear, 4 Studs, 2 Nuts.



674-195

Ford/Lincoln/Mercury

1995-88 Taurus, Windstar, Continental, Sable 3.8L; Front, 4 Studs, 2 Nuts.



674-196

Jeep

1999-91 Cherokee, Comanche, Grand Cherokee, Wagoneer 4.0L; Tubular Design, 2 Bolts, 2 Nuts, 4 Washers, 1 Flange & 1 Manifold.



674-197

GM

1981-76 Passenger Cars 4.4L, 5.0L, 5.7L, 6.6L, 1987-76 Light Duty Truck 5.0L, 5.7L, 6.6L; LH, 3 Studs, 3 Nuts, 3 Lock Washers.

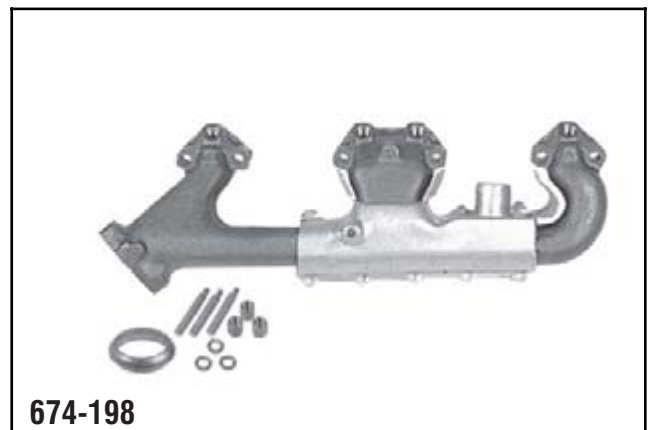

674-198

Chevrolet/GMC Truck

1988-83 G-Series Vans 5.0L, 5.7L; RH, w/Heat Stove, 3 Studs, 3 Nuts, 3 Washers, 1 Flange.

Exhaust Manifold Kits

Exhaust Manifold Kits

Exhaust Manifold Kits



674-199

Chevrolet/GMC Truck
 1972-69 C/K Pickups, G-Series Vans, P-Series Vans, Blazer, Jimmy, Suburban 5.7L; RH, 3 Studs, 3 Nuts, 3 Washers, 1 Flange.



674-200

Chevrolet/Geo
 2000-90 Metro 1.0L; 2 Studs, 2 Springs, 1 Flange & 1 Manifold.



674-201

Chevrolet/GMC Truck
 1972-69 C/K Pickups, G-Series Vans, P-Series Vans, Blazer, Jimmy, Suburban 5.7L; LH, 3 Studs, 3 Nuts, 3 Washers, 1 Flange.

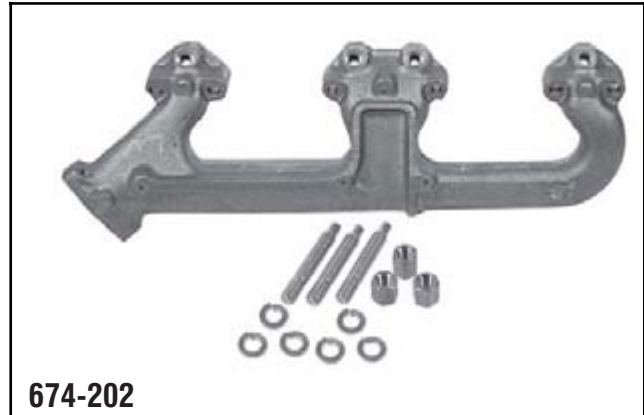

674-202

GM
 1981-76 Passenger Cars 4.4L, 5.0L, 5.7L, 6.6L, 1988-73 Light Duty Truck 5.0L, 5.7L, 6.6L; RH., 3 Studs, 3 Nuts, 6 Washers.



674-203

Chevrolet/GMC Truck
 1973 All Models 5.0L, 1975 All Models 5.7L, 6.6L, 1976 G-Series Vans 6.6L; LH, 3 Studs, 3 Nuts, 6 Washers.



674-204

Ford Truck
 1997-88 E-Series Econoline, F-Series Pickups 7.5L; LH., 2 Studs, 2 Nuts.

Exhaust Manifold Kits

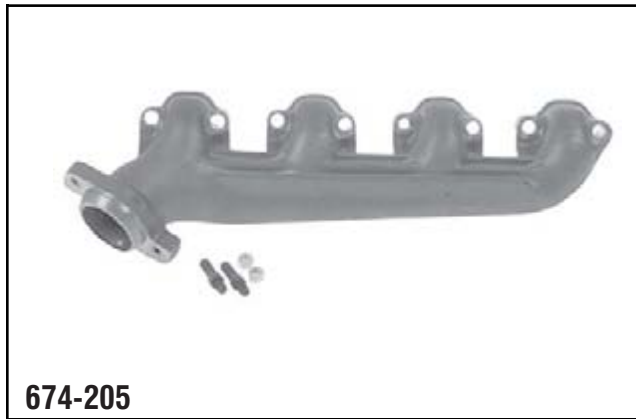

674-205

Ford Truck
1997-88 E-Series Econoline, F-Series Pickups 7.5L; RH, 2 Studs, 2 Nuts.



674-206

Buick, Cadillac, & Chevrolet
1996-94 Roadmaster, Fleetwood, 5.7L, Caprice, 4.3L, 5.7L; RH w/ Heat Shield, 3 Studs, 3 Nuts, 1 Flange & 1 Manifold.



674-208

Chevrolet/GMC Truck
1995-88 S-Series Blazer, Bravada, Jimmy, Pickups, Sonoma 4.3L; LH, w/Heat Stove, 3 Studs, 3 Nuts, 3 Springs, 1 Flange.



674-210

Chevrolet/GMC Truck
1995-88 S-Series Blazer, Bravada, Jimmy, Pickups, Sonoma 4.3L; RH, 3 Studs, 3 Nuts, 3 Springs, 1 Flange.



674-211

Chevrolet/GMC Truck
2005-96 Astro, Safari, S Series Blazer, Bravada, Jimmy, Pickup, Sonoma 4.3L; RH, 3 Studs, 3 Nuts, 3 Springs, 1 Flange.



674-212

Chevrolet/GMC Truck
2001-96 S-Series Blazer, Bravada, Jimmy, Pickups, Sonoma 4.3L; LH w/Heat Shield, 3 Studs, 3 Nuts, 3 Springs, 1 Flange.

Exhaust Manifold Kits

Exhaust Manifold Kits



674-213

Chevrolet/GMC Truck
 1995-88 C,K,R,V Pickups 4.3L, 1995 G-Series Vans 4.3L; RH w/Heat Stove., 3 Studs, 3 Nuts, 3 Springs, 1 Flange.



674-214

Chevrolet/GMC Truck
 1995-88 C,K,R,V Pickups 4.3L, 1995 G-Series Van 4.3L; LH w/Heat Shield, 3 Studs, 3 Nuts, 3 Springs, 1 Flange.



674-215

Chevrolet/GMC Truck
 1998-96 C/K-Series Pickups 4.3L; RH, 3 Studs, 3 Nuts, 1 Flange & 1 Manifold.



674-216

Chevrolet/GMC Truck
 2002-96 Astro, Safari, Express, Savana 4.3L, 1998-96 C/K-Series Pickups 4.3L; LH, 3 Studs, 3 Nuts, 1 Flange & 1 Manifold.



674-217

Chevrolet/GMC Truck & Cadillac
 2000-96 C/K-Series Pickups, Escalade, Suburban, Tahoe, Yukon 5.0L, 5.7L; RH, 3 Studs, 3 Nuts, 1 Flange & 1 Manifold.



674-218

Chevrolet/GMC Truck & Cadillac
 2002-96 C/K-Series Pickups, Escalade, Express, Savana, Suburban, Tahoe, Yukon 5.0L, 5.7L; LH w/Heat Shield, 3 Studs, 3 Nuts, 3 Springs, 1 Flange & 1 Manifold.

Exhaust Manifold Kits



674-220

Nissan Truck
1989-86 Pickups, D21 Pickups 2.4L; w/Heat Shield, 3 Studs, 3 Nuts, 1 Flange & 1 Manifold.



674-221

Ford Truck
1992-86 Bronco II, Ranger 2.9L; RH, 2 Bolts, 2 Washers.



674-222

Ford Truck
1992-86 Bronco II, Ranger 2.9L; LH, 2 Bolts, 2 Washers.



674-223

Nissan Truck
1995-86 Pathfinder, Pickups, D21 Pickups 3.0L; Rear or RH, 3 Studs, 3 Nuts, 2 Flange & 1 Manifold.



674-224

Nissan
1994-90 Maxima 3.0L; SOHC Rear, VG30E Eng. w/Heat Shield, 3 Studs, 3 Nuts, 1 Manifold, 1 Flange.



674-225

AMC/Jeep
1984-83 Eagle 2.5L, 2002-83 Cherokee, CJ Series, Comanche, Scrambler, Wagoneer, Wrangler 2.5L, 2004-96 Dodge Dakota 2.5L; w/Heat Shield, 2 Nuts, 2 Washers.

Exhaust Manifold Kits

Exhaust Manifold Kits



674-226

Ford Truck
1988-80 E-Series Econoline, F-Series Pickups 7.5L; RH, 2 Studs, 4 Nuts, 1 Manifold.



674-227

Ford Truck
1988-80 E-Series Econoline, F-Series Pickups 7.5L; LH., 2 Studs, 4 Nuts, 1 Manifold.



674-228

Ford Truck
1997-93 E-Series Econoline, F-Series Pickups 7.5L; LH, Exc. Calif, 2 Studs, 2 Nuts.



674-229

Ford Truck
1997-93 E-Series Econoline, F-Series Pickups 7.5L; RH, Exc. Calif, 2 Studs, 2 Nuts.

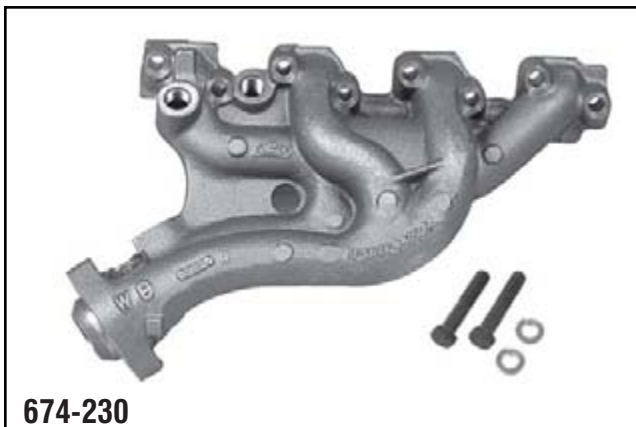

674-230

Ford
1993-83 Mustang, Aerostar, Ranger 2.3L, 2.0L, 2 Bolts, 2 Washers.



674-231

Chevrolet/GMC Truck
1990-87 C,K,R,V Pickups, Blazer, Jimmy, Suburban 5.0L, 5.7L; LH, 3 Studs, 3 Nuts, 3 Springs, 3 Washers, 1 Flange.

Exhaust Manifold Kits



674-232

Chrysler
1987-70 All Models 3.2L, 3.7L, 2 Studs, 2 Nuts, 1 Heat Riser Spring, 1 Flange, 1 Manifold.



674-233

Dodge/Plymouth Truck
1992-78 Pickups, Vans, Ramcharger, Trailduster 5.2L, 5.9L; LH, 2 Bolts, 2 Nuts.



674-234

Chrysler
1980-77 Cars 5.2L, 5.9L, 1988-81 Trucks 5.2L, 5.9L; RH, 2 Studs, 2 Nuts, 1 Flange.



674-235

AMC/Jeep
1979-65 All Models 3.3L, 3.8L, 4.2L, including AMC, 2 Studs, 2 Nuts, 1 Heat Riser Spring, 1 Manifold.



674-236

Ford Truck
1985-80 Bronco, E-Series Econoline, F-Series Pickups 5.0L; RH, 4 Studs, 2 Nuts.



674-237

AMC/Jeep
1990-83 All Models 4.2L, 2 Studs, 2 Nuts.

Exhaust Manifold Kits

Exhaust Manifold Kits



674-238

Chevrolet/GMC Truck
 1998-89 Medium & Heavy Duty 6.0L, 7.0L; LH, 9 Studs, 3 Nuts, 3 Springs.



674-239

Chevrolet/GMC Truck
 1998-89 Medium & Heavy Duty 6.0L, 7.0L; RH w/Heat Shield, 3 Studs, 3 Nuts, 3 Springs, 1 Flange & 1 Manifold.

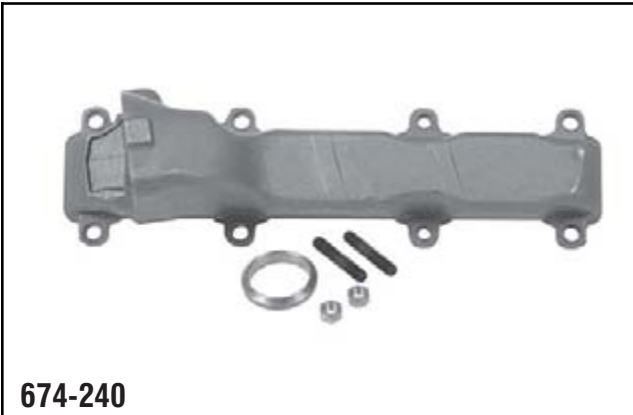

674-240

Ford Truck
 1976-65 E-Series Econoline, F-Series Pickups, Motorhome 5.8L, 5.9L, 6.4L; RH, 2 Studs, 2 Nuts, 1 Flange.



674-241

Ford Truck
 1976-68 F-Series Pickups, Motorhome 5.8L, 5.9L, 6.4L; LH, 2 Studs, 2 Nuts, 1 Flange.



674-244

Chevrolet
 1969-66 All Cars 6.5L, 1969-68 All Cars 7.0L, 1972-67 All Cars 6.6L, 1976-70 All Cars 7.4L, 1980-70 All Light Duty Trucks 7.4L; RH, 9 Studs, 3 Nuts, 3 Springs, 2 Flange.

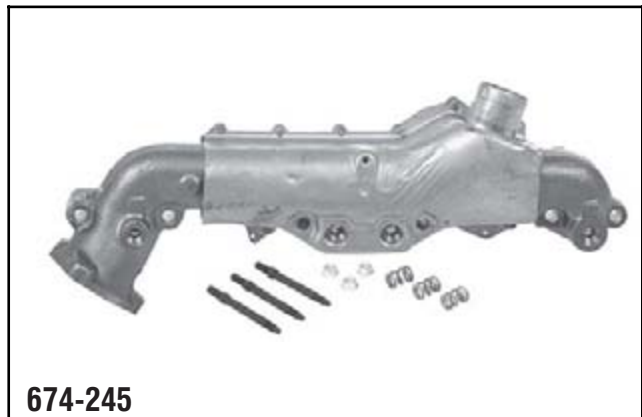

674-245

Chevrolet
 1986-83 C/K Pickups, Suburban 5.7L; RH, w/A.I.R; 1986-85 C/K Pickups, Blazer, Jimmy, Suburban 5.0L, 5.7L; RH w/Heat Stove, 1986-82 GM Sedans, 3 Studs, 3 Springs, 3 Nuts.

Exhaust Manifold Kits



674-247

Mazda
1998-96 Protege 1.5L; 5 Studs, 5 Nuts, 1 Flange, 1 Manifold.



674-248

Isuzu Truck
1992-87 Pickups, Trooper, Amigo 2.6L.; 3 Studs, 6 Nuts, 1 Flange & 1 Manifold.



674-249

Chevrolet/GMC Truck
1994-91 G-Series Vans 5.0L, 5.7L, 1988-87 P-Series Vans 5.7L; RH w/Heat Stove, 3 Studs, 3 Nuts.



674-250

Chevrolet/GMC Truck
1996-89 G-Series Vans, P-Series Vans 5.7L; LH, 3 Studs, 3 Nuts.



674-251

Toyota
1993-90 Celica 1.6L; 2 Holes for Exh pipe Exc. CA, 3 Studs, 3 Nuts, 1 Flange & 1 Manifold.



674-263

Dodge/Mitsubishi/Plymouth
1992-87 Colt, Summit, Mirage 1.5L; 3 Studs, 3 Nuts, 1 Flange & 1 Manifold.

Exhaust Manifold Kits

Exhaust Manifold Kits



674-264

Chrysler/Mitsubishi
1987-81 All Models 2.6L; 5 Bolts, 1 Flange & 1 Manifold.

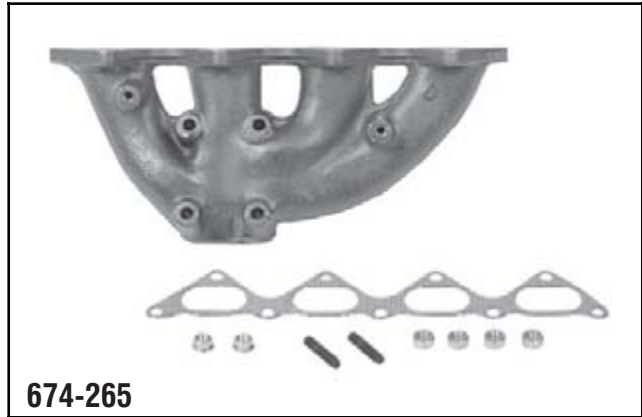

674-265

Eagle/Mitsubishi/Plymouth
1998-90 Talon, Eclipse, Galant, Laser 2.0L M.T. Turbo; 2 Studs, 6 Nuts, 1 Manifold.



674-266

Chrysler
1994-90 Eagle, Talon, Laser 2.0L A.T. Turbo; 2 Studs, 6 Nuts, 1 Flange & 1 Manifold.



674-267

GM
1995-88 C/K-Series 7.4L (454 CID), LH, w/Heat Shield; 3 Studs, 3 Springs, 3 Nuts, 2 Flange & 1 Manifold.



674-268

GM
1995-88 C/K-Series 7.4L (454 CID), RH, w/Heat Shield; 3 Studs, 3 Springs, 3 Nuts, 2 Flange & 1 Manifold.



674-269

GM
1996-93 Grand Prix, Lumina, Cutlass Cierra, Cutlass Supreme 3.1L, Rear; 2 Bolts, 2 Springs, 2 Nuts, 1 Flange.

Exhaust Manifold Kits



674-270

Chrysler
1996-94 Ram, B-Series Vans, Dakota 5.2/5.9; RH, 2 Bolts, 2 Nuts.



674-271

Chrysler
2004-94 Ram, B-Series Vans, Dakota, Durango 5.2/5.9; LH, 2 Bolts, 2 Nuts.

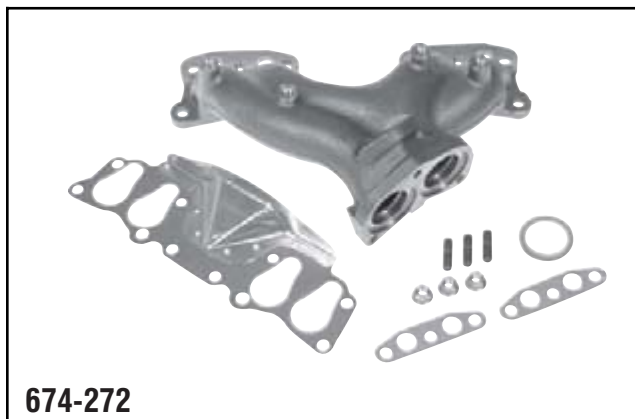

674-272

Toyota
1995-85 Pickups 22R, 1985 Celica 22RE Eng.; 3 Studs, 3 Nuts, 1 Manifold, 2 Flange.

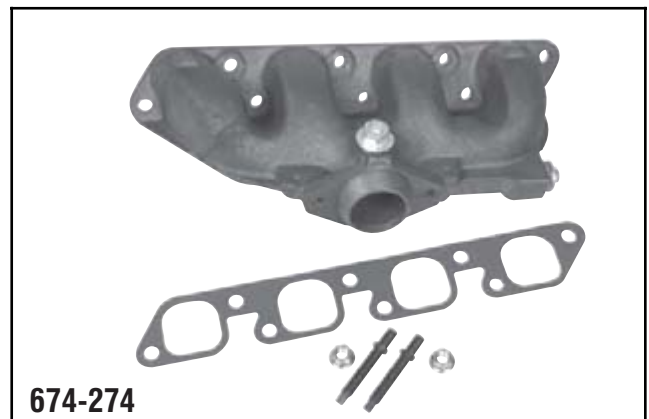

674-274

Ford
1990-87 Explorer, Escort, EXP, Lynx MFI w/heat stove; 2 Studs, 2 Nuts, 1 Manifold.



674-275

Chrysler
1978-72 Trucks 6.6L (440 CID), 7.2L Rear dump RH; 2 Bolts, 2 Nuts, 1 Manifold, 1 Flange.

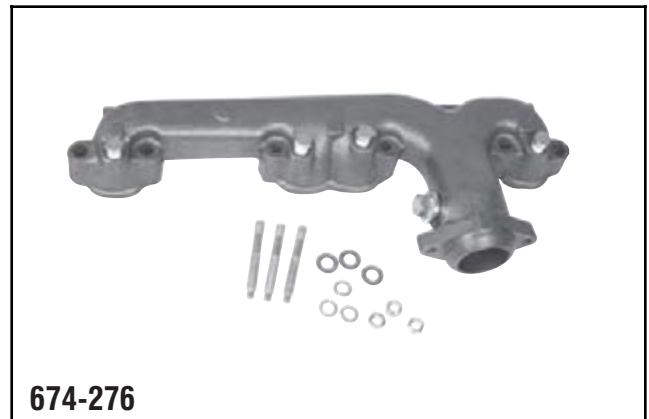

674-276

GM
1986-80 5.0L, 5.7L, 4.4L; LH, 3 Studs, 3 Nuts, 3 Washers, 3 Lock Washers.

Exhaust Manifold Kits

Exhaust Manifold Kits

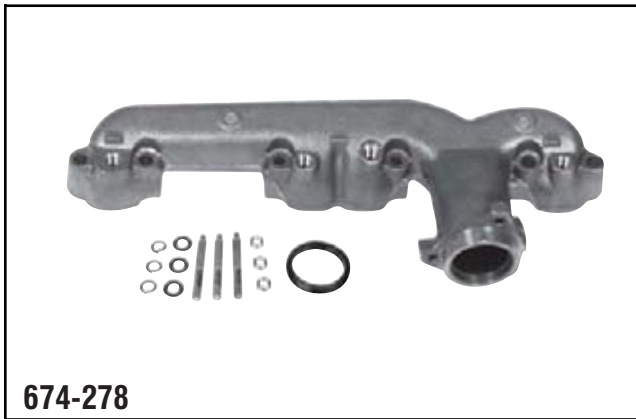

674-278

GM
1986-83 Trucks 8 Cyl-5.0L,5.7L-305/350 CID; LH, 3 Studs, 3 Nuts, 3 Washers, 3 Lock Washers, 1 Flange.



674-280

Ford
1996-93 Escort, Mercury Tracer 4 Cyl-1.9L SOHC, 2 Studs, 3 Nuts, 1 Manifold.

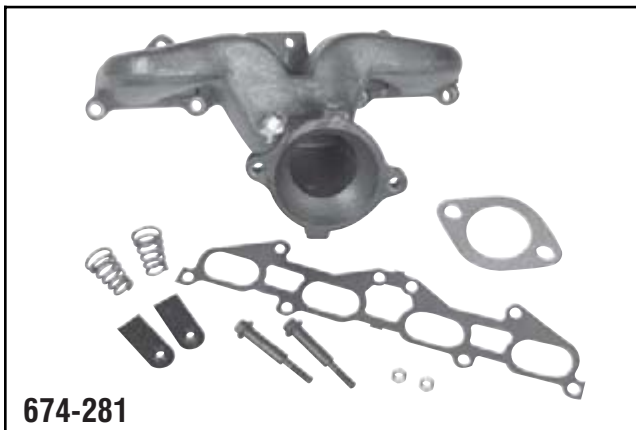

674-281

Chrysler
2000-95 Neon 2.0L DOHC; 2 Bolts, 2 Nuts, 2 Lever Nuts, 2 Springs, 1 Manifold, 1 Flange.



674-282

Chrysler
2000-95 Stratus, Cirrus; 1998-96 Sebring 2.4L; 5 Nuts, 1 Manifold, 1 Flange.

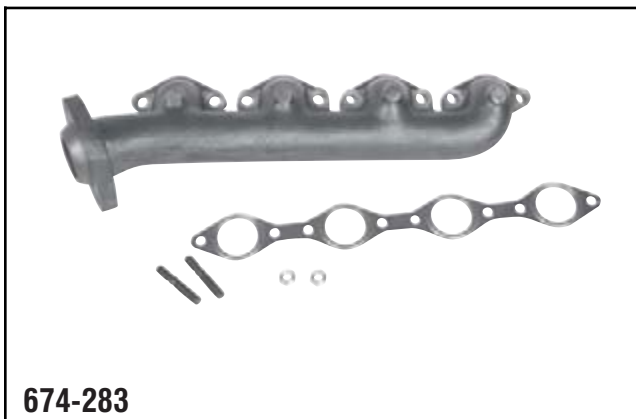

674-283

Ford
1994-83 Ford Trucks F100-350, Vans E100-350 8 Cyl-6.9L, 7.3L-421/445 CID Diesel, RH; 2 Studs, 2 Nuts, 1 Manifold.

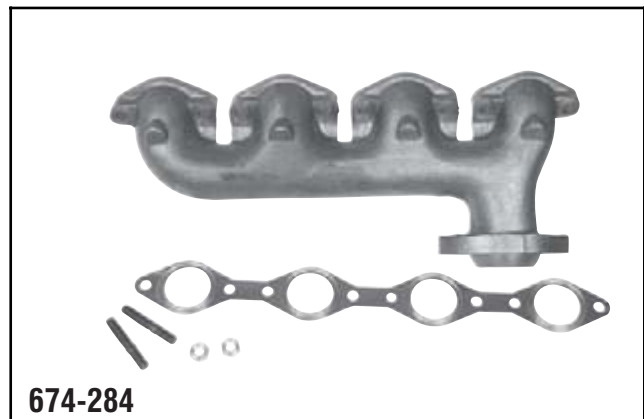

674-284

Ford
1994-90 Ford Vans E100-350 8 Cyl-6.9L,7.3L-421/445 CID Diesel, LH; 2 Studs, 2 Nuts, 1 Manifold.

Exhaust Manifold Kits

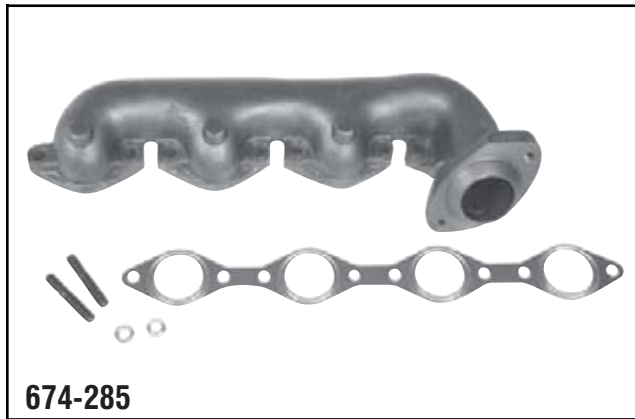

674-285

Ford
1994-83 Ford Trucks, Vans E100/350-F100/350 6.9L, 7.3L-421/445 CID Diesel, LH; 2 Studs, 2 Nuts, 1 Manifold.



674-286

Ford
1998-94 Ford Mustang 3.8L; LH; 2 Studs, 2 Nuts, 1 Manifold.



674-287

Chrysler
1994-89 Eagle, Talon, Eclipse 2.0 w/o Turbo; 3 Studs, 3 Nuts, 1 Manifold, 1 Flange.



674-327

Ford
1984 Topaz, Tempo, 2 Studs, 2 Nuts, 1 Manifold, 1 Flange.



674-329

Ford
2001-98 Truck Explorer/Mountaineer 5.0L, RH; 2 Bolts, 2 Nuts, 1 Manifold.



674-330

Ford
1992-89 Probe with Turbo, 4 Nuts, 1 Manifold, 1 Flange.

Exhaust Manifold Kits

Exhaust Manifold Kits



674-334

Ford
2001-98 Truck Explorer/Mountaineer 5.0L, LH; 2 Bolts, 2 Nuts, 1 Manifold.



674-342

Chrysler
1991-87 Trucks V6 3.9L, RH; 2 Bolts, 2 Nuts, 1 Manifold.



674-343

Ford
1992-91 Ford Escort/Tracer 1.9L; 2 Studs, 2 Nuts, 1 Manifold.



674-356

Ford
1998-96 Truck Explorer/Mountaineer 5.0L LH; 2 Bolts, 2 Nuts, 1 Manifold.



674-357

Ford
1998-96 Truck Explorer/Mountaineer 5.0L, RH; 2 Bolts, 2 Nuts, 1 Manifold.



674-358

Ford
1996-91 Escort, Tracer 1.8L; 2 Studs, 2 Nuts, 1 Manifold, 1 Flange.

Exhaust Manifold Kits



674-359

Ford
1997-94 Windstar, Taurus, Sable, 3.0L; Rear, 2 Studs, 2 Nuts,
1 Manifold.



674-360

Ford
1997-94 Windstar, Taurus, Sable 3.0L; Front, 2 Studs, 2 Nuts,
1 Manifold.



674-361

Ford
1993-91 Truck Ranger 3.0L, LH.; 2 Bolts, 1 Manifold.



674-362

Ford
1999-96 Taurus, Sable 3.0L Rear, 2 Studs, 2 Nuts, 1 Manifold.



674-363

Ford
2005-96 Taurus, Sable 3.0L, 12 Valve ,Front; 2 Studs, 2 Nuts,
1 Manifold.



674-364

Ford
1999-96 Taurus, Sable 12 Valve, 3.0L, Front.; 2 Studs, 2 Nuts,
1 Manifold.

Exhaust Manifold Kits

Exhaust Manifold Kits



674-365

Ford
1998-96 Taurus, Sable 12 Valve, 3.0L, Front; 2 Studs, 2 Nuts, 1 Manifold.



674-366

Ford
2002-99 Windstar 3.0L, Rear; 2 Studs, 2 Nuts, 1 Manifold.



674-367

Ford
2002-99 Windstar, LH; 2 Studs, 2 Nuts, 1 Manifold.



674-368

Ford
1997-90 Explorer, Ranger 4.0L, RH; 2 Bolts, 1 Manifold.



674-371

Ford
1994-90 Explorer, Ranger 4.0L, LH; 2 Bolts, 2 Nuts, 1 Manifold.



674-373

Ford
1997-95 Explorer, Ranger 4.0L, LH; 2 Bolts, 2 Nuts, 1 Manifold.

Exhaust Manifold Kits



674-376

Ford
2000-97 Explorer, Mountaineer 4.0L, RH; 2 Bolts, 2 Nuts; 1 Manifold.



674-378

Ford
2001-98 Explorer, Ranger, 4.0L, RH; 2 Bolts, 2 Nuts, 1 Manifold.



674-379

Ford
2001-98 Explorer, Ranger 4.0L, LH., 2 Bolts, 2 Nuts, 1 Manifold.



674-380

Ford
2002-94 Trucks 7.3L, RH; 2 Bolts, 2 Nuts, 1 Manifold.

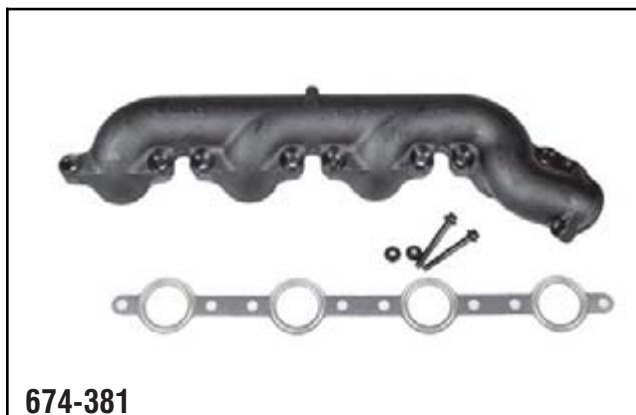

674-381

Ford
1997-94 Trucks 7.3L, LH; 2 Bolts, 2 Nuts, 1 Manifold.



674-383

Ford
2003-95 Trucks 7.3L, LH; 2 Bolts, 2 Nuts, 1 Manifold.

Exhaust Manifold Kits

Exhaust Manifold Kits



674-385

GM
1995-87 Caprice, Astro, G-Series Vans 4.3L, LH; 3 Bolts, 3 Nuts, 1 Manifold, 1 Flange.



674-390

GM
2000-96 Trucks 7.4L, RH; 3 Studs, 3 Nuts, 1 Manifold.



674-391

GM
2000-96 Trucks 7.4L, LH; 3 Studs, 3 Nuts, 1 Manifold.



674-392

Jeep
1988-87 Jeep 5.9L, RH; 2 Nuts, 2 Washers, 1 Manifold.

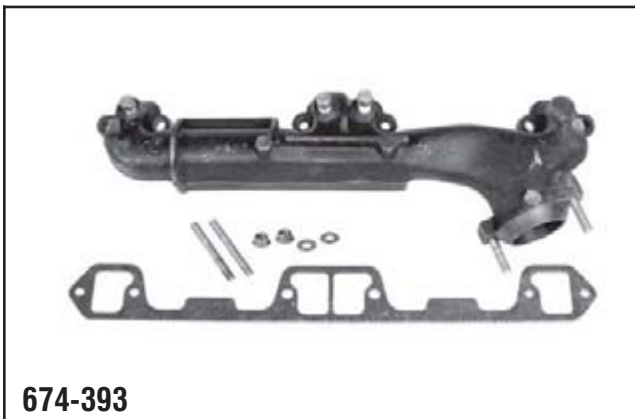

674-393

Jeep
1991-87 Jeep 5.9L, LH; 2 Studs, 2 Nuts, 2 Washers, 1 Manifold.

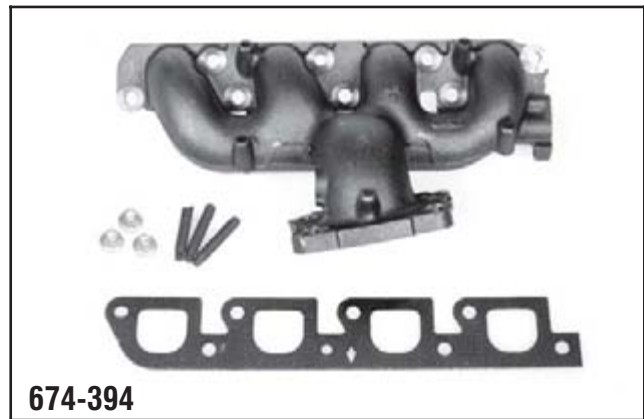

674-394

Ford
2002-97 Escort, Tracer SOHC, 2004-00 Focus; 3 Studs, 3 Nuts, 1 Manifold.

Exhaust Manifold Kits

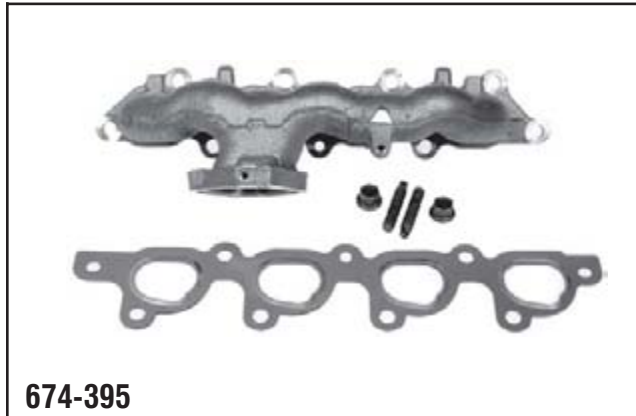

674-395

Ford
2003-94 Escort, ZX2; 2 Studs, 2 Nuts, 1 Manifold, 1 Flange.



674-398

Ford
1998-97 Trucks 5.4L, RH; 2 Bolts, 1 Manifold.



674-399

Ford
1998-97 Trucks 5.4L, LH; 2 Bolts, 1 Manifold.



674-400

GM/Isuzu
2000-98 Trucks 2.2L; 3 Bolts, 3 Nuts, 1 Manifold.



674-404

Ford
1998-97 Trucks 4.2L RH; 2 Studs, 2 Nuts, 1 Manifold.



674-405

Ford
1998-97 Trucks 4.2L LH; 2 Studs, 2 Nuts, 1 Manifold.

Exhaust Manifold Kits

Exhaust Manifold Kits

Exhaust Manifold Kits



674-406

Ford
1998-97 Trucks 4.6L, RH; 2 Studs, 2 Nuts, 1 Manifold.



674-407

Ford
1998-97 Trucks 4.6L, LH; 2 Studs, 2 Nuts, 1 Manifold.



674-408

Ford
1993-86 Aerostar, Ranger, 3.0L, RH; 2 Bolts, 1 Manifold.



674-410

Ford
1996-93 Aerostar, Ranger, 3.0L, RH; 2 Studs, 2 Nuts, 1 Manifold.



674-412

Ford
2000-97 Aerostar, Ranger, 3.0L, RH; 2 Bolts, 1 Manifold.



674-413

Ford
1997 Ranger, 3.0L, LH; 2 Studs, 2 Nuts, 1 Manifold.

Exhaust Manifold Kits



674-431

Nissan
2001-96 Pathfinder, QX4, 3.3L, LH; 6 Studs, 6 Nuts, 1 Manifold.



674-432

Nissan
2001-96 Pathfinder, QX4 3.3L, RH; 6 Studs, 6 Nuts, 1 Manifold.



674-433

Nissan
2005-01 Pathfinder, QX4, 3.5L, LH; 6 Studs, 6 Nuts, 1 Manifold.



674-434

Nissan
2005-01 Pathfinder, QX4, 3.5L, RH; 6 Studs, 6 Nuts, 1 Manifold.



674-435

Chrysler
1999-95 Neon, Breeze, Stratus, 2.0L; 2 Bolts, 2 Nuts, 1 Manifold.



674-438

Chrysler
2004-94 Dakota, Pickups, Vans - 3.9L, Right; 2 Bolts, 2 Nuts, 1 Manifold.

Exhaust Manifold Kits

Exhaust Manifold Kits

Exhaust Manifold Kits



674-439

Honda
2000-96 Civic Models, 1.6L (Not For Use in CA); 7 Studs, 7 Nuts, 1 Manifold.



674-440

Nissan
1989-86 Trucks 3.0L, LH; 3 Studs, 3 Nuts, 1 Manifold.



674-441

Chrysler
2000-1998 Stratus, Breeze, Cirrus 2.0L; 4 Nuts, 1 Manifold.



674-442

Chrysler
1991-87 Trucks V6 3.9L, LH; 2 Bolts, 2 Nuts, 1 Manifold.



674-444

Ford
1997-96 Aerostar 3.0L, LH; 2 Studs, 2 Nuts, 1 Manifold.



674-446

GM
2002-96 Trucks, 5.0L 5.7L, RH; 3 Studs, 3 Nuts, 1 Manifold.

Exhaust Manifold Kits



674-447

Ford
2005-01 Ranger 3.0L, LH; 2 Studs, 2 Nuts, 1 Manifold.

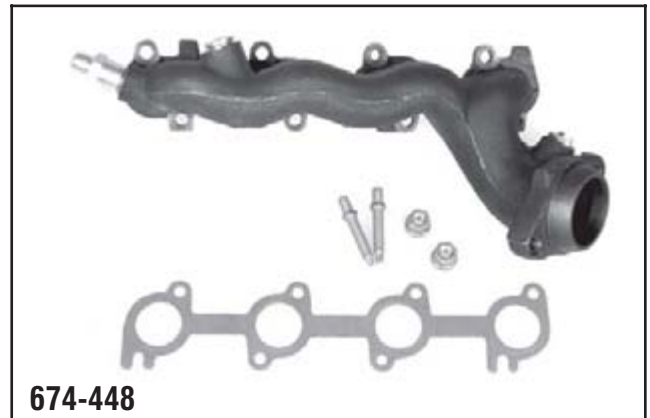

674-448

Ford
1998-96 Mustang, 4.6L, LH; 2 Studs, 2 Nuts, 1 Manifold.



674-449

Ford
2005-00 Taurus, Sable, 24 Valve 3.0L, LH; 2 Nuts, 1 Manifold.



674-450

Ford
2002-98 Continental, LH; 2 Studs, 2 Nuts, 1 Manifold.



674-451

Ford
2000-98 Windstar, 3.0L, Front; 2 Bolts, 2 Nuts, 1 Manifold.



674-452

Lincoln
2002-00 Lincoln LS, 3.0L, LH; 2 Studs, 2 Nuts, 1 Manifold.

Exhaust Manifold Kits

Exhaust Manifold Kits



674-453

Ford
2004-99 Mustang 4.6L, LH; 2 Studs, 2 Nuts, 1 Manifold, 1 Flange.



674-454

Ford
1998-96 Mustang 4.6L, LH; 2 Studs, 2 Nuts, 1 Manifold.



674-455

Lincoln
2002-98 Continental 4.6L, RH; 2 Studs, 2 Nuts, 2 Manifolds.



674-456

Ford
1996 Taurus, Sable 24 Valve, 3.0L, Front; 2 Studs, 2 Nuts, 1 Manifold.



674-457

Ford
2003-96 Mustang 4.6L DOHC, RH; 2 Studs, 2 Nuts, 1 Manifold.



674-458

Ford
2004-96 Mustang 4.6L SOHC, RH; 2 Studs, 2 Nuts, 1 Manifold.

Exhaust Manifold Kits



674-459

Ford Truck
2005-99 E-Series Vans, 4.6L, RH; 2 Studs, 2 Nuts, 1 Manifold.



674-460

Ford
2002-99 Trucks, LH; 2 Studs, 2 Nuts, 1 Manifold.



674-461

Ford
2002-99 Expedition and Blackwood 5.4L, LH; 2 Studs, 2 Nuts, 1 Manifold.



674-462

Ford
1998-97 E-Series Vans 5.4L, LH; 2 Studs, 2 Nuts, 1 Manifold.



674-464

Toyota
2001-96 Trucks 2.4L/2.7L; 3 Studs, 3 Nuts, 1 Manifold, 1 Flange.



674-465

Ford
1999-97 Explorer 4.0L SOHC, LH; 2 Bolts, 1 Manifold.

Exhaust Manifold Kits

Exhaust Manifold Kits



674-466

Ford
1997-94 Cougar, Thunderbird 4.6L, LH; 2 Studs, 2 Nuts, 1 Manifold.



674-467

Chrysler
2004-00 Jeep 4.0L Front Section; 2 Bolts, 2 Nuts, 1 Manifold.



674-468

Jeep
2004-00 Jeep 4.0L Rear Section; 2 Bolts, 2 Nuts.



674-469

Toyota
1996-92 Camry, 2.2L; 3 Studs, 3 Nuts, 1 Manifold, 1 Flange.



674-500

Chevrolet
1971-70 Corvette 5.4L (327 CID), 5.7L (350 CID) 1967-64 Corvette 5.4L (327 CID); LH, w/Square Bracket, 6 Studs, 3 Nuts, 3 Washers, 1 Flange.



674-501

Chevrolet
1980-69 Corvette 5.7L (350 CID), 1968-66 Corvette 5.4L (327 CID), 1957 Corvette 4.6L (283 CID), 1990-83 Medium Duty, School Bus 5.7L; LH & RH, 6 Studs, 3 Nuts, 3 Washers, 1 Flange.

Exhaust Manifold Kits



674-502

Chevrolet

1963-62 Corvette 5.4L (327 CID), 1961-57 Corvette 4.6L (283 CID); LH, 6 Studs, 3 Nuts, 3 Washers, 1 Flange.



674-503

GM

1965-62 5.4L (327 CID) Corvette Ram's Horn, RH, 2-1/2" Dia., 2-1/2" Dia.; 3 Studs, 3 Nuts, 3 Washers, 3 Lock Washers, 1 Flange.

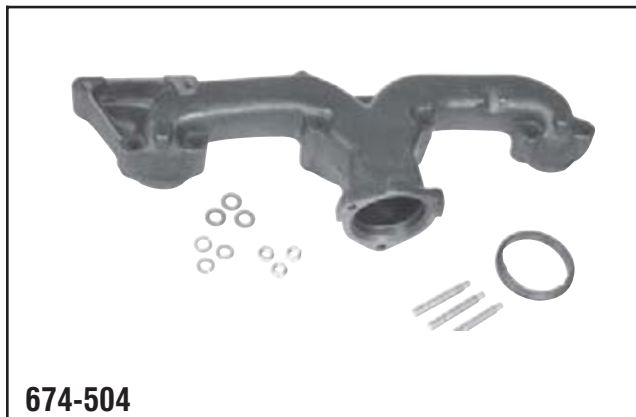

674-504

GM

1963-62 5.4L (327 CID) Corvette Ram's Horn, LH, 2-1/2" Dia., 2-1/2" Dia.; 3 Studs, 3 Nuts, 3 Washers, 3 Lock Washers, 1 Flange.

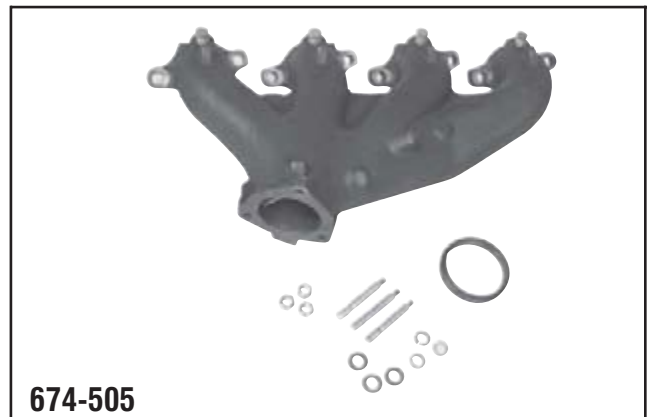

674-505

GM

1974-66 Corvette Big Block 7.0L (427 CID) 7.4L (454 CID) with 2-1/2" Dia Pipe, RH; 3 Studs, 3 Nuts, 3 Washers, 3 Lock Washers, 1 Flange.

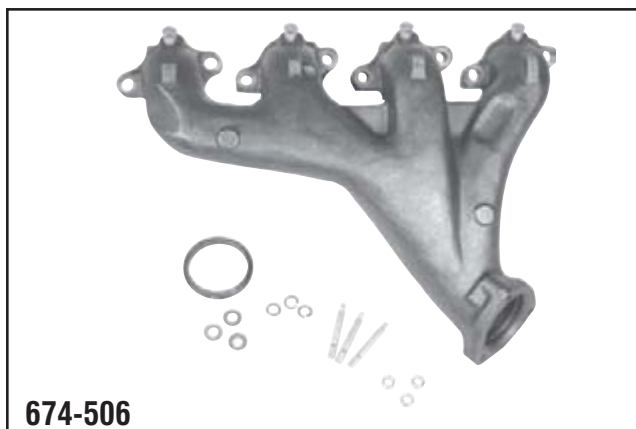

674-506

GM

1974-70 7.4L (454 CID) 2-1/2" Dia Corvette, LH; 3 Studs, 3 Nuts, 3 Washers, 3 Lock Washers, 1 Flange.



674-507

Hyundai

1997-96 Elantra, Tiburon 1.8L, 1998 Elantra 2.0L; 3 Studs, 3 Nuts, 3 Washers, 1 Manifold.

Exhaust Manifold Kits

Exhaust Manifold Kits



674-508

Nissan
2001-98 Altima 2.4L; 3 Nuts, 1 Manifold.



674-509

Honda
1999-94 Accord/CL/Odyssey 2.2L, 2.3L; 3 Studs, 3 Nuts, 1 Flange.

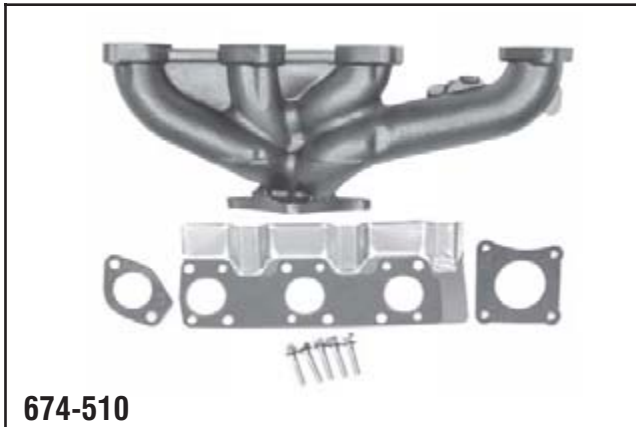

674-510

Chrysler
2000-96 Dodge Caravan 3.0L, RH; 4 Bolts, 4 Washers, 1 Manifold, 1 Flange.



674-511

Chrysler
1995-89 Chrysler Various Models 3.0L, RH; 2 Bolts, 2 Nuts, 1 Manifold, 1 Flange.



674-512

Honda
1998-92 Civic and Civic Del Sol Si, 1.6L; 3 Studs, 3 Nuts, 1 Manifold.



674-513

Chrysler
2000-90 Various Models 3.3L/3.8L, LH; 2 Bolts, 2 Springs, 4 Nuts, 2 Lever Nuts, 1 Manifold, 1 Flange.

Exhaust Manifold Kits



674-514

Chrysler
2000-96 Dodge Caravan 3.3L/3.8L, RH; 4 Bolts, 4 Washers, 1 Manifold, 1 Flange.

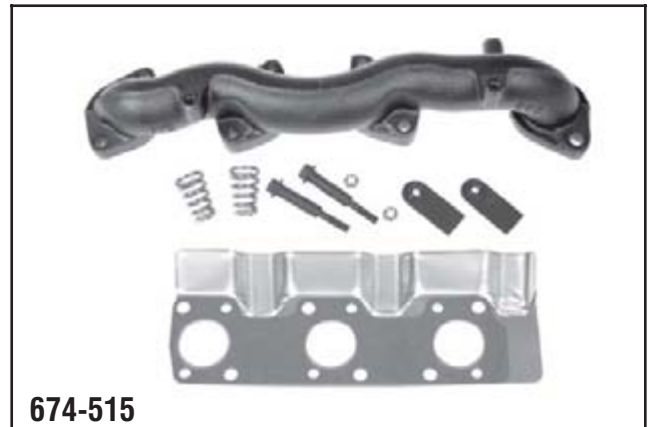

674-515

Chrysler
2000-87 Various Models 3.0L, LH; 2 Bolts, 2 Springs, 2 Nuts, 2 Lever Nuts, 1 Manifold, 1 Flange.



674-516

GM
1995-90 Chevrolet/GMC Truck 4.3L, RH; 3 Studs, 3 Springs, 3 Nuts, 1 Manifold, 1 Flange.



674-517

GM
1996-91 Chevrolet/GMC Truck 5.7L, RH; 3 Studs, 3 Springs, 3 Nuts, 1 Manifold, 1 Flange.



674-518

GM
1992-87 Camaro and Firebird 5.0L, LH; 4 Studs, 4 Nuts, 1 Manifold.

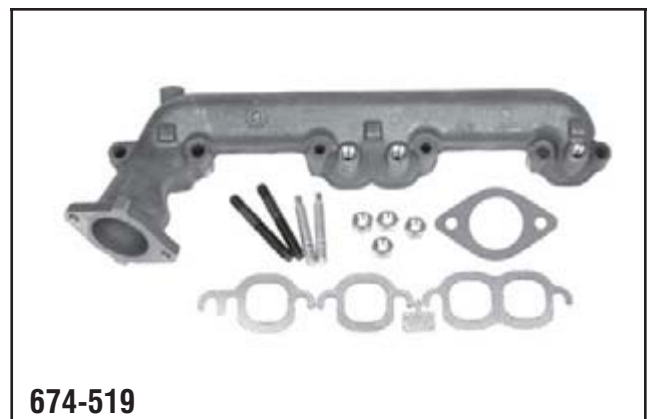

674-519

GM
1992-87 Camaro and Firebird 5.0L, RH; 4 Studs, 4 Nuts, 1 Manifold.

Exhaust Manifold Kits

Exhaust Manifold Kits



674-520

Chrysler
1996-93 Mitsubishi/Dodge Mirage/Colt 1.5L; 3 Studs, 3 Nuts, 3 Washers, 1 Manifold, 1 Flange.



674-522

GM
2005-99 GM Trucks 5.3L w/o and w/AIR, 6.0L and H2, LH; 3 Studs, 3 Nuts, 3 Studs, 3 Nuts.

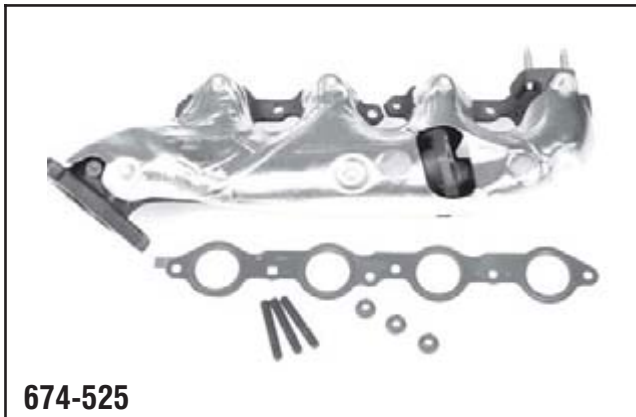

674-525

GM
2005-99 GM Trucks 4.8/5.3/6.0L w/o AIR Calif. RH; 3 Studs, 3 Nuts, 1 Manifold.



674-526

GM
1993-89 GM Mid-Size Century/Skylark/Achieva 3.3L, RH; 2 Bolts, 2 Springs, 1 Manifold, 1 Flange.

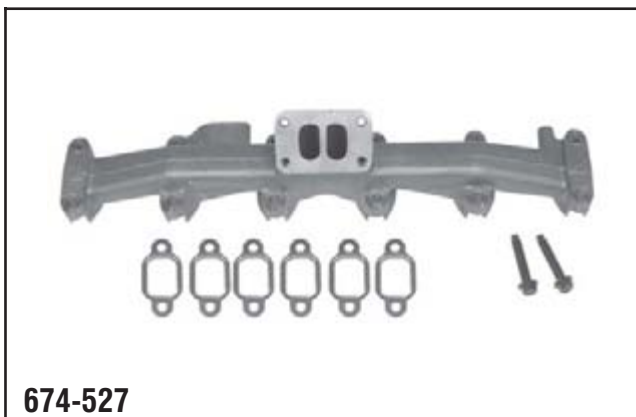

674-527

Chrysler
1997-96 Dodge Ram Pickups 2500/3500 5.9L Turbo Diesel; 2 Bolts, 1 Manifold, 1 Flange.



674-528

Chrysler
1995-90 Caravan, Imperial, New Yorker, 3.3L RH; 2 Bolts, 2 Springs, 2 Nuts, 2 Lever Nuts, 1 Manifold, 1 Flange.

Exhaust Manifold Kits



674-529

Honda
1996-90 Honda Accord, Prelude 2.2L; 3 Studs, 3 Nuts, 1 Manifold, 1 Flange.



674-530

GM
1988-85 Chevrolet/GMC Truck 5.7L, RH; 3 Studs, 3 Springs, 6 Nuts, 1 Manifold, 1 Flange.



674-531

GM
1988-85 Chevrolet/GMC Truck 5.7L, LH; 3 Studs, 3 Springs, 6 Nuts, 1 Manifold, 1 Flange.



674-532

GM
1995-89 Geo Tracker 1.6L; 3 Studs, 3 Nuts, 3 Washers, 1 Manifold, 1 Flange.



674-533

Chrysler
1994-89 Mitsubishi/Dodge Eclipse, Colt, Talon 1.8L; 3 Studs, 3 Nuts, 3 Washers, 1 Manifold, 1 Flange.



674-534

Chrysler
1999-95 Sebring/Avenger/Talon 2.0L; 2 Bolts, 2 Springs, 2 Nuts, 2 Lever Nuts, 1 Manifold.

Exhaust Manifold Kits

Exhaust Manifold Kits



674-535

Ford
2004-99 Mustang 3.8L, LH; 1 Manifold.



674-536

Ford
2000-99 Mustang 3.8L, RH; 1 Manifold.



674-537

GM
1994-87 G10/20/15/25 Vans 5.0/5.7L, LH; 3 Studs, 1 Manifold, 1 Flange.

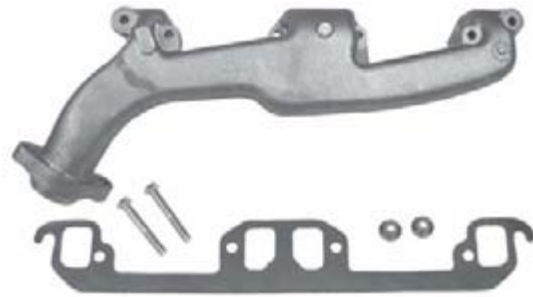

674-538

Chrysler
2004-96 Dodge Trucks 5.2/5.9L, RH; 2 Bolts, 2 Nuts, 1 Manifold.



674-540

GM
2005-95 GM Mid-Size Grand Prix/Impala/Regal 3.8L, LH; 2 Studs, 2 Nuts, 1 Manifold.



674-541

GM
2004-00 GM Mid-Size Grand Prix/Impala/Regal 3.8L, RH; 2 Studs, 2 Nuts, 1 Manifold, 1 Flange.

Exhaust Manifold Kits



674-544

GM
2004-93 GM Mid-Size 3.1L, 3.4L Front; 2 Bolts, 2 Springs, 2 Nuts, 1 Manifold, 1 Flange.

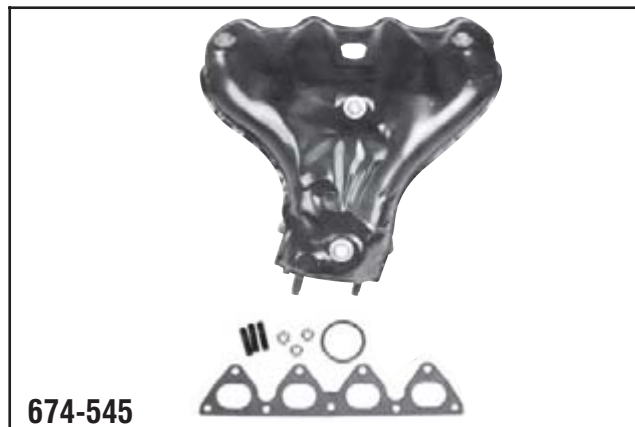

674-545

Honda
1995-88 Honda Civic 1.5/1.6L; 3 Studs, 3 Nuts, 1 Manifold, 1 Flange.



674-546

GM & Toyota
2002-98 GM & Toyota; Prizm, Corolla 1ZZFE Eng.; 2 Bolts, 2 Springs, 1 Manifold.



674-549

Nissan
1993-90 Pickups 2.4L KA24E Eng.; 3 Studs, 3 Nuts, 1 Manifold; 1 Flange.



674-550

GM
1989-86 Blazer S10, S15 Jimmy; 1992-85 Camaro, 1992-85 Firebird, 1994-91 Isuzu PU, 1992-91 Rodeo; All LH; w/o Heat Stove, 4 Bolts, 2 Springs, 4 Nuts, 1 Manifold, 1 Flange.



674-551*

Hyundai
2001-99 Elantra & Tiburon 2.0L (Not For Use in CA); 5 Bolts, 2 Nuts, 1 Head, 1 Flange.

*See page 133 for warranty information.

Exhaust Manifold Kits

Exhaust Manifold Kits



674-552

Hyundai
1990-95 Trucks and Pathfinder with VG30E Eng; 3 Studs, 3 Nuts, 1 Manifold, 1 Flange.



674-553

Chrysler
2000-99 Caravan/ Voyager 2.4L; 4 Studs, 4 Nuts, 1 Flange, 1 Manifold.



674-554

Ford
2005-99 F150, E150, E250; 4.2L; RH, 2 Studs, 2 Nuts, 1 Manifold.



674-555

Ford
2005-99 F150, E150, E250; 4.2L; LH, 2 Studs, 2 Nuts, 1 Manifold.



674-556

Toyota
1995-94 Celica 1.8L 7AFE Eng; 1996-94 Corolla 1.6/1.8L 4/7AFE Eng; w/O2 sensor in Manifold, 4 Studs, 4 Nuts, 1 Manifold, 1 Flange.



674-557

Ford
2002-95 Ford Crown Victoria; Lincoln Town Car; Mercury Grand Marquis; 4.6L, RH, 2 Studs, 2 Nuts, 1 Manifold.

Exhaust Manifold Kits

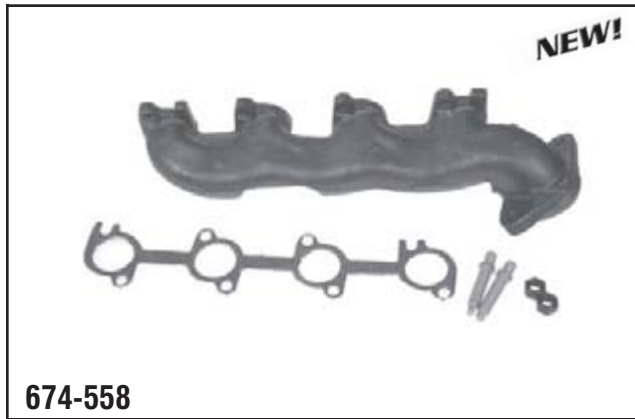

674-558

Ford
2002-95 Ford Crown Victoria, Grand Marquis, Lincoln Town Car; LH, 2 Studs, 2 Nuts, 1 Manifold.



674-559

Ford
2005-00 F150 Pickups, F250/350 Super Duty; 2002-00 E Series Super Duty; 05-00 E150/250/350/Ecursion; 02-99 Expedition; 1999 F250 PU; 5.4L (330 CID), RH, 2 Studs; 2 Nuts, 1 Manifold.



674-560

Ford
2005-00 F250/350 Super Duty; 2002-00 E Series Super Duty; 2005-00 E150/250/350 Excursion; 01-99 F150 PU; 99 F250 PU; 5.4L (330 CID) LH, 2 Studs; 2 Nuts, 1 Manifold.



674-566

Ford
2003-00 Ford Taurus and Mercury Sable, 12 Valve, 3.0L; 4 Nuts, 1 Manifold.



674-567

GM
2003-99 Alero, Grand Am, Montana 3.4L; 2003-97 Century, Malibu, Venture, Grand Prix 3.1L & 3.4L; 2003-96 Silhouette 3.1L; 2003-02 Rendezvous 3.4L; 2003-01 Aztek 3.4L; 2003-00 Impala, Monte Carlo 3.4L; 2001-97 Lumina 3.1L; 1999-97 Monte Carlo, Cutlass 3.1L; 1998-97 Achieva; 3 Studs, 3 Nuts, 1 Manifold, 1 Flange.



674-568

General Motors
2005-97 Buick LeSabre, Pontiac Bonneville; 2005-99 Buick Park Ave; 1999 Buick Rivier, Oldsmobile Delta 88; 1999-97 Oldsmobile LSS; 1998-95 Oldsmobile 88; 3.8L (231 CID); RH, 2 Studs, 2 Nuts, 1 Manifold, 2 Flange.

Exhaust Manifold Kits

Exhaust Manifold Kits



674-569

GM
 2001 Astro, Safari Vans; 2001-98 S10 Blazer, S10 Pickups, S15 Jimmy, Sonoma, Bravada; 4.3L; RH w/Air Pump, 3 Studs, 2 Mounting Studs, 3 Nuts, 2 Flange Nuts, 1 Manifold, 1 Flange.



674-570

GM
 2001-98 S10 Blazer, S10 Pickups, S15 Jimmy, Sonoma, Bravada; 4.3L; LH; w/Air Pump; 3 Studs, 3 Nuts, 2 Mounting Studs, 2 Flange Nuts, 1 Manifold, 1 Flange.



674-571

GM
 2002-98 Cavalier, Sunfire, 2.2L; VIN 4, 2 Bolts, 2 Washers, 1 Manifold, 1 Flange.

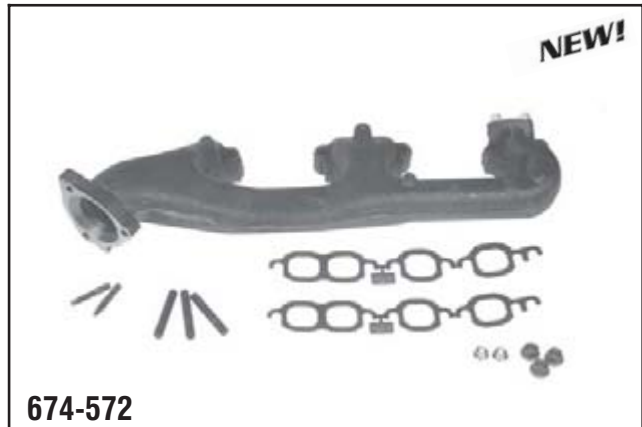

674-572

GM
 1999-98 C/K Pickups & Suburban, 5.7L, RH; 2000-98 C/K Pickups, Yukon, Tahoe, 5.7L, RH; 2000-99 Cadillac Escalade, 5.7L; RH, 3 Studs, 3 Nuts, 2 Mounting Studs, 2 Flange Nuts, 1 Manifold, 1 Flange.



674-573

GM
 2002-00 Express, Savana (Calif); 2000-99 Escalade; 2000-98 Pickup, Tahoe, Yukon, 1999-98 Suburban; 5.7L; LH; w/Air Pump, 3 Studs, 3 Nuts, 2 Mounting Studs, 2 Flange Nuts, 1 Manifold, 1 Flange.



674-575

GM
 1996-94 Century, Beretta, Corsica, Cutlass Ciera; 1997-94 Cavalier; 1997-95 Sunfire; 2.2L, 2 Bolts, 2 Washers, 1 Manifold, 1 Flange.

Exhaust Manifold Kits



674-577

GM
 1995-93 LeSabre, Minivans, Park Avenue, 88, 98, Bonneville, Riviera, 3.8L; 1995-92 Regal, 3.8L; 1996 LSS, 3.8L; 2 Studs, 1 Manifold, 1 Flange.



674-578

Infiniti/Nissan
 2001-96 Infiniti I30 V6-3.0L, LH; 2001-95 Nissan Maxima V6-3.0L; RH, 3 Studs, 3 Nuts, 1 Manifold.



674-579

Nissan/Infiniti
 1999 I30 3.0L (Exc Calif), RH; 1998-96 I30 3.0L, RH; 2001-99 Maxima 3.0L (Exc Calif), LH; 1998-95 Maxima 3.0L; LH, 3 Studs, 3 Nuts, 1 Manifold.



674-583

GM
 1989-86 S15 Jimmy, S10 Blazer, 1993-86 Sonoma, S10 Pickups; 2.8L; RH, 2 Studs, 2 Springs, 1 Manifold, 1 Flange.



674-584

Volvo
 1995-93 Volvo 850, 10 Valve, 2.4L; 4 Studs, 4 Nuts, 1 Manifold.



674-585

Volvo
 1997-94 Volvo 850, 2.4L; 1998 Volvo C70, 2.4L; 2000-98 Volvo S70, V70, 2.4L; 2004-01 Volvo V70, 2.4L; 4 Studs, 4 Nuts, 1 Manifold.

Exhaust Manifold Kits

Exhaust Manifold Kits



674-586

Ford
2002-99 F150, Expedition 4.6L and 1999 F250 4.6L, RH; 4 Studs, 4 Nuts; 1 Manifold.



674-587

Ford
2002-99 F150, Expedition & F250 4.6L, LH; 4 Studs, 4 Nuts, 1 Manifold.



674-588

Chrysler
2000 Dodge/ Plymouth Neon SOHC VIN C and 2001 Exc. R/T; 4 Studs, 4 Nuts, 2 Manifold, 1 Flange.



674-589

Nissan
2001-98 Frontier 2.4L; 3 Studs, 3 Nuts, 4 Manifold, 1 Flange.



674-592

Chrysler
1995-89 Various Models 3.0L, RH; 2 Studs, 2 Nuts, 2 Manifold, 1 Flange.



674-593*

Toyota
2003-01 RAV4 (Not for Use in CA) 2 Studs; 2 Nuts, 9 Bolts, 9 Washers, 1 Flange.

*See page 133 for warranty information.

Exhaust Manifold Kits



674-596*

Hyundai

2002-00 Accent 1.5L & 2001 1.6L SOHC, Not for use in CA;
4 Studs, 4 Nuts, 1 Manifold, 1 Flange.

Tech Tip

To ensure proper installation,
Use **Torque Spec Chart** on page 134.

Exhaust Manifold Kit Applications

Make/Model/Eng	Years	Description	LH/Front	RH/Rear
ACURA				
CL				
4 Cyl - 2.2L (2156cc)	1997	-	674-509	NR
4 Cyl - 2.3L (2254cc)	1999-98	-	674-509	NR
AMERICAN MOTORS				
AMBASSADOR				
6 Cyl - 3.3L (199 CID)	1967	From Eng No 905-L-09	674-235	NR
6 Cyl - 3.8L (232 CID)	1970-68	-	674-235	NR
6 Cyl - 3.8L (232 CID)	1967	wo/Air Pump, From Eng No 905-L-09	674-235	NR
6 Cyl - 4.2L (258 CID)	1971	-	674-235	NR
AMERICAN				
6 Cyl - 3.3L (199 CID)	1968	-	674-235	NR
6 Cyl - 3.3L (199 CID)	1967	From Eng No 905-L-09	674-235	NR
6 Cyl - 3.8L (232 CID)	1968	-	674-235	NR
6 Cyl - 3.8L (232 CID)	1967	wo/Air Pump, From Eng No 905-L-09	674-235	NR
AMX, CONCORD				
6 Cyl - 3.8L (232 CID)	1979-78	-	674-235	NR
6 Cyl - 4.2L (258 CID)	1983-80	-	674-237	NR
6 Cyl - 4.2L (258 CID)	1979-78	-	674-235	NR
EAGLE				
4 Cyl - 2.5L (150 CID)	1984-83	Cast Iron, AMC Eng	674-225	NR
6 Cyl - 4.2L (258 CID)	1988-80	-	674-237	NR
GREMLIN, HORNET				
6 Cyl - 3.3L (199 CID)	1970	-	674-235	NR
6 Cyl - 3.8L (232 CID)	1978-74	-	674-235	NR
6 Cyl - 3.8L (232 CID)	1973	wo/Air Pump	674-235	NR
6 Cyl - 3.8L (232 CID)	1972-70	-	674-235	NR
6 Cyl - 4.2L (258 CID)	1978-74	-	674-235	NR
6 Cyl - 4.2L (258 CID)	1973	wo/Air Pump	674-235	NR
6 Cyl - 4.2L (258 CID)	1972-71	-	674-235	NR
JAVELIN, MARLIN, MATADOR				
6 Cyl - 3.3L (199 CID)	1967	From Eng No 905-L-09	674-235	NR
6 Cyl - 3.8L (232 CID)	1974	-	674-235	NR
6 Cyl - 3.8L (232 CID)	1973	wo/Air Pump	674-235	NR
6 Cyl - 3.8L (232 CID)	1972-68	-	674-235	NR
6 Cyl - 3.8L (232 CID)	1967	wo/Air Pump, From Eng No 905-L-09	674-235	NR
6 Cyl - 4.2L (258 CID)	1978-77	1-Bbl	674-235	NR
6 Cyl - 4.2L (258 CID)	1976-74	-	674-235	NR
6 Cyl - 4.2L (258 CID)	1973	wo/Air Pump	674-235	NR
6 Cyl - 4.2L (258 CID)	1972-71	-	674-235	NR
PACER				
6 Cyl - 3.8L (232 CID)	1978-75	-	674-235	NR
6 Cyl - 4.2L (258 CID)	1980	-	674-237	NR
6 Cyl - 4.2L (258 CID)	1979-75	-	674-235	NR
RAMBLER, REBEL, ROGUE				
6 Cyl - 3.3L (199 CID)	1969	-	674-235	NR
6 Cyl - 3.3L (199 CID)	1967	From Eng No 905-L-09	674-235	NR
6 Cyl - 3.8L (232 CID)	1970-68	-	674-235	NR

*See page 133 for warranty information.

Make/Model/Eng	Years	Description	LH/Front	RH/Rear
AMERICAN MOTORS (continued)				
RAMBLER, REBEL, ROGUE (continued)				
6 Cyl - 3.8L (232 CID)	1967	wo/Air Pump, From Eng No 905-L-09	674-235	NR
SPIRIT				
6 Cyl - 3.8L (232 CID)	1979	-	674-235	NR
6 Cyl - 4.2L (258 CID)	1983-80	-	674-237	NR
6 Cyl - 4.2L (258 CID)	1979	-	674-235	NR
BUICK				
CENTURY				
4 Cyl - 2.2L (134 CID)	1996-94	-	674-575	NR
4 Cyl - 2.5L (151 CID)	1987-85	-	674-101	NR
6 Cyl - 3.1L (189 CID)	2004-97	-	674-544	674-567
6 Cyl - 3.1L (189 CID)	1996-94	-	674-544	674-269
6 Cyl - 3.3L (204 CID)	1993-89	-	—	674-526
8 Cyl - 5.0L (305 CID)	1980	-	674-276	—
8 Cyl - 5.0L (305 CID)	1977	VIN H	—	674-202
8 Cyl - 5.0L (305 CID)	1977	VIN U	674-197	674-202
8 Cyl - 5.7L (350 CID)	1979-78	-	674-197	—
8 Cyl - 5.7L (350 CID)	1977	VIN L	674-197	674-202
LESABRE				
6 Cyl - 3.8L (231 CID)	2005-97	-	674-540	674-568
6 Cyl - 3.8L (231 CID)	1996	-	674-540	—
6 Cyl - 3.8L (231 CID)	1995-93	-	674-577	—
8 Cyl - 5.0L (305 CID)	1978	-	674-197	674-202
PARK AVENUE				
6 Cyl - 3.8L (231 CID)	2005-97	-	674-540	674-568
6 Cyl - 3.8L (231 CID)	1996	-	674-540	—
6 Cyl - 3.8L (231 CID)	1995	VIN 1	674-577	—
6 Cyl - 3.8L (231 CID)	1995	VIN K	674-540	—
6 Cyl - 3.8L (231 CID)	1994-93	-	674-577	—
REGAL				
6 Cyl - 3.1L (189 CID)	1996-94	-	674-544	674-269
6 Cyl - 3.8L (231 CID)	2004	-	674-540	—
6 Cyl - 3.8L (231 CID)	2003	-	674-540	674-541
6 Cyl - 3.8L (231 CID)	2002-00	Calif	674-540	674-541
6 Cyl - 3.8L (231 CID)	2002-00	Exc. Calif	674-540	674-541
6 Cyl - 3.8L (231 CID)	1999-96	-	674-540	674-541
6 Cyl - 3.8L (231 CID)	1995-92	-	674-577	—
8 Cyl - 5.0L (305 CID)	1982-80	-	674-276	—
8 Cyl - 5.0L (305 CID)	1977	-	674-197	674-202
8 Cyl - 5.7L (350 CID)	1977	VIN L	674-197	674-202
RENDEZVOUS				
6 Cyl - 3.4L (207 CID)	2003-02	-	674-544	674-567
RIVIERA				
6 Cyl - 3.8L (231 CID)	1999	-	674-540	674-568
6 Cyl - 3.8L (231 CID)	1998-96	-	674-540	—
6 Cyl - 3.8L (231 CID)	1995	VIN 1	674-577	—
6 Cyl - 3.8L (231 CID)	1995	VIN K	674-540	—
6 Cyl - 3.8L (231 CID)	1993	-	674-577	—
ROADMASTER				
8 Cyl - 5.7L (350 CID)	1996-94	-	—	674-206

Exhaust Manifold Kits

Exhaust Manifold Kit Applications

Make/Model/Eng	Years	Description	LH/Front	RH/Rear
BUICK (continued)				
SKYHAWK				
4 Cyl - 2.0L (122 CID)	1987	w/Turbo, VIN M	674-102	NR
4 Cyl - 2.0L (122 CID)	1986-85	-	674-102T	NR
SKYLARK				
4 Cyl - 2.5L (151 CID)	1987-85	-	674-101	NR
6 Cyl - 3.1L (189 CID)	1998-94	-	674-544	—
6 Cyl - 3.3L (204 CID)	1993-89	-	—	674-526
8 Cyl - 5.0L (305 CID)	1979-77	-	674-197	674-202
8 Cyl - 5.7L (350 CID)	1979-77	VIN L	674-197	674-202
SOMERSET				
4 Cyl - 2.5L (151 CID)	1987-85	-	674-101	NR
CADILLAC				
CIMARRON				
4 Cyl - 2.0L (122 CID)	1986-85	-	674-102T	NR
ESCALADE				
8 Cyl - 5.3L (323 CID)	2006-03	-	674-522	—
8 Cyl - 5.3L (323 CID)	2002	-	674-522	674-525
8 Cyl - 5.7L (350 CID)	2000-99	w/Air Pump	674-573	674-572
8 Cyl - 5.7L (350 CID)	2000-99	wo/Air Pump	674-218	674-217
8 Cyl - 6.0L (364 CID)	2006-03	-	674-522	—
8 Cyl - 6.0L (364 CID)	2002	-	674-522	674-525
FLEETWOOD				
8 Cyl - 5.7L (350 CID)	1996-94	-	—	674-206
CHEVROLET				
BERETTA				
4 Cyl - 2.2L (134 CID)	1996-94	-	674-575	NR
6 Cyl - 3.1L (189 CID)	1996-94	-	674-544	—
CAMARO				
6 Cyl - 2.8L (173 CID)	1989-85	-	674-550	—
6 Cyl - 3.1L (189 CID)	1992-90	-	674-550	—
8 Cyl - 4.4L (267 CID)	1981	Calif	—	674-202
8 Cyl - 4.4L (267 CID)	1981	Exc. Calif	674-197	674-202
8 Cyl - 4.4L (267 CID)	1980	-	674-197	674-202
8 Cyl - 5.0L (305 CID)	1992-90	VIN F	674-518	—
8 Cyl - 5.0L (305 CID)	1989-87	VIN F	674-518	674-519
8 Cyl - 5.0L (305 CID)	1981-80	Calif	674-276	674-202
8 Cyl - 5.0L (305 CID)	1981-80	Exc. Calif	674-197	674-202
8 Cyl - 5.0L (305 CID)	1979-76	-	674-197	674-202
8 Cyl - 5.7L (350 CID)	1992-87	-	674-518	674-519
8 Cyl - 5.7L (350 CID)	1981-80	Calif	674-276	674-202
8 Cyl - 5.7L (350 CID)	1981-80	Exc. Calif	674-197	674-202
8 Cyl - 5.7L (350 CID)	1979-76	-	674-197	674-202
8 Cyl - 6.5L (396 CID)	1969-67	-	—	674-244
8 Cyl - 7.0L (427 CID)	1969	-	—	674-244
CAPRICE, BELAIR, BISCAYNE, BROOKWOOD				
6 Cyl - 4.3L (262 CID)	1993-92	-	674-385	—
8 Cyl - 4.3L (265 CID)	1996-94	-	—	674-206
8 Cyl - 5.0L (305 CID)	1986-80	-	674-276	—
8 Cyl - 5.0L (305 CID)	1979-77	-	674-197	674-202
8 Cyl - 5.7L (350 CID)	1996-94	-	—	674-206
8 Cyl - 5.7L (350 CID)	1986-85	Gas Eng	—	674-245
8 Cyl - 5.7L (350 CID)	1982	Gas Eng	—	674-245
8 Cyl - 5.7L (350 CID)	1980	Gas Eng	674-276	—
8 Cyl - 5.7L (350 CID)	1979-76	-	674-197	674-202
8 Cyl - 6.5L (396 CID)	1969-68	-	—	674-244
8 Cyl - 6.6L (400 CID)	1976	-	674-197	674-202
8 Cyl - 6.6L (402 CID)	1972-71	-	—	674-244
8 Cyl - 7.0L (427 CID)	1969-68	-	—	674-244
8 Cyl - 7.4L (454 CID)	1976-73	w/Air Pump, Exc. Police	—	674-244
8 Cyl - 7.4L (454 CID)	1976-73	w/Air Pump, Police	674-159	674-244
8 Cyl - 7.4L (454 CID)	1972-70	-	—	674-244
CAVALIER				
4 Cyl - 2.0L (122 CID)	1986-85	-	674-102T	NR
4 Cyl - 2.2L (134 CID)	2002-98	VIN 4	674-571	NR
4 Cyl - 2.2L (134 CID)	1997-94	-	674-575	NR
CELEBRITY				
4 Cyl - 2.5L (151 CID)	1987-85	-	674-101	NR
CHEVELLE				
8 Cyl - 6.5L (396 CID)	1969-66	-	—	674-244
8 Cyl - 6.6L (402 CID)	1972-70	-	—	674-244
8 Cyl - 7.4L (454 CID)	1973-70	-	—	674-244
CHEVY II				
8 Cyl - 6.5L (396 CID)	1969-68	-	—	674-244
CITATION				
4 Cyl - 2.5L (151 CID)	1985	-	674-101	NR
CORSICA				
4 Cyl - 2.2L (134 CID)	1996-94	-	674-575	NR
6 Cyl - 3.1L (189 CID)	1996-94	-	674-544	—
CORVETTE				
8 Cyl - 4.6L (283 CID)	1961-58	-	674-502	—

Make/Model/Eng	Years	Description	LH/Front	RH/Rear
CHEVROLET (continued)				
CORVETTE (continued)				
8 Cyl - 4.6L (283 CID)	1957	Carb	674-502	—
8 Cyl - 4.6L (283 CID)	1957	Fuel Inj, Exc. Hi Lift Cam	674-501	674-501
8 Cyl - 5.4L (327 CID)	1968	wo/Square Bracket	674-501	674-501
8 Cyl - 5.4L (327 CID)	1967-66	w/Square Bracket	674-500	—
8 Cyl - 5.4L (327 CID)	1967-66	wo/Square Bracket	674-501	674-501
8 Cyl - 5.4L (327 CID)	1965-64	Fuel Inj, w/Left Side Square Bracket	674-500	674-503
8 Cyl - 5.4L (327 CID)	1965-64	Fuel Inj, wo/Left Side Square Bracket	—	674-500
8 Cyl - 5.4L (327 CID)	1963-62	Carb	674-502	—
8 Cyl - 5.4L (327 CID)	1963-62	Fuel Inj	674-504	674-503
8 Cyl - 5.7L (350 CID)	1980-72	-	674-501	674-501
8 Cyl - 5.7L (350 CID)	1971-70	w/Square Bracket	674-500	—
8 Cyl - 5.7L (350 CID)	1971-70	wo/Bracket	—	674-501
8 Cyl - 5.7L (350 CID)	1969	wo/Bracket	—	674-501
8 Cyl - 7.0L (427 CID)	1969-66	-	—	674-505
8 Cyl - 7.4L (454 CID)	1974-70	-	674-506	674-505
EL CAMINO				
8 Cyl - 5.0L (305 CID)	1986-80	-	674-276	—
8 Cyl - 5.0L (305 CID)	1977-76	-	674-197	674-202
8 Cyl - 5.7L (350 CID)	1978	-	674-197	—
8 Cyl - 5.7L (350 CID)	1977-76	-	674-197	674-202
8 Cyl - 6.5L (396 CID)	1969-67	-	—	674-244
8 Cyl - 6.6L (400 CID)	1976	-	674-197	674-202
8 Cyl - 6.6L (402 CID)	1972-71	-	—	674-244
8 Cyl - 7.4L (454 CID)	1975-70	-	—	674-244
IMPALA				
6 Cyl - 3.4L (207 CID)	2003-00	-	674-544	674-567
6 Cyl - 3.8L (231 CID)	2004	-	674-540	—
6 Cyl - 3.8L (231 CID)	2003	-	674-540	674-541
6 Cyl - 3.8L (231 CID)	2002-00	Calif	674-540	674-541
6 Cyl - 3.8L (231 CID)	2002-00	Exc. Calif	674-540	674-541
IMPALA, IMPALA SS, KINGSWOOD, TOWNSMAN				
8 Cyl - 5.0L (305 CID)	1985-80	-	674-276	—
8 Cyl - 5.0L (305 CID)	1979-77	-	674-197	674-202
8 Cyl - 5.7L (350 CID)	1996-94	-	—	674-206
8 Cyl - 5.7L (350 CID)	1985-83	Gas Eng	—	674-245
8 Cyl - 5.7L (350 CID)	1982-80	Gas Eng	674-276	—
8 Cyl - 5.7L (350 CID)	1979-76	-	674-197	674-202
8 Cyl - 6.5L (396 CID)	1969-68	-	—	674-244
8 Cyl - 6.6L (400 CID)	1976	-	674-197	674-202
8 Cyl - 6.6L (402 CID)	1972-71	-	—	674-244
8 Cyl - 7.0L (427 CID)	1969-68	-	—	674-244
8 Cyl - 7.4L (454 CID)	1976-73	w/Air Pump, Exc. Police	—	674-244
8 Cyl - 7.4L (454 CID)	1976-73	w/Air Pump, Police	674-159	674-244
8 Cyl - 7.4L (454 CID)	1972-70	-	—	674-244
LUMINA				
6 Cyl - 3.1L (189 CID)	2001-97	-	674-544	674-567
6 Cyl - 3.1L (189 CID)	1996-95	-	674-544	674-269
6 Cyl - 3.8L (231 CID)	1999-98	-	674-540	674-541
LUMINA APV				
6 Cyl - 3.4L (207 CID)	1996	-	674-544	674-567
6 Cyl - 3.8L (231 CID)	1995-93	-	674-577	—
MALIBU				
6 Cyl - 3.1L (189 CID)	2003-00	-	674-544	674-567
6 Cyl - 3.1L (189 CID)	1999	VIN M	674-544	674-567
6 Cyl - 3.1L (189 CID)	1998-97	-	674-544	674-567
MALIBU, LAGUNA				
8 Cyl - 5.0L (305 CID)	1983-80	-	674-276	—
8 Cyl - 5.0L (305 CID)	1977-76	-	674-197	674-202
8 Cyl - 5.7L (350 CID)	1981-80	-	674-276	—
8 Cyl - 5.7L (350 CID)	1978	-	674-197	—
8 Cyl - 5.7L (350 CID)	1977-76	-	674-197	674-202
8 Cyl - 6.6L (400 CID)	1976	-	674-197	674-202
8 Cyl - 7.4L (454 CID)	1975-73	-	—	674-244
METRO				
3 Cyl - 1.0L (61 CID)	2000-99	Exc. Calif	674-200	NR
MONTE CARLO				
6 Cyl - 3.1L (189 CID)	1999-97	-	674-544	674-567
6 Cyl - 3.1L (189 CID)	1996-95	-	674-544	674-269
6 Cyl - 3.4L (207 CID)	2003-00	-	674-544	674-567
6 Cyl - 3.8L (231 CID)	2004	-	674-540	—
6 Cyl - 3.8L (231 CID)	2003	-	674-540	674-541
6 Cyl - 3.8L (231 CID)	2002-00	Calif	674-540	674-541
6 Cyl - 3.8L (231 CID)	2002-00	Exc. Calif	674-540	674-541
6 Cyl - 3.8L (231 CID)	1999-98	-	674-540	674-541
8 Cyl - 5.0L (305 CID)	1986-80	-	674-276	—
8 Cyl - 5.0L (305 CID)	1977-76	-	674-197	674-202
8 Cyl - 5.7L (350 CID)	1981	-	674-276	—

Exhaust Manifold Kits

Exhaust Manifold Kit Applications

Make/Model/Eng	Years	Description	LH/Front	RH/Rear
CHEVROLET (continued)				
MONTE CARLO (continued)				
8 Cyl - 5.7L (350 CID)	1977-76	-	674-197	674-202
8 Cyl - 6.6L (400 CID)	1976	-	674-197	674-202
8 Cyl - 6.6L (402 CID)	1972-70	-	—	674-244
8 Cyl - 7.4L (454 CID)	1975-70	-	—	674-244
MONZA				
8 Cyl - 5.0L (305 CID)	1977-76	-	674-197	—
NOVA				
4 Cyl - 1.6L (98 CID)	1988	Exc. Calif, VIN 5	674-164	NR
8 Cyl - 5.0L (305 CID)	1979-76	-	674-197	674-202
8 Cyl - 5.7L (350 CID)	1979-76	-	674-197	674-202
SPECTRUM				
4 Cyl - 1.5L (92 CID)	1988-87	wo/Turbo, 5-Bolt Flange, VIN 7	674-175	NR
VENTURE VAN				
6 Cyl - 3.4L (207 CID)	2003-97	-	674-544	674-567
CHEVROLET/GMC TRUCK				
ASTRO				
6 Cyl - 4.3L (262 CID)	2005-02	-	—	674-211
6 Cyl - 4.3L (262 CID)	2001	w/Air Pump	674-216	674-569
6 Cyl - 4.3L (262 CID)	2001	wo/Air Pump	674-216	674-211
6 Cyl - 4.3L (262 CID)	2000-96	-	674-216	674-211
6 Cyl - 4.3L (262 CID)	1995-90	2WD	674-385	—
6 Cyl - 4.3L (262 CID)	1989	-	674-385	—
AVALANCHE				
8 Cyl - 5.3L (323 CID)	2006-03	-	674-522	—
8 Cyl - 5.3L (323 CID)	2002	-	674-522	674-525
BLAZER				
8 Cyl - 5.0L (305 CID)	1987	w/Air Pump	674-231	674-158
8 Cyl - 5.0L (305 CID)	1987	wo/Air Pump	—	674-158
8 Cyl - 5.0L (305 CID)	1986-85	-	—	674-245
8 Cyl - 5.0L (305 CID)	1984-83	-	674-278	—
8 Cyl - 5.0L (305 CID)	1980-77	-	674-197	674-202
8 Cyl - 5.0L (307 CID)	1973	Exc. Calif	674-203	674-202
8 Cyl - 5.7L (350 CID)	1994-88	-	674-157	674-156
8 Cyl - 5.7L (350 CID)	1987	-	674-231	674-158
8 Cyl - 5.7L (350 CID)	1986-85	-	—	674-245
8 Cyl - 5.7L (350 CID)	1984-83	-	674-278	—
8 Cyl - 5.7L (350 CID)	1980-76	-	674-197	674-202
8 Cyl - 5.7L (350 CID)	1975	-	674-203	674-202
8 Cyl - 5.7L (350 CID)	1974	4-Bbl, w/AT, Exc. Calif	674-203	674-202
8 Cyl - 5.7L (350 CID)	1974	Exc. 4-Bbl, AT, Exc. Calif	—	674-202
8 Cyl - 5.7L (350 CID)	1973	w/LPG	674-203	674-202
8 Cyl - 5.7L (350 CID)	1973	wo/LPG	—	674-202
8 Cyl - 5.7L (350 CID)	1972-69	-	674-201	674-199
8 Cyl - 6.6L (400 CID)	1979-76	-	674-197	674-202
8 Cyl - 6.6L (400 CID)	1975	-	674-203	674-202
8 Cyl - 7.4L (454 CID)	1978-73	-	—	674-244
C,K,R,V10/15/1500 PICKUP				
6 Cyl - 4.3L (262 CID)	1998-96	-	674-216	674-215
6 Cyl - 4.3L (262 CID)	1995-88	-	674-214	674-213
8 Cyl - 5.0L (305 CID)	1999-96	-	674-218	674-217
8 Cyl - 5.0L (305 CID)	1995-88	-	674-157	674-156
8 Cyl - 5.0L (305 CID)	1987	w/Air Pump	674-231	674-158
8 Cyl - 5.0L (305 CID)	1987	wo/Air Pump	—	674-158
8 Cyl - 5.0L (305 CID)	1986-85	-	—	674-245
8 Cyl - 5.0L (305 CID)	1984-83	-	674-278	—
8 Cyl - 5.0L (305 CID)	1980-76	-	674-197	674-202
8 Cyl - 5.0L (307 CID)	1973	Calif	—	674-202
8 Cyl - 5.0L (307 CID)	1973	Exc. Calif	674-203	674-202
8 Cyl - 5.7L (350 CID)	2000-98	w/Air Pump	674-573	674-572
8 Cyl - 5.7L (350 CID)	2000-98	wo/Air Pump	674-218	674-217
8 Cyl - 5.7L (350 CID)	1997-96	-	674-218	674-217
8 Cyl - 5.7L (350 CID)	1995-88	-	674-157	674-156
8 Cyl - 5.7L (350 CID)	1987	-	674-231	674-158
8 Cyl - 5.7L (350 CID)	1986-85	VIN L	—	674-245
8 Cyl - 5.7L (350 CID)	1986-85	VIN M, Cast Iron	674-278	674-245
8 Cyl - 5.7L (350 CID)	1984-83	VIN L	674-278	—
8 Cyl - 5.7L (350 CID)	1984-83	VIN M	674-278	674-245
8 Cyl - 5.7L (350 CID)	1981	VIN M	674-197	674-202
8 Cyl - 5.7L (350 CID)	1980-76	Gas Eng	674-197	674-202
8 Cyl - 5.7L (350 CID)	1975	-	674-203	674-202
8 Cyl - 5.7L (350 CID)	1974	4-Bbl, w/AT, Exc. Calif	674-203	674-202
8 Cyl - 5.7L (350 CID)	1974	Exc. 4-Bbl, AT, Exc. Calif	—	674-202
8 Cyl - 5.7L (350 CID)	1973	w/LPG	674-203	674-202
8 Cyl - 5.7L (350 CID)	1973	wo/LPG	—	674-202
8 Cyl - 5.7L (350 CID)	1972-69	-	674-201	674-199
8 Cyl - 6.6L (400 CID)	1980-76	-	674-197	674-202
8 Cyl - 6.6L (400 CID)	1975	-	674-203	674-202
8 Cyl - 7.4L (454 CID)	1993-90	C,K Series	674-267	674-268

Make/Model/Eng	Years	Description	LH/Front	RH/Rear
CHEVROLET/GMC TRUCK (continued)				
C,K,R,V10/15/1500 PICKUP (continued)				
8 Cyl - 7.4L (454 CID)	1980-73	-	674-159	674-244
C,K,R,V20/25/2500 PICKUP				
6 Cyl - 4.3L (262 CID)	1995-88	-	674-214	674-213
8 Cyl - 5.0L (305 CID)	1999-96	-	674-218	674-217
8 Cyl - 5.0L (305 CID)	1995-88	-	674-157	674-156
8 Cyl - 5.0L (305 CID)	1987	w/Air Pump	674-231	674-158
8 Cyl - 5.0L (305 CID)	1987	wo/Air Pump	—	674-158
8 Cyl - 5.0L (305 CID)	1986-85	-	—	674-245
8 Cyl - 5.0L (305 CID)	1984-83	-	674-278	—
8 Cyl - 5.0L (305 CID)	1980-77	-	674-197	674-202
8 Cyl - 5.0L (307 CID)	1973	Calif	—	674-202
8 Cyl - 5.0L (307 CID)	1973	Exc. Calif	674-203	674-202
8 Cyl - 5.7L (350 CID)	2000-98	w/Air Pump	674-573	674-572
8 Cyl - 5.7L (350 CID)	2000-98	wo/Air Pump	674-218	674-217
8 Cyl - 5.7L (350 CID)	1997-96	-	674-218	674-217
8 Cyl - 5.7L (350 CID)	1995-90	-	674-157	674-156
8 Cyl - 5.7L (350 CID)	1989-88	C,K Series	674-157	674-156
8 Cyl - 5.7L (350 CID)	1989-88	R,V Series	674-231	674-158
8 Cyl - 5.7L (350 CID)	1987	-	674-231	674-158
8 Cyl - 5.7L (350 CID)	1986-85	VIN L	—	674-245
8 Cyl - 5.7L (350 CID)	1986-85	VIN M, Cast Iron	674-278	674-245
8 Cyl - 5.7L (350 CID)	1986-85	VIN M, Stainless Steel	674-531	674-530
8 Cyl - 5.7L (350 CID)	1984-83	VIN L	674-278	—
8 Cyl - 5.7L (350 CID)	1984-83	VIN M	674-278	674-245
8 Cyl - 5.7L (350 CID)	1982-81	VIN M	674-197	674-202
8 Cyl - 5.7L (350 CID)	1980-76	Gas Eng	674-197	674-202
8 Cyl - 5.7L (350 CID)	1975	-	674-203	674-202
8 Cyl - 5.7L (350 CID)	1974	4-Bbl, w/AT, Exc. Calif	674-203	674-202
8 Cyl - 5.7L (350 CID)	1974	Exc. 4-Bbl, AT, Exc. Calif	—	674-202
8 Cyl - 5.7L (350 CID)	1973	w/LPG	674-203	674-202
8 Cyl - 5.7L (350 CID)	1973	wo/LPG	—	674-202
8 Cyl - 5.7L (350 CID)	1972-69	-	674-201	674-199
8 Cyl - 6.6L (400 CID)	1980-76	-	674-197	674-202
8 Cyl - 6.6L (400 CID)	1975	-	674-203	674-202
8 Cyl - 7.4L (454 CID)	2000-96	w/Air Pump	674-391	674-390
8 Cyl - 7.4L (454 CID)	2000-96	wo/Air Pump	674-391	—
8 Cyl - 7.4L (454 CID)	1995-91	C,K Series	674-267	674-268
8 Cyl - 7.4L (454 CID)	1989-87	Cast Iron, R,V Series, VIN N	674-159	674-161
8 Cyl - 7.4L (454 CID)	1989-87	Exc. Cast Iron, R,V Series, VIN N	674-159	—
8 Cyl - 7.4L (454 CID)	1986-85	Calif	674-159	—
8 Cyl - 7.4L (454 CID)	1986-85	Cast Iron	—	674-161
8 Cyl - 7.4L (454 CID)	1984-81	-	674-159	674-244
8 Cyl - 7.4L (454 CID)	1980-73	-	674-159	674-244
C,K,R,V30/35/3500 PICKUP				
8 Cyl - 5.0L (305 CID)	1986	-	—	674-245
8 Cyl - 5.0L (305 CID)	1980-77	-	674-197	674-202
8 Cyl - 5.0L (307 CID)	1973	Calif	—	674-202
8 Cyl - 5.0L (307 CID)	1973	Exc. Calif	674-203	674-202
8 Cyl - 5.7L (350 CID)	2000-98	w/Air Pump	674-573	674-572
8 Cyl - 5.7L (350 CID)	2000-98	wo/Air Pump	674-218	674-217
8 Cyl - 5.7L (350 CID)	1997-96	-	674-218	674-217
8 Cyl - 5.7L (350 CID)	1995-92	-	674-157	674-156
8 Cyl - 5.7L (350 CID)	1991-89	C,K Series	674-157	674-156
8 Cyl - 5.7L (350 CID)	1991-89	R,V Series	674-231	674-158
8 Cyl - 5.7L (350 CID)	1988	C,K Series	674-157	674-156
8 Cyl - 5.7L (350 CID)	1988	Carb VIN M	674-531	674-530
8 Cyl - 5.7L (350 CID)	1988	R,V Series	674-231	674-158
8 Cyl - 5.7L (350 CID)	1987	-	674-231	674-158
8 Cyl - 5.7L (350 CID)	1987	Carb VIN M	674-531	674-530
8 Cyl - 5.7L (350 CID)	1986-85	VIN L	—	674-245
8 Cyl - 5.7L (350 CID)	1986-85	VIN M, Cast Iron	674-278	674-245
8 Cyl - 5.7L (350 CID)	1986-85	VIN M, Stainless Steel	674-531	674-530
8 Cyl - 5.7L (350 CID)	1984-83	VIN L	674-278	—
8 Cyl - 5.7L (350 CID)	1984-83	VIN M	674-278	674-245
8 Cyl - 5.7L (350 CID)	1982-81	VIN M	674-197	674-202
8 Cyl - 5.7L (350 CID)	1980-76	Gas Eng	674-197	674-202
8 Cyl - 5.7L (350 CID)	1975	-	674-203	674-202
8 Cyl - 5.7L (350 CID)	1974	4-Bbl, w/AT, Exc. Calif	674-203	674-202
8 Cyl - 5.7L (350 CID)	1974	Exc. 4-Bbl, AT, Exc. Calif	—	674-202
8 Cyl - 5.7L (350 CID)	1973	Calif	—	674-202
8 Cyl - 5.7L (350 CID)	1973	Exc. Calif	674-203	674-202
8 Cyl - 5.7L (350 CID)	1972-69	-	674-201	674-199
8 Cyl - 6.6L (400 CID)	1980-76	-	674-197	674-202
8 Cyl - 6.6L (400 CID)	1975	-	—	674-202
8 Cyl - 7.4L (454 CID)	2000-96	w/Air Pump	674-391	674-390
8 Cyl - 7.4L (454 CID)	2000-96	wo/Air Pump	674-391	—
8 Cyl - 7.4L (454 CID)	1995-88	C,K Series	674-267	674-268

Exhaust Manifold Kits

Clock Springs
pg. 21-24

Control Arms
pg. 25-54

CV Joint Boots & Accessories
pg. 55-66

Door Lock Actuators
pg. 67-72

Exhaust Manifold Kits
pg. 73-134

Gaskets and Hardware Included Where Required

Exhaust Manifold Kits
121

Exhaust Manifold Kit Applications

Exhaust Manifold Kits

Make/Model/Eng	Years	Description	LH/Front	RH/Rear
CHEVROLET/GMC TRUCK (continued)				
C,K,R,V30/35/3500 PICKUP (continued)				
8 Cyl - 7.4L (454 CID)	1991-87	Cast Iron, R,V Series, VIN N	674-159	674-161
8 Cyl - 7.4L (454 CID)	1991-87	Exc. Cast Iron, R,V Series, VIN N	674-159	—
8 Cyl - 7.4L (454 CID)	1986-85	Calif	674-159	—
8 Cyl - 7.4L (454 CID)	1986-85	Cast Iron	—	674-161
8 Cyl - 7.4L (454 CID)	1984-81	-	674-159	674-244
8 Cyl - 7.4L (454 CID)	1980-73	-	674-159	674-244
CABALLERO				
8 Cyl - 5.0L (305 CID)	1986-80	-	674-276	—
8 Cyl - 5.7L (350 CID)	1978	-	674-197	—
DENALI				
8 Cyl - 6.0L (364 CID)	2002-01	-	674-522	674-525
DENALI XL				
8 Cyl - 6.0L (364 CID)	2002-01	-	674-522	674-525
EXPRESS 1500/3500 VAN				
6 Cyl - 4.3L (262 CID)	2002-00	wo/Air Pump	674-216	—
6 Cyl - 4.3L (262 CID)	1999-96	-	674-216	—
8 Cyl - 4.8L (294 CID)	2006-03	-	674-522	—
8 Cyl - 5.0L (305 CID)	2002-96	-	674-218	674-446
8 Cyl - 5.3L (323 CID)	2006-03	-	674-522	—
8 Cyl - 5.7L (350 CID)	2002-00	Exc. Calif	674-218	674-446
8 Cyl - 5.7L (350 CID)	1999-96	-	674-218	674-446
8 Cyl - 6.0L (364 CID)	2006-03	Calif	674-522	674-525
8 Cyl - 6.0L (364 CID)	2006-03	Exc. Calif	674-522	—
8 Cyl - 7.4L (454 CID)	2000-96	w/Air Pump	674-391	674-390
8 Cyl - 7.4L (454 CID)	2000-96	wo/Air Pump	674-391	—
G10/15 VAN				
6 Cyl - 4.3L (262 CID)	1995	-	674-214	674-213
6 Cyl - 4.3L (262 CID)	1994-87	-	674-385	—
8 Cyl - 5.0L (305 CID)	1995	-	674-157	674-156
8 Cyl - 5.0L (305 CID)	1994-91	-	674-537	674-249
8 Cyl - 5.0L (305 CID)	1990	-	674-537	—
8 Cyl - 5.0L (305 CID)	1989	Auto Trans	674-537	—
8 Cyl - 5.0L (305 CID)	1987	-	—	674-198
8 Cyl - 5.0L (305 CID)	1986-83	-	674-197	674-198
8 Cyl - 5.0L (305 CID)	1982-77	-	674-197	—
8 Cyl - 5.0L (307 CID)	1973	Exc. Calif	674-203	—
8 Cyl - 5.7L (350 CID)	1994	-	674-537	—
8 Cyl - 5.7L (350 CID)	1993-91	-	674-537	674-249
8 Cyl - 5.7L (350 CID)	1990-87	-	674-537	—
8 Cyl - 5.7L (350 CID)	1986-83	-	674-197	674-198
8 Cyl - 5.7L (350 CID)	1982-76	-	674-197	—
8 Cyl - 5.7L (350 CID)	1975	-	674-203	—
8 Cyl - 5.7L (350 CID)	1974	4-Bbl, w/AT, Exc. Calif	674-203	—
8 Cyl - 5.7L (350 CID)	1973	-	674-203	—
8 Cyl - 5.7L (350 CID)	1972-70	-	674-201	674-199
G20/25 VAN				
6 Cyl - 4.3L (262 CID)	1995	-	674-214	674-213
6 Cyl - 4.3L (262 CID)	1994-87	-	674-385	—
8 Cyl - 5.0L (305 CID)	1998-96	-	—	674-446
8 Cyl - 5.0L (305 CID)	1995	-	674-157	674-156
8 Cyl - 5.0L (305 CID)	1994-91	-	674-537	674-249
8 Cyl - 5.0L (305 CID)	1990	-	674-537	—
8 Cyl - 5.0L (305 CID)	1989	Auto Trans	674-537	—
8 Cyl - 5.0L (305 CID)	1987	-	—	674-198
8 Cyl - 5.0L (305 CID)	1986-83	-	674-197	674-198
8 Cyl - 5.0L (305 CID)	1982-77	-	674-197	—
8 Cyl - 5.0L (307 CID)	1973	Exc. Calif	674-203	—
8 Cyl - 5.7L (350 CID)	1995	-	674-157	674-156
8 Cyl - 5.7L (350 CID)	1994-91	-	674-537	674-249
8 Cyl - 5.7L (350 CID)	1990-87	-	674-537	—
8 Cyl - 5.7L (350 CID)	1986-85	VIN L	674-197	674-198
8 Cyl - 5.7L (350 CID)	1986-85	VIN M, Stainless Steel	674-531	674-530
8 Cyl - 5.7L (350 CID)	1984-83	-	674-197	674-198
8 Cyl - 5.7L (350 CID)	1982-76	-	674-197	—
8 Cyl - 5.7L (350 CID)	1975	-	674-203	—
8 Cyl - 5.7L (350 CID)	1974	4-Bbl, w/AT, Exc. Calif	674-203	—
8 Cyl - 5.7L (350 CID)	1973	-	674-203	—
8 Cyl - 5.7L (350 CID)	1972-70	-	674-201	674-199
8 Cyl - 6.6L (400 CID)	1980-76	-	674-197	—
8 Cyl - 6.6L (400 CID)	1975	-	674-203	—
8 Cyl - 7.4L (454 CID)	1979-74	-	674-159	674-244
G30/35 VAN				
6 Cyl - 4.3L (262 CID)	1996-91	-	—	674-516
6 Cyl - 4.3L (262 CID)	1990-87	-	674-385	—
8 Cyl - 5.0L (305 CID)	1985	-	674-197	674-198
8 Cyl - 5.0L (305 CID)	1982-78	-	674-197	—
8 Cyl - 5.7L (350 CID)	1996	VIN K	674-250	674-517

Make/Model/Eng	Years	Description	LH/Front	RH/Rear
CHEVROLET/GMC TRUCK (continued)				
G30/35 VAN (continued)				
8 Cyl - 5.7L (350 CID)	1996	VIN R	674-218	674-446
8 Cyl - 5.7L (350 CID)	1995-91	-	674-250	674-517
8 Cyl - 5.7L (350 CID)	1988-87	Carb, VIN M, Stainless Steel	674-531	674-530
8 Cyl - 5.7L (350 CID)	1988-87	EFI, VIN K	674-537	674-249
8 Cyl - 5.7L (350 CID)	1988-87	VIN M, Cast Iron	—	674-198
8 Cyl - 5.7L (350 CID)	1986-85	VIN L	674-197	674-198
8 Cyl - 5.7L (350 CID)	1986-85	VIN M, Stainless Steel	674-531	674-530
8 Cyl - 5.7L (350 CID)	1984-83	-	674-197	674-198
8 Cyl - 5.7L (350 CID)	1982-76	-	674-197	—
8 Cyl - 5.7L (350 CID)	1975	-	674-203	—
8 Cyl - 5.7L (350 CID)	1974	4-Bbl, w/AT, Exc. Calif	674-203	—
8 Cyl - 5.7L (350 CID)	1973	-	674-203	—
8 Cyl - 5.7L (350 CID)	1972-71	-	674-201	674-199
8 Cyl - 6.6L (400 CID)	1980-76	-	674-197	—
8 Cyl - 6.6L (400 CID)	1976	Exc. Calif	674-203	—
8 Cyl - 6.6L (400 CID)	1975	-	674-203	—
8 Cyl - 7.4L (454 CID)	1996-92	-	—	674-161
8 Cyl - 7.4L (454 CID)	1991	-	—	674-244
8 Cyl - 7.4L (454 CID)	1990-89	-	674-159	674-244
8 Cyl - 7.4L (454 CID)	1988	-	674-159	674-161
8 Cyl - 7.4L (454 CID)	1979-74	-	674-159	674-244
JIMMY				
8 Cyl - 5.0L (305 CID)	1987	w/Air Pump	674-231	674-158
8 Cyl - 5.0L (305 CID)	1987	wo/Air Pump	—	674-158
8 Cyl - 5.0L (305 CID)	1986-85	-	—	674-245
8 Cyl - 5.0L (305 CID)	1984-83	-	674-278	—
8 Cyl - 5.0L (305 CID)	1980-77	-	674-197	674-202
8 Cyl - 5.7L (350 CID)	1991-88	-	674-157	674-156
8 Cyl - 5.7L (350 CID)	1987	-	674-231	674-158
8 Cyl - 5.7L (350 CID)	1986-85	-	—	674-245
8 Cyl - 5.7L (350 CID)	1984-83	-	674-278	—
8 Cyl - 5.7L (350 CID)	1980-76	-	674-197	674-202
8 Cyl - 5.7L (350 CID)	1975	-	674-203	674-202
8 Cyl - 5.7L (350 CID)	1974	4-Bbl, w/AT, Exc. Calif	674-203	—
8 Cyl - 5.7L (350 CID)	1973	w/LPG	674-203	—
8 Cyl - 5.7L (350 CID)	1972-69	-	674-201	674-199
8 Cyl - 6.6L (400 CID)	1979-76	-	674-197	674-202
8 Cyl - 6.6L (400 CID)	1975	-	674-203	674-202
8 Cyl - 7.4L (454 CID)	1978-73	-	—	674-244
KODIAK				
8 Cyl - 6.0L (366 CID)	1998-90	-	674-238	674-239
8 Cyl - 7.0L (427 CID)	1998-90	-	674-238	674-239
MEDIUM DUTY CONVENTIONAL CAB; C40/70 SERIES				
8 Cyl - 5.7L (350 CID)	1990-88	w/Emissions Override Option NC7	674-501	674-501
8 Cyl - 5.7L (350 CID)	1987-83	-	674-501	674-501
8 Cyl - 6.0L (366 CID)	1990-89	4-Bbl, 1/4"-18 A.I.R. Holes	674-162	674-163
8 Cyl - 6.0L (366 CID)	1990-89	w/TBI	674-238	674-239
8 Cyl - 6.0L (366 CID)	1988-83	4-Bbl, 1/4"-18 A.I.R. Holes	674-162	674-163
8 Cyl - 7.0L (427 CID)	1990-83	4-Bbl, 1/4"-18 A.I.R. Holes	674-162	674-163
MEDIUM DUTY FORWARD CONTROL; P40/60 SERIES				
8 Cyl - 5.7L (350 CID)	1990-83	w/Emissions Override Option NC7	674-501	674-501
8 Cyl - 6.0L (366 CID)	1996-92	-	674-238	674-239
8 Cyl - 6.0L (366 CID)	1990-83	1/4"-18 A.I.R. Holes	674-162	674-163
8 Cyl - 7.0L (427 CID)	1996-92	-	674-238	674-239
MEDIUM DUTY TILT CAB; F60/70 SERIES				
8 Cyl - 6.0L (366 CID)	1998-97	-	674-238	674-239
P10/15 FORWARD CONTROL, VAN				
8 Cyl - 5.0L (305 CID)	1979	-	674-197	—
8 Cyl - 5.7L (350 CID)	1975	-	674-203	—
8 Cyl - 5.7L (350 CID)	1973	Exc. Calif	674-203	—
8 Cyl - 6.6L (400 CID)	1980	-	674-197	674-202
8 Cyl - 6.6L (400 CID)	1977	-	674-197	—
8 Cyl - 7.4L (454 CID)	1973	-	—	674-244
P20/25 FORWARD CONTROL, VAN				
8 Cyl - 5.7L (350 CID)	1989	-	674-250	—
8 Cyl - 5.7L (350 CID)	1988	-	—	674-249
8 Cyl - 5.7L (350 CID)	1987	VIN K	—	674-249
8 Cyl - 5.7L (350 CID)	1987	VIN M, Calif NB2	674-197	674-202
8 Cyl - 5.7L (350 CID)	1987	VIN M, Stainless Steel, Exc. Calif NA5	674-531	674-530
8 Cyl - 5.7L (350 CID)	1986-85	VIN M, Calif NB2	674-197	674-202
8 Cyl - 5.7L (350 CID)	1986-85	VIN M, Stainless Steel, Exc. Calif NA5	674-531	674-530
8 Cyl - 5.7L (350 CID)	1984-83	-	674-197	674-202
8 Cyl - 5.7L (350 CID)	1982-79	-	674-197	674-202
8 Cyl - 5.7L (350 CID)	1978-76	-	674-197	674-202

Exhaust Manifold Kit Applications

Make/Model/Eng	Years	Description	LH/Front	RH/Rear
CHEVROLET/GMC TRUCK (continued)				
P20/25 FORWARD CONTROL, VAN (continued)				
8 Cyl - 5.7L (350 CID)	1975	-	674-203	674-202
8 Cyl - 5.7L (350 CID)	1974	4-Bbl, w/AT, Exc. Calif	674-203	674-202
8 Cyl - 5.7L (350 CID)	1974	Exc. 4-Bbl, AT, Exc. Calif	—	674-202
8 Cyl - 5.7L (350 CID)	1973	-	—	674-202
8 Cyl - 5.7L (350 CID)	1973	Exc. Calif	674-203	—
8 Cyl - 5.7L (350 CID)	1972-70	-	674-201	674-199
8 Cyl - 7.4L (454 CID)	1979-70	-	—	674-244
P30/35 FORWARD CONTROL, VAN				
6 Cyl - 4.3L (262 CID)	1995-90	-	—	674-516
8 Cyl - 5.7L (350 CID)	1999-96	-	—	674-446
8 Cyl - 5.7L (350 CID)	1995-91	-	674-250	674-517
8 Cyl - 5.7L (350 CID)	1990-89	-	674-250	—
8 Cyl - 5.7L (350 CID)	1988-87	VIN K	—	674-249
8 Cyl - 5.7L (350 CID)	1988-87	VIN M, Calif NB2	674-197	674-202
8 Cyl - 5.7L (350 CID)	1988-87	VIN M, Stainless Steel, Exc. Calif NA5	674-531	674-530
8 Cyl - 5.7L (350 CID)	1986-85	VIN M, Calif NB2	674-197	674-202
8 Cyl - 5.7L (350 CID)	1986-85	VIN M, Stainless Steel, Exc. Calif NA5	674-531	674-530
8 Cyl - 5.7L (350 CID)	1984-83	-	674-197	674-202
8 Cyl - 5.7L (350 CID)	1982-80	Exc. Motor Home	674-197	674-202
8 Cyl - 5.7L (350 CID)	1982-80	Motor Home	674-197	—
8 Cyl - 5.7L (350 CID)	1979	Exc. Motor Home	674-197	674-202
8 Cyl - 5.7L (350 CID)	1979	Motor Home, Exc. Calif	674-197	674-202
8 Cyl - 5.7L (350 CID)	1978-76	Exc. Motor Home, Calif	674-197	—
8 Cyl - 5.7L (350 CID)	1978-76	Motor Home, Calif	674-197	674-202
8 Cyl - 5.7L (350 CID)	1975	Exc. Motor Home	674-203	674-202
8 Cyl - 5.7L (350 CID)	1975	Motor Home, Calif	674-203	674-202
8 Cyl - 5.7L (350 CID)	1974	4-Bbl, w/AT, Exc. Calif	674-203	—
8 Cyl - 5.7L (350 CID)	1974	Exc. Motor Home	—	674-202
8 Cyl - 5.7L (350 CID)	1974	Motor Home, Calif	—	674-202
8 Cyl - 5.7L (350 CID)	1973	Exc. Calif	674-203	—
8 Cyl - 5.7L (350 CID)	1973	Exc. Motor Home	—	674-202
8 Cyl - 5.7L (350 CID)	1973	Motor Home, Calif	—	674-202
8 Cyl - 5.7L (350 CID)	1972-70	-	674-201	674-199
8 Cyl - 6.6L (400 CID)	1976	-	674-197	—
8 Cyl - 7.4L (454 CID)	1999-98	VIN J	674-391	—
8 Cyl - 7.4L (454 CID)	1997	VIN J	674-391	—
8 Cyl - 7.4L (454 CID)	1997	VIN N	674-159	674-161
8 Cyl - 7.4L (454 CID)	1996-91	VIN N	674-159	674-161
8 Cyl - 7.4L (454 CID)	1990	-	674-159	674-244
8 Cyl - 7.4L (454 CID)	1986-85	-	674-159	—
8 Cyl - 7.4L (454 CID)	1984-81	-	674-159	674-244
8 Cyl - 7.4L (454 CID)	1980	-	674-159	674-244
8 Cyl - 7.4L (454 CID)	1979-70	-	—	674-244
POSTAL VAN				
4 Cyl - 2.5L (151 CID)	1993-87	-	674-100	NR
S10/15 BLAZER, JIMMY				
4 Cyl - 2.5L (151 CID)	1988-85	-	674-100	NR
6 Cyl - 2.8L (173 CID)	1989-86	-	674-550	674-583
6 Cyl - 4.3L (262 CID)	2005-02	-	—	674-211
6 Cyl - 4.3L (262 CID)	2001-98	w/Air Pump	674-570	674-569
6 Cyl - 4.3L (262 CID)	2001-98	wo/Air Pump	674-212	674-211
6 Cyl - 4.3L (262 CID)	1997-96	-	674-212	674-211
6 Cyl - 4.3L (262 CID)	1995-88	-	674-208	674-210
S10/15 PICKUP, SONOMA				
4 Cyl - 2.2L (134 CID)	2000	VIN 4	674-400	NR
4 Cyl - 2.2L (134 CID)	1999-98	-	674-400	NR
4 Cyl - 2.5L (151 CID)	1993-85	-	674-100	NR
6 Cyl - 2.8L (173 CID)	1993-91	2WD	674-550	674-583
6 Cyl - 2.8L (173 CID)	1990-86	-	674-550	674-583
6 Cyl - 4.3L (262 CID)	2004-02	-	—	674-211
6 Cyl - 4.3L (262 CID)	2001-98	w/Air Pump	674-570	674-569
6 Cyl - 4.3L (262 CID)	2001-98	wo/Air Pump	674-212	674-211
6 Cyl - 4.3L (262 CID)	1997-96	-	674-212	674-211
6 Cyl - 4.3L (262 CID)	1995-88	-	674-208	674-210
SAFARI				
6 Cyl - 4.3L (262 CID)	2005-02	-	—	674-211
6 Cyl - 4.3L (262 CID)	2001	w/Air Pump	674-216	674-569
6 Cyl - 4.3L (262 CID)	2001	wo/Air Pump	674-216	674-211
6 Cyl - 4.3L (262 CID)	2000-96	-	674-216	674-211
6 Cyl - 4.3L (262 CID)	1995-90	2WD	674-385	—
6 Cyl - 4.3L (262 CID)	1989	-	674-385	—
SAVANA 1500/3500 VAN				
6 Cyl - 4.3L (262 CID)	2002-00	wo/Air Pump	674-216	—
6 Cyl - 4.3L (262 CID)	1999-96	-	674-216	—
8 Cyl - 4.8L (294 CID)	2006-03	-	674-522	—
8 Cyl - 5.0L (305 CID)	2002-96	-	674-218	674-446
8 Cyl - 5.3L (323 CID)	2006-03	-	674-522	—

Make/Model/Eng	Years	Description	LH/Front	RH/Rear
CHEVROLET/GMC TRUCK (continued)				
SAVANA 1500/3500 VAN (continued)				
8 Cyl - 5.7L (350 CID)	2002-00	Exc. Calif	674-218	674-446
8 Cyl - 5.7L (350 CID)	1999-96	-	674-218	674-446
8 Cyl - 6.0L (364 CID)	2006-03	Calif	674-522	674-525
8 Cyl - 6.0L (364 CID)	2006-03	Exc. Calif	674-522	—
8 Cyl - 7.4L (454 CID)	2000-96	w/Air Pump	674-391	674-390
8 Cyl - 7.4L (454 CID)	2000-96	wo/Air Pump	674-391	—
SCHOOL BUS				
8 Cyl - 5.7L (350 CID)	1990-88	w/Emissions Override Option NC7	674-501	674-501
8 Cyl - 5.7L (350 CID)	1987-83	-	674-501	674-501
8 Cyl - 6.0L (366 CID)	1998-93	-	674-238	674-239
8 Cyl - 6.0L (366 CID)	1990-83	1/4"-18 A.I.R. Holes	674-162	674-163
8 Cyl - 7.0L (427 CID)	1998-93	-	674-238	674-239
8 Cyl - 7.0L (427 CID)	1984-83	1/4"-18 A.I.R. Holes	674-162	674-163
SIERRA				
8 Cyl - 4.8L (294 CID)	2006-02	-	674-522	—
8 Cyl - 4.8L (294 CID)	2001-99	-	674-522	674-525
8 Cyl - 5.3L (323 CID)	2006-03	-	674-522	—
8 Cyl - 5.3L (323 CID)	2002	w/Air Pump	674-522	—
8 Cyl - 5.3L (323 CID)	2002	wo/Air Pump	674-522	674-525
8 Cyl - 5.3L (323 CID)	2001-99	-	674-522	674-525
8 Cyl - 6.0L (364 CID)	2006-03	-	674-522	—
8 Cyl - 6.0L (364 CID)	2002-99	-	674-522	674-525
SILVERADO				
8 Cyl - 4.8L (294 CID)	2006-02	-	674-522	—
8 Cyl - 4.8L (294 CID)	2001-99	-	674-522	674-525
8 Cyl - 5.3L (323 CID)	2006-03	-	674-522	—
8 Cyl - 5.3L (323 CID)	2002	w/Air Pump	674-522	—
8 Cyl - 5.3L (323 CID)	2002	wo/Air Pump	674-522	674-525
8 Cyl - 5.3L (323 CID)	2001-99	-	674-522	674-525
8 Cyl - 6.0L (364 CID)	2006-03	-	674-522	—
8 Cyl - 6.0L (364 CID)	2002-99	-	674-522	674-525
SPRINT				
8 Cyl - 5.0L (305 CID)	1977-76	-	674-197	674-202
8 Cyl - 5.7L (350 CID)	1977-76	-	674-197	674-202
8 Cyl - 6.6L (400 CID)	1976	-	674-197	674-202
8 Cyl - 7.4L (454 CID)	1975-71	-	—	674-244
SUBURBAN				
8 Cyl - 5.0L (305 CID)	1987	w/Air Pump	674-231	674-158
8 Cyl - 5.0L (305 CID)	1987	wo/Air Pump	—	674-158
8 Cyl - 5.0L (305 CID)	1986-85	-	—	674-245
8 Cyl - 5.0L (305 CID)	1984-83	-	674-278	—
8 Cyl - 5.0L (305 CID)	1980-76	-	674-197	674-202
8 Cyl - 5.0L (307 CID)	1973	Calif	—	674-202
8 Cyl - 5.0L (307 CID)	1973	Exc. Calif	674-203	674-202
8 Cyl - 5.3L (323 CID)	2006-03	-	674-522	—
8 Cyl - 5.3L (323 CID)	2002	w/Air Pump	674-522	—
8 Cyl - 5.3L (323 CID)	2002	wo/Air Pump	674-522	674-525
8 Cyl - 5.3L (323 CID)	2001-00	-	674-522	674-525
8 Cyl - 5.7L (350 CID)	1999-98	w/Air Pump	674-573	674-572
8 Cyl - 5.7L (350 CID)	1999-98	wo/Air Pump	674-218	674-217
8 Cyl - 5.7L (350 CID)	1997-96	-	674-218	674-217
8 Cyl - 5.7L (350 CID)	1995-92	-	674-157	674-156
8 Cyl - 5.7L (350 CID)	1991	-	—	674-158
8 Cyl - 5.7L (350 CID)	1990-89	4WD, 1/2-Ton, MT	674-231	674-158
8 Cyl - 5.7L (350 CID)	1990-89	Exc. 4WD, 1/2-Ton, MT	—	674-158
8 Cyl - 5.7L (350 CID)	1988-87	-	674-231	674-158
8 Cyl - 5.7L (350 CID)	1986-85	VIN L, Calif, 4 Holes	674-278	674-245
8 Cyl - 5.7L (350 CID)	1986-85	VIN L, Exc. Calif, 4 Holes	—	674-245
8 Cyl - 5.7L (350 CID)	1986-85	VIN M, Cast Iron	674-278	674-245
8 Cyl - 5.7L (350 CID)	1986-85	VIN M, Stainless Steel	674-531	674-530
8 Cyl - 5.7L (350 CID)	1984-83	VIN L	674-278	—
8 Cyl - 5.7L (350 CID)	1984-83	VIN M	674-278	674-245
8 Cyl - 5.7L (350 CID)	1982-81	VIN M	674-197	674-202
8 Cyl - 5.7L (350 CID)	1980-76	Gas Eng	674-197	674-202
8 Cyl - 5.7L (350 CID)	1975	-	674-203	674-202
8 Cyl - 5.7L (350 CID)	1974	4-Bbl, w/AT, Exc. Calif	674-203	674-202
8 Cyl - 5.7L (350 CID)	1974	Exc. 4-Bbl, AT, Exc. Calif	—	674-202
8 Cyl - 5.7L (350 CID)	1973	2WD	—	674-202
8 Cyl - 5.7L (350 CID)	1973	4WD, 1/2-Ton	—	674-202
8 Cyl - 5.7L (350 CID)	1973	4WD, 3/4-Ton, MT	—	674-202
8 Cyl - 5.7L (350 CID)	1973	w/LPG	674-203	—
8 Cyl - 5.7L (350 CID)	1972-69	-	674-201	674-199
8 Cyl - 6.0L (364 CID)	2006-03	-	674-522	—
8 Cyl - 6.0L (364 CID)	2002-00	-	674-522	674-525
8 Cyl - 6.6L (400 CID)	1980-76	-	674-197	674-202
8 Cyl - 6.6L (400 CID)	1975	-	674-203	674-202
8 Cyl - 7.4L (454 CID)	1999-96	w/Air Pump	674-391	674-390
8 Cyl - 7.4L (454 CID)	1999-96	wo/Air Pump	674-391	—

Exhaust Manifold Kits

Fuel Sending Units
pg. 155-176

Fuel Tanks
pg. 177-228

Harmonic Balancers
pg. 229-254

Heater Hose Assemblies
pg. 255-256

Hydraulic Clutch Lines
pg. 257-260

Gaskets and Hardware Included Where Required

Exhaust Manifold Kits

Exhaust Manifold Kit Applications

Make/Model/Eng	Years	Description	LH/Front	RH/Rear
CHEVROLET/GMC TRUCK (continued)				
SUBURBAN (continued)				
8 Cyl - 7.4L (454 CID)	1995-92	-	674-267	674-268
8 Cyl - 7.4L (454 CID)	1991-85	Calif	674-159	—
8 Cyl - 7.4L (454 CID)	1991-85	Cast Iron	—	674-161
8 Cyl - 7.4L (454 CID)	1984-81	-	674-159	674-244
8 Cyl - 7.4L (454 CID)	1980-73	-	674-159	674-244
TAHOE				
8 Cyl - 4.8L (294 CID)	2006-02	-	674-522	—
8 Cyl - 4.8L (294 CID)	2001-00	-	674-522	674-525
8 Cyl - 5.3L (323 CID)	2006-03	-	674-522	—
8 Cyl - 5.3L (323 CID)	2002-00	-	674-522	674-525
8 Cyl - 5.7L (350 CID)	2000-98	w/Air Pump	674-573	674-572
8 Cyl - 5.7L (350 CID)	2000-98	wo/Air Pump	674-218	674-217
8 Cyl - 5.7L (350 CID)	1997-96	-	674-218	674-217
8 Cyl - 5.7L (350 CID)	1995	-	674-157	674-156
8 Cyl - 6.0L (364 CID)	2000	-	674-522	674-525
TOPKICK				
8 Cyl - 6.0L (366 CID)	1998-90	-	674-238	674-239
8 Cyl - 7.0L (427 CID)	1998-90	-	674-238	674-239
YUKON				
8 Cyl - 4.8L (294 CID)	2006-02	-	674-522	—
8 Cyl - 4.8L (294 CID)	2001-00	-	674-522	674-525
8 Cyl - 5.3L (323 CID)	2006-03	-	674-522	—
8 Cyl - 5.3L (323 CID)	2002-00	-	674-522	674-525
8 Cyl - 5.7L (350 CID)	2000-98	w/Air Pump	674-573	674-572
8 Cyl - 5.7L (350 CID)	2000-98	wo/Air Pump	674-218	674-217
8 Cyl - 5.7L (350 CID)	1997-96	-	674-218	674-217
8 Cyl - 5.7L (350 CID)	1995-92	-	674-157	674-156
8 Cyl - 6.0L (364 CID)	2000	-	674-522	674-525
YUKON XL				
8 Cyl - 5.3L (323 CID)	2006-03	-	674-522	—
8 Cyl - 5.3L (323 CID)	2002	w/Air Pump	674-522	—
8 Cyl - 5.3L (323 CID)	2002	wo/Air Pump	674-522	674-525
8 Cyl - 5.3L (323 CID)	2001	-	674-522	674-525
8 Cyl - 6.0L (364 CID)	2006-03	-	674-522	—
8 Cyl - 6.0L (364 CID)	2002-01	-	674-522	674-525
CHRYSLER				
CIRRUS				
4 Cyl - 2.0L (122 CID)	2000	-	674-441	NR
4 Cyl - 2.4L (148 CID)	2000-95	Solid Flange	674-282	NR
4 Cyl - 2.4L (148 CID)	2000-95	Split Flange	674-463	NR
CORDOBA				
6 Cyl - 3.7L (225 CID)	1983	-	674-232	NR
6 Cyl - 3.7L (225 CID)	1980	-	674-232	NR
8 Cyl - 5.2L (318 CID)	1979-77	w/Air Pump	—	674-234
8 Cyl - 5.9L (360 CID)	1979	w/Air Pump, Exc. Hi-Perf	—	674-234
8 Cyl - 5.9L (360 CID)	1978-77	w/Air Pump	—	674-234
E CLASS				
4 Cyl - 2.6L (156 CID)	1984	Calif	674-264	NR
4 Cyl - 2.6L (156 CID)	1983	-	674-264	NR
EXECUTIVE SEDAN				
4 Cyl - 2.6L (156 CID)	1984	Calif	674-264	NR
4 Cyl - 2.6L (156 CID)	1983	-	674-264	NR
FIFTH AVENUE				
6 Cyl - 3.7L (225 CID)	1983	-	674-232	NR
IMPERIAL				
6 Cyl - 3.3L (201 CID)	1991-90	-	674-513	674-528
6 Cyl - 3.8L (230 CID)	1993-91	-	674-513	674-528
LEBARON				
4 Cyl - 2.6L (156 CID)	1984	Calif	674-264	NR
4 Cyl - 2.6L (156 CID)	1983-82	-	674-264	NR
6 Cyl - 3.0L (181 CID)	1995-93	Auto Trans	674-515	674-592
6 Cyl - 3.0L (181 CID)	1995-93	Manual Trans	674-515	674-511
6 Cyl - 3.0L (181 CID)	1992-90	Calif	674-515	674-592
6 Cyl - 3.0L (181 CID)	1992-90	Exc. Calif	674-515	674-511
6 Cyl - 3.7L (225 CID)	1983	-	674-232	NR
6 Cyl - 3.7L (225 CID)	1980-78	-	674-232	NR
8 Cyl - 5.2L (318 CID)	1979-77	w/Air Pump	—	674-234
8 Cyl - 5.9L (360 CID)	1979	w/Air Pump, Exc. Hi-Perf	—	674-234
8 Cyl - 5.9L (360 CID)	1978	w/Air Pump	—	674-234
NEW YORKER				
4 Cyl - 2.6L (156 CID)	1984	Calif	674-264	NR
4 Cyl - 2.6L (156 CID)	1983	-	674-264	NR
6 Cyl - 3.0L (181 CID)	1990-89	Calif	674-515	674-592
6 Cyl - 3.0L (181 CID)	1990-89	Exc. Calif	674-515	674-511
6 Cyl - 3.0L (181 CID)	1988	-	674-515	—
6 Cyl - 3.3L (201 CID)	1993-90	-	674-513	674-528
6 Cyl - 3.8L (230 CID)	1993-91	-	674-513	674-528
NEWPORT, NEW YORKER				
6 Cyl - 3.7L (225 CID)	1982	-	674-232	NR

Make/Model/Eng	Years	Description	LH/Front	RH/Rear
CHRYSLER (continued)				
NEWPORT, NEW YORKER (continued)				
6 Cyl - 3.7L (225 CID)	1980-79	-	674-232	NR
8 Cyl - 5.2L (318 CID)	1979	w/Air Pump	—	674-234
8 Cyl - 5.9L (360 CID)	1980	4-Bbl, Hi-Perf	—	674-234
8 Cyl - 5.9L (360 CID)	1979	w/Air Pump, Exc. Hi-Perf	—	674-234
8 Cyl - 5.9L (360 CID)	1978	w/Air Pump	—	674-234
SEBRING				
4 Cyl - 2.0L (122 CID)	1999-95	-	674-534	NR
4 Cyl - 2.4L (148 CID)	1998-96	Solid Flange	674-282	NR
4 Cyl - 2.4L (148 CID)	1998-96	Split Flange	674-463	NR
TC MASERATI				
6 Cyl - 3.0L (181 CID)	1991-90	Calif	674-515	—
6 Cyl - 3.0L (181 CID)	1991-90	Exc. Calif	674-515	674-511
TOWN & COUNTRY				
4 Cyl - 2.6L (156 CID)	1984	Calif	674-264	NR
4 Cyl - 2.6L (156 CID)	1983-82	-	674-264	NR
6 Cyl - 3.7L (225 CID)	1983	-	674-232	NR
6 Cyl - 3.7L (225 CID)	1980-78	-	674-232	NR
8 Cyl - 5.9L (360 CID)	1979	w/Air Pump, Exc. Hi-Perf	—	674-234
8 Cyl - 5.9L (360 CID)	1978	w/Air Pump	—	674-234
TOWN & COUNTRY VAN				
6 Cyl - 3.3L (201 CID)	2000-96	-	674-513	674-514
6 Cyl - 3.3L (201 CID)	1995-94	-	674-513	—
6 Cyl - 3.3L (201 CID)	1993-90	-	674-513	674-528
6 Cyl - 3.8L (230 CID)	2000-96	-	674-513	674-514
6 Cyl - 3.8L (230 CID)	1995-94	-	674-513	674-528
VOYAGER				
4 Cyl - 2.4L (148 CID)	2000	-	674-553	NR
6 Cyl - 3.0L (181 CID)	2000	-	674-515	674-510
6 Cyl - 3.3L (201 CID)	2000	-	674-513	674-514
DODGE				
400				
4 Cyl - 2.6L (156 CID)	1983-82	-	674-264	NR
600				
4 Cyl - 2.6L (156 CID)	1984	Calif	674-264	NR
4 Cyl - 2.6L (156 CID)	1983	-	674-264	NR
ARIES				
4 Cyl - 2.6L (156 CID)	1984	Calif	674-264	NR
4 Cyl - 2.6L (156 CID)	1983-81	-	674-264	NR
ASPEN				
6 Cyl - 3.7L (225 CID)	1980-76	-	674-232	NR
8 Cyl - 5.2L (318 CID)	1979-77	w/Air Pump	—	674-234
8 Cyl - 5.9L (360 CID)	1980	4-Bbl, Hi-Perf	—	674-234
8 Cyl - 5.9L (360 CID)	1979	w/Air Pump, Exc. Hi-Perf	—	674-234
8 Cyl - 5.9L (360 CID)	1978-77	w/Air Pump	—	674-234
AVENGER				
4 Cyl - 2.0L (122 CID)	1999-95	-	674-534	NR
CARAVAN, GRAND CARAVAN				
4 Cyl - 2.4L (148 CID)	2000-99	-	674-553	NR
6 Cyl - 3.0L (181 CID)	2000-96	-	674-515	674-510
6 Cyl - 3.0L (181 CID)	1995-93	Auto Trans	674-515	674-592
6 Cyl - 3.0L (181 CID)	1995-93	Manual Trans	674-515	674-511
6 Cyl - 3.0L (181 CID)	1992-89	Calif	674-515	674-592
6 Cyl - 3.0L (181 CID)	1992-89	Exc. Calif	674-515	674-511
6 Cyl - 3.0L (181 CID)	1988-87	-	674-515	—
6 Cyl - 3.3L (201 CID)	2000-96	-	674-513	674-514
6 Cyl - 3.3L (201 CID)	1995-90	-	674-513	674-528
6 Cyl - 3.8L (230 CID)	1999-96	-	674-513	674-514
CARAVAN, MINI RAM VAN, ROYAL VAN				
4 Cyl - 2.6L (156 CID)	1987-84	Calif	674-264	NR
CHALLENGER, CHARGER, CORONET				
6 Cyl - 3.2L (198 CID)	1971-70	-	674-232	NR
6 Cyl - 3.7L (225 CID)	1976-70	-	674-232	NR
8 Cyl - 5.2L (318 CID)	1978-77	w/Air Pump	—	674-234
8 Cyl - 5.9L (360 CID)	1978-77	w/Air Pump	—	674-234
COLT				
4 Cyl - 1.5L (1468cc)	1994-93	Calif	674-520	NR
4 Cyl - 1.5L (1468cc)	1992-91	-	674-263	NR
4 Cyl - 1.5L (1468cc)	1990	Wagon	674-263	NR
4 Cyl - 1.5L (1468cc)	1989-87	Sedan & Wagon	674-263	NR
4 Cyl - 1.6L (1595cc)	1990-89	-	674-263	NR
4 Cyl - 1.8L (1755cc)	1990-89	-	674-533	NR
DART, DEMON				
6 Cyl - 3.2L (198 CID)	1974-70	-	674-232	NR
6 Cyl - 3.7L (225 CID)	1976-70	-	674-232	NR
DAYTONA				
6 Cyl - 3.0L (181 CID)	1993	Auto Trans	674-515	674-592
6 Cyl - 3.0L (181 CID)	1993	Manual Trans	674-515	674-511
6 Cyl - 3.0L (181 CID)	1992-90	Calif	674-515	674-592
6 Cyl - 3.0L (181 CID)	1992-90	Exc. Calif	674-515	674-511

Exhaust Manifold Kit Applications

Make/Model/Eng	Years	Description	LH/Front	RH/Rear	Make/Model/Eng	Years	Description	LH/Front	RH/Rear
DODGE (continued)					DODGE TRUCK (continued)				
DIPLOMAT					B100/3500 VAN (continued)				
6 Cyl - 3.7L (225 CID)	1983-78	-	674-232	NR	8 Cyl - 5.2L (318 CID)	1983	4-Bbl, 1-Ton, Exc. Calif	674-233	674-234
8 Cyl - 5.2L (318 CID)	1979-77	w/Air Pump	—	674-234	8 Cyl - 5.2L (318 CID)	1983	4-Bbl, 3/4-Ton	674-233	674-234
8 Cyl - 5.9L (360 CID)	1979	w/Air Pump, Exc. Hi-Perf	—	674-234	8 Cyl - 5.2L (318 CID)	1982	4-Bbl	674-233	—
8 Cyl - 5.9L (360 CID)	1978	w/Air Pump	—	674-234	8 Cyl - 5.2L (318 CID)	1982	4-Bbl, 1-Ton, Exc. Calif	674-233	674-234
DYNASTY					B100/3500 VAN (continued)				
6 Cyl - 3.0L (181 CID)	1993	Auto Trans	674-515	674-592	8 Cyl - 5.2L (318 CID)	1982	4-Bbl, 1/2 & 3/4 Ton	674-233	674-234
6 Cyl - 3.0L (181 CID)	1993	Manual Trans	674-515	674-511	8 Cyl - 5.2L (318 CID)	1981	4-Bbl, Calif	674-233	—
6 Cyl - 3.0L (181 CID)	1992-89	Calif	674-515	674-592	8 Cyl - 5.2L (318 CID)	1981	4-Bbl, Calif, Light Duty	674-233	674-234
6 Cyl - 3.0L (181 CID)	1992-89	Exc. Calif	674-515	674-511	8 Cyl - 5.2L (318 CID)	1981	4-Bbl, Heavy Duty, 1-Ton	674-233	—
6 Cyl - 3.0L (181 CID)	1988	-	674-515	—	8 Cyl - 5.2L (318 CID)	1980	4-Bbl, 3/4 & 1 Ton, Exc. Heavy Duty	674-233	674-234
6 Cyl - 3.3L (201 CID)	1993-90	-	674-513	674-528	8 Cyl - 5.2L (318 CID)	1980	4-Bbl, Exc. 3/4 & 1 Ton, Exc. Heavy Duty	674-233	—
MAGNUM, MIRADA					B100/3500 VAN (continued)				
6 Cyl - 3.7L (225 CID)	1983-80	-	674-232	NR	8 Cyl - 5.2L (318 CID)	1979	4-Bbl, Calif, 1/2 Ton	674-233	674-234
8 Cyl - 5.2L (318 CID)	1979-78	w/Air Pump	—	674-234	8 Cyl - 5.2L (318 CID)	1979	4-Bbl, Exc. Calif, 1/2 Ton	674-233	—
8 Cyl - 5.9L (360 CID)	1980	4-Bbl, Hi-Perf	—	674-234	8 Cyl - 5.2L (318 CID)	1978	4-Bbl, Calif	674-233	674-234
8 Cyl - 5.9L (360 CID)	1979	w/Air Pump, Exc. Hi-Perf	—	674-234	8 Cyl - 5.2L (318 CID)	1978	Exc. 4-Bbl, Calif	674-233	—
8 Cyl - 5.9L (360 CID)	1978	w/Air Pump	—	674-234	8 Cyl - 5.9L (360 CID)	1998-97	-	674-271	—
MINI RAM VAN					B100/3500 VAN (continued)				
6 Cyl - 3.0L (181 CID)	1988-87	-	674-515	—	8 Cyl - 5.9L (360 CID)	1996	Exc. Heavy Duty	674-271	—
MINI RAM VAN, ROYAL MINI RAM VAN					B100/3500 VAN (continued)				
4 Cyl - 2.6L (156 CID)	1987-84	Calif	674-264	NR	8 Cyl - 5.9L (360 CID)	1996	Heavy Duty	674-271	674-270
MONACO, POLARA, ROYAL MONACO					B100/3500 VAN (continued)				
6 Cyl - 3.7L (225 CID)	1978-77	-	674-232	NR	8 Cyl - 5.9L (360 CID)	1995-94	-	674-271	674-270
6 Cyl - 3.7L (225 CID)	1971-70	-	674-232	NR	8 Cyl - 5.9L (360 CID)	1992-89	-	674-233	—
8 Cyl - 5.2L (318 CID)	1978-77	w/Air Pump	—	674-234	8 Cyl - 5.9L (360 CID)	1988	Dual Exhaust	674-233	—
8 Cyl - 5.9L (360 CID)	1978-77	w/Air Pump	—	674-234	8 Cyl - 5.9L (360 CID)	1988	Single Exhaust	674-233	674-234
NEON					B100/3500 VAN (continued)				
4 Cyl - 2.0L (122 CID)	2005-01	Exc. R/T Model	674-588	NR	8 Cyl - 5.9L (360 CID)	1988	Dual Exhaust	674-233	—
4 Cyl - 2.0L (122 CID)	2000	DOHC, VIN Y	674-281	NR	8 Cyl - 5.9L (360 CID)	1988	Single Exhaust	674-233	674-234
4 Cyl - 2.0L (122 CID)	2000	SOHC, VIN C	674-588	NR	8 Cyl - 5.9L (360 CID)	1987	Dual Exhaust	674-233	—
4 Cyl - 2.0L (122 CID)	1999-95	DOHC, VIN Y	674-281	NR	8 Cyl - 5.9L (360 CID)	1987	Single Exhaust, w/Catalyst	674-233	674-234
4 Cyl - 2.0L (122 CID)	1999-95	SOHC, VIN C	674-435	NR	8 Cyl - 5.9L (360 CID)	1987	Single Exhaust, wo/Catalyst	674-233	—
ROYAL MINI RAM					B100/3500 VAN (continued)				
6 Cyl - 3.0L (181 CID)	1987	-	674-515	—	8 Cyl - 5.9L (360 CID)	1986	w/Catalyst	674-233	674-234
SHADOW					B100/3500 VAN (continued)				
6 Cyl - 3.0L (181 CID)	1994-93	Auto Trans	674-515	674-592	8 Cyl - 5.9L (360 CID)	1986	w/Catalyst	674-233	—
6 Cyl - 3.0L (181 CID)	1994-93	Manual Trans	674-515	674-511	8 Cyl - 5.9L (360 CID)	1985-84	4-Bbl, w/Catalyst	674-233	674-234
6 Cyl - 3.0L (181 CID)	1992	Calif	674-515	674-592	8 Cyl - 5.9L (360 CID)	1985-84	4-Bbl, wo/Catalyst	674-233	—
6 Cyl - 3.0L (181 CID)	1992	Exc. Calif	674-515	674-511	8 Cyl - 5.9L (360 CID)	1983-82	4-Bbl	674-233	—
SPIRIT					B100/3500 VAN (continued)				
6 Cyl - 3.0L (181 CID)	1995-93	Auto Trans	674-515	674-592	8 Cyl - 5.9L (360 CID)	1981	4-Bbl, Heavy Duty	674-233	—
6 Cyl - 3.0L (181 CID)	1995-93	Manual Trans	674-515	674-511	8 Cyl - 5.9L (360 CID)	1981	4-Bbl, Light Duty, Calif	674-233	674-234
6 Cyl - 3.0L (181 CID)	1992-89	Calif	674-515	674-592	8 Cyl - 5.9L (360 CID)	1980	4-Bbl, Medium & Heavy Duty	674-233	—
6 Cyl - 3.0L (181 CID)	1992-89	Exc. Calif	674-515	674-511	8 Cyl - 5.9L (360 CID)	1979	2-Bbl, Light Duty	674-233	—
ST. REGIS					B100/3500 VAN (continued)				
6 Cyl - 3.7L (225 CID)	1980-79	-	674-232	NR	8 Cyl - 5.9L (360 CID)	1979	4-Bbl	674-233	—
8 Cyl - 5.2L (318 CID)	1979	w/Air Pump	—	674-234	8 Cyl - 5.9L (360 CID)	1978	Calif	674-233	—
8 Cyl - 5.9L (360 CID)	1980	4-Bbl, Hi-Perf	—	674-234	B1500 VAN				
8 Cyl - 5.9L (360 CID)	1979	w/Air Pump, Exc. Hi-Perf	—	674-234	8 Cyl - 5.2L (318 CID)	1998-96	-	—	674-538
STRATUS					B1500 VAN				
4 Cyl - 2.0L (122 CID)	2000-98	-	674-441	NR	8 Cyl - 5.2L (318 CID)	1998	-	—	674-538
4 Cyl - 2.0L (122 CID)	1997-95	-	674-435	NR	B2500 VAN				
4 Cyl - 2.4L (148 CID)	2000-95	Solid Flange	674-282	NR	8 Cyl - 5.2L (318 CID)	1998-96	-	—	674-538
4 Cyl - 2.4L (148 CID)	2000-95	Split Flange	674-463	NR	8 Cyl - 5.9L (360 CID)	1998-97	-	—	674-538
DODGE TRUCK					B2500 VAN				
A100 VAN					B2500 VAN				
6 Cyl - 3.2L (198 CID)	1970	-	674-232	NR	8 Cyl - 5.9L (360 CID)	1996	Light Duty	—	674-538
6 Cyl - 3.7L (225 CID)	1970	-	674-232	NR	B3500 VAN				
B100/3500 VAN					B3500 VAN				
6 Cyl - 3.2L (198 CID)	1971	-	674-232	NR	8 Cyl - 5.2L (318 CID)	1998-96	-	—	674-538
6 Cyl - 3.7L (225 CID)	1987-71	-	674-232	NR	8 Cyl - 5.9L (360 CID)	1998-97	-	—	674-538
6 Cyl - 3.9L (239 CID)	1995-94	-	—	674-438	8 Cyl - 5.9L (360 CID)	1996	Light Duty	—	674-538
6 Cyl - 3.9L (239 CID)	1991-88	-	674-442	674-342	CB300 CUTAWAY CAB				
8 Cyl - 5.2L (318 CID)	1995-94	-	674-271	674-270	6 Cyl - 3.7L (225 CID)	1979-74	-	674-232	NR
8 Cyl - 5.2L (318 CID)	1991-88	-	674-233	—	8 Cyl - 5.2L (318 CID)	1980	4-Bbl	674-233	—
8 Cyl - 5.2L (318 CID)	1987-86	Calif or Hi-Alt	674-233	—	8 Cyl - 5.9L (360 CID)	1980-79	4-Bbl	674-233	—
8 Cyl - 5.2L (318 CID)	1987-86	Exc. Calif or Hi-Alt, wo/Aspirator between Air Cleaner & Manifold	674-233	—	8 Cyl - 5.9L (360 CID)	1978	w/Air Pump	674-233	674-233
8 Cyl - 5.2L (318 CID)	1987-86	wo/Aspirator between Air Cleaner & Manifold, w/Air Pump	674-233	674-234	D,W100/450 PICKUP				
8 Cyl - 5.2L (318 CID)	1985-84	2-Bbl, w/Air Pump, w/Catalyst	674-233	674-234	6 Cyl - 3.2L (198 CID)	1971-70	-	674-232	NR
8 Cyl - 5.2L (318 CID)	1985-84	2-Bbl, w/Air Pump, wo/Catalyst	674-233	—	6 Cyl - 3.7L (225 CID)	1987-70	-	674-232	NR
8 Cyl - 5.2L (318 CID)	1985-84	4-Bbl	674-233	—	6 Cyl - 3.9L (239 CID)	1991-88	-	674-442	674-342
8 Cyl - 5.2L (318 CID)	1983	2-Bbl, Calif or Hi-Alt	674-233	—	8 Cyl - 5.2L (318 CID)	1991-88	-	674-233	—
8 Cyl - 5.2L (318 CID)	1983	4-Bbl, Exc. Heavy Duty	674-233	674-234	8 Cyl - 5.2L (318 CID)	1987-86	Calif or Hi-Alt	674-233	—
8 Cyl - 5.2L (318 CID)	1982	4-Bbl, Heavy Duty	674-233	—	8 Cyl - 5.2L (318 CID)	1987-86	Exc. Calif or Hi-Alt, wo/Aspirator between Air Cleaner & Manifold	674-233	—
8 Cyl - 5.2L (318 CID)	1982	4-Bbl, Exc. Heavy Duty	674-233	674-234	8 Cyl - 5.2L (318 CID)	1987-86	wo/Aspirator between Air Cleaner & Manifold, w/Air Pump	674-233	674-234
8 Cyl - 5.2L (318 CID)	1982	4-Bbl, Heavy Duty	674-233	—	8 Cyl - 5.2L (318 CID)	1985-84	2-Bbl, w/Air Pump, w/Catalyst	674-233	674-234
8 Cyl - 5.2L (318 CID)	1981	4-Bbl, 1/2 & 3/4 Ton, Light Duty, Calif	674-233	—	8 Cyl - 5.2L (318 CID)	1985-84	2-Bbl, w/Air Pump, wo/Catalyst	674-233	—

Exhaust Manifold Kits

Exhaust Manifold Kit Applications

Make/Model/Eng	Years	Description	LH/Front	RH/Rear
DODGE TRUCK (continued)				
D,W100/450 PICKUP (continued)				
8 Cyl - 5.2L (318 CID)	1981	4-Bbl, 3/4 & 1 Ton, Heavy Duty	674-233	—
8 Cyl - 5.2L (318 CID)	1981	4-Bbl, Exc. Heavy Duty, Calif	674-233	674-234
8 Cyl - 5.2L (318 CID)	1980	4-Bbl	674-233	—
8 Cyl - 5.2L (318 CID)	1980	4-Bbl, 2WD, 1/2 & 3/4 Ton, Medium Duty	674-233	674-234
8 Cyl - 5.2L (318 CID)	1980	4-Bbl, 4WD, 1/2-Ton	674-233	674-234
8 Cyl - 5.2L (318 CID)	1979	4-Bbl, Calif	674-233	674-234
8 Cyl - 5.2L (318 CID)	1979	4-Bbl, Exc. Calif	674-233	—
8 Cyl - 5.2L (318 CID)	1978	Calif	674-233	—
8 Cyl - 5.9L (360 CID)	1992-89	-	674-233	—
8 Cyl - 5.9L (360 CID)	1988	Dual Exhaust	674-233	—
8 Cyl - 5.9L (360 CID)	1988	Single Exhaust	674-233	674-234
8 Cyl - 5.9L (360 CID)	1987-86	Dual Exhaust	674-233	—
8 Cyl - 5.9L (360 CID)	1987-86	Single Exhaust, w/Catalyst	674-233	674-234
8 Cyl - 5.9L (360 CID)	1987-86	Single Exhaust, w/Catalyst	674-233	—
8 Cyl - 5.9L (360 CID)	1985-84	4-Bbl, w/Catalyst	674-233	674-234
8 Cyl - 5.9L (360 CID)	1985-84	4-Bbl, wo/Catalyst	674-233	—
8 Cyl - 5.9L (360 CID)	1983-82	4-Bbl	674-233	—
8 Cyl - 5.9L (360 CID)	1981	4-Bbl, Exc. Heavy Duty, Calif	674-233	674-234
8 Cyl - 5.9L (360 CID)	1981	4-Bbl, Heavy Duty	674-233	—
8 Cyl - 5.9L (360 CID)	1980	4-Bbl, Exc. Light Duty	674-233	—
8 Cyl - 5.9L (360 CID)	1979	2-Bbl, 1/2 & 3/4 Ton, Light Duty	674-233	—
8 Cyl - 5.9L (360 CID)	1979	4-Bbl	674-233	—
8 Cyl - 5.9L (360 CID)	1978	Calif	674-233	—
8 Cyl - 6.6L (400 CID)	1978-72	Rear Dump	—	674-275
8 Cyl - 6.6L (400 CID)	1978-72	wo/Heat Tube	674-176	—
8 Cyl - 7.2L (440 CID)	1978-72	Rear Dump	—	674-275
8 Cyl - 7.2L (440 CID)	1978-72	wo/Heat Tube	674-176	—
DAKOTA				
4 Cyl - 2.5L (150 CID)	2002-96	Cast Iron	674-225	NR
6 Cyl - 3.9L (239 CID)	2003-02	-	—	674-438
6 Cyl - 3.9L (239 CID)	1995-94	-	—	674-438
6 Cyl - 3.9L (239 CID)	1991-87	-	674-442	674-342
8 Cyl - 5.2L (318 CID)	1999-96	-	674-271	674-538
8 Cyl - 5.2L (318 CID)	1995-94	-	674-271	674-270
8 Cyl - 5.9L (360 CID)	2003-98	-	—	674-538
8 Cyl - 5.9L (360 CID)	2002-98	-	674-271	—
DURANGO				
8 Cyl - 5.2L (318 CID)	2000-98	-	674-271	674-538
8 Cyl - 5.9L (360 CID)	2003-98	-	—	674-538
8 Cyl - 5.9L (360 CID)	2002-98	-	674-271	—
M,R300/600 MOTORHOME				
8 Cyl - 6.6L (400 CID)	1978-72	Rear Dump	—	674-275
8 Cyl - 6.6L (400 CID)	1978-72	wo/Heat Tube	674-176	—
8 Cyl - 6.8L (413 CID)	1975-69	wo/Heat Tube	674-189	674-189
8 Cyl - 7.2L (440 CID)	1978-72	Rear Dump	—	674-275
8 Cyl - 7.2L (440 CID)	1978-72	wo/Heat Tube	674-176	—
MEDIUM DUTY TRUCK				
8 Cyl - 5.9L (361 CID)	1975-72	-	674-189	674-189
8 Cyl - 5.9L (361 CID)	1971-69	Exc. S500/600 School Bus	674-189	674-189
8 Cyl - 5.9L (361 CID)	1971-69	S500/600 School Bus	674-189	—
8 Cyl - 5.9L (361 CID)	1968-63	-	674-189	674-189
8 Cyl - 6.8L (413 CID)	1975-63	-	674-189	674-189
P100/300 STEP VAN				
6 Cyl - 3.7L (225 CID)	1972-70	-	674-232	NR
RAM 1500/3500 PICKUP				
6 Cyl - 5.9L (359 CID)	1999-97	Calif	674-527	NR
6 Cyl - 5.9L (359 CID)	1996	-	674-527	NR
8 Cyl - 5.2L (318 CID)	2002-96	-	674-271	674-538
8 Cyl - 5.2L (318 CID)	1995-94	-	674-271	674-270
8 Cyl - 5.9L (360 CID)	2003-97	-	674-271	674-538
8 Cyl - 5.9L (360 CID)	1996	Heavy Duty	674-271	674-270
8 Cyl - 5.9L (360 CID)	1996	Light Duty	674-271	674-538
8 Cyl - 5.9L (360 CID)	1995-94	-	674-271	674-270
RAM 1500/3500 VAN				
6 Cyl - 3.9L (239 CID)	2003-02	-	—	674-438
6 Cyl - 3.9L (239 CID)	1995-94	-	—	674-438
8 Cyl - 5.2L (318 CID)	2003-99	-	674-271	674-538
8 Cyl - 5.9L (360 CID)	2003-99	-	674-271	674-538
RAMCHARGER				
6 Cyl - 3.7L (225 CID)	1980-74	-	674-232	NR
8 Cyl - 5.2L (318 CID)	1991-88	-	674-233	—
8 Cyl - 5.2L (318 CID)	1987-86	Calif or Hi-Alt	674-233	—

Make/Model/Eng	Years	Description	LH/Front	RH/Rear
DODGE TRUCK (continued)				
RAMCHARGER (continued)				
8 Cyl - 5.2L (318 CID)	1987-86	Exc. Calif or Hi-Alt, wo/Aspirator between Air Cleaner & Manifold	674-233	—
8 Cyl - 5.2L (318 CID)	1987-86	wo/Aspirator between Air Cleaner & Manifold, w/Air Pump	674-233	674-234
8 Cyl - 5.2L (318 CID)	1985-84	2-Bbl, w/Air Pump, w/Catalyst	674-233	674-234
8 Cyl - 5.2L (318 CID)	1985-84	2-Bbl, w/Air Pump, wo/Catalyst	674-233	—
8 Cyl - 5.2L (318 CID)	1985-84	4-Bbl	674-233	—
8 Cyl - 5.2L (318 CID)	1983	2-Bbl, Calif or Hi-Alt	674-233	—
8 Cyl - 5.2L (318 CID)	1983	4-Bbl	674-233	674-234
8 Cyl - 5.2L (318 CID)	1982	4-Bbl	674-233	674-234
8 Cyl - 5.2L (318 CID)	1981	4-Bbl, Calif, Exc. Heavy Duty	674-233	674-234
8 Cyl - 5.2L (318 CID)	1981	4-Bbl, Calif, Heavy Duty	674-233	—
8 Cyl - 5.2L (318 CID)	1980	4-Bbl	674-233	—
8 Cyl - 5.2L (318 CID)	1979	4-Bbl, Calif	674-233	674-234
8 Cyl - 5.2L (318 CID)	1979	4-Bbl, Exc. Calif	674-233	—
8 Cyl - 5.2L (318 CID)	1978	Calif	674-233	—
8 Cyl - 5.9L (360 CID)	1992-89	-	674-233	—
8 Cyl - 5.9L (360 CID)	1988	Dual Exhaust	674-233	—
8 Cyl - 5.9L (360 CID)	1988	Single Exhaust	—	674-234
8 Cyl - 5.9L (360 CID)	1987-86	Dual Exhaust	674-233	—
8 Cyl - 5.9L (360 CID)	1987-86	Single Exhaust, w/Catalyst	674-233	674-234
8 Cyl - 5.9L (360 CID)	1987-86	Single Exhaust, wo/Catalyst	674-233	—
8 Cyl - 5.9L (360 CID)	1985-84	4-Bbl, w/Catalyst	674-233	674-234
8 Cyl - 5.9L (360 CID)	1985-84	4-Bbl, wo/Catalyst	674-233	—
8 Cyl - 5.9L (360 CID)	1983-82	4-Bbl	674-233	—
8 Cyl - 5.9L (360 CID)	1983-82	4-Bbl	674-233	—
8 Cyl - 5.9L (360 CID)	1981	4-Bbl, Exc. Heavy Duty, Calif	674-233	674-234
8 Cyl - 5.9L (360 CID)	1981	4-Bbl, Heavy Duty	674-233	—
8 Cyl - 5.9L (360 CID)	1980	4-Bbl, 2WD, Leaded Fuel	674-233	—
8 Cyl - 5.9L (360 CID)	1980	4-Bbl, 4WD, Medium & Heavy Duty	674-233	—
8 Cyl - 5.9L (360 CID)	1979	2-Bbl, Light Duty	674-233	—
8 Cyl - 5.9L (360 CID)	1979	4-Bbl	674-233	—
8 Cyl - 5.9L (360 CID)	1978	Calif	674-233	—
8 Cyl - 6.6L (400 CID)	1978-72	Rear Dump	—	674-275
8 Cyl - 6.6L (400 CID)	1978-72	wo/Heat Tube	674-176	—
8 Cyl - 7.2L (440 CID)	1978-72	Rear Dump	—	674-275
8 Cyl - 7.2L (440 CID)	1978-72	wo/Heat Tube	674-176	—
EAGLE				
SUMMIT				
4 Cyl - 1.5L (1468cc)	1994-93	Calif	674-520	NR
4 Cyl - 1.5L (1468cc)	1992-91	-	674-263	NR
4 Cyl - 1.5L (1468cc)	1990	Wagon	674-263	NR
4 Cyl - 1.5L (1468cc)	1989	Sedan & Wagon	674-263	NR
4 Cyl - 1.6L (1595cc)	1990-89	-	674-263	NR
TALON				
4 Cyl - 1.8L (107 CID)	1994-93	-	674-533	NR
4 Cyl - 2.0L (122 CID)	1998-95	wo/Turbo	674-534	NR
4 Cyl - 2.0L (1997cc)	1998-95	w/Turbo	674-265	NR
4 Cyl - 2.0L (1997cc)	1994-90	w/Turbo, AT	674-266	NR
4 Cyl - 2.0L (1997cc)	1994-90	w/Turbo, MT	674-265	NR
4 Cyl - 2.0L (1997cc)	1994-90	wo/Turbo	674-287	NR
FORD				
CONTOUR				
6 Cyl - 2.5L (155 CID)	2000-98	-	674-594	674-595
CROWN VICTORIA				
8 Cyl - 4.6L (281 CID)	2002-95	-	674-558	674-557
CROWN VICTORIA, COUNTRY SQUIRE, CUSTOM 500				
6 Cyl - 3.9L (240 CID)	1972-65	-	674-173	NR
8 Cyl - 4.2L (255 CID)	1982-81	-	—	674-236
8 Cyl - 5.0L (302 CID)	1991-86	-	674-184	674-153
8 Cyl - 5.0L (302 CID)	1985-80	-	—	674-236
8 Cyl - 5.8L (351M)	1977-75	8-Bolt Valve Cover	674-193	—
8 Cyl - 5.8L (351W)	1991-83	-	—	674-166
8 Cyl - 6.6L (400 CID)	1977-75	-	674-193	—
ESCORT				
4 Cyl - 1.8L (112 CID)	1996-91	-	674-358	NR
4 Cyl - 1.9L (116 CID)	1996-93	-	674-280	NR
4 Cyl - 1.9L (116 CID)	1992-91	-	674-343	NR
4 Cyl - 1.9L (116 CID)	1990-87	-	674-274	NR
4 Cyl - 2.0L (121 CID)	2002-98	DOHC, VIN 3	674-395	NR
4 Cyl - 2.0L (122 CID)	2002-97	SOHC, VIN P	674-394	NR
EXP				
4 Cyl - 1.9L (116 CID)	1988-87	-	674-274	NR

Exhaust Manifold Kit Applications

Make/Model/Eng	Years	Description	LH/Front	RH/Rear	Make/Model/Eng	Years	Description	LH/Front	RH/Rear
FORD (continued)					FORD (continued)				
FAIRMONT					ZX2				
4 Cyl - 2.3L (140 CID)	1983	wo/A.I.R.	674-230	NR	4 Cyl - 2.0L (121 CID)	2003-02	DOHC, VIN 3	674-395	NR
8 Cyl - 4.2L (255 CID)	1982-80	-	—	674-236	FORD TRUCK				
FOCUS					AEROSTAR				
4 Cyl - 2.0L (122 CID)	2004-00	SOHC, VIN P	674-394	NR	4 Cyl - 2.3L (140 CID)	1987-86	-	674-230	NR
GALAXIE, GALAXIE 500					6 Cyl - 3.0L (182 CID)	1997	-	674-444	674-412
6 Cyl - 3.9L (240 CID)	1972-65	-	674-173	NR	6 Cyl - 3.0L (182 CID)	1996	-	674-444	674-410
GRAN TORINO					6 Cyl - 3.0L (182 CID)	1995-94	-	—	674-410
8 Cyl - 5.8L (351M)	1976-75	8-Bolt Valve Cover	674-193	—	6 Cyl - 3.0L (182 CID)	1993-86	-	—	674-408
8 Cyl - 6.6L (400 CID)	1976-75	-	674-193	—	BRONCO				
GRANADA					6 Cyl - 3.9L (240 CID)	1966	-	674-173	NR
8 Cyl - 4.2L (255 CID)	1981-80	-	—	674-236	6 Cyl - 4.9L (300 CID)	1992-90	-	674-185	674-186
8 Cyl - 5.0L (302 CID)	1980	-	—	674-236	6 Cyl - 4.9L (300 CID)	1986-84	-	674-174	—
LTD					6 Cyl - 4.9L (300 CID)	1983-80	-	674-173	—
4 Cyl - 2.3L (140 CID)	1984-83	wo/A.I.R.	674-230	NR	8 Cyl - 5.0L (302 CID)	1996-88	-	674-152	674-153
8 Cyl - 4.2L (255 CID)	1982-81	-	—	674-236	8 Cyl - 5.0L (302 CID)	1987-86	w/Exhaust Control Valve	674-155	674-153
8 Cyl - 5.0L (302 CID)	1985-80	-	—	674-236	8 Cyl - 5.0L (302 CID)	1987-86	wo/Exhaust Control Valve	674-152	674-153
8 Cyl - 5.8L (351M)	1978-75	8-Bolt Valve Cover	674-193	—	8 Cyl - 5.0L (302 CID)	1985-83	w/Exhaust Control Valve	674-155	674-236
8 Cyl - 6.6L (400 CID)	1978-75	-	674-193	—	8 Cyl - 5.0L (302 CID)	1985-83	wo/Exhaust Control Valve	674-152	674-236
LTD II					8 Cyl - 5.0L (302 CID)	1982-80	-	674-152	674-236
8 Cyl - 5.8L (351M)	1979-77	8-Bolt Valve Cover	674-193	—	8 Cyl - 5.8L (351M)	1981-80	8-Bolt Valve Cover	674-193	674-182
8 Cyl - 6.6L (400 CID)	1978-77	-	674-193	—	8 Cyl - 5.8L (351M)	1979-78	8-Bolt Valve Cover	674-193	—
MUSTANG					8 Cyl - 5.8L (351W)	1996-88	-	674-169	674-165
4 Cyl - 2.3L (140 CID)	1993-87	-	674-230	NR	8 Cyl - 5.8L (351W)	1987-84	-	674-155	674-166
4 Cyl - 2.3L (140 CID)	1983	wo/A.I.R.	674-230	NR	8 Cyl - 5.8L (351W)	1983	From 4/83, w/Exhaust Control Valve	674-155	674-166
6 Cyl - 3.8L (232 CID)	2004-01	-	674-535	—	8 Cyl - 5.8L (351W)	1983	To 4/83, wo/Exhaust Control Valve	674-152	674-166
6 Cyl - 3.8L (232 CID)	2000-99	-	674-535	674-536	8 Cyl - 5.8L (351W)	1982-81	-	674-152	674-166
6 Cyl - 3.8L (232 CID)	1998	Exc. Calif	674-286	—	8 Cyl - 6.6L (400 CID)	1979-78	-	674-193	—
6 Cyl - 3.8L (232 CID)	1997-94	-	674-286	—	BRONCO II				
8 Cyl - 4.2L (255 CID)	1982-80	-	—	674-236	6 Cyl - 2.9L (177 CID)	1990-86	-	674-222	674-221
8 Cyl - 4.6L (281 CID)	2004-03	DOHC, VIN R, wo/Supercharger	674-453	674-457	E-100/150 ECONOLINE				
8 Cyl - 4.6L (281 CID)	2004-03	SOHC, VIN X	—	674-458	6 Cyl - 3.9L (240 CID)	1974-65	-	674-173	NR
8 Cyl - 4.6L (281 CID)	2002-99	DOHC, VIN V	674-453	674-457	6 Cyl - 4.2L (256 CID)	2006-99	-	674-555	674-554
8 Cyl - 4.6L (281 CID)	2002-99	SOHC, VIN X	—	674-458	6 Cyl - 4.2L (256 CID)	1998-97	-	674-405	674-404
8 Cyl - 4.6L (281 CID)	1998-96	DOHC, VIN V	674-448	674-457	6 Cyl - 4.9L (300 CID)	1996	-	674-185	—
8 Cyl - 4.6L (281 CID)	1998-96	SOHC, VIN X	674-454	674-458	6 Cyl - 4.9L (300 CID)	1995	Calif	674-185	—
8 Cyl - 5.0L (302 CID)	1993-87	-	674-190	674-191	6 Cyl - 4.9L (300 CID)	1995	Exc. Calif	674-185	674-186
8 Cyl - 5.0L (302 CID)	1986	Convertible	674-190	—	6 Cyl - 4.9L (300 CID)	1994-90	-	674-185	674-186
8 Cyl - 5.0L (302 CID)	1986	Exc. Convertible	674-190	674-191	6 Cyl - 4.9L (300 CID)	1986-84	-	674-174	—
8 Cyl - 5.0L (302 CID)	1983-82	-	—	674-236	6 Cyl - 4.9L (300 CID)	1983-81	Calif	674-174	—
PROBE					6 Cyl - 4.9L (300 CID)	1983-81	Exc. Calif	674-173	—
4 Cyl - 2.2L (133 CID)	1992-89	Turbo, VIN L	674-330	NR	6 Cyl - 4.9L (300 CID)	1980-72	-	674-173	—
RANCHERO, RANCH WAGON					8 Cyl - 4.6L (281 CID)	2006-99	-	—	674-459
8 Cyl - 5.8L (351M)	1979-75	8-Bolt Valve Cover	674-193	—	8 Cyl - 5.0L (302 CID)	1996-88	-	674-152	674-153
8 Cyl - 6.6L (400 CID)	1978-75	-	674-193	—	8 Cyl - 5.0L (302 CID)	1987-86	w/Exhaust Control Valve	674-155	674-153
TAURUS					8 Cyl - 5.0L (302 CID)	1987-86	wo/Exhaust Control Valve	674-152	674-153
4 Cyl - 2.5L (153 CID)	1991-86	Cast Iron	674-151	NR	8 Cyl - 5.0L (302 CID)	1985-83	w/Exhaust Control Valve	674-155	674-236
6 Cyl - 3.0L (182 CID)	2006-04	12 Valve, VIN U	674-363	—	8 Cyl - 5.0L (302 CID)	1985-83	wo/Exhaust Control Valve	674-152	674-236
6 Cyl - 3.0L (182 CID)	2006-00	24 Valve, VIN S	674-449	—	8 Cyl - 5.0L (302 CID)	1982-80	-	674-152	674-236
6 Cyl - 3.0L (182 CID)	2003-00	12 Valve, VIN U	674-363	674-566	8 Cyl - 5.4L (330 CID)	2006-00	-	674-560	674-559
6 Cyl - 3.0L (182 CID)	1999-97	12 Valve, Flex Fuel, Calif, VIN 1 & 2,	674-363	674-364	8 Cyl - 5.4L (330 CID)	1998-97	-	674-462	—
6 Cyl - 3.0L (182 CID)	1999-97	12 Valve, Flex Fuel, Exc. Calif, VIN 1 & 2	674-365	674-362	8 Cyl - 5.8L (351M)	1981-80	8-Bolt Valve Cover	674-193	674-182
6 Cyl - 3.0L (182 CID)	1999-97	12 Valve, VIN U,	674-365	674-362	8 Cyl - 5.8L (351W)	1996-88	-	674-169	674-165
6 Cyl - 3.0L (182 CID)	1996	Exc. Flex Fuel, Calif, VIN 1 & 2	674-365	674-364	8 Cyl - 5.8L (351W)	1987-84	-	674-155	674-166
6 Cyl - 3.0L (182 CID)	1996	12 Valve, Flex Fuel, Exc. Calif, VIN 1 & 2	674-365	674-362	8 Cyl - 5.8L (351W)	1983	From 4/83, w/Exhaust Control Valve	674-155	674-166
6 Cyl - 3.0L (182 CID)	1996	12 Valve, VIN U,	674-365	674-362	8 Cyl - 5.8L (351W)	1983	To 4/83, wo/Exhaust Control Valve	674-152	674-166
6 Cyl - 3.0L (182 CID)	1996	Exc. Flex Fuel	674-365	674-362	8 Cyl - 6.6L (400 CID)	1980	-	674-193	674-182
6 Cyl - 3.0L (182 CID)	1996	24 Valve, VIN S	674-456	—	8 Cyl - 6.9L (421 CID)	1984	-	674-285	674-283
6 Cyl - 3.0L (182 CID)	1995-94	Calif, VIN U	674-360	—	8 Cyl - 7.5L (460 CID)	1980	w/Air Inj Holes	—	674-226
6 Cyl - 3.0L (182 CID)	1995-94	Exc. Calif, VIN U	674-360	674-359	8 Cyl - 7.5L (460 CID)	1980	wo/Air Inj Holes	674-227	—
6 Cyl - 3.0L (182 CID)	1993-86	-	674-179	674-178	E-200/250 ECONOLINE				
6 Cyl - 3.8L (232 CID)	1995-88	VIN 4	674-195	674-194	6 Cyl - 3.9L (240 CID)	1974-68	-	674-173	NR
TEMPO					6 Cyl - 4.2L (256 CID)	2006-99	-	674-555	674-554
4 Cyl - 2.3L (140 CID)	1994-85	Cast Iron	674-150	NR	6 Cyl - 4.2L (256 CID)	1998-97	-	674-405	674-404
4 Cyl - 2.3L (140 CID)	1984	-	674-327	NR	6 Cyl - 4.9L (300 CID)	1996	-	674-185	—
THUNDERBIRD					6 Cyl - 4.9L (300 CID)	1995	Calif	—	674-186
8 Cyl - 4.2L (255 CID)	1982-80	-	—	674-236	6 Cyl - 4.9L (300 CID)	1995	Exc. Calif	674-185	674-186
8 Cyl - 4.6L (281 CID)	1997-94	-	674-466	—	6 Cyl - 4.9L (300 CID)	1994-90	-	674-185	674-186
8 Cyl - 5.0L (302 CID)	1988-86	-	674-184	674-236	6 Cyl - 4.9L (300 CID)	1986-84	-	674-174	—
8 Cyl - 5.0L (302 CID)	1985-80	-	—	674-236	6 Cyl - 4.9L (300 CID)	1983-81	Calif	674-174	—
8 Cyl - 5.8L (351M)	1979-77	8-Bolt Valve Cover	674-193	—	6 Cyl - 4.9L (300 CID)	1983-81	Exc. Calif	674-173	—
8 Cyl - 6.6L (400 CID)	1978-77	-	674-193	—	6 Cyl - 4.9L (300 CID)	1980-72	-	674-173	—
TORINO					8 Cyl - 5.0L (302 CID)	1991-88	-	674-152	674-153
8 Cyl - 5.8L (351M)	1976-75	8-Bolt Valve Cover	674-193	—	8 Cyl - 5.0L (302 CID)	1987-86	w/Exhaust Control Valve	674-155	674-153
8 Cyl - 6.6L (400 CID)	1976-75	-	674-193	—	8 Cyl - 5.0L (302 CID)	1987-86	wo/Exhaust Control Valve	674-152	674-153

Exhaust Manifold Kits

Window Lift Motors
pg. 535-554

Window Regulators
pg. 555-566

Wiper Motors
pg. 567-572

Wiper Transmission Linkages
pg. 573-576

Gaskets and Hardware
Included Where Required

Exhaust Manifold Kits

Exhaust Manifold Kit Applications

Make/Model/Eng	Years	Description	LH/Front	RH/Rear	Make/Model/Eng	Years	Description	LH/Front	RH/Rear
FORD TRUCK (continued)					FORD TRUCK (continued)				
E-200/250 ECONOLINE (continued)					EXPLORER (continued)				
8 Cyl - 5.0L (302 CID)	1985-83	w/Exhaust Control Valve	674-155	674-236	6 Cyl - 4.0L (245 CID)	2000	OHV, VIN X	674-379	674-378
8 Cyl - 5.0L (302 CID)	1985-83	wo/Exhaust Control Valve	674-152	674-236	6 Cyl - 4.0L (245 CID)	2000	SOHC, VIN E, To 3/2000	674-465	674-376
8 Cyl - 5.0L (302 CID)	1982-80	-	674-152	674-236	6 Cyl - 4.0L (245 CID)	1999-98	OHV, VIN X	674-379	674-378
8 Cyl - 5.4L (330 CID)	2006-00	-	674-560	674-559	6 Cyl - 4.0L (245 CID)	1999-98	SOHC, VIN E	674-465	674-376
8 Cyl - 5.4L (330 CID)	1998-97	-	674-462	—	6 Cyl - 4.0L (245 CID)	1997	OHV, VIN X	674-373	674-368
8 Cyl - 5.8L (351M)	1981-80	8-Bolt Valve Cover	674-193	674-182	6 Cyl - 4.0L (245 CID)	1997	SOHC, VIN E	674-465	674-376
8 Cyl - 5.8L (351W)	1996-88	-	674-169	674-165	6 Cyl - 4.0L (245 CID)	1996-95	OHV, VIN X	674-373	674-368
8 Cyl - 5.8L (351W)	1987-84	-	674-155	674-166	6 Cyl - 4.0L (245 CID)	1994	OHV, VIN X	—	674-368
8 Cyl - 5.8L (351W)	1983	From 4/83, w/Exhaust Control Valve	674-155	674-166	6 Cyl - 4.0L (245 CID)	1993-91	OHV, VIN X	674-371	674-368
8 Cyl - 5.8L (351W)	1983	To 4/83, wo/Exhaust Control Valve	674-152	674-166	8 Cyl - 5.0L (302 CID)	2001-99	-	674-334	674-329
8 Cyl - 5.8L (351W)	1982-81	-	674-152	674-166	8 Cyl - 5.0L (302 CID)	1998	From 2/98	674-334	674-329
8 Cyl - 6.6L (400 CID)	1982-80	-	674-193	674-182	8 Cyl - 5.0L (302 CID)	1998	To 2/98	674-356	674-357
8 Cyl - 6.9L (421 CID)	1987-83	-	674-285	674-283	8 Cyl - 5.0L (302 CID)	1997-96	-	674-356	674-357
8 Cyl - 7.3L (445 CID)	1991-90	-	674-284	674-283	F-100/150 PICKUP				
8 Cyl - 7.3L (445 CID)	1989-88	-	674-285	674-283	6 Cyl - 3.9L (240 CID)	1974-65	-	674-173	NR
8 Cyl - 7.5L (460 CID)	1996	Calif	674-204	674-205	6 Cyl - 4.2L (256 CID)	2006-05	-	674-555	—
8 Cyl - 7.5L (460 CID)	1996	Exc. Calif	674-228	674-229	6 Cyl - 4.2L (256 CID)	2004-99	-	674-555	674-554
8 Cyl - 7.5L (460 CID)	1995-94	-	674-228	674-229	6 Cyl - 4.2L (256 CID)	1998-97	-	674-405	674-404
8 Cyl - 7.5L (460 CID)	1991-89	-	674-204	674-205	6 Cyl - 4.9L (300 CID)	1996	-	674-185	—
8 Cyl - 7.5L (460 CID)	1988	From 2/88	674-204	674-205	6 Cyl - 4.9L (300 CID)	1995	Calif	674-185	—
8 Cyl - 7.5L (460 CID)	1988	To 1/31/88, w/Air Inj Holes	—	674-226	6 Cyl - 4.9L (300 CID)	1995	Exc. Calif	674-185	674-186
8 Cyl - 7.5L (460 CID)	1988	To 1/31/88, wo/Air Inj Holes	674-227	—	6 Cyl - 4.9L (300 CID)	1994-90	-	674-185	674-186
8 Cyl - 7.5L (460 CID)	1987-80	w/Air Inj Holes	—	674-226	6 Cyl - 4.9L (300 CID)	1986-84	-	674-174	—
8 Cyl - 7.5L (460 CID)	1987-80	wo/Air Inj Holes	674-227	—	6 Cyl - 4.9L (300 CID)	1983-81	Calif	674-174	—
E-300/350 ECONOLINE					6 Cyl - 4.9L (300 CID)	1983-81	Exc. Calif	674-173	—
6 Cyl - 3.9L (240 CID)	1974-68	-	674-173	NR	6 Cyl - 4.9L (300 CID)	1980-65	-	674-173	—
6 Cyl - 4.9L (300 CID)	1996	-	674-185	—	8 Cyl - 4.2L (255 CID)	1982-81	-	674-152	674-236
6 Cyl - 4.9L (300 CID)	1995	Exc. Calif	674-185	674-186	8 Cyl - 4.6L (281 CID)	2004	Heritage Series	674-587	674-586
6 Cyl - 4.9L (300 CID)	1994-90	-	674-185	674-186	8 Cyl - 4.6L (281 CID)	2003-99	-	674-587	674-586
6 Cyl - 4.9L (300 CID)	1986-84	-	674-174	—	8 Cyl - 4.6L (281 CID)	1998-97	-	674-407	674-406
6 Cyl - 4.9L (300 CID)	1983-72	-	674-173	—	8 Cyl - 5.0L (302 CID)	1996-88	-	674-152	674-153
8 Cyl - 5.0L (302 CID)	1989	-	674-152	674-153	8 Cyl - 5.0L (302 CID)	1987-86	w/Exhaust Control Valve	674-155	674-153
8 Cyl - 5.0L (302 CID)	1980	-	674-152	674-236	8 Cyl - 5.0L (302 CID)	1987-86	wo/Exhaust Control Valve	674-152	674-153
8 Cyl - 5.4L (330 CID)	2006-00	-	674-560	674-559	8 Cyl - 5.0L (302 CID)	1985-83	w/Exhaust Control Valve	674-155	674-236
8 Cyl - 5.4L (330 CID)	1998-97	-	674-462	674-398	8 Cyl - 5.0L (302 CID)	1985-83	wo/Exhaust Control Valve	674-152	674-236
8 Cyl - 5.8L (351M)	1981-80	8-Bolt Valve Cover	674-193	674-182	8 Cyl - 5.0L (302 CID)	1982-80	-	674-152	674-236
8 Cyl - 5.8L (351W)	1996-88	-	674-169	674-165	8 Cyl - 5.4L (330 CID)	2004	Lightning Series	—	674-559
8 Cyl - 5.8L (351W)	1987-84	-	674-155	674-166	8 Cyl - 5.4L (330 CID)	2003-99	-	674-560	674-559
8 Cyl - 5.8L (351W)	1983	From 4/83, w/Exhaust Control Valve	674-155	674-166	8 Cyl - 5.4L (330 CID)	1998-97	-	674-399	674-398
8 Cyl - 5.8L (351W)	1983	To 4/83, wo/Exhaust Control Valve	674-152	674-166	8 Cyl - 5.8L (351M)	1981-80	8-Bolt Valve Cover	674-193	674-182
8 Cyl - 5.8L (351W)	1982-81	-	674-152	674-166	8 Cyl - 5.8L (351M)	1979-77	8-Bolt Valve Cover	674-193	—
8 Cyl - 6.6L (400 CID)	1982-80	-	674-193	674-182	8 Cyl - 5.8L (351W)	1996-88	-	674-169	674-165
8 Cyl - 6.9L (421 CID)	1987-83	-	674-285	674-283	8 Cyl - 5.8L (351W)	1987-84	-	674-155	674-166
8 Cyl - 7.3L (445 CID)	2003-99	Turbo, VIN F	674-383	—	8 Cyl - 5.8L (351W)	1983	From 4/83, w/Exhaust Control Valve	674-155	674-166
8 Cyl - 7.3L (445 CID)	1998-95	Turbo, VIN F	674-383	674-380	8 Cyl - 5.8L (351W)	1983	To 4/83, wo/Exhaust Control Valve	674-152	674-166
8 Cyl - 7.3L (445 CID)	1994-90	-	674-284	674-283	8 Cyl - 5.8L (351W)	1982-81	-	674-152	674-166
8 Cyl - 7.3L (445 CID)	1989-88	-	674-285	674-283	8 Cyl - 5.8L (352 CID)	1967-65	-	—	674-240
8 Cyl - 7.5L (460 CID)	1996	Calif, Cutaway or Stripped Chassis	674-228	674-229	8 Cyl - 5.9L (360 CID)	1976-68	-	674-241	674-240
8 Cyl - 7.5L (460 CID)	1996	Calif, Exc. Cutaway or Stripped Chassis	674-204	674-205	8 Cyl - 6.4L (390 CID)	1976-68	-	674-241	674-240
8 Cyl - 7.5L (460 CID)	1995-94	Exc. Calif, Exc. Super Duty	674-228	674-229	8 Cyl - 6.6L (400 CID)	1980	-	674-193	674-182
8 Cyl - 7.5L (460 CID)	1993	From 2/1/93	674-228	674-229	8 Cyl - 6.6L (400 CID)	1979-77	-	674-193	—
8 Cyl - 7.5L (460 CID)	1993	To 1/31/93	674-204	674-205	8 Cyl - 6.9L (421 CID)	1984	-	674-285	674-283
8 Cyl - 7.5L (460 CID)	1992-89	-	674-204	674-205	F-250 PICKUP				
8 Cyl - 7.5L (460 CID)	1988	From 2/1/88	674-204	674-205	6 Cyl - 3.9L (240 CID)	1974-65	-	674-173	NR
8 Cyl - 7.5L (460 CID)	1988	To 1/31/88, w/Air Inj Holes	—	674-226	6 Cyl - 4.2L (256 CID)	1998-97	-	674-405	674-404
8 Cyl - 7.5L (460 CID)	1988	To 1/31/88, wo/Air Inj Holes	674-227	—	6 Cyl - 4.9L (300 CID)	1996	-	674-185	—
8 Cyl - 7.5L (460 CID)	1987-80	w/Air Inj Holes	—	674-226	6 Cyl - 4.9L (300 CID)	1995	Calif	674-185	—
8 Cyl - 7.5L (460 CID)	1987-80	wo/Air Inj Holes	674-227	—	6 Cyl - 4.9L (300 CID)	1995	Exc. Calif	674-185	674-186
E-SUPER DUTY					6 Cyl - 4.9L (300 CID)	1994-90	-	674-185	674-186
8 Cyl - 5.4L (330 CID)	2002-00	-	674-560	674-559	6 Cyl - 4.9L (300 CID)	1994-90	-	674-174	—
8 Cyl - 5.4L (330 CID)	1998-97	-	674-462	674-398	6 Cyl - 4.9L (300 CID)	1986-84	-	674-174	—
8 Cyl - 7.3L (445 CID)	2003-98	Turbo, VIN F	674-383	—	6 Cyl - 4.9L (300 CID)	1983-81	Calif	674-174	—
8 Cyl - 7.3L (445 CID)	1997-96	Turbo, VIN F	674-383	674-380	6 Cyl - 4.9L (300 CID)	1983-81	Exc. Calif	674-173	—
EXCURSION					6 Cyl - 4.9L (300 CID)	1980-65	-	674-173	—
8 Cyl - 5.4L (330 CID)	2006-00	-	674-560	674-559	8 Cyl - 4.6L (281 CID)	1999	-	674-587	674-586
EXPEDITION					8 Cyl - 4.6L (281 CID)	1998-97	-	674-407	674-406
8 Cyl - 4.6L (281 CID)	2002-99	-	674-587	674-586	8 Cyl - 5.0L (302 CID)	1996-88	-	674-152	674-153
8 Cyl - 4.6L (281 CID)	1998-97	-	674-407	674-406	8 Cyl - 5.0L (302 CID)	1987-86	w/Exhaust Control Valve	674-155	674-153
8 Cyl - 5.4L (330 CID)	2002-99	-	674-460	—	8 Cyl - 5.0L (302 CID)	1987-86	wo/Exhaust Control Valve	674-152	674-153
8 Cyl - 5.4L (330 CID)	1998-97	-	674-399	674-398	8 Cyl - 5.0L (302 CID)	1985-83	w/Exhaust Control Valve	674-155	674-236
EXPLORER					8 Cyl - 5.0L (302 CID)	1985-83	wo/Exhaust Control Valve	674-152	674-236
6 Cyl - 4.0L (245 CID)	2001	OHV, VIN X	674-379	674-378	8 Cyl - 5.0L (302 CID)	1982-80	-	674-152	674-236
					8 Cyl - 5.0L (302 CID)	1982-80	-	674-152	674-236
					8 Cyl - 5.4L (330 CID)	1999	VIN L, M	674-560	674-559
					8 Cyl - 5.4L (330 CID)	1998-97	-	674-399	674-398
					8 Cyl - 5.8L (351M)	1981-80	8-Bolt Valve Cover	674-193	674-182
					8 Cyl - 5.8L (351M)	1979-77	8-Bolt Valve Cover	674-193	—
					8 Cyl - 5.8L (351W)	1997-88	-	674-169	674-165
					8 Cyl - 5.8L (351W)	1987-84	-	674-155	674-166

Exhaust Manifold Kits

Exhaust Manifold Kit Applications

Make/Model/Eng	Years	Description	LH/Front	RH/Rear
FORD TRUCK (continued)				
F-250 PICKUP (continued)				
8 Cyl - 5.8L (351W)	1983	From 4/83, w/Exhaust Control Valve	674-155	674-166
8 Cyl - 5.8L (351W)	1983	To 4/83, wo/Exhaust Control Valve	674-152	674-166
8 Cyl - 5.8L (351W)	1982-81	-	—	674-240
8 Cyl - 5.8L (352 CID)	1966-65	-	674-241	674-240
8 Cyl - 5.9L (360 CID)	1976-68	-	674-241	674-240
8 Cyl - 6.4L (390 CID)	1976-68	-	674-193	674-182
8 Cyl - 6.6L (400 CID)	1982-80	-	674-193	—
8 Cyl - 6.6L (400 CID)	1979-77	-	674-285	674-283
8 Cyl - 6.9L (421 CID)	1987-83	-	674-381	674-380
8 Cyl - 7.3L (445 CID)	1997-95	Turbo, VIN F	674-381	674-380
8 Cyl - 7.3L (445 CID)	1994	w/Turbo, VIN F	674-381	674-380
8 Cyl - 7.3L (445 CID)	1994	wo/Turbo	674-285	674-283
8 Cyl - 7.3L (445 CID)	1993-88	-	674-285	674-283
8 Cyl - 7.5L (460 CID)	1997-96	Calif	674-204	674-205
8 Cyl - 7.5L (460 CID)	1997-96	Exc. Calif	674-228	674-229
8 Cyl - 7.5L (460 CID)	1995-94	-	674-228	674-229
8 Cyl - 7.5L (460 CID)	1993	From 2/1/93	674-228	674-229
8 Cyl - 7.5L (460 CID)	1993	To 1/31/93	674-204	674-205
8 Cyl - 7.5L (460 CID)	1992-89	-	674-204	674-205
8 Cyl - 7.5L (460 CID)	1988	From 2/1/88	674-204	674-205
8 Cyl - 7.5L (460 CID)	1988	To 1/31/88, w/Air Inj Holes	—	674-226
8 Cyl - 7.5L (460 CID)	1988	To 1/31/88, wo/Air Inj Holes	674-227	—
8 Cyl - 7.5L (460 CID)	1987-83	w/Air Inj Holes	—	674-226
8 Cyl - 7.5L (460 CID)	1987-83	wo/Air Inj Holes	674-227	—
F-250 SUPER DUTY PICKUP				
8 Cyl - 5.4L (330 CID)	2004-99	-	674-560	674-559
F-350 PICKUP				
6 Cyl - 3.9L (240 CID)	1974-65	-	674-173	NR
6 Cyl - 4.9L (300 CID)	1996	-	674-185	—
6 Cyl - 4.9L (300 CID)	1995	Calif	—	674-186
6 Cyl - 4.9L (300 CID)	1995	Exc. Calif	674-185	674-186
6 Cyl - 4.9L (300 CID)	1994-90	-	674-185	674-186
6 Cyl - 4.9L (300 CID)	1986-84	-	674-174	—
6 Cyl - 4.9L (300 CID)	1983-65	-	674-173	—
8 Cyl - 5.0L (302 CID)	1980	-	674-152	674-236
8 Cyl - 5.8L (351M)	1981-80	8-Bolt Valve Cover	674-193	674-182
8 Cyl - 5.8L (351M)	1979-77	8-Bolt Valve Cover	674-193	—
8 Cyl - 5.8L (351W)	1997-88	-	674-169	674-165
8 Cyl - 5.8L (351W)	1987-86	-	674-155	674-166
8 Cyl - 5.8L (351W)	1985-84	w/A.I.R.	—	674-166
8 Cyl - 5.8L (351W)	1985-84	wo/A.I.R.	674-155	674-166
8 Cyl - 5.8L (351W)	1983	From 4/83, w/Exhaust Control Valve	674-155	674-166
8 Cyl - 5.8L (351W)	1983	To 4/83, wo/Exhaust Control Valve	674-152	674-166
8 Cyl - 5.8L (351W)	1982-81	-	674-152	674-166
8 Cyl - 5.8L (352 CID)	1966-65	-	—	674-240
8 Cyl - 5.9L (360 CID)	1976-68	-	674-241	674-240
8 Cyl - 6.4L (390 CID)	1976-68	-	674-241	674-240
8 Cyl - 6.6L (400 CID)	1982-80	-	—	674-182
8 Cyl - 6.6L (400 CID)	1982-77	-	674-193	—
8 Cyl - 6.9L (421 CID)	1987-83	-	674-285	674-283
8 Cyl - 7.3L (445 CID)	1997-95	Turbo, VIN F	674-381	674-380
8 Cyl - 7.3L (445 CID)	1994	w/Turbo, VIN F	674-381	674-380
8 Cyl - 7.3L (445 CID)	1994	wo/Turbo	674-285	674-283
8 Cyl - 7.3L (445 CID)	1993-88	-	674-285	674-283
8 Cyl - 7.5L (460 CID)	1997-96	Calif, Cab & Chassis	674-228	674-229
8 Cyl - 7.5L (460 CID)	1997-96	Calif, Exc. Cab & Chassis	674-204	674-205
8 Cyl - 7.5L (460 CID)	1997-96	Exc. Calif	674-228	674-229
8 Cyl - 7.5L (460 CID)	1995-94	-	674-228	674-229
8 Cyl - 7.5L (460 CID)	1993	From 2/1/93	674-228	674-229
8 Cyl - 7.5L (460 CID)	1993	To 1/31/93	674-204	674-205
8 Cyl - 7.5L (460 CID)	1992-89	-	674-204	674-205
8 Cyl - 7.5L (460 CID)	1988	From 2/1/88	674-204	674-205
8 Cyl - 7.5L (460 CID)	1988	To 1/31/88, w/Air Inj Holes	—	674-226
8 Cyl - 7.5L (460 CID)	1988	To 1/31/88, wo/Air Inj Holes	674-227	—
8 Cyl - 7.5L (460 CID)	1987-83	w/Air Inj Holes	—	674-226
8 Cyl - 7.5L (460 CID)	1987-83	wo/Air Inj Holes	674-227	—
F-350 SUPER DUTY PICKUP				
8 Cyl - 5.4L (330 CID)	2004-99	-	674-560	674-559
F-SERIES STRIPPED CHASSIS				
8 Cyl - 7.3L (445 CID)	1996-95	Turbo, VIN F	674-381	674-380
8 Cyl - 7.3L (445 CID)	1994	w/Turbo, VIN F	674-381	674-380
8 Cyl - 7.3L (445 CID)	1994	wo/Turbo	674-285	674-283
8 Cyl - 7.3L (445 CID)	1993-89	-	674-285	674-283
8 Cyl - 7.5L (460 CID)	1997-96	Calif, Cab & Chassis	674-228	674-229
8 Cyl - 7.5L (460 CID)	1997-96	Calif, Exc. Cab & Chassis	674-204	674-205
8 Cyl - 7.5L (460 CID)	1997-96	Exc. Calif	674-228	674-229
8 Cyl - 7.5L (460 CID)	1995-94	-	674-228	674-229
8 Cyl - 7.5L (460 CID)	1993	From 2/1/93	674-228	674-229
8 Cyl - 7.5L (460 CID)	1993	To 1/31/93	674-204	674-205
8 Cyl - 7.5L (460 CID)	1992-89	-	674-204	674-205
8 Cyl - 7.5L (460 CID)	1988	From 2/1/88	674-204	674-205
8 Cyl - 7.5L (460 CID)	1988	To 1/31/88, w/Air Inj Holes	—	674-226
8 Cyl - 7.5L (460 CID)	1988	To 1/31/88, wo/Air Inj Holes	674-227	—
8 Cyl - 7.5L (460 CID)	1987-83	w/Air Inj Holes	—	674-226
8 Cyl - 7.5L (460 CID)	1987-83	wo/Air Inj Holes	674-227	—

Make/Model/Eng	Years	Description	LH/Front	RH/Rear
FORD TRUCK (continued)				
F-SERIES STRIPPED CHASSIS (continued)				
8 Cyl - 7.5L (460 CID)	1997-96	Exc. Calif	674-228	674-229
8 Cyl - 7.5L (460 CID)	1995-94	-	674-228	674-229
8 Cyl - 7.5L (460 CID)	1993	From 2/1/93	674-228	674-229
8 Cyl - 7.5L (460 CID)	1993	To 1/31/93	674-204	674-205
8 Cyl - 7.5L (460 CID)	1992-89	-	674-204	674-205
F-SERIES SUPER DUTY PICKUP				
8 Cyl - 7.3L (445 CID)	1997-95	Turbo, VIN F	674-381	674-380
8 Cyl - 7.3L (445 CID)	1994	w/Turbo, VIN F	674-381	674-380
8 Cyl - 7.3L (445 CID)	1994	wo/Turbo	674-285	674-283
8 Cyl - 7.3L (445 CID)	1993-88	-	674-285	674-283
8 Cyl - 7.5L (460 CID)	1997-96	Calif, Cab & Chassis	674-228	674-229
8 Cyl - 7.5L (460 CID)	1997-96	Calif, Exc. Cab & Chassis	674-204	674-205
8 Cyl - 7.5L (460 CID)	1997-96	Exc. Calif	674-228	674-229
8 Cyl - 7.5L (460 CID)	1995-94	-	674-228	674-229
8 Cyl - 7.5L (460 CID)	1993	From 2/1/93	674-228	674-229
8 Cyl - 7.5L (460 CID)	1993	To 1/31/93	674-204	674-205
8 Cyl - 7.5L (460 CID)	1992-89	-	674-204	674-205
8 Cyl - 7.5L (460 CID)	1988	From 2/1/88	674-204	674-205
8 Cyl - 7.5L (460 CID)	1988	To 1/31/88, w/Air Inj Holes	—	674-226
8 Cyl - 7.5L (460 CID)	1988	To 1/31/88, wo/Air Inj Holes	674-227	—
FREESTAR				
6 Cyl - 3.9L (238 CID)	2004	To 4/5/04	674-367	—
6 Cyl - 4.2L (256 CID)	2004	To 4/5/04	674-367	—
M-400/450 MOTOR HOME				
8 Cyl - 5.9L (360 CID)	1975-73	-	674-241	674-240
8 Cyl - 6.4L (390 CID)	1975-73	-	674-241	674-240
MEDIUM DUTY				
6 Cyl - 3.9L (240 CID)	1972-65	-	674-173	NR
6 Cyl - 4.9L (300 CID)	1977-75	P-500	674-173	—
6 Cyl - 4.9L (300 CID)	1974-65	500 Series, Light Duty Eng	674-173	—
MEDIUM DUTY 500/750 SERIES				
8 Cyl - 6.1L (370 CID)	1991-79	-	674-168	674-168
8 Cyl - 7.0L (429 CID)	1991-79	-	674-168	674-168
P-350 FORWARD CONTROL				
6 Cyl - 3.9L (240 CID)	1972-65	-	674-173	NR
6 Cyl - 4.9L (300 CID)	1977-65	-	674-173	—
RANGER				
4 Cyl - 2.0L (122 CID)	1988-83	-	674-230	NR
4 Cyl - 2.3L (140 CID)	1992-83	-	674-230	NR
6 Cyl - 2.9L (177 CID)	1992-86	-	674-222	674-221
6 Cyl - 3.0L (182 CID)	2006-01	-	—	674-447
6 Cyl - 3.0L (182 CID)	2000-98	-	—	674-412
6 Cyl - 3.0L (182 CID)	1997	-	674-413	674-412
6 Cyl - 3.0L (182 CID)	1996-94	-	—	674-410
6 Cyl - 3.0L (182 CID)	1993	From 4/93	—	674-410
6 Cyl - 3.0L (182 CID)	1993	To 4/93	674-361	674-408
6 Cyl - 3.0L (182 CID)	1992-91	-	674-361	674-408
6 Cyl - 4.0L (245 CID)	2000-98	OHV, VIN X	674-379	674-378
6 Cyl - 4.0L (245 CID)	1997-95	OHV, VIN X	—	674-368
6 Cyl - 4.0L (245 CID)	1994-90	OHV, VIN X	674-371	674-368
WINDSTAR				
6 Cyl - 3.0L (182 CID)	2000-98	-	674-451	—
6 Cyl - 3.0L (182 CID)	1997-95	-	674-360	674-359
6 Cyl - 3.8L (232 CID)	2003	-	674-367	—
6 Cyl - 3.8L (232 CID)	2002-99	-	674-367	674-366
6 Cyl - 3.8L (232 CID)	1995	-	674-195	674-194
GEO				
METRO				
3 Cyl - 1.0L (61 CID)	1998-95	Exc. Calif	674-200	NR
3 Cyl - 1.0L (61 CID)	1994-90	-	674-200	NR
PRIZM				
4 Cyl - 1.6L (98 CID)	1997-96	-	674-164	NR
4 Cyl - 1.6L (98 CID)	1995-94	Exc. Calif	674-164	NR
4 Cyl - 1.6L (98 CID)	1993-89	VIN 6	674-164	NR
4 Cyl - 1.8L (110 CID)	2002-98	-	674-546	NR
4 Cyl - 1.8L (110 CID)	1997-96	-	674-164	NR
4 Cyl - 1.8L (110 CID)	1995-93	Exc. Calif	674-164	NR
SPECTRUM				
4 Cyl - 1.5L (92 CID)	1989	wo/Turbo, VIN 7	674-175	NR
STORM				
4 Cyl - 1.6L (98 CID)	1993-91	VIN 6	674-180	NR
4 Cyl - 1.6L (98 CID)	1990	Exc. Calif, VIN 6	674-180	NR
TRACKER				
4 Cyl - 1.6L (98 CID)	1995-89	-	674-532	NR
HONDA				
ACCORD				
4 Cyl - 2.2L (2156cc)	1997-94	-	674-509	NR
4 Cyl - 2.2L (2156cc)	1993-90	-	674-529	NR

Exhaust Manifold Kits

Clock Springs
pg. 21-24

Control Arms
pg. 25-54

CV Joint Boots & Accessories
pg. 55-66

Door Lock Actuators
pg. 67-72

Exhaust Manifold Kits
pg. 73-134

Gaskets and Hardware Included Where Required

Exhaust Manifold Kits

Exhaust Manifold Kit Applications

Make/Model/Eng	Years	Description	LH/Front	RH/Rear
HONDA (continued)				
CIVIC				
4 Cyl - 1.5L (1493cc)	1995-88	-	674-545	NR
4 Cyl - 1.6L (1590cc)	2000-99	CX, DX & LX Series	674-439	NR
4 Cyl - 1.6L (1590cc)	1998-96	CX, EX & LX Series	674-512	NR
4 Cyl - 1.6L (1590cc)	1998-96	DX & HX Series, Exc. Calif	674-439	NR
4 Cyl - 1.6L (1590cc)	1995-92	Exc. SI Series	674-545	NR
4 Cyl - 1.6L (1590cc)	1995-92	VX & SI Series	674-512	NR
4 Cyl - 1.6L (1590cc)	1991-88	-	674-545	NR
CIVIC DEL SOL				
4 Cyl - 1.5L (1493cc)	1995-93	-	674-545	NR
4 Cyl - 1.6L (1590cc)	1997-96	SI Series	674-512	NR
4 Cyl - 1.6L (1590cc)	1995-93	-	674-512	NR
CRX				
4 Cyl - 1.5L (1493cc)	1990-88	-	674-545	NR
4 Cyl - 1.6L (1590cc)	1991-88	-	674-545	NR
ODYSSEY				
4 Cyl - 2.2L (2156cc)	1997-95	-	674-509	NR
4 Cyl - 2.3L (2234cc)	1998	-	674-509	NR
PRELUDE				
4 Cyl - 2.2L (2156cc)	1996-92	-	674-529	NR
WAGOVAN				
4 Cyl - 1.5L (1487cc)	1987-82	-	674-545	NR
4 Cyl - 1.5L (1493cc)	1989-88	-	674-545	NR
HUMMER				
H2				
8 Cyl - 6.0L (364 CID)	2006-03	-	674-522	—
HYUNDAI				
ACCENT				
4 Cyl - 1.5L (1495 cc)	2002	Exc. Calif	674-596	NR
4 Cyl - 1.5L (1495 cc)	2001-00	SOHC; Exc. Calif	674-596	NR
4 Cyl - 1.6L (1600 cc)	2001	SOHC; Exc. Calif	674-596	NR
ELANTRA				
4 Cyl - 1.8L (1795cc)	1997-96	-	674-507	NR
4 Cyl - 2.0L (1975 cc)	2000-99	Exc. Calif	674-551	NR
EXCEL				
4 Cyl - 1.5L (1468cc)	1989	-	674-172	NR
TIBURON				
4 Cyl - 1.8L (1795cc)	1997	-	674-507	NR
4 Cyl - 2.0L (1974cc)	1998	-	674-507	NR
4 Cyl - 2.0L (1997 cc)	2001-99	Exc. Calif	674-551	NR
INFINITI				
I30				
6 Cyl - 3.0L (2988 cc)	2001-00	-	—	674-578
6 Cyl - 3.0L (2988 cc)	1999	Exc. Calif	674-579	674-578
6 Cyl - 3.0L (2988 cc)	1998-96	-	674-579	674-578
QX4				
6 Cyl - 3.3L (3275cc)	2000-97	-	674-431	674-432
6 Cyl - 3.5L (3500cc)	2003-01	-	674-433	674-434
INTERNATIONAL				
ALL MODELS				
8 Cyl - 5.6L (345 CID)	1983-68	-	674-188	674-188
8 Cyl - 6.4L (392 CID)	1983-68	-	674-187	674-187
8 Cyl - 6.6L (404 CID)	1983-75	-	674-183	674-183
8 Cyl - 7.3L (446 CID)	1983-75	-	674-183	674-183
ISUZU				
I-MARK				
4 Cyl - 1.5L (1471cc)	1989-87	wo/Turbo, 4XC1 Eng	674-175	NR
STYLUS				
4 Cyl - 1.6L (1588cc)	1993-91	w/Single Cam, Exc. XS Series	674-180	NR
ISUZU TRUCK				
AMIGO				
4 Cyl - 2.6L (2559cc)	1992-89	Exc. Calif, 4ZE1 Eng	674-248	NR
HOMBRE				
4 Cyl - 2.2L (2180cc)	2000-98	-	674-400	NR
PICKUP				
4 Cyl - 2.6L (2559cc)	1992-89	Exc. Calif, 4ZE1 Eng	674-248	NR
4 Cyl - 2.6L (2559cc)	1988	4ZE1 Eng	674-248	NR
RODEO				
4 Cyl - 2.6L (2559cc)	1992-91	4ZE1 Eng	674-248	NR
TROOPER				
4 Cyl - 2.6L (2559cc)	1991-88	4ZE1 Eng	674-248	NR
JEEP				
CHEROKEE				
4 Cyl - 2.5L (150 CID)	2000-84	Cast Iron	674-225	NR
6 Cyl - 4.0L (242 CID)	2001-00	-	674-467	674-468
6 Cyl - 4.0L (242 CID)	1999-91	-	674-196	NR
6 Cyl - 4.0L (242 CID)	1990-87	-	674-170	NR
6 Cyl - 4.2L (258 CID)	1983-81	-	674-237	NR
6 Cyl - 4.2L (258 CID)	1979-75	-	674-235	NR

Make/Model/Eng	Years	Description	LH/Front	RH/Rear
JEEP (continued)				
CHEROKEE (continued)				
6 Cyl - 4.2L (258 CID)	1974	wo/Air Pump	674-235	NR
CJ SERIES				
4 Cyl - 2.5L (150 CID)	1985-83	Cast Iron, AMC Eng	674-225	NR
6 Cyl - 3.8L (232 CID)	1978-75	-	674-235	NR
6 Cyl - 3.8L (232 CID)	1974	wo/Air Pump	674-235	NR
6 Cyl - 3.8L (232 CID)	1972	-	674-235	NR
6 Cyl - 4.2L (258 CID)	1986-81	-	674-237	NR
6 Cyl - 4.2L (258 CID)	1979-75	-	674-235	NR
6 Cyl - 4.2L (258 CID)	1974-73	wo/Air Pump	674-235	NR
6 Cyl - 4.2L (258 CID)	1972	-	674-235	NR
COMANCHE				
4 Cyl - 2.5L (150 CID)	1992-86	Cast Iron	674-225	NR
6 Cyl - 4.0L (242 CID)	1992-91	-	674-196	NR
6 Cyl - 4.0L (242 CID)	1990-87	-	674-170	NR
DJ5, JEEPSTER				
6 Cyl - 3.8L (232 CID)	1974	wo/Air Pump	674-235	NR
6 Cyl - 3.8L (232 CID)	1972	-	674-235	NR
6 Cyl - 4.2L (258 CID)	1974-73	wo/Air Pump	674-235	NR
6 Cyl - 4.2L (258 CID)	1972	-	674-235	NR
GRAND CHEROKEE				
6 Cyl - 4.0L (242 CID)	2004-99	-	674-467	674-468
6 Cyl - 4.0L (242 CID)	1998-93	-	674-196	NR
GRAND WAGONEER				
6 Cyl - 4.2L (258 CID)	1986-84	-	674-237	NR
8 Cyl - 5.9L (360 CID)	1991-87	-	674-393	674-392
PICKUP, GLADIATOR, J-SERIES				
6 Cyl - 3.8L (232 CID)	1971-65	wo/Air Pump	674-235	NR
6 Cyl - 4.2L (258 CID)	1987-81	-	674-237	NR
6 Cyl - 4.2L (258 CID)	1979-75	-	674-235	NR
6 Cyl - 4.2L (258 CID)	1974-72	wo/Air Pump	674-235	NR
8 Cyl - 5.9L (360 CID)	1988-87	-	674-393	674-392
SCRAMBLER				
4 Cyl - 2.5L (150 CID)	1985-83	Cast Iron, AMC Eng	674-225	NR
6 Cyl - 4.2L (258 CID)	1985-81	-	674-237	NR
WAGONEER				
4 Cyl - 2.5L (150 CID)	1987-84	Cast Iron	674-225	NR
6 Cyl - 4.0L (242 CID)	1990-87	-	674-170	NR
6 Cyl - 4.2L (258 CID)	1983-81	-	674-237	NR
6 Cyl - 4.2L (258 CID)	1973-72	wo/Air Pump	674-235	NR
WRANGLER				
4 Cyl - 2.5L (150 CID)	2002-87	Cast Iron	674-225	NR
6 Cyl - 4.0L (242 CID)	2005-00	-	674-467	674-468
6 Cyl - 4.0L (242 CID)	1999-91	-	674-196	NR
6 Cyl - 4.2L (258 CID)	1990-87	-	674-237	NR
LINCOLN				
BLACKWOOD				
8 Cyl - 5.4L (330 CID)	2002	To 10/15/01	674-461	—
CONTINENTAL				
6 Cyl - 3.8L (232 CID)	1994-88	VIN 4	674-195	674-194
8 Cyl - 4.6L (281 CID)	2002-98	-	674-450	674-455
8 Cyl - 5.0L (302 CID)	1987-86	-	674-184	674-153
8 Cyl - 5.0L (302 CID)	1985-80	-	—	674-236
LS				
6 Cyl - 3.0L (182 CID)	2002-00	w/Thermactor	674-452	—
MARK SERIES				
8 Cyl - 5.0L (302 CID)	1992-88	-	674-190	674-191
8 Cyl - 5.0L (302 CID)	1987-86	w/High Output	674-190	674-191
8 Cyl - 5.0L (302 CID)	1987-86	wo/High Output	674-184	674-191
8 Cyl - 5.0L (302 CID)	1985-80	-	—	674-236
NAVIGATOR				
8 Cyl - 5.4L (330 CID)	2002-99	-	674-461	—
8 Cyl - 5.4L (330 CID)	1998	-	674-399	674-398
TOWN CAR				
8 Cyl - 4.6L (281 CID)	2002-95	-	674-558	674-557
8 Cyl - 5.0L (302 CID)	1990-86	-	674-184	674-153
8 Cyl - 5.0L (302 CID)	1985-82	-	—	674-236
VERSAILLES				
8 Cyl - 5.0L (302 CID)	1980	-	—	674-236
MAZDA				
PROTEGE				
4 Cyl - 1.5L (1489cc)	1998-95	-	674-247	NR
MERCURY				
CAPRI				
4 Cyl - 2.3L (140 CID)	1983	wo/A.I.R.	674-230	NR
8 Cyl - 4.2L (255 CID)	1982-80	-	—	674-236
8 Cyl - 5.0L (302 CID)	1986	-	674-190	674-191
8 Cyl - 5.0L (302 CID)	1983-82	-	—	674-236
COLONY PARK				
8 Cyl - 5.0L (302 CID)	1991-86	-	674-184	674-153

Exhaust Manifold Kit Applications

Make/Model/Eng	Years	Description	LH/Front	RH/Rear
MERCURY (continued)				
COLONY PARK (continued)				
8 Cyl - 5.0L (302 CID)	1985-80	-	—	674-236
8 Cyl - 6.6L (400 CID)	1976-75	-	674-193	—
COUGAR				
6 Cyl - 2.5L (155 CID)	2000-99	-	674-594	674-595
8 Cyl - 4.2L (255 CID)	1982-80	-	—	674-236
8 Cyl - 4.6L (281 CID)	1997-94	-	674-466	—
8 Cyl - 5.0L (302 CID)	1988-86	-	674-184	674-153
8 Cyl - 5.0L (302 CID)	1985-80	-	—	674-236
8 Cyl - 5.8L (351M)	1979-75	8-Bolt Valve Cover	674-193	—
8 Cyl - 6.6L (400 CID)	1978-75	-	674-193	—
GRAND MARQUIS				
8 Cyl - 4.2L (255 CID)	1982-81	-	—	674-236
8 Cyl - 4.6L (281 CID)	2002-95	-	674-558	674-557
8 Cyl - 5.0L (302 CID)	1991-86	-	674-184	674-153
8 Cyl - 5.0L (302 CID)	1985-80	-	—	674-236
8 Cyl - 5.8L (351M)	1978	8-Bolt Valve Cover	674-193	—
8 Cyl - 6.6L (400 CID)	1978-75	-	674-193	—
LYNX				
4 Cyl - 1.9L (116 CID)	1987	-	674-274	NR
MARQUIS				
4 Cyl - 2.3L (140 CID)	1984-83	wo/A.I.R.	674-230	NR
8 Cyl - 4.2L (255 CID)	1982-81	-	—	674-236
8 Cyl - 5.0L (302 CID)	1982-80	-	—	674-236
8 Cyl - 5.8L (351M)	1978	8-Bolt Valve Cover	674-193	—
8 Cyl - 6.6L (400 CID)	1978-75	-	674-193	—
MONARCH				
8 Cyl - 4.2L (255 CID)	1980	-	—	674-236
8 Cyl - 5.0L (302 CID)	1980	-	—	674-236
MONTEGO				
8 Cyl - 5.8L (351M)	1976-75	8-Bolt Valve Cover	674-193	—
8 Cyl - 6.6L (400 CID)	1976-75	-	674-193	—
MONTEREY				
6 Cyl - 3.9L (238 CID)	2004	To 4/5/04	674-367	—
6 Cyl - 4.2L (256 CID)	2004	To 4/5/04	674-367	—
MOUNTAINEER				
6 Cyl - 4.0L (245 CID)	2000	SOHC, VIN E, To 3/2000	674-465	674-376
6 Cyl - 4.0L (245 CID)	1999-98	SOHC, VIN E	674-465	674-376
8 Cyl - 5.0L (302 CID)	2001-99	-	674-334	674-329
8 Cyl - 5.0L (302 CID)	1998	From 2/98	674-334	674-329
8 Cyl - 5.0L (302 CID)	1998	To 2/98	674-356	674-357
8 Cyl - 5.0L (302 CID)	1997	-	674-356	674-357
MYSTIQUE				
6 Cyl - 2.5L (155 CID)	2000-98	-	674-594	674-595
SABLE				
4 Cyl - 2.5L (153 CID)	1986	Cast Iron	674-151	NR
6 Cyl - 3.0L (182 CID)	2006-04	12 Valve, VIN U	674-363	—
6 Cyl - 3.0L (182 CID)	2006-00	24 Valve, VIN S	674-449	—
6 Cyl - 3.0L (182 CID)	2003-00	12 Valve, VIN U	674-363	674-566
6 Cyl - 3.0L (182 CID)	1999-97	12 Valve, VIN U	674-365	674-362
6 Cyl - 3.0L (182 CID)	1996	12 Valve, VIN U	674-365	674-362
6 Cyl - 3.0L (182 CID)	1996	24 Valve, VIN S	674-456	—
6 Cyl - 3.0L (182 CID)	1995-94	Calif	674-360	—
6 Cyl - 3.0L (182 CID)	1995-94	Exc. Calif	674-360	674-359
6 Cyl - 3.0L (182 CID)	1993-86	-	674-179	674-178
6 Cyl - 3.8L (232 CID)	1995-88	VIN 4	674-195	674-194
TOPAZ				
4 Cyl - 2.3L (140 CID)	1994-85	Cast Iron	674-150	NR
4 Cyl - 2.3L (140 CID)	1984	-	674-327	NR
TRACER				
4 Cyl - 1.8L (112 CID)	1996-91	-	674-358	NR
4 Cyl - 1.9L (116 CID)	1996-93	-	674-280	NR
4 Cyl - 1.9L (116 CID)	1992-91	-	674-343	NR
4 Cyl - 2.0L (122 CID)	1999-97	SOHC, VIN P	674-394	NR
ZEPHYR				
4 Cyl - 2.3L (140 CID)	1983	wo/A.I.R.	674-230	NR
8 Cyl - 4.2L (255 CID)	1982-80	-	—	674-236

Make/Model/Eng	Years	Description	LH/Front	RH/Rear
MITSUBISHI (continued)				
GALANT (continued)				
4 Cyl - 2.0L (1997cc)	1992-91	wo/Turbo	674-287	NR
4 Cyl - 2.0L (1997cc)	1990-89	wo/Turbo	674-287	NR
MIRAGE				
4 Cyl - 1.5L (1468cc)	1996-94	2-Door	674-520	NR
4 Cyl - 1.5L (1468cc)	1992-87	-	674-263	NR
4 Cyl - 1.6L (1595cc)	1992-89	-	674-263	NR
4 Cyl - 1.8L (1834cc)	1996-94	2-Door	674-520	NR
PRECIS				
4 Cyl - 1.5L (1468cc)	1989	-	674-172	NR
NISSAN				
ALTIMA				
4 Cyl - 2.4L (2389cc)	2001-98	-	674-508	NR
MAXIMA				
6 Cyl - 3.0L (2960cc)	1994-90	SOHC, VG30E Eng	—	674-224
6 Cyl - 3.0L (2988 cc)	2001-99	Exc. Calif	674-579	674-578
6 Cyl - 3.0L (2988 cc)	1998-95	-	674-579	674-578
SENTRA				
4 Cyl - 1.6L (1590cc)	1987	From 4/86, E16S Eng	674-181	NR
NISSAN TRUCK				
FRONTIER				
4 Cyl - 2.4L (2389 cc)	2001-98	2WD (Exc.Calif)	674-589	NR
PATHFINDER				
6 Cyl - 3.0L (2960cc)	1995-90	VG30E Eng	674-552	674-223
6 Cyl - 3.0L (2960cc)	1989-87	VG30I Eng	674-440	674-223
6 Cyl - 3.3L (3275cc)	2000-96	-	674-431	674-432
6 Cyl - 3.5L (3500cc)	2005-01	-	674-433	674-434
PICKUP, D21 PICKUP				
4 Cyl - 2.4L (2389cc)	1993-90	KA24E Eng	674-549	NR
4 Cyl - 2.4L (2389cc)	1989-88	2WD, Z24i Eng	674-220	NR
4 Cyl - 2.4L (2389cc)	1987-86	Z24i Eng	674-220	NR
6 Cyl - 3.0L (2960cc)	1995-90	-	674-552	674-223
6 Cyl - 3.0L (2960cc)	1989-86	-	674-440	674-223
OLDSMOBILE				
88				
6 Cyl - 3.8L (231 CID)	1995	VIN 1	674-577	—
6 Cyl - 3.8L (231 CID)	1994-93	-	674-577	—
98				
6 Cyl - 3.8L (231 CID)	1996	-	674-540	—
6 Cyl - 3.8L (231 CID)	1995	VIN 1	674-577	—
6 Cyl - 3.8L (231 CID)	1995	VIN K	674-540	—
6 Cyl - 3.8L (231 CID)	1994-93	-	674-577	—
ACHIEVA				
6 Cyl - 3.1L (189 CID)	1998-97	-	674-544	674-567
6 Cyl - 3.1L (189 CID)	1996-94	-	674-544	—
6 Cyl - 3.3L (204 CID)	1993-92	-	—	674-526
ALERO				
6 Cyl - 3.4L (207 CID)	2003-99	-	674-544	674-567
BRAVADA				
6 Cyl - 4.3L (262 CID)	2001-98	w/Air Pump	674-570	674-569
6 Cyl - 4.3L (262 CID)	2001-98	wo/Air Pump	674-212	674-211
6 Cyl - 4.3L (262 CID)	1997-96	-	674-212	674-211
6 Cyl - 4.3L (262 CID)	1994-93	-	674-208	674-210
6 Cyl - 4.3L (262 CID)	1992-91	-	674-208	674-210
CUSTOM CRUISER				
8 Cyl - 5.7L (350 CID)	1977	VIN L	674-197	674-202
CUTLASS				
6 Cyl - 3.1L (189 CID)	1999-97	-	674-544	674-567
8 Cyl - 5.0L (305 CID)	1980	-	674-276	—
8 Cyl - 5.7L (350 CID)	1979-78	VIN L	674-197	—
CUTLASS CALAIS				
4 Cyl - 2.5L (151 CID)	1987-85	-	674-101	NR
6 Cyl - 3.3L (204 CID)	1991-89	-	—	674-526
CUTLASS CIERA				
4 Cyl - 2.2L (134 CID)	1996-94	-	674-575	NR
4 Cyl - 2.5L (151 CID)	1987-85	-	674-101	NR
6 Cyl - 3.1L (189 CID)	1996-94	-	674-544	674-269
6 Cyl - 3.3L (204 CID)	1993-89	-	—	674-526
CUTLASS SUPREME				
6 Cyl - 3.1L (189 CID)	1997	-	674-544	674-567
6 Cyl - 3.1L (189 CID)	1996-94	-	674-544	674-269
6 Cyl - 3.1L (189 CID)	1993	VIN M	674-544	674-269
DELTA 88				
6 Cyl - 3.8L (231 CID)	1999-95	-	674-540	674-568
8 Cyl - 5.7L (350 CID)	1977	VIN G, L	674-197	674-202
FIRENZA				
4 Cyl - 2.0L (122 CID)	1986-85	-	674-102T	NR
INTRIGUE				
6 Cyl - 3.8L (231 CID)	1999-98	-	674-540	674-541

Exhaust Manifold Kits

Fuel Sending Units
pg. 155-176

Fuel Tanks
pg. 177-228

Harmonic Balancers
pg. 229-254

Heater Hose Assemblies
pg. 255-256

Hydraulic Clutch Lines
pg. 257-260

Gaskets and Hardware Included Where Required

Exhaust Manifold Kits

Exhaust Manifold Kit Applications

Make/Model/Eng	Years	Description	LH/Front	RH/Rear
OLDSMOBILE (continued)				
LSS				
6 Cyl - 3.8L (231 CID)	1999-97	-	674-540	674-568
6 Cyl - 3.8L (231 CID)	1996	VIN 1	674-577	—
6 Cyl - 3.8L (231 CID)	1996	VIN K	674-540	—
OMEGA				
8 Cyl - 5.0L (305 CID)	1979-77	-	674-197	674-202
8 Cyl - 5.7L (350 CID)	1979-77	VIN L	674-197	674-202
SILHOUETTE				
6 Cyl - 3.4L (207 CID)	2003-96	-	674-544	674-567
6 Cyl - 3.8L (231 CID)	1995-93	-	674-577	—
PLYMOUTH				
ACCLAIM				
6 Cyl - 3.0L (181 CID)	1995-93	Auto Trans	674-515	674-592
6 Cyl - 3.0L (181 CID)	1995-93	Manual Trans	674-515	674-511
6 Cyl - 3.0L (181 CID)	1992-89	Calif	674-515	674-592
6 Cyl - 3.0L (181 CID)	1992-89	Exc. Calif	674-515	674-511
BARRACUDA, CUDA				
6 Cyl - 3.2L (198 CID)	1972-70	-	674-232	NR
6 Cyl - 3.7L (225 CID)	1972-70	-	674-232	NR
BELVEDERE				
6 Cyl - 3.7L (225 CID)	1970	-	674-232	NR
BREEZE				
4 Cyl - 2.0L (122 CID)	2000-98	-	674-441	NR
4 Cyl - 2.0L (122 CID)	1997-96	-	674-435	NR
4 Cyl - 2.4L (148 CID)	2000-95	Solid Flange	674-282	NR
4 Cyl - 2.4L (148 CID)	2000-95	Split Flange	674-463	NR
COLT				
4 Cyl - 1.5L (1468cc)	1994-93	Calif	674-520	NR
4 Cyl - 1.5L (1468cc)	1992-91	-	674-263	NR
4 Cyl - 1.5L (1468cc)	1990	Wagon	674-263	NR
4 Cyl - 1.5L (1468cc)	1989-87	Sedan & Wagon	674-263	NR
4 Cyl - 1.6L (1595cc)	1990-89	-	674-263	NR
4 Cyl - 1.8L (1755cc)	1990-89	-	674-533	NR
DUSTER				
6 Cyl - 3.2L (198 CID)	1974-70	-	674-232	NR
6 Cyl - 3.7L (225 CID)	1976-70	-	674-232	NR
FURY, GRAN FURY				
6 Cyl - 3.7L (225 CID)	1983-70	-	674-232	NR
8 Cyl - 5.2L (318 CID)	1978-77	w/Air Pump	—	674-234
8 Cyl - 5.9L (360 CID)	1980	4-Bbl, Hi-Perf	—	674-234
8 Cyl - 5.9L (360 CID)	1978-77	w/Air Pump	—	674-234
LASER				
4 Cyl - 1.8L (107 CID)	1994-90	-	674-533	NR
4 Cyl - 2.0L (1997cc)	1994-90	Turbo, w/AT	674-266	NR
4 Cyl - 2.0L (1997cc)	1994-90	Turbo, w/MT	674-265	NR
4 Cyl - 2.0L (1997cc)	1994-90	wo/Turbo	674-287	NR
NEON				
4 Cyl - 2.0L (122 CID)	2001	Exc. R/T Model	674-588	NR
4 Cyl - 2.0L (122 CID)	2000	DOHC, VIN Y	674-281	NR
4 Cyl - 2.0L (122 CID)	2000	SOHC, VIN C	674-588	NR
4 Cyl - 2.0L (122 CID)	1999-95	DOHC, VIN Y	674-281	NR
4 Cyl - 2.0L (122 CID)	1999-95	SOHC, VIN C	674-435	NR
RELIANT				
4 Cyl - 2.6L (156 CID)	1984	Calif	674-264	NR
4 Cyl - 2.6L (156 CID)	1983-81	-	674-264	NR
SATELLITE				
6 Cyl - 3.7L (225 CID)	1974-71	-	674-232	NR
SCAMP, VALIANT				
6 Cyl - 3.2L (198 CID)	1974-70	-	674-232	NR
6 Cyl - 3.7L (225 CID)	1976-70	-	674-232	NR
SUNDANCE				
6 Cyl - 3.0L (181 CID)	1994-93	Auto Trans	674-515	674-592
6 Cyl - 3.0L (181 CID)	1994-93	Manual Trans	674-515	674-511
6 Cyl - 3.0L (181 CID)	1992	Calif	674-515	674-592
6 Cyl - 3.0L (181 CID)	1992	Exc. Calif	674-515	674-511
VOLARE				
6 Cyl - 3.7L (225 CID)	1980-76	-	674-232	NR
8 Cyl - 5.2L (318 CID)	1979-77	w/Air Pump	—	674-234
8 Cyl - 5.9L (360 CID)	1980	4-Bbl, Hi-Perf	—	674-234
8 Cyl - 5.9L (360 CID)	1979	w/Air Pump, Exc. Hi-Perf	—	674-234
8 Cyl - 5.9L (360 CID)	1978-77	w/Air Pump	—	674-234
VOYAGER, GRAND VOYAGER				
4 Cyl - 2.4L (148 CID)	2000-99	-	674-553	NR
4 Cyl - 2.6L (156 CID)	1987-84	Calif	674-264	NR
6 Cyl - 3.0L (181 CID)	2000-96	-	674-515	674-510
6 Cyl - 3.0L (181 CID)	1995-93	Auto Trans	674-515	674-592
6 Cyl - 3.0L (181 CID)	1995-93	Manual Trans	674-515	674-511
6 Cyl - 3.0L (181 CID)	1992-89	Calif	674-515	674-592
6 Cyl - 3.0L (181 CID)	1992-89	Exc. Calif	674-515	674-511
6 Cyl - 3.0L (181 CID)	1988-87	-	674-515	—

Make/Model/Eng	Years	Description	LH/Front	RH/Rear
PLYMOUTH (continued)				
VOYAGER, GRAND VOYAGER (continued)				
6 Cyl - 3.3L (201 CID)	2000-96	-	674-513	674-514
6 Cyl - 3.3L (201 CID)	1995-90	-	674-513	674-528
6 Cyl - 3.8L (230 CID)	1999-96	-	674-513	674-514
PLYMOUTH TRUCK				
PB100/350 VAN, VOYAGER				
6 Cyl - 3.7L (225 CID)	1983-74	-	674-232	NR
8 Cyl - 5.2L (318 CID)	1983	2-Bbl, Calif or Hi-Alt	674-233	—
8 Cyl - 5.2L (318 CID)	1983	4-Bbl	674-233	—
8 Cyl - 5.2L (318 CID)	1983	4-Bbl, 1-Ton, Exc. Calif	674-233	674-234
8 Cyl - 5.2L (318 CID)	1983	4-Bbl, 3/4-Ton	674-233	674-234
8 Cyl - 5.2L (318 CID)	1982	4-Bbl	674-233	—
8 Cyl - 5.2L (318 CID)	1982	4-Bbl, 1-Ton, Exc. Calif	674-233	674-234
8 Cyl - 5.2L (318 CID)	1982	4-Bbl, 1/2 & 3/4 Ton	674-233	674-234
8 Cyl - 5.2L (318 CID)	1981	4-Bbl, Calif	674-233	—
8 Cyl - 5.2L (318 CID)	1981	4-Bbl, Calif, Light Duty	674-233	674-234
8 Cyl - 5.2L (318 CID)	1981	4-Bbl, Heavy Duty, 1-Ton	674-233	—
8 Cyl - 5.2L (318 CID)	1980	4-Bbl, 3/4 & 1 Ton, Exc. Heavy Duty	674-233	674-234
8 Cyl - 5.2L (318 CID)	1980	4-Bbl, Exc. 3/4 & 1 Ton, Exc. Heavy Duty	674-233	—
8 Cyl - 5.2L (318 CID)	1979	4-Bbl, Calif, 1/2 Ton	674-233	674-234
8 Cyl - 5.2L (318 CID)	1979	4-Bbl, Exc. Calif, 1/2 Ton	674-233	—
8 Cyl - 5.2L (318 CID)	1978	4-Bbl, Calif	674-233	674-234
8 Cyl - 5.2L (318 CID)	1978	Exc. 4-Bbl, Calif	674-233	—
8 Cyl - 5.9L (360 CID)	1983-82	4-Bbl	674-233	—
8 Cyl - 5.9L (360 CID)	1981	4-Bbl, Heavy Duty	674-233	—
8 Cyl - 5.9L (360 CID)	1981	4-Bbl, Light Duty, Calif	674-233	674-234
8 Cyl - 5.9L (360 CID)	1980	4-Bbl, Medium & Heavy Duty	674-233	—
8 Cyl - 5.9L (360 CID)	1979	2-Bbl, Light Duty	674-233	—
8 Cyl - 5.9L (360 CID)	1979	4-Bbl	674-233	—
8 Cyl - 5.9L (360 CID)	1978	Calif	674-233	—
TRAILDUSTER				
6 Cyl - 3.7L (225 CID)	1980-75	-	674-232	NR
8 Cyl - 5.2L (318 CID)	1981	4-Bbl, Calif, Exc. Heavy Duty	674-233	674-234
8 Cyl - 5.2L (318 CID)	1981	4-Bbl, Calif, Heavy Duty	674-233	—
8 Cyl - 5.2L (318 CID)	1980	4-Bbl	674-233	—
8 Cyl - 5.2L (318 CID)	1979	4-Bbl, Calif	674-233	674-234
8 Cyl - 5.2L (318 CID)	1979	4-Bbl, Exc. Calif	674-233	—
8 Cyl - 5.2L (318 CID)	1978	Calif	674-233	—
8 Cyl - 5.9L (360 CID)	1981	4-Bbl, Exc. Heavy Duty, Calif	674-233	674-234
8 Cyl - 5.9L (360 CID)	1981	4-Bbl, Heavy Duty	674-233	—
8 Cyl - 5.9L (360 CID)	1980	4-Bbl, 2WD, Leaded Fuel	674-233	—
8 Cyl - 5.9L (360 CID)	1980	4-Bbl, 4WD, Medium & Heavy Duty	674-233	—
8 Cyl - 5.9L (360 CID)	1979	2-Bbl, Light Duty	674-233	—
8 Cyl - 5.9L (360 CID)	1979	4-Bbl	674-233	—
8 Cyl - 5.9L (360 CID)	1978	Calif	674-233	—
8 Cyl - 6.6L (400 CID)	1978-74	Rear Dump	—	674-275
8 Cyl - 6.6L (400 CID)	1978-74	wo/Heat Tube	674-176	—
8 Cyl - 7.2L (440 CID)	1978-74	Rear Dump	—	674-275
8 Cyl - 7.2L (440 CID)	1978-74	wo/Heat Tube	674-176	—
PONTIAC				
6000				
4 Cyl - 2.5L (151 CID)	1987-85	-	674-101	NR
AZTEK				
6 Cyl - 3.4L (207 CID)	2003-01	-	674-544	674-567
BONNEVILLE				
6 Cyl - 3.8L (231 CID)	2005-97	-	674-540	674-568
6 Cyl - 3.8L (231 CID)	1996	-	674-540	—
6 Cyl - 3.8L (231 CID)	1995	VIN 1	674-577	—
6 Cyl - 3.8L (231 CID)	1995	VIN K	674-540	—
6 Cyl - 3.8L (231 CID)	1994-93	-	674-577	—
8 Cyl - 5.0L (305 CID)	1986-83	-	674-276	—
CATALINA				
8 Cyl - 5.0L (305 CID)	1977	VIN H	674-197	—
8 Cyl - 5.0L (305 CID)	1977	VIN U	—	674-202
FIERO				
4 Cyl - 2.5L (151 CID)	1987	-	674-101	NR
FIREBIRD				
6 Cyl - 2.8L (173 CID)	1989-85	-	674-550	—
6 Cyl - 3.1L (189 CID)	1992-90	-	674-550	—
8 Cyl - 5.0L (305 CID)	1992-90	VIN F	674-518	—
8 Cyl - 5.0L (305 CID)	1989-87	VIN F	674-518	674-519
8 Cyl - 5.0L (305 CID)	1981-80	-	674-276	674-202
8 Cyl - 5.0L (305 CID)	1979-77	-	674-197	674-202
8 Cyl - 5.7L (350 CID)	1992-87	-	674-518	674-519

Exhaust Manifold Kit Applications

Make/Model/Eng	Years	Description	LH/Front	RH/Rear	Make/Model/Eng	Years	Description	LH/Front	RH/Rear
PONTIAC (continued)					TOYOTA (continued)				
FIREBIRD (continued)					COROLLA				
8 Cyl - 5.7L (350 CID)	1979-78	-	674-197	—	4 Cyl - 1.6L (1587 cc)	1996-94	Calif	674-556	NR
GRAND AM					4 Cyl - 1.6L (1587cc)	1997	4AFE Eng	674-164	NR
4 Cyl - 2.0L (122 CID)	1989-87	w/Turbo, VIN M	674-102	NR	4 Cyl - 1.6L (1587cc)	1993	4AFE Eng, To 3/93	674-164	NR
4 Cyl - 2.5L (151 CID)	1987-85	-	674-101	NR	4 Cyl - 1.6L (1587cc)	1992-90	4AFE Eng	674-164	NR
6 Cyl - 3.1L (189 CID)	1998-94	-	674-544	—	4 Cyl - 1.6L (1587cc)	1989-88	4AF Eng	674-164	NR
6 Cyl - 3.3L (204 CID)	1993-92	-	—	674-526	4 Cyl - 1.8L (1762 cc)	1996-94	Calif	674-556	NR
6 Cyl - 3.4L (207 CID)	2003-99	-	674-544	674-567	4 Cyl - 1.8L (1762cc)	2002-98	1ZZFE Eng	674-546	NR
8 Cyl - 5.0L (305 CID)	1980	-	674-276	—	4 Cyl - 1.8L (1762cc)	1997	7AFE Eng	674-164	NR
GRAND PRIX					4 Cyl - 1.8L (1762cc)	1993	7AFE Eng, To 3/93	674-164	NR
6 Cyl - 3.1L (189 CID)	2003-97	-	674-544	674-567	TOYOTA TRUCK				
6 Cyl - 3.1L (189 CID)	1996-94	-	674-544	674-269	4 RUNNER				
6 Cyl - 3.8L (231 CID)	2004-00	Calif	674-540	674-541	4 Cyl - 2.4L (2366cc)	1995-90	22RE Eng	674-272	NR
6 Cyl - 3.8L (231 CID)	2004-00	Exc. Calif	674-540	674-541	4 Cyl - 2.4L (2366cc)	1989-85	22REC Eng	674-272	NR
6 Cyl - 3.8L (231 CID)	1999-97	-	674-540	674-541	4 Cyl - 2.7L (2694cc)	2000	Exc. Calif	674-464	NR
8 Cyl - 5.0L (305 CID)	1986-80	-	674-276	—	4 Cyl - 2.7L (2694cc)	1999-96	-	674-464	NR
LEMANS, GRAND LEMANS					PICKUP				
8 Cyl - 5.0L (305 CID)	1980	-	674-276	—	4 Cyl - 2.4L (2366cc)	1995-90	22RE Eng	674-272	NR
8 Cyl - 5.0L (305 CID)	1977	-	674-197	674-202	4 Cyl - 2.4L (2366cc)	1990-85	22R Eng	674-272	NR
8 Cyl - 5.7L (350 CID)	1979-78	-	674-197	—	4 Cyl - 2.4L (2366cc)	1988-85	22REC Eng	674-272	NR
MONTANA					RAV4				
6 Cyl - 3.4L (207 CID)	2003-99	-	674-544	674-567	4 Cyl - 2.0L (1998 cc)	2003	-	674-593	NR
PARISIENNE					T100				
8 Cyl - 5.0L (305 CID)	1986-83	-	674-276	—	4 Cyl - 2.7L (2694cc)	1998-94	-	674-464	NR
PHOENIX					TACOMA				
8 Cyl - 5.0L (305 CID)	1979-77	-	674-197	674-202	4 Cyl - 2.4L (2438cc)	2001-00	Exc. Calif	674-464	NR
8 Cyl - 5.7L (350 CID)	1979-77	VIN L	674-197	674-202	4 Cyl - 2.4L (2438cc)	1999-95	-	674-464	NR
SUNBIRD					4 Cyl - 2.7L (2694cc)	2001-00	Exc. Calif	674-464	NR
4 Cyl - 2.0L (122 CID)	1990-87	w/Turbo, VIN M	674-102	NR	4 Cyl - 2.7L (2694cc)	1999-95	-	674-464	NR
4 Cyl - 2.0L (122 CID)	1986-85	-	674-102T	NR	VOLVO				
SUNFIRE					850				
4 Cyl - 2.2L (134 CID)	2002-98	VIN 4	674-571	NR	5 Cyl - 2.4L (2435 cc)	1997-96	20 Valve, w/EGR Valve, Exc. Turbo (B5254FS Eng)	674-585	NR
4 Cyl - 2.2L (134 CID)	1997-95	-	674-575	NR	5 Cyl - 2.4L (2435 cc)	1995-94	10 Valve, Exc. Turbo (B5254FS Eng)	674-584	NR
TRANS SPORT					5 Cyl - 2.4L (2435 cc)	1995-94	20 Valve, AT, Exc. Turbo (B5254FS Eng)	674-585	NR
6 Cyl - 3.4L (207 CID)	1998-96	-	674-544	674-567	5 Cyl - 2.4L (2435 cc)	1993	10 Valve, Exc. Turbo (B5254FS Eng)	674-584	NR
6 Cyl - 3.8L (231 CID)	1995-93	-	674-577	—	C70				
VENTURA					S70				
8 Cyl - 5.0L (305 CID)	1977	VIN U	674-197	674-202	5 Cyl - 2.4L (2435 cc)	2000-98	FWD, Exc. Turbo (B5254FS Eng)	674-585	NR
8 Cyl - 5.7L (350 CID)	1977	VIN L	674-197	674-202	V70				
SUZUKI					5 Cyl - 2.4L (2435 cc)				
SWIFT					2000-98				
4 Cyl - 1.3L (1298cc)	1994-89	DOHC, GT Series	674-160	NR	FWD, Exc. Turbo (B5254FS Eng)				
TOYOTA					674-585				
CAMRY					NR				
4 Cyl - 2.2L (2164cc)	1996-92	Exc. Calif	674-469	NR	S70				
CELICA					5 Cyl - 2.4L (2435 cc)				
4 Cyl - 1.6L (1587cc)	1993-90	Calif, 4AFE Eng	674-164	NR	2004-01				
4 Cyl - 1.6L (1587cc)	1993-90	Exc. Calif, 4AFE Eng	674-251	NR	FWD, Exc. Turbo (B5244S Eng)				
4 Cyl - 1.8L (1762 cc)	1995-94	VIN 7AFE	674-556	NR	674-585				
4 Cyl - 1.8L (1762cc)	1997	7AFE Eng	674-164	NR	NR				
4 Cyl - 1.8L (1762cc)	1996	7AFE Eng, From 3/96	674-164	NR	5 Cyl - 2.4L (2435 cc)				
4 Cyl - 2.4L (2366cc)	1985	22REC Eng	674-272	NR	2000-98				

Exhaust Manifold Kits



Dorman warrants that its catalytic converters are free from defect in materials and workmanship. This catalytic converter has been designed and manufactured to meet State (except California unless otherwise designated) and Federal emission reduction requirements; and, when the vehicle is properly maintained, the catalytic converter is warranted to meet such requirements for 25,000 miles from the time of the installation and it will not constitute a safety hazard. This catalytic converter has been designed and manufactured to meet these warranty requirements.

The manufacturer's warranty is void if the catalytic converter is not properly installed on the vehicle for which it is designed and cataloged; if the catalytic converter has been altered or repaired or damaged by negligence, accident or mishandling. Dorman assumes no liability for catalytic converter failures related to engines not operating within original equipment specification, to vehicles with modified exhaust emission control systems or to the use of leaded fuel.

As Dorman's sole obligation, and as customer's sole and exclusive remedy, Dorman will replace any such defective converter provided that it be returned to an authorized dealer along with proof of purchase and properly completed warranty certificate. If a warranty claim is related to emission performance, proof of failure of an emission test must be provided. Documentation showing the vehicle's current state of tune is also required. Dorman reserves the right to determine what constitutes vehicle's proper operating condition. No other warranty expressed or implied, including merchantability, applies to the catalytic converter, nor is any person or company authorized to assume any other warranty. Dorman does not assume any responsibility for any consequential damages occasioned by the catalytic converter, or inconvenience or interruption in any operation.

Exhaust Manifold Mounting Bolt Torque Specs

Dorman Part #	Torque (Ft. Lbs.)	Dorman Part #	Torque (Ft. Lbs.)	Dorman Part #	Torque (Ft. Lbs.)	Dorman Part #	Torque (Ft. Lbs.)
674-100	32	674-216	24	674-365	15-18	674-502	25
674-101	36	674-217	24	674-366	15-18	674-503	25
674-102	16	674-218	24	674-367	15-18	674-504	25
674-102T	33-44	674-220	12-15	674-368	25-32	674-505	25
674-150	25-34	674-221	20-30	674-371	25-32	674-506	25
674-151	20-30	674-222	20-30	674-373	25-32	674-507	11-14
674-152	18-24	674-223	12-15	674-376	25-32	674-508	25
674-153	18-24	674-224	13-16	674-378	25-32	674-509	16
674-155	18-24	674-225	31	674-379	25-32	674-510	33
674-156	26	674-226	22-30	674-380	45	674-511	33
674-157	26	674-229	22-30	674-381	45	674-512	33
674-158	26	674-230	20-30	674-383	45	674-513	17
674-159	40	674-231	24	674-385	26	674-514	17
674-160	29-43	674-232	24	674-390	22	674-515	16
674-161	40	674-233	20	674-391	22	674-516	26
674-162	40	674-234	20	674-392	25	674-517	24
674-163	40	674-235	24	674-393	25	674-518	30
674-164	25	674-236	18-24	674-394	15-17	674-519	30
674-165	18-24	674-237	24	674-395	10-12	674-520	11-14
674-166	18-24	674-238	24	674-398	17-20	674-522	18
674-168	30	674-239	24	674-399	17-20	674-525	18
674-169	18-24	674-240	28-35	674-400	10	674-526	38
674-170		674-241	28-35	674-404	15-20	674-527	25
	Bolts #1,12,13 (30 ft. lbs.)	674-244	24	674-405	15-20	674-528	21
	#2-9 (23 ft. lbs.)	674-245	24	674-406	17-20	674-529	23
	#10-11 (17 ft. lbs.)	674-247	14-16	674-407	17-20	674-530	26
674-172	11-14	674-248	25	674-408	19	674-531	26
674-173	22-32	674-249	24	674-410	19	674-532	17
674-174	22-32	674-250	24	674-412	19	674-533	13
674-175	17	674-251	31	674-413	19	674-534	17
674-176	20	674-263	18-22	674-431	28-33	674-535	24
674-178	19	674-264	18-22	674-432	28-33	674-536	24
674-179	19	674-265	18-22	674-433	28-33	674-537	25
674-180	30	674-266	18-22	674-434	28-33	674-538	25
674-181	15	674-267	40	674-435	17	674-540	25
674-182	18-24	674-268	40	674-438	25	674-541	12
674-183	30	674-269	18	674-439	25	674-544	12
674-184	18-24	674-270	20	674-440	13-16	674-545	23
674-185	22-32	674-271	20	674-441	17	674-546	30
674-186	22-32	674-272	30	674-442	25	674-549	17
674-187	-	674-274	15-20	674-444	25	674-550	23
674-188	-	674-275	20	674-446	24	674-552	35
674-189	-	674-278	20	674-447	19	674-553	16
674-190	17-22	674-280	16-19	674-448	14-16	674-554	15
674-191	17-22	674-281	17	674-449	15	674-555	24
674-193	17-22	674-282	17	674-450	14-16	674-556	24
674-194	15-22	674-283	30	674-451	14-16	674-557	26
674-195	15-22	674-284	30	674-452	14-16	674-558	20
674-196	24	674-285	30	674-453	14-16	674-559	18
674-197	20	674-286	28-33	674-454	14-16	674-560	18
674-198	20	674-287	30	674-455	14-16	674-566	18
674-199	20	674-327	20-30	674-456	14-16	674-567	13
674-200	17	674-329	18	674-457	14-16	674-568	22
674-201	20	674-330	16-21	674-458	14-16	674-569	22
674-202	20	674-334	30	674-459	18	674-570	22
674-203	20	674-342	10	674-461	18	674-571	10
674-204	25-35	674-343	30	674-462	18	674-572	22
674-205	25-35	674-356	15-18	674-463	33	674-573	22
674-206	20	674-357	15-18	674-464	36	674-575	10
674-208	24	674-358	28-34	674-465	16	674-577	27
674-210	24	674-359	15-22	674-466	14-16	674-578	22
674-211	24	674-360	15-22	674-467	24	674-579	27
674-212	24	674-361	15-18	674-468	24	674-583	23
674-213	24	674-362	15-18	674-469	16	674-584	17
674-214	24	674-363	15-18	674-500	25	674-585	17
674-215	24	674-364	15-18	674-501	25		

DISCLAIMER: These pages are not intended to replace the information contained in a factory level service manual and is intended solely as a "Quick" reference. While accuracy is a main goal of this page, it is not guaranteed. It is recommended that you consult a factory level service manual before making any repairs to your particular vehicle.

Electronic Fan Clutch



Only Aftermarket Replacement Fan Clutch Priced Competitive to OE!

A Must-Have SKU —

Almost a 100% Failure Rate for GM Light Trucks 2006-02

- Failure-prone OE unit still in production
- OE unit fails, causing overheating, leaving vehicle inoperable
- New electronic technology — Not your traditional mechanical fan clutch
- Direct OE Fit and Function — Easy Installation



622-001
GM, Isuzu & Saab
Light Trucks
2006-02

Direct OE Fit and Function — Easy Installation

Activant Path	<i>Cooling System/ Water Pump, Gasket, Fan & Clutch</i>	Activant Code	<i>DOH</i>
----------------------	---	----------------------	------------

**Applications begin
on page 136.**

Electronic Fan Clutch



622-001

GM

2006-04 Buick Rainier; 2006-02 Chevrolet S10 Trailblazer, GMC S15 Envoy; 2004-02 Oldsmobile Bravada

Related Sales - Radiator Fan Relay

10692

Kit Contains:
1 Rad fan relay
2 Screws
1 Harness

Fits 2000-1996 Chrysler Minivans.
OE# for relay 4707286AF,
Harness 4897034AA.
Kit includes relay, harness and hardware
to properly repair vehicle



Electronic Fan Clutch Applications

Make/Model/Engine	Years	Description	Dorman #
BUICK			
RAINIER			
L6 - 4.2L (256 CID)	2006-04	-	622-001
V8 - 5.3L (323 CID)	2006-04	-	622-001
CHEVROLET TRUCK			
S10 TRAILBLAZER			
L6 - 4.2L (256 CID)	2006-02	-	622-001
V8 - 5.3L (323 CID)	2006-03	-	622-001
V8 - 6.0L (364 CID)	2006	-	622-001
GMC TRUCK			
S15 ENVOY			
L6 - 4.2L (256 CID)	2006-02	-	622-001
V8 - 5.3L (323 CID)	2006-03	-	622-001

Make/Model/Engine	Years	Description	Dorman #
ISUZU			
ASCENDER			
L6 - 4.2L (256 CID)	2006-03	-	622-001
V8 - 5.3L (323 CID)	2006-03	-	622-001
OLDSMOBILE			
BRAVADA			
L6 - 4.2L (256 CID)	2004-02	-	622-001
SAAB			
9-7X			
L6 - 4.2L (256 CID)	2006	-	622-001
V8 - 5.3L (323 CID)	2006	-	622-001

Failure-Prone GM Fan Clutch Now Available in the Aftermarket

It is here! Dorman OE Solutions Electronic Fan Clutch is a “must-have” for Parts Distributors. At a near 100% failure rate, this part is on popular 2006-02 GM Light Trucks/SUVs. The fan clutch is computer controlled and regulates the fan speed. This function is performed through the use of a viscous clutch. The fan assembly fails for a variety of reasons including fluid leaks, improper fan speed and inoperative electrical sensors.

The market potential for this one SKU is huge. And while other Temperature Control Suppliers may offer a similar fan clutch, **no one is as competitively priced as Dorman.** Think about it – how are you supposed to compete with your local OE dealer, who is stocking and selling 30-40 of these fan clutches a year, when you are priced at a huge percentage over what they sell to their installers? The answer is that you can’t compete with that situation. And that is what will happen if you are selling this electronic fan clutch from another aftermarket supplier. This is because other Aftermarket suppliers are simply re-packaging OE product and passing the added costs on to you and your customers. **While these suppliers provide a Fan Clutch that lists over what OE sells to their installers, Dorman list is still below that OE installer price.** This competitive price advantage will allow you to still make a good margin on a well priced SKU while ensuring that you do not lose the sale to the OE dealer.

The new Dorman Electronic Fan Clutch is manufactured to meet or exceed OE quality. In addition, it is covered by the Dorman Limited Lifetime Warranty.

Fan Pulley Brackets



Replace the Piece, NOT the Assembly

Bracket is not available separately from the OE dealer, forcing you to buy unneeded components.



300-801
Toyota 3.0L 4Runner,
Pickup T100
1995-93



OE Brackets
Not Available at the
OE Dealer Separately

Now Available in the Aftermarket

- Support belt-driven fans on rear wheel drive vehicles with internally mounted water pumps
- Also known as a Water Pump Bracket
- Remember to check belt for cracking or glazing

COMMON REASONS FOR FAILURE

*Bearings Seize • Mounts Crack
Collision Repair*



Activant Path	Cooling System/ Radiator Cap, Fan Motor and Switch	Activant Code	DRF
----------------------	--	----------------------	-----

**Applications begin
on page 138.**

Fan Pulley Brackets



300-800

Toyota
1992-88 Toyota Pickups, 4-Runner
(6 cyl.).



300-801

Toyota
1995-93 Toyota Pickups, 4-Runner,
1994-93 T100 (all w/3.0L).



300-802

Toyota
2004-95 Toyota Truck, 4-Runner, T100,
Tacoma, Tundra.



300-803

Isuzu
1994-91 3.2L Isuzu Truck, Passport,
Rodeo, Trooper.



300-806

GM
1996-94 GM Sonoma, S10, Postal Service
Vans L4-2.2L.

Also Available From

Electronic Fan Clutch - pgs. 135-136
Power Steering Pulleys - pgs. 317-326
Smog Pump Pulleys - pgs. 469-472
Idler Pulleys - pg. 322

Fan Pulley Bracket Applications

Make/Model/ Engine	Year	Description	Dorman #
CHEVROLET TRUCK			
POSTAL SERVICE VAN			
L4 - 2.2L (134 CID)	1995-94	-	300-806
S10 PICKUP			
L4 - 2.2L (134 CID)	1996-94	-	300-806
GMC TRUCK			
S15 SONOMA			
L4 - 2.2L (134 CID)	1996-94	-	300-806
HONDA			
PASSPORT			
V6 - 3.2L (3165 cc)	1997-94	-	300-803
ISUZU			
RODEO			
V6 - 3.2L (3165 cc)	1997-94	-	300-803
TROOPER			
V6 - 3.2L (3165 cc)	1997-94	-	300-803

Make/Model/ Engine	Year	Description	Dorman #
TOYOTA TRUCK			
4 RUNNER			
V6 - 3.0L (2959 cc)	1992-88	-	300-800
V6 - 3.4L (3378 cc)	2002-96	-	300-802
PICKUP			
V6 - 3.0L (2959 cc)	1992-88	-	300-800
T100			
V6 - 3.0L (2959 cc)	1994-93	-	300-801
V6 - 3.4L (3378 cc)	1998-95	-	300-802
TACOMA			
V6 - 3.4L (3378 cc)	2000-95	-	300-802
TUNDRA			
V6 - 3.4L (3378 cc)	2004-00	-	300-802
V6 - 3.4L (3378 cc)	1999	From 2/99	300-802

Related Sales - Water Pump Stud Kits

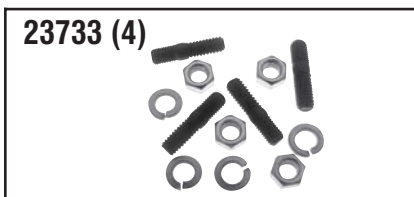

23733 (4)

5/16"-24. Fits most GM water pumps.
Includes 4 studs, 4 nuts and 4 washers.

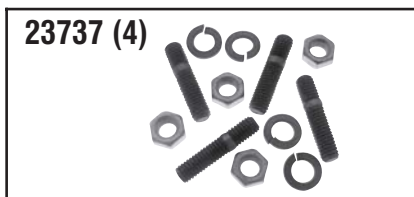

23737 (4)

M8-1.25. Fits S10 Blazer, Jimmy, Pickups,
1994-82. Includes 4 studs, 4 nuts, 4
washers.

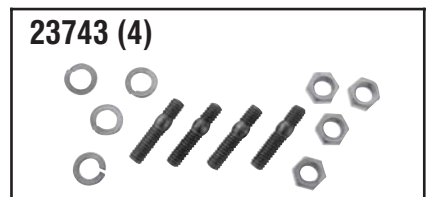

23743 (4)

M6-1.0. Fits imports Honda, Nissan,
Toyota and others. Includes 4 studs, 4
nuts, 4 washers.

Fluid Reservoirs



NEW TO THE AFTERMARKET!

- 9 specific and 1 universal fluid reservoirs covering the most failure-prone applications.
- Over 17 million registered vehicles covered by the Dorman Fluid Reservoir program.
- Exact OE replacement.

CAPS INCLUDED!



603-201
Coolant Reservoir
Ford Taurus and Mercury Sable
2003-96

Includes sensor where applicable

Common Reasons for Fluid Reservoir failures:

- Temperature fluctuations can cause plastic to expand and crack.
- Over time, coolant can corrode the plastic reservoir.
- Due to location in the engine compartment, they are very susceptible to crash damage.

What indicates failure?

- Fluid puddles under the vehicle.
- Loss of washer fluid will trigger low wiper fluid light on dashboard.
- Loss of coolant will cause engine to run hot and possibly overheat/seize.

Activant Path	Coolant Recovery Tank/ Radiator/ Cap/ Fan/ Motor & Switch	Activant Code	DCR
----------------------	---	----------------------	-----

Applications begin on page 141.

Fluid Reservoirs

Fluid Reservoirs



603-001

Universal Fluid Reservoir
Universal Fluid Reservoir.



603-100

Coolant Reservoir
Radiator Overflow Reservoir. Fits GM C/K-Series, Escalade, Blazer, Suburban, Yukon 2002-88



603-101

Coolant Reservoir
1991-84 G-Series Vans (Exc 7.4L)



603-200

Coolant Reservoir
1999-96 Ford Taurus, Mercury Sable 3.0L (12V Eng.)



603-201

Coolant Reservoir
2003-96 Ford Taurus, Mercury Sable 3.0L (24V Eng.)



603-202

Wiper Reservoir
1990-84 Escort, EXP, Lynx 1.9 (W/O Low Fluid Sensor)



603-300

Coolant Reservoir
1996-87 Jeep Cherokee.



603-301

Coolant Reservoir
1997-93 Chrysler Concorde, LHS, New Yorker, Dodge Intrepid, Eagle Vision



603-600

Wiper Reservoir
2001-96 Infiniti I30, 2004-02 Infiniti I35, 2003-94 Nissan Maxima



603-601

Wiper Reservoir
2001-94 Altima

SEE

Page 142...

...for tips on the fluids that fill these reservoirs.

Fluid Reservoir Applications

COOLANT RECOVERY RESERVOIRS

Make/ Model/Years	Description	Dorman #
CADILLAC		
ESCALADE 1999	-	603-100
CHEVROLET TRUCK		
BLAZER 1994-92	Gas Eng	603-100
C/K-SERIES PICKUP 2002-88	Gas Eng	603-100
G SERIES VAN 1991-84	Exc. 7.4L Eng	603-101
SUBURBAN 1999-92	Gas Eng	603-100
TAHOE 2000-95	Gas Eng	603-100
CHRYSLER		
CONCORDE 1997-93	-	603-301
LHS 1997-94	-	603-301
NEW YORKER 1996-94	-	603-301
DODGE		
INTREPID 1997-93	-	603-301

Make/ Model/Years	Description	Dorman #
EAGLE		
VISION 1997-93	-	603-301
FORD		
TAURUS 2003	3.0L 24 Valve Eng, To 12/2/02	603-201
2002-96	3.0L 24 Valve Eng	603-201
1999-96	3.0L 12 Valve Eng	603-200
GMC TRUCK		
C/K-SERIES PICKUP 2002-88	Gas Eng	603-100
G SERIES VAN 1991-84	Exc. 7.4L Eng	603-101
SUBURBAN 1999-92	Gas Eng	603-100
YUKON 2000-92	Gas Eng	603-100
JEEP		
CHEROKEE 1996-87	4.0L Eng	603-300
MERCURY		
SABLE 2003	3.0L 24 Valve Eng, To 12/2/02	603-201
2002-96	3.0L 24 Valve Eng	603-201
1999-96	3.0L 12 Valve Eng	603-200

WINDSHIELD WASHER FLUID RESERVOIRS

Make/ Model/Years	Description	Dorman #
FORD		
ESCORT 1990-84	wo/Low Fluid Sensor	603-202
EXP 1985-84	wo/Low Fluid Sensor	603-202
INFINITI		
I30 2001-96	w/Sensor	603-600
I35 2004-02	-	603-600

Make/ Model/Years	Description	Dorman #
MERCURY		
LYNX 1987-84	wo/Low Fluid Sensor	603-202
NISSAN		
ALTIMA 2001-94	-	603-601
MAXIMA 2003	To 12/31/02	603-600
2002-94	-	603-600



Check Your Cool Quotient With a Cooling System Quiz

A fairly common household disaster is flooding of the laundry area due to a split hose on a washing machine. Also vulnerable to a similar disaster is your car. A bulging radiator hose, carrying hot water (coolant) under pressure, can rupture.

Cooling system neglect is cited as a principal reason for mechanical failure of a vehicle. In addition to the danger and inconvenience of a breakdown, the damage to the engine and transmission can add up to thousands of dollars. Discovering a leaking radiator, hose connection, a sticking thermostat or other cooling system component that's on "borrowed time" can save the life of one's engine.

To underscore the importance of proper care of the cooling system, the Car Care Council offers this multiple choice quiz: See how much you know about this vital engine system.

Cooling System Quiz

- For maximum freeze protection antifreeze mixture should be:
 - half anti-freeze and half water;
 - pure antifreeze;
 - 70% anti-freeze, 30% water.
- In the cooling system the thermostat:
 - controls engine temperature;
 - works the air conditioner;
 - modulates the diodes.
- A radiator cap is designed to:
 - keep water from sloshing out of the radiator;
 - keep the cooling system operating at a specified pressure;
 - last indefinitely.
- A broken drive belt can cause:
 - overheating;
 - loss of power steering;
 - dead battery.
- Cooling systems on many cars today:
 - have no water pump;
 - never need to be flushed;
 - are equipped with an electric fan on the radiator.

Compare your answers against the ones on the next page to see how you did!



Coolant Fluid

DIY Cautions:

When servicing your cooling system yourself, use extreme caution.

Warning:

Opening a hot radiator or coolant reservoir/overflow tank can cause severe burns. Be sure that both the engine and cooling system are cool before you begin any heating/cooling system maintenance or repairs.

Because of lower hood profiles and cramped engine quarters, it's also possible that your car may be equipped with an air bleed for the cooling system. Unless the cooling system is bled properly, air may stay trapped in the system and cause erratic temperatures, or in extreme cases, engine or cooling system damage. If you're unsure about any aspect of cooling system service, have your car looked at by a professional service technician.



Windshield Washer Fluid

Fluid Description

Windshield washer fluid, or solvent as it's sometimes called, usually has a methanol base that gives the fluid its anti-freezing properties. Some fluids use isopropyl alcohol as the anti-freeze agent.

Purpose & Usage

Windshield washer fluid is used for on-road, on-demand cleaning of the windshield through the electrically operated washers. Some vehicles also use a washer system for the rear window as well as the headlights.

Maintenance Tips/Suggestions

- It's wise to keep the windshield washer reservoir full at all times with washer fluid. Running the system out of fluid can damage the windshield washer pump.
- Stay away from water, as it does not provide anti-freeze properties and does not clean as well as washer fluid.
- Some vehicles have multiple washer fluid reservoirs for different parts of the vehicle. During the winter months, where there is a lot of road salt, it's a good idea to keep a bottle of washer fluid in your car.
- If your washers stop working and the reservoir has plenty of fluid, have the washer system checked out at once by a professional service technician. Washers are a critical safety system of your car and should not be left neglected.

Answers to Cooling System Quiz from the preceding page:

1. **(C)** is correct, although a 50/50 solution is adequate for most climates, protecting to -34° F. Never use pure antifreeze.
2. **(A)** is correct. As stated above, a faulty thermostat, causing an engine to run too hot or too cold, can damage the engine.
3. **(B)** is correct. And when replacing the cap, be sure to install the right one for your vehicle. Pressure recommendations vary.
4. Because all three functions are dependent upon the drive belt (or belts) **all three answers are correct.**
5. **(C)** is correct.

Four Wheel Drive Components

100% NEW!



Dorman 4WD Actuators and Transfer Case Motors are 100% NEW – Not Remanufactured – No Core Charge

Dorman is the only aftermarket supplier offering a complete line of 4WD actuators and NEW non-remanufactured transfer case motors.



600-101
4WD Differential Actuator
2005-96 Chevrolet/GMC Trucks

Kit contents include:

Mounting brackets, and mounting hardware where applicable

Features and Benefits

- Direct OE Replacement
- Actuator kits complete with gaskets and seals (when necessary)
- Limited Lifetime Warranty
- 100% NEW
- NO core costs or handling charge



600-901
Transfer Case Motor
2005-98 Chevrolet/GMC Trucks



600-803
Transfer Case Motor
2001-96 Ford Explorer/Mercury Mountaineer

Related Sales:

Transfer Case Switches:



HELP! #49314



HELP! #49315

4WD Switches:



HELP! #49176



HELP! #49177

Activant Path

Drive Axle Parts

Activant Code

DTM

Applications begin on page 146.

Four Wheel Drive Components



600-100C

4WD Actuator

1997-92 Suburban/Yukon, 1997-88 K-1500/
K-2500, 1995-88 K3500, 1994-92 Blazer,
1997-95 Tahoe



600-101

4WD Actuator

2005-95 Tahoe, 2007-99 Sierra/Silverado/
Escalade, 2007-98 Suburban/Yukon, 2000-
98 K2500, 2000-96 K3500, 1999-98
K1500, 2006-04 Canyon/Colorado, 2006-02
Avalanche.



600-102

4WD Actuator

2005-83 Chevrolet/GMC Trucks



600-200

4WD Actuator

1990-81 Cherokee, Wagoneer, Comanche,
1990-87 Wrangler



600-800

Transfer Case Motor

1995-91 Explorer, 1995-90 Ranger, 1990 Bronco II, 1994 B2300,
B3000, B4000, 1994-91 Navajo.
Fits Borg Warner 1354 Transfer Case Round Plug w/7 Pins



600-801

Transfer Case Motor

1996-91 Bronco, 1997-91 F-150
Fits Borg Warner 1356 Transfer Case Round Plug w/7 Pins



600-802

Transfer Case Motor

2002-97 Expedition, 2001-98 Navigator, 2003-96 F-Series Pickups
Fits Borg Warner 4406 Transfer Case Rectangular Plug w/7 Pins



600-803

Transfer Case Motor

2001-96 Explorer/Mountaineer
Fits Borg Warner 4405 Transfer Case Rectangular Plug w/7 Pins



600-804

Transfer Case Motor

1990-87 Bronco
Fits Borg Warner 1356 Transfer Case Round Plug w/7 Pins

Four Wheel Drive Components



600-805
Transfer Case Motor
 2005-00 Excursion, 2006-99 Super Duty Trucks
 Fits New Venture Gear 273 Transfer Case Rectangular Plug w/2 Pins & Square Plug w/6 Pins



600-806
Transfer Case Motor
 2003 Expedition/Navigator
 Fits Borg Warner 4416 Transfer Case Round Plug w/7 Pins



600-807
Transfer Case Motor
 2005-02 Explorer Sport Trac, 2003-00 Ranger, 2003-95 Mazda Pickups
 Fits Borg Warner 1354 Transfer Case Round Plug w/7 Pins



600-900
Transfer Case Motor
 2005-92 S10 Blazer/Pickups/S15 Sonoma, 2001-92 S15 Jimmy/Bravada, 1993-92 Typhoon, 2000-98 Isuzu Hombre
 Fits NVG 233 w/RPO Code NP1 Rectangular Plug w/7 Pins



600-901
Transfer Case Motor
 2005-99 S10 Blazer/Pickups/ S15 Sonoma, 2002-98 Suburban/Tahoe/Yukon, 2002-99 Sierra/Silverado/Escalade, 1999-98 K1500/K2500 Pickups, 2001-99 Bravada/Jimmy
 Fits NVG 136/236/246 w/RPO Code NP8 Square Plug w/4 Pins & Rectangular Plug w/6 Pins



600-902
Transfer Case Motor
 2000-96 K2500 Pickups, 1999-96 K1500 Pickups/Suburban/Tahoe, 2002-01 Dakota/Durango, 1999 Escalade
 Fits New Process 243 w/RPO Code NP1 Rectangular Plug w/2Pins & Rect. Plug w/6 Pins



600-903
Transfer Case Motor
 2006-02 Trail Blazer/Envoy, 2006-03 Isuzu Ascender
 Fits New Process 226 w/RPO Code NP8 Rectangular Plug w/7 Pins



600-904
Transfer Case Motor
 2006-04 Buick Rainier, 2004-02 Oldsmobile Bravada
 Fits New Process 126 w/RPO Code NP4 Oval Plug w/5 Pins

Four Wheel Drive Components

Clock Springs
 pg. 21-24

Control Arms
 pg. 25-54

CV Joint Boots & Accessories
 pg. 55-66

Door Lock Actuators
 pg. 67-72

Exhaust Manifold Kits
 pg. 73-134

Manufactured From 100% NEW Components

4WD Components

Four Wheel Drive Components



600-906

Transfer Case Motor
2004-99 Astro/Safari, 2001-98 S10 Blazer/Pickups/S15 Jimmy/Sonoma
Fits NVG 136/236/246 w/RPO Code NP4 Rectangular Plug w/2 Pins



600-907

Transfer Case Motor
2002-01 Silverado/Sierra
Fits New Process 263 w/RPO Code NP1 Oval Plug w/2 pins & Rect. Plug w/6 Pins

Four Wheel Drive Transfer Case Motor Applications

Make/Model/Years	Description	Dorman #
BUICK		
RAINIER		
2006-04	-	600-904
CADILLAC		
ESCALADE		
2002-00	2-Speed Push Button Transfer Case	600-901
1999	2-Speed Electric Shift Transfer Case	600-902
1999	2-Speed Push Button Transfer Case	600-901
CHEVROLET TRUCK		
ASTRO		
2005-99	-	600-906
AVALANCHE		
2002	2-Speed Push Button Transfer Case	600-901
K1500 PICKUP		
1999-98	2-Speed Push Button Transfer Case	600-901
1999-98	2-Speed Electric Shift Transfer Case	600-902
1997-96	2-Speed Electric Shift Transfer Case	600-902
K2500 PICKUP		
2000	2-Speed Electric Shift Transfer Case	600-902
1999-98	2-Speed Electric Shift Transfer Case	600-902
1999-98	2-Speed Push Button Transfer Case	600-901
1997-96	2-Speed Electric Shift Transfer Case	600-902
S10 BLAZER		
2005-02	2-Speed Push Button Transfer Case	600-901
2005-02	2-Speed Electric Shift Transfer Case	600-900
2001-99	2-Speed Push Button Transfer Case	600-901
2001-99	2-Speed Electric Shift Transfer Case	600-900
2001-99	AWD	600-906
1998	2-Speed Electric Shift Transfer Case	600-900
1998	AWD	600-906
1997-92	2-Speed Electric Shift Transfer Case	600-900
S10 PICKUP		
2004-02	2-Speed Push Button Transfer Case	600-901
2004-02	2-Speed Electric Shift Transfer Case	600-900
2001-99	2-Speed Push Button Transfer Case	600-901
2001-99	AWD	600-906
2001-99	2-Speed Electric Shift Transfer Case	600-900
1998	2-Speed Electric Shift Transfer Case	600-900
1998	AWD	600-906
1997-92	2-Speed Electric Shift Transfer Case	600-900
SILVERADO		
2002-01	2-Speed Push Button Transfer Case	600-901
2002-01	2-Speed Electric Shift Transfer Case	600-907

Make/Model/Years	Description	Dorman #
CHEVROLET TRUCK (continued)		
SILVERADO (continued)		
2000-99	2-Speed Push Button Transfer Case	600-901
SUBURBAN		
2002-00	2-Speed Push Button Transfer Case	600-901
1999-98	2-Speed Electric Shift Transfer Case	600-902
1999-98	2-Speed Push Button Transfer Case	600-901
1997-96	2-Speed Electric Shift Transfer Case	600-902
TAHOE		
2002-00	2-Speed Push Button Transfer Case	600-901
1999-98	2-Speed Electric Shift Transfer Case	600-902
1999-98	2-Speed Push Button Transfer Case	600-901
1997-96	2-Speed Electric Shift Transfer Case	600-902
TRAILBLAZER		
2006-02	4WD	600-903
DODGE TRUCK		
DAKOTA		
2002-01	-	600-902
DURANGO		
2002-01	-	600-902
FORD TRUCK		
BRONCO		
1996-91	Electric Shift Transfer Case	600-801
1990-87	Electric Shift Transfer Case	600-804
BRONCO II		
1990	Electric Shift Transfer Case	600-800
EXCURSION		
2005-00	4WD	600-805
EXPEDITION		
2003	To 3/5/2003	600-806
2002	Torque On Demand, Warner 4406 Transfer Case	600-802
2002	Torque On Demand, Warner 4416 Transfer Case	600-806
2001-00	Torque On Demand	600-802
1999	Torque On Demand, Warner 4406 Transfer Case, ID XL14 7A195-AC, AD	600-802
1998-97	Torque On Demand	600-802
EXPLORER		
2001	Electric Shift Transfer Case, Exc. Sport	600-803
2000	Electric Shift Transfer Case	600-803
1999-96	Electric Shift Transfer Case	600-803
1995	Electric Shift Transfer Case, Warner 1356	600-800
1995	Electric Shift Transfer Case, Warner 4405	600-803
1994-91	Electric Shift Transfer Case	600-800

Four Wheel Drive Components

Four Wheel Drive Transfer Case Motor Applications

Make/ Model/Years	Description	Dorman #
FORD TRUCK (continued)		
EXPLORER SPORT TRAC		
2005-03	Transfer Case ID 1L54 7A195-AC	600-807
2002	Transfer Case ID 1L54 7A195-AC, From 1/31/2002	600-807
F SERIES SUPER DUTY		
2006-99	4WD, w/New Venture Gear Model 273 or 307	600-805
F-150 PICKUP		
2004	Heritage and SVT Series	600-802
2003-98	Electric Shift Transfer Case	600-802
1997	Torque On Demand, Warner 4406 Transfer Case, ID F75A 7A195-HA, HB	600-802
1997	Electric Shift Transfer Case, Warner 1356	600-801
1997	Electric Shift Transfer Case, Warner 4406, ID F75A 7A195-CB	600-802
1996	Electric Shift Transfer Case, Warner 1356	600-801
1996	Electric Shift Transfer Case, Warner 4406	600-802
1995-91	Electric Shift Transfer Case	600-801
F-250 PICKUP		
1999	Electric Shift Transfer Case, ID XL34 7A195-BB	600-802
1998	Electric Shift Transfer Case	600-802
1997	Electric Shift Transfer Case, Warner 4406, ID F75A 7A195-CB	600-802
1997	Torque On Demand, Warner 4406 Transfer Case, ID F75A 7A195-HA, HB	600-802
1996	Electric Shift Transfer Case	600-802
RANGER		
2003-01	Exc. Electric Vehicle	600-807
2000	Electric Shift Transfer Case, ID YL54 7A 195-AA, Exc. Electric Vehicle	600-807
1995	Electric Shift Transfer Case, ID F47A 7A195-DA	600-800
1994-90	Electric Shift Transfer Case	600-800
GMC TRUCK		
ENVY		
2006-02	4WD	600-903
K1500 PICKUP		
1999-98	2-Speed Push Button Transfer Case	600-901
1999-96	2-Speed Electric Shift Transfer Case	600-902
K2500 PICKUP		
2000-96	2-Speed Electric Shift Transfer Case	600-902
1999-98	2-Speed Push Button Transfer Case	600-901
S15 JIMMY		
2001-99	2-Speed Electric Shift Transfer Case	600-900
2001-99	AWD	600-906
2001-99	2-Speed Push Button Transfer Case	600-901
1998	AWD	600-906
1998	2-Speed Electric Shift Transfer Case	600-900
1997-92	2-Speed Electric Shift Transfer Case	600-900
S15 SONOMA		
2004-02	2-Speed Push Button Transfer Case	600-901
2004-02	2-Speed Electric Shift Transfer Case	600-900
2001-99	2-Speed Push Button Transfer Case	600-901
2001-99	AWD	600-906
2001-99	2-Speed Electric Shift Transfer Case	600-900

Make/ Model/Years	Description	Dorman #
GMC TRUCK (continued)		
S15 SONOMA (continued)		
1998	2-Speed Electric Shift Transfer Case	600-900
1998	AWD	600-906
1997-92	2-Speed Electric Shift Transfer Case	600-900
S15 TYPHOON		
1993-92	2-Speed Electric Shift Transfer Case	600-900
SAFARI		
2005-99	-	600-906
SIERRA		
2002-01	2-Speed Push Button Transfer Case	600-901
2002-01	2-Speed Electric Shift Transfer Case	600-907
2000-99	2-Speed Push Button Transfer Case	600-901
SUBURBAN		
1999-98	2-Speed Electric Shift Transfer Case	600-902
1999-98	2-Speed Push Button Transfer Case	600-901
1997-96	2-Speed Electric Shift Transfer Case	600-902
YUKON		
2002-00	2-Speed Push Button Transfer Case	600-901
1999-98	2-Speed Electric Shift Transfer Case	600-902
1999-98	2-Speed Push Button Transfer Case	600-901
1997-96	2-Speed Electric Shift Transfer Case	600-902
YUKON XL		
2002-01	2-Speed Push Button Transfer Case	600-901
ISUZU		
ASCENDER		
2006-03	2-Speed Electric Shift Transfer Case	600-903
HOMBRE		
2000-98	2-Speed Electric Shift Transfer Case	600-900
LINCOLN		
NAVIGATOR		
2003	To 3/5/2003	600-806
2002	Torque On Demand, Warner 4406 Transfer Case	600-802
2002	Torque On Demand, Warner 4416 Transfer Case	600-806
2001-00	Torque On Demand	600-802
1999	Torque On Demand, Warner 4406 Transfer Case, ID XL14 7A195-AC, AD	600-802
1998	Torque On Demand	600-802
MAZDA TRUCK		
B2300, B2500, B3000, B4000 PICKUP		
2003-95	-	600-807
1994	Electric Shift Transfer Case	600-800
NAVAJO		
1994-91	Electric Shift Transfer Case	600-800
MERCURY		
MOUNTAINEER		
2001-00	Electric Shift Transfer Case	600-803
OLDSMOBILE		
BRAVADA		
2004-02	-	600-904
2001-99	2-Speed Push Button Transfer Case	600-901
2001-99	2-Speed Electric Shift Transfer Case	600-900
1998-92	2-Speed Electric Shift Transfer Case	600-900

Related Sales - Transfer Case Switches



49314

For 2WD/4WD operation. Required vacuum switch to lock hubs in 4WD. Fits Jeep Cherokee, Wrangler, Comanche, Wagoneer 1996-84.



49315

For 2WD/4WD operation. Required vacuum switch to lock hubs in 4WD. Fits GM S10/S15 Pickup, Blazer, Jimmy, Sonoma, Bravada 2004-83.



Four Wheel Drive Components

Fuel Sending Units
pg. 155-176

Fuel Tanks
pg. 177-228

Harmonic Balancers
pg. 229-254

Heater Hose Assemblies
pg. 255-256

Hydraulic Clutch Lines
pg. 257-260

Manufactured From 100% NEW Components

4WD Components

Four Wheel Drive Actuator Applications

Make/Model/Years	Description	Dorman #
CADILLAC		
ESCALADE 2007-99	-	600-101
CHEVROLET TRUCK		
AVALANCHE 2006-02	-	600-101
BLAZER 1994-92	-	600-100
COLORADO 2006-04	-	600-101
K1500 PICKUP 1999-98	-	600-101
	1997-88	600-100
K2500 PICKUP 2000-98	-	600-101
	1997-88	600-100
K3500 PICKUP 2000-96	-	600-101
	1995-88	600-100
S10 BLAZER 2005-83	4WD	600-102
S10 PICKUP 2004-83	4WD	600-102
SILVERADO 2006-99	-	600-101
SUBURBAN 2007-98	-	600-101
	1997-92	600-100
TAHOE 2007-95	-	600-101
	1997-95	600-100
GMC TRUCK		
CANYON 2006-04	-	600-101
K1500 PICKUP 1999-98	-	600-101
	1997-88	600-100
K2500 PICKUP 2000-98	-	600-101
	1997-88	600-100
K3500 PICKUP 2000-96	-	600-101
	1995-88	600-100

Make/Model/Years	Description	Dorman #
GMC TRUCK (continued)		
S15 JIMMY 2001-83	4WD	600-102
S15 PICKUP 1990-83	4WD	600-102
S15 SONOMA 2004-91	4WD	600-102
S15 SYCLONE 1991	4WD	600-102
S15 TYPHOON 1993-92	4WD	600-102
SIERRA 2006-99	-	600-101
SIERRA DENALI 2006-02	-	600-101
SUBURBAN 1999-98	-	600-101
	1997-92	600-100
YUKON 2007-98	-	600-101
	1997-92	600-100
YUKON DENALI 2007-05	-	600-101
YUKON XL 2007-01	-	600-101
JEEP		
CHEROKEE 1990-81	4WD	600-200
COMANCHE 1990-81	4WD	600-200
WAGONEER 1990-81	4WD	600-200
WRANGLER 1990-87	4WD	600-200
OLDSMOBILE		
BRAVADA 2001-91	4WD	600-102
PONTIAC		
6000 1990-88	AWD	600-102

4WD Quick Tips

- Never engage 4W-Low range while moving. Doing so could cause internal damage to transfer case. Refer to owners manual for proper operation.
- It is not recommended to engage 4WD, especially 4W-Low range on dry pavement. Doing so could cause internal damage to transfer case.
- Most applications require vehicles to be in neutral before shifting into 4W-Low range. Refer to your owners manual for proper operation.
- Both transfer case and 4WD operation are sensitive to variations in tire size and pressure. Tires should be within 1/4 inch circumference of manufacturer's specifications.
- When installing new transfer case motor, be sure to pay attention to the location of speed sensor wires. They must be reinstalled in the same position on the new motor. See application specific shop manual for proper service procedure.
- When removing speed sensor wires from the old transfer case motor, be sure not to damage plastic clip that holds wires in place. This clip must be reused during installation of new motor. See application-specific shop manual for proper service procedure.
- Always disconnect the battery before working on any part in the 4WD system.

Fuel Lines



21 lines provide coverage for failure-prone applications

- High quality OE line construction prevents comebacks.
- Steel supply lines corrode and break when loosening a connection.
- Saves time and money.

New Expanded Coverage: Fuel Line Hose



800-881
GM Sedans



800-882
GM Sedans



Don't Forget:

Add-on Sales: Complete the job by suggesting a new fuel filter.

Typical Failures: Ends crack during filter removal. Lines leak at crimped ends.

Other Dorman Fluid Lines Available:

Clutch pages 257-260

Heater Hose pages 255-256

Oil Cooler pages 281-302

Transmission pages 485-532

- **No need to buy entire assembly when you can just replace the failed part**



800-855
Ford Focus



Replace the Piece, Not the Assembly

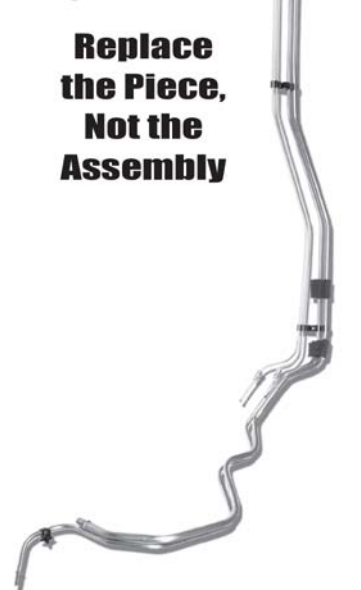

Activant Path

Fuel Pump, Tank & Turbo System

Activant Code

DFQ

Applications begin on page 152.

Fuel Lines

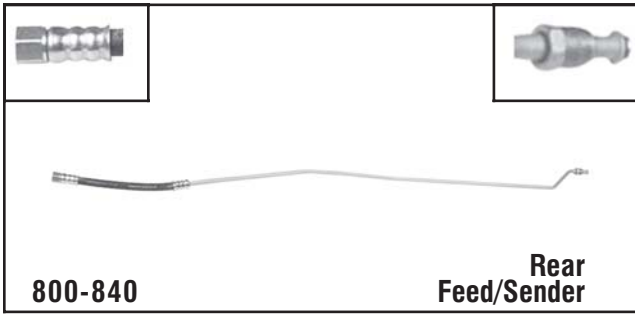

800-840

Rear Feed/Sender

GM
1995-88 GM K1500/K2500/K3500 Pickups; 131.5" Wheel Base, Gas and Diesel

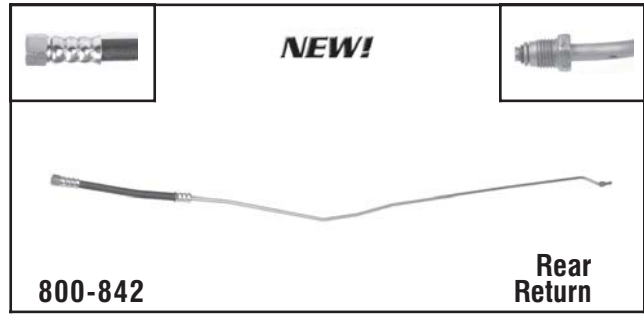

800-842

Rear Return

GM
2000-90 GM K1500/K2500/K3500 Pickups; 131.5" Wheel Base, Gas and Diesel



800-843

Rear Feed/Sender

GM
1995-88 GM K1500 Pickups; 117.5" Wheel Base, Gas

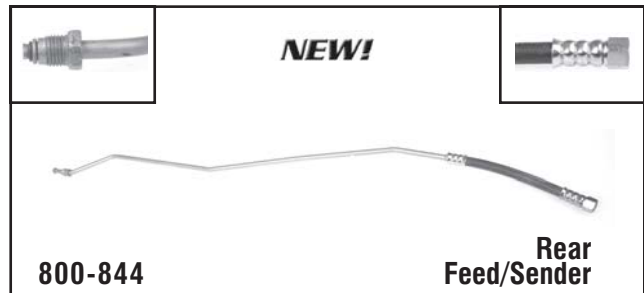

800-844

Rear Feed/Sender

GM
2000-95 GM K1500 Pickups; 117.5" Wheel Base, Gas



800-846

Rear Feed/Sender

GM
2000-88 GM K1500/K2500/K3500 Pickups; 155.5" Wheel Base, Gas and Diesel



800-848

Rear Return

GM
2000-90 GM K1500/K2500/K3500 Pickups; 155.5" Wheel Base, Gas and Diesel

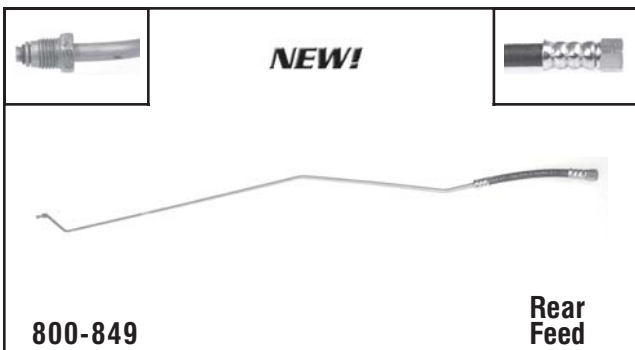

800-849

Rear Feed

GM
2000-88 GM K1500/K2500/K3500 Pickups; 141.5" Wheel Base, Gas and Diesel

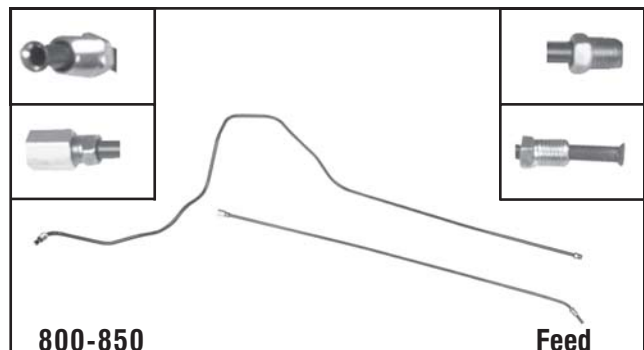

800-850

Feed

Toyota
2001-97 Toyota Camry wo/ CNG Fuel Line; 2 piece design for easy installation., Gas

Fuel Lines



NEW!

800-852 **Rear Return**

GM
2000-90 GM K1500/K2500 Pickups; 141.5" Wheel Base, Gas and Diesel

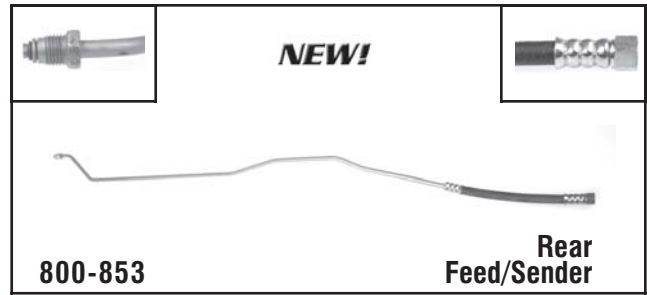

NEW!

800-853 **Rear Feed/Sender**

GM
2000-88 GM C1500/C2500/C3500 Pickups; 131.5" Wheel Base, Gas and Diesel

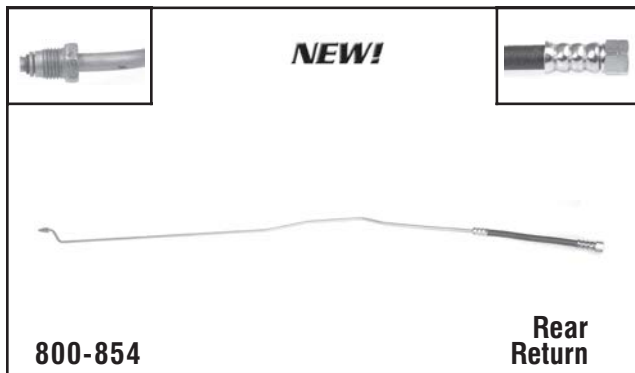

NEW!

800-854 **Rear Return**

GM
2000-90 GM C2500/C3500 Pickups; 1997-90 GM C1500 Pickups; 131.5" Wheel Base, Gas and Diesel

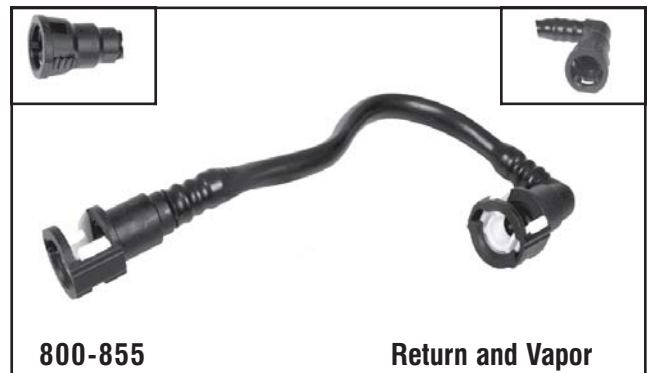

800-855 **Return and Vapor**

Ford
2004-00 Ford Focus Fuel Line Repair Kit, Gas



800-857 **Rear Return and Vapor**

Ford
1999-96 Ford Taurus wo/ Flex Fuel; Mercury Sable, Gas



800-858 **Rear Return and Vapor**

Ford
2000 Ford Taurus, Mercury Sable, Gas



800-859 **Rear Return and Vapor**

Ford
2001 Ford Taurus, Mercury Sable, Gas

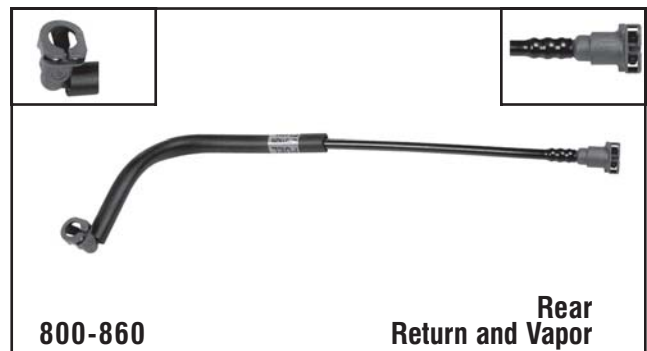

800-860 **Rear Return and Vapor**

Ford
2002 Ford Taurus, Mercury Sable, Gas

Fuel Lines

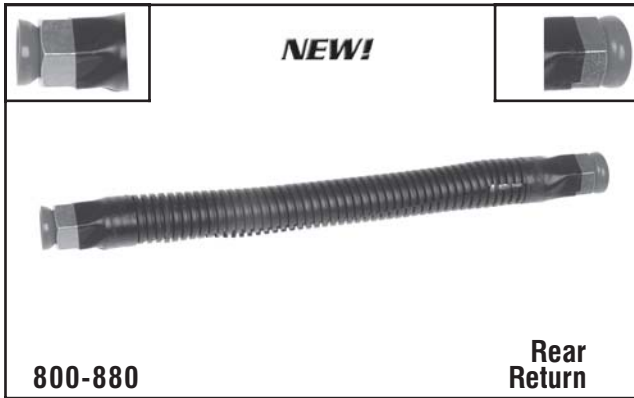

800-880

Rear Return

GM
1991-87 Pontiac Bonneville; 1991-86 Olds Delta 88, Buick LeSabre; 1990-86 Olds 98, Cadillac FWD, Buick Electra, Gas



800-881

Rear Feed

GM
1991-87 Pontiac Bonneville; 1991-86 Olds Delta 88, Buick LeSabre; 1990-86 Olds 98, Cadillac FWD, Buick Electra, Gas

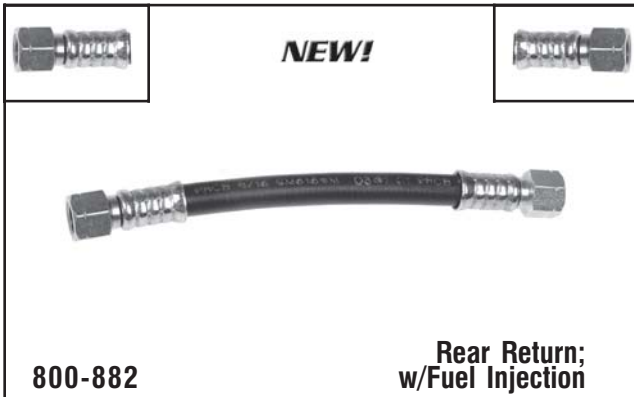

800-882

Rear Return; w/Fuel Injection

GM
1989-86 Buick Century, Chevy Celebrity, Olds Ciera, Pontiac 6000, Gas



800-883

Rear Feed; w/Fuel Injection

GM
1989-86 Buick Century, Chevy Celebrity, Olds Ciera, Pontiac 6000, Gas

Fuel Line Applications

Make/Model/Years	Description	Dorman#
BUICK		
CENTURY		
1989	Return, Rear, Exc. 3.3L Eng	800-882
1988-86	Feed, Rear, w/Fuel Injection	800-883
1988-86	Return, Rear, w/Fuel Injection	800-882
ELECTRA		
1990-86	Feed, Rear	800-881
1990-86	Return, Rear	800-880
LESABRE		
1991-86	Feed, Rear	800-881
1991-86	Return, Rear	800-880
CADILLAC		
DEVILLE		
1990-86	Feed, Rear	800-881
1990-86	Return, Rear	800-880
FLEETWOOD (FWD)		
1990-86	Feed, Rear	800-881
1990-86	Return, Rear	800-880
CHEVROLET		
CELEBRITY		
1989	Return, Rear, w/Fuel Injection	800-882
1988-86	Feed, Rear, w/Fuel Injection	800-883
1988-86	Return, Rear, w/Fuel Injection	800-882
CHEVROLET/GMC TRUCK		
C1500 PICKUP		
2000-98	Feed, Rear, 131.5" Wheel Base, Diesel Eng	800-853
1997-96	Feed, Rear, 131.5" Wheel Base, Diesel Eng	800-853
1997-96	Return, Rear, 131.5" Wheel Base	800-854
1995	Feed, Rear, 131.5" Wheel Base, Diesel Eng	800-853

Make/Model/Years	Description	Dorman#
CHEVROLET/GMC TRUCK (continued)		
C1500 PICKUP (continued)		
1995	Feed, Rear, 131.5" Wheel Base, Used w/2 Pipes on Sender, Gas Eng	800-853
1995	Return, Rear, 131.5" Wheel Base	800-854
1994-90	Feed, Rear, 131.5" Wheel Base	800-853
1994-90	Return, Rear, 131.5" Wheel Base	800-854
1989-88	Feed, Rear, 131.5" Wheel Base	800-853
C2500 PICKUP		
2000-98	Feed, Rear, 131.5" Wheel Base, Diesel Eng	800-853
2000-98	Return, Rear, 131.5" Wheel Base, Diesel Eng	800-854
1997-96	Feed, Rear, 131.5" Wheel Base, Diesel Eng	800-853
1997-96	Return, Rear, 131.5" Wheel Base	800-854
1995	Feed, Rear, 131.5" Wheel Base, Diesel Eng	800-853
1995	Feed, Rear, 131.5" Wheel Base, Used w/2 Pipes on Sender, Gas Eng	800-853
1995	Return, Rear, 131.5" Wheel Base	800-854
1994-90	Feed, Rear, 131.5" Wheel Base	800-853
1994-90	Return, Rear, 131.5" Wheel Base	800-854
2000-98	Feed, Rear, 131.5" Wheel Base, Diesel Eng	800-853
2000-98	Return, Rear, 131.5" Wheel Base, Diesel Eng	800-854
1989-88	Feed, Rear, 131.5" Wheel Base	800-853
C3500 PICKUP		
1997-96	Feed, Rear, 131.5" Wheel Base, Diesel Eng	800-853
1997-96	Return, Rear, 131.5" Wheel Base	800-854
1995	Feed, Rear, 131.5" Wheel Base, Diesel Eng	800-853
1995	Feed, Rear, 131.5" Wheel Base, Used w/2 Pipes on Sender, Gas Eng	800-853
1995	Return, Rear, 131.5" Wheel Base	800-854

Fuel Line Applications

Make/ Model/Years	Description	Dorman#
CHEVROLET/GMC TRUCK (continued)		
K3500 PICKUP (continued)		
1994-90	Feed, Rear, 131.5" Wheel Base	800-853
1994-90	Return, Rear, 131.5" Wheel Base	800-854
1989-88	Feed, Rear, 131.5" Wheel Base	800-853
K1500 PICKUP		
2000-98	Feed, Rear, 117.5" Wheel Base, Gas Eng	800-844
2000-98	Feed, Rear, 141.5" Wheel Base, Diesel Eng	800-849
2000-98	Feed, Rear, 155.5" Wheel Base, Diesel Eng	800-846
2000-98	Return, Rear, 141.5" Wheel Base, Diesel Eng	800-852
2000-98	Return, Rear, 155.5" Wheel Base, Diesel Eng	800-848
1997-96	Feed, Rear, 117.5" Wheel Base, Gas Eng	800-844
1997-96	Feed, Rear, 141.5" Wheel Base, Diesel Eng	800-849
1997-96	Feed, Rear, 155.5" Wheel Base, Diesel Eng	800-84
1997-96	Return, Rear, 131.5" Wheel Base	800-842
1997-96	Return, Rear, 141.5" Wheel Base	800-852
1997-96	Return, Rear, 155.5" Wheel Base	800-848
1995	Feed, Rear, 117.5" Wheel Base, Used w/2 Pipes on Sender, Gas Eng	800-843
1995	Feed, Rear, 117.5" Wheel Base, Used w/4 Pipes on Sender, Gas Eng	800-844
1995	Feed, Rear, 131.5" Wheel Base, Diesel Eng	800-840
1995	Feed, Rear, 131.5" Wheel Base, Gas Eng	800-840
1995	Feed, Rear, 141.5" Wheel Base, Diesel Eng	800-849
1995	Feed, Rear, 141.5" Wheel Base, Used w/2 Pipes on Sender, Gas Eng	800-849
1995	Feed, Rear, 155.5" Wheel Base, Diesel Eng	800-846
1995	Feed, Rear, 155.5" Wheel Base, Used w/2 Pipes on Sender, Gas Eng	800-846
1995	Return, Rear, 131.5" Wheel Base	800-842
1995	Return, Rear, 141.5" Wheel Base	800-852
1995	Return, Rear, 155.5" Wheel Base	800-848
1994-90	Feed, Rear, 117.5" Wheel Base, Gas Eng	800-843
1994-90	Feed, Rear, 131.5" Wheel Base	800-840
1994-90	Feed, Rear, 141.5" Wheel Base	800-849
1994-90	Feed, Rear, 155.5" Wheel Base	800-846
1994-90	Return, Rear, 131.5" Wheel Base	800-842
1994-90	Return, Rear, 141.5" Wheel Base	800-852
1994-90	Return, Rear, 155.5" Wheel Base	800-848
1989-88	Feed, Rear, 117.5" Wheel Base, Gas Eng	800-843
1989-88	Feed, Rear, 131.5" Wheel Base	800-840
1989-88	Feed, Rear, 141.5" Wheel Base	800-849
2000-98	Feed, Rear, 141.5" Wheel Base, Diesel Eng	800-849
1989-88	Feed, Rear, 155.5" Wheel Base	800-846
K2500 PICKUP		
2000-98	Feed, Rear, 155.5" Wheel Base, Diesel Eng	800-846
2000-98	Return, Rear, 131.5" Wheel Base, Diesel Eng	800-842
2000-98	Return, Rear, 141.5" Wheel Base, Diesel Eng	800-852
2000-98	Return, Rear, 155.5" Wheel Base, Diesel Eng	800-848
1997-96	Feed, Rear, 141.5" Wheel Base, Diesel Eng	800-849
1997-96	Feed, Rear, 155.5" Wheel Base, Diesel Eng	800-846
1997-96	Return, Rear, 131.5" Wheel Base	800-842
1997-96	Return, Rear, 141.5" Wheel Base	800-852
1997-96	Return, Rear, 155.5" Wheel Base	800-848
1995	Feed, Rear, 131.5" Wheel Base, Diesel Eng	800-840
1995	Feed, Rear, 131.5" Wheel Base, Gas Eng	800-840
1995	Feed, Rear, 141.5" Wheel Base, Diesel Eng	800-849
1995	Feed, Rear, 141.5" Wheel Base, Used w/2 Pipes on Sender, Gas Eng	800-849
1995	Feed, Rear, 155.5" Wheel Base, Diesel Eng	800-846
1995	Feed, Rear, 155.5" Wheel Base, Used w/2 Pipes on Sender, Gas Eng	800-846
1995	Return, Rear, 131.5" Wheel Base	800-842
1995	Return, Rear, 141.5" Wheel Base	800-852
1995	Return, Rear, 155.5" Wheel Base	800-848
1994-90	Feed, Rear, 131.5" Wheel Base	800-840
1994-90	Feed, Rear, 141.5" Wheel Base	800-849

Make/ Model/Years	Description	Dorman#
CHEVROLET/GMC TRUCK (continued)		
K2500 PICKUP (continued)		
1994-90	Feed, Rear, 155.5" Wheel Base	800-846
1994-90	Return, Rear, 131.5" Wheel Base	800-842
1994-90	Return, Rear, 141.5" Wheel Base	800-852
1994-90	Return, Rear, 155.5" Wheel Base	800-848
1989-88	Feed, Rear, 131.5" Wheel Base	800-840
1989-88	Feed, Rear, 141.5" Wheel Base	800-849
1989-88	Feed, Rear, 155.5" Wheel Base	800-846
K3500 PICKUP		
2000-98	Feed, Rear, 155.5" Wheel Base, Diesel Eng	800-846
2000-98	Return, Rear, 131.5" Wheel Base, Diesel Eng	800-842
2000-98	Return, Rear, 155.5" Wheel Base, Diesel Eng	800-848
1997-96	Feed, Rear, 155.5" Wheel Base, Diesel Eng	800-846
1997-96	Return, Rear, 131.5" Wheel Base	800-842
1997-96	Return, Rear, 155.5" Wheel Base	800-848
1995	Feed, Rear, 131.5" Wheel Base, Diesel Eng	800-840
1995	Feed, Rear, 131.5" Wheel Base, Gas Eng	800-840
1995	Feed, Rear, 155.5" Wheel Base, Diesel Eng	800-846
1995	Feed, Rear, 155.5" Wheel Base, Used w/2 Pipes on Sender, Gas Eng	800-846
1995	Return, Rear, 131.5" Wheel Base	800-842
1995	Return, Rear, 155.5" Wheel Base	800-848
1994-90	Feed, Rear, 131.5" Wheel Base	800-840
1994-90	Feed, Rear, 155.5" Wheel Base	800-846
1994-90	Return, Rear, 131.5" Wheel Base	800-842
1994-90	Return, Rear, 155.5" Wheel Base	800-848
1989-88	Feed, Rear, 131.5" Wheel Base	800-840
1989-88	Feed, Rear, 155.5" Wheel Base	800-846
FORD		
FOCUS		
2004-00	Return & Vapor	800-855
TAURUS		
2002	Return & Vapor, Rear	800-860
2001	Return & Vapor, Rear	800-859
2000	Return & Vapor, Rear	800-858
1999-96	Return & Vapor, Rear, wo/Flex Fuel	800-857
MERCURY		
SABLE		
2002	Return & Vapor, Rear	800-860
2001	Return & Vapor, Rear	800-859
2000	Return & Vapor, Rear	800-858
1999-96	Return & Vapor, Rear	800-857
OLDSMOBILE		
98		
1990-86	Feed, Rear	800-881
1990-86	Return, Rear	800-880
CUTLASS CIERA		
1989	Return, Rear, Exc. 3.3L Eng	800-882
1988-86	Feed, Rear, w/Fuel Injection	800-883
1988-86	Return, Rear, w/Fuel Injection	800-882
DELTA 88		
1991-86	Feed, Rear	800-881
1991-86	Return, Rear	800-880
PONTIAC		
6000		
1989	Return, Rear, Exc. 3.1L Eng	800-882
1988	Feed, Rear, Exc. 3.1L Eng	800-883
1988	Return, Rear, Exc. 3.1L Eng	800-882
1987-86	Feed, Rear, w/Fuel Injection	800-883
1987-86	Return, Rear, w/Fuel Injection	800-882
BONNEVILLE		
1991-87	Feed, Rear	800-881
1991-87	Return, Rear	800-880
TOYOTA		
CAMRY		
2001-97	wo/CNG	800-850

Fuel Lines

Related Sales - Fuel Line Retainer & Repair Kits



55139 (1)



Fuel Line Retaining Clip
Fits Ford 1/4" lines.

55142 (1)



Fuel Line Retaining Clip
Fits Ford 1/2" lines.
Ford duckbill type retainer.

55147 (2)



Fuel Line Retaining Clip
Fits Ford 5/16" lines.

Clock Springs
pg. 21-24

Control Arms
pg. 25-54

CV Joint Boots & Accessories
pg. 55-66

Door Lock Actuators
pg. 67-72

Exhaust Manifold Kits
pg. 73-134

Professional Fuel Line Repair Kit

800-300

Pays for itself after only two jobs

Kit features superior professional quality tool with ergonomic clamp type grip

Innovative clamp block design makes joining nylon to nylon barbed fittings easy

Two 10' rolls of nylon tubing included

Sturdy compartment trays feature removable storage cups

High quality cutter makes trimming nylon tubes easy

Easy-to-use nylon to nylon and nylon to steel compression fittings included

Includes Straight and Elbow Connectors to tackle the most popular applications

Call Your Distributor For More Details!

Hydraulic Clutch Lines

Exact OE Fit

NEW CATEGORY!

628-101
GM C&K Trucks

628-200
Ford F-Series

628-201
Ford F-Series

INCLUDES Release Tool and Attaching Hardware Where Applicable

See pages 257-260 for more details.

Fuel Sending Units

- 95+ SKUs of Popular Failure-Prone Applications
- Dorman Average Dealer Price is 50% Below OE Wholesale Price



Stop Sending Your Customers to the OE Dealer!

692-005
GM Blazer, Jimmy,
S-Series 1991-85



692-000
GM C/K-Series
Pickups 1995-88



692-004
GM Blazer, Jimmy,
S-Series, Typhoon
1994-92



Included!



Strainer, lock ring set, and hardware included where necessary.

Typical Failures

- Fuel gauge not reading properly
- Sending Unit corrodes and breaks during removal from tank when replacing fuel pump



55160 HELP!®
Fuel Pump Pulsator GM

Prevent comebacks. Replace with every GM in-tank fuel pump. Eliminates fuel pump vibration and noise. Mounts directly on fuel pump. Fits various GM vehicles with in-tank mounted fuel pumps, 1999-84. Great add-on sale for pump or sender sales. Always replace the pulsator to eliminate potential comebacks.



Activant Path Fuel Pump, Tank & Turbo System **Activant Code** DFM

Fuel tanks, lock rings and straps, also available.

Applications begin on page 172.

Fuel Sending Units



692-000

GM (Inc. Truck)
 Number of Outlets: 4
 1995-88 Chevrolet & GMC Trucks C/K-Series, w/o High Temp Fuel Sender, w/Gas Eng & FI



692-001

GM (Inc. Truck)
 Number of Outlets: 4
 1995-90 C/K-Series Pickups w/High Temp Fuel Sender, w/E.E.C. Exc. 135.5, 159.5, 183.5 Wheel Base, w/Harness Code, (VPT, VPU), LH w/EFI



692-002

GM (Inc. Truck)
 Number of Outlets: 3
 1996-93 Century, Ciera, w/FI, EXC SW



692-003

GM (Inc. Truck)
 Number of Outlets: 3
 1992-89 Century, Celebrity, Ciera, 6000, w/FI, EXC SW.



692-004

GM (Inc. Truck)
 Number of Outlets: 4
 1994-92 Blazer, S-Series, Jimmy, Typhoon, Sonoma, and Syclone, w/FI, 20 Gal Tank.



692-005

GM (Inc. Truck)
 Number of Outlets: 4
 1991-85 S-Series, Blazer, Jimmy, Sonoma, Syclone, and Typhoon, w/FI, 20 Gal Tank.

Fuel Sending Units



692-006

GM (Inc. Truck)
 Number of Outlets: 3
 1989-80 Chevrolet & GMC Trucks C, K, R, V-Series LH Tank, w/o FI, Gas Eng.



692-007

GM (Inc. Truck)
 Number of Outlets: 4
 1995-92 Chevrolet & GMC Trucks S-Series, w/FI, 20 Gal Tank.



692-008

GM (Inc. Truck)
 Number of Outlets: 4
 1991-87 Chevrolet & GMC Trucks S-Series Pickups, Syclone, Sonoma, w/FI, 20 Gal Tank.



692-009

GM (Inc. Truck)
 Number of Outlets: 4
 1995-92 S-Series Pickups, Sonoma, Syclone w/o EFI, 20 gallon tank only



692-010

GM (Inc. Truck)
 Number of Outlets: 3
 1990-89 Electra, LeSabre, Delta 88, Bonneville, 6 Cyl Eng, w/FI, FWD.



692-011

GM (Inc. Truck)
 Number of Outlets: 3
 1991-89 Bonneville, LeSabre, Delta 88, Regency 98, 6 Cyl Eng, w/FI, FWD.

Fuel Sending Units

Fuel Sending Units



692-012

GM (Inc. Truck)
 Number of Outlets: 3
 1988-86 Bonneville, Delta 88, Electra, LeSabre, Park Avenue,
 Regency 98 w/Fl

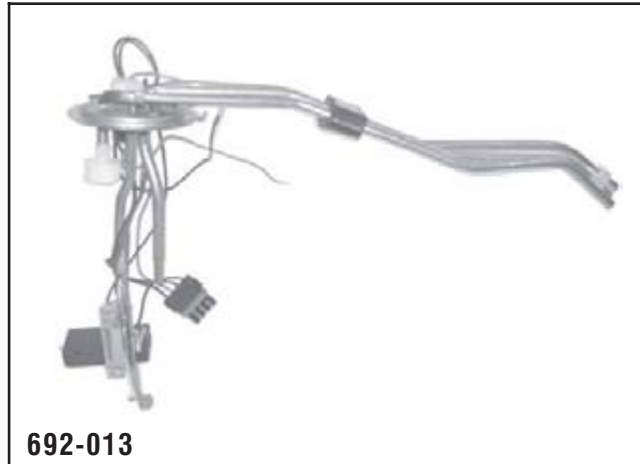

692-013

GM (Inc. Truck)
 Number of Outlets: 3
 1995-91 Electra, Bonneville, Park Avenue, LeSabre, Delta 88,
 Regency 98, V6 Eng 3.8L, w/Fl.

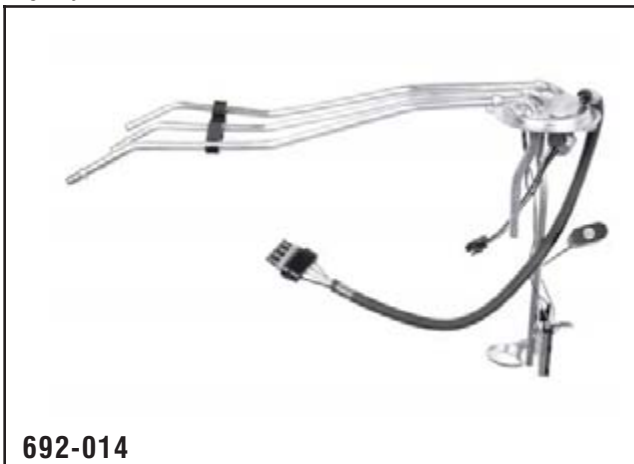

692-014

GM (Inc. Truck)
 Number of Outlets: 3
 1994-93 Bonneville, Delta 88, Electra, LeSabre, Park Avenue,
 Regency 98 V6 Eng. 3.8L w/Fl



692-015

GM (Inc. Truck)
 Number of Outlets: 3
 1991-88 Regal, Lumina, Cutlass Supreme, Grand Prix, 4 & 6 Cyl
 Eng, w/Fl.



692-016

GM (Inc. Truck)
 Number of Outlets: 3
 1991-87 Skyhawk, Skylark, Somerset. Cavalier, Sunbird, Calais, Grand
 Am, w/Fl.



692-017

GM (Inc. Truck)
 Number of Outlets: 4
 1994-88 Astro, Safari Van, w/Fl, L4 2.5L (E), V6 4.3L (B,Z).

Fuel Sending Units



692-018

Ford, Lincoln, Mercury (Inc. Truck)
 Number of Outlets: 2
 1989-87 F150/250/350 (Super Duty), w/FI, 19 Gal Tank.



692-019

Isuzu (Inc. Truck)
 Number of Outlets: 2
 1996-89 Sidekick, Sunrunner, Tracker, 2 Door Only, w/FI



692-020

GM (Inc. Truck)
 Number of Outlets: 3
 1996-88 Chevrolet & GMC Trucks C/K-Series Pickups, w/Diesel Eng.



692-021

GM (Inc. Truck)
 Number of Outlets: 3
 1988-87 Century, Celebrity, Ciera, 6000, 4 Cyl Eng, w/FI, EXC SW.

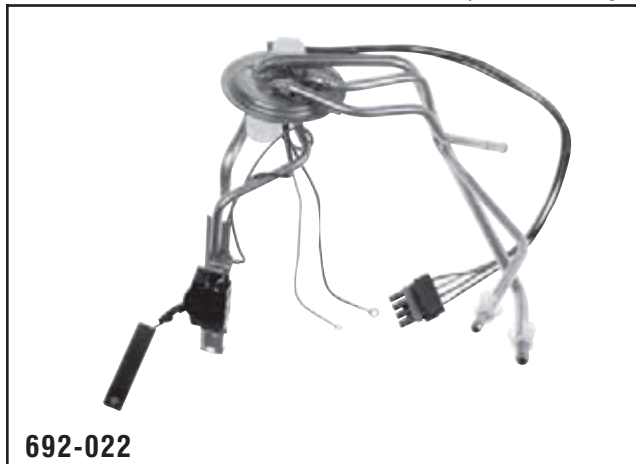

692-022

GM (Inc. Truck)
 Number of Outlets: 3
 1992-89 Century, Celebrity, Ciera, 6000, w/FI, SW



692-023

GM (Inc. Truck)
 Number of Outlets: 3
 1988-87 Century, Celebrity, Ciera, 6000, w/FI, SW.

Fuel Sending Units

Fuel Sending Units



692-024

GM (Inc. Truck)
 Number of Outlets: 3
 1988-87 Century, Celebrity, Ciera, 6000, w/FI.



692-025

GM (Inc. Truck)
 Number of Outlets: 4
 1994-92 S-Series, Blazer, Jimmy, w/FI, 20 Gal Tank.



692-026

GM (Inc. Truck)
 Number of Outlets: 3
 1989-80 Chevrolet & GMC Trucks C/K & R/V-Series, w/o FI, RH Tank, Gas Eng.



692-027

GM (Inc. Truck)
 Number of Outlets: 3
 1991-87 Chevrolet & GMC Trucks R/V-Series Diesel, w/FI, LH Tank.



692-028

GM (Inc. Truck)
 Number of Outlets: 3
 1996-94 Electra, Bonneville, Park Avenue, LeSabre, Delta 88, Regency 98, w/FI.



692-029

GM (Inc. Truck)
 Number of Outlets: 3
 1992 Regal, Lumina, Cutlass Supreme, Grand Prix, w/FI.

Fuel Sending Units



692-030

GM (Inc. Truck)
 Number of Outlets: 3
 1994-93 Cutlass Supreme, Grand Prix, Lumina, Regal w/EFI.



692-031

GM (Inc. Truck)
 Number of Outlets: 3
 1997-93 Regal, Lumina, Cutlass, Grand Prix, w/FI.



692-032

GM (Inc. Truck)
 Number of Outlets: 3
 1989-88 Beretta, Corsica, Tempest, w/FI.



692-033

GM (Inc. Truck)
 Number of Outlets: 4
 1991-87 C/K-Series and R/V-Series Blazer, Jimmy, Suburban, Tahoe, Yukon, Diesel, 31 Gal. Tank



692-034

GM (Inc. Truck)
 Number of Outlets: 4
 1991-88 Suburban w/FI, 40 Gal. Tank



692-035

GM (Inc. Truck)
 Number of Outlets: 4
 1995-87 G-Series Vans, w/FI.

Fuel Sending Units

Fuel Sending Units



692-036

GM (Inc. Truck)
 Number of Outlets: 4
 1995-92 Astro, Safari Van, w/FI, V6 4.3L (W).



692-037

Ford, Lincoln, Mercury (Inc. Truck)
 Number of Outlets: 2
 1989-87 F150, F250, F350 Super Duty, R.M. tank, w/FI



692-038

Ford, Lincoln, Mercury (Inc. Truck)
 Number of Outlets: 2
 1997-89 Ranger, Exc, Super Cab, LH Plastic Tank, w/FI



692-039

Ford, Lincoln, Mercury (Inc. Truck)
 Number of Outlets: 2
 1988-86 Ranger, Super Cab, LH Tank, w/FI



692-040

GM (Inc. Truck)
 Number of Outlets: 3
 1986 Century, Celebrity, Ciera, 6000, 4 Cyl Eng, w/FI, EXC SW.



692-041

GM (Inc. Truck)
 Number of Outlets: 4
 1993-85 S-Series, Blazer, Jimmy, Typhoon, w/FI, 13 Gal Tank.

Fuel Sending Units



692-042

GM (Inc. Truck)
 Number of Outlets: 2
 1984-80 Chevrolet & GMC Trucks C/K-Series, w/o EEC & FI, LH Tank, Gas Eng.



692-043

GM (Inc. Truck)
 Number of Outlets: 2
 1979-73 Chevrolet & GMC Trucks C/K Series, w/o EEC & FI, LH Tank, Gas Eng.



692-044

GM (Inc. Truck)
 Number of Outlets: 3
 1991-87 R/ V Series Pickups w/FI RH Tank



692-045

GM (Inc. Truck)
 Number of Outlets: 4
 1986-85 Chevrolet & GMC Trucks S-Series, w/FI, 20 Gal Tank



692-046

GM (Inc. Truck)
 Number of Outlets: 4
 1993-92 Chevrolet & GMC Trucks S-Series, w/FI, 13 Gal Tank.

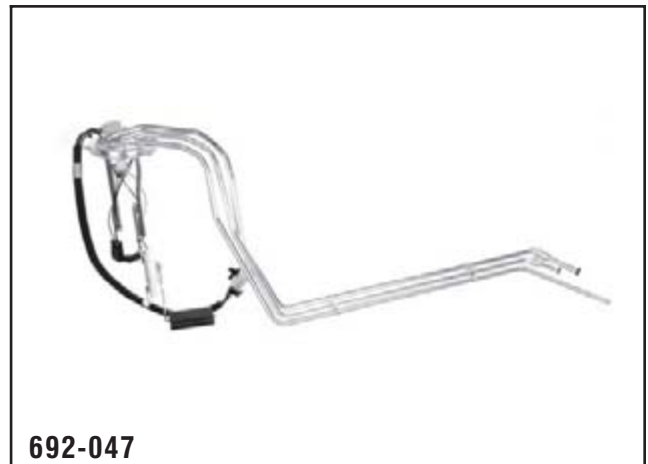

692-047

GM (Inc. Truck)
 Number of Outlets: 3
 1990 Deville, Fleetwood w/EFI FWD only

Fuel Sending Units

Fuel Sending Units



692-048

GM (Inc. Truck)
 Number of Outlets: 3
 1993-91 Deville w/EFI



692-049

GM (Inc. Truck)
 Number of Outlets: 2
 1987-78 Bonneville, Century, Cutlass, Grand Am, Grand Prix, LeMans, Malibu, Monte Carlo, Regal w/o E.E.C. and w/o FI, Gasoline



692-050

GM (Inc. Truck)
 Number of Outlets: 3
 1989-77 Bonneville, Caprice, Catalina, Delta 88, Fleetwood, LeSabre, Riviera, Toronado Full Size RWD only, W/E.E.C. and w/o FI



692-051

GM (Inc. Truck)
 Number of Outlets: 2
 1985-77 Bonneville, Caprice, Catalina, Delta 88, Fleetwood, LeSabre, Riviera, Toronado Full Size RWD only, W/out E.E.C. and w/out FI



692-052

GM (Inc. Truck)
 Number of Outlets: 3
 1989-86 Caprice, Parisienne w/FI



692-053

GM (Inc. Truck)
 Number of Outlets: 3
 1989 Beretta, Corsica w/EFI V6 2.8(W)

Fuel Sending Units



692-054
GM (Inc. Truck)
 Number of Outlets: 4
 1986-78 Blazer, Jimmy, Suburban, Tahoe, Yukon, C/K Pickups, W
 EEC, w/o FI, 25 Gal Tank.



692-055
GM (Inc. Truck)
 Number of Outlets: 4
 1995-90 Chevrolet & GMC Trucks C/K & R/V Series, w/FI, w/ High
 Temp Sender, Gas Eng, 1 Ton.



692-056
GM (Inc. Truck)
 Number of Outlets: 4
 1988-87 R/V Series Blazer, Jimmy, Suburban, Tahoe, Yukon, w/FI, 25
 Gal Tank

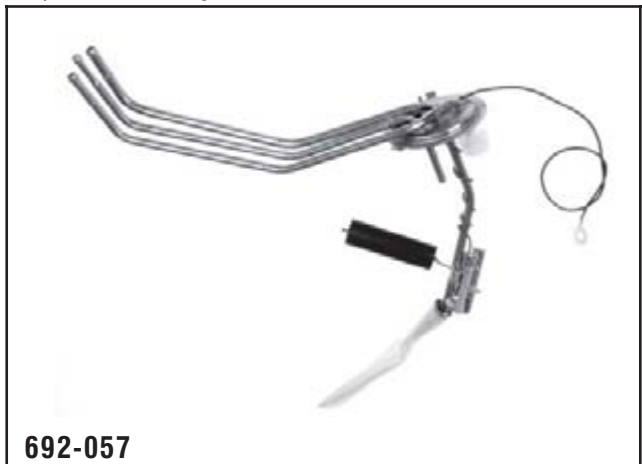

692-057
GM (Inc. Truck)
 Number of Outlets: 3
 1990-77 Bonneville, Caprice, Catalina, Custom Cruiser, Estate Wagon,
 Safari Full size RWD, w/E.E.C., w/o FI S.W. only.



692-058
GM (Inc. Truck)
 Number of Outlets: 4
 1986-85 Chevrolet & GMC Trucks S-Series, w/FI, 13 Gal Tank.



692-059
GM (Inc. Truck)
 Number of Outlets: 3
 1996-92 Lumina APV, Trans Sport, Silhouette, 3.8L, w/FI

Fuel Sending Units

Fuel Sending Units

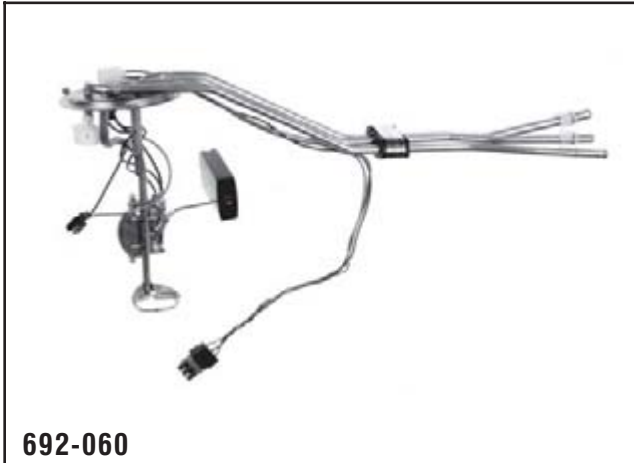

692-060

GM (Inc. Truck)
 Number of Outlets: 3
 1991-90 Beretta Corsica, w/FI



692-061

Chrysler, Dodge, Plymouth (Inc. Truck)
 Number of Outlets: 1
 1990-84 600, Acclaim, Aries, Caravelle, Daytona, Dynasty, E-Class, Lancer, Laser, LeBaron, New Yorker, Reliant, Shadow, Spirit, Sundance, TC, w/FI



692-062

Chrysler, Dodge, Plymouth (Inc. Truck)
 Number of Outlets: 1
 1990-86 600, Acclaim, Aries, Caravelle, Daytona, Dynasty, Lancer, LeBaron, New Yorker, Reliant, Shadow, Spirit, Sundance, w/FI



692-063

Ford, Lincoln, Mercury (Inc. Truck)
 Number of Outlets: 2
 1986-85 F150/250, Rear Mount Tank, w/FI, Rear Mount.



692-064

Ford, Lincoln, Mercury (Inc. Truck)
 Number of Outlets: 2
 1989-87 F150/250/350, w/FI, LH Tank, 17 Gal Tank.



692-066

GM (Inc. Truck)
 Number of Outlets: 3
 1986-85 98 Regency, Electra, Park Avenue, LeSabre w/EFI

Fuel Sending Units

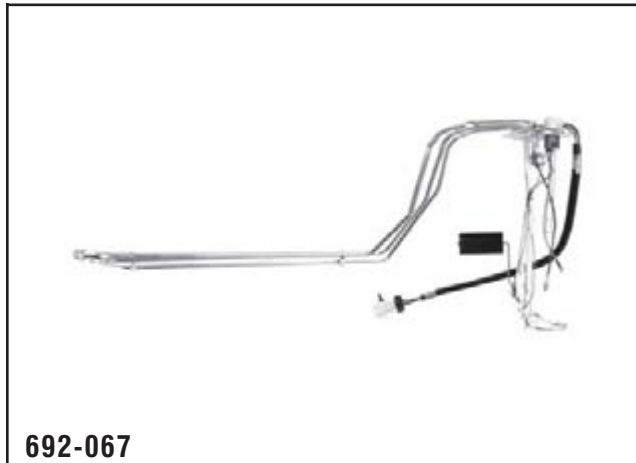

692-067

GM (Inc. Truck)
 Number of Outlets: 3
 1986 Deville, Fleetwood w/EFI FWD only



692-068

GM (Inc. Truck)
 Number of Outlets: 2
 1990-77 Bonneville, Caprice, Catalina, Impala, Custom Cruiser, Estate Wagon, Safari Full size RWD, w/out E.E.C., w/o FI S.W. only.



692-069

GM (Inc. Truck)
 Number of Outlets: 4
 1984-82 S-Series Pickup, w/o EFI 13 Gal. Tank



692-070

GM (Inc. Truck)
 Number of Outlets: 3
 1995-90 Lumina APV, Trans Sport, Silhouette, 3.1L w/FI



692-071

Ford, Lincoln, Mercury (Inc. Truck)
 Number of Outlets: 2
 1997-89 Aerostar, 21 Gal Plastic Tank, w/FI



692-072

Ford, Lincoln, Mercury (Inc. Truck)
 Number of Outlets: 2
 1990-86 E150, E250, E350, RH Tank, w/FI

Fuel Sending Units

Fuel Sending Units



692-073

GM (Inc. Truck)
 Number of Outlets: 2
 1979-73 Chevrolet & GMC Trucks C/K-Series, RH Tank, w/Man Trans, w/o FI, Gas Eng.

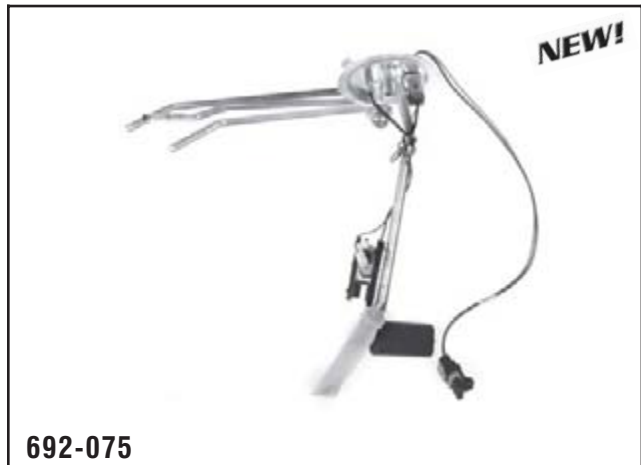

692-075

GM (Inc. Truck)
 Number of Outlets: 3
 1985-82 Century, Celebrity, Citation, Ciera, Cutlass Ciera, 6000, Phoenix, Skylark, Somerset, Omega 2.8L



692-079

GM (Inc. Truck)
 Number of Outlets: 3
 1979-73 C, K-Series Pickups

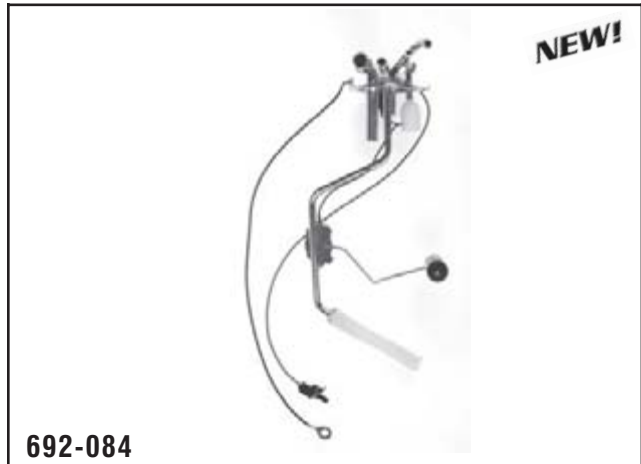

692-084

GM (Inc. Truck)
 Number of Outlets: 4
 1986-85 S-Series Pickups, Sonoma, Syclone; Gas Eng., wo/EFI, 20 Gal. Tank



692-087

GM (Inc. Truck)
 Number of Outlets: 3
 1997-96 LeSabre, 1996 LSS, Bonneville wo/Supercharger; Delta 88, 88



692-091

GM (Inc. Truck)
 Number of Outlets: 3
 1988-87 Cavalier, Firenza, Sunbird; 2.0L

Fuel Sending Units

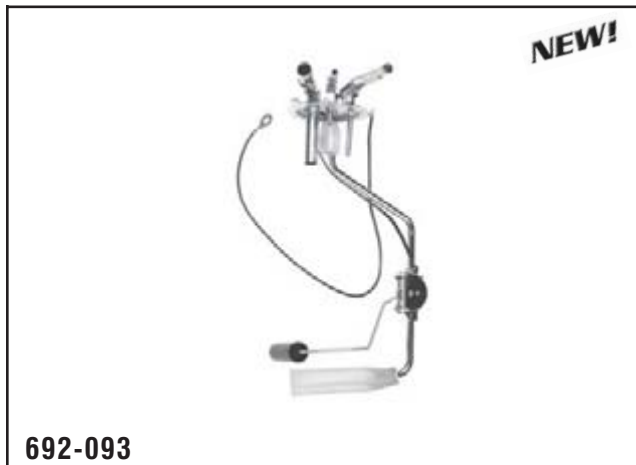

692-093
GM (Inc. Truck)
 Number of Outlets: 4
 1986-78 Suburban ,Blazer, Jimmy, Tahoe, Yukon (Full Size)



692-099
GM (Inc. Truck)
 Number of Outlets: 3
 1985-81 Eldorado, Seville; Exc. Digital Dash

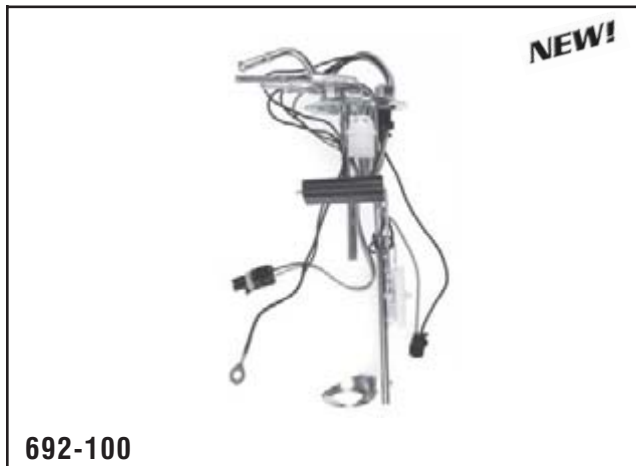

692-100
GM (Inc. Truck)
 Number of Outlets: 4
 1991-87 S-Series Pickups, Sonoma, Syclone w/13 Gal Tank



692-101
GM (Inc. Truck)
 Number of Outlets: 3
 1996 Astro, Safari Van

Fuel Sending Units

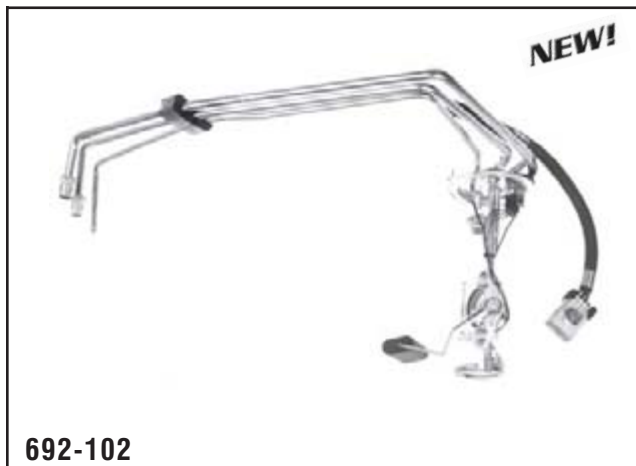

692-102
GM (Inc. Truck)
 Number of Outlets: 3
 1988 Eldorado, Seville



692-105
Ford, Lincoln, Mercury (Inc. Truck)
 Number of Outlets: 2
 1995-86 Taurus, Sable

Fuel Sending Units



692-106
Ford, Lincoln, Mercury (Inc. Truck)
 Number of Outlets: 2
 1986-85 Capri 3.8L, 5.0L, Mustang 2.3L, 3.8L, 5.0L, w/EFI; 1993-87 Mustang 2.3L, 5.0L



692-107
Ford, Lincoln, Mercury (Inc. Truck)
 Number of Outlets: 2
 1989-86 Aerostar



692-109
Ford, Lincoln, Mercury (Inc. Truck)
 Number of Outlets: 2
 1990-87 Escort



692-111
Ford, Lincoln, Mercury (Inc. Truck)
 Number of Outlets: 2
 1988-85 Ranger



692-115
Ford, Lincoln, Mercury (Inc. Truck)
 Number of Outlets: 2
 1990-86 E-Series Vans



692-127
GM (Inc. Truck)
 Number of Outlets: 4
 1995-94 Postal Service Vans

Fuel Sending Units



692-128

GM (Inc. Truck)
 Number of Outlets: 3
 1997-92 Suburban, Blazer, Jimmy, Tahoe, Yukon (Full Size),
 Suburban



692-129

GM (Inc. Truck)
 Number of Outlets: 3
 1990 Caprice



692-130

GM (Inc. Truck)
 Number of Outlets: 3
 1997-92 Blazer, Jimmy, Tahoe, Yukon (Full Size)



692-133

GM (Inc. Truck)
 Number of Outlets: 3
 1988-77 G-Series Vans

Fuel Sending Units

Related Items

Fuel Tank Straps



578-001

GM (Inc. Truck)
 1991-73 Chevrolet/GMC Trucks (Conventional Cabs).
 See pages 209-211.

GM Fuel Pump Pulsator



55160 (1)

Prevent comebacks.
 Replace with every GM in-tank fuel pump.
 Eliminates fuel pump vibration and noise. Mounts
 directly on fuel pump. Fits various GM vehicles
 with in-tank mounted fuel pumps, 1999-84. Great
 add-on sale for pump or sender sales. Always
 replace the pulsator to eliminate potential
 comebacks.

Fuel Sending Unit Applications

Fuel Sending Units

Make/ Model/Years	Description	Dorman #
ASUNA		
SUNRUNNER		
1995-92	1.6L	692-019
BUICK		
CENTURY		
1996-93	Exc. Wagon, w/Harness Code (ARD, ARG)	692-002
1992	2.5L, 2.8L, 3.3L, Exc. Wagon	692-003
1992	3.3L, Wagon, w/Harness Code (APS)	692-022
1991-89	2.5L, 2.8L, 3.3L, Exc. Wagon	692-003
1991-89	2.5L, 2.8L, 3.3L, Wagon	692-022
1988	2.5L, Exc. Wagon, w/Harness Code (APH)	692-021
1988	2.5L, Exc. Wagon, w/Harness Code (ARA)	692-024
1988	2.8L, 3.8L, Exc. Wagon	692-024
1988	2.8L, 3.8L, Wagon	692-023
1987	2.5L, Exc. Wagon	692-021
1987	2.8L, 3.8L, Wagon	692-023
1986	2.5L, Exc. Wagon	692-040
1986	2.8L, 3.8L, Exc. Wagon	692-040
1985	2.8L, Exc. Wagon	692-075
1983-82	2.8L, Exc. Wagon	692-075
1981	6 Cyl Eng, w/Turbo	692-089
1981	6 Cyl Eng, wo/Turbo	692-049
1981	8 Cyl Eng, Exc. Wagon	692-049
1980-79	3.8L, w/Turbo	692-089
1980-79	3.8L, wo/Turbo	692-049
1980-79	4.3L, 5.0L Or 5.7L, Exc. Wagon	692-049
1978	Exc. Wagon	692-049
ELECTRA, PARK AVENUE		
1996	wo/Supercharger, w/Harness Code (CRC)	692-028
1995	w/Supercharger, w/Harness Code (CAB, CPZ)	692-013
1995	wo/Supercharger, w/Harness Code (CRC)	692-028
1994	w/Supercharger, w/Harness Code (CAB, CPZ)	692-013
1994	wo/Supercharger, w/Harness Code (CAC)	692-014
1994	wo/Supercharger, w/Harness Code (CRC)	692-028
1993	w/Supercharger, w/Harness Code (CAB, CPZ)	692-013
1993	wo/Supercharger, w/Harness Code (CAC)	692-014
1992-91	w/Harness Code (CAB, CPZ)	692-013
1988-86	w/Harness Codes (HEL, HEM)	692-012
1985	3.8L	692-066
ESTATE WAGON		
1990-86	w/Vapor Return Line (3 Outlets)	692-057
1990-86	wo/Vapor Return Line (2 Outlets)	692-068
1985-77	Gas Eng, w/Vapor Return Line (3 Outlets)	692-057
1985-77	Gas Eng, wo/Vapor Return Line (2 Outlets)	692-068
LESABRE		
1997	Exc. Lesabre Timing	692-087
1996	-	692-087
1995	-	692-028
1994	w/Harness Code (CAC)	692-014
1994	w/Harness Code (CRC)	692-028
1993	w/Harness Code (CAC)	692-014
1992	-	692-013
1991	w/Harness Code (CPU)	692-011
1990	w/Harness Code (CPK, CPV)	692-010
1990	w/Harness Code (CPU)	692-011
1989	w/Harness Code (CPK, CPV)	692-010
1989	w/Harness Code (CPL)	692-011
1988-87	w/Harness Code (CPD, CPE)	692-085
1988-87	w/Harness Codes (HEL, HEM)	692-012
1986	-	692-012
1985-80	Gas Eng, Exc. Wagon, w/Vapor Return Line (3 Outlets)	692-050
1985-80	Gas Eng, Exc. Wagon, wo/Vapor Return Line (2 Outlets)	692-051
1979-77	Exc. Wagon, 24 Gallon Tank, w/Vapor Return Line (3 Outlets)	692-050
1979-77	Exc. Wagon, 24 Gallon Tank, wo/Vapor Return Line (2 Outlets)	692-051
REGAL		
1996-95	-	692-031
1994-93	w/Harness Code (WAD)	692-030
1994-93	w/Harness Code (WAE)	692-031
1992	w/Harness Code (WEP41, WEN41)	692-029
1991-88	-	692-015
1987-86	wo/EFI, Exc. Digital Dash	692-089
1985-84	Gas Eng, Exc. EFI, w/Vapor Return Line (3 Outlets)	692-089
1985-84	Gas Eng, Exc. EFI, wo/Vapor Return Line (2 Outlets)	692-049
1983-82	Exc. Wagon, Gas Eng, w/Vapor Return Line (3 Outlets)	692-089
1983-82	Exc. Wagon, Gas Eng, wo/Vapor Return Line (2 Outlets)	692-049
1981-78	3.2L, 4.4L, 5.0L	692-049
1981-78	3.8L, w/Turbo	692-089
1981-78	3.8L, wo/Turbo	692-049
RIVIERA		
1985-84	Gas Eng, wo/EFI, Exc. Digital Dash	692-098
1983-82	Gas Eng	692-098
1981	Gas Eng, w/Vapor Return Line	692-098
1978-77	w/Vapor Return Line (3 Outlet)	692-050

Make/ Model/Years	Description	Dorman #
BUICK (continued)		
RIVIERA (continued)		
1978-77	wo/Vapor Return Line (2 Outlet)	692-051
ROADMASTER		
1992	w/Harness Code (BAJ, BEX)	692-088
SKYHAWK		
1989	-	692-016
SKYLARK, SOMERSET		
1991-88	-	692-016
1986	3.0L	692-092
1984-82	2.8L	692-075
CADILLAC		
DEVILLE		
1993-91	w/Harness Code (CAA)	692-048
1990	w/Harness Code (CPW)	692-047
1988	-	692-086
1986	w/Harness Code (HEF)	692-067
ELDORADO		
1988	-	692-102
1985-83	Gas Eng, Exc. Digital Dash	692-099
1982	6 Cyl Eng	692-098
1982	8 Cyl Gas Eng, Exc. Digital Dash	692-099
1981	6.0L, Exc. Digital Dash	692-099
FLEETWOOD (FWD)		
1990	w/Harness Code (CPW)	692-047
1988	-	692-086
1986	w/Harness Code (HEF)	692-067
FLEETWOOD (RWD)		
1989-86	-	692-050
SEVILLE		
1988	-	692-102
1985-83	Gas Eng, Exc. Digital Dash	692-099
1982	6 Cyl Eng	692-098
1982	8 Cyl Gas Eng, Exc. Digital Dash	692-099
1981	6.0L, Exc. Digital Dash	692-099
CHEVROLET		
BERETTA, CORSICA		
1992	2.2L, 2.3L	692-103
1992	3.1L, Auto Trans, w/Harness Code (LKF-41)	692-103
1991-90	2.3L, 3.1L	692-060
1989	2.0L	692-032
1989	2.8L	692-053
1988	2.0L, w/Digital Gauge	692-032
1988	2.8L	692-032
CAPRICE		
1992-91	w/Harness Code (BAJ, BEX)	692-088
1990	w/EFI	692-129
1990	wo/EFI	692-057
1989	Exc. Wagon, w/EFI	692-052
1989	Wagon, wo/EFI, w/Vapor Return Line (3 Outlet)	692-057
1989	Wagon, wo/EFI, wo/Vapor return Line (2 Outlet)	692-068
1988-87	Exc. Wagon, w/EFI	692-052
1988-87	Exc. Wagon, wo/EFI	692-050
1988-87	Wagon	692-057
1986	Exc. Wagon, w/EFI, w/Harness Code (BEB)	692-052
1986	Exc. Wagon, wo/EFI	692-050
1985	Gas Eng, Exc. Wagon, wo/EFI	692-051
1985	Gas Eng, Wagon, wo/EFI	692-068
1984-83	Gas Eng, Exc. Wagon	692-051
1984-83	Gas Eng, Wagon	692-068
1982-81	Gas Eng, Exc. Wagon	692-051
1980-77	Gas Eng, Wagon	692-068
CAVALIER		
1991-90	2.2L	692-016
1989	2.0L	692-016
1988	Digital Dash	692-016
1988	Exc. Digital Dash	692-091
CELEBRITY		
1991-90	2.5L, Exc. Wagon	692-003
1991-90	3.1L, Exc. Wagon	692-003
1991-90	3.1L, Wagon	692-022
1989	2.5L, Exc. Wagon	692-003
1989	2.8L, Exc. Wagon	692-003
1989	2.8L, Wagon	692-022
1988	2.5L, Exc. Wagon, w/Harness Code (APH)	692-021
1988	2.5L, Exc. Wagon, w/Harness Code (ARA)	692-024
1988	2.8L, Exc. Wagon	692-024
1988	2.8L, Wagon	692-023
1987	2.5L, Exc. Wagon	692-021
1987	2.8L, Wagon	692-023
1986	2.5L, Exc. Wagon	692-040
1986	2.8L, w/EFI, Exc. Wagon	692-040
1985-84	2.8L, wo/EFI, Exc. Wagon	692-075

Fuel Sending Unit Applications

Make/ Model/Years	Description	Dorman #
CHEVROLET (continued)		
CELEBRITY (continued)		
1983-82	2.8L	692-075
CITATION		
1985-84	2.8L, wo/EFI	692-075
1983-82	2.8L	692-075
IMPALA		
1985	Gas Eng, Exc. Wagon, wo/EFI	692-051
1985	Gas Eng, Wagon, wo/EFI	692-068
1984-83	Gas Eng, Exc. Wagon	692-051
1984-83	Gas Eng, Wagon	692-068
1982-81	Gas Eng, Exc. Wagon	692-051
1980-77	Gas Eng, Wagon	692-068
LUMINA		
1996-95	-	692-031
1994	w/Harness Code (WAD)	692-030
1994	w/Harness Code (WAE)	692-031
1993	3.1L, 3.4L, w/Harness Code (WAD)	692-030
1992	2.5L, w/Harness Code (WEV43)	692-029
1992	3.1L, 3.4L, w/Harness Code (WEP41)	692-029
1991-90	-	692-015
LUMINA APV		
1996	-	692-059
1995-92	3.1L	692-070
1995-92	3.8L	692-059
1991-90	-	692-070
MALIBU		
1982	Gas Eng, Exc. Wagon, w/Vapor Return Line (3 Outlets)	692-089
1982	Gas Eng, Exc. Wagon, wo/Vapor Return Line (2 Outlets)	692-049
1981-78	Exc. Wagon, w/Vapor Return Line (3 Outlets)	692-089
1981-78	Exc. Wagon, wo/Vapor Return Line (2 Outlets)	692-049
MONTE CARLO		
1988	5.0L	692-089
1987-85	5.0L, w/Vapor Return Line (3 Outlets)	692-089
1987-85	5.0L, wo/Vapor Return Line (2 Outlets)	692-049
1984-82	Gas Eng, w/Vapor Return Line (3 Outlets)	692-089
1984-82	Gas Eng, wo/Vapor Return Line (2 Outlets)	692-049
1981-78	w/Vapor Return Line (3 Outlets)	692-089
1981-78	wo/Vapor Return Line (2 Outlets)	692-049
CHEVROLET/GMC TRUCK		
ASTRO, SAFARI VAN		
1996	-	692-101
1995	-	692-036
1994-92	4.3L VIN W	692-036
1994-92	4.3L VIN Z	692-017
1991-88	-	692-017
BLAZER, JIMMY, TAHOE, YUKON (Full Size)		
1997-92	5.7L, 2-Door, w/Harness Code (VCF, VRX, VSH, VPD)	692-130
1997-92	5.7L, 4-Door, w/Harness Code (VCG, VRK, VRD, VSG, VPF)	692-128
1991-89	Gas Eng, 31 Gallon Tank (4 Outlets)	692-033
1988-87	Gas Eng, 25 Gallon Tank (4 Outlets)	692-056
1988-87	Gas Eng, 31 Gallon Tank (4 Outlets)	692-033
1986-84	Gas Eng, 25 Gallon Tank (4 Outlets)	692-054
1986-84	Gas Eng, 31, 40 Gallon Tank (4 Outlets)	692-093
1983-82	8 Cyl Gas Eng, 25 Gallon Tank (4 Outlets)	692-054
1983-82	8 Cyl Gas Eng, 31, 40 Gallon Tank (4 Outlets)	692-093
1981-78	5.0L, 5.7L, AT, 25 Gallon Tank (4 Outlets)	692-054
1981-78	5.0L, 5.7L, AT, 31, 40 Gallon Tank (4 Outlets)	692-093
1981-78	6.6L, 7.4L, 25 Gallon Tank (4 Outlets)	692-054
1981-78	6.6L, 7.4L, 31, 40 Gallon Tank (4 Outlets)	692-093
C, K SERIES PICKUP		
2002-98	6.5L Diesel Eng, 1 Ton 135.5, 159.5, 183.5 Wheel Base, w/Harness Code (VPC) (3 Outlets)	692-124
1997	5.0L, w/Harness Code (VCD, VCE, VRY, VPV, VRZ) (4 Outlets)	692-074
1997	5.7L, 7.4L, 1/2 & 3/4 Ton, 1 Ton Exc. 135.5, 159.5, 183.5 Wheel Base, w/Harness Code (VCD, VCE, VRY, VPV, VRZ) (4 Outlets)	692-074
1997	6.5L Diesel Eng, 1 Ton 135.5, 159.5, 183.5 Wheel Base, w/Harness Code (VPC) (3 Outlets)	692-124
1996	4.3L, 5.0L, w/Harness Code (VCD, VCE, VRY, VPV, VRZ) (4 Outlets)	692-074
1996	5.7L, 7.4L, 1 Ton 135.5, 159.5, 183.5 Wheel Base, Exc. 31 Gallon Tank, w/Harness Code (VSE, VPB, VRE, VFN, VRP) (4 Outlets)	692-125
1996	5.7L, 7.4L, 1/2 & 3/4 Ton, 1 Ton Exc. 135.5, 159.5, 183.5 Wheel Base, w/Harness Code (VCD, VCE, VRY, VPV, VRZ) (4 Outlets)	692-074
1996	6.5L Diesel Eng, 1 Ton 135.5, 159.5, 183.5 Wheel Base, Exc. 31 Gallon Tank, w/Harness Code (VPC) (3 Outlets)	692-124
1996	6.5L Diesel Eng, 1/2 & 3/4 Ton, 1 Ton Exc. 135.5, 159.5, 183.5 Wheel Base, w/Harness Code (VRB) (3 Outlets)	692-020
1995-94	4.3L, 5.0L, Exc. High Temp Fuel Sender, wo/Pump (4 Outlets)	692-000
1995-94	4.3L, 5.0L, High Temp Fuel Sender, wo/Pump (4 Outlets)	692-001
1995-94	5.7L, 7.4L, 1 Ton 135.5, 159.5, 183.5 Wheel Base, Exc. 31 Gallon Tank, w/Harness Code (VSE, VPB, VRE, VFN, VRP) (4 Outlets)	692-125

Make/ Model/Years	Description	Dorman #
CHEVROLET/GMC TRUCK		
C, K SERIES PICKUP (continued)		
1995-94	5.7L, 7.4L, 1 Ton 135.5, 159.5, 183.5 Wheel Base, High Temp Fuel Sender, 31 Gallon Tank (4 Outlets)	692-055
1995-94	5.7L, 7.4L, 1/2 & 3/4 Ton, 1 Ton Exc. 135.5, 159.5, 183.5 Wheel Base, High Temp Fuel Sender, wo/Pump (4 Outlets)	692-001
1995-94	5.7L, 7.4L, 1/2 & 3/4 Ton, 1 Ton Exc. 135.5, 159.5, 183.5 Wheel Base, w/Harness Code (VCD, VRY, VPV, VRZ) (4 Outlets)	692-074
1995-94	5.7L, 7.4L, 1/2 & 3/4 Ton, 1 Ton Exc. 135.5, 159.5, 183.5 Wheel Base, wo/High Temp Fuel Sender, w/Harness Code (VAH, VEC, VRA, VER, VSD), wo/Pump (4 Outlets)	692-000
1995-94	6.5L Diesel Eng, 1 Ton 135.5, 159.5, 183.5 Wheel Base, 31 Gallon Tank, w/Harness Code (VES) (3 Outlets)	692-095
1995-94	6.5L Diesel Eng, 1 Ton 135.5, 159.5, 183.5 Wheel Base, Exc. 31 Gallon Tank, w/Harness Code (VPC) (4 Outlets)	692-124
1995-94	6.5L Diesel Eng, 1/2 & 3/4 Ton, 1 Ton Exc. 135.5, 159.5, 183.5 Wheel Base (3 Outlets)	692-020
1993-92	4.3L, 5.0L, Exc. High Temp Fuel Sender, wo/Pump (4 Outlets)	692-000
1993-92	4.3L, 5.0L, High Temp Fuel Sender, wo/Pump (4 Outlets)	692-001
1993-92	5.7L, 7.4L, 1 Ton 135.5, 159.5, 183.5 Wheel Base, Exc. 31 Gallon Tank, w/Harness Code (VSE, VPB, VRE, VFN, VRP) (4 Outlets)	692-125
1993-92	5.7L, 7.4L, 1 Ton 135.5, 159.5, 183.5 Wheel Base, High Temp Fuel Sender, 31 Gallon Tank (4 Outlets)	692-055
1993-92	5.7L, 7.4L, 1/2 & 3/4 Ton, 1 Ton Exc. 135.5, 159.5, 183.5 Wheel Base, High Temp Fuel Sender, wo/Pump (4 Outlets)	692-001
1993-92	5.7L, 7.4L, 1/2 & 3/4 Ton, 1 Ton Exc. 135.5, 159.5, 183.5 Wheel Base, wo/High Temp Fuel Sender, w/Harness Code, (VAH, VEC, VRA, VER, VSD) wo/Pump (4 Outlets)	692-000
1993-92	6.2L, 6.5L Diesel Eng, 1 Ton 135.5, 159.5, 183.5 Wheel Base, 31 Gallon Tank, w/Harness Code (VES) (3 Outlets)	692-095
1993-92	6.2L, 6.5L Diesel Eng, 1 Ton 135.5, 159.5, 183.5 Wheel Base, Exc. 31 Gallon Tank, w/Harness Code (VPC) (4 Outlets)	692-124
1993-92	6.2L, 6.5L Diesel Eng, 1/2 & 3/4 Ton, 1 Ton Exc. 135.5, 159.5, 183.5 Wheel Base (3 Outlets)	692-020
1991-90	4.3L, 5.0L, Exc. High Temp Fuel Sender, wo/Pump (4 Outlets)	692-000
1991-90	4.3L, 5.0L, High Temp Fuel Sender, wo/Pump (4 Outlets)	692-001
1991-90	5.7L, 7.4L, 1 Ton 135.5, 159.5, 183.5 Wheel Base, Exc. 31 Gallon Tank, w/Harness Code (VSE, VPB, VRE, VFN, VRP) (4 Outlets)	692-125
1991-90	5.7L, 7.4L, 1 Ton 135.5, 159.5, 183.5 Wheel Base, High Temp Fuel Sender, 31 Gallon Tank (4 Outlets)	692-055
1991-90	5.7L, 7.4L, 1/2 & 3/4 Ton, 1 Ton Exc. 135.5, 159.5, 183.5 Wheel Base, High Temp Fuel Sender, wo/Pump (4 Outlets)	692-001
1991-90	5.7L, 7.4L, 1/2 & 3/4 Ton, 1 Ton Exc. 135.5, 159.5, 183.5 Wheel Base, wo/High Temp Fuel Sender, w/Harness Code, (VAH, VEC, VRA, VER, VSD) wo/Pump (4 Outlets)	692-000
1991-90	6.2L Diesel Eng, 1 Ton 135.5, 159.5, 183.5 Wheel Base, 31 Gallon Tank, w/Harness Code (VES) (3 Outlets)	692-095
1991-90	6.2L Diesel Eng, 1 Ton 135.5, 159.5, 183.5 Wheel Base, Exc. 31 Gallon Tank, w/Harness Code (VPC) (4 Outlets)	692-124
1991-90	6.2L Diesel Eng, 1/2 & 3/4 Ton, 1 Ton Exc. 135.5, 159.5, 183.5 Wheel Base (3 Outlets)	692-020
1989-88	4.3L, 5.0L, 5.7L, 7.4L, wo/Pump (4 Outlets)	692-000
1989-88	6.2L Diesel Eng (3 Outlets)	692-020
1986-85	4.3L, 4.8L, 5.0L, 5.7L, 7.4L (3 Outlets)	692-006
1986-85	4.3L, 4.8L, 5.0L, 5.7L, 7.4L, Auxiliary Tank (3 Outlets)	692-026
1984	4.1L, 4.8L (2 Outlets)	692-042
1984	4.1L, 4.8L, Auxiliary Tank (2 Outlets)	692-080
1984	5.0L, 5.7L, 7.4L (3 Outlets)	692-006
1984	5.0L, 5.7L, 7.4L, Auxiliary Tank (3 Outlets)	692-026
1983-82	4.1L, 4.8L (3 Outlets)	692-042
1983-82	4.1L, 4.8L, Auxiliary Tank (2 Outlets)	692-080
1983-82	5.0L, 5.7L, 7.4L (3 Outlets)	692-006
1983-82	5.0L, 5.7L, 7.4L, Auxiliary Tank (3 Outlets)	692-026
1983-82	6.2L Diesel Eng (3 Outlets)	692-081
1983-82	6.2L Diesel Eng, Auxiliary Tank (3 Outlets)	692-082
1981	4.1L, 1/2 Ton (2 Outlets)	692-080
1981	4.1L, 3/4 Ton, 2WD, Exc. Rear Mounted Tank (2 Outlets)	692-080
1981	4.1L, Auxiliary Tank (2 Outlets)	692-042
1981	4.8L, Auxiliary Tank (2 Outlets)	692-042
1981	4.8L, Exc. Rear Mounted Tank (2 Outlets)	692-080
1981	5.0L (3 Outlets)	692-006
1981	5.7L Gas Eng (3 Outlets)	692-006
1981	5.7L Gas Eng, 3/4 & 1 Ton, Rear Mounted Tank (4 Outlets)	692-054
1981	5.7L Gas Eng, Auxiliary Tank (3 Outlets)	692-026
1981	7.4L, 2WD, Auxiliary Tank (3 Outlets)	692-026
1981	7.4L, 2WD, Calif (3 Outlets)	692-006
1981	7.4L, 2WD, Rear Mounted Tank (4 Outlets)	692-054
1980	4.1L, 1/2 Ton (2 Outlets)	692-080
1980	4.1L, 3/4 Ton, 2WD, Exc. Rear Mounted Tank (2 Outlets)	692-080
1980	4.1L, Auxiliary Tank (2 Outlets)	692-042
1980	4.8L, Auxiliary Tank (2 Outlets)	692-042
1980	4.8L, Exc. Rear Mounted Tank (2 Outlets)	692-080
1980	5.0L, 5.7L Gas Eng, Auxiliary Tank (3 Outlets)	692-006

Fuel Sending Units

Power Steering Pulleys
pg. 317-326

Quick Disconnect™
pg. 327-396

Radiator Fan Assemblies
pg. 397-430

Rear Axle Shaft Kits
pg. 431-434

Side View Mirror Assemblies
pg. 435-468

GM Fuel Pump Pulsator Also Available

Fuel Sending Units

Fuel Sending Unit Applications

Make/Model/Year	Description	Dorman #
CHEVROLET/GMC TRUCK (continued)		
C, K SERIES PICKUP (continued)		
1980	5.0L, 5.7L Gas Eng, Exc. Rear Mounted Tank (3 Outlets)	692-026
1980	5.7L Gas Eng, 3/4 & 1 Ton, Rear Mounted Tank (4 Outlets)	692-054
1980	6.6L, 4WD, 3/4 & 1 Ton, Auxiliary Tank (3 Outlets)	692-006
1980	6.6L, 4WD, 3/4 & 1 Ton, Exc. Rear Mounted Tank (3 Outlets)	692-026
1980	6.6L, 4WD, 3/4 & 1 Ton, Rear Mounted Tank (4 Outlets)	692-054
1980	7.4L, 2WD, 3/4 & 1 Ton, Auxiliary Tank (3 Outlets)	692-006
1980	7.4L, 2WD, 3/4 & 1 Ton, Exc. Rear Mounted Tank (3 Outlets)	692-026
1980	7.4L, 2WD, 3/4 & 1 Ton, Rear Mounted Tank (4 Outlets)	692-054
1979	4.8L, 1 Ton, Exc. Calif (2 Outlets)	692-073
1979	4.8L, 1 Ton, Exc. Calif, Auxiliary Tank (2 Outlets)	692-043
1979	5.7L Gas Eng, 1 Ton, Exc. Calif, AT, Auxiliary Tank (3 Outlets)	692-079
1979	5.7L Gas Eng, 1 Ton, Exc. Calif, MT (2 Outlets)	692-073
1979	5.7L Gas Eng, 1 Ton, Exc. Calif, MT, Auxiliary Tank (2 Outlets)	692-043
1979	5.7L Gas Eng, 3/4 & 1 Ton, AT (4 Outlets)	692-054
1979	5.7L Gas Eng, Exc. Calif, AT (3 Outlets)	692-078
1979	6.6L, 1 Ton, Exc. Calif, Auxiliary Tank (3 Outlets)	692-079
1979	6.6L, Exc. Calif (3 Outlets)	692-078
1979	7.4L Eng, 3/4 & 1 Ton (4 Outlets)	692-054
1979	7.4L, 1 Ton, Exc. Calif, Auxiliary Tank (3 Outlets)	692-079
1979	7.4L, Exc. Calif (3 Outlets)	692-078
1978	4.1L, 4.8L, Exc. Calif (2 Outlets)	692-073
1978	4.1L, 4.8L, Exc. Calif, Auxiliary Tank (2 Outlets)	692-043
1978	5.7L Gas Eng, 2WD, Exc. Calif (2 Outlets)	692-073
1978	5.7L Gas Eng, 2WD, Exc. Calif, Auxiliary Tank (2 Outlets)	692-043
1978	5.7L Gas Eng, 4WD, AT, Exc. Calif (3 Outlets)	692-078
1978	5.7L Gas Eng, 4WD, Auxiliary Tank, AT, Exc. Calif (3 Outlets)	692-079
1978	5.7L Gas Eng, 4WD, MT, Exc. Calif (2 Outlets)	692-073
1978	5.7L Gas Eng, 4WD, MT, Exc. Calif, Auxiliary Tank (2 Outlets)	692-043
1978	6.6L, 4WD, Auxiliary Tank, Exc. Calif (3 Outlets)	692-079
1978	6.6L, 4WD, Exc. Calif (3 Outlets)	692-078
1978	7.4L, 2WD, Auxiliary Tank, Exc. Calif (3 Outlets)	692-079
1978	7.4L, 2WD, Exc. Calif (3 Outlets)	692-078
1977-76	4.1L, 4.8L Or 5.0L (2 Outlets)	692-073
1977-76	4.1L, 4.8L Or 5.0L, Auxiliary Tank (2 Outlets)	692-043
1977-76	5.7L, 2WD (2 Outlets)	692-073
1977-76	5.7L, 2WD, Auxiliary Tank (2 Outlets)	692-043
1977-76	5.7L, 4WD, MT (2 Outlets)	692-073
1977-76	5.7L, 4WD, MT, Auxiliary Tank (2 Outlets)	692-043
1977-76	5.7L, 6.6L, 4WD, AT (3 Outlets)	692-078
1977-76	5.7L, 6.6L, 4WD, AT, 1/2 & 3/4 Ton, Auxiliary Tank (3 Outlets)	692-079
1977-76	7.4L, 2WD, 1/2 Ton, w/HD Suspension (3 Outlets)	692-078
1977-76	7.4L, 2WD, 3/4 & 1 Ton, Exc. 25 Gallon Tank (3 Outlets)	692-079
1977-76	7.4L, 2WD, Auxiliary Tank (3 Outlets)	692-079
1975	4.1L, 4.8L, 5.0L Or 5.7L, Exc. LPG (2 Outlets)	692-073
1975	5.7L, 2WD, 1/2 Ton, Exc. 117.5" Wheel Base, Auxiliary Tank (2 Outlets)	692-043
1975	5.7L, 6.6L, 4WD, 1/2 & 3/4 Ton, Fleetside, Wideside, AT (3 Outlets)	692-079
1975	5.7L, 6.6L, 4WD, Exc. Fleetside, Wideside, AT (3 Outlets)	692-078
1975	7.4L, 2WD, 1/2 Ton, Fleetside, Exc. 117.5" Wheel Base (3 Outlets)	692-079
1975	7.4L, 2WD, 3/4 & 1 Ton, Fleetside (3 Outlets)	692-079
1975	7.4L, 2WD, Exc. Fleetside (3 Outlets)	692-078
1975	7.4L, 4WD (2 Outlets)	692-073
1974-73	4.1L, 4.8L, 5.0L Or 5.7L, Exc. LPG (2 Outlets)	692-073
1974-73	4.1L, 4.8L, 5.0L Or 5.7L, Exc. LPG, Auxiliary Tank (2 Outlets)	692-043
1974-73	5.7L, 2WD, AT (3 Outlets)	692-078
1974-73	7.4L, 2WD (3 Outlets)	692-078
1974-73	7.4L, 2WD, Auxiliary Tank (3 Outlets)	692-079
1974-73	7.4L, 4WD (2 Outlets)	692-073
1974-73	7.4L, 4WD, Auxiliary Tank (2 Outlets)	692-043
G SERIES VAN		
1995-89	4.3L, 5.0L, 5.7L, 7.4L (4 Outlets)	692-035
1988-87	4.3L, 5.0L (4 Outlets)	692-035
1988-87	5.7L, EFI (4 Outlets)	692-035
1988-87	5.7L, Exc. EFI, wo/AC (3 Outlets)	692-133
1986-85	5.0L, 5.7L, wo/AC (3 Outlets)	692-133
1984-79	4.1L, 5.0L, 5.7L, wo/AC (3 Outlets)	692-133
1978	4.1L, 4.8L, 5.0L, 5.7L, wo/AC (3 Outlets)	692-133
1977	4.1L, 4.8L, 5.0L, 5.7L, 1/2 Ton, wo/AC (3 Outlets)	692-133
P SERIES VAN		
1996	5.7L, Exc. School Bus	692-094
1995-94	4.3L, 5.7L, Exc. School Bus	692-094
1995-94	6.5L Diesel Eng, Exc. School Bus, wo/60 Gallon Tank	692-096
1993-90	3.9L Diesel Eng, Exc. School Bus, wo/60 Gallon Tank	692-096
1993-90	4.3L, 5.7L, Exc. School Bus	692-094
1993-90	6.2L Diesel Eng, Exc. School Bus, wo/60 Gallon Tank	692-096
1993-90	7.4L, Exc. 80 Gallon Tank	692-094
POSTAL SERVICE VAN		
1995-94	-	692-127
1993-87	-	692-041

Make/Model/Year	Description	Dorman #
CHEVROLET/GMC TRUCK (continued)		
R, V SERIES PICKUP		
1991-90	5.7L, 7.4L, Auxiliary Tank (3 Outlets)	692-044
1991-90	6.2L Diesel Eng	692-081
1991-89	5.7L, 7.4L (3 Outlets)	692-027
1989	5.7L (3 Outlets)	692-027
1989	5.7L, Auxiliary Tank (3 Outlets)	692-044
1989	6.2L Diesel Eng (3 Outlets)	692-081
1989	7.4L, w/EFI (3 Outlets)	692-027
1989	7.4L, w/EFI, Auxiliary Tank (3 Outlets)	692-044
1989	7.4L, wo/EFI (3 Outlets)	692-006
1989	7.4L, wo/EFI, Auxiliary Tank (3 Outlets)	692-026
1988-87	4.3L, 5.0L, 5.7L, 7.4L, w/EFI (3 Outlets)	692-027
1988-87	4.3L, 5.0L, 5.7L, 7.4L, w/EFI, Auxiliary Tank (3 Outlets)	692-044
1988-87	4.8L, 5.7L, 7.4L, wo/EFI (3 Outlets)	692-006
1988-87	4.8L, 5.7L, 7.4L, wo/EFI, Auxiliary Tank (3 Outlets)	692-026
1988-87	6.2L Diesel Eng (3 Outlets)	692-081
S SERIES BLAZER, JIMMY, TYPHOON		
1995	2-Door, w/Harness Code (SFG)	692-077
1995	4-Door, w/Harness Code (SFK, SFW)	692-126
1994-92	4.3L VIN W	692-004
1994-92	4.3L VIN Z	692-025
1991-88	20 Gallon Tank	692-005
1987-86	13 Gallon Tank	692-041
1987-86	20 Gallon Tank	692-005
1985	2.5L, 2.8L, 13 Gallon Tank	692-041
1985	2.5L, 20 Gallon Tank	692-005
1984-83	Gas Eng, 20 Gallon Tank	692-076
S SERIES PICKUP, SONOMA, SYCLONE		
1995-94	w/Harness Code (SEN, SEZ, VPW, VPX)	692-007
1995-94	w/Harness Code (SES, SFA, VPV)	692-009
1993-92	13 Gallon Tank	692-046
1993-92	20 Gallon Tank, w/Harness Code (SEN, SEZ, VPW, VPX)	692-007
1993-92	20 Gallon Tank, w/Harness Code (SES, SFA, VPV)	692-009
1993-92	20 Gallon Tank, w/Harness Code (SET, SFT)	692-004
1991-87	13 Gallon Tank	692-100
1991-87	20 Gallon Tank	692-008
1986-85	Gas Eng, w/EFI, 13 Gallon Tank	692-058
1986-85	Gas Eng, w/EFI, 20 Gallon Tank	692-045
1986-85	Gas Eng, wo/EFI, 20 Gallon Tank	692-084
1984-82	Gas Eng, 13 Gallon Tank	692-069
1984-82	Gas Eng, 20 Gallon Tank	692-083
SUBURBAN		
1999-98	Diesel Eng, w/Harness Code (VPG)	692-097
1997-94	Diesel Eng, w/Harness Code (VPG)	692-097
1997-94	Gas Eng, w/Harness Code (VCG, VRK, VRD, VSG, VPF)	692-128
1993-92	Gas Eng, w/Harness Code (VCG, VRK, VRD, VSG, VPF)	692-128
1991-90	Gas Eng, 40 Gallon Tank (4 Outlets)	692-034
1989-88	Gas Eng, 31 Gallon Tank (4 Outlets)	692-033
1989-88	Gas Eng, 40 Gallon Tank (4 Outlets)	692-034
1987	Gas Eng, 25 Gallon Tank (4 Outlets)	692-056
1987	Gas Eng, 31 Gallon Tank (4 Outlets)	692-033
1986-84	8 Cyl Gas Eng, 25 Gallon Tank (4 Outlets)	692-054
1986-84	8 Cyl Gas Eng, 31, 40 Gallon Tank (4 Outlets)	692-093
1983-81	8 Cyl Gas Eng, 25 Gallon Tank (4 Outlets)	692-054
1983-81	8 Cyl Gas Eng, 31, 40 Gallon Tank (4 Outlets)	692-093
1980-78	5.0L, 5.7L, AT, 25 Gallon Tank (4 Outlets)	692-054
1980-78	5.0L, 5.7L, AT, 31, 40 Gallon Tank (4 Outlets)	692-093
1980-78	6.6L, 7.4L, 25 Gallon Tank (4 Outlets)	692-054
1980-78	6.6L, 7.4L, 31, 40 Gallon Tank (4 Outlets)	692-093
CHRYSLER		
E-CLASS		
1984	2.2L, w/Turbo	692-061
LASER		
1986-84	2.2L, w/Turbo	692-061
LEBARON		
1990-87	2.2L, 2.5L, w/Turbo	692-061
1990-87	2.2L, 2.5L, wo/Turbo	692-062
1986-84	2.2L, w/Turbo	692-061
NEW YORKER		
1990-88	2.2L, 3.0L, 3.3L	692-061
1987-86	2.2L	692-061
1987-86	2.5L	692-062
1985-84	2.2L, w/Turbo	692-061
TC MASERATI		
1990-89	2.2L, 3.0L	692-061
DODGE		
600		
1988-86	w/Turbo	692-061
1988-86	wo/Turbo	692-062
1985-84	w/Turbo	692-061
ARIES		
1989-86	-	692-062

Fuel Sending Unit Applications

Make/ Model/Years	Description	Dorman #
DODGE (continued)		
COLT		
1988-87	Exc. Wagon	692-122
DAYTONA		
1990-86	w/Turbo	692-061
1990-86	wo/Turbo	692-062
1985-84	w/Turbo	692-061
DYNASTY		
1990-89	2.5L	692-062
1990-89	3.0L, 3.3L	692-061
1988	2.5L	692-062
LANCER		
1989-86	w/Turbo	692-061
1989-86	wo/Turbo	692-062
1985	w/Turbo	692-061
SHADOW		
1990-87	w/Turbo	692-061
1990-87	wo/Turbo	692-062
SPIRIT		
1990-89	2.5L, wo/Turbo	692-062
1990-89	3.0L	692-061
FORD		
CROWN VICTORIA		
1989-83	5.8L, w/Fuel Vapor Return Tube	692-134
ESCORT		
1990-88	1.9L, VIN 9, Exc. GT, 11 Gallon Tank	692-110
1990-87	1.9L, VIN J, GT	692-109
LTD		
1982-81	4.2L, w/Fuel Vapor Return Tube	692-134
1982-80	5.0L, w/Fuel Vapor Return Tube	692-134
1982-79	5.8L, w/Fuel Vapor Return Tube	692-134
LTD II		
1979	5.8L, w/Fuel Vapor Return Line	692-134
MUSTANG		
1993-87	2.3L, 5.0L	692-106
1986	2.3L, 3.8L, 5.0L, w/EFI	692-106
1985	2.3L, 3.8L, 5.0L, w/EFI, From 11/84	692-106
TAURUS		
1995-86	Exc. SHO, 16 Gallon Tank	692-104
1995-86	Exc. SHO, 18.6 Gallon Tank, w/Electronic Dash	692-105
TEMPO		
1991-90	AWD	692-108
1987-84	2.3L, wo/EFI	692-120
FORD TRUCK		
AEROSTAR		
1997-90	21 Gallon Tank	692-071
1989	17 Gallon Tank	692-107
1989	21 Gallon Tank	692-071
1988-86	2.3L, 3.0L, 17 Gallon Tank	692-107
BRONCO II		
1990-89	2.9L	692-112
1988-86	2.9L	692-113
1984	2.8L	692-121
E SERIES VAN		
1990-86	18 Gallon Tank, Located before Axle	692-072
1990-86	22 Gallon Tank, Located after Axle	692-115
EXPLORER		
1994-91	4.0L	692-114
F SERIES PICKUP		
1989-87	Gas Eng, w/EFI, 17 Gallon Tank, Located Midship	692-064
1989-87	Gas Eng, w/EFI, 19 Gallon Tank, Located Midship	692-018
1989-87	Gas Eng, w/EFI, Located after Axle	692-037
1986-85	5.0L Eng, w/EFI	692-063
1984-80	Gas Eng, 16 Gallon Tank, Located Midship	692-119
1984-80	Gas Eng, 19 Gallon Tank, Located after Axle	692-117
1984-80	Gas Eng, 19 Gallon Tank, Located Midship	692-118
RANGER		
1997-89	Regular Cab	692-038
1988-86	2.3L Gas Eng, 2.9L, Regular Cab	692-111
1988-86	2.3L Gas Eng, 2.9L, Super Cab	692-039
1985	2.3L Gas Eng	692-111
GEO		
TRACKER		
1996-89	2 DR	692-019
JEEP		
CJ SERIES		
1986-81	15 Gallon Tank	692-116
1980-77	w/4-3/8" Filter	692-116
SCRAMBLER		
1985-81	15 Gallon Tank	692-116
LINCOLN		
CONTINENTAL		
1980	5.8L, wo/Electronic Instrument Cluster	692-134

Make/ Model/Years	Description	Dorman #
LINCOLN (continued)		
MARK VI		
1980	5.8L, wo/Electronic Instrument Cluster	692-134
MAZDA TRUCK		
B2000		
1987-86	Short Bed	692-123
B2200		
1993-90	w/EFI, Exc. Cab Plus	692-135
1993-90	wo/EFI, AT, Cab Plus	692-136
1993-90	wo/EFI, MT, Short Bed	692-123
1989-87	AT, Cab Plus	692-136
1989-87	MT, Short Bed	692-123
B2600		
1993-90	Exc. Cab Plus	692-135
1988-87	Cab Plus, AT	692-136
MERCURY		
CAPRI		
1986	3.8L, 5.0L	692-106
1985	3.8L, 5.0L, w/EFI, From 11/84	692-106
GRAND MARQUIS, MARQUIS		
1982-81	4.2L, w/Fuel Vapor Return Tube	692-134
1982-80	5.0L, w/Fuel Vapor Return Tube	692-134
1982-79	5.8L, w/Fuel Vapor Return Tube	692-134
LYNX		
1987	1.9L, VIN J, XR3	692-109
SABLE		
1995-86	16 Gallon Tank	692-104
1995-86	18.6 Gallon Tank, w/Electronic Dash	692-105
TOPAZ		
1991-90	AWD	692-108
1987-84	2.3L, wo/EFI	692-120
MITSUBISHI		
MIRAGE		
1988	1.6L	692-122
1987-86	1.5L, 2-Door	692-122
1987-86	1.6L	692-122
OLDSMOBILE		
98, 98 REGENCY		
1996	w/Harness Code (CRC)	692-028
1995	w/Supercharger, w/Harness Code (CAB, CPZ)	692-013
1995	wo/Supercharger, w/Harness Code (CRC)	692-028
1994	w/Supercharger, w/Harness Code (CAB, CPZ)	692-013
1994	wo/Supercharger, w/Harness Code (CAC)	692-014
1994	wo/Supercharger, w/Harness Code (CRC)	692-028
1993	w/Supercharger, w/Harness Code (CAB, CPZ)	692-013
1993	wo/Supercharger, w/Harness Code (CAC)	692-014
1992-91	w/Harness Code (CAB, CPZ)	692-013
1988-87	w/Harness Codes (HEL, HEM)	692-012
1986-85	3.8L	692-066
CALAIS, CUTLASS CALAIS		
1991-88	-	692-016
1987	2.3L, w/Digital Gauge	692-016
1987	2.3L, wo/Digital Gauge	692-092
1986	3.0L	692-092
1985-82	Gas Eng, w/Vapor Return Line	692-089
1981-78	Gas Eng, w/Vapor Return Line (3 Outlets)	692-089
1981-78	Gas Eng, wo/Vapor Return Line (2 Outlets)	692-049
CIERA, CUTLASS CIERA		
1996-93	w/Harness Code (ARD, ARG)	692-002
1992-89	Exc. Wagon	692-003
1992-89	Wagon, w/Harness Code (APS, APY)	692-022
1988	2.5L, w/Harness Code (APH)	692-021
1988	2.5L, w/Harness Code (ARA, AAH, AAG)	692-024
1988	2.8L, 3.8L, Exc. Wagon	692-024
1988	2.8L, 3.8L, Wagon	692-023
1987	2.5L	692-021
1987	2.8L, 3.8L, Exc. Wagon	692-024
1987	2.8L, 3.8L, Wagon	692-023
1986	2.5L	692-040
1986	2.8L, 3.8L, w/EFI	692-040
1985-84	2.8L, wo/EFI	692-075
1983-82	2.8L, wo/EFI	692-075
CUSTOM CRUISER		
1990-86	w/Vapor Return Line (3 Outlets)	692-057
1990-86	wo/Vapor Return Line (2 Outlets)	692-068
1985-77	Gas Eng, w/Vapor Return Line (3 Outlets)	692-057
1985-77	Gas Eng, wo/Vapor Return Line (2 Outlets)	692-068
CUTLASS, CUTLASS SUPREME		
1997-95	-	692-031
1994	w/Harness Code (WAD)	692-030
1994	w/Harness Code (WAE)	692-031
1993	w/Harness Code (WAD)	692-030
1992	w/Harness Code (WEP41)	692-029

Fuel Sending Units

Window
Lift Motors
pg. 535-554

Window
Regulators
pg. 555-566

Wiper
Motors
pg. 567-572

Wiper Transmission
Linkages
pg. 573-576

GM Fuel Pump Pulsator
Also Available

Fuel Sending Units

Fuel Sending Unit Applications

Make/ Model/Years	Description	Dorman #
OLDSMOBILE (continued)		
CUTLASS, CUTLASS SUPREME (continued)		
1991-89	w/Harness Code (WAC, WEC, WEM, WER)	692-015
1988	FWD	692-015
1988	RWD	692-089
1987-86	-	692-089
1985-78	Gas Eng, w/Vapor Return Line (3 Outlets)	692-089
1985-78	Gas Eng, wo/Vapor Return Line (2 Outlets)	692-049
DELTA 88, 88		
1996	-	692-087
1995	w/Supercharger	692-013
1995	wo/Supercharger	692-028
1994	w/Harness Code (CAC)	692-014
1994	w/Harness Code (CRC)	692-028
1993	w/Harness Code (CAC)	692-014
1992	w/Harness Code (CAB, CPZ)	692-013
1991	w/Harness Code (CPL, CPU)	692-011
1990-89	w/Harness Code (CPK, CPV)	692-010
1990-89	w/Harness Code (CPD, CPU)	692-011
1988-87	w/Harness Code (CPD, CPE, CPP)	692-085
1988-87	w/Harness Codes (HEA, HEL, HEM)	692-012
1986	w/Harness Codes (HEA, HEL, HEM)	692-012
1985-78	Gas Eng, 24 Gallon Tank, w/Vapor Return Line (3 Outlets)	692-050
1985-78	Gas Eng, 24 Gallon Tank, wo/Vapor Return Line (2 Outlets)	692-051
1977	24 Gallon Tank, w/Vapor Return Line (3 Outlets)	692-050
1977	24 Gallon Tank, wo/Vapor Return Line (2 Outlets)	692-051
FIRENZA		
1987	2.0L, Vin K	692-091
LSS		
1996	wo/Supercharger	692-087
OMEGA		
1984-82	2.8L	692-075
SILHOUETTE		
1996-95	-	692-059
1994-92	3.1L Eng	692-070
1994-92	3.8L Eng	692-059
1991-90	-	692-070
TORONADO		
1985-84	Gas Eng, Exc. Digital Dash	692-098
1983-82	Gas Eng	692-098
1981	Gas Eng, w/Vapor Return Line	692-098
1977	24 Gallon Tank, w/Vapor Return Line (3 Outlets)	692-050
1977	24 Gallon Tank, wo/Vapor Return Line (2 Outlets)	692-051
PLYMOUTH		
ACCLAIM		
1990	2.5L, w/Turbo	692-061
1990	2.5L, wo/Turbo	692-062
1990	3.0L	692-061
1989	3.0L	692-061
CARAVELLE		
1988-86	w/Turbo	692-061
1988-86	wo/Turbo	692-062
1985	w/Turbo	692-061
COLT		
1988-87	Exc. Wagon	692-122
RELIANT		
1989-86	-	692-062
SUNDANCE		
1990-87	w/Turbo	692-061
1990-87	wo/Turbo	692-062
PONTIAC		
6000		
1991-89	Exc. Wagon	692-003
1991-89	Wagon	692-022
1988	2.5L, w/Harness Code (AAG, ARA)	692-024
1988	2.5L, w/Harness Code (APH, APK)	692-021
1988	2.8L, Exc. Wagon	692-024
1988	2.8L, Wagon	692-023
1987	2.5L	692-021
1987	2.8L, Exc. Wagon, w/4 Wire Harness	692-024
1987	2.8L, Exc. Wagon, w/3 Wire Harness	692-040
1987	2.8L, Wagon	692-023
1986	2.5L	692-040
1986	2.8L, w/EFI	692-040
1985	2.8L, wo/EFI	692-075
1984	2.8L	692-075
1983-82	2.8L	692-075

Make/ Model/Years	Description	Dorman #
PONTIAC (continued)		
BONNEVILLE		
1996	wo/Supercharger	692-087
1995	w/Supercharger	692-013
1995	wo/Supercharger	692-028
1994	w/Supercharger	692-013
1994	wo/Supercharger, w/Harness Code (CAC)	692-014
1994	wo/Supercharger, w/Harness Code (CRC)	692-028
1993	w/Supercharger	692-013
1993	wo/Supercharger	692-014
1992	-	692-013
1991	w/Harness Code (CPL, CPU)	692-011
1990-89	w/Harness Code (CPK, CPV)	692-010
1988-87	w/Harness Code (CPD, CPE, CPP)	692-085
1988-87	w/Harness Codes (HEL, HEM)	692-012
1986	3.8L, 5.0L	692-089
1985-82	Gas Eng, w/Vapor Return Line (3 Outlets)	692-089
1985-82	Gas Eng, wo/Vapor Return Line (2 Outlets)	692-049
1981-80	Gas Eng, Exc. Wagon, w/AC	692-050
1981-80	Gas Eng, Exc. Wagon, wo/AC	692-051
1981-80	Gas Eng, Wagon, w/AC	692-057
1981-80	Gas Eng, Wagon, wo/AC	692-068
1979-77	Exc. Wagon, w/AC, 24 Gallon Tank	692-050
1979-77	Exc. Wagon, wo/AC, 24 Gallon Tank	692-051
1979-77	Wagon, w/AC	692-057
1979-77	Wagon, wo/AC	692-068
CATALINA		
1981-80	Gas Eng, Exc. Wagon, w/AC	692-050
1981-80	Gas Eng, Exc. Wagon, wo/AC	692-051
1981-80	Gas Eng, Wagon, w/AC	692-057
1981-80	Gas Eng, Wagon, wo/AC	692-068
1979-77	Exc. Wagon, w/AC, 24 Gallon Tank	692-050
1979-77	Exc. Wagon, wo/AC, 24 Gallon Tank	692-051
1979-77	Wagon, w/AC	692-057
1979-77	Wagon, wo/AC	692-068
GRAND AM		
1991-87	-	692-016
1986	3.0L	692-092
1980-78	w/Vapor Return Line (3 Outlets)	692-089
1980-78	wo/Vapor Return Line (2 Outlets)	692-049
GRAND PRIX		
1996-95	-	692-031
1994	w/Harness Code (WAD)	692-030
1994	w/Harness Code (WAE)	692-031
1993	w/Harness Code (WAD)	692-030
1992	w/Harness Code (WEP41)	692-029
1991-88	-	692-015
1987-86	3.8L, 5.0L, w/Vapor Return Line (3 Outlets)	692-089
1987-86	3.8L, 5.0L, wo/Vapor Return Line (2 Outlets)	692-049
1985-81	Gas Eng, w/Vapor Return Line (3 Outlets)	692-089
1985-81	Gas Eng, wo/Vapor Return Line (2 Outlets)	692-049
1980-78	w/Vapor Return Line (3 Outlets)	692-089
1980-78	wo/Vapor Return Line (2 Outlets)	692-049
LEMANS, GRAND LEMANS		
1981-78	w/Vapor Return Line (3 Outlets)	692-089
1981-78	wo/Vapor Return Line (2 Outlets)	692-049
PARISIENNE		
1986	4.3L, w/Harness Code (BEG)	692-052
1985-83	3.8L, 5.0L, 24 Gallon Tank	692-051
PHOENIX		
1984	2.8L	692-075
1983-82	2.8L	692-075
SAFARI		
1989-87	w/Vapor Return Line (3 Outlets)	692-057
1989-87	wo/Vapor Return Line (2 Outlets)	692-068
SUNBIRD		
1991-89	2.0L, w/Harness Code (JPR, JPQ)	692-016
1988	2.0L	692-091
1987	2.0L, wo/Turbo	692-091
TRANS SPORT		
1996-95	-	692-059
1994-92	3.1L Eng	692-070
1994-92	3.8L Eng	692-059
1991-90	-	692-070
SUZUKI		
SIDEKICK		
1996-89	1.6L	692-019

Fuel Tanks and Accessories

NEW Fuel Tanks, Straps, Filler Necks and Lock Rings

Direct OE Replacement



Fuel tanks include:

NEW

Lock Ring and Seal



Features and Benefits

- Tanks are constructed from galvanized steel and painted for an extra layer of corrosion protection.
- Dorman Fuel Tank program complements your existing sending unit sales.



Also Available Separately

2006 Quick Ship Program

Order just the Fuel Tanks you need as part of your regular Dorman® order to reduce your freight expense and avoid overstock situations.

Activant Path

Fuel Pump, Tank & Turbo System

Activant Code

DTT

Applications begin on page 212.

Competitive Interchange

Industry #	Dorman	Industry #	Dorman	Industry #	Dorman	Industry #	Dorman	Industry #	Dorman
CR15	576-000	F6C	576-146	GM1C	576-336	H04C	576-604	MZ9	576-722
CR1A	576-001	F6D	576-147	GM20A	576-337	H05	576-605	NS10	576-800
CR1B	576-002	F7A	576-148	GM20B	576-338	H07A	576-606	NS11A	576-801
CR2A	576-003	F7B	576-149	GM20C	576-339	H07B	576-607	NS11B	576-802
CR2B	576-004	F7C	576-150	GM20D	576-340	H08	576-608	NS12A	576-803
CR2C	576-005	F7D	576-151	GM22B	576-341	JP1A	576-650	NS1A	576-804
CR2D	576-006	F8A	576-152	GM22C	576-342	JP1B	576-651	NS1B	576-805
CR2E	576-007	F8B	576-153	GM23B	576-343	JP1C	576-652	NS2	576-806
CR2F	576-008	F8C	576-154	GM23C	576-344	JP1D	576-653	NS3	576-807
CR2G	576-009	F8D	576-155	GM24	576-345	JP1E	576-654	NS4	576-808
CR3A	576-010	F8E	576-156	GM24B	576-346	JP2A	576-655	NS5A	576-809
CR3B	576-011	F9A	576-157	GM25A	576-347	JP2B	576-656	NS5B	576-810
CR5A	576-012	F9B	576-158	GM25B	576-348	JP2C	576-657	NS5C	576-811
CR5B	576-013	F9C	576-159	GM25C	576-349	JP2D	576-658	NS6	576-812
CR5C	576-014	FN05	577-005	GM25H	576-350	JP4A	576-659	NS7	576-813
CR6A	576-015	FN06	577-006	GM306A	576-351	JP4B	576-660	NS8B	576-814
CR7A	576-016	FN07	577-007	GM306C	576-352	JP5A	576-661	NS9A	576-815
CR7B	576-017	FN08	577-008	GM307A	576-353	JP5B	576-662	NS9B	576-816
F10A	576-100	FN09	577-009	GM307C	576-354	LO01	579-001	ST01	578-001
F10B	576-101	FN11	577-011	GM308A	576-355	LO03	579-003	ST03	578-003
F11A	576-102	FN12	577-012	GM309A	576-356	LO04	579-004	ST05	578-005
F11B	576-103	FN13	577-013	GM30A	576-357	LO05	579-005	ST06	578-006
F11C	576-104	FN15	577-015	GM30B	576-358	LO06	579-006	ST07	578-007
F12A	576-105	FN16	577-016	GM310A	576-359	LO07	579-007	ST08	578-008
F12B	576-106	FN58	577-058	GM36	576-360	LO08	579-008	ST09	578-009
F14A	576-107	FN72	577-072	GM39	576-361	LO09	579-009	ST11	578-011
F14B	576-108	FN73	577-073	GM39B	576-362	LO12	579-012	ST12	578-012
F14C	576-109	FN74	577-074	GM3A	576-363	LO13	579-013	ST16	578-016
F14D	576-110	GM11A	576-300	GM3C	576-364	LO14	579-014	ST17	578-017
F15A	576-111	GM11B	576-301	GM411A	576-365	LO15	579-015	ST18	578-018
F15B	576-112	GM11C	576-302	GM411B	576-366	LO20	579-020	ST19	578-019
F15C	576-113	GM1211B	576-303	GM411C	576-367	LO23	579-023	ST20	578-020
F15D	576-114	GM1212B	576-304	GM412A	576-368	LO24	579-024	ST21	578-021
F17	576-115	GM1213A	576-305	GM413A	576-369	LO25	579-025	ST22	578-022
F1A	576-116	GM1213B	576-306	GM413B	576-370	LO32	579-032	ST26	578-026
F1B	576-117	GM1216A	576-307	GM413C	576-371	LO33	579-033	ST28	578-028
F1C	576-118	GM1274A	576-308	GM43C	576-372	LO34	579-034	ST30	578-030
F1D	576-119	GM12A	576-309	GM4A	576-373	LO38	579-038	ST36	578-036
F1E	576-120	GM12B	576-310	GM4B	576-374	LO39	579-039	ST38	578-038
F1G	576-121	GM14A	576-311	GM4C	576-375	LO43	579-043	ST42	578-042
F20A	576-122	GM14B	576-312	GM5	576-376	LO46	579-046	ST43	578-043
F20B	576-123	GM14C	576-313	GM505	576-377	LO91	579-091	ST44	578-044
F20C	576-124	GM14D	576-314	GM515	576-378	MZ10	576-700	ST45	578-045
F20D	576-125	GM14E	576-315	GM515B	576-379	MZ11	576-701	ST46	578-046
F21A	576-126	GM14F	576-316	GM517C	576-380	MZ12A	576-702	ST51	578-051
F21B	576-127	GM14G	576-317	GM517D	576-381	MZ1B	576-703	ST52	578-052
F21C	576-128	GM14H	576-318	GM51A	576-382	MZ2A	576-704	ST54	578-054
F22A	576-129	GM15A	576-319	GM51B	576-383	MZ2B	576-705	ST61	578-061
F22B	576-130	GM15B	576-320	GM56A	576-384	MZ3	576-706	ST70	578-070
F22D	576-131	GM15C	576-321	GM56B	576-385	MZ4	576-707	ST78	578-078
F23B	576-132	GM16A	576-322	GM56C	576-386	MZ5	576-708	TO12	576-850
F23C	576-133	GM16B	576-323	GM60A	576-387	MZ6A	576-709	TO14A	576-851
F28E	576-134	GM16C	576-324	GM60B	576-388	MZ6B	576-710	TO2	576-852
F29	576-135	GM16D	576-325	GM60C	576-389	MZ6C	576-711	TO4A	576-853
F3	576-136	GM17A	576-326	GM62B	576-390	MZ6D	576-712	TO4B	576-854
F39A	576-137	GM17B	576-327	GM8A	576-391	MZ7A	576-713	TO5	576-855
F39B	576-138	GM18A	576-328	GM8B	576-392	MZ7B	576-714	TO6	576-856
F39C	576-139	GM18B	576-329	GM8C	576-393	MZ7C	576-715	VW4A	576-900
F39D	576-140	GM18C	576-330	GM9A	576-394	MZ7D	576-716	VW4B	576-901
F39E	576-141	GM18D	576-331	GM9B	576-395	MZ7E	576-717	VW4C	576-902
F41A	576-142	GM19A	576-332	HO1	576-600	MZ8A	576-718		
F41B	576-143	GM19B	576-333	HO2	576-601	MZ8B	576-719		
F6A	576-144	GM1A	576-334	HO3	576-602	MZ8D	576-720		
F6B	576-145	GM1B	576-335	HO4	576-603	MZ8E	576-721		

Fuel Tanks



576-000
Chrysler, Dodge, Plymouth
 1988-85 Colt, Mirage; Exc. Turbo & SW.

Dimension 23-3/8" x 29-7/8" x 8-1/4"
Lock Ring # Not Available Separately
Gallons 10



576-001
Chrysler, Dodge, Plymouth
 1979-77 Aspen, Caravelle, Diplomat, LeBaron, Volare, Side Vent, Can Replace 576-002.

Dimension 35-3/8" x 29-1/2" x 7"
Lock Ring # 579-005
Gallons 20



576-002
Chrysler, Dodge, Plymouth
 1989-79 Aspen, Caravelle, Cordoba, Diplomat, 5th Ave, w/Roll Over Valve, RWD, Can Replace 576-001.

Dimension 35-3/8" x 29-1/2" x 7"
Lock Ring # 579-005
Gallons 20



576-003
Chrysler, Dodge, Plymouth
 1982-81 Aries, Dodge 400/ 600, LeBaron, Reliant, Gauge Hole w/Internal Ring.

Dimension 34-3/8" x 25" x 7-5/8"
Lock Ring # 579-007
Gallons 13



576-004
Chrysler, Dodge, Plymouth
 1984-83 Aries, Caravelle, Daytona, Dodge 400/600, Reliant, Small Gauge Hole 2".

Dimension 34-3/8" x 25" x 7-5/8"
Lock Ring # 579-006
Gallons 13



576-005
Chrysler, Dodge, Plymouth
 1985 Aries, Caravelle, Daytona, Dodge 400/ 600, LeBaron, wo/ EFI, Large Gauge Hole 3".

Dimension 34-3/8" x 25" x 7-5/8"
Lock Ring # 579-005
Gallons 14



576-006
Chrysler, Dodge, Plymouth
 1985-84 Aries, Laser, LeBaron, New Yorker, Reliant, w/EFI, Large Gauge Hole 3", w/Pan In Tank.

Dimension 34-3/8" x 25" x 7-5/8"
Lock Ring # 579-005
Gallons 14



576-007
Chrysler, Dodge, Plymouth
 1988-83 Aries, Acclaim, Dynasty, Laser, LeBaron, Reliant, w/EFI, 2 Gauge Holes 2" & 3", w/Pan In Tank.

Dimension 34-3/8" x 25" x 7-5/8"
Lock Ring # 579-005, 579-006
Gallons 14



576-008
Chrysler, Dodge, Plymouth
 1990-84 Aries, Daytona, LeBaron, Shadow, Reliant, Sundance, w/EFI, 2 Gauge Holes 2" & 3", w/Pan & Internal Vent Tube.

Dimension 34-3/8" x 25" x 7-5/8"
Lock Ring # 579-005, 579-006
Gallons 14

Fuel Tanks

Fuel Tanks



576-009
Chrysler, Dodge, Plymouth
 1995-91 Daytona, LeBaron, Shadow, Sundance, 2 Gauge Holes 2" & 3", w/o Pan In Tank.
Dimension 34-3/8" x 25" x 7-5/8"
Lock Ring # 579-005, 579-006
Gallons 14

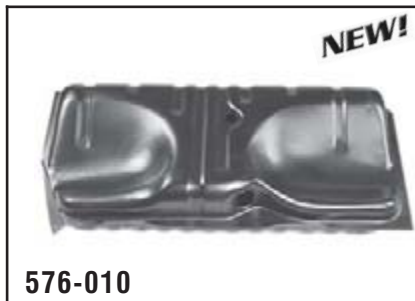

576-010
Chrysler, Dodge, Plymouth
 1987-78 Horizon, Omni, Duster, Charger, w/o Turbo.
Dimension 37-1/2" x 18-1/2" x 8-1/4"
Lock Ring # 579-005
Gallons 13



576-011
Chrysler, Dodge, Plymouth
 1990-85 Horizon, Omni, Duster, Charger, w/ Pan In Tank & EFI.
Dimension 37-1/2" x 18-1/2" x 8-1/4"
Lock Ring # 579-005
Gallons 13



576-012
Chrysler, Dodge, Plymouth
 1987-84 Caravan, Voyager, Mini Ram, 3" Gauge Hole, w/o EFI.
Dimension 33-5/8" x 30-3/8" x 8-3/8"
Lock Ring # 579-005
Gallons 20



576-013
Chrysler, Dodge, Plymouth
 1990-87 Caravan, Mini Ram, Town & Country (Minivans), 2 Gauge Holes 4", w/Pan In Tank, Internal Vent Tube.
Dimension 33-5/8" x 30-3/8" x 8-3/8"
Lock Ring # 579-012, 579-012
Gallons 20



576-014
Chrysler, Dodge, Plymouth
 1995-91 Caravan, Mini Ram, Town & Country (Minivans), 4" Gauge Hole, Exc. 4WD, w/o Pan In Tank.
Dimension 33-5/8" x 30-3/8" x 8-3/8"
Lock Ring # 579-012
Gallons 20



576-015
Chrysler, Dodge, Plymouth
 1985-79 Arrow Truck, Dodge D50, Ram 50, Mitsubishi Trucks, Pickup Truck.
Dimension 34-1/8" x 15-1/4" x 11-1/2"
Lock Ring # 579-014
Gallons 15



576-016
Chrysler, Dodge, Plymouth
 1990-88 Acclaim, Dynasty, 5th Ave, Imperial, LeBaron, NY, Spirit, w/Pan In Tank & Internal Vent Tube.
Dimension 34-3/4" x 27" x 8-3/8"
Lock Ring # 579-005, 579-006
Gallons 16



576-017
Chrysler, Dodge, Plymouth
 1995-91 Acclaim, Dynasty, 5th Ave, Imperial, LeBaron, NY, Spirit, (FWD).
Dimension 34-3/4" x 27" x 8-3/8"
Lock Ring # 579-005, 579-006
Gallons 16

Fuel Tanks



576-100

Ford, Lincoln, Mercury
1984 Bronco II - 94" W.B., Small Gauge Hole 2".

Dimension 29-1/4" x 24-5/8" x 13-7/8"
Lock Ring # 579-003
Gallons 23



576-101

Ford, Lincoln, Mercury
1990-85 Bronco II - 94" W.B., Large Gauge Hole 3-5/8", w/Pan In Tank.

Dimension 29-1/4" x 24-5/8" x 13-7/8"
Lock Ring # 579-004
Gallons 23



576-102

Ford, Lincoln, Mercury
1987-83 Tempo, Topaz, Exc. Diesel, w/o EFI, Small Gauge Hole 2"

Dimension 40-1/2" x 22-1/4" x 8"
Lock Ring # 579-003
Gallons 15



576-103

Ford, Lincoln, Mercury
1987-84 Tempo, Topaz (Exc. AWD, w/Fl), Large Gauge Hole 3-5/8", w/Pan In Tank.

Dimension 40-1/2" x 22-1/4" x 8"
Lock Ring # 579-004
Gallons 15



576-104

Ford, Lincoln, Mercury
1994-88 Tempo, Topaz, Exc. AWD, Large Gauge Hole 3-5/8", w/Pan In Tank.

Dimension 40-1/2" x 22-1/4" x 8"
Lock Ring # 579-004
Gallons 15



576-105

Ford, Lincoln, Mercury
1986-81 Capri & Mustang, Pump On Engine, Single Gauge Hole, w/o Pan In Tank.

Dimension 42-1/2" x 19-1/4" x 10-3/4"
Lock Ring # 579-003
Gallons 15.4



576-106

Ford, Lincoln, Mercury
1997-83 Capri & Mustang, Pump In Tank, Two Gauge Holes, w/Pan In Tank.

Dimension 42-1/2" x 19-1/4" x 10-3/4"
Lock Ring # 579-003, 579-003
Gallons 15.4



576-107

Ford, Lincoln, Mercury
1984-80 F150/250 Man Trans, Side Mount, Short W.B., Small Gauge Hole 2", w/Vent Support In Filler Pipe.

Dimension 42-3/8" x 14-3/8" x 11"
Lock Ring # 579-003
Gallons 16



576-108

Ford, Lincoln, Mercury
1986-85 F150/250, Side Mount, Short W.B., Large Gauge Hole 3-5/8", w/Vent Support In Filler Pipe.

Dimension 42-3/8" x 14-3/8" x 11"
Lock Ring # 579-004
Gallons 16

Fuel Tanks

Fuel Tanks



NEW!

576-109

Ford, Lincoln, Mercury
1996-90 F150/250, Side Mount, Short W.B., Large Gauge Hole 3-5/8", w/o Vent Support In Filler Pipe.

Dimension 42-3/8" x 14-3/8" x 11"
Lock Ring # 579-004
Gallons 16



NEW!

576-110

Ford, Lincoln, Mercury
1989-87 F150/250, Side Mount, Short W.B., Large Gauge Hole 3-5/8", w/Vent Support In Filler Pipe.

Dimension 42-3/8" x 14-3/8" x 11"
Lock Ring # 579-004
Gallons 16



NEW!

576-111

Ford, Lincoln, Mercury
1977-75 Van w/o EEC 300, Rear Mount, w/o Roll Over Valve Hole, Vent Pipe Rear Of Van.

Dimension 33-5/8" x 23-1/2" x 11-1/4"
Lock Ring # 579-003
Gallons 22



NEW!

576-112

Ford, Lincoln, Mercury
1985-75 Vans w/EEC 300 351, Small Gauge Hole 2", w/Roll Over Valve Hole, Vent Pipe Front.

Dimension 33-5/8" x 23-1/2" x 11-1/4"
Lock Ring # 579-003
Gallons 22



NEW!

576-113

Ford, Lincoln, Mercury
1987-86 Vans, Large Gauge Hole 3-5/8", Rear Mount, 6" Filler Pipe.

Dimension 33-1/2" x 23-1/2" x 11-1/8"
Lock Ring # 579-004
Gallons 22



NEW!

576-114

Ford, Lincoln, Mercury
1991-88 Vans, Rear Mount, 2-3/4" Filler Pipe.

Dimension 33-1/2" x 23-1/2" x 11-1/8"
Lock Ring # 579-004
Gallons 22



NEW!

576-115

Ford, Lincoln, Mercury
1989-80 Crown Victoria, LTD, Mark Series, Grand Marquis, Town Car, Pump In Tank, Exc. SW.

Dimension 42-3/4" x 19-3/8" x 10-1/8"
Lock Ring # 579-003, 579-004
Gallons 18



NEW!

576-116

Ford, Lincoln, Mercury
1978-73 F100/150/250/350, Vent Pipe Rear, w/o Roll Over Valve Hole & EEC, Rear Mount.

Dimension 34-3/4" x 27" x 8-1/8"
Lock Ring # 579-003
Gallons 19



NEW!

576-117

Ford, Lincoln, Mercury
1979-73 F100/F350, w/o EEC, Vent Pipe Front, w/Roll Valve Hole; Rear Mount.

Dimension 34-3/4" x 27" x 8-1/8"
Lock Ring # 579-003
Gallons 19

Fuel Tanks



576-118

Ford, Lincoln, Mercury
1984-80 F150/350 (Small Neck), Small Gauge Hole 2", No Vent Pipe, Rear Mount, Aux Tank or Dual Exhaust.

Dimension 34-3/4" x 27" x 8-1/8"
Lock Ring # 579-003
Gallons 19



576-119

Ford, Lincoln, Mercury
1986-85 F150/250/350, Large Gauge Hole 3-5/8", No Vent Pipe; Rear Mount, Auxiliary Tank or Dual Exhaust.

Dimension 34-3/4" x 27" x 7-7/8"
Lock Ring # 579-004
Gallons 19



576-120

Ford, Lincoln, Mercury
1989-87 F150/250/350, Large Gauge Hole 3-5/8", No Vent Pipe, Rear Mount, Auxiliary Tank or Dual Exhaust.

Dimension 34-3/4" x 27" x 7-7/8"
Lock Ring # 579-004
Gallons 19



576-121

Ford, Lincoln, Mercury
1996-90 Trucks, Large Gauge Hole 3-5/8", w/o Vent Support In Filler, Rear Mount, Aux Tank or Dual Exhaust.

Dimension 34-3/4" x 27" x 7-7/8"
Lock Ring # 579-004
Gallons 18



576-122

Ford, Lincoln, Mercury
1985-83 Ranger Under Cab, Small Gauge Hole 2", Plastic Filler.

Dimension 50-3/4" x 11-7/8" x 13"
Lock Ring # 579-003
Gallons 17



576-123

Ford, Lincoln, Mercury
1984-83 Ranger Under Cab, Small Gauge Hole 2", Rubber Filler.

Dimension 50-3/4" x 11-7/8" x 13"
Lock Ring # 579-003
Gallons 17



576-124

Ford, Lincoln, Mercury
1988-85 Ranger Under Cab, Large Gauge Hole 3-5/8", Rubber Filler.

Dimension 50-3/4" x 11-7/8" x 13"
Lock Ring # 579-004
Gallons 17



576-125

Ford, Lincoln, Mercury
1988-86 Ranger Under Cab, Large Gauge Hole 3-5/8", Super Cab.

Dimension 50-3/4" x 11-7/8" x 13"
Lock Ring # 579-004
Gallons 17



576-126

Ford, Lincoln, Mercury
1985-83 Ranger Under Cab, Small Gauge Hole 2", Plastic Filler.

Dimension 51" x 11-7/8" x 12-1/2"
Lock Ring # 579-003
Gallons 17

Fuel Tanks

Fuel Tanks



576-127

Ford, Lincoln, Mercury
1984-83 Ranger Under Cab, Small Gauge Hole 2", Rubber Filler.

Dimension 51" x 11-7/8" x 12-1/2"
Lock Ring # 579-003
Gallons 17



576-128

Ford, Lincoln, Mercury
1988-85 Ranger Under Cab, Large Gauge Hole 3-5/8", Rubber Filler.

Dimension 51" x 11-7/8" x 12-1/2"
Lock Ring # 579-004
Gallons 17



576-129

Ford, Lincoln, Mercury
1988-86 Taurus, Sable, Large Filler Pipe 1-11/16", w/Pan In Tank.

Dimension 40" x 27-3/8" x 8"
Lock Ring # 579-013
Gallons 16



576-130

Ford, Lincoln, Mercury
1995-88 Taurus, Sable, Small Filler Pipe 1-3/8", w/Pan In Tank.

Dimension 40" x 27-3/8" x 8"
Lock Ring # 579-013
Gallons 16



576-131

Ford, Lincoln, Mercury
1995-88 Taurus, Sable, Continental, Small Filler Pipe 1-3/8", w/Pan In Tank.

Dimension 40" x 27-3/8" x 8"
Lock Ring # 579-013
Gallons 18.5



576-132

Ford, Lincoln, Mercury
1996-85 Continental, Cougar, Thunderbird, Mark Series w/Pan In Tank.

Dimension 45" x 27" x 9-3/4"
Lock Ring # 579-003, 579-004
Gallons 22



576-133

Ford, Lincoln, Mercury
1986-85 Cougar, Thunderbird, 2 Gauge Holes 2" & 3-5/8", w/Pan In Tank.

Dimension 45" x 27" x 8-3/4"
Lock Ring # 579-003, 579-004
Gallons 19



576-134

Ford, Lincoln, Mercury
1968-64 Cougar, Mustang

Dimension 32-5/8" x 24-1/2" x 8"
Lock Ring # 579-003
Gallons 16



576-135

Ford, Lincoln, Mercury
1994-90 Crown Victoria, Grand Marquis, Town Car, Pump In Tank, Exc. SW.

Dimension 40-3/4" x 17-3/4" x 9-1/4"
Lock Ring # 579-013
Gallons 20

Fuel Tanks



576-136
Ford, Lincoln, Mercury
 1991-79 Crown Victoria, Marquis, Grand Marquis, Town Car, Mark Series, Pump On Engine, Exc. SW.
Dimension 42-1/4" x 19-3/8" x 9"
Lock Ring # 579-003
Gallons 20



576-137
Ford, Lincoln, Mercury
 1997-96 Taurus, Sable.
Dimension 26-1/2" x 44-1/2" x 9-1/2"
Lock Ring # 579-013
Gallons 16



576-138
Ford, Lincoln, Mercury
 1997-96 Taurus, Sable
Dimension 26-1/2" x 44-1/2" x 9-1/2"
Lock Ring # 579-013
Gallons 18



576-139
Ford, Lincoln, Mercury
 1999-98 Taurus, Sable w/4 Valves, w/o On-Board Recovery System
Dimension 26-1/2" x 44-1/2" x 9-1/2"
Lock Ring # 579-013
Gallons 16



576-140
Ford, Lincoln, Mercury
 1999-98 Taurus, Sable w/o On-Board Recovery System
Dimension 26-1/2" x 44-1/2" x 9-1/2"
Lock Ring # 579-013
Gallons 18



576-141
Ford, Lincoln, Mercury
 1999-98 Taurus, Sable w/ On-Board Vapor Recovery System
Dimension 26-1/2" x 44-1/2" x 9-1/2"
Lock Ring # 579-013
Gallons 16



576-142
Ford, Lincoln, Mercury
 1996-92 E-150, E-250, E-350 Econoline Exc. Cutaway
Dimension 71" x 18" x 11"
Lock Ring # 579-013
Gallons 35



576-143
Ford, Lincoln, Mercury
 2001-97 E-150, E-250, E-350 Econoline Exc. Cutaway
Dimension 71" x 18" x 11"
Lock Ring # Not Available Separately
Gallons 35



576-144
Ford, Lincoln, Mercury
 1984-80 F150/350, Long Wheel Base, Small Gauge Hole 2"; Side Mount.
Dimension 58-7/8" x 12-1/4" x 12-1/2"
Lock Ring # 579-003
Gallons 19

Fuel Tanks

Fuel Tanks



576-145

Ford, Lincoln, Mercury
1986-85 F150/250/350, Long Wheel Base, Large Gauge Hole 3-5/8", w/Vent Support in Filler Pipe; Side Mount.

Dimension 58-7/8" x 12-1/4" x 12-1/2"
Lock Ring # 579-004
Gallons 19



576-146

Ford, Lincoln, Mercury
1996-90 F150/250, Long Wheel Base, Large Gauge Hole 3-5/8", w/o Vent Support In Filler Pipe; Side Mount.

Dimension 58-7/8" x 12-1/4" x 12-1/2"
Lock Ring # 579-004
Gallons 19



576-147

Ford, Lincoln, Mercury
1989-87 Pickup Long Wheel Base, Large Gauge Hole 3-5/8", w/o Vent Support In Filler; Side Mount.

Dimension 58-7/8" x 12-1/4" x 12-1/2"
Lock Ring # 579-004
Gallons 19



576-148

Ford, Lincoln, Mercury
1982-81 Escort, EXP, LN7, Lynx, Large Vent Pipe 5/8" ID

Dimension 36-1/8" x 19" x 8-3/8"
Lock Ring # 579-003
Gallons 11



576-149

Ford, Lincoln, Mercury
1986-83 Escort, EXP, LN7, Lynx (Pump On Engine), Small Gauge Hole 2", Small Vent Pipe 3/8" ID.

Dimension 36-1/8" x 19" x 8-3/8"
Lock Ring # 579-003
Gallons 13



576-150

Ford, Lincoln, Mercury
1986-83 Escort, EXP, LN7, Lynx, Pump In Tank, Large Gauge Hole 3-5/8", w/Pan In Tank.

Dimension 35-5/8" x 19" x 7-7/8"
Lock Ring # 579-004
Gallons 13



576-151

Ford, Lincoln, Mercury
1990-87 Escort, EXP, Lynx, Large Gauge Hole 3-5/8", w/Pan In Tank.

Dimension 35-5/8" x 19" x 7-7/8"
Lock Ring # 579-004
Gallons 13



576-152

Ford, Lincoln, Mercury
1978 Bronco (Full Size), w/o E.E.C, w/o Roll Valve, Vent Pipe Rear.

Dimension 31-7/8" x 22-1/4" x 15-3/4"
Lock Ring # 579-003
Gallons 33



576-153

Ford, Lincoln, Mercury
1979 Bronco (Full Size), w/E.E.C, w/ Roll Valve, Vent Pipe Front.

Dimension 31-7/8" x 22-1/4" x 15-3/4"
Lock Ring # 579-003
Gallons 33

Fuel Tanks



576-154

Ford, Lincoln, Mercury
1986-80 Bronco, Small Gauge Hole 2", No Vent Pipe, 105" W.B.

Dimension 31-7/8" x 22-1/4" x 15-3/4"
Lock Ring # 579-003
Gallons 33



576-155

Ford, Lincoln, Mercury
1996-85 Bronco, Large Gauge Hole 3-5/8", 105" W.B.

Dimension 31-7/8" x 22-1/4" x 15-3/4"
Lock Ring # 579-004
Gallons 33



576-156

Ford, Lincoln, Mercury
1989-87 Bronco II, No Vent, Small Gauge Hole 2", 105" W.B.

Dimension 31-7/8" x 22-1/4" x 15-3/4"
Lock Ring # 579-003
Gallons 33



576-157

Ford, Lincoln, Mercury
1978 Bronco Full Size, No Roll Over Valve, Vent To Rear.

Dimension 31-7/8" x 22-1/4" x 12-3/4"
Lock Ring # 579-003
Gallons 25.5



576-158

Ford, Lincoln, Mercury
1979 Bronco Full Size, w/Roll Over Valve, Vent To Front.

Dimension 31-7/8" x 22-1/4" x 12-3/4"
Lock Ring # 579-003
Gallons 25.5



576-159

Ford, Lincoln, Mercury
1983-80 Bronco Full Size, No External Vent Pipe.

Dimension 31-7/8" x 22-1/4" x 12-3/4"
Lock Ring # 579-003
Gallons 25.5



576-300

GM
1981-73 Chevrolet & GMC Trucks, Small Filler Pipe 1-1/4" ID, RH & LH Side.

Dimension 42-7/8" x 14-1/8" x 11"
Lock Ring # 579-001
Gallons 16



576-301

GM
1987-82 Chevrolet & GMC Trucks, Large Filler Pipe 1-5/8" ID, RH & LH Side.

Dimension 42-7/8" x 14-1/8" x 11"
Lock Ring # 579-001
Gallons 16



576-302

GM
1987 Chevrolet & GMC Trucks, w/Pan In Tank & EFI, RH & LH Side.

Dimension 42-7/8" x 14-1/8" x 11"
Lock Ring # 579-001
Gallons 16

Fuel Tanks

Fuel Tanks



576-303

GM
1980-77 Bonneville, Caprice, Impala, Catalina, Delta 88, Exc. SW or Diesel.

Dimension 39-3/4" x 26-1/2" x 9-1/4"
Lock Ring # 579-001
Gallons 19



576-304

GM
1979-77 Electra, Park Avenue, Riviera, Exc. SW or Diesel.

Dimension 39-3/4" x 26-1/2" x 9-1/4"
Lock Ring # 579-001
Gallons 19



576-305

GM
1977-73 Century, Cutlass, Cutlass Supreme, Cutlass Cruiser, Regal, Exc. SW.

Dimension 39-3/4" x 26-1/2" x 9-1/4"
Lock Ring # 579-001
Gallons 19



576-306

GM
1988-86 Fleetwood, ***Not Able To Ship UPS***

Dimension 39-3/4" x 26-1/2" x 9-1/4"
Lock Ring # 579-001
Gallons 20.5



576-307

GM
1977-74 Century, Regal, Chevelle, Cutlass, Cutlass Supreme, Cutlass Cruiser, Malibu, Monte Carlo, LeMans, Tempest Exc. SW.

Dimension 39-3/4" x 26-1/2" x 9-1/4"
Lock Ring # 579-001
Gallons 19



576-308

GM
1973 Chevelle, Malibu, Cutlass, Cutlass Supreme, Cutlass Cruiser, Monte Carlo, LeMans, Tempest Exc. SW.

Dimension 39-3/4" x 26-1/2" x 9-1/4"
Lock Ring # 579-001
Gallons 22



576-309

GM
1977-73 Century, Regal, LeMans, Tempest, Chevelle, Cutlass, Malibu, Monte Carlo, Exc. SW, **Filler Neck Required; See Applications.**

Dimension 39-3/4" x 26-1/2" x 9-1/4"
Lock Ring # 579-001
Gallons 19



576-310

GM
1988-77 Bonneville, Catalina, Fleetwood, Electra, Park Avenue, Caprice, Impala, Exc. SW, **Filler Neck Required; See Applications.**

Dimension 39-3/4" x 26-1/2" x 9-1/4"
Lock Ring # 579-001
Gallons 19



576-311

GM
1981-73 Suburban, Full Size Blazer & Jimmy, Small Filler Pipe 1-1/4" ID.

Dimension 28-3/4" x 28-1/8" x 12-3/4"
Lock Ring # 579-001
Gallons 31

Fuel Tanks



576-312
GM
 1991-73 Suburban, Full Size Blazer & Jimmy, Large Filler Pipe 1-5/8" ID.

Dimension 28-3/4" x 28-1/8" x 12-3/4"
Lock Ring # 579-001
Gallons 31



576-313
GM
 1991-87 Suburban, Full Size Blazer & Jimmy, w/Pan In Tank & FI.

Dimension 28-3/4" x 28-1/8" x 12-3/4"
Lock Ring # 579-001
Gallons 31



576-314
GM
 1981-79 Chevrolet & GMC P Series FWD Control, Filler Pipe To Left Of Center.

Dimension 28-3/4" x 28-1/8" x 12-3/4"
Lock Ring # 579-001
Gallons 30



576-315
GM
 1995-92 Chevrolet & GMC Trucks, Diesel Eng, Straight Filler Pipe, w/o Pan In Tank.

Dimension 28-3/4" x 28-1/8" x 12-3/4"
Lock Ring # 579-001
Gallons 31



576-316
GM
 1995-92 Chevrolet & GMC Trucks, Gas Eng, Straight Filler Pipe, w/Pan In Tank & EFI.

Dimension 28-3/4" x 28-1/8" x 12-3/4"
Lock Ring # 579-001
Gallons 31



576-317
GM
 1995-90 Chevrolet & GMC Trucks, Diesel Eng, 90 Deg Filler Pipe, w/o Pan In Tank.

Dimension 28-3/4" x 28-1/8" x 12-3/4"
Lock Ring # 579-001
Gallons 31



576-318
GM
 1995-90 Chevrolet & GMC Trucks, Gas Eng, 90 Deg Filler Pipe, w/Pan In Tank & EFI.

Dimension 28-3/4" x 28-1/8" x 12-3/4"
Lock Ring # 579-001
Gallons 31



576-319
GM
 1981-73 Suburban, C/K/R/V-Series Pickups, Small Filler Pipe 1-1/4" ID; Rear Mount.

Dimension 28-3/4" x 28-1/8" x 10-3/4"
Lock Ring # 579-001
Gallons 25



576-320
GM
 1987-73 Suburban, Full Size Blazer & Jimmy, Large Filler Pipe 1-5/8" ID, 106.5" W.B.

Dimension 28-3/4" x 28-1/8" x 10-3/4"
Lock Ring # 579-001
Gallons 25

Fuel Tanks

Fuel Tanks



576-321

GM
1987 Suburban, Full Size Blazer & Jimmy,
w/Pan In Tank & FI; Gas Eng.

Dimension 28-3/4" x 28-1/8" x 10-3/4"
Lock Ring # 579-001
Gallons 25



576-322

GM
1985-82 S-Series Pickups, Syclone, Pump
on Engine.

Dimension 41-1/4" x 14-3/4" x 13-1/2"
Lock Ring # 579-001
Gallons 20



576-323

GM
1995-85 S-Series Pickups, Sonoma,
Syclone, w/Pan In Tank; Pump In Tank.

Dimension 41-1/4" x 14-3/4" x 13-1/2"
Lock Ring # 579-001
Gallons 20



576-324

GM
1996 S-Series Pickups, Sonoma, Syclone

Dimension 41-1/4" x 14-3/4" x 13-1/2"
Lock Ring # 579-091
Gallons 18.5



576-325

GM
2001-97 S Series Pickups, Sonoma, Syclone

Dimension 41-1/4" x 14-3/4" x 13-1/2"
Lock Ring # 579-091
Gallons 18.5



576-326

GM
1987-82 Calais, Grand Am, Cavalier,
Cimarron, Firenza, J2000, Skyhawk,
Somerset, Sunbird, w/o EFI.

Dimension 44-1/4" x 20-3/4" x 9"
Lock Ring # 579-001
Gallons 14



576-327

GM
1991-82 Beretta, Cavalier, Corsica, Grand
Am, Calais, Firenza, J2000, Skyhawk,
Somerset, Sunbird, w/Pan In Tank & EFI.

Dimension 44-1/4" x 20-3/4" x 9"
Lock Ring # 579-001
Gallons 14



576-328

GM
1985-83 S10 Blazer, S15 Jimmy, w/o EFI,
100.5" W.B.

Dimension 33" x 22" x 10-1/2"
Lock Ring # 579-001
Gallons 20



576-329

GM
1995-85 Bravada, S10 Blazer, S15 Jimmy &
Typhoon, w/Pan In Tank & EFI, 100.5" W.B.

Dimension 33" x 22" x 10-1/2"
Lock Ring # 579-001
Gallons 20

Fuel Tanks



576-330
GM
 1996 S10 Blazer, S15 Jimmy. 2 Door Only.

Dimension 33" x 22" x 10-1/2"
Lock Ring # 579-091
Gallons 19



576-331
GM
 2002-97 S10 Blazer, S15 Jimmy. 2 Door Only.

Dimension 33" x 22" x 10-1/2"
Lock Ring # 579-091
Gallons 19



576-332
GM
 1985-83 S10 Blazer, S15 Jimmy, w/o EFI, 100.5" W.B.

Dimension 33" x 22" x 8-7/8"
Lock Ring # 579-001
Gallons 13.2



576-333
GM
 1994-85 S10 Blazer, S15 Jimmy, Postal Service Van, w/EFI.

Dimension 33" x 22" x 8-7/8"
Lock Ring # 579-001
Gallons 13.2



576-334
GM
 1981-73 Chevrolet & GMC Trucks, Long Wheel Base, Small Filler Pipe 1-1/4" ID.

Dimension 56" x 14" x 11"
Lock Ring # 579-001
Gallons 20



576-335
GM
 1991-82 Chevrolet & GMC Trucks, Long Wheel Base, Conventional Cab, Large Filler Pipe 1-5/8" ID; Right & Left Side

Dimension 56" x 14" x 11"
Lock Ring # 579-001
Gallons 20



576-336
GM
 1991-87 Chevrolet & GMC Trucks, Long Wheel Base, w/EFI, w/Pan In Tank, Exc. Diesel.

Dimension 56" x 14" x 11"
Lock Ring # 579-001
Gallons 20



576-337
GM
 1988-85 Bonneville, Catalina, Delta 88/98, DeVille, Electra, Fleetwood, LeSabre, Park Ave, w/EFI & FWD, w/Pan In Tank, Exc. SW.

Dimension 40-1/8" x 28-1/2" x 11-1/2"
Lock Ring # 579-001
Gallons 18



576-338
GM
 1997-89 Bonneville, Catalina, Delta 88/98, DeVille, Electra, Fleetwood, LeSabre, Park Ave; FWD, w/Pan In Tank & EFI.

Dimension 40-1/8" x 28-1/2" x 11-1/2"
Lock Ring # 579-001
Gallons 18

Fuel Tanks

Fuel Tanks



576-339
GM
 1993-90 DeVille, Fleetwood, FWD, w/EFI, w/Pan In Tank.

Dimension 40-1/8" x 28-1/2" x 11-1/2"
Lock Ring # 579-001
Gallons 18



576-340
GM
 1999-96 LeSabre, Delta 88, LSS, Bonneville, Catalina, 98 Regency

Dimension 40-1/8" x 28-1/2" x 11-1/2"
Lock Ring # 579-001
Gallons 18



576-341
GM
 2000-88 Chevrolet & GMC Trucks, C/K Series, Exc. 3500 HD, w/EFI, w/Pan In Tank

Dimension 62" x 17" x 14-1/4"
Lock Ring # 579-001
Gallons 34



576-342
GM
 1998-97 Chevrolet & GMC Trucks, C/K Series, w/Vent Pipe

Dimension 62" x 17" x 14-1/4"
Lock Ring # 579-091
Gallons 34



576-343
GM
 2000-88 Chevrolet & GMC Trucks, C/K Series, w/Pan In Tank & EFI.

Dimension 48-1/2" x 16-1/2" x 14-1/8"
Lock Ring # 579-001
Gallons 25



576-344
GM
 1998-97 Chevrolet & GMC Pickups C/K-Series.

Dimension 48-1/2" x 16-1/2" x 14-1/8"
Lock Ring # 579-091
Gallons 25



576-345
GM
 1996-85 Astro, Safari Van, w/EFI, w/Pan In Tank. Will replace original 17 Gal/ 75 Liter tank using existing strap and gauge.

Dimension 41-3/4" x 18-7/8" x 13-1/4"
Lock Ring # 579-001
Gallons 27



576-346
GM
 1999-97 Astro, Safari Van

Dimension 41-3/4" x 18-7/8" x 13-1/4"
Lock Ring # 579-091
Gallons 27



576-347
GM
 1981-74 Suburban, Small Filler Pipe 1-1/4" ID.

Dimension 35" x 28-3/4" x 13-1/8"
Lock Ring # 579-001
Gallons 40

Fuel Tanks



576-348
GM
 1991-82 Suburban, Large Filler Pipe 1-5/8" ID.

Dimension 35" x 28-3/4" x 13-1/8"
Lock Ring # 579-001
Gallons 40



576-349
GM
 1991-87 Suburban, w/EFI, Exc. Diesel, w/Pan In Tank.

Dimension 35" x 28-3/4" x 13-1/8"
Lock Ring # 579-001
Gallons 40



576-350
GM
 1999-98 Chevrolet & GMC FWD Control P-Series w/out School Bus Equipment

Dimension 35" x 28-3/4" x 13-1/8"
Lock Ring # 579-091
Gallons 40



576-351
GM
 1988-78 Bonneville, Catalina, Grand Am, Grand Prix, Monte Carlo, LeMans, Tempest, Exc. SW, Gas Eng, w/o EFI.

Dimension 36-1/4" x 24-1/4" x 8-7/8"
Lock Ring # 579-001
Gallons 17



576-352
GM
 1988-85 Bonneville, Catalina, Grand Prix, Monte Carlo, Exc. SW, w/Pan In Tank & EFI.

Dimension 36-1/4" x 24-1/4" x 8-7/8"
Lock Ring # 579-001
Gallons 17



576-353
GM
 1987-78 Regal, RWD, w/o EFI, Exc. SW, Gas Eng.

Dimension 36-1/4" x 24-1/4" x 8-7/8"
Lock Ring # 579-001
Gallons 17



576-354
GM
 1987-84 Regal, w/EFI, Exc. SW, w/Turbo, w/Pan In Tank.

Dimension 36-1/4" x 24-1/4" x 8-7/8"
Lock Ring # 579-001
Gallons 17



576-355
GM
 1987-78 Cutlass, Cutlass Supreme, Cutlass Cruiser, Regal, RWD, Exc. SW, Gas Eng.

Dimension 36-1/4" x 24-1/4" x 8-7/8"
Lock Ring # 579-001
Gallons 17



576-356
GM
 1988-81 Cutlass, Cutlass Supreme, Cutlass Cruiser, RWD, Exc. SW, Gas Eng.

Dimension 36-1/4" x 24-1/4" x 8-7/8"
Lock Ring # 579-001
Gallons 17

Fuel Tanks

Fuel Tanks



576-357

GM
1997-88 Cutlass, Cutlass Supreme, Cutlass Cruiser, Grand Prix, Lumina, Monte Carlo, Exc. APV, w/EFI, w/Pan In Tank.

Dimension 30-3/4" x 30-1/4" x 10-1/8"
Lock Ring # 579-020
Gallons 16



576-358

GM
1999-97 Lumina, Monte Carlo, w/o On-Board Vapor Recovery.

Dimension 30-3/4" x 30-1/4" x 10-1/8"
Lock Ring # 579-091
Gallons 16



576-359

GM
1980-78 Cutlass, Cutlass Supreme, Cutlass Cruiser, Exc. SW, Gas Eng.

Dimension 36-1/4" x 24-1/4" x 8-7/8"
Lock Ring # 579-001
Gallons 17



576-360

GM
1991-88 Buick Reatta, 1993-86 Buick Riviera, 1992-88 Cadillac Eldorado and Seville, Oldsmobile Toronado

Dimension 42" x 28-1/2" x 8-5/8"
Lock Ring # 579-001
Gallons 18



576-361

GM
1998-92 Achieva, Beretta, Cavalier, Corsica, Grand Am, Cutlass Supreme, Cutlass Cruiser, Sunbird, Skyhawk, w/EFI, w/Pan In Tank.

Dimension 44-3/8" x 21" x 9-1/4"
Lock Ring # 579-091
Gallons 15



576-362

GM
2001-98 Alero, Grand Am, Cavalier, Sunfire, Cutlass, Cutlass Supreme, Cutlass Cruiser.

Dimension 44-3/8" x 21" x 9-1/4"
Lock Ring # 579-091
Gallons 15



576-363

GM
1988-78 Bonneville, Catalina, Century, Cutlass, Cutlass Supreme, Cutlass Cruiser, Grand Am, Monte Carlo, Regal, Exc. SW, RWD; **Filler Neck Required, See Applications.**

Dimension 36-1/4" x 24-1/4" x 8-7/8"
Lock Ring # 579-001
Gallons 17



576-364

GM
1988-84 Bonneville, Catalina, Grand Prix, Monte Carlo, Regal, w/Pan In Tank, **Filler Neck Required, See Applications.**

Dimension 36-1/4" x 24-1/4" x 8-7/8"
Lock Ring # 579-001
Gallons 17



576-365

GM
1988-80 BelAir, Bonneville, Catalina, Caprice, Electra, Park Avenue, Impala, LeSabre, Delta 88, 98, 98 Regency, Parisienne, Exc. SW, Gas Eng, w/o EFI.

Dimension 39-3/4" x 26-1/2" x 10"
Lock Ring # 579-001
Gallons 24

Fuel Tanks



576-366

GM
1989-80 Caprice, DeVille, Fleetwood, Impala, LeSabre, Delta 88, 98, 98 Regency, Parisienne, Electra, Park Avenue, Exc. SW, w/Pan In Tank & EFI.

Dimension 39-3/4" x 26-1/2" x 10"
Lock Ring # 579-001
Gallons 24



576-367

GM
1990 Caprice, Impala, w/EFI & Exc. SW, w/Pan In Tank.

Dimension 39-3/4" x 26-1/2" x 10"
Lock Ring # 579-001
Gallons 24



576-368

GM
1979-77 Electra, Park Avenue, Riviera, Delta 88, 98, 98 Regency, Exc. SW, Gas Eng, w/o EFI.

Dimension 39-3/4" x 26-1/2" x 10"
Lock Ring # 579-001
Gallons 24



576-369

GM
1992-77 DeVille, Fleetwood, RWD, w/o EFI, Gas Eng.

Dimension 39-3/4" x 26-1/2" x 10"
Lock Ring # 579-001
Gallons 24



576-370

GM
1989-77 DeVille, Fleetwood, RWD w/EFI, Gas Eng, w/Pan In Tank.

Dimension 39-3/4" x 26-1/2" x 10"
Lock Ring # 579-001
Gallons 24



576-371

GM
1992-90 Fleetwood, RWD, w/EFI, Gas Eng, w/Pan In Tank.

Dimension 39-3/4" x 26-1/2" x 10"
Lock Ring # 579-001
Gallons 24



576-372

GM
1999-98 Suburban, Gas Eng.

Dimension 29-3/4" x 33-1/2" x 13-1/8"
Lock Ring # 579-091
Gallons 42



576-373

GM
1992-77 Buick LTD, Caprice, DeVille, Fleetwood, Impala, Exc. SW, w/o EFI, **Filler Neck Required; See Applications.**

Dimension 39-3/4" x 26-1/2" x 10"
Lock Ring # 579-001
Gallons 24



576-374

GM
1989-77 Buick LTD, Caprice, DeVille, Fleetwood, Impala, Exc. SW, w/EFI, w/Pan In Tank, **Filler Neck Required; See Applications.**

Dimension 39-3/4" x 26-1/2" x 10"
Lock Ring # 579-001
Gallons 24

Fuel Tanks

Fuel Tanks



576-375

GM
1992-90 Caprice, Fleetwood, Exc. SW, w/EFI, w/Pan In Tank, **Filler Neck Required; See Applications.**

Dimension 39-3/4" x 26-1/2" x 10"
Lock Ring # 579-001
Gallons 24



576-376

GM
1990-77 BelAir, Bonneville, Catalina, Caprice, Impala, **Filler Neck Required; See Applications.**

Dimension 38-1/2" x 25" x 10-3/4"
Lock Ring # 579-001
Gallons 22



576-377

GM
1990-77 BelAir, Bonneville, Caprice, Catalina, LeSabre, SW, Gas Eng.

Dimension 38-1/2" x 25" x 10-3/4"
Lock Ring # 579-001
Gallons 22



576-378

GM
1987-78 Caballero, Diablo, El Camino, Malibu, Malibu Pickups, w/o EFI, Gas Eng.

Dimension 38-1/2" x 25" x 10-3/4"
Lock Ring # 579-001
Gallons 22



576-379

GM
1987-85 Caballero, Diablo, El Camino, Sprint (GMC), w/EFI, w/Pan In Tank.

Dimension 38-1/2" x 25" x 10-3/4"
Lock Ring # 579-001
Gallons 22



576-380

GM
1987-78 Caballero, Diablo, El Camino, Malibu, Malibu Pickups, w/o EFI, Exc. Diesel, w/Pan In Tank.

Dimension 38-1/2" x 25" x 10-3/4"
Lock Ring # 579-001
Gallons 17



576-381

GM
1986-85 Caballero, Diablo, El Camino, Sprint (GMC), w/EFI, w/Pan In Tank.

Dimension 38-1/2" x 25" x 10-3/4"
Lock Ring # 579-001
Gallons 17



576-382

GM
1997-92 Yukon, Tahoe, Blazer (Full Size) Gas Eng.

Dimension 30-1/2" x 24-3/4" x 14"
Lock Ring # 579-001
Gallons 30



576-383

GM
1999-94 Yukon, Tahoe, Blazer (Full Size) Diesel Eng.

Dimension 30-1/2" x 24-3/4" x 14"
Lock Ring # 579-001
Gallons 30

Fuel Tanks



576-384
GM
1995 S10 Blazer, S15 Jimmy (4 Dr.).

Dimension 48" x 15" x 11-1/4"
Lock Ring # 579-001
Gallons 18



576-385
GM
1996 S10 Blazer, S15 Jimmy (4 Dr.), Bravada.

Dimension 48" x 15" x 11-1/4"
Lock Ring # 579-091
Gallons 18



576-386
GM
1998-97 S10 Blazer, S15 Jimmy (4 Dr.), Bravada (4 Dr.).

Dimension 48" x 15" x 11-1/4"
Lock Ring # 579-091
Gallons 18



576-387
GM
1997 Century, Regal, Grand Prix (1" O.D. Filter) (3.8L)

Dimension 33-1/4" x 27-3/4" x 11-3/4"
Lock Ring # 579-091
Gallons 18



576-388
GM
1997 Grand Prix (1-1/2" O.D. Filter) (3.8L)

Dimension 33-1/4" x 27-3/4" x 11-3/4"
Lock Ring # 579-091
Gallons 18



576-389
GM
2002-98 Intrigue, Grand Prix, Century, Regal

Dimension 33-1/4" x 27-3/4" x 11-3/4"
Lock Ring # 579-091
Gallons 18



576-390
GM
1998-90 Chevrolet & GMC C/K 3500 Series Pickups

Dimension 64" x 11-1/2" x 14"
Lock Ring # 579-001
Gallons 22



576-391
GM
1982-77 Chevrolet & GMC G-Series Vans, Small Filler Pipe 1-1/4" ID.

Dimension 31" x 22" x 12-3/8"
Lock Ring # 579-001
Gallons 21



576-392
GM
1996-83 Chevrolet & GMC G-Series Vans, Large Filler Pipe 1-5/8" ID.

Dimension 31" x 22" x 12-3/8"
Lock Ring # 579-001
Gallons 22

Fuel Tanks

Fuel Tanks



576-393

GM
1996-87 Chevrolet & GMC G Series Van,
w/EFI, w/Pan In Tank.

Dimension 31" x 22" x 12-3/8"
Lock Ring # 579-001
Gallons 22



576-394

GM
1986-82 6000, Celebrity, Century, Cutlass
Ciera, w/o EFI.

Dimension 28-5/8" x 38-1/8" x 10-7/8"
Lock Ring # 579-001
Gallons 15



576-395

GM
1996-84 6000, Celebrity, Century, Cutlass
Ciera, Cutlass Supreme, Cutlass Cruiser,
w/EFI, Exc. AWD, w/Pan In Tank.

Dimension 28-5/8" x 38-1/8" x 10-7/8"
Lock Ring # 579-001
Gallons 15



576-600

Honda
1983-80 Civic, Exc. 4 Dr., One Gauge Hole.

Dimension 31-1/4" x 24-1/8" x 7"
Lock Ring # 579-015
Gallons



576-601

Honda
1987-84 Civic. 4 Dr. Sedan, 2 Gauge Holes;
Filler Pipe On Top.

Dimension 34-1/4" x 22" x 8-7/8"
Lock Ring # 579-015, 579-015
Gallons 12



576-602

Honda
1987-84 Civic, 3 Dr. Hatchback, 2 Gauge
Holes; Filler Pipe On Bottom.

Dimension 34-1/4" x 22" x 7-1/2"
Lock Ring # 579-015, 579-015
Gallons 12



576-603

Honda
1991-88 Civic, 4 Dr Sedan, w/ EFI, w/Pan In
Tank.

Dimension 31-1/2" x 26-1/2" x 10"
Lock Ring # 579-015, 579-024
Gallons 12



576-604

Acura
1993-90 Integra

Dimension 31-1/2" x 26-1/2" x 10"
Lock Ring # 579-024
Gallons 12



576-605

Honda
1991-88 Civic, CRX, 3 Dr. Hatchback, w/EFI,
w/Pan In Tank.

Dimension 31-1/2" x 26-1/2" x 10"
Lock Ring # 579-015, 579-024
Gallons 12

Fuel Tanks



576-606

Honda
1989-86 Accord, w/o EFI, w/Pan In Tank.

Dimension 34-7/8" x 27-3/4" x 10"
Lock Ring # 579-024, 579-025, 579-030
Gallons 16



576-607

Honda
1989-86 Accord, w/EFI, w/Pan In Tank.

Dimension 34-7/8" x 27-3/4" x 10"
Lock Ring # 579-024, 579-025, 579-030
Gallons 16



576-608

Honda
1993-90 Accord, w/EFI, w/Pan In Tank.

Dimension 30-1/4" x 27-1/2" x 9-7/8"
Lock Ring # 579-024, 579-025, 579-043
Gallons 17



576-650

Jeep
1976-73 CJ, DJ, Jeepster, Long Filler Pipe 6", Long Vent Pipe 6".

Dimension 25-1/4" x 18-1/4" x 10-7/8"
Lock Ring # 579-003
Gallons 15



576-651

Jeep
1977 CJ, Scrambler, Short Filler Pipe 1", Long Vent Pipe 6".

Dimension 25-1/4" x 18-1/4" x 10-7/8"
Lock Ring # 579-003
Gallons 15



576-652

Jeep
1986-78 CJ, Scrambler, Gauge Hole 2", Filler Pipe 1", Vent Pipe 1".

Dimension 25-1/4" x 18-1/4" x 10-7/8"
Lock Ring # 579-003
Gallons 15



576-653

Jeep
1990-87 Wrangler, w/o EFI, Large Gauge Hole 3-1/8".

Dimension 25-1/8" x 18-1/2" x 10-7/8"
Lock Ring # 579-001
Gallons 15



576-654

Jeep
1990-87 Wrangler, w/EFI, Large Gauge Hole 3-1/8", w/Pan In Tank.

Dimension 25-1/8" x 18-1/2" x 10-7/8"
Lock Ring # 579-001
Gallons 15



576-655

Jeep
1987-84 Cherokee, Wagoneer, w/o EFI, w/ Straight Internal Vent Pipe, 101" W.B.

Dimension 33-5/8" x 20-3/4" x 13"
Lock Ring # 579-001
Gallons 20

Fuel Tanks



576-656

Jeep
1996-86 Cherokee, Wagoneer, w/EFI, w/Pan In Tank, Straight Internal Vent Pipe, 101" W.B.

Dimension 33-5/8" x 20-3/4" x 13"
Lock Ring # 579-001
Gallons 20



576-657

Jeep
1986-84 Cherokee, Wagoneer, w/o EFI, w/90 Deg Internal Vent Pipe, 101" W.B.

Dimension 33-5/8" x 20-3/4" x 13"
Lock Ring # 579-001
Gallons 13.5



576-658

Jeep
1991-86 Cherokee, Wagoneer, w/EFI, w/Pan In Tank, 90 Deg Internal Vent Pipe, 101" W.B.

Dimension 33-5/8" x 20-3/4" x 13"
Lock Ring # 579-001
Gallons 13.5



576-659

Jeep
1986 Comanche, 120" W.B., w/o EFI, w/o Pan In Tank.

Dimension 36-1/2" x 17-1/4" x 13-5/8"
Lock Ring # 579-001
Gallons 23.5



576-660

Jeep
1992-86 Comanche, 120" W.B., w/EFI, w/Pan In Tank.

Dimension 36-1/2" x 17-1/4" x 13-5/8"
Lock Ring # 579-001
Gallons 23.5



576-661

Jeep
1986 Comanche, 113" W.B., w/o EFI, w/o Pan In Tank.

Dimension 29-3/4" x 17-1/4" x 13-5/8"
Lock Ring # 579-001
Gallons 18



576-662

Jeep
1992-86 Comanche, 113" W.B., w/EFI, w/Pan In Tank.

Dimension 29-3/4" x 17-1/4" x 13-5/8"
Lock Ring # 579-001
Gallons 18



576-700

Mazda
1995-90 Protégé, FWD, w/EFI, w/Pan In Tank.

Dimension 38-1/8" x 28-3/8" x 8"
Lock Ring # 579-039
Gallons 13.1



576-701

Mazda
1982-79 626.

Dimension 40-1/8" x 22-5/8" x 9-3/4"
Lock Ring # Not Available Separately
Gallons 13

Fuel Tanks

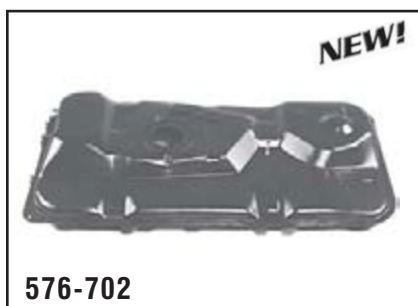

576-702
Mazda
1988-89 MPV (2WD).

Dimension 24-3/4" x 48-3/4" x 8"
Lock Ring # 579-009
Gallons 19.5



576-703
Mazda
1985 626, w/o EFI, Round Gauge, w/o Pan In Tank.

Dimension 39-3/4" x 29-1/4" x 8-1/2"
Lock Ring # 579-009
Gallons 19



576-704
Mazda/Ford
1990-86 323, Tracer, w/o EFI, Oval Gauge.

Dimension 31-7/8" x 25-1/4" x 8-1/2"
Lock Ring # 579-008
Gallons 13



576-705
Mazda/Ford
1990-86 323, Tracer, w/EFI Exc. 4WD, Round Gauge, w/Pan In Tank.

Dimension 31-7/8" x 25-1/4" x 8-1/2"
Lock Ring # 579-009
Gallons 13



576-706
Mazda
1982-81 GLC, Exc.. SW, Small Round Gauge.

Dimension 33" x 24-3/4" x 7-3/4"
Lock Ring # Not Available Separately
Gallons 11



576-707
Mazda
1985-83 GLC, Exc. SW, Oval Gauge.

Dimension 33" x 25-1/4" x 7-3/4"
Lock Ring # 579-008
Gallons 10



576-708
Mazda/Ford
1992-88 626, MX6, Probe, w/EFI, Exc. 4 Wheel Steering, Round Gauge, w/Pan In Tank.

Dimension 40-1/2" x 30-1/8" x 8"
Lock Ring # 579-009
Gallons 16



576-709
Mazda
1991-85 B2000, B2200, Exc. Cab Plus, w/o EFI, Man Trans, Long Box, Single Vent Pipe On Top.

Dimension 42-1/8" x 14-1/4" x 11-5/8"
Lock Ring # 579-008
Gallons 19



576-710
Mazda
1991-85 B2200, B2600, Exc. Cab Plus, w/o EFI, Auto Trans, Long Box, Three Pipes On Top.

Dimension 42-1/8" x 14-1/4" x 11-5/8"
Lock Ring # 579-008
Gallons 19

Fuel Tanks

Fuel Tanks



576-711

Mazda
1993-90 B2200, B2600, Exc. Cab Plus, w/EFI, Long Box, W/Pan In Tank, Two Vent Pipes On Top.
Dimension 42-1/8" x 14-1/4" x 11-5/8"
Lock Ring # 579-008
Gallons 19



576-712

Mazda
1988-86 B2600, 4X4, Exc. Cab Plus, Long Box, w/o Pan In Tank, Three Vent Pipes On Top.
Dimension 42-1/8" x 14-1/4" x 11-5/8"
Lock Ring # 579-008
Gallons 19



576-713

Mazda
1991-85 B2000, B2200, Cab Plus, w/o EFI, Man Trans, Single Vent Pipe On Top.
Dimension 42" x 14" x 11-1/2"
Lock Ring # 579-008
Gallons 17



576-714

Mazda
1991-85 B2200, B2600, Cab Plus, w/o EFI, Auto Trans, Three Vent Pipes On Top.
Dimension 42" x 14" x 11-1/2"
Lock Ring # 579-008
Gallons 17



576-715

Mazda
1990 B2200, B2600, Cab Plus, w/EFI, W/Pan Under Gauge Hole, Single Vent On Top.
Dimension 42" x 14" x 11-1/2"
Lock Ring # 579-008
Gallons 17



576-716

Mazda
1993-91 B2200, B2600, Cab Plus, w/EFI, w/Pan Offset From Gauge Hole, Single Vent On Top.
Dimension 42" x 14" x 11-1/2"
Lock Ring # 579-008
Gallons 17



576-717

Mazda
1988-86 B2600, 4X4, Cab Plus, w/o Pan In Tank, Three Vent Pipes On Top.
Dimension 42" x 14" x 11-1/2"
Lock Ring # 579-008
Gallons 17



576-718

Mazda
1991-85 B2000, B2200, Exc. Cab Plus, w/o EFI, Man Trans, Short Box, Single Vent Pipe On Top.
Dimension 33" x 14-3/8" x 11-3/8"
Lock Ring # 579-008
Gallons 16



576-719

Mazda
1991-85 B2200, B2600, Exc. Cab Plus, w/o EFI, Auto Trans, Short Box, Three Vent Pipes On Top.
Dimension 33" x 14-3/8" x 11-3/8"
Lock Ring # 579-008
Gallons 16

Fuel Tanks



576-720
Mazda
 1988-86 B2600 (4X4), Exc. Cab Plus, Short Box, w/o Pan In Tank, 4 Vent Pipes On Top.

Dimension 33" x 14-3/8" x 11-3/8"
Lock Ring # 579-008
Gallons 16



576-721
Mazda
 1990 B2200, B2600, Exc. Cab Plus, w/EFI, Short Box, w/Pan Under Gauge Hole.

Dimension 33" x 14-3/8" x 11-3/8"
Lock Ring # 579-008
Gallons 16



576-722
Mazda
 1996-90 323, MX3, w/EFI, w/Pan In Tank.

Dimension 35-7/8" x 32-1/4" x 8-1/8"
Lock Ring # 579-039
Gallons 12



576-800
Nissan
 1989-84 Micra, King Cab, 2WD, w/o EFI.

Dimension 31-1/4" x 20-1/2" x 8"
Lock Ring # Not Available Separately
Gallons 10



576-801
Nissan
 1986-84 720 Pickups, King Cab, 2WD, w/o EFI.

Dimension 41-1/2" x 13-5/8" x 13-1/8"
Lock Ring # Not Available Separately
Gallons 15.7



576-802
Nissan
 1986-84 720 Pickups, King Cab, 4WD, w/o EFI, w/o Pan In Tank.

Dimension 41-1/2" x 13-5/8" x 14-1/8"
Lock Ring # Not Available Separately
Gallons 19



576-803
Nissan
 1996-91 Sentra, NX.

Dimension 35" x 25-1/4" x 9"
Lock Ring # Not Available Separately
Gallons 13



576-804
Nissan
 1986-82 Sentra, Exc. Diesel, Straight Vent Pipe.

Dimension 30-3/4" x 22" x 9-3/4"
Lock Ring # Not Available Separately
Gallons 16



576-805
Nissan
 1986-83 Pulsar, Exc. Turbo, 90 Deg Vent Pipe.

Dimension 30-3/4" x 22" x 9-3/4"
Lock Ring # Not Available Separately
Gallons 16

Fuel Tanks

Fuel Tanks



576-806

Nissan
1984-81 810, Maxima, Exc. SW, Gas Eng.

Dimension 40-1/2" x 24" x 9-1/8"
Lock Ring # Not Available Separately
Gallons 16



576-807

Nissan
1986-83 720 Pickups, Exc. King Cab, 2WD, Short Box.

Dimension 32-3/8" x 13-5/8" x 13-1/8"
Lock Ring # Not Available Separately
Gallons 13



576-808

Nissan
1986-83 720 Pickups, Exc. King Cab, 2WD, Long Box.

Dimension 41-1/2" x 13-5/8" x 13-1/8"
Lock Ring # Not Available Separately
Gallons 17.7



576-809

Nissan
1986-85 Maxima, Exc. Digital Gauge, w/EFI, W/Pan In Tank.

Dimension 32-3/4" x 27-1/8" x 9"
Lock Ring # Not Available Separately
Gallons 15.9



576-810

Nissan
1988-86 Maxima, Exc. Digital Gauge, w/EFI, W/Pan In Tank.

Dimension 32-3/4" x 27-1/8" x 9-1/2"
Lock Ring # Not Available Separately
Gallons 17.2



576-811

Nissan
1989-87 Stanza, w/EFI, W/Pan In Tank.

Dimension 32-3/4" x 27-1/8" x 9"
Lock Ring # Not Available Separately
Gallons 15.9



576-812

Nissan
1986-83 720 Pickups, Exc. King Cab, 4WD, w/o EFI, Short Box.

Dimension 32-3/8" x 13-5/8" x 14-1/8"
Lock Ring # Not Available Separately
Gallons 16



576-813

Nissan
1986-83 720 Pickups, Exc. King Cab, 4WD, Long Box.

Dimension 41-1/2" x 13-5/8" x 14-1/8"
Lock Ring # Not Available Separately
Gallons 21



576-814

Nissan
1995-87 Pathfinder

Dimension 34-3/8" x 20-3/4" x 11-3/4"
Lock Ring # Not Available Separately
Gallons 15

Fuel Tanks



576-815
Nissan
1988-87 Sentra, 2WD, w/o EFI.

Dimension 35-1/4" x 25-3/8" x 8-5/8"
Lock Ring # Not Available Separately
Gallons 13



576-816
Nissan
1990-87 Sentra, 2WD, w/EFI, w/Pan In Tank.

Dimension 35-1/4" x 25-3/8" x 8-5/8"
Lock Ring # Not Available Separately
Gallons 13



576-850
Toyota
1983-80 Corolla, Exc. SW

Dimension 33" x 21-3/8" x 9-1/4"
Lock Ring # 579-014, 579-014
Gallons 12



576-851
Toyota
1997-93 Corolla.

Dimension 23" x 37-1/2" x 8-1/2"
Lock Ring # 579-034
Gallons 13



576-852
Toyota/Chevrolet
1988-83 Corolla, Nova, Tercel (Sedan & Liftback).

Dimension 33-1/2" x 23-3/4" x 7-7/8"
Lock Ring # 579-014, 579-023
Gallons 11



576-853
Toyota
1990-88 Corolla, 2WD, wo/ EFI, w/o Pan In Tank, (Sedan & SW).

Dimension 35" x 24-1/8" x 8-1/4"
Lock Ring # 579-032, 579-033, 579-034
Gallons 13



576-854
Toyota
1992-90 Corolla, 2WD, w/o EFI, w/Pan In Tank, (Sedan & SW).

Dimension 35" x 24-1/8" x 8-1/4"
Lock Ring # 579-032, 579-033, 579-034
Gallons 13



576-855
Toyota
1991-87 Camry, Lexus ES250, Exc. 4WD, w/EFI, w/Pan In Tank.

Dimension 38" x 23-1/2" x 8"
Lock Ring # 579-032, 579-033, 579-034, 579-034, 579-034
Gallons 13.5



576-856
Toyota
1996-91 Paseo, Tercel, w/EFI, w/Pan In Tank.

Dimension 37-3/8" x 18" x 9-3/8"
Lock Ring # 579-046
Gallons 11

Fuel Tanks

Fuel Tanks



576-900
Volkswagen
 1984-82 Rabbit, Diesel Eng.

Dimension 34-5/8" x 18-1/8" x 9-1/4"
Lock Ring # Not Available Separately
Gallons 10



576-901
Volkswagen
 1984-80 Jetta, Rabbit, Scirocco (Hatchback, Conv)

Dimension 34-5/8" x 18-1/8" x 9-1/4"
Lock Ring # Not Available Separately
Gallons 10



576-902
Volkswagen
 1984-77 Jetta, Rabbit, Scirocco.

Dimension 34-5/8" x 18-1/8" x 9-1/4"
Lock Ring # Not Available Separately
Gallons 10

Filler Necks



577-005
GM
 1990-77 Electra, Park Avenue, Estate Wagon, LeSabre, Caprice, Impala, Bonneville, Catalina, Delta 88, Parisienne, 98, 98 Regency (SW, 22 Gal Tank).



577-006
GM
 1988-78 Monte Carlo, Bonneville, Catalina, Grand Am, Grand Prix, LeMans, Tempest.



577-007
GM
 1987-78 Regal.



577-008
GM
 1987-78 Century, Regal, Cutlass, Cutlass Supreme & Cruiser.



577-009
GM
 1988-81 Cutlass, Cutlass Supreme, Cutlass Cruiser.



577-011
GM
 1990-77 Electra, Park Avenue, LeSabre, Caprice, Impala, Delta 88, Bonneville, Catalina.

Filler Necks



577-012

GM
1979-77 Electra, Park Avenue, Delta 88,
Regency 98, LeSabre, Riviera.



577-013

GM
1992-73 Century, Regal, DeVille,
Fleetwood, Cutlass, Cutlass Supreme,
Cutlass Cruiser.



577-015

GM
1987-78 El Camino, Caballero, Diablo.



577-016

GM
1977-73 Chevelle, Malibu, Monte Carlo,
LeMans, Tempest.



577-058

GM
1977-75 Grand Prix.



577-072

GM
1973 Grand Prix.



577-073

GM
1974 Grand Prix.



577-074

GM
1973 Chevelle, Malibu, LeMans, Tempest.

Related Sales



55160 (1) GM Fuel Pump Pulsator



Prevent comebacks.
Replace with every GM in-tank
fuel pump. Eliminates fuel pump vibration
and noise. Mounts directly on fuel pump.
Fits various GM vehicles with in-tank
mounted fuel pumps, 1999-84. Great add-on
sale for pump or sender sales. Always
replace the pulsator to eliminate potential
comebacks.

Lock Rings and Gaskets

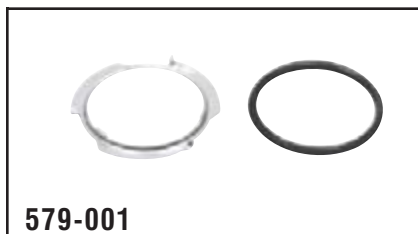

579-001

GM/Jeep
3-1/8" Gauge Hole Dia.



579-003

Ford/Jeep
2" Gauge Hole Dia.



579-004

Ford
3-5/8" Gauge Hole Dia.

Lock Rings and Gaskets

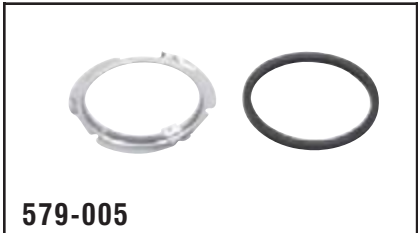

579-005

Chrysler
3" Gauge Hole Dia.



579-006

Chrysler
2" Gauge Hole Dia.

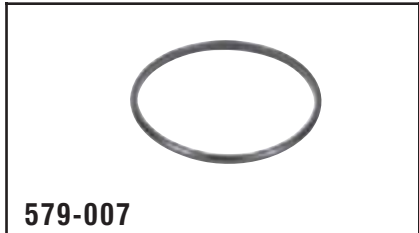

579-007

Chrysler
3-1/2" Gauge Hole Dia.

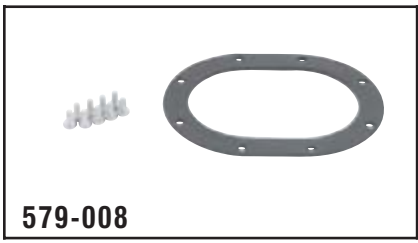

579-008

Mazda
Oval 2-3/4" x 4" Gauge Hole Dia.

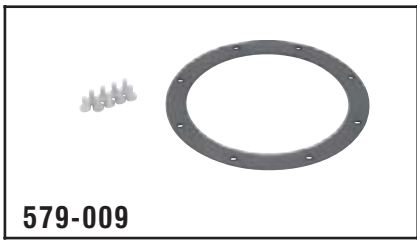

579-009

Mazda
4-1/8" Round Gauge Hole Dia.



579-012

Chrysler
4" Gauge Hole Dia.

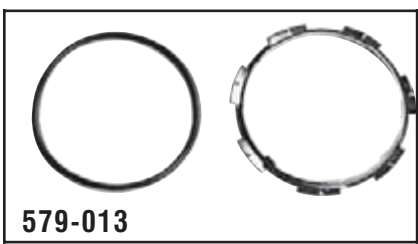

579-013

Mazda
4-5/8" Gauge Hole Dia.

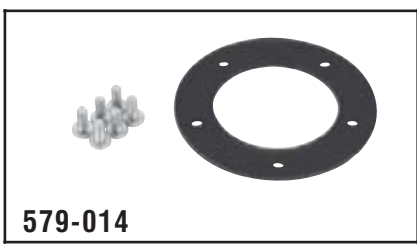

579-014

Toyota/Hyundai
1-3/4" Gauge Hole Dia.



579-015

Honda
1-5/8" Gauge Hole Dia.

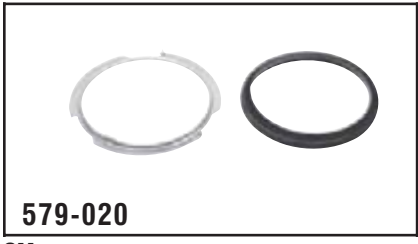

579-020

GM
3-5/8" Gauge Hole Dia.

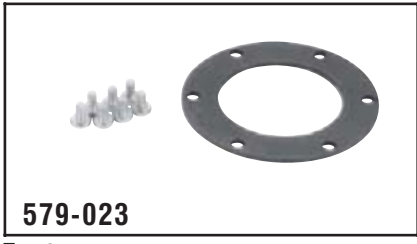

579-023

Toyota
2-1/2" Gauge Hole Dia.



579-024

Honda
2-3/4" Gauge Hole Dia.

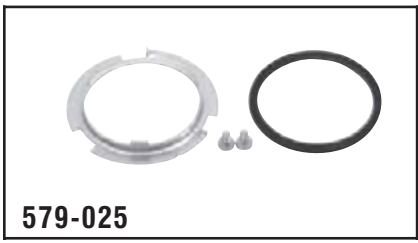

579-025

Honda
2-3/8" Gauge Hole Dia.

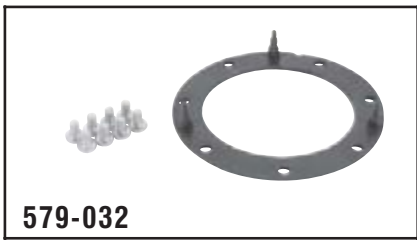

579-032

Toyota
3-1/8" Gauge Hole Dia.

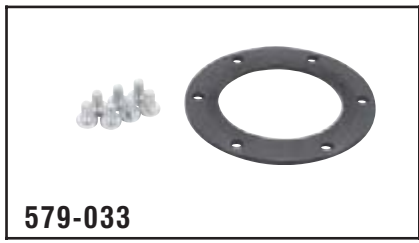

579-033

Toyota
2-1/4" Gauge Hole Dia.

Fuel Tanks

Lock Rings and Gaskets



579-034

Toyota
1-1/4" Gauge Hole Dia.



579-038

GM
1-1/4" Gauge Hole Dia.

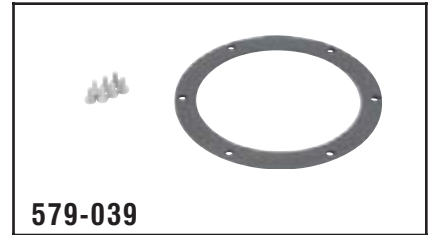

579-039

Mazda
4-1/8" Gauge Hole Dia.



579-043

Honda
1-3/8" Gauge Hole Dia.



579-046

Toyota
3-1/8" Gauge Hole Dia.

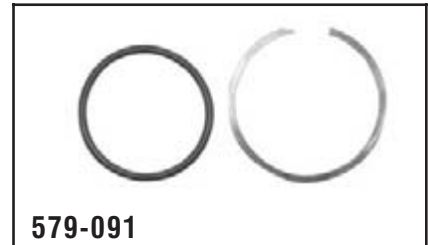

579-091

GM
4-1/8" Gauge Hole Dia.

Fuel Tank Straps



578-001

GM
1991-73 Chevrolet/GMC Trucks
(Conventional Cabs).



578-003

Ford, Lincoln, Mercury
1996-80 F-Series Pickups; 19 Gal
(Conventional Cab, Side Mount).



578-005

Ford, Lincoln, Mercury
1996-80 F-Series Pickups; 16 Gal
(Conventional Cab, Side Mount).

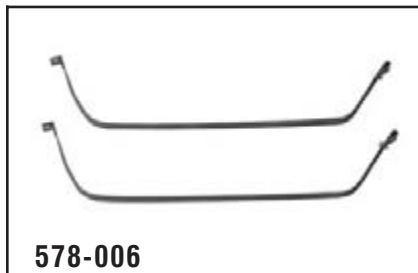

578-006

GM
1988-78 Bonneville, Catalina, LeMans,
Tempest, Century, Malibu, Cutlass, Cutlass
Supreme, Cutlass Cruiser, Regal, Grand
AM, Grand Prix, Monte Carlo (RWD, Exc.
SW).

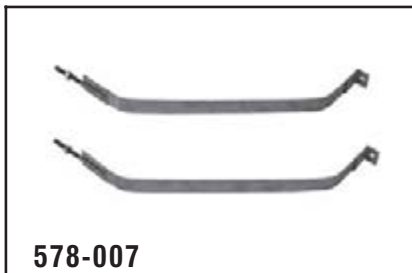

578-007

GM
1995-83 S10 Blazer, S15 Jimmy,
Typhoon, Bravada, Postal Service Van
(100.5" WB, Top Strap Only).

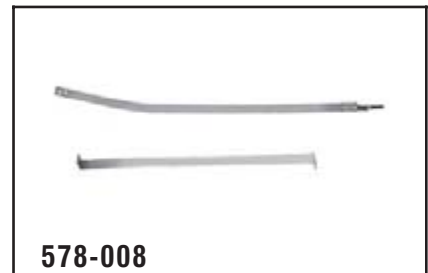

578-008

GM
2001-82 S10/S15 Pickups, Syclone, Baja,
Cameo, Sonoma.

Fuel Tank Straps

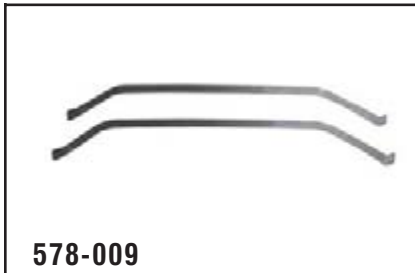

578-009
GM
 1992-77 BelAir, Bonneville, Catalina, Buick LTD, Caprice, Impala, DeVille, Delta 88 & 89, Electra, Fleetwood, Grand Prix, LeSabre, Parisienne, Park Ave, Riviera; 24 Gal (RWD, Exc. SW).

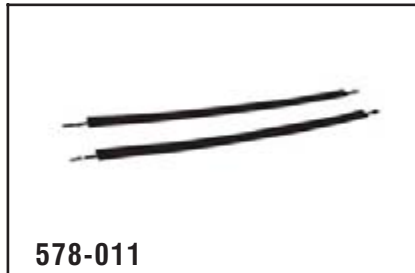

578-011
GM
 1991-73 Full Size Blazer & Jimmy, Suburban; 31 Gal (106.5" WB).

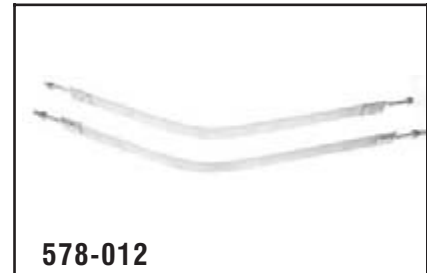

578-012
GM
 1987-73 Full Size Blazer & Jimmy, Suburban; 25 Gal (106.5" WB).



578-016
Ford, Lincoln, Mercury
 1996-73 F-Series Pickups (Conventional Cabs, Rear Mount, Bottom Straps Only).

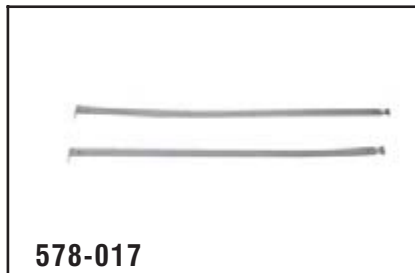

578-017
Chrysler, Dodge, Plymouth
 1995-81 Aries, LeBaron, Caravelle, Lancer, Daytona, New Yorker, Dodge 400 & 600, Reliant, Shadow, E Class, Sundance, Laser, TC (FWD).



578-018
Ford, Lincoln, Mercury
 1988-83 Ranger (Under Cab, Exc. 125" WB, Exc. Super Cab).



578-019
Ford, Lincoln, Mercury
 1988-86 Ranger (Under Cab, 125" WB, Super Cab).

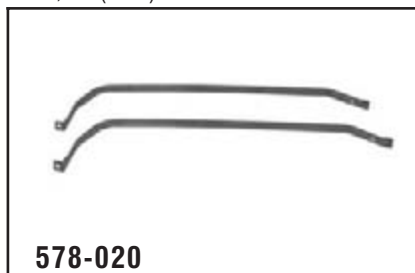

578-020
GM
 1996-82 Celebrity, Ciera, Cutlass, Cutlass Supreme, Cutlass Cruiser, 6000, Century (FWD).



578-021
GM
 1991-82 Beretta, Corsica, J2000, Calais, Skylark, Cavalier, LeMans, Tempest, Firenza, Cimarron, Skyhawk, Sunbird, Somerset, Grand AM (FWD).

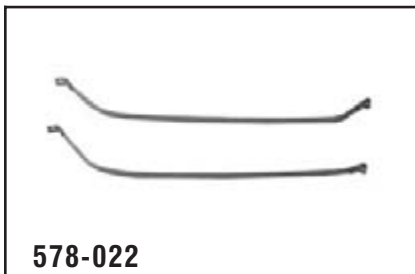

578-022
GM
 1999-85 Bonneville, Catalina, Fleetwood, Delta 88 & 98, DeVille, LeSabre, Electra, Park Avenue, LSS (FWD).



578-026
Ford, Lincoln, Mercury
 1996-78 Bronco (105" WB, Top Straps Only).



578-028
Ford, Lincoln, Mercury
 1990-84 Bronco II (94" WB).

Fuel Tank Straps



578-030
Ford, Lincoln, Mercury
 1991-75 Van (Ahead Of Rear Axle, 124" WB For F24D Only).

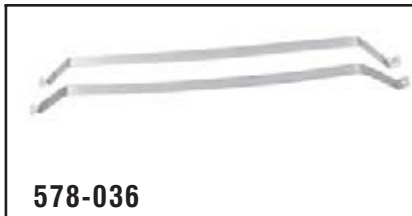

578-036
Chrysler, Dodge, Plymouth
 1995-84 Caravan, Mini Ram, Town & Country (Minivans), Voyager.

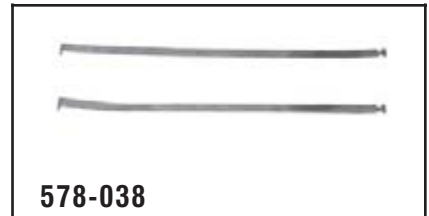

578-038
Chrysler, Dodge, Plymouth
 1995-88 Acclaim, Dynasty, NY, Fifth Ave, Imperial, LeBaron, Spirit.

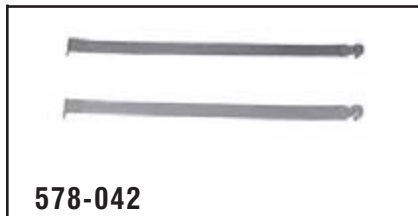

578-042
GM
 2000-88 Chevrolet/GMC Trucks; 34 Gal (C/K/R/V Models).



578-043
GM
 1996-88 Chevrolet/GMC Trucks; 25 Gal (C/K/R/V Models, 8' Box).



578-044
GM
 2000-88 Chevrolet/GMC Trucks; 25 Gal (C/K/R/V Models, 6' Box).



578-045
Ford, Lincoln, Mercury
 1990-83 Escort, ESP, Lynx, LN7.



578-046
Ford, Lincoln, Mercury
 1994-83 Tempo, Topaz (Exc. AWD).

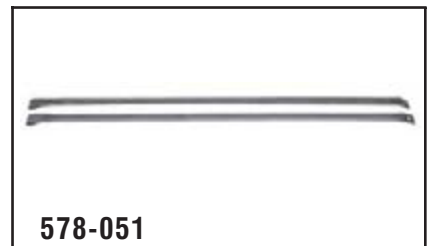

578-051
Ford, Lincoln, Mercury
 1995-86 Continental, Sable, Taurus (Use Supplied Bolt X1 For Higher Capacity Tank Only).



578-052
GM
 2001-92 Achieva, Grand Am, Beretta, Cutlass, Cutlass Supreme, Cutlass Cruiser, Skylark, Cavalier, Sunbird, Corsica.

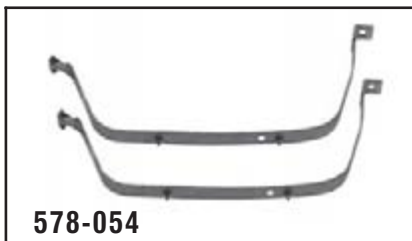

578-054
Jeep
 1992-86 Comanche.

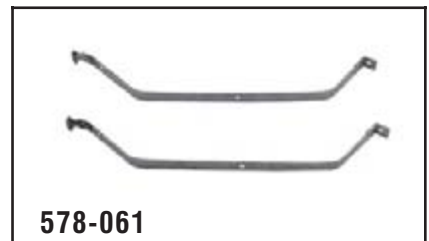

578-061
Jeep
 1996-84 Cherokee, Wagoneer (101" WB).



578-070
GM
 1997-88 Cutlass Supreme, Cutlass Cruiser, Grand Prix, Lumina, Monte Carlo, Regal.



578-078
Mazda
 1995-90 Protégé (Exc. AWD).

Related Sales

DORMAN HELP!

49205 (1)

Fuel Tank Selector Switch
 1997-92 Ford F-Series Pickups.

Fuel Tanks

Fuel Tank Applications

Make/ Model/Years	Description	Fuel Tank (Inc. Lock Ring)	Filler Neck	Tank Strap
ACURA				
INTEGRA				
1993-90	-	576-604	—	—
BUICK				
CENTURY				
1999-98	-	576-389	—	—
1997	-	576-387	—	—
1996-87	-	576-395	—	578-020
1986-84	w/EFI	576-395	—	578-020
1986-84	wo/EFI	576-394	—	578-020
1983-82	-	576-394	—	578-020
1981-78	Exc. Wagon, Gas Eng, w/Filler Neck	576-355	Inc.	578-006
1981-78	Exc. Wagon, wo/Filler Neck	576-363	577-008	578-006
1977-76	2-Door, w/Filler Neck	576-307	Inc.	—
1977-76	2-Door, wo/Filler Neck	576-309	577-013	—
1977-76	4-Door Sedan, w/Filler Neck	576-305	Inc.	—
1977-76	4-Door Sedan, wo/Filler Neck	576-309	577-013	—
1975-73	Exc. Wagon, w/Filler Neck	576-305	Inc.	—
1975-73	Exc. Wagon, wo/Filler Neck	576-309	577-013	—
ELECTRA, PARK AVENUE				
1996-90	Exc. Wagon	576-338	—	578-022
1989	Exc. Wagon	576-338	—	578-022
1989	Wagon, w/Filler Neck	576-377	Inc.	—
1989	Wagon, wo/Filler Neck	576-376	577-005	—
1988-85	Exc. Wagon	576-337	—	578-022
1988-85	Wagon, w/Filler Neck	576-377	Inc.	—
1988-85	Wagon, wo/Filler Neck	576-376	577-005	—
1984	Exc. Wagon, Gas Eng, wo/EFI, w/Filler Neck	576-365	Inc.	578-009
1984	Exc. Wagon, w/EFI, w/Filler Neck	576-366	Inc.	578-009
1984	Exc. Wagon, w/EFI, wo/Filler Neck	576-374	577-011	578-009
1984	Exc. Wagon, wo/EFI, wo/Filler Neck	576-373	577-011	578-009
1984	Wagon, Gas Eng, w/Filler Neck	576-377	Inc.	—
1984	Wagon, wo/Filler Neck	576-376	577-005	—
1983-80	Exc. Wagon, Gas Eng, w/Filler Neck	576-365	Inc.	578-009
1983-80	Exc. Wagon, wo/Filler Neck	576-373	577-011	578-009
1983-80	Wagon, Gas Eng, w/Filler Neck	576-377	Inc.	—
1983-80	Wagon, wo/Filler Neck	576-376	577-005	—
1979-77	Exc. Wagon, 19 Gallon, w/Filler Neck	576-304	Inc.	—
1979-77	Exc. Wagon, 19 Gallon, wo/Filler Neck	576-310	577-012	—
1979-77	Exc. Wagon, 24 Gallon, w/Filler Neck	576-368	Inc.	578-009
1979-77	Exc. Wagon, 24 Gallon, wo/Filler Neck	576-373	577-012	578-009
1979-77	Wagon, w/Filler Neck	576-377	Inc.	—
1979-77	Wagon, wo/Filler Neck	576-376	577-005	—
ESTATE WAGON				
1990-77	Gas Eng, w/Filler Neck	576-377	Inc.	—
1990-77	wo/Filler Neck	576-376	577-005	—
LESABRE				
1999-96	-	576-340	—	578-022
1995-91	-	576-338	—	578-022
1990-89	Exc. Wagon	576-338	—	578-022
1990-89	Wagon, w/Filler Neck	576-377	Inc.	—
1990-89	Wagon, wo/Filler Neck	576-376	577-005	—
1988-86	Exc. Wagon	576-337	—	578-022
1988-86	Wagon, w/Filler Neck	576-377	Inc.	—
1988-86	Wagon, wo/Filler Neck	576-376	577-005	—
1985-84	Exc. Wagon, Gas Eng, wo/EFI, w/Filler Neck	576-365	Inc.	578-009
1985-84	Exc. Wagon, w/EFI, w/Filler Neck	576-366	Inc.	578-009
1985-84	Exc. Wagon, w/EFI, wo/Filler Neck	576-374	577-011	578-009
1985-84	Exc. Wagon, wo/EFI, wo/Filler Neck	576-373	577-011	578-009
1985-84	Wagon, Gas Eng, w/Filler Neck	576-377	Inc.	—
1985-84	Wagon, wo/Filler Neck	576-376	577-005	—
1983-80	Exc. Wagon, Gas Eng, w/Filler Neck	576-365	Inc.	578-009
1983-80	Exc. Wagon, wo/Filler Neck	576-373	577-011	578-009
1983-80	Wagon, Gas Eng, w/Filler Neck	576-377	Inc.	—
1983-80	Wagon, wo/Filler Neck	576-376	577-005	—
1979-77	Exc. Wagon, 19 Gallon, wo/Filler Neck	576-310	577-012	—
1979-77	Exc. Wagon, 24 Gallon, w/Filler Neck	576-368	Inc.	578-009
1979-77	Exc. Wagon, 24 Gallon, wo/Filler Neck	576-373	577-012	578-009
1979-77	Wagon, w/Filler Neck	576-377	Inc.	—
1979-77	Wagon, wo/Filler Neck	576-376	577-005	—
REATA				
1991-88	-	576-360	—	—
REGAL				
1999-98	-	576-389	—	—
1997	-	576-387	—	—
1996-88	Exc. Methanol Fuel	576-357	—	578-070
1987-85	Gas Eng, wo/Turbo, w/Filler Neck	576-353	Inc.	578-006
1987-85	w/Turbo, w/Filler Neck	576-354	Inc.	578-006
1987-85	w/Turbo, wo/Filler Neck	576-364	577-007	578-006

Fuel Tank Applications

Make/ Model/Years	Description	Fuel Tank (Inc. Lock Ring)	Filler Neck	Tank Strap
BUICK (continued)				
REGAL (continued)				
1987-85	wo/Turbo, wo/Filler Neck	576-363	577-007	578-006
1984	2-Door, Gas Eng, wo/Turbo, w/Filler Neck	576-353	Inc.	578-006
1984	2-Door, w/Turbo, w/Filler Neck	576-354	Inc.	578-006
1984	2-Door, w/Turbo, wo/Filler Neck	576-364	577-007	578-006
1984	2-Door, wo/Turbo, wo/Filler Neck	576-363	577-007	578-006
1984	4-Door, Gas Eng, w/Filler Neck	576-355	Inc.	578-006
1984	4-Door, wo/Filler Neck	576-363	577-008	578-006
1983-82	2-Door, Gas Eng, w/Filler Neck	576-353	Inc.	578-006
1983-82	2-Door, wo/Filler Neck	576-363	577-007	578-006
1983-82	4-Door, Gas Eng, w/Filler Neck	576-355	Inc.	578-006
1983-82	4-Door, wo/Filler Neck	576-363	577-008	578-006
1981-78	Gas Eng, w/Filler Neck	576-353	Inc.	578-006
1981-78	wo/Filler Neck	576-363	577-007	578-006
1977-76	2-Door, w/Filler Neck	576-307	Inc.	—
1977-76	2-Door, wo/Filler Neck	576-309	577-013	—
1977-76	4-Door Sedan, w/Filler Neck	576-305	Inc.	—
1977-76	4-Door Sedan, wo/Filler Neck	576-309	577-013	—
1975-73	Exc. Wagon, w/Filler Neck	576-305	Inc.	—
1975-73	Exc. Wagon, wo/Filler Neck	576-309	577-013	—
RIVIERA				
1993-86	-	576-360	—	—
1978	19 Gallon, w/Filler Neck	576-304	Inc.	—
1978	19 Gallon, wo/Filler Neck	576-310	577-012	—
1978	24 Gallon, w/Filler Neck	576-368	Inc.	578-009
1978	24 Gallon, wo/Filler Neck	576-373	577-012	578-009
1977	w/Filler Neck	576-368	Inc.	578-009
1977	wo/Filler Neck	576-373	577-012	578-009
SKYHAWK				
1989-88	-	576-327	—	578-021
1987-82	w/EFI	576-327	—	578-021
1987-82	wo/EFI	576-326	—	578-021
SKYLARK				
1998-92	-	576-361	—	578-052
1991-86	-	576-327	—	578-021
SOMERSET				
1987-85	w/EFI	576-327	—	578-021
1987-85	wo/EFI	576-326	—	578-021
CADILLAC				
CIMARRON				
1988-87	-	576-327	—	578-021
1986-82	w/EFI	576-327	—	578-021
1986-82	wo/EFI	576-326	—	578-021
DEVILLE				
1993-90	4.5L (273)	576-339	—	578-022
1993-90	4.9L (300)	576-339	—	578-022
1993-90	Exc. 4.5L & 4.9L	576-338	—	578-022
1989	-	576-338	—	578-022
1988-85	-	576-337	—	578-022
1984-83	Gas Eng, wo/EFI, w/Filler Neck	576-369	Inc.	578-009
1984-83	w/EFI, w/Filler Neck	576-370	Inc.	578-009
1984-83	w/EFI, wo/Filler Neck	576-374	577-013	578-009
1984-83	wo/EFI, wo/Filler Neck	576-373	577-013	578-009
1982-80	Gas Eng, wo/EFI, 6 Cyl 4.1L (252), w/Filler Neck	576-365	Inc.	578-009
1982-80	Gas Eng, wo/EFI, 8 Cyl 4.1L (252) & 6.0L (368), w/Filler Neck	576-369	Inc.	578-009
1982-80	w/EFI, Exc. Wagon, 6 Cyl 4.1L (252), w/Filler Neck	576-366	Inc.	578-009
1982-80	w/EFI, Exc. Wagon, 6 Cyl 4.1L (252), wo/Filler Neck	576-374	577-011	578-009
1982-80	w/EFI, Exc. Wagon, 8 Cyl 4.1L (252) & 6.0L (368), w/Filler Neck	576-370	Inc.	578-009
1982-80	w/EFI, Exc. Wagon, 8 Cyl 4.1L (252) & 6.0L (368), wo/Filler Neck	576-374	577-013	578-009
1982-80	wo/EFI, 6 Cyl 4.1L (252), wo/Filler Neck	576-373	577-011	578-009
1982-80	wo/EFI, 8 Cyl 4.1L (252) & 6.0L (368), wo/Filler Neck	576-373	577-013	578-009
1979-77	w/EFI, w/Filler Neck	576-370	Inc.	578-009
1979-77	w/EFI, wo/Filler Neck	576-374	577-013	578-009
1979-77	wo/EFI, w/Filler Neck	576-369	Inc.	578-009
1979-77	wo/EFI, wo/Filler Neck	576-373	577-013	578-009
ELDORADO, SEVILLE				
1992-86	-	576-360	—	—
FLEETWOOD				
1993	FWD, 4.9L (300)	576-339	—	578-022
1993	FWD, Exc. 4.9L (300)	576-338	—	578-022
1992-90	FWD, 4.5L (273)	576-339	—	578-022
1992-90	FWD, 4.9L (300)	576-339	—	578-022
1992-90	FWD, Exc. 4.5L & 4.9L	576-338	—	578-022
1992-90	RWD, w/EFI, w/Filler Neck	576-371	Inc.	578-009
1992-90	RWD, w/EFI, wo/Filler Neck	576-375	577-013	578-009
1992-90	RWD, wo/EFI, w/Filler Neck	576-369	Inc.	578-009
1992-90	RWD, wo/EFI, wo/Filler Neck	576-373	577-013	578-009
1989	FWD	576-338	—	578-022

Fuel Tanks

**Power Steering
Pulleys**
pg. 317-326

**Quick
Disconnect™**
pg. 327-396

**Radiator Fan
Assemblies**
pg. 397-430

**Rear Axle
Shaft Kits**
pg. 431-434

**Side View Mirror
Assemblies**
pg. 435-468

**Check Sending Unit and
Screen While Apart**

Fuel Tanks and Accessories

Fuel Tank Applications

Make/ Model/Years	Description	Fuel Tank (Inc. Lock Ring)	Filler Neck	Tank Strap
CADILLAC (continued)				
FLEETWOOD (continued)				
1989	RWD, w/EFI, w/Filler Neck	576-370	Inc.	578-009
1989	RWD, w/EFI, wo/Filler Neck	576-374	577-013	578-009
1989	RWD, wo/EFI, w/Filler Neck	576-369	Inc.	578-009
1989	RWD, wo/EFI, wo/Filler Neck	576-373	577-013	578-009
1988-86	FWD	576-337	—	578-022
1988-86	RWD, Gas Eng, wo/EFI, 24 Gallon, w/Filler Neck	576-369	Inc.	578-009
1988-86	RWD, w/EFI, 20.5 Gallon, w/Filler Neck	576-370	Inc.	578-009
1988-86	RWD, w/EFI, 20.5 Gallon, wo/Filler Neck	576-374	577-013	578-009
1988-86	RWD, wo/EFI, 20.5 Gallon, w/Filler Neck	576-306	Inc.	—
1988-86	RWD, wo/EFI, 20.5 Gallon, wo/Filler Neck	576-310	577-013	—
1988-86	RWD, wo/EFI, 24 Gallon, wo/Filler Neck	576-373	577-013	578-009
1985	FWD	576-337	—	578-022
1985	RWD, Gas Eng, wo/EFI, w/Filler Neck	576-369	Inc.	578-009
1985	RWD, w/EFI, w/Filler Neck	576-370	Inc.	578-009
1985	RWD, w/EFI, wo/Filler Neck	576-374	577-013	578-009
1985	RWD, wo/EFI, w/Filler Neck	576-373	577-013	578-009
1984-83	Gas Eng, wo/EFI, w/Filler Neck	576-369	Inc.	578-009
1984-83	w/EFI, w/Filler Neck	576-370	Inc.	578-009
1984-83	w/EFI, wo/Filler Neck	576-374	577-013	578-009
1984-83	wo/EFI, wo/Filler Neck	576-373	577-013	578-009
1982-80	Gas Eng, wo/EFI, 6 Cyl 4.1L (252), w/Filler Neck	576-365	Inc.	578-009
1982-80	Gas Eng, wo/EFI, 8 Cyl 4.1L (252) & 6.0L (368), w/Filler Neck	576-369	Inc.	578-009
1982-80	w/EFI, Exc. Wagon, 6 Cyl 4.1L (252), w/Filler Neck	576-366	Inc.	578-009
1982-80	w/EFI, Exc. Wagon, 6 Cyl 4.1L (252), wo/Filler Neck	576-374	577-011	578-009
1982-80	w/EFI, Exc. Wagon, 8 Cyl 4.1L (252) & 6.0L (368), w/Filler Neck	576-370	Inc.	578-009
1982-80	w/EFI, Exc. Wagon, 8 Cyl 4.1L (252) & 6.0L (368), wo/Filler Neck	576-374	577-013	578-009
1982-80	wo/EFI, 6 Cyl 4.1L (252), wo/Filler Neck	576-373	577-011	578-009
1982-80	wo/EFI, 8 Cyl 4.1L (252) & 6.0L (368), wo/Filler Neck	576-373	577-013	578-009
1979-77	w/EFI, w/Filler Neck	576-370	Inc.	578-009
1979-77	w/EFI, wo/Filler Neck	576-374	577-013	578-009
1979-77	wo/EFI, w/Filler Neck	576-369	Inc.	578-009
1979-77	wo/EFI, wo/Filler Neck	576-373	577-013	578-009
CHEVROLET				
BERETTA, CORSICA				
1996-93	-	576-361	—	578-052
1989-87	-	576-327	—	578-021
CAPRICE, IMPALA				
1990	Exc. Wagon, w/Filler Neck	576-367	Inc.	578-009
1990	Exc. Wagon, wo/Filler Neck	576-375	577-011	578-009
1990	Wagon, w/Filler Neck	576-377	Inc.	—
1990	Wagon, wo/Filler Neck	576-376	577-005	—
1989	Exc. Wagon, w/Filler Neck	576-366	Inc.	578-009
1989	Exc. Wagon, wo/Filler Neck	576-374	577-011	578-009
1989	Wagon, w/Filler Neck	576-377	Inc.	—
1989	Wagon, wo/Filler Neck	576-376	577-005	—
1988-84	Exc. Wagon, Gas Eng, wo/EFI, w/Filler Neck	576-365	Inc.	578-009
1988-84	Exc. Wagon, w/EFI, w/Filler Neck	576-366	Inc.	578-009
1988-84	Exc. Wagon, w/EFI, wo/Filler Neck	576-374	577-011	578-009
1988-84	Exc. Wagon, wo/EFI, wo/Filler Neck	576-373	577-011	578-009
1988-84	Wagon, Gas Eng, w/Filler Neck	576-377	Inc.	—
1988-84	Wagon, wo/Filler Neck	576-376	577-005	—
1983-80	Exc. Wagon, Gas Eng, w/Filler Neck	576-365	Inc.	578-009
1983-80	Exc. Wagon, wo/Filler Neck	576-373	577-011	578-009
1983-80	Wagon, Gas Eng, w/Filler Neck	576-377	Inc.	—
1983-80	Wagon, wo/Filler Neck	576-376	577-005	—
1979-77	Exc. Wagon, w/Filler Neck	576-303	Inc.	—
1979-77	Exc. Wagon, wo/Filler Neck	576-310	577-011	—
1979-77	Wagon, w/Filler Neck	576-377	Inc.	—
1979-77	Wagon, wo/Filler Neck	576-376	577-005	—
CAVALIER				
2001-99	Steel Tank	576-362	—	578-052
1998-92	-	576-361	—	578-052
1991-88	-	576-327	—	578-021
1987-82	w/EFI	576-327	—	578-021
1987-82	wo/EFI	576-326	—	578-021
CELEBRITY				
1990-87	-	576-395	—	578-020
1986-84	w/EFI	576-395	—	578-020
1986-84	wo/EFI	576-394	—	578-020
1983-82	-	576-394	—	578-020
CHEVELLE, MALIBU				
1977-74	w/Filler Neck	576-307	Inc.	—
1977-74	wo/Filler Neck	576-309	577-016	—
1973	w/Filler Neck (Exc. Wagon)	576-308	Inc.	—
1973	wo/Filler Neck	576-309	577-074	—
LUMINA SEDAN				
1999-97	-	576-358	—	—

Fuel Tank Applications

Make/ Model/Years	Description	Fuel Tank (Inc. Lock Ring)	Filler Neck	Tank Strap
CHEVROLET (continued)				
LUMINA SEDAN (continued)				
1996	-	576-357	—	—
1995-90	Exc. Methanol Fuel	576-357	—	578-070
MONTE CARLO				
1999-97	-	576-358	—	—
1996-95	Exc. Methanol Fuel	576-357	—	578-070
1988-85	4.3L (262), w/Filler Neck	576-352	Inc.	578-006
1988-85	4.3L (262), wo/Filler Neck	576-364	577-006	578-006
1988-85	Exc. 4.3L (262), w/Filler Neck	576-351	Inc.	578-006
1988-85	Exc. 4.3L (262), wo/Filler Neck	576-363	577-006	578-006
1984-78	w/Filler Neck	576-351	Inc.	578-006
1984-78	wo/Filler Neck	576-363	577-006	578-006
1977-74	w/Filler Neck	576-307	Inc.	—
1977-74	wo/Filler Neck	576-309	577-016	—
1973	w/Filler Neck	576-308	Inc.	—
1973	wo/Filler Neck	576-309	577-016	—
NOVA				
1988	Exc. Twin Cam	576-852	—	—
1987-85	-	576-852	—	—
CHEVROLET/GMC TRUCK				
ASTRO				
1999-97	-	576-346	—	—
1996-85	17 Gallon	576-345	—	—
1996-85	27 Gallon	576-345	—	—
BLAZER				
1994	Diesel Eng	576-383	—	—
1994	Gas Eng	576-382	—	—
1993-92	-	576-382	—	—
1991-88	Diesel Eng	576-312	—	578-011
1991-88	Gas Eng	576-313	—	578-011
1987	25 Gallon, Diesel Eng	576-320	—	578-012
1987	25 Gallon, Gas Eng	576-321	—	578-012
1987	31 Gallon, Diesel Eng	576-312	—	578-011
1987	31 Gallon, Gas Eng	576-313	—	578-011
1986-73	25 Gallon	576-320	—	578-012
1986-73	31 Gallon	576-312	—	578-011
C, K, R, V SERIES PICKUP				
2000-99	C & K Series, Diesel Eng, 25 Gallon	576-343	—	578-044
2000-99	C & K Series, Diesel Eng, 34 Gallon	576-341	—	578-042
1998	3500 Series Cab & Chassis, Ahead of Rear Axle, 22 Gallon, Gas Eng	576-390	—	—
1998	C & K Series, Diesel Eng, 25 Gallon	576-343	—	578-044
1998	C & K Series, Diesel Eng, 34 Gallon	576-341	—	578-042
1998	C & K Series, Gas Eng, 25 Gallon	576-344	—	578-044
1998	C & K Series, Gas Eng, 34 Gallon	576-342	—	578-042
1997	3500 Series Cab & Chassis, Ahead of Rear Axle, 22 Gallon, Gas Eng	576-390	—	—
1997	C & K Series, 4.3L(L35), 25 Gallon	576-344	—	—
1997	C & K Series, 4.3L(L35), 34 Gallon	576-342	—	578-042
1997	C & K Series, 5.0L(L30), 5.7L(L31), 7.4L(L29), 25 Gallon	576-343	—	—
1997	C & K Series, 5.0L(L30), 5.7L(L31), 7.4L(L29), 34 Gallon	576-341	—	578-042
1996-92	3500 Series Cab & Chassis, Ahead of Rear Axle, 22 Gallon, Gas Eng	576-390	—	—
1996-92	Ahead of Rear Axle, 25 Gallon, w/6 Box	576-343	—	578-044
1996-92	Ahead of Rear Axle, 25 Gallon, w/8 Box	576-343	—	578-043
1996-92	Ahead of Rear Axle, 34 Gallon	576-341	—	578-042
1995-92	Behind Rear Axle, 3500 HD, Diesel Eng	576-315	—	—
1995-92	Behind Rear Axle, Exc. 3500 HD, Diesel Eng	576-317	—	—
1995-92	Behind Rear Axle, Gas Eng, 3500 HD	576-318	—	—
1995-92	Behind Rear Axle, Gas Eng, 3500 HD	576-316	—	—
1991-90	3500 Series Cab & Chassis, Ahead of Rear Axle, 22 Gallon, Gas Eng	576-390	—	—
1991-90	C & K Series, Ahead of Rear Axle, 25 Gallon, w/6 Box	576-343	—	578-044
1991-90	C & K Series, Ahead of Rear Axle, 25 Gallon, w/8 Box	576-343	—	578-043
1991-90	C & K Series, Ahead of Rear Axle, 34 Gallon	576-341	—	578-042
1991-90	C & K Series, Behind Rear Axle, Diesel Eng	576-317	—	—
1991-90	C & K Series, Behind Rear Axle, Gas Eng	576-318	—	—
1991-90	R & V Series, Diesel Eng	576-335	—	578-001
1991-90	R & V Series, Gas Eng	576-336	—	578-001
1989-88	C & K Series, 25 Gallon, w/6 Box	576-343	—	578-044
1989-88	C & K Series, 25 Gallon, w/8 Box	576-343	—	578-043
1989-88	C & K Series, 34 Gallon	576-341	—	578-042
1989-88	R & V Series, Diesel Eng	576-335	—	578-001
1989-88	R & V Series, Gas Eng	576-336	—	578-001
1987	Long Wheel Base, Diesel Eng	576-335	—	578-001
1987	Long Wheel Base, Gas Eng	576-336	—	578-001
1987	Short Wheel Base, Diesel Eng	576-301	—	578-001
1987	Short Wheel Base, Gas Eng	576-302	—	578-001
1986-82	Long Wheel Base	576-335	—	578-001
1986-82	Short Wheel Base	576-301	—	578-001
1981	Long Wheel Base	576-334	—	578-001
1981	Short Wheel Base	576-300	—	578-001
1980-75	Ahead of Rear Axle, Long Wheel Base	576-334	—	578-001

**Window
Lift Motors**
pg. 535-554

**Window
Regulators**
pg. 555-566

**Wiper
Motors**
pg. 567-572

**Wiper Transmission
Linkages**
pg. 573-576

**Check Sending Unit and
Screen While Apart**

Fuel Tanks and Accessories

Fuel Tanks

Fuel Tank Applications

Make/ Model/Years	Description	Fuel Tank (Inc. Lock Ring)	Filler Neck	Tank Strap
CHEVROLET/GMC TRUCK (continued)				
C, K, R, V SERIES PICKUP (continued)				
1980-75	Ahead of Rear Axle, Short Wheel Base	576-300	—	578-001
1980-75	Behind Rear Axle	576-319	—	578-012
1975-73	Long Wheel Base	576-334	—	578-001
1975-73	Short Wheel Base	576-300	—	578-001
EL CAMINO, CABALLERO, DIABLO				
1987	17 Gallon, wo/EFI, w/Filler Neck	576-380	Inc.	—
1987	22 Gallon, w/EFI, w/Filler Neck	576-379	Inc.	—
1987	22 Gallon, wo/EFI, w/Filler Neck	576-378	Inc.	—
1987	22 Gallon, wo/EFI, wo/Filler Neck	576-376	577-015	—
1986-85	17 Gallon, w/EFI, w/Filler Neck	576-381	Inc.	—
1986-85	17 Gallon, wo/EFI, w/Filler Neck	576-380	Inc.	—
1986-85	22 Gallon, w/EFI, w/Filler Neck	576-379	Inc.	—
1986-85	22 Gallon, wo/EFI, w/Filler Neck	576-378	Inc.	—
1986-85	22 Gallon, wo/EFI, wo/Filler Neck	576-376	577-015	—
1984-78	17 Gallon, w/Filler Neck	576-380	Inc.	—
1984-78	22 Gallon, Gas Eng, w/Filler Neck	576-378	Inc.	—
1984-78	22 Gallon, wo/Filler Neck	576-376	577-015	—
G SERIES VAN				
1996-87	Exc. Express, Savana; Diesel Eng; 22 Gallon	576-392	—	—
1996-87	Exc. Express, Savana; Gas Eng, 22 Gallon	576-393	—	—
1986-83	22 Gallon	576-392	—	—
1982-77	21 Gallon	576-391	—	—
JIMMY				
1991-88	Diesel Eng	576-312	—	578-011
1991-88	Gas Eng	576-313	—	578-011
1987	25 Gallon, Diesel Eng	576-320	—	578-012
1987	25 Gallon, Gas Eng	576-321	—	578-012
1987	31 Gallon, Diesel Eng	576-312	—	578-011
1987	31 Gallon, Gas Eng	576-313	—	578-011
1986-73	25 Gallon	576-320	—	578-012
1986-73	31 Gallon	576-312	—	578-011
P SERIES FORWARD CONTROL				
1999-98	40 Gallon, Gas Eng, Exc. School Bus	576-350	—	—
1981	30 Gallon	576-314	—	—
1980	30 Gallon	576-314	—	—
1979	30 Gallon, School Bus	576-314	—	—
POSTAL SERVICE VAN				
1994-87	-	576-333	—	578-007
S SERIES BLAZER & JIMMY				
2002-99	2-Door	576-331	—	—
1998	2-Door	576-331	—	—
1998	4-Door, wo/Plastic Tank	576-386	—	—
1997	2-Door	576-331	—	—
1997	4-Door	576-386	—	—
1996	2-Door	576-330	—	—
1996	4-Door	576-385	—	—
1995	2-Door	576-329	—	578-007
1995	4-Door	576-384	—	—
1994-88	-	576-329	—	578-007
1987-86	13.2 Gallon	576-333	—	578-007
1987-86	20 Gallon	576-329	—	578-007
1985	13.2 Gallon, w/EFI	576-333	—	578-007
1985	13.2 Gallon, wo/EFI	576-332	—	578-007
1985	20 Gallon, w/EFI	576-329	—	578-007
1985	20 Gallon, wo/EFI	576-328	—	578-007
1984-83	13.2 Gallon	576-332	—	578-007
1984-83	20 Gallon	576-328	—	578-007
S SERIES PICKUP, SONOMA, SYCLONE				
2001-97	18.5 Gallon	576-325	—	578-008
1996	18.5 Gallon	576-324	—	578-008
1995-94	20 Gallon	576-323	—	578-008
1993-86	20 Gallon, Exc. 13.2 Gallon 4WD Regular Cab	576-323	—	578-008
1985	13.2 Gallon (Exc. 4WD), Pump in Tank	576-323	—	578-008
1985	13.2 Gallon (Exc. 4WD), Pump on Engine	576-322	—	578-008
1985	20 Gallon, Pump in Tank	576-323	—	578-008
1985	20 Gallon, Pump on Engine	576-322	—	578-008
1984-82	13.2 Gallon (Exc. 4WD)	576-322	—	578-008
1984-82	20 Gallon	576-322	—	578-008
SAFARI				
1999-97	-	576-346	—	—
1996-85	17 Gallon	576-345	—	—
1996-85	27 Gallon	576-345	—	—
SUBURBAN				
1999-98	Gas Eng	576-372	—	—
1991-88	31 Gallon, Diesel Eng	576-312	—	578-011
1991-88	31 Gallon, Gas Eng	576-313	—	578-011
1991-88	40 Gallon, Diesel Eng	576-348	—	—
1991-88	40 Gallon, Gas Eng	576-349	—	—

Fuel Tank Applications

Make/ Model/Years	Description	Fuel Tank (Inc. Lock Ring)	Filler Neck	Tank Strap
CHEVROLET/GMC TRUCK (continued)				
SUBURBAN (continued)				
1987	25 Gallon, Diesel Eng	576-320	—	578-012
1987	25 Gallon, Gas Eng	576-321	—	578-012
1987	31 Gallon, Diesel Eng	576-312	—	578-011
1987	31 Gallon, Gas Eng	576-313	—	578-011
1987	40 Gallon, Diesel Eng	576-348	—	—
1987	40 Gallon, Gas Eng	576-349	—	—
1986-82	25 Gallon	576-320	—	578-012
1986-82	31 Gallon	576-312	—	578-011
1986-82	40 Gallon	576-348	—	—
1981-74	25 Gallon	576-319	—	578-012
1981-74	31 Gallon	576-311	—	578-011
1981-74	40 Gallon	576-347	—	—
1973	25 Gallon	576-319	—	578-012
1973	31 Gallon	576-311	—	578-011
TAHOE				
1999-98	Diesel Eng	576-383	—	—
1997-95	Diesel Eng	576-383	—	—
1997-95	Gas Eng, 2-Door	576-382	—	—
TYPHOON				
1993-92	-	576-329	—	578-007
YUKON				
1999-98	Diesel Eng	576-383	—	—
1997-95	Diesel Eng	576-383	—	—
1997-95	Gas Eng, 2-Door	576-382	—	—
1994	Diesel Eng	576-383	—	—
1994	Gas Eng	576-382	—	—
1993-92	-	576-382	—	—
CHRYSLER				
CORDOBA				
1983-80	-	576-002	—	—
E CLASS				
1988-86	-	576-008	—	578-017
1985	2.2L (135)	576-007	—	578-017
1985	2.6L (156)	576-005	—	578-017
1984	2.2L (135), w/Turbo	576-007	—	578-017
1984	2.2L (135), wo/Turbo	576-006	—	578-017
1984	2.6L (156)	576-004	—	578-017
1983	-	576-004	—	578-017
FIFTH AVENUE				
1989-82	-	576-002	—	—
IMPERIAL				
1993-91	-	576-017	—	578-038
1990	-	576-016	—	578-038
LASER				
1986	-	576-007	—	578-017
1985	w/EFI	576-006	—	578-017
1985	w/Turbo	576-007	—	578-017
1985	wo/EFI	576-005	—	578-017
1984	w/Turbo	576-007	—	578-017
1984	wo/Turbo	576-004	—	578-017
LEBARON				
1995-91	2-Door	576-009	—	578-017
1995-91	4-Door	576-017	—	578-038
1990	2-Door	576-008	—	578-017
1990	4-Door	576-016	—	578-038
1989-88	-	576-008	—	578-017
1987-86	-	576-007	—	578-017
1985	2.2L (135), w/Turbo	576-007	—	578-017
1985	2.2L (135), wo/Turbo	576-006	—	578-017
1985	2.6L (156)	576-005	—	578-017
1984	w/EFI	576-007	—	578-017
1984	wo/EFI	576-004	—	578-017
1983	w/EFI	576-007	—	578-017
1983	wo/EFI	576-004	—	578-017
1982	-	576-003	—	578-017
1981-80	-	576-002	—	—
1979	From 4/2/79	576-002	—	—
1979	To 4/2/79	576-001	—	—
1978-77	-	576-001	—	—
NEW YORKER				
1993-91	-	576-017	—	578-038
1990-88	-	576-016	—	578-038
1987-86	-	576-008	—	578-017
1985	2.2L (135), w/Turbo	576-007	—	578-017
1985	2.2L (135), wo/Turbo	576-006	—	578-017
1985	2.6L (156)	576-005	—	578-017
1984	2.2L (135)	576-007	—	578-017
1984	2.6L (156)	576-004	—	578-017

Fuel Tank Applications

Make/ Model/Years	Description	Fuel Tank (Inc. Lock Ring)	Filler Neck	Tank Strap
CHRYSLER (continued)				
NEW YORKER (continued)				
1983	-	576-004	—	578-017
1982	-	576-002	—	—
TC By MASERATI				
1991	-	576-009	—	578-017
1990-89	-	576-008	—	578-017
TOWN & COUNTRY VAN				
1995-91	2WD	576-014	—	578-036
1990	-	576-013	—	578-036
DODGE				
400, 600				
1988	-	576-008	—	578-017
1987-86	-	576-007	—	578-017
1985	2.2L (135), w/Turbo	576-007	—	578-017
1985	2.2L (135), wo/Turbo	576-006	—	578-017
1985	2.6L (156)	576-005	—	578-017
1984	w/EFI	576-007	—	578-017
1984	wo/EFI	576-004	—	578-017
1983	-	576-004	—	578-017
1982	-	576-003	—	578-017
ARIES				
1989-88	-	576-008	—	578-017
1987-86	-	576-007	—	578-017
1985	w/EFI	576-006	—	578-017
1985	wo/EFI	576-005	—	578-017
1984	w/EFI	576-007	—	578-017
1984	wo/EFI	576-004	—	578-017
1983	-	576-004	—	578-017
1982-81	-	576-003	—	578-017
ASPEN				
1980	-	576-002	—	—
1979	From 4/2/79	576-002	—	—
1979	To 4/2/79	576-001	—	—
1978	-	576-001	—	—
1977	From 4/1/77	576-001	—	—
CARAVAN, MINI RAM VAN				
1995-91	2WD	576-014	—	578-036
1990-88	-	576-013	—	578-036
1987	w/EFI	576-013	—	578-036
1987	wo/EFI	576-012	—	578-036
1986-84	-	576-012	—	578-036
CHARGER				
1987-85	w/Turbo	576-011	—	—
1987-85	wo/Turbo	576-010	—	—
1984-79	-	576-010	—	—
COLT				
1988	Exc. Wagon, wo/Turbo	576-000	—	—
1987-85	wo/Turbo	576-000	—	—
DAYTONA				
1993-91	-	576-009	—	578-017
1990-86	-	576-008	—	578-017
1985	w/Turbo	576-008	—	578-017
1985	wo/Turbo	576-005	—	578-017
1984	w/Turbo	576-008	—	578-017
1984	wo/Turbo	576-004	—	578-017
DIPLOMAT				
1989-80	-	576-002	—	—
1979	From 4/2/79	576-002	—	—
1979	To 4/2/79	576-001	—	—
1978-77	-	576-001	—	—
DYNASTY				
1993-91	-	576-017	—	578-038
1990-88	-	576-016	—	578-038
LANCER				
1989-88	-	576-008	—	578-017
1987-86	-	576-007	—	578-017
1985	w/Turbo	576-007	—	578-017
1985	wo/Turbo	576-006	—	578-017
MIRADA				
1983-80	-	576-002	—	—
OMNI, 024				
1990-88	-	576-011	—	—
1987-85	w/Turbo	576-011	—	—
1987-85	wo/Turbo	576-010	—	—
1984-78	-	576-010	—	—
SHADOW				
1994-91	-	576-009	—	578-017
1990-88	-	576-008	—	578-017
1987	-	576-007	—	578-017

Fuel Tank Applications

Make/ Model/Years	Description	Fuel Tank (Inc. Lock Ring)	Filler Neck	Tank Strap
DODGE (continued)				
SPIRIT				
1995-91	-	576-017	—	578-038
1990-89	-	576-016	—	578-038
DODGE TRUCK				
D-50 PICKUP				
1985-79	To 7/85 (15 Gallon)	576-015	—	—
RAM 50 PICKUP				
1985-79	To 7/85 (15 Gallon)	576-015	—	—
RAMPAGE				
1984-82	-	576-010	—	—
FORD				
CROWN VICTORIA				
1994-92	Sedan	576-135	—	—
1991-90	Exc. Wagon, w/Pump in Tank, 5.0L (302)	576-135	—	—
1991-90	Exc. Wagon, w/Pump on Engine	576-136	—	—
1989-86	Exc. Wagon, w/Pump in Tank	576-115	—	—
1989-86	Exc. Wagon, w/Pump on Engine	576-136	—	—
1985-83	Exc. Wagon, w/Pump in Tank	576-115	—	—
1985-83	Exc. Wagon, w/Pump on Engine	576-136	—	—
ESCORT, EXP				
1990-87	-	576-151	—	578-045
1986-83	Pump in Tank	576-150	—	578-045
1986-83	Pump on Engine	576-149	—	578-045
1982-81	-	576-148	—	—
LTD				
1986	Exc. Wagon, w/114" Wheel Base, w/Pump in Tank	576-115	—	—
1986	Exc. Wagon, w/114" Wheel Base, w/Pump on Engine	576-136	—	—
1985	Exc. Wagon, w/114" Wheel Base, w/Pump in Tank	576-115	—	—
1985	Exc. Wagon, w/114" Wheel Base, w/Pump on Engine	576-136	—	—
1984	Exc. Wagon, w/114" Wheel Base, w/Pump in Tank	576-115	—	—
1984	Exc. Wagon, w/114" Wheel Base, w/Pump on Engine	576-136	—	—
1983	Exc. Wagon, w/114" Wheel Base, w/Pump in Tank	576-115	—	—
1983	Exc. Wagon, w/114" Wheel Base, w/Pump on Engine	576-136	—	—
1982-81	Exc. Wagon, w/Pump in Tank	576-115	—	—
1982-81	Exc. Wagon, w/Pump on Engine	576-136	—	—
1980-79	Exc. Wagon	576-136	—	—
MUSTANG				
1997-87	-	576-106	—	—
1986-83	Pump in Tank	576-106	—	—
1986-83	Pump on Engine	576-105	—	—
1982	-	576-105	—	—
1981	From 4/81 (15.4 Gallon)	576-105	—	—
1968-64	wo/Drain Plug	576-134	—	—
PROBE				
1992-88	Exc. 4WS	576-708	—	—
TAURUS				
1999	16 Gallon, ID XF12-AA, XF12-AB, XF12-AC, w/On Board Vapor Recovery System	576-141	—	—
1999	16 Gallon, ID XF12-BA, wo/On Board Vapor Recovery System	576-139	—	—
1999	18 Gallon, ID XF12-CA, wo/On Board Vapor Recovery System	576-140	—	—
1998	16 Gallon, ID F8DC-AB, XF12-AA, XF12-AB, XF12-AC	576-141	—	—
1998	16 Gallon, ID F8DC-BB	576-139	—	—
1998	18 Gallon, ID F8DC-CB	576-140	—	—
1997	16 Gallon, Exc. Flex Fuel, ID F7DC-AA thru AD	576-137	—	—
1997	18 Gallon, Exc. Flex Fuel, ID F7DC-BA thru BD	576-138	—	—
1996	16 Gallon, Exc. SHO, ID F6DC-AA thru AV	576-137	—	—
1996	18 Gallon, Exc. SHO, ID F6DC-BA thru BV	576-138	—	—
1995-89	16 Gallon	576-130	—	578-051
1995-89	18.5 Gallon	576-131	—	578-051
1988	16 Gallon, From 4/88	576-130	—	578-051
1988	16 Gallon, To 4/88	576-129	—	578-051
1988	18.5 Gallon	576-131	—	578-051
1987-86	16 Gallon	576-129	—	578-051
TEMPO				
1994-88	Exc. AWD	576-104	—	578-046
1987-86	Exc. AWD, Diesel Eng	576-103	—	578-046
1987-86	Exc. AWD, Gas Eng, w/EFI	576-103	—	578-046
1987-86	Exc. AWD, Gas Eng, wo/EFI	576-102	—	578-046
1985-84	Diesel Eng	576-103	—	578-046
1985-84	Gas Eng, w/EFI	576-103	—	578-046
1985-84	Gas Eng, wo/EFI	576-102	—	578-046
1983	-	576-102	—	578-046
THUNDERBIRD				
1988-87	-	576-132	—	—
1986	w/Turbo	576-133	—	—
1986	wo/Turbo	576-132	—	—
1985	-	576-133	—	—
FORD TRUCK				
BRONCO				
1996-90	-	576-155	—	578-026

Fuel Tanks

Fuel Sending Units
pg. 155-176

Fuel Tanks
pg. 177-228

Harmonic Balancers
pg. 229-254

Heater Hose Assemblies
pg. 255-256

Hydraulic Clutch Lines
pg. 257-260

Check Sending Unit and Screen While Apart

Fuel Tanks and Accessories

Fuel Tank Applications

Make/ Model/Years	Description	Fuel Tank (Inc. Lock Ring)	Filler Neck	Tank Strap
FORD TRUCK (continued)				
BRONCO (continued)				
1989-87	Large Gauge - 3-5/8"	576-155	—	578-026
1989-87	Small Gauge - 2"	576-156	—	578-026
1986-85	Large Gauge - 3-5/8"	576-155	—	578-026
1986-85	Small Gauge - 2"	576-154	—	578-026
1984	-	576-154	—	578-026
1983-80	25.5 Gallon	576-159	—	578-026
1983-80	33 Gallon	576-154	—	578-026
1979	25.5 Gallon	576-158	—	578-026
1979	33 Gallon	576-153	—	578-026
1978	25.5 Gallon	576-157	—	578-026
1978	33 Gallon	576-152	—	578-026
BRONCO II				
1990-85	-	576-101	—	578-028
1984	-	576-100	—	578-028
E SERIES VAN				
2001-97	Exc. Cutaway	576-143	—	—
1996-92	Exc. Cutaway	576-142	—	—
1991-88	Behind Rear Axle, 22 Gallon	576-114	—	—
1987-86	Behind Rear Axle, 22 Gallon	576-113	—	—
1985-81	Behind Rear Axle, 22 Gallon	576-112	—	—
1980	Behind Rear Axle, 22 Gallon	576-112	—	—
1979-78	Behind Rear Axle, 22 Gallon	576-112	—	—
1977-75	Behind Rear Axle, 22 Gallon, w/Roll Over Valve	576-112	—	—
1977-75	Behind Rear Axle, 22 Gallon, wo/Roll Over Valve	576-111	—	—
F SERIES PICKUP				
1996-93	Rear Mount, 18 Gallon	576-121	—	578-016
1996-93	Side Mount, Long Wheel Base	576-146	—	578-003
1996-93	Side Mount, Short Wheel Base	576-109	—	578-005
1992-90	Rear Mount, 18 Gallon	576-121	—	578-016
1992-90	Side Mount, Long Wheel Base	576-146	—	578-003
1992-90	Side Mount, Short Wheel Base	576-109	—	578-005
1989-87	Rear Mount, 19 Gallon	576-120	—	578-016
1989-87	Side Mount, Long Wheel Base	576-147	—	578-003
1989-87	Side Mount, Short Wheel Base	576-110	—	578-005
1986-85	Rear Mount, 19 Gallon	576-119	—	578-016
1986-85	Side Mount, Long Wheel Base	576-145	—	578-003
1986-85	Side Mount, Short Wheel Base	576-108	—	578-005
1984-80	Rear Mount, 19 Gallon	576-118	—	578-016
1984-80	Side Mount, Long Wheel Base	576-144	—	578-003
1984-80	Side Mount, Short Wheel Base	576-107	—	578-005
1979	Rear Mount, 19 Gallon	576-117	—	578-016
1978-77	Rear Mount, 19 Gallon, w/E.E.C.	576-117	—	578-016
1978-77	Rear Mount, 19 Gallon, wo/E.E.C.	576-116	—	578-016
1976-73	Rear Mount, 19 Gallon, w/E.E.C.	576-117	—	578-016
1976-73	Rear Mount, 19 Gallon, wo/E.E.C.	576-116	—	578-016
RANGER				
1988-86	Under Cab, 108 Wheel Base, 2WD	576-124	—	578-018
1988-86	Under Cab, 114 Wheel Base	576-128	—	578-018
1988-86	Under Cab, 125 Wheel Base	576-125	—	578-019
1985	Under Cab, 108 Wheel Base, Plastic Filler, 2WD	576-122	—	578-018
1985	Under Cab, 108 Wheel Base, Rubber Filler, 2WD	576-124	—	578-018
1985	Under Cab, 114 Wheel Base, Plastic Filler	576-126	—	578-018
1985	Under Cab, 114 Wheel Base, Rubber Filler	576-128	—	578-018
1984-83	Under Cab, 108 Wheel Base, Plastic Filler, 2WD	576-122	—	578-018
1984-83	Under Cab, 108 Wheel Base, Rubber Filler, 2WD	576-123	—	578-018
1984-83	Under Cab, 114 Wheel Base, Plastic Filler	576-126	—	578-018
1984-83	Under Cab, 114 Wheel Base, Rubber Filler	576-127	—	578-018
HONDA				
ACCORD				
1993-90	-	576-608	—	—
1989-86	w/EFI	576-607	—	—
1989-86	wo/EFI	576-606	—	—
CIVIC				
1991-88	3-Door Hatchback	576-605	—	—
1991-88	4-Door Sedan	576-603	—	—
1987-86	3-Door Hatchback, wo/EFI	576-602	—	—
1987-86	4-Door Sedan	576-601	—	—
1985-84	3-Door Hatchback	576-602	—	—
1985-84	4-Door Sedan	576-601	—	—
1983	Exc. 4-Door	576-600	—	—
1982-81	Exc. 4-Door	576-600	—	—
1980	Exc. 4-Door	576-600	—	—
CRX				
1991-88	Exc. HF Series	576-605	—	—
JEEP				
CHEROKEE				
1996-92	101 Wheel Base	576-656	—	578-061
1991-88	101 Wheel Base, 13.5 Gallon	576-658	—	578-061

Fuel Tank Applications

Make/ Model/Years	Description	Fuel Tank (Inc. Lock Ring)	Filler Neck	Tank Strap
JEEP (continued)				
CHEROKEE (continued)				
1991-88	101 Wheel Base, 20 Gallon	576-656	—	578-061
1987	101 Wheel Base, 13.5 Gallon	576-658	—	578-061
1987	101 Wheel Base, 20 Gallon, w/EFI	576-656	—	578-061
1987	101 Wheel Base, 20 Gallon, wo/EFI	576-655	—	578-061
1986	101 Wheel Base, 13.5 Gallon, w/EFI	576-658	—	578-061
1986	101 Wheel Base, 13.5 Gallon, wo/EFI	576-657	—	578-061
1986	101 Wheel Base, 20 Gallon, w/EFI	576-656	—	578-061
1986	101 Wheel Base, 20 Gallon, wo/EFI	576-655	—	578-061
1985-84	101 Wheel Base, 13.5 Gallon	576-657	—	578-061
1985-84	101 Wheel Base, 20 Gallon	576-655	—	578-061
CJ SERIES				
1986-82	Steel Tank Only, 15 Gallon	576-652	—	—
1981-78	Steel Tank Only	576-652	—	—
1977	Steel Tank Only	576-651	—	—
1976-73	Steel Tank Only	576-650	—	—
COMANCHE				
1992-87	113 Wheel Base (6' Box)	576-662	—	578-054
1992-87	120 Wheel Base (7' Box)	576-660	—	578-054
1986	113 Wheel Base (6' Box), w/EFI	576-662	—	578-054
1986	113 Wheel Base (6' Box), wo/EFI	576-661	—	578-054
1986	120 Wheel Base (7' Box), w/EFI	576-660	—	578-054
1986	120 Wheel Base (7' Box), wo/EFI	576-659	—	578-054
DJ SERIES				
1973	-	576-650	—	—
J SERIES PICKUP				
1977-73	-	576-663	—	—
JEEPSTER				
1973	-	576-650	—	—
SCRAMBLER				
1986-81	-	576-652	—	—
U. S. POSTAL				
1994-87	-	576-333	—	578-007
WAGONEER				
1990-88	101 Wheel Base, 13.5 Gallon	576-658	—	578-061
1990-88	101 Wheel Base, 20 Gallon	576-656	—	578-061
1987	101 Wheel Base, 13.5 Gallon	576-658	—	578-061
1987	101 Wheel Base, 20 Gallon, w/EFI	576-656	—	578-061
1987	101 Wheel Base, 20 Gallon, wo/EFI	576-655	—	578-061
1986	101 Wheel Base, 13.5 Gallon, w/EFI	576-658	—	578-061
1986	101 Wheel Base, 13.5 Gallon, wo/EFI	576-657	—	578-061
1986	101 Wheel Base, 20 Gallon, w/EFI	576-656	—	578-061
1986	101 Wheel Base, 20 Gallon, wo/EFI	576-655	—	578-061
1985-84	101 Wheel Base, 13.5 Gallon	576-657	—	578-061
1985-84	101 Wheel Base, 20 Gallon	576-655	—	578-061
WRANGLER				
1990-87	15 Gallon, w/EFI	576-654	—	—
1990-87	15 Gallon, wo/EFI	576-653	—	—
LEXUS				
ES250				
1991-90	-	576-855	—	—
LINCOLN				
CONTINENTAL				
1990-88	-	576-131	—	578-051
1987-85	-	576-132	—	—
1980	5.8L (351W)	576-136	—	—
MARK SERIES				
1996-85	-	576-132	—	—
1983-81	-	576-115	—	—
1980	5.0L (302)	576-115	—	—
1980	5.8L (351W)	576-136	—	—
TOWN CAR				
1994-90	-	576-135	—	—
1989-86	-	576-115	—	—
1985-84	-	576-115	—	—
1983-80	w/EFI	576-115	—	—
1983-80	wo/EFI	576-136	—	—
MAZDA				
323				
1994-90	-	576-722	—	—
1989-88	Exc. 4WD	576-705	—	—
1987-86	w/EFI	576-705	—	—
1987-86	wo/EFI	576-704	—	—
626				
1992-89	-	576-708	—	—
1988	Exc. 4WS	576-708	—	—
1985	Round Gauge, wo/Pan in Tank	576-703	—	—
1982-79	-	576-701	—	—

Fuel Tank Applications

Make/ Model/Years	Description	Fuel Tank (Inc. Lock Ring)	Filler Neck	Tank Strap
MAZDA (continued)				
B-2000				
1987-86	Cab Plus	576-713	—	—
1987-86	Exc. Cab Plus, Long Box	576-709	—	—
1987-86	Exc. Cab Plus, Short Box	576-718	—	—
B-2200				
1993-92	Cab Plus	576-716	—	—
1993-92	Exc. Cab Plus, Long Box	576-711	—	—
1991	Cab Plus, w/EFI	576-716	—	—
1991	Cab Plus, wo/EFI, AT	576-714	—	—
1991	Cab Plus, wo/EFI, MT	576-713	—	—
1991	Exc. Cab Plus, Long Box, w/EFI	576-711	—	—
1991	Exc. Cab Plus, Long Box, wo/EFI, AT	576-710	—	—
1991	Exc. Cab Plus, Long Box, wo/EFI, MT	576-709	—	—
1991	Exc. Cab Plus, Short Box, wo/EFI, AT	576-719	—	—
1991	Exc. Cab Plus, Short Box, wo/EFI, MT	576-718	—	—
1990	Cab Plus, w/EFI	576-715	—	—
1990	Cab Plus, wo/EFI, AT	576-714	—	—
1990	Cab Plus, wo/EFI, MT	576-713	—	—
1990	Exc. Cab Plus, Long Box, w/EFI	576-711	—	—
1990	Exc. Cab Plus, Long Box, wo/EFI, AT	576-710	—	—
1990	Exc. Cab Plus, Long Box, wo/EFI, MT	576-709	—	—
1990	Exc. Cab Plus, Short Box, w/EFI	576-721	—	—
1990	Exc. Cab Plus, Short Box, wo/EFI, AT	576-719	—	—
1990	Exc. Cab Plus, Short Box, wo/EFI, MT	576-718	—	—
1989-85	Cab Plus, AT	576-714	—	—
1989-85	Cab Plus, MT	576-713	—	—
1989-85	Exc. Cab Plus, Long Box, AT	576-710	—	—
1989-85	Exc. Cab Plus, Long Box, MT	576-709	—	—
1989-85	Exc. Cab Plus, Short Box, AT	576-719	—	—
1989-85	Exc. Cab Plus, Short Box, MT	576-718	—	—
B-2600				
1993-92	Cab Plus	576-716	—	—
1993-92	Exc. Cab Plus, Long Box	576-711	—	—
1991	Cab Plus, w/EFI	576-716	—	—
1991	Cab Plus, wo/EFI	576-714	—	—
1991	Exc. Cab Plus, Long Box, w/EFI	576-711	—	—
1991	Exc. Cab Plus, Long Box, wo/EFI	576-710	—	—
1991	Exc. Cab Plus, Short Box, wo/EFI	576-719	—	—
1990	Cab Plus, w/EFI	576-715	—	—
1990	Cab Plus, wo/EFI	576-714	—	—
1990	Exc. Cab Plus, Long Box, w/EFI	576-711	—	—
1990	Exc. Cab Plus, Long Box, wo/EFI	576-710	—	—
1990	Exc. Cab Plus, Short Box, w/EFI	576-721	—	—
1990	Exc. Cab Plus, Short Box, wo/EFI	576-719	—	—
1989	Cab Plus	576-714	—	—
1989	Exc. Cab Plus, Long Box	576-710	—	—
1989	Exc. Cab Plus, Short Box	576-719	—	—
1988-86	2WD, Cab Plus	576-714	—	—
1988-86	2WD, Exc. Cab Plus, Long Box	576-710	—	—
1988-86	2WD, Exc. Cab Plus, Short Box	576-719	—	—
1988-86	4WD, Cab Plus	576-717	—	—
1988-86	4WD, Exc. Cab Plus, Long Box	576-712	—	—
1988-86	4WD, Exc. Cab Plus, Short Box	576-720	—	—
GLC				
1985-83	Exc. Wagon	576-707	—	—
1982-81	Exc. Wagon	576-706	—	—
MPV				
1998-89	2WD	576-702	—	—
MX-3				
1996-92	-	576-722	—	—
MX-6				
1992-88	Exc. 4WS	576-708	—	—
PROTEGE				
1995	Vin JM1BG	576-700	—	578-078
1994-90	Exc. AWD	576-700	—	578-078
MERCURY				
CAPRI				
1986-83	Pump in Tank	576-106	—	—
1986-83	Pump on Engine	576-105	—	—
1982	-	576-105	—	—
1981	From 4/81 (15.4 Gallon)	576-105	—	—
COUGAR				
1988-86	-	576-132	—	—
1985	-	576-133	—	—
1968-67	wo/Drain Plug	576-134	—	—
GRAND MARQUIS				
1994-92	Sedan	576-135	—	—
1991-90	Exc. Wagon, w/Pump in Tank, 5.0L (302)	576-135	—	—
1991-90	Exc. Wagon, w/Pump on Engine	576-136	—	—

Fuel Tank Applications

Make/ Model/Years	Description	Fuel Tank (Inc. Lock Ring)	Filler Neck	Tank Strap
MERCURY (continued)				
GRAND MARQUIS (continued)				
1989-86	Exc. Wagon, w/Pump in Tank	576-115	—	—
1989-86	Exc. Wagon, w/Pump on Engine	576-136	—	—
1985-81	Exc. Wagon, w/Pump in Tank	576-115	—	—
1985-81	Exc. Wagon, w/Pump on Engine	576-136	—	—
1980-79	Exc. Wagon	576-136	—	—
LN7, LYNX				
1987	-	576-151	—	578-045
1986-83	Pump in Tank	576-150	—	578-045
1986-83	Pump on Engine	576-149	—	578-045
1982-81	-	576-148	—	—
MARQUIS				
1986	Exc. Wagon, w/114" Wheel Base, w/Pump in Tank	576-115	—	—
1986	Exc. Wagon, w/114" Wheel Base, w/Pump on Engine	576-136	—	—
1985	Exc. Wagon, w/114" Wheel Base, w/Pump in Tank	576-115	—	—
1985	Exc. Wagon, w/114" Wheel Base, w/Pump on Engine	576-136	—	—
1984	Exc. Wagon, w/114" Wheel Base, w/Pump in Tank	576-115	—	—
1984	Exc. Wagon, w/114" Wheel Base, w/Pump on Engine	576-136	—	—
1983	Exc. Wagon, w/114" Wheel Base, w/Pump in Tank	576-115	—	—
1983	Exc. Wagon, w/114" Wheel Base, w/Pump on Engine	576-136	—	—
1982-81	Exc. Wagon, w/Pump in Tank	576-115	—	—
1982-81	Exc. Wagon, w/Pump on Engine	576-136	—	—
1980-79	Exc. Wagon	576-136	—	—
SABLE				
1999	16 Gallon, ID XF12-AA, XF12-AB, XF12-AC, w/On Board Vapor Recovery System	576-141	—	—
1999	16 Gallon, ID XF12-BA, wo/On Board Vapor Recovery System	576-139	—	—
1999	18 Gallon, ID XF12-CA, wo/On Board Vapor Recovery System	576-140	—	—
1998	16 Gallon, ID F8DC-AB, XF12-AA, XF12-AB, XF12-AC	576-141	—	—
1998	16 Gallon, ID F8DC-BB	576-139	—	—
1998	18 Gallon, ID F8DC-CB	576-140	—	—
1997	16 Gallon, ID F7DC-AA thru AD	576-137	—	—
1997	18 Gallon, ID F7DC-BA thru BD	576-138	—	—
1996	16 Gallon, ID F6DC-AA thru AV	576-137	—	—
1996	18 Gallon, ID F6DC-BA thru BV	576-138	—	—
1995-89	16 Gallon	576-130	—	578-051
1995-89	18.5 Gallon	576-131	—	578-051
1988	16 Gallon, From 4/88	576-130	—	578-051
1988	16 Gallon, To 4/88	576-129	—	578-051
1988	18.5 Gallon	576-131	—	578-051
1987-86	16 Gallon	576-129	—	578-051
TOPAZ				
1994-88	Exc. AWD	576-104	—	578-046
1987-86	Exc. AWD, Diesel Eng	576-103	—	578-046
1987-86	Exc. AWD, Gas Eng, w/EFI	576-103	—	578-046
1987-86	Exc. AWD, Gas Eng, wo/EFI	576-102	—	578-046
1985-84	Diesel Eng	576-103	—	578-046
1985-84	Gas Eng, w/EFI	576-103	—	578-046
1985-84	Gas Eng, wo/EFI	576-102	—	578-046
1983	-	576-102	—	578-046
TRACER				
1990-87	w/EFI	576-705	—	—
1990-87	wo/EFI	576-704	—	—
MITSUBISHI				
MIGHTY MAX PICKUP				
1985-83	15 Gallon	576-015	—	—
NISSAN				
720 PICKUP				
1986-85	2WD, Exc. King Cab, Long Box	576-808	—	—
1986-85	2WD, Exc. King Cab, Short Box	576-807	—	—
1986-85	2WD, King Cab	576-801	—	—
1986-85	4WD, wo/EFI, Exc. King Cab, Long Box	576-813	—	—
1986-85	4WD, wo/EFI, Exc. King Cab, Short Box	576-812	—	—
1986-85	4WD, wo/EFI, King Cab	576-802	—	—
1984	2WD, King Cab, wo/Diesel Eng, Exc. King Cab	576-801	—	—
1984	2WD, Long Box, Exc. King Cab	576-808	—	—
1984	2WD, Short Box, Exc. King Cab	576-807	—	—
1984	4WD, King Cab, From 01/83, Exc. King Cab	576-802	—	—
1984	4WD, Long Box, Exc. King Cab	576-813	—	—
1984	4WD, Short Box, Exc. King Cab	576-812	—	—
1983	2WD, Long Box, Exc. King Cab	576-808	—	—
1983	2WD, Short Box, Exc. King Cab	576-807	—	—
1983	4WD, Long Box, Exc. King Cab	576-813	—	—
1983	4WD, Short Box, Exc. King Cab	576-812	—	—
810				
1981	Sedan, Gas Eng	576-806	—	—
MAXIMA				
1988-86	Exc. Digital Gauge, From 08/86	576-810	—	—
1986-85	Exc. Digital Gauge, From 07/84 To 08/86	576-809	—	—
1984-82	Sedan, Gas Eng	576-806	—	—

Fuel Tanks

Window Lift Motors pg. 535-554
Window Regulators pg. 555-566
Wiper Motors pg. 567-572
Wiper Transmission Linkages pg. 573-576

Check Sending Unit and Screen While Apart

Fuel Tanks and Accessories

Fuel Tank Applications

Make/ Model/Years	Description	Fuel Tank (Inc. Lock Ring)	Filler Neck	Tank Strap
NISSAN (continued)				
MICRA				
1989-84	-	576-800	—	—
NX				
1993-91	-	576-803	—	—
PATHFINDER				
1995-90	-	576-814	—	—
1989-87	6 Cyl Eng	576-814	—	—
PULSAR				
1986-83	wo/Turbo	576-805	—	—
SENTRA				
1996-95	2-Door	576-803	—	—
1994-91	-	576-803	—	—
1990-89	2WD	576-816	—	—
1988-87	2WD, w/EFI	576-816	—	—
1988-87	2WD, wo/EFI	576-815	—	—
1986-82	Exc. Diesel Eng	576-804	—	—
STANZA				
1989-87	-	576-811	—	—
OLDSMOBILE				
98, 98 REGENCY				
1998-96	-	576-340	—	578-022
1995-91	-	576-338	—	578-022
1990-89	Exc. Wagon	576-338	—	578-022
1990-89	Wagon, w/Filler Neck	576-377	Inc.	—
1990-89	Wagon, wo/Filler Neck	576-376	577-005	—
1988-85	Exc. Wagon	576-337	—	578-022
1988-85	Wagon, w/Filler Neck	576-377	Inc.	—
1988-85	Wagon, wo/Filler Neck	576-376	577-005	—
1984	Exc. Wagon, Gas Eng, wo/EFI, w/Filler Neck	576-365	Inc.	578-009
1984	Exc. Wagon, w/EFI, w/Filler Neck	576-366	Inc.	578-009
1984	Exc. Wagon, w/EFI, wo/Filler Neck	576-374	577-011	578-009
1984	Exc. Wagon, wo/EFI, wo/Filler Neck	576-373	577-011	578-009
1984	Wagon, Gas Eng, w/Filler Neck	576-377	Inc.	—
1984	Wagon, wo/Filler Neck	576-376	577-005	—
1983-80	Exc. Wagon, Gas Eng, w/Filler Neck	576-365	Inc.	578-009
1983-80	Exc. Wagon, wo/Filler Neck	576-373	577-011	578-009
1983-80	Wagon, Gas Eng, w/Filler Neck	576-377	Inc.	—
1983-80	Wagon, wo/Filler Neck	576-376	577-005	—
1979-77	Exc. Wagon, w/Filler Neck	576-368	Inc.	578-009
1979-77	Exc. Wagon, wo/Filler Neck	576-373	577-012	578-009
1979-77	Wagon, Gas Eng, w/Filler Neck	576-377	Inc.	—
1979-77	Wagon, wo/Filler Neck	576-376	577-005	—
ACHIEVA				
1998-92	-	576-361	—	578-052
ALERO				
1999	Steel Tank	576-362	—	578-052
BRAVADA				
1998	wo/Plastic Tank	576-386	—	—
1997	-	576-386	—	—
1996	-	576-385	—	—
1994-91	-	576-329	—	578-007
CUSTOM CRUISER				
1990-77	Gas Eng, w/Filler Neck	576-377	Inc.	—
1990-77	wo/Filler Neck	576-376	577-005	—
CUTLASS CALAIS				
1991-88	-	576-327	—	578-021
1987-85	w/EFI	576-327	—	578-021
1987-85	wo/EFI	576-326	—	578-021
CUTLASS CIERA				
1996-87	-	576-395	—	578-020
1986-84	w/EFI	576-395	—	578-020
1986-84	wo/EFI	576-394	—	578-020
1983-82	-	576-394	—	578-020
CUTLASS, CUTLASS SUPREME, CUTLASS CRUISER				
1999-98	Steel Tank	576-362	—	578-052
1997	Cutlass	576-361	—	578-052
1997	Cutlass Supreme, Exc. Methanol Fuel	576-357	—	578-070
1996-89	Exc. Methanol Fuel	576-357	—	578-070
1988	FWD	576-395	—	578-020
1988	RWD, w/Filler Neck	576-356	Inc.	578-006
1988	RWD, wo/Filler Neck	576-363	577-009	578-006
1987-84	2-Door, Gas Eng, w/Filler Neck	576-356	Inc.	578-006
1987-84	2-Door, wo/Filler Neck	576-363	577-009	578-006
1987-84	4-Door, Gas Eng, w/Filler Neck	576-355	Inc.	578-006
1987-84	4-Door, wo/Filler Neck	576-363	577-008	578-006
1983-81	2-Door, Gas Eng, w/Filler Neck	576-356	Inc.	578-006
1983-81	2-Door, wo/Filler Neck	576-363	577-009	578-006
1983-81	4-Door, Gas Eng, w/Filler Neck	576-355	Inc.	578-006
1983-81	4-Door, wo/Filler Neck	576-363	577-008	578-006
1980	2-Door Fastback, Gas Eng, w/Filler Neck	576-355	Inc.	578-006
1980	2-Door Fastback, wo/Filler Neck	576-363	577-008	578-006

Fuel Tank Applications

Make/ Model/Years	Description	Fuel Tank (Inc. Lock Ring)	Filler Neck	Tank Strap
OLDSMOBILE (continued)				
CUTLASS, CUTLASS SUPREME, CUTLASS CRUISER (continued)				
1980	2-Door Notchback, wo/Filler Neck	576-363	577-010	578-006
1980	4-Door, Gas Eng, w/Filler Neck	576-355	Inc.	578-006
1980	4-Door, wo/Filler Neck	576-363	577-008	578-006
1980	Notchback, Gas Eng, w/Filler Neck	576-359	Inc.	578-006
1979-78	Fastback, Gas Eng, w/Filler Neck	576-355	Inc.	578-006
1979-78	Fastback, wo/Filler Neck	576-363	577-008	578-006
1979-78	Notchback, Gas Eng, w/Filler Neck	576-359	Inc.	578-006
1979-78	Notchback, wo/Filler Neck	576-363	577-010	578-006
1977-76	2-Door, w/Filler Neck	576-307	Inc.	—
1977-76	2-Door, wo/Filler Neck	576-309	577-013	—
1977-76	4-Door Sedan, w/Filler Neck	576-305	Inc.	—
1977-76	4-Door Sedan, wo/Filler Neck	576-309	577-013	—
1975-74	Exc. Wagon, w/Filler Neck	576-305	Inc.	—
1975-74	Exc. Wagon, wo/Filler Neck	576-309	577-013	—
1973	Exc. Wagon, w/Filler Neck	576-308	Inc.	—
1973	Exc. Wagon, wo/Filler Neck	576-309	577-013	—
DELTA 88				
1999-96	-	576-340	—	578-022
1995-91	-	576-338	—	578-022
1990-89	Exc. Wagon	576-338	—	578-022
1990-89	Wagon, w/Filler Neck	576-377	Inc.	—
1990-89	Wagon, wo/Filler Neck	576-376	577-005	—
1988-86	Exc. Wagon	576-337	—	578-022
1988-86	Wagon, w/Filler Neck	576-377	Inc.	—
1988-86	Wagon, wo/Filler Neck	576-376	577-005	—
1985-84	Exc. Wagon, Gas Eng, wo/EFI, w/Filler Neck	576-365	Inc.	578-009
1985-84	Exc. Wagon, w/EFI, w/Filler Neck	576-366	Inc.	578-009
1985-84	Exc. Wagon, w/EFI, wo/Filler Neck	576-374	577-011	578-009
1985-84	Exc. Wagon, wo/EFI, wo/Filler Neck	576-373	577-011	578-009
1985-84	Wagon, Gas Eng, w/Filler Neck	576-377	Inc.	—
1985-84	Wagon, wo/Filler Neck	576-376	577-005	—
1983-81	Exc. Wagon, Gas Eng, w/Filler Neck	576-365	Inc.	578-009
1983-81	Exc. Wagon, wo/Filler Neck	576-373	577-011	578-009
1983-81	Wagon, Gas Eng, w/Filler Neck	576-377	Inc.	—
1983-81	Wagon, wo/Filler Neck	576-376	577-005	—
1980	Exc. Wagon, 19 Gallon, w/Filler Neck	576-303	Inc.	—
1980	Exc. Wagon, 19 Gallon, wo/Filler Neck	576-310	577-011	—
1980	Exc. Wagon, 24 Gallon, Gas Eng, w/Filler Neck	576-365	Inc.	578-009
1980	Exc. Wagon, 24 Gallon, wo/Filler Neck	576-373	577-011	578-009
1980	Wagon, Gas Eng, w/Filler Neck	576-377	Inc.	—
1980	Wagon, wo/Filler Neck	576-376	577-005	—
1979-77	Exc. Wagon, 19 Gallon, w/Filler Neck	576-303	Inc.	—
1979-77	Exc. Wagon, 19 Gallon, wo/Filler Neck	576-310	577-011	—
1979-77	Exc. Wagon, 24 Gallon, w/Filler Neck	576-368	Inc.	578-009
1979-77	Exc. Wagon, 24 Gallon, wo/Filler Neck	576-373	577-012	578-009
1979-77	Wagon, Gas Eng, w/Filler Neck	576-377	Inc.	—
1979-77	Wagon, wo/Filler Neck	576-376	577-005	—
FIRENZA				
1988-85	-	576-327	—	578-021
1984-82	w/EFI	576-327	—	578-021
1984-82	wo/EFI	576-326	—	578-021
INTRIGUE				
2000-98	-	576-389	—	—
LSS				
1999-98	-	576-340	—	578-022
1997-96	w/Supercharger	576-338	—	578-022
1997-96	wo/Supercharger	576-340	—	578-022
TORONADO				
1992-86	-	576-360	—	—
PLYMOUTH				
ACCLAIM				
1995-91	-	576-017	—	578-038
1990-89	-	576-016	—	578-038
CARAVELLE				
1988-86	-	576-007	—	578-017
1985	2.2L (135), w/Turbo	576-007	—	578-017
1985	2.2L (135), wo/Turbo	576-006	—	578-017
1985	2.6L (156)	576-005	—	578-017
COLT				
1988	Exc. Wagon, wo/Turbo	576-000	—	—
1987-85	wo/Turbo	576-000	—	—
DUSTER				
1987-86	w/Turbo	576-011	—	—
1987-86	wo/Turbo	576-010	—	—
GRAN FURY				
1989-82	-	576-002	—	—
HORIZON, TURISMO, TC3				
1990-88	-	576-011	—	—
1987-85	w/Turbo	576-011	—	—
1987-85	wo/Turbo	576-010	—	—

Fuel Tanks

Clock Springs
pg. 21-24

Control Arms
pg. 25-54

CV Joint Boots & Accessories
pg. 55-66

Door Lock Actuators
pg. 67-72

Exhaust Manifold Kits
pg. 73-134

Check Sending Unit and Screen While Apart

Fuel Tanks and Accessories

Fuel Tank Applications

Make/ Model/Years	Description	Fuel Tank (Inc. Lock Ring)	Filler Neck	Tank Strap
PLYMOUTH (continued)				
HORIZON, TURISMO, TC3 (continued)				
1984-78	-	576-010	—	—
RELIANT				
1989-88	-	576-008	—	578-017
1987-86	-	576-007	—	578-017
1985	w/EFI	576-006	—	578-017
1985	wo/EFI	576-005	—	578-017
1984	w/EFI	576-007	—	578-017
1984	wo/EFI	576-004	—	578-017
1983	-	576-004	—	578-017
1982-81	-	576-003	—	578-017
SUNDANCE				
1994-91	-	576-009	—	578-017
1990-88	-	576-008	—	578-017
1987	-	576-007	—	578-017
VOLARE				
1980	-	576-002	—	—
1979	From 4/2/79	576-002	—	—
1979	To 4/2/79	576-001	—	—
1978	-	576-001	—	—
1977	From 4/1/77	576-001	—	—
VOYAGER				
1995-91	2WD	576-014	—	578-036
1990-88	-	576-013	—	578-036
1987	w/EFI	576-013	—	578-036
1987	wo/EFI	576-012	—	578-036
1986-84	-	576-012	—	578-036
PLYMOUTH TRUCK				
ARROW PICKUP				
1982-79	15 Gallon	576-015	—	—
SCAMP				
1983	-	576-010	—	—
PONTIAC				
6000				
1991	-	576-395	—	578-020
1990-88	Exc. AWD	576-395	—	578-020
1987	-	576-395	—	578-020
1986-84	w/EFI	576-395	—	578-020
1986-84	wo/EFI	576-394	—	578-020
1983-82	-	576-394	—	578-020
BONNEVILLE, CATALINA				
1999-98	-	576-340	—	578-022
1997-96	w/Supercharger	576-338	—	578-022
1997-96	wo/Supercharger	576-340	—	578-022
1995-89	-	576-338	—	578-022
1988-87	-	576-337	—	578-022
1986	4.3L (262), w/Filler Neck	576-352	Inc.	578-006
1986	4.3L (262), wo/Filler Neck	576-364	577-006	578-006
1986	Exc. 4.3L (262), w/Filler Neck	576-351	Inc.	578-006
1986	Exc. 4.3L (262), wo/Filler Neck	576-363	577-006	578-006
1985-84	Gas Eng, w/Filler Neck	576-351	Inc.	578-006
1985-84	wo/Filler Neck	576-363	577-006	578-006
1983-82	Exc. Wagon, Gas Eng, w/Filler Neck	576-351	Inc.	578-006
1983-82	Exc. Wagon, wo/Filler Neck	576-363	577-006	578-006
1981-80	Exc. Wagon, Gas Eng, w/Filler Neck	576-365	Inc.	578-009
1981-80	Exc. Wagon, wo/Filler Neck	576-373	577-011	578-009
1981-80	Wagon, w/Filler Neck	576-377	Inc.	—
1981-80	Wagon, wo/Filler Neck	576-376	577-005	—
1979-77	Exc. Wagon, w/Filler Neck	576-303	Inc.	—
1979-77	Exc. Wagon, wo/Filler Neck	576-310	577-011	—
1979-77	Wagon, Gas Eng, w/Filler Neck	576-377	Inc.	—
1979-77	Wagon, wo/Filler Neck	576-376	577-005	—
GRAND AM				
1999	Steel Tank	576-362	—	578-052
1998-92	-	576-361	—	578-052
1991-88	-	576-327	—	578-021
1987-85	w/EFI	576-327	—	578-021
1987-85	wo/EFI	576-326	—	578-021
1984-78	w/Filler Neck	576-351	Inc.	578-006
1984-78	wo/Filler Neck	576-363	577-006	578-006
GRAND PRIX				
2000-98	-	576-389	—	—
1997	V6 - 3.1L (189 CID), w/1" Filler Neck	576-387	—	—
1997	V6 - 3.1L (189 CID), w/1-1/2" Filler Neck	576-388	—	—
1997	V6 - 3.8L (231 CID)	576-388	—	—
1996-88	Exc. Methanol Fuel	576-357	—	578-070
1987-86	4.3L (262), w/Filler Neck	576-352	Inc.	578-006
1987-86	4.3L (262), wo/Filler Neck	576-364	577-006	578-006
1987-86	Exc. 4.3L (262), w/Filler Neck	576-351	Inc.	578-006
1987-86	Exc. 4.3L (262), wo/Filler Neck	576-363	577-006	578-006
1985-78	Gas Eng, w/Filler Neck	576-351	Inc.	578-006

Fuel Tank Applications

Make/ Model/Years	Description	Fuel Tank (Inc. Lock Ring)	Filler Neck	Tank Strap
PONTIAC (continued)				
GRAND PRIX (continued)				
1985-78	wo/Filler Neck	576-363	577-006	578-006
J2000				
1984-82	w/EFI	576-327	—	578-021
1984-82	wo/EFI	576-326	—	578-021
LEMANS, TEMPEST				
1989-87	-	576-327	—	578-021
1983-78	Exc. Wagon, Gas Eng, w/Filler Neck	576-351	Inc.	578-006
1983-78	Exc. Wagon, wo/Filler Neck	576-363	577-006	578-006
1977-74	Exc. Wagon, w/Filler Neck	576-307	Inc.	—
1977-74	Exc. Wagon, wo/Filler Neck	576-309	577-016	—
1973	Exc. Wagon, w/Filler Neck	576-308	Inc.	—
1973	Exc. Wagon, wo/Filler Neck	576-309	577-074	—
PARISIENNE				
1986-84	Exc. Wagon, Gas Eng, wo/EFI, w/Filler Neck	576-365	Inc.	578-009
1986-84	Exc. Wagon, w/EFI, w/Filler Neck	576-366	Inc.	578-009
1986-84	Exc. Wagon, w/EFI, wo/Filler Neck	576-374	577-011	578-009
1986-84	Exc. Wagon, wo/EFI, wo/Filler Neck	576-373	577-011	578-009
1986-84	Wagon, Gas Eng, w/Filler Neck	576-377	Inc.	—
1986-84	Wagon, wo/Filler Neck	576-376	577-005	—
1983	Exc. Wagon, Gas Eng, w/Filler Neck	576-365	Inc.	578-009
1983	Exc. Wagon, wo/Filler Neck	576-373	577-011	578-009
1983	Wagon, Gas Eng, w/Filler Neck	576-377	Inc.	—
1983	Wagon, wo/Filler Neck	576-376	577-005	—
SAFARI WAGON				
1989-87	w/Filler Neck	576-377	Inc.	—
1989-87	wo/Filler Neck	576-376	577-005	—
SUNBIRD				
1994-92	-	576-361	—	578-052
1991-88	-	576-327	—	578-021
1987-82	w/EFI	576-327	—	578-021
1987-82	wo/EFI	576-326	—	578-021
SUNFIRE				
2001-99	Steel Tank	576-362	—	578-052
1998-95	-	576-361	—	578-052
TOYOTA				
CAMRY				
1991-87	Exc. 4WD	576-855	—	—
COROLLA				
1997-94	-	576-851	—	—
1993	2WD	576-851	—	—
1992-91	Sedan	576-854	—	—
1992-91	Wagon (2WD)	576-854	—	—
1990	Sedan & Wagon (2WD), w/EFI	576-854	—	—
1990	Sedan & Wagon (2WD), wo/EFI	576-853	—	—
1989-88	Sedan & Wagon (2WD)	576-853	—	—
1987-85	Sedan & Liftback	576-852	—	—
1984	Sedan & Liftback	576-852	—	—
1983-80	Exc. Wagon	576-850	—	—
PASEO				
1996-92	-	576-856	—	—
TERCEL				
1996-91	-	576-856	—	—
1987	Wagon (2WD)	576-852	—	—
1986-83	Liftback	576-852	—	—
1986-83	Wagon (2WD)	576-852	—	—
VOLKSWAGEN				
JETTA				
1984-81	Diesel Eng	576-902	—	—
1984-81	Gas Eng	576-901	—	—
1980	Gas Eng	576-901	—	—
RABBIT				
1984-82	Diesel Eng	576-900	—	—
1984-82	Gas Eng	576-901	—	—
1981-80	-	576-901	—	—
1979-77	-	576-902	—	—
SCIROCCO				
1984	To Chassis #022 074	576-901	—	—
1983-82	-	576-901	—	—
1981-77	-	576-902	—	—



2006 Quick Ship Program

Don't Lose the Sale...
 It's Quick...
 It's Easy...
 It's at Your Door Tomorrow. *

Listed below are the categories now available:



It's that easy...
 call your servicing distribution center!

* Additional Charges Apply

Harmonic Balancers



Industry Leading Coverage

NEW! for 2006



594-181

Solid

2006-96 V-6-262; 4.3L, Chevrolet/GM Blazer, Bravada, Chevrolet 1500 Pickups; GMC Van, Envoy, S10, S15



594-189

Serpentine Belt

2006-97 8 Cyl.-280, 4.6L, Ford Truck Expedition, F150, F250, E150, E250

Woodruff Key Included
(where required)



Helpful Tips From Your Harmonic Balancer Experts:

- Inspect Original Balancer for signs of Rubber Deterioration that causes Timing Marks to Slip.
- Check Belt Wear, Front Crank Seal Leakage and Worn Belt Tensioners.
- ALWAYS Compare Timing Marks of Replacement Balancer with the Original Balancer.



Use Harmonic Balancer Puller (**594-999**) for proper installation.



Activant Path

*Timing Parts
& Camshafts*

Activant Code

DHB

**Applications begin
on page 242.**

Harmonic Balancers



594-001

Serpentine Belt

1990-88 3.8L (231) Buick, Oldsmobile, Pontiac.

Diameter 7-1/8"

Width 3-3/4"

Weight (lbs.) 8.35



594-002

Solid Back

1996-69 5.7L (350) Chevrolet, GMC Truck; 1982-77 Motorhome

Diameter 8"

Width 2-3/8"

Weight (lbs.) 10.75



594-003

Serpentine Belt

1988-86 3.8L (231) Buick, Oldsmobile, Pontiac.

Diameter 7"

Width 3-3/4"

Weight (lbs.) 7.7



594-004

Serpentine Belt

2005-93 3.8L (231) Buick, Chevrolet, Oldsmobile, Pontiac.

Diameter 7"

Width 3-3/4"

Weight (lbs.) 8.45



594-005

Serpentine Belt

1992-91 3.8L (231) Buick, Chevrolet, Oldsmobile, Pontiac.

Diameter 7"

Width 2"

Weight (lbs.) 7.88



594-006

Hollow Back

1986-77 5.7L (350) and 5.0L (305) Chevrolet, GMC Truck.

Diameter 8"

Width 2-3/8"

Weight (lbs.) 10.85



594-007

Serpentine Belt

1994-92 2.3L (140) Ford Tempo, Mercury Topaz.

Diameter 5"

Width 2"

Weight (lbs.) 4



594-008

Serpentine Belt

1994-87 2.8L (173), 3.1L (189) Buick, Chevrolet, Oldsmobile, Pontiac.

Diameter 6-1/8"

Width 2"

Weight (lbs.) 5.15



594-009

Hollow Back

1993-77 5.0L (305), 5.7L (350) Buick, Cadillac, Chevrolet, Oldsmobile, Pontiac, GMC Truck.

Diameter 6-3/4"

Width 2-3/8"

Weight (lbs.) 8.65



594-010

Solid; Externally Balanced

1990-70 7.4L (454) Chevrolet, GMC Truck.

Diameter 8"

Width 2-3/4"

Weight (lbs.) 16.88



594-011

Solid; Externally Balanced

1997-82 5.8L (351) Ford, Mercury, Ford Truck.

Diameter 6-3/8"

Width 4-1/8"

Weight (lbs.) 7.25



594-012

Solid

1995-69 5.0L (305), 5.4L (327), 5.7L (350) Chevrolet, GMC Truck, Oldsmobile, Pontiac.

Diameter 6-3/4"

Width 2-3/8"

Weight (lbs.) 8.36

Harmonic Balancers



594-013

Solid; Externally Balanced
1987-82 2.8L (173) Chevrolet, Pontiac, GMC Truck.

Diameter 5-1/2"
Width 3-1/4"
Weight (lbs.) 5.6



594-014

Hollow Back, Double Groove
1974-66 4.1L (250) Buick, Chevrolet, Oldsmobile, Pontiac, GMC Truck.

Diameter 6-3/4"
Width 1-1/2"
Weight (lbs.) 7.5



594-015

Hollow Back, Double Groove
1984-77 4.1L (250) Chevrolet, GMC Truck.

Diameter 6-3/4"
Width 1-7/8"
Weight (lbs.) 8.5



594-016

Solid; Externally Balanced
1980-70 6.6L (400) Chevrolet, GMC Truck.

Diameter 8"
Width 2-3/8"
Weight (lbs.) 12.4



594-017

Serpentine Belt
1997-93 4.3L (265), 5.7L (350) Buick, Chevrolet, Pontiac, Cadillac.

Diameter 7-1/2"
Width 1-3/8"
Weight (lbs.) 8.4



594-018

Serpentine Belt
2000-84 4.0L (242) Jeep; 1986-84 2.8L(173) Cherokee, Comanche

Diameter 7-1/2"
Width 1-7/8"
Weight (lbs.) 8



594-019

Solid, 9/16" Step; Externally Balanced
1981 5.0L (302) Ford Truck Exc. Calif.

Diameter 6-2/5"
Width 4-1/8"
Weight (lbs.) 10



594-020

Solid, Hollow Back
1986-82 2.8L (173) Buick, Chevrolet, Oldsmobile, Pontiac, VIN X, Z Stamped 4874.

Diameter 6-3/8"
Width 2-5/16"
Weight (lbs.) 5.25



594-021

Solid
1993-72 3.9L (239), 5.2L (318), 5.6L (340) Dodge, Plymouth, Chrysler, Dodge Truck, Plymouth Truck, with Forged Steel Crankshaft

Diameter 7-1/4"
Width 2-1/2"
Weight (lbs.) 8



594-022

Single Groove
1986-75 3.8L (232), 4.2L (258) American Motors, Jeep.

Diameter 6-3/4"
Width 1-7/8"
Weight (lbs.) 6.25



594-023

Solid, Hollow Back; Externally Balanced
1980-69 5.0L (302) Ford, Lincoln, Mercury, Ford Truck.

Diameter 6-1/2"
Width 4-1/4"
Weight (lbs.) 11



594-024

Solid; Externally Balanced
1995-84 5.0L (302) Ford, Lincoln, Mercury, Ford Truck.

Diameter 6-1/2"
Width 4-1/4"
Weight (lbs.) 9.5

Harmonic Balancers



594-026

Solid; Externally Balanced

1993-91 7.4L (454) Chevrolet, GMC Truck.

Diameter 8"
Width 2-3/4"
Weight (lbs.) 16.54



594-027

Hollow Back, Serpentine Belt

1992-87 2.5L (151) Buick, Chevrolet, Oldsmobile, Pontiac.

Diameter 6"
Width 1-1/2"
Weight (lbs.) 4.3



594-028

Solid

1990-75 4.3L(260), 5.0L(307), 5.7L(350), 6.6L(403) Buick, Cadillac, Chevrolet, Oldsmobile, Pontiac.

Diameter 5-1/2"
Width 2-3/8"
Weight (lbs.) 5.8



594-029

Hollow Back, Double Groove

1976-75 4.1L (250) Buick, Pontiac, Chevrolet, Oldsmobile, GMC Truck

Diameter 6-3/4"
Width 1-7/8"
Weight (lbs.) 8.4



594-030

Solid

1975-66 6.5L (396), 6.6L (400, 402), 7.0L (427) Chevrolet, GMC Truck.

Diameter 7"
Width 2-3/4"
Weight (lbs.) 10.6



594-031

Double Groove w/1/4" Div.

1990-75 4.8L (292) Chevrolet, GMC Truck.

Diameter 6-3/4"
Width 2-1/2"
Weight (lbs.) 10.45



594-032

Triple Groove w/9/16" Step

1995-85 2.3L (2316) Volvo 240, 242, 244, 245, 740, 745, 760, 780, 940, 940.

Diameter 7"
Width 3-1/2"
Weight (lbs.) 6.9



594-033

Serpentine w/Sensor Ring

2001-91 1.9L (116); 2.0L(122), Mercury Tracer.

Diameter 5-3/4"
Width 1-1/4"
Weight (lbs.) 4.7



594-034

Serpentine Belt

1994-93 3.8L (231) Buick, Chevrolet, Oldsmobile, Pontiac.

Diameter 6-3/4"
Width 3-1/2"
Weight (lbs.) 11.4



594-037

Serpentine Belt Pulley

2002-94 6.5L (395); 1993-88 6.2L(379) Diesel Chevrolet, GMC Truck.

Diameter 7-3/4"
Width 1-1/2"
Weight (lbs.) 7.8



594-042

Serpentine Belt

1995-86 4.1L (250), 4.5L (273), 4.9L (300) Cadillac.

Diameter 7-3/8"
Width 1-3/4"
Weight (lbs.) 5.7



594-043

Serpentine Belt

2002-87 2.3L (138), 2.4L (146) Buick, Chevrolet, Oldsmobile, Pontiac.

Diameter 6-3/4"
Width 1-3/4"
Weight (lbs.) 4

Harmonic Balancers

Harmonic Balancers



594-044

Serpentine Belt

1992-89 3.3L (204) Buick Century, Somerset & Oldsmobile Ciera, Calais.

Diameter 7"
Width 3-1/2"
Weight (lbs.) 7.25



594-047

Solid

1995-85 4.3L (262) Chevrolet, Oldsmobile, GMC Truck.

Diameter 6-1/4"
Width 2-7/8"
Weight (lbs.) 5.35



594-050

Reverse Thread, Plastic Body w/Metal Shaft

2003-96 3.0L (DOHC) Ford Taurus, Mercury Sable

Diameter 6.5"
Width 4.375"
Weight (lbs.) 2.01



594-051

Solid w/ Sensor Ring

1997-94 3.8L (232) Ford Windstar, Thunderbird, Mustang II, Mercury Cougar.

Diameter 6"
Width 3-1/2"
Weight (lbs.) 4.9



594-052

Double Serpentine Belt

1999-94 Hyundai Scoupe, Accent (SOHC) 1.5L.

Diameter 6"
Width 2"
Weight (lbs.) 3.9



594-053

Double Serpentine Belt

1999-95 Hyundai Accent (DOHC) 1.5L & 1.6L

Diameter 5-1/2"
Width 2"
Weight (lbs.) 3.5



594-054

Serpentine Belt

1994-90 1.5L Hyundai Excel, Scoupe, Mitsubishi Precis

Diameter 5-3/4"
Width 1-3/8"
Weight (lbs.) 2.8



594-055

Double Serpentine Belt

1995-92 1.6L (1595cc) Hyundai Elantra, 1998-95 2.0L (1997cc) Hyundai Sonata.

Diameter 6-3/8"
Width 1-7/8"
Weight (lbs.) 4.6



594-056

Single Serpentine Belt

1996-95 3.0L (2972cc) Mitsubishi Montero Sport, 2000-94 3.5L (3497cc) Mitsubishi Montero, Montero Sport

Diameter 6-1/8"
Width 3-5/8"
Weight (lbs.) 9.4



594-057

Triple Groove

1994-85 2.0L (1985cc) Saab 900 w/Turbo.

Diameter 6"
Width 2-1/4"
Weight (lbs.) 5.9



594-058

Triple Groove

1984-79 2.0L (1985cc) Saab 900.

Diameter 6"
Width 2-3/4"
Weight (lbs.) 6.2



594-059

Triple Groove

1994-85 2.0L (1985cc) Saab 900 w/o Turbo.

Diameter 6"
Width 2-1/8"
Weight (lbs.) 5.4

Harmonic Balancers



594-060

Single Serpentine Belt

1990-86 2.0L (1985cc) Saab 9000 w/Turbo.

Diameter 6-1/4"
Width 2-3/8"
Weight (lbs.) 6.2



594-067

Double Serpentine Belt

1997-94 2.2L (2156cc) Honda Accord, Odyssey, 1997 Acura CL.

Diameter 7-1/8"
Width 3-3/8"
Weight (lbs.) 5.5



594-068

Double Serpentine Belt

1996-90 2.2L (2156cc), 2.3 (2259cc) Honda Accord, Prelude.

Diameter 7-1/8"
Width 3-3/8"
Weight (lbs.) 5.6



594-069

Double Serpentine Belt

1993 Hyundai Excel, Scoupe w/Beta 1.5L Engine to Nov. 15,1992

Diameter 6"
Width 2"
Weight (lbs.) 3.9



594-070

Double Serpentine Belt

1993 Hyundai Excel, Scoupe w/Beta Engine from Nov. 15,1992

Diameter 6"
Width 2-1/8"
Weight (lbs.) 7



594-071

Single Serpentine Belt

1998-90 3.0L (2972CC) Hyundai Sonata.

Diameter 6-3/8"
Width 2"
Weight (lbs.) 5.3



594-073

Double V-Groove

1995-78 Toyota Celica, 4 Runner, Truck 22RE, 22REC, 22RTEC 2.4L;2.2L 20R

Diameter 6-1/4"
Width 2-3/8"
Weight (lbs.) 7



594-074

Triple Groove

1993-89 2.3L (2316cc) Volvo 740, 745, 940 B234F.

Diameter 6-1/4"
Width 3-1/8"
Weight (lbs.) 7.8



594-077

Triple Groove

1989-80 4.9L (300) Ford F-Series Pickups, Bronco, Econoline Vans.

Diameter 6-3/4"
Width 2-3/4"
Weight (lbs.) 11



594-078

Single Serpentine Belt

1995-88 3.0L (2958cc, 2959cc) Toyota Pickups, T100, 4 Runner V6.

Diameter 6-1/4"
Width 2-1/2"
Weight (lbs.) 5.6



594-080

Solid

1995-80 7.5L (460) Ford F-Series Pickups, Econoline Vans.

Diameter 6-3/4"
Width 2-1/2"
Weight (lbs.) 8.4



594-081

Serpentine Belt 6 Groove

2003-92 4.6L (281) Ford, Lincoln, Mercury, Ford Truck. 2 WD

Diameter 6-7/8"
Width 1-3/4"
Weight (lbs.) 5.8

Harmonic Balancers

Harmonic Balancers



594-082

Serpentine Belt
1999-96 3.4L (207) Ford Taurus.
Diameter 8"
Width 2"
Weight (lbs.) 8.2



594-083

Solid
1981-75 5.8L (351) Ford, Lincoln, Mercury, Ford Truck w/351M Engine
Diameter 6-1/2"
Width 3-1/2"
Weight (lbs.) 7.4

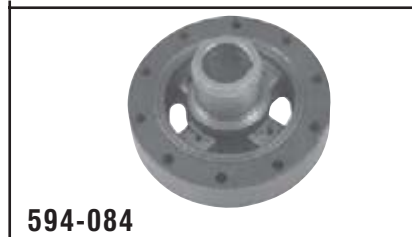

594-084

Solid
1989-86 3.0L Ford Aerostar, Taurus; Mercury Sable
Diameter 5-5/8"
Width 3-3/8"
Weight (lbs.) 6.3



594-085

Solid; Externally Balanced
1994-88 7.3L (445) Diesel Ford F100-350 Trucks, 1994-75 Econoline Vans.
Diameter 7"
Width 3-3/4"
Weight (lbs.) 11.3

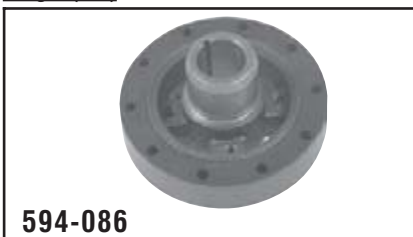

594-086

Solid
1994-90 3.0L (182) Aerostar, Ranger Pickups, Taurus; Mercury Sable.
Diameter 5-1/2"
Width 3-1/4"
Weight (lbs.) 6.2



594-087

Serpentine
1993 Buick, Oldsmobile, Pontiac 3.3L.
Diameter 7"
Width 3-3/4"
Weight (lbs.) 8.2



594-101

Serpentine Belt and Single Groove
1999-95 2.0L (121) Dodge Neon, Stratus.
Diameter 7-7/8"
Width 2"
Weight (lbs.) 5.4



594-102

Double V-Groove
1992-90 Ford 2.9L Bronco II, Ranger
Diameter 6"
Width 4 -3/16"
Weight (lbs.) 7.11



594-103

Serpentine
2006-90 Chrysler 3.3L, 3.8L Chrysler, Dodge, Plymouth.
Diameter 7 -15/16"
Width 2 -1/8"
Weight (lbs.) 6.415



594-106

Double Serpentine Belt
1999-90 2.0L Eagle Talon, Mitsubishi Eclipse, Galant, Plymouth Laser; 2.4L Eagle Summit, Mitsubishi Eclipse, Galant, Spyder, Expo, Plymouth Colt, Vista.
Diameter 6-3/8"
Width 1-13/16"
Weight (lbs.) 5.7



594-107

Serpentine Belt
1996-92 V8-5.7L (350CID) VIN P, Chevrolet Corvette.
Diameter 7-3/32"
Width 2-1/8"
Weight (lbs.) 13.0



594-108

Solid
2006-96 V6-3.0L (182CID) Ford Taurus, Sable 24 Valve DOHC
Diameter 6-3/32"
Width 2-3/8"
Weight (lbs.) 5.3

Harmonic Balancers



594-109

Serpentine Belt

2000-95 V6-2.5L (152CID), V6-3.0L (182CID), Ford Contour, Escape; Mercury Cougar, Mystique.

Diameter 6-15/32"
Width 1-3/4"
Weight (lbs.) 4.6



594-110

Serpentine Belt

2002-96 V6-4.6L (281CID) Ford Mustang.

Diameter 6-13/16"
Width 2-1/16"
Weight (lbs.) 6.2



594-111

Serpentine Belt

2006-91 V6-4.0L (245CID) Ford Truck Explorer, Ranger, Mercury Mountaineer

Diameter 6"
Width 5-5/16"
Weight (lbs.) 7.1



594-112

Serpentine Belt 8 Groove

2000-97 V8-5.4L (330CID) Ford Truck E-Series, E-Super Duty, F-Series Pickups, Lincoln Navigator.

Diameter 7"
Width 2-1/16"
Weight (lbs.) 7.3



594-113

Solid

1970-66 V8-6.5L (396CID), 7.0L (427L) Chevrolet BelAir, Biscayne, Camaro, Caprice, Chevelle, Corvette, El Camino, Impala, Malibu.

Diameter 8"
Width 2-11/16"
Weight (lbs.) 16.0



594-114

Serpentine Belt

1996 V8-5.7L (350CID) VIN 5 Chevrolet Corvette.

Diameter 7-9/16"
Width 1-1/32"
Weight (lbs.) 12.5



594-115

Double Serpentine Belt

2005-01 V8-5.7L (350CID) VIN G & S Chevrolet Corvette, CTS

Diameter 7-17/32"
Width 2-27/32"
Weight (lbs.) 11.0



594-116

Serpentine Belt

1995-90 V8-5.7L (350CID) VIN J Chevrolet Corvette.

Diameter 7-1/8"
Width 2-15/16"
Weight (lbs.) 12.0



594-117

Solid

1986-68 V8-5.7L (350CID), 6.6L (403), 7.5L (455CID) GM Buick, Cadillac, Oldsmobile, Pontiac; 1990-87 V8-5.0L (307CID) Cadillac Fleetwood (VIN 9)

Diameter 6-1/2"
Width 3-7/32"
Weight (lbs.) 8.5



594-118

Serpentine Belt

2004-02 L4-2.0L (122CID) Ford Escort, Focus VIN P, SOHC

Diameter 5-11/16"
Width 1-21/32"
Weight (lbs.) 6.6



594-119

Serpentine Belt

2000 V10-6.8L (415CID) Ford Truck Series E & F Super Duty, Excursion.

Diameter 7-1/32"
Width 2-9/16"
Weight (lbs.) 9.7



594-120

Double Serpentine Belt

2002-93 V6-2.5L (2497cc) Mazda 626, Millenia.

Diameter 5-21/32"
Width 2-7/32"
Weight (lbs.) 4.8

Harmonic Balancers

Harmonic Balancers



594-121

Solid
2002-96 V8-5.7L (350CID) Chevrolet/GMC Truck, Cadillac Escalade

Diameter 8"
Width 2-1/4"
Weight (lbs.) 13.0



594-122

Double Serpentine Belt
2005-95 V6-3.8L (231CID) Buick Park Avenue, Regal, Riviera; Oldsmobile LSS; Pontiac Bonneville, Grand Prix with Supercharged VIN1

Diameter 7-5/32"
Width 3-13/32"
Weight (lbs.) 11.7



594-123

Serpentine Belt
1995-93 V6-3.2L (195CID) Ford Taurus; SHO

Diameter 6-5/32"
Width 1-29/32"
Weight (lbs.) 6.5



594-124

Serpentine Belt
2003-95 V8-7.3L (445CID) Ford Truck E-Super Duty/350; F-Series 250, 350, 450; F59 Stripped.

Diameter 7-1/2"
Width 2-3/4"
Weight (lbs.) 13.0



594-125

Solid
2006-95 V6-3.0L (182CID) Ford Taurus; Ford Truck Aerostar, Ranger, Windstar; Mercury Sable

Diameter 6-5/32"
Width 3-1/4"
Weight (lbs.) 6.8



594-127

Double Serpentine Belt
2006-98 V8-5.7L (350CID) Chevrolet Camaro; Pontiac Firebird, GTO

Diameter 7-1/2"
Width 3-21/32"
Weight (lbs.) 13.5



594-128

Solid
1993-82 V8-6.2L (379CID); V8-6.5L (395CID) Chevrolet/GMC Truck Suburban, P-Series, C,K,R,V-Series; Blazer, Jimmy; Diesel

Diameter 7-29/32"
Width 3-5/32"
Weight (lbs.) 12.5



594-129

Double Serpentine Belt
2005-99 H4-2.0L (1994cc); 2001-99 H4-2.2L (2212cc) Impreza.

Diameter 5-11/32"
Width 1-15/16"
Weight (lbs.) 4.8



594-130

Solid
2000-87 3.0L Chrysler Caravan, Acclaim, Daytona, Dynasty, LeBaron, New Yorker, Shadow, Spirit, Town & Country, Voyager.

Diameter 6"
Width 1-7/8"
Weight (lbs.) 4.8



594-131

Solid
1993-79 V8-5.9L (360CID); Chrysler Truck Model B, D, Ram Charger, Trail Duster; Manual Transmission

Diameter 7-1/4"
Width 3-3/16"
Weight (lbs.) 12.2



594-132

Solid
1993-79 V8-5.9L (360CID) Chrysler Town & Country, Diplomat, Vans, Trucks; Automatic Transmission.

Diameter 7-1/4"
Width 2-17/32"
Weight (lbs.) 8.9



594-133

Serpentine Belt
2003-94 V8-5.9L (360CID) Chrysler Truck Dakota, Durango, Ram, Vans.

Diameter 7-1/4"
Width 4-13/16"
Weight (lbs.) 12.1

Harmonic Balancers



594-134

Double Serpentine Belt
1995-93 L4-2.0L (1991cc) Mazda MX-6, 626;
Ford Probe

Diameter 5-3/4"
Width 1-27/32"
Weight (lbs.) 4.7



594-135

Double Serpentine Belt
1998-75 V8-5.9L (360CID) AMC Matador, Jeep
Cherokee, Grand Cherokee, Wagoneer, Grand
Wagoneer, J10, J20

Diameter 6 -1/2"
Width 1-13/32"
Weight (lbs.) 9.720



594-137

Serpentine Belt
1990-84 4-150, 2.5L American Motors Eagle,
Jeep CJ Series, Cherokee, Comanche,
Wagoneer, Wrangler

Diameter 6.70"
Width 2.15"
Weight (lbs.) 7.35



594-138

Double Serpentine Belt
1991-87 L4-2.0L Toyota Camry; L4-2.0L 1989-87
3 SFE Celica; 1993-90 5 SFE Celica

Diameter 5.71"
Width 2.06"
Weight (lbs.) 5.52



594-139

Double Serpentine Belt
2001-94, L4-2.2L & 2.0 Cyl. Toyota Camry,
Celica, Solara RAV4

Diameter 5.70"
Width 2.09"
Weight (lbs.) 5.33



594-140

Double Serpentine Belt
2006-94 V6/3.0L / 2006-04 3.3L Lexus ES3200,
Toyota Avalon, Camry, Sienna, Solara

Diameter 6.22"
Width 2.11"
Weight (lbs.) 5.07



594-141

Serpentine Belt
2004-95 2.4L ; 2004-94 L4-2.7L, Toyota Truck,
4-Runner & Tacoma.

Diameter 5.76"
Width 2.32"
Weight (lbs.) 4.16



594-142

Solid
1979-78 200, 3.3L; 1984-80 229, 3.8L; 1987-85
262, 4.3L GM Chevrolet, Pontiac, GMC

Diameter 6.12"
Width 2.33"
Weight (lbs.) 4.98



594-143

Double Serpentine Belt
1999-95 L4, 1.6L, (1597cc) Nissan Sentra,
200SX.

Diameter 6.4"
Width 1.98"
Weight (lbs.) 4.53



594-144

Double Serpentine Belt
1999-91 V6, 3.0L (2972cc) Mitsubishi Diamante,
3000GT; Stealth

Diameter 6.07"
Width 2.15"
Weight (lbs.) 4.78



594-145

Double V-Belt
1976-73 Ford Medium Truck, M450.

Diameter 6.92"
Width 2.96"
Weight (lbs.) 17.39



594-146

Solid
1976-73 .8, 5.9, 6.4L (360/390 CID), Ford Truck
F100, F150, F250.

Diameter 6.91"
Width 2.96"
Weight (lbs.) 17.4

Harmonic Balancers

Harmonic Balancers



594-147

Solid

1993-82 V6, 2.8/3.1L 173/189 CID, GM Buick Century, Skylark; Chevrolet Camaro, Celebrity, S10 Blazer, S10 Pickups, GMC S15 Jimmy/ Pickup/Sonoma; Oldsmobile Cutlass Ciera, Omega; Pontiac 6000, Firebird, Phoenix.

Diameter 6.36"
Width 2.29"
Weight (lbs.) 5.42



594-148

Serpentine Belt

2005-93, V6- 3.1L/ 3.4L, 189/207CID, GM Mid-Sized Passenger Cars.

Diameter 6.11"
Width 2.03"
Weight (lbs.) 4.67



594-149

Solid

1995-90 V6-3.8L Ford Taurus, Lincoln Continental, Mercury Sable

Diameter 7.5"
Width 5.23"
Weight (lbs.) 6.98



594-150

Serpentine Belt

1988-86 V6, 3.8L (231 CID), GM Buick Electra, Riviera, Oldsmobile 88, 98, Pontiac Bonneville, Toronado.

Diameter 7.22"
Width 3.71"
Weight (lbs.) 7.94



594-152

Serpentine Belt

1996-87 L6-4.9L (300CID), Ford Bronco, E-150 , E-250, E-350, F-150, F250, F350.

Diameter 6.42"
Width 2.8"
Weight (lbs.) 10.99



594-153

Serpentine Belt

2005-97 V6-3.0L (181 CID), Cadillac Catera, 2005-03 3.2L CTS.

Diameter 6.56"
Width 1.51"
Weight (lbs.) 4.96



594-154

Serpentine Belt

1997-94 V6-2.5L, Saab 900; 2002-95 V6-3.0L, Saab 9-5, 9000

Diameter 6.63"
Width 1.5"
Weight (lbs.) 1.94



594-155

Serpentine Belt

2001-96 V8-5.0L (302CID), Ford Explorer; Mercury Mountaineer.

Diameter 6.3"
Width 4.48"
Weight (lbs.) 11.82



594-156

Solid

1976-75 4.3L Chevrolet Truck; 1973-69 5.0L GM Truck, Chevrolet, GMC, Pontiac.

Diameter 6.11"
Width 2.33"
Weight (lbs.) 11.82



594-158

Solid

1978-68 V8-5.7L (350 CID), 6.6L (400 CID), 7.0L (428 CID), 7.5L (455 CID), GM Pontiac, Buick, Oldsmobile.

Diameter 6.8"
Width 3.24"
Weight (lbs.) 7.7



594-159

Serpentine Belt

1998-93 Volvo L5-2.3L, 2319cc; L5-2.4L (2435cc); C70,S70, V70

Diameter 5.88"
Width 1.42"
Weight (lbs.) 4.8



594-161

Double Serpentine Belt

1994-93 6 cyl., 3.8L GM Full Size Passenger Cars w/Supercharge

Diameter 7.81"
Width 3.75"
Weight (lbs.) 9.21

Harmonic Balancers



594-162

Double Serpentine Belt/V-Belt

1995-94 Honda Passport, 1997-94 Isuzu Rodeo; 3.2L

Diameter 5.18"
Width 3.05"
Weight (lbs.) 8.19



594-164

Serpentine Belt/V-Belt

1994-89 V6-3.0L (2972cc); Mitsubishi Montero, Mighty Max; Dodge Raider, RAM 50 PU

Diameter 5.88"
Width 3.84"
Weight (lbs.) 8.36



594-166

Double Serpentine Belt

2006-99 H4-2.5L, Subaru, Forester, Impreza, Legacy.

Diameter 5.24"
Width 1.95"
Weight (lbs.) 5.65



594-168

V-Belt

1994-85, L4-1.8L, Plymouth Laser, Mitsubishi Eclipse; 1988-85 1.6L Mirage

Diameter 5.65"
Width 1.09"
Weight (lbs.) 3.08



594-169

Serpentine Belt/V-Belt

1997-93 V6-3.3L (201CID), Dodge Intrepid, Concord, Vision.

Diameter 7.51"
Width 2.37"
Weight (lbs.) 5.6



594-170

Solid

2002-94 V8-6.5L (395CID) GM Truck-Diesel.

Diameter 7.86"
Width 2.42"
Weight (lbs.) 12.3



594-174

Double V-Belt

1994-85 1.8L Subaru w/o turbo Loyale & XT Coupe, All models, sedan & 4 cyl. w/overhead cam.

Diameter 5.33"
Width 1.81"
Weight (lbs.) 1.93



594-175

Double Serpentine Belt

1999-96 2.2L; 2.5L, Subaru, Type 2; Legacy, Outback

Diameter 5.32"
Width 1.93"
Weight (lbs.) 4.64



594-176

Double Serpentine Belt

2005-97 V6-3.5L (3497cc), Mitsubishi Diamante; 2005-96 Eclipse Spider, Galant; Dodge Stratus; Chrysler Sebring

Diameter 6.1"
Width 2.12"
Weight (lbs.) 4.96



594-177

Double Serpentine Belt

1999-95 L4-2.0L, Mitsubishi Eclipse w/o Turbo.

Diameter 7.9"
Width 2.1"
Weight (lbs.) 6.42



594-178

Solid

1999-96 V6-3.8L Ford Windstar.

Diameter 7.44"
Width 5.24"
Weight (lbs.) 7.49



594-180

Double Serpentine Belt

1992-90 3.0L Ford Probe.

Diameter 5.67"
Width 2.55"
Weight (lbs.) 5.89

Harmonic Balancers



594-181

Solid

2006-96 V-6-262; 4.3L, Chevrolet/GM Blazer, Bravada, Chevrolet 1500 Pickups; GMC Vans, Envoy, S10, S15

Diameter 6.142"
Width 1.297"
Weight (lbs.) 4.65



594-182

Double Serpentine Belt

1997-93 1.6L/1.8L Toyota 4AFE; Celica, Corolla

Diameter 5.302"
Width 1.589"
Weight (lbs.) 5.74



594-183

Serpentine Belt/V-Belt

2004-93 Chrysler 6-230; 32.L3.5L, 300M, Concord, New Yorker; Dodge Intrepid, Prowler, Vision

Diameter 7.763"
Width 1.676"
Weight (lbs.) 5.888



594-184

Double Serpentine Belt

2003-96 4Cyl.; 1.8L/2.0L; Mazda 626, Protégé

Diameter 5.554"
Width 1.62"
Weight (lbs.) 5.07



594-185

Double Serpentine Belt

2003-00 4L-2.0L / 2.4L; Chrysler/Plymouth Neon, PT Cruiser

Diameter 7.384"
Width 1.681"
Weight (lbs.) 4.198



594-186

Double Serpentine Belt

2000-95 6-153; 2.5L Cirrus, Sebring, Stratus

Diameter 7.913"
Width 1.803"
Weight (lbs.) 8.500



594-187

Double Serpentine Belt

2002-98 4 Cyl., 2.3L Honda Accord, CL

Diameter 7.089"
Width 1.757"
Weight (lbs.) 6.100



594-188

Double Serpentine Belt

2001-95 6 Cyl., 3.0L, Nissan Maxima; 2001-96 Infiniti

Diameter 6.926"
Width 1.960"
Weight (lbs.) 4.938



594-189

Serpentine Belt

2006-97 8 Cyl.-280, 4.6L, Ford Truck Expedition, F150, F250, E150, E250

Diameter 6.775"
Width 1.433"
Weight (lbs.) 5.770



594-190

Serpentine Belt

2002-96 L4-116, 1.9L; Saturn SW, SC, SL

Diameter 6.672"
Width 1.335"
Weight (lbs.) 3.236



594-191

Serpentine Belt

2006-00 V8-287, 4.7L Chrysler Jeep, Dodge Truck; 2006-03 Jeep; Dodge Truck

Diameter 7.247"
Width 3.116"
Weight (lbs.) 9.210



594-192

Double Serpentine Belt

2005-01 1.7L SOHC Honda Civic, EL

Diameter 7.003"
Width 1.718"
Weight (lbs.) 6.118

Harmonic Balancers



594-193

Double Serpentine Belt
1997-96 4 Cyl. 2.0L Mazda 626, MX6 With Manual Transmission

Diameter 5.550"
Width 1.621"
Weight (lbs.) 5.030



594-195

Serpentine Belt
1999-94 GM V8-281, 4.6L, Cadillac Concord, Deville; 1998-95 4.0L Oldsmobile Aurora

Diameter 7.359"
Width 1.078"
Weight (lbs.) 5.320



594-999

Harmonic Balancer Puller
This puller is designed to pull crankshafts, vibration dampers, pulleys or any gear with tapped holes. The four slots in the yoke allow the use of this tool for either two or three hole applications. The floating swivel prevents damage to the shaft ends.

Harmonic Balancer Applications

Make/Model/Engine	Years	Description	Dorman #
ACURA			
CL			
L4 - 2.2L (2156 cc)	1997	-	594-067
L4 - 2.3L (2254 cc)	1999-98	-	594-187
AMERICAN MOTORS			
AMX			
L6 - 4.2L (258 CID)	1980-78	-	594-022
CONCORD			
L6 - 3.8L (232 CID)	1979-78	-	594-022
L6 - 4.2L (258 CID)	1980-78	-	594-022
EAGLE			
L4 - 2.5L (150 CID)	1984	w/Serpentine Belt	594-137
L6 - 4.2L (258 CID)	1980	-	594-022
GREMLIN			
L6 - 3.8L (232 CID)	1978-76	-	594-022
L6 - 3.8L (232 CID)	1975	1.25" Thick	594-022
L6 - 4.2L (258 CID)	1978-76	-	594-022
L6 - 4.2L (258 CID)	1975	1.25" Thick	594-022
HORNET			
L6 - 3.8L (232 CID)	1977-76	-	594-022
L6 - 3.8L (232 CID)	1975	1.25" Thick	594-022
L6 - 4.2L (258 CID)	1977-76	-	594-022
L6 - 4.2L (258 CID)	1975	1.25" Thick	594-022
MATADOR			
L6 - 4.2L (258 CID)	1978-76	-	594-022
L6 - 4.2L (258 CID)	1975	1.25" Thick	594-022
V8 - 5.9L (360 CID)	1978-75	-	594-135
PACER			
L6 - 3.8L (232 CID)	1978-76	-	594-022
L6 - 3.8L (232 CID)	1975	1.25" Thick	594-022
L6 - 4.2L (258 CID)	1980-76	-	594-022
L6 - 4.2L (258 CID)	1975	1.25" Thick	594-022
SPIRIT			
L6 - 3.8L (232 CID)	1979	-	594-022
L6 - 4.2L (258 CID)	1980-79	-	594-022
BUICK			
APOLLO			
L6 - 4.1L (250 CID)	1975	-	594-029
L6 - 4.1L (250 CID)	1974-73	wo/Air Cond Or Heavy Duty Cooling	594-014
V8 - 4.3L (260 CID)	1975	-	594-028
CENTURY			
L4 - 2.5L (151 CID)	1992-87	-	594-027
V6 - 2.8L (173 CID)	1989-87	Auto Trans	594-008
V6 - 2.8L (173 CID)	1986	Stamped 4874	594-020
V6 - 2.8L (173 CID)	1986	Stamped 4955	594-147
V6 - 2.8L (173 CID)	1985-82	Stamped 4874	594-020
V6 - 3.1L (189 CID)	2005-94	-	594-148
V6 - 3.3L (204 CID)	1993	-	594-087
V6 - 3.3L (204 CID)	1992-89	-	594-044
V6 - 3.8L (231 CID)	1988-86	-	594-003
V8 - 5.0L (305 CID)	1980-77	-	594-009
V8 - 5.7L (350 CID)	1979-78	-	594-009
V8 - 5.7L (350 CID)	1977	VIN L	594-009

Make/Model/Engine	Years	Description	Dorman #
BUICK (continued)			
CENTURY (continued)			
V8 - 5.7L (350 CID)	1977	VIN R	594-117
V8 - 6.6L (403 CID)	1977	-	594-117
ELECTRA, ELECTRA 225			
V6 - 3.8L (231 CID)	1990-88	-	594-001
V6 - 3.8L (231 CID)	1987-86	Stamped 25527381 or 25527009	594-003
V6 - 3.8L (231 CID)	1987-86	Stamped 25532179	594-150
V8 - 5.0L (307 CID)	1984-81	-	594-028
V8 - 5.7L (350 CID)	1980-79	VIN R	594-028
V8 - 5.7L (350 CID)	1978-77	VIN R	594-117
V8 - 6.6L (403 CID)	1979	-	594-028
V8 - 6.6L (403 CID)	1978-77	-	594-117
ESTATE WAGON			
V8 - 5.0L (307 CID)	1990-81	-	594-028
V8 - 5.7L (350 CID)	1980-79	VIN R	594-028
V8 - 5.7L (350 CID)	1978-77	VIN R	594-117
V8 - 6.6L (403 CID)	1979	-	594-028
V8 - 6.6L (403 CID)	1978-77	-	594-117
LESABRE			
V6 - 3.8L (231 CID)	1999-95	-	594-004
V6 - 3.8L (231 CID)	1994-93	-	594-034
V6 - 3.8L (231 CID)	1992-91	-	594-005
V6 - 3.8L (231 CID)	1990-89	-	594-001
V6 - 3.8L (231 CID)	1988	VIN 3, Stamped 25527381 or 25527009	594-003
V6 - 3.8L (231 CID)	1988	VIN 3, Stamped 25532179	594-150
V6 - 3.8L (231 CID)	1988	VIN C	594-001
V6 - 3.8L (231 CID)	1987-86	Stamped 25527381 or 25527009	594-003
V6 - 3.8L (231 CID)	1987-86	Stamped 25532179	594-150
V8 - 5.0L (305 CID)	1978	-	594-009
V8 - 5.0L (307 CID)	1985-81	-	594-028
V8 - 5.7L (350 CID)	1980-79	VIN R	594-028
V8 - 5.7L (350 CID)	1978-77	VIN R	594-117
V8 - 6.6L (400 CID)	1975	-	594-158
V8 - 6.6L (403 CID)	1978-77	-	594-117
PARK AVENUE			
V6 - 3.8L (231 CID)	1999-95	VIN 1, Supercharged	594-122
V6 - 3.8L (231 CID)	1999-95	VIN K	594-004
V6 - 3.8L (231 CID)	1994-93	VIN 1, Supercharged	594-161
V6 - 3.8L (231 CID)	1994-93	VIN L	594-034
V6 - 3.8L (231 CID)	1992	VIN L	594-005
V6 - 3.8L (231 CID)	1991	-	594-005
REGAL			
V6 - 2.8L (173 CID)	1989-88	Auto Trans	594-008
V6 - 3.1L (189 CID)	1996-94	-	594-148
V6 - 3.1L (189 CID)	1993	Exc. Calif	594-008
V6 - 3.1L (189 CID)	1992-89	-	594-008
V6 - 3.8L (231 CID)	2004-96	VIN 1, Supercharged	594-122
V6 - 3.8L (231 CID)	2004-96	VIN K	594-004
V6 - 3.8L (231 CID)	1995	-	594-004
V6 - 3.8L (231 CID)	1994-93	-	594-034
V6 - 3.8L (231 CID)	1992-90	-	594-005
V8 - 5.0L (305 CID)	1982	-	594-009

Harmonic Balancer Applications

Make/Model/Engine	Years	Description	Dorman #
BUICK (continued)			
REGAL (continued)			
V8 - 5.0L (305 CID)	1980-77	-	594-009
V8 - 5.0L (307 CID)	1987-86	-	594-028
V8 - 5.7L (350 CID)	1977	VIN L	594-009
V8 - 5.7L (350 CID)	1977	VIN R	594-117
RENDEZVOUS			
V6 - 3.4L (207 CID)	2005-02	-	594-148
RIVIERA, REATTA			
V6 - 3.8L (231 CID)	1999-96	VIN 1, Supercharged	594-122
V6 - 3.8L (231 CID)	1999-96	VIN K	594-004
V6 - 3.8L (231 CID)	1995	VIN 1, Supercharged, Casting 24502031	594-122
V6 - 3.8L (231 CID)	1995	VIN K	594-004
V6 - 3.8L (231 CID)	1992-91	-	594-005
V6 - 3.8L (231 CID)	1990-88	-	594-001
V6 - 3.8L (231 CID)	1987-86	-	594-150
V8 - 5.0L (307 CID)	1985-80	-	594-028
V8 - 5.7L (350 CID)	1980	-	594-028
V8 - 5.7L (350 CID)	1979-77	VIN R	594-117
V8 - 6.6L (403 CID)	1978-77	-	594-117
ROADMASTER			
V8 - 5.0L (305 CID)	1991	-	594-009
V8 - 5.7L (350 CID)	1996-94	-	594-017
V8 - 5.7L (350 CID)	1993-92	-	594-009
SKYLARK, SOMERSET			
L4 - 2.3L (138 CID)	1995-88	-	594-043
L4 - 2.4L (146 CID)	1998-96	-	594-043
L6 - 4.1L (250 CID)	1971-68	wo/Air Cond Or Heavy Duty Cooling	594-014
V6 - 2.8L (173 CID)	1985-84	VIN X,Z-Stamped 4874	594-020
V6 - 2.8L (173 CID)	1985-82	VIN X,Z-Stamped 4955	594-147
V6 - 3.1L (189 CID)	1998-94	-	594-148
V6 - 3.3L (204 CID)	1993	-	594-087
V6 - 3.3L (204 CID)	1992-89	-	594-044
V8 - 4.3L (260 CID)	1976-75	-	594-028
V8 - 5.0L (305 CID)	1979-77	-	594-009
V8 - 5.7L (350 CID)	1979-78	-	594-009
V8 - 5.7L (350 CID)	1977	VIN L	594-009
V8 - 5.7L (350 CID)	1977	VIN R	594-117
SPECIAL			
L6 - 4.1L (250 CID)	1969-68	wo/Air Cond Or Heavy Duty Cooling	594-014
CADILLAC			
ALLANTE			
V8 - 4.1L (250 CID)	1988-87	-	594-042
V8 - 4.5L (273 CID)	1992-89	-	594-042
CATERA			
V6 - 3.0L (181 CID)	2001-97	-	594-153
CIMARRON			
V6 - 2.8L (173 CID)	1988-87	Auto Trans	594-008
CONCOURS			
V8 - 4.6L (281 CID)	1999-94	-	594-195
CTS			
V6 - 3.2L (197 CID)	2005-03	-	594-153
V8 - 5.7L (350 CID)	2005-04	-	594-115
DEVILLE			
V8 - 4.1L (250 CID)	1987-86	-	594-042
V8 - 4.5L (273 CID)	1990-88	-	594-042
V8 - 4.6L (281 CID)	1999-96	-	594-195
V8 - 4.9L (300 CID)	1995-91	-	594-042
ELDORADO			
V8 - 4.1L (250 CID)	1987-86	-	594-042
V8 - 4.5L (273 CID)	1990-88	-	594-042
V8 - 4.6L (281 CID)	1999-94	-	594-195
V8 - 4.9L (300 CID)	1993-91	-	594-042
V8 - 5.7L (350 CID)	1980	VIN 8	594-028
V8 - 5.7L (350 CID)	1979	VIN B	594-117
ESCALADE			
V8 - 5.7L (350 CID)	2000-99	-	594-121
FLEETWOOD, FLEETWOOD BROUGHAM, COMMERCIAL CHASSIS			
V8 - 4.1L (250 CID)	1987-86	-	594-042
V8 - 4.5L (273 CID)	1990-88	-	594-042
V8 - 4.9L (300 CID)	1993-91	-	594-042
V8 - 5.0L (305 CID)	1992-91	-	594-009
V8 - 5.0L (307 CID)	1990-87	VIN 9	594-117
V8 - 5.0L (307 CID)	1990-86	VIN Y	594-028
V8 - 5.7L (350 CID)	1996-94	-	594-017
V8 - 5.7L (350 CID)	1993-90	-	594-009
SEVILLE			
V8 - 4.1L (250 CID)	1987-86	-	594-042
V8 - 4.5L (273 CID)	1990-88	-	594-042
V8 - 4.6L (281 CID)	1999-94	-	594-195
V8 - 4.9L (300 CID)	1993-91	-	594-042

Make/Model/Engine	Years	Description	Dorman #
CADILLAC (continued)			
SEVILLE (continued)			
V8 - 5.7L (350 CID)	1980	VIN 8	594-028
V8 - 5.7L (350 CID)	1978-75	VIN B, R	594-117
CHEVROLET			
BEL AIR, BISCAYNE, BROOKWOOD, KINGSWOOD, TOWNSMAN			
L6 - 4.1L (250 CID)	1973-65	wo/Air Cond Or Heavy Duty Cooling	594-014
V8 - 5.4L (327 CID)	1969	-	594-012
V8 - 5.7L (350 CID)	1975-71	Exc. Special Hi-Perf	594-012
V8 - 5.7L (350 CID)	1970-69	Exc. Special Hi-Perf, 2-Bbl Carb	594-012
V8 - 5.7L (350 CID)	1970-69	Exc. Special Hi-Perf, 4-Bbl Carb	594-002
V8 - 6.5L (396 CID)	1969-68	-	594-030
V8 - 6.6L (400 CID)	1975-73	-	594-016
V8 - 6.6L (400 CID)	1972-70	2-Bbl Carb	594-016
V8 - 6.6L (400 CID)	1972-70	4-Bbl Carb	594-030
V8 - 6.6L (402 CID)	1972-71	-	594-030
V8 - 7.0L (427 CID)	1969-66	Exc. Special Hi-Perf	594-030
V8 - 7.0L (427 CID)	1969-66	Special Hi-Perf	594-113
V8 - 7.4L (454 CID)	1975-70	-	594-010
BERETTA			
L4 - 2.3L (138 CID)	1994-93	-	594-043
L4 - 2.3L (138 CID)	1992-90	164mm Diameter	594-043
V6 - 2.8L (173 CID)	1989-87	Auto Trans	594-008
V6 - 3.1L (189 CID)	1996-94	-	594-148
V6 - 3.1L (189 CID)	1993	Exc. Calif	594-008
V6 - 3.1L (189 CID)	1992-90	-	594-008
CAMARO			
L6 - 4.1L (250 CID)	1979-77	-	594-015
L6 - 4.1L (250 CID)	1976-75	-	594-029
L6 - 4.1L (250 CID)	1974-68	wo/Air Cond Or Heavy Duty Cooling	594-014
V6 - 2.8L (173 CID)	1989-88	-	594-147
V6 - 2.8L (173 CID)	1987-82	Stamped 4955	594-147
V6 - 2.8L (173 CID)	1987-82	Stamped 9033	594-013
V6 - 3.1L (189 CID)	1992-90	-	594-147
V6 - 3.8L (229 CID)	1981-80	-	594-142
V6 - 3.8L (231 CID)	1997	Auto Trans	594-004
V6 - 3.8L (231 CID)	1996-95	-	594-004
V8 - 5.0L (305 CID)	1992-85	VIN E,G,H	594-009
V8 - 5.0L (305 CID)	1992-85	VIN F	594-012
V8 - 5.0L (305 CID)	1984-77	-	594-009
V8 - 5.0L (305 CID)	1976	-	594-012
V8 - 5.0L (307 CID)	1973-69	-	594-156
V8 - 5.4L (327 CID)	1969	-	594-012
V8 - 5.7L (350 CID)	2002-98	-	594-127
V8 - 5.7L (350 CID)	1997-93	-	594-017
V8 - 5.7L (350 CID)	1992-87	-	594-012
V8 - 5.7L (350 CID)	1981-77	-	594-009
V8 - 5.7L (350 CID)	1976	-	594-012
V8 - 5.7L (350 CID)	1975-71	Exc. Special Hi-Perf	594-012
V8 - 5.7L (350 CID)	1970-69	Exc. Special Hi-Perf, 2-Bbl Carb	594-012
V8 - 5.7L (350 CID)	1970-69	Exc. Special Hi-Perf, 4-Bbl Carb	594-002
V8 - 6.5L (396 CID)	1970-67	Exc. Special Hi-Perf	594-030
V8 - 6.5L (396 CID)	1970-67	Special Hi-Perf	594-113
V8 - 6.6L (402 CID)	1972-70	-	594-030
V8 - 7.0L (427 CID)	1969	Exc. Special Hi-Perf	594-030
CAPRICE			
L6 - 4.1L (250 CID)	1979-77	wo/Air Cond	594-015
L6 - 4.1L (250 CID)	1969-67	wo/Air Cond Or Heavy Duty Cooling	594-014
V6 - 3.8L (229 CID)	1984-80	-	594-142
V6 - 4.3L (262 CID)	1993-92	-	594-047
V6 - 4.3L (262 CID)	1986-85	-	594-142
V8 - 4.3L (265 CID)	1996-94	-	594-017
V8 - 5.0L (305 CID)	1993-77	-	594-009
V8 - 5.0L (307 CID)	1990-86	-	594-028
V8 - 5.4L (327 CID)	1969	-	594-012
V8 - 5.7L (350 CID)	1996-94	-	594-017
V8 - 5.7L (350 CID)	1993-86	-	594-009
V8 - 5.7L (350 CID)	1985-80	VIN 6,L	594-009
V8 - 5.7L (350 CID)	1979-77	-	594-009
V8 - 5.7L (350 CID)	1976	-	594-012
V8 - 5.7L (350 CID)	1975-71	Exc. Special Hi-Perf	594-012
V8 - 5.7L (350 CID)	1970-69	Exc. Special Hi-Perf, 2-Bbl Carb	594-012
V8 - 5.7L (350 CID)	1970-69	Exc. Special Hi-Perf, 4-Bbl Carb	594-002
V8 - 6.5L (396 CID)	1969-67	-	594-030
V8 - 6.6L (400 CID)	1976-73	-	594-016
V8 - 6.6L (400 CID)	1972-70	2-Bbl Carb	594-016
V8 - 6.6L (400 CID)	1972-70	4-Bbl Carb	594-030
V8 - 6.6L (402 CID)	1972-71	-	594-030
V8 - 7.0L (427 CID)	1969-66	Exc. Special Hi-Perf	594-030
V8 - 7.0L (427 CID)	1969-66	Special Hi-Perf	594-113
V8 - 7.4L (454 CID)	1976-70	-	594-010

Harmonic Balancers

Power Steering Pulleys
pg. 317-326

Quick Disconnect™
pg. 327-396

Radiator Fan Assemblies
pg. 397-430

Rear Axle Shaft Kits
pg. 431-434

Side View Mirror Assemblies
pg. 435-468

Dorman® Balancers Include New Woodruff Keys (where required)

Harmonic Balancers

Harmonic Balancer Applications

Make/ Model/Engine	Years	Description	Dorman #
CHEVROLET (continued)			
CAVALIER			
L4 - 2.3L (138 CID)	1995	-	594-043
L4 - 2.4L (146 CID)	2002-96	-	594-043
V6 - 2.8L (173 CID)	1989-87	Auto Trans	594-008
V6 - 3.1L (189 CID)	1994-90	-	594-008
CELEBRITY			
L4 - 2.5L (151 CID)	1990-87	-	594-027
V6 - 2.8L (173 CID)	1989-87	Auto Trans	594-008
V6 - 2.8L (173 CID)	1986-82	VIN X,Z-Stamped 4874	594-020
V6 - 2.8L (173 CID)	1986-82	VIN X,Z-Stamped 4955	594-147
V6 - 3.1L (189 CID)	1990	-	594-008
CHEVELLE			
L6 - 4.1L (250 CID)	1973-67	wo/Air Cond Or Heavy Duty Cooling	594-014
V8 - 5.0L (307 CID)	1973-69	-	594-156
V8 - 5.7L (350 CID)	1973-71	Exc. Special Hi-Perf	594-012
V8 - 5.7L (350 CID)	1970-69	Exc. Special Hi-Perf, 2-Bbl Carb	594-012
V8 - 5.7L (350 CID)	1970-69	Exc. Special Hi-Perf, 4-Bbl Carb	594-002
V8 - 6.5L (396 CID)	1969-67	Exc. Special Hi-Perf	594-030
V8 - 6.5L (396 CID)	1969-66	Special Hi-Perf	594-113
V8 - 6.6L (400 CID)	1971-70	2-Bbl Carb	594-016
V8 - 6.6L (400 CID)	1971-70	4-Bbl Carb	594-030
V8 - 6.6L (402 CID)	1972-70	-	594-030
V8 - 7.4L (454 CID)	1973-70	-	594-010
CHEVY II			
V8 - 5.0L (307 CID)	1969	-	594-156
CITATION			
V6 - 2.8L (173 CID)	1985-84	VIN X,Z-Stamped 4874	594-020
V6 - 2.8L (173 CID)	1985-82	VIN X,Z-Stamped 4955	594-147
CORSICA			
V6 - 2.8L (173 CID)	1989-87	Auto Trans	594-008
V6 - 3.1L (189 CID)	1996-94	-	594-148
V6 - 3.1L (189 CID)	1993	Exc. Calif	594-008
V6 - 3.1L (189 CID)	1992-90	-	594-008
CORVETTE			
V8 - 5.0L (305 CID)	1980	-	594-012
V8 - 5.7L (350 CID)	2004-01	VIN G, S	594-115
V8 - 5.7L (350 CID)	1996-92	VIN P	594-107
V8 - 5.7L (350 CID)	1996	VIN 5	594-114
V8 - 5.7L (350 CID)	1995-90	VIN J	594-116
V8 - 5.7L (350 CID)	1991-90	VIN 8	594-012
V8 - 5.7L (350 CID)	1989-81	-	594-012
V8 - 5.7L (350 CID)	1980-72	Exc. Special Hi-Perf	594-012
V8 - 5.7L (350 CID)	1971-69	Exc. Special Hi-Perf	594-002
V8 - 7.0L (427 CID)	1969-66	Exc. Special Hi-Perf (Aluminum Heads)	594-030
V8 - 7.0L (427 CID)	1969-66	Special Hi-Perf	594-113
V8 - 7.4L (454 CID)	1974-70	-	594-010
IMPALA, IMPALA SS			
L6 - 4.1L (250 CID)	1979-77	wo/Air Cond	594-015
L6 - 4.1L (250 CID)	1973-65	wo/Air Cond Or Heavy Duty Cooling	594-014
V6 - 3.4L (207 CID)	2005-00	-	594-148
V6 - 3.8L (229 CID)	1984-80	-	594-142
V6 - 3.8L (231 CID)	2005-04	VIN 1, Supercharged	594-122
V6 - 3.8L (231 CID)	2005-04	VIN K	594-004
V6 - 3.8L (231 CID)	2003-00	-	594-004
V6 - 4.3L (262 CID)	1985	-	594-142
V8 - 5.0L (305 CID)	1985-77	-	594-009
V8 - 5.4L (327 CID)	1969	-	594-012
V8 - 5.7L (350 CID)	1996-94	-	594-017
V8 - 5.7L (350 CID)	1985-80	VIN 6,L	594-009
V8 - 5.7L (350 CID)	1979-77	-	594-009
V8 - 5.7L (350 CID)	1976	-	594-012
V8 - 5.7L (350 CID)	1975-71	Exc. Special Hi-Perf	594-012
V8 - 5.7L (350 CID)	1970-69	Exc. Special Hi-Perf, 2-Bbl Carb	594-012
V8 - 5.7L (350 CID)	1970-69	Exc. Special Hi-Perf, 4-Bbl Carb	594-002
V8 - 6.5L (396 CID)	1969-68	-	594-030
V8 - 6.6L (400 CID)	1975-73	-	594-016
V8 - 6.6L (400 CID)	1972-70	2-Bbl Carb	594-016
V8 - 6.6L (400 CID)	1972-70	4-Bbl Carb	594-030
V8 - 6.6L (402 CID)	1972-71	-	594-030
V8 - 7.0L (427 CID)	1969-66	Exc. Special Hi-Perf	594-030
V8 - 7.0L (427 CID)	1969-66	Special Hi-Perf	594-113
V8 - 7.4L (454 CID)	1976-70	-	594-010
LAGUNA			
V8 - 5.0L (305 CID)	1976	-	594-012
V8 - 5.7L (350 CID)	1976	-	594-012
V8 - 5.7L (350 CID)	1975-73	Exc. Special Hi-Perf	594-012
V8 - 6.6L (400 CID)	1976-74	-	594-016
V8 - 7.4L (454 CID)	1974-73	-	594-010
LUMINA			
L4 - 2.5L (151 CID)	1992-90	-	594-027

Make/ Model/Engine	Years	Description	Dorman #
CHEVROLET (continued)			
LUMINA (continued)			
V6 - 3.1L (189 CID)	2001-95	-	594-148
V6 - 3.1L (189 CID)	1994	-	594-008
V6 - 3.1L (189 CID)	1993	VIN T, Exc. Calif	594-008
V6 - 3.1L (189 CID)	1993	VIN W	594-008
V6 - 3.1L (189 CID)	1992-90	-	594-008
V6 - 3.8L (231 CID)	1999-98	-	594-004
LUMINA APV			
V6 - 3.4L (207 CID)	1996	-	594-148
V6 - 3.8L (231 CID)	1995	-	594-004
V6 - 3.8L (231 CID)	1994-93	-	594-034
V6 - 3.8L (231 CID)	1992	-	594-005
MALIBU			
L4 - 2.4L (146 CID)	1999-97	-	594-043
L6 - 4.1L (250 CID)	1977	-	594-015
L6 - 4.1L (250 CID)	1976-75	-	594-029
L6 - 4.1L (250 CID)	1974-73	wo/Air Cond Or Heavy Duty Cooling	594-014
V6 - 3.1L (189 CID)	2003-97	-	594-148
V6 - 3.3L (200 CID)	1979-78	-	594-142
V6 - 3.8L (229 CID)	1983-80	-	594-142
V8 - 5.0L (305 CID)	1983-77	-	594-009
V8 - 5.0L (305 CID)	1976	-	594-012
V8 - 5.0L (307 CID)	1973	-	594-156
V8 - 5.7L (350 CID)	1981-80	-	594-009
V8 - 5.7L (350 CID)	1979	VIN 4, Exc. Special Hi-Perf	594-012
V8 - 5.7L (350 CID)	1979	VIN L	594-009
V8 - 5.7L (350 CID)	1978-77	-	594-009
V8 - 5.7L (350 CID)	1976	-	594-012
V8 - 5.7L (350 CID)	1975-73	Exc. Special Hi-Perf	594-012
V8 - 6.5L (396 CID)	1967-66	Special Hi-Perf	594-113
V8 - 6.6L (400 CID)	1976-74	-	594-016
V8 - 7.4L (454 CID)	1975-73	-	594-010
MONTE CARLO			
V6 - 3.1L (189 CID)	1999-95	-	594-148
V6 - 3.3L (200 CID)	1979-78	-	594-142
V6 - 3.4L (207 CID)	2005-00	-	594-148
V6 - 3.8L (229 CID)	1984-80	-	594-142
V6 - 3.8L (231 CID)	2005-04	VIN 1, Supercharged	594-122
V6 - 3.8L (231 CID)	2005-04	VIN K	594-004
V6 - 3.8L (231 CID)	2003-98	-	594-004
V6 - 4.3L (262 CID)	1986-85	-	594-142
V8 - 5.0L (305 CID)	1988-77	-	594-009
V8 - 5.0L (305 CID)	1976	-	594-012
V8 - 5.7L (350 CID)	1981-77	-	594-009
V8 - 5.7L (350 CID)	1976	-	594-012
V8 - 5.7L (350 CID)	1975-71	Exc. Special Hi-Perf	594-012
V8 - 5.7L (350 CID)	1970	Exc. Special Hi-Perf, 2-Bbl Carb	594-012
V8 - 5.7L (350 CID)	1970	Exc. Special Hi-Perf, 4-Bbl Carb	594-002
V8 - 6.6L (400 CID)	1976-73	-	594-016
V8 - 6.6L (400 CID)	1972-70	2-Bbl Carb	594-016
V8 - 6.6L (400 CID)	1972-70	4-Bbl Carb	594-030
V8 - 6.6L (402 CID)	1972-70	-	594-030
V8 - 7.4L (454 CID)	1975-70	-	594-010
MONZA			
V8 - 4.3L (262 CID)	1976-75	-	594-156
V8 - 5.0L (305 CID)	1979-76	-	594-012
V8 - 5.7L (350 CID)	1975	Exc. Special Hi-Perf	594-012
NOVA, CHEVY II			
L6 - 4.1L (250 CID)	1979-77	-	594-015
L6 - 4.1L (250 CID)	1976-75	-	594-029
L6 - 4.1L (250 CID)	1974-67	wo/Air Cond Or Heavy Duty Cooling	594-014
V8 - 4.3L (262 CID)	1975	-	594-156
V8 - 5.0L (305 CID)	1979-77	-	594-009
V8 - 5.0L (305 CID)	1976	-	594-012
V8 - 5.0L (307 CID)	1973-70	-	594-156
V8 - 5.7L (350 CID)	1979-77	-	594-009
V8 - 5.7L (350 CID)	1976	-	594-012
V8 - 5.7L (350 CID)	1970-69	Exc. Special Hi-Perf, 2-Bbl Carb	594-012
V8 - 5.7L (350 CID)	1970-69	Exc. Special Hi-Perf, 4-Bbl Carb	594-002
V8 - 6.5L (396 CID)	1970-68	-	594-030
V8 - 6.6L (402 CID)	1970	-	594-030
VENTURE VAN			
V6 - 3.4L (207 CID)	2005-97	-	594-148
CHEVROLET, GMC TRUCK			
ASTRO, SAFARI			
V6 - 4.3L (262 CID)	2005-96	-	594-181
V6 - 4.3L (262 CID)	1995-94	VIN W	594-047
V6 - 4.3L (262 CID)	1993-85	-	594-047
BLAZER, JIMMY, TAHOE, YUKON			
L6 - 4.1L (250 CID)	1982-77	-	594-015

Harmonic Balancer Applications

Make/Model/Engine	Years	Description	Dorman #
CHEVROLET, GMC TRUCK (continued)			
BLAZER, JIMMY, TAHOE, YUKON (continued)			
L6 - 4.1L (250 CID)	1976-75	-	594-029
L6 - 4.1L (250 CID)	1974-73	-	594-014
L6 - 4.1L (250 CID)	1972-69	wo/Air Cond Or Heavy Duty Cooling	594-014
L6 - 4.8L (292 CID)	1975	2-Groove Pulley	594-031
V8 - 5.0L (305 CID)	1987-79	-	594-009
V8 - 5.0L (305 CID)	1978-77	-	594-006
V8 - 5.0L (307 CID)	1973-69	-	594-156
V8 - 5.7L (350 CID)	2000-96	-	594-121
V8 - 5.7L (350 CID)	1995-87	-	594-002
V8 - 5.7L (350 CID)	1986-77	-	594-006
V8 - 5.7L (350 CID)	1976-73	-	594-002
V8 - 5.7L (350 CID)	1972-71	-	594-012
V8 - 5.7L (350 CID)	1970-69	2-Bbl Carb	594-012
V8 - 5.7L (350 CID)	1970-69	4-Bbl Carb	594-002
V8 - 6.2L (379 CID)	1991-82	Diesel - Balancer	594-128
V8 - 6.5L (395 CID)	1999-94	Diesel - Balancer	594-170
V8 - 6.5L (395 CID)	1999-94	Diesel - Pulley	594-037
V8 - 6.6L (400 CID)	1980-75	-	594-016
V8 - 7.4L (454 CID)	1978-73	-	594-010
C,K,R,V SERIES PICKUP			
L6 - 4.1L (250 CID)	1984-77	-	594-015
L6 - 4.1L (250 CID)	1976-75	-	594-029
L6 - 4.1L (250 CID)	1974-73	-	594-014
L6 - 4.1L (250 CID)	1972-66	wo/Air Cond Or Heavy Duty Cooling	594-014
L6 - 4.8L (292 CID)	1988-75	2-Groove Pulley	594-031
V6 - 4.3L (262 CID)	1998-96	-	594-181
V6 - 4.3L (262 CID)	1993-88	-	594-047
V6 - 4.3L (262 CID)	1987-85	-	594-142
V8 - 5.0L (305 CID)	1995-88	-	594-012
V8 - 5.0L (305 CID)	1987-77	-	594-009
V8 - 5.0L (305 CID)	1976	-	594-012
V8 - 5.0L (307 CID)	1973-69	-	594-156
V8 - 5.7L (350 CID)	2000-96	-	594-121
V8 - 5.7L (350 CID)	1995-87	-	594-002
V8 - 5.7L (350 CID)	1986-82	-	594-006
V8 - 5.7L (350 CID)	1981-78	VIN L,M,P	594-006
V8 - 5.7L (350 CID)	1977	-	594-006
V8 - 5.7L (350 CID)	1976-75	-	594-002
V8 - 5.7L (350 CID)	1974	VIN V,Y	594-002
V8 - 5.7L (350 CID)	1974	VIN W	594-012
V8 - 5.7L (350 CID)	1973	-	594-002
V8 - 5.7L (350 CID)	1972-71	-	594-012
V8 - 5.7L (350 CID)	1970-69	2-Bbl Carb	594-012
V8 - 5.7L (350 CID)	1970-69	4-Bbl Carb	594-002
V8 - 6.2L (379 CID)	1993-88	Diesel - Balancer	594-128
V8 - 6.2L (379 CID)	1993-88	Diesel - Pulley - CK Series Only	594-037
V8 - 6.2L (379 CID)	1987-82	Diesel - Balancer	594-128
V8 - 6.5L (395 CID)	2002-94	Diesel - Balancer	594-170
V8 - 6.5L (395 CID)	2002-94	Diesel - Pulley	594-037
V8 - 6.5L (395 CID)	1993-92	Diesel - Balancer	594-128
V8 - 6.5L (395 CID)	1993-92	Diesel - Pulley	594-037
V8 - 6.5L (396 CID)	1969-68	-	594-030
V8 - 6.6L (400 CID)	1980-75	-	594-016
V8 - 6.6L (400 CID)	1972-70	2-Bbl Carb	594-016
V8 - 6.6L (400 CID)	1972-70	4-Bbl Carb	594-030
V8 - 7.4L (454 CID)	1993-91	-	594-026
V8 - 7.4L (454 CID)	1990-79	-	594-010
V8 - 7.4L (454 CID)	1978-73	-	594-010
CABALLERO, EL CAMINO, SPRINT			
L6 - 4.1L (250 CID)	1977	-	594-015
L6 - 4.1L (250 CID)	1976-75	-	594-029
L6 - 4.1L (250 CID)	1973-67	wo/Air Cond Or Heavy Duty Cooling	594-014
V6 - 3.3L (200 CID)	1979-78	-	594-142
V6 - 3.8L (229 CID)	1984-80	-	594-142
V6 - 4.3L (262 CID)	1986-85	-	594-142
V8 - 5.0L (305 CID)	1987-77	-	594-009
V8 - 5.0L (305 CID)	1976	-	594-012
V8 - 5.0L (307 CID)	1973-69	-	594-156
V8 - 5.7L (350 CID)	1979-77	-	594-009
V8 - 5.7L (350 CID)	1976	-	594-012
V8 - 5.7L (350 CID)	1975-71	Exc. Special Hi-Perf	594-012
V8 - 5.7L (350 CID)	1970-69	Exc. Special Hi-Perf, 2-Bbl Carb	594-012
V8 - 5.7L (350 CID)	1970-69	Exc. Special Hi-Perf, 4-Bbl Carb	594-002
V8 - 6.5L (396 CID)	1969-67	Exc. Special Hi-Perf	594-030
V8 - 6.5L (396 CID)	1969-66	Special Hi-Perf	594-113
V8 - 6.6L (400 CID)	1976-74	-	594-016
V8 - 6.6L (400 CID)	1970	2-Bbl Carb	594-016
V8 - 6.6L (400 CID)	1970	4-Bbl Carb	594-030
V8 - 6.6L (402 CID)	1975-71	-	594-030

Make/Model/Engine	Years	Description	Dorman #
CHEVROLET, GMC TRUCK (continued)			
CABALLERO, EL CAMINO, SPRINT (continued)			
V8 - 7.4L (454 CID)	1975-70	-	594-010
G SERIES VAN, EXPRESS, SAVANA			
L6 - 4.1L (250 CID)	1984-77	-	594-015
L6 - 4.1L (250 CID)	1976-75	-	594-029
L6 - 4.1L (250 CID)	1974-73	-	594-014
L6 - 4.1L (250 CID)	1972-67	wo/Air Cond Or Heavy Duty Cooling	594-014
L6 - 4.8L (292 CID)	1979-75	2-Groove Pulley	594-031
V6 - 4.3L (262 CID)	2006-96	-	594-181
V6 - 4.3L (262 CID)	1995	Under 8500 Lb GWW	594-047
V6 - 4.3L (262 CID)	1994-85	-	594-047
V8 - 5.0L (305 CID)	1995-77	-	594-012
V8 - 5.0L (305 CID)	1985-78	-	594-012
V8 - 5.0L (307 CID)	1973-69	-	594-156
V8 - 5.0L (307 CID)	2002-96	VIN R	594-121
V8 - 5.7L (350 CID)	1996	VIN K	594-002
V8 - 5.7L (350 CID)	1995-73	-	594-002
V8 - 5.7L (350 CID)	1972-71	-	594-012
V8 - 5.7L (350 CID)	1970	2-Bbl Carb	594-012
V8 - 5.7L (350 CID)	1970	4-Bbl Carb	594-002
V8 - 6.2L (379 CID)	1993-83	Diesel - Balancer	594-128
V8 - 6.5L (395 CID)	2002-94	Diesel - Balancer	594-170
V8 - 6.5L (395 CID)	2002-94	Diesel - Pulley	594-037
V8 - 6.6L (400 CID)	1980-75	-	594-016
V8 - 7.4L (454 CID)	1993-91	-	594-026
V8 - 7.4L (454 CID)	1990-74	-	594-010
MEDIUM DUTY CONVENTIONAL CAB			
L6 - 4.8L (292 CID)	1987-83	2-Groove Pulley	594-031
V8 - 5.7L (350 CID)	1990-83	-	594-002
MEDIUM DUTY FORWARD CONTROL			
L6 - 4.8L (292 CID)	1990	2-Groove Pulley	594-031
L6 - 4.8L (292 CID)	1989-79	2-Groove Pulley	594-031
V6 - 4.3L (262 CID)	1990	3-Groove Pulley	594-047
V6 - 4.3L (262 CID)	1989	-	594-047
P SERIES FORWARD CONTROL			
L6 - 4.1L (250 CID)	1979-77	-	594-015
L6 - 4.1L (250 CID)	1976-75	-	594-029
L6 - 4.1L (250 CID)	1974-73	-	594-014
L6 - 4.1L (250 CID)	1972-66	wo/Air Cond Or Heavy Duty Cooling	594-014
L6 - 4.8L (292 CID)	1989-75	2-Groove Pulley	594-031
V6 - 4.3L (262 CID)	1999-96	-	594-181
V6 - 4.3L (262 CID)	1994-90	-	594-047
V8 - 5.0L (305 CID)	1979	-	594-009
V8 - 5.0L (307 CID)	1969	-	594-156
V8 - 5.7L (350 CID)	1999-96	-	594-121
V8 - 5.7L (350 CID)	1995-87	-	594-002
V8 - 5.7L (350 CID)	1986-83	-	594-006
V8 - 5.7L (350 CID)	1982-80	Exc. Motorhome	594-006
V8 - 5.7L (350 CID)	1982-80	Motorhome	594-002
V8 - 5.7L (350 CID)	1979-78	-	594-006
V8 - 5.7L (350 CID)	1977	Exc. Motorhome	594-006
V8 - 5.7L (350 CID)	1977	Motorhome	594-002
V8 - 5.7L (350 CID)	1976-73	-	594-002
V8 - 5.7L (350 CID)	1972-71	-	594-012
V8 - 5.7L (350 CID)	1970	2-Bbl Carb	594-012
V8 - 5.7L (350 CID)	1970	4-Bbl Carb	594-002
V8 - 6.2L (379 CID)	1993-82	Diesel - Balancer	594-128
V8 - 6.5L (395 CID)	1999-94	Diesel - Balancer	594-170
V8 - 6.5L (395 CID)	1999-94	Diesel - Pulley	594-037
V8 - 6.6L (400 CID)	1980-76	-	594-016
V8 - 6.6L (400 CID)	1972	2-Bbl Carb	594-016
V8 - 6.6L (400 CID)	1972	4-Bbl Carb	594-030
V8 - 7.4L (454 CID)	1993-91	-	594-026
V8 - 7.4L (454 CID)	1990-70	-	594-010
S SERIES BLAZER, JIMMY			
V6 - 2.8L (173 CID)	1989-88	-	594-147
V6 - 2.8L (173 CID)	1987	-	594-013
V6 - 2.8L (173 CID)	1986-84	Stamped 4955	594-147
V6 - 2.8L (173 CID)	1986-84	Stamped 9033	594-013
V6 - 2.8L (173 CID)	1983	-	594-013
V6 - 4.3L (262 CID)	2005-95	-	594-181
V6 - 4.3L (262 CID)	1994-93	VIN W	594-047
V6 - 4.3L (262 CID)	1992-88	-	594-047
S SERIES PICKUP SONOMA, SYCLONE, TYPHOON			
V6 - 2.8L (173 CID)	1993-88	-	594-147
V6 - 2.8L (173 CID)	1987	-	594-013
V6 - 2.8L (173 CID)	1986-84	Stamped 4955	594-147
V6 - 2.8L (173 CID)	1986-84	Stamped 9033	594-013
V6 - 2.8L (173 CID)	1983-82	-	594-013
V6 - 4.3L (262 CID)	2004-95	-	594-181

Harmonic Balancers

Harmonic Balancer Applications

Make/ Model/Engine	Years	Description	Dorman #
CHEVROLET, GMC TRUCK (continued)			
S SERIES PICKUP, SONOMA, SYCLONE, TYPHOON (continued)			
V6 - 4.3L (262 CID)	1994-93	VIN W	594-047
V6 - 4.3L (262 CID)	1992-88	-	594-047
SCHOOL BUS			
L6 - 4.8L (292 CID)	1983	2-Groove Pulley	594-031
V8 - 5.7L (350 CID)	1991-83	-	594-002
V8 - 6.5L (395 CID)	1998-97	Diesel - Balancer	594-170
V8 - 6.5L (395 CID)	1998-97	Diesel - Pulley	594-037
SIERRA			
V6 - 4.3L (262 CID)	2006-99	-	594-181
SILVERADO			
V6 - 4.3L (262 CID)	2006-99	-	594-181
SUBURBAN			
L6 - 4.1L (250 CID)	1980-77	-	594-015
L6 - 4.1L (250 CID)	1976-75	-	594-029
L6 - 4.1L (250 CID)	1974-73	-	594-014
L6 - 4.1L (250 CID)	1972-66	wo/Air Cond Or Heavy Duty Cooling	594-014
L6 - 4.8L (292 CID)	1986-75	2-Groove Pulley	594-031
V8 - 5.0L (305 CID)	1987-85	-	594-009
V8 - 5.0L (305 CID)	1984-77	-	594-006
V8 - 5.0L (305 CID)	1976	-	594-012
V8 - 5.0L (307 CID)	1973-69	-	594-156
V8 - 5.7L (350 CID)	1999-96	-	594-121
V8 - 5.7L (350 CID)	1995-87	-	594-002
V8 - 5.7L (350 CID)	1986-82	-	594-006
V8 - 5.7L (350 CID)	1981-78	VIN L,M,P	594-006
V8 - 5.7L (350 CID)	1977	-	594-006
V8 - 5.7L (350 CID)	1976-75	-	594-002
V8 - 5.7L (350 CID)	1974	VIN VY	594-002
V8 - 5.7L (350 CID)	1974	VIN W	594-012
V8 - 5.7L (350 CID)	1973	-	594-002
V8 - 5.7L (350 CID)	1972-71	-	594-012
V8 - 5.7L (350 CID)	1970-69	2-Bbl Carb	594-012
V8 - 5.7L (350 CID)	1970-69	4-Bbl Carb	594-002
V8 - 6.2L (379 CID)	1993-82	Diesel - Balancer	594-128
V8 - 6.5L (395 CID)	1999-94	Diesel - Balancer	594-170
V8 - 6.5L (395 CID)	1999-94	Diesel - Pulley	594-037
V8 - 6.5L (395 CID)	1993-92	Diesel - Balancer	594-128
V8 - 6.5L (396 CID)	1969-68	-	594-030
V8 - 6.6L (400 CID)	1980-75	-	594-016
V8 - 6.6L (400 CID)	1972-70	2-Bbl Carb	594-016
V8 - 6.6L (400 CID)	1972-70	4-Bbl Carb	594-030
V8 - 7.4L (454 CID)	1993-91	-	594-026
V8 - 7.4L (454 CID)	1990-73	-	594-010
CHRYSLER			
300M			
V6 - 3.5L (215 CID)	2004-99	-	594-183
CIRRUS			
V6 - 2.5L (152 CID)	2000-95	-	594-186
CONCORDE			
V6 - 3.2L (197 CID)	2001-98	-	594-183
V6 - 3.3L (201 CID)	1996-93	-	594-169
V6 - 3.5L (215 CID)	2004-93	-	594-183
CORDOBA			
V8 - 5.2L (318 CID)	1983-75	-	594-021
V8 - 5.9L (360 CID)	1979	-	594-132
FIFTH AVENUE			
V8 - 5.2L (318 CID)	1989-83	-	594-021
IMPERIAL			
V6 - 3.3L (201 CID)	1991-90	-	594-103
V6 - 3.8L (230 CID)	1993-91	-	594-103
V8 - 5.2L (318 CID)	1983-81	-	594-021
LEBARON			
V6 - 3.0L (181 CID)	1995-90	-	594-130
V8 - 5.2L (318 CID)	1981-77	-	594-021
V8 - 5.9L (360 CID)	1979	-	594-132
LHS			
V6 - 3.5L (215 CID)	2001-94	-	594-183
NEW YORKER			
V6 - 3.0L (181 CID)	1989-88	-	594-130
V6 - 3.3L (201 CID)	1993-90	-	594-103
V6 - 3.5L (215 CID)	1996-94	-	594-183
V6 - 3.8L (230 CID)	1993-91	-	594-103
V8 - 5.2L (318 CID)	1982-79	-	594-021
V8 - 5.9L (360 CID)	1980-79	-	594-132
NEWPORT			
V8 - 5.2L (318 CID)	1981-79	-	594-021
V8 - 5.9L (360 CID)	1980-79	-	594-132
PROWLER			
V6 - 3.5L (215 CID)	2002	-	594-183

Make/ Model/Engine	Years	Description	Dorman #
CHRYSLER (continued)			
PT CRUISER			
L4 - 2.4L (148 CID)	2003-01	-	594-185
SEBRING			
V6 - 2.5L (152 CID)	2000-96	-	594-186
V6 - 3.0L (181 CID)	2005-01	-	594-176
TOWN & COUNTRY			
V8 - 5.2L (318 CID)	1981-78	-	594-021
V8 - 5.9L (360 CID)	1979	-	594-132
TOWN & COUNTRY VAN			
V6 - 3.3L (201 CID)	2006-90	-	594-103
V6 - 3.8L (230 CID)	2006-94	-	594-103
VOYAGER, GRAND VOYAGER			
V6 - 3.0L (181 CID)	2000	-	594-130
V6 - 3.3L (201 CID)	2003-00	-	594-103
DODGE			
ASPEN			
V8 - 5.2L (318 CID)	1980-76	-	594-021
V8 - 5.9L (360 CID)	1980-79	-	594-132
AVENGER			
V6 - 2.5L (152 CID)	1999-95	-	594-186
CARAVAN, GRAND CARAVAN			
V6 - 3.3L (201 CID)	2006-90	-	594-103
V6 - 3.8L (230 CID)	2006-94	-	594-103
CARAVAN, GRAND CARAVAN, MINI RAM VAN, ROYAL MINI RAM			
V6 - 3.0L (181 CID)	2000-87	-	594-130
CHALLENGER			
V8 - 5.2L (318 CID)	1974-72	-	594-021
V8 - 5.6L (340 CID)	1972	w/Forged Steel Crankshaft	594-021
CHARGER			
V8 - 5.2L (318 CID)	1978-72	-	594-021
V8 - 5.6L (340 CID)	1972	w/Forged Steel Crankshaft	594-021
CORONET			
V8 - 5.2L (318 CID)	1976-72	-	594-021
V8 - 5.6L (340 CID)	1972	w/Forged Steel Crankshaft	594-021
DART			
V8 - 5.2L (318 CID)	1976-72	-	594-021
V8 - 5.6L (340 CID)	1972	w/Forged Steel Crankshaft	594-021
DAYTONA			
V6 - 3.0L (181 CID)	1993-90	-	594-130
DIPLOMAT			
V8 - 5.2L (318 CID)	1989-77	-	594-021
V8 - 5.9L (360 CID)	1979	-	594-132
DYNASTY			
V6 - 3.0L (181 CID)	1993-88	-	594-130
V6 - 3.3L (201 CID)	1993-90	-	594-103
INTREPID			
V6 - 3.2L (197 CID)	2001-98	-	594-183
V6 - 3.3L (201 CID)	1997-93	-	594-169
V6 - 3.5L (215 CID)	2004-93	-	594-183
MAGNUM			
V8 - 5.2L (318 CID)	1979-78	-	594-021
V8 - 5.9L (360 CID)	1979	-	594-132
MIRADA			
V8 - 5.2L (318 CID)	1983-80	-	594-021
V8 - 5.9L (360 CID)	1980	-	594-132
MONACO			
V8 - 5.2L (318 CID)	1978-75	-	594-021
NEON			
L4 - 2.0L (122 CID)	2003-00	-	594-185
L4 - 2.0L (122 CID)	1999-96	-	594-101
L4 - 2.0L (122 CID)	1995	SOHC	594-101
L4 - 2.4L (148 CID)	2003	-	594-185
POLARA			
V8 - 5.2L (318 CID)	1973-72	-	594-021
ROYAL MONACO			
V8 - 5.2L (318 CID)	1977-75	-	594-021
SHADOW			
V6 - 3.0L (181 CID)	1994-92	-	594-130
SPIRIT			
V6 - 3.0L (181 CID)	1995-89	-	594-130
ST. REGIS			
V8 - 5.2L (318 CID)	1981-79	-	594-021
V8 - 5.9L (360 CID)	1980-79	-	594-132
STEALTH			
V6 - 3.0L (2972 cc)	1996-91	SOHC	594-144
STRATUS			
L4 - 2.0L (122 CID)	1995	-	594-101
V6 - 2.5L (152 CID)	2000-95	-	594-186
V6 - 3.0L (181 CID)	2005-01	-	594-176

Harmonic Balancer Applications

Make/ Model/Engine	Years	Description	Dorman #
DODGE TRUCK			
B SERIES VAN			
V6 - 3.9L (239 CID)	1991-88	-	594-021
V8 - 5.2L (318 CID)	1993-72	-	594-021
V8 - 5.9L (360 CID)	1998-95	-	594-133
V8 - 5.9L (360 CID)	1993-79	Auto Trans	594-132
V8 - 5.9L (360 CID)	1993-79	Manual Trans	594-131
CB300 CUTAWAY CAB			
V8 - 5.2L (318 CID)	1980-74	-	594-021
V8 - 5.9L (360 CID)	1980-79	Auto Trans	594-132
V8 - 5.9L (360 CID)	1980-79	Manual Trans	594-131
D,W SERIES PICKUP			
V6 - 3.9L (239 CID)	1991-88	-	594-021
V8 - 5.2L (318 CID)	1993-72	-	594-021
V8 - 5.9L (360 CID)	1993-79	Auto Trans	594-132
V8 - 5.9L (360 CID)	1993-79	Manual Trans	594-131
DAKOTA			
V6 - 3.7L (226 CID)	2006-04	-	594-191
V6 - 3.9L (239 CID)	1991-87	-	594-021
V8 - 4.7L (287 CID)	2006-00	-	594-191
V8 - 5.2L (318 CID)	1993-89	-	594-021
V8 - 5.9L (360 CID)	2003-98	-	594-133
DURANGO			
V6 - 3.7L (226 CID)	2006-04	-	594-191
V8 - 4.7L (287 CID)	2006-00	-	594-191
V8 - 5.9L (360 CID)	2003-98	-	594-133
RAIDER			
V6 - 3.0L (2972 cc)	1989	-	594-164
RAM 1500 PICKUP			
V6 - 3.7L (226 CID)	2006-02	-	594-191
V8 - 4.7L (287 CID)	2006-02	-	594-191
RAM 50 PICKUP			
V6 - 3.0L (2972 cc)	1991-90	-	594-164
RAM SERIES PICKUP			
V8 - 5.9L (360 CID)	2003-94	-	594-133
RAM SERIES VAN			
V8 - 5.9L (360 CID)	2003-99	-	594-133
RAMCHARGER			
V8 - 5.2L (318 CID)	1993-74	-	594-021
V8 - 5.9L (360 CID)	1993-79	Auto Trans	594-132
V8 - 5.9L (360 CID)	1993-79	Manual Trans	594-131
EAGLE			
SUMMIT			
L4 - 2.4L (2351 cc)	1993	-	594-106
TALON			
L4 - 1.8L (107 CID)	1994-93	-	594-168
L4 - 2.0L (122 CID)	1994-90	-	594-106
VISION			
V6 - 3.3L (201 CID)	1997-93	-	594-169
V6 - 3.5L (215 CID)	1997-93	-	594-183
FORD			
CONTOUR			
V6 - 2.5L (155 CID)	2000-95	-	594-109
COUNTRY SEDAN			
V8 - 5.0L (302 CID)	1972	-	594-023
V8 - 5.0L (302 CID)	1971-70	Exc. Hi-Perf	594-023
COUNTRY SQUIRE			
V8 - 5.0L (302 CID)	1991-84	-	594-024
V8 - 5.0L (302 CID)	1979	-	594-023
V8 - 5.0L (302 CID)	1972	-	594-023
V8 - 5.0L (302 CID)	1971-70	Exc. Hi-Perf	594-023
V8 - 5.8L (351 CID)	1987-83	-	594-011
V8 - 5.8L (351 CID)	1979-77	351M Eng	594-083
V8 - 5.8L (351 CID)	1976-75	351M Eng, wo/Air Cond	594-083
CROWN VICTORIA			
V8 - 4.6L (281 CID)	2000-93	-	594-081
V8 - 4.6L (281 CID)	1992	From 6/22/92	594-081
V8 - 5.0L (302 CID)	1991-84	-	594-024
V8 - 5.8L (351 CID)	1991-83	-	594-011
CUSTOM, CUSTOM 500			
V8 - 5.0L (302 CID)	1972	-	594-023
V8 - 5.0L (302 CID)	1971-70	Exc. Hi-Perf	594-023
V8 - 5.8L (351 CID)	1977	351M Eng	594-083
V8 - 5.8L (351 CID)	1976-75	351M Eng, wo/Air Cond	594-083
ESCORT			
L4 - 1.9L (116 CID)	1996-91	-	594-033
L4 - 2.0L (122 CID)	2002	SOHC	594-118
L4 - 2.0L (122 CID)	2001-97	SOHC	594-033
FAIRLANE			
V8 - 5.0L (302 CID)	1971-70	Exc. Hi-Perf	594-023

Make/ Model/Engine	Years	Description	Dorman #
FORD (continued)			
FAIRMONT			
V8 - 5.0L (302 CID)	1980	wo/EEC	594-023
FALCON			
V8 - 5.0L (302 CID)	1970	-	594-023
FOCUS			
L4 - 2.0L (122 CID)	2004-02	SOHC	594-118
L4 - 2.0L (122 CID)	2001-00	SOHC	594-033
GALAXIE, GALAXIE 500			
V8 - 5.0L (302 CID)	1972	-	594-023
V8 - 5.0L (302 CID)	1971-70	Exc. Hi-Perf	594-023
GRAN TORINO			
V8 - 5.0L (302 CID)	1974-72	-	594-023
V8 - 5.8L (351 CID)	1976-75	351M Eng	594-083
GRANADA			
V8 - 5.0L (302 CID)	1980	wo/EEC	594-023
V8 - 5.0L (302 CID)	1979-75	-	594-023
V8 - 5.8L (351 CID)	1977-75	351M Eng	594-083
LTD			
V8 - 5.0L (302 CID)	1985-84	-	594-024
V8 - 5.0L (302 CID)	1980	wo/EEC	594-023
V8 - 5.0L (302 CID)	1979-77	-	594-023
V8 - 5.0L (302 CID)	1972	-	594-023
V8 - 5.0L (302 CID)	1971-70	Exc. Hi-Perf	594-023
V8 - 5.8L (351 CID)	1982	-	594-011
V8 - 5.8L (351 CID)	1979	351M Eng	594-083
V8 - 5.8L (351 CID)	1978	351M Eng, Auto Trans	594-083
V8 - 5.8L (351 CID)	1977	351M Eng	594-083
V8 - 5.8L (351 CID)	1976-75	351M Eng, wo/Air Cond	594-083
LTD II			
V8 - 5.0L (302 CID)	1979-77	-	594-023
V8 - 5.8L (351 CID)	1979	351M Eng	594-083
V8 - 5.8L (351 CID)	1978	351M Eng, Auto Trans	594-083
V8 - 5.8L (351 CID)	1977	351M Eng	594-083
MAVERICK			
V8 - 5.0L (302 CID)	1977-70	-	594-023
MUSTANG, MUSTANG II			
V6 - 3.8L (232 CID)	1995-94	-	594-051
V8 - 4.6L (281 CID)	2002-96	DOHC	594-110
V8 - 4.6L (281 CID)	2000-96	SOHC	594-081
V8 - 5.0L (302 CID)	1995-84	-	594-024
V8 - 5.0L (302 CID)	1973-72	-	594-023
V8 - 5.0L (302 CID)	1971-70	Exc. Hi-Perf	594-023
PROBE			
L4 - 2.0L (122 CID)	1995-93	-	594-134
V6 - 2.5L (152 CID)	1997-93	-	594-120
V6 - 3.0L (182 CID)	1992-90	-	594-180
RANCH WAGON			
V8 - 5.0L (302 CID)	1972	-	594-023
V8 - 5.0L (302 CID)	1971-70	Exc. Hi-Perf	594-023
V8 - 5.8L (351 CID)	1976	351M Eng	594-083
RANCHERO			
V8 - 5.0L (302 CID)	1979-72	-	594-023
V8 - 5.0L (302 CID)	1971-70	Exc. Hi-Perf	594-023
V8 - 5.8L (351 CID)	1979	351M Eng	594-083
V8 - 5.8L (351 CID)	1978	351M Eng, Auto Trans	594-083
V8 - 5.8L (351 CID)	1977-75	351M Eng	594-083
TAURUS			
V6 - 3.0L (182 CID)	2006-96	12 Valve	594-125
V6 - 3.0L (182 CID)	2006-96	24 Valve DOHC, Balancer	594-108
V6 - 3.0L (182 CID)	2006-96	24 Valve DOHC, Pulley	594-050
V6 - 3.0L (182 CID)	2006-96	Flex Fuel	594-125
V6 - 3.0L (182 CID)	1995	Exc. SHO	594-125
V6 - 3.0L (182 CID)	1994-90	Exc. SHO	594-086
V6 - 3.0L (182 CID)	1989	Exc. SHO	594-084
V6 - 3.0L (182 CID)	1988-86	-	594-084
V6 - 3.2L (195 CID)	1995-93	SHO	594-123
V6 - 3.8L (232 CID)	1995-90	-	594-149
V8 - 3.4L (207 CID)	1999-96	-	594-082
TEMPO			
L4 - 2.3L (140 CID)	1994-92	-	594-007
THUNDERBIRD			
V6 - 3.8L (232 CID)	1997-96	-	594-051
V6 - 3.8L (232 CID)	1995-94	Exc. Supercharged, Calif	594-051
V8 - 4.6L (281 CID)	1997-94	-	594-081
V8 - 5.0L (302 CID)	1993-85	-	594-024
V8 - 5.0L (302 CID)	1984	Calif, From 2/1/84	594-024
V8 - 5.0L (302 CID)	1984	Exc. Calif	594-024
V8 - 5.0L (302 CID)	1980	wo/EEC, To 12/2/79	594-023
V8 - 5.0L (302 CID)	1979-77	-	594-023
V8 - 5.8L (351 CID)	1979	351M Eng	594-083

Harmonic Balancers

Clock Springs
pg. 21-24

Control Arms
pg. 25-54

CV Joint Boots & Accessories
pg. 55-66

Door Lock Actuators
pg. 67-72

Exhaust Manifold Kits
pg. 73-134

Dorman® Balancers Include New Woodruff Keys (where required)

Harmonic Balancers

Harmonic Balancer Applications

Make/ Model/Engine	Years	Description	Dorman #
FORD (continued)			
THUNDERBIRD (continued)			
V8 - 5.8L (351 CID)	1978	351M Eng, Auto Trans	594-083
V8 - 5.8L (351 CID)	1977-75	351M Eng	594-083
TORINO			
V8 - 5.0L (302 CID)	1974-72	-	594-023
V8 - 5.0L (302 CID)	1971-70	Exc. Hi-Perf	594-023
V8 - 5.8L (351 CID)	1976-75	351M Eng	594-083
FORD TRUCK			
AEROSTAR			
V6 - 3.0L (182 CID)	1997-95	-	594-125
V6 - 3.0L (182 CID)	1994-90	-	594-086
V6 - 3.0L (182 CID)	1989-86	-	594-084
V6 - 4.0L (245 CID)	1997-90	-	594-111
BRONCO			
L6 - 4.9L (300 CID)	1992-90	-	594-152
L6 - 4.9L (300 CID)	1989-87	Single Serpentine Pulley	594-152
L6 - 4.9L (300 CID)	1989-87	Triple Pulley	594-077
L6 - 4.9L (300 CID)	1986-82	-	594-077
V8 - 5.0L (302 CID)	1995-84	-	594-024
V8 - 5.0L (302 CID)	1981	Exc. Calif	594-019
V8 - 5.0L (302 CID)	1980	-	594-023
V8 - 5.8L (351 CID)	1996-85	-	594-011
V8 - 5.8L (351 CID)	1981-79	351M Eng	594-083
V8 - 5.8L (351 CID)	1978	351M Eng, Auto Trans	594-083
BRONCO II			
V6 - 2.9L (177 CID)	1990	-	594-102
E SERIES ECONOLINE VAN			
L6 - 4.9L (300 CID)	1996-90	-	594-152
L6 - 4.9L (300 CID)	1989-87	Single Serpentine Pulley	594-152
L6 - 4.9L (300 CID)	1989-87	Triple Pulley	594-077
L6 - 4.9L (300 CID)	1986-82	-	594-077
L6 - 4.9L (300 CID)	1981-80	Calif	594-077
V8 - 4.6L (281 CID)	2006-97	-	594-189
V8 - 5.0L (302 CID)	1995-84	-	594-024
V8 - 5.0L (302 CID)	1981	Exc. Calif	594-019
V8 - 5.0L (302 CID)	1980-75	-	594-023
V8 - 5.4L (330 CID)	2000-97	-	594-112
V8 - 5.8L (351 CID)	1996-85	-	594-011
V8 - 5.8L (351 CID)	1981-79	351M Eng	594-083
V8 - 5.8L (351 CID)	1978	351M Eng, Auto Trans	594-083
V8 - 5.8L (351 CID)	1977	351M Eng	594-083
V8 - 7.3L (445 CID)	2003-96	-	594-124
V8 - 7.3L (445 CID)	1995	8 Ribs	594-124
V8 - 7.3L (445 CID)	1994-93	Diesel, wo/Turbo	594-085
V8 - 7.3L (445 CID)	1992-88	Diesel	594-085
V8 - 7.5L (460 CID)	1995-80	-	594-080
V10 - 6.8L (415 CID)	2000	-	594-119
E SERIES SUPER DUTY VAN			
L6 - 4.9L (300 CID)	1996	-	594-152
V8 - 5.4L (330 CID)	2000-97	-	594-112
V8 - 7.3L (445 CID)	2002-96	-	594-124
V10 - 6.8L (415 CID)	2000	-	594-119
ESCAPE			
V6 - 3.0L (182 CID)	2006-01	-	594-109
EXCURSION			
V8 - 5.4L (330 CID)	2000	-	594-112
V8 - 7.3L (445 CID)	2003-00	-	594-124
V10 - 6.8L (415 CID)	2000	-	594-119
EXPEDITION			
V8 - 4.6L (281 CID)	2002-97	-	594-189
V8 - 5.4L (330 CID)	2000-97	-	594-112
EXPLORER			
V6 - 4.0L (245 CID)	2006-91	-	594-111
V8 - 5.0L (302 CID)	2001-96	-	594-155
F SERIES PICKUP			
L6 - 4.9L (300 CID)	1995-90	-	594-152
L6 - 4.9L (300 CID)	1989-87	Single Serpentine Pulley	594-152
L6 - 4.9L (300 CID)	1989-87	Triple Pulley	594-077
L6 - 4.9L (300 CID)	1986-82	-	594-077
L6 - 4.9L (300 CID)	1981-80	Calif	594-077
V8 - 4.6L (281 CID)	2003-00	2WD (6 Groove Pulley)	594-081
V8 - 4.6L (281 CID)	2003-00	4WD	594-189
V8 - 4.6L (281 CID)	1999-97	Romeo Eng, 2WD (6 Groove Pulley)	594-081
V8 - 4.6L (281 CID)	1999-97	Romeo Eng, 4WD	594-189
V8 - 4.6L (281 CID)	1999-97	Windsor Eng	594-189
V8 - 5.0L (302 CID)	1995-84	-	594-024
V8 - 5.0L (302 CID)	1981	Exc. Calif	594-019
V8 - 5.0L (302 CID)	1980-69	-	594-023
V8 - 5.4L (330 CID)	2000-99	Exc. Lightning	594-112
V8 - 5.8L (351 CID)	1997-85	-	594-011

Make/ Model/Engine	Years	Description	Dorman #
FORD TRUCK (continued)			
F SERIES PICKUP (continued)			
V8 - 5.8L (351 CID)	1981-79	351M Eng	594-083
V8 - 5.8L (351 CID)	1978	351M Eng, Auto Trans	594-083
V8 - 5.8L (351 CID)	1977	351M Eng	594-083
V8 - 5.9L (360 CID)	1976-73	-	594-146
V8 - 6.4L (390 CID)	1976-73	-	594-146
V8 - 7.3L (445 CID)	2003-96	-	594-124
V8 - 7.3L (445 CID)	1995	8 Ribs	594-124
V8 - 7.3L (445 CID)	1994-93	Diesel, wo/Turbo	594-085
V8 - 7.3L (445 CID)	1992-88	Diesel	594-085
V8 - 7.5L (460 CID)	1995-83	-	594-080
V10 - 6.8L (415 CID)	2000	-	594-119
F SERIES STRIPPED CHASSIS			
V8 - 7.3L (445 CID)	1996	-	594-124
V8 - 7.3L (445 CID)	1995	8 Ribs	594-124
M-450			
V8 - 5.4L (330 CID)	1976-75	-	594-145
V8 - 5.9L (360 CID)	1975	-	594-146
V8 - 6.4L (390 CID)	1975	-	594-146
MEDIUM DUTY			
V8 - 5.4L (330 CID)	1974-73	-	594-145
P-350			
V8 - 5.9L (360 CID)	1973	-	594-146
V8 - 6.4L (390 CID)	1973	-	594-146
P350 FORWARD CONTROL			
V8 - 5.0L (302 CID)	1976-73	-	594-023
RANGER			
V6 - 2.9L (177 CID)	1992-90	-	594-102
V6 - 3.0L (182 CID)	2006-95	-	594-125
V6 - 3.0L (182 CID)	1994-91	-	594-086
V6 - 4.0L (245 CID)	2000-90	-	594-111
WINDSTAR			
V6 - 3.0L (182 CID)	2000-95	-	594-125
V6 - 3.8L (232 CID)	1999-96	-	594-178
V6 - 3.8L (232 CID)	1995	-	594-051
GMC TRUCK			
See CHEVROLET, GMC TRUCK			
HONDA			
ACCORD			
L4 - 2.2L (2156 cc)	1997-94	-	594-067
L4 - 2.2L (2156 cc)	1993-90	-	594-068
L4 - 2.3L (2254 cc)	2002-01	Manual Trans (USA Built)	594-187
L4 - 2.3L (2254 cc)	2000-99	USA Built	594-187
L4 - 2.3L (2254 cc)	1998	-	594-187
CIVIC			
L4 - 1.7L (1668 cc)	2005-01	-	594-192
ODYSSEY			
L4 - 2.2L (2156 cc)	1997-95	-	594-067
PASSPORT			
V6 - 3.2L (3165 cc)	1997-94	-	594-162
PRELUDE			
L4 - 2.2L (2156 cc)	1996-93	Exc. VTEC	594-068
L4 - 2.2L (2156 cc)	1992	-	594-068
L4 - 2.3L (2259 cc)	1996-92	-	594-068
HYUNDAI			
ACCENT			
L4 - 1.5L (1495 cc)	1999-95	DOHC	594-053
L4 - 1.5L (1495 cc)	1999-95	SOHC	594-052
L4 - 1.6L (1600 cc)	2005-01	-	594-053
ELANTRA			
L4 - 1.6L (1596 cc)	1995-92	-	594-055
EXCEL			
L4 - 1.5L (1468 cc)	1994-90	-	594-054
SCOUPE			
L4 - 1.5L (1468 cc)	1992-91	-	594-054
L4 - 1.5L (1495 cc)	1995-94	-	594-052
L4 - 1.5L (1495 cc)	1993	From 11/15/92	594-070
L4 - 1.5L (1495 cc)	1993	To 11/15/92	594-069
SONATA			
L4 - 2.0L (1997 cc)	1998-95	-	594-055
V6 - 3.0L (2972 cc)	1998-90	-	594-071
INFINITI			
I30			
V6 - 3.0L (2988 cc)	2001-96	-	594-188
ISUZU TRUCK			
RODEO			
V6 - 3.2L (3165 cc)	1997-94	-	594-162
JEEP			
CHEROKEE			
L4 - 2.5L (150 CID)	1990-87	-	594-137
L4 - 2.5L (150 CID)	1986-84	w/Serpentine Belt	594-137

Harmonic Balancer Applications

Make/Model/Engine	Years	Description	Dorman #
JEEP (continued)			
CHEROKEE (continued)			
L6 - 4.0L (242 CID)	2000-87	-	594-018
L6 - 4.2L (258 CID)	1983-81	Built In Mexico (15th Digit Of VIN = M)	594-022
L6 - 4.2L (258 CID)	1980-75	-	594-022
V6 - 2.8L (173 CID)	1986-84	-	594-018
V8 - 5.9L (360 CID)	1983-75	-	594-135
CJ5, CJ6, CJ7 SERIES			
L6 - 4.2L (258 CID)	1983-81	Built In Mexico (15th Digit Of VIN = M)	594-022
L6 - 4.2L (258 CID)	1980-75	-	594-022
V6 - 3.8L (232 CID)	1978-75	-	594-022
CJ7			
L4 - 2.5L (150 CID)	1986-84	w/Serpentine Belt	594-137
COMANCHE			
L4 - 2.5L (150 CID)	1990-87	-	594-137
L4 - 2.5L (150 CID)	1986	w/Serpentine Belt	594-137
L6 - 4.0L (242 CID)	1992-87	-	594-018
V6 - 2.8L (173 CID)	1986	-	594-018
COMMANDER			
V6 - 3.7L (226 CID)	2006	-	594-191
V8 - 4.7L (287 CID)	2006	-	594-191
GRAND CHEROKEE			
L6 - 4.0L (242 CID)	2000-93	-	594-018
V6 - 3.7L (226 CID)	2006-05	-	594-191
V8 - 4.7L (287 CID)	2006-00	-	594-191
V8 - 5.9L (360 CID)	1998	-	594-135
GRAND WAGONEER			
L6 - 4.2L (258 CID)	1986-84	Built In Mexico (15th Digit Of VIN = M)	594-022
V8 - 5.9L (360 CID)	1991-84	-	594-135
JSERIES TRUCK			
L6 - 4.2L (258 CID)	1986-81	Built In Mexico (15th Digit Of VIN = M)	594-022
L6 - 4.2L (258 CID)	1980-75	-	594-022
J10			
V8 - 5.9L (360 CID)	1988-75	-	594-135
J20			
V8 - 5.9L (360 CID)	1988-75	-	594-135
LIBERTY			
V6 - 3.7L (226 CID)	2006-03	-	594-191
SCRAMBLER			
L4 - 2.5L (150 CID)	1985-84	w/Serpentine Belt	594-137
L6 - 4.2L (258 CID)	1985-81	Built In Mexico (15th Digit Of VIN = M)	594-022
WAGONEER			
L4 - 2.5L (150 CID)	1987	-	594-137
L4 - 2.5L (150 CID)	1986-84	w/Serpentine Belt	594-137
L6 - 4.0L (242 CID)	1990-87	-	594-018
L6 - 4.2L (258 CID)	1983-81	Built In Mexico (15th Digit Of VIN = M)	594-022
L6 - 4.2L (258 CID)	1980	-	594-022
V6 - 2.8L (173 CID)	1986-84	-	594-018
V8 - 5.9L (360 CID)	1983-75	-	594-135
WRANGLER			
L6 - 4.0L (242 CID)	2000-91	-	594-018
LEXUS			
ES300			
V6 - 3.0L (2959 cc)	1998-97	Built In Japan	594-140
V6 - 3.0L (2959 cc)	1996	-	594-140
V6 - 3.0L (2995 cc)	2004-99	Built In Japan	594-140
V6 - 3.0L (2995 cc)	1995-94	-	594-140
ES330			
V6 - 3.3L (3300 cc)	2005-04	-	594-140
RX300			
V6 - 3.0L (2995 cc)	2003-99	Built In Japan	594-140
RX330			
V6 - 3.3L (3300 cc)	2005-04	-	594-140
RX400H			
V6 - 3.3L (3300 cc)	2006	-	594-140
LINCOLN			
CONTINENTAL			
V6 - 3.8L (232 CID)	1994-90	-	594-149
V8 - 5.0L (302 CID)	1987-85	-	594-024
V8 - 5.0L (302 CID)	1984	Exc. Calif	594-024
V8 - 5.0L (302 CID)	1980	wo/EEC	594-023
MARK SERIES			
V8 - 5.0L (302 CID)	1992-85	-	594-024
V8 - 5.0L (302 CID)	1984	Exc. Calif	594-024
V8 - 5.0L (302 CID)	1980	wo/EEC	594-023
NAVIGATOR			
V8 - 5.4L (330 CID)	2000-98	Exc. 4-Valve	594-112
TOWN CAR			
V8 - 4.6L (281 CID)	2000-93	-	594-081
V8 - 4.6L (281 CID)	1992	From 6/22/92	594-081
V8 - 5.0L (302 CID)	1990-84	-	594-024

Make/Model/Engine	Years	Description	Dorman #
LINCOLN (continued)			
VERSAILLES			
V8 - 5.0L (302 CID)	1980-77	wo/EEC	594-023
V8 - 5.8L (351 CID)	1977	351M Eng	594-083
MAZDA			
626			
L4 - 2.0L (1991 cc)	2002-98	-	594-184
L4 - 2.0L (1991 cc)	1997-96	Auto Trans	594-184
L4 - 2.0L (1991 cc)	1997-96	Manual Trans	594-193
L4 - 2.0L (1991 cc)	1995-93	-	594-134
V6 - 2.5L (2497 cc)	1997-93	-	594-120
MILLENNIA			
V6 - 2.5L (2497 cc)	2002-95	-	594-120
MPV			
V6 - 2.5L (2497 cc)	2001-00	-	594-109
MX-6			
L4 - 2.0L (1991 cc)	1997-96	Auto Trans	594-184
L4 - 2.0L (1991 cc)	1997-96	Manual Trans	594-193
L4 - 2.0L (1991 cc)	1995-93	-	594-134
V6 - 2.5L (2497 cc)	1997-93	-	594-120
PROTEGE			
L4 - 1.8L (1839 cc)	2000-99	-	594-184
L4 - 2.0L (2000 cc)	2003-01	-	594-184
PROTEGE 5			
L4 - 2.0L (1975 cc)	2003-02	-	594-184
TRIBUTE			
V6 - 3.0L (2954 cc)	2005-01	-	594-109
MERCURY			
CAPRI			
V8 - 5.0L (302 CID)	1986-84	-	594-024
COLONY PARK			
V8 - 5.0L (302 CID)	1991-84	-	594-024
V8 - 5.0L (302 CID)	1979	-	594-023
V8 - 5.8L (351 CID)	1979	351M Eng	594-083
COMET			
V8 - 5.0L (302 CID)	1977-71	-	594-023
COUGAR			
V6 - 2.5L (155 CID)	2002-99	-	594-109
V6 - 3.8L (232 CID)	1997-96	-	594-051
V6 - 3.8L (232 CID)	1995-94	Calif	594-051
V8 - 4.6L (281 CID)	1997-94	-	594-081
V8 - 5.0L (302 CID)	1993-85	-	594-024
V8 - 5.0L (302 CID)	1984	Calif, From 2/1/84	594-024
V8 - 5.0L (302 CID)	1984	Exc. Calif	594-024
V8 - 5.0L (302 CID)	1980	wo/EEC, To 12/2/79	594-023
V8 - 5.0L (302 CID)	1979-77	-	594-023
V8 - 5.0L (302 CID)	1971-70	Exc. Hi-Perf	594-023
V8 - 5.8L (351 CID)	1979	351M Eng	594-083
V8 - 5.8L (351 CID)	1978	351M Eng, Auto Trans	594-083
V8 - 5.8L (351 CID)	1977	351M Eng	594-083
V8 - 5.8L (351 CID)	1976-75	351M Eng, wo/Air Cond	594-083
CYCLONE			
V8 - 5.0L (302 CID)	1971-70	-	594-023
GRAND MARQUIS			
V8 - 4.6L (281 CID)	2000-93	-	594-081
V8 - 4.6L (281 CID)	1992	From 6/22/92	594-081
V8 - 5.0L (302 CID)	1991-84	-	594-024
V8 - 5.0L (302 CID)	1980	wo/EEC	594-023
V8 - 5.0L (302 CID)	1979	-	594-023
V8 - 5.8L (351 CID)	1979	351M Eng	594-083
V8 - 5.8L (351 CID)	1978	351M Eng, Auto Trans	594-083
MARINER			
V6 - 3.0L (182 CID)	2006-05	-	594-109
MARQUIS			
V8 - 5.0L (302 CID)	1980	wo/EEC	594-023
V8 - 5.0L (302 CID)	1979	-	594-023
V8 - 5.0L (302 CID)	1971-70	Exc. Hi-Perf	594-023
V8 - 5.8L (351 CID)	1982	-	594-011
V8 - 5.8L (351 CID)	1979	351M Eng	594-083
V8 - 5.8L (351 CID)	1978	351M Eng, Auto Trans	594-083
V8 - 5.8L (351 CID)	1977	351M Eng	594-083
V8 - 5.8L (351 CID)	1976-75	351M Eng, wo/Air Cond	594-083
MONARCH			
V8 - 5.0L (302 CID)	1980	wo/EEC	594-023
V8 - 5.0L (302 CID)	1979-75	-	594-023
V8 - 5.8L (351 CID)	1977-75	351M Eng	594-083
MONTEGO			
V8 - 5.0L (302 CID)	1974-72	-	594-023
V8 - 5.0L (302 CID)	1971-70	Exc. Hi-Perf	594-023
V8 - 5.8L (351 CID)	1976-75	351M Eng, wo/Air Cond	594-083
MONTEREY			
V8 - 5.0L (302 CID)	1971-70	Exc. Hi-Perf	594-023

Harmonic Balancers

Fuel Sending Units
pg. 155-176

Fuel Tanks
pg. 177-228

Harmonic Balancers
pg. 229-254

Heater Hose Assemblies
pg. 255-256

Hydraulic Clutch Lines
pg. 257-260

Dorman® Balancers Include New Woodruff Keys (where required)

Harmonic Balancers

Harmonic Balancer Applications

Make/Model/Engine	Years	Description	Dorman #
MERCURY (continued)			
MOUNTAINEER			
V6 - 4.0L (245 CID)	2006-98	-	594-111
V8 - 5.0L (302 CID)	2001-97	-	594-155
MYSTIQUE			
V6 - 2.5L (155 CID)	2000-95	-	594-109
SABLE			
V6 - 3.0L (182 CID)	2005-96	12 Valve	594-125
V6 - 3.0L (182 CID)	2005-96	24 Valve DOHC, Balancer	594-108
V6 - 3.0L (182 CID)	2005-96	24 Valve DOHC, Pulley	594-050
V6 - 3.0L (182 CID)	1995	-	594-125
V6 - 3.0L (182 CID)	1994-90	-	594-086
V6 - 3.0L (182 CID)	1989-86	-	594-084
V6 - 3.8L (232 CID)	1995-90	-	594-149
TOPAZ			
L4 - 2.3L (140 CID)	1994-92	-	594-007
TRACER			
L4 - 1.9L (116 CID)	1996-91	-	594-033
L4 - 2.0L (122 CID)	1999-97	-	594-033
MITSUBISHI			
3000GT			
V6 - 3.0L (2972 cc)	1999-97	SOHC	594-144
DIAMANTE			
V6 - 3.0L (2972 cc)	1996-92	SOHC	594-144
V6 - 3.5L (3497 cc)	2004-97	-	594-176
ECLIPSE			
L4 - 1.8L (1755 cc)	1994-90	-	594-168
L4 - 2.0L (1997 cc)	1999-95	w/Turbo	594-106
L4 - 2.0L (1997 cc)	1999-95	wo/Turbo	594-177
L4 - 2.0L (1997 cc)	1992-90	-	594-106
V6 - 3.0L (2972 cc)	2005-00	-	594-176
ECLIPSE SPYDER			
L4 - 2.4L (2351 cc)	1999-96	-	594-106
V6 - 3.0L (2972 cc)	2001	-	594-176
EXPO			
L4 - 2.4L (2351 cc)	1993	-	594-106
EXPO LRV			
L4 - 2.4L (2351 cc)	1993	-	594-106
GALANT			
L4 - 2.0L (1997 cc)	1992-89	DOHC	594-106
L4 - 2.4L (2351 cc)	1996-94	-	594-106
V6 - 3.0L (2972 cc)	2003-99	-	594-176
MIRAGE			
L4 - 1.6L (1597 cc)	1988-85	-	594-168
PRECIS			
L4 - 1.5L (1468 cc)	1993-90	-	594-054
MITSUBISHI TRUCK			
MIGHTY MAX			
V6 - 3.0L (2972 cc)	1994-90	-	594-164
MONTERO, MONTERO SPORT			
V6 - 3.0L (2972 cc)	1996-95	-	594-056
V6 - 3.0L (2972 cc)	1994-89	-	594-164
V6 - 3.5L (3497 cc)	2000-94	-	594-056
NISSAN			
200SX			
L4 - 1.6L (1597 cc)	1998-95	-	594-143
MAXIMA			
V6 - 3.0L (2988 cc)	2001-95	-	594-188
SENTRA			
L4 - 1.6L (1597 cc)	1999-95	-	594-143
OLDSMOBILE			
442			
V8 - 5.7L (350 CID)	1970-68	-	594-117
V8 - 6.6L (400 CID)	1969-68	-	594-117
V8 - 7.5L (455 CID)	1971-68	-	594-117
88, DELTA 88, 88 ROYALE, LSS			
V6 - 3.8L (231 CID)	1999-96	VIN K	594-004
V6 - 3.8L (231 CID)	1999-95	VIN 1, Supercharged	594-122
V6 - 3.8L (231 CID)	1995	VIN K	594-004
V6 - 3.8L (231 CID)	1994-93	-	594-034
V6 - 3.8L (231 CID)	1992-91	-	594-005
V6 - 3.8L (231 CID)	1990-89	-	594-001
V6 - 3.8L (231 CID)	1988	VIN 3, Stamped 25527381 or 25527009	594-003
V6 - 3.8L (231 CID)	1988	VIN 3, Stamped 25532179	594-150
V6 - 3.8L (231 CID)	1988	VIN C	594-001
V6 - 3.8L (231 CID)	1987-86	Stamped 25527381 or 25527009	594-003
V6 - 3.8L (231 CID)	1987-86	Stamped 25532179	594-150
V8 - 4.3L (260 CID)	1982-77	-	594-028
V8 - 5.0L (307 CID)	1985-80	-	594-028
V8 - 5.7L (350 CID)	1980-79	VIN R	594-028
V8 - 5.7L (350 CID)	1978-76	VIN R	594-117
V8 - 5.7L (350 CID)	1977	VIN L	594-009

Make/Model/Engine	Years	Description	Dorman #
OLDSMOBILE (continued)			
88, DELTA 88, 88 ROYALE, LSS (continued)			
V8 - 5.7L (350 CID)	1975-68	-	594-117
V8 - 6.6L (400 CID)	1975	-	594-158
V8 - 6.6L (403 CID)	1979	-	594-028
V8 - 6.6L (403 CID)	1978-77	-	594-117
V8 - 7.5L (455 CID)	1976-68	-	594-117
98, 98 REGENCY			
V6 - 3.8L (231 CID)	1996	-	594-004
V6 - 3.8L (231 CID)	1995	VIN 1, Supercharged	594-122
V6 - 3.8L (231 CID)	1995	VIN K	594-004
V6 - 3.8L (231 CID)	1994-93	VIN 1, Supercharged	594-161
V6 - 3.8L (231 CID)	1994-93	VIN L	594-034
V6 - 3.8L (231 CID)	1992	VIN L	594-005
V6 - 3.8L (231 CID)	1991	-	594-005
V6 - 3.8L (231 CID)	1990-88	-	594-001
V6 - 3.8L (231 CID)	1987-86	Stamped 25527381 or 25527009	594-003
V6 - 3.8L (231 CID)	1987-86	Stamped 25532179	594-150
V8 - 5.0L (307 CID)	1984-80	-	594-028
V8 - 5.7L (350 CID)	1980-79	VIN R	594-028
V8 - 5.7L (350 CID)	1978-77	VIN R	594-117
V8 - 5.7L (350 CID)	1973-72	-	594-117
V8 - 6.6L (400 CID)	1975	-	594-158
V8 - 6.6L (403 CID)	1979	-	594-028
V8 - 6.6L (403 CID)	1978-77	-	594-117
V8 - 7.5L (455 CID)	1976-68	-	594-117
ACHIEVA			
L4 - 2.3L (138 CID)	1995-93	-	594-043
L4 - 2.3L (138 CID)	1992	VIN 3,D	594-043
L4 - 2.3L (138 CID)	1992	VIN A, 164mm	594-043
L4 - 2.4L (146 CID)	1998-96	-	594-043
V6 - 3.1L (189 CID)	1998-94	-	594-148
V6 - 3.3L (204 CID)	1993	-	594-087
V6 - 3.3L (204 CID)	1992	-	594-044
ALERO			
L4 - 2.4L (146 CID)	2001-99	-	594-043
V6 - 3.4L (207 CID)	2004-99	-	594-148
AURORA			
V8 - 4.0L (244 CID)	1998-95	-	594-195
BRAVADA			
V6 - 4.3L (262 CID)	2001-96	-	594-181
V6 - 4.3L (262 CID)	1994-91	-	594-047
CALAIS, CUTLASS CALAIS			
L4 - 2.3L (138 CID)	1991-89	VIN A, 164mm	594-043
L4 - 2.3L (138 CID)	1991-89	VIN D	594-043
L4 - 2.3L (138 CID)	1988-87	-	594-043
V6 - 3.3L (204 CID)	1991-89	-	594-044
V8 - 4.3L (260 CID)	1982-80	-	594-028
V8 - 4.3L (260 CID)	1979	VIN F	594-028
V8 - 4.3L (260 CID)	1978	-	594-028
V8 - 5.0L (305 CID)	1980-78	-	594-009
V8 - 5.0L (307 CID)	1984	VIN 9	594-117
V8 - 5.0L (307 CID)	1984	VIN Y	594-028
V8 - 5.0L (307 CID)	1983-82	-	594-028
V8 - 5.7L (350 CID)	1980	VIN R	594-028
V8 - 5.7L (350 CID)	1979	-	594-028
CIERA, CUTLASS CIERA			
L4 - 2.5L (151 CID)	1992-87	-	594-027
V6 - 2.8L (173 CID)	1989-87	Auto Trans	594-008
V6 - 2.8L (173 CID)	1986-82	VIN X,Z-Stamped 4874	594-020
V6 - 2.8L (173 CID)	1986-82	VIN X,Z-Stamped 4955	594-147
V6 - 3.1L (189 CID)	1996-94	-	594-148
V6 - 3.3L (204 CID)	1993	-	594-087
V6 - 3.3L (204 CID)	1992-89	-	594-044
V6 - 3.8L (231 CID)	1988-86	-	594-003
CUSTOM CRUISER			
V8 - 5.0L (305 CID)	1992-91	-	594-009
V8 - 5.0L (307 CID)	1990-80	-	594-028
V8 - 5.7L (350 CID)	1992	-	594-009
V8 - 5.7L (350 CID)	1980-79	VIN R	594-028
V8 - 5.7L (350 CID)	1978-77	VIN R	594-117
V8 - 5.7L (350 CID)	1977	VIN L	594-009
V8 - 5.7L (350 CID)	1973	-	594-117
V8 - 6.6L (400 CID)	1975	-	594-158
V8 - 6.6L (403 CID)	1979	-	594-028
V8 - 6.6L (403 CID)	1978-77	-	594-117
V8 - 7.5L (455 CID)	1976-71	-	594-117
CUTLASS, CUTLASS CRUISER, CUTLASS SUPREME			
L4 - 2.3L (138 CID)	1991	-	594-043
L4 - 2.3L (138 CID)	1990	VIN A, 164mm	594-043
L4 - 2.3L (138 CID)	1990	VIN D	594-043
L6 - 4.1L (250 CID)	1976-75	-	594-029

Harmonic Balancer Applications

Make/ Model/Engine	Years	Description	Dorman #
OLDSMOBILE (continued)			
CUTLASS, CUTLASS CRUISER, CUTLASS SUPREME (continued)			
L6 - 4.1L (250 CID)	1974-68	wo/Air Cond Or Heavy Duty Cooling	594-014
V6 - 2.8L (173 CID)	1989-88	Auto Trans	594-008
V6 - 3.1L (189 CID)	1999-94	-	594-148
V6 - 3.1L (189 CID)	1993	VIN M	594-148
V6 - 3.1L (189 CID)	1993	VIN T, Exc. Calif	594-008
V6 - 3.1L (189 CID)	1992-89	-	594-008
V8 - 4.3L (260 CID)	1982-81	-	594-028
V8 - 4.3L (260 CID)	1980-79	VIN F	594-028
V8 - 4.3L (260 CID)	1978-75	-	594-028
V8 - 5.0L (305 CID)	1982-78	-	594-009
V8 - 5.0L (307 CID)	1987-85	VIN 9	594-117
V8 - 5.0L (307 CID)	1987-85	VIN Y	594-028
V8 - 5.0L (307 CID)	1984-81	-	594-028
V8 - 5.7L (350 CID)	1980	VIN R	594-028
V8 - 5.7L (350 CID)	1979	VIN L	594-009
V8 - 5.7L (350 CID)	1979	VIN R	594-028
V8 - 5.7L (350 CID)	1978	VIN L	594-009
V8 - 5.7L (350 CID)	1977-76	-	594-117
V8 - 5.7L (350 CID)	1975-68	-	594-117
V8 - 6.6L (403 CID)	1977	-	594-117
V8 - 7.5L (455 CID)	1976-70	-	594-117
F-85, HOLIDAY, HOLIDAY 88			
L6 - 4.1L (250 CID)	1971-66	wo/Air Cond Or Heavy Duty Cooling	594-014
V8 - 5.7L (350 CID)	1972-68	-	594-117
V8 - 7.5L (455 CID)	1972-70	-	594-117
FIRENZA			
V6 - 2.8L (173 CID)	1987	Auto Trans	594-008
INTRIGUE			
V6 - 3.8L (231 CID)	1999-98	-	594-004
OMEGA			
L6 - 4.1L (250 CID)	1976-75	-	594-029
L6 - 4.1L (250 CID)	1974-73	wo/Air Cond Or Heavy Duty Cooling	594-014
V6 - 2.8L (173 CID)	1984-82	Stamped 4955	594-147
V6 - 2.8L (173 CID)	1984	Stamped 4874	594-020
V8 - 4.3L (260 CID)	1977-75	-	594-028
V8 - 5.0L (305 CID)	1979-77	-	594-009
V8 - 5.7L (350 CID)	1979-78	-	594-009
V8 - 5.7L (350 CID)	1977	VIN L	594-009
V8 - 5.7L (350 CID)	1977	VIN R	594-117
V8 - 5.7L (350 CID)	1974-73	-	594-117
SILHOUETTE			
V6 - 3.4L (207 CID)	2004-96	-	594-148
V6 - 3.8L (231 CID)	1995	-	594-004
V6 - 3.8L (231 CID)	1994-93	-	594-034
V6 - 3.8L (231 CID)	1992	-	594-005
STARFIRE			
V8 - 5.0L (305 CID)	1979-77	-	594-012
TORONADO, TROFEO			
V6 - 3.8L (231 CID)	1992-91	-	594-005
V6 - 3.8L (231 CID)	1990-88	-	594-001
V6 - 3.8L (231 CID)	1987-86	-	594-150
V8 - 4.3L (260 CID)	1980	-	594-028
V8 - 5.0L (305 CID)	1980	-	594-009
V8 - 5.0L (307 CID)	1985-80	-	594-028
V8 - 5.7L (350 CID)	1980	VIN R	594-028
V8 - 5.7L (350 CID)	1979	VIN R	594-117
V8 - 6.6L (403 CID)	1978-77	-	594-117
V8 - 7.5L (455 CID)	1976-68	-	594-117
VISTA CRUISER			
V8 - 5.7L (350 CID)	1977-68	-	594-117
V8 - 6.6L (403 CID)	1977	-	594-117
V8 - 7.5L (455 CID)	1976-70	-	594-117
PLYMOUTH			
ACCLAIM			
V6 - 3.0L (181 CID)	1995-89	-	594-130
BARRACUDA, CUDA			
V8 - 5.2L (318 CID)	1974-72	-	594-021
V8 - 5.6L (340 CID)	1972	w/Forged Steel Crankshaft	594-021
COLT			
L4 - 2.4L (2351 cc)	1993	-	594-106
COLT VISTA			
L4 - 2.4L (2351 cc)	1993	-	594-106
DUSTER			
V8 - 5.2L (318 CID)	1976-72	-	594-021
V8 - 5.6L (340 CID)	1972	w/Forged Steel Crankshaft	594-021
FURY, FURY I, FURY II, FURY III			
V8 - 5.2L (318 CID)	1978-72	-	594-021
GRAN FURY			
V8 - 5.2L (318 CID)	1989-72	-	594-021
V8 - 5.9L (360 CID)	1980	-	594-132

Make/ Model/Engine	Years	Description	Dorman #
PLYMOUTH (continued)			
LASER			
L4 - 1.8L (107 CID)	1994-90	-	594-168
L4 - 2.0L (122 CID)	1994-90	-	594-106
NEON			
L4 - 2.0L (122 CID)	2001-00	-	594-185
L4 - 2.0L (122 CID)	1999-96	-	594-101
L4 - 2.0L (122 CID)	1995	SOHC	594-101
PROWLER			
V6 - 3.5L (215 CID)	2001-97	-	594-183
ROADRUNNER			
V8 - 5.2L (318 CID)	1975-72	-	594-021
V8 - 5.6L (340 CID)	1972	w/Forged Steel Crankshaft	594-021
SATELLITE			
V8 - 5.2L (318 CID)	1974-72	-	594-021
V8 - 5.6L (340 CID)	1972	w/Forged Steel Crankshaft	594-021
SCAMP			
V8 - 5.2L (318 CID)	1976-72	-	594-021
SUNDANCE			
V6 - 3.0L (181 CID)	1994-92	-	594-130
VALIANT			
V8 - 5.2L (318 CID)	1976-72	-	594-021
VOLARE			
V8 - 5.2L (318 CID)	1980-76	-	594-021
V8 - 5.9L (360 CID)	1980-79	-	594-132
VOYAGER, GRAND VOYAGER			
V6 - 3.0L (181 CID)	2000-87	-	594-130
V6 - 3.3L (201 CID)	2000-90	-	594-103
V6 - 3.8L (230 CID)	1999-94	-	594-103
PLYMOUTH TRUCK			
PB SERIES VAN			
V8 - 5.2L (318 CID)	1983-74	-	594-021
V8 - 5.9L (360 CID)	1983-79	Auto Trans	594-132
V8 - 5.9L (360 CID)	1983-79	Manual Trans	594-131
TRAILDUSTER			
V8 - 5.2L (318 CID)	1981-74	-	594-021
V8 - 5.9L (360 CID)	1981-79	Auto Trans	594-132
V8 - 5.9L (360 CID)	1981-79	Manual Trans	594-131
PONTIAC			
6000			
L4 - 2.5L (151 CID)	1991-87	-	594-027
V6 - 2.8L (173 CID)	1989-87	Auto Trans	594-008
V6 - 2.8L (173 CID)	1986-83	VIN X,Z-Stamped 4874	594-020
V6 - 2.8L (173 CID)	1986-82	VIN X,Z-Stamped 4955	594-147
V6 - 3.1L (189 CID)	1991-88	-	594-008
AZTEK			
V6 - 3.4L (207 CID)	2005-01	-	594-148
BONNEVILLE			
V6 - 3.8L (231 CID)	1999-96	VIN K	594-004
V6 - 3.8L (231 CID)	1999-95	VIN 1, Supercharged	594-122
V6 - 3.8L (231 CID)	1995	VIN K	594-004
V6 - 3.8L (231 CID)	1994-93	VIN 1, Supercharged	594-161
V6 - 3.8L (231 CID)	1994-93	VIN L	594-034
V6 - 3.8L (231 CID)	1992	VIN L	594-005
V6 - 3.8L (231 CID)	1991	-	594-005
V6 - 3.8L (231 CID)	1990-89	-	594-001
V6 - 3.8L (231 CID)	1988	VIN 3, Stamped 25527381 or 25527009	594-003
V6 - 3.8L (231 CID)	1988	VIN 3, Stamped 25532179	594-150
V6 - 3.8L (231 CID)	1988	VIN C	594-001
V6 - 3.8L (231 CID)	1987	Stamped 25527381 or 25527009	594-003
V6 - 3.8L (231 CID)	1987	Stamped 25532179	594-150
V6 - 4.3L (262 CID)	1986	-	594-142
V8 - 5.0L (305 CID)	1986-83	-	594-009
V8 - 5.0L (307 CID)	1981	-	594-028
V8 - 5.7L (350 CID)	1980-79	VIN R	594-028
V8 - 5.7L (350 CID)	1978	VIN R	594-117
V8 - 5.7L (350 CID)	1977	VIN P	594-158
V8 - 5.7L (350 CID)	1977	VIN R	594-117
V8 - 5.7L (350 CID)	1970	wo/Ram Air	594-158
V8 - 6.6L (400 CID)	1978-71	-	594-158
V8 - 6.6L (400 CID)	1970-68	wo/Ram Air	594-158
V8 - 6.6L (403 CID)	1979	-	594-028
V8 - 6.6L (403 CID)	1978-77	-	594-117
V8 - 7.0L (428 CID)	1969-68	wo/Ram Air	594-158
V8 - 7.5L (455 CID)	1976-71	-	594-158
V8 - 7.5L (455 CID)	1970	wo/Ram Air	594-158
CATALINA			
V8 - 5.0L (305 CID)	1977	-	594-009
V8 - 5.0L (307 CID)	1981	-	594-028
V8 - 5.7L (350 CID)	1980-79	VIN R	594-028
V8 - 5.7L (350 CID)	1978	VIN R	594-117
V8 - 5.7L (350 CID)	1977	VIN P	594-158
V8 - 5.7L (350 CID)	1977	VIN R	594-117

Harmonic Balancers

Power Steering Pulleys
pg. 317-326

Quick Disconnect™
pg. 327-396

Radiator Fan Assemblies
pg. 397-430

Rear Axle Shaft Kits
pg. 431-434

Side View Mirror Assemblies
pg. 435-468

Dorman® Balancers Include
New Woodruff Keys (where required)

Harmonic Balancers

Harmonic Balancer Applications

Make/Model/Engine	Years	Description	Dorman #
PONTIAC (continued)			
CATALINA (continued)			
V8 - 5.7L (350 CID)	1976-71	-	594-158
V8 - 5.7L (350 CID)	1970	wo/Ram Air	594-158
V8 - 6.6L (400 CID)	1978-71	-	594-158
V8 - 6.6L (400 CID)	1970-68	wo/Ram Air	594-158
V8 - 6.6L (403 CID)	1979	-	594-028
V8 - 6.6L (403 CID)	1978-77	-	594-117
V8 - 7.0L (428 CID)	1969-68	wo/Ram Air	594-158
V8 - 7.5L (455 CID)	1976-71	-	594-158
V8 - 7.5L (455 CID)	1970	wo/Ram Air	594-158
EXECUTIVE			
V8 - 5.7L (350 CID)	1970	wo/Ram Air	594-158
V8 - 6.6L (400 CID)	1970-68	wo/Ram Air	594-158
V8 - 7.0L (428 CID)	1969-68	wo/Ram Air	594-158
V8 - 7.5L (455 CID)	1970	wo/Ram Air	594-158
FIERO			
L4 - 2.5L (151 CID)	1988-87	-	594-027
FIREBIRD			
L6 - 4.1L (250 CID)	1976-75	-	594-029
L6 - 4.1L (250 CID)	1974-68	wo/Air Cond Or Heavy Duty Cooling	594-014
V6 - 2.8L (173 CID)	1989-88	-	594-147
V6 - 2.8L (173 CID)	1987-85	Stamped 4955	594-147
V6 - 2.8L (173 CID)	1987-85	Stamped 9033	594-013
V6 - 2.8L (173 CID)	1984-82	VIN 1, Supercharged, Stamped 4955	594-147
V6 - 2.8L (173 CID)	1984-82	VIN 1, Supercharged, Stamped 9033	594-013
V6 - 2.8L (173 CID)	1984-82	VIN L	594-013
V6 - 3.1L (189 CID)	1992-90	-	594-147
V6 - 3.8L (231 CID)	1997	Auto Trans	594-004
V6 - 3.8L (231 CID)	1996-95	-	594-004
V8 - 5.0L (305 CID)	1992-85	VIN E,G,H	594-009
V8 - 5.0L (305 CID)	1992-85	VIN F	594-012
V8 - 5.0L (305 CID)	1984-77	-	594-009
V8 - 5.7L (350 CID)	2002-98	-	594-127
V8 - 5.7L (350 CID)	1997-93	-	594-017
V8 - 5.7L (350 CID)	1992-87	-	594-012
V8 - 5.7L (350 CID)	1979-78	-	594-009
V8 - 5.7L (350 CID)	1977	VIN P	594-158
V8 - 5.7L (350 CID)	1977	VIN R	594-117
V8 - 5.7L (350 CID)	1976-71	-	594-158
V8 - 5.7L (350 CID)	1970-68	wo/Ram Air	594-158
V8 - 6.6L (400 CID)	1979-71	-	594-158
V8 - 6.6L (400 CID)	1970-68	wo/Ram Air	594-158
V8 - 6.6L (403 CID)	1979-77	-	594-117
V8 - 7.5L (455 CID)	1976-71	-	594-158
L4 - 2.3L (138 CID)	1995-93	-	594-043
L4 - 2.3L (138 CID)	1992-89	VIN 3,D	594-043
GRAND AM			
L4 - 2.3L (138 CID)	1992-89	VIN A, 164mm	594-043
L4 - 2.3L (138 CID)	1988	-	594-043
L4 - 2.4L (146 CID)	2001-96	-	594-043
V6 - 3.1L (189 CID)	1998-94	-	594-148
V6 - 3.3L (204 CID)	1993	-	594-087
V6 - 3.3L (204 CID)	1992	-	594-044
V6 - 3.4L (207 CID)	2005-99	-	594-148
V8 - 5.0L (305 CID)	1980-78	-	594-009
V8 - 5.7L (350 CID)	1975-73	-	594-158
V8 - 6.6L (400 CID)	1975-73	-	594-158
V8 - 7.5L (455 CID)	1975-73	-	594-158
GRAND PRIX			
L4 - 2.3L (138 CID)	1991-90	-	594-043
V6 - 2.8L (173 CID)	1989-88	Auto Trans	594-008
V6 - 3.1L (189 CID)	2003-94	-	594-148
V6 - 3.1L (189 CID)	1993	Exc. Calif	594-008
V6 - 3.1L (189 CID)	1992-91	-	594-008
V6 - 3.1L (189 CID)	1990-89	VIN T	594-008
V6 - 3.8L (231 CID)	2003-97	VIN 1, Supercharged	594-122
V6 - 3.8L (231 CID)	2003-97	VIN K	594-004
V6 - 4.3L (262 CID)	1986	-	594-142
V8 - 5.0L (305 CID)	1987-78	-	594-009
V8 - 5.7L (350 CID)	1977	VIN P	594-158
V8 - 5.7L (350 CID)	1977	VIN R	594-117
V8 - 5.7L (350 CID)	1976	-	594-158
V8 - 6.6L (400 CID)	1977-71	-	594-158
V8 - 6.6L (400 CID)	1970-68	wo/Ram Air	594-158
V8 - 6.6L (403 CID)	1977	-	594-117
V8 - 7.0L (428 CID)	1969-68	wo/Ram Air	594-158
V8 - 7.5L (455 CID)	1976-71	-	594-158
V8 - 7.5L (455 CID)	1970	wo/Ram Air	594-158
GRAND SAFARI			
V8 - 5.7L (350 CID)	1978-77	VIN R	594-117
V8 - 6.6L (400 CID)	1978-71	-	594-158
V8 - 6.6L (403 CID)	1978-77	-	594-117

Make/Model/Engine	Years	Description	Dorman #
PONTIAC (continued)			
GRAND SAFARI (continued)			
V8 - 7.5L (455 CID)	1976-71	-	594-158
GRANDVILLE			
V8 - 6.6L (400 CID)	1975-71	-	594-158
V8 - 7.5L (455 CID)	1975-71	-	594-158
GTO			
V8 - 5.7L (350 CID)	2004	-	594-127
V8 - 5.7L (350 CID)	1970	wo/Ram Air	594-158
V8 - 6.0L (364 CID)	2006-05	-	594-127
V8 - 6.6L (400 CID)	1971	-	594-158
V8 - 6.6L (400 CID)	1970-68	wo/Ram Air	594-158
V8 - 7.5L (455 CID)	1971	-	594-158
V8 - 7.5L (455 CID)	1970	wo/Ram Air	594-158
LEMANS, GRAND LEMANS			
L6 - 4.1L (250 CID)	1976-75	-	594-029
L6 - 4.1L (250 CID)	1974-68	wo/Air Cond Or Heavy Duty Cooling	594-014
V6 - 3.8L (229 CID)	1980	-	594-142
V8 - 4.3L (260 CID)	1976	-	594-028
V8 - 5.0L (305 CID)	1980-77	-	594-009
V8 - 5.7L (350 CID)	1979-78	-	594-009
V8 - 5.7L (350 CID)	1977	VIN P	594-158
V8 - 5.7L (350 CID)	1977	VIN R	594-117
V8 - 5.7L (350 CID)	1976-71	-	594-158
V8 - 5.7L (350 CID)	1970-68	wo/Ram Air	594-158
V8 - 6.6L (400 CID)	1977-71	-	594-158
V8 - 6.6L (400 CID)	1970-68	wo/Ram Air	594-158
V8 - 6.6L (403 CID)	1977	-	594-117
V8 - 7.0L (428 CID)	1969-68	wo/Ram Air	594-158
V8 - 7.5L (455 CID)	1976-72	-	594-158
V8 - 7.5L (455 CID)	1970	wo/Ram Air	594-158
MONTANA			
V6 - 3.4L (207 CID)	2005-99	-	594-148
PARISIENNE			
V6 - 3.8L (229 CID)	1983	-	594-142
V6 - 4.3L (262 CID)	1986-85	-	594-142
V8 - 5.0L (305 CID)	1986-83	-	594-009
V8 - 5.0L (307 CID)	1986	-	594-028
PHOENIX			
V6 - 2.8L (173 CID)	1984-82	Stamped 4955	594-147
V6 - 2.8L (173 CID)	1984	Stamped 4874	594-020
V8 - 5.0L (305 CID)	1979-77	-	594-009
V8 - 5.7L (350 CID)	1979-78	-	594-009
V8 - 5.7L (350 CID)	1977	VIN L	594-009
V8 - 5.7L (350 CID)	1977	VIN R	594-117
SAFARI			
V8 - 5.0L (307 CID)	1989-87	-	594-028
SUNBIRD			
V6 - 3.1L (189 CID)	1994-91	-	594-008
V8 - 5.0L (305 CID)	1979-78	-	594-012
SUNFIRE			
L4 - 2.3L (138 CID)	1995	-	594-043
L4 - 2.4L (146 CID)	2002-96	-	594-043
TEMPEST			
L6 - 4.1L (250 CID)	1970-68	wo/Air Cond Or Heavy Duty Cooling	594-014
V8 - 5.7L (350 CID)	1970-68	wo/Ram Air	594-158
V8 - 6.6L (400 CID)	1970-68	wo/Ram Air	594-158
V8 - 7.0L (428 CID)	1969	wo/Ram Air	594-158
TRANS SPORT			
V6 - 3.4L (207 CID)	1998-96	-	594-148
V6 - 3.8L (231 CID)	1995	-	594-004
V6 - 3.8L (231 CID)	1994-93	-	594-034
V6 - 3.8L (231 CID)	1992	-	594-005
VENTURA			
L6 - 4.1L (250 CID)	1976-75	-	594-029
L6 - 4.1L (250 CID)	1974-71	wo/Air Cond Or Heavy Duty Cooling	594-014
V8 - 4.3L (260 CID)	1976-75	-	594-028
V8 - 5.0L (305 CID)	1977	VIN R	594-009
V8 - 5.0L (307 CID)	1972-71	-	594-156
V8 - 5.7L (350 CID)	1977	VIN L	594-009
V8 - 5.7L (350 CID)	1977	VIN R	594-117
V8 - 5.7L (350 CID)	1974-72	-	594-158
SAAB			
9-5			
V6 - 3.0L (2961 cc)	2002-99	-	594-154
900			
L4 - 2.0L (1985 cc)	1994-85	w/Turbo	594-057
L4 - 2.0L (1985 cc)	1994-85	wo/Turbo	594-058
L4 - 2.0L (1985 cc)	1984-79	-	594-058
V6 - 2.5L (2498 cc)	1997-94	-	594-154
9000			
L4 - 2.0L (1985 cc)	1990-86	w/Turbo	594-060
V6 - 3.0L (2961 cc)	1997-95	-	594-154

Harmonic Balancer Applications

Make/ Model/Engine	Years	Description	Dorman #
SATURN			
L SERIES			
V6 - 3.0L (181 CID)	2005-02	-	594-153
LS SERIES			
V6 - 3.0L (181 CID)	2001-00	-	594-153
LW SERIES			
V6 - 3.0L (181 CID)	2004-00	-	594-153
SC SERIES			
L4 - 1.9L (116 CID)	2002-96	-	594-190
SL SERIES			
L4 - 1.9L (116 CID)	2002-96	-	594-190
SW SERIES			
L4 - 1.9L (116 CID)	2001-96	-	594-190
VUE			
V6 - 3.0L (181 CID)	2003-02	-	594-153
SUBARU			
BAJA			
H4 - 2.5L (2458 cc)	2006-03	-	594-166
DL			
H4 - 1.8L (1781 cc)	1989-85	-	594-174
FORESTER			
H4 - 2.5L (2458 cc)	2006-00	-	594-166
H4 - 2.5L (2458 cc)	1999	From 5/99	594-166
GL			
H4 - 1.8L (1781 cc)	1989-85	wo/Turbo	594-174
GL-10			
H4 - 1.8L (1781 cc)	1988-85	wo/Turbo	594-174
IMPREZA			
H4 - 2.5L (2458 cc)	2006-99	-	594-166
L4 - 2.0L (1994 cc)	2005-02	-	594-129
L4 - 2.2L (2212 cc)	2001-99	-	594-129
LEGACY			
H4 - 2.2L (2212 cc)	1999-97	-	594-175
H4 - 2.2L (2212 cc)	1996	Code P (9th Digit of Model Plate)	594-175
H4 - 2.5L (2458 cc)	2006-00	-	594-166
H4 - 2.5L (2458 cc)	1996	Code P (9th Digit of Model Plate)	594-175
LEGACY OUTBACK			
H4 - 2.2L (2212 cc)	1996	Code P (9th Digit of Model Plate)	594-175
H4 - 2.5L (2458 cc)	1996	Code P (9th Digit of Model Plate)	594-175
LOYALE			
H4 - 1.8L (1781 cc)	1994-91	-	594-174
H4 - 1.8L (1781 cc)	1990	wo/Turbo	594-174
OUTBACK			
H4 - 2.5L (2458 cc)	2006-01	-	594-166
STANDARD			
H4 - 1.8L (1781 cc)	1987	-	594-174
TOYOTA			
AVALON			
V6 - 3.0L (2995 cc)	2004-95	-	594-140
CAMRY			
L4 - 2.0L (1998 cc)	1991-87	-	594-138
L4 - 2.2L (2164 cc)	2001-92	-	594-139
V6 - 3.0L (2995 cc)	2003-94	-	594-140
CELICA			
L4 - 1.8L (1762 cc)	1997-94	-	594-182
L4 - 2.0L (1998 cc)	1989-87	-	594-138
L4 - 2.2L (2164 cc)	1999-94	-	594-139
L4 - 2.2L (2164 cc)	1993-90	-	594-138
L4 - 2.2L (2189 cc)	1980-78	20R	594-073
L4 - 2.4L (2366 cc)	1985	22REC	594-073
L4 - 2.4L (2366 cc)	1984-83	22REC	594-073
L4 - 2.4L (2366 cc)	1982-81	22R	594-073
COROLLA			
L4 - 1.6L (1587 cc)	1997-94	-	594-182
L4 - 1.6L (1587 cc)	1993	From 9/92	594-182

Make/ Model/Engine	Years	Description	Dorman #
TOYOTA (continued)			
COROLLA (continued)			
L4 - 1.8L (1762 cc)	1997-93	-	594-182
CORONA			
L4 - 2.2L (2189 cc)	1982-78	20R	594-073
SIENNA			
V6 - 3.0L (2995 cc)	2003-98	-	594-140
V6 - 3.3L (3300 cc)	2005-04	-	594-140
SOLARA			
L4 - 2.2L (2164 cc)	2001-99	-	594-139
V6 - 3.0L (2995 cc)	2003-99	-	594-140
V6 - 3.3L (3300 cc)	2005-04	-	594-140
TOYOTA TRUCK			
4 RUNNER			
L4 - 2.4L (2366 cc)	1995-90	22RE	594-073
L4 - 2.4L (2366 cc)	1989-85	22REC	594-073
L4 - 2.4L (2366 cc)	1988-85	22RTEC	594-073
L4 - 2.7L (2694 cc)	2000-96	-	594-141
V6 - 3.0L (2959 cc)	1995-88	3VZE	594-078
HIGHLANDER			
V6 - 3.0L (2995 cc)	2003-01	Built in Japan	594-140
V6 - 3.3L (3300 cc)	2006-04	Built in Japan	594-140
PICKUP			
L4 - 2.2L (2189 cc)	1983-78	20R	594-073
L4 - 2.4L (2366 cc)	1995-90	22RE	594-073
L4 - 2.4L (2366 cc)	1989-85	22REC	594-073
L4 - 2.4L (2366 cc)	1988-85	22RTEC	594-073
L4 - 2.4L (2366 cc)	1984	22REC	594-073
V6 - 3.0L (2959 cc)	1995-88	3VZE	594-078
RAV4			
L4 - 2.0L (1998 cc)	2000-96	-	594-139
T100			
L4 - 2.7L (2694 cc)	1998-94	-	594-141
V6 - 3.0L (2959 cc)	1994-93	3VZE	594-078
TACOMA			
L4 - 2.4L (2438 cc)	2004-95	-	594-141
L4 - 2.7L (2694 cc)	2004-95	-	594-141
VOLVO			
240, 242, 244, 245			
L4 - 2.3L (2316 cc)	1993-85	B230F	594-032
740, 745			
L4 - 2.3L (2316 cc)	1992-85	B230F	594-032
L4 - 2.3L (2316 cc)	1992-85	B230FT	594-032
L4 - 2.3L (2316 cc)	1990-89	B234F	594-074
760			
L4 - 2.3L (2316 cc)	1990-85	B230FT	594-032
780			
L4 - 2.3L (2316 cc)	1991-89	B230FT	594-032
850			
L5 - 2.3L (2319 cc)	1997-94	-	594-159
L5 - 2.4L (2435 cc)	1997-93	-	594-159
940			
L4 - 2.3L (2316 cc)	1995-94	B230FD	594-032
L4 - 2.3L (2316 cc)	1995-91	B230FT	594-032
L4 - 2.3L (2316 cc)	1993-91	B234F	594-074
C70			
L5 - 2.3L (2319 cc)	1998	-	594-159
L5 - 2.4L (2435 cc)	1998	-	594-159
S70			
L5 - 2.3L (2319 cc)	1998	-	594-159
L5 - 2.4L (2435 cc)	1998	-	594-159
V70			
L5 - 2.3L (2319 cc)	1998	-	594-159
L5 - 2.4L (2435 cc)	1998	-	594-159

Harmonic Balancers

Do the Job Right: Use the Proper Tool

- Never use a hammer or crow bar to remove or install a balancer!

Order these Dorman tools:

- Dorman Harmonic Balancer Puller #594-999

Dorman offers quality parts and tools to do the job right and save valuable labor and rack time.

Removing crankshaft balancer using proper puller tool.

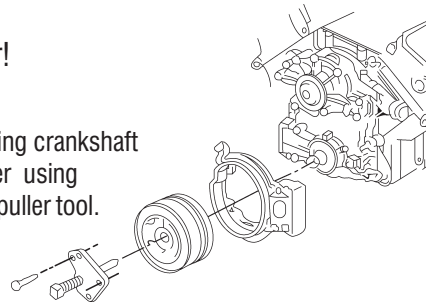

4 Ways to Find the Product You're Looking for

Item Number	Description	Make:	Chrysler
741-550	2000-96 Caravan, Voyager	OE#:	4675587AB
		Orientation:	Front Left
		Type:	Motor/Regulator Assembly
		Brand:	Dorman - OE Solutions
<p>Application Note: LH Front: Regulator w/Motor</p>			

Find Your Part By:

- Vehicle Application Search**
Choose Your Year: [Dropdown]
- OR Part Category Search**
Window Regulators [Dropdown]
- OR Part Number Search**
Enter Dorman or Motormite Part # [Input]
- OR Keyword Search**
Enter Keyword... [Input]

Info Updated Daily

Get the Latest on New Products & Technical Information



698-100



615-177



622-001



New Products

Click Here



Technical Product Information

Click Here

More Product Information

- Browse Catalogs Online
- View Product Videos



Marketing Support

- Advertising
- Product Information Sheets, Print Your Own!
- Audio Clips
- Catalogs
- Line Card
- Activant Line Codes
- Logos
- Online Training
- Posters
- Information Sheets
- Product Interchanges
- Service Dealer Guides
- Product Advertising
- Product Video Clips

Heater Hose Assemblies

NEW! to the Aftermarket



- Direct OE Replacement
- Steel/Rubber Assemblies
- Coverage for the Most Failure-Prone Applications

Typical Failures

- The steel section of the Steel/Rubber Heater Hose Line Assemblies are susceptible to rust
- Rubber dry-rot
- Rubber-to-steel crimp leakage

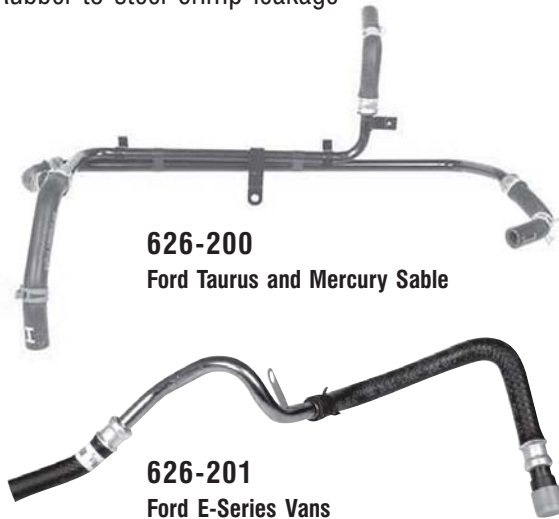

626-200
Ford Taurus and Mercury Sable

626-201
Ford E-Series Vans

AVOID
COMEBACKS
Replace The Entire Assembly

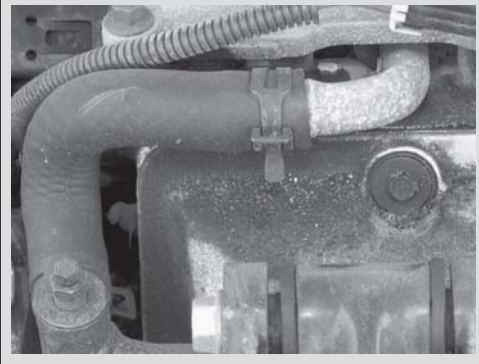

Dorman® OE Solutions™
Heater Hose Assemblies
Feature:

- Direct OE Replacement
- No Adapting at Rubber/Steel Joint

Prevent breakdowns, all Heater Hoses should be replaced at the 60,000 mile service.

- **6 SKUs Available**
- GM Cars – Regal, Lumina, Grand Prix, Achieva, Beretta, Corsica and Skylark
- GM Trucks – S&T Series
- Ford – Taurus & Sable
- Ford Fullsize Vans – Econoline

Other Dorman Fluid Lines Available:

Clutch pages 257-260

Fuel pages 149-154

Oil Cooler pages 281-302

Transmission pages 485-532

Activant Path

Hoses

Activant Code

DEH

Applications begin
on page 256.

Heater Hoses Assemblies

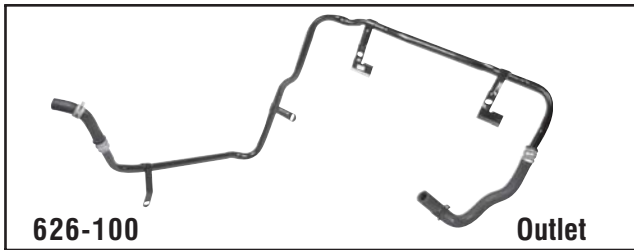

626-100 **Outlet**
GM
 1992-91 Regal, Lumina, Cutlass Supreme, Grand Prix; 3.1L

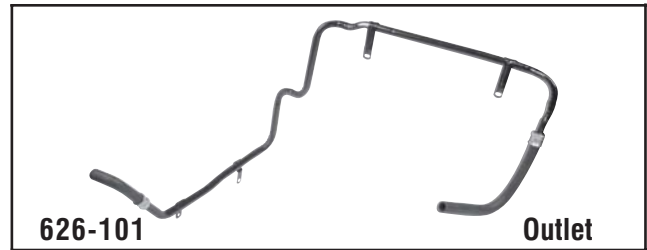

626-101 **Outlet**
GM
 1989 Regal, Cutlass Supreme, Grand Prix; All 3.1L; 1989-88 Regal, Cutlass Supreme; Grand Prix; All 2.8L

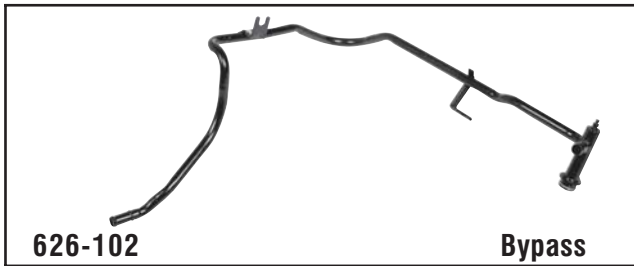

626-102 **Bypass**
GM
 1995-94 Skylark, Achieva, Grand Am, Beretta, Corsica; 3.1L



626-103 **Inlet**
GM
 1992-89 S10 Blazer/Pickups, S15 Jimmy/Pickups/Sonoma; 1992-91 Bravada; All 4.3L, VIN Z, w/AC

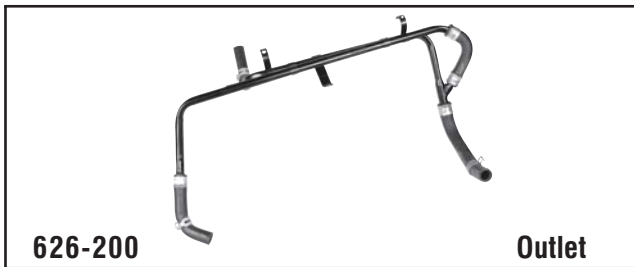

626-200 **Outlet**
Ford
 1995 Taurus, Sable; 3.0L



626-201 **Outlet**
Ford
 1996-93 E- Series Vans 5.8L wo/ Aux Heater; 5.8L

Heater Hose Assembly Applications

Make/Model/Years	Description	Dorman #
BUICK		
REGAL		
1992-91	Heater Outlet: 3.1L Eng	626-100
1989-88	Heater Outlet: 2.8L Eng	626-101
1989	Heater Outlet: 3.1L Eng	626-101
SKYLARK		
1995-94	Heater Bypass:3.1L Eng	626-102
CHEVROLET		
BERETTA		
1995-94	Heater Bypass:3.1L Eng, w/4-Spd AT	626-102
CORSICA		
1995-94	Heater Bypass:3.1L Eng, w/4-Spd AT	626-102
LUMINA		
1992-91	Heater Outlet: 3.1L Eng	626-100
CHEVROLET TRUCK		
S10 BLAZER		
1992-89	Heater Inlet: 4.3L Eng, VIN Z, w/AC	626-103
S10 PICKUP		
1992-89	Heater Inlet: 4.3L Eng, VIN Z, w/AC	626-103
FORD		
TAURUS		
1995	Heater Outlet: 3.0L Eng	626-200
FORD TRUCK		
E-150 ECONOLINE		
1996-93	Heater Outlet: 5.8L Eng, wo/Aux Heater	626-201
E-250 ECONOLINE		
1996-93	Heater Outlet: 5.8L Eng, wo/Aux Heater	626-201
E-350 ECONOLINE		
1996-93	Heater Outlet: 5.8L Eng, wo/Aux Heater	626-201

Make/Model/Years	Description	Dorman #
GMC TRUCK		
S15 JIMMY		
1992-89	Heater Inlet: 4.3L Eng, VIN Z, w/AC	626-103
S15 PICKUP		
1990-89	Heater Inlet: 4.3L Eng, VIN Z, w/AC	626-103
S15 SONOMA		
1992-91	Heater Inlet: 4.3L Eng, VIN Z, w/AC	626-103
MERCURY		
SABLE		
1995	Heater Outlet: 3.0L Eng	626-200
OLDSMOBILE		
ACHIEVA		
1995-94	Heater Bypass:3.1L Eng	626-102
BRAVADA		
1992-91	Heater Inlet: 4.3L Eng, VIN Z, w/AC	626-103
CUTLASS SUPREME		
1992-91	Heater Outlet: 3.1L Eng	626-100
1989-88	Heater Outlet: 2.8L Eng	626-101
1989	Heater Outlet: 3.1L Eng	626-101
PONTIAC		
GRAND AM		
1995-94	Heater Bypass:3.1L Eng	626-102
GRAND PRIX		
1992-91	Heater Outlet: 3.1L Eng	626-100
1989-88	Heater Outlet: 2.8L Eng	626-101
1989	Heater Outlet: 3.1L Eng, VIN T	626-101

Hydraulic Clutch Lines



NEW to the Aftermarket

Inspect Hydraulic Clutch Lines with Every Clutch Service



INCLUDES
Release Tool and
Attaching Hardware
Where Applicable

Features and Benefits

- Dorman® clutch lines are pre-bent to match the OE lines exactly.
- Dorman Lines are 100% pressure tested before they leave the factory to ensure quality.

Other Dorman Fluid Lines Available:

<i>Fuel</i>	<i>pages 149-154</i>	<i>Heater Hose</i>	<i>pages 255-256</i>
<i>Oil Cooler</i>	<i>pages 281-302</i>	<i>Transmission</i>	<i>pages 485-532</i>

Clutch Related Sales



**Clutch Master
Cylinder
CM116209**
Chevrolet/GMC
C&K Series
1991-88



**Clutch
Slave Cylinder
CS37815**
Chevrolet/GMC
C&K Series
1991-88



**Clutch
Master
Cylinder
CM350032**
Ford F-Series
1999-95



**Clutch Slave
Cylinder
CS360016**
Ford F-Series
1999-95

Activant Path

*Clutch Assembly/
Clutch, Flywheel*

Activant Code

TTY

**Applications begin
on page 259.**

Hydraulic Clutch Lines

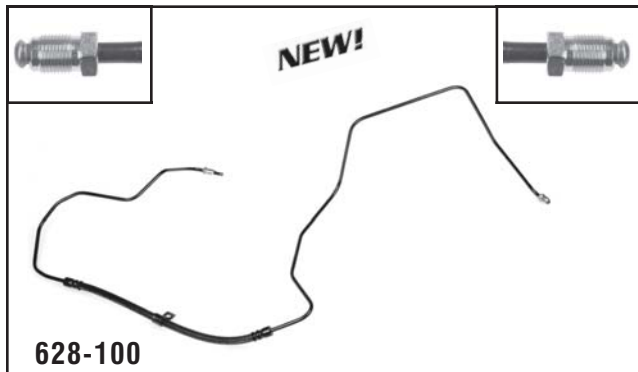

628-100

GM
1991-88 C/K-Series Trucks

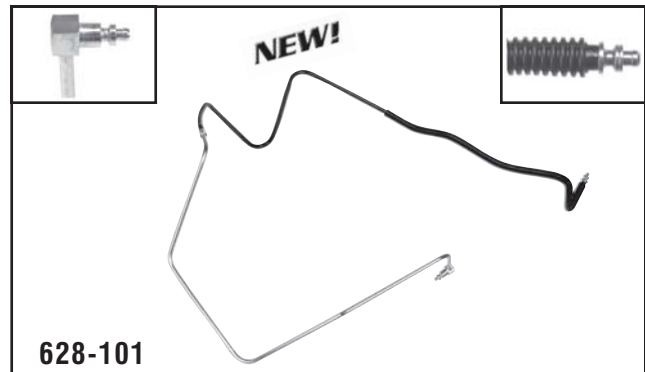

628-101

GM
1995-92 C/K-Series Pickups, Yukon; 1995 Tahoe; 1994-92 Blazer



628-200

Ford
1997-92 F250/F350 Pickups, F450 Super Duty Pickups

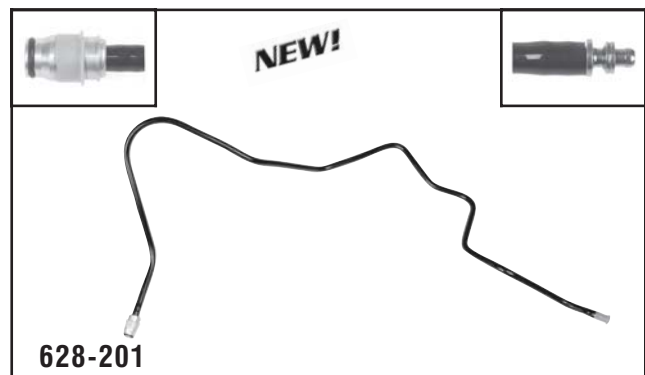

628-201

Ford
1997-92 F150/F250/F350 Pickups; 1996-92 Bronco



628-202

Ford
1991 Explorer; 1991-88 Ranger; 1990-88 Bronco II

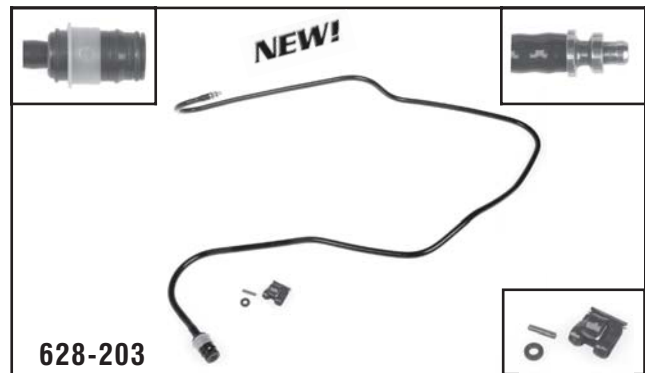

628-203

Ford
1991-88 F150/F250/F350 Pickups, Bronco

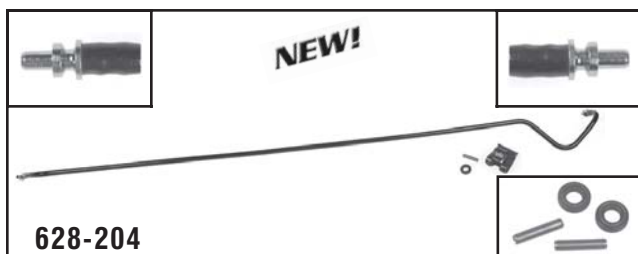

628-204

Ford
1986-84 F150 Pickups, Bronco; 1986-83 F250/F350 Pickups

Hydraulic Clutch Lines

Related Sales - Clutch Pilot Tools 



- Used to ensure proper clutch disc alignment during installation.
- Durable plastic tools duplicate transmission input shaft.
- Custom designed splines speed up installation.

Hydraulic Clutch Line Applications

Make/ Model/Years	Description	Dorman #
CHEVROLET TRUCK		
BLAZER		
1994-92	-	628-101
CK SERIES PICKUP		
1995-92	-	628-101
1991-88	-	628-100
TAHOE		
1995	-	628-101
FORD TRUCK		
BRONCO		
1996-92	Exc.T-18 Trans	628-201
1991-88	Exc.T-18 Trans	628-203
1986-84	-	628-204
BRONCO II		
1990-88	-	628-202
EXPLORER		
1991	-	628-202
F-150 PICKUP		
1997-92	Exc.T-18 Trans	628-201
1991-88	Exc.T-18 Trans	628-203
1986-84	-	628-204
F-250 PICKUP		
1997-92	w/7.3L or 7.5L; w/HD Trans	628-200

Make/ Model/Years	Description	Dorman #
FORD TRUCK (continued)		
F-250 PICKUP (continued)		
1997	w/4.2L, 4.6L, 5.4L, or 5.8L; Exc.T-18 Trans	628-201
1996-92	w/4.9L, 5.0L, or 5.8L; Exc.T-18 Trans	628-201
1991-88	w/4.9L, 5.0L, or 5.8L; Exc.T-18 Trans	628-203
1986-84	-	628-204
1983	w/6.9L or 7.5L	628-204
F-350 PICKUP		
1997-92	w/4.9L or 5.8L; Exc.T-18 Trans	628-201
1997-92	w/7.3L or 7.5L; w/HD Trans	628-200
1991-88	w/4.9L or 5.8L; Exc.T-18 Trans	628-203
1986-84	-	628-204
1983	w/6.9L or 7.5L	628-204
F-450 SUPER DUTY PICKUP		
1997-92	w/HD Trans	628-200
RANGER		
1991-88	-	628-202
GM/BUICK TRUCK		
CK SERIES PICKUP		
1995-92	-	628-101
1991-88	-	628-100
YUKON		
1995-92	-	628-101

Related Sales - Cables

Also Available:

- 04280 - AT Shift Cable
- 04442 - Detent Cable
- 04529 - Accelerator Cable
- 14832 - Clutch Cable
- 16656 - MT Shift Cable
- 03151 - Speedometer Cable



Hydraulic Clutch Lines

4 Ways to Find the Product You're Looking for

Item Number	Description	Make:	Chrysler
741-550	2000-96 Caravan, Voyager	OE#:	4675587AB
		Orientation:	Front Left
		Type:	Motor/Regulator Assembly
		Brand:	Dorman - OE Solutions
Application Note: LH Front: Regulator w/Motor			

Find Your Part By:

- Vehicle Application Search**
Choose Your Year: [Dropdown]
- OR Part Category Search**
Window Regulators: [Dropdown]
- OR Part Number Search**
Enter Dorman or Motormite Part #: [Text]
- OR Keyword Search**
Enter Keyword...: [Text]

Info Updated Daily

Get the Latest on New Products & Technical Information



698-100



615-177



622-001



New Products

Click Here



Technical Product Information

Click Here

More Product Information

- Browse Catalogs Online
- Advertising
- Product Information Sheets, Print Your Own!



Marketing Support

- View Product Videos
- Audio Clips
- Catalogs
- Line Card
- Activant Line Codes
- Logos
- Online Training
- Posters
- Information Sheets
- Product Interchanges
- Service Dealer Guides
- Product Advertising
- Product Video Clips

Hydraulic Clutch Lines

Ignition Distributor Assemblies

100% NEW!



Why take a chance with rebuilt?

Dorman Ignition Distributor Assemblies are 100% New for long service life.



690-163
Chrysler
Cirrus, Sebring
V6 - 2.5L (152 CID)
2000-95

- Includes NEW cap and NEW rotor
- Priced competitively to remanufactured with cap and rotor
- All units are 100% NEW — non-remanufactured



690-145
Ford Probe
Mazda 626
V6 - 2.5L (152 CID)
1994-93

Benefits:

- Dorman Ignition Distributors cover the most failure-prone domestic and import applications
- No core charge



690-174
Volkswagen
Cabrio, Golf, Jetta,
Passat
L4 - 2.0L (1984 cc)
1996-93

Related Products:

Tech Tray #80021 Distributor O-Rings



Activant Path

*Ignition Parts; Tune-Up/
Coils, Modules & Other Ign.*

Activant Code

DDV

**Applications begin
on page 269.**

Ignition Distributor Assemblies



690-100

Honda
1991-90 Civic, CRX (1.5L).
ID # TD-01U w/Coil TC-07A
Plug Configuration 2-pin round & 5-pin rectangular



690-101

Honda
1991-90 Accord 2.2L.
ID # TD-31U, TD-34U
Plug Configuration 2-pin & 7-pin rectangular



690-102

Honda
1995-92 Civic (3Dr, 4Dr), 1995-93 Coupe (DX), Del Sol (1.5L).
ID # TD-41U
Plug Configuration 2-pin & 7-pin rectangular



690-103

Honda
1995-92 Civic (3Dr) VX, SI & (4Dr) EX & (2Dr) EX & 1995-93 Del Sol (1.6L).
ID # TD-42U
Plug Configuration 2-pin & 7-pin rectangular



690-104

Acura/Honda
1995-94 Del Sol VTEC (1.6L DOHC); 1993-92 Integra (1.7L & 1.8L); 1995-94 Integra (1.8L) GSR Model
ID # TD-44U; TD-08U
Plug Configuration 2-pin & 7-pin rectangular



690-105

Honda
1995-92 Accord (2.2L), 1995-92 Prelude.
ID # TD-52U; TD-59U
Plug Configuration 2-pin & 8-pin rectangular



690-106

Honda
1995-92 Prelude (2.2L & 2.3L).
ID # TD-61U
Plug Configuration 2-pin & 8-pin rectangular



690-107

Acura
1989-88 Integra (1.6L).
ID # TD-03U
Plug Configuration 2-pin round & 5-pin rectangular



690-108

Honda
1989-88 Civic, CRX (1.5L & 1.6L).
ID # TD-02U
Plug Configuration 2-pin & 7-pin round

Ignition Distributor Assemblies



690-109

Acura
1993-92 Integra (1.7L & 1.8L).
ID # TD-55U, TD-46U
Plug Configuration 7-pin rectangular



690-110

Honda
1991-90 Civic & CRX (1.5L & 1.6L).
ID # TD-18U
Plug Configuration 2-pin & 7-pin round



690-111

Honda
1989-88 Civic, CRX (1.5L & 1.6L),
Wagovan (1.5L)
ID # TD-01U w/Coil TC-05A
Plug Configuration 2-pin round & 5-pin rectangular



690-112

Mazda/Ford
1994-93 MX6 & 626 (2.0L) MT; 1993
Probe (2.0L) AT.
ID # T6T57871
Plug Configuration 3-pin & 6-pin rectangular



690-113

Nissan
1994-89 Sentra (1.6L); 1990-89 Pulsar NX
(1.6L); 1993-91 NX (1.6L).
ID # T4T84471A
Plug Configuration 4-pin rectangular



690-114

Toyota
1995-92 Camry (2.2L); 1996-93 Celica
(2.2L); 1995-92 MR2 (2.2L); All with
5SFE Eng.
Plug Configuration 4-pin rectangular



690-115

Toyota
1991-87 Camry (2.0L); 1989-87 Celica
(2.0L); All with 3SFE ENG.
Plug Configuration 2-pin oval & 3-pin square



690-117

Toyota
1997-96 Celica (1.8L); 1997-95 Corolla
(1.8L) both w/ 7AFE Eng; 1997-96 Corolla
(1.6L) w/ 4AFE Eng; 1997-95 Geo Prizm
(1.8L) VIN 8.
Plug Configuration 4-pin square



690-118

Acura
1991-90 Integra (1.8L) AT.
ID # TD-24U
Plug Configuration 2-pin & 7-pin round

Ignition Distributor Assemblies



690-119

Acura
1991-90 Integra (1.8L) MT.
ID # TD-23U, w/Coil TC-07A
Plug Configuration 2-pin & 7-pin round



690-120

Honda
1998-96 Civic (1.6L); 1997-96 Civic Del Sol (1.6L); All with TEC Dist.
ID # TD-80U
Plug Configuration 4-pin square



690-121

Nissan
1997-93 Altima (2.4L) KA24DE Eng.
ID # D4P90-02, D4P90-03
Plug Configuration 4-pin rectangular



690-122

Mitsubishi/Chrysler
1994-92 Colt & Colt Vista (1.8L); 1993 EXPO (1.8L); 1994-92 EXPO LRV (1.8L); 1994-93 Mirage (1.8L) & 1995 (1.8L) Exc. Calif.; 1994-92 Summit (1.8L) & 1996-95 (1.8L) Exc. Calif.
ID # T6T57671
Plug Configuration 2-pin & 6-pin rectangular



690-123

Mazda
1991-90 929 (3.0L) SOHC; 1995-93 MPV (3.0L).
Plug Configuration 4-pin square



690-124

Mazda
1993-90 B2200 Pickups (2.2L).
ID # T2T53071
Plug Configuration 4-pin rectangular



690-125

Toyota
1991-88 Camry (2.5L); 1991-90 Lexus ES250 (2.5L); All with 2VZFE Eng.
Plug Configuration 4-pin square



690-129

Honda
1998-97 CRV 2.0L.
ID # TD-97U
Plug Configuration 10-pin round w/ 1 pin blank



690-130

Honda
2001-99 CR-V.
ID # TC-08A
Plug Configuration 8-pin rectangular

Ignition Distributor Assemblies



690-131

Acura
2001-96 Integra (1.8L) Non-GSR Model.
ID # TC-08A
Plug Configuration 10-pin rectangular w/ 1 pin blank



690-132

Toyota
1993-90 Corolla (1.6L), Celica (4Afe).
Plug Configuration 2-pin & 6-pin (w/ 1 pin blank) rectangular



690-133

Nissan
1999-95 Sentra B14 (1.6L), 1998-95 200SX.
Plug Configuration 6-pin oval & 2-pin rectangular



690-134

Volkswagen
1992-87 Golf LI (1.8L), 1993-87 Passat (2.0L), Jetta 1.8L.
Plug Configuration 4 Pin Oval



690-135

Mitsubishi/Chrysler
1994-91 Colt (1.5L).
ID # T6T57171
Plug Configuration 6-pin oval & 2-pin rectangular



690-136

Suzuki
1995-92 Suzuki Swift 4cyl 1.3L (1298cc) SOHC
Plug Configuration 2 Pin Round



690-137

Toyota
1995-94 Toyota Corolla 4cyl 1.6L (1587cc) and 1.8L (1762cc) 4AFE and 7AFE Engine; 1995-94 Celica
Plug Configuration 2 & 6 Pin Square



690-138

Honda
1995-94 Accord DX, LX, 1995-92 Prelude S 2.2L
ID # TD-59U
Plug Configuration 2 Pin Rectangular & 8 Pin Rectangular



690-139

Volvo
1989 Volvo 780; 1989-85 Volvo 760; 1985 Volvo 745; 1989-86 Volvo 740; 4cyl 2.3L (2316cc) B230FT Engine
Plug Configuration 3 Pin Rectangular

Ignition Distributor Assemblies



690-141

Mazda
1996-94 Mazda MX-3 4 cyl 1.6L (1597cc); 1996-95 Mazda Protégé 4 cyl 1.5L (1489cc); 1995 Mazda Protégé 4cyl 1.8L (1839cc)

Plug Configuration 3 & 6 Pin Rectangular



690-142

Mazda
1998-96 Mazda Protégé 4 cyl 1.8L (1839cc) & 1.5L (1489cc)

Plug Configuration 7 Pin Rectangular



690-143

Chrysler/Mitsubishi
1995-93 Mitsubishi Expo; 1994-93 Mitsubishi Expo LRV; 1994-93 Dodge Colt and Colt Vista; 1995-93 Eagle Summit; 4Cyl 2.4L (2351cc)

Plug Configuration 2 & 7 Pin Round



690-145

Mazda/Ford
1994-93 Mazda MX-6 and 626 and 1994-93 Ford Probe 6 cyl 2.5L (2497cc); 1993-92 Mazda 323 6 cyl 1.8L (1845cc)

Plug Configuration 3 & 6 Pin Rectangular



690-153

Honda
1997-95 Honda Accord; 1996 Honda Prelude; 4 cyl 2.2L (2156cc)

ID # TD-76U

Plug Configuration 2 & 4 Pin Rectangular



690-154

Honda
2000-99 Honda Civic; 1997-96 Honda Civic Del Sol; 4 cyl 1.6L (1590cc)

ID # TD-81U

Plug Configuration 9 Pin Square



690-155

Acura
2001-98 Acura Integra GSR and R Type 4 cyl 1.8L (1797cc)

ID # TC-08A

Plug Configuration 9 Pin Square



690-156

Mazda
1995-90 Mazda Protégé 4 cyl 1.8L (1839cc) SOHC

Plug Configuration 4 Pin Rectangular



690-157

Mazda
1994-90 Mazda 323 4 cyl 1.6L (1597cc)

Plug Configuration 4 Pin Rectangular

Ignition Distributor Assemblies



690-158

Mazda
1997-95 Mazda MX-6 and 626 4 cyl 2.0L (1991cc) Manual Transmission
Plug Configuration 3 & 6 Pin



690-162

Honda
2000-99 Honda Civic; 1.6L (1590cc); Tec
ID # TD-73U
Plug Configuration 7 Pin Rectangle



690-163

Chrysler
2000-95 Cirrus, Stratus, Sebring 2.5L
ID # T5T57172
Plug Configuration 2 Pin Rectangular & 6 Pin Oval



690-165

Mazda/Ford
1997-95 Mazda 626, MX-6, Ford Probe; 2002-95 Millenia 2.5L
ID # TOT57271
Plug Configuration 3 Pin Rectangular & 6 Pin Rectangular



690-166

Mazda/Ford
1996-91 Ford Escort, Mercury Tracer; 1991-90 Mazda Protégé 1.8L Optical Type
ID # T2T52471
Plug Configuration 4 Pin Rectangular



690-167

Toyota
1991-88 Toyota 4-Runner & Pickups V6 3VZE Eng.
Plug Configuration 4 Pin Rectangular



690-168

Honda
1995 Accord 2.2L w/ 2 Plugs, VTEC, DOHC
ID # D4J92-04; Hitachi Vin F22B1
Plug Configuration 2 Pin Rectangular & 7 Pin Rectangular



690-169

Acura/Honda
1999-98 Acura CL; 2002-99 Honda Accord 2.3L
ID # D4T96-03; D4T96-07
Plug Configuration 4 Pin Rectangular



690-170

Mitsubishi
1995-94 Galant 2.4L; 1993 Galant 2.0L; 2000-93 GTX
ID # T6T58271
Plug Configuration 2 Pin Rectangular & 6 Pin Rectangular

Ignition Distributor Assemblies



690-171

Mitsubishi/Chrysler
1994-91 Eclipse, Laser; 1994-93 Talon 1.8L

ID # T6T57371

Plug Configuration 2 Pin Rectangular & 6 Pin Oval



690-172

Chrysler
1995-87 Caravan, Voyager; 1995-89 Spirit, Acclaim; 1994-92 Sundance, Shadow, 1995-90 LeBaron; 1993-88 Dynasty

ID # T5T62071

Plug Configuration 4 Pin Round



690-173

Nissan
2001-98 Altima 2.4L

Plug Configuration 2 Pin Rectangular & 6 Pin Rectangular



690-174

Volkswagen
1998-93 Passat; 1996-93 Golf, Jetta; 1996-95 Cabrio

Plug Configuration 3 Pin Rectangular



690-900

GM
2005-95 GM Vehicles w/4.3 L

Plug Configuration 3-pin oval



690-901

GM
1996 G-Series Vans (7.4L); 1999-96 P-Series Vans & Suburban (7.4L); 2000-96 C/K Series Pickups, Express & Savana (7.4L).

Plug Configuration 3-pin oval



690-902

GM
1998-96 G-Series Vans (5.0L); 1999-96 C/K 1500/2500 (5.0L); 1999-96 C/K 1500, Suburban, P-Series Vans (5.7L); 2000-96 Express, Savana (5.0L); 2000-96 C/K 2500/3500, Express, Savana, Tahoe, Yukon (5.7L); 2002-01 Express, Savana (5.0L&5.7L).

Plug Configuration 3-pin oval



690-903

GM
1995-87 G-Series Vans & Suburban; 1996-87 P-Series Van & Firebird; 91-87 R/V Series; 95 Tahoe; 91-87 Jimmy; 95-92 Yukon; 92-90 Fleetwood; 92-87 Camaro; 90-87 Caprice; 88-87 Monte Carlo; 94-87 Blazer; 95-88 C/K Series; 96-92 Delivery Truck; 98-93 School Bus

Plug Configuration 2 and 4 Pin Oval

Ignition Distributor Assembly Applications

Make/ Model/Engine	Year	Description	Dorman #
ACURA			
CL			
L4 - 2.3L (2254 cc)	1999-98	ID #D4T96-07, Hitachi	690-169
INTEGRA			
L4 - 1.6L (1590 cc)	1989-88	ID #TD-03U, Tec	690-107
L4 - 1.7L (1678 cc)	1993-92	ID #TD-44U, Tec	690-104
L4 - 1.7L (1678 cc)	1993-92	ID #TD-55U, Tec	690-109
L4 - 1.8L (1797 cc)	2001-98	ID #TC-08A, Tec, GSR & Type R	690-155
L4 - 1.8L (1797 cc)	1995-94	ID #TD-08A, Tec, GSR	690-104
L4 - 1.8L (1834 cc)	2001-96	ID #TC-08A, Tec, Exc. GSR & Type R	690-131
L4 - 1.8L (1834 cc)	1993-92	ID #TD-44U, Tec	690-104
L4 - 1.8L (1834 cc)	1993-92	ID #TD-55U, Tec	690-109
L4 - 1.8L (1834 cc)	1991-90	Auto Trans, ID #TD-24U, Tec	690-118
L4 - 1.8L (1834 cc)	1991-90	Manual Trans, ID #TD-23U, Tec, w/Coil ID #TC-07A	690-119
CADILLAC			
ESCALADE			
V8 - 5.7L (350 CID)	2000-99	-	690-902
FLEETWOOD			
V8 - 5.0L (305 CID)	1992-91	-	690-903
V8 - 5.7L (350 CID)	1992-90	-	690-903
CHEVROLET			
CAMARO			
V8 - 5.0L (305 CID)	1992-87	-	690-903
V8 - 5.7L (350 CID)	1992-87	-	690-903
CAPRICE			
V8 - 5.0L (305 CID)	1990-87	-	690-903
V8 - 5.7L (350 CID)	1990-87	-	690-903
EL CAMINO			
V8 - 5.0L (305 CID)	1987	-	690-903
MONTE CARLO			
V8 - 5.0L (305 CID)	1988-87	-	690-903
CHEVROLET/GMC TRUCK			
ASTRO			
V6 - 4.3L (262 CID)	2005-96	-	690-900
BLAZER			
V8 - 5.0L (305 CID)	1987	-	690-903
V8 - 5.7L (350 CID)	1994-87	-	690-903
C,K SERIES PICKUP			
V6 - 4.3L (262 CID)	1998-96	-	690-900
V8 - 5.0L (305 CID)	1999-96	-	690-902
V8 - 5.0L (305 CID)	1995-88	-	690-903
V8 - 5.7L (350 CID)	2000-96	-	690-902
V8 - 5.7L (350 CID)	1995-88	-	690-903
V8 - 7.4L (454 CID)	2000-96	-	690-901
V8 - 7.4L (454 CID)	1995-88	-	690-903
CABALLERO			
V8 - 5.0L (305 CID)	1987	-	690-903
DELIVERY TRUCK			
V8 - 6.0L (366 CID)	1996-92	-	690-903
V8 - 7.0L (427 CID)	1996-92	-	690-903
EXPRESS VAN			
V6 - 4.3L (262 CID)	2005-96	-	690-900
V8 - 5.0L (305 CID)	2002-96	-	690-902
V8 - 5.7L (350 CID)	2002-96	-	690-902
V8 - 7.4L (454 CID)	2000-96	-	690-901
G SERIES VAN			
V6 - 4.3L (262 CID)	1998-96	-	690-900
V8 - 5.0L (305 CID)	1998-97	-	690-902
V8 - 5.0L (305 CID)	1996	VIN H	690-903
V8 - 5.0L (305 CID)	1996	VIN M	690-902
V8 - 5.0L (305 CID)	1995-87	-	690-903
V8 - 5.7L (350 CID)	1996	VIN K	690-903
V8 - 5.7L (350 CID)	1996	VIN R	690-902
V8 - 5.7L (350 CID)	1995-89	-	690-903
V8 - 5.7L (350 CID)	1988-87	VIN K	690-903
V8 - 7.4L (454 CID)	1996	VIN J	690-901
V8 - 7.4L (454 CID)	1996	VIN N	690-903
V8 - 7.4L (454 CID)	1995-88	-	690-903
JIMMY			
V8 - 5.0L (305 CID)	1987	-	690-903
V8 - 5.7L (350 CID)	1991-87	-	690-903
V6 - 4.3L (262 CID)	1999-96	-	690-900
V8 - 5.7L (350 CID)	1999-96	-	690-902
CHEVROLET/GMC TRUCK			
P SERIES VAN			
V8 - 5.7L (350 CID)	1988-87	VIN K	690-903
V8 - 7.4L (454 CID)	1999-97	VIN J	690-901
V8 - 7.4L (454 CID)	1996	VIN J	690-901
V8 - 7.4L (454 CID)	1996	VIN N	690-903

Make/ Model/Engine	Year	Description	Dorman #
CHEVROLET/GMC TRUCK (continued)			
P SERIES VAN (continued)			
V8 - 7.4L (454 CID)	1995-90	-	690-903
R,V SERIES PICKUP			
V8 - 5.0L (305 CID)	1987	-	690-903
V8 - 5.7L (350 CID)	1991-89	-	690-903
V8 - 5.7L (350 CID)	1988-87	VIN K	690-903
V8 - 7.4L (454 CID)	1991-90	-	690-903
V8 - 7.4L (454 CID)	1989-87	VIN N	690-903
S SERIES BLAZER, JIMMY			
V6 - 4.3L (262 CID)	2005-96	-	690-900
V6 - 4.3L (262 CID)	1995	VIN W	690-900
S SERIES PICKUP, SONOMA			
V6 - 4.3L (262 CID)	2004-96	-	690-900
V6 - 4.3L (262 CID)	1995	VIN W	690-900
SAFARI			
V6 - 4.3L (262 CID)	2005-96	-	690-900
SAVANA VAN			
V6 - 4.3L (262 CID)	2005-96	-	690-900
V8 - 5.0L (305 CID)	2002-96	-	690-902
V8 - 5.7L (350 CID)	2002-96	-	690-902
V8 - 7.4L (454 CID)	2000-96	-	690-901
SCHOOL BUS			
V8 - 6.0L (366 CID)	1998-93	-	690-903
V8 - 7.0L (427 CID)	1998-93	-	690-903
SIERRA PICKUP			
V6 - 4.3L (262 CID)	2005-99	-	690-900
SILVERADO PICKUP			
V6 - 4.3L (262 CID)	2005-99	-	690-900
STEEL CONVENTIONAL			
V8 - 6.0L (366 CID)	1990-89	w/EFI	690-903
SUBURBAN			
V8 - 5.0L (305 CID)	1987	-	690-903
V8 - 5.7L (350 CID)	1999-96	-	690-902
V8 - 5.7L (350 CID)	1995-87	-	690-903
V8 - 7.4L (454 CID)	1999-96	-	690-901
V8 - 7.4L (454 CID)	1995-87	-	690-903
TAHOE			
V8 - 5.7L (350 CID)	2000-96	-	690-902
V8 - 5.7L (350 CID)	1995	-	690-903
TILT CAB			
V8 - 6.0L (366 CID)	1998-97	-	690-903
TOPKICK, KODIAK			
V8 - 6.0L (366 CID)	1998-90	-	690-903
V8 - 7.0L (427 CID)	1998-90	-	690-903
YUKON			
V8 - 5.7L (350 CID)	2000-96	-	690-902
V8 - 5.7L (350 CID)	1995-92	-	690-903
CHRYSLER			
CIRRUS			
V6 - 2.5L (152 CID)	2000-95	-	690-163
LEBARON			
V6 - 3.0L (181 CID)	1995-90	-	690-172
NEW YORKER			
V6 - 3.0L (181 CID)	1989-88	-	690-172
SEBRING			
V6 - 2.5L (152 CID)	2000-95	-	690-163
TC MASERATI			
V6 - 3.0L (181 CID)	1990	-	690-172
DODGE			
AVENGER			
V6 - 2.5L (152 CID)	2000-95	-	690-163
CARAVAN			
V6 - 3.0L (181 CID)	1995-87	-	690-172
COLT			
L4 - 1.5L (1468 cc)	1994-91	-	690-135
L4 - 1.8L (1834 cc)	1994-93	-	690-122
DAYTONA			
V6 - 3.0L (181 CID)	1993-90	-	690-172
DYNASTY			
V6 - 3.0L (181 CID)	1993-88	-	690-172
GRAND CARAVAN			
V6 - 3.0L (181 CID)	1995-88	-	690-172
SHADOW			
V6 - 3.0L (181 CID)	1994-92	-	690-172
SPIRIT			
V6 - 3.0L (181 CID)	1995-89	-	690-172
STRATUS			
V6 - 2.5L (152 CID)	2000-95	-	690-163

Ignition Distributor Assembly Applications

Make/Model/Engine	Year	Description	Dorman #
DODGE TRUCK			
MINI RAM VAN			
V6 - 3.0L (181 CID)	1988-87	-	690-172
ROYAL MINI RAM			
V6 - 3.0L (181 CID)	1987	-	690-172
EAGLE			
2000 GTX			
L4 - 2.0L (1995 cc)	1993	-	690-170
PREMIER			
V6 - 3.0L (182 CID)	1988	-	690-172
SUMMIT			
L4 - 1.5L (1468 cc)	1996-95	Exc. Calif	690-135
L4 - 1.5L (1468 cc)	1994-91	-	690-135
L4 - 1.8L (1834 cc)	1996-95	Exc. Calif	690-122
L4 - 1.8L (1834 cc)	1994-92	-	690-122
L4 - 2.4L (2351 cc)	1995	2WD, Exc. Calif	690-143
L4 - 2.4L (2351 cc)	1995	4WD	690-143
L4 - 2.4L (2351 cc)	1994-93	-	690-143
TALON			
L4 - 1.8L (107 CID)	1994-93	-	690-171
L4 - 2.0L (122 CID)	1994-91	-	690-171
FORD			
ESCORT			
L4 - 1.8L (112 CID)	1996-91	-	690-166
PROBE			
L4 - 2.0L (122 CID)	1993	Auto Trans, ID #T6T5781	690-112
V6 - 2.5L (152 CID)	1997-95	-	690-165
V6 - 2.5L (152 CID)	1994-93	-	690-145
GEO			
PRIZM			
L4 - 1.6L (98 CID)	1997-96	-	690-117
L4 - 1.8L (110 CID)	1997-95	VIN 8	690-117
HONDA			
ACCORD			
L4 - 2.2L (2156 cc)	1997-96	ID #TD-76U, Tec	690-153
L4 - 2.2L (2156 cc)	1995	DX Series; ID #TD59-U, Tec, Built in Japan	690-105
L4 - 2.2L (2156 cc)	1995	DX Series; ID #TD59-U, Tec, Built in USA	690-138
L4 - 2.2L (2156 cc)	1995	EX Series; ID #D4J92-04, Hitachi	690-168
L4 - 2.2L (2156 cc)	1995	ID #TD-76U, Tec	690-153
L4 - 2.2L (2156 cc)	1995	LX Series; ID #TD59-U, Tec, Built in Japan	690-105
L4 - 2.2L (2156 cc)	1995	LX Series; ID #TD59-U, Tec, Built in USA	690-138
L4 - 2.2L (2156 cc)	1994	DX Series; ID #TD59-U, Tec, Built in Japan	690-105
L4 - 2.2L (2156 cc)	1994	DX Series; ID #TD59-U, Tec, Built in USA	690-138
L4 - 2.2L (2156 cc)	1994	LX Series; ID #TD59-U, Tec, Built in Japan	690-105
L4 - 2.2L (2156 cc)	1994	LX Series; ID #TD59-U, Tec, Built in USA	690-138
L4 - 2.2L (2156 cc)	1993-92	ID #TD-52U, Tec	690-105
L4 - 2.2L (2156 cc)	1991-90	ID #TD-31U, Tec	690-101
L4 - 2.3L (2254 cc)	2002-99	EX Series; ID #D4T97-03, Hitachi	690-169
L4 - 2.3L (2254 cc)	2002-99	LX Series; ID #D4T97-03, Hitachi	690-169
L4 - 2.3L (2254 cc)	2002-00	SE Series; ID #D4T97-03, Hitachi	690-169
L4 - 2.3L (2254 cc)	1998	EX Series; 2-Door; ID #D4T97-03, Hitachi	690-169
L4 - 2.3L (2254 cc)	1998	EX Series; 4-Door; ID #D4T96-07, Hitachi	690-169
L4 - 2.3L (2254 cc)	1998	LX Series; 2-Door; ID #D4T97-03, Hitachi	690-169
L4 - 2.3L (2254 cc)	1998	LX Series; 4-Door; ID #D4T96-07, Hitachi	690-169
CIVIC			
L4 - 1.5L (1493 cc)	1995-92	ID #TD-41U, Tec; CX, DX, LX Series	690-102
L4 - 1.5L (1493 cc)	1995-92	ID #TD-42U, Tec; EX, SI, VX Series	690-103
L4 - 1.5L (1493 cc)	1991-90	ID #TD-01U, Tec, w/Coil ID #TC-07A, 5-Pin	690-100
L4 - 1.5L (1493 cc)	1991-90	ID #TD-18U, Tec, 7-Pin	690-110
L4 - 1.5L (1493 cc)	1989-88	ID #TD-01U, Tec, w/Coil ID #TC-05A; Exc. 4WD	690-111
L4 - 1.5L (1493 cc)	1989-88	ID #TD-02U, Tec, 2WD, 3-Door, MT	690-108
L4 - 1.5L (1493 cc)	1989-88	ID #TD-02U, Tec; 4WD	690-108
L4 - 1.6L (1590 cc)	2000-99	ID #TD-73U, Tec; CX, DX, EX & LX Series	690-162
L4 - 1.6L (1590 cc)	2000-99	ID #TD-81U, Tec; SI Series	690-154
L4 - 1.6L (1590 cc)	1998-96	ID #TD-80U, Tec	690-120
L4 - 1.6L (1590 cc)	1995-92	ID #TD-42U, Tec; EX, SI, VX Series	690-103

Make/Model/Engine	Year	Description	Dorman #
HONDA (continued)			
CIVIC (continued)			
L4 - 1.6L (1590 cc)	1991-90	ID #TD-01U, Tec, w/Coil ID #TC-07A, 5-Pin	690-100
L4 - 1.6L (1590 cc)	1991-90	ID #TD-18U, Tec, 7-Pin	690-110
L4 - 1.6L (1590 cc)	1989-88	ID #TD-01U, Tec, w/Coil ID #TC-05A; Exc. 4WD	690-111
L4 - 1.6L (1590 cc)	1989-88	ID #TD-02U, Tec, 2WD, 3-Door, MT	690-108
L4 - 1.6L (1590 cc)	1989-88	ID #TD-02U, Tec; 4WD	690-108
CIVIC DEL SOL			
L4 - 1.5L (1493 cc)	1995-93	ID #TD-41U, Tec; S Series	690-102
L4 - 1.6L (1590 cc)	1997-96	ID #TD-80U, Tec; S, SI Series	690-120
L4 - 1.6L (1590 cc)	1997-96	ID #TD-81U, Tec; VTEC Series	690-154
L4 - 1.6L (1590 cc)	1995-94	ID #TD-44U, Tec; VTEC Series	690-104
L4 - 1.6L (1590 cc)	1995-93	ID #TD-42U, Tec; SI Series	690-103
CR-V			
L4 - 2.0L (1972 cc)	2001-99	ID #TC-08A, Tec	690-130
L4 - 2.0L (1972 cc)	1998-97	ID #TD-97U, Tec	690-129
CRX			
L4 - 1.5L (1493 cc)	1991-90	ID #TD-01U, Tec, w/Coil ID #TC-07A; DX Series, 5-Pin	690-100
L4 - 1.5L (1493 cc)	1991-90	ID #TD-18U, Tec; HF, SI Series, 7-Pin	690-110
L4 - 1.5L (1493 cc)	1989-88	ID #TD-01U, Tec, w/Coil ID #TC-05A; DX Series	690-111
L4 - 1.5L (1493 cc)	1989-88	ID #TD-02U, Tec; HF, SI Series	690-108
L4 - 1.6L (1590 cc)	1991-90	ID #TD-01U, Tec, w/Coil ID #TC-07A; DX Series, 5-Pin	690-100
L4 - 1.6L (1590 cc)	1991-90	ID #TD-18U, Tec; HF, SI Series, 7-Pin	690-110
L4 - 1.6L (1590 cc)	1989-88	ID #TD-01U, Tec, w/Coil ID #TC-05A; DX Series	690-111
L4 - 1.6L (1590 cc)	1989-88	ID #TD-02U, Tec; HF, SI Series	690-108
PRELUDE			
L4 - 2.2L (2156 cc)	1996	ID #TD-76U, Tec	690-153
L4 - 2.2L (2156 cc)	1995-92	ID #TD-52U, Tec, S Series	690-105
L4 - 2.2L (2156 cc)	1995-92	ID #TD-59U, Tec, S Series	690-138
L4 - 2.2L (2156 cc)	1995-92	ID #TD-61U, Tec, VTEC Series	690-106
L4 - 2.3L (2259 cc)	1995-92	ID #TD-61U, Tec	690-106
WAGOVAN			
L4 - 1.5L (1493 cc)	1989-88	ID #TD-01U, Tec, w/Coil ID #TC-05A	690-111
ISUZU			
HOMBRE			
V6 - 4.3L (4294 cc)	2000-97	-	690-900
LEXUS			
ES250			
V6 - 2.5L (2508 cc)	1991-90	2VZFE Eng	690-125
MAZDA			
323			
L4 - 1.6L (1597 cc)	1994-93	Exc. Calif	690-157
L4 - 1.6L (1597 cc)	1992-90	-	690-157
626			
L4 - 2.0L (1991 cc)	1997-96	Manual Trans	690-158
L4 - 2.0L (1991 cc)	1995	Manual Trans	690-158
L4 - 2.0L (1991 cc)	1994	Manual Trans, ID #T6T5781	690-112
L4 - 2.0L (1991 cc)	1993	ID #T6T5781	690-112
V6 - 2.5L (2497 cc)	1997-95	-	690-165
V6 - 2.5L (2497 cc)	1994-93	-	690-145
929			
V6 - 3.0L (2954 cc)	1991-90	SOHC	690-123
MILLENNIA			
V6 - 2.5L (2497 cc)	2002-95	-	690-165
MPV			
V6 - 3.0L (2954 cc)	1995-93	-	690-123
MX-3			
L4 - 1.6L (1597 cc)	1996-94	-	690-141
V6 - 1.8L (1845 cc)	1993-92	-	690-145
MX-6			
L4 - 2.0L (1991 cc)	1997-96	Manual Trans	690-158
L4 - 2.0L (1991 cc)	1995	Manual Trans	690-158
L4 - 2.0L (1991 cc)	1994	Manual Trans, ID #T6T5781	690-112
L4 - 2.0L (1991 cc)	1993	ID #T6T5781	690-112
V6 - 2.5L (2497 cc)	1997-95	-	690-165
V6 - 2.5L (2497 cc)	1994-93	-	690-145
PROTEGE			
L4 - 1.5L (1489 cc)	1998-97	-	690-142
L4 - 1.5L (1489 cc)	1996	Calif	690-141
L4 - 1.5L (1489 cc)	1996	Exc. Calif	690-142
L4 - 1.5L (1489 cc)	1995	-	690-141
L4 - 1.8L (1839 cc)	1998-96	-	690-142
L4 - 1.8L (1839 cc)	1995	Hatchback	690-156
L4 - 1.8L (1839 cc)	1995	Sedan	690-141

Ignition Distributor Assembly Applications

Make/ Model/Engine	Year	Description	Dorman #
MAZDA (continued)			
PROTEGE (continued)			
L4 - 1.8L (1839 cc)	1994-90	SOHC	690-156
L4 - 1.8L (1839 cc)	1991-90	DOHC	690-166
MAZDA TRUCK			
B2200 PICKUP			
L4 - 2.2L (2184 cc)	1993-90	w/Fuel Injection, ID #T2T53071	690-124
L4 - 2.2L (2184 cc)	1993-90	wo/Fuel Injection	690-175
L4 - 2.2L (2184 cc)	1989-87	-	690-175
MERCURY			
TRACER			
L4 - 1.8L (112 CID)	1996-91	-	690-166
MINI			
ECLIPSE			
L4 - 1.8L (1755 cc)	1994-92	-	690-171
EXPO			
L4 - 2.4L (2351 cc)	1995	2WD, Exc. Calif	690-143
L4 - 2.4L (2351 cc)	1995	4WD	690-143
L4 - 2.4L (2351 cc)	1994-93	-	690-143
EXPO LRV			
L4 - 1.8L (1834 cc)	1994-92	-	690-122
L4 - 2.4L (2351 cc)	1994-93	-	690-143
GALANT			
L4 - 2.0L (1997 cc)	1993	SOHC	690-170
L4 - 2.4L (2351 cc)	1995-94	-	690-170
MIRAGE			
L4 - 1.5L (1468 cc)	1995	Exc. Calif	690-135
L4 - 1.5L (1468 cc)	1994-91	-	690-135
L4 - 1.8L (1834 cc)	1995	Exc. Calif	690-122
L4 - 1.8L (1834 cc)	1994-93	-	690-122
NISSAN			
200SX			
L4 - 1.6L (1597 cc)	1998-96	Hitachi, GA16DE Eng	690-133
L4 - 1.6L (1597 cc)	1995	Hitachi, GA16DE Eng, From 2/95	690-133
ALTIMA			
L4 - 2.4L (2389 cc)	2001-00	-	690-173
L4 - 2.4L (2389 cc)	1999-98	Hap	690-173
L4 - 2.4L (2389 cc)	1997-93	Vendor-HAP, ID #D4P90-02, D4P90-03, KA24DE Eng	690-121
NX			
L4 - 1.6L (1597 cc)	1993-91	ID #T4T84771A, GA16DE Eng	690-113
PULSAR NX			
L4 - 1.6L (1597 cc)	1990-89	ID #T4T84771A, GA16i Eng	690-113
SENTRA			
L4 - 1.6L (1597 cc)	1999-96	Hitachi, GA16DE Eng	690-133
L4 - 1.6L (1597 cc)	1995	Hitachi, GA16DE Eng, From 2/95	690-133
L4 - 1.6L (1597 cc)	1994-91	ID #T4T84771A, GA16DE Eng	690-113
L4 - 1.6L (1597 cc)	1990-89	ID #T4T84771A, GA16i Eng	690-113
OLDSMOBILE			
BRAVADA			
V6 - 4.3L (262 CID)	2001-96	-	690-900
PLYMOUTH			
ACCLAIM			
V6 - 3.0L (181 CID)	1995-89	-	690-172
COLT			
L4 - 1.5L (1468 cc)	1994-91	-	690-135
L4 - 1.8L (1834 cc)	1994-92	-	690-122
L4 - 2.4L (2351 cc)	1994-93	-	690-143
COLT VISTA			
L4 - 1.8L (1834 cc)	1994-92	-	690-122
L4 - 2.4L (2351 cc)	1994-93	-	690-143
GRAND VOYAGER			
V6 - 3.0L (181 CID)	1995-88	-	690-172
LASER			
L4 - 1.8L (107 CID)	1994-91	-	690-171
L4 - 2.0L (122 CID)	1994-91	-	690-171
SUNDANCE			
V6 - 3.0L (181 CID)	1994-92	-	690-172
VOYAGER			
V6 - 3.0L (181 CID)	1995-87	-	690-172

Make/ Model/Engine	Year	Description	Dorman #
PONTIAC			
FIREBIRD			
V8 - 5.0L (305 CID)	1992-87	-	690-903
V8 - 5.7L (350 CID)	1992-87	-	690-903
GRAND PRIX			
V8 - 5.0L (305 CID)	1987	-	690-903
SUZUKI			
SWIFT			
L4 - 1.3L (1298 cc)	1995-92	SOHC	690-136
TOYOTA			
CAMRY			
L4 - 2.0L (1998 cc)	1991-87	3SFE Eng	690-115
L4 - 2.2L (2164 cc)	1995-94	5SFE Eng, Exc. Calif	690-114
L4 - 2.2L (2164 cc)	1993-92	5SFE Eng	690-114
V6 - 2.5L (2508 cc)	1991-90	2VZFE Eng	690-125
V6 - 2.5L (2508 cc)	1989-88	2VZFE Eng	690-125
CELICA			
L4 - 1.8L (1762 cc)	1997-96	7AFE Eng	690-117
L4 - 1.8L (1762 cc)	1995-94	7AFE Eng	690-137
L4 - 2.0L (1998 cc)	1989-87	3SFE Eng	690-115
L4 - 2.2L (2164 cc)	1996	5SFE Eng, To 10/95	690-114
L4 - 2.2L (2164 cc)	1995-94	5SFE Eng	690-114
L4 - 2.2L (2164 cc)	1993	5SFE Eng, From 8/93	690-114
COROLLA			
L4 - 1.6L (1587 cc)	1997-96	4AFE Eng	690-117
L4 - 1.6L (1587 cc)	1995-94	4AFE Eng	690-137
L4 - 1.6L (1587 cc)	1993	4AFE Eng, Exc. Wagon	690-137
L4 - 1.6L (1587 cc)	1993	4AFE Eng, Wagon	690-132
L4 - 1.6L (1587 cc)	1992-91	4AFE Eng, Exc. 4WD Wagon	690-132
L4 - 1.6L (1587 cc)	1990	4AFE Eng	690-132
L4 - 1.8L (1762 cc)	1997-95	7AFE Eng	690-117
L4 - 1.8L (1762 cc)	1994-93	7AFE Eng	690-137
MR2			
L4 - 2.2L (2164 cc)	1995-93	5SFE Eng	690-114
L4 - 2.2L (2164 cc)	1992	5SFE Eng, From 1/92	690-114
TOYOTA TRUCK			
4 RUNNER			
V6 - 3.0L (2959 cc)	1991-88	-	690-167
PICKUP			
V6 - 3.0L (2959 cc)	1991-88	-	690-167
VOLKSWAGEN			
CABRIO			
L4 - 2.0L (1984 cc)	1996	To Chassis 1ET000750	690-174
L4 - 2.0L (1984 cc)	1995	-	690-174
GOLF			
L4 - 1.8L (1780 cc)	1989-87	16-Valve	690-134
L4 - 2.0L (1984 cc)	1996	To Chassis 1HT130600	690-174
L4 - 2.0L (1984 cc)	1995-93	-	690-174
L4 - 2.0L (1984 cc)	1992-90	16-Valve	690-134
JETTA			
L4 - 1.8L (1780 cc)	1989-87	16-Valve	690-134
L4 - 2.0L (1984 cc)	1996	To Chassis 1HT130600	690-174
L4 - 2.0L (1984 cc)	1995-93	-	690-174
L4 - 2.0L (1984 cc)	1992-90	16-Valve	690-134
PASSAT			
L4 - 2.0L (1984 cc)	1996-95	-	690-174
L4 - 2.0L (1984 cc)	1993-90	16-Valve	690-134
SCIROCCO			
L4 - 1.8L (1780 cc)	1988-87	16-Valve	690-134
VOLVO			
740			
L4 - 2.3L (2316 cc)	1989-86	B230FT	690-139
745			
L4 - 2.3L (2316 cc)	1985	B230FT	690-139
760			
L4 - 2.3L (2316 cc)	1989-85	B230FT	690-139
780			
L4 - 2.3L (2316 cc)	1989	B230FT	690-139

Prevent a Breakdown: Watch For These Telltale Signs!



- **Corrosion**
- **Poor Grounds** - overheats electronics
- **Seals & Shafts Wear** - allows oil to get into the electronics/sensors
- **Bushing/Bearing Failure**
- **Excessive Heat** – causes burnt contacts
- **Loose Timing Belts** – allow camshaft that drives Distributor to jump or spin causing loose screws

Diagnostic Tips

Distributor failures are generally mechanical or electrical type failures.

- **Mechanical:** are often the result of a loose timing belt. The slack in the timing belt allows the camshaft that drives the distributor to jump or spin back and forth. Over time, the back and forth motion will loosen screws. The result is a damaged distributor.
- **Electrical:** A poor ground connection will cause the ignitor to fail.



Tech Tips

- Mark the position of the rotor prior to removal of the Distributor. This will aid in installing the replacement unit into the proper position.
- Install the replacement Distributor so the rotor points in the same way.
- Always compare the original distributor to the replacement unit. Pay special attention to the area below the flange. Check all dimensions!
- Lubricate the O-ring before inserting the Distributor into the engine to prevent it from tearing.
- Use caution when plugging in the electrical connectors to prevent bent pins.
- Do not force the Distributor into the engine or use a bolt to pull it into the block! Damage to the Distributor and/or engine may occur.
- Inspect all components (spark plugs, wires, etc.) in the ignition system for wear and/or corrosion. Replace as necessary.

Prevent Comebacks

IMPORTANT!

Compare replacement distributor to original unit before replacement. The replacement distributor's gear size, number of teeth, shaft length and hex drive size (where applicable) must **MATCH** original to prevent damage to engine.

Intake Manifold Kits

Dorman-engineered to prevent failure from reoccurring



- Offering the Manifolds That Are Most **Failure Prone**
- Direct OE Replacement

4.6L GM



Dorman® OE Solutions™

Intake Manifold Kits Feature:

- Reinforced aluminum coolant crossover means no repeat failure due to corrosion and vibration.
- Integrated silicone gaskets mean no separate gaskets to deal with, and fewer leak paths at cylinder heads and throttle body.
- Components included.

Typical Failure

- OE Intake cracks due to coolant corrosion and alternator vibrations.

3.8L GM



Dorman® OE Solutions™

Intake Manifold Kits Feature:

- Reinforced EGR and coolant passage walls for greater durability.
- Includes everything needed to install:
 - Throttle body and intake manifold gasket
 - PCV O-ring and valve cap
 - Breather tube assembly and O-ring
 - Replacement EGR sleeve

Typical Failure

- EGR gas and coolant corrode plastic passages, causing leakage into the engine.

GM Intake Manifold Reseal Kit

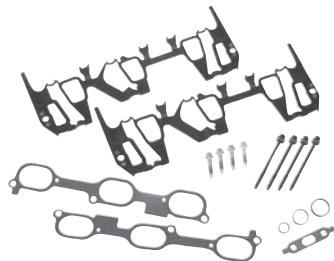

- For GM 3.1-3.4 Intake Manifolds
- **ALL** the components needed to **COMPLETE** the job
- Kit includes:
 - New bolts with thread locker
 - Two heater tube O-rings
 - Distributor O-ring
 - EGR valve gasket

Ford Windstar Intake & Valve Cover Repair Kit



- **Dorman Solution:**
 - Complete Kit/One SKU
 - Includes all parts to repair the problem and prevent recurring symptoms
- OE Recognized Problem - Ford TSB - 03-16-1

Activant Path

Fuel Injection

Activant Code

DII

Applications begin on page 275.

Intake Manifolds Kits

- Reinforced In Failure Prone Areas
- Complete with all Gaskets and O-Rings Needed for Installation



615-175

Ford V8 - 4.6L
2006-99, Includes Thermostat, Alternator Brackets and all Gaskets and O-Rings needed for Installation.



615-176

Ford - 4.0L
2001-97, Includes all Gaskets and O-Rings needed for Installation.

Intake Manifold Kits



615-178

Ford 4.6L V-8
2000-96, Includes Thermostat, Alternator Brackets and all Gaskets and O-Rings needed for Installation.



615-179

GM 3.8L Series I V-6
1995-93, Includes Plastic Vacuum Manifold, and all Gaskets and O-Rings needed for Installation.



615-180

GM 3.8L Series II V-6
2005-95, Includes PCV Valve Retainer, Plastic Vacuum Manifold, and all Gaskets and O-Rings needed for Installation.



615-181

GM 5.0L & 5.7L Vortec® V-8
2002-96, Includes Plastic Vacuum Manifold, and all Gaskets and O-Rings needed for Installation.

Intake Manifolds Kits



615-182

GM 4.3L V-6 Vortec
2006-96, Includes Plastic Vacuum Manifold, and all Gaskets and O-Rings needed for installation.

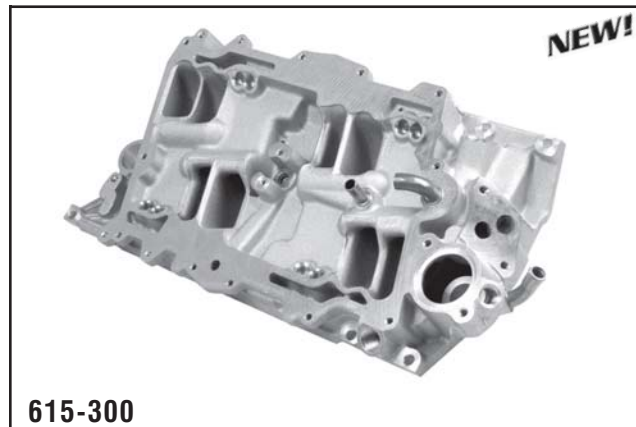

615-300

GM
2002-96 Chevrolet/GMC Trucks. Aluminum lower manifold (use with 615-181 upper plenum).

Gasket Kits



615-177

Valve Cover Repair Kit
Ford Windstar 3.8L, 2003-99. Includes Valve Cover, PVC Line, Fuel Pressure Regulator Vacuum Line, 8 Intake Isolator Bolts, Throttle Body Gasket, Idle Speed Control Gasket, Upper Intake Gasket, 6 Intake Port Gaskets.

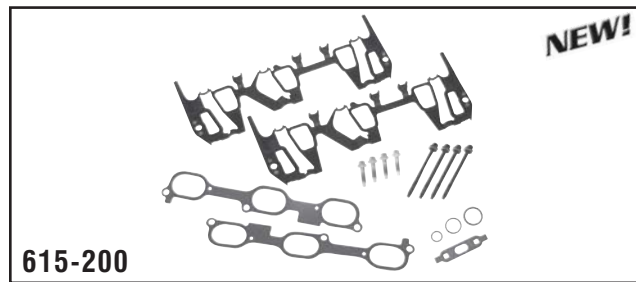

615-200

Valve Cover Repair Kit
GM 3.1L & 3.4L. Includes Upper & Lower Manifold Gasket Set, 8 Intake Bolts with Thread Locker, 2 Heater Tube O-Rings, Distributor O-Ring, EGR Valve Gasket.

Intake Manifold Kits

Intake Manifold Kit Applications

Make/Model/Engine	Years	Description	Upper	Lower	Gasket Kit
BUICK					
CENTURY					
V6 - 3.1L (189 CID)	2003-00	-	-	-	615-200
LESABRE					
V6 - 3.8L (231 CID)	2005-96	VIN-K	615-180	-	-
V6 - 3.8L (231 CID)	1995-93	-	615-179	-	-
PARK AVENUE					
V6 - 3.8L (231 CID)	2005-95	VIN-K	615-180	-	-
V6 - 3.8L (231 CID)	1994-93	VIN-L	615-179	-	-
REGAL					
V6 - 3.8L (231 CID)	2004-96	VIN-K	615-180	-	-
V6 - 3.8L (231 CID)	1995-93	-	615-179	-	-
RENDEZVOUS					
V6 - 3.4L (207 CID)	2003-02	-	-	-	615-200
RIVIERA					
V6 - 3.8L (231 CID)	1997-95	VIN-K	615-180	-	-
CHEVROLET					
IMPALA					
V6 - 3.4L (207 CID)	2003-00	-	-	-	615-200
V6 - 3.8L (231 CID)	2005-00	VIN-K	615-180	-	-
LUMINA					
V6 - 3.1L (189 CID)	2001-00	-	-	-	615-200
V6 - 3.8L (231 CID)	1999-98	VIN-K	615-180	-	-
LUMINA APV					
V6 - 3.4L (207 CID)	1996	-	-	-	615-200
V6 - 3.8L (231 CID)	1995-93	-	615-179	-	-
MALIBU					
V6 - 3.1L (189 CID)	2003-00	-	-	-	615-200
V6 - 3.1L (189 CID)	1999	VIN J	-	-	615-200

Make/Model/Engine	Years	Description	Upper	Lower	Gasket Kit
CHEVROLET (continued)					
MONTE CARLO					
V6 - 3.4L (207 CID)	2003-00	-	-	-	615-200
V6 - 3.8L (231 CID)	2005-98	VIN-K	615-180	-	-
VENTURE VAN					
V6 - 3.4L (207 CID)	2003-97	-	-	-	615-200
CHEVROLET TRUCK					
ASTRO					
V6 - 4.3L (262 CID)	2005-96	-	615-182	-	-
C1500 PICKUP					
V6 - 4.3L (262 CID)	1998-96	-	615-182	-	-
V8 - 5.0L (305 CID)	1999-96	-	615-181	615-300	-
V8 - 5.7L (350 CID)	1999-96	-	615-181	615-300	-
C1500 SUBURBAN					
V8 - 5.7L (350 CID)	1999-96	-	615-181	615-300	-
C2500 PICKUP					
V8 - 5.0L (305 CID)	1999-96	-	615-181	615-300	-
V8 - 5.7L (350 CID)	2000-96	-	615-181	615-300	-
C2500 SUBURBAN					
V8 - 5.7L (350 CID)	1999-96	-	615-181	615-300	-
C3500 PICKUP					
V8 - 5.7L (350 CID)	2000-96	-	615-181	615-300	-
EXPRESS 1500					
V6 - 4.3L (262 CID)	2006-96	-	615-182	-	-
V8 - 5.0L (305 CID)	2002-96	-	615-181	615-300	-
V8 - 5.7L (350 CID)	2002-96	-	615-181	615-300	-
EXPRESS 2500					
V6 - 4.3L (262 CID)	2006-98	-	615-182	-	-
V8 - 5.0L (305 CID)	2002-99	-	615-181	615-300	-

Power Steering Pulleys
pg. 317-326

Quick Disconnect™
pg. 327-396

Radiator Fan Assemblies
pg. 397-430

Rear Axle Shaft Kits
pg. 431-434

Side View Mirror Assemblies
pg. 435-468

Dorman Engineered to be BETTER than OE

Intake Manifold Kits

Intake Manifold Kit Applications

Make/Model/Engine	Years	Description	Upper	Lower	Gasket Kit
CHEVROLET TRUCK (continued)					
EXPRESS 2500 (continued)					
V8 - 5.7L (350 CID)	2002-96	-	615-181	615-300	-
EXPRESS 3500					
V8 - 5.7L (350 CID)	2002-96	-	615-181	615-300	-
G20 VAN					
V6 - 4.3L (262 CID)	1997-96	-	615-182	-	-
V8 - 5.0L (305 CID)	1998-96	-	615-181	615-300	-
G30 VAN					
V8 - 5.7L (350 CID)	1996	-	615-181	615-300	-
G35 VAN					
V6 - 4.3L (262 CID)	1998-96	-	615-182	-	-
K1500 PICKUP					
V6 - 4.3L (262 CID)	1998-96	-	615-182	-	-
V8 - 5.0L (305 CID)	1999-96	-	615-181	615-300	-
V8 - 5.7L (350 CID)	1999-96	-	615-181	615-300	-
K1500 SUBURBAN					
V8 - 5.7L (350 CID)	1999-96	-	615-181	615-300	-
K2500 PICKUP					
V8 - 5.0L (305 CID)	1999-98	-	615-181	615-300	-
V8 - 5.7L (350 CID)	2000-96	-	615-181	615-300	-
K2500 SUBURBAN					
V8 - 5.7L (350 CID)	1999-96	-	615-181	615-300	-
K3500 PICKUP					
V8 - 5.7L (350 CID)	2000-96	-	615-181	615-300	-
P30 VAN					
V6 - 4.3L (262 CID)	1999-96	-	615-182	-	-
V8 - 5.7L (350 CID)	1999-96	-	615-181	615-300	-
S10 BLAZER					
V6 - 4.3L (262 CID)	2005-96	-	615-182	-	-
S10 PICKUP					
V6 - 4.3L (262 CID)	2005-96	-	615-182	-	-
SILVERADO 1500					
V6 - 4.3L (262 CID)	2006-99	-	615-182	-	-
TAHOE					
V8 - 5.7L (350 CID)	2000-96	-	615-181	615-300	-
FORD					
CROWN VICTORIA					
V8 - 4.6L (281 CID)	2006-01	-	615-175	-	-
V8 - 4.6L (281 CID)	2000-96	-	615-178	-	-
MUSTANG					
V8 - 4.6L (281 CID)	2004-99	SOHC, One Piece, Exc. Bullit	615-175	-	-
V8 - 4.6L (281 CID)	1998-96	SOHC; One Piece	615-178	-	-
THUNDERBIRD					
V8 - 4.6L (281 CID)	1997-96	-	615-178	-	-
FORD TRUCK					
EXPLORER					
V6 - 4.0L (245 CID)	2001-97	VIN E, SOHC Engine	-	615-176	-
V8 - 4.6L (281 CID)	2002	-	615-175	-	-
WINDSTAR					
V6 - 3.8L (232 CID)	2003-99	Valve Cover Repair Kit	-	-	615-177
GMC TRUCK					
C1500 PICKUP					
V6 - 4.3L (262 CID)	1998-96	-	615-182	-	-
V8 - 5.0L (305 CID)	1999-96	-	615-181	615-300	-
V8 - 5.7L (350 CID)	1999-96	-	615-181	615-300	-
C1500 SUBURBAN					
V8 - 5.7L (350 CID)	1999-96	-	615-181	615-300	-
C2500 PICKUP					
V8 - 5.0L (305 CID)	1999-96	-	615-181	615-300	-
V8 - 5.7L (350 CID)	2000-96	-	615-181	615-300	-
C2500 SUBURBAN					
V8 - 5.7L (350 CID)	1999-96	-	615-181	615-300	-
C3500 PICKUP					
V8 - 5.7L (350 CID)	2000-96	-	615-181	615-300	-
G2500 VAN					
V6 - 4.3L (262 CID)	1998-96	VIN W	615-182	-	-
V8 - 5.0L (305 CID)	1998-96	-	615-181	615-300	-
G3500 VAN					
V6 - 4.3L (262 CID)	1998-96	VIN W	615-182	-	-
V8 - 5.7L (350 CID)	1996	-	615-181	615-300	-
K1500 PICKUP					
V6 - 4.3L (262 CID)	1998-96	-	615-182	-	-
V8 - 5.0L (305 CID)	1999-96	-	615-181	615-300	-
V8 - 5.7L (350 CID)	1999-96	-	615-181	615-300	-

Make/Model/Engine	Years	Description	Upper	Lower	Gasket Kit
GMC TRUCK (continued)					
K1500 SUBURBAN					
V8 - 5.7L (350 CID)	1999-96	-	615-181	615-300	-
K2500 PICKUP					
V8 - 5.0L (305 CID)	1999-98	-	615-181	615-300	-
V8 - 5.7L (350 CID)	2000-96	-	615-181	615-300	-
K2500 SUBURBAN					
V8 - 5.7L (350 CID)	1999-96	-	615-181	615-300	-
K3500 PICKUP					
V8 - 5.7L (350 CID)	2000-96	-	615-181	615-300	-
P35/P3500 VAN					
V6 - 4.3L (262 CID)	1999-96	-	615-182	-	-
V8 - 5.7L (350 CID)	1999-96	-	615-181	615-300	-
S15 JIMMY					
V6 - 4.3L (262 CID)	2001-96	-	615-182	-	-
S15 SONOMA					
V6 - 4.3L (262 CID)	2005-96	-	615-182	-	-
SAFARI					
V6 - 4.3L (262 CID)	2005-96	-	615-182	-	-
SAVANA 1500					
V6 - 4.3L (262 CID)	2006-96	-	615-182	-	-
V8 - 5.0L (305 CID)	2002-96	-	615-181	615-300	-
V8 - 5.7L (350 CID)	2002-96	-	615-181	615-300	-
SAVANA 2500					
V6 - 4.3L (262 CID)	2006-98	-	615-182	-	-
V8 - 5.0L (305 CID)	2002-99	-	615-181	615-300	-
V8 - 5.7L (350 CID)	2002-96	-	615-181	615-300	-
SAVANA 3500					
V8 - 5.7L (350 CID)	2002-96	-	615-181	615-300	-
SIERRA 1500					
V6 - 4.3L (262 CID)	2006-99	-	615-182	-	-
YUKON					
V8 - 5.7L (350 CID)	2000-96	-	615-181	615-300	-
LINCOLN					
TOWN CAR					
V8 - 4.6L (281 CID)	2006-01	-	615-175	-	-
V8 - 4.6L (281 CID)	2000-96	-	615-178	-	-
MERCURY					
COUGAR					
V8 - 4.6L (281 CID)	1997-96	-	615-178	-	-
GRAND MARQUIS					
V8 - 4.6L (281 CID)	2006-01	-	615-175	-	-
V8 - 4.6L (281 CID)	2000-96	-	615-178	-	-
MOUNTAINEER					
V6 - 4.0L (245 CID)	2001-98	-	-	615-176	-
V8 - 4.6L (281 CID)	2002	-	615-175	-	-
OLDSMOBILE					
88, DELTA 88					
V6 - 3.8L (231 CID)	1999-95	VIN-K	615-180	-	-
V6 - 3.8L (231 CID)	1994-93	-	615-179	-	-
98, 98 REGENCY					
V6 - 3.8L (231 CID)	1996-95	VIN-K	615-180	-	-
V6 - 3.8L (231 CID)	1994-93	VIN-L	615-179	-	-
ALERO					
V6 - 3.4L (207 CID)	2003-99	-	-	-	615-200
BRAVADA					
V6 - 4.3L (262 CID)	2001-96	-	615-182	-	-
INTRIGUE					
V6 - 3.8L (231 CID)	1999-98	VIN-K	615-180	-	-
LSS					
V6 - 3.8L (231 CID)	1999-96	VIN-K	615-180	-	-
SILHOUETTE					
V6 - 3.4L (207 CID)	2003-96	-	-	-	615-200
V6 - 3.8L (231 CID)	1995-93	-	615-179	-	-
PONTIAC					
AZTEK					
V6 - 3.4L (207 CID)	2003-01	-	-	-	615-200
BONNEVILLE					
V6 - 3.8L (231 CID)	2005-95	VIN-K	615-180	-	-
V6 - 3.8L (231 CID)	1994-93	VIN-L	615-179	-	-
GRAND AM					
V6 - 3.4L (207 CID)	2003-99	-	-	-	615-200
GRAND PRIX					
V6 - 3.1L (189 CID)	2003-00	-	-	-	615-200
V6 - 3.8L (231 CID)	2003-97	VIN-K	615-180	-	-
MONTANA					
V6 - 3.4L (207 CID)	2003-99	-	-	-	615-200
TRANS SPORT					
V6 - 3.4L (207 CID)	1998-96	-	-	-	615-200
V6 - 3.8L (231 CID)	1995-93	-	615-179	-	-

Latches



Coverage for most failure-prone domestic and import applications

- Quality construction for long life
- Latches should be checked during routine inspection for rust and/or corrosion



315-100 Hood Latch
GM
2005-82



315-102 Door Latch
GM
2005-93



315-401 Hood Latch
Toyota
1997-93

Features and Benefits

- Direct OE Replacement - Fit, Form and Function
- A “must replace” item (safety)
- Not just a crash item - 65% of failure due to mechanism failure

Related Sales *Door Striker Bolts*

38420 (1)



Door Striker Bolt

1/2"-13. Fits numerous GM cars and trucks 1991-71.

38428 (1)



Door Striker Bolt

7/16"-24. Shoulder diameter .475". Fits various GM cars and trucks 2002-64. Bushing not required.

Activant Path

*Accessories/Fuel Caps,
Hitches and Misc.*

Activant Code

DOG

**Applications begin
on page 279.**

Latches



315-100
Hood
GM Various Models 2005-82



315-102
Door
GM Various Models 2005-93, Left



315-103
Door
GM Various Models 2003-93, Right



315-302
Hood
Jeep Wrangler 2004-97



315-400
Hood
Toyota Camry 2001-97



315-401
Hood
Toyota Corolla 1997-93



315-404
Hood
Toyota Camry 2005-03



315-500
Hood
Honda Accord 2002-98



315-600
Hood
Nissan Altima 2001-98



315-601
Hood
Nissan Maxima 1999-95

Related Sales - Door Jamb Switch



49204 (1)



Taurus, Sable, Expedition, F-Series Pickup, Ranger, Windstar, Navigator, Continental, Mark VIII 2004-95.

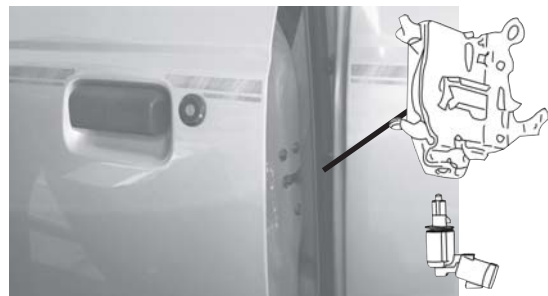

Latch Applications

Make Model/Years	Description	Dorman #	Make Model/Years	Description	Dorman #
DOOR LATCH			CHEVROLET TRUCK		
BUICK			EXPRESS VAN		
CENTURY			2002-96	Front-LH, wo/Actuator	315-102
2005-04	Front-LH, wo/Actuator	315-102	2002-96	Front-RH, wo/Actuator	315-103
2003-97	Front-LH, wo/Actuator	315-102	GMC TRUCK		
2003-97	Front-RH, wo/Actuator	315-103	SAVANA VAN		
REGAL			2002-96	Front-LH, wo/Actuator	315-102
2004	Front-LH, wo/Actuator	315-102	2002-96	Front-RH, wo/Actuator	315-103
2003-97	Front-LH, wo/Actuator	315-102	PONTIAC		
2003-97	Front-RH, wo/Actuator	315-103	FIREBIRD		
CHEVROLET			2002-98	LH, wo/Actuator	315-102
CAMARO			2002-98	RH, wo/Actuator	315-103
2002-98	LH, wo/Actuator	315-102	1997-93	LH, w/Electric Door Locks, wo/Actuator	315-102
2002-98	RH, wo/Actuator	315-103	1997-93	RH, w/Electric Door Locks, wo/Actuator	315-103
1997-93	LH, w/Electric Door Locks, wo/Actuator	315-102	GRAND PRIX		
1997-93	RH, w/Electric Door Locks, wo/Actuator	315-103	2002-93	Front-LH, wo/Actuator	315-102
LUMINA			2003-93	Front-RH, wo/Actuator	315-103
2001-95	Front-LH, wo/Actuator	315-102	MONTE CARLO		
2001-95	Front-RH, wo/Actuator	315-103	1999-95	LH, wo/Actuator	315-102
MONTE CARLO			1999-95	RH, wo/Actuator	315-103
1999-95	LH, wo/Actuator	315-102	HOOD LATCH		
1999-95	RH, wo/Actuator	315-103	BUICK		
CADILLAC			ELECTRA		
1984-82	-	315-100	ESTATE WAGON		
ESTATE WAGON			1990-82		
1990-82	-	315-100	LESABRE		
LESABRE			1985-82		
1985-82	-	315-100	REATTA		
REATTA			1991-88		
1991-88	-	315-100	REGAL		
REGAL			1987-82		
1987-82	-	315-100	RIVIERA		
RIVIERA			1993-82		
1993-82	-	315-100	ROADMASTER		
ROADMASTER			1996-91		
1996-91	-	315-100	SKYLARK		
SKYLARK			1985-82		
1985-82	-	315-100	CHEVROLET TRUCK (continued)		
CADILLAC			CK SERIES PICKUP		
ALLANTE			2002-85		
1993-87	-	315-100	G SERIES VAN		
COMMERCIAL CHASSIS			1996-85		
1984-82	-	315-100	P SERIES VAN		
CONCOURS			1990		
1999-94	-	315-100	RV SERIES PICKUP		
DEVILLE			1991-87		
1999-82	-	315-100	S10 BLAZER		
ELDORADO			2005-94		
2002-82	-	315-100	S10 PICKUP		
FLEETWOOD			2004-94		
1996-82	-	315-100	SUBURBAN		
SEVILLE			1999-85		
1999-82	-	315-100	TAHOE		
CHEVROLET			1999-95		
CAMARO			1999-95		
1992-82	-	315-100	DODGE TRUCK		
CAPRICE			RAM 1500 PICKUP		
1996-82	-	315-100	2002-94		
EL CAMINO			2002-94		
1987-82	-	315-100	RAM 2500 PICKUP		
IMPALA, IMPALA SS			2002-94		
1996-82	-	315-100	RAM 3500 PICKUP		
MALIBU			2002-94		
1983-82	-	315-100	GMC TRUCK		
MONTE CARLO			CK SERIES PICKUP		
1988-82	-	315-100	2002-85		
CHEVROLET TRUCK			G SERIES VAN		
ASTRO			1996-85		
2005-85	-	315-100	JIMMY		
BLAZER			1991-85		
1994-85	-	315-100	P SERIES VAN		
CHEVROLET TRUCK			1990		
ASTRO			RV SERIES PICKUP		
2005-85	-	315-100	1991-87		
BLAZER			S15 JIMMY		
1994-85	-	315-100	2001-94		
CHEVROLET TRUCK			S15 SONOMA		
ASTRO			2004-94		
2005-85	-	315-100	SAFARI		
BLAZER			2005-85		
1994-85	-	315-100	SUBURBAN		
CHEVROLET TRUCK			1999-85		
ASTRO			YUKON		
2005-85	-	315-100	1999-92		
BLAZER			HONDA		
1994-85	-	315-100	ACCORD		
CHEVROLET TRUCK			2002-98		
ASTRO			EX, SE Series		
2005-85	-	315-100	JEEP		
BLAZER			WRANGLER		
1994-85	-	315-100	2004-97		
CHEVROLET TRUCK			Bracket		
ASTRO			315-302		
2005-85	-	315-100	HONDA		
BLAZER			ACCORD		
1994-85	-	315-100	2002-98		
CHEVROLET TRUCK			EX, SE Series		
ASTRO			JEEP		
2005-85	-	315-100	WRANGLER		
BLAZER			2004-97		
1994-85	-	315-100	Bracket		
CHEVROLET TRUCK			315-302		

Latches

Latch Applications

PART TYPE			PART TYPE		
Make	Description	Dorman #	Make	Description	Dorman #
Model/Years			Model/Years		
HOOD LATCH (continued)			OLDSMOBILE (continued)		
NISSAN			TORONADO		
ALTIMA			1992-82	-	315-100
2001-98	-	315-600	PONTIAC		
MAXIMA			BONNEVILLE		
1999-95	-	315-601	1986-82	-	315-100
OLDSMOBILE			FIREBIRD		
98, 98 REGENCY			1992-82	-	315-100
1985-82	-	315-100	GRAND PRIX		
BRAVADA			1987-82	-	315-100
2001-94	-	315-100	PARISIENNE		
CUSTOM CRUISER			1986-83	-	315-100
1992-82	-	315-100	PHOENIX		
CUTLASS			1984-82	-	315-100
1987-85	-	315-100	SAFARI		
CUTLASS CALAIS			1989-87	-	315-100
1984-82	-	315-100	TOYOTA		
CUTLASS CRUISER			CAMRY		
1983-82	-	315-100	2005-04	USA Built, LE, SE Series	315-404
CUTLASS SUPREME			2003	USA Built, LE, SE Series, From 12/02	315-404
1988-82	-	315-100	2001-97	USA Built, wo/Theft Deterrent	315-400
DELTA 88			COROLLA		
1985-82	-	315-100	1997-93	Sedan & Wagon, wo/Theft Deterrent	315-401
OMEGA					
1984-82	-	315-100			

Related Sales - Hood/Hatch Repair Parts



03323 (1)



Hood Release Cable

Universal for GM, Ford, Chrysler. Includes 3 handles, one 94" cable and attaching hardware.

03335 (1)



Hood Release Handle

Chevrolet/GMC C & K Series Pickups, Suburban, Tahoe, Yukon 2000-95.

42410 (1)



Hood Hold-down Latch

Universal. Rubber latch with T-handle secures tightly and will not scratch or damage surface.

42422 (1)



Hood Hold-down Latch

Jeep Wrangler 2004-97.

42423 (1)



Hood Hold-down Latch

Spring loaded, chrome plated. For Jeep CJ models. Can be used for other applications. Mounting hardware included.

45323 (2)



Hood Insulation Retainers

For domestic models.

45391 (10)



Hood Bumper Assortment

Fits hood and trunk lids on most GM and Chrysler cars. Also fits Honda. Kit contains 45392 and 45393.

BETTER VALUE

45396 (6)

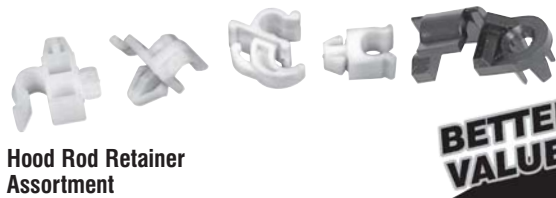

Hood Rod Retainer Assortment

GM, Ford Cars & Trucks 2004-75, VW Beetle 2001-98, Cabrio 1999-95, Corrado 1995-89, Dasher 1977-74, Euro Van 2004-92, Golf 1992-85, Jetta 1998-85, Passat 1997-90. Kit contains 45374 and 45395.

BETTER VALUE

Oil Cooler Line Assemblies

82 SKUs



Dorman® OE Solutions™ Oil Cooler Line Assemblies are made from premium CSM rubber.

- Direct OE Replacement
- Coverage For the Most Failure-Prone Lines
- 2WD and 4WD coverage available



625-100
GM K & V-Series

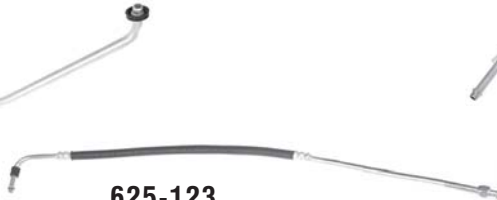

625-123
GM K & V-Series



625-129
GM G-Series Vans

Dorman® OE Solutions™ Oil Cooler Line Assemblies Feature:

- Includes everything needed to install:
O-rings, Gaskets and Connector Retaining Clips (where applicable).

Prevent Breakdown

- Over time, leaks develop at Oil Cooler Line Hose crimps
- Leaking crimps can completely separate causing **Severe Engine Damage**
- Replace defective Quick Connector fittings
- New Quick Connectors/Clips Included (where required)
- Replacing both Oil Cooler Lines at the same time is recommended



See pages 327-362 for Quick Disconnect quick connectors.

Other Dorman Fluid Lines Available:

Clutch	<i>pages 257-260</i>	Fuel	<i>pages 149-154</i>
Heater Hose	<i>pages 255-256</i>	Transmission	<i>pages 485-532</i>

Activant Path

*Pistons/Oil Pump
and Block Parts*

Activant Code

DOL

**Applications begin
on page 293.**

Oil Cooler Line Assemblies

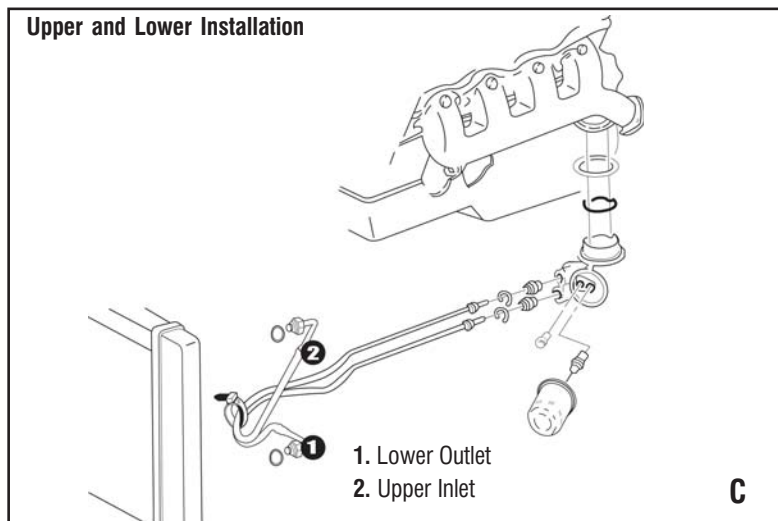
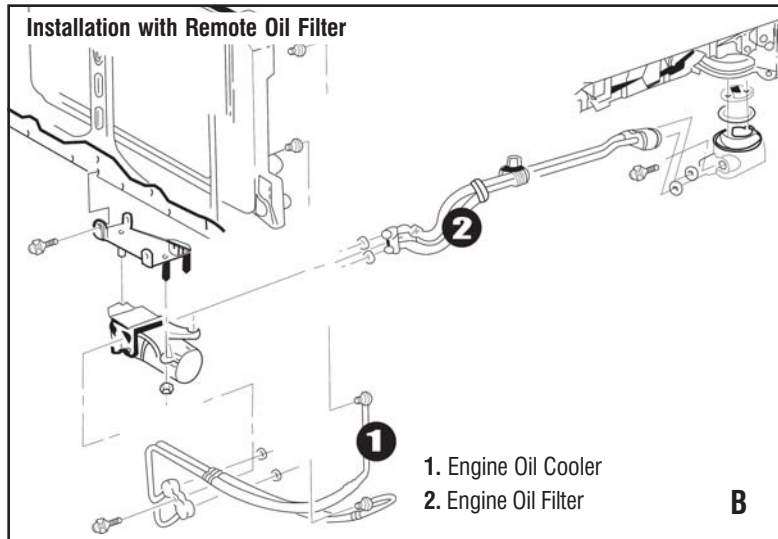
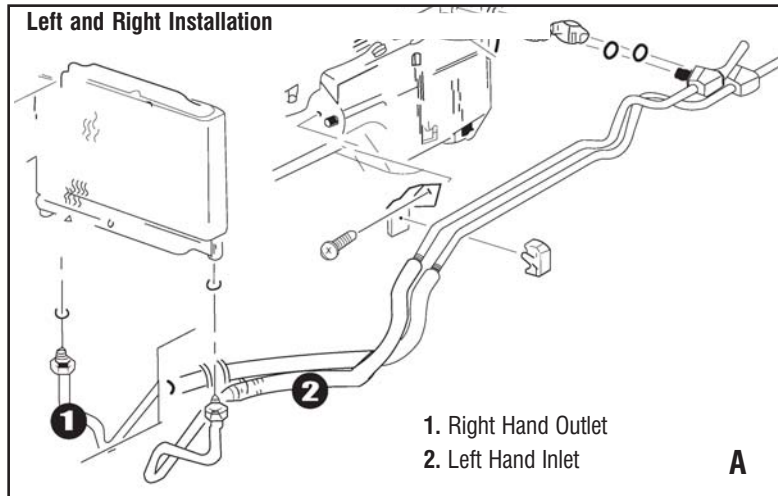

Oil Cooler Line Assemblies

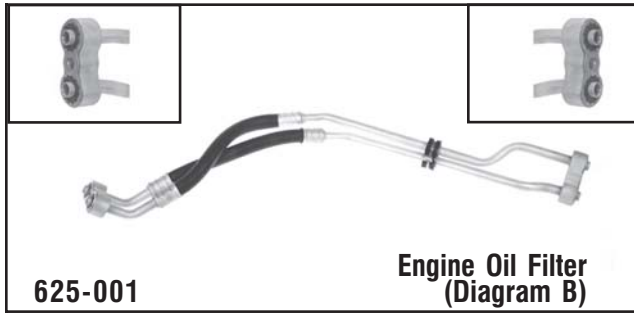

625-001

**Engine Oil Filter
(Diagram B)**

GM
2005-96 S10 Blazer, S15 Jimmy, S15 Sonoma, Bravada w/4.3L V-6 4WD Engine Oil Filter Hose.

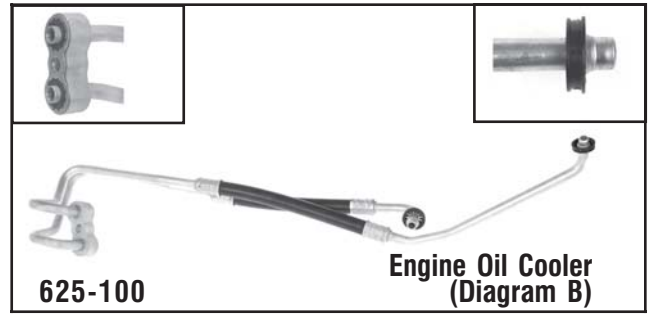

625-100

**Engine Oil Cooler
(Diagram B)**

GM
2002-96 S10 Blazer, S15 Jimmy, S15 Sonoma, Bravada w/4.3L V-6 4WD Eng Oil Cooler Pipe.

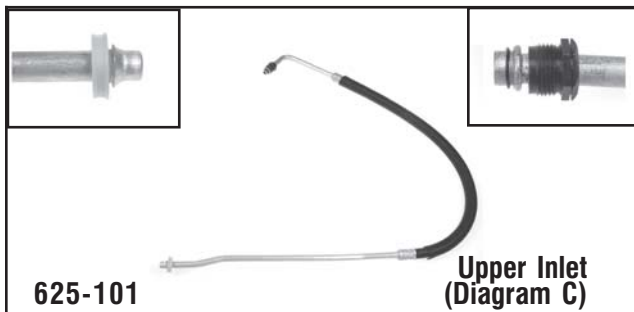

625-101

**Upper Inlet
(Diagram C)**

GM
1999 Escalade, 1999-96 K Series w/5.0L, 2000-96 K-Series w/5.7L, 1999-96 Suburban w/5.7L, 2000-96 Tahoe, Yukon w/5.7L, 4WD Eng Oil Cooler Upper-Inlet Hose.

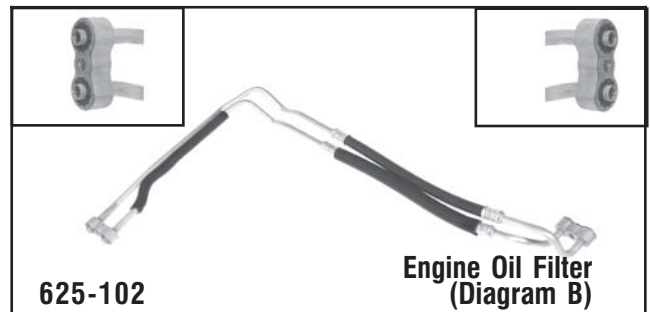

625-102

**Engine Oil Filter
(Diagram B)**

GM
1994-88 S10 Blazer, S15 Jimmy, 1990-88 S15 Pickups, 1993-91 S15 Sonoma, 1991 S15 Syclone, 1993-92 Typhoon, 1994-91 Bravada w/4.3L V-6 4WD Engine Oil Filter Hose.

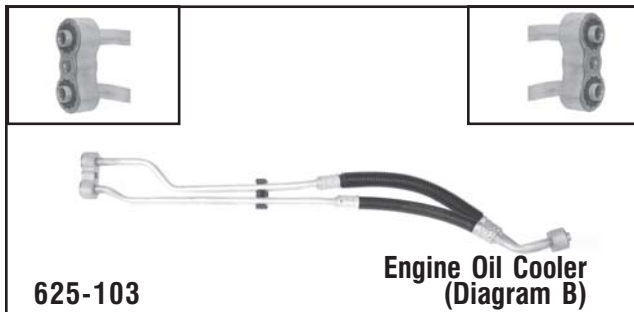

625-103

**Engine Oil Cooler
(Diagram B)**

GM
1995-94 S10 Blazer, S15 Sonoma, 1995 S15 Jimmy w/4WD Eng Oil Filter Hose

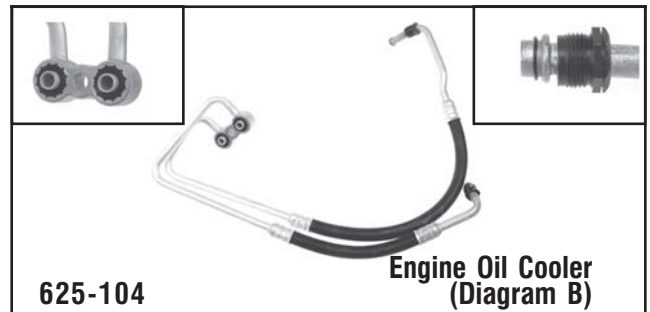

625-104

**Engine Oil Cooler
(Diagram B)**

GM
1995-94 S10 Blazer, S10 Pickups, S15 Jimmy, S15 Sonoma w/4.3L V-6 4WD Eng Oil Cooler Hose.

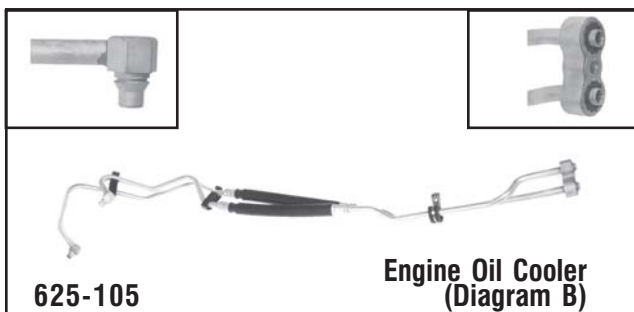

625-105

**Engine Oil Cooler
(Diagram B)**

GM
2005-96 Astro, Safari Vans w/4.3L V-6 Eng Oil Cooler Hose.

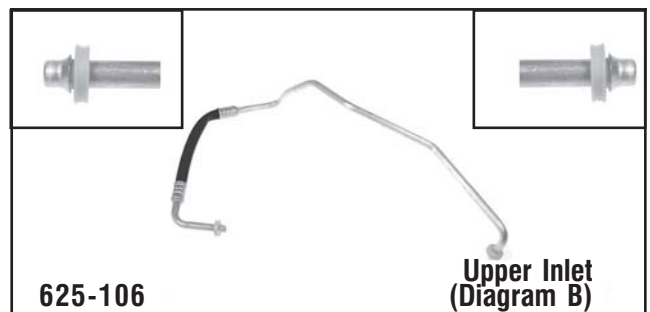

625-106

**Upper Inlet
(Diagram B)**

GM
2002-96 Express & Savana Vans, 1996 G-Series Vans w/6.5L Auxiliary Eng Oil Cooler Upper Inlet Hose.

Oil Cooler Line Assemblies

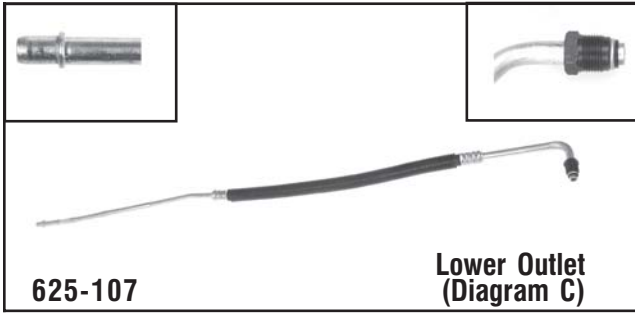

625-107

**Lower Outlet
(Diagram C)**

GM
1994 Blazer, 1995-94 K-Series, Suburban, Yukon, 1995 Tahoe w/
3.42R, 3.73R, 4.10R, 4.56R Eng Oil Cooler Lower Outlet Hose.

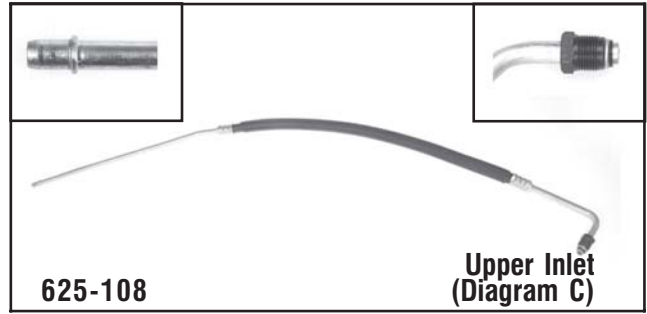

625-108

**Upper Inlet
(Diagram C)**

GM
1994 Blazer, 1995-94 K-Series, Suburban, Yukon, 1995 Tahoe, w/
5.7L 4WD 3.42R, 3.73R, 4.10R, 4.56R Eng Oil Cooler Upper Inlet
Hose.

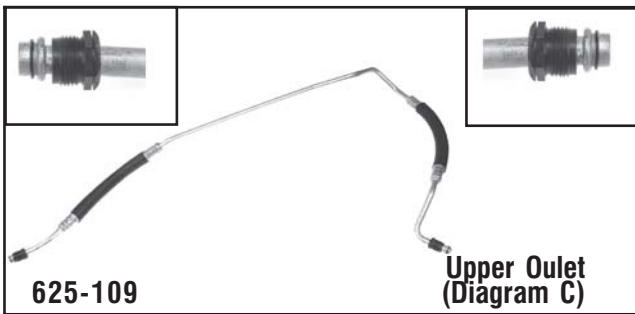

625-109

**Upper Outlet
(Diagram C)**

GM
1996-94 G-Series Vans w/6.5L Eng Oil Cooler Upper Outlet Pipe.

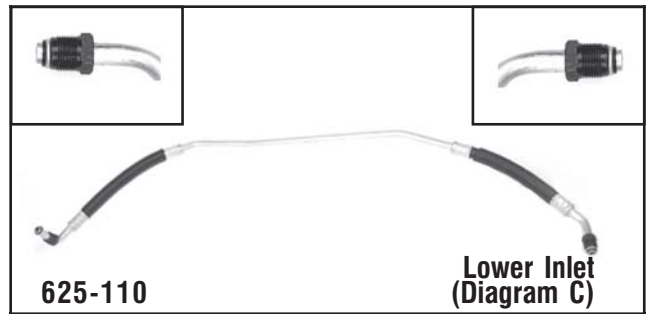

625-110

**Lower Inlet
(Diagram C)**

GM
1996-94 G-Series Vans w/6.5L Eng Oil Cooler Lower Inlet Pipe.

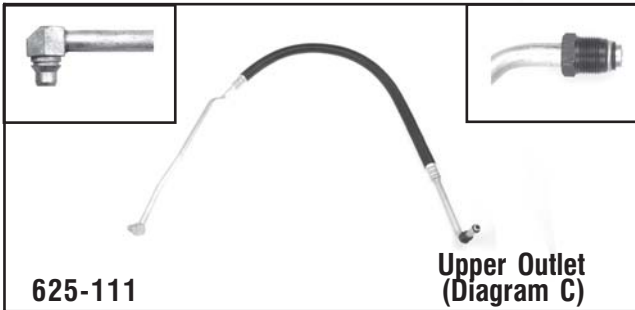

625-111

**Upper Outlet
(Diagram C)**

GM
1995-94 C&K Series, Suburban w/7.5L Eng Oil Cooler Upper
Outlet Hose w/o HD Cooling.

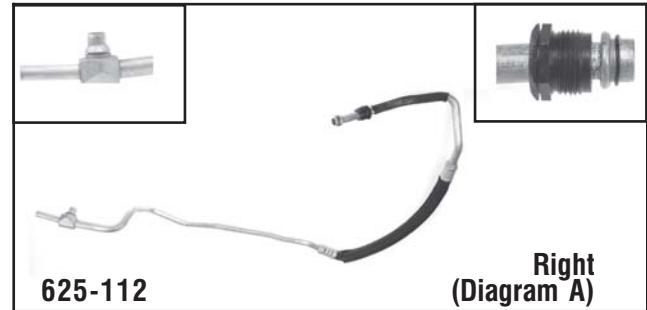

625-112

**Right
(Diagram A)**

GM
2002-98 C-Series Pickups w/6.5L, 1997 1 Ton w/Connecting Nut
27.0mm Across Flats. Eng Oil Cooler. RH Side. Outlet Hose.

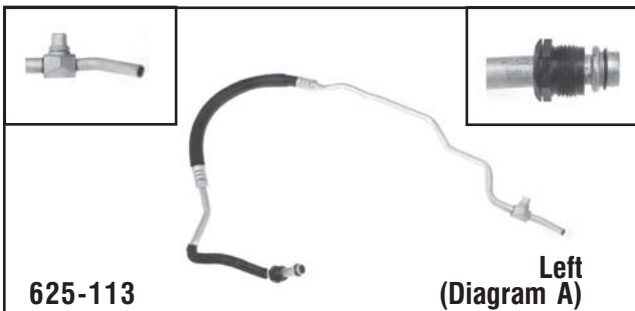

625-113

**Left
(Diagram A)**

GM
2002-98 C-Series, 1997 1 Ton Connecting Nut 27.0mm Across
Flats. w/6.5L Eng Oil Cooler. LH Side. Inlet Hose.

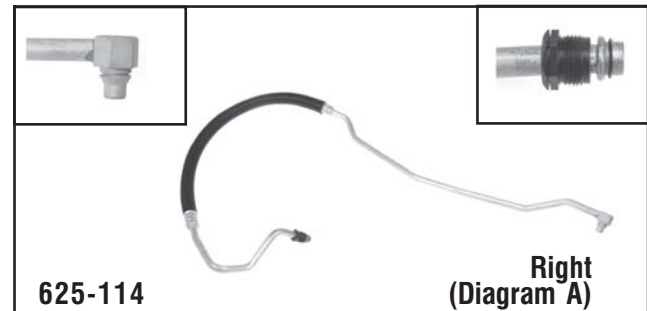

625-114

**Right
(Diagram A)**

GM
1997-95 C&K Series Pickups 1/2 & 3/4 Ton, Suburban, Tahoe,
Yukon, 1997 C&K Series Pickups 1 Ton w/Connecting Nuts
.75mm Across Flats; Exc. 15,000 GVWR, 1996-95 C&K Series
Pickups 1 Ton; Exc. 15,000 GVWR w/6.5L Eng Oil Cooler RH
Side. Outlet Hose.

Oil Cooler Line Assemblies

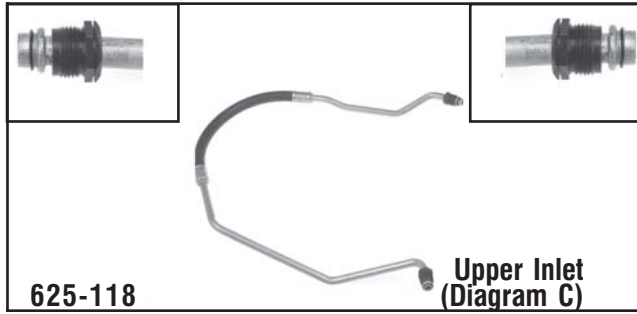

625-118

**Upper Inlet
(Diagram C)**

GM
1993-85 Astro and Safari 2WD, Upper Inlet

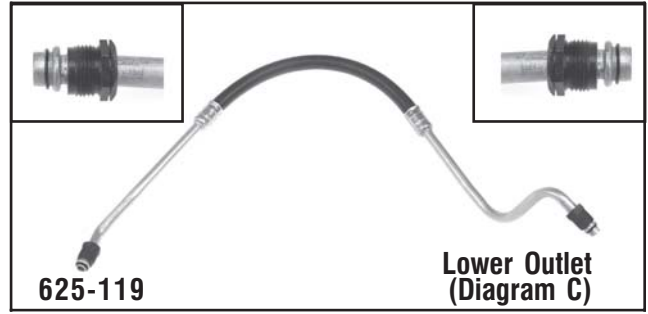

625-119

**Lower Outlet
(Diagram C)**

GM
1993-85 Astro/ Safari 2WD, Lower Outlet

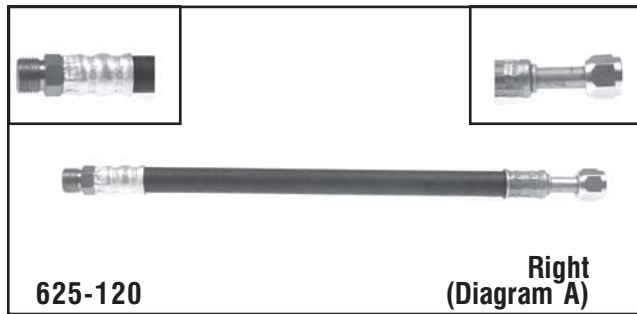

625-120

**Right
(Diagram A)**

GM
1991-85 G-Series Vans 5.0L, 5.7L, Side Inlet

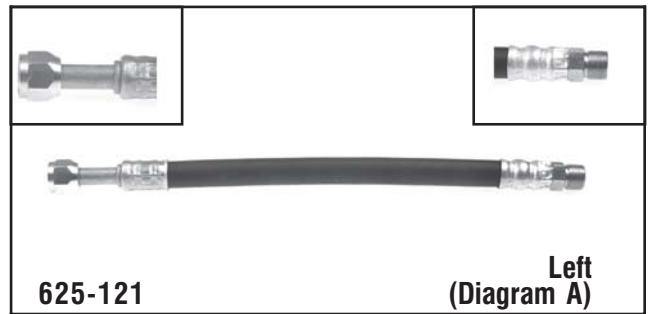

625-121

**Left
(Diagram A)**

GM
1991-85 G-Series Vans 5.0L, 5.7L, Side Outlet

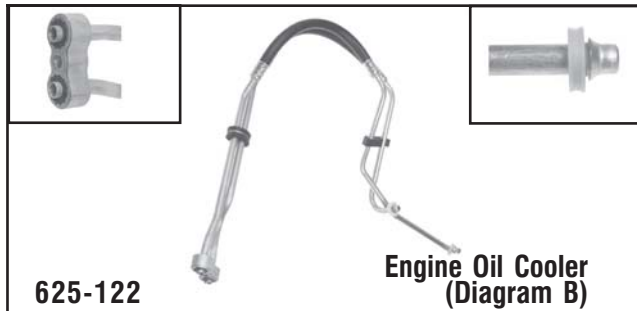

625-122

**Engine Oil Cooler
(Diagram B)**

GM
2005-96 Blazer, S15 Jimmy S10 Pickup, S15 Sonoma 2WD

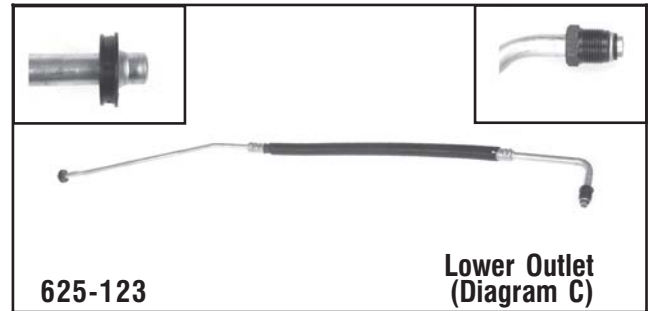

625-123

**Lower Outlet
(Diagram C)**

GM
2000-96 K-Series Pickups, Tahoe and Yukon 4WD, 1999-96 Suburban 4WD Lower Outlet

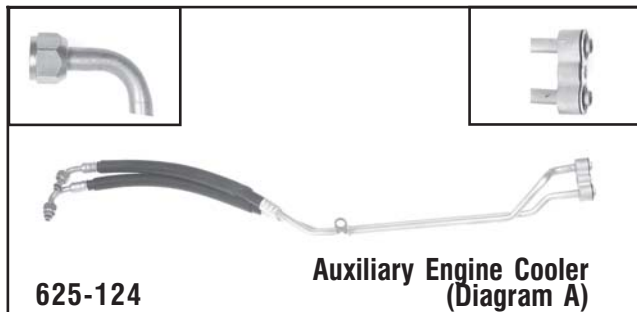

625-124

**Auxiliary Engine Cooler
(Diagram A)**

GM
1996-94 Caprice Police Package

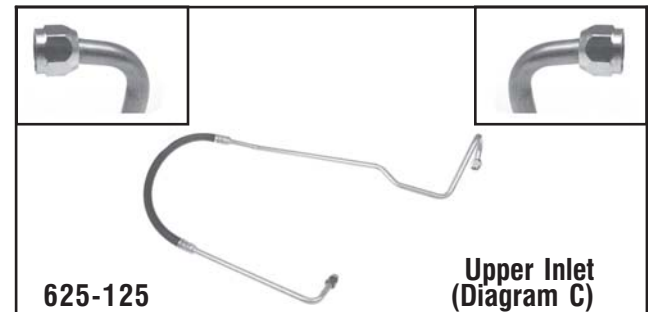

625-125

**Upper Inlet
(Diagram C)**

GM
1991-85 G-Series Vans w/6.2L Diesel, Upper Inlet

Oil Cooler Line Assemblies

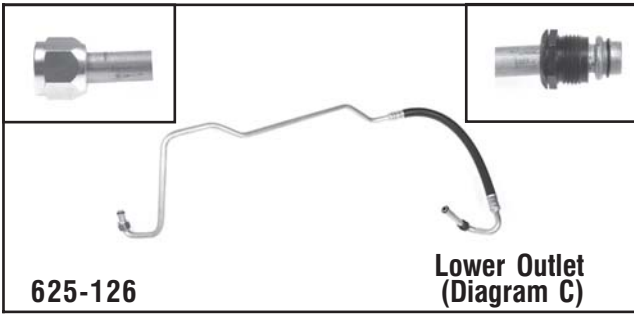

625-126

**Lower Outlet
(Diagram C)**

GM
1991-85 G-Series Vans w/6.2L Diesel, Lower Outlet

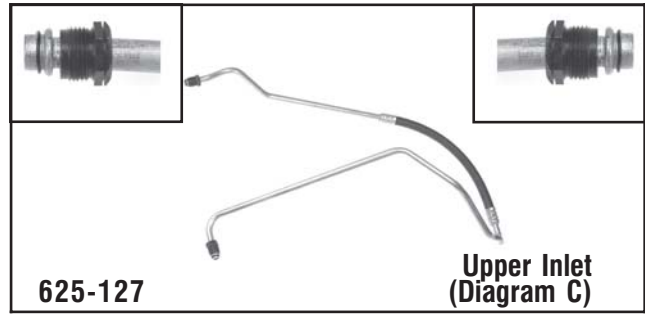

625-127

**Upper Inlet
(Diagram C)**

GM
1995 S 10 Blazer, 1995-94 S10 Pickups, 1995 S15 Jimmy, 1995-94 S15 Sonoma 2WD, Upper Inlet

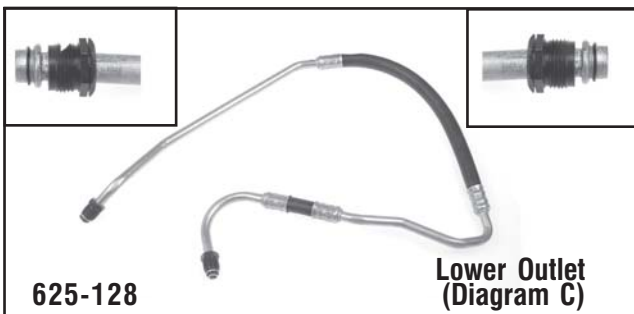

625-128

**Lower Outlet
(Diagram C)**

GM
1995 S 10 Blazer, 1995-94 S10 Pickups, 1995 S15 Jimmy, 1995-94 S15 Sonoma 2WD, Lower Outlet

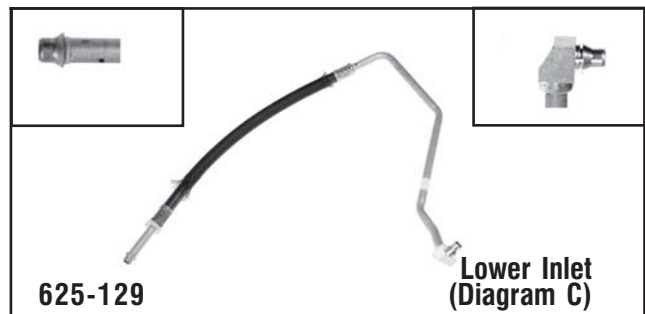

625-129

**Lower Inlet
(Diagram C)**

GM
2002-96 Express, Savana Vans, 1996 G-Series Vans w/ 6.5L V-8 Diesel, Eng Oil Cooler Lower Inlet Hose

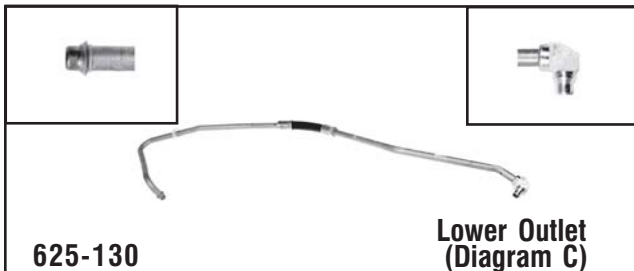

625-130

**Lower Outlet
(Diagram C)**

GM
2002-96 Express, Savana Vans, 1996 G-Series Vans w/ 6.5L V-8 Diesel, Auxiliary Eng Oil Cooler Lower Outlet Hose

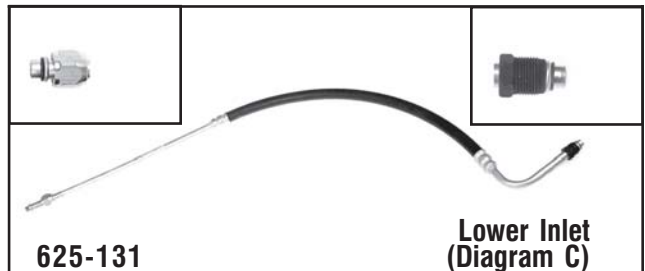

625-131

**Lower Inlet
(Diagram C)**

GM
1991-87 V-Series Pickups w/ 5.0L, 5.7L, 7.4L, 1991-85 Blazer, Jimmy, Suburban w/ 5.0L, 5.7L, 7.4L 4WD, 1986-85 K Series w/ 5.0L, 5.7L, 7.4L Eng Oil Cooler Lower Inlet Hose

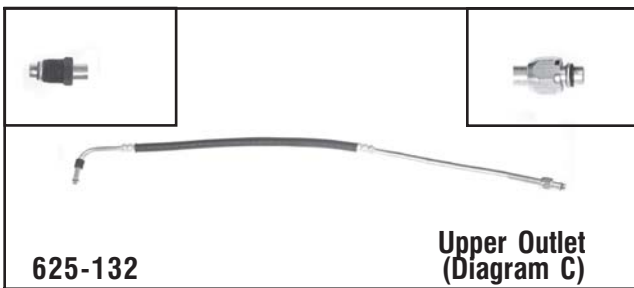

625-132

**Upper Outlet
(Diagram C)**

GM
1991-87 V-Series Pickups w/ 5.0L, 5.7L, 7.4L, 1991-85 Blazer, Jimmy, Suburban w/ 5.0L, 5.7L, 7.4L 4WD, 1986-85 K-Series w/ 5.0L, 5.7L, 7.4L Eng Oil Cooler Upper Outlet Hose

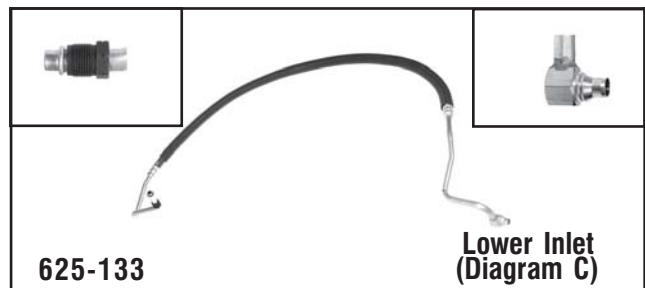

625-133

**Lower Inlet
(Diagram C)**

GM
1992 C&K-Series Pickups, Suburban w/ 6.2L HD Cooling w/ Hose Protector, 1991-88 C&K-Series Pickups w/ 6.2L HD Cooling Eng Oil Cooler Lower Inlet Hose

Oil Cooler Line Assemblies

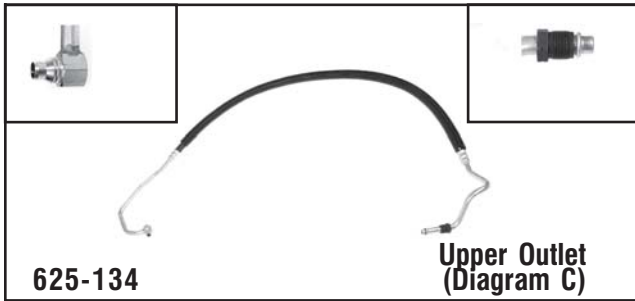

625-134

**Upper Outlet
(Diagram C)**

GM
1994-92 C&K Series Pickups, Suburban Under 12,000 GVW, 1994 Blazer, Yukon w/ 6.5L Diesel, 1993-88 C&K-Series Pickups, w/ 6.2L Diesel w/HD Cooling Eng Oil Cooler Upper Outlet Hose

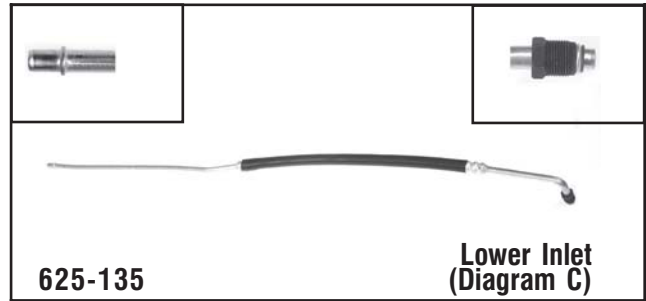

625-135

**Lower Inlet
(Diagram C)**

GM
1995-94 C-Series Pickups 1/2 & 3/4 Ton, Suburban 2WD, Yukon 2WD, 1995 C-Series Pickups 1 Ton, Tahoe 2WD, 1994 Blazer 2WD w/ 5.7L Eng Oil Cooler Lower Inlet Hose

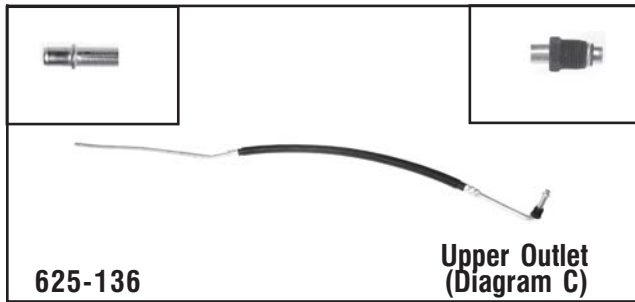

625-136

**Upper Outlet
(Diagram C)**

GM
1995-94 C-Series Pickups 1/2 & 3/4 Ton, Suburban 2WD, Yukon 2WD, 1995 C-Series Pickups 1 Ton, Tahoe 2WD, 1994 Blazer 2WD w/ 5.7L Eng Oil Cooler Upper Outlet Hose

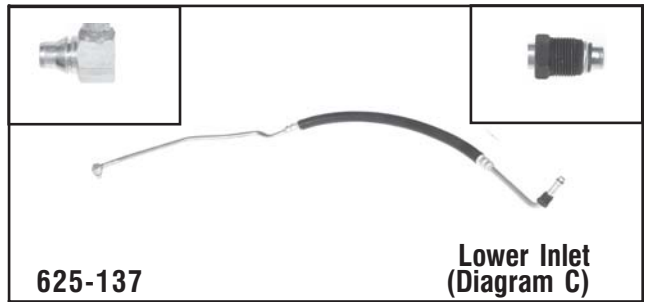

625-137

**Lower Inlet
(Diagram C)**

GM
1995-94 C&K-Series Pickups, Suburban w/ 7.4Lwo/HD Cooling Eng Oil Cooler Lower Inlet Hose

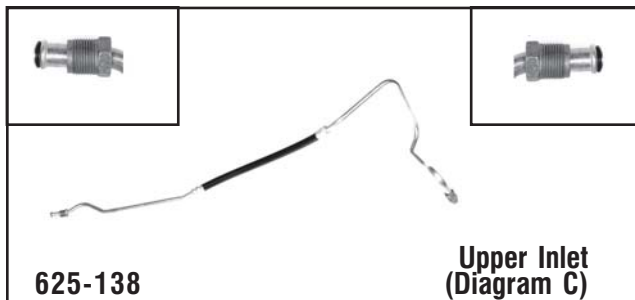

625-138

**Upper Inlet
(Diagram C)**

GM
1995 Astro, Safari Van w/ 4.3L Eng Oil Cooler Upper Inlet Hose

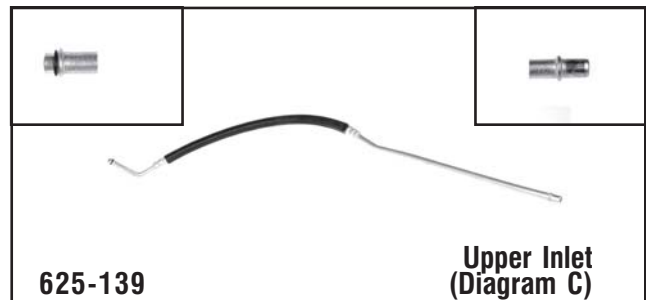

625-139

**Upper Inlet
(Diagram C)**

GM
1995-88 C-Series Pickups w/ 5.0L, 1993-92 Blazer, Suburban, Yukon w/ 5.7L 2WD, 1993-88 C-Series Pickups w/ 5.7L, Eng Oil Cooler Upper Inlet Hose

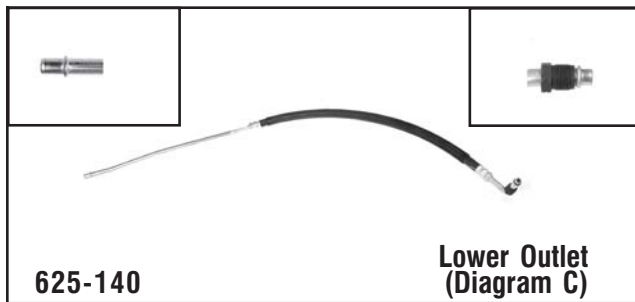

625-140

**Lower Outlet
(Diagram C)**

GM
1995-88 C-Series Pickups w/ 5.0L, 1993-92 Blazer, Suburban, Yukon w/ 5.7L 2WD, 1993-88 C-Series Pickups w/ 5.7L, Eng Oil Cooler Lower Outlet Hose

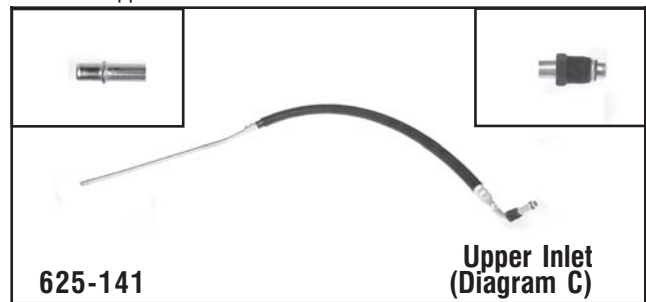

625-141

**Upper Inlet
(Diagram C)**

GM
1995-88 K-Series Pickups w/ 5.0L, 1993-92 Blazer, Suburban, Yukon w/ 5.7L 4WD, 1993-88 K-Series Pickups w/ 5.7L Eng Oil Cooler Upper Inlet Hose

Oil Cooler Line Assemblies

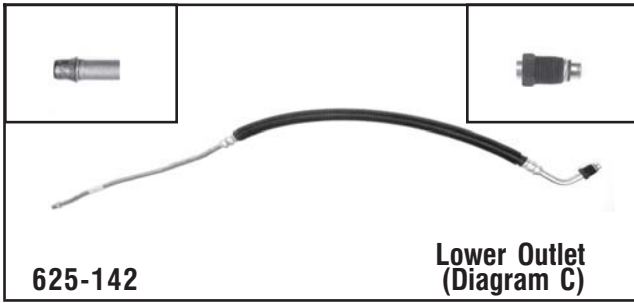

625-142

**Lower Outlet
(Diagram C)**

GM
1995-88 K-Series Pickups w/ 5.0L, 1993-92 Blazer, Suburban, Yukon w/ 5.7L 4WD, 1993-88 K-Series Pickups w/ 5.7L Eng Oil Cooler Lower Outlet Hose

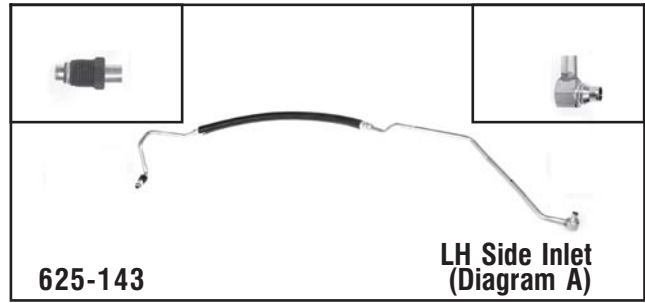

625-143

**LH Side Inlet
(Diagram A)**

GM
1997-95 C&K-Series Pickups Exc. 15,000 GVW, Suburban, Tahoe, Yukon w/ 6.5L Diesel, Connecting Nut .875" Across Flats, Eng Oil Cooler LH Side Inlet Hose

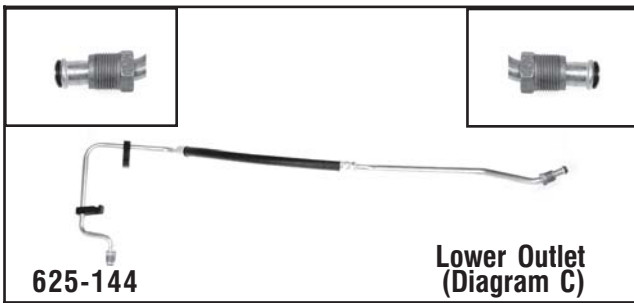

625-144

**Lower Outlet
(Diagram C)**

GM
1995 Astro, Safari w/ 4.3L Eng Oil Cooler Lower Outlet Hose

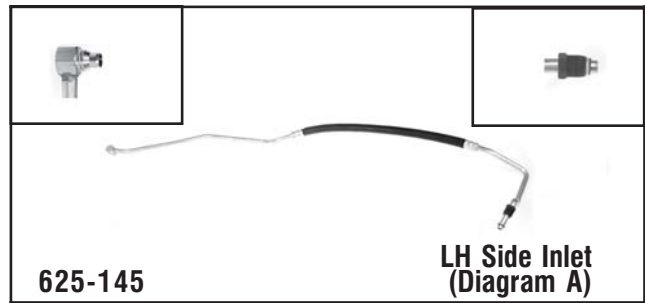

625-145

**LH Side Inlet
(Diagram A)**

GM
1997-95 C-Series Pickups 1 Ton 15,000 GVW w/ 6.5L Diesel Connecting Nut 25.4mm Across Flats, Eng Oil Cooler LH Side Inlet Hose

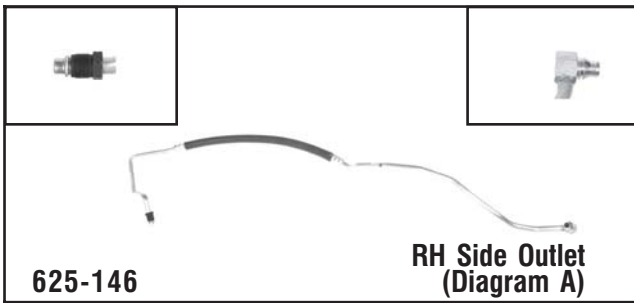

625-146

**RH Side Outlet
(Diagram A)**

GM
1997-95 C-Series Pickups 1 Ton 15,000 GVW w/ 6.5L Diesel Connecting Nut 25.4mm Across Flats, Eng Oil Cooler RH Side Outlet Hose

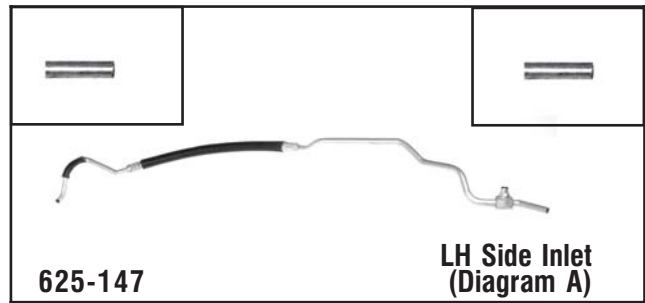

625-147

**LH Side Inlet
(Diagram A)**

GM
2000-97 C&K-Series Pickups, Suburban, Tahoe, Yukon w/ 6.5L Diesel Connecting Nut 27mm Across Flats, Eng Oil Cooler LH Side Inlet Hose

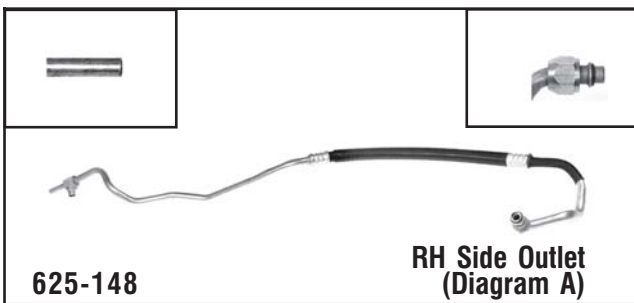

625-148

**RH Side Outlet
(Diagram A)**

GM
2000-97 C&K-Series Pickups, Suburban, Tahoe, Yukon w/ 6.5L Diesel Connecting Nut 27mm Across Flats, Eng Oil Cooler RH Side Outlet Hose

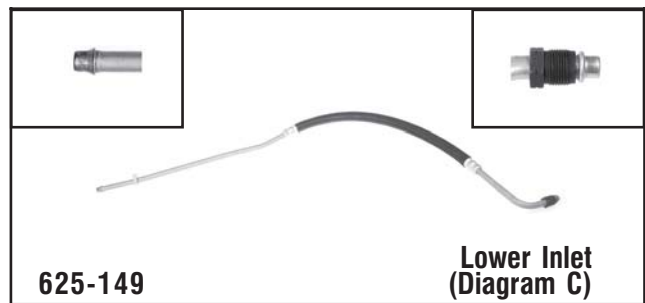

625-149

**Lower Inlet
(Diagram C)**

GM
2000-96 C-Series Pickups, Tahoe 2WD, Yukon 2WD w/ 5.7L, 1999-96 C-Series Pickups w/140 Amp Alternator w/ 5.0L, Suburban 2WD w/ 5.7L Eng Oil Cooler Lower Inlet Hose

Oil Cooler Line Assemblies

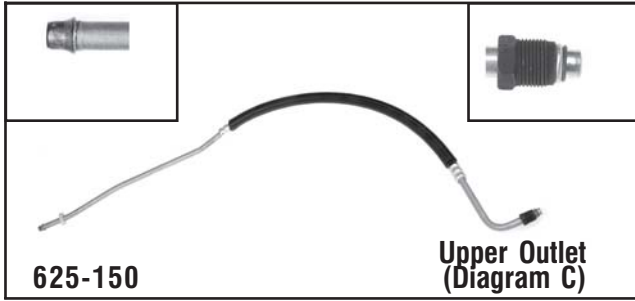

625-150

**Upper Outlet
(Diagram C)**

GM
2000-96 C-Series Pickups, Tahoe 2WD, Yukon 2WD w/ 5.7L,
1999-96 C-Series Pickups w/140 Amp Alternator w/ 5.0L,
Suburban 2WD w/ 5.7L Eng Oil Cooler Upper Outlet Hose

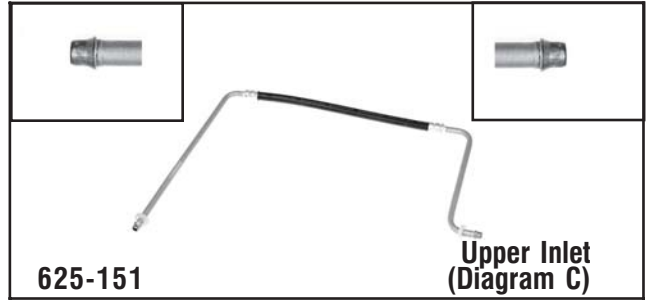

625-151

**Upper Inlet
(Diagram C)**

GM
2002-96 Express Savana Vans, 1996 G-Series Vans Eng Vin R w/
5.7L Eng Oil Cooler Upper Inlet Hose

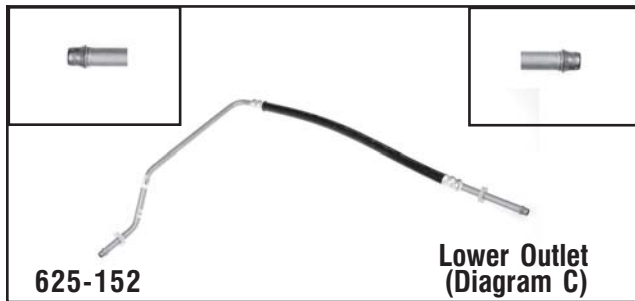

625-152

**Lower Outlet
(Diagram C)**

GM
2002-96 Express Savana Vans, 1996 G-Series Vans Eng Vin R w/
5.7L Eng Oil Cooler Lower Outlet Hose

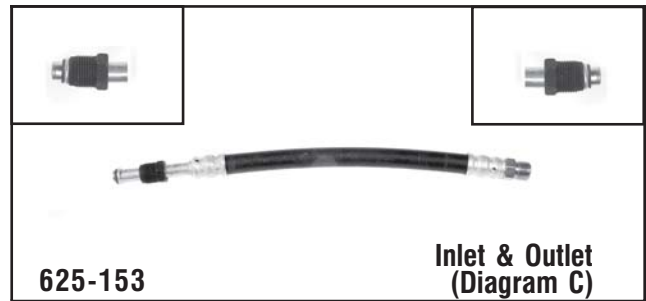

625-153

**Inlet & Outlet
(Diagram C)**

GM
1996 G-Series Vans w/ 5.7L Vin K, 1995-92 G-Series Vans w/
5.0L, 5.7L Eng Oil Cooler Inlet and Outlet Hose

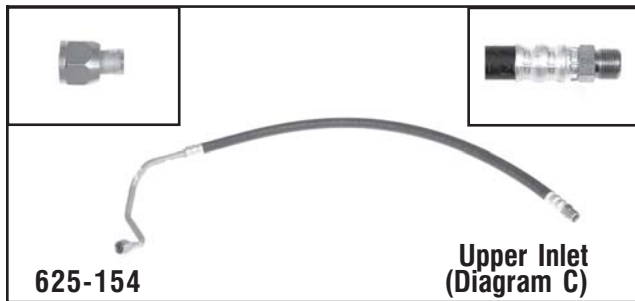

625-154

**Upper Inlet
(Diagram C)**

GM
1991-85 Suburban, 1991-87 R & V-Series Pickups, 1991-85
Jimmy, Blazer, 1986-85 C&K Series Pickups w/ 6.2L Diesel Eng Oil
Cooler Upper Inlet Hose

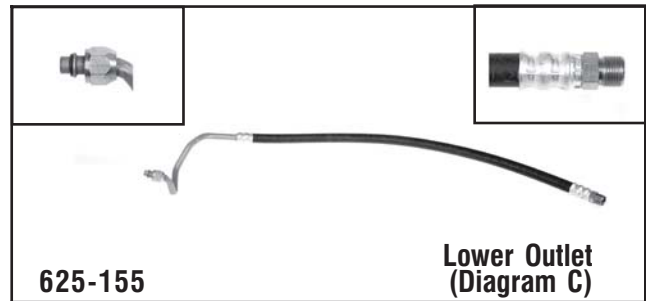

625-155

**Lower Outlet
(Diagram C)**

GM
1991-85 Suburban, 1991-87 R & V-Series Pickups, 1986-85 C&K
Series Pickup w/ 6.2L Diesel Eng Oil Cooler Lower Outlet Hose

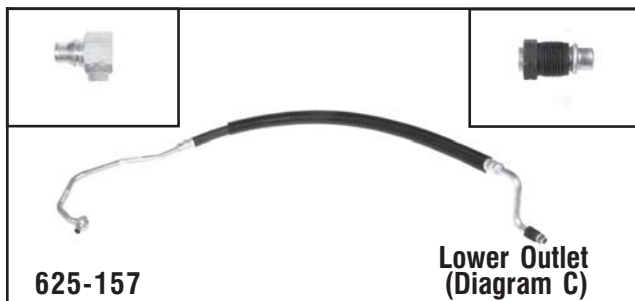

625-157

**Lower Outlet
(Diagram C)**

GM
1993-88 C&K-Series Pickups, 1993-92 Suburban w/ 6.2L Diesel
wo/ HD Cooling, 1993-92 C-Series Pickups 15,000 GVW & Over
w/ 6.5L Diesel Eng Oil Cooler Lower Outlet Hose

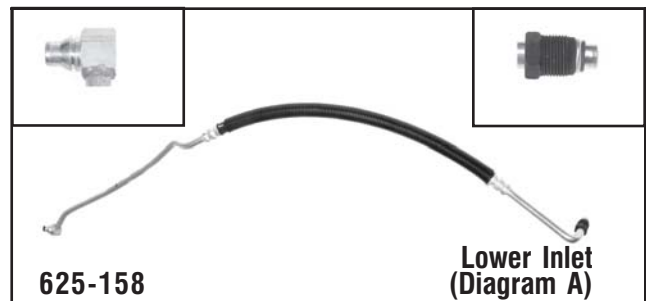

625-158

**Lower Inlet
(Diagram A)**

GM
1993-92 C-Series Pickups, Suburban w/ 7.4L wo/ HD Cooling Oil
Cooler Lower Inlet Hose

Oil Cooler Line Assemblies

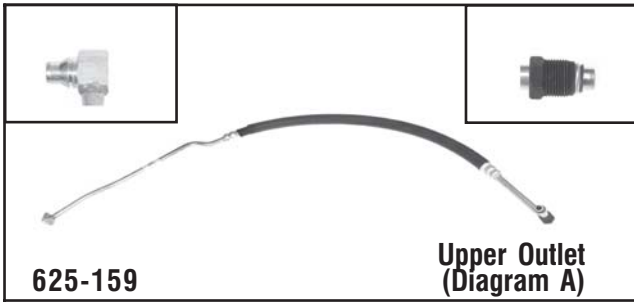

625-159

**Upper Outlet
(Diagram A)**

GM
1993-92 C-Series Pickups, Suburban w/ 7.4L wo/ HD Cooling Oil Cooler Upper Outlet Hose

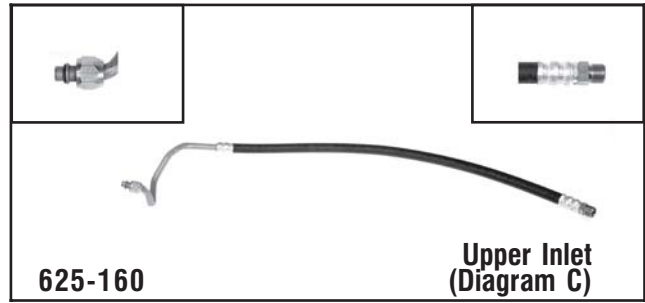

625-160

**Upper Inlet
(Diagram C)**

GM
1993-92 Blazer, Suburban, Yukon 2WD, 1993-88 C-Series Pickups w/ 5.7L Eng Oil Cooler Upper Inlet Hose

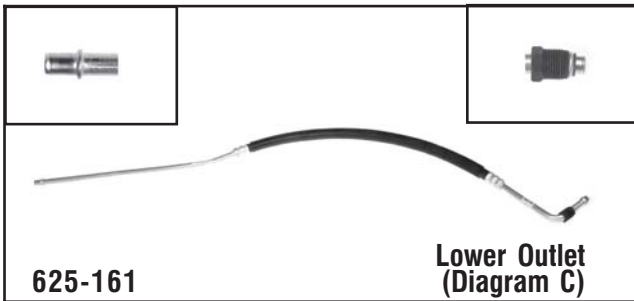

625-161

**Lower Outlet
(Diagram C)**

GM
1993-92 Blazer, Suburban, Yukon 2WD, 1993-88 C-Series Pickups w/ 5.7L Eng Oil Cooler Lower Outlet Hose

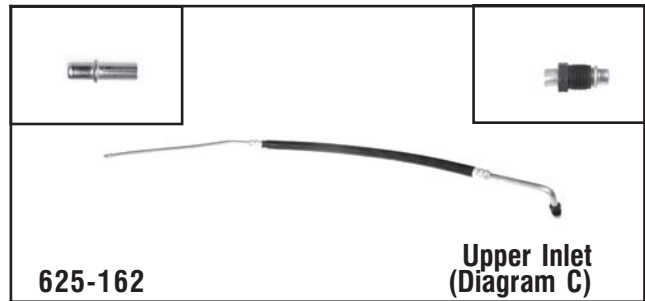

625-162

**Upper Inlet
(Diagram A)**

GM
1993-92 Blazer, Suburban, Yukon 4WD, 1993-91 K-Series w/ 5.7L 4.10R, 4.56R Eng Oil Cooler Upper Inlet Hose

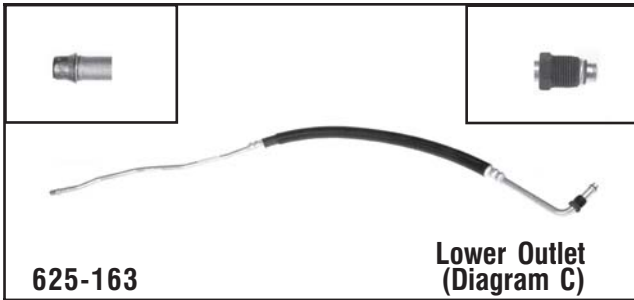

625-163

**Lower Outlet
(Diagram C)**

GM
1993-92 Blazer, Suburban, Yukon 4WD, 1993-91 K-Series w/ 5.7L 4.10R, 4.56R Eng Oil Cooler Lower Outlet Hose

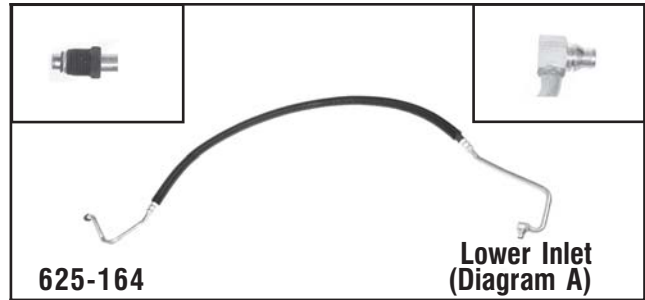

625-164

**Lower Inlet
(Diagram A)**

GM
1994-92 C&K-Series Pickups, Suburban w/ 6.5L Diesel under 12,000 GVW, 1994 Yukon, 1993-92 C&K-Series Pickups, Suburban w/ HD Cooling, w/ 6.2L Diesel Eng Oil Cooler Lower Inlet Hose

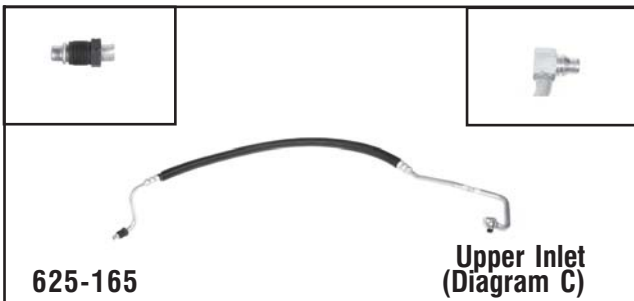

625-165

**Upper Inlet
(Diagram C)**

GM
1993-92 Suburban, 1993-88 C&K-Series Pickups w/ 6.2L Diesel wo/ HD Cooling Eng Oil Cooler Upper Inlet Hose

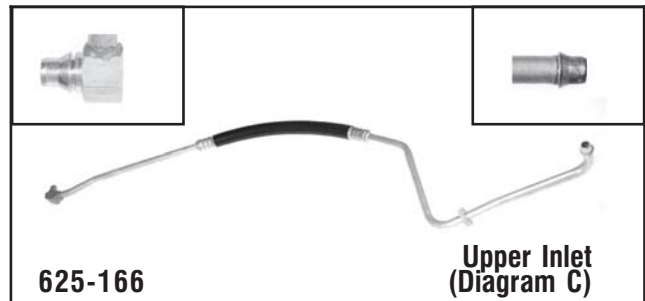

625-166

**Upper Inlet
(Diagram C)**

GM
2003-01 C-Series Pickups w/ 8.1L Eng Oil Cooler Upper Inlet Hose

Oil Cooler Line Assemblies

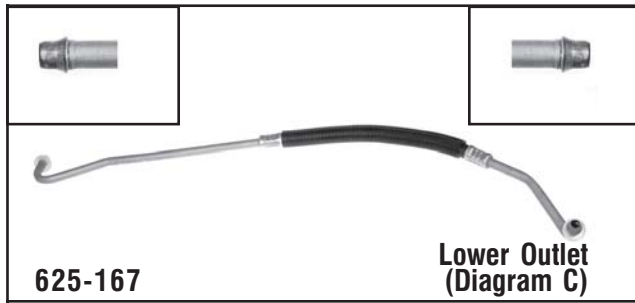

625-167

**Lower Outlet
(Diagram C)**

GM
2003-01 C-Series Pickups w/ 8.1L Eng Oil Cooler Lower Outlet Hose

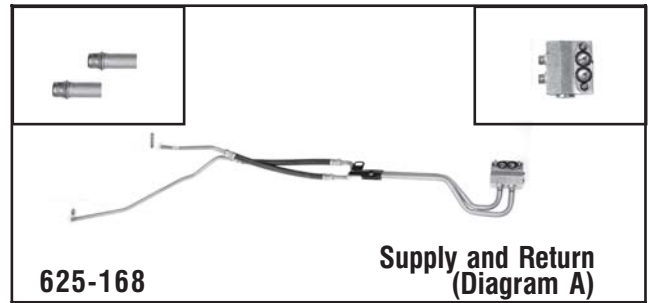

625-168

**Supply and Return
(Diagram A)**

GM
2004-99 Sierra, Silverado, 2004-03 Express, Savana Vans, 2004-02 Escalade, 2004-01 Yukon XL, 2004-00 Suburban, Yukon, 2002-01 Denali, Denali XL w/ 6.0L Eng Oil Cooler Hose

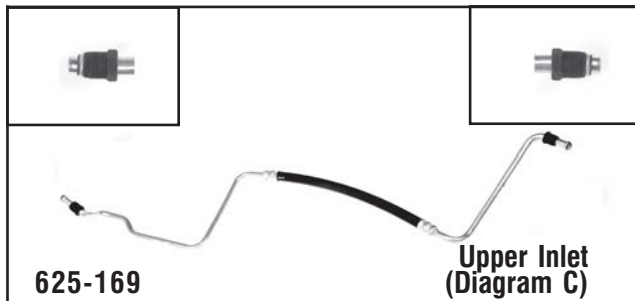

625-169

**Upper Inlet
(Diagram C)**

GM
1993-92 G-Series Vans, 1991-85 G-Series Vans Exc. A/C Manual Control w/ 4.3L Eng Oil Cooler Upper Inlet Hose

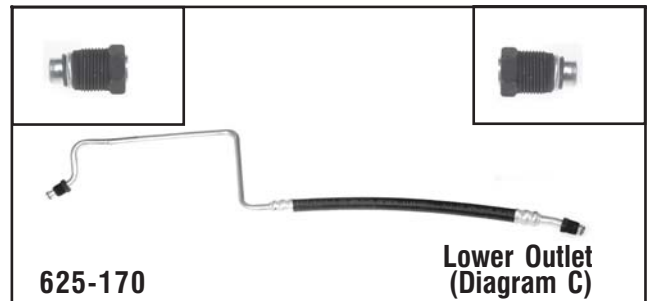

625-170

**Lower Outlet
(Diagram C)**

GM
1993-92 G-Series Vans, 1991-85 G-Series Vans Exc. A/C Manual Control w/ 4.3L Eng Oil Cooler Lower Outlet Hose

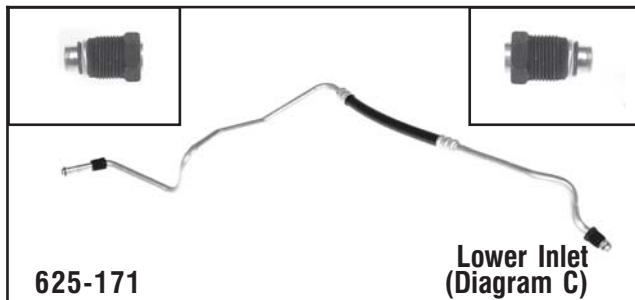

625-171

**Lower Inlet
(Diagram C)**

GM
1996-94 G-Series Vans w/ HD Cooling, 1993-92 G-Series Vans w/ A/C Manual Control w/ 4.3L Eng Oil Cooler Lower Inlet Hose

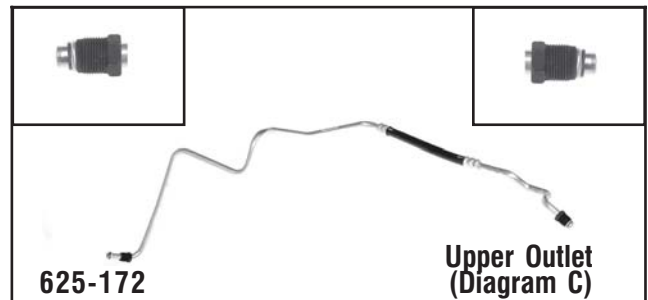

625-172

**Upper Outlet
(Diagram C)**

GM
1996-94 G-Series Vans w/ HD Cooling, 1993-92 G-Series Vans w/ A/C Manual Control w/ 4.3L Eng Oil Cooler Upper Outlet Hose

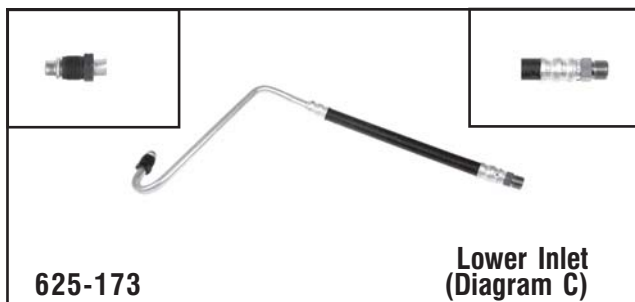

625-173

**Lower Inlet
(Diagram C)**

GM
1993-92 G-Series Vans w/ 6.2L Diesel Eng oil Cooler Lower Inlet Hose

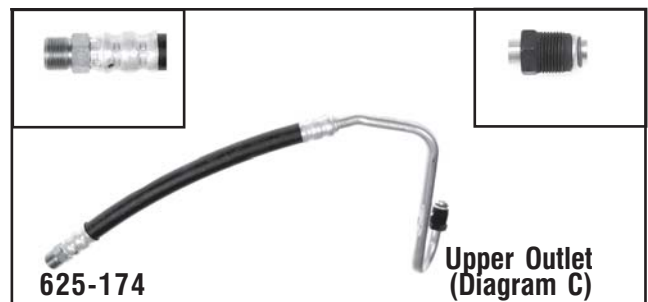

625-174

**Upper Outlet
(Diagram C)**

GM
1993-92 G-Series Vans w/ 6.2L Diesel Eng oil Cooler Upper Outlet Hose

Oil Cooler Line Assemblies

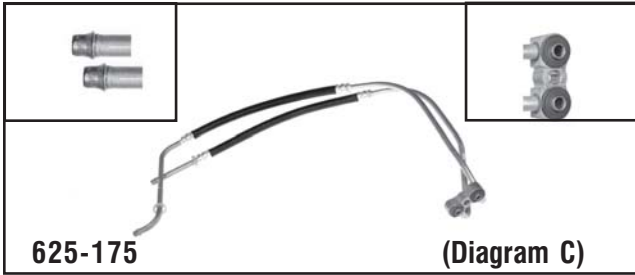

GM
2002-96 Express, Savana Vans, 1997 G-Series Van w/ 4.3L Eng Oil Cooler Hose

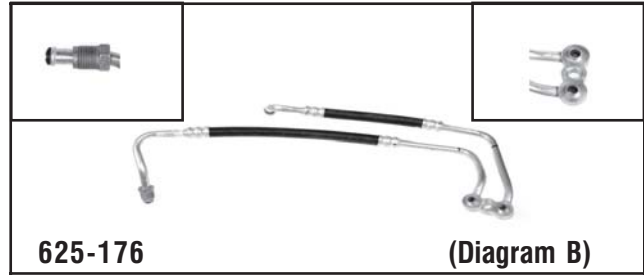

GM
1994-92 Bravada, S10 Blazer, S15 Jimmy w/ Eng VIN Z w/ HD Cooling, 1993-92 S15 Typhoon, 1991-88 S10 Blazer, S15 Jimmy w/ Eng VIN Z, 1991 Bravada Eng VIN Z, S15 Syclone, w/4.3L 4WD Eng Oil Cooler Hose

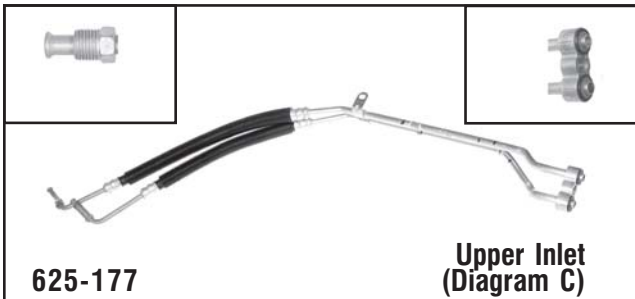

GM
1996-94 Caprice w/4.3L, Caprice Exc. Police Car, Fleetwood, Imapla SS, Roadmaster w/ 5.7L Eng Oil Cooler Upper Inlet Hose

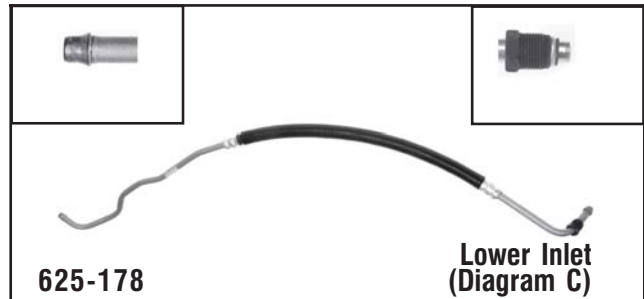

GM
2000-96 C&K-Series Pickups, 1999-96 Suburban w/ 7.4L Under 12,000 GVW Eng Oil Cooler Lower Inlet Hose

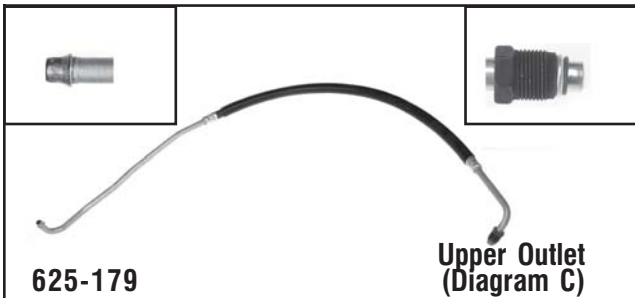

GM
2000-96 C&K-Series Pickups, 1999-96 Suburban w/ 7.4L Eng Oil Cooler Upper Outlet Hose

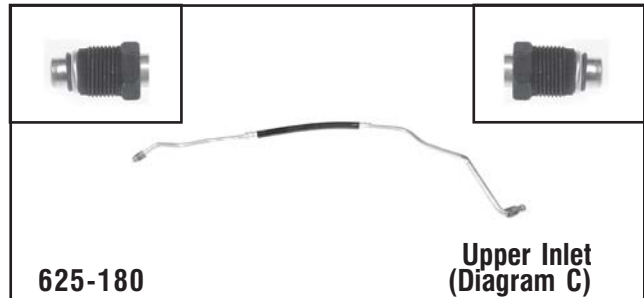

GM
1994 Astro, Safari Vans w/ 4.3L 2WD Eng Oil Cooler Upper Inlet Hose

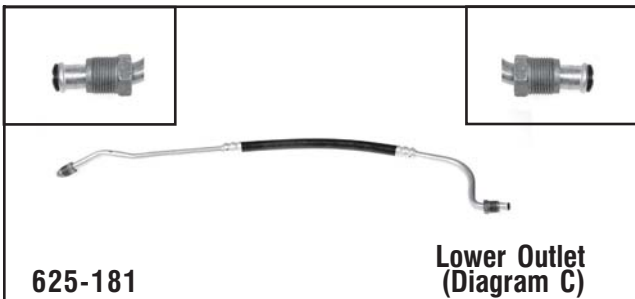

GM
1994 Astro, Safari Vans w/ 4.3L 2WD Eng Oil Cooler Lower Outlet Hose

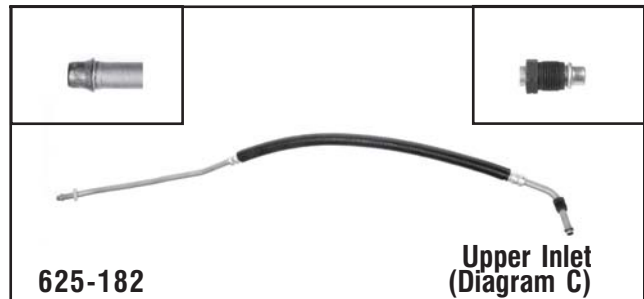

GM
1998-96 C&K-Series Pickups w/ 4.3L Engine Oil Cooler Upper Inlet Hose

Oil Cooler Line Assemblies

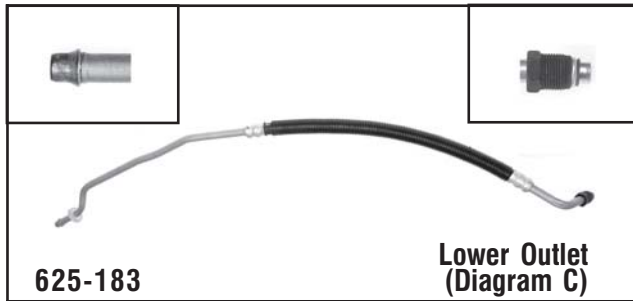

625-183

**Lower Outlet
(Diagram C)**

GM
1998-96 C&K-Series Pickups w/ 4.3L Engine Oil Cooler Lower
Outlet Hose

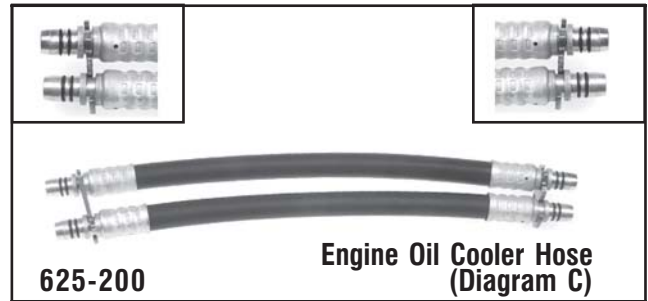

625-200

**Engine Oil Cooler Hose
(Diagram C)**

Ford
2006-96 Crown Victoria, Police Car

Oil Cooler Line Assemblies

Oil Cooler Line Assembly Applications

Make/ Model/Engine	Years	Description	Dorman #
BUICK			
ROADMASTER			
V8 - 5.7L (350 CID)	1996-94	Eng Oil Cooler Hose	625-177
CADILLAC			
ESCALADE			
V8 - 5.7L (350 CID)	1999	Eng Oil Cooler Upper-Inlet Hose	625-101
V8 - 6.0L (364 CID)	2005	Eng Oil Cooler Hose, 7.75MM Length Flared End Tube	625-168
V8 - 6.0L (364 CID)	2004-02	Eng Oil Cooler Hose	625-168
FLEETWOOD			
V8 - 5.7L (350 CID)	1996-94	RWD, Eng Oil Cooler Hose	625-177
CHEVROLET			
CAPRICE			
V8 - 4.3L (262 CID)	1996-94	Eng Oil Cooler Hose	625-177
V8 - 5.7L (350 CID)	1996-94	Exc. Police Car, Eng Oil Cooler Hose	625-177
V8 - 5.7L (350 CID)	1996-94	Police Car, Eng Oil Cooler Hose	625-124
IMPALA SS			
V8 - 5.7L (350 CID)	1996-94	Eng Oil Cooler Hose	625-177
CHEVROLET TRUCK			
ASTRO VAN			
V6 - 4.3L (262 CID)	2005-96	Eng Oil Cooler Hose	625-105
V6 - 4.3L (262 CID)	1995	Eng Oil Cooler Lower-Outlet Hose	625-144
V6 - 4.3L (262 CID)	1995	Eng Oil Cooler Upper-Inlet Hose	625-138
V6 - 4.3L (262 CID)	1994	2WD, Eng Oil Cooler Lower-Outlet Hose	625-181
V6 - 4.3L (262 CID)	1994	2WD, Eng Oil Cooler Upper-Inlet Hose	625-180
V6 - 4.3L (262 CID)	1993-85	2WD, Eng Oil Cooler Lower-Outlet Hose	625-119
V6 - 4.3L (262 CID)	1993-85	2WD, Eng Oil Cooler Upper-Inlet Hose	625-118
AVALANCHE			
V8 - 5.3L (323 CID)	2005	Eng Oil Cooler Hose, VIN Z, Flex Fuel, 7.75MM Length Flared End Tube	625-168
BLAZER			
V8 - 5.0L (305 CID)	1987-85	4WD, Eng Oil Cooler Lower-Inlet Hose	625-131
V8 - 5.0L (305 CID)	1987-85	4WD, Eng Oil Cooler Upper-Outlet Hose	625-132
V8 - 5.7L (350 CID)	1994	2WD, 3.42R, 3.73R, 4.10R, 4.56R, Eng Oil Cooler Lower-Inlet Hose	625-135
V8 - 5.7L (350 CID)	1994	2WD, 3.42R, 3.73R, 4.10R, 4.56R, Eng Oil Cooler Upper-Outlet Hose	625-136
V8 - 5.7L (350 CID)	1994	4WD, 3.42R, 3.73R, 4.10R, 4.56R, Eng Oil Cooler Lower-Outlet Hose	625-107
V8 - 5.7L (350 CID)	1994	4WD, 3.42R, 3.73R, 4.10R, 4.56R, Eng Oil Cooler Upper-Inlet Hose	625-108
V8 - 5.7L (350 CID)	1993-92	2WD, 3.08R, 3.42R, 3.73R, Eng Oil Cooler Lower-Outlet Hose	625-140
V8 - 5.7L (350 CID)	1993-92	2WD, 3.08R, 3.42R, 3.73R, Eng Oil Cooler Upper-Inlet Hose	625-139
V8 - 5.7L (350 CID)	1993-92	2WD, Exc. 3.08R, 3.42R, 3.73R, Eng Oil Cooler Lower-Outlet Hose	625-161
V8 - 5.7L (350 CID)	1993-92	2WD, Exc. 3.08R, 3.42R, 3.73R, Eng Oil Cooler Upper-Inlet Hose	625-160
V8 - 5.7L (350 CID)	1993-92	4WD, 3.42R, 3.73R, Eng Oil Cooler Lower-Outlet Hose	625-142
V8 - 5.7L (350 CID)	1993-92	4WD, 3.42R, 3.73R, Eng Oil Cooler Upper-Inlet Hose	625-141
V8 - 5.7L (350 CID)	1993-92	4WD, 4.10R, 4.56R, Eng Oil Cooler Lower-Outlet Hose	625-163
V8 - 5.7L (350 CID)	1993-92	4WD, 4.10R, 4.56R, Eng Oil Cooler Upper-Inlet Hose	625-162
V8 - 5.7L (350 CID)	1991-85	4WD, Eng Oil Cooler Lower-Inlet Hose	625-131
V8 - 5.7L (350 CID)	1991-85	4WD, Eng Oil Cooler Upper-Outlet Hose	625-132
V8 - 6.2L (379 CID)	1991-85	Diesel, Eng Oil Cooler Upper-Inlet Hose	625-154
V8 - 6.5L (395 CID)	1994	Diesel, Eng Oil Cooler Upper-Outlet Hose	625-134
C SERIES PICKUP			
V6 - 4.3L (262 CID)	1998-96	Eng Oil Cooler Lower-Outlet Hose	625-183
V6 - 4.3L (262 CID)	1998-96	Eng Oil Cooler Upper-Inlet Hose	625-182
V8 - 5.0L (305 CID)	1999-96	Eng Oil Cooler Lower-Inlet Hose, w/140 Amp Alternator	625-149
V8 - 5.0L (305 CID)	1999-96	Eng Oil Cooler Upper-Outlet Hose, w/140 Amp Alternator	625-150
V8 - 5.0L (305 CID)	1995-94	3.08R, 3.42R, 3.73R, 4.10R, Eng Oil Cooler Lower-Outlet Hose	625-140
V8 - 5.0L (305 CID)	1995-94	3.08R, 3.42R, 3.73R, 4.10R, Eng Oil Cooler Upper-Inlet Hose	625-139
V8 - 5.0L (305 CID)	1993-88	Eng Oil Cooler Lower-Outlet Hose	625-140
V8 - 5.0L (305 CID)	1993-88	Eng Oil Cooler Upper-Inlet Hose	625-139
V8 - 5.7L (350 CID)	2000-96	Eng Oil Cooler Lower-Inlet Hose	625-149
V8 - 5.7L (350 CID)	2000-96	Eng Oil Cooler Upper-Outlet Hose	625-150

**Window
Lift Motors**
pg. 535-554

**Window
Regulators**
pg. 555-566

**Wiper
Motors**
pg. 567-572

**Wiper Transmission
Linkages**
pg. 573-576

**Includes O-Rings, Gaskets, & Connector
Retaining Clips (where required)**

Oil Cooler Line Assemblies

Oil Cooler Line Assembly Applications

Make/ Model/Engine	Years	Description	Dorman #
CHEVROLET TRUCK (continued)			
C SERIES PICKUP (continued)			
V8 - 5.7L (350 CID)	1995-94	1/2 & 3/4-Ton, 3.08R, 3.42R, 3.73R, 4.10R, 4.56R, Eng Oil Cooler Lower-Inlet Hose	625-135
V8 - 5.7L (350 CID)	1995-94	1/2 & 3/4-Ton, 3.08R, 3.42R, 3.73R, 4.10R, 4.56R, Eng Oil Cooler Upper-Outlet Hose	625-136
V8 - 5.7L (350 CID)	1995	1-Ton, 131.5", 155.5" Wheel Base, 3.08R, 3.42R, 3.73R, 4.10R, 4.56R, Eng Oil Cooler Lower-Inlet Hose	625-135
V8 - 5.7L (350 CID)	1995	1-Ton, 131.5", 155.5" Wheel Base, 3.08R, 3.42R, 3.73R, 4.10R, 4.56R, Eng Oil Cooler Upper-Outlet Hose	625-136
V8 - 5.7L (350 CID)	1995	1-Ton, 135.5", 159.5" Wheel Base, Eng Oil Cooler Lower-Inlet Hose	625-135
V8 - 5.7L (350 CID)	1995	1-Ton, 135.5", 159.5" Wheel Base, Eng Oil Cooler Upper-Outlet Hose	625-136
V8 - 5.7L (350 CID)	1993-88	2.73R, 3.08R, 3.42R, 3.73R, Eng Oil Cooler Lower-Outlet Hose	625-140
V8 - 5.7L (350 CID)	1993-88	2.73R, 3.08R, 3.42R, 3.73R, Eng Oil Cooler Upper-Inlet Hose	625-139
V8 - 5.7L (350 CID)	1993-88	Exc. 2.73R, 3.08R, 3.42R, 3.73R, Eng Oil Cooler Lower-Outlet Hose	625-161
V8 - 5.7L (350 CID)	1993-88	Exc. 2.73R, 3.08R, 3.42R, 3.73R, Eng Oil Cooler Upper-Inlet Hose	625-160
V8 - 6.2L (379 CID)	1993	Diesel, Eng Oil Cooler Lower-Inlet Hose, w/HD Cooling	625-164
V8 - 6.2L (379 CID)	1993	Diesel, Eng Oil Cooler Lower-Outlet Hose, wo/HD Cooling	625-157
V8 - 6.2L (379 CID)	1993	Diesel, Eng Oil Cooler Upper-Inlet Hose, wo/HD Cooling	625-165
V8 - 6.2L (379 CID)	1993	Diesel, Eng Oil Cooler Upper-Outlet Hose, w/HD Cooling	625-134
V8 - 6.2L (379 CID)	1992	Diesel, Eng Oil Cooler Lower-Inlet Hose, w/HD Cooling, w/Hose Protector	625-164
V8 - 6.2L (379 CID)	1992	Diesel, Eng Oil Cooler Lower-Inlet Hose, w/HD Cooling, wo/Hose Protector	625-133
V8 - 6.2L (379 CID)	1992	Diesel, Eng Oil Cooler Lower-Outlet Hose, wo/HD Cooling	625-157
V8 - 6.2L (379 CID)	1992	Diesel, Eng Oil Cooler Upper-Inlet Hose, wo/HD Cooling	625-165
V8 - 6.2L (379 CID)	1992	Diesel, Eng Oil Cooler Upper-Outlet Hose, w/HD Cooling	625-134
V8 - 6.2L (379 CID)	1991-88	Diesel, Eng Oil Cooler Lower-Inlet Hose, w/HD Cooling	625-133
V8 - 6.2L (379 CID)	1991-88	Diesel, Eng Oil Cooler Lower-Outlet Hose, wo/HD Cooling	625-157
V8 - 6.2L (379 CID)	1991-88	Diesel, Eng Oil Cooler Upper-Inlet Hose, wo/HD Cooling	625-165
V8 - 6.2L (379 CID)	1991-88	Diesel, Eng Oil Cooler Upper-Outlet Hose, w/HD Cooling	625-134
V8 - 6.2L (379 CID)	1986-85	Diesel, Eng Oil Cooler Lower-Outlet Hose	625-155
V8 - 6.2L (379 CID)	1986-85	Diesel, Eng Oil Cooler Upper-Inlet Hose	625-154
V8 - 6.5L (395 CID)	2002-01	Diesel, Eng Oil Cooler LH Side-Inlet Hose (Conn Nut 32mm Across Flats)	625-113
V8 - 6.5L (395 CID)	2002-01	Diesel, Eng Oil Cooler RH Side-Outlet Hose (Conn Nut 32mm Across Flats)	625-112
V8 - 6.5L (395 CID)	2000-98	Diesel, Eng Oil Cooler LH Side-Inlet Hose (Conn Nut 27mm Across Flats)	625-147
V8 - 6.5L (395 CID)	2000-98	Diesel, Eng Oil Cooler LH Side-Inlet Hose (Conn Nut 32mm Across Flats)	625-113
V8 - 6.5L (395 CID)	2000-98	Diesel, Eng Oil Cooler RH Side-Outlet Hose (Conn Nut 27mm Across Flats)	625-148
V8 - 6.5L (395 CID)	2000-98	Diesel, Eng Oil Cooler RH Side-Outlet Hose (Conn Nut 32mm Across Flats)	625-112
V8 - 6.5L (395 CID)	1997	Diesel, 1-Ton, Eng Oil Cooler LH Side-Inlet Hose (Conn Nut .875" Across Flats), Exc. 15,000 GVW	625-143
V8 - 6.5L (395 CID)	1997	Diesel, 1-Ton, Eng Oil Cooler LH Side-Inlet Hose (Conn Nut 25.4mm Across Flats), 15,000 GVW	625-145
V8 - 6.5L (395 CID)	1997	Diesel, 1-Ton, Eng Oil Cooler LH Side-Inlet Hose (Conn Nut 27mm Across Flats), Exc. 15,000 GVW	625-147
V8 - 6.5L (395 CID)	1997	Diesel, 1-Ton, Eng Oil Cooler LH Side-Inlet Hose (Conn Nut 32mm Across Flats)	625-113
V8 - 6.5L (395 CID)	1997	Diesel, 1-Ton, Eng Oil Cooler RH Side-Outlet Hose (Conn Nut 19mm Across Flats), Exc. 15,000 GVW	625-114
V8 - 6.5L (395 CID)	1997	Diesel, 1-Ton, Eng Oil Cooler RH Side-Outlet Hose (Conn Nut 25.4mm Across Flats), 15,000 GVW	625-146
V8 - 6.5L (395 CID)	1997	Diesel, 1-Ton, Eng Oil Cooler RH Side-Outlet Hose (Conn Nut 27mm Across Flats), Exc. 15,000 GVW	625-148
V8 - 6.5L (395 CID)	1997	Diesel, 1-Ton, Eng Oil Cooler RH Side-Outlet Hose (Conn Nut 32mm Across Flats)	625-112
V8 - 6.5L (395 CID)	1997	Diesel, 1/2 & 3/4-Ton, Eng Oil Cooler LH Side-Inlet Hose (Conn Nut .875" Across Flats)	625-143
V8 - 6.5L (395 CID)	1997	Diesel, 1/2 & 3/4-Ton, Eng Oil Cooler LH Side-Inlet Hose (Conn Nut 27mm Across Flats)	625-147
V8 - 6.5L (395 CID)	1997	Diesel, 1/2 & 3/4-Ton, Eng Oil Cooler RH Side-Outlet Hose (Conn Nut 19mm Across Flats)	625-114
V8 - 6.5L (395 CID)	1997	Diesel, 1/2 & 3/4-Ton, Eng Oil Cooler RH Side-Outlet Hose (Conn Nut 27mm Across Flats)	625-148
V8 - 6.5L (395 CID)	1996-95	Diesel, 1-Ton, Eng Oil Cooler LH Side-Inlet Hose (Conn Nut .875" Across Flats), Exc. 15,000 GVW	625-143
V8 - 6.5L (395 CID)	1996-95	Diesel, 1-Ton, Eng Oil Cooler LH Side-Inlet Hose (Conn Nut 25.4mm Across Flats), 15,000 GVW	625-145
V8 - 6.5L (395 CID)	1996-95	Diesel, 1-Ton, Eng Oil Cooler RH Side-Outlet Hose (Conn Nut 19mm Across Flats), Exc. 15,000 GVW	625-114
V8 - 6.5L (395 CID)	1996-95	Diesel, 1-Ton, Eng Oil Cooler RH Side-Outlet Hose (Conn Nut 25.4mm Across Flats), 15,000 GVW	625-146
V8 - 6.5L (395 CID)	1996-95	Diesel, 1/2 & 3/4-Ton, Eng Oil Cooler LH Side-Inlet Hose (Conn Nut .875" Across Flats)	625-143
V8 - 6.5L (395 CID)	1996-95	Diesel, 1/2 & 3/4-Ton, Eng Oil Cooler RH Side-Outlet Hose (Conn Nut 19mm Across Flats)	625-114
V8 - 6.5L (395 CID)	1994-92	Diesel, Eng Oil Cooler Lower-Inlet Hose, Under 12,000 GVW	625-164
V8 - 6.5L (395 CID)	1994-92	Diesel, Eng Oil Cooler Upper-Outlet Hose, Under 12,000 GVW	625-134
V8 - 6.5L (395 CID)	1993-92	Diesel, Eng Oil Cooler Lower-Outlet Hose, 15,000 GVW & Over	625-157
V8 - 7.4L (454 CID)	2000-96	Eng Oil Cooler Lower-Inlet Hose, Under 12,000 GVW	625-178
V8 - 7.4L (454 CID)	2000-96	Eng Oil Cooler Upper-Outlet Hose	625-179
V8 - 7.4L (454 CID)	1995-94	Eng Oil Cooler Lower-Inlet Hose, wo/HD Cooling	625-137
V8 - 7.4L (454 CID)	1995-94	Eng Oil Cooler Upper-Outlet Hose, wo/HD Cooling	625-111
V8 - 7.4L (454 CID)	1993	Eng Oil Cooler Lower-Inlet Hose, wo/HD Cooling	625-158
V8 - 7.4L (454 CID)	1993	Eng Oil Cooler Upper-Outlet Hose, wo/HD Cooling	625-159
V8 - 7.4L (454 CID)	1992	Eng Oil Cooler Lower-Inlet Hose, w/Upper Radiator Shroud Broadcast Code AFB, wo/HD Cooling	625-158
V8 - 7.4L (454 CID)	1992	Eng Oil Cooler Upper-Outlet Hose, w/Upper Radiator Shroud Broadcast Code AFB, wo/HD Cooling	625-159
V8 - 8.1L (496 CID)	2003-01	Eng Oil Cooler Lower-Outlet Hose	625-167
V8 - 8.1L (496 CID)	2003-01	Eng Oil Cooler Upper-Inlet Hose	625-166
EXPRESS VAN			
V6 - 4.3L (262 CID)	2002-96	Eng Oil Cooler Hose	625-175
V8 - 5.7L (350 CID)	2002-96	Eng Oil Cooler Lower-Outlet Hose	625-152
V8 - 5.7L (350 CID)	2002-96	Eng Oil Cooler Upper-Inlet Hose	625-151
V8 - 6.0L (364 CID)	2004-03	Eng Oil Cooler Hose	625-168

Oil Cooler Line Assembly Applications

Make/ Model/Engine	Years	Description	Dorman #
CHEVROLET TRUCK (continued)			
EXPRESS VAN (continued)			
V8 - 6.5L (395 CID)	2002-96	Diesel, Auxiliary Eng Oil Cooler Lower-Outlet Hose	625-130
V8 - 6.5L (395 CID)	2002-96	Diesel, Auxiliary Eng Oil Cooler Upper-Inlet Hose	625-106
V8 - 6.5L (395 CID)	2002-96	Diesel, Eng Oil Cooler Lower-Inlet Hose	625-129
G SERIES VAN			
V6 - 4.3L (262 CID)	1997	Eng Oil Cooler Hose	625-175
V6 - 4.3L (262 CID)	1996-94	Eng Oil Cooler Lower-Inlet Hose, w/HD Cooling	625-171
V6 - 4.3L (262 CID)	1996-94	Eng Oil Cooler Upper-Outlet Hose, w/HD Cooling	625-172
V6 - 4.3L (262 CID)	1993-92	Eng Oil Cooler Lower-Inlet Hose, A/C Manual Control	625-171
V6 - 4.3L (262 CID)	1993-92	Eng Oil Cooler Lower-Outlet Hose, Exc. A/C Manual Control	625-170
V6 - 4.3L (262 CID)	1993-92	Eng Oil Cooler Upper-Inlet Hose, Exc. A/C Manual Control	625-169
V6 - 4.3L (262 CID)	1993-92	Eng Oil Cooler Upper-Outlet Hose, A/C Manual Control	625-172
V6 - 4.3L (262 CID)	1991-85	Eng Oil Cooler Lower-Outlet Hose	625-170
V6 - 4.3L (262 CID)	1991-85	Eng Oil Cooler Upper-Inlet Hose	625-169
V8 - 5.0L (305 CID)	1995-92	Eng Oil Cooler Inlet Hose	625-153
V8 - 5.0L (305 CID)	1995-92	Eng Oil Cooler Outlet Hose	625-153
V8 - 5.0L (305 CID)	1991-87	Eng Oil Cooler LH Side-Outlet Hose	625-121
V8 - 5.0L (305 CID)	1991-87	Eng Oil Cooler RH Side-Inlet Hose	625-120
V8 - 5.7L (350 CID)	1996	Eng Vin K, Eng Oil Cooler Inlet Hose	625-153
V8 - 5.7L (350 CID)	1996	Eng Vin K, Eng Oil Cooler Outlet Hose	625-153
V8 - 5.7L (350 CID)	1996	Eng Vin R, Eng Oil Cooler Lower-Outlet Hose	625-152
V8 - 5.7L (350 CID)	1996	Eng Vin R, Eng Oil Cooler Upper-Inlet Hose	625-151
V8 - 5.7L (350 CID)	1995-92	Eng Oil Cooler Inlet Hose	625-153
V8 - 5.7L (350 CID)	1995-92	Eng Oil Cooler Outlet Hose	625-153
V8 - 5.7L (350 CID)	1991-87	Eng Oil Cooler LH Side-Outlet Hose	625-121
V8 - 5.7L (350 CID)	1991-87	Eng Oil Cooler RH Side-Inlet Hose	625-120
V8 - 5.7L (350 CID)	1986-85	Eng Vin M, Eng Oil Cooler LH Side-Outlet Hose	625-121
V8 - 5.7L (350 CID)	1986-85	Eng Vin M, Eng Oil Cooler RH Side-Inlet Hose	625-120
V8 - 6.2L (379 CID)	1993-92	Diesel, Eng Oil Cooler Lower-Inlet Hose	625-173
V8 - 6.2L (379 CID)	1993-92	Diesel, Eng Oil Cooler Upper-Outlet Hose	625-174
V8 - 6.2L (379 CID)	1991-85	Diesel, Eng Oil Cooler Lower-Outlet Hose	625-126
V8 - 6.2L (379 CID)	1991-85	Diesel, Eng Oil Cooler Upper-Inlet Hose	625-125
V8 - 6.5L (395 CID)	1996-94	Diesel, Eng Oil Cooler Lower-Inlet Pipe	625-110
V8 - 6.5L (395 CID)	1996-94	Diesel, Eng Oil Cooler Upper-Outlet Pipe	625-109
V8 - 6.5L (395 CID)	1996	Diesel, Auxiliary Eng Oil Cooler Lower-Outlet Hose	625-130
V8 - 6.5L (395 CID)	1996	Diesel, Auxiliary Eng Oil Cooler Upper-Inlet Hose	625-106
V8 - 6.5L (395 CID)	1996	Diesel, Eng Oil Cooler Lower-Inlet Hose	625-129
K SERIES PICKUP			
V6 - 4.3L (262 CID)	1998-96	Eng Oil Cooler Lower-Outlet Hose	625-183
V6 - 4.3L (262 CID)	1998-96	Eng Oil Cooler Upper-Inlet Hose	625-182
V8 - 5.0L (305 CID)	1999-96	Eng Oil Cooler Lower-Outlet Hose, w/140 Amp Alternator	625-123
V8 - 5.0L (305 CID)	1999-96	Eng Oil Cooler Upper-Inlet Hose, w/140 Amp Alternator	625-101
V8 - 5.0L (305 CID)	1995-94	3.42R, 3.73R, Eng Oil Cooler Lower-Outlet Hose	625-142
V8 - 5.0L (305 CID)	1995-94	3.42R, 3.73R, Eng Oil Cooler Upper-Inlet Hose	625-141
V8 - 5.0L (305 CID)	1993-88	Eng Oil Cooler Lower-Outlet Hose	625-142
V8 - 5.0L (305 CID)	1993-88	Eng Oil Cooler Upper-Inlet Hose	625-141
V8 - 5.0L (305 CID)	1986-85	Eng Oil Cooler Lower-Inlet Hose	625-131
V8 - 5.0L (305 CID)	1986-85	Eng Oil Cooler Upper-Outlet Hose	625-132
V8 - 5.7L (350 CID)	2000-96	Eng Oil Cooler Lower-Outlet Hose	625-123
V8 - 5.7L (350 CID)	2000-96	Eng Oil Cooler Upper-Inlet Hose	625-101
V8 - 5.7L (350 CID)	1995-94	1-Ton, 131.5", 155.5" Wheel Base, 3.73R, 4.10R, 4.56R, Eng Oil Cooler Lower-Outlet Hose	625-107
V8 - 5.7L (350 CID)	1995-94	1-Ton, 131.5", 155.5" Wheel Base, 3.73R, 4.10R, 4.56R, Eng Oil Cooler Upper-Inlet Hose	625-108
V8 - 5.7L (350 CID)	1995-94	1-Ton, 135.5", 159.5" Wheel Base, Eng Oil Cooler Lower-Outlet Hose	625-107
V8 - 5.7L (350 CID)	1995-94	1-Ton, 135.5", 159.5" Wheel Base, Eng Oil Cooler Upper-Inlet Hose	625-108
V8 - 5.7L (350 CID)	1995-94	1/2 & 3/4-Ton, 3.42R, 3.73R, 4.10R, 4.56R, Eng Oil Cooler Lower-Outlet Hose	625-107
V8 - 5.7L (350 CID)	1995-94	1/2 & 3/4-Ton, 3.42R, 3.73R, 4.10R, 4.56R, Eng Oil Cooler Upper-Inlet Hose	625-108
V8 - 5.7L (350 CID)	1993-91	4.10R, 4.56R, Eng Oil Cooler Lower-Outlet Hose	625-163
V8 - 5.7L (350 CID)	1993-91	4.10R, 4.56R, Eng Oil Cooler Upper-Inlet Hose	625-162
V8 - 5.7L (350 CID)	1993-88	3.42R, 3.73R, Eng Oil Cooler Lower-Outlet Hose	625-142
V8 - 5.7L (350 CID)	1993-88	3.42R, 3.73R, Eng Oil Cooler Upper-Inlet Hose	625-141
V8 - 5.7L (350 CID)	1986-85	Eng Oil Cooler Lower-Inlet Hose	625-131
V8 - 5.7L (350 CID)	1986-85	Eng Oil Cooler Upper-Outlet Hose	625-132
V8 - 6.2L (379 CID)	1993	Diesel, Eng Oil Cooler Lower-Inlet Hose, w/HD Cooling	625-164
V8 - 6.2L (379 CID)	1993	Diesel, Eng Oil Cooler Lower-Outlet Hose, wo/HD Cooling	625-157
V8 - 6.2L (379 CID)	1993	Diesel, Eng Oil Cooler Upper-Inlet Hose, wo/HD Cooling	625-165
V8 - 6.2L (379 CID)	1993	Diesel, Eng Oil Cooler Upper-Outlet Hose, w/HD Cooling	625-134
V8 - 6.2L (379 CID)	1992	Diesel, Eng Oil Cooler Lower-Inlet Hose, w/HD Cooling, w/Hose Protector	625-164
V8 - 6.2L (379 CID)	1992	Diesel, Eng Oil Cooler Lower-Inlet Hose, w/HD Cooling, wo/Hose Protector	625-133
V8 - 6.2L (379 CID)	1992	Diesel, Eng Oil Cooler Lower-Outlet Hose, wo/HD Cooling	625-157
V8 - 6.2L (379 CID)	1992	Diesel, Eng Oil Cooler Upper-Inlet Hose, wo/HD Cooling	625-165
V8 - 6.2L (379 CID)	1992	Diesel, Eng Oil Cooler Upper-Outlet Hose, w/HD Cooling	625-134
V8 - 6.2L (379 CID)	1991-88	Diesel, Eng Oil Cooler Lower-Inlet Hose, w/HD Cooling	625-133
V8 - 6.2L (379 CID)	1991-88	Diesel, Eng Oil Cooler Lower-Outlet Hose, wo/HD Cooling	625-157
V8 - 6.2L (379 CID)	1991-88	Diesel, Eng Oil Cooler Upper-Inlet Hose, wo/HD Cooling	625-165
V8 - 6.2L (379 CID)	1991-88	Diesel, Eng Oil Cooler Upper-Outlet Hose, w/HD Cooling	625-134
V8 - 6.2L (379 CID)	1986-85	Diesel, Eng Oil Cooler Lower-Outlet Hose	625-155
V8 - 6.2L (379 CID)	1986-85	Diesel, Eng Oil Cooler Upper-Inlet Hose	625-154
V8 - 6.5L (395 CID)	2000-98	Diesel, Eng Oil Cooler LH Side-Inlet Hose (Conn Nut 27mm Across Flats)	625-147
V8 - 6.5L (395 CID)	2000-98	Diesel, Eng Oil Cooler RH Side-Outlet Hose (Conn Nut 27mm Across Flats)	625-148
V8 - 6.5L (395 CID)	1997	Diesel, Eng Oil Cooler LH Side-Inlet Hose (Conn Nut .875" Across Flats)	625-143
V8 - 6.5L (395 CID)	1997	Diesel, Eng Oil Cooler LH Side-Inlet Hose (Conn Nut 27mm Across Flats)	625-147
V8 - 6.5L (395 CID)	1997	Diesel, Eng Oil Cooler RH Side-Outlet Hose (Conn Nut 19mm Across Flats)	625-114

Oil Cooler Line Assembly Applications

Make/ Model/Engine	Years	Description	Dorman #
CHEVROLET TRUCK (continued)			
K SERIES PICKUP (continued)			
V8 - 6.5L (395 CID)	1997	Diesel, Eng Oil Cooler RH Side-Outlet Hose (Conn Nut 27mm Across Flats)	625-148
V8 - 6.5L (395 CID)	1996-95	Diesel, Eng Oil Cooler LH Side-Inlet Hose (Conn Nut .875" Across Flats)	625-143
V8 - 6.5L (395 CID)	1996-95	Diesel, Eng Oil Cooler RH Side-Outlet Hose (Conn Nut 19mm Across Flats)	625-114
V8 - 6.5L (395 CID)	1994-92	Diesel, Eng Oil Cooler Lower-Inlet Hose, Under 12,000 GVW	625-164
V8 - 6.5L (395 CID)	1994-92	Diesel, Eng Oil Cooler Upper-Outlet Hose, Under 12,000 GVW	625-134
V8 - 7.4L (454 CID)	2000-96	Eng Oil Cooler Lower-Inlet Hose, Under 12,000 GVW	625-178
V8 - 7.4L (454 CID)	2000-96	Eng Oil Cooler Upper-Outlet Hose	625-179
V8 - 7.4L (454 CID)	1995-94	Eng Oil Cooler Lower-Inlet Hose, wo/HD Cooling	625-137
V8 - 7.4L (454 CID)	1995-94	Eng Oil Cooler Upper-Outlet Hose, wo/HD Cooling	625-111
V8 - 7.4L (454 CID)	1986-85	Eng Oil Cooler Lower-Inlet Hose	625-131
V8 - 7.4L (454 CID)	1986-85	Eng Oil Cooler Upper-Outlet Hose	625-132
R SERIES PICKUP			
V8 - 6.2L (379 CID)	1991-87	Diesel, Eng Oil Cooler Lower-Outlet Hose	625-155
V8 - 6.2L (379 CID)	1991-87	Diesel, Eng Oil Cooler Upper-Inlet Hose	625-154
S10 BLAZER			
V6 - 4.3L (262 CID)	2005-96	2WD, Eng Oil Cooler Hose	625-122
V6 - 4.3L (262 CID)	2005-96	4WD, Eng Oil Cooler Pipe	625-100
V6 - 4.3L (262 CID)	2005-96	4WD, Eng Oil Filter Hose	625-001
V6 - 4.3L (262 CID)	1995	2WD, Eng Oil Cooler Lower-Outlet Hose	625-128
V6 - 4.3L (262 CID)	1995	2WD, Eng Oil Cooler Upper-Inlet Hose	625-127
V6 - 4.3L (262 CID)	1995	4WD, Eng Oil Cooler Hose	625-104
V6 - 4.3L (262 CID)	1995	4WD, Eng Oil Filter Hose	625-103
V6 - 4.3L (262 CID)	1994-92	4WD, Eng Vin Z, Eng Oil Cooler Hose, w/HD Cooling	625-176
V6 - 4.3L (262 CID)	1994-88	4WD, Eng Oil Filter Hose	625-102
V6 - 4.3L (262 CID)	1991-88	4WD, Eng Vin Z, Eng Oil Cooler Hose	625-176
S10 PICKUP			
V6 - 4.3L (262 CID)	2004-96	2WD, Eng Oil Cooler Hose	625-122
V6 - 4.3L (262 CID)	2004-96	4WD, Eng Oil Cooler Pipe	625-100
V6 - 4.3L (262 CID)	2004-96	4WD, Eng Oil Filter Hose	625-001
V6 - 4.3L (262 CID)	1995-94	2WD, Eng Oil Cooler Lower-Outlet Hose	625-128
V6 - 4.3L (262 CID)	1995-94	2WD, Eng Oil Cooler Upper-Inlet Hose	625-127
V6 - 4.3L (262 CID)	1995-94	4WD, Eng Oil Cooler Hose	625-104
V6 - 4.3L (262 CID)	1995-94	4WD, Eng Oil Filter Hose	625-103
V6 - 4.3L (262 CID)	1993-88	4WD, Eng Oil Filter Hose	625-102
SILVERADO			
V8 - 5.3L (323 CID)	2005	Eng Oil Cooler Hose, VIN Z, Flex Fuel, 7.75MM Length Flared End Tube	625-168
V8 - 6.0L (364 CID)	2005	Eng Oil Cooler Hose, 7.75MM Length Flared End Tube	625-168
V8 - 6.0L (364 CID)	2004-99	Eng Oil Cooler Hose	625-168
SUBURBAN			
V8 - 5.0L (305 CID)	1986-85	4WD, Eng Oil Cooler Lower-Inlet Hose	625-131
V8 - 5.0L (305 CID)	1986-85	4WD, Eng Oil Cooler Upper-Outlet Hose	625-132
V8 - 5.3L (323 CID)	2005	Eng Oil Cooler Hose, VIN Z, Flex Fuel, 7.75MM Length Flared End Tube	625-168
V8 - 5.7L (350 CID)	1999-96	2WD, Eng Oil Cooler Lower-Inlet Hose	625-149
V8 - 5.7L (350 CID)	1999-96	2WD, Eng Oil Cooler Upper-Outlet Hose	625-150
V8 - 5.7L (350 CID)	1999-96	4WD, Eng Oil Cooler Lower-Outlet Hose	625-123
V8 - 5.7L (350 CID)	1999-96	4WD, Eng Oil Cooler Upper-Inlet Hose	625-101
V8 - 5.7L (350 CID)	1995-94	2WD, 3.08R, 3.42R, 3.73R, 4.10R, 4.56R, Eng Oil Cooler Lower-Inlet Hose	625-135
V8 - 5.7L (350 CID)	1995-94	2WD, 3.08R, 3.42R, 3.73R, 4.10R, 4.56R, Eng Oil Cooler Upper-Outlet Hose	625-136
V8 - 5.7L (350 CID)	1995-94	4WD, 3.42R, 3.73R, 4.10R, 4.56R, Eng Oil Cooler Lower-Outlet Hose	625-107
V8 - 5.7L (350 CID)	1995-94	4WD, 3.42R, 3.73R, 4.10R, 4.56R, Eng Oil Cooler Upper-Inlet Hose	625-108
V8 - 5.7L (350 CID)	1993-92	2WD, 3.08R, 3.42R, 3.73R, Eng Oil Cooler Lower-Outlet Hose	625-140
V8 - 5.7L (350 CID)	1993-92	2WD, 3.08R, 3.42R, 3.73R, Eng Oil Cooler Upper-Inlet Hose	625-139
V8 - 5.7L (350 CID)	1993-92	2WD, Exc. 3.08R, 3.42R, 3.73R, Eng Oil Cooler Lower-Outlet Hose	625-161
V8 - 5.7L (350 CID)	1993-92	2WD, Exc. 3.08R, 3.42R, 3.73R, Eng Oil Cooler Upper-Inlet Hose	625-160
V8 - 5.7L (350 CID)	1993-92	4WD, 3.42R, 3.73R, Eng Oil Cooler Lower-Outlet Hose	625-142
V8 - 5.7L (350 CID)	1993-92	4WD, 3.42R, 3.73R, Eng Oil Cooler Upper-Inlet Hose	625-141
V8 - 5.7L (350 CID)	1993-92	4WD, 4.10R, 4.56R, Eng Oil Cooler Lower-Outlet Hose	625-163
V8 - 5.7L (350 CID)	1993-92	4WD, 4.10R, 4.56R, Eng Oil Cooler Upper-Inlet Hose	625-162
V8 - 5.7L (350 CID)	1991-85	4WD, Eng Oil Cooler Lower-Inlet Hose	625-131
V8 - 5.7L (350 CID)	1991-85	4WD, Eng Oil Cooler Upper-Outlet Hose	625-132
V8 - 6.0L (364 CID)	2005	Eng Oil Cooler Hose, 7.75MM Length Flared End Tube	625-168
V8 - 6.0L (364 CID)	2004-00	Eng Oil Cooler Hose	625-168
V8 - 6.2L (379 CID)	1993	Diesel, Eng Oil Cooler Lower-Inlet Hose, w/HD Cooling	625-164
V8 - 6.2L (379 CID)	1993	Diesel, Eng Oil Cooler Lower-Outlet Hose, wo/HD Cooling	625-157
V8 - 6.2L (379 CID)	1993	Diesel, Eng Oil Cooler Upper-Inlet Hose, wo/HD Cooling	625-165
V8 - 6.2L (379 CID)	1993	Diesel, Eng Oil Cooler Upper-Outlet Hose, w/HD Cooling	625-134
V8 - 6.2L (379 CID)	1992	Diesel, Eng Oil Cooler Lower-Inlet Hose, w/HD Cooling, w/Hose Protector	625-164
V8 - 6.2L (379 CID)	1992	Diesel, Eng Oil Cooler Lower-Outlet Hose, w/HD Cooling, wo/Hose Protector	625-133
V8 - 6.2L (379 CID)	1992	Diesel, Eng Oil Cooler Lower-Outlet Hose, wo/HD Cooling	625-157
V8 - 6.2L (379 CID)	1992	Diesel, Eng Oil Cooler Upper-Inlet Hose, wo/HD Cooling	625-165
V8 - 6.2L (379 CID)	1992	Diesel, Eng Oil Cooler Upper-Outlet Hose, w/HD Cooling	625-134
V8 - 6.2L (379 CID)	1991-87	Diesel, Eng Oil Cooler Lower-Outlet Hose	625-155
V8 - 6.2L (379 CID)	1991-87	Diesel, Eng Oil Cooler Upper-Inlet Hose	625-154
V8 - 6.2L (379 CID)	1986-85	Diesel, Eng Oil Cooler Lower-Outlet Hose	625-155
V8 - 6.2L (379 CID)	1986-85	Diesel, Eng Oil Cooler Upper-Inlet Hose	625-154
V8 - 6.5L (395 CID)	1999-98	Diesel, Eng Oil Cooler LH Side-Inlet Hose (Conn Nut 27mm Across Flats)	625-147
V8 - 6.5L (395 CID)	1999-98	Diesel, Eng Oil Cooler RH Side-Outlet Hose (Conn Nut 27mm Across Flats)	625-148
V8 - 6.5L (395 CID)	1997	Diesel, Eng Oil Cooler LH Side-Inlet Hose (Conn Nut .875" Across Flats)	625-143
V8 - 6.5L (395 CID)	1997	Diesel, Eng Oil Cooler LH Side-Inlet Hose (Conn Nut 27mm Across Flats)	625-147
V8 - 6.5L (395 CID)	1997	Diesel, Eng Oil Cooler RH Side-Outlet Hose (Conn Nut 19mm Across Flats)	625-114
V8 - 6.5L (395 CID)	1997	Diesel, Eng Oil Cooler RH Side-Outlet Hose (Conn Nut 27mm Across Flats)	625-148

Oil Cooler Line Assembly Applications

Make/ Model/Engine	Years	Description	Dorman #
CHEVROLET TRUCK (continued)			
SUBURBAN (continued)			
V8 - 6.5L (395 CID)	1996-95	Diesel, Eng Oil Cooler LH Side-Inlet Hose	625-143
V8 - 6.5L (395 CID)	1996-95	Diesel, Eng Oil Cooler RH Side-Outlet Hose	625-114
V8 - 6.5L (395 CID)	1994-92	Diesel, Eng Oil Cooler Lower-Inlet Hose, Under 12,000 GVW	625-164
V8 - 6.5L (395 CID)	1994-92	Diesel, Eng Oil Cooler Upper-Outlet Hose, Under 12,000 GVW	625-134
V8 - 7.4L (454 CID)	1999-96	Eng Oil Cooler Lower-Inlet Hose, Under 12,000 GVW	625-178
V8 - 7.4L (454 CID)	1999-96	Eng Oil Cooler Upper-Outlet Hose	625-179
V8 - 7.4L (454 CID)	1995-94	Eng Oil Cooler Lower-Inlet Hose, wo/HD Cooling	625-137
V8 - 7.4L (454 CID)	1995-94	Eng Oil Cooler Upper-Outlet Hose, wo/HD Cooling	625-111
V8 - 7.4L (454 CID)	1993	Eng Oil Cooler Lower-Inlet Hose, wo/HD Cooling	625-158
V8 - 7.4L (454 CID)	1993	Eng Oil Cooler Upper-Outlet Hose, wo/HD Cooling	625-159
V8 - 7.4L (454 CID)	1992	Eng Oil Cooler Lower-Inlet Hose, w/Upper Radiator Shroud Broadcast Code AFB, wo/HD Cooling	625-158
V8 - 7.4L (454 CID)	1992	Eng Oil Cooler Upper-Outlet Hose, w/Upper Radiator Shroud Broadcast Code AFB, wo/HD Cooling	625-159
V8 - 7.4L (454 CID)	1990-85	4WD, Eng Oil Cooler Lower-Inlet Hose	625-131
V8 - 7.4L (454 CID)	1990-85	4WD, Eng Oil Cooler Upper-Outlet Hose	625-132
TAHOE			
V8 - 5.3L (323 CID)	2005	Eng Oil Cooler Hose, VIN Z, Flex Fuel, 7.75MM Length Flared End Tube	625-168
V8 - 5.7L (350 CID)	2000-96	2WD, Eng Oil Cooler Lower-Inlet Hose	625-149
V8 - 5.7L (350 CID)	2000-96	2WD, Eng Oil Cooler Upper-Outlet Hose	625-150
V8 - 5.7L (350 CID)	2000-96	4WD, Eng Oil Cooler Lower-Outlet Hose	625-123
V8 - 5.7L (350 CID)	2000-96	4WD, Eng Oil Cooler Upper-Inlet Hose	625-101
V8 - 5.7L (350 CID)	1995	2WD, 3.08R, 3.42R, 3.73R, 4.10R, 4.56R, Eng Oil Cooler Lower-Inlet Hose	625-135
V8 - 5.7L (350 CID)	1995	2WD, 3.08R, 3.42R, 3.73R, 4.10R, 4.56R, Eng Oil Cooler Upper-Outlet Hose	625-136
V8 - 5.7L (350 CID)	1995	4WD, 3.42R, 3.73R, 4.10R, 4.56R, Eng Oil Cooler Lower-Outlet Hose	625-107
V8 - 5.7L (350 CID)	1995	4WD, 3.42R, 3.73R, 4.10R, 4.56R, Eng Oil Cooler Upper-Inlet Hose	625-108
V8 - 6.5L (395 CID)	1999-98	Diesel, Eng Oil Cooler LH Side-Inlet Hose (Conn Nut 27mm Across Flats)	625-147
V8 - 6.5L (395 CID)	1999-98	Diesel, Eng Oil Cooler RH Side-Outlet Hose (Conn Nut 27mm Across Flats)	625-148
V8 - 6.5L (395 CID)	1997	Diesel, Eng Oil Cooler LH Side-Inlet Hose (Conn Nut .875" Across Flats)	625-143
V8 - 6.5L (395 CID)	1997	Diesel, Eng Oil Cooler LH Side-Inlet Hose (Conn Nut 27mm Across Flats)	625-147
V8 - 6.5L (395 CID)	1997	Diesel, Eng Oil Cooler RH Side-Outlet Hose (Conn Nut 19mm Across Flats)	625-114
V8 - 6.5L (395 CID)	1997	Diesel, Eng Oil Cooler RH Side-Outlet Hose (Conn Nut 27mm Across Flats)	625-148
V8 - 6.5L (395 CID)	1996-95	Diesel, Eng Oil Cooler LH Side-Inlet Hose	625-143
V8 - 6.5L (395 CID)	1996-95	Diesel, Eng Oil Cooler RH Side-Outlet Hose	625-114
V SERIES PICKUP			
V8 - 5.0L (305 CID)	1987	Eng Oil Cooler Lower-Inlet Hose	625-131
V8 - 5.0L (305 CID)	1987	Eng Oil Cooler Upper-Outlet Hose	625-132
V8 - 5.7L (350 CID)	1991-87	Eng Oil Cooler Lower-Inlet Hose	625-131
V8 - 5.7L (350 CID)	1991-87	Eng Oil Cooler Upper-Outlet Hose	625-132
V8 - 6.2L (379 CID)	1991-87	Diesel, Eng Oil Cooler Lower-Outlet Hose	625-155
V8 - 6.2L (379 CID)	1991-87	Diesel, Eng Oil Cooler Upper-Inlet Hose	625-154
V8 - 7.4L (454 CID)	1990-87	Eng Oil Cooler Lower-Inlet Hose	625-131
V8 - 7.4L (454 CID)	1990-87	Eng Oil Cooler Upper-Outlet Hose	625-132
FORD			
CROWN VICTORIA			
V8 - 4.6L (281 CID)	2006-96	Eng Oil Cooler Hose	625-200
GMC TRUCK			
C SERIES PICKUP			
V6 - 4.3L (262 CID)	1998-96	Eng Oil Cooler Lower-Outlet Hose	625-183
V6 - 4.3L (262 CID)	1998-96	Eng Oil Cooler Upper-Inlet Hose	625-182
V8 - 5.0L (305 CID)	1999-96	Eng Oil Cooler Lower-Inlet Hose, w/140 Amp Alternator	625-149
V8 - 5.0L (305 CID)	1999-96	Eng Oil Cooler Upper-Outlet Hose, w/140 Amp Alternator	625-150
V8 - 5.0L (305 CID)	1995-94	3.08R, 3.42R, 3.73R, 4.10R, Eng Oil Cooler Lower-Outlet Hose	625-140
V8 - 5.0L (305 CID)	1995-94	3.08R, 3.42R, 3.73R, 4.10R, Eng Oil Cooler Upper-Inlet Hose	625-139
V8 - 5.0L (305 CID)	1993-88	Eng Oil Cooler Lower-Outlet Hose	625-140
V8 - 5.0L (305 CID)	1993-88	Eng Oil Cooler Upper-Inlet Hose	625-139
V8 - 5.7L (350 CID)	2000-96	Eng Oil Cooler Lower-Inlet Hose	625-149
V8 - 5.7L (350 CID)	2000-96	Eng Oil Cooler Upper-Outlet Hose	625-150
V8 - 5.7L (350 CID)	1995-94	1/2 & 3/4-Ton, 3.08R, 3.42R, 3.73R, 4.10R, 4.56R, Eng Oil Cooler Lower-Inlet Hose	625-135
V8 - 5.7L (350 CID)	1995-94	1/2 & 3/4-Ton, 3.08R, 3.42R, 3.73R, 4.10R, 4.56R, Eng Oil Cooler Upper-Outlet Hose	625-136
V8 - 5.7L (350 CID)	1995	1-Ton, 131.5", 155.5" Wheel Base, 3.08R, 3.42R, 3.73R, 4.10R, 4.56R, Eng Oil Cooler Lower-Inlet Hose	625-135
V8 - 5.7L (350 CID)	1995	1-Ton, 131.5", 155.5" Wheel Base, 3.08R, 3.42R, 3.73R, 4.10R, 4.56R, Eng Oil Cooler Upper-Outlet Hose	625-136
V8 - 5.7L (350 CID)	1995	1-Ton, 135.5", 159.5" Wheel Base, Eng Oil Cooler Lower-Inlet Hose	625-135
V8 - 5.7L (350 CID)	1995	1-Ton, 135.5", 159.5" Wheel Base, Eng Oil Cooler Upper-Outlet Hose	625-136
V8 - 5.7L (350 CID)	1993-88	2.73R, 3.08R, 3.42R, 3.73R, Eng Oil Cooler Lower-Outlet Hose	625-140
V8 - 5.7L (350 CID)	1993-88	2.73R, 3.08R, 3.42R, 3.73R, Eng Oil Cooler Upper-Inlet Hose	625-139
V8 - 5.7L (350 CID)	1993-88	Exc. 2.73R, 3.08R, 3.42R, 3.73R, Eng Oil Cooler Lower-Outlet Hose	625-161
V8 - 5.7L (350 CID)	1993-88	Exc. 2.73R, 3.08R, 3.42R, 3.73R, Eng Oil Cooler Upper-Inlet Hose	625-160
V8 - 6.2L (379 CID)	1993	Diesel, Eng Oil Cooler Lower-Inlet Hose, w/HD Cooling	625-164
V8 - 6.2L (379 CID)	1993	Diesel, Eng Oil Cooler Lower-Outlet Hose, wo/HD Cooling	625-157
V8 - 6.2L (379 CID)	1993	Diesel, Eng Oil Cooler Upper-Inlet Hose, wo/HD Cooling	625-165
V8 - 6.2L (379 CID)	1993	Diesel, Eng Oil Cooler Upper-Outlet Hose, w/HD Cooling	625-134
V8 - 6.2L (379 CID)	1992	Diesel, Eng Oil Cooler Lower-Inlet Hose, w/HD Cooling, w/Hose Protector	625-164
V8 - 6.2L (379 CID)	1992	Diesel, Eng Oil Cooler Lower-Inlet Hose, w/HD Cooling, wo/Hose Protector	625-133
V8 - 6.2L (379 CID)	1992	Diesel, Eng Oil Cooler Lower-Outlet Hose, wo/HD Cooling	625-157
V8 - 6.2L (379 CID)	1992	Diesel, Eng Oil Cooler Upper-Inlet Hose, wo/HD Cooling	625-165
V8 - 6.2L (379 CID)	1992	Diesel, Eng Oil Cooler Upper-Outlet Hose, w/HD Cooling	625-134
V8 - 6.2L (379 CID)	1991-88	Diesel, Eng Oil Cooler Lower-Inlet Hose, w/HD Cooling	625-133
V8 - 6.2L (379 CID)	1991-88	Diesel, Eng Oil Cooler Lower-Outlet Hose, wo/HD Cooling	625-157

Oil Cooler Line Assembly Applications

Make/ Model/Engine	Years	Description	Dorman #
GMC TRUCK (continued)			
C SERIES PICKUP (continued)			
V8 - 6.2L (379 CID)	1991-88	Diesel, Eng Oil Cooler Upper-Inlet Hose, wo/HD Cooling	625-165
V8 - 6.2L (379 CID)	1991-88	Diesel, Eng Oil Cooler Upper-Outlet Hose, w/HD Cooling	625-134
V8 - 6.2L (379 CID)	1986-85	Diesel, Eng Oil Cooler Lower-Outlet Hose	625-155
V8 - 6.2L (379 CID)	1986-85	Diesel, Eng Oil Cooler Upper-Inlet Hose	625-154
V8 - 6.5L (395 CID)	2002-01	Diesel, Eng Oil Cooler LH Side-Inlet Hose (Conn Nut 32mm Across Flats)	625-113
V8 - 6.5L (395 CID)	2002-01	Diesel, Eng Oil Cooler RH Side-Outlet Hose (Conn Nut 32mm Across Flats)	625-112
V8 - 6.5L (395 CID)	2000-98	Diesel, Eng Oil Cooler LH Side-Inlet Hose (Conn Nut 27mm Across Flats)	625-147
V8 - 6.5L (395 CID)	2000-98	Diesel, Eng Oil Cooler LH Side-Inlet Hose (Conn Nut 32mm Across Flats)	625-113
V8 - 6.5L (395 CID)	2000-98	Diesel, Eng Oil Cooler RH Side-Outlet Hose (Conn Nut 27mm Across Flats)	625-148
V8 - 6.5L (395 CID)	2000-98	Diesel, Eng Oil Cooler RH Side-Outlet Hose (Conn Nut 32mm Across Flats)	625-112
V8 - 6.5L (395 CID)	1997	Diesel, 1-Ton, Eng Oil Cooler LH Side-Inlet Hose (Conn Nut, 875" Across Flats), Exc. 15,000 GVW	625-143
V8 - 6.5L (395 CID)	1997	Diesel, 1-Ton, Eng Oil Cooler LH Side-Inlet Hose (Conn Nut 25.4mm Across Flats), 15,000 GVW	625-145
V8 - 6.5L (395 CID)	1997	Diesel, 1-Ton, Eng Oil Cooler LH Side-Inlet Hose (Conn Nut 27mm Across Flats), Exc. 15,000 GVW	625-147
V8 - 6.5L (395 CID)	1997	Diesel, 1-Ton, Eng Oil Cooler LH Side-Inlet Hose (Conn Nut 32mm Across Flats)	625-113
V8 - 6.5L (395 CID)	1997	Diesel, 1-Ton, Eng Oil Cooler RH Side-Outlet Hose (Conn Nut 19mm Across Flats), Exc. 15,000 GVW	625-114
V8 - 6.5L (395 CID)	1997	Diesel, 1-Ton, Eng Oil Cooler RH Side-Outlet Hose (Conn Nut 25.4mm Across Flats), 15,000 GVW	625-146
V8 - 6.5L (395 CID)	1997	Diesel, 1-Ton, Eng Oil Cooler RH Side-Outlet Hose (Conn Nut 27mm Across Flats), Exc. 15,000 GVW	625-148
V8 - 6.5L (395 CID)	1997	Diesel, 1-Ton, Eng Oil Cooler RH Side-Outlet Hose (Conn Nut 32mm Across Flats)	625-112
V8 - 6.5L (395 CID)	1997	Diesel, 1/2 & 3/4-Ton, Eng Oil Cooler LH Side-Inlet Hose (Conn Nut .875" Across Flats)	625-143
V8 - 6.5L (395 CID)	1997	Diesel, 1/2 & 3/4-Ton, Eng Oil Cooler LH Side-Inlet Hose (Conn Nut 27mm Across Flats)	625-147
V8 - 6.5L (395 CID)	1997	Diesel, 1/2 & 3/4-Ton, Eng Oil Cooler RH Side-Outlet Hose (Conn Nut 19mm Across Flats)	625-114
V8 - 6.5L (395 CID)	1997	Diesel, 1/2 & 3/4-Ton, Eng Oil Cooler RH Side-Outlet Hose (Conn Nut 27mm Across Flats)	625-148
V8 - 6.5L (395 CID)	1996-95	Diesel, 1-Ton, Eng Oil Cooler LH Side-Inlet Hose (Conn Nut, 875" Across Flats), Exc. 15,000 GVW	625-143
V8 - 6.5L (395 CID)	1996-95	Diesel, 1-Ton, Eng Oil Cooler LH Side-Inlet Hose (Conn Nut 25.4mm Across Flats), 15,000 GVW	625-145
V8 - 6.5L (395 CID)	1996-95	Diesel, 1-Ton, Eng Oil Cooler RH Side-Outlet Hose (Conn Nut 19mm Across Flats), Exc. 15,000 GVW	625-114
V8 - 6.5L (395 CID)	1996-95	Diesel, 1-Ton, Eng Oil Cooler RH Side-Outlet Hose (Conn Nut 25.4mm Across Flats), 15,000 GVW	625-146
V8 - 6.5L (395 CID)	1996-95	Diesel, 1/2 & 3/4-Ton, Eng Oil Cooler LH Side-Inlet Hose	625-143
V8 - 6.5L (395 CID)	1996-95	Diesel, 1/2 & 3/4-Ton, Eng Oil Cooler RH Side-Outlet Hose	625-114
V8 - 6.5L (395 CID)	1994-92	Diesel, Eng Oil Cooler Lower-Inlet Hose, Under 12,000 GVW	625-164
V8 - 6.5L (395 CID)	1994-92	Diesel, Eng Oil Cooler Upper-Outlet Hose, Under 12,000 GVW	625-134
V8 - 6.5L (395 CID)	1993-92	Diesel, Eng Oil Cooler Lower-Outlet Hose, 15,000 GVW & Over	625-157
V8 - 7.4L (454 CID)	2000-96	Eng Oil Cooler Lower-Inlet Hose, Under 12,000 GVW	625-178
V8 - 7.4L (454 CID)	2000-96	Eng Oil Cooler Upper-Outlet Hose	625-179
V8 - 7.4L (454 CID)	1995-94	Eng Oil Cooler Lower-Inlet Hose, wo/HD Cooling	625-137
V8 - 7.4L (454 CID)	1995-94	Eng Oil Cooler Upper-Outlet Hose, wo/HD Cooling	625-111
V8 - 7.4L (454 CID)	1993	Eng Oil Cooler Lower-Inlet Hose, wo/HD Cooling	625-158
V8 - 7.4L (454 CID)	1993	Eng Oil Cooler Upper-Outlet Hose, wo/HD Cooling	625-159
V8 - 7.4L (454 CID)	1992	Eng Oil Cooler Lower-Inlet Hose, w/Upper Radiator Shroud Broadcast Code AFB, wo/HD Cooling	625-158
V8 - 7.4L (454 CID)	1992	Eng Oil Cooler Upper-Outlet Hose, w/Upper Radiator Shroud Broadcast Code AFB, wo/HD Cooling	625-159
V8 - 8.1L (496 CID)	2003-01	Eng Oil Cooler Lower-Outlet Hose	625-167
V8 - 8.1L (496 CID)	2003-01	Eng Oil Cooler Upper-Inlet Hose	625-166
DENALI			
V8 - 6.0L (364 CID)	2005	Eng Oil Cooler Hose, 7.75MM Length Flared End Tube	625-168
V8 - 6.0L (364 CID)	2004-01	Eng Oil Cooler Hose	625-168
DENALI XL			
V8 - 6.0L (364 CID)	2005	Eng Oil Cooler Hose, 7.75MM Length Flared End Tube	625-168
V8 - 6.0L (364 CID)	2004-01	Eng Oil Cooler Hose	625-168
G SERIES VAN			
V6 - 4.3L (262 CID)	1997	Eng Oil Cooler Hose	625-175
V6 - 4.3L (262 CID)	1996-94	Eng Oil Cooler Lower-Inlet Hose, w/HD Cooling	625-171
V6 - 4.3L (262 CID)	1996-94	Eng Oil Cooler Upper-Outlet Hose, w/HD Cooling	625-172
V6 - 4.3L (262 CID)	1993-92	Eng Oil Cooler Lower-Inlet Hose, A/C Manual Control	625-171
V6 - 4.3L (262 CID)	1993-92	Eng Oil Cooler Lower-Outlet Hose, Exc. A/C Manual Control	625-170
V6 - 4.3L (262 CID)	1993-92	Eng Oil Cooler Upper-Inlet Hose, Exc. A/C Manual Control	625-169
V6 - 4.3L (262 CID)	1993-92	Eng Oil Cooler Upper-Outlet Hose, A/C Manual Control	625-172
V6 - 4.3L (262 CID)	1991-85	Eng Oil Cooler Lower-Outlet Hose	625-170
V6 - 4.3L (262 CID)	1991-85	Eng Oil Cooler Upper-Inlet Hose	625-169
V8 - 5.0L (305 CID)	1995-92	Eng Oil Cooler Inlet Hose	625-153
V8 - 5.0L (305 CID)	1995-92	Eng Oil Cooler Outlet Hose	625-153
V8 - 5.0L (305 CID)	1991-87	Eng Oil Cooler LH Side-Outlet Hose	625-121
V8 - 5.0L (305 CID)	1991-87	Eng Oil Cooler RH Side-Inlet Hose	625-120
V8 - 5.7L (350 CID)	1996	Eng Vin K, Eng Oil Cooler Inlet Hose	625-153
V8 - 5.7L (350 CID)	1996	Eng Vin K, Eng Oil Cooler Outlet Hose	625-153
V8 - 5.7L (350 CID)	1996	Eng Vin R, Eng Oil Cooler Lower-Outlet Hose	625-152
V8 - 5.7L (350 CID)	1996	Eng Vin R, Eng Oil Cooler Upper-Inlet Hose	625-151
V8 - 5.7L (350 CID)	1995-92	Eng Oil Cooler Inlet Hose	625-153
V8 - 5.7L (350 CID)	1995-92	Eng Oil Cooler Outlet Hose	625-153
V8 - 5.7L (350 CID)	1991-87	Eng Oil Cooler LH Side-Outlet Hose	625-121
V8 - 5.7L (350 CID)	1991-87	Eng Oil Cooler RH Side-Inlet Hose	625-120

Oil Cooler Line Assembly Applications

Make/ Model/Engine	Years	Description	Dorman #
GMC TRUCK (continued)			
G SERIES VAN (continued)			
V8 - 5.7L (350 CID)	1986-85	Eng Vin M, Eng Oil Cooler LH Side-Outlet Hose	625-121
V8 - 5.7L (350 CID)	1986-85	Eng Vin M, Eng Oil Cooler RH Side-Inlet Hose	625-120
V8 - 6.2L (379 CID)	1993-92	Diesel, Eng Oil Cooler Lower-Inlet Hose	625-173
V8 - 6.2L (379 CID)	1993-92	Diesel, Eng Oil Cooler Upper-Outlet Hose	625-174
V8 - 6.2L (379 CID)	1991-85	Diesel, Eng Oil Cooler Lower-Outlet Hose	625-126
V8 - 6.2L (379 CID)	1991-85	Diesel, Eng Oil Cooler Upper-Inlet Hose	625-125
V8 - 6.5L (395 CID)	1996-94	Diesel, Eng Oil Cooler Lower-Inlet Pipe	625-110
V8 - 6.5L (395 CID)	1996-94	Diesel, Eng Oil Cooler Upper-Outlet Pipe	625-109
V8 - 6.5L (395 CID)	1996	Diesel, Auxiliary Eng Oil Cooler Lower-Outlet Hose	625-130
V8 - 6.5L (395 CID)	1996	Diesel, Auxiliary Eng Oil Cooler Upper-Inlet Hose	625-106
V8 - 6.5L (395 CID)	1996	Diesel, Eng Oil Cooler Lower-Inlet Hose	625-129
JIMMY			
V8 - 5.0L (305 CID)	1987-85	4WD, Eng Oil Cooler Lower-Inlet Hose	625-131
V8 - 5.0L (305 CID)	1987-85	4WD, Eng Oil Cooler Upper-Outlet Hose	625-132
V8 - 5.7L (350 CID)	1991-85	4WD, Eng Oil Cooler Lower-Inlet Hose	625-131
V8 - 5.7L (350 CID)	1991-85	4WD, Eng Oil Cooler Upper-Outlet Hose	625-132
V8 - 6.2L (379 CID)	1991-85	Diesel, Eng Oil Cooler Upper-Inlet Hose	625-154
K SERIES PICKUP			
V6 - 4.3L (262 CID)	1998-96	Eng Oil Cooler Lower-Outlet Hose	625-183
V6 - 4.3L (262 CID)	1998-96	Eng Oil Cooler Upper-Inlet Hose	625-182
V8 - 5.0L (305 CID)	1999-96	Eng Oil Cooler Lower-Outlet Hose, w/140 Amp Alternator	625-123
V8 - 5.0L (305 CID)	1999-96	Eng Oil Cooler Upper-Inlet Hose, w/140 Amp Alternator	625-101
V8 - 5.0L (305 CID)	1995-94	3.42R, 3.73R, Eng Oil Cooler Lower-Outlet Hose	625-142
V8 - 5.0L (305 CID)	1995-94	3.42R, 3.73R, Eng Oil Cooler Upper-Inlet Hose	625-141
V8 - 5.0L (305 CID)	1993-88	Eng Oil Cooler Lower-Outlet Hose	625-142
V8 - 5.0L (305 CID)	1993-88	Eng Oil Cooler Upper-Inlet Hose	625-141
V8 - 5.0L (305 CID)	1986-85	Eng Oil Cooler Lower-Inlet Hose	625-131
V8 - 5.0L (305 CID)	1986-85	Eng Oil Cooler Upper-Outlet Hose	625-132
V8 - 5.7L (350 CID)	2000-96	Eng Oil Cooler Lower-Outlet Hose	625-123
V8 - 5.7L (350 CID)	2000-96	Eng Oil Cooler Upper-Inlet Hose	625-101
V8 - 5.7L (350 CID)	1995-94	1-Ton, 131.5", 155.5" Wheel Base, 3.73R, 4.10R, 4.56R, Eng Oil Cooler Lower-Outlet Hose	625-107
V8 - 5.7L (350 CID)	1995-94	1-Ton, 131.5", 155.5" Wheel Base, 3.73R, 4.10R, 4.56R, Eng Oil Cooler Upper-Inlet Hose	625-108
V8 - 5.7L (350 CID)	1995-94	1-Ton, 135.5", 159.5" Wheel Base, Eng Oil Cooler Lower-Outlet Hose	625-107
V8 - 5.7L (350 CID)	1995-94	1-Ton, 135.5", 159.5" Wheel Base, Eng Oil Cooler Upper-Inlet Hose	625-108
V8 - 5.7L (350 CID)	1995-94	1/2 & 3/4-Ton, 3.42R, 3.73R, 4.10R, 4.56R, Eng Oil Cooler Lower-Outlet Hose	625-107
V8 - 5.7L (350 CID)	1995-94	1/2 & 3/4-Ton, 3.42R, 3.73R, 4.10R, 4.56R, Eng Oil Cooler Upper-Inlet Hose	625-108
V8 - 5.7L (350 CID)	1993-91	4.10R, 4.56R, Eng Oil Cooler Lower-Outlet Hose	625-163
V8 - 5.7L (350 CID)	1993-91	4.10R, 4.56R, Eng Oil Cooler Upper-Inlet Hose	625-162
V8 - 5.7L (350 CID)	1993-88	3.42R, 3.73R, Eng Oil Cooler Lower-Outlet Hose	625-142
V8 - 5.7L (350 CID)	1993-88	3.42R, 3.73R, Eng Oil Cooler Upper-Inlet Hose	625-141
V8 - 5.7L (350 CID)	1986-85	Eng Oil Cooler Lower-Inlet Hose	625-131
V8 - 5.7L (350 CID)	1986-85	Eng Oil Cooler Upper-Outlet Hose	625-132
V8 - 6.2L (379 CID)	1993	Diesel, Eng Oil Cooler Lower-Inlet Hose, w/HD Cooling	625-164
V8 - 6.2L (379 CID)	1993	Diesel, Eng Oil Cooler Lower-Outlet Hose, wo/HD Cooling	625-157
V8 - 6.2L (379 CID)	1993	Diesel, Eng Oil Cooler Upper-Inlet Hose, wo/HD Cooling	625-165
V8 - 6.2L (379 CID)	1993	Diesel, Eng Oil Cooler Upper-Outlet Hose, w/HD Cooling	625-134
V8 - 6.2L (379 CID)	1992	Diesel, Eng Oil Cooler Lower-Inlet Hose, w/HD Cooling, w/Hose Protector	625-164
V8 - 6.2L (379 CID)	1992	Diesel, Eng Oil Cooler Lower-Outlet Hose, w/HD Cooling, wo/Hose Protector	625-133
V8 - 6.2L (379 CID)	1992	Diesel, Eng Oil Cooler Lower-Outlet Hose, wo/HD Cooling	625-157
V8 - 6.2L (379 CID)	1992	Diesel, Eng Oil Cooler Upper-Inlet Hose, wo/HD Cooling	625-165
V8 - 6.2L (379 CID)	1992	Diesel, Eng Oil Cooler Upper-Outlet Hose, w/HD Cooling	625-134
V8 - 6.2L (379 CID)	1991-88	Diesel, Eng Oil Cooler Lower-Inlet Hose, w/HD Cooling	625-133
V8 - 6.2L (379 CID)	1991-88	Diesel, Eng Oil Cooler Lower-Outlet Hose, wo/HD Cooling	625-157
V8 - 6.2L (379 CID)	1991-88	Diesel, Eng Oil Cooler Upper-Inlet Hose, wo/HD Cooling	625-165
V8 - 6.2L (379 CID)	1991-88	Diesel, Eng Oil Cooler Upper-Outlet Hose, w/HD Cooling	625-134
V8 - 6.2L (379 CID)	1986-85	Diesel, Eng Oil Cooler Lower-Outlet Hose	625-155
V8 - 6.2L (379 CID)	1986-85	Diesel, Eng Oil Cooler Upper-Inlet Hose	625-154
V8 - 6.5L (395 CID)	2000-98	Diesel, Eng Oil Cooler LH Side-Inlet Hose (Conn Nut 27mm Across Flats)	625-147
V8 - 6.5L (395 CID)	2000-98	Diesel, Eng Oil Cooler RH Side-Outlet Hose (Conn Nut 27mm Across Flats)	625-148
V8 - 6.5L (395 CID)	1997	Diesel, Eng Oil Cooler LH Side-Inlet Hose (Conn Nut .875" Across Flats)	625-143
V8 - 6.5L (395 CID)	1997	Diesel, Eng Oil Cooler LH Side-Inlet Hose (Conn Nut 27mm Across Flats)	625-147
V8 - 6.5L (395 CID)	1997	Diesel, Eng Oil Cooler RH Side-Outlet Hose (Conn Nut 19mm Across Flats)	625-114
V8 - 6.5L (395 CID)	1997	Diesel, Eng Oil Cooler RH Side-Outlet Hose (Conn Nut 27mm Across Flats)	625-148
V8 - 6.5L (395 CID)	1996-95	Diesel, Eng Oil Cooler LH Side-Inlet Hose (Conn Nut .875" Across Flats)	625-143
V8 - 6.5L (395 CID)	1996-95	Diesel, Eng Oil Cooler RH Side-Outlet Hose (Conn Nut 19mm Across Flats)	625-114
V8 - 6.5L (395 CID)	1994-92	Diesel, Eng Oil Cooler Lower-Inlet Hose, Under 12,000 GVW	625-164
V8 - 6.5L (395 CID)	1994-92	Diesel, Eng Oil Cooler Upper-Outlet Hose, Under 12,000 GVW	625-134
V8 - 7.4L (454 CID)	2000-96	Eng Oil Cooler Lower-Inlet Hose, Under 12,000 GVW	625-178
V8 - 7.4L (454 CID)	2000-96	Eng Oil Cooler Upper-Outlet Hose	625-179
V8 - 7.4L (454 CID)	1995-94	Eng Oil Cooler Lower-Inlet Hose, wo/HD Cooling	625-137
V8 - 7.4L (454 CID)	1995-94	Eng Oil Cooler Upper-Outlet Hose, wo/HD Cooling	625-111
V8 - 7.4L (454 CID)	1986-85	Eng Oil Cooler Lower-Inlet Hose	625-131
V8 - 7.4L (454 CID)	1986-85	Eng Oil Cooler Upper-Outlet Hose	625-132
R SERIES PICKUP			
V8 - 6.2L (379 CID)	1991-87	Diesel, Eng Oil Cooler Lower-Outlet Hose	625-155
V8 - 6.2L (379 CID)	1991-87	Diesel, Eng Oil Cooler Upper-Inlet Hose	625-154
S15 JIMMY			
V6 - 4.3L (262 CID)	2001-96	2WD, Eng Oil Cooler Hose	625-122
V6 - 4.3L (262 CID)	2001-96	4WD, Eng Oil Cooler Pipe	625-100
V6 - 4.3L (262 CID)	2001-96	4WD, Eng Oil Filter Hose	625-001
V6 - 4.3L (262 CID)	1995	2WD, Eng Oil Cooler Lower-Outlet Hose	625-128

Oil Cooler Line Assembly Applications

Make/ Model/Engine	Years	Description	Dorman #
GMC TRUCK (continued)			
S15 JIMMY (continued)			
V6 - 4.3L (262 CID)	1995	2WD, Eng Oil Cooler Upper-Inlet Hose	625-127
V6 - 4.3L (262 CID)	1995	4WD, Eng Oil Cooler Hose	625-104
V6 - 4.3L (262 CID)	1995	4WD, Eng Oil Filter Hose	625-103
V6 - 4.3L (262 CID)	1994-92	4WD, Eng VIN Z, Eng Oil Cooler Hose, w/HD Cooling	625-176
V6 - 4.3L (262 CID)	1994-88	4WD, Eng Oil Filter Hose	625-102
V6 - 4.3L (262 CID)	1991-88	4WD, Eng VIN Z, Eng Oil Cooler Hose	625-176
S15 PICKUP			
V6 - 4.3L (262 CID)	1990-88	4WD, Eng Oil Filter Hose	625-102
S15 SONOMA			
V6 - 4.3L (262 CID)	2004-96	2WD, Eng Oil Cooler Hose	625-122
V6 - 4.3L (262 CID)	2004-96	4WD, Eng Oil Cooler Pipe	625-100
V6 - 4.3L (262 CID)	2004-96	4WD, Eng Oil Filter Hose	625-001
V6 - 4.3L (262 CID)	1995-94	2WD, Eng Oil Cooler Lower-Outlet Hose	625-128
V6 - 4.3L (262 CID)	1995-94	2WD, Eng Oil Cooler Upper-Inlet Hose	625-127
V6 - 4.3L (262 CID)	1995-94	4WD, Eng Oil Cooler Hose	625-104
V6 - 4.3L (262 CID)	1995-94	4WD, Eng Oil Filter Hose	625-103
V6 - 4.3L (262 CID)	1993-91	4WD, Eng Oil Filter Hose	625-102
S15 SYCLONE			
V6 - 4.3L (262 CID)	1991	4WD, Eng Oil Cooler Hose	625-176
V6 - 4.3L (262 CID)	1991	4WD, Eng Oil Filter Hose	625-102
S15 TYPHOON			
V6 - 4.3L (262 CID)	1993-92	4WD, Eng Oil Cooler Hose	625-176
V6 - 4.3L (262 CID)	1993-92	4WD, Eng Oil Filter Hose	625-102
SAFARI VAN			
V6 - 4.3L (262 CID)	2005-96	Eng Oil Cooler Hose	625-105
V6 - 4.3L (262 CID)	1995	Eng Oil Cooler Lower-Outlet Hose	625-144
V6 - 4.3L (262 CID)	1995	Eng Oil Cooler Upper-Inlet Hose	625-138
V6 - 4.3L (262 CID)	1994	2WD, Eng Oil Cooler Lower-Outlet Hose	625-181
V6 - 4.3L (262 CID)	1994	2WD, Eng Oil Cooler Upper-Inlet Hose	625-180
V6 - 4.3L (262 CID)	1993-85	2WD, Eng Oil Cooler Lower-Outlet Hose	625-119
V6 - 4.3L (262 CID)	1993-85	2WD, Eng Oil Cooler Upper-Inlet Hose	625-118
SAVANA VAN			
V6 - 4.3L (262 CID)	2002-96	Eng Oil Cooler Hose	625-175
V8 - 5.7L (350 CID)	2002-96	Eng Oil Cooler Lower-Outlet Hose	625-152
V8 - 5.7L (350 CID)	2002-96	Eng Oil Cooler Upper-Inlet Hose	625-151
V8 - 6.0L (364 CID)	2004-03	Eng Oil Cooler Hose	625-168
V8 - 6.5L (395 CID)	2002-96	Diesel, Auxiliary Eng Oil Cooler Lower-Outlet Hose	625-130
V8 - 6.5L (395 CID)	2002-96	Diesel, Auxiliary Eng Oil Cooler Upper-Inlet Hose	625-106
V8 - 6.5L (395 CID)	2002-96	Diesel, Eng Oil Cooler Lower-Inlet Hose	625-129
SIERRA			
V8 - 5.3L (323 CID)	2005	Eng Oil Cooler Hose, VIN Z, Flex Fuel, 7.75MM Length Flared End Tube	625-168
V8 - 6.0L (364 CID)	2005	Eng Oil Cooler Hose, 7.75MM Length Flared End Tube	625-168
V8 - 6.0L (364 CID)	2004-99	Eng Oil Cooler Hose	625-168
SUBURBAN			
V8 - 5.0L (305 CID)	1986-85	4WD, Eng Oil Cooler Lower-Inlet Hose	625-131
V8 - 5.0L (305 CID)	1986-85	4WD, Eng Oil Cooler Upper-Outlet Hose	625-132
V8 - 5.7L (350 CID)	1999-96	2WD, Eng Oil Cooler Lower-Inlet Hose	625-149
V8 - 5.7L (350 CID)	1999-96	2WD, Eng Oil Cooler Upper-Outlet Hose	625-150
V8 - 5.7L (350 CID)	1999-96	4WD, Eng Oil Cooler Lower-Outlet Hose	625-123
V8 - 5.7L (350 CID)	1999-96	4WD, Eng Oil Cooler Upper-Inlet Hose	625-101
V8 - 5.7L (350 CID)	1995-94	2WD, 3.08R, 3.42R, 3.73R, 4.10R, 4.56R, Eng Oil Cooler Lower-Inlet Hose	625-135
V8 - 5.7L (350 CID)	1995-94	2WD, 3.08R, 3.42R, 3.73R, 4.10R, 4.56R, Eng Oil Cooler Upper-Outlet Hose	625-136
V8 - 5.7L (350 CID)	1995-94	4WD, 3.42R, 3.73R, 4.10R, 4.56R, Eng Oil Cooler Lower-Outlet Hose	625-107
V8 - 5.7L (350 CID)	1995-94	4WD, 3.42R, 3.73R, 4.10R, 4.56R, Eng Oil Cooler Upper-Inlet Hose	625-108
V8 - 5.7L (350 CID)	1993-92	2WD, 3.08R, 3.42R, 3.73R, Eng Oil Cooler Lower-Outlet Hose	625-140
V8 - 5.7L (350 CID)	1993-92	2WD, 3.08R, 3.42R, 3.73R, Eng Oil Cooler Upper-Inlet Hose	625-139
V8 - 5.7L (350 CID)	1993-92	2WD, Exc. 3.08R, 3.42R, 3.73R, Eng Oil Cooler Lower-Outlet Hose	625-161
V8 - 5.7L (350 CID)	1993-92	2WD, Exc. 3.08R, 3.42R, 3.73R, Eng Oil Cooler Upper-Inlet Hose	625-160
V8 - 5.7L (350 CID)	1993-92	4WD, 3.42R, 3.73R, Eng Oil Cooler Lower-Outlet Hose	625-142
V8 - 5.7L (350 CID)	1993-92	4WD, 3.42R, 3.73R, Eng Oil Cooler Upper-Inlet Hose	625-141
V8 - 5.7L (350 CID)	1993-92	4WD, 4.10R, 4.56R, Eng Oil Cooler Lower-Outlet Hose	625-163
V8 - 5.7L (350 CID)	1993-92	4WD, 4.10R, 4.56R, Eng Oil Cooler Upper-Inlet Hose	625-162
V8 - 5.7L (350 CID)	1991-85	4WD, Eng Oil Cooler Lower-Inlet Hose	625-131
V8 - 5.7L (350 CID)	1991-85	4WD, Eng Oil Cooler Upper-Outlet Hose	625-132
V8 - 6.2L (379 CID)	1993-92	Diesel, Eng Oil Cooler Upper-Outlet Hose, Auxiliary Cooler	625-134
V8 - 6.2L (379 CID)	1993	Diesel, Eng Oil Cooler Lower-Inlet Hose, w/HD Cooling	625-164
V8 - 6.2L (379 CID)	1993	Diesel, Eng Oil Cooler Lower-Outlet Hose, wo/HD Cooling	625-157
V8 - 6.2L (379 CID)	1993	Diesel, Eng Oil Cooler Upper-Inlet Hose, wo/HD Cooling	625-165
V8 - 6.2L (379 CID)	1993	Diesel, Eng Oil Cooler Upper-Outlet Hose, w/HD Cooling	625-134
V8 - 6.2L (379 CID)	1992	Diesel, Eng Oil Cooler Lower-Inlet Hose, w/HD Cooling, w/Hose Protector	625-164
V8 - 6.2L (379 CID)	1992	Diesel, Eng Oil Cooler Lower-Outlet Hose, w/HD Cooling, wo/Hose Protector	625-133
V8 - 6.2L (379 CID)	1992	Diesel, Eng Oil Cooler Lower-Outlet Hose, wo/HD Cooling	625-157
V8 - 6.2L (379 CID)	1992	Diesel, Eng Oil Cooler Upper-Inlet Hose, wo/HD Cooling	625-165
V8 - 6.2L (379 CID)	1992	Diesel, Eng Oil Cooler Upper-Outlet Hose, w/HD Cooling	625-134
V8 - 6.2L (379 CID)	1991-87	Diesel, Eng Oil Cooler Lower-Outlet Hose	625-155
V8 - 6.2L (379 CID)	1991-87	Diesel, Eng Oil Cooler Upper-Inlet Hose	625-154
V8 - 6.2L (379 CID)	1986-85	Diesel, Eng Oil Cooler Lower-Outlet Hose	625-155
V8 - 6.2L (379 CID)	1986-85	Diesel, Eng Oil Cooler Upper-Inlet Hose	625-154
V8 - 6.5L (395 CID)	1999-98	Diesel, Eng Oil Cooler LH Side-Inlet Hose (Conn Nut 27mm Across Flats)	625-147
V8 - 6.5L (395 CID)	1999-98	Diesel, Eng Oil Cooler RH Side-Inlet Hose (Conn Nut 27mm Across Flats)	625-148
V8 - 6.5L (395 CID)	1997	Diesel, Eng Oil Cooler LH Side-Inlet Hose (Conn Nut .875" Across Flats)	625-143

Oil Cooler Line Assembly Applications

Make/ Model/Engine	Years	Description	Dorman #
GMC TRUCK (continued)			
SUBURBAN (continued)			
V8 - 6.5L (395 CID)	1997	Diesel, Eng Oil Cooler LH Side-Inlet Hose (Conn Nut 27mm Across Flats)	625-147
V8 - 6.5L (395 CID)	1997	Diesel, Eng Oil Cooler RH Side-Outlet Hose (Conn Nut 19mm Across Flats)	625-114
V8 - 6.5L (395 CID)	1997	Diesel, Eng Oil Cooler RH Side-Outlet Hose (Conn Nut 27mm Across Flats)	625-148
V8 - 6.5L (395 CID)	1996-95	Diesel, Eng Oil Cooler LH Side-Inlet Hose	625-143
V8 - 6.5L (395 CID)	1996-95	Diesel, Eng Oil Cooler RH Side-Outlet Hose	625-114
V8 - 6.5L (395 CID)	1994-92	Diesel, Eng Oil Cooler Lower-Inlet Hose, Under 12,000 GVW	625-164
V8 - 6.5L (395 CID)	1994-92	Diesel, Eng Oil Cooler Upper-Outlet Hose, Under 12,000 GVW	625-134
V8 - 6.5L (395 CID)	1993-92	Diesel, Eng Oil Cooler Upper-Outlet Hose	625-134
V8 - 7.4L (454 CID)	1999-96	Eng Oil Cooler Lower-Inlet Hose, Under 12,000 GVW	625-178
V8 - 7.4L (454 CID)	1999-96	Eng Oil Cooler Upper-Outlet Hose	625-179
V8 - 7.4L (454 CID)	1995-94	Eng Oil Cooler Lower-Inlet Hose, wo/HD Cooling	625-137
V8 - 7.4L (454 CID)	1995-94	Eng Oil Cooler Upper-Outlet Hose, wo/HD Cooling	625-111
V8 - 7.4L (454 CID)	1993	Eng Oil Cooler Lower-Inlet Hose, wo/HD Cooling	625-158
V8 - 7.4L (454 CID)	1993	Eng Oil Cooler Upper-Outlet Hose, wo/HD Cooling	625-159
V8 - 7.4L (454 CID)	1992	Eng Oil Cooler Lower-Inlet Hose, w/Upper Radiator Shroud Broadcast Code AFB, wo/HD Cooling	625-158
V8 - 7.4L (454 CID)	1992	Eng Oil Cooler Upper-Outlet Hose, w/Upper Radiator Shroud Broadcast Code AFB, wo/HD Cooling	625-159
V8 - 7.4L (454 CID)	1990-85	4WD, Eng Oil Cooler Lower-Inlet Hose	625-131
V8 - 7.4L (454 CID)	1990-85	4WD, Eng Oil Cooler Upper-Outlet Hose	625-132
V SERIES PICKUP			
V8 - 5.0L (305 CID)	1987	Eng Oil Cooler Lower-Inlet Hose	625-131
V8 - 5.0L (305 CID)	1987	Eng Oil Cooler Upper-Outlet Hose	625-132
V8 - 5.7L (350 CID)	1991-87	Eng Oil Cooler Lower-Inlet Hose	625-131
V8 - 5.7L (350 CID)	1991-87	Eng Oil Cooler Upper-Outlet Hose	625-132
V8 - 6.2L (379 CID)	1991-87	Diesel, Eng Oil Cooler Lower-Outlet Hose	625-155
V8 - 6.2L (379 CID)	1991-87	Diesel, Eng Oil Cooler Upper-Inlet Hose	625-154
V8 - 7.4L (454 CID)	1990-87	Eng Oil Cooler Lower-Inlet Hose	625-131
V8 - 7.4L (454 CID)	1990-87	Eng Oil Cooler Upper-Outlet Hose	625-132
YUKON			
V8 - 5.3L (323 CID)	2005	Eng Oil Cooler Hose, VIN Z, Flex Fuel, 7.75MM Length Flared End Tube	625-168
V8 - 5.7L (350 CID)	2000-96	2WD, Eng Oil Cooler Lower-Inlet Hose	625-149
V8 - 5.7L (350 CID)	2000-96	2WD, Eng Oil Cooler Upper-Outlet Hose	625-150
V8 - 5.7L (350 CID)	2000-96	4WD, Eng Oil Cooler Lower-Outlet Hose	625-123
V8 - 5.7L (350 CID)	2000-96	4WD, Eng Oil Cooler Upper-Inlet Hose	625-101
V8 - 5.7L (350 CID)	1995-94	2WD, 3.08R, 3.42R, 3.73R, 4.10R, 4.56R, Eng Oil Cooler Lower-Inlet Hose	625-135
V8 - 5.7L (350 CID)	1995-94	2WD, 3.08R, 3.42R, 3.73R, 4.10R, 4.56R, Eng Oil Cooler Upper-Outlet Hose	625-136
V8 - 5.7L (350 CID)	1995-94	4WD, 3.42R, 3.73R, 4.10R, 4.56R, Eng Oil Cooler Lower-Outlet Hose	625-107
V8 - 5.7L (350 CID)	1995-94	4WD, 3.42R, 3.73R, 4.10R, 4.56R, Eng Oil Cooler Upper-Inlet Hose	625-108
V8 - 5.7L (350 CID)	1993-92	2WD, 3.08R, 3.42R, 3.73R, Eng Oil Cooler Lower-Outlet Hose	625-140
V8 - 5.7L (350 CID)	1993-92	2WD, 3.08R, 3.42R, 3.73R, Eng Oil Cooler Upper-Inlet Hose	625-139
V8 - 5.7L (350 CID)	1993-92	2WD, Exc. 3.08R, 3.42R, 3.73R, Eng Oil Cooler Lower-Outlet Hose	625-161
V8 - 5.7L (350 CID)	1993-92	2WD, Exc. 3.08R, 3.42R, 3.73R, Eng Oil Cooler Upper-Inlet Hose	625-160
V8 - 5.7L (350 CID)	1993-92	4WD, 3.42R, 3.73R, Eng Oil Cooler Lower-Outlet Hose	625-142
V8 - 5.7L (350 CID)	1993-92	4WD, 3.42R, 3.73R, Eng Oil Cooler Upper-Inlet Hose	625-141
V8 - 5.7L (350 CID)	1993-92	4WD, 4.10R, 4.56, Eng Oil Cooler Lower-Outlet Hose	625-163
V8 - 5.7L (350 CID)	1993-92	4WD, 4.10R, 4.56R, Eng Oil Cooler Upper-Inlet Hose	625-162
V8 - 6.0L (364 CID)	2005	Eng Oil Cooler Hose, 7.75MM Length Flared End Tube	625-168
V8 - 6.0L (364 CID)	2004-00	Eng Oil Cooler Hose	625-168
V8 - 6.5L (395 CID)	1999-98	Diesel, Eng Oil Cooler LH Side-Inlet Hose (Conn Nut 27mm Across Flats)	625-147
V8 - 6.5L (395 CID)	1999-98	Diesel, Eng Oil Cooler RH Side-Outlet Hose (Conn Nut 27mm Across Flats)	625-148
V8 - 6.5L (395 CID)	1997	Diesel, Eng Oil Cooler LH Side-Inlet Hose (Conn Nut .875" Across Flats)	625-143
V8 - 6.5L (395 CID)	1997	Diesel, Eng Oil Cooler LH Side-Inlet Hose (Conn Nut 27mm Across Flats)	625-147
V8 - 6.5L (395 CID)	1997	Diesel, Eng Oil Cooler RH Side-Outlet Hose (Conn Nut 19mm Across Flats)	625-114
V8 - 6.5L (395 CID)	1997	Diesel, Eng Oil Cooler RH Side-Outlet Hose (Conn Nut 27mm Across Flats)	625-148
V8 - 6.5L (395 CID)	1996-95	Diesel, Eng Oil Cooler LH Side-Inlet Hose	625-143
V8 - 6.5L (395 CID)	1996-95	Diesel, Eng Oil Cooler RH Side-Outlet Hose	625-114
V8 - 6.5L (395 CID)	1994	Diesel, Eng Oil Cooler Lower-Inlet Hose	625-164
V8 - 6.5L (395 CID)	1994	Diesel, Eng Oil Cooler Upper-Outlet Hose	625-134
YUKON XL			
V8 - 6.0L (364 CID)	2005	Eng Oil Cooler Hose, 7.75MM Length Flared End Tube	625-168
V8 - 6.0L (364 CID)	2004-01	Eng Oil Cooler Hose	625-168
LINCOLN			
TOWN CAR			
V8 - 4.6L (281 CID)	2006-96	Eng Oil Cooler Hose	625-200
MERCURY			
GRAND MARQUIS			
V8 - 4.6L (281 CID)	2006-96	Eng Oil Cooler Hose	625-200
OLDSMOBILE			
BRAVADA			
V6 - 4.3L (262 CID)	2001-96	4WD, Eng Oil Cooler Pipe	625-100
V6 - 4.3L (262 CID)	2001-96	4WD, Eng Oil Filter Hose	625-001
V6 - 4.3L (262 CID)	1994-92	4WD, Eng Vin Z, Eng Oil Cooler Hose, w/HD Cooling	625-176
V6 - 4.3L (262 CID)	1994-91	4WD, Eng Oil Filter Hose	625-102
V6 - 4.3L (262 CID)	1991	4WD, Eng Vin Z, Eng Oil Cooler Hose	625-176

TECH TRAYS



Have the Part You Need, When You Need It
STOP WASTING BAY TIME!

Part # 030-541 OIL DRAIN PLUG GASKETS TECH TRAY
• 20 SKUs, 115 pieces • Tray measures 13-1/8" W x 2-5/16" H x 9" D

095-001 Copper 1/2" (M12)	095-014 Metal Crush 1/2"	097-003 Nylon 1 1/16"	097-016 Fiber M12	097-022 Nylon 1/2" (M12)
095-002 Copper 5/8" (M16)	095-015 Aluminum 14.5mm	097-004 Nylon 3/4" (M18)	097-018 Fiber M18	097-025 Rubber/Metal 9/16"
095-004 Copper 3/4"	097-001 Nylon 1/2" (M12)	097-005 Nylon 7/8" (M20)	097-019 Fiber M20	097-026 Fiber 9/16"
095-010 Copper 9/16"	097-002 Nylon 5/8"	097-010 Nylon 9/16"	097-021 Rubber/Metal 1/2" (M12)	097-027 Fiber 1/2"

030-541
Oil Drain
Plug Gaskets



Part # 030-539 OIL DRAIN PLUGS WITH GASKETS TECH TRAY
• 22 SKUs, 44 pieces • Tray measures 13-1/8" W x 2-5/16" H x 9" D

090-005 1/2"-20 Standard	090-034 M12-1.75 Pilot Point	090-042 M18-1.5 Standard	090-055 M20-1.5 Standard	090-075 M14-1.5 Standard	090-088 M12-1.5 Standard
090-015 1/2"-20 Single Oversized	090-038 M12-1.25 Standard	090-049 M12-1.25 Pilot Point	090-058 1/2"-20 Pilot Point w/ Molded Gasket	090-076 M14-1.25 Pilot Point	090-098 M14-1.5 Pilot Point w/ Molded Gasket
090-031 1/2"-20 Double Oversized	090-039 M16-1.33 Standard	090-052 1/2"-20 Pilot Point	090-059 M12-1.75 Pilot Point w/ Molded Gasket	090-079 M12-1.75 Pilot Point w/ Inset Gasket	
090-033 M14-1.5 Standard	090-040 M20-1.5 Standard	090-053 M14-1.5 Pilot Point	090-060 M12-1.75 Pilot Point w/ Inset Gasket	090-084 M18-1.5 Pilot Point	

030-539
Oil Drain Plugs
with Gaskets



Oil Pans



Dorman OE Solutions Oil Pans Feature:

- 75 SKUs of failure-prone domestic-import applications
- 95% market coverage
- Steel pans coated for superior corrosion resistance
- New, not reconditioned



Includes Drain Plug
and Drain Plug
Seal



3 Cast Aluminum Aftermarket Exclusives



264-101

GM Beretta, Cutlass Calais & Supreme,
Grand Am, Grand Prix, Skylark 1991-87



264-102

GM Beretta, Cutlass Calais &
Supreme, Grand Am, Grand Prix,
Skylark 1994-87



264-200

Dodge Neon, Plymouth Breeze,
Chrysler Cirrus, Dodge Stratus
2004-95

Typical Failures



- Rust due to thinner OE materials in use
- Accident damage
- Damage from bottoming out on today's vehicles that ride closer to the road
- Stripped drain plug threads

Related Oil Pan Sales

Oil Pan Bolts



45661

Kit contains 45655 and 45660.

Sizes: 1/4"-20 and 5/16"-18

Type: Standard

Lengths: 1/2" and 5/8"

Head Types: 5/16" and 3/8" Hex
Flanged Head

45655 (8)

Size: 1/4"-20

Type: Standard

Lengths: 1/2"

Head Types: 5/16" Hex
Flanged Head

45665 (8)

Size: M8-1.25

Type: Standard

Lengths: 14mm

Head Types: 10mm Hex
Flanged Head

Activant Path

Engine Assembly & Parts/
Eng. Misc. (Switch, Cap, Mounts)

Activant Code DOP

Applications begin
on page 310.

Oil Pans



264-002

Ford, Lincoln, Mercury
1996-80 F-Series Pickups, Bronco,
E-Series Econoline Vans (Exc 5.8L).



264-003

Ford, Lincoln, Mercury
1987-81 F-Series Pickups, Bronco,
E-Series Econoline Vans, Dipstick Tube in
Pan.



264-004

Ford, Lincoln, Mercury
1992-91 Aerostar, Ranger; Aerostar from
3/27/90 (3.0L).



264-005

Ford, Lincoln, Mercury
1997-88 F-Series Pickups, Bronco,
E-Series Econoline Vans (5.8L Only).



264-006

Ford, Lincoln, Mercury
1995-84 Mustang; 1993-84 Cougar,
Thunderbird; 1992-84 Mark Series; 1990-
84 Town Car. 5.0L w/Oil Level Sensor
Hole.



264-009

Ford, Lincoln, Mercury
1990-86 Sable, Taurus 3.0L (Exc. SHO),
wo/ Oil Level Sensor Hole.



264-010

Ford, Lincoln, Mercury
1998-90 Sable, Taurus (Exc. SHO), Probe,
Windstar, w/Oil Level Sensor Hole.



264-011

Ford, Lincoln, Mercury
1996-83 E-Series Econoline & Super Duty
Vans, F-Series Pickups, Bronco
(4.9L Only).



264-012

Ford, Lincoln, Mercury
1984-81 E-Series Econoline Vans



264-013

Ford, Lincoln, Mercury
1994-83 E-Series Econoline Vans and
F-Series Pickups; (6.9L , 7.3L Diesel)



264-014

Ford, Lincoln, Mercury/Mazda
2001-93 Ranger, B3000 Pickups;
1997-95 Aerostar, wo/ Oil Level Sensor
Hole.



264-015

Ford, Lincoln, Mercury
2001-88 Sable, Taurus, Topaz, Tempo,
wo/ Oil Level Sensor Hole.

Oil Pans



264-016

Ford, Lincoln, Mercury
1989-83 F-Series Pickups V8, 7.5L (460CID) (To 3/28/89)



264-017

Ford, Lincoln, Mercury
1992-89 F-Series Pickups V8, 7.5L (460CID) (From 3/28/89)



264-018

Ford, Lincoln, Mercury
1990-86 Aerostar, Sable, Taurus (3.0L) w/Sensor Hole



264-019

Ford, Lincoln, Mercury
1997-93 F-Series Pickups V8, 7.5L (460CID)



264-020

Mazda
2001-99 Protégé, L4, 1.6L (1589 CC),
1993-92 MX-3, L4, 1.6L (1587CC),
1994-90 323, L4, 1.6L (1587CC)



264-021

Mazda
2003-99 Protégé, 1997-93 MX-6 and Probe, 2002-93 626



264-022

Ford, Lincoln, Mercury
1993-80 Country Squire, Crown Victoria, Fairmont, LTD, Mustang, Mustang II, Thunderbird, Continental, Mark VI, VII, Town Car, Capri, Colony Park, Cougar, Grand Marquis, Marquis, Zephyr



264-023

Ford, Lincoln, Mercury
1979-78 Country Squire, Fairmont, LTD, Mustang, Mustang II, Capri, Colony Park, Grand Marquis, Marquis, Zephyr, w/Oil Level Indicator & Tube in Pan



264-024

Ford, Lincoln, Mercury
1982-80 F-Series Pickups L6, 4.9L (300 CID)



264-026

Ford, Lincoln, Mercury
1994-93 Aerostar, Ranger, w/Sensor Hole, V6, 3.0L (182 CID)



264-029

Ford, Lincoln, Mercury/Mazda
1989-88 Tracer, Festiva, 323, L4, 1.6L



264-030

Ford, Lincoln, Mercury/Mazda
1992-88 Probe, MX6, 626, L4, 2.2L

Oil Pans

Oil Pans



264-031

Mazda
1995-94 MX-3 L4 - 1.6L (1597 cc),
1995 Protégé L4, 1.5L (1489 cc),
(Upper Pan)



264-034

Ford, Lincoln, Mercury
1979-72 F-Series Pickups, E-Series Vans
L6, 4.9L (300 CID), 1974-67 F-Series
Pickups, E-Series Vans L6, 3.9L (240
CID)



264-100

GM
2002-86 C/K/R/V-Pickups, Suburban,
Yukon, Savana, Camaro, Caprice,
Bonneville, 4 Quart wo/ Oil Level Sensor
Hole.



264-101

GM
1991-87 Beretta, Cutlass Calais &
Supreme, Grand Am, Grand Prix, Skylark,
Stamped 22538921.



264-102

GM
1994-87 Beretta, Cutlass Calais &
Supreme, Grand Am, Grand Prix, Skylark,
Stamped 24570333 Thru 1991.



264-103

GM
1986-80 Camaro, Firebird, Caprice,
Bonneville, Caballero, Century, Monte
Carlo, Malibu, Blazer, Jimmy, Suburban,
Trucks & Vans.



264-104

GM
1980-65 Century, Regal, Skylark, Chevelle,
Nova, Impala, Camaro, P-Series Vans,
Suburban.

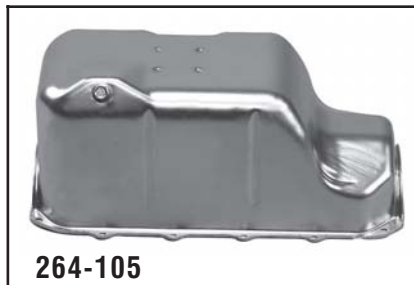

264-105

GM
1995-87 Century, Regal, Beretta, Cavalier,
Corsica.



264-106

GM
1997-95 Lumina, Monte Carlo, 1996-95
Cutlass Supreme, Grand Prix



264-107

GM
1997-91 Camaro, Firebird, Caprice,
Roadmaster, Fleetwood, Estate Wagon,
w/Oil Level Sensor Hole.



264-108

GM
1997-86 G&P-Series, Safari, Astro Vans;
C/K/R/V-Pickups.



264-110

GM/Suzuki/Geo
1995-89 Esteem, Firefly, Metro, Swift
(1.3L).

Oil Pans



264-111

GM/Suzuki/Geo
1995-89 Sidekick, Tracker (1.6L).



264-117

GM
1986-80 Century, Skylark, Cimarron, Citation, Celebrity, Cavalier, Cutlass Ciera, Omega, Firenza, Fiero, 6000, Phoenix V6, 2.8L (173 CID)



264-118

GM
1979-78 El Camino, Monte Carlo, Camaro V8, 4.4L (267 CID), 1979-78 LeMans, Grand Prix, Grand LeMans, Grand AM, Cutlass, Cutlass Supreme/Cruiser/Galais, Caballero, Monte Carlo, Malibu, El Camino, Regal, Century V8, 5.0L (305 CID)



264-119

GM
1990-89 Lemans (Vin K), 1992-87 Sunbird, 1989-87 Grand Am (Vin M), Beretta, Corsica, Cavalier; 1988-87 Skyhawk (Vin M, K), Firenza (Vin K), 1995-93 Century, Cutlass Ciera



264-120

GM
1994-93 Sunbird, L4, 2.0L (122 CID)



264-121

GM
1986-82 Camaro, Firebird, 1986-83 S15 Pickups (2WD), S15 Jimmy (2WD), S10 Pickups (2WD), S10 Blazer (2WD), V6, 2.8L (173 CID)



264-122

GM
1993-87 Camaro, Firebird, V6, 3.1L, (189 CID), 1993-87 S15 Pickups & Jimmy, S10 Pickups & Blazer, 2WD, V6, 2.8L, (173 CID)



264-123

GM
1995-88 S10 Pickups & Blazer, S15 Jimmy, 1995-91 S15 Sonoma, 1993-92 S15 Typhoon, 1991 S15 Syclone, 2WD, V6, 4.3L (262 CID)



264-200

Chrysler, Dodge, Plymouth
2005-95 Neon, 2000-97 Breeze, 2000 Cirrus, 2000-95 Stratus.



264-201

Chrysler, Dodge, Plymouth,
2000-87 LeBaron, Caravan, Voyager, Shadow (3.0L)



264-202

Chrysler, Dodge, Plymouth,
1994-87 Colt, Excel, Mirage, Precis, Scoupe, Summit (1.5L).



264-203

Chrysler, Dodge, Plymouth,
1996-91 Colt, Mirage, Summit (1.5L).

Oil Pans

Oil Pans



264-204

Chrysler, Dodge, Plymouth,
2002-90 Caravan, New Yorker, Voyager,
Imperial, Dynasty (3.3L, 3.8L) wo/ Oil
Level Sensor Hole



264-205

Chrysler, Dodge, Plymouth,
2002-90 Caravan, Town & Country,
Voyager, New Yorker, Dynasty (3.3L,
3.8L) w/ Oil Level Sensor Hole



264-206

Chrysler, Dodge, Plymouth,
1997-93 Vision, Intrepid, Concorde V6,
3.3L (201 CID), 1997-93 Vision, Intrepid,
Concorde, Prowler, New Yorker V6, 3.5L
(215 CID)



264-208

Chrysler, Dodge, Plymouth,
1999-95 Eclipse wo/ Turbo, Sebring;
1996-95 Talon wo/ Turbo, Avenger, L4,
2.0L (122 CID)



264-209

Chrysler, Dodge, Plymouth,
1988-86 LeBaron, LeBaron GTS, New
Yorker, Town & Country, Laser, Daytona,
600, Caravan, Grand Caravan, Lancer,
Shadow, Aries, Voyager, Grand Voyager,
Caravelle, Reliant, Sundance



264-210

Chrysler, Dodge, Plymouth,
1991-78 Ramcharger, DW-Series Pickups,
B-Series Vans, 1983-78 PB-Series Vans,
1981-78 Trailduster, V8, 5.2L (318 CID)



264-220

Chrysler, Dodge, Plymouth,
1999-87 Wagoneer, Comanche,
Cherokee, Wrangler, Grand Cherokee L6,
4.0L (242 CID), wo/Sensor Hole



264-221

Chrysler, Dodge, Plymouth,
1996-93 Cherokee, Wrangler, Grand
Cherokee L6, 4.0L (242 CID), w/Sensor
Hole



264-222

Chrysler, Dodge, Plymouth,
1990-72 Jeepster, Wagoneer, J-Series
Pickup, Cherokee, Scrambler, CJ/DJ
Series, Grand Wagoneer, Wrangler L6, 4.2L
(258 CID) Exc. Mexico Built



264-300

Toyota
1993-88 Celica, Corolla, MR2, wo/ Oil
Cooler.



264-301

Toyota
1991-88 Corolla; 1989-88 MR2 L4, 1.6L
(1587 cc)



264-303

Toyota
1988-84 Corolla, Corolla FX, 1987-85
MR2 L4, 1.6L (1587 cc); 1992-88 Prizm
L4, 1.6L (98 CID); 1988-85 Nova L4,
1.6L (98 CID)

Oil Pans



264-304

Toyota
1998-95 Tercel, Paseo, L4, 1.5L, (1497 CC)



264-305

Toyota
2001-92 Camry and Solara 4 cyl



264-307

Toyota
1994-87 Tercel L4, 1.5L (1456 CC),
1994-92 Paseo L4, 1.5L (1497 CC)



264-308

Toyota
1992-88 Corolla Wagon L4, 1.8L (1762 CC)



264-309

Toyota
1997-94 Corolla, 1993 Corolla Exc.
Wagon L4, 1.6L (1587 CC)



264-400

Honda
1989-86 Accord, 1985-82 Accord SEI,
1987-84 Prelude, Dipstick Tube in Pan.



264-401

Honda
1985 Accord wo/Fuel Injection, 1984
Accord L4, 1.8L (1829 CC)



264-402

Honda
1995-88 Civic, Civic Del Sol, CRX (1.6L).



264-403

Honda
1997-90 Accord, Prelude, Odyssey;
1997-96 Isuzu Oasis.



264-405

Honda
2000-96 Civic, (CX, DX, LX Models),
1997-96 Civic Del Sol Exc V-Tec, L4, 1.6L
(1590CC)



264-406

Honda/Acura
2002-98 Accord, 1998 Odyssey, 1999-
98 CL, L4, 2.3L (2433 CC)



264-407

Honda
2001-97 CR-V, L4, 2.0L (1972 CC)

Oil Pans

Oil Pans



264-500

Nissan
2003-91 Sentra, 1998-95 200SX, 1993-91 NX, L4, 1.6L



264-502

Nissan/Infiniti
1999-96 I30, 1999-95 Maxima, V6, 3.0L (2988 CC), (Lower)



264-900

International
1993-75 All Models Diesel Eng V8, 7.3L (445 CID)

Oil Pan Applications

Oil Pans

Make/Model/Engine	Year	Description	Dorman #
ACURA			
CL			
L4 - 2.2L (2156 cc)	1997	-	264-403
L4 - 2.3L (2254 cc)	1999-98	-	264-406
BUICK			
CENTURY			
L4 - 2.2L (134 CID)	1995-93	-	264-119
V6 - 2.8L (173 CID)	1989-87	-	264-105
V6 - 2.8L (173 CID)	1986	-	264-117
V8 - 5.0L (305 CID)	1980	-	264-103
V8 - 5.0L (305 CID)	1979-78	-	264-118
V8 - 5.0L (305 CID)	1977	-	264-104
V8 - 5.7L (350 CID)	1979	-	264-118
V8 - 5.7L (350 CID)	1978-77	VIN L	264-104
LESABRE			
V8 - 5.0L (305 CID)	1978	-	264-104
REGAL			
V6 - 2.8L (173 CID)	1989-88	-	264-105
V6 - 3.1L (189 CID)	1993-89	-	264-105
V8 - 5.0L (305 CID)	1982-80	-	264-103
V8 - 5.0L (305 CID)	1979-78	-	264-118
V8 - 5.0L (305 CID)	1977	-	264-104
V8 - 5.7L (350 CID)	1977	VIN L	264-104
ROADMASTER			
V8 - 5.0L (305 CID)	1991	w/Low Oil Sensor	264-107
V8 - 5.0L (305 CID)	1991	wo/Low Oil Sensor	264-100
V8 - 5.7L (350 CID)	1996-92	-	264-107
SKYHAWK			
L4 - 2.0L (122 CID)	1988-87	VIN K, M	264-119
SKYLARK			
L4 - 2.3L (138 CID)	1994-92	-	264-102
L4 - 2.3L (138 CID)	1991-88	Stamped 22538921	264-101
L4 - 2.3L (138 CID)	1991-88	Stamped 24570333	264-102
V6 - 2.8L (173 CID)	1985-80	-	264-117
V8 - 5.0L (305 CID)	1979-77	-	264-104
V8 - 5.7L (350 CID)	1979-77	VIN L	264-104
CADILLAC			
CIMARRON			
V6 - 2.8L (173 CID)	1988-87	-	264-105
V6 - 2.8L (173 CID)	1986-85	-	264-117
ESCALADE			
V8 - 5.7L (350 CID)	2000-99	-	264-100
FLEETWOOD			
V8 - 5.0L (305 CID)	1992-91	-	264-100
V8 - 5.7L (350 CID)	1996-93	-	264-107
V8 - 5.7L (350 CID)	1992-90	-	264-100
CHEVROLET			
BEL AIR			
V8 - 4.6L (283 CID)	1967-65	-	264-104
V8 - 5.0L (307 CID)	1968	-	264-104
V8 - 5.4L (327 CID)	1969-65	-	264-104
V8 - 5.7L (350 CID)	1975-69	-	264-104
V8 - 6.6L (400 CID)	1975-70	-	264-104
V8 - 6.6L (402 CID)	1972-71	-	264-104

Make/Model/Engine	Year	Description	Dorman #
CHEVROLET (continued)			
BERETTA			
L4 - 2.0L (122 CID)	1989-87	-	264-119
L4 - 2.2L (134 CID)	1995-90	-	264-119
L4 - 2.3L (138 CID)	1994-92	-	264-102
L4 - 2.3L (138 CID)	1991-90	Stamped 22538921	264-101
L4 - 2.3L (138 CID)	1991-90	Stamped 24570333	264-102
V6 - 2.8L (173 CID)	1989-87	-	264-105
V6 - 3.1L (189 CID)	1993-90	-	264-105
BISCAYNE			
V8 - 4.6L (283 CID)	1967-65	-	264-104
V8 - 5.0L (307 CID)	1968	-	264-104
V8 - 5.4L (327 CID)	1969-65	-	264-104
V8 - 5.7L (350 CID)	1972-69	-	264-104
V8 - 6.6L (400 CID)	1972-70	-	264-104
V8 - 6.6L (402 CID)	1972-71	-	264-104
BROOKWOOD			
V8 - 5.7L (350 CID)	1972-69	-	264-104
V8 - 6.6L (400 CID)	1972-70	-	264-104
V8 - 6.6L (402 CID)	1972	-	264-104
CAMARO			
V6 - 2.8L (173 CID)	1989-87	-	264-122
V6 - 2.8L (173 CID)	1986-82	-	264-121
V6 - 3.1L (189 CID)	1992-90	-	264-122
V8 - 4.4L (267 CID)	1981-80	-	264-103
V8 - 5.0L (305 CID)	1992-86	-	264-100
V8 - 5.0L (305 CID)	1985-80	-	264-103
V8 - 5.0L (305 CID)	1979-76	-	264-104
V8 - 5.0L (307 CID)	1973-69	-	264-104
V8 - 5.4L (327 CID)	1969-67	-	264-104
V8 - 5.7L (350 CID)	1997-93	-	264-107
V8 - 5.7L (350 CID)	1992-87	-	264-100
V8 - 5.7L (350 CID)	1981-80	-	264-103
V8 - 5.7L (350 CID)	1979-67	-	264-104
V8 - 6.6L (402 CID)	1972-70	-	264-104
CAPRICE			
V8 - 4.3L (265 CID)	1996-94	-	264-107
V8 - 4.4L (267 CID)	1982-80	-	264-103
V8 - 4.6L (283 CID)	1967-66	-	264-104
V8 - 5.0L (305 CID)	1993-92	-	264-107
V8 - 5.0L (305 CID)	1991	w/Low Oil Sensor	264-107
V8 - 5.0L (305 CID)	1991	wo/Low Oil Sensor	264-100
V8 - 5.0L (305 CID)	1990-86	-	264-100
V8 - 5.0L (305 CID)	1985-80	-	264-103
V8 - 5.0L (305 CID)	1979-77	-	264-104
V8 - 5.0L (307 CID)	1968	-	264-104
V8 - 5.4L (327 CID)	1969-66	-	264-104
V8 - 5.7L (350 CID)	1996-92	-	264-107
V8 - 5.7L (350 CID)	1991-86	-	264-100
V8 - 5.7L (350 CID)	1982-80	Gas Eng	264-103
V8 - 5.7L (350 CID)	1979-69	-	264-104
V8 - 6.6L (400 CID)	1976-70	-	264-104
V8 - 6.6L (402 CID)	1972-71	-	264-104

Oil Pan Applications

Make/ Model/Engine	Years	Description	Dorman #
CHEVROLET (continued)			
CAVALIER			
L4 - 2.0L (122 CID)	1989-87	-	264-119
L4 - 2.2L (134 CID)	1995-90	-	264-119
V6 - 2.8L (173 CID)	1989-87	-	264-105
V6 - 2.8L (173 CID)	1986-85	-	264-117
V6 - 3.1L (189 CID)	1994-90	-	264-105
CELEBRITY			
V6 - 2.8L (173 CID)	1989-87	-	264-105
V6 - 2.8L (173 CID)	1986-83	-	264-117
V6 - 2.8L (173 CID)	1982	Export, Use With Rear Seal	264-117
V6 - 3.1L (189 CID)	1990	-	264-105
CHEVELLE			
V8 - 4.6L (283 CID)	1967-65	-	264-104
V8 - 5.0L (307 CID)	1973-68	-	264-104
V8 - 5.4L (327 CID)	1968-65	-	264-104
V8 - 5.7L (350 CID)	1973-69	-	264-104
V8 - 6.6L (400 CID)	1971-70	-	264-104
V8 - 6.6L (402 CID)	1972-70	-	264-104
CHEVY II			
V8 - 4.6L (283 CID)	1967-65	-	264-104
V8 - 5.0L (307 CID)	1969-68	-	264-104
V8 - 5.4L (327 CID)	1968-65	-	264-104
V8 - 5.7L (350 CID)	1969-68	-	264-104
CITATION			
V6 - 2.8L (173 CID)	1985-83	-	264-117
V6 - 2.8L (173 CID)	1982	Use With Rear Seal	264-117
CORSICA			
L4 - 2.0L (122 CID)	1989-87	-	264-119
L4 - 2.2L (134 CID)	1995-90	-	264-119
V6 - 2.8L (173 CID)	1989-87	-	264-105
V6 - 3.1L (189 CID)	1993-90	-	264-105
CORVETTE			
V8 - 5.4L (327 CID)	1968-65	-	264-104
V8 - 5.7L (350 CID)	1979-74	Exc. Special High Performance	264-104
V8 - 5.7L (350 CID)	1973-69	-	264-104
EL CAMINO			
V8 - 4.4L (267 CID)	1982-80	-	264-103
V8 - 4.4L (267 CID)	1979	-	264-118
V8 - 4.6L (283 CID)	1967-65	-	264-104
V8 - 5.0L (305 CID)	1987-85	-	264-100
V8 - 5.0L (305 CID)	1984-80	-	264-103
V8 - 5.0L (305 CID)	1979-78	-	264-118
V8 - 5.0L (305 CID)	1977-76	-	264-104
V8 - 5.0L (307 CID)	1973-68	-	264-104
V8 - 5.4L (327 CID)	1968-65	-	264-104
V8 - 5.7L (350 CID)	1979-69	-	264-104
V8 - 6.6L (400 CID)	1976-70	-	264-104
V8 - 6.6L (402 CID)	1972-71	-	264-104
IMPALA			
V8 - 4.4L (267 CID)	1982-80	-	264-103
V8 - 4.6L (283 CID)	1967-65	-	264-104
V8 - 5.0L (305 CID)	1985-80	-	264-103
V8 - 5.0L (305 CID)	1979-77	-	264-104
V8 - 5.0L (307 CID)	1968	-	264-104
V8 - 5.4L (327 CID)	1969-65	-	264-104
V8 - 5.7L (350 CID)	1982-80	Gas Eng	264-103
V8 - 5.7L (350 CID)	1979-69	-	264-104
V8 - 6.6L (400 CID)	1976-70	-	264-104
V8 - 6.6L (402 CID)	1972-71	-	264-104
IMPALA SS			
V8 - 5.7L (350 CID)	1996-94	-	264-107
KINGSWOOD			
V8 - 5.7L (350 CID)	1972-69	-	264-104
V8 - 6.6L (400 CID)	1972-70	-	264-104
V8 - 6.6L (402 CID)	1972-71	-	264-104
LAGUNA			
V8 - 5.0L (305 CID)	1976	-	264-104
V8 - 5.7L (350 CID)	1976-73	-	264-104
V8 - 6.6L (400 CID)	1976-74	-	264-104
LUMINA			
V6 - 3.1L (189 CID)	1994-90	-	264-105
V6 - 3.4L (207 CID)	1997-95	-	264-106
V6 - 3.4L (207 CID)	1994-91	-	264-105
LUMINA APV			
V6 - 3.1L (189 CID)	1995-90	-	264-105
MALIBU			
V8 - 4.4L (267 CID)	1982-80	-	264-103
V8 - 4.4L (267 CID)	1979	-	264-118
V8 - 4.6L (283 CID)	1967-65	-	264-104
V8 - 5.0L (305 CID)	1983-80	-	264-103

Make/ Model/Engine	Years	Description	Dorman #
CHEVROLET (continued)			
MALIBU (continued)			
V8 - 5.0L (305 CID)	1979-78	-	264-118
V8 - 5.0L (305 CID)	1977-76	-	264-104
V8 - 5.0L (307 CID)	1973	-	264-104
V8 - 5.4L (327 CID)	1967-65	-	264-104
V8 - 5.7L (350 CID)	1981-80	Gas Eng	264-103
V8 - 5.7L (350 CID)	1979-73	-	264-104
V8 - 6.6L (400 CID)	1976-74	-	264-104
MONTE CARLO			
V6 - 3.4L (207 CID)	1997-95	-	264-106
V8 - 4.4L (267 CID)	1982-80	-	264-103
V8 - 4.4L (267 CID)	1979	-	264-118
V8 - 5.0L (305 CID)	1988-85	-	264-100
V8 - 5.0L (305 CID)	1984-80	-	264-103
V8 - 5.0L (305 CID)	1979-78	-	264-118
V8 - 5.0L (305 CID)	1977-76	-	264-104
V8 - 5.0L (307 CID)	1972	-	264-104
V8 - 5.7L (350 CID)	1981	Gas Eng	264-103
V8 - 5.7L (350 CID)	1977-70	-	264-104
V8 - 6.6L (400 CID)	1976-70	-	264-104
V8 - 6.6L (402 CID)	1972-70	-	264-104
MONZA			
V8 - 5.0L (305 CID)	1978	-	264-104
V8 - 5.7L (350 CID)	1975	-	264-104
NOVA			
L4 - 1.6L (98 CID)	1988	VIN 5, EFI	264-303
V8 - 4.3L (262 CID)	1975	-	264-104
V8 - 4.6L (283 CID)	1967-65	-	264-104
V8 - 5.0L (305 CID)	1979-76	-	264-104
V8 - 5.0L (307 CID)	1973-70	-	264-104
V8 - 5.4L (327 CID)	1967-65	-	264-104
V8 - 5.7L (350 CID)	1979-70	-	264-104
V8 - 6.6L (402 CID)	1970	-	264-104
TOWNSMAN			
V8 - 5.7L (350 CID)	1972-69	-	264-104
V8 - 6.6L (400 CID)	1972-70	-	264-104
V8 - 6.6L (402 CID)	1972	-	264-104
CHEVROLET/GMC TRUCK			
ASTRO VAN			
V6 - 4.3L (262 CID)	1995-90	2WD	264-108
V6 - 4.3L (262 CID)	1989-86	-	264-108
BLAZER			
V8 - 5.0L (305 CID)	1987-86	-	264-100
V8 - 5.0L (305 CID)	1985-80	-	264-103
V8 - 5.0L (305 CID)	1979-77	-	264-104
V8 - 5.7L (350 CID)	1994-86	-	264-100
V8 - 5.7L (350 CID)	1985-80	-	264-103
V8 - 5.7L (350 CID)	1979-73	-	264-104
V8 - 6.6L (400 CID)	1979-75	-	264-104
CABALLERO			
V8 - 5.0L (305 CID)	1987-85	-	264-100
V8 - 5.0L (305 CID)	1984-80	-	264-103
V8 - 5.0L (305 CID)	1979-78	-	264-118
V8 - 5.7L (350 CID)	1984-83	Gas Eng	264-103
V8 - 5.7L (350 CID)	1979-78	-	264-104
CK SERIES PICKUP			
V6 - 4.3L (262 CID)	1995-86	-	264-108
V8 - 5.0L (305 CID)	1999-86	-	264-100
V8 - 5.0L (305 CID)	1985-80	-	264-103
V8 - 5.0L (305 CID)	1979-76	-	264-104
V8 - 5.7L (350 CID)	2000-86	-	264-100
V8 - 5.7L (350 CID)	1985-80	Gas Eng	264-103
V8 - 5.7L (350 CID)	1979-73	-	264-104
V8 - 6.6L (400 CID)	1980-75	-	264-104
EXPRESS			
V8 - 5.0L (305 CID)	2002-96	-	264-100
V8 - 5.7L (350 CID)	2002-96	-	264-100
G SERIES VAN			
V6 - 4.3L (262 CID)	1997-86	Exc. Express, Savana	264-108
V8 - 5.0L (305 CID)	1998-86	-	264-100
V8 - 5.0L (305 CID)	1985-80	-	264-103
V8 - 5.0L (305 CID)	1979-77	-	264-104
V8 - 5.7L (350 CID)	1996-86	-	264-100
V8 - 5.7L (350 CID)	1985-80	-	264-103
V8 - 5.7L (350 CID)	1979-73	-	264-104
V8 - 6.6L (400 CID)	1980-75	-	264-104
JIMMY			
V8 - 5.0L (305 CID)	1987-86	-	264-100
V8 - 5.0L (305 CID)	1985-80	-	264-103
V8 - 5.0L (305 CID)	1979-77	-	264-104

Oil Pans

Clock Springs
pg. 21-24

Control Arms
pg. 25-54

CV Joint Boots & Accessories
pg. 55-66

Door Lock Actuators
pg. 67-72

Exhaust Manifold Kits
pg. 73-134

New Drain Plug & Seal Included Where Required

Oil Pans
311

Oil Pan Applications

Make/ Model/Engine	Years	Description	Dorman #
CHEVROLET/GMC TRUCK (continued)			
JIMMY (continued)			
V8 - 5.7L (350 CID)	1991-86	-	264-100
V8 - 5.7L (350 CID)	1985-80	-	264-103
V8 - 5.7L (350 CID)	1979-73	-	264-104
V8 - 6.6L (400 CID)	1979-75	-	264-104
P SERIES VAN			
L6 - 4.8L (292 CID)	1980	-	264-104
V6 - 4.3L (262 CID)	1995-90	-	264-108
V8 - 5.0L (305 CID)	1979	-	264-104
V8 - 5.7L (350 CID)	1999-86	-	264-100
V8 - 5.7L (350 CID)	1985-80	-	264-103
V8 - 5.7L (350 CID)	1979-73	-	264-104
V8 - 6.6L (400 CID)	1977-76	-	264-104
RV SERIES PICKUP			
V6 - 4.3L (262 CID)	1987	-	264-108
V8 - 5.0L (305 CID)	1987	-	264-100
V8 - 5.7L (350 CID)	1991-87	-	264-100
S10 BLAZER			
V6 - 2.8L (173 CID)	1990-87	2WD	264-122
V6 - 2.8L (173 CID)	1986-83	2WD	264-121
V6 - 4.3L (262 CID)	1995-88	2WD	264-123
S10 PICKUP			
V6 - 2.8L (173 CID)	1993-87	2WD	264-122
V6 - 2.8L (173 CID)	1986-83	2WD	264-121
V6 - 4.3L (262 CID)	1995-88	2WD	264-123
S15 JIMMY			
V6 - 2.8L (173 CID)	1989-87	2WD	264-122
V6 - 2.8L (173 CID)	1986-83	2WD	264-121
V6 - 4.3L (262 CID)	1995-88	2WD	264-123
S15 PICKUP			
V6 - 2.8L (173 CID)	1990-87	2WD	264-122
V6 - 2.8L (173 CID)	1986-83	2WD	264-121
V6 - 4.3L (262 CID)	1990-88	2WD	264-123
S15 SONOMA			
V6 - 2.8L (173 CID)	1993-91	2WD	264-122
V6 - 4.3L (262 CID)	1995-91	2WD	264-123
S15 SYCLONE			
V6 - 4.3L (262 CID)	1991	2WD	264-123
S15 TYPHOON			
V6 - 4.3L (262 CID)	1993-92	2WD	264-123
SAFARI VAN			
V6 - 4.3L (262 CID)	1995-90	2WD	264-108
V6 - 4.3L (262 CID)	1989-86	-	264-108
SAVANA			
V8 - 5.0L (305 CID)	2002-96	-	264-100
V8 - 5.7L (350 CID)	2002-96	-	264-100
SPRINT			
V8 - 5.0L (305 CID)	1977-76	-	264-104
V8 - 5.0L (307 CID)	1973-71	-	264-104
V8 - 5.7L (350 CID)	1977-74	-	264-104
V8 - 6.6L (400 CID)	1976-74	-	264-104
V8 - 6.6L (402 CID)	1975-71	-	264-104
SUBURBAN			
V6 - 4.3L (262 CID)	1989-88	-	264-108
V8 - 5.0L (305 CID)	1999-86	-	264-100
V8 - 5.0L (305 CID)	1985-80	-	264-103
V8 - 5.0L (305 CID)	1979-76	-	264-104
V8 - 5.7L (350 CID)	1999-86	-	264-100
V8 - 5.7L (350 CID)	1985-80	Gas Eng	264-103
V8 - 5.7L (350 CID)	1979-73	-	264-104
V8 - 6.6L (400 CID)	1980-75	-	264-104
TAHOE			
V8 - 5.7L (350 CID)	2000-95	-	264-100
YUKON			
V8 - 5.7L (350 CID)	2000-92	-	264-100
YUKON XL			
V8 - 5.7L (350 CID)	2000	-	264-100
CHRYSLER			
CIRRUS			
L4 - 2.0L (122 CID)	2000	-	264-200
CONCORDE			
V6 - 3.3L (201 CID)	1996-93	-	264-206
V6 - 3.5L (215 CID)	1997-93	-	264-206
IMPERIAL			
V6 - 3.3L (201 CID)	1991-90	-	264-204
V6 - 3.8L (230 CID)	1993-91	-	264-204
LASER			
L4 - 2.5L (153 CID)	1986	-	264-209
LEBARON			
L4 - 2.5L (153 CID)	1988-86	-	264-209

Make/ Model/Engine	Years	Description	Dorman #
CHRYSLER (continued)			
LEBARON (continued)			
V6 - 3.0L (181 CID)	1995-90	-	264-201
LEBARON GTS			
L4 - 2.5L (153 CID)	1988-86	-	264-209
LHS			
V6 - 3.5L (215 CID)	1997-94	-	264-206
NEW YORKER			
L4 - 2.5L (153 CID)	1987-86	-	264-209
V6 - 3.0L (181 CID)	1989-88	-	264-201
V6 - 3.3L (201 CID)	1993-90	w/Oil Level Sensor	264-205
V6 - 3.3L (201 CID)	1993-90	wo/Oil Level Sensor	264-204
V6 - 3.5L (215 CID)	1996-94	-	264-206
V6 - 3.8L (230 CID)	1993-91	w/Oil Level Sensor	264-205
V6 - 3.8L (230 CID)	1993-91	wo/Oil Level Sensor	264-204
SEBRING			
L4 - 2.0L (122 CID)	1999-95	-	264-208
TC MASERATI			
V6 - 3.0L (181 CID)	1991-90	-	264-201
TOWN & COUNTRY			
L4 - 2.5L (153 CID)	1988-86	-	264-209
TOWN & COUNTRY VAN			
V6 - 3.3L (201 CID)	2002-90	w/Oil Level Sensor	264-205
V6 - 3.3L (201 CID)	2002-90	wo/Oil Level Sensor	264-204
V6 - 3.8L (230 CID)	2002-94	w/Oil Level Sensor	264-205
V6 - 3.8L (230 CID)	2002-94	wo/Oil Level Sensor	264-204
VOYAGER, GRAND VOYAGER			
V6 - 3.0L (181 CID)	2000	-	264-201
V6 - 3.3L (201 CID)	2002-00	w/Oil Level Sensor	264-205
V6 - 3.3L (201 CID)	2002-00	wo/Oil Level Sensor	264-204
DODGE			
600			
L4 - 2.5L (153 CID)	1988-86	-	264-209
ARIES			
L4 - 2.5L (153 CID)	1988-86	-	264-209
AVENGER			
L4 - 2.0L (122 CID)	1996-95	-	264-208
CARAVAN, GRAND CARAVAN, MINI RAM VAN, ROYAL MINI RAM VAN			
L4 - 2.5L (153 CID)	1988-87	-	264-209
V6 - 3.0L (181 CID)	2000-87	-	264-201
V6 - 3.3L (201 CID)	2002-90	w/Oil Level Sensor	264-205
V6 - 3.3L (201 CID)	2002-90	wo/Oil Level Sensor	264-204
V6 - 3.8L (230 CID)	2002-94	w/Oil Level Sensor	264-205
V6 - 3.8L (230 CID)	2002-94	wo/Oil Level Sensor	264-204
COLT			
L4 - 1.5L (90 CID)	1994-91	Exc. Wagon	264-203
L4 - 1.5L (90 CID)	1994-91	Wagon	264-202
L4 - 1.5L (90 CID)	1990-87	-	264-202
DAYTONA			
L4 - 2.5L (153 CID)	1988-86	-	264-209
V6 - 3.0L (181 CID)	1993-90	-	264-201
DYNASTY			
L4 - 2.5L (153 CID)	1988	-	264-209
V6 - 3.0L (181 CID)	1993-88	-	264-201
V6 - 3.3L (201 CID)	1993-90	w/Oil Level Sensor	264-205
V6 - 3.3L (201 CID)	1993-90	wo/Oil Level Sensor	264-204
INTREPID			
V6 - 3.3L (201 CID)	1997-93	-	264-206
V6 - 3.5L (215 CID)	1997-93	-	264-206
LANCER			
L4 - 2.5L (153 CID)	1988-86	-	264-209
MONACO			
V6 - 3.0L (181 CID)	1992-90	-	264-201
NEON			
L4 - 2.0L (122 CID)	2005-95	-	264-200
SHADOW			
L4 - 2.5L (153 CID)	1988	-	264-209
V6 - 3.0L (181 CID)	1994-92	-	264-201
SPIRIT			
V6 - 3.0L (181 CID)	1995-89	-	264-201
STRATUS			
L4 - 2.0L (122 CID)	2000-95	-	264-200
DODGE TRUCK			
B SERIES VAN			
V8 - 5.2L (318 CID)	1991-78	-	264-210
DW SERIES PICKUP			
V8 - 5.2L (318 CID)	1991-78	-	264-210
RAMCHARGER			
V8 - 5.2L (318 CID)	1991-78	-	264-210

Oil Pan Applications

Make/ Model/Engine	Years	Description	Dorman #
EAGLE			
SUMMIT			
L4 - 1.5L (90 CID)	1996-95	-	264-203
L4 - 1.5L (90 CID)	1994-91	Exc. Wagon	264-203
L4 - 1.5L (90 CID)	1994-91	Wagon	264-202
L4 - 1.5L (90 CID)	1990-89	-	264-202
TALON			
L4 - 2.0L (122 CID)	1998-95	wo/Turbo	264-208
VISION			
V6 - 3.3L (201 CID)	1997-93	-	264-206
V6 - 3.5L (215 CID)	1997-93	-	264-206
FORD			
COUNTRY SQUIRE			
V8 - 5.0L (302 CID)	1991-84	w/Low Oil Sensor	264-006
V8 - 5.0L (302 CID)	1991-84	wo/Low Oil Sensor	264-022
V8 - 5.0L (302 CID)	1983-80	-	264-022
V8 - 5.0L (302 CID)	1979	w/Oil Level Indicator & Tube in Pan	264-023
CROWN VICTORIA			
V8 - 4.6L (281 CID)	2002-92	-	264-032
V8 - 5.0L (302 CID)	1991-84	w/Low Oil Sensor	264-006
V8 - 5.0L (302 CID)	1991-84	wo/Low Oil Sensor	264-022
V8 - 5.0L (302 CID)	1983	-	264-022
FAIRMONT			
V8 - 4.2L (255 CID)	1982-80	-	264-022
V8 - 5.0L (302 CID)	1979	w/Oil Level Indicator & Tube in Pan	264-023
V8 - 5.0L (302 CID)	1978	-	264-023
FESTIVA			
L4 - 1.3L (81 CID)	1989-88	-	264-029
GRANADA			
V8 - 4.2L (255 CID)	1981	-	264-022
LTD			
V8 - 4.2L (255 CID)	1982-81	-	264-022
V8 - 5.0L (302 CID)	1985-84	w/Low Oil Sensor	264-006
V8 - 5.0L (302 CID)	1985-84	wo/Low Oil Sensor	264-022
V8 - 5.0L (302 CID)	1982-80	-	264-022
V8 - 5.0L (302 CID)	1979	w/Oil Level Indicator & Tube in Pan	264-023
MUSTANG, MUSTANG II			
V8 - 4.2L (255 CID)	1982-80	-	264-022
V8 - 5.0L (302 CID)	1995-90	-	264-006
V8 - 5.0L (302 CID)	1989-84	w/Low Oil Sensor	264-006
V8 - 5.0L (302 CID)	1989-84	wo/Low Oil Sensor	264-022
V8 - 5.0L (302 CID)	1983-82	-	264-022
V8 - 5.0L (302 CID)	1979	w/Oil Level Indicator & Tube in Pan	264-023
PROBE			
L4 - 2.0L (122 CID)	1997-93	-	264-021
L4 - 2.2L (133 CID)	1992-89	wo/Low Oil Sensor	264-030
V6 - 3.0L (182 CID)	1992-90	-	264-010
TAURUS			
V6 - 3.0L (182 CID)	2001-96	12 Valve Eng	264-015
V6 - 3.0L (182 CID)	1995-91	Exc. SHO, w/Low Oil Sensor	264-010
V6 - 3.0L (182 CID)	1995-91	Exc. SHO, wo/Low Oil Sensor	264-015
V6 - 3.0L (182 CID)	1990-86	Exc. SHO, w/Low Oil Sensor	264-018
V6 - 3.0L (182 CID)	1990-86	Exc. SHO, wo/Low Oil Sensor	264-009
V6 - 3.8L (232 CID)	1995-88	wo/Low Oil Sensor	264-015
TEMPO			
V6 - 3.0L (182 CID)	1994-92	-	264-015
THUNDERBIRD			
V8 - 4.2L (255 CID)	1982-80	-	264-022
V8 - 5.0L (302 CID)	1993-84	w/Low Oil Sensor	264-006
V8 - 5.0L (302 CID)	1993-84	wo/Low Oil Sensor	264-022
V8 - 5.0L (302 CID)	1983-80	-	264-022
FORD TRUCK			
AEROSTAR			
V6 - 3.0L (182 CID)	1997-95	-	264-014
V6 - 3.0L (182 CID)	1994-93	-	264-026
V6 - 3.0L (182 CID)	1992-91	-	264-004
V6 - 3.0L (182 CID)	1990	From 3/27/90	264-004
V6 - 3.0L (182 CID)	1990	To 3/27/90	264-018
V6 - 3.0L (182 CID)	1989-86	-	264-018
BRONCO			
L6 - 3.9L (240 CID)	1967-66	-	264-034
L6 - 4.9L (300 CID)	1993-83	-	264-011
L6 - 4.9L (300 CID)	1982-80	-	264-024
V8 - 5.0L (302 CID)	1996-80	-	264-002
V8 - 5.8L (351 CID)	1996-88	-	264-005
V8 - 5.8L (351 CID)	1987-82	-	264-003
V8 - 5.8L (351 CID)	1981	Calif	264-003
CLUB WAGON			
L6 - 3.9L (240 CID)	1967	-	264-034
E SERIES ECONOLINE VAN			
L6 - 3.9L (240 CID)	1974-67	-	264-034

Make/ Model/Engine	Years	Description	Dorman #
FORD TRUCK (continued)			
E SERIES ECONOLINE VAN (continued)			
L6 - 4.9L (300 CID)	1996-83	-	264-011
L6 - 4.9L (300 CID)	1982-80	-	264-024
L6 - 4.9L (300 CID)	1979-72	-	264-034
V8 - 5.0L (302 CID)	1996-85	-	264-002
V8 - 5.0L (302 CID)	1984-81	-	264-012
V8 - 5.8L (351 CID)	1996-88	-	264-005
V8 - 5.8L (351 CID)	1987-82	-	264-003
V8 - 5.8L (351 CID)	1981	Calif	264-003
V8 - 6.9L (420 CID)	1987-83	-	264-013
V8 - 7.3L (445 CID)	1994-88	-	264-013
E SERIES SUPER DUTY VAN			
L6 - 4.9L (300 CID)	1996	-	264-011
V8 - 5.8L (351 CID)	1996	-	264-005
F SERIES PICKUP			
L6 - 3.9L (240 CID)	1976-65	-	264-034
L6 - 4.9L (300 CID)	1996-83	-	264-011
L6 - 4.9L (300 CID)	1982-80	-	264-024
L6 - 4.9L (300 CID)	1979-65	-	264-034
V8 - 4.2L (255 CID)	1982-81	-	264-002
V8 - 5.0L (302 CID)	1996-80	-	264-002
V8 - 5.8L (351 CID)	1997-88	-	264-005
V8 - 5.8L (351 CID)	1987-82	-	264-003
V8 - 5.8L (351 CID)	1981	Calif	264-003
V8 - 6.9L (420 CID)	1987-83	-	264-013
V8 - 7.3L (445 CID)	1994-88	-	264-013
V8 - 7.5L (460 CID)	1997-93	-	264-019
V8 - 7.5L (460 CID)	1992-90	-	264-017
V8 - 7.5L (460 CID)	1989	From 3/28/89	264-017
V8 - 7.5L (460 CID)	1989	To 3/28/89	264-016
V8 - 7.5L (460 CID)	1988-83	-	264-016
P-350			
L6 - 3.9L (240 CID)	1972-68	-	264-034
L6 - 4.9L (300 CID)	1976-68	-	264-034
RANGER			
V6 - 3.0L (182 CID)	2001-95	-	264-014
V6 - 3.0L (182 CID)	1994-93	w/Low Oil Sensor	264-026
V6 - 3.0L (182 CID)	1994-93	wo/Low Oil Sensor	264-014
V6 - 3.0L (182 CID)	1992-91	-	264-004
WINDSTAR			
V6 - 3.0L (182 CID)	2000-99	-	264-015
V6 - 3.0L (182 CID)	1998-95	w/Low Oil Sensor	264-010
V6 - 3.0L (182 CID)	1998-95	wo/Low Oil Sensor	264-015
V6 - 3.8L (232 CID)	1998-96	-	264-015
GEO			
METRO			
L4 - 1.3L (79 CID)	1994-92	-	264-110
PRIZM			
L4 - 1.6L (98 CID)	1992-90	VIN 5, DOHC	264-303
TRACKER			
L4 - 1.6L (98 CID)	1995-89	-	264-111
HONDA			
ACCORD			
L4 - 1.8L (1829 cc)	1985-84	Carb	264-400
L4 - 1.8L (1829 cc)	1985-84	EFI	264-401
L4 - 2.0L (1955 cc)	1989-86	-	264-400
L4 - 2.2L (2156 cc)	1997-90	-	264-403
L4 - 2.3L (2234 cc)	2002-98	-	264-406
CIVIC			
L4 - 1.5L (1493 cc)	1995-88	-	264-402
L4 - 1.6L (1590 cc)	2000-96	CX, DX, LX Models	264-405
L4 - 1.6L (1590 cc)	1995-88	-	264-402
CIVIC DEL SOL			
L4 - 1.5L (1493 cc)	1995-93	Exc. V-TEC Eng	264-402
L4 - 1.6L (1590 cc)	1997-96	Exc. V-TEC Eng	264-405
L4 - 1.6L (1590 cc)	1995-93	Exc. V-TEC Eng	264-402
CR-V			
L4 - 2.0L (1972 cc)	2001-97	-	264-407
CRX			
L4 - 1.5L (1493 cc)	1991-88	-	264-402
L4 - 1.6L (1590 cc)	1991-88	-	264-402
ODYSSEY			
L4 - 2.2L (2156 cc)	1997-95	-	264-403
L4 - 2.3L (2234 cc)	1998	-	264-406
PRELUDE			
L4 - 1.8L (1829 cc)	1987-83	-	264-400
L4 - 2.0L (1955 cc)	1987-85	-	264-400
L4 - 2.2L (2156 cc)	1996-92	-	264-403
L4 - 2.3L (2259 cc)	1996-92	-	264-403

Oil Pans

**Power Steering
Pulleys**
pg. 317-326

**Quick
Disconnect™**
pg. 327-396

**Radiator Fan
Assemblies**
pg. 397-430

**Rear Axle
Shaft Kits**
pg. 431-434

**Side View Mirror
Assemblies**
pg. 435-468

**New Drain Plug & Seal
Included Where Required**

**Oil Pans
313**

Oil Pan Applications

Make/Model/Engine	Years	Description	Dorman #
HONDA (continued)			
WAGOVAN			
L4 - 1.5L (1493 cc)	1989-88	-	264-402
HYUNDAI			
EXCEL			
L4 - 1.5L (1468 cc)	1994-90	-	264-202
SCOUPE			
L4 - 1.5L (1468 cc)	1992-91	-	264-202
INFINITI			
I30			
V6 - 3.0L (2988 cc)	1999-96	Lower	264-502
INTERNATIONAL			
ALL MODELS			
V8 - 7.3L (445 CID)	1993-75	Diesel Eng	264-900
ISUZU			
OASIS			
L4 - 2.2L (2156 cc)	1997-96	-	264-403
JEEP			
CHEROKEE			
L6 - 4.0L (242 CID)	1998-97	-	264-220
L6 - 4.0L (242 CID)	1996-94	w/Sensor Hole	264-221
L6 - 4.0L (242 CID)	1996-94	wo/Sensor Hole	264-220
L6 - 4.0L (242 CID)	1993-87	-	264-220
L6 - 4.2L (258 CID)	1983-74	-	264-222
CJ, DJ SERIES			
L6 - 4.2L (258 CID)	1986-72	-	264-222
COMANCHE			
L6 - 4.0L (242 CID)	1992-87	-	264-220
GRAND CHEROKEE			
L6 - 4.0L (242 CID)	1999-97	-	264-220
L6 - 4.0L (242 CID)	1996-93	w/Sensor Hole	264-221
L6 - 4.0L (242 CID)	1996-93	wo/Sensor Hole	264-220
GRAND WAGONEER			
L6 - 4.2L (258 CID)	1986-84	Exc. Mexico Built	264-222
J SERIES PICKUP			
L6 - 4.2L (258 CID)	1986-84	Exc. Mexico Built	264-222
L6 - 4.2L (258 CID)	1983-72	-	264-222
JEEPSTER			
L6 - 4.2L (258 CID)	1973-72	-	264-222
SCRAMBLER			
L6 - 4.2L (258 CID)	1985-81	-	264-222
WAGONEER			
L6 - 4.0L (242 CID)	1990-87	-	264-220
L6 - 4.2L (258 CID)	1983-72	-	264-222
WRANGLER			
L6 - 4.0L (242 CID)	1999-97	-	264-220
L6 - 4.0L (242 CID)	1995-94	w/Sensor Hole	264-221
L6 - 4.0L (242 CID)	1995-94	wo/Sensor Hole	264-220
L6 - 4.0L (242 CID)	1993-91	-	264-220
L6 - 4.2L (258 CID)	1990-87	-	264-222
LINCOLN			
CONTINENTAL			
V8 - 5.0L (302 CID)	1987-84	w/Low Oil Sensor	264-006
V8 - 5.0L (302 CID)	1987-84	wo/Low Oil Sensor	264-022
V8 - 5.0L (302 CID)	1983-80	-	264-022
MARK VI			
V8 - 5.0L (302 CID)	1983-80	-	264-022
MARK VII			
V8 - 5.0L (302 CID)	1992-84	w/Low Oil Sensor	264-006
V8 - 5.0L (302 CID)	1992-84	wo/Low Oil Sensor	264-022
TOWN CAR			
V8 - 4.6L (281 CID)	2002-91	-	264-032
V8 - 5.0L (302 CID)	1990-84	w/Low Oil Sensor	264-006
V8 - 5.0L (302 CID)	1990-84	wo/Low Oil Sensor	264-022
V8 - 5.0L (302 CID)	1983-82	-	264-022
VERSAILLES			
V8 - 5.0L (302 CID)	1980	-	264-022
MAZDA			
323			
L4 - 1.6L (1597 cc)	1994-90	-	264-020
L4 - 1.6L (1597 cc)	1989-88	wo/Turbo	264-029
626			
L4 - 2.0L (1991 cc)	2002-93	Lower	264-021
L4 - 2.2L (2184 cc)	1992-88	-	264-030
MX-3			
L4 - 1.6L (1597 cc)	1995-94	Upper Pan	264-031
L4 - 1.6L (1597 cc)	1993-92	-	264-020
MX-6			
L4 - 2.0L (1991 cc)	1997-93	Lower	264-021
L4 - 2.2L (2184 cc)	1992-88	-	264-030

Make/Model/Engine	Years	Description	Dorman #
MAZDA (continued)			
PROTEGE			
L4 - 1.5L (1489 cc)	1995	Upper Pan, To 2/95	264-031
L4 - 1.6L (1589 cc)	2001-99	-	264-020
L4 - 1.8L (1839 cc)	2000-99	Lower	264-021
L4 - 2.0L (2000 cc)	2003-01	Lower, w/MPS or Sport Suspension	264-021
PROTEGE 5			
L4 - 2.0L (2000 cc)	2003-01	Lower, w/MPS or Sport Suspension	264-021
MAZDA TRUCK			
B3000 PICKUP			
V6 - 3.0L (182 CID)	2001-94	-	264-014
MERCURY			
CAPRI			
V8 - 4.2L (255 CID)	1982-80	-	264-022
V8 - 5.0L (302 CID)	1986-84	w/Low Oil Sensor	264-006
V8 - 5.0L (302 CID)	1986-84	wo/Low Oil Sensor	264-022
V8 - 5.0L (302 CID)	1983-82	-	264-022
V8 - 5.0L (302 CID)	1979	w/Oil Level Indicator & Tube in Pan	264-023
COLONY PARK			
V8 - 5.0L (302 CID)	1991-84	w/Low Oil Sensor	264-006
V8 - 5.0L (302 CID)	1991-84	wo/Low Oil Sensor	264-022
V8 - 5.0L (302 CID)	1983-80	-	264-022
V8 - 5.0L (302 CID)	1979	w/Oil Level Indicator & Tube in Pan	264-023
COUGAR			
V8 - 4.2L (255 CID)	1982-80	-	264-022
V8 - 5.0L (302 CID)	1993-84	w/Low Oil Sensor	264-006
V8 - 5.0L (302 CID)	1993-84	wo/Low Oil Sensor	264-022
V8 - 5.0L (302 CID)	1983-80	-	264-022
V8 - 5.0L (302 CID)	1979	w/Oil Level Indicator & Tube in Pan	264-023
GRAND MARQUIS			
V8 - 4.2L (255 CID)	1982-81	-	264-022
V8 - 4.6L (281 CID)	2002-92	-	264-032
V8 - 5.0L (302 CID)	1991-84	w/Low Oil Sensor	264-006
V8 - 5.0L (302 CID)	1991-84	wo/Low Oil Sensor	264-022
V8 - 5.0L (302 CID)	1983-80	-	264-022
V8 - 5.0L (302 CID)	1979	w/Oil Level Indicator & Tube in Pan	264-023
MARQUIS			
V8 - 4.2L (255 CID)	1982-81	-	264-022
V8 - 5.0L (302 CID)	1985-84	w/Low Oil Sensor	264-006
V8 - 5.0L (302 CID)	1985-84	wo/Low Oil Sensor	264-022
V8 - 5.0L (302 CID)	1980-82	-	264-022
V8 - 5.0L (302 CID)	1979	w/Oil Level Indicator & Tube in Pan	264-023
SABLE			
V6 - 3.0L (182 CID)	2001-96	12 Valve Eng	264-015
V6 - 3.0L (182 CID)	1995-91	w/Low Oil Sensor	264-010
V6 - 3.0L (182 CID)	1995-91	wo/Low Oil Sensor	264-015
V6 - 3.0L (182 CID)	1990-86	w/Low Oil Sensor	264-018
V6 - 3.0L (182 CID)	1990-86	wo/Low Oil Sensor	264-009
V6 - 3.8L (232 CID)	1995-88	wo/Low Oil Sensor	264-015
TOPAZ			
V6 - 3.0L (182 CID)	1994-92	-	264-015
TRACER			
L4 - 1.6L (98 CID)	1989-88	-	264-029
ZEPHYR			
V8 - 4.2L (255 CID)	1982-80	-	264-022
V8 - 5.0L (302 CID)	1979	w/Oil Level Indicator & Tube in Pan	264-023
V8 - 5.0L (302 CID)	1978	-	264-023
MINI			
COOPER			
L4 - 2.0L (122 CID)	1999-95	wo/Turbo	264-208
MIRAGE			
L4 - 1.5L (1468 cc)	1996-91	-	264-203
L4 - 1.5L (1468 cc)	1990-87	-	264-202
PRECIS			
L4 - 1.5L (1468 cc)	1994-90	-	264-202
NISSAN			
200SX			
L4 - 1.6L (1597 cc)	1998-95	-	264-500
MAXIMA			
V6 - 3.0L (2988 cc)	1999-95	Lower	264-502
NX			
L4 - 1.6L (1597 cc)	1993-91	-	264-500
SENTRA			
L4 - 1.6L (1597 cc)	1999-91	-	264-500
L4 - 1.8L (1809 cc)	2003-02	CA Model	264-500
OLDSMOBILE			
ACHIEVA			
L4 - 2.3L (138 CID)	1994-92	-	264-102
CUSTOM CRUISER			
V8 - 5.0L (305 CID)	1992-91	w/Low Oil Sensor	264-107
V8 - 5.0L (305 CID)	1992-91	wo/Low Oil Sensor	264-100

Oil Pan Applications

Make/ Model/Engine	Years	Description	Dorman #
OLDSMOBILE (continued)			
CUSTOM CRUISER (continued)			
V8 - 5.7L (350 CID)	1992-91	-	264-107
V8 - 5.7L (350 CID)	1977	VIN L	264-104
CUTLASS			
V8 - 5.0L (305 CID)	1980	-	264-103
V8 - 5.0L (305 CID)	1979-78	-	264-118
CUTLASS CALAIS			
L4 - 2.3L (138 CID)	1991-87	Stamped 22538921	264-101
L4 - 2.3L (138 CID)	1991-87	Stamped 24570333	264-102
V8 - 5.0L (305 CID)	1980	-	264-103
V8 - 5.0L (305 CID)	1979-78	-	264-118
CUTLASS CIERA			
L4 - 2.2L (134 CID)	1995-93	-	264-119
V6 - 2.8L (173 CID)	1989-87	-	264-105
V6 - 2.8L (173 CID)	1986	-	264-117
V6 - 2.8L (173 CID)	1985-83	Export	264-117
V6 - 2.8L (173 CID)	1982	Export, Use With Rear Seal	264-117
CUTLASS CRUISER			
V8 - 5.0L (305 CID)	1982-80	-	264-103
V8 - 5.0L (305 CID)	1979-78	-	264-118
V8 - 5.7L (350 CID)	1979	VIN L	264-118
CUTLASS SUPREME			
L4 - 2.3L (138 CID)	1991-90	Stamped 22538921	264-101
L4 - 2.3L (138 CID)	1991-90	Stamped 24570333	264-102
V6 - 2.8L (173 CID)	1989-88	-	264-105
V6 - 3.1L (189 CID)	1993-89	-	264-105
V6 - 3.4L (207 CID)	1996-95	-	264-106
V6 - 3.4L (207 CID)	1994-91	-	264-105
V8 - 5.0L (305 CID)	1980	-	264-103
V8 - 5.0L (305 CID)	1979-78	-	264-118
V8 - 5.7L (350 CID)	1978	VIN L	264-104
DELTA 88			
V8 - 5.7L (350 CID)	1977	VIN L	264-104
FIRENZA			
L4 - 2.0L (122 CID)	1988-87	VIN K	264-119
V6 - 2.8L (173 CID)	1987	-	264-105
V6 - 2.8L (173 CID)	1986-85	-	264-117
OMEGA			
V6 - 2.8L (173 CID)	1984-80	-	264-117
V8 - 5.0L (305 CID)	1979-77	-	264-104
V8 - 5.7L (350 CID)	1979-77	VIN L	264-104
SILHOUETTE			
V6 - 3.1L (189 CID)	1994-90	-	264-105
STARFIRE			
V8 - 5.0L (305 CID)	1977	-	264-104
PLYMOUTH			
ACCLAIM			
V6 - 3.0L (181 CID)	1995-89	-	264-201
BREEZE			
L4 - 2.0L (122 CID)	2000-96	-	264-200
CARAVELLE			
L4 - 2.5L (153 CID)	1988-86	-	264-209
COLT			
L4 - 1.5L (90 CID)	1994-91	Exc. Wagon	264-203
L4 - 1.5L (90 CID)	1994-91	Wagon	264-202
L4 - 1.5L (90 CID)	1990-87	-	264-202
NEON			
L4 - 2.0L (122 CID)	2001-95	-	264-200
PROWLER			
V6 - 3.5L (215 CID)	1997	-	264-206
RELIANT			
L4 - 2.5L (153 CID)	1988-86	-	264-209
SUNDANCE			
L4 - 2.5L (153 CID)	1988	-	264-209
V6 - 3.0L (181 CID)	1994-92	-	264-201
VOYAGER, GRAND VOYAGER			
L4 - 2.5L (153 CID)	1988-87	-	264-209
V6 - 3.0L (181 CID)	2000-87	-	264-201
V6 - 3.3L (201 CID)	2000-90	w/Oil Level Sensor	264-205
V6 - 3.3L (201 CID)	2000-90	wo/Oil Level Sensor	264-204
V6 - 3.8L (230 CID)	1999-94	w/Oil Level Sensor	264-205
V6 - 3.8L (230 CID)	1999-94	wo/Oil Level Sensor	264-204
PLYMOUTH TRUCK			
PB SERIES VAN			
V8 - 5.2L (318 CID)	1983-78	-	264-210
TRAILDUSTER			
V8 - 5.2L (318 CID)	1981-78	-	264-210
PONTIAC			
6000			
V6 - 2.8L (173 CID)	1989-87	-	264-105
Make/ Model/Engine			
Years			
Description			
Dorman #			
PONTIAC (continued)			
6000 (continued)			
V6 - 2.8L (173 CID)	1986-83	-	264-117
V6 - 2.8L (173 CID)	1982	Export, Use With Rear Seal	264-117
V6 - 3.1L (189 CID)	1991-88	-	264-105
BONNEVILLE			
V8 - 5.0L (305 CID)	1986-83	-	264-103
FIERO			
V6 - 2.8L (173 CID)	1988-87	-	264-105
V6 - 2.8L (173 CID)	1986-85	-	264-117
FIREBIRD			
V6 - 2.8L (173 CID)	1989-87	-	264-122
V6 - 2.8L (173 CID)	1986-82	-	264-121
V6 - 3.1L (189 CID)	1992-90	-	264-122
V8 - 5.0L (305 CID)	1992-86	-	264-100
V8 - 5.0L (305 CID)	1985-80	-	264-103
V8 - 5.0L (305 CID)	1979-77	-	264-104
V8 - 5.7L (350 CID)	1997-93	-	264-107
V8 - 5.7L (350 CID)	1992-87	-	264-100
V8 - 5.7L (350 CID)	1979-78	-	264-104
GRAND AM			
L4 - 2.0L (122 CID)	1989-87	VIN M	264-119
L4 - 2.3L (138 CID)	1994-92	-	264-102
L4 - 2.3L (138 CID)	1991-88	Stamped 22538921	264-101
L4 - 2.3L (138 CID)	1991-88	Stamped 24570333	264-102
V8 - 5.0L (305 CID)	1980	-	264-103
V8 - 5.0L (305 CID)	1979-78	-	264-118
GRAND LEMANS			
V8 - 5.0L (305 CID)	1980	-	264-103
V8 - 5.0L (305 CID)	1979-78	-	264-118
V8 - 5.0L (305 CID)	1977	-	264-104
V8 - 5.7L (350 CID)	1979	-	264-118
V8 - 5.7L (350 CID)	1978	-	264-104
GRAND PRIX			
L4 - 2.3L (138 CID)	1991-90	Stamped 22538921	264-101
L4 - 2.3L (138 CID)	1991-90	Stamped 24570333	264-102
V6 - 2.8L (173 CID)	1989-88	-	264-105
V6 - 3.1L (189 CID)	1993-91	-	264-105
V6 - 3.1L (189 CID)	1990-88	wo/Turbo	264-105
V6 - 3.4L (207 CID)	1996-95	-	264-106
V6 - 3.4L (207 CID)	1994-91	-	264-105
V8 - 5.0L (305 CID)	1987-86	-	264-100
V8 - 5.0L (305 CID)	1985-80	-	264-103
V8 - 5.0L (305 CID)	1979-78	-	264-118
LEMANS			
L4 - 2.0L (122 CID)	1990-89	VIN K	264-119
V8 - 5.0L (305 CID)	1980	-	264-103
V8 - 5.0L (305 CID)	1979-78	-	264-118
V8 - 5.0L (305 CID)	1977	-	264-104
V8 - 5.7L (350 CID)	1979	-	264-118
V8 - 5.7L (350 CID)	1978	-	264-104
PARISIENNE			
V8 - 5.0L (305 CID)	1986	-	264-100
V8 - 5.0L (305 CID)	1985-83	-	264-103
PHOENIX			
V6 - 2.8L (173 CID)	1984-80	-	264-117
V8 - 5.0L (305 CID)	1979-77	-	264-104
V8 - 5.7L (350 CID)	1979-77	VIN L	264-104
SUNBIRD			
L4 - 2.0L (122 CID)	1994-93	-	264-120
L4 - 2.0L (122 CID)	1992-87	-	264-119
V6 - 3.1L (189 CID)	1994-91	-	264-105
V8 - 5.0L (305 CID)	1979-78	-	264-104
SUNFIRE			
L4 - 2.2L (134 CID)	1995	-	264-119
TRANS SPORT			
V6 - 3.1L (189 CID)	1995-90	-	264-105
VENTURA			
V8 - 5.0L (305 CID)	1977	-	264-104
V8 - 5.7L (350 CID)	1977	VIN L	264-104
SUZUKI			
ESTEEM			
L4 - 1.6L (1590 cc)	1995	-	264-110
SIDEKICK			
L4 - 1.6L (1590 cc)	1995-89	-	264-111
SWIFT			
L4 - 1.3L (1298 cc)	1995-89	-	264-110
L4 - 1.6L (1590 cc)	1993-92	-	264-110
TOYOTA			
CAMRY			
L4 - 2.2L (2164 cc)	2001-92	5SFE, 5SNFE Eng	264-305

Oil Pans

**Power Steering
Pulleys**
pg. 317-326

**Quick
Disconnect™**
pg. 327-396

**Radiator Fan
Assemblies**
pg. 397-430

**Rear Axle
Shaft Kits**
pg. 431-434

**Side View Mirror
Assemblies**
pg. 435-468

**New Drain Plug & Seal
Included Where Required**

Oil Pans
315

Oil Pan Applications

Make/ Model/Engine	Years	Description	Dorman #
TOYOTA (continued)			
CELICA			
L4 - 1.6L (1587 cc)	1993-90	-	264-300
COROLLA			
L4 - 1.6L (1587 cc)	1997-94	-	264-309
L4 - 1.6L (1587 cc)	1993	Exc. Wagon	264-309
L4 - 1.6L (1587 cc)	1992-88	4AGE Eng	264-301
L4 - 1.6L (1587 cc)	1991-88	GT-S	264-301
L4 - 1.6L (1587 cc)	1989-88	4AF Eng	264-300
L4 - 1.6L (1587 cc)	1987-84	-	264-303
L4 - 1.8L (1762 cc)	1992-88	Wagon	264-308
COROLLA FX			
L4 - 1.6L (1587 cc)	1988-87	EFI	264-303
MR2			
L4 - 1.6L (1587 cc)	1989-88	w/Oil Cooler	264-301

Make/ Model/Engine	Years	Description	Dorman #
TOYOTA (continued)			
MR2 (continued)			
L4 - 1.6L (1587 cc)	1989-88	wo/Oil Cooler	264-300
L4 - 1.6L (1587 cc)	1987-85	w/Oil Cooler	264-303
PASEO			
L4 - 1.5L (1497 cc)	1998-95	-	264-304
L4 - 1.5L (1497 cc)	1994-92	-	264-307
SOLARA			
L4 - 2.2L (2164 cc)	2001-99	5SFE Eng	264-305
TERCEL			
L4 - 1.5L (1456 cc)	1994-87	-	264-307
L4 - 1.5L (1497 cc)	1998-95	-	264-304

Oil Pans

Fan Pulley Brackets **NEW!**

Brackets
Not Available
Separately At
the OE Dealer

*Make a Customer For Life...
Replace Only the Piece
That is Broken*

300-801

Toyota 3.0L
4Runner, Pickup T100
1995-93



ADDITIONAL APPLICATIONS

300-800: Toyota Pickups, 1992-88
300-802: Toyota Trucks, 2004-95
300-803: Isuzu Rodeo, Trooper, 1997-91

Smog Pump Pulleys

Simplifies Returning Vehicles
to Emission Legal

NEW!



300-920

Ford Cars & Trucks
1982-74

300-911

Cadillac 4.5L V8
1987-80

Power Steering Pulleys



Check Power Steering Pulley When Replacing Power Steering Pump

			
300-003 Ford Taurus, Aerostar, Mercury Sable, Bronco, F-Series, 2004-85	300-201 GM 2004-93	300-306 Jeep Cherokee 1998-94	300-308 Dodge Intrepid 2004-98; Plymouth Prowler 2002-98



HAVE YOU EVER SEEN THIS?

- Power Steering Pulleys Bend and Break During Removal
- Order the Power Steering Pulley When you Order the Pump

Signs to check Power Steering Pulley:



Bent or Flat Shaft

- Squeal or Noisy Belts
- Power Steering Pulley is BENT or Cracked
- Power Steering is Stiff, Sluggish or Non-functional



Road Debris Damage

- Damaged Drive Belt
- Chipped Grooves on Pulley
- Belt Repeatedly Coming Off

Tech Tip: Check belt for cracking and glazing.

Activant Path

*Power Steering; Steering & Suspension/
P/S Hose & Pumps*

Activant Code

DSW

Applications begin on page 322.

Power Steering Pulley to Pump Interchange

Replacement Pump #	Dorman #
20-273	300-008
20-275	300-009
20-276	300-011
20-278	300-011
20-302	300-120
20-704	300-303
20-830*	300-123, 300-201
20-840	300-121
20-860	300-200
20-862	300-200
20-888*	300-123, 300-201
20-899*	300-303, 300-304
20-902	300-311
20-904	300-308
20-906	300-308
20-5844	300-400
20-6240*	300-003, 300-005
20-6246	300-003
20-6248	300-003
20-6800	300-121
20-7241*	300-002, 300-003, 300-004, 300-005
20-7252	300-004
20-7254	300-003
20-7255	300-003
20-7803*	300-121, 300-122
20-7828	300-200
20-7832	300-200

Replacement Pump #	Dorman #
20-7840	300-200
20-7853	300-307
20-7903	300-100
20-7920*	300-121, 300-122
20-7922	300-122
20-7923	300-200
20-7942	300-101
20-7944*	300-003, 300-006, 300-010
20-7950	300-307
20-8704	300-200
20-8741	300-200
20-8748	300-200
20-8751*	300-121, 300-122, 300-200
20-8752*	300-101, 300-305
20-28888	300-123
20-38771	300-302
20-38893	300-301
20-39771*	300-302, 300-306, 300-310
20-39772	300-306
20-39881	300-306
20-57830	300-201
20-57888	300-201
20-57900	300-201
20-59400	300-124
21-5926	300-102
21-5993	300-500
21-5998	300-311

* Check specific application to determine correct Pulley.

Power Steering Pulleys

Power Steering Pulleys



300-002

Steel
1997-94 Ford Pickups, Vans w/7.3 Diesel
Diameter 5-25/32"
Width 1-11/32"
Belt Type Serpentine
I.D. .685"



300-003

Plastic
2006-84 Taurus, Sable 3.0L, Aerostar 2.3L, Bronco, F-Series 5.0L, 5.8L
Diameter 5-13/16"
Width 1-15/32"
Belt Type Serpentine
I.D. .685"



300-004

Plastic
2001-90 Ford Explorer, Ranger 4.0L
Diameter 5-1/4"
Width 1-29/32"
Belt Type Serpentine
I.D. .685"



300-005

Steel
1995-90 Taurus, Sable, 1998-95 Windstar 3.8L
Diameter 6-1/4"
Width 1-7/8"
Belt Type Serpentine
I.D. .685"



300-006

Steel
2006-97 5.4L Ford Truck F250 - F550
Diameter 5-5/8"
Width 1-3/8"
Belt Type Serpentine
I.D. .626"



300-007

Plastic
2000 Ford Focus SOHC
Diameter 4-31/32"
Width 1-11/64"
Belt Type Serpentine
I.D. .59"

Power Steering Pulleys



300-008
Steel
 2006-96 Ford Taurus; Mercury Sable DOHC
Diameter 5-37/64"
Width 1-7/64"
Belt Type Serpentine
I.D. .625"



300-009
Steel
 2005-96 Ford Explorer; Mercury Mountaineer
Diameter 5-7/32"
Width 1-3/64"
Belt Type Serpentine
I.D. 1.141"



300-010
Steel
 2006-93 Ford Mustang, Thunderbird, Crown Victoria, E150-250, F150; Mercury Cougar, Grand Marquis
Diameter 5-5/8"
Width 1-3/64"
Belt Type Serpentine
I.D. .626"



300-011
Steel
 2002-97 Ford Escort; Mercury Tracer SOHC
Diameter 4-33/64"
Width 1-3/16"
Belt Type Serpentine
I.D. 1.023"



300-100
Plastic
 1995-91 Caravan, Voyager 3.0L
Diameter 6-9/16"
Width 1-21/32"
Belt Type Serpentine
I.D. .749"



300-101
Plastic
 2000-90 Caravan, Voyager 3.3L, 3.8L
Diameter 6-1/2"
Width 1-3/8"
Belt Type Serpentine
I.D. .749"



300-102
Steel
 1999-95 Neon
Diameter 5-7/8"
Width 1-1/4"
Belt Type V-Belt
I.D. .706"



300-120
Steel
 2000-1981 Chevrolet/GMC Medium Duty Truck (various engines)
Diameter 6.21"
Width 1.76"
Belt Type V-Belt
I.D. .625"



300-121
Steel
 1993-76 General Motors Cars & Trucks, 2 Groove (various engines)
Diameter 5.8"
Width 2.257"
Belt Type Double V-Belt
I.D. .748"

Power Steering Pulleys

Power Steering Pulleys



300-122

Steel

1995-82 General Motors Cars & Trucks w/o Air Conditioning (various engines)

Diameter 5.8"
Width 1.61"
Belt Type V-Belt
I.D. .748"



300-123

Plastic

1997-91 General Motors, V6-3.1L & 3.4L; Midsize Cars J, L, W Body

Diameter 5-3/16"
Width 1-5/32"
Belt Type Serpentine
I.D. .748"



300-124

Steel

2005-93 General Motors Cadillac Concours, Deville, Eldorado, Seville; Chevrolet Truck S10; GMC Truck S15 Sonoma

Diameter 6-1/2"
Width 1-3/64"
Belt Type Serpentine
I.D. .653"



300-200

Steel

2006-87 General Motors Chevrolet Passenger Cars & Trucks; GMC Trucks 4.3L, 5.0L, 5.7L

Diameter 6-15/32"
Width 1-13/16"
Belt Type Serpentine
I.D. .748"



300-201

Plastic

2005-93 General Motors Passenger Cars 3.1L, 3.4L

Diameter 5-3/16"
Width 1-13/32"
Belt Type Serpentine
I.D. .748"



300-301

Steel

1996-87 Jeep Cherokee, Comanche, Wagoneer, Wrangler; Eagle Premier, L4-2.5L & L6-4.0L Engine

Diameter 5-5/16"
Width 1-1/16"
Belt Type Serpentine
I.D. .662"



300-302

Steel

2005-97 Dodge Truck Dakota; Jeep Cherokee, Grand Cherokee, Wrangler, L4-2.5L, L6-4.0L & V8-4.7L

Diameter 5-5/16"
Width 1-1/16"
Belt Type Serpentine
I.D. .662"



300-303

Plastic

1994-93 Chrysler Concorde, LHS, New Yorker; Dodge Intrepid; Eagle Vision, V-6 - 3.3L & 3.5L Engine

Diameter 6-1/2"
Width 1-5/32"
Belt Type Serpentine
I.D. .662"



300-304

Plastic

1997-95 Chrysler Concorde, LHS, New Yorker; Dodge Intrepid; Eagle Vision V-6 3.3L & 3.5L

Diameter 6-1/2"
Width 1-5/32"
Belt Type Serpentine
I.D. .748"

Power Steering Pulleys



300-305

Plastic

2000-96 Chrysler, Dodge, Plymouth Minivans, V6-3.0L

Diameter 6-1/4"
Width 1-23/32"
Belt Type Serpentine
I.D. .747"



300-306

Plastic

1998-93 5.2L, Jeep Cherokee; 2002-97 Dodge Viper V10-8.0L

Diameter 6-1/64"
Width 1-21/64"
Belt Type Serpentine
I.D. .661"



300-307

Steel

2003-94 3.9L, Dodge Dakota, RAM Trucks & Vans; 2003-98 Dodge Durango

Diameter 5-63/64"
Width 1-19/64"
Belt Type Serpentine
I.D. .746"



300-308

Plastic

2004-98 2.7L, Dodge Intrepid; 2002-98 2.7L, Dodge Prowler

Diameter 6-29/64"
Width 1-3/16"
Belt Type Serpentine
I.D. .704"



300-309

Plastic

2003-00 Dodge/Plymouth Neon

Diameter 5-19/32"
Width 27/32"
Belt Type Serpentine
I.D. .7"



300-310

Plastic

2004-99 Jeep Cherokee, Grand Cherokee, Wrangler; Dodge TR Dakota

Diameter 5-7/16"
Width 1-1/8"
Belt Type Serpentine
I.D. .657"



300-311

Plastic

2000-95 Chrysler Cirrus, Dodge Stratus, Plymouth Breeze

Diameter 4-13/16"
Width 7/8"
Belt Type Serpentine
I.D. .704"



300-400

Steel

1995-88 Toyota Trucks 4-Runner, Pickups, T100, V6-3.0L Engine

Diameter 5.35"
Width 1.70"
Belt Type V-Belt
I.D. .550"



300-500

Steel

2002-96 Honda Accord, Odyssey, Acura CL

Diameter 4-25/64"
Width 53/64"
Belt Type Serpentine
I.D. .586"

Power Steering Pulleys

Idler Pulleys



300-600

Metal

2002-93 Mazda Millenia Power Steering Idler Pulley

Diameter 3-1/4"
Width 21/32"
Belt Type Solid
I.D. 1.566"



300-601

Metal

2002-93 Mazda Millenia Idler Alternator Pulley

Diameter 4-9/64"
Width 21/32"
Belt Type Solid
I.D. 1.566"

Related Sales



**82570 (1)
 Power Steering
 Pulley Shields
 4-1/4"**



Pulley shield keeps snow and rain from dislodging serpentine belt. Fits Caravan, Grand Caravan, Voyager, Grand Voyager 2000-97. Includes shield and bolt.

- Sell with new power steering pump in cold weather states.
- Prevents ice and snow from throwing serpentine belt.
- Keeps belt from slipping off the pulley.

Power Steering Pulley Applications

Make/Model/Engine	Years	Description	Dorman #
BUICK			
CENTURY			
V6 - 3.1 (189 CID)	2005-94	-	300-201
V8 - 5.0 (305 CID)	1980-78	w/Axial Compressor, 80 Amp, Heavy Duty Cooling, 2 Groove	300-121
V8 - 5.0 (305 CID)	1977	w/Air Cond., Stamped AC, 2 Groove	300-121
V8 - 5.7 (350 CID)	1979-78	w/Axial Compressor, 80 Amp, Heavy Duty Cooling, 2 Groove	300-121
LESABRE			
V8 - 5.0 (305 CID)	1978	w/Air Cond., Stamped AC, 2 Groove	300-121
REGAL			
V6 - 3.1 (189 CID)	1995-94	-	300-201
V6 - 3.1 (189 CID)	1993-92	-	300-123
V6 - 3.1 (189 CID)	1991	Coupe	300-123
V6 - 3.1 (189 CID)	1991	Sedan, From Vin 800001	300-123
V8 - 5.0 (305 CID)	1980-78	w/Axial Compressor, 80 Amp, Heavy Duty Cooling, 2 Groove	300-121
V8 - 5.0 (305 CID)	1977	w/Air Cond., Stamped AC, 2 Groove	300-121
RENDEZVOUS			
V6 - 3.4 (207 CID)	2005-03	-	300-201
ROADMASTER			
V8 - 5.0 (305 CID)	1991	-	300-200
V8 - 5.7 (350 CID)	1993-92	-	300-200
SKYLARK			
V6 - 3.1 (189 CID)	1998-94	-	300-201
V8 - 5.0 (305 CID)	1979-77	w/Air Cond., 2 Groove	300-121
V8 - 5.7 (350 CID)	1979-77	w/Air Cond., 2 Groove	300-121
CADILLAC			
ALLANTE			
V8 - 4.6 (281 CID)	1993	-	300-124
CONCOURS			
V8 - 4.6 (281 CID)	1999-94	-	300-124
DEVILLE			
V8 - 4.6 (281 CID)	2005-96	-	300-124
ELDORADO			
V8 - 4.6 (281 CID)	2002-93	-	300-124
ESCALADE			
V8 - 5.3 (323 CID)	2005-03	-	300-200
V8 - 5.7 (350 CID)	2000-99	-	300-200
V8 - 6.0 (364 CID)	2006-03	-	300-200
FLEETWOOD			
V8 - 5.0 (305 CID)	1992-91	-	300-200
V8 - 5.7 (350 CID)	1993-90	-	300-200
SEVILLE			
V8 - 4.6 (281 CID)	2004-93	-	300-124
CHEVROLET			
BERETTA			
V6 - 3.1 (189 CID)	1996-94	-	300-201
V6 - 3.1 (189 CID)	1993-91	-	300-123
CAMARO			
V6 - 3.8 (229 CID)	1981-80	w/Air Cond., 2 Groove	300-121
V8 - 4.4 (267 CID)	1981-80	w/Air Cond., 2 Groove	300-121

Make/Model/Engine	Years	Description	Dorman #
CHEVROLET (continued)			
CAMARO (continued)			
V8 - 5.0 (305 CID)	1992-88	-	300-200
V8 - 5.0 (305 CID)	1987-82	wo/Air Cond.	300-122
V8 - 5.0 (305 CID)	1981-77	w/Air Cond., 2 Groove	300-121
V8 - 5.7 (350 CID)	1992-88	-	300-200
V8 - 5.7 (350 CID)	1987	wo/Air Cond.	300-122
V8 - 5.7 (350 CID)	1981-77	w/Air Cond., 2 Groove	300-121
CAPRICE			
V6 - 3.8 (229 CID)	1984-82	w/Air Cond., 2 Groove	300-121
V6 - 3.8 (229 CID)	1984-82	wo/Air Cond.	300-122
V6 - 4.3 (262 CID)	1993-89	-	300-200
V6 - 4.3 (262 CID)	1988-85	wo/Air Cond.	300-122
V8 - 4.4 (267 CID)	1982	wo/Air Cond.	300-122
V8 - 5.0 (305 CID)	1993-89	-	300-200
V8 - 5.0 (305 CID)	1988-83	wo/Air Cond.	300-122
V8 - 5.0 (305 CID)	1978	w/Air Cond., 2 Groove	300-121
V8 - 5.7 (350 CID)	1993-89	-	300-200
V8 - 5.7 (350 CID)	1988-82	wo/Air Cond.	300-122
V8 - 5.7 (350 CID)	1981-76	w/Air Cond., 2 Groove	300-121
V8 - 6.6 (400 CID)	1976	w/Air Cond., 2 Groove	300-121
V8 - 7.4 (454 CID)	1976	w/Air Cond., 2 Groove	300-121
CAVALIER			
V6 - 3.1 (189 CID)	1994-91	-	300-123
CORSICA			
V6 - 3.1 (189 CID)	1996-94	-	300-201
V6 - 3.1 (189 CID)	1993-91	-	300-123
EL CAMINO			
V6 - 3.8 (229 CID)	1984-82	w/Air Cond., 2 Groove	300-121
V6 - 3.8 (229 CID)	1984-82	wo/Air Cond.	300-122
V6 - 3.8 (229 CID)	1981-80	w/Air Cond., 2 Groove	300-121
V6 - 4.3 (262 CID)	1987-85	wo/Air Cond.	300-122
V8 - 4.4 (267 CID)	1982	wo/Air Cond.	300-122
V8 - 5.0 (305 CID)	1987-82	wo/Air Cond.	300-122
V8 - 5.0 (305 CID)	1978-77	w/Air Cond., 2 Groove	300-121
V8 - 5.7 (350 CID)	1979-77	w/Air Cond., 2 Groove	300-121
IMPALA			
V6 - 3.4 (207 CID)	2005-00	-	300-201
V6 - 3.8 (229 CID)	1984-82	w/Air Cond., 2 Groove	300-121
V6 - 3.8 (229 CID)	1984-82	wo/Air Cond.	300-122
V6 - 4.3 (262 CID)	1985	wo/Air Cond.	300-122
V8 - 4.4 (267 CID)	1982	wo/Air Cond.	300-122
V8 - 5.0 (305 CID)	1985-83	wo/Air Cond.	300-122
V8 - 5.0 (305 CID)	1978	w/Air Cond., 2 Groove	300-121
V8 - 5.7 (350 CID)	1985-82	wo/Air Cond.	300-122
V8 - 5.7 (350 CID)	1981-76	w/Air Cond., 2 Groove	300-121
V8 - 6.6 (400 CID)	1976	w/Air Cond., 2 Groove	300-121
V8 - 7.4 (454 CID)	1976	w/Air Cond., 2 Groove	300-121
LUMINA			
V6 - 3.1 (189 CID)	2001-95	-	300-201
V6 - 3.1 (189 CID)	1994-91	-	300-123
V6 - 3.4 (207 CID)	1997-91	-	300-123

Power Steering Pulleys

Power Steering Pulley Applications

Make/ Model/Engine	Years	Description	Dorman #	Make/ Model/Engine	Years	Description	Dorman #
CHEVROLET (continued)				CHEVROLET/GMC TRUCK (continued)			
LUMINA APV				G SERIES VAN			
V6 - 3.4 (207 CID)	1996	-	300-201	V6 - 4.3 (262 CID)	1998-92	-	300-200
MALIBU				V6 - 4.3 (262 CID)	1991-87	w/Air Cond.	300-200
V6 - 3.1 (189 CID)	2003-97	-	300-201	V6 - 4.3 (262 CID)	1986-85	wo/Air Cond., Auto Trans	300-122
V6 - 3.8 (229 CID)	1983-82	w/Air Cond., 2 Groove	300-121	V8 - 5.0 (305 CID)	1998-92	-	300-200
V6 - 3.8 (229 CID)	1983-82	wo/Air Cond.	300-122	V8 - 5.0 (305 CID)	1991-87	w/Air Cond.	300-200
V6 - 3.8 (229 CID)	1981-80	w/Air Cond., 2 Groove	300-121	V8 - 5.0 (305 CID)	1986-85	wo/Air Cond., Auto Trans	300-122
V8 - 4.4 (267 CID)	1982	wo/Air Cond.	300-122	V8 - 5.7 (350 CID)	1996-92	-	300-200
V8 - 5.0 (305 CID)	1983-82	wo/Air Cond.	300-122	V8 - 5.7 (350 CID)	1991-89	w/Air Cond.	300-200
V8 - 5.0 (305 CID)	1978-77	w/Air Cond., 2 Groove	300-121	V8 - 5.7 (350 CID)	1988-87	w/Air Cond. (VIN-K)	300-200
V8 - 5.7 (350 CID)	1980-77	w/Air Cond., 2 Groove	300-121	V8 - 5.7 (350 CID)	1986-85	wo/Air Cond., Auto Trans	300-122
MONTE CARLO				V8 - 6.2 (379 CID)	1993-87	w/Air Cond., 2 Groove	300-121
V6 - 3.1 (189 CID)	1999-95	-	300-201	V8 - 6.2 (379 CID)	1986-85	w/Air Cond., 2 Groove	300-121
V6 - 3.4 (207 CID)	2005-00	-	300-201	V8 - 6.2 (379 CID)	1986-85	wo/Air Cond., Auto Trans	300-122
V6 - 3.4 (207 CID)	1997-95	-	300-123	V8 - 6.2 (379 CID)	1984-83	w/Air Cond., 2 Groove	300-121
V6 - 3.8 (229 CID)	1984-82	w/Air Cond., 2 Groove	300-121	V8 - 7.4 (454 CID)	1996-92	-	300-200
V6 - 3.8 (229 CID)	1984-82	wo/Air Cond.	300-122	JIMMY			
V6 - 3.8 (229 CID)	1981-80	w/Air Cond., 2 Groove	300-121	V8 - 5.0 (305 CID)	1987-85	wo/Air Cond.	300-122
V6 - 4.3 (262 CID)	1988-85	wo/Air Cond.	300-122	V8 - 5.7 (350 CID)	1991-90	-	300-200
V8 - 4.4 (267 CID)	1982	wo/Air Cond.	300-122	V8 - 5.7 (350 CID)	1989-88	w/Air Cond.	300-200
V8 - 5.0 (305 CID)	1988-82	wo/Air Cond.	300-122	V8 - 5.7 (350 CID)	1989-88	wo/Air Cond.	300-122
V8 - 5.0 (305 CID)	1978-77	w/Air Cond., 2 Groove	300-121	V8 - 5.7 (350 CID)	1987-85	wo/Air Cond.	300-122
V8 - 5.7 (350 CID)	1977	w/Air Cond., 2 Groove	300-121	V8 - 6.2 (379 CID)	1986-85	wo/Air Cond.	300-122
NOVA				KODIAK			
V8 - 5.0 (305 CID)	1979-77	w/Air Cond., 2 Groove	300-121	All	1996-81	-	300-120
V8 - 5.7 (350 CID)	1979-77	w/Air Cond., 2 Groove	300-121	P SERIES VAN			
VENTURE VAN				L6 - 4.8 (292 CID)	1989-85	wo/Air Cond.	300-122
V6 - 3.4 (207 CID)	2005-97	-	300-201	V6 - 4.3 (262 CID)	1999-96	-	300-200
CHEVROLET/GMC TRUCK				V6 - 4.3 (262 CID)	1995-91	wo/Air Cond.	300-122
ASTRO				V8 - 5.7 (350 CID)	1999-96	-	300-200
V6 - 4.3 (262 CID)	2005-90	-	300-200	V8 - 5.7 (350 CID)	1995-85	wo/Air Cond.	300-122
V6 - 4.3 (262 CID)	1989-87	w/Air Cond.	300-200	V8 - 6.2 (379 CID)	1993-82	2 Groove	300-121
AVALANCHE				V8 - 6.5 (395 CID)	1999-96	-	300-200
V8 - 5.3 (323 CID)	2006-03	-	300-200	V8 - 7.4 (454 CID)	1999-98	VIN-J	300-200
V8 - 8.1 (496 CID)	2006-03	-	300-200	V8 - 7.4 (454 CID)	1997-96	-	300-200
BLAZER				V8 - 7.4 (454 CID)	1986-79	2 Groove	300-121
V8 - 5.0 (305 CID)	1987-85	wo/Air Cond.	300-122	R,V SERIES PICKUP			
V8 - 5.7 (350 CID)	1994-90	-	300-200	V6 - 4.3 (262 CID)	1987	wo/Air Cond.	300-122
V8 - 5.7 (350 CID)	1989-88	w/Air Cond.	300-200	V8 - 5.0 (305 CID)	1987	wo/Air Cond.	300-122
V8 - 5.7 (350 CID)	1989-88	wo/Air Cond.	300-122	V8 - 5.7 (350 CID)	1991-87	wo/Air Cond.	300-122
V8 - 5.7 (350 CID)	1987-85	wo/Air Cond.	300-122	S SERIES BLAZER, JIMMY			
V8 - 6.2 (379 CID)	1986-85	wo/Air Cond.	300-122	L4 - 1.9 (119 CID)	1984-83	wo/Air Cond.	300-122
C,K SERIES PICKUP				V6 - 4.3 (262 CID)	2005-88	-	300-200
L6 - 4.8 (292 CID)	1986-85	wo/Air Cond.	300-122	S SERIES PICKUP, SONOMA			
V6 - 4.3 (262 CID)	1998-90	-	300-200	L4 - 1.9 (119 CID)	1985-82	wo/Air Cond.	300-122
V6 - 4.3 (262 CID)	1989-88	w/Air Cond.	300-200	V6 - 4.3 (262 CID)	2004-88	-	300-200
V6 - 4.3 (262 CID)	1986-85	wo/Air Cond.	300-122	S SERIES SYCLONE, TYPHOON			
V8 - 5.0 (305 CID)	1999-90	-	300-200	V6 - 4.3 (262 CID)	1993-91	-	300-200
V8 - 5.0 (305 CID)	1989-88	w/Air Cond.	300-200	SAFARI			
V8 - 5.0 (305 CID)	1986-85	wo/Air Cond.	300-122	V6 - 4.3 (262 CID)	2005-90	-	300-200
V8 - 5.0 (305 CID)	1983-82	w/Air Cond., 2 Groove	300-121	V6 - 4.3 (262 CID)	1989-87	w/Air Cond.	300-200
V8 - 5.7 (350 CID)	2000-90	-	300-200	SAVANA			
V8 - 5.7 (350 CID)	1989-88	w/Air Cond.	300-200	V6 - 4.3 (262 CID)	2006-96	-	300-200
V8 - 5.7 (350 CID)	1986-85	wo/Air Cond.	300-122	V8 - 4.8 (294 CID)	2006-03	-	300-200
V8 - 5.7 (350 CID)	1983-79	w/Air Cond., 2 Groove	300-121	V8 - 5.0 (305 CID)	2002-96	-	300-200
V8 - 6.2 (379 CID)	1986-85	wo/Air Cond.	300-122	V8 - 5.3 (323 CID)	2006-03	-	300-200
V8 - 6.2 (379 CID)	1983-82	w/Air Cond., 2 Groove	300-121	V8 - 5.7 (350 CID)	2002-96	-	300-200
V8 - 6.5 (395 CID)	2002-96	-	300-200	V8 - 6.0 (364 CID)	2006-03	-	300-200
V8 - 6.6 (400 CID)	1980-79	w/Air Cond., 2 Groove	300-121	V8 - 6.5 (395 CID)	2002-96	-	300-200
V8 - 7.4 (454 CID)	2000-94	-	300-200	V8 - 7.4 (454 CID)	2000-96	-	300-200
V8 - 7.4 (454 CID)	1986	wo/Air Cond.	300-122	V8 - 8.1 (496 CID)	2002-01	-	300-200
V8 - 7.4 (454 CID)	1985	w/Manual Control Air Cond., 2 Groove	300-121	SCHOOL BUS			
V8 - 7.4 (454 CID)	1985	wo/Air Cond.	300-122	All	2000-83	-	300-120
V8 - 7.4 (454 CID)	1984-79	w/Air Cond., 2 Groove	300-121	SIERRA			
V8 - 8.1 (496 CID)	2002-01	-	300-200	V6 - 4.3 (262 CID)	2006-99	-	300-200
DENALI				V8 - 4.8 (294 CID)	2006-99	-	300-200
V8 - 6.0 (364 CID)	2006-01	-	300-200	V8 - 5.3 (323 CID)	2006-99	-	300-200
EXPRESS				V8 - 6.0 (364 CID)	2006-99	-	300-200
V6 - 4.3 (262 CID)	2006-96	-	300-200	V8 - 6.6 (400 CID)	2002-01	-	300-200
V8 - 4.8 (294 CID)	2006-03	-	300-200	V8 - 8.1 (496 CID)	2006-01	-	300-200
V8 - 5.0 (305 CID)	2002-96	-	300-200	SILVERADO			
V8 - 5.3 (323 CID)	2006-03	-	300-200	V6 - 4.3 (262 CID)	2006-99	-	300-200
V8 - 5.7 (350 CID)	2002-96	-	300-200	V8 - 4.8 (294 CID)	2006-99	-	300-200
V8 - 6.0 (364 CID)	2006-03	-	300-200	V8 - 5.3 (323 CID)	2006-99	-	300-200
V8 - 6.5 (395 CID)	2002-96	-	300-200	V8 - 6.0 (364 CID)	2006-99	-	300-200
V8 - 7.4 (454 CID)	2000-96	-	300-200	V8 - 6.6 (400 CID)	2002-01	-	300-200
V8 - 8.1 (496 CID)	2002-01	-	300-200	V8 - 8.1 (496 CID)	2006-01	-	300-200
FORWARD CONTROL				STEEL CONVENTIONAL			
All	1996-81	-	300-120	All	2000-83	-	300-120

Power Steering Pulleys

Power Steering Pulley Applications

Make/ Model/Engine	Years	Description	Dorman #
CHEVROLET/GMC TRUCK (continued)			
SUBURBAN			
L6 - 4.8 (292 CID)	1986-85	wo/Air Cond.	300-122
V8 - 5.0 (305 CID)	1987-85	wo/Air Cond.	300-122
V8 - 5.0 (305 CID)	1983-82	w/Air Cond., 2 Groove	300-121
V8 - 5.3 (323 CID)	2006-00	-	300-200
V8 - 5.7 (350 CID)	1999-91	-	300-200
V8 - 5.7 (350 CID)	1990-88	w/Air Cond.	300-200
V8 - 5.7 (350 CID)	1990-88	wo/Air Cond.	300-122
V8 - 5.7 (350 CID)	1987-85	wo/Air Cond.	300-122
V8 - 5.7 (350 CID)	1983-82	w/Air Cond., 2 Groove	300-121
V8 - 6.0 (364 CID)	2006-00	-	300-200
V8 - 6.2 (379 CID)	1986-85	wo/Air Cond.	300-122
V8 - 6.2 (379 CID)	1983-82	w/Air Cond., 2 Groove	300-121
V8 - 6.5 (395 CID)	1999-96	-	300-200
V8 - 7.4 (454 CID)	1999-94	-	300-200
V8 - 7.4 (454 CID)	1986	wo/Air Cond.	300-122
V8 - 7.4 (454 CID)	1985	w/Manual Control Air Cond., 2 Groove	300-121
V8 - 7.4 (454 CID)	1985	wo/Air Cond.	300-122
V8 - 7.4 (454 CID)	1983-79	w/Air Cond., 2 Groove	300-121
V8 - 8.1 (496 CID)	2006-01	-	300-200
TAHOE			
V8 - 4.8 (294 CID)	2006-00	-	300-200
V8 - 5.3 (323 CID)	2006-00	-	300-200
V8 - 5.7 (350 CID)	2000-95	-	300-200
V8 - 6.5 (395 CID)	1999-96	-	300-200
TOPKICK			
All	1996-81	-	300-120
YUKON			
V8 - 4.8 (294 CID)	2006-00	-	300-200
V8 - 5.3 (323 CID)	2006-00	-	300-200
V8 - 5.7 (350 CID)	2000-92	-	300-200
V8 - 6.0 (364 CID)	2006-00	-	300-200
V8 - 6.5 (395 CID)	1999-96	-	300-200
V8 - 8.1 (496 CID)	2006-01	-	300-200
CHRYSLER			
300M			
V6 - 3.5 (215 CID)	2004-99	-	300-308
CIRRUS			
L4 - 2.0 (122 CID)	2000	-	300-311
L4 - 2.4 (148 CID)	2000-95	-	300-311
V6 - 2.5 (152 CID)	2000-95	-	300-311
CONCORDE			
V6 - 2.7 (167 CID)	2004-98	-	300-308
V6 - 3.2 (197 CID)	2001-98	-	300-308
V6 - 3.3 (201 CID)	1996-95	-	300-304
V6 - 3.3 (201 CID)	1994-93	-	300-303
V6 - 3.5 (215 CID)	2004-02	-	300-308
V6 - 3.5 (215 CID)	1997-95	-	300-304
V6 - 3.5 (215 CID)	1994-93	-	300-303
LEBARON			
V6 - 3.0 (181 CID)	1995-91	-	300-100
LHS			
V6 - 3.5 (215 CID)	2001-99	-	300-308
V6 - 3.5 (215 CID)	1997-95	-	300-304
V6 - 3.5 (215 CID)	1994	-	300-303
NEW YORKER			
V6 - 3.5 (215 CID)	1996-95	-	300-304
V6 - 3.5 (215 CID)	1994	-	300-303
SEBRING			
L4 - 2.4 (148 CID)	1998-96	Convertible	300-311
V6 - 2.5 (152 CID)	2000-96	Convertible	300-311
TC MASERATI			
V6 - 3.0 (181 CID)	1991	-	300-100
TOWN & COUNTRY VAN			
V6 - 3.3 (201 CID)	2000-90	-	300-101
V6 - 3.8 (230 CID)	2000-94	-	300-101
VOYAGER, GRAND VOYAGER			
V6 - 3.0 (181 CID)	2000	-	300-305
V6 - 3.3 (201 CID)	2000	-	300-101
DODGE			
CARAVAN, GRAND CARAVAN			
V6 - 3.0 (181 CID)	2000-96	-	300-305
V6 - 3.0 (181 CID)	1995-91	-	300-100
V6 - 3.3 (201 CID)	2000-90	-	300-101
V6 - 3.8 (230 CID)	2000-94	-	300-101
DAYTONA			
V6 - 3.0 (181 CID)	1993-91	-	300-100
DYNASTY			
V6 - 3.0 (181 CID)	1993-91	-	300-100

Make/ Model/Engine	Years	Description	Dorman #
DODGE (continued)			
INTREPID			
V6 - 2.7 (167 CID)	2004-98	-	300-308
V6 - 3.2 (197 CID)	2001-98	-	300-308
V6 - 3.3 (201 CID)	1997-95	-	300-304
V6 - 3.3 (201 CID)	1994-93	-	300-303
V6 - 3.5 (215 CID)	2004-00	-	300-308
V6 - 3.5 (215 CID)	1997-95	-	300-304
V6 - 3.5 (215 CID)	1994-93	-	300-303
MONACO			
V6 - 3.0 (181 CID)	1992-91	-	300-100
NEON			
L4 - 2.0 (122 CID)	2003-00	-	300-309
L4 - 2.0 (122 CID)	1999-95	-	300-102
SHADOW			
V6 - 3.0 (181 CID)	1994-92	-	300-100
SPIRIT			
V6 - 3.0 (181 CID)	1995-91	-	300-100
STRATUS			
L4 - 2.0 (122 CID)	2000-95	-	300-311
L4 - 2.4 (148 CID)	2000-95	-	300-311
V6 - 2.5 (152 CID)	2000-95	-	300-311
VIPER			
V10 - 8.0 (488 CID)	2002-97	-	300-306
DODGE TRUCK			
B100/150/1500 VAN (1/2 TON)			
V6 - 3.9 (239 CID)	1998	-	300-307
V6 - 3.9 (239 CID)	1997-94	-	300-307
V8 - 5.2 (318 CID)	1998	-	300-307
V8 - 5.2 (318 CID)	1997-94	-	300-307
V8 - 5.9 (360 CID)	1998	-	300-307
B200/250/2500 VAN (3/4 TON)			
V6 - 3.9 (239 CID)	1998-94	-	300-307
V8 - 5.2 (318 CID)	1998-94	-	300-307
V8 - 5.9 (360 CID)	1998-94	-	300-307
B300/350/3500 VAN (1 TON)			
V6 - 3.9 (239 CID)	1994	-	300-307
V8 - 5.2 (318 CID)	1998-95	-	300-307
V8 - 5.2 (318 CID)	1994	-	300-307
V8 - 5.9 (360 CID)	1998-95	-	300-307
V8 - 5.9 (360 CID)	1994	-	300-307
DAKOTA			
L4 - 2.5 (153 CID)	2002-99	-	300-310
L4 - 2.5 (153 CID)	1998-97	-	300-302
V6 - 3.9 (239 CID)	2003-00	-	300-307
V6 - 3.9 (239 CID)	1999-98	-	300-307
V6 - 3.9 (239 CID)	1997	-	300-307
V8 - 4.7 (287 CID)	2003-00	-	300-307
V8 - 5.2 (318 CID)	1999-98	-	300-307
V8 - 5.2 (318 CID)	1997	-	300-307
V8 - 5.9 (360 CID)	2003-00	-	300-307
V8 - 5.9 (360 CID)	1999-98	-	300-307
DURANGO			
V6 - 3.9 (239 CID)	1999-98	-	300-307
V8 - 5.2 (318 CID)	1999-98	-	300-307
V8 - 5.9 (360 CID)	2003-00	-	300-307
V8 - 5.9 (360 CID)	1999-98	-	300-307
RAM 1500 PICKUP (1/2 TON)			
V6 - 3.9 (239 CID)	2001-94	-	300-307
V8 - 5.2 (318 CID)	2001-94	-	300-307
V8 - 5.9 (360 CID)	2002-94	-	300-307
RAM 1500 VAN (1/2 TON)			
V6 - 3.9 (239 CID)	2003-99	-	300-307
V8 - 5.2 (318 CID)	2003-99	-	300-307
V8 - 5.9 (360 CID)	2003-99	-	300-307
RAM 2500 PICKUP (3/4 TON)			
L6 - 5.9 (359 CID)	2002-94	-	300-307
V10 - 8.0 (488 CID)	2002-94	-	300-307
V8 - 5.2 (318 CID)	1998-94	-	300-307
V8 - 5.9 (360 CID)	2002-94	-	300-307
RAM 2500 VAN (3/4 TON)			
V8 - 5.2 (318 CID)	2003-99	-	300-307
V8 - 5.9 (360 CID)	2003-99	-	300-307
RAM 3500 PICKUP (1 TON)			
L6 - 5.9 (359 CID)	2002-94	-	300-307
V10 - 8.0 (488 CID)	2002-94	-	300-307
V8 - 5.9 (360 CID)	2002-94	-	300-307
RAM 3500 VAN (1 TON)			
V8 - 5.2 (318 CID)	2003-99	-	300-307
V8 - 5.9 (360 CID)	2003-99	-	300-307

Power Steering Pulley Applications

Make/ Model/Engine	Years	Description	Dorman #
EAGLE			
PREMIER			
L4 - 2.5 (150 CID)	1989-88	-	300-301
VISION			
V6 - 3.3 (201 CID)	1997-95	-	300-304
V6 - 3.3 (201 CID)	1994-93	-	300-303
V6 - 3.5 (215 CID)	1997-95	-	300-304
V6 - 3.5 (215 CID)	1994-93	-	300-303
FORD			
CROWN VICTORIA			
V8 - 4.6 (281 CID)	2006-93	-	300-010
ESCORT			
L4 - 2.0 (122 CID)	2002-97	SOHC	300-011
FOCUS			
L4 - 2.0 (122 CID)	2000	SOHC	300-007
MUSTANG			
V8 - 4.6 (281 CID)	2004-03	Mach 1	300-010
V8 - 4.6 (281 CID)	1997-96	-	300-010
TAURUS			
V6 - 3.0 (182 CID)	2006-96	DOHC (VIN-S)	300-008
V6 - 3.0 (182 CID)	2006-96	OHV (VIN-U)	300-003
V6 - 3.0 (182 CID)	1995-89	Exc. SHO (VIN-U)	300-003
V6 - 3.0 (182 CID)	1988-86	-	300-003
V6 - 3.8 (232 CID)	1995-90	-	300-005
THUNDERBIRD			
V8 - 4.6 (281 CID)	1997-94	-	300-010
V8 - 5.0 (302 CID)	1988-86	-	300-003
FORD TRUCK			
AEROSTAR			
L4 - 2.3 (140 CID)	1987-86	-	300-003
V6 - 3.0 (182 CID)	1997-95	-	300-004
V6 - 4.0 (245 CID)	1997-90	-	300-004
BRONCO			
V8 - 5.0 (302 CID)	1996-87	-	300-003
V8 - 5.8 (351 CID)	1996-87	-	300-003
ESUPER DUTY			
V8 - 7.3 (445 CID)	1997-96	-	300-002
E-100/150 ECONOLINE (1/2 TON)			
V6 - 4.2 (256 CID)	2003-97	-	300-010
V8 - 5.4 (330 CID)	2002-97	8-Groove	300-006
E-200/250 ECONOLINE (3/4 TON)			
V6 - 4.2 (256 CID)	2003-97	-	300-010
V8 - 5.4 (330 CID)	2001-97	8-Groove	300-006
E-300/350 ECONOLINE (1 TON)			
V10 - 6.8 (415 CID)	2006-97	8-Groove	300-006
V8 - 5.4 (330 CID)	2006-97	8-Groove	300-006
V8 - 7.3 (445 CID)	1997-95	-	300-002
EXCURSION			
V10 - 6.8 (415 CID)	2002-00	8-Groove	300-006
EXPEDITION			
V8 - 5.4 (330 CID)	2003-99	8-Groove	300-006
EXPLORER			
V6 - 4.0 (245 CID)	2005-02	-	300-009
V6 - 4.0 (245 CID)	2001-97	OHV (VIN X)	300-004
V6 - 4.0 (245 CID)	2001-97	SOHC (VIN E)	300-009
V6 - 4.0 (245 CID)	1996-91	-	300-004
V8 - 5.0 (302 CID)	2001-96	-	300-009
EXPLORER SPORT			
V6 - 4.0 (245 CID)	2003-01	-	300-009
EXPLORER SPORT TRAC			
V6 - 4.0 (245 CID)	2005-01	-	300-009
F-150/350 PICKUP			
V6 - 4.2 (256 CID)	2004-97	-	300-010
V8 - 5.0 (302 CID)	1996-87	-	300-003
V8 - 5.8 (351 CID)	1996-87	-	300-003
V8 - 7.3 (445 CID)	1997-94	-	300-002
V8 - 7.5 (460 CID)	1997-87	-	300-003
F-250 SUPER DUTY PICKUP (3/4 TON)			
V10 - 6.8 (415 CID)	2006-99	8-Groove	300-006
V8 - 5.4 (330 CID)	2006-99	8-Groove	300-006
V8 - 6.0 (363 CID)	2006-03	8-Groove	300-006
V8 - 7.3 (445 CID)	2003-99	8-Groove	300-006
F-350 SUPER DUTY PICKUP (1 TON)			
V10 - 6.8 (415 CID)	2006-99	8-Groove	300-006
V8 - 5.4 (330 CID)	2006-99	8-Groove	300-006
V8 - 6.0 (363 CID)	2006-03	8-Groove	300-006
V8 - 7.3 (445 CID)	2003-99	8-Groove	300-006
F-450 SUPER DUTY PICKUP (1 TON)			
V10 - 6.8 (415 CID)	2006-99	8-Groove	300-006
V8 - 6.0 (363 CID)	2006-99	8-Groove	300-006
V8 - 7.3 (445 CID)	2003-99	8-Groove	300-006

Make/ Model/Engine	Years	Description	Dorman #
FORD TRUCK (continued)			
F-450 SUPER DUTY PICKUP (1 TON) (continued)			
V8 - 7.3 (445 CID)	1997-94	-	300-002
V8 - 7.5 (460 CID)	1997-88	-	300-003
F-550 SUPER DUTY PICKUP (1 TON)			
V10 - 6.8 (415 CID)	2006-03	8-Groove	300-006
V8 - 6.0 (363 CID)	2006-03	8-Groove	300-006
V8 - 7.3 (445 CID)	2003	8-Groove	300-006
F53 STRIPPED CHASSIS			
V8 - 7.5 (460 CID)	1997-89	-	300-003
F59 STRIPPED CHASSIS			
V8 - 7.3 (445 CID)	1997-94	-	300-002
RANGER			
L4 - 2.3 (140 CID)	1997-95	-	300-004
L4 - 2.3 (140 CID)	1994-86	-	300-003
L4 - 2.3 (140 CID)	1985	From 1/85	300-003
L4 - 2.5 (150 CID)	2001-98	-	300-004
V6 - 3.0 (182 CID)	2005-97	-	300-003
V6 - 4.0 (245 CID)	2000-90	-	300-004
WINDSTAR			
V6 - 3.0 (182 CID)	2000-95	-	300-003
V6 - 3.8 (232 CID)	1998-95	-	300-005
HONDA			
ACCORD			
L4 - 2.3 (2254 cc)	2002-98	-	300-500
V6 - 3.0 (2997 cc)	2002-98	-	300-500
CIVIC			
L4 - 1.6 (1590 cc)	2000-96	-	300-500
CR-V			
L4 - 2.0 (1972 cc)	2001-97	-	300-500
JEEP			
CHEROKEE			
L4 - 2.5 (150 CID)	2000-99	-	300-310
L4 - 2.5 (150 CID)	1998-97	-	300-302
L4 - 2.5 (150 CID)	1996-92	-	300-301
L6 - 4.0 (242 CID)	2001-99	-	300-310
L6 - 4.0 (242 CID)	1998-97	-	300-302
L6 - 4.0 (242 CID)	1996-87	-	300-301
COMANCHE			
L4 - 2.5 (150 CID)	1992	-	300-301
L6 - 4.0 (242 CID)	1992-87	-	300-301
GRAND CHEROKEE			
L6 - 4.0 (242 CID)	2004-99	-	300-310
L6 - 4.0 (242 CID)	1998-97	-	300-302
V8 - 4.7 (287 CID)	2004-99	-	300-310
V8 - 5.2 (318 CID)	1998-93	-	300-306
V8 - 5.9 (360 CID)	1998	-	300-306
LIBERTY			
V6 - 3.7 (226 CID)	2005-02	-	300-302
WAGONEER			
L6 - 4.0 (242 CID)	1990-87	-	300-301
WRANGLER			
L4 - 2.5 (150 CID)	2002-99	-	300-310
L4 - 2.5 (150 CID)	1998-97	-	300-302
L4 - 2.5 (150 CID)	1995-92	-	300-301
L6 - 4.0 (242 CID)	2004-99	-	300-310
L6 - 4.0 (242 CID)	1998-97	-	300-302
L6 - 4.0 (242 CID)	1995-91	-	300-301
LINCOLN			
CONTINENTAL			
L6 - 2.4 (146 CID)	1985-84	-	300-003
V8 - 4.6 (281 CID)	2002-95	-	300-010
V8 - 5.0 (302 CID)	1987-85	-	300-003
MARK VII			
L6 - 2.4 (146 CID)	1985-84	-	300-003
V8 - 5.0 (302 CID)	1992-85	-	300-003
MARK VIII			
V8 - 4.6 (281 CID)	1998-93	-	300-010
NAVIGATOR			
V8 - 5.4 (330 CID)	2003-99	8-Groove	300-006
TOWN CAR			
V8 - 4.6 (281 CID)	2006-93	-	300-010
V8 - 5.0 (302 CID)	1990-85	-	300-003
MAZDA			
626			
V6 - 2.5 (2497 cc)	2002-93	Idler Pulley, Alternator	300-601
V6 - 2.5 (2497 cc)	2002-93	Idler Pulley, Power Steering	300-600
MILLENNIA			
V6 - 2.5 (2497 cc)	2002-95	Idler Pulley, Alternator	300-601
V6 - 2.5 (2497 cc)	2002-95	Idler Pulley, Power Steering	300-600

Power Steering Pulleys

Window
Lift Motors
pg. 535-554

Window
Regulators
pg. 555-566

Wiper
Motors
pg. 567-572

Wiper Transmission
Linkages
pg. 573-576

Replace the Power Steering Pulley
when you replace your Pump

Power Steering Pulleys

Power Steering Pulley Applications

Make/ Model/Engine	Years	Description	Dorman #
MAZDA (continued)			
MX-6			
V6 - 2.5 (2497 cc)	1997-93	Idler Pulley, Alternator	300-601
V6 - 2.5 (2497 cc)	1997-93	Idler Pulley, Power Steering	300-600
MERCURY			
COUGAR			
V8 - 4.6 (281 CID)	1997-94	-	300-010
V8 - 5.0 (302 CID)	1988-86	-	300-003
GRAND MARQUIS			
V8 - 4.6 (281 CID)	2006-93	-	300-010
MARAUDER			
V8 - 4.6 (281 CID)	2004-03	-	300-010
MOUNTAINEER			
V6 - 4.0 (245 CID)	2005-98	-	300-009
V8 - 5.0 (302 CID)	2001-97	-	300-009
SABLE			
V6 - 3.0 (182 CID)	2006-96	DOHC (VIN-S)	300-008
V6 - 3.0 (182 CID)	2006-96	OHV (VIN-U)	300-003
V6 - 3.0 (182 CID)	1995-86	-	300-003
V6 - 3.8 (232 CID)	1995-90	-	300-005
TRACER			
L4 - 2.0 (122 CID)	1999-97	SOHC	300-011
OLDSMOBILE			
ACHIEVA			
V6 - 3.1 (189 CID)	1998-94	-	300-201
ALERO			
V6 - 3.4 (207 CID)	2004-99	-	300-201
AURORA			
V8 - 4.0 (244 CID)	2003-95	-	300-124
BRAVADA			
V6 - 4.3 (262 CID)	2001-91	-	300-200
CUSTOM CRUISER			
V8 - 5.0 (305 CID)	1992-91	-	300-200
V8 - 5.7 (350 CID)	1992	-	300-200
CUTLASS			
V6 - 3.1 (189 CID)	1999-97	-	300-201
V8 - 5.0 (305 CID)	1978	w/Heavy Duty Cooling, 2 Groove	300-121
CUTLASS CALAIS			
V8 - 5.0 (305 CID)	1978	w/Heavy Duty Cooling, 2 Groove	300-121
CUTLASS CIERA			
V6 - 3.1 (189 CID)	1996-94	-	300-201
CUTLASS CRUISER			
V8 - 5.0 (305 CID)	1982	wo/Air Cond.	300-122
V8 - 5.0 (305 CID)	1978	w/Heavy Duty Cooling, 2 Groove	300-121
V8 - 5.7 (350 CID)	1979-78	w/Heavy Duty Cooling, 2 Groove	300-121
CUTLASS SUPREME			
V6 - 3.1 (189 CID)	1997-94	-	300-201
V6 - 3.1 (189 CID)	1993	VIN-M	300-201
V6 - 3.1 (189 CID)	1993	VIN-T	300-123
V6 - 3.1 (189 CID)	1992-91	-	300-123
V6 - 3.4 (207 CID)	1996-91	-	300-123
V8 - 5.0 (305 CID)	1978	w/Heavy Duty Cooling, 2 Groove	300-121
V8 - 5.7 (350 CID)	1978	w/Heavy Duty Cooling, 2 Groove	300-121
OMEGA			
V8 - 5.0 (305 CID)	1979-77	w/Air Cond., 2 Groove	300-121
V8 - 5.7 (350 CID)	1979-77	w/Air Cond., 2 Groove	300-121
SILHOUETTE			
V6 - 3.4 (207 CID)	2004-96	-	300-201
PLYMOUTH			
ACCLAIM			
V6 - 3.0 (181 CID)	1995-91	-	300-100
BREEZE			
L4 - 2.0 (122 CID)	2000-96	-	300-311
L4 - 2.4 (148 CID)	2000-98	-	300-311
NEON			
L4 - 2.0 (122 CID)	2001-00	-	300-309
L4 - 2.0 (122 CID)	1999-95	-	300-102
PROWLER			
V6 - 3.5 (215 CID)	2002-99	-	300-308

Make/ Model/Engine	Years	Description	Dorman #
PLYMOUTH (continued)			
SUNDANCE			
V6 - 3.0 (181 CID)	1994-92	-	300-100
VOYAGER, GRAND VOYAGER			
V6 - 3.0 (181 CID)	2000-96	-	300-305
V6 - 3.0 (181 CID)	1995-91	-	300-100
V6 - 3.3 (201 CID)	2000-90	-	300-101
V6 - 3.8 (230 CID)	1999-94	-	300-101
PONTIAC			
6000			
V6 - 3.1 (189 CID)	1991	-	300-123
AZTEK			
V6 - 3.4 (207 CID)	2005-01	-	300-201
BONNEVILLE			
V6 - 3.8 (231 CID)	1983	4-Door Sedan, w/Air Cond., 2 Groove	300-121
V6 - 4.3 (262 CID)	1986	wo/Air Cond.	300-122
V8 - 4.6 (281 CID)	2005-04	-	300-124
V8 - 5.0 (305 CID)	1986-83	wo/Air Cond.	300-122
FIREBIRD			
V8 - 5.0 (305 CID)	1992-88	-	300-200
V8 - 5.0 (305 CID)	1987-82	wo/Air Cond.	300-122
V8 - 5.0 (305 CID)	1981-77	w/Air Cond., 2 Groove	300-121
V8 - 5.7 (350 CID)	1992-88	-	300-200
V8 - 5.7 (350 CID)	1987	wo/Air Cond.	300-122
V8 - 5.7 (350 CID)	1979-78	w/Air Cond., 2 Groove	300-121
GRAND AM			
V6 - 3.1 (189 CID)	1998-94	-	300-201
V6 - 3.4 (207 CID)	2005-99	-	300-201
V8 - 5.0 (305 CID)	1978	w/Air Cond., 2 Groove	300-121
GRAND LEMANS			
V6 - 3.8 (229 CID)	1980	w/Air Cond., 2 Groove	300-121
V8 - 5.0 (305 CID)	1978-77	w/Air Cond., 2 Groove	300-121
V8 - 5.7 (350 CID)	1979-78	w/Air Cond., 2 Groove	300-121
GRAND PRIX			
V6 - 3.1 (189 CID)	2003-94	-	300-201
V6 - 3.1 (189 CID)	1993-91	-	300-123
V6 - 3.4 (207 CID)	1996-91	-	300-123
V6 - 4.3 (262 CID)	1987-86	wo/Air Cond.	300-122
V8 - 5.0 (305 CID)	1987-83	wo/Air Cond.	300-122
V8 - 5.0 (305 CID)	1980-79	w/Axial Compressor, Stamped AC, 2 Groove	300-121
LEMANS			
V6 - 3.8 (229 CID)	1980	w/Air Cond., 2 Groove	300-121
V8 - 5.0 (305 CID)	1978-77	w/Air Cond., 2 Groove	300-121
V8 - 5.7 (350 CID)	1979-78	w/Air Cond., 2 Groove	300-121
MONTANA			
V6 - 3.4 (207 CID)	2005-99	-	300-201
PARISIENNE			
V6 - 3.8 (229 CID)	1983	wo/Air Cond.	300-122
V6 - 4.3 (262 CID)	1986-85	wo/Air Cond.	300-122
V8 - 5.0 (305 CID)	1986-83	wo/Air Cond.	300-122
PHOENIX			
V8 - 5.0 (305 CID)	1979-77	w/Air Cond., 2 Groove	300-121
V8 - 5.7 (350 CID)	1979-77	w/Air Cond., 2 Groove	300-121
SUNBIRD			
V6 - 3.1 (189 CID)	1994-91	-	300-123
TRANS SPORT			
V6 - 3.4 (207 CID)	1998-96	-	300-201
VENTURA			
V8 - 5.0 (305 CID)	1977	w/Air Cond., 2 Groove	300-121
V8 - 5.7 (350 CID)	1977	w/Air Cond., 2 Groove	300-121
TOYOTA TRUCK			
4-RUNNER			
V6 - 3.0 (2959 cc)	1995-88	-	300-400
PICKUP			
V6 - 3.0 (2959 cc)	1995-88	-	300-400
T100			
V6 - 3.0 (2959 cc)	1994-93	-	300-400

Quick Disconnect™

The only Aftermarket Source for a Full Line of Quick Connectors...

Fuel Sending Unit & Fuel Line Repair Kits

- Repairs rusted, twisted, or broken nylon & steel fuel lines
- Repairs rusted, broken sending unit lines...No need to replace entire unit!



Transmission and Oil Cooler Connectors

- Connect transmission lines to transmission & radiator
- OE exact-fit replacements



Cooling System Quick Connectors

- Heater hose quick connectors & retaining clips
- Direct OE Replacement



Activant Line Codes

DMC - Cooling/Heating Connectors
DFQ - Fuel Line Connectors
DMT - Transmission Connectors

Applications begin on page 343.

800-500 Steel Fuel Line Repair Kit

**OVER
150
PIECES**



- **Easily Repair Any Fuel Problem**
- **Save Time & Money! Replace Only the Damaged Section**

Like Having 1,000 Fuel Lines in Your Toolbox!

800-300 Nylon Fuel Line Repair Kit

Quick Disconnect



- Easily Attach Quick Connector Fittings
- Splice Plastic Lines



Repair a Broken Plastic End

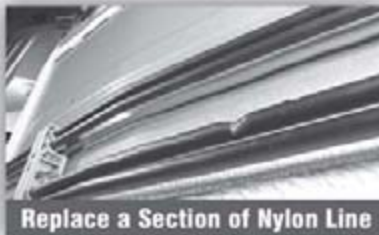

Replace a Section of Nylon Line

















Replace the Entire Plastic Fuel Line Assembly



- Easily Repair Any Fuel Problem
- Save Time & Money!
Replace Only the Damaged Section

Like Having 1,000 Fuel Lines in Your Toolbox!

Fuel Line Connectors, Retainers & Repair Kits

 <p>800-001 (5)</p>	 <p>800-002 (5)</p>	 <p>800-014 (6)</p> <p style="text-align: right;">ASSORTMENT VALUE</p>
<p>Fuel Line Retaining Clips Fits Ford 1/4" lines Ford Duckbill type retainer</p>	<p>Fuel Line Retaining Clips Fits Ford 1/2" lines Ford Duckbill type retainer</p>	<p>Fuel Line Retaining Clip Assortment Fits Ford with 1/4" and 1/2" lines Assortment includes 3 of each size</p>
 <p>800-003 (5)</p>	 <p>800-004 (5)</p>	 <p>800-015 (6)</p> <p style="text-align: right;">ASSORTMENT VALUE</p>
<p>Fuel Line Retaining Clips Fits Ford 5/16" lines</p>	<p>Fuel Line Retaining Clips Fits Ford 3/8" lines</p>	<p>Fuel Line Retaining Clip Assortment Fits Ford with 5/16" and 3/8" lines Assortment includes 3 of each size</p>
 <p>800-005 (5)</p>	 <p>800-006 (5)</p>	 <p>800-016 (6)</p> <p style="text-align: right;">ASSORTMENT VALUE</p>
<p>Fuel Line Retaining Clips GM/Chrysler 5/16 fuel line retainers</p>	<p>Fuel Line Retaining Clips GM/Chrysler 3/8" fuel line retainers</p>	<p>Fuel Line Retaining Clip Assortment Fits GM and Chrysler with 5/16" and 3/8" lines Assortment includes 3 of each size</p>
 <p>800-007 (3)</p>	 <p>800-008 (3)</p>	 <p>800-017 (6)</p> <p style="text-align: right;">ASSORTMENT VALUE</p>
<p>Metal Fuel Line Retaining Clips Fits Ford 10.5mm lines</p>	<p>Metal Fuel Line Retaining Clips Fits Ford 13mm lines</p>	<p>Metal Fuel Line Retaining Clip Assortment Fits Ford with 10.5mm and 13mm lines Assortment includes 3 of each size</p>
 <p>800-023 (1)</p> <p style="text-align: right;">ASSORTMENT VALUE</p>	 <p>800-025 (1)</p> <p style="text-align: right;">ASSORTMENT VALUE</p>	 <p>800-026 (1)</p> <p style="text-align: right;">ASSORTMENT VALUE</p>
<p>Fuel Line Clips - Ford 5/16" and 3/8"</p>	<p>Metal Retainer Clips 5/16" and 3/8"</p>	<p>Nylon Retaining Clips GM/Chrysler 5/16" & 3/8"</p>













Fuel Line Connectors, Retainers & Repair Kits

 <p>800-009 (1)</p>	 <p>800-010 (1)</p>	 <p>800-018 (2)</p> <p>ASSORTMENT VALUE</p>
<p>Fuel Line Disconnect Tool For use with 1/4" to 3/8" lines Tool for removing quick connect connectors on fuel & transmission lines. For use with 1/4" to 3/8" lines Works for 1/4", 5/16", and 3/8" lines.</p>	<p>Fuel Line Disconnect Tool For use with 1/2" lines.</p>	<p>Fuel Line Disconnect Tool Includes 2 tools for use with 1/4" to 1/2" lines. Tool for removing quick connect connectors on fuel & transmission lines. Works for 1/4", 5/16", 3/8" and 1/2" lines.</p>

Quick Disconnect

Fuel Fittings Repair Kits

- Fitting with 18" nylon line and union

 <p>800-050 (1)</p>	 <p>800-051 (1)</p>	 <p>800-052 (1)</p>
<p>Nylon Fuel Line Repair Ford 5/16" straight</p>	<p>Nylon Fuel Line Repair Ford 5/16" elbow</p>	<p>Nylon Fuel Line Repair Ford 3/8" straight</p>
 <p>800-053 (1)</p>	 <p>800-054 (1)</p>	 <p>800-055 (1)</p>
<p>Nylon Fuel Line Repair Ford 1/4" Female x 5/16" tube</p>	<p>Nylon Fuel Line Repair Ford 5/16" Female x 3/8" tube</p>	<p>Nylon Fuel Line Repair Ford 3/8" Female x 5/16" tube</p>
 <p>800-056 (1)</p>	 <p>800-057 (1)</p>	 <p>800-058 (1)</p>
<p>Nylon Fuel Line Repair Ford 3/8" elbow</p>	<p>Nylon Fuel Line Repair Chrysler/GM 5/16" straight</p>	<p>Nylon Fuel Line Repair Chrysler/GM 3/8" straight</p>
 <p>800-059 (1)</p>	 <p>800-060 (1)</p>	 <p>800-163 (1)</p>
<p>Nylon Fuel Line Repair Chrysler/GM 3/8" elbow with 18" tube</p>	<p>Nylon Fuel Line Repair Chrysler/GM 5/16" elbow</p>	<p>Nylon Fuel Line Repair GM 3/8" elbow x 5/16" tube</p>

Power Steering Pulleys
pg. 317-326

Quick Disconnect™
pg. 327-396

Radiator Fan Assemblies
pg. 397-430

Rear Axle Shaft Kits
pg. 431-434

Side View Mirror Assemblies
pg. 435-468

Use Quick Disconnect Fittings & Clips for Fast, Economical Repairs

Quick Disconnect
331

Fuel Fittings Repair Kits

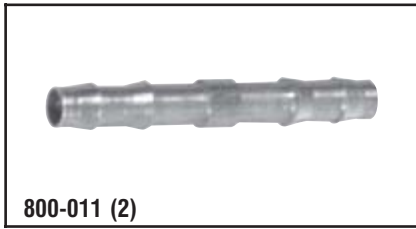

800-011 (2)

Nylon Fuel Line Repair
3/8" Union
For repairing 3/8" nylon fuel line

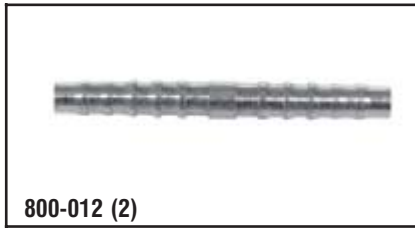

800-012 (2)

Fuel Line Union
5/16" Union
Carbon steel union for repair of hard plastic electronic fuel injection lines. Includes two stainless steel clamps.

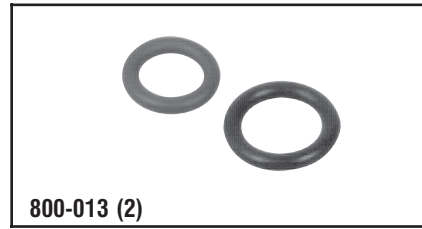

800-013 (2)

Viton® O-Rings for Steel Lines
5/16" (2) & 3/8" (2)
For fuel line flares on Ford, GM, & Chrysler fuel injected vehicles. Includes 2 each for 5/16" & 3/8" lines.

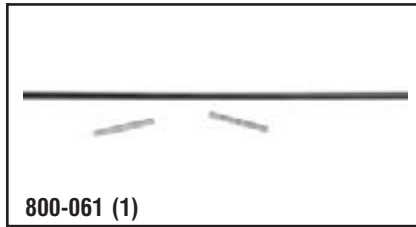

800-061 (1)

Nylon Fuel Line Repair Kit
Universal 5/16" nylon tube, 18" nylon with unions

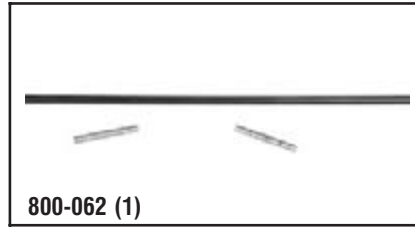

800-062 (1)

Nylon Fuel Line Repair Kit
Universal 3/8" nylon tube, 18" nylon with unions



Nylon Fuel Line Tubing

	5/16"	3/8"
10'	800-074	800-075
25'	800-071	800-072
100'	800-073	800-076

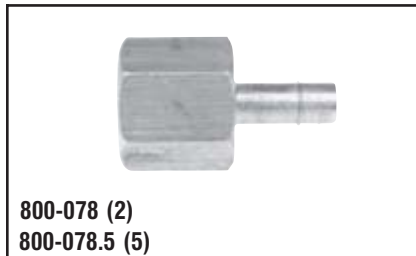

800-078 (2)
800-078.5 (5)

Fuel Line Connectors
Metric Fuel Fitting adapts from 3/8"(10mm) nylon to M16 female thread

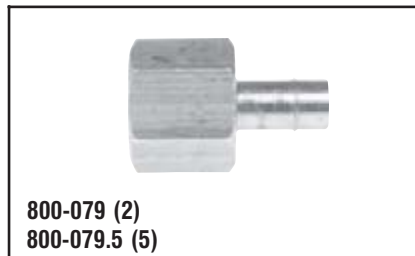

800-079 (2)
800-079.5 (5)

Fuel Line Connectors
Metric Fuel Fitting adapts from 5/16" (8mm) nylon to M14 female thread



800-080 (2)
800-080.5 (5)

Fuel Line Connectors
5/16" Steel to 5/16"(8mm) nylon straight adapter



800-081 (2)
800-081.5 (5)

Fuel Line Connectors
5/16" Steel to 5/16"(8mm) nylon elbow adapter



800-082 (2)
800-082.5 (5)

Fuel Line Connectors
3/8" Steel to 3/8"(10mm) nylon straight adapter

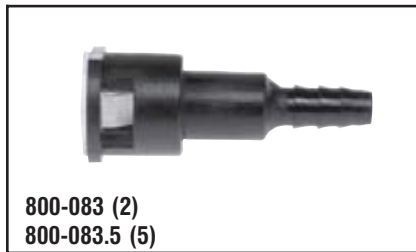

800-083 (2)
800-083.5 (5)

Fuel Line Connectors
1/4" Steel to 5/16" (8mm) nylon straight adapter



800-084 (2)
800-084.5 (5)

Fuel Line Connectors
5/16" Steel to 3/8"(10mm) nylon straight adapter



800-085 (2)
800-085.5 (5)

Fuel Line Connectors
3/8" Steel to 5/16"(8mm) nylon straight adapter

Fuel Line Connectors, Retainers & Repair Kits

Quick Disconnect



800-086 (2)
800-086.5 (5)
Fuel Line Connectors
3/8" Steel to 3/8" (10mm) nylon elbow adapter

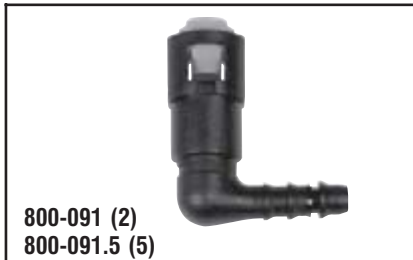

800-091 (2)
800-091.5 (5)
Fuel Line Connectors
3/8" Steel to 5/16" (8mm) nylon elbow adapter



800-092 (2)
800-092.5 (5)
Fuel Line Connectors
5/16" Steel to 3/8" (10mm) nylon elbow adapter

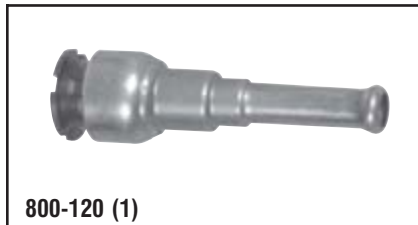

800-120 (1)
Steel Fuel Line Repair
5/16" Body Connector for 5/16" hose and line

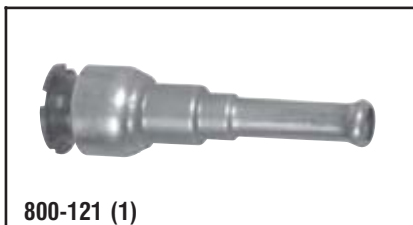

800-121 (1)
Steel Fuel Line Repair
3/8" Body Connector for 3/8" hose and line

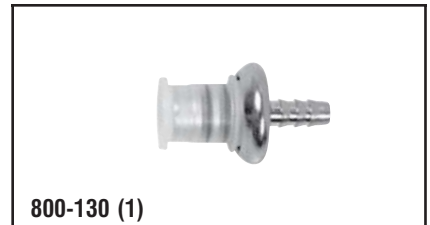

800-130 (1)
Springlock Fuel Line Connector
Ford 11mm

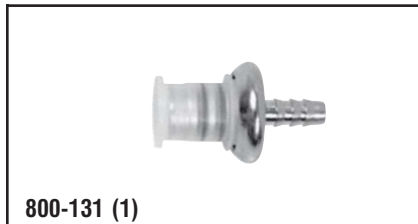

800-131 (1)
Fuel Line Connector
Ford 14.17mm

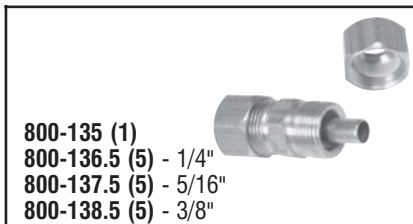

800-135 (1)
800-136.5 (5) - 1/4"
800-137.5 (5) - 5/16"
800-138.5 (5) - 3/8"
Fuel Line Connector Assortment
Nylon to Steel 1/4", 5/16" & 3/8"

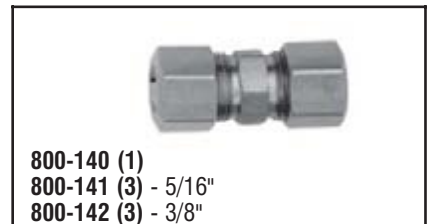

800-140 (1)
800-141 (3) - 5/16"
800-142 (3) - 3/8"
Fuel Line Connector Assortment
Steel to Steel 1/4", 5/16" & 3/8"

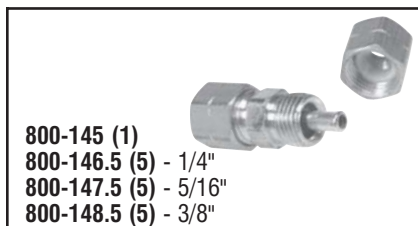

800-145 (1)
800-146.5 (5) - 1/4"
800-147.5 (5) - 5/16"
800-148.5 (5) - 3/8"
Fuel Line Connector Assortment
Nylon to Nylon 1/4", 5/16" & 3/8"

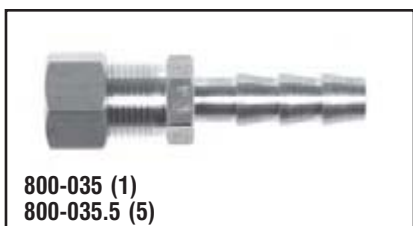

800-035 (1)
800-035.5 (5)
3/8" Steel Compression to 3/8" Nylon Tube

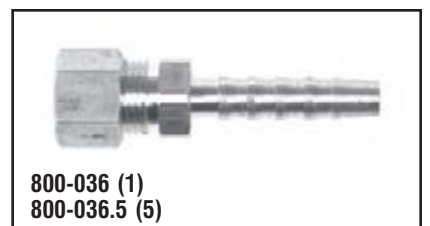

800-036 (1)
800-036.5 (5)
5/16" Steel Compression to 5/16" Nylon Tube

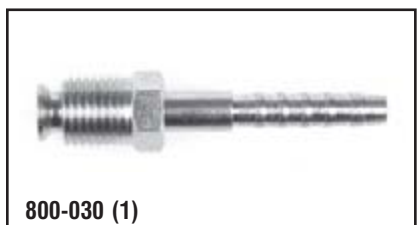

800-030 (1)
Import Adapter
M14 x 1.5 Flare to 5/16" Nylon Tube

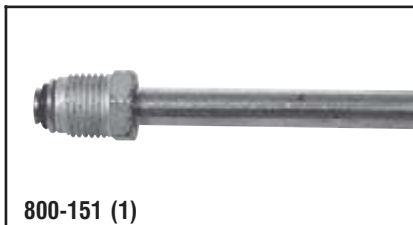

800-151 (1)
Steel Fuel Line Repair
5/16" x 18" with 14mm compression fitting

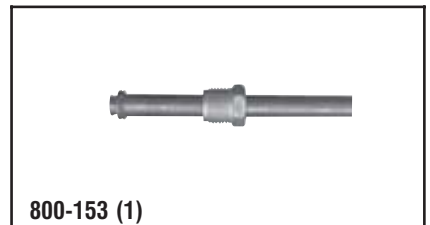

800-153 (1)
Steel Fuel Line Repair
3/8" x 18" with 16mm compression fitting

Fuel Line Connectors, Retainers & Repair Kits

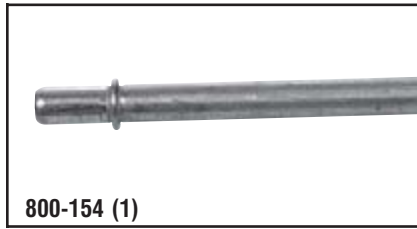

800-154 (1)

Steel Fuel Line Repair
5/16" x 12" Double Bead Line

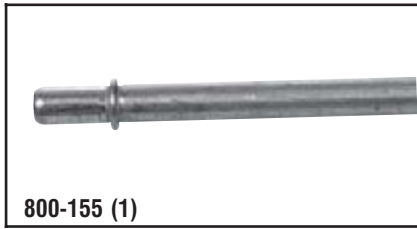

800-155 (1)

Steel Fuel Line Repair
3/8" x 12" Double Bead Line

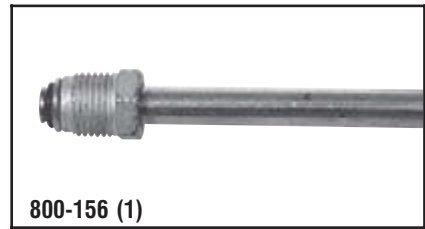

800-156 (1)

Steel Fuel Line Repair
5/16 tube x 30" length with compression fitting

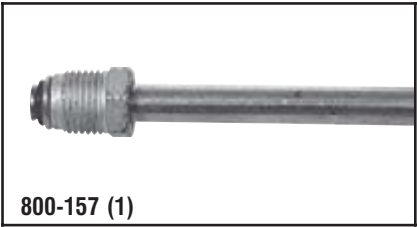

800-157 (1)

Steel Fuel Line Repair
3/8" tube x 30" length with compression fitting

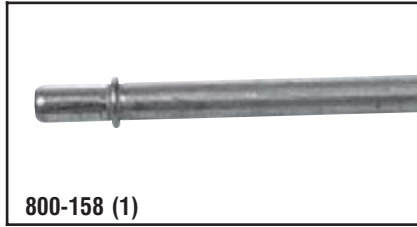

800-158 (1)

Steel Fuel Line Repair
1/4" x 12" Double Bead Line

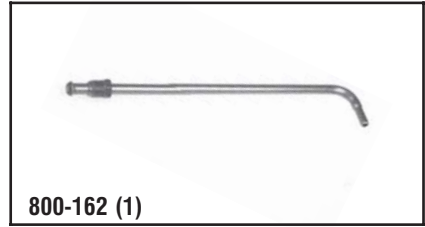

800-162 (1)

Steel Fuel Line Repair
GM 3/8" Tube x 12" length w/M16 fitting

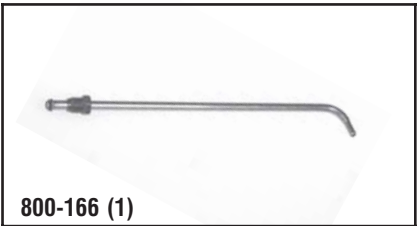

800-166 (1)

Steel Fuel Line Repair
GM 5/16" x 12" length tube w/M14 fitting

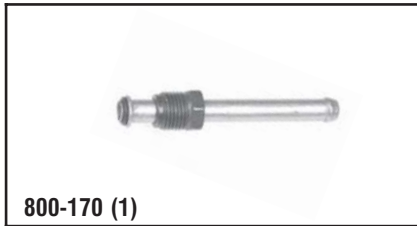

800-170 (1)

Steel Fuel Line Repair
GM 3/8" x 4" length w/M16 fitting

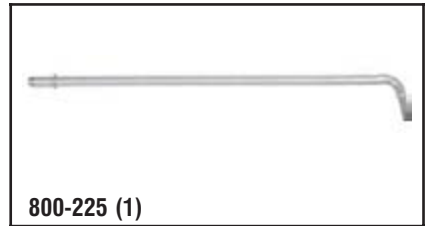

800-225 (1)

Fuel Sending Unit Repair
5/16" x 12" Double Bead

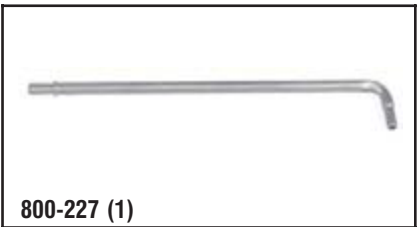

800-227 (1)

Fuel Sending Unit Repair
3/8" x 12" Double Bead

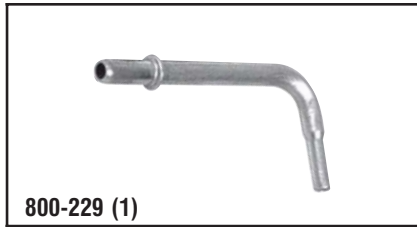

800-229 (1)

Fuel Sending Unit Repair
5/16" x 4-3/4" Double Bead

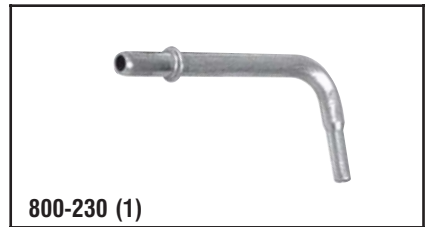

800-230 (1)

Fuel Sending Unit Repair
3/8" x 4-3/4" Double Bead



800-231 (1)

Fuel Sending Unit Repair
5/16" x 4-3/4" Steel Nut, O-ring Flare

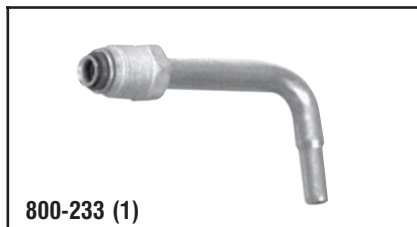

800-233 (1)

Fuel Sending Unit Repair
3/8" x 4-3/4" Steel Nut, O-ring Flare

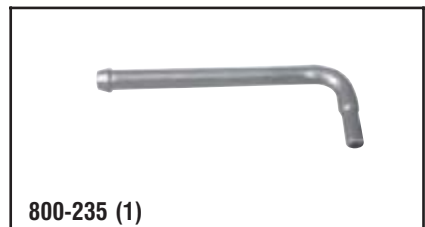

800-235 (1)

Fuel Sending Unit Repair
5/16" x 12" Hose Barb

Fuel Line Connectors, Retainers & Repair Kits

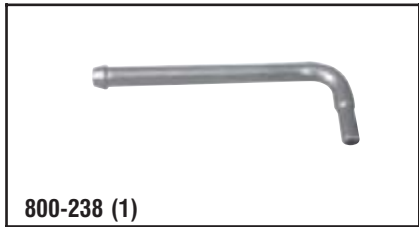

800-238 (1)

Fuel Sending Unit Repair
3/8" x 12" Hose Barb

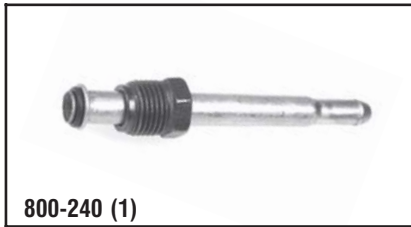

800-240 (1)

Fuel Sending Unit Repair
GM 3/8" x 3-3/4" tube w/M16 fitting straight



800-303 (3)

360° Seal Clamps
21mm - 13/16 ID



800-304 (1)

Fuel Injection Hose Clamps
Fits 1/4", 5/16", 3/8", 7/16" hose

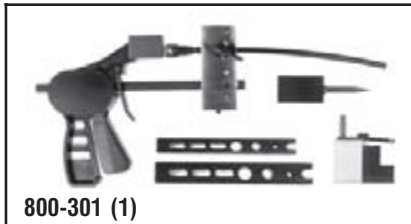

800-301 (1)

Fuel Line Repair Tool



800-308 (10) - 5/16"
800-309 (10) - 3/8"
800-306 (10) - Assortment

Fuel Line Clamps

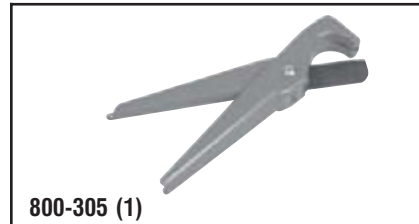

800-305 (1)

Tubing Cutter

Quick Disconnect

Quick Disconnect Heater Hose Connectors

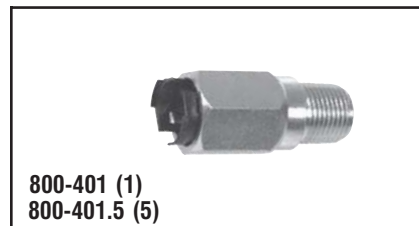

800-401 (1)
800-401.5 (5)

Heater Hose Connector
GM 2002-90 3.1L, 3.4L, 5.0L, 5.7L, 6.2L

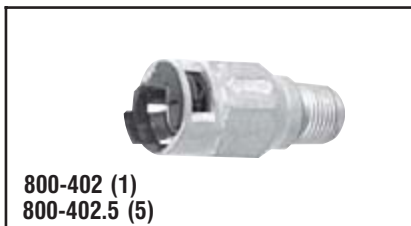

800-402 (1)
800-402.5 (5)

Heater Hose Connector
1995-87 GM Astro/Safari



800-403 (1)

Heater Hose Connector
1999-90 Ford Trucks w/ 3/4" tube

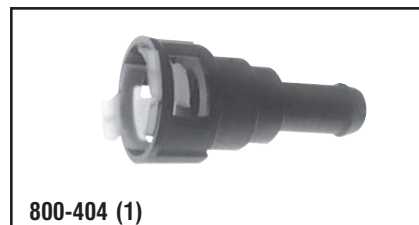

800-404 (1)

Heater Hose Connector
1999-86 Ford Trucks w/ 5/8" tube



800-405 (1)

Heater Hose Retaining Clip
Use for 800-401

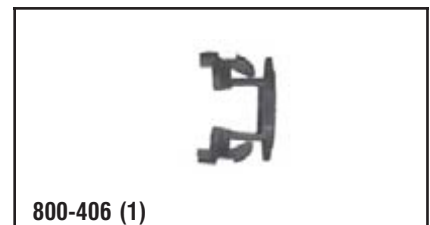

800-406 (1)

Heater Hose Retaining Clip
1995-87 GM Astro/Safari, 3/4" heater hose fitting clip. O-Ring included

Quick Disconnect Heater Hose Connectors

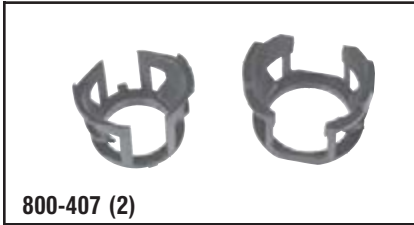

800-407 (2)

Heater Hose Retaining Clips
Includes 2 sizes for use with 800-401 thru 800-403

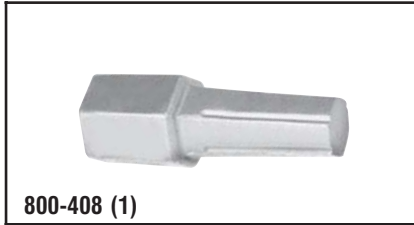

800-408 (1)

Heater Hose Connector Removal Tool
Use w/Connectors 800-401, 800-402



800-409 (1)

Coolant Connector
2007-99 GM C&K Series Pickups. Inlet/Outlet.

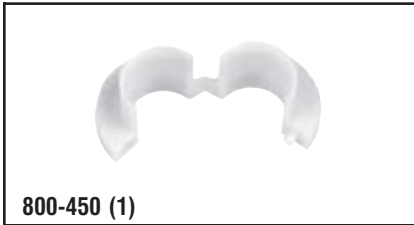

800-450 (1)

Heater Core Connector Removal Tool
GM C&K Series w/4.3L

Quick Disconnect Oil Cooler Connectors

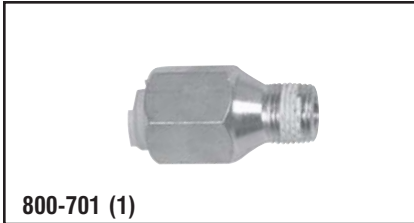

800-701 (1)

Oil Cooler Connector
GM C&K Series 1996-92, 4.3L, 5.0L, 5.7L

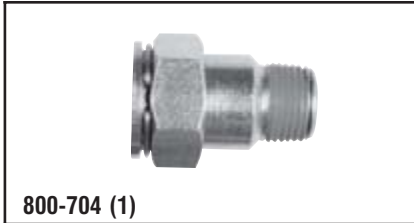

800-704 (1)

Oil Cooler Line Connector
GM 1995-85 6.2L, 6.5L

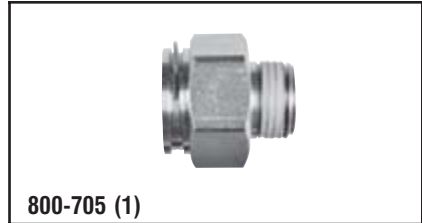

800-705 (1)

Oil Cooler Line Connector
GM 2002-96 6.5L



800-707 (1)

Oil Cooler Line Connector
GM 2007-03 6.6L, 8.1L

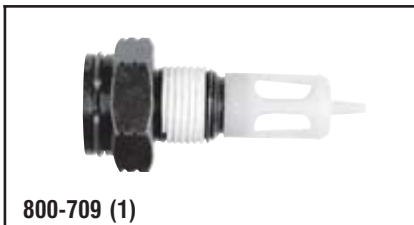

800-709 (1)

Oil Cooler Line Connector
GM 2000-96 7.4L

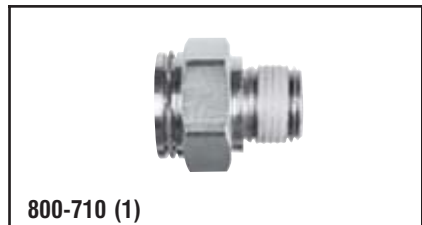

800-710 (1)

Oil Cooler Line Connector
GM 2002-96 6.5L, 6.6L, 8.1L

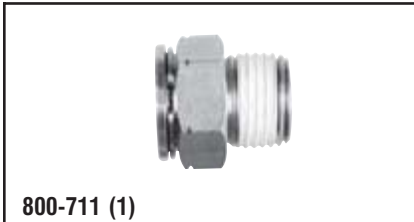

800-711 (1)

Oil Cooler Line Connector
GM 1997-87 6.2L, 6.5L



800-712 (1)

Oil Cooler Line Connector
GM 2007-03 8.1L



800-802 (1)

Oil Cooler Line Retaining Clips
GM 1/2"

Quick Disconnect Transmission Line Connectors

Quick Disconnect



800-601 (1)
Transmission Connector
 Taurus/Sable 1999-96

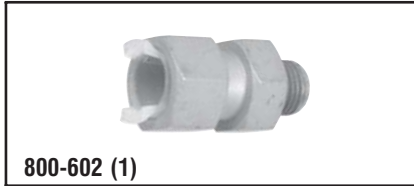

800-602 (1)
Transmission Connector
 FMC 2003-93 w/ 3/8" Tube

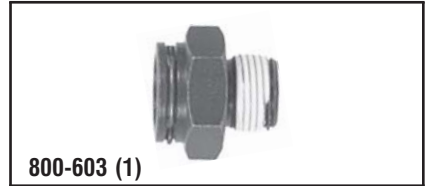

800-603 (1)
Transmission Connector
 GM C/K, G-Trucks 2000-96

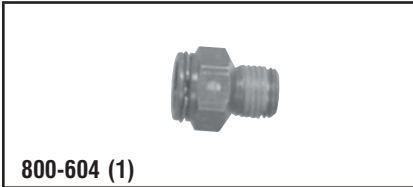

800-604 (1)
Transmission Connector
 GM Trucks S/T, C/K, Astro/Safari 2000-96

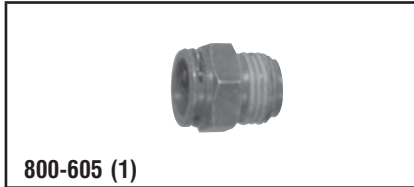

800-605 (1)
Transmission Connector
 GM C/K, S/T, L/M Trucks 2000-96 & W Cars 2000-98

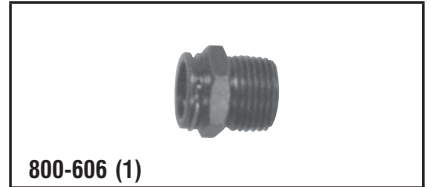

800-606 (1)
Transmission Connector
 GM L/M, S/T Trucks 2000-96

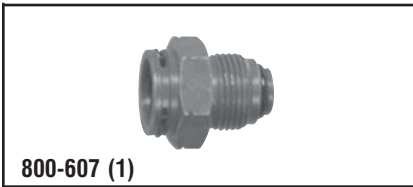

800-607 (1)
Transmission/Oil Cooler Connector
 GM C/K Trucks 2006-96

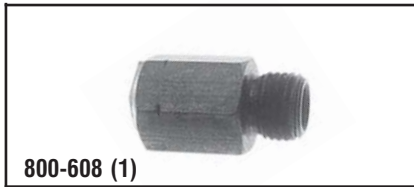

800-608 (1)
Transmission Connector
 Ford 2000-82 w/ 5/16" Tube
 Connects transmission coolant line to radiator.



800-609 (1)
Transmission Connector
 Threaded Connector
 Fits Ford 2000-1982



800-610 (1)
Transmission Line Connector
 Chrysler Ram Trucks and Vans 1999-94, Jeep Grand Cherokee/Wrangler 2003-97



800-612 (1)
Transmission Line Repair Hose
 Repairs Damaged 3/8" Lines



800-713 (1)
Transmission Line Connector
 Fits Dodge 2004-90 3.9L, 4.7L, 5.2L, 5.9L



800-714 (1)
Transmission Line Connector
 Fits Jeep Cherokee, Comanche & Wagoneer 2001-87



800-715 (1)
Transmission Line Connector
 Fits Dodge Ram 1998-97 5.9L Diesel



800-716 (1)
Transmission Line Connector
 Fits Dodge Ram 2006-99 5.9L Diesel
 Transmission End



800-717 (1)
Transmission Line Connector
 Fits Dodge Ram 2002-98 5.9L Diesel



800-718 (1)
Transmission Line Connector
 Fits Dodge 2002-97 3.9L, 5.2L, 5.9L



800-751 (1)
Transmission Line Connector
 Fits Dodge 2000-97 5.2L

Quick Disconnect Transmission Line Connectors



800-752 (1)

Transmission Line Connector
Fits GM Cars 1999-94



800-753 (1)

Transmission Line Connector
Fits Ford Cars, Trucks & SUVs 2005-74



800-754 (1)

Transmission Line Connector
Fits GM Cars & Trucks 2005-81



800-755 (1)

Transmission Line Connector
Fits GM Cars & Trucks 2002-76

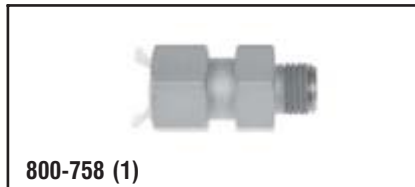

800-758 (1)

Transmission Line Connector
Fits Ford Explorer 2001-96, Mountaineer 2001-94



800-811 (1)

Transmission Line Connector
Fits GM Trucks, Vans & SUVs 1996-85

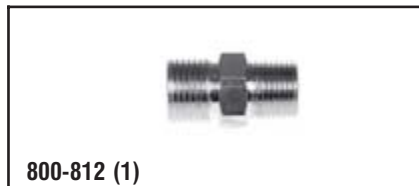

800-812 (1)

Transmission Line Connector
Fits GM Cars & Trucks 1993-83

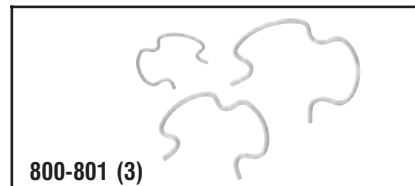

800-801 (3)

Quick Connector Clips
3/8", 1/2", 5/8", Steel

Quick Disconnect Tech Trays

Part # 800-500 Steel Fuel Line Repair Kit

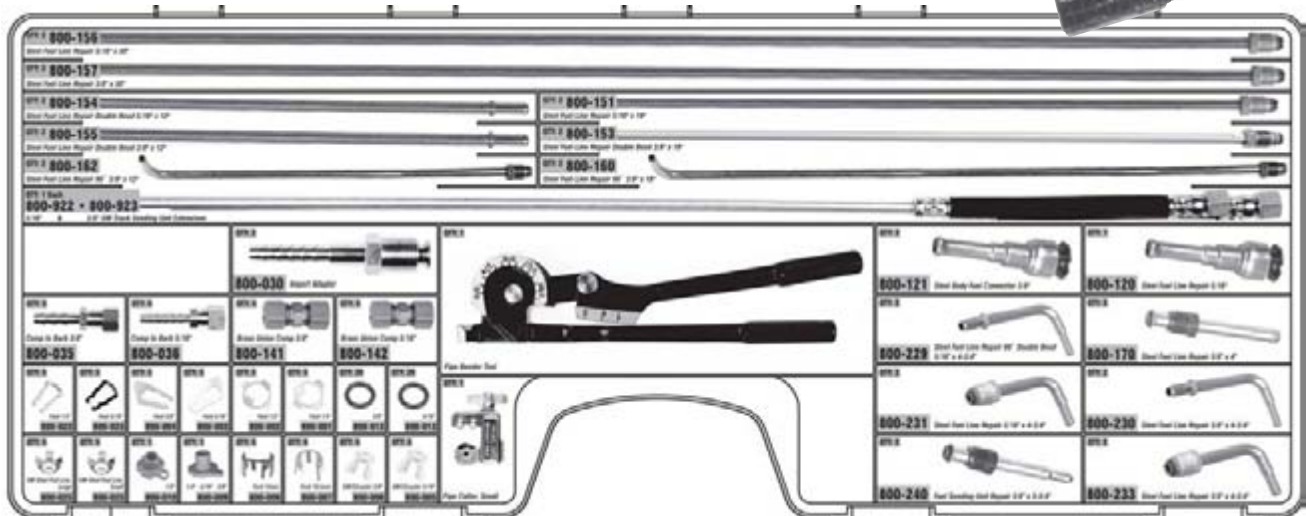











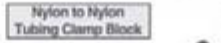

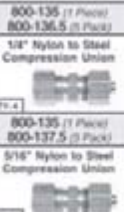
Quick Disconnect Tech Trays

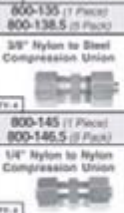

Part # 800-300*

DORMAN FUEL LINE REPAIR KIT

• 26 SKUs, 104 pieces • Tray measures 16-1/2"W x 2"H x 13"D

 Straight Connector Holder		 Nylon to Nylon Tubing Clamp Block		 Elbow Connector Holder		800-078 (2 Pack) 800-078.5 (2 Pack) Metric Fitting 10mm Nylon to 10mm QTY: 2	800-012 (2 Pack) 5/16" Barbed Union QTY: 10	800-011 (2 Pack) 3/8" Barbed Union QTY: 10	
 800-135 (1 Pack) 800-136.5 (1 Pack) 1/4" Nylon to Steel Compression Union QTY: 4		 800-135 (1 Pack) 800-137.5 (1 Pack) 5/16" Nylon to Steel Compression Union QTY: 4		 800-081 (2 Pack) 800-081.5 (2 Pack) 5/16" Steel to 5/16" 8mm Nylon Elbow QTY: 4		 800-082 (2 Pack) 800-082.5 (2 Pack) 3/8" Steel to 3/8" 10mm Nylon Straight QTY: 4		 800-083 (2 Pack) 800-083.5 (2 Pack) 1/4" Steel to 5/16" 8mm Nylon Straight QTY: 2	
 800-145 (1 Pack) 800-146.5 (1 Pack) 1/4" Nylon to Nylon Compression Union QTY: 4		 800-145 (1 Pack) 800-147.5 (1 Pack) 5/16" Nylon to Nylon Compression Union QTY: 4		 800-084 (2 Pack) 800-084.5 (2 Pack) 5/16" Steel to 3/8" 10mm Nylon Straight QTY: 2		 800-085 (2 Pack) 800-085.5 (2 Pack) 3/8" Steel to 5/16" 8mm Nylon Straight QTY: 2		 800-086 (2 Pack) 800-086.5 (2 Pack) 3/8" Steel to 5/16" 8mm Nylon Elbow QTY: 2	
 800-091 (2 Pack) 800-091.5 (2 Pack) 3/8" Steel to 5/16" 8mm Nylon Elbow QTY: 4		 800-092 (2 Pack) 800-092.5 (2 Pack) 5/16" Steel to 3/8" 10mm Nylon Elbow QTY: 2		PATENT PENDING					

Quick Disconnect

Part # 800-094*

COOLING / TRANSMISSION CONNECTORS & CLIPS TECH TRAY

• 7 SKUs, 44 pieces • Tray measures 11"W x 1-3/4"H x 6-3/4"D



<p>800-401 Heater Hose Connector 2002-1990 GM 3.1, 3.4, 5.7, 6.0, 6.2, 7.0, 7.4</p>  <p>Reorder Qty: 1 Assortment Qty: 2</p>	<p>800-402 Heater Hose Connector 1995-1989 GM Astro / Safari</p>  <p>Reorder Qty: 1 Assortment Qty: 1</p>	<p>800-608 47144 HELPF® 5/16" Tube 1994-1982 Ford Various Models</p>  <p>Reorder Qty: 1 Assortment Qty: 1</p>	<p>800-003 55147 Helpf Retainers 5/16" Ford</p>  <p>Reorder Qty: 5 Assortment Qty: 10</p>	<p>800-005 Retainers, 5/16" GM, Chrysler</p>  <p>Reorder Qty: 5 Assortment Qty: 10</p>
			<p>800-004 55148 Helpf Retainers, 3/8" Ford</p>  <p>Reorder Qty: 5 Assortment Qty: 10</p>	<p>800-006 Retainers, 3/8" GM, Chrysler</p>  <p>Reorder Qty: 5 Assortment Qty: 10</p>

Quick Disconnect Tech Trays

Quick Disconnect



Part # 800-095*

CONNECTORS TECH TRAY

• 12 SKUs, 12 pieces • Tray measures 13-1/8"W x 2-5/16"H x 9"D

<p>800-120 Steel Body Fuel Connector 5/16"</p>  <p>Reorder Qty: 1 Assortment Qty: 1</p>	<p>800-121 Steel Body Fuel Connector 3/8"</p>  <p>Reorder Qty: 1 Assortment Qty: 1</p>	<p>800-401 Heater Hose Connector, 2003-1990, GM 3.1, 3.4, 5.7 (Corvette Only), 6.2</p>  <p>Reorder Qty: 1 Assortment Qty: 1</p>	<p>800-402 Heater Hose Connector, 1995-1999 GM Astro/Safari</p>  <p>Reorder Qty: 1 Assortment Qty: 1</p>	<p>800-403 47165 HELP! Heater Hose Connector, Ford Trucks 2003-1988 w/5/16"</p>  <p>Reorder Qty: 1 Assortment Qty: 1</p>	<p>800-404 47164 HELP! Heater Hose Connector, Ford Trucks 2003-1988 w/3/4"</p>  <p>Reorder Qty: 1 Assortment Qty: 1</p>
<p>800-602 Transmission Connector, Ford Various Models, 2003-1993, 3/8" Tube</p>  <p>Reorder Qty: 1 Assortment Qty: 1</p>	<p>800-603 Transmission Connector, 2003-1996 GM Trucks G, C/K</p>  <p>Reorder Qty: 1 Assortment Qty: 1</p>	<p>800-604 Transmission Connector, 2003-1996 GM Trucks S/T, C/K, Astro/Safari</p>  <p>Reorder Qty: 1 Assortment Qty: 1</p>	<p>800-605 Transmission Connector, 2003-1996 GM Trucks S/T, C/K, Astro/Safari, 2000-1998 w/Body</p>  <p>Reorder Qty: 1 Assortment Qty: 1</p>	<p>800-606 Transmission Connector, 2003-1996 GM Trucks S/T, Astro/Safari</p>  <p>Reorder Qty: 1 Assortment Qty: 1</p>	<p>800-608 47144 HELP! Ford Various Models, 1994-1982, 5/16" Tube</p>  <p>Reorder Qty: 1 Assortment Qty: 1</p>



Part # 800-096*

RETAINING CLIPS TECH TRAY

• 6 SKUs, 26 pieces • Tray measures 8"W x 1-1/4"H x 4"D

<p>800-003 55147 HELP! Ford Retainers, 5/16"</p>  <p>Reorder Qty: 5 Assortment Qty: 5</p>	<p>800-004 55148 HELP! Ford Retainers, 3/8"</p>  <p>Reorder Qty: 5 Assortment Qty: 5</p>	<p>800-005 GM Retainers, 5/16"</p>  <p>Reorder Qty: 5 Assortment Qty: 5</p>	<p>800-006 GM Retainers, 3/8"</p>  <p>Reorder Qty: 5 Assortment Qty: 5</p>	<p>800-007 55137 HELP! Ford Metal Retainers, 10.5mm</p>  <p>Reorder Qty: 3 Assortment Qty: 3</p>	<p>800-008 55138 HELP! Ford Metal Retainers, 13mm</p>  <p>Reorder Qty: 3 Assortment Qty: 3</p>
--	---	--	---	---	---







Quick Disconnect Tech Trays



Quick Disconnect

Part # 800-299* **FUEL LINE & SENDING UNIT REPAIR TECH TRAY**

















• 6 SKUs, 8 pieces • Tray measures 8"W x 1-1/4"H x 4"D

<p>800-231 Sending Unit Repair W/Steel Nut 5/16"x4-3/4"</p> 	<p>800-233 Sending Unit Repair W/Steel Nut 3/8"x4-3/4"</p> 	<p>800-229 Sending Unit Repair Double Bead 5/16"x4-3/4"</p> 	<p>800-230 Sending Unit Repair Double Bead 3/8"x4-3/4"</p> 	<p>800-011 Nylon Union 5/16"</p> 	<p>800-012 Nylon Union 3/8"</p> 
Reorder Qty: 1	Reorder Qty: 1	Reorder Qty: 1	Reorder Qty: 1	Reorder Qty: 2	Reorder Qty: 2
Assortment Qty: 1	Assortment Qty: 1	Assortment Qty: 1	Assortment Qty: 1	Assortment Qty: 2	Assortment Qty: 2



Part # 800-101* **TRANSMISSION LINE CONNECTORS TECH TRAY**

• 16 SKUs, 28 pieces • Tray measures 13-1/8"W x 2-5/16"H x 9"D

<p>800-601 Ford Taurus & Mercury Sable</p> 	<p>800-602 Various Ford Models 3/8" Tube</p> 	<p>800-603 GM C&K Series and G Series Trucks</p> 	<p>800-604 GM C&K Series, L&M Series and S&T Series Trucks</p> 
Reorder Qty: 1	Reorder Qty: 1	Reorder Qty: 1	Reorder Qty: 1
Assortment Qty: 1	Assortment Qty: 1	Assortment Qty: 1	Assortment Qty: 1
<p>800-605 GM C&K Series, S&T Series, L&M Series Trucks and W-Body Cars</p> 	<p>800-606 GM L&M Series, S&T Series Trucks</p> 	<p>800-607 GM C&K Series Trucks</p> 	<p>800-608 Ford 1991-92 5/16" Tube</p> 
Reorder Qty: 1	Reorder Qty: 1	Reorder Qty: 1	Reorder Qty: 1
Assortment Qty: 1	Assortment Qty: 1	Assortment Qty: 1	Assortment Qty: 1
<p>800-609 Ford Various Models</p> 	<p>800-610 Dodge Ram Trucks & Vans, Jeep Grand Cherokee</p> 	<p>800-713 Dodge Trucks</p> 	<p>800-714 Jeep Cherokee</p> 
Reorder Qty: 1	Reorder Qty: 1	Reorder Qty: 1	Reorder Qty: 1
Assortment Qty: 1	Assortment Qty: 1	Assortment Qty: 1	Assortment Qty: 1
<p>800-715 Dodge Ram Trucks, Diesels</p> 	<p>800-752 GM Cars</p> 	<p>800-812 GM Cars & Trucks</p> 	<p>800-801 3/8", 1/2", 5/8" Connector Clips</p> 
Reorder Qty: 1	Reorder Qty: 1	Reorder Qty: 1	Reorder Qty: 1
Assortment Qty: 1	Assortment Qty: 1	Assortment Qty: 1	Assortment Qty: 1

Quick Disconnect Tech Trays



Quick Disconnect

Part # 800-102*

OIL LINE CONNECTORS TECH TRAY

• 10 SKUs, 32 pieces • Tray measures 11"W x 1-3/4"H x 6-3/4"D



















<p>800-607 GM C/K Trucks 2003-06</p>  <p>REORDER QTY: 1 ASSORTMENT QTY: 1</p>	<p>800-701 GM C & K Series Trucks</p>  <p>REORDER QTY: 1 ASSORTMENT QTY: 1</p>	<p>800-704 Oil Cooler Line Connector GM</p>  <p>REORDER QTY: 1 ASSORTMENT QTY: 1</p>	<p>800-705 Oil Cooler Line Connector GM</p>  <p>REORDER QTY: 1 ASSORTMENT QTY: 1</p>	<p>800-710 Oil Cooler Line Connector GM</p>  <p>REORDER QTY: 1 ASSORTMENT QTY: 1</p>	<p>800-711 Oil Cooler Line Connector GM</p>  <p>REORDER QTY: 1 ASSORTMENT QTY: 1</p>
<p>800-801 3/8" Connector Clip</p>  <p>REORDER QTY: 4 ASSORTMENT QTY: 8</p>	<p>800-801 1/2" Connector Clip</p>  <p>REORDER QTY: 4 ASSORTMENT QTY: 8</p>	<p>800-801 5/8" Connector Clip</p>  <p>REORDER QTY: 4 ASSORTMENT QTY: 8</p>	<p>800-802 Oil Cooler Retaining Clips Plastic</p>  <p>REORDER QTY: 2 ASSORTMENT QTY: 2</p>		



Part # 800-103*

MASTER TECH TRAY

• 19 SKUs, 54 pieces • Tray measures 16-1/2"W x 2"H x 13"D

<p>800-003 Fuel Line Clip Ford 5/16"</p>  <p>REORDER QTY: 2 ASSORTMENT QTY: 2</p>	<p>800-004 Fuel Line Clip Ford 3/8"</p>  <p>REORDER QTY: 2 ASSORTMENT QTY: 2</p>	<p>800-005 Fuel Line Clip GM 5/16"</p>  <p>REORDER QTY: 2 ASSORTMENT QTY: 2</p>	<p>800-006 Fuel Line Clip GM 3/8"</p>  <p>REORDER QTY: 2 ASSORTMENT QTY: 2</p>	<p>800-007 Fuel Line Retainer Clip Ford 10.5mm</p>  <p>REORDER QTY: 2 ASSORTMENT QTY: 2</p>
<p>800-011 Nylon Fuel Line Union 3/8"</p>  <p>REORDER QTY: 2 ASSORTMENT QTY: 2</p>	<p>800-012 Nylon Fuel Line Union 5/16"</p>  <p>REORDER QTY: 2 ASSORTMENT QTY: 2</p>	<p>800-120 Fuel Line Connector Steel 5/16"</p>  <p>REORDER QTY: 2 ASSORTMENT QTY: 2</p>	<p>800-701 Oil Cooler Connector</p>  <p>REORDER QTY: 1 ASSORTMENT QTY: 1</p>	<p>800-802 Connector Oil Cooler Retaining Clip GM</p>  <p>REORDER QTY: 2 ASSORTMENT QTY: 2</p>
<p>800-401 Heater Hose Quick Connectors GM Cars & Trucks</p>  <p>REORDER QTY: 1 ASSORTMENT QTY: 1</p>	<p>800-402 Heater Hose Quick Connectors GM 4.3L</p>  <p>REORDER QTY: 1 ASSORTMENT QTY: 1</p>	<p>800-404 Heater Hose Quick Connectors Ford Cars & Trucks, 3/4" Tube</p>  <p>REORDER QTY: 1 ASSORTMENT QTY: 1</p>	<p>800-608 Transmission Quick Connector Ford with 5/16" Tube</p>  <p>REORDER QTY: 1 ASSORTMENT QTY: 1</p>	<p>800-610 Transmission Quick Connector Dodge Trucks & Vans, Jeep</p>  <p>REORDER QTY: 1 ASSORTMENT QTY: 1</p>
		<p>800-405 Heater Hose Retaining Clip Small</p>  <p>REORDER QTY: 2 ASSORTMENT QTY: 2</p>	<p>800-801 Steel Connector Clip 3/8"</p>  <p>REORDER QTY: 2 ASSORTMENT QTY: 4</p>	<p>800-801 Steel Connector Clip 1/2"</p>  <p>REORDER QTY: 2 ASSORTMENT QTY: 4</p>
			<p>800-801 Steel Connector Clip 3/8"</p>  <p>REORDER QTY: 2 ASSORTMENT QTY: 4</p>	

Quick Disconnect Fuel Line Connector Applications

Make/ Model/Engine/Years	Description	Style	Inlet Size	Inlet	Outlet Size	Outlet	Return Size	Return
BUICK								
CENTURY								
L4 - 2.2L (134 CID)								
1996-93	-	Nylon Elbow	3/8 x 3/8	800-059	3/8 x 3/8	800-059	-	-
1996-93	-	Nylon Straight	3/8 x 3/8	800-058	3/8 x 3/8	800-058	-	-
L4 - 2.5L (151 CID)								
1992-89	-	Nylon Elbow	3/8 x 3/8	800-059	3/8 x 3/8	800-059	-	-
1992-89	-	Nylon Straight	3/8 x 3/8	800-058	3/8 x 3/8	800-058	-	-
1988-83	-	Steel Line Gasket	3/8 x M16-1.50	800-153	3/8 x M16-1.50	800-153	-	-
V6 - 2.8L (173 CID)								
1989	-	Nylon Elbow	3/8 x 3/8	800-059	3/8 x 3/8	800-059	-	-
1989	-	Nylon Straight	3/8 x 3/8	800-058	3/8 x 3/8	800-058	-	-
1988-87	-	Steel Line Gasket	3/8 x M16-1.50	800-153	3/8 x M16-1.50	800-153	-	-
V6 - 3.1L (189 CID)								
2005-97	-	Nylon Elbow	3/8 x 3/8	800-059	-	-	-	-
2005-97	-	Nylon Straight	3/8 x 3/8	800-058	-	-	-	-
2005-97	-	Steel Line Gasket	-	-	3/8 x M16-1.50	800-153	-	-
1996-94	-	Nylon Elbow	3/8 x 3/8	800-059	3/8 x 3/8	800-059	-	-
1996-94	-	Nylon Straight	3/8 x 3/8	800-058	3/8 x 3/8	800-058	-	-
V6 - 3.3L (204 CID)								
1993-89	-	Nylon Elbow	3/8 x 3/8	800-059	3/8 x 3/8	800-059	-	-
1993-89	-	Nylon Straight	3/8 x 3/8	800-058	3/8 x 3/8	800-058	-	-
V6 - 3.8L (231 CID)								
1988-86	-	Steel Line Gasket	3/8 x M16-1.50	800-153	3/8 x M16-1.50	800-153	-	-
1985-84	-	Steel Line Gasket	-	-	3/8 x M16-1.50	800-153	-	-
ELECTRA								
V6 - 3.8L (231 CID)								
1991	-	Nylon Elbow	3/8 x 3/8	800-059	3/8 x 3/8	800-059	-	-
1991	-	Nylon Straight	3/8 x 3/8	800-058	3/8 x 3/8	800-058	-	-
1990-86	-	Steel Line Gasket	3/8 x M16-1.50	800-153	3/8 x M16-1.50	800-153	-	-
1985	-	Steel Line Gasket	-	-	3/8 x M16-1.50	800-153	-	-
LESABRE								
V6 - 3.0L (181 CID)								
1986	-	Steel Line Gasket	3/8 x M16-1.50	800-153	3/8 x M16-1.50	800-153	-	-
V6 - 3.8L (231 CID)								
2005-94	-	Nylon Elbow	3/8 x 3/8	800-059	-	-	-	-
2005-94	-	Nylon Straight	3/8 x 3/8	800-058	-	-	-	-
2005-94	-	Steel Line Gasket	-	-	3/8 x M16-1.50	800-153	-	-
1993-92	-	Nylon Elbow	3/8 x 3/8	800-059	3/8 x 3/8	800-059	-	-
1993-92	-	Nylon Straight	3/8 x 3/8	800-058	3/8 x 3/8	800-058	-	-
1991-86	-	Steel Line Gasket	3/8 x M16-1.50	800-153	3/8 x M16-1.50	800-153	-	-
PARK AVENUE								
V6 - 3.8L (231 CID)								
2005-94	-	Nylon Elbow	3/8 x 3/8	800-059	-	-	-	-
2005-94	-	Nylon Straight	3/8 x 3/8	800-058	-	-	-	-
2005-94	-	Steel Line Gasket	-	-	3/8 x M16-1.50	800-153	-	-
1993-91	-	Nylon Elbow	3/8 x 3/8	800-059	3/8 x 3/8	800-059	-	-
1993-91	-	Nylon Straight	3/8 x 3/8	800-058	3/8 x 3/8	800-058	-	-
REATTA								
V6 - 3.8L (231 CID)								
1991-90	-	Nylon Elbow	5/16 x 5/16	800-060	5/16 x 5/16	800-060	-	-
1991-90	-	Nylon Straight	5/16 x 5/16	800-057	5/16 x 5/16	800-057	-	-
1989-88	-	Steel Line Gasket	3/8 x M16-1.50	800-153	3/8 x M16-1.50	800-153	-	-
REGAL								
V6 - 2.8L (173 CID)								
1989-88	-	Steel Line Gasket	3/8 x M16-1.50	800-153	3/8 x M16-1.50	800-153	-	-
V6 - 3.1L (189 CID)								
1996-92	-	Nylon Elbow	3/8 x 3/8	800-059	-	-	-	-
1996-92	-	Nylon Straight	3/8 x 3/8	800-058	-	-	-	-
1996-92	-	Steel Line Gasket	-	-	3/8 x M16-1.50	800-153	-	-
1991-89	-	Steel Line Gasket	3/8 x M16-1.50	800-153	3/8 x M16-1.50	800-153	-	-
V6 - 3.8L (231 CID)								
2004-92	-	Nylon Elbow	3/8 x 3/8	800-059	-	-	-	-
2004-92	-	Nylon Straight	3/8 x 3/8	800-058	-	-	-	-
2004-92	-	Steel Line Gasket	-	-	3/8 x M16-1.50	800-153	-	-
1991-84	-	Steel Line Gasket	3/8 x M16-1.50	800-153	3/8 x M16-1.50	800-153	-	-
RENDEZVOUS								
V6 - 3.4L (207 CID)								
2002	-	Nylon Elbow	3/8 x 3/8	800-059	3/8 x 3/8	800-059	-	-
2002	-	Nylon Straight	3/8 x 3/8	800-058	3/8 x 3/8	800-058	-	-
RIVIERA								
V6 - 3.8L (231 CID)								
1999-95	-	Nylon Elbow	3/8 x 3/8	800-059	-	-	-	-
1999-95	-	Nylon Straight	3/8 x 3/8	800-058	-	-	-	-
1999-95	-	Steel Line Gasket	-	-	3/8 x M16-1.50	800-153	-	-
1993	-	Nylon Elbow	3/8 x 3/8	800-059	3/8 x 3/8	800-059	-	-
1993	-	Nylon Straight	3/8 x 3/8	800-058	3/8 x 3/8	800-058	-	-
1992-90	-	Nylon Elbow	5/16 x 5/16	800-060	5/16 x 5/16	800-060	-	-
1992-90	-	Nylon Straight	5/16 x 5/16	800-057	5/16 x 5/16	800-057	-	-
1989-84	-	Steel Line Gasket	3/8 x M16-1.50	800-153	3/8 x M16-1.50	800-153	-	-

Quick Disconnect

Quick Disconnect Fuel Line Connector Applications

Quick Disconnect

Make/ Model/Engine/Years	Description	Style	Inlet Size	Inlet	Outlet Size	Outlet	Return Size	Return
BUICK (continued)								
ROADMASTER								
V8 - 5.0L (305 CID)								
1991 -	-	Nylon Elbow	3/8 x 3/8	800-059	3/8 x 3/8	800-059	-	-
1991 -	-	Nylon Straight	3/8 x 3/8	800-058	3/8 x 3/8	800-058	-	-
V8 - 5.7L (350 CID)								
1996-92 -	-	Nylon Elbow	3/8 x 3/8	800-059	3/8 x 3/8	800-059	-	-
1996-92 -	-	Nylon Straight	3/8 x 3/8	800-058	3/8 x 3/8	800-058	-	-
SKYHAWK								
L4 - 1.8L (112 CID)								
1986-82 -	-	Steel Line Gasket	3/8 x M16-1.50	800-153	3/8 x M16-1.50	800-153	-	-
L4 - 2.0L (122 CID)								
1989-83 -	-	Steel Line Gasket	3/8 x M16-1.50	800-153	3/8 x M16-1.50	800-153	-	-
SKYLARK								
L4 - 2.3L (138 CID)								
1995-92 -	-	Nylon Elbow	3/8 x 3/8	800-059	-	-	-	-
1995-92 -	-	Nylon Straight	3/8 x 3/8	800-058	-	-	-	-
1995-92 -	-	Steel Line Gasket	-	-	3/8 x M16-1.50	800-153	-	-
1991-88 -	-	Steel Line Gasket	3/8 x M16-1.50	800-153	3/8 x M16-1.50	800-153	-	-
L4 - 2.4L (146 CID)								
1998-96 -	-	Nylon Elbow	3/8 x 3/8	800-059	-	-	-	-
1998-96 -	-	Nylon Straight	3/8 x 3/8	800-058	-	-	-	-
1998-96 -	-	Steel Line Gasket	-	-	3/8 x M16-1.50	800-153	-	-
L4 - 2.5L (151 CID)								
1991-84 -	-	Steel Line Gasket	3/8 x M16-1.50	800-153	3/8 x M16-1.50	800-153	-	-
1983 -	-	Steel Line Gasket	-	-	3/8 x M16-1.50	800-153	-	-
V6 - 2.8L (173 CID)								
1985 -	-	Steel Line Gasket	-	-	3/8 x M16-1.50	800-153	-	-
V6 - 3.0L (181 CID)								
1988-86 -	-	Steel Line Gasket	3/8 x M16-1.50	800-153	3/8 x M16-1.50	800-153	-	-
V6 - 3.1L (189 CID)								
1998-94 -	-	Nylon Elbow	3/8 x 3/8	800-059	-	-	-	-
1998-94 -	-	Nylon Straight	3/8 x 3/8	800-058	-	-	-	-
1998-94 -	-	Steel Line Gasket	-	-	3/8 x M16-1.50	800-153	-	-
V6 - 3.3L (204 CID)								
1993-92 -	-	Nylon Elbow	3/8 x 3/8	800-059	-	-	-	-
1993-92 -	-	Nylon Straight	3/8 x 3/8	800-058	-	-	-	-
1993-92 -	-	Steel Line Gasket	-	-	3/8 x M16-1.50	800-153	-	-
1991-89 -	-	Steel Line Gasket	3/8 x M16-1.50	800-153	3/8 x M16-1.50	800-153	-	-
SOMERSET								
L4 - 2.5L (151 CID)								
1987-85 -	-	Steel Line Gasket	3/8 x M16-1.50	800-153	3/8 x M16-1.50	800-153	-	-
V6 - 3.0L (181 CID)								
1987-85 -	-	Steel Line Gasket	3/8 x M16-1.50	800-153	3/8 x M16-1.50	800-153	-	-
CADILLAC								
ALLANTE								
V8 - 4.1L (252 CID)								
1988-87 -	-	Steel Line Gasket	3/8 x M16-1.50	800-153	3/8 x M16-1.50	800-153	-	-
V8 - 4.5L (273 CID)								
1992-89 -	-	Steel Line Gasket	3/8 x M16-1.50	800-153	3/8 x M16-1.50	800-153	-	-
V8 - 4.6L (281 CID)								
1993 -	-	Nylon Elbow	3/8 x 3/8	800-059	3/8 x 3/8	800-059	-	-
1993 -	-	Nylon Straight	3/8 x 3/8	800-058	3/8 x 3/8	800-058	-	-
CATERA								
V6 - 3.0L (181 CID)								
2001-97 -	-	Steel Line Gasket	3/8 x M16-1.50	800-153	3/8 x M16-1.50	800-153	-	-
CIMARRON								
L4 - 2.0L (121 CID)								
1986-83 -	-	Steel Line Gasket	3/8 x M16-1.50	800-153	3/8 x M16-1.50	800-153	-	-
V6 - 2.8L (173 CID)								
1988-85 -	-	Steel Line Gasket	3/8 x M16-1.50	800-153	3/8 x M16-1.50	800-153	-	-
CONCOURS								
V8 - 4.6L (281 CID)								
1999-97 -	-	Nylon Elbow	3/8 x 3/8	800-059	-	-	-	-
1999-97 -	-	Nylon Straight	3/8 x 3/8	800-058	-	-	-	-
1999-97 -	-	Steel Line Gasket	-	-	3/8 x M16-1.50	800-153	-	-
1996-94 -	-	Nylon Elbow	3/8 x 3/8	800-059	3/8 x 3/8	800-059	-	-
1996-94 -	-	Nylon Straight	3/8 x 3/8	800-058	3/8 x 3/8	800-058	-	-
CTS								
V6 - 3.2L (197 CID)								
2003 -	-	Nylon Elbow	3/8 x 3/8	800-059	-	-	-	-
2003 -	-	Nylon Straight	3/8 x 3/8	800-058	-	-	-	-
2003 -	-	Steel Line Gasket	-	-	3/8 x M16-1.50	800-153	-	-
DEVILLE								
V8 - 4.1L (252 CID)								
1987-86 -	-	Steel Line Gasket	3/8 x M16-1.50	800-153	3/8 x M16-1.50	800-153	-	-
1985 -	-	Steel Line Gasket	-	-	3/8 x M16-1.50	800-153	-	-
V8 - 4.5L (273 CID)								
1990-88 -	-	Steel Line Gasket	3/8 x M16-1.50	800-153	3/8 x M16-1.50	800-153	-	-
V8 - 4.6L (281 CID)								
2005-97 -	-	Nylon Elbow	3/8 x 3/8	800-059	-	-	-	-

Quick Disconnect Fuel Line Connector Applications

Make/ Model/Engine/Years	Description	Style	Inlet Size	Inlet	Outlet Size	Outlet	Return Size	Return
CADILLAC (continued)								
DEVILLE (continued)								
V8 - 4.6L (281 CID) (continued)								
2005-97	-	Nylon Straight	3/8 x 3/8	800-058	-	-	-	-
2005-97	-	Steel Line Gasket	-	-	3/8 x M16-1.50	800-153	-	-
1996	-	Nylon Elbow	3/8 x 3/8	800-059	3/8 x 3/8	800-059	-	-
1996	-	Nylon Straight	3/8 x 3/8	800-058	3/8 x 3/8	800-058	-	-
V8 - 4.9L (300 CID)								
1995-91	-	Nylon Elbow	3/8 x 3/8	800-059	3/8 x 3/8	800-059	-	-
1995-91	-	Nylon Straight	3/8 x 3/8	800-058	3/8 x 3/8	800-058	-	-
ELDORADO								
V8 - 4.1L (252 CID)								
1987-86	-	Steel Line Gasket	3/8 x M16-1.50	800-153	3/8 x M16-1.50	800-153	-	-
V8 - 4.5L (273 CID)								
1990	-	Nylon Elbow	5/16 x 5/16	800-060	5/16 x 5/16	800-060	-	-
1990	-	Nylon Straight	5/16 x 5/16	800-057	5/16 x 5/16	800-057	-	-
1989-88	-	Steel Line Gasket	3/8 x M16-1.50	800-153	3/8 x M16-1.50	800-153	-	-
V8 - 4.6L (281 CID)								
2002-97	-	Nylon Elbow	3/8 x 3/8	800-059	-	-	-	-
2002-97	-	Nylon Straight	3/8 x 3/8	800-058	-	-	-	-
2002-97	-	Steel Line Gasket	-	-	3/8 x M16-1.50	800-153	-	-
1996-93	-	Nylon Elbow	3/8 x 3/8	800-059	3/8 x 3/8	800-059	-	-
1996-93	-	Nylon Straight	3/8 x 3/8	800-058	3/8 x 3/8	800-058	-	-
V8 - 4.9L (300 CID)								
1993	-	Nylon Elbow	3/8 x 3/8	800-059	3/8 x 3/8	800-059	-	-
1993	-	Nylon Straight	3/8 x 3/8	800-058	3/8 x 3/8	800-058	-	-
1992-91	-	Nylon Elbow	5/16 x 5/16	800-060	5/16 x 5/16	800-060	-	-
1992-91	-	Nylon Straight	5/16 x 5/16	800-057	5/16 x 5/16	800-057	-	-
ESCALADE								
V8 - 5.3L (323 CID)								
2003-02	-	Steel Line Gasket	3/8 x M16-1.50	800-153	3/8 x M16-1.50	800-153	-	-
V8 - 5.7L (350 CID)								
2000-99	-	Steel Line Gasket	3/8 x M16-1.50	800-153	3/8 x M16-1.50	800-153	-	-
V8 - 6.0L (364 CID)								
2003-02	-	Steel Line Gasket	3/8 x M16-1.50	800-153	3/8 x M16-1.50	800-153	-	-
FLEETWOOD								
V8 - 4.1L (252 CID)								
1987-86	-	Steel Line Gasket	3/8 x M16-1.50	800-153	3/8 x M16-1.50	800-153	-	-
1985	-	Steel Line Gasket	-	-	3/8 x M16-1.50	800-153	-	-
V8 - 4.5L (273 CID)								
1990-88	-	Steel Line Gasket	3/8 x M16-1.50	800-153	3/8 x M16-1.50	800-153	-	-
V8 - 4.9L (300 CID)								
1993-91	-	Nylon Elbow	3/8 x 3/8	800-059	3/8 x 3/8	800-059	-	-
1993-91	-	Nylon Straight	3/8 x 3/8	800-058	3/8 x 3/8	800-058	-	-
V8 - 5.0L (305 CID)								
1992-91	-	Nylon Elbow	3/8 x 3/8	800-059	3/8 x 3/8	800-059	-	-
1992-91	-	Nylon Straight	3/8 x 3/8	800-058	3/8 x 3/8	800-058	-	-
V8 - 5.7L (350 CID)								
1996-90	-	Nylon Elbow	3/8 x 3/8	800-059	3/8 x 3/8	800-059	-	-
1996-90	-	Nylon Straight	3/8 x 3/8	800-058	3/8 x 3/8	800-058	-	-
SEVILLE								
V8 - 4.1L (252 CID)								
1987-86	-	Steel Line Gasket	3/8 x M16-1.50	800-153	3/8 x M16-1.50	800-153	-	-
V8 - 4.5L (273 CID)								
1990	-	Nylon Elbow	5/16 x 5/16	800-060	5/16 x 5/16	800-060	-	-
1990	-	Nylon Straight	5/16 x 5/16	800-057	5/16 x 5/16	800-057	-	-
1989-88	-	Steel Line Gasket	3/8 x M16-1.50	800-153	3/8 x M16-1.50	800-153	-	-
V8 - 4.6L (281 CID)								
2005-97	-	Nylon Elbow	3/8 x 3/8	800-059	-	-	-	-
2005-97	-	Nylon Straight	3/8 x 3/8	800-058	-	-	-	-
2005-97	-	Steel Line Gasket	-	-	3/8 x M16-1.50	800-153	-	-
1996-93	-	Nylon Elbow	3/8 x 3/8	800-059	3/8 x 3/8	800-059	-	-
1996-93	-	Nylon Straight	3/8 x 3/8	800-058	3/8 x 3/8	800-058	-	-
V8 - 4.9L (300 CID)								
1993	-	Nylon Elbow	3/8 x 3/8	800-059	3/8 x 3/8	800-059	-	-
1993	-	Nylon Straight	3/8 x 3/8	800-058	3/8 x 3/8	800-058	-	-
1992-91	-	Nylon Elbow	5/16 x 5/16	800-060	5/16 x 5/16	800-060	-	-
1992-91	-	Nylon Straight	5/16 x 5/16	800-057	5/16 x 5/16	800-057	-	-
CHEVROLET								
BERETTA								
L4 - 2.0L (122 CID)								
1989-87	-	Steel Line Gasket	3/8 x M16-1.50	800-153	3/8 x M16-1.50	800-153	-	-
L4 - 2.2L (134 CID)								
1996-93	-	Nylon Elbow	3/8 x 3/8	800-059	-	-	-	-
1996-93	-	Nylon Straight	3/8 x 3/8	800-058	-	-	-	-
1996-93	-	Steel Line Gasket	-	-	3/8 x M16-1.50	800-153	-	-
1992-90	-	Nylon Elbow	3/8 x 3/8	800-059	3/8 x 3/8	800-059	-	-
1992-90	-	Nylon Straight	3/8 x 3/8	800-058	3/8 x 3/8	800-058	-	-
L4 - 2.3L (138 CID)								
1994	-	Nylon Elbow	3/8 x 3/8	800-059	-	-	-	-
1994	-	Nylon Straight	3/8 x 3/8	800-058	-	-	-	-

Quick Disconnect

Quick Disconnect Fuel Line Connector Applications

Quick Disconnect

Make/ Model/Engine/Years	Description	Style	Inlet Size	Inlet	Outlet Size	Outlet	Return Size	Return
CHEVROLET (continued)								
BERETTA (continued)								
L4 - 2.3L (138 CID) (continued)								
1994 -	-	Steel Line Gasket	-	-	3/8 x M16-1.50	800-153	-	-
1993-90 -	-	Nylon Elbow	3/8 x 3/8	800-059	3/8 x 3/8	800-059	-	-
1993-90 -	-	Nylon Straight	3/8 x 3/8	800-058	3/8 x 3/8	800-058	-	-
V6 - 2.8L (173 CID)								
1989-87 -	-	Steel Line Gasket	3/8 x M16-1.50	800-153	3/8 x M16-1.50	800-153	-	-
V6 - 3.1L (189 CID)								
1996-93 -	-	Nylon Elbow	3/8 x 3/8	800-059	-	-	-	-
1996-93 -	-	Nylon Straight	3/8 x 3/8	800-058	-	-	-	-
1996-93 -	-	Steel Line Gasket	-	-	3/8 x M16-1.50	800-153	-	-
1992-90 -	-	Nylon Elbow	3/8 x 3/8	800-059	3/8 x 3/8	800-059	-	-
1992-90 -	-	Nylon Straight	3/8 x 3/8	800-058	3/8 x 3/8	800-058	-	-
CAMARO								
L4 - 2.5L (151 CID)								
1986-84 -	-	Steel Line Gasket	3/8 x M16-1.50	800-153	3/8 x M16-1.50	800-153	-	-
1983 -	-	Steel Line Gasket	-	-	3/8 x M16-1.50	800-153	-	-
V6 - 2.8L (173 CID)								
1989-85 -	-	Steel Line Gasket	3/8 x M16-1.50	800-153	3/8 x M16-1.50	800-153	-	-
V6 - 3.1L (189 CID)								
1992-90 -	-	Steel Line Gasket	3/8 x M16-1.50	800-153	3/8 x M16-1.50	800-153	-	-
V6 - 3.4L (207 CID)								
1995-93 -	-	Nylon Elbow	3/8 x 3/8	800-059	-	-	-	-
1995-93 -	-	Nylon Straight	3/8 x 3/8	800-058	-	-	-	-
1995-93 -	-	Steel Line Gasket	-	-	3/8 x M16-1.50	800-153	-	-
V6 - 3.8L (231 CID)								
2002-95 -	-	Nylon Elbow	3/8 x 3/8	800-059	-	-	-	-
2002-95 -	-	Nylon Straight	3/8 x 3/8	800-058	-	-	-	-
2002-95 -	-	Steel Line Gasket	-	-	3/8 x M16-1.50	800-153	-	-
V8 - 5.0L (305 CID)								
1992-85 -	-	Steel Line Gasket	3/8 x M16-1.50	800-153	3/8 x M16-1.50	800-153	-	-
V8 - 5.7L (350 CID)								
2002-93 -	-	Nylon Elbow	3/8 x 3/8	800-059	-	-	-	-
2002-93 -	-	Nylon Straight	3/8 x 3/8	800-058	-	-	-	-
2002-93 -	-	Steel Line Gasket	-	-	3/8 x M16-1.50	800-153	-	-
1992-87 -	-	Steel Line Gasket	3/8 x M16-1.50	800-153	3/8 x M16-1.50	800-153	-	-
CAPRICE								
V6 - 4.3L (262 CID)								
1993-90 -	-	Nylon Elbow	3/8 x 3/8	800-059	3/8 x 3/8	800-059	-	-
1993-90 -	-	Nylon Straight	3/8 x 3/8	800-058	3/8 x 3/8	800-058	-	-
1989-85 -	-	Steel Line Gasket	3/8 x M16-1.50	800-153	3/8 x M16-1.50	800-153	-	-
V8 - 4.3L (265 CID)								
1996-94 -	-	Nylon Elbow	3/8 x 3/8	800-059	3/8 x 3/8	800-059	-	-
1996-94 -	-	Nylon Straight	3/8 x 3/8	800-058	3/8 x 3/8	800-058	-	-
V8 - 5.0L (305 CID)								
1993-90 -	-	Nylon Elbow	3/8 x 3/8	800-059	3/8 x 3/8	800-059	-	-
1993-90 -	-	Nylon Straight	3/8 x 3/8	800-058	3/8 x 3/8	800-058	-	-
1989 -	-	Steel Line Gasket	3/8 x M16-1.50	800-153	3/8 x M16-1.50	800-153	-	-
V8 - 5.7L (350 CID)								
1996-90 -	-	Nylon Elbow	3/8 x 3/8	800-059	3/8 x 3/8	800-059	-	-
1996-90 -	-	Nylon Straight	3/8 x 3/8	800-058	3/8 x 3/8	800-058	-	-
1989 -	-	Steel Line Gasket	3/8 x M16-1.50	800-153	3/8 x M16-1.50	800-153	-	-
CAVALIER								
L4 - 2.0L (122 CID)								
1989-83 -	-	Steel Line Gasket	3/8 x M16-1.50	800-153	3/8 x M16-1.50	800-153	-	-
L4 - 2.2L (134 CID)								
2005-92 -	-	Nylon Elbow	3/8 x 3/8	800-059	-	-	-	-
2005-92 -	-	Nylon Straight	3/8 x 3/8	800-058	-	-	-	-
2005-92 -	-	Steel Line Gasket	-	-	3/8 x M16-1.50	800-153	-	-
1991-90 -	-	Steel Line Gasket	3/8 x M16-1.50	800-153	3/8 x M16-1.50	800-153	-	-
L4 - 2.3L (138 CID)								
1995 -	-	Nylon Elbow	3/8 x 3/8	800-059	-	-	-	-
1995 -	-	Nylon Straight	3/8 x 3/8	800-058	-	-	-	-
1995 -	-	Steel Line Gasket	-	-	3/8 x M16-1.50	800-153	-	-
L4 - 2.4L (146 CID)								
2002-96 -	-	Nylon Elbow	3/8 x 3/8	800-059	-	-	-	-
2002-96 -	-	Nylon Straight	3/8 x 3/8	800-058	-	-	-	-
2002-96 -	-	Steel Line Gasket	-	-	3/8 x M16-1.50	800-153	-	-
V6 - 2.8L (173 CID)								
1989-85 -	-	Steel Line Gasket	3/8 x M16-1.50	800-153	3/8 x M16-1.50	800-153	-	-
V6 - 3.1L (189 CID)								
1994-92 -	-	Nylon Elbow	3/8 x 3/8	800-059	-	-	-	-
1994-92 -	-	Nylon Straight	3/8 x 3/8	800-058	-	-	-	-
1994-92 -	-	Steel Line Gasket	-	-	3/8 x M16-1.50	800-153	-	-
1991-90 -	-	Steel Line Gasket	3/8 x M16-1.50	800-153	3/8 x M16-1.50	800-153	-	-
CELEBRITY								
L4 - 2.5L (151 CID)								
1990-89 -	-	Nylon Elbow	3/8 x 3/8	800-059	3/8 x 3/8	800-059	-	-
1990-89 -	-	Nylon Straight	3/8 x 3/8	800-058	3/8 x 3/8	800-058	-	-
1988-84 -	-	Steel Line Gasket	3/8 x M16-1.50	800-153	3/8 x M16-1.50	800-153	-	-

Quick Disconnect Fuel Line Connector Applications

Make/ Model/Engine/Years	Description	Style	Inlet Size	Inlet	Outlet Size	Outlet	Return Size	Return
CHEVROLET (continued)								
CELEBRITY (continued)								
L4 - 2.5L (151 CID) (continued)								
1983	-	Steel Line Gasket	-	-	3/8 x M16-1.50	800-153	-	-
V6 - 2.8L (173 CID)								
1989	-	Nylon Elbow	3/8 x 3/8	800-059	3/8 x 3/8	800-059	-	-
1989	-	Nylon Straight	3/8 x 3/8	800-058	3/8 x 3/8	800-058	-	-
1988-86	-	Steel Line Gasket	3/8 x M16-1.50	800-153	3/8 x M16-1.50	800-153	-	-
1985	-	Steel Line Gasket	-	-	3/8 x M16-1.50	800-153	-	-
V6 - 3.1L (189 CID)								
1990	-	Nylon Elbow	3/8 x 3/8	800-059	3/8 x 3/8	800-059	-	-
1990	-	Nylon Straight	3/8 x 3/8	800-058	3/8 x 3/8	800-058	-	-
CITATION								
L4 - 2.5L (151 CID)								
1985-84	-	Steel Line Gasket	3/8 x M16-1.50	800-153	3/8 x M16-1.50	800-153	-	-
1983	-	Steel Line Gasket	-	-	3/8 x M16-1.50	800-153	-	-
V6 - 2.8L (173 CID)								
1985	-	Steel Line Gasket	-	-	3/8 x M16-1.50	800-153	-	-
CORSICA								
L4 - 2.0L (122 CID)								
1989-87	-	Steel Line Gasket	3/8 x M16-1.50	800-153	3/8 x M16-1.50	800-153	-	-
L4 - 2.2L (134 CID)								
1996-93	-	Nylon Elbow	3/8 x 3/8	800-059	-	-	-	-
1996-93	-	Nylon Straight	3/8 x 3/8	800-058	-	-	-	-
1996-93	-	Steel Line Gasket	-	-	3/8 x M16-1.50	800-153	-	-
1992-90	-	Nylon Elbow	3/8 x 3/8	800-059	3/8 x 3/8	800-059	-	-
1992-90	-	Nylon Straight	3/8 x 3/8	800-058	3/8 x 3/8	800-058	-	-
V6 - 2.8L (173 CID)								
1989-87	-	Steel Line Gasket	3/8 x M16-1.50	800-153	3/8 x M16-1.50	800-153	-	-
V6 - 3.1L (189 CID)								
1996-93	-	Nylon Elbow	3/8 x 3/8	800-059	-	-	-	-
1996-93	-	Nylon Straight	3/8 x 3/8	800-058	-	-	-	-
1996-93	-	Steel Line Gasket	-	-	3/8 x M16-1.50	800-153	-	-
1992-90	-	Nylon Elbow	3/8 x 3/8	800-059	3/8 x 3/8	800-059	-	-
1992-90	-	Nylon Straight	3/8 x 3/8	800-058	3/8 x 3/8	800-058	-	-
CORVETTE								
V8 - 5.7L (350 CID)								
2003	Exc. 2nd Design Fuel System (FFS)	Nylon Elbow	5/16 x 5/16	800-060	3/8 x 3/8	800-059	3/8 x 3/8	800-059
2003	Exc. 2nd Design Fuel System (FFS)	Nylon Straight	5/16 x 5/16	800-057	3/8 x 3/8	800-058	3/8 x 3/8	800-058
2002-99	-	Nylon Elbow	5/16 x 5/16	800-060	3/8 x 3/8	800-059	3/8 x 3/8	800-059
2002-99	-	Nylon Straight	5/16 x 5/16	800-057	3/8 x 3/8	800-058	3/8 x 3/8	800-058
1998-97	-	Nylon Elbow	3/8 x 3/8	800-059	3/8 x 3/8	800-059	-	-
1998-97	-	Nylon Straight	3/8 x 3/8	800-058	3/8 x 3/8	800-058	-	-
1996	VIN 5	Steel Line Gasket	3/8 x M16-1.50	800-153	3/8 x M16-1.50	800-153	-	-
1996	VIN P	Nylon Elbow	3/8 x 3/8	800-059	3/8 x 3/8	800-059	-	-
1996	VIN P	Nylon Straight	3/8 x 3/8	800-058	3/8 x 3/8	800-058	-	-
1995-85	-	Steel Line Gasket	3/8 x M16-1.50	800-153	3/8 x M16-1.50	800-153	-	-
EL CAMINO								
V6 - 4.3L (262 CID)								
1988-85	-	Steel Line Gasket	3/8 x M16-1.50	800-153	3/8 x M16-1.50	800-153	-	-
IMPALA								
V6 - 3.4L (207 CID)								
2005-00	-	Nylon Elbow	3/8 x 3/8	800-059	-	-	-	-
2005-00	-	Nylon Straight	3/8 x 3/8	800-058	-	-	-	-
2005-00	-	Steel Line Gasket	-	-	3/8 x M16-1.50	800-153	-	-
V6 - 3.8L (231 CID)								
2005-00	-	Nylon Elbow	3/8 x 3/8	800-059	-	-	-	-
2005-00	-	Nylon Straight	3/8 x 3/8	800-058	-	-	-	-
2005-00	-	Steel Line Gasket	-	-	3/8 x M16-1.50	800-153	-	-
V6 - 4.3L (262 CID)								
1985	-	Steel Line Gasket	3/8 x M16-1.50	800-153	3/8 x M16-1.50	800-153	-	-
IMPALA SS								
V8 - 5.7L (350 CID)								
1996-94	-	Nylon Elbow	3/8 x 3/8	800-059	3/8 x 3/8	800-059	-	-
1996-94	-	Nylon Straight	3/8 x 3/8	800-058	3/8 x 3/8	800-058	-	-
LUMINA								
L4 - 2.2L (134 CID)								
1993	-	Nylon Elbow	3/8 x 3/8	800-059	-	-	-	-
1993	-	Nylon Straight	3/8 x 3/8	800-058	-	-	-	-
1993	-	Steel Line Gasket	-	-	3/8 x M16-1.50	800-153	-	-
L4 - 2.5L (151 CID)								
1992	-	Nylon Elbow	3/8 x 3/8	800-059	-	-	-	-
1992	-	Nylon Straight	3/8 x 3/8	800-058	-	-	-	-
1992	-	Steel Line Gasket	-	-	3/8 x M16-1.50	800-153	-	-
1991-90	-	Steel Line Gasket	3/8 x M16-1.50	800-153	3/8 x M16-1.50	800-153	-	-
V6 - 3.1L (189 CID)								
2001-92	-	Nylon Elbow	3/8 x 3/8	800-059	-	-	-	-
2001-92	-	Nylon Straight	3/8 x 3/8	800-058	-	-	-	-
2001-92	-	Steel Line Gasket	-	-	3/8 x M16-1.50	800-153	-	-

Quick Disconnect

Quick Disconnect Fuel Line Connector Applications

Quick Disconnect

Make/ Model/Engine/Years	Description	Style	Inlet Size	Inlet	Outlet Size	Outlet	Return Size	Return
CHEVROLET (continued)								
LUMINA (continued)								
V6 - 3.1L (189 CID) (continued)								
1991-90	-	Steel Line Gasket	3/8 x M16-1.50	800-153	3/8 x M16-1.50	800-153	-	-
V6 - 3.4L (207 CID)								
1997-92	-	Nylon Elbow	3/8 x 3/8	800-059	-	-	-	-
1997-92	-	Nylon Straight	3/8 x 3/8	800-058	-	-	-	-
1997-92	-	Steel Line Gasket	-	-	3/8 x M16-1.50	800-153	-	-
1991	-	Steel Line Gasket	3/8 x M16-1.50	800-153	3/8 x M16-1.50	800-153	-	-
V6 - 3.8L (231 CID)								
1999-98	-	Nylon Elbow	3/8 x 3/8	800-059	-	-	-	-
1999-98	-	Nylon Straight	3/8 x 3/8	800-058	-	-	-	-
1999-98	-	Steel Line Gasket	-	-	3/8 x M16-1.50	800-153	-	-
LUMINA APV								
V6 - 3.1L (189 CID)								
1995-90	-	Nylon Elbow	3/8 x 3/8	800-059	3/8 x 3/8	800-059	-	-
1995-90	-	Nylon Straight	3/8 x 3/8	800-058	3/8 x 3/8	800-058	-	-
V6 - 3.4L (207 CID)								
1996	-	Nylon Elbow	3/8 x 3/8	800-059	3/8 x 3/8	800-059	-	-
1996	-	Nylon Straight	3/8 x 3/8	800-058	3/8 x 3/8	800-058	-	-
V6 - 3.8L (231 CID)								
1995-92	-	Nylon Elbow	3/8 x 3/8	800-059	3/8 x 3/8	800-059	-	-
1995-92	-	Nylon Straight	3/8 x 3/8	800-058	3/8 x 3/8	800-058	-	-
MALIBU								
L4 - 2.4L (146 CID)								
1999-97	-	Nylon Elbow	3/8 x 3/8	800-059	-	-	-	-
1999-97	-	Nylon Straight	3/8 x 3/8	800-058	-	-	-	-
1999-97	-	Steel Line Gasket	-	-	3/8 x M16-1.50	800-153	-	-
V6 - 3.1L (189 CID)								
2005-97	-	Nylon Elbow	3/8 x 3/8	800-059	-	-	-	-
2005-97	-	Nylon Straight	3/8 x 3/8	800-058	-	-	-	-
2005-97	-	Steel Line Gasket	-	-	3/8 x M16-1.50	800-153	-	-
MONTE CARLO								
V6 - 3.1L (189 CID)								
1999-95	-	Nylon Elbow	3/8 x 3/8	800-059	-	-	-	-
1999-95	-	Nylon Straight	3/8 x 3/8	800-058	-	-	-	-
1999-95	-	Steel Line Gasket	-	-	3/8 x M16-1.50	800-153	-	-
V6 - 3.4L (207 CID)								
2005-00	-	Nylon Elbow	3/8 x 3/8	800-059	-	-	-	-
2005-00	-	Nylon Straight	3/8 x 3/8	800-058	-	-	-	-
2005-00	-	Steel Line Gasket	-	-	3/8 x M16-1.50	800-153	-	-
1997-95	-	Nylon Elbow	3/8 x 3/8	800-059	-	-	-	-
1997-95	-	Nylon Straight	3/8 x 3/8	800-058	-	-	-	-
1997-95	-	Steel Line Gasket	-	-	3/8 x M16-1.50	800-153	-	-
V6 - 3.8L (231 CID)								
2005-98	-	Nylon Elbow	3/8 x 3/8	800-059	-	-	-	-
2005-98	-	Nylon Straight	3/8 x 3/8	800-058	-	-	-	-
2005-98	-	Steel Line Gasket	-	-	3/8 x M16-1.50	800-153	-	-
V6 - 4.3L (262 CID)								
1988-85	-	Steel Line Gasket	3/8 x M16-1.50	800-153	3/8 x M16-1.50	800-153	-	-
NOVA								
L4 - 1.6L (98 CID)								
1988	-	Steel Line Gasket	-	-	3/8 x M16-1.50	800-153	-	-
VENTURE VAN								
V6 - 3.4L (207 CID)								
2005-97	-	Nylon Elbow	3/8 x 3/8	800-059	3/8 x 3/8	800-059	-	-
2005-97	-	Nylon Straight	3/8 x 3/8	800-058	3/8 x 3/8	800-058	-	-
CHEVROLET/GMC TRUCK								
ASTRO								
L4 - 2.5L (151 CID)								
1990-85	-	Steel Line Gasket	3/8 x M16-1.50	800-153	3/8 x M16-1.50	800-153	-	-
V6 - 4.3L (262 CID)								
2005-86	-	Steel Line Gasket	3/8 x M16-1.50	800-153	3/8 x M16-1.50	800-153	-	-
AVALANCHE								
V8 - 5.3L (323 CID)								
2003-02	-	Steel Line Gasket	3/8 x M16-1.50	800-153	3/8 x M16-1.50	800-153	-	-
V8 - 8.1L (496 CID)								
2003-02	-	Steel Line Gasket	3/8 x M16-1.50	800-153	3/8 x M16-1.50	800-153	-	-
BLAZER								
V8 - 5.0L (305 CID)								
1987	-	Steel Line Gasket	3/8 x M16-1.50	800-153	3/8 x M16-1.50	800-153	-	-
V8 - 5.7L (350 CID)								
1994-87	-	Steel Line Gasket	3/8 x M16-1.50	800-153	3/8 x M16-1.50	800-153	-	-
C1500 PICKUP (1/2 TON)								
V6 - 4.3L (262 CID)								
1998-88	-	Steel Line Gasket	3/8 x M16-1.50	800-153	3/8 x M16-1.50	800-153	-	-
V8 - 5.0L (305 CID)								
1999-88	-	Steel Line Gasket	3/8 x M16-1.50	800-153	3/8 x M16-1.50	800-153	-	-
V8 - 5.7L (350 CID)								
1999-88	-	Steel Line Gasket	3/8 x M16-1.50	800-153	3/8 x M16-1.50	800-153	-	-

Quick Disconnect Fuel Line Connector Applications

Make/ Model/Engine/Years	Description	Style	Inlet Size	Inlet	Outlet Size	Outlet	Return Size	Return
CHEVROLET/GMC TRUCK (continued)								
C1500 PICKUP (1/2 TON) (continued)								
V8 - 7.4L (454 CID)								
1993-90 -		Steel Line Gasket	3/8 x M16-1.50	800-153	3/8 x M16-1.50	800-153	-	-
C2500 PICKUP (3/4 TON)								
V6 - 4.3L (262 CID)								
1995-88 -		Steel Line Gasket	3/8 x M16-1.50	800-153	3/8 x M16-1.50	800-153	-	-
V8 - 5.0L (305 CID)								
1999-88 -		Steel Line Gasket	3/8 x M16-1.50	800-153	3/8 x M16-1.50	800-153	-	-
V8 - 5.7L (350 CID)								
2000-88 -		Steel Line Gasket	3/8 x M16-1.50	800-153	3/8 x M16-1.50	800-153	-	-
V8 - 7.4L (454 CID)								
2000-91 -		Steel Line Gasket	3/8 x M16-1.50	800-153	3/8 x M16-1.50	800-153	-	-
C3500 PICKUP (1 TON)								
V8 - 5.7L (350 CID)								
2000-88 -		Steel Line Gasket	3/8 x M16-1.50	800-153	3/8 x M16-1.50	800-153	-	-
V8 - 7.4L (454 CID)								
2000-88 -		Steel Line Gasket	3/8 x M16-1.50	800-153	3/8 x M16-1.50	800-153	-	-
V8 - 8.1L (496 CID)								
2002-01 -		Steel Line Gasket	3/8 x M16-1.50	800-153	3/8 x M16-1.50	800-153	-	-
CABALLERO								
V6 - 4.3L (262 CID)								
1987-85 -		Steel Line Gasket	3/8 x M16-1.50	800-153	3/8 x M16-1.50	800-153	-	-
EXPRESS								
V6 - 4.3L (262 CID)								
2006-96 -		Nylon Elbow	3/8 x 3/8	800-059	3/8 x 3/8	800-059	-	-
2006-96 -		Nylon Straight	3/8 x 3/8	800-058	3/8 x 3/8	800-058	-	-
V8 - 4.8L (294 CID)								
2003 -		Nylon Elbow	3/8 x 3/8	800-059	3/8 x 3/8	800-059	-	-
2003 -		Nylon Straight	3/8 x 3/8	800-058	3/8 x 3/8	800-058	-	-
V8 - 5.0L (305 CID)								
2002-96 -		Nylon Elbow	3/8 x 3/8	800-059	3/8 x 3/8	800-059	-	-
2002-96 -		Nylon Straight	3/8 x 3/8	800-058	3/8 x 3/8	800-058	-	-
V8 - 5.3L (323 CID)								
2003 -		Nylon Elbow	3/8 x 3/8	800-059	3/8 x 3/8	800-059	-	-
2003 -		Nylon Straight	3/8 x 3/8	800-058	3/8 x 3/8	800-058	-	-
V8 - 5.7L (350 CID)								
2003-96 -		Nylon Elbow	3/8 x 3/8	800-059	3/8 x 3/8	800-059	-	-
2003-96 -		Nylon Straight	3/8 x 3/8	800-058	3/8 x 3/8	800-058	-	-
V8 - 6.0L (364 CID)								
2003 -		Nylon Elbow	3/8 x 3/8	800-059	3/8 x 3/8	800-059	-	-
2003 -		Nylon Straight	3/8 x 3/8	800-058	3/8 x 3/8	800-058	-	-
V8 - 7.4L (454 CID)								
2000-96 -		Nylon Elbow	3/8 x 3/8	800-059	3/8 x 3/8	800-059	-	-
2000-96 -		Nylon Straight	3/8 x 3/8	800-058	3/8 x 3/8	800-058	-	-
V8 - 8.1L (496 CID)								
2002-01 -		Nylon Elbow	3/8 x 3/8	800-059	3/8 x 3/8	800-059	-	-
2002-01 -		Nylon Straight	3/8 x 3/8	800-058	3/8 x 3/8	800-058	-	-
G10, G15, G1500 VAN (1/2 TON)								
V6 - 4.3L (262 CID)								
1995-87 -		Steel Line Gasket	3/8 x M16-1.50	800-153	3/8 x M16-1.50	800-153	-	-
V8 - 5.0L (305 CID)								
1995-87 -		Steel Line Gasket	3/8 x M16-1.50	800-153	3/8 x M16-1.50	800-153	-	-
V8 - 5.7L (350 CID)								
1995-87 -		Steel Line Gasket	3/8 x M16-1.50	800-153	3/8 x M16-1.50	800-153	-	-
G20, G25, G2500 VAN (3/4 TON)								
V6 - 4.3L (262 CID)								
1998-97 -		Nylon Elbow	3/8 x 3/8	800-059	3/8 x 3/8	800-059	-	-
1998-97 -		Nylon Straight	3/8 x 3/8	800-058	3/8 x 3/8	800-058	-	-
1995-87 -		Steel Line Gasket	3/8 x M16-1.50	800-153	3/8 x M16-1.50	800-153	-	-
V8 - 5.0L (305 CID)								
1998-97 -		Nylon Elbow	3/8 x 3/8	800-059	3/8 x 3/8	800-059	-	-
1998-97 -		Nylon Straight	3/8 x 3/8	800-058	3/8 x 3/8	800-058	-	-
1996-87 -		Steel Line Gasket	3/8 x M16-1.50	800-153	3/8 x M16-1.50	800-153	-	-
V8 - 5.7L (350 CID)								
1995-87 -		Steel Line Gasket	3/8 x M16-1.50	800-153	3/8 x M16-1.50	800-153	-	-
G30, G35, G3500 VAN (1 TON)								
V6 - 4.3L (262 CID)								
1996-87 -		Steel Line Gasket	3/8 x M16-1.50	800-153	3/8 x M16-1.50	800-153	-	-
V8 - 5.7L (350 CID)								
1996-87 -		Steel Line Gasket	3/8 x M16-1.50	800-153	3/8 x M16-1.50	800-153	-	-
V8 - 7.4L (454 CID)								
1996-88 -		Steel Line Gasket	3/8 x M16-1.50	800-153	3/8 x M16-1.50	800-153	-	-
JIMMY								
V8 - 5.0L (305 CID)								
1987 -		Steel Line Gasket	3/8 x M16-1.50	800-153	3/8 x M16-1.50	800-153	-	-
V8 - 5.7L (350 CID)								
1991-87 -		Steel Line Gasket	3/8 x M16-1.50	800-153	3/8 x M16-1.50	800-153	-	-
K1500 PICKUP								
V6 - 4.3L (262 CID)								
1998-88 -		Steel Line Gasket	3/8 x M16-1.50	800-153	3/8 x M16-1.50	800-153	-	-

Quick Disconnect

Quick Disconnect Fuel Line Connector Applications

Quick Disconnect

Make/ Model/Engine/Years	Description	Style	Inlet Size	Inlet	Outlet Size	Outlet	Return Size	Return
CHEVROLET/GMC TRUCK (continued)								
K1500 PICKUP (continued)								
V8 - 5.0L (305 CID)								
1999-88 -		Steel Line Gasket	3/8 x M16-1.50	800-153	3/8 x M16-1.50	800-153	-	-
V8 - 5.7L (350 CID)								
1999-88 -		Steel Line Gasket	3/8 x M16-1.50	800-153	3/8 x M16-1.50	800-153	-	-
K2500 PICKUP								
V6 - 4.3L (262 CID)								
1995-88 -		Steel Line Gasket	3/8 x M16-1.50	800-153	3/8 x M16-1.50	800-153	-	-
V8 - 5.0L (305 CID)								
1999-88 -		Steel Line Gasket	3/8 x M16-1.50	800-153	3/8 x M16-1.50	800-153	-	-
V8 - 5.7L (350 CID)								
2000-88 -		Steel Line Gasket	3/8 x M16-1.50	800-153	3/8 x M16-1.50	800-153	-	-
V8 - 7.4L (454 CID)								
2000-91 -		Steel Line Gasket	3/8 x M16-1.50	800-153	3/8 x M16-1.50	800-153	-	-
K3500 PICKUP								
V8 - 5.7L (350 CID)								
2000-88 -		Steel Line Gasket	3/8 x M16-1.50	800-153	3/8 x M16-1.50	800-153	-	-
V8 - 7.4L (454 CID)								
2000-88 -		Steel Line Gasket	3/8 x M16-1.50	800-153	3/8 x M16-1.50	800-153	-	-
P20, P25, P2500 VAN (3/4 TON)								
V8 - 5.7L (350 CID)								
1989-87 -		Steel Line Gasket	3/8 x M16-1.50	800-153	3/8 x M16-1.50	800-153	-	-
P30, P35, P3500 VAN (1 TON)								
V6 - 4.3L (262 CID)								
1999-90 -		Steel Line Gasket	3/8 x M16-1.50	800-153	3/8 x M16-1.50	800-153	-	-
V8 - 5.7L (350 CID)								
1999-87 -		Steel Line Gasket	3/8 x M16-1.50	800-153	3/8 x M16-1.50	800-153	-	-
V8 - 7.4L (454 CID)								
1999-90 -		Steel Line Gasket	3/8 x M16-1.50	800-153	3/8 x M16-1.50	800-153	-	-
POSTAL SERVICE VEHICLE								
L4 - 2.2L (134 CID)								
1995-94 -		Steel Line Gasket	3/8 x M16-1.50	800-153	3/8 x M16-1.50	800-153	-	-
L4 - 2.5L (151 CID)								
1993-87 -		Steel Line Gasket	3/8 x M16-1.50	800-153	3/8 x M16-1.50	800-153	-	-
R10, R1500 PICKUP (1/2 TON)								
V6 - 4.3L (262 CID)								
1987 -		Steel Line Gasket	3/8 x M16-1.50	800-153	3/8 x M16-1.50	800-153	-	-
V8 - 5.0L (305 CID)								
1987 -		Steel Line Gasket	3/8 x M16-1.50	800-153	3/8 x M16-1.50	800-153	-	-
V8 - 5.7L (350 CID)								
1987 -		Steel Line Gasket	3/8 x M16-1.50	800-153	3/8 x M16-1.50	800-153	-	-
R20, R2500 PICKUP (3/4 TON)								
V6 - 4.3L (262 CID)								
1987 -		Steel Line Gasket	3/8 x M16-1.50	800-153	3/8 x M16-1.50	800-153	-	-
V8 - 5.0L (305 CID)								
1987 -		Steel Line Gasket	3/8 x M16-1.50	800-153	3/8 x M16-1.50	800-153	-	-
V8 - 5.7L (350 CID)								
1989-87 -		Steel Line Gasket	3/8 x M16-1.50	800-153	3/8 x M16-1.50	800-153	-	-
V8 - 7.4L (454 CID)								
1989-87 -		Steel Line Gasket	3/8 x M16-1.50	800-153	3/8 x M16-1.50	800-153	-	-
R30, R3500 PICKUP (1 TON)								
V8 - 5.7L (350 CID)								
1991-87 -		Steel Line Gasket	3/8 x M16-1.50	800-153	3/8 x M16-1.50	800-153	-	-
V8 - 7.4L (454 CID)								
1991-87 -		Steel Line Gasket	3/8 x M16-1.50	800-153	3/8 x M16-1.50	800-153	-	-
S10 BLAZER								
L4 - 2.5L (151 CID)								
1988-85 -		Steel Line Gasket	3/8 x M16-1.50	800-153	3/8 x M16-1.50	800-153	-	-
V6 - 2.8L (173 CID)								
1989-86 -		Steel Line Gasket	-	-	3/8 x M16-1.50	800-153	-	-
V6 - 4.3L (262 CID)								
2005-98 -		Nylon Elbow	-	-	3/8 x 3/8	800-059	-	-
2005-98 -		Nylon Straight	-	-	3/8 x 3/8	800-058	-	-
2005-98 -		Steel Line Gasket	3/8 x M16-1.50	800-153	-	-	-	-
1997-88 -		Steel Line Gasket	3/8 x M16-1.50	800-153	3/8 x M16-1.50	800-153	-	-
S10 PICKUP								
L4 - 2.2L (134 CID)								
2003 -		Nylon Elbow	-	-	3/8 x 3/8	800-059	-	-
2003 -		Nylon Straight	-	-	3/8 x 3/8	800-058	-	-
2003 -		Steel Line Gasket	3/8 x M16-1.50	800-153	-	-	-	-
2002-00 VIN 4		Nylon Elbow	-	-	3/8 x 3/8	800-059	-	-
2002-00 VIN 4		Nylon Straight	-	-	3/8 x 3/8	800-058	-	-
2002-00 VIN 4		Steel Line Gasket	3/8 x M16-1.50	800-153	-	-	-	-
2002-00 VIN 5		Nylon Elbow	3/8 x 3/8	800-059	5/16 x 5/16	800-060	3/8 x 3/8	800-059
2002-00 VIN 5		Nylon Straight	3/8 x 3/8	800-058	5/16 x 5/16	800-057	3/8 x 3/8	800-058
1999-98 -		Nylon Elbow	-	-	3/8 x 3/8	800-059	-	-
1999-98 -		Nylon Straight	-	-	3/8 x 3/8	800-058	-	-
1999-98 -		Steel Line Gasket	3/8 x M16-1.50	800-153	-	-	-	-
1997-94 -		Steel Line Gasket	3/8 x M16-1.50	800-153	3/8 x M16-1.50	800-153	-	-

Quick Disconnect Fuel Line Connector Applications

Make/ Model/Engine/Years	Description	Style	Inlet Size	Inlet	Outlet Size	Outlet	Return Size	Return
CHEVROLET/GMC TRUCK (continued)								
S10 PICKUP (continued)								
L4 - 2.5L (151 CID)								
1993-85	-	Steel Line Gasket	3/8 x M16-1.50	800-153	3/8 x M16-1.50	800-153	-	-
V6 - 2.8L (173 CID)								
1993-86	-	Steel Line Gasket	-	-	3/8 x M16-1.50	800-153	-	-
V6 - 4.3L (262 CID)								
2004-98	-	Nylon Elbow	-	-	3/8 x 3/8	800-059	-	-
2004-98	-	Nylon Straight	-	-	3/8 x 3/8	800-058	-	-
2004-98	-	Steel Line Gasket	3/8 x M16-1.50	800-153	-	-	-	-
1997-88	-	Steel Line Gasket	3/8 x M16-1.50	800-153	3/8 x M16-1.50	800-153	-	-
S10 TRAILBLAZER								
L6 - 4.2L (256 CID)								
2004-02	-	Nylon Elbow	3/8 x 3/8	800-059	3/8 x 3/8	800-059	-	-
2004-02	-	Nylon Straight	3/8 x 3/8	800-058	3/8 x 3/8	800-058	-	-
V8 - 5.3L (323 CID)								
2003	-	Nylon Elbow	3/8 x 3/8	800-059	3/8 x 3/8	800-059	-	-
2003	-	Nylon Straight	3/8 x 3/8	800-058	3/8 x 3/8	800-058	-	-
S15 ENVOY								
L6 - 4.2L (256 CID)								
2004-02	-	Nylon Elbow	3/8 x 3/8	800-059	3/8 x 3/8	800-059	-	-
2004-02	-	Nylon Straight	3/8 x 3/8	800-058	3/8 x 3/8	800-058	-	-
V8 - 5.3L (323 CID)								
2003	-	Nylon Elbow	3/8 x 3/8	800-059	3/8 x 3/8	800-059	-	-
2003	-	Nylon Straight	3/8 x 3/8	800-058	3/8 x 3/8	800-058	-	-
S15 JIMMY								
L4 - 2.5L (151 CID)								
1988-85	-	Steel Line Gasket	3/8 x M16-1.50	800-153	3/8 x M16-1.50	800-153	-	-
V6 - 2.8L (173 CID)								
1989-86	-	Steel Line Gasket	-	-	3/8 x M16-1.50	800-153	-	-
V6 - 4.3L (262 CID)								
2001-98	-	Nylon Elbow	-	-	3/8 x 3/8	800-059	-	-
2001-98	-	Nylon Straight	-	-	3/8 x 3/8	800-058	-	-
2001-98	-	Steel Line Gasket	3/8 x M16-1.50	800-153	-	-	-	-
1997-88	-	Steel Line Gasket	3/8 x M16-1.50	800-153	3/8 x M16-1.50	800-153	-	-
S15 PICKUP								
L4 - 2.5L (151 CID)								
1990-85	-	Steel Line Gasket	3/8 x M16-1.50	800-153	3/8 x M16-1.50	800-153	-	-
V6 - 2.8L (173 CID)								
1990-86	-	Steel Line Gasket	-	-	3/8 x M16-1.50	800-153	-	-
V6 - 4.3L (262 CID)								
1990-88	-	Steel Line Gasket	3/8 x M16-1.50	800-153	3/8 x M16-1.50	800-153	-	-
S15 SONOMA								
L4 - 2.2L (134 CID)								
2003	-	Nylon Elbow	-	-	3/8 x 3/8	800-059	-	-
2003	-	Nylon Straight	-	-	3/8 x 3/8	800-058	-	-
2003	-	Steel Line Gasket	3/8 x M16-1.50	800-153	-	-	-	-
2002-00	VIN 4	Nylon Elbow	-	-	3/8 x 3/8	800-059	-	-
2002-00	VIN 4	Nylon Straight	-	-	3/8 x 3/8	800-058	-	-
2002-00	VIN 4	Steel Line Gasket	3/8 x M16-1.50	800-153	-	-	-	-
2002-00	VIN 5	Nylon Elbow	3/8 x 3/8	800-059	5/16 x 5/16	800-060	3/8 x 3/8	800-059
2002-00	VIN 5	Nylon Straight	3/8 x 3/8	800-058	5/16 x 5/16	800-057	3/8 x 3/8	800-058
1999-98	-	Nylon Elbow	-	-	3/8 x 3/8	800-059	-	-
1999-98	-	Nylon Straight	-	-	3/8 x 3/8	800-058	-	-
1999-98	-	Steel Line Gasket	3/8 x M16-1.50	800-153	-	-	-	-
1997-94	-	Steel Line Gasket	3/8 x M16-1.50	800-153	3/8 x M16-1.50	800-153	-	-
L4 - 2.5L (151 CID)								
1993-91	-	Steel Line Gasket	3/8 x M16-1.50	800-153	3/8 x M16-1.50	800-153	-	-
V6 - 2.8L (173 CID)								
1993-91	-	Steel Line Gasket	-	-	3/8 x M16-1.50	800-153	-	-
V6 - 4.3L (262 CID)								
2004-98	-	Nylon Elbow	-	-	3/8 x 3/8	800-059	-	-
2004-98	-	Nylon Straight	-	-	3/8 x 3/8	800-058	-	-
2004-98	-	Steel Line Gasket	3/8 x M16-1.50	800-153	-	-	-	-
1997-91	-	Steel Line Gasket	3/8 x M16-1.50	800-153	3/8 x M16-1.50	800-153	-	-
S15 SYCLONE								
V6 - 4.3L (262 CID)								
1992-91	-	Steel Line Gasket	3/8 x M16-1.50	800-153	3/8 x M16-1.50	800-153	-	-
S15 TYPHOON								
V6 - 4.3L (262 CID)								
1993-92	-	Steel Line Gasket	3/8 x M16-1.50	800-153	3/8 x M16-1.50	800-153	-	-
SAFARI								
L4 - 2.5L (151 CID)								
1990-85	-	Steel Line Gasket	3/8 x M16-1.50	800-153	3/8 x M16-1.50	800-153	-	-
V6 - 4.3L (262 CID)								
2005-86	-	Steel Line Gasket	3/8 x M16-1.50	800-153	3/8 x M16-1.50	800-153	-	-
SAVANA								
V6 - 4.3L (262 CID)								
2006-96	-	Nylon Elbow	3/8 x 3/8	800-059	3/8 x 3/8	800-059	-	-
2006-96	-	Nylon Straight	3/8 x 3/8	800-058	3/8 x 3/8	800-058	-	-

Quick Disconnect

Quick Disconnect Fuel Line Connector Applications

Quick Disconnect

Make/ Model/Engine/Years	Description	Style	Inlet Size	Inlet	Outlet Size	Outlet	Return Size	Return
CHEVROLET/GMC TRUCK (continued)								
SAVANA (continued)								
V8 - 4.8L (294 CID)								
2003	-	Nylon Elbow	3/8 x 3/8	800-059	3/8 x 3/8	800-059	-	-
2003	-	Nylon Straight	3/8 x 3/8	800-058	3/8 x 3/8	800-058	-	-
V8 - 5.0L (305 CID)								
2002-96	-	Nylon Elbow	3/8 x 3/8	800-059	3/8 x 3/8	800-059	-	-
2002-96	-	Nylon Straight	3/8 x 3/8	800-058	3/8 x 3/8	800-058	-	-
V8 - 5.3L (323 CID)								
2003	-	Nylon Elbow	3/8 x 3/8	800-059	3/8 x 3/8	800-059	-	-
2003	-	Nylon Straight	3/8 x 3/8	800-058	3/8 x 3/8	800-058	-	-
V8 - 5.7L (350 CID)								
2003-96	-	Nylon Elbow	3/8 x 3/8	800-059	3/8 x 3/8	800-059	-	-
2003-96	-	Nylon Straight	3/8 x 3/8	800-058	3/8 x 3/8	800-058	-	-
V8 - 6.0L (364 CID)								
2003	-	Nylon Elbow	3/8 x 3/8	800-059	3/8 x 3/8	800-059	-	-
2003	-	Nylon Straight	3/8 x 3/8	800-058	3/8 x 3/8	800-058	-	-
V8 - 7.4L (454 CID)								
2000-96	-	Nylon Elbow	3/8 x 3/8	800-059	3/8 x 3/8	800-059	-	-
2000-96	-	Nylon Straight	3/8 x 3/8	800-058	3/8 x 3/8	800-058	-	-
V8 - 8.1L (496 CID)								
2002-01	-	Nylon Elbow	3/8 x 3/8	800-059	3/8 x 3/8	800-059	-	-
2002-01	-	Nylon Straight	3/8 x 3/8	800-058	3/8 x 3/8	800-058	-	-
SIERRA								
V6 - 4.3L (262 CID)								
2006-99	-	Steel Line Gasket	3/8 x M16-1.50	800-153	3/8 x M16-1.50	800-153	-	-
V8 - 4.8L (294 CID)								
2003-99	-	Steel Line Gasket	3/8 x M16-1.50	800-153	3/8 x M16-1.50	800-153	-	-
V8 - 5.3L (323 CID)								
2003-99	VIN T	Steel Line Gasket	3/8 x M16-1.50	800-153	3/8 x M16-1.50	800-153	-	-
V8 - 6.0L (364 CID)								
2003-99	-	Steel Line Gasket	3/8 x M16-1.50	800-153	3/8 x M16-1.50	800-153	-	-
V8 - 8.1L (496 CID)								
2003-01	-	Steel Line Gasket	3/8 x M16-1.50	800-153	3/8 x M16-1.50	800-153	-	-
SIERRA C3								
V8 - 6.0L (364 CID)								
2001	-	Steel Line Gasket	3/8 x M16-1.50	800-153	3/8 x M16-1.50	800-153	-	-
SIERRA DENALI								
V8 - 6.0L (364 CID)								
2003-02	-	Steel Line Gasket	3/8 x M16-1.50	800-153	3/8 x M16-1.50	800-153	-	-
SILVERADO								
V6 - 4.3L (262 CID)								
2006-99	-	Steel Line Gasket	3/8 x M16-1.50	800-153	3/8 x M16-1.50	800-153	-	-
V8 - 4.8L (294 CID)								
2003-99	-	Steel Line Gasket	3/8 x M16-1.50	800-153	3/8 x M16-1.50	800-153	-	-
V8 - 5.3L (323 CID)								
2003-99	VIN T	Steel Line Gasket	3/8 x M16-1.50	800-153	3/8 x M16-1.50	800-153	-	-
V8 - 6.0L (364 CID)								
2003-99	-	Steel Line Gasket	3/8 x M16-1.50	800-153	3/8 x M16-1.50	800-153	-	-
V8 - 8.1L (496 CID)								
2003-01	-	Steel Line Gasket	3/8 x M16-1.50	800-153	3/8 x M16-1.50	800-153	-	-
SUBURBAN								
V8 - 5.0L (305 CID)								
1987	-	Steel Line Gasket	3/8 x M16-1.50	800-153	3/8 x M16-1.50	800-153	-	-
V8 - 5.3L (323 CID)								
2003-00	VIN T	Steel Line Gasket	3/8 x M16-1.50	800-153	3/8 x M16-1.50	800-153	-	-
V8 - 5.7L (350 CID)								
1999-87	-	Steel Line Gasket	3/8 x M16-1.50	800-153	3/8 x M16-1.50	800-153	-	-
V8 - 6.0L (364 CID)								
2003-00	-	Steel Line Gasket	3/8 x M16-1.50	800-153	3/8 x M16-1.50	800-153	-	-
V8 - 7.4L (454 CID)								
1999-87	-	Steel Line Gasket	3/8 x M16-1.50	800-153	3/8 x M16-1.50	800-153	-	-
V8 - 8.1L (496 CID)								
2003-01	-	Steel Line Gasket	3/8 x M16-1.50	800-153	3/8 x M16-1.50	800-153	-	-
TAHOE								
V8 - 4.8L (294 CID)								
2003-00	-	Steel Line Gasket	3/8 x M16-1.50	800-153	3/8 x M16-1.50	800-153	-	-
V8 - 5.3L (323 CID)								
2003-00	VIN T	Steel Line Gasket	3/8 x M16-1.50	800-153	3/8 x M16-1.50	800-153	-	-
V8 - 5.7L (350 CID)								
2000-95	-	Steel Line Gasket	3/8 x M16-1.50	800-153	3/8 x M16-1.50	800-153	-	-
TRACKER								
L4 - 1.6L (98 CID)								
1998	-	Steel Line Gasket	3/8 x M16-1.50	800-153	3/8 x M16-1.50	800-153	-	-
V10, V1500 PICKUP (1/2 TON)								
V6 - 4.3L (262 CID)								
1987	-	Steel Line Gasket	3/8 x M16-1.50	800-153	3/8 x M16-1.50	800-153	-	-
V8 - 5.0L (305 CID)								
1987	-	Steel Line Gasket	3/8 x M16-1.50	800-153	3/8 x M16-1.50	800-153	-	-
V8 - 5.7L (350 CID)								
1987	-	Steel Line Gasket	3/8 x M16-1.50	800-153	3/8 x M16-1.50	800-153	-	-

Quick Disconnect Fuel Line Connector Applications

Make/ Model/Engine/Years	Description	Style	Inlet Size	Inlet	Outlet Size	Outlet	Return Size	Return
CHEVROLET/GMC TRUCK (continued)								
V20, V2500 PICKUP (3/4 TON) (continued)								
V8 - 5.7L (350 CID) (continued)								
1987	-	Steel Line Gasket	3/8 x M16-1.50	800-153	3/8 x M16-1.50	800-153	-	-
V8 - 7.4L (454 CID)								
1987	-	Steel Line Gasket	3/8 x M16-1.50	800-153	3/8 x M16-1.50	800-153	-	-
V30, V3500 PICKUP (1 TON)								
V8 - 5.7L (350 CID)								
1991-87	-	Steel Line Gasket	3/8 x M16-1.50	800-153	3/8 x M16-1.50	800-153	-	-
V8 - 7.4L (454 CID)								
1991-87	-	Steel Line Gasket	3/8 x M16-1.50	800-153	3/8 x M16-1.50	800-153	-	-
YUKON								
V8 - 4.8L (294 CID)								
2003-00	-	Steel Line Gasket	3/8 x M16-1.50	800-153	3/8 x M16-1.50	800-153	-	-
V8 - 5.3L (323 CID)								
2003-00	VIN T	Steel Line Gasket	3/8 x M16-1.50	800-153	3/8 x M16-1.50	800-153	-	-
V8 - 5.7L (350 CID)								
2000-92	-	Steel Line Gasket	3/8 x M16-1.50	800-153	3/8 x M16-1.50	800-153	-	-
V8 - 6.0L (364 CID)								
2000	-	Steel Line Gasket	3/8 x M16-1.50	800-153	3/8 x M16-1.50	800-153	-	-
YUKON XL								
V8 - 5.3L (323 CID)								
2003-01	VIN T	Steel Line Gasket	3/8 x M16-1.50	800-153	3/8 x M16-1.50	800-153	-	-
V8 - 6.0L (364 CID)								
2003-01	-	Steel Line Gasket	3/8 x M16-1.50	800-153	3/8 x M16-1.50	800-153	-	-
V8 - 8.1L (496 CID)								
2003-01	-	Steel Line Gasket	3/8 x M16-1.50	800-153	3/8 x M16-1.50	800-153	-	-
CHRYSLER								
CIRRUS								
L4 - 2.0L (122 CID)								
2000	-	Nylon Elbow	3/8 x 3/8	800-059	5/16 x 5/16	800-060	5/16 x 5/16	800-060
2000	-	Nylon Straight	3/8 x 3/8	800-058	5/16 x 5/16	800-057	5/16 x 5/16	800-057
L4 - 2.4L (148 CID)								
2000	-	Nylon Elbow	3/8 x 3/8	800-059	5/16 x 5/16	800-060	5/16 x 5/16	800-060
2000	-	Nylon Straight	3/8 x 3/8	800-058	5/16 x 5/16	800-057	5/16 x 5/16	800-057
V6 - 2.5L (152 CID)								
2000-98	-	Nylon Elbow	3/8 x 3/8	800-059	5/16 x 5/16	800-060	5/16 x 5/16	800-060
2000-98	-	Nylon Straight	3/8 x 3/8	800-058	5/16 x 5/16	800-057	5/16 x 5/16	800-057
CONCORDE								
V6 - 3.3L (201 CID)								
1996-93	-	Nylon Elbow	3/8 x 3/8	800-059	5/16 x 5/16	800-060	-	-
1996-93	-	Nylon Straight	3/8 x 3/8	800-058	5/16 x 5/16	800-057	-	-
V6 - 3.5L (215 CID)								
1997-93	-	Nylon Elbow	3/8 x 3/8	800-059	5/16 x 5/16	800-060	-	-
1997-93	-	Nylon Straight	3/8 x 3/8	800-058	5/16 x 5/16	800-057	-	-
LEBARON								
L4 - 2.5L (153 CID)								
1993	4-Door	Nylon Elbow	5/16 x 5/16	800-060	3/8 x 3/8	800-059	-	-
1993	4-Door	Nylon Straight	5/16 x 5/16	800-057	3/8 x 3/8	800-058	-	-
LHS								
V6 - 3.5L (215 CID)								
1997-94	-	Nylon Elbow	3/8 x 3/8	800-059	5/16 x 5/16	800-060	-	-
1997-94	-	Nylon Straight	3/8 x 3/8	800-058	5/16 x 5/16	800-057	-	-
NEW YORKER								
V6 - 3.5L (215 CID)								
1996-94	-	Nylon Elbow	3/8 x 3/8	800-059	5/16 x 5/16	800-060	-	-
1996-94	-	Nylon Straight	3/8 x 3/8	800-058	5/16 x 5/16	800-057	-	-
SEBRING								
L4 - 2.4L (148 CID)								
1998-97	-	Nylon Elbow	3/8 x 3/8	800-059	5/16 x 5/16	800-060	5/16 x 5/16	800-060
1998-97	-	Nylon Straight	3/8 x 3/8	800-058	5/16 x 5/16	800-057	5/16 x 5/16	800-057
V6 - 2.5L (152 CID)								
2000	Sedan	Nylon Elbow	3/8 x 3/8	800-059	5/16 x 5/16	800-060	5/16 x 5/16	800-060
2000	Sedan	Nylon Straight	3/8 x 3/8	800-058	5/16 x 5/16	800-057	5/16 x 5/16	800-057
1998-97	-	Nylon Elbow	3/8 x 3/8	800-059	5/16 x 5/16	800-060	5/16 x 5/16	800-060
1998-97	-	Nylon Straight	3/8 x 3/8	800-058	5/16 x 5/16	800-057	5/16 x 5/16	800-057
TOWN & COUNTRY VAN								
V6 - 3.3L (201 CID)								
2000-97	Extended Wheel Base	Nylon Elbow	3/8 x 3/8	800-059	5/16 x 5/16	800-060	5/16 x 5/16	800-060
2000-97	Extended Wheel Base	Nylon Straight	3/8 x 3/8	800-058	5/16 x 5/16	800-057	5/16 x 5/16	800-057
V6 - 3.8L (230 CID)								
2000-97	Extended Wheel Base	Nylon Elbow	3/8 x 3/8	800-059	5/16 x 5/16	800-060	5/16 x 5/16	800-060
2000-97	Extended Wheel Base	Nylon Straight	3/8 x 3/8	800-058	5/16 x 5/16	800-057	5/16 x 5/16	800-057
VOYAGER, GRAND VOYAGER								
L4 - 2.4L (148 CID)								
2000	Extended Wheel Base	Nylon Elbow	3/8 x 3/8	800-059	5/16 x 5/16	800-060	5/16 x 5/16	800-060
2000	Extended Wheel Base	Nylon Straight	3/8 x 3/8	800-058	5/16 x 5/16	800-057	5/16 x 5/16	800-057
V6 - 3.0L (181 CID)								
2000	Extended Wheel Base	Nylon Elbow	3/8 x 3/8	800-059	5/16 x 5/16	800-060	5/16 x 5/16	800-060
2000	Extended Wheel Base	Nylon Straight	3/8 x 3/8	800-058	5/16 x 5/16	800-057	5/16 x 5/16	800-057

Quick Disconnect

Fuel Sending Units
pg. 155-176

Fuel Tanks
pg. 177-228

Harmonic Balancers
pg. 229-254

Heater Hose Assemblies
pg. 255-256

Hydraulic Clutch Lines
pg. 257-260

Use Quick Disconnect Fittings & Clips for Fast, Economical Repairs

Quick Disconnect
353

Quick Disconnect Fuel Line Connector Applications

Quick Disconnect

Make/ Model/Engine/Years	Description	Style	Inlet Size	Inlet	Outlet Size	Outlet	Return Size	Return
CHRYSLER (continued)								
V6 - 3.3L (201 CID)								
2000	Extended Wheel Base	Nylon Elbow	3/8 x 3/8	800-059	5/16 x 5/16	800-060	5/16 x 5/16	800-060
2000	Extended Wheel Base	Nylon Straight	3/8 x 3/8	800-058	5/16 x 5/16	800-057	5/16 x 5/16	800-057
DODGE								
CARAVAN, GRAND CARAVAN								
L4 - 2.4L (148 CID)								
2000-97	Extended Wheel Base	Nylon Elbow	3/8 x 3/8	800-059	5/16 x 5/16	800-060	5/16 x 5/16	800-060
2000-97	Extended Wheel Base	Nylon Straight	3/8 x 3/8	800-058	5/16 x 5/16	800-057	5/16 x 5/16	800-057
V6 - 3.0L (181 CID)								
2000-97	Extended Wheel Base	Nylon Elbow	3/8 x 3/8	800-059	5/16 x 5/16	800-060	5/16 x 5/16	800-060
2000-97	Extended Wheel Base	Nylon Straight	3/8 x 3/8	800-058	5/16 x 5/16	800-057	5/16 x 5/16	800-057
V6 - 3.3L (201 CID)								
2000-97	Extended Wheel Base	Nylon Elbow	3/8 x 3/8	800-059	5/16 x 5/16	800-060	5/16 x 5/16	800-060
2000-97	Extended Wheel Base	Nylon Straight	3/8 x 3/8	800-058	5/16 x 5/16	800-057	5/16 x 5/16	800-057
V6 - 3.8L (230 CID)								
2000-97	Extended Wheel Base	Nylon Elbow	3/8 x 3/8	800-059	5/16 x 5/16	800-060	5/16 x 5/16	800-060
2000-97	Extended Wheel Base	Nylon Straight	3/8 x 3/8	800-058	5/16 x 5/16	800-057	5/16 x 5/16	800-057
INTREPID								
V6 - 3.3L (201 CID)								
1997-93	-	Nylon Elbow	3/8 x 3/8	800-059	5/16 x 5/16	800-060	-	-
1997-93	-	Nylon Straight	3/8 x 3/8	800-058	5/16 x 5/16	800-057	-	-
V6 - 3.5L (215 CID)								
1997-93	-	Nylon Elbow	3/8 x 3/8	800-059	5/16 x 5/16	800-060	-	-
1997-93	-	Nylon Straight	3/8 x 3/8	800-058	5/16 x 5/16	800-057	-	-
MONACO								
V6 - 3.0L (182 CID)								
1992-90	-	Nylon Elbow	3/8 x 3/8	800-059	5/16 x 5/16	800-060	-	-
1992-90	-	Nylon Straight	3/8 x 3/8	800-058	5/16 x 5/16	800-057	-	-
NEON								
L4 - 2.0L (122 CID)								
1996	-	Nylon Elbow	3/8 x 3/8	800-059	5/16 x 5/16	800-060	5/16 x 5/16	800-060
1996	-	Nylon Straight	3/8 x 3/8	800-058	5/16 x 5/16	800-057	5/16 x 5/16	800-057
SPIRIT								
L4 - 2.5L (153 CID)								
1994-93	-	Nylon Elbow	5/16 x 5/16	800-060	3/8 x 3/8	800-059	-	-
1994-93	-	Nylon Straight	5/16 x 5/16	800-057	3/8 x 3/8	800-058	-	-
1994-93	4-Door	Nylon Elbow	5/16 x 5/16	800-060	3/8 x 3/8	800-059	-	-
1994-93	4-Door	Nylon Straight	5/16 x 5/16	800-057	3/8 x 3/8	800-058	-	-
STRATUS								
L4 - 2.0L (122 CID)								
2000-98	-	Nylon Elbow	3/8 x 3/8	800-059	5/16 x 5/16	800-060	5/16 x 5/16	800-060
2000-98	-	Nylon Straight	3/8 x 3/8	800-058	5/16 x 5/16	800-057	5/16 x 5/16	800-057
L4 - 2.4L (148 CID)								
2000-98	-	Nylon Elbow	3/8 x 3/8	800-059	5/16 x 5/16	800-060	5/16 x 5/16	800-060
2000-98	-	Nylon Straight	3/8 x 3/8	800-058	5/16 x 5/16	800-057	5/16 x 5/16	800-057
V6 - 2.5L (152 CID)								
2000-98	-	Nylon Elbow	3/8 x 3/8	800-059	5/16 x 5/16	800-060	5/16 x 5/16	800-060
2000-98	-	Nylon Straight	3/8 x 3/8	800-058	5/16 x 5/16	800-057	5/16 x 5/16	800-057
VIPER								
V10 - 8.0L (488 CID)								
2002-92	-	Nylon Elbow	5/16 x 5/16	800-060	5/16 x 5/16	800-060	-	-
2002-92	-	Nylon Straight	5/16 x 5/16	800-057	5/16 x 5/16	800-057	-	-
DODGE TRUCK								
B150 VAN (1/2 TON)								
V6 - 3.9L (239 CID)								
1993	-	Nylon Elbow	5/16 x 5/16	800-060	-	-	-	-
1993	-	Nylon Straight	5/16 x 5/16	800-057	-	-	-	-
V8 - 5.2L (318 CID)								
1993	-	Nylon Elbow	5/16 x 5/16	800-060	-	-	-	-
1993	-	Nylon Straight	5/16 x 5/16	800-057	-	-	-	-
B250 VAN (3/4 TON)								
V6 - 3.9L (239 CID)								
1993	-	Nylon Elbow	5/16 x 5/16	800-060	-	-	-	-
1993	-	Nylon Straight	5/16 x 5/16	800-057	-	-	-	-
V8 - 5.2L (318 CID)								
1993	-	Nylon Elbow	5/16 x 5/16	800-060	-	-	-	-
1993	-	Nylon Straight	5/16 x 5/16	800-057	-	-	-	-
V8 - 5.9L (360 CID)								
1993	-	Nylon Elbow	5/16 x 5/16	800-060	-	-	-	-
1993	-	Nylon Straight	5/16 x 5/16	800-057	-	-	-	-
B350 VAN (1 TON)								
V8 - 5.2L (318 CID)								
1993	-	Nylon Elbow	5/16 x 5/16	800-060	-	-	-	-
1993	-	Nylon Straight	5/16 x 5/16	800-057	-	-	-	-
V8 - 5.9L (360 CID)								
1993	-	Nylon Elbow	5/16 x 5/16	800-060	-	-	-	-
1993	-	Nylon Straight	5/16 x 5/16	800-057	-	-	-	-

Quick Disconnect Fuel Line Connector Applications

Make/ Model/Engine/Years	Description	Style	Inlet Size	Inlet	Outlet Size	Outlet	Return Size	Return
EAGLE								
PREMIER								
L4 - 2.5L (150 CID)								
1989-88	-	Nylon Elbow	3/8 x 3/8	800-059	5/16 x 5/16	800-060	-	-
1989-88	-	Nylon Straight	3/8 x 3/8	800-058	5/16 x 5/16	800-057	-	-
V6 - 3.0L (182 CID)								
1992-88	-	Nylon Elbow	3/8 x 3/8	800-059	5/16 x 5/16	800-060	-	-
1992-88	-	Nylon Straight	3/8 x 3/8	800-058	5/16 x 5/16	800-057	-	-
VISION								
V6 - 3.3L (201 CID)								
1997-93	-	Nylon Elbow	3/8 x 3/8	800-059	5/16 x 5/16	800-060	-	-
1997-93	-	Nylon Straight	3/8 x 3/8	800-058	5/16 x 5/16	800-057	-	-
V6 - 3.5L (215 CID)								
1997-93	-	Nylon Elbow	3/8 x 3/8	800-059	5/16 x 5/16	800-060	-	-
1997-93	-	Nylon Straight	3/8 x 3/8	800-058	5/16 x 5/16	800-057	-	-
FORD								
CONTOUR								
L4 - 2.0L (121 CID)								
2000-95	-	Nylon Elbow	5/16 x 5/16	800-051	5/16 x 5/16	800-051	-	-
2000-95	-	Nylon Straight	3/8 x 5/16	800-054	3/8 x 5/16	800-054	-	-
V6 - 2.5L (155 CID)								
2000-95	-	Nylon Elbow	5/16 x 5/16	800-051	5/16 x 5/16	800-051	-	-
2000-95	-	Nylon Straight	3/8 x 5/16	800-054	3/8 x 5/16	800-054	-	-
COUNTRY SQUIRE								
V8 - 5.0L (302 CID)								
1991-84	-	Nylon Elbow	5/16 x 5/16	800-051	5/16 x 5/16	800-051	-	-
1991-84	-	Nylon Straight	3/8 x 5/16	800-054	3/8 x 5/16	800-054	-	-
1983	From 3/83	Nylon Elbow	5/16 x 5/16	800-051	5/16 x 5/16	800-051	-	-
1983	From 3/83	Nylon Straight	3/8 x 5/16	800-054	3/8 x 5/16	800-054	-	-
CROWN VICTORIA								
V8 - 4.6L (281 CID)								
1997-92	Exc. Compressed Natural Gas	Nylon Elbow	5/16 x 5/16	800-051	5/16 x 5/16	800-051	-	-
1997-92	Exc. Compressed Natural Gas	Nylon Straight	3/8 x 5/16	800-054	3/8 x 5/16	800-054	-	-
V8 - 5.0L (302 CID)								
1991-84	-	Nylon Elbow	5/16 x 5/16	800-051	5/16 x 5/16	800-051	-	-
1991-84	-	Nylon Straight	3/8 x 5/16	800-054	3/8 x 5/16	800-054	-	-
1983	From 3/83	Nylon Elbow	5/16 x 5/16	800-051	5/16 x 5/16	800-051	-	-
1983	From 3/83	Nylon Straight	3/8 x 5/16	800-054	3/8 x 5/16	800-054	-	-
ESCORT								
L4 - 1.6L (98 CID)								
1985-83	-	Nylon Elbow	5/16 x 5/16	800-051	5/16 x 5/16	800-051	-	-
1985-83	-	Nylon Straight	3/8 x 5/16	800-054	3/8 x 5/16	800-054	-	-
L4 - 1.8L (1839cc)								
1996-91	-	Nylon Elbow	5/16 x 5/16	800-051	5/16 x 5/16	800-051	-	-
1996-91	-	Nylon Straight	3/8 x 5/16	800-054	3/8 x 5/16	800-054	-	-
L4 - 1.9L (116 CID)								
1996-85	-	Nylon Elbow	5/16 x 5/16	800-051	5/16 x 5/16	800-051	-	-
1996-85	-	Nylon Straight	3/8 x 5/16	800-054	3/8 x 5/16	800-054	-	-
EXP								
L4 - 1.6L (98 CID)								
1985-83	-	Nylon Elbow	5/16 x 5/16	800-051	5/16 x 5/16	800-051	-	-
1985-83	-	Nylon Straight	3/8 x 5/16	800-054	3/8 x 5/16	800-054	-	-
LTD								
V6 - 3.8L (232 CID)								
1986-83	-	Nylon Elbow	5/16 x 5/16	800-051	5/16 x 5/16	800-051	-	-
1986-83	-	Nylon Straight	3/8 x 5/16	800-054	3/8 x 5/16	800-054	-	-
V8 - 5.0L (302 CID)								
1985-84	-	Nylon Elbow	5/16 x 5/16	800-051	5/16 x 5/16	800-051	-	-
1985-84	-	Nylon Straight	3/8 x 5/16	800-054	3/8 x 5/16	800-054	-	-
1983	From 3/83	Nylon Elbow	5/16 x 5/16	800-051	5/16 x 5/16	800-051	-	-
1983	From 3/83	Nylon Straight	3/8 x 5/16	800-054	3/8 x 5/16	800-054	-	-
MUSTANG								
L4 - 2.3L (140 CID)								
1993-87	-	Nylon Elbow	5/16 x 5/16	800-051	5/16 x 5/16	800-051	-	-
1993-87	-	Nylon Straight	3/8 x 5/16	800-054	3/8 x 5/16	800-054	-	-
V6 - 3.8L (232 CID)								
1997-94	-	Nylon Elbow	5/16 x 5/16	800-051	5/16 x 5/16	800-051	-	-
1997-94	-	Nylon Straight	3/8 x 5/16	800-054	3/8 x 5/16	800-054	-	-
1986-84	-	Nylon Elbow	5/16 x 5/16	800-051	5/16 x 5/16	800-051	-	-
1986-84	-	Nylon Straight	3/8 x 5/16	800-054	3/8 x 5/16	800-054	-	-
V8 - 4.6L (281 CID)								
1997-96	-	Nylon Elbow	5/16 x 5/16	800-051	5/16 x 5/16	800-051	-	-
1997-96	-	Nylon Straight	3/8 x 5/16	800-054	3/8 x 5/16	800-054	-	-
V8 - 5.0L (302 CID)								
1995-83	-	Nylon Elbow	5/16 x 5/16	800-051	5/16 x 5/16	800-051	-	-
1995-83	-	Nylon Straight	3/8 x 5/16	800-054	3/8 x 5/16	800-054	-	-
PROBE								
V6 - 3.0L (182 CID)								
1992-90	-	Nylon Elbow	5/16 x 5/16	800-051	5/16 x 5/16	800-051	-	-
1992-90	-	Nylon Straight	3/8 x 5/16	800-054	3/8 x 5/16	800-054	-	-

Quick Disconnect

Quick Disconnect Fuel Line Connector Applications

Quick Disconnect

Make/ Model/Engine/Years	Description	Style	Inlet Size	Inlet	Outlet Size	Outlet	Return Size	Return
FORD (continued)								
TAURUS								
L4 - 2.5L (153 CID)								
1990-86	-	Nylon Elbow	5/16 x 5/16	800-051	5/16 x 5/16	800-051	-	-
1990-86	-	Nylon Straight	3/8 x 5/16	800-054	3/8 x 5/16	800-054	-	-
V6 - 3.0L (182 CID)								
2003-02	w/Flex Fuel	Nylon Elbow	5/16 x 5/16	800-051	5/16 x 5/16	800-051	-	-
2003-02	w/Flex Fuel	Nylon Straight	3/8 x 5/16	800-054	3/8 x 5/16	800-054	-	-
2003-02	wo/Flex Fuel	Nylon Elbow	5/16 x 5/16	800-051	5/16 x 5/16	800-051	-	-
2003-02	wo/Flex Fuel	Nylon Straight	3/8 x 5/16	800-054	3/8 x 5/16	800-054	-	-
2001	w/Flex Fuel	Nylon Elbow	5/16 x 5/16	800-051	3/8 x 3/8	800-056	-	-
2001	w/Flex Fuel	Nylon Straight	3/8 x 5/16	800-054	5/16 x 3/8	800-055	-	-
2001	wo/Flex Fuel	Nylon Elbow	5/16 x 5/16	800-051	5/16 x 5/16	800-051	3/8 x 3/8	800-056
2001	wo/Flex Fuel	Nylon Straight	3/8 x 5/16	800-054	3/8 x 5/16	800-054	5/16 x 3/8	800-055
2000	w/Flex Fuel	Nylon Elbow	5/16 x 5/16	800-051	3/8 x 3/8	800-056	-	-
2000	w/Flex Fuel	Nylon Straight	3/8 x 5/16	800-054	5/16 x 3/8	800-055	-	-
2000	wo/Flex Fuel	Nylon Elbow	5/16 x 5/16	800-051	3/8 x 3/8	800-056	-	-
2000	wo/Flex Fuel	Nylon Straight	3/8 x 3/8	800-052	3/8 x 5/16	800-054	-	-
1999-93	w/Flex Fuel	Nylon Elbow	5/16 x 5/16	800-051	3/8 x 3/8	800-056	-	-
1999-93	w/Flex Fuel	Nylon Straight	3/8 x 5/16	800-054	5/16 x 3/8	800-055	-	-
1999-93	wo/Flex Fuel	Nylon Elbow	5/16 x 5/16	800-051	5/16 x 5/16	800-051	-	-
1999-93	wo/Flex Fuel	Nylon Straight	3/8 x 5/16	800-054	3/8 x 5/16	800-054	-	-
1992-86	-	Nylon Elbow	5/16 x 5/16	800-051	5/16 x 5/16	800-051	-	-
1992-86	-	Nylon Straight	3/8 x 5/16	800-054	3/8 x 5/16	800-054	-	-
V6 - 3.2L (195 CID)								
1995-93	-	Nylon Elbow	5/16 x 5/16	800-051	5/16 x 5/16	800-051	-	-
1995-93	-	Nylon Straight	3/8 x 5/16	800-054	3/8 x 5/16	800-054	-	-
V6 - 3.8L (232 CID)								
1995-88	-	Nylon Elbow	5/16 x 5/16	800-051	5/16 x 5/16	800-051	-	-
1995-88	-	Nylon Straight	3/8 x 5/16	800-054	3/8 x 5/16	800-054	-	-
V8 - 3.4L (207 CID)								
1999-97	-	Nylon Elbow	5/16 x 5/16	800-051	5/16 x 5/16	800-051	-	-
1999-97	-	Nylon Straight	3/8 x 5/16	800-054	3/8 x 5/16	800-054	-	-
TEMPO								
L4 - 2.3L (140 CID)								
1994-85	-	Nylon Elbow	5/16 x 5/16	800-051	5/16 x 5/16	800-051	-	-
1994-85	-	Nylon Straight	3/8 x 5/16	800-054	3/8 x 5/16	800-054	-	-
V6 - 3.0L (182 CID)								
1994-92	-	Nylon Elbow	5/16 x 5/16	800-051	5/16 x 5/16	800-051	-	-
1994-92	-	Nylon Straight	3/8 x 5/16	800-054	3/8 x 5/16	800-054	-	-
THUNDERBIRD								
L4 - 2.3L (140 CID)								
1988-83	-	Nylon Elbow	5/16 x 5/16	800-051	5/16 x 5/16	800-051	-	-
1988-83	-	Nylon Straight	3/8 x 5/16	800-054	3/8 x 5/16	800-054	-	-
V6 - 3.8L (232 CID)								
1997-92	-	Nylon Elbow	5/16 x 5/16	800-051	3/8 x 3/8	800-056	-	-
1997-92	-	Nylon Straight	3/8 x 5/16	800-054	5/16 x 3/8	800-055	-	-
1991	From 11/90	Nylon Elbow	5/16 x 5/16	800-051	3/8 x 3/8	800-056	-	-
1991	From 11/90	Nylon Straight	3/8 x 5/16	800-054	5/16 x 3/8	800-055	-	-
1988-83	-	Nylon Elbow	5/16 x 5/16	800-051	5/16 x 5/16	800-051	-	-
1988-83	-	Nylon Straight	3/8 x 5/16	800-054	3/8 x 5/16	800-054	-	-
V8 - 4.6L (281 CID)								
1997-94	-	Nylon Elbow	5/16 x 5/16	800-051	3/8 x 3/8	800-056	-	-
1997-94	-	Nylon Straight	3/8 x 5/16	800-054	5/16 x 3/8	800-055	-	-
V8 - 5.0L (302 CID)								
1993-92	-	Nylon Elbow	5/16 x 5/16	800-051	3/8 x 3/8	800-056	-	-
1993-92	-	Nylon Straight	3/8 x 5/16	800-054	5/16 x 3/8	800-055	-	-
1991	From 11/90	Nylon Elbow	5/16 x 5/16	800-051	3/8 x 3/8	800-056	-	-
1991	From 11/90	Nylon Straight	3/8 x 5/16	800-054	5/16 x 3/8	800-055	-	-
1988-83	-	Nylon Elbow	5/16 x 5/16	800-051	5/16 x 5/16	800-051	-	-
1988-83	-	Nylon Straight	3/8 x 5/16	800-054	3/8 x 5/16	800-054	-	-
FORD TRUCK								
AEROSTAR								
L4 - 2.3L (140 CID)								
1987-86	-	Nylon Elbow	5/16 x 5/16	800-051	5/16 x 5/16	800-051	-	-
1987-86	-	Nylon Straight	3/8 x 5/16	800-054	3/8 x 5/16	800-054	-	-
V6 - 2.8L (171 CID)								
1986	-	Nylon Elbow	5/16 x 5/16	800-051	5/16 x 5/16	800-051	-	-
1986	-	Nylon Straight	3/8 x 5/16	800-054	3/8 x 5/16	800-054	-	-
V6 - 3.0L (182 CID)								
1997-86	-	Nylon Elbow	5/16 x 5/16	800-051	5/16 x 5/16	800-051	-	-
1997-86	-	Nylon Straight	3/8 x 5/16	800-054	3/8 x 5/16	800-054	-	-
V6 - 4.0L (245 CID)								
1997-90	-	Nylon Elbow	5/16 x 5/16	800-051	5/16 x 5/16	800-051	-	-
1997-90	-	Nylon Straight	3/8 x 5/16	800-054	3/8 x 5/16	800-054	-	-
BRONCO								
L6 - 4.9L (300 CID)								
1993-86	-	Nylon Elbow	5/16 x 5/16	800-051	5/16 x 5/16	800-051	-	-
1993-86	-	Nylon Straight	3/8 x 5/16	800-054	3/8 x 5/16	800-054	-	-
V8 - 5.0L (302 CID)								
1996-86	-	Nylon Elbow	5/16 x 5/16	800-051	5/16 x 5/16	800-051	-	-

Quick Disconnect Fuel Line Connector Applications

Make/ Model/Engine/Years	Description	Style	Inlet Size	Inlet	Outlet Size	Outlet	Return Size	Return
FORD TRUCK (continued)								
BRONCO (continued)								
V8 - 5.0L (302 CID) (continued)								
1996-86	-	Nylon Straight	3/8 x 5/16	800-054	3/8 x 5/16	800-054	-	-
V8 - 5.8L (351 CID)								
1996-87	-	Nylon Elbow	5/16 x 5/16	800-051	5/16 x 5/16	800-051	-	-
1996-87	-	Nylon Straight	3/8 x 5/16	800-054	3/8 x 5/16	800-054	-	-
BRONCO II								
L4 - 2.3L (140 CID)								
1986-85	-	Nylon Elbow	5/16 x 5/16	800-051	5/16 x 5/16	800-051	-	-
1986-85	-	Nylon Straight	3/8 x 5/16	800-054	3/8 x 5/16	800-054	-	-
V6 - 2.9L (177 CID)								
1990	-	Nylon Elbow	5/16 x 5/16	800-051	5/16 x 5/16	800-051	-	-
1990	-	Nylon Straight	3/8 x 5/16	800-054	3/8 x 5/16	800-054	-	-
E SUPER DUTY								
V10 - 6.8L (415 CID)								
2001-99	-	Nylon Elbow	5/16 x 5/16	800-051	5/16 x 5/16	800-051	-	-
2001-99	-	Nylon Straight	3/8 x 5/16	800-054	3/8 x 5/16	800-054	-	-
V8 - 5.4L (330 CID)								
2001-00	-	Nylon Elbow	5/16 x 5/16	800-051	5/16 x 5/16	800-051	-	-
2001-00	-	Nylon Straight	3/8 x 5/16	800-054	3/8 x 5/16	800-054	-	-
E-150 ECONOLINE								
L6 - 4.9L (300 CID)								
1996-86	-	Nylon Elbow	5/16 x 5/16	800-051	5/16 x 5/16	800-051	-	-
1996-86	-	Nylon Straight	3/8 x 5/16	800-054	3/8 x 5/16	800-054	-	-
V6 - 4.2L (256 CID)								
2001-97	-	Nylon Elbow	5/16 x 5/16	800-051	5/16 x 5/16	800-051	-	-
2001-97	-	Nylon Straight	3/8 x 5/16	800-054	3/8 x 5/16	800-054	-	-
V8 - 4.6L (281 CID)								
2001-97	-	Nylon Elbow	5/16 x 5/16	800-051	5/16 x 5/16	800-051	-	-
2001-97	-	Nylon Straight	3/8 x 5/16	800-054	3/8 x 5/16	800-054	-	-
V8 - 5.0L (302 CID)								
1996-86	-	Nylon Elbow	5/16 x 5/16	800-051	5/16 x 5/16	800-051	-	-
1996-86	-	Nylon Straight	3/8 x 5/16	800-054	3/8 x 5/16	800-054	-	-
V8 - 5.4L (330 CID)								
2001-97	-	Nylon Elbow	5/16 x 5/16	800-051	5/16 x 5/16	800-051	-	-
2001-97	-	Nylon Straight	3/8 x 5/16	800-054	3/8 x 5/16	800-054	-	-
V8 - 5.8L (351 CID)								
1996-87	-	Nylon Elbow	5/16 x 5/16	800-051	5/16 x 5/16	800-051	-	-
1996-87	-	Nylon Straight	3/8 x 5/16	800-054	3/8 x 5/16	800-054	-	-
E-250 ECONOLINE								
L6 - 4.9L (300 CID)								
1996-86	-	Nylon Elbow	5/16 x 5/16	800-051	5/16 x 5/16	800-051	-	-
1996-86	-	Nylon Straight	3/8 x 5/16	800-054	3/8 x 5/16	800-054	-	-
V6 - 4.2L (256 CID)								
2001-97	-	Nylon Elbow	5/16 x 5/16	800-051	5/16 x 5/16	800-051	-	-
2001-97	-	Nylon Straight	3/8 x 5/16	800-054	3/8 x 5/16	800-054	-	-
V8 - 4.6L (281 CID)								
1998	-	Nylon Elbow	5/16 x 5/16	800-051	5/16 x 5/16	800-051	-	-
1998	-	Nylon Straight	3/8 x 5/16	800-054	3/8 x 5/16	800-054	-	-
V8 - 5.0L (302 CID)								
1995-86	-	Nylon Elbow	5/16 x 5/16	800-051	5/16 x 5/16	800-051	-	-
1995-86	-	Nylon Straight	3/8 x 5/16	800-054	3/8 x 5/16	800-054	-	-
V8 - 5.4L (330 CID)								
2001-97	-	Nylon Elbow	5/16 x 5/16	800-051	5/16 x 5/16	800-051	-	-
2001-97	-	Nylon Straight	3/8 x 5/16	800-054	3/8 x 5/16	800-054	-	-
V8 - 5.8L (351 CID)								
1996-87	-	Nylon Elbow	5/16 x 5/16	800-051	5/16 x 5/16	800-051	-	-
1996-87	-	Nylon Straight	3/8 x 5/16	800-054	3/8 x 5/16	800-054	-	-
V8 - 7.5L (460 CID)								
1996-87	-	Nylon Elbow	5/16 x 5/16	800-051	5/16 x 5/16	800-051	-	-
1996-87	-	Nylon Straight	3/8 x 5/16	800-054	3/8 x 5/16	800-054	-	-
E-350 ECONOLINE								
L6 - 4.9L (300 CID)								
1996-86	-	Nylon Elbow	5/16 x 5/16	800-051	5/16 x 5/16	800-051	-	-
1996-86	-	Nylon Straight	3/8 x 5/16	800-054	3/8 x 5/16	800-054	-	-
V10 - 6.8L (415 CID)								
2001-97	-	Nylon Elbow	5/16 x 5/16	800-051	5/16 x 5/16	800-051	-	-
2001-97	-	Nylon Straight	3/8 x 5/16	800-054	3/8 x 5/16	800-054	-	-
V8 - 5.4L (330 CID)								
2001-97	-	Nylon Elbow	5/16 x 5/16	800-051	5/16 x 5/16	800-051	-	-
2001-97	-	Nylon Straight	3/8 x 5/16	800-054	3/8 x 5/16	800-054	-	-
V8 - 5.8L (351 CID)								
1996-87	-	Nylon Elbow	5/16 x 5/16	800-051	5/16 x 5/16	800-051	-	-
1996-87	-	Nylon Straight	3/8 x 5/16	800-054	3/8 x 5/16	800-054	-	-
V8 - 7.5L (460 CID)								
1996-87	-	Nylon Elbow	5/16 x 5/16	800-051	5/16 x 5/16	800-051	-	-
1996-87	-	Nylon Straight	3/8 x 5/16	800-054	3/8 x 5/16	800-054	-	-
ESCAPE								
L4 - 2.0L (122 CID)								
2003-01	-	Nylon Elbow	5/16 x 5/16	800-051	5/16 x 5/16	800-051	-	-

Quick Disconnect

Quick Disconnect Fuel Line Connector Applications

Quick Disconnect

Make/ Model/Engine/Years	Description	Style	Inlet Size	Inlet	Outlet Size	Outlet	Return Size	Return
FORD TRUCK (continued)								
ESCAPE (continued)								
L4 - 2.0L (122 CID) (continued)								
2003-01 -		Nylon Straight	3/8 x 5/16	800-054	3/8 x 5/16	800-054	-	-
V6 - 3.0L (182 CID)								
2003-01 -		Nylon Elbow	5/16 x 5/16	800-051	5/16 x 5/16	800-051	-	-
2003-01 -		Nylon Straight	3/8 x 5/16	800-054	3/8 x 5/16	800-054	-	-
EXCURSION								
V8 - 5.4L (330 CID)								
2003-00 -		Nylon Elbow	5/16 x 5/16	800-051	5/16 x 5/16	800-051	-	-
2003-00 -		Nylon Straight	3/8 x 5/16	800-054	3/8 x 5/16	800-054	-	-
V10 - 6.8L (415 CID)								
2003-00 -		Nylon Elbow	5/16 x 5/16	800-051	5/16 x 5/16	800-051	-	-
2003-00 -		Nylon Straight	3/8 x 5/16	800-054	3/8 x 5/16	800-054	-	-
EXPEDITION								
V8 - 4.6L (281 CID)								
1998-97 -		Nylon Elbow	5/16 x 5/16	800-051	5/16 x 5/16	800-051	-	-
1998-97 -		Nylon Straight	3/8 x 5/16	800-054	3/8 x 5/16	800-054	-	-
V8 - 5.4L (330 CID)								
1998-97 -		Nylon Elbow	5/16 x 5/16	800-051	5/16 x 5/16	800-051	-	-
1998-97 -		Nylon Straight	3/8 x 5/16	800-054	3/8 x 5/16	800-054	-	-
EXPLORER								
V6 - 4.0L (245 CID)								
1998-91 -		Nylon Elbow	5/16 x 5/16	800-051	5/16 x 5/16	800-051	-	-
1998-91 -		Nylon Straight	3/8 x 5/16	800-054	3/8 x 5/16	800-054	-	-
V8 - 5.0L (302 CID)								
1998-97 -		Nylon Elbow	5/16 x 5/16	800-051	5/16 x 5/16	800-051	-	-
1998-97 -		Nylon Straight	3/8 x 5/16	800-054	3/8 x 5/16	800-054	-	-
F-150 PICKUP								
L6 - 4.9L (300 CID)								
1996-86 -		Nylon Elbow	-	-	5/16 x 5/16	800-051	-	-
1996-86 -		Nylon Straight	3/8 x 5/16	800-054	3/8 x 5/16	800-054	-	-
1995-86 -		Nylon Elbow	5/16 x 5/16	800-051	-	-	-	-
V6 - 4.2L (256 CID)								
2001-97 -		Nylon Elbow	5/16 x 5/16	800-051	5/16 x 5/16	800-051	-	-
2001-97 -		Nylon Straight	3/8 x 5/16	800-054	3/8 x 5/16	800-054	-	-
V8 - 4.6L (281 CID)								
2001-97 -		Nylon Elbow	5/16 x 5/16	800-051	5/16 x 5/16	800-051	-	-
2001-97 -		Nylon Straight	3/8 x 5/16	800-054	3/8 x 5/16	800-054	-	-
V8 - 5.0L (302 CID)								
1996-86 -		Nylon Elbow	5/16 x 5/16	800-051	5/16 x 5/16	800-051	-	-
1996-86 -		Nylon Straight	3/8 x 5/16	800-054	3/8 x 5/16	800-054	-	-
V8 - 5.4L (330 CID)								
2001-97 -		Nylon Elbow	5/16 x 5/16	800-051	5/16 x 5/16	800-051	-	-
2001-97 -		Nylon Straight	3/8 x 5/16	800-054	3/8 x 5/16	800-054	-	-
V8 - 5.8L (351 CID)								
1996-87 -		Nylon Elbow	5/16 x 5/16	800-051	5/16 x 5/16	800-051	-	-
1996-87 -		Nylon Straight	3/8 x 5/16	800-054	3/8 x 5/16	800-054	-	-
F-250 PICKUP								
L6 - 4.9L (300 CID)								
1996-86 -		Nylon Elbow	5/16 x 5/16	800-051	5/16 x 5/16	800-051	-	-
1996-86 -		Nylon Straight	3/8 x 5/16	800-054	3/8 x 5/16	800-054	-	-
V6 - 4.2L (256 CID)								
1998-97 -		Nylon Elbow	5/16 x 5/16	800-051	5/16 x 5/16	800-051	-	-
1998-97 -		Nylon Straight	3/8 x 5/16	800-054	5/16 x 5/16	800-050	-	-
V8 - 4.6L (281 CID)								
1999-97 -		Nylon Elbow	5/16 x 5/16	800-051	5/16 x 5/16	800-051	-	-
1999-97 -		Nylon Straight	3/8 x 5/16	800-054	5/16 x 5/16	800-050	-	-
V8 - 5.0L (302 CID)								
1996-86 -		Nylon Elbow	5/16 x 5/16	800-051	5/16 x 5/16	800-051	-	-
1996-86 -		Nylon Straight	3/8 x 5/16	800-054	5/16 x 5/16	800-050	-	-
V8 - 5.4L (330 CID)								
1999-97 -		Nylon Elbow	5/16 x 5/16	800-051	5/16 x 5/16	800-051	-	-
1999-97 -		Nylon Straight	3/8 x 5/16	800-054	5/16 x 5/16	800-050	-	-
V8 - 5.8L (351 CID)								
1997-87 -		Nylon Elbow	5/16 x 5/16	800-051	5/16 x 5/16	800-051	-	-
1997-87 -		Nylon Straight	3/8 x 5/16	800-054	5/16 x 5/16	800-050	-	-
V8 - 7.5L (460 CID)								
1997-87 -		Nylon Elbow	5/16 x 5/16	800-051	5/16 x 5/16	800-051	-	-
1997-87 -		Nylon Straight	3/8 x 5/16	800-054	5/16 x 5/16	800-050	-	-
F-250 SUPER DUTY PICKUP								
V10 - 6.8L (415 CID)								
2003-99 -		Nylon Elbow	5/16 x 5/16	800-051	5/16 x 5/16	800-051	-	-
2003-99 -		Nylon Straight	3/8 x 5/16	800-054	5/16 x 5/16	800-050	-	-
V8 - 5.4L (330 CID)								
2003-99 -		Nylon Elbow	5/16 x 5/16	800-051	5/16 x 5/16	800-051	-	-
2003-99 -		Nylon Straight	3/8 x 5/16	800-054	5/16 x 5/16	800-050	-	-
F-350 PICKUP								
L6 - 4.9L (300 CID)								
1996-86 -		Nylon Elbow	5/16 x 5/16	800-051	5/16 x 5/16	800-051	-	-
1996-86 -		Nylon Straight	3/8 x 5/16	800-054	5/16 x 5/16	800-050	-	-

Quick Disconnect Fuel Line Connector Applications

Make/ Model/Engine/Years	Description	Style	Inlet Size	Inlet	Outlet Size	Outlet	Return Size	Return
FORD TRUCK (continued)								
F-350 PICKUP (continued)								
V8 - 5.8L (351 CID)								
1997-86	-	Nylon Elbow	5/16 x 5/16	800-051	5/16 x 5/16	800-051	-	-
1997-86	-	Nylon Straight	3/8 x 5/16	800-054	5/16 x 5/16	800-050	-	-
V8 - 7.5L (460 CID)								
1997-87	-	Nylon Elbow	5/16 x 5/16	800-051	5/16 x 5/16	800-051	-	-
1997-87	-	Nylon Straight	3/8 x 5/16	800-054	5/16 x 5/16	800-050	-	-
F-350 SUPER DUTY PICKUP								
V10 - 6.8L (415 CID)								
2003-99	-	Nylon Elbow	5/16 x 5/16	800-051	5/16 x 5/16	800-051	-	-
2003-99	-	Nylon Straight	3/8 x 5/16	800-054	5/16 x 5/16	800-050	-	-
V8 - 5.4L (330 CID)								
2003-99	-	Nylon Elbow	5/16 x 5/16	800-051	5/16 x 5/16	800-051	-	-
2003-99	-	Nylon Straight	3/8 x 5/16	800-054	5/16 x 5/16	800-050	-	-
F-450 SUPER DUTY PICKUP								
V10 - 6.8L (415 CID)								
2003-99	-	Nylon Elbow	5/16 x 5/16	800-051	5/16 x 5/16	800-051	-	-
2003-99	-	Nylon Straight	3/8 x 5/16	800-054	5/16 x 5/16	800-050	-	-
V8 - 7.5L (460 CID)								
1997-88	-	Nylon Elbow	5/16 x 5/16	800-051	5/16 x 5/16	800-051	-	-
1997-88	-	Nylon Straight	3/8 x 5/16	800-054	5/16 x 5/16	800-050	-	-
F-550 SUPER DUTY PICKUP								
V10 - 6.8L (415 CID)								
2003-99	-	Nylon Elbow	5/16 x 5/16	800-051	5/16 x 5/16	800-051	-	-
2003-99	-	Nylon Straight	3/8 x 5/16	800-054	5/16 x 5/16	800-050	-	-
F53 STRIPPED CHASSIS								
V8 - 7.5L (460 CID)								
1997-89	-	Nylon Elbow	5/16 x 5/16	800-051	5/16 x 5/16	800-051	-	-
1997-89	-	Nylon Straight	3/8 x 5/16	800-054	5/16 x 5/16	800-050	-	-
RANGER								
L4 - 2.3L (140 CID)								
2001	-	Nylon Elbow	5/16 x 5/16	800-051	5/16 x 5/16	800-051	3/8 x 3/8	800-056
2001	-	Nylon Straight	3/8 x 5/16	800-054	5/16 x 5/16	800-050	5/16 x 3/8	800-055
1997-85	-	Nylon Elbow	5/16 x 5/16	800-051	5/16 x 5/16	800-051	-	-
1997-85	-	Nylon Straight	3/8 x 5/16	800-054	5/16 x 5/16	800-050	-	-
L4 - 2.5L (153 CID)								
2001-00	-	Nylon Elbow	5/16 x 5/16	800-051	5/16 x 5/16	800-051	3/8 x 3/8	800-056
2001-00	-	Nylon Straight	3/8 x 5/16	800-054	5/16 x 5/16	800-050	5/16 x 3/8	800-055
V6 - 2.9L (177 CID)								
1992-90	-	Nylon Elbow	5/16 x 5/16	800-051	5/16 x 5/16	800-051	-	-
1992-90	-	Nylon Straight	3/8 x 5/16	800-054	5/16 x 5/16	800-050	-	-
V6 - 3.0L (182 CID)								
2003-00	-	Nylon Elbow	5/16 x 5/16	800-051	5/16 x 5/16	800-051	3/8 x 3/8	800-056
2003-00	-	Nylon Straight	3/8 x 5/16	800-054	5/16 x 5/16	800-050	5/16 x 3/8	800-055
1997-91	-	Nylon Elbow	5/16 x 5/16	800-051	5/16 x 5/16	800-051	-	-
1997-91	-	Nylon Straight	3/8 x 5/16	800-054	5/16 x 5/16	800-050	-	-
V6 - 4.0L (245 CID)								
2001-00	-	Nylon Elbow	5/16 x 5/16	800-051	5/16 x 5/16	800-051	3/8 x 3/8	800-056
2001-00	-	Nylon Straight	3/8 x 5/16	800-054	5/16 x 5/16	800-050	5/16 x 3/8	800-055
1997-90	-	Nylon Elbow	5/16 x 5/16	800-051	5/16 x 5/16	800-051	-	-
1997-90	-	Nylon Straight	3/8 x 5/16	800-054	5/16 x 5/16	800-050	-	-
WINDSTAR								
V6 - 3.0L (182 CID)								
1998-95	-	Nylon Elbow	5/16 x 5/16	800-051	5/16 x 5/16	800-051	-	-
1998-95	-	Nylon Straight	3/8 x 5/16	800-054	5/16 x 5/16	800-050	-	-
V6 - 3.8L (232 CID)								
1998-95	-	Nylon Elbow	5/16 x 5/16	800-051	5/16 x 5/16	800-051	-	-
1998-95	-	Nylon Straight	3/8 x 5/16	800-054	5/16 x 5/16	800-050	-	-
GEO								
PRIZM								
L4 - 1.6L (98 CID)								
1997-93	-	Steel Line Gasket	-	-	3/8 x M16-1.50	800-153	-	-
L4 - 1.8L (110 CID)								
1997-93	-	Steel Line Gasket	-	-	3/8 x M16-1.50	800-153	-	-
TRACKER								
L4 - 1.6L (98 CID)								
1997-94	-	Steel Line Gasket	3/8 x M16-1.50	800-153	3/8 x M16-1.50	800-153	-	-
1995-89	-	Steel Line Gasket	3/8 x M16-1.50	800-153	3/8 x M16-1.50	800-153	-	-
JEEP								
GRAND CHEROKEE								
L6 - 4.0L (242 CID)								
1996-92	-	Nylon Elbow	3/8 x 3/8	800-059	5/16 x 5/16	800-060	-	-
1996-92	-	Nylon Straight	3/8 x 3/8	800-058	5/16 x 5/16	800-057	-	-
V8 - 5.2L (318 CID)								
1996-93	-	Nylon Elbow	3/8 x 3/8	800-059	5/16 x 5/16	800-060	-	-
1996-93	-	Nylon Straight	3/8 x 3/8	800-058	5/16 x 5/16	800-057	-	-
LINCOLN								
CONTINENTAL								
V6 - 3.8L (232 CID)								
1994-88	-	Nylon Elbow	5/16 x 5/16	800-051	5/16 x 5/16	800-051	-	-

Quick Disconnect

Clock Springs
pg. 21-24

Control Arms
pg. 25-54

CV Joint Boots & Accessories
pg. 55-66

Door Lock Actuators
pg. 67-72

Exhaust Manifold Kits
pg. 73-134

Use Quick Disconnect Fittings & Clips for Fast, Economical Repairs

Quick Disconnect

Quick Disconnect Fuel Line Connector Applications

Quick Disconnect

Make/ Model/Engine/Years	Description	Style	Inlet Size	Inlet	Outlet Size	Outlet	Return Size	Return
LINCOLN (continued)								
CONTINENTAL (continued)								
V6 - 3.8L (232 CID) (continued)								
1994-88	-	Nylon Straight	3/8 x 5/16	800-054	3/8 x 5/16	800-054	-	-
V8 - 4.6L (281 CID)								
2002-95	-	Nylon Elbow	5/16 x 5/16	800-051	5/16 x 5/16	800-051	-	-
2002-95	-	Nylon Straight	3/8 x 5/16	800-054	3/8 x 5/16	800-054	-	-
V8 - 5.0L (302 CID)								
1987-83	-	Nylon Elbow	5/16 x 5/16	800-051	5/16 x 5/16	800-051	-	-
1987-83	-	Nylon Straight	3/8 x 5/16	800-054	3/8 x 5/16	800-054	-	-
MARK VI								
V8 - 5.0L (302 CID)								
1983	From 3/83	Nylon Elbow	5/16 x 5/16	800-051	5/16 x 5/16	800-051	-	-
1983	From 3/83	Nylon Straight	3/8 x 5/16	800-054	3/8 x 5/16	800-054	-	-
MARK VII								
V8 - 5.0L (302 CID)								
1992-84	-	Nylon Elbow	5/16 x 5/16	800-051	5/16 x 5/16	800-051	-	-
1992-84	-	Nylon Straight	3/8 x 5/16	800-054	3/8 x 5/16	800-054	-	-
MARK VIII								
V8 - 4.6L (281 CID)								
1998-93	-	Nylon Elbow	5/16 x 5/16	800-051	3/8 x 3/8	800-056	-	-
1998-93	-	Nylon Straight	3/8 x 5/16	800-054	5/16 x 3/8	800-055	-	-
NAVIGATOR								
V8 - 5.4L (330 CID)								
1998	-	Nylon Elbow	5/16 x 5/16	800-051	5/16 x 5/16	800-051	-	-
1998	-	Nylon Straight	3/8 x 5/16	800-054	3/8 x 5/16	800-054	-	-
TOWN CAR								
V8 - 4.6L (281 CID)								
1997-91	-	Nylon Elbow	5/16 x 5/16	800-051	5/16 x 5/16	800-051	-	-
1997-91	-	Nylon Straight	3/8 x 5/16	800-054	3/8 x 5/16	800-054	-	-
V8 - 5.0L (302 CID)								
1990-84	-	Nylon Elbow	5/16 x 5/16	800-051	5/16 x 5/16	800-051	-	-
1990-84	-	Nylon Straight	3/8 x 5/16	800-054	3/8 x 5/16	800-054	-	-
1983	From 3/83	Nylon Elbow	5/16 x 5/16	800-051	5/16 x 5/16	800-051	-	-
1983	From 3/83	Nylon Straight	3/8 x 5/16	800-054	3/8 x 5/16	800-054	-	-
MERCURY								
CAPRI								
V6 - 3.8L (232 CID)								
1986-84	-	Nylon Elbow	5/16 x 5/16	800-051	5/16 x 5/16	800-051	-	-
1986-84	-	Nylon Straight	3/8 x 5/16	800-054	3/8 x 5/16	800-054	-	-
V8 - 5.0L (302 CID)								
1986-83	-	Nylon Elbow	5/16 x 5/16	800-051	5/16 x 5/16	800-051	-	-
1986-83	-	Nylon Straight	3/8 x 5/16	800-054	3/8 x 5/16	800-054	-	-
COLONY PARK								
V8 - 5.0L (302 CID)								
1991-84	-	Nylon Elbow	5/16 x 5/16	800-051	5/16 x 5/16	800-051	-	-
1991-84	-	Nylon Straight	3/8 x 5/16	800-054	3/8 x 5/16	800-054	-	-
1983	From 3/83	Nylon Elbow	5/16 x 5/16	800-051	5/16 x 5/16	800-051	-	-
1983	From 3/83	Nylon Straight	3/8 x 5/16	800-054	3/8 x 5/16	800-054	-	-
COUGAR								
L4 - 2.0L (121 CID)								
2002-99	-	Nylon Elbow	5/16 x 5/16	800-051	5/16 x 5/16	800-051	-	-
2002-99	-	Nylon Straight	3/8 x 5/16	800-054	3/8 x 5/16	800-054	-	-
L4 - 2.3L (140 CID)								
1986-84	-	Nylon Elbow	5/16 x 5/16	800-051	5/16 x 5/16	800-051	-	-
1986-84	-	Nylon Straight	3/8 x 5/16	800-054	3/8 x 5/16	800-054	-	-
V6 - 2.5L (155 CID)								
2002-99	-	Nylon Elbow	5/16 x 5/16	800-051	5/16 x 5/16	800-051	-	-
2002-99	-	Nylon Straight	3/8 x 5/16	800-054	3/8 x 5/16	800-054	-	-
V6 - 3.8L (232 CID)								
1997-92	-	Nylon Elbow	5/16 x 5/16	800-051	3/8 x 3/8	800-056	-	-
1997-92	-	Nylon Straight	3/8 x 5/16	800-054	5/16 x 3/8	800-055	-	-
1991	From 11/90	Nylon Elbow	5/16 x 5/16	800-051	3/8 x 3/8	800-056	-	-
1991	From 11/90	Nylon Straight	3/8 x 5/16	800-054	5/16 x 3/8	800-055	-	-
1988-83	-	Nylon Elbow	5/16 x 5/16	800-051	5/16 x 5/16	800-051	-	-
1988-83	-	Nylon Straight	3/8 x 5/16	800-054	3/8 x 5/16	800-054	-	-
V8 - 4.6L (281 CID)								
1997-94	-	Nylon Elbow	5/16 x 5/16	800-051	3/8 x 3/8	800-056	-	-
1997-94	-	Nylon Straight	3/8 x 5/16	800-054	5/16 x 3/8	800-055	-	-
V8 - 5.0L (302 CID)								
1993-92	-	Nylon Elbow	5/16 x 5/16	800-051	3/8 x 3/8	800-056	-	-
1993-92	-	Nylon Straight	3/8 x 5/16	800-054	5/16 x 3/8	800-055	-	-
1991	From 11/90	Nylon Elbow	5/16 x 5/16	800-051	3/8 x 3/8	800-056	-	-
1991	From 11/90	Nylon Straight	3/8 x 5/16	800-054	5/16 x 3/8	800-055	-	-
1988-83	-	Nylon Elbow	5/16 x 5/16	800-051	5/16 x 5/16	800-051	-	-
1988-83	-	Nylon Straight	3/8 x 5/16	800-054	3/8 x 5/16	800-054	-	-
GRAND MARQUIS								
V8 - 4.6L (281 CID)								
1997-92	-	Nylon Elbow	5/16 x 5/16	800-051	5/16 x 5/16	800-051	-	-
1997-92	-	Nylon Straight	3/8 x 5/16	800-054	3/8 x 5/16	800-054	-	-

Quick Disconnect Fuel Line Connector Applications

Make/ Model/Engine/Years	Description	Style	Inlet Size	Inlet	Outlet Size	Outlet	Return Size	Return
MERCURY (continued)								
GRAND MARQUIS (continued)								
V8 - 5.0L (302 CID)								
1991-84	-	Nylon Elbow	5/16 x 5/16	800-051	5/16 x 5/16	800-051	-	-
1991-84	-	Nylon Straight	3/8 x 5/16	800-054	3/8 x 5/16	800-054	-	-
1983	From 3/83	Nylon Elbow	5/16 x 5/16	800-051	5/16 x 5/16	800-051	-	-
1983	From 3/83	Nylon Straight	3/8 x 5/16	800-054	3/8 x 5/16	800-054	-	-
LN7								
L4 - 1.6L (98 CID)								
1983	-	Nylon Elbow	5/16 x 5/16	800-051	5/16 x 5/16	800-051	-	-
1983	-	Nylon Straight	3/8 x 5/16	800-054	3/8 x 5/16	800-054	-	-
LYNX								
L4 - 1.6L (98 CID)								
1985-84	-	Nylon Elbow	5/16 x 5/16	800-051	5/16 x 5/16	800-051	-	-
1985-84	-	Nylon Straight	3/8 x 5/16	800-054	3/8 x 5/16	800-054	-	-
L4 - 1.9L (116 CID)								
1987-85	-	Nylon Elbow	5/16 x 5/16	800-051	5/16 x 5/16	800-051	-	-
1987-85	-	Nylon Straight	3/8 x 5/16	800-054	3/8 x 5/16	800-054	-	-
MARQUIS								
V6 - 3.8L (232 CID)								
1986-83	-	Nylon Elbow	5/16 x 5/16	800-051	5/16 x 5/16	800-051	-	-
1986-83	-	Nylon Straight	3/8 x 5/16	800-054	3/8 x 5/16	800-054	-	-
V8 - 5.0L (302 CID)								
1985-84	-	Nylon Elbow	5/16 x 5/16	800-051	5/16 x 5/16	800-051	-	-
1985-84	-	Nylon Straight	3/8 x 5/16	800-054	3/8 x 5/16	800-054	-	-
1983	From 3/83	Nylon Elbow	5/16 x 5/16	800-051	5/16 x 5/16	800-051	-	-
1983	From 3/83	Nylon Straight	3/8 x 5/16	800-054	3/8 x 5/16	800-054	-	-
MOUNTAINEER								
V6 - 4.0L (245 CID)								
1998	-	Nylon Elbow	5/16 x 5/16	800-051	5/16 x 5/16	800-051	-	-
1998	-	Nylon Straight	3/8 x 5/16	800-054	3/8 x 5/16	800-054	-	-
V8 - 5.0L (302 CID)								
1998-97	-	Nylon Elbow	5/16 x 5/16	800-051	5/16 x 5/16	800-051	-	-
1998-97	-	Nylon Straight	3/8 x 5/16	800-054	3/8 x 5/16	800-054	-	-
MYSTIQUE								
L4 - 2.0L (121 CID)								
2000-95	-	Nylon Elbow	5/16 x 5/16	800-051	5/16 x 5/16	800-051	-	-
2000-95	-	Nylon Straight	3/8 x 5/16	800-054	3/8 x 5/16	800-054	-	-
V6 - 2.5L (155 CID)								
2000-95	-	Nylon Elbow	5/16 x 5/16	800-051	5/16 x 5/16	800-051	-	-
2000-95	-	Nylon Straight	3/8 x 5/16	800-054	3/8 x 5/16	800-054	-	-
SABLE								
L4 - 2.5L (153 CID)								
1987-86	-	Nylon Elbow	5/16 x 5/16	800-051	5/16 x 5/16	800-051	-	-
1987-86	-	Nylon Straight	3/8 x 5/16	800-054	3/8 x 5/16	800-054	-	-
V6 - 3.0L (182 CID)								
2003-02	-	Nylon Elbow	5/16 x 5/16	800-051	5/16 x 5/16	800-051	-	-
2003-02	-	Nylon Straight	3/8 x 5/16	800-054	3/8 x 5/16	800-054	-	-
2001	-	Nylon Elbow	5/16 x 5/16	800-051	5/16 x 5/16	800-051	3/8 x 3/8	800-056
2001	-	Nylon Straight	3/8 x 5/16	800-054	3/8 x 5/16	800-054	3/8 x 3/8	800-052
2000	-	Nylon Elbow	3/8 x 3/8	800-056	5/16 x 5/16	800-051	-	-
2000	-	Nylon Straight	3/8 x 3/8	800-052	3/8 x 5/16	800-054	-	-
1999-86	-	Nylon Elbow	5/16 x 5/16	800-051	5/16 x 5/16	800-051	-	-
1999-86	-	Nylon Straight	3/8 x 5/16	800-054	3/8 x 5/16	800-054	-	-
V6 - 3.8L (232 CID)								
1995-88	-	Nylon Elbow	5/16 x 5/16	800-051	5/16 x 5/16	800-051	-	-
1995-88	-	Nylon Straight	3/8 x 5/16	800-054	3/8 x 5/16	800-054	-	-
TOPAZ								
L4 - 2.3L (140 CID)								
1994-85	-	Nylon Elbow	5/16 x 5/16	800-051	5/16 x 5/16	800-051	-	-
1994-85	-	Nylon Straight	3/8 x 5/16	800-054	3/8 x 5/16	800-054	-	-
V6 - 3.0L (182 CID)								
1994-92	-	Nylon Elbow	5/16 x 5/16	800-051	5/16 x 5/16	800-051	-	-
1994-92	-	Nylon Straight	3/8 x 5/16	800-054	3/8 x 5/16	800-054	-	-
TRACER								
L4 - 1.8L (1839cc)								
1996-91	-	Nylon Elbow	5/16 x 5/16	800-051	5/16 x 5/16	800-051	-	-
1996-91	-	Nylon Straight	3/8 x 5/16	800-054	3/8 x 5/16	800-054	-	-
L4 - 1.9L (116 CID)								
1996-91	-	Nylon Elbow	5/16 x 5/16	800-051	5/16 x 5/16	800-051	-	-
1996-91	-	Nylon Straight	3/8 x 5/16	800-054	3/8 x 5/16	800-054	-	-
MERKUR								
XR4TI								
L4 - 2.3L (140 CID)								
1989-85	-	Nylon Elbow	5/16 x 5/16	800-051	5/16 x 5/16	800-051	-	-
1989-85	-	Nylon Straight	3/8 x 5/16	800-054	3/8 x 5/16	800-054	-	-
OLDSMOBILE								
88, DELTA 88								
V6 - 3.0L (181 CID)								
1986	-	Steel Line Gasket	3/8 x M16-1.50	800-153	3/8 x M16-1.50	800-153	-	-

Quick Disconnect

Fuel Sending Units
pg. 155-176

Fuel Tanks
pg. 177-228

Harmonic Balancers
pg. 229-254

Heater Hose Assemblies
pg. 255-256

Hydraulic Clutch Lines
pg. 257-260

Use Quick Disconnect Fittings & Clips for Fast, Economical Repairs

Quick Disconnect
361

Quick Disconnect Fuel Line Connector Applications

Quick Disconnect

Make/ Model/Engine/Years	Description	Style	Inlet Size	Inlet	Outlet Size	Outlet	Return Size	Return
OLDSMOBILE (continued)								
88, DELTA 88 (continued)								
V6 - 3.8L (231 CID)								
1999-94 -		Nylon Elbow	3/8 x 3/8	800-059	-	-	-	-
1999-94 -		Nylon Straight	3/8 x 3/8	800-058	-	-	-	-
1999-94 -		Steel Line Gasket	-	-	3/8 x M16-1.50	800-153	-	-
1993-92 -		Nylon Elbow	3/8 x 3/8	800-059	3/8 x 3/8	800-059	-	-
1993-92 -		Nylon Straight	3/8 x 3/8	800-058	3/8 x 3/8	800-058	-	-
1991-86 -		Steel Line Gasket	3/8 x M16-1.50	800-153	3/8 x M16-1.50	800-153	-	-
98, 98 REGENCY								
V6 - 3.8L (231 CID)								
1996-94 -		Nylon Elbow	3/8 x 3/8	800-059	-	-	-	-
1996-94 -		Nylon Straight	3/8 x 3/8	800-058	-	-	-	-
1996-94 -		Steel Line Gasket	-	-	3/8 x M16-1.50	800-153	-	-
1993-91 -		Nylon Elbow	3/8 x 3/8	800-059	3/8 x 3/8	800-059	-	-
1993-91 -		Nylon Straight	3/8 x 3/8	800-058	3/8 x 3/8	800-058	-	-
1990-86 -		Steel Line Gasket	3/8 x M16-1.50	800-153	3/8 x M16-1.50	800-153	-	-
1985 -		Steel Line Gasket	-	-	3/8 x M16-1.50	800-153	-	-
ACHIEVA								
L4 - 2.3L (138 CID)								
1995-92 -		Nylon Elbow	3/8 x 3/8	800-059	-	-	-	-
1995-92 -		Nylon Straight	3/8 x 3/8	800-058	-	-	-	-
1995-92 -		Steel Line Gasket	-	-	3/8 x M16-1.50	800-153	-	-
L4 - 2.4L (146 CID)								
1998-96 -		Nylon Elbow	3/8 x 3/8	800-059	-	-	-	-
1998-96 -		Nylon Straight	3/8 x 3/8	800-058	-	-	-	-
1998-96 -		Steel Line Gasket	-	-	3/8 x M16-1.50	800-153	-	-
V6 - 3.1L (189 CID)								
1998-94 -		Nylon Elbow	3/8 x 3/8	800-059	-	-	-	-
1998-94 -		Nylon Straight	3/8 x 3/8	800-058	-	-	-	-
1998-94 -		Steel Line Gasket	-	-	3/8 x M16-1.50	800-153	-	-
V6 - 3.3L (204 CID)								
1993-92 -		Nylon Elbow	3/8 x 3/8	800-059	-	-	-	-
1993-92 -		Nylon Straight	3/8 x 3/8	800-058	-	-	-	-
1993-92 -		Steel Line Gasket	-	-	3/8 x M16-1.50	800-153	-	-
ALERO								
L4 - 2.2L (134 CID)								
2004-02 -		Nylon Elbow	3/8 x 3/8	800-059	-	-	-	-
2004-02 -		Nylon Straight	3/8 x 3/8	800-058	-	-	-	-
2004-02 -		Steel Line Gasket	-	-	3/8 x M16-1.50	800-153	-	-
L4 - 2.4L (146 CID)								
2001-99 -		Nylon Elbow	3/8 x 3/8	800-059	-	-	-	-
2001-99 -		Nylon Straight	3/8 x 3/8	800-058	-	-	-	-
2001-99 -		Steel Line Gasket	-	-	3/8 x M16-1.50	800-153	-	-
V6 - 3.4L (207 CID)								
2004-99 -		Nylon Elbow	3/8 x 3/8	800-059	-	-	-	-
2004-99 -		Nylon Straight	3/8 x 3/8	800-058	-	-	-	-
2004-99 -		Steel Line Gasket	-	-	3/8 x M16-1.50	800-153	-	-
AURORA								
V6 - 3.5L (214 CID)								
2002-01 -		Nylon Elbow	3/8 x 3/8	800-059	-	-	-	-
2002-01 -		Nylon Straight	3/8 x 3/8	800-058	-	-	-	-
2002-01 -		Steel Line Gasket	-	-	3/8 x M16-1.50	800-153	-	-
V8 - 4.0L (244 CID)								
2003-95 -		Nylon Elbow	3/8 x 3/8	800-059	-	-	-	-
2003-95 -		Nylon Straight	3/8 x 3/8	800-058	-	-	-	-
2003-95 -		Steel Line Gasket	-	-	3/8 x M16-1.50	800-153	-	-
BRAVADA								
L6 - 4.2L (256 CID)								
2004-02 -		Nylon Elbow	3/8 x 3/8	800-059	3/8 x 3/8	800-059	-	-
2004-02 -		Nylon Straight	3/8 x 3/8	800-058	3/8 x 3/8	800-058	-	-
V6 - 4.3L (262 CID)								
2001-97 -		Nylon Elbow	-	-	3/8 x 3/8	800-059	-	-
2001-97 -		Nylon Straight	-	-	3/8 x 3/8	800-058	-	-
2001-97 -		Steel Line Gasket	3/8 x M16-1.50	800-153	-	-	-	-
1996-91 -		Steel Line Gasket	3/8 x M16-1.50	800-153	3/8 x M16-1.50	800-153	-	-
CUSTOM CRUISER								
V8 - 5.0L (305 CID)								
1992-91 -		Nylon Elbow	3/8 x 3/8	800-059	3/8 x 3/8	800-059	-	-
1992-91 -		Nylon Straight	3/8 x 3/8	800-058	3/8 x 3/8	800-058	-	-
V8 - 5.7L (350 CID)								
1992 -		Nylon Elbow	3/8 x 3/8	800-059	3/8 x 3/8	800-059	-	-
1992 -		Nylon Straight	3/8 x 3/8	800-058	3/8 x 3/8	800-058	-	-
CUTLASS CALAIS								
L4 - 2.3L (138 CID)								
1991-87 -		Steel Line Gasket	3/8 x M16-1.50	800-153	3/8 x M16-1.50	800-153	-	-
L4 - 2.5L (151 CID)								
1991-85 -		Steel Line Gasket	3/8 x M16-1.50	800-153	3/8 x M16-1.50	800-153	-	-
V6 - 3.0L (181 CID)								
1988-85 -		Steel Line Gasket	3/8 x M16-1.50	800-153	3/8 x M16-1.50	800-153	-	-

Quick Disconnect Fuel Line Connector Applications

Make/ Model/Engine/Years	Description	Style	Inlet Size	Inlet	Outlet Size	Outlet	Return Size	Return
OLDSMOBILE (continued)								
CUTLASS CALAIS (continued)								
V6 - 3.3L (204 CID)								
1991-89	-	Steel Line Gasket	3/8 x M16-1.50	800-153	3/8 x M16-1.50	800-153	-	-
CUTLASS CIERA								
L4 - 2.2L (134 CID)								
1996-93	-	Nylon Elbow	3/8 x 3/8	800-059	3/8 x 3/8	800-059	-	-
1996-93	-	Nylon Straight	3/8 x 3/8	800-058	3/8 x 3/8	800-058	-	-
L4 - 2.5L (151 CID)								
1992-89	-	Nylon Elbow	3/8 x 3/8	800-059	3/8 x 3/8	800-059	-	-
1992-89	-	Nylon Straight	3/8 x 3/8	800-058	3/8 x 3/8	800-058	-	-
1988-84	-	Steel Line Gasket	3/8 x M16-1.50	800-153	3/8 x M16-1.50	800-153	-	-
1983	-	Steel Line Gasket	-	-	3/8 x M16-1.50	800-153	-	-
V6 - 2.8L (173 CID)								
1989	-	Nylon Elbow	3/8 x 3/8	800-059	3/8 x 3/8	800-059	-	-
1989	-	Nylon Straight	3/8 x 3/8	800-058	3/8 x 3/8	800-058	-	-
1988-86	-	Steel Line Gasket	3/8 x M16-1.50	800-153	3/8 x M16-1.50	800-153	-	-
V6 - 3.1L (189 CID)								
1996-94	-	Nylon Elbow	3/8 x 3/8	800-059	3/8 x 3/8	800-059	-	-
1996-94	-	Nylon Straight	3/8 x 3/8	800-058	3/8 x 3/8	800-058	-	-
V6 - 3.3L (204 CID)								
1993-89	-	Nylon Elbow	3/8 x 3/8	800-059	3/8 x 3/8	800-059	-	-
1993-89	-	Nylon Straight	3/8 x 3/8	800-058	3/8 x 3/8	800-058	-	-
V6 - 3.8L (231 CID)								
1988-86	-	Steel Line Gasket	3/8 x M16-1.50	800-153	3/8 x M16-1.50	800-153	-	-
1985-84	-	Steel Line Gasket	-	-	3/8 x M16-1.50	800-153	-	-
CUTLASS, CUTLASS SUPREME								
L4 - 2.3L (138 CID)								
1991-90	-	Steel Line Gasket	3/8 x M16-1.50	800-153	3/8 x M16-1.50	800-153	-	-
V6 - 2.8L (173 CID)								
1989-88	-	Steel Line Gasket	3/8 x M16-1.50	800-153	3/8 x M16-1.50	800-153	-	-
V6 - 3.1L (189 CID)								
1999-92	-	Nylon Elbow	3/8 x 3/8	800-059	-	-	-	-
1999-92	-	Nylon Straight	3/8 x 3/8	800-058	-	-	-	-
1999-92	-	Steel Line Gasket	-	-	3/8 x M16-1.50	800-153	-	-
1991-89	-	Steel Line Gasket	3/8 x M16-1.50	800-153	3/8 x M16-1.50	800-153	-	-
V6 - 3.4L (207 CID)								
1996-92	-	Nylon Elbow	3/8 x 3/8	800-059	-	-	-	-
1996-92	-	Nylon Straight	3/8 x 3/8	800-058	-	-	-	-
1996-92	-	Steel Line Gasket	-	-	3/8 x M16-1.50	800-153	-	-
1991	-	Steel Line Gasket	3/8 x M16-1.50	800-153	3/8 x M16-1.50	800-153	-	-
FIRENZA								
L4 - 1.8L (112 CID)								
1986-82	-	Steel Line Gasket	3/8 x M16-1.50	800-153	3/8 x M16-1.50	800-153	-	-
L4 - 2.0L (122 CID)								
1988-83	-	Steel Line Gasket	3/8 x M16-1.50	800-153	3/8 x M16-1.50	800-153	-	-
V6 - 2.8L (173 CID)								
1987-85	-	Steel Line Gasket	3/8 x M16-1.50	800-153	3/8 x M16-1.50	800-153	-	-
INTRIGUE								
V6 - 3.5L (214 CID)								
2002-99	-	Nylon Elbow	3/8 x 3/8	800-059	-	-	-	-
2002-99	-	Nylon Straight	3/8 x 3/8	800-058	-	-	-	-
2002-99	-	Steel Line Gasket	-	-	3/8 x M16-1.50	800-153	-	-
V6 - 3.8L (231 CID)								
1999-98	-	Nylon Elbow	3/8 x 3/8	800-059	-	-	-	-
1999-98	-	Nylon Straight	3/8 x 3/8	800-058	-	-	-	-
1999-98	-	Steel Line Gasket	-	-	3/8 x M16-1.50	800-153	-	-
LSS								
V6 - 3.8L (231 CID)								
1999-96	-	Nylon Elbow	3/8 x 3/8	800-059	-	-	-	-
1999-96	-	Nylon Straight	3/8 x 3/8	800-058	-	-	-	-
1999-96	-	Steel Line Gasket	-	-	3/8 x M16-1.50	800-153	-	-
OMEGA								
L4 - 2.5L (151 CID)								
1984	-	Steel Line Gasket	3/8 x M16-1.50	800-153	3/8 x M16-1.50	800-153	-	-
1983	-	Steel Line Gasket	-	-	3/8 x M16-1.50	800-153	-	-
SILHOUETTE								
V6 - 3.1L (189 CID)								
1995-90	-	Nylon Elbow	3/8 x 3/8	800-059	3/8 x 3/8	800-059	-	-
1995-90	-	Nylon Straight	3/8 x 3/8	800-058	3/8 x 3/8	800-058	-	-
V6 - 3.4L (207 CID)								
2004-96	-	Nylon Elbow	3/8 x 3/8	800-059	3/8 x 3/8	800-059	-	-
2004-96	-	Nylon Straight	3/8 x 3/8	800-058	3/8 x 3/8	800-058	-	-
V6 - 3.8L (231 CID)								
1995-92	-	Nylon Elbow	3/8 x 3/8	800-059	3/8 x 3/8	800-059	-	-
1995-92	-	Nylon Straight	3/8 x 3/8	800-058	3/8 x 3/8	800-058	-	-
TORONADO								
V6 - 3.8L (231 CID)								
1992-90	-	Nylon Elbow	5/16 x 5/16	800-060	5/16 x 5/16	800-060	-	-
1992-90	-	Nylon Straight	5/16 x 5/16	800-057	5/16 x 5/16	800-057	-	-
1989-86	-	Steel Line Gasket	3/8 x M16-1.50	800-153	3/8 x M16-1.50	800-153	-	-

Quick Disconnect

Quick Disconnect Fuel Line Connector Applications

Quick Disconnect

Make/ Model/Engine/Years	Description	Style	Inlet Size	Inlet	Outlet Size	Outlet	Return Size	Return
OLDSMOBILE (continued)								
TROFEO								
V6 - 3.8L (231 CID)								
1991-90	-	Nylon Elbow	5/16 x 5/16	800-060	5/16 x 5/16	800-060	-	-
1991-90	-	Nylon Straight	5/16 x 5/16	800-057	5/16 x 5/16	800-057	-	-
1989-88	-	Steel Line Gasket	3/8 x M16-1.50	800-153	3/8 x M16-1.50	800-153	-	-
PLYMOUTH								
ACCLAIM								
L4 - 2.5L (153 CID)								
1994-94	-	Nylon Elbow	5/16 x 5/16	800-060	3/8 x 3/8	800-059	-	-
1994-94	-	Nylon Straight	5/16 x 5/16	800-057	3/8 x 3/8	800-058	-	-
1994-93	4-Door	Nylon Elbow	5/16 x 5/16	800-060	3/8 x 3/8	800-059	-	-
1994-93	4-Door	Nylon Straight	5/16 x 5/16	800-057	3/8 x 3/8	800-058	-	-
BREEZE								
L4 - 2.0L (122 CID)								
2000-98	-	Nylon Elbow	3/8 x 3/8	800-059	5/16 x 5/16	800-060	5/16 x 5/16	800-060
2000-98	-	Nylon Straight	3/8 x 3/8	800-058	5/16 x 5/16	800-057	5/16 x 5/16	800-057
L4 - 2.4L (148 CID)								
2000-98	-	Nylon Elbow	3/8 x 3/8	800-059	5/16 x 5/16	800-060	5/16 x 5/16	800-060
2000-98	-	Nylon Straight	3/8 x 3/8	800-058	5/16 x 5/16	800-057	5/16 x 5/16	800-057
NEON								
L4 - 2.0L (122 CID)								
1996	-	Nylon Elbow	3/8 x 3/8	800-059	5/16 x 5/16	800-060	5/16 x 5/16	800-060
1996	-	Nylon Straight	3/8 x 3/8	800-058	5/16 x 5/16	800-057	5/16 x 5/16	800-057
VOYAGER, GRAND VOYAGER								
L4 - 2.4L (148 CID)								
2000-97	Extended Wheel Base	Nylon Elbow	3/8 x 3/8	800-059	5/16 x 5/16	800-060	5/16 x 5/16	800-060
2000-97	Extended Wheel Base	Nylon Straight	3/8 x 3/8	800-058	5/16 x 5/16	800-057	5/16 x 5/16	800-057
V6 - 3.0L (181 CID)								
2000-97	Extended Wheel Base	Nylon Elbow	3/8 x 3/8	800-059	5/16 x 5/16	800-060	5/16 x 5/16	800-060
2000-97	Extended Wheel Base	Nylon Straight	3/8 x 3/8	800-058	5/16 x 5/16	800-057	5/16 x 5/16	800-057
V6 - 3.3L (201 CID)								
2000-97	Extended Wheel Base	Nylon Elbow	3/8 x 3/8	800-059	5/16 x 5/16	800-060	5/16 x 5/16	800-060
2000-97	Extended Wheel Base	Nylon Straight	3/8 x 3/8	800-058	5/16 x 5/16	800-057	5/16 x 5/16	800-057
V6 - 3.8L (230 CID)								
1999	Extended Wheel Base	Nylon Elbow	3/8 x 3/8	800-059	5/16 x 5/16	800-060	5/16 x 5/16	800-060
1999	Extended Wheel Base	Nylon Straight	3/8 x 3/8	800-058	5/16 x 5/16	800-057	5/16 x 5/16	800-057
PONTIAC								
6000								
L4 - 2.5L (151 CID)								
1991-89	-	Nylon Elbow	3/8 x 3/8	800-059	3/8 x 3/8	800-059	-	-
1991-89	-	Nylon Straight	3/8 x 3/8	800-058	3/8 x 3/8	800-058	-	-
1988-84	-	Steel Line Gasket	3/8 x M16-1.50	800-153	3/8 x M16-1.50	800-153	-	-
1983	-	Steel Line Gasket	-	-	3/8 x M16-1.50	800-153	-	-
V6 - 2.8L (173 CID)								
1989	-	Nylon Elbow	3/8 x 3/8	800-059	3/8 x 3/8	800-059	-	-
1989	-	Nylon Straight	3/8 x 3/8	800-058	3/8 x 3/8	800-058	-	-
1988-86	-	Steel Line Gasket	3/8 x M16-1.50	800-153	3/8 x M16-1.50	800-153	-	-
1985	-	Steel Line Gasket	-	-	3/8 x M16-1.50	800-153	-	-
V6 - 3.1L (189 CID)								
1991	-	Nylon Elbow	3/8 x 3/8	800-059	3/8 x 3/8	800-059	-	-
1991	-	Nylon Straight	3/8 x 3/8	800-058	3/8 x 3/8	800-058	-	-
1990	2WD	Nylon Elbow	3/8 x 3/8	800-059	3/8 x 3/8	800-059	-	-
1990	2WD	Nylon Straight	3/8 x 3/8	800-058	3/8 x 3/8	800-058	-	-
1990	4WD	Steel Line Gasket	3/8 x M16-1.50	800-153	3/8 x M16-1.50	800-153	-	-
1989-88	-	Steel Line Gasket	3/8 x M16-1.50	800-153	3/8 x M16-1.50	800-153	-	-
AZTEK								
V6 - 3.4L (207 CID)								
2002-01	-	Nylon Elbow	3/8 x 3/8	800-059	3/8 x 3/8	800-059	-	-
2002-01	-	Nylon Straight	3/8 x 3/8	800-058	3/8 x 3/8	800-058	-	-
BONNEVILLE								
V6 - 3.8L (231 CID)								
2005-94	-	Nylon Elbow	3/8 x 3/8	800-059	-	-	-	-
2005-94	-	Nylon Straight	3/8 x 3/8	800-058	-	-	-	-
2005-94	-	Steel Line Gasket	-	-	3/8 x M16-1.50	800-153	-	-
1993-92	-	Nylon Elbow	3/8 x 3/8	800-059	3/8 x 3/8	800-059	-	-
1993-92	-	Nylon Straight	3/8 x 3/8	800-058	3/8 x 3/8	800-058	-	-
1991-87	-	Steel Line Gasket	3/8 x M16-1.50	800-153	3/8 x M16-1.50	800-153	-	-
V6 - 4.3L (262 CID)								
1986	-	Steel Line Gasket	3/8 x M16-1.50	800-153	3/8 x M16-1.50	800-153	-	-
FIERO								
L4 - 2.5L (151 CID)								
1988-84	-	Steel Line Gasket	3/8 x M16-1.50	800-153	3/8 x M16-1.50	800-153	-	-
V6 - 2.8L (173 CID)								
1988-85	-	Steel Line Gasket	3/8 x M16-1.50	800-153	3/8 x M16-1.50	800-153	-	-
FIREBIRD								
L4 - 2.5L (151 CID)								
1986-84	-	Steel Line Gasket	3/8 x M16-1.50	800-153	3/8 x M16-1.50	800-153	-	-
1983	-	Steel Line Gasket	-	-	3/8 x M16-1.50	800-153	-	-
V6 - 2.8L (173 CID)								
1989-85	-	Steel Line Gasket	3/8 x M16-1.50	800-153	3/8 x M16-1.50	800-153	-	-

Quick Disconnect Fuel Line Connector Applications

Make/ Model/Engine/Years	Description	Style	Inlet Size	Inlet	Outlet Size	Outlet	Return Size	Return
PONTIAC (continued)								
FIREBIRD (continued)								
V6 - 3.1L (189 CID)								
1992-90 -		Steel Line Gasket	3/8 x M16-1.50	800-153	3/8 x M16-1.50	800-153	-	-
V6 - 3.4L (207 CID)								
1995-93 -		Nylon Elbow	3/8 x 3/8	800-059	-	-	-	-
1995-93 -		Nylon Straight	3/8 x 3/8	800-058	-	-	-	-
1995-93 -		Steel Line Gasket	-	-	3/8 x M16-1.50	800-153	-	-
V6 - 3.8L (231 CID)								
2002-95 -		Nylon Elbow	3/8 x 3/8	800-059	-	-	-	-
2002-95 -		Nylon Straight	3/8 x 3/8	800-058	-	-	-	-
2002-95 -		Steel Line Gasket	-	-	3/8 x M16-1.50	800-153	-	-
1989 -		Steel Line Gasket	3/8 x M16-1.50	800-153	3/8 x M16-1.50	800-153	-	-
V8 - 5.0L (305 CID)								
1992-85 -		Steel Line Gasket	3/8 x M16-1.50	800-153	3/8 x M16-1.50	800-153	-	-
V8 - 5.7L (350 CID)								
2002-93 -		Nylon Elbow	3/8 x 3/8	800-059	-	-	-	-
2002-93 -		Nylon Straight	3/8 x 3/8	800-058	-	-	-	-
2002-93 -		Steel Line Gasket	-	-	3/8 x M16-1.50	800-153	-	-
1992-87 -		Steel Line Gasket	3/8 x M16-1.50	800-153	3/8 x M16-1.50	800-153	-	-
GRAND AM								
L4 - 2.0L (122 CID)								
1989-87 -		Steel Line Gasket	3/8 x M16-1.50	800-153	3/8 x M16-1.50	800-153	-	-
L4 - 2.2L (134 CID)								
2005-02 -		Nylon Elbow	3/8 x 3/8	800-059	-	-	-	-
2005-02 -		Nylon Straight	3/8 x 3/8	800-058	-	-	-	-
2005-02 -		Steel Line Gasket	-	-	3/8 x M16-1.50	800-153	-	-
L4 - 2.3L (138 CID)								
1995-92 -		Nylon Elbow	3/8 x 3/8	800-059	-	-	-	-
1995-92 -		Nylon Straight	3/8 x 3/8	800-058	-	-	-	-
1995-92 -		Steel Line Gasket	-	-	3/8 x M16-1.50	800-153	-	-
1991-88 -		Steel Line Gasket	3/8 x M16-1.50	800-153	3/8 x M16-1.50	800-153	-	-
L4 - 2.4L (146 CID)								
2001-96 -		Nylon Elbow	3/8 x 3/8	800-059	-	-	-	-
2001-96 -		Nylon Straight	3/8 x 3/8	800-058	-	-	-	-
2001-96 -		Steel Line Gasket	-	-	3/8 x M16-1.50	800-153	-	-
L4 - 2.5L (151 CID)								
1991-85 -		Steel Line Gasket	3/8 x M16-1.50	800-153	3/8 x M16-1.50	800-153	-	-
V6 - 3.0L (181 CID)								
1987-85 -		Steel Line Gasket	3/8 x M16-1.50	800-153	3/8 x M16-1.50	800-153	-	-
V6 - 3.1L (189 CID)								
1998-94 -		Nylon Elbow	3/8 x 3/8	800-059	-	-	-	-
1998-94 -		Nylon Straight	3/8 x 3/8	800-058	-	-	-	-
1998-94 -		Steel Line Gasket	-	-	3/8 x M16-1.50	800-153	-	-
V6 - 3.3L (204 CID)								
1993-92 -		Nylon Elbow	3/8 x 3/8	800-059	-	-	-	-
1993-92 -		Nylon Straight	3/8 x 3/8	800-058	-	-	-	-
1993-92 -		Steel Line Gasket	-	-	3/8 x M16-1.50	800-153	-	-
V6 - 3.4L (207 CID)								
2005-99 -		Nylon Elbow	3/8 x 3/8	800-059	-	-	-	-
2005-99 -		Nylon Straight	3/8 x 3/8	800-058	-	-	-	-
2005-99 -		Steel Line Gasket	-	-	3/8 x M16-1.50	800-153	-	-
GRAND PRIX								
L4 - 2.3L (138 CID)								
1991-90 -		Steel Line Gasket	3/8 x M16-1.50	800-153	3/8 x M16-1.50	800-153	-	-
V6 - 2.8L (173 CID)								
1989-88 -		Steel Line Gasket	3/8 x M16-1.50	800-153	3/8 x M16-1.50	800-153	-	-
V6 - 3.1L (189 CID)								
2003-92 -		Nylon Elbow	3/8 x 3/8	800-059	-	-	-	-
2003-92 -		Nylon Straight	3/8 x 3/8	800-058	-	-	-	-
2003-92 -		Steel Line Gasket	-	-	3/8 x M16-1.50	800-153	-	-
1991-89 -		Steel Line Gasket	3/8 x M16-1.50	800-153	3/8 x M16-1.50	800-153	-	-
V6 - 3.4L (207 CID)								
1996-92 -		Nylon Elbow	3/8 x 3/8	800-059	-	-	-	-
1996-92 -		Nylon Straight	3/8 x 3/8	800-058	-	-	-	-
1996-92 -		Steel Line Gasket	-	-	3/8 x M16-1.50	800-153	-	-
1991 -		Steel Line Gasket	3/8 x M16-1.50	800-153	3/8 x M16-1.50	800-153	-	-
V6 - 3.8L (231 CID)								
2003-97 -		Nylon Elbow	3/8 x 3/8	800-059	-	-	-	-
2003-97 -		Nylon Straight	3/8 x 3/8	800-058	-	-	-	-
2003-97 -		Steel Line Gasket	-	-	3/8 x M16-1.50	800-153	-	-
V6 - 4.3L (262 CID)								
1987-86 -		Steel Line Gasket	3/8 x M16-1.50	800-153	3/8 x M16-1.50	800-153	-	-
J2000								
L4 - 1.8L (112 CID)								
1986-82 -		Steel Line Gasket	3/8 x M16-1.50	800-153	3/8 x M16-1.50	800-153	-	-
L4 - 2.0L (121 CID)								
1986-83 -		Steel Line Gasket	3/8 x M16-1.50	800-153	3/8 x M16-1.50	800-153	-	-
LEMANS								
L4 - 1.6L (98 CID)								
1993-88 -		Steel Line Gasket	3/8 x M16-1.50	800-153	3/8 x M16-1.50	800-153	-	-
L4 - 2.0L (122 CID)								
1990-89 -		Steel Line Gasket	3/8 x M16-1.50	800-153	3/8 x M16-1.50	800-153	-	-

Quick Disconnect

Quick Disconnect Fuel Line Connector Applications

Make/ Model/Engine/Years	Description	Style	Inlet Size	Inlet	Outlet Size	Outlet	Return Size	Return
PONTIAC (continued)								
MONTANA								
V6 - 3.4L (207 CID)								
2005-99	-	Nylon Elbow	3/8 x 3/8	800-059	3/8 x 3/8	800-059	-	-
2005-99	-	Nylon Straight	3/8 x 3/8	800-058	3/8 x 3/8	800-058	-	-
PARISIENNE								
V6 - 4.3L (262 CID)								
1986-85	-	Steel Line Gasket	3/8 x M16-1.50	800-153	3/8 x M16-1.50	800-153	-	-
PHOENIX								
L4 - 2.5L (151 CID)								
1984	-	Steel Line Gasket	3/8 x M16-1.50	800-153	3/8 x M16-1.50	800-153	-	-
1983	-	Steel Line Gasket	-	-	3/8 x M16-1.50	800-153	-	-
SUNBIRD								
L4 - 1.8L (112 CID)								
1986	-	Steel Line Gasket	3/8 x M16-1.50	800-153	3/8 x M16-1.50	800-153	-	-
L4 - 2.0L (122 CID)								
1994-92	-	Nylon Elbow	3/8 x 3/8	800-059	-	-	-	-
1994-92	-	Nylon Straight	3/8 x 3/8	800-058	-	-	-	-
1994-92	-	Steel Line Gasket	-	-	3/8 x M16-1.50	800-153	-	-
1991-86	-	Steel Line Gasket	3/8 x M16-1.50	800-153	3/8 x M16-1.50	800-153	-	-
V6 - 3.1L (189 CID)								
1994-92	-	Nylon Elbow	3/8 x 3/8	800-059	-	-	-	-
1994-92	-	Nylon Straight	3/8 x 3/8	800-058	-	-	-	-
1994-92	-	Steel Line Gasket	-	-	3/8 x M16-1.50	800-153	-	-
1991	-	Steel Line Gasket	3/8 x M16-1.50	800-153	3/8 x M16-1.50	800-153	-	-
SUNFIRE								
L4 - 2.2L (134 CID)								
2005-95	-	Nylon Elbow	3/8 x 3/8	800-059	-	-	-	-
2005-95	-	Nylon Straight	3/8 x 3/8	800-058	-	-	-	-
2005-95	-	Steel Line Gasket	-	-	3/8 x M16-1.50	800-153	-	-
L4 - 2.3L (138 CID)								
1995	-	Nylon Elbow	3/8 x 3/8	800-059	-	-	-	-
1995	-	Nylon Straight	3/8 x 3/8	800-058	-	-	-	-
1995	-	Steel Line Gasket	-	-	3/8 x M16-1.50	800-153	-	-
L4 - 2.4L (146 CID)								
2002-96	-	Nylon Elbow	3/8 x 3/8	800-059	-	-	-	-
2002-96	-	Nylon Straight	3/8 x 3/8	800-058	-	-	-	-
2002-96	-	Steel Line Gasket	-	-	3/8 x M16-1.50	800-153	-	-
TRANS SPORT								
V6 - 3.1L (189 CID)								
1995-90	-	Nylon Elbow	3/8 x 3/8	800-059	3/8 x 3/8	800-059	-	-
1995-90	-	Nylon Straight	3/8 x 3/8	800-058	3/8 x 3/8	800-058	-	-
V6 - 3.4L (207 CID)								
1998-96	-	Nylon Elbow	3/8 x 3/8	800-059	3/8 x 3/8	800-059	-	-
1998-96	-	Nylon Straight	3/8 x 3/8	800-058	3/8 x 3/8	800-058	-	-
V6 - 3.8L (231 CID)								
1995-92	-	Nylon Elbow	3/8 x 3/8	800-059	3/8 x 3/8	800-059	-	-
1995-92	-	Nylon Straight	3/8 x 3/8	800-058	3/8 x 3/8	800-058	-	-

Quick Disconnect Fuel Line Spring Lock Coupling Applications

Make/ Model/Engine	Years	Description	Dorman #
FORD			
ASPIRE			
L4 - 1.3L (81 CID)	1997-94	11mm Connector Body, 6.25mm Hose x 9.5mm Push Connect	800-130
L4 - 1.3L (81 CID)	1997-94	14.17mm Connector Body, 6.35mm Hose x 12.7mm Push Connect	800-131
CONTOUR			
L4 - 2.0L (122 CID)	2000-95	11mm Connector Body, 6.25mm Hose x 9.5mm Push Connect	800-130
L4 - 2.0L (122 CID)	2000-95	14.17mm Connector Body, 6.35mm Hose x 12.7mm Push Connect	800-131
V6 - 2.5L (152 CID)	2000-95	11mm Connector Body, 6.25mm Hose x 9.5mm Push Connect	800-130
V6 - 2.5L (152 CID)	2000-95	14.17mm Connector Body, 6.35mm Hose x 12.7mm Push Connect	800-131
COUNTRY SQUIRE			
V8 - 5.0L (302 CID)	1991	11mm Connector Body, 6.25mm Hose x 9.5mm Push Connect	800-130
V8 - 5.0L (302 CID)	1991	14.17mm Connector Body, 6.35mm Hose x 12.7mm Push Connect	800-131
CROWN VICTORIA			
V8 - 4.6L (281 CID)	2006-92	11mm Connector Body, 6.25mm Hose x 9.5mm Push Connect	800-130
V8 - 4.6L (281 CID)	2006-92	14.17mm Connector Body, 6.35mm Hose x 12.7mm Push Connect	800-131
V8 - 5.0L (302 CID)	1991	11mm Connector Body, 6.25mm Hose x 9.5mm Push Connect	800-130
V8 - 5.0L (302 CID)	1991	14.17mm Connector Body, 6.35mm Hose x 12.7mm Push Connect	800-131
V8 - 5.8L (351 CID)	1991	11mm Connector Body, 6.25mm Hose x 9.5mm Push Connect	800-130
V8 - 5.8L (351 CID)	1991	14.17mm Connector Body, 6.35mm Hose x 12.7mm Push Connect	800-131
ESCORT			
L4 - 1.8L (110 CID)	1996-91	11mm Connector Body, 6.25mm Hose x 9.5mm Push Connect	800-130
L4 - 1.8L (110 CID)	1996-91	14.17mm Connector Body, 6.35mm Hose x 12.7mm Push Connect	800-131
L4 - 1.9L (116 CID)	1996-91	11mm Connector Body, 6.25mm Hose x 9.5mm Push Connect	800-130
L4 - 1.9L (116 CID)	1996-91	14.17mm Connector Body, 6.35mm Hose x 12.7mm Push Connect	800-131
L4 - 2.0L (122 CID)	2003-97	11mm Connector Body, 6.25mm Hose x 9.5mm Push Connect	800-130
L4 - 2.0L (122 CID)	2003-97	14.17mm Connector Body, 6.35mm Hose x 12.7mm Push Connect	800-131
FESTIVA			
L4 - 1.3L (81 CID)	1993-91	11mm Connector Body, 6.25mm Hose x 9.5mm Push Connect	800-130
L4 - 1.3L (81 CID)	1993-91	14.17mm Connector Body, 6.35mm Hose x 12.7mm Push Connect	800-131

Quick Disconnect Fuel Line Spring Lock Coupling Applications

Make/ Model/Engine	Years	Description	Dorman #
FORD (continued)			
FOCUS			
L4 - 2.0L (122 CID)	2003-00	11mm Connector Body, 6.25mm Hose x 9.5mm Push Connect	800-130
L4 - 2.0L (122 CID)	2003-00	14.17mm Connector Body, 6.35mm Hose x 12.7mm Push Connect	800-131
MUSTANG			
L4 - 2.3L (140 CID)	1993-91	11mm Connector Body, 6.25mm Hose x 9.5mm Push Connect	800-130
L4 - 2.3L (140 CID)	1993-91	14.17mm Connector Body, 6.35mm Hose x 12.7mm Push Connect	800-131
V6 - 3.8L (232 CID)	2004-94	11mm Connector Body, 6.25mm Hose x 9.5mm Push Connect	800-130
V6 - 3.8L (232 CID)	2004-94	14.17mm Connector Body, 6.35mm Hose x 12.7mm Push Connect	800-131
V8 - 4.6L (281 CID)	2006-96	11mm Connector Body, 6.25mm Hose x 9.5mm Push Connect	800-130
V8 - 4.6L (281 CID)	2006-96	14.17mm Connector Body, 6.35mm Hose x 12.7mm Push Connect	800-131
V8 - 5.0L (302 CID)	1995-91	11mm Connector Body, 6.25mm Hose x 9.5mm Push Connect	800-130
V8 - 5.0L (302 CID)	1995-91	14.17mm Connector Body, 6.35mm Hose x 12.7mm Push Connect	800-131
V8 - 5.8L (351 CID)	1995	11mm Connector Body, 6.25mm Hose x 9.5mm Push Connect	800-130
V8 - 5.8L (351 CID)	1995	14.17mm Connector Body, 6.35mm Hose x 12.7mm Push Connect	800-131
PROBE			
L4 - 2.0L (122 CID)	1997-93	11mm Connector Body, 6.25mm Hose x 9.5mm Push Connect	800-130
L4 - 2.0L (122 CID)	1997-93	14.17mm Connector Body, 6.35mm Hose x 12.7mm Push Connect	800-131
L4 - 2.2L (133 CID)	1992-91	11mm Connector Body, 6.25mm Hose x 9.5mm Push Connect	800-130
L4 - 2.2L (133 CID)	1992-91	14.17mm Connector Body, 6.35mm Hose x 12.7mm Push Connect	800-131
V6 - 2.5L (152 CID)	1997-93	11mm Connector Body, 6.25mm Hose x 9.5mm Push Connect	800-130
V6 - 2.5L (152 CID)	1997-93	14.17mm Connector Body, 6.35mm Hose x 12.7mm Push Connect	800-131
V6 - 3.0L (182 CID)	1992-91	11mm Connector Body, 6.25mm Hose x 9.5mm Push Connect	800-130
V6 - 3.0L (182 CID)	1992-91	14.17mm Connector Body, 6.35mm Hose x 12.7mm Push Connect	800-131
TAURUS			
L4 - 2.5L (153 CID)	1991	11mm Connector Body, 6.25mm Hose x 9.5mm Push Connect	800-130
L4 - 2.5L (153 CID)	1991	14.17mm Connector Body, 6.35mm Hose x 12.7mm Push Connect	800-131
V6 - 3.0L (182 CID)	2006-91	11mm Connector Body, 6.25mm Hose x 9.5mm Push Connect	800-130
V6 - 3.0L (182 CID)	2006-91	14.17mm Connector Body, 6.35mm Hose x 12.7mm Push Connect	800-131
V6 - 3.2L (195 CID)	1995-93	11mm Connector Body, 6.25mm Hose x 9.5mm Push Connect	800-130
V6 - 3.2L (195 CID)	1995-93	14.17mm Connector Body, 6.35mm Hose x 12.7mm Push Connect	800-131
V6 - 3.8L (232 CID)	1995-91	11mm Connector Body, 6.25mm Hose x 9.5mm Push Connect	800-130
V6 - 3.8L (232 CID)	1995-91	14.17mm Connector Body, 6.35mm Hose x 12.7mm Push Connect	800-131
V8 - 3.4L (207 CID)	1999-96	11mm Connector Body, 6.25mm Hose x 9.5mm Push Connect	800-130
V8 - 3.4L (207 CID)	1999-96	14.17mm Connector Body, 6.35mm Hose x 12.7mm Push Connect	800-131
TEMPO			
L4 - 2.3L (140 CID)	1994-91	11mm Connector Body, 6.25mm Hose x 9.5mm Push Connect	800-130
L4 - 2.3L (140 CID)	1994-91	14.17mm Connector Body, 6.35mm Hose x 12.7mm Push Connect	800-131
V6 - 3.0L (182 CID)	1994-92	11mm Connector Body, 6.25mm Hose x 9.5mm Push Connect	800-130
V6 - 3.0L (182 CID)	1994-92	14.17mm Connector Body, 6.35mm Hose x 12.7mm Push Connect	800-131
THUNDERBIRD			
V6 - 3.8L (232 CID)	1997-91	11mm Connector Body, 6.25mm Hose x 9.5mm Push Connect	800-130
V6 - 3.8L (232 CID)	1997-91	14.17mm Connector Body, 6.35mm Hose x 12.7mm Push Connect	800-131
V8 - 3.9L (242 CID)	2005-02	11mm Connector Body, 6.25mm Hose x 9.5mm Push Connect	800-130
V8 - 3.9L (242 CID)	2005-02	14.17mm Connector Body, 6.35mm Hose x 12.7mm Push Connect	800-131
V8 - 4.6L (281 CID)	1997-94	11mm Connector Body, 6.25mm Hose x 9.5mm Push Connect	800-130
V8 - 4.6L (281 CID)	1997-94	14.17mm Connector Body, 6.35mm Hose x 12.7mm Push Connect	800-131
V8 - 5.0L (302 CID)	1993-91	11mm Connector Body, 6.25mm Hose x 9.5mm Push Connect	800-130
V8 - 5.0L (302 CID)	1993-91	14.17mm Connector Body, 6.35mm Hose x 12.7mm Push Connect	800-131
FORD TRUCK			
AEROSTAR			
V6 - 3.0L (182 CID)	1997-91	11mm Connector Body, 6.25mm Hose x 9.5mm Push Connect	800-130
V6 - 3.0L (182 CID)	1997-91	14.17mm Connector Body, 6.35mm Hose x 12.7mm Push Connect	800-131
V6 - 4.0L (245 CID)	1997-91	11mm Connector Body, 6.25mm Hose x 9.5mm Push Connect	800-130
V6 - 4.0L (245 CID)	1997-91	14.17mm Connector Body, 6.35mm Hose x 12.7mm Push Connect	800-131
BRONCO			
L6 - 4.9L (300 CID)	1993-91	11mm Connector Body, 6.25mm Hose x 9.5mm Push Connect	800-130
L6 - 4.9L (300 CID)	1993-91	14.17mm Connector Body, 6.35mm Hose x 12.7mm Push Connect	800-131
V8 - 5.0L (302 CID)	1996-91	11mm Connector Body, 6.25mm Hose x 9.5mm Push Connect	800-130
V8 - 5.0L (302 CID)	1996-91	14.17mm Connector Body, 6.35mm Hose x 12.7mm Push Connect	800-131
V8 - 5.8L (351 CID)	1996-91	11mm Connector Body, 6.25mm Hose x 9.5mm Push Connect	800-130
V8 - 5.8L (351 CID)	1996-91	14.17mm Connector Body, 6.35mm Hose x 12.7mm Push Connect	800-131
E SUPER DUTY			
L6 - 4.9L (300 CID)	1996	11mm Connector Body, 6.25mm Hose x 9.5mm Push Connect	800-130
L6 - 4.9L (300 CID)	1996	14.17mm Connector Body, 6.35mm Hose x 12.7mm Push Connect	800-131
V8 - 5.4L (330 CID)	2002-97	11mm Connector Body, 6.25mm Hose x 9.5mm Push Connect	800-130
V8 - 5.4L (330 CID)	2002-97	14.17mm Connector Body, 6.35mm Hose x 12.7mm Push Connect	800-131
V8 - 5.8L (351 CID)	1996	11mm Connector Body, 6.25mm Hose x 9.5mm Push Connect	800-130
V8 - 5.8L (351 CID)	1996	14.17mm Connector Body, 6.35mm Hose x 12.7mm Push Connect	800-131
V8 - 7.3L (445 CID)	2002-96	11mm Connector Body, 6.25mm Hose x 9.5mm Push Connect	800-130
V8 - 7.3L (445 CID)	2002-96	14.17mm Connector Body, 6.35mm Hose x 12.7mm Push Connect	800-131
V8 - 7.5L (460 CID)	1996	11mm Connector Body, 6.25mm Hose x 9.5mm Push Connect	800-130
V8 - 7.5L (460 CID)	1996	14.17mm Connector Body, 6.35mm Hose x 12.7mm Push Connect	800-131
V10 - 6.8L (415 CID)	2002-97	11mm Connector Body, 6.25mm Hose x 9.5mm Push Connect	800-130
V10 - 6.8L (415 CID)	2002-97	14.17mm Connector Body, 6.35mm Hose x 12.7mm Push Connect	800-131
E-150 ECONOLINE			
L6 - 4.9L (300 CID)	1996-91	11mm Connector Body, 6.25mm Hose x 9.5mm Push Connect	800-130
L6 - 4.9L (300 CID)	1996-91	14.17mm Connector Body, 6.35mm Hose x 12.7mm Push Connect	800-131
V6 - 4.2L (256 CID)	2003-97	11mm Connector Body, 6.25mm Hose x 9.5mm Push Connect	800-130
V6 - 4.2L (256 CID)	2003-97	14.17mm Connector Body, 6.35mm Hose x 12.7mm Push Connect	800-131
V8 - 4.6L (281 CID)	2006-97	11mm Connector Body, 6.25mm Hose x 9.5mm Push Connect	800-130

Quick Disconnect

Clock Springs
pg. 21-24

Control Arms
pg. 25-54

CV Joint Boots & Accessories
pg. 55-66

Door Lock Actuators
pg. 67-72

Exhaust Manifold Kits
pg. 73-134

Use Quick Disconnect Fittings & Clips for Fast, Economical Repairs

Quick Disconnect

Quick Disconnect Fuel Line Spring Lock Coupling Applications

Quick Disconnect

Make/ Model/Engine	Years	Description	Dorman #
FORD TRUCK (continued)			
E-150 ECONOLINE (continued)			
V8 - 4.6L (281 CID)	2006-97	14.17mm Connector Body, 6.35mm Hose x 12.7mm Push Connect	800-131
V8 - 5.0L (302 CID)	1996-91	11mm Connector Body, 6.25mm Hose x 9.5mm Push Connect	800-130
V8 - 5.0L (302 CID)	1996-91	14.17mm Connector Body, 6.35mm Hose x 12.7mm Push Connect	800-131
V8 - 5.4L (330 CID)	2006-97	11mm Connector Body, 6.25mm Hose x 9.5mm Push Connect	800-130
V8 - 5.4L (330 CID)	2006-97	14.17mm Connector Body, 6.35mm Hose x 12.7mm Push Connect	800-131
V8 - 5.8L (351 CID)	1996-91	11mm Connector Body, 6.25mm Hose x 9.5mm Push Connect	800-130
V8 - 5.8L (351 CID)	1996-91	14.17mm Connector Body, 6.35mm Hose x 12.7mm Push Connect	800-131
E-250 ECONOLINE			
L6 - 4.9L (300 CID)	1996-91	11mm Connector Body, 6.25mm Hose x 9.5mm Push Connect	800-130
L6 - 4.9L (300 CID)	1996-91	14.17mm Connector Body, 6.35mm Hose x 12.7mm Push Connect	800-131
V6 - 4.2L (256 CID)	2003-97	11mm Connector Body, 6.25mm Hose x 9.5mm Push Connect	800-130
V6 - 4.2L (256 CID)	2003-97	14.17mm Connector Body, 6.35mm Hose x 12.7mm Push Connect	800-131
V8 - 4.6L (281 CID)	1998-97	11mm Connector Body, 6.25mm Hose x 9.5mm Push Connect	800-130
V8 - 4.6L (281 CID)	1998-97	14.17mm Connector Body, 6.35mm Hose x 12.7mm Push Connect	800-131
V8 - 5.0L (302 CID)	1993-91	11mm Connector Body, 6.25mm Hose x 9.5mm Push Connect	800-130
V8 - 5.0L (302 CID)	1993-91	14.17mm Connector Body, 6.35mm Hose x 12.7mm Push Connect	800-131
V8 - 5.4L (330 CID)	2006-97	11mm Connector Body, 6.25mm Hose x 9.5mm Push Connect	800-130
V8 - 5.4L (330 CID)	2006-97	14.17mm Connector Body, 6.35mm Hose x 12.7mm Push Connect	800-131
V8 - 5.8L (351 CID)	1996-91	11mm Connector Body, 6.25mm Hose x 9.5mm Push Connect	800-130
V8 - 5.8L (351 CID)	1996-91	14.17mm Connector Body, 6.35mm Hose x 12.7mm Push Connect	800-131
V8 - 7.3L (445 CID)	1991	11mm Connector Body, 6.25mm Hose x 9.5mm Push Connect	800-130
V8 - 7.3L (445 CID)	1991	14.17mm Connector Body, 6.35mm Hose x 12.7mm Push Connect	800-131
V8 - 7.5L (460 CID)	1996-91	11mm Connector Body, 6.25mm Hose x 9.5mm Push Connect	800-130
V8 - 7.5L (460 CID)	1996-91	14.17mm Connector Body, 6.35mm Hose x 12.7mm Push Connect	800-131
V10 - 6.8L (415 CID)	1997	11mm Connector Body, 6.25mm Hose x 9.5mm Push Connect	800-130
V10 - 6.8L (415 CID)	1997	14.17mm Connector Body, 6.35mm Hose x 12.7mm Push Connect	800-131
E-350 ECONOLINE			
L6 - 4.9L (300 CID)	1996-91	11mm Connector Body, 6.25mm Hose x 9.5mm Push Connect	800-130
L6 - 4.9L (300 CID)	1996-91	14.17mm Connector Body, 6.35mm Hose x 12.7mm Push Connect	800-131
V8 - 5.4L (330 CID)	2006-97	11mm Connector Body, 6.25mm Hose x 9.5mm Push Connect	800-130
V8 - 5.4L (330 CID)	2006-97	14.17mm Connector Body, 6.35mm Hose x 12.7mm Push Connect	800-131
V8 - 5.8L (351 CID)	1996-91	11mm Connector Body, 6.25mm Hose x 9.5mm Push Connect	800-130
V8 - 5.8L (351 CID)	1996-91	14.17mm Connector Body, 6.35mm Hose x 12.7mm Push Connect	800-131
V8 - 6.0L (363 CID)	2006-04	11mm Connector Body, 6.25mm Hose x 9.5mm Push Connect	800-130
V8 - 6.0L (363 CID)	2006-04	14.17mm Connector Body, 6.35mm Hose x 12.7mm Push Connect	800-131
V8 - 7.3L (445 CID)	2003-91	11mm Connector Body, 6.25mm Hose x 9.5mm Push Connect	800-130
V8 - 7.3L (445 CID)	2003-91	14.17mm Connector Body, 6.35mm Hose x 12.7mm Push Connect	800-131
V8 - 7.5L (460 CID)	1996-91	11mm Connector Body, 6.25mm Hose x 9.5mm Push Connect	800-130
V8 - 7.5L (460 CID)	1996-91	14.17mm Connector Body, 6.35mm Hose x 12.7mm Push Connect	800-131
V10 - 6.8L (415 CID)	2006-97	11mm Connector Body, 6.25mm Hose x 9.5mm Push Connect	800-130
V10 - 6.8L (415 CID)	2006-97	14.17mm Connector Body, 6.35mm Hose x 12.7mm Push Connect	800-131
ESCAPE			
L4 - 2.0L (122 CID)	2004-01	11mm Connector Body, 6.25mm Hose x 9.5mm Push Connect	800-130
L4 - 2.0L (122 CID)	2004-01	14.17mm Connector Body, 6.35mm Hose x 12.7mm Push Connect	800-131
L4 - 2.3L (140 CID)	2006-05	11mm Connector Body, 6.25mm Hose x 9.5mm Push Connect	800-130
L4 - 2.3L (140 CID)	2006-05	14.17mm Connector Body, 6.35mm Hose x 12.7mm Push Connect	800-131
V6 - 3.0L (182 CID)	2006-01	11mm Connector Body, 6.25mm Hose x 9.5mm Push Connect	800-130
V6 - 3.0L (182 CID)	2006-01	14.17mm Connector Body, 6.35mm Hose x 12.7mm Push Connect	800-131
EXCURSION			
V8 - 5.4L (330 CID)	2005-00	11mm Connector Body, 6.25mm Hose x 9.5mm Push Connect	800-130
V8 - 5.4L (330 CID)	2005-00	14.17mm Connector Body, 6.35mm Hose x 12.7mm Push Connect	800-131
V8 - 6.0L (363 CID)	2005-03	11mm Connector Body, 6.25mm Hose x 9.5mm Push Connect	800-130
V8 - 6.0L (363 CID)	2005-03	14.17mm Connector Body, 6.35mm Hose x 12.7mm Push Connect	800-131
V8 - 7.3L (445 CID)	2003-00	11mm Connector Body, 6.25mm Hose x 9.5mm Push Connect	800-130
V8 - 7.3L (445 CID)	2003-00	14.17mm Connector Body, 6.35mm Hose x 12.7mm Push Connect	800-131
V10 - 6.8L (415 CID)	2005-00	11mm Connector Body, 6.25mm Hose x 9.5mm Push Connect	800-130
V10 - 6.8L (415 CID)	2005-00	14.17mm Connector Body, 6.35mm Hose x 12.7mm Push Connect	800-131
EXPEDITION			
V8 - 4.6L (281 CID)	2006-97	11mm Connector Body, 6.25mm Hose x 9.5mm Push Connect	800-130
V8 - 4.6L (281 CID)	2006-97	14.17mm Connector Body, 6.35mm Hose x 12.7mm Push Connect	800-131
V8 - 5.4L (330 CID)	2006-97	11mm Connector Body, 6.25mm Hose x 9.5mm Push Connect	800-130
V8 - 5.4L (330 CID)	2006-97	14.17mm Connector Body, 6.35mm Hose x 12.7mm Push Connect	800-131
EXPLORER			
V6 - 4.0L (245 CID)	2006-91	11mm Connector Body, 6.25mm Hose x 9.5mm Push Connect	800-130
V6 - 4.0L (245 CID)	2006-91	14.17mm Connector Body, 6.35mm Hose x 12.7mm Push Connect	800-131
V8 - 4.6L (281 CID)	2006-02	11mm Connector Body, 6.25mm Hose x 9.5mm Push Connect	800-130
V8 - 4.6L (281 CID)	2006-02	14.17mm Connector Body, 6.35mm Hose x 12.7mm Push Connect	800-131
V8 - 5.0L (302 CID)	2001-96	11mm Connector Body, 6.25mm Hose x 9.5mm Push Connect	800-130
V8 - 5.0L (302 CID)	2001-96	14.17mm Connector Body, 6.35mm Hose x 12.7mm Push Connect	800-131
F-150 PICKUP			
L6 - 4.9L (300 CID)	1996-91	11mm Connector Body, 6.25mm Hose x 9.5mm Push Connect	800-130
L6 - 4.9L (300 CID)	1996-91	14.17mm Connector Body, 6.35mm Hose x 12.7mm Push Connect	800-131
V6 - 4.2L (256 CID)	2006-97	11mm Connector Body, 6.25mm Hose x 9.5mm Push Connect	800-130
V6 - 4.2L (256 CID)	2006-97	14.17mm Connector Body, 6.35mm Hose x 12.7mm Push Connect	800-131
V8 - 4.6L (281 CID)	2006-97	11mm Connector Body, 6.25mm Hose x 9.5mm Push Connect	800-130
V8 - 4.6L (281 CID)	2006-97	14.17mm Connector Body, 6.35mm Hose x 12.7mm Push Connect	800-131
V8 - 5.0L (302 CID)	1996-91	11mm Connector Body, 6.25mm Hose x 9.5mm Push Connect	800-130
V8 - 5.0L (302 CID)	1996-91	14.17mm Connector Body, 6.35mm Hose x 12.7mm Push Connect	800-131
V8 - 5.4L (330 CID)	2006-97	11mm Connector Body, 6.25mm Hose x 9.5mm Push Connect	800-130

Quick Disconnect Fuel Line Spring Lock Coupling Applications

Make/ Model/Engine	Years	Description	Dorman #
FORD TRUCK (continued)			
F-150 PICKUP (continued)			
V8 - 5.4L (330 CID)	2006-97	14.17mm Connector Body, 6.35mm Hose x 12.7mm Push Connect	800-131
V8 - 5.8L (351 CID)	1996-91	11mm Connector Body, 6.25mm Hose x 9.5mm Push Connect	800-130
V8 - 5.8L (351 CID)	1996-91	14.17mm Connector Body, 6.35mm Hose x 12.7mm Push Connect	800-131
F-250 PICKUP			
L6 - 4.9L (300 CID)	1996-91	11mm Connector Body, 6.25mm Hose x 9.5mm Push Connect	800-130
L6 - 4.9L (300 CID)	1996-91	14.17mm Connector Body, 6.35mm Hose x 12.7mm Push Connect	800-131
V6 - 4.2L (256 CID)	1998-97	11mm Connector Body, 6.25mm Hose x 9.5mm Push Connect	800-130
V6 - 4.2L (256 CID)	1998-97	14.17mm Connector Body, 6.35mm Hose x 12.7mm Push Connect	800-131
V8 - 4.6L (281 CID)	1999-97	11mm Connector Body, 6.25mm Hose x 9.5mm Push Connect	800-130
V8 - 4.6L (281 CID)	1999-97	14.17mm Connector Body, 6.35mm Hose x 12.7mm Push Connect	800-131
V8 - 5.0L (302 CID)	1996-91	11mm Connector Body, 6.25mm Hose x 9.5mm Push Connect	800-130
V8 - 5.0L (302 CID)	1996-91	14.17mm Connector Body, 6.35mm Hose x 12.7mm Push Connect	800-131
V8 - 5.4L (330 CID)	1999-97	11mm Connector Body, 6.25mm Hose x 9.5mm Push Connect	800-130
V8 - 5.4L (330 CID)	1999-97	14.17mm Connector Body, 6.35mm Hose x 12.7mm Push Connect	800-131
V8 - 5.8L (351 CID)	1997-91	11mm Connector Body, 6.25mm Hose x 9.5mm Push Connect	800-130
V8 - 5.8L (351 CID)	1997-91	14.17mm Connector Body, 6.35mm Hose x 12.7mm Push Connect	800-131
V8 - 7.3L (445 CID)	1997-91	11mm Connector Body, 6.25mm Hose x 9.5mm Push Connect	800-130
V8 - 7.3L (445 CID)	1997-91	14.17mm Connector Body, 6.35mm Hose x 12.7mm Push Connect	800-131
V8 - 7.5L (460 CID)	1997-91	11mm Connector Body, 6.25mm Hose x 9.5mm Push Connect	800-130
V8 - 7.5L (460 CID)	1997-91	14.17mm Connector Body, 6.35mm Hose x 12.7mm Push Connect	800-131
F-250 SUPER DUTY PICKUP			
V8 - 5.4L (330 CID)	2006-99	11mm Connector Body, 6.25mm Hose x 9.5mm Push Connect	800-130
V8 - 5.4L (330 CID)	2006-99	14.17mm Connector Body, 6.35mm Hose x 12.7mm Push Connect	800-131
V8 - 6.0L (363 CID)	2006-03	11mm Connector Body, 6.25mm Hose x 9.5mm Push Connect	800-130
V8 - 6.0L (363 CID)	2006-03	14.17mm Connector Body, 6.35mm Hose x 12.7mm Push Connect	800-131
V8 - 7.3L (445 CID)	2003-99	11mm Connector Body, 6.25mm Hose x 9.5mm Push Connect	800-130
V8 - 7.3L (445 CID)	2003-99	14.17mm Connector Body, 6.35mm Hose x 12.7mm Push Connect	800-131
V10 - 6.8L (415 CID)	2006-99	11mm Connector Body, 6.25mm Hose x 9.5mm Push Connect	800-130
V10 - 6.8L (415 CID)	2006-99	14.17mm Connector Body, 6.35mm Hose x 12.7mm Push Connect	800-131
F-350 PICKUP			
L6 - 4.9L (300 CID)	1996-91	11mm Connector Body, 6.25mm Hose x 9.5mm Push Connect	800-130
L6 - 4.9L (300 CID)	1996-91	14.17mm Connector Body, 6.35mm Hose x 12.7mm Push Connect	800-131
V8 - 5.8L (351 CID)	1997-91	11mm Connector Body, 6.25mm Hose x 9.5mm Push Connect	800-130
V8 - 5.8L (351 CID)	1997-91	14.17mm Connector Body, 6.35mm Hose x 12.7mm Push Connect	800-131
V8 - 7.3L (445 CID)	1997-91	11mm Connector Body, 6.25mm Hose x 9.5mm Push Connect	800-130
V8 - 7.3L (445 CID)	1997-91	14.17mm Connector Body, 6.35mm Hose x 12.7mm Push Connect	800-131
V8 - 7.5L (460 CID)	1997-91	11mm Connector Body, 6.25mm Hose x 9.5mm Push Connect	800-130
V8 - 7.5L (460 CID)	1997-91	14.17mm Connector Body, 6.35mm Hose x 12.7mm Push Connect	800-131
F-350 SUPER DUTY PICKUP			
V8 - 5.4L (330 CID)	2006-99	11mm Connector Body, 6.25mm Hose x 9.5mm Push Connect	800-130
V8 - 5.4L (330 CID)	2006-99	14.17mm Connector Body, 6.35mm Hose x 12.7mm Push Connect	800-131
V8 - 6.0L (363 CID)	2006-03	11mm Connector Body, 6.25mm Hose x 9.5mm Push Connect	800-130
V8 - 6.0L (363 CID)	2006-03	14.17mm Connector Body, 6.35mm Hose x 12.7mm Push Connect	800-131
V8 - 7.3L (445 CID)	2003-99	11mm Connector Body, 6.25mm Hose x 9.5mm Push Connect	800-130
V8 - 7.3L (445 CID)	2003-99	14.17mm Connector Body, 6.35mm Hose x 12.7mm Push Connect	800-131
V10 - 6.8L (415 CID)	2006-99	11mm Connector Body, 6.25mm Hose x 9.5mm Push Connect	800-130
V10 - 6.8L (415 CID)	2006-99	14.17mm Connector Body, 6.35mm Hose x 12.7mm Push Connect	800-131
F-450 SUPER DUTY PICKUP			
V8 - 6.0L (363 CID)	2006-03	11mm Connector Body, 6.25mm Hose x 9.5mm Push Connect	800-130
V8 - 6.0L (363 CID)	2006-03	14.17mm Connector Body, 6.35mm Hose x 12.7mm Push Connect	800-131
V8 - 7.3L (445 CID)	2003-91	11mm Connector Body, 6.25mm Hose x 9.5mm Push Connect	800-130
V8 - 7.3L (445 CID)	2003-91	14.17mm Connector Body, 6.35mm Hose x 12.7mm Push Connect	800-131
V8 - 7.5L (460 CID)	1997-91	11mm Connector Body, 6.25mm Hose x 9.5mm Push Connect	800-130
V8 - 7.5L (460 CID)	1997-91	14.17mm Connector Body, 6.35mm Hose x 12.7mm Push Connect	800-131
V10 - 6.8L (415 CID)	2006-99	11mm Connector Body, 6.25mm Hose x 9.5mm Push Connect	800-130
V10 - 6.8L (415 CID)	2006-99	14.17mm Connector Body, 6.35mm Hose x 12.7mm Push Connect	800-131
F-550 SUPER DUTY PICKUP			
V8 - 6.0L (363 CID)	2006-03	11mm Connector Body, 6.25mm Hose x 9.5mm Push Connect	800-130
V8 - 6.0L (363 CID)	2006-03	14.17mm Connector Body, 6.35mm Hose x 12.7mm Push Connect	800-131
V8 - 7.3L (445 CID)	2003-99	11mm Connector Body, 6.25mm Hose x 9.5mm Push Connect	800-130
V8 - 7.3L (445 CID)	2003-99	14.17mm Connector Body, 6.35mm Hose x 12.7mm Push Connect	800-131
V10 - 6.8L (415 CID)	2006-99	11mm Connector Body, 6.25mm Hose x 9.5mm Push Connect	800-130
V10 - 6.8L (415 CID)	2006-99	14.17mm Connector Body, 6.35mm Hose x 12.7mm Push Connect	800-131
F53 STRIPPED CHASSIS			
V8 - 7.5L (460 CID)	1997-91	11mm Connector Body, 6.25mm Hose x 9.5mm Push Connect	800-130
V8 - 7.5L (460 CID)	1997-91	14.17mm Connector Body, 6.35mm Hose x 12.7mm Push Connect	800-131
F59 STRIPPED CHASSIS			
V8 - 7.3L (445 CID)	1997-91	11mm Connector Body, 6.25mm Hose x 9.5mm Push Connect	800-130
V8 - 7.3L (445 CID)	1997-91	14.17mm Connector Body, 6.35mm Hose x 12.7mm Push Connect	800-131
RANGER			
L4 - 2.3L (140 CID)	2006-91	11mm Connector Body, 6.25mm Hose x 9.5mm Push Connect	800-130
L4 - 2.3L (140 CID)	2006-91	14.17mm Connector Body, 6.35mm Hose x 12.7mm Push Connect	800-131
L4 - 2.5L (150 CID)	2001-98	11mm Connector Body, 6.25mm Hose x 9.5mm Push Connect	800-130
L4 - 2.5L (150 CID)	2001-98	14.17mm Connector Body, 6.35mm Hose x 12.7mm Push Connect	800-131
V6 - 2.9L (177 CID)	1992-91	11mm Connector Body, 6.25mm Hose x 9.5mm Push Connect	800-130
V6 - 2.9L (177 CID)	1992-91	14.17mm Connector Body, 6.35mm Hose x 12.7mm Push Connect	800-131
V6 - 3.0L (182 CID)	2006-91	11mm Connector Body, 6.25mm Hose x 9.5mm Push Connect	800-130
V6 - 3.0L (182 CID)	2006-91	14.17mm Connector Body, 6.35mm Hose x 12.7mm Push Connect	800-131
V6 - 4.0L (245 CID)	2006-91	11mm Connector Body, 6.25mm Hose x 9.5mm Push Connect	800-130

Quick Disconnect

Fuel Sending Units
pg. 155-176

Fuel Tanks
pg. 177-228

Harmonic Balancers
pg. 229-254

Heater Hose Assemblies
pg. 255-256

Hydraulic Clutch Lines
pg. 257-260

Use Quick Disconnect Fittings & Clips for Fast, Economical Repairs

Quick Disconnect
369

Quick Disconnect Fuel Line Spring Lock Coupling Applications

Quick Disconnect

Make/ Model/Engine	Years	Description	Dorman #
FORD TRUCK (continued)			
RANGER (continued)			
V6 - 4.0L (245 CID)	2006-91	14.17mm Connector Body, 6.35mm Hose x 12.7mm Push Connect	800-131
WINDSTAR			
V6 - 3.0L (182 CID)	2000-95	11mm Connector Body, 6.25mm Hose x 9.5mm Push Connect	800-130
V6 - 3.0L (182 CID)	2000-95	14.17mm Connector Body, 6.35mm Hose x 12.7mm Push Connect	800-131
V6 - 3.8L (232 CID)	2003-95	11mm Connector Body, 6.25mm Hose x 9.5mm Push Connect	800-130
V6 - 3.8L (232 CID)	2003-95	14.17mm Connector Body, 6.35mm Hose x 12.7mm Push Connect	800-131
LINCOLN			
AVIATOR			
V8 - 4.6L (281 CID)	2005-03	11mm Connector Body, 6.25mm Hose x 9.5mm Push Connect	800-130
V8 - 4.6L (281 CID)	2005-03	14.17mm Connector Body, 6.35mm Hose x 12.7mm Push Connect	800-131
BLACKWOOD			
V8 - 5.4L (330 CID)	2002	11mm Connector Body, 6.25mm Hose x 9.5mm Push Connect	800-130
V8 - 5.4L (330 CID)	2002	14.17mm Connector Body, 6.35mm Hose x 12.7mm Push Connect	800-131
CONTINENTAL			
V6 - 3.8L (232 CID)	1994-91	11mm Connector Body, 6.25mm Hose x 9.5mm Push Connect	800-130
V6 - 3.8L (232 CID)	1994-91	14.17mm Connector Body, 6.35mm Hose x 12.7mm Push Connect	800-131
V8 - 4.6L (281 CID)	2002-95	11mm Connector Body, 6.25mm Hose x 9.5mm Push Connect	800-130
V8 - 4.6L (281 CID)	2002-95	14.17mm Connector Body, 6.35mm Hose x 12.7mm Push Connect	800-131
LS			
V6 - 3.0L (182 CID)	2005-00	11mm Connector Body, 6.25mm Hose x 9.5mm Push Connect	800-130
V6 - 3.0L (182 CID)	2005-00	14.17mm Connector Body, 6.35mm Hose x 12.7mm Push Connect	800-131
V8 - 3.9L (242 CID)	2006-00	11mm Connector Body, 6.25mm Hose x 9.5mm Push Connect	800-130
V8 - 3.9L (242 CID)	2006-00	14.17mm Connector Body, 6.35mm Hose x 12.7mm Push Connect	800-131
MARK VII			
V8 - 5.0L (302 CID)	1992-91	11mm Connector Body, 6.25mm Hose x 9.5mm Push Connect	800-130
V8 - 5.0L (302 CID)	1992-91	14.17mm Connector Body, 6.35mm Hose x 12.7mm Push Connect	800-131
MARK VIII			
V8 - 4.6L (281 CID)	1998-93	11mm Connector Body, 6.25mm Hose x 9.5mm Push Connect	800-130
V8 - 4.6L (281 CID)	1998-93	14.17mm Connector Body, 6.35mm Hose x 12.7mm Push Connect	800-131
NAVIGATOR			
V8 - 5.4L (330 CID)	2006-98	11mm Connector Body, 6.25mm Hose x 9.5mm Push Connect	800-130
V8 - 5.4L (330 CID)	2006-98	14.17mm Connector Body, 6.35mm Hose x 12.7mm Push Connect	800-131
TOWN CAR			
V8 - 4.6L (281 CID)	2006-91	11mm Connector Body, 6.25mm Hose x 9.5mm Push Connect	800-130
V8 - 4.6L (281 CID)	2006-91	14.17mm Connector Body, 6.35mm Hose x 12.7mm Push Connect	800-131
MERCURY			
CAPRI			
L4 - 1.6L (98 CID)	1994-91	11mm Connector Body, 6.25mm Hose x 9.5mm Push Connect	800-130
L4 - 1.6L (98 CID)	1994-91	14.17mm Connector Body, 6.35mm Hose x 12.7mm Push Connect	800-131
COLONY PARK			
V8 - 5.0L (302 CID)	1991	11mm Connector Body, 6.25mm Hose x 9.5mm Push Connect	800-130
V8 - 5.0L (302 CID)	1991	14.17mm Connector Body, 6.35mm Hose x 12.7mm Push Connect	800-131
COUGAR			
L4 - 2.0L (122 CID)	2002-99	11mm Connector Body, 6.25mm Hose x 9.5mm Push Connect	800-130
L4 - 2.0L (122 CID)	2002-99	14.17mm Connector Body, 6.35mm Hose x 12.7mm Push Connect	800-131
V6 - 2.5L (152 CID)	2002-99	11mm Connector Body, 6.25mm Hose x 9.5mm Push Connect	800-130
V6 - 2.5L (152 CID)	2002-99	14.17mm Connector Body, 6.35mm Hose x 12.7mm Push Connect	800-131
V6 - 3.8L (232 CID)	1997-91	11mm Connector Body, 6.25mm Hose x 9.5mm Push Connect	800-130
V6 - 3.8L (232 CID)	1997-91	14.17mm Connector Body, 6.35mm Hose x 12.7mm Push Connect	800-131
V8 - 4.6L (281 CID)	1997-94	11mm Connector Body, 6.25mm Hose x 9.5mm Push Connect	800-130
V8 - 4.6L (281 CID)	1997-94	14.17mm Connector Body, 6.35mm Hose x 12.7mm Push Connect	800-131
V8 - 5.0L (302 CID)	1993-91	11mm Connector Body, 6.25mm Hose x 9.5mm Push Connect	800-130
V8 - 5.0L (302 CID)	1993-91	14.17mm Connector Body, 6.35mm Hose x 12.7mm Push Connect	800-131
GRAND MARQUIS			
V8 - 4.6L (281 CID)	2006-92	11mm Connector Body, 6.25mm Hose x 9.5mm Push Connect	800-130
V8 - 4.6L (281 CID)	2006-92	14.17mm Connector Body, 6.35mm Hose x 12.7mm Push Connect	800-131
V8 - 5.0L (302 CID)	1991	11mm Connector Body, 6.25mm Hose x 9.5mm Push Connect	800-130
V8 - 5.0L (302 CID)	1991	14.17mm Connector Body, 6.35mm Hose x 12.7mm Push Connect	800-131
MARAUDER			
V8 - 4.6L (281 CID)	2004-03	11mm Connector Body, 6.25mm Hose x 9.5mm Push Connect	800-130
V8 - 4.6L (281 CID)	2004-03	14.17mm Connector Body, 6.35mm Hose x 12.7mm Push Connect	800-131
MOUNTAINEER			
V6 - 4.0L (245 CID)	2006-98	11mm Connector Body, 6.25mm Hose x 9.5mm Push Connect	800-130
V6 - 4.0L (245 CID)	2006-98	14.17mm Connector Body, 6.35mm Hose x 12.7mm Push Connect	800-131
V8 - 4.6L (281 CID)	2006-02	11mm Connector Body, 6.25mm Hose x 9.5mm Push Connect	800-130
V8 - 4.6L (281 CID)	2006-02	14.17mm Connector Body, 6.35mm Hose x 12.7mm Push Connect	800-131
V8 - 5.0L (302 CID)	2001-97	11mm Connector Body, 6.25mm Hose x 9.5mm Push Connect	800-130
V8 - 5.0L (302 CID)	2001-97	14.17mm Connector Body, 6.35mm Hose x 12.7mm Push Connect	800-131
MYSTIQUE			
L4 - 2.0L (122 CID)	2000-95	11mm Connector Body, 6.25mm Hose x 9.5mm Push Connect	800-130
L4 - 2.0L (122 CID)	2000-95	14.17mm Connector Body, 6.35mm Hose x 12.7mm Push Connect	800-131
V6 - 2.5L (152 CID)	2000-95	11mm Connector Body, 6.25mm Hose x 9.5mm Push Connect	800-130
V6 - 2.5L (152 CID)	2000-95	14.17mm Connector Body, 6.35mm Hose x 12.7mm Push Connect	800-131
SABLE			
V6 - 3.0L (182 CID)	2006-91	11mm Connector Body, 6.25mm Hose x 9.5mm Push Connect	800-130
V6 - 3.0L (182 CID)	2006-91	14.17mm Connector Body, 6.35mm Hose x 12.7mm Push Connect	800-131
V6 - 3.8L (232 CID)	1995-91	11mm Connector Body, 6.25mm Hose x 9.5mm Push Connect	800-130
V6 - 3.8L (232 CID)	1995-91	14.17mm Connector Body, 6.35mm Hose x 12.7mm Push Connect	800-131

Quick Disconnect Fuel Line Spring Lock Coupling Applications

Make/ Model/Engine	Years	Description	Dorman #
MERCURY (continued)			
TOPAZ			
L4 - 2.3L (140 CID)	1994-91	11mm Connector Body, 6.25mm Hose x 9.5mm Push Connect	800-130
L4 - 2.3L (140 CID)	1994-91	14.17mm Connector Body, 6.35mm Hose x 12.7mm Push Connect	800-131
V6 - 3.0L (182 CID)	1994-92	11mm Connector Body, 6.25mm Hose x 9.5mm Push Connect	800-130
V6 - 3.0L (182 CID)	1994-92	14.17mm Connector Body, 6.35mm Hose x 12.7mm Push Connect	800-131
TRACER			
L4 - 1.8L (110 CID)	1996-91	11mm Connector Body, 6.25mm Hose x 9.5mm Push Connect	800-130
L4 - 1.8L (110 CID)	1996-91	14.17mm Connector Body, 6.35mm Hose x 12.7mm Push Connect	800-131
L4 - 1.9L (116 CID)	1996-91	11mm Connector Body, 6.25mm Hose x 9.5mm Push Connect	800-130
L4 - 1.9L (116 CID)	1996-91	14.17mm Connector Body, 6.35mm Hose x 12.7mm Push Connect	800-131
L4 - 2.0L (122 CID)	1999-97	11mm Connector Body, 6.25mm Hose x 9.5mm Push Connect	800-130
L4 - 2.0L (122 CID)	1999-97	14.17mm Connector Body, 6.35mm Hose x 12.7mm Push Connect	800-131
VILLAGER			
V6 - 3.0L (182 CID)	1998-93	11mm Connector Body, 6.25mm Hose x 9.5mm Push Connect	800-130
V6 - 3.0L (182 CID)	1998-93	14.17mm Connector Body, 6.35mm Hose x 12.7mm Push Connect	800-131
V6 - 3.3L (201 CID)	2002-99	11mm Connector Body, 6.25mm Hose x 9.5mm Push Connect	800-130
V6 - 3.3L (201 CID)	2002-99	14.17mm Connector Body, 6.35mm Hose x 12.7mm Push Connect	800-131

Quick Disconnect Heater Hose Applications

Make/ Model/Engine	Years	Description	Dorman
BUICK			
CENTURY			
V6 - 3.1L (189 CID)	1996-94	Heater Inlet Hose Fitting at Eng	800-401
REGAL			
V6 - 3.1L (189 CID)	1996-90	Heater Inlet Hose Fitting at Eng	800-401
SKYLARK			
V6 - 3.1L (189 CID)	1998-94	Heater Inlet Hose Fitting at Eng	800-401
CADILLAC			
ESCALADE			
V8 - 5.7L (350 CID)	1999	Heater Inlet Hose 5/8" Tube To 1/2"	800-401
CHEVROLET			
BERETTA, CORSICA			
V6 - 3.1L (189 CID)	1996-90	Heater Inlet Hose Fitting at Eng	800-401
CAMARO			
V6 - 3.1L (189 CID)	1992-90	Heater Inlet Hose Fitting at Eng	800-401
V6 - 3.4L (207 CID)	1995-93	Heater Inlet Hose Fitting at Eng	800-401
CAVALIER			
V6 - 3.1L (189 CID)	1994-90	Heater Inlet Hose Fitting at Eng	800-401
CORVETTE			
V8 - 5.7L (350 CID)	1995-90	Heater Inlet Hose Fitting at Eng, ZR-1	800-401
LUMINA			
V6 - 3.1L (189 CID)	1996-90	Heater Inlet Hose Fitting at Eng	800-401
V6 - 3.4L (207 CID)	1996-95	Heater Inlet Hose Fitting at Eng	800-401
LUMINA APV			
V6 - 3.1L (189 CID)	1995-93	Heater Inlet Hose Fitting at Eng	800-401
V6 - 3.1L (189 CID)	1992	Heater Inlet Hose Fitting at Eng, wo/Rear Heater/AC Unit	800-401
V6 - 3.1L (189 CID)	1991-90	Heater Inlet Hose Fitting at Eng	800-401
V6 - 3.4L (207 CID)	1996	Heater Inlet Hose Fitting at Eng	800-401
V6 - 3.8L (231 CID)	1995-93	Heater Inlet Hose Fitting at Eng	800-401
MALIBU			
V6 - 3.1L (189 CID)	1997	Heater Inlet Hose Fitting at Eng	800-401
MONTE CARLO			
V6 - 3.1L (189 CID)	1996-95	Heater Inlet Hose Fitting at Eng	800-401
V6 - 3.4L (207 CID)	1996-95	Heater Inlet Hose Fitting at Eng	800-401
VENTURE VAN			
V6 - 3.4L (207 CID)	1997	Heater Inlet Hose Fitting at Eng	800-401
CHEVROLET/GMC TRUCK			
ASTRO			
V6 - 4.3L (262 CID)	1995-90	Heater Hose Water Shutoff Valve Fitting	800-402
BLAZER			
V8 - 5.7L (350 CID)	1994-92	Heater Inlet Hose 5/8" Tube To 1/2"	800-401
CK SERIES PICKUP			
V6 - 4.3L (262 CID)	1998-90	Heater Inlet Hose 5/8" Tube To 1/2"	800-401
V8 - 5.0L (305 CID)	1999-90	Heater Inlet Hose 5/8" Tube To 1/2"	800-401
V8 - 5.7L (350 CID)	2000-90	Heater Inlet Hose 5/8" Tube To 1/2"	800-401
V8 - 7.4L (454 CID)	2000-90	Heater Inlet Hose 5/8" Tube To 1/2"	800-401
V8 - 8.1L (496 CID)	2002-01	Heater Inlet Hose 5/8" Tube To 1/2"	800-401
KODIAK			
V8 - 6.0L (366 CID)	1998-91	Heater Inlet Hose Fitting at Eng	800-401
V8 - 7.0L (427 CID)	1998-91	Heater Inlet Hose Fitting at Eng	800-401
V8 - 6.0L (366 CID)	1990	Heater Inlet Hose Fitting at Eng	800-401
V8 - 7.0L (427 CID)	1990	Heater Inlet Hose Fitting at Eng	800-401

Make/ Model/Engine	Years	Description	Dorman
CHEVROLET/GMC TRUCK (continued)			
S SERIES BLAZER, JIMMY			
V6 - 4.3L (262 CID)	1994-92	VIN Z, Heater Inlet Hose Fitting at Eng	800-401
V6 - 4.3L (262 CID)	1991-89	Heater Inlet Hose Fitting at Eng	800-401
S SERIES PICKUP, SONOMA			
L4 - 2.2L (134 CID)	1996-94	Heater Inlet Hose Fitting at Eng	800-401
V6 - 4.3L (262 CID)	1994-92	VIN Z, Heater Inlet Hose Fitting at Eng	800-401
V6 - 4.3L (262 CID)	1991-89	Heater Inlet Hose Fitting at Eng	800-401
SAFARI			
V6 - 4.3L (262 CID)	1995-90	Heater Hose Water Shutoff Valve Fitting	800-402
SIERRA			
V6 - 4.3L (262 CID)	2004-99	Heater Inlet & Outlet Hose Fitting At Heatercore	800-409
V8 - 4.8L (294 CID)	2000-99	Heater Inlet & Outlet Hose Fitting At Heatercore	800-409
V8 - 5.3L (323 CID)	2000-99	Heater Inlet & Outlet Hose Fitting At Heatercore	800-409
V8 - 6.0L (364 CID)	2000-99	Heater Inlet & Outlet Hose Fitting At Heatercore	800-409
V8 - 6.6L (400 CID)	2004-01	Heater Inlet & Outlet Hose Fitting At Heatercore, Exc. Ambulance	800-409
V8 - 8.1L (496 CID)	2004-01	Heater Inlet & Outlet Hose Fitting At Heatercore	800-409
SILVERADO			
V6 - 4.3L (262 CID)	2004-99	Heater Inlet & Outlet Hose Fitting At Heatercore	800-409
V8 - 4.8L (294 CID)	2000-99	Heater Inlet & Outlet Hose Fitting At Heatercore	800-409
V8 - 5.3L (323 CID)	2000-99	Heater Inlet & Outlet Hose Fitting At Heatercore	800-409
V8 - 6.0L (364 CID)	2000-99	Heater Inlet & Outlet Hose Fitting At Heatercore	800-409
V8 - 6.6L (400 CID)	2004-01	Heater Inlet & Outlet Hose Fitting At Heatercore, Exc. Ambulance	800-409
V8 - 8.1L (496 CID)	2004-01	Heater Inlet & Outlet Hose Fitting At Heatercore	800-409
SUBURBAN			
V8 - 5.7L (350 CID)	1999-92	Heater Inlet Hose 5/8" Tube To 1/2"	800-401
V8 - 5.7L (350 CID)	1999-92	Heater Inlet Hose Fitting at Eng, For Rear Heater	800-401
V8 - 7.4L (454 CID)	1999-92	Heater Inlet Hose 5/8" Tube To 1/2"	800-401
V8 - 7.4L (454 CID)	1999-92	Heater Inlet Hose Fitting at Eng, For Rear Heater	800-401
TAHOE			
V8 - 5.7L (350 CID)	2000-95	Heater Inlet Hose 5/8" Tube To 1/2"	800-401
V8 - 5.7L (350 CID)	2000-95	Heater Inlet Hose Fitting at Eng, For Rear Heater	800-401
TOPKICK			
V8 - 6.0L (366 CID)	1998-91	Heater Inlet Hose Fitting at Eng	800-401
V8 - 7.0L (427 CID)	1998-91	Heater Inlet Hose Fitting at Eng	800-401
YUKON			
V8 - 5.7L (350 CID)	2000-92	Heater Inlet Hose 5/8" Tube To 1/2"	800-401
V8 - 5.7L (350 CID)	2000-92	Heater Inlet Hose Fitting at Eng, For Rear Heater	800-401

Quick Disconnect Heater Hose Applications

Make/ Model/Engine	Years	Description	Dorman #
FORD TRUCK (continued)			
F450 SUPER DUTY PICKUP (continued)			
V8 - 6.0L (363 CID)	2006-03	Heater Hose To 5/8" Tube	800-404
V8 - 7.3L (445 CID)	2003-88	Heater Hose To 3/4" Tube	800-403
V8 - 7.3L (445 CID)	2003-88	Heater Hose To 5/8" Tube	800-404
V8 - 7.5L (460 CID)	1997-88	Heater Hose To 3/4" Tube	800-403
V8 - 7.5L (460 CID)	1997-88	Heater Hose To 5/8" Tube	800-404
V10 - 6.8L (415 CID)	2006-99	Heater Hose To 3/4" Tube	800-403
V10 - 6.8L (415 CID)	2006-99	Heater Hose To 5/8" Tube	800-404
F53 STRIPPED CHASSIS			
V8 - 7.5L (460 CID)	1997-89	Heater Hose To 3/4" Tube	800-403
V8 - 7.5L (460 CID)	1997-89	Heater Hose To 5/8" Tube	800-404
F550 SUPER DUTY PICKUP			
V8 - 6.0L (363 CID)	2006-03	Heater Hose To 3/4" Tube	800-403
V8 - 6.0L (363 CID)	2006-03	Heater Hose To 5/8" Tube	800-404
V8 - 7.3L (445 CID)	2003-99	Heater Hose To 3/4" Tube	800-403
V8 - 7.3L (445 CID)	2003-99	Heater Hose To 5/8" Tube	800-404
V10 - 6.8L (415 CID)	2006-99	Heater Hose To 3/4" Tube	800-403
V10 - 6.8L (415 CID)	2006-99	Heater Hose To 5/8" Tube	800-404
F59 STRIPPED CHASSIS			
V8 - 7.3L (445 CID)	1996-89	Heater Hose To 3/4" Tube	800-403
V8 - 7.3L (445 CID)	1996-89	Heater Hose To 5/8" Tube	800-404
WINDSTAR			
V6 - 3.0L (182 CID)	2000-95	Heater Hose To 3/4" Tube	800-403
V6 - 3.0L (182 CID)	2000-95	Heater Hose To 5/8" Tube	800-404
V6 - 3.8L (232 CID)	2003-95	Heater Hose To 3/4" Tube	800-403
V6 - 3.8L (232 CID)	2003-95	Heater Hose To 5/8" Tube	800-404
LINCOLN			
NAVIGATOR			
V8 - 5.4L (330 CID)	2006-98	Heater Hose To 3/4" Tube	800-403
V8 - 5.4L (330 CID)	2006-98	Heater Hose To 5/8" Tube	800-404
OLDSMOBILE			
ACHIEVA			
V6 - 3.1L (189 CID)	1998-94	Heater Inlet Hose Fitting at Eng	800-401

Make/ Model/Engine	Years	Description	Dorman #
OLDSMOBILE (continued)			
CIERA			
V6 - 3.1L (189 CID)	1996-95	Heater Inlet Hose Fitting at Eng	800-401
CUTLASS			
V6 - 3.1L (189 CID)	1998-97	Heater Inlet Hose Fitting at Eng	800-401
CUTLASS CIERA			
V6 - 3.1L (189 CID)	1994	Heater Inlet Hose Fitting at Eng	800-401
CUTLASS SUPREME			
V6 - 3.1L (189 CID)	1996-90	Heater Inlet Hose Fitting at Eng	800-401
V6 - 3.4L (207 CID)	1996-92	Heater Inlet Hose Fitting at Eng	800-401
SILHOUETTE			
V6 - 3.1L (189 CID)	1994-93	Heater Inlet Hose Fitting at Eng	800-401
V6 - 3.1L (189 CID)	1992	Heater Inlet Hose Fitting at Eng, wo/Rear Heater/AC Unit	800-401
V6 - 3.1L (189 CID)	1991-90	Heater Inlet Hose Fitting at Eng	800-401
V6 - 3.4L (207 CID)	1997-96	Heater Inlet Hose Fitting at Eng	800-401
PONTIAC			
FIREBIRD			
V6 - 3.1L (189 CID)	1992-90	Heater Inlet Hose Fitting at Eng	800-401
V6 - 3.4L (207 CID)	1995-93	Heater Inlet Hose Fitting at Eng	800-401
GRAND AM			
V6 - 3.1L (189 CID)	1998-94	Heater Inlet Hose Fitting at Eng	800-401
GRAND PRIX			
V6 - 3.4L (207 CID)	1996-92	Heater Inlet Hose Fitting at Eng	800-401
SUNBIRD			
V6 - 3.1L (189 CID)	1994-91	Heater Inlet Hose Fitting at Eng	800-401
TRANS SPORT			
V6 - 3.1L (189 CID)	1995-93	Heater Inlet Hose Fitting at Eng	800-401
V6 - 3.1L (189 CID)	1992	Heater Inlet Hose Fitting at Eng, wo/Rear Heater/AC Unit	800-401
V6 - 3.1L (189 CID)	1991-90	Heater Inlet Hose Fitting at Eng	800-401
V6 - 3.4L (207 CID)	1997-96	Heater Inlet Hose Fitting at Eng	800-401
V6 - 3.8L (231 CID)	1995-93	Heater Inlet Hose Fitting at Eng	800-401

Quick Disconnect

Quick Disconnect Engine Oil Cooler Line Connector Applications

Make/ Model/Engine	Years	Description	Dorman
BUICK			
CENTURY			
L4 - 2.2L (134 CID)	1996-94	Trans Fluid Cooler Pipe Fitting At Trans, w/Check Valve, (M13) Trans	800-752
L4 - 2.2L (134 CID)	1996-94	Trans Fluid Cooler Pipe Fitting Inlet To Case, (M13) Trans	800-754
L4 - 2.2L (134 CID)	1996-93	Trans Fluid Cooler Pipe Fitting To Case, (MD9) Trans	800-755
L4 - 2.5L (151 CID)	1992-82	Trans Fluid Cooler Pipe Fitting To Case, (MD9, ME9) Trans	800-755
V6 - 2.8L (173 CID)	1989-86	Trans Fluid Cooler Pipe Fitting To Case, (MD9, ME9) Trans	800-755
V6 - 3.0L (181 CID)	1985-82	Trans Fluid Cooler Pipe Fitting To Case, (MD9, ME9) Trans	800-755
V6 - 3.1L (189 CID)	1999-94	Trans Fluid Cooler Pipe Fitting At Trans, w/Check Valve, (M13) Trans	800-752
V6 - 3.1L (189 CID)	1999-94	Trans Fluid Cooler Pipe Fitting Inlet To Case, (M13, ME9, MN3, MN7) Trans	800-754
V6 - 3.1L (189 CID)	1996-94	Trans Fluid Cooler Pipe Fitting To Case, (MD9) Trans	800-755
V6 - 3.2L (196 CID)	1979-78	Trans Fluid Cooler Pipe Fitting To Case	800-755
V6 - 3.3L (204 CID)	1993-89	Trans Fluid Cooler Pipe Fitting To Case, (MD9, ME9) Trans	800-755
V6 - 3.8L (231 CID)	1988-76	Trans Fluid Cooler Pipe Fitting To Case, (MD9, ME9) Trans	800-755
V6 - 4.3L (260 CID)	1985-80	Trans Fluid Cooler Pipe Fitting To Case, (MD9, ME9) Trans	800-755
V8 - 4.9L (301 CID)	1980-79	Trans Fluid Cooler Pipe Fitting To Case	800-755
V8 - 5.0L (305 CID)	1980-77	Trans Fluid Cooler Pipe Fitting To Case	800-755
V8 - 5.7L (350 CID)	1981-76	Trans Fluid Cooler Pipe Fitting To Case	800-755
V8 - 6.6L (403 CID)	1977	Trans Fluid Cooler Pipe Fitting To Case	800-755
ELECTRA			
V6 - 3.0L (181 CID)	1985	Trans Fluid Cooler Pipe Fitting To Case, (ME9) Trans	800-755
V6 - 3.8L (231 CID)	1990-85	Trans Fluid Cooler Pipe Fitting To Case, (ME9) Trans	800-755
V6 - 4.1L (252 CID)	1984-82	Trans Fluid Cooler Pipe Fitting To Case, (ME9, MW9) Trans	800-755
V6 - 4.1L (252 CID)	1981-80	Trans Fluid Cooler Pipe Fitting To Case	800-755
V6 - 4.3L (260 CID)	1985	Trans Fluid Cooler Pipe Fitting To Case, (ME9) Trans	800-755
V8 - 5.0L (307 CID)	1984-82	Trans Fluid Cooler Pipe Fitting To Case, (ME9, MW9) Trans	800-755
V8 - 5.0L (307 CID)	1981	Trans Fluid Cooler Pipe Fitting To Case	800-755
V8 - 5.7L (350 CID)	1983-82	Trans Fluid Cooler Pipe Fitting To Case, (ME9) Trans	800-755
V8 - 5.7L (350 CID)	1981-77	Trans Fluid Cooler Pipe Fitting To Case	800-755
V8 - 6.6L (403 CID)	1979-77	Trans Fluid Cooler Pipe Fitting To Case	800-755
V8 - 7.5L (455 CID)	1976	Trans Fluid Cooler Pipe Fitting To Case	800-755
ESTATE WAGON			
V8 - 4.9L (301 CID)	1980	Trans Fluid Cooler Pipe Fitting To Case	800-755
V8 - 5.0L (307 CID)	1990-82	Trans Fluid Cooler Pipe Fitting To Case, (MD8, MW9) Trans	800-755
V8 - 5.0L (307 CID)	1981	Trans Fluid Cooler Pipe Fitting To Case	800-755
V8 - 5.7L (350 CID)	1985-82	Trans Fluid Cooler Pipe Fitting To Case, (MD8, MW9) Trans	800-755
V8 - 5.7L (350 CID)	1981-77	Trans Fluid Cooler Pipe Fitting To Case	800-755
V8 - 6.6L (403 CID)	1979-77	Trans Fluid Cooler Pipe Fitting To Case	800-755
V8 - 7.5L (455 CID)	1976	Trans Fluid Cooler Pipe Fitting To Case	800-755
LESABRE			
V6 - 3.0L (181 CID)	1986	Trans Fluid Cooler Pipe Fitting To Case, (ME9) Trans	800-755
V6 - 3.8L (231 CID)	1999-94	Trans Fluid Cooler Pipe Fitting At Trans, w/Check Valve, (M13, M15, MN3, MN7) Trans	800-752

**Window
Lift Motors**
pg. 535-554

**Window
Regulators**
pg. 555-566

**Wiper
Motors**
pg. 567-572

**Wiper Transmission
Linkages**
pg. 573-576

**Use Quick Disconnect Fittings &
Clips for Fast, Economical Repairs**

Quick Disconnect

Quick Disconnect Engine Oil Cooler Line Connector Applications

Make/ Model/Engine	Years	Description	Dorman #
BUICK (continued)			
LESABRE (continued)			
V6 - 3.8L (231 CID)	1999-91	Trans Fluid Cooler Pipe Fitting Inlet To Case, (M13, M15, ME9, MN3) Trans	800-754
V6 - 3.8L (231 CID)	1990-82	Trans Fluid Cooler Pipe Fitting To Case, (MD8, ME9, MW9) Trans	800-755
V6 - 3.8L (231 CID)	1981-76	Trans Fluid Cooler Pipe Fitting To Case	800-755
V6 - 4.1L (252 CID)	1984-82	Trans Fluid Cooler Pipe Fitting To Case, (MD8, MW9) Trans	800-755
V6 - 4.1L (252 CID)	1981-80	Trans Fluid Cooler Pipe Fitting To Case	800-755
V8 - 4.9L (301 CID)	1980-77	Trans Fluid Cooler Pipe Fitting To Case	800-755
V8 - 5.0L (305 CID)	1978	Trans Fluid Cooler Pipe Fitting To Case	800-755
V8 - 5.0L (307 CID)	1985-82	Trans Fluid Cooler Pipe Fitting To Case, (MD8, MW9) Trans	800-755
V8 - 5.0L (307 CID)	1981	Trans Fluid Cooler Pipe Fitting To Case	800-755
V8 - 5.7L (350 CID)	1985-82	Trans Fluid Cooler Pipe Fitting To Case, (MD8, MW9) Trans	800-755
V8 - 5.7L (350 CID)	1981-76	Trans Fluid Cooler Pipe Fitting To Case	800-755
V8 - 6.6L (403 CID)	1978-77	Trans Fluid Cooler Pipe Fitting To Case	800-755
V8 - 7.5L (455 CID)	1976	Trans Fluid Cooler Pipe Fitting To Case	800-755
PARK AVENUE			
V6 - 3.8L (231 CID)	1999-91	Trans Fluid Cooler Pipe Fitting Inlet To Case, (M13, MN3, MN7) Trans	800-754
V6 - 3.8L (231 CID)	1996-94	Trans Fluid Cooler Pipe Fitting At Trans, w/Check Valve, (M13) Trans	800-752
REATTA			
V6 - 3.8L (231 CID)	1991	Trans Fluid Cooler Pipe Fitting Inlet To Case, (M13) Trans	800-754
V6 - 3.8L (231 CID)	1990-88	Trans Fluid Cooler Pipe Fitting To Case, (ME9) Trans	800-755
REGAL			
V6 - 2.8L (173 CID)	1989-88	Trans Fluid Cooler Pipe Fitting To Case, (MD9, ME9) Trans	800-755
V6 - 3.1L (189 CID)	1996-94	Trans Fluid Cooler Pipe Fitting At Trans, w/Check Valve, (M13) Trans	800-752
V6 - 3.1L (189 CID)	1996-90	Trans Fluid Cooler Pipe Fitting Inlet To Case, (M13, ME9, MN3, MN7) Trans	800-754
V6 - 3.1L (189 CID)	1992-89	Trans Fluid Cooler Pipe Fitting To Case, (MD9, ME9) Trans	800-755
V6 - 3.2L (196 CID)	1979-78	Trans Fluid Cooler Pipe Fitting To Case	800-755
V6 - 3.8L (231 CID)	1999-94	Trans Fluid Cooler Pipe Fitting At Trans, w/Check Valve, (M13) Trans	800-752
V6 - 3.8L (231 CID)	1999-90	Trans Fluid Cooler Pipe Fitting Inlet To Case, (M13, ME9, MN3, MN7) Trans	800-754
V6 - 3.8L (231 CID)	1992-90	Trans Fluid Cooler Pipe Fitting To Case, (MD9, ME9) Trans	800-755
V6 - 3.8L (231 CID)	1987-82	Trans Fluid Cooler Pipe Fitting To Case, (MV9, MW9) Trans	800-755
V6 - 3.8L (231 CID)	1981-76	Trans Fluid Cooler Pipe Fitting To Case	800-755
V6 - 4.1L (252 CID)	1984-82	Trans Fluid Cooler Pipe Fitting To Case, (MV9, MW9) Trans	800-755
V6 - 4.3L (260 CID)	1984-82	Trans Fluid Cooler Pipe Fitting To Case, (MV9, MW9) Trans	800-755
V8 - 4.3L (265 CID)	1981-80	Trans Fluid Cooler Pipe Fitting To Case	800-755
V8 - 4.9L (301 CID)	1980-79	Trans Fluid Cooler Pipe Fitting To Case	800-755
V8 - 5.0L (305 CID)	1980-77	Trans Fluid Cooler Pipe Fitting To Case	800-755
V8 - 5.0L (307 CID)	1987-86	Trans Fluid Cooler Pipe Fitting To Case, (MV9, MW9) Trans	800-755
V8 - 5.7L (350 CID)	1985-82	Trans Fluid Cooler Pipe Fitting To Case, (MV9, MW9) Trans	800-755
V8 - 5.7L (350 CID)	1977-76	Trans Fluid Cooler Pipe Fitting To Case	800-755
RIVIERA			
V6 - 3.8L (231 CID)	1999-91	Trans Fluid Cooler Pipe Fitting Inlet To Case, (M13, MN3, MN7) Trans	800-754
V6 - 3.8L (231 CID)	1996-95	Trans Fluid Cooler Pipe Fitting At Trans, w/Check Valve, (M13) Trans	800-752
V6 - 3.8L (231 CID)	1990-82	Trans Fluid Cooler Pipe Fitting To Case, (M57, ME9) Trans	800-755
V6 - 3.8L (231 CID)	1981-79	Trans Fluid Cooler Pipe Fitting To Case	800-755
V6 - 4.1L (252 CID)	1984-82	Trans Fluid Cooler Pipe Fitting To Case, (M57) Trans	800-755
V6 - 4.1L (252 CID)	1981	Trans Fluid Cooler Pipe Fitting To Case	800-755
V8 - 5.0L (307 CID)	1985-82	Trans Fluid Cooler Pipe Fitting To Case, (M57) Trans	800-755
V8 - 5.0L (307 CID)	1981-80	Trans Fluid Cooler Pipe Fitting To Case	800-755
V8 - 5.7L (350 CID)	1985-82	Trans Fluid Cooler Pipe Fitting To Case, (M57) Trans	800-755
V8 - 5.7L (350 CID)	1981-77	Trans Fluid Cooler Pipe Fitting To Case	800-755
V8 - 6.6L (403 CID)	1978-77	Trans Fluid Cooler Pipe Fitting To Case	800-755
V8 - 7.5L (455 CID)	1976	Trans Fluid Cooler Pipe Fitting To Case	800-755
ROADMASTER			
V8 - 5.0L (305 CID)	1991	Eng Oil Cooler Line Fitting	800-812
V8 - 5.0L (305 CID)	1991	Trans Fluid Cooler Pipe Fitting To Case, (MD8) Trans	800-755
V8 - 5.7L (350 CID)	1996-94	Trans Fluid Cooler Pipe Fitting Inlet To Case, (M30) Trans	800-754
V8 - 5.7L (350 CID)	1993-92	Eng Oil Cooler Line Fitting	800-812
V8 - 5.7L (350 CID)	1993-92	Trans Fluid Cooler Pipe Fitting To Case, (MD8) Trans	800-755
SKYHAWK			
L4 - 1.8L (112 CID)	1986-82	Trans Fluid Cooler Pipe Fitting To Case, (MD9) Trans	800-755
L4 - 2.0L (122 CID)	1989-83	Trans Fluid Cooler Pipe Fitting To Case, (MD9) Trans	800-755
V6 - 3.8L (231 CID)	1980-76	Trans Fluid Cooler Pipe Fitting To Case	800-755
SKYLARK			
L4 - 2.3L (138 CID)	1995-94	Trans Fluid Cooler Pipe Fitting At Trans, w/Check Valve, (M13) Trans	800-752
L4 - 2.3L (138 CID)	1995-94	Trans Fluid Cooler Pipe Fitting Inlet To Case, (M13) Trans	800-754
L4 - 2.3L (138 CID)	1995-88	Trans Fluid Cooler Pipe Fitting To Case, (MD9) Trans	800-755
L4 - 2.4L (146 CID)	1998-96	Trans Fluid Cooler Pipe Fitting At Trans, w/Check Valve, (M13) Trans	800-752
L4 - 2.4L (146 CID)	1998-96	Trans Fluid Cooler Pipe Fitting Inlet To Case, (M13) Trans	800-754
L4 - 2.5L (151 CID)	1991-86	Trans Fluid Cooler Pipe Fitting To Case, (MD9) Trans	800-755
L4 - 2.5L (151 CID)	1985-80	Trans Fluid Cooler Pipe Fitting To Case	800-755
V6 - 2.8L (173 CID)	1985-80	Trans Fluid Cooler Pipe Fitting To Case	800-755
V6 - 3.0L (181 CID)	1988-86	Trans Fluid Cooler Pipe Fitting To Case, (MD9) Trans	800-755
V6 - 3.1L (189 CID)	1998-94	Trans Fluid Cooler Pipe Fitting At Trans, w/Check Valve, (M13) Trans	800-752
V6 - 3.1L (189 CID)	1998-94	Trans Fluid Cooler Pipe Fitting Inlet To Case, (M13) Trans	800-754
V6 - 3.1L (189 CID)	1995-94	Trans Fluid Cooler Pipe Fitting To Case, (MD9) Trans	800-755
V6 - 3.3L (204 CID)	1993-89	Trans Fluid Cooler Pipe Fitting To Case, (MD9) Trans	800-755
V6 - 3.8L (231 CID)	1979-76	Trans Fluid Cooler Pipe Fitting To Case	800-755
V8 - 4.3L (260 CID)	1976	Trans Fluid Cooler Pipe Fitting To Case	800-755
V8 - 4.9L (301 CID)	1977	Trans Fluid Cooler Pipe Fitting To Case	800-755
V8 - 5.0L (305 CID)	1979-77	Trans Fluid Cooler Pipe Fitting To Case	800-755
V8 - 5.7L (350 CID)	1979-76	Trans Fluid Cooler Pipe Fitting To Case	800-755
SOMERSET			
L4 - 2.5L (151 CID)	1987-85	Trans Fluid Cooler Pipe Fitting To Case, (MD9) Trans	800-755
V6 - 3.0L (181 CID)	1987-85	Trans Fluid Cooler Pipe Fitting To Case, (MD9) Trans	800-755

Quick Disconnect Engine Oil Cooler Line Connector Applications

Make/ Model/Engine	Years	Description	Dorman #
CADILLAC			
ALLANTE			
V8 - 4.1L (250 CID)	1988-87	Trans Fluid Cooler Pipe Fitting To Case, (ME9) Trans	800-755
V8 - 4.5L (273 CID)	1992-90	Trans Fluid Cooler Pipe Fitting Inlet To Case, (ME9) Trans	800-754
V8 - 4.5L (273 CID)	1989	Trans Fluid Cooler Pipe Fitting To Case, (ME9) Trans	800-755
CALAIS			
V8 - 8.2L (500 CID)	1976	Trans Fluid Cooler Pipe Fitting To Case	800-755
CIMARRON			
L4 - 1.8L (112 CID)	1982	Trans Fluid Cooler Pipe Fitting To Case, (MD9) Trans	800-755
L4 - 2.0L (122 CID)	1986-83	Trans Fluid Cooler Pipe Fitting To Case, (MD9) Trans	800-755
V6 - 2.8L (173 CID)	1988-85	Trans Fluid Cooler Pipe Fitting To Case, (MD9) Trans	800-755
COMMERCIAL CHASSIS			
V8 - 5.7L (350 CID)	1996-94	Trans Fluid Cooler Pipe Fitting Inlet To Case, (M30) Trans	800-754
V8 - 5.7L (350 CID)	1993	Trans Fluid Cooler Pipe Fitting To Case, (MD8) Trans	800-755
V8 - 6.0L (368 CID)	1984-82	Trans Fluid Cooler Pipe Fitting To Case, (M40) Trans	800-755
V8 - 6.0L (368 CID)	1981-80	Trans Fluid Cooler Pipe Fitting To Case	800-755
V8 - 7.0L (425 CID)	1979-77	Trans Fluid Cooler Pipe Fitting To Case	800-755
V8 - 8.2L (500 CID)	1976	Trans Fluid Cooler Pipe Fitting To Case	800-755
CONCOURS			
V8 - 4.6L (281 CID)	1995-94	Trans Fluid Cooler Pipe Fitting To Case, (MH1) Trans	800-755
DEVILLE			
V6 - 4.1L (252 CID)	1982	Trans Fluid Cooler Pipe Fitting To Case, (ME9) Trans	800-755
V6 - 4.1L (252 CID)	1981-80	Trans Fluid Cooler Pipe Fitting To Case	800-755
V6 - 4.3L (260 CID)	1985	Trans Fluid Cooler Pipe Fitting To Case, (ME9) Trans	800-755
V8 - 4.1L (250 CID)	1987-82	Trans Fluid Cooler Pipe Fitting To Case, (ME9, MW9) Trans	800-755
V8 - 4.5L (273 CID)	1990-88	Trans Fluid Cooler Pipe Fitting To Case, (ME9) Trans	800-755
V8 - 4.9L (300 CID)	1995-94	Trans Fluid Cooler Pipe Fitting At Trans, w/Check Valve, 2.73 Axle (FP3)	800-752
V8 - 4.9L (300 CID)	1995-94	Trans Fluid Cooler Pipe Fitting Inlet To Case, 2.73 Axle (FP3)	800-754
V8 - 4.9L (300 CID)	1995-94	Trans Fluid Cooler Pipe Fitting To Case, (MH1) Trans	800-755
V8 - 4.9L (300 CID)	1993-91	Trans Fluid Cooler Pipe Fitting Inlet To Case, (M13) Trans	800-754
V8 - 5.7L (350 CID)	1984-82	Trans Fluid Cooler Pipe Fitting To Case, (ME9, MW9) Trans	800-755
V8 - 5.7L (350 CID)	1981-79	Trans Fluid Cooler Pipe Fitting To Case	800-755
V8 - 6.0L (368 CID)	1981-80	Trans Fluid Cooler Pipe Fitting To Case	800-755
V8 - 7.0L (425 CID)	1979-77	Trans Fluid Cooler Pipe Fitting To Case	800-755
V8 - 8.2L (500 CID)	1976	Trans Fluid Cooler Pipe Fitting To Case	800-755
ELDORADO			
V6 - 4.1L (252 CID)	1981	Trans Fluid Cooler Pipe Fitting To Case	800-755
V8 - 4.1L (250 CID)	1987-82	Trans Fluid Cooler Pipe Fitting To Case, (M57, ME9) Trans	800-755
V8 - 4.5L (273 CID)	1990-88	Trans Fluid Cooler Pipe Fitting To Case, (ME9) Trans	800-755
V8 - 4.6L (281 CID)	1995-94	Trans Fluid Cooler Pipe Fitting To Case, (MH1) Trans	800-755
V8 - 4.6L (281 CID)	1993	Trans Fluid Cooler Pipe Fitting Inlet To Case, (M13) Trans	800-754
V8 - 4.9L (300 CID)	1993-91	Trans Fluid Cooler Pipe Fitting Inlet To Case, (M13) Trans	800-754
V8 - 5.7L (350 CID)	1985-82	Trans Fluid Cooler Pipe Fitting To Case, (M57) Trans	800-755
V8 - 5.7L (350 CID)	1981-79	Trans Fluid Cooler Pipe Fitting To Case	800-755
V8 - 6.0L (368 CID)	1981-80	Trans Fluid Cooler Pipe Fitting To Case	800-755
V8 - 7.0L (425 CID)	1978-77	Trans Fluid Cooler Pipe Fitting To Case	800-755
V8 - 8.2L (500 CID)	1976	Trans Fluid Cooler Pipe Fitting To Case	800-755
ESCALADE			
V8 - 5.7L (350 CID)	1999	Trans Fluid Cooler Pipe Fitting Inlet To Case, (M30, MT1) Trans	800-754
FLEETWOOD			
V6 - 4.1L (252 CID)	1981-80	Trans Fluid Cooler Pipe Fitting To Case	800-755
V8 - 4.1L (250 CID)	1987-82	Trans Fluid Cooler Pipe Fitting To Case, (ME9, MW9) Trans	800-755
V8 - 4.5L (273 CID)	1990-88	Trans Fluid Cooler Pipe Fitting To Case, (ME9) Trans	800-755
V8 - 4.9L (300 CID)	1993-91	Trans Fluid Cooler Pipe Fitting Inlet To Case, (M13) Trans	800-754
V8 - 5.0L (305 CID)	1992-86	Trans Fluid Cooler Pipe Fitting To Case, (MD8, MW9) Trans	800-755
V8 - 5.7L (350 CID)	1996-94	Trans Fluid Cooler Pipe Fitting Inlet To Case, (M30) Trans	800-754
V8 - 5.7L (350 CID)	1993-90	Trans Fluid Cooler Pipe Fitting To Case, (MD8) Trans	800-755
V8 - 5.7L (350 CID)	1993	Eng Oil Cooler Line Fitting	800-812
V8 - 5.7L (350 CID)	1985-82	Trans Fluid Cooler Pipe Fitting To Case, (ME9, MW9) Trans	800-755
V8 - 5.7L (350 CID)	1981-79	Trans Fluid Cooler Pipe Fitting To Case	800-755
V8 - 6.0L (368 CID)	1984-82	Trans Fluid Cooler Pipe Fitting To Case, (MW9) Trans	800-755
V8 - 6.0L (368 CID)	1981-80	Trans Fluid Cooler Pipe Fitting To Case	800-755
V8 - 7.0L (425 CID)	1979-77	Trans Fluid Cooler Pipe Fitting To Case	800-755
V8 - 8.2L (500 CID)	1976	Trans Fluid Cooler Pipe Fitting To Case	800-755
SEVILLE			
V6 - 4.1L (252 CID)	1981	Trans Fluid Cooler Pipe Fitting To Case	800-755
V8 - 4.1L (250 CID)	1987-82	Trans Fluid Cooler Pipe Fitting To Case, (M57, ME9) Trans	800-755
V8 - 4.5L (273 CID)	1990-88	Trans Fluid Cooler Pipe Fitting To Case, (ME9) Trans	800-755
V8 - 4.6L (281 CID)	1995-94	Trans Fluid Cooler Pipe Fitting To Case, (MH1) Trans	800-755
V8 - 4.6L (281 CID)	1993	Trans Fluid Cooler Pipe Fitting Inlet To Case, (M13) Trans	800-754
V8 - 4.9L (300 CID)	1993-91	Trans Fluid Cooler Pipe Fitting Inlet To Case, (M13) Trans	800-754
V8 - 5.7L (350 CID)	1985-82	Trans Fluid Cooler Pipe Fitting To Case, (M57) Trans	800-755
V8 - 5.7L (350 CID)	1981-76	Trans Fluid Cooler Pipe Fitting To Case	800-755
V8 - 6.0L (368 CID)	1981-80	Trans Fluid Cooler Pipe Fitting To Case	800-755
CHEVROLET			
BERETTA			
L4 - 2.0L (122 CID)	1989-87	Trans Fluid Cooler Pipe Fitting To Case, (MD9) Trans	800-755
L4 - 2.2L (134 CID)	1996-94	Trans Fluid Cooler Pipe Fitting At Trans, w/Check Valve, (M13) Trans	800-752
L4 - 2.2L (134 CID)	1996-94	Trans Fluid Cooler Pipe Fitting Inlet To Case, (M13) Trans	800-754
L4 - 2.2L (134 CID)	1996-90	Trans Fluid Cooler Pipe Fitting To Case, (MD9) Trans	800-755
L4 - 2.3L (138 CID)	1994-90	Trans Fluid Cooler Pipe Fitting To Case, (MD9) Trans	800-755
L4 - 2.3L (138 CID)	1994	Trans Fluid Cooler Pipe Fitting At Trans, w/Check Valve, (M13) Trans	800-752
L4 - 2.3L (138 CID)	1994	Trans Fluid Cooler Pipe Fitting Inlet To Case, (M13) Trans	800-754
V6 - 2.8L (173 CID)	1989-87	Trans Fluid Cooler Pipe Fitting To Case, (MD9) Trans	800-755
V6 - 3.1L (189 CID)	1996-94	Trans Fluid Cooler Pipe Fitting At Trans, w/Check Valve, (M13) Trans	800-752
V6 - 3.1L (189 CID)	1996-94	Trans Fluid Cooler Pipe Fitting Inlet To Case, (M13) Trans	800-754
V6 - 3.1L (189 CID)	1996-90	Trans Fluid Cooler Pipe Fitting To Case, (MD9) Trans	800-755

Quick Disconnect

Clock Springs
pg. 21-24

Control Arms
pg. 25-54

CV Joint Boots & Accessories
pg. 55-66

Door Lock Actuators
pg. 67-72

Exhaust Manifold Kits
pg. 73-134

Use Quick Disconnect Fittings & Clips for Fast, Economical Repairs

Quick Disconnect
375

Quick Disconnect Engine Oil Cooler Line Connector Applications

Quick Disconnect

Make/ Model/Engine	Years	Description	Dorman #
CHEVROLET (continued)			
CAMARO			
L4 - 2.5L (151 CID)	1986-82	Trans Fluid Cooler Pipe Fitting To Case, (MD8, MV9) Trans	800-755
L6 - 4.1L (250 CID)	1979-76	Trans Fluid Cooler Pipe Fitting To Case	800-755
V6 - 2.8L (173 CID)	1989-82	Trans Fluid Cooler Pipe Fitting To Case, (MD8, MV9) Trans	800-755
V6 - 3.1L (189 CID)	1992-90	Trans Fluid Cooler Pipe Fitting To Case, (MD8) Trans	800-755
V6 - 3.4L (207 CID)	1995-93	Trans Fluid Cooler Pipe Fitting To Case, (M30, MD8) Trans	800-755
V6 - 3.8L (231 CID)	1998-95	Trans Fluid Cooler Pipe Fitting To Case, (M30, MD8) Trans	800-755
V6 - 3.8L (231 CID)	1981-80	Trans Fluid Cooler Pipe Fitting To Case	800-755
V8 - 4.4L (267 CID)	1981-80	Trans Fluid Cooler Pipe Fitting To Case	800-755
V8 - 5.0L (305 CID)	1992-82	Trans Fluid Cooler Pipe Fitting To Case, (MD8, MV9) Trans	800-755
V8 - 5.0L (305 CID)	1981-76	Trans Fluid Cooler Pipe Fitting To Case	800-755
V8 - 5.7L (350 CID)	1998-87	Trans Fluid Cooler Pipe Fitting To Case, (M30, MD8) Trans	800-755
V8 - 5.7L (350 CID)	1981-76	Trans Fluid Cooler Pipe Fitting To Case	800-755
CAPRICE			
L6 - 4.1L (250 CID)	1979-77	Trans Fluid Cooler Pipe Fitting To Case	800-755
V6 - 3.8L (229 CID)	1984-82	Trans Fluid Cooler Pipe Fitting To Case, (MD8, MW9) Trans	800-755
V6 - 3.8L (229 CID)	1981-80	Trans Fluid Cooler Pipe Fitting To Case	800-755
V6 - 3.8L (231 CID)	1984-82	Trans Fluid Cooler Pipe Fitting To Case, (MD8, MW9) Trans	800-755
V6 - 3.8L (231 CID)	1981-80	Trans Fluid Cooler Pipe Fitting To Case	800-755
V6 - 4.3L (262 CID)	1993-92	Eng Oil Cooler Line Fitting	800-812
V6 - 4.3L (262 CID)	1993-85	Trans Fluid Cooler Pipe Fitting To Case, (MD8, MW9) Trans	800-755
V8 - 4.3L (265 CID)	1996-94	Trans Fluid Cooler Pipe Fitting Inlet To Case, (M30) Trans	800-754
V8 - 4.4L (267 CID)	1982	Trans Fluid Cooler Pipe Fitting To Case, (MD8, MW9) Trans	800-755
V8 - 4.4L (267 CID)	1981-80	Trans Fluid Cooler Pipe Fitting To Case	800-755
V8 - 5.0L (305 CID)	1993-91	Eng Oil Cooler Line Fitting	800-812
V8 - 5.0L (305 CID)	1993-82	Trans Fluid Cooler Pipe Fitting To Case, (MD8, MW9) Trans	800-755
V8 - 5.0L (305 CID)	1981-77	Trans Fluid Cooler Pipe Fitting To Case	800-755
V8 - 5.0L (307 CID)	1990-86	Trans Fluid Cooler Pipe Fitting To Case, (MD8, MW9) Trans	800-755
V8 - 5.7L (350 CID)	1996-94	Trans Fluid Cooler Pipe Fitting Inlet To Case, (M30) Trans	800-754
V8 - 5.7L (350 CID)	1993-91	Eng Oil Cooler Line Fitting	800-812
V8 - 5.7L (350 CID)	1993-82	Trans Fluid Cooler Pipe Fitting To Case, (MD8, MW9) Trans	800-755
V8 - 5.7L (350 CID)	1981-76	Trans Fluid Cooler Pipe Fitting To Case	800-755
V8 - 6.6L (400 CID)	1976	Trans Fluid Cooler Pipe Fitting To Case	800-755
V8 - 7.4L (454 CID)	1976	Trans Fluid Cooler Pipe Fitting To Case	800-755
CAVALIER			
L4 - 1.8L (112 CID)	1982	Trans Fluid Cooler Pipe Fitting To Case, (MD9) Trans	800-755
L4 - 2.0L (122 CID)	1989-83	Trans Fluid Cooler Pipe Fitting To Case, (MD9) Trans	800-755
L4 - 2.2L (134 CID)	2001-90	Trans Fluid Cooler Pipe Fitting To Case, (MD9) Trans	800-755
L4 - 2.3L (138 CID)	1995	Trans Fluid Cooler Pipe Fitting To Case, (MD9) Trans	800-755
L4 - 2.4L (146 CID)	2001-96	Trans Fluid Cooler Pipe Fitting To Case, (MD9) Trans	800-755
V6 - 2.8L (173 CID)	1989-85	Trans Fluid Cooler Pipe Fitting To Case, (MD9) Trans	800-755
V6 - 3.1L (189 CID)	1994-90	Trans Fluid Cooler Pipe Fitting To Case, (MD9) Trans	800-755
CELEBRITY			
L4 - 2.5L (151 CID)	1990-82	Trans Fluid Cooler Pipe Fitting To Case, (MD9, ME9) Trans	800-755
V6 - 2.8L (173 CID)	1989-82	Trans Fluid Cooler Pipe Fitting To Case, (MD9, ME9) Trans	800-755
V6 - 3.1L (189 CID)	1990	Trans Fluid Cooler Pipe Fitting To Case, (MD9, ME9) Trans	800-755
V6 - 4.3L (260 CID)	1985-82	Trans Fluid Cooler Pipe Fitting To Case, (MD9, ME9) Trans	800-755
CHEVETTE			
L4 - 1.4L (85 CID)	1977-76	Trans Fluid Cooler Pipe Fitting To Case	800-755
L4 - 1.6L (98 CID)	1984-82	Trans Fluid Cooler Pipe Fitting To Case, (MV9) Trans	800-755
L4 - 1.6L (98 CID)	1981-76	Trans Fluid Cooler Pipe Fitting To Case	800-755
L4 - 1.8L (110 CID)	1984-82	Trans Fluid Cooler Pipe Fitting To Case, (MV9) Trans	800-755
L4 - 1.8L (110 CID)	1981	Trans Fluid Cooler Pipe Fitting To Case	800-755
CITATION			
L4 - 2.5L (151 CID)	1985-80	Trans Fluid Cooler Pipe Fitting To Case	800-755
V6 - 2.8L (173 CID)	1985-80	Trans Fluid Cooler Pipe Fitting To Case	800-755
CORSICA			
L4 - 2.0L (122 CID)	1989-87	Trans Fluid Cooler Pipe Fitting To Case, (MD9) Trans	800-755
L4 - 2.2L (134 CID)	1996-94	Trans Fluid Cooler Pipe Fitting At Trans, w/Check Valve, (M13) Trans	800-752
L4 - 2.2L (134 CID)	1996-94	Trans Fluid Cooler Pipe Fitting Inlet To Case, (M13) Trans	800-754
L4 - 2.2L (134 CID)	1996-90	Trans Fluid Cooler Pipe Fitting To Case, (MD9) Trans	800-755
V6 - 2.8L (173 CID)	1989-87	Trans Fluid Cooler Pipe Fitting To Case, (MD9) Trans	800-755
V6 - 3.1L (189 CID)	1996-94	Trans Fluid Cooler Pipe Fitting At Trans, w/Check Valve, (M13) Trans	800-752
V6 - 3.1L (189 CID)	1996-94	Trans Fluid Cooler Pipe Fitting Inlet To Case, (M13) Trans	800-754
V6 - 3.1L (189 CID)	1996-90	Trans Fluid Cooler Pipe Fitting To Case, (MD9) Trans	800-755
CORVETTE			
V8 - 5.7L (350 CID)	2004-97	Trans Fluid Cooler Pipe Fitting Inlet To Case, (M30) Trans	800-754
V8 - 5.7L (350 CID)	1996-94	Trans Fluid Cooler Pipe Fitting To Case, (M30) Trans	800-755
EL CAMINO			
L6 - 4.1L (250 CID)	1977-76	Trans Fluid Cooler Pipe Fitting To Case	800-755
V6 - 3.3L (200 CID)	1979-78	Trans Fluid Cooler Pipe Fitting To Case	800-755
V6 - 3.8L (229 CID)	1984-82	Trans Fluid Cooler Pipe Fitting To Case, (MV9, MW9) Trans	800-755
V6 - 3.8L (229 CID)	1981-80	Trans Fluid Cooler Pipe Fitting To Case	800-755
V6 - 3.8L (231 CID)	1984-82	Trans Fluid Cooler Pipe Fitting To Case, (MV9, MW9) Trans	800-755
V6 - 3.8L (231 CID)	1981-78	Trans Fluid Cooler Pipe Fitting To Case	800-755
V6 - 4.3L (262 CID)	1987-85	Trans Fluid Cooler Pipe Fitting To Case, (MV9, MW9) Trans	800-755
V8 - 4.4L (267 CID)	1982	Trans Fluid Cooler Pipe Fitting To Case, (MV9, MW9) Trans	800-755
V8 - 4.4L (267 CID)	1981-79	Trans Fluid Cooler Pipe Fitting To Case	800-755
V8 - 5.0L (305 CID)	1987-82	Trans Fluid Cooler Pipe Fitting To Case, (MV9, MW9) Trans	800-755
V8 - 5.0L (305 CID)	1981-76	Trans Fluid Cooler Pipe Fitting To Case	800-755
V8 - 5.7L (350 CID)	1984-83	Trans Fluid Cooler Pipe Fitting To Case, (MV9, MW9) Trans	800-755
V8 - 5.7L (350 CID)	1979-76	Trans Fluid Cooler Pipe Fitting To Case	800-755
V8 - 6.6L (400 CID)	1976	Trans Fluid Cooler Pipe Fitting To Case	800-755
IMPALA			
L6 - 4.1L (250 CID)	1979-77	Trans Fluid Cooler Pipe Fitting To Case	800-755
V6 - 3.8L (229 CID)	1984-82	Trans Fluid Cooler Pipe Fitting To Case, (MD8, MW9) Trans	800-755

Quick Disconnect Engine Oil Cooler Line Connector Applications

Make/ Model/Engine	Years	Description	Dorman #
CHEVROLET (continued)			
IMPALA (continued)			
V6 - 3.8L (229 CID)	1981-80	Trans Fluid Cooler Pipe Fitting To Case	800-755
V6 - 3.8L (231 CID)	1984-82	Trans Fluid Cooler Pipe Fitting To Case, (MD8, MW9) Trans	800-755
V6 - 3.8L (231 CID)	1981-80	Trans Fluid Cooler Pipe Fitting To Case	800-755
V6 - 4.3L (262 CID)	1985	Trans Fluid Cooler Pipe Fitting To Case, (MD8, MW9) Trans	800-755
V8 - 4.4L (267 CID)	1982	Trans Fluid Cooler Pipe Fitting To Case, (MD8, MW9) Trans	800-755
V8 - 4.4L (267 CID)	1981-80	Trans Fluid Cooler Pipe Fitting To Case	800-755
V8 - 5.0L (305 CID)	1985-82	Trans Fluid Cooler Pipe Fitting To Case, (MD8, MW9) Trans	800-755
V8 - 5.0L (305 CID)	1981-77	Trans Fluid Cooler Pipe Fitting To Case	800-755
V8 - 5.7L (350 CID)	1985-82	Trans Fluid Cooler Pipe Fitting To Case, (MD8, MW9) Trans	800-755
V8 - 5.7L (350 CID)	1981-76	Trans Fluid Cooler Pipe Fitting To Case	800-755
V8 - 6.6L (400 CID)	1976	Trans Fluid Cooler Pipe Fitting To Case	800-755
V8 - 7.4L (454 CID)	1976	Trans Fluid Cooler Pipe Fitting To Case	800-755
IMPALA SS			
V8 - 5.7L (350 CID)	1996-94	Trans Fluid Cooler Pipe Fitting Inlet To Case, (M30) Trans	800-754
LAGUNA			
V8 - 5.0L (305 CID)	1976	Trans Fluid Cooler Pipe Fitting To Case	800-755
V8 - 5.7L (350 CID)	1976	Trans Fluid Cooler Pipe Fitting To Case	800-755
V8 - 6.6L (400 CID)	1976	Trans Fluid Cooler Pipe Fitting To Case	800-755
LUMINA			
L4 - 2.2L (133 CID)	1993	Trans Fluid Cooler Pipe Fitting Inlet To Case, (M13, M15, ME9) Trans	800-754
L4 - 2.5L (151 CID)	1992-91	Trans Fluid Cooler Pipe Fitting Inlet To Case, (M13, M15, ME9) Trans	800-754
L4 - 2.5L (151 CID)	1992-90	Trans Fluid Cooler Pipe Fitting To Case, (MD9, ME9) Trans	800-755
V6 - 3.1L (189 CID)	1999-91	Trans Fluid Cooler Pipe Fitting Inlet To Case, (M13, M15, ME9) Trans	800-754
V6 - 3.1L (189 CID)	1992-90	Trans Fluid Cooler Pipe Fitting To Case, (MD9, ME9) Trans	800-755
V6 - 3.4L (207 CID)	1997-91	Trans Fluid Cooler Pipe Fitting Inlet To Case, (M13, M15, ME9) Trans	800-754
V6 - 3.4L (207 CID)	1992-91	Trans Fluid Cooler Pipe Fitting To Case, (MD9, ME9) Trans	800-755
V6 - 3.8L (231 CID)	1999-98	Trans Fluid Cooler Pipe Fitting Inlet To Case, (M13, M15, ME9) Trans	800-754
LUMINA APV			
V6 - 3.1L (189 CID)	1995-94	Trans Fluid Cooler Pipe Fitting At Trans, w/Check Valve, (M13) Trans	800-752
V6 - 3.1L (189 CID)	1995-92	Trans Fluid Cooler Pipe Fitting Inlet To Case, (M13, M15) Trans	800-754
V6 - 3.1L (189 CID)	1995-90	Trans Fluid Cooler Pipe Fitting To Case, (MD9) Trans	800-755
V6 - 3.4L (207 CID)	1996	Trans Fluid Cooler Pipe Fitting At Trans, w/Check Valve, (M13) Trans	800-752
V6 - 3.4L (207 CID)	1996	Trans Fluid Cooler Pipe Fitting Inlet To Case, (M13, M15) Trans	800-754
V6 - 3.8L (231 CID)	1995-94	Trans Fluid Cooler Pipe Fitting At Trans, w/Check Valve, (M13) Trans	800-752
V6 - 3.8L (231 CID)	1995-92	Trans Fluid Cooler Pipe Fitting Inlet To Case, (M13, M15) Trans	800-754
V6 - 3.8L (231 CID)	1995-92	Trans Fluid Cooler Pipe Fitting To Case, (MD9) Trans	800-755
MALIBU			
L6 - 4.1L (250 CID)	1977-76	Trans Fluid Cooler Pipe Fitting To Case	800-755
V6 - 3.3L (200 CID)	1979-78	Trans Fluid Cooler Pipe Fitting To Case	800-755
V6 - 3.8L (229 CID)	1983-82	Trans Fluid Cooler Pipe Fitting To Case, (MV9, MW9) Trans	800-755
V6 - 3.8L (229 CID)	1981-80	Trans Fluid Cooler Pipe Fitting To Case	800-755
V6 - 3.8L (231 CID)	1983-82	Trans Fluid Cooler Pipe Fitting To Case, (MV9, MW9) Trans	800-755
V6 - 3.8L (231 CID)	1981-78	Trans Fluid Cooler Pipe Fitting To Case	800-755
V6 - 4.3L (260 CID)	1983-82	Trans Fluid Cooler Pipe Fitting To Case, (MV9, MW9) Trans	800-755
V8 - 4.4L (267 CID)	1982	Trans Fluid Cooler Pipe Fitting To Case, (MV9, MW9) Trans	800-755
V8 - 4.4L (267 CID)	1981-79	Trans Fluid Cooler Pipe Fitting To Case	800-755
V8 - 5.0L (305 CID)	1983-82	Trans Fluid Cooler Pipe Fitting To Case, (MV9, MW9) Trans	800-755
V8 - 5.0L (305 CID)	1981-76	Trans Fluid Cooler Pipe Fitting To Case	800-755
V8 - 5.7L (350 CID)	1983-82	Trans Fluid Cooler Pipe Fitting To Case, (MV9, MW9) Trans	800-755
V8 - 5.7L (350 CID)	1981-76	Trans Fluid Cooler Pipe Fitting To Case	800-755
V8 - 6.6L (400 CID)	1976	Trans Fluid Cooler Pipe Fitting To Case	800-755
MONTE CARLO			
V6 - 3.1L (189 CID)	1999-95	Trans Fluid Cooler Pipe Fitting Inlet To Case, (M13, M15, ME9) Trans	800-754
V6 - 3.3L (200 CID)	1979-78	Trans Fluid Cooler Pipe Fitting To Case	800-755
V6 - 3.4L (207 CID)	1997-95	Trans Fluid Cooler Pipe Fitting Inlet To Case, (M13, M15, ME9) Trans	800-754
V6 - 3.8L (229 CID)	1984-82	Trans Fluid Cooler Pipe Fitting To Case, (MV9, MW9) Trans	800-755
V6 - 3.8L (229 CID)	1981-80	Trans Fluid Cooler Pipe Fitting To Case	800-755
V6 - 3.8L (231 CID)	1999-98	Trans Fluid Cooler Pipe Fitting Inlet To Case, (M13, M15, ME9) Trans	800-754
V6 - 3.8L (231 CID)	1984-82	Trans Fluid Cooler Pipe Fitting To Case, (MV9, MW9) Trans	800-755
V6 - 3.8L (231 CID)	1981-78	Trans Fluid Cooler Pipe Fitting To Case	800-755
V6 - 4.3L (262 CID)	1988-82	Trans Fluid Cooler Pipe Fitting To Case, (MV9, MW9) Trans	800-755
V8 - 4.4L (267 CID)	1982	Trans Fluid Cooler Pipe Fitting To Case, (MV9, MW9) Trans	800-755
V8 - 4.4L (267 CID)	1981-79	Trans Fluid Cooler Pipe Fitting To Case	800-755
V8 - 5.0L (305 CID)	1988-82	Trans Fluid Cooler Pipe Fitting To Case, (MV9, MW9) Trans	800-755
V8 - 5.0L (305 CID)	1981-76	Trans Fluid Cooler Pipe Fitting To Case	800-755
V8 - 5.7L (350 CID)	1984-82	Trans Fluid Cooler Pipe Fitting To Case, (MV9, MW9) Trans	800-755
V8 - 5.7L (350 CID)	1981-76	Trans Fluid Cooler Pipe Fitting To Case	800-755
V8 - 6.6L (400 CID)	1976	Trans Fluid Cooler Pipe Fitting To Case	800-755
MONZA			
L4 - 2.3L (140 CID)	1977-76	Trans Fluid Cooler Pipe Fitting To Case	800-755
L4 - 2.5L (151 CID)	1980-78	Trans Fluid Cooler Pipe Fitting To Case	800-755
V6 - 3.2L (196 CID)	1979-78	Trans Fluid Cooler Pipe Fitting To Case	800-755
V6 - 3.8L (231 CID)	1980-78	Trans Fluid Cooler Pipe Fitting To Case	800-755
V8 - 4.3L (262 CID)	1976	Trans Fluid Cooler Pipe Fitting To Case	800-755
V8 - 5.0L (305 CID)	1979-76	Trans Fluid Cooler Pipe Fitting To Case	800-755
NOVA			
L6 - 4.1L (250 CID)	1979-76	Trans Fluid Cooler Pipe Fitting To Case	800-755
V8 - 5.0L (305 CID)	1979-76	Trans Fluid Cooler Pipe Fitting To Case	800-755
V8 - 5.7L (350 CID)	1979-76	Trans Fluid Cooler Pipe Fitting To Case	800-755
VEGA			
L4 - 2.0L (122 CID)	1976	Trans Fluid Cooler Pipe Fitting To Case	800-755
L4 - 2.3L (140 CID)	1977-76	Trans Fluid Cooler Pipe Fitting To Case	800-755
VENTURE VAN			
V6 - 3.4L (207 CID)	1999-97	Trans Fluid Cooler Pipe Fitting Inlet To Case, (M13, M15) Trans	800-754
V6 - 3.4L (207 CID)	1998-97	Trans Fluid Cooler Pipe Fitting At Trans, w/Check Valve, (M13) Trans	800-752

Quick Disconnect

**Fuel Sending
Units**
pg. 155-176

**Fuel
Tanks**
pg. 177-228

**Harmonic
Balancers**
pg. 229-254

**Heater Hose
Assemblies**
pg. 255-256

**Hydraulic
Clutch Lines**
pg. 257-260

**Use Quick Disconnect Fittings &
Clips for Fast, Economical Repairs**

Quick Disconnect

Quick Disconnect Engine Oil Cooler Line Connector Applications

Quick Disconnect

Make/ Model/Engine	Years	Description	Dorman #
CHEVROLET/GMC TRUCK			
ASTRO			
L4 - 2.5L (151 CID)	1990-85	Eng Oil Cooler Line	800-811
L4 - 2.5L (151 CID)	1990-85	Trans Fluid Cooler Pipe Fitting To Case, (MD8) Trans	800-755
V6 - 4.3L (262 CID)	1995-85	Trans Fluid Cooler Pipe Fitting To Case, (M30, MD8) Trans	800-755
V6 - 4.3L (262 CID)	1993-85	Eng Oil Cooler Line	800-811
AVALANCHE			
V8 - 5.3L (323 CID)	2004-02	Trans Fluid Cooler Pipe Fitting To Case, (MN8, MT1) Trans	800-755
V8 - 8.1L (496 CID)	2006-03	Eng Oil Cooler Line	800-712
V8 - 8.1L (496 CID)	2006-03	Trans Oil Cooler Line	800-707
V8 - 8.1L (496 CID)	2004-02	Trans Fluid Cooler Pipe Fitting To Case, (MN8, MT1) Trans	800-755
V8 - 8.1L (496 CID)	2002	Trans Oil Cooler Line	800-710
BLAZER			
L6 - 4.1L (250 CID)	1982-79	Trans Fluid Cooler Pipe Fitting To Case, (M38, M40, MD8) Trans	800-755
V8 - 5.0L (305 CID)	1987-85	Eng Oil Cooler Line Fitting	800-812
V8 - 5.0L (305 CID)	1987-79	Trans Fluid Cooler Pipe Fitting To Case, (M38, M40, MD8, MT1, MV4) Trans	800-755
V8 - 5.7L (350 CID)	1994-92	Eng Oil Cooler Line	800-701
V8 - 5.7L (350 CID)	1994-79	Trans Fluid Cooler Pipe Fitting To Case, (M30, M38, M40, MD8, MT1, MV4) Trans	800-755
V8 - 5.7L (350 CID)	1991-85	Eng Oil Cooler Line Fitting	800-812
V8 - 6.2L (379 CID)	1991-87	Eng Oil Cooler Line Connector, 3/8-18 at Case	800-704
V8 - 6.2L (379 CID)	1991-87	Eng Oil Cooler Line Fitting, 1/2-14 at Case	800-711
V8 - 6.2L (379 CID)	1991-87	Eng Oil Cooler Line Fitting, 3/8-18 at Case	800-812
V8 - 6.2L (379 CID)	1991-82	Trans Fluid Cooler Pipe Fitting To Case, (M40, MD8, MT1, MV4) Trans	800-755
V8 - 6.2L (379 CID)	1986-85	Eng Oil Cooler Line Connector	800-704
V8 - 6.2L (379 CID)	1986-85	Eng Oil Cooler Line Fitting	800-812
V8 - 6.5L (395 CID)	1994	Eng Oil Cooler Line	800-704
V8 - 6.5L (395 CID)	1994	Eng Oil Cooler Line, Outlet Hose	800-708
V8 - 6.5L (395 CID)	1994	Trans Fluid Cooler Pipe Fitting To Case, (M30, MD8, MT1) Trans	800-755
V8 - 6.6L (400 CID)	1979	Trans Fluid Cooler Pipe Fitting To Case, (M38, M40) Trans	800-755
C,K SERIES PICKUP			
L6 - 4.1L (250 CID)	1984-79	Trans Fluid Cooler Pipe Fitting To Case, (M38, M40, MD8, MV4) Trans	800-755
L6 - 4.8L (292 CID)	1986-79	Trans Fluid Cooler Pipe Fitting To Case, (M38, M40, MD8, MV4) Trans	800-755
V6 - 4.3L (262 CID)	1998-96	Eng Oil Cooler Line	800-603
V6 - 4.3L (262 CID)	1998-96	Trans Fluid Cooler Pipe Fitting Inlet To Case, (M30, MT1) Trans	800-754
V6 - 4.3L (262 CID)	1995-88	Eng Oil Cooler Line	800-701
V6 - 4.3L (262 CID)	1995-85	Trans Fluid Cooler Pipe Fitting To Case, (M30, M40, MD8, MT1, MV4) Trans	800-755
V6 - 4.3L (262 CID)	1986-85	Eng Oil Cooler Line	800-811
V8 - 5.0L (305 CID)	1999-96	Eng Oil Cooler Line	800-603
V8 - 5.0L (305 CID)	1999-96	Trans Fluid Cooler Pipe Fitting Inlet To Case, (M30, MT1) Trans	800-754
V8 - 5.0L (305 CID)	1999-79	Trans Fluid Cooler Pipe Fitting To Case, (M30, M38, M40, MD8, MT1, MV4) Trans	800-755
V8 - 5.0L (305 CID)	1995-88	Eng Oil Cooler Line	800-701
V8 - 5.0L (305 CID)	1986-85	Eng Oil Cooler Line Fitting	800-812
V8 - 5.7L (350 CID)	2000-96	Eng Oil Cooler Line	800-603
V8 - 5.7L (350 CID)	2000-96	Trans Fluid Cooler Pipe Fitting Inlet To Case, (M30, MT1) Trans	800-754
V8 - 5.7L (350 CID)	2000-79	Trans Fluid Cooler Pipe Fitting To Case, (M30, M38, M40, MD8, MT1, MV4) Trans	800-755
V8 - 5.7L (350 CID)	1995-88	Eng Oil Cooler Line	800-701
V8 - 5.7L (350 CID)	1986-85	Eng Oil Cooler Line Fitting	800-812
V8 - 6.2L (379 CID)	1993-88	Eng Oil Cooler Line	800-704
V8 - 6.2L (379 CID)	1993-88	Eng Oil Cooler Line, Outlet Hose	800-708
V8 - 6.2L (379 CID)	1993-82	Trans Fluid Cooler Pipe Fitting To Case, (M30, M40, MD8, MT1, MV4) Trans	800-755
V8 - 6.2L (379 CID)	1986-85	Eng Oil Cooler Line Connector	800-704
V8 - 6.2L (379 CID)	1986-85	Eng Oil Cooler Line Fitting	800-812
V8 - 6.5L (395 CID)	2002-98	Eng Oil Cooler Line	800-705
V8 - 6.5L (395 CID)	2002-92	Trans Fluid Cooler Pipe Fitting To Case, (M30, MD8, MT1) Trans	800-755
V8 - 6.5L (395 CID)	2000-96	Trans Fluid Cooler Pipe Fitting Inlet To Case, (M30, MT1) Trans	800-754
V8 - 6.5L (395 CID)	1997-96	Eng Oil Cooler Line, 1/2" Line Fitting	800-711
V8 - 6.5L (395 CID)	1997-96	Eng Oil Cooler Line, 5/8" Line Fitting	800-705
V8 - 6.5L (395 CID)	1996-92	Eng Oil Cooler Line, Outlet Hose	800-708
V8 - 6.5L (395 CID)	1995-92	Eng Oil Cooler Line	800-704
V8 - 6.6L (400 CID)	1980-79	Trans Fluid Cooler Pipe Fitting To Case, (M38, M40, MD8) Trans	800-755
V8 - 7.4L (454 CID)	2000-96	Eng Oil Cooler Line, Inlet Hose, w/Bypass	800-709
V8 - 7.4L (454 CID)	2000-96	Eng Oil Cooler Line, wo/Bypass	800-603
V8 - 7.4L (454 CID)	2000-96	Trans Fluid Cooler Pipe Fitting Inlet To Case, (M30, MT1) Trans	800-754
V8 - 7.4L (454 CID)	2000-79	Trans Fluid Cooler Pipe Fitting To Case, (M30, M38, M40, MD8, MT1, MV4) Trans	800-755
V8 - 7.4L (454 CID)	1995-92	Eng Oil Cooler Line, Outlet Hose	800-708
V8 - 7.4L (454 CID)	1991-90	Eng Oil Cooler Line	800-701
V8 - 7.4L (454 CID)	1986-85	Eng Oil Cooler Line Fitting	800-812
V8 - 8.1L (496 CID)	2002-01	Eng Oil Cooler Line, 5/8" Conn Asm - 1/2" NP	800-710
V8 - 8.1L (496 CID)	2002-01	Trans Fluid Cooler Pipe Fitting To Case, (MT1) Trans	800-755
CABALLERO			
V6 - 3.3L (200 CID)	1979-78	Trans Fluid Cooler Pipe Fitting To Case	800-755
V6 - 3.8L (229 CID)	1984-82	Trans Fluid Cooler Pipe Fitting To Case, (M40, MD8, MV4, MV9, MW9) Trans	800-755
V6 - 3.8L (229 CID)	1981-80	Trans Fluid Cooler Pipe Fitting To Case	800-755
V6 - 3.8L (231 CID)	1984-82	Trans Fluid Cooler Pipe Fitting To Case, (M40, MD8, MV4, MV9, MW9) Trans	800-755
V6 - 3.8L (231 CID)	1981-78	Trans Fluid Cooler Pipe Fitting To Case	800-755
V6 - 4.3L (262 CID)	1987-85	Trans Fluid Cooler Pipe Fitting To Case, (MV9, MW9) Trans	800-755
V8 - 5.0L (305 CID)	1987-82	Trans Fluid Cooler Pipe Fitting To Case, (M40, MD8, MV4, MV9, MW9) Trans	800-755
V8 - 5.0L (305 CID)	1981-78	Trans Fluid Cooler Pipe Fitting To Case	800-755
V8 - 5.7L (350 CID)	1984-83	Trans Fluid Cooler Pipe Fitting To Case, (M40, MD8, MV4, MV9, MW9) Trans	800-755
V8 - 5.7L (350 CID)	1979-78	Trans Fluid Cooler Pipe Fitting To Case	800-755
EXPRESS			
V6 - 4.3L (262 CID)	2006-96	Trans Fluid Cooler Pipe Fitting To Case, (MN8, MT1) Trans	800-755
V6 - 4.3L (262 CID)	1996	Trans Fluid Cooler Pipe Fitting Inlet To Case, (M30, MT1) Trans	800-754
V8 - 4.8L (294 CID)	2006-03	Trans Fluid Cooler Pipe Fitting To Case, (MN8, MT1) Trans	800-755
V8 - 5.0L (305 CID)	2002-99	Trans Fluid Cooler Pipe Fitting To Case, (MT1) Trans	800-755
V8 - 5.0L (305 CID)	1996	Trans Fluid Cooler Pipe Fitting Inlet To Case, (M30, MT1) Trans	800-754

Quick Disconnect Engine Oil Cooler Line Connector Applications

Make/ Model/Engine	Years	Description	Dorman #
CHEVROLET/GMC TRUCK (continued)			
EXPRESS (continued)			
V8 - 5.3L (323 CID)	2006-03	Trans Fluid Cooler Pipe Fitting To Case, (MN8, MT1) Trans	800-755
V8 - 5.7L (350 CID)	2002-96	Eng Oil Cooler Line, Connects to Engine	800-603
V8 - 5.7L (350 CID)	2002-96	Trans Fluid Cooler Pipe Fitting To Case, (MT1) Trans	800-755
V8 - 5.7L (350 CID)	1996	Trans Fluid Cooler Pipe Fitting Inlet To Case, (M30, MT1) Trans	800-754
V8 - 6.0L (364 CID)	2006-03	Trans Fluid Cooler Pipe Fitting To Case, (MN8, MT1) Trans	800-755
V8 - 6.5L (395 CID)	2002-96	Eng Oil Cooler Line, 1/2-14 NPT x 18.2	800-705
V8 - 6.5L (395 CID)	2002-96	Eng Oil Cooler Line, 5/8" Conn Asm - 1/2" NP	800-710
V8 - 6.5L (395 CID)	2002-96	Trans Fluid Cooler Pipe Fitting To Case, (MT1) Trans	800-755
V8 - 6.5L (395 CID)	1996	Trans Fluid Cooler Pipe Fitting Inlet To Case, (M30, MT1) Trans	800-754
V8 - 7.4L (454 CID)	2000-96	Eng Oil Cooler Line, VIN J, Inlet Hose, w/Bypass	800-709
V8 - 7.4L (454 CID)	2000-96	Eng Oil Cooler Line, VIN J, wo/Bypass	800-603
V8 - 7.4L (454 CID)	2000-96	Trans Fluid Cooler Pipe Fitting To Case, (MT1) Trans	800-755
V8 - 7.4L (454 CID)	1996	Trans Fluid Cooler Pipe Fitting Inlet To Case, (M30, MT1) Trans	800-754
V8 - 8.1L (496 CID)	2002-01	Eng Oil Cooler Line, 5/8" Conn Asm - 1/2" NP	800-710
V8 - 8.1L (496 CID)	2002-01	Trans Fluid Cooler Pipe Fitting To Case, (MT1) Trans	800-755
G SERIES VAN			
L6 - 4.1L (250 CID)	1984-79	Trans Fluid Cooler Pipe Fitting To Case, (M38, M40, MD8, MV4) Trans	800-755
L6 - 4.8L (292 CID)	1980-79	Trans Fluid Cooler Pipe Fitting To Case, (M38, M40, MD8) Trans	800-755
V6 - 4.3L (262 CID)	1998-85	Trans Fluid Cooler Pipe Fitting To Case, (M30, M40, MD8, MT1, MV4) Trans	800-755
V6 - 4.3L (262 CID)	1996-85	Eng Oil Cooler Line	800-811
V8 - 5.0L (305 CID)	1998-79	Trans Fluid Cooler Pipe Fitting To Case, (M30, M38, M40, MD8, MT1, MV4) Trans	800-755
V8 - 5.0L (305 CID)	1996	Trans Fluid Cooler Pipe Fitting Inlet To Case, (M30, MT1) Trans	800-754
V8 - 5.0L (305 CID)	1995-92	Eng Oil Cooler Line	800-811
V8 - 5.0L (305 CID)	1991-85	Eng Oil Cooler Line Fitting	800-812
V8 - 5.7L (350 CID)	1996-79	Trans Fluid Cooler Pipe Fitting To Case, (M30, M38, M40, MD8, MT1, MV4) Trans	800-755
V8 - 5.7L (350 CID)	1996	Eng Oil Cooler Line	800-603
V8 - 5.7L (350 CID)	1996	Eng Oil Cooler Line	800-811
V8 - 5.7L (350 CID)	1996	Trans Fluid Cooler Pipe Fitting Inlet To Case, (M30, MT1) Trans	800-754
V8 - 5.7L (350 CID)	1995-92	Eng Oil Cooler Line	800-811
V8 - 5.7L (350 CID)	1991-85	Eng Oil Cooler Line Fitting	800-812
V8 - 6.2L (379 CID)	1993-92	Eng Oil Cooler Line	800-704
V8 - 6.2L (379 CID)	1993-92	Eng Oil Cooler Line	800-811
V8 - 6.2L (379 CID)	1993-83	Trans Fluid Cooler Pipe Fitting To Case, (M30, M40, MD8, MT1, MV4) Trans	800-755
V8 - 6.2L (379 CID)	1991-85	Eng Oil Cooler Line Connector	800-704
V8 - 6.2L (379 CID)	1991-85	Eng Oil Cooler Line Fitting	800-812
V8 - 6.5L (395 CID)	1996-94	Trans Fluid Cooler Pipe Fitting To Case, (M30, MD8, MT1) Trans	800-755
V8 - 6.5L (395 CID)	1996	Eng Oil Cooler Line	800-811
V8 - 6.5L (395 CID)	1996	Trans Fluid Cooler Pipe Fitting Inlet To Case, (M30, MT1) Trans	800-754
V8 - 6.5L (395 CID)	1995-94	Eng Oil Cooler Line	800-811
V8 - 6.5L (395 CID)	1995-94	Eng Oil Cooler Line	800-704
V8 - 6.6L (400 CID)	1980-79	Trans Fluid Cooler Pipe Fitting To Case, (M38, M40, MD8) Trans	800-755
V8 - 7.4L (454 CID)	1996-79	Trans Fluid Cooler Pipe Fitting To Case, (M30, M38, M40, MD8, MT1, MV4) Trans	800-755
V8 - 7.4L (454 CID)	1996	Eng Oil Cooler Line	800-811
V8 - 7.4L (454 CID)	1996	Eng Oil Cooler Line, VIN J, Inlet Hose, w/Bypass	800-709
V8 - 7.4L (454 CID)	1996	Eng Oil Cooler Line, VIN J, wo/Bypass	800-603
V8 - 7.4L (454 CID)	1996	Trans Fluid Cooler Pipe Fitting Inlet To Case, (M30, MT1) Trans	800-754
V8 - 7.4L (454 CID)	1995-88	Eng Oil Cooler Line	800-811
JIMMY			
L6 - 4.1L (250 CID)	1982-79	Trans Fluid Cooler Pipe Fitting To Case, (M38, M40, MD8) Trans	800-755
V8 - 5.0L (305 CID)	1987-85	Eng Oil Cooler Line Fitting	800-812
V8 - 5.0L (305 CID)	1987-79	Trans Fluid Cooler Pipe Fitting To Case, (M30, M38, M40, MD8, MT1, MV4) Trans	800-755
V8 - 5.7L (350 CID)	1991-85	Eng Oil Cooler Line Fitting	800-812
V8 - 5.7L (350 CID)	1991-79	Trans Fluid Cooler Pipe Fitting To Case, (M30, M38, M40, MD8, MT1, MV4) Trans	800-755
V8 - 6.2L (379 CID)	1991-87	Eng Oil Cooler Line Connector, 3/8-18 at Case	800-704
V8 - 6.2L (379 CID)	1991-87	Eng Oil Cooler Line Fitting, 1/2-14 at Case	800-711
V8 - 6.2L (379 CID)	1991-87	Eng Oil Cooler Line Fitting, 3/8-18 at Case	800-812
V8 - 6.2L (379 CID)	1991-82	Trans Fluid Cooler Pipe Fitting To Case, (M38, M40, MD8, MT1, MV4) Trans	800-755
V8 - 6.2L (379 CID)	1986-85	Eng Oil Cooler Line Connector	800-704
V8 - 6.2L (379 CID)	1986-85	Eng Oil Cooler Line Fitting	800-812
V8 - 6.6L (400 CID)	1979	Trans Fluid Cooler Pipe Fitting To Case, (M38, M40) Trans	800-755
LLV (POSTAL VEHICLE)			
L4 - 2.2L (134 CID)	1995-94	Trans Fluid Cooler Pipe Fitting To Case, (M30, MD8) Trans	800-755
L4 - 2.5L (151 CID)	1993-87	Trans Fluid Cooler Pipe Fitting To Case, (M30, MD8, MV9) Trans	800-755
P SERIES VAN			
L4 - 3.9L (239 CID)	1991-89	Trans Fluid Cooler Pipe Fitting To Case, (M40, MT1) Trans	800-755
L6 - 4.1L (250 CID)	1979	Trans Fluid Cooler Pipe Fitting To Case, (M38, M40) Trans	800-755
L6 - 4.8L (292 CID)	1989-79	Trans Fluid Cooler Pipe Fitting To Case, (M38, M40, MD8, MV4) Trans	800-755
L6 - 4.8L (292 CID)	1984-83	Eng Oil Cooler Line Fitting	800-812
V6 - 4.3L (262 CID)	1999-90	Trans Fluid Cooler Pipe Fitting To Case, (M40, MT1) Trans	800-755
V6 - 4.3L (262 CID)	1996-94	Eng Oil Cooler Line	800-701
V6 - 4.3L (262 CID)	1993-91	Eng Oil Cooler Line Fitting	800-812
V8 - 5.0L (305 CID)	1979	Trans Fluid Cooler Pipe Fitting To Case, (M38, M40) Trans	800-755
V8 - 5.7L (350 CID)	1999-79	Trans Fluid Cooler Pipe Fitting To Case, (M38, M40, MD8, MT1, MV4) Trans	800-755
V8 - 5.7L (350 CID)	1996-94	Eng Oil Cooler Line	800-701
V8 - 5.7L (350 CID)	1993-83	Eng Oil Cooler Line Fitting	800-812
V8 - 6.2L (379 CID)	1993-91	Eng Oil Cooler Line Connector	800-704
V8 - 6.2L (379 CID)	1993-82	Trans Fluid Cooler Pipe Fitting To Case, (M40, MD8, MT1, MV4) Trans	800-755
V8 - 6.2L (379 CID)	1990-85	Eng Oil Cooler Line Connector	800-704
V8 - 6.2L (379 CID)	1990-85	Eng Oil Cooler Line Fitting	800-812
V8 - 6.2L (379 CID)	1984-83	Eng Oil Cooler Line Fitting	800-812
V8 - 6.5L (395 CID)	1999-98	Eng Oil Cooler Line, 1/2-14 NPT x 18.2	800-705
V8 - 6.5L (395 CID)	1999-98	Eng Oil Cooler Line, 5/8" Conn Asm - 1/2" NP	800-710
V8 - 6.5L (395 CID)	1999-94	Trans Fluid Cooler Pipe Fitting To Case, (MT1) Trans	800-755
V8 - 6.5L (395 CID)	1996-94	Eng Oil Cooler Line	800-701

Quick Disconnect

Quick Disconnect Engine Oil Cooler Line Connector Applications

Quick Disconnect

Make/ Model/Engine	Years	Description	Dorman #
CHEVROLET/GMC TRUCK (continued)			
P SERIES VAN (continued)			
V8 - 7.4L (454 CID)	1999-98	Eng Oil Cooler Line, VIN B, Inlet Hose, w/Bypass	800-709
V8 - 7.4L (454 CID)	1999-98	Eng Oil Cooler Line, VIN B, wo/Bypass	800-603
V8 - 7.4L (454 CID)	1999-98	Eng Oil Cooler Line, VIN J, Outlet Hose	800-708
V8 - 7.4L (454 CID)	1999-79	Trans Fluid Cooler Pipe Fitting To Case, (M38, M40, MD8, MT1, MV4) Trans	800-755
V8 - 7.4L (454 CID)	1997	Eng Oil Cooler Line, VIN J, Outlet Hose	800-708
V8 - 7.4L (454 CID)	1996-94	Eng Oil Cooler Line	800-701
V8 - 7.4L (454 CID)	1996-94	Eng Oil Cooler Line, Outlet Hose	800-708
V8 - 7.4L (454 CID)	1993-90	Eng Oil Cooler Line, Outlet Hose	800-708
V8 - 7.4L (454 CID)	1984-83	Eng Oil Cooler Line Fitting	800-812
R,V SERIES PICKUP			
L6 - 4.8L (292 CID)	1988-87	Trans Fluid Cooler Pipe Fitting To Case, (MD8, MT1) Trans	800-755
V6 - 4.3L (262 CID)	1987	Eng Oil Cooler Line	800-811
V6 - 4.3L (262 CID)	1987	Trans Fluid Cooler Pipe Fitting To Case, (MD8, MT1) Trans	800-755
V8 - 5.0L (305 CID)	1987	Eng Oil Cooler Line Fitting	800-812
V8 - 5.0L (305 CID)	1987	Trans Fluid Cooler Pipe Fitting To Case, (MD8, MT1) Trans	800-755
V8 - 5.7L (350 CID)	1991-87	Eng Oil Cooler Line Fitting	800-812
V8 - 5.7L (350 CID)	1991-87	Trans Fluid Cooler Pipe Fitting To Case, (MD8, MT1) Trans	800-755
V8 - 6.2L (379 CID)	1991-87	Eng Oil Cooler Line Connector, 3/8-18 at Case	800-704
V8 - 6.2L (379 CID)	1991-87	Eng Oil Cooler Line Fitting, 1/2-14 at Case	800-711
V8 - 6.2L (379 CID)	1991-87	Eng Oil Cooler Line Fitting, 3/8-18 at Case	800-812
V8 - 6.2L (379 CID)	1991-87	Trans Fluid Cooler Pipe Fitting To Case, (MD8, MT1) Trans	800-755
V8 - 7.4L (454 CID)	1991-87	Trans Fluid Cooler Pipe Fitting To Case, (MD8, MT1) Trans	800-755
V8 - 7.4L (454 CID)	1990-87	Eng Oil Cooler Line Fitting	800-812
S SERIES PICKUP, SONOMA			
L4 - 1.9L (119 CID)	1985-82	Trans Fluid Cooler Pipe Fitting To Case, (M40, MD8, MV4, MV9) Trans	800-755
L4 - 2.0L (122 CID)	1984-83	Trans Fluid Cooler Pipe Fitting To Case, (M40, MD8, MV4, MV9) Trans	800-755
L4 - 2.2L (134 CID)	1997-83	Trans Fluid Cooler Pipe Fitting To Case, (M30, M40, MD8, MV4, MV9) Trans	800-755
L4 - 2.5L (151 CID)	1993-85	Trans Fluid Cooler Pipe Fitting To Case, (M30, MD8, MV9) Trans	800-755
V6 - 2.8L (173 CID)	1993-82	Trans Fluid Cooler Pipe Fitting To Case, (M30, M40, MD8, MV4, MV9) Trans	800-755
V6 - 4.3L (262 CID)	1997-88	Trans Fluid Cooler Pipe Fitting To Case, (M30, MD8, MV9) Trans	800-755
S10 BLAZER			
L4 - 1.9L (119 CID)	1984-83	Trans Fluid Cooler Pipe Fitting To Case, (M40, MD8, MV4, MV9) Trans	800-755
L4 - 2.0L (122 CID)	1984-83	Trans Fluid Cooler Pipe Fitting To Case, (M40, MD8, MV4, MV9) Trans	800-755
L4 - 2.2L (134 CID)	1984	Trans Fluid Cooler Pipe Fitting To Case, (M40, MD8, MV4, MV9) Trans	800-755
L4 - 2.5L (151 CID)	1988-85	Trans Fluid Cooler Pipe Fitting To Case, (MD8, MV9) Trans	800-755
V6 - 2.8L (173 CID)	1990-83	Trans Fluid Cooler Pipe Fitting To Case, (M40, MD8, MV4, MV9) Trans	800-755
V6 - 4.3L (262 CID)	1997-88	Trans Fluid Cooler Pipe Fitting To Case, (M30, MD8, MV9) Trans	800-755
S15 JIMMY			
L4 - 1.9L (119 CID)	1984-83	Trans Fluid Cooler Pipe Fitting To Case, (M40, MD8, MV4, MV9) Trans	800-755
L4 - 2.0L (122 CID)	1984-83	Trans Fluid Cooler Pipe Fitting To Case, (M40, MD8, MV4, MV9) Trans	800-755
L4 - 2.5L (151 CID)	1988-85	Trans Fluid Cooler Pipe Fitting To Case, (MD8, MV9) Trans	800-755
V6 - 2.8L (173 CID)	1990-83	Trans Fluid Cooler Pipe Fitting To Case, (M40, MD8, MV4, MV9) Trans	800-755
V6 - 4.3L (262 CID)	1997-88	Trans Fluid Cooler Pipe Fitting To Case, (M30, MD8, MV9) Trans	800-755
S15 SYCLONE			
V6 - 4.3L (262 CID)	1991	Trans Fluid Cooler Pipe Fitting To Case, (M30, MD8) Trans	800-755
S15 TYPHOON			
V6 - 4.3L (262 CID)	1993-92	Trans Fluid Cooler Pipe Fitting To Case, (M30, MD8) Trans	800-755
SAFARI			
L4 - 2.5L (151 CID)	1990-85	Eng Oil Cooler Line	800-811
L4 - 2.5L (151 CID)	1990-85	Trans Fluid Cooler Pipe Fitting To Case, (M30, MD8) Trans	800-755
V6 - 4.3L (262 CID)	1995-85	Trans Fluid Cooler Pipe Fitting To Case, (M30, MD8) Trans	800-755
V6 - 4.3L (262 CID)	1993-85	Eng Oil Cooler Line	800-811
SAVANA			
V6 - 4.3L (262 CID)	2006-96	Trans Fluid Cooler Pipe Fitting To Case, (MN8, MT1) Trans	800-755
V6 - 4.3L (262 CID)	1996	Trans Fluid Cooler Pipe Fitting Inlet To Case, (M30, MT1) Trans	800-754
V8 - 4.8L (294 CID)	2006-03	Trans Fluid Cooler Pipe Fitting To Case, (MN8, MT1) Trans	800-755
V8 - 5.0L (305 CID)	2002-99	Trans Fluid Cooler Pipe Fitting To Case, (MT1) Trans	800-755
V8 - 5.0L (305 CID)	1996	Trans Fluid Cooler Pipe Fitting Inlet To Case, (M30, MT1) Trans	800-754
V8 - 5.3L (323 CID)	2006-03	Trans Fluid Cooler Pipe Fitting To Case, (MN8, MT1) Trans	800-755
V8 - 5.7L (350 CID)	2002-96	Eng Oil Cooler Line, Connects to Engine	800-603
V8 - 5.7L (350 CID)	2002-96	Trans Fluid Cooler Pipe Fitting To Case, (MT1) Trans	800-755
V8 - 5.7L (350 CID)	1996	Trans Fluid Cooler Pipe Fitting Inlet To Case, (M30, MT1) Trans	800-754
V8 - 6.0L (364 CID)	2006-03	Trans Fluid Cooler Pipe Fitting To Case, (MN8, MT1) Trans	800-755
V8 - 6.5L (395 CID)	2002-96	Eng Oil Cooler Line, 1/2-14 NPT x 18.2	800-705
V8 - 6.5L (395 CID)	2002-96	Eng Oil Cooler Line, 5/8" Conn Asm - 1/2" NP	800-710
V8 - 6.5L (395 CID)	2002-96	Trans Fluid Cooler Pipe Fitting To Case, (MT1) Trans	800-755
V8 - 6.5L (395 CID)	1996	Trans Fluid Cooler Pipe Fitting Inlet To Case, (M30, MT1) Trans	800-754
V8 - 7.4L (454 CID)	2000-96	Eng Oil Cooler Line, VIN J, Inlet Hose, w/Bypass	800-709
V8 - 7.4L (454 CID)	2000-96	Eng Oil Cooler Line, VIN J, wo/Bypass	800-603
V8 - 7.4L (454 CID)	2000-96	Trans Fluid Cooler Pipe Fitting To Case, (MT1) Trans	800-755
V8 - 7.4L (454 CID)	1996	Trans Fluid Cooler Pipe Fitting Inlet To Case, (M30, MT1) Trans	800-754
V8 - 8.1L (496 CID)	2002-01	Eng Oil Cooler Line, 5/8" Conn Asm - 1/2" NP	800-710
V8 - 8.1L (496 CID)	2002-01	Trans Fluid Cooler Pipe Fitting To Case, (MT1) Trans	800-755
SIERRA			
V6 - 4.3L (262 CID)	2004-99	Trans Fluid Cooler Pipe Fitting To Case, (MN8, MT1) Trans	800-755
V8 - 4.8L (294 CID)	2004-99	Trans Fluid Cooler Pipe Fitting To Case, (MN8, MT1) Trans	800-755
V8 - 5.3L (323 CID)	2004-99	Trans Fluid Cooler Pipe Fitting To Case, (MN8, MT1) Trans	800-755
V8 - 6.0L (364 CID)	2004-99	Trans Fluid Cooler Pipe Fitting To Case, (MN8, MT1) Trans	800-755
V8 - 6.0L (364 CID)	2002-01	Trans Oil Cooler Line	800-710
V8 - 6.6L (400 CID)	2006-03	Trans Oil Cooler Line	800-707
V8 - 6.6L (400 CID)	2004-01	Trans Fluid Cooler Pipe Fitting To Case, (MN8, MT1) Trans	800-755
V8 - 6.6L (400 CID)	2002-01	Trans Oil Cooler Line	800-710
V8 - 8.1L (496 CID)	2006-03	Eng Oil Cooler Line	800-712
V8 - 8.1L (496 CID)	2006-03	Trans Oil Cooler Line	800-707
V8 - 8.1L (496 CID)	2004-01	Trans Fluid Cooler Pipe Fitting To Case, (MN8, MT1) Trans	800-755

Quick Disconnect Engine Oil Cooler Line Connector Applications

Make/ Model/Engine	Years	Description	Dorman #
CHEVROLET/GMC TRUCK (continued)			
SIERRA (continued)			
V8 - 8.1L (496 CID)	2002-01	Trans Oil Cooler Line	800-710
SILVERADO			
V6 - 4.3L (262 CID)	2004-99	Trans Fluid Cooler Pipe Fitting To Case, (MN8, MT1) Trans	800-755
V8 - 4.8L (294 CID)	2004-99	Trans Fluid Cooler Pipe Fitting To Case, (MN8, MT1) Trans	800-755
V8 - 5.3L (323 CID)	2004-99	Trans Fluid Cooler Pipe Fitting To Case, (MN8, MT1) Trans	800-755
V8 - 6.0L (364 CID)	2004-99	Trans Fluid Cooler Pipe Fitting To Case, (MN8, MT1) Trans	800-755
V8 - 6.0L (364 CID)	2002-01	Trans Oil Cooler Line	800-710
V8 - 6.6L (400 CID)	2006-03	Trans Oil Cooler Line	800-707
V8 - 6.6L (400 CID)	2004-01	Trans Fluid Cooler Pipe Fitting To Case, (MN8, MT1) Trans	800-755
V8 - 6.6L (400 CID)	2002-01	Trans Oil Cooler Line	800-710
V8 - 8.1L (496 CID)	2006-03	Eng Oil Cooler Line	800-712
V8 - 8.1L (496 CID)	2006-03	Trans Oil Cooler Line	800-707
V8 - 8.1L (496 CID)	2004-01	Trans Fluid Cooler Pipe Fitting To Case, (MN8, MT1) Trans	800-755
V8 - 8.1L (496 CID)	2002-01	Trans Oil Cooler Line	800-710
SPRINT			
L6 - 4.1L (250 CID)	1977-76	Trans Fluid Cooler Pipe Fitting To Case	800-755
V8 - 5.0L (305 CID)	1977-76	Trans Fluid Cooler Pipe Fitting To Case	800-755
V8 - 5.7L (350 CID)	1977-76	Trans Fluid Cooler Pipe Fitting To Case	800-755
V8 - 6.6L (400 CID)	1976	Trans Fluid Cooler Pipe Fitting To Case	800-755
SUBURBAN			
L6 - 4.1L (250 CID)	1980-79	Trans Fluid Cooler Pipe Fitting To Case, (M38, M40, MD8) Trans	800-755
L6 - 4.8L (292 CID)	1986-79	Trans Fluid Cooler Pipe Fitting To Case, (M38, M40, MD8, MV4) Trans	800-755
V8 - 5.0L (305 CID)	1999-96	Trans Fluid Cooler Pipe Fitting Inlet To Case, (M30, MT1) Trans	800-754
V8 - 5.0L (305 CID)	1999-92	Trans Fluid Cooler Pipe Fitting To Case, (M30, MD8, MT1) Trans	800-755
V8 - 5.0L (305 CID)	1987-85	Eng Oil Cooler Line Fitting	800-812
V8 - 5.0L (305 CID)	1987-79	Trans Fluid Cooler Pipe Fitting To Case, (M38, M40, MD8, MT1, MV4) Trans	800-755
V8 - 5.3L (323 CID)	2004-00	Trans Fluid Cooler Pipe Fitting To Case, (MN8, MT1) Trans	800-755
V8 - 5.7L (350 CID)	1999-96	Eng Oil Cooler Line	800-603
V8 - 5.7L (350 CID)	1999-96	Trans Fluid Cooler Pipe Fitting Inlet To Case, (M30, MT1) Trans	800-754
V8 - 5.7L (350 CID)	1999-92	Trans Fluid Cooler Pipe Fitting To Case, (M30, MD8, MT1) Trans	800-755
V8 - 5.7L (350 CID)	1995-92	Eng Oil Cooler Line	800-701
V8 - 5.7L (350 CID)	1991-87	Trans Fluid Cooler Pipe Fitting To Case, (MD8, MT1) Trans	800-755
V8 - 5.7L (350 CID)	1991-85	Eng Oil Cooler Line Fitting	800-812
V8 - 5.7L (350 CID)	1986-79	Trans Fluid Cooler Pipe Fitting To Case, (M38, M40, MD8, MV4) Trans	800-755
V8 - 6.0L (364 CID)	2004-00	Trans Fluid Cooler Pipe Fitting To Case, (MN8, MT1) Trans	800-755
V8 - 6.0L (364 CID)	2002-01	Trans Oil Cooler Line	800-710
V8 - 6.2L (379 CID)	1993-92	Eng Oil Cooler Line	800-704
V8 - 6.2L (379 CID)	1993-92	Eng Oil Cooler Line, Outlet Hose	800-708
V8 - 6.2L (379 CID)	1993-92	Trans Fluid Cooler Pipe Fitting To Case, (M30, MD8, MT1) Trans	800-755
V8 - 6.2L (379 CID)	1991-87	Eng Oil Cooler Line Connector, 3/8-18 at Case	800-704
V8 - 6.2L (379 CID)	1991-87	Eng Oil Cooler Line Fitting, 1/2-14 at Case	800-711
V8 - 6.2L (379 CID)	1991-87	Eng Oil Cooler Line Fitting, 3/8-18 at Case	800-812
V8 - 6.2L (379 CID)	1991-87	Trans Fluid Cooler Pipe Fitting To Case, (MD8, MT1) Trans	800-755
V8 - 6.2L (379 CID)	1986-85	Eng Oil Cooler Line Connector	800-704
V8 - 6.2L (379 CID)	1986-85	Eng Oil Cooler Line Fitting	800-812
V8 - 6.2L (379 CID)	1986-82	Trans Fluid Cooler Pipe Fitting To Case, (M40, MD8, MV4) Trans	800-755
V8 - 6.5L (395 CID)	1999-96	Eng Oil Cooler Line	800-705
V8 - 6.5L (395 CID)	1999-96	Trans Fluid Cooler Pipe Fitting Inlet To Case, (M30, MT1) Trans	800-754
V8 - 6.5L (395 CID)	1999-92	Trans Fluid Cooler Pipe Fitting To Case, (M30, MD8, MT1) Trans	800-755
V8 - 6.5L (395 CID)	1997-96	Eng Oil Cooler Line, 1/2" Line Fitting	800-711
V8 - 6.5L (395 CID)	1996-92	Eng Oil Cooler Line, Outlet Hose	800-708
V8 - 6.5L (395 CID)	1995-92	Eng Oil Cooler Line	800-704
V8 - 6.6L (400 CID)	1980-79	Trans Fluid Cooler Pipe Fitting To Case, (M38, M40, MD8) Trans	800-755
V8 - 7.4L (454 CID)	1999-96	Eng Oil Cooler Line, Inlet Hose, w/Bypass	800-709
V8 - 7.4L (454 CID)	1999-96	Eng Oil Cooler Line, wo/Bypass	800-603
V8 - 7.4L (454 CID)	1999-96	Trans Fluid Cooler Pipe Fitting Inlet To Case, (M30, MT1) Trans	800-754
V8 - 7.4L (454 CID)	1999-92	Trans Fluid Cooler Pipe Fitting To Case, (M30, MD8, MT1) Trans	800-755
V8 - 7.4L (454 CID)	1995-92	Eng Oil Cooler Line, Outlet Hose	800-708
V8 - 7.4L (454 CID)	1991-87	Trans Fluid Cooler Pipe Fitting To Case, (MD8, MT1) Trans	800-755
V8 - 7.4L (454 CID)	1990-85	Eng Oil Cooler Line Fitting	800-812
V8 - 7.4L (454 CID)	1986-79	Trans Fluid Cooler Pipe Fitting To Case, (M38, M40, MD8, MV4) Trans	800-755
V8 - 8.1L (496 CID)	2006-03	Eng Oil Cooler Line	800-712
V8 - 8.1L (496 CID)	2006-03	Trans Oil Cooler Line	800-707
V8 - 8.1L (496 CID)	2004-01	Trans Fluid Cooler Pipe Fitting To Case, (MN8, MT1) Trans	800-755
V8 - 8.1L (496 CID)	2002-01	Trans Oil Cooler Line	800-710
TAHOE			
V8 - 4.8L (294 CID)	2004-00	Trans Fluid Cooler Pipe Fitting To Case, (MN8, MT1) Trans	800-755
V8 - 5.3L (323 CID)	2004-00	Trans Fluid Cooler Pipe Fitting To Case, (MN8, MT1) Trans	800-755
V8 - 5.7L (350 CID)	2000-96	Eng Oil Cooler Line	800-603
V8 - 5.7L (350 CID)	2000-96	Trans Fluid Cooler Pipe Fitting Inlet To Case, (M30, MT1) Trans	800-754
V8 - 5.7L (350 CID)	2000-95	Trans Fluid Cooler Pipe Fitting To Case, (M30, MD8, MT1) Trans	800-755
V8 - 5.7L (350 CID)	1995	Eng Oil Cooler Line	800-701
V8 - 6.5L (395 CID)	1999-97	Eng Oil Cooler Line	800-705
V8 - 6.5L (395 CID)	1999-96	Trans Fluid Cooler Pipe Fitting Inlet To Case, (M30, MT1) Trans	800-754
V8 - 6.5L (395 CID)	1999-95	Trans Fluid Cooler Pipe Fitting To Case, (M30, MD8, MT1) Trans	800-755
V8 - 6.5L (395 CID)	1997-96	Eng Oil Cooler Line, 1/2" Line Fitting	800-711
V8 - 6.5L (395 CID)	1996-95	Eng Oil Cooler Line, Outlet Hose	800-708
V8 - 6.5L (395 CID)	1995	Eng Oil Cooler Line	800-704
YUKON			
V8 - 4.8L (294 CID)	2004-00	Trans Fluid Cooler Pipe Fitting To Case, (MN8, MT1) Trans	800-755
V8 - 5.3L (323 CID)	2004-00	Trans Fluid Cooler Pipe Fitting To Case, (MN8, MT1) Trans	800-755
V8 - 5.7L (350 CID)	2000-96	Eng Oil Cooler Line	800-603
V8 - 5.7L (350 CID)	2000-96	Trans Fluid Cooler Pipe Fitting Inlet To Case, (M30, MT1) Trans	800-754
V8 - 5.7L (350 CID)	2000-92	Trans Fluid Cooler Pipe Fitting To Case, (M30, MD8, MT1) Trans	800-755

Quick Disconnect

Quick Disconnect Engine Oil Cooler Line Connector Applications

Quick Disconnect

Make/ Model/Engine	Years	Description	Dorman #
CHEVROLET/GMC TRUCK (continued)			
YUKON (continued)			
V8 - 5.7L (350 CID)	1995-92	Eng Oil Cooler Line	800-701
V8 - 6.0L (364 CID)	2004-00	Trans Fluid Cooler Pipe Fitting To Case, (MN8, MT1) Trans	800-755
V8 - 6.5L (395 CID)	1999-97	Eng Oil Cooler Line	800-705
V8 - 6.5L (395 CID)	1999-96	Trans Fluid Cooler Pipe Fitting Inlet To Case, (M30, MT1) Trans	800-754
V8 - 6.5L (395 CID)	1999-94	Trans Fluid Cooler Pipe Fitting To Case, (M30, MD8, MT1) Trans	800-755
V8 - 6.5L (395 CID)	1997-96	Eng Oil Cooler Line, 1/2" Line Fitting	800-711
V8 - 6.5L (395 CID)	1996-94	Eng Oil Cooler Line, Outlet Hose	800-708
V8 - 6.5L (395 CID)	1995-94	Eng Oil Cooler Line	800-704
YUKON XL			
V8 - 5.3L (323 CID)	2004-01	Trans Fluid Cooler Pipe Fitting To Case, (MN8, MT1) Trans	800-755
V8 - 6.0L (364 CID)	2004-01	Trans Fluid Cooler Pipe Fitting To Case, (MN8, MT1) Trans	800-755
V8 - 6.0L (364 CID)	2002-01	Trans Oil Cooler Line	800-710
V8 - 8.1L (496 CID)	2006-03	Eng Oil Cooler Line	800-712
V8 - 8.1L (496 CID)	2006-03	Trans Oil Cooler Line	800-707
V8 - 8.1L (496 CID)	2004-01	Trans Fluid Cooler Pipe Fitting To Case, (MN8, MT1) Trans	800-755
V8 - 8.1L (496 CID)	2002-01	Trans Oil Cooler Line	800-710
DODGE TRUCK			
B SERIES VAN			
V6 - 3.9L (239 CID)	1998-97	Trans Oil Cooler Line Connector To Trans, 3 & 4-Speed Trans	800-713
V6 - 3.9L (239 CID)	1996-94	Trans Oil Cooler Line Connector To Trans, 36RH, 42RH Trans	800-713
V6 - 3.9L (239 CID)	1993-90	Trans Oil Cooler Line Connector To Trans, Exc. Diesel Eng	800-713
V8 - 5.2L (318 CID)	1998-97	Trans Oil Cooler Line Connector To Trans, 3 & 4-Speed Trans	800-713
V8 - 5.2L (318 CID)	1996-94	Trans Oil Cooler Line Connector To Trans, 36RH, 42RH Trans	800-713
V8 - 5.2L (318 CID)	1993-90	Trans Oil Cooler Line Connector To Trans, Exc. Diesel Eng	800-713
V8 - 5.9L (360 CID)	1998-97	Trans Oil Cooler Line Connector To Trans, 3 & 4-Speed Trans	800-713
V8 - 5.9L (360 CID)	1996-94	Trans Oil Cooler Line Connector To Trans, 36RH, 42RH Trans	800-713
V8 - 5.9L (360 CID)	1993-90	Trans Oil Cooler Line Connector To Trans, Exc. Diesel Eng	800-713
DAKOTA			
L4 - 2.5L (153 CID)	2003-00	Trans Oil Cooler Line Connector To Trans, 42RE, 46RE Trans	800-713
L4 - 2.5L (153 CID)	1999-97	Trans Oil Cooler Line Connector To Trans, 42RE, 44RE, 46RE Trans	800-713
L4 - 2.5L (153 CID)	1996-94	Trans Oil Cooler Line Connector To Trans, 42RH Trans	800-713
L4 - 2.5L (153 CID)	1993-90	Trans Oil Cooler Line Connector To Trans	800-713
V6 - 3.9L (239 CID)	2003	Trans Oil Cooler Line Connector To Trans, 42RE, 46RE Trans	800-713
V6 - 3.9L (239 CID)	2002-01	Trans Oil Cooler Line Connector From Trans, 46RE Trans	800-751
V6 - 3.9L (239 CID)	2002-01	Trans Oil Cooler Line Connector To Trans, 42RE, 46RE Trans	800-713
V6 - 3.9L (239 CID)	2000	Trans Oil Cooler Line Connector From Trans	800-751
V6 - 3.9L (239 CID)	2000	Trans Oil Cooler Line Connector To Trans, 42RE, 46RE Trans	800-713
V6 - 3.9L (239 CID)	1999-97	Trans Oil Cooler Line Connector From Trans	800-751
V6 - 3.9L (239 CID)	1999-97	Trans Oil Cooler Line Connector To Trans, 42RE, 44RE, 46RE Trans	800-713
V6 - 3.9L (239 CID)	1996-94	Trans Oil Cooler Line Connector To Trans, 42RH Trans	800-713
V6 - 3.9L (239 CID)	1993-90	Trans Oil Cooler Line Connector To Trans	800-713
V8 - 4.7L (287 CID)	2003-00	Trans Oil Cooler Line Connector To Trans, 42RE, 46RE Trans	800-713
V8 - 5.2L (318 CID)	1999-97	Trans Oil Cooler Line Connector From Trans	800-751
V8 - 5.2L (318 CID)	1999-97	Trans Oil Cooler Line Connector To Trans, 42RE, 44RE, 46RE Trans	800-713
V8 - 5.2L (318 CID)	1996-94	Trans Oil Cooler Line Connector To Trans, 42RH Trans	800-713
V8 - 5.2L (318 CID)	1993-90	Trans Oil Cooler Line Connector To Trans	800-713
V8 - 5.9L (360 CID)	2003	Trans Oil Cooler Line Connector To Trans, 42RE, 46RE Trans	800-713
V8 - 5.9L (360 CID)	2002-01	Trans Oil Cooler Line Connector From Trans, 46RE Trans	800-751
V8 - 5.9L (360 CID)	2002-01	Trans Oil Cooler Line Connector To Trans, 42RE, 46RE Trans	800-713
V8 - 5.9L (360 CID)	2000	Trans Oil Cooler Line Connector From Trans	800-751
V8 - 5.9L (360 CID)	2000	Trans Oil Cooler Line Connector To Trans, 42RE, 46RE Trans	800-713
V8 - 5.9L (360 CID)	1999-98	Trans Oil Cooler Line Connector From Trans	800-751
V8 - 5.9L (360 CID)	1999-98	Trans Oil Cooler Line Connector To Trans, 42RE, 44RE, 46RE Trans	800-713
V8 - 5.9L (360 CID)	1997	Trans Oil Cooler Line Connector From Trans	800-751
DURANGO			
V6 - 3.9L (239 CID)	1999-98	Trans Oil Cooler Line Connector To Trans, 42RE, 44RE, 46RE Trans	800-713
V8 - 4.7L (287 CID)	2003-01	Trans Oil Cooler Line Connector To Trans, 46RE Trans	800-713
V8 - 4.7L (287 CID)	2000	Trans Oil Cooler Line Connector To Trans, 42RE, 44RE, 46RE Trans	800-713
V8 - 5.2L (318 CID)	2000	Trans Oil Cooler Line Connector To Trans, 42RE, 44RE, 46RE Trans	800-713
V8 - 5.2L (318 CID)	1999-98	Trans Oil Cooler Line Connector To Trans, 42RE, 44RE, 46RE Trans	800-713
V8 - 5.9L (360 CID)	2003-01	Trans Oil Cooler Line Connector To Trans, 46RE Trans	800-713
V8 - 5.9L (360 CID)	2000	Trans Oil Cooler Line Connector To Trans, 42RE, 44RE, 46RE Trans	800-713
V8 - 5.9L (360 CID)	1999-98	Trans Oil Cooler Line Connector To Trans, 42RE, 44RE, 46RE Trans	800-713
DW SERIES PICKUP			
V6 - 3.9L (239 CID)	1993-90	Trans Oil Cooler Line Connector To Trans, Exc. Diesel Eng	800-713
V8 - 5.2L (318 CID)	1993-90	Trans Oil Cooler Line Connector To Trans, Exc. Diesel Eng	800-713
V8 - 5.9L (360 CID)	1993-90	Trans Oil Cooler Line Connector To Trans, Exc. Diesel Eng	800-713
RAM SERIES PICKUP			
L6 - 5.9L (359 CID)	2003-99	Trans Oil Cooler Line Connector To Trans, 47RE Trans	800-716
L6 - 5.9L (359 CID)	2002-98	Trans Oil Cooler Line Connector To Oil Cooler, Diesel Eng	800-717
L6 - 5.9L (359 CID)	1998-97	Trans Oil Cooler Line Threaded Connector, Diesel Eng	800-715
V6 - 3.9L (239 CID)	2003-01	Trans Oil Cooler Line Connector To Trans, 46RE Trans	800-713
V6 - 3.9L (239 CID)	2003-01	Trans Oil Cooler Line Connector To Trans, 47RE Trans	800-716
V6 - 3.9L (239 CID)	2000-99	Trans Oil Cooler Line Connector To Trans, 42RE, 46RE Trans	800-713
V6 - 3.9L (239 CID)	2000-99	Trans Oil Cooler Line Connector To Trans, 47RE Trans	800-716
V6 - 3.9L (239 CID)	2000	Trans Oil Cooler Line Connector To Oil Cooler, 42RE, 46RE Trans	800-751
V6 - 3.9L (239 CID)	1999-97	Trans Oil Cooler Line Connector To Oil Cooler	800-751
V6 - 3.9L (239 CID)	1999-97	Trans Oil Cooler Line Connector To Trans	800-718
V6 - 3.9L (239 CID)	1998-97	Trans Oil Cooler Line Connector To Trans, 42RE, 46RE, 47RE Trans	800-713
V6 - 3.9L (239 CID)	1996-94	Trans Oil Cooler Line Connector To Trans, 42RH Trans	800-713
V8 - 5.2L (318 CID)	2003-01	Trans Oil Cooler Line Connector To Trans, 46RE Trans	800-713
V8 - 5.2L (318 CID)	2003-01	Trans Oil Cooler Line Connector To Trans, 47RE Trans	800-716
V8 - 5.2L (318 CID)	2001	Trans Oil Cooler Line Connector To Oil Cooler, 46RE Trans	800-751
V8 - 5.2L (318 CID)	2000-99	Trans Oil Cooler Line Connector To Trans, 42RE, 46RE Trans	800-713

Quick Disconnect Engine Oil Cooler Line Connector Applications

Make/ Model/Engine	Years	Description	Dorman #
DODGE TRUCK (continued)			
RAM SERIES PICKUP (continued)			
V8 - 5.2L (318 CID)	2000-99	Trans Oil Cooler Line Connector To Trans, 47RE Trans	800-716
V8 - 5.2L (318 CID)	2000	Trans Oil Cooler Line Connector To Oil Cooler, 42RE, 46RE Trans	800-751
V8 - 5.2L (318 CID)	1999-97	Trans Oil Cooler Line Connector To Oil Cooler	800-751
V8 - 5.2L (318 CID)	1999-97	Trans Oil Cooler Line Connector To Trans	800-718
V8 - 5.2L (318 CID)	1998-97	Trans Oil Cooler Line Connector To Trans, 42RE, 46RE, 47RE Trans	800-713
V8 - 5.2L (318 CID)	1996-94	Trans Oil Cooler Line Connector To Trans, 42RH Trans	800-713
V8 - 5.9L (360 CID)	2003-01	Trans Oil Cooler Line Connector To Trans, 46RE Trans	800-713
V8 - 5.9L (360 CID)	2003-01	Trans Oil Cooler Line Connector To Trans, 47RE Trans	800-716
V8 - 5.9L (360 CID)	2001	Trans Oil Cooler Line Connector To Oil Cooler, 46RE Trans	800-751
V8 - 5.9L (360 CID)	2000-99	Trans Oil Cooler Line Connector To Trans, 42RE, 46RE Trans	800-713
V8 - 5.9L (360 CID)	2000-99	Trans Oil Cooler Line Connector To Trans, 47RE Trans	800-716
V8 - 5.9L (360 CID)	2000	Trans Oil Cooler Line Connector To Oil Cooler, 42RE, 46RE Trans	800-751
V8 - 5.9L (360 CID)	1999-97	Trans Oil Cooler Line Connector To Oil Cooler	800-751
V8 - 5.9L (360 CID)	1999-97	Trans Oil Cooler Line Connector To Trans	800-718
V8 - 5.9L (360 CID)	1998-97	Trans Oil Cooler Line Connector To Trans, 42RE, 46RE, 47RE Trans	800-713
V8 - 5.9L (360 CID)	1996-94	Trans Oil Cooler Line Connector To Trans, 42RH Trans	800-713
RAM SERIES VAN			
V6 - 3.9L (239 CID)	2003-99	Trans Oil Cooler Line Connector To Trans, 3 & 4-Speed Trans	800-713
V8 - 5.2L (318 CID)	2003-99	Trans Oil Cooler Line Connector To Trans, 3 & 4-Speed Trans	800-713
V8 - 5.9L (360 CID)	2003-99	Trans Oil Cooler Line Connector To Trans, 3 & 4-Speed Trans	800-713
FORD			
COUNTRY SQUIRE			
V8 - 5.0L (302 CID)	1991-89	Connector Oil Cooler Tube, AOD & 4R70W Trans	800-753
V8 - 5.0L (302 CID)	1988	Connector Oil Cooler Tube, AOD Trans, From 4/18/88	800-753
V8 - 5.0L (302 CID)	1982	Connector Oil Cooler Tube, AOD Trans, To 6/15/82	800-753
V8 - 5.0L (302 CID)	1981	Connector Oil Cooler Tube, C4 & AOD Trans, From 1/5/81	800-753
V8 - 5.0L (302 CID)	1980-79	Connector Oil Cooler Tube, C6 Trans	800-753
V8 - 5.8L (351 CID)	1981	Connector Oil Cooler Tube, C4 & AOD Trans, From 1/5/81	800-753
V8 - 5.8L (351 CID)	1980-79	Connector Oil Cooler Tube, C6 Trans	800-753
V8 - 6.6L (400 CID)	1978-77	Connector Oil Cooler Tube, C6 Trans	800-753
V8 - 7.5L (460 CID)	1978-77	Connector Oil Cooler Tube, C6 Trans	800-753
CROWN VICTORIA			
V8 - 4.6L (281 CID)	2006-92	Connector Oil Cooler Tube, AOD & 4R70W Trans	800-753
V8 - 5.0L (302 CID)	1991-89	Connector Oil Cooler Tube, AOD & 4R70W Trans	800-753
V8 - 5.0L (302 CID)	1988	Connector Oil Cooler Tube, AOD Trans, From 4/18/88	800-753
V8 - 5.8L (351 CID)	1991-89	Connector Oil Cooler Tube, AOD & 4R70W Trans	800-753
V8 - 5.8L (351 CID)	1988	Connector Oil Cooler Tube, AOD Trans, From 4/18/88	800-753
CUSTOM 500			
V8 - 5.8L (351 CID)	1977	Connector Oil Cooler Tube, C6 Trans	800-753
V8 - 6.6L (400 CID)	1977	Connector Oil Cooler Tube, C6 Trans	800-753
ESCORT			
L4 - 1.6L (98 CID)	1983-81	Connector Oil Cooler Tube, w/Tapered Diff. Ball Bearing, ATX Trans	800-753
EXP			
L4 - 1.6L (98 CID)	1983-82	Connector Oil Cooler Tube, w/Tapered Diff. Ball Bearing, ATX Trans	800-753
FAIRMONT			
L4 - 2.3L (140 CID)	1983-80	Connector Oil Cooler Tube, C3 Trans	800-753
L4 - 2.3L (140 CID)	1981	Connector Oil Cooler Tube, C4 Trans, From 1/5/81	800-753
L4 - 2.3L (140 CID)	1978	Connector Oil Cooler Tube, C6 Trans	800-753
L6 - 3.3L (200 CID)	1983-80	Connector Oil Cooler Tube, C3 Trans	800-753
L6 - 3.3L (200 CID)	1982	Connector Oil Cooler Tube, C5 Trans	800-753
L6 - 3.3L (200 CID)	1981	Connector Oil Cooler Tube, C4 Trans, From 1/5/81	800-753
V8 - 4.2L (255 CID)	1982-80	Connector Oil Cooler Tube, C3 Trans	800-753
V8 - 4.2L (255 CID)	1982	Connector Oil Cooler Tube, C5 Trans	800-753
V8 - 4.2L (255 CID)	1981	Connector Oil Cooler Tube, C4 Trans, From 1/5/81	800-753
GRANADA			
L4 - 2.3L (140 CID)	1982-81	Connector Oil Cooler Tube, C3 Trans	800-753
L4 - 2.3L (140 CID)	1981	Connector Oil Cooler Tube, C4 Trans, From 1/5/81	800-753
L6 - 3.3L (200 CID)	1982-81	Connector Oil Cooler Tube, C3 Trans	800-753
L6 - 3.3L (200 CID)	1982	Connector Oil Cooler Tube, C5 Trans	800-753
L6 - 3.3L (200 CID)	1981	Connector Oil Cooler Tube, C4 Trans, From 1/5/81	800-753
L6 - 4.1L (250 CID)	1980	Connector Oil Cooler Tube, C3 Trans	800-753
V6 - 3.8L (232 CID)	1982	Connector Oil Cooler Tube, C3 Trans	800-753
V8 - 4.2L (255 CID)	1981-80	Connector Oil Cooler Tube, C3 Trans	800-753
V8 - 4.2L (255 CID)	1981	Connector Oil Cooler Tube, C4 Trans, From 1/5/81	800-753
V8 - 5.0L (302 CID)	1980	Connector Oil Cooler Tube, C3 Trans	800-753
LTD			
L4 - 2.3L (140 CID)	1986-83	Connector Oil Cooler Tube, C3 Trans	800-753
L6 - 3.3L (200 CID)	1983	Connector Oil Cooler Tube, C3 Trans	800-753
V6 - 3.8L (232 CID)	1986-83	Connector Oil Cooler Tube, C3 Trans	800-753
V8 - 4.2L (255 CID)	1982	Connector Oil Cooler Tube, AOD Trans, To 6/15/82	800-753
V8 - 4.2L (255 CID)	1981	Connector Oil Cooler Tube, C4 & AOD Trans, From 1/5/81	800-753
V8 - 5.0L (302 CID)	1985-84	Connector Oil Cooler Tube, C3 Trans	800-753
V8 - 5.0L (302 CID)	1982	Connector Oil Cooler Tube, AOD Trans, To 6/15/82	800-753
V8 - 5.0L (302 CID)	1981	Connector Oil Cooler Tube, C4 & AOD Trans, From 1/5/81	800-753
V8 - 5.0L (302 CID)	1980-77	Connector Oil Cooler Tube, C6 Trans	800-753
V8 - 5.8L (351 CID)	1982	Connector Oil Cooler Tube, AOD Trans, To 6/15/82	800-753
V8 - 5.8L (351 CID)	1981	Connector Oil Cooler Tube, C4 & AOD Trans, From 1/5/81	800-753
V8 - 5.8L (351 CID)	1980-77	Connector Oil Cooler Tube, C6 Trans	800-753
V8 - 6.6L (400 CID)	1978-77	Connector Oil Cooler Tube, C6 Trans	800-753
V8 - 7.5L (460 CID)	1978-77	Connector Oil Cooler Tube, C6 Trans	800-753
LTD II			
V8 - 5.0L (302 CID)	1979-77	Connector Oil Cooler Tube, C6 Trans	800-753
V8 - 5.8L (351 CID)	1979-77	Connector Oil Cooler Tube, C6 Trans	800-753
V8 - 6.6L (400 CID)	1978-77	Connector Oil Cooler Tube, C6 Trans	800-753

Quick Disconnect

Quick Disconnect Engine Oil Cooler Line Connector Applications

Make/ Model/Engine	Years	Description	Dorman #
FORD (continued)			
MUSTANG			
L4 - 2.3L (140 CID)	1993-90	Connector Oil Cooler Tube, AOD & 4R70W Trans	800-753
L4 - 2.3L (140 CID)	1989	Connector Oil Cooler Tube, AOD Trans	800-753
L4 - 2.3L (140 CID)	1988	Connector Oil Cooler Tube, AOD Trans, From 4/18/88	800-753
L4 - 2.3L (140 CID)	1986-80	Connector Oil Cooler Tube, C3 Trans	800-753
L4 - 2.3L (140 CID)	1981	Connector Oil Cooler Tube, C4 Trans, From 1/5/81	800-753
L6 - 3.3L (200 CID)	1982-80	Connector Oil Cooler Tube, C3 Trans	800-753
L6 - 3.3L (200 CID)	1982	Connector Oil Cooler Tube, C5 Trans	800-753
L6 - 3.3L (200 CID)	1981	Connector Oil Cooler Tube, C4 Trans, From 1/5/81	800-753
V6 - 3.8L (232 CID)	2004-94	Connector Oil Cooler Tube, AOD & 4R70W Trans	800-753
V6 - 3.8L (232 CID)	1986-83	Connector Oil Cooler Tube, C3 Trans	800-753
V8 - 4.2L (255 CID)	1982-80	Connector Oil Cooler Tube, C3 Trans	800-753
V8 - 4.2L (255 CID)	1982	Connector Oil Cooler Tube, C5 Trans	800-753
V8 - 4.2L (255 CID)	1981	Connector Oil Cooler Tube, C4 Trans, From 1/5/81	800-753
V8 - 4.6L (281 CID)	2004-96	Connector Oil Cooler Tube, AOD & 4R70W Trans	800-753
V8 - 5.0L (302 CID)	1995-90	Connector Oil Cooler Tube, AOD & 4R70W Trans	800-753
V8 - 5.0L (302 CID)	1989	Connector Oil Cooler Tube, AOD Trans	800-753
V8 - 5.0L (302 CID)	1988	Connector Oil Cooler Tube, AOD Trans, From 4/18/88	800-753
V8 - 5.0L (302 CID)	1986-82	Connector Oil Cooler Tube, C3 Trans	800-753
V8 - 5.0L (302 CID)	1982	Connector Oil Cooler Tube, C5 Trans	800-753
V8 - 5.8L (351 CID)	1995	Connector Oil Cooler Tube, AOD & 4R70W Trans	800-753
PINTO			
L4 - 2.3L (140 CID)	1980	Connector Oil Cooler Tube, C3 Trans	800-753
RANCHERO			
V8 - 5.0L (302 CID)	1979-77	Connector Oil Cooler Tube, C6 Trans	800-753
V8 - 5.8L (351 CID)	1979-77	Connector Oil Cooler Tube, C6 Trans	800-753
V8 - 6.6L (400 CID)	1978-77	Connector Oil Cooler Tube, C6 Trans	800-753
V8 - 7.5L (460 CID)	1977	Connector Oil Cooler Tube, C6 Trans	800-753
THUNDERBIRD			
L4 - 2.3L (140 CID)	1986-83	Connector Oil Cooler Tube, C3 Trans	800-753
L6 - 3.3L (200 CID)	1982-80	Connector Oil Cooler Tube, C3 Trans	800-753
L6 - 3.3L (200 CID)	1982	Connector Oil Cooler Tube, AOD Trans, To 6/15/82	800-753
L6 - 3.3L (200 CID)	1982	Connector Oil Cooler Tube, C5 w/PEB Trans	800-753
L6 - 3.3L (200 CID)	1981	Connector Oil Cooler Tube, C4 & AOD Trans, From 1/5/81	800-753
V6 - 3.8L (232 CID)	1997-90	Connector Oil Cooler Tube, AOD & 4R70W Trans	800-753
V6 - 3.8L (232 CID)	1989	Connector Oil Cooler Tube, AOD Trans	800-753
V6 - 3.8L (232 CID)	1986-82	Connector Oil Cooler Tube, C3 Trans	800-753
V6 - 3.8L (232 CID)	1982	Connector Oil Cooler Tube, AOD Trans, To 6/15/82	800-753
V8 - 4.2L (255 CID)	1982-80	Connector Oil Cooler Tube, C3 Trans	800-753
V8 - 4.2L (255 CID)	1982	Connector Oil Cooler Tube, AOD Trans, To 6/15/82	800-753
V8 - 4.2L (255 CID)	1981	Connector Oil Cooler Tube, C4 & AOD Trans, From 1/5/81	800-753
V8 - 4.6L (281 CID)	1997-94	Connector Oil Cooler Tube, AOD & 4R70W Trans	800-753
V8 - 5.0L (302 CID)	1993-91	Connector Oil Cooler Tube, AOD & 4R70W Trans	800-753
V8 - 5.0L (302 CID)	1986-80	Connector Oil Cooler Tube, C3 Trans	800-753
V8 - 5.0L (302 CID)	1981	Connector Oil Cooler Tube, C4 & AOD Trans, From 1/5/81	800-753
V8 - 5.0L (302 CID)	1979-77	Connector Oil Cooler Tube, C6 Trans	800-753
V8 - 5.8L (351 CID)	1979-77	Connector Oil Cooler Tube, C6 Trans	800-753
V8 - 6.6L (400 CID)	1978-77	Connector Oil Cooler Tube, C6 Trans	800-753
FORD TRUCK			
AEROSTAR			
L4 - 2.3L (140 CID)	1987-86	Connector Oil Cooler Tube, A4LD Trans	800-753
V6 - 2.8L (171 CID)	1986	Connector Oil Cooler Tube, A4LD Trans	800-753
V6 - 3.0L (182 CID)	1995-90	Connector Oil Cooler Tube, C6 & AOD Trans	800-753
V6 - 3.0L (182 CID)	1987-86	Connector Oil Cooler Tube, A4LD Trans	800-753
V6 - 4.0L (245 CID)	1995-90	Connector Oil Cooler Tube, C6 & AOD Trans	800-753
BRONCO			
L6 - 4.9L (300 CID)	1993-80	Connector Oil Cooler Tube, C6 & AOD Trans	800-753
L6 - 4.9L (300 CID)	1989-82	Connector Oil Cooler Tube, AOT-(F10D) Trans	800-753
L6 - 4.9L (300 CID)	1981	Connector Oil Cooler Tube, AOT-(F10D) Trans, From 5/1/81	800-753
V8 - 5.0L (302 CID)	1995-77	Connector Oil Cooler Tube, C6 & AOD Trans	800-753
V8 - 5.0L (302 CID)	1989-82	Connector Oil Cooler Tube, AOT-(F10D) Trans	800-753
V8 - 5.0L (302 CID)	1981	Connector Oil Cooler Tube, AOT-(F10D) Trans, From 5/1/81	800-753
V8 - 5.8L (351 CID)	1995-78	Connector Oil Cooler Tube, C6 & AOD Trans	800-753
V8 - 5.8L (351 CID)	1989-82	Connector Oil Cooler Tube, AOT-(F10D) Trans	800-753
V8 - 5.8L (351 CID)	1981	Connector Oil Cooler Tube, AOT-(F10D) Trans, From 5/1/81	800-753
V8 - 6.6L (400 CID)	1979-78	Connector Oil Cooler Tube, C6 Trans	800-753
BRONCO II			
V6 - 2.8L (171 CID)	1985-84	Connector Oil Cooler Tube, C5 Trans	800-753
V6 - 2.8L (171 CID)	1985	Connector Oil Cooler Tube, A4LD Trans	800-753
V6 - 2.9L (177 CID)	1990	Connector Oil Cooler Tube, C6 & AOD Trans	800-753
V6 - 2.9L (177 CID)	1987-86	Connector Oil Cooler Tube, A4LD Trans	800-753
V6 - 2.9L (177 CID)	1986	Connector Oil Cooler Tube, C5 Trans	800-753
E SERIES VAN			
L6 - 3.9L (240 CID)	1974-73	Connector Oil Cooler Tube, C6 Trans	800-753
L6 - 4.9L (300 CID)	1996-94	Connector Oil Cooler Tube, 4R70W Trans	800-753
L6 - 4.9L (300 CID)	1995-89	Connector Oil Cooler Tube, wo/Cooler Bypass Tube, E40D Trans	800-753
L6 - 4.9L (300 CID)	1995-73	Connector Oil Cooler Tube, C6 & AOD Trans	800-753
L6 - 4.9L (300 CID)	1989-83	Connector Oil Cooler Tube, AOT-(F10D) Trans	800-753
V6 - 4.2L (256 CID)	2003-97	Connector Oil Cooler Tube, 4R70W & 4R75W Trans	800-753
V8 - 4.6L (281 CID)	2006-97	Connector Oil Cooler Tube, 4R70W & 4R75W Trans	800-753
V8 - 5.0L (302 CID)	1996-94	Connector Oil Cooler Tube, 4R70W & 4R75W Trans	800-753
V8 - 5.0L (302 CID)	1995-89	Connector Oil Cooler Tube, wo/Cooler Bypass Tube, E40D Trans	800-753
V8 - 5.0L (302 CID)	1995-73	Connector Oil Cooler Tube, C6 & AOD Trans	800-753
V8 - 5.0L (302 CID)	1989-83	Connector Oil Cooler Tube, AOT-(F10D) Trans	800-753
V8 - 5.4L (330 CID)	2006-97	Connector Oil Cooler Tube, 4R70W & 4R75W Trans	800-753

Quick Disconnect Engine Oil Cooler Line Connector Applications

Make/ Model/Engine	Years	Description	Dorman #
FORD TRUCK (continued)			
E SERIES VAN (continued)			
V8 - 5.8L (351 CID)	1996-94	Connector Oil Cooler Tube, 4R70W & 4R75W Trans	800-753
V8 - 5.8L (351 CID)	1995-89	Connector Oil Cooler Tube, wo/Cooler Bypass Tube, E40D Trans	800-753
V8 - 5.8L (351 CID)	1995-75	Connector Oil Cooler Tube, C6 & AOD Trans	800-753
V8 - 5.8L (351 CID)	1989-83	Connector Oil Cooler Tube, AOT-(F10D) Trans	800-753
V8 - 6.0L (363 CID)	2006-05	Connector Oil Cooler Tube, 4R70W & 4R75W Trans	800-753
V8 - 6.6L (400 CID)	1982-80	Connector Oil Cooler Tube, C6 Trans	800-753
V8 - 6.9L (420 CID)	1987-83	Connector Oil Cooler Tube, AOT-(F10D) Trans	800-753
V8 - 6.9L (420 CID)	1987-83	Connector Oil Cooler Tube, C6 Trans	800-753
V8 - 7.3L (445 CID)	1995-89	Connector Oil Cooler Tube, wo/Cooler Bypass Tube, E40D Trans	800-753
V8 - 7.3L (445 CID)	1995-88	Connector Oil Cooler Tube, C6 & AOD Trans	800-753
V8 - 7.3L (445 CID)	1989-88	Connector Oil Cooler Tube, AOT-(F10D) Trans	800-753
V8 - 7.5L (460 CID)	1995-89	Connector Oil Cooler Tube, wo/Cooler Bypass Tube, E40D Trans	800-753
V8 - 7.5L (460 CID)	1995-75	Connector Oil Cooler Tube, C6 & AOD Trans	800-753
V8 - 7.5L (460 CID)	1989-83	Connector Oil Cooler Tube, AOT-(F10D) Trans	800-753
V10 - 6.8L (415 CID)	2006-97	Connector Oil Cooler Tube, 4R70W & 4R75W Trans	800-753
EXPEDITION			
V8 - 4.6L (281 CID)	2006-97	Connector Oil Cooler Tube, 4R70W & 4R75W Trans	800-753
V8 - 5.4L (330 CID)	2006-97	Connector Oil Cooler Tube, 4R70W & 4R75W Trans	800-753
EXPLORER			
V6 - 4.0L (245 CID)	1995-94	Connector Oil Cooler Tube, C6 Trans	800-753
V6 - 4.0L (245 CID)	1993-91	Connector Oil Cooler Tube, C6 & AOD Trans	800-753
V8 - 5.0L (302 CID)	2001-96	Connector Oil Cooler Tube, 4R70W & 4R75W Trans	800-758
F SERIES PICKUP			
L6 - 3.9L (240 CID)	1976-73	Connector Oil Cooler Tube, C6 Trans	800-753
L6 - 4.9L (300 CID)	1996-94	Connector Oil Cooler Tube, 4R70W & 4R75W Trans	800-753
L6 - 4.9L (300 CID)	1995-89	Connector Oil Cooler Tube, wo/Cooler Bypass Tube, E40D Trans	800-753
L6 - 4.9L (300 CID)	1995-73	Connector Oil Cooler Tube, C6 & AOD Trans	800-753
L6 - 4.9L (300 CID)	1989-82	Connector Oil Cooler Tube, AOT-(F10D) Trans	800-753
L6 - 4.9L (300 CID)	1986-82	Connector Oil Cooler Tube, C5 Trans	800-753
L6 - 4.9L (300 CID)	1981	Connector Oil Cooler Tube, AOT-(F10D) Trans, From 5/1/81	800-753
L6 - 4.9L (300 CID)	1981	Connector Oil Cooler Tube, C4 Trans, From 1/5/81	800-753
V6 - 3.8L (232 CID)	1983-82	Connector Oil Cooler Tube, AOT-(F10D) Trans	800-753
V6 - 3.8L (232 CID)	1983-82	Connector Oil Cooler Tube, C5 Trans	800-753
V6 - 3.8L (232 CID)	1983-82	Connector Oil Cooler Tube, C6 Trans	800-753
V6 - 4.2L (256 CID)	2006-97	Connector Oil Cooler Tube, 4R70W & 4R75W Trans	800-753
V6 - 4.2L (256 CID)	1998-97	Connector Oil Cooler Tube, 4R70W & 4R75W Trans	800-753
V8 - 4.2L (255 CID)	1982-81	Connector Oil Cooler Tube, C6 Trans	800-753
V8 - 4.2L (255 CID)	1982	Connector Oil Cooler Tube, AOT-(F10D) Trans	800-753
V8 - 4.2L (255 CID)	1982	Connector Oil Cooler Tube, C5 Trans	800-753
V8 - 4.2L (255 CID)	1981	Connector Oil Cooler Tube, AOT-(F10D) Trans, From 5/1/81	800-753
V8 - 4.2L (255 CID)	1981	Connector Oil Cooler Tube, C4 Trans, From 1/5/81	800-753
V8 - 4.6L (281 CID)	2006-97	Connector Oil Cooler Tube, 4R70W & 4R75W Trans	800-753
V8 - 5.0L (302 CID)	1996-94	Connector Oil Cooler Tube, 4R70W & 4R75W Trans	800-753
V8 - 5.0L (302 CID)	1995-89	Connector Oil Cooler Tube, wo/Cooler Bypass Tube, E40D Trans	800-753
V8 - 5.0L (302 CID)	1995-73	Connector Oil Cooler Tube, C6 & AOD Trans	800-753
V8 - 5.0L (302 CID)	1989-82	Connector Oil Cooler Tube, AOT-(F10D) Trans	800-753
V8 - 5.0L (302 CID)	1986-82	Connector Oil Cooler Tube, C5 Trans	800-753
V8 - 5.0L (302 CID)	1981	Connector Oil Cooler Tube, AOT-(F10D) Trans, From 5/1/81	800-753
V8 - 5.0L (302 CID)	1981	Connector Oil Cooler Tube, C4 Trans, From 1/5/81	800-753
V8 - 5.4L (330 CID)	2006-97	Connector Oil Cooler Tube, 4R70W & 4R75W Trans	800-753
V8 - 5.8L (351 CID)	1997-94	Connector Oil Cooler Tube, 4R70W & 4R75W Trans	800-753
V8 - 5.8L (351 CID)	1995-89	Connector Oil Cooler Tube, wo/Cooler Bypass Tube, E40D Trans	800-753
V8 - 5.8L (351 CID)	1995-77	Connector Oil Cooler Tube, C6 & AOD Trans	800-753
V8 - 5.8L (351 CID)	1989-82	Connector Oil Cooler Tube, AOT-(F10D) Trans	800-753
V8 - 5.8L (351 CID)	1986-82	Connector Oil Cooler Tube, C5 Trans	800-753
V8 - 5.8L (351 CID)	1981	Connector Oil Cooler Tube, AOT-(F10D) Trans, From 5/1/81	800-753
V8 - 5.8L (351 CID)	1981	Connector Oil Cooler Tube, C4 Trans, From 1/5/81	800-753
V8 - 5.9L (360 CID)	1976-73	Connector Oil Cooler Tube, C6 Trans	800-753
V8 - 6.4L (390 CID)	1976-73	Connector Oil Cooler Tube, C6 Trans	800-753
V8 - 6.6L (400 CID)	1982-77	Connector Oil Cooler Tube, C6 Trans	800-753
V8 - 6.6L (400 CID)	1982	Connector Oil Cooler Tube, AOT-(F10D) Trans	800-753
V8 - 6.6L (400 CID)	1981	Connector Oil Cooler Tube, AOT-(F10D) Trans, From 5/1/81	800-753
V8 - 6.9L (420 CID)	1987-83	Connector Oil Cooler Tube, AOT-(F10D) Trans	800-753
V8 - 6.9L (420 CID)	1987-83	Connector Oil Cooler Tube, C6 Trans	800-753
V8 - 6.9L (420 CID)	1984	Connector Oil Cooler Tube, C5 Trans	800-753
V8 - 7.3L (445 CID)	1999-97	Connector Oil Cooler Tube, 4R70W & 4R75W Trans	800-753
V8 - 7.3L (445 CID)	1995-89	Connector Oil Cooler Tube, wo/Cooler Bypass Tube, E40D Trans	800-753
V8 - 7.3L (445 CID)	1995-88	Connector Oil Cooler Tube, C6 & AOD Trans	800-753
V8 - 7.3L (445 CID)	1989-88	Connector Oil Cooler Tube, AOT-(F10D) Trans	800-753
V8 - 7.5L (460 CID)	1997	Connector Oil Cooler Tube, 4R70W & 4R75W Trans	800-753
V8 - 7.5L (460 CID)	1995-89	Connector Oil Cooler Tube, wo/Cooler Bypass Tube, E40D Trans	800-753
V8 - 7.5L (460 CID)	1995-73	Connector Oil Cooler Tube, C6 & AOD Trans	800-753
V8 - 7.5L (460 CID)	1989-83	Connector Oil Cooler Tube, AOT-(F10D) Trans	800-753
V10 - 6.8L (415 CID)	1999	Connector Oil Cooler Tube, 4R70W & 4R75W Trans	800-753
F53 STRIPPED CHASSIS			
V8 - 7.5L (460 CID)	1995-90	Connector Oil Cooler Tube, C6 & AOD Trans	800-753
V8 - 7.5L (460 CID)	1995-89	Connector Oil Cooler Tube, wo/Cooler Bypass Tube, E40D Trans	800-753
F59 STRIPPED CHASSIS			
V8 - 7.3L (445 CID)	1994-90	Connector Oil Cooler Tube, C6 & AOD Trans	800-753
V8 - 7.3L (445 CID)	1994-89	Connector Oil Cooler Tube, wo/Cooler Bypass Tube, E40D Trans	800-753
RANGER			
L4 - 2.0L (122 CID)	1987-85	Connector Oil Cooler Tube, A4LD Trans	800-753
L4 - 2.3L (140 CID)	1995-94	Connector Oil Cooler Tube, C6 Trans	800-753
L4 - 2.3L (140 CID)	1993-90	Connector Oil Cooler Tube, C6 & AOD Trans	800-753
L4 - 2.3L (140 CID)	1987-85	Connector Oil Cooler Tube, A4LD Trans	800-753

**Fuel Sending
Units**
pg. 155-176

**Fuel
Tanks**
pg. 177-228

**Harmonic
Balancers**
pg. 229-254

**Heater Hose
Assemblies**
pg. 255-256

**Hydraulic
Clutch Lines**
pg. 257-260

**Use Quick Disconnect Fittings &
Clips for Fast, Economical Repairs**

Quick Disconnect
385

Quick Disconnect

Quick Disconnect Engine Oil Cooler Line Connector Applications

Make/ Model/Engine	Years	Description	Dorman #
FORD TRUCK (continued)			
RANGER (continued)			
V6 - 2.8L (171 CID)	1985	Connector Oil Cooler Tube, A4LD Trans	800-753
V6 - 2.9L (177 CID)	1992-90	Connector Oil Cooler Tube, C6 & AOD Trans	800-753
V6 - 2.9L (177 CID)	1987-86	Connector Oil Cooler Tube, A4LD Trans	800-753
V6 - 3.0L (182 CID)	1995-91	Connector Oil Cooler Tube, C6 & AOD Trans	800-753
V6 - 4.0L (245 CID)	1995-94	Connector Oil Cooler Tube, C6 Trans	800-753
V6 - 4.0L (245 CID)	1993-90	Connector Oil Cooler Tube, C6 & AOD Trans	800-753
WINDSTAR			
V6 - 3.0L (182 CID)	1995	Connector Oil Cooler Tube, C6 Trans	800-753
V6 - 3.8L (232 CID)	1995	Connector Oil Cooler Tube, C6 Trans	800-753
JEEP			
CHEROKEE			
L4 - 2.5L (150 CID)	2001-94	Trans Oil Cooler Line Connector To Trans, 4-Speed Trans	800-714
L4 - 2.5L (150 CID)	1993	Trans Oil Cooler Line Connector To Trans	800-714
L4 - 2.5L (150 CID)	1992-91	Trans Oil Cooler Line Connector To Trans	800-714
L4 - 2.5L (150 CID)	1990-87	Trans Oil Cooler Line Connector To Trans	800-714
L6 - 4.0L (242 CID)	2001-94	Trans Oil Cooler Line Connector To Trans, 4-Speed Trans	800-714
L6 - 4.0L (242 CID)	1993	Trans Oil Cooler Line Connector To Trans	800-714
L6 - 4.0L (242 CID)	1992-91	Trans Oil Cooler Line Connector To Trans	800-714
L6 - 4.0L (242 CID)	1990-87	Trans Oil Cooler Line Connector To Trans	800-714
COMANCHE			
L4 - 2.5L (150 CID)	1992-91	Trans Oil Cooler Line Connector To Trans	800-714
L4 - 2.5L (150 CID)	1990-87	Trans Oil Cooler Line Connector To Trans	800-714
L6 - 4.0L (242 CID)	1992-91	Trans Oil Cooler Line Connector To Trans	800-714
L6 - 4.0L (242 CID)	1990-87	Trans Oil Cooler Line Connector To Trans	800-714
GRAND CHEROKEE			
L6 - 4.0L (242 CID)	1993	Trans Oil Cooler Line Connector To Trans, AW4 Trans	800-714
V8 - 5.2L (318 CID)	1993	Trans Oil Cooler Line Connector To Trans, AW4 Trans	800-714
WAGONEER			
L4 - 2.5L (150 CID)	1990-87	Trans Oil Cooler Line Connector To Trans	800-714
L6 - 4.0L (242 CID)	1990-87	Trans Oil Cooler Line Connector To Trans	800-714
LINCOLN			
CONTINENTAL			
V8 - 5.0L (302 CID)	1981	Connector Oil Cooler Tube, AOD Trans, From 5/1/81	800-753
V8 - 6.6L (400 CID)	1979-77	Connector Oil Cooler Tube, C6 Trans	800-753
V8 - 7.5L (460 CID)	1978-77	Connector Oil Cooler Tube, C6 Trans	800-753
MARK V			
V8 - 6.6L (400 CID)	1979-77	Connector Oil Cooler Tube, C6 Trans	800-753
V8 - 7.5L (460 CID)	1978-77	Connector Oil Cooler Tube, C6 Trans	800-753
MARK VI			
V8 - 5.0L (302 CID)	1982	Connector Oil Cooler Tube, AOD Trans, To 6/15/82	800-753
V8 - 5.0L (302 CID)	1981	Connector Oil Cooler Tube, AOD Trans, From 5/1/81	800-753
MARK VII			
V8 - 5.0L (302 CID)	1992-89	Connector Oil Cooler Tube, AOD & 4R70W Trans	800-753
V8 - 5.0L (302 CID)	1988	Connector Oil Cooler Tube, AOD Trans, From 4/18/88	800-753
MARK VIII			
V8 - 4.6L (281 CID)	1998-93	Connector Oil Cooler Tube, AOD & 4R70W Trans	800-753
TOWN CAR			
V8 - 4.6L (281 CID)	2006-91	Connector Oil Cooler Tube, AOD & 4R70W Trans	800-753
V8 - 5.0L (302 CID)	1990-89	Connector Oil Cooler Tube, AOD & 4R70W Trans	800-753
V8 - 5.0L (302 CID)	1988	Connector Oil Cooler Tube, AOD Trans, From 4/18/88	800-753
MERCURY			
BOBCAT			
L4 - 2.3L (140 CID)	1980	Connector Oil Cooler Tube, C3 Trans	800-753
CAPRI			
L4 - 2.3L (140 CID)	1986-80	Connector Oil Cooler Tube, C3 Trans	800-753
L4 - 2.3L (140 CID)	1981	Connector Oil Cooler Tube, C4 Trans, From 1/5/81	800-753
L4 - 2.3L (140 CID)	1979	Connector Oil Cooler Tube, C6 Trans	800-753
L6 - 3.3L (200 CID)	1982-80	Connector Oil Cooler Tube, C3 Trans	800-753
L6 - 3.3L (200 CID)	1982	Connector Oil Cooler Tube, C5 Trans	800-753
L6 - 3.3L (200 CID)	1981	Connector Oil Cooler Tube, C4 Trans, From 1/5/81	800-753
L6 - 3.3L (200 CID)	1979	Connector Oil Cooler Tube, C6 Trans	800-753
V6 - 2.8L (171 CID)	1979	Connector Oil Cooler Tube, C6 Trans	800-753
V6 - 3.8L (232 CID)	1986-83	Connector Oil Cooler Tube, C3 Trans	800-753
V8 - 4.2L (255 CID)	1982-80	Connector Oil Cooler Tube, C3 Trans	800-753
V8 - 4.2L (255 CID)	1982	Connector Oil Cooler Tube, C5 Trans	800-753
V8 - 4.2L (255 CID)	1981	Connector Oil Cooler Tube, C4 Trans, From 1/5/81	800-753
V8 - 5.0L (302 CID)	1986-82	Connector Oil Cooler Tube, C3 Trans	800-753
V8 - 5.0L (302 CID)	1982	Connector Oil Cooler Tube, C5 Trans	800-753
V8 - 5.0L (302 CID)	1979	Connector Oil Cooler Tube, C6 Trans	800-753
COLONY PARK			
V8 - 5.0L (302 CID)	1991-89	Connector Oil Cooler Tube, AOD & 4R70W Trans	800-753
V8 - 5.0L (302 CID)	1988	Connector Oil Cooler Tube, AOD Trans, From 4/18/88	800-753
V8 - 5.0L (302 CID)	1982	Connector Oil Cooler Tube, AOD Trans, To 6/15/82	800-753
V8 - 5.0L (302 CID)	1981	Connector Oil Cooler Tube, C4 & AOD Trans, From 1/5/81	800-753
V8 - 5.0L (302 CID)	1980-79	Connector Oil Cooler Tube, C6 Trans	800-753
V8 - 5.8L (351 CID)	1981	Connector Oil Cooler Tube, C4 & AOD Trans, From 1/5/81	800-753
V8 - 5.8L (351 CID)	1980-79	Connector Oil Cooler Tube, C6 Trans	800-753
COUGAR			
L4 - 2.3L (140 CID)	1986-81	Connector Oil Cooler Tube, C3 Trans	800-753
L4 - 2.3L (140 CID)	1981	Connector Oil Cooler Tube, C4 & AOD Trans, From 1/5/81	800-753
L6 - 3.3L (200 CID)	1982-80	Connector Oil Cooler Tube, C3 Trans	800-753
L6 - 3.3L (200 CID)	1982	Connector Oil Cooler Tube, AOD Trans, To 6/15/82	800-753
L6 - 3.3L (200 CID)	1982	Connector Oil Cooler Tube, C5 w/PEB Trans	800-753
L6 - 3.3L (200 CID)	1981	Connector Oil Cooler Tube, C4 & AOD Trans, From 1/5/81	800-753

Quick Disconnect Engine Oil Cooler Line Connector Applications

Make/ Model/Engine	Years	Description	Dorman #
MERCURY (continued)			
COUGAR (continued)			
V6 - 3.8L (232 CID)	1997-90	Connector Oil Cooler Tube, AOD & 4R70W Trans	800-753
V6 - 3.8L (232 CID)	1989	Connector Oil Cooler Tube, AOD Trans	800-753
V6 - 3.8L (232 CID)	1988	Connector Oil Cooler Tube, AOD Trans, From 4/18/88	800-753
V6 - 3.8L (232 CID)	1986-82	Connector Oil Cooler Tube, C3 Trans	800-753
V6 - 3.8L (232 CID)	1982	Connector Oil Cooler Tube, AOD Trans, To 6/15/82	800-753
V8 - 4.2L (255 CID)	1982-80	Connector Oil Cooler Tube, C3 Trans	800-753
V8 - 4.2L (255 CID)	1982	Connector Oil Cooler Tube, AOD Trans, To 6/15/82	800-753
V8 - 4.2L (255 CID)	1981	Connector Oil Cooler Tube, C4 & AOD Trans, From 1/5/81	800-753
V8 - 4.6L (281 CID)	1997-94	Connector Oil Cooler Tube, AOD & 4R70W Trans	800-753
V8 - 5.0L (302 CID)	1993-91	Connector Oil Cooler Tube, AOD & 4R70W Trans	800-753
V8 - 5.0L (302 CID)	1988	Connector Oil Cooler Tube, AOD Trans, From 4/18/88	800-753
V8 - 5.0L (302 CID)	1986-80	Connector Oil Cooler Tube, C3 Trans	800-753
V8 - 5.0L (302 CID)	1981	Connector Oil Cooler Tube, C4 & AOD Trans, From 1/5/81	800-753
V8 - 5.0L (302 CID)	1979-77	Connector Oil Cooler Tube, C6 Trans	800-753
V8 - 5.8L (351 CID)	1979-77	Connector Oil Cooler Tube, C6 Trans	800-753
V8 - 6.6L (400 CID)	1978-77	Connector Oil Cooler Tube, C6 Trans	800-753
GRAND MARQUIS			
V8 - 4.2L (255 CID)	1982	Connector Oil Cooler Tube, AOD Trans, To 6/15/82	800-753
V8 - 4.2L (255 CID)	1981	Connector Oil Cooler Tube, C4 & AOD Trans, From 1/5/81	800-753
V8 - 4.6L (281 CID)	2006-92	Connector Oil Cooler Tube, AOD & 4R70W Trans	800-753
V8 - 5.0L (302 CID)	1991-89	Connector Oil Cooler Tube, AOD & 4R70W Trans	800-753
V8 - 5.0L (302 CID)	1988	Connector Oil Cooler Tube, AOD Trans, From 4/18/88	800-753
V8 - 5.0L (302 CID)	1982	Connector Oil Cooler Tube, AOD Trans, To 6/15/82	800-753
V8 - 5.0L (302 CID)	1981	Connector Oil Cooler Tube, C4 & AOD Trans, From 1/5/81	800-753
V8 - 5.0L (302 CID)	1980-79	Connector Oil Cooler Tube, C6 Trans	800-753
V8 - 5.8L (351 CID)	1981	Connector Oil Cooler Tube, C4 & AOD Trans, From 1/5/81	800-753
V8 - 5.8L (351 CID)	1980-78	Connector Oil Cooler Tube, C6 Trans	800-753
V8 - 6.6L (400 CID)	1978-77	Connector Oil Cooler Tube, C6 Trans	800-753
V8 - 7.5L (460 CID)	1978-77	Connector Oil Cooler Tube, C6 Trans	800-753
LN7			
L4 - 1.6L (98 CID)	1983-82	Connector Oil Cooler Tube, w/Tapered Diff. Ball Bearing, ATX Trans	800-753
LYNX			
L4 - 1.6L (98 CID)	1983-81	Connector Oil Cooler Tube, w/Tapered Diff. Ball Bearing, ATX Trans	800-753
MARAUDER			
V8 - 4.6L (281 CID)	2004-03	Connector Oil Cooler Tube, AOD & 4R70W Trans	800-753
MARQUIS			
L4 - 2.3L (140 CID)	1986-83	Connector Oil Cooler Tube, C3 Trans	800-753
L6 - 3.3L (200 CID)	1983	Connector Oil Cooler Tube, C3 Trans	800-753
V6 - 3.8L (232 CID)	1986-83	Connector Oil Cooler Tube, C3 Trans	800-753
V8 - 4.2L (255 CID)	1982	Connector Oil Cooler Tube, AOD Trans, To 6/15/82	800-753
V8 - 4.2L (255 CID)	1981	Connector Oil Cooler Tube, C4 & AOD Trans, From 1/5/81	800-753
V8 - 5.0L (302 CID)	1985	Connector Oil Cooler Tube, C3 Trans	800-753
V8 - 5.0L (302 CID)	1982	Connector Oil Cooler Tube, AOD Trans, To 6/15/82	800-753
V8 - 5.0L (302 CID)	1981	Connector Oil Cooler Tube, C4 & AOD Trans, From 1/5/81	800-753
V8 - 5.0L (302 CID)	1980-79	Connector Oil Cooler Tube, C6 Trans	800-753
V8 - 5.8L (351 CID)	1982	Connector Oil Cooler Tube, AOD Trans, To 6/15/82	800-753
V8 - 5.8L (351 CID)	1981	Connector Oil Cooler Tube, C4 & AOD Trans, From 1/5/81	800-753
V8 - 5.8L (351 CID)	1980-78	Connector Oil Cooler Tube, C6 Trans	800-753
V8 - 6.6L (400 CID)	1978-77	Connector Oil Cooler Tube, C6 Trans	800-753
V8 - 7.5L (460 CID)	1978-77	Connector Oil Cooler Tube, C6 Trans	800-753
MONARCH			
L6 - 4.1L (250 CID)	1980	Connector Oil Cooler Tube, C3 Trans	800-753
V8 - 4.2L (255 CID)	1980	Connector Oil Cooler Tube, C3 Trans	800-753
V8 - 5.0L (302 CID)	1980	Connector Oil Cooler Tube, C3 Trans	800-753
MOUNTAINEER			
V8 - 5.0L (302 CID)	2001-97	Connector Oil Cooler Tube, 4R70W & 4R75W Trans	800-758
ZEPHYR			
L4 - 2.3L (140 CID)	1983-80	Connector Oil Cooler Tube, C3 Trans	800-753
L4 - 2.3L (140 CID)	1981	Connector Oil Cooler Tube, C4 Trans, From 1/5/81	800-753
L6 - 3.3L (200 CID)	1983-80	Connector Oil Cooler Tube, C3 Trans	800-753
L6 - 3.3L (200 CID)	1982	Connector Oil Cooler Tube, C5 Trans	800-753
L6 - 3.3L (200 CID)	1981	Connector Oil Cooler Tube, C4 Trans, From 1/5/81	800-753
V8 - 4.2L (255 CID)	1982-80	Connector Oil Cooler Tube, C3 Trans	800-753
V8 - 4.2L (255 CID)	1982	Connector Oil Cooler Tube, C5 Trans	800-753
V8 - 4.2L (255 CID)	1981	Connector Oil Cooler Tube, C4 Trans, From 1/5/81	800-753
OLDSMOBILE			
88			
V6 - 3.8L (231 CID)	1998-94	Trans Fluid Cooler Pipe Fitting At Trans, w/Check Valve, (M13, M15, MN3) Trans	800-752
V6 - 3.8L (231 CID)	1998-91	Trans Fluid Cooler Pipe Fitting Inlet To Case, (M13, M15, ME9, MN3, MN7) Trans	800-754
98			
V6 - 3.0L (181 CID)	1985	Trans Fluid Cooler Pipe Fitting To Case, (ME9) Trans	800-755
V6 - 3.8L (231 CID)	1996-94	Trans Fluid Cooler Pipe Fitting At Trans, w/Check Valve, (M13) Trans	800-752
V6 - 3.8L (231 CID)	1990-85	Trans Fluid Cooler Pipe Fitting To Case, (ME9) Trans	800-755
V6 - 4.1L (252 CID)	1981	Trans Fluid Cooler Pipe Fitting To Case	800-755
V6 - 4.3L (260 CID)	1985	Trans Fluid Cooler Pipe Fitting To Case, (ME9) Trans	800-755
V8 - 5.0L (307 CID)	1981-80	Trans Fluid Cooler Pipe Fitting To Case	800-755
V8 - 5.7L (350 CID)	1981-77	Trans Fluid Cooler Pipe Fitting To Case	800-755
V8 - 6.6L (403 CID)	1979-77	Trans Fluid Cooler Pipe Fitting To Case	800-755
V8 - 7.5L (455 CID)	1976	Trans Fluid Cooler Pipe Fitting To Case	800-755
ACHIEVA			
L4 - 2.3L (138 CID)	1995-94	Trans Fluid Cooler Pipe Fitting At Trans, w/Check Valve, (M13) Trans	800-752
L4 - 2.3L (138 CID)	1995-94	Trans Fluid Cooler Pipe Fitting Inlet To Case, (M13) Trans	800-754
L4 - 2.3L (138 CID)	1995-92	Trans Fluid Cooler Pipe Fitting To Case, (MD9) Trans	800-755
L4 - 2.4L (146 CID)	1998-96	Trans Fluid Cooler Pipe Fitting At Trans, w/Check Valve, (M13) Trans	800-752

Quick Disconnect

Quick Disconnect Engine Oil Cooler Line Connector Applications

Make/ Model/Engine	Years	Description	Dorman #
OLDSMOBILE (continued)			
ACHIEVA (continued)			
L4 - 2.4L (146 CID)	1998-96	Trans Fluid Cooler Pipe Fitting Inlet To Case, (M13) Trans	800-754
V6 - 3.1L (189 CID)	1998-94	Trans Fluid Cooler Pipe Fitting At Trans, w/Check Valve, (M13) Trans	800-752
V6 - 3.1L (189 CID)	1998-94	Trans Fluid Cooler Pipe Fitting Inlet To Case, (M13) Trans	800-754
V6 - 3.1L (189 CID)	1995-94	Trans Fluid Cooler Pipe Fitting To Case, (MD9) Trans	800-755
V6 - 3.3L (204 CID)	1993-92	Trans Fluid Cooler Pipe Fitting To Case, (MD9) Trans	800-755
AURORA			
V8 - 4.0L (244 CID)	1995	Trans Fluid Cooler Pipe Fitting To Case	800-755
CUSTOM CRUISER			
V8 - 5.0L (305 CID)	1992-91	Eng Oil Cooler Line Fitting	800-812
V8 - 5.0L (307 CID)	1992-82	Trans Fluid Cooler Pipe Fitting To Case, (MD8, MW9) Trans	800-755
V8 - 5.0L (307 CID)	1981-80	Trans Fluid Cooler Pipe Fitting To Case	800-755
V8 - 5.7L (350 CID)	1992-82	Trans Fluid Cooler Pipe Fitting To Case, (MD8, MW9) Trans	800-755
V8 - 5.7L (350 CID)	1992	Eng Oil Cooler Line Fitting	800-812
V8 - 5.7L (350 CID)	1981-77	Trans Fluid Cooler Pipe Fitting To Case	800-755
V8 - 6.6L (403 CID)	1979-77	Trans Fluid Cooler Pipe Fitting To Case	800-755
V8 - 7.5L (455 CID)	1976	Trans Fluid Cooler Pipe Fitting To Case	800-755
CUTLASS			
L6 - 4.1L (250 CID)	1976	Trans Fluid Cooler Pipe Fitting To Case	800-755
V6 - 3.1L (189 CID)	1998-97	Trans Fluid Cooler Pipe Fitting At Trans, w/Check Valve, (M13) Trans	800-752
V6 - 3.1L (189 CID)	1998-97	Trans Fluid Cooler Pipe Fitting Inlet To Case, (M13) Trans	800-754
V6 - 3.8L (231 CID)	1987-85	Trans Fluid Cooler Pipe Fitting To Case, (MV9, MW9) Trans	800-755
V6 - 3.8L (231 CID)	1981-77	Trans Fluid Cooler Pipe Fitting To Case	800-755
V8 - 4.3L (260 CID)	1981-76	Trans Fluid Cooler Pipe Fitting To Case	800-755
V8 - 5.0L (305 CID)	1980-78	Trans Fluid Cooler Pipe Fitting To Case	800-755
V8 - 5.0L (307 CID)	1987-85	Trans Fluid Cooler Pipe Fitting To Case, (MV9, MW9) Trans	800-755
V8 - 5.7L (350 CID)	1985	Trans Fluid Cooler Pipe Fitting To Case, (MV9, MW9) Trans	800-755
V8 - 5.7L (350 CID)	1981-76	Trans Fluid Cooler Pipe Fitting To Case	800-755
V8 - 6.6L (403 CID)	1977	Trans Fluid Cooler Pipe Fitting To Case	800-755
V8 - 7.5L (455 CID)	1976	Trans Fluid Cooler Pipe Fitting To Case	800-755
CUTLASS CALAIS			
L4 - 2.3L (138 CID)	1991-87	Trans Fluid Cooler Pipe Fitting To Case, (MD9) Trans	800-755
L4 - 2.5L (151 CID)	1991-85	Trans Fluid Cooler Pipe Fitting To Case, (MD9) Trans	800-755
V6 - 3.0L (181 CID)	1988-85	Trans Fluid Cooler Pipe Fitting To Case, (MD9) Trans	800-755
V6 - 3.3L (204 CID)	1991-89	Trans Fluid Cooler Pipe Fitting To Case, (MD9) Trans	800-755
V6 - 3.8L (231 CID)	1984-82	Trans Fluid Cooler Pipe Fitting To Case, (MV9, MW9) Trans	800-755
V6 - 3.8L (231 CID)	1981-78	Trans Fluid Cooler Pipe Fitting To Case	800-755
V6 - 4.3L (260 CID)	1984-82	Trans Fluid Cooler Pipe Fitting To Case, (MV9, MW9) Trans	800-755
V8 - 4.3L (260 CID)	1981-78	Trans Fluid Cooler Pipe Fitting To Case	800-755
V8 - 5.0L (305 CID)	1980-78	Trans Fluid Cooler Pipe Fitting To Case	800-755
V8 - 5.0L (307 CID)	1984-82	Trans Fluid Cooler Pipe Fitting To Case, (MV9, MW9) Trans	800-755
V8 - 5.7L (350 CID)	1984-82	Trans Fluid Cooler Pipe Fitting To Case, (MV9, MW9) Trans	800-755
V8 - 5.7L (350 CID)	1981-79	Trans Fluid Cooler Pipe Fitting To Case	800-755
CUTLASS CIERA			
L4 - 2.2L (134 CID)	1996-94	Trans Fluid Cooler Pipe Fitting At Trans, w/Check Valve, (M13) Trans	800-752
L4 - 2.2L (134 CID)	1996-94	Trans Fluid Cooler Pipe Fitting Inlet To Case, (M13) Trans	800-754
L4 - 2.2L (134 CID)	1996-93	Trans Fluid Cooler Pipe Fitting To Case, (MD9) Trans	800-755
L4 - 2.5L (151 CID)	1992-82	Trans Fluid Cooler Pipe Fitting To Case, (MD9, ME9) Trans	800-755
V6 - 2.8L (173 CID)	1989-82	Trans Fluid Cooler Pipe Fitting To Case, (MD9, ME9) Trans	800-755
V6 - 3.0L (181 CID)	1985-82	Trans Fluid Cooler Pipe Fitting To Case, (MD9, ME9) Trans	800-755
V6 - 3.1L (189 CID)	1996-94	Trans Fluid Cooler Pipe Fitting At Trans, w/Check Valve, (M13) Trans	800-752
V6 - 3.1L (189 CID)	1996-94	Trans Fluid Cooler Pipe Fitting Inlet To Case, (M13) Trans	800-754
V6 - 3.1L (189 CID)	1996-94	Trans Fluid Cooler Pipe Fitting To Case, (MD9) Trans	800-755
V6 - 3.3L (204 CID)	1993-89	Trans Fluid Cooler Pipe Fitting To Case, (MD9, ME9) Trans	800-755
V6 - 3.8L (231 CID)	1988-84	Trans Fluid Cooler Pipe Fitting To Case, (MD9, ME9) Trans	800-755
V6 - 4.3L (260 CID)	1985-82	Trans Fluid Cooler Pipe Fitting To Case, (MD9, ME9) Trans	800-755
CUTLASS CRUISER			
V6 - 3.8L (231 CID)	1983-82	Trans Fluid Cooler Pipe Fitting To Case, (MV9, MW9) Trans	800-755
V6 - 3.8L (231 CID)	1981-78	Trans Fluid Cooler Pipe Fitting To Case	800-755
V8 - 4.3L (260 CID)	1982	Trans Fluid Cooler Pipe Fitting To Case, (MV9, MW9) Trans	800-755
V8 - 4.3L (260 CID)	1981-78	Trans Fluid Cooler Pipe Fitting To Case	800-755
V8 - 5.0L (305 CID)	1982	Trans Fluid Cooler Pipe Fitting To Case, (MV9, MW9) Trans	800-755
V8 - 5.0L (305 CID)	1980-78	Trans Fluid Cooler Pipe Fitting To Case	800-755
V8 - 5.0L (307 CID)	1983-82	Trans Fluid Cooler Pipe Fitting To Case, (MV9, MW9) Trans	800-755
V8 - 5.0L (307 CID)	1981	Trans Fluid Cooler Pipe Fitting To Case	800-755
V8 - 5.7L (350 CID)	1983-82	Trans Fluid Cooler Pipe Fitting To Case, (MV9, MW9) Trans	800-755
V8 - 5.7L (350 CID)	1981-78	Trans Fluid Cooler Pipe Fitting To Case	800-755
CUTLASS SUPREME			
L4 - 2.3L (138 CID)	1991-90	Trans Fluid Cooler Pipe Fitting To Case, (MD9, ME9) Trans	800-755
L4 - 2.3L (138 CID)	1991	Trans Fluid Cooler Pipe Fitting Inlet To Case, (M13, M15, ME9, MN3) Trans	800-754
L6 - 4.1L (250 CID)	1976	Trans Fluid Cooler Pipe Fitting To Case	800-755
V6 - 2.8L (173 CID)	1989-88	Trans Fluid Cooler Pipe Fitting To Case, (MD9, ME9) Trans	800-755
V6 - 3.1L (189 CID)	1997-94	Trans Fluid Cooler Pipe Fitting At Trans, w/Check Valve, (M13, M15, MN3) Trans	800-752
V6 - 3.1L (189 CID)	1997-91	Trans Fluid Cooler Pipe Fitting Inlet To Case, (M13, M15, ME9, MN3) Trans	800-754
V6 - 3.1L (189 CID)	1992-89	Trans Fluid Cooler Pipe Fitting To Case, (MD9, ME9) Trans	800-755
V6 - 3.4L (207 CID)	1996-94	Trans Fluid Cooler Pipe Fitting At Trans, w/Check Valve, (M13, M15, MN3) Trans	800-752
V6 - 3.4L (207 CID)	1996-91	Trans Fluid Cooler Pipe Fitting Inlet To Case, (M13, M15, ME9, MN3) Trans	800-754
V6 - 3.4L (207 CID)	1992-91	Trans Fluid Cooler Pipe Fitting To Case, (MD9, ME9) Trans	800-755
V6 - 3.8L (231 CID)	1987-82	Trans Fluid Cooler Pipe Fitting To Case, (MV9, MW9) Trans	800-755
V6 - 3.8L (231 CID)	1981-77	Trans Fluid Cooler Pipe Fitting To Case	800-755
V6 - 4.3L (260 CID)	1985-82	Trans Fluid Cooler Pipe Fitting To Case, (MV9, MW9) Trans	800-755
V8 - 4.3L (260 CID)	1981-76	Trans Fluid Cooler Pipe Fitting To Case	800-755
V8 - 5.0L (305 CID)	1980-78	Trans Fluid Cooler Pipe Fitting To Case	800-755
V8 - 5.0L (307 CID)	1988-82	Trans Fluid Cooler Pipe Fitting To Case, (MV9, MW9) Trans	800-755
V8 - 5.7L (350 CID)	1985-82	Trans Fluid Cooler Pipe Fitting To Case, (MV9, MW9) Trans	800-755
V8 - 5.7L (350 CID)	1981-76	Trans Fluid Cooler Pipe Fitting To Case	800-755

Quick Disconnect Engine Oil Cooler Line Connector Applications

Make/ Model/Engine	Years	Description	Dorman #
OLDSMOBILE (continued)			
CUTLASS SUPREME (continued)			
V8 - 6.6L (403 CID)	1977	Trans Fluid Cooler Pipe Fitting To Case	800-755
V8 - 7.5L (455 CID)	1976	Trans Fluid Cooler Pipe Fitting To Case	800-755
DELTA 88			
V6 - 3.0L (181 CID)	1986	Trans Fluid Cooler Pipe Fitting To Case, (ME9) Trans	800-755
V6 - 3.8L (231 CID)	1999-91	Trans Fluid Cooler Pipe Fitting Inlet To Case, (M13, M15, ME9, MN3, MN7) Trans	800-754
V6 - 3.8L (231 CID)	1999	Trans Fluid Cooler Pipe Fitting At Trans, w/Check Valve, (M13, M15, MN3) Trans	800-752
V6 - 3.8L (231 CID)	1990-82	Trans Fluid Cooler Pipe Fitting To Case, (MD8, ME9, MW9) Trans	800-755
V6 - 3.8L (231 CID)	1981-77	Trans Fluid Cooler Pipe Fitting To Case	800-755
V8 - 4.3L (260 CID)	1982	Trans Fluid Cooler Pipe Fitting To Case, (MD8, MW9) Trans	800-755
V8 - 4.3L (260 CID)	1981-77	Trans Fluid Cooler Pipe Fitting To Case	800-755
V8 - 4.9L (301 CID)	1979	Trans Fluid Cooler Pipe Fitting To Case	800-755
V8 - 5.0L (307 CID)	1985-82	Trans Fluid Cooler Pipe Fitting To Case, (MD8, MW9) Trans	800-755
V8 - 5.0L (307 CID)	1981-80	Trans Fluid Cooler Pipe Fitting To Case	800-755
V8 - 5.7L (350 CID)	1985-82	Trans Fluid Cooler Pipe Fitting To Case, (MD8, MW9) Trans	800-755
V8 - 5.7L (350 CID)	1981-76	Trans Fluid Cooler Pipe Fitting To Case	800-755
V8 - 6.6L (403 CID)	1979-77	Trans Fluid Cooler Pipe Fitting To Case	800-755
V8 - 7.5L (455 CID)	1976	Trans Fluid Cooler Pipe Fitting To Case	800-755
FIRENZA			
L4 - 1.8L (112 CID)	1986-82	Trans Fluid Cooler Pipe Fitting To Case, (MD9) Trans	800-755
L4 - 2.0L (122 CID)	1988-83	Trans Fluid Cooler Pipe Fitting To Case, (MD9) Trans	800-755
V6 - 2.8L (173 CID)	1987-85	Trans Fluid Cooler Pipe Fitting To Case, (MD9) Trans	800-755
INTRIGUE			
V6 - 3.5L (214 CID)	1999	Trans Fluid Cooler Pipe Fitting At Trans, w/Check Valve, (M13, M15, MN3) Trans	800-752
V6 - 3.5L (214 CID)	1999	Trans Fluid Cooler Pipe Fitting Inlet To Case, (M13, M15, ME9, MN3) Trans	800-754
V6 - 3.8L (231 CID)	1999-98	Trans Fluid Cooler Pipe Fitting At Trans, w/Check Valve, (M13, M15, MN3) Trans	800-752
V6 - 3.8L (231 CID)	1999-98	Trans Fluid Cooler Pipe Fitting Inlet To Case, (M13, M15, ME9, MN3) Trans	800-754
LSS			
V6 - 3.8L (231 CID)	1999-96	Trans Fluid Cooler Pipe Fitting At Trans, w/Check Valve, (M13, M15, MN3) Trans	800-752
V6 - 3.8L (231 CID)	1999-96	Trans Fluid Cooler Pipe Fitting Inlet To Case, (M13, M15, ME9, MN3, MN7) Trans	800-754
OMEGA			
L4 - 2.5L (151 CID)	1984-80	Trans Fluid Cooler Pipe Fitting To Case	800-755
L6 - 4.1L (250 CID)	1976	Trans Fluid Cooler Pipe Fitting To Case	800-755
V6 - 2.8L (173 CID)	1984-80	Trans Fluid Cooler Pipe Fitting To Case	800-755
V6 - 3.8L (231 CID)	1979-77	Trans Fluid Cooler Pipe Fitting To Case	800-755
V8 - 4.3L (260 CID)	1977-76	Trans Fluid Cooler Pipe Fitting To Case	800-755
V8 - 5.0L (305 CID)	1979-77	Trans Fluid Cooler Pipe Fitting To Case	800-755
V8 - 5.7L (350 CID)	1979-76	Trans Fluid Cooler Pipe Fitting To Case	800-755
SILHOUETTE			
V6 - 3.1L (189 CID)	1994-92	Trans Fluid Cooler Pipe Fitting Inlet To Case, (M13, M15) Trans	800-754
V6 - 3.1L (189 CID)	1994-90	Trans Fluid Cooler Pipe Fitting To Case, (MD9) Trans	800-755
V6 - 3.1L (189 CID)	1994	Trans Fluid Cooler Pipe Fitting At Trans, w/Check Valve, (M13) Trans	800-752
V6 - 3.4L (207 CID)	1999-96	Trans Fluid Cooler Pipe Fitting Inlet To Case, (M13, M15) Trans	800-754
V6 - 3.4L (207 CID)	1998-96	Trans Fluid Cooler Pipe Fitting At Trans, w/Check Valve, (M13) Trans	800-752
V6 - 3.8L (231 CID)	1995-94	Trans Fluid Cooler Pipe Fitting At Trans, w/Check Valve, (M13) Trans	800-752
V6 - 3.8L (231 CID)	1995-92	Trans Fluid Cooler Pipe Fitting Inlet To Case, (M13, M15) Trans	800-754
V6 - 3.8L (231 CID)	1995-92	Trans Fluid Cooler Pipe Fitting To Case, (MD9) Trans	800-755
STARFIRE			
L4 - 2.3L (140 CID)	1977-76	Trans Fluid Cooler Pipe Fitting To Case	800-755
L4 - 2.5L (151 CID)	1980-78	Trans Fluid Cooler Pipe Fitting To Case	800-755
V6 - 3.8L (231 CID)	1980-76	Trans Fluid Cooler Pipe Fitting To Case	800-755
V8 - 5.0L (305 CID)	1979-77	Trans Fluid Cooler Pipe Fitting To Case	800-755
TORONADO			
V6 - 3.8L (231 CID)	1992-91	Trans Fluid Cooler Pipe Fitting Inlet To Case, (M13) Trans	800-754
V6 - 3.8L (231 CID)	1990-86	Trans Fluid Cooler Pipe Fitting To Case, (ME9) Trans	800-755
V6 - 4.1L (252 CID)	1981	Trans Fluid Cooler Pipe Fitting To Case	800-755
V8 - 5.0L (307 CID)	1981-80	Trans Fluid Cooler Pipe Fitting To Case	800-755
V8 - 5.7L (350 CID)	1981-77	Trans Fluid Cooler Pipe Fitting To Case	800-755
V8 - 6.6L (403 CID)	1978-77	Trans Fluid Cooler Pipe Fitting To Case	800-755
V8 - 7.5L (455 CID)	1976	Trans Fluid Cooler Pipe Fitting To Case	800-755
VISTA CRUISER			
V8 - 5.7L (350 CID)	1977-76	Trans Fluid Cooler Pipe Fitting To Case	800-755
V8 - 6.6L (403 CID)	1977	Trans Fluid Cooler Pipe Fitting To Case	800-755
V8 - 7.5L (455 CID)	1976	Trans Fluid Cooler Pipe Fitting To Case	800-755
PONTIAC			
6000			
L4 - 2.5L (151 CID)	1991-82	Trans Fluid Cooler Pipe Fitting To Case, (MD9, ME9) Trans	800-755
V6 - 2.8L (173 CID)	1989-82	Trans Fluid Cooler Pipe Fitting To Case, (MD9, ME9) Trans	800-755
V6 - 3.1L (189 CID)	1991-88	Trans Fluid Cooler Pipe Fitting To Case, (MD9, ME9) Trans	800-755
V6 - 4.3L (260 CID)	1985-82	Trans Fluid Cooler Pipe Fitting To Case, (MD9, ME9) Trans	800-755
ASTRE			
L4 - 2.3L (140 CID)	1977-76	Trans Fluid Cooler Pipe Fitting To Case	800-755
L4 - 2.5L (151 CID)	1977	Trans Fluid Cooler Pipe Fitting To Case	800-755
AZTEK			
V6 - 3.4L (207 CID)	2001	Trans Fluid Cooler Pipe Fitting Inlet To Case, (M76) Trans	800-754
BONNEVILLE			
V6 - 3.8L (231 CID)	1999-94	Trans Fluid Cooler Pipe Fitting At Trans, w/Check Valve, (M13, M15, MN3, MN7) Trans	800-752
V6 - 3.8L (231 CID)	1999-91	Trans Fluid Cooler Pipe Fitting Inlet To Case, (M13, M15, ME9, MN3, MN7) Trans	800-754
V6 - 3.8L (231 CID)	1990-82	Trans Fluid Cooler Pipe Fitting To Case, (ME9, MV9, MW9) Trans	800-755
V6 - 3.8L (231 CID)	1981-80	Trans Fluid Cooler Pipe Fitting To Case	800-755
V6 - 4.1L (252 CID)	1982	Trans Fluid Cooler Pipe Fitting To Case, (MV9, MW9) Trans	800-755
V6 - 4.3L (262 CID)	1986	Trans Fluid Cooler Pipe Fitting To Case, (MV9, MW9) Trans	800-755
V8 - 4.3L (265 CID)	1981-80	Trans Fluid Cooler Pipe Fitting To Case	800-755
V8 - 4.9L (301 CID)	1980-77	Trans Fluid Cooler Pipe Fitting To Case	800-755
V8 - 5.0L (305 CID)	1986-83	Trans Fluid Cooler Pipe Fitting To Case, (MV9, MW9) Trans	800-755
V8 - 5.0L (307 CID)	1981	Trans Fluid Cooler Pipe Fitting To Case	800-755

Quick Disconnect

Quick Disconnect Engine Oil Cooler Line Connector Applications

Make/ Model/Engine	Years	Description	Dorman #
PONTIAC (continued)			
BONNEVILLE (continued)			
V8 - 5.7L (350 CID)	1984-82	Trans Fluid Cooler Pipe Fitting To Case, (MV9, MW9) Trans	800-755
V8 - 5.7L (350 CID)	1981-77	Trans Fluid Cooler Pipe Fitting To Case	800-755
V8 - 6.6L (403 CID)	1979-76	Trans Fluid Cooler Pipe Fitting To Case	800-755
V8 - 7.5L (455 CID)	1976	Trans Fluid Cooler Pipe Fitting To Case	800-755
CATALINA			
V6 - 3.8L (231 CID)	1981-77	Trans Fluid Cooler Pipe Fitting To Case	800-755
V8 - 4.3L (265 CID)	1981-80	Trans Fluid Cooler Pipe Fitting To Case	800-755
V8 - 4.9L (301 CID)	1980-77	Trans Fluid Cooler Pipe Fitting To Case	800-755
V8 - 5.0L (307 CID)	1981	Trans Fluid Cooler Pipe Fitting To Case	800-755
V8 - 5.7L (350 CID)	1981-76	Trans Fluid Cooler Pipe Fitting To Case	800-755
V8 - 6.6L (403 CID)	1979-76	Trans Fluid Cooler Pipe Fitting To Case	800-755
V8 - 7.5L (455 CID)	1976	Trans Fluid Cooler Pipe Fitting To Case	800-755
FIERO			
L4 - 2.5L (151 CID)	1988-84	Trans Fluid Cooler Pipe Fitting To Case, (MD9) Trans	800-755
V6 - 2.8L (173 CID)	1988-85	Trans Fluid Cooler Pipe Fitting To Case, (MD9) Trans	800-755
FIREBIRD			
L4 - 2.5L (151 CID)	1986-82	Trans Fluid Cooler Pipe Fitting To Case, (MD8, MV9) Trans	800-755
L6 - 4.1L (250 CID)	1976	Trans Fluid Cooler Pipe Fitting To Case	800-755
V6 - 2.8L (173 CID)	1989-82	Trans Fluid Cooler Pipe Fitting To Case, (MD8, MV9) Trans	800-755
V6 - 3.1L (189 CID)	1992-90	Trans Fluid Cooler Pipe Fitting To Case, (MD8) Trans	800-755
V6 - 3.4L (207 CID)	1995-93	Trans Fluid Cooler Pipe Fitting To Case, (M30, MD8) Trans	800-755
V6 - 3.8L (231 CID)	1998-89	Trans Fluid Cooler Pipe Fitting To Case, (M30, MD8) Trans	800-755
V6 - 3.8L (231 CID)	1981-77	Trans Fluid Cooler Pipe Fitting To Case	800-755
V8 - 4.3L (265 CID)	1981	Trans Fluid Cooler Pipe Fitting To Case	800-755
V8 - 4.9L (301 CID)	1981-77	Trans Fluid Cooler Pipe Fitting To Case	800-755
V8 - 5.0L (305 CID)	1992-82	Trans Fluid Cooler Pipe Fitting To Case, (MD8, MV9) Trans	800-755
V8 - 5.0L (305 CID)	1981-77	Trans Fluid Cooler Pipe Fitting To Case	800-755
V8 - 5.7L (350 CID)	1998-87	Trans Fluid Cooler Pipe Fitting To Case, (M30, MD8) Trans	800-755
V8 - 5.7L (350 CID)	1979-76	Trans Fluid Cooler Pipe Fitting To Case	800-755
V8 - 6.6L (403 CID)	1979-76	Trans Fluid Cooler Pipe Fitting To Case	800-755
V8 - 7.5L (455 CID)	1976	Trans Fluid Cooler Pipe Fitting To Case	800-755
GRAND AM			
L4 - 2.0L (122 CID)	1989-87	Trans Fluid Cooler Pipe Fitting To Case, (MD9) Trans	800-755
L4 - 2.3L (138 CID)	1995-94	Trans Fluid Cooler Pipe Fitting At Trans, w/Check Valve, (M13) Trans	800-752
L4 - 2.3L (138 CID)	1995-94	Trans Fluid Cooler Pipe Fitting Inlet To Case, (M13) Trans	800-754
L4 - 2.3L (138 CID)	1995-88	Trans Fluid Cooler Pipe Fitting To Case, (MD9) Trans	800-755
L4 - 2.4L (146 CID)	1998-96	Trans Fluid Cooler Pipe Fitting At Trans, w/Check Valve, (M13) Trans	800-752
L4 - 2.4L (146 CID)	1998-96	Trans Fluid Cooler Pipe Fitting Inlet To Case, (M13) Trans	800-754
L4 - 2.5L (151 CID)	1991-85	Trans Fluid Cooler Pipe Fitting To Case, (MD9) Trans	800-755
V6 - 3.0L (181 CID)	1987-85	Trans Fluid Cooler Pipe Fitting To Case, (MD9) Trans	800-755
V6 - 3.1L (189 CID)	1998-94	Trans Fluid Cooler Pipe Fitting At Trans, w/Check Valve, (M13) Trans	800-752
V6 - 3.1L (189 CID)	1998-94	Trans Fluid Cooler Pipe Fitting Inlet To Case, (M13) Trans	800-754
V6 - 3.1L (189 CID)	1995-94	Trans Fluid Cooler Pipe Fitting To Case, (MD9) Trans	800-755
V6 - 3.3L (204 CID)	1993-92	Trans Fluid Cooler Pipe Fitting To Case, (MD9) Trans	800-755
V6 - 3.8L (231 CID)	1979	Trans Fluid Cooler Pipe Fitting To Case	800-755
V8 - 4.9L (301 CID)	1980-78	Trans Fluid Cooler Pipe Fitting To Case	800-755
V8 - 5.0L (305 CID)	1980-78	Trans Fluid Cooler Pipe Fitting To Case	800-755
GRAND LEMANS			
L6 - 4.1L (250 CID)	1976	Trans Fluid Cooler Pipe Fitting To Case	800-755
V6 - 3.8L (231 CID)	1981-77	Trans Fluid Cooler Pipe Fitting To Case	800-755
V8 - 4.3L (265 CID)	1981-76	Trans Fluid Cooler Pipe Fitting To Case	800-755
V8 - 4.9L (301 CID)	1981-77	Trans Fluid Cooler Pipe Fitting To Case	800-755
V8 - 5.0L (305 CID)	1980-77	Trans Fluid Cooler Pipe Fitting To Case	800-755
V8 - 5.7L (350 CID)	1979-76	Trans Fluid Cooler Pipe Fitting To Case	800-755
V8 - 6.6L (403 CID)	1977-76	Trans Fluid Cooler Pipe Fitting To Case	800-755
V8 - 7.5L (455 CID)	1976	Trans Fluid Cooler Pipe Fitting To Case	800-755
GRAND PRIX			
L4 - 2.3L (138 CID)	1991-90	Trans Fluid Cooler Pipe Fitting Inlet To Case, (M13, M15, ME9, MN7) Trans	800-754
L4 - 2.3L (138 CID)	1991-90	Trans Fluid Cooler Pipe Fitting To Case, (MD9, ME9) Trans	800-755
V6 - 2.8L (173 CID)	1989-88	Trans Fluid Cooler Pipe Fitting To Case, (MD9, ME9) Trans	800-755
V6 - 2.8L (173 CID)	1989	Trans Fluid Cooler Pipe Fitting Inlet To Case, (M13, M15, ME9, MN7) Trans	800-754
V6 - 3.1L (189 CID)	1999-94	Trans Fluid Cooler Pipe Fitting At Trans, w/Check Valve, (M13, M15, MN7) Trans	800-752
V6 - 3.1L (189 CID)	1999-89	Trans Fluid Cooler Pipe Fitting Inlet To Case, (M13, M15, ME9, MN7) Trans	800-754
V6 - 3.1L (189 CID)	1992-89	Trans Fluid Cooler Pipe Fitting To Case, (MD9, ME9) Trans	800-755
V6 - 3.4L (207 CID)	1996-94	Trans Fluid Cooler Pipe Fitting At Trans, w/Check Valve, (M13, M15, MN7) Trans	800-752
V6 - 3.4L (207 CID)	1996-91	Trans Fluid Cooler Pipe Fitting Inlet To Case, (M13, M15, ME9, MN7) Trans	800-754
V6 - 3.4L (207 CID)	1992-91	Trans Fluid Cooler Pipe Fitting To Case, (MD9, ME9) Trans	800-755
V6 - 3.8L (231 CID)	1999-97	Trans Fluid Cooler Pipe Fitting At Trans, w/Check Valve, (M13, M15, MN7) Trans	800-752
V6 - 3.8L (231 CID)	1999-97	Trans Fluid Cooler Pipe Fitting Inlet To Case, (M13, M15, ME9, MN7) Trans	800-754
V6 - 3.8L (231 CID)	1987-82	Trans Fluid Cooler Pipe Fitting To Case, (MV9, MW9) Trans	800-755
V6 - 3.8L (231 CID)	1981-78	Trans Fluid Cooler Pipe Fitting To Case	800-755
V6 - 4.1L (252 CID)	1982	Trans Fluid Cooler Pipe Fitting To Case, (MV9, MW9) Trans	800-755
V6 - 4.3L (262 CID)	1987-86	Trans Fluid Cooler Pipe Fitting To Case, (MV9, MW9) Trans	800-755
V8 - 4.3L (265 CID)	1981-80	Trans Fluid Cooler Pipe Fitting To Case	800-755
V8 - 4.9L (301 CID)	1980-77	Trans Fluid Cooler Pipe Fitting To Case	800-755
V8 - 5.0L (305 CID)	1987-83	Trans Fluid Cooler Pipe Fitting To Case, (MV9, MW9) Trans	800-755
V8 - 5.0L (305 CID)	1980-78	Trans Fluid Cooler Pipe Fitting To Case	800-755
V8 - 5.7L (350 CID)	1984-82	Trans Fluid Cooler Pipe Fitting To Case, (MV9, MW9) Trans	800-755
V8 - 5.7L (350 CID)	1981-76	Trans Fluid Cooler Pipe Fitting To Case	800-755
V8 - 6.6L (403 CID)	1977-76	Trans Fluid Cooler Pipe Fitting To Case	800-755
V8 - 7.5L (455 CID)	1976	Trans Fluid Cooler Pipe Fitting To Case	800-755
GRAND SAFARI			
V8 - 4.9L (301 CID)	1977	Trans Fluid Cooler Pipe Fitting To Case	800-755
V8 - 5.7L (350 CID)	1977	Trans Fluid Cooler Pipe Fitting To Case	800-755

Quick Disconnect Engine Oil Cooler Line Connector Applications

Make/ Model/Engine	Years	Description	Dorman #
PONTIAC (continued)			
GRAND SAFARI (continued)			
V8 - 6.6L (403 CID)	1978-76	Trans Fluid Cooler Pipe Fitting To Case	800-755
V8 - 7.5L (455 CID)	1976	Trans Fluid Cooler Pipe Fitting To Case	800-755
J2000			
L4 - 1.8L (112 CID)	1984-82	Trans Fluid Cooler Pipe Fitting To Case, (MD9) Trans	800-755
L4 - 2.0L (122 CID)	1984-83	Trans Fluid Cooler Pipe Fitting To Case, (MD9) Trans	800-755
LEMANS			
L4 - 1.6L (98 CID)	1993-88	Trans Fluid Cooler Pipe Fitting To Case, (MD9) Trans	800-755
L4 - 2.0L (122 CID)	1990-89	Trans Fluid Cooler Pipe Fitting To Case, (MD9) Trans	800-755
L6 - 4.1L (250 CID)	1976	Trans Fluid Cooler Pipe Fitting To Case	800-755
V6 - 3.8L (231 CID)	1981-77	Trans Fluid Cooler Pipe Fitting To Case	800-755
V8 - 4.3L (265 CID)	1981-76	Trans Fluid Cooler Pipe Fitting To Case	800-755
V8 - 4.9L (301 CID)	1981-77	Trans Fluid Cooler Pipe Fitting To Case	800-755
V8 - 5.0L (305 CID)	1980-77	Trans Fluid Cooler Pipe Fitting To Case	800-755
V8 - 5.7L (350 CID)	1979-76	Trans Fluid Cooler Pipe Fitting To Case	800-755
V8 - 6.6L (403 CID)	1977-76	Trans Fluid Cooler Pipe Fitting To Case	800-755
V8 - 7.5L (455 CID)	1976	Trans Fluid Cooler Pipe Fitting To Case	800-755
MONTANA			
V6 - 3.4L (207 CID)	1999	Trans Fluid Cooler Pipe Fitting Inlet To Case, (M13, M15) Trans	800-754
PARISIENNE			
V6 - 3.8L (231 CID)	1984-83	Trans Fluid Cooler Pipe Fitting To Case, (MD8, MW9) Trans	800-755
V6 - 4.3L (262 CID)	1986-85	Trans Fluid Cooler Pipe Fitting To Case, (MD8, MW9) Trans	800-755
V8 - 5.0L (307 CID)	1986-83	Trans Fluid Cooler Pipe Fitting To Case, (MD8, MW9) Trans	800-755
V8 - 5.7L (350 CID)	1985-83	Trans Fluid Cooler Pipe Fitting To Case, (MD8, MW9) Trans	800-755
PHOENIX			
L4 - 2.5L (151 CID)	1984-77	Trans Fluid Cooler Pipe Fitting To Case	800-755
V6 - 2.8L (173 CID)	1984-80	Trans Fluid Cooler Pipe Fitting To Case	800-755
V6 - 3.8L (231 CID)	1979-77	Trans Fluid Cooler Pipe Fitting To Case	800-755
V8 - 5.0L (305 CID)	1979-77	Trans Fluid Cooler Pipe Fitting To Case	800-755
V8 - 5.7L (350 CID)	1979-77	Trans Fluid Cooler Pipe Fitting To Case	800-755
SAFARI			
V8 - 5.0L (307 CID)	1989-87	Trans Fluid Cooler Pipe Fitting To Case, (MD8, MW9) Trans	800-755
SUNBIRD			
L4 - 1.8L (112 CID)	1986-85	Trans Fluid Cooler Pipe Fitting To Case, (MD9) Trans	800-755
L4 - 2.0L (122 CID)	1994-85	Trans Fluid Cooler Pipe Fitting To Case, (MD9) Trans	800-755
L4 - 2.3L (140 CID)	1977-76	Trans Fluid Cooler Pipe Fitting To Case	800-755
L4 - 2.5L (151 CID)	1980-77	Trans Fluid Cooler Pipe Fitting To Case	800-755
V6 - 3.1L (189 CID)	1994-91	Trans Fluid Cooler Pipe Fitting To Case, (MD9) Trans	800-755
V6 - 3.8L (231 CID)	1980-76	Trans Fluid Cooler Pipe Fitting To Case	800-755
V8 - 5.0L (305 CID)	1979-78	Trans Fluid Cooler Pipe Fitting To Case	800-755
SUNFIRE			
L4 - 2.2L (134 CID)	2001-95	Trans Fluid Cooler Pipe Fitting To Case, (MD9) Trans	800-755
L4 - 2.3L (138 CID)	1995	Trans Fluid Cooler Pipe Fitting To Case, (MD9) Trans	800-755
L4 - 2.4L (146 CID)	2001-96	Trans Fluid Cooler Pipe Fitting To Case, (MD9) Trans	800-755
T1000			
L4 - 1.6L (98 CID)	1984-82	Trans Fluid Cooler Pipe Fitting To Case, (MV9) Trans	800-755
L4 - 1.6L (98 CID)	1981	Trans Fluid Cooler Pipe Fitting To Case	800-755
TRANS SPORT			
V6 - 3.1L (189 CID)	1995-94	Trans Fluid Cooler Pipe Fitting At Trans, w/Check Valve, (M13) Trans	800-752
V6 - 3.1L (189 CID)	1995-92	Trans Fluid Cooler Pipe Fitting Inlet To Case, (M13, M15) Trans	800-754
V6 - 3.1L (189 CID)	1995-90	Trans Fluid Cooler Pipe Fitting To Case, (MD9) Trans	800-755
V6 - 3.4L (207 CID)	1998-96	Trans Fluid Cooler Pipe Fitting At Trans, w/Check Valve, (M13) Trans	800-752
V6 - 3.4L (207 CID)	1998-96	Trans Fluid Cooler Pipe Fitting Inlet To Case, (M13, M15) Trans	800-754
V6 - 3.8L (231 CID)	1995-94	Trans Fluid Cooler Pipe Fitting At Trans, w/Check Valve, (M13) Trans	800-752
V6 - 3.8L (231 CID)	1995-92	Trans Fluid Cooler Pipe Fitting Inlet To Case, (M13, M15) Trans	800-754
V6 - 3.8L (231 CID)	1995-92	Trans Fluid Cooler Pipe Fitting To Case, (MD9) Trans	800-755
VENTURA			
L4 - 2.5L (151 CID)	1977	Trans Fluid Cooler Pipe Fitting To Case	800-755
L6 - 4.1L (250 CID)	1976	Trans Fluid Cooler Pipe Fitting To Case	800-755
V6 - 3.8L (231 CID)	1977	Trans Fluid Cooler Pipe Fitting To Case	800-755
V8 - 4.3L (260 CID)	1976	Trans Fluid Cooler Pipe Fitting To Case	800-755
V8 - 4.9L (301 CID)	1977	Trans Fluid Cooler Pipe Fitting To Case	800-755
V8 - 5.0L (305 CID)	1977	Trans Fluid Cooler Pipe Fitting To Case	800-755
V8 - 5.7L (350 CID)	1977-76	Trans Fluid Cooler Pipe Fitting To Case	800-755

Quick Disconnect

Quick Disconnect Transmission Oil Cooler Line Connector Applications

Make/ Model/Engine	Years	Description	Dorman #
BUICK			
CENTURY			
V6 - 3.1L (189 CID)	2004-00	Oil Cooler Line To Trans, wo/Ball Check	800-604
V6 - 3.1L (189 CID)	2000-98	Oil Cooler Line To Radiator	800-605
LESABRE			
V6 - 3.8L (231 CID)	2005-00	Oil Cooler Line To Radiator	800-605
V6 - 3.8L (231 CID)	2004-00	Oil Cooler Line To Trans, wo/Ball Check	800-604
PARK AVENUE			
V6 - 3.8L (231 CID)	2004-00	Oil Cooler Line To Radiator	800-605
V6 - 3.8L (231 CID)	2004-00	Oil Cooler Line To Trans, wo/Ball Check	800-604
RAINIER			
V6 - 4.2L (256 CID)	2005-04	Oil Cooler Line To Trans, wo/Ball Check	800-604
V8 - 5.3L (323 CID)	2005-04	Oil Cooler Line To Trans, wo/Ball Check	800-604
REGAL			
V6 - 3.8L (231 CID)	2004-00	Oil Cooler Line To Trans, wo/Ball Check	800-604
V6 - 3.8L (231 CID)	2000-98	Oil Cooler Line To Radiator	800-605
RENDEZVOUS			
V6 - 3.4L (207 CID)	2004-02	Oil Cooler Line To Trans, wo/Ball Check	800-604
CADILLAC			
CONCOURS			
V8 - 4.6L (281 CID)	1999-98	Eng Oil Cooler Line To Cooler	800-606
V8 - 4.6L (281 CID)	1999-98	Oil Cooler Line To Radiator	800-605
DEVILLE			
V8 - 4.6L (281 CID)	2005-98	Oil Cooler Line To Radiator	800-605
V8 - 4.6L (281 CID)	2005-00	Eng Oil Cooler Line To Cooler	800-606
ESCALADE			
V8 - 5.3L (323 CID)	2005-02	Oil Cooler Line To Trans Cooler, Heavy Duty Trans Cooling Pkg	800-607
V8 - 5.3L (323 CID)	2005-02	Oil Cooler Line To Trans, wo/Ball Check	800-604
V8 - 5.3L (323 CID)	2003-02	Oil Cooler Line To Radiator	800-605
V8 - 5.7L (350 CID)	2000-99	Oil Cooler Line To Trans Cooler, Heavy Duty Trans Cooling Pkg	800-607
V8 - 5.7L (350 CID)	2000-99	Oil Cooler Line To Trans, wo/Ball Check	800-604
V8 - 6.0L (364 CID)	2006-02	Oil Cooler Line To Trans Cooler, Heavy Duty Trans Cooling Pkg	800-607
V8 - 6.0L (364 CID)	2005-02	Oil Cooler Line To Trans, wo/Ball Check	800-604
V8 - 6.0L (364 CID)	2003-02	Eng Oil Cooler Line To Cooler	800-606
V8 - 6.0L (364 CID)	2003-02	Oil Cooler Line To Radiator	800-605
SEVILLE			
V8 - 4.6L (281 CID)	2004-98	Eng Oil Cooler Line To Cooler	800-606
V8 - 4.6L (281 CID)	2004-98	Oil Cooler Line To Radiator	800-605
CHEVROLET			
CAMARO			
V6 - 3.8L (231 CID)	2002-98	Oil Cooler Line To Trans, wo/Ball Check	800-604
V8 - 5.7L (350 CID)	2002-98	Oil Cooler Line To Trans, wo/Ball Check	800-604
CORVETTE			
V8 - 5.7L (350 CID)	2004	Oil Cooler Line To Trans, wo/Ball Check	800-604
V8 - 6.0L (364 CID)	2006-05	Eng Oil Cooler Line To Cooler	800-606
V8 - 6.0L (364 CID)	2005	Oil Cooler Line To Trans, wo/Ball Check	800-604
IMPALA			
V6 - 3.4L (207 CID)	2004-00	Oil Cooler Line To Trans, wo/Ball Check	800-604
V6 - 3.4L (207 CID)	2001-00	Oil Cooler Line To Radiator	800-605
V6 - 3.8L (231 CID)	2004-00	Oil Cooler Line To Trans, wo/Ball Check	800-604
V6 - 3.8L (231 CID)	2001-00	Oil Cooler Line To Radiator	800-605
LUMINA			
V6 - 3.1L (189 CID)	2001-98	Oil Cooler Line To Radiator	800-605
V6 - 3.1L (189 CID)	2001-00	Oil Cooler Line To Trans, wo/Ball Check	800-604
V6 - 3.8L (231 CID)	1999-98	Oil Cooler Line To Radiator	800-605
MONTÉ CARLO			
V6 - 3.1L (189 CID)	1999-98	Oil Cooler Line To Radiator	800-605
V6 - 3.4L (207 CID)	2004-00	Oil Cooler Line To Trans, wo/Ball Check	800-604
V6 - 3.4L (207 CID)	2001-00	Oil Cooler Line To Radiator	800-605
V6 - 3.8L (231 CID)	2004-00	Oil Cooler Line To Trans, wo/Ball Check	800-604
V6 - 3.8L (231 CID)	2001-98	Oil Cooler Line To Radiator	800-605
VENTURE VAN			
V6 - 3.4L (207 CID)	2004-00	Oil Cooler Line To Trans, wo/Ball Check	800-604
V6 - 3.4L (207 CID)	2000	Oil Cooler Line To Radiator	800-605
CHEVROLET/GMC TRUCK			
ASTRO			
V6 - 4.3L (262 CID)	2005-96	Eng Oil Cooler Line To Cooler	800-606
V6 - 4.3L (262 CID)	2005-96	Oil Cooler Line To Radiator	800-605
V6 - 4.3L (262 CID)	2005-96	Oil Cooler Line To Trans, wo/Ball Check	800-604
AVALANCHE			
V8 - 5.3L (323 CID)	2006-02	Oil Cooler Line To Trans Cooler, Heavy Duty Trans Cooling Pkg	800-607
V8 - 5.3L (323 CID)	2005-02	Oil Cooler Line To Trans, wo/Ball Check	800-604
V8 - 5.3L (323 CID)	2003-02	Oil Cooler Line To Radiator	800-605
V8 - 8.1L (496 CID)	2006-02	Oil Cooler Line To Trans Cooler, Heavy Duty Trans Cooling Pkg	800-607
V8 - 8.1L (496 CID)	2005-02	Oil Cooler Line To Trans, wo/Ball Check	800-604
V8 - 8.1L (496 CID)	2003-02	Oil Cooler Line To Radiator	800-605

Make/ Model/Engine	Years	Description	Dorman #
CHEVROLET/GMC TRUCK (continued)			
BLAZER			
V8 - 5.7L (350 CID)	1994-92	Eng Oil Cooler Outlet Pipe Fitting, 3/8"-18	800-701
V8 - 6.5L (395 CID)	1994	Eng Oil Cooler Line To Eng Inlet/Outlet	800-603
CK1500/3500 PICKUP			
V6 - 4.3L (262 CID)	1998-96	Eng Oil Cooler Line To Eng Inlet/Outlet	800-603
V6 - 4.3L (262 CID)	1998-96	Oil Cooler Line To Trans Cooler, Heavy Duty Trans Cooling Pkg	800-607
V6 - 4.3L (262 CID)	1998-96	Oil Cooler Line To Trans, wo/Ball Check	800-604
V6 - 4.3L (262 CID)	1996-88	Eng Oil Cooler Outlet Pipe Fitting, 3/8"-18	800-701
V8 - 5.0L (305 CID)	1999-96	Eng Oil Cooler Line To Eng Inlet/Outlet	800-603
V8 - 5.0L (305 CID)	1999-96	Oil Cooler Line To Trans Cooler, Heavy Duty Trans Cooling Pkg	800-607
V8 - 5.0L (305 CID)	1999-96	Oil Cooler Line To Trans, wo/Ball Check	800-604
V8 - 5.0L (305 CID)	1995-88	Eng Oil Cooler Outlet Pipe Fitting, 3/8"-18	800-701
V8 - 5.7L (350 CID)	2000-96	Eng Oil Cooler Line To Eng Inlet/Outlet	800-603
V8 - 5.7L (350 CID)	2000-96	Oil Cooler Line To Trans Cooler, Heavy Duty Trans Cooling Pkg	800-607
V8 - 5.7L (350 CID)	2000-96	Oil Cooler Line To Trans, wo/Ball Check	800-604
V8 - 5.7L (350 CID)	1995-88	Eng Oil Cooler Outlet Pipe Fitting, 3/8"-18	800-701
V8 - 6.2L (379 CID)	1993-86	Eng Oil Cooler Line To Eng Inlet/Outlet	800-603
V8 - 6.5L (395 CID)	2002-96	Oil Cooler Line To Trans Cooler, Heavy Duty Trans Cooling Pkg	800-607
V8 - 6.5L (395 CID)	2002-96	Oil Cooler Line To Trans, wo/Ball Check	800-604
V8 - 6.5L (395 CID)	1996-93	Eng Oil Cooler Line To Eng Inlet/Outlet	800-603
V8 - 7.4L (454 CID)	2000-96	Eng Oil Cooler Line To Eng Outlet	800-603
V8 - 7.4L (454 CID)	2000-96	Oil Cooler Line To Trans Cooler, Heavy Duty Trans Cooling Pkg	800-607
V8 - 7.4L (454 CID)	2000-96	Oil Cooler Line To Trans, wo/Ball Check	800-604
V8 - 8.1L (496 CID)	2002-01	Oil Cooler Line To Trans Cooler, Heavy Duty Trans Cooling Pkg	800-607
V8 - 8.1L (496 CID)	2002-01	Oil Cooler Line To Trans, wo/Ball Check	800-604
DENALI, DENALI XL			
V8 - 6.0L (364 CID)	2006-01	Oil Cooler Line To Trans Cooler, Heavy Duty Trans Cooling Pkg	800-607
V8 - 6.0L (364 CID)	2005-01	Oil Cooler Line To Trans, wo/Ball Check	800-604
V8 - 6.0L (364 CID)	2003-01	Eng Oil Cooler Line To Cooler	800-606
V8 - 6.0L (364 CID)	2003-01	Oil Cooler Line To Radiator	800-605
EXPRESS VAN			
V6 - 4.3L (262 CID)	2006-96	Oil Cooler Line To Radiator	800-605
V6 - 4.3L (262 CID)	2005-96	Oil Cooler Line To Trans, wo/Ball Check	800-604
V6 - 4.3L (262 CID)	2002-96	Eng Oil Cooler Line To Cooler	800-606
V8 - 4.8L (294 CID)	2006-03	Eng Oil Cooler Line To Cooler	800-606
V8 - 4.8L (294 CID)	2006-03	Oil Cooler Line To Radiator	800-605
V8 - 4.8L (294 CID)	2005-03	Oil Cooler Line To Trans, wo/Ball Check	800-604
V8 - 5.0L (305 CID)	2002-96	Oil Cooler Line To Radiator	800-605
V8 - 5.0L (305 CID)	2002-96	Oil Cooler Line To Trans, wo/Ball Check	800-604
V8 - 5.3L (323 CID)	2006-03	Oil Cooler Line To Radiator	800-605
V8 - 5.3L (323 CID)	2005-03	Oil Cooler Line To Trans, wo/Ball Check	800-604
V8 - 5.7L (350 CID)	2002-96	Eng Oil Cooler Line To Cooler	800-606
V8 - 5.7L (350 CID)	2002-96	Eng Oil Cooler Line To Eng Inlet/Outlet	800-603
V8 - 5.7L (350 CID)	2002-96	Oil Cooler Line To Radiator	800-605
V8 - 5.7L (350 CID)	2002-96	Oil Cooler Line To Trans, wo/Ball Check	800-604
V8 - 6.0L (364 CID)	2006-03	Eng Oil Cooler Line To Cooler	800-606
V8 - 6.0L (364 CID)	2006-03	Oil Cooler Line To Radiator	800-605
V8 - 6.0L (364 CID)	2005-03	Oil Cooler Line To Trans, wo/Ball Check	800-604
V8 - 6.5L (395 CID)	2002-96	Oil Cooler Line To Radiator	800-605
V8 - 6.5L (395 CID)	2002-96	Oil Cooler Line To Trans, wo/Ball Check	800-604
V8 - 7.4L (454 CID)	2000-96	Eng Oil Cooler Line To Cooler	800-606
V8 - 7.4L (454 CID)	2000-96	Eng Oil Cooler Line To Eng Outlet	800-603
V8 - 7.4L (454 CID)	2000-96	Oil Cooler Line To Radiator	800-605
V8 - 7.4L (454 CID)	2000-96	Oil Cooler Line To Trans, wo/Ball Check	800-604
V8 - 8.1L (496 CID)	2002-01	Oil Cooler Line To Radiator	800-605
V8 - 8.1L (496 CID)	2002-01	Oil Cooler Line To Trans, wo/Ball Check	800-604
G SERIES VAN			
V6 - 4.3L (262 CID)	1998-96	Oil Cooler Line To Radiator	800-605
V6 - 4.3L (262 CID)	1998-96	Oil Cooler Line To Trans, wo/Ball Check	800-604
V8 - 5.0L (305 CID)	1998-96	Oil Cooler Line To Radiator	800-605
V8 - 5.0L (305 CID)	1998-96	Oil Cooler Line To Trans, wo/Ball Check	800-604
V8 - 5.7L (350 CID)	1996	Oil Cooler Line To Radiator	800-605
V8 - 5.7L (350 CID)	1996	Oil Cooler Line To Trans, wo/Ball Check	800-604
V8 - 6.5L (395 CID)	1996	Oil Cooler Line To Radiator	800-605
V8 - 6.5L (395 CID)	1996	Oil Cooler Line To Trans, wo/Ball Check	800-604
V8 - 7.4L (454 CID)	1996	Oil Cooler Line To Radiator	800-605
V8 - 7.4L (454 CID)	1996	Oil Cooler Line To Trans, wo/Ball Check	800-604
P SERIES VAN			
V6 - 4.3L (262 CID)	1999-98	Oil Cooler Line To Radiator	800-605
V6 - 4.3L (262 CID)	1999-98	Oil Cooler Line To Trans Cooler, Heavy Duty Trans Cooling Pkg	800-607

Quick Disconnect Transmission Oil Cooler Line Connector Applications

Make/ Model/Engine	Years	Description	Dorman #
CHEVROLET/GMC TRUCK (continued)			
P SERIES VAN (continued)			
V6 - 4.3L (262 CID)	1999-98	Oil Cooler Line To Trans, wo/Ball Check	800-604
V6 - 4.3L (262 CID)	1996-94	Eng Oil Cooler Outlet Pipe Fitting, 3/8"-18	800-701
V8 - 5.7L (350 CID)	1999-98	Oil Cooler Line To Radiator	800-605
V8 - 5.7L (350 CID)	1999-98	Oil Cooler Line To Trans Cooler, Heavy Duty Trans Cooling Pkg	800-607
V8 - 5.7L (350 CID)	1999-98	Oil Cooler Line To Trans, wo/Ball Check	800-604
V8 - 5.7L (350 CID)	1996-94	Eng Oil Cooler Outlet Pipe Fitting, 3/8"-18	800-701
V8 - 6.5L (395 CID)	1999-98	Oil Cooler Line To Radiator	800-605
V8 - 6.5L (395 CID)	1999-98	Oil Cooler Line To Trans Cooler, Heavy Duty Trans Cooling Pkg	800-607
V8 - 6.5L (395 CID)	1999-98	Oil Cooler Line To Trans, wo/Ball Check	800-604
V8 - 6.5L (395 CID)	1996-94	Eng Oil Cooler Outlet Pipe Fitting, 3/8"-18	800-701
V8 - 7.4L (454 CID)	1999-98	Eng Oil Cooler Line To Eng Outlet, Motor Home w/Cab	800-603
V8 - 7.4L (454 CID)	1999-98	Oil Cooler Line To Radiator	800-605
V8 - 7.4L (454 CID)	1999-98	Oil Cooler Line To Trans Cooler, Heavy Duty Trans Cooling Pkg	800-607
V8 - 7.4L (454 CID)	1999-98	Oil Cooler Line To Trans, wo/Ball Check	800-604
S SERIES BLAZER, JIMMY			
V6 - 4.3L (262 CID)	2005-96	Eng Oil Cooler Line To Cooler	800-606
V6 - 4.3L (262 CID)	2005-96	Oil Cooler Line To Radiator	800-605
V6 - 4.3L (262 CID)	2005-96	Oil Cooler Line To Trans, wo/Ball Check	800-604
S SERIES COLORADO, CANYON			
L4 - 2.8L (169 CID)	2005-04	Oil Cooler Line To Trans, wo/Ball Check	800-604
L5 - 3.5L (211 CID)	2005-04	Oil Cooler Line To Trans, wo/Ball Check	800-604
S SERIES PICKUP, SONOMA			
L4 - 2.2L (134 CID)	2004-96	Oil Cooler Line To Radiator	800-605
L4 - 2.2L (134 CID)	2004-96	Oil Cooler Line To Trans, wo/Ball Check	800-604
V6 - 4.3L (262 CID)	2004-96	Eng Oil Cooler Line To Cooler	800-606
V6 - 4.3L (262 CID)	2004-96	Oil Cooler Line To Radiator	800-605
V6 - 4.3L (262 CID)	2004-96	Oil Cooler Line To Trans, wo/Ball Check	800-604
S SERIES SSR			
V8 - 5.3L (323 CID)	2004	Oil Cooler Line To Trans, wo/Ball Check	800-604
V8 - 6.0L (364 CID)	2005	Oil Cooler Line To Trans, wo/Ball Check	800-604
S SERIES TRAILBLAZER, ENVVOY			
V6 - 4.2L (256 CID)	2004-02	Oil Cooler Line To Trans, wo/Ball Check	800-604
V8 - 5.3L (323 CID)	2004-03	Oil Cooler Line To Trans, wo/Ball Check	800-604
SAFARI			
V6 - 4.3L (262 CID)	2005-96	Eng Oil Cooler Line To Cooler	800-606
V6 - 4.3L (262 CID)	2005-96	Oil Cooler Line To Radiator	800-605
V6 - 4.3L (262 CID)	2005-96	Oil Cooler Line To Trans, wo/Ball Check	800-604
SAVANA VAN			
V6 - 4.3L (262 CID)	2006-96	Oil Cooler Line To Radiator	800-605
V6 - 4.3L (262 CID)	2005-96	Oil Cooler Line To Trans, wo/Ball Check	800-604
V6 - 4.3L (262 CID)	2002-96	Eng Oil Cooler Line To Cooler	800-606
V8 - 4.8L (294 CID)	2006-03	Eng Oil Cooler Line To Cooler	800-606
V8 - 4.8L (294 CID)	2006-03	Oil Cooler Line To Radiator	800-605
V8 - 4.8L (294 CID)	2005-03	Oil Cooler Line To Trans, wo/Ball Check	800-604
V8 - 5.0L (305 CID)	2002-96	Oil Cooler Line To Radiator	800-605
V8 - 5.0L (305 CID)	2002-96	Oil Cooler Line To Trans, wo/Ball Check	800-604
V8 - 5.3L (323 CID)	2006-03	Oil Cooler Line To Radiator	800-605
V8 - 5.3L (323 CID)	2005-03	Oil Cooler Line To Trans, wo/Ball Check	800-604
V8 - 5.7L (350 CID)	2002-96	Eng Oil Cooler Line To Cooler	800-606
V8 - 5.7L (350 CID)	2002-96	Eng Oil Cooler Line To Eng Inlet/Outlet	800-603
V8 - 5.7L (350 CID)	2002-96	Oil Cooler Line To Radiator	800-605
V8 - 5.7L (350 CID)	2002-96	Oil Cooler Line To Trans, wo/Ball Check	800-604
V8 - 6.0L (364 CID)	2006-03	Eng Oil Cooler Line To Cooler	800-606
V8 - 6.0L (364 CID)	2006-03	Oil Cooler Line To Radiator	800-605
V8 - 6.0L (364 CID)	2005-03	Oil Cooler Line To Trans, wo/Ball Check	800-604
V8 - 6.5L (395 CID)	2002-96	Oil Cooler Line To Radiator	800-605
V8 - 6.5L (395 CID)	2002-96	Oil Cooler Line To Trans, wo/Ball Check	800-604
V8 - 7.4L (454 CID)	2000-96	Eng Oil Cooler Line To Cooler	800-606
V8 - 7.4L (454 CID)	2000-96	Eng Oil Cooler Line To Eng Outlet	800-603
V8 - 7.4L (454 CID)	2000-96	Oil Cooler Line To Radiator	800-605
V8 - 7.4L (454 CID)	2000-96	Oil Cooler Line To Trans, wo/Ball Check	800-604
V8 - 8.1L (496 CID)	2002-01	Oil Cooler Line To Radiator	800-605
V8 - 8.1L (496 CID)	2002-01	Oil Cooler Line To Trans, wo/Ball Check	800-604
SIERRA			
V6 - 4.3L (262 CID)	2006-99	Oil Cooler Line To Trans Cooler, Heavy Duty Trans Cooling Pkg	800-607
V6 - 4.3L (262 CID)	2005-99	Oil Cooler Line To Trans, wo/Ball Check	800-604
V6 - 4.3L (262 CID)	2003-99	Oil Cooler Line To Radiator	800-605
V8 - 4.8L (294 CID)	2006-99	Oil Cooler Line To Trans Cooler, Heavy Duty Trans Cooling Pkg	800-607
V8 - 4.8L (294 CID)	2005-99	Oil Cooler Line To Trans, wo/Ball Check	800-604
V8 - 4.8L (294 CID)	2003-99	Oil Cooler Line To Radiator	800-605
V8 - 5.3L (323 CID)	2006-99	Oil Cooler Line To Trans Cooler, Heavy Duty Trans Cooling Pkg	800-607
V8 - 5.3L (323 CID)	2005-99	Oil Cooler Line To Trans, wo/Ball Check	800-604
V8 - 5.3L (323 CID)	2003-99	Oil Cooler Line To Radiator	800-605
V8 - 5.7L (350 CID)	2000-96	Oil Cooler Line To Trans Cooler, Heavy Duty Trans Cooling Pkg	800-607
V8 - 5.7L (350 CID)	2000-96	Oil Cooler Line To Trans, wo/Ball Check	800-604

Make/ Model/Engine	Years	Description	Dorman #
CHEVROLET/GMC TRUCK (continued)			
SIERRA (continued)			
V8 - 5.3L (323 CID)	2005-99	Oil Cooler Line To Trans, wo/Ball Check	800-604
V8 - 5.3L (323 CID)	2003-99	Oil Cooler Line To Radiator	800-605
V8 - 6.0L (364 CID)	2006-99	Oil Cooler Line To Trans Cooler, Heavy Duty Trans Cooling Pkg	800-607
V8 - 6.0L (364 CID)	2005-99	Oil Cooler Line To Trans, wo/Ball Check	800-604
V8 - 6.0L (364 CID)	2003-99	Eng Oil Cooler Line To Cooler	800-606
V8 - 6.0L (364 CID)	2003-99	Oil Cooler Line To Radiator	800-605
V8 - 6.6L (400 CID)	2006-01	Oil Cooler Line To Trans Cooler, Heavy Duty Trans Cooling Pkg	800-607
V8 - 6.6L (400 CID)	2005-01	Oil Cooler Line To Trans, wo/Ball Check	800-604
V8 - 6.6L (400 CID)	2003-01	Oil Cooler Line To Radiator	800-605
V8 - 8.1L (496 CID)	2006-01	Oil Cooler Line To Trans Cooler, Heavy Duty Trans Cooling Pkg	800-607
V8 - 8.1L (496 CID)	2005-01	Oil Cooler Line To Trans, wo/Ball Check	800-604
V8 - 8.1L (496 CID)	2003-01	Oil Cooler Line To Radiator	800-605
SILVERADO			
V6 - 4.3L (262 CID)	2006-99	Oil Cooler Line To Trans Cooler, Heavy Duty Trans Cooling Pkg	800-607
V6 - 4.3L (262 CID)	2005-99	Oil Cooler Line To Trans, wo/Ball Check	800-604
V6 - 4.3L (262 CID)	2003-99	Oil Cooler Line To Radiator	800-605
V8 - 4.8L (294 CID)	2006-99	Oil Cooler Line To Trans Cooler, Heavy Duty Trans Cooling Pkg	800-607
V8 - 4.8L (294 CID)	2005-99	Oil Cooler Line To Trans, wo/Ball Check	800-604
V8 - 4.8L (294 CID)	2003-99	Oil Cooler Line To Radiator	800-605
V8 - 5.3L (323 CID)	2006-99	Oil Cooler Line To Trans Cooler, Heavy Duty Trans Cooling Pkg	800-607
V8 - 5.3L (323 CID)	2005-99	Oil Cooler Line To Trans, wo/Ball Check	800-604
V8 - 5.3L (323 CID)	2003-99	Oil Cooler Line To Radiator	800-605
V8 - 6.0L (364 CID)	2006-99	Oil Cooler Line To Trans Cooler, Heavy Duty Trans Cooling Pkg	800-607
V8 - 6.0L (364 CID)	2005-99	Oil Cooler Line To Trans, wo/Ball Check	800-604
V8 - 6.0L (364 CID)	2003-99	Eng Oil Cooler Line To Cooler	800-606
V8 - 6.0L (364 CID)	2003-99	Oil Cooler Line To Radiator	800-605
V8 - 6.6L (400 CID)	2006-01	Oil Cooler Line To Trans Cooler, Heavy Duty Trans Cooling Pkg	800-607
V8 - 6.6L (400 CID)	2005-01	Oil Cooler Line To Trans, wo/Ball Check	800-604
V8 - 6.6L (400 CID)	2003-01	Oil Cooler Line To Radiator	800-605
V8 - 8.1L (496 CID)	2006-01	Oil Cooler Line To Trans Cooler, Heavy Duty Trans Cooling Pkg	800-607
V8 - 8.1L (496 CID)	2005-01	Oil Cooler Line To Trans, wo/Ball Check	800-604
V8 - 8.1L (496 CID)	2003-01	Oil Cooler Line To Radiator	800-605
SUBURBAN			
V8 - 5.3L (323 CID)	2006-00	Oil Cooler Line To Trans Cooler, Heavy Duty Trans Cooling Pkg	800-607
V8 - 5.3L (323 CID)	2005-00	Oil Cooler Line To Trans, wo/Ball Check	800-604
V8 - 5.3L (323 CID)	2003-00	Oil Cooler Line To Radiator	800-605
V8 - 5.7L (350 CID)	1999-96	Eng Oil Cooler Line To Eng Inlet/Outlet	800-603
V8 - 5.7L (350 CID)	1999-96	Oil Cooler Line To Trans Cooler, Heavy Duty Trans Cooling Pkg	800-607
V8 - 5.7L (350 CID)	1999-96	Oil Cooler Line To Trans, wo/Ball Check	800-604
V8 - 5.7L (350 CID)	1995-92	Eng Oil Cooler Outlet Pipe Fitting, 3/8"-18	800-701
V8 - 6.0L (364 CID)	2006-00	Oil Cooler Line To Trans Cooler, Heavy Duty Trans Cooling Pkg	800-607
V8 - 6.0L (364 CID)	2005-00	Oil Cooler Line To Trans, wo/Ball Check	800-604
V8 - 6.0L (364 CID)	2003-00	Eng Oil Cooler Line To Cooler	800-606
V8 - 6.0L (364 CID)	2003-00	Oil Cooler Line To Radiator	800-605
V8 - 6.2L (379 CID)	1993-92	Eng Oil Cooler Line To Eng Inlet/Outlet	800-603
V8 - 6.5L (395 CID)	1999-96	Oil Cooler Line To Trans Cooler, Heavy Duty Trans Cooling Pkg	800-607
V8 - 6.5L (395 CID)	1999-96	Oil Cooler Line To Trans, wo/Ball Check	800-604
V8 - 6.5L (395 CID)	1996-93	Eng Oil Cooler Line To Eng Inlet/Outlet	800-603
V8 - 7.4L (454 CID)	1999-96	Eng Oil Cooler Line To Eng Outlet	800-603
V8 - 7.4L (454 CID)	1999-96	Oil Cooler Line To Trans Cooler, Heavy Duty Trans Cooling Pkg	800-607
V8 - 7.4L (454 CID)	1999-96	Oil Cooler Line To Trans, wo/Ball Check	800-604
V8 - 8.1L (496 CID)	2006-01	Oil Cooler Line To Trans Cooler, Heavy Duty Trans Cooling Pkg	800-607
V8 - 8.1L (496 CID)	2005-01	Oil Cooler Line To Trans, wo/Ball Check	800-604
V8 - 8.1L (496 CID)	2003-01	Oil Cooler Line To Radiator	800-605
TAHOE			
V8 - 4.8L (294 CID)	2006-00	Oil Cooler Line To Trans Cooler, Heavy Duty Trans Cooling Pkg	800-607
V8 - 4.8L (294 CID)	2005-00	Oil Cooler Line To Trans, wo/Ball Check	800-604
V8 - 4.8L (294 CID)	2003-00	Oil Cooler Line To Radiator	800-605
V8 - 5.3L (323 CID)	2006-00	Oil Cooler Line To Trans Cooler, Heavy Duty Trans Cooling Pkg	800-607
V8 - 5.3L (323 CID)	2005-00	Oil Cooler Line To Trans, wo/Ball Check	800-604
V8 - 5.3L (323 CID)	2003-00	Oil Cooler Line To Radiator	800-605
V8 - 5.7L (350 CID)	2000-96	Oil Cooler Line To Trans Cooler, Heavy Duty Trans Cooling Pkg	800-607
V8 - 5.7L (350 CID)	2000-96	Oil Cooler Line To Trans, wo/Ball Check	800-604

Quick Disconnect

Fuel Sending Units
pg. 155-176

Fuel Tanks
pg. 177-228

Harmonic Balancers
pg. 229-254

Heater Hose Assemblies
pg. 255-256

Hydraulic Clutch Lines
pg. 257-260

Use Quick Disconnect Fittings & Clips for Fast, Economical Repairs

Quick Disconnect
393

Quick Disconnect Transmission Oil Cooler Line Connector Applications

Make/ Model/Engine	Years	Description	Dorman #
CHEVROLET/GMC TRUCK (continued)			
TAHOE (continued)			
V8 - 5.7L (350 CID)	1999-96	Eng Oil Cooler Line To Eng Inlet/Outlet	800-603
V8 - 5.7L (350 CID)	1995-92	Eng Oil Cooler Outlet Pipe Fitting, 3/8"-18	800-701
V8 - 6.5L (395 CID)	1999-96	Oil Cooler Line To Trans Cooler, Heavy Duty Trans Cooling Pkg	800-607
V8 - 6.5L (395 CID)	1999-96	Oil Cooler Line To Trans, wo/Ball Check	800-604
V8 - 6.5L (395 CID)	1996-95	Eng Oil Cooler Line To Eng Inlet/Outlet	800-603
YUKON, YUKON XL			
V8 - 4.8L (294 CID)	2006-00	Oil Cooler Line To Trans Cooler, Heavy Duty Trans Cooling Pkg	800-607
V8 - 4.8L (294 CID)	2005-00	Oil Cooler Line To Trans, wo/Ball Check	800-604
V8 - 4.8L (294 CID)	2003-00	Oil Cooler Line To Radiator	800-605
V8 - 5.3L (323 CID)	2006-00	Oil Cooler Line To Trans Cooler, Heavy Duty Trans Cooling Pkg	800-607
V8 - 5.3L (323 CID)	2005-00	Oil Cooler Line To Trans, wo/Ball Check	800-604
V8 - 5.3L (323 CID)	2003-00	Oil Cooler Line To Radiator	800-605
V8 - 5.7L (350 CID)	2000-96	Oil Cooler Line To Trans Cooler, Heavy Duty Trans Cooling Pkg	800-607
V8 - 5.7L (350 CID)	2000-96	Oil Cooler Line To Trans, wo/Ball Check	800-604
V8 - 5.7L (350 CID)	1999-96	Eng Oil Cooler Line To Eng Inlet/Outlet	800-603
V8 - 5.7L (350 CID)	1995-92	Eng Oil Cooler Outlet Pipe Fitting, 3/8"-18	800-701
V8 - 6.0L (364 CID)	2006-00	Oil Cooler Line To Trans Cooler, Heavy Duty Trans Cooling Pkg	800-607
V8 - 6.0L (364 CID)	2005-00	Oil Cooler Line To Trans, wo/Ball Check	800-604
V8 - 6.0L (364 CID)	2003-00	Eng Oil Cooler Line To Cooler	800-606
V8 - 6.0L (364 CID)	2003-00	Oil Cooler Line To Radiator	800-605
V8 - 6.5L (395 CID)	1999-96	Oil Cooler Line To Trans Cooler, Heavy Duty Trans Cooling Pkg	800-607
V8 - 6.5L (395 CID)	1999-96	Oil Cooler Line To Trans, wo/Ball Check	800-604
V8 - 6.5L (395 CID)	1996-94	Eng Oil Cooler Line To Eng Inlet/Outlet	800-603
V8 - 8.1L (496 CID)	2006-01	Oil Cooler Line To Trans Cooler, Heavy Duty Trans Cooling Pkg	800-607
V8 - 8.1L (496 CID)	2005-01	Oil Cooler Line To Trans, wo/Ball Check	800-604
V8 - 8.1L (496 CID)	2003-01	Oil Cooler Line To Radiator	800-605
DODGE TRUCK			
B150/3500 VAN			
V6 - 3.9L (239 CID)	1998-94	Oil Cooler Line Connector, 3/8"	800-610
V8 - 5.2L (318 CID)	1998-94	Oil Cooler Line Connector, 3/8"	800-610
V8 - 5.9L (360 CID)	1998-94	Oil Cooler Line Connector, 3/8"	800-610
RAM 1500/3500 PICKUP			
V6 - 3.9L (239 CID)	1999-94	Oil Cooler Line Connector, 3/8"	800-610
V8 - 5.2L (318 CID)	1999-94	Oil Cooler Line Connector, 3/8"	800-610
V8 - 5.9L (360 CID)	1999-94	Oil Cooler Line Connector, 3/8"	800-610
RAM 1500/3500 VAN			
V6 - 3.9L (239 CID)	2003-99	Oil Cooler Line Connector, 3/8"	800-610
V8 - 5.2L (318 CID)	2003-99	Oil Cooler Line Connector, 3/8"	800-610
V8 - 5.9L (360 CID)	2003-99	Oil Cooler Line Connector, 3/8"	800-610
FORD			
COUNTRY SQUIRE			
V8 - 5.0L (302 CID)	1991-84	Oil Cooler Line To Radiator	800-609
V8 - 5.0L (302 CID)	1983	Oil Cooler Line To Radiator, 1/2"-20 Female x 1/4" NPTF Male	800-609
V8 - 5.0L (302 CID)	1983	Oil Cooler Line To Radiator, 1/4" Straight Pipe Thread	800-608
V8 - 5.0L (302 CID)	1982	Oil Cooler Line To Radiator	800-608
V8 - 5.8L (351 CID)	1987-84	Oil Cooler Line To Radiator	800-609
V8 - 5.8L (351 CID)	1983	Oil Cooler Line To Radiator, 1/2"-20 Female x 1/4" NPTF Male	800-609
V8 - 5.8L (351 CID)	1983	Oil Cooler Line To Radiator, 1/4" Straight Pipe Thread	800-608
CROWN VICTORIA			
V8 - 4.6L (281 CID)	2006-92	Oil Cooler Line To Radiator	800-609
V8 - 5.0L (302 CID)	1991-84	Oil Cooler Line To Radiator	800-609
V8 - 5.0L (302 CID)	1983	Oil Cooler Line To Radiator, 1/2"-20 Female x 1/4" NPTF Male	800-609
V8 - 5.0L (302 CID)	1983	Oil Cooler Line To Radiator, 1/4" Straight Pipe Thread	800-608
V8 - 5.8L (351 CID)	1991-84	Oil Cooler Line To Radiator	800-609
V8 - 5.8L (351 CID)	1983	Oil Cooler Line To Radiator, 1/2"-20 Female x 1/4" NPTF Male	800-609
V8 - 5.8L (351 CID)	1983	Oil Cooler Line To Radiator, 1/4" Straight Pipe Thread	800-608
ESCORT			
L4 - 1.9L (116 CID)	1990	Oil Cooler Line To Radiator	800-608
FAIRMONT			
L4 - 2.3L (140 CID)	1983	Oil Cooler Line To Radiator	800-608
L6 - 3.3L (200 CID)	1983	Oil Cooler Line To Radiator	800-608
LTD			
L4 - 2.3L (140 CID)	1986-84	Oil Cooler Line To Radiator	800-609

Make/ Model/Engine	Years	Description	Dorman #
FORD (continued)			
LTD (continued)			
L4 - 2.3L (140 CID)	1983	Oil Cooler Line To Radiator, 1/2"-20 Female x 1/4" NPTF Male	800-609
L4 - 2.3L (140 CID)	1983	Oil Cooler Line To Radiator, 1/4" Straight Pipe Thread	800-608
L6 - 3.3L (200 CID)	1983	Oil Cooler Line To Radiator, 1/2"-20 Female x 1/4" NPTF Male	800-609
L6 - 3.3L (200 CID)	1983	Oil Cooler Line To Radiator, 1/4" Straight Pipe Thread	800-608
V6 - 3.8L (232 CID)	1986-84	Oil Cooler Line To Radiator	800-609
V6 - 3.8L (232 CID)	1983	Oil Cooler Line To Radiator, 1/2"-20 Female x 1/4" NPTF Male	800-609
V6 - 3.8L (232 CID)	1983	Oil Cooler Line To Radiator, 1/4" Straight Pipe Thread	800-608
V8 - 4.2L (255 CID)	1982	Oil Cooler Line To Radiator	800-608
V8 - 5.0L (302 CID)	1985-84	Oil Cooler Line To Radiator	800-609
V8 - 5.0L (302 CID)	1982	Oil Cooler Line To Radiator	800-608
V8 - 5.8L (351 CID)	1982	Oil Cooler Line To Radiator	800-608
MUSTANG			
L4 - 2.3L (140 CID)	1993-84	Oil Cooler Line To Radiator	800-609
L4 - 2.3L (140 CID)	1983	Oil Cooler Line To Radiator, 1/2"-20 Female x 1/4" NPTF Male	800-609
L4 - 2.3L (140 CID)	1983	Oil Cooler Line To Radiator, 1/4" Straight Pipe Thread	800-608
V6 - 3.8L (232 CID)	2004-94	Oil Cooler Line To Radiator	800-609
V6 - 3.8L (232 CID)	1986-84	Oil Cooler Line To Radiator	800-609
V6 - 3.8L (232 CID)	1983	Oil Cooler Line To Radiator, 1/2"-20 Female x 1/4" NPTF Male	800-609
V6 - 3.8L (232 CID)	1983	Oil Cooler Line To Radiator, 1/4" Straight Pipe Thread	800-608
V8 - 4.6L (281 CID)	2004-96	Oil Cooler Line To Radiator	800-609
V8 - 5.0L (302 CID)	1995-84	Oil Cooler Line To Radiator	800-609
V8 - 5.0L (302 CID)	1983	Oil Cooler Line To Radiator, 1/2"-20 Female x 1/4" NPTF Male	800-609
V8 - 5.0L (302 CID)	1983	Oil Cooler Line To Radiator, 1/4" Straight Pipe Thread	800-608
V8 - 5.8L (351 CID)	1995	Oil Cooler Line To Radiator	800-609
TAURUS			
L4 - 2.5L (153 CID)	1990	Oil Cooler Line To Radiator, 1/2"-20 Female x 1/4" NPTF Male	800-609
L4 - 2.5L (153 CID)	1990	Oil Cooler Line To Radiator, 1/4" Straight Pipe Thread	800-608
L4 - 2.5L (153 CID)	1989-86	Oil Cooler Line To Radiator	800-609
V6 - 3.0L (182 CID)	2006-96	Oil Cooler Line To Radiator	800-601
V6 - 3.0L (182 CID)	2006-93	Oil Cooler Line To Trans	800-602
V6 - 3.0L (182 CID)	1995-91	Oil Cooler Line To Radiator	800-609
V6 - 3.0L (182 CID)	1990	Oil Cooler Line To Radiator, 1/2"-20 Female x 1/4" NPTF Male	800-609
V6 - 3.0L (182 CID)	1990	Oil Cooler Line To Radiator, 1/4" Straight Pipe Thread	800-608
V6 - 3.0L (182 CID)	1989-86	Oil Cooler Line To Radiator	800-609
V6 - 3.2L (195 CID)	1995-93	Oil Cooler Line To Radiator	800-609
V6 - 3.2L (195 CID)	1995-93	Oil Cooler Line To Trans	800-602
V6 - 3.8L (232 CID)	1995-93	Oil Cooler Line To Trans	800-602
V6 - 3.8L (232 CID)	1995-91	Oil Cooler Line To Radiator	800-609
V6 - 3.8L (232 CID)	1990	Oil Cooler Line To Radiator, 1/2"-20 Female x 1/4" NPTF Male	800-609
V6 - 3.8L (232 CID)	1990	Oil Cooler Line To Radiator, 1/4" Straight Pipe Thread	800-608
V6 - 3.8L (232 CID)	1989-88	Oil Cooler Line To Radiator	800-609
V8 - 3.4L (207 CID)	1999-96	Oil Cooler Line To Radiator	800-601
V8 - 3.4L (207 CID)	1999-96	Oil Cooler Line To Trans	800-602
TEMPO			
L4 - 2.3L (140 CID)	1994-90	Oil Cooler Line To Radiator	800-608
V6 - 3.0L (182 CID)	1994-92	Oil Cooler Line To Radiator	800-608
THUNDERBIRD			
L4 - 2.3L (140 CID)	1988-84	Oil Cooler Line To Radiator	800-609
L4 - 2.3L (140 CID)	1983	Oil Cooler Line To Radiator, 1/2"-20 Female x 1/4" NPTF Male	800-609
L4 - 2.3L (140 CID)	1983	Oil Cooler Line To Radiator, 1/4" Straight Pipe Thread	800-608
V6 - 3.8L (232 CID)	1994-84	Oil Cooler Line To Radiator	800-609
V6 - 3.8L (232 CID)	1983	Oil Cooler Line To Radiator, 1/2"-20 Female x 1/4" NPTF Male	800-609
V6 - 3.8L (232 CID)	1983	Oil Cooler Line To Radiator, 1/4" Straight Pipe Thread	800-608
V8 - 4.6L (281 CID)	1994	Oil Cooler Line To Radiator	800-609
V8 - 5.0L (302 CID)	1993-91	Oil Cooler Line To Radiator	800-609
V8 - 5.0L (302 CID)	1988-84	Oil Cooler Line To Radiator	800-609
V8 - 5.0L (302 CID)	1983	Oil Cooler Line To Radiator, 1/2"-20 Female x 1/4" NPTF Male	800-609

Quick Disconnect Transmission Oil Cooler Line Connector Applications

Make/ Model/Engine	Years	Description	Dorman #	Make/ Model/Engine	Years	Description	Dorman #
FORD (continued)				FORD TRUCK (continued)			
THUNDERBIRD (continued)				WINDSTAR			
V8 - 5.0L (302 CID)	1983	Oil Cooler Line To Radiator, 1/4" Straight Pipe Thread	800-608	V6 - 3.0L (182 CID)	2000-99	Oil Cooler Line To Radiator	800-601
FORD TRUCK				V6 - 3.8L (232 CID)	2003-99	Oil Cooler Line To Radiator	800-601
AEROSTAR				HUMMER			
V6 - 2.8L (171 CID)	1986	Oil Cooler Line To Radiator, w/A4LD	800-609	H2			
BRONCO				V8 - 6.0L (364 CID)	2005-03	Oil Cooler Line To Trans Cooler, Heavy Duty Trans Cooling Pkg	800-607
L6 - 4.9L (300 CID)	1992-82	Oil Cooler Line To Radiator	800-609	V8 - 6.0L (364 CID)	2005-03	Oil Cooler Line To Trans, wo/Ball Check	800-604
V8 - 5.0L (302 CID)	1996-82	Oil Cooler Line To Radiator	800-609	V8 - 6.0L (364 CID)	2004-03	Eng Oil Cooler Line To Cooler	800-606
V8 - 5.8L (351 CID)	1996-82	Oil Cooler Line To Radiator	800-609	V8 - 6.0L (364 CID)	2003	Oil Cooler Line To Radiator	800-605
BRONCO II				JEEP			
V6 - 2.8L (171 CID)	1987-86	Oil Cooler Line To Radiator	800-609	GRAND CHEROKEE			
V6 - 2.8L (171 CID)	1985-84	Oil Cooler Line To Radiator	800-609	L6 - 4.0L (242 CID)	1998-93	Oil Cooler Line Connector, 3/8"	800-610
E100 ECONOLINE				V8 - 5.2L (318 CID)	1998-93	Oil Cooler Line Connector, 3/8"	800-610
L6 - 4.9L (300 CID)	1983-82	Oil Cooler Line To Radiator	800-609	WRANGLER			
V8 - 5.0L (302 CID)	1983-82	Oil Cooler Line To Radiator	800-609	L6 - 4.0L (242 CID)	2003-97	Oil Cooler Line Connector, 3/8"	800-610
V8 - 5.8L (351 CID)	1983-82	Oil Cooler Line To Radiator	800-609	LINCOLN			
E150 ECONOLINE				CONTINENTAL			
L6 - 4.9L (300 CID)	1996-82	Oil Cooler Line To Radiator	800-609	L6 - 2.4L (146 CID)	1984	Oil Cooler Line To Radiator, 1/2"-20 Female x 1/4" NPTF Male	800-609
V6 - 4.2L (256 CID)	2006-97	Oil Cooler Line To Radiator	800-609	L6 - 2.4L (146 CID)	1984	Oil Cooler Line To Radiator, 1/4" Straight Pipe Thread	800-608
V8 - 4.6L (281 CID)	2006-97	Oil Cooler Line To Radiator	800-609	V6 - 3.8L (232 CID)	1994-93	Oil Cooler Line To Trans	800-602
V8 - 5.0L (302 CID)	1996-82	Oil Cooler Line To Radiator	800-609	V6 - 3.8L (232 CID)	1994-91	Oil Cooler Line To Radiator	800-609
V8 - 5.4L (330 CID)	2006-97	Oil Cooler Line To Radiator	800-609	V6 - 3.8L (232 CID)	1990	Oil Cooler Line To Radiator, 1/2"-20 Female x 1/4" NPTF Male	800-609
V8 - 5.8L (351 CID)	1996-82	Oil Cooler Line To Radiator	800-609	V6 - 3.8L (232 CID)	1990	Oil Cooler Line To Radiator, 1/4" Straight Pipe Thread	800-608
V8 - 6.6L (400 CID)	1982	Oil Cooler Line To Radiator	800-609	V6 - 3.8L (232 CID)	1989-88	Oil Cooler Line To Radiator	800-609
V8 - 6.9L (421 CID)	1987-83	Oil Cooler Line To Radiator	800-609	V6 - 3.8L (232 CID)	1982	Oil Cooler Line To Radiator	800-608
V8 - 7.3L (444 CID)	1991-88	Oil Cooler Line To Radiator	800-609	V8 - 4.6L (281 CID)	2002-95	Oil Cooler Line To Trans	800-602
V8 - 7.5L (460 CID)	1996-82	Oil Cooler Line To Radiator	800-609	V8 - 4.6L (281 CID)	1995	Oil Cooler Line To Radiator	800-609
E350 ECONOLINE				V8 - 5.0L (302 CID)	1987-86	Oil Cooler Line To Radiator	800-609
L4 - 3.7L (226 CID)	1982	Oil Cooler Line To Radiator	800-609	V8 - 5.0L (302 CID)	1985-83	Oil Cooler Line To Radiator, 1/2"-20 Female x 1/4" NPTF Male	800-609
L6 - 4.9L (300 CID)	1996-82	Oil Cooler Line To Radiator	800-609	V8 - 5.0L (302 CID)	1985-83	Oil Cooler Line To Radiator, 1/4" Straight Pipe Thread	800-608
V8 - 4.6L (281 CID)	2006-97	Oil Cooler Line To Radiator	800-609	V8 - 5.0L (302 CID)	1982	Oil Cooler Line To Radiator	800-608
V8 - 5.0L (302 CID)	1991-82	Oil Cooler Line To Radiator	800-609	MARK SERIES			
V8 - 5.4L (330 CID)	2006-97	Oil Cooler Line To Radiator	800-609	L6 - 2.4L (146 CID)	1984	Oil Cooler Line To Radiator, 1/2"-20 Female x 1/4" NPTF Male	800-609
V8 - 5.8L (351 CID)	1996-82	Oil Cooler Line To Radiator	800-609	L6 - 2.4L (146 CID)	1984	Oil Cooler Line To Radiator, 1/4" Straight Pipe Thread	800-608
V8 - 6.6L (400 CID)	1982	Oil Cooler Line To Radiator	800-609	V8 - 4.6L (281 CID)	1998-93	Oil Cooler Line To Radiator	800-609
V8 - 6.9L (421 CID)	1987-83	Oil Cooler Line To Radiator	800-609	V8 - 5.0L (302 CID)	1992-86	Oil Cooler Line To Radiator	800-609
V8 - 7.3L (444 CID)	2003-88	Oil Cooler Line To Radiator	800-609	V8 - 5.0L (302 CID)	1985-83	Oil Cooler Line To Radiator, 1/2"-20 Female x 1/4" NPTF Male	800-609
V8 - 7.5L (460 CID)	1996-82	Oil Cooler Line To Radiator	800-609	V8 - 5.0L (302 CID)	1985-83	Oil Cooler Line To Radiator, 1/4" Straight Pipe Thread	800-608
V10 - 6.8L (415 CID)	2006-97	Oil Cooler Line To Radiator	800-609	V8 - 5.0L (302 CID)	1982	Oil Cooler Line To Radiator	800-608
F100 PICKUP				TOWN CAR			
L6 - 4.9L (300 CID)	1983-82	Oil Cooler Line To Radiator	800-609	V8 - 4.6L (281 CID)	2006-91	Oil Cooler Line To Radiator	800-609
V6 - 3.8L (232 CID)	1983-82	Oil Cooler Line To Radiator	800-609	V8 - 5.0L (302 CID)	1990-84	Oil Cooler Line To Radiator	800-609
V8 - 4.2L (255 CID)	1982	Oil Cooler Line To Radiator	800-609	V8 - 5.0L (302 CID)	1983	Oil Cooler Line To Radiator, 1/2"-20 Female x 1/4" NPTF Male	800-609
V8 - 5.0L (302 CID)	1983-82	Oil Cooler Line To Radiator	800-609	V8 - 5.0L (302 CID)	1983	Oil Cooler Line To Radiator, 1/4" Straight Pipe Thread	800-608
F150 PICKUP				V8 - 5.0L (302 CID)	1982	Oil Cooler Line To Radiator	800-608
L6 - 4.9L (300 CID)	1996-82	Oil Cooler Line To Radiator	800-609	MERCURY			
V6 - 3.8L (232 CID)	1982	Oil Cooler Line To Radiator	800-609	CAPRI			
V8 - 5.0L (302 CID)	1996-82	Oil Cooler Line To Radiator	800-609	L4 - 2.3L (140 CID)	1986-84	Oil Cooler Line To Radiator	800-609
V8 - 5.8L (351 CID)	1996-82	Oil Cooler Line To Radiator	800-609	L4 - 2.3L (140 CID)	1983	Oil Cooler Line To Radiator, 1/2"-20 Female x 1/4" NPTF Male	800-609
V8 - 6.6L (400 CID)	1982	Oil Cooler Line To Radiator	800-609	L4 - 2.3L (140 CID)	1983	Oil Cooler Line To Radiator, 1/4" Straight Pipe Thread	800-608
V8 - 6.9L (421 CID)	1987-83	Oil Cooler Line To Radiator	800-609	V6 - 3.8L (232 CID)	1986-84	Oil Cooler Line To Radiator	800-609
V8 - 6.9L (421 CID)	1984	Oil Cooler Line To Radiator	800-609	V6 - 3.8L (232 CID)	1983	Oil Cooler Line To Radiator, 1/2"-20 Female x 1/4" NPTF Male	800-609
V8 - 7.5L (460 CID)	1989	Oil Cooler Line To Radiator	800-609	V6 - 3.8L (232 CID)	1983	Oil Cooler Line To Radiator, 1/4" Straight Pipe Thread	800-608
F250 PICKUP				V8 - 5.0L (302 CID)	1986-84	Oil Cooler Line To Radiator	800-609
L6 - 4.9L (300 CID)	1996-82	Oil Cooler Line To Radiator	800-609	V8 - 5.0L (302 CID)	1983	Oil Cooler Line To Radiator, 1/2"-20 Female x 1/4" NPTF Male	800-609
V6 - 3.8L (232 CID)	1983	Oil Cooler Line To Radiator	800-609	V8 - 5.0L (302 CID)	1983	Oil Cooler Line To Radiator, 1/4" Straight Pipe Thread	800-608
V8 - 5.0L (302 CID)	1996-82	Oil Cooler Line To Radiator	800-609	V8 - 5.0L (302 CID)	1983	Oil Cooler Line To Radiator	800-609
V8 - 5.8L (351 CID)	1996-82	Oil Cooler Line To Radiator	800-609	V8 - 5.0L (302 CID)	1983	Oil Cooler Line To Radiator, 1/2"-20 Female x 1/4" NPTF Male	800-609
V8 - 6.6L (400 CID)	1982	Oil Cooler Line To Radiator	800-609	V8 - 5.0L (302 CID)	1983	Oil Cooler Line To Radiator, 1/4" Straight Pipe Thread	800-608
V8 - 6.9L (421 CID)	1987-83	Oil Cooler Line To Radiator	800-609	COLONY PARK			
V8 - 7.3L (444 CID)	1996-88	Oil Cooler Line To Radiator	800-609	V8 - 5.0L (302 CID)	1991-84	Oil Cooler Line To Radiator	800-609
V8 - 7.5L (460 CID)	1996-83	Oil Cooler Line To Radiator	800-609	V8 - 5.0L (302 CID)	1983	Oil Cooler Line To Radiator, 1/2"-20 Female x 1/4" NPTF Male	800-609
F350 PICKUP				V8 - 5.0L (302 CID)	1983	Oil Cooler Line To Radiator, 1/4" Straight Pipe Thread	800-608
L6 - 4.9L (300 CID)	1996-82	Oil Cooler Line To Radiator	800-609	V8 - 5.0L (302 CID)	1982	Oil Cooler Line To Radiator	800-608
V8 - 5.8L (351 CID)	1996-82	Oil Cooler Line To Radiator	800-609	RANGER			
V8 - 6.6L (400 CID)	1982	Oil Cooler Line To Radiator	800-609	L4 - 2.0L (122 CID)	1987-83	Oil Cooler Line To Radiator	800-609
V8 - 6.9L (421 CID)	1987-83	Oil Cooler Line To Radiator	800-609	L4 - 2.2L (134 CID)	1984-83	Oil Cooler Line To Radiator	800-609
V8 - 7.3L (444 CID)	1996-88	Oil Cooler Line To Radiator	800-609	L4 - 2.3L (140 CID)	1987-83	Oil Cooler Line To Radiator	800-609
V8 - 7.5L (460 CID)	1996-83	Oil Cooler Line To Radiator	800-609	V6 - 2.8L (171 CID)	1985-83	Oil Cooler Line To Radiator	800-609
RANGER				V6 - 2.9L (177 CID)	1987-86	Oil Cooler Line To Radiator	800-609
L4 - 2.0L (122 CID)	1987-83	Oil Cooler Line To Radiator	800-609				
L4 - 2.2L (134 CID)	1984-83	Oil Cooler Line To Radiator	800-609				
L4 - 2.3L (140 CID)	1987-83	Oil Cooler Line To Radiator	800-609				
V6 - 2.8L (171 CID)	1985-83	Oil Cooler Line To Radiator	800-609				
V6 - 2.9L (177 CID)	1987-86	Oil Cooler Line To Radiator	800-609				

Quick Disconnect

Quick Disconnect Transmission Oil Cooler Line Connector Applications

Quick Disconnect

Make/ Model/Engine	Years	Description	Dorman #
MERCURY (continued)			
COUGAR			
L4 - 2.3L (140 CID)	1986-84	Oil Cooler Line To Radiator	800-609
V6 - 3.8L (232 CID)	1994-84	Oil Cooler Line To Radiator	800-609
V6 - 3.8L (232 CID)	1983	Oil Cooler Line To Radiator, 1/2"-20 Female x 1/4" NPTF Male	800-609
V6 - 3.8L (232 CID)	1983	Oil Cooler Line To Radiator, 1/4" Straight Pipe Thread	800-608
V8 - 4.6L (281 CID)	1994	Oil Cooler Line To Radiator	800-609
V8 - 5.0L (302 CID)	1993-91	Oil Cooler Line To Radiator	800-609
V8 - 5.0L (302 CID)	1988-84	Oil Cooler Line To Radiator	800-609
V8 - 5.0L (302 CID)	1983	Oil Cooler Line To Radiator, 1/2"-20 Female x 1/4" NPTF Male	800-609
V8 - 5.0L (302 CID)	1983	Oil Cooler Line To Radiator, 1/4" Straight Pipe Thread	800-608
GRAND MARQUIS			
V8 - 4.2L (255 CID)	1982	Oil Cooler Line To Radiator	800-608
V8 - 4.6L (281 CID)	2006-92	Oil Cooler Line To Radiator	800-609
V8 - 5.0L (302 CID)	1991-84	Oil Cooler Line To Radiator	800-609
V8 - 5.0L (302 CID)	1983	Oil Cooler Line To Radiator, 1/2"-20 Female x 1/4" NPTF Male	800-609
V8 - 5.0L (302 CID)	1983	Oil Cooler Line To Radiator, 1/4" Straight Pipe Thread	800-608
V8 - 5.0L (302 CID)	1982	Oil Cooler Line To Radiator	800-608
MARQUIS			
L4 - 2.3L (140 CID)	1986-84	Oil Cooler Line To Radiator	800-609
L4 - 2.3L (140 CID)	1983	Oil Cooler Line To Radiator, 1/2"-20 Female x 1/4" NPTF Male	800-609
L4 - 2.3L (140 CID)	1983	Oil Cooler Line To Radiator, 1/4" Straight Pipe Thread	800-608
L6 - 3.3L (200 CID)	1983	Oil Cooler Line To Radiator, 1/2"-20 Female x 1/4" NPTF Male	800-609
L6 - 3.3L (200 CID)	1983	Oil Cooler Line To Radiator, 1/4" Straight Pipe Thread	800-608
V6 - 3.8L (232 CID)	1986-84	Oil Cooler Line To Radiator	800-609
V6 - 3.8L (232 CID)	1983	Oil Cooler Line To Radiator, 1/2"-20 Female x 1/4" NPTF Male	800-609
V6 - 3.8L (232 CID)	1983	Oil Cooler Line To Radiator, 1/4" Straight Pipe Thread	800-608
V8 - 4.2L (255 CID)	1982	Oil Cooler Line To Radiator	800-608
V8 - 5.0L (302 CID)	1982	Oil Cooler Line To Radiator	800-608
V8 - 5.8L (351 CID)	1982	Oil Cooler Line To Radiator	800-608
SABLE			
L4 - 2.5L (153 CID)	1986	Oil Cooler Line To Radiator	800-609
V6 - 3.0L (182 CID)	2005-96	Oil Cooler Line To Radiator	800-601
V6 - 3.0L (182 CID)	2005-93	Oil Cooler Line To Trans	800-602
V6 - 3.0L (182 CID)	1995-91	Oil Cooler Line To Radiator	800-609
V6 - 3.0L (182 CID)	1990	Oil Cooler Line To Radiator, 1/2"-20 Female x 1/4" NPTF Male	800-609
V6 - 3.0L (182 CID)	1990	Oil Cooler Line To Radiator, 1/4" Straight Pipe Thread	800-608
V6 - 3.0L (182 CID)	1989-86	Oil Cooler Line To Radiator	800-609
V6 - 3.8L (232 CID)	1995-93	Oil Cooler Line To Trans	800-602

Make/ Model/Engine	Years	Description	Dorman #
MERCURY (continued)			
SABLE (continued)			
V6 - 3.8L (232 CID)	1995-91	Oil Cooler Line To Radiator	800-609
V6 - 3.8L (232 CID)	1990	Oil Cooler Line To Radiator, 1/2"-20 Female x 1/4" NPTF Male	800-609
V6 - 3.8L (232 CID)	1990	Oil Cooler Line To Radiator, 1/4" Straight Pipe Thread	800-608
V6 - 3.8L (232 CID)	1989-88	Oil Cooler Line To Radiator	800-609
TOPAZ			
L4 - 2.3L (140 CID)	1994-90	Oil Cooler Line To Radiator	800-608
V6 - 3.0L (182 CID)	1994-92	Oil Cooler Line To Radiator	800-608
ZEPHYR			
L4 - 2.3L (140 CID)	1983	Oil Cooler Line To Radiator	800-608
L6 - 3.3L (200 CID)	1983	Oil Cooler Line To Radiator	800-608
MERKUR			
XR4TI			
L4 - 2.3L (140 CID)	1989-85	Oil Cooler Line To Radiator	800-608
OLDSMOBILE			
AURORA			
V6 - 3.5L (214 CID)	2002-01	Oil Cooler Line To Trans, wo/Ball Check	800-604
BRAVADA			
V6 - 4.2L (256 CID)	2004-02	Oil Cooler Line To Trans, wo/Ball Check	800-604
V6 - 4.3L (262 CID)	2001-96	Eng Oil Cooler Line To Cooler	800-606
V6 - 4.3L (262 CID)	2001-96	Oil Cooler Line To Radiator	800-605
V6 - 4.3L (262 CID)	2001-96	Oil Cooler Line To Trans, wo/Ball Check	800-604
INTRIGUE			
V6 - 3.5L (214 CID)	2002-00	Oil Cooler Line To Trans, wo/Ball Check	800-604
V6 - 3.5L (214 CID)	1999	Oil Cooler Line To Radiator	800-605
V6 - 3.8L (231 CID)	1999-98	Oil Cooler Line To Radiator	800-605
SILHOUETTE			
V6 - 3.4L (207 CID)	2004-00	Oil Cooler Line To Trans, wo/Ball Check	800-604
V6 - 3.4L (207 CID)	2000	Oil Cooler Line To Radiator	800-605
PONTIAC			
AZTEK			
V6 - 3.4L (207 CID)	2004-01	Oil Cooler Line To Trans, wo/Ball Check	800-604
BONNEVILLE			
V6 - 3.8L (231 CID)	2005-00	Oil Cooler Line To Radiator	800-605
V6 - 3.8L (231 CID)	2004-00	Oil Cooler Line To Trans, wo/Ball Check	800-604
V8 - 4.6L (281 CID)	2005-04	Eng Oil Cooler Line To Cooler	800-606
FIREBIRD			
V6 - 3.8L (231 CID)	2002-98	Oil Cooler Line To Trans, wo/Ball Check	800-604
V8 - 5.7L (350 CID)	2002-98	Oil Cooler Line To Trans, wo/Ball Check	800-604
GRAND PRIX			
V6 - 3.1L (189 CID)	2004-99	Oil Cooler Line To Trans, wo/Ball Check	800-604
V6 - 3.1L (189 CID)	2000-98	Oil Cooler Line To Radiator	800-605
V6 - 3.8L (231 CID)	2004-99	Oil Cooler Line To Trans, wo/Ball Check	800-604
V6 - 3.8L (231 CID)	2000-98	Oil Cooler Line To Radiator	800-605
GTO			
V8 - 5.7L (350 CID)	2004	Oil Cooler Line To Trans, wo/Ball Check	800-604
V8 - 6.0L (364 CID)	2005	Oil Cooler Line To Trans, wo/Ball Check	800-604
MONTANA			
V6 - 3.4L (207 CID)	2004-00	Oil Cooler Line To Trans, wo/Ball Check	800-604
V6 - 3.4L (207 CID)	2000	Oil Cooler Line To Radiator	800-605

Radiator Fan Assemblies



Dorman Radiator Fan Assemblies Save Time and Money



Option 1: Unprofitable

Rebuild the Fan Assembly with replacement motors

- Rebuilding takes up to an extra 1-1/2 hours to replace the motors.
- Some OE motors are permanently staked to the shroud, requiring grinding to remove.
- Replacement motors do not include new fan retainers and motor mounting hardware.
- Rebuilding risks breaking the fan or shroud.



Option 2: Profitable

Install a NEW Dorman Radiator Fan Assembly

- Reduce labor complexity with a bolt-off/bolt-on installation.
- Saves valuable service bay time vs. component replacement.
- Better value vs. component pricing
- More professional job/reduce comebacks when second motor fails.

Dorman Radiator Fan Assemblies Offer Quality Products and High Application Coverage

- Dorman assemblies meet or exceed service dealers expectations for electrical performance, air flow, and strength
- All motors are tested by an independent lab to ensure quality
- Dorman has re-engineered failure-prone OE versions correcting original design problems
- Dorman offers 259 assemblies, leading the marketplace in application coverage



Activant Path	<i>Radiator, Cap, Fan Mtr & Switch</i>	Activant Code	<i>DRF</i>
----------------------	--	----------------------	------------

Applications begin on page 420.

Radiator Fan Assemblies



620-001

Jeep
2001-87 Cherokee, Comanche, Wagoneer.
Radiator Fan. Left.



620-002

Chrysler
1995-93 Caravan, Town & Country, Voyager.
Radiator Fan.



620-003

Chrysler
2000-96 Caravan, Town & Country, Voyager.
Radiator/Condenser Fan.



620-004

Chrysler
1997-93 LHS, Concorde, Intrepid, Vision,
New Yorker. Radiator/Condenser Fan.

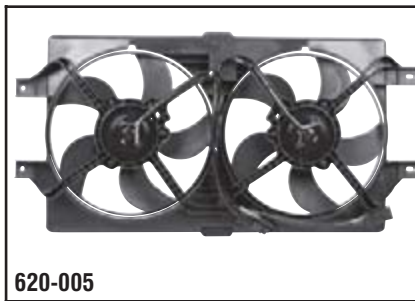

620-005

Chrysler
2004-98 300M, LHS, Intrepid, Concorde.
Radiator/Condenser Fan.

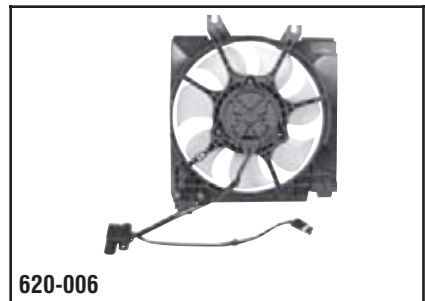

620-006

Chrysler
1999-95 Neon w/AC & AT. Condenser Fan,
Right.



620-007

Chrysler
1999-95 Neon w/AC & AT. Radiator Fan,
Left.

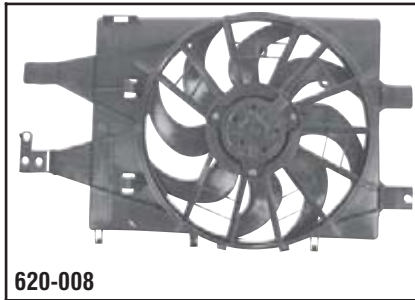

620-008

Chrysler
1995-91 Acclaim, Shadow, Spirit,
Sundance, Lebaron, Daytona. Radiator Fan.

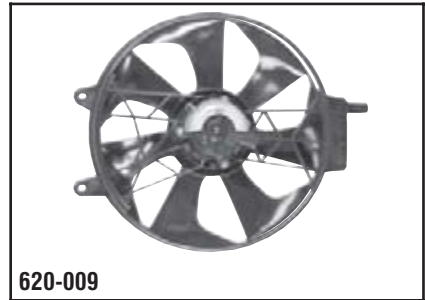

620-009

Chrysler/Mitsubishi
1992-91 Caravan, Town & Country, Voyager,
Grand Voyager (15" blade). Radiator Fan,
Left.



620-010

Jeep
2004-99 Jeep Grand Cherokee. Radiator
Fan, Left.



620-011

Chrysler/Mitsubishi
2004-00 Sebring, Stratus Coupe, Eclipse,
Eclipse Spyder. Radiator Fan, Left.



620-012

Chrysler
2002-01 Sebring, Stratus, Eclipse, Eclipse
Spyder. Condenser Fan, Right.

Radiator Fan Assemblies

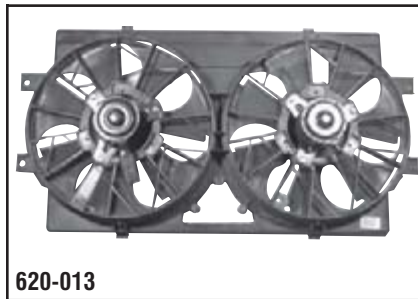

620-013

Chrysler
2000-95 Breeze, Cirrus, Stratus. Radiator/
Condenser Fan.

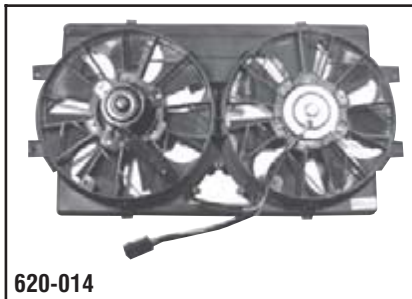

620-014

Chrysler
2000-95 Cirrus, Stratus (Stamped
4595782). Radiator/Condenser Fan.

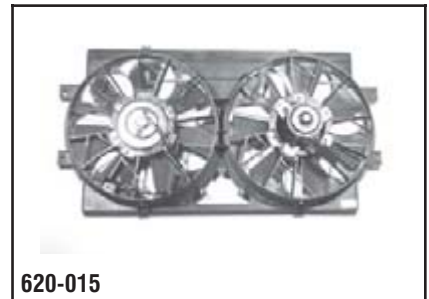

620-015

Chrysler
2000-95 Cirrus Stratus (Stamped
4662156). Radiator/Condenser Fan.



620-017

Chrysler
2002-01 Caravan, Town & Country, Voyager.
Condenser Fan, Right.



620-018

Chrysler
2002-01 Caravan, Town & Country, Voyager.
Radiator Fan, Left.

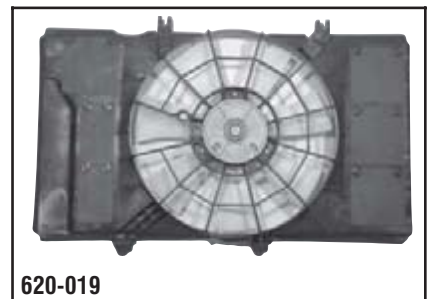

620-019

Chrysler
2004-00 Neon w/3 Speed MT. Condenser
Fan, Right.



620-021

Chrysler
1990 Dynasty. Radiator Fan, Left.

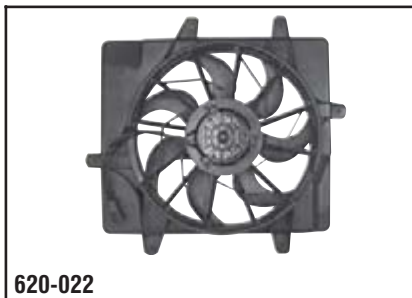

620-022

Chrysler
2002-01 PT Cruiser 2.4L. Radiator Fan.



620-026

Chrysler
1998-96 Sebring Convertible. Radiator Fan.

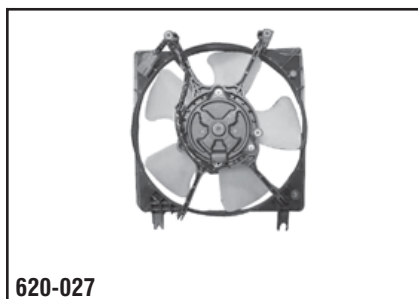

620-027

Chrysler
2000-98 Sebring Coupe, Avenger
w/California Emissions. Radiator Fan.



620-028

Chrysler
2000-98 Sebring, Avenger Coupe w/
California Emissions. Condenser Fan.

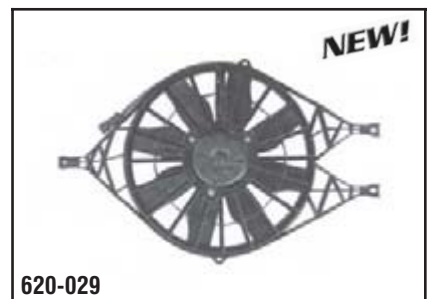

620-029

Chrysler
2004-00 Dakota, 2000 Durango. Radiator
Fan.

Radiator Fan Assemblies

Radiator Fan Assemblies



620-100

Ford
1994-90 Tempo, Topaz. Radiator Fan, Left.



620-101

Ford
1995-90 Taurus, Sable, Continental. Radiator Fan.



620-102

Ford
1998-95 Windstar. Radiator/Condenser Fan.

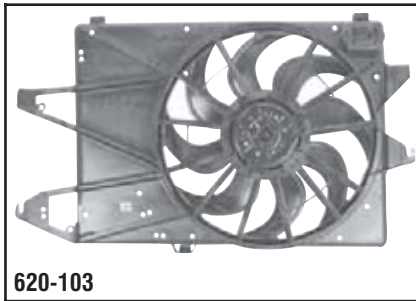

620-103

Ford
1999-95 Contour, Mystique. Radiator Fan.

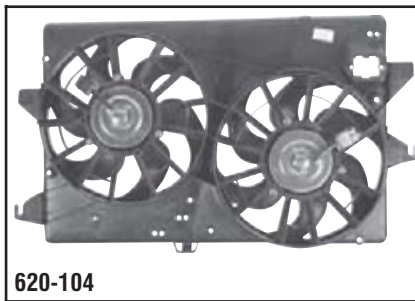

620-104

Ford
1999-95 Contour, Mystique. Radiator/Condenser Fan.

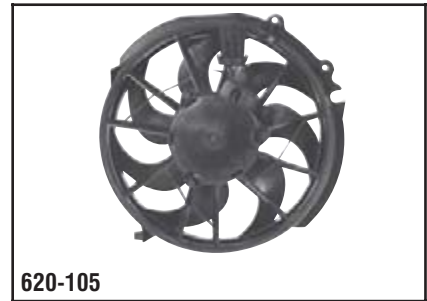

620-105

Ford
2005-96 Taurus, Sable. Condenser Fan, Right.



620-106

Ford
2005-96 Taurus, Sable. Radiator Fan, Left.

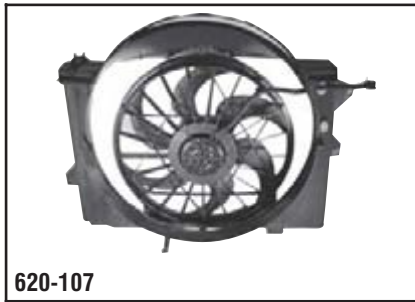

620-107

Ford
1997-95 Crown Victoria, Grand Marquis, Town Car. Radiator Fan.



620-108

Ford
2000-98 Crown Victoria, Grand Marquis, Town Car. Radiator Fan.

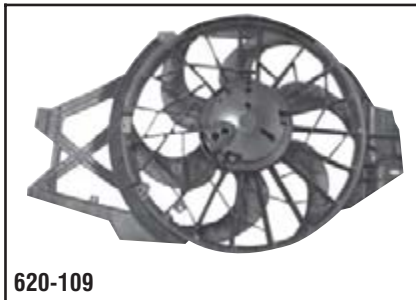

620-109

Ford
2003-97 Mustang. Radiator/Condenser Fan.

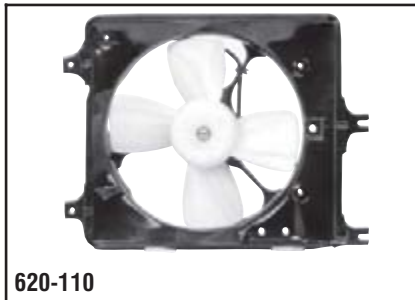

620-110

Ford
1992-90 Probe w/AT, 2.2L. Radiator Fan.

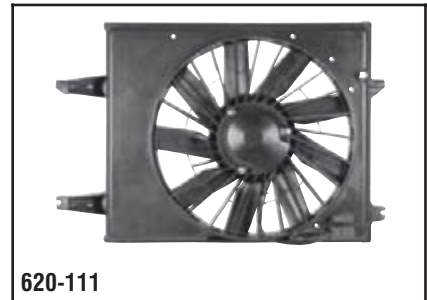

620-111

Ford/Nissan
1995-93 Villager, Quest Standard Duty. Radiator Fan.

Radiator Fan Assemblies



620-112

Ford
2004-85 Aerostar, Capri, Explorer, Mustang, Ranger - Plastic Blade Only. Fan Blade.



620-113

Ford/Nissan
2002-99 Villager, Quest. Radiator Fan.



620-114

Ford
1996-93 Escort, Tracer w/AC. Radiator/Condenser Fan.

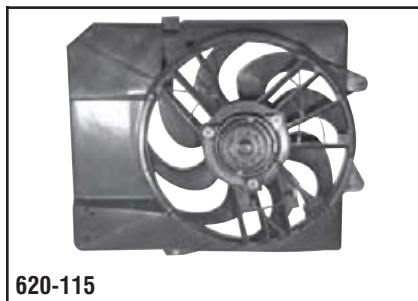

620-115

Ford
2001-97 Escort, Tracer w/AC. Radiator/Condenser Fan.

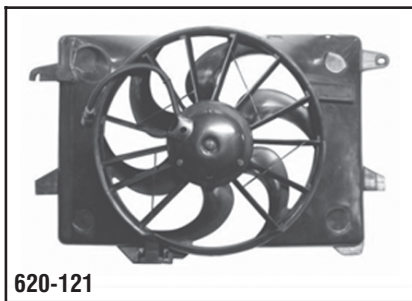

620-121

Ford
2001-00 Crown Victoria, Town Car, Grand Marquis. Radiator Fan.



620-122

Ford
1993-90 Festiva. Radiator Fan, Left.

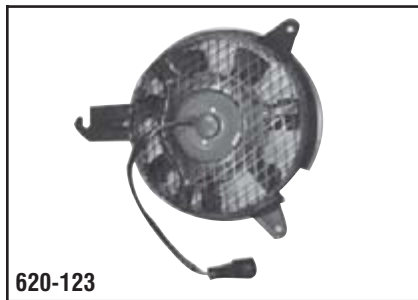

620-123

Ford
1993-88 Festiva. Condenser Fan, Right.

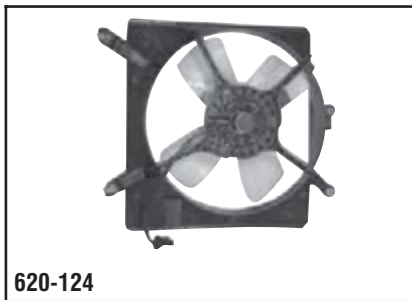

620-124

Ford
1997-94 Aspire. Radiator Fan, Left.

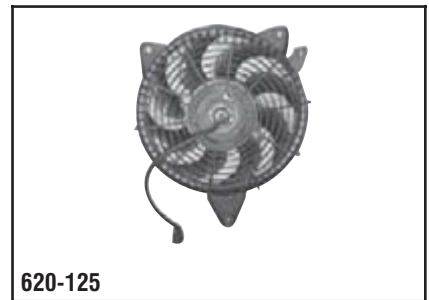

620-125

Ford
1997-94 Aspire. Condenser Fan, Right.

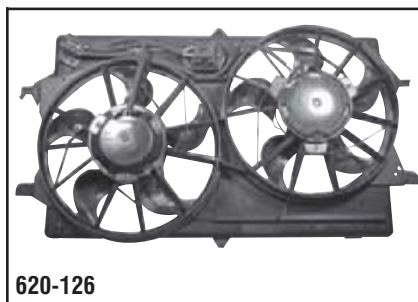

620-126

Ford
2003-01 Focus w/AC,w/AT DOHC Only. Radiator/Condenser Fan.



620-127

Ford
1998-96 Villager, Nissan Quest. Radiator Fan.

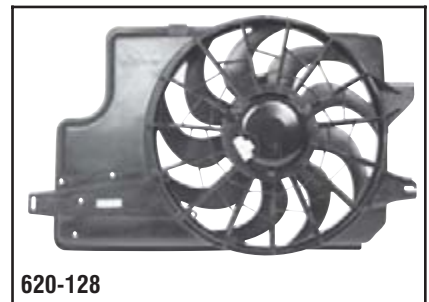

620-128

Ford
1996-94 Mustang. Radiator/Condenser Fan.

Radiator Fan Assemblies

Radiator Fan Assemblies

Radiator Fan Assemblies



620-129

Ford
1993-92 Taurus, Sable 3.0L, 1991 Taurus 2.5L. Radiator Fan.



620-130

Ford
2000-97 Mustang 4.6L. Radiator Fan.

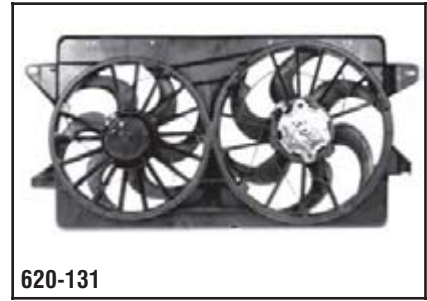

620-131

Ford
2003-99 Windstar. Radiator Fan.



620-132

Ford
2005-01 Escape. Radiator/Condenser Fan.

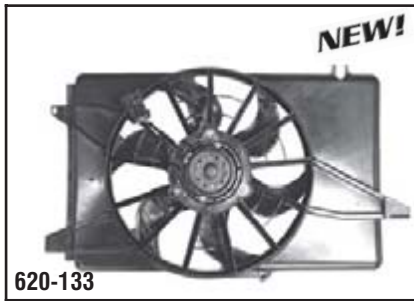

620-133

Ford
1995-94 Taurus, Sable 3.0L. Radiator/Condenser Fan.



620-134

Ford
1994-92 Tempo, Topaz 3.0L. Radiator Fan.



620-200

Honda
1997-94 Accord, 2001-97 Prelude. Radiator Fan, Left.



620-201

Honda/Acura
2001-97 Prelude, 1997-94 Accord, 1997-99 CL. Condenser Fan, Right.



620-202

Honda
1995-92 Civic. Condenser Fan, Right.



620-203

Honda
1998-96 Civic. Condenser Fan, Right.

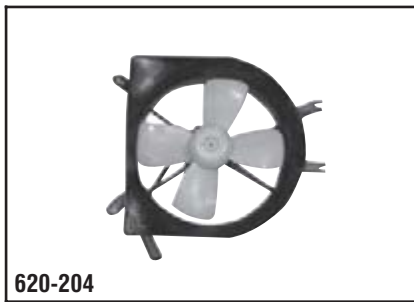

620-204

Honda
1998-92 Civic (Denso). Radiator Fan, Left.



620-206

Acura
2001-94 Integra (Denso). Radiator Fan, Left.

Radiator Fan Assemblies



620-207

Honda/Acura
2001-94 Integra, CR-V. Condenser Fan, Right.



620-208

Acura
1993-90 Integra w/AT. Radiator Fan, Left.

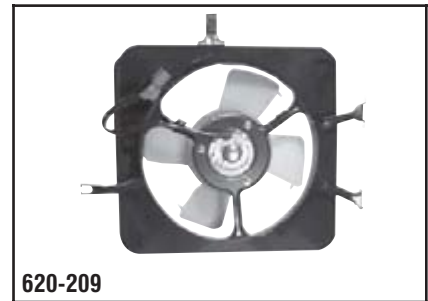

620-209

Acura
1993-92 Integra. Condenser Fan, Right.

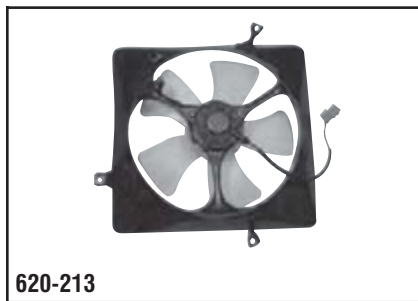

620-213

Honda
1987-84 Civic, CRX (Denso). Radiator Fan, Left.



620-214

Honda
1987-84 Civic, CRX, Wagovan. Condenser Fan, Right.

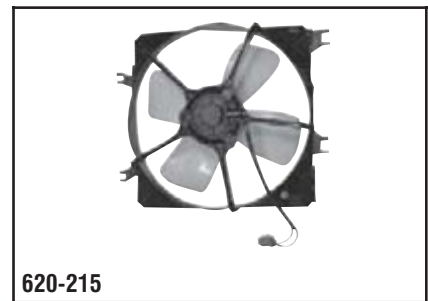

620-215

Honda
1991-88 Civic, CRX (Denso). Radiator Fan, Left.

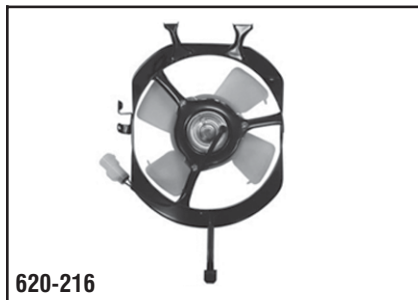

620-216

Honda
1991-88 Civic, CRX, Wagovan. Condenser Fan, Right.



620-217

Honda
2000-99 Civic (Denso). Radiator Fan, Left.



620-218

Honda
2000-99 Civic. Condenser Fan, Right.

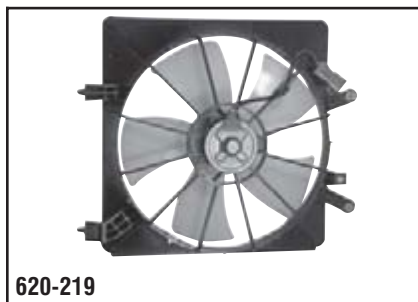

620-219

Honda
2003-01 Civic, Hatchback & Sedan (Denso). Radiator Fan, Left.

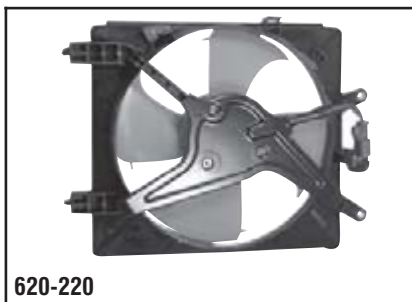

620-220

Honda
2004-01 Civic, Hatchback & Sedan. Condenser Fan, Right.



620-221

Honda
1989-86 Accord (Denso). Radiator Fan, Left.

Radiator Fan Assemblies

Radiator Fan Assemblies

Radiator Fan Assemblies

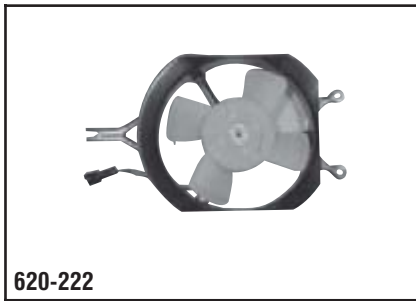

620-222

Honda
1989-86 Accord. Condenser Fan, Right.



620-223

Honda
1996-90 Accord, Prelude. Radiator Fan, Left.

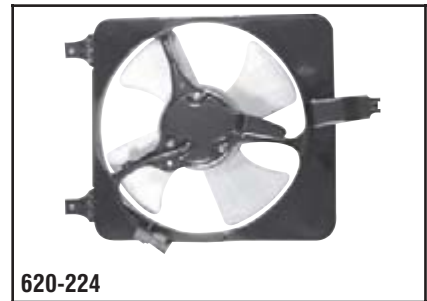

620-224

Honda
1996-90 Accord, Prelude. Condenser Fan, Right.



620-226

Honda/Acura
2003-98 Accord, CL, TL 6 Cyl. Radiator Fan, Left.



620-227

Honda
2002-98 Accord 4 Cyl. Radiator Fan, Left.



620-228

Honda/Acura
2002-98 Accord, TL 6 Cyl. Condenser Fan, Right.

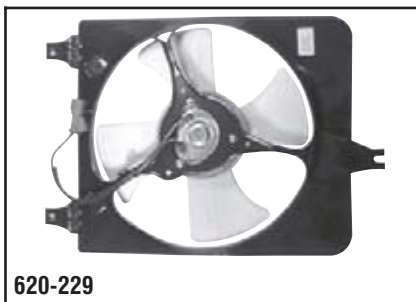

620-229

Honda
2002-98 Accord 4 Cyl. Condenser Fan, Right.

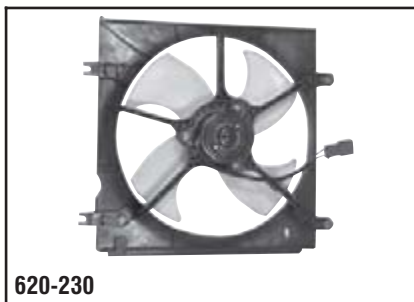

620-230

Honda
2001-97 CR-V. Radiator Fan, Left.



620-231

Honda
2004-99 Odyssey. Condenser Fan.



620-232

Honda
2006-02 CR-V (Japan Built). Radiator Fan.



620-233

Honda
2006-02 CR-V (Japan Built). Condensor Fan.



620-234

Honda
2006-03 Accord Exc. Hybrid. Condensor Fan.

Radiator Fan Assemblies



620-235

Honda
2006-03 Accord Exc. Hybrid. Radiator Fan.

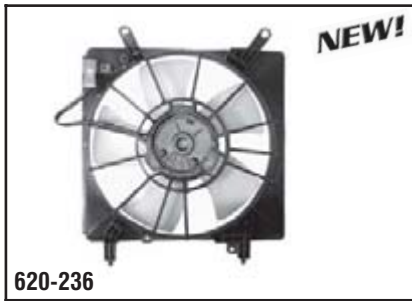

620-236

Acura
2006-02 RSX w/AT. Radiator Fan.



620-237

Acura
2006-02 RSX. Condenser Fan.



620-238

Honda
2002-01 MDX, 2004-03 Pilot. Radiator Fan.



620-239

Honda
2004-99 Odyssey. Radiator Fan.

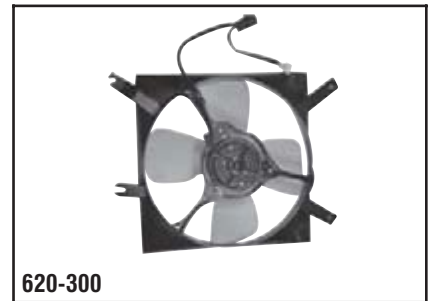

620-300

Mitsubishi
1994-90 Eclipse, Eclipse Spyder. Radiator Fan, Left.



620-301

Mitsubishi
1994-90 Eclipse, Eclipse Spyder. Condenser Fan, Right.



620-302

Mitsubishi
1999-95 Eclipse, Eclipse Spyder. Radiator Fan, Left.



620-303

Mitsubishi
1999-95 Eclipse, Eclipse Spyder. Condenser Fan, Right.

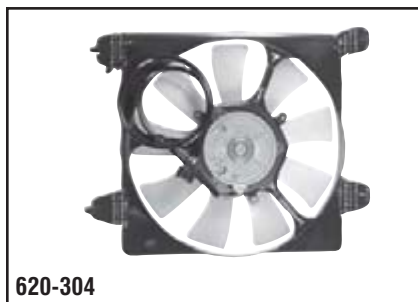

620-304

Mitsubishi/Chrysler
2001-00 Eclipse, Eclipse Spyder, Sebring, Stratus. Condenser Fan, Right.

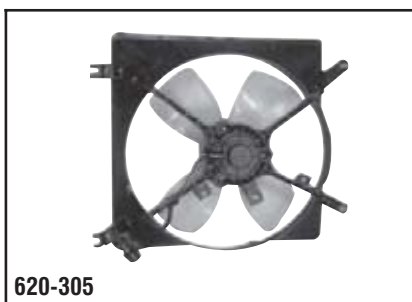

620-305

Mitsubishi/Chrysler
1996-93 Colt, Mirage, Summit. Radiator Fan, Left.



620-306

Mitsubishi/Chrysler
1996-93 Colt, Mirage, Summit. Condenser Fan, Right.

Radiator Fan Assemblies

Radiator Fan Assemblies

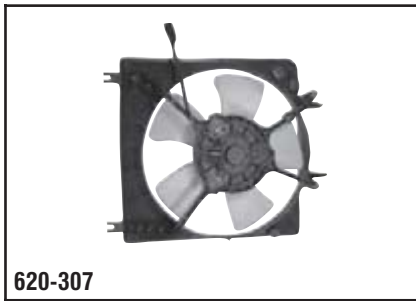

620-307

Mitsubishi
2002-97 Mirage. Radiator Fan, Left.

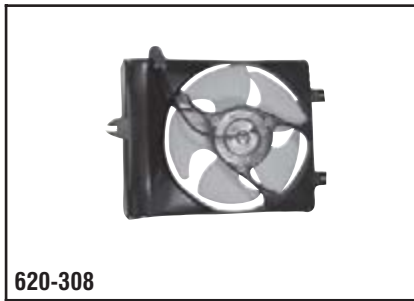

620-308

Mitsubishi
2002-97 Mirage. Condenser Fan, Right.

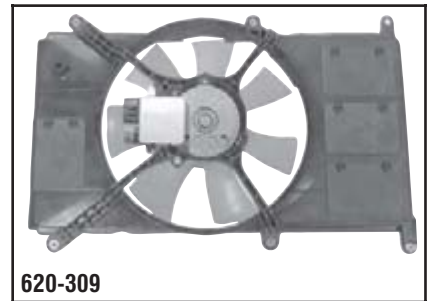

620-309

Mitsubishi
2000 Eclipse, Eclipse Spyder. Radiator Fan.

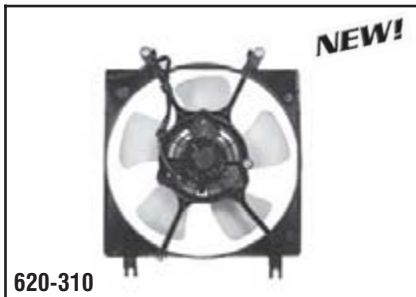

620-310

Mitsubishi/Chrysler
1999-95 Eclipse, Eclipse Spyder, Talon, Sebring, Avenger. Radiator Fan.



620-311

Mitsubishi
2005-02 Lancer. Condenser Fan.

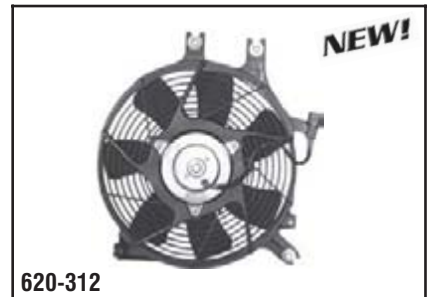

620-312

Mitsubishi
2004-98 Montero Sport. Condenser Fan.

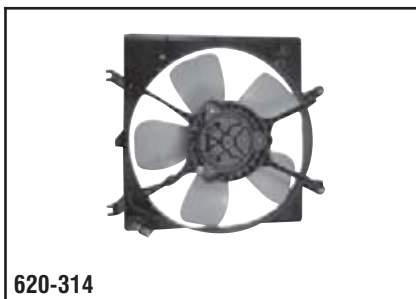

620-314

Mitsubishi
1998-94 Galant. Radiator Fan, Left.



620-317

Mitsubishi/Chrysler
1998-94 Galant, 3000GT, Stealth. Condenser Fan, Right.

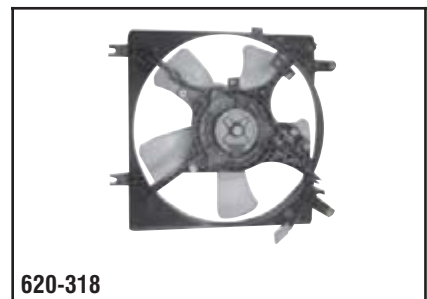

620-318

Mitsubishi
2002-99 Galant. Radiator Fan, Left.

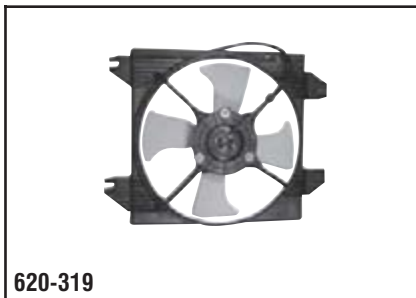

620-319

Mitsubishi
2002-99 Galant. Condenser Fan, Right.

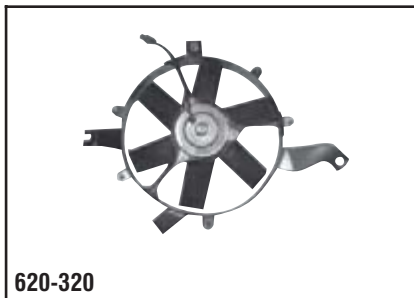

620-320

Mitsubishi
2000-92 Montero. Condenser Fan, Left.



620-350

Chrysler
2004-01 Sebring Convertible & Sedan, Stratus Sedan. Radiator/Condenser Fan.

Radiator Fan Assemblies

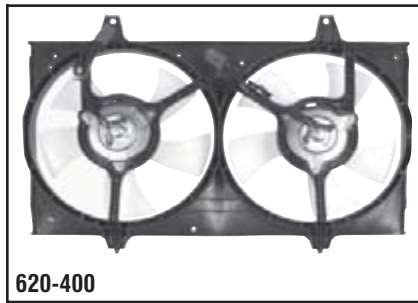

620-400

Nissan
1996-95 Maxima. Radiator/Condenser Fan.

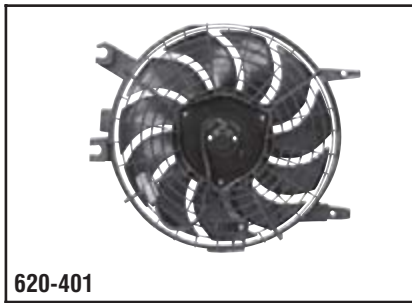

620-401

Nissan
1997-93 Altima. Radiator Fan, Left.

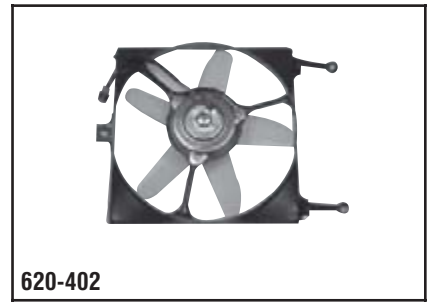

620-402

Nissan
1986-82 Sentra w/AT. Radiator Fan, Left.



620-403

Nissan
1986-82 Sentra w/AT. Condenser Fan, Right.

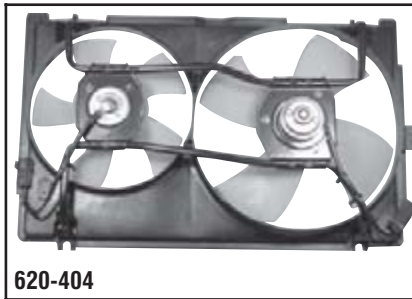

620-404

Nissan
1987-88 Sentra w/AT. Radiator/Condenser Fan.

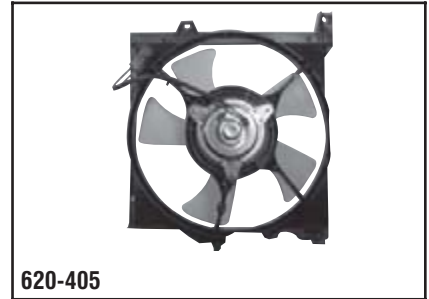

620-405

Nissan
1999-91 Sentra, 200SX, NX w/AC, MT. Radiator Fan, Left.



620-406

Nissan
1994-91 Sentra, NX w/AT. Radiator Fan.



620-407

Nissan
1999-91 200SX, Sentra, NX w/MT. Condenser Fan, Right.

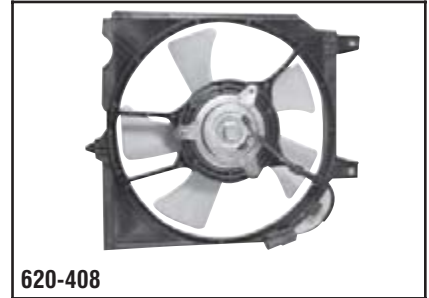

620-408

Nissan
1999-91 Sentra, 200SX, NX w/AT. Condenser Fan, Right.

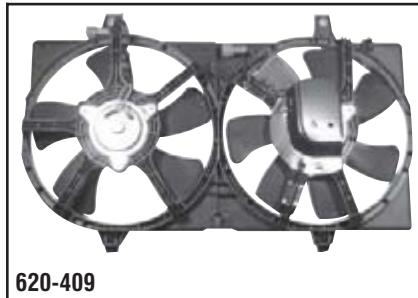

620-409

Nissan
2002-00 Sentra w/AC. Radiator/Condenser Fan.

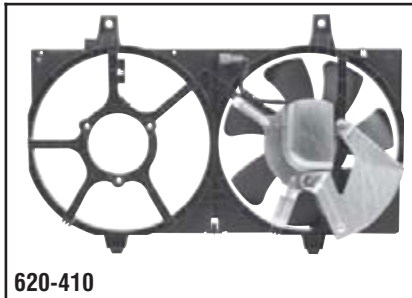

620-410

Nissan
2002-00 Sentra wo/ AC. Radiator Fan.



620-411

Nissan
1994-89 Maxima. Radiator/Condenser Fan.

Radiator Fan Assemblies

Radiator Fan Assemblies



620-412

Nissan
2006-03 Murano. Condenser Fan.

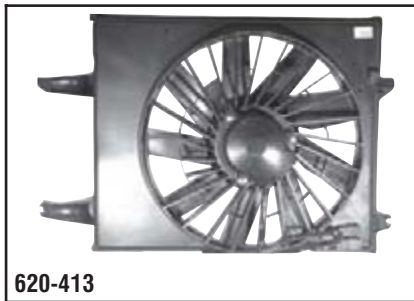

620-413

Ford/Nissan
1995-93 Villager, Quest Heavy Duty. Radiator Fan, Left.



620-415

Nissan
2001-98 Altima. Radiator/Condenser Fan.

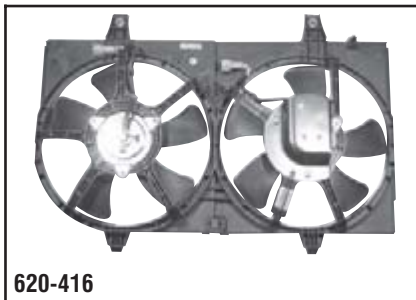

620-416

Nissan/Infiniti
2001-00 Maxima, I30. Radiator/Condenser Fan.

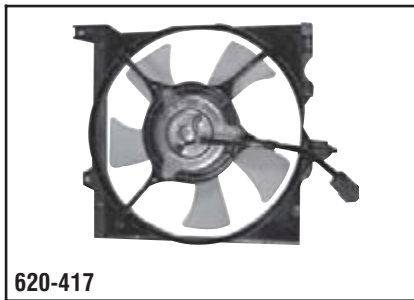

620-417

Infiniti
1996-91 G20. Radiator Fan, Left.

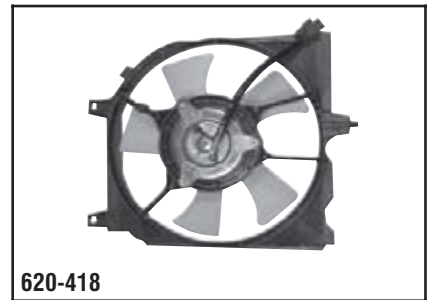

620-418

Infiniti
1993-91 G20 w/AT. Condenser Fan, Right.



620-419

Nissan
2006-02 Altima. Radiator/Condenser Fan.

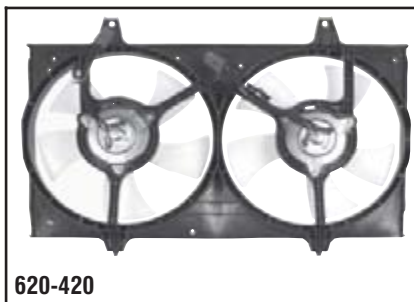

620-420

Nissan/Infiniti
1999-95 Maxima, I30 Federal Emissions. Radiator/Condenser Fan.



620-500

Toyota/GEO
1997-93 Corolla, Prizm. Radiator Fan, Left.



620-501

Toyota
1996-92 Camry. Radiator Fan, Left.



620-502

Toyota
1996-92 Camry w/AC. Condenser Fan, Right.



620-503

Toyota
1996-95 Camry. Condenser Fan, Left.

Radiator Fan Assemblies



620-504

Toyota
1996-95 Camry. Radiator Fan, Left.

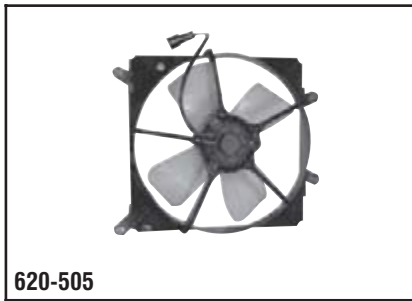

620-505

Toyota/GEO
1992-88 Corolla, Prizm. Radiator Fan, Left.

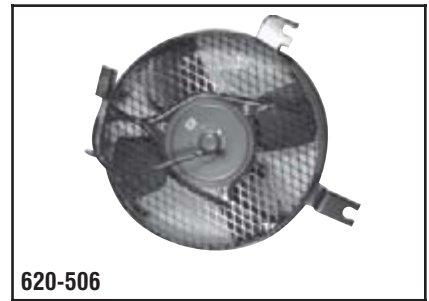

620-506

Toyota/GEO
1992-88 Corolla, Prizm. Condenser Fan, Right.

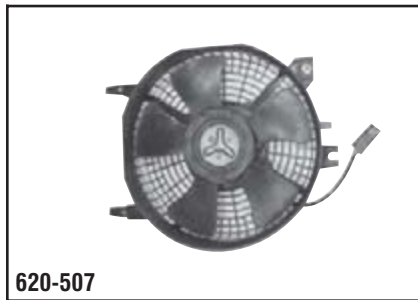

620-507

Toyota/GEO
1995-93 Corolla, Prizm. Condenser Fan, Right.



620-508

Toyota/GEO
1997-96 Corolla, Prizm. Condenser Fan, Right.

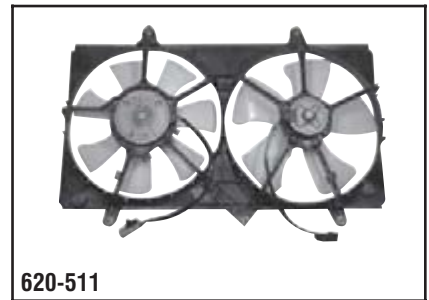

620-511

Toyota/GEO
2002-98 Corolla, Prizm w/AC. Radiator/Condenser Fan.

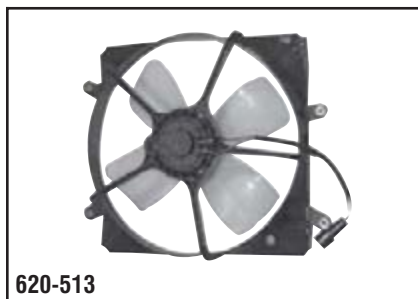

620-513

Toyota
1991-87 Camry w/AT. Radiator Fan, Left.

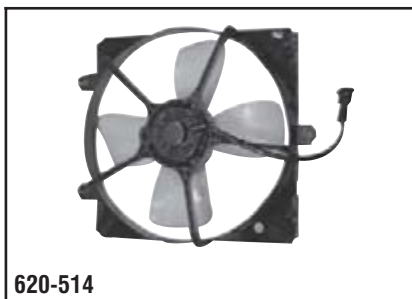

620-514

Toyota
1991-87 Camry. Condenser Fan, Right.

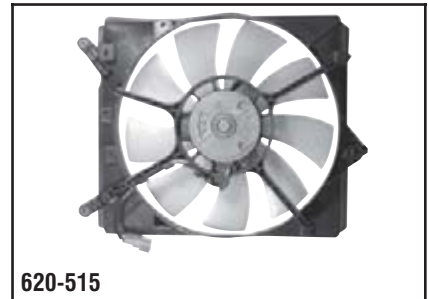

620-515

Toyota
2004-00 Avalon (ID # 0A17). Radiator Fan, Left.

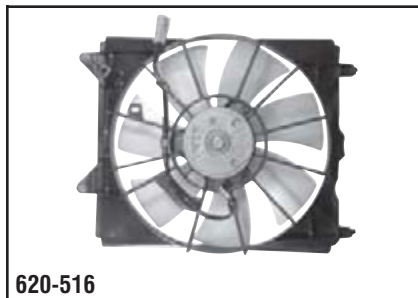

620-516

Toyota
2004-00 Avalon (ID # 0A18). Condenser Fan, Right.

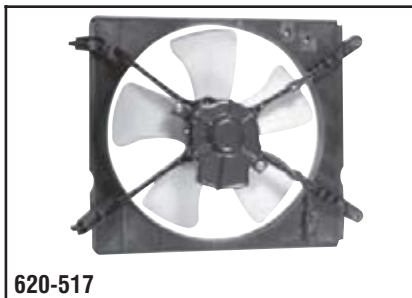

620-517

Toyota
2001-97 Camry, Solara. Radiator Fan, Left.

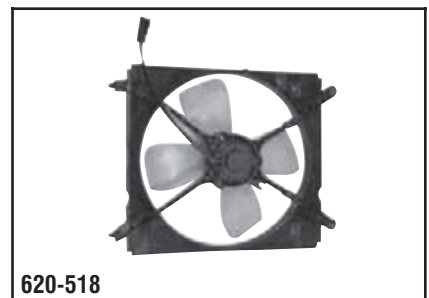

620-518

Toyota
1998-97 Camry. Radiator Fan, Left.

Radiator Fan Assemblies

Radiator Fan Assemblies

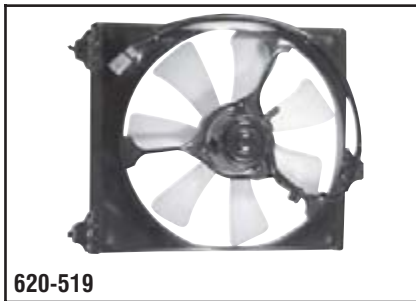

620-519

Toyota
1999-97 Camry (Metal Shroud). Condenser Fan, Right.

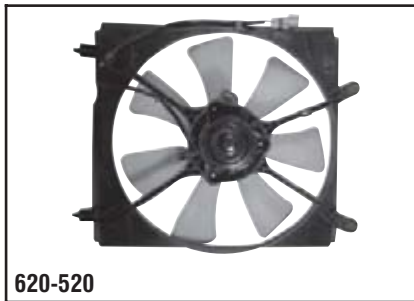

620-520

Toyota
1998-97 Camry (Metal Shroud). Radiator Fan, Left.



620-522

Toyota
2001-99 Camry, Solara. Condenser Fan, Right.

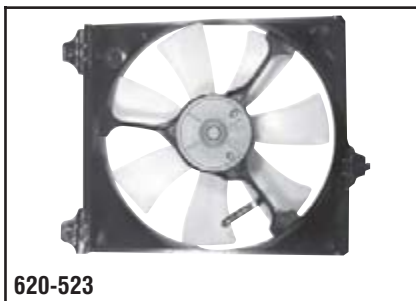

620-523

Toyota
2001-99 Camry, Solara V6 - 3.0L (Plastic Shroud). Condenser Fan, Right.

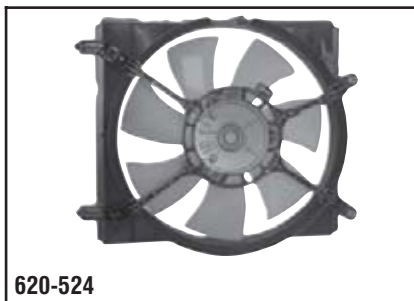

620-524

Toyota
2001-99 Camry, Solara V6 - 3.0L (Plastic Shroud). Radiator Fan, Left.

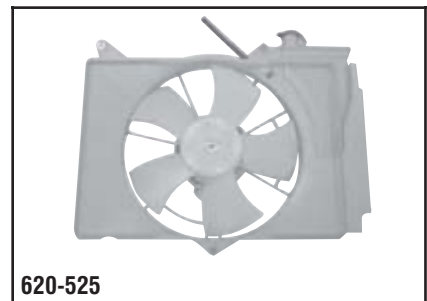

620-525

Toyota/Scion
2004-00 Echo, XA, XB. Condenser Fan, Right.

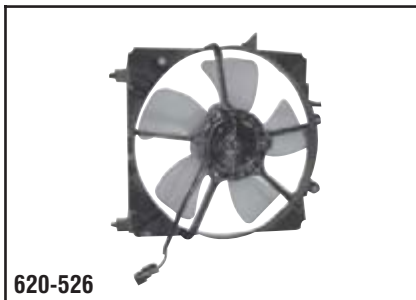

620-526

Toyota
1998-95 Tercel, Paseo w/MT. Radiator Fan, Left.

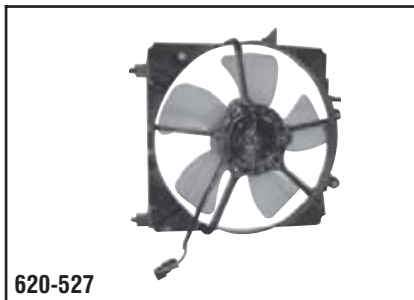

620-527

Toyota
1998-95 Tercel, Paseo w/AT. Radiator Fan, Left.

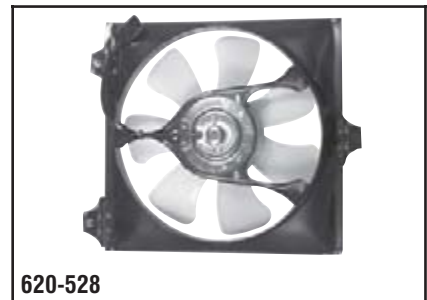

620-528

Toyota
1998-95 Tercel, Paseo w/AT. Condenser Fan, Right.

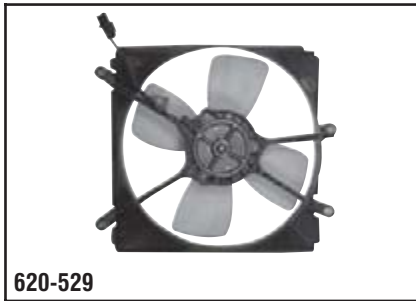

620-529

Toyota
2000-96 Rav 4. Radiator Fan, Left.



620-530

Toyota
2000-96 Rav 4. Condenser Fan, Right.

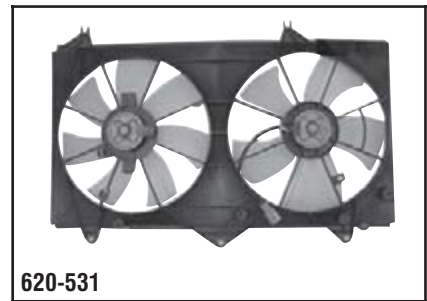

620-531

Toyota
2004-02 Camry, Solara 2.4L. Radiator/Condenser Fan.

Radiator Fan Assemblies

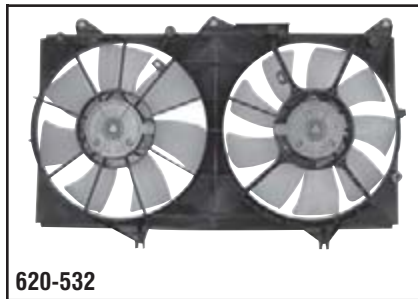

620-532

Toyota
2004-02 Camry, Solara 6 cyl. Radiator/
Condenser Fan.



620-533

Toyota
1998-94 T100, 2000-96 4 Runner, 2005-
95 Tacoma 4 Cyl. Fan Blade.



620-534

Toyota
1998-95 T100, 2002-96 4 Runner, 2004-
95 Tacoma, 2004-00 Tundra 6 Cyl. Fan
Blade.



620-535

Toyota
1994 T100, 1995-94 4 Runner & Pickups.
Fan Blade.



620-536

Toyota
2003-98 Sienna (Stamped T1). Radiator
Fan.



620-537

Toyota
2003-98 Sienna (Stamped T2). Radiator
Fan.



620-538

Toyota
2004-01 Rav 4. Radiator Fan.



620-539

Toyota
2005-01 Rav 4. Condenser Fan.



620-600

GM
2004-95 Cavalier, Sunfire w/AC. Condenser
Fan, Right.



620-601

GM
2001-95 Cutlass Supreme, Grand Prix,
Lumina, Century, Monte Carlo RH.
Condenser Fan, Right.



620-602

GM
2006-96 S15 Jimmy/Sonoma, S10 Pickup/
Blazer, Astro, Safari, Bravada, Savana 1500,
Express Van, H2. Radiator Fan Blade.



620-603

GM
2001-94 Cutlass Supreme, Grand Prix,
Lumina, Monte Carlo, Regal. Radiator Fan,
Left.

Radiator Fan Assemblies

Radiator Fan Assemblies

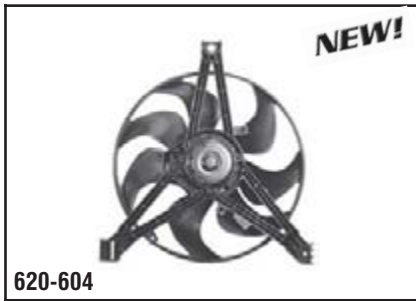

620-604

GM
1998-97 Century, Grand Prix. Radiator Fan.



620-605

GM
1993-89 Century, Cutlass Ciera. Radiator Fan.



620-606

GM
1998-97 Silhouette, Trans Sport, Venture Van. Condenser Fan.



620-607

GM
2003-99 Silhouette, Venture Van, Montana, Grand Prix. Radiator/Condenser Fan.



620-611

GM
2006-01 Aztec, Montana, Rendezvous, Silhouette, Venture w/o rear AC. Radiator/Condenser Fan.

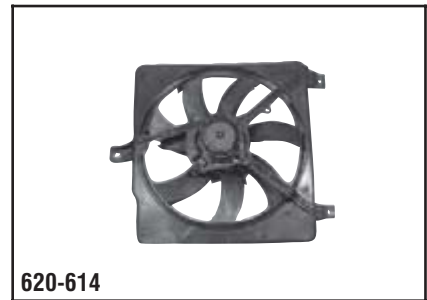

620-614

GM
1994-84 Cavalier, Sunbird, J2000. Condenser Fan, Right.



620-615

GM
1993-87 Corsica, Beretta w/AC. Radiator/Condenser Fan.

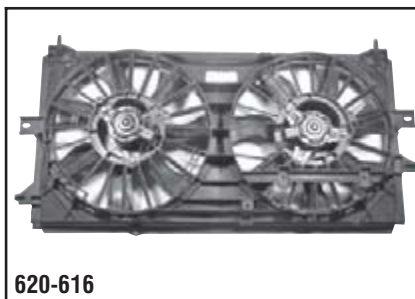

620-616

GM
2003-00 Impala, Monte Carlo (Standard Cooling). Radiator/Condenser Fan.

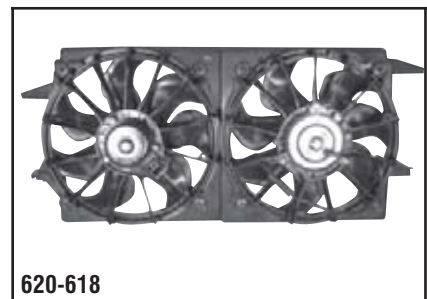

620-618

GM
2005-97 Alero, Cutlass, Grand AM, Malibu. Radiator/Condenser Fan.

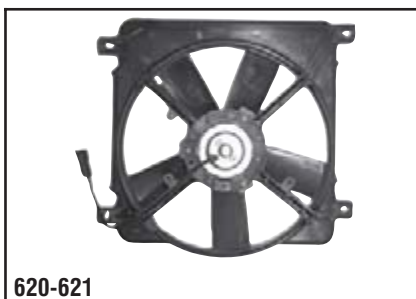

620-621

GM
1996-92 Lumina, APV, Silhouette, Trans Sport. Radiator Fan, Left.

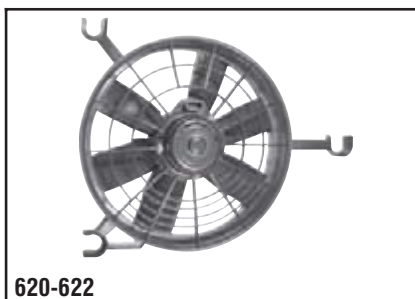

620-622

GM
1995-92 Lumina, APV, Silhouette, Trans Sport. Radiator Fan, Left.



620-623

GM
1999-91 LeSabre, LSS, Delta 88, Park Ave, Bonneville, Deville, Fleetwood. Condenser Fan, Right.

Radiator Fan Assemblies

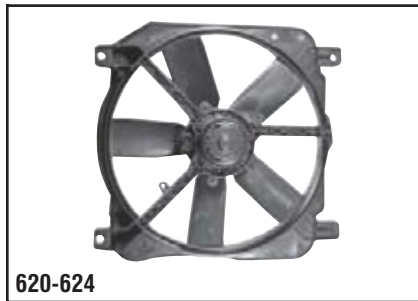

620-624

GM
1995-91 98, Park Ave, Deville, Fleetwood.
Radiator Fan, Left.

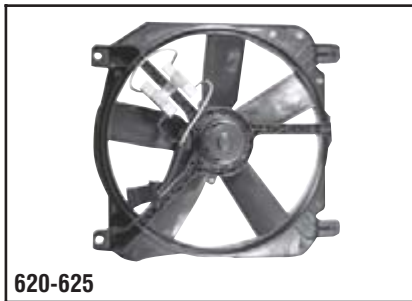

620-625

GM
1999-91 98, Park Ave, LeSabre, 88, LSS,
Bonneville. Radiator Fan, Left.

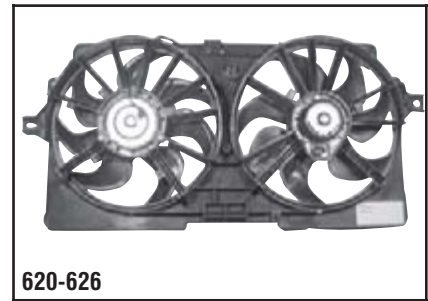

620-626

GM
2003-99 Century, Grand Prix, Lumina,
Monte Carlo. Radiator/Condenser Fan.

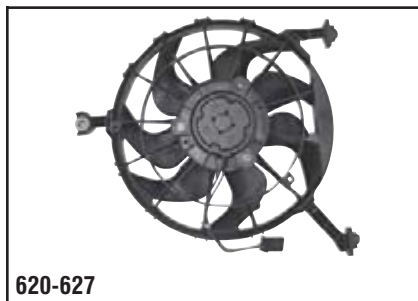

620-627

GM
1998-95 Skylark, Achieva, Grand AM.
Radiator Fan, Left.



620-628

GM
1999 Regal. Radiator/Condenser Fan.

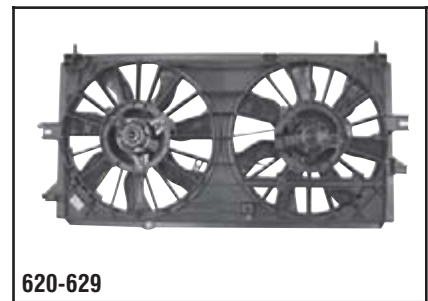

620-629

GM
2003-00 Impala 3.4L & 3.8L w/HD Cooling.
Radiator/Condenser Fan.



620-636

GM
2005-00 LeSabre, Bonneville 3.8L. Radiator/
Condenser Fan.



620-637

GM
2000-93 Eldorado, Deville, Concours,
Seville, Allante (All 4.6L). Radiator Fan.



620-641

GM
2000-93 Eldorado, Deville, Concours,
Seville, Allante (All 4.6L). Condenser Fan.

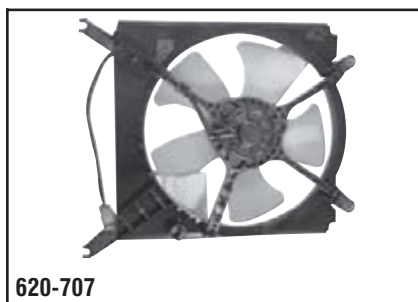

620-707

Suzuki/GEO
2001-95 Swift, Metro. Radiator Fan, Left.

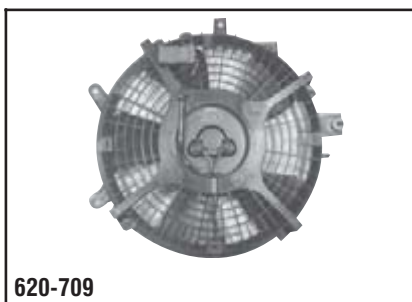

620-709

Suzuki/GEO
2001-95 Swift, Metro. Condenser Fan,
Right.



620-710

Kia
2004-98 Sephia, Spectra. Condenser Fan.

Radiator Fan Assemblies

Radiator Fan Assemblies



620-711
Kia
 2001-98 Spectra, Sephia w/AT. Radiator Fan.



620-712
Hyundai
 2005-01 Santa Fe. Radiator Fan.

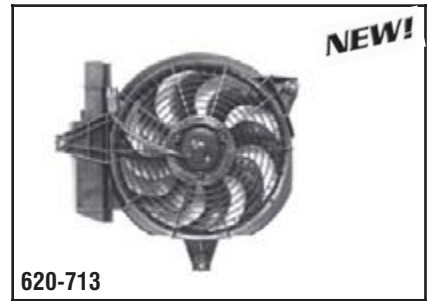

620-713
Hyundai
 2002-01 Santa Fe. Condenser Fan.

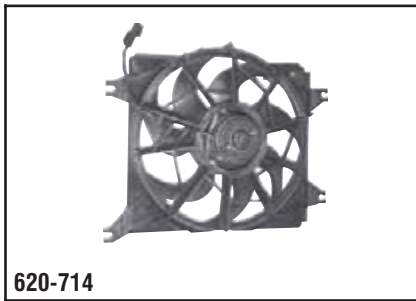

620-714
Hyundai
 1999-95 Accent. Radiator Fan, Left.

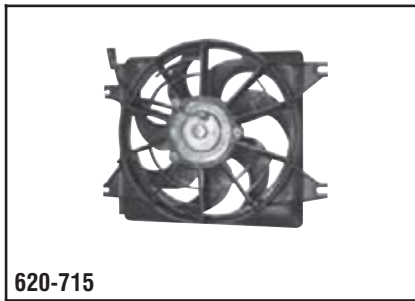

620-715
Hyundai
 1999-95 Accent. Condenser Fan, Right.

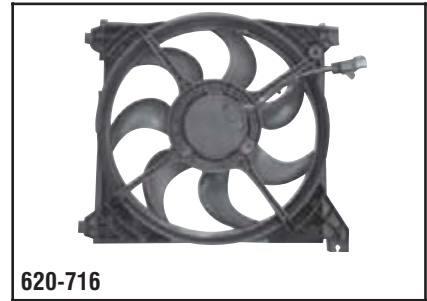

620-716
Hyundai/Kia
 2004-99 Sonata, XG Series, Optima. Radiator Fan, Left.



620-717
Hyundai/Kia
 2004-99 Sonata, XG Series, Optima. Condenser Fan, Right.



620-718
Hyundai
 1995-92 Elantra. Radiator Fan, Left.

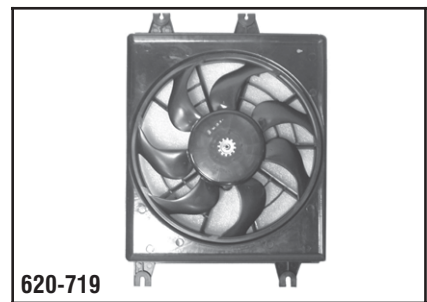

620-719
Hyundai
 1995-92 Elantra. Condenser Fan.

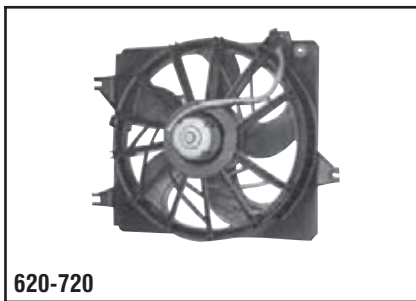

620-720
Hyundai
 2001-96 Elantra, Tiburon. Radiator Fan, Left.

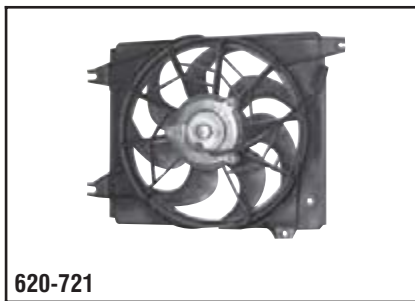

620-721
Hyundai
 2001-96 Elantra, Tiburon. Condenser Fan, Right.

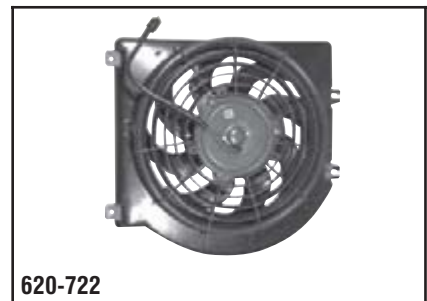

620-722
Isuzu/Honda
 2004-98 Amigo, Rodeo, Axiom, Passport w/AT. Condenser Fan, Right.

Radiator Fan Assemblies



620-723

Lexus
1994-90 LS400. Condenser Fan, Right.

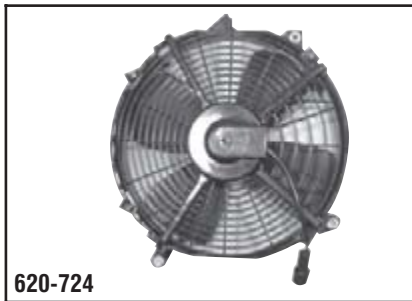

620-724

Lexus
1994-90 LS400. Condenser Fan, Right.

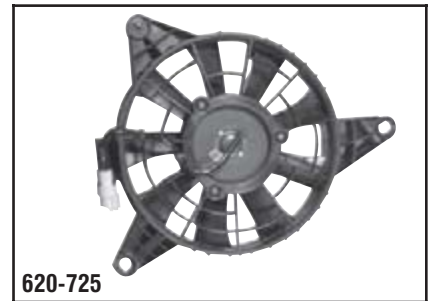

620-725

Kia
2002-95 Sportage. Condenser Fan, Right.

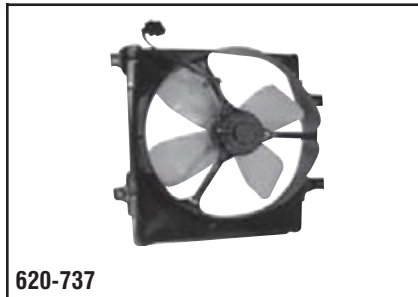

620-737

Mazda
1989-86 323. Radiator Fan, Left.

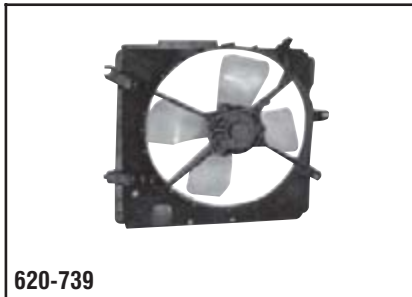

620-739

Mazda
1994-90 323, Protégé w/MT. Radiator Fan, Left.



620-740

Mazda
1994-90 323, Protégé w/AT. Radiator Fan, Left.

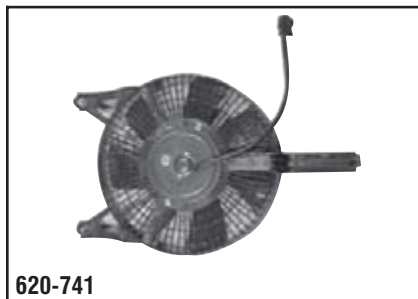

620-741

Mazda
1994-90 323, Protégé. Condenser Fan, Right.

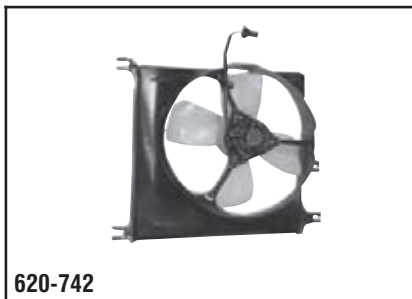

620-742

Mazda
1987-83 626 w/MT. Radiator Fan, Left.

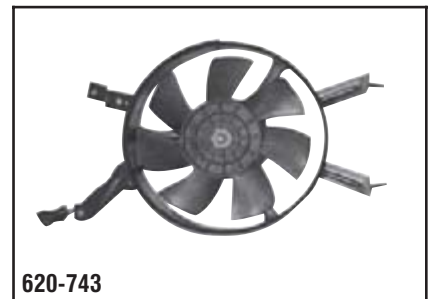

620-743

Mazda
1987-83 626. Condenser Fan, Right.



620-744

Mazda
1992-88 626, MX6. Radiator Fan, Left.



620-746

Mazda
1992-88 626, MX-6 w/MT. Condenser Fan, Right.

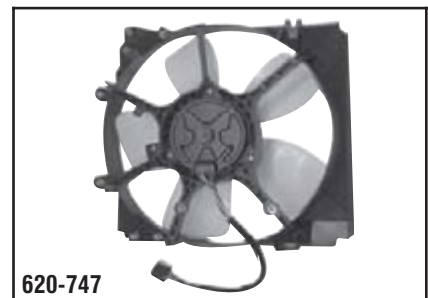

620-747

Mazda
1997-93 626, MX6. Radiator Fan, Left.

Radiator Fan Assemblies

Radiator Fan Assemblies

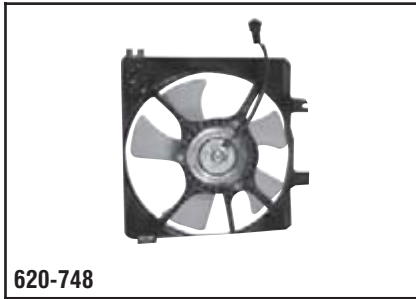

620-748

Mazda
1997-93 626, MX6. Condenser Fan, Right.

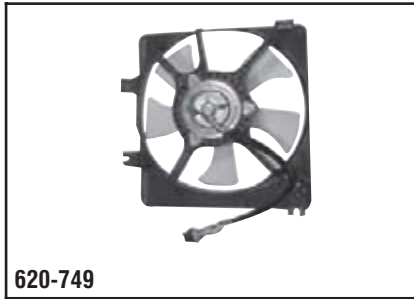

620-749

Mazda
1997-93 626, MX6. Condenser Fan, Right.



620-750

Mazda
1999-98 626 w/AC, AT. Radiator Fan, Left.

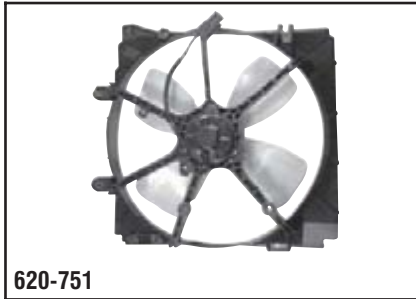

620-751

Mazda
1999-98 626. Radiator Fan, Left.

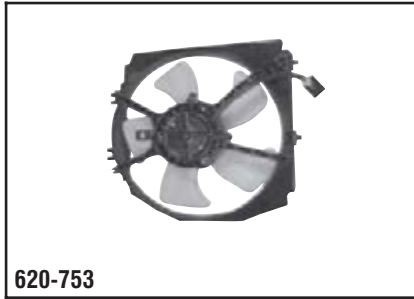

620-753

Mazda
1998-95 Protégé w/AT. Radiator Fan, Left.

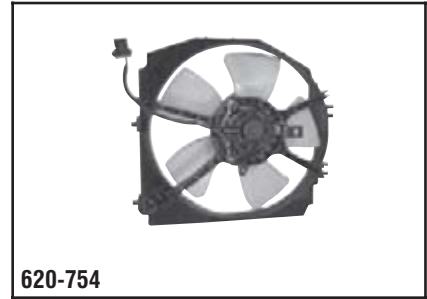

620-754

Mazda
1998-95 Protégé w/MT. Radiator Fan, Left.

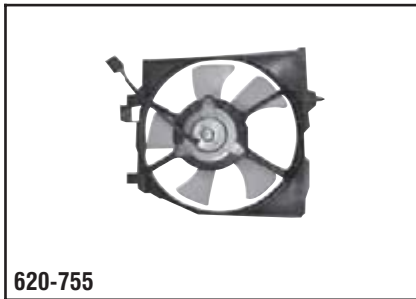

620-755

Mazda
1998-95 Protégé. Condenser Fan, Right.

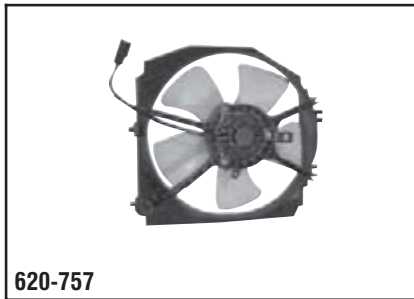

620-757

Mazda
2003-99 Protégé, Protégé 5 w/AT. Radiator Fan, Left.

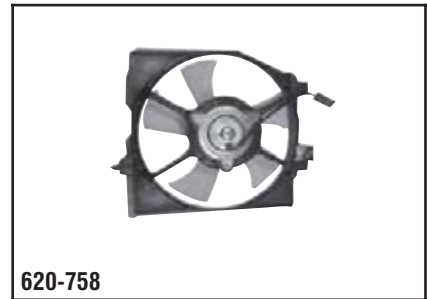

620-758

Mazda
2003-99 Protégé, Protégé 5. Condenser Fan, Right.

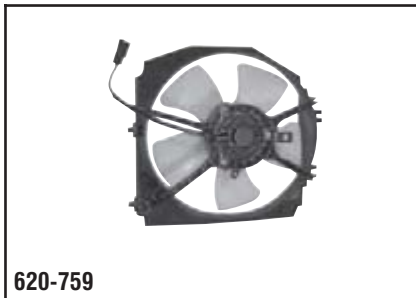

620-759

Mazda
2003-99 Protégé, Protégé 5 w/MT. Radiator Fan, Left.



620-760

Subaru
1994-89 Justy. Radiator Fan, Left.

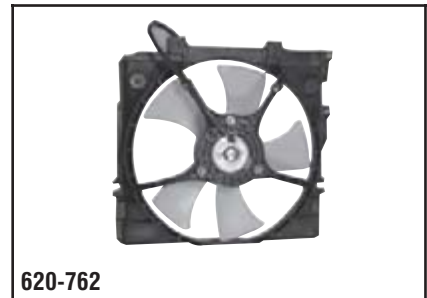

620-762

Subaru
1999-95 Legacy, Legacy Outback. Radiator Fan, Left.

Radiator Fan Assemblies

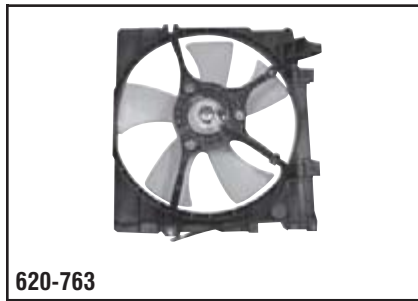

620-763

Subaru
1999-95 Legacy, Legacy Outback.
Condenser Fan, Right.



620-764

Subaru
1996-93 Impreza. Radiator Fan, Left.

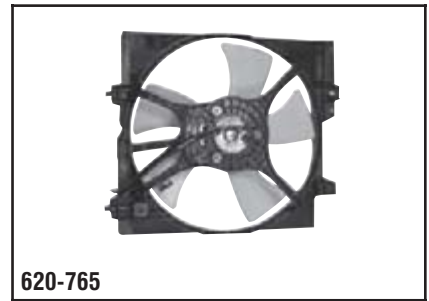

620-765

Subaru
1998-97 Impreza. Condenser Fan, Right.

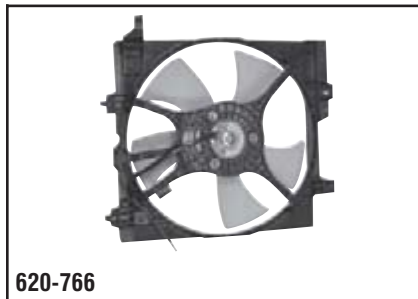

620-766

Subaru
1996-93 Impreza. Condenser Fan, Right.

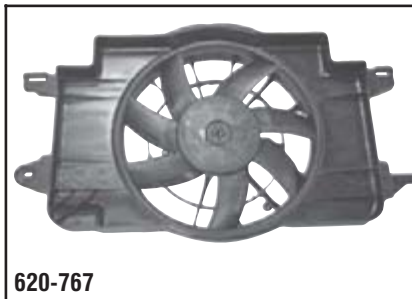

620-767

Saturn
2002-94 S-Series. Condenser Fan.

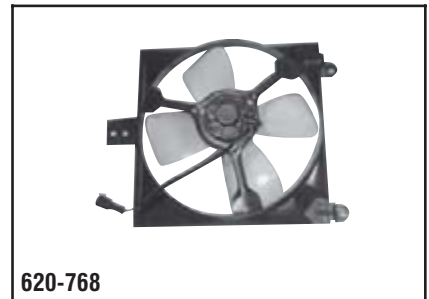

620-768

Suzuki
1994-89 Swift. Radiator Fan, Left.

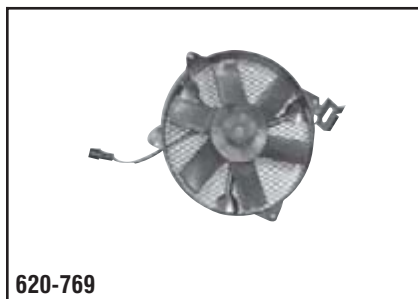

620-769

Suzuki
1994-89 Swift. Condenser Fan, Right.



620-770

Suzuki
1998-89 Sidekick. Condenser Fan, Right.

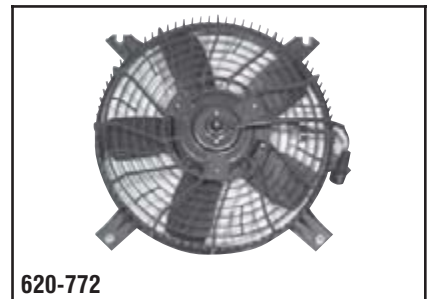

620-772

Suzuki
2002-99 Vitara, Grand Vitara. Condenser
Fan, Right.

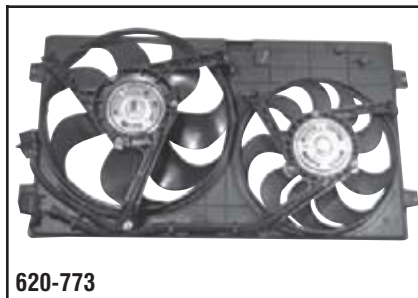

620-773

VW
2006-98 Beetle. Radiator/Condenser Fan.



620-774

Volvo
1998-92 940, 960, V90, S90. Radiator Fan,
Left.

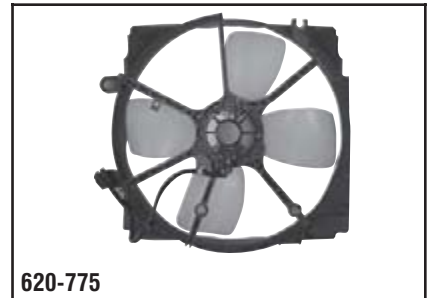

620-775

Mazda
1997-93 626. Radiator Fan, Left.

Radiator Fan Assemblies

Radiator Fan Assemblies

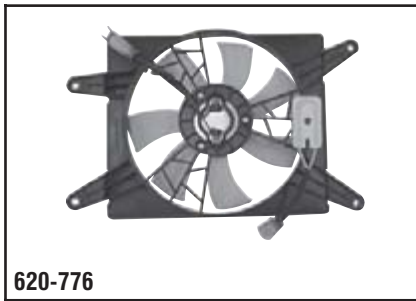

620-776

Hyundai/Mitsubishi
1994-90 Excel, Scoupe, Precis 1.5L.
Condenser Fan, Right.

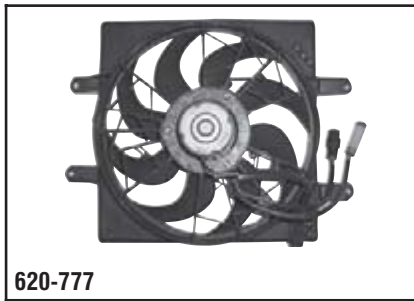

620-777

Hyundai/Mitsubishi
1994-90 Excel, Scoupe, Precis 1.5L.
Radiator Fan, Left.



620-778

Mazda
2002-00 626 2.0L. Radiator/Condenser
Fan.



620-800

VW
2000-97 Passat 2.8L. Condenser Fan,
Right.



620-810

Hyundai
2004-01 Accent 1.6L, 2002-00 Accent
1.5L. Radiator Fan.



620-811

Hyundai
2004-01 Accent 1.6L, 2002-00 Accent
1.5L. Condenser Fan.



620-812

Hyundai
2004-01 Elantra. Radiator Fan.



620-813

Hyundai
2004-01 Elantra. Condenser Fan.



620-820

Subaru
2004-00 Legacy, Legacy Outback 2.5L,
2004-03 Baja 2.5L. Radiator Fan.



620-821

Subaru
2002-99 Forester, 2001-99 Impreza.
Radiator Fan.



620-822

Subaru
2002-99 Forester, 2001-99 Impreza.
Condenser Fan.

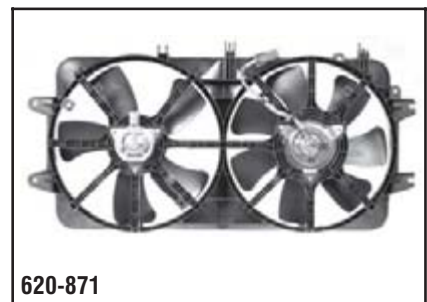

620-871

Mazda
2002-00 626. Radiator/Condenser Fan.

Radiator Fan Assemblies



620-880

Volvo
1987-86 244, 245. Radiator Fan.



620-881

Volvo
1993-90 240, 1989-88 244, 1989-88 245.
Radiator Fan.



620-883

Volvo
1997-94 850 2.3L, 1997-93 850 2.4L.
Radiator Fan.



620-886

Volvo
1989-85 740 2.3L, 1987-84 760 2.3L,
1986-83 760 2.8L, 1985-83 760 2.4L.
Radiator Fan.



620-887

Volvo
1990-87 760 2.8L, 1990-88 760 2.3L,
1991-89 780 2.3L, 1990-87 780 2.8L,
1991-90 740 2.3L, 1991 940 2.3L.
Radiator Fan.



620-900

BMW
1999-93 318, 323, 325, 328 Series.
Condenser Fan.



620-901

BMW
1997-92 M5; 318, 525, 530, 535, 540,
735 740, 750, 840 & 850 Series.
Condenser Fan.

Electronic Fan Clutch **NEW!**

622-001
GM, Isuzu & Saab
Light Trucks
2006-02

Fan Pulley Brackets **NEW!**

*Make a Customer For Life...
Replace Only the Piece
That is Broken*

300-801
Toyota 3.0L
4Runner, Pickup T100
1995-93

**Brackets
Not Available
Separately At
the OE Dealer**

ADDITIONAL APPLICATIONS
300-800: Toyota Pickups, 1992-88
300-802: Toyota Trucks, 2004-95
300-803: Isuzu Rodeo, Trooper, 1997-91

Radiator Fan Assemblies

Radiator Fan Assemblies

Make/Model Engine/Years	Description	Dorman #
ACURA		
CL		
L4 - 2.2L (2156 cc) 1997 AC Fan		620-201
L4 - 2.3L (2234 cc) 1999-98 AC Fan		620-201
V6 - 3.0L (2997 cc) 1999-97 AC Fan		620-201
V6 - 3.2L (3210 cc) 2003-01 Radiator Fan, Exc. S Series		620-226
INTEGRA		
L4 - 1.7L (1678 cc) 1993-92 AC Fan		620-209
1993-92 Radiator Fan, Denso		620-208
1993-92 Tuner Fan		621-003
L4 - 1.8L (1797 cc) 2001-94 AC Fan, Exc. GSR Series		620-207
2001-94 Radiator Fan, Denso		620-206
2001-94 Tuner Fan, Exc. GSR Series		621-004
L4 - 1.8L (1834 cc) 2001-94 AC Fan		620-207
2001-94 Radiator Fan, Denso		620-206
2001-94 Tuner Fan		621-004
1993-90 AC Fan		620-209
1993-90 Radiator Fan, Denso		620-208
1993-90 Tuner Fan		621-003
MDX		
V6 - 3.5L (3471 cc) 2002-01 Radiator Fan		620-238
RSX		
L4 - 2.0L (1998 cc) 2006-02 AC Fan		620-237
2006-02 Radiator Fan, w/AT		620-236
TL		
V6 - 3.2L (3210 cc) 2003-02 Radiator Fan, Exc. S Series		620-226
2001-99 AC Fan		620-228
2001-99 Radiator Fan		620-226
BMW		
318 SERIES		
L4 - 1.8L (1796 cc) 1995-93 AC Fan		620-900
1992 AC Fan		620-901
323 SERIES		
L6 - 2.5L (2494 cc) 1999-98 AC Fan		620-900
325 SERIES		
L6 - 2.5L (2494 cc) 1995-93 AC Fan		620-900
328 SERIES		
L6 - 2.8L (2793 cc) 1999-96 AC Fan		620-900
525 SERIES		
L6 - 2.5L (2494 cc) 1995-89 AC Fan		620-901
530 SERIES		
V8 - 3.0L (2997 cc) 1995-94 AC Fan		620-901
535 SERIES		
L6 - 3.5L (3430 cc) 1993-89 AC Fan		620-901
540 SERIES		
V8 - 4.0L (3982 cc) 1995-94 AC Fan		620-901
735 SERIES		
L6 - 3.5L (3430 cc) 1992-88 AC Fan		620-901
740 SERIES		
V8 - 4.0L (3982 cc) 1994-93 AC Fan		620-901
750 SERIES		
V12 - 5.0L (4988 cc) 1994-88 AC Fan		620-901
840 SERIES		
V8 - 4.0L (3982 cc) 1995-94 AC Fan		620-901
V8 - 4.4L (4398 cc) 1997-96 AC Fan		620-901
850 SERIES		
V12 - 5.0L (4988 cc) 1994-91 AC Fan		620-901

Make/Model Engine/Years	Description	Dorman #
BMW (continued)		
850 SERIES (continued)		
V12 - 5.4L (5379 cc) 1997-95 AC Fan		620-901
V12 - 5.6L (5576 cc) 1995-94 AC Fan		620-901
M5		
L6 - 3.6L (3553 cc) 1993-91 AC Fan		620-901
BUICK		
CENTURY		
V6 - 3.1L (189 CID) 1999 Radiator & AC Fan		620-626
1998-97 AC Fan		620-601
1998-97 Radiator Fan		620-604
V6 - 3.3L (204 CID) 1993-90 Radiator Fan		620-605
1989 Radiator Fan, wo/HDC		620-605
LESABRE		
V6 - 3.8L (231 CID) 2005-00 Radiator & AC Fan		620-636
1999-91 AC Fan		620-623
1999-91 Radiator Fan		620-625
PARK AVENUE		
V6 - 3.8L (231 CID) 1996 AC Fan		620-623
1996 Radiator Fan		620-625
1995-91 AC Fan		620-623
1995-91 Radiator Fan		620-624
REGAL		
V6 - 3.1L (189 CID) 1996-94 Radiator Fan		620-603
V6 - 3.8L (231 CID) 1999 Radiator & AC Fan		620-628
1998-97 Radiator Fan		620-603
RENDEZVOUS		
V6 - 3.4L (207 CID) 2005-02 Radiator & AC Fan, wo/HDC		620-611
V6 - 3.5L (213 CID) 2006 Radiator & AC Fan, wo/HDC		620-611
SKYLARK		
L4 - 2.3L (138 CID) 1995 Radiator Fan		620-627
L4 - 2.4L (146 CID) 1998-96 Radiator Fan		620-627
V6 - 3.1L (189 CID) 1998-95 Radiator Fan		620-627
CADILLAC		
ALLANTE		
V8 - 4.6L (281 CID) 1993 AC Fan		620-641
1993 Radiator Fan		620-637
CONCOURS		
V8 - 4.6L (281 CID) 1999-94 AC Fan		620-641
1999-94 Radiator Fan		620-637
DEVILLE		
V8 - 4.6L (281 CID) 1999-96 AC Fan		620-641
1999-96 Radiator Fan		620-637
V8 - 4.9L (300 CID) 1993-91 AC Fan		620-623
1993-91 Radiator Fan		620-624
ELDORADO		
V8 - 4.6L (281 CID) 2000-93 AC Fan		620-641
2000-93 Radiator Fan		620-637
FLEETWOOD		
V8 - 4.9L (300 CID) 1993-91 AC Fan		620-623
1993-91 Radiator Fan		620-624
SEVILLE		
V8 - 4.6L (281 CID) 1997-93 AC Fan		620-641
1997-93 Radiator Fan		620-637
CHEVROLET		
BERETTA		
L4 - 2.0L (122 CID) 1989-87 Radiator & AC Fan		620-615
L4 - 2.2L (134 CID) 1993-90 Radiator & AC Fan		620-615

Radiator Fan Assemblies

Make/Model Engine/Years	Description	Dorman #
CHEVROLET (continued)		
BERETTA (continued)		
V6 - 2.8L (173 CID)		
1989-87	Radiator & AC Fan	620-615
V6 - 3.1L (189 CID)		
1993-90	Radiator & AC Fan	620-615
CAVALIER		
L4 - 2.0L (122 CID)		
1989-84	AC Fan	620-614
L4 - 2.2L (134 CID)		
2004-95	AC Fan	620-600
1994-90	AC Fan	620-614
L4 - 2.3L (138 CID)		
1995	AC Fan	620-600
L4 - 2.4L (146 CID)		
2002-96	AC Fan	620-600
CORSICA		
L4 - 2.0L (122 CID)		
1989-87	Radiator & AC Fan	620-615
L4 - 2.2L (134 CID)		
1993-90	Radiator & AC Fan	620-615
V6 - 2.8L (173 CID)		
1989-87	Radiator & AC Fan	620-615
V6 - 3.1L (189 CID)		
1993-90	Radiator & AC Fan	620-615
IMPALA		
V6 - 3.4L (207 CID)		
2003-00	Radiator & AC Fan, Police Or Towing Package	620-629
2003-00	Radiator & AC Fan, w/HDC, Exc. Police Or Towing Package	620-629
2003-00	Radiator & AC Fan, wo/HDC, Exc. Police Or Towing Package	620-616
V6 - 3.8L (231 CID)		
2003-00	Radiator & AC Fan, Police Or Towing Package	620-629
2003-00	Radiator & AC Fan, w/HDC, Exc. Police Or Towing Package	620-629
2003-00	Radiator & AC Fan, wo/HDC, Exc. Police Or Towing Package	620-616
LUMINA		
V6 - 3.1L (189 CID)		
2001-00	AC Fan	620-601
2001-00	Radiator Fan	620-603
1999	AC Fan, Single Fan	620-601
1999	Radiator & AC Fan, Dual Fan	620-626
1999	Radiator Fan, Single Fan	620-603
1998-95	AC Fan	620-601
1998-95	Radiator Fan	620-603
LUMINA APV		
V6 - 3.1L (189 CID)		
1993-92	Radiator Fan, Primary	620-622
V6 - 3.4L (207 CID)		
1996	Radiator Fan, Primary	620-621
V6 - 3.8L (231 CID)		
1995-92	Radiator Fan, Aux	620-622
1995-92	Radiator Fan, Primary	620-621
MALIBU		
L4 - 2.4L (146 CID)		
1999-97	Radiator & AC Fan	620-618
V6 - 3.1L (189 CID)		
2003-97	Radiator & AC Fan	620-618
METRO		
L3 - 1.0L (61 CID)		
2001-99	AC Fan	620-709
2001-99	Radiator Fan	620-707
L4 - 1.3L (79 CID)		
2001-99	AC Fan	620-709
2001-99	Radiator Fan	620-707
MONTE CARLO		
V6 - 3.1L (189 CID)		
1999	AC Fan, Single Fan	620-601
1999	Radiator & AC Fan, Dual Fan	620-626
1999	Radiator Fan, Single Fan	620-603
1998-95	AC Fan	620-601
1998-95	Radiator Fan	620-603
V6 - 3.4L (207 CID)		
2003-00	Radiator & AC Fan	620-616
V6 - 3.8L (231 CID)		
2003-00	Radiator & AC Fan	620-616

Make/Model Engine/Years	Description	Dorman #
CHEVROLET (continued)		
PRIZM		
L4 - 1.8L (110 CID)		
2002-98	Radiator & AC Fan	620-511
VENTURE VAN		
V6 - 3.4L (207 CID)		
2005-01	Radiator & AC Fan	620-611
2000-99	Radiator & AC Fan, wo/HDC	620-607
1998-97	AC Fan	620-606
CHEVROLET/GMC TRUCK		
ASTRO		
V6 - 4.3L (262 CID)		
2005-96	Radiator Fan Blade Only	620-602
EXPRESS VAN		
V6 - 4.3L (262 CID)		
2006-03	Radiator Fan Blade Only	620-602
V8 - 5.3L (323 CID)		
2006-03	Radiator Fan Blade Only	620-602
S10 BLAZER		
V6 - 4.3L (262 CID)		
2005-96	Radiator Fan Blade Only, w/AC	620-602
S10 PICKUP		
V6 - 4.3L (262 CID)		
2004-96	Radiator Fan Blade Only, w/AC	620-602
S15 JIMMY		
V6 - 4.3L (262 CID)		
2001-96	Radiator Fan Blade Only, w/AC	620-602
S15 SONOMA		
V6 - 4.3L (262 CID)		
2004-96	Radiator Fan Blade Only, w/AC	620-602
SAFARI		
V6 - 4.3L (262 CID)		
2005-96	Radiator Fan Blade Only	620-602
SAVANA 1500		
V6 - 4.3L (262 CID)		
2006-03	Radiator Fan Blade Only	620-602
V8 - 5.3L (323 CID)		
2006-03	Radiator Fan Blade Only	620-602
CHRYSLER		
300M		
V6 - 3.5L (215 CID)		
2004-99	Radiator & AC Fan	620-005
CIRRUS		
L4 - 2.0L (122 CID)		
2000	Radiator & AC Fan	620-013
L4 - 2.4L (148 CID)		
2000-95	Radiator & AC Fan	620-013
V6 - 2.5L (152 CID)		
2000-95	Radiator & AC Fan, Stamped 4595782	620-014
2000-95	Radiator & AC Fan, Stamped 4662156	620-015
CONCORDE		
V6 - 2.7L (167 CID)		
2004-98	Radiator & AC Fan	620-005
V6 - 3.2L (197 CID)		
2001-98	Radiator & AC Fan	620-005
V6 - 3.3L (201 CID)		
1996-93	Radiator & AC Fan	620-004
V6 - 3.5L (215 CID)		
2004-02	Radiator & AC Fan	620-005
1997-93	Radiator & AC Fan	620-004
LEBARON		
L4 - 2.5L (153 CID)		
1992	Radiator Fan, Stamped 4401901, 4401937, 4546369 or 4546380	620-008
1991	Radiator Fan, Stamped 4401951	620-008
V6 - 3.0L (181 CID)		
1994	Radiator Fan, Stamped 4546578, 4546614 or 4495753	620-008
LHS		
V6 - 3.5L (215 CID)		
2001-99	Radiator & AC Fan	620-005
1997-94	Radiator & AC Fan	620-004
NEW YORKER		
V6 - 3.5L (215 CID)		
1996-94	Radiator & AC Fan	620-004
PT CRUISER		
L4 - 2.4L (148 CID)		
2002-01	Radiator Fan	620-022
SEBRING		
L4 - 2.0L (122 CID)		
1999	Radiator Fan, Coupe	620-310

Radiator Fan Assemblies

Window
Lift Motors
pg. 535-554

Window
Regulators
pg. 555-566

Wiper
Motors
pg. 567-572

Wiper Transmission
Linkages
pg. 573-576

Save valuable labor time...
Replace the entire assembly!

Radiator Fan Assemblies

Radiator Fan Assemblies

Make/Model Engine/Years	Description	Dorman #
CHRYSLER (continued)		
SEBRING (continued)		
L4 - 2.0L (122 CID) (continued)		
1998	Radiator Fan, Coupe, w/AT, Calif, LX	620-027
1998	Radiator Fan, w/MT, Coupe	620-310
1997-95	Radiator Fan, w/MT, Coupe	620-310
L4 - 2.4L (148 CID)		
2004-01	Radiator Fan, Convertible & Sedan	620-350
2004-01	Radiator Fan, Coupe	620-011
1998	Radiator Fan, Convertible	620-026
1997-96	Radiator Fan, Convertible	620-026
V6 - 2.5L (152 CID)		
2000-99	AC Fan, Coupe, Calif, LX & LXI	620-028
2000-99	Radiator Fan, Coupe, Calif, LX & LXI	620-027
1998	AC Fan, Coupe, w/AT, Calif, LX & LXI	620-028
1998	Radiator Fan, Convertible	620-026
1998	Radiator Fan, Coupe, w/AT, Calif, LX	620-027
1998	Radiator Fan, w/MT, Coupe	620-310
1997-96	Radiator Fan, Convertible	620-026
1997-95	Radiator Fan, w/MT, Coupe	620-310
V6 - 2.7L (167 CID)		
2004-01	Radiator Fan, Convertible & Sedan	620-350
V6 - 3.0L (181 CID)		
2004-03	Radiator Fan, Coupe	620-011
2002	AC Fan, Coupe	620-012
2002	Radiator Fan, Coupe	620-011
2001	AC Fan, Coupe, From 6/1/01	620-012
2001	AC Fan, Coupe, To 6/1/01	620-304
2001	Radiator Fan, Coupe	620-011
TOWN & COUNTRY VAN		
V6 - 3.3L (201 CID)		
2002-01	AC Fan	620-017
2002-01	Radiator Fan	620-018
2000-96	Radiator & AC Fan	620-003
1995-93	Radiator Fan	620-002
1992-91	Radiator Fan	620-009
V6 - 3.8L (230 CID)		
2002-01	AC Fan	620-017
2002-01	Radiator Fan	620-018
2000-96	Radiator & AC Fan	620-003
1995-94	Radiator Fan	620-002
VOYAGER, GRAND VOYAGER		
L4 - 2.4L (148 CID)		
2002-01	AC Fan	620-017
2002-01	Radiator Fan	620-018
2000	Radiator & AC Fan	620-003
V6 - 3.0L (181 CID)		
2000	Radiator & AC Fan	620-003
V6 - 3.3L (201 CID)		
2002-01	AC Fan	620-017
2002-01	Radiator Fan	620-018
2000	Radiator & AC Fan	620-003
DODGE		
AVENGER		
L4 - 2.0L (122 CID)		
1999	Radiator Fan	620-310
1998	Radiator Fan, w/AT, Calif	620-027
1998	Radiator Fan, w/MT	620-310
1997-95	Radiator Fan, w/MT	620-310
V6 - 2.5L (152 CID)		
2000-99	AC Fan, Coupe, Calif	620-028
2000-99	Radiator Fan, Calif	620-027
1998	AC Fan, Coupe, w/AT, Calif	620-028
1998	Radiator Fan, w/AT, Calif	620-027
1998	Radiator Fan, w/MT	620-310
1997-95	Radiator Fan, w/MT	620-310
CARAVAN, GRAND CARAVAN		
L4 - 2.4L (148 CID)		
2002-01	AC Fan	620-017
2002-01	Radiator Fan	620-018
2000-96	Radiator & AC Fan	620-003
L4 - 2.5L (153 CID)		
1995-93	Radiator Fan	620-002
1992-91	Radiator Fan	620-009
V6 - 3.0L (181 CID)		
2000-96	Radiator & AC Fan	620-003
1995-93	Radiator Fan	620-002
1992-91	Radiator Fan	620-009
V6 - 3.3L (201 CID)		
2002-01	AC Fan	620-017
2002-01	Radiator Fan	620-018

Make/Model Engine/Years	Description	Dorman #
DODGE (continued)		
CARAVAN, GRAND CARAVAN (continued)		
V6 - 3.3L (201 CID) (continued)		
2000-96	Radiator & AC Fan	620-003
1995-93	Radiator Fan	620-002
1992-91	Radiator Fan	620-009
V6 - 3.8L (230 CID)		
2002-01	AC Fan	620-017
2002-01	Radiator Fan	620-018
2000-96	Radiator & AC Fan	620-003
1995-94	Radiator Fan	620-002
COLT		
L4 - 1.5L (1468 cc)		
1994	AC Fan	620-306
1994	Radiator Fan, Coupe, w/AT	620-305
1993	AC Fan, AT	620-306
1993	Radiator Fan, Coupe, w/AT	620-305
L4 - 1.8L (1834 cc)		
1994	AC Fan	620-306
1993	AC Fan	620-306
1993	Radiator Fan, MT	620-305
DAYTONA		
L4 - 2.5L (153 CID)		
1993	Radiator Fan	620-008
1992	Radiator Fan, Stamped 4401901, 4401937, 4546369 or 4546380	620-008
1991	Radiator Fan, Stamped 4401951	620-008
DYNASTY		
L4 - 2.5L (153 CID)		
1990	Radiator Fan, ID #4401686	620-021
INTREPID		
V6 - 2.7L (167 CID)		
2004-98	Radiator & AC Fan	620-005
V6 - 3.2L (197 CID)		
2001-98	Radiator & AC Fan	620-005
V6 - 3.3L (201 CID)		
1997-93	Radiator & AC Fan	620-004
V6 - 3.5L (215 CID)		
2004-00	Radiator & AC Fan	620-005
1997-93	Radiator & AC Fan	620-004
NEON		
L4 - 2.0L (122 CID)		
2004-00	AC Fan, MT, 3-Speed	620-019
1999-95	AC Fan, w/AT	620-006
1999-95	Radiator Fan, w/AT, & w/AC	620-007
SHADOW		
L4 - 2.2L (135 CID)		
1994-92	Radiator Fan	620-008
1991	Radiator Fan, Stamped 4401951	620-008
L4 - 2.5L (153 CID)		
1994-92	Radiator Fan	620-008
1991	Radiator Fan, Stamped 4401951	620-008
V6 - 3.0L (181 CID)		
1994	Radiator Fan, Stamped 4546578, 4546614 or 4495753	620-008
SPIRIT		
L4 - 2.5L (153 CID)		
1995-94	Radiator Fan, AT, w/AC	620-008
1993	Radiator Fan	620-008
1992	Radiator Fan, Stamped 4401901, 4401937, 4546369 or 4546380	620-008
1991	Radiator Fan, Stamped 4401951	620-008
V6 - 3.0L (181 CID)		
1994	Radiator Fan, Stamped 4546578, 4546614 or 4495753	620-008
STEALTH		
V6 - 3.0L (2972 cc)		
1996-92	AC Fan	620-317
STRATUS		
L4 - 2.0L (122 CID)		
2000-95	Radiator & AC Fan	620-013
L4 - 2.4L (148 CID)		
2004-01	Radiator Fan, Coupe	620-011
2004-01	Radiator Fan, Sedan	620-350
2000-95	Radiator & AC Fan	620-013
V6 - 2.5L (152 CID)		
2000-95	Radiator & AC Fan, Stamped 4595782	620-014
2000-95	Radiator & AC Fan, Stamped 4662156	620-015
V6 - 2.7L (167 CID)		
2004-01	Radiator Fan, Sedan	620-350
V6 - 3.0L (181 CID)		
2004-03	Radiator Fan, Coupe	620-011
2002	AC Fan, Coupe	620-012

Radiator Fan Assemblies

Make/Model Engine/Years	Description	Dorman #
DODGE (continued)		
STRATUS (continued)		
V6 - 3.0L (181 CID) (continued)		
2002	Radiator Fan, Coupe	620-011
2001	AC Fan, Coupe, From 6/1/01	620-012
2001	AC Fan, Coupe, To 6/1/01	620-304
2001	Radiator Fan, Coupe	620-011
DODGE TRUCK		
DAKOTA		
L4 - 2.5L (153 CID)		
2002-00	Radiator Fan	620-029
V6 - 3.7L (226 CID)		
2004	Radiator Fan	620-029
V8 - 4.7L (287 CID)		
2004-01	Radiator Fan	620-029
DURANGO		
V8 - 4.7L (287 CID)		
2000	Radiator Fan	620-029
EAGLE		
SUMMIT		
L4 - 1.5L (1468 cc)		
1996-94	AC Fan	620-306
1996-94	Radiator Fan, Coupe, w/AT	620-305
1993	AC Fan, AT	620-306
1993	Radiator Fan, Coupe, w/AT	620-305
L4 - 1.8L (1834 cc)		
1996-94	AC Fan	620-306
1993	AC Fan	620-306
1993	Radiator Fan, MT	620-305
TALON		
L4 - 2.0L (122 CID)		
1998-95	Radiator Fan, wo/Turbo, w/MT	620-310
VISION		
V6 - 3.3L (201 CID)		
1997-93	Radiator & AC Fan	620-004
V6 - 3.5L (215 CID)		
1997-93	Radiator & AC Fan	620-004
FORD		
ASPIRE		
L4 - 1.3L (81 CID)		
1997-94	AC Fan, w/Factory Air	620-125
1997-94	Radiator Fan	620-124
CONTOUR		
L4 - 2.0L (122 CID)		
1999	Radiator Fan, To 2/99	620-103
1998-95	Radiator Fan	620-103
V6 - 2.5L (152 CID)		
1999	Radiator & AC Fan, To 2/99	620-104
1998-95	Radiator & AC Fan	620-104
CROWN VICTORIA		
V8 - 4.6L (281 CID)		
2002-01	Radiator Fan, ID# 1W1H 8C607-AA	620-121
2000-98	Radiator Fan, To 4/8/00	620-108
2000	Radiator Fan, From 4/8/00	620-121
1997-95	Radiator Fan	620-107
ESCORT		
L4 - 1.8L (110 CID)		
1996-93	Radiator & AC Fan, AT	620-114
L4 - 1.9L (116 CID)		
1996-93	Radiator & AC Fan	620-114
L4 - 2.0L (122 CID)		
2001-97	Radiator & AC Fan	620-115
FESTIVA		
L4 - 1.3L (81 CID)		
1993-90	AC Fan	620-123
1993-90	Radiator Fan	620-122
1989-88	AC Fan	620-123
FOCUS		
L4 - 2.0L (122 CID)		
2003-01	Radiator & AC Fan, w/DOHC (VIN 3, 5)	620-126
MUSTANG		
V6 - 3.8L (232 CID)		
1998-97	Radiator & AC Fan	620-109
1996-94	Radiator & AC Fan	620-128
V8 - 4.6L (281 CID)		
2003-01	Radiator & AC Fan	620-109
2000-97	Radiator Fan	620-130
1996	Radiator & AC Fan	620-128
V8 - 5.0L (302 CID)		
1995-94	Radiator & AC Fan	620-128
1993-90	Radiator Fan Blade Only	620-112

Make/Model Engine/Years	Description	Dorman #
FORD (continued)		
MUSTANG (continued)		
V8 - 5.0L (302 CID) (continued)		
1989-86	Radiator Fan Blade Only, w/Standard Cooling & AC	620-112
1985	Radiator Fan Blade Only, w/Standard Cooling & AC, MT	620-112
PROBE		
L4 - 2.2L (133 CID)		
1992-90	Radiator Fan	620-110
TAURUS		
L4 - 2.5L (153 CID)		
1991	Radiator Fan	620-129
V6 - 3.0L (182 CID)		
2005-96	AC Fan	620-105
2005-96	Radiator Fan	620-106
1995-94	Radiator & AC Fan, Exc. SHO	620-133
1993-92	Radiator Fan, Exc. SHO	620-129
V6 - 3.8L (232 CID)		
1995-90	Radiator Fan	620-101
V8 - 3.4L (207 CID)		
1999-96	AC Fan	620-105
1999-96	Radiator Fan	620-106
TEMPO		
L4 - 2.3L (140 CID)		
1994-92	Radiator Fan	620-100
1991	Radiator Fan, w/AC	620-100
1990	Radiator Fan, w/AC & AT	620-100
V6 - 3.0L (182 CID)		
1994-92	Radiator Fan	620-134
FORD TRUCK		
AEROSTAR		
V6 - 4.0L (245 CID)		
1997-90	Radiator Fan Blade Only, w/Super Cooling & AT	620-112
ESCAPE		
V6 - 3.0L (182 CID)		
2005-01	Radiator Fan	620-132
EXPLORER		
V6 - 4.0L (245 CID)		
1994-91	Radiator Fan Blade Only	620-112
RANGER		
V6 - 4.0L (245 CID)		
2004-95	Radiator Fan Blade Only, w/Super Cooling & AT	620-112
1994-91	Radiator Fan Blade Only	620-112
1990	Radiator Fan Blade Only, w/Super Cooling & AT	620-112
WINDSTAR		
V6 - 3.0L (182 CID)		
2000-99	Radiator Fan	620-131
1998-95	Radiator & AC Fan	620-102
V6 - 3.8L (232 CID)		
2003-99	Radiator Fan	620-131
1998-95	Radiator & AC Fan	620-102
GEO		
METRO		
L3 - 1.0L (61 CID)		
1998-95	AC Fan	620-709
1998-95	Radiator Fan	620-707
L4 - 1.3L (79 CID)		
1998-95	AC Fan	620-709
1998-95	Radiator Fan	620-707
PRIZM		
L4 - 1.6L (98 CID)		
1997-96	AC Fan	620-508
1997-96	Radiator Fan	620-500
1995-93	AC Fan, 5-Blade	620-507
1995-93	Radiator Fan	620-500
1992-89	AC Fan, 4-Blade	620-506
1992-89	Radiator Fan, 4-Blade	620-505
L4 - 1.8L (110 CID)		
1997-96	AC Fan	620-508
1997-96	Radiator Fan	620-500
1995-93	AC Fan, 5-Blade	620-507
1995-93	Radiator Fan	620-500
HONDA		
ACCORD		
L4 - 2.0L (1955 cc)		
1989-86	AC Fan	620-222
1989-86	Radiator Fan, Denso	620-221
L4 - 2.2L (2156 cc)		
1997-94	AC Fan	620-201
1997-94	Radiator Fan	620-200
1993-90	AC Fan	620-224
1993-90	Radiator Fan	620-223

Radiator Fan Assemblies

Clock Springs
pg. 21-24

Control Arms
pg. 25-54

CV Joint Boots & Accessories
pg. 55-66

Door Lock Actuators
pg. 67-72

Exhaust Manifold Kits
pg. 73-134

**Save valuable labor time...
Replace the entire assembly!**

Radiator Fan Assemblies

Radiator Fan Assemblies

Make/Model Engine/Years	Description	Dorman #
HONDA (continued)		
ACCORD (continued)		
L4 - 2.3L (2254 cc)		
2002-98 AC Fan		620-229
2002-98 Radiator Fan		620-227
V6 - 2.7L (2675 cc)		
1997-95 AC Fan		620-201
1997-95 Radiator Fan		620-200
V6 - 3.0L (2997 cc)		
2006-05 AC Fan, Exc. Hybrid		620-234
2006-05 Radiator Fan, Exc. Hybrid		620-235
2004-03 AC Fan		620-234
2004-03 Radiator Fan		620-235
2002-98 AC Fan		620-228
2002-98 Radiator Fan		620-226
CIVIC		
L4 - 1.3L (1342 cc)		
1987-84 AC Fan		620-214
1987-84 Radiator Fan (Denso)		620-213
L4 - 1.5L (1487 cc)		
1987-84 AC Fan		620-214
1987-84 Radiator Fan (Denso)		620-213
L4 - 1.5L (1493 cc)		
1995-92 AC Fan		620-202
1995-92 Radiator Fan (Denso)		620-204
1995-92 Tuner Fan		621-001
1991-88 AC Fan		620-216
1991-88 Radiator Fan		620-215
L4 - 1.6L (1590 cc)		
2000-99 AC Fan		620-218
2000-99 Radiator Fan (Denso)		620-217
1998-96 AC Fan		620-203
1998-96 Radiator Fan (Denso)		620-204
1998-96 Tuner Fan		621-002
1995-92 AC Fan		620-202
1995-92 Radiator Fan (Denso)		620-204
1995-92 Tuner Fan		621-001
1991-88 AC Fan		620-216
1991-88 Radiator Fan		620-215
L4 - 1.7L (1700 cc)		
2004-01 AC Fan, Hatchback & Sedan		620-220
2003-01 Radiator Fan, Hatchback & Sedan (Denso)		620-219
L4 - 2.0L (1998 cc)		
2004-02 AC Fan, Hatchback & Sedan		620-220
2003-02 Radiator Fan, Hatchback & Sedan (Denso)		620-219
CR-V		
L4 - 2.0L (1972 cc)		
2001-97 AC Fan		620-207
2001-97 Radiator Fan		620-230
L4 - 2.4L (2354 cc)		
2006-02 AC Fan, Japan Built		620-233
2006-02 Radiator Fan, Japan Built		620-232
CRX		
L4 - 1.3L (1342 cc)		
1984 AC Fan		620-214
1984 Radiator Fan (Denso)		620-213
L4 - 1.5L (1487 cc)		
1987-84 AC Fan		620-214
1987-84 Radiator Fan (Denso)		620-213
L4 - 1.5L (1493 cc)		
1991-88 AC Fan		620-216
1991-88 Radiator Fan		620-215
L4 - 1.6L (1590 cc)		
1991-88 AC Fan		620-216
1991-88 Radiator Fan		620-215
ODYSSEY		
V6 - 3.5L (3474 cc)		
2004-99 Radiator Fan		620-239
V6 - 3.5L (3474cc)		
2004-99 AC Fan		620-231
PASSPORT		
V6 - 3.2L (3165 cc)		
2002-98 AC Fan		620-722
PILOT		
V6 - 3.5L (3475 cc)		
2004-03 Radiator Fan		620-238
PRELUDE		
L4 - 2.2L (2156 cc)		
2001-97 AC Fan		620-201
2001-97 Radiator Fan		620-200
1996-92 AC Fan		620-224

Make/Model Engine/Years	Description	Dorman #
HONDA (continued)		
PRELUDE (continued)		
L4 - 2.2L (2156 cc) (continued)		
1996-92 Radiator Fan, S Series		620-223
WAGOVAN		
L4 - 1.5L (1487 cc)		
1987-86 AC Fan		620-214
L4 - 1.5L (1493 cc)		
1988 AC Fan		620-216
HUMMER		
H2		
V8 - 6.0L (364 CID)		
2006-03 Radiator Fan Blade Only		620-602
HYUNDAI		
ACCENT		
L4 - 1.5L (1495 cc)		
2002-00 AC Fan, w/AT		620-811
2002-00 Radiator Fan		620-810
1999-95 AC Fan		620-715
1999-95 Radiator Fan		620-714
L4 - 1.6L (1600 cc)		
2004-01 AC Fan		620-811
2004-01 Radiator Fan		620-810
ELANTRA		
L4 - 1.6L (1596 cc)		
1995-92 AC Fan		620-719
1995-92 Radiator Fan		620-718
L4 - 1.8L (1795 cc)		
1997-96 AC Fan		620-721
1997-96 Radiator Fan		620-720
L4 - 1.8L (1796 cc)		
1999-98 AC Fan		620-721
1999-98 Radiator Fan		620-720
L4 - 1.8L (1836 cc)		
1995-93 AC Fan		620-719
1995-93 Radiator Fan		620-718
L4 - 2.0L (1975 cc)		
2004-01 AC Fan		620-813
2004-01 Radiator Fan		620-812
2000-99 AC Fan		620-721
2000-99 Radiator Fan		620-720
EXCEL		
L4 - 1.5L (1468 cc)		
1994-90 AC Fan		620-776
1994-90 Radiator Fan		620-777
SANTA FE		
L4 - 2.4L (2351 cc)		
2004-03 Radiator Fan		620-712
2002-01 AC Fan		620-713
2002-01 Radiator Fan		620-712
V6 - 2.7L (2656 cc)		
2005-03 Radiator Fan		620-712
2002-01 AC Fan		620-713
2002-01 Radiator Fan		620-712
SCOUPE		
L4 - 1.5L (1468 cc)		
1992-91 AC Fan		620-776
1992-91 Radiator Fan		620-777
SONATA		
L4 - 2.4L (2351 cc)		
2004-99 AC Fan		620-717
2003-99 Radiator Fan		620-716
V6 - 2.5L (2500 cc)		
2001-99 AC Fan		620-717
2001-99 Radiator Fan		620-716
V6 - 2.7L (2700 cc)		
2004-02 AC Fan		620-717
2003-02 Radiator Fan		620-716
TIBURON		
L4 - 1.8L (1795 cc)		
1997 AC Fan		620-721
1997 Radiator Fan		620-720
L4 - 2.0L (1975 cc)		
1997 AC Fan		620-721
1997 Radiator Fan		620-720
L4 - 2.0L (1997 cc)		
2001-98 AC Fan		620-721
2001-98 Radiator Fan		620-720
XG300		
V6 - 3.0L (2972 cc)		
2001 AC Fan		620-717

Radiator Fan Assemblies

Make/Model Engine/Years	Description	Dorman #
HYUNDAI (continued)		
XG300 (continued)		
V6 - 3.0L (2972 cc) (continued)		
2001	Radiator Fan	620-716
XG350		
V6 - 3.5L (3500 cc)		
2004-02	AC Fan	620-717
2004-02	Radiator Fan	620-716
INFINITI		
G20		
L4 - 2.0L (1998 cc)		
1996-94	Radiator Fan, MT	620-417
1993	AC Fan, AT	620-418
1993	Radiator Fan	620-417
1992-91	AC Fan, AT	620-418
1992-91	Radiator Fan, AT	620-417
I30		
V6 - 3.0L (2988 cc)		
2001-00	Radiator & AC Fan	620-416
1999-96	Radiator & AC Fan	620-420
ISUZU TRUCK		
AMIGO		
V6 - 3.2L (3165 cc)		
2000-98	AC Fan	620-722
AXIOM		
V6 - 3.5L (3475 cc)		
2004-02	AC Fan	620-722
RODEO		
V6 - 3.2L (3165 cc)		
2004-98	AC Fan	620-722
RODEO SPORT		
V6 - 3.2L (3165 cc)		
2003-01	AC Fan	620-722
JEEP		
CHEROKEE		
L4 - 2.5L (150 CID)		
2000-95	Radiator Fan	620-001
L6 - 4.0L (242 CID)		
2001-87	Radiator Fan	620-001
COMANCHE		
L6 - 4.0L (242 CID)		
1992-87	Radiator Fan	620-001
GRAND CHEROKEE		
L6 - 4.0L (242 CID)		
2004-99	Radiator Fan	620-010
V8 - 4.7L (285 CID)		
2000-99	Radiator Fan	620-010
WAGONEER		
L6 - 4.0L (242 CID)		
1990-87	Radiator Fan	620-001
KIA		
OPTIMA		
L4 - 2.4L (2351 cc)		
2001-00	AC Fan	620-717
2001-00	Radiator Fan	620-716
V6 - 2.5L (2500 cc)		
2001	AC Fan	620-717
2001	Radiator Fan	620-716
V6 - 2.7L (2700 cc)		
2002	AC Fan	620-717
2002	Radiator Fan	620-716
SEPHIA		
L4 - 1.8L (1793 cc)		
2001-98	AC Fan	620-710
2001-98	Radiator Fan, AT	620-711
SPECTRA		
L4 - 1.8L (1793 cc)		
2004-00	AC Fan	620-710
2001-00	Radiator Fan, AT	620-711
SPORTAGE		
L4 - 2.0L (1998 cc)		
2002-95	AC Fan	620-725
LEXUS		
LS400		
V8 - 4.0L (3967 cc)		
1994-90	AC Fan, LH	620-724
1994-90	AC Fan, RH	620-723
LINCOLN		
CONTINENTAL		
V6 - 3.8L (232 CID)		
1994-90	Radiator Fan	620-101

Make/Model Engine/Years	Description	Dorman #
LINCOLN (continued)		
TOWN CAR		
V8 - 4.6L (281 CID)		
2002-01	Radiator Fan	620-121
2000-98	Radiator Fan, To 4/8/00	620-108
2000	Radiator Fan, From 4/8/00	620-121
1997-95	Radiator Fan	620-107
MAZDA		
323		
L4 - 1.6L (1597 cc)		
1994-90	AC Fan	620-741
1994-90	Radiator Fan, AT	620-740
1994-90	Radiator Fan, MT	620-739
1989-86	Radiator Fan	620-737
626		
L4 - 2.0L (1970 cc)		
1983	AC Fan	620-743
1983	Radiator Fan, MT	620-742
L4 - 2.0L (1991 cc)		
2002-00	Radiator & AC Fan	620-778
1999-98	AC Fan	620-750
1999-98	Radiator Fan	620-751
1997-96	AC Fan, 5-Blade	620-748
1997-96	Radiator Fan	620-775
1995-93	AC Fan, 5-Blade	620-748
1995-93	Radiator Fan, AT	620-747
1995-93	Radiator Fan, MT	620-775
L4 - 2.0L (1998 cc)		
1987-86	AC Fan	620-743
1987-86	Radiator Fan, MT, wo/Turbo	620-742
1985-84	AC Fan	620-743
1985-84	Radiator Fan, MT	620-742
L4 - 2.2L (2184 cc)		
1992-88	AC Fan, MT	620-746
1992-88	Radiator Fan	620-744
V6 - 2.5L (2497 cc)		
2002-00	Radiator & AC Fan	620-871
1999-98	AC Fan	620-750
1999-98	Radiator Fan	620-751
1997-93	AC Fan	620-749
1997-93	Radiator Fan	620-747
MX-6		
L4 - 2.0L (1991 cc)		
1997-93	AC Fan, 5-Blade	620-748
1995-93	Radiator Fan, AT	620-747
L4 - 2.2L (2184 cc)		
1992-88	AC Fan, MT	620-746
1992-88	Radiator Fan	620-744
V6 - 2.5L (2497 cc)		
1997-93	AC Fan	620-749
1997-93	Radiator Fan	620-747
PROTEGE		
L4 - 1.5L (1489 cc)		
1998-95	AC Fan	620-755
1998-95	Radiator Fan	620-754
L4 - 1.6L (1589 cc)		
2001-99	AC Fan	620-758
2001-99	Radiator Fan, AT	620-757
2001-99	Radiator Fan, MT	620-759
L4 - 1.8L (1839 cc)		
2000-99	AC Fan	620-758
2000-99	Radiator Fan, AT	620-757
2000-99	Radiator Fan, MT	620-759
1998-95	AC Fan	620-755
1998-95	Radiator Fan, AT	620-753
1996-95	Radiator Fan, MT	620-754
1994-90	AC Fan	620-741
1994-90	Radiator Fan, AT	620-740
1994-90	Radiator Fan, MT	620-739
L4 - 2.0L (2000 cc)		
2003-01	AC Fan	620-758
2003-01	Radiator Fan, AT	620-757
2003-01	Radiator Fan, MT	620-759
PROTEGE 5		
L4 - 2.0L (2000 cc)		
2003-02	AC Fan	620-758
2003-02	Radiator Fan, AT	620-757
2003-02	Radiator Fan, MT	620-759

Radiator Fan Assemblies

Fuel Sending Units
pg. 155-176

Fuel Tanks
pg. 177-228

Harmonic Balancers
pg. 229-254

Heater Hose Assemblies
pg. 255-256

Hydraulic Clutch Lines
pg. 257-260

**Save valuable labor time...
Replace the entire assembly!**

Radiator Fan Assemblies

Radiator Fan Assemblies

Make/Model Engine/Years	Description	Dorman #
MERCURY		
CAPRI		
V8 - 5.0L (302 CID)		
1986	Radiator Fan Blade Only, w/Standard Cooling & AC	620-112
1985	Radiator Fan Blade Only, w/Standard Cooling & AC, MT	620-112
GRAND MARQUIS		
V8 - 4.6L (281 CID)		
2002-01	Radiator Fan, ID# 1W1H 8C607-AA	620-121
2000-98	Radiator Fan, To 4/8/00	620-108
2000	Radiator Fan, From 4/8/00	620-121
1997-95	Radiator Fan	620-107
MYSTIQUE		
L4 - 2.0L (122 CID)		
1999	Radiator Fan, To 2/99	620-103
1998-95	Radiator Fan	620-103
V6 - 2.5L (152 CID)		
1999	Radiator & AC Fan, To 2/99	620-104
1998-95	Radiator & AC Fan	620-104
SABLE		
V6 - 3.0L (182 CID)		
2005-96	AC Fan	620-105
2005-96	Radiator Fan	620-106
1995-94	Radiator & AC Fan	620-133
1993-92	Radiator Fan	620-129
V6 - 3.8L (232 CID)		
1995-90	Radiator Fan	620-101
TOPAZ		
L4 - 2.3L (140 CID)		
1994-92	Radiator Fan	620-100
1991	Radiator Fan, w/AC	620-100
1990	Radiator Fan, w/AC & AT	620-100
V6 - 3.0L (182 CID)		
1994-92	Radiator Fan	620-134
TRACER		
L4 - 1.8L (110 CID)		
1996-93	Radiator & AC Fan, AT	620-114
L4 - 1.9L (116 CID)		
1996-93	Radiator & AC Fan, w/AC	620-114
L4 - 2.0L (122 CID)		
1999-97	Radiator & AC Fan, w/AC	620-115
VILLAGER		
V6 - 3.0L (182 CID)		
1998-96	Radiator Fan	620-127
1995-93	Radiator Fan, Heavy Duty	620-413
1995-93	Radiator Fan, Standard Duty	620-111
V6 - 3.3L (201 CID)		
2002-99	Radiator Fan	620-113
MITSUBISHI		
3000GT		
V6 - 3.0L (2972 cc)		
1996-92	AC Fan	620-317
ECLIPSE, ECLIPSE SPYDER		
L4 - 1.8L (1755 cc)		
1994-90	AC Fan	620-301
1994-90	Radiator Fan, MT	620-300
L4 - 2.0L (1997 cc)		
1999-95	AC Fan, w/Turbo	620-303
1999-95	Radiator Fan, AT, wo/Turbo	620-302
1999-95	Radiator Fan, MT, w/Turbo	620-302
1999-95	Radiator Fan, MT, wo/Turbo	620-310
1994-91	AC Fan	620-301
1994-91	Radiator Fan, AT, 2WD, wo/Turbo	620-300
1994-91	Radiator Fan, MT	620-300
1990	AC Fan	620-301
1990	Radiator Fan	620-300
L4 - 2.4L (2351 cc)		
2004-01	Radiator Fan, Coupe	620-011
2000	Radiator Fan	620-309
V6 - 3.0L (2972 cc)		
2004-00	Radiator Fan	620-011
2002-01	AC Fan, Coupe	620-012
2000	AC Fan	620-304
GALANT		
L4 - 2.4L (2351 cc)		
2002-01	Radiator Fan	620-318
1998-94	AC Fan	620-317
1998-94	Radiator Fan	620-314
V6 - 3.0L (2972 cc)		
2002-99	AC Fan	620-319
2002-99	Radiator Fan	620-318

Make/Model Engine/Years	Description	Dorman #
MITSUBISHI (continued)		
LANCER		
L4 - 2.0L (1999 cc)		
2005-02	AC Fan	620-311
MIRAGE		
L4 - 1.5L (1468 cc)		
2002-97	AC Fan	620-308
2002-97	Radiator Fan	620-307
1996-94	AC Fan	620-306
1996-94	Radiator Fan, Coupe, w/AT	620-305
1993	AC Fan, AT	620-306
1993	Radiator Fan, Coupe, w/AT	620-305
L4 - 1.8L (1834 cc)		
2002-97	AC Fan	620-308
2002-97	Radiator Fan, MT	620-307
1996-94	AC Fan	620-306
1993	AC Fan	620-306
1993	Radiator Fan, MT	620-305
PRECIS		
L4 - 1.5L (1468 cc)		
1993-90	AC Fan	620-776
1993-90	Radiator Fan	620-777
MITSUBISHI TRUCK		
MONTERO		
V6 - 3.0L (2972 cc)		
1996-92	AC Fan	620-320
V6 - 3.5L (3497 cc)		
2000-94	AC Fan	620-320
MONTERO SPORT		
L4 - 2.4L (2351 cc)		
1999-98	AC Fan	620-312
V6 - 3.0L (2972 cc)		
2003-98	AC Fan	620-312
V6 - 3.5L (3497 cc)		
2004-99	AC Fan	620-312
NISSAN		
200SX		
L4 - 1.6L (1597 cc)		
1998-95	AC Fan, AT	620-408
1998-95	AC Fan, MT	620-407
1998-95	Radiator Fan, MT	620-405
L4 - 2.0L (1998 cc)		
1998-95	AC Fan, AT	620-408
ALTIMA		
L4 - 2.4L (2389 cc)		
2001-98	Radiator & AC Fan	620-415
1997-93	Radiator Fan	620-401
L4 - 2.5L (2500 cc)		
2006-02	Radiator Fan	620-419
MAXIMA		
V6 - 3.0L (2960 cc)		
1994-89	Radiator & AC Fan	620-411
V6 - 3.0L (2988 cc)		
2001-00	Radiator & AC Fan	620-416
1999-97	Radiator & AC Fan	620-420
1996	Radiator & AC Fan, Calif	620-420
1996	Radiator & AC Fan, Exc. Calif	620-400
1995	Radiator & AC Fan, Calif	620-400
1995	Radiator & AC Fan, Exc. Calif	620-420
MURANO		
V6 - 3.5L (3498 cc)		
2006-03	AC Fan	620-412
NX		
L4 - 1.6L (1597 cc)		
1993-91	AC Fan, AT	620-408
1993-91	AC Fan, MT	620-407
1993-91	Radiator Fan, AT	620-406
1993-91	Radiator Fan, MT	620-405
L4 - 2.0L (1998 cc)		
1993-91	AC Fan, AT	620-408
1993-91	AC Fan, MT	620-407
1993-91	Radiator Fan, AT	620-406
1993-91	Radiator Fan, MT	620-405
QUEST		
V6 - 3.0L (2960 cc)		
1998-96	Radiator Fan	620-127
1995-93	Radiator Fan, Heavy Duty	620-413
1995-93	Radiator Fan, Standard Duty	620-111
V6 - 3.3L (3275 cc)		
2002-99	Radiator Fan	620-113

Radiator Fan Assemblies

Make/Model Engine/Years	Description	Dorman #
NISSAN (continued)		
SENTRA		
L4 - 1.5L (1488 cc)		
1983-82	AC Fan, AT	620-403
1983-82	Radiator Fan, AT	620-402
L4 - 1.6L (1597 cc)		
1999-91	AC Fan, AT	620-408
1999-91	AC Fan, MT	620-407
1999-91	Radiator Fan, MT	620-405
1994-91	Radiator Fan, AT	620-406
1988-87	Radiator & AC Fan, AT	620-404
1986-83	AC Fan, AT	620-403
1986-83	Radiator Fan, AT	620-402
L4 - 1.8L (1809 cc)		
2002-00	Radiator & AC Fan	620-409
2002-00	Radiator Fan, wo/AC	620-410
L4 - 2.0L (1998 cc)		
2001-00	Radiator & AC Fan	620-409
2001-00	Radiator Fan, wo/AC	620-410
1999-95	AC Fan, AT	620-408
1994-91	AC Fan, AT	620-408
1994-91	AC Fan, MT	620-407
1994-91	Radiator Fan, AT	620-406
1994-91	Radiator Fan, MT	620-405
OLDSMOBILE		
98		
V6 - 3.8L (231 CID)		
1996	AC Fan	620-623
1996	Radiator Fan	620-625
1995-91	AC Fan	620-623
1995-91	Radiator Fan	620-624
ACHIEVA		
L4 - 2.3L (138 CID)		
1995	Radiator Fan	620-627
L4 - 2.4L (146 CID)		
1998-96	Radiator Fan	620-627
V6 - 3.1L (189 CID)		
1998-95	Radiator Fan	620-627
ALERO		
L4 - 2.2L (134 CID)		
2004-02	Radiator & AC Fan	620-618
L4 - 2.4L (146 CID)		
2001-99	Radiator & AC Fan	620-618
V6 - 3.4L (207 CID)		
2004-99	Radiator & AC Fan	620-618
BRAVADA		
V6 - 4.3L (262 CID)		
2001-96	Radiator Fan Blade Only, w/AC	620-602
CUTLASS		
V6 - 3.1L (189 CID)		
1999-97	Radiator & AC Fan	620-618
CUTLASS CIERA		
V6 - 3.3L (204 CID)		
1993-90	Radiator Fan	620-605
1989	Radiator Fan, wo/HDC	620-605
CUTLASS SUPREME		
V6 - 3.1L (189 CID)		
1997-96	AC Fan	620-601
1997-96	Radiator Fan	620-603
DELTA 88, 88, LSS		
V6 - 3.8L (231 CID)		
1999-91	AC Fan	620-623
1999-91	Radiator Fan	620-625
SILHOUETTE		
V6 - 3.1L (189 CID)		
1993-92	Radiator Fan, Primary	620-622
V6 - 3.4L (207 CID)		
2004-01	Radiator & AC Fan	620-611
2000-99	Radiator & AC Fan, wo/HDC	620-607
1998-97	AC Fan	620-606
1996	Radiator Fan, Primary	620-621
V6 - 3.8L (231 CID)		
1995-92	Radiator Fan, Aux	620-622
1995-92	Radiator Fan, Primary	620-621
PLYMOUTH		
ACCLAIM		
L4 - 2.5L (153 CID)		
1995-94	Radiator Fan, AT, w/AC	620-008
1993	Radiator Fan	620-008
1992	Radiator Fan, Stamped 4401901, 4401937, 4546369 or 4546380	620-008

Make/Model Engine/Years	Description	Dorman #
PLYMOUTH (continued)		
ACCLAIM (continued)		
L4 - 2.5L (153 CID) (continued)		
1991	Radiator Fan, Stamped 4401951	620-008
V6 - 3.0L (181 CID)		
1994	Radiator Fan, Stamped 4546578, 4546614 or 4495753	620-008
BREEZE		
L4 - 2.0L (122 CID)		
2000-96	Radiator & AC Fan	620-013
L4 - 2.4L (148 CID)		
2000-96	Radiator & AC Fan	620-013
COLT		
L4 - 1.5L (1468 cc)		
1994	AC Fan	620-306
1994	Radiator Fan, Coupe, w/AT	620-305
1993	AC Fan, AT	620-306
1993	Radiator Fan, Coupe, w/AT	620-305
L4 - 1.8L (1834 cc)		
1994	AC Fan	620-306
1993	AC Fan	620-306
1993	Radiator Fan, MT	620-305
NEON		
L4 - 2.0L (122 CID)		
2001-00	AC Fan, MT, 3-Speed	620-019
1999-95	AC Fan, w/AT	620-006
1999-95	Radiator Fan, w/AT, & w/AC	620-007
SUNDANCE		
L4 - 2.2L (135 CID)		
1994-92	Radiator Fan	620-008
1991	Radiator Fan, Stamped 4401951	620-008
L4 - 2.5L (153 CID)		
1994-92	Radiator Fan	620-008
1991	Radiator Fan, Stamped 4401951	620-008
V6 - 3.0L (181 CID)		
1994	Radiator Fan, Stamped 4546578, 4546614 or 4495753	620-008
VOYAGER, GRAND VOYAGER		
L4 - 2.4L (148 CID)		
2000-96	Radiator & AC Fan	620-003
L4 - 2.5L (153 CID)		
1995-93	Radiator Fan	620-002
V6 - 3.0L (181 CID)		
2000-96	Radiator & AC Fan	620-003
1995-93	Radiator Fan	620-002
1992-91	Radiator Fan	620-009
V6 - 3.3L (201 CID)		
2000-96	Radiator & AC Fan	620-003
1995-93	Radiator Fan	620-002
1992-91	Radiator Fan	620-009
V6 - 3.8L (230 CID)		
2000-96	Radiator & AC Fan	620-003
1995-94	Radiator Fan	620-002
PONTIAC		
AZTEK		
V6 - 3.4L (207 CID)		
2005-01	Radiator & AC Fan, wo/HDC	620-611
BONNEVILLE		
V6 - 3.8L (231 CID)		
2005-00	Radiator & AC Fan	620-636
1999-91	AC Fan	620-623
1999-91	Radiator Fan	620-625
GRAND AM		
L4 - 2.2L (134 CID)		
2005-02	Radiator & AC Fan	620-618
L4 - 2.3L (138 CID)		
1995	Radiator Fan	620-627
L4 - 2.4L (146 CID)		
2001-97	Radiator & AC Fan	620-618
1998-96	Radiator Fan	620-627
V6 - 3.1L (189 CID)		
1998-97	Radiator & AC Fan	620-618
1998-95	Radiator Fan	620-627
V6 - 3.4L (207 CID)		
2005-99	Radiator & AC Fan	620-618
GRAND PRIX		
V6 - 3.1L (189 CID)		
2003-00	Radiator & AC Fan	620-626
1999	AC Fan, Single Fan	620-601
1999	Radiator & AC Fan, Dual Fan	620-626
1999	Radiator Fan, Single Fan	620-603
1998-97	AC Fan	620-601
1998-97	Radiator Fan	620-604

Radiator Fan Assemblies

Radiator Fan Assemblies

Make/Model Engine/Years	Description	Dorman #
PONTIAC (continued)		
GRAND PRIX (continued)		
V6 - 3.8L (231 CID)		
1996-95 AC Fan		620-601
1996-95 Radiator Fan		620-603
2003-99 Radiator & AC Fan		620-607
J2000		
L4 - 1.8L (112 CID)		
1985-84 AC Fan		620-614
L4 - 2.0L (122 CID)		
1985-84 AC Fan		620-614
MONTANA		
V6 - 3.4L (207 CID)		
2005-01 Radiator & AC Fan		620-611
2000-99 Radiator & AC Fan, wo/HDC		620-607
SUNBIRD		
L4 - 1.8L (112 CID)		
1986-85 AC Fan		620-614
L4 - 2.0L (122 CID)		
1994-85 AC Fan		620-614
SUNFIRE		
L4 - 2.2L (134 CID)		
2004-95 AC Fan		620-600
L4 - 2.3L (138 CID)		
1995 AC Fan		620-600
L4 - 2.4L (146 CID)		
2002-96 AC Fan		620-600
TRANS SPORT		
V6 - 3.1L (189 CID)		
1993-92 Radiator Fan, Primary		620-622
V6 - 3.4L (207 CID)		
1998-97 AC Fan		620-606
1996 Radiator Fan, Primary		620-621
V6 - 3.8L (231 CID)		
1995-92 Radiator Fan, Aux		620-622
1995-92 Radiator Fan, Primary		620-621
SATURN		
SC SERIES		
L4 - 1.9L (116 CID)		
2002-94 AC Fan		620-767
SL SERIES		
L4 - 1.9L (116 CID)		
2002-94 AC Fan		620-767
SW SERIES		
L4 - 1.9L (116 CID)		
2001-94 AC Fan		620-767
SCION		
XA		
L4 - 1.5L (1497 cc)		
2004 AC Fan		620-525
XB		
L4 - 1.5L (1497 cc)		
2004 AC Fan		620-525
SUBARU		
BAJA		
H4 - 2.5L (2458 cc)		
2004-03 Radiator Fan, w/MT		620-820
FORESTER		
H4 - 2.5L (2458 cc)		
2002-99 AC Fan		620-822
2002-99 Radiator Fan		620-821
IMPREZA		
H4 - 1.8L (1781 cc)		
1997 AC Fan		620-765
1996-93 AC Fan		620-766
1996-93 Radiator Fan		620-764
H4 - 2.2L (2212 cc)		
2001-99 AC Fan		620-822
2001-99 Radiator Fan		620-821
1998-97 AC Fan		620-765
1996-95 AC Fan		620-766
1996-95 Radiator Fan		620-764
H4 - 2.5L (2458 cc)		
2001-99 AC Fan		620-822
2001-99 Radiator Fan		620-821
1998 AC Fan		620-765
JUSTY		
L3 - 1.2L (1189 cc)		
1994-89 Radiator Fan		620-760

Make/Model Engine/Years	Description	Dorman #
SUBARU (continued)		
LEGACY, LEGACY OUTBACK		
H4 - 2.2L (2212 cc)		
1999-95 AC Fan		620-763
1999-95 Radiator Fan		620-762
H4 - 2.5L (2458 cc)		
2004-00 Radiator Fan		620-820
1999-96 AC Fan		620-763
1999-96 Radiator Fan		620-762
SUZUKI		
GRAND VITARA		
V6 - 2.5L (2500 cc)		
2002-99 AC Fan, Suzuki		620-772
V6 - 2.7L (2700 cc)		
2002-01 AC Fan, Suzuki		620-772
SIDEKICK		
L4 - 1.3L (1325 cc)		
1989 AC Fan		620-770
L4 - 1.6L (1590 cc)		
1998-89 AC Fan		620-770
L4 - 1.8L (1840 cc)		
1998-96 AC Fan		620-770
SWIFT		
L4 - 1.3L (1298 cc)		
2001-95 AC Fan		620-709
2001-95 Radiator Fan		620-707
1994-89 AC Fan		620-769
1994-89 Radiator Fan		620-768
VITARA		
L4 - 1.6L (1590 cc)		
2002-99 AC Fan, Suzuki		620-772
L4 - 2.0L (2000 cc)		
2002-99 AC Fan, Suzuki		620-772
TOYOTA		
AVALON		
V6 - 3.0L (2995 cc)		
2004-00 AC Fan, Stamped 0A18		620-516
2004-00 Radiator Fan, Stamped 0A17		620-515
CAMRY		
L4 - 2.0L (1998 cc)		
1991-87 AC Fan		620-514
1991-87 Radiator Fan		620-513
L4 - 2.2L (2164 cc)		
2001-99 AC Fan		620-522
2001-99 Radiator Fan		620-517
1998-97 AC Fan		620-518
1998-97 Radiator Fan		620-517
1996-92 AC Fan		620-502
1996-92 Radiator Fan		620-501
L4 - 2.4L (2398 cc)		
2004-02 Radiator & AC Fan		620-531
V6 - 3.0L (2995 cc)		
2004-02 Radiator & AC Fan		620-532
2001-99 AC Fan		620-523
2001-99 Radiator Fan		620-524
1998-97 AC Fan		620-519
1998-97 Radiator Fan		620-520
1996-95 AC Fan		620-503
1996-95 Radiator Fan		620-504
COROLLA		
L4 - 1.6L (1587 cc)		
1997-96 AC Fan		620-508
1997-96 Radiator Fan		620-500
1995-93 AC Fan, 5-Blade		620-507
1995-93 Radiator Fan		620-500
1991-88 AC Fan, 4-Blade		620-506
1991-88 Radiator Fan, 4-Blade		620-505
L4 - 1.8L (1762 cc)		
2001-98 Radiator & AC Fan		620-511
1997-96 AC Fan		620-508
1997-96 Radiator Fan		620-500
1995-93 AC Fan, 5-Blade		620-507
1995-93 Radiator Fan		620-500
ECHO		
L4 - 1.5L (1497 cc)		
2004-00 AC Fan		620-525
PASEO		
L4 - 1.5L (1497 cc)		
1998-96 AC Fan		620-528
1998-96 Radiator Fan, AT		620-527
1998-96 Radiator Fan, MT		620-526

Radiator Fan Assemblies

Make/Model Engine/Years	Description	Dorman #
TOYOTA (continued)		
SIENNA		
V6 - 3.0L (2995 cc)		
2003-98	AC Fan, Stamped T2	620-537
2003-98	Radiator Fan, Stamped T1	620-536
SOLARA		
L4 - 2.2L (2164 cc)		
2001-99	AC Fan	620-522
2001-99	Radiator Fan	620-517
L4 - 2.4L (2398 cc)		
2004	Radiator & AC Fan	620-531
V6 - 3.0L (2995 cc)		
2004	Radiator & AC Fan	620-532
2001-99	AC Fan	620-523
2001-99	Radiator Fan	620-524
TERCEL		
L4 - 1.5L (1497 cc)		
1998-95	AC Fan	620-528
1998-95	Radiator Fan, AT	620-527
1998-95	Radiator Fan, MT	620-526
TOYOTA TRUCK		
4 RUNNER		
L4 - 2.7L (2694 cc)		
2000-96	Radiator Fan Blade Only	620-533
V6 - 3.0L (2959 cc)		
1995-94	Radiator Fan Blade Only	620-535
V6 - 3.4L (3378 cc)		
2002-96	Radiator Fan Blade Only	620-534
PICKUP		
V6 - 3.0L (2959 cc)		
1995-94	Radiator Fan Blade Only	620-535
RAV4		
L4 - 2.0L (1998 cc)		
2003-01	AC Fan	620-539
2003-01	Radiator Fan	620-538
2000-96	AC Fan	620-530
2000-96	Radiator Fan	620-529
L4 - 2.4L (2398 cc)		
2005-04	AC Fan	620-539
2004	Radiator Fan	620-538
T100		
L4 - 2.7L (2694 cc)		
1998-94	Radiator Fan Blade Only	620-533
V6 - 3.0L (2959 cc)		
1994	Radiator Fan Blade Only	620-535
V6 - 3.4L (3378 cc)		
1998-95	Radiator Fan Blade Only	620-534
TACOMA		
L4 - 2.4L (2438 cc)		
2004-95	Radiator Fan Blade Only	620-533
L4 - 2.7L (2694 cc)		
2005-95	Radiator Fan Blade Only	620-533
V6 - 3.4L (3378 cc)		
2004-95	Radiator Fan Blade Only	620-534
TUNDRA		
V6 - 3.4L (3378 cc)		
2004-00	Radiator Fan Blade Only	620-534
VOLKSWAGEN		
BEETLE		
L4 - 1.8L (1800 cc)		
2006-99	Radiator & AC Fan	620-773
L4 - 1.9L (1896 cc)		
2006-98	Radiator & AC Fan	620-773

Make/Model Engine/Years	Description	Dorman #
VOLKSWAGEN (continued)		
BEETLE (continued)		
L4 - 2.0L (1984 cc)		
2006-98	Radiator & AC Fan	620-773
PASSAT		
V6 - 2.8L (2771 cc)		
2000-97	AC Fan	620-800
VOLVO		
240		
L4 - 2.3L (2316 cc)		
1993-90	Radiator Fan	620-881
244		
L4 - 2.3L (2316 cc)		
1989-88	Radiator Fan	620-881
1987-86	Radiator Fan	620-880
245		
L4 - 2.3L (2316 cc)		
1989-88	Radiator Fan	620-881
1987-86	Radiator Fan	620-880
740		
L4 - 2.3L (2316 cc)		
1991-90	Radiator Fan	620-887
1989-85	Radiator Fan	620-886
L6 - 2.4L (2383 cc)		
1986	Radiator Fan	620-886
745		
L4 - 2.3L (2316 cc)		
1985	Radiator Fan	620-886
L6 - 2.4L (2383 cc)		
1985	Radiator Fan	620-886
760		
L4 - 2.3L (2316 cc)		
1990-88	Radiator Fan	620-887
1987-84	Radiator Fan	620-886
L6 - 2.4L (2383 cc)		
1985-83	Radiator Fan	620-886
V6 - 2.8L (2849 cc)		
1990-87	Radiator Fan	620-887
1986-83	Radiator Fan	620-886
780		
L4 - 2.3L (2316 cc)		
1991-89	Radiator Fan	620-887
V6 - 2.8L (2849 cc)		
1990-87	Radiator Fan	620-887
850		
L5 - 2.3L (2319 cc)		
1997-94	Radiator Fan	620-883
L5 - 2.4L (2435 cc)		
1997-93	Radiator Fan	620-883
940		
L4 - 2.3L (2316 cc)		
1995-92	Radiator Fan	620-774
1991	Radiator Fan	620-887
960		
L6 - 2.9L (2917 cc)		
1998-92	Radiator Fan	620-774
S90		
L6 - 2.9L (2917 cc)		
1998	Radiator Fan	620-774
V90		
L6 - 2.9L (2917 cc)		
1998	Radiator Fan	620-774

Radiator Fan Assemblies

100% New Window Lift Motors

NEW For The Same Price as Reman

DORMAN

742-252
Ford
Crown Victoria/
Grand Marquis/
Town Car/
Marauder
2006-90

No Splicing -
Wiring Harness
Included

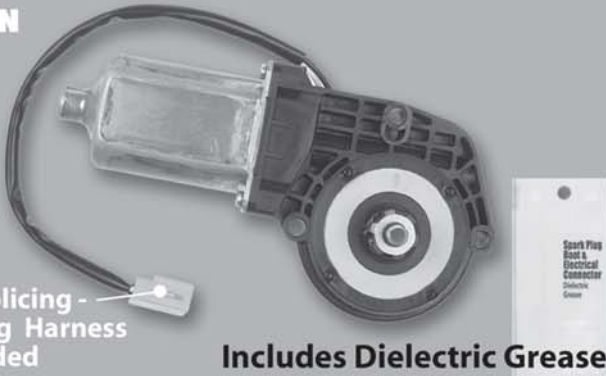

Includes Dielectric Grease

REMAN

Splicing Required
Wiring Harness
Not Included

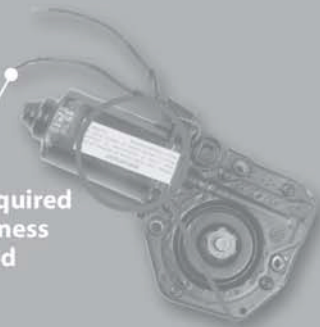

REMAN LABEL WARNING:

NOTICE: Do not be alarmed, smoke coming from motor is due to fresh paint. Condition is normal. Allow 1 hour of operating to clear smoke.

100% New Wiper Motors

Ask for Dorman **NEW**... Better Price and Quality

DORMAN



601-300
Chrysler
1997-89

REMAN



88136
Wiper Pulse Board
GM Trucks 2003-88
Includes New Cover Plate and Hardware.



Wiper Transmission Linkages

40% of Windshield Wiper System Failures
Are Due to the Linkage Assembly

NEW!



602-202
GM Alero, Cavalier,
Grand Am, Sunfire
2003-98



602-002
Nissan Maxima (LH)
1994-89



602-300
Ford Taurus
1995-87

Rear Axle Shaft Kits

- 41 total Part Numbers covering the most failure-prone RWD vehicles
- Over 33 million registered vehicles covered by the Dorman Rear Axle Kit Program



Dorman Rear Axle Shaft Kits – Do the job right!

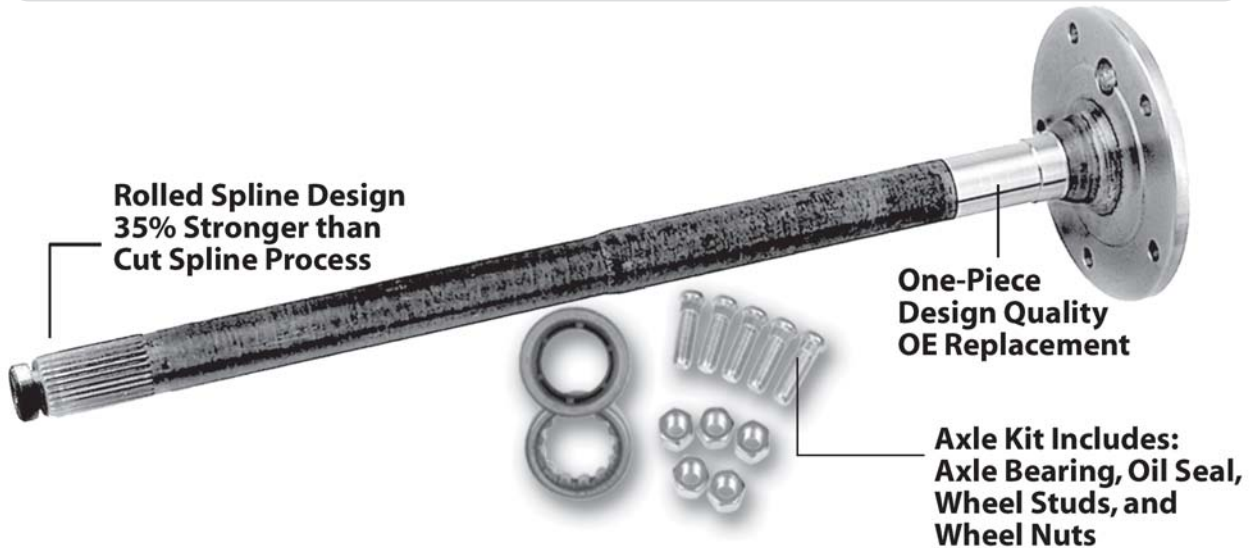

Common signs to replace your Rear Axle:

- Grinding sound in axle area could mean the bearing has seized to the shaft surface
- Bent Rear Axle – Shakes vehicle when driving
- Unusual tire wear
- Loss of rear wheel drive or power

Always **CHECK** Rear Axle Splines and Axle Shaft for cracks or flat spots when doing Rear Axle overhauls and repairs.

Related Rear Axle Shaft Sales

81048



Differential Shaft Lock Bolt

Fits GM vehicles 1994-90, Ford 2003-80, Ford cars and trucks 2003-80. Retains pinion shaft. Must be removed to perform rear differential work or when replacing rear axle shafts. Bolts break, wear out or are often misplaced.

81050



Axle Shaft Lock (C-Clips)

GM. Replaces lost or damaged rear axle locks. Worn or damaged locks should be replaced to ensure proper axle lock-in. Axle locks should be replaced whenever axle work is performed. Available in two sizes to provide a proper fit.

81053



Pinion Nut

GM 1995-61. Prevailing torque style. 7/8"-14.

Activant Path

*Differential Axle/
Drive Train*

Activant Code

DDA

**Applications begin
on page 433.**

Rear Axle Shafts Kits



	Part #	Length	No. of Holes	Spline	Applications	Orientation
GM						
	630-100	33-5/16"	5	30	1995-88 10 Bolt 8.5" Dia. Ring Gear; GM/GMC Vans 1/2 & 3/4 Ton, RH & LH; 2 Wheel Drive	Left or Right
	630-101	33"	6	30	1999-88 GM 10 Bolt, 8.5" Dia. Ring Gear; Tahoe & Yukon with 4 Wheel Drive; Chevy Blazer/Jimmy/Suburban 4 WD, Chev / GMC Pickups 1500 4x4; Fits 2000 Model OLD Body Style "R" Applications	Left or Right
	630-102	31-5/16"	6	28	1988-78 GM 10 Bolt, 8.5" Dia. Ring Gear; Blazer, Jimmy, Pickups and Suburban 1/2 Ton; 4x4	Left or Right
	630-103	29"	5	28	1997-88 GM 7-5/8" Dia. Ring Gear; S-10 Blazer, Jimmy, Pickups and Sonoma with 4x4	Left or Right
	630-104	31-5/16"	6	30	1991-87 GM 10 Bolt 8.5" Dia. Ring Gear; "R/V" Blazer, Jimmy, Pickups 1/2 Ton with 4x4	Left or Right
	630-105	31-9/32"	6	30	1981-70 GM 12 Bolt, 8-7/8" Dia. Ring Gear; Blazer, Jimmy, Pickups and Suburban 1/2 Ton with 4x4	Left or Right
	630-106	31-13/16"	5	30	1999-88 GM 10 Bolt, 8.5" Dia. Ring Gear; "C" Pickup, Suburban 1/2 Ton, 2 Wheel Drive; GMC Yukon, 2 Wheel Drive; fits 2000 Model Old Body Style Applications	Left or Right
	630-107	31-3/8"	5	30	1991-87 GM 10 Bolt, 8.5" Dia. Ring Gear; Chevy Blazer, Suburban 10/1500 Ser., 2 Wheel Drive	Left or Right
	630-108	33-9/32"	5	30	2004-96 & Up Chevrolet/GMC 1/2 Ton	Left & Right
	630-109	34-3/4"	5	28	2004-94 GM Astro/Safari w/ABS	Right
	630-110	30-5-16"	5	28	2004-94 GM Astro/Safari w/ABS	Left
	630-111	28-13/16"	5	28	2003-98 GM Blazer, Bravada, Isuzu	Left & Right
	630-112	29"	5	28	1993-91 Chevy/GMC Blazer, S10, Jimmy, Bravada, Syclyone, Typhoon	Right & Left
NEW	630-113	30-1/2"	5	26	1990-82 GM Passenger B & C 7.5 Ratio 4 3/4" Bolt Circle	Left & Right
NEW	630-114	30-3/8"	5	28	1990-77 GM Passenger B&C 8.5 Ratio	Left & Right
NEW	630-115	30-1/4"	5	30	1991-87 GM Camaro, Firebird 9 Bolt Axle Cover; 7-3/4" Gear	Right
NEW	630-116	30-3/8"	5	30	1990-89 GM Caprice 8-1/2" Ring Gear, 4-3/4" Bolt Circle	Left & Right
NEW	630-117	30-7/16"	5	30	1992-91 GM Chevrolet Caprice, Cadillac Fleetwood; 1996-92 Buick Roadmaster Sedan	Left & Right
NEW	630-118	31-13/16"	5	30	1996-91 GM Chevrolet Caprice SW, Oldsmobile Custom Cruiser, Buick Roadmaster SW	Left & Right
NEW	630-119	30-7/16"	5	26	1992-91 GM Chevrolet Caprice Sedan 9-1/2" Brakes; 7-1/2" Ring Gear, 3.08 & 3.23 Ratio	Left & Right
FORD						
NEW	630-200	31-1/16"	5	31	1996-87 Ford 8.8" Diag. Ring Gear; Ford E; 1996-87 F-150 & Bronco; 2/4 Wheel Drive	Right
NEW	630-201	33-3/16"	5	31	1996-87 Ford 8.8" Dia. Ring Gear; Ford F150, Bronco	Left
NEW	630-202	35-5/8"	5	31	1996-87 Ford E150	Left
NEW	630-203	31-1/16"	5	31	1986-83 Ford 8.8" Dia. Ring Gear; F100/150, Bronco, 2 & 4 Wheel Drive	Right
NEW	630-204	33-3/16"	5	31	1991-83 Ford 8.8" Dia. Ring Gear; Bronco, F100 / 150, 2 & 4 Wheel Drive	Left
NEW	630-205	32-1/4"	5	28	2002-98 Ford Crown Victoria or w/ABS	Left & Right
NEW	630-207	31"	5	31	2000-97 Ford Van 1/2 Ton	Right
NEW	630-208	35-11/16"	5	31	2000-97 Ford Van 1/2 Ton	Left
NEW	630-209	30-29/32"	5	28	1989-79 Lincoln Town Car, Mercury Grand Marquis, Ford Crown Victoria	Right & Left
NEW	630-210	31-1/2"	5	28	1997-91 Ford Crown Victoria, Mercury Grand Marquis, Lincoln & Town Car w/o ABS	
NEW	630-211	31-1/2"	5	28	1997-91 Ford Crown Victoria, Mercury Grand Marquis, Lincoln & Town Car w/ ABS	
NEW	630-212	31-3/4"	5	31	2003-97 Ford Truck F150, E150, 7700; 8.8"	Right
NEW	630-213	33-3/8"	5	31	2003-97 Ford F150, E150, 7700 8.8"	Left
JEEP						
NEW	630-300	29-3/4"	5	27	1996-85 Jeep 8.25" Dia. Ring Gear; 1996-92 Cherokee (w/Rear Brake Drum & ABS)	Left & Right
NEW	630-301	30-1/2"	5	27	1998-94 Jeep Grand Cherokee	Right & Left
NEW	630-302	30-1/4"	5	30	1998-96 Jeep Grand Cherokee (Left)	Left
NEW	630-303	30-9/16"	5	27	1991-90 Jeep Cherokee, Comanche, 1990 Wagoneer, 1992-90 Wrangler (Left)	Left
NEW	630-304	29"	5	27	1991-90 Jeep Cherokee, Comanche, 1990 Wagoneer, 1992-90 Wrangler (Right)	Right
NEW	630-305	29-1/4"	5	30	1998-96 Jeep Grand Cherokee (Right)	Right
NEW	630-306	29-1/8"	5	27	1996-94 Jeep Grand Cherokee Dana 35 w/Rear Disc Brakes	Right
CHRYSLER						
NEW	630-400	31-5/8"	5	31	1993-84 Dodge 9-1/4" Dia. Ring Gear; Dodge Ramcharger, Pickups, 4 Wheel Drive	Left or Right

Rear Axle Shaft Kit Applications

Make/ Model/Years	Description	Dorman #	Make/ Model/Years	Description	Dorman #
BUICK			CHEVROLET/GMC TRUCK (continued)		
ELECTRA			G20/25/2500 VAN (3/4 TON)		
1984	LH & RH; 7-1/2" Dia Ring Gear; 5" Bolt Circle	630-114	1995-89	LH & RH; 8-1/2" Dia Ring Gear; 30 Spline	630-100
1983-82	LH & RH; 7-1/2" Dia Ring Gear; 4-3/4" Bolt Circle	630-113	1988	LH & RH; 8-1/2" Dia Ring Gear; 30 Spline	630-100
1983-82	LH & RH; 7-1/2" Dia Ring Gear; 5" Bolt Circle	630-114	1999-92	2WD; LH & RH; 8-1/2"; 8-5/8" Dia Ring Gear; 30 Spline	630-106
1981-80	LH & RH; 7-1/2" Dia Ring Gear; 5" Bolt Circle	630-114	1999-92	4WD; LH & RH; 8-1/2"; 8-5/8" Dia Ring Gear; 30 Spline	630-101
ESTATE WAGON			1991-88	LH & RH; 30 Spline	630-104
1990-89	LH & RH; 8-1/2" Dia Ring Gear; 30 Spline	630-118	1988-81	4WD; LH & RH; 8-1/2" Dia Ring Gear; 28 Spline	630-102
1986	LH & RH; 7-1/2" Dia Ring Gear; 4-3/4" Bolt Circle	630-113	1981-70	4WD; LH & RH; 8-3/4"; 8-7/8" Dia Ring Gear; 30 Spline	630-105
1985-81	LH & RH; 7-1/2" Dia Ring Gear; 4-3/4" Bolt Circle	630-113	K10/15/1500 4WD PICKUP (1/2 TON)		
1985-81	LH & RH; 7-1/2" Dia Ring Gear; 5" Bolt Circle	630-114	1999-89	LH & RH; 8-1/2"; 8-5/8" Dia Ring Gear; 30 Spline	630-101
1980-77	LH & RH; 7-1/2" Dia Ring Gear; 4-3/4" Bolt Circle	630-113	1988	LH & RH; 8-1/2"; 8-5/8" Dia Ring Gear; 30 Spline	630-101
LESABRE			1986-81	LH & RH; 8-1/2" Dia Ring Gear; 28 Spline	630-102
1985-81	LH & RH; 7-1/2" Dia Ring Gear; 4-3/4" Bolt Circle	630-113	1981-70	LH & RH; 8-3/4"; 8-7/8" Dia Ring Gear; 30 Spline	630-105
1985-81	LH & RH; 7-1/2" Dia Ring Gear; 5" Bolt Circle	630-114	S10 BLAZER, S15 JIMMY, S15 TYPHOON		
1980-77	LH & RH; 7-1/2" Dia Ring Gear; 4-3/4" Bolt Circle	630-113	2005-03	2WD; LH & RH; 7-5/8" Dia Ring Gear; w/Positraction; 29 1/2" Lg	630-111
RIVIERA			2005-03	4WD; LH & RH; 7-5/8" Dia Ring Gear; 29 1/2" Lg	630-111
1978-77	LH & RH; 7-1/2" Dia Ring Gear; 4-3/4" Bolt Circle	630-113	2002-98	4WD; LH & RH; 7-5/8" Dia Ring Gear; 29 1/2" Lg	630-111
ROADMASTER			1997-96	4WD; LH & RH; 7-5/8" Dia Ring Gear; Exc. All Wheel Drive; 28 Spline	630-103
1996-91	LH & RH; 8-1/2"; 8-5/8" Dia Ring Gear; 30 Spline; Wagon	630-118	1997	4WD; LH & RH; 7-5/8" Dia Ring Gear; All Wheel Drive	630-111
1996-91	LH & RH; 8-1/2"; 8-5/8" Dia Ring Gear; Exc. Wagon	630-117	1995	4WD; LH & RH; 7-5/8" Dia Ring Gear; Exc. All Wheel Drive; 28 Spline	630-103
CADILLAC			1994	4WD; LH & RH; 7-5/8" Dia Ring Gear; 28 Spline	630-103
DEVILLE			1993-91	4WD; LH & RH; 7-5/8" Dia Ring Gear; 28 Spline	630-103
1984-82	LH & RH; 7-1/2" Dia Ring Gear; 5" Bolt Circle	630-114	1993-91	4WD; LH & RH; 7-5/8" Dia Ring Gear; 4 Sensor System	630-112
ESCALADE			1990	4WD; LH & RH; 7-5/8" Dia Ring Gear; 28 Spline	630-103
1999	2WD; LH & RH; 8-1/2"; 8-5/8" Dia Ring Gear; 30 Spline	630-106	1989-88	4WD; LH & RH; 7-5/8" Dia Ring Gear; 28 Spline	630-103
1999	4WD; LH & RH; 8-1/2"; 8-5/8" Dia Ring Gear; 30 Spline	630-101	S10 PICKUP, S15 PICKUP, SONOMA, S15 SYCLONE		
FLEETWOOD			2005-03	4WD; LH & RH; 7-5/8" Dia Ring Gear; 29 1/2" Lg	630-111
1992-91	LH & RH; 8-1/2"; 8-5/8" Dia Ring Gear	630-117	2002-98	4WD; LH & RH; 7-5/8" Dia Ring Gear; 29 1/2" Lg	630-111
1990-89	LH & RH; 7-1/2" Dia Ring Gear; 5" Bolt Circle	630-114	1997-90	4WD; LH & RH; 7-5/8" Dia Ring Gear; 28 Spline	630-103
1990-89	LH & RH; 8-1/2"; 8-5/8" Dia Ring Gear; 3.08R, 3.42R; 30 Spline	630-115	1991	4WD; LH & RH; 7-5/8" Dia Ring Gear; 4 Sensor System	630-112
1988-82	LH & RH; 7-1/2" Dia Ring Gear; 5" Bolt Circle	630-114	1989-88	4WD; LH & RH; 7-5/8" Dia Ring Gear; 28 Spline	630-103
CHEVROLET			SAFARI		
CAPRICE			2002-93	LH Rear Axle	630-110
1996-93	LH & RH; 8-1/2"; 8-5/8" Dia Ring Gear; 2.73R, 2.93R, 3.23R; w/HD Brakes; Exc. Wagon	630-117	2002-93	RH Rear Axle	630-109
1996-93	LH & RH; 8-1/2"; 8-5/8" Dia Ring Gear; 30 Spline; Wagon	630-118	1992	LH Rear Axle, 2WD, w/Rear Wheel ABS(JA4)	630-110
1992-91	LH & RH; 7-1/2" Dia Ring Gear	630-119	1992	RH Rear Axle, 2WD, w/Rear Wheel ABS(JA4)	630-109
1992-91	LH & RH; 8-1/2"; 8-5/8" Dia Ring Gear; 30 Spline; Wagon	630-118	1992	RH Rear Axle, 4WD, wo/Speed Sensor Ring	630-109
1992-91	LH & RH; 8-1/2"; 8-5/8" Dia Ring Gear; Exc. Wagon	630-117	1991-90	LH Rear Axle, w/Rear Wheel ABS(JA4), 2WD	630-110
1990-88	LH & RH; 7-1/2" Dia Ring Gear; 4-3/4" Bolt Circle	630-113	1991-90	RH Rear Axle, w/Rear Wheel ABS(JA4)	630-109
1990-88	LH & RH; 8-1/2" Dia Ring Gear; 2.73R, 3.08R; Exc. Limited Slip; 30 Spline; Exc. Wagon	630-116	SAVANA 1500 VAN (1/2 TON)		
1990-88	LH & RH; 8-1/2" Dia Ring Gear; 3.08R, 3.42R; Limited Slip; 30 Spline; Exc. Wagon	630-115	2002-96	LH & RH; 10 Bolt	630-108
1990-88	LH & RH; 8-1/2"; 8-5/8" Dia Ring Gear; 30 Spline; Wagon	630-118	SUBURBAN		
1987-86	LH & RH; 7-1/2" Dia Ring Gear; 4-3/4" Bolt Circle	630-113	1999-95	1/2 Ton; 2WD; LH & RH; 8-1/2"; 8-5/8" Dia Ring Gear; 30 Spline	630-106
1985-83	LH & RH; 7-1/2" Dia Ring Gear; 4-3/4" Bolt Circle	630-113	1999-95	1/2 Ton; 4WD; LH & RH; 8-1/2"; 8-5/8" Dia Ring Gear; 30 Spline	630-101
1985-83	LH & RH; 7-1/2" Dia Ring Gear; 5" Bolt Circle	630-114	1994-92	1/2 Ton; 2WD; LH & RH; 8-1/2"; 8-5/8" Dia Ring Gear; 30 Spline	630-106
1982-77	LH & RH; 7-1/2" Dia Ring Gear; 4-3/4" Bolt Circle	630-113	1994-92	1/2 Ton; 4WD; LH & RH; 8-1/2"; 8-5/8" Dia Ring Gear; 30 Spline	630-101
IMPALA			1991-87	1/2 Ton; 2WD; LH & RH; 30 Spline	630-107
1985-83	LH & RH; 7-1/2" Dia Ring Gear; 4-3/4" Bolt Circle	630-113	1991-87	1/2 Ton; 4WD; LH & RH; 30 Spline	630-104
1985-83	LH & RH; 7-1/2" Dia Ring Gear; 5" Bolt Circle	630-114	1986-82	1/2 Ton; 4WD; LH & RH; 8-1/2" Dia Ring Gear; 28 Spline	630-102
1982-77	LH & RH; 7-1/2" Dia Ring Gear; 4-3/4" Bolt Circle	630-113	1981-78	1/2 Ton; 4WD; LH & RH; 8-3/4"; 8-7/8" Dia Ring Gear; 30 Spline	630-105
IMPALA SS			1977-73	1/2 Ton; 4WD; LH & RH; 8-3/4"; 8-7/8" Dia Ring Gear; 30 Spline	630-105
1996-94	LH & RH; 8-1/2"; 8-5/8" Dia Ring Gear; 2.93R, 3.23R; w/HD Brakes	630-117	1972-70	1/2 Ton; 4WD; LH & RH; 8-3/4"; 8-7/8" Dia Ring Gear; 30 Spline	630-105
CHEVROLET/GMC TRUCK			V10/1500 4WD PICKUP (1/2 TON)		
ASTRO			1987	LH & RH; 8-1/2" Dia Ring Gear; 28 Spline	630-102
2002-93	LH Rear Axle	630-110	DODGE TRUCK		
2002-93	RH Rear Axle	630-109	D100/150 2WD PICKUP (1/2 TON)		
1992	LH Rear Axle, 2WD, w/Rear Wheel ABS(JA4)	630-110	1993-85	LH & RH; 9-1/4" Dia Ring Gear; 31 Spline	630-400
1992	RH Rear Axle, 2WD, w/Rear Wheel ABS(JA4)	630-109	RAMCHARGER		
1992	RH Rear Axle, 4WD, wo/Speed Sensor Ring	630-109	1993-85	LH & RH; 9-1/4" Dia Ring Gear; 31 Spline	630-400
1991-90	LH Rear Axle, w/Rear Wheel ABS(JA4), 2WD	630-110	1984	4WD; LH & RH; From 4/2/84; 9-1/4" Dia Ring Gear; 31 Spline	630-400
1991-90	RH Rear Axle, w/Rear Wheel ABS(JA4)	630-109	W100/150 4WD PICKUP (1/2 TON)		
BLAZER, TAHOE			1993-85	LH & RH; 9-1/4" Dia Ring Gear; 31 Spline	630-400
1999-92	2WD; LH & RH; 8-1/2"; 8-5/8" Dia Ring Gear; 30 Spline	630-106	1984	LH & RH; From 4/2/84; 9-1/4" Dia Ring Gear; 31 Spline	630-400
1999-92	4WD; LH & RH; 8-1/2"; 8-5/8" Dia Ring Gear; 30 Spline	630-101	FORD		
1991-88	LH & RH; 30 Spline	630-104	COUNTRY SQUIRE		
1987-82	4WD; LH & RH; 8-1/2" Dia Ring Gear; 28 Spline	630-102	1991	LH & RH; w/ABS	630-211
1981-78	4WD; LH & RH; 8-1/2" Dia Ring Gear; 28 Spline	630-102	1991	LH & RH; wo/ABS	630-210
1981-78	4WD; LH & RH; 8-3/4"; 8-7/8" Dia Ring Gear; 30 Spline	630-105	1989-79	LH & RH	630-209
1977-70	4WD; LH & RH; 8-3/4"; 8-7/8" Dia Ring Gear; 30 Spline	630-105	Fuel Sending Units		
C10/15/1500 2WD PICKUP (1/2 TON)			pg. 155-176		
1999-88	LH & RH; 8-1/2"; 8-5/8" Dia Ring Gear; 30 Spline	630-106	Fuel Tanks		
EXPRESS 1500 VAN (1/2 TON)			pg. 177-228		
2002-96	LH & RH; 10 Bolt	630-108	Harmonic Balancers		
G10/15/1500 VAN (1/2 TON)			pg. 229-254		
1995-89	LH & RH; 8-1/2" Dia Ring Gear; 30 Spline	630-100	Heater Hose Assemblies		
1988	LH & RH; 8-1/2" Dia Ring Gear; 30 Spline	630-100	pg. 255-256		
			Hydraulic Clutch Lines		
			pg. 257-260		

Rear Axle Shaft Kit Applications

Make/ Model/Years	Description	Dorman #
FORD (continued)		
CROWN VICTORIA		
2002-01	LH & RH; w/ABS	630-205
2000-98	LH & RH; w/ABS	630-205
1997-91	LH & RH; w/ABS	630-211
1997-91	LH & RH; wo/ABS	630-210
1989-83	LH & RH	630-209
LTD		
1982-79	LH & RH	630-209
FORD TRUCK		
BRONCO		
1996-87	LH; 31 Spline	630-201
1996-87	RH; 31 Spline	630-200
1986-83	LH; 31 Spline	630-204
1986-83	RH; 31 Spline	630-203
BRONCO II		
1990-89	LH; 31 Spline	630-201
E-150 ECONOLINE (1/2 TON)		
2000-97	LH; w/8.8" Dia Ring Gear; 31 Spline	630-208
2000-97	RH; w/8.8" Dia Ring Gear; 31 Spline	630-207
1996-87	LH; 31 Spline	630-202
1996-87	RH; 31 Spline	630-200
EXPEDITION		
2000-97	LH; w/8.8" Dia Ring Gear (WDR Non-Locking Rear); Tag No. 824A, 826A, 828A, 852A, 852B, 854A, 854B, 862A, 862B, 862C	630-213
2000-97	RH; w/8.8" Dia Ring Gear (WDR Non-Locking Rear); Tag No. 824A, 826A, 828A, 852A, 852B, 854A, 854B, 862A, 862B, 862C	630-212
1999-97	LH; w/8.8" Dia Ring Gear (WFL Locking Rear); Tag No. 829A, 829C, 869A, 869B, 869C, 871A, 871B	630-213
1999-97	RH; w/8.8" Dia Ring Gear (WFL Locking Rear); Tag No. 829A, 829C, 869A, 869B, 869C, 871A, 871B	630-212
F-100/150 PICKUP (1/2 TON)		
2000-97	LH; w/8.8" Dia Ring Gear; (WDR Non-Locking Rear); Tag No. 824A, 826A, 828A, 852A, 852B, 854A, 854B, 862A, 862B, 862C	630-213
2000-97	RH; w/8.8" Dia Ring Gear; (WDR Non-Locking Rear); Tag No. 824A, 826A, 828A, 852A, 852B, 854A, 854B, 862A, 862B, 862C	630-212
1999-97	LH; w/8.8" Dia Ring Gear; (WFL Locking Rear); Tag No. 829A, 829C, 869A, 869B, 869C, 871A, 871B	630-213
1999-97	RH; w/8.8" Dia Ring Gear; (WFL Locking Rear); Tag No. 829A, 829C, 869A, 869B, 869C, 871A, 871B	630-212
1996-92	LH; 31 Spline	630-201
1996-92	RH; 31 Spline	630-200
1991-83	LH; 31 Spline	630-204
1991-83	RH; 31 Spline	630-203
RANGER		
1992-89	LH; 31 Spline	630-201
1992-89	RH; 31 Spline	630-200
JEEP		
CHEROKEE		
2001-92	RH; w/Dana 35 Axle	630-300
1991-90	LH; w/Dana 35 Axle	630-303
1991-90	RH; w/Dana 35 Axle	630-304
CJ SERIES (CJ5, CJ7)		
1986-82	LH; CJ5	630-303
1986-82	LH; CJ7	630-301
1981-76	LH; wo/Quadra Trac	630-303
COMANCHE		
1991-90	LH; w/Dana 35 Axle	630-303
1991-90	RH; w/Dana 35 Axle	630-304
GRAND CHEROKEE		
1998-94	LH; w/Dana 44 Axle	630-302
1998-94	RH; w/Dana 44 Axle	630-305
1998-93	LH; w/Dana 35 Axle; w/Rear Disc Brakes	630-301
1998-93	RH; w/Dana 35 Axle; w/Rear Disc Brakes	630-306
SCRAMBLER		
1985-82	LH	630-301
1981	LH; wo/Quadra Trac	630-303

Make/ Model/Years	Description	Dorman #
JEEP (continued)		
WAGONEER		
1990	LH; w/Dana 35 Axle	630-303
1990	RH; w/Dana 35 Axle	630-304
WRANGLER		
1992-91	LH; w/Dana 35 Axle	630-303
1992-91	RH; w/Dana 35 Axle	630-304
LINCOLN		
CONTINENTAL		
1981-80	LH & RH	630-209
MARK VI		
1983-80	LH & RH	630-209
TOWN CAR		
2002-01	LH & RH; w/ABS	630-205
2000-98	LH & RH; w/ABS	630-205
1997-91	LH & RH; w/ABS; Exc. Limo	630-211
1997-91	LH & RH; wo/ABS; Exc. Limo	630-210
1989-82	LH & RH	630-209
MERCURY		
COLONY PARK		
1991	LH & RH; w/ABS	630-211
1991	LH & RH; wo/ABS	630-210
1989-79	LH & RH	630-209
GRAND MARQUIS		
2002-01	LH & RH; w/ABS	630-205
2000-98	LH & RH; w/ABS	630-205
1997-91	LH & RH; w/ABS	630-211
1997-91	LH & RH; wo/ABS	630-210
1989-79	LH & RH	630-209
MARQUIS		
1982-79	LH & RH	630-209
OLDSMOBILE		
98		
1984	LH & RH; 7-1/2" Dia Ring Gear; 5" Bolt Circle	630-114
1983-82	LH & RH; 7-1/2" Dia Ring Gear; 4-3/4" Bolt Circle	630-113
1983-82	LH & RH; 7-1/2" Dia Ring Gear; 5" Bolt Circle	630-114
1981-80	LH & RH; 7-1/2" Dia Ring Gear; 5" Bolt Circle	630-114
BRAVADA		
2001-97	4WD; LH & RH; 7-5/8" Dia Ring Gear	630-111
1994-91	4WD; LH & RH; 7-5/8" Dia Ring Gear; 28 Spline	630-103
1993-91	4WD; LH & RH; 7-5/8" Dia Ring Gear; 4 Sensor System	630-112
CUSTOM CRUISER		
1992-89	LH & RH; 8-1/2"; 8-5/8" Dia Ring Gear; 30 Spline	630-118
1986-84	LH & RH; 7-1/2" Dia Ring Gear; 4-3/4" Bolt Circle	630-113
1983-82	LH & RH; 7-1/2" Dia Ring Gear; 4-3/4" Bolt Circle	630-113
1983-82	LH & RH; 7-1/2" Dia Ring Gear; 5" Bolt Circle	630-114
1981-77	LH & RH; 7-1/2" Dia Ring Gear; 4-3/4" Bolt Circle	630-113
DELTA 88		
1985-84	LH & RH; 7-1/2" Dia Ring Gear; 4-3/4" Bolt Circle	630-113
1983-82	LH & RH; 7-1/2" Dia Ring Gear; 4-3/4" Bolt Circle	630-113
1983-82	LH & RH; 7-1/2" Dia Ring Gear; 5" Bolt Circle	630-114
1981-77	LH & RH; 7-1/2" Dia Ring Gear; 4-3/4" Bolt Circle	630-113
PONTIAC		
BONNEVILLE		
1981	LH & RH; 7-1/2" Dia Ring Gear; 4-3/4" Bolt Circle	630-113
1980	LH & RH; 7-1/2" Dia Ring Gear; 4-3/4" Bolt Circle	630-113
1980	LH & RH; 7-1/2" Dia Ring Gear; 5" Bolt Circle	630-114
1979-77	LH & RH; 7-1/2" Dia Ring Gear; 4-3/4" Bolt Circle	630-113
CATALINA		
1981	LH & RH; 7-1/2" Dia Ring Gear; 4-3/4" Bolt Circle	630-113
1980	LH & RH; 7-1/2" Dia Ring Gear; 4-3/4" Bolt Circle	630-113
1980	LH & RH; 7-1/2" Dia Ring Gear; 5" Bolt Circle	630-114
1979-77	LH & RH; 7-1/2" Dia Ring Gear; 4-3/4" Bolt Circle	630-113
GRAND SAFARI		
1978-77	LH & RH; 7-1/2" Dia Ring Gear; 4-3/4" Bolt Circle	630-113
PARISIENNE		
1986-83	LH & RH; 7-1/2" Dia Ring Gear; 4-3/4" Bolt Circle	630-113
SAFARI		
1989	LH & RH; 8-1/2"; 8-5/8" Dia Ring Gear; 30 Spline	630-118

Side View Mirrors



Over 480 assemblies available!



955-105(L) **955-106(R)**
GM 1998-88 Chevy/GMC Pickups, Suburban (Manual)



955-201(L) **955-202(R)**
1995-89 Pickups (Window Mount w/o Vent)



955-305(L) **955-306(R)**
GM 1997-96 S10, Sonoma Pickups, Blazer, Jimmy

Features and Benefits

- Direct Fit, OE Replacement — Out of the Box, Onto the Vehicle

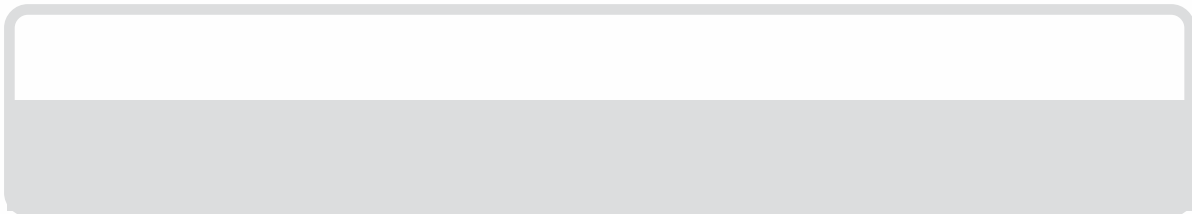

Activant Path

Accessories/Fuel Caps,
Hitches & Misc

Activant Code

DMA

**Applications begin
on page 454.**

Side View Mirrors



955-000 Left **955-001 Right**

GM
2001-99 Grand AM (ST/SE Models)
Power
Color: Black



955-002 Left **955-003 Right**

Ford
2000-98 Expedition
Power
Color: Black



955-004 Left **955-005 Right**

Ford
2004-94 Econoline Vans
Manual Swing Lock
Color: Black



955-006 Left **955-007 Right**

Ford
2002-98 Ranger
Manual
Color: Black



955-008 Left **955-009 Right**

Ford
2001-98 Explorer
Power, w/Lamp
Color: Black



955-010 Left **955-011 Right**

Ford
1997-93 Ranger
Manual
Color: Black



955-012 Left **955-013 Right**

Ford
1997 Crown Victoria
Power
Color: Black



955-014 Left **955-015 Right**

Ford
2002-97 F-Series Pickups
Manual
Color: Black



955-016 Left **955-017 Right**

Ford
1996-95 Lincoln Town Car
Power, w/o Memory
Color: Black

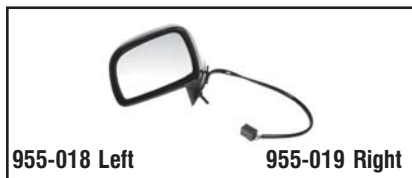

955-018 Left **955-019 Right**

Ford
1997 Lincoln Town Car
Power, w/o Memory
Color: Black



955-020 Left **955-021 Right**

Ford
2002-00 Focus
Power
Color: Black

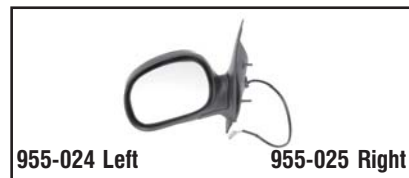

955-024 Left **955-025 Right**

Ford
1997 Expedition
Power
Color: Black



955-026 Left **955-027 Right**

Ford
2001-98 Expedition
Power
Color: Chrome



955-028 Left **955-029 Right**

Ford
2001-98 Expedition
Power, Heated
Color: Chrome



955-030 Left **955-031 Right**

Ford
2001-98 Expedition
Power, Heated
Color: Black

Side View Mirrors



Ford
2000-99 Windstar
Power
Color: Black



Ford
2001-98 Crown Victoria
Power
Color: Black



Ford
2000-98 Contour, Mystique
Power
Color: Black



GM
1999-95 Monte Carlo
Power
Color: Black



GM
1999-95 Monte Carlo
Manual Cable Controlled
Color: Black



GM
1999 Astro, Safari
Power
Color: Black



Ford
2005-02 Explorer, Mountaineer
Power, w/o Puddle Lamp
Color: Black



Ford
2005-02 Explorer, Mountaineer
Power, w/Puddle Lamp
Color: Black



Ford
2005-02 Explorer, Mountaineer
Power, w/Puddle Lamp, Heated
Color: Black



GM
2000-98 Intrigue
Power, Heated
Color: Black



GM
2000-88 C/K-Series, Suburban, Tahoe, Yukon
Manual, Sail-Mount
Color: Black



GM
2003-97 Grand Prix; Dual Arm
Power
Color: Paint to match



GM
1998-97 Silhouette, Trans Sport & Venture
Power
Color: Black



GM
2004-99 Montana, Silhouette, Venture, 2004 Trans Sport
Power, Heated
Color: Black



GM
1997-90 Cutlass Supreme Sedan, Coupe.
Manual
Color: Black

Side View Mirrors

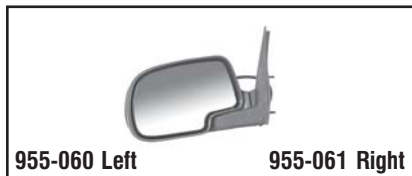

955-060 Left **955-061 Right**
GM
 2002-99 Silverado, Sierra Pickups
 Power
 Color: Black/Chrome

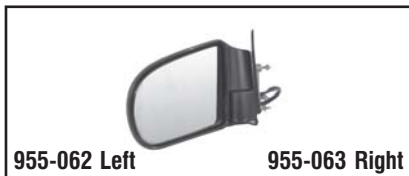

955-062 Left **955-063 Right**
GM
 1998 S10/S15 Blazer, Jimmy, Envoy,
 Sonoma
 Power, Standard
 Color: Black

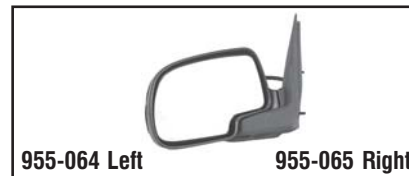

955-064 Left **955-065 Right**
GM
 2002-99 Silverado, Sierra Pickups
 Power, Heated
 Color: Black and Chrome



955-066 Left **955-067 Right**
GM
 2002-99 S10 Pickups, Envoy, Blazer, Jimmy
 Manual
 Color: Black



955-068 Left **955-069 Right**
GM
 2002-99 Silverado, Sierra Pickups;
 Suburban, Tahoe
 Manual-Remote, W/ Opt DE2
 Color: Black

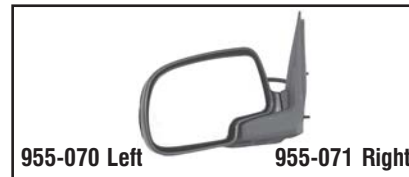

955-070 Left **955-071 Right**
GM
 2002-99 Silverado, Sierra Pickups
 (with opt DL8)
 Power, Heated, W/ Body Clad
 Color: Black



955-072 Left **955-073 Right**
GM
 2002-99 S10/15 Pickups
 Power, Heated, WO/ Auto Dim, Textured
 Color: Black



955-074 Left **955-075 Right**
GM
 2005-99 Sierra 1500/2500/3500 Pickups,
 Silverado 1500/2500, Tahoe, Yukon
 Manual, Sail-Mount
 Color: Black

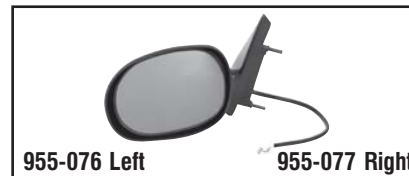

955-076 Left **955-077 Right**
Chrysler
 2004-98 Concorde, Intrepid
 Power, Fixed, w/o Memory
 Color: Black



955-078 Left **955-079 Right**
Chrysler
 2001-97 Dakota Pickups, 2000-98 Durango
 Power, Fixed (5x7)
 Color: Black

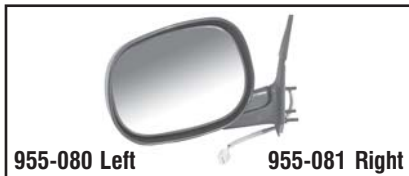

955-080 Left **955-081 Right**
Chrysler
 2001-97 Dakota Pickups, 2000-98 Durango
 Power, Foldaway 6x9
 Color: Black



955-082 Left **955-083 Right**
Chrysler
 2001-97 Dakota Pickups
 Manual
 Color: Black

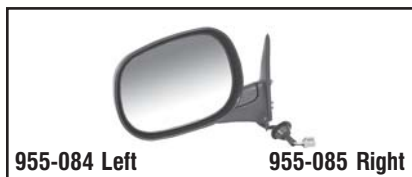

955-084 Left **955-085 Right**
Chrysler
 2001-98 Dodge Pickups
 Power, Heated, Foldaway
 Color: Black



955-086 Left **955-087 Right**
Chrysler
 2000-95 Breeze, Cirrus, Stratus
 Manual Remote
 Color: Black



955-088 Left **955-089 Right**
Chrysler
 2000-95 Breeze, Cirrus, Stratus
 Power, Heated
 Color: Black

Side View Mirrors



955-090 Left **955-091 Right**
GM
 1998 S10/15, Bravada, Sonoma, Blazer, Pickups
 Power, Heated
 Color: Black



955-092 Left **955-093 Right**
GM
 1994-89 Geo Metro
 Manual
 Color: Black



955-094 Left **955-095 Right**
GM
 2002-99 Silverado, Sierra Pickups
 Power
 Color: Chrome



955-096 Left **955-097 Right**
GM
 1990-89 Geo Prizm
 Manual Remote
 Color: Black



955-098 Left **955-099 Right**
GM
 1998-96 Grand AM GT
 Power
 Color: Black



955-100 Left
GM
 1998-96 Grand AM GT
 Manual Remote
 Color: Black



955-101 Left
Chrysler
 1997-94 Intrepid, Vision, Concorde, LHS, New Yorker
 Power, Heated, Foldaway
 Color: Black



955-102 Left **955-103 Right**
Chrysler
 1997-94 Concorde, Intrepid, Vision, New Yorker, LHS
 Power
 Color: Black



955-104 Left
GM
 1994-90 Lumina, 1995-92 Grand Prix
 Manual Remote, Below Eyeline
 Color: Black



955-105 Right **955-106 Left**
GM
 1991-88 Chev/GMC Pickup, Suburban
 Manual
 Color: Black



955-107 Left **955-108 Right**
GM
 1996-87 Beretta, Corsica.
 Manual Remote
 Color: Black



955-109 Left **955-110 Right**
GM
 1994-88 Cavalier, Sunbird (Exc. SE, GT models).
 Manual Cable Controlled
 Color: Black



955-111 Left **955-112 Right**
Chrysler
 1999-96 Neon
 Power
 Color: Black



955-113 Left **955-114 Right**
Chrysler
 1999-96 Neon
 Manual Cable Controlled
 Color: Black



955-115 Left
Ford
 1993-90 Festiva
 Manual Remote
 Color: Black

Side View Mirrors



955-116 Left 955-117 Right

Ford
1994-92 Taurus, Sable (Exc. SHO Models)
Power
Color: Black



955-118 Left 955-119 Right

Ford
1996-91 Escort, Tracer
Power
Color: Black



955-120 Left

Ford
1994-88 Tempo, Topaz 4DR
Power
Color: Black

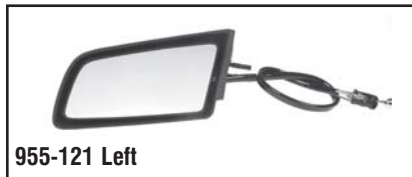

955-121 Left

GM
1996-82 Celebrity, Century, Ciera & Pontiac
6000
Manual Remote
Color: Black



955-122 Left 955-123 Right

GM
1996-88 Regal, Grand Prix Sedan & Coupe
Power
Color: Black

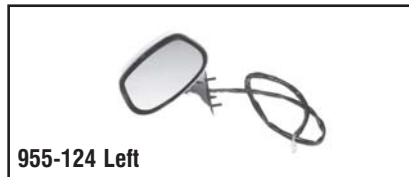

955-124 Left

GM
1990-82 LeSabre, Electra, Custom Cruiser
w/o Sport
Power
Color: Chrome



955-125 Left 955-126 Right

GM
1990-86 Caprice & Sport Models
Manual Remote
Color: Black



955-127 Left

GM
1993-82 Cavalier, Sunbird & SE/GT, Skyhawk
Manual Cable Controlled
Color: Black



955-128 Left 955-129 Right

GM
1994-91 Caprice, Roadmaster, Fleetwood
Power
Color: Black



955-130 Right

GM
1985-80 Caprice, Custom Cruiser
Manual
Color: Black



955-131 Left 955-132 Right

GM
1995-89 Regal Coupe (110 mm base)
Manual Remote
Color: Black



955-133 Right

GM
1994-90 Lumina
Manual Remote
Color: Black



955-134 Left 955-135 Right

Honda
2002-98 Accord Sedan
Manual
Color: Black

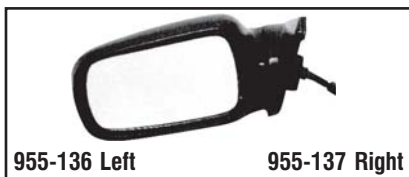

955-136 Left 955-137 Right

Honda
1991-88 Civic Hatchback
Manual Lever Controlled
Color: Black



955-138 Left 955-139 Right

Honda
1995-92 Civic Sedan Only
Manual Remote
Color: Black

Side View Mirrors



955-140 Left
Honda
 1995-92 Civic Hatchback, Sedan
 Power
 Color: Black



955-141 Left **955-142 Right**
Honda
 1995-92 Civic Hatchback, Sedan
 Manual Remote
 Color: Black

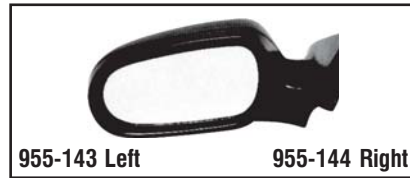

955-143 Left **955-144 Right**
Honda
 1993-90 Accord Sedan, Wagon
 Power
 Color: Black



955-145 Left **955-146 Right**
Honda
 1991-90 Accord Sedan & Coupe
 Manual
 Color: Black

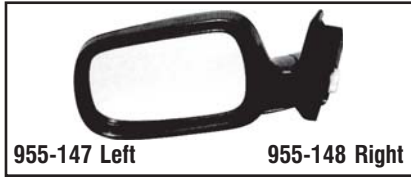

955-147 Left **955-148 Right**
Honda
 1997-94 Accord Sedan (USA Built)
 Power
 Color: Black



955-149 Left **955-150 Right**
Nissan
 1994-91 Sentra Sedan
 Power
 Color: Black



955-151 Left **955-152 Right**
Nissan
 1994-91 Sentra Sedan
 Manual Remote
 Color: Black



955-153 Left **955-154 Right**
Nissan
 1999-91 Sentra, 200 SX
 Power
 Color: Black

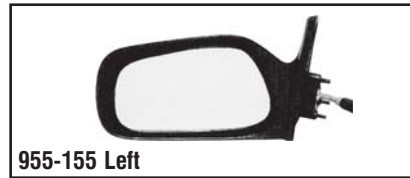

955-155 Left
Toyota
 1990-89 Corolla Sedan (USA Built)
 Power
 Color: Black



955-156 Left **955-157 Right**
Toyota
 1992-89 Corolla Sedan (USA Built)
 Manual, w/o Remote
 Color: Black



955-158 Left **955-159 Right**
Honda
 2002-98 Accord Sedan
 Power
 Color: Black



955-160 Left **955-161 Right**
Toyota
 1997-93 Corolla Sedan, Wagon LE Model
 Power
 Color: Black



955-162 Right
Toyota
 1997-93 Corolla Sedan, Wagon
 Manual
 Color: Black



955-163 Left **955-164 Right**
Toyota
 1991-87 Camry
 Manual Remote
 Color: Black



955-165 Left **955-166 Right**
Toyota
 1996-92 Camry (Japan Built)
 Manual
 Color: Black

Side View Mirrors



955-167 Left 955-168 Right

Toyota
1996-92 Camry LE & XLE Models (USA Built)
Power
Color: Black



955-169 Right

Chrysler
1990-84 Caravan, Voyager & 1990 Town & Country
Manual Remote
Color: Black



955-170 Left 955-171 Right

GM
1996-95 Caprice, Road Master
Manual
Color: Black



955-172 Left 955-173 Right

GM
1996-95 Caprice, Road Master, Fleetwood Brougham
Power
Color: Black



955-174 Left 955-175 Right

Chrysler
1990-87 Caravan, Voyager & 1990 Town & Country
Power
Color: Black



955-176 Left 955-177 Right

Chrysler
1995-92 Caravan, Town & Country & Voyager
Power, Foldaway
Color: Black



955-178 Left or Right

Chrysler
1993-84 Full-Size Vans (Low Mounted)
Manual
Color: Chrome



955-179 Left or Right

Ford
1989-80 Full-Size Bronco; 1986-80 Full-Size Pickup Trucks
Manual, Swinglock Design
Color: Chrome



955-180 Left or Right

Ford
1990-80 Full-Size Pickups & Bronco
Manual, Swinglock Design
Color: Chrome



955-181 Left 955-182 Right

GM
1993-82 S10/15 Pickups; 1994-83 Jimmy, Blazer; 1994-91 Bravada
Manual, Below Eyeline
Color: Black



955-183 Left 955-184 Right

GM
1993-84 S10/15, Blazer, Jimmy, Bravada, Sonoma Pickups
Manual Standard
Color: Black



955-185 Left 955-186 Right

GM
1990-82 S10 Blazer, S15 Jimmy
Manual, Standard, Below Eyeline
Color: Chrome

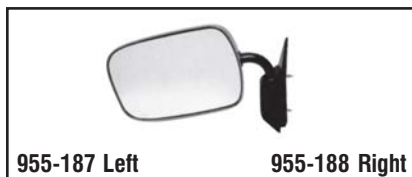

955-187 Left 955-188 Right

GM
2000-88 Chev/GMC Suburban, Escalade, Blazer, Tahoe, Yukon; 1999-88 C/K-Series
Manual
Color: Chrome



955-189 Right

GM
1995-92 Full-Size Chevy, GMC Vans
Manual
Color: Chrome



955-190 Left or Right

GM
1984-80 Full-Size Chev/GMC Pickups, Blazer, Jimmy, Suburban
Manual, Low-Mount
Color: Chrome

Side View Mirrors



955-191 Left **955-192 Right**
GM
 2000-92 Chev/GMC Pickups; Suburban, Blazer, Yukon, Tahoe
 Power
 Color: Black



955-193 Left **955-194 Right**
GM
 1998-94 S10, Sonoma Pickups
 Manual, Standard
 Color: Black



955-195 Left **955-196 Right**
Isuzu
 1993-88 Pickups (Japan Built)
 Manual
 Color: Black



955-197 Left
Isuzu
 1987-81 Pickups
 Manual, Standard
 Color: Black



955-198 Left **955-199 Right**
Mazda
 1993-86 Pickups
 Manual
 Color: Black



955-200 Left **955-201 Right**
Nissan
 1995-86 Pathfinder, Hardbody Pickups
 Manual
 Color: Chrome

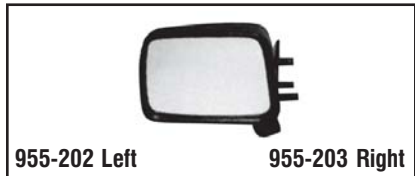

955-202 Left **955-203 Right**
Nissan
 1995-86 Pathfinder, Hardbody Pickups
 Manual
 Color: Black



955-204 Left **955-205 Right**
Nissan
 1986-85 Pickups
 Manual
 Color: Chrome



955-206 Left **955-207 Right**
Nissan
 1986-84 Pickups
 Manual
 Color: Black



955-208 Left **955-209 Right**
Suzuki
 1997-89 Sidekick 2 Door
 Manual
 Color: Black



955-210 Left **955-211 Right**
Toyota
 1995-89 Pickups
 Manual, Window Mount w/o Vent
 Color: Chrome



955-212 Left **955-213 Right**
Toyota
 1995-89 Pickups
 Manual, Window Mount w/o Vent
 Color: Black



955-214 Left **955-215 Right**
Toyota
 1995-87 Pickups, 1988-87 4 Runner
 Manual W/Mounting Cap; Door Mount
 Color: Black



955-216 Left **955-217 Right**
Toyota
 1986-84 Pickups, 4 Runner
 Manual, Door Mount
 Color: Black



955-218 Left **955-219 Right**
Toyota
 1983-79 Pickups
 Manual
 Color: Black

Side View Mirrors



955-220 Right

Chrysler
1993-87 D50 Pickups
Manual, Sail Mount
Color: Black

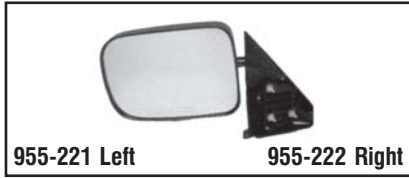

955-221 Left 955-222 Right

Chrysler
1997-94 Full-Size Pickups
Manual, 6x9
Color: Black & Chrome

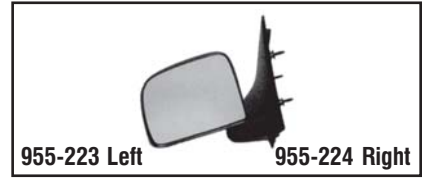

955-223 Left 955-224 Right

Ford
1997-93 Ranger, Pickups
Manual
Color: Black



955-225 Left 955-226 Right

Ford
1992-85 Ranger, 1990-85 Bronco II
Manual
Color: Black



955-227 Left 955-228 Right

Ford
1997-92 F150/250 Pickups
Manual
Color: Black & Chrome



955-229 Left or Right

Chrysler
1986-81 CJ
Manual, W & W/O Mount
Color: Black

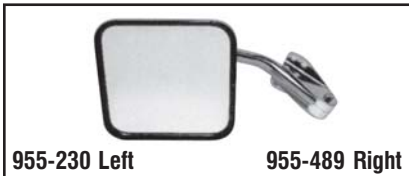

955-230 Left 955-489 Right

Chrysler
1985-53 CJ
Manual, W & W/O Mount.
Color: Chrome



955-231 Left 955-232 Right

Chrysler
1993-90 Wrangler
Manual
Color: Black



955-233 Right 955-234 Left

Chrysler
1993-87 Cherokee, Comanche, 1990-87
Wagoneer
Manual
Color: Black



955-235 Right 955-236 Left

Chrysler
1995-93 Cherokee
Power
Color: Black



955-237 Right 955-238 Left

Chrysler
1995-90 Cherokee; 1992-90 Comanche
Manual Remote
Color: Black



955-239 Right

Ford
1994-92 Taurus SHO & Wagon, Sable
Wagon
Power
Color: Black



955-240 Right 955-241 Left

Chrysler
1995-92 Caravan, Town & Country &
Voyager
Manual, Foldaway
Color: Black



955-242 Left 955-243 Right

Chrysler
1995-93 Grand Cherokee
Power
Color: Black



955-244 Left 955-245 Right

Chrysler
1995-93 Grand Cherokee, Base & Sport
Laredo
Power, Heated
Color: Black

Side View Mirrors



955-246 Left 955-247 Right

Chrysler
1998-96 Grand Cherokee
Power, Heated, w/o Memory
Color: Black



955-248 Left 955-249 Right

Chrysler
1997-94 Dodge Pickups
Power, 6x9
Color: Chrome

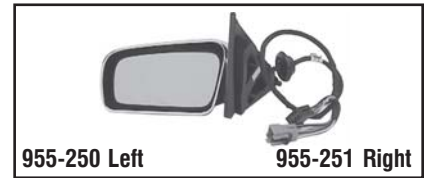

955-250 Left 955-251 Right

Chrysler
1995-93 Grand Cherokee, Base & Sport
Laredo
Manual
Color: Black

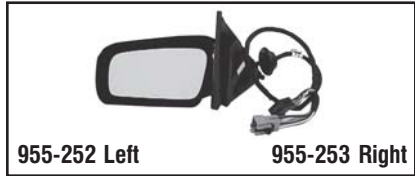

955-252 Left 955-253 Right

Chrysler
1995-93 Grand Cherokee Limited, Grand
Wagoner
Power
Color: Black



955-254 Right

Chrysler
1997-94 Intrepid, Vision, Concorde, LHS,
New Yorker
Power, Heated, Foldaway
Color: Black



955-255 Left 955-256 Right

Chrysler
2001-98 Dodge Pickups
Manual, 6x9
Color: Black



955-257 Left 955-258 Right

Chrysler
1999-96 Caravan, Town & Country, Voyager
Power, Heated, w/o Memory & Auto Dim
Color: Black



955-259 Left 955-260 Right

Ford
1993-92 Econoline Vans
Manual, Swinglock
Color: Black



955-261 Left 955-262 Right

Ford
1994-92 Grand Marquis, Crown Victoria
Power
Color: Black



955-263 Left 955-264 Right

Ford
1996-95 Grand Marquis, Crown Victoria
Power, Heated
Color: Black



955-265 Left 955-266 Right

Ford
1996-92 F150/250 Pickups, Full-Size
Bronco
Power, Paddle Design
Color: Black & Chrome



955-267 Left 955-268 Right

Ford
2002-93 F150/250 Pickups, Full-Size
Bronco
Power, Paddle Design
Color: Black



955-269 Left 955-270 Right

Ford
1996-93 F150/250 Pickups
Manual
Color: Black



955-271 Left 955-272 Right

Ford
2001-95 Explorer, 2001-97 Mountaineer
Power
Color: Black



955-273 Left

Ford
1992-89 Thunderbird
Manual Remote
Color: Black

Side View Mirrors



955-274 Right

Ford
1997-89 Thunderbird LX, Standard, 1997-89 Cougar LS, 1997-95 XR7
Power
Color: Black



955-275 Left 955-276 Right

Ford
1997-89 Thunderbird LX
Power
Color: Black



955-277 Left 955-278 Right

Ford
1999-96 Taurus, Sable
Power, Heated
Color: Black



955-279 Left 955-280 Right

Ford
2002-97 F150/250 (Light Duty)
Power, w/o Signal
Color: Black & Chrome



955-281 Left 955-282 Right

Ford
2002-97 F150/250 (Light Duty)
Power, w/o Signal
Color: Black



955-283 Left 955-284 Right

Ford
2002-97 F150/250 Pickups (Light Duty)
Manual
Color: Black



955-285 Left 955-286 Right

Ford
1995-94 Mustang
Power
Color: Black



955-287 Left 955-288 Right

Ford
1999-96 Taurus, Sable
Power
Color: Black



955-289 Left 955-290 Right

Ford
1990-82 Bronco, 1994-91 Econoline Vans, 1992-83 Pickups
Manual
Color: Black



955-291 Left 955-292 Right

Ford
1994-91 Explorer
Power, Paddle Design
Color: Black



955-293 Left 955-294 Right

Ford
1997-86 Aerostar
Manual, Paddle Design, Pillar Mount
Color: Black



955-295 Left 955-296 Right

Ford
1997-90 Aerostar
Power, Pillar Mount
Color: Black



955-297 Left 955-298 Right

Ford
1997-93 Explorer
Manual
Color: Black



955-299 Left 955-300 Right

Ford
1995-93 Villager, Nissan Quest
Manual
Color: Black



955-301 Left 955-302 Right

GM
1997-94 Blazer, Jimmy, S10, Sonoma;
1997-95 Bravada
Power
Color: Black

Side View Mirrors



955-303 Left **955-304 Right**
Ford
 1998-96 Villager
 Manual
 Color: Black



955-305 Left **955-306 Right**
GM
 1997-94 S10 Mini Pickups, Sonoma
 Pickups, Blazer, Jimmy
 Manual, Retractable Head
 Color: Black



955-307 Left **955-308 Right**
GM
 1995 Lumina
 Power
 Color: Black



955-309 Left **955-310 Right**
GM
 1995 Lumina
 Manual Remote
 Color: Black



955-311 Left **955-312 Right**
GM
 2002-95 Cavalier Coupe, Sunfire Coupe
 Manual Remote
 Color: Black



955-314 Right
GM
 2002-95 Cavalier Sedan, Sunfire Sedan
 Manual
 Color: Black



955-315 Left
GM
 1999-96 LeSabre, 1996-91 Park Ave, 1999-92 88/LSS
 Power
 Color: Black



955-316 Right **955-317 Left**
GM
 1999-96 LeSabre, 1996-91 Park Ave, 1999-92 88/LSS
 Power
 Color: Black



955-318 Right
GM
 1999-92 LeSabre, 1996-91 Park Ave, 1999-91 Regency, 1999-92 88/LSS
 Power
 Color: Black



955-319 Right
GM
 1999-96 Achieva
 Manual Remote
 Color: Black



955-320 Left **955-321 Right**
GM
 2005-97 Malibu
 Power
 Color: Black



955-322 Left **955-323 Right**
GM
 2003-97 Malibu
 Manual
 Color: Black



955-324 Left **955-325 Right**
Ford
 2002-93 Ranger
 Power
 Color: Black



955-326 Left **955-327 Right**
GM
 1997-90 Cutlass Supreme Coupe & Sedan
 Power
 Color: Black



955-328 Left **955-329 Right**
Ford
 1998-96 Villager
 Power
 Color: Black

Side View Mirrors



955-330 Left **955-331 Right**
GM
 1998-92 Grand Am, Skylark
 Power
 Color: Black



955-332 Left
GM
 1995-92 Grand Am
 Manual
 Color: Black



955-333 Right
GM
 1998-92 Grand Am, 1995-92 Skylark
 Manual
 Color: Black



955-336 Right **955-337 Left**
GM
 1990 Trans Sport, Lumina APV, Silhouette
 Manual Remote
 Color: Black



955-338 Right **955-339 Left**
GM
 1998-96 Astro, Safari Vans
 Power, Below Eyeline
 Color: Black



955-340 Right **955-341 Left**
GM
 2005-85 Astro, Safari Vans
 Manual, Below Eyeline
 Color: Black



955-342 Right **955-343 Left**
GM
 1989-88 Regal Coupe
 Power
 Color: Black



955-344 Left
GM
 1996-88 Regal Coupe (90mm Base)
 Manual
 Color: Black



955-345 Left **955-346 Right**
Ford
 2002-97 F150 Pickups Heavy Duty
 Power, w/o Signal, Removable Back.
 Color: Black, w/Chrome Backing



955-347 Left **955-348 Right**
Ford
 2000-97 Escort, Tracer Sedan & Wagon
 Manual
 Color: Black



955-349 Left **955-350 Right**
Ford
 1997-95 Windstar
 Power
 Color: Black



955-351 Left **955-352 Right**
Ford
 1997-95 Explorer, 1997 Mountaineer
 Power, Heated, w/o Lamp
 Color: Black



955-353 Left **955-354 Right**
Ford
 2000-97 Escort, Tracer Sedan & Wagon
 Power
 Color: Black



955-355 Left **955-356 Right**
Ford
 2002-98 Ranger (Step Side Design)
 Power
 Color: Black



955-357 Left **955-358 Right**
Ford
 1997-95 Windstar
 Manual Remote
 Color: Black

Side View Mirrors



955-359 Right

Ford
1997-95 Windstar
Power, Heated
Color: Black



955-360 Left

Ford
1997-95 Contour, Mystique
Manual Remote
Color: Black



955-361 Left

955-362 Right

Ford
2001-99 F250/350 Heavy & Super Duty
Pickups
Manual, Telescopic
Color: Black



955-363 Left

955-364 Right

Ford
2001-99 F250/350 Heavy & Super Duty
Pickups
Power, Telescopic
Color: Black



955-365 Left

955-366 Right

Ford
2002-97 F-Series Pickups
Manual, Contour Type
Color: Chrome



955-367 Left

955-368 Right

Chrysler
2000-96 Caravan, Town & Country, Voyager
Manual
Color: Black

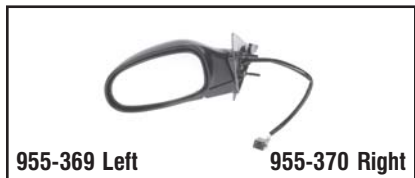

955-369 Left

955-370 Right

Chrysler
1999-97 Dodge Neon
Power, Foldaway
Color: Black



955-371 Left

955-372 Right

Chrysler
1996-94 Dodge Vans
Power
Color: Black

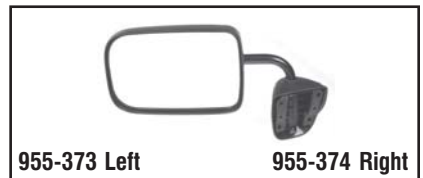

955-373 Left

955-374 Right

Chrysler
1997-94 Dodge Vans
Manual 6x9
Color: Black

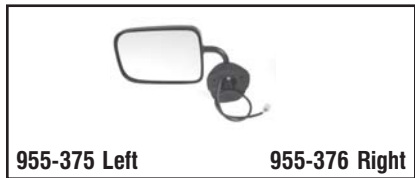

955-375 Left

955-376 Right

Chrysler
1997 Dodge Vans
Power
Color: Black



955-377 Left

955-378 Right

Chrysler
1996-88 Dodge Dakota
Manual Remote 5x7
Color: Black



955-379 Left

955-380 Right

Chrysler
1996-88 Dodge Dakota
Manual 5x7
Color: Black



955-381 Left

955-382 Right

Chrysler
1996-88 Dodge Dakota
Power 6x9
Color: Black



955-383 Left

955-384 Right

Chrysler
2000-99 Dodge Durango
Power, Heated, Foldaway
Color: Black



955-385 Left

955-386 Right

Chrysler
1996-88 Dodge Dakota
Manual 6x9
Color: Black

Side View Mirrors



955-387 Left 955-388 Right

Chrysler
2004-00 Dodge Neon
Manual Cable Controlled
Color: Black



955-389 Left 955-390 Right

Chrysler
2002-97 Dodge Dakota, Durango
Power, Fixed 5x7
Color: Black



955-391 Left 955-392 Right

Chrysler
2002-01 Caravan, Town & Country, Voyager
Power
Color: Black



955-393 Right

Saturn
1995-91 Sedan, Wagon
Power
Color: Black



955-394 Left 955-395 Right

Saturn
1995-91 Sedan, Wagon
Manual Remote
Color: Black



955-396 Right

Saturn
1996-91 Coupe
Power
Color: Black



955-397 Left 955-398 Right

Saturn
1996-91 Coupe
Manual
Color: Black

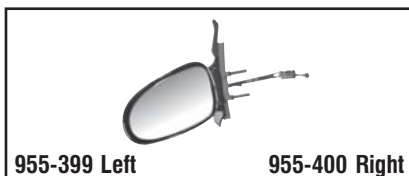

955-399 Left 955-400 Right

Saturn
2001-96 Sedan, Wagon
Power
Color: Black

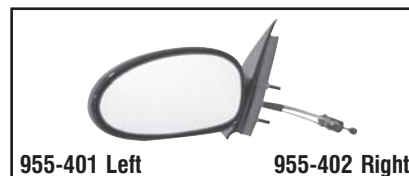

955-401 Left 955-402 Right

Saturn
2001-97 Coupe
Manual Remote
Color: Black

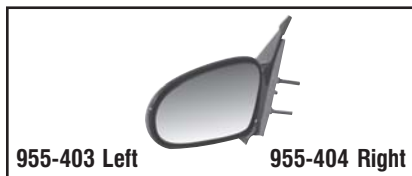

955-403 Left 955-404 Right

Saturn
2001-96 Sedan, Wagon
Manual Remote
Color: Black



955-405 Right

Saturn
2001-97 Coupe
Power
Color: Black



955-406 Left 955-407 Right

Isuzu
1997-91 Rodeo & Honda Passport,
1996-95 Pickups
Manual
Color: Black



955-408 Left 955-409 Right

Chrysler
2002-99 Jeep Grand Cherokee
Power
Color: Black



955-410 Left 955-411 Right

Mazda
1998-89 MPV
Power
Color: Black



955-412 Left 955-413 Right

Mazda
1993-86 Pickups
Manual
Color: Chrome

Side View Mirrors

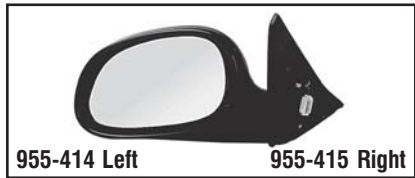

955-414 Left 955-415 Right

Honda
1995-92 Civic Sedan Only
Power
Color: Black



955-416 Left 955-417 Right

Honda
1997-94 Accord Sedan
Manual
Color: Black



955-418 Left 955-419 Right

Honda
1997-94 Accord Coupe
Power
Color: Black



955-420 Left 955-421 Right

Honda
2000-96 Civic Coupe
Power
Color: Black



955-422 Left 955-423 Right

Honda
2000-96 Civic Sedan
Power
Color: Black

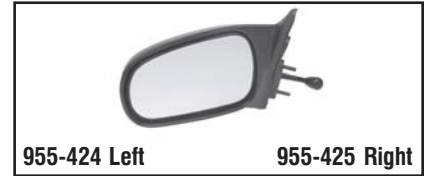

955-424 Left 955-425 Right

Honda
2000-96 Civic Sedan
Manual
Color: Black



955-426 Left 955-427 Right

Honda
2002-98 Accord Sedan (Japan Built)
Power
Color: Black



955-428 Left 955-429 Right

Honda
2002-98 Accord Coupe
Power
Color: Black



955-431 Left 955-432 Right

Nissan
1999-96 Maxima
Power, Heated
Color: Black



955-433 Left 955-434 Right

Nissan
1999-98 Altima
Power
Color: Black



955-435 Left 955-436 Right

Nissan
2001-00 Altima
Power
Color: Black



955-437 Left 955-438 Right

Nissan
1997-93 Altima GLE
Power
Color: Black



955-439 Left 955-440 Right

Nissan
2002-00 Sentra
Power, Heated
Color: Black



955-441 Left 955-442 Right

Nissan
1999-96 Maxima
Power
Color: Black



955-443 Left 955-444 Right

VW
2005-00 Golf Hatchback, Jetta
Power
Color: Chrome

Side View Mirrors

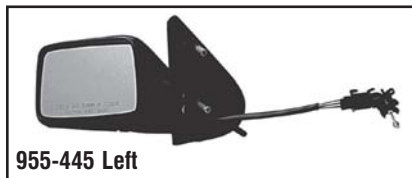

955-445 Left

VW
1999-93 Golf, Jetta
Manual Remote
Color: Black



955-446 Left

Toyota
2004-02 Camry (LE/SE) (USA Built)
Power
Color: Black



955-447 Left

955-448 Right

Toyota
1996-92 Camry (Japan Built)
Power
Color: Black



955-449 Left

955-450 Right

Toyota
1999-95 Tacoma Pickups
Manual
Color: Black



955-451 Left

955-452 Right

Toyota
1991-89 Camry
Power
Color: Black



955-453 Left

955-454 Right

Toyota
2001-97 Camry (Japan Built)
Power
Color: Black



955-455 Left

955-456 Right

Toyota
2001-98 Corolla
Power
Color: Black



955-457 Left

955-458 Right

Toyota
2001-98 Corolla
Manual Remote
Color: Black



955-459 Left

955-460 Right

Toyota
2001-98 Corolla
Manual
Color: Black



955-461 Left

955-462 Right

Toyota
2001-97 Camry (USA Built)
Power, Heated
Color: Black



955-463 Left

955-464 Right

Toyota
2001-97 Camry (Japan Built)
Power, Heated
Color: Black



955-465 Left

955-466 Right

Ford
1998-96 Mustang
Power
Color: Black



955-467 Left

955-468 Right

Ford
2000-99 Windstar
Power
Color: Black



955-469 Left

955-470 Right

Ford
2002-01 Windstar
Power
Color: Black



955-471 Left

955-472 Right

Ford
2002-00 Focus
Manual Lever Controlled
Color: Black

Side View Mirrors



955-473 Left **955-474 Right**
Ford
 2001-99 Mustang
 Power
 Color: Black



955-476 Right
Toyota
 1995-89 Toyota Pickups (Door Mount)
 Power Foldaway
 Color: Chrome



955-479 Left **955-480 Right**
Nissan
 1999-95 Nissan Sentra, 200SX
 Power Foldaway
 Color: Black



955-481 Left
Nissan
 2004-98 Nissan Frontier Pickups SE Model
 Power, Foldaway, w/o Memory
 Color: Black



955-482 Right
Ford
 2001-97 Ford F150, F250 LD Pickups
 Power Foldaway
 Color: Black

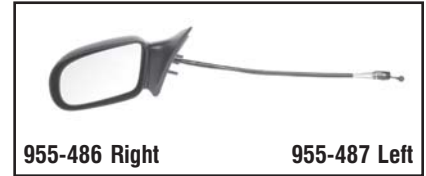

955-486 Right **955-487 Left**
GM
 1998-92 Skylark
 Manual Remote
 Color: Black



955-490 Left
Chrysler
 1993-87 D50 Pickups
 Manual, Sail Mount
 Color: Black

Related Sales **DORMAN**
HELP!

76864 (3)

Metal. Assortment of 3 most popular mirror brackets. Applications cover GM, Ford, Chrysler, Honda, VW. **Kit contains 76975, 76990 and 76995.**

BETTER VALUE

Side View Mirrors

Side View Mirror Applications

Make/Model/Years	Type	Description	LH	RH
BUICK				
CENTURY				
1985-82	Manual	Sport Mirror, Black, Remote	955-121	-
1996-86	Manual	Sport Mirror, Black, Remote	955-121	-
ELECTRA				
1984-82	Power	Chrome	955-124	-
ESTATE WAGON				
1985-82	Manual	Black	-	955-130
1981-80	Manual	Black	-	955-130
1990-86	Power	Chrome	955-124	-
1985-82	Power	Chrome	955-124	-
LESABRE				
1985-82	Manual	Black	-	955-130
1995-92	Power	-	955-315	955-318
1985-82	Power	Chrome	955-124	-
1999-96	Power	wo/Light Sensor	955-315	955-318
PARK AVENUE				
1996-91	Power	-	955-315	955-318
REGAL				
1989	Manual	110mm Base, Remote	955-131	-
1995	Manual	110mm Base, Remote	955-131	-
1991-90	Manual	110mm Base, Remote	955-131	-
1996	Manual	110mm Base, Remote	-	955-132
1996	Manual	2-Door, 90mm Base, Remote	955-344	-
1996	Manual	4-Door, 110mm Base, Remote	955-131	-
1988	Manual	90mm Base, Remote	955-344	-
1989	Manual	90mm Base, Remote	955-344	-
1996	Power	-	955-485	955-123
1989	Power	117mm Base	955-122	-
1995	Power	117mm Base	955-122	-
1994-92	Power	117mm Base	955-122	-
1991-90	Power	117mm Base	955-122	-
1989	Power	90mm Base	955-343	955-342
1988	Power	90mm Base	955-343	955-342
ROADMASTER				
1996-95	Manual	-	-	955-171
1996-95	Manual	Remote	955-170	-
1996-95	Power	-	955-172	955-173
1994-91	Power	-	955-128	955-129
SKYHAWK				
1989-82	Manual	Cable Controlled, Remote	955-127	-
SKYLARK				
1995-92	Manual	Remote	955-487	955-486
1998-96	Manual	Remote	955-487	-
1985-83	Manual	Sport Mirror, Black, Remote	955-121	-
1998-96	Power	-	955-330	955-331
1995-92	Power	-	955-330	955-331
CADILLAC				
ESCALADE				
1999	Manual	Sail Mount, Black	955-051	-
1999	Manual	Standard Mirror, Black	-	955-052
2004-00	Manual	Wide Load, Foldaway, Stainless Steel	955-074	955-075
FLEETWOOD (RWD)				
1996-95	Power	-	955-172	955-173
1994-93	Power	-	955-128	955-129
CHEVROLET				
BERETTA				
1996-93	Manual	Black, Remote	955-107	955-108
1992-91	Manual	Black, Remote	955-107	-
1990-87	Manual	Black, Remote	955-107	-
CAPRICE				
1996-95	Manual	-	-	955-171
1980	Manual	Black	-	955-130
1985-82	Manual	Black	-	955-130
1990-89	Manual	Remote	955-125	955-126
1996-95	Manual	Remote	955-170	-
1988-86	Manual	Remote	955-125	955-126
1996-95	Power	-	955-172	955-173
1994-91	Power	-	955-128	955-129
CAVALIER				
1989-88	Manual	Cable Controlled, Remote	955-127	-
1987-82	Manual	Cable Controlled, Remote	955-127	-
2002-95	Manual	Coupe, Remote	955-311	955-312
1994-92	Manual	Low Gloss Black, Cable Controlled, Remote	955-109	955-110
1991-90	Manual	Low Gloss Black, Cable Controlled, Remote	955-109	-
1989-88	Manual	Low Gloss Black, Cable Controlled, Remote	955-109	-
2002-95	Manual	Sedan, Remote	955-313	955-314
CELEBRITY				
1990-82	Manual	Sport Mirror, Black, Remote	955-121	-
CITATION				
1985-83	Manual	Sport Mirror, Black, Remote	955-121	-

Side View Mirror Applications

Make/Model/Years	Type	Description	LH	RH
CHEVROLET (continued)				
CORSICA				
1990-87	Manual	Black, Remote	955-107	-
1996-91	Manual	Black, Remote	955-107	955-108
IMPALA				
1985-82	Manual	Black	-	955-130
1980	Manual	Black	-	955-130
IMPALA SS				
1996-95	Manual	-	-	955-171
1996-95	Manual	Remote	955-170	-
1996-95	Power	-	955-172	955-173
1994	Power	-	955-128	955-129
LUMINA				
1995	Manual	4-Door	-	955-310
1995	Manual	4-Door, Remote	955-309	-
1994-90	Manual	Black, Remote	955-104	-
1994-90	Manual	Remote	-	955-133
1995	Power	4-Door	955-307	955-308
LUMINA APV				
1990	Manual	180mm x 90mm, Remote	955-337	955-336
MALIBU				
2003-97	Manual	Remote	955-322	955-323
2003-97	Power	-	955-320	955-321
2005-04	Power	Classic	955-320	955-321
MONTE CARLO				
1999-95	Manual	Cable Controlled, Remote	955-040	955-041
1999-95	Power	-	955-038	955-039
VENTURE VAN				
1998-97	Power	-	955-055	955-056
2004-99	Power	Heated	955-057	955-058
CHEVROLET TRUCK				
ASTRO				
1988-85	Manual	Low Mount, Flat Face Mirror	955-341	-
2005-00	Manual	Low Mount, Mirror Complete	-	955-340
1999	Manual	Low Mount, Mirror Complete	-	955-340
1998-96	Manual	Low Mount, Mirror Complete	-	955-340
1999	Power	-	955-042	955-043
1998-96	Power	Low Mount, Mirror Complete	955-339	955-338
AVALANCHE				
2004-03	Manual	Wide Load, Foldaway, Stainless Steel	955-074	955-075
2002	Manual	Wide Load, Foldaway, Stainless Steel	955-074	955-075
BLAZER				
1994-92	Manual	Low Mount, Stainless Steel, Mirror Complete	955-187	955-188
1984-80	Manual	Low Mount, Stainless Steel, Mirror Complete, (9.5 x 6)	955-190	955-190
1994-92	Manual	Low Mount, Unpainted, Mirror Complete	955-475	-
1994-92	Manual	Sail Mount, Black	955-051	-
1994-92	Manual	Standard Mirror, Black	-	955-052
1994-92	Power	-	955-191	955-192
C, K SERIES PICKUP				
2000-96	Manual	Low Mount, Stainless Steel, Mirror Complete	955-187	955-188
1991-88	Manual	Low Mount, Stainless Steel, Mirror Complete	955-187	955-188
1995-92	Manual	Low Mount, Stainless Steel, Mirror Complete	955-187	955-188
1984-80	Manual	Low Mount, Stainless Steel, Mirror Complete, (9.5 x 6)	955-190	955-190
1995-92	Manual	Low Mount, Unpainted, Mirror Complete	955-475	-
1991-88	Manual	Low Mount, Unpainted, Mirror Complete	955-475	-
2000-96	Manual	Low Mount, Unpainted, Mirror Complete	955-475	-
2000-96	Manual	Sail Mount, Black	955-051	-
1991-88	Manual	Sail Mount, Black	955-051	-
1995-92	Manual	Sail Mount, Black	955-051	-
1995-92	Manual	Standard Mirror, Black	-	955-052
2000-96	Manual	Standard Mirror, Black	-	955-052
1991-88	Manual	Standard Mirror, Black	-	955-052
2000-96	Power	-	955-191	955-192
1995-92	Power	-	955-191	955-192
G SERIES VAN				
1995-92	Manual	Low Mount, Stainless Steel, Mirror Head, (9.5 x 6)	-	955-189
S10 BLAZER				
2002-99	Manual	-	955-066	955-067
1994	Manual	Black (4 x 6.5)	955-193	955-194
1983	Manual	Low Mount, Mirror Head, (9.5 x 6)	955-181	955-182
1990-84	Manual	Low Mount, Mirror Head, (9.5 x 6)	955-181	955-182
1993-91	Manual	Low Mount, Mirror Head, (9.5 x 6)	955-181	955-182
1994	Manual	Low Mount, Mirror Head, (9.5 x 6)	955-181	955-182
1983	Manual	Low Mount, Stainless Steel, Mirror Head, (9.5 x 6)	955-185	955-186
1990-84	Manual	Low Mount, Stainless Steel, Mirror Head, (9.5 x 6)	955-185	955-186
1994	Manual	Retractable Head, Black (6 x 7)	-	955-306
1997-96	Manual	Retractable Head, Black (6 x 7)	-	955-306
1995	Manual	Retractable Head, Black (6 x 7)	-	955-306
1997-96	Manual	Retractable Head, Remote	955-305	-
1993-91	Manual	Standard Mirror, Grained Finish	955-183	955-184
1990-84	Manual	Standard Mirror, Grained Finish	955-183	955-184

Side View Mirrors

Clock Springs
pg. 21-24

Control Arms
pg. 25-54

CV Joint Boots & Accessories
pg. 55-66

Door Lock Actuators
pg. 67-72

Exhaust Manifold Kits
pg. 73-134

**Out of the Box,
On to the Vehicle**

Side View Mirrors

Side View Mirror Applications

Make/Model/Years	Type	Description	LH	RH
CHEVROLET TRUCK (continued)				
S10 BLAZER (continued)				
1997-96	Power	-	955-301	955-302
1998	Power	Heated	955-090	955-091
2002-99	Power	Heated, wo/Light Sensor	955-072	955-073
1998	Power	Non-Heated	955-062	955-063
S10 PICKUP				
2002-99	Manual	-	955-066	955-067
1994	Manual	Black (4 x 6.5)	955-193	955-194
1998	Manual	Black (4 x 6.5)	955-193	955-194
1997-96	Manual	Black (4 x 6.5)	955-193	955-194
1990-84	Manual	Low Mount, Mirror Head, (9.5 x 6)	955-181	955-182
1993-91	Manual	Low Mount, Mirror Head, (9.5 x 6)	955-181	955-182
1994	Manual	Low Mount, Mirror Head, (9.5 x 6)	955-181	955-182
1983-82	Manual	Low Mount, Mirror Head, (9.5 x 6)	955-181	955-182
1990-84	Manual	Low Mount, Stainless Steel, Mirror Head, (9.5 x 6)	955-185	955-186
1983-82	Manual	Low Mount, Stainless Steel, Mirror Head, (9.5 x 6)	955-185	955-186
1994	Manual	Retractable Head, Black (6 x 7)	-	955-306
1995	Manual	Retractable Head, Black (6 x 7)	-	955-306
1997-96	Manual	Retractable Head, Black (6 x 7)	-	955-306
1998	Manual	Retractable Head, Black (6 x 7)	-	955-306
1997-96	Manual	Retractable Head, Remote	955-305	-
1993-91	Manual	Standard Mirror, Grained Finish	955-183	955-184
1990-84	Manual	Standard Mirror, Grained Finish	955-183	955-184
1997-96	Power	-	955-301	955-302
1998	Power	Heated	955-090	955-091
2002-99	Power	Heated, wo/Light Sensor	955-072	955-073
1998	Power	Non-Heated	955-062	955-063
SILVERADO				
2001-99	Manual	Sail Mount, Remote	955-068	955-069
2005-99	Manual	Wide Load, Foldaway, Stainless Steel	955-074	955-075
2002-99	Power	Heated	955-064	955-065
2002-99	Power	Non-Heated, Black	955-060	955-061
2002-99	Power	Non-Heated, Chrome	955-094	955-095
SUBURBAN				
1991-88	Manual	Black	955-105	955-106
2000-98	Manual	Low Mount, Stainless Steel, Mirror Complete	955-187	955-188
1997-96	Manual	Low Mount, Stainless Steel, Mirror Complete	955-187	955-188
1995-92	Manual	Low Mount, Stainless Steel, Mirror Complete	955-187	-
1984-80	Manual	Low Mount, Stainless Steel, Mirror Complete, (9.5 x 6)	955-190	955-190
1995-92	Manual	Low Mount, Stainless Steel, Mirror Complete, Standard	-	955-188
1995-92	Manual	Low Mount, Unpainted, Mirror Complete	955-475	-
2000-98	Manual	Low Mount, Unpainted, Mirror Complete	955-475	-
1997-96	Manual	Low Mount, Unpainted, Mirror Complete	955-475	-
1995-92	Manual	Sail Mount, Black	955-051	-
2002-01	Manual	Sail Mount, Remote	955-068	955-069
1995-92	Manual	Standard Mirror, Black	-	955-052
2002-01	Manual	Wide Load, Foldaway, Stainless Steel	955-074	955-075
2004-03	Manual	Wide Load, Foldaway, Stainless Steel	955-074	955-075
2000-98	Power	-	955-191	955-192
1995-92	Power	-	955-191	955-192
1997-96	Power	-	955-191	955-192
TAHOE				
1995	Manual	Low Mount, Stainless Steel, Mirror Complete	955-187	955-188
1997-96	Manual	Low Mount, Stainless Steel, Mirror Complete	955-187	955-188
2000-98	Manual	Low Mount, Stainless Steel, Mirror Complete	955-187	955-188
1997-96	Manual	Low Mount, Unpainted, Mirror Complete	955-475	-
2000-98	Manual	Low Mount, Unpainted, Mirror Complete	955-475	-
1995	Manual	Low Mount, Unpainted, Mirror Complete	955-475	-
2000-98	Manual	Sail Mount, Black	955-051	-
1997-96	Manual	Sail Mount, Black	955-051	-
2002-01	Manual	Sail Mount, Remote	955-068	955-069
1997-96	Manual	Standard Mirror, Black	-	955-052
2000-98	Manual	Standard Mirror, Black	-	955-052
2002-01	Manual	Wide Load, Foldaway, Stainless Steel	955-074	-
2004-03	Manual	Wide Load, Foldaway, Stainless Steel	-	955-075
1997-96	Power	-	955-191	955-192
2000-98	Power	-	955-191	955-192
1995	Power	-	955-191	955-192
CHRYSLER				
CIRRUS				
2000-95	Manual	Remote	955-086	955-087
2000-95	Power	Heated	955-088	955-089
CONCORDE				
1997-96	Power	Heated, Foldaway, Black	955-101	955-254
1995	Power	Heated, Foldaway, Black	955-101	955-254
1994	Power	Heated, Foldaway, Black (From 2/27/93)	955-101	955-254
1994	Power	Heated, Non-Foldaway	955-102	955-103
1997-96	Power	Heated, Non-Foldaway	955-102	955-103
2000-98	Power	Non-Foldaway, wo/Memory	955-076	-
2004-01	Power	Non-Foldaway, wo/Memory	955-076	955-077

Side View Mirror Applications

Make/Model/Years	Type	Description	LH	RH
CHRYSLER (continued)				
LHS				
1997-96	Power	Heated, Foldaway, Black	955-101	955-254
1995	Power	Heated, Foldaway, Black	955-101	955-254
1994	Power	Heated, Foldaway, Black (From 2/27/93)	955-101	955-254
1997-96	Power	Heated, Non-Foldaway	955-102	955-103
1994	Power	Heated, Non-Foldaway	955-102	955-103
NEW YORKER				
1995	Power	Heated, Foldaway, Black	955-101	955-254
1996	Power	Heated, Foldaway, Black	955-101	955-254
1994	Power	Heated, Foldaway, Black (From 2/27/93)	955-101	955-254
1994	Power	Heated, Non-Foldaway	955-102	955-103
1996	Power	Heated, Non-Foldaway	955-102	955-103
TOWN & COUNTRY				
2000-96	Manual	-	955-367	955-368
1995-92	Manual	Foldaway, Sail Mount	955-241	955-240
1990	Manual	Remote	-	955-169
1990	Power	-	955-174	955-175
2000-96	Power	Heated, wo/Memory & Auto Dim	955-257	955-258
2002-01	Power	Non-Heated	955-391	955-392
1995-92	Power	Non-Heated, Foldaway, Sail Mount, Grained Texture	955-176	955-177
VOYAGER				
2002-01	Power	Non-Heated	955-391	955-392
DODGE				
CARAVAN, GRAND CARAVAN				
2000-96	Manual	-	955-367	955-368
1995-92	Manual	Foldaway, Sail Mount	955-241	955-240
1990-84	Manual	Remote	-	955-169
1990-87	Power	-	955-174	955-175
2000-96	Power	Heated, wo/Memory & Auto Dim	955-257	955-258
2002-01	Power	Non-Heated	955-391	955-392
1995-92	Power	Non-Heated, Foldaway, Sail Mount, Grained Texture	955-176	955-177
INTREPID				
1997-96	Power	Heated, Foldaway, Black	955-101	955-254
1995	Power	Heated, Foldaway, Black	955-101	955-254
1994	Power	Heated, Foldaway, Black (From 2/27/93)	955-101	955-254
1997-96	Power	Heated, Non-Foldaway	955-102	955-103
1994	Power	Heated, Non-Foldaway	955-102	955-103
2004-01	Power	Non-Foldaway, wo/Memory	955-076	955-077
2000-98	Power	Non-Foldaway, wo/Memory	955-076	-
NEON				
2004-03	Manual	Cable Controlled	955-387	-
2001-00	Manual	Cable Controlled	955-387	955-388
2002	Manual	Cable Controlled	955-387	-
1999-97	Manual	Sail Mount, Cable Controlled, Remote	955-113	955-114
1996	Manual	Sail Mount, Cable Controlled, Remote	955-113	955-114
1999-97	Power	Foldaway	955-369	955-370
1999-97	Power	Sail Mount	955-111	955-112
1996	Power	Sail Mount	955-111	955-112
STRATUS				
2000-95	Manual	Remote	955-086	955-087
2000-95	Power	Heated	955-088	955-089
DODGE TRUCK				
B SERIES VAN				
1997	Manual	6 x 9	-	955-374
1996-94	Manual	6 x 9	955-373	-
1985-84	Manual	Mirror, Complete, Low Mount, Chrome	955-178	955-178
1983	Manual	Mirror, Complete, Low Mount, Chrome (From 4/11/83)	955-178	955-178
1997	Power	-	955-375	955-376
1996-94	Power	-	955-371	955-372
DAKOTA				
2001-97	Manual	-	955-082	955-083
1996-88	Manual	5 x 7	955-379	955-380
1996-88	Manual	6 x 9	955-385	955-386
1996-88	Manual	Remote (5 x 7)	955-377	955-378
1996-88	Power	6 x 9	955-381	955-382
2001-97	Power	Foldaway, Non-Heated	955-080	955-081
2002	Power	Non-Foldaway (5 x 7)	955-389	955-390
2001-97	Power	Non-Foldaway (5 x 7)	955-389	955-390
2001-97	Power	Non-Foldaway, Non-Heated	955-078	955-079
DURANGO				
2000-98	Power	Foldaway, Non-Heated	955-080	-
2000-99	Power	Heated, Foldaway	955-383	955-384
2002-01	Power	Non-Foldaway (5 x 7)	955-389	955-390
2000-98	Power	Non-Foldaway, Non-Heated	955-078	-
RAM 1500/3500 PICKUP				
2001-98	Manual	Mirror, Complete (6 x 9)	955-255	955-256
1997-94	Manual	Mirror, Complete (6 x 9)	955-221	955-222
1997-94	Power	Chrome	955-248	-
1997-94	Power	Chrome, Convex Glass	-	955-249
2001-98	Power	Heated, Foldaway	955-084	955-085

Side View Mirror Applications

Make/Model/Years	Type	Description	LH	RH
DODGE TRUCK (continued)				
RAM 50 PICKUP				
1993-87	Manual	Delbar, Black	955-490	955-220
EAGLE				
VISION				
1997-96	Power	Heated, Foldaway, Black	955-101	955-254
1995	Power	Heated, Foldaway, Black	955-101	955-254
1994	Power	Heated, Foldaway, Black (From 2/27/93)	955-101	955-254
1994	Power	Heated, Non-Foldaway	955-102	955-103
1997-96	Power	Heated, Non-Foldaway	955-102	955-103
FORD				
CONTOUR				
1997-95	Manual	Remote	955-360	-
2000-97	Power	Smooth Finish	955-036	955-037
CROWN VICTORIA, COUNTRY SQUIRE				
2001-98	Power	-	955-034	955-035
1997	Power	-	955-012	955-013
1994-92	Power	-	955-261	955-262
1996-95	Power	Heated	955-264	955-263
ESCORT				
2000-97	Manual	Sedan Or Wagon	955-347	955-348
1996-91	Power	-	955-118	955-119
2000-97	Power	Sedan Or Wagon	955-353	955-354
FESTIVA				
1993-90	Manual	Remote	955-115	-
FOCUS				
2002-00	Manual	Lever Controlled, Remote	955-471	955-472
2002-00	Power	-	955-020	955-021
MUSTANG				
2001-99	Power	-	955-473	955-474
1995-94	Power	-	955-285	955-286
1998-96	Power	-	955-465	955-466
TAURUS				
1999-96	Power	Heated	955-277	955-278
1999-96	Power	Non-Heated	955-287	955-288
1994-92	Power	Sedan	955-116	955-117
1994-92	Power	Wagon	-	955-239
TEMPO				
1994-88	Power	4-Door	955-120	-
THUNDERBIRD				
1992-89	Manual	Remote	955-273	-
1997-93	Power	-	955-275	-
1992-89	Power	-	955-275	-
1997-93	Power	Black	-	955-274
1992-89	Power	Black	-	955-274
FORD TRUCK				
AEROSTAR				
1997-90	Manual	Paddle Type	-	955-294
1989-86	Manual	Paddle Type	955-293	-
1997-90	Power	-	955-295	955-296
BRONCO				
1996-92	Manual	Foldaway, Black/Chrome	-	955-482
1981-80	Manual	Rectangular, Chrome, Passenger Type	955-180	-
1989-82	Manual	Rectangular, Chrome, Swinglock Design	-	955-179
1981-80	Manual	Rectangular, Chrome, Swinglock Design	-	955-179
1989-82	Manual	Swing Lock, Low Profile, Top Mounted, Passenger Type, Chrome (5 x 8)	955-180	955-180
1996-92	Power	Foldaway, Black/Chrome, Exc. Performance Package	-	955-227
BRONCO II				
1990	Manual	Paddle Type, Swing Lock, Black (4 x 5)	955-225	-
1989-85	Manual	Paddle Type, Swing Lock, Black (4 x 5)	955-225	955-226
1989-85	Manual	Rectangular, Chrome, Passenger Type	955-180	955-180
1984	Manual	Rectangular, Chrome, Passenger Type	955-180	955-180
1984	Manual	Rectangular, Chrome, Swinglock Design	-	955-179
1989-85	Manual	Rectangular, Chrome, Swinglock Design	-	955-179
1990	Manual	Swing Lock, Low Profile, Top Mounted, Passenger Type, Chrome (5 x 8)	955-289	955-290
1984	Manual	Swing Lock, Low Profile, Top Mounted, Passenger Type, Chrome (5 x 8)	955-289	955-290
1989-85	Manual	Swing Lock, Low Profile, Top Mounted, Passenger Type, Chrome (5 x 8)	955-289	955-290
E-SERIES ECONOLINE VAN				
1993-92	Manual	Paddle Type, Swing Lock, Sail Mount, Black	955-259	-
1993-92	Manual	Paddle Type, Swing Lock, Sail Mount, Black Convex	-	955-260
2004-94	Manual	Swing Lock	955-004	955-005
EXPEDITION				
1997	Power	Black	955-024	955-025
1997	Power	Chrome	955-022	955-023
2001-98	Power	Heated, Black	955-030	955-031
2001-98	Power	Heated, Chrome	955-028	955-029
2001-98	Power	Non-Heated, Chrome	955-026	955-027
2001-98	Power	Non-Heated, wo/Lamp, Black	955-002	955-003
EXPLORER				
1997-95	Manual	-	955-297	955-298
1991	Manual	Paddle Type, Swing Lock, Black (4 x 5)	955-225	955-226

Side View Mirror Applications

Make/Model/Years	Type	Description	LH	RH
FORD TRUCK (continued)				
EXPLORER (continued)				
1994-92	Manual	Paddle Type, Swing Lock, Black (4 x 5)	-	955-226
1991	Manual	Swing Lock, Low Profile, Top Mounted, Passenger Type, Chrome (5 x 8)	955-289	955-290
1994-92	Manual	Swing Lock, Low Profile, Top Mounted, Passenger Type, Chrome (5 x 8)	955-289	955-290
2001-98	Power	Heated, w/Lamp	955-008	955-009
2005-02	Power	Heated, w/Puddle Lamp	955-048	955-049
1997-95	Power	Heated, wo/Lamp	955-351	955-352
2005-02	Power	Non-Heated, w/Puddle Lamp	955-046	955-047
1997-95	Power	Non-Heated, wo/Lamp	955-271	955-272
2001-98	Power	Non-Heated, wo/Lamp	955-271	955-272
2005-02	Power	Non-Heated, wo/Puddle Lamp	955-044	955-045
1991	Power	Paddle Type, Swing Lock (4-1/2 x 7-1/4)	-	955-292
1994-92	Power	Paddle Type, Swing Lock (4-1/2 x 7-1/4)	-	955-292
1991	Power	Paddle Type, Swing Lock (4-1/2 x 7-1/4) (From 11/90)	955-291	-
F-250 PICKUP				
1996-93	Manual	Foldaway, Black/Chrome	-	955-482
1992	Manual	Foldaway, Black/Chrome	-	955-482
1997	Manual	Foldaway, Black/Chrome, Over 8500Lb GVW	-	955-482
1997	Manual	Paddle Type, Swing Lock	955-482	-
1996-93	Manual	Paddle Type, Swing Lock, Black	955-269	-
1992	Manual	Paddle Type, Swing Lock, Black & Chrome	955-227	-
1996-93	Manual	Paddle Type, Swing Lock, Black & Chrome	955-227	-
1996-93	Manual	Paddle Type, Swing Lock, Black & Chrome Convex	-	955-228
1992	Manual	Paddle Type, Swing Lock, Black & Chrome Convex	-	955-228
1997	Manual	Paddle Type, Swing Lock, Black & Chrome Convex, Over 8500 GVW	-	955-228
1997	Manual	Paddle Type, Swing Lock, Black & Chrome, Over 8500 GVW	955-227	-
1991	Manual	Paddle Type, Swing Lock, Black (4 x 5)	955-225	955-226
1990	Manual	Paddle Type, Swing Lock, Black (4 x 5)	955-225	955-226
1989-85	Manual	Paddle Type, Swing Lock, Black (4 x 5)	955-225	955-226
1996-93	Manual	Paddle Type, Swing Lock, Black Convex	-	955-270
1997	Manual	Paddle Type, Swing Lock, Black Convex, Over 8500 GVW	-	955-270
1997	Manual	Paddle Type, Swing Lock, Black, Over 8500 GVW	955-269	-
1984-80	Manual	Rectangular, Chrome, Passenger Type	955-180	-
1984-80	Manual	Rectangular, Chrome, Swinglock Design	-	955-179
1989-85	Manual	Rectangular, Chrome, Swinglock Design	-	955-179
1989-85	Manual	Swing Lock, Low Profile, Top Mounted, Passenger Type, Chrome (5 x 8)	-	955-180
1984-80	Manual	Swing Lock, Low Profile, Top Mounted, Passenger Type, Chrome (5 x 8)	-	955-180
1990	Manual	Swing Lock, Low Profile, Top Mounted, Passenger Type, Chrome (5 x 8) (To 6/90)	-	955-180
2001-99	Manual	Telescopic Type	955-361	955-362
1996-93	Power	Foldaway, Black/Chrome, Exc. Lightning & Performance Package	-	955-227
1992	Power	Foldaway, Black/Chrome, Exc. Lightning & Performance Package	-	955-227
1997	Power	Foldaway, Black/Chrome, Over 8500Lb GVW	-	955-227
1996-93	Power	Paddle Type, Swing Lock, Black	955-267	955-268
1997	Power	Paddle Type, Swing Lock, Black	955-267	955-268
1996-93	Power	Paddle Type, Swing Lock, Black & Chrome, wo/Signal	955-265	955-266
1997	Power	Paddle Type, Swing Lock, Black & Chrome, wo/Signal	955-265	955-266
1992	Power	Paddle Type, Swing Lock, Black & Chrome, wo/Signal	955-265	955-266
1997	Power	Paddle Type, Swing Lock, wo/Signal	955-281	955-282
2001-99	Power	Telescopic Type	955-363	955-364
F-350 PICKUP				
1996-93	Manual	Foldaway, Black/Chrome	-	955-482
1997	Manual	Foldaway, Black/Chrome	-	955-482
1992	Manual	Foldaway, Black/Chrome	-	955-482
1996-93	Manual	Paddle Type, Swing Lock, Black	955-269	-
1996-93	Manual	Paddle Type, Swing Lock, Black & Chrome	955-227	-
1992	Manual	Paddle Type, Swing Lock, Black & Chrome	955-227	-
1992	Manual	Paddle Type, Swing Lock, Black & Chrome Convex	-	955-228
1996-93	Manual	Paddle Type, Swing Lock, Black & Chrome Convex	-	955-228
1990	Manual	Paddle Type, Swing Lock, Black (4 x 5)	955-225	955-226
1989-85	Manual	Paddle Type, Swing Lock, Black (4 x 5)	955-225	955-226
1991	Manual	Paddle Type, Swing Lock, Black (4 x 5)	955-225	955-226
1996-93	Manual	Paddle Type, Swing Lock, Black Convex	-	955-270
1984-80	Manual	Rectangular, Chrome, Passenger Type	955-180	-
1989-85	Manual	Rectangular, Chrome, Swinglock Design	-	955-179
1984-80	Manual	Rectangular, Chrome, Swinglock Design	-	955-179
1989-85	Manual	Swing Lock, Low Profile, Top Mounted, Passenger Type, Chrome (5 x 8)	-	955-180
1984-80	Manual	Swing Lock, Low Profile, Top Mounted, Passenger Type, Chrome (5 x 8)	-	955-180
1990	Manual	Swing Lock, Low Profile, Top Mounted, Passenger Type, Chrome (5 x 8) (To 6/90)	-	955-180
1997	Power	Foldaway, Black/Chrome	-	955-227
1996-93	Power	Foldaway, Black/Chrome, Exc. Lightning & Performance Package	-	955-227
1992	Power	Foldaway, Black/Chrome, Exc. Lightning & Performance Package	-	955-227
1996-93	Power	Paddle Type, Swing Lock, Black	955-267	955-268
1996-93	Power	Paddle Type, Swing Lock, Black & Chrome, wo/Signal	955-265	955-266
1997	Power	Paddle Type, Swing Lock, Black & Chrome, wo/Signal	-	955-266
1992	Power	Paddle Type, Swing Lock, Black & Chrome, wo/Signal	955-265	955-266
1997	Power	Paddle Type, Swing Lock, wo/Signal	-	955-282
F-450 SUPER DUTY PICKUP				
1997	Manual	Foldaway, Black/Chrome	-	955-482
1996-92	Manual	Foldaway, Black/Chrome	-	955-482
1997	Power	Foldaway, Black/Chrome	-	955-227

Side View Mirror Applications

Make/Model/Years	Type	Description	LH	RH
FORD TRUCK (continued)				
F-450 SUPER DUTY PICKUP (continued)				
1996-92	Power	Foldaway, Black/Chrome, Exc. Lightning & Performance Package	-	955-227
F-SERIES SUPER DUTY				
2001-99	Manual	Telescopic Type	955-361	955-362
2001-99	Power	Telescopic Type	955-363	955-364
F100, F150 PICKUP				
2002-97	Manual	Contour Type, Black	955-014	955-015
2002-97	Manual	Contour Type, Chrome	955-365	955-366
1992	Manual	Foldaway, Black/Chrome	-	955-482
1996-94	Manual	Foldaway, Black/Chrome	-	955-482
1993	Manual	Foldaway, Black/Chrome	-	955-482
2002-97	Manual	Paddle Type	955-283	955-284
1997	Manual	Paddle Type, Swing Lock	955-482	-
1996-94	Manual	Paddle Type, Swing Lock, Black	955-269	-
1993	Manual	Paddle Type, Swing Lock, Black	955-269	-
1992	Manual	Paddle Type, Swing Lock, Black & Chrome	955-227	-
1993	Manual	Paddle Type, Swing Lock, Black & Chrome	955-227	-
1996-94	Manual	Paddle Type, Swing Lock, Black & Chrome	955-227	-
1992	Manual	Paddle Type, Swing Lock, Black & Chrome Convex	-	955-228
1993	Manual	Paddle Type, Swing Lock, Black & Chrome Convex	-	955-228
1996-94	Manual	Paddle Type, Swing Lock, Black & Chrome Convex	-	955-228
1989-85	Manual	Paddle Type, Swing Lock, Black (4 x 5)	955-225	955-226
1990	Manual	Paddle Type, Swing Lock, Black (4 x 5)	955-225	955-226
1991	Manual	Paddle Type, Swing Lock, Black (4 x 5)	955-225	955-226
1993	Manual	Paddle Type, Swing Lock, Black Convex	-	955-270
1996-94	Manual	Paddle Type, Swing Lock, Black Convex	-	955-270
1984-80	Manual	Rectangular, Chrome, Passenger Type	955-180	-
1984-80	Manual	Rectangular, Chrome, Swinglock Design	-	955-179
1989-85	Manual	Rectangular, Chrome, Swinglock Design	-	955-179
1984-80	Manual	Swing Lock, Low Profile, Top Mounted, Passenger Type, Chrome (5 x 8)	-	955-180
1989-85	Manual	Swing Lock, Low Profile, Top Mounted, Passenger Type, Chrome (5 x 8)	-	955-180
1990	Manual	Swing Lock, Low Profile, Top Mounted, Passenger Type, Chrome (5 x 8) (To 6/90)	-	955-180
2002-97	Power	Black	-	955-346
2002-97	Power	Black, Exc. Super Crew	955-345	-
1993	Power	Foldaway, Black/Chrome, Exc. Lightning & Performance Package	-	955-227
1992	Power	Foldaway, Black/Chrome, Exc. Lightning & Performance Package	-	955-227
1996-94	Power	Foldaway, Black/Chrome, Exc. Lightning & Performance Package	-	955-227
1993	Power	Paddle Type, Swing Lock, Black	955-267	955-268
1996-94	Power	Paddle Type, Swing Lock, Black	955-267	955-268
2002-97	Power	Paddle Type, Swing Lock, Black	955-267	955-268
1992	Power	Paddle Type, Swing Lock, Black & Chrome, wo/Signal	955-265	955-266
1993	Power	Paddle Type, Swing Lock, Black & Chrome, wo/Signal	955-265	955-266
1996-94	Power	Paddle Type, Swing Lock, Black & Chrome, wo/Signal	955-265	955-266
2002-97	Power	Paddle Type, Swing Lock, wo/Signal	955-281	955-282
2002-97	Power	wo/Signal, Chrome	955-279	955-280
F350 PICKUP				
1997	Manual	Paddle Type, Swing Lock, Black	955-269	-
1997	Manual	Paddle Type, Swing Lock, Black & Chrome	955-227	-
1997	Manual	Paddle Type, Swing Lock, Black & Chrome Convex	-	955-228
1997	Manual	Paddle Type, Swing Lock, Black Convex	-	955-270
2001-99	Manual	Telescopic Type	955-361	955-362
1997	Power	Paddle Type, Swing Lock, Black	955-267	955-268
1997	Power	Paddle Type, Swing Lock, Black & Chrome, wo/Signal	955-265	-
1997	Power	Paddle Type, Swing Lock, wo/Signal	955-281	-
2001-99	Power	Telescopic Type	955-363	955-364
RANGER				
2002-98	Manual	-	955-006	955-007
1997-93	Manual	Paddle Type, Swing Lock, Black	955-223	955-224
1992-90	Manual	Paddle Type, Swing Lock, Black (4 x 5)	955-225	955-226
1989-85	Manual	Paddle Type, Swing Lock, Black (4 x 5)	955-225	955-226
1997-93	Manual	Post Mount, Black	955-010	955-011
1989-85	Manual	Rectangular, Chrome, Passenger Type	955-180	955-180
1984-83	Manual	Rectangular, Chrome, Passenger Type	955-180	955-180
1989-85	Manual	Rectangular, Chrome, Swinglock Design	-	955-179
1984-83	Manual	Rectangular, Chrome, Swinglock Design	-	955-179
1992-90	Manual	Swing Lock, Low Profile, Top Mounted, Passenger Type, Chrome (5 x 8)	955-289	955-290
1989-85	Manual	Swing Lock, Low Profile, Top Mounted, Passenger Type, Chrome (5 x 8)	955-289	955-290
1984-83	Manual	Swing Lock, Low Profile, Top Mounted, Passenger Type, Chrome (5 x 8)	955-289	955-290
2002-98	Power	-	955-324	955-356
1997-93	Power	-	955-324	955-325
2002-98	Power	Step Side Design	955-355	-
WINDSTAR				
1997-95	Manual	Remote	955-357	955-358
2002-01	Power	-	955-469	955-470
1997-95	Power	Heated	-	955-359
2000-99	Power	Heated	955-467	955-468
2000-99	Power	Non-Heated	955-032	955-033
1997-95	Power	Non-Heated	955-349	955-350

Side View Mirror Applications

Make/Model/Years	Type	Description	LH	RH
GEO				
METRO				
1994-89	Manual	-	955-092	955-093
PRIZM				
1990-89	Manual	Remote	955-096	955-097
GMC TRUCK				
C, K SERIES PICKUP				
2000-96	Manual	Low Mount, Stainless Steel, Mirror Complete	955-187	955-188
1995-92	Manual	Low Mount, Stainless Steel, Mirror Complete	955-187	955-188
1991-88	Manual	Low Mount, Stainless Steel, Mirror Complete	955-187	955-188
1984-80	Manual	Low Mount, Stainless Steel, Mirror Complete, (9.5 x 6)	955-190	955-190
2000-96	Manual	Low Mount, Unpainted, Mirror Complete	955-475	-
1991-88	Manual	Low Mount, Unpainted, Mirror Complete	955-475	-
1995-92	Manual	Low Mount, Unpainted, Mirror Complete	955-475	-
1991-88	Manual	Sail Mount, Black	955-051	-
2000-96	Manual	Sail Mount, Black	955-051	-
1995-92	Manual	Sail Mount, Black	955-051	-
2000-96	Manual	Standard Mirror, Black	-	955-052
1995-92	Manual	Standard Mirror, Black	-	955-052
1991-88	Manual	Standard Mirror, Black	-	955-052
1995-92	Power	-	955-191	955-192
2000-96	Power	-	955-191	955-192
G SERIES VAN				
1995-92	Manual	Low Mount, Stainless Steel, Mirror Head, (9.5 x 6)	-	955-189
JIMMY				
1984-80	Manual	Low Mount, Stainless Steel, Mirror Complete, (9.5 x 6)	955-190	955-190
S15 JIMMY				
2002-99	Manual	-	955-066	955-067
1994	Manual	Black (4 x 6.5)	955-193	955-194
1990-84	Manual	Low Mount, Mirror Head, (9.5 x 6)	955-181	955-182
1993-91	Manual	Low Mount, Mirror Head, (9.5 x 6)	955-181	955-182
1994	Manual	Low Mount, Mirror Head, (9.5 x 6)	955-181	955-182
1983	Manual	Low Mount, Mirror Head, (9.5 x 6)	955-181	955-182
1983	Manual	Low Mount, Stainless Steel, Mirror Head, (9.5 x 6)	955-185	955-186
1990-84	Manual	Low Mount, Stainless Steel, Mirror Head, (9.5 x 6)	955-185	955-186
1995	Manual	Retractable Head, Black (6 x 7)	-	955-306
1994	Manual	Retractable Head, Black (6 x 7)	-	955-306
1997-96	Manual	Retractable Head, Black (6 x 7)	-	955-306
1997-96	Manual	Retractable Head, Remote	955-305	-
1990-84	Manual	Standard Mirror, Grained Finish	955-183	955-184
1993-91	Manual	Standard Mirror, Grained Finish	955-183	955-184
1997-96	Power	-	955-301	955-302
1998	Power	Heated	955-090	955-091
2002-99	Power	Heated, wo/Light Sensor	955-072	955-073
1998	Power	Non-Heated	955-062	955-063
S15 PICKUP, SONOMA				
2002-99	Manual	-	955-066	955-067
1994	Manual	Black (4 x 6.5)	955-193	955-194
1998	Manual	Black (4 x 6.5)	955-193	955-194
1997-96	Manual	Black (4 x 6.5)	955-193	955-194
1994	Manual	Low Mount, Mirror Head, (9.5 x 6)	955-181	955-182
1983-82	Manual	Low Mount, Mirror Head, (9.5 x 6)	955-181	955-182
1990-84	Manual	Low Mount, Mirror Head, (9.5 x 6)	955-181	955-182
1993-91	Manual	Low Mount, Mirror Head, (9.5 x 6)	955-181	955-182
1983-82	Manual	Low Mount, Stainless Steel, Mirror Head, (9.5 x 6)	955-185	955-186
1990-84	Manual	Low Mount, Stainless Steel, Mirror Head, (9.5 x 6)	955-185	955-186
1994	Manual	Retractable Head, Black (6 x 7)	-	955-306
1998	Manual	Retractable Head, Black (6 x 7)	-	955-306
1995	Manual	Retractable Head, Black (6 x 7)	-	955-306
1997-96	Manual	Retractable Head, Black (6 x 7)	-	955-306
1997-96	Manual	Retractable Head, Remote	955-305	-
1990-84	Manual	Standard Mirror, Grained Finish	955-183	955-184
1993-91	Manual	Standard Mirror, Grained Finish	955-183	955-184
1997-96	Power	-	955-301	955-302
1998	Power	Heated	955-090	955-091
2002-99	Power	Heated, wo/Light Sensor	955-072	955-073
1998	Power	Non-Heated	955-062	955-063
S15 SYCLONE				
1991	Manual	Low Mount, Mirror Head, (9.5 x 6)	955-181	955-182
1991	Manual	Standard Mirror, Grained Finish	955-183	955-184
S15 TYPHOON				
1993-92	Manual	Low Mount, Mirror Head, (9.5 x 6)	955-181	955-182
1993-92	Manual	Standard Mirror, Grained Finish	955-183	955-184
SAFARI				
1988-85	Manual	Low Mount, Flat Face Mirror	955-341	-
1999	Manual	Low Mount, Mirror Complete	-	955-340
2005-00	Manual	Low Mount, Mirror Complete	-	955-340
1998-96	Manual	Low Mount, Mirror Complete	-	955-340
1999	Power	-	955-042	955-043
1998-96	Power	Low Mount, Mirror Complete	955-339	955-338

Side View Mirror Applications

Make/Model/Years	Type	Description	LH	RH
GMC TRUCK (continued)				
SIERRA				
2001-99	Manual	Sail Mount, Remote	955-068	955-069
2005-99	Manual	Wide Load, Foldaway, Stainless Steel	955-074	955-075
2002-99	Power	Heated	955-064	955-065
2002-99	Power	Non-Heated, Black	955-060	955-061
2002-99	Power	Non-Heated, Chrome	955-094	955-095
SUBURBAN				
1991-88	Manual	Black	955-105	955-106
1999-98	Manual	Low Mount, Stainless Steel, Mirror Complete	955-187	955-188
1995-92	Manual	Low Mount, Stainless Steel, Mirror Complete	955-187	-
1997-96	Manual	Low Mount, Stainless Steel, Mirror Complete	955-187	955-188
1984-80	Manual	Low Mount, Stainless Steel, Mirror Complete, (9.5 x 6)	955-190	955-190
1995-92	Manual	Low Mount, Stainless Steel, Mirror Complete, Standard	-	955-188
1995-92	Manual	Low Mount, Unpainted, Mirror Complete	955-475	-
1997-96	Manual	Low Mount, Unpainted, Mirror Complete	955-475	-
1999-98	Manual	Low Mount, Unpainted, Mirror Complete	955-475	-
1995-92	Manual	Sail Mount, Black	955-051	-
1995-92	Manual	Standard Mirror, Black	-	955-052
1995-92	Power	-	955-191	955-192
1997-96	Power	-	955-191	955-192
1999-98	Power	-	955-191	955-192
YUKON				
2000-98	Manual	Low Mount, Stainless Steel, Mirror Complete	955-187	955-188
1995-92	Manual	Low Mount, Stainless Steel, Mirror Complete	955-187	955-188
1997-96	Manual	Low Mount, Stainless Steel, Mirror Complete	955-187	955-188
1997-96	Manual	Low Mount, Unpainted, Mirror Complete	955-475	-
1995-92	Manual	Low Mount, Unpainted, Mirror Complete	955-475	-
2000-98	Manual	Low Mount, Unpainted, Mirror Complete	955-475	-
1997-96	Manual	Sail Mount, Black	955-051	-
2000-98	Manual	Sail Mount, Black	955-051	-
2002-01	Manual	Sail Mount, Remote	955-068	955-069
2000-98	Manual	Standard Mirror, Black	-	955-052
1997-96	Manual	Standard Mirror, Black	-	955-052
2004-03	Manual	Wide Load, Foldaway, Stainless Steel	955-074	955-075
1995-92	Power	-	955-191	955-192
1997-96	Power	-	955-191	955-192
2000-98	Power	-	955-191	955-192
YUKON XL				
2000	Manual	Low Mount, Stainless Steel, Mirror Complete	955-187	955-188
2002-01	Manual	Sail Mount, Remote	955-068	955-069
2002-01	Manual	Wide Load, Foldaway, Stainless Steel	955-074	955-075
2004-03	Manual	Wide Load, Foldaway, Stainless Steel	955-074	955-075
2000	Power	-	955-191	955-192
HONDA				
ACCORD				
1997-94	Manual	4-Door, Remote	955-416	955-417
2002-98	Manual	4-Door, Remote	955-134	955-135
1991-90	Manual	4-Door, Remote (Japan Built)	955-145	955-146
2002-98	Power	4-Door (Japan Built)	955-426	955-427
1991-90	Power	4-Door (Japan Built)	-	955-144
1993-92	Power	4-Door (Japan Built)	-	955-144
1991-90	Power	4-Door (USA Built)	955-143	-
1993-92	Power	4-Door (USA Built)	955-143	-
1997-94	Power	4-Door (USA Built)	955-147	955-148
2002-98	Power	4-Door (USA Built)	955-158	955-159
1997-94	Power	Coupe	955-418	955-419
2002-98	Power	Coupe, Non-Heated	955-428	955-429
CIVIC				
1990-89	Manual	3-Door, Lever Controlled, Remote	955-136	955-137
1991	Manual	3-Door, Lever Controlled, Remote	955-136	-
1988	Manual	3-Door, Lever Controlled, Remote	955-136	-
1995-92	Manual	3-Door, Remote	955-141	955-142
2000-96	Manual	4-Door	955-424	955-425
1995-92	Manual	4-Door, Remote	955-138	955-139
2000-96	Power	2-Door	955-420	955-421
1995-92	Power	2-Door, 3-Door	955-140	-
1995-92	Power	4-Door	955-414	955-415
2000-96	Power	4-Door	955-422	955-423
PASSPORT				
1997-94	Manual	Standard Mirror, Black	955-406	955-407
INFINITI				
I30				
1999-96	Power	Heated	955-431	955-432
1999-96	Power	Non-Heated	955-441	955-442
ISUZU TRUCK				
HOMBRE				
1997-96	Manual	Retractable Head, Remote	955-305	955-306
1997-96	Power	-	955-301	955-302
PICKUP				
1993-88	Manual	-	955-195	955-196

Side View Mirror Applications

Make/Model/Years	Type	Description	LH	RH
ISUZU TRUCK (continued)				
PICKUP (continued)				
1987-81	Manual	-	955-197	-
1995-94	Manual	-	955-406	955-407
RODEO				
1997-91	Manual	-	955-406	955-407
JEEP				
CHEROKEE				
1986-84	Manual	Black, Fixed	955-234	955-233
1993	Manual	Black, Fixed	955-234	955-233
1989-87	Manual	Black, Fixed	955-234	955-233
1992-90	Manual	Black, Fixed	955-234	955-233
1992-90	Manual	Black, Foldaway	955-231	955-232
1989-87	Manual	Black, Foldaway	955-231	955-232
1993	Manual	Black, Foldaway	955-231	955-232
1992-90	Manual	Black, Remote	955-238	955-237
1995-94	Manual	Black, Remote	955-238	955-237
1993	Power	Black	955-235	955-236
1995-94	Power	Black	955-235	955-236
CJ SERIES				
1986-53	Manual	Chrome, w/Mount	955-230	955-489
1986-81	Manual	Mirror Head, Chrome (6-3/4 x 6-3/4)	955-229	955-229
COMANCHE				
1989-87	Manual	Black, Fixed	955-234	955-233
1992-90	Manual	Black, Fixed	955-234	955-233
1986	Manual	Black, Fixed	955-234	955-233
1989-87	Manual	Black, Foldaway	955-231	955-232
1992-90	Manual	Black, Foldaway	955-231	955-232
1992-90	Manual	Black, Remote	955-238	955-237
GRAND CHEROKEE				
1995-93	Manual	-	955-250	955-251
1995-93	Power	Heated, Laredo & Sport Models	955-244	955-245
1995-93	Power	Heated, Limited Models	955-252	955-253
1998-96	Power	Heated, wo/Memory	955-246	955-247
2002-99	Power	Non-Heated	955-408	955-409
1995-93	Power	Non-Heated	955-242	955-243
SCRAMBLER				
1985-81	Manual	Mirror Head, Chrome (6-3/4 x 6-3/4)	955-229	955-229
WAGONEER				
1989-87	Manual	Black, Fixed	955-234	955-233
1986-84	Manual	Black, Fixed	955-234	955-233
1990	Manual	Black, Fixed	955-234	955-233
1989-87	Manual	Black, Foldaway	955-231	955-232
1990	Manual	Black, Foldaway	955-231	955-232
1990	Manual	Black, Remote	955-238	955-237
WRANGLER				
1993-87	Manual	Black, Foldaway	955-231	955-232
LINCOLN				
TOWN CAR				
1997	Power	wo/Memory	955-018	955-019
1996-95	Power	wo/Memory	955-016	955-017
MAZDA				
MPV				
1998-96	Power	-	955-410	955-411
1995-89	Power	-	955-410	955-411
MAZDA TRUCK				
B2000				
1987-86	Manual	Black	955-198	955-199
1987-86	Manual	Chrome	955-412	955-413
1987-86	Manual	Foldaway, Black	955-477	955-478
B2200				
1993-87	Manual	Black	955-198	955-199
1993-87	Manual	Chrome	955-412	955-413
1993-87	Manual	Foldaway, Black	955-477	955-478
B2600				
1993-87	Manual	Black	955-198	955-199
1993-87	Manual	Chrome	955-412	955-413
1993-87	Manual	Foldaway, Black	955-477	955-478
MERCURY				
COUGAR				
1997-89	Power	-	955-275	-
1997-89	Power	Black	-	955-274
GRAND MARQUIS, COLONY PARK				
2001-98	Power	-	955-034	955-035
1997	Power	-	955-012	955-013
1994-92	Power	-	955-261	955-262
1996-95	Power	Heated	955-264	955-263
MOUNTAINEER				
2001-98	Power	Heated, w/Lamp	955-008	955-009
2005-02	Power	Heated, w/Puddle Lamp	955-048	955-049
1997	Power	Heated, wo/Lamp	955-351	955-352

Side View Mirrors

Clock Springs
pg. 21-24

Control Arms
pg. 25-54

CV Joint Boots & Accessories
pg. 55-66

Door Lock Actuators
pg. 67-72

Exhaust Manifold Kits
pg. 73-134

**Out of the Box,
On to the Vehicle**

Side View Mirrors

Side View Mirror Applications

Make/Model/Years	Type	Description	LH	RH
MERCURY (continued)				
MOUNTAINEER (continued)				
2005-02	Power	Non-Heated, w/Puddle Lamp	955-046	955-047
2001-98	Power	Non-Heated, wo/Lamp	955-271	955-272
1997	Power	Non-Heated, wo/Lamp	955-271	955-272
2005-02	Power	Non-Heated, wo/Puddle Lamp	955-044	955-045
MYSTIQUE				
1997-95	Manual	Remote	955-360	-
2000-97	Power	Smooth Finish	955-036	955-037
SABLE				
1999-96	Power	Heated	955-277	955-278
1999-96	Power	Non-Heated	955-287	955-288
1994-92	Power	Sedan	955-116	955-117
1994-92	Power	Wagon	-	955-239
TOPAZ				
1994-88	Power	4-Door	955-120	-
TRACER				
1999-97	Manual	-	955-347	955-348
1999-97	Power	-	955-353	955-354
1996-91	Power	-	955-118	955-119
VILLAGER				
1995-93	Manual	-	955-299	955-300
1998-96	Manual	-	955-303	955-304
1995-93	Power	Non-Heated	955-334	955-335
1998-96	Power	Non-Heated	955-328	955-329
NISSAN				
200SX				
1999-95	Power	North American Built	-	955-154
ALTIMA				
2001-00	Power	-	955-435	955-436
1999-98	Power	-	955-433	955-434
1997-93	Power	-	955-437	955-438
MAXIMA				
1999-96	Power	Heated	955-431	955-432
1999-96	Power	Non-Heated	955-441	955-442
QUEST				
1995-93	Manual	-	955-299	955-300
1995-93	Power	Non-Heated	955-334	955-335
SENTRA				
1994-91	Manual	4-Door Sedan, Remote (Japan Built)	955-151	-
1994-91	Manual	4-Door Sedan, Remote (USA Built)	-	955-152
1997-95	Manual	Remote, North American Built	955-479	955-480
1994-91	Power	4-Door Sedan (Japan Built)	955-149	955-150
1994-91	Power	4-Door Sedan (USA Built)	955-153	-
2002-00	Power	Heated	955-439	955-440
1999-95	Power	North American Built	-	955-154
NISSAN TRUCK				
720 PICKUP				
1986-85	Manual	Black	955-207	-
1984	Manual	Black	955-207	955-206
1986-85	Manual	Chrome	955-204	955-205
FRONTIER				
2004-98	Manual	Foldaway	955-481	955-203
PATHFINDER				
1995-86	Manual	Black	955-202	955-203
1995-86	Manual	Chrome	955-200	955-201
PICKUP				
1995-86	Manual	Black	955-202	955-203
1995-86	Manual	Chrome	955-200	955-201
XTERRA				
2004-00	Manual	Foldaway	955-481	955-203
OLDSMOBILE				
88				
1999-92	Power	-	955-315	955-318
98				
1996-91	Power	-	955-315	955-318
1984-82	Power	Chrome	955-124	-
ACHIEVA				
1999-96	Manual	Remote	-	955-319
1999-96	Power	-	955-317	955-316
BRAVADA				
1994	Manual	Black (4 x 6.5)	955-193	955-194
1994	Manual	Low Mount, Mirror Head, (9.5 x 6)	955-181	955-182
1993-91	Manual	Low Mount, Mirror Head, (9.5 x 6)	955-181	955-182
1997-96	Manual	Retractable Head, Black (6 x 7)	-	955-306
1994	Manual	Retractable Head, Black (6 x 7)	-	955-306
1997-96	Manual	Retractable Head, Remote	955-305	-
1993-91	Manual	Standard Mirror, Grained Finish	955-183	955-184
1997-96	Power	-	955-301	955-302
CUSTOM CRUISER				
1985-82	Manual	Black	-	955-130

Side View Mirror Applications

Make/Model/Years	Type	Description	LH	RH
OLDSMOBILE (continued)				
CUSTOM CRUISER (continued)				
1992-91	Power	-	955-128	955-129
1985-82	Power	Chrome	955-124	-
1990-89	Power	Chrome	955-124	-
1988-86	Power	Chrome	955-124	-
CUTLASS				
1999-97	Manual	Remote	955-322	955-323
1999-97	Power	-	955-320	955-321
CUTLASS CIERA				
1996-94	Manual	Sport Mirror, Black, Remote	955-121	-
1993-92	Manual	Sport Mirror, Black, Remote	955-121	-
1991-82	Manual	Sport Mirror, Black, Remote	955-121	-
CUTLASS SUPREME				
1997-90	Manual	-	-	955-059
1997-90	Power	Black	955-326	955-327
DELTA 88				
1985-82	Manual	Black	-	955-130
1985-82	Power	Chrome	955-124	-
FIRENZA				
1988-82	Manual	Cable Controlled, Remote	955-127	-
INTRIGUE				
2000-98	Power	Heated	-	955-050
LSS				
1999-96	Power	-	955-315	955-318
OMEGA				
1984-83	Manual	Sport Mirror, Black, Remote	955-121	-
SILHOUETTE				
1990	Manual	180mm x 90mm, Remote	955-337	955-336
1998-97	Power	-	955-055	955-056
2004-99	Power	Heated	955-057	955-058
PLYMOUTH				
BREEZE				
2000-96	Manual	Remote	955-086	955-087
2000-96	Power	Heated	955-088	955-089
NEON				
2001-00	Manual	Cable Controlled	955-387	955-388
1999-97	Manual	Sail Mount, Cable Controlled, Remote	955-113	955-114
1996	Manual	Sail Mount, Cable Controlled, Remote	955-113	955-114
1999-97	Power	Foldaway	955-369	955-370
1996	Power	Sail Mount	955-111	955-112
1999-97	Power	Sail Mount	955-111	955-112
VOYAGER, GRAND VOYAGER				
2000-96	Manual	-	955-367	955-368
1995-92	Manual	Foldaway, Sail Mount	955-241	955-240
1990-87	Manual	Remote	-	955-169
1986-84	Manual	Remote	-	955-169
1990-87	Power	-	955-174	955-175
2000-96	Power	Heated, wo/Memory & Auto Dim	955-257	955-258
1995-92	Power	Non-Heated, Foldaway, Sail Mount, Grained Texture	955-176	955-177
PLYMOUTH TRUCK				
PB SERIES VOYAGER VAN				
1983	Manual	Mirror, Complete, Low Mount, Chrome (From 1/11/83)	955-178	955-178
PONTIAC				
6000				
1991-82	Manual	Sport Mirror, Black, Remote	955-121	-
GRAND AM				
1995-92	Manual	-	-	955-333
1998-96	Manual	GT Models	955-100	-
1995-92	Manual	Remote	955-332	-
1998-96	Manual	SE Models	-	955-333
1995-92	Power	-	955-330	955-331
1998-96	Power	GT Models	955-098	955-099
2002-99	Power	GT, SE Models	955-000	955-001
1998-96	Power	SE Models	955-330	955-331
GRAND PRIX				
1995-92	Manual	Black, Remote	955-104	-
1991-90	Manual	Black, Remote	955-104	-
1996	Power	-	955-485	955-123
1995-92	Power	117mm Base	955-122	-
1989-88	Power	117mm Base	955-122	-
1989-88	Power	90mm Base	955-343	955-342
2003-97	Power	Non-Heated	955-053	955-054
J2000				
1986-82	Manual	Cable Controlled, Remote	955-127	-
MONTANA				
2004-99	Power	Heated	955-057	955-058
PARISIENNE				
1985-83	Manual	Black	-	955-130
PHOENIX				
1984-82	Manual	Sport Mirror, Black, Remote	955-121	-

Side View Mirrors

Side View Mirror Applications

Make/Model/Years	Type	Description	LH	RH
PONTIAC (continued)				
SAFARI				
1989-88	Manual	Remote	955-125	955-126
SUNBIRD				
1987-85	Manual	Cable Controlled, Remote	955-127	-
1994	Manual	Convertible, Low Gloss Black, Cable Controlled, Remote	955-109	955-110
1993-92	Manual	Convertible, Low Gloss Black, Cable Controlled, Remote	955-109	955-110
1994	Manual	Coupe and Sedan, Cable Controlled, Remote	955-127	-
1993-92	Manual	Coupe and Sedan, Cable Controlled, Remote	955-127	-
1991-88	Manual	Coupe and Sedan, Cable Controlled, Remote	955-127	-
TRANS SPORT				
1990	Manual	180mm x 90mm, Remote	955-337	955-336
1998-97	Power	-	955-055	955-056
SATURN				
SC COUPE				
1996-91	Manual	-	955-397	955-398
2001-97	Manual	Remote	955-401	955-402
1996-91	Power	-	-	955-396
2001-97	Power	-	-	955-405
SL SEDAN				
2001-96	Manual	-	-	955-404
2001-96	Manual	Remote	955-403	-
1995-91	Manual	Remote	955-394	955-395
2001-96	Power	-	955-399	955-400
1995-91	Power	-	-	955-393
SW WAGON				
2001-96	Manual	-	-	955-404
2001-96	Manual	Remote	955-403	-
1995-93	Manual	Remote	955-394	955-395
1995-93	Power	-	-	955-393
2001-96	Power	-	955-399	955-400
SUZUKI				
SIDEKICK				
1997-89	Manual	-	955-208	955-209
TOYOTA				
CAMRY				
1988-87	Manual	Remote	955-163	-
1996-92	Manual	TMM Plant	955-165	955-166
1991-89	Manual	TMM Plant, Remote	-	955-164
1991-89	Power	-	955-451	955-452
2001-97	Power	Japan Built, Heated	955-463	955-464
2001-97	Power	Japan Built, Non-Heated	955-453	955-454
1996-92	Power	Tsutsumi Plant	955-447	955-448
1996-92	Power	USA Built	955-167	955-168
2001-97	Power	USA Built, Heated	955-461	955-462
2004-02	Power	USA Built; Non-Heated; LE, SE Series	955-446	-
COROLLA				
1995-94	Manual	-	-	955-162
2001-98	Manual	-	955-459	955-460
1997-96	Manual	-	-	955-162
2001-98	Manual	Remote	955-457	955-458
1990-89	Manual	Sedan and Wagon	955-156	955-157
1992-91	Manual	Sedan and Wagon (2WD)	955-156	955-157
1993	Manual	Sedan and Wagon (2WD)	-	955-162
2001-98	Power	-	955-455	955-456
1990-89	Power	Sedan and Wagon	955-155	-
1997-96	Power	TMC Plant	955-160	955-161
1993	Power	TMC Plant	955-160	955-161
1995-94	Power	TMC Plant	955-160	955-161
TOYOTA TRUCK				
4 RUNNER				
1986-84	Manual	-	955-216	955-217
1988-87	Manual	Black	-	955-215
PICKUP				
1981-79	Manual	-	955-218	-
1983-82	Manual	-	955-218	955-219
1986-84	Manual	-	955-216	955-217
1988-87	Manual	Black	-	955-215
1991-89	Manual	Black (Pedestal)	-	955-476
1995-92	Manual	Black, Sail Mount	955-212	955-213
1991-89	Manual	Black, Sail Mount	955-212	955-213
1991-89	Manual	Chrome, Pedestal	-	955-211
1991-89	Manual	Chrome, Sail Mount	955-210	-
1995-92	Manual	Chrome, Sail Mount	955-210	-
1995-92	Manual	Foldaway, Door Mount	955-483	-
1991-89	Manual	Foldaway, Door Mount	955-483	-
TACOMA				
1999-95	Manual	-	955-449	955-450
VOLKSWAGEN				
GOLF				
1999-93	Manual	Remote	955-445	-

Side View Mirror Applications

Make/Model/Years	Type	Description	LH	RH
VOLKSWAGEN (continued)				
GOLF (continued)				
2005-00	Power	Hatchback	955-443	955-444
JETTA				
1999-93	Manual	Remote	955-445	-
2005-00	Power	-	955-443	955-444
VOLVO				
940, 960				
1997-91	Power	Heated	-	955-430
S90, V90				
1998	Power	Heated	-	955-430

TECH TRAYS

Have the Part You Need, When You Need It
STOP WASTING BAY TIME!



Part # 030-722 FORD BODY RETAINERS TECH TRAY **NEW!** SECTION 20

• 14 SKUs, 164 pieces • Tray measures 11" W x 1-3/4" H x 6-3/4" D

700-404 Reveal Molding Clip	700-408 Reveal Molding Clip	700-397 Splash Shield Retainer	700-365 Trim Panel Retainer
700-399 Door Panel Retainer	700-474 Hood Insulation Retainer	700-413 Panel Trim Retainer	700-337 Panel Trim Retainer
700-340 Bumper Trim Panel Retainer	700-341 Hood Insulation Retainer	700-398 Panel Trim Retainer	700-416 Panel Trim Retainer



030-722
FORD
Body
Retainers

Part # 030-720 GM/CHRYSLER BODY RETAINERS TECH TRAY **NEW!** SECTION 20

• 20 SKUs, 272 pieces • Tray measures 13-1/8" W x 2-5/16" H x 9" D

700-367 Trim Panel Retainer	700-336 Trim Panel Retainer	700-365 Trim Panel Retainer	700-363 Hood Insulation Retainer	700-353 Molding Retainer #10-24 x 1" Chrysler
700-338 Trim Panel Retainer	700-366 Trim Panel Retainer	700-333 Trim Panel Retainer	703-478 Trim Panel Retainer	700-368 Trim Panel Retainer
700-340 Bumper Trim Panel Retainer	700-332 Trim Panel Retainer	700-339 Trim Panel Retainer	700-330 Trim Panel Retainer	700-343 Trim Panel Retainer
700-414 Trim Panel Retainer	700-415 Trim Panel Retainer	700-420 Trim Panel Retainer	703-467 Door Panel Retainer	700-871 Window Guide



030-720
GM/CHRYSLER
Body
Retainers

Part # 030-724 IMPORT BODY RETAINERS TECH TRAY **NEW!** SECTION 20

• 15 SKUs, 195 pieces • Tray measures 11" W x 1-3/4" H x 6-3/4" D

700-731 Panel Retainer Nissan	700-732 Panel Retainer Nissan	700-733 Panel Retainer Nissan	700-734 Panel Retainer Nissan	700-412 Panel Retainer Nissan	700-418 Headliner Retainer Honda
700-419 Bumper Retainer Toyota	700-423 Panel Retainer Nissan	700-866 Hood/Trunk Molding Retainer Honda	700-422 Panel Retainer Toyota	703-461 Panel Retainer Toyota	
703-481 Panel Retainer Honda		700-462 Grill Retainer Toyota	700-467 Grill Retainer Toyota		700-464 Weatherstrip Retainer Honda



030-724
IMPORT
Body
Retainers

Side View Mirrors



2006 Quick Ship Program

Side View Mirrors

Don't Lose the Sale...
 It's Quick...
 It's Easy...
 It's at Your Door Tomorrow.*

Listed below are the categories now available:

 Air Door Actuators	 Air Filter Boxes	 Air Intake Hoses	 Caliper Brackets	 Camshaft Synchronizers	 Clock Springs	 CV Boots	 Door Lock Actuators
 Electronic Fan Clutches	 Exhaust Manifold Kits	 Fan Pulley Brackets	 Fluid Lines	 Fluid Reservoirs	 Four Wheel Drive Actuators	 Fuel Sending Units	 Fuel Tanks
 Harmonic Balancers	 New Ignition Distributor Assemblies	 Intake Manifold Kits	 Latches	 Mirror Assemblies	 Oil Pans	 Power Steering Pulleys	 Quick Disconnect
 Radiator Fan Assemblies	 Rear Axle Shaft Kits	 Side View Mirrors	 Smog Pump Pulleys	 Timing Cover Kits	 Transfer Case Motors	 New Window Lift Motors	 New Window Regulators
 New Wiper Motors	 Wiper Transmissions Linkages						

Now you can have the parts your customers need, when they need them!

It's that easy...
 call your servicing distribution center!

*Additional Charges Apply

Smog Pump Pulleys



Complements Your Existing Smog Pump Sales

NEW
to the Aftermarket -
Direct OE
Replacement

NEW!



300-920
Ford Cars & Trucks
1982-74

300-911
Cadillac 4.5L V8
1987-80

- Simplifies returning vehicles to emission legal.
- Stop wasting time searching for a used pulley.
- Pumps do not come with pulleys.

Related Emissions Parts:



46002



Crankcase Vent Hose

GM w/3.1L eng. 1994-90.

46003



Vacuum Harness

Jeep Cherokee, Wagoneer, Comanche
w/4.0L Eng. 1990-88. Front Position.

Activant Path Emission/Emission Parts **Activant Code** DOY

Applications begin
on page 470.

Smog Pump Pulleys



300-911
Steel
 1980-87 Cadillac 4.5L V8, Stamping 1640145 MU
Diameter 4.46"
Width 1.06"
Belt Type Serpentine



300-912
Steel
 1993-87 Chevrolet/GMC Trucks Gas Engine 4.3L, 5.7L, 7.4L Stamping WVN
Diameter 5.69"
Width 1.28"
Belt Type Serpentine



300-913
Steel
 1985-68 GM 2.0L, 4.1L, 5.0L, 7.4L Passenger Cars & LT Trucks Stamping AD, BDC, FAB, MU
Diameter 5.9"
Width 0.614"
Belt Type V-Belt



300-920
Steel
 1984-80 Ford Passenger Cars & Trucks, Lincoln Continental, Mercury Passenger Cars; 2.3L, 4.1L, 5.0L, 5.9L, 6.4L, 7.5L
Diameter 6.24"
Width .79"
Belt Type V-Belt



300-921
Steel
 1996-87 Ford Bronco, E150/250 Vans, F150/250 Pickups 5.0L, 5.8L
Diameter 5.35"
Width 1.165"
Belt Type Serpentine



300-930
Steel
 1993-87 Dodge Trucks: B150/350, D100/350, W100/350 Dakota, Ramcharger, 3.9L, 5.2L, 5.9L
Diameter 5.45"
Width 0.649"
Belt Type V-Belt

Smog Pump Pulleys

Smog Pump Pulley Applications

Make/Model/Years	Description	Dorman #
BUICK		
APOLLO		
1975-73	4.1L Eng; (Stamped AD, BDC, FAB)	300-913
CENTURY		
1980	5.0L Eng; (Stamped AD, BDC, FAB)	300-913
1979-76	Stamped AD, BDC, FAB	300-913
ELECTRA		
1979-76	Stamped AD, BDC, FAB	300-913
ESTATE WAGON		
1979-76	Stamped AD, BDC, FAB	300-913
LESABRE		
1979-76	Stamped AD, BDC, FAB	300-913
REGAL		
1980	5.0L Eng; (Stamped AD, BDC, FAB)	300-913
1979-76	Stamped AD, BDC, FAB	300-913
RIVIERA		
1979-76	Stamped AD, BDC, FAB	300-913
SKYHAWK		
1983-82	Stamped AD, BDC, FAB	300-913
1979-76	Stamped AD, BDC, FAB	300-913
SKYLARK		
1979-76	Stamped AD, BDC, FAB	300-913
CADILLAC		
ALLANTE		
1988-87	Stamped 1640145	300-911
CIMARRON		
1983-82	Stamped AD, BDC	300-913
DEVILLE		
1990-87	Stamped MU	300-911
ELDORADO		
1990-87	Stamped MU	300-911
FLEETWOOD (FWD)		
1990-87	Stamped MU	300-911

Make/Model/Years	Description	Dorman #
CADILLAC (continued)		
SEVILLE		
1990-87	Stamped MU	300-911
CHEVROLET		
BEL AIR		
1975-72	148mm Dia, (Stamped AA, AD, BDC, FAB)	300-913
BISCAYNE		
1972	148mm Dia, (Stamped AA, AD, BDC, FAB)	300-913
BROOKWOOD		
1972	148mm Dia, (Stamped AA, AD, BDC, FAB)	300-913
CAMARO		
1981-80	3.8L (229 CID), 4.4L, 5.0L, 5.7L Engs; 148mm Dia, (Stamped AA, AD, BDC, FAB)	300-913
1979-72	148mm Dia, (Stamped AA, AD, BDC, FAB)	300-913
CAPRICE		
1981-80	3.8L (229 CID), 4.4L, 5.0L, 5.7L (VIN L) Engs; 148mm Dia, (Stamped AA, AD, BDC, FAB)	300-913
1979-72	148mm Dia, (Stamped AA, AD, BDC, FAB)	300-913
CAVALIER		
1983-82	148mm Dia, (Stamped AA, AD, BDC, FAB)	300-913
CHEVELLE		
1973-72	148mm Dia, (Stamped AA, AD, BDC, FAB)	300-913
CHEVETTE		
1979-76	148mm Dia, (Stamped AA, AD, BDC, FAB)	300-913
CITATION		
1981	2.8L Eng, wo/Power Steering; 148mm Dia, (Stamped AA, AD, BDC, FAB)	300-913
CORVETTE		
1981-68	148mm Dia, (Stamped AA, AD, BDC, FAB)	300-913
EL CAMINO		
1981-80	3.8L (229 CID), 4.4L, 5.0L Engs; 148mm Dia, (Stamped AA, AD, BDC, FAB)	300-913
1979-72	148mm Dia, (Stamped AA, AD, BDC, FAB)	300-913

Smog Pump Pulley Applications

Make/ Model/Years	Description	Dorman #
CHEVROLET (continued)		
IMPALA		
1981-80	3.8L (229 CID), 4.4L, 5.0L, 5.7L (VIN L) Engs; 148mm Dia, (Stamped AA, AD, BDC, FAB)	300-913
1979-72	148mm Dia, (Stamped AA, AD, BDC, FAB)	300-913
KINGSWOOD		
1972	148mm Dia, (Stamped AA, AD, BDC, FAB)	300-913
LAGUNA		
1976-73	148mm Dia, (Stamped AA, AD, BDC, FAB)	300-913
MALIBU		
1981-80	3.8L (229 CID), 4.4L, 5.0L, 5.7L Engs; 148mm Dia, (Stamped AA, AD, BDC, FAB)	300-913
1979-73	148mm Dia, (Stamped AA, AD, BDC, FAB)	300-913
MONTE CARLO		
1981-80	3.8L (229 CID), 4.4L, 5.0L, 5.7L Engs; 148mm Dia, (Stamped AA, AD, BDC, FAB)	300-913
1979-72	148mm Dia, (Stamped AA, AD, BDC, FAB)	300-913
MONZA		
1979-75	148mm Dia, (Stamped AA, AD, BDC, FAB)	300-913
NOVA		
1979-72	148mm Dia, (Stamped AA, AD, BDC, FAB)	300-913
TOWNSMAN		
1972	148mm Dia, (Stamped AA, AD, BDC, FAB)	300-913
VEGA		
1977-76	148mm Dia, (Stamped AA, AD, BDC, FAB)	300-913
CHEVROLET TRUCK		
ASTRO		
1989-87	4.3L Eng, w/AC, (Stamped WWN)	300-912
BLAZER		
1993-92	-	300-912
1990-89	5.7L Eng, 4WD	300-912
1984-79	Gas Eng, (Stamped BDC, FAB)	300-913
C,K SERIES PICKUP		
1993-91	Gas Eng, (Stamped WWN)	300-912
1990-88	Gas Eng, w/AC, (Stamped WWN)	300-912
1985	7.4L Eng, (Stamped BDC, FAB)	300-913
1984-79	Gas Eng, (Stamped BDC, FAB)	300-913
G SERIES VAN		
1991	4.3L Eng, w/AC	300-912
1990-87	Gas Eng, w/AC, (Stamped WWN)	300-912
1984-79	Stamped BDC, FAB	300-913
P SERIES VAN		
1989-87	7.4L Eng, (Stamped WWN)	300-912
1985	7.4L Eng, (Stamped BDC, FAB)	300-913
1984-79	Gas Eng, (Stamped BDC, FAB)	300-913
R,V SERIES PICKUP		
1990-89	5.7L Eng, 4WD, 1/2 Ton	300-912
1989-87	7.4L Eng, (Stamped WWN), RH	300-912
S10 BLAZER		
1984-83	2.0L Eng, (Stamped BDC)	300-913
S10 PICKUP		
1984-83	2.0L Eng, (Stamped BDC)	300-913
SUBURBAN		
1993-92	Gas Eng	300-912
1990-89	5.7L Eng, 4WD, 1/2 Ton	300-912
1989-87	7.4L Eng, (Stamped WWN), RH	300-912
1985	7.4L Eng, (Stamped BDC, FAB)	300-913
1984-79	Gas Eng, (Stamped BDC, FAB)	300-913
DODGE TRUCK		
B150 VAN		
1993-88	3.9L Eng, V Belt	300-930
1993-87	5.2L Eng, V Belt	300-930
B250 VAN		
1993-90	5.9L Eng, V Belt	300-930
1993-88	3.9L Eng, V Belt	300-930
1993-87	5.2L Eng, V Belt	300-930
1989-87	5.9L Eng, w/Dual Exhaust	300-930
1989-87	5.9L Eng, w/Single Exhaust	300-930
B350 VAN		
1993-90	5.9L Eng, V Belt	300-930
1993-87	5.2L Eng, V Belt	300-930
1992-90	3.9L Eng, V Belt	300-930
1989-87	5.9L Eng, w/Dual Exhaust	300-930
1989-87	5.9L Eng, w/Single Exhaust	300-930
D100/150 PICKUP		
1993-90	5.9L Eng, V Belt	300-930

Make/ Model/Years	Description	Dorman #
DODGE TRUCK (continued)		
D100/150 PICKUP (continued)		
1993-88	3.9L Eng, V Belt	300-930
1993-87	5.2L Eng, V Belt	300-930
1989-87	5.9L Eng, w/Dual Exhaust	300-930
1989-87	5.9L Eng, w/Single Exhaust	300-930
D250 PICKUP		
1993-90	5.9L Eng, V Belt	300-930
1993-88	3.9L Eng, V Belt	300-930
1993-87	5.2L Eng, V Belt	300-930
1989-87	5.9L Eng, w/Dual Exhaust	300-930
1989-87	5.9L Eng, w/Single Exhaust	300-930
D350 PICKUP		
1993-90	5.9L Eng, V Belt	300-930
1989-87	5.9L Eng, w/Dual Exhaust	300-930
1989-87	5.9L Eng, w/Single Exhaust	300-930
DAKOTA		
1993-88	3.9L Eng, V Belt	300-930
1990-89	5.2L Eng, V Belt	300-930
RAMCHARGER		
1993-90	5.9L Eng, V Belt	300-930
1993-87	5.2L Eng, V Belt	300-930
1989-87	5.9L Eng, w/Dual Exhaust	300-930
1989-87	5.9L Eng, w/Single Exhaust	300-930
W100/150 PICKUP		
1993-90	5.9L Eng, V Belt	300-930
1993-89	3.9L Eng, V Belt	300-930
1993-87	5.2L Eng, V Belt	300-930
1989-87	5.9L Eng, w/Dual Exhaust	300-930
1989-87	5.9L Eng, w/Single Exhaust	300-930
W250 PICKUP		
1993-90	5.9L Eng, V Belt	300-930
1993-87	5.2L Eng, V Belt	300-930
1989-87	5.9L Eng, w/Dual Exhaust	300-930
1989-87	5.9L Eng, w/Single Exhaust	300-930
W350 PICKUP		
1993-90	5.9L Eng, V Belt	300-930
1989-87	5.9L Eng, w/Dual Exhaust	300-930
1989-87	5.9L Eng, w/Single Exhaust	300-930
FORD		
FAIRMONT		
1983	2.3L Eng	300-920
LTD		
1984-83	2.3L Eng	300-920
MUSTANG		
1984-83	2.3L Eng	300-920
FORD TRUCK		
BRONCO		
1996-88	5.8L Eng	300-921
1996-87	5.0L Eng	300-921
1981-80	5.8L M Eng, w/AT	300-920
E150 ECONOLINE VAN		
1996-88	5.8L Eng	300-921
1996-87	5.0L Eng	300-921
E250 ECONOLINE VAN		
1996-88	5.8L Eng, Under 8500 GVW	300-921
1996-87	5.0L Eng	300-921
1982	6.6L Eng	300-920
E350 ECONOLINE VAN		
1982	6.6L Eng	300-920
1981-80	5.8L M Eng, w/AT	300-920
1981-80	6.6L Eng, w/AT	300-920
F100/150 PICKUP		
1981-80	5.8L M Eng, w/AT	300-920
F150 PICKUP		
1996-88	5.8L Eng	300-921
1996-87	5.0L Eng	300-921
F250 PICKUP		
1996-88	5.8L Eng, Under 8500 GVW	300-921
1996-87	5.0L Eng	300-921
1982	6.6L Eng	300-920
1981-80	5.8L M Eng, w/AT	300-920
1981-80	6.6L Eng, w/AT	300-920
F350 PICKUP		
1982	6.6L Eng	300-920
1981-80	5.8L M Eng, w/AT	300-920

Smog Pump Pulleys

Clock Springs
pg. 21-24

Control Arms
pg. 25-54

CV Joint Boots & Accessories
pg. 55-66

Door Lock Actuators
pg. 67-72

Exhaust Manifold Kits
pg. 73-134

Remember to Check Belt for Cracking or Glazing

Smog Pump Pulleys

Smog Pump Pulley Applications

Make/ Model/Years	Description	Dorman #
FORD TRUCK (continued)		
F350 PICKUP (continued)		
1981-80	6.6L Eng, w/AT	300-920
GMC TRUCK		
C,K SERIES PICKUP		
1993-91	Gas Eng, (Stamped WWN)	300-912
1990-88	Gas Eng, w/AC, (Stamped WWN)	300-912
1985	7.4L Eng, (Stamped BDC, FAB)	300-913
1984-79	Gas Eng, (Stamped BDC, FAB)	300-913
G SERIES VAN		
1991	4.3L Eng, w/AC	300-912
1990-87	Gas Eng, w/AC, (Stamped WWN)	300-912
1984-79	Stamped BDC, FAB	300-913
JIMMY		
1990-89	5.7L Eng, 4WD	300-912
1984-79	Gas Eng, (Stamped BDC, FAB)	300-913
P SERIES VAN		
1989-87	7.4L Eng, (Stamped WWN)	300-912
1985	7.4L Eng, (Stamped BDC, FAB)	300-913
1984-79	Gas Eng, (Stamped BDC, FAB)	300-913
R,V SERIES PICKUP		
1990-89	5.7L Eng, 4WD, 1/2 Ton	300-912
1989-87	7.4L Eng, (Stamped WWN), RH	300-912
S15 JIMMY		
1984-83	2.0L Eng, (Stamped BDC)	300-913
S15 PICKUP		
1984-83	2.0L Eng, (Stamped BDC)	300-913
SAFARI		
1989-87	4.3L Eng, w/AC, (Stamped WWN)	300-912
SUBURBAN		
1993-92	Gas Eng	300-912
1990-89	5.7L Eng, 4WD, 1/2 Ton	300-912
1989-87	7.4L Eng, (Stamped WWN), RH	300-912
1985	7.4L Eng, (Stamped BDC, FAB)	300-913
1984-79	Gas Eng, (Stamped BDC, FAB)	300-913
YUKON		
1993-92	-	300-912
MERCURY		
CAPRI		
1984-83	2.3L Eng	300-920
MARQUIS		
1984-83	2.3L Eng	300-920
ZEPHYR		
1983	2.3L Eng	300-920
OLDSMOBILE		
98		
1979-76	Stamped AD, BDC	300-913
CUSTOM CRUISER		
1979-76	Stamped AD, BDC	300-913
CUTLASS		
1980	5.0L Eng; (Stamped AD, BDC)	300-913
1979-76	Stamped AD, BDC	300-913
CUTLASS CALAIS		
1980	5.0L Eng; (Stamped AD, BDC)	300-913
1979-78	Stamped AD, BDC	300-913

Make/ Model/Years	Description	Dorman #
OLDSMOBILE (continued)		
CUTLASS CRUISER		
1980	5.0L Eng; (Stamped AD, BDC)	300-913
1979-78	Stamped AD, BDC	300-913
CUTLASS SUPREME		
1980	5.0L Eng; (Stamped AD, BDC)	300-913
1979-76	Stamped AD, BDC	300-913
DELTA 88		
1979-76	Stamped AD, BDC	300-913
FIRENZA		
1983-82	Stamped AD, BDC	300-913
OMEGA		
1979-76	Stamped AD, BDC	300-913
1975-73	4.1L Eng; (Stamped AD, BDC)	300-913
STARFIRE		
1979-76	Stamped AD, BDC	300-91
TORONADO		
1979-76	Stamped AD, BDC	300-913
VISTA CRUISER		
1977-76	Stamped AD, BDC	300-913
PONTIAC		
ASTRE		
1977-76	Stamped AD, BDC, FAB	300-913
BONNEVILLE		
1979-76	Stamped AD, BDC, FAB	300-913
CATALINA		
1979-76	Stamped AD, BDC, FAB	300-913
FIREBIRD		
1981-80	5.0L Eng; (Stamped AD, BDC, FAB)	300-913
1979-76	Stamped AD, BDC, FAB	300-913
GRAND AM		
1979-78	Stamped AD, BDC, FAB	300-913
GRAND LEMANS		
1980	3.8L (229 CID) Eng, (Stamped AD, BDC, FAB)	300-913
1979-76	Stamped AD, BDC, FAB	300-913
GRAND PRIX		
1979-76	Stamped AD, BDC, FAB	300-913
GRAND SAFARI		
1978-76	Stamped AD, BDC, FAB	300-913
J2000		
1983-82	Stamped AD, BDC, FAB	300-913
LEMANS		
1980	3.8L (229 CID) Eng, (Stamped AD, BDC, FAB)	300-913
1979-76	Stamped AD, BDC, FAB	300-913
1975-72	4.1L Eng; (Stamped AD, BDC, FAB)	300-913
PARISIENNE		
1979-76	Stamped AD, BDC, FAB	300-913
PHOENIX		
1979-77	Stamped AD, BDC, FAB	300-913
SUNBIRD		
1979-76	Stamped AD, BDC, FAB	300-913
VENTURA		
1977-76	Stamped AD, BDC, FAB	300-913
1975-73	4.1L Eng; (Stamped AD, BDC, FAB)	300-913
1972	4.1L, 5.0L Eng; (Stamped AD, BDC, FAB)	300-913

Timing Cover Kits



Signs that a Timing Cover needs to be replaced:

- Aluminum Timing Covers can
 - Leak
 - Warp
 - Crack
- Can be damaged upon removal
- Failure of the Timing Chain can also cause damage internally to the Cover.

Kit contents include:

- Timing Cover
- Gasket
- Seal, if necessary
- Oil Pump Gasket, when required



Replace Timing Cover during:

- Front End Collision
- Harmonic Balancer Failure
- Oil Pump or Water Pumps Failure
- Timing Chain Replacement



- Investigate all unusual engine noises! A wobbling water pump impeller can rub through the Timing Case Cover, causing antifreeze to enter the engine oiling system. Engine lubrication failure and damage to the bearings and other engine components will occur very quickly!
- When performing Timing Case Cover replacement, check all accessory drive belts, timing belt, harmonic balancer, water pump, and engine hoses. Replace as necessary.

Activant Path

*Engine Assembly & Parts/
Timing Parts & Camshaft*

Activant Code

DTI

**Applications begin
on page 476.**

Timing Cover Kits



635-100

Ford
1997-87 Reverse Flow, Late & Front Seat.
5.0L (302 CID) & 5.8L (351W CID).



635-101

Ford
1996-68 Universal Style Timing Cover.
Fits All Makes and Models w/7.0L (429
CID) & 4.5L (460 CID) Engines.



635-102

Ford
1993-79 Universal Style Timing Cover.
5.0L (302CID) & 5.8L (351W CID).



635-105

Ford
2003-96 Cougar, Thunderbird 3.8L(232
CID), F150, Van 4.2L (256 CID), Mustang
3.8L(232 CID), Windstar 3.8L(232 CID).
Includes an installed Oil Pump.



635-106

Ford
2001-96 Explorer 5.0L (8-302 CID),
Mountaineer 5.0L (8-302 CID).



635-107

Ford
1984-66 5.0L(302 CID), 5.8L (351
Windsor CID) w/Dipstick Hole & Cover.



635-108

Ford
1986-84 Capri, LTD, Thunderbird, Cougar,
Marquis, Thunderbird, V6, 3.8L (323
CID), Vin 3.



635-109

Ford
1996-65 Ford Trucks L6, 3.9L (240 CID)
& 4.9L (300 CID).



635-201

Nissan
1990-89 Sentra L4-1.6L (1597cc).



635-202

Nissan
1994-91 Sentra 1.6L (1597cc); 1993-91
NX Coupe 1.6L (1597cc).



635-203

Nissan
1999-95 NX, 200SX, Sentra, L4, 1.6L
(1597CC), Vin GA16DE.



635-204

Nissan
1992-90 Stanza, 1990 Axxess, L4, 2.4L,
(2389 CC), Vin KA24E.

Timing Cover Kits

Timing Cover Kits



635-205

Nissan
1996-90 D21 Pickups, L4, 2.4L (2389CC), Vin KA24E.

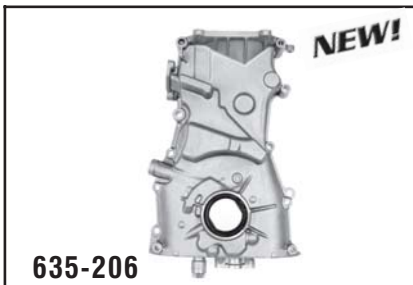

635-206

Nissan
2001-93 Altima; L4 2.4L (2389cc), VIN K24DE.

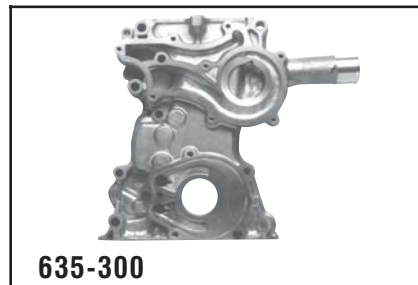

635-300

Toyota
1995-85 L4-2.4L (2366cc) 22 Rec engine w/o Turbo.



635-301

Toyota
1984-81 Pickups, 1983-81 Celica & Corona, 1984 4 Runner, L4, 2.4L, (2366CC), Vin 22R.



635-400

Chrysler
1991-70 Chrysler, Dodge, Plymouth Various Models, V6, 3.9L (239 CID), V8, 5.2L/5.6L/5.9L, (318/340/360 CID).



635-501

GM
1991-87 Grand Am, Calais, Skylark; L4-2.5L (151 CID)



635-502

GM
2003-95 GM Various Models 4.3L (262 CID) Engine



635-503

GM
1989-79 GM Various Models, V6, 3.0L/3.8L (181/231 CID).



635-504

GM
1984-77 GM Various Models, V6, 3.2L/3.8L/4.1L (196/231/252 CID), V8, 5.7L (350 CID).



635-505

GM
2002-87 GM/Chevrolet/GMC Truck 5.0L(305 CID) and 5.7L(350 CID).



635-506

GM
1990-82 Buick Century, Pontiac Firebird; L4 2.5L (151 CID).



635-507

GM
1993-82 Chevrolet S10 Blazer & Pickups; Pontiac Firebird; 2.8 (173 CID); 3.1L (189 CID).

Timing Cover Kits

Timing Cover Kits



635-508

GM
1993-92 Chevrolet Camaro; Pontiac Firebird; V8-5.7LT1 (350 CID).



635-509

GM
1993-82 Cadillac, Chevrolet Passenger Cars & Trucks, GMC, Pontiac; V8 5.0L (305 CID) w/ 7" Balancer.



635-510

GM
1995-69 Cadillac, Chevrolet Passenger Cars & Trucks, GMC, Pontiac; V8 5.0L (305 CID); 5.7L (350 CID) w/ 8" Balancer.



635-511

GM
1990-66 Chevrolet Passenger Cars & Trucks, GMC, Pontiac; V8 6.5 (396 CID) /6.7 (402 CID) /7.0 (427 CID) /7.4L (454 CID).



635-512

GM
1994-87 Chevrolet Astro, Blazer, C/G/10, 20 Pickups, G10,20,30 Vans; GMC C/G/ K15,1500/2500;35/3500; V6 4.3L (262 CID) VIN N & B.

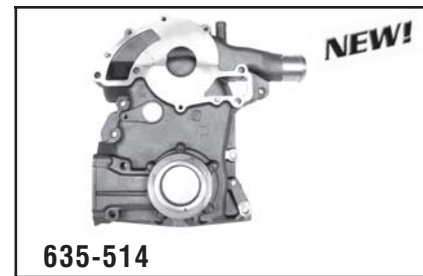

635-514

GM
1992-90 Buick Park Avenue late style, V6 3.8L (231 CID).

Timing Cover Kit Applications

Make/Model/Engine	Years	Description	Dorman #
BUICK			
CENTURY			
L4 - 2.5L (151 CID)	1990-82	-	635-506
V6 - 3.0L (181 CID)	1985	20 Bolt Oil Pan	635-503
V6 - 3.8L (231 CID)	1988-86	-	635-503
V6 - 3.8L (231 CID)	1985	20 Bolt Oil Pan	635-503
V6 - 3.8L (231 CID)	1981	14 Bolt Oil Pan	635-504
V6 - 3.8L (231 CID)	1981	20 Bolt Oil Pan, Vin A	635-503
V6 - 3.8L (231 CID)	1980-79	14 Bolt Oil Pan	635-504
V6 - 3.8L (231 CID)	1980-79	20 Bolt Oil Pan, Vin 3	635-503
V6 - 3.8L (231 CID)	1980-79	20 Bolt Oil Pan, Vin A	635-503
V6 - 3.8L (231 CID)	1978-76	-	635-504
V8 - 5.7L (350 CID)	1977-76	Vin H	635-504
V8 - 5.7L (350 CID)	1977-76	Vin J	635-504
ELECTRA			
V6 - 3.0L (181 CID)	1985	20 Bolt Oil Pan	635-503
V6 - 3.8L (231 CID)	1987-86	-	635-503
V6 - 3.8L (231 CID)	1985	20 Bolt Oil Pan	635-503
V6 - 4.1L (252 CID)	1984-82	14 Bolt Oil Pan	635-504
V6 - 4.1L (252 CID)	1981-80	-	635-504
V8 - 5.7L (350 CID)	1980-78	Vin X	635-504
V8 - 5.7L (350 CID)	1977	Vin H	635-504
V8 - 5.7L (350 CID)	1977	Vin J	635-504
ESTATE WAGON			
V8 - 5.7L (350 CID)	1980-78	Vin X	635-504
LESABRE			
V6 - 3.0L (181 CID)	1986	-	635-503
V6 - 3.8L (231 CID)	1992-91	-	635-514
V6 - 3.8L (231 CID)	1988-86	Vin 3	635-503
V6 - 3.8L (231 CID)	1985	-	635-503
V6 - 3.8L (231 CID)	1984-82	14 Bolt Oil Pan	635-504
V6 - 3.8L (231 CID)	1984-82	20 Bolt Oil Pan	635-503
V6 - 3.8L (231 CID)	1981-79	14 Bolt Oil Pan	635-504
V6 - 3.8L (231 CID)	1981-79	20 Bolt Oil Pan, Vin A	635-503
V6 - 3.8L (231 CID)	1978-76	-	635-504
V6 - 4.1L (252 CID)	1984-82	14 Bolt Oil Pan	635-504

Make/Model/Engine	Years	Description	Dorman #
BUICK (continued)			
LESABRE (continued)			
V6 - 4.1L (252 CID)	1981-80	-	635-504
V8 - 5.7L (350 CID)	1980-78	Vin X	635-504
V8 - 5.7L (350 CID)	1977-76	Vin J	635-504
V8 - 5.7L (350 CID)	1977	Vin H	635-504
PARK AVENUE			
V6 - 3.8L (231 CID)	1992-91	-	635-514
REATTA			
V6 - 3.8L (231 CID)	1991	-	635-514
REGAL			
V6 - 3.8L (231 CID)	1992-90	-	635-514
V6 - 3.8L (231 CID)	1987-86	20 Bolt Oil Pan, Vin 7	635-503
V6 - 3.8L (231 CID)	1987-86	20 Bolt Oil Pan, Vin A	635-503
V6 - 3.8L (231 CID)	1985	20 Bolt Oil Pan, Vin 9	635-503
V6 - 3.8L (231 CID)	1985	20 Bolt Oil Pan, Vin A	635-503
V6 - 3.8L (231 CID)	1984-81	14 Bolt Oil Pan	635-504
V6 - 3.8L (231 CID)	1984-81	20 Bolt Oil Pan, Vin A	635-503
V6 - 3.8L (231 CID)	1980-79	14 Bolt Oil Pan	635-504
V6 - 3.8L (231 CID)	1980-79	20 Bolt Oil Pan, Vin 3	635-503
V6 - 3.8L (231 CID)	1980-79	20 Bolt Oil Pan, Vin A	635-503
V6 - 3.8L (231 CID)	1978-76	-	635-504
V6 - 4.1L (252 CID)	1984-82	14 Bolt Oil Pan	635-504
V8 - 5.7L (350 CID)	1977-76	Vin H	635-504
V8 - 5.7L (350 CID)	1977-76	Vin J	635-504
RIVIERA			
V6 - 3.8L (231 CID)	1992-91	-	635-514
V6 - 3.8L (231 CID)	1987-85	-	635-503
V6 - 3.8L (231 CID)	1984-82	14 Bolt Oil Pan	635-504
V6 - 4.1L (252 CID)	1984-82	14 Bolt Oil Pan	635-504
V6 - 4.1L (252 CID)	1981	-	635-504
V8 - 5.7L (350 CID)	1978	Vin X	635-504
V8 - 5.7L (350 CID)	1977	Vin J	635-504
ROADMASTER			
V8 - 5.0L (305 CID)	1991	-	635-509
V8 - 5.7L (350 CID)	1993-92	-	635-509

Timing Cover Kits

Timing Cover Kit Applications

Make/ Model/Engine	Years	Description	Dorman #
BUICK (continued)			
SKYHAWK			
V6 - 3.8L (231 CID)	1980	14 Bolt Oil Pan	635-504
V6 - 3.8L (231 CID)	1979	14 Bolt Oil Pan	635-504
V6 - 3.8L (231 CID)	1979	20 Bolt Oil Pan	635-503
V6 - 3.8L (231 CID)	1978-77	-	635-504
V6 - 3.8L (231 CID)	1976	-	635-504
SKYLARK			
L4 - 2.5L (151 CID)	1991-87	-	635-501
L4 - 2.5L (151 CID)	1985-82	-	635-506
V6 - 3.0L (181 CID)	1988-86	-	635-503
V6 - 3.8L (231 CID)	1979	14 Bolt Oil Pan	635-504
V6 - 3.8L (231 CID)	1978-76	-	635-504
V8 - 5.7L (350 CID)	1976	Vin H	635-504
V8 - 5.7L (350 CID)	1976	Vin J	635-504
SOMERSET			
L4 - 2.5L (151 CID)	1987	-	635-501
V6 - 3.0L (181 CID)	1987-86	-	635-503
V6 - 3.0L (181 CID)	1985	2 Water Bypass Nipples	635-503
CADILLAC			
DEVILLE			
V6 - 4.1L (252 CID)	1982	14 Bolt Oil Pan	635-504
V6 - 4.1L (252 CID)	1981-80	-	635-504
ELDORADO			
V6 - 4.1L (252 CID)	1982	14 Bolt Oil Pan	635-504
V6 - 4.1L (252 CID)	1981	-	635-504
ESCALADE			
V8 - 5.7L (350 CID)	2000-99	-	635-505
FLEETWOOD			
V6 - 4.1L (252 CID)	1982	14 Bolt Oil Pan	635-504
V6 - 4.1L (252 CID)	1981-80	-	635-504
FLEETWOOD (RWD)			
V8 - 5.0L (305 CID)	1992-91	-	635-509
V8 - 5.7L (350 CID)	1993-90	-	635-509
SEVILLE			
V6 - 4.1L (252 CID)	1982	14 Bolt Oil Pan	635-504
V6 - 4.1L (252 CID)	1981	-	635-504
CHEVROLET			
BEL AIR			
V8 - 6.5L (396 CID)	1969-66	-	635-511
V8 - 6.6L (400 CID)	1971-70	w/4 Barrel Carburetor	635-511
V8 - 6.6L (402 CID)	1972-71	-	635-511
V8 - 7.0L (427 CID)	1969-66	-	635-511
V8 - 7.4L (454 CID)	1975-70	-	635-511
BISCAYNE			
V8 - 6.5L (396 CID)	1969-66	-	635-511
V8 - 6.6L (400 CID)	1971-70	w/4 Barrel Carburetor	635-511
V8 - 6.6L (402 CID)	1972-71	-	635-511
V8 - 7.0L (427 CID)	1969-66	-	635-511
V8 - 7.4L (454 CID)	1972-70	-	635-511
BROOKWOOD			
V8 - 6.6L (400 CID)	1970	w/4 Barrel Carburetor	635-511
V8 - 6.6L (402 CID)	1972	-	635-511
CAMARO			
L4 - 2.5L (151 CID)	1986-82	-	635-506
V6 - 2.8L (173 CID)	1989-82	-	635-507
V6 - 3.1L (189 CID)	1992-90	-	635-507
V6 - 3.8L (231 CID)	1981-80	14 Bolt Oil Pan	635-504
V8 - 5.0L (305 CID)	1987-85	wo/EFI	635-509
V8 - 5.0L (305 CID)	1984-82	-	635-509
V8 - 5.7L (350 CID)	1994-93	-	635-508
V8 - 6.5L (396 CID)	1970-67	-	635-511
V8 - 6.6L (402 CID)	1972-70	-	635-511
CAPRICE			
V6 - 3.8L (231 CID)	1984-80	14 Bolt Oil Pan	635-504
V6 - 3.8L (231 CID)	1984-80	20 Bolt Oil Pan	635-503
V6 - 4.3L (262 CID)	1993-92	w/Welded Pointer	635-512
V8 - 4.4L (267 CID)	1982	-	635-509
V8 - 5.0L (305 CID)	1993-82	-	635-509
V8 - 5.7L (350 CID)	1993-91	-	635-509
V8 - 6.5L (396 CID)	1969-66	-	635-511
V8 - 6.6L (400 CID)	1971-70	w/4 Barrel Carburetor	635-511
V8 - 6.6L (402 CID)	1972-71	-	635-511
V8 - 7.0L (427 CID)	1969-66	-	635-511
V8 - 7.4L (454 CID)	1976-70	-	635-511
CELEBRITY			
L4 - 2.5L (151 CID)	1990-82	-	635-506
CHEVELLE			
V8 - 6.5L (396 CID)	1969-66	-	635-511
V8 - 6.6L (400 CID)	1971-70	w/4 Barrel Carburetor	635-511
V8 - 6.6L (402 CID)	1972-70	-	635-511

Make/ Model/Engine	Years	Description	Dorman #
CHEVROLET (continued)			
CHEVELLE (continued)			
V8 - 7.4L (454 CID)	1973-70	-	635-511
CHEVY II			
V8 - 6.5L (396 CID)	1969-68	-	635-511
CITATION			
L4 - 2.5L (151 CID)	1985-82	-	635-506
CORVETTE			
V8 - 5.7L (350 CID)	1994-92	Exc. ZR-1	635-508
V8 - 7.0L (427 CID)	1969-66	-	635-511
V8 - 7.4L (454 CID)	1974-70	-	635-511
EL CAMINO			
V6 - 3.8L (231 CID)	1984-82	14 Bolt Oil Pan	635-504
V6 - 3.8L (231 CID)	1984-82	20 Bolt Oil Pan	635-503
V6 - 3.8L (231 CID)	1981-80	14 Bolt Oil Pan, Vin A	635-504
V6 - 3.8L (231 CID)	1981-80	20 Bolt Oil Pan, Vin A	635-503
V6 - 3.8L (231 CID)	1979	14 Bolt Oil Pan	635-504
V6 - 3.8L (231 CID)	1979	20 Bolt Oil Pan	635-503
V6 - 3.8L (231 CID)	1978	14 Bolt Oil Pan	635-504
V8 - 4.4L (267 CID)	1982	-	635-509
V8 - 5.0L (305 CID)	1987-82	-	635-509
V8 - 6.5L (396 CID)	1970-66	-	635-511
V8 - 6.6L (400 CID)	1970	w/4 Barrel Carburetor	635-511
V8 - 6.6L (402 CID)	1972-71	-	635-511
V8 - 7.4L (454 CID)	1974-70	-	635-511
IMPALA			
V6 - 3.8L (231 CID)	1984-80	14 Bolt Oil Pan	635-504
V6 - 3.8L (231 CID)	1984-80	20 Bolt Oil Pan	635-503
V8 - 4.4L (267 CID)	1982	-	635-509
V8 - 5.0L (305 CID)	1985-82	-	635-509
V8 - 6.5L (396 CID)	1969-66	-	635-511
V8 - 6.6L (400 CID)	1971-70	w/4 Barrel Carburetor	635-511
V8 - 6.6L (402 CID)	1972-71	-	635-511
V8 - 7.0L (427 CID)	1969-66	-	635-511
V8 - 7.4L (454 CID)	1976-70	-	635-511
KINGSWOOD			
V8 - 6.6L (400 CID)	1971-70	w/4 Barrel Carburetor	635-511
V8 - 6.6L (402 CID)	1972-71	-	635-511
V8 - 7.4L (454 CID)	1972-70	-	635-511
LAGUNA			
V8 - 7.4L (454 CID)	1974-73	-	635-511
LUMINA			
L4 - 2.5L (151 CID)	1990	-	635-506
LUMINA APV			
V6 - 3.8L (231 CID)	1992	-	635-514
MALIBU			
V6 - 3.8L (231 CID)	1983-82	14 Bolt Oil Pan	635-504
V6 - 3.8L (231 CID)	1983-82	20 Bolt Oil Pan	635-503
V6 - 3.8L (231 CID)	1981-80	14 Bolt Oil Pan, Vin A	635-504
V6 - 3.8L (231 CID)	1981-80	20 Bolt Oil Pan, Vin A	635-503
V6 - 3.8L (231 CID)	1979	14 Bolt Oil Pan	635-504
V6 - 3.8L (231 CID)	1979	20 Bolt Oil Pan	635-503
V6 - 3.8L (231 CID)	1978	14 Bolt Oil Pan	635-504
V8 - 4.4L (267 CID)	1982	-	635-509
V8 - 5.0L (305 CID)	1983-82	-	635-509
V8 - 6.5L (396 CID)	1967-66	-	635-511
V8 - 7.4L (454 CID)	1975-73	-	635-511
MONTE CARLO			
V6 - 3.8L (231 CID)	1984-82	14 Bolt Oil Pan	635-504
V6 - 3.8L (231 CID)	1984-82	20 Bolt Oil Pan	635-503
V6 - 3.8L (231 CID)	1981-80	14 Bolt Oil Pan, Vin A	635-504
V6 - 3.8L (231 CID)	1981-80	20 Bolt Oil Pan, Vin A	635-503
V6 - 3.8L (231 CID)	1979	14 Bolt Oil Pan	635-504
V6 - 3.8L (231 CID)	1979	20 Bolt Oil Pan	635-503
V6 - 3.8L (231 CID)	1978	14 Bolt Oil Pan	635-504
V8 - 4.4L (267 CID)	1982	-	635-509
V8 - 5.0L (305 CID)	1988-82	-	635-509
V8 - 6.6L (400 CID)	1971-70	w/4 Barrel Carburetor	635-511
V8 - 6.6L (402 CID)	1972-70	-	635-511
V8 - 7.4L (454 CID)	1975-70	-	635-511
MONZA			
V6 - 3.2L (196 CID)	1979-78	14 Bolt Oil Pan	635-504
V6 - 3.8L (231 CID)	1980-79	14 Bolt Oil Pan, Vin A	635-504
V6 - 3.8L (231 CID)	1980-79	20 Bolt Oil Pan, Vin A	635-503
V6 - 3.8L (231 CID)	1978	14 Bolt Oil Pan	635-504
NOVA			
V8 - 6.5L (396 CID)	1970	-	635-511
V8 - 6.6L (402 CID)	1970	-	635-511
TOWNSMAN			
V8 - 6.6L (400 CID)	1971-70	w/4 Barrel Carburetor	635-511
V8 - 6.6L (402 CID)	1972	-	635-511

Timing Cover Kits

**Window
Lift Motors**
pg. 535-554

**Window
Regulators**
pg. 555-566

**Wiper
Motors**
pg. 567-572

**Wiper Transmission
Linkages**
pg. 573-576

**Includes All Gaskets
and Seals as Required**

Timing Cover Kits

Timing Cover Kit Applications

Make/ Model/Engine	Years	Description	Dorman #
CHEVROLET (continued)			
TOWNSMAN (continued)			
V8 - 7.4L (454 CID)	1972-70	-	635-511
CHEVROLET/GMC TRUCK			
ASTRO			
L4 - 2.5L (151 CID)	1990-85	-	635-506
V6 - 4.3L (262 CID)	2003-96	-	635-502
V6 - 4.3L (262 CID)	1993-92	Vin Z, w/Welded Pointer	635-512
V6 - 4.3L (262 CID)	1991-87	w/Welded Pointer	635-512
BLAZER			
V8 - 5.0L (305 CID)	1987-85	-	635-509
V8 - 5.0L (305 CID)	1978-77	-	635-510
V8 - 5.7L (350 CID)	1994-87	-	635-505
V8 - 5.7L (350 CID)	1986-77	Gas Engine	635-510
V8 - 7.4L (454 CID)	1978-73	-	635-511
C,K SERIES PICKUP			
V6 - 4.3L (262 CID)	1998-96	-	635-502
V6 - 4.3L (262 CID)	1993-88	w/Welded Pointer	635-512
V8 - 5.0L (305 CID)	1999-88	-	635-505
V8 - 5.0L (305 CID)	1986-85	-	635-509
V8 - 5.7L (350 CID)	2000-88	-	635-505
V8 - 5.7L (350 CID)	1986-77	Gas Engine	635-510
V8 - 6.0L (366 CID)	1966	-	635-511
V8 - 6.5L (396 CID)	1969-68	-	635-511
V8 - 6.6L (400 CID)	1971-70	w/4 Barrel Carburetor	635-511
V8 - 6.6L (402 CID)	1972-71	-	635-511
V8 - 7.4L (454 CID)	1990-88	-	635-511
V8 - 7.4L (454 CID)	1986-73	-	635-511
EXPRESS			
V6 - 4.3L (262 CID)	2003-96	-	635-502
V8 - 5.0L (305 CID)	2002-96	-	635-505
V8 - 5.7L (350 CID)	2002-96	-	635-505
G SERIES VAN			
V6 - 4.3L (262 CID)	1998-96	-	635-502
V8 - 5.0L (305 CID)	1998-87	-	635-505
V8 - 5.7L (350 CID)	1996-87	-	635-505
V8 - 7.4L (454 CID)	1990-73	-	635-511
JIMMY			
V8 - 5.0L (305 CID)	1987-85	-	635-509
V8 - 5.0L (305 CID)	1978-77	-	635-510
V8 - 5.7L (350 CID)	1991-87	-	635-505
V8 - 5.7L (350 CID)	1986-77	Gas Engine	635-510
V8 - 7.4L (454 CID)	1976-73	-	635-511
LLV (POSTAL VEHICLE)			
L4 - 2.5L (151 CID)	1993-87	-	635-506
MEDIUM DUTY TRUCK			
V8 - 6.0L (366 CID)	1990-83	-	635-511
V8 - 7.0L (427 CID)	1990-83	-	635-511
P SERIES VAN			
V6 - 4.3L (262 CID)	1999-96	-	635-502
V6 - 4.3L (262 CID)	1994-90	w/Welded Pointer	635-512
V8 - 5.7L (350 CID)	1999-87	-	635-505
V8 - 5.7L (350 CID)	1986-77	Exc. Motor Home	635-510
V8 - 6.0L (366 CID)	1967-66	-	635-511
V8 - 7.4L (454 CID)	1990-70	-	635-511
R,V SERIES PICKUP			
V8 - 5.0L (305 CID)	1987	-	635-509
V8 - 5.7L (350 CID)	1991-87	-	635-505
V8 - 7.4L (454 CID)	1990-87	-	635-511
S10 BLAZER			
L4 - 2.5L (151 CID)	1988-85	-	635-506
V6 - 2.8L (173 CID)	1990-83	-	635-507
V6 - 4.3L (262 CID)	2003-95	-	635-502
V6 - 4.3L (262 CID)	1992	Vin Z, w/Welded Pointer	635-512
V6 - 4.3L (262 CID)	1991-88	w/Welded Pointer	635-512
S10 PICKUP			
L4 - 2.5L (151 CID)	1993-85	-	635-506
V6 - 2.8L (173 CID)	1993-82	-	635-507
V6 - 4.3L (262 CID)	2003-95	-	635-502
V6 - 4.3L (262 CID)	1992	Vin Z, w/Welded Pointer	635-512
V6 - 4.3L (262 CID)	1991-88	w/Welded Pointer	635-512
S15 JIMMY			
L4 - 2.5L (151 CID)	1988-85	-	635-506
V6 - 2.8L (173 CID)	1989-83	-	635-507
V6 - 4.3L (262 CID)	2001-95	-	635-502
V6 - 4.3L (262 CID)	1992	Vin Z, w/Welded Pointer	635-512
V6 - 4.3L (262 CID)	1991-88	w/Welded Pointer	635-512
S15 PICKUP			
L4 - 2.5L (151 CID)	1990-85	-	635-506
V6 - 2.8L (173 CID)	1990-82	-	635-507
V6 - 4.3L (262 CID)	1990-88	w/Welded Pointer	635-512

Make/ Model/Engine	Years	Description	Dorman #
CHEVROLET/GMC TRUCK (continued)			
S15 SONOMA			
L4 - 2.5L (151 CID)	1993-91	-	635-506
V6 - 2.8L (173 CID)	1993-91	-	635-507
V6 - 4.3L (262 CID)	2003-95	-	635-502
V6 - 4.3L (262 CID)	1992	Vin Z, w/Welded Pointer	635-512
V6 - 4.3L (262 CID)	1991	w/Welded Pointer	635-512
S15 SYCLONE			
V6 - 4.3L (262 CID)	1991	w/Welded Pointer	635-512
S15 TYPHOON			
V6 - 4.3L (262 CID)	1993-92	w/Welded Pointer	635-512
SAFARI			
L4 - 2.5L (151 CID)	1990-85	-	635-506
V6 - 4.3L (262 CID)	2003-96	-	635-502
V6 - 4.3L (262 CID)	1993-92	Vin Z, w/Welded Pointer	635-512
V6 - 4.3L (262 CID)	1991-87	w/Welded Pointer	635-512
SAVANA			
V6 - 4.3L (262 CID)	2003-96	-	635-502
V8 - 5.0L (305 CID)	2002-96	-	635-505
V8 - 5.7L (350 CID)	2002-96	-	635-505
SIERRA			
V6 - 4.3L (262 CID)	2003-99	-	635-502
SILVERADO			
V6 - 4.3L (262 CID)	2003-99	-	635-502
SPRINT			
V8 - 6.6L (402 CID)	1975-71	-	635-511
V8 - 7.4L (454 CID)	1975-71	-	635-511
SUBURBAN			
V8 - 5.0L (305 CID)	1987-85	-	635-509
V8 - 5.0L (305 CID)	1978-77	-	635-510
V8 - 5.7L (350 CID)	1999-87	-	635-505
V8 - 5.7L (350 CID)	1986-77	Gas Engine	635-510
V8 - 6.0L (366 CID)	1966	-	635-511
V8 - 6.5L (396 CID)	1969-68	-	635-511
V8 - 6.6L (400 CID)	1971-70	w/4 Barrel Carburetor	635-511
V8 - 6.6L (402 CID)	1972-71	-	635-511
V8 - 7.4L (454 CID)	1990-73	-	635-511
TAHOE			
V8 - 5.7L (350 CID)	2000-95	-	635-505
YUKON			
V8 - 5.7L (350 CID)	2000-92	-	635-505
CHRYSLER			
CORDOBA			
V8 - 5.2L (318 CID)	1983-75	-	635-400
V8 - 5.9L (360 CID)	1979-75	-	635-400
FIFTH AVENUE			
V8 - 5.2L (318 CID)	1989-83	-	635-400
IMPERIAL			
V8 - 5.2L (318 CID)	1983-81	-	635-400
LEBARON			
V8 - 5.2L (318 CID)	1981-77	-	635-400
V8 - 5.9L (360 CID)	1979-78	-	635-400
NEW YORKER			
V8 - 5.2L (318 CID)	1982-79	-	635-400
V8 - 5.9L (360 CID)	1980-77	-	635-400
NEWPORT			
V8 - 5.2L (318 CID)	1981-79	-	635-400
V8 - 5.9L (360 CID)	1980-71	-	635-400
TOWN & COUNTRY			
V8 - 5.2L (318 CID)	1981-78	-	635-400
V8 - 5.9L (360 CID)	1979-78	-	635-400
DODGE			
ASPEN			
V8 - 5.2L (318 CID)	1980-76	-	635-400
V8 - 5.9L (360 CID)	1980-76	-	635-400
CHALLENGER			
V8 - 5.2L (318 CID)	1974-70	-	635-400
V8 - 5.6L (340 CID)	1973-70	-	635-400
V8 - 5.9L (360 CID)	1974	-	635-400
CHARGER			
V8 - 5.2L (318 CID)	1978-70	-	635-400
V8 - 5.6L (340 CID)	1973-71	-	635-400
V8 - 5.9L (360 CID)	1978-74	-	635-400
CORONET			
V8 - 5.2L (318 CID)	1976-70	-	635-400
V8 - 5.6L (340 CID)	1973-72	-	635-400
V8 - 5.9L (360 CID)	1976-73	-	635-400
DART			
V8 - 5.2L (318 CID)	1976-70	-	635-400
V8 - 5.6L (340 CID)	1973-70	-	635-400
V8 - 5.9L (360 CID)	1976-74	-	635-400

Timing Cover Kit Applications

Make/ Model/Engine	Years	Description	Dorman #
DODGE (continued)			
DIPLOMAT			
V8 - 5.2L (318 CID)	1989-77	-	635-400
V8 - 5.9L (360 CID)	1979-78	-	635-400
MAGNUM			
V8 - 5.2L (318 CID)	1979-78	-	635-400
V8 - 5.9L (360 CID)	1979-78	-	635-400
MIRADA			
V8 - 5.2L (318 CID)	1983-80	-	635-400
V8 - 5.9L (360 CID)	1980	-	635-400
MONACO			
V8 - 5.2L (318 CID)	1978-70	-	635-400
V8 - 5.9L (360 CID)	1978-71	-	635-400
POLARA			
V8 - 5.2L (318 CID)	1973-70	-	635-400
V8 - 5.9L (360 CID)	1973-71	-	635-400
ROYAL MONACO			
V8 - 5.2L (318 CID)	1977-75	-	635-400
V8 - 5.9L (360 CID)	1977-75	-	635-400
ST. REGIS			
V8 - 5.2L (318 CID)	1981-79	-	635-400
V8 - 5.9L (360 CID)	1980-79	-	635-400
DODGETRUCK			
A100 VAN			
V8 - 5.2L (318 CID)	1970	-	635-400
B100 VAN			
V8 - 5.2L (318 CID)	1980-71	-	635-400
V8 - 5.9L (360 CID)	1978-71	-	635-400
B150 VAN			
V6 - 3.9L (239 CID)	1991-88	-	635-400
V8 - 5.2L (318 CID)	1991-81	-	635-400
B200 VAN			
V8 - 5.2L (318 CID)	1980-71	-	635-400
V8 - 5.9L (360 CID)	1980-71	-	635-400
B250 VAN			
V6 - 3.9L (239 CID)	1991-88	-	635-400
V8 - 5.2L (318 CID)	1991-81	-	635-400
V8 - 5.9L (360 CID)	1989-81	-	635-400
B300 VAN			
V8 - 5.2L (318 CID)	1980-71	-	635-400
V8 - 5.9L (360 CID)	1980-71	-	635-400
B350 VAN			
V6 - 3.9L (239 CID)	1991-90	-	635-400
V8 - 5.2L (318 CID)	1991-81	-	635-400
V8 - 5.9L (360 CID)	1989-81	-	635-400
CB300			
V8 - 5.2L (318 CID)	1980-74	-	635-400
V8 - 5.9L (360 CID)	1980-74	-	635-400
D100 PICKUP			
V6 - 3.9L (239 CID)	1989-88	-	635-400
V8 - 5.2L (318 CID)	1989-70	-	635-400
V8 - 5.9L (360 CID)	1988-71	-	635-400
D150 PICKUP			
V6 - 3.9L (239 CID)	1991-88	-	635-400
V8 - 5.2L (318 CID)	1991-77	-	635-400
V8 - 5.9L (360 CID)	1989-77	-	635-400
D200 PICKUP			
V8 - 5.2L (318 CID)	1980-70	-	635-400
V8 - 5.9L (360 CID)	1980-71	-	635-400
D250 PICKUP			
V6 - 3.9L (239 CID)	1991-88	-	635-400
V8 - 5.2L (318 CID)	1991-81	-	635-400
V8 - 5.9L (360 CID)	1989-81	-	635-400
D300 PICKUP			
V8 - 5.2L (318 CID)	1980-70	-	635-400
V8 - 5.9L (360 CID)	1980-71	-	635-400
D350 PICKUP			
V8 - 5.2L (318 CID)	1983-81	-	635-400
V8 - 5.9L (360 CID)	1989-81	-	635-400
D400 PICKUP			
V8 - 5.9L (360 CID)	1981-78	-	635-400
D450 PICKUP			
V8 - 5.9L (360 CID)	1981-78	-	635-400
DAKOTA			
V6 - 3.9L (239 CID)	1991-87	-	635-400
V8 - 5.2L (318 CID)	1991-89	-	635-400
M300			
V8 - 5.2L (318 CID)	1974	-	635-400
M350			
V8 - 5.2L (318 CID)	1974	-	635-400

Make/ Model/Engine	Years	Description	Dorman #
DODGETRUCK (continued)			
P200 VAN			
V8 - 5.9L (360 CID)	1972-70	-	635-400
P300 VAN			
V8 - 5.9L (360 CID)	1972-71	-	635-400
RAMCHARGER			
V8 - 5.2L (318 CID)	1991-74	-	635-400
V8 - 5.9L (360 CID)	1989-74	-	635-400
RD200 PICKUP			
V8 - 5.2L (318 CID)	1980-78	-	635-400
V8 - 5.9L (360 CID)	1980-78	-	635-400
W100 PICKUP			
V6 - 3.9L (239 CID)	1989	-	635-400
V8 - 5.2L (318 CID)	1989-70	-	635-400
V8 - 5.9L (360 CID)	1988-72	-	635-400
W150 PICKUP			
V6 - 3.9L (239 CID)	1991-89	-	635-400
V8 - 5.2L (318 CID)	1991-77	-	635-400
V8 - 5.9L (360 CID)	1989-77	-	635-400
W200 PICKUP			
V8 - 5.2L (318 CID)	1980-70	-	635-400
V8 - 5.9L (360 CID)	1980-71	-	635-400
W250 PICKUP			
V8 - 5.2L (318 CID)	1991-81	-	635-400
V8 - 5.9L (360 CID)	1989-81	-	635-400
W300 PICKUP			
V8 - 5.2L (318 CID)	1980-70	-	635-400
V8 - 5.9L (360 CID)	1980-71	-	635-400
W350 PICKUP			
V8 - 5.2L (318 CID)	1983-82	-	635-400
V8 - 5.9L (360 CID)	1989-81	-	635-400
FORD			
COBRA			
V8 - 7.0L (429 CID)	1971-70	-	635-101
COUNTRY SEDAN			
L6 - 3.9L (240 CID)	1970-65	-	635-109
V8 - 4.7L (289 CID)	1967-66	-	635-107
V8 - 5.0L (302 CID)	1972-68	-	635-107
V8 - 5.8L (351 CID)	1974-69	Windsor Engine	635-107
V8 - 7.0L (429 CID)	1973-69	-	635-101
V8 - 7.5L (460 CID)	1974-72	-	635-101
COUNTRY SQUIRE			
L6 - 3.9L (240 CID)	1967-65	-	635-109
V8 - 4.7L (289 CID)	1967-66	-	635-107
V8 - 5.0L (302 CID)	1991-81	-	635-102
V8 - 5.0L (302 CID)	1980	Calif	635-102
V8 - 5.0L (302 CID)	1980	Exc. Calif	635-107
V8 - 5.0L (302 CID)	1979-68	-	635-107
V8 - 5.8L (351 CID)	1986-84	-	635-102
V8 - 5.8L (351 CID)	1983-80	w/EEC	635-102
V8 - 5.8L (351 CID)	1983-80	wo/EEC	635-107
V8 - 5.8L (351 CID)	1979	Windsor Engine, w/EEC	635-102
V8 - 5.8L (351 CID)	1979	Windsor Engine, wo/EEC	635-107
V8 - 5.8L (351 CID)	1974-69	Windsor Engine	635-107
V8 - 7.0L (429 CID)	1973-69	-	635-101
V8 - 7.5L (460 CID)	1978-72	-	635-101
CROWN VICTORIA			
V8 - 5.0L (302 CID)	1991-83	-	635-102
V8 - 5.8L (351 CID)	1991-84	-	635-102
V8 - 5.8L (351 CID)	1983	w/EEC	635-102
V8 - 5.8L (351 CID)	1983	wo/EEC	635-107
CUSTOM			
L6 - 3.9L (240 CID)	1972-68	-	635-109
V8 - 4.7L (289 CID)	1967-66	-	635-107
V8 - 5.0L (302 CID)	1972-68	-	635-107
V8 - 5.8L (351 CID)	1972-69	Windsor Engine	635-107
V8 - 7.0L (429 CID)	1972-69	-	635-101
CUSTOM 500			
L6 - 3.9L (240 CID)	1972-68	-	635-109
V8 - 4.7L (289 CID)	1968	-	635-107
V8 - 5.0L (302 CID)	1972-68	-	635-107
V8 - 5.8L (351 CID)	1977-69	Windsor Engine	635-107
V8 - 7.0L (429 CID)	1973-69	-	635-101
V8 - 7.5L (460 CID)	1976-73	-	635-101
ELITE			
V8 - 5.8L (351 CID)	1976-75	Windsor Engine	635-107
FAIRLANE			
V8 - 4.7L (289 CID)	1968-66	-	635-107
V8 - 5.0L (302 CID)	1970-68	-	635-107
V8 - 5.8L (351 CID)	1970-69	Windsor Engine	635-107

Timing Cover Kits

Clock Springs
pg. 25-24

Control Arms
pg. 55-66

CV Joint Boots & Accessories
pg. 55-66

Door Lock Actuators
pg. 67-72

Exhaust Manifold Kits
pg. 73-134

Includes All Gaskets and Seals as Required

Timing Cover Kits

Timing Cover Kit Applications

Make/ Model/Engine	Years	Description	Dorman #
FORD (continued)			
FAIRLANE (continued)			
V8 - 7.0L (429 CID)	1970	-	635-101
FAIRMONT			
V8 - 4.2L (255 CID)	1982-80	w/EEC	635-102
V8 - 4.2L (255 CID)	1982-80	wo/EEC	635-107
V8 - 5.0L (302 CID)	1979-78	-	635-107
FALCON			
V8 - 4.7L (289 CID)	1968-66	-	635-107
V8 - 5.0L (302 CID)	1970-68	-	635-107
V8 - 7.0L (429 CID)	1970	-	635-101
GALAXIE			
L6 - 3.9L (240 CID)	1967-65	-	635-109
V8 - 4.7L (289 CID)	1967-66	-	635-107
GALAXIE 500			
L6 - 3.9L (240 CID)	1972-68	-	635-109
V8 - 5.0L (302 CID)	1972-68	-	635-107
V8 - 5.8L (351 CID)	1974-69	Windsor Engine	635-107
V8 - 7.0L (429 CID)	1973-69	-	635-101
V8 - 7.5L (460 CID)	1974-73	-	635-101
GRAN TORINO			
V8 - 5.0L (302 CID)	1974-72	-	635-107
V8 - 5.8L (351 CID)	1976-72	Windsor Engine	635-107
V8 - 7.0L (429 CID)	1973-72	-	635-101
V8 - 7.5L (460 CID)	1976-74	-	635-101
GRANADA			
V8 - 4.2L (255 CID)	1981-80	w/EEC	635-102
V8 - 4.2L (255 CID)	1981-80	wo/EEC	635-107
V8 - 5.0L (302 CID)	1980-75	-	635-107
V8 - 5.8L (351 CID)	1977-75	Windsor Engine	635-107
LTD			
V6 - 3.8L (232 CID)	1986-84	Vin 3	635-108
V8 - 4.2L (255 CID)	1982-81	w/EEC	635-102
V8 - 4.2L (255 CID)	1982-81	wo/EEC	635-107
V8 - 4.7L (289 CID)	1968-67	-	635-107
V8 - 5.0L (302 CID)	1985-81	-	635-102
V8 - 5.0L (302 CID)	1980	Calif	635-102
V8 - 5.0L (302 CID)	1980	Exc. Calif	635-107
V8 - 5.0L (302 CID)	1979-68	-	635-107
V8 - 5.8L (351 CID)	1982-80	w/EEC	635-102
V8 - 5.8L (351 CID)	1982-80	wo/EEC	635-107
V8 - 5.8L (351 CID)	1979	Windsor Engine, w/EEC	635-102
V8 - 5.8L (351 CID)	1979	Windsor Engine, w/EEC	635-107
V8 - 5.8L (351 CID)	1978-69	Windsor Engine	635-107
V8 - 7.0L (429 CID)	1973-69	-	635-101
V8 - 7.5L (460 CID)	1978-72	-	635-101
LTD II			
V8 - 5.0L (302 CID)	1979-77	-	635-107
V8 - 5.8L (351 CID)	1979	Windsor Engine, w/EEC	635-102
V8 - 5.8L (351 CID)	1979	Windsor Engine, w/EEC	635-107
V8 - 5.8L (351 CID)	1978-77	Windsor Engine	635-107
MAVERICK			
V8 - 5.0L (302 CID)	1977-71	-	635-107
MUSTANG			
V6 - 3.8L (232 CID)	2002-96	-	635-105
V6 - 3.8L (232 CID)	1986-84	Vin 3	635-108
V8 - 4.2L (255 CID)	1982-80	w/EEC	635-102
V8 - 4.2L (255 CID)	1982-80	wo/EEC	635-107
V8 - 4.7L (289 CID)	1968-66	-	635-107
V8 - 5.0L (302 CID)	1993-82	-	635-102
V8 - 5.0L (302 CID)	1979-68	-	635-107
V8 - 5.8L (351 CID)	1973-69	Windsor Engine	635-107
V8 - 7.0L (429 CID)	1971-70	-	635-101
MUSTANG II			
V8 - 5.0L (302 CID)	1978-75	-	635-107
RANCH WAGON			
L6 - 3.9L (240 CID)	1969-65	-	635-109
V8 - 4.7L (289 CID)	1968-66	-	635-107
V8 - 5.0L (302 CID)	1972-68	-	635-107
V8 - 5.8L (351 CID)	1974-69	Windsor Engine	635-107
V8 - 7.0L (429 CID)	1973-69	-	635-101
V8 - 7.5L (460 CID)	1976-73	-	635-101
RANCHERO			
V8 - 4.7L (289 CID)	1967-66	-	635-107
V8 - 5.0L (302 CID)	1979-68	-	635-107
V8 - 5.8L (351 CID)	1979	Windsor Engine, w/EEC	635-102
V8 - 5.8L (351 CID)	1979	Windsor Engine, w/EEC	635-107
V8 - 5.8L (351 CID)	1978-69	Windsor Engine	635-107

Make/ Model/Engine	Years	Description	Dorman #
FORD (continued)			
RANCHERO (continued)			
V8 - 7.0L (429 CID)	1973-70	-	635-101
V8 - 7.5L (460 CID)	1977-74	-	635-101
THUNDERBIRD			
V6 - 3.8L (232 CID)	1997-96	-	635-105
V6 - 3.8L (232 CID)	1986-84	Vin 3	635-108
V8 - 4.2L (255 CID)	1982-80	w/EEC	635-102
V8 - 4.2L (255 CID)	1982-80	wo/EEC	635-107
V8 - 5.0L (302 CID)	1988-81	-	635-102
V8 - 5.0L (302 CID)	1980	Calif	635-102
V8 - 5.0L (302 CID)	1980	Exc. Calif	635-107
V8 - 5.0L (302 CID)	1979-77	-	635-107
V8 - 5.8L (351 CID)	1979	Windsor Engine, w/EEC	635-102
V8 - 5.8L (351 CID)	1979	Windsor Engine,	
		wo/EEC	635-107
V8 - 5.8L (351 CID)	1978-77	Windsor Engine	635-107
V8 - 7.0L (429 CID)	1973-68	-	635-101
V8 - 7.5L (460 CID)	1976-72	-	635-101
TORINO			
V8 - 4.7L (289 CID)	1968	-	635-107
V8 - 5.0L (302 CID)	1974-68	-	635-107
V8 - 5.8L (351 CID)	1976-69	Windsor Engine	635-107
V8 - 7.0L (429 CID)	1973-70	-	635-101
V8 - 7.5L (460 CID)	1976-73	-	635-101
FORD TRUCK			
BRONCO			
L6 - 3.9L (240 CID)	1967-66	-	635-109
L6 - 4.9L (300 CID)	1993-80	-	635-109
V8 - 4.7L (289 CID)	1968-66	-	635-107
V8 - 5.0L (302 CID)	1996-87	-	635-100
V8 - 5.0L (302 CID)	1986-85	w/EFI	635-102
V8 - 5.0L (302 CID)	1984-80	w/EEC	635-102
V8 - 5.0L (302 CID)	1984-80	wo/EEC	635-107
V8 - 5.0L (302 CID)	1977-68	-	635-107
V8 - 5.8L (351 CID)	1996-88	-	635-100
V8 - 5.8L (351 CID)	1987-83	-	635-102
V8 - 5.8L (351 CID)	1982-81	Windsor Engine	635-102
V8 - 5.8L (351 CID)	1980-78	Windsor Engine	635-102
CLUB WAGON			
L6 - 3.9L (240 CID)	1967	-	635-109
E SUPER DUTY			
L6 - 4.9L (300 CID)	1996	-	635-109
V8 - 5.8L (351 CID)	1996	-	635-100
E-100 ECONOLINE			
L6 - 3.9L (240 CID)	1974-67	-	635-109
L6 - 4.9L (300 CID)	1983-72	-	635-109
V8 - 5.0L (302 CID)	1983-80	w/EEC	635-102
V8 - 5.0L (302 CID)	1983-80	wo/EEC	635-107
V8 - 5.0L (302 CID)	1975-68	-	635-107
V8 - 5.8L (351 CID)	1983	-	635-102
V8 - 5.8L (351 CID)	1982-81	Windsor Engine	635-102
V8 - 5.8L (351 CID)	1980-75	Windsor Engine	635-107
V8 - 7.5L (460 CID)	1978	-	635-101
E-150 ECONOLINE			
L6 - 4.9L (300 CID)	1996-75	-	635-109
V6 - 4.2L (256 CID)	2003-97	-	635-105
V8 - 5.0L (302 CID)	1996-87	-	635-100
V8 - 5.0L (302 CID)	1986	w/EFI	635-102
V8 - 5.0L (302 CID)	1985	wo/EFI	635-102
V8 - 5.0L (302 CID)	1984-80	w/EEC	635-102
V8 - 5.0L (302 CID)	1984-80	wo/EEC	635-107
V8 - 5.0L (302 CID)	1975	-	635-107
V8 - 5.8L (351 CID)	1996-88	-	635-100
V8 - 5.8L (351 CID)	1987-83	-	635-102
V8 - 5.8L (351 CID)	1982-81	Windsor Engine	635-102
V8 - 5.8L (351 CID)	1980-75	Windsor Engine	635-107
V8 - 7.5L (460 CID)	1980-76	-	635-101
E-200 ECONOLINE			
L6 - 3.9L (240 CID)	1974-67	-	635-109
L6 - 4.9L (300 CID)	1974-72	-	635-109
V8 - 5.0L (302 CID)	1974-68	-	635-107
E-250 ECONOLINE			
L6 - 4.9L (300 CID)	1996-75	-	635-109
V6 - 4.2L (256 CID)	2003-97	-	635-105
V8 - 5.0L (302 CID)	1993-87	-	635-100
V8 - 5.0L (302 CID)	1986	w/EFI	635-102
V8 - 5.0L (302 CID)	1985	wo/EFI	635-102
V8 - 5.0L (302 CID)	1984-80	w/EEC	635-102
V8 - 5.0L (302 CID)	1984-80	wo/EEC	635-107
V8 - 5.0L (302 CID)	1975	-	635-107

Timing Cover Kit Applications

Make/ Model/Engine	Years	Description	Dorman #
FORD TRUCK (continued)			
E-250 ECONOLINE (continued)			
V8 - 5.8L (351 CID)	1996-88	-	635-100
V8 - 5.8L (351 CID)	1987-83	-	635-102
V8 - 5.8L (351 CID)	1982-81	Windsor Engine	635-102
V8 - 5.8L (351 CID)	1980-75	Windsor Engine	635-107
V8 - 7.5L (460 CID)	1996-75	-	635-101
E-300 ECONOLINE			
L6 - 3.9L (240 CID)	1974-67	-	635-109
L6 - 4.9L (300 CID)	1974-72	-	635-109
V8 - 5.0L (302 CID)	1974-68	-	635-107
E-350 ECONOLINE			
L6 - 4.9L (300 CID)	1996-75	-	635-109
V8 - 5.0L (302 CID)	1982-80	w/EEC	635-102
V8 - 5.0L (302 CID)	1982-80	wo/EEC	635-107
V8 - 5.0L (302 CID)	1975	-	635-107
V8 - 5.8L (351 CID)	1996-88	-	635-100
V8 - 5.8L (351 CID)	1987-83	-	635-102
V8 - 5.8L (351 CID)	1982-81	Windsor Engine	635-102
V8 - 5.8L (351 CID)	1980-75	Windsor Engine	635-107
V8 - 7.5L (460 CID)	1996-75	-	635-101
EXPLORER			
V8 - 5.0L (302 CID)	2001-96	-	635-106
F-100 PICKUP			
L6 - 3.9L (240 CID)	1975-65	-	635-109
L6 - 4.9L (300 CID)	1983-65	-	635-109
V8 - 4.2L (255 CID)	1982-81	-	635-102
V8 - 5.0L (302 CID)	1983-80	w/EEC	635-102
V8 - 5.0L (302 CID)	1983-80	wo/EEC	635-107
V8 - 5.0L (302 CID)	1979-69	-	635-107
V8 - 5.8L (351 CID)	1981	Windsor Engine	635-102
V8 - 5.8L (351 CID)	1979-77	Windsor Engine	635-107
V8 - 7.5L (460 CID)	1979-73	-	635-101
F-150 PICKUP			
L6 - 3.9L (240 CID)	1976-75	-	635-109
L6 - 4.9L (300 CID)	1996-75	-	635-109
V6 - 4.2L (256 CID)	2003-97	-	635-105
V8 - 5.0L (302 CID)	1996-87	-	635-100
V8 - 5.0L (302 CID)	1986	w/EFI	635-102
V8 - 5.0L (302 CID)	1985	-	635-102
V8 - 5.0L (302 CID)	1984-80	w/EEC	635-102
V8 - 5.0L (302 CID)	1984-80	wo/EEC	635-107
V8 - 5.0L (302 CID)	1979-75	-	635-107
V8 - 5.8L (351 CID)	1996-88	-	635-100
V8 - 5.8L (351 CID)	1987-83	-	635-102
V8 - 5.8L (351 CID)	1982-81	Windsor Engine	635-102
V8 - 5.8L (351 CID)	1980-77	Windsor Engine	635-107
V8 - 7.5L (460 CID)	1979-75	-	635-101
F-250 PICKUP			
L6 - 3.9L (240 CID)	1974-65	-	635-109
L6 - 4.9L (300 CID)	1996-65	-	635-109
V6 - 4.2L (256 CID)	1998-97	-	635-105
V8 - 5.0L (302 CID)	1996-87	-	635-100
V8 - 5.0L (302 CID)	1986	w/EFI	635-102
V8 - 5.0L (302 CID)	1985	-	635-102
V8 - 5.0L (302 CID)	1984-80	w/EEC	635-102
V8 - 5.0L (302 CID)	1984-80	wo/EEC	635-107
V8 - 5.0L (302 CID)	1979-72	-	635-107
V8 - 5.8L (351 CID)	1997-88	-	635-100
V8 - 5.8L (351 CID)	1987-83	-	635-102
V8 - 5.8L (351 CID)	1982-81	Windsor Engine	635-102
V8 - 5.8L (351 CID)	1980-77	Windsor Engine	635-107
V8 - 7.5L (460 CID)	1996-73	-	635-101
F-350 PICKUP			
L6 - 3.9L (240 CID)	1974-65	-	635-109
L6 - 4.9L (300 CID)	1996-65	-	635-109
V8 - 5.0L (302 CID)	1980	w/EEC	635-102
V8 - 5.0L (302 CID)	1980	wo/EEC	635-107
V8 - 5.0L (302 CID)	1979-72	-	635-107
V8 - 5.8L (351 CID)	1997-88	-	635-100
V8 - 5.8L (351 CID)	1987-83	-	635-102
V8 - 5.8L (351 CID)	1982-81	Windsor Engine	635-102
V8 - 5.8L (351 CID)	1980-77	Windsor Engine	635-107
V8 - 7.5L (460 CID)	1996-73	-	635-101
F-450 SUPER DUTY PICKUP			
V8 - 7.5L (460 CID)	1996-88	-	635-101
F53 STRIPPED CHASSIS			
V8 - 7.5L (460 CID)	1996-89	-	635-101
P-350			
L6 - 3.9L (240 CID)	1972-68	-	635-109
L6 - 4.9L (300 CID)	1976-68	-	635-109

Make/ Model/Engine	Years	Description	Dorman #
FORD TRUCK (continued)			
P-350 (continued)			
V8 - 5.0L (302 CID)	1976-72	-	635-107
P-400			
L6 - 4.9L (300 CID)	1976-75	-	635-109
V8 - 5.0L (302 CID)	1976-75	-	635-107
P-500			
L6 - 4.9L (300 CID)	1977-75	-	635-109
V8 - 5.0L (302 CID)	1977-75	-	635-107
WINDSTAR			
V6 - 3.8L (232 CID)	2003-96	-	635-105
LINCOLN			
CONTINENTAL			
V8 - 5.0L (302 CID)	1987-80	-	635-102
V8 - 5.8L (351 CID)	1980	-	635-102
V8 - 7.0L (429 CID)	1968	-	635-101
V8 - 7.5L (460 CID)	1978-68	-	635-101
MARK SERIES			
V8 - 7.5L (460 CID)	1978-68	-	635-101
MARK VI			
V8 - 5.0L (302 CID)	1983-80	-	635-102
V8 - 5.8L (351 CID)	1980	-	635-102
MARK VII			
V8 - 5.0L (302 CID)	1992-84	-	635-102
TOWN CAR			
V8 - 5.0L (302 CID)	1990-82	-	635-102
VERSAILLES			
V8 - 5.0L (302 CID)	1980	-	635-102
V8 - 5.0L (302 CID)	1979-77	-	635-107
V8 - 5.8L (351 CID)	1977	Windsor Engine	635-107
MERCURY			
CALIENTE			
V8 - 4.7L (289 CID)	1967	-	635-107
CAPRI			
V6 - 3.8L (232 CID)	1986-84	Vin 3	635-108
V8 - 4.2L (255 CID)	1982-80	w/EEC	635-102
V8 - 4.2L (255 CID)	1982-80	wo/EEC	635-107
V8 - 5.0L (302 CID)	1986-82	-	635-102
V8 - 5.0L (302 CID)	1979	-	635-107
COLONY PARK			
V8 - 5.0L (302 CID)	1991-81	-	635-102
V8 - 5.0L (302 CID)	1980	Calif	635-102
V8 - 5.0L (302 CID)	1980	Exc. Calif	635-107
V8 - 5.0L (302 CID)	1979	-	635-107
V8 - 5.8L (351 CID)	1981-80	w/EEC	635-102
V8 - 5.8L (351 CID)	1981-80	wo/EEC	635-107
V8 - 5.8L (351 CID)	1979	Windsor Engine, w/EEC	635-102
V8 - 5.8L (351 CID)	1979	Windsor Engine, wo/EEC	635-107
V8 - 5.8L (351 CID)	1973-71	Windsor Engine	635-107
V8 - 7.0L (429 CID)	1973-69	-	635-101
V8 - 7.5L (460 CID)	1976-72	-	635-101
COMET			
V8 - 4.7L (289 CID)	1967-66	-	635-107
V8 - 5.0L (302 CID)	1977-68	-	635-107
V8 - 5.8L (351 CID)	1969	Windsor Engine	635-107
COMMUTER			
V8 - 4.7L (289 CID)	1967	-	635-107
COUGAR			
V6 - 3.8L (232 CID)	1986-84	Vin 3	635-108
V8 - 4.2L (255 CID)	1982-80	w/EEC	635-102
V8 - 4.2L (255 CID)	1982-80	wo/EEC	635-107
V8 - 4.7L (289 CID)	1968-67	-	635-107
V8 - 5.0L (302 CID)	1988-81	-	635-102
V8 - 5.0L (302 CID)	1980	Calif	635-102
V8 - 5.0L (302 CID)	1980	Exc. Calif	635-107
V8 - 5.0L (302 CID)	1979-68	-	635-107
V8 - 5.8L (351 CID)	1979	Windsor Engine, w/EEC	635-102
V8 - 5.8L (351 CID)	1979	Windsor Engine, wo/EEC	635-107
V8 - 5.8L (351 CID)	1978-69	Windsor Engine	635-107
V8 - 5.8L (351 CID)	1971-70	-	635-101
V8 - 7.5L (460 CID)	1976-73	-	635-101
CYCLONE			
V8 - 4.7L (289 CID)	1967-66	-	635-107
V8 - 5.0L (302 CID)	1970-68	-	635-107
V8 - 5.8L (351 CID)	1971-69	Windsor Engine	635-107
V8 - 7.0L (429 CID)	1971-70	-	635-101
GRAND MARQUIS			
V8 - 4.2L (255 CID)	1982-81	w/EEC	635-102
V8 - 4.2L (255 CID)	1982-81	wo/EEC	635-107
V8 - 5.0L (302 CID)	1991-81	-	635-102
V8 - 5.0L (302 CID)	1980	Calif	635-102

Timing Cover Kits

Fuel Sending Units
pg. 155-176

Fuel Tanks
pg. 177-228

Harmonic Balancers
pg. 229-254

Heater Hose Assemblies
pg. 255-256

Hydraulic Clutch Lines
pg. 257-260

Includes All Gaskets and Seals as Required

Timing Cover Kits
481

Timing Cover Kit Applications

Make/ Model/Engine	Years	Description	Dorman #
MERCURY (continued)			
GRAND MARQUIS (continued)			
V8 - 5.0L (302 CID)	1980	Exc. Calif	635-107
V8 - 5.0L (302 CID)	1979	-	635-107
V8 - 5.8L (351 CID)	1981-80	w/EEC	635-102
V8 - 5.8L (351 CID)	1981-80	wo/EEC	635-107
V8 - 5.8L (351 CID)	1979	Windsor Engine, w/EEC	635-102
V8 - 5.8L (351 CID)	1979	Windsor Engine, wo/EEC	635-107
V8 - 5.8L (351 CID)	1978	Windsor Engine	635-107
V8 - 7.5L (460 CID)	1978-75	-	635-101
MARAUDER			
V8 - 7.0L (429 CID)	1970-69	-	635-101
MARQUIS			
V6 - 3.8L (232 CID)	1986-84	Vin 3	635-108
V8 - 4.2L (255 CID)	1982-81	w/EEC	635-102
V8 - 4.2L (255 CID)	1982-81	wo/EEC	635-107
V8 - 5.0L (302 CID)	1985-81	-	635-102
V8 - 5.0L (302 CID)	1980	Calif	635-102
V8 - 5.0L (302 CID)	1980	Exc. Calif	635-107
V8 - 5.0L (302 CID)	1979	-	635-107
V8 - 5.8L (351 CID)	1982-80	w/EEC	635-102
V8 - 5.8L (351 CID)	1982-80	wo/EEC	635-107
V8 - 5.8L (351 CID)	1979	Windsor Engine, w/EEC	635-102
V8 - 5.8L (351 CID)	1979	Windsor Engine,	
		wo/EEC	635-107
V8 - 5.8L (351 CID)	1978-71	Windsor Engine	635-107
V8 - 7.0L (429 CID)	1973-69	-	635-101
V8 - 7.5L (460 CID)	1978-72	-	635-101
MONARCH			
V8 - 4.2L (255 CID)	1980	w/EEC	635-102
V8 - 4.2L (255 CID)	1980	wo/EEC	635-107
V8 - 5.0L (302 CID)	1980-75	-	635-107
V8 - 5.8L (351 CID)	1977-75	Windsor Engine	635-107
MONTEGO			
V8 - 5.0L (302 CID)	1974-68	-	635-107
V8 - 5.8L (351 CID)	1976-69	Windsor Engine	635-107
V8 - 7.0L (429 CID)	1973-70	-	635-101
V8 - 7.5L (460 CID)	1976-73	-	635-101
MONTEREY			
V8 - 5.8L (351 CID)	1973-71	Windsor Engine	635-107
V8 - 7.0L (429 CID)	1973-69	-	635-101
V8 - 7.5L (460 CID)	1974-72	-	635-101
MOUNTAINEER			
V8 - 5.0L (302 CID)	2001-97	-	635-106
VILLAGER			
V8 - 4.7L (289 CID)	1967-66	-	635-107
VOYAGER			
V8 - 4.7L (289 CID)	1967-66	-	635-107
ZEPHYR			
V8 - 4.2L (255 CID)	1982-80	w/EEC	635-102
V8 - 4.2L (255 CID)	1982-80	wo/EEC	635-107
V8 - 5.0L (302 CID)	1979-78	-	635-107
NISSAN			
200SX			
L4 - 1.6L (1597 cc)	1998-95	Vin GA16DE	635-203
ALTIMA			
L4 - 2.4L (2389 cc)	2001-93	-	635-206
AXXESS			
L4 - 2.4L (2389 cc)	1990	Vin KA24E	635-204
NX			
L4 - 1.6L (1597 cc)	1993-91	-	635-202
SENTRA			
L4 - 1.6L (1597 cc)	1999-95	Vin GA16DE	635-203
L4 - 1.6L (1597 cc)	1994-91	-	635-202
L4 - 1.6L (1597 cc)	1990-89	-	635-201
STANZA			
L4 - 2.4L (2389 cc)	1992-90	Vin KA24E	635-204
NISSAN TRUCK			
D21 PICKUP			
L4 - 2.4L (2389 cc)	1996-90	Vin KA24E	635-205
OLDSMOBILE			
88			
V6 - 3.8L (231 CID)	1992	-	635-514
98			
V6 - 3.0L (181 CID)	1985	20 Bolt Oil Pan	635-503
V6 - 3.8L (231 CID)	1992-91	-	635-514
V6 - 3.8L (231 CID)	1987-86	-	635-503
V6 - 3.8L (231 CID)	1985	20 Bolt Oil Pan	635-503
V6 - 4.1L (252 CID)	1983-81	14 Bolt Oil Pan	635-504
BRAVADA			
V6 - 4.3L (262 CID)	1992	Vin Z, w/Welded Pointer	635-512

Make/ Model/Engine	Years	Description	Dorman #
OLDSMOBILE (continued)			
BRAVADA (continued)			
V6 - 4.3L (262 CID)	1991	w/Welded Pointer	635-512
CUSTOM CRUISER			
V8 - 5.0L (305 CID)	1992-91	-	635-509
V8 - 5.7L (350 CID)	1992	-	635-509
CUTLASS			
V6 - 3.8L (231 CID)	1987-85	-	635-503
V6 - 3.8L (231 CID)	1981-79	14 Bolt Oil Pan	635-504
V6 - 3.8L (231 CID)	1981-79	20 Bolt Oil Pan	635-503
V6 - 3.8L (231 CID)	1978-77	-	635-504
CUTLASS CALAIS			
L4 - 2.5L (151 CID)	1991-87	-	635-501
V6 - 3.0L (181 CID)	1988-86	-	635-503
V6 - 3.0L (181 CID)	1985	2 Water Bypass Nipples	635-503
V6 - 3.8L (231 CID)	1984-79	14 Bolt Oil Pan	635-504
V6 - 3.8L (231 CID)	1984-79	20 Bolt Oil Pan	635-503
V6 - 3.8L (231 CID)	1978	-	635-504
CUTLASS CIERA			
L4 - 2.5L (151 CID)	1990-82	-	635-506
V6 - 3.0L (181 CID)	1985	20 Bolt Oil Pan	635-503
V6 - 3.8L (231 CID)	1988-86	-	635-503
V6 - 3.8L (231 CID)	1985	20 Bolt Oil Pan	635-503
CUTLASS CRUISER			
V6 - 3.8L (231 CID)	1983-79	14 Bolt Oil Pan	635-504
V6 - 3.8L (231 CID)	1983-79	20 Bolt Oil Pan	635-503
V6 - 3.8L (231 CID)	1978	-	635-504
V8 - 5.0L (305 CID)	1982	-	635-509
CUTLASS SUPREME			
V6 - 3.8L (231 CID)	1987-85	-	635-503
V6 - 3.8L (231 CID)	1984-79	14 Bolt Oil Pan	635-504
V6 - 3.8L (231 CID)	1984-79	20 Bolt Oil Pan	635-503
V6 - 3.8L (231 CID)	1978-77	-	635-504
DELTA 88			
V6 - 3.0L (181 CID)	1986	-	635-503
V6 - 3.8L (231 CID)	1991	-	635-514
V6 - 3.8L (231 CID)	1988-86	Vin 3	635-503
V6 - 3.8L (231 CID)	1985	-	635-503
V6 - 3.8L (231 CID)	1984-79	14 Bolt Oil Pan	635-504
V6 - 3.8L (231 CID)	1984-79	20 Bolt Oil Pan	635-503
V6 - 3.8L (231 CID)	1978-77	-	635-504
OMEGA			
L4 - 2.5L (151 CID)	1984-82	-	635-506
V6 - 3.8L (231 CID)	1979	14 Bolt Oil Pan	635-504
V6 - 3.8L (231 CID)	1978-77	-	635-504
V8 - 5.7L (350 CID)	1976	-	635-504
SILHOUETTE			
V6 - 3.8L (231 CID)	1992	-	635-514
STARFIRE			
V6 - 3.8L (231 CID)	1980-79	14 Bolt Oil Pan	635-504
V6 - 3.8L (231 CID)	1980-79	20 Bolt Oil Pan	635-503
V6 - 3.8L (231 CID)	1978-76	-	635-504
TORONADO			
V6 - 3.8L (231 CID)	1992-91	-	635-514
V6 - 3.8L (231 CID)	1987-86	-	635-503
V6 - 4.1L (252 CID)	1981	14 Bolt Oil Pan	635-504
PLYMOUTH			
BARRACUDA			
V8 - 5.2L (318 CID)	1974-70	-	635-400
V8 - 5.6L (340 CID)	1973-72	-	635-400
V8 - 5.9L (360 CID)	1974	-	635-400
BELVEDERE			
V8 - 5.2L (318 CID)	1970	-	635-400
CUDA			
V8 - 5.2L (318 CID)	1974-72	-	635-400
V8 - 5.6L (340 CID)	1973-70	-	635-400
V8 - 5.9L (360 CID)	1974	-	635-400
DUSTER			
V8 - 5.2L (318 CID)	1976-70	-	635-400
V8 - 5.6L (340 CID)	1973-70	-	635-400
V8 - 5.9L (360 CID)	1976-74	-	635-400
FURY			
V8 - 5.2L (318 CID)	1978-70	-	635-400
V8 - 5.9L (360 CID)	1978-71	-	635-400
FURY I			
V8 - 5.2L (318 CID)	1973-70	-	635-400
V8 - 5.9L (360 CID)	1974-71	-	635-400
FURY II			
V8 - 5.2L (318 CID)	1973-70	-	635-400
V8 - 5.9L (360 CID)	1974-71	-	635-400

Timing Cover Kit Applications

Make/ Model/Engine	Years	Description	Dorman #
PLYMOUTH (continued)			
FURY III			
V8 - 5.2L (318 CID)	1973-70	-	635-400
V8 - 5.9L (360 CID)	1974-71	-	635-400
GRAN FURY			
V8 - 5.2L (318 CID)	1989-72	-	635-400
V8 - 5.9L (360 CID)	1980-72	-	635-400
ROADRUNNER			
V8 - 5.2L (318 CID)	1975-72	-	635-400
V8 - 5.6L (340 CID)	1973-71	-	635-400
V8 - 5.9L (360 CID)	1975-74	-	635-400
SATELLITE			
V8 - 5.2L (318 CID)	1974-70	-	635-400
V8 - 5.6L (340 CID)	1972	-	635-400
V8 - 5.9L (360 CID)	1974	-	635-400
SCAMP			
V8 - 5.2L (318 CID)	1976-71	-	635-400
VALIANT			
V8 - 5.2L (318 CID)	1976-70	-	635-400
V8 - 5.9L (360 CID)	1976	-	635-400
VOLARE			
V8 - 5.2L (318 CID)	1980-76	-	635-400
V8 - 5.9L (360 CID)	1980-76	-	635-400
PLYMOUTH TRUCK			
PB100 VAN			
V8 - 5.2L (318 CID)	1980-74	-	635-400
V8 - 5.9L (360 CID)	1978-74	-	635-400
PB150 VAN			
V8 - 5.2L (318 CID)	1983-81	-	635-400
PB200 VAN			
V8 - 5.2L (318 CID)	1980-74	-	635-400
V8 - 5.9L (360 CID)	1980-74	-	635-400
PB250 VAN			
V8 - 5.2L (318 CID)	1983-81	-	635-400
V8 - 5.9L (360 CID)	1981	-	635-400
PB300 VAN			
V8 - 5.2L (318 CID)	1980-74	-	635-400
V8 - 5.9L (360 CID)	1980-74	-	635-400
PB350 VAN			
V8 - 5.2L (318 CID)	1983-81	-	635-400
V8 - 5.9L (360 CID)	1983-81	-	635-400
TRAILDUSTER			
V8 - 5.2L (318 CID)	1981-74	-	635-400
V8 - 5.9L (360 CID)	1981-74	-	635-400
PONTIAC			
6000			
L4 - 2.5L (151 CID)	1990-82	-	635-506
BONNEVILLE			
V6 - 3.8L (231 CID)	1992-91	-	635-514
V6 - 3.8L (231 CID)	1988-87	Vin 3	635-503
V6 - 3.8L (231 CID)	1986-85	-	635-503
V6 - 3.8L (231 CID)	1984-80	14 Bolt Oil Pan	635-504
V6 - 3.8L (231 CID)	1984-80	20 Bolt Oil Pan	635-503
V6 - 4.1L (252 CID)	1982	14 Bolt Oil Pan	635-504
V8 - 5.0L (305 CID)	1986-83	-	635-509
V8 - 5.7L (350 CID)	1980-78	14 Bolt Oil Pan, Vin X	635-504
CATALINA			
V6 - 3.8L (231 CID)	1981-79	14 Bolt Oil Pan	635-504
V6 - 3.8L (231 CID)	1981-79	20 Bolt Oil Pan	635-503
V6 - 3.8L (231 CID)	1978-77	-	635-504
V8 - 5.7L (350 CID)	1980-78	14 Bolt Oil Pan, Vin X	635-504
FIERO			
L4 - 2.5L (151 CID)	1988-84	-	635-506

Make/ Model/Engine	Years	Description	Dorman #
PONTIAC (continued)			
FIREBIRD			
L4 - 2.5L (151 CID)	1986-82	-	635-506
V6 - 2.8L (173 CID)	1989-82	-	635-507
V6 - 3.1L (189 CID)	1982-90	-	635-507
V6 - 3.8L (231 CID)	1989	-	635-503
V6 - 3.8L (231 CID)	1981-79	14 Bolt Oil Pan	635-504
V6 - 3.8L (231 CID)	1978-77	-	635-504
V8 - 5.0L (305 CID)	1987-85	wo/EFI	635-509
V8 - 5.0L (305 CID)	1984-82	-	635-509
V8 - 5.7L (350 CID)	1994-93	-	635-508
GRAND AM			
L4 - 2.5L (151 CID)	1991-87	-	635-501
V6 - 3.0L (181 CID)	1987-86	-	635-503
V6 - 3.0L (181 CID)	1985	2 Water Bypass Nipples	635-503
V6 - 3.8L (231 CID)	1979	14 Bolt Oil Pan	635-504
V6 - 3.8L (231 CID)	1979	20 Bolt Oil Pan	635-503
GRAND LEMANS			
V6 - 3.8L (231 CID)	1981-79	14 Bolt Oil Pan	635-504
V6 - 3.8L (231 CID)	1981-79	20 Bolt Oil Pan	635-503
V6 - 3.8L (231 CID)	1978-77	-	635-504
GRAND PRIX			
V6 - 3.8L (231 CID)	1987-85	-	635-503
V6 - 3.8L (231 CID)	1984-80	14 Bolt Oil Pan	635-504
V6 - 3.8L (231 CID)	1984-80	20 Bolt Oil Pan	635-503
V6 - 3.8L (231 CID)	1979-78	-	635-504
V6 - 4.1L (252 CID)	1982	14 Bolt Oil Pan	635-504
V8 - 5.0L (305 CID)	1987-83	-	635-509
LEMANS			
V6 - 3.8L (231 CID)	1981-79	14 Bolt Oil Pan	635-504
V6 - 3.8L (231 CID)	1981-79	20 Bolt Oil Pan	635-503
V6 - 3.8L (231 CID)	1978-77	-	635-504
PARISIENNE			
V6 - 3.8L (231 CID)	1984	14 Bolt Oil Pan	635-504
V6 - 3.8L (231 CID)	1984	20 Bolt Oil Pan	635-503
V8 - 5.0L (305 CID)	1986-83	-	635-509
PHOENIX			
L4 - 2.5L (151 CID)	1984-82	-	635-506
V6 - 3.8L (231 CID)	1979	14 Bolt Oil Pan	635-504
V6 - 3.8L (231 CID)	1978-77	-	635-504
SUNBIRD			
V6 - 3.8L (231 CID)	1980-79	14 Bolt Oil Pan	635-504
V6 - 3.8L (231 CID)	1980-79	20 Bolt Oil Pan	635-503
V6 - 3.8L (231 CID)	1978-76	-	635-504
TRANS SPORT			
V6 - 3.8L (231 CID)	1992	-	635-514
VENTURA			
V6 - 3.8L (231 CID)	1977	-	635-504
V8 - 5.7L (350 CID)	1976	-	635-504
TOYOTA			
CELICA			
L4 - 2.4L (2366 cc)	1985	-	635-300
L4 - 2.4L (2366 cc)	1983-81	Vin 22R	635-301
CORONA			
L4 - 2.4L (2366 cc)	1982-81	Vin 22R	635-301
TOYOTA TRUCK			
4 RUNNER			
L4 - 2.4L (2366 cc)	1995-85	-	635-300
L4 - 2.4L (2366 cc)	1984	Vin 22R	635-301
PICKUP			
L4 - 2.4L (2366 cc)	1995-85	-	635-300
L4 - 2.4L (2366 cc)	1984-81	Vin 22R	635-301

Timing Cover Kits

**Power Steering
Pulleys**
pg. 317-326

**Quick
Disconnect™**
pg. 327-396

**Radiator Fan
Assemblies**
pg. 397-430

**Rear Axle
Shaft Kits**
pg. 431-434

**Side View Mirror
Assemblies**
pg. 435-468

**Includes All Gaskets
and Seals as Required**

Timing Cover Kits

TECH TRAYS



Have the Part You Need, When You Need It
STOP WASTING BAY TIME!

Part # 800-101* **QUICK DISCONNECT TRANSMISSION LINE CONNECTORS TECH TRAY** **NEW!** SECTION HP

* 16 SKUs, 28 pieces • Tray measures 13-1/8"W x 2-5/16"H x 9"D

800-601 Ford Taurus & Mercury Sable REORDER QTY: 1 ASSORTMENT QTY: 1	800-602 Various Ford Models 3/8" Tube REORDER QTY: 1 ASSORTMENT QTY: 1	800-603 GM C&K Series and G Series Trucks REORDER QTY: 1 ASSORTMENT QTY: 1	800-604 GM C&K Series, L&M Series and S&T Series Trucks REORDER QTY: 1 ASSORTMENT QTY: 1
800-605 GM C&K Series, S&T Series, L&M Series Trucks and W-Body Cars REORDER QTY: 1 ASSORTMENT QTY: 1	800-606 GM L&M Series, S&T Series Trucks REORDER QTY: 1 ASSORTMENT QTY: 1	800-607 GM C&K Series Trucks REORDER QTY: 1 ASSORTMENT QTY: 1	800-608 Ford 1994-02 5/16" Tube REORDER QTY: 1 ASSORTMENT QTY: 1
800-609 Ford Various Models REORDER QTY: 1 ASSORTMENT QTY: 1	800-610 Dodge Ram Trucks & Vans, Jeep Grand Cherokee REORDER QTY: 1 ASSORTMENT QTY: 1	800-713 Dodge Trucks REORDER QTY: 1 ASSORTMENT QTY: 1	800-714 Jeep Cherokee REORDER QTY: 1 ASSORTMENT QTY: 1
800-715 Dodge Ram Trucks, Diesels REORDER QTY: 1 ASSORTMENT QTY: 1	800-752 GM Cars REORDER QTY: 1 ASSORTMENT QTY: 1	800-812 GM Cars & Trucks REORDER QTY: 1 ASSORTMENT QTY: 1	800-801 3/8", 1/2", 5/8" Connector Clips REORDER QTY: 404 ASSORTMENT QTY: 404

800-101
Transmission Line Connectors



Part # 800-102* **QUICK DISCONNECT OIL LINE CONNECTORS TECH TRAY** **NEW!** SECTION HP

* 10 SKUs, 32 pieces • Tray measures 11"W x 1-3/4"H x 6-3/4"D

800-607 GM C/K Trucks 2003-96 REORDER QTY: 1 ASSORTMENT QTY: 1	800-701 GM C & K Series Trucks REORDER QTY: 1 ASSORTMENT QTY: 1	800-704 Oil Cooler Line Connector GM REORDER QTY: 1 ASSORTMENT QTY: 1	800-705 Oil Cooler Line Connector GM REORDER QTY: 1 ASSORTMENT QTY: 1	800-710 Oil Cooler Line Connector GM REORDER QTY: 1 ASSORTMENT QTY: 1	800-711 Oil Cooler Line Connector GM REORDER QTY: 1 ASSORTMENT QTY: 1
800-801 3/8" Connector Clip REORDER QTY: 8 ASSORTMENT QTY: 8	800-801 1/2" Connector Clip REORDER QTY: 8 ASSORTMENT QTY: 8	800-801 5/8" Connector Clip REORDER QTY: 8 ASSORTMENT QTY: 8	800-802 Oil Cooler Retaining Clips Plastic REORDER QTY: 2 ASSORTMENT QTY: 2		

800-102
Oil Line Connectors



Timing Cover Kits

Transmission Line Assemblies



*A little leak could mean big problems down the road.
Replace transmission lines at the first sign of failure.*

• **191 SKUs—the coverage you need**

Typical Failures

- Combination steel and rubber lines fail at the crimps due to compression set
- Steel lines corrode at connections
- Rubber lines dry-rot and crack
- If not replaced leaking lines can cause costly transmission damage

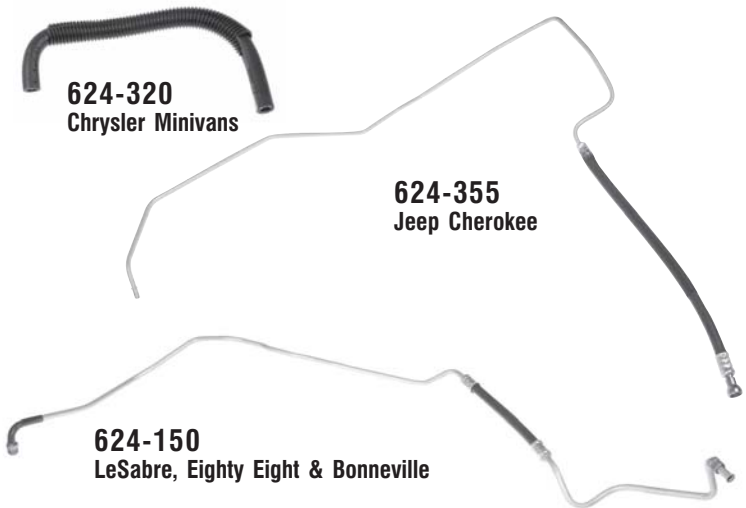

624-320
Chrysler Minivans

624-355
Jeep Cherokee

624-150
LeSabre, Eighty Eight & Bonneville

Dorman® OE Solutions™
Transmission Lines
feature:

- Exact OE Replacement
- Quality construction to prevent comebacks

Transmission Lines should be checked for leaks at every service.

Other Dorman Fluid Lines Available:

<i>Clutch</i>	<i>pages 257-260</i>	<i>Fuel</i>	<i>pages 149-154</i>
<i>Heater Hose</i>	<i>pages 255-256</i>	<i>Oil Cooler</i>	<i>pages 281-302</i>

Quick Disconnect Fittings Begin on page 327-362

Activant Path	<i>Auto Transmission/Transaxle / A/T, Filters & Parts</i>	Activant Code	<i>DTL</i>
----------------------	---	----------------------	------------

Applications begin on page 510.

Transmission Line Assemblies

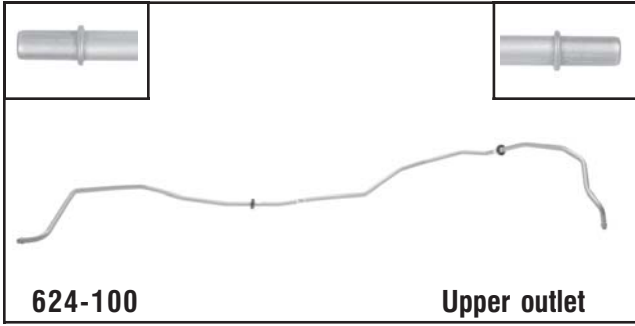

624-100

Upper outlet

GM
Fits 2005-96 S&T-Series 4.3L

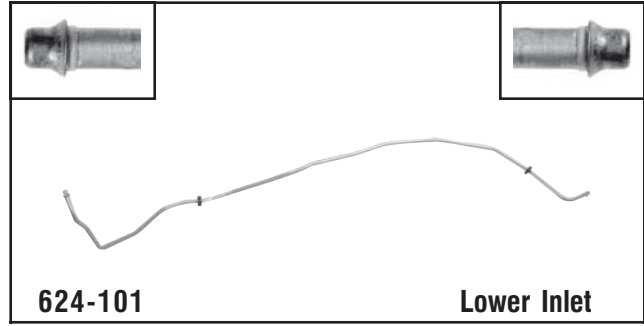

624-101

Lower Inlet

GM
Fits 2005-96 S&T-Series 4.3L

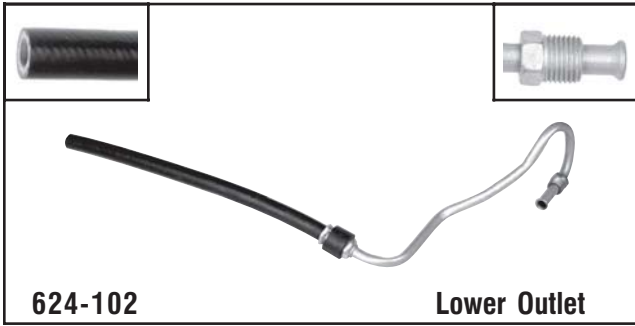

624-102

Lower Outlet

GM
Fits 1999-90 W Bodies w/ 3.1L & 3.4L

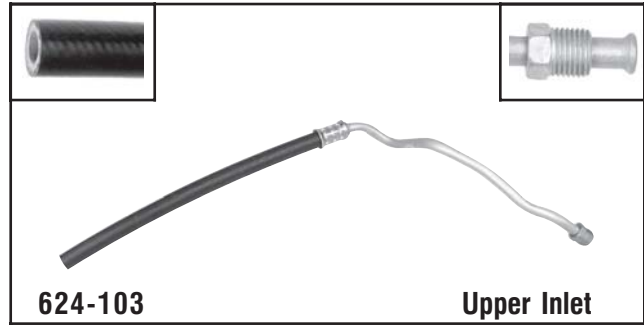

624-103

Upper Inlet

GM
Fits 1999-90 W Bodies w/ 3.1L & 3.4L

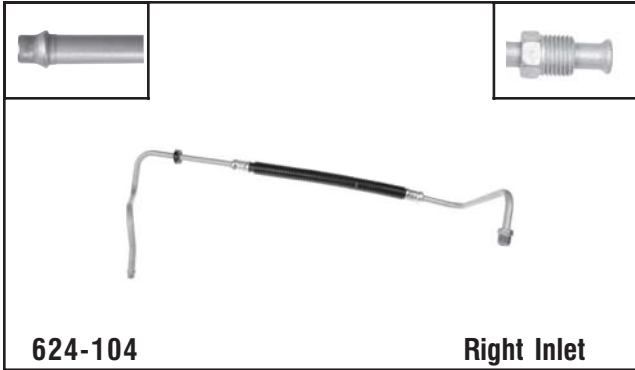

624-104

Right Inlet

GM
Fits 2002-96 C&K 3500 Series Pickups

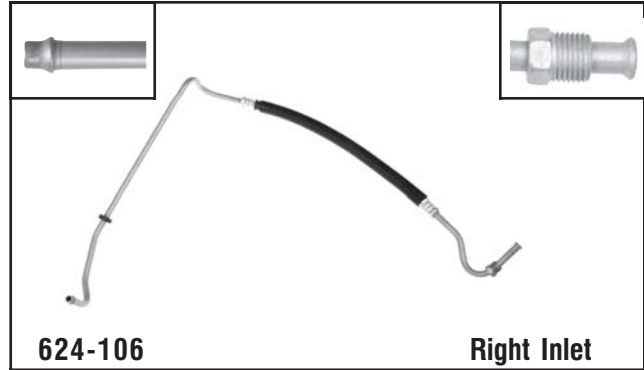

624-106

Right Inlet

GM
Fits 2000-96 C&K 2500 Series Pickups, 1999-96 Suburban

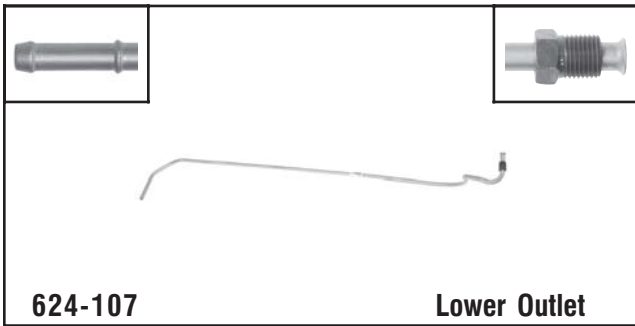

624-107

Lower Outlet

GM
Fits 1990-88 Bonneville, Delta 88, 98, Electra, LeSabre w/ 3.8L, Estate Wagon w/ 5.0L wo/Aux Cooler

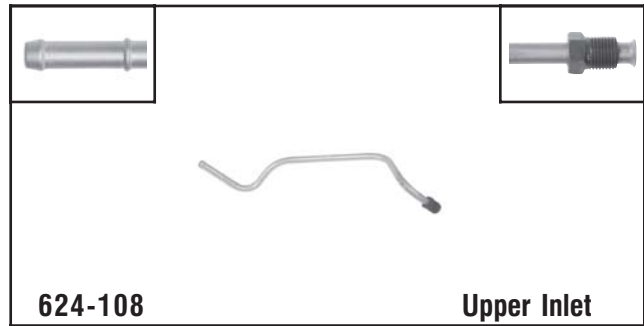

624-108

Upper Inlet

GM
Fits 1990-88 Bonneville, Delta 88, 98, Electra, LeSabre w/ 3.8L, Estate Wagon w/ 5.0L

Transmission Line Assemblies

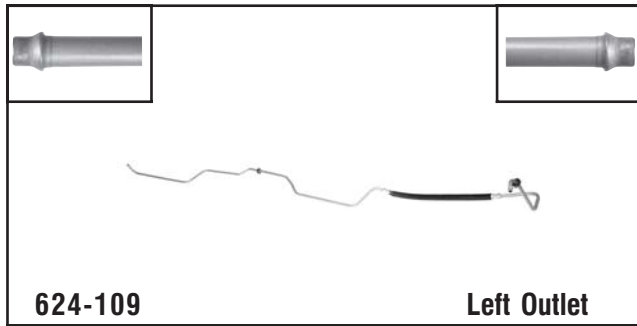

624-109 **Left Outlet**

GM
Fits 2000-97 C&K-Series Pickups, 1999-96 Yukon, 1998-97 Suburban w/ 5.7L

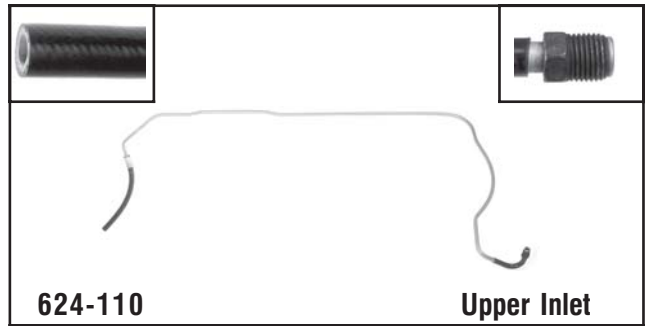

624-110 **Upper Inlet**

GM
Fits 1990-88 Bonneville, Delta 88, 98, Electra, LeSabre w/ 3.8L, Estate Wagon w/ 5.0L w/ Aux Cooler

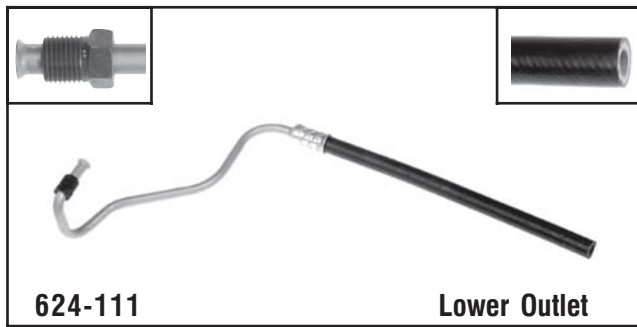

624-111 **Lower Outlet**

GM
Fits 1990-88 Bonneville, Delta 88, 98, Electra, LeSabre w/ 3.8L

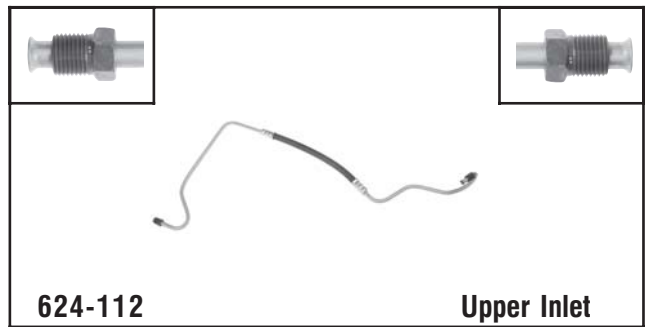

624-112 **Upper Inlet**

GM
Fits 1987-86 Bonneville, Delta 88, 98, Electra, LeSabre w/ 3.8L, Estate Wagon w/ 5.0L

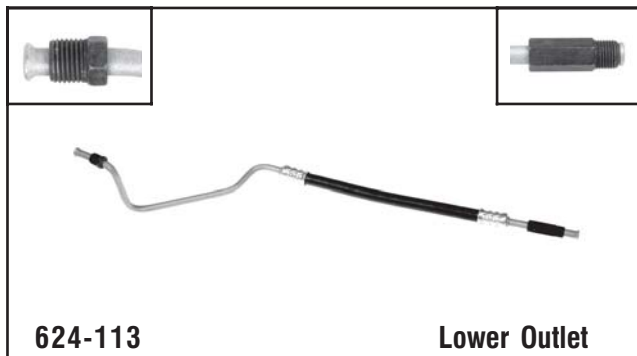

624-113 **Lower Outlet**

GM
Fits 1987-86 Bonneville, Delta 88, 98, Electra, LeSabre w/ 3.8L, Estate Wagon w/ 5.0L

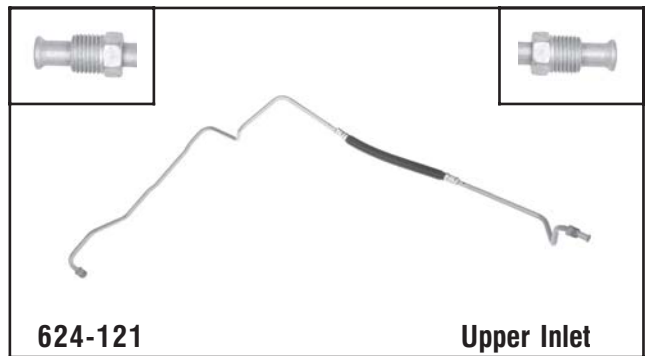

624-121 **Upper Inlet**

GM
Fits 1995-94 Concours, 1995-93 Seville, Eldorado, 1993 Allante w/ 4.6L

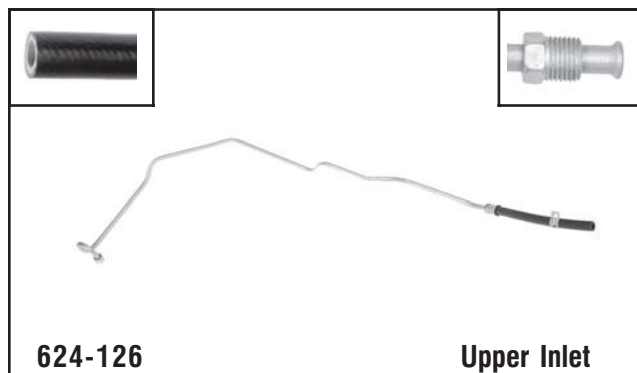

624-126 **Upper Inlet**

GM
Fits 1996 Lumina APV, Silhouette, Trans Sport w/3.4L, 1995-92 w/ 3.8L wo/ Aux Cooler

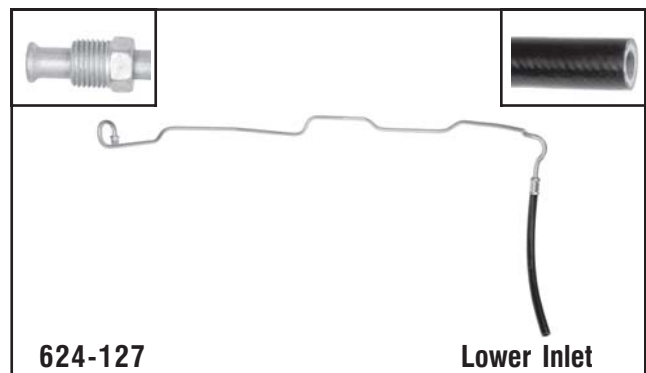

624-127 **Lower Inlet**

GM
Fits 1995-92 Lumina APV, Silhouette, Trans Sport w/ 3.8L w/ Aux Cooler

Transmission Line Assemblies

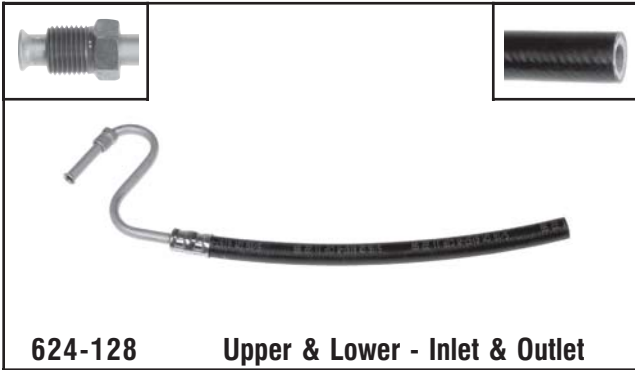

624-128 Upper & Lower - Inlet & Outlet

GM
 Fits 1996-94 Century w/ 2.2L, 1995-90 Lumina APV, Trans Sport w/ 3.1L, 1994-90 Silhouette w/ 3.1L

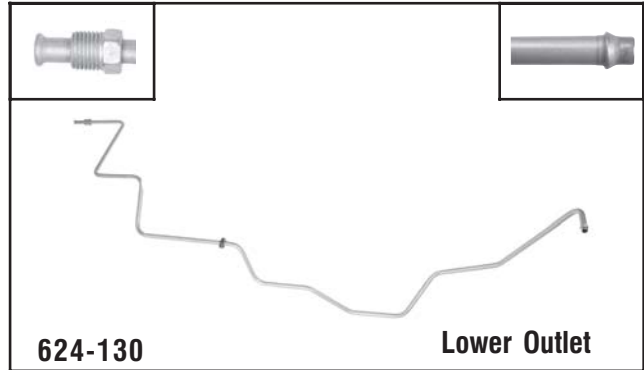

624-130 Lower Outlet

GM
 Fits 2000-98 C&K-Series Pickups w/ 5.0L, 5.7L, Tahoe w/ 5.7L, 2000-99 Escalade w/ 5.7L, 2000 Yukon w/ 5.7L, 1999-98 Suburban w/ 5.7L

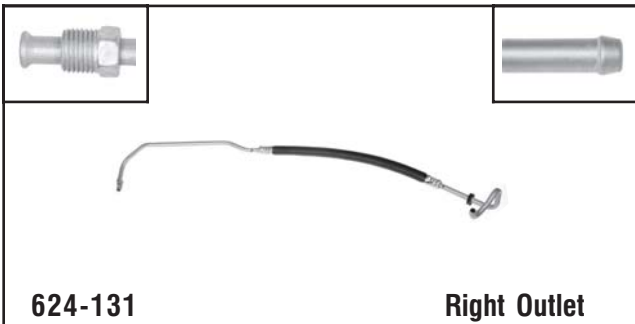

624-131 Right Outlet

GM
 Fits 2000-99 Escalade, 2000-98 C&K-Series Pickups, Tahoe, Yukon, 1998 Suburban w/ 5.7L

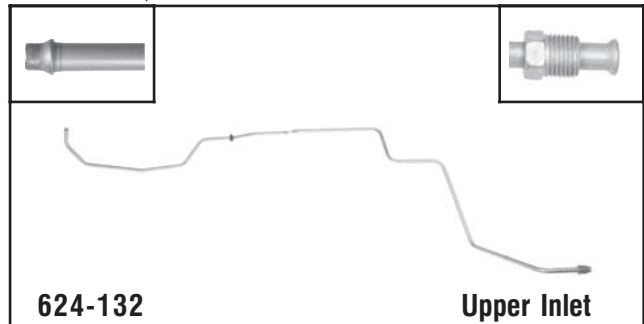

624-132 Upper Inlet

GM
 Fits 2000-99 Escalade w/ 5.7L, 2000-98 C&K-Series Pickups w/ 5.0L, 5.7L, Tahoe, Yukon w/ 5.7L, 1999-98 Suburban w/ 5.7L

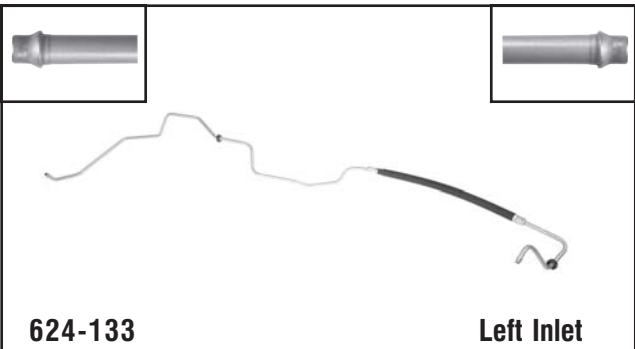

624-133 Left Inlet

GM
 Fits 2000-99 Escalade, 2000-98 C&K-Series Pickups, Tahoe, Yukon, 1998 Suburban w/5.7L

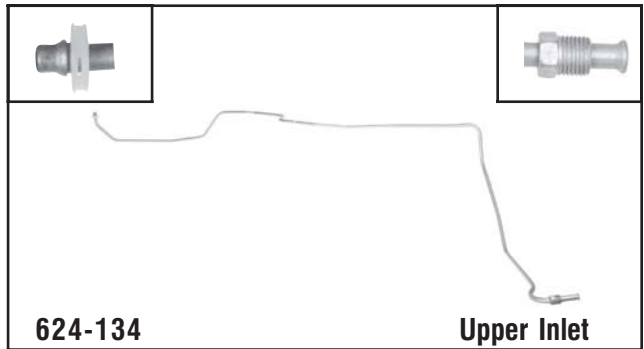

624-134 Upper Inlet

GM
 Fits 1999-98 C&K-Series Pickups w/ 4.3L, 5.0L

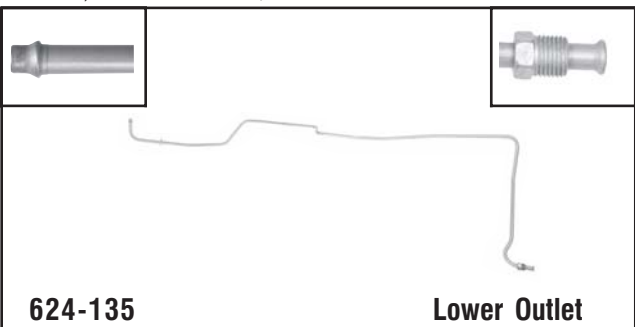

624-135 Lower Outlet

GM
 Fits 1999-98 C&K-Series Pickups w/ 4.3L, 5.0L

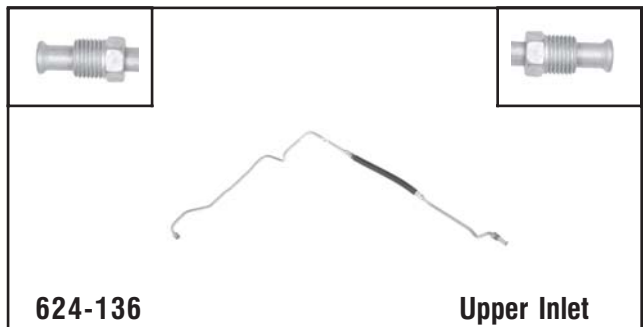

624-136 Upper Inlet

GM
 Fits 2000-96 Eldorado, 1999-96 Deville, Seville w/ 4.6L

Transmission Line Assemblies

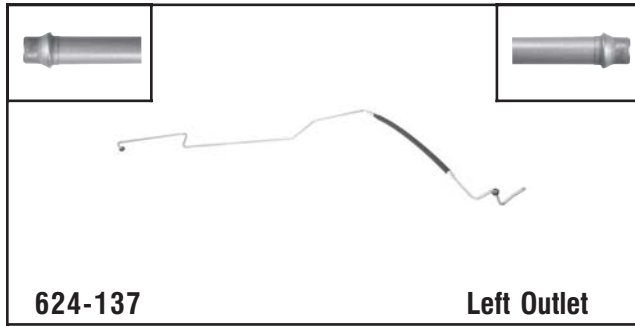

624-137

Left Outlet

GM
Fits 2002-97 C&K 3500 Series Pickups w/ 6.5L, 2000-98 C&K 3500 Series Pickups w/ 5.7L, 2000-96 C&K 3500 Series Pickups w/ 7.4L

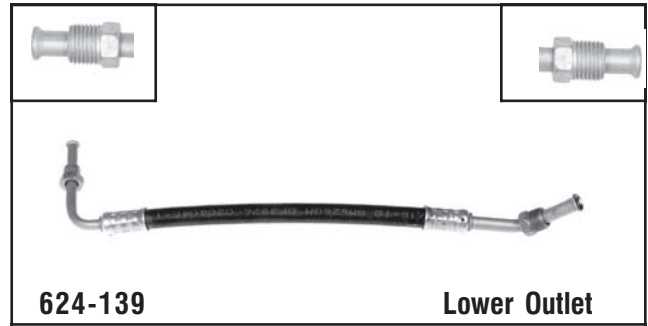

624-139

Lower Outlet

GM
Fits 2001-95 Cavalier, Sunfire w/ 2.2L 3-Speed Trans



624-140

Lower Outlet

GM
1990-88 Bonneville, Delta 88, 98, Electra, LeSabre w/ 3.8L, Estate Wagon w/ 5.0L

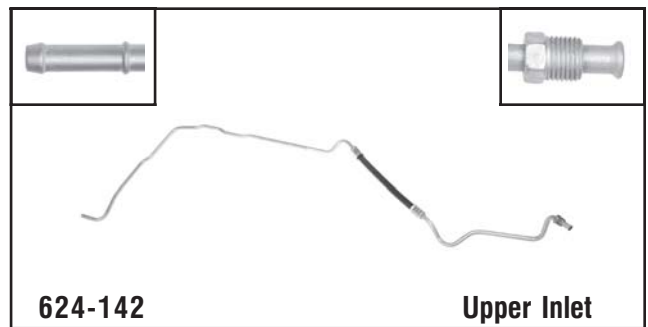

624-142

Upper Inlet

GM
1995-93 Bonneville, 88, 98, LeSabre, Park Avenue w/ 3.8L

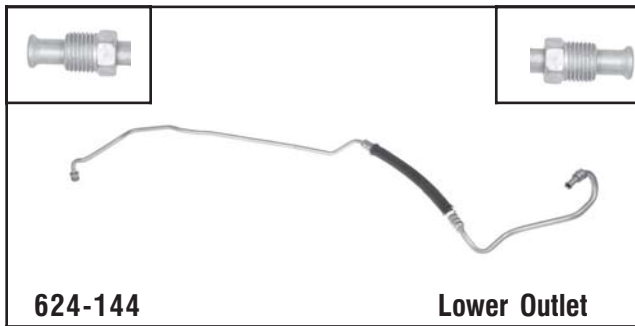

624-144

Lower Outlet

GM
1997-96 Bonneville, 88, 98, LeSabre, Park Avenue w/ 3.8L

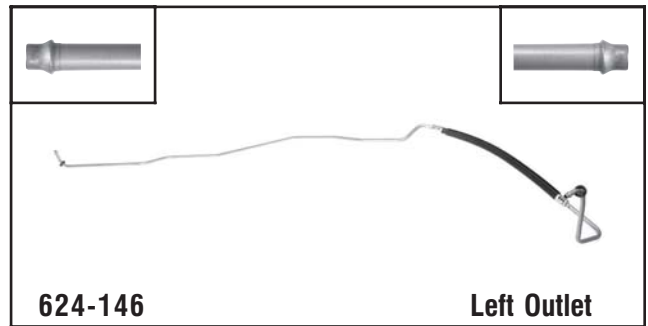

624-146

Left Outlet

GM
2000-97 C&K-Series Pickups, 1999-97 Suburban, Tahoe, Yukon w/ 6.5L

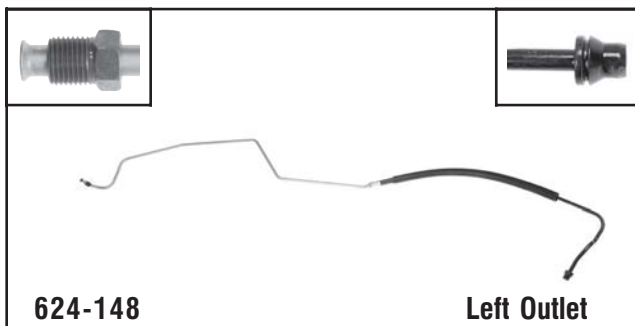

624-148

Left Outlet

GM
1995-94 C&K-Series Pickups w/ 5.7L, 6.5L, 7.4L

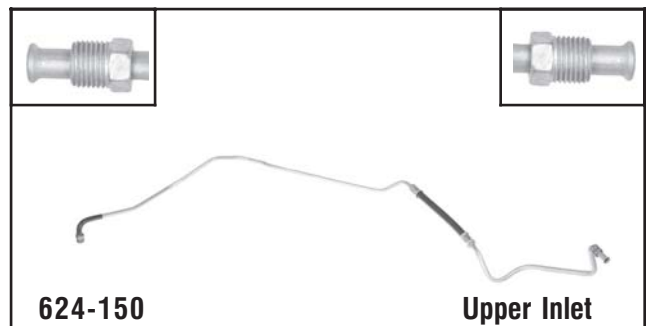

624-150

Upper Inlet

GM
1999 Delta 88, 1999-97, 1995-93 Bonneville, 88, 98, LeSabre, Park Avenue w/ 3.8L

Transmission Line Assemblies

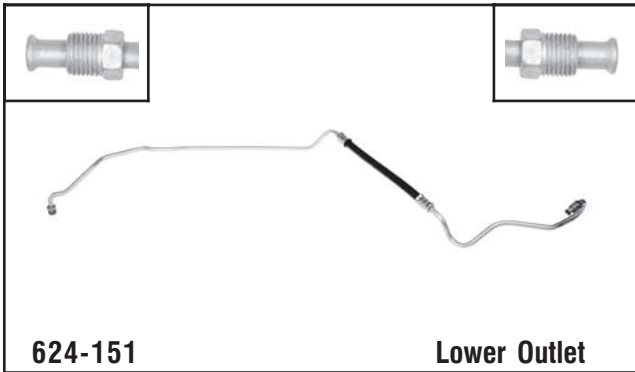

624-151

Lower Outlet

GM
1999 Delta 88, 1999-97, 1995-94 Bonneville, 88, 98, LeSabre, Park Avenue w/ 3.8L

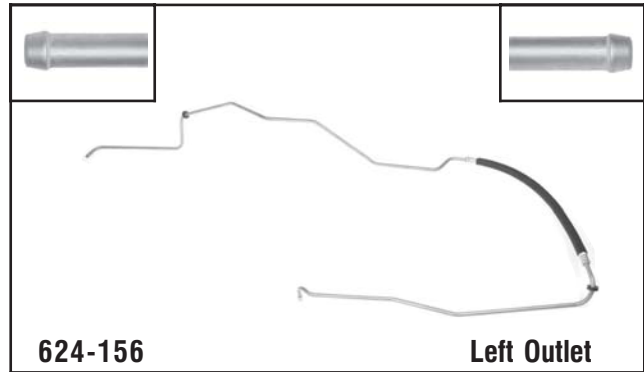

624-156

Left Outlet

GM
2000-96 C&K 2500 & 3500 Series Pickups, 1999-96 2500 Suburban w/ 7.4L

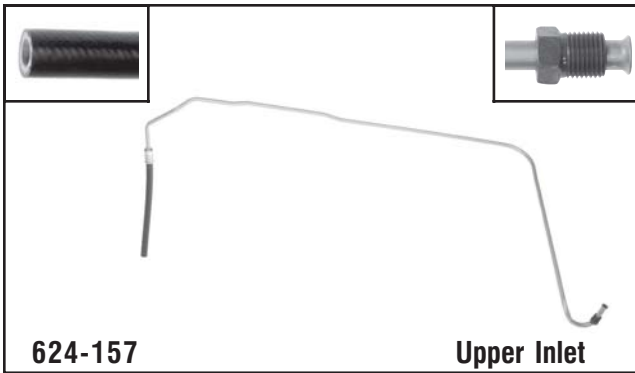

624-157

Upper Inlet

GM
1990-88 Bonneville, Delta 88, 98, Electra, LeSabre w/ 3.8L, Estate Wagon w/ 5.0L

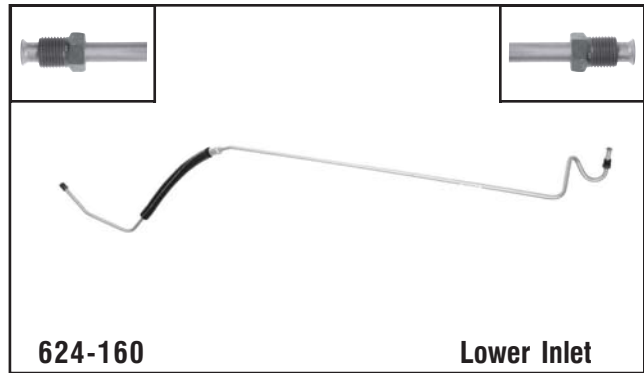

624-160

Lower Inlet

GM
1990 Reatta, 1989-87 Riviera, Toronado w/ 3.8L



624-161

Upper Outlet

GM
1990 Reatta, 1989-88 Riviera, Toronado w/ 3.8L

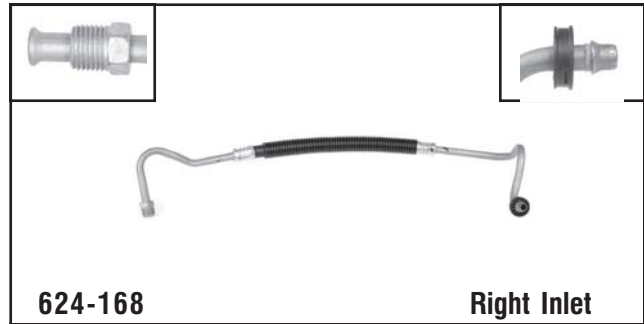

624-168

Right Inlet

GM
2000-96 C&K-Series Pickups, w/ 5.7L, 6.5L, 1999-96 Suburban, Tahoe, Yukon w/ 5.7L, 6.5L

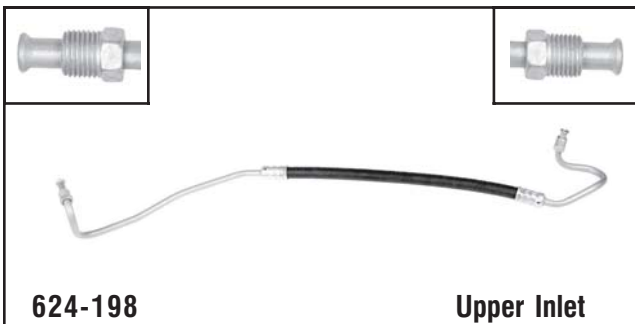

624-198

Upper Inlet

GM
1986-85 Cimarron w/ 2.0L

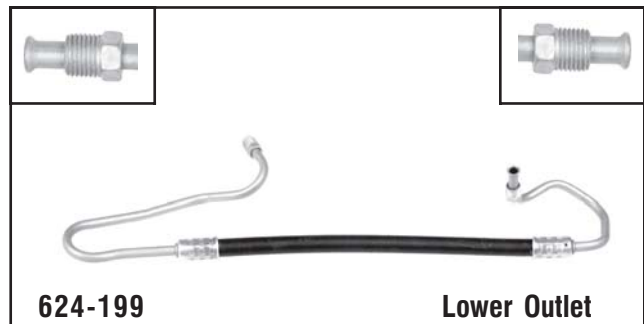

624-199

Lower Outlet

GM
1986-85 Cimarron w/ 2.0L

Transmission Line Assemblies

Transmission Line Assemblies

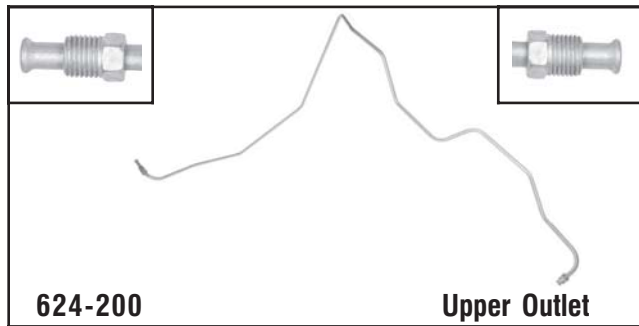

624-200

Upper Outlet

Ford
1997 Mountaineer, 1997-96 Explorer w/ 5.0L



624-201

Lower Inlet

Ford
1997 Mountaineer, 1997-96 Explorer w/ 5.0L

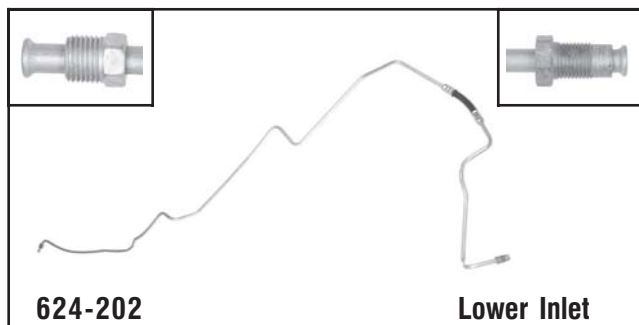

624-202

Lower Inlet

Ford
2002-97 F-Series Pickups w/ 5.4L, 5.8L, 7.3L, 7.5L, Expedition w/ 5.4L, 2000-98 Navigator w/ 5.4L

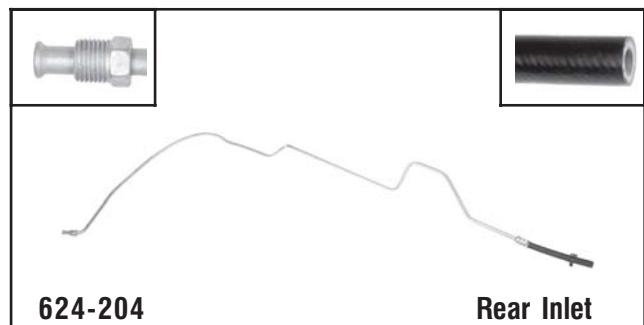

624-204

Rear Inlet

Ford
2002-97 F-Series Pickups w/ 5.4L, 5.8L, 7.3L, 7.5L, 2000-97 Expedition w/ 5.4L, 2000-98 Navigator w/ 5.4L

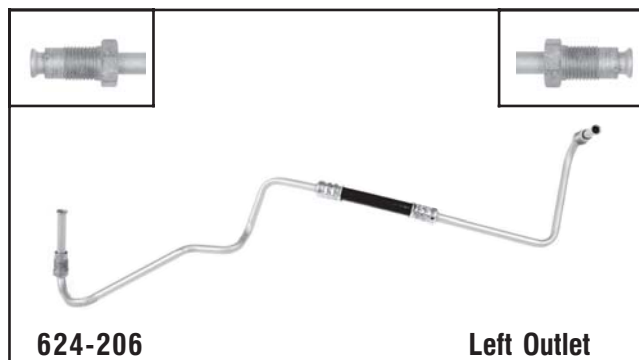

624-206

Left Outlet

Ford
1999-97 F-Series Pickups w/ 5.4L, 5.8L, 7.3L, 7.5L, 2000-97 Expedition w/ 5.4L, 2000-98 Navigator w/ 5.4L

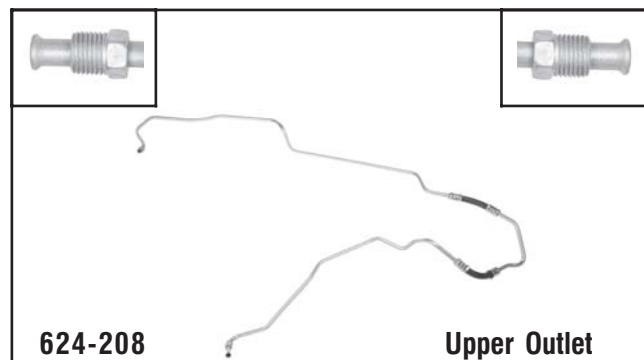

624-208

Upper Outlet

Ford
2003-98 F-Series Pickups, 2002-98 Expedition, 2000-98 Navigator w/ 5.4L

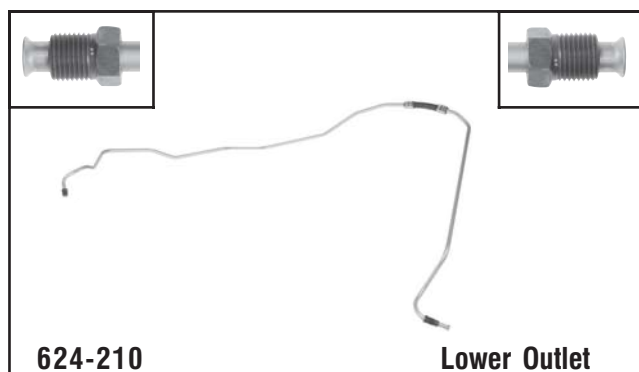

624-210

Lower Outlet

Ford
1995-90 Cougar, Thunderbird w/ 3.8L, 5.0L

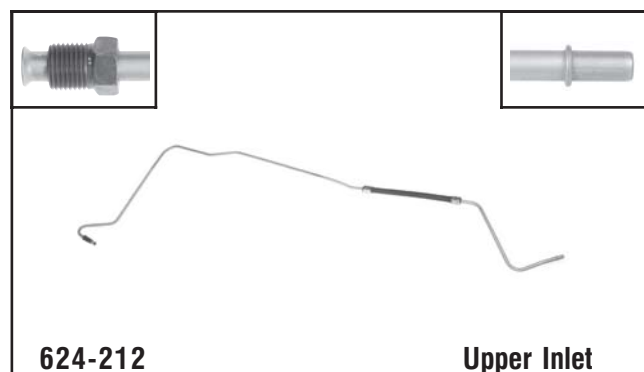

624-212

Upper Inlet

Ford
1994-90 Continental, 1992-90 Sable, Taurus w/ 3.8L

Transmission Line Assemblies

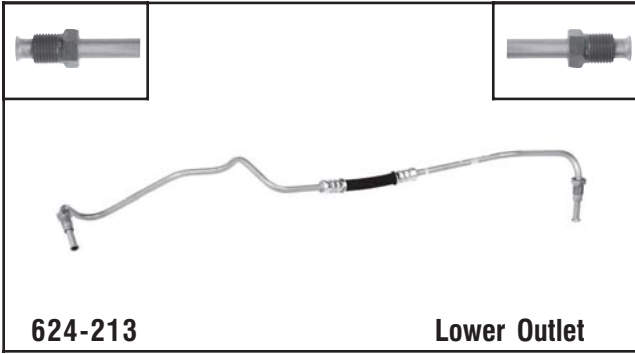

624-213 Lower Outlet

Ford
1995-90 Sable, Taurus w/ 3.0L, 3.8L

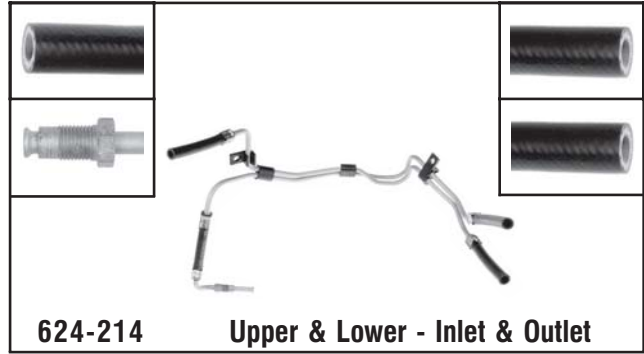

624-214 Upper & Lower - Inlet & Outlet

Ford
2003-95 Crown Victoria, Grand Marquis, 1998-95 Mark VIII w/ 4.6L

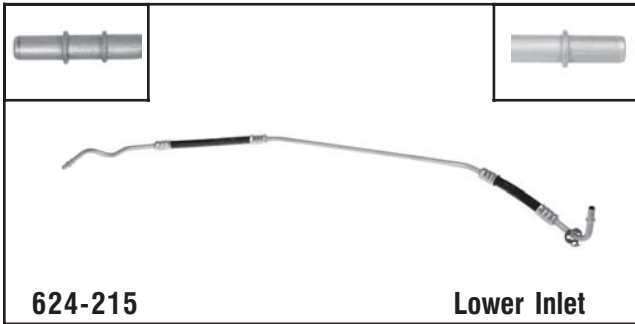

624-215 Lower Inlet

Ford
1996 Sable, Taurus w/ 3.0L



624-217 Lower Outlet

Ford
1999-96 Sable, Taurus w/ 3.0L, 3.4L

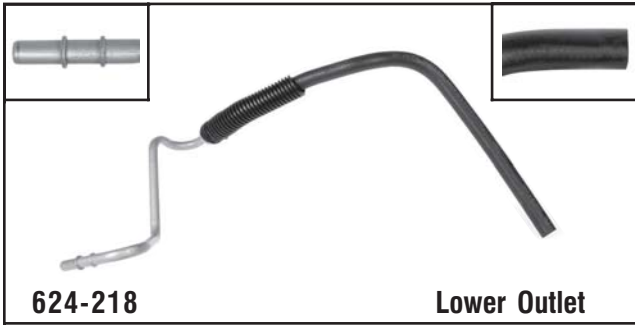

624-218 Lower Outlet

Ford
1998-96 Sable, Taurus w/ 3.0L



624-219 Upper Outlet

Ford
1996 Sable, Taurus w/ 3.0L

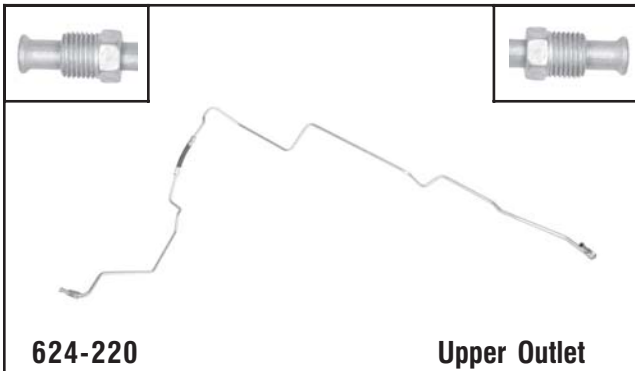

624-220 Upper Outlet

Ford
1998-97 F-Series Pickups w/ 5.4L, 5.8L, 7.5L, Expedition w/ 5.4L

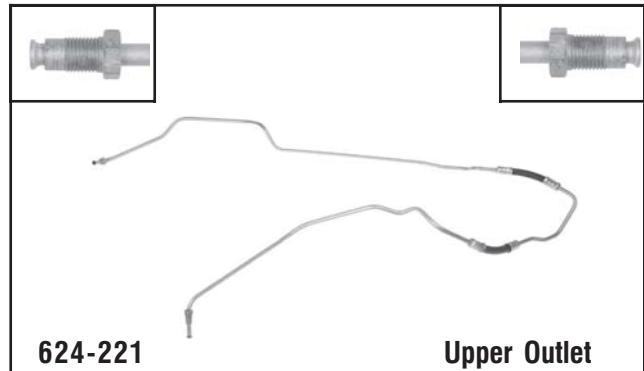

624-221 Upper Outlet

Ford
1998-97 F-Series Pickups w/ 4.2L, 4.6L, 5.4L, Expedition w/ 4.6L

Transmission Line Assemblies

Transmission Line Assemblies

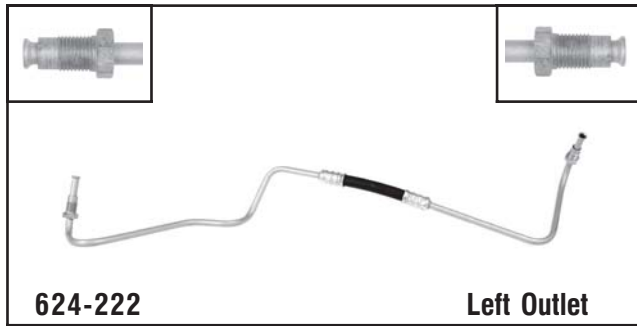

624-222 **Left Outlet**

Ford
2002-97 Expedition w/ 4.6L, F-Series Pickups w/ 4.2L, 4.6L, 5.4L



624-223 **Upper Inlet**

Ford
1999-97 Sable, Taurus w/ 3.0L, 3.4L



624-224 **Right Inlet**

Ford
2000-97 Expedition w/ 5.4L, F-Series Pickups w/ 5.4L, 5.8L, 7.3L, 7.5L, 2000-98 Navigator w/ 5.4L



624-225 **Right Inlet**

Ford
2002-97 Expedition w/ 4.6L, F-Series Pickups w/ 4.2L, 4.6L, 5.4L

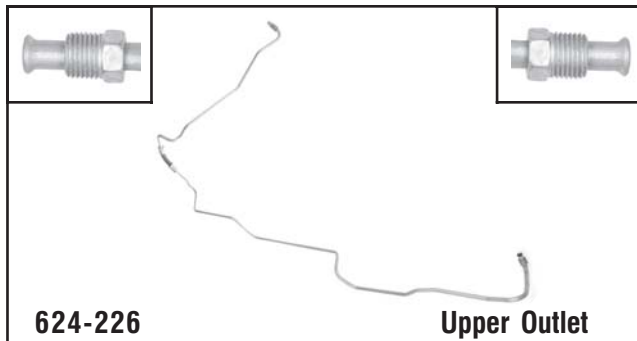

624-226 **Upper Outlet**

Ford
1998-97 Expedition w/ 5.4L, F-Series Pickups w/ 5.4L, 5.8L, 7.3L, 7.5L

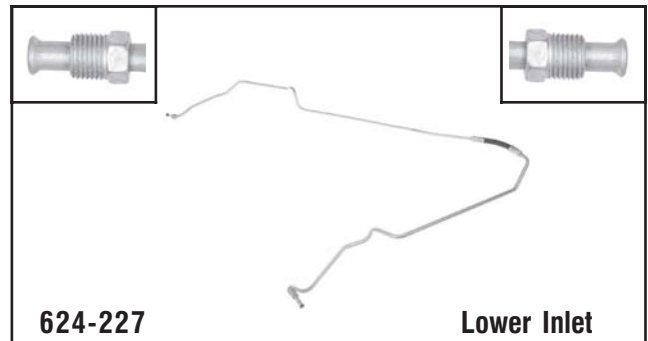

624-227 **Lower Inlet**

Ford
2002-99 F-Series Pickups w/ 4.2L, 4.6L, 5.4L, 2000-99 Expedition w/ 4.6L, 5.4L

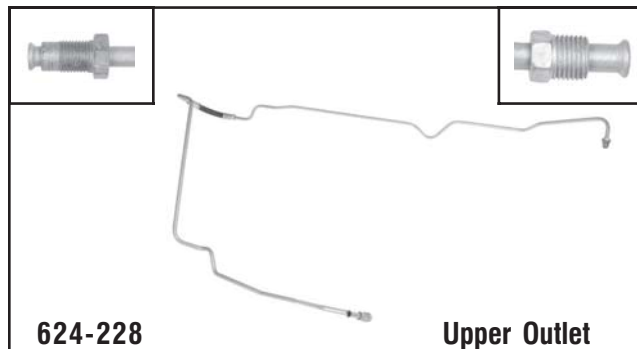

624-228 **Upper Outlet**

Ford
2002-99 Expedition w/ 4.6L, F-Series Pickups w/ 4.2L, 4.6L, 5.4L

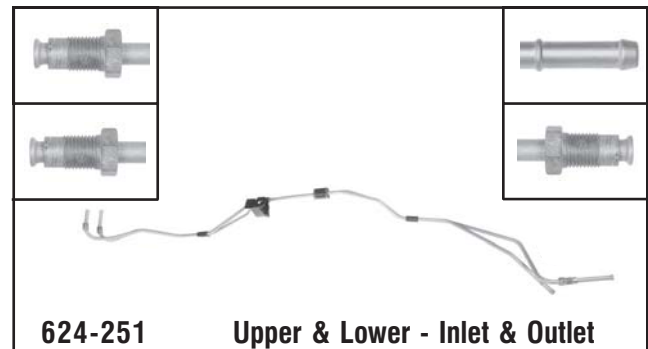

624-251 **Upper & Lower - Inlet & Outlet**

Ford
1997-96 Crown Victoria, Grand Marquis, Town Car w/ 4.6L

Transmission Line Assemblies

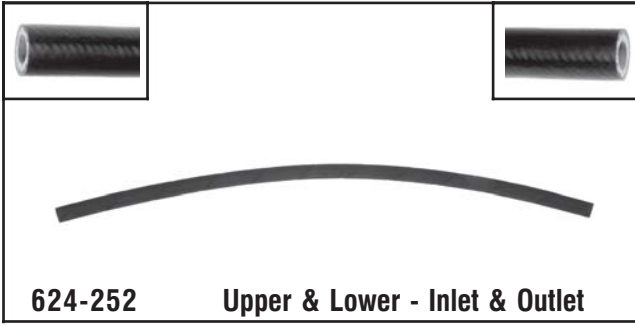

624-252 Upper & Lower - Inlet & Outlet

Ford
2005-03 Crown Victoria, Grand Marquis, Town Car, 2004-03
Marauder w/ 4.6L

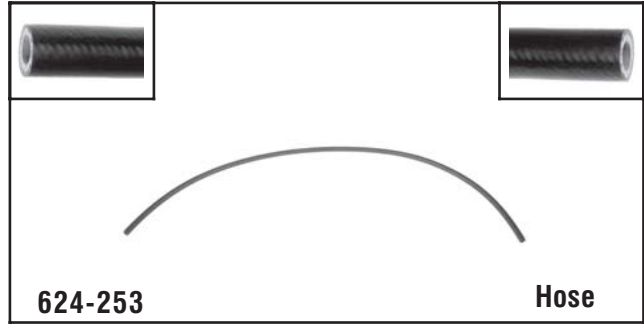

624-253 Hose

Ford
2005-96 Various Ford Trucks and Cars

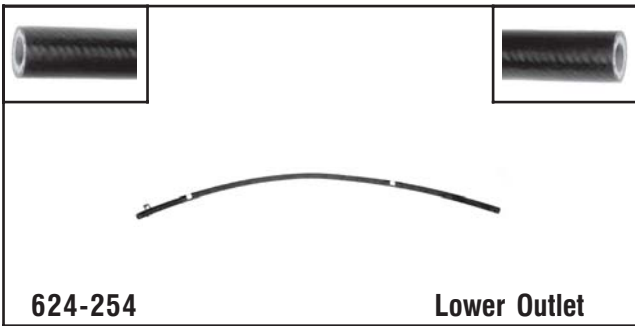

624-254 Lower Outlet

Ford
2003-97 E 150 w/ 4.2L, 4.6L, E 250 w/ 4.2L

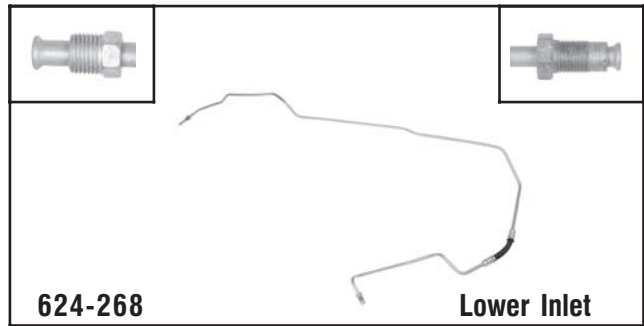

624-268 Lower Inlet

Ford
1998-97 Expedition w/ 4.6L, F-Series Pickups w/ 4.2L, 4.6L, 5.4L



624-269 Upper Inlet

Ford
2002-97 Expedition w/ 4.6L, F-Series Pickups w/ 4.2L, 4.6L, 5.4L
(Upper-Inlet)

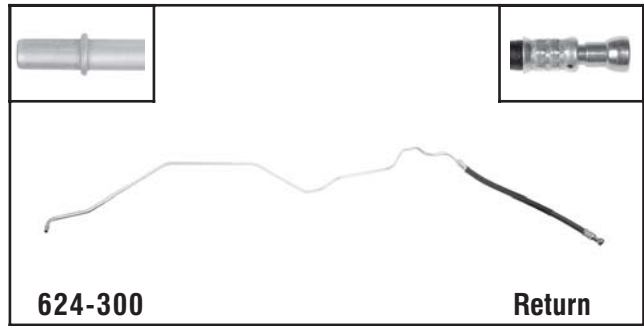

624-300 Return

Jeep
Fits 1996-87 Cherokee 4.0L

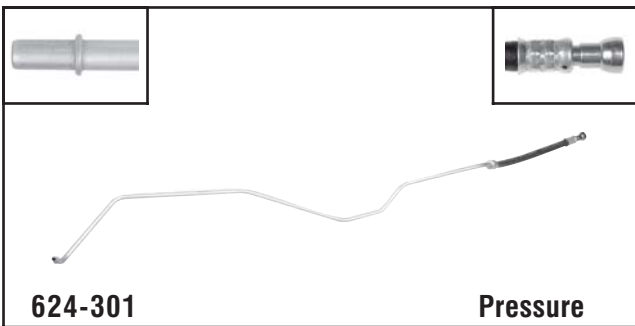

624-301 Pressure

Jeep
Fits 1996-87 Cherokee 4.0L

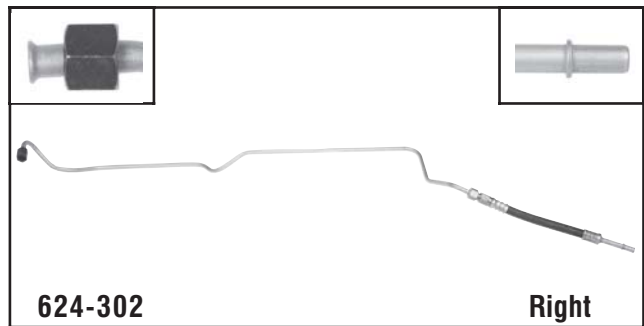

624-302 Right

Dodge
Fits 1997 B-Vans 5.2L & 5.9L

Transmission Line Assemblies

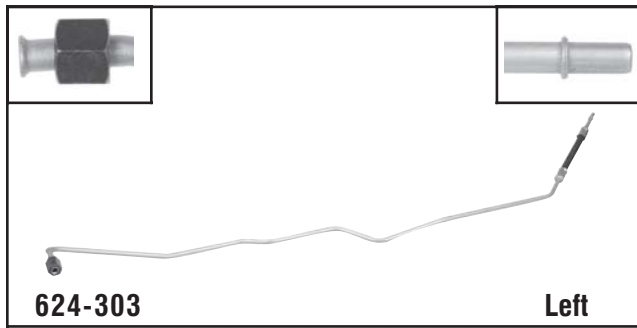

624-303

Left

Dodge
Fits 1997 B-Vans

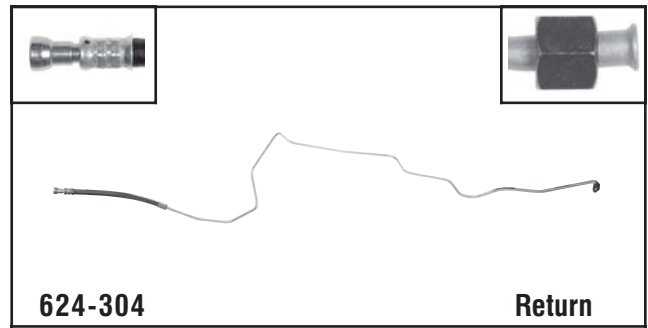

624-304

Return

Dodge
Fits 1999-94 Ram Pickups

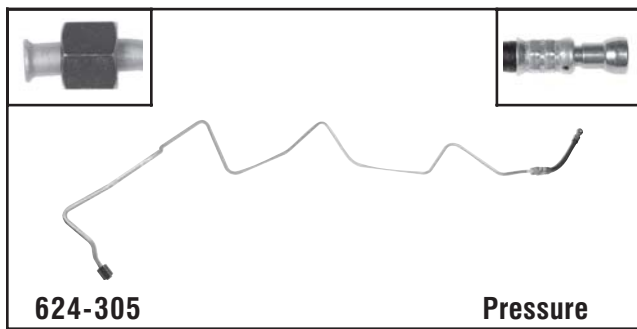

624-305

Pressure

Dodge
Fits 1999-94 Ram Pickups

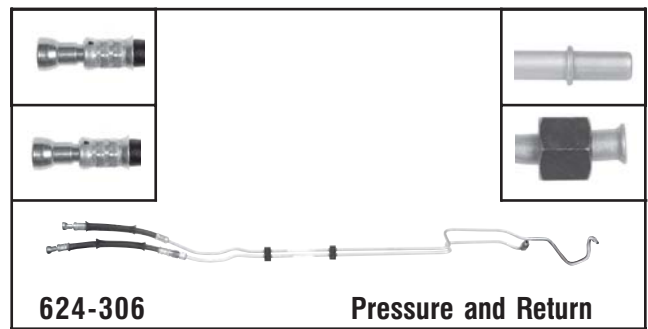

624-306

Pressure and Return

Jeep
Fits 1997-96 Grand Cherokee 4.0L

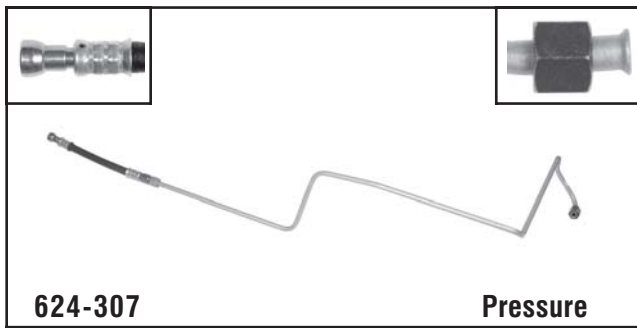

624-307

Pressure

Jeep
Fits 1997-96 Grand Cherokee 5.2L & 5.9L

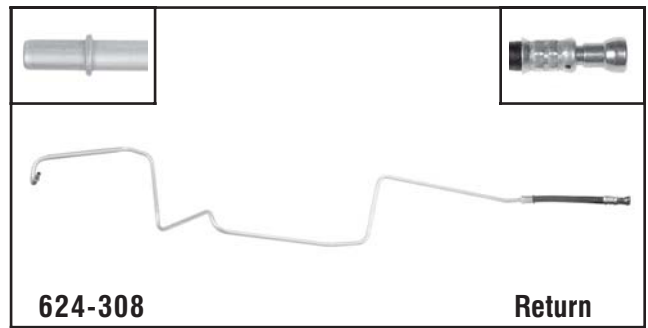

624-308

Return

Jeep
Fits 1997-96 Grand Cherokee 5.2L & 5.9L

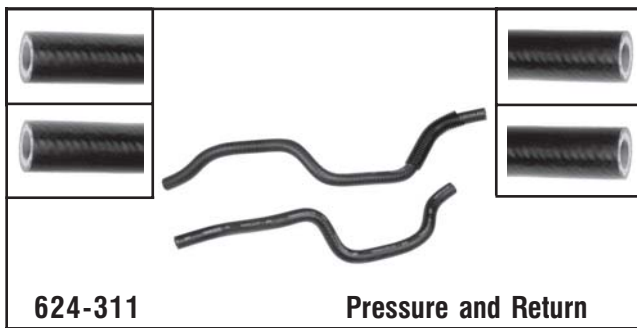

624-311

Pressure and Return

Chrysler
Fits 2000-97 Minivans, 3.0L, 3.3L, 3.8L

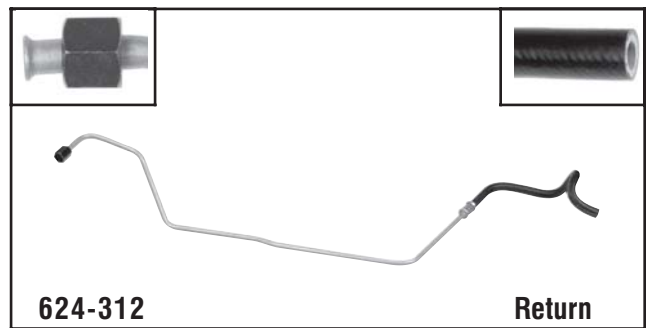

624-312

Return

Chrysler
Fits 1997-93 LH-Series

Transmission Line Assemblies

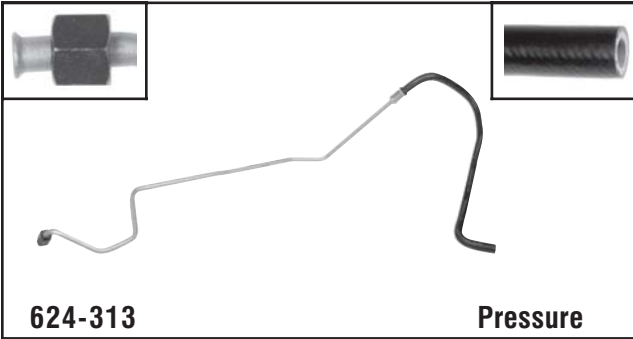

624-313 **Pressure**

Chrysler
Fits 1997-93 LH-Series

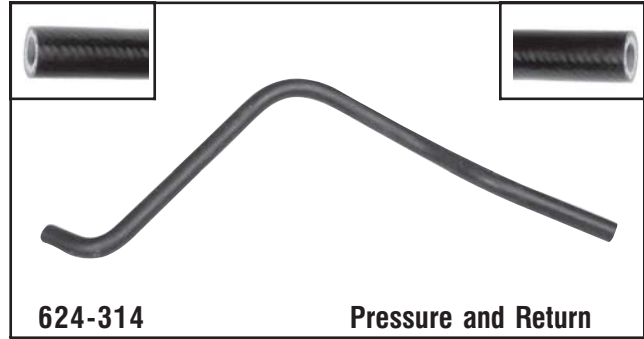

624-314 **Pressure and Return**

Chrysler
Fits 2003-01 Stratus and Sebring



624-320 **Intermediate**

Dodge
2000-97 Caravan, Grand Caravan, Grand Voyager, Town & Country, Voyager w/ 3.0L, 3.3L, 3.8L



624-322 **Lower Outlet**

Dodge
2002-94 Ram 2500 & 3500 Series Pickups w/ 8.0L

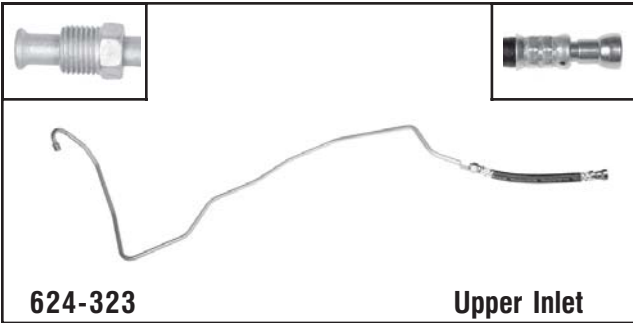

624-323 **Upper Inlet**

Dodge
2002-96 Ram 2500 & 3500 Series Pickups w/ 8.0L

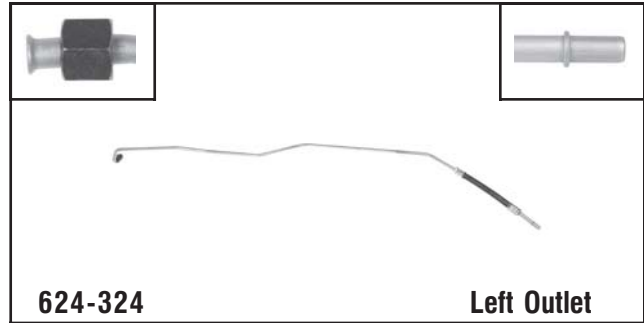

624-324 **Left Outlet**

Dodge
2003-98 Ram 1500, 2500, 3500 Series Vans w/ 3.9L, 5.2L, 5.9L

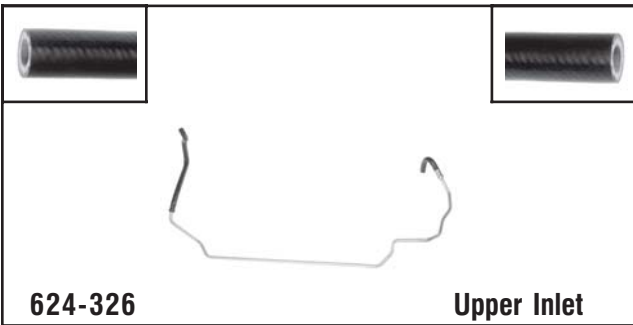

624-326 **Upper Inlet**

Dodge
2000-95 Cirrus, Sebring, Stratus w/ 2.5L

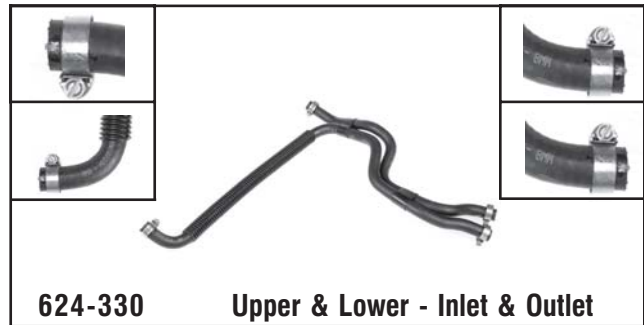

624-330 **Upper & Lower - Inlet & Outlet**

Dodge
2000 Town & Country, 1998-97 Caravan, Grand Caravan, Grand Voyager, Town & Country w/ 3.3L, 3.8L

Transmission Line Assemblies

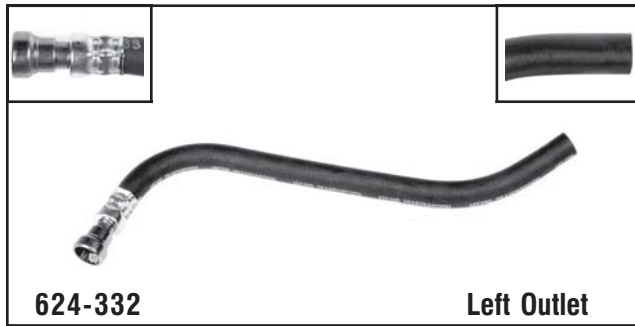

624-332 **Left Outlet**

Dodge
2000-94 Ram 2500 & 3500 Series Pickups w/ 5.9L



624-333 **Right Outlet**

Dodge
2000-94 Ram 2500 & 3500 Series Pickups w/ 5.9L

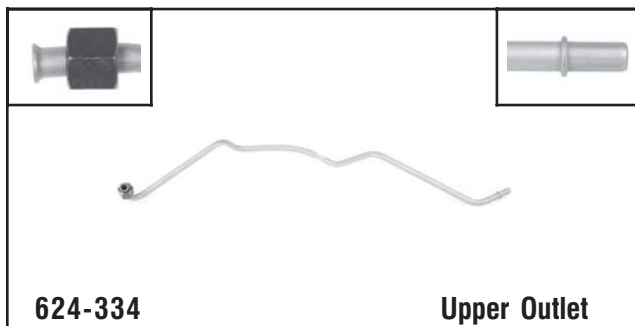

624-334 **Upper Outlet**

Jeep
2001-88 Cherokee, 1992-88 Comanche w/ 2.5L, 4.0L, 1990-88 Wagoneer w/ 4.0L



624-335 **Upper Supply**

Dodge
2002-94 Ram Series Pickups w/ 5.2L, 5.9L



624-336 **Left Outlet**

Dodge
1997-94 B-Series Vans w/ 5.2L, 5.9L

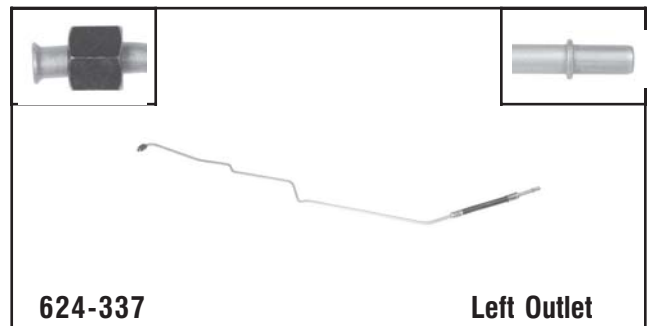

624-337 **Left Outlet**

Dodge
1997-94 B-Series Vans w/ 5.2L, 5.9L



624-340 **Right Inlet**

Dodge
1999-95 Neon w/ 2.0L



624-341 **Left Outlet**

Dodge
1999-95 Neon w/ 2.0L

Transmission Line Assemblies

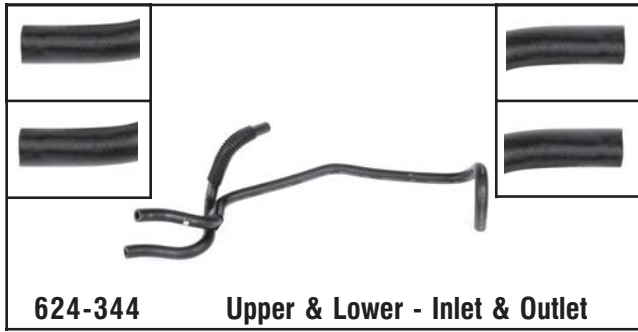

624-344 Upper & Lower - Inlet & Outlet

Dodge
1995-93 Town & Country w/ 3.8L

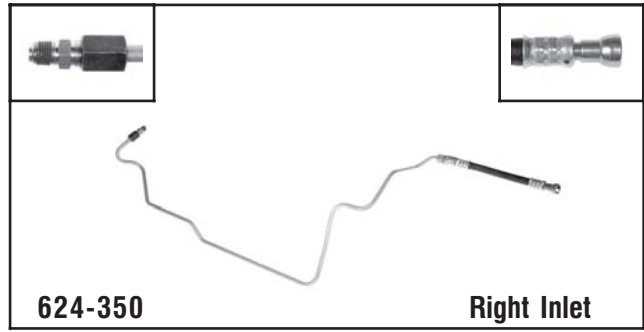

624-350 Right Inlet

Dodge
1996-94 Dakota w/ 3.9L, 5.2L

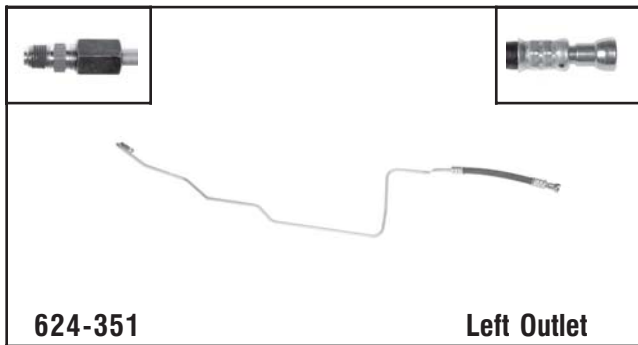

624-351 Left Outlet

Dodge
1996-94 Dakota w/ 5.2L

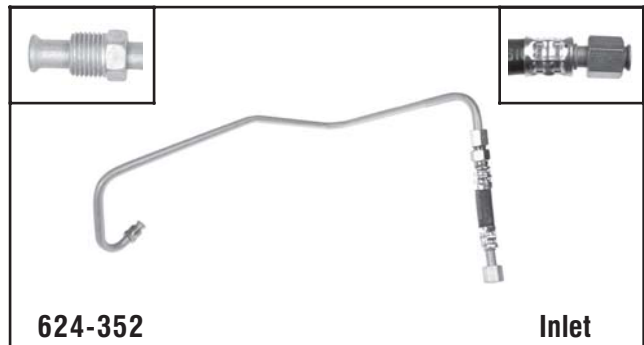

624-352 Inlet

Dodge
1998-94 Ram 2500 & 3500 Series Pickups w/ 5.9L



624-353 Rear Outlet

Dodge
2000-94 Ram 2500 & 3500 Series Pickups w/ 5.9L

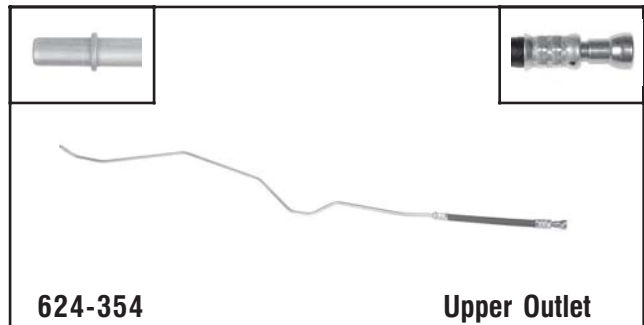

624-354 Upper Outlet

Jeep
2001-97 Cherokee w/ 4.0L

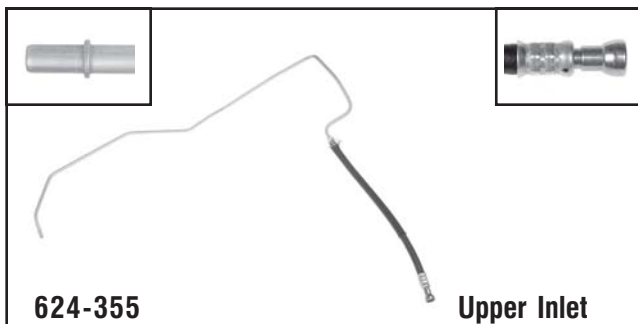

624-355 Upper Inlet

Jeep
2001-97 Cherokee w/ 4.0L

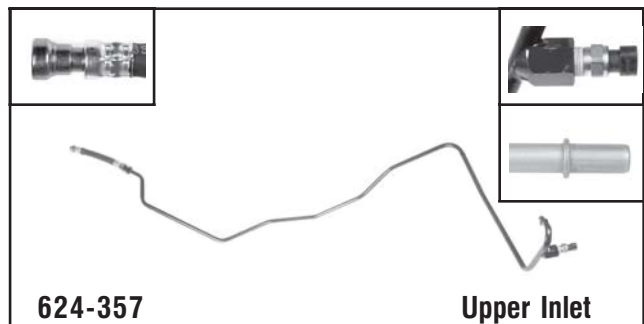

624-357 Upper Inlet

Dodge
2002-94 Ram 2500 & 3500 Series Pickups w/ 8.0L

Transmission Line Assemblies

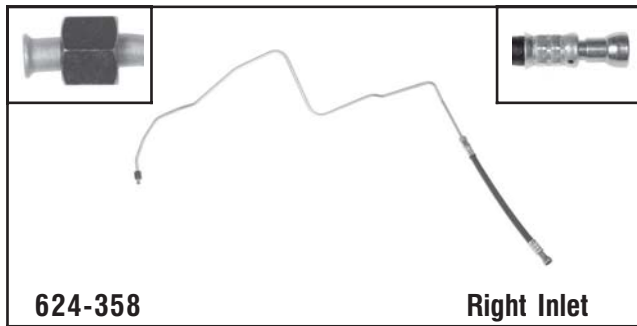

624-358

Right Inlet

Dodge
1999-98 Durango w/ 3.9L, 5.2L, 5.9L (Right-Inlet)

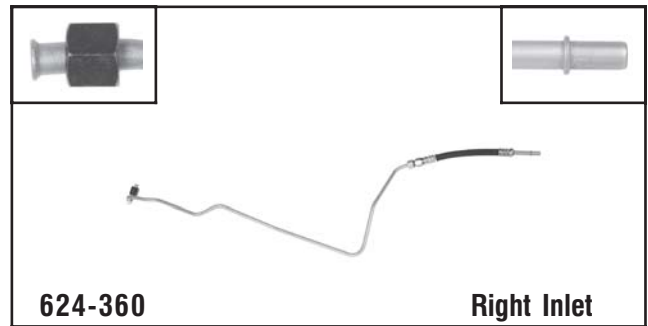

624-360

Right Inlet

Dodge
1997 B 1500 & 2500 Series Vans w/ 3.9L (Right-Inlet)

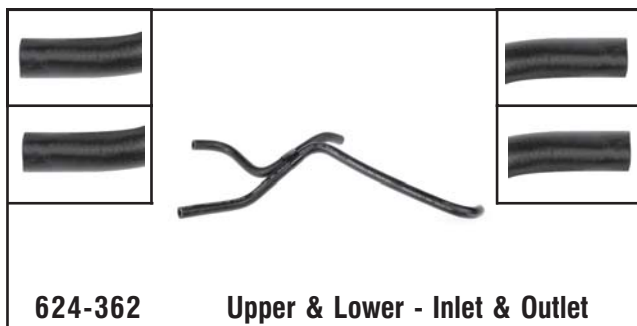

624-362

Upper & Lower - Inlet & Outlet

Dodge
1995-93 Caravan, Grand Caravan, Grand Voyager, Voyager w/ 2.5L, 3.0L

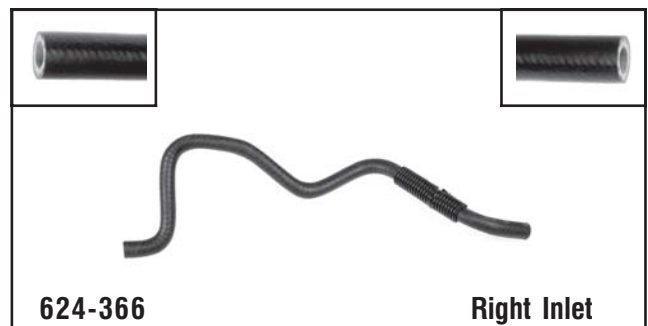

624-366

Right Inlet

Dodge
1998-95 Sebring w/ 2.0L, 2.4L, 1997-95 Cirrus, Stratus w/ 2.0L, 2.4L, 1997-96 Breeze w/ 2.0L

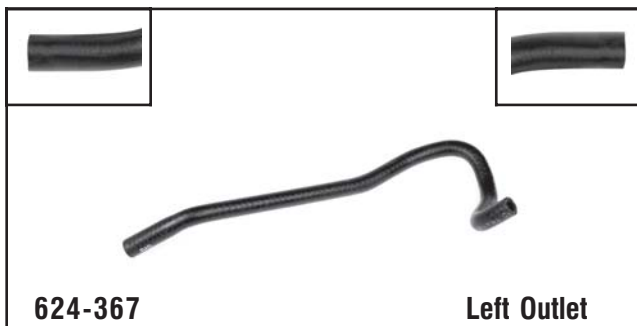

624-367

Left Outlet

Dodge
1998-95 Sebring w/ 2.0L, 2.4L, 1997-95 Cirrus, Stratus w/ 2.0L, 2.4L, 1997-96 Breeze w/ 2.0L



624-368

Inlet

Dodge
1995-93 Caravan, Grand Caravan, Grand Voyager, Town & Country, Voyager w/ 2.5L, 3.0L, 3.3L, 3.8L

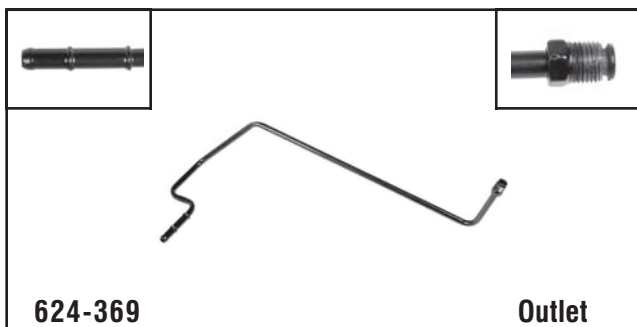

624-369

Outlet

Dodge
1995-93 Caravan, Grand Caravan, Grand Voyager, Town & Country, Voyager w/ 2.5L, 3.0L, 3.3L, 3.8L



624-370

Upper & Lower - Inlet & Outlet

Dodge
1998 Caravan, Grand Caravan, Grand Voyager, Town & Country, Voyager w/ 3.3L, 3.8L

Transmission Line Assemblies

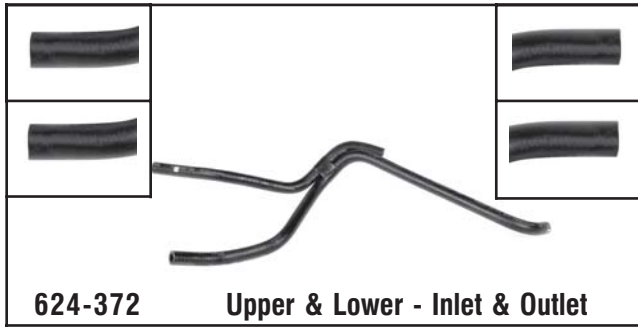

624-372 Upper & Lower - Inlet & Outlet

Dodge
1995-93 Caravan, Grand Caravan, Grand Voyager, Voyager w/ 3.0L



624-373 Elbow

Dodge
1998-94 Ram 2500 & 3500 Series Pickups, 1993-89 W&D Series Pickups w/ 5.9L

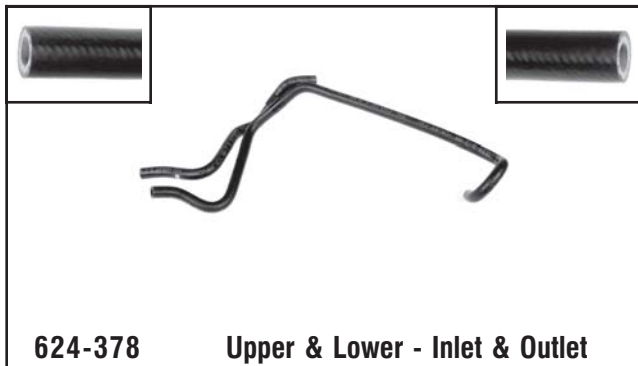

624-378 Upper & Lower - Inlet & Outlet

Dodge
1995-93 Caravan, Grand Caravan, Grand Voyager, Town & Country, Voyager w/ 3.3L, 3.8L

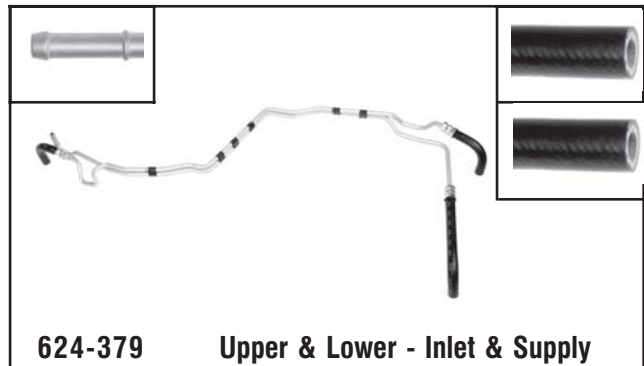

624-379 Upper & Lower - Inlet & Supply

Dodge
1998-96 Caravan, Grand Caravan, Grand Voyager, Town & Country, Voyager w/ 3.0L, 3.3L, 3.8L

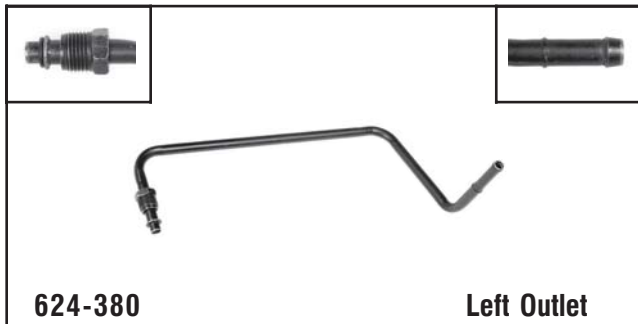

624-380 Left Outlet

Dodge
1998-96 Sebring w/ 2.0L, 2.4L, 2.5L, 1996-95 Cirrus w/ 2.4L, 2.5L, 1995 Stratus w/ 2.0L, 2.4L, 2.5L



624-382 Lower Outlet

Jeep
1995-94 Grand Cherokee w/ 4.0L



624-383 Upper Inlet

Jeep
1995-94 Grand Cherokee w/ 4.0L



624-384 Upper Elbow

Jeep
1997-93 Grand Cherokee w/ 4.0L, 5.2L, 1995-94 Wrangler w/ 2.5L, 4.0L

Transmission Line Assemblies

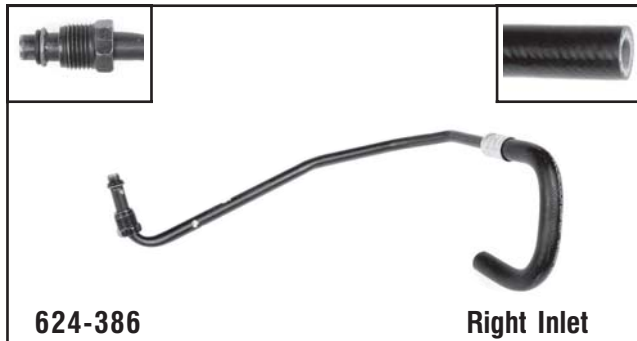

624-386

Right Inlet

Chrysler
1998-95 Sebring w/ 2.0L, 2.5L, 1996-95 Cirrus w/ 2.4L, 2.5L,
1996 Sebring w/ 2.4L, 1995 Stratus w/ 2.0L, 2.4L, 2.5L

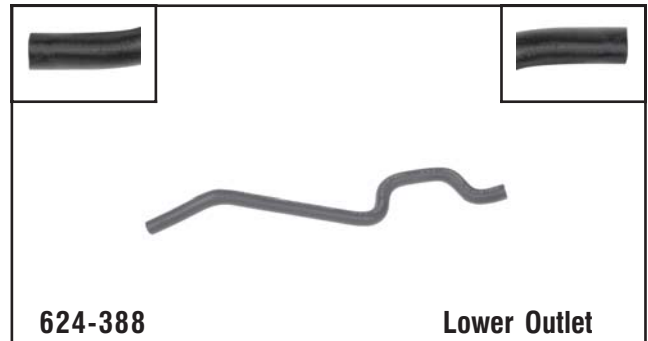

624-388

Lower Outlet

Chrysler
1999-95 Cirrus, Sebring, Stratus w/ 2.5L



624-393

Upper Outlet

Dodge
1996-94 Dakota w/ 3.9L, 5.2L

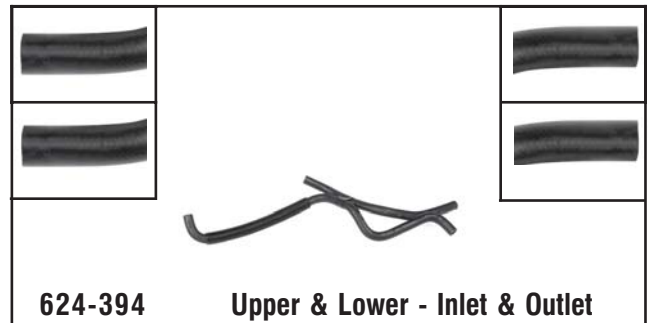

624-394

Upper & Lower - Inlet & Outlet

Dodge
1996 Caravan, Grand Caravan, Grand Voyager, Voyager w/ 2.4L,
3.0L

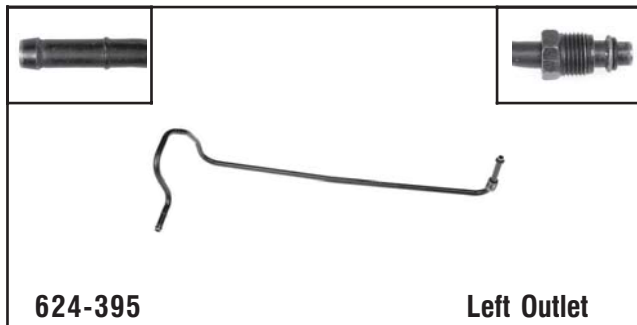

624-395

Left Outlet

Dodge
1997-93 Concorde, Intrepid, LHS, New Yorker, Vision w/ 3.3L,
3.5L

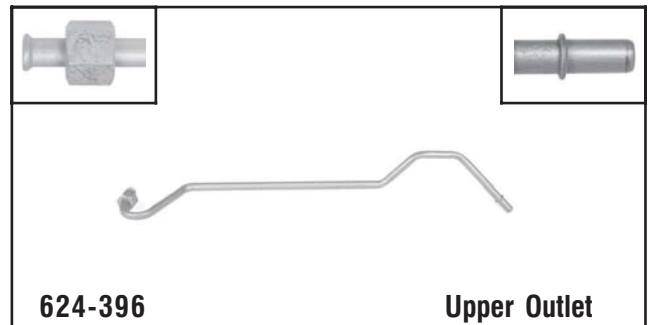

624-396

Upper Outlet

Dodge
1999-98 Dakota, Durango w/ 3.9L, 5.2L, 5.9L



624-397

Lower Inlet

Dodge
1999-98 Dakota, Durango w/ 3.9L, 5.2L, 5.9L

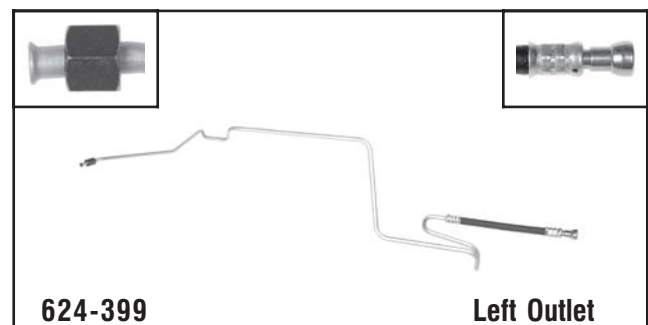

624-399

Left Outlet

Dodge
1996-94 Dakota w/ 3.9L

Transmission Line Assemblies

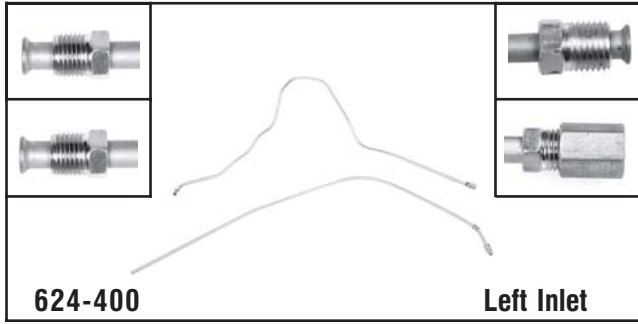

624-400

Left Inlet

Toyota
2001-97 Camry w/ 2.2L



624-401

Right Outlet

Toyota
1996-92 Camry w/ 2.2L

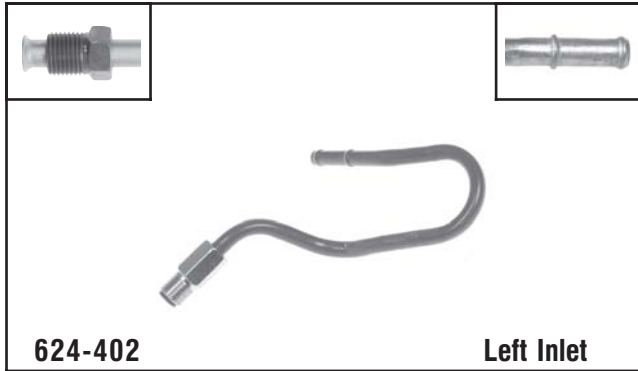

624-402

Left Inlet

Toyota
1996-92 Camry w/ 2.2L

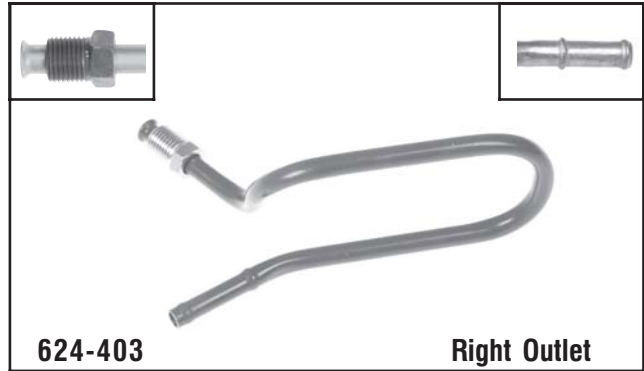

624-403

Right Outlet

Toyota
2001-97 Camry w/ 2.2L

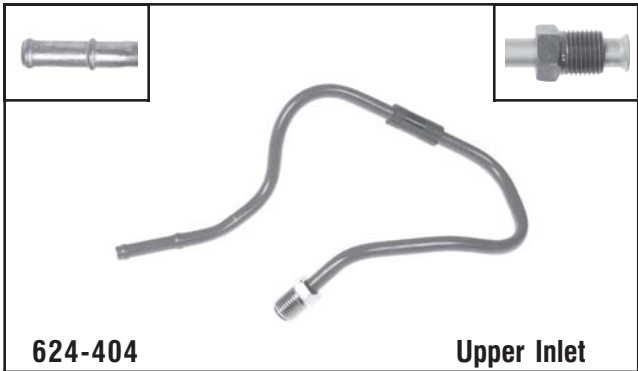

624-404

Upper Inlet

Toyota
1997-93 Corolla w/ 1.6L

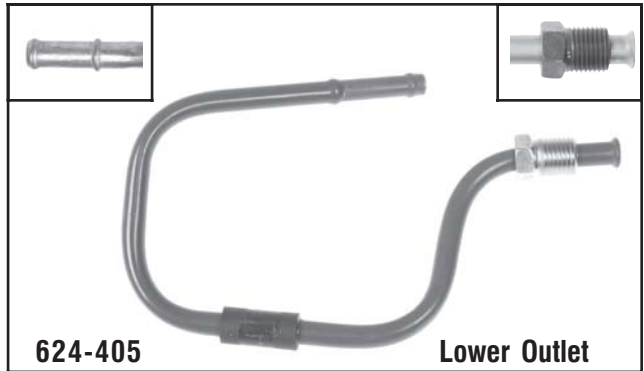

624-405

Lower Outlet

Toyota
1997-93 Corolla w/ 1.6L

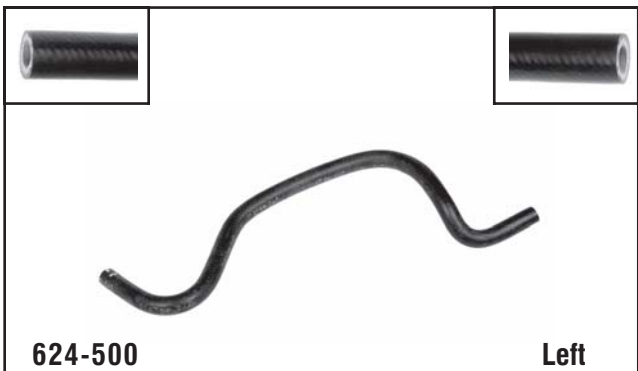

624-500

Left

Nissan
Fits 1999-93 Altima



624-501

Right

Nissan
Fits 1998-93 Altima

Transmission Line Assemblies



Nissan
1999-95 Maxima w/3.0L

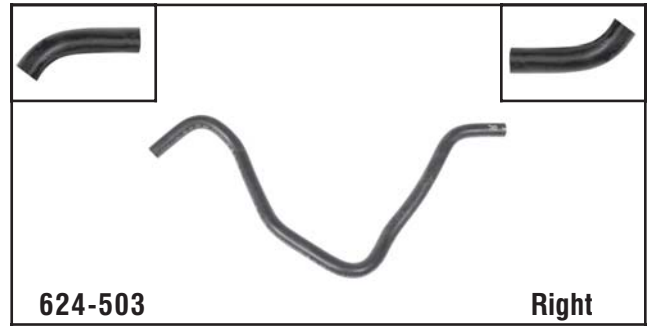

Nissan
1999-95 Maxima w/3.0L

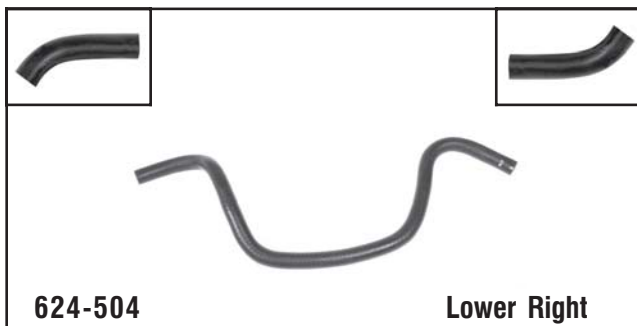

Nissan
1997 Altima w/ 2.4L



Nissan
1997 Altima w/ 2.4L



Honda
2002-98 Accord w/ 2.3L

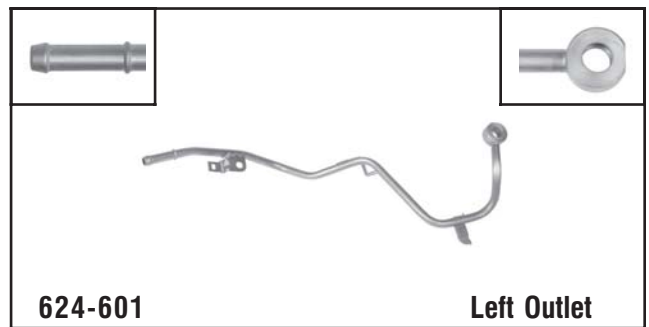

Honda
2002-98 Accord w/ 2.3L

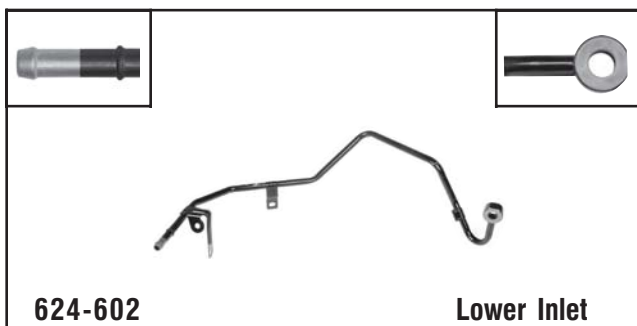

Honda
2000-96 Civic w/ 1.6L

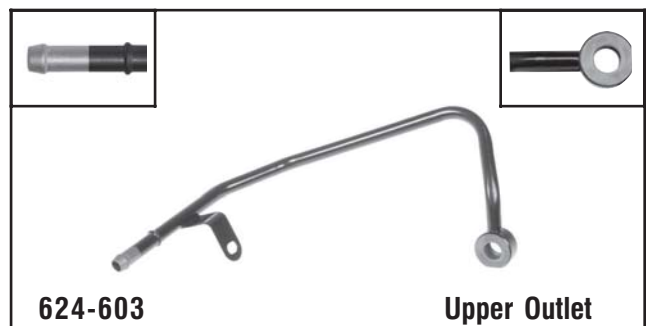

Honda
2000-96 Civic w/ 1.6L

Transmission Line Assemblies

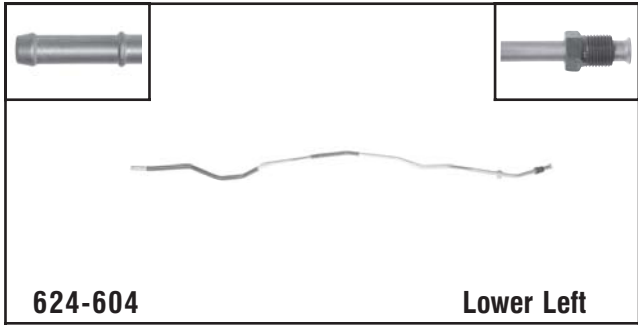

624-604 Lower Left

Honda/Isuzu
2002-00 Passport w/ 3.2L, 2002-01 Rodeo w/ 2.2L, 3.2L

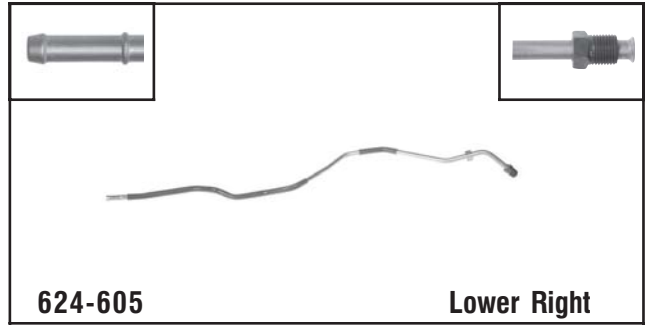

624-605 Lower Right

Honda/Isuzu
2002-00 Passport w/ 3.2L, 2002-01 Rodeo w/ 2.2L, 3.2L

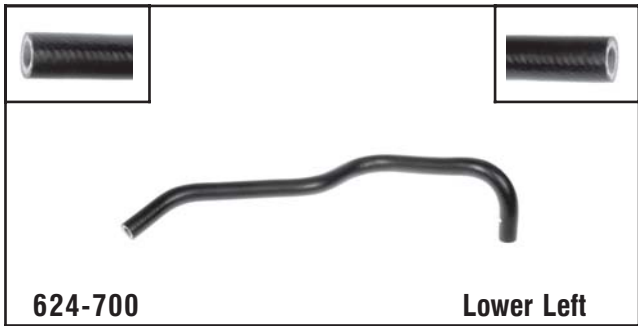

624-700 Lower Left

Mitsubishi
2004-97 Montero Sport w/ 3.0L, 3.5L

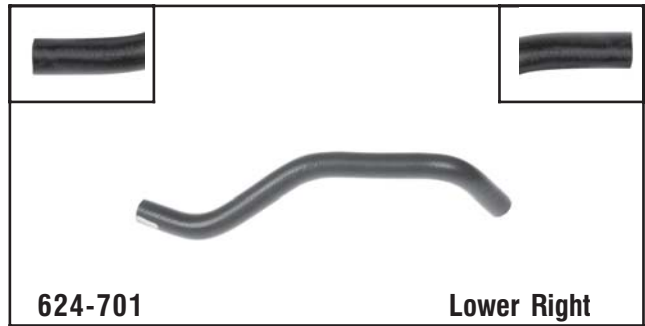

624-701 Lower Right

Mitsubishi
2004-97 Montero Sport w/ 3.0L, 3.5L



624-702 Lower Left

Subaru
2004-03 Baja, 2004-00 Legacy, 2003-01 Outback w/ 2.5L

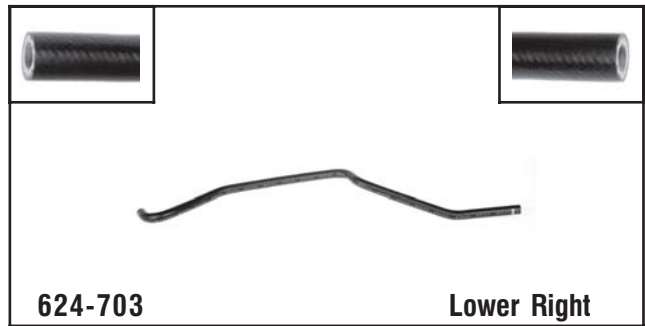

624-703 Lower Right

Subaru
2004-03 Baja, 2004-00 Legacy, 2003-01 Outback w/ 2.5L

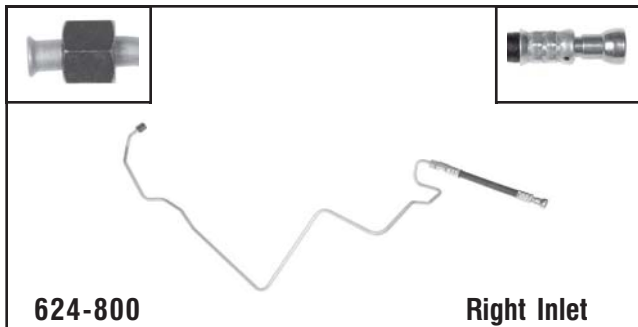

624-800 Right Inlet

Dodge
1996-94 Dakota w/ 3.9L



624-801 Lower Inlet

Jeep
2001-97 Cherokee w/ 2.5L, 4.0L

Transmission Line Assemblies

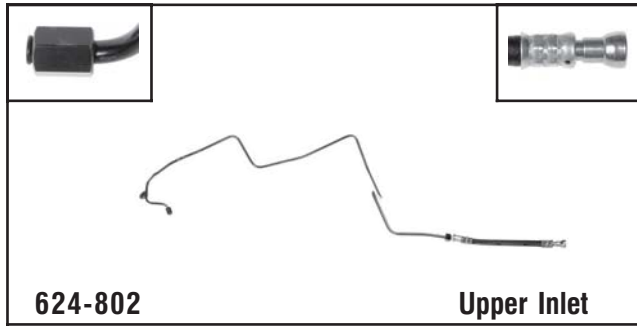

Dodge
1995-94 Ram Series Pickups w/ 5.2L, 5.9L

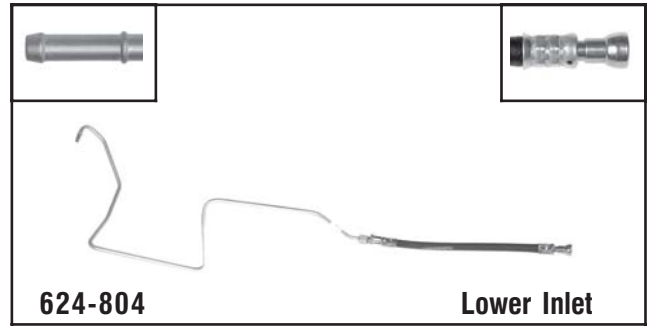

Jeep
1995-94 Grand Cherokee w/ 5.2L



Jeep
1997-96 Grand Cherokee w/ 4.0L

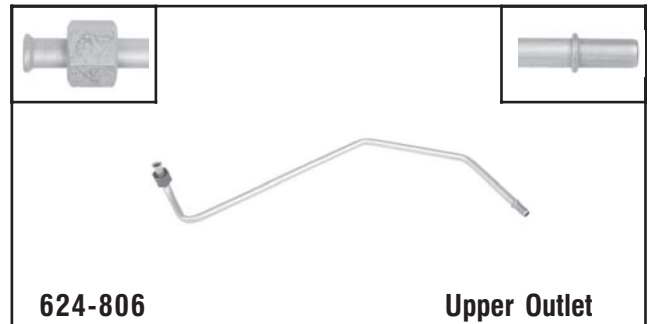

Jeep
1996-94 Grand Cherokee w/ 4.0L



Jeep
1993 Grand Cherokee w/ 5.2L

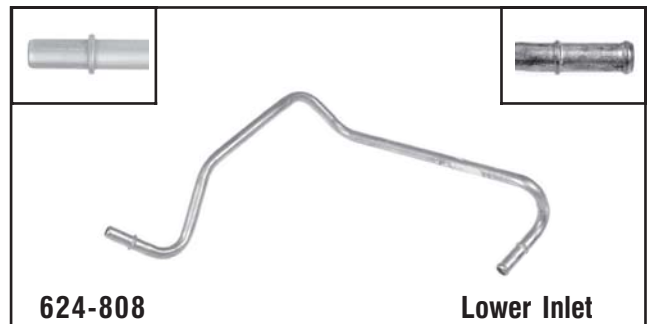

Dodge
1996-94 Dakota w/ 3.9L, 5.2L



Jeep
1997-94 Grand Cherokee w/ 5.2L

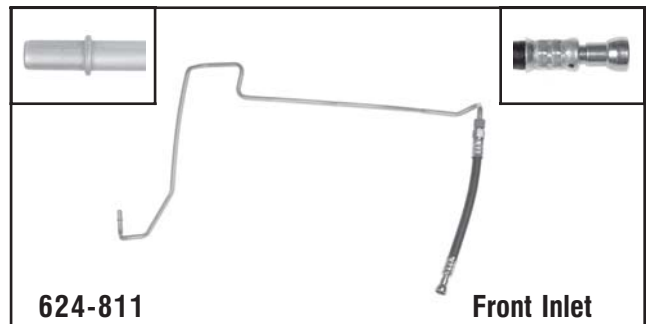

Jeep
1998-94 Cherokee w/ 2.5L

Transmission Line Assemblies

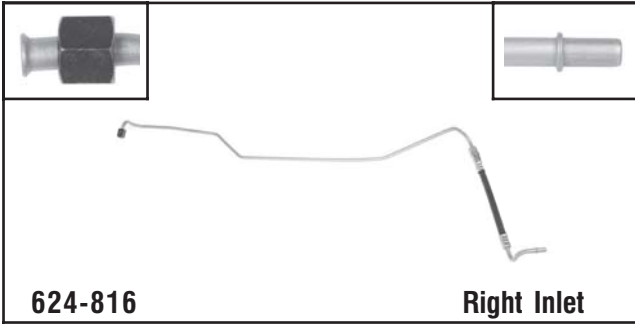

624-816

Right Inlet

Dodge
2003-98 Ram Series Vans w/ 3.9L, 5.2L, 5.9L

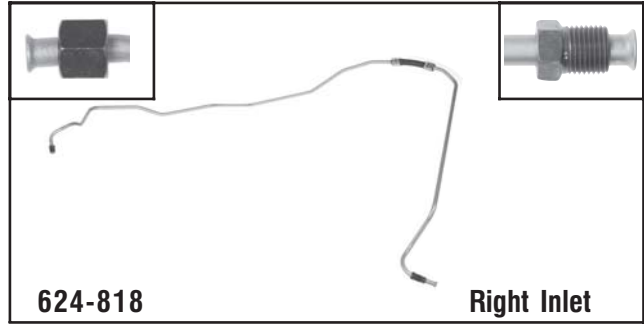

624-818

Right Inlet

Dodge
1999-97 Dakota w/ 3.9L, 5.2L

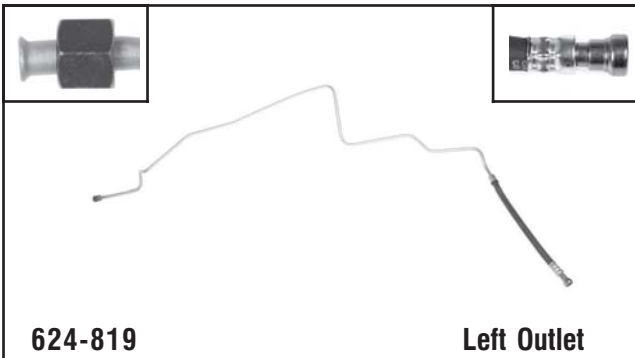

624-819

Left Outlet

Dodge
1999-97 Dakota w/ 3.9L, 5.2L

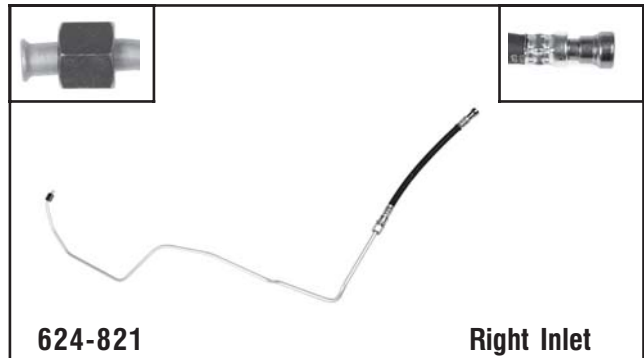

624-821

Right Inlet

Dodge
2003-97 Dakota, 2003-99 Durango w/ 3.9L, 5.2L, 5.9L

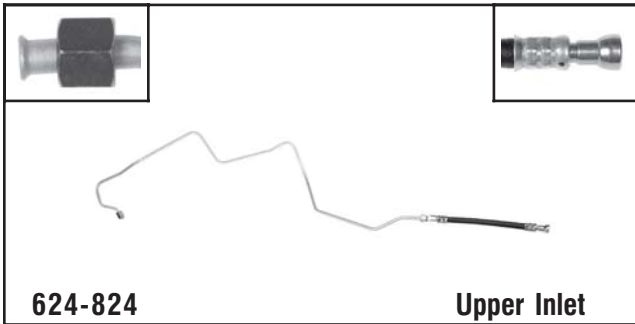

624-824

Upper Inlet

Dodge
2001-96 Ram 1500 Pickups w/ 3.9L

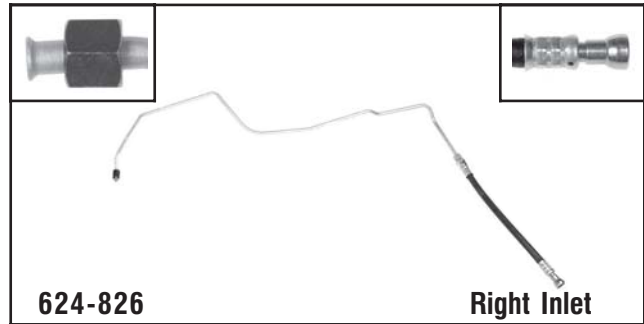

624-826

Right Inlet

Dodge
1999-98 Dakota, 1999 Durango w/ 5.9L



624-828

Right Inlet

Dodge
1999-98 Dakota w/ 5.9L

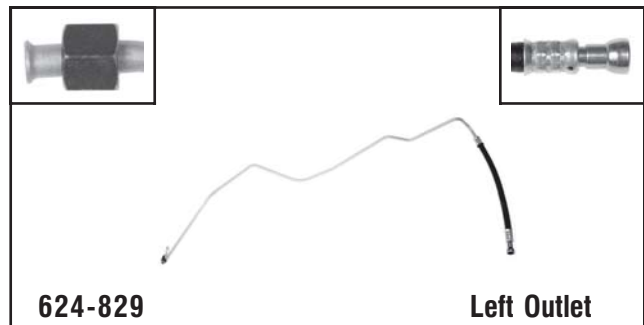

624-829

Left Outlet

Dodge
2003-98 Dakota, 2003-99 Durango w/ 5.9L

Transmission Line Assemblies

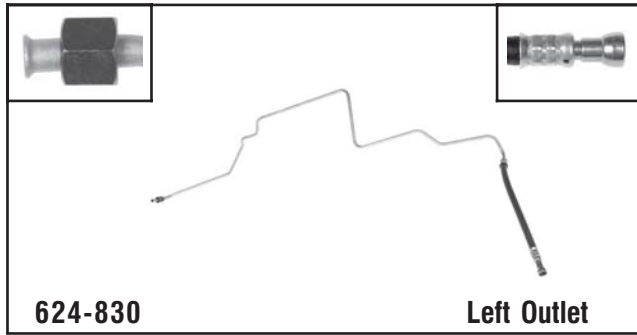

624-830

Left Outlet

Dodge
1999-98 Dakota w/ 5.9L

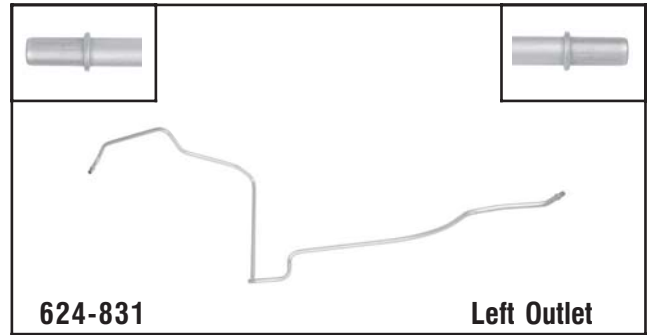

624-831

Left Outlet

Dodge
1999-98 Durango w/ 3.9L, 5.2L, 5.9L



624-832

Lower Outlet

Dodge
2001-97 Ram 1500 Pickups w/ 3.9L

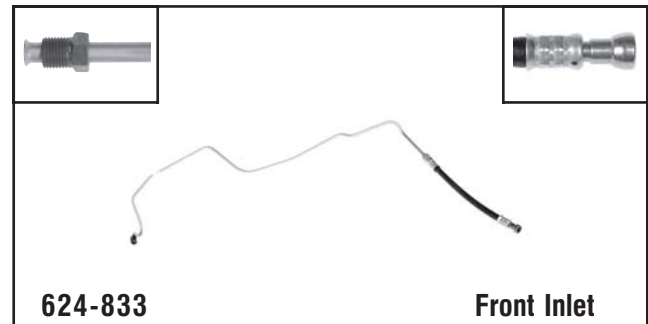

624-833

Front Inlet

Dodge
2003-01 Dakota, Durango w/ 5.9L

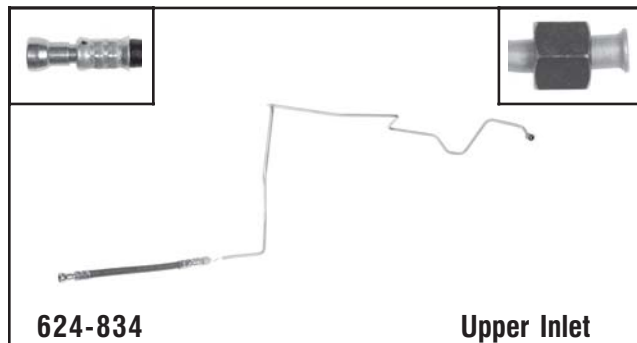

624-834

Upper Inlet

Dodge
2002-00 Ram Series Pickups w/ 5.2L, 5.9L



624-836

Upper Inlet

Jeep
1996 Grand Cherokee w/ 4.0L

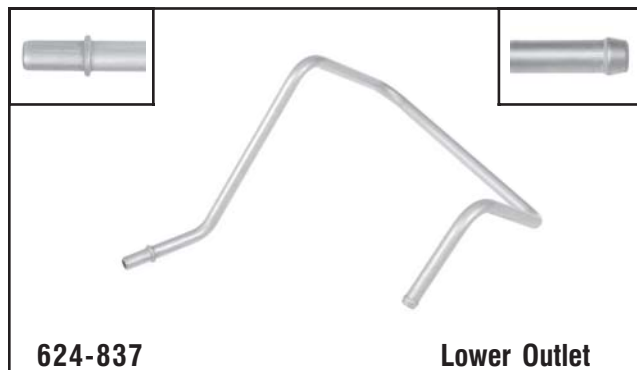

624-837

Lower Outlet

Jeep
1996 Grand Cherokee w/ 4.0L

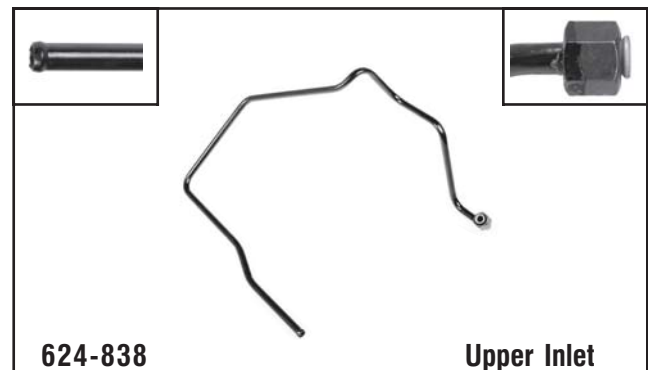

624-838

Upper Inlet

Jeep
1997-93 Grand Cherokee w/ 4.0L, 5.2L

Transmission Line Assemblies

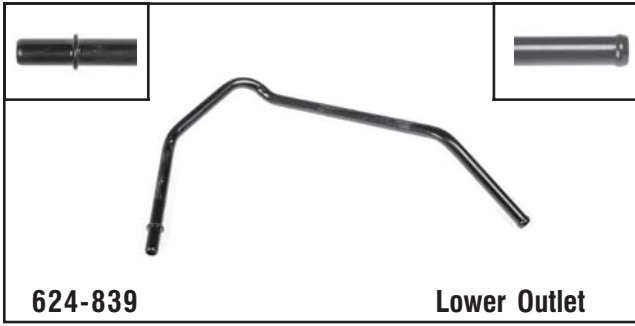

624-839 Lower Outlet

Jeep
1997-93 Grand Cherokee w/ 5.2L

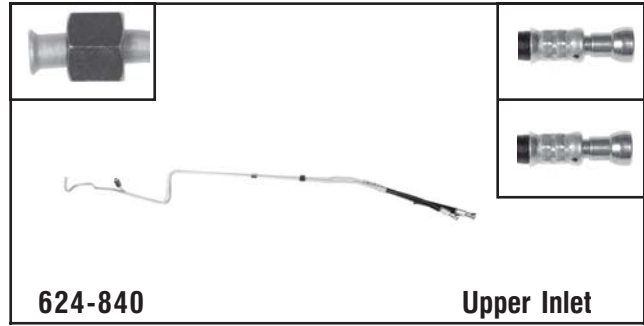

624-840 Upper Inlet

Jeep
1997-96 Grand Cherokee w/ 4.0L

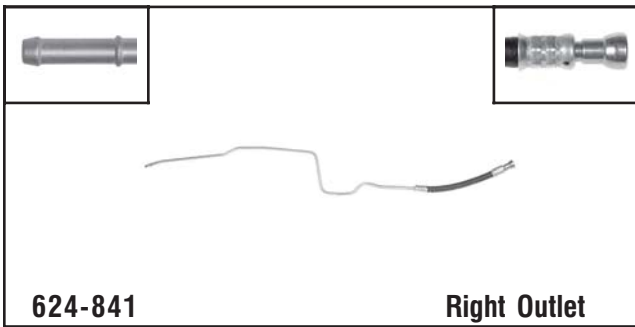

624-841 Right Outlet

Jeep
1993-87 Cherokee w/ 2.1L, 2.5L, 1992-87 Comanche w/ 2.1L, 2.5L, 1987 Wagoneer w/ 2.5L

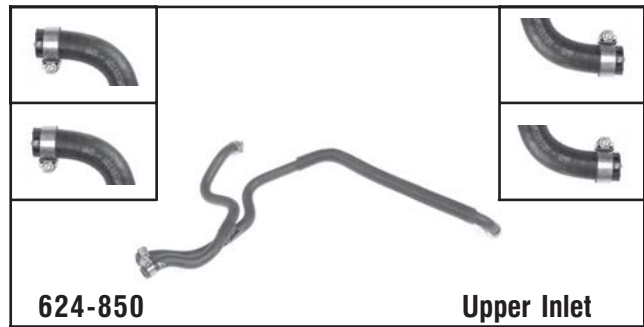

624-850 Upper Inlet

Dodge
1997 Caravan, Grand Caravan, Grand Voyager, Voyager w/ 2.4L

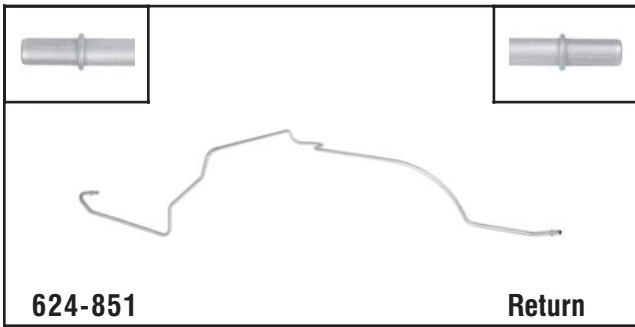

624-851 Return

Jeep
1998-94 Cherokee w/ 2.5L



624-854 Right Inlet

Dodge
1997-93 Concorde, Intrepid, LHS, Vision w/ 3.3L, 3.5L, 1996-94 New Yorker w/ 3.5L



624-882 Left Outlet

Dodge
1999-95 Neon w/ 2.0L

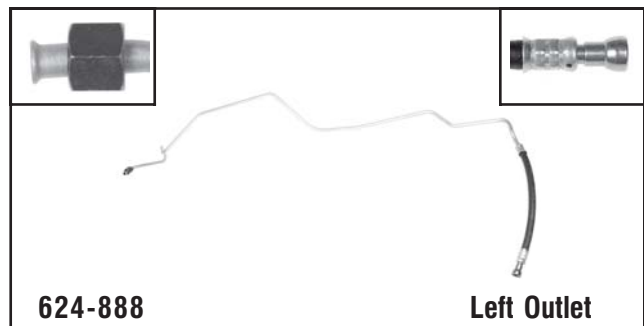

624-888 Left Outlet

Dodge
2000-97 Dakota, 1999 Durango w/ 3.9L, 5.2L

Transmission Line Assemblies



624-895

Lower Outlet

Dodge

1997 Caravan, Grand Caravan, Grand Voyager, Voyager w/ 2.4L

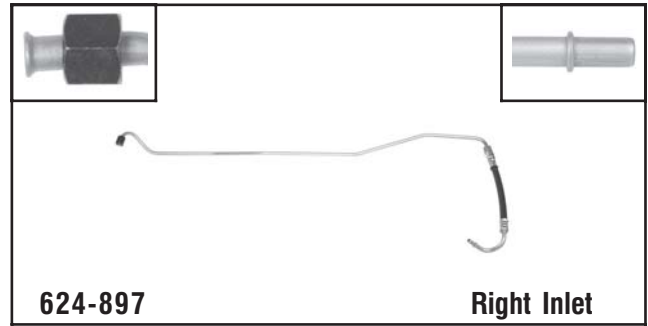

624-897

Right Inlet

Jeep

2003-99 Ram Series Vans w/ 3.9L, 5.2L, 5.9L, 1998 B 1500 & 2500 Series Vans w/ 3.9L



624-898

Right Inlet

Dodge

1999-95 Neon w/ 2.0L

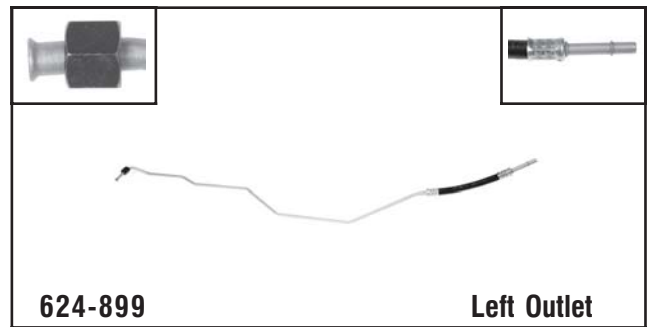

624-899

Left Outlet

Dodge

2003-02 Ram Series Vans w/ 3.9L, 5.2L, 5.9L



624-900

VW

2004-99 Jetta w/ 2.0L

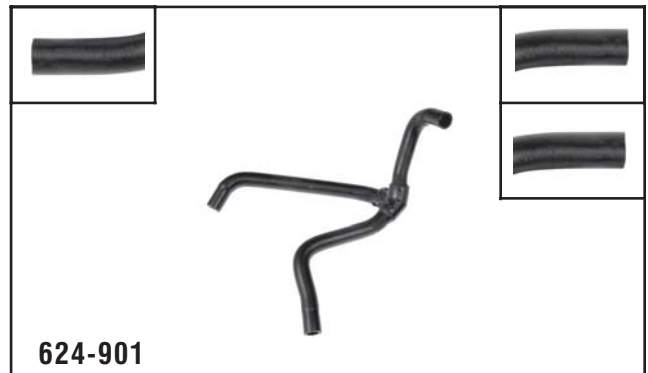

624-901

VW

1998-93 Golf, Jetta w/ 2.0L

Related Sales - Repair Kits



43600 (1)



Transmission Line Repair Kit

Repairs damaged or leaking transmission cooling lines. Avoid the cost and labor of replacing entire line. Quick and easy installation. Fits most domestic models.

47148 (1)



Quick Connector Repair Kit

Special kit to repair radiator to transmission coolant line quick connectors. Kit includes two O-rings, two retaining clips, two tools, and instructions.

Transmission Line Assembly Applications

Make/ Model/Engine	Years	Description	Dorman #
BUICK			
CENTURY			
L4 - 2.2L (134 CID)	1996-94	Upper & Lower- Inlet & Outlet To Trans	624-128
V6 - 3.1L (189 CID)	1997	Lower-Outlet	624-102
V6 - 3.1L (189 CID)	1997	Upper-Inlet	624-103
ELECTRA			
V6 - 3.8L (231 CID)	1990-88	Lower-Outlet Hose To Trans	624-111
V6 - 3.8L (231 CID)	1990-88	Lower-Outlet Tube From Radiator, w/Aux Cooler	624-140
V6 - 3.8L (231 CID)	1990-88	Lower-Outlet Tube From Radiator, wo/Aux Cooler	624-107
V6 - 3.8L (231 CID)	1990-88	Upper-Inlet Hose From Radiator, w/Aux Cooler	624-110
V6 - 3.8L (231 CID)	1990-88	Upper-Inlet Tube From Radiator, wo/Aux Cooler	624-157
V6 - 3.8L (231 CID)	1990-88	Upper-Inlet Tube To Trans	624-108
V6 - 3.8L (231 CID)	1987-86	Lower-Outlet	624-113
V6 - 3.8L (231 CID)	1987-86	Upper-Inlet	624-112
ESTATE WAGON			
V8 - 5.0L (307 CID)	1990-88	Lower-Outlet Tube From Radiator, w/Aux Cooler	624-140
V8 - 5.0L (307 CID)	1990-88	Lower-Outlet Tube From Radiator, wo/Aux Cooler	624-107
V8 - 5.0L (307 CID)	1990-88	Upper-Inlet Hose From Radiator, w/Aux Cooler	624-110
V8 - 5.0L (307 CID)	1990-88	Upper-Inlet Tube From Radiator, wo/Aux Cooler	624-157
V8 - 5.0L (307 CID)	1990-88	Upper-Inlet Tube To Trans	624-108
V8 - 5.0L (307 CID)	1987-86	Lower-Outlet	624-113
V8 - 5.0L (307 CID)	1987-86	Upper-Inlet	624-112
LESABRE			
V6 - 3.8L (231 CID)	1999-98	Lower-Outlet From Radiator	624-151
V6 - 3.8L (231 CID)	1999-98	Upper-Inlet From Radiator	624-150
V6 - 3.8L (231 CID)	1997	Lower-Outlet From Radiator, From 2/18/97	624-151
V6 - 3.8L (231 CID)	1997	Lower-Outlet From Radiator, To 2/18/97	624-144
V6 - 3.8L (231 CID)	1997	Upper-Inlet From Radiator, From 2/18/97	624-150
V6 - 3.8L (231 CID)	1996	Lower-Outlet From Radiator	624-144
V6 - 3.8L (231 CID)	1995-94	Lower-Outlet From Radiator	624-151
V6 - 3.8L (231 CID)	1995-94	Upper-Inlet From Radiator, w/Aux Cooler	624-142
V6 - 3.8L (231 CID)	1995-94	Upper-Inlet From Radiator, wo/Aux Cooler	624-150
V6 - 3.8L (231 CID)	1993	Upper-Inlet From Radiator, w/Aux Cooler	624-142
V6 - 3.8L (231 CID)	1993	Upper-Inlet From Radiator, wo/Aux Cooler	624-150
V6 - 3.8L (231 CID)	1990-88	Lower-Outlet Hose To Trans	624-111
V6 - 3.8L (231 CID)	1990-88	Lower-Outlet Tube From Radiator, w/Aux Cooler	624-140
V6 - 3.8L (231 CID)	1990-88	Lower-Outlet Tube From Radiator, wo/Aux Cooler	624-107
V6 - 3.8L (231 CID)	1990-88	Upper-Inlet Hose From Radiator, w/Aux Cooler	624-110
V6 - 3.8L (231 CID)	1990-88	Upper-Inlet Tube From Radiator, wo/Aux Cooler	624-157
V6 - 3.8L (231 CID)	1990-88	Upper-Inlet Tube To Trans	624-108
V6 - 3.8L (231 CID)	1987-86	Lower-Outlet	624-113
V6 - 3.8L (231 CID)	1987-86	Upper-Inlet	624-112
PARK AVENUE			
V6 - 3.8L (231 CID)	1997	Lower-Outlet From Radiator, From 2/18/97	624-151
V6 - 3.8L (231 CID)	1997	Lower-Outlet From Radiator, To 2/18/97	624-144
V6 - 3.8L (231 CID)	1997	Upper-Inlet From Radiator, From 2/18/97	624-150
V6 - 3.8L (231 CID)	1996	Lower-Outlet From Radiator	624-144
V6 - 3.8L (231 CID)	1995-94	Lower-Outlet From Radiator	624-151
V6 - 3.8L (231 CID)	1995-94	Upper-Inlet From Radiator, w/Aux Cooler	624-142
V6 - 3.8L (231 CID)	1995-94	Upper-Inlet From Radiator, wo/Aux Cooler	624-150
V6 - 3.8L (231 CID)	1993	Upper-Inlet From Radiator, w/Aux Cooler	624-142
V6 - 3.8L (231 CID)	1993	Upper-Inlet From Radiator, wo/Aux Cooler	624-150
REATA			
V6 - 3.8L (231 CID)	1990	Lower-Inlet Hose To Cooler	624-160
V6 - 3.8L (231 CID)	1990	Upper-Outlet Hose From Cooler	624-161
REGAL			
V6 - 3.1L (189 CID)	1996-90	Lower-Outlet	624-102
V6 - 3.1L (189 CID)	1996-90	Upper-Inlet	624-103
V6 - 3.8L (231 CID)	1997-90	Lower-Outlet	624-102
V6 - 3.8L (231 CID)	1997-90	Upper-Inlet	624-103
RIVIERA			
V6 - 3.8L (231 CID)	1989-88	Lower-Inlet Hose To Cooler	624-160
V6 - 3.8L (231 CID)	1989-88	Upper-Outlet Hose From Cooler	624-161
V6 - 3.8L (231 CID)	1987	Lower-Inlet Hose To Cooler	624-160
CADILLAC			
ALLANTE			
V8 - 4.6L (281 CID)	1993	Upper-Inlet From Radiator	624-121
CIMARRON			
L4 - 2.0L (122 CID)	1986-85	Lower-Outlet	624-199
L4 - 2.0L (122 CID)	1986-85	Upper-Inlet	624-198
CONCOURS			
V8 - 4.6L (281 CID)	1995-94	Upper-Inlet From Radiator	624-121
DEVILLE			
V8 - 4.6L (281 CID)	1999-96	Upper-Inlet	624-136
ELDORADO			
V8 - 4.6L (281 CID)	2000-96	Upper-Inlet	624-136
V8 - 4.6L (281 CID)	1995-93	Upper-Inlet From Radiator	624-121
ESCALADE			
V8 - 5.7L (350 CID)	2000-99	Left-Inlet Aux Cooler	624-133
V8 - 5.7L (350 CID)	2000-99	Lower-Outlet, wo/Aux Cooler	624-130
V8 - 5.7L (350 CID)	2000-99	Right-Outlet Aux Cooler	624-131

Transmission Line Assembly Applications

Make/ Model/Engine	Years	Description	Dorman #
CADILLAC (continued)			
ESCALADE (continued)			
V8 - 5.7L (350 CID)	2000-99	Upper-Inlet, wo/Aux Cooler	624-132
SEVILLE			
V8 - 4.6L (281 CID)	1999-96	Upper-Inlet	624-136
V8 - 4.6L (281 CID)	1995-93	Upper-Inlet From Radiator	624-121
CHEVROLET			
CAVALIER			
L4 - 2.2L (134 CID)	2001-95	Lower-Outlet 3-Speed Trans	624-139
L4 - 2.2L (134 CID)	2001-95	Upper-Inlet, 3-Speed Trans	624-138
LUMINA			
V6 - 3.1L (189 CID)	1999-91	Lower-Outlet	624-102
V6 - 3.1L (189 CID)	1999-91	Upper-Inlet	624-103
V6 - 3.4L (207 CID)	1997-91	Lower-Outlet	624-102
V6 - 3.4L (207 CID)	1997-91	Upper-Inlet	624-103
V6 - 3.8L (231 CID)	1999-98	Lower-Outlet	624-102
V6 - 3.8L (231 CID)	1999-98	Upper-Inlet	624-103
LUMINA APV			
V6 - 3.1L (189 CID)	1995-90	Upper & Lower- Inlet & Outlet To Trans	624-128
V6 - 3.4L (207 CID)	1996	Upper-Inlet From Radiator	624-126
V6 - 3.8L (231 CID)	1995-92	Lower-Inlet From Radiator, w/Aux Cooler	624-127
V6 - 3.8L (231 CID)	1995-92	Upper-Inlet From Radiator, wo/Aux Cooler	624-126
MONTE CARLO			
V6 - 3.1L (189 CID)	1999-95	Lower-Outlet	624-102
V6 - 3.1L (189 CID)	1999-95	Upper-Inlet	624-103
V6 - 3.4L (207 CID)	1997-95	Lower-Outlet	624-102
V6 - 3.4L (207 CID)	1997-95	Upper-Inlet	624-103
V6 - 3.8L (231 CID)	1999-98	Lower-Outlet	624-102
V6 - 3.8L (231 CID)	1999-98	Upper-Inlet	624-103
CHEVROLET TRUCK			
C1500 PICKUP			
V6 - 4.3L (262 CID)	1998	Lower-Outlet	624-135
V6 - 4.3L (262 CID)	1998	Upper-Inlet	624-134
V8 - 5.0L (305 CID)	1999-98	Lower-Outlet, w/140Amp Generator (8A5)	624-130
V8 - 5.0L (305 CID)	1999-98	Lower-Outlet, wo/140Amp Generator (8A5)	624-135
V8 - 5.0L (305 CID)	1999-98	Upper-Inlet, w/140Amp Generator (8A5)	624-132
V8 - 5.0L (305 CID)	1999-98	Upper-Inlet, wo/140Amp Generator (8A5)	624-134
V8 - 5.7L (350 CID)	1999-98	Left-Inlet Aux Cooler, (M30) Trans	624-133
V8 - 5.7L (350 CID)	1999-98	Left-Outlet Aux Cooler, (MT1) Trans	624-109
V8 - 5.7L (350 CID)	1999-98	Lower-Outlet, wo/Aux Cooler	624-130
V8 - 5.7L (350 CID)	1999-98	Right-Inlet Aux Cooler, (MT1) Trans	624-168
V8 - 5.7L (350 CID)	1999-98	Right-Outlet Aux Cooler, (M30) Trans	624-131
V8 - 5.7L (350 CID)	1999-98	Upper-Inlet, wo/Aux Cooler	624-132
V8 - 5.7L (350 CID)	1997	Left-Outlet Aux Cooler, (MT1) Trans	624-109
V8 - 5.7L (350 CID)	1997	Right-Inlet Aux Cooler, (MT1) Trans	624-168
V8 - 5.7L (350 CID)	1996	Right-Inlet Aux Cooler, (MT1) Trans	624-168
V8 - 5.7L (350 CID)	1995-94	Left-Outlet Aux Cooler	624-148
V8 - 6.5L (395 CID)	1998-97	Left-Outlet Aux Cooler	624-146
V8 - 6.5L (395 CID)	1998-97	Right-Inlet Aux Cooler	624-168
V8 - 6.5L (395 CID)	1995-94	Left-Outlet Aux Cooler	624-148
C1500 SUBURBAN			
V8 - 6.5L (395 CID)	1999-97	Left-Outlet Aux Cooler	624-146
C2500 PICKUP			
V8 - 5.0L (305 CID)	1999-98	Lower-Outlet, w/140Amp Generator (8A5)	624-130
V8 - 5.0L (305 CID)	1999-98	Lower-Outlet, wo/140Amp Generator (8A5)	624-135
V8 - 5.0L (305 CID)	1999-98	Upper-Inlet, w/140Amp Generator (8A5)	624-132
V8 - 5.0L (305 CID)	1999-98	Upper-Inlet, wo/140Amp Generator (8A5)	624-134
V8 - 5.7L (350 CID)	2000-98	Left-Inlet Aux Cooler, (M30) Trans	624-133
V8 - 5.7L (350 CID)	2000-98	Left-Outlet Aux Cooler, (MT1) Trans	624-109
V8 - 5.7L (350 CID)	2000-98	Lower-Outlet, wo/Aux Cooler	624-130
V8 - 5.7L (350 CID)	2000-98	Right-Inlet Aux Cooler, (MT1) Trans	624-168
V8 - 5.7L (350 CID)	2000-98	Right-Outlet Aux Cooler, (M30) Trans	624-131
V8 - 5.7L (350 CID)	2000-98	Upper-Inlet, wo/Aux Cooler	624-132
V8 - 5.7L (350 CID)	1997	Left-Outlet Aux Cooler, (MT1) Trans	624-109
V8 - 5.7L (350 CID)	1997	Right-Inlet Aux Cooler, (MT1) Trans	624-168
V8 - 5.7L (350 CID)	1996	Right-Inlet Aux Cooler, (MT1) Trans	624-168
V8 - 5.7L (350 CID)	1995-94	Left-Outlet Aux Cooler	624-148
V8 - 6.5L (395 CID)	2000-97	Left-Outlet Aux Cooler	624-146
V8 - 6.5L (395 CID)	2000-97	Right-Inlet Aux Cooler	624-168
V8 - 6.5L (395 CID)	1995-94	Left-Outlet Aux Cooler	624-148
V8 - 7.4L (454 CID)	2000-96	Left-Outlet Aux Cooler	624-156
V8 - 7.4L (454 CID)	2000-96	Right-Inlet Aux Cooler	624-106
V8 - 7.4L (454 CID)	1995-94	Left-Outlet Aux Cooler	624-148
C2500 SUBURBAN			
V8 - 6.5L (395 CID)	1999-97	Left-Outlet Aux Cooler	624-146
V8 - 7.4L (454 CID)	1999-96	Left-Outlet Aux Cooler	624-156
V8 - 7.4L (454 CID)	1999-96	Right-Inlet Aux Cooler	624-106
C3500 PICKUP			
V8 - 5.7L (350 CID)	2000-98	Left-Inlet Aux Cooler, (M30) Trans, Exc. HD	624-133
V8 - 5.7L (350 CID)	2000-98	Left-Outlet Aux Cooler, (MT1) Trans, Exc. HD	624-109
V8 - 5.7L (350 CID)	2000-98	Left-Outlet Aux Cooler, HD	624-137

Transmission Line Assembly Applications

Make/ Model/Engine	Years	Description	Dorman #
CHEVROLET TRUCK (continued)			
C3500 PICKUP (continued)			
V8 - 5.7L (350 CID)	2000-98	Lower-Outlet, wo/Aux Cooler	624-130
V8 - 5.7L (350 CID)	2000-98	Right-Inlet Aux Cooler, (MT1) Trans, Exc. HD	624-168
V8 - 5.7L (350 CID)	2000-98	Right-Inlet Aux Cooler, HD	624-104
V8 - 5.7L (350 CID)	2000-98	Right-Outlet Aux Cooler, (M30) Trans, Exc. HD	624-131
V8 - 5.7L (350 CID)	2000-98	Upper-Inlet, wo/Aux Cooler	624-132
V8 - 5.7L (350 CID)	1997	Left-Outlet Aux Cooler, (MT1) Trans, Exc. HD	624-109
V8 - 5.7L (350 CID)	1997	Right-Inlet Aux Cooler, (MT1) Trans, Exc. HD	624-168
V8 - 5.7L (350 CID)	1996	Right-Inlet Aux Cooler, (MT1) Trans, Exc. HD	624-168
V8 - 5.7L (350 CID)	1995-94	Left-Outlet Aux Cooler, HD	624-148
V8 - 6.5L (395 CID)	2002-01	Left-Outlet Aux Cooler, HD	624-137
V8 - 6.5L (395 CID)	2002-01	Right-Inlet Aux Cooler, HD	624-104
V8 - 6.5L (395 CID)	2000-98	Left-Outlet Aux Cooler, Exc. HD	624-146
V8 - 6.5L (395 CID)	2000-98	Left-Outlet Aux Cooler, HD	624-137
V8 - 6.5L (395 CID)	2000-98	Right-Inlet Aux Cooler, HD	624-104
V8 - 6.5L (395 CID)	1997	Left-Outlet Aux Cooler, Exc. HD	624-146
V8 - 6.5L (395 CID)	1997	Left-Outlet Aux Cooler, HD	624-137
V8 - 6.5L (395 CID)	1997	Right-Inlet Aux Cooler, HD	624-104
V8 - 6.5L (395 CID)	1996	Right-Inlet Aux Cooler, HD	624-104
V8 - 6.5L (395 CID)	1995-94	Left-Outlet Aux Cooler, HD	624-148
V8 - 7.4L (454 CID)	2000-96	Left-Outlet Aux Cooler, Exc. HD	624-156
V8 - 7.4L (454 CID)	2000-96	Left-Outlet Aux Cooler, HD	624-137
V8 - 7.4L (454 CID)	2000-96	Right-Inlet Aux Cooler, Exc. HD	624-106
V8 - 7.4L (454 CID)	2000-96	Right-Inlet Aux Cooler, HD	624-104
V8 - 7.4L (454 CID)	1995-94	Left-Outlet Aux Cooler, HD	624-148
K1500 PICKUP			
V6 - 4.3L (262 CID)	1998	Lower-Outlet	624-135
V6 - 4.3L (262 CID)	1998	Upper-Inlet	624-134
V8 - 5.0L (305 CID)	1999-98	Lower-Outlet, w/140Amp Generator (8A5)	624-130
V8 - 5.0L (305 CID)	1999-98	Lower-Outlet, wo/140Amp Generator (8A5)	624-135
V8 - 5.0L (305 CID)	1999-98	Upper-Inlet, w/140Amp Generator (8A5)	624-132
V8 - 5.0L (305 CID)	1999-98	Upper-Inlet, wo/140Amp Generator (8A5)	624-134
V8 - 5.7L (350 CID)	1999-98	Left-Inlet Aux Cooler, (M30) Trans	624-133
V8 - 5.7L (350 CID)	1999-98	Left-Outlet Aux Cooler, (MT1) Trans	624-109
V8 - 5.7L (350 CID)	1999-98	Lower-Outlet, wo/Aux Cooler	624-130
V8 - 5.7L (350 CID)	1999-98	Right-Inlet Aux Cooler, (MT1) Trans	624-168
V8 - 5.7L (350 CID)	1999-98	Right-Outlet Aux Cooler, (M30) Trans	624-131
V8 - 5.7L (350 CID)	1999-98	Upper-Inlet, wo/Aux Cooler	624-132
V8 - 5.7L (350 CID)	1997	Left-Outlet Aux Cooler, (MT1) Trans	624-109
V8 - 5.7L (350 CID)	1997	Right-Inlet Aux Cooler, (MT1) Trans	624-168
V8 - 5.7L (350 CID)	1996	Right-Inlet Aux Cooler, (MT1) Trans	624-168
V8 - 5.7L (350 CID)	1995-94	Left-Outlet Aux Cooler	624-148
V8 - 6.5L (395 CID)	1998-97	Left-Outlet Aux Cooler	624-146
V8 - 6.5L (395 CID)	1998-97	Right-Inlet Aux Cooler	624-168
V8 - 6.5L (395 CID)	1995-94	Left-Outlet Aux Cooler	624-148
K1500 SUBURBAN			
V8 - 6.5L (395 CID)	1999-97	Left-Outlet Aux Cooler	624-146
K2500 PICKUP			
V8 - 5.0L (305 CID)	1999-98	Lower-Outlet, w/140Amp Generator (8A5)	624-130
V8 - 5.0L (305 CID)	1999-98	Lower-Outlet, wo/140Amp Generator (8A5)	624-135
V8 - 5.0L (305 CID)	1999-98	Upper-Inlet, w/140Amp Generator (8A5)	624-132
V8 - 5.0L (305 CID)	1999-98	Upper-Inlet, wo/140Amp Generator (8A5)	624-134
V8 - 5.7L (350 CID)	2000-98	Left-Inlet Aux Cooler, (M30) Trans	624-133
V8 - 5.7L (350 CID)	2000-98	Left-Outlet Aux Cooler, (MT1) Trans	624-109
V8 - 5.7L (350 CID)	2000-98	Lower-Outlet, wo/Aux Cooler	624-130
V8 - 5.7L (350 CID)	2000-98	Right-Inlet Aux Cooler, (MT1) Trans	624-168
V8 - 5.7L (350 CID)	2000-98	Right-Outlet Aux Cooler, (M30) Trans	624-131
V8 - 5.7L (350 CID)	2000-98	Upper-Inlet, wo/Aux Cooler	624-132
V8 - 5.7L (350 CID)	1997	Left-Outlet Aux Cooler, (MT1) Trans	624-109
V8 - 5.7L (350 CID)	1997	Right-Inlet Aux Cooler, (MT1) Trans	624-168
V8 - 5.7L (350 CID)	1996	Right-Inlet Aux Cooler, (MT1) Trans	624-168
V8 - 5.7L (350 CID)	1995-94	Left-Outlet Aux Cooler	624-148
V8 - 6.5L (395 CID)	2000-97	Left-Outlet Aux Cooler	624-146
V8 - 6.5L (395 CID)	2000-97	Right-Inlet Aux Cooler	624-168
V8 - 6.5L (395 CID)	1995-94	Left-Outlet Aux Cooler	624-148
V8 - 7.4L (454 CID)	2000-96	Left-Outlet Aux Cooler	624-156
V8 - 7.4L (454 CID)	2000-96	Right-Inlet Aux Cooler	624-106
V8 - 7.4L (454 CID)	1995-94	Left-Outlet Aux Cooler	624-148
K2500 SUBURBAN			
V8 - 6.5L (395 CID)	1999-97	Left-Outlet Aux Cooler	624-146
V8 - 7.4L (454 CID)	1999-96	Left-Outlet Aux Cooler	624-156
V8 - 7.4L (454 CID)	1999-96	Right-Inlet Aux Cooler	624-106
K3500 PICKUP			
V8 - 5.7L (350 CID)	2000-98	Left-Inlet Aux Cooler, (M30) Trans, Exc. HD	624-133
V8 - 5.7L (350 CID)	2000-98	Left-Outlet Aux Cooler, (MT1) Trans, Exc. HD	624-109
V8 - 5.7L (350 CID)	2000-98	Left-Outlet Aux Cooler, HD	624-137
V8 - 5.7L (350 CID)	2000-98	Lower-Outlet, wo/Aux Cooler	624-130
V8 - 5.7L (350 CID)	2000-98	Right-Inlet Aux Cooler, (MT1) Trans, Exc. HD	624-168
V8 - 5.7L (350 CID)	2000-98	Right-Inlet Aux Cooler, HD	624-104
V8 - 5.7L (350 CID)	2000-98	Right-Outlet Aux Cooler, (M30) Trans, Exc. HD	624-131

Transmission Line Assembly Applications

Make/ Model/Engine	Years	Description	Dorman #
CHEVROLET TRUCK (continued)			
K3500 PICKUP (continued)			
V8 - 5.7L (350 CID)	2000-98	Upper-Inlet, wo/Aux Cooler	624-132
V8 - 5.7L (350 CID)	1997	Left-Outlet Aux Cooler, (MT1) Trans, Exc. HD	624-109
V8 - 5.7L (350 CID)	1997	Right-Inlet Aux Cooler, (MT1) Trans, Exc. HD	624-168
V8 - 5.7L (350 CID)	1996	Right-Inlet Aux Cooler, (MT1) Trans, Exc. HD	624-168
V8 - 5.7L (350 CID)	1995-94	Left-Outlet Aux Cooler, HD	624-148
V8 - 6.5L (395 CID)	2002-01	Left-Outlet Aux Cooler, HD	624-137
V8 - 6.5L (395 CID)	2000-97	Left-Outlet Aux Cooler, Exc. HD	624-146
V8 - 6.5L (395 CID)	2000-97	Left-Outlet Aux Cooler, HD	624-137
V8 - 6.5L (395 CID)	2000-97	Right-Inlet Aux Cooler, Exc. HD	624-168
V8 - 6.5L (395 CID)	2000-97	Right-Inlet Aux Cooler, HD	624-104
V8 - 6.5L (395 CID)	1996	Right-Inlet Aux Cooler, HD	624-104
V8 - 6.5L (395 CID)	1995-94	Left-Outlet Aux Cooler, HD	624-148
V8 - 7.4L (454 CID)	2000-96	Left-Outlet Aux Cooler, Exc. HD	624-156
V8 - 7.4L (454 CID)	2000-96	Left-Outlet Aux Cooler, HD	624-137
V8 - 7.4L (454 CID)	2000-96	Right-Inlet Aux Cooler, Exc. HD	624-106
V8 - 7.4L (454 CID)	2000-96	Right-Inlet Aux Cooler, HD	624-104
V8 - 7.4L (454 CID)	1995-94	Left-Outlet Aux Cooler, HD	624-148
S10 BLAZER			
V6 - 4.3L (262 CID)	2005-96	Lower-Inlet	624-101
V6 - 4.3L (262 CID)	2005-96	Upper-Outlet	624-100
S10 PICKUP			
V6 - 4.3L (262 CID)	2004-96	Lower-Inlet	624-101
V6 - 4.3L (262 CID)	2004-96	Upper-Outlet	624-100
SUBURBAN			
V8 - 5.7L (350 CID)	1999	Left-Outlet Aux Cooler, (MT1) Trans	624-109
V8 - 5.7L (350 CID)	1999	Lower-Outlet, (M30) Trans, wo/Aux Cooler	624-130
V8 - 5.7L (350 CID)	1999	Right-Inlet Aux Cooler, (MT1) Trans	624-168
V8 - 5.7L (350 CID)	1999	Upper-Inlet, (M30) Trans, wo/Aux Cooler	624-132
V8 - 5.7L (350 CID)	1998	Left-Inlet Aux Cooler, (M30) Trans	624-133
V8 - 5.7L (350 CID)	1998	Left-Outlet Aux Cooler, (MT1) Trans	624-109
V8 - 5.7L (350 CID)	1998	Lower-Outlet, (M30) Trans, wo/Aux Cooler	624-130
V8 - 5.7L (350 CID)	1998	Right-Inlet Aux Cooler, (MT1) Trans	624-168
V8 - 5.7L (350 CID)	1998	Right-Outlet Aux Cooler, (M30) Trans	624-131
V8 - 5.7L (350 CID)	1998	Upper-Inlet, (M30) Trans, wo/Aux Cooler	624-132
V8 - 5.7L (350 CID)	1997	Left-Outlet Aux Cooler, (MT1) Trans	624-109
V8 - 5.7L (350 CID)	1997	Right-Inlet Aux Cooler, (MT1) Trans	624-168
V8 - 5.7L (350 CID)	1996	Right-Inlet Aux Cooler, (MT1) Trans	624-168
TAHOE			
V8 - 5.7L (350 CID)	2000-98	Left-Inlet Aux Cooler	624-133
V8 - 5.7L (350 CID)	2000-98	Lower-Outlet, wo/Aux Cooler	624-130
V8 - 5.7L (350 CID)	2000-98	Right-Outlet Aux Cooler	624-131
V8 - 5.7L (350 CID)	2000-98	Upper-Inlet, wo/Aux Cooler	624-132
V8 - 6.5L (395 CID)	1999-97	Left-Outlet Aux Cooler	624-146
V8 - 6.5L (395 CID)	1999-97	Right-Inlet Aux Cooler	624-168
CHRYSLER			
CIRRUS			
L4 - 2.4L (148 CID)	1997	Left-Outlet Hose	624-367
L4 - 2.4L (148 CID)	1997	Right-Inlet Hose	624-366
L4 - 2.4L (148 CID)	1996-95	Left-Outlet Hose	624-367
L4 - 2.4L (148 CID)	1996-95	Left-Outlet Tube Aux Cooler	624-380
L4 - 2.4L (148 CID)	1996-95	Right-Inlet Hose	624-366
L4 - 2.4L (148 CID)	1996-95	Right-Inlet Tube Aux Cooler	624-386
V6 - 2.5L (152 CID)	2000	Upper-Inlet Hose, Sedan	624-326
V6 - 2.5L (152 CID)	1999-97	Lower-Outlet Hose	624-388
V6 - 2.5L (152 CID)	1999-97	Upper-Inlet Hose	624-326
V6 - 2.5L (152 CID)	1996-95	Left-Outlet Tube Aux Cooler	624-380
V6 - 2.5L (152 CID)	1996-95	Lower-Outlet Hose	624-388
V6 - 2.5L (152 CID)	1996-95	Right-Inlet Tube Aux Cooler	624-386
V6 - 2.5L (152 CID)	1996-95	Upper-Inlet Hose	624-326
CONCORDE			
V6 - 3.3L (201 CID)	1996-93	Left-Outlet Aux Cooler	624-395
V6 - 3.3L (201 CID)	1996-93	Lower-Outlet, wo/Aux Cooler	624-312
V6 - 3.3L (201 CID)	1996-93	Right-Inlet Aux Cooler	624-854
V6 - 3.3L (201 CID)	1996-93	Upper-Inlet, wo/Aux Cooler	624-313
V6 - 3.5L (215 CID)	1997-93	Left-Outlet Aux Cooler	624-395
V6 - 3.5L (215 CID)	1997-93	Lower-Outlet, wo/Aux Cooler	624-312
V6 - 3.5L (215 CID)	1997-93	Right-Inlet Aux Cooler	624-854
V6 - 3.5L (215 CID)	1997-93	Upper-Inlet, wo/Aux Cooler	624-313
GRAND VOYAGER			
V6 - 3.0L (181 CID)	2000	Intermediate Aux Cooler Tube	624-320
V6 - 3.0L (181 CID)	2000	Upper & Lower-Inlet & Outlet, wo/Aux Cooler	624-311
V6 - 3.3L (201 CID)	2000	Intermediate Aux Cooler Tube	624-320
V6 - 3.8L (230 CID)	2000	Upper & Lower-Inlet & Outlet, wo/Aux Cooler	624-311
LHS			
V6 - 3.3L (201 CID)	1997-94	Lower-Outlet, wo/Aux Cooler	624-312
V6 - 3.3L (201 CID)	1997-94	Upper-Inlet, wo/Aux Cooler	624-313
V6 - 3.5L (215 CID)	1997-94	Lower-Outlet, wo/Aux Cooler	624-312

Transmission Line Assembly Applications

Make/ Model/Engine	Years	Description	Dorman #
CHRYSLER (continued)			
LHS (continued)			
V6 - 3.5L (215 CID)	1997-94	Upper-Inlet, wo/Aux Cooler	624-313
V6 - 3.5L (215 CID)	1997-93	Left-Outlet Aux Cooler	624-395
V6 - 3.5L (215 CID)	1997-93	Right-Inlet Aux Cooler	624-854
NEW YORKER			
V6 - 3.3L (201 CID)	1996-94	Lower-Outlet, wo/Aux Cooler	624-312
V6 - 3.3L (201 CID)	1996-94	Upper-Inlet, wo/Aux Cooler	624-313
V6 - 3.5L (215 CID)	1996-94	Left-Outlet Aux Cooler	624-395
V6 - 3.5L (215 CID)	1996-94	Lower-Outlet, wo/Aux Cooler	624-312
V6 - 3.5L (215 CID)	1996-94	Right-Inlet Aux Cooler	624-854
V6 - 3.5L (215 CID)	1996-94	Upper-Inlet, wo/Aux Cooler	624-313
SEBRING			
L4 - 2.0L (122 CID)	1996-95	Left-Outlet Hose	624-367
L4 - 2.0L (122 CID)	1996-95	Left-Outlet Tube Aux Cooler	624-380
L4 - 2.0L (122 CID)	1996-95	Right-Inlet Hose	624-366
L4 - 2.0L (122 CID)	1996-95	Right-Inlet Tube Aux Cooler	624-386
L4 - 2.4L (148 CID)	2004-01	Upper & Lower-Inlet & Outlet Hose, Convertible & Sedan	624-314
L4 - 2.4L (148 CID)	1998-97	Left-Outlet Hose	624-367
L4 - 2.4L (148 CID)	1998-97	Right-Inlet Hose	624-366
L4 - 2.4L (148 CID)	1996	Left-Outlet Hose	624-367
L4 - 2.4L (148 CID)	1996	Left-Outlet Tube Aux Cooler	624-380
L4 - 2.4L (148 CID)	1996	Right-Inlet Hose	624-366
L4 - 2.4L (148 CID)	1996	Right-Inlet Tube Aux Cooler	624-386
V6 - 2.5L (152 CID)	2000	Upper-Inlet Hose, Sedan	624-326
V6 - 2.5L (152 CID)	1999	Lower-Outlet Hose, Convertible	624-388
V6 - 2.5L (152 CID)	1999	Upper-Inlet Hose, Convertible	624-326
V6 - 2.5L (152 CID)	1998-97	Left-Outlet Tube Aux Cooler, Convertible	624-380
V6 - 2.5L (152 CID)	1998-97	Lower-Outlet Hose, Convertible	624-388
V6 - 2.5L (152 CID)	1998-97	Right-Inlet Tube Aux Cooler, Convertible	624-386
V6 - 2.5L (152 CID)	1998-97	Upper-Inlet Hose, Convertible	624-326
V6 - 2.5L (152 CID)	1996-95	Lower-Outlet Hose	624-388
V6 - 2.5L (152 CID)	1996-95	Right-Inlet Tube Aux Cooler	624-386
V6 - 2.5L (152 CID)	1996-95	Upper-Inlet Hose	624-326
V6 - 2.7L (167 CID)	2004-01	Upper & Lower-Inlet & Outlet Hose, Convertible & Sedan	624-314
TOWN & COUNTRY VAN			
V6 - 3.3L (201 CID)	2000	Intermediate Aux Cooler Tube	624-320
V6 - 3.3L (201 CID)	2000	Upper & Lower-Inlet & Outlet, wo/AC	624-330
V6 - 3.3L (201 CID)	2000	Upper & Lower-Inlet & Outlet, wo/Aux Cooler	624-311
V6 - 3.3L (201 CID)	1999	Intermediate Aux Cooler Tube	624-320
V6 - 3.3L (201 CID)	1999	Upper & Lower-Inlet & Outlet, wo/Aux Cooler	624-311
V6 - 3.3L (201 CID)	1998	Intermediate Aux Cooler Tube	624-320
V6 - 3.3L (201 CID)	1998	Upper & Lower, Inlet & Supply Radiator Oil Cooler	624-379
V6 - 3.3L (201 CID)	1998	Upper & Lower-Inlet & Outlet, w/HD Radiator	624-370
V6 - 3.3L (201 CID)	1998	Upper & Lower-Inlet & Outlet, w/Rear AC	624-330
V6 - 3.3L (201 CID)	1998	Upper & Lower-Inlet & Outlet, wo/Aux Cooler	624-311
V6 - 3.3L (201 CID)	1997	Intermediate Aux Cooler Tube	624-320
V6 - 3.3L (201 CID)	1997	Upper & Lower, Inlet & Supply Radiator Oil Cooler, w/Tow Package	624-379
V6 - 3.3L (201 CID)	1997	Upper & Lower-Inlet & Outlet, 4-Speed Trans, w/Rear AC	624-330
V6 - 3.3L (201 CID)	1997	Upper & Lower-Inlet & Outlet, wo/Aux Cooler	624-311
V6 - 3.3L (201 CID)	1996	Upper & Lower, Inlet & Supply Radiator Oil Cooler, w/Tow Package	624-379
V6 - 3.3L (201 CID)	1993	Inlet, Hose, Air Cooled Trans	624-368
V6 - 3.3L (201 CID)	1993	Outlet, Tube, Air Cooled Trans	624-369
V6 - 3.3L (201 CID)	1993	Upper & Lower-Inlet & Outlet, Water Cooled Trans, wo/AC	624-378
V6 - 3.8L (230 CID)	2000-97	Intermediate Aux Cooler Tube	624-320
V6 - 3.8L (230 CID)	2000	Upper & Lower-Inlet & Outlet, wo/AC	624-330
V6 - 3.8L (230 CID)	2000	Upper & Lower-Inlet & Outlet, wo/Aux Cooler	624-311
V6 - 3.8L (230 CID)	1999	Upper & Lower-Inlet & Outlet, wo/Aux Cooler	624-311
V6 - 3.8L (230 CID)	1998	Upper & Lower, Inlet & Supply Radiator Oil Cooler	624-379
V6 - 3.8L (230 CID)	1998	Upper & Lower-Inlet & Outlet, w/HD Radiator	624-370
V6 - 3.8L (230 CID)	1998	Upper & Lower-Inlet & Outlet, w/Rear AC	624-330
V6 - 3.8L (230 CID)	1998	Upper & Lower-Inlet & Outlet, wo/Aux Cooler	624-311
V6 - 3.8L (230 CID)	1997-96	Upper & Lower, Inlet & Supply Radiator Oil Cooler, w/Tow Package	624-379
V6 - 3.8L (230 CID)	1997	Upper & Lower-Inlet & Outlet, wo/Aux Cooler	624-311
V6 - 3.8L (230 CID)	1995-94	Inlet, Hose, Air Cooled Trans	624-368
V6 - 3.8L (230 CID)	1995-94	Outlet, Tube, Air Cooled Trans	624-369
V6 - 3.8L (230 CID)	1995-93	Upper & Lower-Inlet & Outlet, Water Cooled Trans,	624-344
V6 - 3.8L (230 CID)	1995-93	Upper & Lower-Inlet & Outlet, Water Cooled Trans, wo/AC	624-378
VOYAGER			
V6 - 3.0L (181 CID)	2000	Intermediate Aux Cooler Tube	624-320
V6 - 3.0L (181 CID)	2000	Upper & Lower-Inlet & Outlet, wo/Aux Cooler	624-311
V6 - 3.3L (201 CID)	2000	Intermediate Aux Cooler Tube	624-320
V6 - 3.8L (230 CID)	2000	Upper & Lower-Inlet & Outlet, wo/Aux Cooler	624-311
DODGE			
CARAVAN			
L4 - 2.4L (148 CID)	1997	Lower-Outlet, 4-Speed Trans	624-895
L4 - 2.4L (148 CID)	1997	Upper-Inlet, 4-Speed Trans	624-850
L4 - 2.4L (148 CID)	1996	Upper & Lower-Inlet & Outlet, 3-Speed Trans	624-394
L4 - 2.5L (153 CID)	1995-93	Inlet, Hose, Air Cooled Trans	624-368
L4 - 2.5L (153 CID)	1995-93	Outlet, Tube, Air Cooled Trans	624-369
L4 - 2.5L (153 CID)	1995-93	Upper & Lower-Inlet & Outlet, Water Cooled Trans	624-362

Transmission Line Assembly Applications

Make/ Model/Engine	Years	Description	Dorman #
DODGE (continued)			
CARAVAN (continued)			
V6 - 3.0L (181 CID)	2000-99	Intermediate Aux Cooler Tube	624-320
V6 - 3.0L (181 CID)	2000	Upper & Lower-Inlet & Outlet, wo/Aux Cooler	624-311
V6 - 3.0L (181 CID)	1998	Upper & Lower, Inlet & Supply Radiator Oil Cooler, 3-Speed Trans	624-379
V6 - 3.0L (181 CID)	1996	Upper & Lower-Inlet & Outlet, 3-Speed Trans	624-394
V6 - 3.0L (181 CID)	1995-94	Upper & Lower-Inlet & Outlet, Water Cooled Trans, 3-Speed Trans, w/Rear AC	624-376
V6 - 3.0L (181 CID)	1995-94	Upper-Inlet, Water Cooled Trans, 4-Speed Trans, w/AC	624-346
V6 - 3.0L (181 CID)	1995-93	Inlet, Hose, Air Cooled Trans	624-368
V6 - 3.0L (181 CID)	1995-93	Outlet, Tube, Air Cooled Trans	624-369
V6 - 3.0L (181 CID)	1995-93	Upper & Lower-Inlet & Outlet, Water Cooled Trans, 3-Speed Trans, wo/Rear AC	624-362
V6 - 3.0L (181 CID)	1995-93	Upper & Lower-Inlet & Outlet, Water Cooled Trans, 4-Speed DGL Trans, wo/AC	624-372
V6 - 3.0L (181 CID)	1995-93	Upper-Inlet, Water Cooled Trans, 4-Speed Trans, wo/AC	624-374
V6 - 3.3L (201 CID)	2000	Intermediate Aux Cooler Tube	624-320
V6 - 3.3L (201 CID)	2000	Upper & Lower-Inlet & Outlet, wo/Aux Cooler	624-311
V6 - 3.3L (201 CID)	1999	Intermediate Aux Cooler Tube	624-320
V6 - 3.3L (201 CID)	1999	Upper & Lower-Inlet & Outlet, wo/Aux Cooler	624-311
V6 - 3.3L (201 CID)	1998	Intermediate Aux Cooler Tube	624-320
V6 - 3.3L (201 CID)	1998	Upper & Lower, Inlet & Supply Radiator Oil Cooler	624-379
V6 - 3.3L (201 CID)	1998	Upper & Lower-Inlet & Outlet, w/HD Radiator	624-370
V6 - 3.3L (201 CID)	1998	Upper & Lower-Inlet & Outlet, w/Rear AC	624-330
V6 - 3.3L (201 CID)	1998	Upper & Lower-Inlet & Outlet, wo/Aux Cooler	624-311
V6 - 3.3L (201 CID)	1997	Intermediate Aux Cooler Tube	624-320
V6 - 3.3L (201 CID)	1997	Upper & Lower, Inlet & Supply Radiator Oil Cooler, w/Tow Package	624-379
V6 - 3.3L (201 CID)	1997	Upper & Lower-Inlet & Outlet, w/Rear AC	624-330
V6 - 3.3L (201 CID)	1997	Upper & Lower-Inlet & Outlet, wo/Aux Cooler	624-311
V6 - 3.3L (201 CID)	1996	Upper & Lower, Inlet & Supply Radiator Oil Cooler, w/Tow Package	624-379
V6 - 3.3L (201 CID)	1995-94	Inlet, Hose, Air Cooled Trans	624-368
V6 - 3.3L (201 CID)	1995-94	Outlet, Tube, Air Cooled Trans	624-369
V6 - 3.3L (201 CID)	1995-94	Upper & Lower-Inlet & Outlet, Water Cooled Trans, w/AC	624-347
V6 - 3.3L (201 CID)	1995-94	Upper & Lower-Inlet & Outlet, Water Cooled Trans, wo/AC	624-378
V6 - 3.3L (201 CID)	1993	Inlet, Hose, Air Cooled Trans	624-368
V6 - 3.3L (201 CID)	1993	Outlet, Tube, Air Cooled Trans	624-369
V6 - 3.3L (201 CID)	1993	Upper & Lower-Inlet & Outlet, Water Cooled Trans, wo/AC	624-378
V6 - 3.8L (230 CID)	2000	Upper & Lower-Inlet & Outlet, wo/Aux Cooler	624-311
V6 - 3.8L (230 CID)	1999-97	Intermediate Aux Cooler Tube	624-320
V6 - 3.8L (230 CID)	1999	Upper & Lower-Inlet & Outlet, wo/Aux Cooler	624-311
V6 - 3.8L (230 CID)	1998-97	Upper & Lower-Inlet & Outlet, w/Rear AC	624-330
V6 - 3.8L (230 CID)	1998	Upper & Lower, Inlet & Supply Radiator Oil Cooler	624-379
V6 - 3.8L (230 CID)	1998	Upper & Lower-Inlet & Outlet, w/HD Radiator	624-370
V6 - 3.8L (230 CID)	1998	Upper & Lower-Inlet & Outlet, wo/Aux Cooler	624-311
V6 - 3.8L (230 CID)	1997-96	Upper & Lower, Inlet & Supply Radiator Oil Cooler, w/Tow Package	624-379
V6 - 3.8L (230 CID)	1997	Upper & Lower-Inlet & Outlet, wo/Aux Cooler	624-311
GRAND CARAVAN			
L4 - 2.4L (148 CID)	1997	Lower-Outlet, 4-Speed Trans	624-895
L4 - 2.4L (148 CID)	1997	Upper-Inlet, 4-Speed Trans	624-850
L4 - 2.4L (148 CID)	1996	Upper & Lower-Inlet & Outlet, 3-Speed Trans	624-394
V6 - 3.0L (181 CID)	2000-99	Intermediate Aux Cooler Tube	624-320
V6 - 3.0L (181 CID)	2000	Upper & Lower-Inlet & Outlet, wo/Aux Cooler	624-311
V6 - 3.0L (181 CID)	1998	Upper & Lower, Inlet & Supply Radiator Oil Cooler, 3-Speed Trans	624-379
V6 - 3.0L (181 CID)	1996	Upper & Lower-Inlet & Outlet, 3-Speed Trans	624-394
V6 - 3.0L (181 CID)	1995-94	Upper & Lower-Inlet & Outlet, Water Cooled Trans, 3-Speed Trans, w/Rear AC	624-376
V6 - 3.0L (181 CID)	1995-94	Upper-Inlet, Water Cooled Trans, 4-Speed Trans, w/AC	624-346
V6 - 3.0L (181 CID)	1995-93	Inlet, Hose, Air Cooled Trans	624-368
V6 - 3.0L (181 CID)	1995-93	Outlet, Tube, Air Cooled Trans	624-369
V6 - 3.0L (181 CID)	1995-93	Upper & Lower-Inlet & Outlet, Water Cooled Trans, 3-Speed Trans, wo/Rear AC	624-362
V6 - 3.0L (181 CID)	1995-93	Upper & Lower-Inlet & Outlet, Water Cooled Trans, 4-Speed DGL Trans, wo/AC	624-372
V6 - 3.0L (181 CID)	1995-93	Upper-Inlet, Water Cooled Trans, 4-Speed Trans, wo/AC	624-374
V6 - 3.3L (201 CID)	2000-97	Upper & Lower-Inlet & Outlet, wo/Aux Cooler	624-311
V6 - 3.3L (201 CID)	2000	Intermediate Aux Cooler Tube	624-320
V6 - 3.3L (201 CID)	1999	Intermediate Aux Cooler Tube	624-320
V6 - 3.3L (201 CID)	1998	Intermediate Aux Cooler Tube	624-320
V6 - 3.3L (201 CID)	1998	Upper & Lower, Inlet & Supply Radiator Oil Cooler	624-379
V6 - 3.3L (201 CID)	1998	Upper & Lower-Inlet & Outlet, w/HD Radiator	624-370
V6 - 3.3L (201 CID)	1998	Upper & Lower-Inlet & Outlet, w/Rear AC	624-330
V6 - 3.3L (201 CID)	1997	Intermediate Aux Cooler Tube	624-320
V6 - 3.3L (201 CID)	1997	Upper & Lower, Inlet & Supply Radiator Oil Cooler, w/Tow Package	624-379
V6 - 3.3L (201 CID)	1997	Upper & Lower-Inlet & Outlet, w/Rear AC	624-330
V6 - 3.3L (201 CID)	1996	Upper & Lower, Inlet & Supply Radiator Oil Cooler, w/Tow Package	624-379
V6 - 3.3L (201 CID)	1995-94	Inlet, Hose, Air Cooled Trans	624-368
V6 - 3.3L (201 CID)	1995-94	Outlet, Tube, Air Cooled Trans	624-369
V6 - 3.3L (201 CID)	1995-94	Upper & Lower-Inlet & Outlet, Water Cooled Trans, w/AC	624-347
V6 - 3.3L (201 CID)	1995-94	Upper & Lower-Inlet & Outlet, Water Cooled Trans, wo/AC	624-378
V6 - 3.3L (201 CID)	1993	Inlet, Hose, Air Cooled Trans	624-368
V6 - 3.3L (201 CID)	1993	Outlet, Tube, Air Cooled Trans	624-369
V6 - 3.3L (201 CID)	1993	Upper & Lower-Inlet & Outlet, Water Cooled Trans, wo/AC	624-378
V6 - 3.8L (230 CID)	2000-97	Intermediate Aux Cooler Tube	624-320
V6 - 3.8L (230 CID)	2000-97	Upper & Lower-Inlet & Outlet, wo/Aux Cooler	624-311
V6 - 3.8L (230 CID)	1998-97	Upper & Lower-Inlet & Outlet, w/Rear AC	624-330
V6 - 3.8L (230 CID)	1998	Upper & Lower, Inlet & Supply Radiator Oil Cooler	624-379
V6 - 3.8L (230 CID)	1998	Upper & Lower-Inlet & Outlet, w/HD Radiator	624-370

Transmission Line Assembly Applications

Make/ Model/Engine	Years	Description	Dorman #
DODGE (continued)			
GRAND CARAVAN (continued)			
V6 - 3.8L (230 CID)	1997-96	Upper & Lower, Inlet & Supply Radiator Oil Cooler, w/Tow Package	624-379
V6 - 3.8L (230 CID)	1995-94	Inlet, Hose, Air Cooled Trans	624-368
V6 - 3.8L (230 CID)	1995-94	Outlet, Tube, Air Cooled Trans	624-369
V6 - 3.8L (230 CID)	1995-94	Upper & Lower-Inlet & Outlet, Water Cooled Trans, w/AC	624-347
V6 - 3.8L (230 CID)	1995-93	Upper & Lower-Inlet & Outlet, Water Cooled Trans, wo/AC	624-378
INTREPID			
V6 - 3.3L (201 CID)	1997-93	Left-Outlet Aux Cooler	624-395
V6 - 3.3L (201 CID)	1997-93	Lower-Outlet, wo/Aux Cooler	624-312
V6 - 3.3L (201 CID)	1997-93	Right-Inlet Aux Cooler	624-854
V6 - 3.3L (201 CID)	1997-93	Upper-Inlet, wo/Aux Cooler	624-313
V6 - 3.5L (215 CID)	1997-93	Left-Outlet Aux Cooler	624-395
V6 - 3.5L (215 CID)	1997-93	Lower-Outlet, wo/Aux Cooler	624-312
V6 - 3.5L (215 CID)	1997-93	Right-Inlet Aux Cooler	624-854
V6 - 3.5L (215 CID)	1997-93	Upper-Inlet, wo/Aux Cooler	624-313
NEON			
L4 - 2.0L (122 CID)	1999-95	Left-Outlet, Hose, wo/AC	624-882
L4 - 2.0L (122 CID)	1999-95	Left-Outlet, w/AC	624-341
L4 - 2.0L (122 CID)	1999-95	Right-Inlet, w/AC	624-340
L4 - 2.0L (122 CID)	1999-95	Right-Inlet, wo/AC	624-898
STRATUS			
L4 - 2.0L (122 CID)	1997-95	Left-Outlet Hose	624-367
L4 - 2.0L (122 CID)	1997-95	Right-Inlet Hose	624-366
L4 - 2.0L (122 CID)	1995	Left-Outlet Tube Aux Cooler	624-380
L4 - 2.0L (122 CID)	1995	Right-Inlet Tube Aux Cooler	624-386
L4 - 2.4L (148 CID)	2004-01	Upper & Lower-Inlet & Outlet Hose, Sedan	624-314
L4 - 2.4L (148 CID)	1997-96	Left-Outlet Hose	624-367
L4 - 2.4L (148 CID)	1997-96	Right-Inlet Hose	624-366
L4 - 2.4L (148 CID)	1995	Left-Outlet Hose	624-367
L4 - 2.4L (148 CID)	1995	Left-Outlet Tube Aux Cooler	624-380
L4 - 2.4L (148 CID)	1995	Right-Inlet Hose	624-366
L4 - 2.4L (148 CID)	1995	Right-Inlet Tube Aux Cooler	624-386
V6 - 2.5L (152 CID)	2000	Upper-Inlet Hose	624-326
V6 - 2.5L (152 CID)	1999-96	Lower-Outlet Hose	624-388
V6 - 2.5L (152 CID)	1999-96	Upper-Inlet Hose	624-326
V6 - 2.5L (152 CID)	1995	Left-Outlet Tube Aux Cooler	624-380
V6 - 2.5L (152 CID)	1995	Lower-Outlet Hose	624-388
V6 - 2.5L (152 CID)	1995	Right-Inlet Tube Aux Cooler	624-386
V6 - 2.5L (152 CID)	1995	Upper-Inlet Hose	624-326
V6 - 2.7L (167 CID)	2004-01	Upper & Lower-Inlet & Outlet Hose, Sedan	624-314
DODGE TRUCK			
B150 VAN			
V6 - 3.9L (239 CID)	1994	Left-Outlet, 3-Speed & 4-Speed Trans (36RH Or 60HD)	624-303
V8 - 5.2L (318 CID)	1994	Left-Outlet, 3-Speed Trans	624-336
V8 - 5.2L (318 CID)	1994	Left-Outlet, 4-Speed Trans	624-337
V8 - 5.2L (318 CID)	1994	Right-Inlet	624-302
V8 - 5.9L (360 CID)	1994	Right-Inlet	624-302
B1500 VAN			
V6 - 3.9L (239 CID)	1998	Right-Inlet Tube To Trans, 3-Speed Trans	624-897
V6 - 3.9L (239 CID)	1997	Left-Outlet, 3-Speed & 4-Speed Trans (36RH Or 60HD)	624-303
V6 - 3.9L (239 CID)	1997	Right-Inlet, Tube & Hose, From Cooler	624-360
V6 - 3.9L (239 CID)	1996-95	Left-Outlet, 3-Speed & 4-Speed Trans (36RH Or 60HD)	624-303
V8 - 5.2L (318 CID)	1997-95	Left-Outlet, 3-Speed Trans	624-336
V8 - 5.2L (318 CID)	1997-95	Left-Outlet, 4-Speed Trans	624-337
V8 - 5.2L (318 CID)	1997-95	Right-Inlet	624-302
V8 - 5.9L (360 CID)	1997-95	Right-Inlet	624-302
B250 VAN			
V6 - 3.9L (239 CID)	1994	Left-Outlet, 3-Speed & 4-Speed Trans (36RH Or 60HD)	624-303
V8 - 5.2L (318 CID)	1994	Left-Outlet, 3-Speed Trans	624-336
V8 - 5.2L (318 CID)	1994	Left-Outlet, 4-Speed Trans	624-337
V8 - 5.2L (318 CID)	1994	Right-Inlet	624-302
V8 - 5.9L (360 CID)	1994	Left-Outlet, 4-Speed Trans	624-337
V8 - 5.9L (360 CID)	1994	Right-Inlet	624-302
B2500 VAN			
V6 - 3.9L (239 CID)	1998	Right-Inlet Tube To Trans, 3-Speed Trans	624-897
V6 - 3.9L (239 CID)	1997	Left-Outlet, 3-Speed & 4-Speed Trans (36RH Or 60HD)	624-303
V6 - 3.9L (239 CID)	1997	Right-Inlet, Tube & Hose, From Cooler	624-360
V6 - 3.9L (239 CID)	1996-95	Left-Outlet, 3-Speed & 4-Speed Trans (36RH Or 60HD)	624-303
V8 - 5.2L (318 CID)	1997-95	Left-Outlet, 3-Speed Trans	624-336
V8 - 5.2L (318 CID)	1997-95	Left-Outlet, 4-Speed Trans	624-337
V8 - 5.2L (318 CID)	1997-95	Right-Inlet	624-302
V8 - 5.9L (360 CID)	1997-95	Right-Inlet	624-302
V8 - 5.9L (360 CID)	1997	Left-Outlet, 3-Speed Trans	624-336
V8 - 5.9L (360 CID)	1997	Left-Outlet, 4-Speed Trans	624-337
V8 - 5.9L (360 CID)	1996-95	Left-Outlet, 4-Speed Trans	624-337
B350 VAN			
V8 - 5.2L (318 CID)	1994	Left-Outlet, 3-Speed Trans	624-336
V8 - 5.2L (318 CID)	1994	Left-Outlet, 4-Speed Trans	624-337

Transmission Line Assembly Applications

Make/ Model/Engine	Years	Description	Dorman #
DODGE TRUCK (continued)			
B350 VAN (continued)			
V8 - 5.2L (318 CID)	1994	Right-Inlet	624-302
V8 - 5.9L (360 CID)	1994	Left-Outlet, 4-Speed Trans	624-337
V8 - 5.9L (360 CID)	1994	Right-Inlet	624-302
B3500 VAN			
V8 - 5.2L (318 CID)	1997-95	Left-Outlet, 3-Speed Trans	624-336
V8 - 5.2L (318 CID)	1997-95	Left-Outlet, 4-Speed Trans	624-337
V8 - 5.2L (318 CID)	1997-95	Right-Inlet	624-302
V8 - 5.9L (360 CID)	1997-95	Right-Inlet	624-302
V8 - 5.9L (360 CID)	1997	Left-Outlet, 3-Speed Trans	624-336
V8 - 5.9L (360 CID)	1997	Left-Outlet, 4-Speed Trans	624-337
V8 - 5.9L (360 CID)	1996-95	Left-Outlet, 4-Speed Trans	624-337
D150 PICKUP			
V8 - 5.9L (360 CID)	1993-89	Elbow (2 Required)	624-373
D250 PICKUP			
L6 - 5.9L (359 CID)	1993-89	Elbow (2 Required)	624-373
V8 - 5.9L (360 CID)	1993-89	Elbow (2 Required)	624-373
D350 PICKUP			
L6 - 5.9L (359 CID)	1993-89	Elbow (2 Required)	624-373
V8 - 5.9L (360 CID)	1993-89	Elbow (2 Required)	624-373
DAKOTA			
V6 - 3.9L (239 CID)	2002-01	Right-Inlet Hose From Radiator	624-821
V6 - 3.9L (239 CID)	2000	Left-Outlet	624-888
V6 - 3.9L (239 CID)	2000	Right-Inlet Hose From Radiator	624-821
V6 - 3.9L (239 CID)	1999-97	Left-Outlet To Trans, 4WD	624-819
V6 - 3.9L (239 CID)	1999-97	Left-Outlet, 2WD	624-888
V6 - 3.9L (239 CID)	1999-97	Lower-Inlet Tube From Radiator To Aux Cooler	624-397
V6 - 3.9L (239 CID)	1999-97	Right-Inlet Hose From Radiator, 2WD	624-821
V6 - 3.9L (239 CID)	1999-97	Right-Inlet Tube To Trans, 4WD	624-818
V6 - 3.9L (239 CID)	1999-97	Upper-Outlet Tube From Radiator To Aux Cooler	624-396
V6 - 3.9L (239 CID)	1996-94	Left-Outlet	624-399
V6 - 3.9L (239 CID)	1996-94	Lower-Inlet Tube From Radiator To Aux Cooler	624-808
V6 - 3.9L (239 CID)	1996-94	Right-Inlet Tube To Trans & Hose From Radiator, wo/Snow Plow Package	624-350
V6 - 3.9L (239 CID)	1996-94	Right-Inlet Tube To Trans, wo/Snow Plow Package	624-800
V6 - 3.9L (239 CID)	1996-94	Upper-Outlet Tube From Radiator To Aux Cooler	624-393
V8 - 5.2L (318 CID)	1999-97	Left-Outlet To Trans, 4WD	624-819
V8 - 5.2L (318 CID)	1999-97	Left-Outlet, 2WD	624-888
V8 - 5.2L (318 CID)	1999-97	Lower-Inlet Tube From Radiator To Aux Cooler	624-397
V8 - 5.2L (318 CID)	1999-97	Right-Inlet Hose From Radiator, 2WD	624-821
V8 - 5.2L (318 CID)	1999-97	Right-Inlet Tube To Trans, 4WD	624-818
V8 - 5.2L (318 CID)	1999-97	Upper-Outlet Tube From Radiator To Aux Cooler	624-396
V8 - 5.2L (318 CID)	1996-94	Left-Outlet	624-351
V8 - 5.2L (318 CID)	1996-94	Lower-Inlet Tube From Radiator To Aux Cooler	624-808
V8 - 5.2L (318 CID)	1996-94	Right-Inlet Tube To Trans & Hose From Radiator, wo/Snow Plow Package	624-350
V8 - 5.2L (318 CID)	1996-94	Upper-Outlet Tube From Radiator To Aux Cooler	624-393
V8 - 5.9L (360 CID)	2003-01	Front-Inlet Tube To Trans	624-833
V8 - 5.9L (360 CID)	2003-00	Left-Outlet From Radiator	624-829
V8 - 5.9L (360 CID)	2003-00	Right-Inlet Hose From Radiator	624-821
V8 - 5.9L (360 CID)	2000	Right-Inlet Tube To Trans	624-827
V8 - 5.9L (360 CID)	1999-98	Left-Outlet From Radiator, 2WD	624-829
V8 - 5.9L (360 CID)	1999-98	Left-Outlet From Radiator, 4WD	624-830
V8 - 5.9L (360 CID)	1999-98	Lower-Inlet Tube From Radiator To Aux Cooler	624-397
V8 - 5.9L (360 CID)	1999-98	Right-Inlet Hose From Radiator, 2WD	624-821
V8 - 5.9L (360 CID)	1999-98	Right-Inlet Tube To Trans, 2WD	624-826
V8 - 5.9L (360 CID)	1999-98	Right-Inlet Tube To Trans, 4WD	624-828
V8 - 5.9L (360 CID)	1999-98	Upper-Outlet Tube From Radiator To Aux Cooler	624-396
DURANGO			
V6 - 3.9L (239 CID)	1999	Left-Outlet To Trans, 4WD	624-831
V6 - 3.9L (239 CID)	1999	Left-Outlet, 2WD	624-888
V6 - 3.9L (239 CID)	1999	Right-Inlet Hose From Radiator, 2WD	624-821
V6 - 3.9L (239 CID)	1999	Right-Inlet Tube To Trans, 4WD	624-358
V6 - 3.9L (239 CID)	1998	Left-Outlet To Trans	624-831
V6 - 3.9L (239 CID)	1998	Right-Inlet Tube To Trans	624-358
V8 - 5.2L (318 CID)	2000	Right-Inlet Hose From Radiator	624-821
V8 - 5.2L (318 CID)	1999	Left-Outlet From Radiator, 2WD	624-888
V8 - 5.2L (318 CID)	1999	Left-Outlet To Trans, 4WD	624-831
V8 - 5.2L (318 CID)	1999	Lower-Inlet Tube From Radiator To Aux Cooler	624-397
V8 - 5.2L (318 CID)	1999	Right-Inlet Hose From Radiator, 2WD	624-821
V8 - 5.2L (318 CID)	1999	Right-Inlet Tube To Trans, 4WD	624-358
V8 - 5.2L (318 CID)	1999	Upper-Outlet Tube From Radiator To Aux Cooler	624-396
V8 - 5.2L (318 CID)	1998	Left-Outlet To Trans	624-831
V8 - 5.2L (318 CID)	1998	Lower-Inlet Tube From Radiator To Aux Cooler	624-397
V8 - 5.2L (318 CID)	1998	Right-Inlet Tube To Trans	624-358
V8 - 5.2L (318 CID)	1998	Upper-Outlet Tube From Radiator To Aux Cooler	624-396
V8 - 5.9L (360 CID)	2003-01	Front-Inlet Tube To Trans	624-833
V8 - 5.9L (360 CID)	2003-00	Left-Outlet From Radiator	624-829
V8 - 5.9L (360 CID)	2003-00	Right-Inlet Hose From Radiator	624-821
V8 - 5.9L (360 CID)	2000	Right-Inlet Tube To Trans	624-827
V8 - 5.9L (360 CID)	1999-98	Lower-Inlet Tube From Radiator To Aux Cooler	624-397
V8 - 5.9L (360 CID)	1999-98	Upper-Outlet Tube From Radiator To Aux Cooler	624-396

Transmission Line Assembly Applications

Make/ Model/Engine	Years	Description	Dorman #
DODGE TRUCK (continued)			
DURANGO (continued)			
V8 - 5.9L (360 CID)	1999	Left-Outlet From Radiator, 2WD	624-829
V8 - 5.9L (360 CID)	1999	Left-Outlet To Trans, 4WD	624-831
V8 - 5.9L (360 CID)	1999	Right-Inlet Hose From Radiator, 2WD	624-821
V8 - 5.9L (360 CID)	1999	Right-Inlet Tube To Trans, 2WD	624-826
V8 - 5.9L (360 CID)	1999	Right-Inlet Tube To Trans, 4WD	624-358
V8 - 5.9L (360 CID)	1998	Left-Outlet To Trans	624-831
V8 - 5.9L (360 CID)	1998	Right-Inlet Tube To Trans	624-358
RAM 1500 PICKUP			
V6 - 3.9L (239 CID)	2001-97	Lower-Outlet From Radiator	624-832
V6 - 3.9L (239 CID)	2001-97	Upper-Inlet Tube To Trans, 42RH Trans	624-824
V6 - 3.9L (239 CID)	1996	Upper-Inlet Tube From Radiator, 46RH Trans	624-392
V6 - 3.9L (239 CID)	1996	Upper-Inlet Tube To Trans, 42RH Trans	624-824
V6 - 3.9L (239 CID)	1995-94	Upper-Inlet Tube From Radiator, 46RH Trans	624-392
V8 - 5.2L (318 CID)	2001	Upper Aux Cooler Supply From Radiator	624-335
V8 - 5.2L (318 CID)	2001	Upper-Inlet Tube From Radiator, w/Aux Cooler	624-392
V8 - 5.2L (318 CID)	2001	Upper-Inlet Tube To Trans	624-834
V8 - 5.2L (318 CID)	2000	Upper Aux Cooler Supply From Radiator	624-335
V8 - 5.2L (318 CID)	2000	Upper-Inlet Tube From Radiator, Standard Cab, To 1/16/00	624-392
V8 - 5.2L (318 CID)	2000	Upper-Inlet Tube To Trans	624-834
V8 - 5.2L (318 CID)	1999-96	Lower-Outlet, 4-Speed Trans (46RE), Will Not Fit Thheaded Applications w/Aux Bypass	624-304
V8 - 5.2L (318 CID)	1999-96	Upper Aux Cooler Supply From Radiator	624-335
V8 - 5.2L (318 CID)	1999-96	Upper-Inlet, 4-Speed Trans (46RE), Will Not Fit Thheaded Applications w/Aux Bypass	624-305
V8 - 5.2L (318 CID)	1995-94	Upper Aux Cooler Supply From Radiator	624-335
V8 - 5.2L (318 CID)	1995-94	Upper-Inlet Tube From Radiator, w/46RH Trans	624-392
V8 - 5.2L (318 CID)	1995-94	Upper-Inlet Tube To Trans, w/Sensor Port	624-802
V8 - 5.9L (360 CID)	2002-95	Upper Aux Cooler Supply From Radiator	624-335
V8 - 5.9L (360 CID)	2002-00	Upper-Inlet Tube To Trans	624-834
V8 - 5.9L (360 CID)	2000	Upper-Inlet Tube From Radiator, Standard Cab, To 1/16/00	624-392
V8 - 5.9L (360 CID)	1999-96	Lower-Outlet, 4-Speed Trans (46RE), Will Not Fit Thheaded Applications w/Aux Bypass	624-304
V8 - 5.9L (360 CID)	1999-96	Upper-Inlet, 4-Speed Trans (46RE), Will Not Fit Thheaded Applications w/Aux Bypass	624-305
V8 - 5.9L (360 CID)	1995-94	Upper-Inlet Tube To Trans, w/Sensor Port	624-802
RAM 1500 VAN			
V6 - 3.9L (239 CID)	2003-02	Left-Outlet To Trans, 3-Speed Trans	624-899
V6 - 3.9L (239 CID)	2003-02	Left-Outlet To Trans, 4-Speed Trans	624-324
V6 - 3.9L (239 CID)	2003-02	Right-Inlet Tube To Trans, 3-Speed Trans	624-897
V6 - 3.9L (239 CID)	2003-02	Right-Inlet Tube To Trans, 4-Speed Trans	624-816
V6 - 3.9L (239 CID)	2001-00	Left-Outlet To Trans, 4-Speed Trans	624-324
V6 - 3.9L (239 CID)	2001-00	Right-Inlet Tube To Trans, 3-Speed Trans	624-897
V6 - 3.9L (239 CID)	2001-00	Right-Inlet Tube To Trans, 4-Speed Trans	624-816
V6 - 3.9L (239 CID)	1999	Right-Inlet Tube To Trans, 3-Speed Trans	624-897
V8 - 5.2L (318 CID)	2003-02	Left-Outlet To Trans, 3-Speed Trans	624-899
V8 - 5.2L (318 CID)	2003-02	Left-Outlet To Trans, 4-Speed Trans	624-324
V8 - 5.2L (318 CID)	2003-02	Right-Inlet Tube To Trans, 3-Speed Trans	624-897
V8 - 5.2L (318 CID)	2003-02	Right-Inlet Tube To Trans, 4-Speed Trans	624-816
V8 - 5.2L (318 CID)	2001-00	Left-Outlet To Trans, 4-Speed Trans	624-324
V8 - 5.2L (318 CID)	2001-00	Right-Inlet Tube To Trans, 3-Speed Trans	624-897
V8 - 5.2L (318 CID)	2001-00	Right-Inlet Tube To Trans, 4-Speed Trans	624-816
V8 - 5.2L (318 CID)	1999-98	Left-Outlet To Trans	624-324
V8 - 5.2L (318 CID)	1999-98	Right-Inlet Tube To Trans	624-816
V8 - 5.9L (360 CID)	2003-02	Left-Outlet To Trans, 3-Speed Trans	624-899
V8 - 5.9L (360 CID)	2003-00	Left-Outlet To Trans, 4-Speed Trans	624-324
V8 - 5.9L (360 CID)	2003-00	Right-Inlet Tube To Trans, 3-Speed Trans	624-897
V8 - 5.9L (360 CID)	2003-00	Right-Inlet Tube To Trans, 4-Speed Trans	624-816
V8 - 5.9L (360 CID)	1999-98	Left-Outlet To Trans	624-324
V8 - 5.9L (360 CID)	1999-98	Right-Inlet Tube To Trans	624-816
RAM 2500 PICKUP			
L6 - 5.9L (359 CID)	2000-99	Left-Outlet Aux Cooler	624-332
L6 - 5.9L (359 CID)	2000-99	Rear-Outlet Hose Oil Cooler To Trans	624-353
L6 - 5.9L (359 CID)	2000-99	Right-Outlet Aux Cooler	624-333
L6 - 5.9L (359 CID)	1998-97	Elbow (3 Required), Turbo	624-373
L6 - 5.9L (359 CID)	1998-97	Inlet, Oil Cooler Hose To Tube, wo/Sensor Port	624-352
L6 - 5.9L (359 CID)	1998-97	Left-Outlet Aux Cooler	624-332
L6 - 5.9L (359 CID)	1998-97	Rear-Outlet Hose Oil Cooler To Trans	624-353
L6 - 5.9L (359 CID)	1998-97	Right-Outlet Aux Cooler	624-333
L6 - 5.9L (359 CID)	1996-94	Elbow (3 Required)	624-373
L6 - 5.9L (359 CID)	1996-94	Inlet, Oil Cooler Hose To Tube	624-352
L6 - 5.9L (359 CID)	1996-94	Left-Outlet Aux Cooler	624-332
L6 - 5.9L (359 CID)	1996-94	Rear-Outlet Hose Oil Cooler To Trans	624-353
L6 - 5.9L (359 CID)	1996-94	Right-Outlet Aux Cooler	624-333
V10 - 8.0L (488 CID)	2002-96	Lower-Outlet	624-322
V10 - 8.0L (488 CID)	2002-96	Upper-Inlet Hose From Radiator	624-357
V10 - 8.0L (488 CID)	2002-96	Upper-Inlet Tube From Radiator	624-323
V10 - 8.0L (488 CID)	1995-94	Lower-Outlet	624-322
V10 - 8.0L (488 CID)	1995-94	Upper-Inlet Hose From Radiator	624-357
V8 - 5.2L (318 CID)	1999-96	Lower-Outlet, 4-Speed Trans (46RE), Will Not Fit Thheaded Applications w/Aux Bypass	624-304
V8 - 5.2L (318 CID)	1999-96	Upper-Inlet, 4-Speed Trans (46RE), Will Not Fit Thheaded Applications w/Aux Bypass	624-305
V8 - 5.2L (318 CID)	1998-96	Upper Aux Cooler Supply From Radiator	624-335
V8 - 5.2L (318 CID)	1995-94	Upper Aux Cooler Supply From Radiator	624-335
V8 - 5.2L (318 CID)	1995-94	Upper-Inlet Tube From Radiator, w/46RH Trans	624-392

Transmission Line Assembly Applications

Make/ Model/Engine	Years	Description	Dorman #
DODGE TRUCK (continued)			
RAM 2500 PICKUP (continued)			
V8 - 5.2L (318 CID)	1995-94	Upper-Inlet Tube To Trans, w/Sensor Port	624-802
V8 - 5.9L (360 CID)	2002-95	Upper Aux Cooler Supply From Radiator	624-335
V8 - 5.9L (360 CID)	2002-00	Upper-Inlet Tube To Trans	624-834
V8 - 5.9L (360 CID)	2000	Upper-Inlet Tube From Radiator, Standard Cab, To 1/16/00	624-392
V8 - 5.9L (360 CID)	1999-96	Lower-Outlet, 4-Speed Trans (46RE), Will Not Fit Theaded Applications w/Aux Bypass	624-304
V8 - 5.9L (360 CID)	1999-96	Upper-Inlet, 4-Speed Trans (46RE), Will Not Fit Theaded Applications w/Aux Bypass	624-305
V8 - 5.9L (360 CID)	1995-94	Upper-Inlet Tube To Trans, w/Sensor Port	624-802
RAM 2500 VAN			
V8 - 5.2L (318 CID)	2003-02	Left-Outlet To Trans, 3-Speed Trans	624-899
V8 - 5.2L (318 CID)	2003-02	Left-Outlet To Trans, 4-Speed Trans	624-324
V8 - 5.2L (318 CID)	2003-02	Right-Inlet Tube To Trans, 3-Speed Trans	624-897
V8 - 5.2L (318 CID)	2003-02	Right-Inlet Tube To Trans, 4-Speed Trans	624-816
V8 - 5.2L (318 CID)	2001-00	Left-Outlet To Trans, 4-Speed Trans	624-324
V8 - 5.2L (318 CID)	2001-00	Right-Inlet Tube To Trans, 3-Speed Trans	624-897
V8 - 5.2L (318 CID)	2001-00	Right-Inlet Tube To Trans, 4-Speed Trans	624-816
V8 - 5.2L (318 CID)	1999-98	Left-Outlet To Trans	624-324
V8 - 5.2L (318 CID)	1999-98	Right-Inlet Tube To Trans	624-816
V8 - 5.9L (360 CID)	2003-02	Left-Outlet To Trans, 3-Speed Trans	624-899
V8 - 5.9L (360 CID)	2003-00	Left-Outlet To Trans, 4-Speed Trans	624-324
V8 - 5.9L (360 CID)	2003-00	Right-Inlet Tube To Trans, 3-Speed Trans	624-897
V8 - 5.9L (360 CID)	2003-00	Right-Inlet Tube To Trans, 4-Speed Trans	624-816
V8 - 5.9L (360 CID)	1999-98	Left-Outlet To Trans	624-324
V8 - 5.9L (360 CID)	1999-98	Right-Inlet Tube To Trans	624-816
RAM 3500 PICKUP			
L6 - 5.9L (359 CID)	2000-99	Left-Outlet Aux Cooler	624-332
L6 - 5.9L (359 CID)	2000-99	Rear-Outlet Hose Oil Cooler To Trans	624-353
L6 - 5.9L (359 CID)	2000-99	Right-Outlet Aux Cooler	624-333
L6 - 5.9L (359 CID)	1998-97	Elbow (3 Required), Turbo	624-373
L6 - 5.9L (359 CID)	1998-97	Inlet, Oil Cooler Hose To Tube, wo/Sensor Port	624-352
L6 - 5.9L (359 CID)	1998-97	Left-Outlet Aux Cooler	624-332
L6 - 5.9L (359 CID)	1998-97	Rear-Outlet Hose Oil Cooler To Trans	624-353
L6 - 5.9L (359 CID)	1998-97	Right-Outlet Aux Cooler	624-333
L6 - 5.9L (359 CID)	1996-94	Elbow (3 Required)	624-373
L6 - 5.9L (359 CID)	1996-94	Inlet, Oil Cooler Hose To Tube	624-352
L6 - 5.9L (359 CID)	1996-94	Left-Outlet Aux Cooler	624-332
L6 - 5.9L (359 CID)	1996-94	Rear-Outlet Hose Oil Cooler To Trans	624-353
L6 - 5.9L (359 CID)	1996-94	Right-Outlet Aux Cooler	624-333
V10 - 8.0L (488 CID)	2002-96	Lower-Outlet	624-322
V10 - 8.0L (488 CID)	2002-96	Upper-Inlet Hose From Radiator	624-357
V10 - 8.0L (488 CID)	2002-96	Upper-Inlet Tube From Radiator	624-323
V10 - 8.0L (488 CID)	1995-94	Lower-Outlet	624-322
V10 - 8.0L (488 CID)	1995-94	Upper-Inlet Hose From Radiator	624-357
V8 - 5.9L (360 CID)	2002-95	Upper Aux Cooler Supply From Radiator	624-335
V8 - 5.9L (360 CID)	2002-00	Upper-Inlet Tube To Trans	624-834
V8 - 5.9L (360 CID)	2000	Upper-Inlet Tube From Radiator, Standard Cab, To 1/16/00	624-392
V8 - 5.9L (360 CID)	1999-96	Lower-Outlet, 4-Speed Trans (46RE), Will Not Fit Theaded Applications w/Aux Bypass	624-304
V8 - 5.9L (360 CID)	1999-96	Upper-Inlet, 4-Speed Trans (46RE), Will Not Fit Theaded Applications w/Aux Bypass	624-305
V8 - 5.9L (360 CID)	1995-94	Upper-Inlet Tube To Trans, w/Sensor Port	624-802
RAM 3500 VAN			
V8 - 5.2L (318 CID)	2003-02	Left-Outlet To Trans, 3-Speed Trans	624-899
V8 - 5.2L (318 CID)	2003-02	Left-Outlet To Trans, 4-Speed Trans	624-324
V8 - 5.2L (318 CID)	2003-02	Right-Inlet Tube To Trans, 3-Speed Trans	624-897
V8 - 5.2L (318 CID)	2003-02	Right-Inlet Tube To Trans, 4-Speed Trans	624-816
V8 - 5.2L (318 CID)	2001-00	Left-Outlet To Trans, 4-Speed Trans	624-324
V8 - 5.2L (318 CID)	2001-00	Right-Inlet Tube To Trans, 3-Speed Trans	624-897
V8 - 5.2L (318 CID)	2001-00	Right-Inlet Tube To Trans, 4-Speed Trans	624-816
V8 - 5.2L (318 CID)	1999-98	Left-Outlet To Trans	624-324
V8 - 5.2L (318 CID)	1999-98	Right-Inlet Tube To Trans	624-816
V8 - 5.9L (360 CID)	2003-02	Left-Outlet To Trans, 3-Speed Trans	624-899
V8 - 5.9L (360 CID)	2003-00	Left-Outlet To Trans, 4-Speed Trans	624-324
V8 - 5.9L (360 CID)	2003-00	Right-Inlet Tube To Trans, 3-Speed Trans	624-897
V8 - 5.9L (360 CID)	2003-00	Right-Inlet Tube To Trans, 4-Speed Trans	624-816
V8 - 5.9L (360 CID)	1999-98	Left-Outlet To Trans	624-324
V8 - 5.9L (360 CID)	1999-98	Right-Inlet Tube To Trans	624-816
W150 PICKUP			
V8 - 5.9L (360 CID)	1993-89	Elbow (2 Required)	624-373
W250 PICKUP			
L6 - 5.9L (359 CID)	1993-89	Elbow (2 Required)	624-373
V8 - 5.9L (360 CID)	1993-89	Elbow (2 Required)	624-373
W350 PICKUP			
L6 - 5.9L (359 CID)	1993-89	Elbow (2 Required)	624-373
V8 - 5.9L (360 CID)	1993-89	Elbow (2 Required)	624-373
EAGLE			
VISION			
V6 - 3.3L (201 CID)	1997-93	Left-Outlet Aux Cooler	624-395
V6 - 3.3L (201 CID)	1997-93	Lower-Outlet, wo/Aux Cooler	624-312
V6 - 3.3L (201 CID)	1997-93	Right-Inlet Aux Cooler	624-854
V6 - 3.3L (201 CID)	1997-93	Upper-Inlet, wo/Aux Cooler	624-313
V6 - 3.5L (215 CID)	1997-93	Left-Outlet Aux Cooler	624-395

Transmission Line Assembly Applications

Make/ Model/Engine	Years	Description	Dorman #
EAGLE (continued)			
VISION (continued)			
V6 - 3.5L (215 CID)	1997-93	Lower-Outlet, wo/Aux Cooler	624-312
V6 - 3.5L (215 CID)	1997-93	Right-Inlet Aux Cooler	624-854
V6 - 3.5L (215 CID)	1997-93	Upper-Inlet, wo/Aux Cooler	624-313
FORD			
CROWN VICTORIA			
V8 - 4.6L (281 CID)	2005-04	Hose, To 5/16" Cooler Lines	624-253
V8 - 4.6L (281 CID)	2005-04	Upper & Lower-Inlet & Outlet, Tube Assembly	624-252
V8 - 4.6L (281 CID)	2003	Hose, To 5/16" Cooler Lines	624-253
V8 - 4.6L (281 CID)	2003	Upper & Lower-Inlet & Outlet Aux Cooler	624-214
V8 - 4.6L (281 CID)	2003	Upper & Lower-Inlet & Outlet, Tube Assembly	624-252
V8 - 4.6L (281 CID)	2002-98	Hose, To 5/16" Cooler Lines	624-253
V8 - 4.6L (281 CID)	2002-98	Upper & Lower-Inlet & Outlet Aux Cooler	624-214
V8 - 4.6L (281 CID)	1997-96	Hose, To 5/16" Cooler Lines	624-253
V8 - 4.6L (281 CID)	1997-96	Upper & Lower-Inlet & Outlet Aux Cooler	624-214
V8 - 4.6L (281 CID)	1997-96	Upper & Lower-Inlet & Outlet To Trans	624-251
V8 - 4.6L (281 CID)	1995	Upper & Lower-Inlet & Outlet Aux Cooler	624-214
MUSTANG			
V6 - 3.8L (232 CID)	2000-96	Hose, To 5/16" Cooler Lines	624-253
V8 - 4.6L (281 CID)	2000-96	Hose, To 5/16" Cooler Lines	624-253
TAURUS			
V6 - 3.0L (182 CID)	1999	Lower-Outlet, AX4N Trans, w/Aux Cooler	624-217
V6 - 3.0L (182 CID)	1999	Upper-Inlet, AX4N Trans, w/Aux Cooler	624-223
V6 - 3.0L (182 CID)	1998-97	Lower-Outlet, AX4N Trans, w/Aux Cooler	624-217
V6 - 3.0L (182 CID)	1998-97	Lower-Outlet, AX4S Trans, w/Aux Cooler	624-218
V6 - 3.0L (182 CID)	1998-97	Upper-Inlet, AX4N Trans, w/Aux Cooler	624-223
V6 - 3.0L (182 CID)	1996	Lower-Inlet, AX4S Trans, wo/Aux Cooler	624-215
V6 - 3.0L (182 CID)	1996	Lower-Outlet, AX4N Trans, w/Aux Cooler	624-217
V6 - 3.0L (182 CID)	1996	Lower-Outlet, AX4S Trans, w/Aux Cooler	624-218
V6 - 3.0L (182 CID)	1996	Upper-Inlet, AX4S Trans, w/Aux Cooler	624-216
V6 - 3.0L (182 CID)	1996	Upper-Outlet, AX4S Trans, wo/Aux Cooler	624-219
V6 - 3.0L (182 CID)	1995-93	Lower-Outlet Aux Cooler Tube	624-213
V6 - 3.8L (232 CID)	1995-93	Lower-Outlet Aux Cooler Tube	624-213
V6 - 3.8L (232 CID)	1992-90	Lower-Outlet Aux Cooler Tube	624-213
V6 - 3.8L (232 CID)	1992-90	Upper-Inlet To Trans	624-212
V8 - 3.4L (207 CID)	1999-97	Lower-Outlet, AX4N Trans, w/Aux Cooler	624-217
V8 - 3.4L (207 CID)	1999-97	Upper-Inlet, AX4N Trans, w/Aux Cooler	624-223
V8 - 3.4L (207 CID)	1996	Lower-Outlet, AX4N Trans, w/Aux Cooler	624-217
THUNDERBIRD			
V6 - 3.8L (232 CID)	1997-96	Hose, To 5/16" Cooler Lines	624-253
V6 - 3.8L (232 CID)	1995-90	Lower-Outlet, wo/Supercharger	624-210
V8 - 4.6L (281 CID)	1997-96	Hose, To 5/16" Cooler Lines	624-253
V8 - 5.0L (302 CID)	1993-91	Lower-Outlet, wo/Supercharger	624-210
FORD TRUCK			
AEROSTAR			
V6 - 3.0L (182 CID)	1997-96	Hose, To 5/16" Cooler Lines	624-253
V6 - 4.0L (245 CID)	1997-96	Hose, To 5/16" Cooler Lines	624-253
BRONCO			
V8 - 5.0L (302 CID)	1996	Hose, To 5/16" Cooler Lines	624-253
V8 - 5.8L (351 CID)	1996	Hose, To 5/16" Cooler Lines	624-253
F SUPER DUTY			
L6 - 4.9L (300 CID)	1996	Hose, To 5/16" Cooler Lines	624-253
V10 - 6.8L (415 CID)	2002-97	Hose, To 5/16" Cooler Lines	624-253
V8 - 5.4L (330 CID)	2002-97	Hose, To 5/16" Cooler Lines	624-253
V8 - 5.8L (351 CID)	1996	Hose, To 5/16" Cooler Lines	624-253
V8 - 7.3L (445 CID)	2002-96	Hose, To 5/16" Cooler Lines	624-253
V8 - 7.5L (460 CID)	1996	Hose, To 5/16" Cooler Lines	624-253
E-150 ECONOLINE			
L6 - 4.9L (300 CID)	1996	Hose, To 5/16" Cooler Lines	624-253
V6 - 4.2L (256 CID)	2003-97	Hose, To 5/16" Cooler Lines	624-253
V6 - 4.2L (256 CID)	2003-97	Lower-Outlet Hose From Aux Cooler	624-254
V8 - 4.6L (281 CID)	2005-04	Hose, To 5/16" Cooler Lines	624-253
V8 - 4.6L (281 CID)	2003-97	Hose, To 5/16" Cooler Lines	624-253
V8 - 4.6L (281 CID)	2003-97	Lower-Outlet Hose From Aux Cooler	624-254
V8 - 5.0L (302 CID)	1996	Hose, To 5/16" Cooler Lines	624-253
V8 - 5.4L (330 CID)	2005-97	Hose, To 5/16" Cooler Lines	624-253
V8 - 5.8L (351 CID)	1996	Hose, To 5/16" Cooler Lines	624-253
E-250 ECONOLINE			
L6 - 4.9L (300 CID)	1996	Hose, To 5/16" Cooler Lines	624-253
V10 - 6.8L (415 CID)	2005-97	Hose, To 5/16" Cooler Lines	624-253
V6 - 4.2L (256 CID)	2003-97	Hose, To 5/16" Cooler Lines	624-253
V6 - 4.2L (256 CID)	2003-97	Lower-Outlet Hose From Aux Cooler	624-254
V8 - 4.6L (281 CID)	1998-97	Hose, To 5/16" Cooler Lines	624-253
V8 - 5.4L (330 CID)	2005-97	Hose, To 5/16" Cooler Lines	624-253
V8 - 5.8L (351 CID)	1996	Hose, To 5/16" Cooler Lines	624-253
V8 - 6.0L (363 CID)	2005	Hose, To 5/16" Cooler Lines	624-253
V8 - 7.5L (460 CID)	1996	Hose, To 5/16" Cooler Lines	624-253
E-350 ECONOLINE			
L6 - 4.9L (300 CID)	1996	Hose, To 5/16" Cooler Lines	624-253
V10 - 6.8L (415 CID)	2005-97	Hose, To 5/16" Cooler Lines	624-253

Transmission Line Assembly Applications

Make/ Model/Engine	Years	Description	Dorman #
FORD TRUCK (continued)			
E-350 ECONOLINE (continued)			
V8 - 5.4L (330 CID)	2005-97	Hose, To 5/16" Cooler Lines	624-253
V8 - 5.8L (351 CID)	1996	Hose, To 5/16" Cooler Lines	624-253
V8 - 6.0L (363 CID)	2005-04	Hose, To 5/16" Cooler Lines	624-253
V8 - 7.3L (445 CID)	2003-96	Hose, To 5/16" Cooler Lines	624-253
V8 - 7.5L (460 CID)	1996	Hose, To 5/16" Cooler Lines	624-253
E-450 ECONOLINE			
V10 - 6.8L (415 CID)	2005-03	Hose, To 5/16" Cooler Lines	624-253
V8 - 5.4L (330 CID)	2005-03	Hose, To 5/16" Cooler Lines	624-253
V8 - 6.0L (363 CID)	2005-04	Hose, To 5/16" Cooler Lines	624-253
V8 - 7.3L (440 CID)	2003	Hose, To 5/16" Cooler Lines	624-253
EXCURSION			
V10 - 6.8L (415 CID)	2005-00	Hose, To 5/16" Cooler Lines	624-253
V8 - 5.4L (330 CID)	2005-00	Hose, To 5/16" Cooler Lines	624-253
V8 - 6.0L (363 CID)	2005-03	Hose, To 5/16" Cooler Lines	624-253
V8 - 7.3L (445 CID)	2003-00	Hose, To 5/16" Cooler Lines	624-253
EXPEDITION			
V8 - 4.6L (281 CID)	2002-01	Hose, To 5/16" Cooler Lines	624-253
V8 - 4.6L (281 CID)	2002-01	Left-Outlet Aux Cooler, w/Super Cooling	624-222
V8 - 4.6L (281 CID)	2002-01	Right-Inlet Aux Cooler Tube Fitting, w/Super Cooling	624-225
V8 - 4.6L (281 CID)	2002-01	Upper-Inlet, Under 8500Lb GVW, w/Super Cooling	624-269
V8 - 4.6L (281 CID)	2002-01	Upper-Outlet From Radiator, w/Super Cooling	624-228
V8 - 4.6L (281 CID)	2000	Hose, To 5/16" Cooler Lines	624-253
V8 - 4.6L (281 CID)	2000	Left-Outlet Aux Cooler, w/Super Cooling	624-222
V8 - 4.6L (281 CID)	2000	Lower-Inlet From Radiator, wo/Aux Cooler, To 4/1/00	624-227
V8 - 4.6L (281 CID)	2000	Right-Inlet Aux Cooler Tube Fitting, w/Super Cooling	624-225
V8 - 4.6L (281 CID)	2000	Upper-Inlet, Under 8500Lb GVW, w/Super Cooling	624-269
V8 - 4.6L (281 CID)	2000	Upper-Outlet From Radiator, w/Super Cooling	624-228
V8 - 4.6L (281 CID)	1999	Hose, To 5/16" Cooler Lines	624-253
V8 - 4.6L (281 CID)	1999	Left-Outlet Aux Cooler	624-222
V8 - 4.6L (281 CID)	1999	Lower-Inlet From Radiator, wo/Aux Cooler	624-227
V8 - 4.6L (281 CID)	1999	Upper-Inlet, Under 8500Lb GVW, w/Aux Cooler	624-269
V8 - 4.6L (281 CID)	1999	Upper-Outlet From Radiator	624-228
V8 - 4.6L (281 CID)	1998-97	Hose, To 5/16" Cooler Lines	624-253
V8 - 4.6L (281 CID)	1998-97	Left-Outlet Aux Cooler	624-222
V8 - 4.6L (281 CID)	1998-97	Lower-Inlet From Radiator, wo/Aux Cooler	624-268
V8 - 4.6L (281 CID)	1998-97	Right-Inlet Aux Cooler Tube Fitting	624-225
V8 - 4.6L (281 CID)	1998-97	Upper-Inlet, Under 8500Lb GVW, w/Aux Cooler	624-269
V8 - 4.6L (281 CID)	1998-97	Upper-Outlet From Radiator	624-221
V8 - 5.4L (330 CID)	2002-01	Upper-Outlet From Radiator, 4R100 Trans	624-208
V8 - 5.4L (330 CID)	2000	Left-Outlet Aux Cooler	624-206
V8 - 5.4L (330 CID)	2000	Lower-Inlet From Radiator, wo/Aux Cooler	624-202
V8 - 5.4L (330 CID)	2000	Rear-Inlet To Trans, w/Aux Cooler	624-204
V8 - 5.4L (330 CID)	2000	Right-Inlet Aux Cooler Tube Fitting	624-224
V8 - 5.4L (330 CID)	2000	Upper-Outlet From Radiator, 4R100 Trans	624-208
V8 - 5.4L (330 CID)	1999	Left-Outlet Aux Cooler	624-206
V8 - 5.4L (330 CID)	1999	Lower-Inlet From Radiator, wo/Aux Cooler	624-202
V8 - 5.4L (330 CID)	1999	Lower-Inlet From Radiator, wo/Aux Cooler	624-227
V8 - 5.4L (330 CID)	1999	Rear-Inlet To Trans, w/Aux Cooler	624-204
V8 - 5.4L (330 CID)	1999	Right-Inlet Aux Cooler Tube Fitting	624-224
V8 - 5.4L (330 CID)	1999	Upper-Outlet From Radiator, 4R100 Trans	624-208
V8 - 5.4L (330 CID)	1998	Hose, To 5/16" Cooler Lines	624-253
V8 - 5.4L (330 CID)	1998	Left-Outlet Aux Cooler	624-206
V8 - 5.4L (330 CID)	1998	Lower-Inlet From Radiator, wo/Aux Cooler	624-202
V8 - 5.4L (330 CID)	1998	Rear-Inlet To Trans, w/Aux Cooler	624-204
V8 - 5.4L (330 CID)	1998	Upper-Outlet From Radiator, From 1/15/98	624-208
V8 - 5.4L (330 CID)	1998	Upper-Outlet From Radiator, w/Aux Cooler	624-220
V8 - 5.4L (330 CID)	1998	Upper-Outlet From Radiator, wo/Aux Cooler, To 1/14/98	624-226
V8 - 5.4L (330 CID)	1997	Left-Outlet Aux Cooler	624-206
V8 - 5.4L (330 CID)	1997	Lower-Inlet From Radiator, wo/Aux Cooler	624-202
V8 - 5.4L (330 CID)	1997	Rear-Inlet To Trans, w/Aux Cooler	624-204
V8 - 5.4L (330 CID)	1997	Right-Inlet Aux Cooler Tube Fitting	624-224
V8 - 5.4L (330 CID)	1997	Upper-Outlet From Radiator, w/Aux Cooler	624-220
V8 - 5.4L (330 CID)	1997	Upper-Outlet From Radiator, wo/Aux Cooler	624-226
EXPLORER			
V6 - 4.0L (245 CID)	2001-96	Hose, To 5/16" Cooler Lines	624-253
V8 - 5.0L (302 CID)	2001-98	Hose, To 5/16" Cooler Lines	624-253
V8 - 5.0L (302 CID)	1997-96	Hose, To 5/16" Cooler Lines	624-253
V8 - 5.0L (302 CID)	1997-96	Lower-Inlet From Radiator	624-201
V8 - 5.0L (302 CID)	1997-96	Upper-Outlet From Radiator	624-200
EXPLORER SPORT			
V6 - 4.0L (245 CID)	2001	Hose, To 5/16" Cooler Lines	624-253
EXPLORER SPORT TRAC			
V6 - 4.0L (245 CID)	2001	Hose, To 5/16" Cooler Lines	624-253
F-150 PICKUP			
L6 - 4.9L (300 CID)	1996	Hose, To 5/16" Cooler Lines	624-253
V6 - 4.2L (256 CID)	2005-03	Hose, To 5/16" Cooler Lines	624-253
V6 - 4.2L (256 CID)	2002-00	Hose, To 5/16" Cooler Lines	624-253
V6 - 4.2L (256 CID)	2002-00	Left-Outlet Aux Cooler, w/Super Cooling	624-222
V6 - 4.2L (256 CID)	2002-00	Lower-Inlet, Under 8500Lb GVW, wo/Aux Cooler	624-227

Transmission Line Assembly Applications

Make/ Model/Engine	Years	Description	Dorman #
FORD TRUCK (continued)			
F-150 PICKUP (continued)			
V6 - 4.2L (256 CID)	2002-00	Right-Inlet Aux Cooler Tube Fitting, w/Super Cooling	624-225
V6 - 4.2L (256 CID)	2002-00	Upper-Inlet, Under 8500Lb GVW, w/Super Cooling	624-269
V6 - 4.2L (256 CID)	2002-00	Upper-Outlet From Radiator, w/Super Cooling	624-228
V6 - 4.2L (256 CID)	1999	Hose, To 5/16" Cooler Lines	624-253
V6 - 4.2L (256 CID)	1999	Left-Outlet Aux Cooler	624-222
V6 - 4.2L (256 CID)	1999	Upper-Inlet, Under 8500Lb GVW, w/Aux Cooler	624-269
V6 - 4.2L (256 CID)	1999	Upper-Outlet From Radiator	624-228
V6 - 4.2L (256 CID)	1998-97	Hose, To 5/16" Cooler Lines	624-253
V6 - 4.2L (256 CID)	1998-97	Left-Outlet Aux Cooler	624-222
V6 - 4.2L (256 CID)	1998-97	Lower-Inlet From Radiator, wo/Aux Cooler	624-268
V6 - 4.2L (256 CID)	1998-97	Right-Inlet Aux Cooler Tube Fitting	624-225
V6 - 4.2L (256 CID)	1998-97	Upper-Inlet, Under 8500Lb GVW, w/Aux Cooler	624-269
V6 - 4.2L (256 CID)	1998-97	Upper-Outlet From Radiator	624-221
V8 - 4.6L (281 CID)	2005-03	Hose, To 5/16" Cooler Lines	624-253
V8 - 4.6L (281 CID)	2002-00	Hose, To 5/16" Cooler Lines	624-253
V8 - 4.6L (281 CID)	2002-00	Left-Outlet Aux Cooler, w/Super Cooling	624-222
V8 - 4.6L (281 CID)	2002-00	Lower-Inlet, Under 8500Lb GVW, wo/Aux Cooler	624-227
V8 - 4.6L (281 CID)	2002-00	Right-Inlet Aux Cooler Tube Fitting, w/Super Cooling	624-225
V8 - 4.6L (281 CID)	2002-00	Upper-Inlet, Under 8500Lb GVW, w/Super Cooling	624-269
V8 - 4.6L (281 CID)	2002-00	Upper-Outlet From Radiator, w/Super Cooling	624-228
V8 - 4.6L (281 CID)	1999	Hose, To 5/16" Cooler Lines	624-253
V8 - 4.6L (281 CID)	1999	Left-Outlet Aux Cooler	624-222
V8 - 4.6L (281 CID)	1999	Upper-Inlet, Under 8500Lb GVW, w/Aux Cooler	624-269
V8 - 4.6L (281 CID)	1999	Upper-Outlet From Radiator	624-228
V8 - 4.6L (281 CID)	1998-97	Hose, To 5/16" Cooler Lines	624-253
V8 - 4.6L (281 CID)	1998-97	Left-Outlet Aux Cooler	624-222
V8 - 4.6L (281 CID)	1998-97	Lower-Inlet From Radiator, wo/Aux Cooler	624-268
V8 - 4.6L (281 CID)	1998-97	Right-Inlet Aux Cooler Tube Fitting	624-225
V8 - 4.6L (281 CID)	1998-97	Upper-Inlet, Under 8500Lb GVW, w/Aux Cooler	624-269
V8 - 4.6L (281 CID)	1998-97	Upper-Outlet From Radiator	624-221
V8 - 5.0L (302 CID)	1996	Hose, To 5/16" Cooler Lines	624-253
V8 - 5.4L (330 CID)	2005-04	Hose, To 5/16" Cooler Lines	624-253
V8 - 5.4L (330 CID)	2003	Hose, To 5/16" Cooler Lines	624-253
V8 - 5.4L (330 CID)	2003	Upper-Outlet From Radiator, 4R100 Trans	624-208
V8 - 5.4L (330 CID)	2002-01	Hose, To 5/16" Cooler Lines	624-253
V8 - 5.4L (330 CID)	2002-01	Left-Outlet Aux Cooler, 4R70W Trans, w/Super Cooling	624-222
V8 - 5.4L (330 CID)	2002-01	Lower-Inlet From Radiator, 4R100 Trans, wo/Aux Cooler	624-202
V8 - 5.4L (330 CID)	2002-01	Lower-Inlet, Under 8500Lb GVW, 4R70W Trans, wo/Aux Cooler	624-227
V8 - 5.4L (330 CID)	2002-01	Rear-Inlet To Trans, Under 8500Lb GVW, 4R100 Trans, w/Aux Cooler	624-204
V8 - 5.4L (330 CID)	2002-01	Right-Inlet Aux Cooler Tube Fitting, 4R70W Trans, w/Super Cooling	624-225
V8 - 5.4L (330 CID)	2002-01	Upper-Inlet, 4R70W Trans, w/Super Cooling	624-269
V8 - 5.4L (330 CID)	2002-01	Upper-Outlet From Radiator, 4R100 Trans	624-208
V8 - 5.4L (330 CID)	2002-01	Upper-Outlet From Radiator, 4R70W Trans, w/Super Cooling	624-228
V8 - 5.4L (330 CID)	2000	Hose, To 5/16" Cooler Lines	624-253
V8 - 5.4L (330 CID)	2000	Left-Outlet Aux Cooler, 4R70W Trans, w/Super Cooling	624-222
V8 - 5.4L (330 CID)	2000	Lower-Inlet From Radiator, 4R100 Trans, wo/Aux Cooler	624-202
V8 - 5.4L (330 CID)	2000	Lower-Inlet, Under 8500Lb GVW, 4R70W Trans, wo/Aux Cooler	624-227
V8 - 5.4L (330 CID)	2000	Rear-Inlet To Trans, Under 8500Lb GVW, 4R100 Trans, w/Aux Cooler	624-204
V8 - 5.4L (330 CID)	2000	Right-Inlet Aux Cooler Tube Fitting, 4R100 Trans	624-224
V8 - 5.4L (330 CID)	2000	Right-Inlet Aux Cooler Tube Fitting, 4R70W Trans, w/Super Cooling	624-225
V8 - 5.4L (330 CID)	2000	Upper-Inlet, 4R70W Trans, w/Super Cooling	624-269
V8 - 5.4L (330 CID)	2000	Upper-Outlet From Radiator, 4R100 Trans	624-208
V8 - 5.4L (330 CID)	2000	Upper-Outlet From Radiator, 4R70W Trans, w/Super Cooling	624-228
V8 - 5.4L (330 CID)	1999	Hose, To 5/16" Cooler Lines	624-253
V8 - 5.4L (330 CID)	1999	Left-Outlet Aux Cooler, 4R100 Trans	624-206
V8 - 5.4L (330 CID)	1999	Left-Outlet Aux Cooler, 4R70W Trans	624-222
V8 - 5.4L (330 CID)	1999	Lower-Inlet From Radiator, 4R100 Trans, Under 8500 GVW	624-227
V8 - 5.4L (330 CID)	1999	Lower-Inlet From Radiator, 4R100 Trans, wo/Aux Cooler	624-202
V8 - 5.4L (330 CID)	1999	Rear-Inlet To Trans, 4R100 Trans, w/Aux Cooler	624-204
V8 - 5.4L (330 CID)	1999	Right-Inlet Aux Cooler Tube Fitting, 4R100 Trans	624-224
V8 - 5.4L (330 CID)	1999	Upper-Inlet, Under 8500Lb GVW, 4R70W Trans, w/Aux Cooler	624-269
V8 - 5.4L (330 CID)	1999	Upper-Outlet From Radiator, 4R100 Trans	624-208
V8 - 5.4L (330 CID)	1999	Upper-Outlet From Radiator, 4R70W Trans	624-228
V8 - 5.4L (330 CID)	1998	Hose, To 5/16" Cooler Lines	624-253
V8 - 5.4L (330 CID)	1998	Left-Outlet Aux Cooler, 4R100 Trans	624-206
V8 - 5.4L (330 CID)	1998	Left-Outlet Aux Cooler, 4R70W Trans	624-222
V8 - 5.4L (330 CID)	1998	Lower-Inlet From Radiator, 4R100 Trans, wo/Aux Cooler	624-202
V8 - 5.4L (330 CID)	1998	Lower-Inlet From Radiator, wo/Aux Cooler, 4R70W Trans	624-268
V8 - 5.4L (330 CID)	1998	Rear-Inlet To Trans, 4R100 Trans, w/Aux Cooler	624-204
V8 - 5.4L (330 CID)	1998	Right-Inlet Aux Cooler Tube Fitting	624-224
V8 - 5.4L (330 CID)	1998	Right-Inlet Aux Cooler Tube Fitting, 4R70W Trans	624-225
V8 - 5.4L (330 CID)	1998	Upper-Inlet, Under 8500Lb GVW, 4R70W Trans, w/Aux Cooler	624-269
V8 - 5.4L (330 CID)	1998	Upper-Outlet From Radiator, 4R100 Trans, w/Aux Cooler	624-220
V8 - 5.4L (330 CID)	1998	Upper-Outlet From Radiator, 4R100 Trans, wo/Aux Cooler, From 1/14/98	624-208
V8 - 5.4L (330 CID)	1998	Upper-Outlet From Radiator, 4R70W Trans	624-221
V8 - 5.4L (330 CID)	1998	Upper-Outlet From Radiator, E40D Trans, wo/Aux Cooler, To 1/14/98	624-226
V8 - 5.4L (330 CID)	1997	Hose, To 5/16" Cooler Lines	624-253
V8 - 5.4L (330 CID)	1997	Left-Outlet Aux Cooler, 4R70W Trans	624-222
V8 - 5.4L (330 CID)	1997	Left-Outlet Aux Cooler, E40D Trans	624-206

Transmission Line Assembly Applications

Make/ Model/Engine	Years	Description	Dorman #
FORD TRUCK (continued)			
F-150 PICKUP (continued)			
V8 - 5.4L (330 CID)	1997	Lower-Inlet From Radiator, E40D Trans, wo/Aux Cooler	624-202
V8 - 5.4L (330 CID)	1997	Lower-Inlet From Radiator, wo/Aux Cooler, 4R70W Trans	624-268
V8 - 5.4L (330 CID)	1997	Rear-Inlet To Trans, E40D Trans, w/Aux Cooler	624-204
V8 - 5.4L (330 CID)	1997	Right-Inlet Aux Cooler Tube Fitting	624-224
V8 - 5.4L (330 CID)	1997	Right-Inlet Aux Cooler Tube Fitting, 4R70W Trans	624-225
V8 - 5.4L (330 CID)	1997	Upper-Inlet, Under 8500Lb GVW, 4R70W Trans, w/Aux Cooler	624-269
V8 - 5.4L (330 CID)	1997	Upper-Outlet From Radiator, 4R70W Trans	624-221
V8 - 5.4L (330 CID)	1997	Upper-Outlet From Radiator, E40D Trans, w/Aux Cooler	624-220
V8 - 5.4L (330 CID)	1997	Upper-Outlet From Radiator, E40D Trans, wo/Aux Cooler	624-226
V8 - 5.8L (351 CID)	1996	Hose, To 5/16" Cooler Lines	624-253
F-250 PICKUP			
L6 - 4.9L (300 CID)	1996	Hose, To 5/16" Cooler Lines	624-253
V6 - 4.2L (256 CID)	1998-97	Hose, To 5/16" Cooler Lines	624-253
V6 - 4.2L (256 CID)	1998-97	Lower-Inlet From Radiator, wo/Aux Cooler	624-268
V6 - 4.2L (256 CID)	1998-97	Upper-Outlet From Radiator	624-221
V8 - 4.6L (281 CID)	1999	Hose, To 5/16" Cooler Lines	624-253
V8 - 4.6L (281 CID)	1999	Left-Outlet Aux Cooler	624-222
V8 - 4.6L (281 CID)	1999	Upper-Inlet, Under 8500Lb GVW, w/Aux Cooler	624-269
V8 - 4.6L (281 CID)	1999	Upper-Outlet From Radiator	624-228
V8 - 4.6L (281 CID)	1998-97	Hose, To 5/16" Cooler Lines	624-253
V8 - 4.6L (281 CID)	1998-97	Left-Outlet Aux Cooler	624-222
V8 - 4.6L (281 CID)	1998-97	Lower-Inlet From Radiator, wo/Aux Cooler	624-268
V8 - 4.6L (281 CID)	1998-97	Right-Inlet Aux Cooler Tube Fitting	624-225
V8 - 4.6L (281 CID)	1998-97	Upper-Inlet, Under 8500Lb GVW, w/Aux Cooler	624-269
V8 - 4.6L (281 CID)	1998-97	Upper-Outlet From Radiator	624-221
V8 - 5.0L (302 CID)	1996	Hose, To 5/16" Cooler Lines	624-253
V8 - 5.4L (330 CID)	2002-00	Lower-Inlet From Radiator, 4R100 Trans, wo/Aux Cooler	624-202
V8 - 5.4L (330 CID)	1999	Left-Outlet Aux Cooler, 4R100 Trans	624-206
V8 - 5.4L (330 CID)	1999	Lower-Inlet From Radiator, 4R100 Trans, Under 8500 GVW	624-227
V8 - 5.4L (330 CID)	1999	Lower-Inlet From Radiator, 4R100 Trans, wo/Aux Cooler	624-202
V8 - 5.4L (330 CID)	1999	Rear-Inlet To Trans, 4R100 Trans, w/Aux Cooler	624-204
V8 - 5.4L (330 CID)	1999	Upper-Outlet From Radiator, 4R70W Trans	624-228
V8 - 5.4L (330 CID)	1998	Hose, To 5/16" Cooler Lines	624-253
V8 - 5.4L (330 CID)	1998	Left-Outlet Aux Cooler, 4R100 Trans	624-206
V8 - 5.4L (330 CID)	1998	Left-Outlet Aux Cooler, 4R70W Trans	624-222
V8 - 5.4L (330 CID)	1998	Lower-Inlet From Radiator, 4R100 Trans, wo/Aux Cooler	624-202
V8 - 5.4L (330 CID)	1998	Lower-Inlet From Radiator, wo/Aux Cooler, 4R70W Trans	624-268
V8 - 5.4L (330 CID)	1998	Rear-Inlet To Trans, 4R100 Trans, w/Aux Cooler	624-204
V8 - 5.4L (330 CID)	1998	Right-Inlet Aux Cooler Tube Fitting, 4R70W Trans	624-225
V8 - 5.4L (330 CID)	1998	Upper-Inlet, Under 8500Lb GVW, 4R70W Trans, w/Aux Cooler	624-269
V8 - 5.4L (330 CID)	1998	Upper-Outlet From Radiator, 4R100 Trans, w/Aux Cooler	624-220
V8 - 5.4L (330 CID)	1998	Upper-Outlet From Radiator, 4R100 Trans, wo/Aux Cooler, From 1/14/98	624-208
V8 - 5.4L (330 CID)	1998	Upper-Outlet From Radiator, 4R70W Trans	624-221
V8 - 5.4L (330 CID)	1998	Upper-Outlet From Radiator, E40D Trans, wo/Aux Cooler, To 1/14/98	624-226
V8 - 5.4L (330 CID)	1997	Hose, To 5/16" Cooler Lines	624-253
V8 - 5.4L (330 CID)	1997	Left-Outlet Aux Cooler, 4R70W Trans	624-222
V8 - 5.4L (330 CID)	1997	Left-Outlet Aux Cooler, E40D Trans	624-206
V8 - 5.4L (330 CID)	1997	Lower-Inlet From Radiator, E40D Trans, wo/Aux Cooler	624-202
V8 - 5.4L (330 CID)	1997	Lower-Inlet From Radiator, wo/Aux Cooler, 4R70W Trans	624-268
V8 - 5.4L (330 CID)	1997	Rear-Inlet To Trans, E40D Trans, w/Aux Cooler	624-204
V8 - 5.4L (330 CID)	1997	Right-Inlet Aux Cooler Tube Fitting, 4R70W Trans	624-225
V8 - 5.4L (330 CID)	1997	Right-Inlet Aux Cooler Tube Fitting, wo/Super Cooling	624-224
V8 - 5.4L (330 CID)	1997	Upper-Inlet, Under 8500Lb GVW, 4R70W Trans, w/Aux Cooler	624-269
V8 - 5.4L (330 CID)	1997	Upper-Outlet From Radiator, 4R70W Trans	624-221
V8 - 5.4L (330 CID)	1997	Upper-Outlet From Radiator, E40D Trans, w/Aux Cooler	624-220
V8 - 5.4L (330 CID)	1997	Upper-Outlet From Radiator, E40D Trans, wo/Aux Cooler	624-226
V8 - 5.8L (351 CID)	1997	Hose, To 5/16" Cooler Lines	624-253
V8 - 5.8L (351 CID)	1997	Left-Outlet Aux Cooler	624-206
V8 - 5.8L (351 CID)	1997	Lower-Inlet From Radiator	624-202
V8 - 5.8L (351 CID)	1997	Rear-Inlet To Trans, w/Aux Cooler	624-204
V8 - 5.8L (351 CID)	1997	Right-Inlet Aux Cooler Tube Fitting	624-224
V8 - 5.8L (351 CID)	1997	Upper-Outlet From Radiator, w/Aux Cooler	624-220
V8 - 5.8L (351 CID)	1997	Upper-Outlet From Radiator, wo/Aux Cooler	624-226
V8 - 5.8L (351 CID)	1996	Hose, To 5/16" Cooler Lines	624-253
V8 - 7.3L (445 CID)	1997	Hose, To 5/16" Cooler Lines	624-253
V8 - 7.3L (445 CID)	1997	Left-Outlet Aux Cooler	624-206
V8 - 7.3L (445 CID)	1997	Lower-Inlet From Radiator	624-202
V8 - 7.3L (445 CID)	1997	Rear-Inlet To Trans, w/Aux Cooler	624-204
V8 - 7.3L (445 CID)	1997	Right-Inlet Aux Cooler Tube Fitting	624-224
V8 - 7.3L (445 CID)	1997	Upper-Outlet From Radiator, wo/Aux Cooler	624-226
V8 - 7.3L (445 CID)	1996	Hose, To 5/16" Cooler Lines	624-253
V8 - 7.5L (460 CID)	1997	Hose, To 5/16" Cooler Lines	624-253
V8 - 7.5L (460 CID)	1997	Left-Outlet Aux Cooler	624-206
V8 - 7.5L (460 CID)	1997	Lower-Inlet From Radiator	624-202
V8 - 7.5L (460 CID)	1997	Rear-Inlet To Trans, w/Aux Cooler	624-204
V8 - 7.5L (460 CID)	1997	Right-Inlet Aux Cooler Tube Fitting	624-224
V8 - 7.5L (460 CID)	1997	Upper-Outlet From Radiator, w/Aux Cooler	624-220
V8 - 7.5L (460 CID)	1997	Upper-Outlet From Radiator, wo/Aux Cooler	624-226
V8 - 7.5L (460 CID)	1996	Hose, To 5/16" Cooler Lines	624-253

Transmission Line Assembly Applications

Make/ Model/Engine	Years	Description	Dorman #
FORD TRUCK (continued)			
F-250 SUPER DUTY PICKUP			
V10 - 6.8L (415 CID)	2005-99	Hose, To 5/16" Cooler Lines	624-253
V8 - 5.4L (330 CID)	2005-03	Hose, To 5/16" Cooler Lines	624-253
V8 - 5.4L (330 CID)	2002-00	Hose, To 5/16" Cooler Lines	624-253
V8 - 5.4L (330 CID)	2002-00	Left-Outlet Aux Cooler, 4R70W Trans, w/Super Cooling	624-222
V8 - 5.4L (330 CID)	2002-00	Lower-Inlet From Radiator, 4R100 Trans, wo/Aux Cooler	624-202
V8 - 5.4L (330 CID)	2002-00	Lower-Inlet, Under 8500Lb GVW, 4R70W Trans, wo/Aux Cooler	624-227
V8 - 5.4L (330 CID)	2002-00	Rear-Inlet To Trans, Under 8500Lb GVW, 4R100 Trans, w/Aux Cooler	624-204
V8 - 5.4L (330 CID)	2002-00	Right-Inlet Aux Cooler Tube Fitting, 4R70W Trans, w/Super Cooling	624-225
V8 - 5.4L (330 CID)	2002-00	Upper-Inlet, 4R70W Trans, w/Super Cooling	624-269
V8 - 5.4L (330 CID)	2002-00	Upper-Outlet From Radiator, 4R70W Trans, w/Super Cooling	624-228
V8 - 5.4L (330 CID)	1999	Hose, To 5/16" Cooler Lines	624-253
V8 - 5.4L (330 CID)	1999	Left-Outlet Aux Cooler, 4R100 Trans	624-206
V8 - 5.4L (330 CID)	1999	Left-Outlet Aux Cooler, 4R70W Trans	624-222
V8 - 5.4L (330 CID)	1999	Lower-Inlet From Radiator, 4R100 Trans, Under 8500 GVW	624-227
V8 - 5.4L (330 CID)	1999	Lower-Inlet From Radiator, 4R100 Trans, wo/Aux Cooler	624-202
V8 - 5.4L (330 CID)	1999	Rear-Inlet To Trans, 4R100 Trans, w/Aux Cooler	624-204
V8 - 5.4L (330 CID)	1999	Upper-Inlet, Under 8500Lb GVW, 4R70W Trans, w/Aux Cooler	624-269
V8 - 5.4L (330 CID)	1999	Upper-Outlet From Radiator, 4R100 Trans	624-208
V8 - 5.4L (330 CID)	1999	Upper-Outlet From Radiator, 4R70W Trans	624-228
V8 - 6.0L (363 CID)	2005-03	Hose, To 5/16" Cooler Lines	624-253
V8 - 7.3L (445 CID)	2003-99	Hose, To 5/16" Cooler Lines	624-253
F-350 PICKUP			
L6 - 4.9L (300 CID)	1996	Hose, To 5/16" Cooler Lines	624-253
V8 - 5.8L (351 CID)	1997	Hose, To 5/16" Cooler Lines	624-253
V8 - 5.8L (351 CID)	1997	Left-Outlet Aux Cooler	624-206
V8 - 5.8L (351 CID)	1997	Lower-Inlet From Radiator	624-202
V8 - 5.8L (351 CID)	1997	Rear-Inlet To Trans, w/Aux Cooler	624-204
V8 - 5.8L (351 CID)	1997	Right-Inlet Aux Cooler Tube Fitting	624-224
V8 - 5.8L (351 CID)	1997	Upper-Outlet From Radiator, w/Aux Cooler	624-220
V8 - 5.8L (351 CID)	1997	Upper-Outlet From Radiator, wo/Aux Cooler	624-226
V8 - 5.8L (351 CID)	1996	Hose, To 5/16" Cooler Lines	624-253
V8 - 7.3L (445 CID)	1997	Hose, To 5/16" Cooler Lines	624-253
V8 - 7.3L (445 CID)	1997	Left-Outlet Aux Cooler	624-206
V8 - 7.3L (445 CID)	1997	Lower-Inlet From Radiator	624-202
V8 - 7.3L (445 CID)	1997	Rear-Inlet To Trans, w/Aux Cooler	624-204
V8 - 7.3L (445 CID)	1997	Right-Inlet Aux Cooler Tube Fitting	624-224
V8 - 7.3L (445 CID)	1997	Upper-Outlet From Radiator, wo/Aux Cooler	624-226
V8 - 7.3L (445 CID)	1996	Hose, To 5/16" Cooler Lines	624-253
V8 - 7.5L (460 CID)	1997	Hose, To 5/16" Cooler Lines	624-253
V8 - 7.5L (460 CID)	1997	Left-Outlet Aux Cooler	624-206
V8 - 7.5L (460 CID)	1997	Lower-Inlet From Radiator	624-202
V8 - 7.5L (460 CID)	1997	Rear-Inlet To Trans, w/Aux Cooler	624-204
V8 - 7.5L (460 CID)	1997	Right-Inlet Aux Cooler Tube Fitting	624-224
V8 - 7.5L (460 CID)	1997	Upper-Outlet From Radiator, w/Aux Cooler	624-220
V8 - 7.5L (460 CID)	1997	Upper-Outlet From Radiator, wo/Aux Cooler	624-226
V8 - 7.5L (460 CID)	1996	Hose, To 5/16" Cooler Lines	624-253
F-350 SUPER DUTY PICKUP			
V10 - 6.8L (415 CID)	2005-99	Hose, To 5/16" Cooler Lines	624-253
V8 - 5.4L (330 CID)	2005-03	Hose, To 5/16" Cooler Lines	624-253
V8 - 5.4L (330 CID)	2002-00	Hose, To 5/16" Cooler Lines	624-253
V8 - 5.4L (330 CID)	2002-00	Left-Outlet Aux Cooler, 4R70W Trans, w/Super Cooling	624-222
V8 - 5.4L (330 CID)	2002-00	Lower-Inlet From Radiator, 4R100 Trans, wo/Aux Cooler	624-202
V8 - 5.4L (330 CID)	2002-00	Lower-Inlet, Under 8500Lb GVW, 4R70W Trans, wo/Aux Cooler	624-227
V8 - 5.4L (330 CID)	2002-00	Rear-Inlet To Trans, Under 8500Lb GVW, 4R100 Trans, w/Aux Cooler	624-204
V8 - 5.4L (330 CID)	2002-00	Right-Inlet Aux Cooler Tube Fitting, 4R70W Trans, w/Super Cooling	624-225
V8 - 5.4L (330 CID)	2002-00	Upper-Inlet, 4R70W Trans, w/Super Cooling	624-269
V8 - 5.4L (330 CID)	2002-00	Upper-Outlet From Radiator, 4R70W Trans, w/Super Cooling	624-228
V8 - 5.4L (330 CID)	1999	Hose, To 5/16" Cooler Lines	624-253
V8 - 5.4L (330 CID)	1999	Left-Outlet Aux Cooler, 4R100 Trans	624-206
V8 - 5.4L (330 CID)	1999	Left-Outlet Aux Cooler, 4R70W Trans	624-222
V8 - 5.4L (330 CID)	1999	Lower-Inlet From Radiator, 4R100 Trans, Under 8500 GVW	624-227
V8 - 5.4L (330 CID)	1999	Lower-Inlet From Radiator, 4R100 Trans, wo/Aux Cooler	624-202
V8 - 5.4L (330 CID)	1999	Rear-Inlet To Trans, 4R100 Trans, w/Aux Cooler	624-204
V8 - 5.4L (330 CID)	1999	Upper-Inlet, Under 8500Lb GVW, 4R70W Trans, w/Aux Cooler	624-269
V8 - 5.4L (330 CID)	1999	Upper-Outlet From Radiator, 4R70W Trans	624-228
V8 - 6.0L (363 CID)	2005-03	Hose, To 5/16" Cooler Lines	624-253
V8 - 7.3L (445 CID)	2003-99	Hose, To 5/16" Cooler Lines	624-253
F-450 SUPER DUTY			
V10 - 6.8L (415 CID)	2005	Hose, To 5/16" Cooler Lines	624-253
V8 - 6.0L (363 CID)	2005	Hose, To 5/16" Cooler Lines	624-253
F-450 SUPER DUTY PICKUP			
V10 - 6.8L (415 CID)	2004-99	Hose, To 5/16" Cooler Lines	624-253
V8 - 6.0L (363 CID)	2004-03	Hose, To 5/16" Cooler Lines	624-253
V8 - 7.3L (445 CID)	2003-98	Hose, To 5/16" Cooler Lines	624-253
V8 - 7.3L (445 CID)	1997	Hose, To 5/16" Cooler Lines	624-253
V8 - 7.3L (445 CID)	1997	Left-Outlet Aux Cooler	624-206
V8 - 7.3L (445 CID)	1997	Lower-Inlet From Radiator	624-202
V8 - 7.3L (445 CID)	1997	Rear-Inlet To Trans, w/Aux Cooler	624-204
V8 - 7.3L (445 CID)	1997	Right-Inlet Aux Cooler Tube Fitting	624-224

Transmission Line Assembly Applications

Make/ Model/Engine	Years	Description	Dorman #
FORD TRUCK (continued)			
F-450 SUPER DUTY PICKUP (continued)			
V8 - 7.3L (445 CID)	1997	Upper-Outlet From Radiator, wo/Aux Cooler	624-226
V8 - 7.3L (445 CID)	1996	Hose, To 5/16" Cooler Lines	624-253
V8 - 7.5L (460 CID)	1997	Hose, To 5/16" Cooler Lines	624-253
V8 - 7.5L (460 CID)	1997	Left-Outlet Aux Cooler	624-206
V8 - 7.5L (460 CID)	1997	Lower-Inlet From Radiator	624-202
V8 - 7.5L (460 CID)	1997	Rear-Inlet To Trans, w/Aux Cooler	624-204
V8 - 7.5L (460 CID)	1997	Right-Inlet Aux Cooler Tube Fitting	624-224
V8 - 7.5L (460 CID)	1997	Upper-Outlet From Radiator, w/Aux Cooler	624-220
V8 - 7.5L (460 CID)	1997	Upper-Outlet From Radiator, wo/Aux Cooler	624-226
V8 - 7.5L (460 CID)	1996	Hose, To 5/16" Cooler Lines	624-253
F-550 SUPER DUTY			
V10 - 6.8L (415 CID)	2005	Hose, To 5/16" Cooler Lines	624-253
V8 - 6.0L (363 CID)	2005	Hose, To 5/16" Cooler Lines	624-253
F-550 SUPER DUTY PICKUP			
V10 - 6.8L (415 CID)	2004-99	Hose, To 5/16" Cooler Lines	624-253
V8 - 6.0L (363 CID)	2004-03	Hose, To 5/16" Cooler Lines	624-253
V8 - 7.3L (445 CID)	2003-99	Hose, To 5/16" Cooler Lines	624-253
F53 STRIPPED CHASSIS			
V8 - 7.5L (460 CID)	1997-96	Hose, To 5/16" Cooler Lines	624-253
F59 STRIPPED CHASSIS			
V8 - 7.3L (445 CID)	1996	Hose, To 5/16" Cooler Lines	624-253
RANGER			
ELECTRIC	2002-98	Hose, To 5/16" Cooler Lines	624-253
L4 - 2.3L (140 CID)	2003-96	Hose, To 5/16" Cooler Lines	624-253
L4 - 2.5L (153 CID)	2001-98	Hose, To 5/16" Cooler Lines	624-253
V6 - 3.0L (182 CID)	2003-96	Hose, To 5/16" Cooler Lines	624-253
V6 - 4.0L (245 CID)	2003-96	Hose, To 5/16" Cooler Lines	624-253
GMC TRUCK			
C1500 PICKUP			
V6 - 4.3L (262 CID)	1998	Lower-Outlet	624-135
V6 - 4.3L (262 CID)	1998	Upper-Inlet	624-134
V8 - 5.0L (305 CID)	1999-98	Lower-Outlet, w/140Amp Generator (8A5)	624-130
V8 - 5.0L (305 CID)	1999-98	Lower-Outlet, wo/140Amp Generator (8A5)	624-135
V8 - 5.0L (305 CID)	1999-98	Upper-Inlet, w/140Amp Generator (8A5)	624-132
V8 - 5.0L (305 CID)	1999-98	Upper-Inlet, wo/140Amp Generator (8A5)	624-134
V8 - 5.7L (350 CID)	1999-98	Left-Inlet Aux Cooler, (M30) Trans	624-133
V8 - 5.7L (350 CID)	1999-98	Left-Outlet Aux Cooler, (MT1) Trans	624-109
V8 - 5.7L (350 CID)	1999-98	Lower-Outlet, wo/Aux Cooler	624-130
V8 - 5.7L (350 CID)	1999-98	Right-Inlet Aux Cooler, (MT1) Trans	624-168
V8 - 5.7L (350 CID)	1999-98	Right-Outlet Aux Cooler, (M30) Trans	624-131
V8 - 5.7L (350 CID)	1999-98	Upper-Inlet, wo/Aux Cooler	624-132
V8 - 5.7L (350 CID)	1997	Left-Outlet Aux Cooler, (MT1) Trans	624-109
V8 - 5.7L (350 CID)	1997	Right-Inlet Aux Cooler, (MT1) Trans	624-168
V8 - 5.7L (350 CID)	1996	Right-Inlet Aux Cooler, (MT1) Trans	624-168
V8 - 5.7L (350 CID)	1995-94	Left-Outlet Aux Cooler	624-148
V8 - 6.5L (395 CID)	1998-97	Left-Outlet Aux Cooler	624-146
V8 - 6.5L (395 CID)	1998-97	Right-Inlet Aux Cooler	624-168
V8 - 6.5L (395 CID)	1995-94	Left-Outlet Aux Cooler	624-148
C1500 SUBURBAN			
V8 - 6.5L (395 CID)	1999-97	Left-Outlet Aux Cooler	624-146
C2500 PICKUP			
V8 - 5.0L (305 CID)	1999-98	Lower-Outlet, w/140Amp Generator (8A5)	624-130
V8 - 5.0L (305 CID)	1999-98	Lower-Outlet, wo/140Amp Generator (8A5)	624-135
V8 - 5.0L (305 CID)	1999-98	Upper-Inlet, w/140Amp Generator (8A5)	624-132
V8 - 5.0L (305 CID)	1999-98	Upper-Inlet, wo/140Amp Generator (8A5)	624-134
V8 - 5.7L (350 CID)	2000-98	Left-Inlet Aux Cooler, (M30) Trans	624-133
V8 - 5.7L (350 CID)	2000-98	Left-Outlet Aux Cooler, (MT1) Trans	624-109
V8 - 5.7L (350 CID)	2000-98	Lower-Outlet, wo/Aux Cooler	624-130
V8 - 5.7L (350 CID)	2000-98	Right-Inlet Aux Cooler, (MT1) Trans	624-168
V8 - 5.7L (350 CID)	2000-98	Right-Outlet Aux Cooler, (M30) Trans	624-131
V8 - 5.7L (350 CID)	2000-98	Upper-Inlet, wo/Aux Cooler	624-132
V8 - 5.7L (350 CID)	1997	Left-Outlet Aux Cooler, (MT1) Trans	624-109
V8 - 5.7L (350 CID)	1997	Right-Inlet Aux Cooler, (MT1) Trans	624-168
V8 - 5.7L (350 CID)	1996	Right-Inlet Aux Cooler, (MT1) Trans	624-168
V8 - 5.7L (350 CID)	1995-94	Left-Outlet Aux Cooler	624-148
V8 - 6.5L (395 CID)	2000-97	Left-Outlet Aux Cooler	624-146
V8 - 6.5L (395 CID)	2000-97	Right-Inlet Aux Cooler	624-168
V8 - 6.5L (395 CID)	1995-94	Left-Outlet Aux Cooler	624-148
V8 - 7.4L (454 CID)	2000-96	Left-Outlet Aux Cooler	624-156
V8 - 7.4L (454 CID)	2000-96	Right-Inlet Aux Cooler	624-106
V8 - 7.4L (454 CID)	1995-94	Left-Outlet Aux Cooler	624-148
C2500 SUBURBAN			
V8 - 6.5L (395 CID)	1999-97	Left-Outlet Aux Cooler	624-146
V8 - 7.4L (454 CID)	1999-96	Left-Outlet Aux Cooler	624-156
V8 - 7.4L (454 CID)	1999-96	Right-Inlet Aux Cooler	624-106
C3500 PICKUP			
V8 - 5.7L (350 CID)	2000-98	Left-Inlet Aux Cooler, (M30) Trans, Exc. HD	624-133
V8 - 5.7L (350 CID)	2000-98	Left-Outlet Aux Cooler, (MT1) Trans, Exc. HD	624-109
V8 - 5.7L (350 CID)	2000-98	Left-Outlet Aux Cooler, HD	624-137

Transmission Line Assembly Applications

Make/ Model/Engine	Years	Description	Dorman #
GMC TRUCK (continued)			
C3500 PICKUP (continued)			
V8 - 5.7L (350 CID)	2000-98	Lower-Outlet, wo/Aux Cooler	624-130
V8 - 5.7L (350 CID)	2000-98	Right-Inlet Aux Cooler, (MT1) Trans, Exc. HD	624-168
V8 - 5.7L (350 CID)	2000-98	Right-Inlet Aux Cooler, HD	624-104
V8 - 5.7L (350 CID)	2000-98	Right-Outlet Aux Cooler, (M30) Trans, Exc. HD	624-131
V8 - 5.7L (350 CID)	2000-98	Upper-Inlet, wo/Aux Cooler	624-132
V8 - 5.7L (350 CID)	1997	Left-Outlet Aux Cooler, (MT1) Trans, Exc. HD	624-109
V8 - 5.7L (350 CID)	1997	Right-Inlet Aux Cooler, (MT1) Trans, Exc. HD	624-168
V8 - 5.7L (350 CID)	1996	Right-Inlet Aux Cooler, (MT1) Trans, Exc. HD	624-168
V8 - 5.7L (350 CID)	1995-94	Left-Outlet Aux Cooler, HD	624-148
V8 - 6.5L (395 CID)	2002-01	Left-Outlet Aux Cooler, HD	624-137
V8 - 6.5L (395 CID)	2002-01	Right-Inlet Aux Cooler, HD	624-104
V8 - 6.5L (395 CID)	2000-98	Left-Outlet Aux Cooler, Exc. HD	624-146
V8 - 6.5L (395 CID)	2000-98	Left-Outlet Aux Cooler, HD	624-137
V8 - 6.5L (395 CID)	2000-98	Right-Inlet Aux Cooler, HD	624-104
V8 - 6.5L (395 CID)	1997	Left-Outlet Aux Cooler, Exc. HD	624-146
V8 - 6.5L (395 CID)	1997	Left-Outlet Aux Cooler, HD	624-137
V8 - 6.5L (395 CID)	1997	Right-Inlet Aux Cooler, HD	624-104
V8 - 6.5L (395 CID)	1996	Right-Inlet Aux Cooler, HD	624-104
V8 - 6.5L (395 CID)	1995-94	Left-Outlet Aux Cooler, HD	624-148
V8 - 7.4L (454 CID)	2000-96	Left-Outlet Aux Cooler, Exc. HD	624-156
V8 - 7.4L (454 CID)	2000-96	Left-Outlet Aux Cooler, HD	624-137
V8 - 7.4L (454 CID)	2000-96	Right-Inlet Aux Cooler, Exc. HD	624-106
V8 - 7.4L (454 CID)	2000-96	Right-Inlet Aux Cooler, HD	624-104
V8 - 7.4L (454 CID)	1995-94	Left-Outlet Aux Cooler, HD	624-148
K1500 PICKUP			
V6 - 4.3L (262 CID)	1998	Lower-Outlet	624-135
V6 - 4.3L (262 CID)	1998	Upper-Inlet	624-134
V8 - 5.0L (305 CID)	1999-98	Lower-Outlet, w/140Amp Generator (8A5)	624-130
V8 - 5.0L (305 CID)	1999-98	Lower-Outlet, wo/140Amp Generator (8A5)	624-135
V8 - 5.0L (305 CID)	1999-98	Upper-Inlet, w/140Amp Generator (8A5)	624-132
V8 - 5.0L (305 CID)	1999-98	Upper-Inlet, wo/140Amp Generator (8A5)	624-134
V8 - 5.7L (350 CID)	1999-98	Left-Inlet Aux Cooler, (M30) Trans	624-133
V8 - 5.7L (350 CID)	1999-98	Left-Outlet Aux Cooler, (MT1) Trans	624-109
V8 - 5.7L (350 CID)	1999-98	Lower-Outlet, wo/Aux Cooler	624-130
V8 - 5.7L (350 CID)	1999-98	Right-Inlet Aux Cooler, (MT1) Trans	624-168
V8 - 5.7L (350 CID)	1999-98	Right-Outlet Aux Cooler, (M30) Trans	624-131
V8 - 5.7L (350 CID)	1999-98	Upper-Inlet, wo/Aux Cooler	624-132
V8 - 5.7L (350 CID)	1997	Left-Outlet Aux Cooler, (MT1) Trans	624-109
V8 - 5.7L (350 CID)	1997	Right-Inlet Aux Cooler, (MT1) Trans	624-168
V8 - 5.7L (350 CID)	1996	Right-Inlet Aux Cooler, (MT1) Trans	624-168
V8 - 5.7L (350 CID)	1995-94	Left-Outlet Aux Cooler	624-148
V8 - 6.5L (395 CID)	1998-97	Left-Outlet Aux Cooler	624-146
V8 - 6.5L (395 CID)	1998-97	Right-Inlet Aux Cooler	624-168
V8 - 6.5L (395 CID)	1995-94	Left-Outlet Aux Cooler	624-148
K1500 SUBURBAN			
V8 - 6.5L (395 CID)	1999-97	Left-Outlet Aux Cooler	624-146
K2500 PICKUP			
V8 - 5.0L (305 CID)	1999-98	Lower-Outlet, w/140Amp Generator (8A5)	624-130
V8 - 5.0L (305 CID)	1999-98	Lower-Outlet, wo/140Amp Generator (8A5)	624-135
V8 - 5.0L (305 CID)	1999-98	Upper-Inlet, w/140Amp Generator (8A5)	624-132
V8 - 5.0L (305 CID)	1999-98	Upper-Inlet, wo/140Amp Generator (8A5)	624-134
V8 - 5.7L (350 CID)	2000-98	Left-Inlet Aux Cooler, (M30) Trans	624-133
V8 - 5.7L (350 CID)	2000-98	Left-Outlet Aux Cooler, (MT1) Trans	624-109
V8 - 5.7L (350 CID)	2000-98	Lower-Outlet, wo/Aux Cooler	624-130
V8 - 5.7L (350 CID)	2000-98	Right-Inlet Aux Cooler, (MT1) Trans	624-168
V8 - 5.7L (350 CID)	2000-98	Right-Outlet Aux Cooler, (M30) Trans	624-131
V8 - 5.7L (350 CID)	2000-98	Upper-Inlet, wo/Aux Cooler	624-132
V8 - 5.7L (350 CID)	1997	Left-Outlet Aux Cooler, (MT1) Trans	624-109
V8 - 5.7L (350 CID)	1997	Right-Inlet Aux Cooler, (MT1) Trans	624-168
V8 - 5.7L (350 CID)	1996	Right-Inlet Aux Cooler, (MT1) Trans	624-168
V8 - 5.7L (350 CID)	1995-94	Left-Outlet Aux Cooler	624-148
V8 - 6.5L (395 CID)	2000-97	Left-Outlet Aux Cooler	624-146
V8 - 6.5L (395 CID)	2000-97	Right-Inlet Aux Cooler	624-168
V8 - 6.5L (395 CID)	1995-94	Left-Outlet Aux Cooler	624-148
V8 - 7.4L (454 CID)	2000-96	Left-Outlet Aux Cooler	624-156
V8 - 7.4L (454 CID)	2000-96	Right-Inlet Aux Cooler	624-106
V8 - 7.4L (454 CID)	1995-94	Left-Outlet Aux Cooler	624-148
K2500 SUBURBAN			
V8 - 6.5L (395 CID)	1999-97	Left-Outlet Aux Cooler	624-146
V8 - 7.4L (454 CID)	1999-96	Left-Outlet Aux Cooler	624-156
V8 - 7.4L (454 CID)	1999-96	Right-Inlet Aux Cooler	624-106
K3500 PICKUP			
V8 - 5.7L (350 CID)	2000-98	Left-Inlet Aux Cooler, (M30) Trans, Exc. HD	624-133
V8 - 5.7L (350 CID)	2000-98	Left-Outlet Aux Cooler, (MT1) Trans, Exc. HD	624-109
V8 - 5.7L (350 CID)	2000-98	Left-Outlet Aux Cooler, HD	624-137
V8 - 5.7L (350 CID)	2000-98	Lower-Outlet, wo/Aux Cooler	624-130
V8 - 5.7L (350 CID)	2000-98	Right-Inlet Aux Cooler, (MT1) Trans, Exc. HD	624-168
V8 - 5.7L (350 CID)	2000-98	Right-Inlet Aux Cooler, HD	624-104
V8 - 5.7L (350 CID)	2000-98	Right-Outlet Aux Cooler, (M30) Trans, Exc. HD	624-131

Transmission Line Assembly Applications

Make/ Model/Engine	Years	Description	Dorman #
GMC TRUCK (continued)			
K3500 PICKUP (continued)			
V8 - 5.7L (350 CID)	2000-98	Upper-Inlet, wo/Aux Cooler	624-132
V8 - 5.7L (350 CID)	1997	Left-Outlet Aux Cooler, (MT1) Trans, Exc. HD	624-109
V8 - 5.7L (350 CID)	1997	Right-Inlet Aux Cooler, (MT1) Trans, Exc. HD	624-168
V8 - 5.7L (350 CID)	1996	Right-Inlet Aux Cooler, (MT1) Trans, Exc. HD	624-168
V8 - 5.7L (350 CID)	1995-94	Left-Outlet Aux Cooler, HD	624-148
V8 - 6.5L (395 CID)	2002-01	Left-Outlet Aux Cooler, HD	624-137
V8 - 6.5L (395 CID)	2000-97	Left-Outlet Aux Cooler, Exc. HD	624-146
V8 - 6.5L (395 CID)	2000-97	Left-Outlet Aux Cooler, HD	624-137
V8 - 6.5L (395 CID)	2000-97	Right-Inlet Aux Cooler, Exc. HD	624-168
V8 - 6.5L (395 CID)	2000-97	Right-Inlet Aux Cooler, HD	624-104
V8 - 6.5L (395 CID)	1996	Right-Inlet Aux Cooler, HD	624-104
V8 - 6.5L (395 CID)	1995-94	Left-Outlet Aux Cooler, HD	624-148
V8 - 7.4L (454 CID)	2000-96	Left-Outlet Aux Cooler, Exc. HD	624-156
V8 - 7.4L (454 CID)	2000-96	Left-Outlet Aux Cooler, HD	624-137
V8 - 7.4L (454 CID)	2000-96	Right-Inlet Aux Cooler, Exc. HD	624-106
V8 - 7.4L (454 CID)	2000-96	Right-Inlet Aux Cooler, HD	624-104
V8 - 7.4L (454 CID)	1995-94	Left-Outlet Aux Cooler, HD	624-148
S15 JIMMY			
V6 - 4.3L (262 CID)	2001-96	Lower-Inlet	624-101
V6 - 4.3L (262 CID)	2001-96	Upper-Outlet	624-100
S15 SONOMA			
V6 - 4.3L (262 CID)	2004-96	Lower-Inlet	624-101
V6 - 4.3L (262 CID)	2004-96	Upper-Outlet	624-100
SUBURBAN			
V8 - 5.7L (350 CID)	1999	Left-Outlet Aux Cooler, (MT1) Trans	624-109
V8 - 5.7L (350 CID)	1999	Lower-Outlet, (M30) Trans, wo/Aux Cooler	624-130
V8 - 5.7L (350 CID)	1999	Right-Inlet Aux Cooler, (MT1) Trans	624-168
V8 - 5.7L (350 CID)	1999	Upper-Inlet, (M30) Trans, wo/Aux Cooler	624-132
V8 - 5.7L (350 CID)	1998	Left-Inlet Aux Cooler, (M30) Trans	624-133
V8 - 5.7L (350 CID)	1998	Left-Outlet Aux Cooler, (MT1) Trans	624-109
V8 - 5.7L (350 CID)	1998	Lower-Outlet, (M30) Trans, wo/Aux Cooler	624-130
V8 - 5.7L (350 CID)	1998	Right-Inlet Aux Cooler, (MT1) Trans	624-168
V8 - 5.7L (350 CID)	1998	Right-Outlet Aux Cooler, (M30) Trans	624-131
V8 - 5.7L (350 CID)	1998	Upper-Inlet, (M30) Trans, wo/Aux Cooler	624-132
V8 - 5.7L (350 CID)	1997	Left-Outlet Aux Cooler, (MT1) Trans	624-109
V8 - 5.7L (350 CID)	1997	Right-Inlet Aux Cooler, (MT1) Trans	624-168
V8 - 5.7L (350 CID)	1996	Right-Inlet Aux Cooler, (MT1) Trans	624-168
YUKON			
V8 - 5.7L (350 CID)	2000	Left-Inlet Aux Cooler	624-133
V8 - 5.7L (350 CID)	2000	Lower-Outlet, wo/Aux Cooler	624-130
V8 - 5.7L (350 CID)	2000	Right-Outlet Aux Cooler	624-131
V8 - 5.7L (350 CID)	2000	Upper-Inlet, wo/Aux Cooler	624-132
V8 - 5.7L (350 CID)	1999-98	Left-Inlet Aux Cooler, (M30) Trans	624-133
V8 - 5.7L (350 CID)	1999-98	Left-Outlet Aux Cooler, (MT1) Trans	624-109
V8 - 5.7L (350 CID)	1999-98	Lower-Outlet, (M30) Trans, wo/Aux Cooler	624-130
V8 - 5.7L (350 CID)	1999-98	Right-Inlet Aux Cooler, (MT1) Trans	624-168
V8 - 5.7L (350 CID)	1999-98	Right-Outlet Aux Cooler, (M30) Trans	624-131
V8 - 5.7L (350 CID)	1999-98	Upper-Inlet, (M30) Trans, wo/Aux Cooler	624-132
V8 - 5.7L (350 CID)	1997-96	Left-Outlet Aux Cooler, (MT1) Trans	624-109
V8 - 5.7L (350 CID)	1997-96	Right-Inlet Aux Cooler, (MT1) Trans	624-168
V8 - 6.5L (395 CID)	1999-97	Left-Outlet Aux Cooler	624-146
V8 - 6.5L (395 CID)	1999-97	Right-Inlet Aux Cooler	624-168
HONDA			
ACCORD			
L4 - 2.3L (2254 cc)	2002-98	Left-Outlet Tube From Trans	624-601
L4 - 2.3L (2254 cc)	2002-98	Right-Inlet Tube To Trans	624-600
CIVIC			
L4 - 1.6L (1590 cc)	2000-96	Lower-Inlet Tube To Trans	624-602
L4 - 1.6L (1590 cc)	2000-96	Upper-Outlet Tube From Trans	624-603
PASSPORT			
V6 - 3.2L (3165 cc)	2002-00	Lower-Left To Hose From Trans	624-604
V6 - 3.2L (3165 cc)	2002-00	Lower-Right To Hose From Trans	624-605
ISUZU TRUCK			
RODEO			
L4 - 2.2L (2180 cc)	2002-01	Lower-Left To Hose From Trans	624-604
L4 - 2.2L (2180 cc)	2002-01	Lower-Right To Hose From Trans	624-605
V6 - 3.2L (3165 cc)	2002-01	Lower-Left To Hose From Trans	624-604
V6 - 3.2L (3165 cc)	2002-01	Lower-Right To Hose From Trans	624-605
JEEP			
CHEROKEE			
L4 - 2.1L (126 CID)	1987	Right-Outlet Tube From Trans, 4-Cyl Eng	624-841
L4 - 2.5L (150 CID)	2000-99	Lower-Inlet Aux Cooler	624-801
L4 - 2.5L (150 CID)	2000-99	Upper-Outlet Tube From Radiator	624-334
L4 - 2.5L (150 CID)	1998-97	Front-Inlet Tube To Trans & Upper-Inlet Hose From Radiator	624-811
L4 - 2.5L (150 CID)	1998-97	Lower-Inlet Aux Cooler	624-801
L4 - 2.5L (150 CID)	1998-97	Return	624-851
L4 - 2.5L (150 CID)	1998-97	Upper-Outlet Tube From Radiator	624-334
L4 - 2.5L (150 CID)	1996-94	Front-Inlet Tube To Trans & Upper-Inlet Hose From Radiator	624-811
L4 - 2.5L (150 CID)	1996-94	Return	624-851

Transmission Line Assembly Applications

Make/ Model/Engine	Years	Description	Dorman #
JEEP (continued)			
CHEROKEE (continued)			
L4 - 2.5L (150 CID)	1996-94	Upper-Outlet Tube From Radiator	624-334
L4 - 2.5L (150 CID)	1993-89	Right-Outlet Tube From Trans, 4-Cyl Eng	624-841
L4 - 2.5L (150 CID)	1993-89	Upper-Outlet Tube From Radiator	624-334
L4 - 2.5L (150 CID)	1988	Right-Outlet Tube From Trans, 4-Cyl Eng	624-841
L4 - 2.5L (150 CID)	1988	Upper-Outlet Tube From Radiator	624-334
L4 - 2.5L (150 CID)	1987	Right-Outlet Tube From Trans, 4-Cyl Eng	624-841
L6 - 4.0L (242 CID)	2001-97	Lower-Inlet Aux Cooler	624-801
L6 - 4.0L (242 CID)	2001-97	Upper-Inlet Tube From Radiator	624-355
L6 - 4.0L (242 CID)	2001-97	Upper-Outlet Aux Cooler	624-354
L6 - 4.0L (242 CID)	2001-97	Upper-Outlet Tube From Radiator	624-334
L6 - 4.0L (242 CID)	1996-88	Upper-Outlet Tube From Radiator	624-334
L6 - 4.0L (242 CID)	1996-87	Lower-Outlet, Will Not Fit Theaded Applications w/Aux Bypass	624-300
L6 - 4.0L (242 CID)	1996-87	Upper-Inlet, Will Not Fit Theaded Applications w/Aux Bypass	624-301
COMANCHE			
L4 - 2.1L (126 CID)	1987	Right-Outlet Tube From Trans, 4-Cyl Eng	624-841
L4 - 2.5L (150 CID)	1992-88	Right-Outlet Tube From Trans, 4-Cyl Eng	624-841
L4 - 2.5L (150 CID)	1992-88	Upper-Outlet Tube From Radiator	624-334
L4 - 2.5L (150 CID)	1987	Right-Outlet Tube From Trans, 4-Cyl Eng	624-841
L6 - 4.0L (242 CID)	1992-88	Upper-Outlet Tube From Radiator	624-334
L6 - 4.0L (242 CID)	1992-87	Lower-Outlet, Will Not Fit Theaded Applications w/Aux Bypass	624-300
L6 - 4.0L (242 CID)	1992-87	Upper-Inlet, Will Not Fit Theaded Applications w/Aux Bypass	624-301
GRAND CHEROKEE			
L6 - 4.0L (242 CID)	1997-96	Upper & Lower-Inlet & Outlet	624-306
L6 - 4.0L (242 CID)	1997	Elbow, Aux Cooler Hose (2 Required)	624-384
L6 - 4.0L (242 CID)	1997	Upper-Inlet Hose From Radiator	624-805
L6 - 4.0L (242 CID)	1997	Upper-Inlet Tube Aux Cooler From Radiator	624-838
L6 - 4.0L (242 CID)	1997	Upper-Inlet Tube From Radiator To Trans Front	624-840
L6 - 4.0L (242 CID)	1996	Elbow, Aux Cooler Hose (2 Required)	624-384
L6 - 4.0L (242 CID)	1996	Lower-Outlet Aux Cooler Tube From Radiator	624-837
L6 - 4.0L (242 CID)	1996	Upper-Inlet Aux Cooler Tube From Radiator	624-836
L6 - 4.0L (242 CID)	1996	Upper-Inlet Hose From Radiator	624-805
L6 - 4.0L (242 CID)	1996	Upper-Inlet Tube From Radiator To Trans Front	624-840
L6 - 4.0L (242 CID)	1996	Upper-Outlet Tube From Radiator, wo/Aux Cooler	624-806
L6 - 4.0L (242 CID)	1995-94	Elbow, Aux Cooler Hose (2 Required)	624-384
L6 - 4.0L (242 CID)	1995-94	Lower-Outlet Aux Cooler Tube	624-382
L6 - 4.0L (242 CID)	1995-94	Upper-Inlet Aux Cooler Tube	624-383
L6 - 4.0L (242 CID)	1995-94	Upper-Outlet Tube From Radiator, wo/Aux Cooler	624-806
V8 - 5.2L (318 CID)	1997-96	Elbow, Aux Cooler Hose (2 Required)	624-384
V8 - 5.2L (318 CID)	1997-96	Lower-Inlet	624-308
V8 - 5.2L (318 CID)	1997-96	Lower-Inlet Tube From Radiator	624-809
V8 - 5.2L (318 CID)	1997-96	Lower-Outlet Tube Aux Cooler	624-839
V8 - 5.2L (318 CID)	1997-96	Upper-Inlet Tube Aux Cooler From Radiator	624-838
V8 - 5.2L (318 CID)	1997-96	Upper-Outlet	624-307
V8 - 5.2L (318 CID)	1995-94	Elbow, Aux Cooler Hose (2 Required)	624-384
V8 - 5.2L (318 CID)	1995-94	Lower-Inlet Tube From Radiator	624-809
V8 - 5.2L (318 CID)	1995-94	Lower-Inlet Tube To Trans & Hose From Radiator	624-804
V8 - 5.2L (318 CID)	1995-94	Lower-Outlet Tube Aux Cooler	624-839
V8 - 5.2L (318 CID)	1995-94	Upper-Inlet Tube Aux Cooler From Radiator	624-838
V8 - 5.2L (318 CID)	1993	Elbow, Aux Cooler Hose (2 Required)	624-384
V8 - 5.2L (318 CID)	1993	Lower-Inlet Tube From Radiator	624-807
V8 - 5.2L (318 CID)	1993	Lower-Outlet Tube Aux Cooler	624-839
V8 - 5.2L (318 CID)	1993	Upper-Inlet Tube Aux Cooler From Radiator	624-838
WAGONEER			
L4 - 2.5L (150 CID)	1987	Right-Outlet Tube From Trans, 4-Cyl Eng	624-841
L6 - 4.0L (242 CID)	1990-88	Upper-Outlet Tube From Radiator	624-334
L6 - 4.0L (242 CID)	1990-87	Lower-Outlet, Will Not Fit Theaded Applications w/Aux Bypass	624-300
L6 - 4.0L (242 CID)	1990-87	Upper-Inlet, Will Not Fit Theaded Applications w/Aux Bypass	624-301
WRANGLER			
L4 - 2.5L (150 CID)	1995-94	Upper-Elbow Aux Cooler Hose	624-384
L6 - 4.0L (242 CID)	1995-94	Upper-Elbow Aux Cooler Hose	624-384
LINCOLN			
CONTINENTAL			
V6 - 3.8L (232 CID)	1994-90	Upper-Inlet To Trans	624-212
MARK VIII			
V8 - 4.6L (281 CID)	1998-96	Hose, To 5/16" Cooler Lines	624-253
V8 - 4.6L (281 CID)	1998-96	Upper & Lower-Inlet & Outlet Aux Cooler	624-214
V8 - 4.6L (281 CID)	1995	Upper & Lower-Inlet & Outlet Aux Cooler	624-214
NAVIGATOR			
V8 - 5.4L (330 CID)	2002-01	Hose, To 5/16" Cooler Lines	624-253
V8 - 5.4L (330 CID)	2000-98	Hose, To 5/16" Cooler Lines	624-253
V8 - 5.4L (330 CID)	2000-98	Left-Outlet Aux Cooler	624-206
V8 - 5.4L (330 CID)	2000-98	Lower-Inlet From Radiator, wo/Aux Cooler	624-202
V8 - 5.4L (330 CID)	2000-98	Rear-Inlet To Trans, w/Aux Cooler	624-204
V8 - 5.4L (330 CID)	2000-98	Right-Inlet Aux Cooler Tube Fitting	624-224
V8 - 5.4L (330 CID)	2000-98	Upper-Outlet From Radiator, 4R100 Trans	624-208
TOWN CAR			
V8 - 4.6L (281 CID)	2006-04	Upper & Lower-Inlet & Outlet, Tube Assembly	624-252
V8 - 4.6L (281 CID)	2003	Hose, To 5/16" Cooler Lines	624-253
V8 - 4.6L (281 CID)	2003	Upper & Lower-Inlet & Outlet, Tube Assembly	624-252

Transmission Line Assembly Applications

Make/ Model/Engine	Years	Description	Dorman #
LINCOLN (continued)			
TOWN CAR (continued)			
V8 - 4.6L (281 CID)	2002-98	Hose, To 5/16" Cooler Lines	624-253
V8 - 4.6L (281 CID)	1997-96	Hose, To 5/16" Cooler Lines	624-253
V8 - 4.6L (281 CID)	1997-96	Upper & Lower-Inlet & Outlet To Trans	624-251
MERCURY			
COUGAR			
V6 - 3.8L (232 CID)	1997-96	Hose, To 5/16" Cooler Lines	624-253
V6 - 3.8L (232 CID)	1995-91	Lower-Outlet	624-210
V6 - 3.8L (232 CID)	1990	Lower-Outlet, wo/Supercharger	624-210
V8 - 4.6L (281 CID)	1997-96	Hose, To 5/16" Cooler Lines	624-253
V8 - 5.0L (302 CID)	1993-91	Lower-Outlet	624-210
GRAND MARQUIS			
V8 - 4.6L (281 CID)	2005-04	Hose, To 5/16" Cooler Lines	624-253
V8 - 4.6L (281 CID)	2005-04	Upper & Lower-Inlet & Outlet, Tube Assembly	624-252
V8 - 4.6L (281 CID)	2003	Hose, To 5/16" Cooler Lines	624-253
V8 - 4.6L (281 CID)	2003	Upper & Lower-Inlet & Outlet Aux Cooler	624-214
V8 - 4.6L (281 CID)	2003	Upper & Lower-Inlet & Outlet, Tube Assembly	624-252
V8 - 4.6L (281 CID)	2002-98	Hose, To 5/16" Cooler Lines	624-253
V8 - 4.6L (281 CID)	2002-98	Upper & Lower-Inlet & Outlet Aux Cooler	624-214
V8 - 4.6L (281 CID)	1997-96	Hose, To 5/16" Cooler Lines	624-253
V8 - 4.6L (281 CID)	1997-96	Upper & Lower-Inlet & Outlet Aux Cooler	624-214
V8 - 4.6L (281 CID)	1997-96	Upper & Lower-Inlet & Outlet To Trans	624-251
V8 - 4.6L (281 CID)	1995	Upper & Lower-Inlet & Outlet Aux Cooler	624-214
MARAUDER			
V8 - 4.6L (281 CID)	2004-03	Hose, To 5/16" Cooler Lines	624-253
V8 - 4.6L (281 CID)	2004-03	Upper & Lower-Inlet & Outlet, Tube Assembly	624-252
MOUNTAINEER			
V6 - 4.0L (245 CID)	2001-98	Hose, To 5/16" Cooler Lines	624-253
V8 - 5.0L (302 CID)	2001-98	Hose, To 5/16" Cooler Lines	624-253
V8 - 5.0L (302 CID)	1997	Hose, To 5/16" Cooler Lines	624-253
V8 - 5.0L (302 CID)	1997	Lower-Inlet From Radiator	624-201
V8 - 5.0L (302 CID)	1997	Upper-Outlet From Radiator	624-200
SABLE			
V6 - 3.0L (182 CID)	1999	Lower-Outlet, AX4N Trans, w/Aux Cooler	624-217
V6 - 3.0L (182 CID)	1999	Upper-Inlet, AX4N Trans, w/Aux Cooler	624-223
V6 - 3.0L (182 CID)	1998-97	Lower-Outlet, AX4N Trans, w/Aux Cooler	624-217
V6 - 3.0L (182 CID)	1998-97	Lower-Outlet, AX4S Trans, w/Aux Cooler	624-218
V6 - 3.0L (182 CID)	1998-97	Upper-Inlet, AX4N Trans, w/Aux Cooler	624-223
V6 - 3.0L (182 CID)	1996	Lower-Inlet, AX4S Trans, wo/Aux Cooler	624-215
V6 - 3.0L (182 CID)	1996	Lower-Outlet, AX4N Trans, w/Aux Cooler	624-217
V6 - 3.0L (182 CID)	1996	Lower-Outlet, AX4S Trans, w/Aux Cooler	624-218
V6 - 3.0L (182 CID)	1996	Upper-Inlet, AX4S Trans, w/Aux Cooler	624-216
V6 - 3.0L (182 CID)	1996	Upper-Outlet, AX4S Trans, wo/Aux Cooler	624-219
V6 - 3.0L (182 CID)	1995-93	Lower-Outlet Aux Cooler Tube	624-213
V6 - 3.8L (232 CID)	1995-93	Lower-Outlet Aux Cooler Tube	624-213
V6 - 3.8L (232 CID)	1992-90	Lower-Outlet Aux Cooler Tube	624-213
V6 - 3.8L (232 CID)	1992-90	Upper-Inlet To Trans	624-212
MITSUBISHI TRUCK			
MONTERO SPORT			
V6 - 3.0L (2972 cc)	2003-97	Lower-Left, 6-Cyl Eng	624-700
V6 - 3.0L (2972 cc)	2003-97	Lower-Right, 6-Cyl Eng	624-701
V6 - 3.5L (3497 cc)	2004-99	Lower-Left, 6-Cyl Eng	624-700
V6 - 3.5L (3497 cc)	2004-99	Lower-Right, 6-Cyl Eng	624-701
NISSAN			
ALTIMA			
L4 - 2.4L (2389 cc)	1997	Lower-Left From Cooler, From 12/96	624-505
L4 - 2.4L (2389 cc)	1997	Lower-Left From Cooler, To 12/96	624-500
L4 - 2.4L (2389 cc)	1997	Lower-Right From Cooler, From 12/96	624-504
L4 - 2.4L (2389 cc)	1997	Lower-Right From Cooler, To 12/96	624-501
L4 - 2.4L (2389 cc)	1996-93	Lower-Left From Cooler	624-500
L4 - 2.4L (2389 cc)	1996-93	Lower-Right From Cooler	624-501
MAXIMA			
V6 - 3.0L (2988 cc)	1999	Left, To 3/99	624-502
V6 - 3.0L (2988 cc)	1999	Right, To 3/99	624-503
V6 - 3.0L (2988 cc)	1998-95	Left	624-502
V6 - 3.0L (2988 cc)	1998-95	Right	624-503
OLDSMOBILE			
88			
V6 - 3.8L (231 CID)	1998	Lower-Outlet From Radiator	624-151
V6 - 3.8L (231 CID)	1998	Upper-Inlet From Radiator	624-150
V6 - 3.8L (231 CID)	1997	Lower-Outlet From Radiator, From 2/18/97	624-151
V6 - 3.8L (231 CID)	1997	Lower-Outlet From Radiator, To 2/18/97	624-144
V6 - 3.8L (231 CID)	1997	Upper-Inlet From Radiator, From 2/18/97	624-150
V6 - 3.8L (231 CID)	1996	Lower-Outlet From Radiator	624-144
V6 - 3.8L (231 CID)	1995-94	Lower-Outlet From Radiator	624-151
V6 - 3.8L (231 CID)	1995-94	Upper-Inlet From Radiator, w/Aux Cooler	624-142
V6 - 3.8L (231 CID)	1995-94	Upper-Inlet From Radiator, wo/Aux Cooler	624-150
V6 - 3.8L (231 CID)	1993	Upper-Inlet From Radiator, w/Aux Cooler	624-142
V6 - 3.8L (231 CID)	1993	Upper-Inlet From Radiator, wo/Aux Cooler	624-150

Transmission Line Assembly Applications

Make/ Model/Engine	Years	Description	Dorman #
OLDSMOBILE (continued)			
98			
V6 - 3.8L (231 CID)	1996	Lower-Outlet From Radiator	624-144
V6 - 3.8L (231 CID)	1995-94	Lower-Outlet From Radiator	624-151
V6 - 3.8L (231 CID)	1995-94	Upper-Inlet From Radiator, w/Aux Cooler	624-142
V6 - 3.8L (231 CID)	1995-94	Upper-Inlet From Radiator, wo/Aux Cooler	624-150
V6 - 3.8L (231 CID)	1993	Upper-Inlet From Radiator, w/Aux Cooler	624-142
V6 - 3.8L (231 CID)	1993	Upper-Inlet From Radiator, wo/Aux Cooler	624-150
V6 - 3.8L (231 CID)	1990-88	Lower-Outlet Hose To Trans	624-111
V6 - 3.8L (231 CID)	1990-88	Lower-Outlet Tube From Radiator, w/Aux Cooler	624-140
V6 - 3.8L (231 CID)	1990-88	Lower-Outlet Tube From Radiator, wo/Aux Cooler	624-107
V6 - 3.8L (231 CID)	1990-88	Upper-Inlet Hose From Radiator, w/Aux Cooler	624-110
V6 - 3.8L (231 CID)	1990-88	Upper-Inlet Tube From Radiator, wo/Aux Cooler	624-157
V6 - 3.8L (231 CID)	1990-88	Upper-Inlet Tube To Trans	624-108
V6 - 3.8L (231 CID)	1987-86	Lower-Outlet	624-113
V6 - 3.8L (231 CID)	1987-86	Upper-Inlet	624-112
BRAVADA			
V6 - 4.3L (262 CID)	2001-96	Lower-Inlet	624-101
V6 - 4.3L (262 CID)	2001-96	Upper-Outlet	624-100
CUTLASS SUPREME			
V6 - 3.1L (189 CID)	1991	Lower-Outlet	624-102
V6 - 3.1L (189 CID)	1991	Upper-Inlet	624-103
V6 - 3.4L (207 CID)	1997-92	Lower-Outlet	624-102
V6 - 3.4L (207 CID)	1997-92	Upper-Inlet	624-103
DELTA 88			
V6 - 3.8L (231 CID)	1999	Lower-Outlet From Radiator	624-151
V6 - 3.8L (231 CID)	1999	Upper-Inlet From Radiator	624-150
V6 - 3.8L (231 CID)	1990-88	Lower-Outlet Hose To Trans	624-111
V6 - 3.8L (231 CID)	1990-88	Lower-Outlet Tube From Radiator, w/Aux Cooler	624-140
V6 - 3.8L (231 CID)	1990-88	Lower-Outlet Tube From Radiator, wo/Aux Cooler	624-107
V6 - 3.8L (231 CID)	1990-88	Upper-Inlet Hose From Radiator, w/Aux Cooler	624-110
V6 - 3.8L (231 CID)	1990-88	Upper-Inlet Tube From Radiator, wo/Aux Cooler	624-157
V6 - 3.8L (231 CID)	1990-88	Upper-Inlet Tube To Trans	624-108
V6 - 3.8L (231 CID)	1987-86	Lower-Outlet	624-113
V6 - 3.8L (231 CID)	1987-86	Upper-Inlet	624-112
INTRIGUE			
V6 - 3.8L (231 CID)	1998	Lower-Outlet From Radiator	624-102
V6 - 3.8L (231 CID)	1998	Upper-Inlet From Radiator	624-103
SILHOUETTE			
V6 - 3.1L (189 CID)	1994-90	Upper & Lower- Inlet & Outlet To Trans	624-128
V6 - 3.4L (207 CID)	1996	Upper-Inlet From Radiator	624-126
V6 - 3.8L (231 CID)	1995-92	Lower-Inlet From Radiator, w/Aux Cooler	624-127
V6 - 3.8L (231 CID)	1995-92	Upper-Inlet From Radiator, wo/Aux Cooler	624-126
TORONADO			
V6 - 3.8L (231 CID)	1989-88	Lower-Inlet Hose To Cooler	624-160
V6 - 3.8L (231 CID)	1989-88	Upper-Outlet Hose From Cooler	624-161
V6 - 3.8L (231 CID)	1987	Lower-Inlet Hose To Cooler	624-160
PLYMOUTH			
BREEZE			
L4 - 2.0L (122 CID)	1997-96	Left-Outlet Hose	624-367
L4 - 2.0L (122 CID)	1997-96	Right-Inlet Hose	624-366
GRAND VOYAGER			
L4 - 2.4L (148 CID)	1997	Lower-Outlet, 4-Speed Trans	624-895
L4 - 2.4L (148 CID)	1997	Upper-Inlet, 4-Speed Trans	624-850
L4 - 2.4L (148 CID)	1996	Upper & Lower-Inlet & Outlet, 3-Speed Trans	624-394
V6 - 3.0L (181 CID)	2000-99	Intermediate Aux Cooler Tube	624-320
V6 - 3.0L (181 CID)	2000	Upper & Lower-Inlet & Outlet, wo/Aux Cooler	624-311
V6 - 3.0L (181 CID)	1998	Upper & Lower, Inlet & Supply Radiator Oil Cooler, 3-Speed Trans	624-379
V6 - 3.0L (181 CID)	1996	Upper & Lower-Inlet & Outlet, 3-Speed Trans	624-394
V6 - 3.0L (181 CID)	1995-94	Upper & Lower-Inlet & Outlet, Water Cooled Trans, 3-Speed Trans, w/Rear AC	624-376
V6 - 3.0L (181 CID)	1995-94	Upper-Inlet, Water Cooled Trans, 4-Speed Trans, w/AC	624-346
V6 - 3.0L (181 CID)	1995-93	Inlet, Hose, Air Cooled Trans	624-368
V6 - 3.0L (181 CID)	1995-93	Outlet, Tube, Air Cooled Trans	624-369
V6 - 3.0L (181 CID)	1995-93	Upper & Lower-Inlet & Outlet, Water Cooled Trans, 3-Speed Trans, wo/Rear AC	624-362
V6 - 3.0L (181 CID)	1995-93	Upper & Lower-Inlet & Outlet, Water Cooled Trans, 4-Speed DGL Trans, wo/AC	624-372
V6 - 3.0L (181 CID)	1995-93	Upper-Inlet, Water Cooled Trans, 4-Speed Trans, wo/AC	624-374
V6 - 3.3L (201 CID)	2000-97	Upper & Lower-Inlet & Outlet, wo/Aux Cooler	624-311
V6 - 3.3L (201 CID)	2000	Intermediate Aux Cooler Tube	624-320
V6 - 3.3L (201 CID)	1999	Intermediate Aux Cooler Tube	624-320
V6 - 3.3L (201 CID)	1998	Intermediate Aux Cooler Tube	624-320
V6 - 3.3L (201 CID)	1998	Upper & Lower, Inlet & Supply Radiator Oil Cooler	624-379
V6 - 3.3L (201 CID)	1998	Upper & Lower-Inlet & Outlet, w/HD Radiator	624-370
V6 - 3.3L (201 CID)	1998	Upper & Lower-Inlet & Outlet, w/Rear AC	624-330
V6 - 3.3L (201 CID)	1997	Intermediate Aux Cooler Tube	624-320
V6 - 3.3L (201 CID)	1997	Upper & Lower, Inlet & Supply Radiator Oil Cooler, w/Tow Package	624-379
V6 - 3.3L (201 CID)	1997	Upper & Lower-Inlet & Outlet, w/Rear AC	624-330
V6 - 3.3L (201 CID)	1996	Upper & Lower, Inlet & Supply Radiator Oil Cooler, w/Tow Package	624-379
V6 - 3.3L (201 CID)	1995-94	Inlet, Hose, Air Cooled Trans	624-368
V6 - 3.3L (201 CID)	1995-94	Outlet, Tube, Air Cooled Trans	624-369
V6 - 3.3L (201 CID)	1995-94	Upper & Lower-Inlet & Outlet, Water Cooled Trans, w/AC	624-347
V6 - 3.3L (201 CID)	1995-94	Upper & Lower-Inlet & Outlet, Water Cooled Trans, wo/AC	624-378

Transmission Line Assembly Applications

Make/ Model/Engine	Years	Description	Dorman #
PLYMOUTH (continued)			
GRAND VOYAGER (continued)			
V6 - 3.3L (201 CID)	1993	Inlet, Hose, Air Cooled Trans	624-368
V6 - 3.3L (201 CID)	1993	Outlet, Tube, Air Cooled Trans	624-369
V6 - 3.3L (201 CID)	1993	Upper & Lower-Inlet & Outlet, Water Cooled Trans, wo/AC	624-378
V6 - 3.8L (230 CID)	2000-97	Upper & Lower-Inlet & Outlet, wo/Aux Cooler	624-311
V6 - 3.8L (230 CID)	1999-97	Intermediate Aux Cooler Tube	624-320
V6 - 3.8L (230 CID)	1998-97	Upper & Lower-Inlet & Outlet, w/Rear AC	624-330
V6 - 3.8L (230 CID)	1995-94	Inlet, Hose, Air Cooled Trans	624-368
V6 - 3.8L (230 CID)	1995-94	Outlet, Tube, Air Cooled Trans	624-369
V6 - 3.8L (230 CID)	1995-94	Upper & Lower-Inlet & Outlet, Water Cooled Trans, w/AC	624-347
V6 - 3.8L (230 CID)	1995-93	Upper & Lower-Inlet & Outlet, Water Cooled Trans, wo/AC	624-378
NEON			
L4 - 2.0L (122 CID)	1999-95	Left-Outlet, Hose, wo/AC	624-882
L4 - 2.0L (122 CID)	1999-95	Left-Outlet, w/AC	624-341
L4 - 2.0L (122 CID)	1999-95	Right-Inlet, w/AC	624-340
L4 - 2.0L (122 CID)	1999-95	Right-Inlet, wo/AC	624-898
VOYAGER			
L4 - 2.4L (148 CID)	1997	Lower-Outlet, 4-Speed Trans	624-895
L4 - 2.4L (148 CID)	1997	Upper-Inlet, 4-Speed Trans	624-850
L4 - 2.4L (148 CID)	1996	Upper & Lower-Inlet & Outlet, 3-Speed Trans	624-394
L4 - 2.5L (153 CID)	1995-93	Inlet, Hose, Air Cooled Trans	624-368
L4 - 2.5L (153 CID)	1995-93	Outlet, Tube, Air Cooled Trans	624-369
L4 - 2.5L (153 CID)	1995-93	Upper & Lower-Inlet & Outlet, Water Cooled Trans	624-362
V6 - 3.0L (181 CID)	2000-99	Intermediate Aux Cooler Tube	624-320
V6 - 3.0L (181 CID)	2000	Upper & Lower-Inlet & Outlet, wo/Aux Cooler	624-311
V6 - 3.0L (181 CID)	1998	Upper & Lower, Inlet & Supply Radiator Oil Cooler, 3-Speed Trans	624-379
V6 - 3.0L (181 CID)	1996	Upper & Lower-Inlet & Outlet, 3-Speed Trans	624-394
V6 - 3.0L (181 CID)	1995-94	Upper & Lower-Inlet & Outlet, Water Cooled Trans, 3-Speed Trans, w/Rear AC	624-376
V6 - 3.0L (181 CID)	1995-94	Upper-Inlet, Water Cooled Trans, 4-Speed Trans, w/AC	624-346
V6 - 3.0L (181 CID)	1995-93	Inlet, Hose, Air Cooled Trans	624-368
V6 - 3.0L (181 CID)	1995-93	Outlet, Tube, Air Cooled Trans	624-369
V6 - 3.0L (181 CID)	1995-93	Upper & Lower-Inlet & Outlet, Water Cooled Trans, 3-Speed Trans, wo/Rear AC	624-362
V6 - 3.0L (181 CID)	1995-93	Upper & Lower-Inlet & Outlet, Water Cooled Trans, 4-Speed DGL Trans, wo/AC	624-372
V6 - 3.0L (181 CID)	1995-93	Upper-Inlet, Water Cooled Trans, 4-Speed Trans, wo/AC	624-374
V6 - 3.3L (201 CID)	2000	Intermediate Aux Cooler Tube	624-320
V6 - 3.3L (201 CID)	2000	Upper & Lower-Inlet & Outlet, wo/Aux Cooler	624-311
V6 - 3.3L (201 CID)	1999	Intermediate Aux Cooler Tube	624-320
V6 - 3.3L (201 CID)	1999	Upper & Lower-Inlet & Outlet, wo/Aux Cooler	624-311
V6 - 3.3L (201 CID)	1998	Intermediate Aux Cooler Tube	624-320
V6 - 3.3L (201 CID)	1998	Upper & Lower, Inlet & Supply Radiator Oil Cooler	624-379
V6 - 3.3L (201 CID)	1998	Upper & Lower-Inlet & Outlet, w/HD Radiator	624-370
V6 - 3.3L (201 CID)	1998	Upper & Lower-Inlet & Outlet, w/Rear AC	624-330
V6 - 3.3L (201 CID)	1998	Upper & Lower-Inlet & Outlet, wo/Aux Cooler	624-311
V6 - 3.3L (201 CID)	1997	Intermediate Aux Cooler Tube	624-320
V6 - 3.3L (201 CID)	1997	Upper & Lower, Inlet & Supply Radiator Oil Cooler, w/Tow Package	624-379
V6 - 3.3L (201 CID)	1997	Upper & Lower-Inlet & Outlet, w/Rear AC	624-330
V6 - 3.3L (201 CID)	1997	Upper & Lower-Inlet & Outlet, wo/Aux Cooler	624-311
V6 - 3.3L (201 CID)	1996	Upper & Lower, Inlet & Supply Radiator Oil Cooler, w/Tow Package	624-379
V6 - 3.3L (201 CID)	1995-94	Inlet, Hose, Air Cooled Trans	624-368
V6 - 3.3L (201 CID)	1995-94	Outlet, Tube, Air Cooled Trans	624-369
V6 - 3.3L (201 CID)	1995-94	Upper & Lower-Inlet & Outlet, Water Cooled Trans, w/AC	624-347
V6 - 3.3L (201 CID)	1995-94	Upper & Lower-Inlet & Outlet, Water Cooled Trans, wo/AC	624-378
V6 - 3.3L (201 CID)	1993	Inlet, Hose, Air Cooled Trans	624-368
V6 - 3.3L (201 CID)	1993	Outlet, Tube, Air Cooled Trans	624-369
V6 - 3.3L (201 CID)	1993	Upper & Lower-Inlet & Outlet, Water Cooled Trans, wo/AC	624-378
V6 - 3.8L (230 CID)	2000	Upper & Lower-Inlet & Outlet, wo/Aux Cooler	624-311
V6 - 3.8L (230 CID)	1999-97	Intermediate Aux Cooler Tube	624-320
V6 - 3.8L (230 CID)	1999	Upper & Lower-Inlet & Outlet, wo/Aux Cooler	624-311
V6 - 3.8L (230 CID)	1998-97	Upper & Lower-Inlet & Outlet, w/Rear AC	624-330
V6 - 3.8L (230 CID)	1998	Upper & Lower-Inlet & Outlet, wo/Aux Cooler	624-311
V6 - 3.8L (230 CID)	1997	Upper & Lower-Inlet & Outlet, wo/Aux Cooler	624-311
PONTIAC			
BONNEVILLE			
V6 - 3.8L (231 CID)	1999-98	Lower-Outlet From Radiator	624-151
V6 - 3.8L (231 CID)	1999-98	Upper-Inlet From Radiator	624-150
V6 - 3.8L (231 CID)	1997	Lower-Outlet From Radiator, From 2/18/97	624-151
V6 - 3.8L (231 CID)	1997	Lower-Outlet From Radiator, To 2/18/97	624-144
V6 - 3.8L (231 CID)	1997	Upper-Inlet From Radiator, From 2/18/97	624-150
V6 - 3.8L (231 CID)	1996	Lower-Outlet From Radiator	624-144
V6 - 3.8L (231 CID)	1995-94	Lower-Outlet From Radiator	624-151
V6 - 3.8L (231 CID)	1995-94	Upper-Inlet From Radiator, w/Aux Cooler	624-142
V6 - 3.8L (231 CID)	1995-94	Upper-Inlet From Radiator, wo/Aux Cooler	624-150
V6 - 3.8L (231 CID)	1993	Upper-Inlet From Radiator, w/Aux Cooler	624-142
V6 - 3.8L (231 CID)	1993	Upper-Inlet From Radiator, wo/Aux Cooler	624-150
V6 - 3.8L (231 CID)	1990-88	Lower-Outlet Hose To Trans	624-111
V6 - 3.8L (231 CID)	1990-88	Lower-Outlet Tube From Radiator, w/Aux Cooler	624-140
V6 - 3.8L (231 CID)	1990-88	Lower-Outlet Tube From Radiator, wo/Aux Cooler	624-107
V6 - 3.8L (231 CID)	1990-88	Upper-Inlet Hose From Radiator, w/Aux Cooler	624-110
V6 - 3.8L (231 CID)	1990-88	Upper-Inlet Tube From Radiator, wo/Aux Cooler	624-157
V6 - 3.8L (231 CID)	1990-88	Upper-Inlet Tube To Trans	624-108

Transmission Line Assembly Applications

Make/ Model/Engine	Years	Description	Dorman #
PONTIAC (continued)			
BONNEVILLE (continued)			
V6 - 3.8L (231 CID)	1987-86	Lower-Outlet	624-113
V6 - 3.8L (231 CID)	1987-86	Upper-Inlet	624-112
GRAND PRIX			
V6 - 3.1L (189 CID)	1997-91	Lower-Outlet	624-102
V6 - 3.1L (189 CID)	1997-91	Upper-Inlet	624-103
V6 - 3.4L (207 CID)	1996-91	Lower-Outlet	624-102
V6 - 3.4L (207 CID)	1996-91	Upper-Inlet	624-103
V6 - 3.8L (231 CID)	1997	Lower-Outlet	624-102
V6 - 3.8L (231 CID)	1997	Upper-Inlet	624-103
SUNFIRE			
L4 - 2.2L (134 CID)	2001-95	Lower-Outlet 3-Speed Trans	624-139
L4 - 2.2L (134 CID)	2001-95	Upper-Inlet, 3-Speed Trans	624-138
TRANS SPORT			
V6 - 3.1L (189 CID)	1995-90	Upper & Lower- Inlet & Outlet To Trans	624-128
V6 - 3.4L (207 CID)	1996	Upper-Inlet From Radiator	624-126
V6 - 3.8L (231 CID)	1995-92	Lower-Inlet From Radiator, w/Aux Cooler	624-127
V6 - 3.8L (231 CID)	1995-92	Upper-Inlet From Radiator, wo/Aux Cooler	624-126
SUBARU			
BAJA			
H4 - 2.5L (2458 cc)	2006-03	Lower-Left, wo/Turbo	624-702
H4 - 2.5L (2458 cc)	2006-03	Lower-Right, wo/Turbo	624-703
LEGACY			
H4 - 2.5L (2458 cc)	2006-00	Lower-Left, wo/Turbo	624-702
H4 - 2.5L (2458 cc)	2006-00	Lower-Right, wo/Turbo	624-703
OUTBACK			
H4 - 2.5L (2458 cc)	2003-01	Lower-Left, wo/Turbo	624-702
H4 - 2.5L (2458 cc)	2003-01	Lower-Right, wo/Turbo	624-703
TOYOTA			
CAMRY			
L4 - 2.2L (2164 cc)	2001-97	Left-Inlet Tube, 4-Cyl Eng, USA Built	624-400
L4 - 2.2L (2164 cc)	2001-97	Right-Outlet Tube, 4-Cyl Eng, USA Built	624-403
L4 - 2.2L (2164 cc)	1996-92	Left-Inlet Tube, 4-Cyl Eng	624-402
L4 - 2.2L (2164 cc)	1996-92	Right-Outlet Tube, 4-Cyl Eng	624-401
COROLLA			
L4 - 1.6L (1587 cc)	1997-93	Lower-Outlet Tube, 1.6L Eng	624-405
L4 - 1.6L (1587 cc)	1997-93	Upper-Inlet Tube, 1.6L Eng	624-404
VOLKSWAGEN			
GOLF			
L4 - 2.0L (1984 cc)	1998-93	-	624-901
JETTA			
L4 - 2.0L (1984 cc)	2004-99	-	624-900
L4 - 2.0L (1984 cc)	1998-93	-	624-901

Transmission Shift Solenoid Pack

Direct OE Replacement



1 SKU
Covers Over
20 Different Models
and 10 Million
Registered
Vehicles

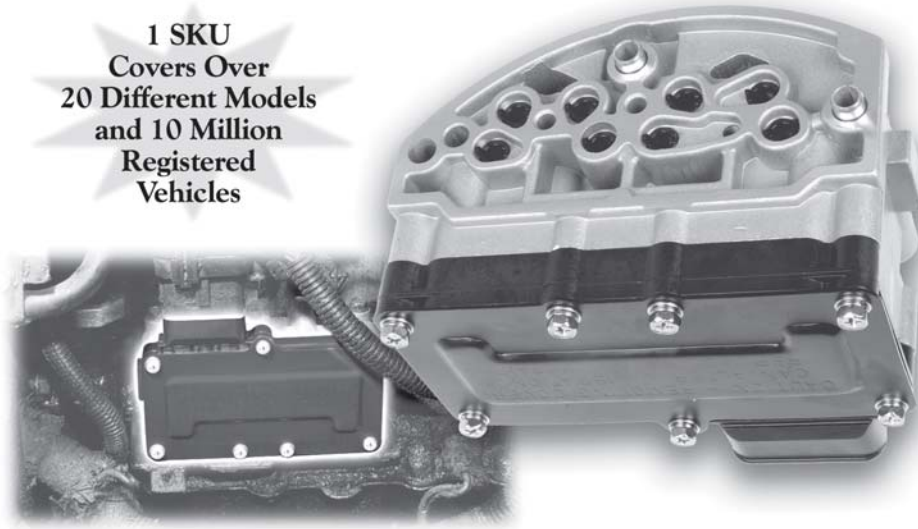

Easy to Diagnose

- Poor Shifting Quality
- Suddenly Locks into Second Gear (“Limp Home” mode)

Easy to Replace - Externally Mounted

- Extremely Failure-Prone Chrysler Transmission Shift Solenoid Available at a Price That is Competitive with OE!
- Fits 2004-89 Chrysler Cars/Minivans with Overdrive (A604) Transmissions
- New **Hydraulic** Solenoid Technology — NOT Included in Most Traditional Transmission Solenoid Suppliers’ Programs

Activant Path

Auto Transmission/
Transaxle/
A/T Filters & Parts

Activant Code

DPD

Applications begin
on page 534.

Transmission Shift Solenoid



698-100

Chrysler
2004-89 Chrysler vehicles w/ A604
Transmission

Transmission Shift Solenoid Applications

Transmission Shift Solenoid

Make/ Model/Year	Description	Dorman #
CHRYSLER		
CIRRUS 2000-95	-	698-100
IMPERIAL 1993-90	-	698-100
LEBARON 1995-89	-	698-100
NEW YORKER 1993-89	-	698-100
PACIFICA 2004	-	698-100
PT CRUISER 2003-01	-	698-100
SEBRING 2004-01 2000-95	Exc. Coupe -	698-100 698-100
TC MASERATI 1991-89	-	698-100
TOWN & COUNTRY VAN 2003-90	w/A604 4-Speed Auto Trans	698-100
VOYAGER, GRAND VOYAGER 2003-00	w/A604 4-Speed Auto Trans	698-100
DODGE		
AVENGER 2000-95	-	698-100
CARAVAN, GRAND CARAVAN 2003-89	w/A604 4-Speed Auto Trans	698-100
DAYTONA 1993-89	w/A604 4-Speed Auto Trans	698-100

Make/ Model/Year	Description	Dorman #
DODGE (continued)		
DYNASTY 1993-89	w/A604 4-Speed Auto Trans	698-100
NEON 2003-01	w/A604 4-Speed Auto Trans	698-100
SHADOW 1994-89	w/A604 4-Speed Auto Trans	698-100
SPIRIT 1995-89	w/A604 4-Speed Auto Trans	698-100
STRATUS 2004-01 2000-95	Sedan -	698-100 698-100
EAGLE		
TALON 1998-95	w/A604 4-Speed Auto Trans, wo/Turbo	698-100
PLYMOUTH		
ACCLAIM 1995-89	w/A604 4-Speed Auto Trans	698-100
BREEZE 2000-96	-	698-100
NEON 2001	w/A604 4-Speed Auto Trans	698-100
SUNDANCE 1994-89	w/A604 4-Speed Auto Trans	698-100
VOYAGER, GRAND VOYAGER 2000-89	w/A604 4-Speed Auto Trans	698-100

Transmission Shift Solenoid #698-100

Symptom: Poor Shift Quality. Car goes into "Limp Mode."

Solution: Dorman OE Solutions™ #698-100, just one SKU covers 2005-89 Chrysler Cars/Minivans with A604 transmission. That translates into coverage for over 20 different models and 10 million registered vehicles.

Dorman's **698-100** provides a solution that is easy to replace and externally mounted.

Window Lift Motor Kits

100% NEW!



Dorman Window Lift Motor Kits – NEW for the same price as reman!

- Dorman quality Window Lift Motor Kits mean fewer comebacks.
- Supplied with OE type connector, no wire cutting or splicing.
- Do the job right the first time.
- All the parts necessary to do the job.

Install With Confidence Using 100% NEW Dorman Window Lift Motors

OE and Other Aftermarket Suppliers – 3 SKUs



Dorman #	OE #
742-250	= F43Z-54233V94-BRM
	E9AZ-54233V95-ARM
	F1TZ-78233V95-CRM

The Dorman Solution: 1 SKU – 3 Pigtails



- Engineered consolidations to give you the greatest coverage with minimal skus.
- Reduces storage space.
- Prevents lost sales
- Each Dorman kit comes with all the parts necessary to perform the installation.

NEW For The Same Price as Reman

DORMAN

742-252

Ford
Crown Victoria/
Grand Marquis/
Town Car/
Marauder
2006-90



**No Splicing -
Wiring Harness
Included**

Includes Dielectric Grease

REMAN

**Splicing Required
Wiring Harness
Not Included**

REMAN LABEL WARNING:

NOTICE: Do not be alarmed, smoke coming from motor is due to fresh paint. Condition is normal. Allow 1 hour of operating to clear smoke.

Activant Path

*Window Motor/Fuel
Caps, Hitches & Misc.*

Activant Code

DWF

**Applications begin
on page 545.**

Window Lift Motor Kits



742-101

GM
2002-85 Camaro, Firebird,
2001-85 Astro, Safari Van



742-102

GM
1996-88 Regal, 1994-90 Lumina,
1996-88 Cutlass, 1996-88 Grand Prix



742-103

GM
1996-88 Regal, 1994-90 Lumina,
1996-88 Cutlass, 1996-88 Grand Prix



742-104

GM
2005-91 Park Avenue, 2002-92 Eldorado,
1999-92 LeSabre, 1999-94 Concours,
1999-92 Deville, Delta 88, Bonneville



742-105

GM
2005-91 Park Avenue, 2002-92 Eldorado,
1999-92 LeSabre, 1999-94 Concours,
1999-92 Deville, Delta 88, Bonneville



742-106

GM
1996-87 Beretta, Corsica, 2000-92 C/K
Pickups, 1999-92 Suburban,
2000-95 Tahoe, Yukon



742-107

GM
1996-87 Beretta, Corsica, 2000-92 C/K
Pickups, 1999-92 Suburban,
2000-95 Tahoe, Yukon



742-108

GM
1996-87 Corsica, 1992-87 Allante,
1991-88 Bonneville, Eighty Eight,
LeSabre, 1993-88 Deville, Fleetwood,
1990-88 Electra

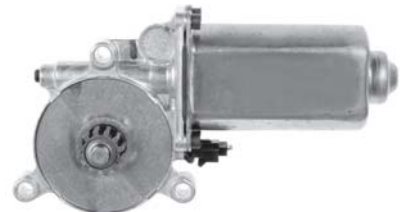

742-109

GM
1996-87 Corsica, 1992-87 Allante,
1991-88 Bonneville, Eighty Eight,
LeSabre, 1993-88 Deville, Fleetwood,
1990-88 Electra



742-110

GM
1997-90 Cutlass Supreme, 1996-91
Regal, 1996-90 Grand Prix, 1994-90
Lumina



742-111

GM
1997-90 Cutlass Supreme, 1996-91
Regal, 1996-90 Grand Prix, 1994-90
Lumina



742-112

GM
2002-96 Express Van, Savana

Window Lift Motor Kits



742-113

GM
2002-96 Express Van, Savana



742-114

Saturn
2005-00 L-Series



742-115

Saturn
2005-00 L-Series



742-116

Saturn
2005-00 L-Series



742-117

Saturn
2005-00 L-Series



742-118

GM
2004-97 Venture, Silhouette, 2004-99
Montana, 1999-97 Trans Sport,
2005-97 Malibu



742-119

GM
2006-97 Venture, Silhouette, 2006-99
Montana, 1999-97 Trans Sport,
2003-97 Malibu



742-120

GM
2002-96 Saturn S-Series,
1997-95 Lumina, Monte Carlo



742-121

GM
2002-96 Saturn S-Series,
1997-95 Lumina, Monte Carlo



742-122

GM
2004-01 Escalade, 2004-02 Avalanche,
2002-01 Denali, 2004-00 Suburban,
Tahoe, Yukon



742-123

GM
2004-01 Escalade, 2004-02 Avalanche,
2002-01 Denali, 2004-00 Suburban,
Tahoe, Yukon



742-124

GM
2005-97 Century, 2005-03 Impala,
2004-97 Regal, 2003-97 Grand Prix,
2002-98 Intrigue

Window Lift Motor Kits

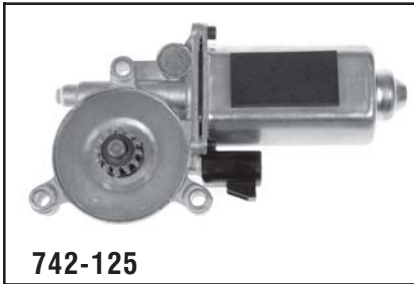

742-125

GM
2005-97 Century, 2005-03 Impala,
2004-97 Regal, 2003-97 Grand Prix,
2002-98 Intrigue



742-126

GM
2005-01 Alero, Grand Am



742-127

GM
2005-01 Alero, Grand Am



742-128

GM
2005-99 Alero, Grand Am, 2005-00
LeSabre, Bonneville, 2003-01 Aurora

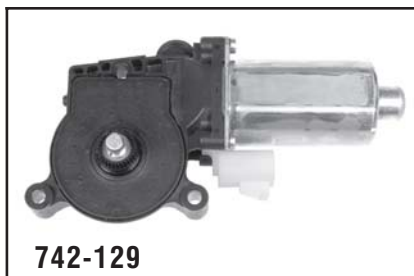

742-129

GM
2005-99 Alero, Grand Am, 2005-00
LeSabre, Bonneville, 2003-01 Aurora



742-130

GM
2005-04 Malibu Classic, 2003-97 Malibu

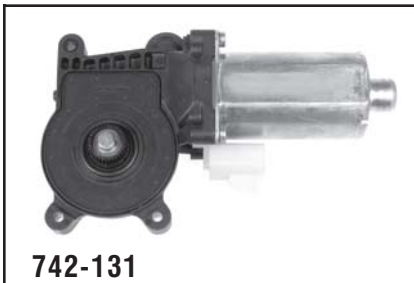

742-131

GM
2005-04 Malibu Classic, 2003-97 Malibu



742-136

GM
2004-01 LeSabre/Bonneville
(Kamco Motors Only)



742-137

GM
2004-01 LeSabre/Bonneville
(Kamco Motors Only)



742-150

GM
2005-79 Various Models

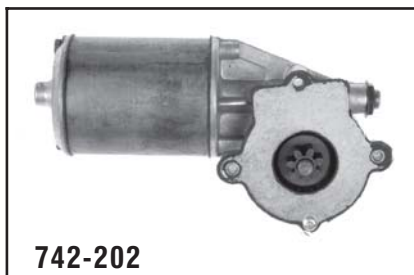

742-202

Ford
1978-73 Colony Park, LTD, 1976-74
Thunderbird, 1979-72 Continental,
1979-74 Mark Series, 1978-74 Monterey

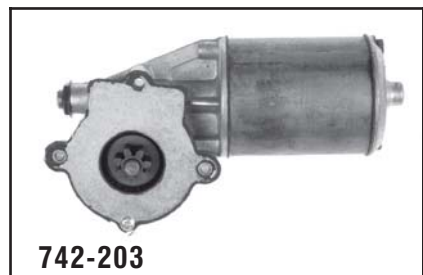

742-203

Ford
1978-73 Colony Park, LTD, 1976-74
Thunderbird, 1979-72 Continental,
1979-74 Mark Series, 1978-74 Monterey

Window Lift Motor Kits



742-204

Ford
1992-88 Continental

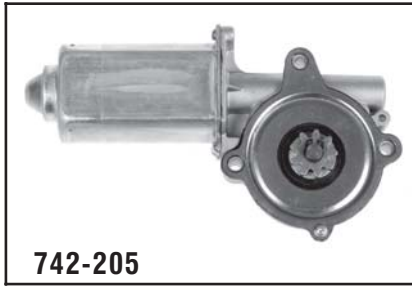

742-205

Ford
1992-88 Continental



742-206

Ford
1995-86 Taurus, Sable,
1993-88 Continental



742-207

Ford
1995-86 Taurus, Sable,
1993-88 Continental



742-208

Ford
1992-87 Ranger, 1990-87 Bronco II



742-209

Ford
1992-87 Ranger, 1990-87 Bronco II

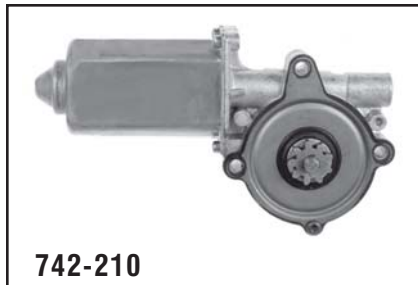

742-210

Ford
1988-87 Cougar, Thunderbird

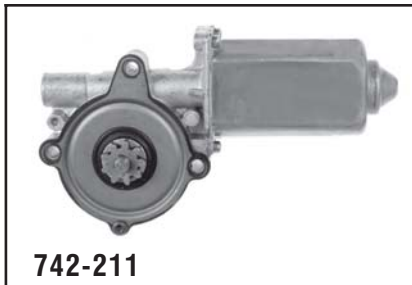

742-211

Ford
1988-87 Cougar, Thunderbird



742-218

Ford
2003-94 Mustang

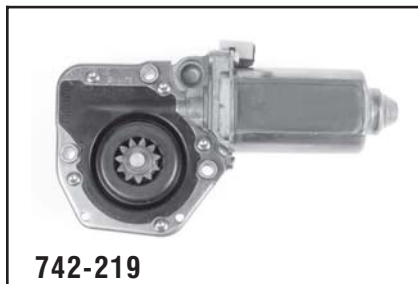

742-219

Ford
2003-94 Mustang



742-220

Ford
2003-94 Mustang



742-221

Ford
2003-94 Mustang

Window Lift Motor Kits

Window Lift Motor Kits



742-222

Ford
1998-97 Mark Series



742-223

Ford
1998-97 Mark Series



742-224

Ford
2002-97 Continental



742-225

Ford
2002-97 Continental



742-226

Ford
2002-95 Continental



742-227

Ford
2002-95 Continental



742-228

Ford
2004-97 F150 Pickups



742-229

Ford
2004-97 F150 Pickups



742-230

Ford
2002-97 Expedition, 2002-98 Navigator



742-231

Ford
2002-97 Expedition, 2002-98 Navigator



742-232

Ford
2002-97 Expedition, 2002-98 Navigator



742-233

Ford
2002-97 Expedition, 2002-98 Navigator

Window Lift Motor Kits



742-234

Ford
2006-92 E-Series Vans, 1994-91 Explorer



742-235

Ford
2006-92 E-Series Vans, 1994-91 Explorer



742-236

Ford
2006-01 Explorer Sport Trac, 2001-95 Explorer, 2001-97 Mountaineer



742-237

Ford
2006-01 Explorer Sport Trac, 2001-95 Explorer, 2001-97 Mountaineer



742-238

Ford
2006-01 Explorer Sport Trac, 2001-95 Explorer, 2001-97 Mountaineer



742-239

Ford
2006-01 Explorer Sport Trac, 2001-95 Explorer, 2001-97 Mountaineer



742-240

Ford
2004-96 Taurus, Sable



742-241

Ford
2004-96 Taurus, Sable



742-242

Ford
1996-93 Ranger



742-243

Ford
1996-93 Ranger

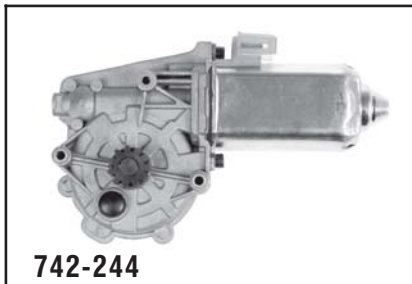

742-244

Ford
2006-97 Ranger, 1998-95 Windstar



742-245

Ford
2006-97 Ranger, 1998-95 Windstar

Window Lift Motor Kits

Window Lift Motor Kits



742-246

Ford
1993-80 Mustang - Low Torque



742-247

Ford
1993-80 Mustang - Low Torque



742-250

Ford
1998-65 Various Models



742-251

Ford
1998-65 Various Models



742-252

Ford
2006-92 Crown Victoria, Grand Marquis,
2005-90 Town Car, 2004-03 Marauder



742-253

Ford
2006-92 Crown Victoria, Grand Marquis,
2005-90 Town Car, 2004-03 Marauder



742-256

Ford
1989-81 Town Car, 1983-77 Mark Series,
1987-84 Continental



742-257

Ford
1989-81 Town Car, 1983-77 Mark Series,
1987-84 Continental



742-258

Ford
1993-80 Mustang, 1986-81 Capri -
High Torque



742-259

Ford
1993-80 Mustang, 1986-81 Capri -
High Torque



742-260

Ford
2006-00 Excursion/Super Duty Pickups



742-261

Ford
2006-00 Excursion/Super Duty Pickups

Window Lift Motor Kits



742-300

Chrysler
1988-69 Various Models



742-301

Chrysler
1988-69 Various Models



742-302

Chrysler
1983-74 Various Models



742-303

Chrysler
1983-74 Various Models



742-304

Chrysler
1989-82 Various Models, 1986-84
Cherokee, Comanche, Wagoneer



742-305

Chrysler
1989-82 Various Models, 1986-84
Cherokee, Comanche, Wagoneer



742-306

Chrysler
1993-90 Full-Size Pickups, Ramcharger



742-307

Chrysler
1993-90 Full-Size Pickups, Ramcharger



742-308

Chrysler
2001-00 Neon



742-309

Chrysler
2001-00 Neon

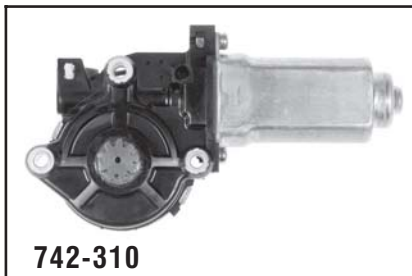

742-310

Chrysler
1997-93 Intrepid, Concorde,
1998-90 B-Series Vans, 1998-95 Stratus,
Breeze, 1995-92 Spirit, Acclaim,
1997-94 New Yorker



742-311

Chrysler
1997-93 Intrepid, Concorde,
1998-90 B-Series Vans, 1998-95 Stratus,
Breeze, 1995-92 Spirit, Acclaim,
1997-94 New Yorker

Window Lift Motor Kits

Window Lift Motor Kits



742-312

Chrysler
1995-91 Various Models, Caravan,
Voyager



742-313

Chrysler
1995-91 Various Models, Caravan,
Voyager



742-314

Chrysler
2000-95 Cirrus, 1998-95 Stratus,
1998-96 Breeze, 2000-97 Dakota



742-315

Chrysler
2000-95 Cirrus, 1998-95 Stratus,
1998-96 Breeze, 2000-97 Dakota



742-343

Chrysler
2000-96 Caravan/Voyager/Town &
Country



742-344

Chrysler
2000-96 Caravan/Voyager/Town &
Country



742-345

Chrysler
2004-98 Intrepid/Concorde,
2004-99 300M, 2001-99 LHS



742-346

Chrysler
2004-98 Intrepid/Concorde,
2004-99 300M, 2001-99 LHS



742-375

Chrysler
1998-93 Grand Cherokee



742-376

Chrysler
1998-93 Grand Cherokee



742-412

Ford
1994-91 Explorer, Navajo



742-413

Ford
1994-91 Explorer, Navajo

Window Lift Motor Kits



742-503

Nissan
2001-93 Altima

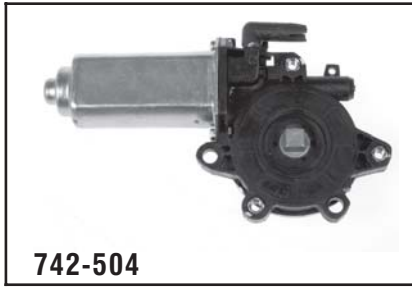

742-504

Nissan
2001-93 Altima

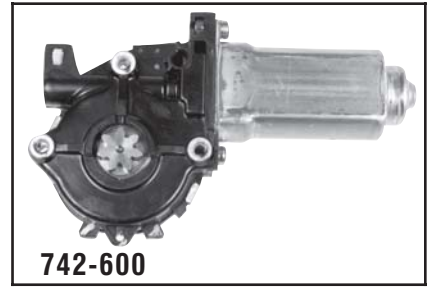

742-600

Toyota
2001-97 Camry



742-601

Toyota
2001-97 Camry



742-602

Toyota
1996-92 Camry



742-603

Toyota
1996-92 Camry



742-840

Honda
1993-90 Accord Sedan



742-841

Honda
1993-90 Accord Sedan

Window Lift Motor Kit Applications

Make / Model/Year	Description	Front Left	Front Right	Rear Left	Rear Right
BUICK					
CENTURY					
2005-97	-	742-124	742-125	742-124	742-125
1996-82	-	742-150	742-150	742-150	742-150
1981-79	-	742-150	742-150	742-150	742-150
ELECTRA					
1990-88	-	742-150	742-150	742-109	742-108
1987-80	-	742-150	742-150	742-150	742-150
ESTATE WAGON					
1990-80	-	742-150	742-150	742-150	742-150
LESABRE					
2005-00	-	742-132	742-133	742-135	742-134
1999-92	-	742-105	742-104	742-104	742-105
1991-90	2-Door	742-107	742-106	—	—
1991-90	4-Door	742-150	742-150	742-109	742-108
1989-87	-	742-150	742-150	742-109	742-108
1986-80	-	742-150	742-150	742-150	742-150
PARK AVENUE					
2005-91	-	742-105	742-104	742-104	742-105
1990-88	-	742-150	742-150	742-109	742-108
1987-80	-	742-150	742-150	742-150	742-150
REATA					
1991-88	-	742-150	742-150	—	—

Fuel Sending Units
pg. 155-176

Fuel Tanks
pg. 177-228

Harmonic Balancers
pg. 229-254

Heater Hose Assemblies
pg. 255-256

Hydraulic Clutch Lines
pg. 257-260

Gaskets and Hardware Included Where Required

Window Lift Motor Kits

545

Window Lift Motor Kits

Window Lift Motor Kit Applications

Make / Model/Year	Description	Front Left	Front Right	Rear Left	Rear Right
BUICK (continued)					
REGAL					
2004-97	-	742-124	742-125	742-124	742-125
1996-90	2-Door	742-102	742-103	—	—
1996-90	4-Door	742-103	742-102	742-111	742-110
1989-88	-	742-102	742-103	—	—
1987-79	-	742-150	742-150	—	—
RIVIERA					
1999-95	-	742-104	742-105	—	—
1993-79	-	742-150	742-150	—	—
ROADMASTER					
1996-91	Sedan	742-103	742-102	742-105	742-104
1996-91	Wagon	742-103	742-102	742-104	742-105
SKYHAWK					
1989-80	-	742-150	742-150	742-150	742-150
SKYLARK					
1998-92	-	742-150	742-150	742-150	742-150
1991-80	-	742-150	742-150	742-150	742-150
SOMERSET					
1987-85	-	742-150	742-150	742-150	742-150
TERRAZA					
2006-05	-	742-119	742-118	—	—
CADILLAC					
ALLANTE					
1993-87	-	742-108	742-109	—	—
CIMARRON					
1988-82	-	742-150	742-150	742-150	742-150
CONCOURS					
1999-94	-	742-104	742-105	742-104	742-105
DEVILLE					
1999-94	-	742-105	742-104	742-104	742-105
1993-90	-	742-109	742-108	742-109	742-108
1989	-	742-150	742-150	742-109	742-108
1988-85	-	742-150	742-150	742-150	742-150
1984-80	-	742-150	742-150	742-150	742-150
ELDORADO					
2002-92	-	742-104	742-105	—	—
1991-80	-	742-150	742-150	—	—
ESCALADE					
2006-00	-	742-122	742-123	742-122	742-123
1999	-	742-104	742-105	742-107	742-106
FLEETWOOD					
1996-94	-	742-103	742-102	742-104	742-105
1993	FWD	742-109	742-108	742-109	742-108
1993	RWD	742-103	742-102	742-104	742-105
1992-90	FWD	742-109	742-108	742-109	742-108
1992-90	RWD	742-150	742-150	742-150	742-150
1989-80	-	742-150	742-150	742-150	742-150
SEVILLE					
1999-92	-	742-105	742-104	742-104	742-105
1991-80	-	742-150	742-150	742-150	742-150
CHEVROLET					
BERETTA					
1996-87	-	742-107	742-106	—	—
CAMARO					
2002-93	-	742-101	742-101	—	—
1992-82	-	742-150	742-150	—	—
CAPRICE					
1996-91	-	742-103	742-102	742-104	742-105
1990-80	-	742-150	742-150	742-150	742-150
CAVALIER					
2005-82	-	742-150	742-150	742-150	742-150
CELEBRITY					
1990-82	-	742-150	742-150	742-150	742-150
CITATION					
1985-80	-	742-150	742-150	742-150	742-150
CORSICA					
1996-87	-	742-106	742-107	742-109	742-108
CORVETTE					
1996-86	-	742-104	742-105	—	—
1985-84	w/12 Tooth Gear	742-150	742-150	—	—
1985-84	w/9 Tooth Gear	742-104	742-105	—	—
IMPALA					
2005-03	-	742-124	742-125	742-124	742-125
1996-94	-	742-103	742-102	742-104	742-105
1985-80	-	742-150	742-150	742-150	742-150
LUMINA					
2001-95	-	742-121	742-120	742-121	742-120
1994-90	2-Door	742-102	742-103	—	—
1994-90	4-Door	742-103	742-102	742-111	742-110

Window Lift Motor Kit Applications

Make / Model/Year	Description	Front Left	Front Right	Rear Left	Rear Right
CHEVROLET (continued)					
LUMINA APV 1996-90	-	742-150	742-150	—	—
MALIBU 2005-04	Classic	742-118	742-119	742-131	742-130
2003-97	-	742-118	742-119	742-131	742-130
1996-95	-	742-121	742-120	—	—
1983-79	-	742-150	742-150	742-150	742-150
MONTE CARLO 1999-95	-	742-121	742-120	—	—
1988-79	-	742-150	742-150	—	—
UPLANDER 2006-05	-	742-119	742-118	—	—
VENTURE 2005-97	-	742-119	742-118	—	—
CHEVROLET/GMC TRUCK					
ASTRO VAN 2001-85	-	742-101	742-101	—	—
AVALANCHE 2006-02	-	742-122	742-123	742-122	742-123
BLAZER 1994-92	-	742-104	742-105	—	—
1991-82	-	742-150	742-150	—	—
C, K SERIES PICKUP 2000-92	-	742-104	742-105	742-107	742-106
1991-88	-	742-104	742-105	—	—
1987-82	-	742-150	742-150	742-150	742-150
CABALLERO 1987-78	-	742-150	742-150	—	—
DENALI 2006-01	-	742-122	742-123	742-122	742-123
EL CAMINO 1987-79	-	742-150	742-150	—	—
EXPRESS VAN 2002-96	-	742-113	742-112	—	—
G SERIES VAN 1996-81	-	742-150	742-150	—	—
JIMMY 1991-82	-	742-150	742-150	—	—
P SERIES VAN 1996-93	-	742-150	742-150	—	—
R, V SERIES PICKUP 1991-87	-	742-150	742-150	742-150	742-150
S10 BLAZER 2005-04	-	742-105	742-105	742-105	742-104
2003-95	-	742-105	742-104	742-105	742-104
1994-91	-	742-150	742-150	742-150	742-150
1990-83	-	742-150	742-150	—	—
S10 PICKUP 2004	-	742-105	742-105	742-105	742-104
2003-94	-	742-105	742-104	742-105	742-104
1993-82	-	742-150	742-150	—	—
S15 JIMMY 2001-95	-	742-105	742-104	742-105	742-104
1994-91	-	742-150	742-150	742-150	742-150
1990-83	-	742-150	742-150	—	—
S15 PICKUP 1990-82	-	742-150	742-150	—	—
S15 SONOMA 2004	-	742-105	742-105	742-105	742-104
2003-94	-	742-105	742-104	742-105	742-104
1993-91	-	742-150	742-150	—	—
S15 SYCLONE 1991	-	742-150	742-150	—	—
S15 TYPHOON 1993-92	-	742-150	742-150	—	—
SAFARI VAN 2001-85	-	742-101	742-101	—	—
SAVANA 2002-96	-	742-113	742-112	—	—
SIERRA 2006-99	-	742-122	742-123	742-122	742-123
SILVERADO 2006-99	-	742-122	742-123	742-122	742-123
SUBURBAN 2006-00	-	742-122	742-123	742-122	742-123
1999-92	-	742-104	742-105	742-107	742-106
1991-82	-	742-150	742-150	742-150	742-150
TAHOE 2006-01	-	742-122	742-123	742-122	742-123
2000	5.7L Eng	742-104	742-105	742-107	742-106

Window Lift Motor Kits

Window Lift Motor Kit Applications

Make / Model/Year	Description	Front Left	Front Right	Rear Left	Rear Right
CHEVROLET/GMC TRUCK (continued)					
TAHOE (continued)					
2000	Exc. 5.7L Eng	742-122	742-123	742-122	742-123
1999-97	-	742-104	742-105	742-107	742-106
1996-95	-	742-104	742-105	—	—
YUKON					
2006-01	-	742-122	742-123	742-122	742-123
2000	5.7L Eng	742-104	742-105	742-107	742-106
2000	Exc. 5.7L Eng	742-122	742-123	742-122	742-123
1999-97	-	742-104	742-105	742-107	742-106
1996-92	-	742-104	742-105	—	—
CHRYSLER					
300					
2004-99	-	742-346	742-345	—	—
CIRRUS					
2000-97	-	742-314	742-315	742-314	742-315
1996-95	Front Has 7 Tooth Gear	742-314	742-315	742-311	742-310
1996-95	Front Has 9 Tooth Gear	742-310	742-311	742-311	742-310
CONCORDE					
2004-98	-	742-346	742-345	—	—
1997-93	-	742-310	742-311	742-310	742-311
CORDOBA					
1983-75	-	742-302	742-303	—	—
E CLASS					
1984-83	-	742-305	742-304	—	—
EXECUTIVE LIMO, EXECUTIVE SEDAN					
1985-83	-	742-305	742-304	—	—
FIFTH AVENUE					
1989	-	742-301	742-300	—	—
1988	-	742-300	742-301	—	—
1987-83	-	742-300	742-301	742-300	742-301
IMPERIAL					
1993-91	-	742-312	742-313	—	—
1983-81	-	742-302	742-303	—	—
1975-74	Exc. Quarter Window	742-302	742-303	742-302	742-303
1975-74	Quarter Window	742-302	742-303	742-301	742-303
LEBARON					
1995-90	-	—	—	742-301	742-300
1988-87	4-Door, Exc. GTS	742-305	742-304	—	—
1986-85	Exc. GTS	742-305	742-304	—	—
1984-82	-	742-305	742-304	—	—
1981-77	2-Door	742-302	742-303	—	—
1981-77	4-Door	742-300	742-301	742-301	742-300
LHS					
2001-99	-	742-346	742-345	—	—
NEW YORKER					
1997-94	-	742-310	742-311	742-310	742-311
1993-91	-	742-312	742-313	—	—
1988	Turbo	742-305	742-304	—	—
1987-83	-	742-305	742-304	—	—
1982	-	742-300	742-301	742-300	742-301
1981-80	-	742-301	742-300	742-301	742-300
1979-78	2-Door	742-302	742-303	742-302	742-303
1979-78	4-Door	742-300	742-301	742-300	742-301
1977-74	-	742-302	742-303	742-302	742-303
NEWPORT					
1981-79	-	742-301	742-300	742-301	742-300
1978-74	Exc. Quarter Window	742-302	742-303	742-302	742-303
1978-74	Quarter Window	742-302	742-303	742-301	742-303
1973-69	-	742-301	742-300	—	—
TOWN & COUNTRY					
1988-82	-	742-305	742-304	—	—
1981-77	-	742-301	742-300	742-301	742-300
TOWN & COUNTRY VAN					
2000-96	-	742-344	742-343	—	—
1995-91	-	742-312	742-313	—	—
VOYAGER, GRAND VOYAGER					
2000	-	742-344	742-343	—	—
DODGE					
400					
1983-82	-	742-305	742-304	—	—
600					
1988-83	-	742-305	742-304	—	—
ARIES					
1989-82	-	742-305	742-304	—	—
ASPEN					
1980-76	2-Door	742-302	742-303	—	—
1980-76	4-Door	742-300	742-301	742-300	742-301
CARAVAN, GRAND CARAVAN					
2000-96	-	742-344	742-343	—	—
1995-91	-	742-312	742-313	—	—

Window Lift Motor Kit Applications

Make / Model/Year	Description	Front Left	Front Right	Rear Left	Rear Right
DODGE (continued)					
CHALLENGER					
1974-70	-	742-301	742-300	742-301	742-300
CHARGER					
1983	-	742-302	742-303	—	—
1978-76	-	742-302	742-303	—	—
1975	2-Door	742-302	742-303	—	—
1975	4-Door	742-301	742-300	742-301	742-300
1974-71	-	742-301	742-300	742-301	742-300
1970-69	Convertible	742-301	742-300	—	—
1970-69	Exc. Convertible	742-301	742-300	742-301	742-300
CORONET					
1976	-	742-301	742-300	742-301	742-300
1975	2-Door	742-302	742-303	—	—
1975	4-Door	742-301	742-300	742-301	742-300
1974-69	Convertible	742-301	742-300	—	—
1974-69	Exc. Convertible	742-301	742-300	742-301	742-300
DIPLOMAT					
1989	-	742-301	742-300	742-301	742-300
1988	-	742-300	742-301	742-301	742-300
1987-82	-	742-300	742-301	742-300	742-301
1981-77	2-Door	742-302	742-303	—	—
1981-77	4-Door	742-300	742-301	742-300	742-301
DYNASTY					
1993-91	-	742-312	742-313	—	—
INTREPID					
2004-98	-	742-346	742-345	—	—
1997-93	-	742-310	742-311	742-310	742-311
MAGNUM					
1979-78	-	742-302	742-303	—	—
MIRADA					
1983-80	-	742-302	742-303	—	—
MONACO					
1978-77	2-Door	742-302	742-303	742-302	742-303
1978-77	4-Door	742-301	742-300	742-301	742-300
1976-74	-	742-302	742-303	742-302	742-303
NEON					
2001-00	-	742-309	742-308	—	—
ROYAL MONACO					
1977-75	-	742-302	742-303	742-302	742-303
SPIRIT					
1995-92	-	742-310	742-311	742-301	742-300
1991-89	-	—	—	742-301	742-300
ST REGIS					
1981-80	-	742-301	742-300	742-301	742-300
1979	2-Door	742-302	742-303	—	—
1979	4-Door	742-301	742-300	742-301	742-300
STRATUS					
2000-97	-	742-314	742-315	742-311	742-310
1996-95	Front Has 7 Tooth Gear	742-314	742-315	742-311	742-310
1996-95	Front Has 9 Tooth Gear	742-310	742-311	742-311	742-310
DODGE TRUCK					
B SERIES VAN					
1998-90	-	742-311	742-310	—	—
1989-80	-	742-301	742-300	—	—
D, W SERIES PICKUP					
1993-90	-	742-307	742-306	—	—
1989-80	-	742-301	742-300	—	—
DAKOTA					
2001	Exc. Quad Cab	742-315	742-314	—	—
2000-97	-	742-315	742-314	—	—
1996-95	-	742-311	742-310	—	—
RAM SERIES PICKUP					
2002	3/4 Ton Or 1 Ton	742-315	742-314	—	—
2001-94	-	742-315	742-314	—	—
RAMCHARGER					
1993-90	-	742-307	742-306	—	—
1989-80	-	742-301	742-300	—	—
EAGLE					
VISION					
1997-93	-	742-310	742-311	742-310	742-311
FORD					
COUNTRY SQUIRE					
1991-79	-	742-251	742-250	742-250	742-251
1978-73	-	742-203	742-202	742-250	742-251
1972-65	-	742-250	742-251	742-250	742-251
CROWN VICTORIA					
2006-92	-	742-252	742-253	742-253	742-252
1991-83	-	742-251	742-250	742-250	742-251
CUSTOM, CUSTOM 500					
1972-64	-	742-250	742-251	742-250	742-251

Window Lift Motor Kit Applications

Make / Model/Year	Description	Front Left	Front Right	Rear Left	Rear Right
FORD (continued)					
FAIRMONT					
1983-78	2-Door	742-251	742-250	—	—
1983-78	4-Door	742-250	742-251	742-250	742-251
GALAXIE					
1974-73	2-Door	742-250	742-251	—	—
1974-73	4-Door	742-203	742-202	742-250	742-251
1972-65	-	742-250	742-251	742-250	742-251
GRANADA					
1982-75	-	742-250	742-251	742-250	742-251
LTD					
1986-83	-	742-250	742-251	742-250	742-251
1982-79	-	742-251	742-250	742-250	742-251
1978-73	2-Door	742-250	742-251	—	—
1978-73	4-Door	742-203	742-202	742-250	742-251
1972-67	-	742-250	742-251	742-250	742-251
LTD II					
1979-77	-	742-250	742-251	742-250	742-251
MUSTANG					
2004-94	Inc. Convertible	742-218	742-219	742-220	742-221
1993-84	High Torque	742-259	742-258	—	—
1993-84	Low Torque	742-246	742-247	—	—
1983-80	-	742-259	742-258	—	—
1979-71	-	742-250	742-251	—	—
RANCHERO					
1979-68	-	742-250	742-251	—	—
TAURUS					
2004-96	-	742-240	742-241	742-240	742-241
1995-86	-	742-206	742-207	742-207	742-206
TEMPO					
1994-84	-	742-251	742-250	742-251	742-250
THUNDERBIRD					
1997-89	-	742-250	742-251	—	—
1988-87	-	742-211	742-210	—	—
1986-81	-	742-251	742-250	—	—
1980	-	742-251	742-250	742-250	742-251
1979-77	-	742-250	742-251	742-250	742-251
1976-74	Front Has 7 Tooth Gear	742-203	742-202	742-250	742-251
1976-74	Front Has 9 Tooth Gear	742-250	742-251	742-250	742-251
1973	-	742-250	742-251	742-250	742-251
1972	-	742-250	742-251	742-251	742-250
1971-67	2-Door	742-251	742-250	742-250	742-251
1971-67	4-Door	742-251	742-250	742-251	742-250
TORINO					
1976-68	-	742-250	742-251	742-250	742-251
FORD TRUCK					
AEROSTAR					
1994-91	-	742-213	742-212	—	—
1990	From 11/01/89	742-213	742-212	—	—
1989	To 11/01/89	742-250	742-251	—	—
1988-86	-	742-250	742-251	—	—
BRONCO					
1996-81	-	742-250	742-251	—	—
BRONCO II					
1990-88	-	742-209	742-208	—	—
1987	From 11/01/86	742-209	742-208	—	—
1987	To 11/01/86	742-250	742-251	—	—
1986-84	-	742-250	742-251	—	—
E SERIES VAN					
2006-92	-	742-234	742-235	—	—
1991	-	742-213	742-212	—	—
1990-81	-	742-250	742-251	—	—
EXCURSION					
2005-00	-	742-260	742-261	742-261	742-260
EXPEDITION					
2002-97	-	742-230	742-231	742-232	742-233
EXPLORER					
2006-04	Sport Trac	742-236	—	742-239	742-238
2003-02	Sport & Sport Trac	742-236	—	742-239	742-238
2001	Exc. Sport & Sport Trac	742-236	742-237	742-239	742-238
2001	Sport & Sport Trac, From 1/30/01	742-236	—	742-239	742-238
2001	Sport & Sport Trac, To 1/30/01	742-236	742-237	742-239	742-238
2000-95	-	742-236	742-237	742-239	742-238
1994-91	-	742-413	742-412	742-235	742-234
F SERIES PICKUP					
2004	F150, Lightning & Heritage	742-229	742-228	—	—
2003-01	F150, Exc. Crew Cab	742-229	742-228	—	—
2000-99	F150	742-229	742-228	—	—
1999	F250, Under 8500 Lb GVW	742-229	742-228	—	—

Window Lift Motor Kit Applications

Make / Model/Year	Description	Front Left	Front Right	Rear Left	Rear Right
FORD TRUCK (continued)					
F SERIES PICKUP (continued)					
1998-97	-	742-229	742-228	—	—
1996-93	-	742-250	742-251	—	—
1992	From 5/01/92	742-250	742-251	—	—
1992	To 5/01/92	742-250	742-251	742-250	742-251
1991-81	-	742-250	742-251	—	—
F SERIES SUPER DUTY					
2006-00	-	742-260	742-261	—	—
1995-93	-	742-250	742-251	742-250	742-251
1992	From 5/01/92	742-250	742-251	742-250	742-251
1992	To 5/01/92	742-250	742-251	—	—
1991-88	-	742-250	742-251	—	—
RANGER					
2006-97	-	742-244	742-245	—	—
1996-93	-	742-243	742-242	—	—
1992-88	-	742-209	742-208	—	—
1987	From 11/01/86	742-209	742-208	—	—
1987	To 11/01/86	742-250	742-251	—	—
1986-83	-	742-250	742-251	—	—
WINDSTAR					
1998-95	-	742-244	742-245	—	—
HONDA					
ACCORD					
1993-90	4-Door	742-840	742-841	—	—
ISUZU					
HOMBRE					
2000-96	-	742-105	742-104	—	—
JEEP					
CHEROKEE					
1986-84	-	742-304	742-305	742-304	—
COMANCHE					
1986-84	-	742-304	742-305	742-304	—
GRAND CHEROKEE					
1998-93	-	742-315	742-314	742-376	742-375
WAGONEER					
1986-84	-	742-304	742-305	742-304	—
LINCOLN					
CONTINENTAL					
2002-97	-	742-224	742-225	742-226	742-227
1996-95	-	742-226	742-227	742-226	742-227
1994-88	-	742-206	742-207	742-204	742-205
1987-84	-	742-257	742-256	742-250	742-251
1983-82	-	742-250	742-251	742-250	742-251
1981-80	-	742-257	742-256	742-257	742-256
1979-73	Front Has 7 Tooth Gear	742-203	742-202	742-250	742-251
1979-73	Front Has 9 Tooth Gear	742-250	742-251	742-250	742-251
1972	-	742-203	742-202	742-203	742-202
1971-66	-	742-250	742-251	742-250	742-251
MARK SERIES					
1998-97	-	742-223	742-222	—	—
1996-84	-	742-251	742-250	—	—
1983-77	-	742-257	742-256	—	—
1976-72	Front Has 7 Tooth Gear	742-203	742-202	—	—
1976-72	Front Has 9 Tooth Gear	742-250	742-251	—	—
1971-69	-	742-251	742-250	—	—
NAVIGATOR					
2002-98	-	742-230	742-231	742-232	742-233
TOWN CAR					
2005-98	-	742-252	742-253	742-252	742-253
1997-90	-	742-252	742-253	742-252	742-253
1989	-	742-257	742-256	742-251	742-250
1988-81	-	742-257	742-256	742-250	742-251
VERSAILLES					
1980-77	-	742-250	742-251	742-250	742-251
MAZDA					
NAVAJO					
1994-91	-	742-413	742-412	—	—
MERCURY					
CAPRI					
1986-81	-	742-259	742-258	—	—
COLONY PARK					
1991-79	-	742-251	742-250	742-250	742-251
1978-73	-	742-203	742-202	742-250	742-251
1972-65	-	742-250	742-251	742-250	742-251
COMET					
1977-66	Inc. Convertible	742-250	742-251	742-250	742-251
COUGAR					
1997-89	-	742-250	742-251	—	—
1988-87	-	742-211	742-210	—	—
1986-83	-	742-251	742-250	—	—

Window Lift Motor Kits

Window Lift Motor Kit Applications

Make / Model/Year	Description	Front Left	Front Right	Rear Left	Rear Right
MERCURY (continued)					
COUGAR (continued)					
1982-81	2-Door	742-251	742-250	—	—
1982-81	4-Door	742-250	742-251	742-250	742-251
1980	-	742-251	742-250	—	—
1979-74	-	742-250	742-251	742-250	742-251
1973-69	-	742-250	742-251	—	—
CYCLONE					
1971-66	-	742-250	742-251	742-250	742-251
GRAND MARQUIS					
2006-92	-	742-252	742-253	742-253	742-252
1991-83	-	742-251	742-250	742-250	742-251
MARAUDER					
2004-03	-	742-252	742-253	742-253	742-252
MARQUIS					
1986-83	-	742-250	742-251	742-250	742-251
1982-79	-	742-251	742-250	742-250	742-251
1978-73	2-Door	742-250	742-251	—	—
1978-73	4-Door	742-203	742-202	742-250	742-251
1972-65	-	742-250	742-251	742-250	742-251
MONARCH					
1980-75	-	742-250	742-251	742-250	742-251
MONTEGO					
1976-68	Front Has 7 Tooth Gear	742-203	742-202	742-250	742-251
1976-68	Front Has 9 Tooth Gear	742-250	742-251	742-250	742-251
MONTEREY					
1974-65	Front Has 7 Tooth Gear	742-203	742-202	742-250	742-251
1974-65	Front Has 9 Tooth Gear	742-251	742-250	742-250	742-251
MOUNTAINEER					
2001-97	-	742-236	742-237	742-239	742-238
SABLE					
2004-96	-	742-240	742-241	742-240	742-241
1995-86	-	742-206	742-207	742-207	742-206
TOPAZ					
1994-84	-	742-251	742-250	742-251	742-250
ZEPHYR					
1983-78	2-Door	742-251	742-250	—	—
1983-78	4-Door	742-250	742-251	742-250	742-251
NISSAN					
ALTIMA					
2001-93	-	742-504	742-503	—	—
OLDSMOBILE					
98 REGENCY					
1998-91	-	742-105	742-104	742-104	742-105
1990	-	742-150	742-150	742-109	742-108
1989-80	-	742-150	742-150	742-150	742-150
ACHIEVA					
1998-92	-	742-150	742-150	742-150	742-150
ALERO					
2004-01	-	742-128	742-129	742-126	742-127
2000-99	-	742-128	742-129	—	—
AURORA					
2003-01	-	—	—	742-135	742-134
1999-95	-	742-104	742-105	742-105	742-104
BRAVADA					
2001-96	-	742-105	742-104	742-105	742-104
1994-91	-	742-150	742-150	742-150	742-150
CUSTOM CRUISER					
1992-91	-	742-103	742-102	742-104	742-105
1990-80	-	742-150	742-150	742-150	742-150
CUTLASS CALAIS					
1991-85	-	742-150	742-150	742-150	742-150
CUTLASS CIERA					
1996-82	-	742-150	742-150	742-150	742-150
CUTLASS, CUTLASS CRUISER, CUTLASS SUPREME					
1999-97	-	742-118	742-119	742-131	742-130
1996-90	2-Door	742-102	742-103	—	—
1996-90	4-Door	742-103	742-102	742-111	742-110
1989	-	742-102	742-103	—	—
1988	FWD	742-102	742-103	—	—
1988	RWD	742-150	742-150	—	—
1987-79	-	742-150	742-150	—	—
DELTA 88					
1999-92	-	742-105	742-104	742-104	742-105
1991-90	2-Door	742-107	742-106	—	—
1991-90	4-Door	742-150	742-150	742-109	742-108
1989-80	-	742-150	742-150	742-150	742-150
FIRENZA					
1988-82	-	742-150	742-150	742-150	742-150
INTRIGUE					
2002-98	-	742-124	742-125	742-124	742-125

Window Lift Motor Kit Applications

Make / Model/Year	Description	Front Left	Front Right	Rear Left	Rear Right
OLDSMOBILE (continued)					
LSS					
1999-96	-	742-105	742-104	742-104	742-105
OMEGA					
1984-80	-	742-150	742-150	742-150	742-150
SILHOUETTE					
2004-97	-	742-119	742-118	—	—
1996-90	-	742-150	742-150	—	—
TORONADO					
1992-79	-	742-150	742-150	—	—
PLYMOUTH					
ACCLAIM					
1995-92	-	742-310	742-311	742-301	742-300
1991-89	-	—	—	742-301	742-300
BARRACUDA					
1974-69	-	742-301	742-300	742-301	742-300
BREEZE					
2000-97	-	742-310	742-311	742-311	742-310
1996	Front Has 7 Tooth Gear	742-314	742-315	742-311	742-310
1996	Front Has 9 Tooth Gear	742-310	742-311	742-311	742-310
CARAVELLE					
1988-85	-	742-305	742-304	—	—
FURY					
1978-75	2-Door	742-302	742-303	—	—
1978-75	4-Door	742-301	742-300	742-301	742-300
1974	2-Door	742-302	742-303	742-301	742-303
1974	4-Door	742-302	742-303	742-302	742-303
GRAND FURY					
1989	-	742-301	742-300	742-301	742-300
1988	-	742-300	742-301	742-301	742-300
1987-82	-	742-300	742-301	742-300	742-301
1981-80	-	742-301	742-300	742-301	742-300
1977	2-Door	742-302	742-303	—	—
1977	4-Door	742-302	742-303	742-302	742-303
1976-74	-	742-302	742-303	742-302	742-303
NEON					
2001-00	-	742-309	742-308	—	—
RELIANT					
1989-82	-	742-305	742-304	—	—
SATELLITE					
1974-71	-	742-301	742-300	742-301	742-300
VOLARE					
1980-76	2-Door	742-302	742-303	—	—
1980-76	4-Door	742-300	742-301	742-300	742-301
VOYAGER, GRAND VOYAGER					
2000-96	-	742-344	742-343	—	—
1995-91	-	742-312	742-313	—	—
PLYMOUTH TRUCK					
PB SERIES VAN					
1983-80	-	742-301	742-300	—	—
TRAILDUSTER					
1981-80	-	742-301	742-300	—	—
PONTIAC					
6000					
1991-82	-	742-150	742-150	742-150	742-150
BONNEVILLE					
2005-00	-	742-135	742-134	—	—
1999-92	-	742-105	742-104	742-104	742-105
1991-88	-	742-150	742-150	742-109	742-108
1987-82	-	742-150	742-150	742-150	742-150
1981-80	-	742-150	742-150	742-150	742-150
CATALINA					
1981-80	-	742-150	742-150	742-150	742-150
FIERO					
1988-84	-	742-150	742-150	—	—
FIREBIRD					
2002-93	-	742-101	742-101	—	—
1992-82	-	742-150	742-150	—	—
GRAND AM					
2005-99	-	742-128	742-129	742-126	742-127
1998-92	-	742-150	742-150	742-150	742-150
1991-85	-	742-150	742-150	742-150	742-150
1984-79	-	742-150	742-150	742-150	742-150
GRAND PRIX					
2003-97	-	742-124	742-125	742-124	742-125
1996-90	4-Door	742-103	742-102	742-111	742-110
1996-88	2-Door	742-102	742-103	—	—
1989-88	-	742-102	742-103	—	—
1987-79	-	742-150	742-150	—	—
J2000					
1986-82	-	742-150	742-150	742-150	742-150

Fuel Sending Units
pg. 155-176

Fuel Tanks
pg. 177-228

Harmonic Balancers
pg. 229-254

Heater Hose Assemblies
pg. 255-256

Hydraulic Clutch Lines
pg. 257-260

Gaskets and Hardware Included Where Required

Window Lift Motor Kits

Window Lift Motor Kit Applications

Make / Model/Year	Description	Front Left	Front Right	Rear Left	Rear Right
PONTIAC (continued)					
LEMANS, GRAND LEMANS					
1981-79	-	742-150	742-150	742-150	742-150
MONTANA					
2005-99	-	742-119	742-118	—	—
PARISIENNE					
1986-83	-	742-150	742-150	742-150	742-150
PHOENIX					
1985-80	-	742-150	742-150	742-150	742-150
SAFARI					
1989-87	-	742-150	742-150	742-150	742-150
SUNBIRD					
1994-85	-	742-150	742-150	742-150	742-150
SUNFIRE					
2005-95	-	742-150	742-150	742-150	742-150
SV6					
2006-05	-	742-119	742-118	—	—
TRANS SPORT					
1999-97	-	742-119	742-118	—	—
1996-90	-	742-150	742-150	—	—
SATURN					
L SERIES					
2005-02	-	742-114	742-115	742-116	742-117
LS SERIES					
2001-00	-	742-114	742-115	742-116	742-117
LW SERIES					
2004-00	-	742-114	742-115	742-116	742-117
RELAY					
2005	-	742-119	742-118	—	—
SC SERIES					
1999-97	Coupe	742-120	742-121	—	—
SL SERIES					
1999-96	Sedan	742-120	742-121	742-120	742-121
SW SERIES					
1999-96	Wagon	742-120	742-121	742-120	742-121
TOYOTA					
CAMRY					
2001-97	-	742-600	742-601	—	—
1996-92	-	742-602	742-602	742-602	742-603



WINDOW LIFT MOTOR KITS

- Compare the replacement unit to the original. Note all mounting bolts and brackets locations.
 - Follow all window alignment procedures outlined in the shop manual.
 - Carefully follow all warnings and cautions outlined in the vehicle's service manual.
-
- Use the proper tools for removal of the door panel.
 - Use caution when removing interior door panels. Plastic panels can be easily damaged.
 - Replace all broken door panel clips.
-
- Use caution when handling or removing glass.
 - Bolts and nuts may be substituted for pop rivets.
- See instructions included with part.

45319 (10)



Door Panel Retainer Assortment

Special molded nylon. Holds panel to door frame. Four sizes. Fits domestic models.

Window Lift Motor Kits

100% NEW!



Dorman Window Lift Motor Kits – NEW for the same price as reman!

- Dorman quality Window Lift Motor Kits mean fewer comebacks.
- Supplied with OE type connector, no wire cutting or splicing.
- Do the job right the first time.
- All the parts necessary to do the job.

Install With Confidence Using 100% NEW Dorman Window Lift Motors

OE and Other Aftermarket Suppliers – 3 SKUs



Dorman #	OE #
742-250	= F43Z-54233V94-BRM
	E9AZ-54233V95-ARM
	F1TZ-78233V95-CRM

The Dorman Solution: 1 SKU – 3 Pigtails



- Engineered consolidations to give you the greatest coverage with minimal skus.
- Reduces storage space.
- Prevents lost sales
- Each Dorman kit comes with all the parts necessary to perform the installation.

NEW For The Same Price as Reman

DORMAN

742-252

Ford
Crown Victoria/
Grand Marquis/
Town Car/
Marauder
2006-90



**No Splicing -
Wiring Harness
Included**

Includes Dielectric Grease

REMAN

**Splicing Required
Wiring Harness
Not Included**

REMAN LABEL WARNING:

NOTICE: Do not be alarmed, smoke coming from motor is due to fresh paint. Condition is normal. Allow 1 hour of operating to clear smoke.

Activant Path

*Window Motor/Fuel
Caps, Hitches & Misc.*

Activant Code

DWF

**Applications begin
on page 545.**

Window Lift Motor Kits



742-101

GM
2002-85 Camaro, Firebird,
2001-85 Astro, Safari Van



742-102

GM
1996-88 Regal, 1994-90 Lumina,
1996-88 Cutlass, 1996-88 Grand Prix



742-103

GM
1996-88 Regal, 1994-90 Lumina,
1996-88 Cutlass, 1996-88 Grand Prix



742-104

GM
2005-91 Park Avenue, 2002-92 Eldorado,
1999-92 LeSabre, 1999-94 Concours,
1999-92 Deville, Delta 88, Bonneville



742-105

GM
2005-91 Park Avenue, 2002-92 Eldorado,
1999-92 LeSabre, 1999-94 Concours,
1999-92 Deville, Delta 88, Bonneville



742-106

GM
1996-87 Beretta, Corsica, 2000-92 C/K
Pickups, 1999-92 Suburban,
2000-95 Tahoe, Yukon



742-107

GM
1996-87 Beretta, Corsica, 2000-92 C/K
Pickups, 1999-92 Suburban,
2000-95 Tahoe, Yukon



742-108

GM
1996-87 Corsica, 1992-87 Allante,
1991-88 Bonneville, Eighty Eight,
LeSabre, 1993-88 Deville, Fleetwood,
1990-88 Electra

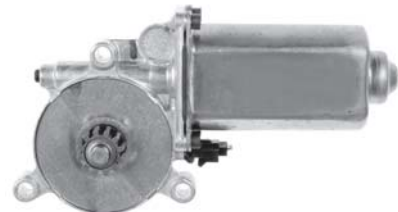

742-109

GM
1996-87 Corsica, 1992-87 Allante,
1991-88 Bonneville, Eighty Eight,
LeSabre, 1993-88 Deville, Fleetwood,
1990-88 Electra



742-110

GM
1997-90 Cutlass Supreme, 1996-91
Regal, 1996-90 Grand Prix, 1994-90
Lumina



742-111

GM
1997-90 Cutlass Supreme, 1996-91
Regal, 1996-90 Grand Prix, 1994-90
Lumina



742-112

GM
2002-96 Express Van, Savana

Window Lift Motor Kits



742-113

GM
2002-96 Express Van, Savana



742-114

Saturn
2005-00 L-Series



742-115

Saturn
2005-00 L-Series



742-116

Saturn
2005-00 L-Series



742-117

Saturn
2005-00 L-Series



742-118

GM
2004-97 Venture, Silhouette, 2004-99 Montana, 1999-97 Trans Sport, 2005-97 Malibu



742-119

GM
2006-97 Venture, Silhouette, 2006-99 Montana, 1999-97 Trans Sport, 2003-97 Malibu



742-120

GM
2002-96 Saturn S-Series, 1997-95 Lumina, Monte Carlo



742-121

GM
2002-96 Saturn S-Series, 1997-95 Lumina, Monte Carlo



742-122

GM
2004-01 Escalade, 2004-02 Avalanche, 2002-01 Denali, 2004-00 Suburban, Tahoe, Yukon



742-123

GM
2004-01 Escalade, 2004-02 Avalanche, 2002-01 Denali, 2004-00 Suburban, Tahoe, Yukon



742-124

GM
2005-97 Century, 2005-03 Impala, 2004-97 Regal, 2003-97 Grand Prix, 2002-98 Intrigue

Window Lift Motor Kits

Window Lift Motor Kits

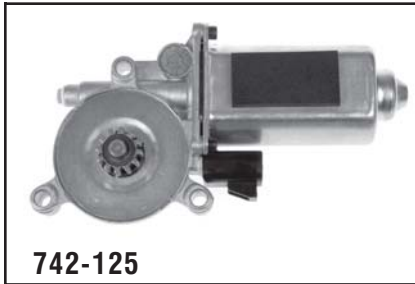

742-125

GM
2005-97 Century, 2005-03 Impala,
2004-97 Regal, 2003-97 Grand Prix,
2002-98 Intrigue



742-126

GM
2005-01 Alero, Grand Am



742-127

GM
2005-01 Alero, Grand Am



742-128

GM
2005-99 Alero, Grand Am, 2005-00
LeSabre, Bonneville, 2003-01 Aurora

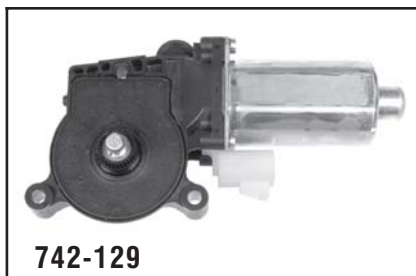

742-129

GM
2005-99 Alero, Grand Am, 2005-00
LeSabre, Bonneville, 2003-01 Aurora



742-130

GM
2005-04 Malibu Classic, 2003-97 Malibu

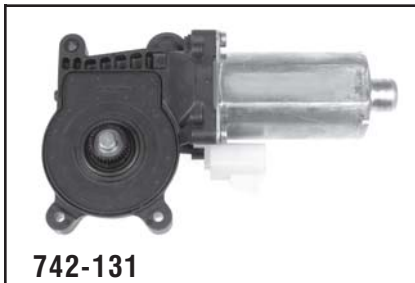

742-131

GM
2005-04 Malibu Classic, 2003-97 Malibu



742-136

GM
2004-01 LeSabre/Bonneville
(Kamco Motors Only)



742-137

GM
2004-01 LeSabre/Bonneville
(Kamco Motors Only)



742-150

GM
2005-79 Various Models

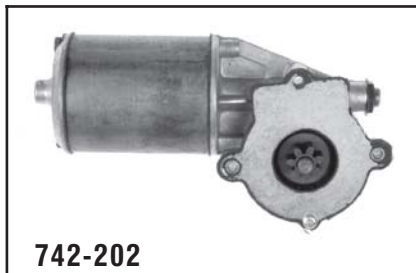

742-202

Ford
1978-73 Colony Park, LTD, 1976-74
Thunderbird, 1979-72 Continental,
1979-74 Mark Series, 1978-74 Monterey

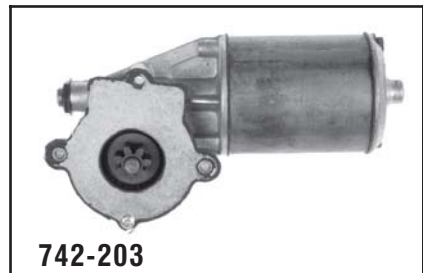

742-203

Ford
1978-73 Colony Park, LTD, 1976-74
Thunderbird, 1979-72 Continental,
1979-74 Mark Series, 1978-74 Monterey

Window Lift Motor Kits



742-204

Ford
1992-88 Continental

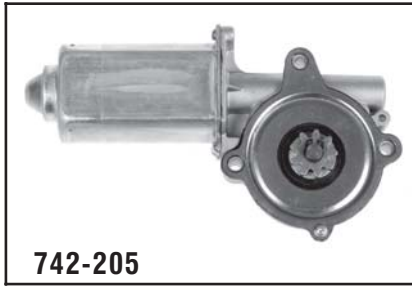

742-205

Ford
1992-88 Continental



742-206

Ford
1995-86 Taurus, Sable,
1993-88 Continental



742-207

Ford
1995-86 Taurus, Sable,
1993-88 Continental



742-208

Ford
1992-87 Ranger, 1990-87 Bronco II



742-209

Ford
1992-87 Ranger, 1990-87 Bronco II

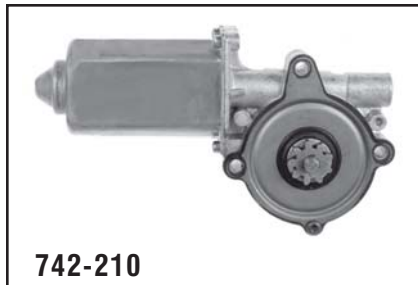

742-210

Ford
1988-87 Cougar, Thunderbird

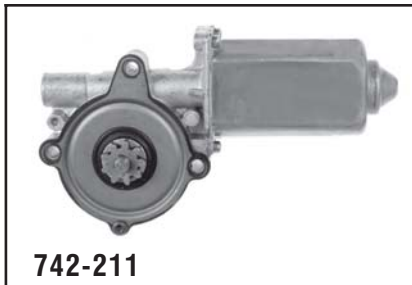

742-211

Ford
1988-87 Cougar, Thunderbird



742-218

Ford
2003-94 Mustang

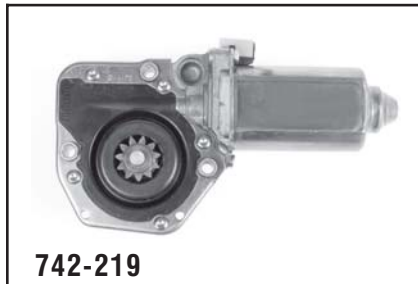

742-219

Ford
2003-94 Mustang



742-220

Ford
2003-94 Mustang



742-221

Ford
2003-94 Mustang

Window Lift Motor Kits

Window Lift Motor Kits



742-222

Ford
1998-97 Mark Series



742-223

Ford
1998-97 Mark Series



742-224

Ford
2002-97 Continental



742-225

Ford
2002-97 Continental



742-226

Ford
2002-95 Continental



742-227

Ford
2002-95 Continental



742-228

Ford
2004-97 F150 Pickups



742-229

Ford
2004-97 F150 Pickups



742-230

Ford
2002-97 Expedition, 2002-98 Navigator



742-231

Ford
2002-97 Expedition, 2002-98 Navigator



742-232

Ford
2002-97 Expedition, 2002-98 Navigator



742-233

Ford
2002-97 Expedition, 2002-98 Navigator

Window Lift Motor Kits



742-234

Ford
2006-92 E-Series Vans, 1994-91 Explorer



742-235

Ford
2006-92 E-Series Vans, 1994-91 Explorer



742-236

Ford
2006-01 Explorer Sport Trac, 2001-95 Explorer, 2001-97 Mountaineer



742-237

Ford
2006-01 Explorer Sport Trac, 2001-95 Explorer, 2001-97 Mountaineer



742-238

Ford
2006-01 Explorer Sport Trac, 2001-95 Explorer, 2001-97 Mountaineer



742-239

Ford
2006-01 Explorer Sport Trac, 2001-95 Explorer, 2001-97 Mountaineer



742-240

Ford
2004-96 Taurus, Sable



742-241

Ford
2004-96 Taurus, Sable



742-242

Ford
1996-93 Ranger



742-243

Ford
1996-93 Ranger

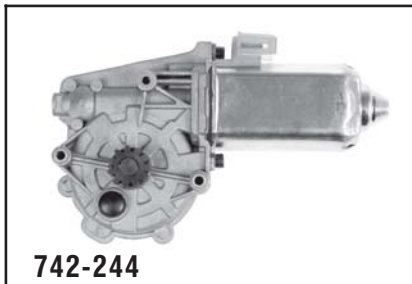

742-244

Ford
2006-97 Ranger, 1998-95 Windstar



742-245

Ford
2006-97 Ranger, 1998-95 Windstar

Window Lift Motor Kits

Window Lift Motor Kits



742-246

Ford
1993-80 Mustang - Low Torque



742-247

Ford
1993-80 Mustang - Low Torque



742-250

Ford
1998-65 Various Models



742-251

Ford
1998-65 Various Models



742-252

Ford
2006-92 Crown Victoria, Grand Marquis,
2005-90 Town Car, 2004-03 Marauder



742-253

Ford
2006-92 Crown Victoria, Grand Marquis,
2005-90 Town Car, 2004-03 Marauder



742-256

Ford
1989-81 Town Car, 1983-77 Mark Series,
1987-84 Continental



742-257

Ford
1989-81 Town Car, 1983-77 Mark Series,
1987-84 Continental



742-258

Ford
1993-80 Mustang, 1986-81 Capri -
High Torque



742-259

Ford
1993-80 Mustang, 1986-81 Capri -
High Torque



742-260

Ford
2006-00 Excursion/Super Duty Pickups



742-261

Ford
2006-00 Excursion/Super Duty Pickups

Window Lift Motor Kits



742-300

Chrysler
1988-69 Various Models



742-301

Chrysler
1988-69 Various Models



742-302

Chrysler
1983-74 Various Models



742-303

Chrysler
1983-74 Various Models



742-304

Chrysler
1989-82 Various Models, 1986-84
Cherokee, Comanche, Wagoneer



742-305

Chrysler
1989-82 Various Models, 1986-84
Cherokee, Comanche, Wagoneer



742-306

Chrysler
1993-90 Full-Size Pickups, Ramcharger



742-307

Chrysler
1993-90 Full-Size Pickups, Ramcharger



742-308

Chrysler
2001-00 Neon



742-309

Chrysler
2001-00 Neon

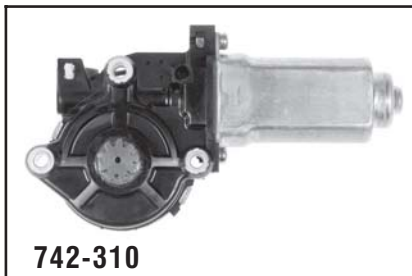

742-310

Chrysler
1997-93 Intrepid, Concorde,
1998-90 B-Series Vans, 1998-95 Stratus,
Breeze, 1995-92 Spirit, Acclaim,
1997-94 New Yorker



742-311

Chrysler
1997-93 Intrepid, Concorde,
1998-90 B-Series Vans, 1998-95 Stratus,
Breeze, 1995-92 Spirit, Acclaim,
1997-94 New Yorker

Window Lift Motor Kits

Window Lift Motor Kits



742-312

Chrysler
1995-91 Various Models, Caravan,
Voyager



742-313

Chrysler
1995-91 Various Models, Caravan,
Voyager



742-314

Chrysler
2000-95 Cirrus, 1998-95 Stratus,
1998-96 Breeze, 2000-97 Dakota



742-315

Chrysler
2000-95 Cirrus, 1998-95 Stratus,
1998-96 Breeze, 2000-97 Dakota



742-343

Chrysler
2000-96 Caravan/Voyager/Town &
Country



742-344

Chrysler
2000-96 Caravan/Voyager/Town &
Country



742-345

Chrysler
2004-98 Intrepid/Concorde,
2004-99 300M, 2001-99 LHS



742-346

Chrysler
2004-98 Intrepid/Concorde,
2004-99 300M, 2001-99 LHS



742-375

Chrysler
1998-93 Grand Cherokee



742-376

Chrysler
1998-93 Grand Cherokee



742-412

Ford
1994-91 Explorer, Navajo



742-413

Ford
1994-91 Explorer, Navajo

Window Lift Motor Kits



742-503

Nissan
2001-93 Altima

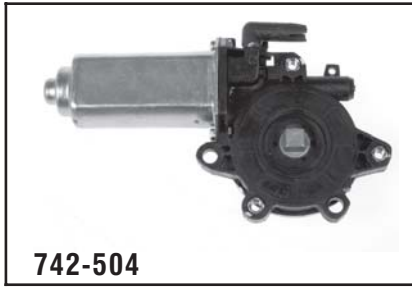

742-504

Nissan
2001-93 Altima

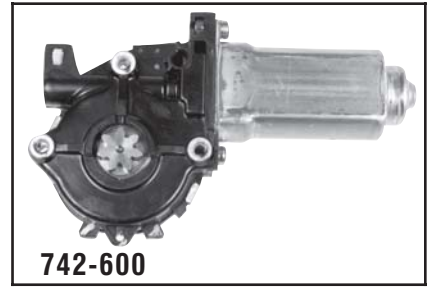

742-600

Toyota
2001-97 Camry



742-601

Toyota
2001-97 Camry



742-602

Toyota
1996-92 Camry



742-603

Toyota
1996-92 Camry



742-840

Honda
1993-90 Accord Sedan



742-841

Honda
1993-90 Accord Sedan

Window Lift Motor Kit Applications

Make / Model/Year	Description	Front Left	Front Right	Rear Left	Rear Right
BUICK					
CENTURY					
2005-97	-	742-124	742-125	742-124	742-125
1996-82	-	742-150	742-150	742-150	742-150
1981-79	-	742-150	742-150	742-150	742-150
ELECTRA					
1990-88	-	742-150	742-150	742-109	742-108
1987-80	-	742-150	742-150	742-150	742-150
ESTATE WAGON					
1990-80	-	742-150	742-150	742-150	742-150
LESABRE					
2005-00	-	742-132	742-133	742-135	742-134
1999-92	-	742-105	742-104	742-104	742-105
1991-90	2-Door	742-107	742-106	—	—
1991-90	4-Door	742-150	742-150	742-109	742-108
1989-87	-	742-150	742-150	742-109	742-108
1986-80	-	742-150	742-150	742-150	742-150
PARK AVENUE					
2005-91	-	742-105	742-104	742-104	742-105
1990-88	-	742-150	742-150	742-109	742-108
1987-80	-	742-150	742-150	742-150	742-150
REATA					
1991-88	-	742-150	742-150	—	—

Fuel Sending Units
pg. 155-176

Fuel Tanks
pg. 177-228

Harmonic Balancers
pg. 229-254

Heater Hose Assemblies
pg. 255-256

Hydraulic Clutch Lines
pg. 257-260

Gaskets and Hardware Included Where Required

Window Lift Motor Kits

545

Window Lift Motor Kits

Window Lift Motor Kit Applications

Make / Model/Year	Description	Front Left	Front Right	Rear Left	Rear Right
BUICK (continued)					
REGAL					
2004-97	-	742-124	742-125	742-124	742-125
1996-90	2-Door	742-102	742-103	—	—
1996-90	4-Door	742-103	742-102	742-111	742-110
1989-88	-	742-102	742-103	—	—
1987-79	-	742-150	742-150	—	—
RIVIERA					
1999-95	-	742-104	742-105	—	—
1993-79	-	742-150	742-150	—	—
ROADMASTER					
1996-91	Sedan	742-103	742-102	742-105	742-104
1996-91	Wagon	742-103	742-102	742-104	742-105
SKYHAWK					
1989-80	-	742-150	742-150	742-150	742-150
SKYLARK					
1998-92	-	742-150	742-150	742-150	742-150
1991-80	-	742-150	742-150	742-150	742-150
SOMERSET					
1987-85	-	742-150	742-150	742-150	742-150
TERRAZA					
2006-05	-	742-119	742-118	—	—
CADILLAC					
ALLANTE					
1993-87	-	742-108	742-109	—	—
CIMARRON					
1988-82	-	742-150	742-150	742-150	742-150
CONCOURS					
1999-94	-	742-104	742-105	742-104	742-105
DEVILLE					
1999-94	-	742-105	742-104	742-104	742-105
1993-90	-	742-109	742-108	742-109	742-108
1989	-	742-150	742-150	742-109	742-108
1988-85	-	742-150	742-150	742-150	742-150
1984-80	-	742-150	742-150	742-150	742-150
ELDORADO					
2002-92	-	742-104	742-105	—	—
1991-80	-	742-150	742-150	—	—
ESCALADE					
2006-00	-	742-122	742-123	742-122	742-123
1999	-	742-104	742-105	742-107	742-106
FLEETWOOD					
1996-94	-	742-103	742-102	742-104	742-105
1993	FWD	742-109	742-108	742-109	742-108
1993	RWD	742-103	742-102	742-104	742-105
1992-90	FWD	742-109	742-108	742-109	742-108
1992-90	RWD	742-150	742-150	742-150	742-150
1989-80	-	742-150	742-150	742-150	742-150
SEVILLE					
1999-92	-	742-105	742-104	742-104	742-105
1991-80	-	742-150	742-150	742-150	742-150
CHEVROLET					
BERETTA					
1996-87	-	742-107	742-106	—	—
CAMARO					
2002-93	-	742-101	742-101	—	—
1992-82	-	742-150	742-150	—	—
CAPRICE					
1996-91	-	742-103	742-102	742-104	742-105
1990-80	-	742-150	742-150	742-150	742-150
CAVALIER					
2005-82	-	742-150	742-150	742-150	742-150
CELEBRITY					
1990-82	-	742-150	742-150	742-150	742-150
CITATION					
1985-80	-	742-150	742-150	742-150	742-150
CORSICA					
1996-87	-	742-106	742-107	742-109	742-108
CORVETTE					
1996-86	-	742-104	742-105	—	—
1985-84	w/12 Tooth Gear	742-150	742-150	—	—
1985-84	w/9 Tooth Gear	742-104	742-105	—	—
IMPALA					
2005-03	-	742-124	742-125	742-124	742-125
1996-94	-	742-103	742-102	742-104	742-105
1985-80	-	742-150	742-150	742-150	742-150
LUMINA					
2001-95	-	742-121	742-120	742-121	742-120
1994-90	2-Door	742-102	742-103	—	—
1994-90	4-Door	742-103	742-102	742-111	742-110

Window Lift Motor Kit Applications

Make / Model/Year	Description	Front Left	Front Right	Rear Left	Rear Right
CHEVROLET (continued)					
LUMINA APV 1996-90	-	742-150	742-150	—	—
MALIBU 2005-04	Classic	742-118	742-119	742-131	742-130
2003-97	-	742-118	742-119	742-131	742-130
1996-95	-	742-121	742-120	—	—
1983-79	-	742-150	742-150	742-150	742-150
MONTE CARLO 1999-95	-	742-121	742-120	—	—
1988-79	-	742-150	742-150	—	—
UPLANDER 2006-05	-	742-119	742-118	—	—
VENTURE 2005-97	-	742-119	742-118	—	—
CHEVROLET/GMC TRUCK					
ASTRO VAN 2001-85	-	742-101	742-101	—	—
AVALANCHE 2006-02	-	742-122	742-123	742-122	742-123
BLAZER 1994-92	-	742-104	742-105	—	—
1991-82	-	742-150	742-150	—	—
C, K SERIES PICKUP 2000-92	-	742-104	742-105	742-107	742-106
1991-88	-	742-104	742-105	—	—
1987-82	-	742-150	742-150	742-150	742-150
CABALLERO 1987-78	-	742-150	742-150	—	—
DENALI 2006-01	-	742-122	742-123	742-122	742-123
EL CAMINO 1987-79	-	742-150	742-150	—	—
EXPRESS VAN 2002-96	-	742-113	742-112	—	—
G SERIES VAN 1996-81	-	742-150	742-150	—	—
JIMMY 1991-82	-	742-150	742-150	—	—
P SERIES VAN 1996-93	-	742-150	742-150	—	—
R, V SERIES PICKUP 1991-87	-	742-150	742-150	742-150	742-150
S10 BLAZER 2005-04	-	742-105	742-105	742-105	742-104
2003-95	-	742-105	742-104	742-105	742-104
1994-91	-	742-150	742-150	742-150	742-150
1990-83	-	742-150	742-150	—	—
S10 PICKUP 2004	-	742-105	742-105	742-105	742-104
2003-94	-	742-105	742-104	742-105	742-104
1993-82	-	742-150	742-150	—	—
S15 JIMMY 2001-95	-	742-105	742-104	742-105	742-104
1994-91	-	742-150	742-150	742-150	742-150
1990-83	-	742-150	742-150	—	—
S15 PICKUP 1990-82	-	742-150	742-150	—	—
S15 SONOMA 2004	-	742-105	742-105	742-105	742-104
2003-94	-	742-105	742-104	742-105	742-104
1993-91	-	742-150	742-150	—	—
S15 SYCLONE 1991	-	742-150	742-150	—	—
S15 TYPHOON 1993-92	-	742-150	742-150	—	—
SAFARI VAN 2001-85	-	742-101	742-101	—	—
SAVANA 2002-96	-	742-113	742-112	—	—
SIERRA 2006-99	-	742-122	742-123	742-122	742-123
SILVERADO 2006-99	-	742-122	742-123	742-122	742-123
SUBURBAN 2006-00	-	742-122	742-123	742-122	742-123
1999-92	-	742-104	742-105	742-107	742-106
1991-82	-	742-150	742-150	742-150	742-150
TAHOE 2006-01	-	742-122	742-123	742-122	742-123
2000	5.7L Eng	742-104	742-105	742-107	742-106

Window Lift Motor Kits

Window Lift Motor Kit Applications

Make / Model/Year	Description	Front Left	Front Right	Rear Left	Rear Right
CHEVROLET/GMC TRUCK (continued)					
TAHOE (continued)					
2000	Exc. 5.7L Eng	742-122	742-123	742-122	742-123
1999-97	-	742-104	742-105	742-107	742-106
1996-95	-	742-104	742-105	—	—
YUKON					
2006-01	-	742-122	742-123	742-122	742-123
2000	5.7L Eng	742-104	742-105	742-107	742-106
2000	Exc. 5.7L Eng	742-122	742-123	742-122	742-123
1999-97	-	742-104	742-105	742-107	742-106
1996-92	-	742-104	742-105	—	—
CHRYSLER					
300					
2004-99	-	742-346	742-345	—	—
CIRRUS					
2000-97	-	742-314	742-315	742-314	742-315
1996-95	Front Has 7 Tooth Gear	742-314	742-315	742-311	742-310
1996-95	Front Has 9 Tooth Gear	742-310	742-311	742-311	742-310
CONCORDE					
2004-98	-	742-346	742-345	—	—
1997-93	-	742-310	742-311	742-310	742-311
CORDOBA					
1983-75	-	742-302	742-303	—	—
E CLASS					
1984-83	-	742-305	742-304	—	—
EXECUTIVE LIMO, EXECUTIVE SEDAN					
1985-83	-	742-305	742-304	—	—
FIFTH AVENUE					
1989	-	742-301	742-300	—	—
1988	-	742-300	742-301	—	—
1987-83	-	742-300	742-301	742-300	742-301
IMPERIAL					
1993-91	-	742-312	742-313	—	—
1983-81	-	742-302	742-303	—	—
1975-74	Exc. Quarter Window	742-302	742-303	742-302	742-303
1975-74	Quarter Window	742-302	742-303	742-301	742-303
LEBARON					
1995-90	-	—	—	742-301	742-300
1988-87	4-Door, Exc. GTS	742-305	742-304	—	—
1986-85	Exc. GTS	742-305	742-304	—	—
1984-82	-	742-305	742-304	—	—
1981-77	2-Door	742-302	742-303	—	—
1981-77	4-Door	742-300	742-301	742-301	742-300
LHS					
2001-99	-	742-346	742-345	—	—
NEW YORKER					
1997-94	-	742-310	742-311	742-310	742-311
1993-91	-	742-312	742-313	—	—
1988	Turbo	742-305	742-304	—	—
1987-83	-	742-305	742-304	—	—
1982	-	742-300	742-301	742-300	742-301
1981-80	-	742-301	742-300	742-301	742-300
1979-78	2-Door	742-302	742-303	742-302	742-303
1979-78	4-Door	742-300	742-301	742-300	742-301
1977-74	-	742-302	742-303	742-302	742-303
NEWPORT					
1981-79	-	742-301	742-300	742-301	742-300
1978-74	Exc. Quarter Window	742-302	742-303	742-302	742-303
1978-74	Quarter Window	742-302	742-303	742-301	742-303
1973-69	-	742-301	742-300	—	—
TOWN & COUNTRY					
1988-82	-	742-305	742-304	—	—
1981-77	-	742-301	742-300	742-301	742-300
TOWN & COUNTRY VAN					
2000-96	-	742-344	742-343	—	—
1995-91	-	742-312	742-313	—	—
VOYAGER, GRAND VOYAGER					
2000	-	742-344	742-343	—	—
DODGE					
400					
1983-82	-	742-305	742-304	—	—
600					
1988-83	-	742-305	742-304	—	—
ARIES					
1989-82	-	742-305	742-304	—	—
ASPEN					
1980-76	2-Door	742-302	742-303	—	—
1980-76	4-Door	742-300	742-301	742-300	742-301
CARAVAN, GRAND CARAVAN					
2000-96	-	742-344	742-343	—	—
1995-91	-	742-312	742-313	—	—

Window Lift Motor Kit Applications

Make / Model/Year	Description	Front Left	Front Right	Rear Left	Rear Right
DODGE (continued)					
CHALLENGER					
1974-70	-	742-301	742-300	742-301	742-300
CHARGER					
1983	-	742-302	742-303	—	—
1978-76	-	742-302	742-303	—	—
1975	2-Door	742-302	742-303	—	—
1975	4-Door	742-301	742-300	742-301	742-300
1974-71	-	742-301	742-300	742-301	742-300
1970-69	Convertible	742-301	742-300	—	—
1970-69	Exc. Convertible	742-301	742-300	742-301	742-300
CORONET					
1976	-	742-301	742-300	742-301	742-300
1975	2-Door	742-302	742-303	—	—
1975	4-Door	742-301	742-300	742-301	742-300
1974-69	Convertible	742-301	742-300	—	—
1974-69	Exc. Convertible	742-301	742-300	742-301	742-300
DIPLOMAT					
1989	-	742-301	742-300	742-301	742-300
1988	-	742-300	742-301	742-301	742-300
1987-82	-	742-300	742-301	742-300	742-301
1981-77	2-Door	742-302	742-303	—	—
1981-77	4-Door	742-300	742-301	742-300	742-301
DYNASTY					
1993-91	-	742-312	742-313	—	—
INTREPID					
2004-98	-	742-346	742-345	—	—
1997-93	-	742-310	742-311	742-310	742-311
MAGNUM					
1979-78	-	742-302	742-303	—	—
MIRADA					
1983-80	-	742-302	742-303	—	—
MONACO					
1978-77	2-Door	742-302	742-303	742-302	742-303
1978-77	4-Door	742-301	742-300	742-301	742-300
1976-74	-	742-302	742-303	742-302	742-303
NEON					
2001-00	-	742-309	742-308	—	—
ROYAL MONACO					
1977-75	-	742-302	742-303	742-302	742-303
SPIRIT					
1995-92	-	742-310	742-311	742-301	742-300
1991-89	-	—	—	742-301	742-300
ST REGIS					
1981-80	-	742-301	742-300	742-301	742-300
1979	2-Door	742-302	742-303	—	—
1979	4-Door	742-301	742-300	742-301	742-300
STRATUS					
2000-97	-	742-314	742-315	742-311	742-310
1996-95	Front Has 7 Tooth Gear	742-314	742-315	742-311	742-310
1996-95	Front Has 9 Tooth Gear	742-310	742-311	742-311	742-310
DODGE TRUCK					
B SERIES VAN					
1998-90	-	742-311	742-310	—	—
1989-80	-	742-301	742-300	—	—
D, W SERIES PICKUP					
1993-90	-	742-307	742-306	—	—
1989-80	-	742-301	742-300	—	—
DAKOTA					
2001	Exc. Quad Cab	742-315	742-314	—	—
2000-97	-	742-315	742-314	—	—
1996-95	-	742-311	742-310	—	—
RAM SERIES PICKUP					
2002	3/4 Ton Or 1 Ton	742-315	742-314	—	—
2001-94	-	742-315	742-314	—	—
RAMCHARGER					
1993-90	-	742-307	742-306	—	—
1989-80	-	742-301	742-300	—	—
EAGLE					
VISION					
1997-93	-	742-310	742-311	742-310	742-311
FORD					
COUNTRY SQUIRE					
1991-79	-	742-251	742-250	742-250	742-251
1978-73	-	742-203	742-202	742-250	742-251
1972-65	-	742-250	742-251	742-250	742-251
CROWN VICTORIA					
2006-92	-	742-252	742-253	742-253	742-252
1991-83	-	742-251	742-250	742-250	742-251
CUSTOM, CUSTOM 500					
1972-64	-	742-250	742-251	742-250	742-251

Window Lift Motor Kit Applications

Make / Model/Year	Description	Front Left	Front Right	Rear Left	Rear Right
FORD (continued)					
FAIRMONT					
1983-78	2-Door	742-251	742-250	—	—
1983-78	4-Door	742-250	742-251	742-250	742-251
GALAXIE					
1974-73	2-Door	742-250	742-251	—	—
1974-73	4-Door	742-203	742-202	742-250	742-251
1972-65	-	742-250	742-251	742-250	742-251
GRANADA					
1982-75	-	742-250	742-251	742-250	742-251
LTD					
1986-83	-	742-250	742-251	742-250	742-251
1982-79	-	742-251	742-250	742-250	742-251
1978-73	2-Door	742-250	742-251	—	—
1978-73	4-Door	742-203	742-202	742-250	742-251
1972-67	-	742-250	742-251	742-250	742-251
LTD II					
1979-77	-	742-250	742-251	742-250	742-251
MUSTANG					
2004-94	Inc. Convertible	742-218	742-219	742-220	742-221
1993-84	High Torque	742-259	742-258	—	—
1993-84	Low Torque	742-246	742-247	—	—
1983-80	-	742-259	742-258	—	—
1979-71	-	742-250	742-251	—	—
RANCHERO					
1979-68	-	742-250	742-251	—	—
TAURUS					
2004-96	-	742-240	742-241	742-240	742-241
1995-86	-	742-206	742-207	742-207	742-206
TEMPO					
1994-84	-	742-251	742-250	742-251	742-250
THUNDERBIRD					
1997-89	-	742-250	742-251	—	—
1988-87	-	742-211	742-210	—	—
1986-81	-	742-251	742-250	—	—
1980	-	742-251	742-250	742-250	742-251
1979-77	-	742-250	742-251	742-250	742-251
1976-74	Front Has 7 Tooth Gear	742-203	742-202	742-250	742-251
1976-74	Front Has 9 Tooth Gear	742-250	742-251	742-250	742-251
1973	-	742-250	742-251	742-250	742-251
1972	-	742-250	742-251	742-251	742-250
1971-67	2-Door	742-251	742-250	742-250	742-251
1971-67	4-Door	742-251	742-250	742-251	742-250
TORINO					
1976-68	-	742-250	742-251	742-250	742-251
FORD TRUCK					
AEROSTAR					
1994-91	-	742-213	742-212	—	—
1990	From 11/01/89	742-213	742-212	—	—
1989	To 11/01/89	742-250	742-251	—	—
1988-86	-	742-250	742-251	—	—
BRONCO					
1996-81	-	742-250	742-251	—	—
BRONCO II					
1990-88	-	742-209	742-208	—	—
1987	From 11/01/86	742-209	742-208	—	—
1987	To 11/01/86	742-250	742-251	—	—
1986-84	-	742-250	742-251	—	—
E SERIES VAN					
2006-92	-	742-234	742-235	—	—
1991	-	742-213	742-212	—	—
1990-81	-	742-250	742-251	—	—
EXCURSION					
2005-00	-	742-260	742-261	742-261	742-260
EXPEDITION					
2002-97	-	742-230	742-231	742-232	742-233
EXPLORER					
2006-04	Sport Trac	742-236	—	742-239	742-238
2003-02	Sport & Sport Trac	742-236	—	742-239	742-238
2001	Exc. Sport & Sport Trac	742-236	742-237	742-239	742-238
2001	Sport & Sport Trac, From 1/30/01	742-236	—	742-239	742-238
2001	Sport & Sport Trac, To 1/30/01	742-236	742-237	742-239	742-238
2000-95	-	742-236	742-237	742-239	742-238
1994-91	-	742-413	742-412	742-235	742-234
F SERIES PICKUP					
2004	F150, Lightning & Heritage	742-229	742-228	—	—
2003-01	F150, Exc. Crew Cab	742-229	742-228	—	—
2000-99	F150	742-229	742-228	—	—
1999	F250, Under 8500 Lb GVW	742-229	742-228	—	—

Window Lift Motor Kit Applications

Make / Model/Year	Description	Front Left	Front Right	Rear Left	Rear Right
FORD TRUCK (continued)					
F SERIES PICKUP (continued)					
1998-97	-	742-229	742-228	—	—
1996-93	-	742-250	742-251	—	—
1992	From 5/01/92	742-250	742-251	—	—
1992	To 5/01/92	742-250	742-251	742-250	742-251
1991-81	-	742-250	742-251	—	—
F SERIES SUPER DUTY					
2006-00	-	742-260	742-261	—	—
1995-93	-	742-250	742-251	742-250	742-251
1992	From 5/01/92	742-250	742-251	742-250	742-251
1992	To 5/01/92	742-250	742-251	—	—
1991-88	-	742-250	742-251	—	—
RANGER					
2006-97	-	742-244	742-245	—	—
1996-93	-	742-243	742-242	—	—
1992-88	-	742-209	742-208	—	—
1987	From 11/01/86	742-209	742-208	—	—
1987	To 11/01/86	742-250	742-251	—	—
1986-83	-	742-250	742-251	—	—
WINDSTAR					
1998-95	-	742-244	742-245	—	—
HONDA					
ACCORD					
1993-90	4-Door	742-840	742-841	—	—
ISUZU					
HOMBRE					
2000-96	-	742-105	742-104	—	—
JEEP					
CHEROKEE					
1986-84	-	742-304	742-305	742-304	—
COMANCHE					
1986-84	-	742-304	742-305	742-304	—
GRAND CHEROKEE					
1998-93	-	742-315	742-314	742-376	742-375
WAGONEER					
1986-84	-	742-304	742-305	742-304	—
LINCOLN					
CONTINENTAL					
2002-97	-	742-224	742-225	742-226	742-227
1996-95	-	742-226	742-227	742-226	742-227
1994-88	-	742-206	742-207	742-204	742-205
1987-84	-	742-257	742-256	742-250	742-251
1983-82	-	742-250	742-251	742-250	742-251
1981-80	-	742-257	742-256	742-257	742-256
1979-73	Front Has 7 Tooth Gear	742-203	742-202	742-250	742-251
1979-73	Front Has 9 Tooth Gear	742-250	742-251	742-250	742-251
1972	-	742-203	742-202	742-203	742-202
1971-66	-	742-250	742-251	742-250	742-251
MARK SERIES					
1998-97	-	742-223	742-222	—	—
1996-84	-	742-251	742-250	—	—
1983-77	-	742-257	742-256	—	—
1976-72	Front Has 7 Tooth Gear	742-203	742-202	—	—
1976-72	Front Has 9 Tooth Gear	742-250	742-251	—	—
1971-69	-	742-251	742-250	—	—
NAVIGATOR					
2002-98	-	742-230	742-231	742-232	742-233
TOWN CAR					
2005-98	-	742-252	742-253	742-252	742-253
1997-90	-	742-252	742-253	742-252	742-253
1989	-	742-257	742-256	742-251	742-250
1988-81	-	742-257	742-256	742-250	742-251
VERSAILLES					
1980-77	-	742-250	742-251	742-250	742-251
MAZDA					
NAVAJO					
1994-91	-	742-413	742-412	—	—
MERCURY					
CAPRI					
1986-81	-	742-259	742-258	—	—
COLONY PARK					
1991-79	-	742-251	742-250	742-250	742-251
1978-73	-	742-203	742-202	742-250	742-251
1972-65	-	742-250	742-251	742-250	742-251
COMET					
1977-66	Inc. Convertible	742-250	742-251	742-250	742-251
COUGAR					
1997-89	-	742-250	742-251	—	—
1988-87	-	742-211	742-210	—	—
1986-83	-	742-251	742-250	—	—

Window Lift Motor Kit Applications

Make / Model/Year	Description	Front Left	Front Right	Rear Left	Rear Right
MERCURY (continued)					
COUGAR (continued)					
1982-81	2-Door	742-251	742-250	—	—
1982-81	4-Door	742-250	742-251	742-250	742-251
1980	-	742-251	742-250	—	—
1979-74	-	742-250	742-251	742-250	742-251
1973-69	-	742-250	742-251	—	—
CYCLONE					
1971-66	-	742-250	742-251	742-250	742-251
GRAND MARQUIS					
2006-92	-	742-252	742-253	742-253	742-252
1991-83	-	742-251	742-250	742-250	742-251
MARAUDER					
2004-03	-	742-252	742-253	742-253	742-252
MARQUIS					
1986-83	-	742-250	742-251	742-250	742-251
1982-79	-	742-251	742-250	742-250	742-251
1978-73	2-Door	742-250	742-251	—	—
1978-73	4-Door	742-203	742-202	742-250	742-251
1972-65	-	742-250	742-251	742-250	742-251
MONARCH					
1980-75	-	742-250	742-251	742-250	742-251
MONTEGO					
1976-68	Front Has 7 Tooth Gear	742-203	742-202	742-250	742-251
1976-68	Front Has 9 Tooth Gear	742-250	742-251	742-250	742-251
MONTEREY					
1974-65	Front Has 7 Tooth Gear	742-203	742-202	742-250	742-251
1974-65	Front Has 9 Tooth Gear	742-251	742-250	742-250	742-251
MOUNTAINEER					
2001-97	-	742-236	742-237	742-239	742-238
SABLE					
2004-96	-	742-240	742-241	742-240	742-241
1995-86	-	742-206	742-207	742-207	742-206
TOPAZ					
1994-84	-	742-251	742-250	742-251	742-250
ZEPHYR					
1983-78	2-Door	742-251	742-250	—	—
1983-78	4-Door	742-250	742-251	742-250	742-251
NISSAN					
ALTIMA					
2001-93	-	742-504	742-503	—	—
OLDSMOBILE					
98 REGENCY					
1998-91	-	742-105	742-104	742-104	742-105
1990	-	742-150	742-150	742-109	742-108
1989-80	-	742-150	742-150	742-150	742-150
ACHIEVA					
1998-92	-	742-150	742-150	742-150	742-150
ALERO					
2004-01	-	742-128	742-129	742-126	742-127
2000-99	-	742-128	742-129	—	—
AURORA					
2003-01	-	—	—	742-135	742-134
1999-95	-	742-104	742-105	742-105	742-104
BRAVADA					
2001-96	-	742-105	742-104	742-105	742-104
1994-91	-	742-150	742-150	742-150	742-150
CUSTOM CRUISER					
1992-91	-	742-103	742-102	742-104	742-105
1990-80	-	742-150	742-150	742-150	742-150
CUTLASS CALAIS					
1991-85	-	742-150	742-150	742-150	742-150
CUTLASS CIERA					
1996-82	-	742-150	742-150	742-150	742-150
CUTLASS, CUTLASS CRUISER, CUTLASS SUPREME					
1999-97	-	742-118	742-119	742-131	742-130
1996-90	2-Door	742-102	742-103	—	—
1996-90	4-Door	742-103	742-102	742-111	742-110
1989	-	742-102	742-103	—	—
1988	FWD	742-102	742-103	—	—
1988	RWD	742-150	742-150	—	—
1987-79	-	742-150	742-150	—	—
DELTA 88					
1999-92	-	742-105	742-104	742-104	742-105
1991-90	2-Door	742-107	742-106	—	—
1991-90	4-Door	742-150	742-150	742-109	742-108
1989-80	-	742-150	742-150	742-150	742-150
FIRENZA					
1988-82	-	742-150	742-150	742-150	742-150
INTRIGUE					
2002-98	-	742-124	742-125	742-124	742-125

Window Lift Motor Kit Applications

Make / Model/Year	Description	Front Left	Front Right	Rear Left	Rear Right
OLDSMOBILE (continued)					
LSS					
1999-96	-	742-105	742-104	742-104	742-105
OMEGA					
1984-80	-	742-150	742-150	742-150	742-150
SILHOUETTE					
2004-97	-	742-119	742-118	—	—
1996-90	-	742-150	742-150	—	—
TORONADO					
1992-79	-	742-150	742-150	—	—
PLYMOUTH					
ACCLAIM					
1995-92	-	742-310	742-311	742-301	742-300
1991-89	-	—	—	742-301	742-300
BARRACUDA					
1974-69	-	742-301	742-300	742-301	742-300
BREEZE					
2000-97	-	742-310	742-311	742-311	742-310
1996	Front Has 7 Tooth Gear	742-314	742-315	742-311	742-310
1996	Front Has 9 Tooth Gear	742-310	742-311	742-311	742-310
CARAVELLE					
1988-85	-	742-305	742-304	—	—
FURY					
1978-75	2-Door	742-302	742-303	—	—
1978-75	4-Door	742-301	742-300	742-301	742-300
1974	2-Door	742-302	742-303	742-301	742-303
1974	4-Door	742-302	742-303	742-302	742-303
GRAND FURY					
1989	-	742-301	742-300	742-301	742-300
1988	-	742-300	742-301	742-301	742-300
1987-82	-	742-300	742-301	742-300	742-301
1981-80	-	742-301	742-300	742-301	742-300
1977	2-Door	742-302	742-303	—	—
1977	4-Door	742-302	742-303	742-302	742-303
1976-74	-	742-302	742-303	742-302	742-303
NEON					
2001-00	-	742-309	742-308	—	—
RELIANT					
1989-82	-	742-305	742-304	—	—
SATELLITE					
1974-71	-	742-301	742-300	742-301	742-300
VOLARE					
1980-76	2-Door	742-302	742-303	—	—
1980-76	4-Door	742-300	742-301	742-300	742-301
VOYAGER, GRAND VOYAGER					
2000-96	-	742-344	742-343	—	—
1995-91	-	742-312	742-313	—	—
PLYMOUTH TRUCK					
PB SERIES VAN					
1983-80	-	742-301	742-300	—	—
TRAILDUSTER					
1981-80	-	742-301	742-300	—	—
PONTIAC					
6000					
1991-82	-	742-150	742-150	742-150	742-150
BONNEVILLE					
2005-00	-	742-135	742-134	—	—
1999-92	-	742-105	742-104	742-104	742-105
1991-88	-	742-150	742-150	742-109	742-108
1987-82	-	742-150	742-150	742-150	742-150
1981-80	-	742-150	742-150	742-150	742-150
CATALINA					
1981-80	-	742-150	742-150	742-150	742-150
FIERO					
1988-84	-	742-150	742-150	—	—
FIREBIRD					
2002-93	-	742-101	742-101	—	—
1992-82	-	742-150	742-150	—	—
GRAND AM					
2005-99	-	742-128	742-129	742-126	742-127
1998-92	-	742-150	742-150	742-150	742-150
1991-85	-	742-150	742-150	742-150	742-150
1984-79	-	742-150	742-150	742-150	742-150
GRAND PRIX					
2003-97	-	742-124	742-125	742-124	742-125
1996-90	4-Door	742-103	742-102	742-111	742-110
1996-88	2-Door	742-102	742-103	—	—
1989-88	-	742-102	742-103	—	—
1987-79	-	742-150	742-150	—	—
J2000					
1986-82	-	742-150	742-150	742-150	742-150

Window Lift Motor Kit Applications

Make / Model/Year	Description	Front Left	Front Right	Rear Left	Rear Right
PONTIAC (continued)					
LEMANS, GRAND LEMANS					
1981-79	-	742-150	742-150	742-150	742-150
MONTANA					
2005-99	-	742-119	742-118	—	—
PARISIENNE					
1986-83	-	742-150	742-150	742-150	742-150
PHOENIX					
1985-80	-	742-150	742-150	742-150	742-150
SAFARI					
1989-87	-	742-150	742-150	742-150	742-150
SUNBIRD					
1994-85	-	742-150	742-150	742-150	742-150
SUNFIRE					
2005-95	-	742-150	742-150	742-150	742-150
SV6					
2006-05	-	742-119	742-118	—	—
TRANS SPORT					
1999-97	-	742-119	742-118	—	—
1996-90	-	742-150	742-150	—	—
SATURN					
L SERIES					
2005-02	-	742-114	742-115	742-116	742-117
LS SERIES					
2001-00	-	742-114	742-115	742-116	742-117
LW SERIES					
2004-00	-	742-114	742-115	742-116	742-117
RELAY					
2005	-	742-119	742-118	—	—
SC SERIES					
1999-97	Coupe	742-120	742-121	—	—
SL SERIES					
1999-96	Sedan	742-120	742-121	742-120	742-121
SW SERIES					
1999-96	Wagon	742-120	742-121	742-120	742-121
TOYOTA					
CAMRY					
2001-97	-	742-600	742-601	—	—
1996-92	-	742-602	742-602	742-602	742-603



WINDOW LIFT MOTOR KITS

- Compare the replacement unit to the original. Note all mounting bolts and brackets locations.
 - Follow all window alignment procedures outlined in the shop manual.
 - Carefully follow all warnings and cautions outlined in the vehicle's service manual.
-
- Use the proper tools for removal of the door panel.
 - Use caution when removing interior door panels. Plastic panels can be easily damaged.
 - Replace all broken door panel clips.
-
- Use caution when handling or removing glass.
 - Bolts and nuts may be substituted for pop rivets.
- See instructions included with part.

45319 (10)



Door Panel Retainer Assortment

Special molded nylon. Holds panel to door frame. Four sizes. Fits domestic models.

Window Regulators



189 SKUs Covering Over 120,000,000 Vehicles

- Largest coverage of window regulators in the aftermarket. Coverage includes most domestic and import applications, **MANUAL and POWER** regulators
- Regulators include all of the components necessary to do the job right the first time
- Engineered to match original equipment quality, PLUS includes additional value-added components to help with installation not offered with OE regulator.



740-836, 740-835
Grand Am, Skylark, Achieva; Manual

Where applicable Kit contents include:

Rivets, Hardware, and Door Panel Clips



Part No. **Prefix 740 = Regulator w/o Motors**

740-664, 740-665
Ford Crown Victoria



Part No. **Prefix 741 = Regulator/Motor Assembly**

741-817, 741-818
Pontiac Bonneville

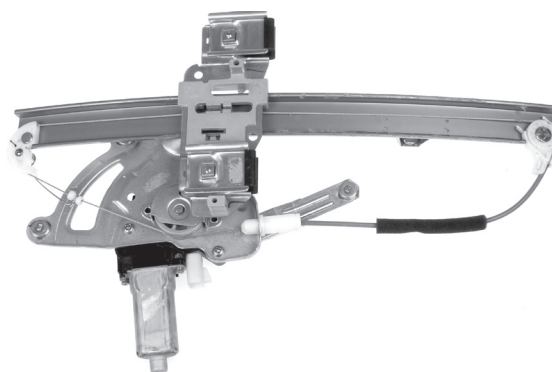

Activant Path

*Accessories; Caps: Gas, Oil & Radiator;
Cruise Control; Gauges/Speedometer/
Fuel Caps, Hitches & Misc*

Activant Code

DWG

**Applications begin
on page 563.**

Window Regulators - Chrysler

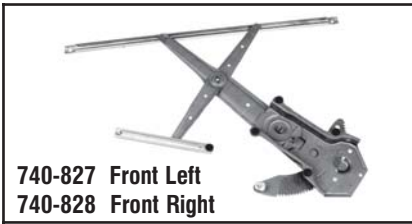

740-827 Front Left
740-828 Front Right

Chrysler
1999-97 Neon Coupe.
Regulator Only, Power.

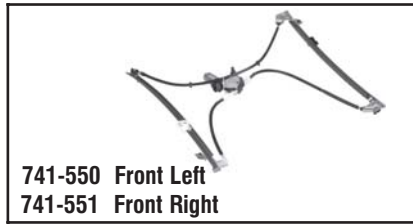

741-550 Front Left
741-551 Front Right

Chrysler
2000-96 Caravan, Voyager.
Motor/Regulator Assembly.

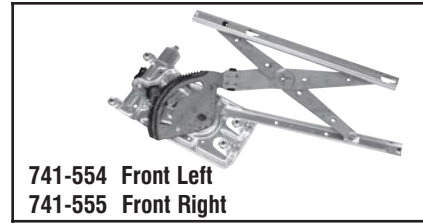

741-554 Front Left
741-555 Front Right

Chrysler
2000-96 Intrepid, 2000-99 Concorde, LHS,
2000-98 300M.
Motor/Regulator Assembly.

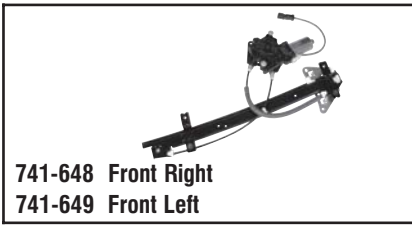

741-648 Front Right
741-649 Front Left

Chrysler
2003-98 Durango, 2003-00 Dakota.
Motor/Regulator Assembly.



741-752 Front Right
741-753 Front Left

Chrysler
2002-94 Ram Pickups.
Motor/Regulator Assembly.

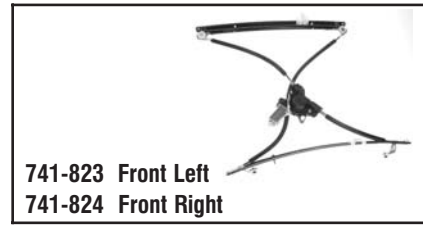

741-823 Front Left
741-824 Front Right

Chrysler
2002-01 Caravan/Voyager/Town & Country.
Motor/Regulator Assembly.

Window Regulators - Ford



740-652 Front Right
740-653 Front Left

Ford
1991-80 Bronco, F-Series Pickups.
Regulator Only, Manual.

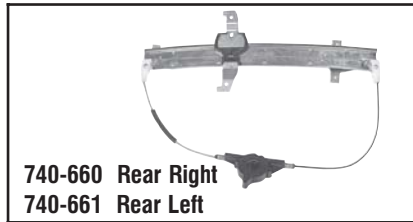

740-660 Rear Right
740-661 Rear Left

Ford
1994-90 Lincoln Town Car.
Regulator Only, Power.

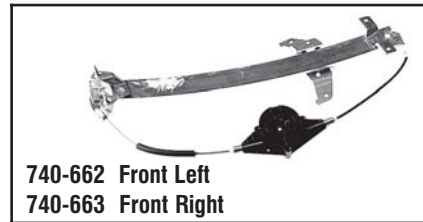

740-662 Front Left
740-663 Front Right

Ford
1997-95 Lincoln Town Car.
Regulator Only, Power.



740-664 Front Left
740-665 Front Right

Ford
2005-92 Crown Victoria, Grand Marquis.
Regulator Only, Power.

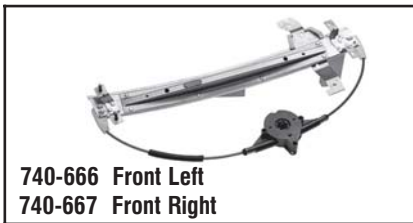

740-666 Front Left
740-667 Front Right

Ford
1994-90 Lincoln Town Car.
Regulator Only, Power.

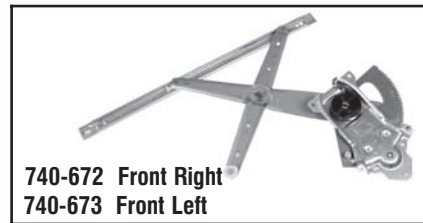

740-672 Front Right
740-673 Front Left

Ford
2005-91 Explorer, Mercury Mountaineer.
Regulator Only, Power.

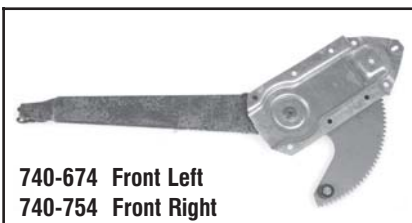

740-674 Front Left
740-754 Front Right

Ford
1996-80 F-Series Pickups & Bronco.
Regulator Only, Power.



740-678 Rear Right
740-679 Rear Left

Ford
2005-92 Crown Victoria.
Regulator Only, Power.

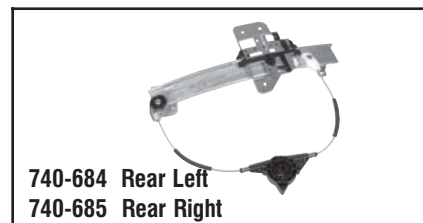

740-684 Rear Left
740-685 Rear Right

Ford
1997-95 Lincoln Town Car.
Regulator Only, Power.

Window Regulators - Ford



740-686 Front Left
740-687 Front Right

Ford
2005-98 Lincoln Town Car.
Regulator Only, Power.



740-688 Rear Left
740-689 Rear Right

Ford
2005-98 Lincoln Town Car.
Regulator Only, Power.

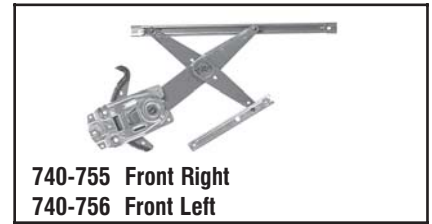

740-755 Front Right
740-756 Front Left

Ford
2005-96 Taurus, Sable.
Regulator Only, Power.



740-831 Front Left
740-832 Front Right

Ford
2005-93 Ranger. Regulator Only, Power.



740-848 Front Left
740-849 Front Right

Ford
2003-01 F-150 Reg & Super Cab, 2004 F-150 Heritage, 2000-99 F-150, 1999 F-250. Regulator Only, Power.

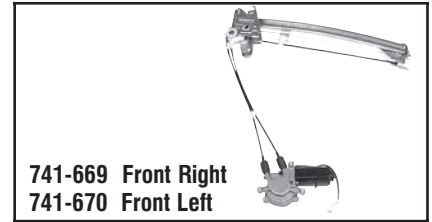

741-669 Front Right
741-670 Front Left

Ford
1992-89 Probe. Motor/Regulator Assembly.



741-807 Front Left
741-808 Front Right

Ford
2000-95 Contour/Mystique.
Motor/Regulator Assembly.



741-813 Front Left
741-814 Front Right

Ford
2006-02 Explorer 4-Door Except Sport Trac, 2006-02 Mountaineer, 2005-03 Aviator (Front Right Only).
Motor/Regulator Assembly.

Window Regulators - GM

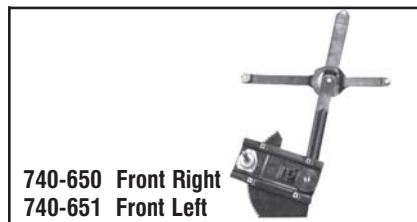

740-650 Front Right
740-651 Front Left

GM
1991-77 C/K Pickups, Jimmy, Blazer, Suburban. Regulator Only, Manual.

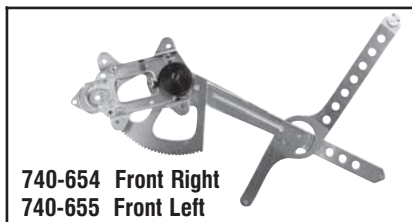

740-654 Front Right
740-655 Front Left

GM
2003-88 C/K Pickups, 2000-92 Suburban/ Yukon, 1999 Escalade, 1994-92 Blazer. Regulator Only, Power.



740-682 Front Left
740-683 Front Right

GM
1998-92 Grand Am, Achieva, Skylark Sedan. Regulator Only, Power.



740-692 Front Left
740-693 Front Right

GM
2005-97 Venture, 2004-97 Silhouette, 1998-97 Trans Sport, 2005-99 Montana. Regulator Arm Only, Power.



740-821 Front Left
740-822 Front Right

GM
2003-97 Malibu, 2005-04 Malibu Classic, 1999-97 Cutlass. Regulator Only, Power.



740-835 Front Right
740-836 Front Left

GM
1998-92 Grand Am, Skylark, Achieva, Coupe. Regulator Only, Manual.

Window Regulators - GM

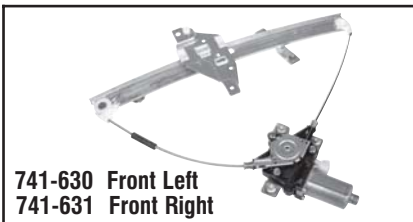

741-630 Front Left
741-631 Front Right

GM
2005-00 Impala. Motor/Regulator Assembly.



741-637 Front Left
741-638 Front Right

GM
2005-97 Century and Regal,
2002-98 Intrigue. Motor/Regulator
Assembly.

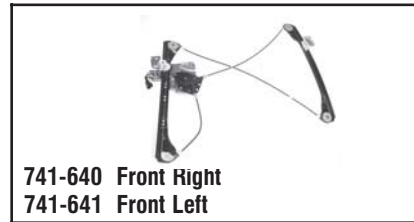

741-640 Front Right
741-641 Front Left

GM
2004-99 Grand Am, Alero Coupe.
Motor/Regulator Assembly.



741-642 Front Right
741-643 Front Left

GM
2004-99 Grand Am, Alero Sedan.
Motor/Regulator Assembly.

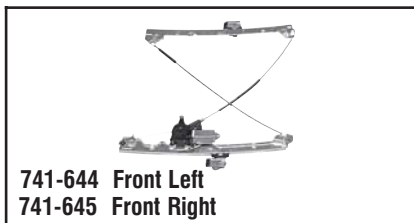

741-644 Front Left
741-645 Front Right

GM
2005-99 Escalade, Suburban, Tahoe, Yukon,
Silverado, Sierra. Motor/Regulator Assembly.



741-646 Front Right
741-647 Front Left

GM
2003-97 Grand Prix Sedan.
Motor/Regulator Assembly.



741-658 Front Right
741-659 Front Left

GM
1998-92 Skylark Coupe, 1997-92 Achieva,
Grand Am Coupe.
Motor/Regulator Assembly.



741-690 Front Left
741-691 Front Right

GM
2005-02 Trail Blazer, Envoy.
Motor/Regulator Assembly.

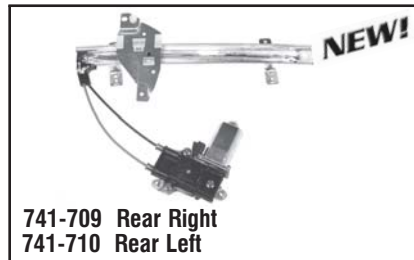

741-709 Rear Right
741-710 Rear Left

GM
2004-97 Century, 2002-98 Intrigue,
2004-97 Regal. Motor/Regulator Assembly.

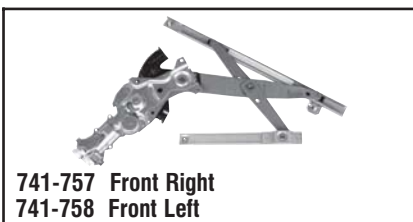

741-757 Front Right
741-758 Front Left

GM
2005-96 Cavalier, Sunfire Sedan.
Motor/Regulator Assembly.

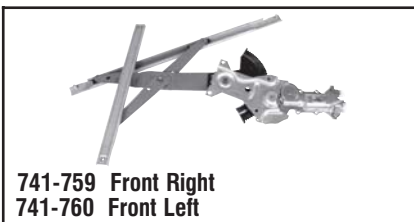

741-759 Front Right
741-760 Front Left

GM
2005-96 Cavalier, Sunfire Coupe.
Motor/Regulator Assembly.



741-761 Front Right
741-762 Front Left

GM
2005-00 Buick LeSabre.
Motor/Regulator Assembly.

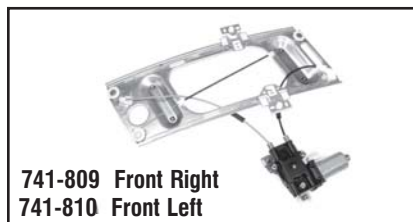

741-809 Front Right
741-810 Front Left

GM
2002-97 Grand Prix Coupe.
Motor/Regulator Assembly.



741-811 Rear Left
741-812 Rear Right

GM
2005-00 LeSabre.
Motor/Regulator Assembly.

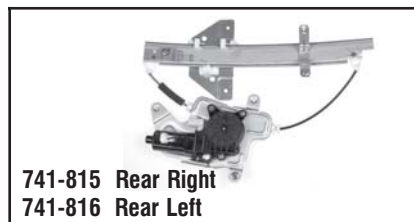

741-815 Rear Right
741-816 Rear Left

GM
2005-99 Grand Am, 2004-99 Alero.
Motor/Regulator Assembly.

Window Regulators - GM



741-817 Front Left
741-818 Front Right

GM
2005-00 Bonneville.
Motor/Regulator Assembly.

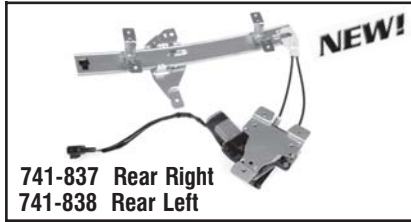

741-837 Rear Right
741-838 Rear Left

GM
2003-97 Grand Prix.
Motor/Regulator Assembly.

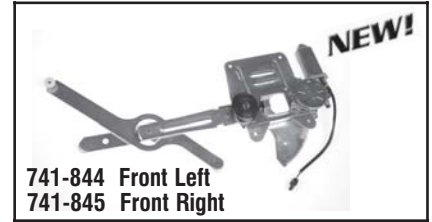

741-844 Front Left
741-845 Front Right

GM
2004-95 S10 Blazer/Pickups, S15 Jimmy/
Pickups, 2001-96 Bravada, 2000-98 Envoy,
2000-98 Isuzu Hombre.
Motor/Regulator Assembly.

Window Regulators - Honda



740-736 Front Right
740-737 Front Left

Honda
2000-96 Civic. Regulator Only, Power.



740-763 Front Left
740-764 Front Right

Honda
1995-92 Civic Sedan. Regulator Only, Power.



741-711 Rear Left
741-712 Rear Right

Honda
1993-90 Accord. Motor/Regulator Assembly.



741-713 Front Left
741-765 Front Right

Honda
1997-94 Accord Sedan, Wagon.
Motor/Regulator Assembly.

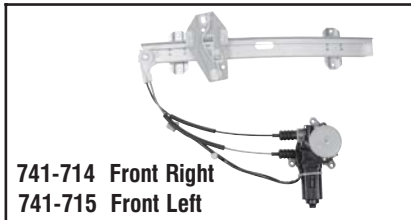

741-714 Front Right
741-715 Front Left

Honda
1997-94 Accord Coupe, Acura CL Series.
Motor/Regulator Assembly.

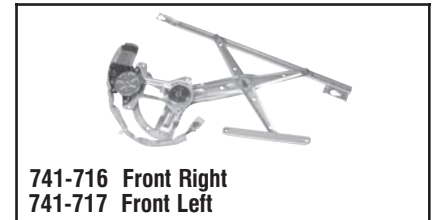

741-716 Front Right
741-717 Front Left

Honda
1993-90 Accord. Motor/Regulator Assembly.



741-731 Front Left
741-732 Front Right

Honda
1989-86 Accord Sedan.
Motor/Regulator Assembly.



741-734 Front Left
741-735 Front Right

Honda
2000-96 Civic Sedan.
Motor/Regulator Assembly.

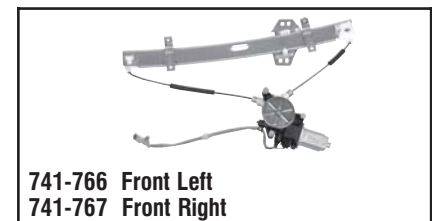

741-766 Front Left
741-767 Front Right

Honda
2002-98 Accord Sedan.
Motor/Regulator Assembly.



741-819 Rear Left
741-820 Rear Right

Honda
1997-94 Accord. Motor/Regulator Assembly.

Window Regulators - Isuzu

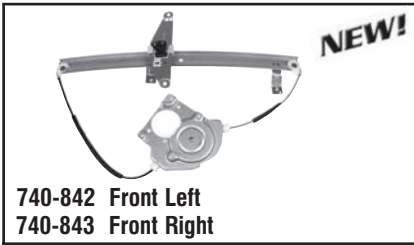

740-842 Front Left
740-843 Front Right

Isuzu/Honda
1997-94 Isuzu Rodeo, Honda Passport.
Regulator Only, Power.

Window Regulators - Jeep

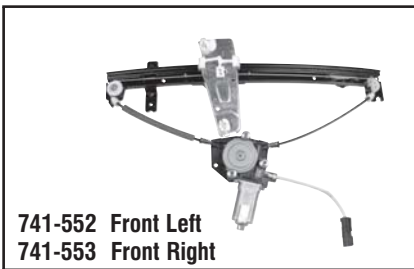

741-552 Front Left
741-553 Front Right

Jeep
2000-99 Grand Cherokee.
Motor/Regulator Assembly.



741-556 Front Left
741-557 Front Right

Jeep
2005-01 Grand Cherokee.
Motor/Regulator Assembly.



741-768 Front Left
741-769 Front Right

Jeep
2001-97 Jeep Cherokee.
Motor/Regulator Assembly.

Window Regulators - Mazda



741-750 Front Left
741-751 Front Right

Mazda
1995-92 Mazda 929.
Motor/Regulator Assembly.



741-770 Front Right
741-771 Front Left

Mazda
1998-96 Protégé. Motor/Regulator Assembly.

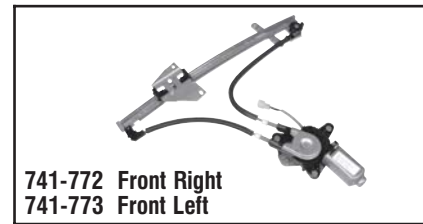

741-772 Front Right
741-773 Front Left

Mazda
1997-93 626. Motor/Regulator Assembly.

Window Regulators - Nissan

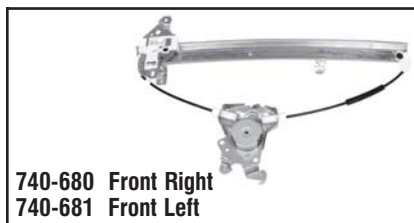

740-680 Front Right
740-681 Front Left

Nissan
2004-98 Xterra, Frontier.
Regulator Only, Power.

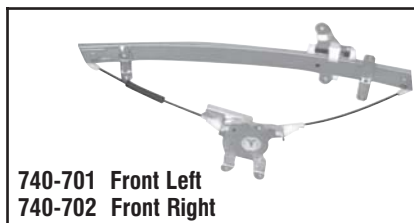

740-701 Front Left
740-702 Front Right

Nissan
1994-89 Maxima. Regulator Only, Power.

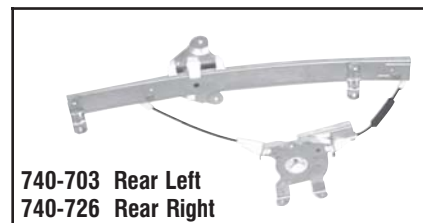

740-703 Rear Left
740-726 Rear Right

Nissan
1994-89 Maxima. Regulator Only, Power.

Window Regulators - Nissan

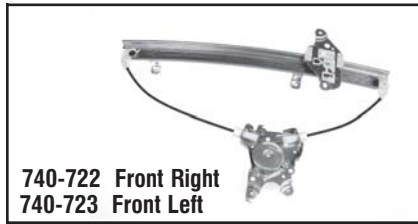

740-722 Front Right
740-723 Front Left

Nissan
2001-00 Maxima. Regulator Only, Power.



740-724 Front Right
740-725 Front Left

Nissan
1997-93 Altima. Regulator Only, Power.

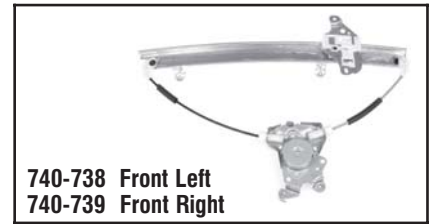

740-738 Front Left
740-739 Front Right

Nissan
2001-98 Altima. Regulator Only, Power.

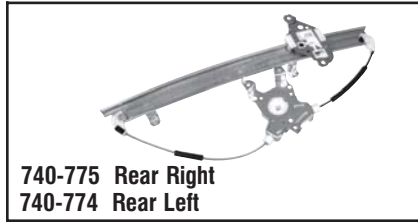

740-775 Rear Right
740-774 Rear Left

Nissan
2003-00 Maxima. Regulator Only, Power.

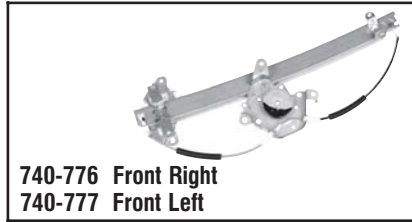

740-776 Front Right
740-777 Front Left

Nissan
1999-95 Sentra, 200SX.
Regulator Only, Power.



740-778 Rear Right
740-779 Rear Left

Nissan
1999-95 Maxima, 1999-96 Infiniti I30.
Regulator Only, Power.



740-780 Front Left
740-781 Front Right

Nissan
1999-95 Maxima, 1999-96 Infiniti I30.
Regulator Only, Power.

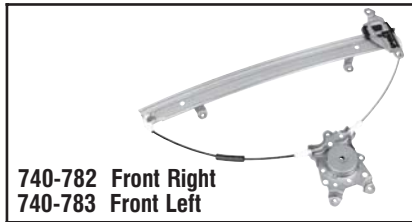

740-782 Front Right
740-783 Front Left

Nissan
1994-91 Sentra Sedan.
Regulator Only, Power.

Window Regulators - Toyota



740-705 Front Left

Toyota
1988-84 Pickups (w/o vent).
Regulator Only, Manual.



740-720 Front Right
740-721 Front Left

Toyota
2001-97 Camry.
Regulator Only, Power.



740-727 Front Left
740-728 Front Right

Toyota
1991-87 Camry.
Regulator Only, Power.



740-729 Rear Right
740-730 Rear Left

Toyota
1991-87 Camry. Regulator Only, Power.

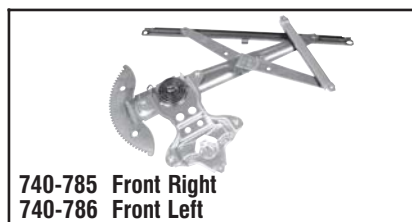

740-785 Front Right
740-786 Front Left

Toyota
1992-88 Corolla. Regulator Only, Power.

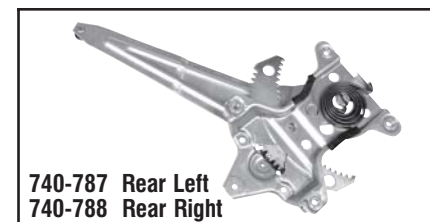

740-787 Rear Left
740-788 Rear Right

Toyota
1992-88 Corolla. Regulator Only, Power.

Window Regulators - Toyota



740-789 Front Right
740-790 Front Left

Toyota
1995-89 Pickups, 1995-90 4-Runner
w/vent. Regulator Only, Power.

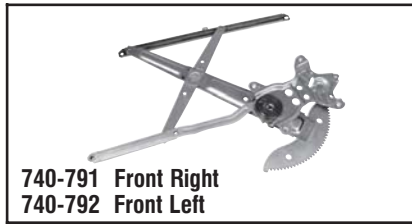

740-791 Front Right
740-792 Front Left

Toyota
1995-89 Pickups, 1995-90 4-Runner
w/o vent. Regulator Only, Power.

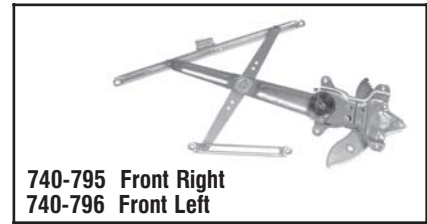

740-795 Front Right
740-796 Front Left

Toyota
1997-91 Land Cruiser, 1997-96 Lexus LX450.
Regulator Only, Power.

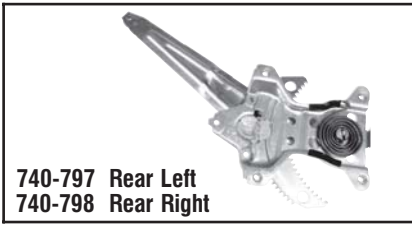

740-797 Rear Left
740-798 Rear Right

Toyota
1997-93 Corolla. Regulator Only, Power.

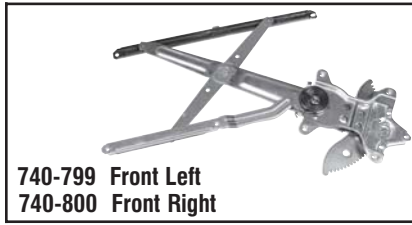

740-799 Front Left
740-800 Front Right

Toyota
2004-95 Tacoma. Regulator Only, Power.

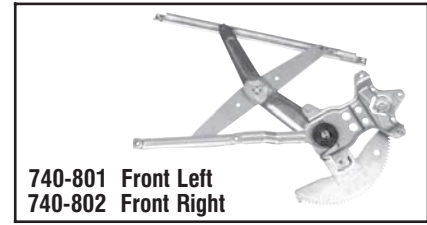

740-801 Front Left
740-802 Front Right

Toyota
2002-98 Corolla. Regulator Only, Power.

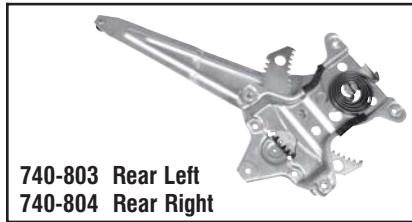

740-803 Rear Left
740-804 Rear Right

Toyota
2002-98 Corolla. Regulator Only, Power.



741-706 Front Left
741-784 Front Right

Toyota
1997-93 Corolla Sedan, Wagon & Geo Prizm.
Motor/Regulator Assembly.



741-707 Front Right
741-708 Front Left

Toyota
1996-92 Camry. Motor/Regulator Assembly.

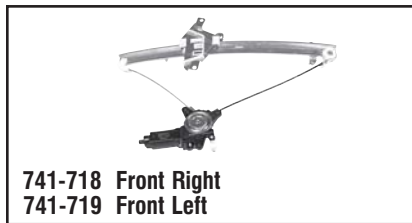

741-718 Front Right
741-719 Front Left

Toyota
1996-94 Camry Coupe.
Motor/Regulator Assembly.



741-793 Rear Right
741-794 Rear Left

Toyota
1996-92 Camry Sedan.
Motor/Regulator Assembly.



741-829 Rear Left
741-830 Rear Right

Toyota
2001-97 Camry.
Motor/Regulator Assembly.

Window Regulators - VW

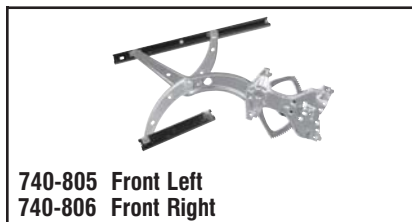

740-805 Front Left
740-806 Front Right

VW
1997-90 Passat. Regulator Only, Power.



740-825 Front Right
740-826 Front Left

VW
1998-92 Jetta, Golf. Regulator Only, Power.

Window Regulator Applications

Make/Model/Years	Description	Front Left	Front Right	Rear Left	Rear Right
ACURA					
CL					
1997	Motor/Regulator Assy, 2.2L Eng	741-715	741-714	—	—
BUICK					
CENTURY					
2005-97	Motor/Regulator Assy	741-637	741-638	741-710	741-709
LESABRE					
2005-00	Motor/Regulator Assy	741-762	741-761	741-811	741-812
RAINIER					
2006-04	Motor/Regulator Assy	741-690	741-691	—	—
REGAL					
2004-97	Motor/Regulator Assy	741-637	741-638	741-710	741-709
SKYLARK					
1998-92	Motor/Regulator Assy, 2-Door	741-659	741-658	—	—
1998-92	Regulator Only, Power, 4-Door	740-682	740-683	—	—
1997-92	Regulator Only, Manual, 2-Door	740-836	740-835	—	—
TERRAZA					
2006-05	Regulator Only, Power	740-692	740-693	—	—
CADILLAC					
ESCALADE					
2006-00	Motor/Regulator Assy	741-644	741-645	—	—
1999	Regulator Only, Power	740-655	740-654	—	—
CHEVROLET					
CAVALIER					
2005-96	Motor/Regulator Assy, 2-Door, Exc. Convertible	741-760	741-759	—	—
2005-96	Motor/Regulator Assy, 4-Door	741-758	741-757	—	—
IMPALA					
2005-00	Motor/Regulator Assy	741-630	741-631	—	—
MALIBU					
2003-97	Regulator Only, Power	740-821	740-822	—	—
MALIBU CLASSIC					
2005-04	Regulator Only, Power	740-821	740-822	—	—
UPLANDER					
2006-05	Regulator Only, Power	740-692	740-693	—	—
VENTURE					
2005-97	Regulator Only, Power	740-692	740-693	—	—
CHEVROLET TRUCK					
AVALANCHE					
2006-02	Motor/Regulator Assy	741-644	741-645	—	—
BLAZER					
1994-92	Regulator Only, Power	740-655	740-654	—	—
1991-78	Regulator Only, Manual	740-651	740-650	—	—
C,K SERIES PICKUP					
2002-88	Regulator Only, Power	740-655	740-654	—	—
1986-78	Regulator Only, Manual	740-651	740-650	—	—
R,V SERIES PICKUP					
1991-87	Regulator Only, Manual	740-651	740-650	—	—
S10 BLAZER					
2005-95	Motor/Regulator Assy	741-844	741-845	—	—
S10 PICKUP					
2004-94	Motor/Regulator Assy	741-844	741-845	—	—
S10 TRAILBLAZER					
2006-02	Motor/Regulator Assy	741-690	741-691	—	—
SILVERADO					
2006-99	Motor/Regulator Assy	741-644	741-645	—	—
SUBURBAN					
2006-01	Motor/Regulator Assy	741-644	741-645	—	—
2000	Motor/Regulator Assy, Exc. 5.7L Eng	741-644	741-645	—	—
2000	Regulator Only, Power, 5.7L Eng	740-655	740-654	—	—
1999-92	Regulator Only, Power	740-655	740-654	—	—
1991-78	Regulator Only, Manual	740-651	740-650	—	—
TAHOE					
2006-01	Motor/Regulator Assy	741-644	741-645	—	—
2000	Motor/Regulator Assy, Exc. 5.7L Eng	741-644	741-645	—	—
2000	Regulator Only, Power, 5.7L Eng	740-655	740-654	—	—
1999-95	Regulator Only, Power	740-655	740-654	—	—
CHRYSLER					
300M					
2000-99	Motor/Regulator Assy	741-554	741-555	—	—
CONCORDE					
2000-98	Motor/Regulator Assy	741-554	741-555	—	—
LHS					
2000-99	Motor/Regulator Assy	741-554	741-555	—	—
TOWN & COUNTRY VAN					
2003-01	Motor/Regulator Assy	741-823	741-824	—	—
2000-96	Motor/Regulator Assy	741-550	741-551	—	—
VOYAGER, GRAND VOYAGER					
2003-01	Motor/Regulator Assy	741-823	741-824	—	—
2000	Motor/Regulator Assy	741-550	741-551	—	—
DODGE					
CARAVAN, GRAND CARAVAN					
2003-01	Motor/Regulator Assy	741-823	741-824	—	—
2000-96	Motor/Regulator Assy	741-550	741-551	—	—

Window Regulator Applications

Make/Model/Years	Description	Front Left	Front Right	Rear Left	Rear Right
DODGE (continued)					
INTREPID					
2000-98	Motor/Regulator Assy	741-554	741-555	—	—
NEON					
1999-95	Regulator Only, Power, 2-Door	740-827	740-828	—	—
DODGE TRUCK					
DAKOTA					
2003-00	Motor/Regulator Assy, Cable Operated	741-649	741-648	—	—
DURANGO					
2003-98	Motor/Regulator Assy	741-649	741-648	—	—
RAM 1500 PICKUP					
2001-94	Motor/Regulator Assy	741-753	741-752	—	—
RAM 2500 PICKUP					
2002-94	Motor/Regulator Assy	741-753	741-752	—	—
RAM 3500 PICKUP					
2002-94	Motor/Regulator Assy	741-753	741-752	—	—
FORD					
CONTOUR					
2000-95	Motor/Regulator Assy	741-807	741-808	—	—
CROWN VICTORIA					
2005-92	Regulator Only, Power	740-664	740-665	740-679	740-678
PROBE					
1992-89	Motor/Regulator Assy	741-669	741-670	—	—
TAURUS					
2006-96	Regulator Only, Power	740-756	740-755	—	—
FORD TRUCK					
BRONCO					
1996-92	Regulator Only, Power	740-674	740-754	—	—
1991-80	Regulator Only, Manual	740-653	740-652	—	—
1991-80	Regulator Only, Power	740-674	740-754	—	—
EXPLORER					
2006	Motor/Regulator Assy, Exc. Sport Trac, To 12/05	—	741-814	—	—
2006	Regulator Only, Power, Sport Trac, To 6/30/05	740-673	740-672	—	—
2005-02	Motor/Regulator Assy, Exc. Sport & Sport Trac	741-813	741-814	—	—
2005-02	Regulator Only, Power, Sport & Sport Trac	740-673	740-672	—	—
2001-91	Regulator Only, Power	740-673	740-672	—	—
F-SERIES PICKUP					
2004	Regulator Only, Power, Heritage & Lightning	740-848	740-849	—	—
2003-01	Regulator Only, Power, Regular Cab, Super Cab, F-150	740-848	740-849	—	—
2000-99	Regulator Only, Power, F-150	740-848	740-849	—	—
1999	Regulator Only, Power, F-250	740-848	740-849	—	—
1997	Regulator Only, Power, F-250 Over 8500 GWW	740-674	740-754	—	—
1997	Regulator Only, Power, F-350, F-450 Super Duty	740-674	740-754	—	—
1996-92	Regulator Only, Power	740-674	740-754	—	—
1991-80	Regulator Only, Manual	740-653	740-652	—	—
1991-80	Regulator Only, Power	740-674	740-754	—	—
RANGER					
2006-93	Regulator Only, Power	740-831	740-832	—	—
GEO					
PRIZM					
1997-93	Motor/Regulator Assy	741-706	741-784	—	—
GMC TRUCK					
C,K SERIES PICKUP					
2003-88	Regulator Only, Power	740-655	740-654	—	—
1986-78	Regulator Only, Manual	740-651	740-650	—	—
DENALI					
2006-01	Motor/Regulator Assy	741-644	741-645	—	—
JIMMY					
1991-78	Regulator Only, Manual	740-651	740-650	—	—
R,V SERIES PICKUP					
1991-87	Regulator Only, Manual	740-651	740-650	—	—
S15 ENVOY					
2006-02	Motor/Regulator Assy	741-690	741-691	—	—
S15 JIMMY					
2001-95	Motor/Regulator Assy	741-844	741-845	—	—
S15 PICKUP SONOMA					
2004-94	Motor/Regulator Assy	741-844	741-845	—	—
SIERRA					
2006-99	Motor/Regulator Assy	741-644	741-645	—	—
SIERRA DENALI					
2006-02	Motor/Regulator Assy	741-644	741-645	—	—
SUBURBAN					
1999-92	Regulator Only, Power	740-655	740-654	—	—
1991-78	Regulator Only, Manual	740-651	740-650	—	—
YUKON					
2006-00	Motor/Regulator Assy	741-644	741-645	—	—
2000	Motor/Regulator Assy, Exc. 5.7L Eng	741-644	741-645	—	—
2000	Regulator Only, Power, 5.7L Eng	740-655	740-654	—	—
1999-92	Regulator Only, Power	740-655	740-654	—	—
YUKON XL					
2006-00	Motor/Regulator Assy	741-644	741-645	—	—

Window Regulator Applications

Make/Model/Years	Description	Front Left	Front Right	Rear Left	Rear Right
HONDA					
ACCORD					
2002-98	Motor/Regulator Assy, 4-Door	741-766	741-767	—	—
1997-94	Motor/Regulator Assy, 2-Door	741-715	741-714	—	—
1997-94	Motor/Regulator Assy, 4-Door	741-713	741-765	741-819	741-820
1993-90	Motor/Regulator Assy, 4-Door, Japan Built	741-717	741-716	741-711	741-712
1989-86	Motor/Regulator Assy	741-731	741-732	—	—
CIVIC					
2000-96	Motor/Regulator Assy, 4-Door	741-734	741-735	—	—
2000-96	Regulator Only, Power, 2-Door	740-737	740-736	—	—
1995-92	Regulator Only, Power, 4-Door	740-763	740-764	—	—
PASSPORT					
1997-94	Regulator Only, Power	740-842	740-843	—	—
INFINITI					
I30					
1999-96	Regulator Only, Power	740-780	740-781	740-779	740-778
ISUZU TRUCK					
RODEO					
1997-94	Regulator Only, Power	740-842	740-843	—	—
JEEP					
CHEROKEE					
2001-97	Motor/Regulator Assy, 4-Door	741-768	741-769	—	—
GRAND CHEROKEE					
2004-01	Motor/Regulator Assy	741-556	741-557	—	—
2000-99	Motor/Regulator Assy	741-552	741-553	—	—
LEXUS					
LX450					
1997-96	Regulator Only, Power	740-796	740-795	—	—
LINCOLN					
TOWN CAR					
2006	Regulator Only, Power, Exc. Limo	740-686	740-687	740-688	—
2006	Regulator Only, Power, Limo	740-686	740-687	—	—
2005-03	Regulator Only, Power, Limo	740-686	740-687	—	—
2005-03	Regulator Only, Power, Exc. Limo	740-686	740-687	740-688	740-689
2002-98	Regulator Only, Power	740-686	740-687	740-688	740-689
1997-95	Regulator Only, Power	740-662	740-663	740-684	740-685
1994	Regulator Only, Power, w/Cable slide block at top of rail	740-666	740-667	740-661	740-660
1994	Regulator Only, Power, w/Cable pulley at top of rail	740-662	740-663	—	—
1993	Regulator Only, Power, w/Cable slide block at top of rail	740-666	740-667	740-661	740-660
1993	Regulator Only, Power, w/Cable pulley at top of rail	740-662	740-663	740-661	740-660
1992-90	Regulator Only, Power	740-666	740-667	740-661	740-660
MAZDA					
626					
1997-93	Motor/Regulator Assy	741-773	741-772	—	—
929					
1995-92	Motor/Regulator Assy	741-750	741-751	—	—
PROTEGE					
1998-96	Motor/Regulator Assy	741-771	741-770	—	—
MERCURY					
GRAND MARQUIS					
2005-92	Regulator Only, Power	740-664	740-665	740-679	740-678
MARAUDER					
2004-03	Regulator Only, Power	740-664	740-665	740-679	740-678
MOUNTAINEER					
2006	Motor/Regulator Assy, To 12/05	—	741-814	—	—
2005-02	Motor/Regulator Assy	741-813	741-814	—	—
2001-97	Regulator Only, Power	740-673	740-672	—	—
MYSTIQUE					
2000-95	Motor/Regulator Assy	741-807	741-808	—	—
SABLE					
2005-96	Regulator Only, Power	740-756	740-755	—	—
NISSAN					
200SX					
1996-95	Regulator Only, Power	740-777	740-776	—	—
ALTIMA					
2001-98	Regulator Only, Power	740-738	740-739	—	—
1997-93	Regulator Only, Power	740-725	740-724	—	—
FRONTIER					
2004-98	Regulator Only, Power	740-681	740-680	—	—
MAXIMA					
2003	Regulator Only, Power, To 12/02	—	—	740-775	740-774
2002	Regulator Only, Power	—	—	740-775	740-774
2001-00	Regulator Only, Power	740-723	740-722	740-775	740-774
1999	Regulator Only, Power	740-780	740-781	—	—
1999	Regulator Only, Power, From 4/99	—	—	740-775	740-774
1999	Regulator Only, Power, To 3/99	—	—	740-779	740-778
1998-95	Regulator Only, Power	740-780	740-781	740-779	740-778
1994-89	Regulator Only, Power	740-701	740-702	740-703	740-726
SENTRA					
1999-95	Regulator Only, Power	740-777	740-776	—	—
1994-91	Regulator Only, Power	740-783	740-782	—	—
XTERRA					
2004-00	Regulator Only, Power	740-681	740-680	—	—

Window Regulator Applications

Make/Model/Years	Description	Front Left	Front Right	Rear Left	Rear Right
OLDSMOBILE					
ACHIEVA					
1998-92	Motor/Regulator Assy, 2-Door	741-659	741-658	—	—
1998-92	Regulator Only, Manual, 2-Door	740-836	740-835	—	—
1998-92	Regulator Only, Power, 4-Door	740-682	740-683	—	—
ALERO					
2004-99	Motor/Regulator Assy, 2-Door	741-641	741-640	—	—
2004-99	Motor/Regulator Assy, 4-Door	741-643	741-642	741-816	741-815
BRAVADA					
2004-02	Motor/Regulator Assy	741-690	741-691	—	—
2001-96	Motor/Regulator Assy	741-844	741-845	—	—
CUTLASS					
1999-97	Regulator Only, Power	740-821	740-822	—	—
INTRIGUE					
2002-98	Motor/Regulator Assy	741-637	741-638	741-710	741-709
SILHOUETTE					
2004-97	Regulator Only, Power	740-692	740-693	—	—
PLYMOUTH					
NEON					
1999-95	Regulator Only, Power, 2-Door	740-827	740-828	—	—
VOYAGER, GRAND VOYAGER					
2000-96	Motor/Regulator Assy	741-550	741-551	—	—
PONTIAC					
BONNEVILLE					
2005-00	Motor/Regulator Assy	741-817	741-818	—	—
GRAND AM					
2005-99	Motor/Regulator Assy, 4-Door	741-643	741-642	741-816	741-815
2004-99	Motor/Regulator Assy, 2-Door	741-641	741-640	—	—
1998-92	Motor/Regulator Assy, 2-Door	741-659	741-658	—	—
1998-92	Regulator Only, Manual, 2-Door	740-836	740-835	—	—
1998-92	Regulator Only, Power, 4-Door	740-682	740-683	—	—
GRAND PRIX					
2003-97	Motor/Regulator Assy, 4-Door	741-647	741-646	741-838	741-837
2002-97	Motor/Regulator Assy, 2-Door	741-810	741-809	—	—
MONTANA					
2006-99	Regulator Only, Power	740-692	740-693	—	—
SUNFIRE					
2005-96	Motor/Regulator Assy, 2-Door, Exc. Convertible	741-760	741-759	—	—
2005-96	Motor/Regulator Assy, 4-Door	741-758	741-757	—	—
SV6					
2006-05	Regulator Only, Power	740-692	740-693	—	—
TRANS SPORT					
1998-97	Regulator Only, Power	740-692	740-693	—	—
SATURN					
RELAY					
2005	Regulator Only, Power	740-692	740-693	—	—
TOYOTA					
CAMRY					
2001-97	Motor/Regulator Assy	—	—	741-829	741-830
2001-97	Regulator Only, Power	740-721	740-720	—	—
1996-95	Motor/Regulator Assy, 2-Door	741-719	741-718	—	—
1996-95	Motor/Regulator Assy, 4-Door	—	741-707	741-794	741-793
1994	Motor/Regulator Assy, 2-Door	741-719	741-718	—	—
1994	Motor/Regulator Assy, 4-Door	741-708	741-707	741-794	741-793
1993-92	Motor/Regulator Assy, 4-Door	741-708	741-707	741-794	741-793
1991-87	Regulator Only, Power	740-727	740-728	740-730	740-729
COROLLA					
2002-98	Regulator Only, Power	740-801	740-802	740-803	740-804
1997-93	Motor/Regulator Assy	741-706	741-784	740-797	740-798
1992	Regulator Only, Power	740-786	740-785	740-787	740-788
1991-88	Regulator Only, Power, Sedan & Wagon	740-786	740-785	740-787	740-788
TOYOTA TRUCK					
4-RUNNER					
1995-89	Regulator Only, Power, w/Vent Window	740-790	740-789	—	—
1995-89	Regulator Only, Power, wo/Vent Window	740-792	740-791	—	—
1989-84	Regulator Only, Manual, wo/Vent Window	740-705	—	—	—
LAND CRUISER					
1997-91	Regulator Only, Power	740-796	740-795	—	—
PICKUP					
1995-89	Regulator Only, Power, w/Vent Window	740-790	740-789	—	—
1995-89	Regulator Only, Power, wo/Vent Window	740-792	740-791	—	—
1988-84	Regulator Only, Manual, wo/Vent Window	740-705	—	—	—
TACOMA					
2004-95	Regulator Only, Power	740-799	740-800	—	—
VOLKSWAGEN					
GOLF					
1998-92	Regulator Only, Power	740-826	740-825	—	—
JETTA					
1998-92	Regulator Only, Power	740-826	740-825	—	—
PASSAT					
1997-90	Regulator Only, Power	740-805	740-806	—	—

Wiper Motors

100% NEW!

Why take a chance with rebuilt? Dorman Wiper Motors are 100% New for long service life.

- Direct OE Replacement
- Include Control Boards, Board Covers and Bushings
- No Core Charge!

Wiper Motors

601-115

2005-98 Chevrolet/
GMC Trucks

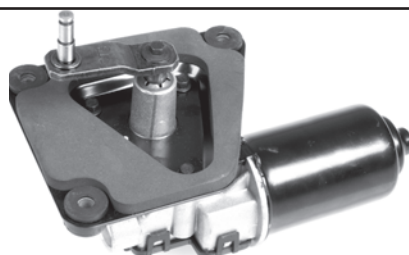
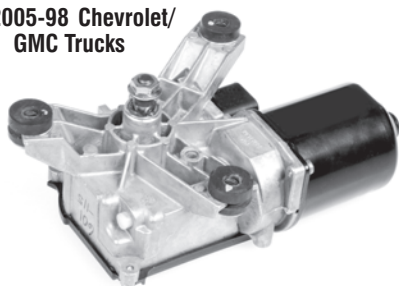

601-201
1997-87 Ford Trucks

601-300

1997-89 Chrysler Cars,
Trucks & Vans



AVOID COMEBACKS

Avoid comebacks from inconsistent reman quality. Would you want your customers to see smoke?



REMAN LABEL WARNING:

NOTICE: Do not be alarmed, smoke coming from motor is due to fresh paint. Condition is normal. Allow 1 hour of operating to clear smoke.

Also Available from HELP! Check Motormite® Catalog #MM24010 for more details.

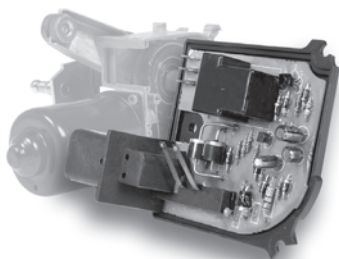

88136

Wiper Pulse Board

- Includes new cover plate to increase board life
- Includes new screws for added convenience
- Fits over 6 million registered GM vehicles

88138

- 2004-92 Astro, Safari, C&K Series, Yukon, Suburban, Blazer, Rear



Activant Path

Wipers, Arms & Related

Activant Code

DOW

Applications begin
on page 570.

Wiper Motors

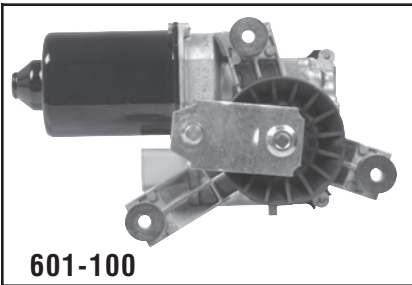

601-100

GM
Front
2000-92 Blazer, Jimmy, Tahoe, Suburban,
2002-88 C/K-Series Pickups, 1999
Escalade - w/o Pulse

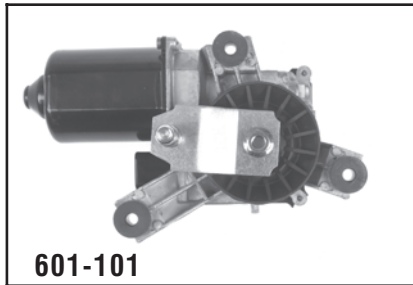

601-101

GM
Front
2000-92 Blazer, Jimmy, Tahoe, Suburban,
2002-88 C/K-Series Pickups, 1999
Escalade - w/Pulse

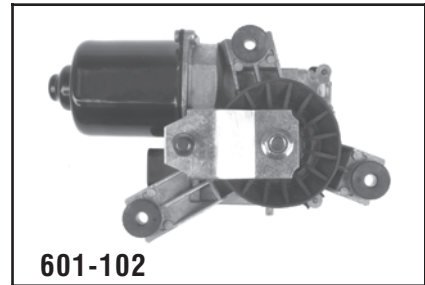

601-102

GM
Front
1997-95 S10 Blazer, S15, Jimmy,
Pickups, 1997-96 Bravada

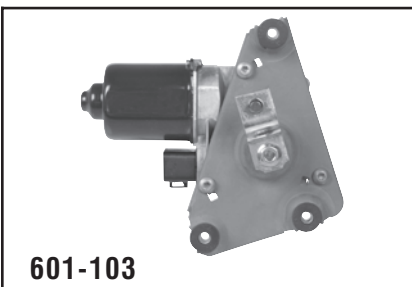

601-103

GM
Front
2005-94 Astro, Safari Vans

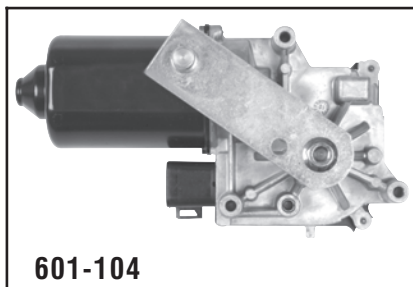

601-104

GM
Front
1996-90 Lumina APV, Silhouette, Trans
Sport

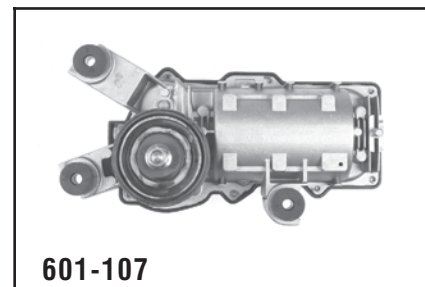

601-107

GM
Front
1994-82 Various Models w/o Pulse

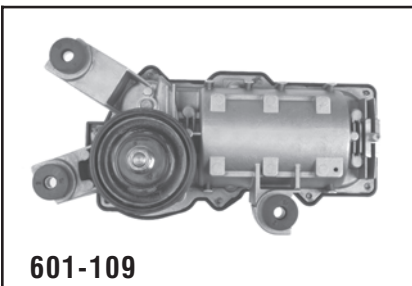

601-109

GM
Front
1994-84 Various Models w/Pulse

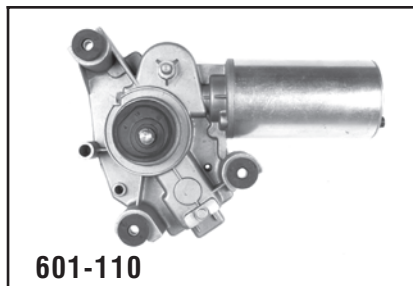

601-110

GM
Front
1996-87 Various Models

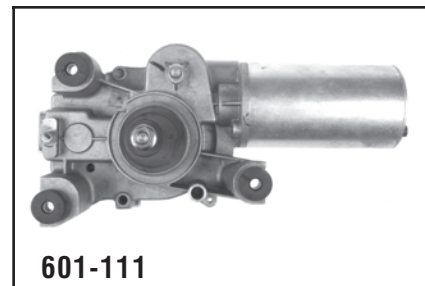

601-111

GM
Front
1989-84 Various Models w/Pulse

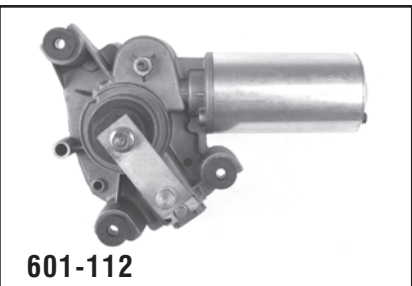

601-112

GM
Front
1996-84 Various Models

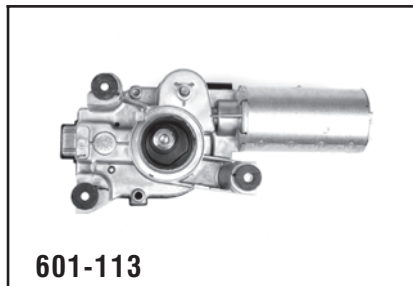

601-113

GM
Front
2002-87 Various Models

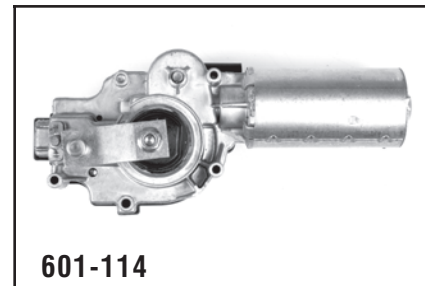

601-114

GM
Front
1997-88 Various Models

Wiper Motors

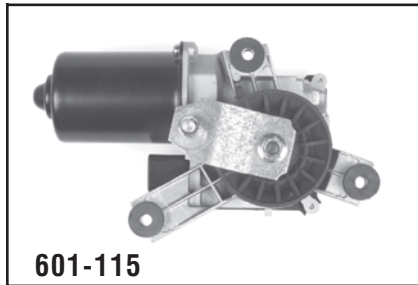

601-115

GM
Front
2005-98 S10 Blazer, S15 Jimmy, Pickups,
2001-98 Bravada



601-116

GM
Front
1996-92 Full-Size Vans

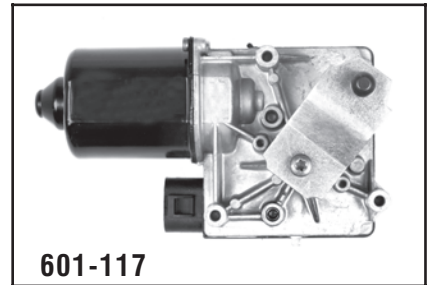

601-117

GM
Front
1997-95 Cavalier, Sunfire

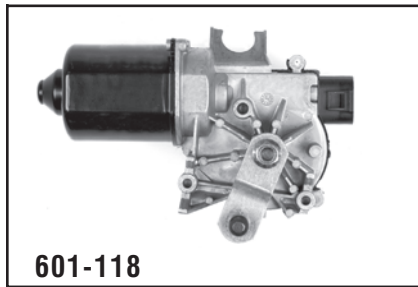

601-118

GM
Front
2005-04 Malibu Classic, 2003-97 Malibu,
1999-97 Cutlass

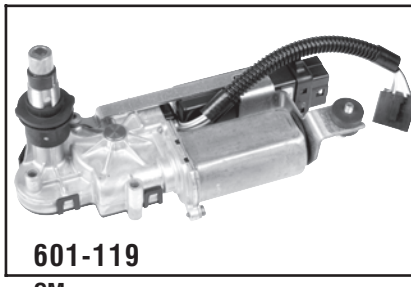

601-119

GM
Rear
2005-95 S10 Blazer/Jimmy, 2001-96
Bravada, 2000-98 Envoy

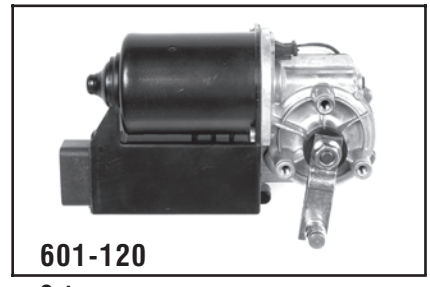

601-120

Saturn
Front
2000-91 S-Series

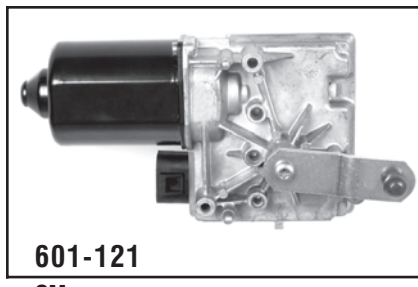

601-121

GM
Front
2005-97 Century, 2004-97 Regal,
2003-97 Grand Prix, 2005-00 Impala,
Monte Carlo, 2002-98 Intrigue

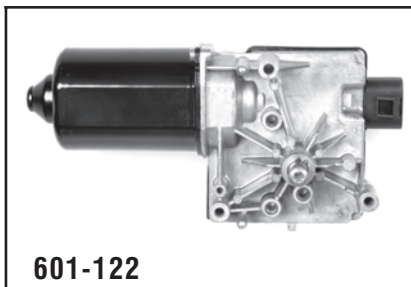

601-122

GM
Front
2005-97 Venture, 2004-97 Silhouette,
2005-99 Montana, 1998-97 Trans Sport

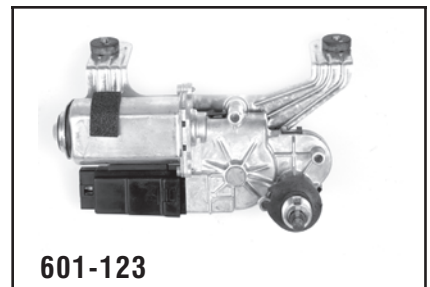

601-123

GM
Rear
2005-97 Venture, 2004-97 Silhouette,
2005-99 Montana, 1998-97 Trans Sport

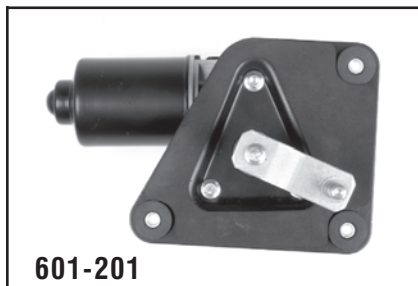

601-201

Ford
Front
1996-87 Bronco, F-150, 1997-87 F-250,
F-350



601-202

Ford
Front
1997-86 Aerostar



601-203

Ford
Front
1994-92 Crown Victoria, Grand Marquis,
1994-90 Town Car

Wiper Motors

Wiper Motors

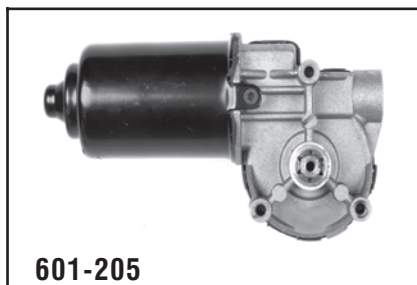

601-205

Ford
Front
1999-97 Expedition, F-150, 250,
1999-98 Navigator, 1999-96 Taurus,
Sable



601-206

Ford
Front
2002-95 Crown Victoria, Grand Marquis,
1997-95 Town Car

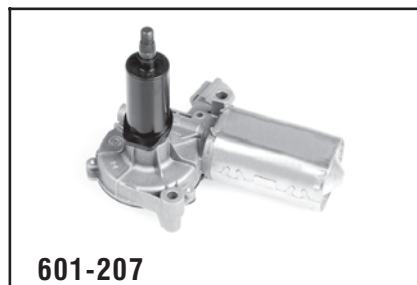

601-207

Ford
Rear
2002-97 Expedition, 2003-02 Explorer
Sport, 2001-98 Explorer, 2002-98
Navigator, 2001-98 Mountaineer

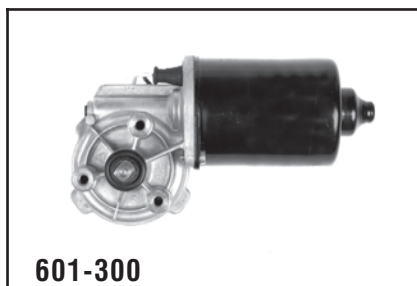

601-300

Chrysler
Front
1995-89 Various Models

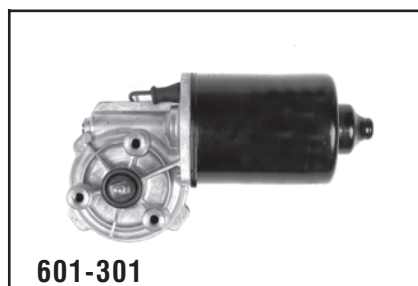

601-301

Chrysler
Front
1995-90 Acclaim, Spirit, LeBaron,
1996-90 Dakota, 1993-89 New Yorker,
Imperial, Dynasty, 1994-89 Sundance,
Shadow

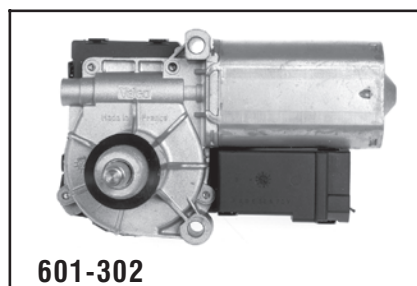

601-302

Chrysler
Rear
1998-93 Grand Cherokee



601-303

Chrysler
Front
2002-96 Ram Series Pickups

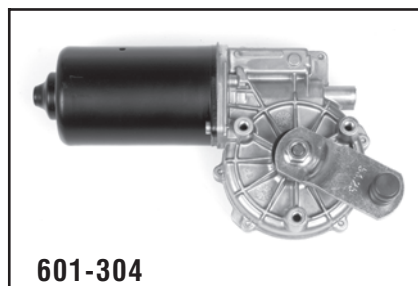

601-304

Chrysler
Front
1999-96 Caravan, Voyager,
Town & Country



601-305

Chrysler
Front
2000-95 Cirrus, Stratus,
2000-96 Sebring Convertible, Breeze

Wiper Motor Applications

Make/ Model/Years	Description	Dorman #
BUICK		
CENTURY		
2005-97	Front	601-121
1996-87	Front	601-110
1986-84	Front	601-112
ELECTRA		
1990-87	Front	601-113
1986-84	Front	601-111
LESABRE		
1999-87	Front	601-113
1986	Front	601-111
PARK AVENUE		
1996-91	Front	601-113
REATA		
1991-88	Front	601-113

Make/ Model/Years	Description	Dorman #
BUICK (continued)		
REGAL		
2004-97	Front	601-121
1996-88	Front	601-114
1987-84	Front	601-112
RIVIERA		
1999-88	Front	601-113
1987-86	Front	601-111
ROADMASTER		
1996-91	Front	601-113
SKYHAWK		
1989-84	Front, w/Pulse Wiper	601-109
1989-82	Front, wo/Pulse Wiper	601-107
SKYLARK		
1998-88	Front	601-113
1987-85	Front	601-111

Wiper Motor Applications

Make/Model/Years	Description	Dorman #
BUICK (continued)		
SOMERSET		
1987-85	Front	601-111
CADILLAC		
ALLANTE		
1993-90	Front	601-113
1989-87	Front	601-111
CIMARRON		
1988-84	Front, w/Pulse Wiper	601-109
1988-82	Front, wo/Pulse Wiper	601-107
CONCOURS		
1999-94	Front	601-113
DEVILLE		
1999-87	Front	601-113
1986-84	Front	601-111
ELDORADO		
2002-88	Front	601-113
1987-86	Front	601-111
ESCALADE		
2000-99	Front, w/Intermittent Wipers	601-101
2000-99	Front, wo/Intermittent Wipers	601-100
FLEETWOOD (FWD)		
1993-87	Front	601-113
1986-85	Front	601-111
FLEETWOOD (RWD)		
1996-93	Front	601-113
SEVILLE		
1999-88	Front	601-113
1987-86	Front	601-111
CHEVROLET		
BERETTA		
1996-89	Front	601-113
1988-87	Front	601-111
CAMARO		
1992-88	Front	601-110
1987-84	Front	601-112
CAPRICE		
1996-91	Front	601-113
CAVALIER		
1997-95	Front	601-117
1994-84	Front, w/Pulse Wiper	601-109
1994-84	Front, wo/Pulse Wiper	601-107
CELEBRITY		
1990-87	Front	601-110
1986-84	Front	601-112
CORSICA		
1996-89	Front	601-113
1988-87	Front	601-111
CORVETTE		
1996-84	Front	601-112
EL CAMINO		
1988-84	Front	601-112
IMPALA		
2005-00	Front	601-121
IMPALA SS		
1996-94	Front	601-113
LUMINA		
1994-90	Front	601-114
LUMINA APV		
1996-90	Front	601-104
MALIBU		
2003-97	Front	601-118
MALIBU CLASSIC		
2005-04	Front	601-118
MONTE CARLO		
2005-00	Front	601-121
1988-84	Front	601-112
VENTURE VAN		
2005-97	Front	601-122
2005-97	Rear	601-123
CHEVROLET/GMC TRUCK		
ASTRO		
2005-96	Front	601-103
1995-94	Front	601-103
1993-92	Front	601-109
1991	Front	601-109
1990-85	Front, w/Pulse Wiper	601-109
1990-85	Front, wo/Pulse Wiper	601-107
BLAZER, JIMMY, TAHOE, YUKON		
2000-92	Front, w/Intermittent Wipers	601-101
2000-92	Front, wo/Intermittent Wipers	601-100
C,K SERIES PICKUP		
2002-88	Front, w/Intermittent Wipers	601-101

Make/Model/Years	Description	Dorman #
CHEVROLET/GMC TRUCK (continued)		
C,K SERIES PICKUP (continued)		
2002-88	Front, wo/Intermittent Wipers	601-100
G SERIES VAN		
1996-92	Front	601-116
P SERIES VAN		
1996-93	Front	601-116
S10 BLAZER, S15 JIMMY, S15 TYPHOON		
2005-98	Front	601-115
2005-98	Rear	601-119
1997-95	Front	601-102
1997-95	Rear	601-119
1994-85	Front, w/Pulse Wiper	601-109
1993-83	Front, wo/Pulse Wiper	601-107
S10 PICKUP, S15 PICKUP, S15 SONOMA, S15 SYCLONE		
2004-98	Front	601-115
1997-95	Front	601-102
1994-85	Front, w/Pulse Wiper	601-109
1993-82	Front, wo/Pulse Wiper	601-107
SAFARI		
2005-96	Front	601-103
1995-94	Front	601-103
1993-92	Front	601-109
1991	Front	601-109
1990-85	Front, w/Pulse Wiper	601-109
1990-85	Front, wo/Pulse Wiper	601-107
SUBURBAN		
2000-92	Front, w/Intermittent Wipers	601-101
2000-92	Front, wo/Intermittent Wipers	601-100
TOPKICK, KODIAK		
2002-90	Front	601-100
CHRYSLER		
CIRRUS		
2000-95	Front	601-305
IMPERIAL		
1993-90	Front	601-301
LEBARON		
1995-90	Front, 2 Door	601-300
1995-90	Front, 4 Door	601-301
1989	Front	601-300
NEW YORKER		
1993-89	Front	601-301
SEBRING		
2000-96	Front, Convertible	601-305
TC MASERATI		
1991-89	Front	601-300
TOWN & COUNTRY VAN		
1999-96	Front	601-304
1995-91	Front	601-300
1990	Front	601-300
DODGE		
CARAVAN, GRAND CARAVAN		
1999-96	Front	601-304
1995-91	Front	601-300
1990	Front	601-300
1989	Front, From 11/1/88	601-300
DAYTONA		
1993-90	Front	601-300
1989	Front, From 9/28/88	601-300
DYNASTY		
1993-89	Front	601-301
OMNI		
1990	Front	601-300
SHADOW		
1994-89	Front	601-301
SPIRIT		
1995-90	Front	601-301
STRATUS		
2000-95	Front	601-305
DODGE TRUCK		
B SERIES VAN		
1997-90	Front	601-300
1989	Front, From 11/2/88	601-300
D,W SERIES PICKUP		
1993-90	Front	601-300
1989	Front, From 10/3/88	601-300
DAKOTA		
1996-90	Front	601-301
RAM 1500 PICKUP		
2002-96	Front	601-303
RAM 2500 PICKUP		
2002-96	Front	601-303

Wiper Motor Applications

Make/ Model/Years	Description	Dorman #
DODGE TRUCK (continued)		
RAM 3500 PICKUP		
2002-96	Front	601-303
RAMCHARGER		
1993-90	Front	601-300
1989	Front, From 10/3/88	601-300
FORD		
CROWN VICTORIA		
2002-95	Front	601-206
1994-92	Front	601-203
TAURUS		
1999-96	Front	601-205
FORD TRUCK		
AEROSTAR		
1997-86	Front	601-202
BRONCO		
1996-87	Front	601-201
EXPEDITION		
2002-00	Rear	601-207
1999-97	Front	601-205
1999-97	Rear	601-207
EXPLORER		
2003-02	Rear, Sport Only	601-207
2001-98	Rear	601-207
F150 PICKUP		
1999-97	Front	601-205
1996-87	Front	601-201
F250 PICKUP		
1999-98	Front, Under 8500 GVW	601-205
1997	Front, Over 8500 GVW	601-201
1997	Front, Under 8500 GVW	601-205
1996-87	Front	601-201
F350 PICKUP		
1997-87	Front	601-201
F53 STRIPPED CHASSIS		
1997-88	Front	601-201
F59 STRIPPED CHASSIS		
1996-88	Front	601-201
JEEP		
GRAND CHEROKEE		
1998-93	Rear	601-302
GRAND WAGONEER		
1993	Rear	601-302
LINCOLN		
NAVIGATOR		
2002-00	Rear	601-207
1999-98	Front	601-205
1999-98	Rear	601-207
TOWN CAR		
1997-95	Front	601-206
1994-90	Front	601-203
MERCURY		
GRAND MARQUIS		
2002-95	Front	601-206
1994-92	Front	601-203
MOUNTAINEER		
2001-98	Rear	601-207
SABLE		
1999-96	Front	601-205
OLDSMOBILE		
88, DELTA 88		
1999-87	Front	601-113
1986	Front	601-111
98, 98 REGENCY		
1996-87	Front	601-113
1986-84	Front	601-111
ACHIEVA		
1998-92	Front	601-113
AURORA		
1999-95	Front	601-113
BRAVADA		
2001-98	Front	601-115
2001-98	Rear	601-119
1997-96	Front	601-102
1997-96	Rear	601-119
1994-91	Front, w/Pulse Wiper	601-109
1993-91	Front, wo/Pulse Wiper	601-107
CIERA, CUTLASS CIERA		
1996-87	Front	601-110
1986-84	Front	601-112
CUSTOM CRUISER		
1992-91	Front	601-113

Make/ Model/Years	Description	Dorman #
OLDSMOBILE (continued)		
CUTLASS		
1999-97	Front	601-118
1996-88	Front	601-114
1987-84	Front	601-112
CUTLASS CALAIS		
1991-88	Front	601-113
1987-85	Front	601-111
CUTLASS SUPREME		
1997-89	Front	601-114
1988	Front, FWD	601-114
1988	Front, RWD	601-112
1987-84	Front	601-112
FIRENZA		
1988-84	Front, w/Pulse Wiper	601-109
1988-82	Front, wo/Pulse Wiper	601-107
INTRIGUE		
2002-98	Front	601-121
LSS		
1999-96	Front	601-113
SILHOUETTE		
2004-97	Front	601-122
2004-97	Rear	601-123
1996-90	Front	601-104
TORONADO		
1992-88	Front	601-113
1987-86	Front	601-111
PLYMOUTH		
ACCLAIM		
1995-90	Front	601-301
BREEZE		
2000-96	Front	601-305
HORIZON		
1990	Front	601-300
SUNDANCE		
1994-89	Front	601-301
VOYAGER, GRAND VOYAGER		
1999-96	Front	601-304
1995-91	Front	601-300
1990	Front	601-300
1989	Front, From 11/1/88	601-300
PONTIAC		
6000		
1991-87	Front	601-110
1986-84	Front	601-112
BONNEVILLE		
1999-87	Front	601-113
FIERO		
1988-84	Front, w/Pulse Wiper	601-109
1988-84	Front, wo/Pulse Wiper	601-107
FIREBIRD		
1992-88	Front	601-110
1987-84	Front	601-112
GRAND AM		
1998-88	Front	601-113
1987-85	Front	601-111
GRAND PRIX		
2003-97	Front	601-121
1996-88	Front	601-114
1987-84	Front	601-112
J2000		
1984-82	Front, wo/Pulse Wiper	601-107
1984	Front, w/Pulse Wiper	601-109
MONTANA		
2005-99	Front	601-122
2005-99	Rear	601-123
SUNBIRD		
1994-85	Front, w/Pulse Wiper	601-109
1994-85	Front, wo/Pulse Wiper	601-107
SUNFIRE		
1997-95	Front	601-117
TRANS SPORT		
1998-97	Front	601-122
1998-97	Rear	601-123
1996-90	Front	601-104
SATURN		
SC SERIES		
2000	Front, w/Narrow Blades & Oblong Slots	601-120
1999-91	Front	601-120
SL SERIES		
1999-91	Front	601-120
SW SERIES		
1999-93	Front	601-120

Wiper Transmission Linkages

- 12 Different Wiper Transmissions to Fit the Most Failure-Prone Applications
- Great Coverage for Fast Moving Domestic and Import Applications
- Competitively Priced Alternative to the OE Dealer



Brand New to the Aftermarket



602-002
Nissan Maxima (LH)
1994-89



602-300
Ford Taurus
1995-87



602-202
GM Alero, Cavalier,
Grand Am, Sunfire
2003-98

Other Wiper Products Available...

Wiper Motor Pulse Boards



88136
GM Trucks
2005-88



88138
GM Astro, Safari,
C&K Series
2004-92

Wiper Arms



Wiper Motors



Activant Path

Wiper Blades Arms & Motors/
Wiper Arms & Related

Activant Code DWP

Applications begin
on page 575.

Wiper Transmission Linkages

- The mechanical linkage between the Wiper Motor and the Wiper Arms.
- Original equipment construction.

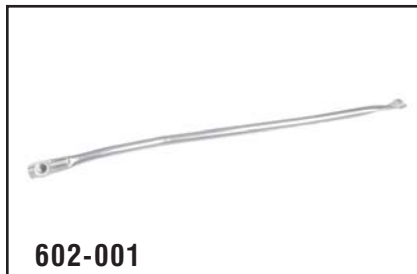

602-001

Nissan
Maxima, RH, 1994-89

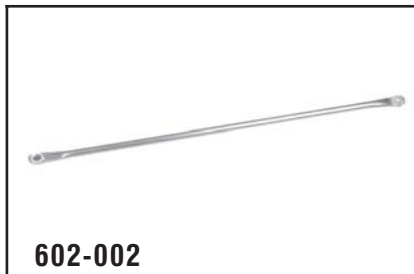

602-002

Nissan
Maxima, LH, 1994-89



602-003

Nissan
Sentra, RH, 1999-95

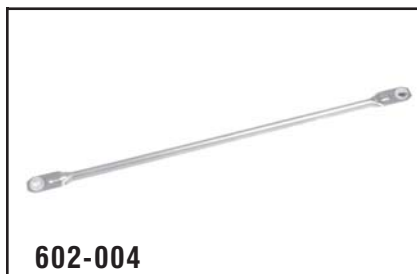

602-004

Nissan
Sentra, LH, 1999-95



602-005

Nissan
Altima, RH, 1997-93

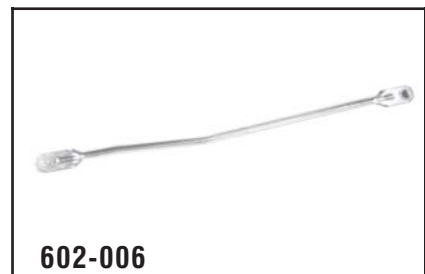

602-006

Nissan
Altima, LH, 2001-93



602-007

Nissan
Altima, RH, 2001-98



602-202

GM
Alero, Cavalier, Grand Am, Sunfire
2003-98



602-203

GM
C&K-Series, Trucks, LH 2002-98



602-204

GM
C&K-Series Trucks, RH, 2002-98



602-205

Chevrolet
Venture Van Motor Crank 2005-97



602-300

Ford
Taurus Motor Drive 1995-87

Wiper Transmission Linkages

Wiper Transmission Linkage Applications

Make/Model/Year	Description	Dorman #	Make/Model/Year	Description	Dorman #
BUICK			GMC TRUCK (continued)		
RAINIER			YUKON (continued)		
2004	w/Rain Sensitive Pulse Wipers	602-200	1999-98	LH	602-203
2004	wo/Rain Sensitive Pulse Wipers	602-201	1999-98	RH	602-204
CADILLAC			JEEP		
ESCALADE			CHEROKEE		
1999	LH	602-203	2001-94	-	602-100
1999	RH	602-204	LINCOLN		
CHEVROLET			CONTINENTAL		
CAVALIER			1988 - 602-300		
2003	Lordstown Plant, To 1/2/03	602-202	TOWN CAR		
2003	Ramus Plant, To 1/13/03	602-202	1990 - 602-300		
2002-98	-	602-202	MERCURY		
MALIBU			SABLE		
2005-04	Classic Series	602-206	1995-87 - 602-300		
2003-97	-	602-206	NISSAN		
VENTURE VAN			200SX		
2005-97	-	602-205	1998-95	LH	602-003
CHEVROLET TRUCK			1998-95	RH	602-004
C,K SERIES PICKUP			ALTIMA		
2002-98	LH	602-203	2001-98	RH	602-007
2002-98	RH	602-204	2001-93	LH	602-006
S10 TRAILBLAZER			1997-93	RH	602-005
2005-02	w/Rain Sensitive Pulse Wipers	602-200	MAXIMA		
2005-02	wo/Rain Sensitive Pulse Wipers	602-201	1994-89	LH	602-002
SUBURBAN			1994-89	RH	602-001
1999-98	LH	602-203	SENTRA		
1999-98	RH	602-204	1999-95	LH	602-003
TAHOE			1999-95	RH	602-004
2000	LH, 5.7L Eng	602-203	OLDSMOBILE		
2000	RH, 5.7L Eng	602-204	ALERO		
1999-98	LH	602-203	2003	To 2/3/03	602-202
1999-98	RH	602-204	2002-99	-	602-202
DODGE TRUCK			BRAVADA		
RAM SERIES PICKUP			2005-02	w/Rain Sensitive Pulse Wipers	602-200
2002-94	-	602-101	2005-02	wo/Rain Sensitive Pulse Wipers	602-201
FORD			CUTLASS		
TAURUS			1999-97 - 602-206		
1995-87	-	602-300	SILHOUETTE		
GMC TRUCK			2004-97 - 602-205		
C,K SERIES PICKUP			PONTIAC		
2002-98	LH	602-203	GRAND AM		
2002-98	RH	602-204	2003	To 2/3/03	602-202
S15 ENVOY			2002-99	-	602-202
2005-02	w/Rain Sensitive Pulse Wipers	602-200	MONTANA		
2005-02	wo/Rain Sensitive Pulse Wipers	602-201	2005-99 - 602-205		
SUBURBAN			SUNFIRE		
1999-98	LH	602-203	2003	Lordstown Plant, To 1/2/03	602-202
1999-98	RH	602-204	2003	Ramus Plant, To 1/13/03	602-202
YUKON			2002-98	-	602-202
2000	LH, 5.7L Eng	602-203	TRANS SPORT		
2000	RH, 5.7L Eng	602-204	1998-97 - 602-205		

Related Sales - Windshield Wiper Linkage Bushings

49447 (7)



Windshield Wiper Linkage Bushing Assortment **BETTER VALUE**

Chrysler 2004-74, Jeep Cherokee 2000-93, GM C/K Series 2004-88. Bushings are part of wiper transmission linkage and connector assembly. Not sold separately at OE dealer. Kit contains 49440, 49445 and 49446.

49448 (5)



Windshield Wiper Linkage Bushings

Fits Toyota Camry 2001-97, Corolla 2002-98. Bushings are part of the wiper pivot arm and connector assembly. Easily repair worn bushings instead of replacing entire linkage. Bushings not available separately from OE dealer.

49449 (2)



Windshield Wiper Linkage Bushings

Nissan Altima 2001-88. Not available separately from dealer.



Wiper Transmission Linkages

Clock Springs
pg. 21-24

Control Arms
pg. 25-54

CV Joint Boots & Accessories
pg. 55-66

Door Lock Actuators
pg. 67-72

Exhaust Manifold Kits
pg. 73-134

Manufactured from
100% NEW Components

Wiper Transmission Linkages

Will it Work or Not?

- **GM Recalls OE Boards**

General Motors used an intermittent wiper board assembly that covered GM trucks from 1988 through 2003 model years. Unknown at the time of production, were several design defects that did not surface until later. These defects eventually led to a recall by GM.



88136
GM Wiper Pulse Board

GM trucks, 2003-88. Includes new cover plate and hardware.

- **Original Unit Failures**

The original unit used a technique in which the electronic components were soldered to the surface of the board. As part of the build process, a clear coating called “Conformal” coat was sprayed on the board to protect the electronic components and the circuit board from corrosion. In the original configuration, the Conformal coating would move components that were soldered to the board as it heated and cooled. This pushing and pulling motion caused component connections to come loose. As a direct result of thermal stress, cracks would appear on the surface of the printed circuit board. These cracks (due to poor quality solder joints), would open when the board got hot. Any of these conditions could lead to intermittent operation or in some cases complete failure of the intermittent function of the wipers.

- **DORMAN® Improvements**

The Dorman® **88136** incorporates several improvements:

- new soldering techniques
- a double sided board with plated through holes
- better terminal solder adhesion
- better resistance to thermal stress

OE Interchange

OE #	Dorman
33326770059	520-746
03544702	624-121
037-905-237-BX	690-174
03AZ 5723395-A	742-250
0446843CZ	674-183
04720-S00-A01	740-736
04725-S00-A01	740-737
0519-052-05C	690-134
OK01134200A	520-810
OK01561710G	620-725
OK1134200A	520-810
OK2AB-15025B	620-711
10041215	674-101
10044282	674-100
10044374	674-101
10044603	635-506
10044869	674-550
10044878	674-583
10045106	674-102
10045298	594-047
10045315	674-157
10045321	674-214
10045702	300-912
10045731	674-267
10045732	674-244
10049009	635-507
10054764	674-210
10054809	264-108
10055524	674-385
10055570	674-516
10066045	594-012
10066046	594-009
10077964	635-502
10078999	264-122
10080391	626-101
10085755	300-200
10093091	674-385
10101160	594-026
10101369	594-027
10101737	635-501
10106046	674-102
1010737	635-501
10108371	955-344
10110837	264-100
10113762	955-129
10113763	955-128
10113834	955-124
10113858	955-126
10113870	955-125
10114663	520-147
10114664	520-148
10114665	520-147
10114666	520-148
10115821	300-123
10122422	955-336
10122423	955-337
10128489	594-107
10131027	264-105
10141212	594-010
10144805	955-131
10145142	626-100
10146863	594-147
10147916	576-374
10151631	264-105
10153517	594-116
10154688	594-170
10166143	674-250
10166144	674-517
10166145	674-537
10166158	674-249
10166335	300-201
10167870	955-041
10167871	955-040
10169576	955-039
10169577	955-038
10171016	674-575
10172764	594-047
10172787	674-385
10172789	264-123

OE #	Dorman
10172857	674-208
10182321	674-544
10182322	674-269
10184901	300-806
10188119	955-122
10188135	955-104
10188140	955-327
10188141	955-326
10188146	955-133
10189219	626-102
10199651	955-092
10205231	624-128
10216338	594-026
10221960	674-390
10223342	674-268
10224885	594-181
10225133	594-116
10230859	674-391
10231120	955-173
10231121	955-172
10231160	955-171
10231161	955-170
10232819	520-117
10232820	520-118
10233403	740-693
10233404	740-692
10243271	594-121
10244605	674-269
10250888	955-308
10250889	955-307
10254786	741-710
10255863	955-309
10255864	955-310
10256558	741-837
10256559	741-838
10260341	625-124
10269713	625-177
10273348	624-126
10273349	624-127
10273666	624-103
10278901	624-128
10280286	955-123
10280287	955-485
10281014	955-132
10284771	955-121
10287315	741-631
10290000	624-102
10301559	520-103
10301560	520-104
10308801	955-058
10308802	955-057
10308803	955-056
10308804	955-055
10309979	741-809
10309979	742-125
10309980	741-810
10309980	742-124
10312052	955-054
10312053	955-053
10315137	741-646
10315138	741-647
10315140	741-837
10315141	741-838
10315144	741-637
10315144	742-124
10315146	741-709
10315147	741-710
10321731	741-837
10321732	741-838
10321733	741-709
10321734	741-710
10330790	576-389
10334396	741-638
10334396	742-125
10334397	741-637
10334397	742-124
10334398	741-709
10334399	741-710
10338859	741-631

OE #	Dorman
10338860	741-630
10344930	520-145
10344931	520-146
10348654	520-103
10348655	520-104
10357004	741-690
10357005	741-691
10360625	741-690
10360626	741-691
10413614	741-837
10413615	741-838
10413617	741-710
10414628	742-120
10414629	742-121
10414630	742-120
10414631	742-121
10419167	620-616
10419167	620-629
10427834/10312887	620-611 M2
10427835	620-611 M2
10427836	620-611 M2
10427837	620-611 M2
10427858	620-611 M2
10433907	955-050
10434728	741-631
10434881	741-638
10434881	742-125
10434883	741-837
10434884	741-838
10434885	741-709
10434886	741-710
10435233	620-616
10435233	620-629
10442010	741-631
10442011	741-630
10442824	741-837
10442825	741-838
10442826	741-709
10442827	741-710
1058279	520-210
1058280	520-209
1103698	690-903
1103749	690-903
1103791	690-903
1103838	690-903
1103880	690-903
1103917	690-900
1103952	690-903
1103976	690-900
1104040	690-901
1104048	690-903
1104051	690-902
1104052	690-901
1104058	690-902
1104059	690-901
1104078	690-900
1104079	690-902
11110-31U10	264-502
11110-77A12	264-500
11200-P08-020	264-402
11200-P2A-000	264-405
11200-P2E-000	264-405
11200-P3F-000	264-407
11200-PAA-A00	264-406
11200-PC6-305	264-400
11200-PD2-000	264-400
11200-PH1-030	264-400
11200PH2010	264-401
11200-PM1-010	264-402
11200-PM3-010	264-402
11200-PM3-020	264-402
11200-PT0-000	264-403
11200-PT0-010	264-403
11302-35010	635-300
11302-38010	635-301
11510-60A01	264-111
11510-71C00	264-110
11510-71C01	264-110
12101-03031	264-305

OE #	Dorman
1210111060	264-304
12101-15070	264-300
12101-16030	264-303
12101-16060	264-301
12101-74111	264-305
12303-0M210	594-143
12303-31U00	594-188
12303-31U10	594-188
12305 AA001	594-174
12305 AA130	594-129
12305 AA210	594-175
12305 AA242	594-129
12305 AA251	594-166
12329552	635-504
1233304607	520-756
1233304707	520-755
12335391	955-486
12335392	955-487
12335393	955-331
12335394	955-330
12339997	594-044
12353384	635-514
12361035	520-129
12361036	520-130
12362507	620-626 M1
12362507	620-628 S
12362508	620-626 M1
12362508	620-628 S
12362564	620-618 M1
12362565	620-618 M1
12362566	620-618 M1
12362567/12362568	620-618 M1
12362571	620-618 M1
12362575	620-601 M1
12362900	742-100
12362901	742-100
12363317	601-117
12363332	602-202
12363370	742-119
12363371	742-118
12363387	620-601 M1
12365300	620-601 M1
12365300	620-603 S
12365300	620-626 M1
12365300	620-628 S
12365327	620-625
12365368	601-119
12365370	620-600 S
12366546	800-153
12367288	620-626 M1
12367288	620-628 S
12368606	601-106
12368625	620-627 S
12368637	620-621 S
12368637	620-641 M1
12368685	601-122
12368695	601-102
12368696	601-116
12368702	601-100
12368703	601-115
12376265	520-137
12376266	520-138
12382562	576-335
12386247	600-902
12387709	628-101
12388064	800-006
12395578	955-342
12395579	955-343
12455112	594-010
12456459	619-002
12463008	620-636 M2
12463009	620-636 M2
12463019	601-104
12463044	742-120
12463045	742-121
12463046	742-121
12463047	742-120
12463067	602-203
12463095	601-118

OE Interchange

* OE component used in multiple assemblies. Please refer to application/ photo section for specific Dorman number. M1 = Motor 1; M2 = Motor 2; S = Shroud; B1 = Blade 1; B2 = Blade 2; O=Other

OE Interchange (continued)

OE Interchange

OE #	Dorman	OE #	Dorman	OE #	Dorman	OE #	Dorman
12472195	625-131	12524289	674-206	13408-74031	594-139	14085401	594-013
12472196	625-132	12524503	264-107	13408-74041	594-139	14085836	576-379
12472199	625-154	12524690	264-100	13408-75030	594-141	14086036	674-102T
12472200	625-155	12527743	264-107	13470-16080	594-182	14087008	300-913
12472217	625-169	12528916	264-100	13470-16090	594-182	14087545	594-010
12472218	625-170	12531283	635-510	13470-35020	594-073	14089825	264-105
12472219	625-125	12543947	520-137	13500-0M301	635-203	14089850	674-583
12472220	625-126	12543948	520-138	13500-0M302	635-203	14091337	576-381
12472221	625-118	12543987	741-844	13500-1E402	635-206	14091896	594-008
12472222	625-119	12543988	741-845	13500-1E404	635-206	14093653	674-231
12472223	625-120	12543997	520-123	13500-30R00	635-204	14093658	674-156
12472224	625-121	12543998	520-124	13500-53401	635-203	14093660	674-158
12472257	625-153	12550120	674-215	13500-53F01	635-203	14093682	674-249
12472258	625-173	12550122	674-211	13500-53Y02	635-202	14094063	674-518
12472259	625-174	12551138	594-017	13500-53Y03	635-202	14094064	674-519
12472260	625-171	12551385	674-238	13500-77A01	635-201	14094065	674-530
12472261	625-172	12551387	674-239	13500-88R00	635-203	14097023	594-010
12472263	625-133	12551443	674-161	13501-40F81	635-205	14097024	594-010
12472264	625-157	12551444	674-159	13789169	620-887	14097258	594-012
12472265	625-134	12551445	674-267	13810-POA-003	594-067	14100630	594-147
12472277	625-108	12551486	594-114	13810-PAA-A01	594-187	14102016	674-156
12472278	625-107	12551537	594-012	13810-PLM-A01	594-192	14102096	300-200
12472279	625-135	12551636	635-508	13810-PT1-003	594-068	14102164	674-213
12472280	625-136	12551948	594-009	14002-14C00	674-220	14103135	674-267
12472281	625-137	12552325	674-216	14002-85E10	674-224	14103191	674-159
12472282	625-111	12552436	594-042	14004-0W000	674-432	14103206	674-158
12472283	625-139	12552437	594-195	14004-12G04	674-223	14111-86501	674-160
12472284	625-140	12553118	594-127	14004-1W600	674-431	14111-86X50	674-160
12472285	625-141	12553146	674-390	14004-2W600	674-432	15001800	955-340
12472286	625-142	12553149	674-391	14004-31U00	674-578	15003923	520-135
12472287	625-158	12553194	674-208	14004-4W000	674-434	15003924	520-136
12472288	625-159	12554258	264-123	14004-61A01	674-181	15017934	576-341
12472289	625-165	12554555	635-502	14004-86G05	674-549	15017939	576-342
12472290	625-164	12554557	635-502	14004-86G06	674-549	15018807	520-141
12472293	625-160	12554973	674-217	14004-86G07	674-549	15018808	520-142
12472294	625-161	12554981	674-446	14004-F4009	674-549	15019340	576-325
12472295	625-162	12555082	674-212	14004-F4402	674-508	15019923	576-344
12472296	625-163	12555596	800-153	14004-F4500	674-589	15023957	800-844
12472299	625-144	12556039	674-573	14004-F4506	674-589	15024357	955-066
12472304	625-110	12556040	674-572	14006-0W000	674-431	15024358	955-067
12472305	625-109	12556041	674-573	14006-12G04	674-440	15024360	955-073
12472306	625-176	12556053	674-569	14006-1W600	674-431	15027937	800-849
12472311	625-102	12556731	674-206	14006-31U00	674-579	15031782	955-043
12472312	625-143	12557345	594-037	14006-4W001	674-433	15031783	955-042
12472313	625-145	12557557	264-107	14006-88G00	674-552	15036007	601-101
12472314	625-114	12557558	264-100	14007400	674-276	15036008	601-115
12472315	625-146	12557828	674-218	14012381	742-100	15036360	955-192
12472316	625-180	12558343	635-505	14012382	742-100	15036361	955-106
12472318	625-181	12558529	300-124	14022671	594-128	15036362	955-105
12472320	625-138	12560115	594-115	14026581	520-113	15037957	955-068
12474041	600-906	12560937	674-215	14026582	520-114	15037958	955-069
12474401	600-901	12561164	674-570	14027431	740-651	15043152	741-844
12475479	520-127	12562235	674-522	14027432	740-650	15043153	741-845
12475480	520-128	12562236	674-525	14033699	742-100	15043741	800-603
12475485	520-116	12562333	674-525	14033700	742-100	15047200	520-116
12478067	520-125	12562818	635-505	14034069	674-245	15047905	955-060
12478068	520-126	12563267	594-004	14039009	520-119	15047906	955-061
12478096	600-907	12563268	594-122	14039010	520-120	15049881	520-150
12481873	742-133	12564157	674-525	14039547	630-102	15051890	624-130
12481874	742-132	12564159	674-522	14041678	576-328	15051892	624-131
12481875	742-135	12564161	674-525	14045181	674-162	15051894	624-168
12481876	742-134	12571678	674-522	14045182	674-163	15051895	624-104
12487606	620-636 M2	12571679	674-522	14048362	674-244	15051898	624-132
12487630	742-100	12573728	300-200	14050233	674-278	15051900	624-133
12487666	740-654	12589753	594-042	14050282	674-198	15053195	624-201
12494758	601-117	1263300607	520-757	14050684	576-312	15053198	624-100
12494790	601-119	1263300707	520-758	14050685	576-320	15053983	601-119
12494825	602-205	12740411	620-880 S	14056095	742-100	15062880	955-094
12497971	742-100	12740429	620-880 S	14056096	742-100	15062881	955-095
12509037	635-507	12740452	620-880 S	14067365	674-197	15062885	955-070
12512994	742-100	1274496	620-886 B1	14068667	674-531	15062886	955-071
12513704	264-119	1274497	620-886 B1	14071750	630-105	15065206	625-166
12513961	635-512	1275801-7	594-159	14077878	264-121	15068498	746-011
12523197	674-268	13101722	594-153	14079296	674-245	15074199	625-151
12523972	635-505	13408-20010	594-140	14081202	594-047	15074201	625-152
12523973	635-505	13408-38010	594-073	14082324	594-142	15074204	625-175
12523974	635-509	13408-65011	594-078	14083394	594-020	15077853	741-644
12524201	520-120	13408-74010	594-138	14083448	264-103	15077854	741-645
12524204	520-119	13408-74020	594-138	14084343	300-121	15080913	520-143

*OE component used in multiple assemblies. Please refer to application/ photo section for specific Dorman number. M1 = Motor 1; M2 = Motor 2; S = Shroud; B1 = Blade 1; B2 = Blade 2; O=Other

OE Interchange (continued)

OE #	Dorman	OE #	Dorman	OE #	Dorman	OE #	Dorman
15080914	520-144	15601876	576-346	15746784	601-103	16363-11080	620-527 ^S
15095067	741-690	15615624	576-313	15748403	624-106	16363-16010	620-513 ^S
15095068	741-691	15615625	576-349	15753773	625-167	16363-22010	620-511 ^{M2}
15095843	741-644	15622861	800-401	15755430	741-645	16363-23030	620-525 ^S
15095843	742-122	15624668	576-336	15755431	741-644	16363-64030	620-505 ^{B1}
15095844	741-645	15633889	576-318	15757070	625-122	16363-74020	620-500 ^S
15095844	742-123	15633890	576-390	15757186	955-072	16363-74170	620-529 ^S
15096844	625-129	15633891	576-343	15757371	315-100	16363-74180	620-528 ^{B1}
15096851	625-106	15636251	576-316	15759292	625-105	16363-74190	620-530 ^{B1}
15096854	625-130	15636696	600-900	15760333	625-100	16363-74360	620-522 ^{M1}
15099936	601-123	15637916	955-093	15760334	625-001	1640145	300-911
15101785	741-644	15638098	800-005	15764375	625-105	1643063	576-360
15101785	742-122	15638950	576-317	15764757	955-191	1643064	576-360
15101786	741-645	15642506	626-103	15765392	741-645	1649753	624-161
15101786	742-123	15642571	955-181	15765393	741-644	1649754	624-160
15104801	625-113	15642572	955-182	15765439	625-168	16590-1W600	674-433
15104802	625-112	15642573	955-185	15777768	520-142	16603085	746-014
15110013	520-150	15642574	955-186	15953702	625-127	16607732	746-011
15110505	746-017	15650373	603-100	15953703	625-128	16621658	740-683
15110506	746-011	15650656	576-345	15976889	620-602	16621659	740-682
15110507	746-017	15659269	576-329	15977933	955-193	16622779	742-101
15110508	746-011	15659270	576-333	15977934	955-194	16624970	746-011
15110509	746-017	15661507	520-139	15978416	624-148	16624971	746-017
15110510	746-011	15661508	520-140	15982250	625-104	1662796202	742-103
15110641	746-017	15662021	576-317	15982251	625-103	16627972	746-011
15110643	746-017	15662022	576-315	15985758	625-179	16627973	746-017
15110645	746-011	15662731	576-382	15985759	625-149	16628208	742-105
15110646	746-017	15665554	520-121	15985760	625-150	16628740	742-110
15110647	746-011	15665555	520-122	15996516	625-101	16628741	742-111
15110650	746-011	15668728	741-845	15996517	625-123	16629278	742-100
15110651	746-017	15675113	955-183	15996928	625-105	16629282	741-759
15112870	625-123	15675114	955-184	16124922	604-100	16629470	740-693
15112871	625-101	15691507	800-603	16141802	604-102	16629471	740-692
15128149	741-844	15695619	800-843	16149192	604-103	16629726	315-103
15149849	576-372	15695639	800-840	16307-62011	300-802	16629727	315-102
15150849	955-305	15697329	955-475	16307-65020	300-800	16629834	742-113
15150850	955-306	15697331	955-187	16307-65030	300-801	16629835	742-112
15150851	955-301	15697332	955-188	16307-65040	300-801	16630576	742-105
15150852	955-302	15697335	955-051	16331090	740-835	16630577	742-104
15151117	955-062	15697336	955-052	16361-03070	620-522 ^{M1}	16630578	742-105
15151118	955-063	15700037	955-189	16361-0A010	620-504 ^{M1}	16630579	742-104
15151119	955-090	15703401	955-064	16361-0A020	620-503 ^S	16632014	746-011
15151120	955-091	15703402	955-065	16361-0A030	620-520 ^{B1}	16632015	746-017
15152623	625-106	15703982	800-840	16361-0A120	620-516 ^S	16632436	740-835
15155113	741-690	15705143	741-844	16361-0A120	620-523 ^{B1}	16632437	740-836
15158526	625-112	15705144	741-845	16361-0A120	620-532 ^{B1}	16633098	740-835
15158540	625-148	15711939	955-339	16361-0A130	620-515 ^{M1}	16633099	740-836
15158541	625-113	15711940	955-338	16361-0A130	620-524 ^S	16636174	740-835
15158542	625-147	15718023	800-603	16361-0A130	620-532 ^{B1}	16636175	740-836
15172059	955-075	15719695	800-605	16361-0D020	620-511 ^{M2}	16636560	746-011
15194577	625-122	15719697	800-606	16361-0H010	620-531 ^{M1}	16636574	746-011
15194578	625-100	15721309	576-350	16361-0H020	620-531 ^{M1}	16636575	746-017
15194579	625-001	15721551	576-385	16361-11020	620-500 ^S	16636616	741-658
15203890	625-168	15722264	800-846	16361-11020	620-526 ^{M1}	16636617	741-659
15205950	741-690	15722290	800-848	16361-20030	620-519 ^S	16637841	746-017
15205951	741-691	15722291	800-842	16361-23050	620-525 ^S	16640084	746-011
15216918	520-134	15722293	800-854	1636162010	620-534	16711-02014	620-532 ^{B1}
15216919	520-133	15722295	800-852	16361-63020	620-505 ^{B1}	16711-0A010	620-504 ^{M1}
15217436	520-101	15722320	800-853	16361-64030	620-529 ^S	16711-0A020	620-503 ^S
15217437	520-102	15723417	624-134	1636165020	620-535	16711-0A080	620-516 ^S
15218046	741-760	15723421	624-135	16361-74010	620-513 ^S	16711-0A130	620-523 ^{B1}
15218050	741-759	15723501	576-331	16361-74060	620-501 ^{B1}	16711-0A140	620-524 ^S
15218051	741-758	15723937	576-384	16361-74060	620-518 ^S	16711-0A160	620-515 ^{M1}
15218059	741-757	15724728	800-607	16361-74070	620-527 ^S	16711-0D010	620-511 ^{M2}
15240529	741-631	15725302	576-386	1636175020	620-533	16711-0H030	620-531 ^{M1}
15240530	741-630	15726903	625-100	16363-0A011	620-504 ^{M1}	16711-11260	620-527 ^S
15255016	746-011	15728599	576-324	16363-0A020	620-503 ^S	16711-11270	620-526 ^{M1}
15255017	746-017	15730171	625-001	16363-0A030	620-520 ^{B1}	16711-15240	620-505 ^{B1}
15293048	622-001	15731530	576-330	16363-0A040	620-519 ^S	16711-15270	620-500 ^S
15298272	520-143	15733310	576-383	16363-0A050	620-515 ^{M1}	16711-20050	620-520 ^{B1}
15298273	520-144	15733866	625-178	16363-0A050	620-523 ^{B1}	16711-20060	620-519 ^S
15522287	576-393	15738129	625-182	16363-0A060	620-524 ^S	16711-21030	620-525 ^S
15532457	955-341	15738138	625-183	16363-0A090	620-516 ^S	1671174110	620-513 ^S
15548961	576-321	15739936	800-401	16363-0A100	620-532 ^{B1}	16711-74410	620-501 ^{B1}
15548967	576-302	15745473	624-146	16363-0D010	620-511 ^{M2}	16711-74540	620-529 ^S
15585421	628-100	15745475	624-137	16363-11020	620-501 ^{B1}	16711-74610	620-518 ^S
15589753	594-037	15745476	624-156	16363-11050	620-517 ^S	16711-74611	620-522 ^{M1}
15595742	603-101	15745477	624-109	16363-11050	620-518 ^S	16711-74620	620-517 ^S
15601704	800-402	15745509	955-074	16363-11070	620-526 ^{M1}	1710063BIOS	620-768 ^{M1}

OE Interchange

* OE component used in multiple assemblies. Please refer to application/ photo section for specific Dorman number. M1 = Motor 1; M2 = Motor 2; S = Shroud; B1 = Blade 1; B2 = Blade 2; O=Other

OE Interchange (continued)

OE Interchange

OE #	Dorman
17104-0D020	674-546
17104-22010	674-546
1711184010	620-768 M1
17113044	615-179
17113136	615-180
17113541	615-181
17113542	615-182
171136201	615-300
17113697	615-183
17120 71C10	620-768 M1
17141-16200	674-251
17141-16220	674-164
17141-16221	674-164
17141-16290	674-556
17141-19015	674-164
17141-19016	674-164
17141-35080	674-272
17141-35100	674-272
17141-35140	674-272
17141-74130	674-469
17141-75030	674-464
1719362	746-014
1719363	746-014
1720216E00	576-809
1720242E00	576-810
1720261G00	576-814
17500SE0A06	576-606
17500SE0A36	576-607
17500SK7A33	576-604
17500SM4Y32	576-608
17700-07041	258-501
17700-07060	258-504
17700-0C010	258-500
17700-0C020	258-500
17760 63B00	620-768 M1
17881174640	696-702
1788162040	696-701
17881-65011	696-703
17881-65020	696-703
1788174390	696-700
18000-POA-000	674-509
18021519	619-001
18100-P08-000	674-512
18100-P2J-000	674-512
18100-PEM-G00	674-512
18100-PM6-307	674-545
18100-PM6-H00	674-545
18100-PT3-A00	674-529
18160-P2E-A00	674-439
18160-P2E-A10	674-439
18160-P2E-A12	674-439
18160-P2E-A21	674-439
18160-P2E-A22	674-439
18160-P2E-L00	674-439
1859760	674-189
1871009	602-204
19000-PLF-513	620-219 S
19005-P08-003	620-204 S
19005-PAA-A01	620-227 B1
19005-PE1-013	620-213 M1
19005-PM3-003	620-215 M1
19005-PP1-003	620-223 S
19015-P08-003	620-204 S
19015-P08-003	620-217 S
19015-POA-003	620-200 S
19015-P3F-004	620-230 M1
19015-P72-003	620-206 B1
19015-P8C-A01	620-226 B1
19015-PAA-A01	620-227 B1
19015-PE0-023	620-213 M1
19015-PH4-667	620-221 B1
19015-PM3-004	620-215 M1
19015-PM6-A51	620-219 S
19015-PR3-906	620-208 B1
19015-PT0-003	620-223 S
19016-POA-004	620-200 S
19020-	620-217 S
19020-16280	690-137
19020-P08-003	620-204 S

OE #	Dorman
19020-P08-003	620-221 B1
19020-P5M-004	620-230 M1
19020-P8C-A01	620-226 B1
19020-PAA-	620-227 B1
19020-PE0-003	620-213 M1
19020-PK1-901	620-223 S
19020-PLC-003	620-219 S
19020-PLC-003	620-531 M1
19020-PM3-003	620-215 M1
19020-PM3-004	620-208 B1
19020-PT0-003	620-200 S
19020-PT0-003	620-206 B1
19030-16140	690-132
19030-P08-013	620-204 S
19030-P080-13	620-206 B1
19030-P3F-024	620-230 M1
19030-P8C-A01	620-226 B1
19030-PAA-A01	620-219 S
19030-PAA-A01	620-227 B1
19030-PE0-663	620-213 M1
19030-PEJ-003	620-217 S
19030-PH7-003	620-221 B1
19030-PM3-003	620-215 M1
19030-PR4-A02	620-208 B1
19030-PT0-003	620-200 S
19030-PT0-003	620-223 S
19040-74031	690-115
19040-74040	690-115
19050-16030	690-117
19050-74010	690-114
19050-74030	690-114
19050-74040	690-114
19050-74050	690-114
19100-62020	690-125
19100-62030	690-125
19100-65010	690-167
1C0 121 206A/	
1C0 121 206B	620-773 S
1C0 121 207C	620-773 S
1C0 959 455	620-773 S
1C2Z 1523200-AA	741-853
1C2Z 1523200-AA	742-235
1C2Z 1523201-AA	741-852
1C2Z 1523201-AA	742-234
1F01-10-400	264-014
1F1Z 6A312-AA	594-050
1F1Z 9431-AA	674-363
1F1Z9002HA	576-141
1F1Z-9S278-AD	600-859
1F24-17-645A	600-807
1F24-17-645B	600-807
1F2Z 3078-AA	520-253
1F2Z 3079-AA	520-253
1F2Z 7D273-AA	800-601
1F2Z17682GAA	955-469
1F2Z17683GAA	955-470
1H0 837 461A	740-826
1H0 837 462A	740-825
1H0-121-109G	624-901
1H0959653E	525-700
1H185750701C	955-445
1J0 407 151C	520-760
1J0 959 445T	620-773 S
1J0-121-058AC	624-900
1J0959653C	525-701
1J1857507D01C	955-443
1J1857508K01C	955-444
1K2A1-61710A	620-710
1L2Z 7823394-BC	742-238
1L2Z 7823395-BB	742-236
1L2Z 7823395-BC	742-239
1L2Z17682AAA	955-045
1L2Z17682BAA	955-047
1L2Z17682CAA	955-049
1L2Z17683AAA	955-044
1L2Z17683BAA	955-046
1L2Z17683CAA	955-048
1L3Z14A664AA	525-213
1L5Z 3078-AA	520-240

OE #	Dorman
1L5Z 3079-AA	520-239
1L5Z 7G360-CA	600-807
1L5Z 7G360-CB	600-807
1L5Z 9431-AA	674-447
1M5Z-9I291-AA	800-855
1R3Z 7623394-AA	742-221
1R3Z 7623395-AA	742-220
1S4Z 8C607-AA	620-126
1S4Z 8C607-AC	620-126
1S4Z 8C607-AD	620-126
1S4Z17682LAA	955-472
1S4Z17683LAA	955-471
1W1Z 5423208-AA	740-687
1W1Z 5423209-AA	740-686
1W1Z 5423394-AA	742-216
1W1Z 5423395-AA	742-217
1W1Z 5427008-AA	740-689
1W1Z 5427009-AA	740-688
1W1Z 8C607-AA	620-121
1W1Z 5423208-AA	740-665
1W1Z 5423209-AA	740-664
1W1Z 5423394-AA	742-252
1W1Z 5423394-BA	742-253
1W1Z 5423395-AA	742-253
1W1Z 5423395-BA	742-252
1W7Z9424AA	615-175
1W7Z9424AAA	615-175
1W7Z9424AB	615-175
1W7Z9424BA	615-175
20021912	746-014
20021913	746-014
20030445	742-100
20105348	742-100
20105349	742-100
20105350	742-100
20113632	955-130
2015646AB	698-100
20201150	742-100
20201151	742-100
20220048	742-100
20294111	955-127
20299831	742-100
20325087	742-100
20329501	742-100
20421231	742-100
20421232	742-100
20432632	746-014
20435573	742-100
20435574	742-100
20474092	746-014
20474093	746-014
20606301	742-100
20710114	746-014
20710115	746-014
20744294	955-318
21007717	594-190
21010856	520-151
21010857	520-152
21031513	620-767 B1
21055768	601-120
21096065	955-395
21096082	955-393
21096099	955-394
21096372	955-398
21096373	955-396
21096374	955-397
21097596	955-402
21097597	955-405
21097598	955-401
21170584	955-403
21170588	955-404
21170589	955-399
21170590	955-400
2132-2B001	624-505
21481-0B010	620-413
21481-0B011	620-413
21481-0B070	620-111
21481-0Z001	620-415
21481-0Z801	620-415

OE #	Dorman
21481-1B000	620-127
21481-2L700	620-420
21481-36A67	620-402
21481-38U00	620-400
21481-51C86	620-405
21481-57A13	620-404
21481-5B600	620-401 B2
21481-60Y10	620-406
21481-62J00	620-417 S
21481-6M100	620-409
21481-6M110	620-410
21481-79R00	620-406
21481-8J100	620-419
21481-96E01	620-411
21481-96E10	620-411
21481-CA000	620-412
21483-2B500	620-401 B2
21483-79N00	620-417 S
21483-79N10	620-418 M1
21486-1E400	620-401 B2
21486-1E410	620-401 B2
21486-5E300	620-418 M1
21486-58Y00	620-417 S
21487-5B600	620-401 B2
21487-60Y00	620-417 S
21510-24000	264-202
21510-24001	264-203
21631-2B001	624-501
21631-2B001	624-504
21631-31U10	624-503
21632-2B001	624-500
21632-31U10	624-502
22010458	742-100
22020256	746-014
22020291	742-100
22020900	742-100
22021670	742-100
22029187	742-100
22029188	742-100
22029191	742-100
22029192	742-100
22029595	601-108
22029848	742-100
22030651	742-100
22030652	742-100
22030652	742-150
22039328	601-111
22039707	742-100
22039929	742-100
22048034	742-100
22048553	742-100
22049815	601-107
22049816	601-109
22054198	601-111
22054201	601-105
22062528	742-100
22062567	742-108
22062568	742-109
22062740	746-014
22062913	601-109
22062915	601-107
22063224	742-105
22063296	742-106
22063297	742-107
22071769	601-101
22071770	601-100
22071946	746-014
22071947	746-014
22071948	740-654
22071949	740-655
22072787	601-114
22072788	601-110
22072789	601-111
22072790	601-112
22073443	742-108
22073444	742-109
22087325	742-103
22087326	742-102
22087327	742-100

*OE component used in multiple assemblies. Please refer to application/photo section for specific Dorman number. M1 = Motor 1; M2 = Motor 2; S = Shroud; B1 = Blade 1; B2 = Blade 2; O = Other

OE Interchange (continued)

OE #	Dorman	OE #	Dorman	OE #	Dorman	OE #	Dorman
22087328	742-100	22514722	800-013	22710850	520-134	25001613	692-089
22094407	742-110	22516256	800-013	22710851	520-133	25002006	692-080
22094408	742-111	22519891	630-113	22723561	740-821	25002007	692-026
22098786	620-622 ^S	22522648	635-504	22723562	740-822	25002009	692-042
22098790	620-614 ^{B1}	22523080	576-364	22723575	746-011	25002010	692-006
22098790	620-615 ^{M1}	22527443	576-376	22723576	746-017	25002019	692-093
22098793	620-624 ^{M1}	22527443	576-377	22728844	955-312	25002211	692-068
22099170	620-622 ^S	22527471	800-881	22728846	955-311	25002212	692-057
22099171	620-622 ^S	22528784	800-883	22730702	741-815	25002511	692-099
22100-0M200	690-133	22528785	800-882	22730702	742-126	25003257	692-082
22100-0M220	690-133	22538921	264-101	22730703	741-816	25003258	692-081
22100-0M300	690-133	22542026	746-014	22730703	742-127	25003302	692-069
22100-1E400	690-121	22542027	746-014	23124-22000	594-069	25003303	692-083
22100-1E420	690-121	22552574	576-361	23124-22001	594-070	25003520	692-076
22100-1E420RE	690-121	22570241	955-109	23124-22020	594-052	25004085	692-081
22100-78A00	690-113	22570242	955-110	23124-22030	594-052	25004154	692-045
22100-9E001RE	690-173	22579750	624-198	23124-24010	594-054	25004158	692-058
22101637	601-104	22579792	624-199	23124-26010	594-053	25004172	692-084
22102019	742-101	22591230	955-108	23124-26011	594-053	25026732	692-095
22110871	601-113	22591231	955-107	23124-33111	594-055	25026816	692-053
22110872	601-114	22593838	955-323	23129-35010	594-071	25026821	692-032
22115157	620-621 ^S	22593839	955-322	2373110Y00	689-305	25027046	692-096
22115158	620-621 ^S	22593855	955-320	2373160U13	689-307	25027211	692-011
22121186	601-103	22603952	520-132	2373167U01	689-308	25027290	692-010
22121553	742-100	22603953	520-131	2373197E05	689-306	25027332	692-047
22121967	601-102	22605939	955-100	24005834	620-767 ^{B1}	25027414	692-130
22122774	746-011	22605940	955-099	24205102	800-604	25027459	692-097
22122794	742-108	22605941	955-098	24404446	742-117	25027490	692-050
22123863	620-615 ^{M1}	22605942	955-316	24404447	742-116	25027547	692-029
22125855	620-627 ^S	22605943	955-317	24405464	742-115	25027568	692-013
22125855	620-641 ^{M1}	22605944	955-333	24405465	742-114	25027572	692-048
22126185	620-637 ^O	22605945	955-332	24416188	742-115	25027657	692-124
22134154	620-623	22605946	955-331	24416189	742-114	25027758	692-052
22134671	620-615 ^{M1}	22605947	955-330	24500171	674-526	25027771	692-046
22134777	620-614 ^{B1}	22611124	520-101	24500781	594-044	25028124	692-103
22134817	620-641 ^{M1}	22611125	520-102	24501201	594-005	25028199	692-070
22135857	620-637 ^O	22611133	520-131	24501515	635-514	25028222	692-059
22136414	620-601 ^{M1}	22611134	520-132	24501985	594-044	25028229	692-088
22136898	620-767 ^{B1}	22613016	955-321	24502130	674-526	25028282	692-014
22136922	620-603 ^S	22613584	955-001	24502174	594-161	25028327	692-036
22137100	620-624 ^{M1}	22613585	955-000	24502175	594-087	25028349	692-015
22137318	620-600 ^S	22617055	576-362	24502176	594-034	25028359	692-002
22137318	620-603 ^S	22619442	741-640	24502380	674-577	25028383	692-125
22137318	620-614 ^{B1}	22619443	741-641	24503065	594-034	25028386	692-001
22137318	620-624 ^{M1}	22619446	741-643	24503067	594-087	25028499	692-001
22137318	620-626 ^{M1}	22619447	741-642	24503311	674-540	25028501	692-055
22137318	620-628 ^S	22621946	741-757	24503557	264-106	25028611	692-000
22137319	620-637 ^O	22621947	741-758	24503681	800-401	25028613	692-020
22137329	620-627 ^S	22621948	741-759	24503682	800-401	25028674	692-127
22137782	601-116	22621949	741-760	24503783	264-105	25028713	692-060
22137979	742-101	22645913	624-138	24503918	674-541	25028811	692-035
22138298	601-114	22645914	624-139	24503920	674-568	25028842	692-025
22138706	742-121	22645919	620-600 ^S	24504379	674-540	25028845	692-004
22138765	742-102	22652876	955-312	24504609	594-148	25028889	692-007
22143945	742-104	22652877	955-311	24504611	594-008	25028896	692-009
22143946	742-105	22656480	742-130	24504719	264-105	25028941	692-028
22143947	742-104	22656481	742-131	24504737	594-004	25028982	692-030
22143948	742-105	22658100	955-319	24504739	594-122	25029738	692-031
22144260	742-100	22658134	955-314	24506309	674-567	25029911	692-077
22144360	746-011	22658135	955-313	24507414	594-161	25031740	600-102
22144361	746-017	22677167	740-821	24507481	674-541	25051-28260	674-593
22144362	746-011	22682244	742-116	24507558	594-004	25055052	800-153
22144363	746-017	22682245	742-117	24507560	594-122	25055083	800-153
22154371	742-100	22683777	741-816	24570333	264-102	25090066	692-075
22154666	742-113	22683777	742-127	24571250	264-102	25090084	692-098
22154667	742-112	22683778	741-815	24573015	594-043	25090465	692-040
22154965	601-119	22683778	742-126	24574643	696-101	25090837	692-044
22154977	742-104	22694616	740-822	24575562	594-043	25090846	692-027
22154978	742-105	22697440	741-643	24577258	674-571	25090855	692-056
22154979	742-104	22697441	741-642	24577409	674-400	25091657	692-066
22154980	742-105	22702131	742-126	2477954	300-120	25092098	692-092
22155408	742-106	22702132	742-127	25000599	692-051	25092134	692-040
22155409	742-107	22702135	742-128	25000610	692-073	25092346	692-021
22155684	742-121	22702136	742-129	25000611	692-078	25092349	692-021
22504959	630-114	22702137	741-642	25000612	692-043	25092710	692-041
22506477	630-113	22702138	741-643	25000613	692-079	25092727	692-012
22506730	594-028	22702139	742-118	25001484	692-054	25092751	692-091
22511383	576-373	22702140	742-119	25001486	692-093	25092972	692-067
22511894	576-326	22702141	741-641	25001612	692-049		

* OE component used in multiple assemblies. Please refer to application/
photo section for specific Dorman number. M1 = Motor 1; M2 = Motor 2;
S = Shroud; B1 = Blade 1; B2 = Blade 2; O=Other

OE Interchange

OE Interchange (continued)

OE Interchange

OE #	Dorman
25093299	692-086
25093316	692-085
25093484	692-102
25093498	692-102
25093511	692-091
25093521	692-024
25093773	692-016
25093783	692-016
25093908	692-017
25093914	692-008
25093914	692-045
25093919	692-100
25093924	692-005
25094100	692-010
25094114	692-003
25094539	692-033
25094553	692-034
25094609	692-129
25094633	692-094
25094740	692-023
25098669	696-100
25121537	800-153
25121587	800-153
25121598	800-153
25121757	800-153
25121792	800-153
25121915	800-153
25161153	692-101
25162242	692-087
25162587	692-070
25162589	692-059
25162589	692-070
25168316	692-126
25171792	800-153
25178860	692-074
25178861	692-074
25178862	692-130
25178863	692-128
25210P4R000	624-602
25220P4R000	624-603
25231-	620-812 ^{M1}
25231-24000	620-718 ^{M1}
25231-24000	620-719 ^{M1}
25231-24000	620-777 ^S
25231-25000	620-810 ^S
25231-29000	620-720 ^{B1}
25231-38000	620-716 ^S
25312064	576-388
25320900	576-358
25328266	576-387
25350-222000	620-714 ^S
25350-24000	620-777 ^S
25350-25000	620-810 ^S
25350-28100	620-718 ^{M1}
25350-29000	620-720 ^{B1}
25350-2D000	620-812 ^{M1}
25350-38000	620-716 ^S
25380-22200	620-777 ^S
25380-29000	620-720 ^{B1}
25380-38010	620-718 ^{M1}
25386-22020	620-714 ^S
25386-24000	620-777 ^S
25386-25001	620-810 ^S
25386-28000	620-718 ^{M1}
25386-29000	620-720 ^{B1}
25386-2D000	620-812 ^{M1}
25386-38050	620-716 ^S
25391-24000	620-776 ^{B1}
25391-28000	620-719 ^{M1}
25504959	630-114
25515465	635-503
25522653	635-504
25527166	624-112
25527167	624-113
25527381	594-003
25527547	576-337
25528623	800-880
25532179	594-150
25533256	624-108

OE #	Dorman
25533258	624-140
25533260	624-107
25533480	594-044
25533850	624-110
25533851	624-157
25533852	624-111
25534911	594-005
25535485	594-001
25551197	955-315
25623918	624-142
25624176	624-144
25624842	576-340
25658710	624-136
25660782	624-151
25663931	624-150
25664019	746-011
25664020	746-017
25664287	746-011
25664288	746-017
25698790	800-606
25713422	741-762
25715115	741-812
25715116	741-811
25743672	741-818
25750513	741-762
25750514	741-817
25750518	741-812
25750519	741-811
25769927	741-761
25769928	741-762
25910PAX000	624-600
25920PAX000	624-601
26010414	630-104
26010415	630-107
26010416	630-101
26010417	630-106
26011055	630-109
26013313	630-100
26013495	600-100
26013882	630-103
26014036	630-116
26014037	630-115
26014038	630-118
26015260	630-112
26015580	630-109
26018079	630-118
26018080	630-117
26019539	630-119
26042818	630-108
26047182	630-110
26050549	630-111
26060073	600-101
26087272	525-003
26087273	525-006
26096190	525-005
2802763	742-301
2802787	742-301
2802788	742-300
2802789	742-301
2808763	742-301
2808764	742-300
2808765	742-301
2808766	742-301
28510-22680	674-596
28510-23430	674-551
28510-23431	674-551
28511-21321	674-172
28511-23052	674-507
288414B000	602-003
288415B6000	602-007
2884188E00	602-001
28841D9000	602-005
288424B0000	602-004
2884285E00	602-002
28842D9000	602-006
289102B100	603-601
2891040U00	603-600
2925975	742-300
2951671	635-400

OE #	Dorman
2951841	674-232
2999326	742-300
2999327	742-301
2999332	742-301
2999333	742-301
2999334	742-300
2999335	742-301
2999336	742-300
2999337	742-301
2999338	742-300
2999339	742-301
2C2Z9002FA	576-143
2F1Z-9S278-AA	800-860
2L1Z 7G360-AB	600-806
2L1Z 9429-CA	674-460
2L2Z 3078-BA	520-224
2L2Z 3079-BA	520-223
2L3Z 3078-AB	520-220
2L3Z 3079-AB	520-219
2L3Z 6019 CA	635-105
2L3Z-3A733-AB	300-006
2L5Z 3082-AA	520-222
2L5Z 3083-AA	520-221
2L5Z 9431-AA	674-447
2L8Z 8C607-GA	620-132
2M5Z 6312-AA	594-118
2W1Z 5427009-AA	740-688
2W7Z 5427009-AA	740-679
30000151	692-019
3004125	742-301
3004126	742-300
30100-P06-A02	690-102
30100-P08-006	690-103
30100-P0A-A02	690-168
30100-P0B-A01	690-153
30100-P0J-A01	690-138
30100-P12-A01	690-105
30100-P14-A01	690-106
30100-P2E-A01	690-120
30100-P2E-A11	690-162
30100-P2T-004	690-154
30100-P30-006	690-104
30100-P3F-A02	690-129
30100-P6T-T01	690-130
30100-P72-006	690-104
30100-P73-A02	690-155
30100-P75-A03	690-131
30100-PAA-A02	690-169
30100-PM5-A04	690-111
30100-PM5-A07	690-100
30100-PM6-026	690-108
30100-PM6-046	690-108
30100-PM6-A04	690-110
30100-PM7-056	690-107
30100-PR4-A03	690-119
30100-PR4-A05	690-119
30100-PR4-A12	690-109
30100-PR4-A53	690-118
30100-PR4-A55	690-118
30100-PT3-A03	690-101
30100-PT3-A12	690-105
30100-PT3-A72	690-101
3080699	746-014
309222C1	674-187
31121092609	520-737
31121092610	520-738
31121108384	520-722
31121108385	520-721
31121123025	520-725
31121123026	520-726
31121127725	520-731
31121127726	520-732
31121129362	520-727
31121129363	520-728
31121132353	520-729
31121132354	520-730
31121139987	520-733
31121139988	520-734
31121139991	520-734

OE #	Dorman
31121139992	520-733
31121141097	520-735
31121141098	520-736
31121142087	520-743
31121142088	520-744
31126758513	520-740
323518C12	674-188
3237426	674-237
3237427	674-237
3242625	674-225
32921-06010	624-402
32921-06080	624-400
32921-12291	624-404
32921-32051	624-403
32922-06010	624-401
32922-12291	624-405
33002509	674-225
33002509	674-225
33002920	594-018
33002920AC	594-018
33007072	674-196
330849	594-010
330850	635-511
33100-71C30	690-136
3310077E20	689-300
33321090031	520-741
33321095042	520-742
33326770060	520-746
3367110	674-203
343787	674-159
3454240	742-300
3454241	742-301
346222	674-202
3462334	264-210
3481060A11	692-019
3481070E20	692-019
3508206	742-300
3508207	742-301
352153	594-029
35400910	620-881
3548364	742-303
3548365	742-302
3548746	742-300
3548747	742-301
3586312	742-300
3586313	742-301
3586742	742-300
3586743	742-301
3614369	594-021
3635350	746-017
3635351	746-011
3671860	674-232
372243	674-501
3726808	742-300
3726809	742-301
3743078	742-300
3743079	742-301
3744827	674-232
3744830	674-232
3749965	674-502
375312	576-391
3760246	742-303
3760247	742-302
3760528	742-300
3760529	742-301
3760586	742-303
3760587	742-302
37611-PD2-661	620-222 ^{M1}
3769103	674-176
3769109	674-176
3769964	635-400
3797901	674-504
3814970	674-503
3830481	594-021
3846559	674-500
3857352	594-031
3860008	594-030
3860010	594-113
38605-PAA-A01	620-229 ^S

* OE component used in multiple assemblies. Please refer to application/ photo section for specific Dorman number. M1 = Motor 1; M2 = Motor 2; S = Shroud; B1 = Blade 1; B2 = Blade 2; O = Other

OE Interchange (continued)

OE #	Dorman
38605-PC0-G01	620-201 M1
38605-PLC-J013	620-220 M1
3861077	742-302
3861106	742-300
3861107	742-301
38611-P8C-A01	620-218 M1
38611-P8C-A01	620-228 S
38611-P8F-A01	620-231 S
38611-PAA-A01	620-229 S
38611-PK1-003	620-209 M1
38611-PMM-A01	620-220 M1
38611-PT2-J02	620-201 M1
38611-PT2-J02	620-207 B1
38611-PT2-J02	620-224 S
38611-SB2-013	620-214 S
38612-SB2-033	620-214 S
3861465	742-302
38615-POA-000	620-201 M1
38615-P72-000	620-207 B1
38615-P8C-A00	620-228 S
38615-P8F-A00	620-231 S
38615-PAA-A00	620-229 S
38615-PH4-660	620-222 M1
38615-PMM-C00	620-220 M1
38615-PR3-020	620-209 M1
38615-PT3-A00	620-224 S
38615-SB2-040	620-214 S
38616-P8C-A01	620-228 S
38616-P8F-A01	620-231 S
38616-PAA-A01	620-229 S
38616-PH4-661	620-209 M1
38616-PH4-661	620-222 M1
38616-PMM-A01	620-220 M1
38616-PT3-A03	620-201 M1
38616-PT3-A03	620-207 B1
38616-PT3-A03	620-224 S
3870088	300-930
3871148	742-300
3871149	742-301
38791089135	955-215
3879720	674-233
3880834	674-505
3882138	742-303
3882150	742-303
3882151	742-302
3882152	742-303
3882164	742-300
3882165	742-301
3882240	742-300
3882241	742-301
3882288	742-300
3882289	742-301
3882738	742-300
3882739	742-301
3885048	635-511
3896590	594-014
3905364	674-199
3931033010	689-303
3932469	674-201
3937731	635-511
3963529	594-010
3963530	594-010
3969923	674-506
3A0 837 461	740-805
3A0 837 462	740-806
3F1Z 8C607AA	620-106
3F1Z 8C607-EA	620-105
3F1Z8A080EA	603-201
3F2Z 9431-CA	674-367
3L2Z 7823208-AA	740-672
3L2Z 7823209-AA	740-673
3L5Z 1023208-AA	740-832
3L5Z 1023209-AA	740-831
3L5Z 1523394-BA	742-245
3L5Z 1523395-BA	742-244
3L5Z 3078-AA	520-240
3L5Z 3079-AA	520-239
3L5Z 3083-AA	520-221
3L5Z 3084-AA	520-222

OE #	Dorman
3L5Z 3084-DA	520-237
3L5Z 3085-DA	520-238
3W1Z 5423394-AA	742-216
3W1Z 5423395-AA	742-217
3W1Z-7A030-AA	624-252
3W7Z 5427008-AA	740-678
3W7Z-6A715-AA	625-200
4041261	674-234
4041468	674-275
4071609	674-275
4095633	594-021
41001-0M800	619-505
41001-2B001	619-504
41001-88E02	619-504
4100445	674-232
41011-0M800	619-505
41011-2B001	619-504
41011-88E02	619-504
4105425	674-232
4137429	630-400
415418	576-308
4164464	520-336
4164465	520-335
4166124	742-300
4166125	742-301
417142	594-117
4173443	594-021
4173445	594-131
4173447	594-132
4184210	742-300
4184211	742-301
4184212	742-303
4184213	742-302
4184214	742-300
4184215	742-301
4184216	742-300
4184217	742-301
4184316	742-304
4184317	742-305
4185334	576-003
4186239	674-232
4203673	576-012
4210584	520-334
4210585	520-333
4210872	520-316
4210872AB	520-316
4210872AD	520-316
4210872AE	520-316
4210873	520-315
4210873AB	520-315
4210873AD	520-315
4210873AE	520-315
4210874	520-316
4210875	520-315
4210876	520-318
4210876AD	520-318
4210876AE	520-318
4210877	520-317
4210877AD	520-317
4210877AE	520-317
4212628	742-300
4212629	742-301
4216039	955-178
4227885	674-233
4240515	742-301
4240516	742-300
4240517	742-302
4240518	742-303
4240519	742-301
4240520	742-300
4240521	742-301
4240522	742-300
4266125	742-301
4267233	674-232
4279479	576-002
4279653	576-005
4279657	576-006
4280640	742-304
4280641	742-305

OE #	Dorman
4299676	955-175
4299677	955-174
43018-SE0-937	619-303
43018-SE0-937RM	619-303
43018-SV4-A00	619-301
43018-SV4-A00RM	619-301
43019-SE0-900	619-303
43019-SE0-900RM	619-303
43019-SR3-000	619-302
43019-SR3-000RM	619-302
43019-SV4-A00	619-301
43019-SV4-A00RM	619-301
4315767	674-528
4318274	955-169
43230-SR3-023	619-302
43230-SR3-023RM	619-302
4323777	674-342
4323780	674-442
4336600	742-304
4336601	742-305
4343460	300-930
4343620	264-209
4343742	674-442
4354344	955-380
4354345	955-379
4354560	742-301
4354561	742-300
4354838	742-300
4354839	742-301
437 407 121A	520-710
437 407 151A	520-709
437 407 152A	520-710
4387606	264-210
4389131	601-301
4389132	601-300
4389132AB	601-300
4396402	742-304
4396403	742-305
44001-0E601	619-501
44001-0M800	619-502
44001-31U13	619-503
44001-97E00	619-501
44011-0E601	619-501
44011-0M800	619-502
44011-31U13	619-503
4401150	620-021 B1
44011-97E00	619-501
4401319	620-021 B1
4401894	620-009 B1
4401958	620-008 M1
441 407 151AC	520-709
441 407 152AC	520-710
4431135020	300-400
4443214	594-154
4443258	955-220
4443259	955-490
4448009	674-513
4448886	594-103
4448889	264-204
4448909	674-528
4467282	742-306
4467283	742-307
4467304	742-300
4467305	742-301
4480302	742-300
4480303	742-301
4483220	300-101
4483733AB	264-205
4483939	674-442
4486525	674-235
4495597	620-008 M1
45018-SK7-A00	619-304
45018-SM4-A00	619-305
45018-SM5-000	619-306
45018-SR3-A00	619-307
45018-SV1-A00	619-305
45018-SK7-A00	619-304
45019-SM4-A00	619-305
45019-SM5-000	619-306

OE #	Dorman
45019-SR3-A00	619-308
45019-SV1-A00	619-305
4504570	698-100
4504570AB	698-100
4509774	520-326
4509775	520-325
45121 AC000	620-762 S
45121 AE02A	620-820 M1
45121 FA030	620-764 M1
45121 FC050	620-821 S
45122 AE01A	620-820 M1
45131 AE01A	620-820 M1
45137 AC000	620-762 S
45137 FA002	620-764 M1
45137 FA002	620-765 S
45137 FC050	620-821 S
45151 FA060	620-765 S
45200-60830	520-846
45200-60840	520-845
4520068	742-300
4520069	742-301
45200-82000	520-106
45201-50G00	520-112
45201-56B00	520-846
45201-56B01	520-846
4520160	520-110
45201-60A00	520-846
45201-60B01	520-110
45202-50G00	520-111
45202-56B00	520-845
45202-56B01	520-845
45202-60A00	520-845
45202-60B01	520-109
4536153	300-100
4546051	620-008 M1
4546557	624-362
4546693	624-326
4546814	624-388
4549202	620-021 B1
45520AE00A	624-702
45520AE02A	624-703
4556730	674-435
4573747	300-311
4574092AS	741-555
4574093AS	741-554
4574606AG	955-077
4574607AG	955-076
458149	594-015
458652	594-006
458653	594-009
4592067	603-301
4592084	620-004 M2
4592084	620-013 M1
4592084	620-014 B2
4592084	620-015 B2
4592085	620-004 M2
4592087	620-004 M2
4592087	620-014 B2
4592088	620-004 M2
4592162	624-366
4596212	620-004 M2
4596253AB	624-314
4596402AA	620-005
4610051	624-367
4612242	300-102
4615178	746-253
4615547	742-310
4615706	955-240
4615707	955-241
4616402	520-304
4616403	520-303
4616922	520-302
4616923	520-301
46201-60B00	520-108
46201-60B11	520-108
46202-60B00	520-107
46202-60B11	520-107
4621662	674-514

OE Interchange

* OE component used in multiple assemblies. Please refer to application/ photo section for specific Dorman number. M1 = Motor 1; M2 = Motor 2; S = Shroud; B1 = Blade 1; B2 = Blade 2; O = Other

OE Interchange (continued)

OE #	Dorman
4624624	742-311
4624625	742-310
4626272	520-326
4626273	520-325
462846	635-510
46300-50G00	520-848
46300-60B00	520-850
46300-60B10	520-850
4638427	624-373
4644367	620-002
4644662	624-368
4644663	624-369
46446802	955-087
46446803	955-086
4646308	955-089
4646309	955-088
465221	264-104
4656730AD	520-328
4656730AH	520-328
4656730AL	520-328
4656731AD	520-327
4656731AH	520-327
4656731AL	520-327
4658888	955-114
4658889	955-113
4658890	955-112
4658891	955-111
4663096	264-200
4663175	594-169
4663176	594-183
4663769	674-282
4667488	674-435
4667547	264-208
4667714	674-281
4667756	594-101
4667765	594-101
4667785	264-200
4668252	300-309
4673013AA	601-304
4675180	742-313
4675181	742-312
4675570	955-258
4675576	955-368
4675577	955-367
4675586AB	741-551
4675587AB	741-550
4675870	746-253
4677380	624-370
4682279	624-394
4682349	620-009 ^{B1}
4682360	624-372
4682555	624-378
4682624AB	620-003
4682649	624-344
4682741	624-379
4685712AC	525-101
4687628	525-106
4687630	525-100
4694760	520-344
4694760AC	520-344
4694761	520-343
4694761AC	520-343
4696850	955-103
4696851	955-102
4713055	674-225
4713476	300-303
471681	576-300
4717766AB	741-824
4717767AB	741-823
4717960AA	746-253
4723153	955-177
4723154	955-176
4728643	624-393
4728884	520-346
4728885	520-345
4743834AA	520-342
4743835AA	520-341
475428	576-319
475429	576-347

OE #	Dorman
47550017	576-380
4758186AB	624-854
4758187	624-395
4758903	620-004 ^{M2}
4758916	624-312
4758925	624-313
4761507	620-013 ^{M1}
4761507	620-014 ^{B2}
4761507	620-015 ^{B2}
4761509	620-015 ^{B2}
4762194	630-306
4762195	630-301
4762345	620-006 ^{B1}
4762347	620-007 ^{B1}
4762349	620-007 ^{B1}
4762350	620-007 ^{B1}
4764408AC	520-340
4764409AC	520-339
4766622AA	520-342
4766623AA	520-341
47721-06040	619-406
47721-33020	619-402
47721-33040	619-404
47722-33020	619-403
47722-33030	619-405
47750-30-30260	619-401
47750-30-33100	619-401
477682	594-158
4777054	674-534
4777300AB	264-200
4777300AD	264-200
4777303	264-200
4777335	264-208
4777618AA	594-185
4777618AB	594-185
4777618AD	594-185
4777618AE	594-185
4777619AA	674-588
4777619AB	674-588
4777619AC	674-588
4777636AA	674-441
4778375	601-305
4781086AA	674-553
4782974AD	520-340
4782975AE	520-339
4783396	955-370
4783397	955-369
4783560AF	955-388
4783561AF	955-387
4792118	300-308
4792197	264-200
4796318AB	742-343
4796319AB	742-344
4797882	692-062
4797887	692-061
4798544	620-026 ^{B1}
4798545	620-026 ^{B1}
4798875AB	624-332
4798876AB	624-333
4798894	620-013 ^{M1}
4798895	620-013 ^{M1}
4798895	620-014 ^{B2}
48068-02010	520-418
48068-06070	520-402
48068-06080	520-402
48068-12110	520-422
48068-12130	520-420
48068-12171	520-418
48068-12180	520-418
48068-16060	520-434
48068-19036	520-414
48068-19095	520-442
48068-19105	520-412
48068-20150	520-424
48068-20151	520-424
48068-20160	520-410
48068-20180	520-410
48068-29045	520-430
48068-29095	520-428

OE #	Dorman
48068-29115	520-426
48068-33010	520-406
48068-33020	520-406
48068-33030	520-404
48068-42012	520-438
48068-42040	520-436
48068-59035	520-432
48069-02010	520-417
48069-06070	520-401
48069-06080	520-401
48069-12110	520-421
48069-12130	520-419
48069-12171	520-417
48069-12180	520-417
48069-16060	520-433
48069-19036	520-413
48069-19085	520-411
48069-19105	520-411
48069-20150	520-423
48069-20151	520-423
48069-20160	520-409
48069-20180	520-409
48069-29045	520-429
48069-29095	520-427
48069-29115	520-425
48069-33010	520-405
48069-33020	520-405
48069-33030	520-403
48069-42012	520-437
48069-42040	520-435
48069-59035	520-431
4809136AA	624-320
4809170AC	620-017
4809170AE	620-017
4809171AC	620-018
4809171AF	620-018
4809262AD	624-311
4809375AB	624-330
4809380AC	624-850
4809390	624-895
4856332	630-305
4856333	630-302
4856541	624-386
4856542	624-380
4857876AA	955-392
4857877AA	955-391
4861065	696-300
48620-32040	520-408
48630-19025	520-444
4863999	620-026 ^{B1}
48640-32040	520-407
4874458	620-006 ^{B1}
4874494	300-304
4882284	740-828
4882285	740-827
4882627	620-014 ^{B2}
4882798	620-006 ^{B1}
4883020	955-243
4883022	955-245
4883023	955-244
4883317AB	624-335
4883352	674-527
4883385	674-196
4883709AA	624-396
4883710AA	624-397
4883802AB	624-351
4883803AB	624-399
4883804AB	624-350
4883806AB	624-800
4894069AB	746-253
4894536AA	741-824
4894537AA	741-823
4897396AA	746-253
4897826AA	746-253
4961608	601-106
4A0 407 151	520-717
4A0 407 152	520-718
4B3 407 151A	520-762
4B3 407 151C	520-762

OE #	Dorman
4D0 407 151P	520-762
4D0 407 505F	520-720
4D0 407 505H	520-720
4D0 407 509D	520-767
4D0 407 509J	520-764
4D0 407 510D	520-768
4D0 407 510J	520-763
4F1Z 5423394-AA	742-240
4F2Z6582BA	615-177
4L2Z 7823200-BA	741-814
4L2Z 7823201-BA	741-813
4W1Z 3084	520-205
4W1Z 3084-RH	520-205
4W1Z 3085	520-206
4W1Z 3085-LH	520-206
4W1Z 5423200-AA	740-687
4W1Z 5423201-AA	740-686
4W1Z 5427000-AA	740-689
4W1Z 5427001-AA	740-688
5003096AC	624-801
5003216AA	746-253
5003376AA	746-253
5003714AA	624-802
5011244AA	624-352
5012170AA	601-305
5012544AB	742-345
5012544AD	742-345
5012545AB	742-346
5012545AD	742-346
5012710AA	604-001
5013845AA	624-804
5014577AA	620-019 ^S
5014578AA	620-019 ^S
5014579AA	620-019 ^S
5015218AC	742-308
5015219AA	742-309
5015646AB	698-100
5015646AC	698-100
5017407AA	620-022
5019290AA	620-350 ^{B2}
5019291AA	620-350 ^{B2}
5019292	620-350 ^{B2}
5019293AA	620-350 ^{B2}
5019471	600-902
5019471AB	600-902
5045678	746-014
5045694	746-014
5045695	746-014
5048907	742-100
5048908	742-100
50501-8H310	520-512
5066430AC	741-648
5066431AC	741-649
5066448AA	624-805
5072220	742-306
5080860AA	674-282
5082050AA	525-101
5093254AA	525-100
5093329AA	525-106
51206116AB	520-350
51250-SA5-013	520-664
51260-SA5-013	520-663
51301-SB2-677	520-683
51301-SB2-677	520-684
51301-SB2-677	520-685
51301-SB2-677	520-686
5134384AA	520-316
5134385AA	520-315
5134386AA	520-318
5134387AA	520-317
51350-659-010	520-690
51350-659-325	520-690
51350-671-033	520-666
51350-671-405	520-666
51350-692-050	520-660
51350-S01-A00	520-668
51350-S04-G00	520-668
51350-S10-020	520-650
51350-S10-A00	520-650

* OE component used in multiple assemblies. Please refer to application/ photo section for specific Dorman number. M1 = Motor 1; M2 = Motor 2; S = Shroud; B1 = Blade 1; B2 = Blade 2; O=Other

OE Interchange (continued)

OE #	Dorman
51350-SA0-030	520-688
51350-SA0-505	520-688
51350-SA5-013	520-664
51350-SA5-020	520-662
51350-SR3-020	520-674
51350-SZ3-000	520-606
51351-SB2-013	520-684
51351-SB6-931	520-684
5135250AA	741-824
5135251AA	741-823
51355-S1A-E00	520-624
51355-S84-A00	520-624
51355-SE0-010	520-644
51355-SH3-010	520-678
51355-SK7-010	520-678
51355-SM4-040	520-634
51355-SV4-000	520-626
51355-SW5-000	520-604
51360-671-033	520-665
51360-671-405	520-665
51360-S01-A00	520-667
51360-S04-G00	520-667
51360-S10-020	520-649
51360-S10-A00	520-649
51360-SA5-013	520-663
51360-SA5-020	520-661
51360-SA5-506	520-661
51360-SR3-020	520-673
51360-SZ3-000	520-605
51361-SB2-013	520-683
51361-SB6-931	520-683
51365-S1A-E00	520-623
51365-S84-A00	520-623
51365-SE0-010	520-643
51365-SH3-010	520-677
51365-SK7-010	520-677
51365-SM4-040	520-633
51365-SV4-000	520-625
51365-SW5-000	520-603
51450-S01-023	520-670
51450-S04-023	520-670
51450-S10-020	520-648
51450-S1A-E01	520-622
51450-S30-003	520-654
51450-S84-A01	520-622
51450-SG0-003	520-612
51450-SG0-003	520-614
51450-SH3-010	520-612
51450-SH3-023	520-612
51450-SK7-043	520-608
51450-SL5-961	520-620
51450-SM1-A03	520-640
51450-SM4-A03	520-640
51450-SP0-033	520-610
51450-SR0-A02	520-676
51450-SS0-003	520-656
51450-SV4-000	520-628
51450-SZ3-013	520-618
51459-SE0-000	520-642
51459-SE0-003	520-642
51460-S01-023	520-669
51460-S04-023	520-669
51460-S10-020	520-647
51460-S1A-E01	520-621
51460-S30-003	520-653
51460-S84-A01	520-621
51460-SG0-003	520-611
51460-SG0-003	520-613
51460-SH3-010	520-611
51460-SH3-023	520-611
51460-SK7-043	520-607
51460-SL5-961	520-619
51460-SM1-A03	520-639
51460-SM4-A03	520-639
51460-SP0-033	520-609
51460-SR0-A02	520-675
51460-SS0-003	520-655
51460-SV4-000	520-627
51460-SZ3-013	520-617

OE #	Dorman
51469-SE0-000	520-641
51469-SE0-003	520-641
5170940AA	741-824
5170941AA	741-823
52005748	620-001
52027674	624-806
52027675	624-382
52027677	624-383
52027684	624-384
52027867	624-807
52027984	603-300
52027994	624-808
52028328	624-334
52028391	624-809
52028471	800-610
52028475AB	624-357
52028504	624-811
52028566	624-300
52028566AD	624-354
52028605	624-301
52028605AD	624-355
52028629	800-610
52028645AF	624-897
52028646AG	624-816
52028647AE	624-899
52028654AF	624-818
52028655AF	624-888
52028656AF	624-819
52028658AB	624-303
52028659	624-302
52028662	624-336
52028670AH	624-305
52028671AD	624-323
52028671AD	624-357
52028672AD	624-322
52028673	624-353
52028753AK	624-821
52028757	624-360
52028761	624-337
52028767AI	624-824
52028769AE	624-304
52028782AH	624-826
52028782AJ	624-826
52028783AF	624-828
52028784AE	624-829
52028784AG	624-829
52028784AI	624-829
52028785AF	624-830
52028817AD	624-358
52028819AD	624-831
52028841AF	624-324
52028868AE	624-832
52028897AC	624-833
52029303AC	624-834
52030033AC/AD	620-029
52037648	520-332
52037649	520-331
52038406	520-330
52038407	520-329
52038730	520-338
52038902AC	520-308
52038903	520-307
52038903AC	520-307
52039410AB	520-312
52039411	520-311
52039411AB	520-311
52079528AB	620-010
52079588	624-836
52079589	624-837
52079590	624-838
52079591	624-839
52079676AB	624-306
52079676AB	624-840
52079677AB	624-307
52079692AB	624-308
52088208AC	520-322
520882171D	520-320
52088632AB	520-354
52106116AA	520-350

OE #	Dorman
52106386AB	520-310
52106386AC	520-310
52106386AE	520-310
52106387	520-309
52106396AA	520-306
52106397AA	520-305
52106577IE	520-314
52113208AB	520-314
52113209AB	520-314
52118569	624-851
52345-SM4-A00	520-632
52350-SM4-A00	520-631
52350-SP0-003	520-616
52350-SP0-J01	520-616
52355-SM4-A10	520-636
52360-SM4-A10	520-635
52360-SP0-003	520-615
52360-SP0-J01	520-615
52390-S30-003	520-652
52390-SE0-043	520-646
52390-SM1-033	520-638
52390-SM1-A03	520-638
52390-SM1-A04	520-638
52390-SM4-033	520-630
52390-SP0-013	520-602
52390-SR0-A00	520-672
52390-SS0-003	520-658
52400-S30-003	520-651
52400-SM1-033	520-637
52400-SM1-A03	520-637
52400-SM1-A04	520-637
52400-SM4-033	520-629
52400-SP0-013	520-601
52400-SR0-A00	520-671
52400-SS0-003	520-657
52474810	604-101
52485038	800-605
5252801	620-009 ^{B1}
5252948	630-304
5252949	630-303
52550-SP0-J01	520-616
52560-SP0-J01	520-615
5272116	520-346
5272117	520-345
5272236	520-324
5272236AB	520-324
5272236AC	520-324
5272236AE	520-324
5272236AF	520-324
5272236AK	520-324
5272237	520-323
5272237AB	520-323
5272237AC	520-323
5272237AE	520-323
5272237AF	520-323
5272237AK	520-323
5278603AA	624-340
5278604AA	624-341
5278605AA	624-898
5278606AA	624-882
5281262	300-101
5281325	300-305
5288416AE	601-305
53002867	624-841
53002909	300-301
53005614	300-307
53006244	674-170
53008134	630-300
53008860	674-225
53009872	264-210
53010184	674-438
53010187	674-271
53010188	674-270
53010189	674-271
53010196	674-467
53010199	674-468
53010258AB	300-310
53010258AC	300-302
53010615AA	689-200

OE #	Dorman
53011017	300-306
53020182	594-133
53020689AB	594-191
53021284AA	594-133
53030872AB	674-438
53030873	674-538
53030873AB	674-538
5351002020	315-401
53510AA010	315-400
53510AA070	315-404
5355314	576-650
54499-01W00	520-509
54499-04W00	520-509
54499-W2200	520-504
54499-W2210	520-504
54500-01W00	520-510
54500-04W00	520-510
54500-0B000	520-276
54500-0M010	520-524
54500-0M060	520-524
54500-0W000	520-502
54500-0W001	520-502
54500-2B010	520-514
54500-2Y411	520-518
54500-2Y412	520-518
54500-40U00	520-520
54500-41U00	520-520
54500-41U01	520-520
54500-41U02	520-520
54500-50A00	520-528
54500-52F00	520-506
54500-52Y10	520-526
54500-52Y70	520-526
54500-67L00	520-503
54500-7B000	520-274
54500-85E01	520-521
54500-8J000	520-511
54500-9B000	520-514
54500-W2210	520-503
54501-0B000	520-275
54501-0M010	520-523
54501-0M020	520-523
54501-0M060	520-523
54501-0W000	520-501
54501-0W001	520-501
54501-2B010	520-513
54501-2Y411	520-517
54501-2Y412	520-517
54501-40U00	520-519
54501-41U00	520-519
54501-41U01	520-519
54501-41U02	520-519
54501-50A00	520-527
54501-52F00	520-505
54501-52Y10	520-525
54501-52Y70	520-525
54501-67L00	520-504
54501-7B000	520-273
54501-85E01	520-522
54501-8J000	520-512
54501-9B000	520-513
54502-01G90	520-516
54502-24001	520-803
54502-55G90	520-516
54502-92G90	520-516
54503-01G90	520-515
54503-24001	520-804
54503-55G90	520-515
54503-92G90	520-515
54526-B5100	520-510
54529-B5100	520-510
54530-20600	520-509
55000558	742-305
55000559	742-304
55000660	742-305
55000661	742-304
55022240	955-222
55022241	955-221
55025868	955-378

* OE component used in multiple assemblies. Please refer to application/ photo section for specific Dorman number. M1 = Motor 1; M2 = Motor 2; S = Shroud; B1 = Blade 1; B2 = Blade 2; O=Other

OE Interchange

OE Interchange (continued)

OE #	Dorman
55025869	955-377
55027207	955-231
55027208	955-232
55034122	955-237
55034123	955-238
55034131	955-234
55074996	955-386
55074997	955-385
55075432	955-235
55075433	955-236
55075660	955-251
55075661	955-250
55076466AB	741-553
55076467AB	741-552
55076478AC	955-256
55076479AC	955-255
55076488AB	955-085
55076489AB	955-084
55076549AC	601-303
55076549AF	601-303
55076549AG	601-303
55076549AH	601-303
55076878AA	955-376
55076879AA	955-375
55077078AB	955-384
55077079AA	955-383
55077250AA	955-390
55077251AA	955-389
55154620	742-375
55154621	742-376
55154666	955-382
55154667	955-381
55154698	955-372
55154699	955-371
55154787	601-302
55154802	955-247
55154803	955-246
55154811	955-242
55154842AB	955-079
55154843	955-078
55154844AD	955-081
55154845AE	955-080
55154846AB	955-083
55154847AB	955-082
55154924	741-752
55154925	741-753
55154925	742-315
55154958AI	741-769
55154959AI	741-768
55154968	955-374
55154969	955-373
55155006	955-249
55155007	955-248
55155446AB	955-409
55155447AB	955-408
55176428AC	315-302
55176636AD	315-302
55202-26500	520-805
55203-26500	520-806
55255618	742-314
55255619	742-315
552701	576-309
55275379AB	315-300
55363286AA	741-557
55363286AB	741-557
55363286AC	741-557
55363286AD	741-557
55363287AA	741-556
55363287AB	741-556
55363287AC	741-556
55363287AD	741-556
559453	576-310
56005164	742-314
56005165	742-315
56005194	601-302
56007627	525-103
56020038AB	525-103
56045455AC	525-103
56045456AG	525-104

OE #	Dorman
56483-P2A-003	300-500
5-86202-076-0	264-403
5DU41MC9	955-252
5F1Z 5423200-AA	740-755
5F1Z 5423201-AA	740-756
6272221	594-012
6272222	594-002
6272223	594-156
6272225	594-016
6272280	674-244
64508364093	620-900
64541392913	620-901
6520750	520-750
6560140U05	315-601
656019E000	315-600
69801-02040	740-802
69801-06011	741-707
69801-12100	740-785
69801-32030	740-728
69801-35030	740-791
69801-35070	740-789
69801-35100	740-800
69801-60010	740-795
69801-AA020	740-720
69802-02040	740-801
69802-06011	741-708
69802-12100	740-786
69802-32030	740-727
69802-35030	740-792
69802-35070	740-790
69802-35090	740-799
69802-60010	740-796
69802-89107	740-705
69802-89108	740-910
69802-AA020	740-721
69803-02030	740-804
69803-12060	740-788
69803-12080	740-798
69803-32020	740-729
69803-AA010	741-830
69804-02030	740-803
69804-12060	740-787
69804-12080	740-797
69804-32020	740-730
69804-AA010	741-829
69810-02051	741-784
69810-06021	741-707
69810-06021	742-603
69810-AA020	741-718
69820-02051	741-706
69820-06021	741-708
69820-06021	742-602
69820-AA020	741-719
69830-32090	741-793
69830-32090	742-603
69840-32090	741-794
69840-32090	742-602
6L2Z 7823200-AA	741-814
6L5Z 3078-AA	520-240
6L5Z 3078-BA	520-224
6L5Z 3079-AA	520-239
6L5Z 3079-BA	520-223
6L5Z 3084-AA	520-222
6L5Z 3084-BA	520-237
6L5Z 3085-AA	520-221
6L5Z 3085-BA	520-238
6W1Z 3084-RH	520-205
6W1Z 3085-LH	520-206
6W1Z 5423200-AA	740-687
6W1Z 5423201-AA	740-686
6W1Z 5427001-AA	740-688
7013584	800-405
72155-SV4-A21	746-360
72210-S04-A02	741-735
72210-S84-A02	741-767
72210-SE3-A02	741-732
72210-SV2-003	741-714
72210-SV4-A01	741-765
72211-SE3-901	741-732

OE #	Dorman
72211-SM4-003	741-716
72211-SR4-J01	740-764
72215-SM4-A01	742-841
72250-S04-A03	741-734
72250-S84-A02	741-766
72250-SE3-A03	741-731
72250-SV2-003	741-715
72250-SV4-A01	741-713
72251-SE3-901	741-731
72251-SM4-003	741-717
72251-SR4-J01	740-763
72255-SM4-A01	742-840
72710-SM4-J01	741-712
72710-SV4-003	741-820
72750-SM4-J01	741-711
72750-SV4-003	741-819
73042 AA001	620-763 ^S
73043 AA000	620-763 ^S
73310 AC000	620-763 ^S
73310 FA030	620-766 ^S
73310 FA050	620-822 ^S
73311 AC000	620-763 ^S
73313 AC000	620-763 ^S
73313 FA002	620-766 ^S
73313 FC050	620-822 ^S
73331 GA130	620-763 ^S
74120S84A21	315-500
74512 2190	620-760 ^{M1}
74512 3370	620-760 ^{M1}
745121310	620-760 ^{M1}
74513 7260	620-760 ^{M1}
7501950	594-058
76200S01A05	955-424
76200S01A15	955-423
76200S02A25ZB	955-421
76200S4KA41	955-427
76200S84A01	955-135
76200S84A21	955-159
76200S84A21	955-429
76200SH3A01	955-137
76200SM4A11	955-146
76200SM4C2Z2C	955-144
76200SR1A16	955-415
76200SR3A04	955-142
76200SR4A04	955-139
76200SV2A25	955-419
76200SV4A03	955-417
76200SV5A05ZD	955-148
76250S01A05	955-425
76250S01A15	955-422
76250S02A25ZB	955-420
76250S4KA41	955-426
76250S82A21	955-158
76250S82A21	955-428
76250S84A01	955-134
76250SH3A02	955-136
76250SM1C26ZC	955-143
76250SM4A11	955-145
76250SR0A26ZB	955-140
76250SR1A16	955-414
76250SR3A05	955-141
76250SR4A05	955-138
76250SV2A25	955-418
76250SV4A03	955-416
76250SV5A05ZD	955-147
77001 12931	576-851
77001 19545	576-853
77001 39285	576-855
77001 62200	576-856
77001 9605	576-854
77251-33050	800-850
77900S10A11	525-605
77900SSAA13	525-604
77900S84A11	525-601
77900S84A41	525-602
77900SV4A81	525-600
800-401, 800-402	800-408
8-01104-057-0	690-900
80151-S04-003	620-218 ^{M1}

OE #	Dorman
80151-SR3-000	620-202 ^{M1}
80151-SR3-013	620-202 ^{M1}
80151-SR3-104	620-203 ^O
80151-SR3-K01	620-202 ^{M1}
80152-SR3-013	620-203 ^O
80161-S04-000	620-203 ^O
80161-S04-000	620-218 ^{M1}
80161-SR3-000	620-202 ^{M1}
80162SR3000	620-203 ^O
80162SR3000	620-218 ^{M1}
80720-0E717	740-724
80720-0M001	740-776
80720-2Y000	740-723
80720-3S500	740-680
80720-40U10	740-781
80720-55Y17	740-782
80720-85E00	740-702
80720-85E05	740-702
80720-9E010	740-739
80721-0E717	740-725
80721-0M001	740-777
80721-2Y900	740-722
80721-3S500	740-681
80721-40U10	740-780
80721-55Y17	740-783
80721-85E00	740-701
80721-85E05	740-701
80721-9E010	740-738
80730-0E701	740-724
80730-0E701	742-501
80730-0Z800	742-504
80731-0E701	740-725
80731-0E701	742-502
80731-0Z800	742-503
8124999	674-235
8125075	674-235
8126798	576-651
8128585	576-652
8134627	746-014
8151508490	955-305
8151508500	955-306
8151508510	955-301
8151508520	955-302
8-15636-696-0	600-900
8-16628-208-0	742-105
82200314	955-233
8-22143-947-0	742-104
8-24557-409-0	674-400
82720-2Y000	740-775
82720-40U10	740-778
82720-85E00	740-726
82720-85E01	740-726
82721-2Y000	740-774
82721-40U10	740-779
82721-85E00	740-703
82721-85E01	740-703
8350 3113	600-200
83500267	576-655
83500787	594-018
83500844	594-018
83501488	594-018
83502632	576-660
83502635	576-659
83502960	576-654
83502961	576-653
83503398	576-662
83505282	576-661
8470165A015PK	955-209
8470265A005PK	955-208
85710-AA020	742-601
85710-AA030	741-830
85720-AA020	742-600
85720-AA030	741-829
8603279-4	690-139
8789315	594-059
8791002090	955-460
8791002100	955-458
8791002190	955-456
8791004030	955-450

* OE component used in multiple assemblies. Please refer to application/ photo section for specific Dorman number. M1 = Motor 1; M2 = Motor 2; S = Shroud; B1 = Blade 1; B2 = Blade 2; O = Other

OE Interchange (continued)

OE #	Dorman
8791006030C0	955-168
8791006040	955-166
879101A640	955-157
879101E160	955-162
879101E170	955-161
8791032250	955-164
8791032370J3	955-452
8791033040C0	955-448
8791033150	955-454
8791033280	955-464
8791089109	955-219
8791089121	955-217
8791089140	955-476
8791089143	955-211
8791089149	955-213
87910AA040	955-461
8794002090	955-459
8794002100	955-457
8794002190	955-455
8794004040	955-449
8794006010	955-165
8794006030C0	955-167
879401A760	955-155
879401A770	955-156
879401E170	955-160
8794032220	955-163
8794032400J3	955-451
8794033040C0	955-447
8794033150	955-453
8794033230	955-463
8794089112	955-218
8794089118	955-216
8794089135	955-214
8794089139	955-483
8794089141	955-210
8794089147	955-212
87940AA040	955-462
87940AA080	955-446
88453-01020	620-506 M1
88453-10020	620-507 M1
88453-10021	620-508 S
88453-20080	620-528 B1
88453-32030	620-514 M1
88453-33010	620-502 S
88453-33010	620-517 S
88453-42010	620-530 B1
88453-50010	620-723 B1
88453-50020	620-724 M1
88454-01020	620-506 M1
88454-12130	620-507 M1
88454-12130	620-508 S
88454-16140	620-528 B1
88454-32041	620-514 M1
88454-33011	620-502 S
88454-42021	620-530 B1
88454-50010	620-723 B1
88454-50020	620-724 M1
88550-01020	620-506 M1
88550-12130	620-507 M1
88550-12130	620-508 S
88550-32050	620-514 M1
88550-33010	620-502 S
88550-50010	620-723 B1
88550-50010	620-724 M1
88550-50040	620-723 B1
88550-50040	620-724 M1
88590-01030	620-506 M1
88590-03010	620-514 M1
88590-12210	620-507 M1
88590-12270	620-508 S
88590-16070	620-528 B1
88590-33011	620-502 S
88590-42021	620-530 B1
88891732	800-401
88891733	800-701
88891735	800-401
88892-50020	620-723 B1
88892-50020	620-724 M1
88892898	620-636 M2

OE #	Dorman
88892899	620-636 M2
88895183	955-059
88937199	742-122
88937200	742-123
88951544	742-125
88951545	742-124
8895268	594-005
88958109	601-121
88958395	601-121
88959266	594-003
88959267	594-001
88959443	742-101
88960088	742-101
88960260	594-044
88960262	594-087
88960263	594-004
88960264	594-122
88960265	594-161
88961173	601-109
88961292	601-110
88961293	601-111
88961294	601-112
88961295	601-114
88961296	601-107
88980649	740-655
88981018	742-122
88981019	742-123
88987649	742-124
8898765	742-124
88987650	742-125
88987652	742-125
88996604	600-902
88996637	600-903
88996638	600-904
89017230	615-183
89017259	635-502
89017272	615-180
89017279	615-200
89017363	615-183
89018356	604-100
89018369	604-102
89044649	741-641
89044650	741-640
89044651	741-642
89044652	741-643
89045625	741-641
89045626	741-640
89045627	741-642
89059275	600-903
89059278	600-904
8-94401-273-2	674-175
8944015990	955-197
8-94464-410-2	674-248
8-94464-410-3	674-248
8955000558	742-305
8955000559	742-304
8-97061-518-1	674-180
8970851061	955-195
8970851071	955-196
8970853713	955-407
8970853723	955-406
8-97086-826-0	594-162
8971087851	300-803
8-97143-255-0	620-722
8-97165-879-2	740-843
8-97165-880-2	740-842
8-97234-064-0	624-605
8-97234-067-0	624-604
8BU269120	955-478
8D0 959 455C	620-800
8E0 407 505A	520-763
8E0 407 505A	520-767
8E0 407 505A/C	520-763
8E0 407 506A	520-764
8E0 407 506A	520-768
8E0 407 506A/C	520-764
8E0 407 509A	520-767
8E0 407 510A	520-768
8E0 407 693Q	520-765

OE #	Dorman
8E0 407 694Q	520-766
90542540	800-153
9107665	594-057
91171194	620-707 B1
91171197	620-707 B1
91171585	620-709 M1
91171586	620-709 M1
91172245	264-110
91173224	520-110
91173225	520-109
91173753	520-112
91173754	520-111
91174658	689-309
9135194-0	594-032
9135195-7	594-074
9141249	620-883
91428805	620-774
92120-51C28	620-407
92120-54J00	620-418 M1
92120-5B400	620-407
92120-5B410	620-408
92120-60R25	620-408
92120-60Y01	620-408
92120-61Y25	620-408
92121-01A05	620-403 B1
92122-01A00	620-403 B1
92122-78J00	620-418 M1
92123-01A01	620-403 B1
9228479	594-153
9313313	594-058
93205953	264-120
9321530	594-060
93386009	741-844
93412387	742-100
93412388	742-100
93413451	742-100
93413452	742-100
93430150	300-122
93441558	690-902
93441559	690-900
93800970	635-505
94401273	674-175
94477866	955-430
94658136	264-119
9471933-3	674-584
9471934-1	674-585
9483900	594-154
94844782	800-153
94850371	955-097
94850372	955-096
94853663	674-556
94854916	800-153
94855714	690-117
94856515	674-164
94856791	674-546
94858430	674-546
95320-57B51	620-770
95320-60A50	620-770
95320-60B10	620-769
95560-65000	620-772
96052254	520-106
96064359	264-111
96068060	620-707 B1
96069341	674-200
96069343	674-532
96268454	520-801
96268455	520-802
9630103W10	955-206
9630102811	955-436
9630111G20	955-201
963012B500	955-438
963013S510	955-203
963014B000	955-154
963014B010	955-480
963015M010	955-440
963016Y000	955-150
9630166Y00	955-153
963019E016	955-434
96301Q5710	955-152

OE #	Dorman
9630203W10	955-207
963020Z811	955-435
9630211G20	955-200
9630211G70	955-202
963022B500	955-437
963023S510	955-481
963024B010	955-479
963025M010	955-439
9630265Y00	955-151
9630266Y00	955-149
963029E016	955-433
97061518	674-180
976G 3042-BA	520-204
97730-22010	620-715 S
97730-24002	620-776 B1
97730-25000	620-811
97730-26150	620-713
97730-28000	620-719 M1
97730-29050	620-721 B1
97730-2D000	620-813 B1
97731-38000	620-717 B1
97735-22000	620-715 S
97735-24000	620-776 B1
97735-28000	620-719 M1
97735-29000	620-721 B1
97735-2D000	620-813 B1
97735-38000	620-717 B1
97737-22000	620-714 S
97737-24000	620-776 B1
97737-25000	620-813 B1
97737-29000	620-721 B1
97737-37100	620-715 S
97786-22010	620-715 S
97786-29000	620-721 B1
97786-2D000	620-813 B1
97786-38000	620-717 B1
97BG 3051-BA	520-203
996220	955-190
A5134-015-651	620-216
A720265Y11	576-803
AJ03-11-400	594-109
AM17-13-350C	692-136
B092-34-310A	520-812
B092-34-360A	520-811
B1481-5U002	620-416
B1482-U003	620-416
B308-10-400B	264-029
B366-10-400A	264-020
B3Y5-10-400	264-029
B455-34-300E	520-818
B455-34-350E	520-817
B455-617-10R	620-741 S
B59513220A	696-600
B61F-15-140	620-740 S
B61F-15-150A	620-740 S
B61H-15-150A	620-739 S
B61H-15-150A	620-741 S
B61W-15-025BA	620-739 S
B61W-15-210	620-739 S
B61W-15-210	620-741 S
B6BF-15-210A	620-754 S
B6BF-18-200A	690-141
B6BG-15-150	620-753 M1
B6BG-15-210A	620-753 M1
B6DN-15-150	620-754 S
BC1E-58-560B	741-770
BC1E-58-590A	741-770
BC1E-59-560B	741-771
BC1E-59-590A	741-771
BP01-18-200	690-157
BP01-18-200A	690-156
BP02-18-200	690-156
BP02-18-200A	690-156
BP05-15-025	620-740 S
BP05-15-210	620-740 S
BP0518200ROB	690-166
BP1A-18-200	690-142
BR70-28-600	520-816
BR70-28-620	520-814

OE Interchange

* OE component used in multiple assemblies. Please refer to application/photo section for specific Dorman number. M1 = Motor 1; M2 = Motor 2; S = Shroud; B1 = Blade 1; B2 = Blade 2; O=Other

OE Interchange (continued)

OE #	Dorman
BR70-28-630	520-813
BR70-34-300B	520-818
BR70-34-300E	520-818
BR70-34-350B	520-817
BR70-34-350E	520-817
BR7042110B	576-700
BR9342110B	576-333
BR9342110B	576-722
C4DZ 3078-A	520-228
C5Z9002D	576-134
C7DZ 3078-A	520-234
C7DZ 3078-B	520-226
C8TZ 9431-B	674-241
CH13EL	955-257
DOAZ 5123394-A	742-250
DOAZ 5323394-A	742-251
DOAZ 5323395-A	742-250
DOAZ 5723394-A	742-251
DOAZ 5723395-A	742-250
DORY 3078-A	520-270
DORY 3079-A	520-269
D0TZ 9430-A	674-240
D0VY 5323394-A	742-202
D0VY 5323395-A	742-203
D1AZ 7123394-A	742-202
D1AZ 9426-A	674-173
D2OZ 5323394-A	742-251
D2OZ 5323395-A	742-250
D2OZ 6019-A	635-107
D2OZ 6316-A	594-023
D2VY 5323394-A	742-202
D2VY 5323395-A	742-203
D3OZ 6019-A	635-107
D3AZ 5723394-A	742-251
D3AZ 5723394-B	742-251
D3AZ 5723395-B	742-250
D3AZ 6523394-A	742-251
D3AZ 6523395-A	742-250
D3AZ 7123394-A	742-202
D3AZ 7123394-B	742-202
D3TZ 6312-A	594-145
D4AZ 5723394-A	742-202
D4AZ 5723395-A	742-203
D5AZ 6316-A	594-083
D5AZ 9431-A	674-193
D5AZ-7B093-A	624-253
D5TZ 6316-D	594-146
D5TZ 9426-A	674-117
D5TZ9002B	576-117
D7DZ 3078-A	520-234
D7DZ 3078-B	520-226
D7TZ 9430-A	674-182
D7WY 6523394-A	742-251
D7WY 6523395-A	742-250
D8TZ 1023200-A	740-867
D8TZ 1023201-A	740-866
D8TZ 6316-B	594-023
D8TZ 9823394-A	742-251
D8TZ9002A	576-157
D8TZ9002B	576-152
D8TZ9002C	576-153
D8TZ9002D	576-158
D8TZ9002M	576-116
D9AZ 4234-A	630-209
D9BZ 3623394-A	742-251
D9BZ 3623395-A	742-250
D9BZ 5423394-A	742-251
D9BZ 5423395-A	742-250
D9BZ6675A	264-023
D9TZ 6316-C	594-080
D9TZ-9430-C	674-168
EOAZ 6019-A	635-102
EOAZ 6019-B	635-107
EOAZ 6019-C	635-107
EOLY 9275-A	692-134
EOLY 9275-B	692-134
EOPZ 9430-A	674-236
EOTZ 9275-A	692-117
EOTZ 9275-F	692-119

OE #	Dorman
EOTZ 9275-G	692-118
EOTZ 9B447-B	300-920
EOTZ17682D	955-180
EOTZ17682E	955-180
EOTZ9002D	576-118
EOTZ9002F	576-159
E0VY 6623394-A	742-256
E0VY 6623395-A	742-257
E1DZ 7D273-A	800-608
E1FZ 3078-A	520-212
E1FZ 3079-A	520-211
E1TZ 6316-D	594-019
E1VF 14A389-A1A	742-257
E1VY 6623394-A	742-256
E1VY 6623395-A	742-257
E1VZ 66233V94-ARM	742-256
E1VZ 66233V95-ARM	742-257
E1ZZ 6623394-A	742-258
E1ZZ 6623395-A	742-259
E1ZZ 66233V94-ARM	742-258
E1ZZ 66233V95-ARM	742-259
E2FZ9002C	576-148
E2TZ 7D273-A	800-609
E2VZ 17V508-ARM	601-203
E301-15-150	620-742 ^S
E358-15-140	620-759 ^S
E385-15-140	620-754 ^S
E3AE 6059-AB	635-107
E3AE 6059-BB1	635-107
E3AE 6059-DA1	635-107
E3AZ 5423394-A	742-251
E3AZ 5423395-A	742-250
E3AZ 54233V94-ARM	742-251
E3AZ 54233V95-ARM	742-250
E3AZ 66218A42-A	746-145
E3FZ 9291-B	800-053
E3FZ 9291-C	800-050
E3FZ 9291-E	800-154
E3FZ 9291-F	800-158
E3TZ 4234-D	630-203
E3TZ 4234-E	630-204
E3TZ 6312-E	594-077
E3TZ 6675-C	264-013
E3TZ 9426-B	674-173
E3TZ 9426-D	674-173
E3TZ 9430-A	674-283
E3TZ 9431-A	674-155
E3TZ 9431-B	674-285
E3TZ 9431-C	674-284
E3TZ17723B	955-289
E3TZ-7A512-A	628-204
E3TZ9002M	576-144
E43Z 3078-A	520-214
E43Z 3079-A	520-213
E43Z 5423394-A	742-251
E43Z 5423395-A	742-250
E43Z 9430-E	674-327
E4AZ 6019-B	635-102
E4AZ 6019-C	635-102
E4AZ9002C	576-136
E4FZ17618A	603-202
E4TZ 6316-A	594-024
E4TZ 6316-B	594-011
E4TZ 9275-B	692-121
E4TZ 9426-D	674-174
E4TZ9002B	576-100
E4ZZ 6623394-A	742-247
E4ZZ 6623395-A	742-246
E4ZZ 66233V94-ARM	742-247
E4ZZ 66233V95-ARM	742-246
E4ZZ-9B447-AA	300-920
E53Z 9430-A	674-150
E548-15-140	620-742 ^S
E57Y 3A733-A	300-003
E5D4E-15-025AH	620-737
E5HC 9431-C	674-227
E5HZ 9430-B	674-226
E5HZ-9430-F	674-168
E5RY 3079-A	520-271

OE #	Dorman
E5SZ9002B	576-133
E5TZ 1023394-A	742-251
E5TZ 1023395-A	742-250
E5TZ 10233V94-ARM	742-251
E5TZ 10233V95-ARM	742-250
E5TZ 6019-H	635-109
E5TZ 6019-K	635-101
E5TZ 9291-AG	800-056
E5TZ 9430-C	674-166
E5TZ 9430-D	674-166
E5TZ 9431-B	674-155
E5TZ 9H307-B	692-063
E5TZ 9H307-BA	692-063
E5TZ17682C	955-226
E5TZ17682D	955-225
E5TZ17696A	955-180
E5TZ17696B	955-179
E5TZ17696D	955-290
E5TZ9002C	576-128
E5TZ9002E	576-119
E5TZ9002L	576-145
E5TZ9002M	576-108
E5ZZ 9430-A	674-230
E63Z 9275-A	692-120
E69Z 18D434-A	800-404
E69Z 18D434-B	800-403
E69Z 9430-C	674-408
E6AZ 9430-E	674-151
E6AZ 9430-F	674-178
E6AZ 9430-G	674-153
E6AZ 9431-E	674-179
E6DF 14A365-AB	742-206
E6DF 14A365-BB	742-206
E6DF 14A366-AB	742-207
E6DF 14A366-BB	742-207
E6DZ 3078-A	520-248
E6DZ 3079-A	520-247
E6DZ 5423394-A	742-206
E6DZ 5423394-B	742-206
E6DZ 5423395-A	742-207
E6DZ 5423395-B	742-207
E6DZ 54233V95-ARM	742-207
E6DZ 54233V95-BRM	742-207
E6FZ9002B	576-149
E6PZ 8K621-A	620-100 ^{B1}
E6SZ 6019-B	635-108
E6SZ 9431-A	674-184
E6TZ 9430-A	674-221
E6TZ 9431-A	674-222
E6UZ 9H307-J	692-115
E6VY 7D273-A	800-608
E6ZZ 9430-A	674-230
E6ZZ 9430-C	674-191
E6ZZ 9431-A	674-190
E79Z 17508-A	601-202
E79Z 17V508-ARM	601-202
E7AZ 6019-A	635-107
E7AZ 6675-B	264-022
E7AZ 6675-C	264-006
E7FZ 9430-B	674-274
E7FZ9002A	576-151
E7PZ 6019-A	635-102
E7SZ 6323394-A	742-211
E7SZ 6323395-A	742-210
E7TZ 1523200-A	740-652
E7TZ 1523201-A	740-653
E7TZ 4234-A	630-200
E7TZ 4234-B	630-201
E7TZ 6019-A	635-100
E7TZ 9430-B	674-230
E7TZ 9H307-A	692-064
E7TZ 9H307-B	692-018
E7TZ 9H307-BA	692-018
E7TZ-6675A	264-016
E7TZ-6675-E	264-003
E7TZ9002E	576-156
E7UZ 4234-E	630-202
E7ZZ 9430-B	674-230
E80Y 3078-A	520-258

OE #	Dorman
E80Y 3079-A	520-257
E80Y 5423394-A	742-207
E80Y 5423394-B	742-205
E80Y 5423395-A	742-206
E80Y 5423395-B	742-204
E83Z17682D	955-120
E89Z 9H307-B	692-107
E89Z 9H307-BA	692-107
E8BZ 18527-B	620-123
E8BZ 3078-A	520-230
E8BZ9002A	576-104
E8DZ 6316-A	594-084
E8DZ 9430-A	674-194
E8DZ 9431-A	674-195
E8FZ 9H307-D	692-110
E8SZ9002A	576-132
E8TE 6059-AA	635-101
E8TZ 6316-A	594-085
E8TZ 6316-B	594-011
E8TZ 6675-A	264-005
E8TZ 6675-B	264-011
E8TZ 7G360-B	600-804
E8TZ 7G360-CA	600-800
E8TZ 9430-A	674-165
E8TZ 9430-B	674-165
E8TZ 9431-A	674-169
E8TZ 9431-B	674-169
E8TZ 9823394-A	742-251
E8TZ 9H307-AA	692-039
E8TZ 9H307-B	692-037
E8TZ 9H307-BA	692-111
E8TZ 9H307-DA	692-037
E8TZ 9H307-E	692-113
E8TZ 9H307-EA	692-113
E8TZ-7A512-B	628-203
E8UZ 9H307-G	692-072
E8UZ 9H307-GA	692-072
E92Z 3078-A	520-264
E92Z 3079-A	520-263
E92Z 8146-B	620-110 ^{M1}
E92Z 8600-B	620-110 ^{M1}
E92Z 8K621-C	620-110 ^{M1}
E92Z 9430-B	674-330
E97Z9002P	576-101
E99Z17682A	955-296
E9AZ 54233V94-ARM	742-251
E9AZ 54233V95-ARM	742-250
E9DZ 3078-A	520-246
E9DZ 3079-A	520-245
E9DZ 6675-D	264-015
E9DZ 6675-F	264-009
E9DZ 6675-G	264-018
E9FZ 9H307-A	692-109
E9GZ 6675-A	264-029
E9RY 3078-A	520-278
E9RY 3079-A	520-277
E9SZ 3084-A	520-250
E9SZ 3085-A	520-249
E9SZ 6323394-A	742-251
E9SZ 6323395-A	742-250
E9SZ 7A031 A	624-210
E9SZ17682A	955-276
E9SZ17682B	955-275
E9SZ17682C	955-273
E9TZ 10218A42-A	746-147
E9TZ 1526594-A	746-147
E9TZ 9430-B	674-205
E9TZ 9431-A	674-204
E9TZ 9H307-D	692-112
E9TZ 9H307-DA	692-112
E9TZ6675B	264-017
E9TZ9002S	576-147
E9TZ9002T	576-109
E9TZ-9B447-B	300-921
E9UZ 9B307-A	800-008
E9UZ 9B307-B	800-007
E9UZ 9H307-C	692-072
E9WY17682A	955-274
E0UZ6675B	264-012

*OE component used in multiple assemblies. Please refer to application/photo section for specific Dorman number. M1 = Motor 1; M2 = Motor 2; S = Shroud; B1 = Blade 1; B2 = Blade 2; O = Other

OE Interchange (continued)

OE #	Dorman
ER5Y 3078-A	520-272
F02Z 3078-A	520-268
F02Z 3079-A	520-267
F02Z 6123208-A	741-670
F02Z 6123209-A	741-669
F03Z 54218A42-A	746-147
F03Z 8146-B	620-100 ^{B1}
F03Z 8600-B	620-100 ^{B1}
F03Z 9H307-A	692-108
F03Z 9H307-AA	692-108
F07B 14A365-AB	742-208
F07B 14A366-AB	742-209
F09Z 1123394-A	742-208
F09Z 1123395-A	742-209
F09Z 11233V94-ARM	742-208
F09Z 11233V95-ARM	742-209
F09Z 6675-A	264-004
F0AZ 6019-A	635-102
F0BZ 8146-A	620-122 ^S
F0BZ 8600-A	620-122 ^S
F0BZ 8K621-A	620-122 ^S
F0CZ117682C	955-119
F0CZ17682D	955-118
F0DZ 6316-A	594-086
F0DZ 7A030 D	624-212
F0DZ 9430-B	674-194
F0DZ 9431-D	674-195
F0HZ 9430-A	674-168
F0TZ 3A733-A	300-004
F0TZ 6B321-A	594-111
F0TZ 6B321-B	594-102
F0TZ 9431-B	674-222
F0VY17V436ARM	602-300
F0ZZ 66218A42-A	746-147
F1Z2 6316-A	594-180
F1Z29B697A	696-201
F17E 6675-AA	264-004
F19Z17682B	955-294
F19Z17683A	955-293
F1AZ 54218A42-A	746-147
F1BZ17682A	955-115
F1CZ 9430-A	674-358
F1CZ12127A	690-166
F1CZ9B697C	696-200
F1DZ 2B511-A	619-101
F1DZ 2B512-A	619-102
F1DZ 7C410 AA	624-213
F1DZ 8C607-D	620-129
F1SZ 6675-A	264-006
F1SZ 6675-B	264-022
F1TZ 1023394-A	742-208
F1TZ 1023395-A	742-209
F1TZ 10233V94-ARM	742-208
F1TZ 10233V95-ARM	742-209
F1TZ 6675-A	264-002
F1TZ 6675-B	264-011
F1TZ 7823394-C	742-412
F1TZ 7823395-C	742-413
F1TZ 78233V94-CRM	742-412
F1TZ 78233V95-CRM	742-413
F1TZ 7G630-C	600-801
F1TZ17682G	955-292
F1TZ17683G	955-291
F1TZ-7A512-A	628-202
F1VY14A664D	525-201
F1ZZ 9A407-B	692-106
F1ZZ 9A407-BA	692-106
F1ZZ 9A407-C	692-106
F1ZZ 9A407-CA	692-106
F201-15-025	620-744 ^{M1}
F201-15-140	620-744 ^{M1}
F201-15-150A	620-744 ^{M1}
F202-15-150A	620-746 ^S
F203-15-210A	620-744 ^{M1}
F204-15-210B	620-746 ^S
F23Z 3078-B	520-214
F23Z 3079-B	520-213
F23Z 8C607-C	620-100 ^{B1}
F23Z8C607D	620-134

OE #	Dorman
F2AZ4234B	630-211
F2AZ4234C	630-210
F2DZ 6675-A	264-010
F2G8-13-350B	692-135
F2G8-18-200C	690-124
F2G8-18-200ROC	690-124
F2HZ-9430-E	674-168
F2TZ 9430-B	674-153
F2TZ 9430-D	674-226
F2TZ 9431-B	674-152
F2TZ 9431-C	674-227
F2TZ 9H307-L	692-114
F2TZ 9H307-LA	692-114
F2UZ17682B	955-260
F2UZ17683B	955-259
F2VY 17V508-ARM	601-203
F2VY 5423208-A	740-667
F2VY 5423209-A	740-666
F2VY 5423394-B	742-252
F2VY 5423395-B	742-253
F2VY 5427008-A	740-660
F2VY 5427009-A	740-661
F2VZ 54233V94-BRM	742-253
F2VZ 54233V95-BRM	742-252
F3Z2 12127-A	690-112
F3Z2 12127-C	690-145
F3Z2 3078-B	520-266
F3Z2 3079-B	520-265
F3Z2 6312-AA	594-134
F3Z2 6C337-A	594-120
F3Z29B697B	696-204
F3Z29B697C	696-203
F35Z-2B511A	619-109
F3Z7 1023394-A	742-242
F3Z7 1023395-A	742-243
F3Z7 10233V94-ARM	742-242
F3Z7 10233V95-ARM	742-243
F3Z7 9431-H	674-361
F3Z7 9431-K	674-371
F3Z712A362A	689-108
F3Z717682A	955-224
F3Z717683A	955-223
F3AZ 5423208-B	740-665
F3AZ 5423209-B	740-664
F3AZ 6316-A	594-081
F3AZ17682A	955-262
F3AZ17682B	955-261
F3AZ9002A	576-135
F3CZ 9430-C	674-280
F3CZ 9430-D	674-343
F3DZ 2B296-A	619-103
F3DZ 2B511-A	619-103
F3DZ 6B321-A	594-123
F3DZ 9430-H	674-194
F3DZ17682B	955-116
F3DZ17682C	955-239
F3DZ28682A	955-117
F3LY 3078-A	520-262
F3LY 3079-A	520-261
F3SZ 3084-A	520-250
F3SZ 3085-A	520-249
F3SZ-2B292A	619-106
F3TZ 8600-C	620-112 ^{B1}
F3TZ 9430-L	674-153
F3TZ 9431-N	674-152
F3TZ6675A	264-019
F3TZ-7A512-A	628-201
F3TZ9002A	576-121
F3TZ9002L	576-109
F3UZ-18472-BA	626-201
F3VY 5423208-A	740-663
F3VY 5423209-A	740-662
F3XY 8C607-BB	620-111
F3XY17696A	955-334
F3XY17696B	955-335
F3XY17696C	955-300
F3XY17696D	955-299
F3ZZ 8600-A	620-112 ^{B1}
F40Y 5423394-B	742-207

OE #	Dorman
F40Y 5423395-B	742-206
F40Z 54233V94-ARM	742-204
F40Z 54233V95-ARM	742-205
F43Z 8C607-C	620-100 ^{B1}
F47Z 9430-A	674-410
F47Z17682EA	955-325
F48Z 9431-E	674-195
F4BZ 19A805-A	620-125
F4BZ 8146-A	620-124 ^{M1}
F4BZ 8600-A	620-124 ^{M1}
F4BZ 8K621-A	620-124 ^{M1}
F4DZ 2B296-A	619-104
F4DZ 3078-A	520-248
F4DZ 3078-B	520-246
F4DZ 3079-A	520-247
F4DZ 3079-B	520-245
F4DZ 6B321-A	594-149
F4DZ 8C607-CA	620-101
F4DZ 9430-B	674-359
F4DZ 9431-C	674-360
F4DZ 9H307-A	692-104
F4DZ 9H307-AA	692-104
F4DZ 9H307-C	692-105
F4DZ 9H307-CA	692-105
F4DZ8C607B	620-133
F4SZ 63233V94-ARM	742-251
F4SZ 63233V95-ARM	742-250
F4SZ 6B321-C	594-051
F4TZ 9430-A	674-165
F4TZ 9430-B	674-380
F4TZ 9430-C	674-229
F4TZ 9430-D	674-165
F4TZ 9430-E	674-165
F4TZ 9431-A	674-169
F4TZ 9431-B	674-381
F4TZ 9431-C	674-228
F4TZ 9431-D	674-169
F4TZ 9431-E	674-169
F4TZ14A664B	525-200
F4UZ17682C	955-005
F4UZ17683A	955-004
F4XY 8C607-AA	620-413
F4ZE 6675-CA	264-006
F4ZZ17682A	955-286
F4ZZ17682B	955-285
F4ZZ-2B511A	619-105
F508 5423394-AD	742-225
F50B 5423395-AD	742-224
F50B 5427144-AD	742-227
F50B 5427145-AD	742-226
F50Y 5423394-A	742-227
F50Y 5423394-B	742-225
F50Y 5423395-A	742-226
F50Y 5423395-B	742-224
F50Z 6675-A	264-010
F57Z 1023208-AA	740-832
F57Z 1023209-AA	740-831
F57Z 7823394-AB	742-238
F57Z 7823395-A	742-236
F57Z 7823395-AB	742-239
F57Z 9H307-E	692-038
F57Z17682B	955-356
F57Z17683B	955-324
F57Z17683C	955-355
F58Z 1623394-A	742-245
F58Z 1623395-A	742-244
F58Z 6B321-A	594-051
F58Z12A362BA	689-104
F58Z17682A	955-357
F58Z17682B	955-350
F58Z17682C	955-359
F58Z17683A	955-358
F58Z17683B	955-349
F59Z 6675-A	264-026
F5AZ 17508-A	601-206
F5AZ 7H168 AF	624-214
F5AZ 8C607-B	620-107
F5AZ 9430-A	674-557
F5AZ 9431-A	674-558

OE #	Dorman
F5AZ-2C396-A	619-110
F5CZ 3078-A	520-210
F5CZ 3079-A	520-209
F5CZ 8C607-A	620-114
F5CZ 8C607-BA	620-115 ^{M1}
F5D7-15-140	620-751 ^{B1}
F5DZ 6675-A	264-010
F5DZ 6675-B	264-015
F5DZ 9431-C	674-456
F5DZ-8A520-A	626-200
F5RZ 3078-B	520-204
F5RZ 3079-B	520-203
F5RZ 5423208-A	741-808
F5RZ 5423209-A	741-807
F5RZ17682B	955-360
F5SZ 9431-A	674-466
F5TZ 3083-A	520-221
F5TZ 3A733-A	300-002
F5TZ 6316-AA	594-124
F5TZ 7826594-A	746-145
F5TZ 9430-A	674-185
F5TZ 9430-F	674-185
F5TZ 9431-F	674-186
F5TZ17682A	955-298
F5TZ17682B	955-272
F5TZ17682BAA	955-266
F5TZ17682C	955-352
F5TZ17682E	955-268
F5TZ17683A	955-297
F5TZ17683B	955-271
F5TZ17683C	955-351
F5TZ17683E	955-267
F5TZ-2C402-B	619-111
F5TZ-7A512-A	628-200
F5UZ 9431-A	674-383
F5UZ14A664NB	525-205
F5VY 5427008-A	740-685
F5VY 5427009-A	740-684
F5VY17682B	955-016
F5XZ17696CA	955-304
F5XZ17696CAW	955-303
F5ZZ 8C607-B	620-128
F622-15-141	620-753 ^{M1}
F65E 6059-AE	635-105
F65Z 3084-AB	520-218
F65Z 3085-AB	520-217
F65Z 9430-A	674-404
F65Z 9430-B	674-406
F65Z 9431-A	674-405
F65Z 9431-B	674-407
F65Z17683AA	955-482
F65Z-2B292-AA	619-112
F65Z-2B292-BA	619-113
F67B 14A366-AA	742-413
F67Z 6019-AA	635-106
F67Z 6312-AA	594-155
F67Z 7823208-AA	740-672
F67Z 7823209-AA	740-673
F67Z 7A030 VA	624-201
F67Z 7A031 UA	624-200
F67Z 9431-BA	674-356
F67Z12A362AAB	689-105
F67Z12A362AC	689-106
F68Z 6675-AB	264-015
F69Z 9H307-AA	692-071
F6AZ 3A733AA	300-010
F6AZ 3A733AB	300-010
F6AZ 7A031 AA	624-251
F6AZ17682AA	955-264
F6AZ17682BA	955-263
F6CZ 3A733-AB	300-011
F6DZ 17508-AA	601-205
F6DZ 2B292-BA	619-104
F6DZ 3A733A	300-008
F6DZ 54218A42-AD	746-145
F6DZ 54218A43-AD	746-145
F6DZ 5423394-A	742-241
F6DZ 5423395-A	742-240
F6DZ 6312-A	594-050

* OE component used in multiple assemblies. Please refer to application/
photo section for specific Dorman number. M1 = Motor 1; M2 = Motor 2;
S = Shroud; B1 = Blade 1; B2 = Blade 2; O=Other

OE Interchange (continued)

OE #	Dorman
F6DZ 6B321-AA	594-082
F6DZ 7A030 CA	624-215
F6DZ 7A031 DA	624-217
F6DZ 7A031 EA	624-218
F6DZ 7A031 FA	624-219
F6DZ 7D273-BA	800-601
F6DZ 9430-J	674-362
F6DZ 9430-L	674-364
F6DZ 9431-R	674-365
F6DZ 9431-S	674-363
F6DZ8A080B	603-200
F6DZ9002A	576-137
F6DZ9002B	576-138
F6DZ-9S278-A	800-857
F6PZ 6312-AA	594-007
F6RZ 8C607-KB	620-103
F6TB 14A365-AA	742-209
F6TB 14A366-AA	742-208
F6TZ 1523208-AA	740-754
F6TZ 1523209-AA	740-674
F6TZ 1523394-AA	742-209
F6TZ 1523395-AB	742-208
F6TZ 6019-NA	635-100
F6TZ 6675-LA	264-011
F6TZ 6675-MA	264-002
F6TZ 6675-NA	264-005
F6TZ 7G360-AA	600-801
F6TZ 9430-C	674-153
F6TZ 9430-NA	674-205
F6TZ 9431-C	674-152
F6TZ 9431-LA	674-204
F6TZ12A632CB	689-102
F6TZ9002A	576-121
F6TZ9002M	576-109
F6UZ9002A	576-142
F6VZ17682AA	955-017
F6XY 8C607-AA	620-127
F6XZ17696BA	955-329
F6XZ17696BB	955-328
F6ZB 6323394-AC	742-218
F6ZB 6323395-AC	742-219
F6ZC 6312-AB	594-110
F6ZC 6323394AA	742-218
F6ZC 6323395-AA	742-219
F6ZC 6B321-A	594-051
F6ZC 9430-BA	674-457
F6ZC 9430-FA	674-458
F6ZC 9431-BA	674-448
F6ZC 9431-FA	674-454
F6Z14A664AA	525-206
F6Z17682AA	955-466
F6Z17682BA	955-465
F758 14A366B-A	742-232
F75B 14A365-AA	742-231
F75B 14A365-BA	742-233
F75B 14A366-AA	742-230
F75Z 17508-AA	601-207
F75Z 3078-EB	520-220
F75Z 3079-EB	520-219
F75Z 3084-BA	520-216
F75Z 3085-BA	520-215
F75Z 6312-AC	594-112
F75Z 6312-BA	594-189
F75Z 7823394-AA	742-231
F75Z 7823394-BA	742-233
F75Z 7823395-AA	742-230
F75Z 7823395-BA	742-232
F75Z 7A030 AA	624-202
F75Z 7A030 GA	624-204
F75Z 7A030 LA	624-268
F75Z 7A030 MA	624-269
F75Z 7A031 AA	624-220
F75Z 7A031 LA	624-221
F75Z 7C410 EA	624-222
F75Z 9430-HB	674-398
F75Z 9431-DB	674-399
F75Z17682AAB	955-025
F75Z17682HAA	955-284
F75Z17683AAB	955-024

OE #	Dorman
F75Z17683JAA	955-282
F75Z17683JAB	955-281
F75Z4234NA	630-212
F75Z4234NB	630-213
F77Z 3078-FA	520-224
F77Z 3079-FA	520-223
F77Z 3082-CA	520-222
F77Z 3A733A	300-009
F77Z 9430-AA	674-368
F77Z 9430-CA	674-376
F77Z 9430-HA	674-412
F77Z 9430-JA	674-357
F77Z 9431-AA	674-373
F77Z 9431-CA	674-465
F77Z 9431-GA	674-413
F78Z 3078-CA	520-256
F78Z 3079-CA	520-255
F78Z 3A733-AA	300-005
F78Z 8C607-BA	620-102
F78Z 9431-AA	674-451
F78Z6B321AA	594-178
F79Z 9431-AB	674-444
F7AZ 17508-AA	601-206
F7AZ17682AA	955-013
F7AZ17682BA	955-012
F7CZ 54218A42-AA	746-145
F7CZ 6316-BA	594-033
F7CZ 8C607-BE	620-115 ^{M1}
F7CZ 9430-FB	674-394
F7CZ17682AA	955-348
F7CZ17682BA	955-354
F7CZ17682CA	955-347
F7CZ17682DA	955-353
F7DZ 6316-AA	594-125
F7DZ 7A030 BA	624-223
F7DZ 7D273-AA	800-602
F7DZ17682CA	955-288
F7DZ17682DA	955-287
F7DZ17682FA	955-277
F7LB 14A365-AA	742-223
F7LB 14A366-AA	742-222
F7LZ 3084-AA	520-260
F7LZ 3085-AA	520-259
F7LZ 5423394-AA	742-223
F7LZ 5423395-AA	742-222
F7RZ 6316-AA	594-109
F7TZ 6312-A	594-152
F7TZ 7F112 DC	624-224
F7TZ 7F112 EB	624-225
F7TZ 7F113 DD	624-206
F7TZ12A362AC	689-103
F7TZ17682AAB	955-270
F7TZ17682BAA	955-227
F7TZ17682BAB	955-265
F7TZ17682DAA	955-228
F7TZ17683AAB	955-269
F7TZ17683DAB	955-227
F7UZ 1523200-AA	742-235
F7UZ 1523201-AA	742-234
F7UZ 4234-BA	630-207
F7UZ 4234-BB	630-208
F7UZ 9431-VB	674-462
F7VZ17682AA	955-019
F7VZ17682BA	955-018
F7ZH 8C607-AE	620-130
F7ZZ 8C607-AB	620-130
F7ZZ 8C607-BA	620-109
F7ZZ 8C607-BB	620-109
F801-15-025A	620-742 ^S
F801-15-210	620-742 ^S
F80Z 9430-CA	674-455
F80Z 9431-CA	674-450
F81Z 6316-AA	594-124
F85Z 7A031 BA	624-226
F85Z17682BAA	955-015
F85Z17682FAA	955-280
F85Z17682HAB	955-031
F85Z17683BAA	955-014
F85Z17683FAA	955-346

OE #	Dorman
F85Z17683FAB	955-279
F85Z17683FAB	955-345
F85Z17683GAA	955-003
F85Z17683GAB	955-002
F85Z17683HAB	955-030
F85Z17K707AD	955-283
F871Z7682AAB	955-009
F871Z7683BAB	955-008
F87B 14A365-AA	742-237
F87B 7827144-AA	742-238
F87B 7827145-AA	742-239
F87Z 17508-AD	601-207
F87Z 3078-AA	520-240
F87Z 3079-AA	520-239
F87Z 6675-AA	264-014
F87Z 7823394-AA	742-237
F87Z 7823395-AA	742-236
F87Z 9430-AA	674-378
F87Z 9431-AA	674-379
F87Z 9431-BA	674-413
F87Z17682RAA	955-007
F87Z17682SAA	955-011
F87Z17683RAA	955-006
F87Z17683SAB	955-010
F87Z19E616AA	604-201
F8AZ 4234-DA	630-205
F8AZ 54218A42-AA	746-145
F8AZ 5426594-AA	746-145
F8AZ17682AA	955-035
F8AZ17682BA	955-034
F8AZ-6A715-AA	625-200
F8AZ2424BC	615-178
F8CZ 9430-FD	674-395
F8DB 5423394-AA	742-240
F8DB 5423395-AA	742-241
F8DZ 3078-AA	520-242
F8DZ 3078-AB	520-244
F8DZ 3079-AA	520-241
F8DZ 3079-AB	520-243
F8DZ 5423208-AA	740-755
F8DZ 5423209-AA	740-756
F8DZ 5423394-AA	742-240
F8DZ 5423395-AA	742-241
F8DZ 8C607-AC	620-106
F8DZ12A362AA	689-107
F8DZ17682DA	955-278
F8DZ2009BB	576-139
F8DZ9002CB	576-140
F8RZ 3078-BA	520-202
F8RZ 3079-BA	520-201
F8RZ 5G232-AC	674-594
F8RZ 5G232-BC	674-595
F8RZ 8C607-GE	620-104
F8RZ 8C607-KA	620-103
F8RZ17682EA	955-037
F8RZ17682FA	955-036
F8VB 5423394-AC	742-216
F8VB 5423395-AC	742-217
F8VB 5427144-AA	742-216
F8VB 5427145-AA	742-217
F8VZ 5423394-AA	742-216
F8VZ 5423394-AB	742-216
F8VZ 5423395-AA	742-217
F8VZ 5423395-AB	742-217
F8VZ 8C607-AA	620-108
F8ZZ 8C607-BA	620-109
F8ZZ 9431-DA	674-448
F8ZZ 9431-EA	674-286
F99Z17683A	955-295
F9PZ 17508-AA	601-201
F9TZ 7G360-AA	600-800
F9TZ 14A366-AA	742-236
FE3N10400B	264-030
FE68-15-140A	620-775 ^{M1}
FE69-15-140	620-746 ^S
FEH5-15-140	620-739 ^S
FEH5-15-140	620-741 ^S
FP13-18-200A	690-158
FS01-18-200A	690-112

OE #	Dorman
FS05-11-401	594-134
FS11-11-401	594-134
FS11-15-150	620-775 ^{M1}
FS11-15-210	620-775 ^{M1}
FS12-15-140	620-747 ^{M1}
FS12-15-210A	620-747 ^{M1}
FS19-15-025	620-775 ^{M1}
FS1G-15-025B	620-778 ^{M1}
FS1G-15-140	620-778 ^{M1}
FS1G-15-150	620-778 ^{M1}
FS1G-15-210	620-778 ^{M1}
FS1H-15-140	620-778 ^{M1}
FS20-15-025	620-747 ^{M1}
FS59-10-400A	264-021
FSB-11-400	594-193
FSB-811-400	594-184
FSD7-15-025B	620-751 ^{B1}
FSD7-15-035A	620-750 ^S
FSD7-15-150	620-751 ^{B1}
FSD7-15-210	620-751 ^{B1}
FSD9-15-150	620-750 ^S
FSD9-15-210	620-750 ^S
G030-34-300F	520-820
G030-34-350F	520-819
G030-61-710A	620-743
GA2B-34-300A	520-266
GA2B-34-350A	520-265
GA2E-61-710A	620-749
GB6J-58-560D	741-772
GB6J-59-560D	741-773
GD1E-61-710	620-748
GJ22-34-300A	520-264
GJ22-34-300B	520-264
GJ22-34-350A	520-263
GJ22-34-350B	520-263
GY01-11-400A	594-109
H2Y0-34-300	520-824
H2Y0-34-300C	520-824
H2Y0-34-350C	520-823
H380-34-300A	520-822
H380-34-350A	520-821
HG30-58-560D	741-751
HG30-59-560D	741-750
J3225201	594-022
J3230131	594-135
J3237426	674-237
J3237427	674-237
J3242625	674-225
J3242886	594-137
J3743078	742-300
J3743079	742-301
J5357373	692-116
J5751193	955-229
J8121274	674-392
J8124999	674-235
J8125075	674-235
J8129210	674-393
J8134627	746-014
JE1513220A	696-603
JF07-18-200B	690-123
JF07-18-200C	690-123
JF52PBX	955-254
JF53PBX	955-101
K630111G26	955-203
K630153U01	955-442
K630155U01	955-432
K630253U01	955-441
K630255U01	955-431
K8051594XA	300-600
K8051594YA/YB	300-601
KF34-18-200ROA	690-165
KJ0118230A	689-301
KL01-11-400A	594-120
KL01-11-400B	594-120
KL01-18-200C	690-145
KL1113220D	696-602
KL20-15-150	620-747 ^{M1}
KL4713221	696-605
KL64-15-140	620-750 ^S

* OE component used in multiple assemblies. Please refer to application/photo section for specific Dorman number. M1 = Motor 1; M2 = Motor 2; S = Shroud; B1 = Blade 1; B2 = Blade 2; O = Other

OE Interchange (continued)

OE #	Dorman
KLR9-15-025B	620-871
LA01-34-300	520-830
LA0169110E	955-411
LA0169170F	955-410
LB82-34-300	520-830
M04667547	264-208
M04777335	264-208
MB303374	520-355
MB303375	520-356
MB349444	520-355
MB349445	520-356
MB439892	620-301
MB487703	692-122
MB573093	520-837
MB573094	520-838
MB573098	520-838
MB605002	620-300 ^S
MB605002	620-305 ^S
MB605399	620-300 ^S
MB605401	620-300 ^S
MB657380	620-320
MB660581	620-305 ^S
MB809220	520-843
MB809221	520-844
MB809222	520-841
MB809223	520-842
MB831555	520-833
MB831556	520-834
MB831557	520-831
MB831558	520-832
MB845072	620-307 ^S
MB845078	620-305 ^S
MB845862	620-314 ^S
MB845865	620-315 ^S
MB845869	620-314 ^{B1}
MB869473	620-306
MB890938	620-315 ^{B1}
MB906421	620-302 ^{B1}
MB906423	620-302 ^{B1}
MB906423	620-303 ^{B1}
MB912077	520-839
MB912078	520-840
MB912505	520-835
MB912506	520-836
MB912509	520-357
MB912510	520-358
MB912511	520-347
MB912512	520-348
MB924464	620-027 ^{B1}
MB938914	620-317
MD025534	674-264
MD090767	594-168
MD095636	264-202
MD096778	594-130
MD096958	674-515
MD101341	674-533
MD101659	674-264
MD101661	674-263
MD110686	264-201
MD116211	690-172
MD117624	674-592
MD121786	689-304
MD125362	674-265
MD130250	594-106
MD134390	674-511
MD136545	674-287
MD138339	594-144
MD141468	594-164
MD149770	674-263
MD150195	264-203
MD153199	690-135
MD155852	690-171
MD157769	674-266
MD167021	674-287
MD180936	690-122
MD182813	674-265

OE #	Dorman
MD182814	674-266
MD184028	674-520
MD184529	689-302
MD188610	690-170
MD189191	264-201
MD190168	690-143
MD190967	674-287
MD195540	674-287
MD195541	674-287
MD195559	674-287
MD197582	594-186
MD307345	674-510
MD308197	674-265
MD309537	264-203
MD311472	594-056
MD316173	690-163
MD324796	594-186
MD325051	690-135
MD333325	594-176
MD338319	594-106
MD343019	690-163
MD354781	594-130
MD376608	594-106
MD377604	594-106
MN119375	594-176
MO4667772	594-177
MR127280	620-314 ^S
MR127282	620-315 ^{B1}
MR127757	620-302 ^{B1}
MR146417	620-303 ^{B1}
MR146418	620-303 ^{B1}
MR162579	520-357
MR162580	520-358
MR188151	620-307 ^S
MR188156	620-307 ^S
MR201374	620-308
MR232924	624-701
MR296295	520-357
MR296296	520-358
MR296319	520-347
MR296320	520-348
MR312178	620-318 ^{B1}
MR312236	620-318 ^{B1}
MR312238	620-309 ^S
MR315303	620-012
MR315303	620-304
MR325576	520-358
MR325577	520-357
MR350892	624-700
MR355973	620-027 ^{B1}
MR355974	620-027 ^{B1}
MR360589	620-028
MR373109	620-011 ^{M1}
MR373149	620-011 ^{M1}
MR404166	620-309 ^S
MR404167	620-309 ^S
MR460922	620-308
MR481726	620-011 ^{M1}
MR481726	620-318 ^{B1}
MR491345	520-843
MR491346	520-844
MR491347	520-841
MR491348	520-842
MR500515	620-319
MR500561	620-303 ^{B1}
MR513360	620-012
MR958398	620-311
N802239S	800-003
N802241S	800-004
N802441S	800-002
N802710S190	800-001
N803430S	800-012
N803431S	800-011
N806206-S190	800-130
N806207-S190	800-131
QH22RC9	955-253

OE #	Dorman
TA04-34-300F	520-828
TA04-34-350F	520-827
UB39-34-300D	520-826
UB39-34-310C	520-826
UB39-34-350D	520-825
UB39-34-360C	520-825
UB39-60-960C	692-123
UB4569110B	955-199
UB4569170B	955-198
UB4569180	955-477
UC8642110C	576-720
UC9042110D	576-712
UC9442110B	576-717
UE3942110D	576-715
UE5569120	955-413
UE5569180	955-412
UF1042110A	576-716
XC22 9430-AA	674-459
XC2219E616AA	604-200
XC329B659AA	696-202
XF1Z 6316-AA	594-108
XF1Z17682FAA	955-288
XF1Z17682FAA	955-484
XF2Z 6675-EA	264-015
XF2Z 8C607-AB	620-131
XF2Z 9430-BA	674-366
XF2Z 9431-AA	674-451
XF2Z 9431-BA	674-367
XF2Z12A362AA	689-100
XF2Z17682BAA	955-033
XF2Z17682EAA	955-468
XF2Z17683BAA	955-032
XF2Z17683EAA	955-467
XF2Z19E616FB	604-203
XF3Z 9430-AA	674-455
XF3Z 9431-AA	674-450
XF5Z 3078-AA	520-274
XF5Z 3079-AA	520-273
XF5Z 8C607-AA	620-113
XL1Z 17508-AA	601-207
XL1Z 7823394-AA	742-231
XL1Z 7823394-BA	742-233
XL1Z 7823395-AA	742-230
XL1Z 7823395-BA	742-232
XL1Z 9431-BA	674-461
XL2Z 6312-BA	594-111
XL2Z 7G360-AA	600-803
XL2Z 9430-CA	674-329
XL2Z 9431-CA	674-334
XL2Z12A362AA	689-101
XL34 14A365-AA	742-228
XL34 14A366-AA	742-229
XL3Z 1523208-AA	740-849
XL3Z 1523209-AA	740-848
XL3Z 1523394-AA	742-229
XL3Z 1523395-AA	742-228
XL3Z 3084-AA	520-218
XL3Z 3084-BA	520-216
XL3Z 3085-AA	520-217
XL3Z 3085-BA	520-215
XL3Z 6312-CA	594-112
XL3Z 7A030 AA	624-227
XL3Z 7A031 AA	624-228
XL3Z 7A031 BC	624-208
XL3Z 9430-AA	674-554
XL3Z 9430-CA	674-586
XL3Z 9430-GA	674-559
XL3Z 9431-AA	674-555
XL3Z 9431-BA	674-587
XL3Z 9431-FA	674-460
XL5Z12A362AB	689-109
XR3Z 3078-BA	520-236
XR3Z 3079-BA	520-235
XR3Z 8C607-AA	620-130
XR3Z 9430-AC	674-536
XR3Z 9430-BA	674-536

OE #	Dorman
XR3Z 9430-BC	674-536
XR3Z 9430-CC	674-457
XR3Z 9430-FA	674-458
XR3Z 9431-BC	674-535
XR3Z 9431-CB	674-453
XR3Z 9431-DC	674-535
XR3Z17682AA	955-474
XR3Z17682BA	955-473
XW1Z 3078-BA	520-208
XW1Z 3079-BA	520-207
XW4Z 3A733AA	300-008
XW4Z 9431-BE	674-452
XW73 5427144-AA	742-253
XW73 5427145-AA	742-252
XW7Z 5423394-BA	742-253
XW7Z 5423395-BA	742-252
XW7Z 5427008-AA	740-678
Y54Z 3078-BA	520-232
YC2Z 6312-AA	594-119
YC2Z 9430-BA	674-459
YC2Z 9431-EA	674-560
YC2Z-4234-CA	630-207
YC2Z-4234-CB	630-208
YC2Z-7B028-BA	624-254
YC3Z 1523394-AA	742-261
YC3Z 1523395-AA	742-260
YC3Z 7G360-AA	600-805
YC3Z17682FAA	955-364
YC3Z17682JAA	955-362
YC3Z17683FAA	955-363
YC3Z17683JAA	955-361
YF1Z 3A733-AA	300-003
YF1Z 8C607-BD	620-105
YF1Z 9430-ED	674-566
YF1Z 9431-BC	674-363
YF1Z 9431-FD	674-449
YF1Z-9S278-AA	800-858
YL1Z 7G360-AA	600-802
YL1Z 7G360-AB	600-802
YL2Z 3079-AA	520-223
YL2Z 7G360-AA	600-803
YL2Z 7G360-AB	600-803
YL2Z 7G360-B	600-800
YL2Z9424AA	615-176
YL3Z 7G360-AA	600-802
YL3Z 7G360-AB	600-802
YL5Z 6675-AA	264-014
YL5Z19E616AA	604-202
YS4Z 3078-BA	520-232
YS4Z 3079-BA	520-231
YS4Z 3A733AA	300-007
YS4Z 3A733BA	300-007
YS4Z14A664CA	525-212
YS4Z17682MBA	955-021
YS4Z17683MAA	955-020
YS4Z-9L291-FC	800-855
Z501-15-035	620-755
Z509-13-451	674-247
ZL01-15-025B	620-759 ^S
ZL01-15-035A	620-758
ZL01-15-150	620-759 ^S
ZL01-15-210B	620-759 ^S
ZL04-15-025B	620-757 ^{M1}
ZL04-15-140	620-757 ^{M1}
ZL04-15-150	620-757 ^{M1}
ZL04-15-210	620-757 ^{M1}
ZL0 58-8XA	742-412
ZL0 59-58XA	742-413
ZL1 58-560	740-672
ZL1 59-560	740-673
ZZM0-17-645	600-807
ZZM1-10-400	264-014
ZZM4-10-400	264-014
ZZM7-10-400	264-014

* OE component used in multiple assemblies. Please refer to application/photo section for specific Dorman number. M1 = Motor 1; M2 = Motor 2; S = Shroud; B1 = Blade 1; B2 = Blade 2; O = Other

Product #	Page #	Product #	Page #	Product #	Page #	Product #	Page #	Product #	Page #
03618	58	300-011	319	520-209	27	520-408	31	520-668	35
258-500	6	300-100	319	520-210	27	520-409	31	520-669	35
258-501	6	300-101	319	520-211	28	520-410	31	520-670	35
258-504	6	300-102	319	520-212	28	520-411	31	520-671	35
264-002	304	300-120	319	520-213	28	520-412	31	520-672	35
264-003	304	300-121	319	520-214	28	520-414	31	520-673	35
264-004	304	300-122	320	520-215	28	520-417	32	520-674	35
264-005	304	300-123	320	520-216	28	520-418	32	520-675	36
264-006	304	300-124	320	520-217	28	520-419	32	520-676	36
264-009	304	300-200	320	520-218	28	520-420	32	520-677	36
264-010	304	300-201	320	520-219	28	520-421	32	520-678	36
264-011	304	300-301	320	520-220	28	520-422	32	520-683	36
264-012	304	300-302	320	520-221	28	520-423	32	520-684	36
264-013	304	300-303	320	520-222	28	520-424	32	520-688	36
264-014	304	300-304	320	520-223	28	520-425	32	520-690	36
264-015	304	300-305	321	520-224	28	520-426	32	520-709	36
264-016	305	300-306	321	520-230	28	520-427	32	520-710	36
264-017	305	300-307	321	520-231	28	520-428	32	520-717	36
264-018	305	300-308	321	520-232	28	520-429	32	520-718	36
264-019	305	300-309	321	520-239	28	520-430	32	520-721	36
264-020	305	300-310	321	520-240	28	520-433	32	520-722	36
264-021	305	300-311	321	520-247	28	520-434	32	520-726	36
264-022	305	300-400	321	520-248	28	520-437	32	520-727	36
264-023	305	300-500	321	520-249	28	520-438	32	520-728	36
264-024	305	300-600	322	520-250	28	520-442	32	520-729	36
264-026	305	300-601	322	520-255	29	520-443	32	520-730	36
264-029	305	300-800	138	520-256	29	520-444	32	520-731	36
264-030	305	300-801	138	520-257	29	520-501	32	520-732	36
264-031	306	300-802	138	520-258	29	520-502	32	520-733	37
264-034	306	300-803	138	520-263	29	520-503	33	520-734	37
264-100	306	300-806	138	520-264	29	520-504	33	520-735	37
264-101	306	300-911	470	520-265	29	520-506	33	520-736	37
264-102	306	300-912	470	520-266	29	520-509	33	520-737	37
264-103	306	300-913	470	520-267	29	520-510	33	520-738	37
264-104	306	300-920	470	520-268	29	520-511	33	520-740	37
264-105	306	300-921	470	520-271	29	520-512	33	520-743	37
264-106	306	300-930	470	520-272	29	520-513	33	520-744	37
264-107	306	315-100	278	520-273	29	520-514	33	520-755	37
264-108	306	315-102	278	520-274	29	520-517	33	520-756	37
264-110	306	315-103	278	520-275	29	520-518	33	520-757	37
264-111	307	315-302	278	520-276	29	520-519	33	520-758	37
264-117	307	315-400	278	520-301	29	520-520	33	520-760	37
264-118	307	315-401	278	520-302	29	520-521	33	520-762	37
264-119	307	315-404	278	520-303	29	520-522	33	520-763	37
264-120	307	315-500	278	520-304	29	520-523	33	520-764	37
264-121	307	315-600	278	520-305	29	520-525	33	520-765	37
264-122	307	315-601	278	520-306	29	520-526	33	520-766	37
264-123	307	520-101	26	520-307	29	520-527	33	520-767	37
264-200	307	520-102	26	520-308	29	520-528	33	520-768	37
264-201	307	520-107	26	520-309	30	520-607	33	520-803	37
264-202	307	520-108	26	520-310	30	520-608	33	520-804	37
264-203	307	520-111	26	520-311	30	520-610	34	520-811	38
264-204	308	520-112	26	520-312	30	520-611	34	520-812	38
264-205	308	520-113	26	520-314	30	520-612	34	520-813	38
264-206	308	520-114	26	520-315	30	520-621	34	520-814	38
264-208	308	520-116	26	520-316	30	520-622	34	520-816	38
264-209	308	520-119	26	520-317	30	520-623	34	520-817	38
264-210	308	520-120	26	520-318	30	520-624	34	520-818	38
264-220	308	520-121	26	520-323	30	520-625	34	520-819	38
264-221	308	520-122	26	520-324	30	520-626	34	520-820	38
264-222	308	520-125	26	520-325	30	520-627	34	520-821	38
264-300	308	520-126	26	520-326	30	520-628	34	520-822	38
264-301	308	520-127	26	520-327	30	520-629	34	520-824	38
264-303	308	520-128	26	520-328	30	520-630	34	520-825	38
264-304	309	520-129	26	520-333	30	520-631	34	520-826	38
264-305	309	520-130	26	520-334	30	520-632	34	520-830	38
264-307	309	520-131	26	520-335	30	520-633	34	520-835	38
264-308	309	520-132	26	520-336	30	520-634	34	520-836	38
264-309	309	520-133	26	520-341	30	520-637	34	520-837	38
264-400	309	520-134	26	520-342	30	520-638	34	520-838	38
264-401	309	520-135	27	520-343	30	520-639	34	520-839	38
264-402	309	520-136	27	520-344	30	520-640	34	520-840	38
264-403	309	520-137	27	520-345	31	520-641	34	520-841	39
264-405	309	520-138	27	520-346	31	520-642	34	520-842	39
264-406	309	520-139	27	520-347	31	520-643	35	520-843	39
264-407	309	520-142	27	520-348	31	520-644	35	520-844	39
264-500	310	520-143	27	520-350	31	520-646	35	520-845	39
264-502	310	520-144	27	520-355	31	520-647	35	520-846	39
264-900	310	520-145	27	520-356	31	520-648	35	520-848	39
300-002	318	520-146	27	520-357	31	520-650	35	520-850	39
300-003	318	520-150	27	520-358	31	520-660	35	525-003	22
300-004	318	520-151	27	520-401	31	520-661	35	525-005	22
300-005	318	520-152	27	520-402	31	520-662	35	525-006	22
300-006	318	520-201	27	520-403	31	520-663	35	525-100	22
300-007	318	520-202	27	520-404	31	520-664	35	525-101	22
300-008	319	520-203	27	520-405	31	520-665	35	525-103	22
300-009	319	520-204	27	520-406	31	520-666	35	525-104	22
300-010	319	520-208	27	520-407	31	520-667	35	525-106	22

Product #	Page #	Product #	Page #	Product #	Page #	Product #	Page #	Product #	Page #
525-200	22	576-157	187	576-385	197	577-011	206	594-024	231
525-201	22	576-158	187	576-386	197	577-012	207	594-026	232
525-205	22	576-159	187	576-387	197	577-013	207	594-027	232
525-206	22	576-300	187	576-388	197	577-015	207	594-028	232
525-212	22	576-301	187	576-389	197	577-016	207	594-029	232
525-213	22	576-302	187	576-390	197	577-058	207	594-030	232
525-600	22	576-303	188	576-391	197	577-072	207	594-031	232
525-601	23	576-304	188	576-392	197	577-073	207	594-032	232
525-602	23	576-305	188	576-393	198	577-074	207	594-033	232
525-604	23	576-306	188	576-394	198	578-001	209	594-034	232
525-605	23	576-307	188	576-395	198	578-003	209	594-037	232
525-700	23	576-308	188	576-600	198	578-005	209	594-042	232
525-701	23	576-309	188	576-601	198	578-006	209	594-043	232
576-000	179	576-310	188	576-602	198	578-007	209	594-044	233
576-001	179	576-311	188	576-603	198	578-008	209	594-047	233
576-002	179	576-312	189	576-604	198	578-009	210	594-050	233
576-003	179	576-313	189	576-605	198	578-011	210	594-051	233
576-004	179	576-314	189	576-606	199	578-012	210	594-052	233
576-005	179	576-315	189	576-607	199	578-016	210	594-053	233
576-006	179	576-316	189	576-608	199	578-017	210	594-054	233
576-007	179	576-317	189	576-650	199	578-018	210	594-055	233
576-008	179	576-318	189	576-651	199	578-019	210	594-056	233
576-009	180	576-319	189	576-652	199	578-020	210	594-057	233
576-010	180	576-320	189	576-653	199	578-021	210	594-058	233
576-011	180	576-321	190	576-654	199	578-022	210	594-059	233
576-012	180	576-322	190	576-655	199	578-026	210	594-060	234
576-013	180	576-323	190	576-656	200	578-028	210	594-067	234
576-014	180	576-324	190	576-657	200	578-030	211	594-068	234
576-015	180	576-325	190	576-658	200	578-036	211	594-069	234
576-016	180	576-326	190	576-659	200	578-038	211	594-070	234
576-017	180	576-327	190	576-660	200	578-042	211	594-071	234
576-100	181	576-328	190	576-661	200	578-043	211	594-073	234
576-101	181	576-329	190	576-662	200	578-044	211	594-074	234
576-102	181	576-330	191	576-700	200	578-045	211	594-077	234
576-103	181	576-331	191	576-701	200	578-046	211	594-078	234
576-104	181	576-332	191	576-702	201	578-051	211	594-080	234
576-105	181	576-333	191	576-703	201	578-052	211	594-081	234
576-106	181	576-334	191	576-704	201	578-054	211	594-082	235
576-107	181	576-335	191	576-705	201	578-061	211	594-083	235
576-108	181	576-336	191	576-706	201	578-070	211	594-084	235
576-109	182	576-337	191	576-707	201	578-078	211	594-085	235
576-110	182	576-338	191	576-708	201	579-001	207	594-086	235
576-111	182	576-339	192	576-709	201	579-003	207	594-087	235
576-112	182	576-340	192	576-710	201	579-004	207	594-101	235
576-113	182	576-341	192	576-711	202	579-005	208	594-102	235
576-114	182	576-342	192	576-712	202	579-006	208	594-103	235
576-115	182	576-343	192	576-713	202	579-007	208	594-106	235
576-116	182	576-344	192	576-714	202	579-008	208	594-107	235
576-117	182	576-345	192	576-715	202	579-009	208	594-108	235
576-118	183	576-346	192	576-716	202	579-012	208	594-109	236
576-119	183	576-347	192	576-717	202	579-013	208	594-110	236
576-120	183	576-348	193	576-718	202	579-014	208	594-111	236
576-121	183	576-349	193	576-719	202	579-015	208	594-112	236
576-122	183	576-350	193	576-720	203	579-020	208	594-113	236
576-123	183	576-351	193	576-721	203	579-023	208	594-114	236
576-124	183	576-352	193	576-722	203	579-024	208	594-115	236
576-125	183	576-353	193	576-800	203	579-025	208	594-116	236
576-126	183	576-354	193	576-801	203	579-032	208	594-117	236
576-127	184	576-355	193	576-802	203	579-033	208	594-118	236
576-128	184	576-356	193	576-803	203	579-034	209	594-119	236
576-129	184	576-357	194	576-804	203	579-038	209	594-120	236
576-130	184	576-358	194	576-805	203	579-039	209	594-121	237
576-131	184	576-359	194	576-806	204	579-043	209	594-122	237
576-132	184	576-360	194	576-807	204	579-046	209	594-123	237
576-133	184	576-361	194	576-808	204	579-091	209	594-124	237
576-134	184	576-362	194	576-809	204	594-001	230	594-125	237
576-135	184	576-363	194	576-810	204	594-002	230	594-127	237
576-136	185	576-364	194	576-811	204	594-003	230	594-128	237
576-137	185	576-365	194	576-812	204	594-004	230	594-129	237
576-138	185	576-366	195	576-813	204	594-005	230	594-130	237
576-139	185	576-367	195	576-814	204	594-006	230	594-131	237
576-140	185	576-368	195	576-815	205	594-007	230	594-132	237
576-141	185	576-369	195	576-816	205	594-008	230	594-133	237
576-142	185	576-370	195	576-850	205	594-009	230	594-134	238
576-143	185	576-371	195	576-851	205	594-010	230	594-135	238
576-144	185	576-372	195	576-852	205	594-011	230	594-137	238
576-145	186	576-373	195	576-853	205	594-012	230	594-138	238
576-146	186	576-374	195	576-854	205	594-013	231	594-139	238
576-147	186	576-375	196	576-855	205	594-014	231	594-140	238
576-148	186	576-376	196	576-856	205	594-015	231	594-141	238
576-149	186	576-377	196	576-900	206	594-016	231	594-142	238
576-150	186	576-378	196	576-901	206	594-017	231	594-143	238
576-151	186	576-379	196	576-902	206	594-018	231	594-144	238
576-152	186	576-380	196	577-005	206	594-019	231	594-145	238
576-153	186	576-381	196	577-006	206	594-020	231	594-146	238
576-154	187	576-382	196	577-007	206	594-021	231	594-147	239
576-155	187	576-383	196	577-008	206	594-022	231	594-148	239
576-156	187	576-384	197	577-009	206	594-023	231	594-149	239

NUMERICAL INDEX

Product #	Page #
594-150	239
594-152	239
594-153	239
594-154	239
594-155	239
594-156	239
594-158	239
594-159	239
594-161	239
594-162	240
594-164	240
594-166	240
594-168	240
594-169	240
594-170	240
594-174	240
594-175	240
594-176	240
594-177	240
594-178	240
594-180	240
594-181	241
594-182	241
594-183	241
594-184	241
594-185	241
594-186	241
594-187	241
594-188	241
594-189	241
594-190	241
594-191	241
594-192	241
594-193	242
594-195	242
594-999	242
600-100C	144
600-101	144
600-102	144
600-200	144
600-800	144
600-801	144
600-802	144
600-803	144
600-804	144
600-805	145
600-806	145
600-807	145
600-900	145
600-901	145
600-902	145
600-903	145
600-904	145
600-906	146
600-907	146
601-100	568
601-101	568
601-102	568
601-103	568
601-104	568
601-107	568
601-109	568
601-110	568
601-111	568
601-112	568
601-113	568
601-114	568
601-115	569
601-116	569
601-117	569
601-118	569
601-119	569
601-120	569
601-121	569
601-122	569
601-123	569
601-201	569
601-202	569
601-203	569
601-205	570
601-206	570
601-207	570
601-300	570
601-301	570
601-302	570
601-303	570
601-304	570
601-305	570

Product #	Page #
602-001	574
602-002	574
602-003	574
602-004	574
602-005	574
602-006	574
602-007	574
602-202	574
602-203	574
602-204	574
602-205	574
602-300	574
603-001	140
603-100	140
603-101	140
603-200	140
603-201	140
603-202	140
603-300	140
603-301	140
603-600	140
603-601	140
604-001	2
604-100	2
604-101	2
604-102	2
604-103	2
604-200	2
604-201	2
604-202	2
604-203	2
614-001	57
614-002	57
614-003	57
614-004	57
614-012	57
614-030	56
614-050	56
614-064	58
614-072	58
615-175	274
615-176	274
615-177	275
615-178	274
615-179	274
615-180	274
615-181	274
615-182	275
615-200	275
615-300	275
619-001	14
619-002	14
619-101	14
619-102	14
619-103	14
619-104	14
619-105	14
619-106	14
619-109	14
619-110	14
619-111	14
619-112	14
619-113	14
619-301	14
619-302	14
619-303	15
619-304	15
619-305	15
619-306	15
619-307	15
619-308	15
619-401	15
619-402	15
619-403	15
619-404	15
619-405	15
619-406	15
619-501	15
619-502	15
619-503	15
619-504	16
619-505	16
620-001	398
620-002	398
620-003	398
620-004	398
620-005	398
620-006	398

Product #	Page #
620-007	398
620-008	398
620-009	398
620-010	398
620-011	398
620-012	398
620-013	399
620-014	399
620-015	399
620-017	399
620-018	399
620-019	399
620-021	399
620-022	399
620-026	399
620-027	399
620-028	399
620-029	399
620-100	400
620-101	400
620-102	400
620-103	400
620-104	400
620-105	400
620-106	400
620-107	400
620-108	400
620-109	400
620-110	400
620-111	400
620-112	401
620-113	401
620-114	401
620-115	401
620-121	401
620-122	401
620-123	401
620-124	401
620-125	401
620-126	401
620-127	401
620-128	401
620-129	402
620-130	402
620-131	402
620-132	402
620-133	402
620-134	402
620-200	402
620-201	402
620-202	402
620-203	402
620-204	402
620-206	402
620-207	403
620-208	403
620-209	403
620-213	403
620-214	403
620-215	403
620-216	403
620-217	403
620-218	403
620-219	403
620-220	403
620-221	403
620-222	404
620-223	404
620-224	404
620-226	404
620-227	404
620-228	404
620-229	404
620-230	404
620-231	404
620-232	404
620-233	404
620-234	404
620-235	405
620-236	405
620-237	405
620-238	405
620-239	405
620-300	405
620-301	405
620-302	405
620-303	405
620-304	405

Product #	Page #
620-305	405
620-306	405
620-307	406
620-308	406
620-309	406
620-310	406
620-311	406
620-312	406
620-314	406
620-317	406
620-318	406
620-319	406
620-320	406
620-350	406
620-400	407
620-401	407
620-402	407
620-403	407
620-404	407
620-405	407
620-406	407
620-407	407
620-408	407
620-409	407
620-410	407
620-411	407
620-412	408
620-413	408
620-415	408
620-416	408
620-417	408
620-418	408
620-419	408
620-420	408
620-500	408
620-501	408
620-502	408
620-503	408
620-504	409
620-505	409
620-506	409
620-507	409
620-508	409
620-511	409
620-513	409
620-514	409
620-515	409
620-516	409
620-517	409
620-518	409
620-519	410
620-520	410
620-522	410
620-523	410
620-524	410
620-525	410
620-526	410
620-527	410
620-528	410
620-529	410
620-530	410
620-531	410
620-532	411
620-533	411
620-534	411
620-535	411
620-536	411
620-537	411
620-538	411
620-539	411
620-600	411
620-601	411
620-602	411
620-603	411
620-604	412
620-605	412
620-606	412
620-607	412
620-611	412
620-614	412
620-615	412
620-616	412
620-618	412
620-621	412
620-622	412
620-623	412
620-624	413
620-625	413

Product #	Page #
620-626	413
620-627	413
620-628	413
620-629	413
620-636	413
620-637	413
620-641	413
620-707	413
620-709	413
620-710	413
620-711	414
620-712	414
620-713	414
620-714	414
620-715	414
620-716	414
620-717	414
620-718	414
620-719	414
620-720	414
620-721	414
620-722	414
620-723	415
620-724	415
620-725	415
620-737	415
620-739	415
620-740	415
620-741	415
620-742	415
620-743	415
620-744	415
620-746	415
620-747	415
620-748	416
620-749	416
620-750	416
620-751	416
620-753	416
620-754	416
620-755	416
620-757	416
620-758	416
620-759	416
620-760	416
620-762	416
620-763	417
620-764	417
620-765	417
620-766	417
620-767	417
620-768	417
620-769	417
620-770	417
620-772	417
620-773	417
620-774	417
620-775	417
620-776	418
620-777	418
620-778	418
620-800	418
620-810	418
620-811	418
620-812	418
620-813	418
620-820	418
620-821	418
620-822	418
620-871	418
620-880	419
620-881	419
620-883	419
620-886	419
620-887	419
620-900	419
620-901	419
622-001	136
624-100	486
624-101	486
624-102	486
624-103	486
624-104	486
624-106	486
624-107	486
624-108	486
624-109	487
624-110	487

Product #	Page #	Product #	Page #	Product #	Page #	Product #	Page #	Product #	Page #
624-111	487	624-351	498	624-898	509	626-102	256	674-198	81
624-112	487	624-352	498	624-899	509	626-103	256	674-199	82
624-113	487	624-353	498	624-900	509	626-200	256	674-200	82
624-121	487	624-354	498	624-901	509	626-201	256	674-201	82
624-126	487	624-355	498	625-001	283	628-100	258	674-202	82
624-127	487	624-357	498	625-100	283	628-101	258	674-203	82
624-128	488	624-358	499	625-101	283	628-200	258	674-204	82
624-130	488	624-360	499	625-102	283	628-201	258	674-205	83
624-131	488	624-362	499	625-103	283	628-202	258	674-206	83
624-132	488	624-366	499	625-104	283	628-203	258	674-208	83
624-133	488	624-367	499	625-105	283	628-204	258	674-210	83
624-134	488	624-368	499	625-106	283	635-100	474	674-211	83
624-135	488	624-369	499	625-107	284	635-101	474	674-212	83
624-136	488	624-370	499	625-108	284	635-102	474	674-213	84
624-137	489	624-372	500	625-109	284	635-105	474	674-214	84
624-139	489	624-373	500	625-110	284	635-106	474	674-215	84
624-140	489	624-378	500	625-111	284	635-107	474	674-216	84
624-142	489	624-379	500	625-112	284	635-108	474	674-217	84
624-144	489	624-380	500	625-113	284	635-109	474	674-218	84
624-146	489	624-382	500	625-114	284	635-201	474	674-220	85
624-148	489	624-383	500	625-118	285	635-202	474	674-221	85
624-150	489	624-384	500	625-119	285	635-203	474	674-222	85
624-151	490	624-386	501	625-120	285	635-204	474	674-223	85
624-156	490	624-388	501	625-121	285	635-205	475	674-224	85
624-157	490	624-393	501	625-122	285	635-206	475	674-225	85
624-160	490	624-394	501	625-123	285	635-300	475	674-226	86
624-161	490	624-395	501	625-124	285	635-301	475	674-227	86
624-168	490	624-396	501	625-125	285	635-400	475	674-228	86
624-198	490	624-397	501	625-126	286	635-501	475	674-229	86
624-199	490	624-399	501	625-127	286	635-502	475	674-230	86
624-200	491	624-400	502	625-128	286	635-503	475	674-231	86
624-201	491	624-401	502	625-129	286	635-504	475	674-232	87
624-202	491	624-402	502	625-130	286	635-505	475	674-233	87
624-204	491	624-403	502	625-131	286	635-506	475	674-234	87
624-206	491	624-404	502	625-132	286	635-507	475	674-235	87
624-208	491	624-405	502	625-133	286	635-508	476	674-236	87
624-210	491	624-500	502	625-134	287	635-509	476	674-237	87
624-212	491	624-501	502	625-135	287	635-510	476	674-238	88
624-213	492	624-502	503	625-136	287	635-511	476	674-239	88
624-214	492	624-503	503	625-137	287	635-512	476	674-240	88
624-215	492	624-504	503	625-138	287	635-514	476	674-241	88
624-217	492	624-505	503	625-139	287	674-100	74	674-244	88
624-218	492	624-600	503	625-140	287	674-101	74	674-245	88
624-219	492	624-601	503	625-141	287	674-102	74	674-247	89
624-220	492	624-602	503	625-142	288	674-102T	74	674-248	89
624-221	492	624-603	503	625-143	288	674-150	74	674-249	89
624-222	493	624-604	504	625-144	288	674-151	74	674-250	89
624-223	493	624-605	504	625-145	288	674-152	75	674-251	89
624-224	493	624-700	504	625-146	288	674-153	75	674-263	89
624-225	493	624-701	504	625-147	288	674-155	75	674-264	90
624-226	493	624-702	504	625-148	288	674-156	75	674-265	90
624-227	493	624-703	504	625-149	288	674-157	75	674-266	90
624-228	493	624-800	504	625-150	289	674-158	75	674-267	90
624-251	493	624-801	504	625-151	289	674-159	76	674-268	90
624-252	494	624-802	505	625-152	289	674-160	76	674-269	90
624-253	494	624-804	505	625-153	289	674-161	76	674-270	91
624-254	494	624-805	505	625-154	289	674-162	76	674-271	91
624-268	494	624-806	505	625-155	289	674-163	76	674-272	91
624-269	494	624-807	505	625-157	289	674-164	76	674-274	91
624-300	494	624-808	505	625-158	289	674-165	77	674-275	91
624-301	494	624-809	505	625-159	290	674-166	77	674-276	91
624-302	494	624-811	505	625-160	290	674-168	77	674-278	92
624-303	495	624-816	506	625-161	290	674-169	77	674-280	92
624-304	495	624-818	506	625-162	290	674-170	77	674-281	92
624-305	495	624-819	506	625-163	290	674-172	77	674-282	92
624-306	495	624-821	506	625-164	290	674-173	78	674-283	92
624-307	495	624-824	506	625-165	290	674-174	78	674-284	92
624-308	495	624-826	506	625-166	290	674-175	78	674-285	93
624-311	495	624-828	506	625-167	291	674-176	78	674-286	93
624-312	495	624-829	506	625-168	291	674-178	78	674-287	93
624-313	496	624-830	507	625-169	291	674-179	79	674-327	93
624-314	496	624-831	507	625-170	291	674-180	79	674-329	93
624-320	496	624-832	507	625-171	291	674-181	79	674-330	93
624-322	496	624-833	507	625-172	291	674-182	79	674-334	94
624-323	496	624-834	507	625-173	291	674-183	79	674-342	94
624-324	496	624-836	507	625-174	291	674-184	79	674-343	94
624-326	496	624-837	507	625-175	292	674-185	79	674-356	94
624-330	496	624-838	507	625-176	292	674-186	80	674-357	94
624-332	497	624-839	508	625-177	292	674-187	80	674-358	94
624-333	497	624-840	508	625-178	292	674-188	80	674-359	95
624-334	497	624-841	508	625-179	292	674-189	80	674-360	95
624-335	497	624-850	508	625-180	292	674-190	80	674-361	95
624-336	497	624-851	508	625-181	292	674-191	80	674-362	95
624-337	497	624-854	508	625-182	292	674-193	81	674-363	95
624-340	497	624-882	508	625-183	293	674-194	81	674-364	95
624-341	497	624-888	508	625-200	293	674-195	81	674-365	95
624-344	498	624-895	509	626-100	256	674-196	81	674-366	96
624-350	498	624-897	509	626-101	256	674-197	81	674-367	96

Product #	Page #
674-368	96
674-371	96
674-373	96
674-376	97
674-378	97
674-379	97
674-380	97
674-381	97
674-383	97
674-385	98
674-390	98
674-391	98
674-392	98
674-393	98
674-394	98
674-395	99
674-398	99
674-399	99
674-400	99
674-404	99
674-405	99
674-406	100
674-407	100
674-408	100
674-410	100
674-412	100
674-413	100
674-431	101
674-432	101
674-433	101
674-434	101
674-435	101
674-438	101
674-439	102
674-440	102
674-441	102
674-442	102
674-444	102
674-446	102
674-447	103
674-448	103
674-449	103
674-450	103
674-451	103
674-452	103
674-453	104
674-454	104
674-455	104
674-456	104
674-457	104
674-458	104
674-459	105
674-460	105
674-461	105
674-462	105
674-464	105
674-465	105
674-466	106
674-467	106
674-468	106
674-469	106
674-500	106
674-501	106
674-502	107
674-503	107
674-504	107
674-505	107
674-506	107
674-507	107
674-508	108
674-509	108
674-510	108
674-511	108
674-512	108
674-513	108
674-514	109
674-515	109
674-516	109
674-517	109
674-518	109
674-519	109
674-520	110
674-522	110
674-525	110
674-526	110
674-527	110
674-528	110
674-529	111

Product #	Page #
674-530	111
674-531	111
674-532	111
674-533	111
674-534	111
674-535	112
674-536	112
674-537	112
674-538	112
674-540	112
674-541	112
674-544	113
674-545	113
674-546	113
674-549	113
674-550	113
674-551	113
674-552	114
674-553	114
674-554	114
674-555	114
674-556	114
674-557	114
674-558	115
674-559	115
674-560	115
674-566	115
674-567	115
674-568	115
674-569	116
674-570	116
674-571	116
674-572	116
674-573	116
674-575	116
674-577	117
674-578	117
674-579	117
674-583	117
674-584	117
674-585	117
674-586	118
674-587	118
674-588	118
674-589	118
674-592	118
674-593	118
674-596	119
689-100	18
689-101	18
689-102	18
689-103	18
689-104	18
689-105	18
689-106	18
689-107	18
689-108	18
689-109	18
689-200	18
689-300	18
689-301	18
689-302	18
689-303	18
689-304	18
689-305	18
689-306	18
689-307	19
689-308	19
689-309	19
690-100	262
690-101	262
690-102	262
690-103	262
690-104	262
690-105	262
690-106	262
690-107	262
690-108	262
690-109	263
690-110	263
690-111	263
690-112	263
690-113	263
690-114	263
690-115	263
690-117	263
690-118	263
690-119	264

Product #	Page #
690-120	264
690-121	264
690-122	264
690-123	264
690-124	264
690-125	264
690-129	264
690-130	264
690-131	265
690-132	265
690-133	265
690-134	265
690-135	265
690-136	265
690-137	265
690-138	265
690-139	265
690-141	266
690-142	266
690-143	266
690-145	266
690-153	266
690-154	266
690-155	266
690-156	266
690-157	266
690-158	267
690-162	267
690-163	267
690-165	267
690-166	267
690-167	267
690-168	267
690-169	267
690-170	267
690-171	268
690-172	268
690-173	268
690-174	268
690-900	268
690-901	268
690-902	268
690-903	268
692-000	156
692-001	156
692-002	156
692-003	156
692-004	156
692-005	156
692-006	157
692-007	157
692-008	157
692-009	157
692-010	157
692-011	157
692-012	158
692-013	158
692-014	158
692-015	158
692-016	158
692-017	158
692-018	159
692-019	159
692-020	159
692-021	159
692-022	159
692-023	159
692-024	160
692-025	160
692-026	160
692-027	160
692-028	160
692-029	160
692-030	161
692-031	161
692-032	161
692-033	161
692-034	161
692-035	161
692-036	162
692-037	162
692-038	162
692-039	162
692-040	162
692-041	162
692-042	163
692-043	163
692-044	163

Product #	Page #
692-045	163
692-046	163
692-047	163
692-048	164
692-049	164
692-050	164
692-051	164
692-052	164
692-053	164
692-054	165
692-055	165
692-056	165
692-057	165
692-058	165
692-059	165
692-060	166
692-061	166
692-062	166
692-063	166
692-064	166
692-066	166
692-067	167
692-068	167
692-069	167
692-070	167
692-071	167
692-072	167
692-073	168
692-075	168
692-079	168
692-084	168
692-087	168
692-091	168
692-093	169
692-099	169
692-100	169
692-101	169
692-102	169
692-105	169
692-106	170
692-107	170
692-109	170
692-111	170
692-115	170
692-127	170
692-128	171
692-129	171
692-130	171
692-133	171
696-100	8
696-101	8
696-200	8
696-201	8
696-202	8
696-203	8
696-204	8
696-300	8
696-600	8
696-602	8
696-603	8
696-605	8
696-700	9
696-701	9
696-702	9
696-703	9
698-100	534
740-650	557
740-651	557
740-652	556
740-653	556
740-654	557
740-655	557
740-660	556
740-661	556
740-662	556
740-663	556
740-664	556
740-665	556
740-666	556
740-667	556
740-672	556
740-673	556
740-674	556
740-678	556
740-679	556
740-680	560
740-681	560
740-682	557

Product #	Page #
740-683	557
740-684	556
740-685	556
740-686	557
740-687	557
740-688	557
740-689	557
740-692	557
740-693	557
740-701	560
740-702	560
740-703	560
740-705	561
740-720	561
740-721	561
740-722	561
740-724	561
740-725	561
740-726	560
740-727	561
740-728	561
740-729	561
740-730	561
740-736	559
740-737	559
740-738	561
740-739	561
740-754	556
740-755	557
740-756	557
740-763	559
740-764	559
740-774	561
740-775	561
740-776	561
740-777	561
740-778	561
740-779	561
740-780	561
740-781	561
740-782	561
740-783	561
740-785	561
740-786	561
740-787	561
740-788	561
740-789	562
740-790	562
740-791	562
740-792	562
740-795	562
740-796	562
740-797	562
740-798	562
740-799	562
740-800	562
740-801	562
740-802	562
740-803	562
740-804	562
740-805	562
740-806	562
740-821	557
740-822	557
740-825	562
740-826	562
740-827	556
740-828	556
740-831	557
740-832	557
740-835	557
740-836	557
740-842	560
740-843	560
740-848	557
740-849	557
741-550	556
741-551	556
741-552	560
741-553	560
741-554	556
741-555	556
741-556	560
741-557	560
741-630	558
741-631	558
741-637	558
741-638	558

Product #	Page #	Product #	Page #	Product #	Page #	Product #	Page #	Product #	Page #
741-640	558	742-111	536	742-314	544	800-092	333	800-801	338
741-641	558	742-112	536	742-315	544	800-092.5	333	800-802	336
741-642	558	742-113	537	742-343	544	800-094	339	800-811	338
741-643	558	742-114	537	742-344	544	800-095	340	800-812	338
741-644	558	742-115	537	742-345	544	800-096	340	800-840	150
741-645	558	742-116	537	742-346	544	800-101	341	800-842	150
741-646	558	742-117	537	742-375	544	800-102	342	800-843	150
741-647	558	742-118	537	742-376	544	800-103	342	800-844	150
741-648	556	742-119	537	742-412	544	800-120	333	800-846	150
741-649	556	742-120	537	742-413	544	800-121	333	800-848	150
741-658	558	742-121	537	742-503	545	800-130	333	800-849	150
741-659	558	742-122	537	742-504	545	800-131	333	800-850	150
741-669	557	742-123	537	742-600	545	800-135	333	800-852	151
741-670	557	742-124	537	742-601	545	800-140	333	800-853	151
741-690	558	742-125	538	742-602	545	800-145	333	800-854	151
741-691	558	742-126	538	742-603	545	800-151	333	800-855	151
741-706	562	742-127	538	742-840	545	800-153	333	800-857	151
741-707	562	742-128	538	742-841	545	800-154	334	800-858	151
741-708	562	742-129	538	746-011	68	800-155	334	800-859	151
741-709	558	742-130	538	746-014	68	800-156	334	800-860	151
741-710	558	742-131	538	746-017	68	800-157	334	800-880	152
741-711	559	742-136	538	746-145	68	800-158	334	800-881	152
741-712	559	742-137	538	746-147	68	800-162	334	800-882	152
741-713	559	742-150	538	746-253	68	800-163	331	800-883	152
741-714	559	742-202	538	746-360	68	800-166	334	955-000	436
741-715	559	742-203	538	800-001	330	800-170	334	955-001	436
741-716	559	742-204	539	800-002	330	800-225	334	955-002	436
741-717	559	742-205	539	800-003	330	800-227	334	955-003	436
741-718	562	742-206	539	800-004	330	800-229	334	955-004	436
741-719	562	742-207	539	800-005	330	800-230	334	955-005	436
741-731	559	742-208	539	800-006	330	800-231	334	955-006	436
741-732	559	742-209	539	800-007	330	800-233	334	955-007	436
741-734	559	742-210	539	800-008	330	800-235	334	955-008	436
741-735	559	742-211	539	800-009	331	800-238	335	955-009	436
741-750	560	742-218	539	800-010	331	800-240	335	955-010	436
741-751	560	742-219	539	800-011	332	800-299	341	955-011	436
741-752	556	742-220	539	800-012	332	800-300	329, 339	955-012	436
741-753	556	742-221	539	800-013	332	800-301	335	955-013	436
741-757	558	742-222	540	800-014	330	800-303	335	955-014	436
741-758	558	742-223	540	800-015	330	800-304	335	955-015	436
741-759	558	742-224	540	800-016	330	800-305	335	955-016	436
741-760	558	742-225	540	800-017	330	800-306	335	955-017	436
741-761	558	742-226	540	800-018	331	800-308	335	955-018	436
741-762	558	742-227	540	800-023	330	800-309	335	955-019	436
741-765	559	742-228	540	800-025	330	800-401	335	955-020	436
741-766	559	742-229	540	800-026	330	800-401.5	335	955-021	436
741-767	559	742-230	540	800-030	333	800-402	335	955-024	436
741-768	560	742-231	540	800-035	333	800-402.5	335	955-025	436
741-769	560	742-232	540	800-036	333	800-403	335	955-026	436
741-770	560	742-233	540	800-050	331	800-404	335	955-027	436
741-771	560	742-234	541	800-051	331	800-405	335	955-028	436
741-772	560	742-235	541	800-052	331	800-406	335	955-029	436
741-773	560	742-236	541	800-053	331	800-407	336	955-030	436
741-784	562	742-237	541	800-054	331	800-408	336	955-031	436
741-793	562	742-238	541	800-055	331	800-409	336	955-032	436
741-794	562	742-239	541	800-056	331	800-450	336	955-033	437
741-807	557	742-240	541	800-057	331	800-500	328, 338	955-034	437
741-808	557	742-241	541	800-058	331	800-601	337	955-035	437
741-809	558	742-242	541	800-059	331	800-602	337	955-036	437
741-810	558	742-243	541	800-060	331	800-603	337	955-037	437
741-811	558	742-244	541	800-061	332	800-604	337	955-038	437
741-812	558	742-245	541	800-062	332	800-605	337	955-039	437
741-813	557	742-246	542	800-071	332	800-606	337	955-040	437
741-814	557	742-247	542	800-072	332	800-607	337	955-041	437
741-815	558	742-250	542	800-073	332	800-608	337	955-042	437
741-816	558	742-251	542	800-074	332	800-609	337	955-043	437
741-817	559	742-252	542	800-075	332	800-610	337	955-044	437
741-818	559	742-253	542	800-076	332	800-612	337	955-045	437
741-819	559	742-256	542	800-078	332	800-701	336	955-046	437
741-820	559	742-257	542	800-078.5	332	800-704	336	955-047	437
741-823	556	742-258	542	800-079	332	800-705	336	955-048	437
741-824	556	742-259	542	800-079.5	332	800-707	336	955-049	437
741-829	562	742-260	542	800-080	332	800-709	336	955-050	437
741-830	562	742-261	542	800-080.5	332	800-710	336	955-051	437
741-837	559	742-300	543	800-081	332	800-711	336	955-052	437
741-838	559	742-301	543	800-081.5	332	800-712	336	955-053	437
741-844	559	742-302	543	800-082	332	800-713	337	955-054	437
741-845	559	742-303	543	800-082.5	332	800-714	337	955-055	437
742-101	536	742-304	543	800-083	332	800-715	337	955-056	437
742-102	536	742-305	543	800-083.5	332	800-716	337	955-057	437
742-103	536	742-306	543	800-084	332	800-717	337	955-058	437
742-104	536	742-307	543	800-084.5	332	800-718	337	955-059	437
742-105	536	742-308	543	800-085	332	800-751	337	955-060	438
742-106	536	742-309	543	800-085.5	332	800-752	338	955-061	438
742-107	536	742-310	543	800-086	333	800-753	338	955-062	438
742-108	536	742-311	543	800-086.5	333	800-754	338	955-063	438
742-109	536	742-312	544	800-091	333	800-755	338	955-064	438
742-110	536	742-313	544	800-091.5	333	800-758	338	955-065	438

Product #	Page #	Product #	Page #	Product #	Page #	Product #	Page #	Product #	Page #
955-066	438	955-150	441	955-233	444	955-317	447	955-502	450
955-067	438	955-151	441	955-234	444	955-318	447	955-403	450
955-068	438	955-152	441	955-235	444	955-319	447	955-404	450
955-069	438	955-153	441	955-236	444	955-320	447	955-405	450
955-070	438	955-154	441	955-237	444	955-321	447	955-406	450
955-071	438	955-155	441	955-238	444	955-322	447	955-407	450
955-072	438	955-156	441	955-239	444	955-323	447	955-408	450
955-073	438	955-157	441	955-240	444	955-324	447	955-409	450
955-074	438	955-158	441	955-241	444	955-325	447	955-410	450
955-075	438	955-159	441	955-242	444	955-326	447	955-411	450
955-076	438	955-160	441	955-243	444	955-327	447	955-412	450
955-077	438	955-161	441	955-244	444	955-328	447	955-413	450
955-078	438	955-162	441	955-245	444	955-329	447	955-414	451
955-079	438	955-163	441	955-246	445	955-330	448	955-415	451
955-080	438	955-164	441	955-247	445	955-331	448	955-416	451
955-081	438	955-165	441	955-248	445	955-332	448	955-417	451
955-082	438	955-166	441	955-249	445	955-333	448	955-418	451
955-083	438	955-167	442	955-250	445	955-336	448	955-419	451
955-084	438	955-168	442	955-251	445	955-337	448	955-420	451
955-085	438	955-169	442	955-252	445	955-338	448	955-421	451
955-086	438	955-170	442	955-253	445	955-339	448	955-422	451
955-087	438	955-171	442	955-254	445	955-340	448	955-423	451
955-088	438	955-172	442	955-255	445	955-341	448	955-424	451
955-089	438	955-173	442	955-256	445	955-342	448	955-425	451
955-090	439	955-174	442	955-257	445	955-343	448	955-426	451
955-091	439	955-175	442	955-258	445	955-344	448	955-427	451
955-092	439	955-176	442	955-259	445	955-345	448	955-428	451
955-093	439	955-177	442	955-260	445	955-346	448	955-429	451
955-094	439	955-178	442	955-261	445	955-347	448	955-431	451
955-095	439	955-179	442	955-262	445	955-348	448	955-432	451
955-096	439	955-180	442	955-263	445	955-349	448	955-433	451
955-097	439	955-181	442	955-264	445	955-350	448	955-434	451
955-098	439	955-182	442	955-265	445	955-351	448	955-435	451
955-099	439	955-183	442	955-266	445	955-352	448	955-436	451
955-100	439	955-184	442	955-267	445	955-353	448	955-437	451
955-101	439	955-185	442	955-268	445	955-354	448	955-438	451
955-102	439	955-186	442	955-269	445	955-355	448	955-439	451
955-103	439	955-187	442	955-270	445	955-356	448	955-440	451
955-104	439	955-188	442	955-271	445	955-357	448	955-441	451
955-105	439	955-189	442	955-272	445	955-358	448	955-442	451
955-106	439	955-190	442	955-273	445	955-359	449	955-443	451
955-107	439	955-191	443	955-274	446	955-360	449	955-444	451
955-108	439	955-192	443	955-275	446	955-361	449	955-445	452
955-109	439	955-193	443	955-276	446	955-362	449	955-446	452
955-110	439	955-194	443	955-277	446	955-363	449	955-447	452
955-111	439	955-195	443	955-278	446	955-364	449	955-448	452
955-112	439	955-196	443	955-279	446	955-365	449	955-449	452
955-113	439	955-197	443	955-280	446	955-366	449	955-450	452
955-114	439	955-198	443	955-281	446	955-367	449	955-451	452
955-115	439	955-199	443	955-282	446	955-368	449	955-452	452
955-116	440	955-200	443	955-283	446	955-369	449	955-453	452
955-117	440	955-201	443	955-284	446	955-370	449	955-454	452
955-118	440	955-202	443	955-285	446	955-371	449	955-455	452
955-119	440	955-203	443	955-286	446	955-372	449	955-456	452
955-120	440	955-204	443	955-287	446	955-373	449	955-457	452
955-121	440	955-205	443	955-288	446	955-374	449	955-458	452
955-122	440	955-206	443	955-289	446	955-375	449	955-459	452
955-123	440	955-207	443	955-290	446	955-376	449	955-460	452
955-124	440	955-208	443	955-291	446	955-377	449	955-461	452
955-125	440	955-209	443	955-292	446	955-378	449	955-462	452
955-126	440	955-210	443	955-293	446	955-379	449	955-463	452
955-127	440	955-211	443	955-294	446	955-380	449	955-464	452
955-128	440	955-212	443	955-295	446	955-381	449	955-465	452
955-129	440	955-213	443	955-296	446	955-382	449	955-466	452
955-130	440	955-214	443	955-297	446	955-383	449	955-467	452
955-131	440	955-215	443	955-298	446	955-384	449	955-468	452
955-132	440	955-216	443	955-299	446	955-385	449	955-469	452
955-133	440	955-217	443	955-300	446	955-386	449	955-470	452
955-134	440	955-218	443	955-301	446	955-387	450	955-471	452
955-136	440	955-219	443	955-302	446	955-388	450	955-472	452
955-137	440	955-220	444	955-303	447	955-389	450	955-473	453
955-138	440	955-221	444	955-304	447	955-390	450	955-474	453
955-139	440	955-222	444	955-305	447	955-391	450	955-476	453
955-140	441	955-223	444	955-306	447	955-392	450	955-479	453
955-141	441	955-224	444	955-307	447	955-393	450	955-480	453
955-142	441	955-225	444	955-308	447	955-394	450	955-481	453
955-143	441	955-226	444	955-309	447	955-395	450	955-482	453
955-144	441	955-227	444	955-310	447	955-396	450	955-486	453
955-145	441	955-228	444	955-311	447	955-397	450	955-487	453
955-146	441	955-229	444	955-312	447	955-398	450	955-489	444
955-147	441	955-230	444	955-314	447	955-399	450	955-490	453
955-148	441	955-231	444	955-315	447	955-400	450		
955-149	441	955-232	444	955-316	447	955-401	450		