



DVEB
OFFROAD

2020

ACCESSORIES
CATALOG



2020

TRAIL GEAR

DV8 OFF ROAD HISTORY

JL PRODUCT LINE

BUMPERS

- 7.....FRONT
- 9.....REAR

- 11.....TIRE CARRIERS
- 13.....FENDERS
- 15.....INNER FENDERS

DOORS

- 16.....ROCK DOORS
- 16.....HALF DOORS

ARMOR

- 17.....ROCK SLIDERS/STEPS
- 19.....SKID PLATES

- 20.....LIGHT BRACKETS

- 21.....MOUNTS

- 22.....HOODS

- 22.....GRILLS

- 23.....HARD TOPS

JK PRODUCT LINE

BUMPERS

- 27.....FRONT
- 29.....REAR

- 31.....TIRE CARRIERS

- 33.....FENDERS

- 35.....INNER FENDERS

DOORS

- 36.....ROCK DOORS

ARMOR

- 37.....ROCK SLIDERS/STEPS

- 38.....MOUNTS

- 39.....HOODS

- 39.....GRILLES

- 40.....HARD TOPS

- 43.....SUSPENSION

JT PRODUCT LINE

BUMPERS

- 47.....FRONT
- 48.....REAR

- 49.....FENDERS
- 50.....TIRE CARRIERS
- 50.....INNER FENDERS

ARMOR

- 50.....ROCK SLIDERS/STEPS

- 51.....CHASE RACKS

- 52.....COMPATABILITY CHART

TRUCK BUMPERS

- 55.....BUMPER CHART

- 57.....CHEVROLET

- 59.....GMC

- 60.....FORD

- 63.....DODGE (RAM)

- 65.....TOYOTA

ACCESSORIES

- 71.....JK

- 78.....JL/JT

- 79.....TJ

- 82.....YJ

UNIVERSAL PRODUCTS

- 83.....LIGHTS

- 85.....WINCHES

- 87.....WHEELS





DV8TM OFFROAD

BEHIND THE BRAND

WHY CHOOSE US?

Born in Southern California, DV8 Off Road understands Jeeps and the importance of creating a product that stands the test of time on and off the trail. We build durable and long lasting parts that compliment the natural lines of a Jeep. We also understand that along with style, Jeep enthusiasts need functional and reliable equipment that protects their investment. This is why we test all of our products on our Jeeps before releasing them to the public. These vehicles are used as daily drivers and trail vehicles. Our staff enjoys pushing the DV8 Jeeps to their limits on some of the most extreme trails in the country. This is to ensure that we are providing high quality accessories that are just as amazing as the Jeeps themselves.

OUR TEAM

Our team is made up of men and women who embody the Jeep lifestyle. They are outgoing, active and willing to DV8 from the beaten path. This passion goes toward creating and delivering the best products available to the off road community. Because of this, we are proud to stand behind all of our products. For DV8 Off Road, having a jeep is not just a way to get around, it's an expression of who you are.



DVB
OFFROAD

2018 +

JL PRODUCT
LINE





FBJL-01



FRONT BUMPERS

Stubby Front Bumper w/Bull Bar

The FBJL-01 features a high clearance design and incorporates a protected 20" slim LED light bar for increased visibility. The bumper is rated for, up to, a 12,500 lbs winch. This bumper is designed specifically for the Jeep JL and requires no drilling to install.

- High clearance design - aggressive angles and styling
- Incorporates a 20" LED light bar
- Reinforced bull bar

*Dim: w55" x h15" x d13"
*Weight: 70lbs

FBJL-10



Full-width

Full Width & Stubby Modular Front Bumper w/Bull Bar

The FBJL-10 features a high clearance design and incorporates a modular design so you can go between full and stubby designs. The bumper is rated for, up to, a 12,500 lbs winch. This bumper is designed specifically for the Jeep JL and requires no drilling to install.

- High clearance design - aggressive angles and styling
- Modular design
- Incorporates stock LED fog lights
- Reinforced bull bar

*Dim: w67" x h11" x d1"
*Weight: 102lbs



Stubby



ABJL-01

FRONT BUMPER ADAPTER Patent Pending

JK to JLFront Bumper Adapter Bracket

- JK to JL adapter bracket allows for the use of any DV8 JK 2007-2018 front bumpers on 2018+ Jeep JL
- Brackets are made of 3/16" cold rolled steel and powder coated textured black
- Comes with Grade 8 hardware
- Maintains winch capability

*Dim: w8" x h5.5" x d5.5"
*Weight: 8lbs



2018 Jeep Wrangler Product Line

Current JK front bumpers that are compatible w/2018+ Jeep JL & Gladiator

PRODUCT	PART NO.	DESCRIPTION
FS-1	FBSHTB-01	Full Length Front Bumper
FS-6	FBSHTB-06	Mid Front Bumper
FS-7	FBSHTB-07	Mid Front Bumper w/LED Lights
FS-8	FBSHTB-08	Mid Front Bumper w/LED Lights
FS-11	FBSHTB-11	Mid Front Bumper 11 w/ LED Lights
FS-13	FBSHTB-13	Stubby Front Bumper w/Fog Lights (lights not included)
FS-14	FBSHTB-14	Mid Front Bumper w/Fog Lights & LED (lights not included)
FS-15	FBSHTB-15	Stubby Front Bumper w/Fog Lights (lights not included)
FS-24	FBSHTB-24	Stubby Front Bumper w/Light bracket & winch plate
FS-25	FBSHTB-25	Stubby Front Bumper w/20" Light Bar & winch plate (Light Bar not included)



REAR BUMPERS | Fit all 2018+ JL models

RBJL-01



Full Length Rear Bumper

- Made from 3/16" cold rolled steel and highly UV resistant dual layer powder coat that resists rust.
- Accommodates backup sensors, factory hitch, two integrated LED lights, license plate mount, and D-rings included
- Flush mount lights included
- Compatible with TCJL-06 tire carrier
- Full wrap around design

*Dim: w74" x h19" x d11"

*Weight: 86lbs

RBJL-02

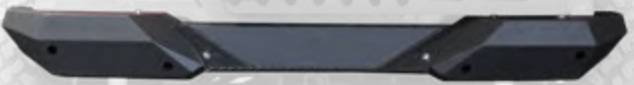

Full Length High Clearance Rear Bumper

- High clearance design with aggressive angles and styling
- End caps are removable but rigid (bolting up to body mounts)
- Accommodates backup sensors

*Dim: w69" x h19" x d11"

*Weight: 91.5lbs

RBJL-03



Full Length High Clearance Rear Bumper

- Aggressive angles and styling
- High clearance design and two recovery shackle attachments
- Incorporates two integrated LED Backup Lights (included)
- Accommodates backup sensors and license plate mount

*Dim: w74" x h16" x d10"

*Weight: 48lbs

RBJL-04



Stubby Length High Clearance Rear Bumper

- High clearance design with aggressive angles and styling
- Lightweight
- Accommodates backup sensors

*Dim: w68" x h14" x d10"

*Weight: 48lbs

* Product dimensions and weights are approximate

RBJL-06

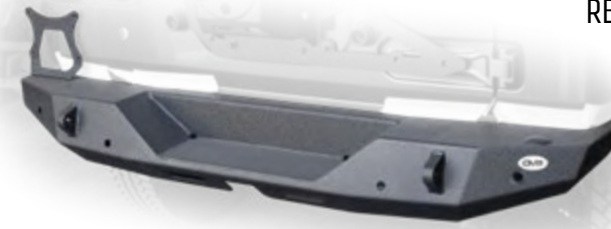

Mid Length Rear Bumper

- High clearance design with aggressive angles and styling
- License plate mounting system with light
- Accommodates backup sensors
- Mid-width design accommodates TCJL-06

*Dim: w67" x h15" x d10"

*Weight: 60lbs

RBJL-07



Mid Length High Clearance Rear Bumper

- High clearance design with aggressive angles and styling
- License plate mounting system with light
- Lightweight
- Accommodates backup sensors

*Dim: w68" x h14" x d10"

*Weight: 48lbs

* Product dimensions and weights are approximate





RBJL-08



Bumper Mount Tire Carrier

- High clearance design with aggressive angles and styling
- Tire carrier hooks to rear tailgate for easy operation
- Accommodates up to a 40" tire
- Tire carrier mounts directly to the bumper
- Easy to install
- Accommodates backup sensors
- Accommodates backup camera.

*Dim: n/a
*Weight: n/a

TCJL-01



Tire Carrier

- DV8 Adjustable Tire Carrier allows for mounting up to a 35" tire to the factory tailgate
- This tire carrier allows for the utilization of the JL's factory 3rd brake light.
- Made from 3/16" cold rolled steel.
- Accommodates factory 3rd brake light assembly
- Remounts factory back up camera in a stout steel housing.

*Dim: w31" x h16" x d8"
*Weight: 32lbs

TCJL-02



Body Mounted Tire Carrier

TCJL-02 uses a combination of tubing, boxed steel and internal bracing to accommodate up to a 37" tire and wheel combo. This carrier can be used with any rear bumper.

- Accommodates up to a 40" x 12.50 tire
- Fits any bolt pattern wheel
- Spring loaded pin system to make opening and closing the tire carrier easy
- Rigid mounting system w/internal bracing
- Accommodates the OEM back-up camera

*Dim: w52" x h30" x d17"
*Weight: 89lbs

TCJL-06



Bumper Mounted Tire Carrier

TCJL-06 is a bumper mounted tire carrier that can be added to the RBJL-01 or RBJL-06. The carrier attaches to the tailgate of the JL and operates just like the factory spare tire carrier but with the added support of being mounted to the frame.

- Accommodates up to a 37" tire and wheel combo
- Allows for adjustability of how high the spare is mounted
- Accommodates the factory backup camera, 3rd brake light, and has a highlift mount built in.

*Dim: w40" x h9" x d21"
*Weight: 76lbs

TCJL-07



Interior Tire Carrier with Rotopax Mounts

Patent Pending

Interior tire carrier features a hydraulic lifting mechanism to move the spare out of the way for storage. The TCJL-07 works great with the JL tailgate replacement and bolts to the factory cage and floor panels.

- Accommodates up to a 40" tire and space to mount 2 rotopax (not included)
- Moves the heavy spare assembly to a better balance point.

*Dim: n/a
*Weight: n/a



TSJL-02



Spare Tire Delete w/Camera Mount Kit

The DV8 Offroad TSJL-02 spare tire delete kit allows you to remove the spare tire from your Jeep JL and also provides a housing for the factory backup camera. This product completely changes the look of the Jeep while protecting and relocating the backup camera. It also allows you to legally relocate your license plate from the bumper and includes LED light to illuminate it.

*Dim: w14" x h2" x d18.5"
*Weight: 9lbs

* Product dimensions and weights are approximate



FDJL-01

High Clearance Armor Fenders *Patent Pending*

Slim Design for max protection and clearance. Aluminum vents can be color matched to give your Jeep an overall custom look.

- 100% bolt on and requires no cutting or drilling
- Integrated LED turn signals
- Lightweight yet built tough



*Dim: w53" x h13" x d25"
*Weight: 80lbs

FDJL-02

High Clearance Slim Fenders *Patent Pending*

- Slim Design for max protection and clearance
- 100% bolt on and require no cutting or drilling
- Integrated LED turn signals
- Light weight yet built tough
- Fender width: 7" front | 4.75" rear



*Dim: w48" x h9" x d25"
*Weight: 60lbs

FDJL-04

High Clearance Full Flat Fenders *Patent Pending*

FDJL-04 Flat Fenders were designed to improve tire clearance and keep everything completely street legal when running oversize tires. The fenders are 12.75 inches wide in the front and 8.75 inches wide in the rear.

- Wide Design for max protection and coverage
- 100% bolt on requires no cutting or drilling
- Integrated LED turn signals
- Lightweight yet built tough

*Dim: w55" x h16" x d25"
*Weight: 70lbs



FDJL-03

Fender Delete Kit

The FDJL-03 fender delete kit was designed to maximize tire clearance and completely eliminate the factory fenders. Eliminating the fenders keeps the body of the Jeep further away from obstacles such as trees, rocks, and boulders and allows you to squeeze through tight spots that would be impossible to get through with a full width Jeep.

- Laser cut 3/16" steel
- Form fitting and textured powdercoat
- Closes gaps left after removing fenders
- 100% bolt on design
- Includes LED Turn Signal

*Dim: w50" x h6" x d22"
*Weight: 51lbs

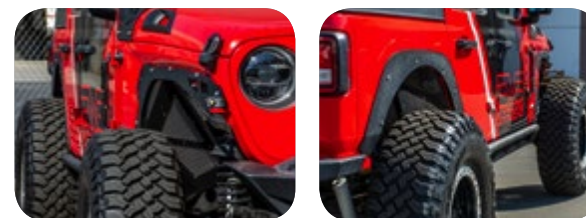

* Product dimensions and weights are approximate



INFEND-03FR

Front Inner Fenders *Patent Pending*

- Protects the engine compartment from mud, dust, and debris
- Better airflow to keep your engine compartment cooler
- Mounts with the factory fenders and most aftermarket fenders
- Available in raw aluminum or black powder coating.

Black Inner Fenders **INFEND-03FB**

*Dim: w30.75" x h30.75" x d10"

*Weight: 9.3lbs

INFEND-03RR

Rear Inner Fenders *Patent Pending*

- Protects components while not reducing tire clearance
- Mounts with the factory fenders and most aftermarket fenders
- Available in raw aluminum or black powder coating.

Black Inner Fenders **INFEND-03RB**

*Dim: w41.5" x h23.5" x d10.25"

*Weight: 10.2lbs

*Product dimensions and weights are approximate

RDJL-01

Rock Doors

- Comes with perforated aluminum screens
- Screens can be painted to match Jeep
- Doorless visibility with added protection
- Limit straps to prevent door from swinging too far open
- Rattle preventing stopper integrated into the design
- Available for 2 door or 4 door models
- Comes with replacement mirrors

*Dim: w38" x h6" x d23"

*Weight: 45lbs

HDJL-01

Half Doors

- Comes with perforated aluminum screens
- Screens can be painted to match Jeep
- OEM styling
- Doorless visibility with added protection
- Available for 2 door or 4 door models
- Comes with replacement mirrors

*Dim: w43" x h10" x d29"

*Weight: 78lbs

⚠ WARNING:

The products identified on this page can expose you to chemicals including lead, DEHP, and other chemicals which are known to the State of California to cause cancer and birth defects or other reproductive harm.





SRJL-01

**Boatside Rock Sliders** *Patent Pending*

Built extremely tough and designed to take a beating so you can keep moving forward with confidence

- Protection extends down to the frame rails
- Boat side design prevents hang ups
- Removable plates for replacement/recoating
- 100% bolt on
- Boxed supports
- Extreme protection

*Dim: w77" x h8.5" x d21"
*Weight: 80lbs

SRJL-21

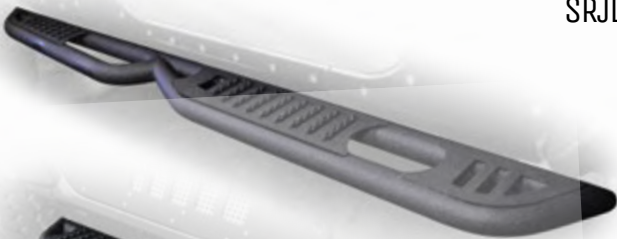

SRJL-02

**Tubular Side Step/Slider**

SRJL-02 sliders are a perfect combination of a step and slider for protection and ease when getting in the Jeep. Made from .160 wall 2" rolled steel tubing and completely bolt on, no drilling required.

- High Clearance
- Slider/ Step without losing clearance
- Non Slip Gripping Step Design
- Easy Installation

*Dim: w75" x h12" x d7"
*Weight: 65lbs

SRJL-22



SRJL-03

**Tubular Rock Slider with Plated End Caps***Patent Pending*

SRJL-03 sliders are a trail tested and proven design. Made from .160 wall 2" rolled steel tubing and completely bolt on, no drilling required.

- Maximum protection
- High Clearance
- Plated Ends
- Easy Install
- Sliders utilize factory hardware

*Dim: w74" x h14" x d11"
*Weight: 60lbs

SRJL-23

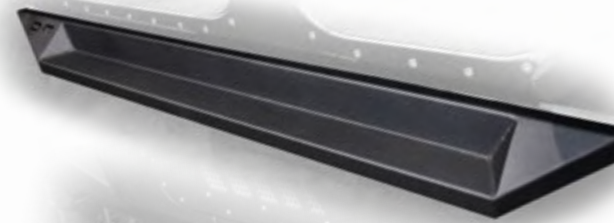

SRJL-04

**Plated Side Step/ Slider**

SRJL-04 step sliders use a boxed in plated design that provides a rigid rock slider. The step will make struggling to get into your lifted JL a thing of the past all while improving the looks and functionality of the Jeep.

- Easy installation
- No modifications needed
- Easy Installation

*Dim: w75" x h14" x d12"
*Weight: 77lbs

SRJL-24

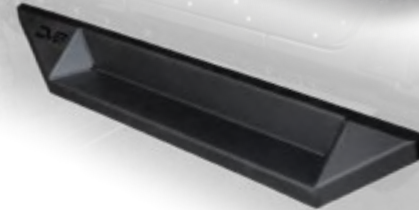

SRJL-05

**Rock Skins**

SRJL-05 Rock Skins can be used with most JL step or slider and contour around either factory or aftermarket fenders. They are designed to add protection to the exposed body between the door and the bottom of the body.

- Made with 3/16" steel
- Attach securely using nutserts
- Offers protection for Rocker Panel

*Dim: w69" x h2" x d10"
*Weight: 23lbs

SRJL-25



SRJL-06

**Rock Sliders** *Patent Pending*

The most vulnerable areas on the body are the rocker panels. Sliders protect your rocker panel area while enabling you to slide over rocks and obstacles.

- Sliders use body mounts and rock skins for ultimate durability
- Attach with factory hardware and nutserts
- Great for Jeeps that will be used in extreme conditions regularly
- Body and Frame mounted design

*Dim: w73" x h21" x d4"
*Weight: 93lbs

SRJL-26

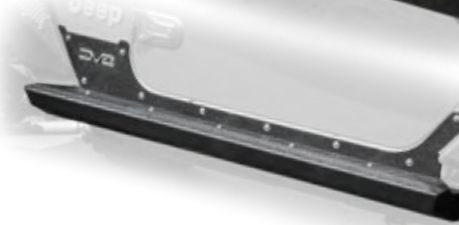

* Product dimensions and weights are approximate

* Product dimensions and weights are approximate



SPJL-01

Swaybar Disconnect Skid Plate

- Protects the exposed sway bar disconnect and factory crash bar
- Cleans up the aesthetics when installing an aftermarket bumper
- Works with most DV8 Offroad front bumpers
- Fits all trims of JL Jeep

*Dim: w37" x h13" x d9"
*Weight: 30lbs

SPJL-02

Skid Plate 2 Door

- Bolt on undercarriage protection for your Jeep JL
- Protects the most vulnerable area of the undercarriage and drivetrain
- No drilling required
- Made of 3/16" steel
- Comes powdercoated black

*Dim: n/a
*Weight: n/a

SPJL-03

DANA 44 Front Differential Skid Plate

- Bolt on front axle differential protection
- Protects the lowest hanging part of the axle
- Designed to deflect rock hits
- Comes powdercoated with DV8 textured finish
- Protects vital components of the differential

*Dim: n/a
*Weight: n/a

SPJL-04

DANNA 44 Rear Differential Skid Plate

- Bolt on rear axle protection
- Protects differential and axle tubes
- Full protection for your rear axle
- Designed to deflect rock hits
- Comes powdercoated with DV8 textured finish
- Protects the axle yoke from rock hits
- Utilizes factory shock mounts

*Dim: w46" x h21" x d8"
*Weight: 80lbs

* Product dimensions and weights are approximate

LBJL-01

Over Windshield Light Bar Bracket

Patent Pending

- Secure mounting of a 50" LED light bar over the windshield of the JL
- 51.5" mount to mount
- Lightweight and strong
- Space for wiring is provided
- Hardware included

*Dim: w35" x h11" x d7"
*Weight: 20lbs

LBJL-02

Dual Pod Light Lower A Pillar Mount

- Securely mount 4 LED pod lights on the JL (DV8 P/N: B3CE16W4W)
- Easy Bolt on install
- Comes powdercoated DV8 textured black
- Hardware included

*Dim: w16" x h4" x d13"
*Weight: 6lbs

LBJL-03

Over Hood 30" Light Bar Mount

- Securely mount a 30" LED light bar (DV8 P/N: BS30E150W5W)
- Gusseted design for sturdy mounting
- Comes powdercoated DV8 textured black
- Will not affect hood opening and closing
- Easy to wire and mount using factory hardware

*Dim: w8" x h5" x d4"
*Weight: 3lbs

TJL-01

Tail Light Guard

- Easy to install tail light guards
- Protect tail light from damage on the trail
- No drilling or modification of the light housing required

Note: Only works on non sensor tail lights (Halogen)

*Dim: w13" x h9" x d10"
*Weight: 11lbs

* Product dimensions and weights are approximate



CMJL-01

Engine Bay Compressor Mount for ARB

This is the only mount on the market today that allows for an ARB twin compressor to be mounted inside the JL engine bay as it was meant to be! The mount comes with all hardware needed for install and is powdercoated standard DV8 black. It will work with either our inner fenders or with the OEM inner fenders. NOTE: will only work with 3.6 L engines.

*Dim: w24" x h6" x d12"
*Weight: 7lbs

Mounts Continued



STJL-02

Hinge Mounted Foot Pegs

These Pegs were designed to provide a stable point just outside of the door of your Jeep to kick a foot out and enjoy a doorless ride even more!

- Made from 3/16" Steel with lock In design
- Sold in pairs
- Bolt on installation

*Dim: w7" x h4" x d2"
*Weight: 21lbs



TTJL-01

Folding Trail Table

Constructed from solid steel and powdercoated for protection, the DV8 TTJL-01 is a convenient table that folds down from the tailgate. Whether you are doing a trail repair or just making lunch, this table just makes life easier.

- Rattle free design that can hold up to 100 lbs
- Bolts to factory mounting points

Note: Drilling through plastic tailgate applique is required

*Dim: w26" x h4" x d1"
*Weight: 11lbs



HDMBJL-01

Heat Dispersion Hood

Constructed from stamped steel offering added strength and reduced heat. This design provides much better air flow with its vented layout and allows engine heat to disperse through vents which helps in keeping the engine and overall compartment temps down resulting in all-around increased performance.

Note: Recommend professional installation including prep, fitting, seam sealer and painting for ultimate fitment. Always test fit before painting.



BCABJL-01

Headlight Adapter w/Wiring

An adapter kit to fit 7" JK or TJ headlights onto a Jeep JL and Gladiator. Let's face it, there are a lot of really cool and inexpensive 7" headlights for older generation Jeeps. With this kit, you have everything you need to mount aftermarket headlights into your Jeep!

- Plug and play with harness adapters for wiring
- Will work with any 7" JK or adjustable TJ headlight similar to OEM

*Dim: w6" x h4" x d4"
*Weight: 21lbs



HDMBJL-TA

Rubicon Replica Hood

Constructed from stamped steel offering added strength and reduced weight. This design is meant as an upgrade for the standard JL Wrangler hood.

Our hoods come with an under hood insulation liner and are prepped with a rust inhibitor ready to be prepped, painted, and installed.

*Dim: w44" x h64" x d18"
*Weight: 135 - 145lbs



STJL-01

Hinge Mounted Steps

These hinge mounted steps for the JL allow easy access to the roof of your Jeep and flips up to be out of the way when not in use. Ball catches hold the step in place in the upward position, and it comes with special washers to keep the step from damaging the paint. Finally, a pedal style step that ensures you won't slip in mud sand or snow.

- Stainless steel hardware - Easy to mount
- Anti-slip step with ball Catch hinge

*Dim: n/a
*Weight: n/a



GRJL-01

Replacement Grill Black

The DV8 Offroad GRJL-01 replacement grill adds a menacing look to the front end of your ride. With the JL's larger 9 inch headlights, the angry eye look has never been so mean.

- Replaces OEM grill
- Easy to paint and easy to install

*Dim: w51" x h19" x d10"
*Weight: 11lbs

* Product dimensions and weights are approximate

* Product dimensions and weights are approximate



HTJLFB-B

Fast Back Hard Top

- DV8 Off Road Hard Tops are built in the United States and use high quality seals, fiberglass, and advanced aerodynamics to produce the quietest tops on the market.
- Hand laid honeycomb reinforced fiberglass for added durability
 - 31% tint DOT approved glass
 - Military grade carpeted headliner for increased insulation and noise reduction
 - UV stable GEL coat - Extra thick
 - Quick release latching system
 - Improved aerodynamic shape, One piece targa design
 - Defrost rear windows

*Dim: w72" x h48" x d90"
*Weight: 300lbs



HTJL02-B

Fast Back Hard Top Razor Series

- DV8 Off Road Hard Tops are built in the United States and use high quality seals, fiberglass, and advanced aerodynamics to produce the quietest tops on the market. This DV8 top is a 2 piece design so the part over the front driver and passenger lifts off like a targa top.
- Hand laid honeycomb reinforced fiberglass for added durability
 - 31% tint DOT approved glass
 - Military grade carpeted headliner for increased insulation and noise reduction
 - UV stable GEL coat - Extra thick
 - Quick release latching system
 - Improved aerodynamic shape, One piece targa design
 - Rear spoiler lip

*Dim: w72" x h48" x d90"
*Weight: 300lbs



HTJL-L

Hard Top Latch Closure Mechanism

Patent Pending

- Secure mounting of a 50" LED light bar over the windshield of the JL
- Light weight and strong
- Space for wiring is provided
- Patent pending

*Dim: n/a
*Weight: n/a

HTJL-H

Billet T-Handles for JL Hardtop

The HTJL-H kit is designed to replace the brittle plastic OEM hardtop closure handles with strong billet aluminum handles. These handles are precision made by a CNC machine and anodized for a clean black finish. The kit comes with all hardware necessary to mount your new handles and each kit comes with 6 handles.

- Replace brittle OEM handles
- Made of high grade aluminum
- CNC precision made
- Anodized black finish
- Come with all hardware

*Dim: n/a
*Weight: n/a



HTJL-BR

OEM Style Hardtop Mounting Brackets

The DV8 Offroad HTJL-BR Mounting Bracket Set is used to mount a hardtop on a JL Wrangler that came from the factory with the soft top package. Most won't even know that they need this until they purchase an aftermarket or second hand hard top and try to install it on their Jeep! To solve this issue DV8 has developed an inexpensive solution in similar form to the OEM brackets which cost hundreds if purchased directly from Jeep.

- Allows JL owners to mount a hardtop
- Meant for Jeeps that came with a soft top
- Much less expensive than OEM alternatives
- Includes all hardware and brackets necessary

*Dim: n/a
*Weight: n/a



* Product dimensions and weights are approximate

DVE
OFF-ROAD

2007-18

JK PRODUCT
LINE





2007-18 JK Jeep Wranglers

- 3/16" & 1/4" cold rolled steel
- High clearance angles and raised corners
- Light tabs and Solid D-ring mounts w/ D-rings included
- Textured black powder coating
- Trail tested and proven designs
- Will accommodate up to a 12,500 lbs winch
- .120 wall tubing for better durability
- Fit all 2007-2018 JK Jeep Wranglers w/ no drilling required
- Easy installation, Hardware included



FBSHTB-01

Full Width front Bumper

- Accepts Factory Lights (not included)
- Winch Plate included
- *Dim: w72" x h19" x d14"
- *Weight: 100lbs



FBSHTB-07

Mid Width front Bumper

- Comes with integrated LED lights
- Recessed Winch Plate
- *Dim: w61" x h15.5" x d10"
- *Weight: 72lbs



FBSHTB-08

Mid Width front Bumper

- Comes with integrated LED lights
- Recessed Winch Plate
- *Dim: w60" x h9" x d20"
- *Weight: 94lbs



FBSHTB-11

Stubby Width front Bumper

- Comes with integrated LED lights
- Bolt on Winch Plate included
- *Dim: w58" x h24" x d14"
- *Weight: 70lbs



FBSHTB-13

Stubby Width front Bumper

- Accepts Factory Lights (not included)
- Bolt on Winch Plate included
- *Dim: w49" x h21" x d9"
- *Weight: 116lbs



FBSHTB-14

Mid Width front Bumper

- Accepts Factory Lights (not included)
- Fits 10" LED light bar
- Recessed Winch Plate
- *Dim: w60" x h21" x d10"
- *Weight: 110lbs



FBSHTB-15

Stubby Width front Bumper Patent Pending

- Accepts Factory Lights (not included)
- Bolt on Winch Plate included
- *Dim: w47" x h17" x d11"
- *Weight: 110lbs

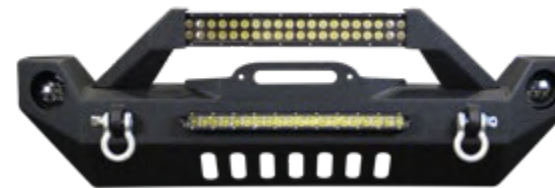

FBSHTB-17

Mid Width front Bumper Patent Pending

- Accepts Factory Lights (not included)(20" single row integrated light bar not included/20" light bar required for use of stinger bar
- Integrated Skid Plate
- *Dim: w52" x h12" x d8"
- *Weight: 80lbs



FBSHTB-18

Full Width front Bumper

- Accepts Factory Lights, fits 20" light bar (BS20 shown - not included)
- Recessed Winch Plate
- Integrated Skid Plate
- *Dim: w71" x h16" x d15"
- *Weight: 93lbs



FBSHTB-24

Stubby Width front Bumper

- Accepts 20" light bar (BS20 shown - not included)
- Recessed Winch Plate
- Dim: 49w x 8h x 12d
- Weight: 78lbs



FBSHTB-25

Stubby Width front Bumper Patent Pending

- Accepts Factory Lights (not included)
- (Accepts 20" single row light bar - BS20 shown - not included)
- Bolt on Winch Plate included
- *Dim: 51w x 21h x 14d
- *Weight: 100lbs

* Product dimensions and weights are approximate



2007-18 JK Jeep Wranglers

- 3/16" & 1/4" cold rolled steel
- High clearance - high degree angles and raised corners
- Solid D-ring mounts w/rings included
- Textured black powder coating
- Class 3 hitch receivers
- Trail tested and proven designs
- All tire carriers will fit up to a 40" tire
- Tire carriers include a heavy duty dual tapered bearing style for easy access to rear door
- Easy installation, NO modifications needed, Hardware included



RBSTTB-01

Mid Width Rear Bumper Tire Carrier

*Dim: w67" x h18" x d18"
*Weight: 62lbs

or RS-1BR (tapered bearing model)

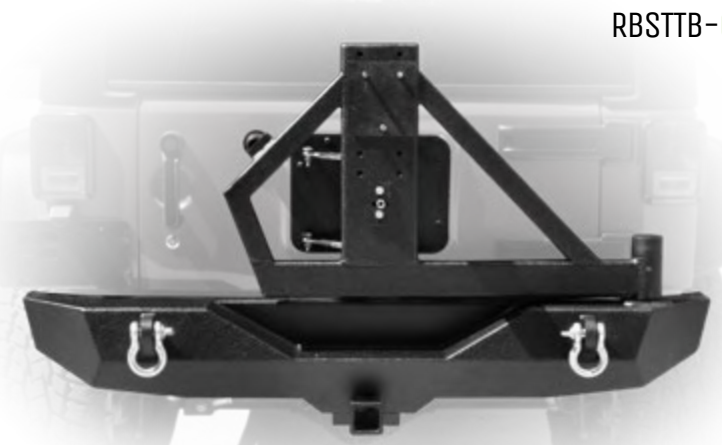

RBSTTB-02

Mid Width Rear Bumper Tire Carrier

*Dim: w69" x h17" x d19"
*Weight: 100lbs

Single Action Bumper and Tire Carrier

Door and Tire Carrier open in one action for effortless access offering aftermarket versatility with factory convenience.



RBSTTB-04

Stubby Width Rear Bumper

- D-rings included
- Class 3 receiver

*Dim: w67" x h16" x d13"
*Weight: 97lbs



RBSTTB-06

Mid Width Rear Bumper Patent Pending

- D-rings included
- High Clearance Class 3 Hitch receiver

*Dim: w67" x h19" x d10"
*Weight: 94lbs



RBSTTB-09

Full Width Rear Bumper Patent Pending

- D-rings included
- High Clearance Class 3 Hitch receiver

*Dim: w75" x h22" x d11"
*Weight: 99lbs



RBSTTB-10

Full Width Rear Bumper Patent Pending

- D-rings included
- High Clearance Class 3 Hitch receiver
- 2 flush mount pod lights included

*Dim: w74" x h19" x d11"
*Weight: 93lbs



RBSTTB-11

Full Width Rear Bumper Patent Pending

- D-rings included
- High Clearance Class 3 Hitch receiver
- 2 flush mount pod lights included

*Dim: w72" x h9" x d12"
*Weight: 95lbs



RBSTTB-14

Mid Width Rear Bumper Patent Pending

- Fits factory receiver (2" square LED's not included)

*Dim: w69" x h19" x d10"
*Weight: 88lbs

* Product dimensions and weights are approximate



2007-18 JK Jeep Wranglers

The DV8 body mounted tire carrier provides a high clearance tire mounting solution that is all about function. This carrier can be run with ANY aftermarket bumper for the JK. The Carrier holds the tire tighter to the body for better departure angles, and will fit any bolt pattern wheel. Includes a license plate relocation bracket and a cover for the old license plate mount.



TC-1

Body Mount Tire Carrier

- Bolt on Tire Carrier accepts up to a 42" Tire
- .120 wall tubing to increase strength
- Will accept any bolt pattern
- High Quality Bushings for a quiet ride
- Removable plates make color matching easy
- Comes with License plate mount
- Some Drilling Required for Installation

*Dim: w55" x h34" x h21"
*Weight: 89lbs

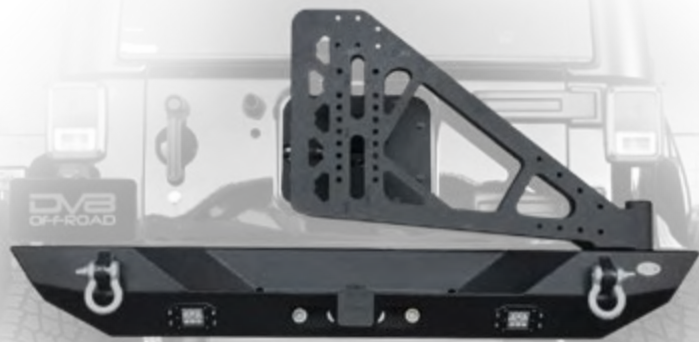

TC-6

Bumper Mount Tire Carrier

The TC-6 is a tire carrier that extends from the bumper (RS-10 & RS-11) to the Jeep's rear tailgate. Much like the DV8 RS-2, it opens along with the tailgate in 1 simple step. This carrier is designed to bolt onto your existing RS-10 or RS-11 bumper. It has a multitude of mounting points so you can mount your hi-lift jack, gas and water cans, or whatever else you like to bring with you.

*Dim: w39" x h24" x h8"
*Weight: 60lbs



TCSTTB-09



Interior Tire Carrier with Rotopax Mounts

Interior tire carrier features hydraulic lifting mechanism to move the spare out of the way for storage and bolts to the factory cage and floor panels.

- Accomodates up to a 40" tire
- Space to mount two rotopax (not included)
- Moves the spare inside the Jeep for hardcore offroading
- Increases departure angle clearances
- Moves the heavy spare assembly to a better balance point.

*Dim: n/a
*Weight: n/a

TS01RJK



Tramp Stamp

The DV8 Tramp Stamp fits over the raised vent area in the center of the tailgate. Used for those who have deleted or relocated the spare tire. CNC-laser cut from 3/16" steel and installs easily using the stock tire carrier mounting bolts.

Fits 2007-2018 Jeep Wranglers

*Dim: w16" x h12" x d1"
*Weight: 5lbs



* Product dimensions and weights are approximate



FENDB-02

DV8 Flat Fenders

DV8 Flat Fenders line up perfectly with the JK body lines and installation is extremely simple with precision cut holes to match the factory fender holes. DV8 fenders also come with our exclusive turn signal mounting bracket that can be used to mount an after market turn signal light. Ditch the factory plastic fenders that leave your JK vulnerable to expensive body damage and upgrade to DV8 steel fenders.

- Front width: 10.5"
- Rear width: 5.0"
- Sand Textured 3 stage powdercoat
- Solid steel construction - Light weight
- Bolt on installation

*Dim: w50" x h31" x h12"
*Weight: 72lbs

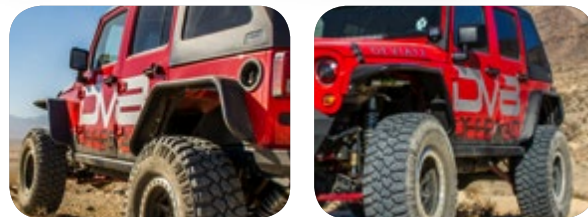

FENDB-06

DV8 Slim Fenders

DV8's Slim Fenders were designed for maximum clearance when traversing narrow passages that would rip off an ordinary width fender. They bolt on with no drilling required and feature a turn signal light that can integrate into the factory harness.

- Front width: 7.375"
- Rear width: 4.75"
- Slim design - Textured three stage powdercoat
- Solid steel construction - Light weight
- Bolt on installation

*Dim: w47" x h27" x h10"
*Weight: 61lbs

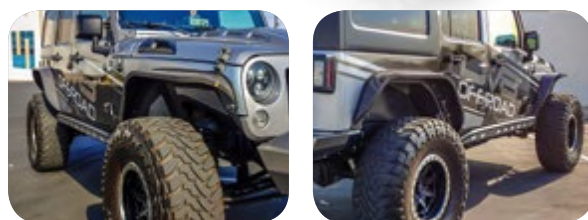

FENDB-08

DV8 Fender Deletes

DV8 JK fender delete kit was designed to maximize tire clearance and completely eliminate the factory fenders. Eliminating the fenders keeps the body of the Jeep further away from obstacles such as trees rocks and boulders and allows you to squeeze through tight spots that would be impossible to get through with a full width Jeep.

- Laser cut 3/16" steel
- Form fitting - Textured powdercoat
- Closes gaps left after removing fenders
- Requires cutting/drilling

*Dim: w51" x h26" x h3"
*Weight: 66lbs



FENDB-09

DV8 Armor Fenders

DV8 JK Armor Style Fenders are the ultimate bolt on armor fender. These fenders are easy to install and feature mesh aluminum accents, tight and functional design, and are 100% bolt on. Available for the 2 door or 4 door JK DV8 has run these fenders through countless trails and offroad miles and they truly rise to any offroad challenge.

- Front and rear fenders
- Bolt on design - Textured powdercoat
- Slim design - Excellent tire clearance

*Dim: w55" x h15" x h23"
*Weight: 82lbs



* Product dimensions and weights are approximate



2007-18 JK Jeep Wranglers

DV8 Off Road Aluminum inner fenders are designed to reseal your engine compartment when using after market fenders, Clean up your inner fender, and provide better air flow where it counts. DV8 Inner fenders are available in raw aluminum or powder coated black.

- Material: Aluminum
- Raw or Powder Coated Black
- Easy installation, NO modifications needed, Hardware included



INFEND-01FR US Patent No. D785,522



INFEND-01RR US Patent No. D785,522



INFEND-01FB US Patent No. D785,522



INFEND-01RB US Patent No. D785,522



INFEND-01FBRL

US Patent No. D785,522



DV8 Inner Fender with integrated Rock Lights and bluetooth control module



INFEND-02FR

INFEND-02FB

2nd Generation Inner Fender with more clearance, protection and venting. Available in black or raw aluminum.

Patent Pending

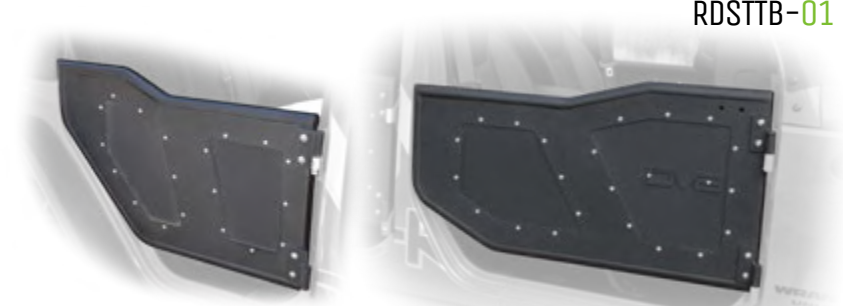

RDSTTB-01

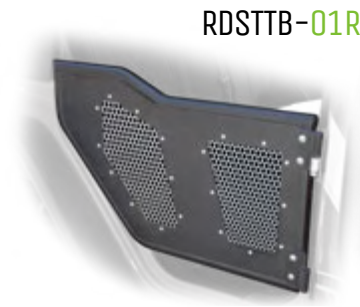

RDSTTB-01R

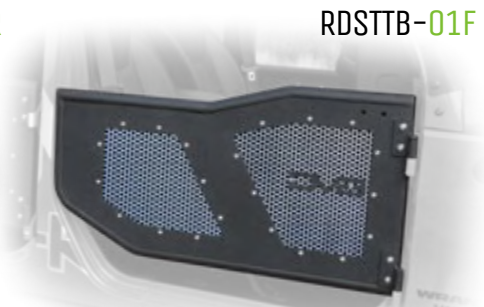

RDSTTB-01F

DV8 Rock Doors

- Rock Doors available for 2007-2018 Jeep Wrangler (2 and 4 door models)

*Dim: w33" x h22" x d8"
*Weight: 105lbs

- Limit straps to prevent door from swinging too far open
- Fully plated design (more protection from brush and debris)
- Rattle preventing stopper integrated into the design
- High quality latches, Simple and easy to install, Plates can be removed to paint



2007-18 JK Jeep Wranglers

- Made from 2" .160 wall tubing and 3/16" cold rolled steel
- Trail tested and proven designs
- Two staged textured black powder coating
- Easy installation, NO modifications needed, Hardware included
- Available for 2 Door and 4 Door Jeep Wranglers 2007-2018

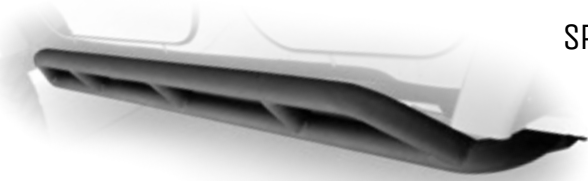

SRSOTB-01

4 Door Rock Slider
*Dim: w73" x h6" x d16"
*Weight: 56lbs



SRSOTB-03

2 Door Rock Slider
*Dim: w56" x h6" x d19"
*Weight: 56lbs



SRSOTB-04

4 Door Plated Rock Slider
*Dim: w73" x h6" x d16"
*Weight: 56lbs



SRSOTB-06

2 & 4 Door Tube Steps
*Dim: w71" x h5" x d10"
*Weight: 63lbs

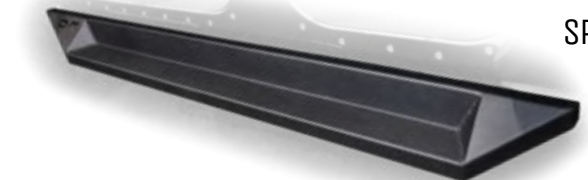

SRSOTB-10

4 Door Plated Steps
*Dim: w72" x h9" x d12"
*Weight: 83lbs



SRSOTB-05

2 & 4 Door Rock Skins
- Note: Drilling Required for Installation
*Dim: w73" x h12" x d3"
*Weight: 29lbs



SRSOTB-12
2 DOOR

2 & 4 Door Rock Sliders
- Sliders use body mounts and rock skins for ultimate durability

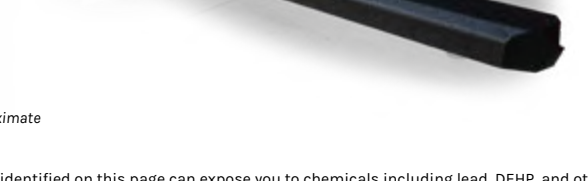

SRSOTB-13
4 DOOR

- Attach with factory hardware and nutserts
*Dim: w73" x h12" x d3"
*Weight: n/a

*Product dimensions and weights are approximate



LBSRTB-04

Hood Hinge Light Bar Mount
Mounts behind hood hinges for a low profile off road lighting solution. Will fit 30" light bars and longer with bottom mounts. Fits 2007-2018 Jeep Wranglers. Easy Installation with no drilling
*Dim: w6" x h6" x d4"
*Weight: 2lbs



LBSRTB-05

50" Light Bar Mount
Compatible with end mounted or bottom mounted 50" LED Light Bars. Padded Mounts to protect painted surfaces. Easy Installation with no drilling required. Fits 2007-2018 Jeep Wranglers
*Dim: w52" x h9" x d5"
*Weight: 17lbs



LBSWTB-01

Pod Mount
Easy installation using factory windshield bracket bolts. Fits 2007-2018 Jeep Wranglers



TJK-01

Folding Trail Table
Constructed from solid steel and powder-coated for protection the DV8 TJK-01 is a convenient table that folds down from the tailgate. Whether you are doing a trail repair or just making lunch, this table just makes life easier.
- Fold up design makes storage convenient
- Can hold up to 100 lbs
- Bolts to factory mounting points
- Rattle free design
*Dim: w25" x h13" x d4"
*Weight: 91lbs



HDMB07-TA

**10th Anniversary
Replica Hood**

DV8 Off Road hoods provide better air flow and reduced weight with dual vented designs. DV8 hoods are constructed from stamped steel.

- Easy Bolt on installation
 - Better Air flow for increased performance
 - Reduce weight
- Stamped Steel 10th Anniversary Edition replica hood.

*Dim: w40" x h10" x d42"
*Weight: 75lbs



HDMB07-02

Heat Dispersion Hood

- Stamped Steel DV8 Heat Dispersion hood.

*Dim: w40" x h10" x d42"
*Weight: 80lbs



GRAB07-04

**LED Grill
ABS Grille with steel mesh insert**

Made from ABS plastic, this grille is thicker and more durable than your factory grille. All grilles come with necessary seals and installation hardware. Grilles are available in textured black.

- ABS plastic
- Color - Textured black
- Easy installation, NO modifications needed, reuse factory hardware

20" Light Bar not included

* Product dimensions and weights are approximate

**2007-18
JK Jeep
Wranglers**

DV8 Off Road Hard Tops are built in the United States and use high quality seals, fiberglass, and advanced aerodynamics to produce the quietest tops on the market.

- Hand laid honeycomb reinforced fiberglass for added durability
- 31% tint DOT approved glass
- Military grade carpeted headliner for increased insulation and noise reduction
- UV stable GEL coat - Extra thick
- Quick release latching system
- Improved aerodynamic shape, Two piece targa designs
- Defrost rear windows
- Made in the USA

* Product dimensions and weights are approximate



HT07FB42

**RANGER-FB
FAST BACK HARD TOP**

- FITS 4 DOOR 07-18
JK JEEP WRANGLERS

*Dim: w90" x h48" x d72"
*Weight: 300lbs



HT96SB22

**Ranger-TJ
TJ Hard Top**

- Fits 1996-2006
Jeep Wranglers

*Dim: w65" x h48" x d72"
*Weight: 300lbs



HT07SB42

**Ranger-4
4 Door Hard Top**

- Fits 4 Door 07-18
JK Jeep Wranglers

*Dim: w90" x h48" x d72"
*Weight: 300lbs



HT07SB22

**Ranger-2
2 Door Hard Top**

- Fits 2 Door 07-18
JK Jeep Wranglers

*Dim: w72" x h48" x d72"
*Weight: 300lbs



HT07FB22

Ranger-JK 2 Door Fast Back Hard Top

- Fits 2 Door 07-18
JK Jeep Wranglers

*Dim: w72" x h48" x d72"
*Weight: 300lbs



HARDTOP BREAKDOWN

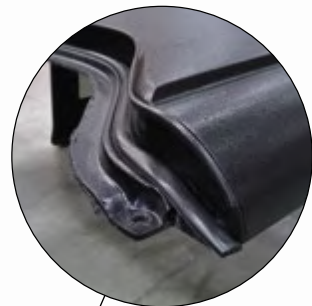

2 piece Targa Design with high quality automotive grade seals



Aluminum Machined Hinges



Mil Spec Carpeted Headliner



High quality automotive grade seals
Extra thick UV stable gel coating

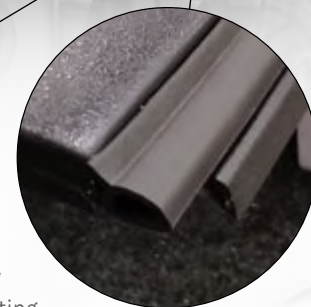

* Product dimensions and weights are approximate



RRJK-01

**Rock Runner 3.5" Lift Kit**

DV8 Rock Runner Kit comes with front & rear track bars 4 DV8 Nitro Monotube shocks, 4 dual rate coil springs, extended sway bar endlinks, and extended brake lines.

- 3.5" lift kit, clears 35" tires, easy bolt on installation
- Vehicle specific spring rates, Stock drive line compatible
- Front & rear track bars – heim jointed chromoly track bars
- 4 patent pending DV8 progressive Rate coil springs
- Extended sway bar endlinks, Extended brake line brackets
- Includes four Monotube Rock Shocks

RR25JK-01

**Rock Roller 2.5" Lift Kit**

The DV8 off road rock roller 2.5" lift kit was designed for those who want to gain additional ground clearance and accommodate 35" tires without compromising the factory ride. We accomplished this with longer springs and all of the necessary components to correct the suspension geometry for the lift. Add our unique shock extension kit or a set of DV8 monotube shocks for increased articulation and a completely dialed in ride.

- 2.5" lift kit, clears 35" tires, easy bolt on installation
- Vehicle specific spring rates, Stock drive line compatible
- Front & rear track bar brackets
- Four patent pending DV8 progressive Rate coil springs, Alignment washers
- Extended sway bar endlinks, Extended brake line brackets, Bump stop extensions

NITRO MONOTUBE
ROCK SHOCKS**2.0" Rock Shocks**

Simply put, the thing that makes our monotube shocks stand out from the crowd is their size. Having a thicker body allows us to put more fluid into the shock which in turn results in better performance for longer.

Internal bump stops protect your shocks and suspension at full flex.

Finally, when a customer orders one of our lift kits we provide monotube shocks that are designed for that specific kit. The result is perfect harmony between ride quality and off road performance.

- 2" Diameter Shock Body
- Kit comes with four shocks
- Shock Valving is JK Specific

RR25JK-01SE

**2.5" Shock Extension Kit**

Add our shock extension kit! Properly positions factory length shocks to work with a 2.5" lift. Unique 1/4" brackets sandwich the factory mounts for more rigidity & less chance of bending compared to the competition. Hand milled billet aluminum rear extensions.

BUSHING STYLE
TRACK BARSTBJK-01F
TBJK-01R**Adjustable Track Bars**

DV8 bushing style adjustable track bars.

Note: Not Compatible With Frame Mounted Trackbar DropBrackets

- Fully adjustable for a perfectly aligned ride
- Over double the diameter of the factory track bars at 1.5 inches (Front) -- 1.25 inches (Rear)
- Thick .375 wall DOM Steel Tubing (Front) and .250 Wall DOM Steel Tubing (Rear) Zinc Plated and Powder coated for corrosion resistance.
- Maintains the correct geometry with lift for better handling
- Can accommodate from 1-6 inches of suspension lift
- Quiet ride high flex rubber bushings

RRBS2-01

**Bump Stops**

DV8 Threaded Body 2.0 Bump Stop with 2.5" Stroke. These heavy duty bump stops install directly into the JK coil bucket and prevent the suspension from bottoming out through the last few inches of travel.

Whether dropping off of a rock ledge or hitting the whoops, the factory bump stops can not effectively keep up with the force that is being exerted on them. Our bump stops control the last few inches of travel and provide additional dampening where it is most needed. DV8 Bump Stops will help to save you and your Jeep from harshly bottoming out and allow for a more comfortable ride as you push your rig to its limits.

- Installs easily into the factory JK coil bucket
- Completely serviceable and rebuildable
- Valved perfectly for Jeep JK
- Locking Rings lock against each other for firm mounting
- Fully adjustable for different lift heights and tire sizes
- Comes with complete install instructions
- Sold in pairs

* Product dimensions and weights are approximate

DVB
OFF-ROAD

2020 JT

GLADIATOR
PRODUCT LINE





2020 JEEP GLADIATOR

The All-New Jeep® Gladiator, engineered from the ground up to be a true pickup truck, and DV8 Offroad has designed trail gear to take your Gladiator far and beyond where average trucks can go. Our designs set the benchmark when it comes to the ultimate look of adventure and protection, yet are easy on budget.

2020 Jeep Gladiator Compatible Products

Current JK/JL Front Bumpers that are compatible w/2020+ JT Jeep Gladiator

PRODUCT	PART NO.	DESCRIPTION
FS-1	FBSHTB-01	Full Length Front Bumper
FS-6	FBSHTB-06	Mid Front Bumper
FS-7	FBSHTB-07	Mid Front Bumper w/LED Lights
FS-8	FBSHTB-08	Mid Front Bumper w/LED Lights
FS-11	FBSHTB-11	Mid Front Bumper 11 w/ LED Lights
FS-13	FBSHTB-13	Stubby Front Bumper w/Fog Lights (lights not included)
FS-14	FBSHTB-14	Mid Front Bumper w/Fog Lights & LED (lights not included)
FS-15	FBSHTB-15	Stubby Front Bumper w/Fog Lights (lights not included)
FS-24	FBSHTB-24	Stubby Front Bumper w/Light bracket & winch plate
FS-25	FBSHTB-25	Stubby Front Bumper w/20" Light Bar & winch plate (Light Bar not included)
JL	FBJL-01	Stubby Front Bumper
JL	FBJL-10	Full Width/Stubby Width Front Bumper
JL	ABJL-01	Front Bumper Adapter JK to JT



RBGL-01

High Clearance Rear Bumper

The DV8 Offroad RBGL-01 was designed to be tucked up and out of the way for traversing difficult trails and coming off of rock ledges. The bumper features 2 recovery shackle attachments and a license plate mounting system with lights and comes with the standard DV8 Offroad textured black powdercoat. It is designed to work with the OEM hitch and mounts with no drilling or modification to the vehicle.

- High clearance design with aggressive angles and styling
- Lightweight, Accommodates backup sensors

*Dim: w67" x h11" x d11"
*Weight: 61lbs



RBGL-03

Rear Step Bumper with Drawer

The DV8 Offroad RBGL-03 was designed to give you more space to store your gear safely. The sliding, locking, drawer in the bumper will be the most secure place on your entire Gladiator and act as an external safe. The bumper also features cutouts that function as steps to allow easy access in and out of the bed.

- Sliding and locking drawer
- Step cutouts for easy entry and exit
- Aggressive angles and styling
- Easy to install
- Accommodates backup sensors

Note: Install requires minor modifications and relocation of the spare tire

*Dim: n/a
*Weight: n/a



RBGL-04

Mid Length High Clearance Rear Bumper

- High clearance design with aggressive angles and styling
- License plate mounting system with light
- Lightweight, Accommodates backup sensors

*Dim: n/a
*Weight: n/a

* Product dimensions and weights are approximate



FDGL-01

High Clearance Flat Slim Fenders

- Slim Design for max protection and clearance
- 100% bolt on and require no cutting or drilling
- Integrated LED turn signals
- Lightweight and built tough

*Dim: n/a
*Weight: n/a

FRONT



REAR



FDGL-02

High Clearance Armor Fenders

- Slim Design for max protection and clearance
- 100% bolt on and require no cutting or drilling
- Lightweight and built tough

*Dim: n/a
*Weight: n/a

FRONT



REAR



* Product dimensions and weights are approximate

TCGL-01

Inner Bed Tire Carrier

Interior bed tire carrier features a hydraulic lifting mechanism to move the spare out of the way for storage.

- Accommodates up to a 42" tire
- Moves the heavy spare assembly to a better balance point.
- Adjustable for storage access.

*Dim: n/a
*Weight: n/a

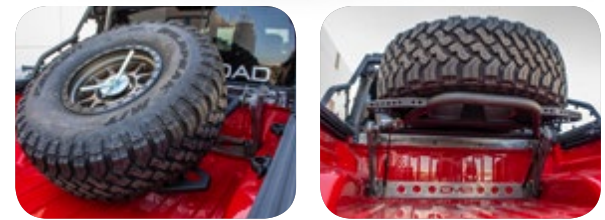

INFEND-04BR

Inner Rear Fenders

The DV8 Offroad Gladiator rear inner fenders are designed to add a finished look to your Gladiator with aftermarket fenders. Our inner fenders cover up and protect the unsightly components that are exposed when the OEM inner fender is removed. These are precision bent, powdercoated, and easy to install.

*Dim: n/a
*Weight: n/a



SRGL-01

Bedside Slider Protection

The DV8 Offroad SRGL-01 bedside sliders provide great protection for the bed of your Gladiator when coming off of an obstacle. It's no secret that the departure angle of the Gladiator can create times where you will be happy you had adequate bedside protection. DV8 has over-engineered this product to take a beating. It's made of a combination of 1/4" and 1/2" steel which is fully gusseted.

- Fully gusseted
- Made of thick high grade steel
- Excellent protection
- Bolt on install
- Sand black powdercoat finish

*Dim: w13" x h16" x d12"
*Weight: 53lbs

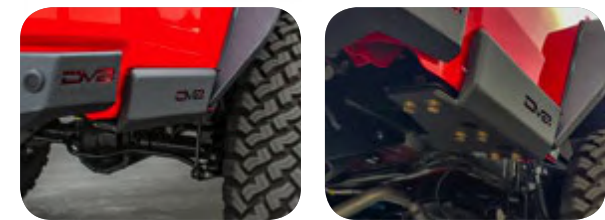

* Product dimensions and weights are approximate



SRGL-02



Boxed Sliders

The most vulnerable areas on the body are the rocker panels. Sliders protect your rocker panel area while enabling you to slide over rocks and obstacles.

- Sliders use body mounts for ultimate durability
- Attach with factory hardware
- Great for Jeeps that will be used in extreme conditions regularly

*Dim: n/a
*Weight: n/a

SRGL-03



Rock Slider/Step

SRGL-03 sliders are a trail tested and proven design. Made from .160 wall 2" rolled steel tubing and completely bolt on, no drilling required.

- Slider/ Step without losing clearance
- Non Slip Gripping Step Design
- Easy Install and the steps utilize factory hardware

*Dim: n/a
*Weight: n/a

RRGL-01



Bolt On Chase Rack

The DV8 Offroad RRGL-01 Chase Rack is a completely bolt on rack that features multiple mounting options for lights. The rack bolts securely to the bed of the gladiator and completely enhanced the looks of the truck. This rack also features mesh aluminum accents that can be unbolted and color keyed to match your vehicle or theme. This rack features the option to mount a 50 inch light bar behind the cab where wind noise is much less of a factor than a standard windshield mount light bar.

- Multiple lighting configurations
- Solid steel construction - Light weight
- Bolt on installation
- Side lights shown are DV8 P/N B3CE16W4W
- Upper light shown is DV8 P/N BS50E250W5W
- Rear facing light shown is DV8 P/N BS10E50W5W

*Dim: n/a
*Weight: n/a

* Product dimensions and weights are approximate

Current JL products that are compatible w/2020+ JT Jeep Gladiator

MODEL	PART NO.	DESCRIPTION
JL	INFEND-03FR	Front Inner Fender
JL	INFEND-03FB	Front Inner Fender Black
JL	RDJL-01	Rock Doors
JL	HDJL-01	Half Doors
JL	SPJL-01	Swaybar Disconnect Skid Plate
JL	LBJL-01	Over Windshield Light Bar Bracket
JL	LBJL-02	Dual Pod Light Lower A Pillar mount
JL	LBJL-03	Over Hood 30" Light Bar Mount
JL	CMJL-01	Engine Bay Compressor Mount for ABS
JL	BCABJL-01	Headlight Adapter w/Wiring
JL	STJL-01	Hinge Mounted Steps
JL	STJL-02	Hinge Mounted Foot Pegs
JL	HDMBJL-01	Heat Dispersion Hood
JL	HDMBJL-TA	Rubicon Replica Hood
JL	GRJL-01	Replacement Grill Black
JL	HTJL-L	Hard Top Latch Closure Mechanism
JL	HTJL-H	Billet T-Handles for JL Hardtop
JL	HTJL-BR	OEM Style Hardtop Mounting Brackets
JL	HLCJL-01	9" JL/JT LED Chrome Light w/Halo

NOTE: For a list of compatible front bumpers see chart on page 47 for details

DV8
OFF-ROAD

DV8 Off Road truck bumpers
are built with abuse in mind

TRUCK
ACCESSORY

PRODUCT LINE





VEHICLE	PART NO.	DESCRIPTION	FRONT	REAR	
CHEVROLET	FBCSI-01	2007-2013	Chevy Silverado Front		
	FBCSI-04	2007-2013	Chevrolet Silverado Front 1500		
	RBCSI-01	2007-2013	Chevrolet Silverado Rear 1500		
	FBCSI-02	2014-2015	Chevrolet Silverado Front 1500		
	FBCSI-05	2016-2018	Chevrolet Silverado Front 1500		
	FBCSI-06	2016-2018	Chevrolet Silverado Front 1500		
	RBCSI-02	2016-2018	Chevrolet Silverado Rear 1500		
	FBCS2-01	2011-2014	Chevrolet Silverado Front 2500/3500		
	FBCS2-02	2011-2014	Chevrolet Silverado Front 2500/3500		
	RBCS2-01	2011-2014	Chevrolet Silverado Rear 2500/3500		
	FORD	FBFF1-06	2004-2008	Ford Front F-150	
		FBFF1-02	2009-2014	Ford Front F-150	
FBFF1-01		2009-2014	Ford Front F-150		
RBFF1-01		2009-2014	Ford Rear F-150		
FBFF1-07		2015-2017	Ford Front F-150		
FBFF1-08		2018+	Ford Front F-150		
RBFF1-02		2015-2018	Ford Rear F-150		
FBFF2-01		2011-2016	Ford Front F-250/350/450		
RBFF2-01		1999-2016	Ford Rear F-250/350/450		
FBFF2-05		2008-2010	Ford Front F-250/350/450		
FBFF2-02		2011-2016	Ford Front F-250/350/450		
FBFF2-03		2017-2018	Ford Front F-250/350/450		
RBFF2-02		2017-2018	Ford Rear F-250/350/450		
DODGE RAM		FBDR1-01	2013-2018	Ram Front 1500	
	RBDR1-01	2010-2018	Ram Rear 1500		
	FBDR1-02	2013-2018	Ram Front 1500		
	FBDR2-03	2006-2009	Dodge Ram Front 2500/3500		
	FBDR2-02	2010-2018	Ram Front 2500/3500		
	FBDR2-04	2010-2018	Ram Front 2500/3500		
	RBDR2-01	2010-2018	Ram Rear 2500/3500		

TOYOTA	FBTT2-02	2007-2013	Toyota Tundra Front
	FBTT2-01	2014-2019	Toyota Tundra Front
	FBTT2-03	2007-2013	Toyota Tundra Front
	RBTT2-01	2014-2018	Toyota Tundra Rear
	RBTT2-02	2007-2013	Toyota Tundra Rear
	FBTT1-01	2005-2015	Toyota Tacoma Front
	FBTT1-02	2005-2015	Toyota Tacoma Front
	RBTT1-01	2005-2015	Toyota Tacoma Rear
	FBTT1-03	2016+	Toyota Tacoma Front
	FBTT1-05	2016+	Toyota Tacoma Front
RBTT1-03	2016+	Toyota Tacoma Rear	
GMC	FBGC-01	2015+	GMC Canyon Front
	RBGC-01	2015+	GMC Canyon/Colorado Front
DV8 Baja Style Truck Bumpers			
CHEVROLET	FBCSI-03	2014-2018	Chevrolet Silverado 1500 Front Baja Style
FORD	FBFF1-04	2009-2014	Ford F-150 Front Baja Style
	FBFF1-03	2015-2017	Ford F-150 Front Baja Style



LPBM-01

Flip Up License Plate Relocation Bracket Fairlead Mounted

The DV8 LPBM-01 was introduced due to the demand for a functional 50 state legal license plate mount that allows Jeepers to flip and winch. Just pull the plate up and you are ready for recovery. Mounts to any fairlead (roller or hawse) and keeps your rig street legal.

- Universal design
- Matches DV8 bumpers
- Excellent durability
- Flips out of the way

*Dim: w80" x h19" x d29"
*Weight: 120lbs

* Product dimensions and weights are approximate



FBCS1-01

Silverado Front Bumper

- 1500 / 2007-2013
- Accepts four 3.5" round LED lights (not included)
- 3 piece design
- *Dim: w80" x h16" x d26"
- *Weight: 110lbs



FBCS1-04

Silverado Front Bumper

- 1500 / 2007-2013
- Four flush mount LEDs (included)
- 3 piece design
- *Dim: w87" x h17" x d29"
- *Weight: 125lbs



FBCS1-02

Silverado Front Bumper

- 1500 / 2014-2015
- Four flush mount LEDs (included)
- 3 piece design
- *Dim: w82" x h18" x d30"
- *Weight: 115lbs



FBCS1-03

Silverado Front Bumper

- 1500 / 2014-2015
- 40" radius LED light bar (included)
- 3 piece design
- *Dim: w"80 x h18" x d29"
- *Weight: 120lbs



FBCS2-01

Silverado Front Bumper

- 2500 / 2011-2014
- Accepts four 3.5" round LED lights (not included)
- 3 piece design
- *Dim: w84" x h22" x d29"
- *Weight: 188lbs



FBCS2-02

Silverado Front Bumper

- 2500/3500 / 2011-2014
- Two flush mount LEDs (included)
- 3 piece design
- *Dim: w80" x h19" x d29"
- *Weight: 120lbs



FBCS1-06

Silverado Front Bumper

- 1500 / 2016-2018+
- Two 3" cube lights (not included)
- 3 piece design
- *Dim: w82" x h21" x d15"
- *Weight: 75lbs



RBCS1-01

REAR BUMPER

Silverado Rear Bumper

- 1500 / 2007-2013
- Accepts Two 3.5" round LED lights (not included)
- *Dim: w77" x h10" x d14"
- *Weight: 75lbs



RBCS1-02

Silverado Rear Bumper

- 1500 / 2016-2018+
- Two 3" cube lights (not included)
- *Dim: w77" x h12" x d16"
- *Weight: 80lbs



RBCS2-01

Silverado Rear Bumper

- 2500 / 2011-2014
- Accepts Two 3.5" round LED lights (not included)
- *Dim: w77" x h10" x d14"
- *Weight: 75lbs

* Product dimensions and weights are approximate



FBGC-01

GMC Center Mount Front Bumper

- Canyon 2015+

*Dim: w80" x h16" x d26"

*Weight: 110lbs



RBGC-01

GMC Rear Bumper

- Canyon/Colorado 2015+

- Two 3" flush mount lights LEDs (included)

*Dim: w80" x h16" x d26"

*Weight: 110lbs

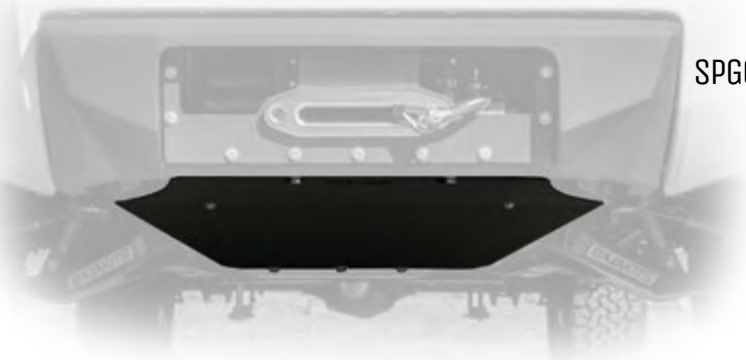

SPGC-01

GMC Center Mount Front Bumper Skid Plate

- Canyon 2015+

*Dim: w80" x h16" x d26"

*Weight: 110lbs



FBGC-01

GMC Front Bumper

- Sierra 2007-2013

- Four flush mount LEDs (included)

- 3 piece design

*Dim: w80" x h16" x d26"

*Weight: 110lbs



FBFF1-06

Ford Front Bumper

- F 150 / 2004-2008

- Four flush mount LEDs (included)

- 3 piece design

*Dim: w86" x h19" x d33"

*Weight: 123lbs



FBFF1-01

Ford Front Bumper

- F 150 / 2009-2014

- Accepts four 3.5" round LED lights (not included)

- 3 piece design

*Dim: w76" x h22" x d31"

*Weight: 118lbs



FBFF1-04

Ford Front Bumper

- F 150 / 2009-2014

- 40" radius LED light bar (included)

- NOTE: is not compatible with cross member extension or control arm drop bracket style lift kits.

*Dim: w78" x h17" x d25"

*Weight: 118lbs



FBFF1-02

Ford Front Bumper

- F 150 / 2009-2014

- Four flush mount LEDs (included)

- 3 piece design

*Dim: w81" x h16" x d36"

*Weight: 128lbs



FBFF1-03

Ford Front Bumper

- F 150 / 2015-2017

- 40" radius LED light bar (included)

- NOTE: is not compatible with cross member extension or control arm drop bracket style lift kits.

*Dim: w78" x h32" x d12"

*Weight: 118lbs

* Product dimensions and weights are approximate

* Product dimensions and weights are approximate



FBFF1-07

Ford Front Bumper
 - F 150 / 2015-2018
 - 3 piece design
 *Dim: w79" x h20" x d10"
 *Weight: 109lbs



FBFF1-08

Ford Front Bumper
 - F 150 / 2018+
 - Two 3" cube lights (not included)
 - 3 piece design
 *Dim: w40" x h11.8" x d14"
 *Weight: 97lbs



FBFF2-01

F 250/350
Ford Front Bumper
 - F 250/350 / 2011-2016
 - Accepts four 3.5" round LED lights (not included)
 - 3 piece design
 *Dim: w77" x h19" x d27"
 *Weight: 178lbs



FBFF2-02

Ford Front Bumper
 - F 250/350 / 2011-2014
 - Four flush mount LEDs (included)
 - 3 piece design
 *Dim: w86" x h18" x d28"
 *Weight: 112lbs



FBFF2-03

Ford Front Bumper
 - F 250/350 / 2017+
 - Two 3" cube lights (not included)(10" single row light bar not included)
 - 3 piece design
 *Dim: w43" x h16" x d16"
 *Weight: 116lbs

* Product dimensions and weights are approximate



RBFF1-01

REAR BUMPER
Ford Rear Bumper
 - F 150 / 2009-2014
 - Accepts Two 3.5" round LED lights (not included)
 *Dim: w76" x h10" x d18"
 *Weight: 82lbs



RBFF1-02

Ford Rear Bumper
 - F 150 / 2018+
 - Two flush mount LEDs (included)
 *Dim: w77" x h12" x d18"
 *Weight: 90lbs



RBFF1-03

Ford Rear Bumper
 - F 150 / 2015-2017
 - Two flush mount LEDs (included)
 *Dim: w77" x h12" x d18"
 *Weight: 90lbs



RBFF2-02

F 250
Ford Rear Bumper
 - F 250/350 / 2017+
 - Two flush mount LEDs (included)
 *Dim: w86" x h28" x d19"
 *Weight: 110lbs



RBFF2-01

Ford Rear Bumper
 - F 250/350 / 2011-2016
 - Accepts Two 3.5" round LED lights (not included)
 *Dim: w76" x h18" x d10"
 *Weight: 108lbs

* Product dimensions and weights are approximate



FBDR1-01

RAM Front Bumper

- 1500 / 2013-2018
- Accepts four 3.5" round LED lights (not included)
- 3 piece design
- *Dim: w82" x h21" x d35"
- *Weight: 108lbs



FBDR1-02

RAM Front Bumper

- 1500 / 2013-2018
- Four flush mount LEDs (included)
- 3 piece design
- *Dim: w84" x h17" x d35"
- *Weight: 118lbs

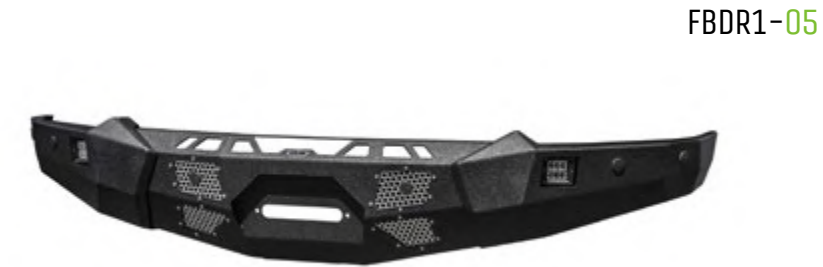

FBDR1-05

RAM Front Bumper

- 1500 / 2019+
- Two Cube LEDs (included)
- 3 piece design
- *Dim: w84" x h17" x d35"
- *Weight: 118lbs



FBDR2-03

Dodge Front Bumper

- Ram 2500/3500 / 2006-2009
- Four flush mount LEDs (included)
- 3 piece design
- *Dim: w82" x h18" x d32"
- *Weight: 110lbs



FBDR2-02

RAM Front Bumper

- 2500/3500 / 2010-2018
- Four flush mount LEDs (included)
- 3 piece design
- *Dim: w81" x h16" x d31"
- *Weight: 108lbs



FBDR2-04

RAM Front Bumper

- 2500/3500 / 2010-2018
- Four 3" cube lights (not included)
- 3 piece design
- *Dim: w80" x h18" x d30"
- *Weight: 100lbs



RBDR1-01

RAM Rear Bumper

- 1500 / 2013-2018
- Accepts Two 3.5" round LED lights (not included)
- *Dim: w79" x h13" x d20"
- *Weight: 90lbs



RBDR2-01

RAM Rear Bumper

- 2500/3500 / 2010-2018
- Two flush mount LEDs (included)
- *Dim: w79" x h13" x d20"
- *Weight: 95lbs



* Product dimensions and weights are approximate



FBTT1-01

Toyota Front Bumper

- Tacoma 2005-2015
- Accepts Two 3.5" round LED lights (not included)
- 3 piece design
- *Dim: w74" x h22" x d18"
- *Weight: 130lbs



FBTT1-02

Toyota Front Bumper

- Tacoma 2005-2015
- Two 3" lights (included), Accepts Two 3.5" round LED lights (not included)
- 3 piece design
- *Dim: n/a
- *Weight: n/a



FBTT1-03

Toyota Front Bumper

- Tacoma 2016+
- Two 3" cube lights - 30" single row light bar (not included)
- 3 piece design
- *Dim: n/a
- *Weight: n/a



FBTT1-05

Toyota Front Bumper

- Tacoma 2016+
- Accepts 20" single row light bar (not included)
- *Dim: w80" x h17" x d28"
- *Weight: 108lbs

REAR BUMPER



RBTT1-01

Toyota Rear Bumper

- Tacoma 2005-2015
- Two flush mount LEDs (included)
- *Dim: w70" x h11" x d15"
- *Weight: 75lbs



RBTT1-03

Toyota Rear Bumper

- Tacoma 2016+
- Two flush mount LEDs (included)
- *Dim: w69" x h16" x d16"
- *Weight: 110lbs



RBTT1-03ST

Toyota Rear Bumper Step Bolt on Step

- Tacoma 2016+
- *Dim: n/a
- *Weight: n/a

TUNDRA



FBTT2-01

Toyota Front Bumper

- Tundra 2014-2019
- Accepts four 3.5" round LED lights (not included)
- 3 piece design
- *Dim: w75" x h22" x d18"
- *Weight: 148lbs



FBTT2-02

Toyota Front Bumper

- Tundra 2007-2013
- Four flush mount LEDs (included)
- 3 piece design
- *Dim: w80" x h17" x d28"
- *Weight: 108lbs



FBTT2-03

Toyota Front Bumper

- Tundra 2007-2013
- 3 piece design
- *Dim: w75" x h22" x d18"
- *Weight: 148lbs

* Product dimensions and weights are approximate



RBTT2-01

REAR BUMPER

Toyota Rear Bumper

- Tundra 2014-2019
- Accepts Two 3.5" round LED lights (not included)

*Dim: w71" x h12" x d15"
*Weight: 118lbs



RBTT2-02

Toyota Rear Bumper

- Tundra 2007-2013
- Accepts Two 3.5" round LED lights (not included)

*Dim: w71" x h12" x d15"
*Weight: 118lbs



* Product dimensions and weights are approximate



SRTT1-01

Toyota Rock Sliders

- Tacoma 2016+
- *Dim: w87" x h19" x d9"
- *Weight: 220lbs



SPTT1-01

Toyota Skid Plate

- Tacoma 2016+
- *Dim: w40" x h29" x d8"
- *Weight: 43lbs



RRTT1-01

Toyota Roof Rack

- Tacoma 2016+
- Fits 45" light bar (not included) and four 10" single row light bar (not included)
- *Dim: w65" x h7" x d9"
- *Weight: 25lbs





2020

ACCESSORIES PRODUCT LINE

D-JP-190001-K

JK HOOD HOLD DOWNS

DV8's billet aluminum turnbuckle and stainless steel heim joint hold downs. The quick-release push pin provides easy access to opening your hood and won't be lost thanks to the attached, stainless steel lanyard.

D-JP-190021-K TJ HOLD DOWNS

D-JP-190031-K LJ HOLD DOWNS



D-JP-190001/21

JK HOOD HOLD DOWN TURNBUCKLES

DV8's Hood Hold Downs (in standard and lockable versions) can be upgraded with an optional black turnbuckle to replace the standard silver color.



D-JP-190005-BL

JK BILLET FUEL CAP

DV8 Off Road's Billet Fuel Cap is an easy way to secure access to your fuel with a lockable cap and the billet finish looks great!

D-JP-190005-BLK JK BILLET FUEL CAP

D-JP-190025-BL TJ BILLET FUEL CAP



D-FIREX-MNT-DOR

QUICK RELEASE FIRE EXTINGUISHER MOUNT

NHRA-approved, this quick release fire extinguisher mount is Baja-proven! It features CNC-machined 6061-T6 billet aluminum construction with a red, anodized, quick release pull knob. It can be installed in just about any location.

D-FIREX-MNT-S-DOR SILVER



D-LIGHT-MNT-DOR

QUICK RELEASE FLASHLIGHT MOUNT

Based on the same design as the extinguisher mount, this system is designed to hold your flashlight via a CNC-machined billet aluminum holder and quick-release, red anodized knob.



D-JP-110001-D35 (shown)

DANA DIFFERENTIAL COVERS

Add character and increase the structural rigidity of the whole axle with a DV8 Differential Cover. Increased oil capacity decreases the operating temperature of the gear oil. Engineered from high tensile nodular cast iron with a thick 1/2" mounting flange and a 1/4" housing, this differential cover is ready to protect your gears and locker from the most punishing rocks and trail hazards!

D-JP-110001-D30 DANA 30 COVER

D-JP-110001-D44 DANA 44 COVER





HOOD ACCESSORIES

D-JP-190001-K

JK HOOD HOLD DOWNS

DV8's billet aluminum turnbuckle and stainless steel heim joint hold downs. The quick-release push pin provides easy access to opening your hood and won't be lost thanks to the attached, stainless steel lanyard.



D-JP-190001-LK

JK LOCKING HOOD HOLD DOWNS

DV8's billet aluminum turnbuckle and stainless steel heim joint hold downs. The locking pin provides security, unwanted theft, and won't be lost thanks to the attached, stainless steel lanyard.



D-JP-190001-LKCNV

JK LOCKING HOOD PIN UPGRADE

For Customers that already own the DV8 Hood Hold Downs, but would like to upgrade to a lockable version, this is an easy install upgrade.



D-JP-190011-K

JK ROCKLAW™ HOOD CATCH SYSTEM

DV8's patented RockLaw™ Hood Catch System are made from a rigid die-cast which eliminates the flutter. They are height-adjustable to allow for a precise tension. Comes with high-quality stainless steel mounting hardware.



D-JP-190011-K1

JK ALUMINUM INSERT FOR ROCKLAW™ HOOD CATCH SYSTEM

The stick-on aluminum inserts for the DV8 RockLaw™ system.



D-JP-190022

JK HOOD ISOLATORS

Great replacement for the stock hood isolator in case you lost it or it deteriorated over time.



D-JP-190001/21

JK HOOD HOLD DOWN TURNBUCKLES

DV8's Hood Hold Downs (in standard and lockable versions) can be upgraded with an optional black turnbuckle to replace the standard silver color.



BEZELS

D-JP-180000-AL

JK AC VENT BEZEL TRIM 4 PIECE SET

This set of (4) bezels are machined-aluminum and easily install over the original plastic trim with an adhesive mount. A quick and easy way to add a more refined finish to your Jeep's interior.



D-JP-180001-AL

JK GLOVE BOX HANDLE COVER

Made from stamped-aluminum and designed to fit over the existing glove box handle, this is a quick way to add a little flash to your Jeep's interior.



D-JP-180004-BL

JK CONSOLE SHIFT BEZEL A/T

Made from machined-aluminum and easily install over the original plastic trim with an adhesive mount.



D-JP-180005-BL

JK CUP HOLDER BEZEL

Machined from 6061-T6 billet aluminum, this bezel is designed to replace the plastic, original piece. A nice complement to the shifter bezel, vent bezels and glove box handle cover for your Jeep's interior.



D-JP-180007-BL

JK PARKING BRAKE BEZEL

Machined from 6061-T6 billet aluminum, this bezel is designed to replace the plastic, original piece. A nice complement to the cup holder, shifter bezel, vent bezels and glove box handle cover for your Jeep's interior.



D-JP-180009-BK

JK EMERGENCY BRAKE HANDLE COVER BLACK

Made from 6061-T6 billet aluminum, these handle covers have a cross pattern design (for better grip) that is anodized. Also available in silver.



D-JP-180009-BL

JK EMERGENCY BRAKE HANDLE COVER SILVER



D-JP-180026-BL

JK BILLET PEDAL COVERS, MANUAL 3 PC

Our grooved, billet aluminum pedal covers will help keep your shoes from sliding off the pedals especially when you're putting your foot into it (more gas, less brake!)



D-JP-181109-G

JK EMERGENCY BRAKE HANDLE COVER GREY

Made from ABS plastic and embossed with 'Since 1941' (the birth year of Jeep), it features an easy, slip-on installation. Also available in silver.



D-JP-181109-S

JK EMERGENCY BRAKE HANDLE COVER SILVER

Made from ABS plastic and embossed with 'Since 1941' (the birth year of Jeep), it features an easy, slip-on installation. Also available in grey.



D-JP-1812004-AL

JK SHIFTER PLATE AUTOMATIC

Brushed aluminum and easy, adhesive tape installation, these add a nice pop to the Jeep's interior and nicely complement the vent bezel trim, cup holder bezels and climate control knobs.



D-JP-190032

JK DOOR OR HOOD HINGE COVERS SOLD IN PAIRS

These JK Door / Hood Hinge Covers were designed to match the same style of the 'picatinny' rail system that DV8 offers for Hoods, A-pillars and Roof Mounts. They perform as tough as their mil-spec look.



CAPS

D-JP-120001-BL

JK POWER STEERING CAP

Machined from 6061-T6 billet aluminum with a brushed & textured surface and clear anodized finish, these caps are the perfect dress-up accessory for showing off what's under your Jeep's hood.



D-JP-120004-BL

JK 3.8L OIL CAPP

Machined from 6061-T6 billet aluminum with a brushed & textured surface and clear anodized finish, these caps are the perfect dress-up accessory for showing off what's under your Jeep's hood.



D-JP-120005-BL

JK WASHER FLUID CAP

Machined from 6061-T6 billet aluminum with a brushed & textured surface and clear anodized finish, these caps are the perfect dress-up accessory for showing off what's under your Jeep's hood.



D-JP-120006-BL

JK COOLANT RESERVOIR CAP

Machined from 6061-T6 billet aluminum with a brushed & textured surface and clear anodized finish, these caps are the perfect dress-up accessory for showing off what's under your Jeep's hood.



D-JP-121204-BL

JK TWIST ON BILLET OIL CAP

Machined from 6061-T6 billet aluminum with a brushed & textured surface and clear anodized finish, these caps are the perfect dress-up accessory for showing off what's under your Jeep's hood.



D-JP-190005-BL

JK BILLET FUEL CAP

DV8 Off Road's Billet Fuel Cap is an easy way to secure access to your fuel with a lockable cap, and the billet finish looks great!



D-JP-190005-BLK

JK DODGE CHALLENGER BILLET GAS CAP BLACK

DV8's black, billet lockable gas cap is designed to fit the 2001-18 Jeep TJ/JK & 2008-13 Dodge Challenger.

ANTENNA

D-JP-190002-BK

JK BILLET ANTENNA BLACK

The 8" billet aluminum antenna are machined from 6061-T6 material for added strength and style. Also available in silver.



MOUNT/BRACKET

D-JP-181110-A

JK FIRE EXTINGUISHER / FLASHLIGHT FLOOR MOUNT BRACKET KIT

DV8's Fire Extinguisher floor mount bracket allows you to quickly reach your flashlight or fire extinguisher at the base of the driver's (or passenger's) seat.



COWLS

D-JP-190003-A

JK COWL COVERS BLACK

Looking to cover the Jeep JK's 'mirror dent'? These black cowl covers (which can be painted to match your Jeep), provide a nice accent and install easily with stainless steel mounting screws and 3M VHB adhesive.



FUEL DOORS

D-JP-190004-BLK

JK FUEL DOOR ASSEMBLY ALL BLACK

The black, billet aluminum fuel door assembly features a magnetic closure and adds a more refined look to your Jeep's stock fuel filler space.



GRILLE ACCESSORIES

D-JP-190008-BLACK

JK GRILLE INSERTS BLACK

Our Jeep Grille Inserts are made from solid, billet aluminum so bugs will really know what hit them. Comes with the necessary hardware and installation instructions and is also available in Brushed and Polished finishes.



D-JP-190008-BRUSH

JK GRILLE INSERTS BRUSHED



D-JP-190008-POLSH

JK GRILLE INSERTS POLISHED



D-JP-190010-BK

JK MESH GRILLE BLACK

The Jeep JK Mesh Grille installs easily as a single unit and is a great way to dress up the front end of your Jeep and helps keep the bugs out of its teeth. Also available in chromed stainless steel.

TIE DOWNS

D-JP-181115-A

JK CARGO TIE DOWN SYSTEM

This tie down system is designed to allow you to choose any combination of straps, tethers or cargo nets to secure your load.



HANDLES & INSERTS

D-JP-180002-BL

JK INTERIOR PASSENGER GRAB HANDLE

Machined from solid billet aluminum and complete with mounting hardware, this passenger grab bar is an eye-catcher and a great way to complete the interior trim upgrade inside of your Jeep.



D-JP-190015-AL-3

JK ALUMINUM DOOR HANDLE INSERTS 2 DOOR & TAILGATE

DV8's best selling JK handle door inserts are made of high-quality stainless steel with screw-in installation. 2-door version gets three handles (one for the rear gate!) 4-door version gets five handles (one for the rear gate!)



D-JP-190015-AL-5

JK ALUMINUM INSERTS 4 DOOR

D-JP-190015-BK-3

JK ALUMINUM INSERTS 2 DOOR BLACK



D-JP-190015-BK-5

JK ALUMINUM INSERTS 4 DOOR BLACK

D-JP-190015-TT-3

JK ALUMINUM INSERTS 2 DOOR BLACK



D-JP-190015-TT-5

JK ALUMINUM INSERTS 4 DOOR BLACK



D-JP-190026-AL-3
JK ALUMINUM SLOT STYLE DOOR HANDLE INSERTS SET OF 3

DV8's best selling JK handle door inserts are made of Aircraft Grade Cast Aluminum with screw-in installation. 2-door version gets three handles (one for the rear gate!) 4-door version gets five handles (one for the rear gate!)



D-JP-190026-AL-5
JK ALUMINUM INSERTS 4 DOOR

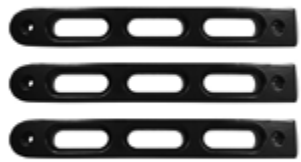

D-JP-190026-BK-3
JK ALUMINUM INSERTS 2 DOOR BLACK

D-JP-190026-BK-5
JK ALUMINUM INSERTS 4 DOOR BLACK

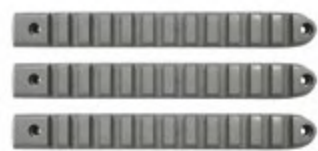

D-JP-190028-AL-3
JK SILVER RAIL STYLE DOOR HANDLE INSERTS SET OF 3

DV8's best selling JK handle door inserts are made of Aircraft Grade Cast Aluminum with screw-in installation. 2-door version gets three handles (one for the rear gate!) 4-door version gets five handles (one for the rear gate!)

D-JP-190028-AL-5
JK ALUMINUM INSERTS 4 DOOR SILVER

D-JP-190028-BK-3
JK ALUMINUM INSERTS 2 DOOR BLACK

D-JP-190028-BK-5
JK ALUMINUM INSERTS 4 DOOR BLACK



D-JP-190059-AL-3
JK ALUMINUM DOOR HANDLE INSERTS SET OF 3 STICK ON

DV8's JK Door Handle inserts new version, race-inspired 'dimple-die' design in an effortlessly-easy, stick-on installation. Made from cast zinc, they are built to withstand the elements. 2-door version gets three handles (one for the rear gate!) 4-door version gets five handles (one for the rear gate!)

D-JP-190059-AL-5
JK ALUMINUM INSERTS 4 DOOR

KNOBS

D-JP-180014-BL
JK CLIMATE CONTROL KNOBS

Made from billet aluminum and slotted to allow the knob to illuminate, the set of (3) install easily and add a nice look to the Jeep's interior.

D-JP-180027-BL
JK BILLET DOOR SURROUND KNOBS 2 DOOR

Don't go topless without a set of billet aluminum door surround knobs to replace the stock ones from the factory that deteriorate over time

D-JP-180028-BL
JK BILLET DOOR SURROUND KNOBS 4 DOOR



LIGHT GUARDS

D-JP-190007-BK
JK TAIL LAMP GUARDS BLACK

These black, powder coat lamp guards are rugged enough to handle whatever the trail throws at you and since they're stainless steel, won't ever corrode through snow, mud or rain. Easy bolt-in installation: no modifications or drilling. Also available in polished stainless steel.



D-JP-190007-SS
JK TAIL LAMP GUARDS STAINLESS

SILL GUARDS

D-JP-18040-AL
JK 2 DOOR SILL PLATES

Made from extruded aluminum, they are black anodized and come with raised brushed accent bars to ensure a grippy mount into (or dismount from) your Jeep.



D-JP-18041-AL
JK 4 DOOR SILL PLATES



RAIL SYSTEMS

D-JP-190051-HD
JK HOOD MOUNTED RAIL SYSTEM

Our picatinny 'rail' system features mil-spec, hard-anodized, billet machined, extruded aluminum which means your gear's cocked, locked and ready to rock! Mount lights, a GoPro, grab handles, high-jack lifts, shovels or a mirror...



D-JP-190052-PIL
JK A PILLAR MOUNTED RAIL SYSTEM

Our modular system fits the 2007-18 Jeep JK stock hood mount, A-Pillar, roof rail and more hinge mounts to come.



D-JP-190053-RF
JK ROOF RAIL MOUNTED SYSTEM

Our modular system fits the 2007-18 Jeep JK stock hood mount, A-Pillar, roof rail and more hinge mounts to come.



D-JP-190054-GP
JK GO PRO RAIL MOUNT SYSTEM

This GoPro adapter fits the new DV8 Off Road picatinny 'rail' system which features mil-spec, hard-anodized, billet machined, extruded aluminum.



D-JP-190055-POD
JK POD STYLE LIGHT MOUNT FOR RAIL MOUNT SYSTEM

This A-pillar Pod Mounting adapter fits the new DV8 Off Road picatinny 'rail' system which features mil-spec, hard-anodized, billet machined, extruded aluminum.



D-JP-190056-JK
JK HI LIFT MOUNT BRACKET FOR RAIL MOUNT SYSTEM

This Hi-Lift Bracket Mounting adapter fits the new DV8 Off Road picatinny 'rail' system which features mil-spec, hard-anodized, billet machined, extruded aluminum.



D-JP-190057-LT

JK LIGHT BAR MOUNT FOR RAIL MOUNT SYSTEM

This Light Bar Mounting adapter fits the new DV8 Off Road picatinny 'rail' system which features mil-spec, hard-anodized, billet machined, extruded aluminum.



D-JP-190058-M16

JK M16 STYLED GRAB HANDLE FOR RAIL MOUNT SYSTEM

This rail grab handle is designed to fit the new DV8 Off Road picatinny 'rail' system which features mil-spec, hard-anodized, billet machined, extruded aluminum.

SHIFTERS & TRAYS

D-JP-180008-BL

JK BILLET ALUMINUM MANUAL TRANSMISSION

Machined from 6061-T6 billet aluminum, designed to replace the plastic, original piece. It comes with the stainless steel mounting hardware, but NOT the rubber boot. It also requires a permanent modification to the original trim.stainless steel.



D-JP-180011-BK

JK 4WD SHIFT KNOB BLACK FINISH

DV8 Off Road's shift knobs are made from billet aluminum and feature our 'Tired Tread' design grip which feels good in your hand, but also provides a better tactile feel when it comes time to throw a shift.



D-JP-180011-BL

JK 4WD SHIFT KNOB BILLET FINISH



D-JP-180013-BK

JK AUTOMATIC TRANSMISSION SHIFT KNOB BLACK FINISH

DV8 Off Road's shift knobs are made from billet aluminum and feature our 'Tired Tread' design grip which feels good in your hand, but also provides a better tactile feel when it comes time to throw a shift.



D-JP-180013-BL

JK AUTOMATIC TRANSMISSION SHIFT KNOB BILLET FINISH



D-JP-181101-BL

JK PISTOL GRIP SHIFT HANDLE

The pistol grip is machined from 6061-T6 billet aluminum and was designed to look and feel like your favorite firearm in your hand.



D-JP-181112-BK

JK 6-SPEED SHIFT KNOB BLACK

DV8 Off Road's shift knobs are made from billet aluminum and feature our 'Tired Tread' design grip which feels good in your hand, but also provides a better tactile feel when it comes time to throw a shift.



D-JP-181112-BL

JK 6-SPEED SHIFT KNOB BILLET



D-JP-181113-BK

JK SHIFT KNOB AUTOMATIC BLACK

DV8 Off Road's shift knobs are made from billet aluminum and feature our 'Tired Tread' design grip which feels good in your hand, but also provides a better tactile feel when it comes time to throw a shift.



D-JP-181113-BL

JK SHIFT KNOB AUTOMATIC BILLET



D-JP-180012-BK

JK 6-SPEED SHIFT KNOB BLACK FINISH

DV8 Off Road's shift knobs are made from billet aluminum and feature our 'Tired Tread' design grip which feels good in your hand, but also provides a better tactile feel when it comes time to throw a shift.



D-JP-180012-BL

JK 6-SPEED SHIFT KNOB BILLET FINISH



D-JP-180030-B

JK DASH CONSOLE TRAY

This dash tray features foam, anti-slip pads to help keep your items from moving around and is a versatile add-on. No drill installation and will fit all dashes without Sirius XM radios.

JL/JT ACCESSORIES

JL & JT



D-JP-190001-K

JL/JT HOOD HOLD DOWNS

DV8's billet aluminum turnbuckle and stainless steel heim joint hold downs. The quick-release push pin provides easy access to opening your hood and won't be lost thanks to the attached, stainless steel lanyard.



D-JP-190001-LK

JL/JT LOCKING HOOD HOLD DOWNS

DV8's billet aluminum turnbuckle and stainless steel heim joint hold downs. The locking pin provides security, unwanted theft, and won't be lost thanks to the attached, stainless steel lanyard.



ANTENNAS

D-JP-190012

TJ ANTENNA BLACK

The TJ replacement antenna is a stainless steel mast with e-coated black finish. OEM style grommet, cable and foam insulating cover. Includes new base cover with rubber gasket.



D-JP-190012-BK

TJ ANTENNA BLACK

The 8" billet aluminum antenna is machined from 6061-T6 material for added strength and style.



BEZELS

D-JP-180029-BK

TJ BILLET EMERGENCY BRAKE HANDLE COVER

Made from 6061-T6 billet aluminum, these handle covers have a cross pattern design (for better grip) that is anodized. Also available in Black.



FUEL DOORS

D-JP-190024-BLK

TJ BLACK FUEL DOOR

The 1997 - 06 Jeep TJ black, billet aluminum fuel door assembly features a magnetic closure and adds a more refined look to your Jeep's stock fuel filler space.



CAPS

D-JP-120007-BL

TJ OIL DIP STICK HANDLE

Machined from 6061-T6 billet aluminum with a brushed & textured surface and clear anodized finish, this handle is the perfect dress-up accessory for showing off what's under your Jeep's hood.

D-JP-190025-BL

TJ BILLET FUEL CAP

DV8 Off Road's TJ 1997 - 06 Billet Fuel Cap is an easy way to secure access to your fuel with a lockable cap and the billet finish looks great!



D-JP-190005-BL

TJ BILLET FUEL CAP

DV8 Off Road's TJ 2001 - 14 Billet Fuel Cap is an easy way to secure access to your fuel with a lockable cap and the billet finish looks great!



D-JP-190005-BLK

TJ DODGE CHALLENGER BILLET GAS CAP

DV8's black, billet lockable gas cap is designed to fit the 2001-18 Jeep TJ/JK & 2008-13 Dodge Challenger.



HOOD ACCESSORIES

D-JP-120013-BL

TJ BATTERY HOLD DOWN BILLET

Machined from 6061-T6 billet aluminum with a brushed & textured surface and clear anodized finish, this battery hold-down not only looks great, but it's built to keep that battery from moving around in your next off road adventure.



D-JP-120018-S

TJ HOOD PROP ROD

The polished, stainless steel hood prop rod adds a nice touch when showing off your handiwork under the hood.



D-JP-190021-K

TJ HOOD HOLD DOWNS

DV8's billet aluminum turnbuckle and stainless steel heim joint hold downs. The quick-release push pin provides easy access to opening your hood and won't be lost thanks to the attached, stainless steel lanyard.



D-JP-190001/21

TJ HOOD HOLD DOWN TURNBUCKLES

DV8's Hood Hold Downs (in standard and lockable versions) can be upgraded with an optional black turnbuckle to replace the standard silver color.



D-JP-190021-LK

TJ LOCKING HOOD HOLD DOWNS

DV8's billet aluminum turnbuckle and stainless steel heim joint hold downs. The locking pin provides security, unwanted theft, and won't be lost thanks to the attached, stainless steel lanyard.



SHIFTERS

D-JP-180021-BK

TJ SHIFT KNOB W/ASSEMBLY BLACK

DV8 Off Road's shift knobs are made from billet aluminum and feature our 'Tired Tread' design grip which feels good in your hand, but also provides a better tactile feel when it comes time to throw a shift.

D-JP-180021-BL

TJ SHIFT KNOB W/ASSEMBLY BILLET

DV8 Off Road's shift knobs are made from billet aluminum and feature our 'Tired Tread' design grip which feels good in your hand, but also provides a better tactile feel when it comes time to throw a shift.



D-JP-180022-BK

TJ 5-SPEED SHIFT KNOB & LEVER BLACK

DV8 Off Road's shift knobs are made from billet aluminum and feature our 'Tired Tread' design grip which feels good in your hand, but also provides a better tactile feel when it comes time to throw a shift.



D-JP-180022-BL

TJ 5-SPEED SHIFT KNOB & LEVER BILLET

DV8 Off Road's shift knobs are made from billet aluminum and feature our 'Tired Tread' design grip which feels good in your hand, but also provides a better tactile feel when it comes time to throw a shift.





SHIFTERS CONT.

D-JP-180023-BK

TJ AUTO SHIFT LEVER BLACK

DV8 Off Road's shift knobs are made from billet aluminum and feature our 'Tired Tread' design grip which feels good in your hand, but also provides a better tactile feel when it comes time to throw a shift.



D-JP-180023-BL

TJ AUTO SHIFT LEVER BILLET

DV8 Off Road's shift knobs are made from billet aluminum and feature our 'Tired Tread' design grip which feels good in your hand, but also provides a better tactile feel when it comes time to throw a shift.



D-JP-180012-BK

TJ 6-SPEED SHIFT KNOB BLACK FINISH

DV8 Off Road's shift knobs are made from billet aluminum and feature our 'Tired Tread' design grip which feels good in your hand, but also provides a better tactile feel when it comes time to throw a shift.



D-JP-180012-BL

TJ 6-SPEED SHIFT KNOB & LEVER BILLET

DV8 Off Road's shift knobs are made from billet aluminum and feature our 'Tired Tread' design grip which feels good in your hand, but also provides a better tactile feel when it comes time to throw a shift.



KNOBBS

D-JP-180017-BL

TJ BILLET DOOR SURROUND KNOBS

Don't go topless without a set of billet aluminum door surround knobs to replace the stock ones from the factory that deteriorate over time.

GRILL ACCESSORIES

D-JP-190018-BLACK

TJ GRILLE INSERTS BLACK

Our Jeep Grille Inserts are made from solid, billet aluminum so bugs will really know what hit them. Comes with the necessary hardware and installation instructions and is also available in Brushed and Polished finishes.

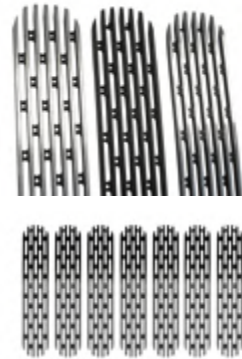

KNOBBS

D-JP-180031-BK

YJ TRANSFER CASE KNOB BLACK

DV8 Off Road's shift knobs are made from billet aluminum and feature our 'Tired Tread' design grip which feels good in your hand, but also provides a better tactile feel when it comes time to throw a shift.



D-JP-180031-BL

YJ TRANSFER CASE KNOB BILLET



SHIFTER KNOBS

D-JP-180032-BK

YJ 5-SPEED SHIFTER KNOB BLACK

DV8 Off Road's shift knobs are made from billet aluminum and feature our 'Tired Tread' design grip which feels good in your hand, but also provides a better tactile feel when it comes time to throw a shift.



D-JP-180032-BL

YJ 5-SPEED SHIFTER KNOB BILLET



HOOD ACCESSORIES

D-JP-190031-K

YJ HOOD HOLD DOWNS

DV8's billet aluminum turnbuckle and stainless steel heim joint hold downs. The quick-release push pin provides easy access to opening your hood and won't be lost thanks to the attached, stainless steel lanyard.



UNIVERSAL

D-FIREX-MNT-DOR

QUICK RELEASE FIRE EXTINGUISHER MOUNT

NHRA-approved, this quick release fire extinguisher mount is Baja-proven! It features CNC-machined 6061-T6 billet aluminum construction with a red, anodized, quick release pull knob. It can be installed in just about any location.



D-FIREX-MNT-S-DOR

QUICK RELEASE FIRE EXTINGUISHER MOUNT SILVER



D-LIGHT-MNT-DOR

QUICK RELEASE FLASHLIGHT MOUNT

Based on the same design this system is designed to hold your flashlight via a CNC-machined billet aluminum holder and quick-release, red anodized knob.



D-FIRE-CLMP-L-DOR

FIRE EXTINGUISHER MOUNT CLAMPS LARGE

DV8's Quick Release Fire Extinguisher system does not come with clamps to hold the fire extinguisher in place. This clamp is large enough to support a larger, portable fire extinguisher system.



D-FIRE-CLMP-S-DOR

FIRE EXTINGUISHER MOUNT CLAMPS SMALL

This clamp is designed to hold a smaller, portable fire extinguisher system.





BR-20

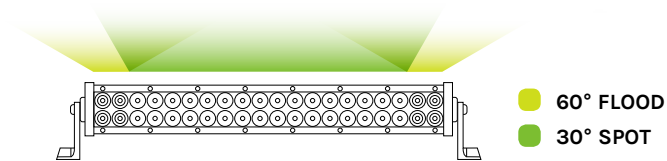

BRS Pro Series -Universal fitment

These lights have a black textured face, polycarbonate lens, and a IP68 rating. All DV8 LED lights use 3 watt CREE LEDs rated to 50,000 hours, have end and bottom mounts.

- **BRS-5**
24W total, 2000 Lumens, 5.5x3.25x3
- **BRS-12**
72W total, 7000 Lumens, 13.5x3.25x3
- **BRS-20**
120W total, 10100 Lumens, 21.5x3.25x3
- **BRS-30**
180W total, 13000 Lumens, 31.5x3.25x3
- **BRS-40**
198W total, 16000 Lumens, 41.5x3.25x3
- **BRS-50**
300W total, 21500 Lumens, 52x3.25x3

BC-20

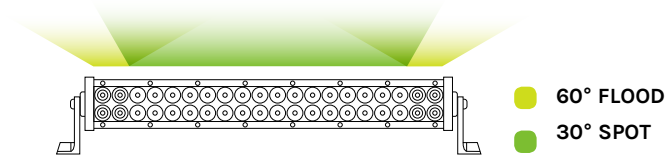

Chrome Series -Universal fitment

Come with a polycarbonate lens, IP68 rating, flood/spot combo light pattern, and 3 watt CREE LEDs rated to 50,000 hours. All Chrome series lights come with end and bottom mounts.

- **BC-5**
24W total, 2000 Lumens, 5.5x3.25x3
- **BC-12**
72W total, 7000 Lumens, 13.5x3.25x3
- **BC-20**
120W total, 10100 Lumens, 21.5x3.25x3
- **BC-30**
180W total, 14500 Lumens, 31.5x3.25x3
- **BC-50**
300W total, 21500 Lumens, 52x3.25x3

BS-20

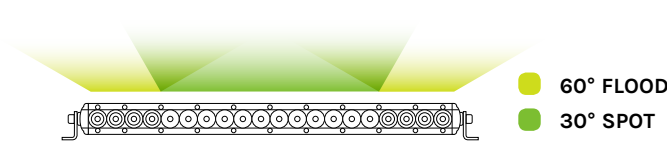

SL8 Series -Universal fitment

Comes with a polycarbonate lens, IP68 rating, flood/spot light pattern, and 5 watt CREE LEDs that are rated to 50,000 hours. A low-profile design while still achieving maximum light output. End mounting only.

- **BS-10**
50W total, 3850 Lumens, 11x1.5x3
- **BS-20**
100W total, 7700 Lumens, 21x1.5x3
- **BS-30**
140W total, 11550 Lumens, 31x1.5x3
- **BS-40**
190W total, 14800 Lumens, 39.5x1.5x3
- **BS-50**
250W total, 19250 Lumens, 51.5x1.5x3



HLCJL-01
w/Halo

LED OEM JL Projector Headlights

The DV8 Offroad HLCJL-01 is the ultimate JL replacement headlight. This light is 9" wide (factory size) and is made of OEM quality materials inside and out. The light replicates the upgraded LED kit from Jeep for a fraction of the price. The lights come with everything necessary for install including wiring harnesses, ballasts and installation hardware.



HL-01



HL-02
w/Halo

LED Projector Headlights

LED projector headlights are a huge upgrade from stock JK headlights in both brightness and style. They use advanced optical technology to make the most of the LED lights that are housed within them.



TL-1



TL-2

LED Tail Lights

Off road LED Tail Lights are just the thing to set your Jeep apart from the others and are great to replace lights that have been damaged out on the trail.



R4-FL

LED Fog Lights

Lights are sized to be a direct factory replacement and will work in place of the factory fog lights in any application.



BC-M

LED Mirror Housing

The Off road LED mirror housing allows drivers to have a wider range of visibility. LEDs are angled slightly outward from center to promote a better field of view. The mirror also works as a turn signal to replace the factory fender signals when moving to after market fenders.



BC-3



BC-3FM



BC-4



R3.5

LED Cube and Rock Lights

Optical Technology and cutting edge design delivers unparalleled light output. These small rock lights deliver light right where you need it.



WB-12SC

Steel Cable Winch

- 12,000 lb Capacity
- 6hp motor 12DC
- Gear Train: 3 staged planetary, Gear Reduction Ratio 256:1
- Steel Cable, Steel Roller Fairlead
- 12.5' wired and wireless remote included.
- Steel Control Box for added durability



WB-12SR

Synthetic Line Winch

- 12,000 lb Capacity
- 6hp motor 12DC
- Gear Train: 3 staged planetary, Gear Reduction Ratio 256:1
- Synthetic Line, Hulse Aluminum Fairlead
- 12.5' wired and wireless remote included.
- Steel Control Box for added durability

DV8 Off Road Winch Accessories and Gear

APPLICATION	PART NO.	DESCRIPTION
UNIVERSAL	WC12SC	Winch Cover 12K Winch Black
UNIVERSAL	WHS12	Wired Remote 12K Winch
UNIVERSAL	WARK-1	Winch Accessory Recover Kit
UNIVERSAL	WWRC12	Wireless Remote For 12K Winch
UNIVERSAL	WMK12K	Winch Mounting Kit DV8 12K Winches For Use W/Winch Plates
UNIVERSAL	LPBM-01	Flip Up License Plate Relocation Bracket Fairlead Mounted





2020

DV8 / REV PRODUCT LINE

REV Off Road Wheels are designed for exceptional off road performance and aggressive styling to keep your vehicle off road ready. REV Off Road wheels are offered in a variety of finishes including matte black, gloss black, milled, and machined. All our wheels are tested to exceed factory specifications.

DV8-886
Simulated Beadlock
Wheels, 20"





DV8-882

Beadlock Racing Wheels

Patent Pending

- Wheels are constructed from 356-T6 Aluminum
- 3,500 lbs load rating
- 6061 T6 rings are 5/8" thick with tapered edge to avoid breaks
- Powder coated matte black with polished ring
- Recessed bolt holes to prevent shears
- Grade 8 Hardware included
- Sizes: 17x8.5, 20x9.5 - 5, 6, and 8 Lug
- Offset: -20mm to 0mm



REV-885

Finishes: Gloss Black, Gloss Black & Milled, Machined Rivets
 Sizes: 17x9, 20x9
 5 and 6 lug
 0 to -12mm
 Patent Pending



REV-865

Finishes: Gloss Black & Milled, Machined Rivets
 Sizes: 17x9, 20x9
 5 and 6 lug
 0 to -12mm
 Patent Pending



DV8-887

Simulated Beadlock

Patent Pending

- One piece cast wheels, 2,500 lbs load rating
- Powder coated matte black with machined lip, bronze with matte black ring
- Sizes: 17x9, 6 x 120, Offset: +20mm
- GM Fitment only



REV-895

Finishes: Gloss Black & Milled, Gloss Black Machined Rivets
 Sizes: 17x9, 20x9, 20x12, 22x12 - 5 and 6 lug
 0 to -44mm
 Patent Pending



REV-AMERICANA

Finishes: Matte Black w/Milling
 Sizes: 20x9
 6 and 8 lug
 +18mm to 0



DV8-886

Simulated Beadlock

Patent Pending

- One piece cast wheels, 2,500 lbs load rating
- Powder coated matte black with machined lip, bronze with matte black ring
- Sizes: 17x9, 20x9, 20x12 - 5, 6, and 8 Lug, Offset: 0mm to -44mm



REV-823

Finishes: Gloss Black w/ Milling, Gloss Black, Machined Rivets
 Sizes: 17x9, 20x9 - 5, 6 and 8 lug
 0 to -12mm
 Patent Pending



CS-15

Finishes: Gunmetal, Black
 One Piece design
 2,400 lbs. rated
 Sizes: 17x9
 5 x 127
 +12mm



DV8-883

Simulated Beadlock

Patent Pending

- One piece cast wheels, 2,500 lbs load rating
- Powder coated matte black with machined lip, bronze with matte black ring
- Sizes: 17x9, 20x9 - 5 and 6 Lug, Offset: 0mm to -12mm



REV-840 ANACONDA

Finishes: Matte Black & Milled
 Sizes: 17x9, 20x9
 5 and 6 lug
 +20mm to 0



CS25

Finishes: Gunmetal, Black
 One Piece design
 2,400 lbs. rated
 Sizes: 17x9
 5 x 127
 +12mm

