

Dynacorn International LLC The muscle car people

**FORD[®]
TRUCK**



Ford® Truck Index

A

Arm Rest: 22

B

Battery Tray & Components: 17, 18

Bed & Bedside Wheel Arch: 41

Bed Cross Sills: 41, 42

Bed Floor Panel: 39

Bed Panels: 41

Bedside Panels: 39, 40, 41

Bumper Bracket: 4

Bumpers & Stone Deflectors: 1, 2, 3

C

Cab Back Panel: 27, 28, 29

Cab Corner: 29, 30

Cab Floor & Components: 25, 26, 27, 28, 29, 30

Cab Mount: 30

Cowl Panels & Components: 19, 20

Cowl Vent Air Cover: 20

D

Dash Panels & Components: 20, 21, 22

Decals: 47

Door Handle: 38, 39

Door Hinge: 36

Door Patch: 34

Doors & Hardware: 34, 35, 36, 37, 38, 39

Door Shell: 35

Doors Hinge: 37

Doors Skin: 35, 36

Door Weatherstrip: 37

E

Emergency Brake: 16

Engine & Components: 16

Engine Splash Shield: 16

Exterior Bezels & Light Assy: 50

Exterior Electrical & Components: 48, 49, 50, 51

F

Fenders & Components: 10, 11, 12, 13, 14

Firewall: 18, 19

Firewall & Brackets: 18, 19

Floor Cab Skirt Channel: 26

Floor Panel Assembly: 25

G

Gas Pedal: 16

Gas Tank Access Panel & Straps: 44

Gas Tank & Fuel Sending Unit: 45, 46

Grille Bar: 5

Grille Insert: 7

Grille Moldings: 7

Grille Panel Upper: 7

Grille & Support: 5, 6, 7

H

Header Panel: 9

Headlamps & Hardware: 8

Hood: 15

Hood Air Deflector Front: 15

Hood Emblem: 15

Hood Front Molding: 15

Hood Hinge Spring: 14

Hood Latch: 15

Hood Latch Panel: 15

Hood Locking Panel: 14

Hoods & Components: 14, 15, 16

Hoods Hinge: 14

Hood Trim: 16

L

License Plate Brackets: 4

Locks: 52

M

Mirror Interior/ Exterior: 22, 23

R

Radiator & Radiator Support: 9, 10

Radiator Support Air Deflector: 9

Rear Wheelhouse: 47

Rocker Panel: 30

Roll Pan: 44

Roof Back Filler Panel: 30

Roof Panel & Components: 30, 31

S

Seat Belts: 52

Splash Apron: 5

Steering Wheel: 24

Sunvisor Bracket & Components: 22

T

Tailgate & Hardware: 42, 43, 44

Tail Pan: 44

Transmission Cover: 24

U

Upper Grille Panel: 7

V

Vent Windows: 32, 33

W

Wheel Opening Moldings: 48

Window Regulator: 31, 32

Window Vent Handles: 33, 34

Windshield Frame Assembly: 30

Windshield/ Window Mldg: 47

Wipers & Components: 23



Ford Oval and Mustang are registered trademarks owned by Ford Motor Company.

FORD® PICK UP TRUCK

Bumpers & Stone Deflectors

3041

1953 Front Bumper Stone Deflector
w/o Park Lamp Hole & Frame Hole



3041A

1954 Front Bumper Stone Deflector
w/o Park Lamp Hole w/ Frame Hole



3042

1955-56 Front Bumper Stone Deflector
w/ Park Light Hole w/o Frame Hole



3042A

1955-56 Front Bumper Stone Deflector
w/ Park Light Hole & Bumper Bracket Hole



3045

1967-72 Front Bumper Stone Deflector Lower



3001A

1948-52 Front Bumper, Chrome



3001B

1951-52 Front Bumper, Chrome



3002

1953-56 Front Bumper Painted w/ Bracket



Bumpers & Stone Deflectors

3003

1953-56 Front Bumper, Painted w/o Bracket



3004

1953-56 Front Bumper, Chrome w/ Bracket



3005

1953-56 Front Bumper, Chrome w/o Bracket



3006

1960 Front Bumper, Painted (Modified to fit 57-59)



3006A

1960 Front Bumper, Chrome (modify to fit 57-59)



3006B

1961-63 Front Bumper, Chrome



3007

1964-77 Front Bumper, Painted w/o Pad Hole
w/ License Plate Hole



3007A

1964-77 Front Bumper, Chrome w/o Pad Hole
w/ License Plate Hole



FORD® PICK UP TRUCK

Bumpers & Stone Deflectors

3008

1978-79 Front Bumper, Chrome



3001

1948-72 Rear Bumper Stepside, Chrome, F100
1973-77 Rear Bumper Stepside, Chrome, F250, 4WD



3015B

1957-80 Rear Bumper Styleside, Chrome



3015

1964-72 Rear Bumper Styleside, Chrome



3000

1948-72 Rear Bumper Stepside, Painted, F100
1973-77 Rear Bumper Stepside, Painted, F250 4WD



3015A

1951-52 Rear Bumper Stepside, Chrome



3014

1964-72 Rear Bumper Styleside, Painted



3016A

1973-79 Rear Bumper Styleside, Chrome, 2WD

3016

1973-79 Rear Bumper Styleside, Painted, 2WD

3016A



3017

1980-86 Rear Bumper, Chrome



Bumper Bracket

3020
1948-72 Rear Bumper Bracket Set, 4 pcs, Flareside
no Rivet w/ Hardware



3023
1948-72 Rear Bumper Bracket, Styleside



3021
1953-56 Front Bumper Bracket Set, Painted
w/ Hardware



3022
1953-56 Front Bumper Bracket Set, Chrome
w/ Hardware



License Plate Brackets

3024
1948-UP License Plate Rear Bracket, Black,
Stepside



3024A
1948-UP License Plate Rear Bracket, Chrome,
Stepside



FORD® PICK UP TRUCK

Splash Apron

3040E
1951-52 Front Splash Apron



Grille & Support

3031
1948-50 Grille Bar, Stainless, 5 pcs,
w/o Crank Cut Hole



3031A
1948-50 Grille Bar, Stainless, 5 pcs,
w Crank Cut Hole



3030
1948-50 Grille Panel w/ Park Lamp Bezel
w/ Bar & Crank Hole, Painted



3030A
1948-50 Grille Panel w/o Bar, Crank Hole, w/ Park
Lamp Bezel, All Chrome



3030B
1948-50 Grille Panel Chrome Bar, Painted Housing
w/o Park & Crank Hole



Grille & Support

3040
1948-50 Lower Header / Grille Valance Panel,
Painted Black



3040A
1948-50 Lower Header Grille Valance Panel &
Lower Splash Apron, Pair



3032B
1956 Grille w/ Support Bracket, Chrome



3032C
1956 Grille w/ Support Bracket, Black



FORD® PICK UP TRUCK

Grille & Support

3034

1978-79 Grille, Chrome / Argent



3035

1978-79 Grille, Argent



3033A

1976-77 Grille Insert, Silver & Black, RH

3033B

1976-77 Grille Insert, Silver & Black, LH



3033A

3037

1982-86 Grille Insert, Chrome / Black



Upper Grille Panel

3044

1967-72 Upper Grille Panel, Painted

3046

1967-72 Upper Grille Panel, Chrome



3044

Grille Moldings

M3720

1980-86 Upper Grille Molding



M3721

1980-86 Lower Grille Molding



Headlamps & Hardware

3034A

1978-79 Door Headlamp Round, Argent, RH

3034B

1978-79 Door Headlamp Round, Argent, LH



3034A

3035A

1978-79 Door Headlamp Rectangle, Argent / Black, RH

3035B

1978-79 Door Headlamp Rectangle, Argent / Black, LH



3035B

3036A

1978-79 Door Headlamp Rectangle Chrome, RH

3036B

1978-79 Door Headlamp Rectangle Chrome, LH



3036B

3037A

1980-81 Door Headlamp Chrome / Gray, RH

3037B

1980-81 Door Headlamp Chrome / Gray, LH



3037A

3037C

1982-86 Door Headlamp Chrome / Black, RH

3037D

1982-86 Door Headlamp Chrome / Black, LH



3037C

3037E

1982-86 Door Headlamp Chrome / Grey, RH

3037F

1982-86 Door Headlamp Chrome / Grey, LH



3037E

FORD® PICK UP TRUCK

Header Panel

3148A
1948-50 Header Upper Panel



3148B
1951-52 Header Upper Panel



3128
1948-50 Radiator Support



3129
1951-52 Radiator Support



Radiator & Radiator Support

3130A
1956 Radiator Support Air Deflector, RH

3130B
1956 Radiator Support Air Deflector, LH



3130A

3130
1953-56 Radiator Support



Radiator & Radiator Support

3133
1961-64 Radiator Support Assembly, 2WD



3136
1973-79 Radiator Support w/ 2 Mount Holes



3134
1967-72 Radiator Support



3137
1965-66 Radiator Support



3135
1973-79 Radiator Support w/ 4 Mount Holes



Fenders & Components

3060
1948-50 Fender, Steel, RH

3061
1948-50 Fender, Steel, LH



FORD® PICK UP TRUCK

Fenders & Components

3062
1951-52 Fender, RH

3063
1951-52 Fender, Steel, LH



3062

3064
1953-56 Fender, Steel, RH

3065
1953-56 Fender, Steel, LH



3064

3066
1961-66 Fender, Steel, RH

3067
1961-66 Fender, Steel, LH



3066

3068
1967-72 Fender, RH

3069
1967-72 Fender, LH



3068

3070
1973-79 Fender, RH

3071
1973-79 Fender, LH



3070

3072
1948-50 Rear Fender, RH

3073
1948-50 Rear Fender, LH



3072

Fenders & Components

3074
1951-52 Rear Fender, Painted Silver, RH

3075
1951-52 Rear Fender, Painted Silver, LH



3076
1953-72 Rear Fender, Stepside, RH

3077
1953-72 Rear Fender, Stepside, LH



3080
1953-55 Fender Inner to Lower
Cab Angle Brace, Set



3081
1958 Inner Fender to Lower Cab Angle Brace, Set



3082
1953-56 Inner Fender, RH

3083
1953-56 Inner Fender, LH



3084
1961-84 Inner Fender, RH

3085
1961-84 Inner Fender, LH



FORD® PICK UP TRUCK

Fenders & Components

3086

1967-72 Inner Fender, Not Big Block, RH



3087

1967-72 Inner Fender Apron, LH



3086A

1967-72 Inner Fender, 8 Cyl., RH



3088A

1973-86 Inner Fender Shield / Hinge Support, RH

3088B

1973-86 Inner Fender Shield / Hinge Support, LH



3088A

3081A

1948-52 Front Fender to Running Board
Filler Brace Set, Painted Silver



3061A

1948-50 Lower Fender Splash Apron, RH

3061B

1948-50 Lower Fender Splash Apron, LH



3061A

Fenders & Components

3081D
1953-56 Right Low Cab Fender
Reinforcement

3081E
1953-56 Left Low Cab Fender
Reinforcement

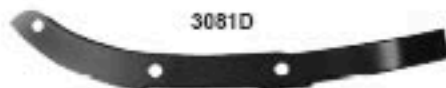

3081C
1953-56 Right Upper Fender
Cowl Mounting Bracket

3081B
1953-56 Left Upper Fender
Cowl Mounting Bracket



Hoods & Components

3051E
1948-52 Hood Hinge, RH

3051F
1948-52 Hood Hinge, LH



3051G
1948-52 Hood Hinge Outer Plate,
RH

3051H
1948-52 Hood Hinge Outer Plate,
LH



3052A
1953-55 Hood Hinge Assembly, RH

3052B
1953-55 Hood Hinge Assembly, LH



3052A

3053A
1956 Hood Hinge Assembly, RH

3053B
1956 Hood Hinge Assembly, LH



3053A

3052C
1953-56 Hood Hinge Spring



3054
1961-66 Hood Hinge Set, RH & LH



3131
1953-56 Hood Locking Panel



3131B
1951-52 Hood Locking Panel



FORD® PICK UP TRUCK

Hoods & Components

3131C

1948-52 Front Hood Air Deflector



M3051

Hood Front Molding, Pair



3048

1953-56 Hood



3050

1973-79 Hood



3130C

1948-50 Hood Latch



Back View

3131A

1948-50 Hood Latch Panel



M3053

1953-56 Hood Emblem w/ Gasket Hardware



Ford Oval and Mustang are registered trademarks owned by Ford Motor Company.

Hoods & Components

M3050

1948-50 Hood Side Trim, 4 pcs, Stainless



M3052

1948-50 Hood Trim & Handle Kit w/ Spring Installation Hardware



Engine & Components

3057D

1948-52 Engine Splash Shield



3059C

1965-79 Oil Pan, 8 Cyl.



Gas Pedal

3059A

1967-72 Gas Pedal



Emergency Brake

3059

1967-72 Emergency Brake Assy



Battery Tray & Components

3090A
1948-52 Battery Tray, 6 Cyl.



3090B
1948-52 Battery Tray, V8



3094
1965-72 Battery Tray (Also fits 1978-79 Bronco)



3096
1967-79 Battery Tray



3092
1956-60 Battery Tray Assembly



3091
1954-55 Battery Tray Assembly



Battery Tray & Components

3093
1953-55 Battery Hole Cover Locking, Short,
Painted Black



3090
1948-52 Battery Hold Down



Firewall & Brackets

3140A
1948-52 Firewall Bracket Set, Weld
Through Primer



3092A
1958 Battery Hole Cover, Painted Black



3095
1957-64 Battery Hold Down



3141A
1953-55 Firewall w/o Heater Hole



FORD® PICK UP TRUCK

Firewall & Brackets

3140

1948-52 Firewall w/ Supporting Bracket

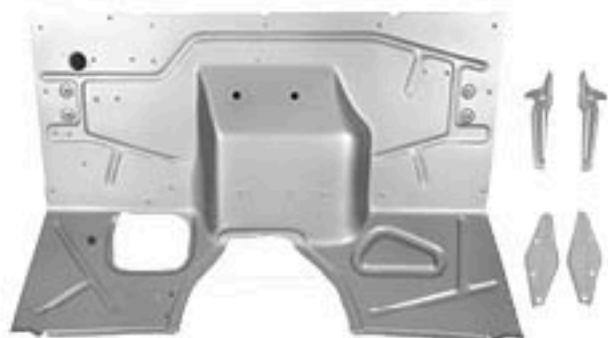

3141

1953-55 Firewall w/ Heater Hole



3142

1958 Firewall w/ Heater Hole



3142A

1958 Firewall w/o Heater Motor Hole



Cowl Panels & Components

3200

1948-52 Cowl Side Panel Complete, RH

3200A

1948-52 Cowl Side Panel Complete, LH



3200

3200G

1948-52 Cowl Lower Patch, RH

3200H

1948-52 Cowl Lower Patch, LH



3200G

Cowl Panels & Components

3200E
1953-56 Cowl Side Lower Patch, RH

3200F
1953-56 Cowl Side Lower Patch, LH



3200E

Cowl Vent Air Cover

3190
1958 Cowl Vent Air Cover Assembly



3200J
1953-56 Front Outer Cowl Side Lower Patch, RH

3200K
1953-56 Front Outer Cowl Side Lower Patch, LH

3200K



Dash Panels & Components

3206
1948-50 Glove Box Door



3206A
1951-52 Glove Box Door



3205
1953-55 Glove Box Door, Painted Black



3213
1958 Glove Box Door, Painted Black



FORD® PICK UP TRUCK

Dash Panels & Components

3210
1951-52 Radio Hole Cover,
Painted w/o Letter



3211
1951-52 Radio Hole Cover,
Chrome w/o Letter



3212
1951-52 Radio Hole Cover,
Chrome w/ Letter



3201
1951-52 Dash Speaker Grille,
Chrome



3203
1951-52 Dash Speaker Grille,
Painted Black

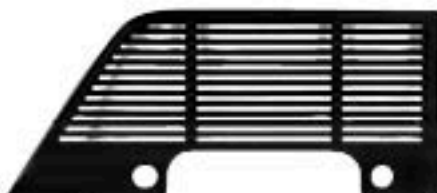

3202
1951-52 Dash Speaker Grille Trim
w/ Clip, Stainless



3203A
1951-52 Dash Speaker Grille Trim,
Chrome, Stainless w/ Clip Stainless



3203B
1956 Dash Bezel Instrument,
Chrome



3204
1953-55 Ash Tray Cover, Painted
Black



3215
1961-66 Defrost Round Louver Vent
Set, 2 pcs, Chrome



3216
1961-66 Defrost Round Louver Vent
Set, 2 pcs, Black



Dash Panels & Components

L3070
1958-80 Turn Signal Switch



L3071
1967-72 Turn Signal Switch
w/ Cruise Control



Arm Rest

3115M
1968-72 Arm Rest, Black, RH
(Also fits 1968-69 Ranchero)

3115N
1968-72 Arm Rest, Black, LH
(Also fits 1968-69 Ranchero)



3115M

Sunvisor Bracket & Pad

3117B
1948-52 Sunvisor Bracket, Chrome,
RH=LH



3117C
1948-52 Sunvisor Bracket, Black,
RH=LH



3117D
1953-55 Sunvisor Bracket, Chrome,
RH=LH



3117E
1958 Sunvisor Bracket



3117F
1948-52 Sunvisor Pad, Black,
RH=LH



3117J
1953-55 Sunvisor Pad, Gray

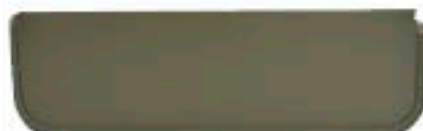

3117K
1958 Sunvisor Pad, Gray, RH=LH

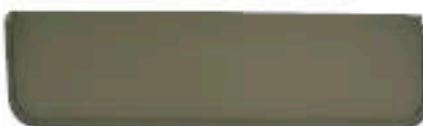

Mirror Interior

3117L
1948-52 Interior Mirror



FORD® PICK UP TRUCK

Mirror Exterior

3117

1953-56 Exterior Mirror, RH=LH



3117A

1967-79 Exterior Mirror, Chrome, RH=LH



Wipers & Components

3117M

1948-52 Wiper Blade, 10", RH=LH



3117N

1953-60 Wiper Blade, 10", RH=LH



3117P

1961-96 Wiper Blade, 15", RH=LH



1103VE

1956-60 Wiper Arm, RH

1103VF

1956-60 Wiper Arm, LH



Reverse View Closeup



1103VE

3117W

1953-55 Wiper Linkage, RH=LH



3117Y

1956 Wiper Linkage, RH=LH



Steering Wheel

SW50

1948-52 Steering Wheel, Black



SW51

1953-55 Steering Wheel, Black



SW52

1956-80 Steering Wheel, Black



SW53

1961-70 Steering Wheel, Black



Transmission Cover

3141B

1953-56 Floor Transmission Cover Panel



3142H

1948-52 Transmission Cover, Painted Black



3160

1967-72 Transmission Cover
w/ Column Shift



3161

1967-72 Transmission Cover
w/ Floor Shift

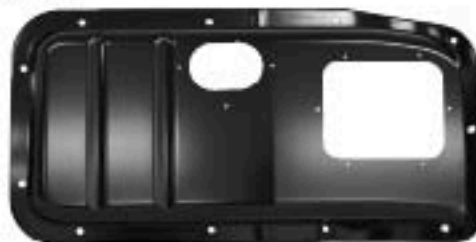

FORD® PICK UP TRUCK

Cab Floor & Components

3152

1948-52 Floor Panel Assembly Front
w/ Crossmember, Weld Through Primer



3151

1956 Floor Panel Complete Assembly



3150

1953-55 Floor Panel Complete Assembly



3154

1981-88 Floor Pan Complete



Cab Floor & Components

3150A

1953-56 Cab Floor Panel Skirt Seal Set



3155D

1948-52 Floor Cab Skirt Channel



3155A

1948-52 Floor Rear Cab Mount Pan



3155B

1948-52 Floor Center Cab Mount Panel



3155C

1948-52 Floor Cab / Gas Tank Brace



3155E

1948-52 Floor Cab Rear Corner Support



3155F

1967-72 Floor Cab Rear Crossmember



FORD® PICK UP TRUCK

Cab Floor & Components

3240A

1953-55 Cab Back Panel Large Window
w/o Gas Filler Hole



3240

1953-55 Cab Back Panel Assy Large Window
w/o Gas Hole w/ Inner Brace Kit



Inner Brace



3240B

1953-55 Cab Back Panel Small Window
w/o Gas Filler Hole



3241

1956 Cab Panel Assy Small Window
w/ Gas Filler Hole w/ Inner Brace Kit



Gas Filler Hole



Inner Brace Kit

Cab Floor & Components

3240C

1953-55 Cab Back Panel Assy Small Window
w/o Gas Hole w/ Inner Brace Kit



3241C

1956 Cab Back Panel Small Window
w/ Gas Filler Hole



3241A

1956 Cab Panel Assy Big Window w/ Gas Filler Hole
w/ Inner Brace Kit



3241D

1956 Cab Back Panel Large Window
w/ Gas Filler Hole



FORD® PICK UP TRUCK

Cab Floor & Components

3245

1953-56 Cab Back Panel Rear Small Window
w/ Inner Brace Kit



3244

1956 Cab Back Panel Rear Big Window
w/ Inner Brace Kit, 7 pcs



3235A

1961-66 Cab Corner, RH

3235B

1961-66 Cab Corner, LH



3235A

3236C

1973-79 Cab Corner, RH

3236D

1973-79 Cab Corner, LH



3236C

3241W

1948-52 Outer Rear Cab Corner, RH

3241X

1948-52 Outer Rear Cab Corner, LH



3241W

3230

1967-72 Cab Corner, RH

3231

1967-72 Cab Corner, LH



3230

3236A

1973-79 Cab Corner, Supercab, RH

3236B

1973-79 Cab Corner, Supercab, LH



3236A

3242

1953-58 Outer Rear Cab Corner, RH

3243

1953-58 Outer Rear Cab Corner, LH



3242

Cab Floor & Components

3243A
1953-56 Inner Cab Corner, RH

3243B
1953-56 Inner Cab Corner, LH



3243B

3232
1967-83 Front Cab Mount, RH

3233
1967-83 Front Cab Mount, LH



3232

3234
1967-79 Cab Floor Front Section, RH

3235
1967-79 Cab Floor Front Section, LH



3234

Rocker Panel

3113R
1948-52 Rocker Panel, Pair



3113S
1953-56 Rocker Panel, RH

3113T
1953-56 Rocker Panel, LH



3113T

3114
1961-72 Rocker Panel Repair Panel,
RH=LH



Roof Panels & Components

3142C
1956 Outer Roof Panel, Steel,
Painted Black



3142D
1956 Roof Back Filler Panel, OE Type
w/o Lower Extension



3142E
1956 Roof Back Filler Panel
Custom Type w/ Lower extension



3143
1956 Roof Support Windshield
Header, Steel, Painted Black Brace
Front



3180
1956 Windshield Frame Assembly



3143A
1956 Roof Support Header, Steel
Painted Black, RH

3143B
1956 Roof Support Header, Steel
Painted Black, LH



FORD® PICK UP TRUCK

Roof Panels & Components

3144

1956 Roof Drip Rail Set w/ Clip,
Painted Black



3145

1956 Roof Center Brace & Dome
Light Set, 3 pcs, Steel, Painted
Black



Window Regulator

3114D

1948-52 Window Regulator Handle
w/ Black Knob



3114A

1953-55 Window Regulator Handle
w/ Black Knob, w/ Zinc Clip Type RH=LH



3114B

1956 Window Regulator Handle
w/ Black Knob, Screw Type RH=LH



3114C

1961-66 Window Regulator Handle



3114E

1968-72 Window Regulator Handle
w/o Knob



3114F

1968-72 Window Regulator Handle
Knob



3120

1953-55 Window Regulator, RH

3120A

1953-55 Window Regulator, LH



3120B

1956 Window Regulator, RH

3120C

1956 Window Regulator, LH



3121

1957-60 Front Window Regulator, RH

3121A

1957-60 Front Window Regulator, LH



3123A

1968-72 Front Window Regulator, RH

3123B

1968-72 Front Window Regulator, LH



Window Regulator

- 3124A**
1973-79 Window Regulator
w/ Screw Hole, RH
- 3124B**
1973-79 Window Regulator
w/ Screw Hole, LH



3124A

- 3125**
1948-52 Window Regulator, RH
- 3125A**
1948-52 Window Regulator, LH



3125

- 3126C**
1948-50 Vent Window Assy, Tint
Glass, RH
- 3126D**
1948-50 Vent Window Assy, Tint
Glass, LH



3126C

- 3126G**
1951-52 Vent Window Assy, Tint
Glass, RH
- 3126H**
1951-52 Vent Window Assy, Tint
Glass, LH



3126G

Vent Windows

- 3126A**
1948-50 Vent Window Assy,
Clear Glass, RH
- 3126B**
1948-50 Vent Window Assy,
Clear Glass, LH



3126A

- 3126E**
1951-52 Vent Window Assy,
Clear Glass, RH
- 3126F**
1951-52 Vent Window Assy,
Clear Glass, LH



3126E

- 3126J**
1953-55 Vent Window Assy, Tint
Glass, RH
- 3126K**
1953-55 Vent Window Assy, Tint
Glass, LH



3126J

FORD® PICK UP TRUCK

Vent Windows

3126L
1953-55 Vent Window Assy, Clear Glass, RH

3126M
1953-55 Vent Window Assy, Clear Glass, LH



3126L

3126Q
1956 Vent Window Assy, Tint Glass, RH

3126R
1956 Vent Window Assy, Tint Glass, LH



3126Q

3126N
1956 Vent Window Assy, Clear Glass, RH

3126P
1956 Vent Window Assy, Clear Glass, LH



3126N

Vent Window Handles

3127A
1948-50 Vent Window Handle, RH

3127B
1948-50 Vent Window Handle, LH



3127A

3127E
1953-55 Vent Window Handle, RH

3127F
1953-55 Vent Window Handle, LH



3127E

3127J
1967 Vent Window Handle, RH

3127K
1967 Vent Window Handle, LH



3127K

3127C
1951-52 Vent Window Handle, RH

3127D
1951-52 Vent Window Handle, LH



3127C

3127G
1956-60 Vent Window Handle, RH

3127H
1956-60 Vent Window Handle, LH



3127G

M3529C
1967 Vent Window Handle, Pair



Vent Window Handles

M3529E

1968-77 Vent Window Handle
w/ Nylon Tab, Pair



3127N

1951-60 Vent Window Handle Button
Kit



3114G

1948-52 Door Latch Remote, RH

3114J

1948-52 Door Latch Remote, LH



3114J

Doors & Hardware

3100A

1953-55 Door Latch Assembly, RH

3100B

1953-55 Door Latch Assembly, LH



3100A

3102A

1956 Door Latch Assembly, RH

3102B

1956 Door Latch Assembly, LH



3102B

3100L

1948-52 Lower Outer Door Patch, RH

3100M

1948-52 Lower Outer Door Patch, LH



3100L

3103A

1953-56 Lower Outer Door Patch, RH

3103B

1953-56 Lower Outer Door Patch, LH



3103B

3100N

1948-50 Lower Inner Door Patch, RH

3100P

1948-50 Lower Inner Door Patch, LH



3100N

3100R

1951-52 Lower Inner Door Patch, RH

3100S

1951-52 Lower Inner Door Patch, LH



3100R

3100T

1953-56 Lower Inner Door Patch, RH

3100U

1953-56 Lower Inner Door Patch, LH



3100T

FORD® PICK UP TRUCK

Doors & Hardware

3100
1953-55 Door Shell, RH

3101
1953-55 Door Shell, LH



3110
1973-79 Door Shell, RH

3111
1973-79 Door Shell, LH



3102
1958 Door Shell, RH

3103
1958 Door Shell, LH



3108
1967-72 Door Skin Half,
Fits Both RH & LH



3109
1967-72 Front Lower Door Skin,
Fits Both RH & LH



Doors & Hardware

3109G
1973-79 Door Skin Lower Half, RH
3109H
1973-79 Door Skin Lower Half, LH



3109G

3112
1973-79 Door Skin Half, RH
3113
1973-79 Door Skin Half, LH



3112

3108A
1967-72 Inner Door Bottom, RH
3108B
1967-72 Inner Door Bottom, LH



3108A

3109C
1973-79 Inner Lower Door Bottom, RH
3109D
1973-79 Inner Lower Door Bottom, LH



3108A

3109E
1967-79 Lower Door Post Repair Panel, RH
3109F
1967-79 Lower Door Post Repair Panel, LH



3109E

3114H
1953-62 Door Striker Plate

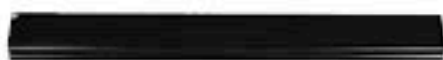

3109K
1948-52 Upper Door Hinge, RH
3109L
1948-52 Upper Door Hinge, LH



3109K

3109M
1948-52 Lower Door Hinge, RH
3109N
1948-52 Lower Door Hinge, LH



3109M

3110A
1953-58 Upper/Lower Door Hinge
RH&LH



FORD® PICK UP TRUCK

Doors & Hardware

3110B

1961-66 Front Door Hinge, RH

3110C

1961-66 Front Door Hinge, LH



3110B

3118A

1967-72 Upper Door Hinge, RH

3118B

1967-72 Upper Door Hinge, LH



3118B

3118C

1967-72 Lower Door Hinge, RH

3118D

1967-72 Lower Door Hinge, LH



3118C

3115

1953-56 Door Hinge Cover



3115A

1973-79 Outer Door Weatherstrip Belt, RH

3115B

1973-79 Outer Door Weatherstrip Belt, LH



3116A

1973-79 Inner Door Weatherstrip Belt, RH

3116B

1973-79 Inner Door Weatherstrip Belt, LH



3116C

1981-86 Door Kick Plate, RH

3116D

1981-86 Door Kick Plate, LH



3116C

3119A

1981-86 Door Step Plate, RH

3119B

1981-86 Door Step Plate, LH



3119A

3118E

1953-56 Front Door Relay, Long Shaft, RH=LH



3119C

1953-56 Door Relay, Short Shaft, RH=LH



Doors & Hardware

3119D
1953-56 Front Door Relay, Long
Shaft, RH=LH



3119E
1953-56 Front Door Relay, Short
Shaft, RH=LH



3119F
1957-80 Door Relay, Latch Control
RH=LH



3127P
1968-72 Door Lock Knobs



3115F
1948-52 Outer Door Handle, RH

3115C
1948-52 Outer Door Handle, LH



3115D
1953-80 Outer Door Handle, RH
w/ Button, Pad, Screw

3115E
1953-80 Outer Door Handle, LH
w/ Button, Pad, Screw



3115FA
1961-66 Outer Door Handle, Pair



3115FF
1973-79 Outer Door Handle, RH

3115FG
1973-79 Outer Door Handle, LH



3115G
1948-52 Inside Door Handle
Fits Both Right & Left Side



3115GA
1953-55 Interior Door Handle
Fits Both Right & Left Side



3115GB
1956 Interior Door Handle
Fits Both Right & Left Side



3115H
1967 Interior Door Handle



FORD® PICK UP TRUCK

Doors & Hardware

3315J

1973-79 Inside Door Handle, RH
Chrome

3315K

1973-79 Inside Door Handle, LH
Chrome



3315J

3115I

1987-72 Inside Door Handle Cup
Black



3115J

1987-72 Inside Door Handle Cup Tan



Bed Floor Panel

3157

1973-79 Long Bed Floor Panel Assembly



Bedside Panels

3250

1951-52 Bedside Panel Shortbed w/ Stake Pocket Hole, RH

3251

1951-52 Bedside Panel Shortbed w/ Stake Pocket Hole, LH

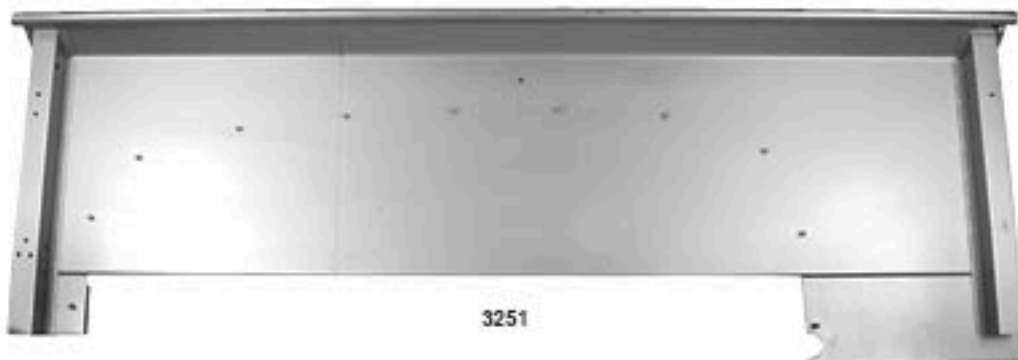

3251

Bedside Panels

3252

1953-56 Bedside w/o Stake Hole Stepside, RH

3253

1953-56 Bedside w/o Stake Hole Stepside, LH



3252

3260

1973-79 Bedside Assembly w/o Hole,
Outer Panel + Inner Panel, RH

3261

1973-79 Bedside Assembly Dual Square
Hole, Outer Panel + Inner Panel, LH



3260

3262

1973-79 Bedside Skin w/o Hole, RH

3263

1973-79 Bedside Skin Square Hole Single Fuel
Opening, LH



3262

3263A

1973-79 Bedside Skin Square Hole
Dual Fuel Opening, LH



3264

1973-86 Inner Bedside Longbed w/ Inner Wheelhouse
Styleside, RH

3265

1973-86 Inner Bedside Longbed w/ Inner Wheelhouse
Styleside, LH



3269C

1973-79 Rear Bedside Lower Section, RH

3269D

1973-79 Rear Bedside Lower Section, LH



3269C

Bed & Bedside Wheel Arch

3269E

1973-79 Bedside Wheel Arch Extension, w/o Hole, RH

3269F

1973-79 Bedside Wheel Arch Extension, w/ Hole, LH



3269A

1973-79 Bed Upper Wheel Arch, RH

3269B

1973-79 Bed Upper Wheel Arch, LH



3256

1951-72 Front Bed Panel, I Shortbed



Bed Panels

3254

1973-86 Front Bed Panel

Box Size 66" x 22.25" x 3 Weight 25 lbs.



3255

1942-50 Front Bed Panel, Stepside



Bed Cross Sills

3078D

1951-52 Front Bed Cross Sill



3078F

1951-80 Center Bed Cross Sill



Bed Cross Sills

3078E
1953-80 Front Bed Cross Sill



3078C
1951-72 Rear Bed Cross Sill, Shortbed, Stepside



Tailgate & Hardware

3301A
1942-50 Tailgate, Stepside



3301B
1942-50 Tailgate, Stepside w/ Ford



3301C
1951-52 Tailgate, Stepside



3301D
1951-52 Tailgate, Stepside w/ Ford



3301E
1953-72 Tailgate, Stepside



FORD® PICK UP TRUCK

Tailgate & Hardware

3300

1964-72 Tailgate, Styleside w/o Ford



3301

1964-72 Tailgate, Styleside w/ Ford



3303

1973-79 Tailgate, Styleside



3311

1964-72 Tailgate Linkage / Support Set, Styleside,
2 pcs, Stainless



3315

1964-72 Tailgate Linkage / Support Set, Styleside,
2 pcs, Black



Tailgate Hardware

3310
1964-72 Tailgate Hinge Set,
Styleside 2pcs, Stainless



3314
1964-72 Tailgate Hinge Set, 2pc,
Styleside, Black



3316
1973-79 Tailgate Handle



3317
1973-79 Tailgate Handle, Chrome



Tail Pan

3302
1973-79 Tail Pan Assembly



Roll Pan

3057A
1953 Front Roll Pan



3057B
1954 Front Roll Pan



Gas Tank Access Panel & Straps

T3010
1956 Gas Tank Access
Panel



T3250
1968-72 Gas Tank Filler
Neck



T3011
1973-85 Gas Tank Strap Rear
Mount, 2pc



T3012
1953-55 Gas Tank Strap



FORD® PICK UP TRUCK

Gas Tank & Fuel Sending Unit

T3004
1948-52 Gas Tank



T3005
1953-55 Gas Tank



T3006
1956 Gas Tank



T3007
1957-80 Gas Tank



T3008
1961-72 Gas Tank



T3009
1972-73 Gas Tank



T3000
1973-78 Gas Tank, 38 Gallons



T3001
1973-79 Gas Tank, 38 Gallons



T3002
1973-78 Gas Tank Rear Mount, Vent
Pipe Towards Rear, 19 Gallons



T3003
1973-79 Gas Tank Rear Mount,
Vent Pipe Towards Front, 19 Gallons



T3202
1948-52 Fuel Sending Unit



Gas Tank & Fuel Sending Unit

T3200
1948-55 Fuel Sending Unit,
12V, Long Arm



T3201
1948-55 Fuel Sending Unit,
Short Arm



T3204
1953-55 Fuel Sending Unit



T3203
1957-60 Fuel Sending Unit



T3205
1956 Fuel Sending Unit



T3237
1961-77 Fuel Sending Unit



T3206
1973-79 Fuel Sending Unit



T3206A
1973-79 Fuel Sending Unit
w/ Mid Frame Fuel tank



T3206B
1977-79 Fuel Sending Unit
w/ Mid Frame Fuel tank, 4x4 Only



FORD® PICK UP TRUCK

Rear Wheelhouse

3078A

1967-72 Rear Wheelhouse, RH

3078B

1967-72 Rear Wheelhouse, LH



3078A

3170

1973-79 Inner Rear Wheelhouse, RH for Box Side

3171

1973-79 Inner Rear Wheelhouse, LH for Box Side



3170

Decals

ML01

1966-67 "Ford" Door Sill Decal, Black



Ford Oval and Mustang are registered trademarks owned by Ford Motor Company.

ML02

1968-77 "Ford" Door Sill Decal, Blue



Ford Oval and Mustang are registered trademarks owned by Ford Motor Company.

Windshield/ Window Mldg

M3100

1956 Molding Windshield Front Set, 4pcs, Aluminum

M3100SS

1956 Molding Windshield Front Set, 4pcs, Stainless

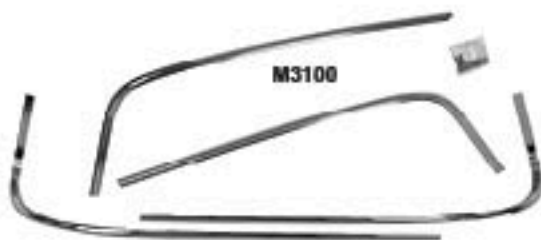

M3100

M3101

1956 Molding Window Back Set, 4pcs, Aluminum

M3101SS

1956 Molding Window Back Set, 6pcs, Stainless



M3101

M3104

1957 Molding Front Windshield Set, 4pcs, Stainless



Wheel Opening Moldings

M3700
1973-79 Wheel Opening Molding, Front, RH

M3701
1973-79 Wheel Opening Molding, Front, LH



M3700

M3702
1973-79 Wheel Opening Molding, Rear, RH

M3703
1973-79 Wheel Opening Molding, Rear, LH



M3702

M3704
1980-88 Wheel Opening Molding, Front, RH

M3705
1980-88 Wheel Opening Molding, Front, LH



M3704

M3706
1980-88 Wheel Opening Molding, Rear, RH

M3707
1980-88 Wheel Opening Molding, Rear, LH



M3706

M3708
1980-88 Wheel Opening Molding, Front, RH

M3709
1980-88 Wheel Opening Molding, Front, LH



M3708

M3710
1987-98 Wheel Opening Molding, Rear, RH

M3711
1987-98 Wheel Opening Molding, Rear, LH



M3710

Exterior Electrical & Components

3320
1987-89 Tail Light Panel Complete, Rear Bedside Corner Panel, RH

3321
1987-89 Tail Light Panel Complete, Rear Bedside Corner Panel, LH



3320

3323
1970-72 Tail Light Panel Complete, Rear Bedside Corner Panel, RH

3322
1970-72 Tail Light Panel Complete, Rear Bedside Corner Panel, LH



3322

FORD® PICK UP TRUCK

Exterior Electrical & Components

L3000

1948-56 Headlight Bezel, Stainless,
RH=LH



L3001

1956 Headlight Bezel, Stainless,
RH=LH



X3694

1940-57 & 61-78 Headlamp Retaining
Ring



X3699A

1967-69 Headlamp Adjusting
Bucket, RH

X3699B

1967-69 Headlamp Adjusting
Bucket, LH



X3699A

L3042

1953-56 Tail Lens, Shield Style



L3043

1953-56 Tail Light Lens,
w/ Ford RH=LH



Ford Oval and Mustang are registered trademarks
owned by Ford Motor Company.

L3040

1953-56 Tail Light Assembly, RH

L3041

1953-56 Tail Light Assembly, LH



L3040

L3046

1974-79 Tail Light Assy Red / Clear
Back up Lens, RH

L3047

1974-79 Tail Light Assy Red / Clear
Back up Lens, LH



L3046

Exterior Bezels & Light Assy

L3020
1955 Park Light Assy, Clear Lens



L3022
1956 Park Light Assy, Clear Lens, RH=LH



L3030
1975-77 Park Light Assy, Clear Lens, RH=LH



L3031
1975-77 Park Light Assy, Amber Lens, RH=LH



L3032
1978-79 Park Light Assy, Amber Lens, RH=LH



L3033
1978-79 Park Light Assy, Amber Lens, RH=LH



L3034
1980-86 Park Light Assy, RH=LH



L3021
1955 Park Light Bezel, Stainless, RH=LH



L3023
1956 Park Light Bezel, Stainless



L3024
1948-50 Park Light Lens, Clear, RH=LH

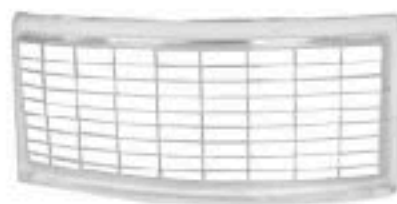

L3024A
1948-50 Park Light Lens, Amber, RH=LH

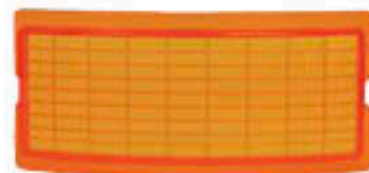

L3025
1951-52 Park Light Lens, Clear, RH=LH



FORD® PICK UP TRUCK

Exterior Electrical & Components

L3025A

1951-52 Park Light Lens, Amber,
RH=LH



L3026

1953-54 Park Light Lens, Clear,
RH=LH



L3026A

1953-54 Park Light Lens, Amber,
RH=LH



L3027

1955-58 Park Light Lens, Clear,
RH=LH



L3027A

1955-58 Park Light Lens, Amber,



L3050

1973-79 Marker Lamp Front,
Amber, RH=LH



L3051

1973-79 Marker Lamp Rear, Red,
RH=LH



L3059

1953-58 Dome Light Switch,
RH=LH



L3060

1953-58 Dome Light Lens



L3061

1953-58 Dome Light Assy w/ Switch
Open



L3062

1953-58 Dome Light Assy
w/o Switch Open



3079

1978-79 Antenna



Seat Belts

SBP-BK60
1960 Seat Belt, Black,
Push Button Latch



SBP-BK74
1974 Seat Belt, Black,
Push Button Latch



Locks

CL-1400
1953-59 Ignition Lock



CL-363
1953-59 Ignition Lock & Doors



CL-4877
1966-77 Ignition & Door Lock Set,
Standard Ford®



CL-1401
1966-77 Ignition Lock Set,
Small Head Keys
(Also Fits 1960-66)



CL-364
1953-60 Ignition Lock



CL-1550
1967-79 Door Locks, Pair



CL-1402
1978-79 Ignition Lock Set,
Large Head Keys



CL-367
1980-83 Lock Kit Ignition & Door

