

Dynatech[®] Competition Exhaust Systems

**HIGH PERFORMANCE, DRAG
RACING, OVAL TRACK RACING**



2020
MASTER **CATALOG**

Dynatech®

WHO WE ARE Dynatech® continues to be the exhaust leader in all forms of racing and high performance applications. Advances in racing, engineering, and design have automakers bringing a whole new breed of cars and trucks to the streets and tracks. This same excitement and new wave of technology is apparent at Dynatech® as you view the pages of our latest catalog. We continue to be focused on new products and award-winning designs.



WORLD CLASS DESIGN & ENGINEERING

Virtual reality exhaust design systems allow engineers to design the exhaust system in virtual space that will meet all necessary design criteria. Key interference and mounting points are captured and then transferred into engineering computer stations. Tube routings, lengths, and diameters can all be manipulated for proper fit and function. These processes cut design time by 90% and produce a much more efficient and powerful design.



TECHNOLOGY & MANUFACTURING

At Dynatech®, we strive for 100% perfection on all of the products that we manufacture. Everything we manufacture goes through proven assembly steps and procedures to provide the end user with a product that we stake our reputation on. We have instituted numerous fitment and quality control inspections. All high performance systems are 100% tested to be leak free and 100% jig tested for fitment.



UNMATCHED SALES & CUSTOMER SERVICE

Our team members are more than welders, machinists, engineers and salespeople. We are racers and enthusiasts just like you. We understand the needs of our customers and respond accordingly with outstanding technical support and customer service. In some cases, the very people that build the product speak with the end user. Fast and friendly service before, during and after the sale all come standard when you purchase Dynatech® products.

CONTENTS

2020 DYNATECH® CATALOG

★★★★★ SUPERIOR PRODUCTS

Dynatech® products provide superior performance and fit for a wide range of exhaust applications. One thing that you can always count on regardless of what Dynatech® product you buy is excellent fit, function and performance. We understand the value of offering no hassle, maintenance-free products to our customers.

5

DRAG RACING

Headers

Dragster / Strut Front Headers	06
Weld-up / Strut Front Header Kits	09
Camaro / Nova Headers	10
<i>Standard / Tall Deck Headers</i>	
Mustang K-Member Headers	11
Mufflers & Collectors	12
Exhaust Accessories	14

19

MUSCLE CAR

Headers

'67-'69 Camaro Headers	20
'68-'74 Nova Headers	22
'70-'81 Camaro Headers	24
Block Hugger Headers	25

26

HIGH PERFORMANCE

Headers

'18-'19 Ford Mustang GT	29
'15-'17 Ford Mustang Shelby GT350 Headers	30
'11-'17 Ford Mustang 5.0	31
'07-'14 Ford Mustang Shelby GT500 Headers	32
'05-'10 Ford Mustang GT Headers	33
'05-'17 Challenger / Charger / Magnum Headers	34
'14-'18 C7 / Z06 Chevy Corvette Headers	35
'05-'13 C6 / Z06 Chevy Corvette Headers	36
'97-'04 C5 Chevy Corvette Headers	37
'09-'15 Cadillac CTS-V Headers	38
'16-'17 Chevy Camaro SS / ZL1 Headers	39
'10-'15 Chevy Camaro Headers	40
'98-'02 Chevy Camaro / Trans Am	41
Exhaust Accessories	42

45

TRUCK / SUV

Headers

'15-'17 Ford F-150	47
'11-'14 Ford F-150	48
'04-'08 Ford F-150 Truck Headers	49
'99-'03 Ford F-150 Truck Headers	50
'99-'04 Ford Lightning	50
'14-'19 Chevy / GMC Truck / SUV Headers	51
'07-'13 Chevy 1500 Truck / SUV Headers	52
'99-'06 Chevy 1500 Truck / SUV Headers	53
'00-'09 Hummer H2 Headers	54
'04-'05 Dodge 1500 Truck Headers	55

56

OVAL TRACK

Headers

Crate Modified Headers	58
Modified Headers	59
Dirt Late Model Headers	60
Exhaust Accessories	61

Apparel & More

AFCO Performance Group Apparel	62
--------------------------------	----

FEATURES & BENEFITS

WHAT IS IN A QUALITY SYSTEM?



*CNC LASER-CUT
FLANGES*



*EQUAL LENGTH
PRIMARY TUBES*



*FIBER
GASKETS*

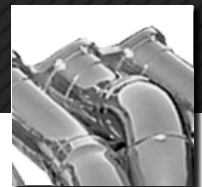

*360° GUSSET
SUPPORTS*

PERFECT, DIRECT BOLT-ON FIT

100% *JIG ASSEMBLED AND CHECKED
FOR AN EXCELLENT FIT*

OPTIMIZED TUBE LENGTH
FOR INCREASED H.P. AND TORQUE

CERAMIC COATED FINISH

ALL FLANGES



*MACHINE SURFACED
AFTER WELDING*

MADE IN THE U.S.A.



DRAG RACING

We have taken out all the guess work when it comes to selecting the right header for your race car. Dynatech® Drag Racing Headers are purpose-built to fit your specific application.



TIG-welded flanges are accurate to +/- .003" and improve weld flow for increased durability.

360° Gusset supports increase durability for muffler applications.

All drag headers are Chrome or high-temperature, silver ceramic coated inside and out.

Jig located U-tabs for easy bolt on collector installation.



DRAG RACING

2^{STEP} DRAGSTER **CHROME** HEADERS TWO-STEP VERSION

- Large radius, CNC mandrel bent, equal length primary tubes.
- Equal length for superior acceleration.
- 360° gusset supports increased durability.
- CNC laser-cut flanges for superior quality and accuracy.
- Broader performance range with a combination of two tube sizes.
- A great combination of low end Tq and high end Hp over a non-stepped header.



*Pan E-vac/O2 Kit included
with all Standard Collectors.
785-10095

1 YEAR LIMITED WARRANTY
MADE IN THE U.S.A.

APPLICATION	TUBE SIZE	PART #
CHROME DRAGSTER W/ STANDARD 4.500" COLLECTORS (2 STEP)*	2.250" - 2.375"	750-96410
CHROME DRAGSTER W/ STANDARD 4.500" COLLECTORS (2 STEP)*	2.375" - 2.500"	750-98410
CHROME DRAGSTER W/ 4.500" MERGE COLLECTORS (2 STEP)	2.250" - 2.375"	750-97410
CHROME DRAGSTER W/ 4.500" MERGE COLLECTORS (2 STEP)	2.375" - 2.500"	750-99410



LONG TUBE BIG BLOCK CHEVY SIDE EXIT HEADER KIT

These Long Tube Big Block Chevy Header kits are designed with ease of assembly and performance in mind. The tubes are tack welded together to make it easy to completely assemble or make changes. Collectors are sold separately and come in a variety of sizes in standard or merge style configurations. Optional ceramic coating is available once you assemble your kit. After assembly, the 16 gauge steel construction and CNC laser-cut, surfaced flanges make this a durable header for multiple racing seasons.

- 0.375" thick CNC laser cut and surfaced flanges.
- Stepped tube sizes to optimize torque and horsepower.
- Designed to run out the side fender of a tube chassis door car with a BBC.
- 28.000" primaries.
- **Collectors sold separately (page 13).**



APPLICATION	TUBE SIZE	PART #
SIDE EXIT HEADER KIT	2.250" - 2.375"	760-42410
SIDE EXIT HEADER KIT	2.375" - 2.500"	760-44410
SIDE EXIT HEADER KIT (14° HEAD)	2.250" - 2.375"	760-46410
SIDE EXIT HEADER KIT (14° HEAD)	2.375" - 2.500"	760-47410



DON O'NEAL

DRAG RACING

HEADERS SLIP-ON COLLECTORS

1 YEAR LIMITED WARRANTY
MADE IN THE U.S.A.

DRAGSTER, BIG BLOCK CHEVY, STRUT FRONT & DOOR SLAMMER

- CNC laser cut flanges feature raised port location for increased power.
- Unique port gussets eliminate cracking caused by tire shake and muffler applications.
- Jig located U-tabs for hassle free, bolt-on collectors.
- Five models in straight or stepped header tubes.
- 28.000" equal length design.
- High-temp., silver ceramic coated inside and out. Ceramic coating comes with a three year limited warranty.



Ceramic Coated



*Pan E-vac/O2 Kit included with all Standard Ceramic Collectors. (Collectors sold separately)



APPLICATION	TUBE SIZE	PART #	+	PART # / OUTLET SIZE
STRUT TYPE, DRAGSTER	2.250"	750-91410		783-71241 (4.000")
STRUT TYPE, DRAGSTER	2.250" - 2.375"	750-92410		783-81241 (4.000") 783-81246 (4.500")
STRUT TYPE, DRAGSTER	2.375" - 2.500"	750-94410		783-91246 (4.500")

WELD-UP HEADER KITS

BIG BLOCK CHEVY STRUT FRONT AND DRAGSTER HEADERS

Designed specifically for strut type front end cars and dragsters, this kit allows you to fabricate your own headers to save money or make changes to the kit to fit your specific needs. These kits are assembled in the same jig we use for our finished headers. Then, we simply tack-weld all connections. If needed, you can cut a tack-weld to reposition the tube, or you can simply finish weld the kit and have the same header offered by Dynatech®.

- Same exact header as a Dynatech® finished header.
- Tack-welded to make it easy to change or finish weld.
- CNC laser-cut flanges, gaskets, gussets and bolts included.
- Optimum port exit angle for added power.
- **Collectors must be purchased separately (see below.)**
- **Star Plugs must be purchased separately (see page 13.)**

BIG BLOCK DRAGSTER/STRUT TYPE HEADERS

TUBE SIZE	HEADER KIT
2.250"	760-91410
2.250" - 2.375"	760-92410
2.375"	760-93410
2.375" - 2.500"	760-94410
2.500"	760-95410

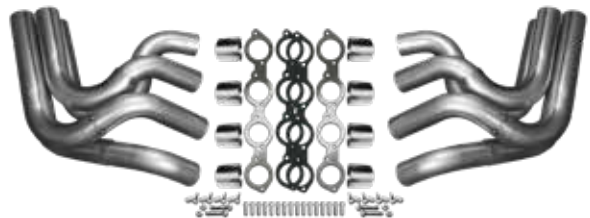

STANDARD COLLECTOR

TUBE SIZE	OUTLET SIZE	PART#
2.000"	3.500"	783-51235
2.250"	4.000"	783-71240
2.375"	4.500"	783-81245
2.500"	4.500"	783-91245
2.500"	5.000"	783-91250



MERGE COLLECTOR

TUBE SIZE	OUTLET SIZE	PART#
2.250"	4.000"	780-02518
2.375"	4.500"	780-03519
2.500"	4.500"	780-03510

Note: Does not include O2 bungs. To purchase separately please order: **785-10097** (pg. 16).

BIG BLOCK

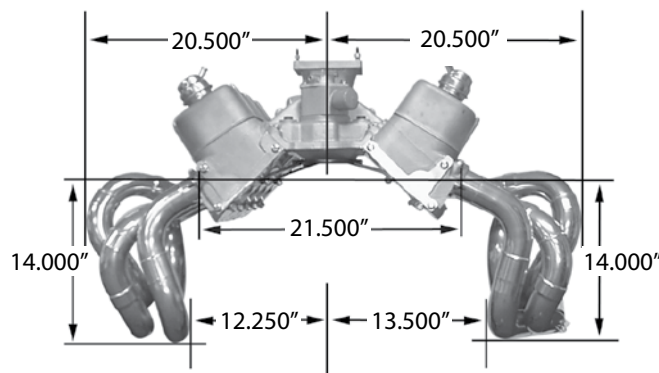

DRAG RACING

DRAG RACING EXHAUST BIG BLOCK CHEVY STD. & TALL DECK "572"

1 YEAR LIMITED WARRANTY
MADE IN THE U.S.A.

'67 – '69 CAMARO
'68 – '74 NOVA

▶ COATED

- Designed for BBC tall deck motors.
- Mandrel bent 2.125" primary tubes.
- CNC laser-cut flanges feature optimum port location for increased power.
- Designed for stock engine location.
- Fits factory, manual, and power steering box.



*Pan E-vac/O2 Kit included
with all Standard Coated Collectors.

- High-temp., silver ceramic coated inside and out.
- Ceramic coated headers require separate purchase of collectors.
- 10.200" Deck height.



**HEADERS
ONLY**



APPLICATION	TUBE SIZE	PART #	OUTLET SIZE	PART #
BBC GM 572 TALL DECK	2.125"	750-91010	3.500"	783-61236
			4.000"	783-61241



'67 – '69 CAMARO
'68 – '74 NOVA

▶ PAINTED

- Painted headers come with collectors installed.
- Reducer kit included.
- Built for use with the factory subframe.
- Fits around Manual and Power Steering boxes as well as factory A/C boxes and factory power brake booster.
- Fits Automatic or 4 speed.
- Ceramic coating services are available. Call for details.



Black
Painted
750-91910
shown

APPLICATION	TUBE SIZE	PART #	OUTLET SIZE
BBC GM 572 TALL DECK (PAINTED) 10.2" DECK HEIGHT	2.125"	750-91910	3.500"
BBC GM STANDARD DECK (PAINTED) 9.8" DECK HEIGHT	2.125"	740-59310	3.500"

MUSTANG K-MEMBER HEADERS '79 - '04 MUSTANGS

- For use with AJE, TEAMZ, and P.A. Racing K Members.
- Fits with factory starter, master cylinder, brake booster & proportioning valve (SBC, SBF, LSX only).
- Designed to be used with a wide variety of transmissions.
- '79-'93 requires after market steering shaft.
- May require a "cable style" shifter linkage.
- Not designed for use with motorplate.



1 YEAR LIMITED WARRANTY
MADE IN THE U.S.A.



LSX

'79 - '93 w/ LS Based Chevy: 1.875" Tube w/ 3.000" Collector

715-91410

'94 - '04 w/ LS Based Chevy: 1.875" Tube w/ 3.000" Collector

715-91310



SBC

SMALL BLOCK CHEVY:

1.750"- 1.875" Tube
3.000" Collector

701-23010



BBC

BIG BLOCK CHEVY:

2.125" Tube
3.500" Collector

750-91110



SBF

351 WINDSOR & 302*:

1.750"- 1.875" Tube
3.000" Collector

704-23010

**Will work with 302 by spacing engine up 0.625" between engine block and motor mount.*

DRAG RACING

MUFFLERS

Auger Style Muffler



- 11.000" long – fits inside 3.000" or 3.500" O.D. pipe.
- Weighs only 1.000 lb.
- 6-7 dB reduction.

APPLICATION	SIZE	PART #
AUGER STYLE MUFFLER	3.000"	776-24302
AUGER STYLE MUFFLER	3.500"	776-24352

SPLIT-FLOW[®] RACING MUFFLERS

The Split-Flow[®] racing muffler is the "hot topic" among racers, and for good reason. The straight-thru design can handle big power. The exclusive dual pattern core reduces dB levels while maintaining a powerful sound. The all-aluminized, fully welded construction makes it a top choice for racing and high performance applications.

- Straight-thru design for maximum flow.
- Dual-pattern core for reduced sound levels.
- All-aluminized materials and welded construction.
- Stainless steel sound absorbing material for no burnout.
- Lightweight design.
- Meets or exceeds dB requirements at most muffler-required sanctioned events.

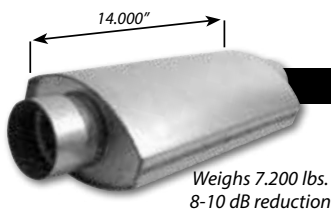
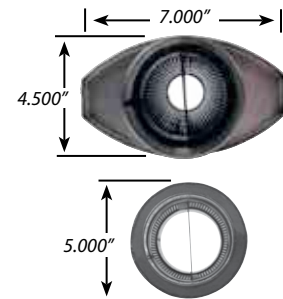

OVAL (14.000"L X 7.000"W X 4.500"H DIA.)	INLET I.D.	OUTLET I.D.	PART #
SPLIT-FLOW [®] OVAL	2.500"	2.500"	776-14252
SPLIT-FLOW [®] OVAL	3.000"	3.000"	776-14302
SPLIT-FLOW [®] OVAL	3.500"	3.500"	776-14352

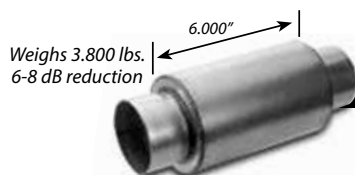

ROUND (6.000"L X 5.000" DIA.)	INLET I.D.	OUTLET I.D.	PART #
SPLIT-FLOW [®] ROUND	3.000"	3.000"	776-06302
SPLIT-FLOW [®] ROUND	3.500"	3.500"	776-06352

STANDARD COLLECTORS

Dynatech® slip-on race collectors offer great performance at an affordable price. All collectors come race-ready right out of the box. They are available in a wide variety of primary tube and collector outlet sizes for all popular applications.

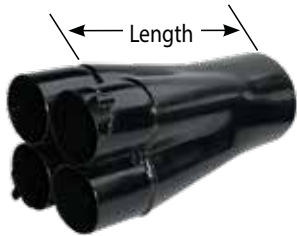

PAINTED MILD STEEL SLIP-ON COLLECTORS

TUBE SIZE	OUTLET SIZE	LENGTH	PART#
1.750"	3.000"	12.000"	783-31230
1.875"	3.000"	12.000"	783-41230
1.875"	3.500"	12.000"	783-41235
2.000"	3.500"	12.000"	783-51235
2.125"	3.500"	12.000"	783-61235
2.250"	4.000"	12.000"	783-71240
2.375"	4.500"	12.000"	783-81245
2.500"	4.500"	12.000"	783-91245
2.500"	5.000"	12.000"	783-91250



CERAMIC COATED MILD STEEL SLIP-ON COLLECTORS

TUBE SIZE	OUTLET SIZE	LENGTH	PART#
2.125"	3.500"	12.000"	783-61236
2.125"	4.000"	12.000"	783-61241
2.250"	4.000"	12.000"	783-71241
2.375"	4.000"	12.000"	783-81241
2.375"	4.500"	12.000"	783-81246
2.375"	5.000"	12.000"	783-81251
2.500"	4.500"	12.000"	783-91246



*Pan E-vac/O2 Kit included with all Standard Collectors.



Required when using non-slip-on/weld-on collectors.



STAR PLUGS

TUBE SIZE	PART#
SMALL UP TO 2.250" TUBE SIZE	794-00012
X-LARGE 2.375" TUBE SIZE AND UP	794-00022



COLLECTOR SPIKE/GOILET

COLLECTOR SPIKE	PART#
COLLECTOR SPIKE	550000620

ACCESSORIES

MERGE COLLECTORS

In order to understand how the merge collector works, you must first know why one exhaust system can generate more torque and horsepower than another. The ability of a header/exhaust system to maintain exhaust gas velocity has a tremendous impact on realizing maximum torque and horsepower. Any significant changes in the system, such as baffles (mufflers) or collectors, will have an impact on exhaust gas velocity. The large area change seen at the transition from the primary tube to the collector causes an immediate reduction in exhaust gas speed. This reduction in speed decreases the efficiency of the system, thereby reducing scavenging ability. Scavenging ability is the key factor by which an exhaust system is evaluated. The more efficient the system, the more air/fuel mixture that can be pulled into the combustion chamber. Obviously, the greater quantity of air/fuel mixture that can be burned, the more torque and power potential the engine has.

The construction of a merge collector is such that the change in area at the primary tube to collector transition point is minimized. This gradual transition allows the exhaust gas to maintain as much velocity as possible. Maintaining gas velocity is the key to allowing the exhaust system to reach its efficiency potential.

Merge collectors significantly improve the efficiency of the exhaust system. If your combination has been optimized to a header with standard collectors, it's possible to over-scavenge when adding merge collectors. Over-scavenging will normally decrease torque and horsepower when compared to your optimized, previous setup. We recommend dyno testing to arrive at the final camshaft combination when using this style of collector. If you need that last little edge and are willing to do the testing required to realize the potential gains, merge collectors are one of the most economical ways to gain significant amounts of torque and horsepower in the entire engine combination.

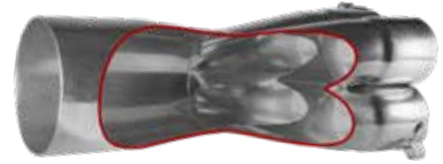

- 100% TIG-welded.
- Optimum reduction angle.
- Increases torque and horsepower.
- Sold Individually.

Note: Does not include O2 bungs. To purchase separately please order: 785-10097 (pg. 16).

Mild Steel Merge Collectors

SLIP OVER	OUTLET	PART #
2.250"	4.000"	780-02518
2.375"	4.500"	780-03519
2.500"	4.500"	780-03510

INSERT CONES

VORTEX® INSERT CONE

NEW LOWER PRICING!

- 100% T-304 stainless steel construction.
- Ultra-lightweight, less than .500 lbs. each.
- Little or no power loss.
- Easy bolt-in installation.

HOW IT WORKS:

The Vortex® Insert Cone, installed near the exit of the header collector or muffler outlet, provides a large friction area to reflect and dissipate sound energy, thus reducing the dB level. The open area of the cone is actually greater than the area of the collector or exhaust pipe, thus reducing a back pressure condition. Because no significant back pressure has been introduced, the engine is still able to use the scavenge ability of a good header to create horsepower and torque. Dyno and track testing show significant noise reduction with little or no power loss.



TUBE SIZE	A	B	PART #
3.000"	3.750"	1.000"	772-32520
3.500"	4.750"	1.000"	772-32510
4.000"	6.250"	1.000"	772-32530
4.500"	6.750"	1.000"	772-32540

Weights less than 1/2 lbs. 1-3 dB reduction.

TURN DOWNS WITH CONES

The Vortex® Turn Down is expanded to slip over collector outlets or tail pipes. Greater sound reduction can be achieved by directing the outlet away from the meter or sound test point. U-tab mounting hardware is included.



DESCRIPTION	TUBE SIZE	PART #
TURN DOWN WITH 3.000" CONE INSTALLED	3.000"	780-01100
TURN DOWN WITH 3.500" CONE INSTALLED	3.500"	780-01200

CONES ARE SOLD INDIVIDUALLY, TWO REQUIRED PER V-8 ENGINE.

FLANGES & GASKETS

MUSCLE CAR APPLICATIONS

A great exhaust system starts at the beginning — the flange. One of Dynatech®'s biggest advantages is our wide selection of port matched flanges. All of our flanges are CNC laser cut for unparalleled quality and fit.



Mild Steel Flanges



Fiber Gasket

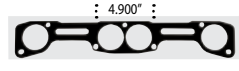
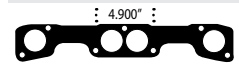
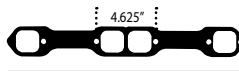
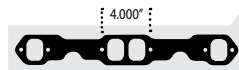

DESCRIPTION	FLANGE (single)	PORT	X	Y	THICKNESS	GASKET (pair)
SMALL BLOCK CHEVY 23°	796-00613	1.750"	1.485"	1.880"	.375"	794-00001
SMALL BLOCK CHEVY 23°	796-00622	1.625"	1.485"	1.685"	.375"	794-00001
SMALL BLOCK CHEVY 23°	796-00022	1.625"	1.485"	1.685"	.250"	794-00001
SMALL BLOCK CHEVY 23°	796-00013	1.750"	1.485"	1.880"	.250"	794-00001
SMALL BLOCK CHEVY 18°	796-00564	1.875"	1.839"	1.697"	.3125"	-
LS1 GM	796-60514	1.875"	1.946"	1.946"	.3125"	794-20001
STAHL ROUND PATTERN	796-01514	1.875"	1.944"	1.944"	.3125"	-
SPREAD PORT CHEVY	796-00534	1.875"	1.950"	1.950"	.3125"	794-00000
SPREAD PORT CHEVY	796-00535	2.000"	2.070"	2.070"	.3125"	794-00000
SPREAD PORT CHEVY	-	2.125"	2.196"	2.196"	.3125"	794-00000
BIG BLOCK CHEVY	796-31536	2.125"	2.224"	2.224"	.3125"	794-50011
BIG BLOCK CHEVY	796-21637	2.250"	2.350"	2.350"	.375"	794-50001
BIG BLOCK CHEVY	796-21638	2.375"	2.476"	2.476"	.375"	794-50001
BIG BLOCK CHEVY	796-21639	2.500"	2.600"	2.600"	.375"	794-50001

CERAMIC COATING

All headers purchased with this option are coated inside and outside. The coating will significantly reduce the underhood temperature of your car — which translates into horsepower gain. **Headers purchased with this ceramic coating come with a 3 year warranty and a customer satisfaction guarantee.**

DESCRIPTION	PART#
CERAMIC COATING FOR HEADERS	790-00100
CERAMIC COATING FOR X & Y PIPES	790-00101
CERAMIC COATING FOR ELBOWS	790-00102
CERAMIC COATING FOR COLLECTORS	790-00103

Note: Ceramic coating not available for Catalytic converters.

ACCESSORIES

CLAMP COLLAR KIT



These clamp collar kits allow you to connect extension pipes, Y-pipes, X-pipes, and mufflers without welding. The clamps also allow you to quickly disconnect if needed.

DESCRIPTION	TUBE SIZE	PART#
CLAMP COLLAR KIT	2.500"	794-90250
CLAMP COLLAR KIT	3.000"	794-90200
CLAMP COLLAR KIT	3.500"	794-90350
CLAMP COLLAR KIT	4.000"	794-90400

O2/PAN E-VAC KIT

Complete kit w/ weld-on bung.

- Increase horsepower.
- Better ring seal.
- Reduce crankcase pressure.



This kit has been dyno-proven to pull as much as 3 inches of vacuum on your typical bracket engine. The U-weld kit features an 18mm threaded bung that will also accept a standard O2 sensor found on EFI applications. Threaded adapter has standard .500" mpt for typical valve cover plumbing installation. 1-kit required per collector.

DESCRIPTION	PART#
O2 SENSOR/PAN E-VAC COMPLETE KIT	785-10095
18MM WELD ON BUNG	785-10097
O2/E-VAC MALE ADAPTER	785-10096
18MM PLUG	785-10094
18MM SEALING WASHER	785-10093

V-CLAMP KITS



Kit includes two weld-on v-clamp rings and stainless steel v-band clamp. Models for 2.500", 3.000", or 3.500" pipe sizes.

DESCRIPTION	PART#
V-CLAMP COLLAR ASSEMBLY 2.500"	794-91225
V-CLAMP COLLAR ASSEMBLY 3.000"	794-91230
V-CLAMP COLLAR ASSEMBLY 3.500"	794-91235

HEADER BOLT KITS

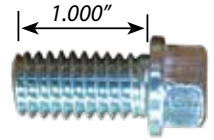

DESCRIPTION	THREAD	PART#
12 POINT HEAD	3/8-16	794-00120
HEX BOLTS (16 PACK)	3/8-16	794-00118

MANDREL BENT J-BENDS

Dynatech® stocks a complete inventory of mandrel bent J-bends. These are made from premium grade mild steel tubing.

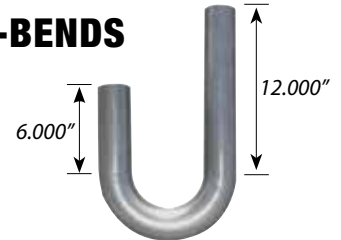

SIZE	CLR	MILD STEEL PART#	STAINLESS PART#
1.625"	2.625"	794-60202	794-60302
1.750"	2.625"	794-60203	-
2.000"	3.000"	794-60205	-
2.125"	3.188"	794-60206	-
2.250"	3.375"	794-60207	-
2.325"	3.563"	794-60208	-
2.500"	3.750"	794-60209	-

U-TAB KIT



These are the same U-tabs we use on all Dynatech® headers and collectors. Kit includes: U-tabs and hardware.

DESCRIPTION	PART#
U-TAB KIT (2 TABS, 1 BOLT)	794-00310
U-TAB KIT (4 TABS, 2 BOLTS)	794-00313
U-TAB KIT (8 TABS, 4 BOLTS)	794-00320

EXTENSIONS

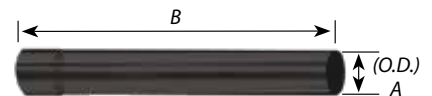

- Manufactured from mild steel.
- Designed to slip over 3.000" or 3.500" outer diameter on one end.
- Ideal for finishing your exhaust system.

"A"	"B"	PART#
3.500"	24.000"	780-00301
3.000"	24.000"	780-00302

ACCESSORIES

EXHAUST ELBOWS

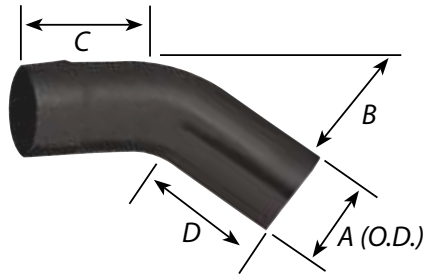

"A"	"B"	"C"	"D"	PART#
3.000"	30°	6.000"	6.000"	780-30301
3.500"	30°	6.000"	7.000"	780-30351
3.000"	42°	6.000"	12.000"	780-42301
3.500"	42°	6.000"	12.000"	780-42351
3.000"	80°	2.000"	5.875"	780-80301
3.500"	80°	2.000"	5.750"	780-80351

STEPPED BAND CLAMPS

Smooth transition taper allows proper fit to seal expanded slip-fit connections. Great for muffler/tail pipe connections.



DESCRIPTION	PART#
BAND CLAMP FOR 2.500" JUNCTION	789-70250
BAND CLAMP FOR 2.750" JUNCTION	789-70275
BAND CLAMP FOR 3.000" JUNCTION	789-70300
BAND CLAMP FOR 3.500" JUNCTION	789-70350

Models for 2.500", 2.750" 3.000" or 3.500" pipe sizes. 1 clamp/pkg.

EXHAUST TIPS

With their unique insert design, TQ Tips® allow for a flush fit with the outside diameter of your exhaust's tail pipe. This makes for a smooth, clean look that doesn't take away from your car's appearance like bulky, clamped-on tips tend to do. Another quality feature of these tips is the billet aluminum construction, giving them unmatched strength and function.



DESCRIPTION	PART#
TQ TIP FOR 2.500" OUTLET (SINGLE TIP)	794-93025
TQ TIP FOR 3.000" OUTLET (SINGLE TIP)	794-93030
TQ TIP FOR 2.500" OUTLET (2 PACK)	794-93026
TQ TIP FOR 3.000" OUTLET (2 PACK)	794-93031

TURNDOWNS

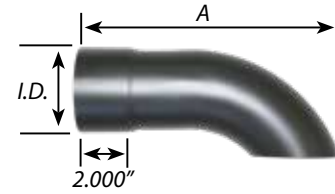

INNER DIAMETER	A	PART#
3.000"	10.000"	780-00100
3.500"	10.000"	780-00200
4.000"	11.000"	780-00050

ADAPTER PLATE KIT



DESCRIPTION	OPENING SIZE	PART#
SBC STD. 23° TO STAHL PATTERN (0.625" THICK)	1.125" X 1.125"	796-00100

Includes plates and hardware for both heads.

Designed to be machined to size, to port match Head port.

FEATURES & BENEFITS

WHAT IS IN A QUALITY SYSTEM?



*0.375" THICK
CNC LASER-CUT
FLANGES*



*4-BOLT BALL &
SOCKET COLLECTOR
FLANGES*



*FIBER
GASKETS*



*3.000" WIDE / 2-BOLT
BAND CLAMPS*

PERFECT, DIRECT BOLT-ON FIT

100% *JIG ASSEMBLED AND CHECKED
FOR AN EXCELLENT FIT*

OPTIMIZED TUBE LENGTH
FOR INCREASED H.P. AND TORQUE

CERAMIC COATED FINISH

ALL FLANGES



*MACHINE SURFACED
AFTER WELDING*

MADE IN THE U.S.A.



*DETAILED
INSTRUCTIONS
& HARDWARE
INCLUDED*



MUSCLE CAR



.375" thick, laser-cut, surfaced flanges for an excellent seal.

Unique port design accommodates Std. 23 Degree Chevy, "D" Port, and many other Std. Chevy Bolt pattern heads (aluminum and cast iron).

Long tube headers for maximum torque and horsepower across the power range.

Clears 600 Series and all factory steering boxes, power and manual styles.

Ceramic Coating INSIDE AND OUT with a three year warranty on the coating.



Unique "Ball & Socket" designed reducer cones, included with every set.

- *Designed with excellent ground clearance in mind, when using standard Small Block Chevy Engine Mounts and Factory Front Subframe.*
- *Using Big Block Engine Mounts / Stands and Aftermarket Subframes typically set the engine lower which will result in ground clearance issues.*
- *LSX Conversion Models must use specified mounts described in the installation manual.*
- *Available in multiple sizes, depending on application.*

MUSCLE CAR

MUSCLEMAXX®

'67 - '69 CAMARO

STAINLESS STEEL, CERAMIC COATED & PAINTED HEADERS

► FITS: **LSX** / SBC / BBC

1 YEAR LIMITED WARRANTY

MADE IN THE U.S.A.

- 0.375" thick, laser-cut flanges to provide the ultimate leak-free seal.
- SBC flanges specifically designed to fit: 23 deg. standard port, D-port, Fast Burn, LT1 and crate engines.
- CNC laser-cut flanges feature raised port location for increased power.
- BBC headers come painted standard **ceramic coating is optional.**
- LSX & SBC headers comes in high-temp, silver ceramic coating inside and out.
- Race-proven stepped tube design for maximum street/strip performance.
- New design clears the following steering boxes: 600, 700, 800 & factory manual/power with 23° aluminum/factory heads/straight or angle plugs.
- Includes bolts and gaskets.
- Direct bolt-on fit.
- 794-03006 Bracket Set is needed for all MuscleMAXX® Camaro & Chevelle headers for factory air compressor mounting.

NEW!



MUSCLE CAR

Reducer cone kit
included w/ all headers.



BLACK
PAINTED



HEADER TUBE SIZE

	2.500" REDUCER	3.000" REDUCER
1.625" - 1.750" (SBC) STAINLESS NEW!	740-11510	740-21510
1.750" - 1.875" (SBC) STAINLESS NEW!	740-11610	740-21610
2.125" - 3.500" (BBC STD) PAINTED	-	740-59310
2.125" - 3.500" (BBC TALL) PAINTED	-	750-91910
1.875" STAINLESS (LS SERIES)	715-31425***	715-31430***

*** Designed around: Muscle Rods Engine Mount Kit #106-1302-00, Detroit Speed Engine Mount Kit #DSE-060401, Muscle Rods Sure Fit Crossmember Kit #106-2200-00, 4LS0E transmission, factory AC, power brakes, and factory subframe. Steering boxes 600 series/factory manual/power will clear factory LS style plug wires. Designed for maximum ground clearance. If using with Exhaust System 793-91125 some modification will be required (modification of the 793-91125).

* Aftermarket plug wires required for fuel injected applications.
 ** Engine Mounts: Detroit Speed Motor Mount Kit # DSE-060401.
 Transmission Cross Member: BPT-1002 (Fit up with a 4L60 Transmission).
 **** On convertible Camaro models, the 3.000" system cannot be used.
 The 2.500" system and use of Hotchkis Performance X-Brace is required. Hotchkis Part# 1404.
 Subframe: OEM Factory Original GM - Using these headers with any combination other than what is specified may cause fitment issues.

MUSCLE CAR

MUSCLEMAXX®

'68-'74 NOVA

STAINLESS STEEL, CERAMIC COATED & PAINTED HEADERS

► FITS: **LSX** / SBC / BBC

1 YEAR LIMITED WARRANTY

MADE IN THE U.S.A.

- 0.375" thick, laser-cut flanges to provide the ultimate leak-free seal.
- Flanges fit most 23° SBC standard port heads including: D-Port, Fast Burn, LT1, LS and crate engines.
- CNC laser-cut flanges feature raised port location for increased power.
- BBC headers comes painted standard - ceramic coating is optional.
- LSX & SBC headers comes in high-temp, silver ceramic coating inside and out.
- Race-proven stepped tube design for maximum street/strip performance.
- New design clears the following steering boxes: 600 & factory manual/power with 23° aluminum / factory heads / straight or angle plugs.
- Includes bolts and gaskets.
- Direct bolt-on fit.

NEW!



MUSCLE CAR

Reducer cone kit
included w/ all headers.



BLACK
PAINTED



HEADER TUBE SIZE

	2.500" REDUCER	3.000" REDUCER
1.625" - 1.750" (SBC) STAINLESS NEW!	740-11510	740-21510
1.750" - 1.875" (SBC) STAINLESS NEW!	740-11610	740-21610
2.125" - 3.500" (BBC STD) PAINTED	-	740-59310
2.125" - 3.500" (BBC TALL) PAINTED	-	750-91910
1.875" STAINLESS (LS SERIES)	715-31425***	715-31430***

*** Designed around: Muscle Rods Engine Mount Kit #106-1302-00, Detroit Speed Engine Mount Kit #DSE-060401, Muscle Rods Sure Fit Crossmember Kit #106-2200-00, 4LS0E transmission, factory AC, power brakes, and factory subframe. Steering boxes 600 series/factory manual/power will clear factory LS style plug wires. Designed for maximum ground clearance. If using with Exhaust System 793-91125 some modification will be required (modification of the 793-91125).

* Aftermarket plug wires required for fuel injected applications.
 ** Engine Mounts: Detroit Speed Motor Mount Kit # DSE-060401.
 Transmission Cross Member: BPT-1002 (Fit up with a 4L60 Transmission).
 **** On convertible Camaro models, the 3.000" system cannot be used.
 The 2.500" system and use of Hotchkis Performance X-Brace is required. Hotchkis Part# 1404.
 Subframe: OEM Factory Original GM - Using these headers with any combination other than what is specified may cause fitment issues.

MUSCLE CAR

MUSCLEMAXX®

'70-'81 CAMARO

CERAMIC COATED HEADERS

► FITS: **LSX** / SBC

1 YEAR LIMITED WARRANTY

MADE IN THE U.S.A.

- 0.375" thick, laser-cut flanges to provide the ultimate leak-free seal.
- SBC flanges specifically designed to fit: 23 deg. standard port, D-port, Fast Burn, LT1 and crate engines.
- Comes in high-temp. silver ceramic coating inside and out.
- CNC laser-cut flanges feature raised port location for increased power.
- Race-proven stepped tube design for maximum street/strip performance.
- Includes bolts and gaskets.
- Direct bolt-on fit.
- 794-03006 Bracket Set is needed for all MuscleMAXX® Camaro & Chevelle headers for factory air compressor mounting.



CERAMIC COATED



Reducer cone kit included w/ all headers.



Headers not included with exhaust kit.



HEADER TUBE SIZE

1.750" - 1.875" X 3.000" (SBC)

*1.875" X 3.000" (LS SERIES)

2.500" REDUCER

740-19310

715-19410

3.000" REDUCER

740-29310

715-29410

Transmission Cross member: Stock OEM Subframe: OEM Factory Original GM
 * Aftermarket plug wires required for fuel injected applications.

* Engine Mounts: Speedway Motors part# 910-18012 (DO NOT use Big Block Chevy engine mount brackets. They are approximately .250" narrower and will lower the engine, causing ground clearance issues.)

Use 916-7081 Kit, or 910-18012 Mount & 910-18016 LS Adapt Plates.

STAINLESS STEEL **PRO CRUISER**

BLOCK HUGGER HEADERS

► **FITS: SBC 23°**

1 YEAR LIMITED WARRANTY

For applications where space is a primary concern, sometimes a short header is the only solution. For these cases, we offer our all-stainless Pro Cruiser Series block hugger header. They feature the same exceptional levels of quality, fit, and finish in a compact package.

- SBC Standard 23° 6-bolt pattern.
- 0.375" flange.
- 1.625" primaries.
- 2.500" collector.
- 2.000" reducer cones.
- 100% stainless steel construction.
- Includes bolts & gaskets.



DESCRIPTION

BLOCK HUGGER HOT ROD HEADERS (Fits Straight Head Plugs Only)

PART#

730-10010



Machined flange is flat ground for proper fit and leak-free performance.

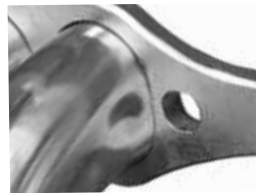

Machined flange features unique bevel that adds a quality look.

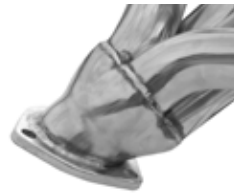

High-flow contoured collector for increased power.



Finished welds offer smooth exhaust flow and excellent seal.





HIGH PERFORMANCE

- Perfect, direct bolt-on fit.
- 0.375" Thick CNC laser-cut flanges.
- 4-Bolt ball & socket collector flanges.
- All flanges machine surfaced after welding.
- 3.000" Wide, 2-bolt band clamps.
- Optimized tube length for Hp and torque.
- 100% jig assembled and checked for an excellent fit.
- Triple layer stainless steel gaskets.
- T304 stainless steel construction.
- Detailed instructions & all hardware included.

HOW TO PURCHASE YOUR DYNATECH® EXHAUST SYSTEM

1 HEADERS

The headers consist of a long tube set of headers with all of the required hardware included for the installation. The headers alone cannot be installed as a "Bolt In" to your factory catalytic converters and system.



2 INTERMEDIATE SECTION

The intermediate section consists of the required components to connect the headers to your factory or aftermarket "Cat-Back" exhaust system. In most cases, you have two choices when it comes to selecting your intermediate section. You can choose either the "Catted" or "Non Catted" version.

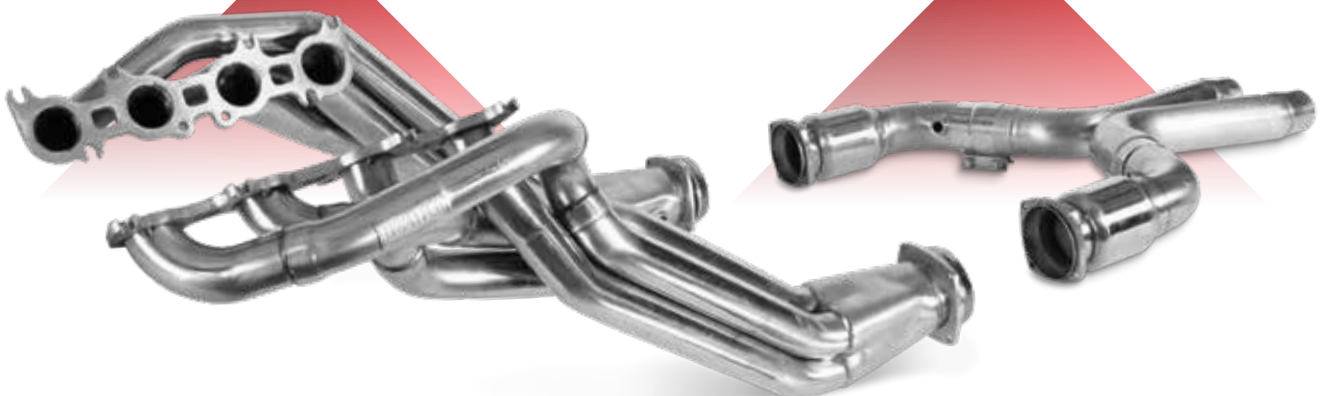

These products are intended for racing and off-road applications. Not legal for sale or use in the state of California, nor in states which have adopted California emission standards.

HIGH PERFORMANCE QUICK GUIDE

FORD



APPLICATION	YEAR	ENGINE	HEADERS	CATTED	NON-CATTED	HP GAIN	INST. TIME	PAGE
MUSTANG GT	'18 - '19	5.0L	722-44310	722-75320	722-75330	32	5-7 hrs	29
MUSTANG SHELBY GT350	'15 - '17	5.0L	722-65310	722-65320	722-65330	26	5-6 hrs	30
MUSTANG GT 5.0	'11 - '14	5.0L	722-74310	722-74320	722-74330	32	5-7 hrs	31
MUSTANG GT 5.0	'15 - '17	5.0L	722-74310	722-75320	722-75330	32	5-7 hrs	31
MUSTANG SHELBY GT500	'07 - '10	ALL	722-64310	722-54320	722-54330	15	6-8 hrs	32
MUSTANG SHELBY GT500	'11 - '14	ALL	722-84310	722-74420	722-74330	15	6-8 hrs	32
MUSTANG GT	'05 - '10	4.6L	722-54310	722-54320	722-54330	30	5-7 hrs	33

DODGE



APPLICATION	YEAR	ENGINE	HEADERS	CATTED	NON-CATTED	HP GAIN	INST. TIME	PAGE
CHALLENGER, MAGNUM, CHARGER, 300C	'05 - '17	5.7L HEMI	724-73310	724-73320	724-73330	30	5-7 hrs	34
CHALLENGER, MAGNUM, CHARGER, 300C	'05 - '17	SRT-8 6.1L & 6.4L HEMI	728-73310	728-73320	728-73330	30	5-7 hrs	34

GM



APPLICATION	YEAR	ENGINE	HEADERS	CATTED	NON-CATTED	HP GAIN	INST. TIME	PAGE
CORVETTE C7	'14 - '18	V8	715-63810	715-63820	715-63830	25	6-8 hrs	35
CORVETTE C7 Z06	'14 - '18	V8	715-63810	715-63920	715-63830	25	6-8 hrs	35
CORVETTE C6	'05 - '08	V8	715-63510	715-63520	715-63530	25	4-6 hrs	36
CORVETTE C6	'09 - '13	V8	715-63510	715-63540	715-63550	25	4-6 hrs	36
CORVETTE C6 Z06	'05 - '13	V8	715-63510	715-63620	715-63630	25	4-6 hrs	36
CORVETTE C5	'97 - '00	V8	715-73610	715-73720	715-73730	30	4-6 hrs	37
CORVETTE C5	'01 - '03	V8	715-73710	715-73720	715-73730	30	4-6 hrs	37
CORVETTE C5	'04	V8	715-74710	715-74720	715-74730	30	4-6 hrs	37
CADILLAC CTS-V 1.875"	'09 - '15	6.2L	715-75010	715-75020	715-75030	64	4-6 hrs	38
CADILLAC CTS-V 2.000"	'09 - '15	6.2L	715-75210	715-75040	715-75050	64	4-6 hrs	38
CAMARO SS/ZL1 1.875"	'16 - '17	6.2L	715-75510	715-75520	715-75530	28	4-6 hrs	39
CAMARO SS/ZL1 2.000"	'16 - '17	6.2L	715-76010	715-75520	715-75530	28	4-6 hrs	39
CAMARO (5TH GEN.) 1.875"	'10 - '15	6.2L	715-74010	715-73920	715-73930	36	4-6 hrs	40
CAMARO (5TH GEN.) 2.000"	'10 - '15	6.2L	715-74110	715-74020	715-74030	36	4-6 hrs	40
CAMARO, FIREBIRD, F-BODY	'98 - '99	V8	715-73210	715-73220	715-73230	19	4-6 hrs	41
CAMARO, FIREBIRD, F-BODY	'00 - '02	V8	715-73310	715-73220	715-73230	19	4-6 hrs	41

These products are intended for racing and off-road applications. Not legal for sale or use in the state of California, nor in states which have adopted California emission standards.

FEATURES & BENEFITS

WHAT IS IN A QUALITY SYSTEM?



*0.375" THICK
CNC LASER-CUT
FLANGES*



*DONUT
GASKET*



*TRIPLE LAYER
STAINLESS
STEEL GASKETS*



*3.000" WIDE / 2-BOLT
BAND CLAMPS*

PERFECT, DIRECT BOLT-ON FIT

100% *JIG ASSEMBLED AND CHECKED
FOR AN EXCELLENT FIT*

OPTIMIZED TUBE LENGTH
FOR INCREASED H.P. AND TORQUE

100% T304 *STAINLESS STEEL
CONSTRUCTION*

ALL FLANGES



*MACHINE SURFACED
AFTER WELDING*

MADE IN THE U.S.A.



*DETAILED
INSTRUCTIONS
& HARDWARE
INCLUDED*

These products are intended for racing and off-road applications. Not legal for sale or use in the state of California, nor in states which have adopted California emission standards.

NEW!

SUPERMAXX®

2018-19 MUSTANG GT

STAINLESS STEEL HEADERS

LIMITED LIFETIME WARRANTY

MADE IN THE U.S.A.



5.000"
INTERMEDIATE
TUBES W/ CATS



5.000"
INTERMEDIATE
TUBES W/O CATS



FEATURES

PRIMARY TUBE SIZE: 1.875"

COLLECTOR SIZE: 3.000"

SYSTEM TUBE SIZE: 3.000"

MATERIAL: T304 Stainless

TRANS: Manual & Automatic

INCLUDED: Detailed instructions and all needed hardware.

FIT: Some cutting required for any factory or O.E. size aftermarket cat back.

INSTALL TIME: 5-7 hours

+32 HORSEPOWER
+20 FT-LBS TORQUE

*Ceramic Coating Services
are Available.*

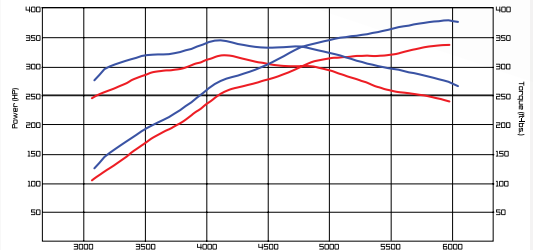

Dyno Chart

■ Stock ■ SuperMAXX®

APPLICATION

2018-19 MUSTANG GT

HEADERS ONLY

722-44310



INTERMEDIATE TUBES W/ CATS

722-75320



INTERMEDIATE TUBES W/O CATS

722-75330

These products are intended for racing and off-road applications. Not legal for sale or use in the state of California, nor in states which have adopted California emission standards.



SUPERMAXX®

'15 - '17 MUSTANG SHELBY GT350

STAINLESS STEEL HEADERS

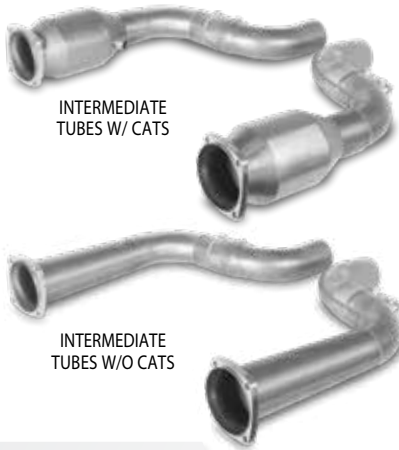

INTERMEDIATE
TUBES W/ CATS

INTERMEDIATE
TUBES W/O CATS



FEATURES

PRIMARY TUBE SIZE: 1.750" - 1.875" Stepped
COLLECTOR SIZE: 3.000"
SYSTEM TUBE SIZE: 3.000"
MATERIAL: T304 Stainless
TRANS: Manual & Automatic
INCLUDED: Detailed instructions and all needed hardware.
FIT: Direct Bolt-Up to any factory or O.E. size aftermarket cat back.
INSTALL TIME: 5-6 hours

+26 HORSEPOWER
+13 FT-LBS TORQUE
**with a tune.*

*Ceramic Coating Services
 are Available.*

LIMITED LIFETIME WARRANTY
MADE IN THE U.S.A.

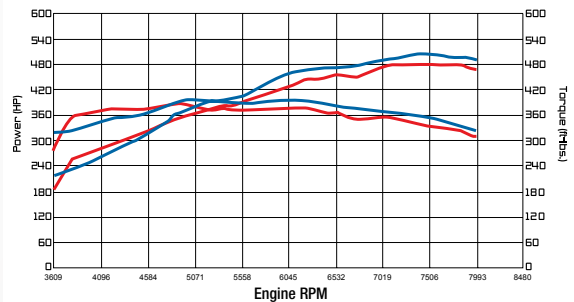

Dyno Chart ■ Stock ■ SuperMAXX®

APPLICATION

'15 - '17 MUSTANG GT350

HEADERS ONLY

722-65310



INTERMEDIATE TUBES W/ CATS

722-65320



INTERMEDIATE TUBES W/O CATS

722-65330



SUPERMAXX®

'11-'17 MUSTANG 5.0

STAINLESS STEEL HEADERS

LIMITED LIFETIME WARRANTY
MADE IN THE U.S.A.



5.000"
INTERMEDIATE
TUBES W/ CATS



5.000"
INTERMEDIATE
TUBES W/O CATS



FEATURES

- PRIMARY TUBE SIZE:** 1.750" - 1.875"
- COLLECTOR SIZE:** 3.000"
- SYSTEM TUBE SIZE:** 3.000"
- MATERIAL:** T304 Stainless
- TRANS:** Manual & Automatic
- INCLUDED:** Detailed instructions and all needed hardware.
- FIT:** Some cutting required for any factory or O.E. size aftermarket cat back.
- INSTALL TIME:** 5-7 hours

+32 HORSEPOWER
+20 FT-LBS TORQUE

*Ceramic Coating Services
 are Available.*

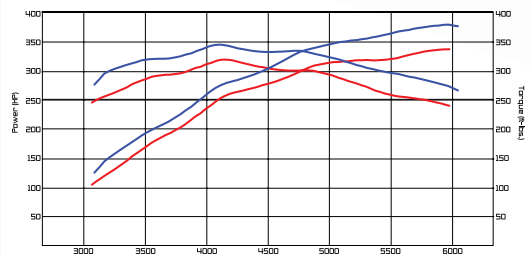

Dyno Chart ■ Stock ■ SuperMAXX®

APPLICATION	HEADERS ONLY	+	INTERMEDIATE TUBES W/ CATS	OR	INTERMEDIATE TUBES W/O CATS	OR	SUPERCHARGED SUPERCATTED 3.000"
'15 - '17 MUSTANG 5.0/CONVERTIBLE	722-74310		722-75320		722-75330		722-75420
'11 - '14 MUSTANG 5.0	722-74310		722-74320		722-74330		722-74420

These products are intended for racing and off-road applications. Not legal for sale or use in the state of California, nor in states which have adopted California emission standards.



SUPERMAXX®

'07 - '14 MUSTANG SHELBY GT500

STAINLESS STEEL HEADERS

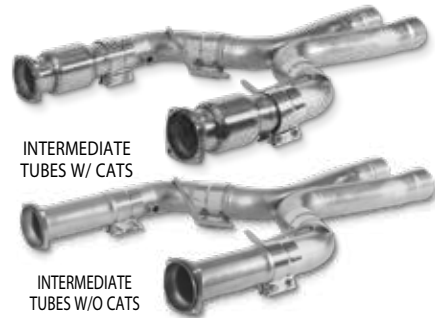

INTERMEDIATE TUBES W/ CATS

INTERMEDIATE TUBES W/O CATS

FEATURES

- PRIMARY TUBE SIZE:** 1.875"
- COLLECTOR SIZE:** 3.000"
- SYSTEM TUBE SIZE:** 2.500" or 3.000"
- MATERIAL:** T304 Stainless
- TRANS:** Manual & Automatic
- INCLUDED:** Detailed instructions and all needed hardware.
- FIT:** Direct Bolt-Up to any factory or O.E. size aftermarket cat back.
- INSTALL TIME:** 6-8 hours

LIMITED LIFETIME WARRANTY
MADE IN THE U.S.A.

Dyno Chart

■ Stock ■ SuperMAXX®

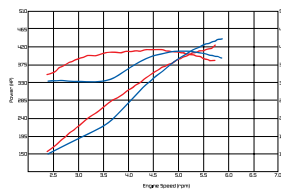

'07-'12

▶ **+15 HORSEPOWER**
▶ **+24 FT-LBS TORQUE**

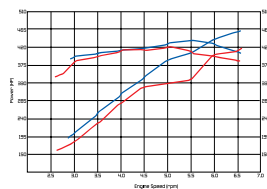

2013

▶ **+49 HORSEPOWER**
▶ **+32 FT-LBS TORQUE**

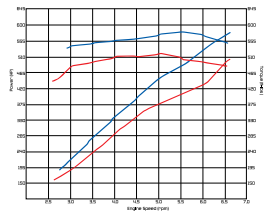

2014

▶ **+70 HORSEPOWER**
▶ **+59 FT-LBS TORQUE**

Ceramic Coating Services are A

DESCRIPTION	'07 - '10 SHELBY GT500	'11 - '14 SHELBY GT500
HEADERS ONLY	722-64310	722-84310
+ 2.500" INTERMEDIATE TUBES W/ CATS	722-54320	-
2.500" INTERMEDIATE TUBES W/O CATS	722-54330	-
3.000" INTERMEDIATE TUBES W/ CATS (SUPER CATTED)	-	722-74420
3.000" INTERMEDIATE TUBES W/O CATS	-	722-74330



SUPERMAXX®
'05 - '10 MUSTANG GT
STAINLESS STEEL HEADERS

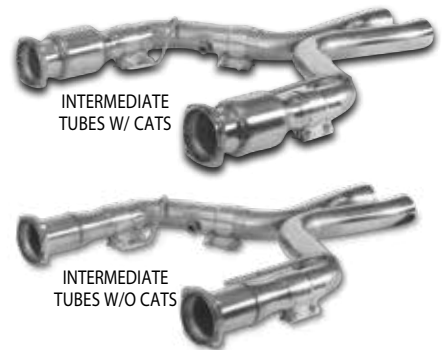

INTERMEDIATE
TUBES W/ CATS

INTERMEDIATE
TUBES W/O CATS

FEATURES

- PRIMARY TUBE SIZE:** 1.750"
- COLLECTOR SIZE:** 3.000"
- SYSTEM TUBE SIZE:** 2.500"
- MATERIAL:** T304 Stainless
- TRANS:** Manual & Automatic
- INCLUDED:** Detailed instructions and all needed hardware.
- FIT:** Direct Bolt-Up to any factory or O.E. size aftermarket cat back.
- INSTALL TIME:** 5-7 hours

+30 HORSEPOWER
+30 FT-LBS TORQUE

*Ceramic Coating Services
are Available.*

LIMITED LIFETIME WARRANTY
MADE IN THE U.S.A.

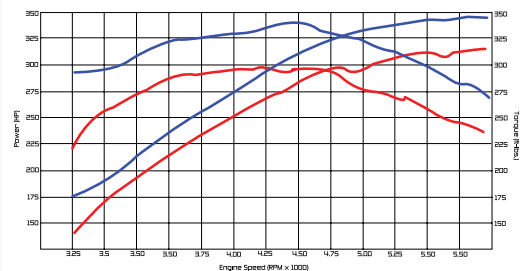

Dyno Chart

■ Stock ■ SuperMAXX®

APPLICATION

'05 - '10 MUSTANG GT

**HEADERS
ONLY**

722-54310



**INTERMEDIATE
TUBES W/ CATS**

722-54320



**INTERMEDIATE
TUBES W/O CATS**

722-54330

These products are intended for racing and off-road applications. Not legal for sale or use in the state of California, nor in states which have adopted California emission standards.



SUPERMAXX

'05 - '17 CHALLENGER / CHARGER / 300C / MAGNUM

**LIMITED LIFETIME WARRANTY
MADE IN THE U.S.A.**

STAINLESS STEEL HEADERS

MATERIAL: T304 Stainless

TRANS: Manual & Automatic

INCLUDED: Detailed instructions and all needed hardware.

FIT: Direct Bolt-Up to any factory or O.E. size aftermarket cat back.

INSTALL TIME: 5-7 hours

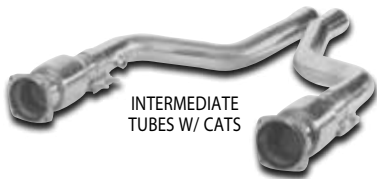

INTERMEDIATE
TUBES W/ CATS

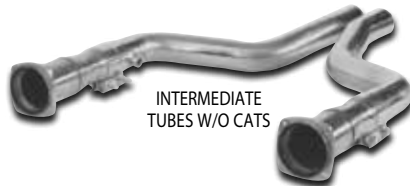

INTERMEDIATE
TUBES W/O CATS

5.7 Hemi

PRIMARY TUBE SIZE: 1.750"
COLLECTOR SIZE: 3.000"
SYSTEM TUBE SIZE: 2.500"

**+30 HORSEPOWER
+30 FT-LBS TORQUE**

SRT-8 (6.1 & 6.4 Hemi)

PRIMARY TUBE SIZE: 1.875"
COLLECTOR SIZE: 3.000"
SYSTEM TUBE SIZE: 2.750" & 3.000"

**+30 HORSEPOWER
+24 FT-LBS TORQUE**

*Ceramic Coating Services
are Available.*



SRT-8
Port Matched
Flange

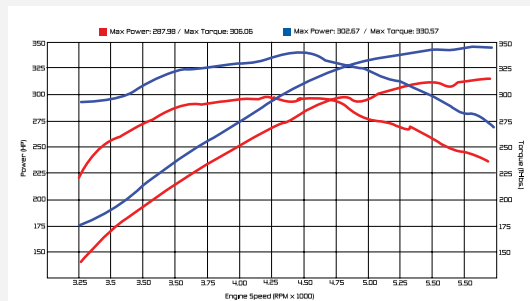

Dyno Chart ■ Stock ■ SuperMAXX®

DESCRIPTION	5.7 HEMI
HEADERS ONLY	724-73310
INTERMEDIATE TUBES W/ CATS	724-73320
INTERMEDIATE TUBES W/O CATS	724-73330

DESCRIPTION	SRT-8
HEADERS ONLY	728-73310
INTERMEDIATE TUBES W/ CATS	728-73320
INTERMEDIATE TUBES W/O CATS	728-73330
3.000" INTERMEDIATE TUBES W/ CATS	728-73340
3.000" INTERMEDIATE TUBES W/O CATS	728-73350

These products are intended for racing and off-road applications. Not legal for sale or use in the state of California, nor in states which have adopted California emission standards.



SUPERMAXX®

'14 - '18 CORVETTE C7/Z06

STAINLESS STEEL HEADERS

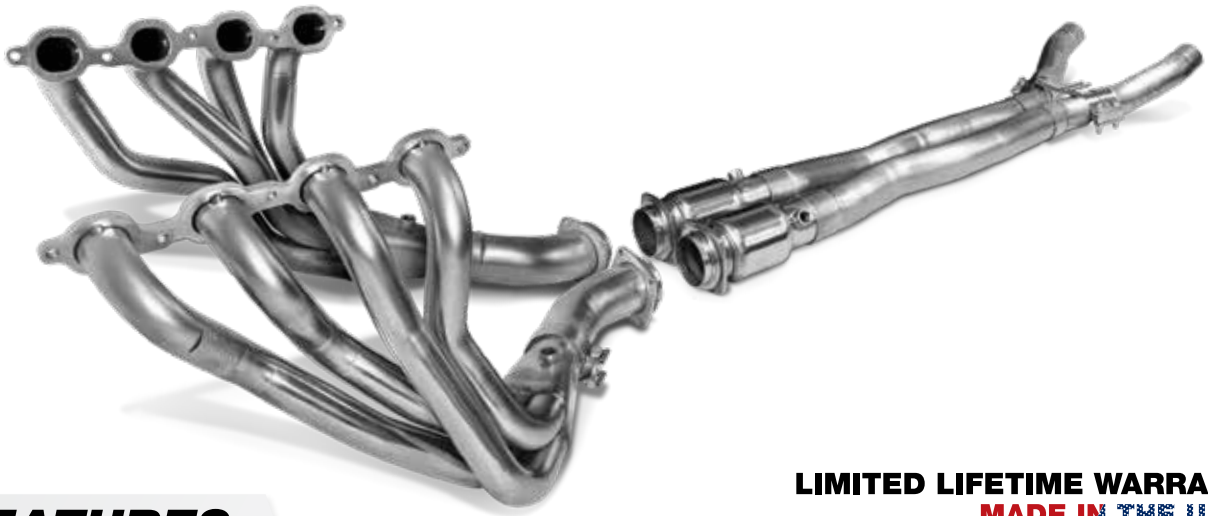

FEATURES

- PRIMARY TUBE SIZE: 1.875"
- COLLECTOR SIZE: 3.000"
- SYSTEM TUBE SIZE: 3.000"
- MATERIAL: T304 Stainless
- TRANS: Manual & Automatic
- INCLUDED: Detailed instructions, and all needed hardware.
- FIT: Direct Bolt-Up to any factory or O.E. size aftermarket cat back.
- INSTALL TIME: 6-8 hours

+25 HORSEPOWER
+25 FT-LBS TORQUE

*Ceramic Coating Services
are Available.*

LIMITED LIFETIME WARRANTY
MADE IN THE U.S.A.

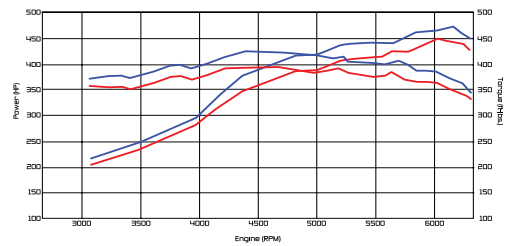

Dyno Chart ■ Stock ■ SuperMAXX®

APPLICATION	HEADERS ONLY	+	INTERMEDIATE TUBES W/ CATS	OR	INTERMEDIATE TUBES W/O CATS
'14 - '18 CORVETTE C7	715-63810		715-63820		715-63830
'14 - '18 CORVETTE Z06	715-63810		715-63920		715-63830

These products are intended for racing and off-road applications. Not legal for sale or use in the state of California, nor in states which have adopted California emission standards.

SUPERMAXX

'05 - '13 CORVETTE C6/Z06

STAINLESS STEEL HEADERS

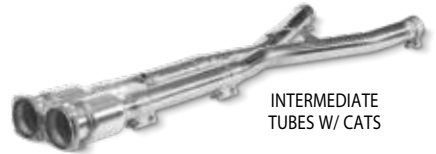

LIMITED LIFETIME WARRANTY
MADE IN THE U.S.A.

FEATURES

- PRIMARY TUBE SIZE:** 1.875"
- COLLECTOR SIZE:** 3.000"
- SYSTEM TUBE SIZE:** 2.500" or 3.000"
- MATERIAL:** T304 Stainless
- TRANS:** Manual & Automatic
- INCLUDED:** Detailed instructions and all needed hardware.
- FIT:** Direct Bolt-Up to any factory or O.E. size aftermarket cat back.
- INSTALL TIME:** 4-6 hours

+25 HORSEPOWER
+25 FT-LBS TORQUE

Ceramic Coating Services are Available.

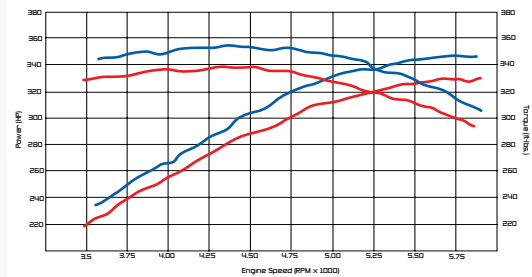

Dyno Chart ■ Stock ■ SuperMAXX®

APPLICATION	HEADERS ONLY	+	INTERMEDIATE TUBES W/ CATS	OR	INTERMEDIATE TUBES W/O CATS
'05 - '08 CORVETTE C6	715-63510		715-63520		715-63530
'09 - '13 CORVETTE C6	715-63510		715-63540		715-63550
'05 - '13 CORVETTE Z06	715-63510		715-63620		715-63630

These products are intended for racing and off-road applications. Not legal for sale or use in the state of California, nor in states which have adopted California emission standards.

SUPERMAXX

'97-'04 CORVETTE C5

STAINLESS STEEL HEADERS



INTERMEDIATE TUBES W/ CATS

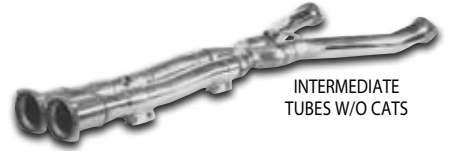

INTERMEDIATE TUBES W/O CATS



LIMITED LIFETIME WARRANTY
MADE IN THE U.S.A.

FEATURES

PRIMARY TUBE SIZE: 1.750"

COLLECTOR SIZE: 3.000"

SYSTEM TUBE SIZE: 2.500"

MATERIAL: T304 Stainless

TRANS: Manual & Automatic

INCLUDED: Detailed instructions and all needed hardware.

FIT: Direct Bolt-Up to any factory or O.E. size aftermarket cat back.

Works with convertible models.

INSTALL TIME: 4-6 hours

+30 HORSEPOWER
+30 FT-LBS TORQUE

Ceramic Coating Services are Available.

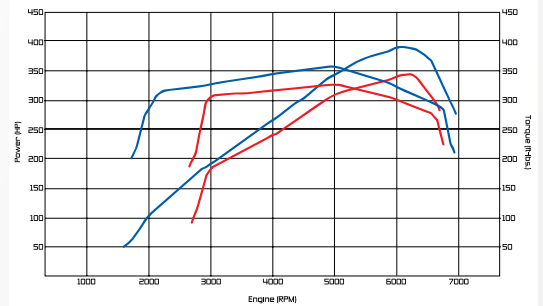

Dyno Chart ■ Stock ■ SuperMAXX®

APPLICATION	HEADERS ONLY	+	INTERMEDIATE TUBES W/ CATS	OR	INTERMEDIATE TUBES W/O CATS
'97 - '00 CORVETTE C5	715-73610		715-73720		715-73730
'01 - '03 CORVETTE C5	715-73710		715-73720		715-73730
'04 CORVETTE C5	715-74710		715-74720		715-74730

These products are intended for racing and off-road applications. Not legal for sale or use in the state of California, nor in states which have adopted California emission standards.

SUPERMAXX

'09 - '15 CADILLAC CTS-V

STAINLESS STEEL HEADERS

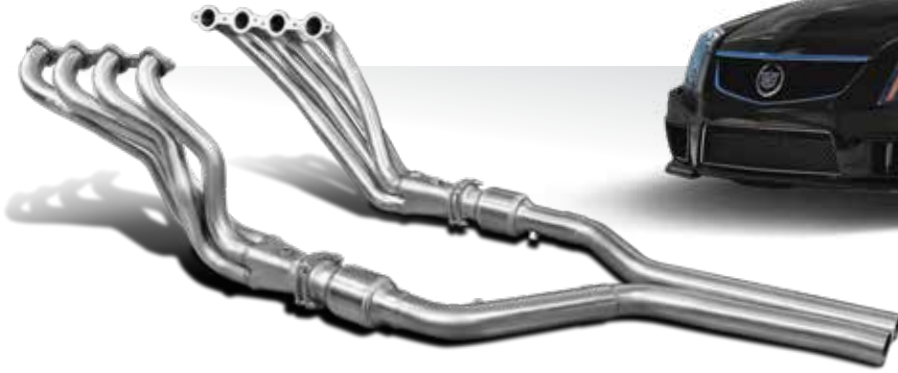

LIMITED LIFETIME WARRANTY
MADE IN THE U.S.A.

FEATURES

- ENGINE:** 6.2L
- PRIMARY TUBE SIZE:** 1.875 or 2.000"
- COLLECTOR SIZE:** 3.000"
- SYSTEM TUBE SIZE:** 2.500" or 3.000"
- MATERIAL:** T304 Stainless
- TRANS:** Manual & Automatic
- INCLUDED:** Detailed instructions and all needed hardware.
- FIT:** Some cutting required for any factory or O.E. size aftermarket cat back.
- INSTALL TIME:** 4-6 hours

+64 HORSEPOWER
+58 FT-LBS TORQUE

Ceramic Coating Services are Available.

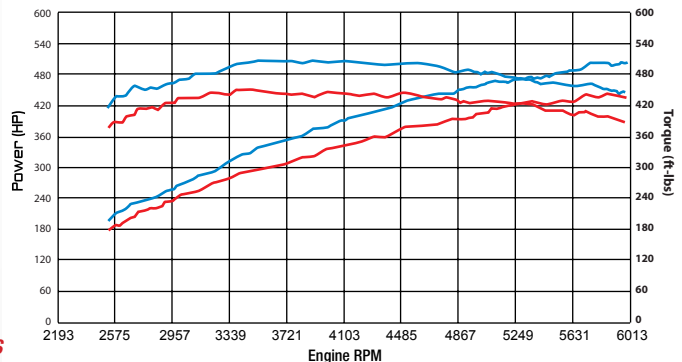

Dyno Chart

■ Stock ■ SuperMAXX®

DESCRIPTION

PART #

HEADERS ONLY (1.875")

715-75010

HEADERS ONLY (2.000")

715-75210



2.500" INTERMEDIATE TUBES W/ CATS

715-75020

2.500" INTERMEDIATE TUBES W/O CATS

715-75030

3.000" INTERMEDIATE TUBES W/ CATS

715-75040

3.000" INTERMEDIATE TUBES W/O CATS

715-75050

These products are intended for racing and off-road applications. Not legal for sale or use in the state of California, nor in states which have adopted California emission standards.



SUPERMAXX®

'16 - '17 CAMARO SS/ZL1

STAINLESS STEEL HEADERS

INTERMEDIATE
TUBES KIT
(sold separately)



LIMITED LIFETIME WARRANTY
MADE IN THE U.S.A.

FEATURES

- ENGINE:** 6.2L
- PRIMARY TUBE SIZE:** 1.875" or 2.000"
- COLLECTOR SIZE:** 3.000"
- SYSTEM TUBE SIZE:** 2.750"
- MATERIAL:** T304 Stainless
- TRANS:** Manual & Automatic
- INCLUDED:** Detailed instructions and all needed hardware.
- FIT:** Some cutting required for any factory or O.E. size aftermarket cat back.
- INSTALL TIME:** 4-6 Hours

+28 HORSEPOWER
+10 FT-LBS TORQUE

*Ceramic Coating Services
are Available.*

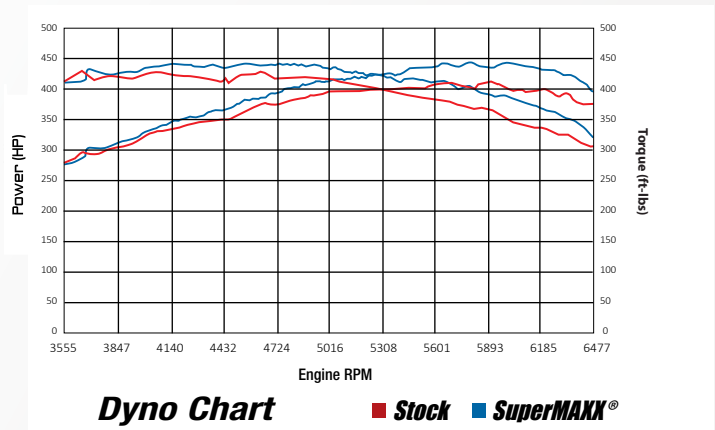

DESCRIPTION	HEADERS ONLY	+	2.750" INTERMEDIATE TUBES W/ CATS	OR	2.750" INTERMEDIATE TUBES W/O CATS	OR	2.750" INT. TUBES W/ POWERCAT PLUS
1.875"	715-75510		715-75520		715-75530		715-76020
2.000"	715-76010		715-75520		715-75530		715-76020

These products are intended for racing and off-road applications. Not legal for sale or use in the state of California, nor in states which have adopted California emission standards.

SUPERMAXX

'10 - '15 CAMARO (6.2L V8)

STAINLESS STEEL HEADERS

*Fits hard top and convertible models.

**NOW AVAILABLE
FOR Z28**

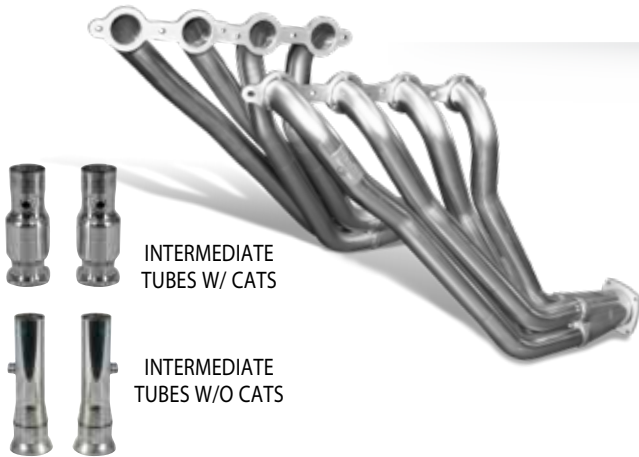

INTERMEDIATE
TUBES W/ CATS

INTERMEDIATE
TUBES W/O CATS



*2010-2015 Chevy Camaro SS
Coupe and Convertible
Stainless Steel Exhaust System (Part #793-73925)
Will not fit Z/28 or ZL1.
Not compatible with factory ground effects.
For models with factory round tail pipes.
May not fit with rectangle rear fascia.

FEATURES

- PRIMARY TUBE SIZE:** 1.875" or 2.000"
- COLLECTOR SIZE:** 3.000"
- SYSTEM TUBE SIZE:** 2.500", 2.750" or 3.000"
- MATERIAL:** T304 Stainless
- TRANS:** Manual & Automatic
- INCLUDED:** Detailed instructions and all needed hardware.
- FIT:** Direct Bolt-Up to any factory or O.E. size aftermarket cat back.
- INSTALL TIME:** 4-6 hours

**+36 HORSEPOWER
+25 FT-LBS TORQUE**

*Ceramic Coating Services
are Available.*

LIMITED LIFETIME WARRANTY MADE IN THE U.S.A.

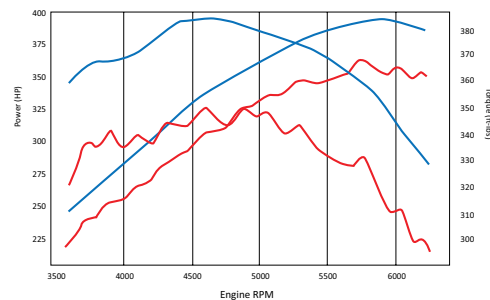

Dyno Chart ■ Stock ■ SuperMAXX®

DESCRIPTION	Z28 CAMARO	'10 - '15 CAMARO	ZL1 + SUPERCHARGED
HEADERS ONLY (1.875")	715-74010	715-74010	715-74010
HEADERS ONLY (2.000")	715-74110	715-74110	715-74110
+ 2.500" INTERMEDIATE TUBES W/ CATS	.	715-73920	.
2.500" INTERMEDIATE TUBES W/O CATS	.	715-73930	.
2.750" INTERMEDIATE TUBES W/ CATS	715-75120	.	.
2.750" INTERMEDIATE TUBES W/O CATS	715-74230	.	.
3.000" INTERMEDIATE TUBES W/ CATS	.	715-74020	.
3.000" INTERMEDIATE TUBES W/O CATS	715-74330	715-74030	.
CAT-BACK EXHAUST SYSTEM ('10-'15)*	.	793-73925	.
2.500" SUPERCATTED INTER. SECTION	.	.	715-74120
3.000" SUPERCATTED INTER. SECTION	.	.	715-74220

These products are intended for racing and off-road applications. Not legal for sale or use in the state of California, nor in states which have adopted California emission standards.

SUPERMAXX[®]

'98 - '02 CAMARO / TRANS AM

STAINLESS STEEL HEADERS

* Will not fit convertible models.

LIMITED LIFETIME WARRANTY
MADE IN THE U.S.A.



FEATURES

PRIMARY TUBE SIZE: 1.750"

COLLECTOR SIZE: 3.000"

SYSTEM TUBE SIZE: 2.500"

MATERIAL: T304 Stainless

TRANS: Manual & Automatic

INCLUDED: Detailed instructions and all needed hardware.

FIT: Direct Bolt-Up to any factory or O.E. size aftermarket cat back.

INSTALL TIME: 4-6 hours

+19 HORSEPOWER
+15 FT-LBS TORQUE

*Ceramic Coating Services
are Available.*

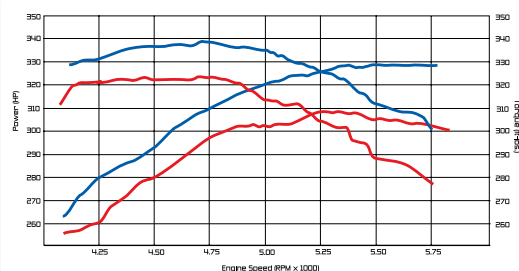

Dyno Chart

■ Stock ■ SuperMAXX[®]

APPLICATION

'98 - '99 4TH GENERATION F-BODY

'00 - '02 4TH GENERATION F-BODY

HEADERS ONLY

715-73210

715-73310



INTERMEDIATE TUBES W/ CATS

715-73220

715-73220



INTERMEDIATE TUBES W/O CATS

715-73230

715-73230

These products are intended for racing and off-road applications. Not legal for sale or use in the state of California, nor in states which have adopted California emission standards.

ACCESSORIES

POWERCAT CATALYTIC CONVERTERS

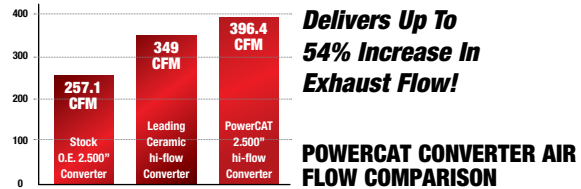

POWERCAT CATALYTIC CONVERTERS

- Premium metallic substrate.
- Superior strength and durability.
- Stainless steel housing.
- Quicker lightoff due to higher thermal conductivity.
- Low pressure drop.
- Higher flow rates compared to stock and most after-market converters.

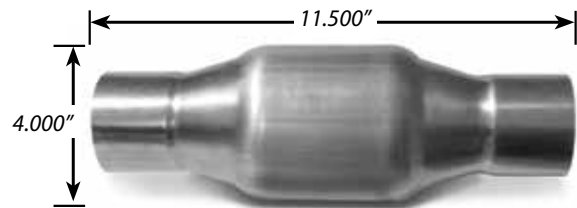

NOTE: These products are intended for racing and off-road applications. Not legal for sale or use in the state of California, nor in states which have adopted California emission standards.

DESCRIPTION	PART#
POWERCAT 2.500" INLET AND OUTLET	779-40025
POWERCAT 3.000" INLET AND OUTLET	779-40030

POWERCAT PLUS CATALYTIC CONVERTERS

- **Designed for supercharged & higher horsepower applications.**
- Premium metallic substrate.
- Superior strength and durability.
- Stainless steel housing.
- Quicker lightoff due to higher thermal conductivity.
- Low pressure drop.
- Higher flow rates compared to stock and most after-market converters.

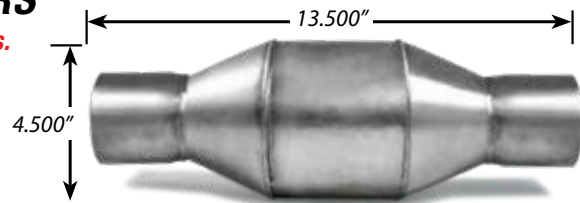

NOTE: These products are intended for racing and off-road applications. Not legal for sale or use in the state of California, nor in states which have adopted California emission standards.

DESCRIPTION	PART#
UNIVERSAL POWERCAT PLUS 2.500" INLET / OUTLET	779-50025
UNIVERSAL POWERCAT PLUS 3.000" INLET / OUTLET	779-50030

ACCESSORIES

BALL & SOCKET KIT



Unlike common metal to metal connections, Dynatech®'s unique "4-Bolt, Ball and Socket" connection uses a 0.500" thick, tapered donut gasket, which allows for expansion and contraction while maintaining a long lasting leak free seal. We also use four bolts instead of two or three for added durability. For use with any 3.000" O.D. collector and 100% stainless steel.

DESCRIPTION	TUBE SIZE	PART#
STUB KIT	2.500"	791-09025
STUB KIT	3.000"	791-09030

STEPPED BAND CLAMPS

Smooth transition taper allows proper fit to seal expanded slip-fit connections. Great for muffler, tail pipe, and merge pipe connections.



DESCRIPTION	PART#
BAND CLAMP FOR 2.500" JUNCTION	789-70250
BAND CLAMP FOR 2.750" JUNCTION	789-70275
BAND CLAMP FOR 3.000" JUNCTION	789-70300
BAND CLAMP FOR 3.500" JUNCTION	789-70350

Models for 2.500", 2.750", 3.000", or 3.500" pipe sizes. 1 clamp/ pkg.

V-CLAMP KITS



Kit includes two weld-on v-clamp rings and stainless steel v-band clamp. Models for 2.500", 3.000", and 3.500" pipe sizes.

DESCRIPTION	PART#
V-CLAMP COLLAR ASSEMBLY 2.500"	794-91225
V-CLAMP COLLAR ASSEMBLY 3.000"	794-91230
V-CLAMP COLLAR ASSEMBLY 3.500"	794-91235

MANDREL BENT J-BENDS

Dynatech® stocks a complete inventory of mandrel bent J-bends. These are made from premium grade mild steel tubing.

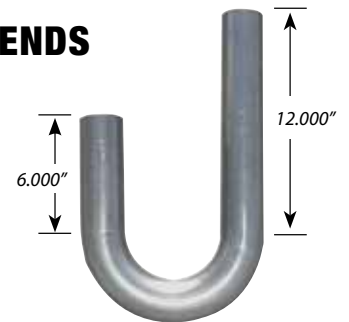

SIZE	CLR	STAINLESS PART#
1.625"	2.625"	794-60302

ACCESSORIES

FLANGES & GASKETS

HIGH PERFORMANCE APPLICATIONS

A great exhaust system starts at the beginning - the flange. One of Dynatech's biggest advantages is our wide selection of port matched flanges. All of our flanges are CNC laser cut for unparalleled quality and fit.













Stainless Steel Flanges



Stainless Steel Gasket



	DESCRIPTION	FLANGE (single)	PORT	X	Y	THICKNESS	GASKET (pair)
	LS1	796-13000	1.750"	1.820"	1.820"	.375"	794-30001
	LS1	796-16061	1.875"	1.940"	1.940"	.375"	794-30001
	LS1	796-16062	2.000"	2.070"	2.070"	.375"	794-30006
	4.6 FORD	796-18061	1.750"	1.824"	1.824"	.375"	794-70001
	4 VALVE COBRA 4.6L	796-16071	1.875"	2.243"	1.465"	.375"	-
	6.1L HEMI	796-10661	1.875"	2.082"	1.508"	.375"	794-20002
	5.7L HEMI DRIVERS SIDE	796-10761	1.750"	1.820"	1.820"	.375"	794-10001
	5.7L HEMI PASS. SIDE	796-10762	1.750"	1.820"	1.820"	.375"	794-10001
	5.4L TRITON FORD 3 VALVE	796-18062	1.625"	1.696"	1.696"	.375"	794-70001
	5.4L FORD (PRE 2004)	796-19061	1.625"	1.696"	1.696"	.375"	794-90001
	5.0L FORD	796-17070	1.750"	1.815"	1.815"	.375"	794-70005
	5.0L FORD	796-17071	1.875"	1.940"	1.940"	.375"	794-70005
	5.3/6.2L CHEVY LT	796-13010	1.750"	1.980"	1.560"	.375"	794-30007
	5.3/6.2L CHEVY LT	796-13011	1.875"	2.100"	1.680"	.375"	794-30007
	5.3/6.2L CHEVY LT	796-13012	2.000"	2.216"	1.796"	.375"	794-30007



TRUCK / SUV

- Perfect, direct bolt-on fit.
- 0.375" Thick CNC laser-cut flanges.
- 3-Bolt ball-&-socket collector flanges.
- All flanges machine surfaced after welding.
- 3.000" Wide, 2-bolt band clamps.
- Optimized tube length for Hp and torque.
- 100% jig assembled and checked for an excellent fit.
- Triple layer stainless steel gaskets.
- T304 stainless steel construction.
- Detailed instructions & all hardware included.

HOW TO PURCHASE YOUR DYNATECH® EXHAUST SYSTEM

1 HEADERS

The headers consist of a long tube set of headers with all of the required hardware included for the installation. The headers alone cannot be installed as a "Bolt In" to your factory catalytic converters and system.

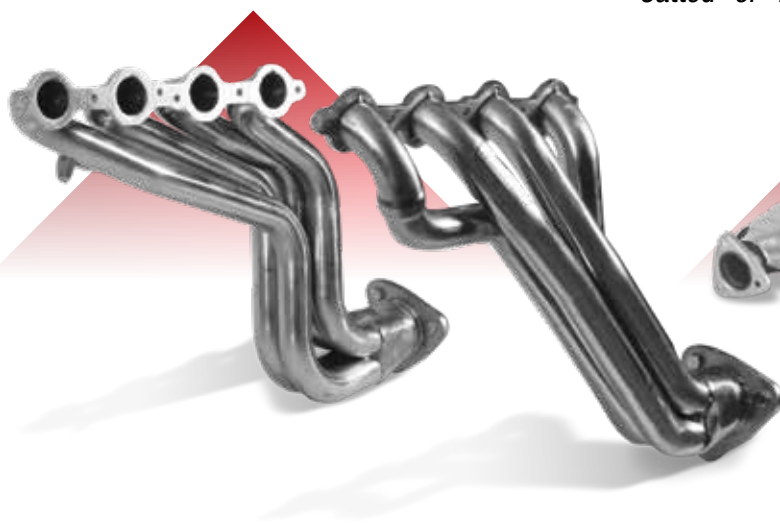

2 INTERMEDIATE SECTION

The intermediate section consists of the required components to connect the headers to your factory or aftermarket "Cat-Back" exhaust system. In most cases, you have two choices when it comes to selecting your intermediate section. You can choose either the "Catted" or "Non Catted" version.

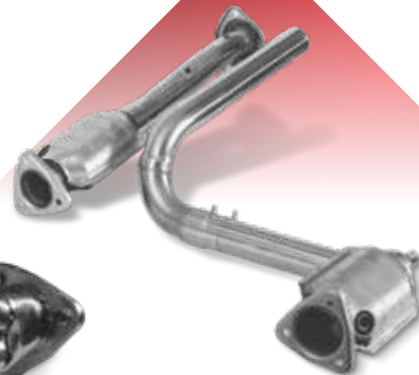

These products are intended for racing and off-road applications. Not legal for sale or use in the state of California, nor in states which have adopted California emission standards.

FORD



APPLICATION	YEAR	ENGINE	HEADERS	CATTED	NON-CATTED	HP GAIN	INST. TIME	PAGE
F-150	'15-'17	5.0L	722-55210	722-54220	722-54230	30	5-7 hrs	47
F-150	'11-'14	5.0L	722-52210	722-52220	722-52230	31	5-7 hrs	48
F-150 2WD	'04 - '08	5.4L	722-62210	722-62320	-	14	4-6 hrs	49
F-150 4WD	'04 - '08	5.4L	722-62210	722-62220	722-62230	14	4-6 hrs	49
F-150 LIGHTNING EDITION	'99 - '04	5.4L	722-84210	722-84320	722-84330	20	4-6 hrs	50
F-150 2WD & 4WD	'99 - '03	5.4L	722-84210	722-84220	-	15	4-6 hrs	50

GM



APPLICATION	YEAR	ENGINE	HEADERS	CATTED	NON-CATTED	HP GAIN	INST. TIME	PAGE
SILVERADO, AVALANCHE, TAHOE, YUKON, DENALI, ESCALADE	'14 - '19	5.3L & 6.2L	715-34110	715-34120	715-44120	32	4-6 hrs	51
	'07 - '13	6.2L	715-14110	715-14620	-	15	4-6 hrs	52
	'07 - '13	4.8, 5.3 & 6.0L	715-14110	715-14420	715-14430	15	4-6 hrs	52
	'99 - '06	6.0L	715-84110	715-84220	715-84230	15	4-6 hrs	53
	'99 - '06	4.8 - 5.3L	715-84110	715-84120	715-84130	25	4-6 hrs	53
H2 HUMMER	'07 - '09	6.0L	715-14110	715-14320	715-14330	25	4-6 hrs	54
H2 HUMMER	'00 - '06	6.0L	715-84110	715-84220	715-84230	25	4-6 hrs	54

DODGE



APPLICATION	YEAR	ENGINE	HEADERS	CATTED	NON-CATTED	HP GAIN	INST. TIME	PAGE
DODGE RAM HEMI 2WD	'04 - '05	5.7L HEMI	724-84310	724-84520	-	17	4-6 hrs	55
DODGE RAM HEMI 4WD	'04 - '05	5.7L HEMI	724-84410	724-84620	-	17	4-6 hrs	55



SUPERMAXX®

'15 - '17 FORD F-150

STAINLESS STEEL HEADERS



INTERMEDIATE
TUBES W/ CATS



INTERMEDIATE
TUBES W/O CATS

FEATURES

- PRIMARY TUBE SIZE:** 1.875"
- COLLECTOR SIZE:** 2.500"
- SYSTEM TUBE SIZE:** 2.500"
- MATERIAL:** T304 Stainless Steel
- TRANS:** Manual & Automatic
- INCLUDED:** Detailed instructions and all needed hardware.
- FIT:** Some cutting required for any factory or O.E. size aftermarket cat back.
- INSTALL TIME:** 5-7 hours

+30 HORSEPOWER
+47 FT-LBS TORQUE

*Ceramic Coating Services
are Available.*

LIMITED LIFETIME WARRANTY
MADE IN THE U.S.A.

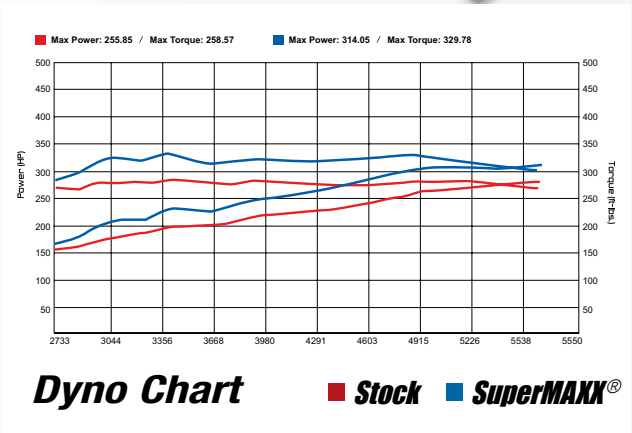

DESCRIPTION

1.875" HEADERS

INTERMEDIATE SECTION W/CATS

INTERMEDIATE SECTION W/O CATS

PART

722-55210

722-54220

722-54230

These products are intended for racing and off-road applications. Not legal for sale or use in the state of California, nor in states which have adopted California emission standards.



SUPERMAXX

'11 - '14 FORD F-150

STAINLESS STEEL HEADERS



FEATURES

PRIMARY TUBE SIZE: 1.750" & 1.875"

COLLECTOR SIZE: 2.500"

SYSTEM TUBE SIZE: 2.500"

MATERIAL: T304 Stainless

TRANS: Manual & Automatic

INCLUDED: Detailed instructions and all needed hardware.

FIT: Some cutting required for any factory or O.E. size aftermarket cat back.

INSTALL TIME: 5-7 hours

+31 HORSEPOWER
+27 FT-LBS TORQUE

LIMITED LIFETIME WARRANTY
MADE IN THE U.S.A.

Ceramic Coating Services are Available.

DESCRIPTION

1.750" HEADER SET

1.875" HEADER SET

CATTED SECTION

NON-CATTED SECTION

PART

722-52210

722-53210

722-52220

722-52230

These products are intended for racing and off-road applications. Not legal for sale or use in the state of California, nor in states which have adopted California emission standards.



SUPERMAXX

'04 - '08 FORD F-150

STAINLESS STEEL HEADERS



INTERMEDIATE
TUBES W/ CATS



INTERMEDIATE
TUBES W/O CATS



FEATURES

PRIMARY TUBE SIZE: 1.625"

COLLECTOR SIZE: 2.500"

SYSTEM TUBE SIZE: 2.500"

MATERIAL: T304 Stainless

TRANS: Manual & Automatic

INCLUDED: Detailed instructions and all needed hardware.

FIT: Direct Bolt-Up to any factory or O.E. size aftermarket cat back.

INSTALL TIME: 4-6 hours

+14 HORSEPOWER
+9 FT-LBS TORQUE

LIMITED LIFETIME WARRANTY
MADE IN THE U.S.A.

Ceramic Coating Services are Available.

DESCRIPTION	'04 - '08 2WD (5.4L)	'04 - '08 4WD (5.4L)
HEADERS ONLY	722-62210	722-62210
INTERMEDIATE TUBES W/ CATS	722-62320	722-62220
INTERMEDIATE TUBES W/O CATS	.	722-62230

These products are intended for racing and off-road applications. Not legal for sale or use in the state of California, nor in states which have adopted California emission standards.

SUPERMAXX®

'99 - '03 FORD F-150 '99 - '04 FORD LIGHTNING

STAINLESS STEEL HEADERS



CAT BACK EXHAUST SYSTEM FOR LIGHTNING ONLY



FEATURES

PRIMARY TUBE SIZE: 1.625"
COLLECTOR SIZE: 2.500"
SYSTEM TUBE SIZE: 2.500"
MATERIAL: T304 Stainless
TRANS: Manual & Automatic
INCLUDED: Detailed instructions and all needed hardware.
FIT: Direct Bolt-Up to any factory or O.E. size aftermarket cat back.
INSTALL TIME: 4-6 hours

+20 HORSEPOWER
+14 FT-LBS TORQUE

LIMITED LIFETIME WARRANTY
MADE IN THE U.S.A.

Ceramic Coating Services are Available.



INTERMEDIATE TUBES W/ CATS FOR F-150

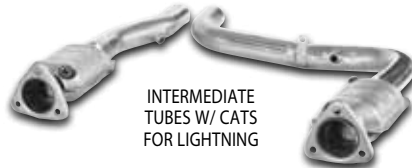

INTERMEDIATE TUBES W/ CATS FOR LIGHTNING



INTERMEDIATE TUBES W/O CATS FOR LIGHTNING

DESCRIPTION	'99 - '03 F-150 2WD/4WD (5.4L)	'99 - '04 LIGHTNING
HEADERS ONLY	722-84210	722-84210
INTERMEDIATE TUBES W/ CATS	722-84220	722-84320
INTERMEDIATE TUBES W/O CATS	.	722-84330
CAT BACK SYSTEM: X-PIPE W/ DUAL 4.000" MUFFLERS	.	722-84231

SUPERMAXX

'14 - '19 CHEVY/GMC 1500 TRUCK & SUV

STAINLESS STEEL HEADERS

NEW!

LIMITED LIFETIME WARRANTY
MADE IN THE U.S.A.



+32 HORSEPOWER
+43 FT-LBS TORQUE

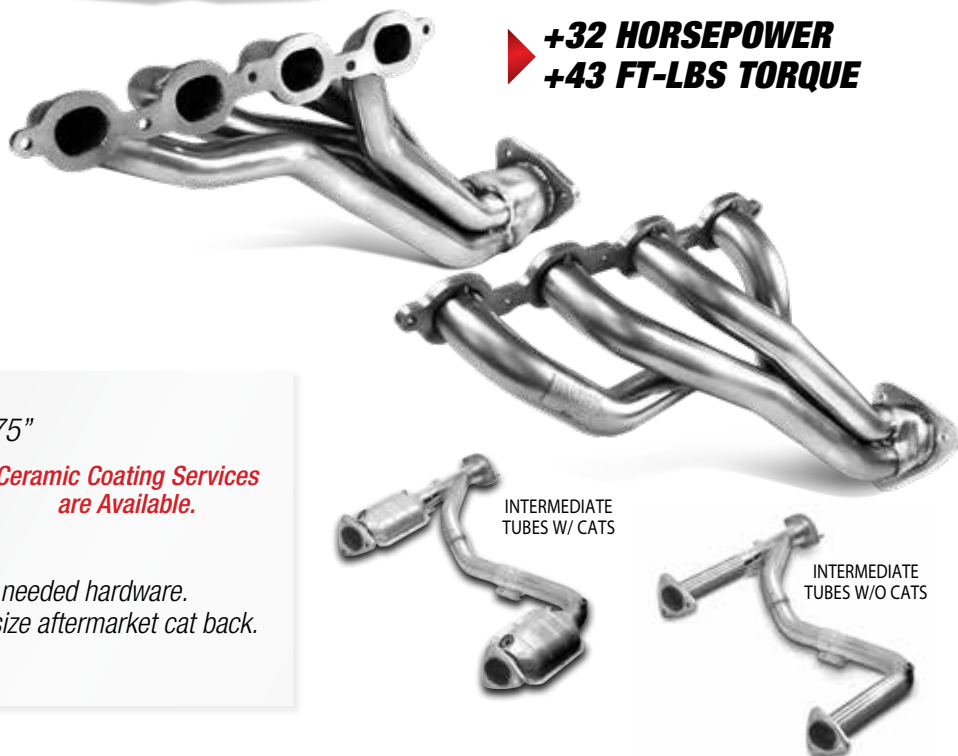

FEATURES

PRIMARY TUBE SIZE: 1.750" or 1.875"
COLLECTOR SIZE: 2.500"
SYSTEM TUBE SIZE: 2.500"
MATERIAL: T304 Stainless
TRANS: Manual or Automatic
INCLUDED: Detailed instructions and all needed hardware.
FIT: Direct Bolt-up to any factory or O.E. size aftermarket cat back.
INSTALL TIME: 4-6 hours

Ceramic Coating Services are Available.

HEADER PRIMARY TUBE SIZE	PART #	ENGINE
1.750"	715-34110	5.3L & 6.2L
1.875"	715-44110	5.3L & 6.2L
1.750" (2019 GM1500) NEW!	715-54110	5.3L
1.875" (2019 GM1500) NEW!	715-64110	5.3L

DESCRIPTION	PART #	ENGINE	CATS
INTERMEDIATE TUBE SECTION	715-34120	5.3L	W/CATS
INTERMEDIATE TUBE SECTION	715-34130	5.3L	W/O CATS
INTERMEDIATE TUBE SECTION	715-44120	6.2L	W/ CATS
INTERMEDIATE TUBE SECTION	715-44130	6.2L	W/O CATS
INTERMEDIATE TUBE SECTION 2019 NEW!	715-54120	5.3L	W/ CATS
INTERMEDIATE TUBE SECTION 2019 NEW!	715-54130	5.3L	W/O CATS

These products are intended for racing and off-road applications. Not legal for sale or use in the state of California, nor in states which have adopted California emission standards.



SUPERMAXX[®]

'07 - '13 CHEVY 1500 TRUCK / SUV

STAINLESS STEEL HEADERS



INTERMEDIATE
TUBES W/ CATS



INTERMEDIATE
TUBES W/O CATS

FEATURES

PRIMARY TUBE SIZE: 1.750"

COLLECTOR SIZE: 2.500"

SYSTEM TUBE SIZE: 2.500"

MATERIAL: T304 Stainless

TRANS: Manual & Automatic

INCLUDED: Detailed instructions
and all needed hardware.

FIT: Direct Bolt-Up to any factory or
O.E. size aftermarket cat back.

INSTALL TIME: 4-6 hours

*Ceramic Coating
Services are
Available.*

+15 HORSEPOWER
+38.5 FT-LBS TORQUE

'07 - '13 (4.8L, 5.3L, & 6.0L) / DESCRIPTION

PART#

HEADERS ONLY	715-14110
INTERMEDIATE TUBES W/ CATS ('07-'08)	715-14120
INTERMEDIATE TUBES W/O CATS ('07-'08)	715-14130
INTERMEDIATE TUBES W/ CATS ('09-'13)	715-14420
INTERMEDIATE TUBES W/O CATS ('09-'13)	715-14430

'07 - '13 (6.2L) / DESCRIPTION

PART#

HEADERS ONLY	715-14110
INTERMEDIATE TUBES W/ CATS ('07-'10)	715-14220
INTERMEDIATE TUBES W/O CATS ('07-'10)	715-14230
INTERMEDIATE TUBES W/ CATS ('11-'13)	715-14620

LIMITED LIFETIME WARRANTY
MADE IN THE U.S.A.



SUPERMAXX

'99-'06 CHEVY 1500 TRUCK / SUV

STAINLESS STEEL HEADERS

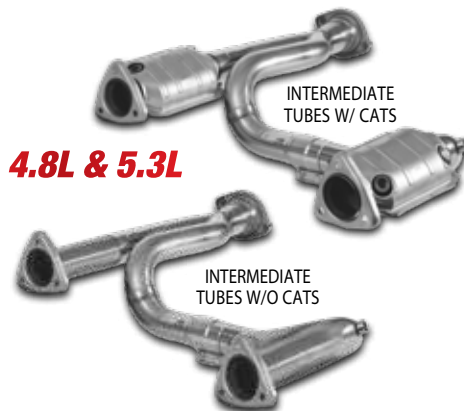
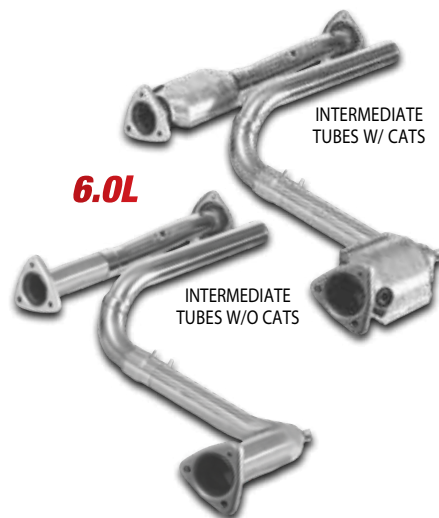

FEATURES

PRIMARY TUBE SIZE: 1.750"

COLLECTOR SIZE: 2.500"

SYSTEM TUBE SIZE: 2.500"

MATERIAL: T304 Stainless

TRANS: Manual & Automatic

INCLUDED: Detailed instructions and all needed hardware.

FIT: Direct Bolt-Up to any factory or O.E. size aftermarket cat back.

INSTALL TIME: 4-6 hours

▶ **+25 HORSEPOWER**
+15 FT-LBS TORQUE

Ceramic Coating Services are Available.

LIMITED LIFETIME WARRANTY

MADE IN THE U.S.A.

DESCRIPTION

HEADERS ONLY

INTERMEDIATE TUBES W/ CATS

INTERMEDIATE TUBES W/O CATS

**'99 - '06
CHEVY TRUCK
(4.8L & 5.3L)**

715-84110

715-84120

715-84130

**'99 - '06
CHEVY TRUCK
(6.0L)**

715-84110

715-84220

715-84230

These products are intended for racing and off-road applications. Not legal for sale or use in the state of California, nor in states which have adopted California emission standards.



SUPERMAXX

'00 - '09 HUMMER H2

STAINLESS STEEL HEADERS



FEATURES

PRIMARY TUBE SIZE: 1.750"
COLLECTOR SIZE: 2.500"
SYSTEM TUBE SIZE: 2.500"
MATERIAL: T304 Stainless
TRANS: Manual & Automatic
INCLUDED: Detailed instructions and all needed hardware.
FIT: Direct Bolt-Up to any factory or O.E. size aftermarket cat back.
INSTALL TIME: 4-6 hours

▶ **+25 HORSEPOWER**
+15 FT-LBS TORQUE

Ceramic Coating Services are Available.

LIMITED LIFETIME WARRANTY
MADE IN THE U.S.A.

DESCRIPTION	'00 - '06 HUMMER H2	'07 - '09 HUMMER H2
HEADERS ONLY	715-84110	-
HEADERS ONLY	-	715-14110
INTERMEDIATE TUBES W/ CATS	715-84220	715-14320
INTERMEDIATE TUBES W/O CATS	715-84230	715-14330

These products are intended for racing and off-road applications. Not legal for sale or use in the state of California, nor in states which have adopted California emission standards.



SUPERMAXX

'04 - '05 DODGE 1500 2WD/4WD

STAINLESS STEEL HEADERS

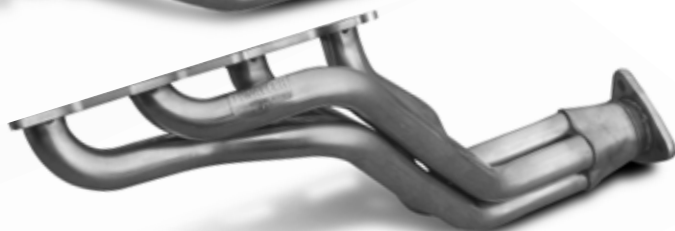

FIT 5.7L HEMI
ENGINE ONLY

FEATURES

PRIMARY TUBE SIZE: 1.750"

COLLECTOR SIZE: 2.500"

SYSTEM TUBE SIZE: 2.500"

MATERIAL: T304 Stainless

TRANS: Manual & Automatic

INCLUDED: Detailed instructions and all needed hardware.

FIT: Direct Bolt-Up to any factory or O.E. size aftermarket cat back.

INSTALL TIME: 4-6 hours

+17 HORSEPOWER
+15 FT-LBS TORQUE

LIMITED LIFETIME WARRANTY
MADE IN THE U.S.A.

Ceramic Coating Services are Available.

DESCRIPTION	HEADERS (5.7L HEMI)
2WD HEADERS ONLY	724-84310
4WD HEADERS ONLY	724-84410
2WD INTERMEDIATE TUBES W/ CATS	724-84520
4WD INTERMEDIATE TUBES W/ CATS	724-84620

These products are intended for racing and off-road applications. Not legal for sale or use in the state of California, nor in states which have adopted California emission standards.



OVAL TRACK

**604
CRATE**

604 CRATE ENGINES:

604 Crate Engines have a unique cylinder head port design that, unlike the 602 Crate engines, has a much higher port ceiling. This requires a special flange to obtain maximum exhaust flow. Dynatech® has responded to these demands by offering a flange specifically designed for the 604 Crate Engines. This flange is currently offered on a number of our headers. If you find an application in our catalog that does not offer this unique flange on the header, please contact us and request it. We are always looking for more ways to satisfy our customers.



OVAL TRACK EXHAUST



1/2 SET CRASH REPLACEMENTS AVAILABLE

100% JIG ASSEMBLED AND CHECKED FOR AN EXCELLENT FIT

OPTIMIZED TUBE LENGTH FOR MAXIMUM H.P. AND TORQUE

17 GAUGE STAINLESS & MILD STEEL CONSTRUCTION

ALWAYS CHECK YOUR SANCTIONING BODY'S RULE BOOK FOR COMPLIANCE BEFORE MAKING A PURCHASE.

CNC LASER CUT FLANGES



ALL FLANGES MACHINE SURFACED AFTER WELDING

MADE IN THE U.S.A.

High Temperature Ceramic Coating

Inside & Outside • Available Upon Request

WHY SETTLE FOR LESS?

All Dynatech® header flanges are machine surfaced after final welding to prevent leakage.



Dynatech

OTHERS

CRATE MODIFIED



2010-2014 SHAW CHASSIS

MADE IN THE U.S.A.

- Accommodates raising the engine 1.000".
 - High quality stainless steel for increased header life and exhaust velocity vs. mild steel.
 - Fully TIG-welded construction improves weld quality.
 - 9.000" long collector for IMCA rules.
 - Laser cut flanges w/ 604 crate port design.
 - Three inch collector outlet diameter.
 - Triple-step long tube design optimized on "in-house" engine dyno.
 - Gaskets and bolts included.
 - Accommodates raised & offset engine positions.
 - 1/2 sets are available for crash replacement.
 - Ceramic coating services are available.
- Call Dynatech® for details.
- 1 Year Limited Warranty.



DESCRIPTION	TUBE SIZE	COLL.	H.P.	PART #
604 CRATE - STAINLESS STEEL	1.625"-1.750"-1.875"	3.000"	604 CRATE	701-17310



2010-2015 JET CHASSIS 2015 KAZZBUILT CHASSIS

MADE IN THE U.S.A.

- Accommodates raising the engine 1.250".
 - High quality stainless steel for increased header life and exhaust velocity vs. mild steel.
 - Fully TIG-welded construction improves weld quality.
 - 9.000" long collector for IMCA rules.
 - Laser cut flanges w/ 604 crate port design.
 - Three inch collector outlet diameter.
 - Triple-step long tube design optimized on "in-house" engine dyno.
 - Gaskets and bolts included.
 - Accommodates raised & offset engine positions.
 - 1/2 sets are available for crash replacement.
 - Ceramic coating services are available.
- Call Dynatech® for details.
- 1 Year Limited Warranty.



DESCRIPTION	TUBE SIZE	COLL.	H.P.	PART #
604 CRATE - STAINLESS STEEL	1.625"-1.750"-1.875"	3.000"	604 CRATE	701-17410

**DIRT WORKS • IMPRESSIVE • LIGHTNING
• HOFFMAN • SHAW**

- Fits standard Chevy engines with angle or straight plug heads.
- Gaskets and bolts included.
- 1/2 sets available.
- Slip on collectors.
- Ceramic coating services are available. Call Dynatech® for details.
- 1 Year Limited Warranty.



MADE IN THE U.S.A.

DESCRIPTION	TUBE SIZE	COLL.	H.P.	INTERCHANGE #	PART #
STANDARD CHEVY	1.750"	3.500"	300-450	172 & 172CM	701-19810

**DIRT WORKS • BMS • JET • SMILEY'S
• PIERCE • HOFFMAN • VICTORY • LAZER**

- Fits angle or straight plug heads.
- Gaskets and bolts included.
- Longer primaries for maximum torque and horsepower.
- 1/2 sets available.
- Ceramic coating services are available. Call Dynatech® for details.
- 1 Year Limited Warranty.



MADE IN THE U.S.A.

DESCRIPTION	TUBE SIZE	COLL.	H.P.	INTERCHANGE #	PART #
STANDARD CHEVY	1.750" - 1.875"	3.500"	450+	1186V	701-10610

2010-2014 SHAW CHASSIS

- Accommodates raising the engine 1.000".
- 9.000" long collector for IMCA rules.
- 3.000" inch collector outlet diameter.
- 1-5/8" Straight through design for crate motors and classes that require 1-5/8" tubes.
- Gaskets and bolts included.
- Accommodates raised & offset engine positions.
- 1/2 sets are available for crash replacement.
- Ceramic coating services are available. Call Dynatech® for details.
- 1 Year Limited Warranty.



MADE IN THE U.S.A.

DESCRIPTION	TUBE SIZE	COLL.	H.P.	INTERCHANGE #	PART #
SPORT/ B MOD	1.625"	3.000"	300-400	1185V	701-17610

CRATE DIRT LATE MODEL

BARRY WRIGHT • MORRIS • ROCKET • SWARTZ
• OTHERS W/ 2.625" OFFSET & 6.000" SETBACK

- Unique flange design fits standard Chevy and 602 Crate heads with a single part number.
- 604 Crate available in port matched mild steel or Stainless Steel.
- Increase Torque with Extension Kits and Torque Boosters sold in kits. (see p.69)
- Machine surfaced flanges – no leaks.
- 1/2 sets available.
- 1 year limited warranty.



MADE IN THE U.S.A.



DESCRIPTION	TUBE SIZE	COLL.	PART #
604 CRATE - STAINLESS STEEL ULTIMATE TORQUE PACKAGE**	1.625"-1.750"	3.000"	711-65810
604 CRATE - STAINLESS STEEL HEADERS / EXTENSION KIT*	1.625"-1.750"	3.000"	711-55810
604 CRATE - STAINLESS STEEL HEADERS	1.625"-1.750"	3.000"	711-45810

**Includes Headers, Extension Kit, and Torque Boosters
 *Includes Headers, 80° Elbow & 14.000" Extension Pipe.

FAST • GRT • SHAW • TRAKSTAR
• OTHERS W/ 0.625" OFFSET & 6.000" SETBACK

- Unique flange design fits standard Chevy and 602 Crate heads with a single part number.
- 604 Crate available in port matched mild steel or Stainless Steel.
- Increase Torque with Extension Kits and Torque Boosters sold in kits. (see p.69)
- Machine surfaced flanges – no leaks.
- 1/2 sets available.
- 1 year limited warranty.



MADE IN THE U.S.A.



DESCRIPTION	TUBE SIZE	COLL.	PART #
604 CRATE - STAINLESS STEEL ULTIMATE TORQUE PACKAGE**	1.625"-1.750"	3.000"	711-66410
604 CRATE - STAINLESS HEADER / EXTENSION KIT*	1.625"-1.750"	3.000"	711-56410
604 CRATE - STAINLESS HEADER	1.625"-1.750"	3.000"	711-46410

**Includes Headers, Extension Kit, and Torque Boosters
 *Includes Headers, 80° Elbow & 14.000" Extension Pipe.

CRATE DIRT LATE MODEL

**BERNHEISEL • LAZER • MASTERSBILT
• RAYBURN • WARRIOR**

MADE IN THE U.S.A.

- Unique flange design fits standard Chevy and 602 Crate heads with a single part number.
- 604 Crate available in port matched mild steel or Stainless Steel.
- Increase Torque with Extension Kits and Torque Boosters sold in kits below.
- Machine surfaced flanges – no leaks.
- 1/2 sets available.
- 1 year limited warranty.



DESCRIPTION	TUBE SIZE	COLL.	PART #
604 CRATE - STAINLESS STEEL ULTIMATE TORQUE PACKAGE**	1.625"-1.750"	3.000"	711-65910
604 CRATE - STAINLESS STEEL HEADERS / EXTENSION KIT*	1.625"-1.750"	3.000"	711-55910
604 CRATE - STAINLESS HEADER	1.625"-1.750"	3.000"	711-45910

*Includes Headers, 80° Elbow & 14.000" Extension Pipe.
**Includes Headers, Extension Kit, and Torque Boosters.

COLLECTOR EXTENSIONS

14" EXTENSIONS



- Designed for use with crate engines.
- Equalizes crate engine exhaust system when used with 80° elbow.



80° ELBOW EXTENSION

- Designed for use on driver's side dirt late model headers.
- Used to route exhaust toward rear of car.

————— PURCHASE 604 CRATE ACCESSORIES INDIVIDUALLY —————

APPLICATION	PART #	APPLICATION	PART #
14.000" EXTENSION	780-00314	80° ELBOW	780-80301
14.000" STAINLESS EXTENSION	780-01314	80° ELBOW STAINLESS STEEL	780-80311

TORQUE BOOSTERS

The Dynatech® Torque Booster is a great way to pick up some low end torque on many engines. The gains are usually between 2500 and 4200 rpm, which is an excellent benefit for restarts. This device is a simple way to quickly add that well needed torque on the low end without sacrificing any power on the top end.



- Easy install.
- Excellent add-on for crate engines.
- Increased torque on restarts.
- Promotes torque gains of 10% or more.

APPLICATION	INLET SIZE	OUTLET SIZE	PART #
TORQUE BOOSTER (602 & 604 CRATE)	3.000"	3.000"	772-06312
TORQUE BOOSTER (500-600 HP Engines)	3.000"	3.500"	772-06302
TORQUE BOOSTER (600+ HP Engines)	3.500"	3.500"	772-06352
TORQUE BOOSTER STAINLESS STEEL (604)	3.000"	3.000"	772-06322