

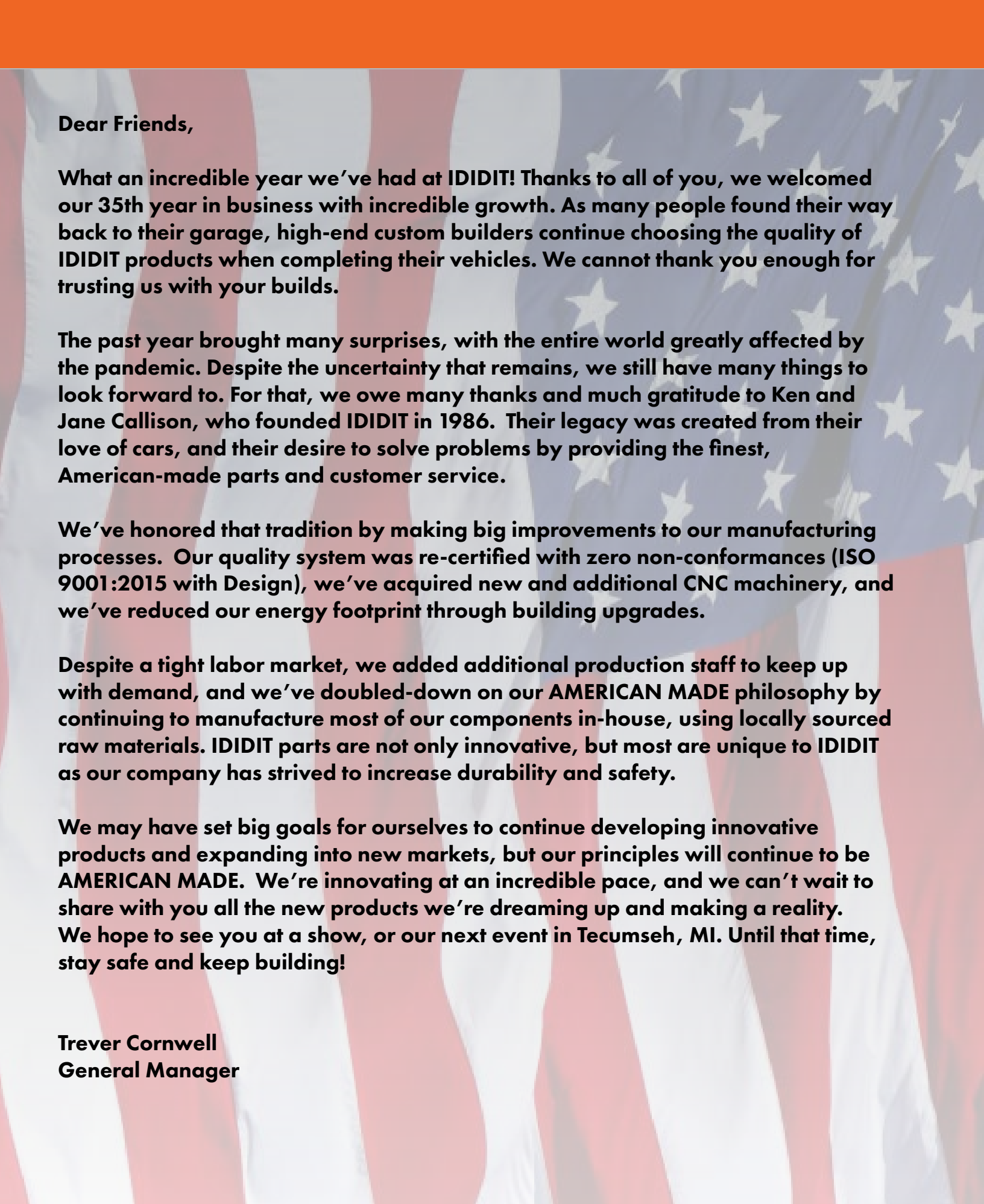

**Driven by Quality,
Steered by You!**



Volume 28

The background of the entire page is a stylized, semi-transparent American flag. The stars and stripes are visible but faded, serving as a backdrop for the text.

Dear Friends,

What an incredible year we've had at IDIDIT! Thanks to all of you, we welcomed our 35th year in business with incredible growth. As many people found their way back to their garage, high-end custom builders continue choosing the quality of IDIDIT products when completing their vehicles. We cannot thank you enough for trusting us with your builds.

The past year brought many surprises, with the entire world greatly affected by the pandemic. Despite the uncertainty that remains, we still have many things to look forward to. For that, we owe many thanks and much gratitude to Ken and Jane Callison, who founded IDIDIT in 1986. Their legacy was created from their love of cars, and their desire to solve problems by providing the finest, American-made parts and customer service.

We've honored that tradition by making big improvements to our manufacturing processes. Our quality system was re-certified with zero non-conformances (ISO 9001:2015 with Design), we've acquired new and additional CNC machinery, and we've reduced our energy footprint through building upgrades.

Despite a tight labor market, we added additional production staff to keep up with demand, and we've doubled-down on our AMERICAN MADE philosophy by continuing to manufacture most of our components in-house, using locally sourced raw materials. IDIDIT parts are not only innovative, but most are unique to IDIDIT as our company has strived to increase durability and safety.

We may have set big goals for ourselves to continue developing innovative products and expanding into new markets, but our principles will continue to be AMERICAN MADE. We're innovating at an incredible pace, and we can't wait to share with you all the new products we're dreaming up and making a reality. We hope to see you at a show, or our next event in Tecumseh, MI. Until that time, stay safe and keep building!

**Trever Cornwell
General Manager**

Index

INTRODUCTION

New Products.....	3
Anatomy of a Steering Column.....	4
How to Measure a Steering Column.....	5
How to Measure a Column Drop.....	6
Part Number Guide.....	6

UNIVERSAL SERIES

Classic Straight.....	8
Old School Straight.....	8
Straight Floor Shift.....	9
Aluminum Straight Floor Shift.....	9
Straight Column Shift.....	10
Tilt Floor Shift.....	10
Aluminum Tilt Floor Shift.....	11
Tilt Column Shift.....	11
Aluminum Tilt Column Shift.....	12
Tilt & Telescoping Floor Shift.....	12
Tilt & Telescoping Column Shift.....	13
Shorty.....	13
Theory of a Collapsible Column.....	14
Collapsible Floor Shift Column.....	15
Collapsible Column Accessories.....	15
Right Hand Drive Collapsible Columns.....	16
Right Hand Drive Non-Collapsible Columns.....	16
Right Hand Drive Tilt Column Shift.....	17
40's Style Straight Column Shift.....	17
Customer Testimonials.....	18

RETROFIT SERIES CAR COLUMNS

Quick Reference Guide.....	20
Individual Kit Components.....	21
1955-57 Chevy Tri-Five.....	22-23

1970-75 Camaro.....	25
1967-72 Chevelle/El Camino/GTO.....	26-27
1953-68 Corvette.....	28-29
1958-76 Impala.....	30-31
1962-72 Nova.....	32-33
1964-65 Falcon.....	34
1965 Mercury Comet.....	35
1964.5-69 Mustang.....	36-37
1970-74 Cuda/Challenger.....	38
1967-73 Chrysler Charger/Roadrunner.....	39
1970-76 Chrysler Dart/Duster/Demon.....	40

RETROFIT SERIES TRUCK COLUMNS

1947-78 Chevy Truck.....	42-44
1974-79 Ford Bronco.....	45
1953-79 Ford 1/2 Ton Truck.....	46-48
1976-86 Jeep CJ5 & CJ7.....	49

GOLF CART STEERING COLUMNS

Golf Cart Columns.....	51
Golf Cart Installation Kits.....	52

ADD-ONS & ACCESSORIES

Floor Mounts.....	54
Column Drops.....	55-56
Shift Indicators.....	56
Cruise Control Units.....	57
Cable Shift Linkage.....	58
Dress-Up Kits.....	59
Knobs & Levers.....	60
Steering Wheel Adapters.....	61
Side Step Steering Box.....	62

IDIDIT PERFORMANCE

Pro-Fab Steering Columns.....	64
Pro-Lite Steering Columns.....	64
Quick Release Steering Hubs.....	65
Cowl Steering.....	65
Digital Dash Mounts.....	66

VINTAGE WIRES.....

BORGESON UNIVERSAL PARTS

Borgeson Products.....	68
Borgeson Product Chart.....	679

Frequently Asked Questions.....

What's New at IDIDIT

1967 Corvette Column
(pg 29)

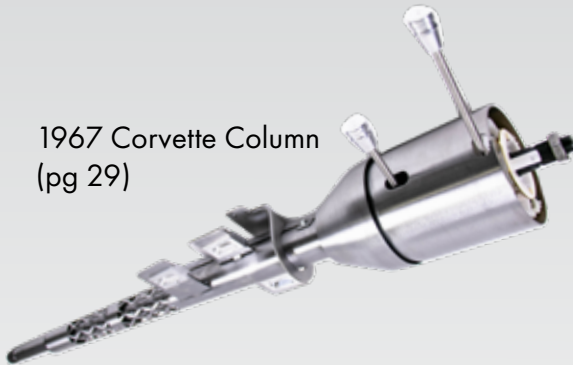

1965-79 Ford Truck Column
(pg 47)



Billet Levers (pg 60)

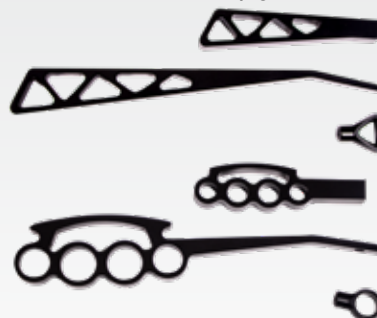

Quick Release Steering Hub with Centering
(pg 65)



Pro-Fab S550 2015-Current
Mustang Column (pg 64)



Anatomy of a Steering Column

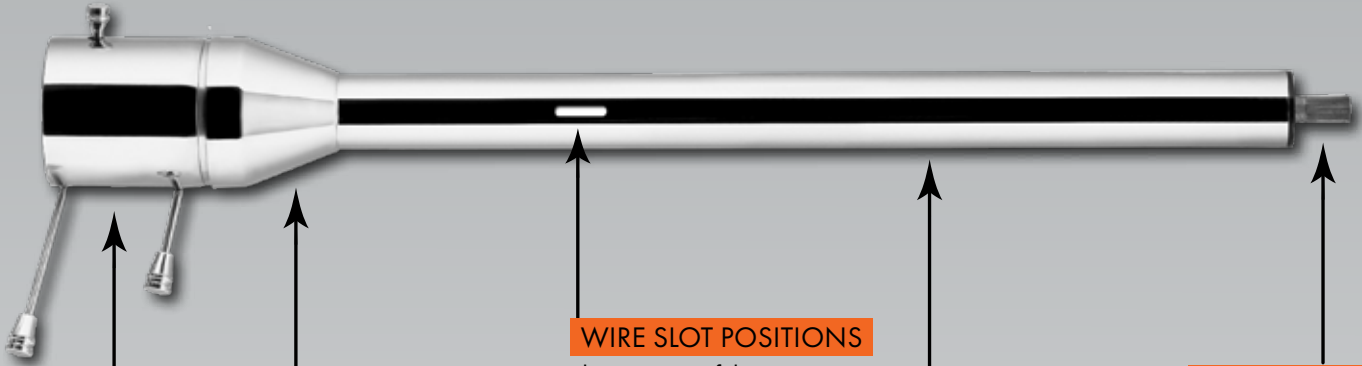

UPPER SLEEVE AND SHIFT HUB

The size of these two pieces cannot be changed. Measure 4" (floor shift) or 6 1/8" (column shift) from the top of the column and mark the position on the dowel.

Add 1/4" to represent the gap between the sleeve and the cone.

LOWER CONE

This part of the column can be customized. The standard length is 3.25" and can be shortened to 1.5" upon request (a custom charge will apply). Measure 3.25" (or custom length if applicable) from the bottom of the sleeve or shift hub and mark the dowel. **Shortened cones may expose wiring.**

WIRE SLOT POSITIONS

The position of the wire slot is important because it will determine where your underdash mount will attach to the column. On our tilt floor shift column, the standard wire slot position is 11.5" from the top of the sleeve to the top of the wire slot, at 12 o'clock. On our tilt column shift, the standard position is 13.25". The wire slot location can also be customized. The maximum is 22" from the top of the sleeve to the top of the wiring slot. Be sure to specify what position (on a clock face, i.e. 12 o'clock) you would like it to be. Measure 11.5" (or custom length if applicable) from the top of the sleeve and mark the position on the dowel.

TUBE

The tube can be made to any length, but cannot be any shorter than 4". The tube can protrude through the firewall as far as you like, or it can stop inside the vehicle like it does with our "shorty" column. In standard applications, the tube should protrude through the firewall 1-3". On column shift versions, the lower shift linkage will attach to the end of the tube. Mark the dowel where the firewall will meet the tube.

SHAFT

The standard length of the lower shaft is 1.5" and can be made to any length between 1" to 8", from the bottom of the tube. The shaft type is available as a 1" 48 spline, 1" DD, 3/4" 36 spline, or 3/4" DD (custom charges may apply). Measure 1.5" (or custom length if applicable) from the end of the tube. Mark the dowel where the shaft will end.

How to Measure a Steering Column

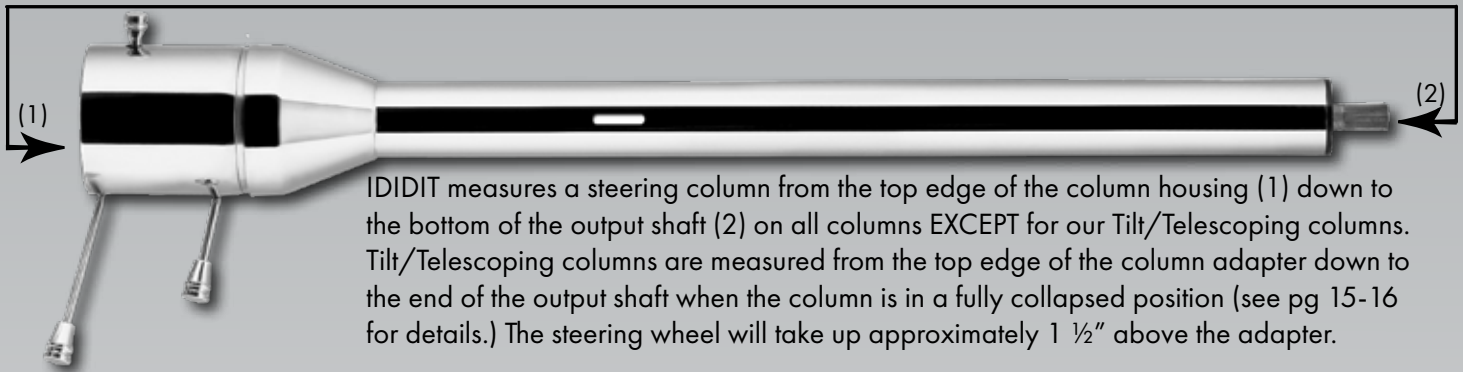

IDIDIT measures a steering column from the top edge of the column housing (1) down to the bottom of the output shaft (2) on all columns EXCEPT for our Tilt/Telescoping columns. Tilt/Telescoping columns are measured from the top edge of the column adapter down to the end of the output shaft when the column is in a fully collapsed position (see pg 15-16 for details.) The steering wheel will take up approximately 1 ½" above the adapter.

STEP 1

The seat you will be using, or a good facsimile, MUST be in place before measuring for your new steering column. That means NO milk crates or lawn chairs! The steering wheel position and the pedal position all relate to the comfort of the driver. So if you want to be comfortable behind the wheel take your time and measure correctly.

STEP 2

Equally important are the locations of the engine, cylinder head, and headers. These components, or good mock-ups, should be in place to ensure you have proper clearance for your steering linkages.

STEP 3

The position of the transmission linkage is also vital. If you do not have clearance for a solid rod style linkage kit, a cable shift linkage kit may be necessary. Be sure to leave two inches of space between the columns lower shift linkage and firewall.

STEP 4

Center the column on the drivers seat to ensure proper alignment. If your column is installed offset or angled, it may feel awkward and uncomfortable.

STEP 5

After adjusting the seat for optional pedal control, position the column/ steering wheel so that your arms are in a relaxed, comfortable position.

STEP 6

You will also need to position the column for maximum use of the tilt mechanism. It doesn't do any good to have the wheel tilted into the dash or down toward the seat.

STEP 7

The Column drop should fit snugly and in a stable position on both the bottom of the dash and the column with no wobbling or vibration.

STEP 8

The lower mounts should be stable and able to fit the angle of the floor or firewall where the column will pass through (or a fixed custom built mount). This mount MUST be sealed tightly to prevent exhaust fumes, heat, dirt, and water from entering the interior.

STEP 9

If you have a floor mounted brake and/or clutch pedal assembly, make sure you have enough clearance for the column.

STEP 10

Use of more than two u-joints require the use of support bearing to keep the linkage operation smooth, strong, stable and safe. For safety purposes, IDIDIT recommends using a splined or DD shafting instead of a welded or pinned shafting.

Tech Tips

USING A PIE TIN & DOWEL TO FIND THE PERFECT COLUMN POSITION

As silly as it may sound, we have found that using an aluminum pie tin and a wooden dowel is an excellent way to determine the column length needed and its position. You will need a 3' dowel piece. Add between 1 ½" and 3" beyond the firewall/floor if using a steering box. If you are using a rack, you can go as far as 5" into the engine compartment. Watch for clearance. First, tack the tin to the dowel (steering wheel to column), then position yourself comfortably in the drivers seat while holding the dowel system in place. Have a friend measure and mark essential dimensions such as overall length, and the distance between the center of the column and the bottom of the dash. Don't forget to mark the point where the column will pass into the engine compartment and the center-line of the drivers body/seat as they are also important measurements.

MEASURE FOR YOUR STEERING WHEEL - PLEASE REMEMBER THE WHEEL & ADAPTER WILL ADD LENGTH TO YOUR COLUMN

Most aftermarket steering wheels add 3-6 inches from the gripping surface of the wheel to the top of the outer housing of the steering column. Measure and mark the dowel accordingly.

How to Measure a Column Drop



A Guide to IDIDIT Part Number and Finishes

Each number in the part number in our part number sequence has a specific meaning, that tells us vital information about the item you are ordering. For example, the last two numbers of any sequence indicates the finish type.

Example: 1120280020 = 28" tilt floor shift with a chrome finish. The images here show the finish type and its correlating part number.



10 = PAINTABLE STEEL
made from a mild steel material that can rust without the proper primer and paint.



20 = CHROME
chrome plated steel for a beautiful mirrored finish.



30 = BRUSHED ALUMINUM
professionally brushed for a satin finish.

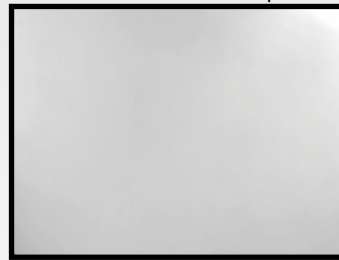

40 = POLISHED ALUMINUM
a quality aluminum will hold its shine for year to come!



51 = BLACK POWDER COAT
semi-gloss finish.

Universal Series Steering Columns

THE BENEFITS OF IDIDIT UNIVERSAL STEERING COLUMNS

IDIDIT Universal Series steering columns can easily be installed in your street rod, hot rod, kit car, or any application you see fit. IDIDIT customers are continuously pushing the boundaries of where our Universal Series columns can go, while adding performance, style, and function.

Because of the endless possibilities, our Straight and Tilt Universal columns are sold by length rather than by application. The most important factor to consider when measuring for a universal steering column is driver comfort and functionality. In this catalog, we provide you with all the information you'll need to correctly measure and install your IDIDIT steering column.

Use the detailed drawings and column specifications on the following pages to help you determine the critical measurements for your application, and any customizing that you may need to make. In all cases, planning ahead will greatly increase the success of your project.

We have a wide array of column types to choose from with more choices to fit your style and several sizes to ensure the perfect fit. We also offer custom sizes that truly custom project.

STRAIGHT



Classic pg 8



Old School pg 8



Straight Floor Shift
pg 9



Straight Column Shift
pg 10

TILT & TILT/TELESCOPING



Tilt Floor Shift
pg 10



Tilt Column Shift
pg 11



Tilt/Tele Floor Shift
pg 12



Shorty Accessories
pg 13

Tilt/Tele Column
Shift pg 13

Classic Straight Column Universal Series



IDIDIT'S Classic Straight Steering Column comes in a great vintage look that will add style and class to your ride! This straight column features a sleek, stylish head, with a slim tube diameter. Self-canceling turn signals, 4-way flashers, horn wiring, and our standard dress-up kit are all included with this column.

SPECIFICATIONS:

- Tube diameter: 1 3/4"
- 16" Length: 3/4" DD lower shaft
- 28"-35" Lengths: 1" DD lower shaft
- Accepts 1969 or newer GM passenger car steering wheels & adapters
- 3 7/8" GM style wiring plug
- All IDIDIT steering wheel adapters will fit this column
- Custom lengths available

	Paintable Steel	Chrome	Black Powder Coated
16"	1011160010	1011160020	1011160051
28"	1011280010	1011280020	1011280051
30"	1011300010	1011300020	1011300051
32"	1011320010	1011320020	1011320051
35"	1011350010	1011350020	1011350051

Old School Straight Universal Series



IDIDIT's Old School Straight Column is our do-it-yourself column. An economical choice for that special, custom fit for your Hot Rod. This sleek and uniquely designed column comes in a standard length of 36" that can easily be cut it down to any length desired (as short as 6".) This column package comes with the column tube, column shaft and 3-bolt steering wheel adapter, (2) bearings, (2) bearing seating tools, wavy washer, and locking collar.

SPECIFICATIONS:

- Tube diameter: 1 1/2"
- Full length 3/4" DD lower shaft
- Accepts only 3-Bolt wheels

	Paintable Steel	Polished Stainless Steel
36"	#1012360010	#1012360025

OLD SCHOOL HORN KIT

#2612100340

Complete with horn plunger, brass sleeve with delrin end caps, and a horn kit with button.

UNDERDASH MOUNT

Available in 4 lengths

2 1/2" #2302680010

3 1/2" #2303680010

5 1/2" #2305680010

6 1/2" #2306680010



COLLAPSIBLE FLOOR MOUNT WITH PLATE

#2401120010

The plate allows you to cover any holes in the firewall left behind by the existing column. Trim to fit.



COLLAPSIBLE FLOOR MOUNT

#2401110010



Straight Floor Shift Universal Series



IDIDIT'S Universal Straight Column is similar to factory columns but has a much cleaner design. The shorter head on this column allows it to fit in the smallest of driving compartments, yet still remain completely functional. This column comes standard with self-canceling turn signals, 4-way flashers, horn wiring, and our dress-up kit. Available in Paintable Steel, Chrome, and Black Powder Coat finishes.

SPECIFICATIONS:

- Tube Diameter: 2"
- 16" Length: 3/4" DD Lower Shaft
28"-35" Lengths: 1" DD Lower Shaft
- Accepts 1969 or newer GM Passenger car steering wheels and adapters
- 3 7/8" GM Style Wiring Plug
- Custom lengths available

	Paintable Steel	Chrome	Black Powder Coated
16"	1010160010	1010160020	1010160051
28"	1010280010	1010280020	1010280051
30"	1010300010	1010300020	1010300051
32"	1010320010	1010320020	1010320051
35"	1010350010	1010350020	1010350051

Aluminum Straight Floor Shift Universal



IDIDIT'S Aluminum Straight Column offers you all the same space-saving features as the steel straight column but, comes with a 1 3/4" tube diameter. This column includes horn wiring, self-canceling turn signals, four-way flashers, and a dress-up kit, and is available in Brushed or Polished Aluminum finishes.

SPECIFICATIONS:

- Tube Diameter: 1-3/4"
- 16" Length: 3.4" DD Lower Shaft
28" - 35" Lengths : 1"-48 Lower Shaft
- Accepts 1969 or newer GM Passenger car steering wheels and adapters
- 3 7/8" GM Style Wiring Plug
- Custom lengths available

	Brushed Aluminum	Polished Aluminum
16"	1020160030	1020160040
28"	1020280030	1020280040
30"	1020300030	1020300040
32"	1020320030	1020320040
35"	1020350030	1020350040

Straight Column Shift Universal Series



IDIDIT's Straight Column Shift Column is a full two inches shorter than our standard tilt column shift due to removing the tilt portion. This column features a removable, indexable lower shift arm with 12 possible positions self-canceling turn signals, 4-way flashers, horn wiring and our standard dress-up kit. Compatible with GM, Ford, and Chrysler 3 or 4 speed automatic transmissions.

SPECIFICATIONS:

- Tube Diameter: 2 1/4"
 - 18" Length: 3/4" DD Lower Shaft
 - 28" - 35" Lengths: 1" DD Lower Shaft
 - Accepts 1969 or newer GM Passenger car steering wheels and adapters
 - 3 7/8" GM Style wiring Plug
 - Custom lengths available
- **NOTE**** If you need a Neutral Safety Switch please call our Customer Service Department to discuss

TECH TIP:

If you would like to add a neutral safety switch, the location must be determined before purchasing. Additional Charges will apply.

	Paintable Steel	Chrome	Black Powder Coated
18"	1160180010	1160180020	1160180051
28"	1160280010	1160280020	1160280051
30"	1160300010	1160300020	1160300051
33"	1160330010	1160330020	1160330051
35"	1160350010	1160350020	1160350051

Tilt Floor Shift Universal Series



IDIDIT'S Universal Tilt Series Column is our most popular steering column and an industry standard. Our Tilt Floor Shift column features our unique 8-position tilt, which cannot be found anywhere else in the market. 4-way flashers, self-canceling turn signals, horn wiring, and our standard dress-up kit are all included with this column.

SPECIFICATIONS:

- Tube Diameter: 2"
- 12" & 16" Lengths: 3/4" DD Lower Shaft
- 28"-35" Lengths: 1" DD Lower Shaft
- Accepts 1969 or newer GM Passenger car steering wheels and adapters
- 3 7/8" GM Style wiring Plug
- Custom lengths available

	Paintable Steel	Chrome	Black Powder Coated
12"	1120120010	1120120020	1120120051
16"	1120160010	1120160020	1120160051
28"	1120280010	1120280020	1120280051
30"	1120300010	1120300020	1120300051
32"	1120320010	1120320020	1120320051
35"	1120350010	1120350020	1120350051

Aluminum Tilt Floor Shift Universal Series

IDIDIT'S Universal Tilt Floor Shift Column is also available with Aluminum construction. The Aluminum Tilt Floor Shift Column features our unique 8-position tilt, 4-way flashers, self-canceling turn signals, horn wiring and our standard dress-up kit. Brush and Polished finishes are also available.

SPECIFICATIONS:

- Tube Diameter: 2"
- 12" & 16" Lengths: 3/4" DD Lower Shaft
28" - 35" Lengths: 1"-48 Lower Shaft
- Accepts 1969 or newer GM Passenger car steering wheels and adapters
- 3 7/8" GM Style wiring Plug
- Custom lengths available



	Brushed Aluminum	Polished Aluminum
12"	1030120030	1030120040
16"	1030160030	1030160040
28"	1030280030	1030280040
30"	1030300030	1030300040
32"	1030320030	1030320040
35"	1030350030	1030350040

Tilt Column Shift Universal Series

IDIDIT'S Universal Tilt Column Shift Column features a removable, indexable lower shift arm that allows for 12 possible positions. This column features our unique 8-position tilt, 4-way flashers, self-canceling turn signals, horn wiring, and our standard dress-up kit. Works with GM, Ford, and Chrysler 3 or 4 speed automatic transmissions.

SPECIFICATIONS:

- Tube Diameter: 2 1/4"
- 18" Length: 3/4" DD Lower Shaft
28"-35" Lengths: 1"-48 Lower Shaft
- Accepts 1969 or newer GM Passenger car steering wheels and adapters
- 3 7/8" GM Style wiring Plug
- Custom lengths available

****NOTE**** If you need a Neutral Safety Switch please call our Customer Service Department to discuss



	Paintable Steel	Chrome	Black Powder Coated
18"	1130180010	1130180020	1130180051
28"	1130280010	1130280020	1130280051
30"	1130300010	1130300020	1130300051
33"	1130330010	1130330020	1130330051
35"	1130350010	1130350020	1130350051

Aluminum Tilt Column Shift Universal Series



IDIDIT'S Universal Tilt Column Shift Column is also available in Aluminum. Features a removable, indexable lower shift arm that allows for 12 possible positions. This column features our unique 8-position tilt, 4-way flashers, self-canceling turn signals, horn wiring, and our standard dress-up kit. Works with GM, Ford, and Chrysler 3 or 4 speed automatic transmissions.

SPECIFICATIONS:

- Tube Diameter: 2 1/4"
 - 18" Length: 3/4" DD Lower Shaft
 - 28" - 35" Lengths: 1" -48 Lower Shaft
 - Accepts 1969 or newer GM Passenger car steering wheels and adapters
 - 3 7/8" GM Style wiring Plug
 - Custom lengths available
- **NOTE**** If you need a Neutral Safety Switch please call our Customer Service Department to discuss

	Brushed Aluminum	Polished Aluminum
18"	1050180030	1050180040
28"	1050280030	1050280040
30"	1050300030	1050300040
33"	1050330030	1050330040
35"	1050350030	1050350040

TECH TIP:

If you would like to add a neutral safety switch, the location must be determined before purchasing. Additional Charges will apply.

Tilt & Telescoping Floor Shift Universal Series



IDIDIT'S Tilt and Telescoping Column is one of the most luxurious steering columns. The top head has a built-in, locking wheel adapter that allows you to move the steering wheel 1 1/2" in or out. 9-bolt, 6-bolt, and 5-bolt adapters are available for this column and must be specified when ordering. The adapter is an integral part of the column and must be included in the measurement. This column also features our unique 8-position tilt, self-canceling turn signals, 4-way flashers, horn wiring, and our standard dress-up kit.

SPECIFICATIONS:

- Steel Tube Diameter: 2"
- Aluminum Tube Diameter: 2 1/4"
- 19 1/4" Length: 3/4" DD Lower Shaft
- 31 1/4"-38 1/4" Length Steel: 1" DD Lower Shaft
- 31 1/4"-38 1/4" Length Aluminum: 1" -48 Lower Shaft
- 3 7/8" GM Style wiring Plug
- Custom lengths available
- Measurements are taken while in the collapsed position, the column will telescope 1 1/2" toward the driver.

TILT / TELE CONVERSION CHART (Adapter included in measurement)

16" Tilt Column =	19 1/4" Tilt/Tele Column
28" Tilt Column =	31 1/4" Tilt/Tele Column
30" Tilt Column =	33 1/4" Tilt/Tele Column
32" Tilt Column =	35 1/4" Tilt/Tele Column
35" Tilt Column =	38 1/4" Tilt/Tele Column

9-BOLT PART NUMBERS

	Paintable Steel	Chrome	Black Powder Coated
19 1/4"	1180160010	1180160020	1180160051
31 1/4"	1180280010	1180280020	1180280051
33 1/4"	1180300010	1180300020	1180300051
35 1/4"	1180320010	1180320020	1180320051
38 1/4"	1180350010	1180350020	1180350051

Tilt & Telescoping Column Shift Universal Series



IDIDIT'S Tilt and Telescoping Column Shift Column has the same great features as the floor shift column, but includes a removable, indexable lower shift arm that allows 12 possible positions. This column also features our unique 8-position tilt, self-canceling turn signals, 4-way flashers, horn wiring, and our standard dress-up kit. Will work with GM, Ford, and Chrysler 3 or 4 speed automatic transmissions.

SPECIFICATIONS:

- Tube Diameter: 2 1/4"
- 21 1/4" Length: 3/4" DD Lower Shaft
- 31 1/4" - 38 1/4" Length Steel: 1" DD Lower Shaft
- 31 1/4" - 38 1/4" Length Aluminum: 1" -48 Lower Shaft
- 3 7/8" GM Style wiring Plug
- Custom lengths available
- 9-bolt, 6-bolt & 5-bolt adapters are available. Must be specified when ordering.
- Measurements are in the collapsed position, the column will telescope 1 1/2" toward the driver

TILT / TELE CONVERSION CHART (Adapter included in measurement)	
18" Tilt Column	= 21 1/4" Tilt/Tele Column
28" Tilt Column	= 31 1/4" Tilt/Tele Column
30" Tilt Column	= 33 1/4" Tilt/Tele Column
33" Tilt Column	= 36 1/4" Tilt/Tele Column
35" Tilt Column	= 38 1/4" Tilt/Tele Column

****NOTE**** If you need a Neutral Safety Switch please call our Customer Service

9-BOLT PART NUMBERS			
	Paintable Steel	Chrome	Black Powder Coated
21 1/4"	1190180010	1190180020	1190180051
31 1/4"	1190280010	1190280020	1190280051
33 1/4"	1190300010	1190300020	1190300051
36 1/4"	1190330010	1190330020	1190330051
38 1/4"	1190350010	1190350020	1190350051

Department to discuss

Shorty Accessories



IDIDIT'S Shorty Column gives you the extra space you need and works with any angle issues you might be experiencing. Our Shorty column is designed to move around your big block and/or headers and can fit your custom applications. The Shorty column is the go-to problem solver that allows you to choose the best angle for driver comfort. Shorty columns are available in Classic, Straight, Tilt, and Telescoping styles in either floor or column shift models.

SUPPORT BEARING

Aluminum #3000650000
Polished Aluminum #3000660000



ROD END BEARING

Steel # 3000700000
Stainless # 3000710000
Polished Stainless # 3000720000



ADJUSTABLE UNDERDASH MOUNT
#2301000010



FLANGE BEARING
#MSD52130



Enjoy increased foot and pedal space, as well as added clearance around your engine - still have full use of your tilt column!

Theory of a Collapsible Column

IDIDIT collapsible columns are designed to collapse on impact from either end. To help you further understand this valuable safety feature, we have included a general guide to the physics of steering column impact and its effects on different steering column applications. In general, there are two different types of steering column impacts that can occur during an accident.

IMPACT 1 - Gearbox and shaft hit the bottom of the column

This is caused by the frame collapsing and pushing toward the firewall. This type of impact will cause the column to shear the shaft pins internally and shorten the shaft and outer housings of the lower half of the column. Following U.S. Federal Motor Vehicle Safety Standards, the IDIDIT collapsible column will collapse into itself 5 inches (127mm). In order for this to occur, the floor mount must allow the column to slip towards the driver as it absorbs the impact. This slipping action can only take place at the lower mount. When choosing or designing your lower mount, please consider the fact that it must shear or slip with less than 550 lbs of pressure. IDIDIT offers a mount that meets these requirements and can be adapted to most vehicles (see page 19).

IMPACT 2 - Driver hits the wheel

As a column collapses on the engine side, the upper mount must absorb that energy in order to stop the column from hitting the driver. This requires the mount to be rigid enough on one side that it can absorb >750 lbs of pressure from the impact of the engine, yet collapsible on the other side to accommodate up to 550 lbs from the impact of the driver. This configuration ensures that the column collapses forward and away from driver. See page 19 for IDIDIT collapsible underdash mount.

The relationship between seat belt usage and column positioning:

LAP BELT - Your lap belt creates a hinge that causes you to impact the steering wheel at a forward and downward arc. This means you will impact the wheel/collapsible column within intended angle. This scenario is most common with Street Rod columns, as they tend to have more of a vertical angle when installed in the firewall (see Figure 1).

NO SEAT BELT - Figure 2 shows the result of an unprotected driver being lifted off the seat and impacting the steering wheel with full force. Due to the vertical angle of the column, the steering wheel is unable to stop the driver from hitting the windshield. While you should always wear a seat belt regardless, Figures 3 and 4 demonstrate how angling the columns in a more horizontal position, allows it to collapse properly on impact and will give the body less tendency to go over the wheel and into the windshield. Wear your seat belt.

SEAT BELT WITH SHOULDER HARNESS - This is the ideal system that combines the safety of the seat belt and shoulder harness with the horizontal angle of the column (shown in Figures 3 & 4) to help keep you in your seat, allowing the collapsible column do its job properly and lessen the impact of the crash.

Figure 4 shows an alternative safety system using an IDIDIT Performance Side Step. In this system, the column is angled in a more horizontal position, which prevents the column from hitting the engine upon impact. The addition of the Side Step unit allows the column to stop at the firewall and allows the output shaft to be offset, positioning it lower in order to clear the engine. This, in conjunction with a collapsible intermediate shaft, is an effective way to keep you safe and secure. In this system, the rack or gearbox can take a hit and the collapsible intermediate shaft will absorb the force.

We have provided you with this information to help give you a better understanding of the different system theories. Each application will vary and proper installation is vital for the collapsible column to function as designed. Additional information was gathered from The Society of Automotive Engineers Recommended Practice # J944

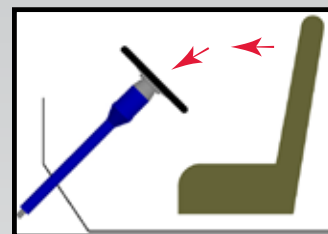

FIGURE 1

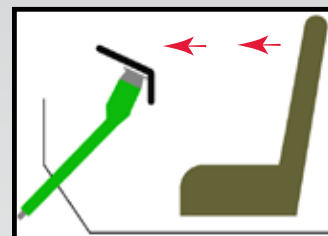

FIGURE 2

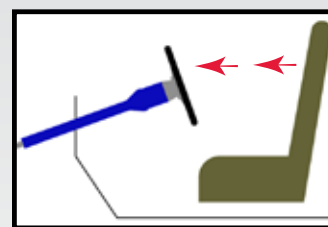

FIGURE 3

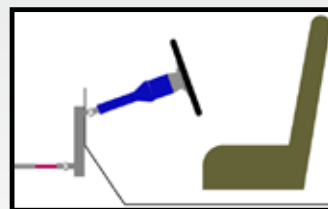

FIGURE 4

Collapsible Floor Shift Column



IDIDIT's collapsible column is one of the safest products you can install in your vehicle. When combined with the proper collapsible floor mount and underdash mount, this column sustains impacts better than any standard steering column. IDIDIT has done extensive research to ensure we offer the latest technology in collapsibility and durability. You won't feel like you have to sacrifice style for safety - our columns offer you both! Our collapsible columns have the same clean look as our non-collapsible ones and feature our unique 8-position tilt, self-canceling turn signals, 4-way flashers, and a standard dress-up kit.

SPECIFICATIONS:

- Tube Diameter: Upper 2 1/4", Lower 2"
- 1" DD Lower Shaft
- Accepts 1969 or newer GM Passenger Car Steering Wheel
- 3 7/8" GM Style wiring Plug
- Please call Customer Service if you are looking for a different length.

	Paintable Steel	Chrome	Black Powder Coated
28"	1300280010	1300280020	1300280051
30"	1300300010	1300300020	1300300051
32"	1300320010	1300320020	1300320051
35"	1300350010	1300350020	1300350051

Collapsible Column Accessories

Safely secure your column with these collapsible floor and dash mounts specifically designed to work with your IDIDIT collapsible column.



COLLAPSIBLE UNDERDASH MOUNT
2" #2301410010
2 1/4" #2301310010

This dash mount is specifically designed for the IDIDIT Collapsible Series steering column. The mounts located on either side of the brackets have aluminum release that when impacted slip or release, allowing the mount to collapse forward and away from the driver.



COLLAPSIBLE DASH PLATE
#2302000010

These column drops combine the universal mounting nature of our conventional drops with the additional feature of release blocks.



COLLAPSIBLE FLOOR MOUNT WITH PLATE
2" #2401020010
2 1/4" #2402020010

This floor mount is designed to mount a steering column to the floor or firewall, and can be installed on either side of the firewall. It includes extra material to allow you to cover any holes in the firewall left behind by the existing steering column. Trim to fit.



COLLAPSIBLE FLOOR MOUNT
2" #2401010010
2 1/4" #2402010010

This floor mount is designed to mount a steering column to the floor or firewall, and can be installed on either side of the firewall.

TECH TIP:

If you are welding your collapsible floor mount to secure it to the floor, remove the O-Ring before you start.

Right Hand Drive Tilt Floor Shift

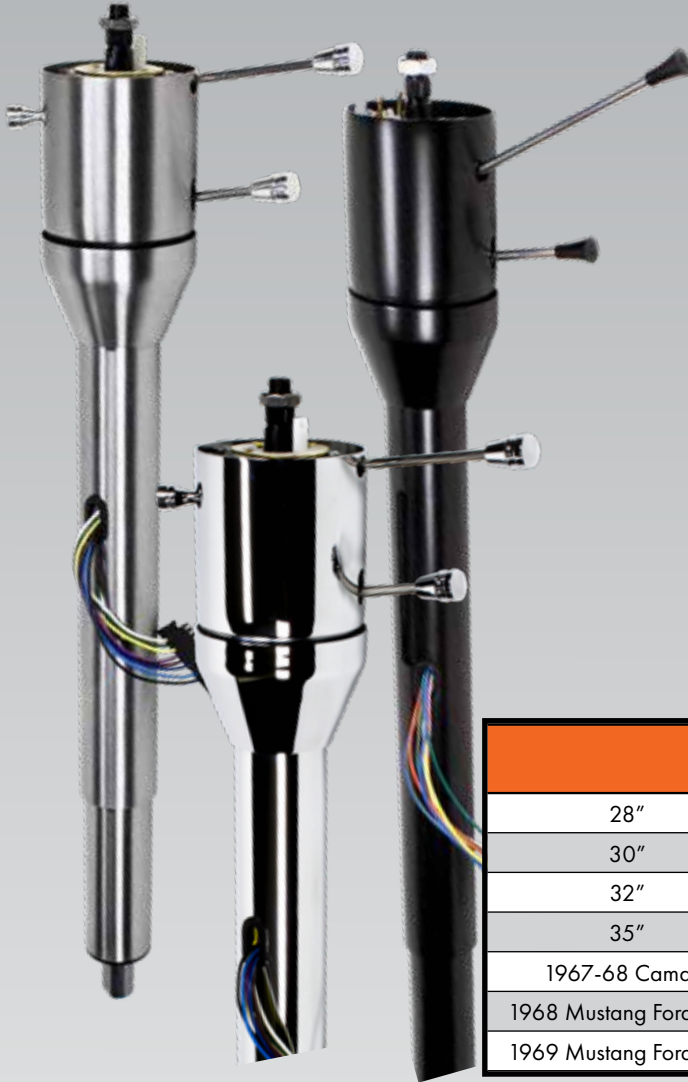

IDIDIT's Right Hand Drive Collapsible Tilt Floor Shift

column was designed with International enthusiasts in mind. When combined with the proper collapsible floor mount and underdash mount, this column sustains impacts better than any standard steering column. Our Right Hand Drive Collapsible Tilt column has the same clean look as our non-collapsible columns and feature our unique 8-position tilt, self-canceling turn signals, 4-way flashers and our standard dress-up kit.

SPECIFICATIONS:

- Tube Diameter:
Upper 2 1/4", Lower 2"
Camaro Upper: 2" Camaro Lower: 2 1/4"
- Regular Length Steel: 1" DD Lower Shaft
1967-68 Camaro: 1" -48 Lower Shaft
1968-1969 Mustang: 3/4" -36 Lower Shaft
- GM Shaft accepts 1969 or newer GM Passenger Car Steering Wheel
- Ford Shaft accepts same year stock wheel or adapter for the same year column

	Paintable Steel	Chrome	Black Powder Coated
28"	1250280010	1250280020	1250280051
30"	1250300010	1250300020	1250300051
32"	1250320010	1250320020	1250320051
35"	1250350010	1250350020	1250350051
1967-68 Camaro	1250680010	1250680020	1250680051
1968 Mustang Ford Shaft	1250644010	1250644020	1250644051
1969 Mustang Ford Shaft	1250646010	1250646020	1250646051

Right Hand Drive & Non-Collapsible Columns

1955-56 CHEVY COMES WITH

- 8-Position Tilt
- Self-Cancelling Turn Signals
- 4-Way Flashers
- Retro Style Knobs and Levers
- 3 7/8" Wiring Plug
- Tube Diameter: 2"
- 1" DD Lower Shaft
- Accepts 1969 or newer GM Passenger car steering wheel

1965-67 MUSTANG COMES WITH

- 8-Position Tilt
- Ford Turn Signal switch
- Ford Splined Top Shaft
- Ford Style Knobs & Levers
- Floor Mount
- 4-way Flashers (67 Only)
- Tube Diameter: 2 1/4"
- 3/4" -36 Lower Shaft
- Accepts the same year stock wheel or adapter for the same year column

IDIDIT also offers Right Hand Drive Non-Collapsible Tilt columns for International applications. These columns are for Chevy Tri-Five or 1965-67 Ford Mustang models. These columns have the same great features as their Retro-Fit Series counterparts but are designed to fit your right hand drive vehicle. If you cannot find what you need, contact our sales department and we can find you what you need!

	Paintable Steel	Chrome	Black Powder Coated
1955-56 Chevy	1260550010	1260550020	1260550051
1965-66 Mustang	1260642010	1260642020	1260642051
1967 Mustang	1260643010	1260643020	1260643051

TECH TIP:

If using a stock Ford steering wheel it must be for the same year application as the column. Use of a different year will result in damage to the turn signal switch.

Right Hand Drive Tilt Column Shift

IDIDIT's Right Hand Drive Collapsible Tilt Column Shift column was designed for International applications that require the shifter on the column. When combined with the proper collapsible floor mount and underdash mount, this column can sustain impact better than any standard steering column. Our Right Hand Drive Collapsible Tilt columns have the same clean look as our non-collapsible columns and feature our unique 8-position tilt, self-canceling turn signals, 4-way flashers and our standard dress-up kit.

SPECIFICATIONS:

- Tube Diameter:
Upper 2 1/4", Lower 2"
Camaro Upper: 2" Camaro Lower: 2 1/4"
- Regular Length Steel: 1" DD Lower Shaft
1967-68 Camaro: 1" -48 Lower Shaft
1968-1969 Mustang: 3/4" -36 Lower Shaft
- GM Shaft accepts 1969 or newer GM Passenger Car Steering Wheel
- Ford Shaft accepts same year stock wheel or adapter for the same year column

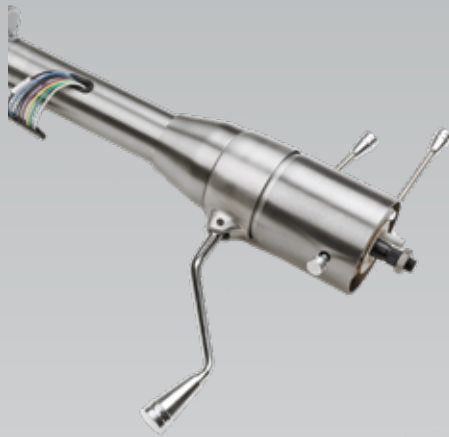

	Paintable Steel	Chrome	Black Powder Coated
30"	1280300010	1280300020	1280300051
33"	1280330010	1280330020	1280330051
35"	1280350010	1280350020	1280350051

40's Style Straight Column Shift

IDIDIT's 40's Style Straight Column Shift combines vintage style with modern convenience. This column is great for any early 30's - 60's car or truck, featuring a nostalgic exposed shift tube and a 40's-style dress-up kit with brass knobs, vintage-style brass shift indicator, and a cutting-edge locking detent. This column comes with horn wiring, self-canceling turn signals, 4-way flashers, and a 3 7/8" GM style wiring plug.

SPECIFICATIONS:

- 3/4" -36 Lower Shaft
- 3 7/8" GM style wiring plug
- Accepts 1969 or newer GM Passenger car steering wheels and adapters
- Vintage style brass shift indicator, knobs, and lower shift lever.

	Brushed Stainless Steel
30' 3 Speed	1400300015
30" 4 Speed	1400300115
33" 3 Speed	1400330015
33" 4 Speed	1400330115

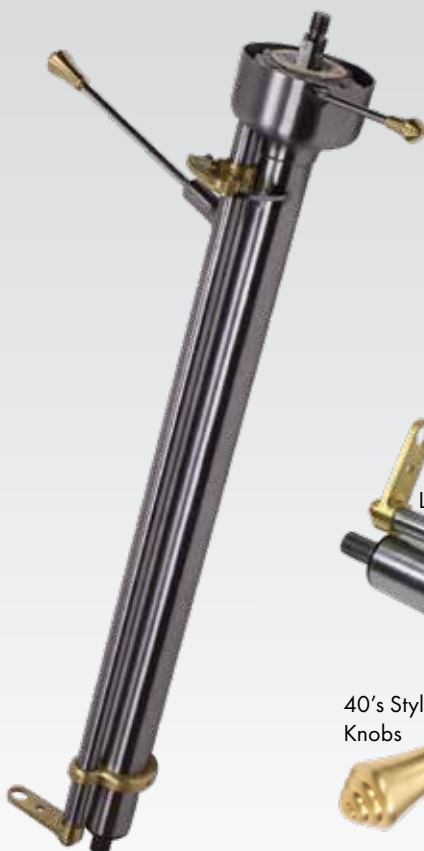

Testimonials from Industry Experts

Dave Kindig, Kindig-It Design

We love working with companies whose focus is high quality products. Whether it's polished, brushed, or paintable, Kindig-it Design relies on IDIDIT for high quality and a perfect fit every time. IDIDIT will steer your project right!

Zane Cullen, Cotati Speed Shop

Cotati Speed Shop customers demand the finest components available. The team at IDIDIT deliver excellent customer service and quality products every time.

Alan Johnson, Johnson's Hot Rod Shop Inc.

We never settle for less than the best for our customers and the projects we build. That is why I choose IDIDIT and have done so for over 25 years. Their products and customer service have never let us down.

Roy Brizio, Roy Brizio Street Rods

I have been using IDIDIT steering columns since their inception. Ken helped us car builders out so much when he introduced the IDIDIT column. We no longer had to go to the wrecking yard to find a column to bring back to the shop and rebuild. Your product is the best, and that's what we want to put in our cars.

Jesse Greening, Greening Auto Company

For more than a decade we have been putting IDIDIT columns in our builds. It doesn't matter if it's a Ridler build or a pro-touring/daily driver, it's getting an IDIDIT. There is no beating the fit, finish, safety, and customer service of an IDIDIT column.

Sam Memmolo, Motor Head Garage TV

How can you beat a company that was born in America over 35 years ago and has grown to 32,000 square feet of good old American Quality Manufacturing. IDIDIT continues to demonstrate their incredible ingenuity with laser cuts, precision welders and meeting the growing needs of their customers with products that match. I have used several IDIDIT columns over the past 15 years and have always been pleased with their service and technical expertise. Made in America means a lot to me!

John Reid, Rods by Reid

At Rods by Reid in Tauranga New Zealand, we have been using and recommending IDIDIT products for nearly 20 years. Their top quality, American made product meets our high standards for safety, reliability, style, performance & function. IDIDIT is the industry leader when it comes to custom steering columns.... producing steering columns you can trust.

Jim and Mike Ring, Ringbrothers

We've been using IDIDIT forever. There's no one better in the industry. Superior quality and fantastic service is why every Ringbrothers build is equipped with IDIDIT.

Josh Henning, Roadster Shop

Roadster Shop trusts IDIDIT for their steering columns not only for the amazing and repetitive quality of the product but the unsurpassed customer service and support. When your only as good as the weakest link, there is no place for subpar parts and materials in any build that leaves the Roadster Shop.

Chris Womack, CW Restoration Shop

When it comes to a high quality, well built, and made in the USA, CW Restoration Shop only uses IDIDIT products which complement all our builds. The team at IDIDIT can answer all your questions and concerns, to steer you in the right direction.

Application Specific Steering Columns - Cars

BENEFITS OF CHOOSING AN IDIDIT APPLICATION SPECIFIC STEERING COLUMN

“Application Specific” means we have done the research, that we have designed and developed a column that will fit your specific vehicle, often times with no modification required to your vehicle. When you buy one of our Application Specific columns you are getting a perfectly engineered aftermarket column that will sit in the original steering column location, and in most cases, will put the steering wheel back in its original position. This is not a stock replacement, it’s better! IDIDIT Application Specific columns are designed with the vehicle in our shop to ensure the perfect fit and flawless installation. We’ve done the work so you won’t have to!

If you are unsure of what you have or have any questions regarding this please give us a call and we will be more than happy to help guide you through it.

GM COLUMNS



Tri-Five
pg 20



Camaro/Firebird
pg 26



Chevelle/El Camino/GTO
pg 28



Corvette
pg 30



Impala
pg 32



Nova
pg 34

FORD COLUMNS



Falcon
pg 36



Comet/Cyclone
pg 37



Mustang
pg 38

MOPAR COLUMNS



Cuda/Challenger
pg 40



Charger/Roadrunner
pg 41



Dart/Demon/Duster
pg 41

Quick Reference Guide

USE THIS CHART TO FIND WHICH ESSENTIAL PARTS ARE INCLUDED WITH YOUR COLUMN

GM Retrofit	Dash Mount	Floor Mount	Wiring Adapter	Dash Locating Slot (s)	Other
1955-56 Chevy	OEM			✓	
1957 Chevy	OEM				
1967 Camaro	OEM		✓		
1968 Camaro	OEM		✓		
1969 Camaro	OEM				
1970-75 Camaro	OEM	✓	✓		
1964-65 Chevelle	OEM				
1966 Chevelle	OEM				
1967-68 Chevelle	OEM				
1969-72 Chevelle	OEM				
1953-57 Corvette	OEM				
1958-62 Corvette	OEM	✓			
1963-66 Corvette	OEM				
1967 Corvette					
1968 Corvette	✓	✓	✓		
1969-76 Corvette	✓	✓	✓		
1958 Impala	OEM				
1959-60 Impala/ El Camino	OEM				
1961-62 Impala	OEM				
1963-64 Impala	OEM				Dash Bezel
1965-66 Impala	OEM			✓	
1967 Impala	OEM		✓		
1971-76 Impala/ Caprice	OEM				
1962-66 Nova	OEM			✓	
1967 Nova	OEM		✓		
1969-73 Nova	OEM				
Ford Retrofit (Ford Style)					
1964 Falcon	OEM	✓	✓	✓	Gearbox Cover
1965 Falcon	OEM	✓	✓	✓	Gearbox Cover
1965 Comet/ Cyclone	OEM	✓	✓		
1965-66 Mustang	OEM	✓	✓	✓	Gearbox Cover
1967 Mustang	OEM	✓	✓	✓	
1968 Mustang	OEM	✓	✓	✓	
1969 Mustang	OEM	✓	✓	✓	
Ford Retrofit (GM Style)					
1964.5-66.5 Mustang	OEM		✓		
1966.5-69 Mustang	OEM		✓		

Mopar Retrofit	Dash Mount	Floor Mount	Wiring Adapter	Dash Locating Slot (s)	Other
1970-74 Cuda/ Challenger	✓	✓	✓		Ext Shaft*
1970-74 Cuda/ Challenger w/ OE Wheel Adapter	✓	✓	✓		Ext Shaft* & OE Wheel Adapter
1967-69 Challenger/ Roadrunner	OEM	✓	✓		
1973 Challenger/ Road Runner	OEM	✓	✓		
Dart/Demon/Duster					
GM Truck Retrofit					
1947-54 Chevy Truck	✓	✓			
1955-59 Chevy Truck	✓	✓			Gearbox Cover
1960-66 Chevy Truck	OEM	OEM		✓	
1967-72 Chevy Truck	OEM	OEM	✓		
1967-72 Chevy Truck Column Shift	OEM	OEM	✓	✓	NSS*
1973-78 Chevy Truck			✓		
FORD (Ford Style) Truck Retrofit					
1974-75 Bronco	✓	OEM	✓		
1976-77 Bronco	✓	OEM	✓		
1965-66 Ford Truck	✓	OEM	✓		Ext Shaft*
1967-72 Ford Truck	✓	OEM	✓		Ext Shaft*
1973-77 Ford Truck	✓	OEM	✓		Ext Shaft*
1978-79 Ford Truck	✓	OEM	✓		
FORD (GM Style) Truck Retrofit					
1953-56 Ford Truck			✓		Horn Relay
1965-66 Ford Truck	✓	OEM	✓		Horn Relay
1967-72 Ford Truck	✓	OEM	✓		Horn Relay
1973-77 Ford Truck	✓	OEM	✓		Horn Relay
1978-79 Ford Truck	✓	OEM	✓		Horn Relay
JEEP Retrofit					
1976-86 CJ5 & CJ7		OEM	✓		

PLEASE NOTE: Most column shift versions include a neutral safety switch

* Ext Shaft - Extended Shaft

* NSS - Neutral Safety Switch

Individual Kit Components

INTERMEDIATE SHAFT



A mild steel shaft cut to length and installed in the Rag Joint and/or U-Joint. Set screws lock it in place. The 3/4" DD shape offers a safe & inexpensive alternative for your old shaft. Collapsible shafts are available; ask your sales representative for details.

3/4"DD x 36
P# 3000409436

MODIFIED SHAFT



If you are using your original manual box and purchasing an Econo Kit, for some applications, you will need to cut and modify your 3/4" round shaft into what is referred to as 3/4" DD shape. Instructions can be found in the supplied installation instruction booklet. To watch the video, visit our YouTube Channel.

COUPLER



These are used to make an In-Line connection from the intermediate shaft to the column.

3/4"-36 x 3/4"DD
3000313449
3/4"-36 x 3/4"-36
3000313434
1"DD x 3/4"DD
3000315249
1"-48 x 3/4"DD
3000314349

VIBRATION JOINT



A Vibration Joint reduces vibration between your intermediate shaft & gearbox and is used when an angle is present in your steering setup.

3/4"DD x 3/4"-30
3000034931
3/4"DD x 13/16"-36
3000034940

Shaft and U-Joint are available in Stainless Steel and Polished Steel finishes

****NOTE: Not all Part Numbers are listed, only the most popular are shown, many more available!****

RAG JOINT

Reduces vibration between your intermediate shaft and gearbox

3/4"- 36 x 3/4"-30 # 3000053431	1" - 48 x 3/4"-36 # 3000054334
3/4"- 36 x 3/4"-36 # 3000053434	3/4"DD x 3/4"-30 # 3000054931
3/4"- 36 x 13/16"-36 # 3000053440	3/4"DD x 13/16"-36 # 3000054940
3/4"DD x 3/4"-36 # 3000053449	1"DD x 3/4"-30 # 3000055231
1"DD x 3/4"-36 # 3000053452	1"DD x 13/16"-36 # 3000055240



UNIVERSAL JOINT



A U-Joint connects the Intermediate Shaft to the IDIDIT column and is used whenever there is any type of bend from your column to your box or rack.

3/4"-36 x 3/4"DD
3000013449
1"DD x 3/4" DD
3000014952
1" -48 x 3/4"DD
3000014349

4-WAY FLASHER KIT

This wiring kit is used to adapt your stock wiring to your IDIDIT column, while adding the safety of a 4-Way Flasher to your vehicle.

1955 Chevy & 1953-62 Corvette
3100035775

1956 Chevy
3100035780

1957-58 Chevy
3100035785

1964-66 Chevelle & 1966 Nova
3100037542

1959-62 Chevy, 1962 Nova, and 1963 Corvette
3100037616

63-66 Full Size Chevy & Truck, 63-65 Nova & 64-66 Vette
3100037618

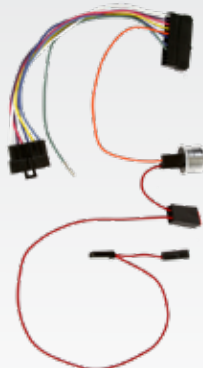

1955-1957 Chevy Tri-Five

TILT FLOOR SHIFT

When considering the popularity of the 1955-57 Chevy, IDIDIT knew there had to be a retrofit column for this legendary machine. Whether you are using the original manual gearbox, aftermarket power box, or converting to an all new rack and pinion*, IDIDIT has the column and the installation pieces you need to make the classic car even better!

COMES WITH:

- 8-Position Tilt
- Self-Cancelling turn signals
- 4-Way Flashers
- Retro Knobs and Levers
- 3 7/8" Wiring Plug
- 1" DD Lower Shaft

TECH TIP:

If you want to use your original steering wheel with your IDIDIT column, you can with the help of the IDIDIT 1955-68 Horn Kit. See page 61 for more details. Modification to the original wheel is required with the use of this kit.

*Some rack and pinion applications may require a longer column. Call us for more information.

* Please note: Cable Shift Linkage Kit does not work with Tri-Fives. Call us for more information.



	Paintable Steel	Chrome	Black Powder Coated	Brushed Aluminum	Polished Aluminum
1955 Chevy	1120550010	1120550020	1120550051	1070550030	1070550040
1956 Chevy	1120550010	1120550020	1120550051	1070550030	1070550040
1957 Chevy	1120570010	1120570020	1120570051	1070570030	1070570040

TILT COLUMN SHIFT

This column comes in either 8-position tilt or straight and column comes with everything you'll need to use your original dash indicator (*aftermarket indicators sold separately*). The shift pattern allows you to use either a 3 or 4 speed automatic transmission. (*except early Powerglides, as they are a reverse pattern transmission*) A solid shift linkage (new or original) is required for installation and will attach to the lower shift arm provided on the column.

COMES WITH:

- 8-Position Tilt
- Self-Cancelling turn signals
- 4-Way Flashers
- Neutral Safety Switch (Shift indicator not included)
- Retro Knobs and Levers
- 3 7/8" Wiring Plug
- 3/4" -36 Lower Shaft

TECH TIP:

IDIDIT offers a 9-bolt "shorty" steering wheel adapter that affixes to the top of your IDIDIT Tri-Five column and brings the wheel 2" closer to the dash, giving you more "Belly Room". See page 61 for more details.



	Paintable Steel	Chrome	Black Powder Coated	Brushed Aluminum	Polished Aluminum
1955 Tilt	1140550010	1140550020	1140550051	1150550030	1150550040
1955 Straight	1160550010	1160550020	1160550051	N/A	N/A
1956 Tilt	1140550010	1140550020	1140550051	1150550030	1150550040
1956 Straight	1160550010	1160550020	1160550051	N/A	N/A
1957 Tilt	1140570010	1140570020	1140570051	1150570030	1150570040
1957 Straight	1160570010	1160570020	1160570051	N/A	N/A

1955-1957 Chevy Tri-Five Installation Kits

ORIGINAL HARNESS

	Rag Joint	Coupler	Floor Mount	4-Way Flasher Kit
605 POWER GEARBOX				
1955 (Floor Shift) # 3005001005	✓		✓	✓
1956 (Floor Shift) # 3005001006	✓		✓	✓
1957 (Floor Shift) # 3005001007	✓		✓	✓
1955 (Column Shift) # 3005004005	✓		✓	✓
1956 (Column Shift) # 3005004006	✓		✓	✓
1957 (Column Shift) # 3005004007	✓		✓	✓
MANUAL GEARBOX				
1955 (Floor Shift) # 3004002005		✓	✓	✓
1956 (Floor Shift) # 3004002006		✓	✓	✓
1957 (Floor Shift) # 3004002007		✓	✓	✓
1955 (Column Shift) # 3004001005		✓	✓	✓
1956 (Column Shift) # 3004001006		✓	✓	✓
1957 (Column Shift) # 3004001007		✓	✓	✓
NO GEARBOX SPECIFIED				
1955 # 3008001005			✓	✓
1956 # 3008001006			✓	✓
1957 # 3008001007			✓	✓

AFTERMARKET HARNESS

	Rag Joint	Coupler	Floor Mount	4-Way Flasher Kit
605 POWER GEARBOX				
1955-57 (Floor Shift) # 3005001000	✓		✓	
1955-57 (Column Shift) # 3005004000	✓		✓	
MANUAL GEARBOX				
1955-57 (Floor Shift) # 3005001000		✓	✓	✓
1955-57 (Column Shift) # 3005004000		✓	✓	✓
NO GEARBOX SPECIFIED				
1955-1957 # 2401400010		✓	✓	

HAVE A RACK & PINION?

Due to the variety of rack & pinion set ups available, call our sales department for details on the u-joints & shafting you'll need.

NOT SURE WHAT YOU HAVE? Call our sales department and we can help determine what you have and what application will work the best.

1955-57 FLOOR MOUNT

Use this Borgeson mount to fill the gap/hole in the floor when mounting the steering column.

Brushed Aluminum
BOR909011
Polished Aluminum
BOR909012



CHEVY FLOOR MOUNT

2401400010

IDIDIT'S Classic Chevy Floor mount uses the two original holes in the floor of your 55-57 Chevy to mount the bracket. Comes complete with a clamp to secure the bracket to the column. A new floor mount is required for ALL installations. The original will not fit the IDIDIT steering column



1967-1969 Camaro/ Firebird

TILT FLOOR SHIFT

Designed to fit your Camaro or Firebird with no modification required to your original vehicle. Installs in the same location as the old column using your original underdash mount, floor mount and a new rag joint installation kit. Using an adapter, add an aftermarket wheel or call our sales department for more information on retro-fitting the original wheel to the column.

COMES WITH:

- 8-Position Tilt
- Self-Cancelling turn signals
- 4-Way Flashers
- Knobs and Levers
- 3 7/8" Wiring Plug
- 67-68 1" -48 Lower Shaft
- 69 3/4" -36 Lower Shaft
- 67- 68 includes wiring harness adapter
- 69 plugs directly into factory wiring
- 69 includes ignition & relay pack

Wiring Harness Adapter

	Paintable Steel	Chrome	Black Powder Coated	Brushed Aluminum	Polished Aluminum
1967-68	1120680010	1120680020	1120680051	1070680030	1070680040
1969 w/ Key*	1520790010	1520790020	1520790051	N/A	N/A

* If running original ignition on 1969 Firebird, please call us for more information on this set-up

TECH TIP: The original 1969 Camaro came with a Neutral Safety Switch (NSS). When installing your new IDIDIT 1969 Camaro Floor Shift Column, you will need to relocate the NSS to the transmission.

TILT COLUMN SHIFT

This column shift has all the same great features as the floor shift, and is just as easy to install! The shift pattern on the column allows you to use either a 3 or 4-speed automatic transmission. A shift linkage (new or original) is required for installation and will attach to the lower shift arm provided on the column. Using an adapter, add an aftermarket wheel, and the gripping surface will be in the same location as the stock wheel.

COMES WITH:

- 8-Position Tilt
 - Self-Cancelling turn signals
 - 4-Way Flashers
 - Knobs and Levers
 - Neutral Safety Switch
 - 3 7/8" Wiring Plug
 - 3/4" -36 Lower Shaft
 - 67-68 includes wiring harness adapter
 - 69 plugs directly into factory wiring
 - 69 includes ignition & relay pack
- (Shift Indicator sold separately, see page 56)*

* Ignition excluded on '69 Firebird. Call IDIDIT to find out why.

	Paintable Steel	Chrome	Black Powder Coated	Brushed Aluminum	Polished Aluminum
1967-68	1140680010	1140680020	1140680051	1150680030	1150680040
1969 w/ Key*	1540790010	1540790020	1540790051	N/A	N/A

RAG JOINT INSTALLATION KITS

	Rag Joint		Rag Joint		Rag Joint
3/4" -30 MANUAL GEARBOX		3/4" -36 MANUAL GEARBOX		13/16" -36 POWER GEARBOX	
1967-68 (Floor Shift) # 3000054331	1" -48 x 3/4" -30	1967-68 (Floor Shift) # 3000054334	1" - 48 x 3/4" -36	1967-68 (Floor Shift) # 3000054334	1" -48 x 13/16" -36
1967-68 (Column Shift) & 69 (all) # 3000053431	3/4" -36 x 3/4" -30	1967-68 (Column Shift) & 69 (all) # 3000053434	3/4" -36 x 3/4" -36	1967-68 (Column Shift) & 69 (all) # 3000053434	1" -48 x 13/16" -36

TECH TIP:

You can bolt your stock 1969 Camaro steering wheel directly to the IDIDIT steering column!



1970-1975 Camaro



TILT FLOOR SHIFT

Designed to fit your Camaro with no modification required to your original vehicle. The 1970-75 Camaro column is fully collapsible and comes standard with a keyed ignition in the original GM location. Installs in the same location as the old column using your original underdash mount and an IDIDIT installation kit. Using an adapter, add an aftermarket wheel and the gripping surface will be in the same location as the stock wheel. You can also bolt your original 1970-75 Camaro wheel directly to this column.

COMES WITH:

- 8-Position Tilt
- Ignition & Relay Pack
- Self-Cancelling turn signals
- 4-Way Flashers
- Knobs and Levers
- Horn Wire
- 70-74 3 7/8" Wiring Plug
- 75 4 1/4" Wiring Plug
- 1" -48 Lower Shaft
- Model specific floor mount
- Provisions for mounting bracket

	Paintable Steel	Chrome	Black Powder Coated
1970-75 w/ Key	1620860010	1620860020	1620860051

***NOTE:** This column does not have the provision needed for the OEM Neutral Safety Switch or indicator. An alternate method must be used, please call us for more information!



INSTALLATION KITS

	U-Joint	Rag Joint	Shaft	Floor Mount
3/4" -36 MANUAL GEARBOX				
1970-75 # 3011008000	1"-48 x 3/4" DD	3/4"-36 x 1" DD	Collapsible Intermediate	✓
13/16" -36 POWER GEARBOX				
1970-75 # 3011009000	1"-48 x 3/4" DD	13/16"-36 x 1" DD	Collapsible Intermediate	✓

TECH TIP:

You can install your stock 1970-75 Camaro steering wheel directly to the IDIDIT steering column!

1967-1972 Chevelle/ El Camino/ GTO

TILT FLOOR SHIFT

Designed to fit your Chevelle, El Camino or GTO with no modification required to your original vehicle. Installs in the same location as the old column using your original underdash mount, floor mount, and an IDIDIT installation kit. Using an adapter, add an aftermarket wheel and the gripping surface will be in the same location as the stock wheel. Call our sales department for more information on retro-fitting the original wheel to the column.

COMES WITH:

- 8-Position Tilt
- Self-Cancelling turn signals
- 4-Way Flashers
- Knobs and Levers
- 1964-68 3 7/8" Wiring Plug
- 1965-75 4 1/4" Wiring Plug
- 1964-65 3/4" -36 Lower Shaft
- 1966 1" DD Lower Shaft
- 1967-72 1" -48 Lower Shaft
- 1967-68 Includes wiring harness adapter
- 1969-72 Includes ignition & relay pack

1967-68
Wiring Harness
Adapter

	Paintable Steel	Chrome	Black Powder Coated	Brushed Aluminum	Polished Aluminum
1964-65	1120640010	1120640020	1120640051	1070640030	1070640040
1966	1120610010	1120610020	1120610051	1070610030	1070610040
1967-68	1120680010	1120680020	1120680051	1070680030	1070680040
1969-72 w/ Key*	1520690010	1520690020	1520690051	N/A	N/A

* If running original ignition on 1969 & 1970 GTO, please call us for more information on this set-up
***NOTE:** The 1969-72 column does not have the provision needed for the OEM Neutral Safety Switch or indicator. An alternate method must be used. See page 56 for shift indicators

TECH TIP:

You can install most stock wheels to your IDIDIT column with the help of IDIDIT's 1955-68 Horn kit, . See page 61 for more details

TILT COLUMN SHIFT

This column shift has all the same great features as the floor shift - and is just as easy to install! The shift pattern on the column allows you to use either a 3 or 4-speed automatic transmission. A shift linkage (new or original) is required for installation and will attach to the lower shift arm provided on the column. Using an adapter, add an aftermarket wheel and the gripping surface will be in the same location as the stock wheel.

COMES WITH:

- 8-Position Tilt
 - Self-Cancelling turn signals
 - 4-Way Flashers
 - Knobs and Levers
 - Neutral Safety Switch
 - 1964-68 3 7/8" Wiring Plug
 - 1969-72 4 1/4" Wiring Plug
 - 1964-68 3/4" -36 Lower Shaft
 - 1969-72 1" -48 Lower Shaft
 - 1969-72 Includes ignition & relay pack
 - 1969-72 4 1/4" Wiring Plug
- (Shift Indicator sold separately, see page 56)*

	Paintable Steel	Chrome	Black Powder Coated	Brushed Aluminum	Polished Aluminum
1964-65*	1140640010	1140640020	1140640051	1150640030	1150640040
1966	1140610010	1140610020	1140610051	1150610030	1150610040
1967-68	1140680010	1140680020	1140680051	1150680030	1150680040
1969-72 w/Key**	1540690010	1540690020	1540690051	N/A	N/A

* Column shift will not fit 1964-65 GTO's

** If using the original ignition on 1969 & 1970 GTO, please call us for more information on this set-up



Chevelle/ El Camino/ GTO Installation Kits

ORIGINAL FACTORY HARNESS	Coupler	Rag Joint	U-Joint	Intermediate Shaft	Floor Mount
3/4" -30 MANUAL GEARBOX					
1964/65 (F/S) & 1966 (C/S) # 3006001003	✓	✓		✓	✓
1966 (F/S) # 3006004003	✓	✓		✓	✓
3/4" -36 MANUAL GEARBOX					
1964/65 (F/S) & 1966 (C/S) # 3006002003	✓	✓		✓	✓
1966 (F/S) # 3006005003	✓	✓		✓	✓
13/16" -36 POWER GEARBOX					
1964/65 (F/S) & 1966 (C/S) # 3006003003	✓	✓		✓	✓
1966 (F/S) # 3006006003	✓	✓		✓	✓
AFTERMARKET HARNESS					
3/4" -30 MANUAL GEARBOX					
1964/65 (F/S) & 1966 (C/S) # 3006001000	✓	✓		✓	
1966 (F/S) # 3006004000	✓	✓		✓	
1967-68 (F/S) # 3006007000	✓	✓		✓	
1967-68 (C/S) # 3006001000	✓	✓		✓	
1969-72 # 3011007000		✓	✓	✓ Collapsible	
3/4" -36 MANUAL GEARBOX					
1964/65 (F/S) & 1966 (C/S) # 3006002000	✓	✓		✓	
1966 (F/S) # 3006005000	✓	✓		✓	
1967-68 (F/S) # 3006008000	✓	✓		✓	
1967-68 (C/S) # 3006002000	✓	✓		✓	
1969-72 # 3011008000		✓	✓	✓ Collapsible	
13/16" -36 POWER GEARBOX					
1964/65 (F/S) & 1966 (C/S) # 3006003000	✓	✓		✓	
1966 (F/S) # 3006006000	✓	✓		✓	
1967-68 (F/S) # 3006009000	✓	✓		✓	
1967-68 (C/S) # 3006003000	✓	✓		✓	
1969-72 # 3011009000		✓	✓	✓ Collapsible	

NOTE: F/S = Floor Shift; C/S = Column Shift

ECONO KITS ORIGINAL HARNESS	Coupler	Rag Joint	Floor Mount
1964/65 (F/S) & 1966 (C/S) # 3006001003	✓ 3/4" DD	Check for Wear	✓
1966 (F/S) # 3001002003	✓ 3/4" DD	Check for Wear	✓
ECONO KITS AFTERMARKET HARNESS			
1964/65 (F/S) & 1966 (C/S) # 3000313449	✓ 3/4" DD	Check for Wear	✓
1966 (F/S) # 3000315249	✓ 3/4" DD	Check for Wear	✓

NOTE: F/S = Floor Shift; C/S = Column Shift

With our Econo Kits, the original joint and intermediate shaft are used. The shaft will need to be cut and modified to match the 3/4" DD coupler. The original rag joint may be worn due to age, so always check to make sure it is in good working condition. We always recommend replacing the rag joint!



1953-1966 Corvette



1953-62 STRAIGHT FLOOR SHIFT

Due to lack of space in front of the dash, the 1953-62 Corvette column is only available in straight floor shift model. To install, simply remove the old column, saving your original underdash mount. You will need to fabricate your own floor mount to safely secure the column to the firewall. The solid shaft that extends from inside the gearbox to the steering wheel will need to be cut and modified into the 3/4" DD shape in order to fit a coupler. Using an IDIDIT installation kit, install your new steering column in place of the old. Add an aftermarket wheel with the help of the IDIDIT 1956-62 Corvette Steering Wheel Adapter.

COMES WITH:

- Self-Cancelling Turn Signals
- 4-Way Flashers
- Retro Style Knobs and Levers
- 3 7/8" Wiring Plug
- 3/4" -36 Lower Shaft
- 58-62 Includes Model Specific Floor Mount

	Paintable Steel	Chrome	Black Powder Coated	Brushed Aluminum	Polished Aluminum
1953-57 Straight	1010710010	1010710020	1010710051	N/A	N/A
1958-62 Straight	1010720010	1010720020	1010720051	1020720030	1020720040

1963-66 TILT FLOOR SHIFT

This stylish, 8-position tilt column is designed to fit your 1963-66 Corvette and does not require modification to your original vehicle to install. Easily installs in the same location as the old column using your original underdash mount, floor mount and a rag joint. You may use the original rag joint to connect to your gearbox as long as it's in good working condition, but due to age, it is highly recommended that you purchase a new one. Add an aftermarket wheel or use your original steering wheel with the help of an IDIDIT 1963-66 Corvette Steering Wheel Adapter.

COMES WITH:

- 8-Position Tilt
- Self-Cancelling Turn Signals
- 4-Way Flashers
- Knobs and Levers
- 3 7/8" Wiring Plug
- 3/4" -36 Lower Shaft

	Paintable Steel	Chrome	Black Powder Coated
1963-66 Tilt	1120770010	1120770020	1120770051

*** Please note:** The space differences when using the original steering wheel versus an aftermarket wheel. Tilt column with original column is 1/2" closer to the driver, Tilt column with an aftermarket wheel is 1 1/2" closer to the dash.

1953-68 INSTALLATION KITS

ORIGINAL FACTORY HARNESS	Coupler	Rag Joint	4-way Flasher
1953-62 Part # 3003003005	✓ 3/4" -36 x 3/4" DD		✓
1963 Part # 3003004001		✓ 3/4" -36 x 3/4" -36	✓
1964-66 Part # 3003004003		✓ 3/4" -36 x 3/4" -36	✓

AFTERMARKET HARNESS	Coupler	Rag Joint	4-way Flasher
1953-62 Part # 3000313449	✓ 3/4" -36 x 3/4" DD		
1963-67 Part # 3000053434		✓ 3/4" -36 x 3/4" -36	
1968 Part # 3000054334		✓ 1" -48 x 3/4" -36	

1967-1976 Corvette



1967 TILT FLOOR SHIFT

This 8-position tilt column is designed to accommodate increased safety measures that Chevy originally released with this car, special dash mounts and column collapsibility. This column easily installs without the need for modification to your original vehicle. You may use the original rag joint to connect to your gearbox as long as it's in good working condition, but due to age, it is highly recommended that you purchase a new one. Add an aftermarket wheel or use your original steering wheel with the help of an IDIDIT 1967 Corvette Steering Wheel Adapter. **COMES WITH:**

- 8-Position Tilt
- Self-Cancelling Turn Signals
- 4-Way Flashers
- Knobs and Levers
- 3 7/8" Wiring Plug
- 3/4" -36 Lower Shaft
- Special Dash Bezel and Wire Cover
- Full Collapsibility in case of impact
- Wiring Harness Adapter

	Paintable Steel	Chrome	Black Powder Coated
1967 Tilt	1300710010	1300710020	1300710051



1968 TILT FLOOR SHIFT

This stylish, 8-position tilt column is designed to fit your 1968 Corvette and does not require modification to your original vehicle to install. Easily installs in the same location as the old column using the new dash mount, floor mount, and a rag joint. You may use the original rag joint to connect to your gearbox as long as it's in good working condition, but due to age, it is highly recommended that you purchase a new one. Add an aftermarket wheel or use your original steering wheel with the help of an IDIDIT 1968 Corvette Steering Wheel Adapter.

COMES WITH:

- 8-Position Tilt
- Self-Cancelling Turn Signals
- 4-Way Flashers
- Knobs and Levers
- 3 7/8" Wiring Plug
- 3/4" -36 Lower Shaft
- Pre-Welded Under Dash Mount
- Model Specific Floor Mount
- Wiring Harness Adapter

	Paintable Steel	Chrome	Black Powder Coated
1968 Tilt	1120700010	1120700020	1120700051



1969-76 TILT FLOOR SHIFT

This 8-position tilt column is engineered to perfection for 1969-76 Corvettes and does not require modification to your original vehicle to install. This column easily installs in the same location as the old column using the new pre-welded dash mount, floor mount, and a rag joint (or u-joint if using rack and pinion). Using an adapter, add an aftermarket wheel or bolt your original 1969-76 Corvette wheel directly to this column, putting the steering wheel back in the original position. **COMES WITH:**

- 8-Position Tilt
- Self-Cancelling Turn Signals
- 4-Way Flashers
- Knobs and Levers
- 3 7/8" & 4 1/4" Wiring Plug
- 3/4" DD Extendable Lower Shaft
- Pre-Welded Underdash Mount
- Model Specific Floor Mount
- Ignition and Relay pack

1969-76 INSTALLATION KITS

	Rag Joint	U-Joint	4-way Flasher
1969-76 MANUAL BOX Part # 3000054949	✓ 3/4" -36 x 3/4" DD		✓
1969-76 POWER BOX Part # 3000054940	✓ 3/4" -36 x 13/16" -36		✓
1969-76 RACK & PINION Part # 3000014949		✓	✓

	Paintable Steel	Chrome	Black Powder Coated
1969-76 Tilt	1520710010	1520710020	1520710051

1958-1976 Impala

TILT FLOOR SHIFT

Designed to fit your 1958-67 & 1971-76 Impala, 1959-60 El Camino or 1971-76 Caprice with no modifications to your original vehicle. Installs in the same location as the old column using the original underdash mount, floor mount, and IDIDIT installation kit. A new aluminum dash bezel is included with the 1963-64 column, however all the other columns will match the dash perfectly using the original bezel. Add an aftermarket wheel (using an adapter) or original wheel but keep in mind that an aftermarket wheel may push the wheel closer to the driver, and the original wheel will increase the overall length of the column towards the driver.

COMES WITH:

- 8-Position Tilt
- Self-Cancelling Turn Signals
- 4-Way Flashers
- Knobs and Levers
- 3 7/8" Wiring Plug
- 1958-67 3/4" -36 Lower Shaft
- 1971-76 1" -48 Lower Shaft
- 1963-64 Includes New Dash Bezel
- 1967 Includes Wire Harness Adapter
- 1971-76 Includes Ignition and Relay Pack

TECH TIP:

The IDIDIT Column is not compatible with the 1963-64 Impala factory tachometer

	Paintable Steel	Chrome	Black Powder Coated	Brushed Aluminum	Polished Aluminum
1958	1120580010	1120580020	1120580051	1070580030	1070580040
1959-60 Impala/El Camino	1120600010	1120600020	1120600051	1070600030	1070600040
1961-62	1120620010	1120620020	1120620051	1070620030	1070620040
1963-64	1120670010	1120670020	1120670051	1070670030	1070670040
1965-66	1120660010	1120660020	1120660051	1070660030	1070660040
1967	1120780010	1120780020	1120780051	1070780030	1070780040
1971-76 Imp/Caprice w/Key	1520760010	1520760020	1520760051	N/A	N/A

TILT COLUMN SHIFT

The shift pattern on the column shift columns allows you to use either a 3 or 4-speed automatic transmission. A new aluminum dash bezel is included with the 1963-64 column, however all the other columns will match the dash perfectly using the original bezel. A shift linkage (new or original) is required for installation and will attach to the lower shift arm provided on the column. Add an aftermarket wheel (using an adapter) or use your original wheel but keep in mind that an aftermarket wheel may push the wheel closer to the driver and the original wheel will increase the overall length of the column towards the driver.

COMES WITH:

- 8-Position Tilt
- Self-Cancelling Turn Signals
- 4-Way Flashers
- Knobs and Levers
- 3 7/8" Wiring Plug
- 1958-67 3/4" -36 Lower Shaft
- 1971-76 1" -48 Lower Shaft
- 1963-64 Includes New Dash Bezel
- 1967 Includes Wire Harness Adapter
- 1971-76 Includes Ignition and Relay Pack
- Neutral Safety Switch, (Shift indicator sold separately)



	Paintable Steel	Chrome	Black Powder Coated	Brushed Aluminum	Polished Aluminum
1958	1140580010	1140580020	1140580051	1150580030	1150580040
1959-60 Imp/El Cam	1140600010	1140600020	1140600051	1150600030	1150600040
1961-62	1140620010	1140620020	1140620051	1150620030	1150620040
1963-64	1140670010	1140670020	1140670051	N/A	N/A
1965-66	1140660010	1140660020	1140660051	1150660030	1150660040
1967	1140780010	1140780020	1140780051	1150780030	1150780040
1971-76 Imp/Caprice w/Key	1540760010	1540760020	1540760051	N/A	N/A



1958-1976 Impala Installation Kits

ORIGINAL FACTORY HARNESS	Rag Joint	U-Joint	Intermediate Shaft	4-Way Flasher
3/4" -30 MANUAL GEARBOX				
1958 # 3007001007	✓	✓	✓	✓
1959-62 # 3007001001	✓	✓	✓	✓
1963-64 # 3007001002	✓	✓	✓	✓
1965-66 # 3003001002	✓			✓
3/4" -36 MANUAL GEARBOX				
1958 # 3007002007	✓	✓	✓	✓
1959-62 # 3007002001	✓	✓	✓	✓
1963-64 # 3007002002	✓	✓	✓	✓
1965-66 # 3003002002	✓			✓
13/16" -36 POWER GEARBOX				
1965-66 # 3003003002	✓			✓
AFTERMARKET HARNESS				
3/4" -30 MANUAL GEARBOX				
1958-64 # 3007001000	✓	✓	✓	
1965-67 # 3000053431	✓			
3/4" -36 MANUAL GEARBOX				
1958-64 # 3007002000	✓	✓	✓	
1965-67 Part # 3000053434	✓			
13/16" -36 POWER GEARBOX				
1965-67 # 3000053440	✓			

ECONO KITS ORIGINAL HARNESS	Rag Joint	U-Joint	4-Way Flasher
1958 # 3002001007		✓	✓
1959-62 # 3002001001		✓	✓
1963-64 # 3002001002		✓	✓
ECONO KITS AFTERMARKET HARNESS			
1958-64 # 3000013434		✓ 3/4" -36	

1963-64 DASH BEZEL

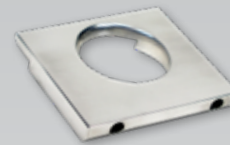

In the 1963-64 Impala the existing dash bezel is permanently attached to the original column. Therefore we've included a new dash bezel with your new 1963-64 IDIDIT retrofit steering column.

TECH TIP:
The original dash indicator cannot be used with the 1967 Column Shift Column. An Aftermarket indicator is required.

TECH TIP:
1958-60 Impala: the Column Shift Column will move the steering wheel closer to your body compared to the original. Ask how a Shorty adapter or Non-Tilt Column can help.



1962-1972 Nova

TILT FLOOR SHIFT

Designed to fit your Nova without modification to your original vehicle. Installs in the same location as the old column. 1969-73 uses original underdash mount, floor mount and an IDIDIT installation kit. 1962-67 Nova's can also reuse the original underdash mounts, but it is recommended that you purchase a NEW IDIDIT 1962-67 Nova Floor Mount. Using an adapter, add an aftermarket wheel and the gripping surface will be in the same location as the stock wheel. Call IDIDIT for info on retrofitting the original wheel to the column.

COMES WITH:

- 8-Position Tilt
- Self-Cancelling Turn Signals
- 4-Way Flashers
- Knobs and Levers
- 3 7/8" Wiring Plug
- 3/4" -36 Lower Shaft
- 1962-66 Includes Dash locating slot
- 1969-73 Includes Ignition and Relay Pack

	Paintable Steel	Chrome	Black Powder Coated	Brushed Aluminum	Polished Aluminum
1962-66	1120646010	1120646020	1120646051	1070646030	1070646040
1967	1120630010	1120630020	1120630051	1070630030	1070630040
1968	1300680010	1300680020	1300680051	N/A	N/A
1969-73	1520720010	1520720020	1520720051	N/A	N/A

*If using an aftermarket steering box please call us for more information

TILT COLUMN SHIFT

This column shift has all the same great features as the floor shift, and is just as easy to install! The shift pattern on the column allows you to use either a 3- or 4-speed automatic transmission. A shift linkage (new or original) is required for installation and will attach to the lower shift arm provided on the column. Using an adapter, add an aftermarket wheel and the gripping surface will be in the same location as the stock wheel.

COMES WITH:

- 8-Position Tilt
- Self-Cancelling Turn Signals
- 4-Way Flashers
- Neutral Safety Switch
(Shift Indicator sold separately)
- Knobs and Levers
- 3 7/8" Wiring Plug
- 3/4" -36 Lower Shaft
- 1962-66 Includes Dash locating slot
- 1969-73 Includes Ignition and Relay Pack

	Paintable Steel	Chrome	Black Powder Coated	Brushed Aluminum	Polished Aluminum
1962-66	1140646010	1140646020	1140646051	1150646030	1150646040
1967	1140630010	1140630020	1140630051	1150630030	1150630040
1968	N/A	N/A	N/A	N/A	N/A
1969-73 w/ Key	1540720010	1540720020	1540720051	N/A	N/A



1962-1972 Nova Installation Kits

ORIGINAL FACTORY HARNESS	Coupler	Rag Joint	4-way Flasher
1962 # 3001001001	✓ 3/4" -36 x 3/4" DD		✓
1963-65 # 3001001002	✓ 3/4" -36 x 3/4" DD		✓
1966 # 3001001003	✓ 3/4" -36 x 3/4" DD		✓
AFTERMARKET HARNESS			
1962-66 # 3000313449	✓ 3/4" -36 x 3/4" DD		
ECONO KIT			
1967 # 3000313434	✓ 3/4" -36 x 3/4" -36		
RAG JOINTS			
3/4" -30 MANUAL GEARBOX			
1969-73 # 3000053431		✓ 3/4" -36 x 3/4" -30	
3/4" -36 MANUAL GEARBOX			
1969-73 # 3000053434		✓ 3/4" -36 x 3/4" -36	
13/16" -36 POWER GEARBOX			
1969-73 # 3000053440		✓ 3/4" -36 x 13/16" -36	

1962-67 NOVA FLOOR MOUNT

For your 1962-67 Nova, we recommend this model specific floor mount that secures the lower end of your column to the firewall.

2400020010

Also works great with Rack & Pinion



TECH TIP:

With the help of IDIDIT's 1955-68 Horn Kit, you can bolt most stock wheels to your IDIDIT column. See pg 61 for more details.

TECH TIP:

IDIDIT cable shift linkage kits do not work for most Novas with original or and IDIDIT Steering column. Please call for more information.



1964 - 1965 Falcon



TILT FLOOR SHIFT

The Ford Falcon tilt steering column features all Ford wiring and easily attaches to your modified stock gearbox with a new coupler installation kit. This model installs in the same location as the old column, using the original underdash mount and the new model specific floor mount. Add your stock Falcon wheel and enjoy the convenience of a tilt column and a comfortable ride.

COMES WITH:

- 8-Position Tilt
- Ford Splined Top Shaft
- Ford Turn Signal Switch
- Ford Style Knobs & Levers
- Self-Canceling Turn Signals
- Gearbox Cover
- Locating Slots
- Model Specific Floor Mount
- 3/4" -36 Lower Shaft
- 1965 Comes with Ford Wiring Connectors
- 1964 Comes with Bullet Style Wiring Connector
- 1964 Comes with a Horn Brush

	Paintable Steel	Chrome	Black Powder Coated
1964	1170904010	1170904020	1170904051
1965	1170906010	1170906020	1170906051

NOTE: For Dimmer/Wiper and Cruise Control options on the Ford Style column please call for more information.

TILT COLUMN SHIFT

This column shift has all the same great features as the floor shift, and is just as easy to install! The shift pattern on the column allows you to use either a 3- or 4-speed automatic transmission. This column utilizes the original transmission mounted neutral safety switch. A gear shift indicator is optional, but not included. A shift linkage (new or original) is required for installation and will attach to the lower shift arm provided on the column. Add your stock Falcon wheel directly to the column - no adapter required.

COMES WITH:

- 8-Position Tilt
- Ford Splined Top Shaft
- Ford Turn Signal Switch
- Ford Style Knobs & Levers
- Self-Canceling Turn Signals
- Gearbox Cover
- Locating Slots
- Model Specific Floor Mount
- 3/4" -36 Lower Shaft
- 1965 Comes with Ford Wiring Connectors
- 1964 Comes with Bullet Style Wiring Connector
- 1964 Comes with a Horn Brush

	Paintable Steel	Chrome	Black Powder Coated
1964	1130904010	1130904020	1130904051
1965	1130906010	1130906020	1130906051

Warning: The Column Shift column is 2" longer and will move the steering wheel 2" closer to the driver, compared to the original.

TECH TIP:

When installing the OEM steering wheel to your IDIDIT Ford Style Column, the OEM Wheel must be for the same year application as the column. Use of a different year will result in damage to the turn signal switch.

COUPLER INSTALLATION KIT

Required for installation

The 3/4" solid shaft from your original column will need to be cut & modified into what is referred to as 3/4" DD shape
#3000313449

Includes 3/4" -36 x 3/4" DD Coupler

INCLUDED PARTS

The floor mount and gearbox cover are essential for a flawless installation, that's why they are included with every Falcon column!

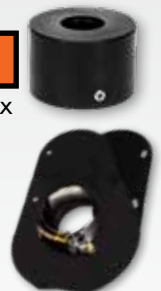

1965 Comet/Cyclone

TILT FLOOR SHIFT

A column for all the Mercury fans out there! This Ford style column will easily attach to your modified stock gearbox with a new coupler installation kit. Installs in the same location as the old column using your original underdash mount and the new model specific floor mount. Once in place, the original Comet wheel will be back in its original location, and you'll have gained the convenience of 8-position tilt for a comfortable ride.

COMES WITH:

- 8-Position Tilt
- Ford Splined Top Shaft
- Ford Turn Signal Switch
- Ford Style Knobs & Levers
- Self-Canceling Turn Signals
- Model Specific Floor Mount
- 3/4" -36 Lower Shaft
- Ford Wiring Connectors

	Paintable Steel	Chrome	Black Powder Coated
1965	1170905010	1170905020	1170905051

Please note: Dimmer/wiper and cruise control options cannot be added to the Ford Style column due to manufacturer design of the Ford Style wiring harness.

COUPLER INSTALLATION KIT

Required for installation

The 3/4" solid shaft from your original column will need to be cut and modified into what is referred to as 3/4" DD shape
#3000313449

Includes 3/4" -36 x 3/4" DD Coupler

FLOOR MOUNT

The floor mount is essential for installation in your 1965 Mercury Comet tilt steering column, and is included with the column package.



TECH TIP:

When installing your OEM steering wheel to your IDIDIT Ford Style Column, the OEM Wheel must be for the same year application as the column. Use of a different year will result in damage to the turn signal switch.



1965 - 1969 Mustang

FORD STYLE TILT FLOOR SHIFT

These Ford Style columns feature all Ford wiring and a Ford top shaft, with two options for your specific year. Our standard column bolts right to the stock box (using an IDIDIT installation kit). Our rack version is made 1" shorter in order to lessen the angle of the U-joint when bolted into your rack and pinion system. Installs in the same location as the old column using your original underdash mount. A new column specific floor mount is included with every column and is designed to fit your application. Add your stock Mustang wheel, and the gripping surface will be in the same location as the original.

COMES WITH:

- 8-Position Tilt
- Ford Splined Top Shaft
- Ford Turn Signal Switch
- Ford Style Knobs & Levers
- Model Specific Floor Mount
- Ford Wiring Connectors
- 3/4" -36 Lower Shaft
- 1968-69 is fully collapsible
- 1979-69 comes with 4-Way Flashers

	Paintable Steel	Chrome	Black Powder Coated
1965-66	1120642010	1120642020	1120642051
1965-66 w/Rack	1120644010	1120644020	1120644051
1967	1120643010	1120643020	1120643051
1967 w/Rack	1120645010	1120645020	1120645051
1968	1300644010	1300644020	1300644051
1968 w/Rack	1300645010	1300645020	1300645051
1969	1300646010	1300646020	1300646051
1969 w/Rack	1300647010	1300647020	1300647051

TECH TIP:

The 1965-66 IDIDIT Mustang Column is not compatible with the 1965-66 factory Rally Pac.

TECH TIP:

When installing your OEM steering wheel to your IDIDIT Ford Style Column, the OEM Wheel must be for the same year application as the column. Use of a different year will result in damage to the turn signal switch.

Please note: Dimmer/wiper and cruise control options can not be added to the Ford Style column due to the manufacturers design of the Ford Style wiring harness.

FLOOR MOUNT

A new floor mount is essential for flawless installation, which is why we include a model specific floor mount with every IDIDIT Mustang column!



TECH TIP:

If using a Borgeson power assisted box on any year Mustang, the column will need to be shorter. Call IDIDIT for additional information.

1965-69 INSTALLATION KITS

	Coupler	Rag Joint	DD Shaft		Coupler	Rag Joint	DD Shaft		Coupler	Rag Joint	U-Joint
MANUAL STOCK BOX				1967 STOCK BOX				RACK & PINION			
1965-66 # 3000313449	✓ 3/4" -36 x 3/4" DD			1967 Short Box # 3006002100	✓ 3/4" -36 x 3/4" DD			1965-66 & 1968-69 #3000013449			✓ 3/4" DD x 3/4" -36
* The solid shaft from your original column will need to be cut & modified into what is referred to as 3/4" DD Shape.				1968 Long Box # 3000313449	✓ 3/4" -36 x 3/4" DD	✓ 3/4" DD x 3/4" -36	✓ 2 5/16" Long	18" DD Shaft #3000409418			
1968 # 3006002100	✓ 3/4" -36 x 3/4" DD	✓ 3/4" DD x 3/4" -36	✓ 2 5/16" Long	*The 1967 Mustang used two types of stock boxes, "Long" and "Short." The Long box had one piece of shafting from the box to the upper shaft of the steering column. The Short box was attached to the column with a rag joint.				* Manual rack will also need a 3/4" DD x ?** U-Joint Power Rack will also need a 3/4" DD x ?** Vibration Joint ** Size of U-Joint or Vibration Joint depends on the size of the Manufacturer's input shaft.			
1969 # 3000053434		✓ 3/4" -36 x 3/4" -36									

1964.5 - 1969 Mustang

GM STYLE TILT FLOOR SHIFT

This GM based Mustang column features a GM upper shaft and 3 7/8" Wiring Plug. Some modification to the original gearbox and wiring will be required. Installs in the same location as the old column using your original underdash mount, floor mount and an IDIDIT installation kit. Comes complete with a female end plug for your wiring. Using an adapter, add an aftermarket wheel and the gripping surface will be in the same location as the original.

COMES WITH:

- 8-Position Tilt
- Self-Cancelling Turn Signals
- 4-Way Flashers
- Knobs and Levers
- 3 7/8" " Wiring Plug
- 3/4" -36 Lower Shaft

	Paintable Steel	Chrome	Black Powder Coated	Brushed Aluminum	Polished Aluminum
1964.5-66.5	1120647110	1120647120	1120647151	1070647130	1070647140
1966.5-69	1120690010	1120690020	1120690051	1070690030	1070690040
1970 w/ ignition	1620880010	1620880020	1620880051	N/A	N/A

Note: Because the GM Style column uses the standard GM wiring harness, dimmer/wiper and cruise control options CAN be added to the column. See pg 57 for more details.

TECH TIP:

A stock Ford steering wheel will not bolt to the IDIDIT GM Style Mustang steering column.

1969-76 INSTALLATION KITS

	Coupler	Rag Joint	DD Shaft
1964.5-66.5 # 3000313449	✓ 3/4" -36 x 3/4" DD		
* The solid shaft from your original column will need to be cut & modified into what is referred to as 3/4" DD Shape.			
1966.5-69 #3000053434	✓ 3/4" -36 x 3/4" -36		
*The rag joint will act as a coupler and vibration reducer between your intermediate shaft and gearbox.			

Turn Signal Wiring

Ford horn systems use two wires and 12 volts of power to control the horn function. IDIDIT uses a ground type relay system. A relay is provided with your kit in order to successfully complete the conversion from the Ford system to the IDIDIT system.



1970 - 1974 Cuda/Challenger

TILT FLOOR SHIFT

This retrofit column is designed to fit your 1970-74 Chrysler E-Body Cuda/Challenger and requires no modifications to your original vehicle for install. Using a new universal joint installation kit this column easily bolts to your manual stock box, power box, or rack and pinion system. This column is unique in that it can fully collapse in 3 different areas, making it the safest aftermarket column available. Do you want to use your OE Tuff Grip steering wheel or reproduction wheel? IDIDIT gives you the option to include our specially designed Cuda/Challenger Steering Wheel Adapter with your column order (use "1970-74 w/OE wheel adapter" part numbers).

COMES WITH:

- 8-Position Tilt
- Ignition and Relay Pack
- Self-Canceling Turn Signals
- 4-Way Flasher
- Knobs & Levers
- 3 7/8" Wiring Plug
- 3/4" DD Extendable Lower Shaft
- Pre-Welded Underdash Mount
- Model Specific Floor Mount
- Mopar Wiring Harness Adapter
- Fully Collapsible

	Paintable Steel	Chrome	Black Powder Coated
1970-74 w/Key	1620810010	1620810020	1620810051
1970-74 w/Key & OE wheel adapter	1620820010	1620820020	1620820051



INCLUDED PARTS

The floor mount and wiring adapter are essential for flawless installation of your IDIDIT 1970-74 Cuda/Challenger Tilt column and are included with this column.



U-JOINT INSTALLATION KITS

A u-joint is required in order to install your IDIDIT 1970-74 Cuda/Challenger column. A u-joint connects the steering box to the IDIDIT column and is used whenever there a bend from the column to the box or rack.

	Coupler	Rag Joint	U-Joint
MANUAL GEARBOX			
1970-74 # 3000013449			✓ 3/4" DD x 3/4" -36
POWER GEARBOX			
1970-74 # 3000014921			✓ 3/4" DD x 5/8" -36C

ADAPTERS & HORN KITS

1970-74 CUDA/CHALLENGER OE WHEEL Adapter

This 3-bolt wheel adapter is specially designed to bolt your OE steering wheel or reproduction wheel to the IDIDIT 1970-74 Cuda/Challenger column.

Available in:

Chrome # 2209320020

Black Powder Coated # 2209320051

Brushed Aluminum # 2209320030

Polished Aluminum # 2209320040



HORN KIT FOR GRANT TUFF GRIP REPRODUCTION WHEEL # 2611010010

This horn kit will allow you to use a Grant Tuff Grip reproduction wheel with your IDIDIT 1970-74 Cuda/Challenger column.



1967-1973 Charger/Road Runner

TILT FLOOR SHIFT

Designed to fit your Chrysler Charger or Road Runner (B-Body) and does not require modification to your original vehicle to install. These columns are fully collapsible and will bolt right in to your manual box, power box, or rack and pinion system. Installs in the same location as the old column using your original underdash mount and an IDIDIT rag joint installation kit. Using an adapter, add an aftermarket wheel, and the gripping surface will be in the same location as the stock wheel.

COMES WITH:

- 8-Position Tilt
- Self-Canceling Turn Signals
- 4-Way Flashers
- Knobs & Levers
- Year Specific Wire Plug
- 3/4" DD Extendable Lower Shaft
- Model Specific Floor Mount
- Wiring Harness Adapter
- Provision for Mounting Brackets
- 1973 Includes Ignition & Relay Pack

	Paintable Steel	Chrome	Black Powder Coated
1967-69	1300840010	1300840020	1300840051
1973 w/Key	1620870010	1620870020	1620870051

* **Please note:** A stock Chrysler steering wheel will not bolt to the IDIDIT Chrysler B-Body steering



INCLUDED PARTS

The floor mount & wiring adapter are essential for flawless installation of your IDIDIT 1967-69 & 1973 Chrysler B-Body Tilt column so we have included them with this column package.



RAG JOINT INSTALLATION KITS

	Coupler	Rag Joint	U-Joint
MANUAL GEARBOX			
1967-69 & 73 # 3000053449		3/4" DD x 3/4" -36	3/4" DD x 3/4" -36
POWER GEARBOX 3/4" -36			
1967-69 & 73 # 3000053449		3/4" DD x 3/4" -36	
POWER GEARBOX 5/8" -36C			
1967-69 & 73 # 3000053449		3/4" DD x 5/8" -36C	

*Note: 2 different spline types were used with the power steering box. Check to verify which spline type you have to ensure proper rag joint fit.



1970 - 1976 Dart/Duster/Demon

TILT FLOOR SHIFT

This retrofit column is designed to fit your Dart, Duster, or Demon (A-Body), and does not require modification to your original vehicle to install. IDIDIT's 1970-76 A-body tilt floor shift column bolts right in to your manual box, power box (with a U-joint), or rack and pinion system. These columns are fully collapsible and come complete with a model specific floor mount, wiring adapter, and a pre-welded underdash mount. For quick and easy installation, use an IDIDIT installation kit to install your new steering column in place of the old.

COMES WITH:

- 8-Position Tilt
- Ignition and Relay Pack
- Self-Canceling Turn Signals
- 4-Way Flasher
- Knobs & Levers
- 3 7/8" Wiring Plug
- 3/4" DD Extendable Lower Shaft
- Pre-Welded Underdash Mount
- Model Specific Floor Mount
- Mopar Wiring Harness Adapter
- Fully Collapsible

	Paintable Steel	Chrome	Black Powder Coated
1970-76	1620840010	1620840020	1620840051



INCLUDED PARTS

The floor mount and wiring adapter are essential for flawless installation of the IDIDIT 1970-76 Dart/Duster/Demon Tilt column, so we have included them with this column



U-JOINT INSTALLATION KITS

	Coupler	Rag Joint	U-Joint
MANUAL GEARBOX			
POWER GEARBOX (WITH U-JOINT)			
RACK & PINION			
1970-1976 # 3000014291			✓ 3/4" DD x 5/8" -36



Application Specific Steering Columns - Trucks

BENEFITS OF CHOOSING AN IDIDIT APPLICATION SPECIFIC STEERING COLUMN

“Application Specific” means we have done the research, that we have designed and developed a column that will fit your specific vehicle, often times with no modification required to your vehicle. When you buy one of our Application Specific columns you are getting a perfectly engineered aftermarket column that will sit in the original steering column location, and in most cases, will put the steering wheel back in its original position. This is not a stock replacement, it’s better! IDIDIT Application Specific columns are designed with the vehicle in our shop to ensure the perfect fit and flawless installation. We’ve done the work so you won’t have to!

If you are unsure of what you have or have any questions regarding this please give us a call and we will be more than happy to help guide you through it.

GM TRUCK



Chevy Trucks pg 40

FORD BRONCO



Ford Bronco pg 43

JEEP® CJ



Jeep CJ5 & CJ7 pg 47

FORD TRUCK



Ford Trucks pg 44

1947 - 1978 Chevy Trucks

TILT FLOOR SHIFT

We have a wide selection of columns designed to fit your classic GM Truck! Each Chevy Truck column installs in the same location as the old and includes everything you need for a flawless installation all that's required is an IDIDIT installation kit. 1947-54 Chevy Truck columns come complete with a new underdash mount and floor mount. The 1955-59 column comes with its own, specially designed underdash mount and floor mount with gasket, as well as an OE gearbox cover designed to protect the original gearbox from dirt and debris. Use your original underdash mount and floor mount to install the 1960-66 column. These columns also come with unique dash locating slots that allow for perfect installation every time. We offer both a standard and rack column for the 1967-72 Chevy Truck. The standard column will bolt right to your stock box (with a u-joint). The rack version is made shorter to lessen the angle of the u-joints. 1967-78 columns all install simply by using the original underdash mount and floor mount. Using an adapter, add an aftermarket wheel, and the gripping surface will be in the same location as the stock wheel. You can bolt your original 1973-78 steering wheel directly to the 1973-78 steering column - no adapter required!

COMES WITH:

- 8-Position Tilt
- Self-Canceling Turn Signals
- 4-Way Flasher
- Knobs & Levers
- 1955-59 Includes Retro Style Knobs
- 3 7/8" Wiring Plug
- 1973-78 4 1/4" Wiring Plug
- 1947-59 1" DD Lower Shaft

- 1960-72 3/4" -36 Lower Shaft
- 1973-78 1" -48 Lower Shaft
- 1947-54 Includes Dash Mount & Floor Mount
- 1955-59 Includes Dash Mount, Model Specific Floor Mount w/ Gasket, & OE Gearbox Cover
- 1960-66 Includes Dash Locating Slot
- 1967-72 Includes Wiring Harness Adapter
- 1973-78 Includes Ignition & Relay Pack



67-72 Wiring Harness Adapter

	Paintable Steel	Chrome	Black Powder Coated	Brushed Aluminum	Polished Aluminum
1947-54	1120651010	1120651020	1120651051	1070651030	1070651040
1955-59	1120652010	1120652020	1120652051	1070652030	1070652040
1960-66	1120650010	1120650020	1120650051	1070650030	1070650040
1967-72	1120657010	1120657020	1120657051	1070657030	1070657040
1967-72 w/ Rack	1120658010	1120658020	1120658051	1070658030	1070658040
1973-78 w/ Key	1520760010	1520760020	1520760051	N/A	N/A

*If using a stock 1960-66 wheel with a 1960-66 IDIDIT column, please call us for more information

*See page 44 for Chevy Truck Installation Kits.

TECH TIP: The 1960-66 Chevy Truck column includes the provisions needed to mount the emergency brake handle. (For steel, chrome, or black ONLY)

TECH TIP: IDIDIT's 1955-68 Horn Kit with ring allows you to use your original steering wheel with the 1967-72 IDIDIT steering column.



1947 - 1978 Chevy Trucks



TILT COLUMN SHIFT

This column shift has the same great features as the floor shift and is just as easy to install! The shift pattern on the column allows you to use either a 3 or 4-speed automatic transmission. A shift linkage (new or original) is required for installation and will attach to the lower shift arm provided on the column. Using an adapter, add an aftermarket wheel, and the gripping surface will be in the same location as the stock wheel. You can bolt your original 1973-78 steering wheel directly to the 1973-78 steering column, no adapter required!

COMES WITH:

- 8-Position Tilt
- Self-Canceling Turn Signals
- 4-Way Flasher
- Knobs & Levers
- 1955-59 Includes Retro Style Knobs
- 3 7/8" Wiring Plug
- 1973-78 4 1/4" Wiring Plug
- 1947-59 1" DD Lower Shaft
- 1955-78 comes with Neutral Safety Switch (shift indicator NOT included)
- 1960-72 3/4" -36 Lower Shaft
- 1973-78 1" -48 Lower Shaft
- 1947-54 Includes Dash Mount & Floor Mount
- 1955-59 Includes Dash Mount, Model Specific Floor Mount w/ Gasket, & OE Gearbox Cover
- 1960-66 Includes Dash Locating Slot
- 1967-72 Includes Wiring Harness Adapter
- 1973-78 Includes Ignition & Relay Pack

	Paintable Steel	Chrome	Black Powder Coated	Brushed Aluminum	Polished Aluminum
1947-54	1130651010	1130651020	1130651051	1150651030	1150651040
1955-59	1140652010	1140652020	1140652051	1150652030	1150652040
1960-66	1140650010	1140650020	1140650051	1150650030	1150650040
1967-72	1140657010	1140657020	1140657051	1150657030	1150657040
1960-66 w/ Rack	1140650110	1140650120	1140650151	N/A	N/A
1967-72 w/ Rack	1140658010	1140658020	1140658051	1150658030	1150658040
1973-78 w/ Key	1540760010	1540760020	1540760051	N/A	N/A

1947-54 CHEVY TRUCK INCLUDES

Each 1947-54 column comes complete with a column-specific underdash mount and classic floor mount for easy, hassle free installation.



1955-59 CHEVY TRUCK INCLUDES

The floor mount with gasket, underdash mount, and OE gearbox cover are essential for flawless installation, which is why they are included with every 1955-59 Chevy truck column.



*A stock 1947-54 column does not come with a Neutral Safety Switch or shift indicator. Call us for more information.

*If using a stock 1960-66 wheel with a 1960-66 IDIDIT column, please call us for more information.

*See page 44 for Chevy Truck Installation Kits.



1947 - 1978 Chevy Trucks Installation Kits

ORIGINAL FACTORY HARNESS	Coupler	Rag Joint	U-Joint	Vibration Joint	Shaft	4-Way Flasher
3/4" -30 MANUAL GEARBOX						
1960-62 # 3006001001	✓	✓			✓ Intermediate	✓
1963-66 # 3006001002	✓	✓			✓ Intermediate	✓
3/4" -36 MANUAL GEARBOX						
1960-62 # 3006002001	✓	✓			✓ Intermediate	✓
1963-66 # 3006002002	✓	✓			✓ Intermediate	✓
AFTERMARKET HARNESS						
3/4" -30 MANUAL/POWER GEARBOX						
1960-66 # 3006001000	✓	✓			✓ Intermediate	
1967-72 # 3007001000	✓		✓		✓ Intermediate	
1977-78 #3010007000	✓	✓			✓ Intermediate	
3/4" -36 MANUAL GEARBOX						
1960-66 # 3006002000	✓	✓			✓ Intermediate	
1967-72 # 3007002000	✓		✓		✓ Intermediate	
13/16" -36 POWER GEARBOX						
1967-72 # 3007002000		✓	✓		✓ Telescoping	
1973-78 # 3010007000	✓	✓			✓ Telescoping	
ECONO KITS						
ORIGINAL FACTORY HARNESS						
1960-62 # 3001001001	✓					✓
1963-66 # 3001001002	✓					✓
AFTERMARKET HARNESS						
1960-66 # 3000313449	3/4-36 x 3/4" DD					
1955-59 INSTALLATION KITS						
1955-59 # 3000315249	3/4" DD x 1" DD					

1955-59 TURN SIGNAL WIRING

If your Chevy Truck was originally equipped with turn signals, you will need one of the following year specific wiring harness adapters.

1955 # 3100035775
 1956 # 3100035780
 1957-59 # 3100035785

If your truck did NOT come with factory turn signals, use this plug to connect your wiring.

Female End Plug # 3106050010

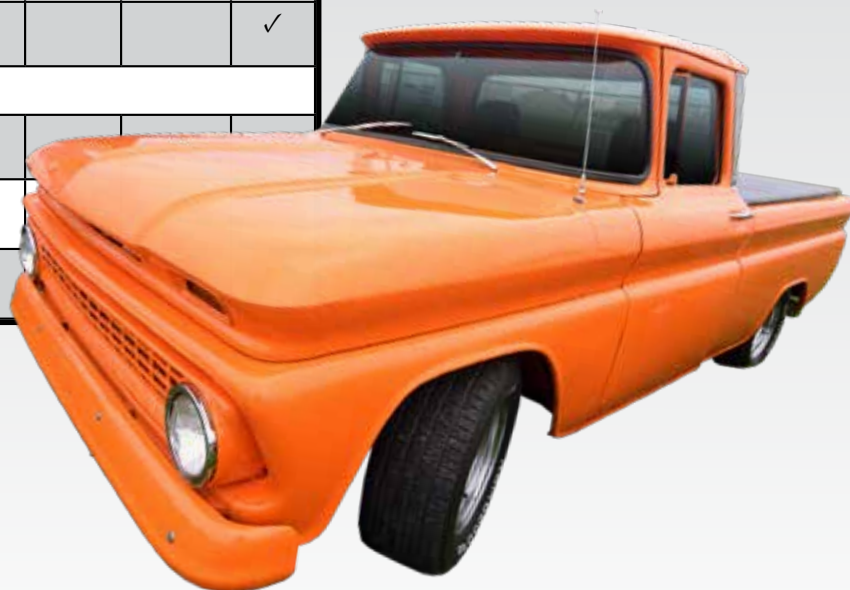

1974-1979 Ford Bronco

TILT FLOOR SHIFT

Designed to fit your Bronco without requiring modifications to your original vehicle. This Ford Style column features all Ford wiring, Ford top shaft, and easily attaches to your stock gearbox with a new half rag joint installation kit. Installs in the same location as the old column using your original floor mount and new dash mount. Add your stock Bronco wheel, and the gripping surface will be in the same location as the original.

COMES WITH:

- 8-Position Tilt
- Ford Splined Top Shaft
- Ford Turn Signal Switch
- Ford Style Knobs & Levers
- 4-Way Flashers
- 3/4" -36 Lower Shaft
- Ford Wiring Connectors
- Pre-Welded Underdash Mount

TECH TIP:

When installing your OEM steering wheel to the IDIDIT Ford Style Column, the OEM wheel must be for the same year application as the column. Use of a different model year will result in turn signal damage.

	Paintable Steel	Chrome	Black Powder Coated
1974-75	1170845010	1170845020	1170845051
1976-77	1170855010	1170855020	1170855051
1978-79	1170815010	1170815020	1170815051

TILT COLUMN SHIFT

This column shift has all the same great features as the floor shift, and is just as easy to install! The shift pattern on the column allows you to use either a 3 or 4-speed automatic transmission. This column utilizes the original transmission mounted neutral safety switch. A gear shift indicator is an option, but not included. A shift linkage (new or original) is required for installation and will attach to the lower shift arm provided on the column. Add your stock Bronco wheel directly to the column, no adapter required.

COMES WITH:

- 8-Position Tilt
- Ford Splined Top Shaft
- Ford Turn Signal Switch
- Ford Style Knobs & Levers
- 4-Way Flashers
- 3/4" -36 Lower Shaft
- Ford Wiring Connectors
- Pre-Welded Underdash Mount

	Paintable Steel	Chrome	Black Powder Coated
1974-75	1130845010	1130845020	1130845051
1976-77	1130855010	1130855020	1130855051
1978-79	SEE PG 47 FOR MORE INFORMATION		

INSTALLATION KITS

	Rag Joint	
1974-75 # 3000383400	✓ 3/4" -36 Half Rag Joint	A half rag joint is required for installation. The original rag joint was pressed into the column and cannot be removed.
1976-77 # 3000941000	✓	Before installing, carefully inspect the rubber on the other half of the original rag joint to be sure it is intact. If it is not, you need to use the replacement in this kit.
1978-79 # 3000053434	✓ 3/4" -36 x 3/4" -36	



FORD SHIFT INDICATORS

Shift Indicators available for your Ford AOD, AODE, C4 or C6 for your Ford transmission. See pg 57 for details.

1953-1979 Ford 1/2 Ton Truck

FORD STYLE TILT FLOOR SHIFT

IDIDIT built this Ford Style column specifically for those who are using stock Ford wiring and wish to use their original steering wheel. It features all Ford wiring and a Ford top shaft and will work with your stock box or rack & pinion system. 1965-77 columns come with an extendable shaft which allows you to adjust the column length to fit your manual or power gearbox. Using a new rag joint installation kit, install your new steering column in place of the old. Add your stock Ford Truck wheel and the gripping surface will be in the same location as the original.

COMES WITH:

- 8-Position Tilt
- Ford Splined Top Shaft
- Ford Turn Signal Switch
- Ford Style Knobs & Levers
- Pre-Welded Underdash Mount
- Ford Wiring Connectors
- 1965-77 Extendable Lower Shaft
- 1973-79 Comes with 4-Way Flashers

	Paintable Steel	Chrome	Black Powder Coated
1965-66	1170825010	1170825020	1170825051
1967-72	1170735010	1170735020	1170735051
1973-77	1170755010	1170755020	1170755051
1978-79	1170815010	1170815020	1170815051

TECH TIP:

When installing your OEM steering wheel to the IDIDIT Ford Style Column, the OEM Wheel must be for the same year application as the column. Use of a different model year will result in damage to the turn signal switch.

RAG JOINT INSTALLATION KITS

Required for FORD STYLE column installation

	Rag Joint		Rag Joint
1965-77 # 3000053449	✓ 3/4" DD x 3/4" -36	1978-79 # 3000053434	✓ 3/4" -36 x 3/4" -36

GM STYLE TILT FLOOR SHIFT

This Ford Truck column features a GM upper shaft, and a 3 7/8" Wiring Plug. This column installs in the same location as the old column using your original floor mount, a pre-welded underdash mount, and an IDIDIT installation kit. 1953-56 columns will require a new swinger-style column drop, floor mount, and u-joint. Using an adapter, add an aftermarket wheel, and the gripping surface will be in the same location as the original.

COMES WITH:

- 8-Position Tilt
- Self-Canceling Turn Signal
- 4-Way Flasher
- Knobs & Levers
- 3 7/8" Wiring Plug
- Female End Plug
- 1953-56 1" DD Lower Shaft
- 1965-79 3/4" -36 Lower Shaft
- 1965-79 Includes Pre-Welded Underdash Mount

	Paintable Steel	Chrome	Black Powder Coated	Brushed Aluminum	Polished Aluminum
1953-56	1120800010	1120800020	1120800051	1070800030	1070800040
1965-66	1170820010	1170820020	1170820051	1070820030	1070820040
1967-72 Manual Box	1170730010	1170730020	1170730051	1070730030	1070730040
1967-72 Power Box	1170740010	1170740020	1170740051	1070740030	1070740040
1973-77	1170750010	1170750020	1170750051	1070750030	1070750040
1978-79	1170810010	1170810020	1170810051	1070810030	1070810040

* **Note:** If trying to bolt a stock Ford steering wheel to this column please call for more information

* **Note:** If you need a column for years 1957-64 , please call for more information

1953-1979 Ford 1/2 Ton Truck

FORD STYLE TILT COLUMN SHIFT

IDIDIT built this Ford Style column specifically for those using stock Ford wiring who wish to use their original steering wheel with the added convenience of a column shift steering column. They feature all Ford wiring and a Ford top shaft, and will work with your stock box or rack and pinion system. Using a new rag joint installation kit, install your new steering column in place of the old. Add your stock Ford Truck wheel, and the gripping surface will be in the same location as the original. **COMES WITH:**

- 8-Position Tilt
- Ford Splined Top Shaft
- Ford Turn Signal Switch
- Ford Style Knobs & Levers
- Pre-Welded Underdash Mount
- Ford Wiring Connectors

	Paintable Steel	Chrome	Black Powder Coated
1965-66	1130821010	1130821020	1130821051
1967-72 Manual Box	1130731010	1130731020	1130731051
1967-72 Power Box	1130741010	1130741020	1130741051
1973-77	1130751010	1130751020	1130751051
1978-79	1130811010	1130811020	1130811051

RAG JOINT INSTALLATION KITS

Required for **FORD STYLE** column installation

	Rag Joint		Rag Joint
1965-77 # 3000053449	✓ 3/4" DD x 3/4" -36	1978-79 # 3000053434	✓ 3/4" -36 x 3/4" -36

GM STYLE TILT COLUMN SHIFT

This column shift has the same great features as the floor shift and is just as easy to install! The shift pattern on the column allows you to use either a 3 or 4-speed automatic transmission. The 1965-77 column shift column comes complete with a neutral safety switch, while the 1978-79 column utilizes the original transmission mounted neutral safety switch. A gear shift indicator is optional, but not included. A shift linkage (new or original) is required for installation and will attach to the lower shift arm provided on the column. Using an adapter, add an aftermarket wheel, and the gripping surface will be in the same location as the stock wheel.

COMES WITH:

- 8-Position Tilt
- Self-Canceling Turn Signal
- 4-Way Flasher
- Knobs & Levers
- 1965-79 Comes with Neutral Safety Switch (Shift Indicator not Included)
- 3 7/8" Wiring Plug
- Female End Plug
- 1953-56 1" DD Lower Shaft
- 1965-79 3/4" -36 Lower Shaft
- 1965-79 Includes Pre-Welded Underdash Mount

	Paintable Steel	Chrome	Black Powder Coated	Brushed Aluminum	Polished Aluminum
1953-56	1130800010	1130800020	1130800051	1150800030	1150800040
1965-66	1130820010	1130820020	1130820051	N/A	N/A
1967-72 Manual Box	1130730010	1130730020	1130730051	1150730030	1150730040
1967-72 Power Box	1130740010	1130740020	1130740051	1150740030	1150740040
1973-77	1130750010	1130750020	1130750051	1150750030	1150750040
1978-79	1130810010	1130810020	1130810051	1150810030	1150810040

FORD SHIFT INDICATOR



Get a Ford AOD, AODE, C4, or C6 shift indicator for your Ford transmission. See pg 56 for details.

* **Note:** If trying to bolt a stock Ford steering wheel to this column, please call for more information

* **Note:** For 1965-66 columns: The Bendix box was frequently used as a replacement for the Saginaw box. If not using the stock steering box, a shorter length column may be required. Call IDIDIT for details.

1953-1979 Ford 1/2 Ton Truck Installation Kits

FORD STYLE COLUMNS	Rag Joint
RAG JOINT INSTALLATION KITS	
1965-77 # 3000053449	✓ 3/4" DD x 3/4" -36
1978-79 # 3000043434	✓ 3/4"-36 x 3/4" -36
GM STYLE COLUMNS	
1953-56 # 3000409436	If you are using your stock manual gearbox you will need to cut & modify this original shaft into what is referred to as a 3/4" DD shape. If using a rack and pinion system, a 3/4"DD x 36" Intermediate Shaft may be required.
1965-79 # 3000053434	✓ 3/4"-36 x 3/4" -36



1976 - 1986 Jeep CJ5 & CJ7



TILT FLOOR SHIFT

Designed to fit your Jeep® CJ5 or CJ7 and does NOT require modification to your original vehicle to install. This rugged and durable column comes complete with a keyed ignition. Installs in the same location as the old column using your original underdash mount and floor mount. Using an adapter, add an aftermarket wheel and the gripping surface will be in the same location as the stock wheel. You can also bolt your stock Jeep CJ wheel directly to this column.

COMES WITH:

- 8-Position Tilt
- Ignition & Relay Pack
- Self-Canceling Turn Signal
- 4-Way Flasher
- Knobs & Levers
- 3 7/8" & 4 1/4" Wiring Plug
- 1" -48 Lower Shaft
- Provision for Mounting Bracket

	Paintable Steel	Chrome	Black Powder Coated
1976-86 with Key	1520800010	1520800020	1520800051

1976-86 JEEP CJ MOUNT

#2312600051



If you are replacing your original tilt column with a new, IDIDIT Jeep Column, a 1976-86 Jeep CJ mount is needed in order to bolt the new column in place of the old. The original tilt CJ column used a different type of mount than the non-tilt CJ column.

INSTALLATION KITS

No installation kit is required if using the original u-joint and shafting. However, if the shafting is worn or missing, we offer these replacement steering shafts for your Jeep CJ, available as a exact replacement for the original.

REGULAR SHAFT

Manual Box: #3000000905

Power Box: #3000000910



VIBRATION REDUCER UPGRADE

Manual Box: # 3000000915

Power Box: # 3000000920



Golf Cart Steering Columns

Get the comfort of driving a luxury car both on the course and around the neighborhood, golf carts aren't just for the course anymore! IDIDIT's line of golf cart columns allows you to enjoy the luxury of tilt steering in your prized cart all, while offering easy access in and out of your cart. And of course we didn't forget about safety, we built in self-cancelling turn signals and 4-way flashers into the column so you have all the safety features of a standard vehicle.

Customize your cart with an IDIDIT Golf Cart tilt steering column! We fit:

- CLUB CAR
- EZ GO
- YAMAHA

Available finishes include chrome or black powder coat. Add a stylish steering wheel, and be the envy of the whole neighborhood. Enjoy the great outdoors while enjoying the ease of a tilt steering column in your golf cart!

CLUB CAR

E-Z GO

YAMAHA



Golf Cart Steering Columns



CLUB CAR TILT

This column was made to fit your Club Car Cart designed to fit into the original dash support. For hassle free installation, the lower shaft of the column matches the spline of the original universal joint. The wiring slot is located at the lower end of the column, allowing the wiring to be easily hidden behind the dash. An installation kit is required to install the IDIDIT Precedent Series columns.

	Chrome	Black Powder Coated
1984-91	1129200120	1129200151
1992-04	1129200020	1129200151
Precedent Series (04-Newer)	1129210020	1129210051

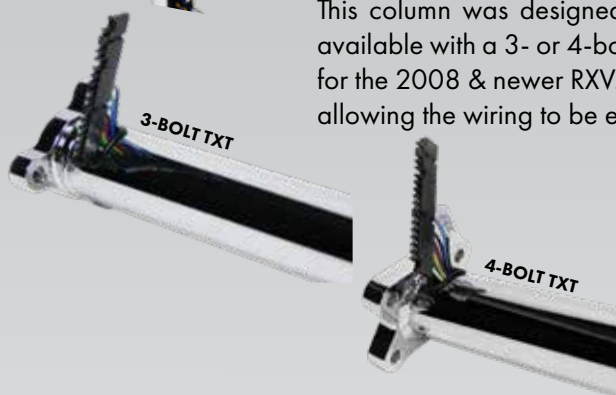

E-Z GO TILT

This column was designed to fit the original floor support of your E-Z Go TXT and is available with a 3- or 4-bolt floor mount. Brand new to IDIDIT's E-Z Go line is a tilt column for the 2008 & newer RXV. The wiring slot is located at the lower end of the each column, allowing the wiring to be easily hidden behind the dash.

	Chrome	Black Powder Coated
TXT 4-Bolt Floor Mount	1129400020	1129400051
TXT 3-Bolt Floor Mount	1129401020	1129401051
RXV (08-Newer)	1129210020	1129210051

YAMAHA TILT

The original box on early model Yamaha carts was built with an integral shaft, making the column and gearbox a one-piece unit. This means that the gearbox will need to be modified before installing the IDIDIT Yamaha tilt column. These columns come with the necessary coupler, as well as detailed instructions on how to modify the gearbox. Late model Yamaha golf carts do not require modifications to the gearbox. IDIDIT's all-new Yamaha Drive tilt column comes in two versions: one for aftermarket light kits, and one for OE light kits. The wiring slot is located at the lower end of the column, allowing the wiring to be easily hidden behind the dash.



	Chrome	Black Powder Coated
Drive (07-Newer) w/OE Light Kit	1129220020	1129220051

STRAIGHT SERIES

Get the "Hot Rod" look for your golf cart with IDIDIT's all new Classic Straight steering column, available for select golf cart models. Comes with self-canceling turn signals, 4-way flashers, and our standard dress-up kit.



	Chrome	Black Powder Coated
Club Car Precedent	1019010020	1019010051
EZ-GO RXV	1019010020	1019010051
Yamaha Drive	1019010020	1019010051

Golf Cart Installation Kits

	U-Joint	Shaft	Floor Mount	4-Way Flasher
CLUB CAR PRECEDENT				
2004 - Current # 3012020009	✓	✓	✓	✓
2004 - Current w/LED Taillights # 3014020010	✓	✓	✓	✓
EZ RXV				
2008-Current #3012021009	✓	✓	✓	✓
2008 - Current w/LED Taillights # 3014021010	✓	✓	✓	✓
YAMAHA DRIVE				
2007- Current w/LED Taillights # 3015020010			✓	✓

4-WAY FLASHER KIT

Add the safety of turn signals & 4-way flashers to your golf cart with this wiring adapter kit.

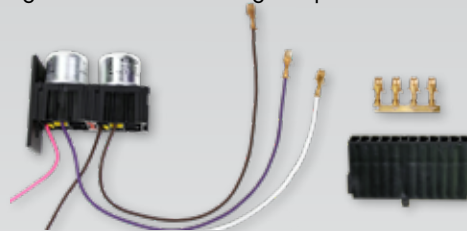

Add-Ons & Accessories

Save yourself time, money, and hassle by planning ahead and choosing the column add-ons and accessories you'll need before ordering your IDIDIT steering column. We can install cruise control, dimmer, wipers, or a neutral safety switch to your IDIDIT column at the time of order placement (additional labor charges may apply), saving you the hassle of having to ship your column back to our facility after you've received it. Planning ahead will greatly increase the success of your project.

Call us with any questions you may have and we will be more than happy to help you choose what you'll need to customize your IDIDIT column.

FLOOR MOUNTS

pg 54



COLUMN DROPS

pg 55



SHIFT INDICATORS

pg 56



CRUISE CONTROL

pg 57



DIMMER/WIPER KITS

pg 57



CABLE SHIFT-LINKAGE KITS

pg 58



DRESS-UP KITS

pg 59



KNOBS & LEVERS

pg 60



WHEEL ADAPTERS

pg 61



SIDE STEP STEERING BOX

pg 62



IGNITION SYSTEMS

pg 62



Floor Mounts

A floor mount is essential for proper installation of your steering column - Do Not overlook this important safety feature! IDIDIT floor mounts are available in a variety of sizes to fit your column.

SWIVEL BALL FLOOR MOUNT

The IDIDIT swivel ball floor mount allows you to position your steering column precisely where you want it. You can move it up, down, side to side, and everything in between. A trim ring for the engine compartment side is included, along with all the hardware you need for installation. Available in polished aluminum. For aftermarket columns only. Please be sure to use the charts below for the correct part number based on column finish. Chrome and Black Powder Coat floor mounts are bored out more due to the thickness of the coating.



Paintable Steel Columns

1 3/4" Polished Aluminum	2400500040
2" Polished Aluminum	2401500040
2 1/4" Polished Aluminum	2402500040

Chrome & Black Powder Coated Columns

1 3/4" Polished Aluminum	2400550040
2" Polished Aluminum	2401550040
2 1/4" Polished Aluminum	2402550040

ADJUSTABLE FLOOR MOUNT WITH TRIM KIT

This kit will not only secure your column, but it will also add style and class to your interior! This kit includes an adjustable floor mount and polished aluminum trim ring with hardware. Add one of our stylish vinyl boots to cover the mount (sold separately) Choose from 4 different colors!

1 3/4" Adjustable Trim Kit	2400800010
2" Adjustable Trim Kit	2401800010
2 1/4" Adjustable Trim Kit	2402800010
Black Boot for Adjustable Trim Kit	2405810010
Bone Boot for Adjustable Trim Kit	2405820010
Brown Boot for Adjustable Trim Kit	2405830010
Grey Boot for Adjustable Trim Kit	2405840010

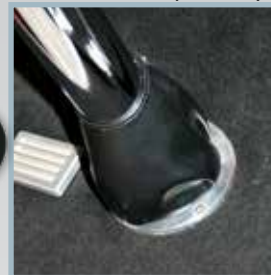

Vinyl Boot available in:



ADJUSTABLE FLOOR MOUNT

This inexpensive, steel floor mount will safely secure your column at the floor board or firewall, and can adjust to fit most angles, up or down.

1 3/4"	2400300010
2"	2401300010
2 1/4"	2402300010



COLLAPSIBLE FLOOR MOUNT WITH PLATE

Designed to mount a steering column to the floor or firewall, this floor mount can be installed on either side of the firewall and includes extra material allowing you to cover any holes left behind by the existing steering column. You trim to fit.



1 1/2"	2401120010	1 3/4"	2401220010
2"	2401020010	2 1/4"	2402020010

CLASSIC CHEVY FLOOR MOUNT

The Classic Chevy Floor mount secures the bracket using the two original holes in the inside floor of your 55-57 Chevy. Comes complete with a clamp to secure the bracket to the column, this floor mount is strongly recommended for all Chevy Tri-Five Installations.

2" Classic Chevy	2401400010
2 1/4" Classic Chevy	2402400010



COLLAPSIBLE FLOOR MOUNT

This floor mount is designed to mount a steering column to the floor or firewall, and can be installed on either side of the firewall.



1 1/2"	2401110010	1 3/4"	2401210010
2"	2401010010	2 1/4"	240200010

Column Drops

ORIGINAL STYLE 2 1/4"

Designed for tubes 2 1/4" in diameter.
Mounting bolts are set 2 5/8" apart.

Drop Length	Brushed AL	Polished AL
2 1/2"	2302370030	2302370040
3 1/2"	2303370030	2303370040
4 1/2"	2304370030	2304370040
5 1/2"	2305370030	2305370040
6 1/2"	2306370030	2306370040
7 1/2"	2307370030	2307370040



ORIGINAL STYLE 2"

Designed for tubes 2" in diameter.
Mounting bolts are set 2 5/8" apart.

Drop Length	Brushed AL	Polished AL
2 1/2"	2302470030	2302470040
3 1/2"	2303470030	2303470040
4 1/2"	2304470030	2304470040
5 1/2"	2305470030	2305470040
6 1/2"	2306470030	2306470040
7 1/2"	2307470030	2307470040



ORIGINAL STYLE 1 3/4"

Designed for tubes 1 3/4" in diameter.
Mounting bolts are set 2 5/8" apart.

Drop Length	Brushed AL	Polished AL
2 1/2"	2302570030	2302570040
3 1/2"	2303570030	2303570040
4 1/2"	2304570030	2304570040
5 1/2"	2305570030	2305570040
6 1/2"	2306570030	2306570040
7 1/2"	2307570030	2307570040



ORIGINAL STYLE GM - 2 3/8"

Designed for tubes 2 3/8" in diameter.
Mounting bolts are set 2 5/8" apart.

Drop Length	Brushed AL	Polished AL
2 1/2"	2302170030	2302170040
3 1/2"	2303170030	2303170040
4 1/2"	2304170030	2304170040
5 1/2"	2305170030	2305170040
6 1/2"	2306170030	2306170040
7 1/2"	2307170030	2307170040



ORIGINAL STYLE VANS - 2"

Designed for tubes 2" in diameter.
Mounting bolts are set 2 5/8" apart.

Drop Length	Brushed AL	Polished AL
2 1/2"	2302270030	2302270040
3 1/2"	2303270030	2303270040
4 1/2"	2304270030	2304270040
5 1/2"	2305270030	2305270040
6 1/2"	2306270030	2306270040
7 1/2"	2307270030	2307270040



ORIGINAL STYLE 1932 FORD

Designed for the 1932 Ford Dash.
Mounting bolts are set 2 5/8" apart
Standard length is 5" from center.

Hole Size	Brushed AL	Polished AL
GM 2 3/8"	2305180030	2305180040
Van 2"	2305280030	2305280040
IDIDIT 2 1/4"	2305380030	2305380040
IDIDIT II 2"	2305480030	2305480040
1 3/4"	2305580030	2305580040



1965-66 FORD F100

Mounting Slots are set 3 5/8" apart

Hole Size	Brushed AL	Polished AL
2"	2311000030	2311000040
2 1/4"	2311500030	2311500040



1947-54 CHEVY TRUCK

IDIDIT's 1947-54 Chevy Truck Dash Bracket is designed to affix the column drop to your dash.

#2301050010



SMOOTH DROPS

IDIDIT's Smooth drops have been designed with rounded edges creating a classier, more finished look.

Drop Length	Hole Size	Brushed AL	Polished AL
2 1/2"	2"	2342470030	2342470040
2 1/2"	2 1/4"	2342370030	2342370040
3 1/2"	2"	2343470030	2343470040
3 1/2"	2 1/4"	2343370030	2343370040



Column Drops

STEEL WELD ON

Designed to weld onto your 2" diameter steering column and under your dash for a custom setup. Mounting slots are 1 3/4" apart (slotted 1 7/8").

Drop Length	Steel
3"	2303490010
4"	2304490010
5"	2305490010
7"	2307490010



GM 1969 OR NEWER UNDERDASH MOUNT

Mounting Slots are set 5 1/4" apart (slotted 1")

Hole Size	Brushed AL	Polished AL
1 3/4"	2310300030	2310300040
2"	2310000030	2310000040
2 1/4"	2310500030	2310500040



Shift Indicators

SHIFT INDICATOR WITH POINTER

IDIDIT offers easy-to-install, acrylic shift indicators for your column shift column. Made from high quality acrylic, these indicators can fit any 4" diameter column. Comes complete with matching acrylic pointer and easily attaches to your column with adhesive tape. Available for your 3-speed or 4-speed automatic transmission.

3 Speed	2600000010
4 Speed	2600050010
Ford AOD 1980-93	2600060010
Ford AODE 1992 & Up	2600070010
Ford C4 & C6	2600071010

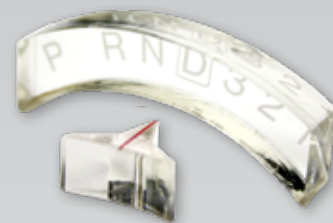

SHIFT INDICATOR WITH POINTER & HOUSING

IDIDIT'S shift indicator with housing comes complete with acrylic indicator, matching aluminum pointer, and two short screws that are used to affix the housing and indicator to your column for your 3-speed or 4-speed automatic transmission. Housing and matching indicators are available in Chrome, Black Powder Coat, Brushed Aluminum, or Polished Aluminum finishes.

	3 Speed	4 Speed	Ford AOD 80-93	Ford AODE 92 & Up	C4 & C6
Chrome	2600200020	2600250020	2600260020	2600270020	2600271020
Black Powder Coated	2600200051	2600250051	2600260051	2600270051	2600271051
Brushed Aluminum	2600200030	2600250030	2600260030	2600270030	2600271030
Polished Aluminum	2600200040	2600250040	2600260040	2600270040	2600271040



SHIFT INDICATOR WITH POINTER & HOUSING

Our shift indicators are also available for your right hand drive column. Available with or without an aluminum housing, these high-quality indicators work great with your 3 speed or 4 speed automatic transmission.

	3 Speed	4 Speed
Indicator w/ Pointer	2600001010	2600051010



Indicator w/ Pointer & Housing	3 Speed	4 Speed
Chrome	2600201020	2600251020
Black Powder Coated	2600201051	2600251051
Brushed Aluminum	2600201030	2600251030
Polished Aluminum	2600201040	2600251040



Cruise Control

Call us today to find out how you can save yourself time and money by having IDIDIT install your cruise control lever while we assemble your column! Labor charges may apply.

****Please note: Cruise Control units can NOT be returned if the wires have been cut.****

NON-COMPUTERIZED ENGINES

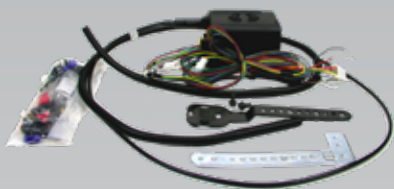

3100020000

This Rostra electric servo unit uses solid state electronics for accuracy and reliability. The servo and control unit are small and easy to mount. Kit includes pulse generator and cruise control lever.

COMPUTERIZED ENGINES



3100010000

This Rostra unit gathers information from your car's computer, so no external sensors are required. Adjustable for 2,000, 4,000 or 8,000 pulses per mile. Small and easy to mount. Kit includes a cruise control lever.

CRUISE CONTROL COVERS

Dress up your cruise control lever with this stylish aluminum cover!

Brushed Aluminum	2501000030
Polished Aluminum	2501000040
Brushed Aluminum Right Hand Drive	2501050030
Polished Aluminum Right Hand Drive	2501050040



THROTTLE BY WIRE

DAKRC-1003-C

Cruise control for your GM Throttle-By-Wire Engines. This easy to install kit includes module, wiring, and lever.

DIMMER KIT

IDIDIT's dimmer kit features a momentary switch and relay pack. The relay pack makes the switch an "on/off" that will toggle your headlights from high beam to low beam and back again. You have the option of putting the switch on either your tilt or turn signal lever.



Kit with Turn Signal Lever Brushed	3100030130
Kit with Turn Signal Lever Polished	3100030140
Kit with Tilt Lever Brushed	3100040030
Kit with Tilt Lever Polished	3100040040

WIPER KIT

IDIDIT'S wiper kit features an on/off function and comes complete with lever and relay pack. The switch on either your tilt or turn signal lever -the choice is yours.



Kit with Turn Signal Lever Brushed	3100050030
Kit with Turn Signal Lever Polished	3100050040
Kit with Tilt Lever Brushed	3100060030
Kit with Tilt Lever Polished	3100060040

FEMALE END PLUG

3106050010

This end plug is the mate to the 3 7/8" wire plug found on your IDIDIT column. Eight crimp-on terminals are included that easily attach to your wires and clip into the plug.

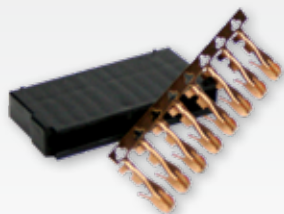

Cable Shift Linkage Kits

KIT CONTENTS

IDIDIT's award winning cable shift linkage kits all contain a 6ft standard shift cable, a column bracket for your IDIDIT or stock column and a transmission bracket. Call if you need a custom kit made for your application.



GM Transmission Bracket except early powerglide or 4L80



Chrysler 727 & 904 Transmission Bracket



Ford AOD Transmission Bracket



Ford C-4 Transmission Bracket



Ford C-6 Transmission Bracket



Ford 4R70W/AODE Transmission Bracket



6 ft. Standard Shift Cable Custom lengths are available



IDIDIT Column Bracket Used with your IDIDIT column



Stock Column Bracket & Horseshoe Bracket Used with your stock column



Cable Shift Linkage Kit w/ stock Column



Cable Shift Linkage Kit w/ IDIDIT Column

GM TRANSMISSION KITS

For a complete list of the compatible GM transmissions visit the Cable Shift Linkage under the Accessory section of our website.

For a 2" IDIDIT column

2801000010
Includes 6 ft shift cable, 2" IDIDIT column bracket, GM transmission bracket.

For a 2 1/4" IDIDIT column

2802000010
Includes 6 ft shift cable, 2 1/4" IDIDIT column bracket, GM transmission bracket.

For a 2" GM stock column

2801050010
Includes 6 ft shift cable, 2" stock column bracket & horseshoe bracket, GM transmission bracket.

C-4 TRANSMISSION KITS

For a 2" IDIDIT column*

2801300010
Includes: 6 ft shift cable, 2" IDIDIT column bracket, Ford C-4 transmission bracket.

For a 2 1/4" IDIDIT column*

2802300010
Includes: 6 ft shift cable, 2 1/4" IDIDIT column bracket, Ford C-4 transmission bracket.

For a 2 1/4" Ford stock column

2802350010
Includes: 6 ft shift cable, 2 1/4" stock column bracket & horseshoe bracket, Ford C-4 transmission bracket.

C-6 TRANSMISSION KITS

For a 2" IDIDIT column*

2801400010
Includes: 6 ft shift cable, 2" IDIDIT column bracket, Ford C-6 transmission bracket.

For a 2 1/4" IDIDIT column*

2802400010
Includes: 6 ft shift cable, 2 1/4" IDIDIT column bracket, Ford C-6 transmission bracket.

For a 2 1/4" Ford stock column

2802450010
Includes: 6 ft shift cable, 2 1/4" stock column bracket & horseshoe bracket, Ford C-6 transmission bracket.

AOD TRANSMISSION KITS

For a 2" IDIDIT column*

2801500010
Includes: 6 ft shift cable, 2" IDIDIT column bracket, Ford AOD transmission bracket.

For a 2 1/4" IDIDIT column*

2802500010
Includes: 6 ft shift cable, 2 1/4" IDIDIT column bracket, Ford AOD transmission bracket.

For a 2 1/4" Ford stock column

2802550010
Includes: 6 ft shift cable, 2 1/4" stock column bracket & horseshoe bracket, Ford AOD transmission bracket.

FORD 4R70W/AODE TRANSMISSION KITS

For a 2" IDIDIT column*

2801600010
Includes 6 ft shift cable, 2" IDIDIT column bracket, Ford 4R70W/AODE transmission bracket.

For a 2 1/4" IDIDIT column*

2802600010
Includes 6 ft shift cable, 2 1/4" IDIDIT column bracket, Ford 4R70W/AODE transmission bracket.

For a 2 1/4" Ford stock column

2802650010
Includes 6 ft shift cable, 2 1/4" stock column bracket & horseshoe bracket, Ford 4R70W/AODE transmission bracket.

CHRYSLER 727 & 904 TRANSMISSION KITS

For a 2" IDIDIT column*

2801700010
Includes 6 ft shift cable, 2" IDIDIT column bracket, Chrysler 727 & 904 transmission bracket.

For a 2 1/4" IDIDIT column*

2802700010
Includes 6 ft shift cable, 2 1/4" IDIDIT column bracket, Chrysler 727 & 904 transmission bracket.

For a 2" Chrysler stock column

2801750010
Includes 6 ft shift cable, 2" stock column bracket & horseshoe bracket, Chrysler 727 & 904 transmission bracket.

HALF MOON SHIFT LEVER

Shift around that pesky brake! The IDIDIT Half Moon Shift Lever will maneuver around your brake pedal. Comes complete with bushing and the hardware needed to mount to your IDIDIT steering column.



2": # 2600700052
2 1/4": # 2600700152

* **THESE KITS WILL NOT WORK WITH 1ST GENERATION IDIDIT STEERING COLUMNS.** 1st generation columns have square lever holes and **DO NOT** come with a serial number sticker located on the inside of the upper sleeve.

Dress-Up Kits

DRESS UP KITS

Each tilt dress-up kit includes turn signal lever with knob, tilt lever with knob and 4-way flasher knob. Non-tilt dress-up kits come with turn signal lever with knob and 4-way flasher knob only.

FINISHES



Chrome

Brushed Aluminum

Polished Aluminum

Black Powder Coated

STYLES



Standard

Retro

Deco

(Deco style knobs are only available in polished aluminum)

PUSH-IN STYLE DRESS-UP KIT

- This kit includes a turn signal lever with knob, a title lever with knob, and a 4-way flasher knob
- The turn signal lever simply snaps into place
- Fits most 1977 and newer GM Columns
- Comes in Standard Style only

Brushed Aluminum # 2500010030

Polished Aluminum #2500010040



TILT DRESS-UP KIT

- This kit includes a turn signal lever with knob, a title lever with knob, and a 4-way flasher knob
- The turn signal lever is flattened and attaches to the column with a single screw
- Fits most 1969 and newer GM and Chrysler Steering Columns

Knob Style	Chrome	Brushed Aluminum	Polished Aluminum	Black Powder Coated
Standard	2500000020	2500000030	2500000040	2500000051
Retro	2520000020	2520000030	2520000040	2520000051
Deco	N/A	N/A	2510000040	N/A
Early Ford	2500260020	2500260030	2500260040	2500260051
Late Ford	2500261020	2500261030	2500261040	2500261051



Late Ford Style

Early Ford Style

* A 4-way flasher knob does NOT come in the Ford Style Dress-up Kit

TILT/TELESCOPING DRESS-UP KIT

- This kit includes a turn signal lever with knob, a title lever with knob, and a 4-way flasher knob
- The turn signal lever is threaded and screws into place
- Fits most 1963 - 76 GM Tilt/Telescoping & Early IDIDIT Universal Series Steering Columns

Knob Style	Chrome	Brushed Aluminum	Polished Aluminum	Black Powder Coated
Standard	2500250020	2500250030	2500250040	2500250051
Retro	2520250020	2520250030	2520250040	2520250051
Deco	N/A	N/A	2510250040	N/A



NON-TILT DRESS-UP KIT

- This kit includes a turn signal lever with knob, a title lever with knob, and a 4-way flasher knob
- The turn signal lever is threaded and screws into place
- Fits most 1963 - 76 GM Tilt/Telescoping & Early IDIDIT Universal Series Steering Columns

Knob Style	Chrome	Brushed Aluminum	Polished Aluminum	Black Powder Coated
Standard	2500100020	2500100030	2500100040	2500100051
Retro	2520100020	2520100030	2520100040	2520100051
Deco	N/A	N/A	2510100040	N/A

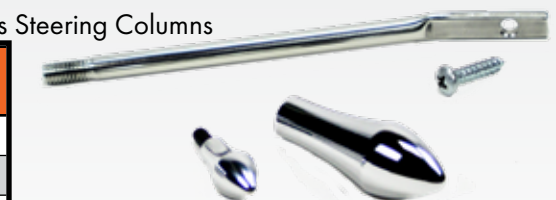

Knobs & Levers

GEAR SHIFT KNOBS

Replace your old, worn out plastic gear shift knob with a new IDIDIT knob! These gear shift knobs will match your IDIDIT dress-up kit perfectly, and attach with a single set screw. They are designed to be used with GM and IDIDIT gear shift handles only.



Knob Style	Chrome	Brushed Aluminum	Polished Aluminum	Black Powder Coated
Standard	2500500020	2500500030	2500500040	2500500051
Retro	2520500020	2520500030	2520500040	2520500051
Deco	N/A	N/A	2510500040	N/A
Early Ford	2500500120	2500500130	2500500140	2500500151
Late Ford	2500500220	2500500230	2500500240	2500500251

SINGLE KNOBS

IDIDIT offers single dash knobs that will add flair to your dash and will match your Standard or Deco column dress-up kit. These dash knobs can be used for your headlight switch, your wiper switches and so much more!

STANDARD STYLE

	Chrome	Brushed Aluminum	Polished Aluminum	Black Powder Coated
10-32	2503300020	2503300030	2503300040	2503300051
10-24	2503200020	2503200030	2503200040	2503200051
1/4" Bore	2503100020	2503100030	2503100040	2503100051
3/16" Bore	2503000020	2503000030	2503000040	2503000051

DECO STYLE

	Polished Aluminum
10-32	2513300040
10-24	2513200040
1/4" Bore	2513200040
3/16" Bore	2513200040

Shift Lever Arms

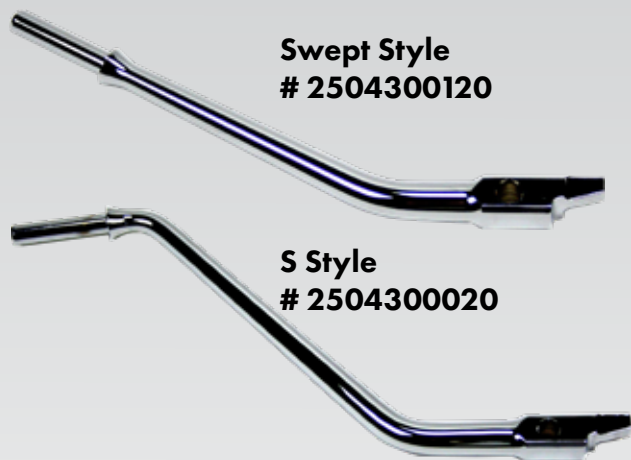

**Swept Style
2504300120**

**S Style
2504300020**



**Swept Style Long
2504300220**

**Straight Style
2504300320**

Billet Lever Kits

The All-New Billet lever kits gives the steering column dress-up kits even more style! Machined from 6061 Billet Aluminum these lever kits come in two different styles, Truss and Grip.

Designed for quick and easy installation, each kit comes with a turn signal lever, tilt lever, and 4-way flasher knob, and installation hardware. These kits are available in Brushed Aluminum, Black Powder Coat, and Gold Anodize finishes.



Truss Style

Grip Style

	Brushed Aluminum	Black Powder Coated	Gold Anodize
Grip Style	2500300030	2500300051	2500300060
Truss Style	2500310030	2500310051	2500310060

Steering Wheel Adapters

Steering wheel adapters are made to adapt the 3 - 5 - 6 - or 9-bolt patterns of a steering wheel to the tapered, splined top shaft of a steering column. All IDIDIT adapters will fit most IDIDIT columns, as well as most 1969 or newer GM passenger car columns, and are secured in place with a single nut. A horn wire is included with most adapters.

9 BOLT ADAPTER

These 9-bolt pattern adapters will match aftermarket wheels from Lecarra, Billet Specialties, Budnik, Colorado Custom, and more! Standard size is 2½" deep.



	Chrome	Brushed Aluminum	Polished Aluminum	Black Powder Coated
Standard No Horn	2201300020	2201300030	2201300040	2201300051
Standard w/Horn	2201310020	2201310030	2201310040	2201310051

9 BOLT "SHORTY" ADAPTER

The IDIDIT 9-bolt Shorty Adapter is uniquely designed to move the bolting surface of the steering wheel 2" closer to the dash, giving you extra "belly room".



	Chrome	Polished Aluminum
Standard w/ Horn	2201100020	2201100040

5 & 6 BOLT ADAPTER

5 & 6-bolt adapters for Grant and Lecarra come with a horn button. Momo, Dino, Nardi, Diablo, and Corvette adapters do not because the horn button is already included on the steering wheel. Standard size is 2½" deep.



	Chrome	Brushed Aluminum	Polished Aluminum	Black Powder Coated
5 Bolt Grant	2207310020	2207310030	2207310040	2207310051
6 Bolt Lecarra	2202310020	2202310030	2202310040	2202310051
6 Bolt Momo	2202320020	2202320030	2202320040	2202320051
6 Bolt Dino/Diablo	2202330020	2202330030	2202330040	2202330051
6 Bolt Nardi	2202340020	2202340030	2202340040	2202340051
6 Bolt 1963-66 & 68 Corvette	2202350020	2202350030	2202350040	2202350051
6 Bolt 1956-62 Corvette	2202360020	2202360030	2202360040	2202360051

3 BOLT ADAPTER

Grant and Wheel Shoppe are the most popular applications for the IDIDIT standard 3-bolt adapter. Add the convenience of a horn button for your Pete & Jake's or other, bell-style wheel with the IDIDIT "Bell" style 3-bolt adapter. Standard size is 1¼" deep.



	Chrome	Brushed Aluminum	Polished Aluminum	Black Powder Coated
3 Bolt STD	2208310020	2208310030	2208310040	2208310051
3 Bolt "Bell"	2209300020	2209300030	2209300040	2209300051
3 Bolt "Bell" with Horn	2209310020	2209310030	2209310040	2209310051
CON2R	2209330020	2209330030	2209330040	2209330051

1955-68 HORN KIT

IDIDIT's 1955-68 Horn Kit has everything needed to adapt most 1955-68 GM stock steering wheels to your IDIDIT steering column. Comes complete with aluminum trim ring, horn contact plate, spring, pin and retainer.

2612100040



1965 IMPALA/CHEVELLE & 1966 NOVA HORN KIT

This Horn kit will adapt a stock 1965 Impala and Chevelle (not the Super Sport) steering wheel to your IDIDIT steering column as well as a stock 1966 Nova wheel. Comes complete with aluminum trim ring, horn contact plate, spring, pin and retainer.

2612100240

Side Step Steering Box

IDIDIT has created a modern solution for the age old steering problem of awkward angles and tight spaces around the steering box. Our development team has created the side step steering box to relocate the position of the shaft. The extra space created can be re-purposed for added horsepower or more leg room in the cab.

The IDIDIT Sidestep is an all-billet piece constructed out of aircraft grade aluminum and is ideal for custom hot rods, race cars and restoration jobs.

- Features a double roller chain
- Measures 3" wide and 2" deep (not including splines)
- 3/4 -36 spline shaft output
- 8", 10", 12" or 16" length available
- Comes in raw machined or polished finishes

	Machined Aluminum	Polished Aluminum
8"	2805080030	2805080040
10"	2805100030	2805100040
12"	2805120030	2805120040
16"	2805160030	2805160040



YdIDIDIT[®] ***PERFORMANCE***

Lose weight the quick and easy way with IDIDIT Performance

Lightweight steering columns and accessories for your performance vehicles



Pro-Fab Steering Columns

Designed for drag, autocross, road course, and off-road racing, the IDIDIT Pro-Fab lightweight columns are direct factory replacements that bolt directly to the factory mounting points and factory steering shaft. These columns weight 3-6lbs, saving you up to 20 pounds of weight depending on the application you are running.

SPECIFICATIONS:

- Precision laser cut tubing and brackets provide superior fit and finish
- Sealed upper ball bearing and Delrin lower bushing means the column will operate smoothly after many years of abuse
- Ultra-Light aluminum tubing and brackets
- Customizable for driver fit
- Comes with a Brushed Aluminum finish

Part Number	Description
1090798655	1979-86 Mustang Race
1090879355	1987-93 Mustang Race
1090940455	1994-2004 Mustang Race
1090051455	2005-14 Mustang S197 Race
1090151955	2015-19 Mustang S550 Race
1090889155	1988-91 EF/CRX Civic Race
1090890555	1989-97 NB 99-05 Miata Race
1090920155	1994-2001 DC Acura Integra/1992-95 EG/96-2000 EK Civic Race



Pro-Lite Steering Columns

Designed to go from street to strip, or any other competition race, the IDIDIT Pro-Lite lightweight column has 5 inches of collapsibility and is equipped with a self-cancelling electronic turn signal switch and four-way hazards. These columns are just under 6lbs, saving you up to 20 pounds of weight, depending on the application you are running.

SPECIFICATIONS:

- Equipped with self-cancelling electronic turn signal switch and 4-way hazards
- Two-Piece shaft with 5" of collapsibility
- Installs easily using original dash mounts and IDIDIT plug-in wiring connectors
- Available in Brushed aluminum or Black Textured finish (BTF)

Part Number	Description
1350009956	Pro-Lite Straight BTF CUSTOM
1350642055	Pro-Lite Straight 65-66 Mustang
1350642056	Pro-Lite Straight 65-66 Mustang BTF
1350646055	Pro-Lite Straight 62-66 Nova
1350646056	Pro-Lite Straight 62-66 Nova BTF
1350680055	Pro-Lite Straight 67-68 Camaro
1350680056	Pro-Lite Straight 67-68 Camaro BTF
1350790055	Pro-Lite Straight 69 Camaro
1350790056	Pro-Lite Straight 69 Camaro BTF
1350860055	Pro-Lite Straight 70-81 Camaro
1350860056	Pro-Lite Straight 70-81 Camaro BTF
1351642055	Pro-Lite Straight Builder 30" QRSH 6 BOLT OE/GM



Quick Release Steering Hubs



Part Number	Description
5010000010	3 Bolt Chevy Shaft Kit
5010000011	3 Bolt Ford Shaft Kit
5010000012	3 Bolt 3/4 Smooth Kit
5010000013	5 Bolt Chevy Shaft Kit
5010000014	5 Bolt Ford Shaft Kit
5010000015	5 Bolt 3/4 Smooth Shaft Kit
5010000016	6 Bolt Chevy Shaft Kit
5010000017	6 Bolt 3/4 Smooth Shaft Kit
5010000018	5 Bolt OE Chevy Shaft Kit
5010000019	5 Bolt OE Ford Shaft Kit
5010000020	5 Bolt OE 3/4 Smooth Shaft Kit
5010000021	6 Bolt OE Chevy Shaft Kit
5010000022	6 Bolt OE Ford Shaft Kit

Racers who need a removable steering wheel can now be assured they will get perfect wheel centering every time. The IDIDIT Performance Quick-Release Steering Hub, which now comes standard with a Centering Pin. The Centering Pin is removable for drivers who prefer a non-centered configuration, as is popular in circle track and Sprint Car racing. All IDIDIT Performance pull-type Quick Release Hubs are SFI certified. All kits listed are two pieces, including the center shaft and hub.

SPECIFICATIONS:

- Available in 3-bolt, 5-bolt, and 6-bolt
- Center splines available in several configurations including OEM style splines
- Tight machining tolerances eliminates backlash in the steering wheel for a tight steering and feel
- Steel spline on an aluminum hub means no binding of the quick-release mechanism when installing or removing the wheel
- The pull ring is made of anodized aluminum for weight savings

***OEM Style quick releases are designed 4" in diameter, Non-OEM quick releases are designed for 3" diameter, 6-Bolt pattern is designed for Momo, NRG, and Sparco bolt patterns.**

*If what you are looking for is not listed, please our customer service department

Cowl Steering



Keep the vintage look in your race or custom vehicle

- Designed with mini/midget sprint cars, period correct vintage racing, and rat-rods in mind
- 8:1 or 6:1 gear ratio available
- Available in various offsets and configurations
- Each steering box is assembled to customer's specifications. Please contact us directly to place your order!
- Made in the USA using original Schroeder Steering tooling and molds
- Service available on existing Schroeder branded steering boxes

Digital Dash Mounts

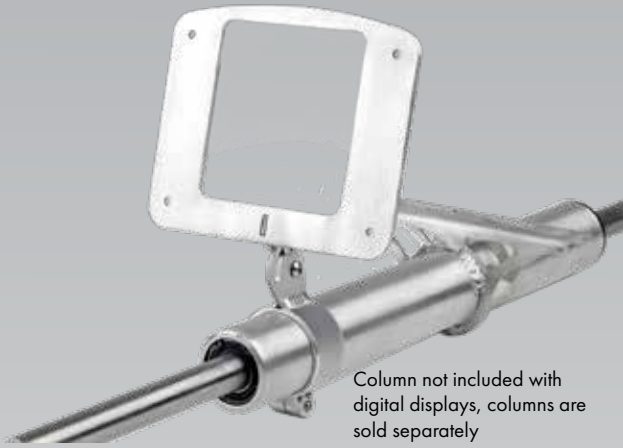

Column not included with digital displays, columns are sold separately

IDIDIT has released a series of ultra-lightweight dash mounts that allow the user to mount a digital dash such as the Racepak, Holley EFI, AEM CD-5 & CD-7, and AIM. These digital dash mounts are made of lightweight aluminum and come in a brushed finish. They slide over the steering tube and clamp on and adjust with ease. Once installed, they offer a rigid mounting surface for the most popular digital dashes. Just like all other IDIDIT products, these digital dash mounts are proudly made in the USA.

SPECIFICATIONS:

- Slides on for easy installation
- Precision laser cut and CNC machined brackets means superior fit and finish
- Ultra light-weight aluminum in an attractive brushed finish
- Customizable for driver fit

Part Number	Description
210000030	AEM CD7 Dash Panel Mount 1 3/4" Race Column
210100030	AEM CD7 Dash Panel Mount 2" Race Column
210200030	AIM MXG Dash Panel Mount 1 3/4" Race Column
210300030	AIM MXG Dash Panel Mount 2" Race Column
210400030	AIM MXS Dash Panel Mount 1 3/4" Race Column
210500030	AIM MXS Dash Panel Mount 2" Race Column
210600030	Autometer Dash Panel Mount 1 3/4" Race Column
210700030	Autometer Dash Panel Mount 2" Race Column
210800030	Holley EFI Dash Panel Mount 1 3/4" Race Column
210900030	Holley EFI Dash Panel Mount 2" Race Column
211000030	RacePak IQ3 Dash Panel Mount 1 3/4" Race Column
211100030	RacePak IQ3 Dash Panel Mount 2" Race Column
211200030	AEM CD5 Dash Panel Mount 1 3/4" Race Column
211300030	AEM CD5 Dash Panel Mount 2" Race Column
211400030	Motec C125/C185 Dash Panel Mount 1 3/4" Race Column
211500030	Motec C125/C185 Dash Panel Mount 2" Race Column
211600030	Motec C127/C187 Dash Panel Mount 1 3/4" Race Column
211700030	Motec C127/C187 Dash Panel Mount 2" Race Column
211800030	Motec C1212/C1812 Dash Panel Mount 1 3/4" Race Column
211900030	Motec C1212/C1812 Dash Panel Mount 2" Race Column
212000030	Fuel Tech FT450/550 Dash Panel Mount 1 3/4" Race Column
212100030	Fuel Tech FT450/550 Dash Panel Mount 2" Race Column
212200030	Fuel Tech FT600 Dash Panel Mount 1 3/4" Race Column
212300030	Fuel Tech FT600 Dash Panel Mount 2" Race Column

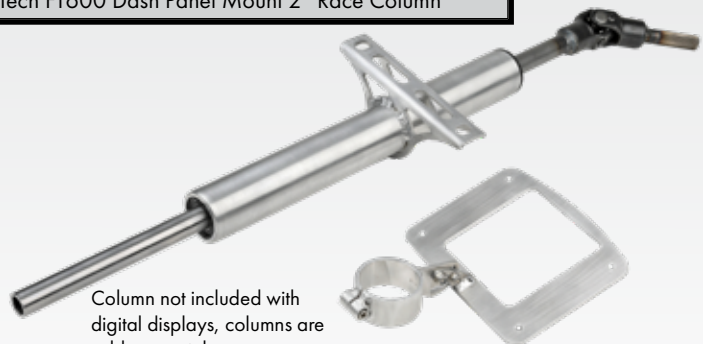

Column not included with digital displays, columns are sold separately

Vintage Wires

VINTAGE WIRES™

Add vintage style to your engine while incorporating the convenience and safety of modern wiring systems. The universal wire kits are the popular choice for vintage racers and other classic projects, as they mimic the old-school look of classic fabric wires but use proven, spark-carrying technology. Vintage Wires aftermarket ignition wires can be used on a variety of applications from vintage cars, motorcycles, boats, and more!

SPECIFICATIONS:

- Ignition wires for 2, 4, 6, or 8 cylinder engines
- Customizable for your application
- Available in 12 different colors
- 7.8mm Braided Spark Plug Wires
- Lacquer covered cotton braid
- Spiral wound suppression core
- EDPM Silicone insulation
- Boots, terminals, dielectric grease, and installation instructions included with every kit.



Types of Shafts

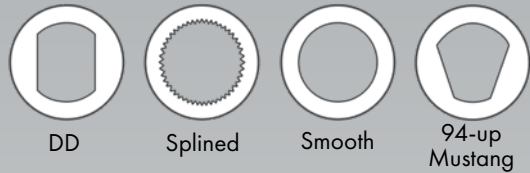

UNIVERSAL JOINTS

Single universal joints work smoothly up to 35 degrees

Single u-joints available in the following styles:

- Smooth bore both ends
- Smooth bore x spline or DD
- Spline or DD x spline or DD
- Available in a variety of finishes



Single U-Joint

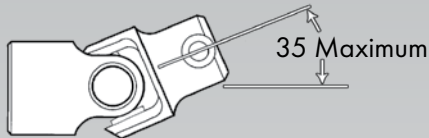
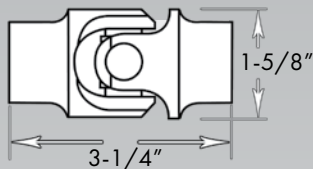

VIBRATION REDUCERS

- Used to stop pulsations from the power steering pump
- A vibration joint will work smoothly up to 35 degrees
- Rag Joints are available and **must be mounted straight!** Any angle of deflection on a rag joint could result in a loss of steering



Rag Joint

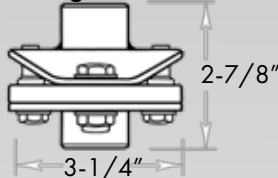

U-Joint Vibration Reducer

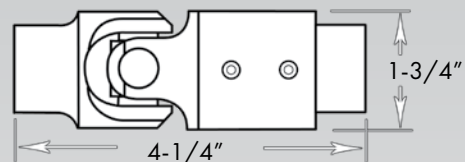

STRAIGHT COUPLERS

- Coupler and adapter must be welded
- Most sizes available
- Pre-welded coupler/adapters available from IDIDIT:
 - 1" 48 x 3/4" DD
 - 1" DD x 3/4" DD
 - 3/4" 36 x 3/4" DD



Coupler



Pre-Welded Coupler

SHAFTS

- Steel Shafts
 - 2" - 36" Splined both ends
 - 2" spline on each end
 - 18" DD Shaft
 - 36" DD Shaft
- Stainless Steel Shafts - available in Polished or Unpolished
 - 4" - 36" Splined both ends
 - 22" DD Shaft
 - 36" DD Shaft

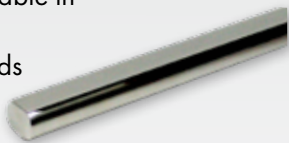

SUPPORT BEARINGS

- Support bearings must be used when using more than 2 U-Joints
- 3/4" DD shafts will work in round support bearings
- Double U-Joints would be counted as 2 U-Joints



SUPPORT BEARING
Aluminum #3000650000
Polished Aluminum #3000660000



Steel Support Bearing
(cut to fit)

ROD END BEARING

- Steel # 3000700000
- Stainless # 3000710000
- Polished Stainless # 3000720000



Vega



525/122



600



700



Mustang



For Splined Shafts with a Flat
Count the number of splines of
half of the circumference
and double that
number for total

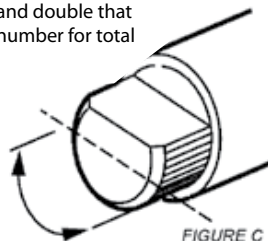

FIGURE C

Popular Splines And Double D Applications

All Measurements can be +/- .015". Precision measuring equipment should be used.

Column Application	Description	Size	Diameter	Splines	Double D Flats
GM Column	Small Spline	3/4"-36	.735	36	
	Large Spline	1"-48	.985	48	
	Small Double D	3/4" DD	.750		.550
	Large Double D	1" DD	.993		.790
Ford Column	Small Spline	3/4"-36	.735	36	
	Small Double D	3/4" DD	.750		.550
	Large Double D	1" DD	.993		.790
Other Manufacturers	International	1"-48	.985	48	
	Ididit-aluminum	1"-48	.985	48	
	Ididit-steel	1" DD	.993		.790
	Flaming River	1" DD (standard)	.993		.790
	Borgeson	3/4"-36	.735	36	
Boxes & Racks Application	Description	Size	Diameter	Splines	Double D Flats
Chrysler Box or Rack	Chrysler	9/16"-17	.562	17	
	Chrysler	9/16"-26	.562	26	
	Chrysler	9/16"-36	.562	36	
	Chrysler	5/8"-36 C*	.625	36	
	Chrysler	11/16"-36	.687	36	
	Chrysler	3/4"-36	.735	36	
	Chrysler	13/16"-36	.812	36	
	Chrysler Omni	9/16"-26	.562	26	
GM Manual Box	Corvair	5/8"-36	.625	36	
	Vega (model 140)	5/8"-36	.625	36	
	Corvette ('63-67)	3/4"-36	.728	36	
	Corvette ('68-83)	3/4"-30	.735	30	
	('58-64)	3/4"-36	.735	36	
	Model 122 ('65-85)	3/4"-30 or 3/4"-36	.730	30 or 36	
	Model 525 ('86 & later)	3/4"-30	.728	30	
GM Power Box	Model 605 ('78-84)	3/4"-30	.728	30	
	Model 700 ('77 & earlier)	13/16"-36	.812	36	
	Model 700 ('78 & later)	3/4"-30	.728	30	
GM Rack	'79 & later	5/8"-36	.625	36	
	Some Models	3/4"-30	.728	30	
	Corvette ('84 & later)	17mm DD	.670		.570
	Fiero	17mm DD	.670		.570
Ford Box	Manual & Power	3/4"-36	.735	36	
Ford Rack	Mustang & Pinto Manual	9/16"-26	.562	26	
	Mustang & Pinto Power	3/4"-36	.735	36	
	94-Later Mustang	3/4"-V	.740		
Other Manufacturers	Borgeson 55-57 Chevy Conversion	18mm DD	.708		.635
	Borgeson 58-64 Chevy Conversion	17mm DD	.670		.570
	Borgeson Chevy II Nova Conversion	11/16"-36	.687	36	
	Borgeson Corvette Conversion Box	18mm DD	.708		.635
	Borgeson Ford Conversion Boxes	11/16"-36	.687	36	
	Heidt's Super Ride Rack	9/16"-26	.562	26	
	Woodward Rack	3/4"-20	.735	20	
	Nissan	11/16"-36	.687	36	
	Jaguar & MGB	3/4"-48	.750	48	
	Unisteer Manual Rack	9/16"-26	.562	26	
	Volkswagen Rabbit Rack	11/16"-40	.687	40	
VW Rabbit Rack Diesel	3/4"-36	.735	36		

*The 5/8"-36 Chrysler is not interchangeable with 5/8"-36.

Learn more about truck bed accessories we have.