

MONROE

MAGNUM

2016 - 2017

MASTER CATALOGUE

200

NEW REFERENCES!



EMEA

TENNECO

MONROE

MAGNUM

COLOUR CHANGES, OE QUALITY REMAINS



OLD X

✓ **NEW**



OUR COMMERCIAL VEHICLE [SHOCKS](#) HAVE CHANGED COLOUR,
BUT YOU'LL ENJOY THE SAME GREAT OE QUALITY INSIDE AND OUT.



100

1916

MONROE

2016

YEARS

DRIVEN BY INNOVATION AND
QUALITY SINCE 1916

THANKS FOR BEING
OUR PARTNER!

100

1916

MONROE

2016

YEARS

TENNECO

MONROE[®]

MAGNUM

Track rod ends



Steering racks



Wheel bearings



Suspensions



Gearboxes

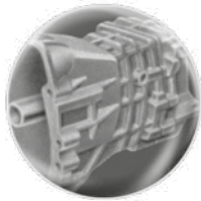

**EVERYTHING GETS OLD.
EVEN YOUR SHOCKS.**



CHANGE YOUR WORN SHOCKS AT 80.000 KM^{*}

WORN SHOCKS COMPROMISE THE SAFETY OF YOUR CAR. CHECK YOUR SHOCKS AT 20.000 KM!
KEEP YOUR SHOCKS FRESH BY INSTALLING THE BRAND TRUSTED BY CAR MANUFACTURERS EVERYWHERE.



Suspension springs



Cabin & Seats
Air Spring

Universal joints



Drive shafts











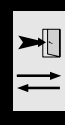

Tyres

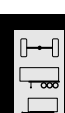









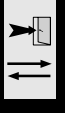

Suspension mounts

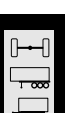

Contents Table

NEW & REPLACED REFERENCES	
CABIN SECTION	
TRUCK SECTION	
AXLE, SEMI TRAILER, TRAILER SECTION	
BUS SECTION	
AGRI SECTION	
VAN SECTION	
SEAT SECTION	
OE <=> MONROE	
TECHNICAL INFO & PICTURES	
WARRANTY PAGES & LEGEND	

Contents Table

	NEW & REPLACED REFERENCES
	CABIN SECTION
	TRUCK SECTION
	AXLE, SEMI TRAILER, TRAILER SECTION
	BUS SECTION
	AGRI SECTION
	VAN SECTION
	SEAT SECTION
	OE \Leftrightarrow MONROE
	TECHNICAL INFO & PICTURES
	WARRANTY PAGES & LEGEND



NEW REFERENCES

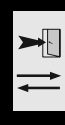

B1326	MERCEDES-BENZ	
B1327	EVOBUS (MERCEDES)	
B1327	MERCEDES-BENZ	
B1328	EVOBUS (K&SSBOHRER, SETRA)	
B1328	IKARBUS	
B1342	VOLVO	
B1343	VOLVO	
B1351	SCANIA	
B1362	VOLVO	
B1363	VDL	
B1364 ⁰	VOLVO	
B1369	SCANIA	
B5397	IVECO	
B5398	RENAULT TRUCKS	
B5404	SCANIA	
B5405	NEOPLAN	
B5405	SOLARIS	
B5419	SCANIA	
B5420	IVECO	
B5421	IVECO	
B5422	RENAULT TRUCKS	
B5424	HEULIEZ	
B5424	IRISBUS	
B5424	IVECO	
B5424	KAROSA	
B5424	RENAULT TRUCKS	
B5425	VOLVO	
B5433	VOLVO	
B5434	VOLVO	
CB0175	VOLVO	
CB0176	SCANIA	
CB0177	SCANIA	
CB0178	SCANIA	
CB0179	IVECO	
CB0180	MAN	
CB0181	MAN	
CB0182	SCANIA	
CB0183	SCANIA	
CB0184	SCANIA	
CB0186	DAF	
CB0187	DAF	
CB0188	DAF	
CB0194	SCANIA	
CB0195	SCANIA	
CB0196	SCANIA	
CB0197	MAN	
CB0198	MAN	
CB0199	ERF	
CB0199	MAN	
CB0200	ERF	



NEW REFERENCES

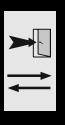

CB0200	MAN	
CB0201	MAN	
CB0202	SCANIA	
CB0203	SCANIA	
CB0204	VOLVO	
CB0205	VOLVO	
CB0206	VOLVO	
CB0207	VOLVO	
CB0208	VOLVO	
CB0209	VOLVO	
CB0210	VOLVO	
CB0211	VOLVO	
CB0212	VOLVO	
CB0213	VOLVO	
CB0214	VOLVO	
CB0215	VOLVO	
CB0216	IVECO	
CB0217	MERCEDES-BENZ	
CB0218	MERCEDES-BENZ	
CB0219	IVECO	
CB0220 ⁰	MERCEDES-BENZ	
CB0221	DAF	
CB0222	DAF	
CB0223	DAF	
CB0224	DAF	
CB0225	DAF	
CB0226	DAF	
CB0227	DAF	
CB0228	DAF	
CB0229	DAF	
CB0230	DAF	
CB0231	DAF	
CB0232	DAF	
CB0233	DAF	
CB0234	NEW HOLLAND	
CB0235	DAF	
CB0236	MERCEDES-BENZ	
CB0237	DAF	
F5311	HENDRICKSON	
F5343	ROR	
F5344	ROR	
F5384	BPW	
F5401	SAF	
F5402	LECINENA	
F5402	WEWELER	
F5407	FRUEHAUF	
F5407	GIGANT (SMB)	
F5408	FRUEHAUF	
F5408	GIGANT (SMB)	
F5409	ROR	



NEW REFERENCES

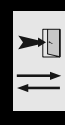

<u>F5423</u>	FLOOR	
<u>SD0008</u>	IRISBUS	
<u>SD0008</u>	IVECO	
<u>SD0008</u>	MAN	
<u>SD0008</u>	MERCEDES-BENZ	
<u>SD0008</u>	RENAULT TRUCKS	
<u>SD0008</u>	SCANIA	
<u>SD0008</u>	VOLVO	
<u>SD0009</u>	DAF	
<u>SD0009</u>	IVECO	
<u>SD0009</u>	MAN	
<u>SD0009</u>	MERCEDES-BENZ	
<u>SD0009</u>	RENAULT TRUCKS	
<u>SD0009</u>	SCANIA	
<u>SD0009</u>	VOLVO	
<u>SD0010</u>	SCANIA	
<u>T1296</u>	VOLVO	
<u>T1314</u>	RENAULT TRUCKS	
<u>T1315</u>	RENAULT TRUCKS	
<u>T1316</u>	RENAULT TRUCKS	
<u>T1329</u>	VOLVO	
<u>T1330</u>	VOLVO	
<u>T1331</u>	VOLVO	
<u>T1332</u>	VOLVO	
<u>T1333</u>	MAN	
<u>T1334</u>	VOLVO	
<u>T1335</u>	VOLVO	
<u>T1336</u>	VOLVO	
<u>T1337</u>	VOLVO	
<u>T1338</u>	VOLVO	
<u>T1339</u>	VOLVO	
<u>T1340</u>	VOLVO	
<u>T1341</u>	VOLVO	
<u>T1344</u>	VOLVO	
<u>T1345</u>	VOLVO	
<u>T1346</u>	VOLVO	
<u>T1347</u>	MAN	
<u>T1348</u>	VOLVO	
<u>T1349</u>	MAN	
<u>T1350</u>	VOLVO	
<u>T1352</u>	VOLVO	
<u>T1353</u>	VOLVO	
<u>T1354</u>	IVECO	
<u>T1355</u>	VOLVO	
<u>T1356</u>	VOLVO	
<u>T1357</u>	VOLVO	
<u>T1358</u>	VOLVO	
<u>T1359</u>	VOLVO	
<u>T1360</u>	VOLVO	
<u>T1361</u>	VOLVO	



NEW REFERENCES

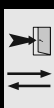

T1365	VOLVO	
T1366	VOLVO	
T1367	VOLVO	
T1368	VOLVO	
T5281	RENAULT TRUCKS	
T5309	VOLVO	
T5348	MAN	
T5351	VOLVO	
T5354	RENAULT TRUCKS	
T5356	VOLVO	
T5360	MERCEDES-BENZ	
T5361	MERCEDES-BENZ	
T5362	VOLVO	
T5364	DAF	
T5365	DAF	
T5367	VOLVO	
T5385	MERCEDES-BENZ	
T5386	MAN	
T5387	VOLVO	
T5388	MAN	
T5389	VOLVO	
T5390	VOLVO	
T5391	VOLVO	
T5392	VOLVO	
T5393	VOLVO	
T5394	VOLVO	
T5395	VOLVO	
T5396	VOLVO	
T5399	MAN	
T5400	MAN	
T5403	MERCEDES-BENZ	
T5406	MAN	
T5410	MAN	
T5411	MAN	
T5413	VOLVO	
T5414	MERCEDES-BENZ	
T5415	VOLVO	
T5416	VOLVO	
T5426	VOLVO	
T5427	VOLVO	
T5428	VOLVO	
T5429	VOLVO	
T5430	VOLVO	
T5431	VOLVO	
T5432	VOLVO	
T5435	VOLVO	
T5436	VOLVO	
V1160	ISUZU	
V1161	ISUZU	
V1188	MERCEDES-BENZ	



NEW REFERENCES



i



V1189	MERCEDES-BENZ	
V1190	MERCEDES-BENZ	
V1191	IVECO	
V1193	ISUZU	
V1194	ISUZU	
V1195 ⁰	IVECO	
V1196	ISUZU	
V1197 ⁰	IVECO	
V1198	NISSAN	
V1199	NISSAN	
V1201	IVECO	
V2137	IVECO	
V2138	RENAULT TRUCKS	
V2142	DAF	
V2144	MERCEDES-BENZ	
V2145	MERCEDES-BENZ	
V2151	IVECO	
V2152	IVECO	

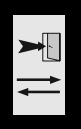

	REPLACED REFERENCES		
		<i>i</i>	

01300018	1300018M	EVOBUS (MERCEDES)	
48363	CB0016	VOLVO	
48364	CB0017	VOLVO	
48365	CB0018	VOLVO	
48366	CB0019	VOLVO	
B1240	-	ALEXANDER DENNIS	
B1263	<u>B1327</u>	EVOBUS (MERCEDES)	
B1285	B1326	MERCEDES-BENZ O405	
B5168	-	ALEXANDER DENNIS	
B5337 ¹	<u>B5424</u>	IRISBUS	
CB0012	<u>CB0186</u>	DAF	
CB0032	<u>CB0187</u>	DAF	
CB0044 ¹	<u>CB0235</u>	DAF	
CB0045 ¹	<u>CB0188</u>	DAF	
CB0049 ¹	<u>CB0237</u>	DAF	
CB0083	-	RENAULT TRUCKS	
F1026	V2097	SAF	
F1047	-	DUNLOP	
F1080	-	HENDRICKSON	
F1080	-	YORK	
F1081	-	NEWAY	
F1085	-	CHEREAU	
F1085	-	NEWAY	
F1085	-	SAMRO	
F1086	-	GRANNING	
F1087	-	GRANNING	
F1092	-	NEWAY	
F1112	-	TADCHURCH	
F1120	-	DUNLOP	
F1139	-	NEWAY	
F1141	-	NEWAY	
F5009	F5008	BPW	
F5026	-	BROSHUIS	
F5027	F5075	WEWELER	
F5028	F5075	CARDI	
F5028	F5075	WEWELER	
F5029	-	BROSHUIS	
F5082	-	GRANNING	
F5086	-	DUNLOP	
F5087	-	GRANNING	
F5125 ¹	F5224	SCHMITZ CARGOBULL	
F5161	-	BROSHUIS	
F5167	-	NEWAY	

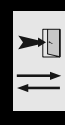

REPLACED REFERENCES

*i*

F5190 ¹	F5011	BPW	
F5190 ¹	F5011	GIGANT	
F5190 ¹	F5011	SAF	
F5190 ¹	F5011	SCHMITZ CARGOBULL	
F5193	-	SAF	
F5197	-	HENDRICKSON	
F5204	-	TROUILLET	
F5220	-	GRANNING	
F5285	-	TROUILLET	
R2607	CB0020	VOLVO G88 G89	
R3819	CB0022	VOLVO	
R3820	CB0021	VOLVO	
R3854	CB0024	VOLVO	
R3855	CB0025	VOLVO	
R3856	CB0026	VOLVO	
R3857	CB0027	VOLVO	
R3911	CB0023	VOLVO	
R3912	CB0028	VOLVO	
R3913	CB0029	VOLVO	
T1001	-	IVECO 150	
T1003	-	MAN 14 15 16 19 20 22 30	
T1006	T1194	MERCEDES-BENZ T2/LN1	
T1008	T1194	MERCEDES-BENZ T2/LN1	
T1010	-	MERCEDES-BENZ 1600 1700 1900	
T1011	-	MERCEDES-BENZ 1600 1700 1800 1900 2000 2200 2400 2500 2600 3000 3200 3300 3500	
T1014	T1016	MERCEDES-BENZ ACTROS - ACTROS MP2/MP3 - ATEGO - NG - SK	
T1015	T1204	MERCEDES-BENZ ACTROS - ACTROS MP2/MP3 - ATEGO - AXOR2 - LK/LN2 - NG - T2/L	
T1017	T1115	MERCEDES-BENZ ATEGO - ATEGO2	
T1019	-	MERCEDES-BENZ 800 900	
T1020	-	MERCEDES-BENZ	
T1021	-	RENAULT TRUCKS MAJOR	
T1023	T1177	VOLVO	
T1024	T1179	VOLVO	
T1030	-	MAN 14	
T1031	-	MAN 14	
T1032	T1058	DAF	
T1033	-	LEYLAND	
T1034	-	MERCEDES-BENZ 1600 1700 2400	
T1035	-	MERCEDES-BENZ 1700 1900	
T1037	T1185	MAN L2000	
T1038	-	MAN 16 19	
T1039	-	MAN 14	

	<h1>REPLACED REFERENCES</h1>		
		<i>i</i>	

T1045	B1239	DAF	
T1046	-	DAF 2105 2500	
T1049	-	FORD	
T1050	-	FORD	
T1051	-	FORD	
T1052	-	FORD	
T1053	-	FORD	
T1054	T1056	MERCEDES-BENZ 45 NG	
T1061	-	MERCEDES-BENZ 400	
T1062	-	MERCEDES-BENZ 600 700 800	
T1063	V2021	MERCEDES-BENZ LP T2/L	
T1065	V1089	MERCEDES-BENZ T2/LN1 VARIO	
T1066	V1089	MERCEDES-BENZ T2/LN1 VARIO	
T1067 ¹	T1069	MERCEDES-BENZ LK/LN2	
T1070	T1111	MERCEDES-BENZ LK/LN2	
T1076	-	RENAULT TRUCKS 100 SERIES	
T1077	T1117	MAN G 90 TGM	
T1078	-	RENAULT TRUCKS 100 SERIES	
T1079	-	RENAULT TRUCKS 100 SERIES	
T1082	-	RENAULT TRUCKS 100 SERIES	
T1083	-	MAN 8 9	
T1084	-	RENAULT TRUCKS 100 SERIES	
T1088	-	FORD	
T1089	-	FORD	
T1095	-	FODEN TRUCKS	
T1097	-	VOLVO FL6 (1985/09-2000/03)	
T1098	-	IVECO 50 60 90	
T1104	T1162	VOLVO	
T1106	-	VOLVO F10	
T1107	-	RENAULT TRUCKS	
T1108	-	LEYLAND	
T1109	-	VOLVO F10 F12	
T1110	-	DAF 45 ROADRUNNER	
T1124	-	FODEN TRUCKS	
T1125	-	FODEN TRUCKS	
T1126	-	RENAULT TRUCKS MANAGER	
T1129	V2088	IVECO	
T1132	V2088	IVECO	
T1134	-	IVECO 130 175	
T1135	-	IVECO 150 160	
T1144	-	MERCEDES-BENZ 2200	
T1147	-	SCANIA 93 113 143	
T1150	T1016	MERCEDES-BENZ	



REPLACED REFERENCES

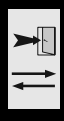

T1153	-	MERCEDES-BENZ 1100 1300	
T1155	-	IVECO 60 70 100	
T1157	-	MERCEDES-BENZ 1100 1300	
T1158	-	MERCEDES-BENZ 1100	
T1159	-	VOLVO FL10 (1985/09-1998/09)	
T1166	-	VOLVO FL6 (1985/09-2000/03)	
T1169	-	VOLVO FL6 (1985/09-2000/03)	
T1170	-	VOLVO FL6 (1985/09-2000/03)	
T1171	T1162	VOLVO	
T1172	-	VOLVO FL6 (1985/09-2000/03)	
T1173	-	VOLVO FL6 (1985/09-2000/03)	
T1175	-	MERCEDES-BENZ	
T1181	T1183	VOLVO	
T1182	T1005	VOLVO	
T1188	-	MAN 10	
T1191	T5053	DAF	
T1192	T1232	MERCEDES-BENZ ACTROS - ACTROS MP2/MP3 - MK - NG	
T1199	-	MAN 17	
T1202	-	MAN 8	
T1205	-	MERCEDES-BENZ 1400	
T1206	B1278	MAN	
T1206	B1278	VOLVO	
T1211	T5372	MERCEDES-BENZ ACTROS - ACTROS MP2/MP3 - AXOR2	
T1212	-	MAN 16 17	
T1213	B1278	VOLVO	
T1219	-	MERCEDES-BENZ 1400	
T1221	-	MERCEDES-BENZ 1400 1600 1700 1800	
T1224	-	RENAULT TRUCKS MANAGER	
T1225	-	RENAULT TRUCKS MANAGER	
T1226	T1223	RENAULT TRUCKS	
T1227	-	RENAULT TRUCKS MANAGER	
T1242 ¹	<u>T1354</u>	IVECO	
T5019	T5059	SCANIA	
T5024	-	IVECO	
T5024	-	RENAULT TRUCKS MANAGER	
T5035	-	MAN 8 9 15	
T5036	-	MAN 16 19 20 22	
T5037	-	MAN 16 19 22 26	
T5040	-	MAN 16 19 22	
T5043	-	MAN 16 19 22	
T5044	<u>T5429</u>	MAN F2000 F90 F90UNTERFLUR M2000L	
T5049	-	MAN 16 22 25 26	
T5050	-	MAN 16 19	

	<h1>REPLACED REFERENCES</h1>		
		<i>i</i>	

T5051	T5056	MAN M90	
T5061	-	SCANIA 82 92 112 142	
T5062	-	DAF 2500	
T5072	-	MAN 19	
T5074	-	MERCEDES-BENZ 1200 1600	
T5079	-	DAF 2100 2300 2500 2700 2800 2900 3300 3600	
T5079	-	MERCEDES-BENZ	
T5081	-	MERCEDES-BENZ	
T5090	-	MERCEDES-BENZ 900 1000 1100 1200 1300 1500	
T5094	T5066	VOLVO FL7 (1985/09-1998/09) FL10 (1985/09-1998/09) F10 F12	
T5101	-	DAF 1600 2105 2300 2500 2800 2805 2825 3300 3305	
T5103	-	DAF 2825	
T5104	T5242	SCANIA	
T5109	-	MERCEDES-BENZ 1800	
T5112	-	VOLVO FL10 (1985/09-1998/09) FL12 (1985/09-1998/09) F10 F12	
T5113	-	VOLVO FL6 (1985/09-2000/03)	
T5118	-	DAF 1100 1300 1500	
T5119 ¹	T5429	MAN F2000 F90 F90UNTERFLUR M2000L	
T5120	-	MAN 18 19 21	
T5122	-	MAN 19	
T5123	-	DAF 2500	
T5124	-	DAF 3300	
T5128	-	MERCEDES-BENZ 1200 1400 1600 1700 1800 UNIMOG	
T5130	-	MERCEDES-BENZ	
T5131	-	MERCEDES-BENZ 1700 1800 2400	
T5132	-	MAN	
T5133	-	SEDDON ATKINSON STRATO	
T5135	-	MAN 16 17 18	
T5136	-	MAN 17 18	
T5138	-	MAN 17	
T5139	-	MAN 17 18	
T5140	-	MAN 22 26	
T5141	-	DAF 1900	
T5142	-	DAF 2805	
T5148	-	RENAULT TRUCKS	
T5211	-	DAF 2600 2605 2800 2805	
T5225	-	MERCEDES-BENZ	
T5234	T5243	SCANIA	
T5238	-	SCANIA 82 92 112 142	
T5239	T5252	SCANIA	
T5240	-	LEYLAND	
T5257	<u>T5385</u>	MERCEDES-BENZ ACTROS - ACTROS MP2/MP3 - ATEGO - AXOR2 - ECONIC	
V2059	-	EVOBUS (MERCEDES)	

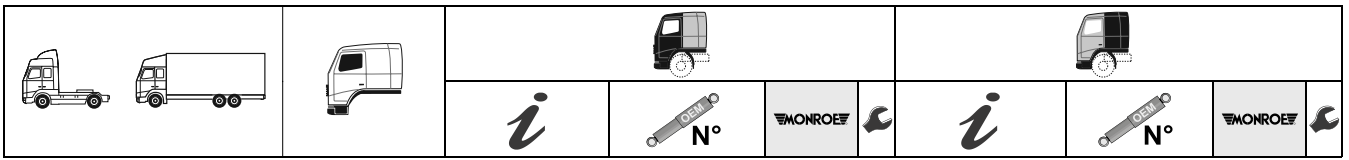

DAF

CF

65CF, 75CF, 85CF 98/02 → 2000/12		1265273 1265274	CB0031	 Q T	1377826 1451155 1792419	CB0013	 Q T
65CF, 75CF, 85CF 98/02 → 2000/12		1260941 1265271 1377825 1818916	CB0187	 Q T	1260942 1265272 1377828 1792420 1818919	CB0188⁰	 Q T
65CF, 75CF, 85CF 98/02 → 2000/12		1260941 1265271 1377825	CB0032¹	 Q T	1260942 1265272 1377828 1792420	CB0045¹	 Q T
65CF, 75CF, 85CF 98/02 → 2000/12		1265281 1285393 1321590 1353450 1353453 1371065 1444147 1622211 375224	CB0033	 Q T	1265282 1285394 1321591 1353451 1353454 1371066 1623477 1792423 299862	CB0034	 Q T
CF65, CF75, CF85 2001/01 →		1265273 1265274	CB0031	 Q T	1377826 1451155 1792419 1380606 1436060 1609020	CB0013	 Q T Q T
CF65, CF75, CF85 2001/01 →		1377827 1818918 375221 762784 1260941 1265271 1377825 1818916 1377827 375221	CB0186	 Q T	1380606 1436060 1609020	CB0047	 Q T
CF65, CF75, CF85 2001/01 →		1260941 1265271 1377825 1818916	CB0187	 Q T	1260942 1265272 1377828 1792420 1818919	CB0188⁰	 Q T
CF65, CF75, CF85 2001/01 →		1377827 375221	CB0012¹	 Q T	1260942 1265272 1377828 1792420	CB0045¹	 Q T
CF65, CF75, CF85 2001/01 →		1260941 1265271 1377825	CB0032¹	 Q T			
CF65, CF75, CF85 2001/01 →		↙ ↗	CB0033	 Q T	↙ ↗ 1380606 1436060 1609020	CB0034	 Q T Q T
CF (EURO 6) 2013/05 →		1872954 1936408 1938642	CB0232⁰	 Q T	1936409 1896514 1936410 1955775	CB0226⁰	 Q T Q T
CF (EURO 6) 2013/05 →		1936406 1938640	CB0231⁰	 Q T	1868685 1936407 1866162	CB0228⁰	 Q T Q T
CF (EURO 6) 2013/05 →		1938641 1938643	CB0222	 Q T	1931026 1866162	CB0223	 Q T Q T

LF

LF45, LF55 2001/01 →		1407079 AFRE011	CB0124	 Q T		1407081 AFRE013 AFRU075	CB0125	 Q T
		1407080 AFRE012	CB0123	 Q T		1407083 AFRE015 AFRU074	CB0132	 Q T
				 Q T		1407082 AFRE014 AFRU076	CB0126	 Q T

DAF XF

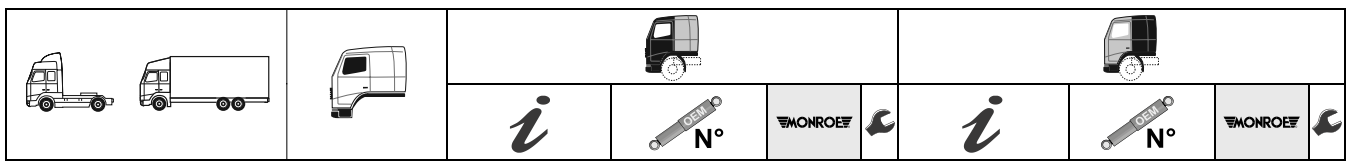

XF							
95XF 97/01 → 2002/09		1319672 1337159 1387327 1623464 1817662	CB0235 Q T		1303516 1436055	CB0042 Q O	
		1319672 1337159 1387327 1623464	CB0044 ¹ Q T		1319673 1387326 1623465 1792422 1817663	CB0237 Q T	1319673 1387326 1623465 1792422
95XF 97/01 → 2002/09		1265281 1285393 1321590 1353450 1353453 1371066 1444147 1622211 375224	CB0033 Q T		1265282 1285394 1321591 1353451 1353454 1371066 1623477 1792423 299862	CB0034 Q T	
					1303516 1436055	CB0042 Q O	
XF95 2002/09 →		1319672 1337159 1387327 1623464 1817662	CB0235 Q T		1303516 1436055	CB0042 Q O	
		1319672 1337159 1387327 1623464	CB0044 ¹ Q T		1319673 1387326 1623465 1792422 1817663	CB0237 Q T	1319673 1387326 1623465 1792422
XF95 2002/09 →			CB0033 Q T			CB0034 Q T	
					1303516 1436055	CB0042 Q O	
XF105 2006/01 →		1319672 1337159 1387327 1623464 1817662	CB0235 Q T		1303516 1436055	CB0042 Q O	
		1319672 1337159 1387327 1623464	CB0044 ¹ Q T		1319673 1387326 1623465 1792422 1817663	CB0237 Q T	1319673 1387326 1623465 1792422
XF105 2006/01 →			CB0033 Q T			CB0034 Q T	
					1303516 1436055	CB0042 Q O	
XF (EURO 6) 2012/10 →		1850676 1936404	CB0224 ⁰ Q O		1850677 1936405	CB0225 ⁰ Q O	
					1955773	CB0229 ⁰ Q O	
XF (EURO 6) 2012/10 →		1850682 1931023	CB0221 Q O		1850683 1931024	CB0223 Q O	
					1955773	CB0229 ⁰ Q O	

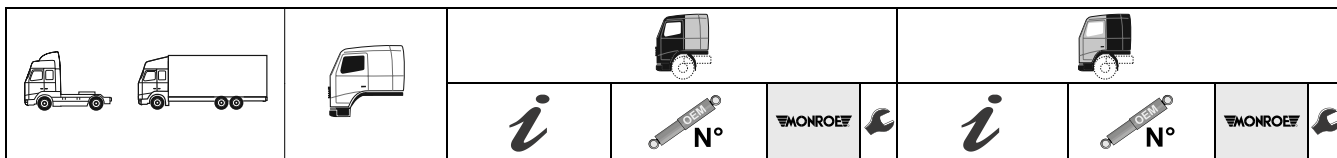

65, 75, 85					
65, 75, 85 92/06 → 98/01		1260941 1265271 1377825 1818916	CB0187		1260942 1265272 1377828 1792420 1818919
		1260941 1265271 1377825	CB0032¹		1260942 1265272 1377828 1792420
95					
95 87/09 → 98/01		1265276	CB0043		1265275 1265277 375222
		1377827 1818918 375221 762784	CB0186		
		1377827 375221	CB0012¹		
95 87/09 → 98/01		1265281 1285393 1321590 1353450 1353453 1371065 1444147 1622211 375224	CB0033		1265282 1285394 1321591 1353451 1353454 1371066 1623477 1792423 299862
2800					
2800FA, 2800FT					260035 656395
					CB0120
3200					
3200FA, 3200 FT					260035 656395
					CB0120

ERF

ECT

18.380FLRC, 18.380FLRS, 18.420FLRC, 18.420FLRS H07			CB0199		
			CB0200		
26.380FNLRC, 26.380FNLLRC, 26.240FNLRC, 26.240FNLLRC H27			CB0199		
			CB0200		
26.380FNLRC, 26.380FFNLLRC, 26.420FNLRC, 26.420FNLLRC H31			CB0199		
26.380FPLRS, 26.240FPLRS H32			CB0199		

IVECO EUROCARGO



IVECO











EUROCARGO

60E Series, 65E Series, 75E Series 91/01 →			42555627 8141735 98408735	CB0146
80E Series, 100E Series, 120E Series, 130E Series, 135E Series, 150E Series, 170E Series, 180E Series, 260E Series 91/01 →	MLL, MLC, MLD 504051670 8140869 98408734	CB0072	504187113 8143658 98408733 99438144 99449560 99469924	CB0138
95E Series, 100E Series, 120E Series, 130E Series, 140E Series, 135E Series, 150E Series, 180E Series, 320E Series Tector 2000/09 →	MLCS, MLCD, MLLS, MLLD 504051670 8140869 98408734	CB0072	504187113 8143658 98408733 99438144 99449560 99469924	CB0138







EUROSTAR (1993/01-2002/02)

180E Series, 190E Series, 240E Series, 260E Series, 400E Series, 440E Series 93/01 → 2002/02	LDL, LDC 41005984 42555629 500348789 504049485 504228086 98472611 98477778 98487778 99431373 99433007 99433008 99433009 99454195 99454196 99454197 41015530 41019150 8169050	CB0073	500307338 500352808 500379698 98472734 99438514 99455937 41028763 41028764 500348793 500377878	CB0098
190E Series, 260E Series, 440E Series Cursor 99/11 → 2002/02	LDLS, LDLD 41005984 42555629 500348789 504049485 504228086 98472611 98477778 98487778 99431373 99433007 99433008 99433009 99454195 99454196 99454197 41015530 41019150 8169050	CB0073	500307338 500352808 500379698 98472734 99438514 99455937 41028763 41028764 500348793 500377878	CB0098







			
<i>i</i>	 N°	 	<i>i</i>
		 N°	 

EUROTECH MH, MP, MT (1992/01-2002/02)

<p>180E Series, 190E Series, 240E Series, 260E Series, 400E Series, 440E Series 92/01 → 2002/02</p>	<p>MPL, MPC</p>		<p>41005984 42555629 500348789 504049485 504228086 98472611 98477778 98487778 99431373 99433007 99433008 99433009 99454195 99454196 99454197</p>	<p>CB0073</p>	<p>⊙ ⊙</p>		<p>41005917 41005918 500307352 500307353 500307354 500307355 500353511 500353513 500379694 500379696 98473215 98487588 98487589 99438384 99438387 99438389 99455909 99455910 99455911 99455912</p>	<p>CB0093</p>	<p>⊥ ⊙</p>
			<p>41015530 41019150 8169050</p>	<p>CB0179</p>	<p>⊙ ⊙</p>		<p>41028759 41028760 41028761 41028762 500332741 500348797 500377859 500377861 500307338 500352808 500379698 98472734 99438514 99455937 41028763 41028764 500348793 500377878</p>	<p>CB0095</p>	<p>⊙ ⊙</p>
<p>190E Series, 260E Series, 440E Series Cursor 99/11 → 2002/02</p>	<p>MPLS, MPLD</p>		<p>41015530 41019150 8169050</p>	<p>CB0073</p>	<p>⊙ ⊙</p>		<p>500307338 500352808 500379698 98472734 99438514 99455937 41028763 41028764 500348793 500377878</p>	<p>CB0093</p>	<p>⊥ ⊙</p>
			<p>41015530 41019150 8169050</p>	<p>CB0179</p>	<p>⊙ ⊙</p>		<p>41028763 41028764 500348793 500377878</p>	<p>CB0095</p>	<p>⊙ ⊙</p>



EUROTRAKKER (1993/01-2004/11)

<p>190E Series, 260E Series, 340E Series, 380E Series, 400E Series, 410E Series, 440E Series, 720E Series 93/01 →</p>	<p>MPL, MPC</p>		<p>41005984 42555629 500348789 504049485 504228086 98472611 98477778 98487778 99431373 99433007 99433008 99433009 99454195 99454196 99454197</p>	<p>CB0073</p>	<p>⊙ ⊙</p>		<p>41005917 41005918 500307352 500307353 500307354 500307355 500353511 500353513 500379694 500379696 98473215 98487588 98487589 99438384 99438387 99438389 99455909 99455910 99455911 99455912</p>	<p>CB0093</p>	<p>⊥ ⊙</p>											
			<p>41015530 41019150 8169050</p>	<p>CB0179</p>	<p>⊙ ⊙</p>		<p>500387621 41028759 41028760 41028761 41028762 500332741 500348797 500377859 500377861 41028763 41028764 500348793 500377878</p>	<p>CB0094</p>	<p>⊙ ⊙</p>		<p>CB0095</p>	<p>⊙ ⊙</p>								

IVECO P/PA (1979/12-1993/12)

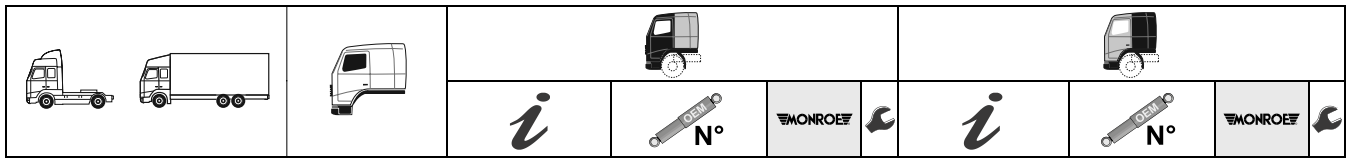

190E Series, 260E Series, 340E Series, 380E Series, 400E Series, 410E Series, 720E Series Cursor 2001/01 →	MPLS, MPCS, PMCD 		CB0073			CB0093	
		41015530 41019150 8169050	CB0179		500387621	CB0094	
						CB0095	
					41028763 41028764 500348793 500377878	CB0099	

P/PA (1979/12-1993/12)

170.23AH, 170.23AHW, 170.25AH, 170.25AHW, 170.34AH, 170.34AHW	N, NC/1			42001826 42001827	CB0159	
190.26H, 190.30H	N, NC/1			42001826 42001827	CB0159	
190.33, 190.38, 190.42, 190.48		42070286 504228332	CB0145			
260.23AH, 260.25AH, 260.25AHB, 260.34AH	N, NC/1			42001826 42001827	CB0159	
300.32AH, 300.34AH	N, NC/1			42001826 42001827	CB0159	
320.32AHB	N, NC/1			42001826 42001827	CB0159	
330PT35, 330.26H, 330.30H, 330.35H	N, NC/1			42001826 42001827	CB0159	

STRALIS (2002/02-)

190Sxx Series, 260Sxx Series, 320Sxx Series, 440Sxx Series	AD		504080348 504084378 504115380	CB0153		504055167 504055168 504080440 504084380 504115382	CB0152	
			2997842 504080540	CB0219		504060233 504060241	CB0149	
190Sxx Series, 260Sxx Series, 320Sxx Series, 440Sxx Series	AT		500392874 504047432 504080349 504084379 504115381	CB0154		504057014 504057016 504080441 504084381	CB0151	
			500340705 500357351	CB0137		504060233 504060241	CB0149	
			2997842 504080540	CB0219				
190Sxx Series, 260Sxx Series, 320Sxx Series, 440Sxx Series	AS		500340705 500357351	CB0137		500340706 500357352	CB0136	

TURBOSTAR (1984/07-1993/12)

190.33, 190.36, 190.42, 190.48, 240.36, 240.48, 260.36, 260.48	N, NL		42070286 504228332	CB0145			
---	-------	--	-----------------------	---------------	--	--	--

TURBOTECH (1990/01-1993/03)

190.26, 190.32, 190.36, 220.36, 240.36	N, NL		42070286 504228332	CB0145			
---	-------	--	-----------------------	---------------	--	--	--



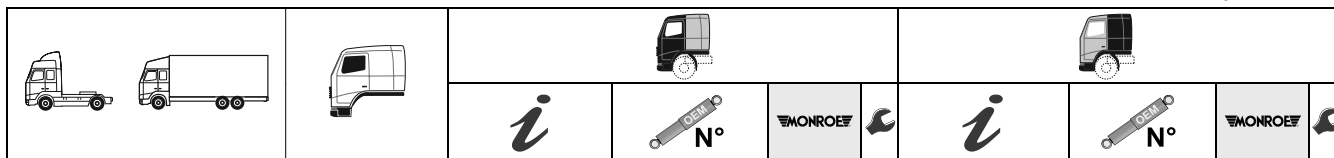







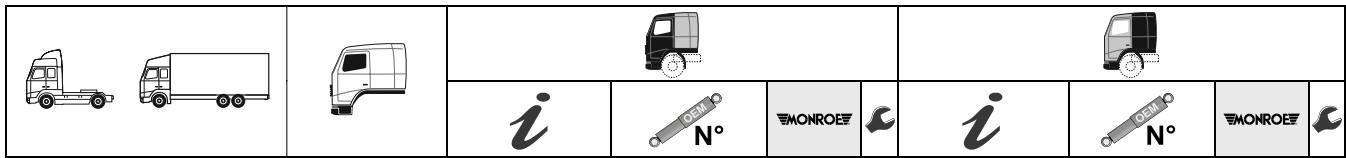

TRAKKER (2004/10-)									
180Txx Series, 190Txx Series, 260Txx Series, 340Txx Series, 380Txx Series, 400Txx Series, 410Txx Series, 440Txx Series, 720Txx Series	AD		504080348	CB0153		504055167	CB0152		
			504084378			504055168			
			504115380			504080440			
						504084380			
						504115382			
380Txx Series, 400Txx Series, 410Txx Series, 440Txx Series, 720Txx Series			2997842	CB0219		504068625	CB0216		
			504080540						
						504060233	CB0149		
						504060241			
180Txx Series, 190Txx Series, 260Txx Series, 340Txx Series, 380Txx Series, 400Txx Series, 410Txx Series, 440Txx Series, 720Txx Series	AT		500392874	CB0154		504057014	CB0151		
			504047432			504057016			
			504080349			504080441			
			504084379			504084381			
			504115381						
380Txx Series, 400Txx Series, 410Txx Series, 440Txx Series, 720Txx Series			2997842	CB0219		504060233	CB0149		
			504080540			504060241			











MAN									
F 8 (-1987/01)									
9.156H, 9.156HAK, 9.156HK, 9.156HS						81 43701 6143	CB0086		
						81 43701 6375			
11.136H, 11.136HAK, 11.136HK, 11.136HS						81 43701 6143	CB0086		
						81 43701 6375			
12.168H, 12.168HA, 12.168HAK, 12.168HAS, 12.168HK, 12.168HS, 12.192U						81 43701 6143	CB0086		
						81 43701 6375			
13.136H, 13.136HA, 13.136HAK, 13.136HK, 13.168H, 13.168HA, 13.168HAK, 13.168HAS, 13.168HK, 13.168HS, 13.192U						81 43701 6143	CB0086		
						81 43701 6375			
13.192U			81 43701 6241	CB0141		81 43701 6185	CB0085		
			81 43701 6291			81 43701 6379			
14.192U			81 43701 6331			81 43701 6143	CB0086		
			88 41701 0012			81 43701 6375			
14.192U			81 43701 6241	CB0141		81 43701 6185	CB0085		
			81 43701 6291			81 43701 6379			
15.136H, 15.136HA, 15.136HAK, 15.136HK, 15.168H, 15.168HA, 15.168HAK, 15.168HK, 15.192H, 15.192HA, 15.192HAK, 15.192HAS, 15.192HK, 15.192HS, 15.192U						81 43701 6143	CB0086		
						81 43701 6375			
15.192U			81 43701 6241	CB0141		81 43701 6185	CB0085		
			81 43701 6291			81 43701 6379			
15.192U			81 43701 6331			81 43701 6143	CB0086		
			88 41701 0012			81 43701 6375			



15.216H, 15.216HA, 15.216HAK, 15.216HAS, 15.216HK, 15.216HS, 15.220H, 15.220HA, 15.220HAK, 15.220HAS, 15.220HK, 15.220HS, 15.240H, 15.240HA, 15.240HAK, 15.240HAS, 15.240HK, 15.240HS					81 43701 6143 81 43701 6375	CB0086	⊥ ○
16.192H, 16.192HA, 16.192HAK, 16.192HAS, 16.192HK, 16.192HS					81 43701 6143 81 43701 6375	CB0086	⊥ ○
16.240H, 16.240HA, 16.240HAK, 16.240HAS, 16.240HK, 16.240HS, 16.256HAK, 16.256HAS, 16.256HK, 16.256HS					81 43701 6143 81 43701 6375	CB0086	⊥ ○
16.291, 16.320U, 16.320UL, 16.321, 16.321U, 16.321UL, 16.361	⊗	81 43701 6241 81 43701 6291 81 43701 6331 88 41701 0012	CB0141	○ ○	81 43701 6185 81 43701 6379	CB0085	○ ○
16.320U, 16.320UK, 16.321, 16.321UL					81 43701 6143 81 43701 6375	CB0086	⊥ ○
17.220FA, 17.240FA	⊗	81 43701 6241 81 43701 6291 81 43701 6331 88 41701 0012	CB0141	○ ○	81 43701 6185 81 43701 6379	CB0085	○ ○
17.220H, 17.220HA, 17.220HAK, 17.220HAS, 17.220HK, 17.220HS					81 43701 6143 81 43701 6375	CB0086	⊥ ○
17.320U, 17.320UK					81 43701 6143 81 43701 6375	CB0086	⊥ ○
19.240H, 19.240HA, 19.240HAK, 19.240HAS, 19.240HK, 19.240HS					81 43701 6143 81 43701 6375	CB0086	⊥ ○
19.291, 19.320U, 19.321, 19.321U, 19.361	⊗	81 43701 6241 81 43701 6291 81 43701 6331 88 41701 0012	CB0141	○ ○	81 43701 6185 81 43701 6379	CB0085	○ ○
19.331UNL, 19.331UNLL, 19.361UNL, 19.361UNLL					81 43701 6143 81 43701 6375	CB0086	⊥ ○
22.291UNL/LL, 22.320UNL, 22.321UNL, 22.331UNL/LL, 22.361UNL/LL	⊗	81 43701 6241 81 43701 6291 81 43701 6331 88 41701 0012	CB0141	○ ○	81 43701 6185 81 43701 6379	CB0085	○ ○
22.331UNL, 22.331UNLL, 22.361UNL, 22.361UNLL					81 43701 6143 81 43701 6375	CB0086	⊥ ○
24.291UNL, 24.291UNLL					81 43701 6143 81 43701 6375	CB0086	⊥ ○
24.291UNL/LL, 24.331UNL/LL, 24.361UNL/LL	⊗	81 43701 6241 81 43701 6291 81 43701 6331 88 41701 0012	CB0141	○ ○	81 43701 6185 81 43701 6379	CB0085	○ ○
24.331UNL, 24.331UNLL, 24.361UNL, 24.361UNLL					81 43701 6143 81 43701 6375	CB0086	⊥ ○
25.291UNL, 25.291UNLL					81 43701 6143 81 43701 6375	CB0086	⊥ ○
25.291UNL/LL, 25.331UNL/LL, 25.361UNL/LL	⊗	81 43701 6241 81 43701 6291 81 43701 6331 88 41701 0012	CB0141	○ ○	81 43701 6185 81 43701 6379	CB0085	○ ○
25.331UNL, 25.331UNLL, 25.361UNL, 25.361UNLL					81 43701 6143 81 43701 6375	CB0086	⊥ ○
26.291UNL, 26.291UNLL					81 43701 6143 81 43701 6375	CB0086	⊥ ○
26.291UNL/LL, 26.331UNL/LL, 26.361UNL/LL	⊗	81 43701 6241 81 43701 6291 81 43701 6331 88 41701 0012	CB0141	○ ○	81 43701 6185 81 43701 6379	CB0085	○ ○
26.331UNL, 26.331UNLL, 26.361UNL, 26.361UNLL					81 43701 6143 81 43701 6375	CB0086	⊥ ○
32.361UNL, 32.361UNLL					81 43701 6143 81 43701 6375	CB0086	⊥ ○

			
<i>i</i>			<i>i</i>
			

F 90 (1986/06-1997/12)							
<p>16.242 4x4FL, 16.262 4x4FL, 16.272 4x4FL, 16.292 4x4FL, 16.302 4x4FL, 16.322 4x4FL, 16.332 4x4FL, 16.332 4x4FLL, 16.362 4x4F, 16.362 4x4FLL, 16.372 4x4FL, 16.372 4x4FLL 16.402 4x4FL, 16.422 4x4FL, 16.422 4x4FLL, 19.242FA</p> <p>F01, F02, F03, F04</p>	<p>81 41722 6016 81 41722 6050</p>		<p>T</p>	<p> s w/Topsleeper</p>	<p>81 41722 6017 81 41722 6045</p>	<p>CB0105</p>	<p>Q Q</p>
				<p> L</p>	<p>81 41722 6010 81 41722 6013</p>	<p>CB0105</p>	<p>Q Q</p>
				<p></p>	<p>81 41722 6030 81 41722 6036</p>	<p>CB0087</p>	<p>Q Q</p>
<p>19.262FA, 19.262FAK, 19.262FAS 89/02 → 90/02 19.272FA, 19.272FAK, 19.272FAS, 19.272FK 90/02 → 95/02 19.292FA, 19.292FAK, 19.292FAS 86/07 → 88/05 19.302FA 88/01 → 90/02 19.322FA, 19.322FAK, 19.322FAS, 19.322FK, 19.372FA, 19.372FAK, 19.372FAS, 19.372FK, 19.422FA, 19.422FAK, 19.422FAS, 19.422FK 90/02 → 96/06 19.332FA, 19.332FAK, 19.332FAS, 19.332FK, 19.362FA, 19.362FAK, 19.362FAS, 19.362FK 88/05 → 90/02 19.342FA, 19.342FAK, 19.342FAS, 19.342FK, 19.402FA, 19.402FAK, 19.402FAS, 19.402FK 94/05 → 96/06</p> <p>F01, F02, F03, F04</p>	<p>81 41722 6016 81 41722 6050</p>		<p>T</p>	<p> s w/Topsleeper</p>	<p>81 41722 6017 81 41722 6045</p>	<p>CB0105</p>	<p>Q Q</p>
				<p> L</p>	<p>81 41722 6010 81 41722 6013</p>	<p>CB0105</p>	<p>Q Q</p>
				<p></p>	<p>81 41722 6030 81 41722 6036</p>	<p>CB0087</p>	<p>Q Q</p>
<p>19.362F, 19.362FL, 19.362FLL, 19.362FLLS, 19.362FLS, 19.362FS, 19.462F, 19.462FL, 19.462FK F01, F02, F03, F04 86/07 → 90/02</p>	<p>81 41722 6014</p>	<p>CB0106</p>	<p>T</p>	<p> s</p>	<p>81 41722 6015</p>	<p>CB0105</p>	<p>Q Q</p>
				<p> L</p>	<p>81 41722 6009 81 41722 6012 81 41722 6033 81 41722 6037</p>	<p>CB0105</p>	<p>Q Q</p>
				<p></p>	<p>81 41722 6010 81 41722 6013</p>	<p>CB0105</p>	<p>Q Q</p>

MAN F 90 UNDERFLOOR (1986/06-1996/09)

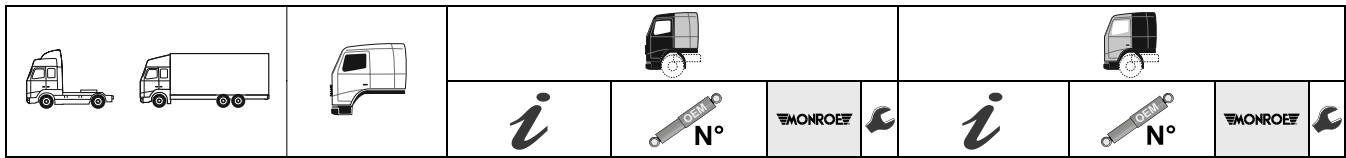





















































































<p>19.372F, 19.372FL, 19.372FLL, 19.372FLLS, 19.372FLS, 19.372FS, 19.422F, 19.422FL, 19.422FLL, 19.422FLLS, 19.422FLS, 19.422FS, 19.402F, 19.402FL, 19.402FLL 90/02 → 95/05 94/05 → 95/05 F01, F02, F03, F04</p>		s 81 41722 6014	<p>CB0106</p>		s 81 41722 6015	
		L 81 41722 6009 81 41722 6012 81 41722 6033 81 41722 6037				
<p>26.292DFK F90 87/09 → 90/02</p>		s 81 41722 6016 81 41722 6050	<p>CB0106</p>		s w/Topsleeper 81 41722 6017 81 41722 6045 CB0105	
		L 81 41722 6010 81 41722 6013 81 41722 6030 81 41722 6036 CB0105 CB0087			L 81 41722 6010 81 41722 6013 CB0105	
<p>26.292DFS F90 87/09 → 90/02</p>		s 81 41722 6014	<p>CB0106</p>		s 81 41722 6015	
		L 81 41722 6009 81 41722 6012 81 41722 6033 81 41722 6037			s w/Topsleeper 81 41722 6017 81 41722 6045 CB0105	

F 90 UNDERFLOOR (1986/06-1996/09)

<p>14.262 4x2U, 14.272 4x2U U01, U03, U11, U13, U20 → 90/05</p>		s 81 41722 6014	<p>CB0106</p>		s 81 41722 6015	
		L 81 41722 6009 81 41722 6012 81 41722 6033 81 41722 6037			L 81 41722 6010 81 41722 6013 81 41722 6017 81 41722 6045 CB0105	
<p>16.322U, 16.322ULL, 16.362U, 16.362ULL, 16.372 4x2U U01, U03, U11, U13, U20</p>		s 81 41722 6014	<p>CB0106</p>		s 81 41722 6015	
		L 81 41722 6009 81 41722 6012 81 41722 6033 81 41722 6037			L 81 41722 6010 81 41722 6013 81 41722 6017 81 41722 6045 CB0105	
<p>17.262 4x2U, 17.272 4x2U U01, U03, U11, U13, U20</p>		s 81 41722 6014	<p>CB0106</p>		s 81 41722 6015	
		L 81 41722 6009 81 41722 6012 81 41722 6033 81 41722 6037			L 81 41722 6010 81 41722 6013 81 41722 6017 81 41722 6045 CB0105	
<p>19.322U, 19.322ULL U01, U03, U11, U13, U20 90/02 → 94/05</p>		s 81 41722 6014	<p>CB0106</p>		s 81 41722 6015	
		L 81 41722 6009 81 41722 6012 81 41722 6033 81 41722 6037			L 81 41722 6010 81 41722 6013 81 41722 6017 81 41722 6045 CB0105	
<p>19.332U, 19.332ULL U01, U03, U11, U13, U20 86/07 → 90/02</p>		s 81 41722 6014	<p>CB0106</p>		s 81 41722 6015	
		L 81 41722 6009 81 41722 6012 81 41722 6033 81 41722 6037			L 81 41722 6010 81 41722 6013 81 41722 6017 81 41722 6045 CB0105	
<p>19.362U, 19.362ULL U01, U03, U11, U13, U20 86/07 → 91/01</p>		s 81 41722 6014	<p>CB0106</p>		s 81 41722 6015	
		L 81 41722 6009 81 41722 6012 81 41722 6033 81 41722 6037			L 81 41722 6010 81 41722 6013 81 41722 6017 81 41722 6045 CB0105	



MAN F 90 UNDERFLOOR (1986/06-1996/09)

										
			<i>i</i>	 N°	 MONROE		<i>i</i>	 N°	 MONROE	
19.372U, 19.372ULL U01, U03, U11, U13, U20 90/02 → 94/05		 S		81 41722 6014			 S	81 41722 6015		
		 L		81 41722 6009 81 41722 6012 81 41722 6033 81 41722 6037	CB0106		 L	81 41722 6010 81 41722 6013 81 41722 6017 81 41722 6045	CB0105	
19.422U, 19.422ULL U01, U03, U11, U13, U20 90/02 → 94/05		 S		81 41722 6014			 S	81 41722 6015		
		 L		81 41722 6009 81 41722 6012 81 41722 6033 81 41722 6037	CB0106		 L	81 41722 6010 81 41722 6013 81 41722 6017 81 41722 6045	CB0105	
22.322UNL, 22.322UNLL, 22.332UNL, 22.332UNLL, 22.362UNL, 22.362UNLL U15, U16		 S		81 41722 6014			 S	81 41722 6015		
		 L		81 41722 6009 81 41722 6012 81 41722 6033 81 41722 6037 81 41722 6016 81 41722 6050	CB0106		 L	81 41722 6010 81 41722 6013 81 41722 6017 81 41722 6045	CB0105	
22.372UNL, 22.372UNLL U15, U16		 S		81 41722 6014			 S	81 41722 6015		
		 L		81 41722 6009 81 41722 6012 81 41722 6033 81 41722 6037 81 41722 6016 81 41722 6050	CB0106		 L	81 41722 6010 81 41722 6013 81 41722 6017 81 41722 6045	CB0105	
22.422UNL, 22.422UNLL U15, U16		 S		81 41722 6014			 S	81 41722 6015		
		 L		81 41722 6009 81 41722 6012 81 41722 6033 81 41722 6037 81 41722 6016 81 41722 6050	CB0106		 L	81 41722 6010 81 41722 6013 81 41722 6017 81 41722 6045	CB0105	
24.322UNL, 24.322UNLL U05, U06, U07, U15, U16 90/02 → 90/12		 S		81 41722 6014			 S	81 41722 6015		
		 L		81 41722 6009 81 41722 6012 81 41722 6033 81 41722 6037 81 41722 6016 81 41722 6050	CB0106		 L	81 41722 6010 81 41722 6013 81 41722 6017 81 41722 6045	CB0105	
24.332UNL, 24.332UNLL U05, U06, U07, U15, U16 86/10 → 90/02		 S		81 41722 6014			 S	81 41722 6015		
		 L		81 41722 6009 81 41722 6012 81 41722 6033 81 41722 6037 81 41722 6016 81 41722 6050	CB0106		 L	81 41722 6010 81 41722 6013 81 41722 6017 81 41722 6045	CB0105	
24.362UNL, 24.362UNLL U05, U06, U07, U15, U16 86/10 → 90/02		 S		81 41722 6014			 S	81 41722 6015		
		 L		81 41722 6009 81 41722 6012 81 41722 6033 81 41722 6037 81 41722 6016 81 41722 6050	CB0106		 L	81 41722 6010 81 41722 6013 81 41722 6017 81 41722 6045	CB0105	
24.372UNL, 24.372UNLL U05, U06, U07, U15, U16 90/02 → 90/12		 S		81 41722 6014			 S	81 41722 6015		
		 L		81 41722 6009 81 41722 6012 81 41722 6033 81 41722 6037 81 41722 6016 81 41722 6050	CB0106		 L	81 41722 6010 81 41722 6013 81 41722 6017 81 41722 6045	CB0105	
24.422UNL, 24.422UNLL U05, U06, U07, U15, U16 90/02 → 90/12		 S		81 41722 6014			 S	81 41722 6015		
		 L		81 41722 6009 81 41722 6012 81 41722 6033 81 41722 6037 81 41722 6016 81 41722 6050	CB0106		 L	81 41722 6010 81 41722 6013 81 41722 6017 81 41722 6045	CB0105	
25.322UNL, 25.322UNLL, 25.332UNL, 25.332UNLL, 25.362UNL, 25.362UNLL, 25.372UNL, 25.372UNLL U05, U06, U07, U15, U16 90/09 → 92/12		 S		81 41722 6014			 S	81 41722 6015		
		 L		81 41722 6009 81 41722 6012 81 41722 6033 81 41722 6037 81 41722 6016 81 41722 6050	CB0106		 L	81 41722 6010 81 41722 6013 81 41722 6017 81 41722 6045	CB0105	



MAN F 2000 (1994/01-)







































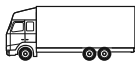





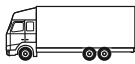





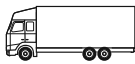





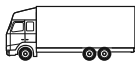





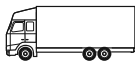





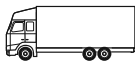





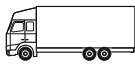





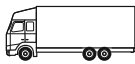





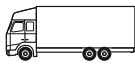





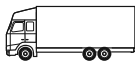





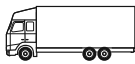





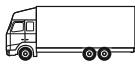





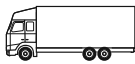





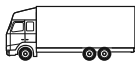





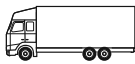





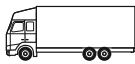





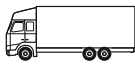





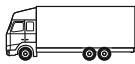





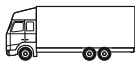





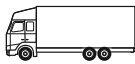





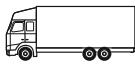





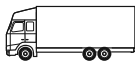





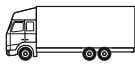





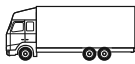





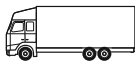





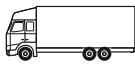





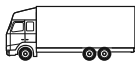





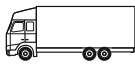





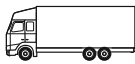





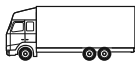





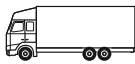





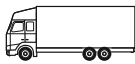





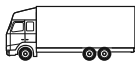





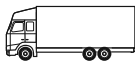





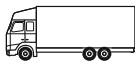





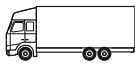





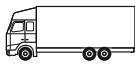





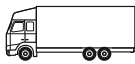





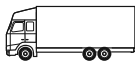





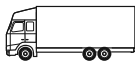





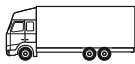





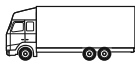





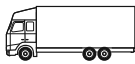





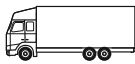





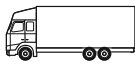





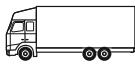





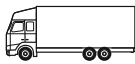





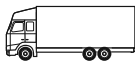





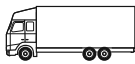





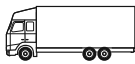





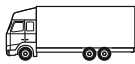





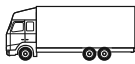





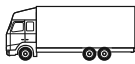





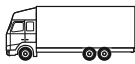





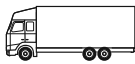

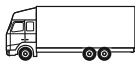

25.422UNL, 25.422UNLL U05, U06, U07, U15, U16 90/09 → 92/12	s L	81 41722 6014 81 41722 6009 81 41722 6012 81 41722 6033 81 41722 6037 81 41722 6016 81 41722 6050	CB0106	Q T Q T Q T Q T	s L	81 41722 6015 81 41722 6010 81 41722 6013 81 41722 6017 81 41722 6045 81 41722 6017 81 41722 6045	CB0105	Q Q Q Q Q Q Q Q
26.322UNL, 26.322UNLL, 26.332UNL, 26.332UNLL, 26.362UNL, 26.362UNLL, 26.372UNL, 26.372UNLL U05, U06, U07, U15, U16 90/09 → 94/05	s L	81 41722 6014 81 41722 6009 81 41722 6012 81 41722 6033 81 41722 6037 81 41722 6016 81 41722 6050	CB0106	Q T Q T Q T Q T	s L	81 41722 6015 81 41722 6010 81 41722 6013 81 41722 6017 81 41722 6045 81 41722 6017 81 41722 6045	CB0105	Q Q Q Q Q Q Q Q
26.422UNL, 26.422UNLL U05, U06, U07, U15, U16 90/09 → 94/05	s L	81 41722 6014 81 41722 6009 81 41722 6012 81 41722 6033 81 41722 6037 81 41722 6016 81 41722 6050	CB0106	Q T Q T Q T	s L	81 41722 6015 81 41722 6010 81 41722 6013 81 41722 6017 81 41722 6045 81 41722 6017 81 41722 6045	CB0105	Q Q Q Q Q Q

F 2000 (1994/01-)

19.273F, 19.273FL, 19.273FLL, 19.323FC, 19.323FLC, 19.323FLLS, 19.323FLS, 19.323FS T03 94/01 → 95/12	s L	81 41722 6014 81 41722 6009 81 41722 6012 81 41722 6033 81 41722 6037	CB0106	Q T Q T	s s w/Top sleeper L	81 41722 6015 81 41722 6017 81 41722 6045 81 41722 6010 81 41722 6013	CB0105	Q Q Q Q
19.293FC, 19.293FLC, 19.293FLLC, 19.293FLLS, 19.293FLS, 19.293FS, 19.343FC, 19.343FLC, 19.343FLLC, 19.343FLLS, 19.343FLS, 19.343FS T03 94/01 →	s L	81 41722 6014 81 41722 6009 81 41722 6012 81 41722 6033 81 41722 6037	CB0106	Q T Q T	s s w/Top sleeper L	81 41722 6015 81 41722 6017 81 41722 6045 81 41722 6010 81 41722 6013	CB0105	Q Q Q Q
23.293FNLLC, 23.403FNLLC, 23.433FNLLC, 23.463FNLLC, 24.273FNLLC, 24.293FNLLC, 24.323FNLLC, 24.343FNLLC, 24.373FNLLC, 24.403FNLLC, 24.423FNLLC, 24.463FNLLC		81 41722 6048 81 41722 6051	CB0092	Q T				
26.273DFC, 26.273DFK, 26.273DFLC, 26.273DFLK, 26.273DFLS, 26.273DFS, 26.323DFC, 26.323DFK, 26.323DFLC, 26.323DFLK, 26.323DFLS, 26.323DFS T09 94/01 → 95/12	s L	81 41722 6014 81 41722 6009 81 41722 6012 81 41722 6033 81 41722 6037	CB0106	Q T Q T	s L	81 41722 6015 81 41722 6010 81 41722 6013 81 41722 6017 81 41722 6045	CB0105	Q Q Q Q

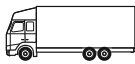

											
<i>i</i>		<i>i</i>		<i>i</i>		<i>i</i>		<i>i</i>		<i>i</i>	
											
											
											
											
											
											
											
											
											
											
											
											
											
											
											
											
											
											
											
											
											
											
											
											
											
											
											
											
											
											
											
											
											
											
											
											
											
											
											
											
											
											
											
											
											
											
											
											
											
											
											
											
											
											
											
											
											
											
											
											
											



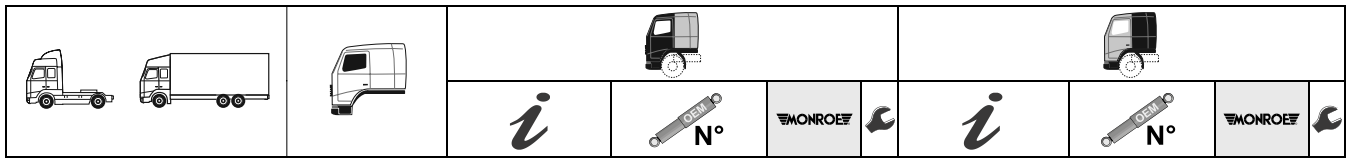





MAN L 2000 (1993/10-2005/06)



























41.403VF, 41.403VFC, 41.403VF-HK, 41.403VFK, 41.403VF-KI, 41.403VFRC, 41.463VF, 41.463VFC, 41.463VF-HK, 41.463VFK, 41.463VF-K, 41.463VFRC T46 95/08 →	s 81 41722 6014	CB0106	s 81 41722 6015	Q T	s 81 41722 6017 81 41722 6045	CB0105	L 81 41722 6010 81 41722 6013	Q Q
	L 81 41722 6009 81 41722 6012 81 41722 6033 81 41722 6037		s w/Topsleeper HD		L			

L 2000 (1993/10-2005/06)









8.103LC, 8.103LK, 8.103LLC, 8.113LC, 8.113LK, 8.113L-KI, 8.113LLC, 8.113LLRC, 8.113LRC, 8.113LRK, 8.113LR-KI 8.145L, 8.145LC, 8.145LF, 8.145L-KI, 8.145LLC, 8.145LLRS, 8.145LLS, 8.145LRK, 8.145LR-KILK, 8.153LAEC, 8.153LAEK, 8.153LC, 8.153LK, 8.153LLC, 8.153LLS			s 85 41722 6001		CB0139	Q Q
			s w/Topsleeper 81 43701 6629		CB0103	Q Q
			L 81 43701 6629		CB0103	Q Q
			L 81 43701 6241		CB0141	Q Q
8.163 LAC, 8.163LAEK, 8.163LAE-LF, 8.163LAERC, 8.163LA-LF, 8.163LARC, 8.163LC, 8.163LK, 8.163L-KI, 8.163LLC, 8.163L-LF, 8.163LLRC, 8.163LLRS, 8.163LLS, 8.163LRC, 8.163LRK, 8.163LR-KI 8.185LC, 8.185LK, 8.185L-KI, 8.185LLC, 8.185L-LF, 8.185LLRC, 8.185LLRS, 8.185LLS, 8.185LRC, 8.185LRK, 8.185LR-KI			s 85 41722 6001		CB0139	Q Q
			s w/Topsleeper 81 43701 6629		CB0103	Q Q
			L 81 43701 6629		CB0103	Q Q
			L 81 43701 6241		CB0141	Q Q
8.223LAEK, 8.223LC, 8.223LK, 8.223LLC 8.224LAC, 8.224LAEK, 8.224LAEK, 8.224LAERC, 8.224LAERK, 8.224LAK, 8.224LARC, 8.224LARK, 8.224LC, 8.224LK, 8.224L-KI, 8.224LLC, 8.224LLRC, 8.224LRC, 8.224LRK, 8.224LR-KI 8.225LC, 8.225LK, 8.225L-KI, 8.225LLC, 8.225LLRC, 8.225LRC, 8.225LRK, 8.225LR-KI			s 85 41722 6001		CB0139	Q Q
			s w/Topsleeper 81 43701 6629		CB0103	Q Q
			L 81 43701 6629		CB0103	Q Q
			L 81 43701 6241		CB0141	Q Q





								
		<i>i</i>			<i>i</i>			

<p>9.145LC, 9.145LK, 9.145L-KI, 9.145LLC, 9.145LLRC, 9.145LLRS, 9.145LLS, 9.145LRC, 9.145LRK, 9.145LR-KI, 9.153LA, 9.153LC, 9.153LK, 9.153LLC, 9.153LLS 9.163LC, 9.163LK, 9.163L-KI, 9.163LLC, 9.163LLRC, 9.163LLRS, 9.163LLS, 9.163LRC, 9.163LRK, 9.163LR-KI, 9.164LA 9.185LC, 9.185LK, 9.185L-KI, 9.185LLC, 9.185LLRC, 9.185LLRS, 9.185LLS, 9.185LRC, 9.185LRK, 9.185LR-KI, 9.223LA, 9.223LC, 9.223LK, 9.223LLC 9.224LA, 9.224LC, 9.224LK, 9.224L-KI, 9.224LLC, 9.224LLRC, 9.224LRC, 9.224LRK, 9.224LR-KI, 9.225LC, 9.225LK, 9.225L-KI, 9.225LLC, 9.225LLRC, 9.225LRC, 9.225LRK, 9.225LR-KI</p>				 S	85 41722 6001	CB0139		
					 S w/Topsleeper	81 43701 6629	CB0103	
					 L	81 43701 6629	CB0103	
					 L	81 43701 6241	CB0141	
<p>10.153LAEK, 10.153LAEK, 10.153LC, 10.153LK, 10.153LLC 10.163LAC, 10.163LAEK, 10.163LAERC, 10.163LAERK, 10.163LAK, 10.163LARC, 10.163LARK, 10.163LC, 10.163LK, 10.163L-KI, 10.163LLC, 10.163LLRC, 10.163LRC, 10.163LRK, 10.163LR-KI 10.223LAEK, 10.224LAC, 10.224LAEK, 10.224LAEK, 10.224LAERC, 10.224LAERK, 10.224LAK, 10.224LARC, 10.224LARK</p>				 S	85 41722 6001	CB0139		
				 S w/Topsleeper	81 43701 6629	CB0103		
				 L	81 43701 6629	CB0103		
				 L	81 43701 6241	CB0141		
<p>11.153LL, 11.163LL, 11.223LL, 11.224LL</p>				 S	85 41722 6001	CB0139		
				 S w/Topsleeper	81 43701 6629	CB0103		
				 L	81 43701 6629	CB0103		









































































M 90 (1988/08-1996/06)								
<p>12.152F, 12.152FK, 12.152FL, 12.152FLS, 12.152FS, 12.192F, 12.192FK, 12.192FL, 12.192FLS, 12.192FS</p> <p>M01</p>						81 43701 6629	CB0103	











MAN M 2000 L (1995/08-2005/12)







































			
<i>i</i>	 N°		<i>i</i>
			

12.232F, 12.232FK, 12.232FL, 12.232FLS, 12.232FS, 12.272F, 12.272FK, 12.272FL, 12.272FLS, 12.272FS M01				81 43701 6629	CB0103	 
---	---	--	--	---------------	---------------	--

M 2000 L (1995/08-2005/12)









12.153L, 12.153LL, 12.163L, 12.163LC, 12.163LL, 12.163LLC, 12.163LLRC, 12.163LRC, 12.223L, 12.223LL, 12.223LLL 12.224L, 12.224LC, 12.224LL, 12.224LLC, 12.224LLL, 12.224LLRC, 12.224LRC, 12.263L, 12.263LL, 12.263LLL, 12.264L, 12.264LL, 12.264LLL,			 s  s w/Topsleeper  L	85 41722 6001 81 43701 6629 81 43701 6629	CB0139 CB0103 CB0103	                       
13.153L, 13.153LL, 13.163L, 13.163LL 13.223L, 13.223LL, 13.223LLL, 13.224L, 13.224LL, 13.263L, 13.263LL, 13.263LLL, 13.264L, 13.264LL, 13.264LLL, 13.283L, 13.283LL, 13.283LLL,			 s  s w/Topsleeper  L	85 41722 6001 81 43701 6629 81 43701 6629	CB0139 CB0103 CB0103	         
14.153L, 14.153LL 14.163L, 14.163LC, 14.163LK, 14.163LL, 14.163LLC, 14.163LLRC, 14.163LRC, 14.163LRK, 14.223L, 14.223LL, 14.223LLL 14.224LC, 14.224LLC, 14.224LLC, 14.224LLRC, 14.224LLRC, 14.224LRC, 14.225LC, 14.225LK, 14.225LLC, 14.225LLC, 14.225LLRC, 14.225LLRC, 14.225LRC, 14.225LRK 14.255LC, 14.255LLC, 14.255LLC, 14.255LLRC, 14.255LRC, 14.263L, 14.263LC, 14.263LL, 14.263LLC, 14.263LLL, 14.263LLC, 14.263LLLRC, 14.263LLRC, 14.263LRC 14.264LC, 14.264LLC, 14.264LLRC, 14.264LLRC, 14.264LLRC, 14.264LRC, 14.285LC, 14.285LLC, 14.285LLRC, 14.285LLRC, 14.285LLRC, 14.285LRC,			 s  s w/Topsleeper  L	85 41722 6001 81 43701 6629 81 43701 6629	CB0139 CB0103 CB0103	                             

			
<i>i</i>	 N°	 	<i>i</i>
	 N°	 	

<p>15.153L, 15.153LL15.163LC, 15.163LK, 15.163LLC, 15.163LRC, 15.163LRK, 15.223L, 15.223LL, 15.223LLL, 15.224LC, 15.224LK, 15.224LLC, 15.224LLLC, 15.224LLLRC, 15.224LLRC, 15.224LRC, 15.224LRK 15.225LC, 15.225LK, 15.225LLC, 15.225LLLC, 15.225LLLRC, 15.225LLRC, 15.225LRC, 15.225LRK, 15.255LC, 15.255LK, 15.255LLC, 15.255LLLC, 15.255LLLRC, 15.255LLRC, 15.255LRC, 15.255LRK 15.263L, 15.263LC, 15.263LK, 15.263LL, 15.263LLC, 15.263LLL, 15.263LLLC, 15.263LLLRC, 15.263LLRC, 15.263LRC, 15.263LRK 15.264LC, 15.264LK, 15.264LLC, 15.264LLLC, 15.264LLLRC, 15.264LLRC, 15.264LRC, 15.264LRK, 15.283L, 15.283LL, 15.283LLL 15.285LC, 15.285LK, 15.285LLC, 15.285LLLC, 15.285LLLRC, 15.285LLRC, 15.285LRC, 15.285LRK</p>		<table border="0"> <tr> <td> S</td> <td>85 41722 6001</td> <td><u>CB0139</u></td> <td></td> </tr> <tr> <td> S</td> <td>w/Topsleeper 81 43701 6629</td> <td><u>CB0103</u></td> <td></td> </tr> <tr> <td> L</td> <td>81 43701 6629</td> <td><u>CB0103</u></td> <td></td> </tr> </table>	 S	85 41722 6001	<u>CB0139</u>		 S	w/Topsleeper 81 43701 6629	<u>CB0103</u>		 L	81 43701 6629	<u>CB0103</u>					
 S	85 41722 6001	<u>CB0139</u>																
 S	w/Topsleeper 81 43701 6629	<u>CB0103</u>																
 L	81 43701 6629	<u>CB0103</u>																
<p>18.223L, 18.223LL, 18.224LC, 18.224LLC, 18.224LLLC, 18.224LLLRC, 18.224LLRC, 18.224LRK 18.225LC, 18.225LLC, 18.225LLLC, 18.225LLLRC, 18.225LLRC, 18.225LLRK, 18.225LRC, 18.225LRK, 18.255LC, 18.255LLC, 18.255LLLC, 18.255LLLRC, 18.255LLRC, 18.255LRC 18.263L, 18.263LL, 18.263LC, 18.263LK, 18.263LLC, 18.263LLK, 18.263LLL, 18.263LLLC, 18.263LLLRC, 18.263LLRC, 18.263LLRK, 18.263LRC, 18.263LRK 18.264LK, 18.264LLK, 18.264LLLRC, 18.264LLRC, 18.264LLRK, 18.264LRC, 18.264LRK,</p>		<table border="0"> <tr> <td> S</td> <td>85 41722 6001</td> <td><u>CB0139</u></td> <td></td> </tr> <tr> <td> S</td> <td>w/Topsleeper 81 43701 6629</td> <td><u>CB0103</u></td> <td></td> </tr> <tr> <td> L</td> <td>81 43701 6629</td> <td><u>CB0103</u></td> <td></td> </tr> <tr> <td> L</td> <td>81 43701 6241</td> <td><u>CB0141</u></td> <td></td> </tr> </table>	 S	85 41722 6001	<u>CB0139</u>		 S	w/Topsleeper 81 43701 6629	<u>CB0103</u>		 L	81 43701 6629	<u>CB0103</u>		 L	81 43701 6241	<u>CB0141</u>	
 S	85 41722 6001	<u>CB0139</u>																
 S	w/Topsleeper 81 43701 6629	<u>CB0103</u>																
 L	81 43701 6629	<u>CB0103</u>																
 L	81 43701 6241	<u>CB0141</u>																













MAN TGA (2000/04-2007/10)

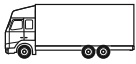













			
<i>i</i>			<i>i</i>
			

<p>18.283L, 18.283LL, 18.283LLL 18.284LC, 18.284LK, 18.284L-KO, 18.284LLC, 18.284LLK, 18.284LLLC, 18.284LLRC, 18.284LLRC, 18.284LLRK, 18.284LRC, 18.284LRK, 18.284LR-KO 18.285LC, 18.285LK, 18.285L-KO, 18.285LLC, 18.285LLK, 18.285LLLC, 18.285LLRC, 18.285LLRC, 18.285LLRK, 18.285LRC, 18.285LRK, 18.285LR-KO18223LLL</p>			 s  s w/Topsleeper  L  L	<p>85 41722 6001 81 43701 6629 81 43701 6629 81 43701 6241</p>	<p>CB0139 CB0103 CB0103 CB0141</p>	<p>○ ○ ○ ○ ○</p>
<p>26.224DL-HK, 26.224DLR-HK, 26.225DL-HK, 26.225DLR-HK, 26.255DL-HK, 26.255DLR-HK, 26.284DL-HK, 26.284DLR-HK, 26.284DLR-TM, 26.284DL-TM, 26.285DL-HK, 26.285DLR-HK, 26.285DL-TM</p>				<p>85 41722 6001</p>	<p>CB0139</p>	<p>○ ○</p>









TGA (2000/04-2007/10)







<p>28.310FNLC, 28.310FNLLC, F92L22, 28S 28.310FNLRK, 28.310FNLRK, 28.310FNLS, 28.360FNLC, 28.360FNLLC, 28.360FNLRK, 28.360FNLS, 28.410FNLC, 28.410FNLLC, 28.410FNLRK, 28.410FNLRK, 28.410FNLS, 28.460FNLC, 28.460FNLLC, 28.460FNLRK, 28.460FNLRK, 28.460FNLS, 28.480FNLC, 28.480FNLLC, 28.480FNLRK, 28.480FNLRK, 28.480FNLS</p>				<p>81 41722 6049 81 41722 6052</p>	<p>CB0091</p>	<p>○ ○</p>
<p>28.510FNLC, 28.510FNLLC, F92L22, 28S 28.510FNLRK, 28.510FNLRK, 28.510FNLS, 28.530FNLC, 28.530FNLLC, 28.530FNLRK, 28.530FNLRK, 28.530FNLS</p>				<p>81 41722 6049 81 41722 6052</p>	<p>CB0091</p>	<p>○ ○</p>

					
<i>i</i>			<i>i</i>		







































<p>18.310FK, 18.310FK-L, H03 18.310FLK, 18.310FLRK, 18.320FK, 18.320FK-L, 18.320FLK, 18.320FLRK, 18.430FC, 18.430FLC, 18.430FLLC, 18.430FLLRC, 18.430FLLRW, 18.430FLLW, 18.430FLRC, 18.440FC, 18.440FFLC, 18.440FLLC, 18.440FLLRC, 18.440FLLRW, 18.440FLLW, 18.430FLRC</p>		<p>s  </p> <p>81417226059 85417226011 85417226019</p> <p>CB0198 ○</p>
<p>18.310FK, 18.310FK-L, H03, H06 FLK, 18.310FLRK, 18.320FK, 18.320FK-L, 18.320FLK, 18.320FLRK, 18.350FK, 18.350FK-L, 18.350FLK, 18.350FLRK, 18.360FK, 18.360FK-L, 18.360FLK, 18.360FLRK, 18.390FK, 18.390FK-L, 18.390FLK, FLRK, 18.400FK, 18.400FK-L, 18.400FLK, 18.400FLRK</p>	<p> 85417226010 85417226017 CB0199 ○</p> <p> 81417226068 CB0200 ○</p>	
<p>18.310FLLRS, 18.310FLLS, H01 18.310FLRS, 18.310FLS, 18.310FLS-TS, 18.360FLLRS, 18.360FLLS, 18.360FLRS, 18.360FLS, 18.360FLS-TS, 18.410FLLRS, 18.410FLLS, 18.410FLRS, 18.410FLS, 18.410FLS-TS, 18.460FLLRS, 18.460FLLS, 18.460FLRS, 18.460FLS, 18.460FLS-TS, 18.480FLLRS, 18.480FLLS, 18.480FLRS, FLS, 18.480FLS-TS</p>	<p> 85417226010 85417226017 CB0199 ○</p>	<p>81417226059 85417226011 85417226019</p> <p>CB0198 ○</p>
<p>18.310FLLRS, 18.310FLLS, H05 18.310FLRS, 18.310FLS, 18.310FLS-TS, 18.360FLLRS, 18.360FLLS, 18.360FLRS, 18.360FLS, 18.360FLS-TS, 18.410FLLRS, 18.410FLLS, 18.410FLRS, 18.410FLS, 18.410FLS-TS, 18.460FLLRS, 18.460FLLS, 18.460FLRS, 18.460FLS, 18.460FLS-TS, 18.480FLLRS, 18.480FLLS, 18.480FLRS, 18.480FLS, 18.480FLS-TS</p>	<p> 85417226010 85417226017 CB0199 ○</p> <p> 81417226068 CB0200 ○</p>	<p>s  </p> <p>81417226059 85417226011 85417226019</p> <p>CB0198 ○</p>
<p>18.310FLLRS, 18.310FLLS, H06 18.310FLRS, 18.310FLS, 18.310FLS-TS, 18.320FLLRS, 18.320FLLS, 18.320FLRS, 18.320FLS, 18.320FLS-TS</p>		<p>s  </p> <p>81417226059 85417226011 85417226019</p> <p>CB0198 ○</p>



			
<i>i</i>			<i>i</i>
			

<p>18.310FLLRS, 18.310FLLS, H12 18.310FLRS, 18.310FLS, 18.310FLS-TS, 18.360FLLRS, 18.360FLLS, 18.360FLRS, 18.360FLS, 18.360FLS-TS, 18.410FLLRS, 18.410FLLS, 18.410FLRS, 18.410FLS, 18.410FLS-TS, 18.460FLLRS, 18.460FLLS, 18.460FLRS, 18.460FLS, 18.460FLS-TS, 18.480FLLRS, 18.480FLLS, 18.480FLRS, 18.480FLS, 18.480FLS-TS</p>		<p>s 81417226059 85417226011 85417226019 CB0198 </p>
<p>18.350FAC, 18.350FARC, H22 18.350FHLC, 18.350FAK, 18.350FAK-L, 18.350FALK, 18.350FALK-L, 18.350FHLK, 18.350FHLK/M, 18.350FALS, 18.350FARS, 18.350FAS, 18.350FHLS, 18.360FAC, 18.360FARC, 18.360FHLC, 18.360FAK, 18.360FAK-L, 18.360FALK, 18.360FALK-L, 18.360FHLK, 18.360FHLK/M, 18.360FALS, 18.360FARS, 18.360FAS, 18.360FHLS</p>	<p> 85417226010 85417226017 CB0199  81417226068 CB0200</p>	<p>s 81417226059 85417226011 85417226019 CB0198   </p>
<p>18.350FAC, 18.350FARC, HV5 18.350FHLC, 18.350FAK, 18.350FAK-L, 18.350FALK, 18.350FALK-L, 18.350FHLK, 18.350FHLK/M, 18.350FALS, 18.350FARS, 18.350FAS, 18.350FHLS, 18.360FAC, 18.360FARC, 18.360FHLC, 18.360FAK, 18.360FAK-L, 18.360FALK, 18.360FALK-L, 18.360FHLK, 18.360FHLK/M, 18.360FALS, 18.360FARS, 18.360FAS, 18.360FHLS</p>	<p> 85417226010 85417226017 CB0199  81417226060 CB0201</p>	<p> 81417226061 CB0197</p>
<p>18.350FC, 18.350FLC, H03, H06 18.350FLLC, 18.350FLLRC, 18.350FLLW, 18.350FLRC, 18.350FLLRW, 18.350FRC, 18.360FC, 18.360FLC, 18.360FLLC, 18.360FLLRC, 18.360FLLW, 18.360FLRC, 18.360FLLRW, 18.360FRC, 18.390FC, 18.390FLC, 18.390FLLC, 18.390FLLRC, 18.390FLLW, 18.390FLRC, 18.390FLLRW, 18.400FC, 18.400FLC, 18.400FLLC, 18.400FLLRC, 18.400FLLW, 18.400FLRC, FLLRW</p>		<p>s 81417226059 85417226011 85417226019 CB0198 </p>







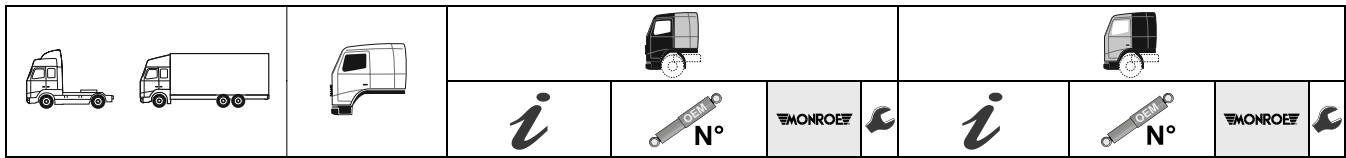































									
									
18.360FLLRS, 18.360FLLS, H08, H12, H13 18.360FLRS, 18.360FLS, 18.360FLS-TS, 18.480FLLRS, 18.480FLLS, 18.480FLRS, FLS, 18.480FLS-TS		85417226010 85417226017	<u>CB0199</u>						
18.360FLLRS, 18.360FLLS, H61, H65 18.360FLRS, 18.360FLS, 18.360FLS-TS	 	85417226010 85417226017 81417226060	<u>CB0199</u> <u>CB0201</u>	 	81417226061	<u>CB0197</u>	 		
18.390FAC, 18.390FARC, H22 18.390FHLC, 18.390FAK, 18.390FAK-L, 18.390FALK, 18.390FALK-L, 18.390FHLK, 18.390FHLK/M, 18.390FALS, 18.390FAS, 18.390FHLS, 18.400FAC, 18.400FARC, 18.400FHLC, 18.400FAK, 18.400FAK-L, 18.400FALK, 18.400FALK-L, 18.400FHLK, 18.400FHLK/M, 18.400FALS, 18.400FAS, 18.400FHLS	 	85417226010 85417226017 81417226068	<u>CB0199</u> <u>CB0200</u>	   	81417226059 85417226011 85417226019	<u>CB0198</u>	  		
18.390FAC, 18.390FARC, HV5 18.390FHLC, 18.390FAK, 18.390FAK-L, 18.390FALK, 18.390FALK-L, 18.390FHLK, 18.390FHLK/M, 18.390FALS, 18.390FAS, 18.390FHLS, 18.400FAC, 18.400FARC, 18.400FHLC, 18.400FAK, 18.400FAK-L, 18.400FALK, 18.400FALK-L, 18.400FHLK, 18.400FHLK/M, 18.400FALS, 18.400FAS, 18.400FHLS	 	85417226010 85417226017 81417226060	<u>CB0199</u> <u>CB0201</u>	 	81417226061	<u>CB0197</u>	 		
18.400FLLRS, 18.400FLLS, H06, H10 18.400FLRS, 18.400FLS, 18.400FLS-TS, 18.430FLLRS, 18.430FLLS, 18.430FLRS, 18.430FLS, 18.430FLS-TS, 18.440FLLRS, 18.440FLLS, 18.440FLRS, 18.440FLS, 18.440FLS-TS, 18.480FLLRS, 18.480FLLS, 18.480FLRS, 18.480FLS, 18.480FLS-TS, 18.540FLLRS, 18.540FLLS, 18.540FLRS, 18.540FLS	 	85417226010 85417226017 81417226068	<u>CB0199</u> <u>CB0200</u>	  					





<p>18.400FLLRS, 18.400FLLS, H08, H13 18.400FLRS, 18.400FLS, 18.400FLS-TS, 18.430FLLRS, 18.430FLLS, 18.430FLRS, 18.430FLS, 18.430FLS-TS, 18.440FLLRS, 18.440FLLS, 18.440FLRS, 18.440FLS, 18.440FLS-TS</p>		<p>85417226010 85417226017</p>	<p>CB0199</p>	<p>○ ○</p>			
<p>18.410FC, 18.410FLC, H02, H05, H09, H14 18.410FLLC, 18.410FLLRC, 18.410FLLRW, 18.410FLLW, 18.410FLRC, 18.410FRC, 18.420FC, 18.420FLC, 18.420FLLC, 18.420FLLRC, 18.420FLLRW, 18.420FLLW, 18.420FLRC, 18.420FRC, 18.460FC, 18.460FLC, 18.460FLLC, 18.460FLLRC, 18.460FLLRW, 18.460FLLW, 18.460FLRC, 18.460FRC</p>		<p>85417226010 85417226017</p> <p>81417226068</p>	<p>CB0199</p> <p>CB0200</p>	<p>○ ○</p> <p>○ ○</p>		<p>81417226059 85417226011 85417226019</p>	<p>CB0198</p> <p>○ ○</p>
<p>18.410FLLRS, 18.410FLLS, H61 18.410FLRS, 18.410FLS, 18.410FLS-TS, 18.460FLLRS, 18.460FLLS, 18.460FLRS, 18.460FLS, 18.460FLS-TS, 18.480FLLRS, 18.480FLLS, 18.480FLRS, 18.480FLS, 18.480FLS-TS</p>		<p>85417226010 85417226017</p> <p>81417226060</p>	<p>CB0199</p> <p>CB0201</p>	<p>○ ○</p> <p>○ ○</p>		<p>81417226061</p>	<p>CB0197</p> <p>○ ○</p>
<p>18.430FAC, 18.430FARC, H22 18.430FHLC, 18.430FAK, 18.430FALK, 18.430FALK-L, 18.430FHLK, 18.430FHLK/M, 18.430FALS, 18.430FAS, 18.430FHLS, 18.440FAC, 18.440FARC, 18.440FHLC, 18.440FAK, 18.440FALK, 18.440FALK-L, 18.440FHLK, 18.440FHLK/M, 18.440FALS, 18.440FAS, 18.440FHLS</p>		<p>85417226010 85417226017</p> <p>81417226068</p>	<p>CB0199</p> <p>CB0200</p>	<p>○ ○</p> <p>○ ○</p>		<p>81417226059 85417226011 85417226019</p>	<p>CB0198</p> <p>○ ○</p>
<p>18.430FAC, 18.430FARC, HV5 18.430FHLC, 18.430FAK, 18.430FALK, 18.430FALK-L, 18.430FHLK, 18.430FHLK/M, 18.430FALS, 18.430FAS, 18.430FHLS, 18.440FAC, 18.440FARC, 18.440FHLC, 18.440FAK, 18.440FALK, 18.440FALK-L, 18.440FHLK, 18.440FHLK/M, 18.440FALS, 18.440FAS, 18.440FHLS</p>		<p>85417226010 85417226017</p> <p>81417226060</p>	<p>CB0199</p> <p>CB0201</p>	<p>○ ○</p> <p>○ ○</p>		<p>81417226061</p>	<p>CB0197</p> <p>○ ○</p>











											
				<i>i</i>	 N°			<i>i</i>	 N°		
18.430FAK, 18.430FALK, 18.430FALK-L, 18.430FHLK, 18.430FHLK/M, 18.430FALS, 18.430FAS, 18.430FHLS, 18.440FAK, 18.440FALK, 18.440FALK-L, 18.440FHLK, 18.440FHLK/M, 18.440FALS, 18.440FAS, 18.440FHLS, 18.480FAK, 18.480FALK, 18.480FALK-L, 18.480FHLK 18.480FHLK/M 18.480FALS, 18.480FARS, 18.480FAS, 18.480FHLS	H52, H80			85417226010 85417226017		CB0199					
18.430FC, 18.430FLC, 18.430FLLC, 18.430FLLRC, 18.430FLLW, 18.430FLRC, 18.430FLLRW, 18.440FC, 18.440FLC, 18.440FLLC, 18.440FLLRC, 18.440FLLW, 18.440FLRC, 18.440FLLRW, 18.480FC, 18.480FLC, 18.480FLLC, 18.480FLLRC, 18.480FLLW, 18.480FLRC, 18.480FLLRW	H03, H06, H10, H15	 		85417226010 85417226017 81417226068		CB0199 CB0200	 				
18.430FK, 18.430FK-L, 18.430FLK, 18.430FLRK, 18.440FK, 18.440FK-L, 18.440FLK, 18.440FLRK, 18.480FK, 18.480FK-L, 18.480FLK, 18.480FLRK	H03, H06	 		85417226010 85417226017 81417226068		CB0199 CB0200	 				
18.430FLLRS, 18.430FLLS, 18.430FLRS, 18.430FLS, 18.430FLS-TS	H13						 s  HD		81417226059 85417226011 85417226019	CB0198	 
18.460FC, 18.460FRC, 18.460FLC, 18.460FLRC, 18.460FLLC, 18.460FLLW, 18.460FLLRC, 18.460FLLRW, 18.460FK, 18.460FK-L, 18.460FLK, 18.460FLRK, 18.480FC, 18.480FLC, 18.480FLRC, 18.480FLLC, 18.480FLLW, 18.480FLLRC, 18.480FLLRW, 18.480FK, 18.480FK-L, 18.480FLK, 18.480FLRK	H05						 s  HD		81417226059 85417226011 85417226019	CB0198	 
18.480FAK, 18.480FAK-L, 18.480FALK, 18.480FALK-L, 18.480FHLK, 18.480FALS, 18.480FARS, 18.480FAS, 18.480FHLS, 18.480FHLC, 18.480FHLK, 18.480FHLK/M, 18.480FHLS, 18.480FHLS/M	H22	 		85417226010 85417226017 81417226068		CB0199 CB0200	 s  HD 		81417226059 85417226011 85417226019	CB0198	  







MAN TGA (2007/10-)











<p>18.480FAK, 18.480FAK-L, H51, H70 18.480FALK, 18.480FALK-L, 18.480FHLK, 18.480FALS, 18.480FARS, 18.480FAS, 18.530FAK, 18.530FAK-L, 18.530FALK, 18.530FALK-L, 18.530FALS, 18.530FAS</p>		<p>85417226010 85417226017</p>	<p>CB0199</p>			<p>81417226059 85417226011 85417226019</p>	<p>CB0198</p>	
<p>18.480FC, 18.480FLC, 18.480FLLC, 18.480FLLRC, 18.480FLLRW, 18.480FLLW, 18.480FLRC, 18.480FHLC, 18.480FHLK, 18.480FHLK/M, 18.480FHLS, 18.480FHLS/M</p>		<p>85417226010 85417226017</p>	<p>CB0199</p>		<p>s</p>	<p>81417226059 85417226011 85417226019</p>	<p>CB0198</p>	
<p>18.480FC, 18.480FLC, H02, H05, H09, H14 18.480FLLC, 18.480FLLRC, 18.480FLLRW, 18.480FLLW, 18.480FLRC, 18.510FC, 18.510FLC, 18.510FLLC, 18.510FLLRC, 18.510FLLRW, 18.510FLLW, 18.510FLRC, 18.510FRC, 18.530FC, 18.530FLC, 18.530FLLC, 18.530FLLRC, 18.530FLLRW, 18.530FLLW, 18.530FLRC</p>		<p>85417226010 85417226017</p> <p>81417226068</p>	<p>CB0199</p> <p>CB0200</p>		<p>s</p>	<p>81417226059 85417226011 85417226019</p>	<p>CB0198</p>	
<p>18.510FLLRS, 18.510FLLS, H05 18.510FLRS, 18.510FLS, 18.530FLLRS, 18.530FLLS, 18.530FLRS, 18.530FLS</p>		<p>85417226010 85417226017</p> <p>81417226068</p>	<p>CB0199</p> <p>CB0200</p>		<p>s</p>	<p>81417226059 85417226011 85417226019</p>	<p>CB0198</p>	
<p>18.510FLLRS, 18.510FLLS, H09 18.510FLRS, 18.510FLS, 18.530FLLRS, 18.530FLLS, 18.530FLRS, 18.530FLS</p>		<p>85417226010 85417226017</p> <p>81417226068</p>	<p>CB0199</p> <p>CB0200</p>					
<p>18.510FLLRS, 18.510FLLS, H12 18.510FLRS, 18.510FLS, 18.530FLLRS, 18.530FLLS, 18.530FLRS, 18.530FLS</p>					<p>s</p>	<p>81417226059 85417226011 85417226019</p>	<p>CB0198</p>	
<p>18.540FLC, 18.540FLLC, H06, H10, H15 18.540FLLRC, 18.540FLLW, 18.540FLRC</p>		<p>85417226010 85417226017</p> <p>81417226068</p>	<p>CB0199</p> <p>CB0200</p>					
<p>18.540FLLRS, 18.540FLLS, 18.540FLRS, 18.540FLS</p>		<p>85417226010 85417226017</p>	<p>CB0199</p>					







									
		<i>i</i>	 OEM N°	 	<i>i</i>	 OEM N°	 		









<p>26.310FDAC, H55 26.310FDARC, 26.310FDHC, 26.360FDAK, 26.360FDALK, 26.360FDHK, 26.360FDHLK, 26.410FDAC, 26.410FDARC, 26.410FDAK, 26.410FDALK, 26.410FDALS, 26.410FDARS, 26.410FDAS, 26.530FDAC, 26.530FDALC, 26.530FDAK, 26.530FDALK, 26.530FDAS, 26.530FDALS</p>	H55		85417226010 85417226017	<u>CB0199</u>		81417226061	<u>CB0197</u>	
<p>26.310FDAC, H56 26.310FDARC, 26.310FDAK, 26.310FDH, 26.310FDHC, 26.310FDHK, 26.320FDAC, 26.320FDAK, 26.320FDAS, 26.320FDH, 26.320FDHC, 26.320FDHK, 26.320FDHS, 26.350FDAC, 26.350FDAK, 26.350FDALK, 26.350FDAS, 26.350FDHC, 26.350FDHK, 26.350FDHLK, 26.350FDHS, 26.360FDAK, 26.360FDALK, 26.360FDARK, 26.360FDHK, 26.360FDHLK</p>	H56		85417226010 85417226017	<u>CB0199</u>		81417226061	<u>CB0197</u>	
<p>26.310FDAK, 26.310FDHK, H55, H56 26.310FDARS, 26.310FDAS, 26.310FDHS, 26.360FDAC, 26.360FDARC, 26.360FDHC, 26.360FDHLC, 26.360FDARS, 26.360FDAS, 26.360FDHLS, 26.360FDHS, 26.480FDAC, 26.480FDALC, 26.480FDARC, 26.480FDHC, 26.480FDHLC, 26.480FDAK, 26.480FDALK, 26.480FDHK, 26.480FDHLK, 26.480FDALS, 26.480FDARS, 26.480FDAS, 26.480FDHLS, 26.480FDHS</p>	H55, H56		85417226010 85417226017	<u>CB0199</u>		81417226061	<u>CB0197</u>	
<p>26.360FDAC, 26.360FDARC, 26.360FDHC, 26.360FDHLC, 26.360FDARS, 26.360FDAS, 26.360FDHLS, 26.360FDHS, 26.480FDAC, 26.480FDALC, 26.480FDARC, 26.480FDHC, 26.480FDHLC, 26.480FDAK, 26.480FDALK, 26.480FDHK, 26.480FDHLK, 26.480FDALS, 26.480FDARS, 26.480FDAS, 26.480FDHLS, 26.480FDHS</p>	H55, H56		85417226010 85417226017	<u>CB0199</u>		81417226061	<u>CB0197</u>	
<p>26.480FDALC, 26.480FDARC, 26.480FDHC, 26.480FDHLC, 26.480FDAK, 26.480FDALK, 26.480FDHK, 26.480FDHLK, 26.480FDALS, 26.480FDARS, 26.480FDAS, 26.480FDHLS, 26.480FDHS</p>	H55, H56		85417226010 85417226017	<u>CB0199</u>		81417226061	<u>CB0197</u>	
<p>26.480FDALC, 26.480FDARC, 26.480FDHC, 26.480FDHLC, 26.480FDAK, 26.480FDALK, 26.480FDHK, 26.480FDHLK, 26.480FDALS, 26.480FDARS, 26.480FDAS, 26.480FDHLS, 26.480FDHS</p>	H55, H56		85417226010 85417226017	<u>CB0199</u>		81417226061	<u>CB0197</u>	

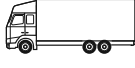













MAN TGA (2007/10-)

			
<i>i</i>	 N°		<i>i</i>
			









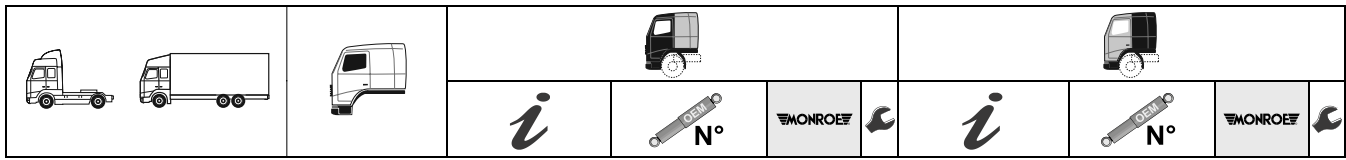



















<p>26.310FNLC, 26.310FNLLC, H18 26.310FNLLRC, 26.310FNLLRW, 26.310FNLLW, 26.310FNLRC, 26.310FNLS, 26.310FNLLS, 26.310FNLRS, 26.310FNLLRS, 26.310FPLRS, 26.310FPLS, 26.320FNLC, 26.320FNLLC, 26.320FNLLRC, 26.320FNLLRW, 26.320FNLLW, 26.320FNLRC, 26.320FNLS, 26.320FNLLS, 26.320FNLRS, 26.320FNLLRS, 26.320FPLRS, 26.320FPLS</p>			<p> s  HD</p>	<p>81417226059 85417226011 85417226019</p>	<p>CB0198 ○ ○</p>
<p>26.310FNLC, 26.310FNLLC, H18, H21 26.310FNLLRC, 26.310FNLLRW, 26.310FNLLW, 26.310FNLRC, 26.310FNLS, 26.310FNLLS, 26.310FNLRS, 26.310FNLLRS, 26.310FPLRS, 26.310FPLS, 26.320FNLC, 26.320FNLLC, 26.320FNLLRC, 26.320FNLLRW, 26.320FNLLW, 26.320FNLRC, 26.320FNLS, 26.320FNLLS, 26.320FNLRS, 26.320FNLLRS, 26.320FPLRS, 26.320FPLS</p>	<p> </p>	<p>85417226010 85417226017 81417226068</p>			<p>CB0199 ○ ○ CB0200 ○ ○</p>
<p>26.310FPLS, 26.310FVLS, H23 26.310FNLS, 26.310FNLLS, 26.310FPLRS, 26.310FNLRS, 26.310FVLR, 26.360FDS, 26.360FDLS, 26.360FNLS, 26.360FNLRS, 26.360FPLS, 26.360FPLRS, 26.360FVLS, 26.360FVLR, 26.410FNLC, 26.410FNLLC, 26.410FNLLRC, 26.410FNLLRW, 26.410FNLLW, 26.410FNLRC, 26.410FVLC, 26.410FPLS, 26.410FPLRS, 26.410FVLS, 26.410FNLS, 26.410FNLLS, 26.410FNLRS</p>			<p> s  HD</p>	<p>81417226059 85417226011 85417226019</p>	<p>CB0198 ○ ○</p>

									
		<i>i</i>				<i>i</i>			

<p>26.310FVHL-KO, 26.320FVHL-KO, 26.350FVHLC, 26.350FVHLS, 26.350FVHL-KO, 26.360FVHL-KO, 26.360FVHLC, 26.360FVHLS, 26.390FVHL-KO, 26.400FVHL-KO, 26.430FVHL-KO, 26.440FVHL-KO, 26.480FVHL-KO</p>	H42		85417226010 85417226017	CB0199	 			
<p>26.310FVLC, 26.310FVL-KO, 26.360FVL-KO, 26.410FVLC, 26.410FVL-KO, 26.410FVLS, 26.410FVLRS, 26.460FVLC, 26.460FVL-KO, 26.480FVL-KO</p>	H23		85417226010 85417226017	CB0199	 			
<p>26.310FVLC, 26.310FVL-KO, 26.320FVLC, 26.320FVL-KO, 26.350FVLC, 26.350FVLS, 26.350FVLRS, 26.350FVL-KO, 26.360FVLC, 26.360FVLS, 26.360FVLRS, 26.360FVL-KO, 26.390FVLC, 26.390FVLS, 26.390FVLRS, 26.390FVL-KO</p>	H24		85417226010 85417226017	CB0199	 			
<p>26.310FVL-KO, 26.310FDK, 26.310FDLK, 26.310FDLRK, 26.310FDRK, 26.310FD-TM, 26.310FDR-TM, 26.310FVHL-KO, 26.320FDK, 26.320FDLK, 26.320FDLRK, 26.320FDRK, 26.320FD-TM, 26.320FDR-TM, 26.320FVHL-KO, 26.350FDK, 26.350FDLK, 26.350FDLRK, 26.350FDRK, 26.350FD-TM, 26.350FDR-TM, 26.350FVHL-KO</p>					  HD	81417226059 85417226011 85417226019	CB0198	 







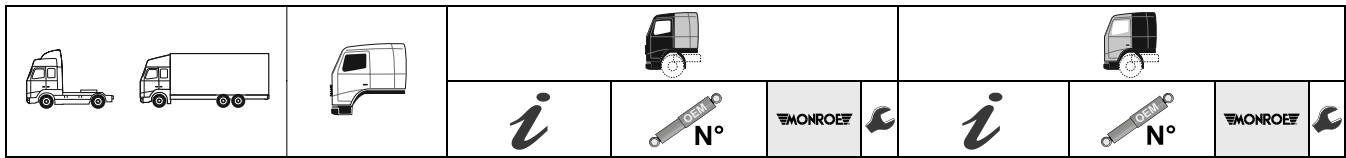



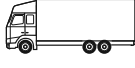











<p>26.350FDAK, 26.350FDALK, 26.350FDHK, 26.350FDHLK, 26.350FDARS, 26.350FDAS, 26.350FDHLS, 26.350FDHS, 26.360FDAC, 26.360FDARC, 26.360FDHC, 26.360FDHLC, 26.360FDAK, 26.360FDALK, 26.360FDHK, 26.360FDHLK, 26.360FDARS, 26.360FDAS, 26.360FDHLS, 26.360FDHS</p>	<p>H47, HH1</p>	<p> </p>	<p>85417226010 85417226017 81417226068</p>	<p>CB0199 CB0200</p>	<p>   </p>	
<p>26.350FDC, 26.350FDLC, 26.350FDLRC, 26.350FDRC, 26.350FNHLC, 26.350FVHLC, 26.350DLRS, 26.350FDLS, 26.350FDRS, 26.350FDS, 26.350FNHLS, 26.350PHLS, 26.350FVHLS, 26.360FDC, 26.360FDLC, 26.360FDLRC, 26.360FDRC, 26.360FNHLC, 26.360FVHLC, 26.360DLRS, 26.360DLRS-WW, 26.360FDLS, 26.360FDRS, 26.360FDS, 26.360FNHLS, 26.360PHLS, 26.360FVHLS</p>	<p>H35</p>	<p> </p>	<p>85417226010 85417226017 81417226068</p>	<p>CB0199 CB0200</p>	<p>   </p>	
<p>26.350FDC, 26.350FDLC, 26.350FDLRC, 26.350FDRC, 26.350FNHLC, 26.350FVHLC, 26.350FDLRC-WW, 26.350FDLS, 26.350FDLRS, 26.350DLRS/M, 26.350DLRS-WW, 26.350FDRS, 26.350FDS, 26.350FNHLS, 26.350PHLS, 26.350FVHLS</p>	<p>H67</p>	<p> </p>	<p>85417226010 85417226017 81417226060</p>	<p>CB0199 CB0201</p>	<p>   </p>	<p> 81417226061 CB0197   </p>
<p>26.350FDLS, 26.350FDLRS, 26.350DLRS/M, 26.350DLRS-WW</p>	<p>H30</p>	<p> </p>	<p>85417226010 85417226017 81417226068</p>	<p>CB0199 CB0200</p>	<p>   </p>	



<p>26.390FDAK, 26.390FDALK, 26.390FDHK, 26.390FDHLK, 26.390FDALS, 26.390FDAS, 26.390FDHLS, 26.390FDHS, 26.390FDHC, 26.390FDHC/M, 26.390FDHLC, 26.400FDAC, 26.400FDALC, 26.400FDHC, 26.400FDHLC, 26.400FDAK, 26.400FDALK, 26.400FDHK, 26.400FDHLK, 26.400FDALS, 26.400FDAS, 26.400FDHLS, 26.400FDHS, 26.400FDHC, 26.400FDHC/M, 26.400FDHLC</p>	<p>H47, HH1</p>	<p>85417226010 85417226017</p> <p>81417226068</p>	<p>CB0199</p> <p>CB0200</p>	<p>Q</p> <p>Q</p> <p>Q</p> <p>Q</p>	
<p>26.390FDC, 26.390FDLC, 26.390FDLRC, 26.390FDR, 26.390FNHLC, 26.390FVHLC, 26.390FDLRS, 26.390FDLS, 26.390FDRS, 26.390FDS, 26.390FNHLS, 26.390FPHLS, 26.400FDC, 26.400FDLC, 26.400FDLRC, 26.400FDR, 26.400FNHLC, 26.400FVHLC, 26.400FDLRS, 26.400FDLS, 26.400FDRS, 26.400FDS, 26.400FNHLS, 26.400FPHLS</p>	<p>H35</p>	<p>85417226010 85417226017</p> <p>81417226068</p>	<p>CB0199</p> <p>CB0200</p>	<p>Q</p> <p>Q</p> <p>Q</p> <p>Q</p>	
<p>26.390FDC, 26.390FDLC, 26.390FDLRC, 26.390FDR, 26.390FNHLC, 26.390FVHLC, 26.390FDLRS, 26.390FDLS, 26.390FDRS, 26.390FDS, 26.390FNHLS, 26.390FPHLS, 26.390FVHLS, 26.400FDC, 26.400FDLC, 26.400FDLRC, 26.400FDR, 26.400FNHLC, 26.400FVHLC, 26.400FDLRS, 26.400FDLS, 26.400FDRS, 26.400FDS, 26.400FNHLS, 26.400FPHLS, 26.400FVHLS</p>	<p>H67</p>	<p>85417226010 85417226017</p> <p>81417226060</p>	<p>CB0199</p> <p>CB0201</p>	<p>Q</p> <p>Q</p> <p>Q</p> <p>Q</p>	<p>81417226061</p> <p>CB0197</p> <p>Q</p> <p>Q</p>







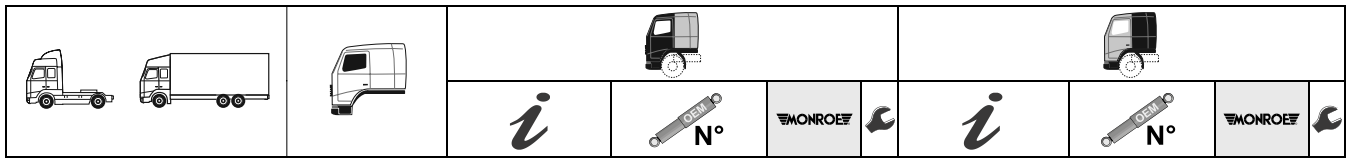































							
<i>i</i>				<i>i</i>			

<p>26.390FNLC, 26.390FNLLC, H18 26.390FNLLRC, 26.390FNLLRW, 26.390FNLLW, 26.390FNLRRC, 26.390FNLS, 26.390FNLLS, 26.390FNLRS, 26.390FNLLRS, 26.390FPLRS, 26.390FPLS, 26.400FNLC, 26.400FNLLC, 26.400FNLLRC, 26.400FNLLRW, 26.400FNLLW, 26.400FNLRRC, 26.400FNLS, 26.400FNLLS, 26.400FNLRS, 26.400FNLLRS, 26.400FPLRS, 26.400FPLS</p>			 s  HD	81417226059 85417226011 85417226019	<u>CB0198</u>	○ ○
<p>26.390FNLC, 26.390FNLLC, HV1 26.390FNLLRC, 26.390FNLLRW, 26.390FNLLW, 26.390FNLRRC, 26.390FNLS, 26.390FNLLS, 26.390FNLRS, 26.390FNLLRS, 26.390FPLS, 26.390FPLRS, 26.400FNLC, 26.400FNLLC, 26.400FNLLRC, 26.400FNLLRW, 26.400FNLLW, 26.400FNLRRC, 26.400FNLS, 26.400FNLLS, 26.400FNLRS, 26.400FNLLRS, 26.400FPLS, 26.400FPLRS</p>	  	85417226010 85417226017 81417226068 81417226060	<u>CB0199</u> ○ ○ <u>CB0200</u> ○ ○ <u>CB0201</u> ○ ○	81417226061	<u>CB0197</u>	○ ○
<p>26.400FDC, 26.400FDLC, H26, H30, H42 26.400FDLRC, 26.400FDRC, 26.400FNHLC, 26.400FVHLC, 26.400FDLRS, 26.400FDLS, 26.400FDRS, 26.400FDS, 26.400FNHLS, 26.400FPHLS, 26.430FDC, 26.430FDLC, 26.430FDLRC, 26.430FDRC, 26.430FNHLC, 26.430FVHLC, 26.430FDLRS, 26.430FDLS, 26.430FDRS, 26.430FDS, 26.430FNHLS, 26.430FPHLS, 26.430FVHLS</p>	 	85417226010 85417226017 81417226068	<u>CB0199</u> ○ ○  s  HD <u>CB0200</u> ○ ○	81417226059 85417226011 85417226019	<u>CB0198</u>	○ ○





<p>26.430FDAK, 26.430FDALK, 26.430FDHK, 26.430FDHLK, 26.430FDALS, 26.430FDAS, 26.430FDHLS, 26.430FDHS, 26.430FDHC, 26.430FDHC/M, 26.430FDHLC, 26.440FDAC, 26.440FDALC, 26.440FDHC, 26.440FDHLC, 26.440FDAK, 26.440FDALK, 26.440FDHK, 26.440FDHLK, 26.440FDALS, 26.440FDAS, 26.440FDHLS, 26.440FDHS, 26.440FDHC, 26.440FDHC/M, 26.440FDHLC</p>	<p>H47, HH1</p>	<p>☺ ☺</p>	<p>85417226010 85417226017 81417226068</p>	<p>CB0199 CB0200</p>	<p>○ ○ ○ ○</p>	
<p>26.430FDC, 26.430FDLC, 26.430FDLRC, 26.430FDRC, 26.430FNHLC, 26.430FVHLC, 26.430FDLRS, 26.430FDLS, 26.430FDRS, 26.430FDS, 26.430FNHLS, 26.430FPHLS, 26.430FVHLS, 26.440FDC, 26.440FDLC, 26.440FDLRC, 26.440FDRC, 26.440FNHLC, 26.440FVHLC, 26.440FDLRS, 26.440FDLS, 26.440FDRS, 26.440FDS, 26.440FNHLS, 26.440FPHLS, 26.440FVHLS</p>	<p>H35</p>	<p>☺ ☺</p>	<p>85417226010 85417226017 81417226068</p>	<p>CB0199 CB0200</p>	<p>○ ○ ○ ○</p>	







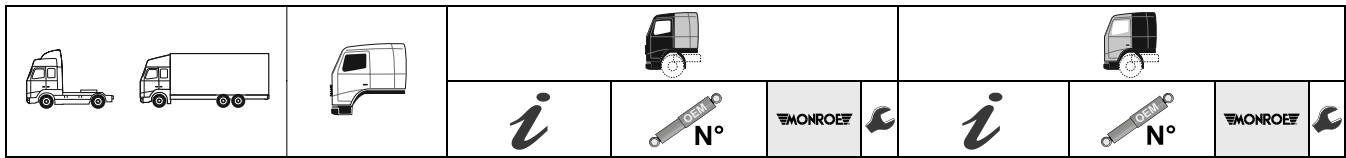

									
									
26.440FDLRS, 26.440FDLS, ^{HV2} 26.440FDRS, 26.440FDS, 26.440FNHLS, 26.440FPHLS, 26.440FVHLS, 26.480FDLRS, 26.480FDLS, 26.480FDRS, 26.480FDS, 26.480FNHLS, 26.480FPHLS, 26.480FVHLS	  	85417226010 85417226017 81417226068 81417226060	<u>CB0199</u> <u>CB0200</u> <u>CB0201</u>	  	81417226061	<u>CB0197</u>	 		
26.460FDC, 26.460FDLC, ^{H25, H29} 26.460FDLRC, 26.460FDRC, 26.460FDK, 26.460FDLK, 26.460FDLRK, 26.460FDRK, 26.460FDLRS, 26.460FDLS, 26.460FDRS, 26.460FDS, 26.510FDC, 26.510FDLC, 26.510FDLRC, 26.510FDRC, 26.510FDS, 26.510FDLS, 26.510FDLS/M, 26.510FDRS, 26.510FDLRS	 	85417226010 85417226017 81417226068	<u>CB0199</u> <u>CB0200</u>	 					
26.460FDC, 26.460FDLC, ^{H63} 26.460FDLRC, 26.460FDRC, 26.460FDLRS, 26.460FDLS, 26.460FDRS, 26.460FDS, 26.480FD-TM	 	85417226010 85417226017 81417226060	<u>CB0199</u> <u>CB0201</u>	 	81417226061	<u>CB0197</u>	 		
26.460FNLC, 26.460FNLLC, ^{H17} 26.460FNLLRC, 26.460FNLLRW, 26.460FNLLW, 26.460FNLRC, 26.460FPLS, 26.460FPLRS, 26.460FVLS, 26.460FVLR, 26.460FNLS, 26.460FNLLS, 26.460FNLRS, 26.480FNLC, 26.480FNLLC, 26.480FNLLRC, 26.480FNLLW, 26.480FNLRC, 26.480FVLC					81417226059 85417226011 85417226019	<u>CB0198</u>	 		
26.460FNLC, 26.460FNLLC, ^{H17, H20} 26.460FNLLRC, 26.460FNLLRW, 26.460FNLLW, 26.460FNLRC	 	85417226010 85417226017 81417226068	<u>CB0199</u> <u>CB0200</u>	 					
26.460FPLS, 26.460FPLRS, ^{H17, H20, H23} 26.460FVLS, 26.460FVLR, 26.460FNLS, 26.460FNLLS, 26.460FNLR, 26.510FNLC, 26.510FNLLC, 26.510FNLLRC, 26.510FNLLRW, 26.510FNLLW, 26.510FNLRC, 26.510FVLC, 26.510FNLS, 26.510FNLLS, 26.510FNLRS, 26.510FPLS, 26.510FVLS, 26.510FVLR	 	85417226010 85417226017 81417226068	<u>CB0199</u> <u>CB0200</u>	 					

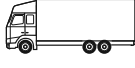













MAN TGA (2007/10-)



<p>26.460FPLS, 26.460FPLRS, H23 26.460FVLS, 26.460FVLRs, 26.460FNLS, 26.460FNLLS, 26.460FNLRS, 26.480FNLC, 26.480FNLLC, 26.480FNLLRC, 26.480FNLLW, 26.480FNLRC, 26.480FVLC</p>					<p>81417226059 85417226011 85417226019</p>	<p>CB0198 ○ ○</p>
<p>26.480FDAC, H47, HH1 26.480FDALC, 26.480FDARC, 26.480FDHC, 26.480FDHLC, 26.480FDAK, 26.480FDALK, 26.480FDHK, 26.480FDHLK, 26.480FDALS, 26.480FDARS, 26.480FDAS, 26.480FDHLS, 26.480FDHS, 26.480FDHC, 26.480FDHC/M, 26.480FDHLC</p>		<p>85417226010 85417226017</p> <p>81417226068</p>	<p>CB0199 ○ ○</p> <p>CB0200 ○ ○</p>			
<p>26.480FDAC, H72, H82 26.480FDALC, 26.480FDARC, 26.480FDHC, 26.480FDHLC, 26.480FDAK, 26.480FDALK, 26.480FDHK, 26.480FDHLK, 26.480FDALS, 26.480FDARS, 26.480FDAS, 26.480FDHLS, 26.480FDHS</p>		<p>85417226010 85417226017</p>	<p>CB0199 ○ ○</p>			
<p>26.480FDC, 26.480FDLC, H25, H26, H29, H30, 26.480FDLRC, H35, H42 26.480FDRC, 26.480FNHLC, 26.480FVHLC, 26.480FDLRS, 26.480FDLS, 26.480FDRS, 26.480FDS, 26.480FNHLS, 26.480FPHLS, 26.480FVHLS</p>		<p>85417226010 85417226017</p> <p>81417226068</p>	<p>CB0199 ○ ○</p> <p>CB0200 ○ ○</p>			
<p>26.480FDC, 26.480FDLC, H63, H67 26.480FDLRC, 26.480FDRC, 26.480FNHLC, 26.480FVHLC, 26.480FDLRS, 26.480FDLS, 26.480FDRS, 26.480FDS, 26.480FNHLS, 26.480FPHLS, 26.480FVHLS</p>		<p>85417226010 85417226017</p> <p>81417226060</p>	<p>CB0199 ○ ○</p> <p>CB0201 ○ ○</p>		<p>81417226061</p>	<p>CB0197 ○ ○</p>
<p>26.480FDK, 26.480FDLK, H25, H26, H29, H30 26.480FDLRK H25, H26 26.480FD-TM</p>		<p>85417226010 85417226017</p> <p>81417226068</p>	<p>CB0199 ○ ○</p> <p>CB0200 ○ ○</p>			













































			
<i>i</i>	 N°	 	<i>i</i>
	 N°	 	









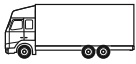

<p>26.480FNLC, 26.480FNLLC, H17, H20, H21, H24 26.480FNLLRC, 26.480FNLLW, 26.480FNLRC, 26.480FVLC, 26.480FNLS, 26.480FNLLS, 26.480FNLRS, 26.480FPLS, 26.480FVLS, 26.480FVLRS</p>	<p></p> <p></p>	<p>85417226010 85417226017</p> <p>81417226068</p>	<p>CB0199</p> <p>CB0200</p>	<p>○</p> <p>○</p> <p>○</p> <p>○</p>	
<p>26.480FNLC, 26.480FNLLC, H18, H23 26.480FNLLRC, 26.480FNLLW, 26.480FNLRC, 26.480FVLC, 26.480FNLS, 26.480FNLLS, 26.480FNLRS, 26.480FPLS, 26.480FVLS, 26.480FVLRS</p>	<p></p> <p></p>	<p>85417226010 85417226017</p> <p>81417226068</p>	<p>CB0199</p> <p>CB0200</p>	<p>○</p> <p>○</p> <p>○</p> <p>○</p>	<p> s</p> <p></p> <p>HD</p> <p>81417226059 85417226011 85417226019</p> <p>CB0198</p> <p>○</p> <p>○</p>
<p>26.480FNLC, 26.480FNLLC, HV1 26.480FNLLRC, 26.480FNLLW, 26.480FNLRC, 26.480FVLC, 26.480FNLS, 26.480FNLLS, 26.480FNLRS, 26.480FPLS, 26.480FVLS, 26.480FVLRS</p>	<p></p> <p></p> <p></p>	<p>85417226010 85417226017</p> <p>81417226068</p> <p>81417226060</p>	<p>CB0199</p> <p>CB0200</p> <p>CB0201</p>	<p>○</p> <p>○</p> <p>○</p> <p>○</p>	<p></p> <p>81417226061</p> <p>CB0197</p> <p>○</p> <p>○</p>
<p>26.510FDC, 26.510FDLC, 26.510FDLRC, 26.510FDRC, 26.510FDS, 26.510FDLS, 26.510FDLS/M, 26.510FDRS, 26.510FDLRS, 26.530FDC, 26.530FDLC, 26.530FDLRC, 26.530FDRC, 26.530FDK, 26.530FDLK, 26.530FDLRK, 26.530FDS, 26.530FDLS, 26.530FDRS, 26.530FDLRS</p>				<p> s</p> <p></p> <p>HD</p>	<p>81417226059 85417226011 85417226019</p> <p>CB0198</p> <p>○</p> <p>○</p>
<p>26.510FNLC, 26.510FNLLC, H17 26.510FNLLRC, 26.510FNLLRW, 26.510FNLLW, 26.510FNLRC, 26.510FVLC, 26.510FNLS, 26.510FNLLS, 26.510FNLRS, 26.510FPLS, 26.510FVLS, 26.510FVLRS, 26.530FNLC, 26.530FNLLC, 26.530FNLLRC, 26.530FNLLRW, 26.530FNLLW, 26.530FNLRC, 26.530FVLC, 26.530FVLRC, 26.530FNLS, 26.530FNLLS, 26.530FNLRS, 26.530FPLS, 26.530FVLS, 26.530FVLRS</p>				<p> s</p> <p>HD</p>	<p>81417226059 85417226011 85417226019</p> <p>CB0198</p> <p>○</p> <p>○</p>











































MAN TGA (2007/10-)



<p>26.510FNLS, 26.510FNLLS, H23 26.510FNLRS, 26.510FPLS, 26.510FVLS, 26.510FVLR, 26.530FNLC, 26.530FNLLC, 26.530FNLLRC, 26.530FNLLRW, 26.530FNLLW, 26.530FNLRC, 26.530FVLC, F26.530VLR, 26.530FNLS, 26.530FNLLS, 26.530FNLRS, 26.530FPLS, 26.530FVLS, 26.530FVLR</p>				 s  HD	81417226059 85417226011 85417226019	CB0198  
<p>26.530FDC, 26.530FDLC, H25, H29 26.530FDLRC, 26.530FDRC, 26.530FDK, 26.530FDLK, 26.530FDLRK, 26.530FDLRS, 26.530FDLS, 26.530FDRS, 26.530FDS</p>	 	85417226010 85417226017 81417226068	CB0199   CB0200  			
<p>26.530FNLC, 26.530FNLLC, H17, H20, H23 26.530FNLLRC, 26.530FNLLRW, 26.530FNLLW, 26.530FNLRC, 26.530FVLC, 26.530FVLR, 26.530FNLS, 26.530FNLLS, 26.530FNLRS, 26.530FPLS, 26.530FVLS, 26.530FVLR</p>	 	85417226010 85417226017 81417226068	CB0199   CB0200  			
<p>26.540FNLC, 26.540FNLLC, H18, H21 26.540FNLLRC, 26.540FNLLW, 26.540FNLRC</p>	 	85417226010 85417226017 81417226068	CB0199   CB0200  			
<p>28.310FNLC, 28.310FNLLC, 28.310FNLRC, 28.310FNLS, 28.310FNLRS, 28.360FNLC, 28.360FNLLC, 28.360FNLRC, 28.360FNLS, 28.360FNLRS, 28.410FNLC, 28.410FNLLC, 28.410FNLRC, 28.410FNLS, 28.410FNLRS, 28.460FNLC, 28.460FNLLC, 28.460FNLRC, 28.460FNLS, 28.460FNLRS, 28.480FNLC, 28.480FNLLC, 28.480FNLRC, 28.480FNLS, 28.480FNLRS</p>				 s  HD	81417226059 85417226011 85417226019	CB0198  
<p>28.310FNLC, 28.310FNLLC, H71 28.360FNLC, 28.360FNLLC, 28.410FNLC, 28.410FNLLC</p>	 	85417226010 85417226017 81417226068	CB0199   CB0200  			
<p>28.310FNLC, 28.310FNLLC, H74, H75 28.310FNLL-LE, 28.310FNLLR-LE, 28.320FNLC, 28.320FNLLC, 28.320FNLL-LE, 28.320FNLLR-LE</p>	 	85417226010 85417226017 81417226068	CB0199   CB0200  			
<p>28.310FNLC, 28.310FNLLC, H85, H87, H89 28.310FNLRC</p>	 	85417226010 85417226017 81417226068	CB0199   CB0200  			









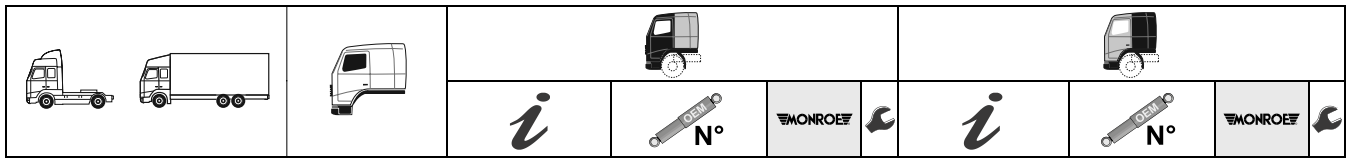





















										
			<i>i</i>	 OEM N°			<i>i</i>	 OEM N°		















































28.310FNLS, 28.310FNLRS, H89 28.320FNLS, 28.320FNLRS, 28.350FNLS, 28.350FNLRS, 28.360FNLS, 28.360FNLRS, 28.390FNLS, 28.390FNLRS, 28.400FNLS, 28.400FNLRS, 28.430FNLS, 28.430FNLRS, 28.440FNLS, 28.440FNLRS		85417226010 85417226017	CB0199	 		
		81417226068	CB0200	 		
28.320FNLC, 28.320FNLLC, H74, H89 28.320FNLLRC, 28.320FNLLR-LE		85417226010 85417226017	CB0199	 		
		81417226068	CB0200	 		
28.320FNLC, 28.320FNLLC, H85, H89 28.320FNLRC		85417226010 85417226017	CB0199	 		
		81417226068	CB0200	 		
28.350FANLC, H84 28.350FANLK, 28.390FANLC, 28.390FANLK, 28.400FANLC, 28.430FANLC, 28.430FANLK, 28.440FANLC, 28.440FANLK		85417226010 85417226017	CB0199	 		
		81417226068	CB0200	 		
28.350FNLC, 28.350FNLLC, H74, H75, H85, H89 28.350FNLRC, 28.350FNLL-LE, 28.350FNLLR-LE, 28.360FNLC, 28.360FNLLC, 28.360FNLRC, 28.360FNLL-LE, 28.360FNLLR-LE, 28.390FNLC, 28.390FNLLC, 28.390FNLRC, 28.400FNLC, 28.400FNLLC, 28.400FNLRC, 28.430FNLC, 28.430FFNLLC, 28.430FFNLRC, 28.440FNLC, 28.440FNLLC, 28.440FNLRC		85417226010 85417226017	CB0199	 		
		81417226068	CB0200	 		
28.350FNLC, 28.350FNLLC, HV4 28.350FNLRC, 28.350FNLL-LE, 28.350FNLLR-LE, 28.350FNLS, 28.350FNLRS, 28.360FNLC, 28.360FNLLC, 28.360FNLRC, 28.360FNLL-LE, 28.360FNLLR-LE, 28.390FNLC, 28.390FNLLC, 28.390FNLRC, 28.390FNLS, 28.390FNLRS		85417226010 85417226017	CB0199	 		81417226061 CB0197 
		81417226068	CB0200	 		
		81417226060	CB0201	 		



MAN TGA (2007/10-)



 <p>28.350FNLC, 28.350FNLLC, 28.350FNLC, 28.350FNLL-LE, 28.350FNLLR-LE, 28.350FNLS, 28.350FNLRS, 28.360FNLC, 28.360FNLLC, 28.360FNLC, 28.360FNLL-LE, 28.360FNLLR-LE, 28.390FNLC, 28.390FNLLC, 28.390FNLC, 28.390FNLS, 28.390FNLRS, 28.400FNLC, 28.400FNLLC, 28.400FNLC</p>	HV7	 	<p>85417226010 85417226017</p> <p>81417226060</p>	<p>CB0199</p> <p>CB0201</p>	 	<p>81417226061</p>	<p>CB0197</p>	 	
	<p>28.360FANLC, 28.360FANLK, 28.480FANLC, 28.480FANLK</p>	H81, H84	 	<p>85417226010 85417226017</p> <p>81417226068</p>	<p>CB0199</p> <p>CB0200</p>	 			
	<p>28.360FNLC, 28.360FNLLC, 28.360FNLC, 28.410FNLC, 28.410FNLLC, 28.410FNLC, 28.460FNLC, 28.460FNLLC, 28.460FNLC, 28.480FNLC, 28.480FNLLC, 28.480FNLC, 28.510FNLC, 28.510FNLLC, 28.510FNLC, 28.530FNLC, 28.530FNLLC, 28.530FNLC</p>	H87	 	<p>85417226010 85417226017</p> <p>81417226068</p>	<p>CB0199</p> <p>CB0200</p>	 			
	<p>28.390FNLLC, 28.410FANLC, 28.410FANLK, 28.530FANLC, 28.530FANLK</p>	H81	 	<p>85417226010 85417226017</p> <p>81417226068</p>	<p>CB0199</p> <p>CB0200</p>	 			
	<p>28.400FANLK</p>	H74	 	<p>85417226010 85417226017</p> <p>81417226068</p>	<p>CB0199</p> <p>CB0200</p>	 			
	<p>28.400FNLC, 28.400FNLLC, 28.400FNLC, 28.430FNLC, 28.430FNLLC, 28.430FNLC, 28.430FNLS, 28.430FNLRS, 28.440FNLC, 28.440FNLLC, 28.440FNLC, 28.480FNLC, 28.480FNLLC, 28.480FNLC, 28.480FNLS, 28.480FNLRS</p>	HV4	  	<p>85417226010 85417226017</p> <p>81417226068</p> <p>81417226060</p>	<p>CB0199</p> <p>CB0200</p> <p>CB0201</p>	  	<p>81417226061</p>	<p>CB0197</p>	 

										
			<i>i</i>	 N°	 	<i>i</i>	 N°	 		
28.430FNLC, 28.430FNLLC, HV7 28.430FNLC, 28.430FNLS, 28.430FNLS, 28.440FNLC, 28.440FNLLC, 28.440FNLC, 28.480FNLC, 28.480FNLC, 28.480FNLLC, F28.480NLS, 28.480FNLS				85417226010 85417226017	CB0199		81417226061	CB0197		
				81417226060	CB0201					
28.480FNLC, H89 28.480FNLC, 28.480FNLLC, 28.480FNLS, 28.480FNLS, 28.540FNLC, 28.540FNLLC, 28.540FNLS				85417226010 85417226017	CB0199					
				81417226068	CB0200					
28.510FNLC, 28.510FNLLC, 28.510FNLC, 28.510FNLS, 28.510FNLS, 28.530FNLC, 28.530FNLLC, 28.530FNLC, 28.530FNLS, 28.530FNLS						 S HD	81417226059 85417226011 85417226019	CB0198		
32.310FFDC, 32.310FFDLC, H40 32.310FFDLC, 32.310FFDRC, 32.310FFDK, 32.310FFDLK, 32.360FFDC, 32.360FFDLC, 32.360FFDLC, 32.360FFDRC, 32.360FFDK, 32.360FFDLK, 32.410FFDC, 32.410FFDLC, 32.410FFDLC, 32.410FFDRC, 32.410FFDK, 32.410FFDLK				85417226010 85417226017	CB0199					
				81417226068	CB0200					
32.350FFDC, 32.350FFDLC, H49 32.350FFDLC, 32.350FFDRC, 32.350FFD-TM, 32.350FFDR-TM, 32.360FFDC, 32.360FFDLC, 32.360FFDLC, 32.360FFDRC, 32.360FFDRC, 32.360FFD-TM, 32.360FFDR-TM, 32.390FFDRC, 32.390FFD-TM, 32.390FFDR-TM, 32.400FFDRC, 32.400FFD-TM, 32.400FFDR-TM				85417226010 85417226017	CB0199					
32.350FFDC, 32.350FFDLC, HV8 32.350FFDLC, 32.350FFDRC, 32.360FFDC, 32.360FFDLC, 32.360FFDLC, 32.360FFDRC, 32.390FFDRC, 32.400FFDRC				85417226010 85417226017	CB0199		81417226061	CB0197		
				81417226060	CB0201					



MAN TGA (2007/10-)

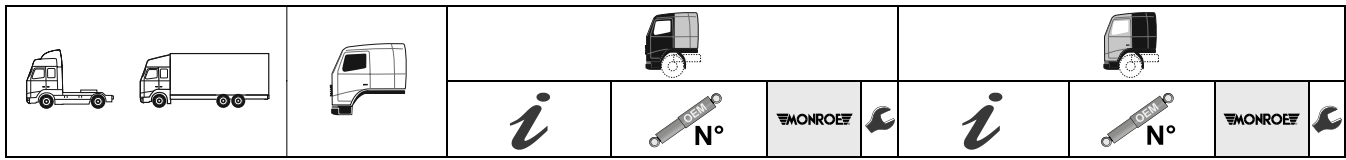

32.360FFD-TM, 32.360FFDR-TM, 32.410FFD-TM, 32.410FFDR-TM, 32.460FFD-TM, 32.460FFDR-TM	H48		85417226010 85417226017	CB0199			
32.430FFDRC, 32.430FFD-TM, 32.430FFDR-TM, 32.440FFDRC, 32.440FFD-TM, 32.440FFDR-TM, 32.480FFDRC	H49		85417226010 85417226017	CB0199			
32.460FFDC, 32.460FFDLC, H40 32.460FFDLRC, 32.460FFDRC, 32.460FFDK, 32.460FFDLK, 32.480FFDC, 32.480FFDLC, 32.480FFDLRC, 32.480FFDRC, 32.480FFDK, 32.480FFDLK		 	85417226010 85417226017 81417226068	CB0199 CB0200	 	 	
32.480FFD-TM, 32.480FFDR-TM	H48, H49		85417226010 85417226017	CB0199			
33.350FDAC, 33.350FDARC, 33.350FDHC, 33.350FDAK, 33.350FDARK, 33.350FDHK, 33.350FDARS, 33.350FDAS, 33.350FDHS, 33.360FDAC, 33.360FDARC, 33.360FDHC, 33.360FDAK, 33.360FDARK, 33.360FDHK, 33.360FDARS, 33.360FDAS, 33.360FDHS, 33.390FDAC, 33.390FDHC, 33.390FDAK, 33.390FDARK, 33.390FDHK, 33.390FDARS, 33.390FDAS, 33.390FDHS	H47	 	85417226010 85417226017 81417226068	CB0199 CB0200	 	 	
33.350FDAC, 33.350FDARC, 33.350FDHC, 33.350FDAK, 33.350FDARK, 33.350FDHK, 33.350FDARS, 33.350FDAS, 33.350FDHS, 33.360FDAC, 33.360FDARC, 33.360FDHC, 33.360FDAK, 33.360FDARK, 33.360FDHK, 33.360FDARS, 33.360FDAS, 33.360FDHS, 33.390FDAC, 33.390FDHC, 33.390FDAK, 33.390FDARK, 33.390FDHK, 33.390FDARS, 33.390FDAS, 33.390FDHS	H56, HW4	 	85417226010 85417226017 81417226060	CB0199 CB0201	 	 	81417226061 CB0197

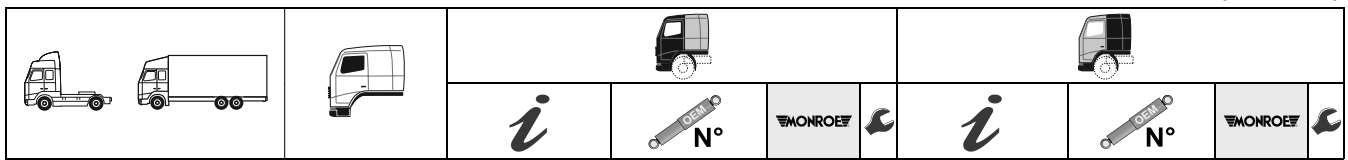





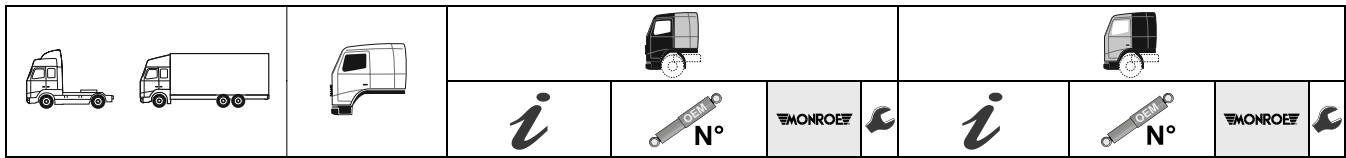



<p>33.350FDC, 33.350FDLC, 33.350FDRC, 33.350FDK, 33.350FDLK, 33.350FDRK, 33.350FDLRS, 33.350FDLS, 33.350FDRS, FDS, 33.360FDC, 33.360FDLC, 33.360FDRC, 33.360FDK, 33.360FDLK, 33.360FDRK, 33.360FDLRS, 33.360FDLS, 33.360FDRS, 33.360FDS, 33.360FD-TM, 33.360FDR-TM, 33.360FDC-TM, 33.360FDRC-TM</p>		<p>s 81417226059 85417226011 85417226019 CB0198 ○ ○</p>
<p>33.350FDC, 33.350FDLC, H26, H30 33.350FDRC, 33.350FDK, 33.350FDLK, 33.350FDRK, 33.350FDLRS, 33.350FDLS, 33.350FDRS, 33.350FDS, 33.360FDC, 33.360FDLC, 33.360FDRC, 33.360FDK, 33.360FDLK, 33.360FDRK, 33.360FDLRS, 33.360FDLS, 33.360FDRS, 33.360FDS, 33.390FDC, 33.390FDLC, 33.390FDRC, 33.390FDLRC, 33.390FDK, 33.390FDLK, 33.390FDRK, 33.390FDLRS, 33.390FDLS, 33.390FDRS, 33.390FDS</p>	<p> 85417226010 85417226017 CB0199 ○ ○  81417226068 CB0200 ○ ○</p>	
<p>33.350FDC, 33.350FDLC, H66, HW2 33.350FDRC, 33.350FDK, 33.350FDLK, 33.350FDRK, 33.350FDLRS, 33.350FDLS, 33.350FDRS, 33.350FDS, 33.360FDC, 33.360FDLC, 33.360FDRC, 33.360FDK, 33.360FDLK, 33.360FDRK, 33.360FDLRS, 33.360FDLS, 33.360FDRS, 33.360FDS, 33.390FDC, 33.390FDLC, 33.390FDRC, 33.390FDLRC, 33.390FDK, 33.390FDLK, 33.390FDRK, 33.390FDLRS, 33.390FDLS, 33.390FDRS, 33.390FDS</p>	<p> 85417226010 85417226017 CB0199 ○ ○  81417226060 CB0201 ○ ○</p>	<p> 81417226061 CB0197 ○ ○</p>
<p>33.350FDC-TM, HW2 33.350FDRC-TM, 33.360FDC-TM, 33.360FDRC-TM, 33.360FDR-TM, 33.360FD-TM, 33.390FDC-TM, 33.390FDRC-TM, 33.400FDC-TM, 33.400FDRC-TM, 33.430FDC-TM, 33.430FDRC-TM, 33.440FDC-TM, 33.440FDRC-TM, 33.480FDC-TM, 33.480FDRC-TM, 33.480FD-TM</p>	<p> 85417226010 85417226017 CB0199 ○ ○  81417226060 CB0201 ○ ○</p>	<p> 81417226061 CB0197 ○ ○</p>

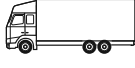









MAN TGA (2007/10-)











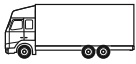

<p>33.350FDLRS, 33.350FDLS, HV2 33.350FDRS, FDS, 33.360FDLRS, 33.360FDLS, 33.360FDRS, 33.360FDS, 33.390FDLRS, 33.390FDLS, 33.390FDRS, FDS, 33.400FDLRS, 33.400FDLS, 33.400FDRS, 33.400FDS</p>	<p>☰ ☰ ☰</p>	<p>85417226010 85417226017 81417226068 81417226060</p>	<p>CB0199 ☰ CB0200 ☰ CB0201 ☰</p>		<p>81417226061</p>	<p>CB0197 ☰</p>
<p>33.360FDAC, H54, H55 33.360FDARC, 33.360FDHC, 33.360FDAK, 33.360FDARK, 33.360FDHK, 33.360FDARS, 33.360FDAS, 33.360FDHS, 33.410FDAC, 33.410FDALC, 33.410FDARC, 33.410FDAK, 33.410FDALK, 33.410FDALS, 33.410FDARS, 33.410FDAS, 33.480FDAC, 33.480FDAC-WW, 33.480FDALC, 33.480FDARC</p>	<p>☰ ☰</p>	<p>85417226010 85417226017 81417226060</p>	<p>CB0199 ☰ CB0201 ☰</p>		<p>81417226061</p>	<p>CB0197 ☰</p>
<p>33.360FDC, 33.360FDLC, H25, H29 33.360FDRC, 33.360FDLRC, 33.360FDK, 33.360FDK-WW, 33.360FDLK, 33.360FDRK-WW, 33.360FDLRS, 33.360FDLS, 33.360FDRS, 33.360FDS, 33.410FDC, 33.410FDLC, 33.410FDRC, 33.410FDLRC, 33.410FDK, 33.410FDK-WW, 33.410FDLK, 33.410FDRK-WW, 33.410FDLRS, 33.410FDLS, 33.410FDRS, 33.410FDS</p>	<p>☰ ☰</p>	<p>85417226010 85417226017 81417226068</p>	<p>CB0199 ☰ CB0200 ☰</p>	<p>s HD</p>	<p>81417226059 85417226011 85417226019</p>	<p>CB0198 ☰</p>
<p>33.360FDC, 33.360FDLC, H28 33.360FDRC, 33.360FDLRC, 33.360FDK, 33.360FDK-WW, 33.360FDLK, 33.360FDRK-WW, 33.360FDLRS, 33.360FDLS, 33.360FDRS, FDS, 33.410FDC, 33.410FDLC, 33.410FDRC, 33.410FDLRC, 33.410FDK, 33.410FDK-WW, 33.410FDLK, 33.410FDRK-WW, 33.410FDLRS, 33.410FDLS, 33.410FDRS, 33.410FDS</p>				<p>s</p>	<p>81417226059 85417226011 85417226019</p>	<p>CB0198 ☰</p>











					
<i>i</i>	 N°		<i>i</i>	 N°	

<p>33.360FDC, 33.360FDLC, H28, H62 33.360FDR, 33.360FDLRC, 33.360FDK, 33.360FDK-WW, 33.360FDLK, 33.360FDRK-WW, 33.360FDLRS, 33.360FDLS, 33.360FDRS, 33.360FDS, 33.410FDC, 33.410FDLC, 33.410FDR, 33.410FDLRC, 33.410FDK, 33.410FDK-WW, 33.410FDLK, 33.410FDRK-WW, 33.410FDLRS, 33.410FDLS, 33.410FDRS, 33.410FDS</p>	<p></p> <p></p>	<p>85417226010 85417226017</p> <p>81417226060</p>	<p>CB0199</p> <p>CB0201</p>	<p>Q</p> <p>Q</p> <p>Q</p> <p>Q</p>	<p></p> <p>81417226061</p> <p>CB0197</p> <p>Q</p> <p>Q</p>
<p>33.360FD-TM, H25 33.360FDR-TM, 33.360FDC-TM, 33.360FDR-TM, 33.410FD-TM, 33.410FDR-TM, 33.460FD-TM, 33.460FDR-TM, 33.480FDC-TM, 33.480FDR-TM, 33.480FD-TM</p>	<p></p> <p></p>	<p>85417226010 85417226017</p> <p>81417226068</p>	<p>CB0199</p> <p>CB0200</p>	<p>Q</p> <p>Q</p> <p>Q</p> <p>Q</p>	
<p>33.390FDC, 33.390FDLC, 33.390FDR, 33.390FDLRC, 33.390FDK, 33.390FDLK, 33.390FDRK, 33.390FDS, 33.390FDLS, 33.390FDLRS, 33.390FDRS, 33.400FDC, 33.400FDLC, 33.400FDR, 33.400FDLRC, 33.400FDK, 33.400FDLK, 33.400FDRK, 33.400FDS, 33.400FDLS, 33.400FDLRS, 33.400FDRS, 33.410FD-TM, 33.410FDR-TM</p>				<p> S</p> <p></p> <p>HD</p>	<p>81417226059 85417226011 85417226019</p> <p>CB0198</p> <p>Q</p> <p>Q</p>
<p>33.390FDS, 33.390FDLS, HW8, HW9 33.390FDLRS, 33.390FDRS, 33.400FDS, 33.400FDLS, 33.400FDLRS, 33.400FDRS, 33.440FDS, 33.440FDLS, 33.440FDRS, 33.480FDS, 33.480FDLS, 33.480FDLRS, 33.480FDRS</p>	<p></p>	<p>81417226060</p>	<p>CB0201</p>	<p>Q</p> <p>Q</p>	<p></p> <p>81417226061</p> <p>CB0197</p> <p>Q</p> <p>Q</p>
<p>33.400FDAC, 33.400FDHC, H47 33.400FDAK, 33.400FDARK, 33.400FDHK, 33.400FDARS, 33.400FDAS, 33.400FDHS, 33.430FDAC, 33.430FDALC, 33.430FDHC, 33.430FDAK, 33.430FDALK, 33.430FDARK, 33.430FDHK, 33.430FDALS, 33.430FDARS, 33.430FDAS, 33.430FDHS</p>	<p></p> <p></p>	<p>85417226010 85417226017</p> <p>81417226068</p>	<p>CB0199</p> <p>CB0200</p>	<p>Q</p> <p>Q</p> <p>Q</p> <p>Q</p>	



										
			<i>i</i>				<i>i</i>			

<p>33.430FDAC, H82 33.430FDALC, 33.430FDHC, 33.430FDAK, 33.430FDALK, 33.430FDARK, 33.430FDHK, 33.430FDALS, 33.430FDARS, 33.430FDAS, 33.430FDHS, 33.440FDAC, 33.440FDALC, 33.440FDHC, 33.440FDAK, 33.440FDALK, 33.440FDARK, 33.440FDHK, 33.440FDALS, 33.440FDARS, 33.440FDAS, 33.440FDHS, 33.480FDAC, 33.480FDALC, 33.480FDARC, 33.480FDHC</p>		<p>85417226010 85417226017</p>	<p>CB0199</p>	<p>Q Q</p>	
<p>33.430FDC, 33.430FDLC, 33.430FDCR, 33.430FDLRC, 33.430FDK, 33.430FDLK, 33.430FDRK, 33.430FDS, 33.430FDLS, 33.430FDLRS, 33.430FDRS, 33.440FDC, 33.440FDLC, 33.440FDCR, 33.440FDLRC, 33.440FDK, 33.440FDLK, 33.440FDRK, 33.440FDS, 33.440FDLS, 33.440FDLRS, 33.440FDRS, 33.460FD-TM, 33.460FDR-TM</p>					<p>s  HD 81417226059 85417226011 85417226019 CB0198 Q Q</p>
<p>33.430FDLRS, 33.430FDLS, HV2 33.430FDRS, 33.430FDS, 33.440FDLRS, 33.440FDLS, 33.440FDRS, 33.440FDS, 33.480FDLRS, 33.480FDLS, 33.480FDRS, 33.480FDS</p>	  	<p>85417226010 85417226017 81417226068 81417226060</p>	<p>CB0199 CB0200 CB0201</p>	<p>Q Q Q Q Q</p>	<p> 81417226061 CB0197 Q Q</p>
<p>33.430FDLRS, 33.430FDLS, HW8 33.430FDRS, 33.430FDS, 33.440FDLRS, 33.440FDLS, 33.440FDRS, 33.440FDS</p>		<p>81417226060</p>	<p>CB0201</p>	<p>Q Q</p>	<p> 81417226061 CB0197 Q Q</p>



MAN TGA (2007/10-)

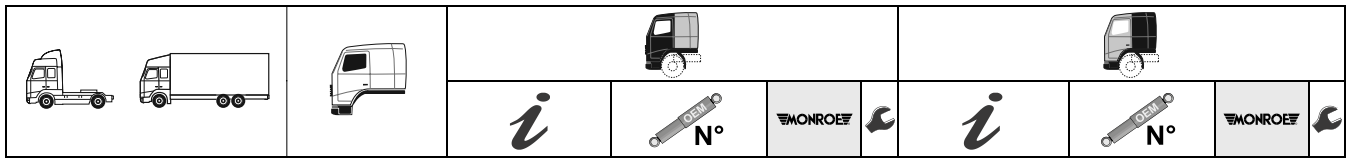

<p>33.440FDAC, 33.440FDALC, 33.440FDHC, 33.440FDAK, 33.440FDALK, 33.440FDARK, 33.440FDHK, 33.440FDALS, 33.440FDARS, 33.440FDAS, 33.440FDHS, 33.480FDAC, 33.480FDALC, 33.480FDARC, 33.480 33.480FDHC, 33.480FDAK, 33.480FDALK, 33.480FDARK, 33.480FDHK, 33.480FDALS, 33.480FDARS, 33.480FDAS, 33.480FDHS</p>	<p>H47</p>	<p>☺ ☺</p>	<p>85417226010 85417226017 81417226068</p>	<p>CB0199 CB0200</p>	<p>○ ○ ○ ○</p>			
<p>33.440FDAC, 33.440FDALC, 33.440FDHC, 33.440FDAK, 33.440FDALK, 33.440FDARK, 33.440FDHK, 33.440FDALS, 33.440FDARS, 33.440FDAS, 33.440FDHS, 33.480FDAC, 33.480FDALC, 33.480FDARC, 33.480FDHC</p>	<p>H56, HW4</p>	<p>☺ ☺</p>	<p>85417226010 85417226017 81417226060</p>	<p>CB0199 CB0201</p>	<p>○ ○ ○ ○</p>	<p>☺ 81417226061</p>	<p>CB0197</p>	<p>○ ○</p>
<p>33.440FDAC, 33.440FDALC, 33.440FDHC, 33.440FDAK, 33.440FDALK, 33.440FDARK, 33.440FDHK, 33.440FDALS, 33.440FDARS, 33.440FDAS, 33.440FDHS</p>	<p>HW4</p>	<p>☺ ☺</p>	<p>85417226010 85417226017 81417226060</p>	<p>CB0199 CB0201</p>	<p>○ ○ ○ ○</p>	<p>☺ 81417226061</p>	<p>CB0197</p>	<p>○ ○</p>
<p>33.440FDC, 33.440FDLC, 33.440FDRC, 33.440FDLRC, 33.440FDK, 33.440FDLK, 33.440FDRK, 33.440FDLRS 33.440FDLS, 33.440FDRS, 33.440FDS, 33.480FDC, 33.480FDLC, 33.480FDRC</p>	<p>H26, H30</p>	<p>☺ ☺</p>	<p>85417226010 85417226017 81417226068</p>	<p>CB0199 CB0200</p>	<p>○ ○ ○ ○</p>			
<p>33.440FDC, 33.440FDLC, 33.440FDRC, 33.440FDLRC, 33.440FDK, 33.440FDLK, 33.440FDRK, 33.440FDLRS, 33.440FDLS, 33.440FDRS, 33.440FDS, 33.480FDC, 33.480FDLC, 33.480FDRC</p>	<p>H66, HW2</p>	<p>☺ ☺</p>	<p>85417226010 85417226017 81417226060</p>	<p>CB0199 CB0201</p>	<p>○ ○ ○ ○</p>	<p>☺ 81417226061</p>	<p>CB0197</p>	<p>○ ○</p>
<p>33.460FDAC, 33.460FDAK, 33.460FDAS</p>	<p>H54</p>	<p>☺ ☺</p>	<p>85417226010 85417226017 81417226060</p>	<p>CB0199 CB0201</p>	<p>○ ○ ○ ○</p>	<p>☺ 81417226061</p>	<p>CB0197</p>	<p>○ ○</p>



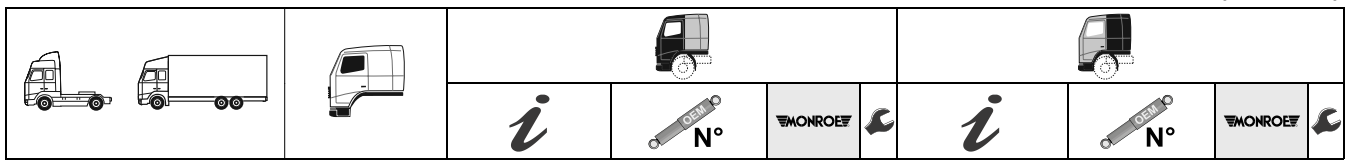





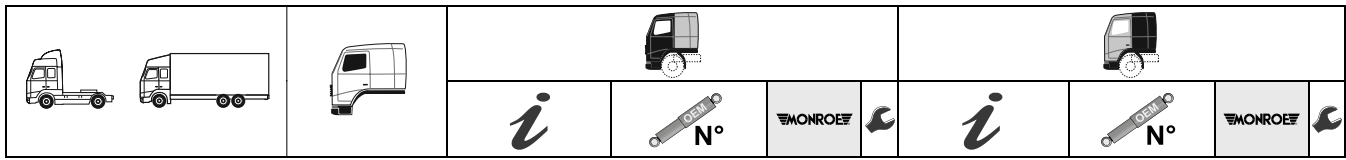







































































33.460FDC, 33.460FDLC, 33.460FDRC, 33.460FDLRC, 33.460FDK, 33.460FDLK, 33.460FDRK, 33.460FDLRS, 33.460FDLS, 33.460FDRS, 33.460FDS, 33.480FDC, 33.480FDLC, 33.480FDRC, 33.480FDLRC	H25, H29		85417226010 85417226017	CB0199	s 	81417226059 85417226011 85417226019	CB0198	
			81417226068	CB0200				
33.460FDC, 33.460FDLC, 33.460FDRC, 33.460FDLRC, 33.460FDK, 33.460FDLK, 33.460FDRK, 33.460FDLRS, 33.460FDLS, 33.460FDRS, 33.460FDS, 33.480FDC, 33.480FDLC, 33.480FDRC, 33.480FDLRC, 33.480FDK, 33.480FDRK, 33.480FDLRS, 33.480FDLS, 33.480FDRS, 33.480FDS	H28				s 	81417226059 85417226011 85417226019	CB0198	
33.460FDC, 33.460FDLC, 33.460FDRC, 33.460FDLRC, 33.460FDK, 33.460FDLK, 33.460FDRK, 33.460FDLRS, 33.460FDLS, 33.460FDRS, 33.460FDS, 33.480FDLC, 33.480FDRC, 33.480FDLRC	H28, H62		85417226010 85417226017	CB0199		81417226061	CB0197	
			81417226060	CB0201				
33.480FDAK, 33.480FDALK, 33.480FDARK, 33.480FDHK, 33.480FDALS, 33.480FDARS, 33.480FDAS, 33.480FDHS	H54, H55, H56, HW4		85417226010 85417226017	CB0199		81417226061	CB0197	
			81417226060	CB0201				
33.480FDAK, 33.480FDALK, 33.480FDARK, 33.480FDHK, 33.480FDALS, 33.480FDARS, 33.480FDAS, 33.480FDHS	H72, H82		85417226010 85417226017	CB0199				
33.480FDC, 33.480FDLC, 33.480FDRC, 33.480FDC-TM, 33.480FDRC-TM, 33.480FD-TM, 33.480FDK, 33.480FDLK, 33.480FDRK, 33.480FDS, 33.480FDLS, 33.480FDLRS, 33.480FDRS					s 	81417226059 85417226011 85417226019	CB0198	
33.480FDK, 33.480FDLK, 33.480FDRK, 33.480FDLRS, 33.480FDLS, 33.480FDRS, 33.480FDS	H25, H26, H29, H30		85417226010 85417226017	CB0199				
			81417226068	CB0200				
33.480FDK, 33.480FDLK, 33.480FDRK, 33.480FDLRS, 33.480FDLS, 33.480FDRS, 33.480FDS	H28, H62, H66, HW2		85417226010 85417226017	CB0199		81417226061	CB0197	
			81417226060	CB0201				

MAN TGA (2007/10-)



35.360FFNLC, 35.480FFNLC	H88, H90		85417226010 85417226017	CB0199			
			81417226068	CB0200			
35.390FDNLC, 35.400FDNLC, 35.430FDNLC, 35.440FDNLC	H92		85417226010 85417226017	CB0199			
			81417226068	CB0200			
35.390FFDAK, 35.390FFDHLK, 35.400FFDAK, 35.400FFDHLK	H59, H93		85417226010 85417226017	CB0199			
			81417226068	CB0200			
35.390FFDAK, 35.400FFDAK, 35.480FFDAK	H96		85417226010 85417226017	CB0199			
			81417226068	CB0200			
35.390FFDAK, 35.430FFDAK, 35.430FFDHLK	HV6		85417226010 85417226017	CB0199		81417226061	CB0197
			81417226060	CB0201			
35.390FFDC, 35.390FFDRC, 35.390FFDLC, 35.390FFDK, 35.390FFDRK, 35.390FFDLK, 35.390FFD-TM, 35.400FFDC, 35.400FFDRC, 35.400FFDLC, 35.400FFDK, 35.400FFDRK, 35.400FFDLK, 35.400FFD-TM	H37		85417226010 85417226017	CB0199			
35.400FFDC, 35.400FFDRC, 35.400FFDLC, 35.400FFDK, 35.400FFDRK, 35.400FFDLK, 35.430FFDC, 35.430FFDRC, 35.430FFDLC, 35.430FFDK, 35.430FFDRK, 35.430FFDLK, 35.440FFDC, 35.440FFDRC, 35.440FFDLC, 35.440FFDK, 35.440FFDRK, 35.440FFDLK	H41		85417226010 85417226017	CB0199			
			81417226068	CB0200			
35.410FDNLC, 35.530FDNLC	H91		85417226010 85417226017	CB0199			
			81417226068	CB0200			
35.410FFDAK, 35.530FFDAK	H73		85417226010 85417226017	CB0199			
			81417226068	CB0200			
35.410FFDAK, 35.480FFDAK, 35.480FFDARS, 35.530FFDAK	H76		85417226010 85417226017	CB0199		81417226061	CB0197
			81417226068	CB0200			
			81417226060	CB0201			

										
			<i>i</i>	 N°	 	<i>i</i>	 N°	 		
35.410FFNLC, 35.460FFNLC, 35.530FFNLC	H88			85417226010 85417226017	CB0199					
				81417226068	CB0200					
35.430FFDAK, 35.430FFDHK, 35.430FFDHLK, 35.430FFDH-TM, 35.440FFDAK, 35.440FFDHK, 35.440FFDHLK, 35.440FFDH-TM, 35.480FFDAK, 35.480FFDHK, 35.480FFDHLK, 35.480FFDH-TM	H50			85417226010 85417226017	CB0199					
				81417226068	CB0200					
				85417226010 85417226017	CB0199					
				81417226068	CB0200					
				85417226010 85417226017	CB0199					
				81417226068	CB0200					
				85417226010 85417226017	CB0199					
				81417226068	CB0200					
				85417226010 85417226017	CB0199					
				81417226068	CB0200					
35.430FFDC, 35.430FFDRC, 35.430FFDLC, 35.430FFDK, 35.430FFDRK, 35.430FFDLK, 35.430FFD-TM, 35.440FFDC, 35.440FFDRC, 35.440FFDLC, 35.440FFDK, 35.440FFDRK, 35.440FFDLK, 35.440FFD-TM	H37			85417226010 85417226017	CB0199					
				81417226068	CB0200					
				85417226010 85417226017	CB0199					
				81417226068	CB0200					
				85417226010 85417226017	CB0199					
				81417226068	CB0200					
				85417226010 85417226017	CB0199					
				81417226068	CB0200					
				85417226010 85417226017	CB0199					
				81417226068	CB0200					
35.460FFDC, 35.460FFDLC, H36 35.460FFDK, 35.460FFDLK, 35.460FFD-TM, 35.530FFDC, 35.530FFDLC, 35.530FFDK, 35.530FFDLK, 35.530FFD-TM	H36			85417226010 85417226017	CB0199					
				81417226068	CB0200					
35.480FDNLC	H91, H92			85417226010 85417226017	CB0199					
				81417226068	CB0200					
35.480FFDAK, 35.480FFDHK, 35.480FFDHLK	H59, H73, H93			85417226010 85417226017	CB0199					
				81417226068	CB0200					
35.480FFDAK	HV6						81417226061	CB0197 		
35.480FFDC, 35.480FFDLC, H36, H37 35.480FFDK, 35.480FFDLK, 35.480FFD-TM	H36, H37			85417226010 85417226017	CB0199					
				81417226068	CB0200					
35.480FFDC, 35.480FFDLC, H40, H41 35.480FFDK, 35.480FFDLK	H40, H41			85417226010 85417226017	CB0199					
				81417226068	CB0200					

MAN TGA (2007/10-)



39.390FVNLC, 39.400FVNLC, 39.430FVNLC, 39.440FVNLC, 39.480FVNLC	H69		85417226010 85417226017	CB0199				
			81417226068	CB0200				
40.390FDAK, 40.390FDARK, 40.390FDARS, 40.390FDAS, 40.400FDAK, 40.400FDARK, 40.400FDARS, 40.400FDAS, 40.430FDAK, 40.430FDARK, 40.430FDARS, 40.430FDAS, 40.440FDAK, 40.440FDARK, 40.440FDARS, 40.440FDAS, 40.480FDRS, 40.480FDAS	H58		85417226010 85417226017	CB0199		81417226061	CB0197	
			81417226060	CB0201				
40.390FDK, 40.390FDRK, 40.400FDK, 40.400FDRK, 40.440FDK, 40.440FDRK, 40.480FDK, 40.480FDRK	H11		85417226010 85417226017	CB0199				
40.390FDK, 40.390FDRK, 40.390FDRS, 40.390FDS, 40.400FDK, 40.400FDRK, 40.400FDRS, 40.400FDS, 40.430FDK, 40.430FDRK, 40.430FDRS, 40.430FDS, 40.440FDK, 40.440FDRK, 40.440FDRS, 40.440FDS	H34		85417226010 85417226017	CB0199		81417226061	CB0197	
			81417226060	CB0201				
40.410FDAK, 40.410FDAS, 40.460FDAK, 40.460FDAS, 40.480FDARS, 40.480FDAS	H57		85417226010 85417226017	CB0199		81417226061	CB0197	
			81417226060	CB0201				
40.410FDK, VFDS, 40.460FDK, 40.460FDS	H33		85417226010 85417226017	CB0199		81417226061	CB0197	
			81417226060	CB0201				
40.410FDK	H68		85417226010 85417226017	CB0199				
40.480FDAK, 40.480FDARK	H57, H58		85417226010 85417226017	CB0199		81417226061	CB0197	
			81417226060	CB0201				
40.480FDARS, 40.480FDAS	H58		85417226010 85417226017	CB0199				
40.480FDK, 40.480FDRK, 40.480FDRS, 40.480FDS	H33, H34		85417226010 85417226017	CB0199		81417226061	CB0197	
			81417226060	CB0201				

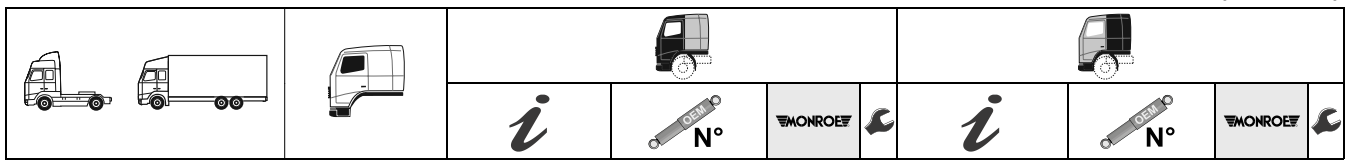

<p>41.350FFD, 41.350FFDC, H39 41.350FFDRC, 41.350FFDC-TM, 41.350FFDRC-TM, 41.350FFD-TM, 41.350FFDK, 41.350FFDRK, 41.360FFD, 41.360FFDC, 41.360FFDRC, 41.360FFDC-TM, 41.360FFDRC-TM, 41.360FFD-TM, 41.360FFDK, 41.360FFDRK, 41.390FFD, 41.390FFDC, 41.390FFDRC, 41.390FFDC-TM, 41.390FFD-TM, 41.390FFDK, 41.390FFDRK</p>	<p>85417226010 85417226017</p>	<p>CB0199</p>	<p>Q Q</p>	
<p>41.350FFD, 41.350FFDC, HW3, HW6 41.350FFDRC, 41.350FFDK, 41.350FFDRK, 41.360FFD, 41.360FFDC, 41.360FFDRC, 41.360FFDK, 41.360FFDRK, 41.390FFDK, 41.390FFDRK, 41.400FFDK, 41.400FFDRK, 41.440FFD, 41.440FFDC, 41.440FFDRC, 41.440FFDK, 41.440FFDRK</p>	<p>85417226010 85417226017</p> <p>81417226060</p>	<p>CB0199</p> <p>CB0201</p>	<p>Q Q Q Q</p>	<p>81417226061</p> <p>CB0197</p> <p>Q Q</p>
<p>41.350FFDC-TM, HW3 41.350FFDRC-TM, 41.360FFDC-TM, 41.360FDRC-TM, 41.390FFDC-TM, 41.390FDRC-TM, 41.390FFD, 41.390FFDC, 41.390FFDRC, 41.400FFDC-TM, 41.400FDRC-TM, 41.400FFD, 41.400FFDC, 41.400FFDRC</p>	<p>85417226010 85417226017</p> <p>81417226060</p>	<p>CB0199</p> <p>CB0201</p>	<p>Q Q Q Q</p>	<p>81417226061</p> <p>CB0197</p> <p>Q Q</p>
<p>41.350FFDC-TM, HW6 41.350FFDRC-TM, 41.350FFD-TM, 41.360FFDC-TM, 41.360FFDRC-TM, 41.360FFD-TM, 41.360FFD, 41.390FFDC-TM, 41.390FFDRC-TM, 41.390FFD-TM, 41.400FFDC-TM, 41.400FFDRC-TM, 41.400FFD-TM, 41.400FFD, 41.440FFD/M, 41.44041.480FFDC-TM, 41.440FFDRC-TM, 41.440FFD-TM, 41.440FFDK</p>	<p>85417226010 85417226017</p> <p>81417226060</p>	<p>CB0199</p> <p>CB0201</p>	<p>Q Q Q Q</p>	<p>81417226061</p> <p>CB0197</p> <p>Q Q</p>





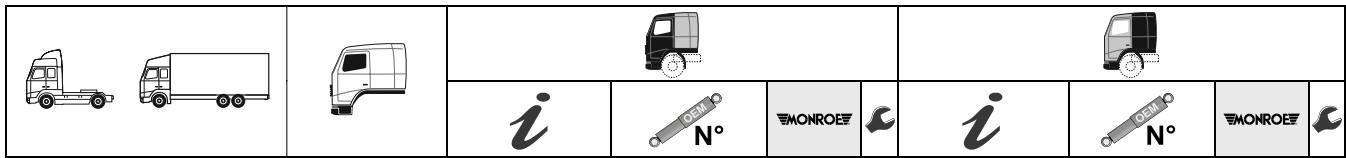



































MAN TGM (2005/10-)



<p>8.210FC, 8.210FRC, 8.210FLC, 8.210FLRC, 8.210FK, 8.210FK-L, 8.210FLK, 8.210FLK-L, 8.210FLRK, 8.210FLRK-L, 8.210FRK, 8.210FRK-L, 8.220FC, 8.220FLC, 8.220FRC, 8.220FLRC,</p>	<p>N03, N13</p>		<p>85417226027 85417226028</p>	<p>CB0180</p>	<p>○ ○</p>	
<p>8.240FC, 8.240FRC, 8.240FLC, 8.240FLRC, 8.240FK, 8.240FK-L, 8.240FLK, 8.240FLK-L, 8.240FLRK, 8.240FLRK-L, 8.240FRK, 8.240FRK-L, 8.250FC, 8.250FLC, 8.250FLRC, 8.250FRC, 8.250FK, 8.250FK-L, 8.250FLK, 8.250FLK-L, 8.250FLRK, 8.250FLRK-L, 8.250FRK, 8.250FRK-L</p>	<p>N02, N12</p>		<p>85417226027 85417226028</p>	<p>CB0180</p>	<p>○ ○</p>	
<p>12.180FC, 12.180FRC, 12.180FLC, 12.180FLRC, 12.180FK, 12.180FLK, 12.180FLRK, 12.180FRK, 12.210FC, 12.210FRC, 12.210FLC, 12.210FLRC, 12.210FK, 12.210FLK, 12.210FLRK, 12.210FRK, 12.220FC, 12.220FRC, 12.220FLC, 12.220FLRC, 12.220FK, 12.220FLK, 12.220FLRK, 12.220FRK</p>	<p>N05, N15</p>		<p>85417226027 85417226028</p>	<p>CB0180</p>	<p>○ ○</p>	
<p>12.240FC, 12.240FRC, 12.240FLC, 12.240FLRC, 12.240FK, 12.240FLK, 12.240FLRK, 12.240FRK, 12.250FC, 12.250FLC, 12.250FRC, 12.250FLRC, 12.250FK, 12.250FLK, 12.250FLRK, 12.250FRK</p>	<p>N04, N14</p>		<p>85417226027 85417226028</p>	<p>CB0180</p>	<p>○ ○</p>	

TGM (2005/10-)







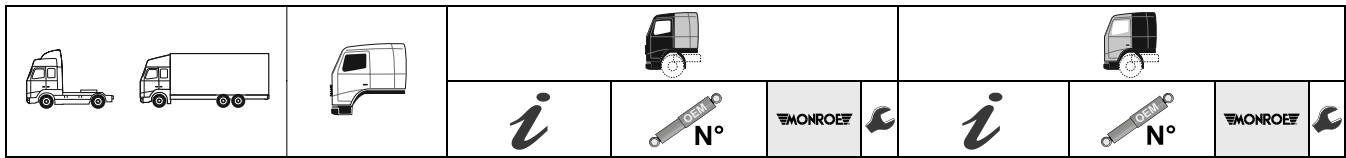

<p>13.240FAL, 13.240FALC, 13.240FALRC, 13.240FAEC, 13.240FAERC, 13.240FALR, 13.250FAEC, 13.250FAERC, 13.250FALC, 13.250FAL, 13.250FALRC, 13.250FALR,</p>	<p>N34, N37</p>		<p>85417226027 85417226028</p>	<p>CB0180</p>	<p>○ ○</p>		<p>85417226025 CB0181</p> <p>○ ○</p>
<p>13.240FAL, 13.240FALC, 13.240FALRC, 13.240FAEC, 13.240FAERC, 13.240FALR, 13.240FALK, 13.240FALRK, 13.240FALK-L, 13.240FALRK-L, 13.250FAEC, 13.250FAERC, 13.250FALC, 13.250FAL, 13.250FALRC, 13.250FALR</p>	<p>N36</p>		<p>85417226027 85417226028</p>	<p>CB0180</p>	<p>○ ○</p>		

























									
									
13.250FALK, 13.250FALRK, N36 13.250FALK-L, 13.250FALRK-L, 13.280FALK, 13.280FALRK, 13.280FALK-L, 13.280FALRK-L, 13.290FALK, 13.290FALRK, 13.290FALK-L, 13.290FALRK-L		85417226027 85417226028	CB0180		85417226025	CB0181			
13.280FAEC, N34, N36, N37 13.280FAERC, 13.280FAL, 13.280FALC, 13.280FALRC, 13.290FAEC, 13.290FAERC, 13.290FAL, 13.290FALR, 13.290FALC, 13.290FALRC		85417226027 85417226028	CB0180		85417226025	CB0181			
15.240FC, 15.240FLC, N26, N63 15.240FLLC, 15.240FLRC, 15.240FLLRC		85417226027 85417226028	CB0180		85417226025	CB0181			
15.240FC, 15.240FLC, N08, N16, N18 15.240FLLC, 15.240FLRC, 15.240FLLRC, 15.250FC, 15.250FLC, 15.250FLLC, 15.250FLRC, 15.250FLLRC, 15.280FC, 15.280FLC, 15.280FLLC, 15.280FLRC, 15.280FLLRC, 15.290FC, 15.290FLC, 15.290FLLC, 15.290FLRC, 15.290FLLRC					85417226025	CB0181			
15.240FLK, 15.240FLRK, N18 15.250FK, 15.250FK-L, 15.250FLK, 15.250FLK-L, 15.250FLRK, 15.280 15.280FLK, 15.280FLRK, 15.290FK, 15.290FK-L, 15.290FLK, 15.290FLK-L, 15.290FLRK, 15.330 15.330FLK, 15.330FLRK, 15.340 15.340FK, 15.340FK-L, 15.340FLK, 15.340FLK-L, 15.340FLRK					85417226025	CB0181			
15.250FC, 15.250FLC, N26 15.250FLLC, 15.250FLRC, 15.250FLLRC, 15.280FC, 15.280FLC, 15.280FLLC, 15.280FLRC, 15.280FLLRC, 15.290FC, 15.290FLC, 15.290FLLC, 15.290FLRC, 15.290FLLRC		85417226027 85417226028	CB0180		85417226025	CB0181			
15.330FC, 15.330FLC, N08, N18 15.330FRC, 15.330FLRC, 15.340FC, 15.340FLC, 15.340FLRC					85417226025	CB0181			
18.240FAC, 18.240FARC N38, N64		85417226027 85417226028	CB0180		85417226025	CB0181			













<p>18.240FAK, 18.240FARK, N38 18.240FAK-L, 18.240FARK-L, 18.250FAC, 18.250FARC, 18.250FAK, 18.250FARK, 18.250FAK-L, 18.250FARK-L, 18.280FAC, 18.280FARC, 18.280FAK, 18.280FARK, 18.280FAK-L, 18.280FARK-L, 18.290FAC, 18.290FARC, 18.290FAK, 18.290FARK, 18.290FAK-L, 18.290FARK-L</p>		<p>85417226027 85417226028</p>	<p>CB0180</p>	s 	<p>85417226025</p>	<p>CB0181</p>
<p>18.240FC, 18.240FRC, N08, N18, N28, N62 18.240FLC, 18.240FLRC, 18.240FLLC, 18.240FLLRC</p>		<p>85417226027 85417226028</p>	<p>CB0180</p>	s 	<p>85417226025</p>	<p>CB0181</p>
<p>18.240FC, 18.240FRC, N08 18.240FLC, 18.240FLRC, 18.240FLLC, 18.240FLLRC</p>		<p>85417226027 85417226028</p>	<p>CB0180</p>			
<p>18.240FK, 18.240FK-L, N08, N18, N62 18.240FLK, 18.240FLK-L, 18.240FLRK, 18.240FLRK-L, 18.240FRK, 18.240FRK-L</p>		<p>85417226027 85417226028</p>	<p>CB0180</p>	s 	<p>85417226025</p>	<p>CB0181</p>
<p>18.250FC, 18.250FLC, N08, N18, N62 18.250FLLC, 18.250FRC, 18.250FLRC, 18.250FLLRC, 18.290FC, 18.290FLC, 18.290FLLC, 18.290FRC, 18.290FLRC, 18.290FLLRC, 18.330FC, 18.330FLC, 18.330FLLC, 18.330FRC, 18.330FLRC, 18.330FLLRC, 18.340FC, 18.340FLC, 18.340FLLC, 18.340FRC, 18.340FLRC, 18.340FLLRC</p>		<p>85417226027 85417226028</p>	<p>CB0180</p>	s 	<p>85417226025</p>	<p>CB0181</p>
<p>18.250FK, 18.250FK-L, N08, N18 18.250FLK, 18.250FLK-L, 18.250FLRK, 18.250FLRK-L, 18.250FRK, 18.250FRK-L, 18.290FK, 18.290FK-L, 18.290FLK, 18.290FLK-L, 18.290FLRK, 18.290FLRK-L, 18.290FRK, 18.290FRK-L</p>		<p>85417226027 85417226028</p>	<p>CB0180</p>	s 	<p>85417226025</p>	<p>CB0181</p>
<p>18.280FC, 18.280FRC, N65 18.280FLC, 18.280FLRC, 18.280FLLC, 18.280FLLRC</p>		<p>85417226027 85417226028</p>	<p>CB0180</p>			
<p>18.280FC, 18.280FRC, N08, N18, N28, N62 18.280FLC, 18.280FLRC, 18.280FLLC, 18.280FLLRC</p>		<p>85417226027 85417226028</p>	<p>CB0180</p>	s 	<p>85417226025</p>	<p>CB0181</p>
<p>18.280FK, 18.280FK-L, N08, N18, N62 18.280FLK, 18.280FLK-L, 18.280FLRK, 18.280FLRK-L, 18.280FRK, 18.280FRK-L</p>		<p>85417226027 85417226028</p>	<p>CB0180</p>	s 	<p>85417226025</p>	<p>CB0181</p>
<p>18.330FAC, 18.330FARC, N38 18.330FAK, 18.330FARK, 18.330FAK-L, 18.330FARK-L, 18.340FAC, 18.340FARC, 18.340FAK, 18.340FARK, 18.340FAK-L, 18.340FARK-L</p>		<p>85417226027 85417226028</p>	<p>CB0180</p>	s 	<p>85417226025</p>	<p>CB0181</p>







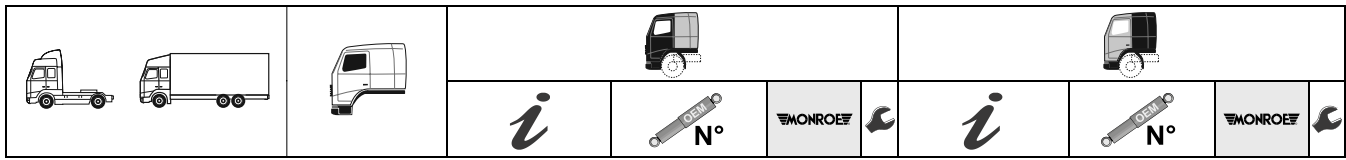



			
<i>i</i>			<i>i</i>
			



































18.330FK, 18.330FK-L, 18.330FLK, 18.330FLK-L, 18.330FLRK, 18.330FLRK-L, 18.330FRK, 18.330FRK-L, 18.340FK, 18.340FK-L, 18.340FLK, 18.340FLK-L, 18.340FLRK, 18.340FLRK-L, 18.340FRK, 18.340FRK-L	N08, N18		85417226027 85417226028	CB0180	 	 s	85417226025	CB0181	 
22.240FNLLC, 22.250FNLLC, 22.280FNLC, 22.280FNLLC, 22.280FNLLRC, 22.280FNLRC, 22.290FNLC, 22.290FNLLC	N26					 s	85417226025	CB0181	 
26.280FD, 26.290FD, 26.290FDR, 26.330FD, 26.330FDR, 26.340FD, 26.340FDR	N48		85417226027 85417226028	CB0180	 				
26.280FDK-HK, 26.280FDRK-HK, 26.280FD-TM, 26.280FDR-TM, 26.290FDK-HK, 26.290DRK-HK, 26.290FD-TM, 26.290FDR-TM, 26.330FDK-HK, 26.330FDRK-HK, 26.330FD-TM, 26.330FDR-TM, 26.340FDK-HK, 26.340FDRK-HK, 26.340FD-TM, 26.340FDR-TM	N48		85417226027 85417226028	CB0180	 	 s	85417226025	CB0181	 
26.280FNLC, 26.280FNLLC, N44, N46 26.280FNLRC, 26.280FNLLRC, 26.290FNLC, 26.290FNLLC, 26.290FNLRC, 26.290FNLLRC, 26.290FVL, 26.330FNLC, 26.330FNLLC, 26.330FNLRC, 26.330FNLLRC, 26.330FVL, 26.340FNLC, 26.340FNLLC, 26.340FNLRC, 26.340FNLLRC	N44, N46		85417226027 85417226028	CB0180	 	 s	85417226025	CB0181	 

TGS (2007/08-)									
18.320FAC, 18.320FHLC, 18.320FAS, 18.320FHLS, 18.320FHLS/M, 18.320FALS, 18.360FAC, 18.360FHLC, 18.400FAC, 18.400FHLC, 18.440FAC, 18.440FHLC, 18.480FAC, 18.480FHLC, 18.540FAC, 18.540FHLC	22S, 52S	 	85417226010 85417226017 81417226068	CB0199 CB0200	   	 s	81417226059 85417226011 85417226019	CB0198	 





















































<p>18.320FAK, 18.320FAK-L, 18.320FALK, 18.320FALK-L, 18.320FHLK, 18.320FHLK/M, 18.360FAK, 18.360FAK-L, 18.360FALK, 18.360FALK-L, 18.360FHLK, 18.360FHLK/M, 18.360FAS, 18.360FALS, 18.360FHLS, 18.360FHLS/M</p>	<p>22S, 52S, 80S</p>		<p>85417226010 85417226017</p>	<p>CB0199</p>	s 	<p>81417226059 85417226011 85417226019</p>	<p>CB0198</p>
<p>18.320FC, 18.320FLC, 18.320FLRC, 18.320FLLC, 18.320FLRC, 18.320FLLC, 18.320FLLW/N, 18.360FC, 18.360FLC, 18.360FLRC, 18.360FLC, 18.360FLLC, 18.360FLLC, 18.360FLLRC, 18.360FLLW, 18.360FLLW/N, 18.400FC, 18.400FLC, 18.400FLRC, 18.400FLC, 18.400FLLC, 18.400FLLC, 18.400FLLRC, 18.400FLLW, 18.400FLLW/N, 18.440FC, 18.440FLC, 18.440FLRC, 18.440FLC, 18.440FLLC, 18.440FLLC, 18.440FLLRC, 18.440FLLW, 18.440FLLW/N</p>	<p>03S, 06S, 10S, 15S</p>		<p>85417226010 85417226017</p>	<p>CB0199</p>	s 	<p>81417226059 85417226011 85417226019</p>	<p>CB0198</p>
<p>18.320FK, 18.320FK-L, 18.320FLK, 18.320FLK/M, 18.360FK, 18.360FK-L, 18.360FLK, 18.360FLK/M, 18.400FK, 18.400FK-L, 18.400FLK, 18.400FLK/M, 18.440FK, 18.400FK-L, 18.400FLK, 18.400FLK/M, 18.480FK, 18.480FK-L, 18.480FLK, 18.480FLK/M, 18.540FK, 18.540FK-L, 18.540FLK, 18.540FLK/M</p>	<p>03S, 06S</p>		<p>85417226010 85417226017</p>	<p>CB0199</p>	s 	<p>81417226059 85417226011 85417226019</p>	<p>CB0198</p>
<p>18.320FLS, 18.320FLS/M, 18.320FLS-TS, 18.320FLRS, 18.320FLRS/M, 18.320FLLS, 18.320FLLS/N, 18.320FLLRS, 18.360FLS, 18.360FLS/M, 18.360FLS-TS, 18.360FLRS, 18.360FLRS/M, 18.360FLLS, 18.360FLLS/N, 18.360FLLRS</p>	<p>06S, 08S, 10S, 13S</p>		<p>85417226010 85417226017</p>	<p>CB0199</p>	s 	<p>81417226059 85417226011 85417226019</p>	<p>CB0198</p>
<p>18.400FAK, F18.400FAK-L, 18.400FALK, 18.400FALK-L, 18.400FHLK, 18.400FHLK/M, 18.400FAS, 18.400FALS, 18.400FHLS, 18.400FHLS/M, 18.440FAK, 18.400FAK-L, 18.400FALK, 18.400FALK-L, 18.400FHLK, 18.400FHLK/M, 18.440FAS, 18.440FALS, 18.440FHLS, 18.440FHLS/M</p>	<p>22S, 52S, 80S</p>		<p>85417226010 85417226017</p>	<p>CB0199</p>	s 	<p>81417226059 85417226011 85417226019</p>	<p>CB0198</p>



































			
<i>i</i>	 N°	 	<i>i</i>
	 N°	 	

18.400FLS, 18.400FLS/M, 18.400FLS-TS, 18.400FLRS, 18.400FLRS/M, 18.400FLLS, 18.400FLLS/N, 18.400FLLRS, 18.440FLS, 18.440FLS/M, 18.440FLS-TS, 18.440FLRS, 18.440FLRS/M, 18.440FLLS, 18.440FLLS/N, 18.440FLLRS, 18.480FLS, 18.480FLS/M, 18.480FLS-TS, 18.480FLRS, 18.480FLRS/M, 18.480FLLS, 18.480FLLS/N, 18.480FLLRS	06S, 08S, 10S, 13S		85417226010 85417226017	CB0199	 s	81417226059 85417226011 85417226019	CB0198	
			81417226068	CB0200				
18.480FAK, 18.480FAK-L, 18.480FALK, 18.480FALK-L, 18.480FHLK, 18.480FHLK/M, 18.480FAS, 18.480FALS, 18.480FHLS, 18.540FAK, 18.540FAK-L, 18.540FALK, 18.540FALK-L, 18.540FHLK, 18.540FHLK/M, 18.540FAS, 18.540FALS, 18.540FHLS, 18.540FHLS/M	22S, 52S, 80S		85417226010 85417226017	CB0199	 s	81417226059 85417226011 85417226019	CB0198	
			81417226068	CB0200				
18.480FC, 18.480FLC, 18.480FLRC, 18.480FLLC, 18.480FLLRC, 18.480FLLW, 18.480FLLW/N, 18.540FC, 18.540FLC, 18.540FLRC, 18.540FLLC, 18.540FLLRC, 18.540FLLW, 18.540FLLW/N	03S, 06S, 10S		85417226010 85417226017	CB0199	 s	81417226059 85417226011 85417226019	CB0198	
			81417226068	CB0200				
18.540FLS, 18.540FLS/M, 18.540FLRS, 18.540FLRS/M, 18.540FLLS, 18.540FLLS/N, 18.540FLLRS	06S, 08S, 10S		85417226010 85417226017	CB0199				
			81417226068	CB0200				
19.360FS, 19.360FLS, 19.360FRS, 19.360FLRS, 19.400FS/M-WW, 19.400FLS/M-WW, 19.400FRS/M-WW, 19.400FLRS/M-WW, 19.440FS-WW, 19.440FRS-WW, 19.440FLS-WW, 19.440FLRS-WW, 19.480FS/M-WW, 19.480FRS/M-WW, 19.480FLS/M-WW, 19.480FLRS/M-WW	03W, 06W		85417226010 85417226017	CB0199		81417226061	CB0197	
			81417226060	CB0201				
24.320FNLLW/N, 24.360FNLLW/N, 24.400 FNLLW/N, 24.440 FNLLW/N	45S		81417226068	CB0200	 s	81417226059 85417226011 85417226019	CB0198	
								



										
										
26.320FNLC, 26.320FNLC, 26.320FNLLC, 26.320FNLR, 26.320FNLLRC, 26.320FNLLW, 26.320FVLC, 26.320FVL-KO, 26.320FNLS, 26.320FNLRS, 26.320FNLLS, 26.320FPLS, 26.320FVLS, 26.320FPLRS, 26.360FNLC, 26.360FNLC, 26.360FNLLC, 26.360FNLLRC, 26.360FVLC, 26.360FVL-KO, 26.360FNLS, 26.360FNLLS, 26.360FNLRS, 26.360FPLS, 26.360FPLRS, 26.360FVLS	18S, 21S, 24S	 	85417226010 85417226017	CB0199	 s 	81417226059 85417226011 85417226019	CB0198	 		
				81417226068	CB0200	 				
26.320FVHLC, 26.360FPHLS, 26.360FVHLS, 26.400FPHLS, 26.400FVHLS, 26.440FPHLS, 26.440FVHLC, 26.440FVHLS, 26.480FPHLS, 26.480FVHLC, 26.480FVHLS	42S	 	85417226010 85417226017	CB0199	 	81417226068	CB0200	 		
26.360FDAC, 26.360FDALC, 26.360FDHLC, 26.360FDHLC/M, 26.360FDAK, 26.360FDALK, 26.360FDHK, 26.360FDHLK, 26.360FDAS, 26.360FDALS, 26.360FDHS, 26.360FDHLS, 26.360FDHLS/M	56S, 82S	 	85417226010 85417226017	CB0199	 s 	81417226059 85417226011 85417226019	CB0198	 		
				81417226068	CB0200	 				
26.360FDAC, 26.360FDALC, 26.360FDHLC, 26.360FDHLC/M, 26.360FDAK, 26.360FDALK, 26.360FDHK, 26.360FDHLK, 26.360FDAS, 26.360FDALS, 26.360FDHS, 26.360FDHLS, 26.360FDHLS/M	70S	 	85417226010 85417226017	CB0199	 s 	81417226059 85417226011 85417226019	CB0198	 		
				81417226068	CB0200	 				
26.360FDC, 26.360FDC, 26.360FDC/M, 26.360FDLC, 26.360FDLRC, 26.360FNHLC, 26.360FDS, 26.360FDRS, 26.360FDLS, 26.360FDLRS, 26.360FNHLS, 26.360FPHLS, 26.360FVHLS	26S, 30S, 35S	 	85417226010 85417226017	CB0199	 s 	81417226059 85417226011 85417226019	CB0198	 		
				81417226068	CB0200	 				































										
			<i>i</i>	 N°	 	<i>i</i>	 N°	 		
28.320FNLC, 28.360FNLC, 28.360FNLC, 28.400FNLC, 28.400FNLC, 28.440FNLC, 28.440FNLC, 28.480FNLC, 28.480FNLC, 28.540FNLC	74S, 89S		85417226010 85417226017	CB0199	 s	81417226059 85417226011 85417226019	CB0198			
			81417226068	CB0200	 HD					
28.320FNLS, 28.360FNLS, 28.360FNLS, 28.400FNLS, 28.400FNLS, 28.440FNLS, 28.440FNLS, 28.480FNLS, 28.480FNLS, 28.540FNLS	89S		85417226010 85417226017	CB0199	 s	81417226059 85417226011 85417226019	CB0198			
			81417226068	CB0200	 HD					
28.360FANLC, 28.360FANLC, 28.360FNHLC, 28.400FANLC, 28.400FANLC, 28.400FNHLC, 28.440FANLC, 28.440FANLC, 28.440FNHLC, 28.480FANLC, 28.480FANLC, 28.480FNHLC	84S		85417226010 85417226017	CB0199	 s	81417226059 85417226011 85417226019	CB0198			
			81417226068	CB0200						
32.320FFD-TM, 32.360FFDRC, 32.360FFD-TM, 32.360FFDR-TM, 32.400FFDRC, 32.400FFD-TM, 32.400FFDR-TM, 32.440FFDRC, 32.440FFD-TM, 32.440FFDR-TM, 32.480FFD-TM	49S		85417226010 85417226017	CB0199	 s	81417226059 85417226011 85417226019	CB0198			
				CB0200	 HD					
33.360FDAC, 33.360FDALC, 33.360FDARC, 33.360FDAK, 33.360FDALK, 33.360FDHK, 33.360FDARK, 33.360FDAS, 33.360FDALS, 33.360FDHS, 33.360FDARS, 33.440FDAC, 33.440FDALC, 33.440FDARC, 33.440FDAK, 33.440FDALK, 33.440FDHK, 33.440FDARK, 33.440FDAS, 33.440FDALS, 33.440FDHS, 33.440FDARS	56S, 82S		85417226010 85417226017	CB0199	 s	81417226059 85417226011 85417226019	CB0198			
			81417226068	CB0200						





<p>33.360FDC, 33.360FDLC, 33.360FDLRC, 33.360FDR, 33.360FDRC, 33.360FDK, 33.360FDLK, F33.360DRK, 33.360FDS, 33.360FDLS, 33.360FDRS, 33.400FDC, 33.400FDLC, 33.400FDLRC, 33.400FDR, 33.400FDRC, 33.400FDK, 33.400FDLK, 33.400FDRK, 33.400FDS, 33.400FDLS, 33.400FDR</p>	<p>26S, 30S</p>		<p>85417226010 85417226017</p>	<p>CB0199</p>	s 	<p>81417226059 85417226011 85417226019</p>	<p>CB0198</p>
<p>33.400FDAC, 33.400FDALC, 33.400FDARC, 33.400FDAK, 33.400FDALK, 33.400FDHK, 33.400FDARK, 33.400FDAS, 33.400FDALS, 33.400FDHS, 33.400FDARS</p>	<p>56S</p>		<p>85417226010 85417226017</p>	<p>CB0199</p>	s 	<p>81417226059 85417226011 85417226019</p>	<p>CB0198</p>
<p>33.440FDC, 33.400FDLC, 33.400FDLRC, 33.400FDR, 33.400FDRC, 33.400FDK, 33.400FDLK, 33.400FDRK, 33.400FDS, 33.400FDLS, 33.400FDLS/M, 33.400FDRS, 33.480FDC, 33.480FDC/M, 33.480FDLC, 33.480FDLC/M, 33.480FDLRC, 33.480FDR, 33.480FDRC, 33.480FDK, 33.480FDLK, 33.480FDS, 33.480FDLS, 33.480FDLS/M, 33.480FDRS</p>	<p>26S, 30S</p>		<p>85417226010 85417226017</p>	<p>CB0199</p>	s 	<p>81417226059 85417226011 85417226019</p>	<p>CB0198</p>
<p>33.480FDAC, 33.480FDALC, 33.480FDARC, 33.480FDAK, 33.480FDALK, 33.480FDARK, 33.480FDHK, 33.480FDAS, 33.480FDALS, 33.480FDHS, 33.480FDARS, 33.540FDAC, 33.540FDALC, 33.540FDAK, 33.540FDALK, 33.540FDAS, 33.540FDALS</p>	<p>56S, 82S</p>		<p>85417226010 85417226017</p>	<p>CB0199</p>	s 	<p>81417226059 85417226011 85417226019</p>	<p>CB0198</p>
<p>33.540FDC, 33.540FDLC, 33.540FDLC/M, 33.540FDLRC, 33.540FDRC, 33.540FDK, 33.540FDLK, 33.540FDS, 33.540FDLS, 33.540FDLS/M</p>	<p>26S, 30S</p>		<p>85417226010 85417226017</p>	<p>CB0199</p>	s 	<p>81417226059 85417226011 85417226019</p>	<p>CB0198</p>



																											
			<i>i</i>	 N°			<i>i</i>	 N°																			
35.320FFDAK, 35.320FFDHLK, 35.360FFDAK, 35.360FFDHLK, 35.400FFDAK, 35.400FFDHLK, 35.440FFDAK, 35.440FFDHLK, 35.480FFDAK, 35.480FFDHLK	59S		85417226010 85417226017	CB0199	 s	81417226059 85417226011 85417226019	CB0198																				
	35.320FFDAK, 35.320FFDHLK, 35.360FFDAK, 35.360FFDHLK, 35.440FFDAK, 35.440FFDHLK, 35.480FFDAK, 35.480FFDHLK	93S		85417226010 85417226017	CB0199	 s	81417226059 85417226011 85417226019	CB0198																			
										35.320FFDAK, 35.320FFDHLK, 35.440FFDAK, 35.440FFDHLK, 35.480FFDAK, 35.480FFDHLK	96S		85417226010 85417226017	CB0199	 s	81417226059 85417226011 85417226019	CB0198										
																			35.320FFDC, 35.320FFDLC, 37S 35.320FFDK, 35.320FFDLK, 35.320FFDRK, 35.320FFDC, 35.320FFDLC, 35.320FDNLC, 35.320FFDK, 35.320FFDLK, 35.320FFDRK, 35.400FFDC, 35.400FFDLC, 35.400FDNLC, 35.400FFDK, 35.400FFDLK, 35.400FFDRK	41S, 92S		85417226010 85417226017	CB0199	 s	81417226059 85417226011 85417226019	CB0198	
35.320FFDK, 35.320FFDLK, 41S 35.320FFDRK, 35.360FFDK, 35.320FFDLK, 35.320FFDRK, 35.400FFDK, 35.400FFDLK, 35.400FFDRK, 35.440FFDK, 35.440FDLK, 35.440FFDRK, 35.480FFDK, 35.480FFDLK, 35.480FFDRK, 35.540FFDK, 35.540FFDLK, 35.540FFDRK	41S		85417226010 85417226017	CB0199	 s	81417226059 85417226011 85417226019	CB0198																				
									35.320FFD-TM, 35.360FFD-TM, 35.400FFD-TM, 35.440FFD-TM, 35.480FFD-TM, 35.540FFD-TM	37S		85417226010 85417226017	CB0199	 s	81417226059 85417226011 85417226019	CB0198											



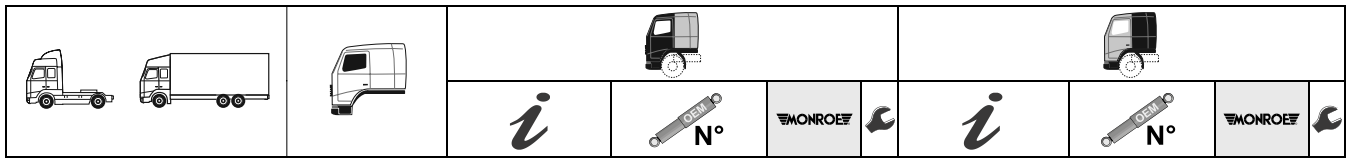

35.320FFNLC, 35.360FFNLC, 35.400FFNLC, 35.440FFNLC, 35.480FFNLC, 35.540FFNLC	90S		85417226010	CB0199	s 	81417226059	CB0198	
			85417226017			85417226011		
35.400FFDAK, 35.400FFDHLK	93S, 96S		85417226010	CB0199	s 	81417226059	CB0198	
			85417226017			85417226011		
35.400FFNHLC, 35.440FFNHLC, 35.480FFNHLC	73S		85417226010	CB0199	s 	81417226059	CB0198	
			85417226017			85417226011		
35.440FDNLC, 35.440FFDC, 35.440FFDLC, 35.440FFDK, 35.440FFDLK, 35.440FFDRK, 35.480FDNLC, 35.480FFDC, 35.480FFDLC, 35.480FFDK, 35.480FFDLK, 35.480FFDRK, 35.540FFDK, 35.540FFDLK, 35.540FFDRK	37S		85417226010	CB0199	s 	81417226059	CB0198	
			85417226017			85417226011		
35.540FDNLC, 35.540FFDC, 35.540FFDLC	92S		85417226010	CB0199	s 	81417226059	CB0198	
			85417226017			85417226011		
35.540FFDAK	96S		85417226010	CB0199				
37.320FFDC, FFDK, 37.360FFDC, FFDK, 37.400FFDC, FFDK, 37.440FFDC, FFDK, 37.480FFDC, FFDK	39S				s 	81417226059	CB0198	
40.400FDAK-WW, 40.400FDARK-WW, 40.400FDAS-WW, 40.400FDARS-WW, 40.440FDAK-WW, 40.400FDARK-WW, 40.400FDAS-WW, 40.400FDARS-WW	58W		85417226010	CB0199		81417226061	CB0197	
			85417226017					
41.320FFDAK, 41.440FFDAK, 41.480FFDAK	93S		85417226010	CB0199				
			85417226017					
41.320FFDAK, 41.440FFDAK, 41.480FFDAK	96S		85417226010	CB0199		81417226059	CB0198	
			85417226017			85417226011		

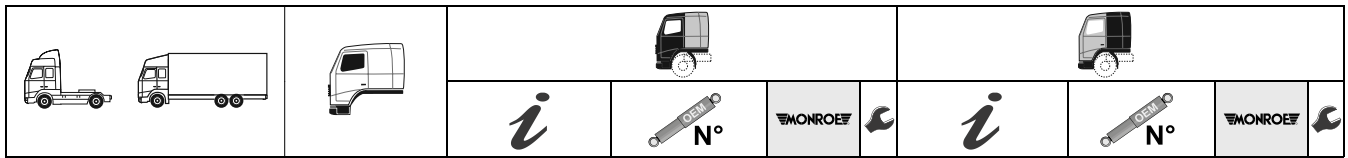

41.360FFD, 41.360FFDC, 39S 41.360FFDRC, 41.360FFDK, 41.360FFDRK, 41.360FFD-TM, 41.360FFDC-TM, 41.360FFDRC-TM, 41.400FFD, 41.400FFDC, 41.400FFDRC, 41.400FFDC-TM, 41.400FFDRC-TM, 41.400FFD-TM, 41.400FFDK, 41.400FFDRK, 41.440FFD, 41.400FFDC, 41.400FFDRC, 41.400FFDC-TM, 41.400FFDRC-TM, 41.400FFD-TM, 41.400FFDK		85417226010 85417226017	CB0199		81417226059 85417226011 85417226019	CB0198
41.360FFDAK, 96S 41.480FFDARC		85417226010 85417226017	CB0199			
41.480FFD, 41.480FFDC, 39S 41.480FFDRC, 41.480FFDC-TM, 41.480FFDRC-TM, 41.480FFD-TM; 41.480FFDK, 41.480FFDRK, 41.540FFDC, 41.540FFDK, 41.540FFD-TM		85417226010 85417226017	CB0199		81417226059 85417226011 85417226019	CB0198
41.540FFDAK 93S, 96S		85417226010 85417226017	CB0199			

TORPEDO SERIES (-1994/01)						
8.156F 9.156F, 9.186F 11.186F 12.156F, 12.186F, 12.215F, 12.240F, 12.240FR		81 43701 6185 81 43701 6379	CB0085		81 43701 6185 81 43701 6379	CB0085
13.192F, 13.168F, 13.215F, 13.230F, 13.250F 5.168F, 15.200F, 15.240F		81 43701 6185 81 43701 6379	CB0085		81 43701 6185 81 43701 6379	CB0085
16.168F, 16.168FKO, 16.168FM, 16.192F, 16.192FKO, 16.192FM 16.200F, 16.200FR, 16.215FN, 16.220FA, 16.230FN, 16.240F, 16.240FR, 16.240FA, 16.256F, 16.256FL, 16.280FL 16.320DF, 16.320DFA, 16.320FL		81 43701 6185 81 43701 6379	CB0085		81 43701 6185 81 43701 6379	CB0085
17.240F, 17.240FR 19.200F, 19.230FN, 19.240F, 19.240FA, 19.256F, 19.280F, 19.281F, 19.320DF, 19.320DFA, 19.320FR		81 43701 6185 81 43701 6379	CB0085		81 43701 6185 81 43701 6379	CB0085
20.320FVLS, 22.200FNLM, 22.320FNL, 22.320FVLS 22.240FNL, 22.280FNLM		81 43701 6185 81 43701 6379	CB0085		81 43701 6185 81 43701 6379	CB0085
26.240DF, 26.240DFA, 26.256DF, 26.256DFA, 26.280DF 26.320DF		81 43701 6185 81 43701 6379	CB0085		81 43701 6185 81 43701 6379	CB0085

MERCEDES-BENZ ACTROS (1996/04-2002/10)

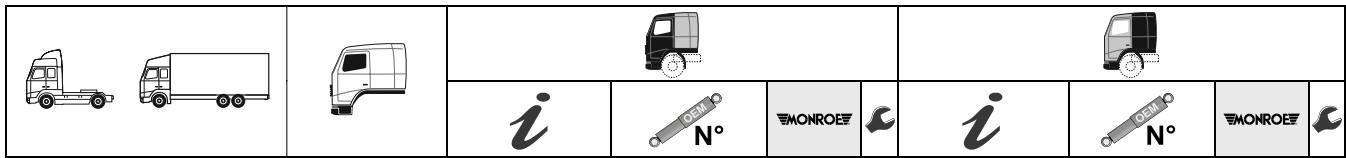

30.240DF, 30.240DFA, 30.240VFR, 30.256DF, 30.256DFA 30.320DF, 30.320DFA, 32.321DF, 32.321DFA	81 43701 6185	CB0085	○	81 43701 6185	CB0085	○
	81 43701 6379		○	81 43701 6379		○

MERCEDES-BENZ

ACTROS (1996/04-2002/10)

1823 → 1857 950. 952. 954. 2031 → 2657, 3231 → 3357 950. 952. 953. 954. 4140 → 4148 952. 953. → Ch.NoK351350	S Comfort 942 890 2619 942 890 5119 A942 890 2619 A942 890 5119	CB0127⁰ ○ ○	S Comfort HD 942 890 3619 942 890 4019 943 890 1019 943 890 1119 943 890 1619 943 890 1719 A942 890 3619 A942 890 4019 A943 890 1019 A943 890 1119 A943 890 1619 A943 890 1719	CB0158 ○ ○
	S Comfort 942 890 5519 943 890 0119 A942 890 5519 A943 890 0119	CB0128⁰ ○ ○	S Comfort 942 890 1119 942 890 3519 943 890 0519 S M Standard 943 890 2319 A942 890 1119 A942 890 3519 A943 890 0519 A943 890 2319	CB0165 ○ □
	S M Comfort 942 890 5019 A942 890 5019	CB0129⁰ ○ ○	L Comfort 942 890 0219 942 890 6019 943 890 3919 A942 890 0219	CB0090 ○ ○
	L Comfort 942 890 2219 942 890 2819 A942 890 2819	CB0100 ○ ○	L Comfort 942 890 4719 A942 890 4719	CB0096 ○ ○
	S M Standard 942 890 0519 958 317 0703 A942 890 0519 A958 317 0703	CB0148 ○ ○	L Comfort 942 890 2319 942 890 3119 943 890 0819 943 890 0919 943 890 1419 943 890 1519	CB0101 ○ ○
	L Comfort 942 890 0119 942 890 2919 A942 890 2919	CB0089 ○ ○	L Comfort ↕	CB0158 ○ ○
	L Comfort 942 890 6919	CB0107 ○ ○		
	S Comfort ↕	CB0127⁰ ○ ○	S Comfort HD ↕	CB0158 ○ ○
	S Comfort ↕	CB0128⁰ ○ ○	S Comfort ↕ S M Standard	CB0165 ○ □
	S M L Comfort ↕	CB0129⁰ ○ ○	L Comfort ↕	CB0090 ○ ○

1823 → 1857
 950.
 952.
 954.

2031 → 2657,
3231 → 3357
 950.
 952.
 953.
 954.

4140 → 4148
 952.
 953.

 Ch.No.K351351 →
 K472725



MERCEDES-BENZ ACTROS MP2 / MP3 (2002/10-2011/07)

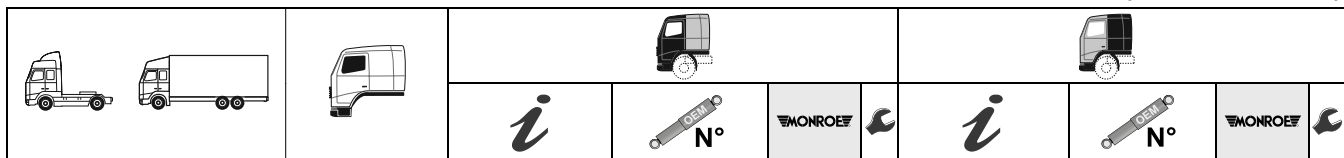

<p>1823 → 1857 950. 952. 954.</p> <p>2031 → 2657, 3231 → 3357 950. 952. 953. 954.</p> <p>4140 → 4148 952. 953.</p> <p>Ch.No.K472726 → K827280</p>							<p>CB0128⁰ <input type="radio"/></p>	<p>CB0158 <input type="radio"/></p>
							<p>CB0148 <input type="radio"/></p>	<p>CB0165 <input type="radio"/></p>
							<p>CB0121 <input type="radio"/></p>	<p>CB0090 <input type="radio"/></p>
							<p>CB0115 <input type="radio"/></p>	<p>CB0096 <input type="radio"/></p>
							<p>CB0122 <input type="radio"/></p>	<p>CB0101 <input type="radio"/></p>
							<p>CB0144 <input type="radio"/></p>	<p>CB0147 <input type="radio"/></p>
							<p>CB0158 <input type="radio"/></p>	<p>CB0158 <input type="radio"/></p>
							<p>CB0144 <input type="radio"/></p>	<p>CB0144 <input type="radio"/></p>
							<p>CB0147 <input type="radio"/></p>	<p>CB0147 <input type="radio"/></p>
							<p>CB0158 <input type="radio"/></p>	<p>CB0158 <input type="radio"/></p>

ACTROS MP2 / MP3 (2002/10-2011/07)

<p>1832AK, 1832K, 1836AK, 1836K, 1841K, 1844AK, 1844K, 1846AK, 1846K, 1848AK, 1848K, 1850AK, 1850K, 1851AK, 1851K</p> <p>1832LLS, 1832LS, 1836LLS, 1836LS, 1841LLS, 1841LS, 1844LLS, 1844LS, 1846LLS, 1846LS, 1848LLS, 1848LS, 1850LLS, 1850LS, 1851LLS, 1851LS, 1854LS, 1858LS</p>							<p>CB0148 <input type="radio"/></p>	<p>CB0165 <input type="radio"/></p>
							<p>CB0128⁰ <input type="radio"/></p>	<p>CB0147 <input type="radio"/></p>
							<p>CB0127⁰ <input type="radio"/></p>	<p>CB0144 <input type="radio"/></p>
							<p>CB0129⁰ <input type="radio"/></p>	<p>CB0158 <input type="radio"/></p>
							<p>CB0115 <input type="radio"/></p>	<p>CB0144 <input type="radio"/></p>
							<p>CB0147 <input type="radio"/></p>	<p>CB0147 <input type="radio"/></p>
							<p>CB0097 <input type="radio"/></p>	<p>CB0097 <input type="radio"/></p>
							<p>CB0217⁰ <input type="radio"/></p>	<p>CB0217⁰ <input type="radio"/></p>
							<p>CB0218⁰ <input type="radio"/></p>	<p>CB0218⁰ <input type="radio"/></p>
							<p>CB0218⁰ <input type="radio"/></p>	<p>CB0218⁰ <input type="radio"/></p>





























































MERCEDES-BENZ ACTROS MP2 / MP3 (2002/10-2011/07)



<p>2032, 2036, 2040, 2048 930 .013-014 .016</p>	L Ch. No. K894001→. 	942 890 5319	CB0115	S			CB0158	
		942 890 5919		S			CB0165	
		943 890 3819		S ND			CB0147	
		A942 890 5319		S HD	942 890 3919	CB0144		
		A942 890 5919		Ch. No. K827281→.	943 890 1319			
		A943 890 3819		S	A942 890 3919			
					A943 890 1319			
					943 890 5019	CB0164		
					A943 890 5019			
					942 890 3919	CB0144		
					943 890 1319			
					A942 890 3919	CB0147		
					A943 890 1319			
					943 890 3419	CB0155		
					943 890 3519			
			A943 890 3419	CB0156				
			A943 890 3519					
			943 890 3119					
			943 890 3219	CB0157				
			A943 890 3119					
			A943 890 3219	CB0158				
			943 890 3319					
			A943 890 3319	CB0161				
			943 890 2919					
			943 890 3019	CB0158				
			A943 890 2919					
			A943 890 3019	CB0116				
			942 890 6119					
			A942 890 6119	CB0097				
			L					



MERCEDES-BENZ ACTROS MP2 / MP3 (2002/10-2011/07)

							
							
							
<p>2032S, 2036S, 2041S, 2044S, 2046S, 2048S, 2050S, 2051S, 2055S 934 .012-013</p>							<p>CB0217⁰ <input type="checkbox"/></p> <p>CB0218⁰ <input type="checkbox"/></p>
<p>2041, 2044, 2046 930 .013-014</p>	<p> L Ch. No. K894001→ </p>	<p>CB0115</p>	<p><input type="checkbox"/></p>	<p>CB0158 <input type="checkbox"/></p>	<p> S</p>		<p>CB0165 <input type="checkbox"/></p>
					<p> S</p>		<p>CB0147 <input type="checkbox"/></p>
					<p> S  </p>		<p>CB0144 <input type="checkbox"/></p>
					<p>Ch. No. K827281→</p>		
					<p> S  </p>		<p>CB0164 <input type="checkbox"/></p>
					<p>Ch. No. K827281→</p>		
					<p> S </p>		<p>CB0144 <input type="checkbox"/></p>
					<p> L</p>		<p>CB0144 <input type="checkbox"/></p>
					<p> L</p>		<p>CB0147 <input type="checkbox"/></p>
					<p> L</p>		<p>CB0155 <input type="checkbox"/></p>
					<p> L</p>		<p>CB0156 <input type="checkbox"/></p>
					<p> L</p>		<p>CB0157 <input type="checkbox"/></p>
					<p> L</p>		<p>CB0161 <input type="checkbox"/></p>
					<p> L</p>		<p>CB0158 <input type="checkbox"/></p>
					<p>Ch. No. K827281→</p>		
					<p> L</p>		<p>CB0116 <input type="checkbox"/></p>
					<p> L</p>		<p>CB0097 <input type="checkbox"/></p>
					<p> L</p>		<p>CB0217⁰ <input type="checkbox"/></p>
					<p> L</p>		<p>CB0218⁰ <input type="checkbox"/></p>
<p>2054S 934 .012</p>					<p></p>		<p>CB0217⁰ <input type="checkbox"/></p>
					<p></p>		<p>CB0218⁰ <input type="checkbox"/></p>
<p>2432LS, 2436LS, 2441LS, 2444LS, 2446LS, 2448LS, 2451LS, 2455LS 934 .233</p>					<p></p>		<p>CB0218⁰ <input type="checkbox"/></p>
<p>2432LS, 2436LS, 2441LS, 2444LS, 2446LS, 2448LS, 2451LS, 2455LS 934 .235</p>					<p></p>		<p>CB0217⁰ <input type="checkbox"/></p>
					<p></p>		<p>CB0218⁰ <input type="checkbox"/></p>

























<i>i</i>			<i>i</i>	

<p>3231K, 3232K, 3331S, 3332S, 3336S, 3336K</p>			CB0148			CB0165
			CB0128⁰			CB0147
			CB0115			CB0158
						CB0144
						CB0144
						CB0147
						CB0161
						CB0158
						CB0116
						CB0097
						CB0217⁰
						CB0218⁰
	<p>3231B, 3235B, 3240B, 3243B 933 .304-305</p> <p>3235K, 3240K, 3241K, 3243K, 3244K, 3246K, 3248K 932 .304-305 .307</p> <p>3232B, 3236B, 3241B, 3244B, 3246B, 3248B 933 .304-305 .307</p>					
						CB0218⁰

























































MERCEDES-BENZ ACTROS MP2 / MP3 (2002/10-2011/07)













<p>3331AK, 3332K, 3332AK</p> <p> S</p> <p> L Ch. No. K894001→</p>	<p> ↗</p> <p> S ↗</p> <p> L ↗ Ch. No. K894001→</p>	<p>CB0148  ○</p> <p>CB0128⁰  ○</p> <p>CB0115  ○</p>	<p> S ↗</p> <p> S ↗</p> <p> S ND S ↗ Ch. No. K827281→</p> <p> S M HD ↗ Ch. No. K827281→</p> <p> L ↗</p> <p> L ↗</p> <p> L ↗</p> <p> L ↗ Ch. No. K827281→</p> <p> L ↗</p> <p> ↗</p> <p> ↗</p>	<p>CB0158 ○</p> <p>CB0165 ○</p> <p>CB0147 ○</p> <p>CB0144 ○</p> <p>CB0144 ○</p> <p>CB0147 ○</p> <p>CB0161 ○</p> <p>CB0158 ○</p> <p>CB0097 ○</p> <p>CB0217⁰ ○</p> <p>CB0218⁰ ○</p>
<p>3331B, 3332B, 3335B, 3336B, 3339B, 3341B, 3343B, 3344B, 3346B, 3348B 933 .161-163</p> <p>3331K, 3332K, 3335K, 3336K, 3339K, 3341K, 3343K, 3344K, 3346K, 3348K 932 .161-163</p> <p>3331S, 3332S, 3336S, 3355S 934 .161</p>			<p> ↗</p> <p> ↗</p>	<p>CB0217⁰ ○</p> <p>CB0218⁰ ○</p>
<p>3332AKE, 3336AKE, 3341AKE, 3344AKE, 3346AKE, 3348AKE 932 .182</p> <p>3332AKE, 3336AKE, 3341AKE, 3344AKE, 3346AKE, 3348AKE, 3351AK, 3355AK, 3360AK 932 .183</p>			<p> ↗</p>	<p>CB0217⁰ ○</p>





										
										
										
<p>3336AK, 3339AK, 3341AK, 3343AK, 3344AK, 3346AK, 3348AK 932 . 182-183</p> <p>3332AS, 3336AS, 3341AS, 3346AS, 3348AS, 3351AS, 3355AS 934 . 182</p>								<u>CB0217</u> ⁰	<input type="checkbox"/>	
<p>3336K 932 . 304-305 . 307</p>								<u>CB0217</u> ⁰	<input type="checkbox"/>	
<p>3341S, 3344S, 3346S, 3348S, 3351S</p> <p>4140AK, 4140K, 4144K</p>				<u>CB0148</u>	<input type="checkbox"/>			<u>CB0165</u>	<input type="checkbox"/>	
				<u>CB0128</u> ⁰	<input type="checkbox"/>			<u>CB0147</u>	<input type="checkbox"/>	
				<u>CB0115</u>	<input type="checkbox"/>			<u>CB0158</u>	<input type="checkbox"/>	
	<p>Ch. No. K894001→</p>							<u>CB0144</u>	<input type="checkbox"/>	
								<u>CB0144</u>	<input type="checkbox"/>	
								<u>CB0147</u>	<input type="checkbox"/>	
								<u>CB0158</u>	<input type="checkbox"/>	
								<u>CB0116</u>	<input type="checkbox"/>	
								<u>CB0097</u>	<input type="checkbox"/>	
<p>3344AS 934 . 182-183</p>								<u>CB0217</u> ⁰	<input type="checkbox"/>	
								<u>CB0218</u> ⁰	<input type="checkbox"/>	
<p>3350S 934 . 251</p>								<u>CB0218</u> ⁰	<input type="checkbox"/>	
<p>3350S 934 . 161</p>										
<p>3351AK 932 . 182</p>								<u>CB0217</u> ⁰	<input type="checkbox"/>	
<p>3351K 932 . 161 . 163</p>								<u>CB0218</u> ⁰	<input type="checkbox"/>	
<p>4140AK, 4141AK, 4143AK, 4144AK, 4146AK, 4148AK, 4150AK, 4151AK 932 . 336</p> <p>4140B, 4143B 933 . 314 . 317</p>								<u>CB0217</u> ⁰	<input type="checkbox"/>	
								<u>CB0218</u> ⁰	<input type="checkbox"/>	











MERCEDES-BENZ ATEGO (1998/01-2004/10)

			
<i>i</i>	 N°		
<i>i</i>	 N°		









<p>4140K, 4141K, 4144K, 4146K, 4148K 932 .314-315 .317 .325</p> <p>4141 932 .319</p> <p>4141B, 4144B, 4146B, 4148B 933 .314 .317 .319</p> <p>4143K 932 .325</p> <p>4150K, 4151K 932 .314-315 .325</p>		 	<p>CB0217⁰ <input type="checkbox"/></p> <p>CB0218⁰ <input type="checkbox"/></p>
<p>4155K, 4160K 932 .314-315</p> <p>5041K, 5044K, 5046K 932 .317</p>			<p>CB0217⁰ <input type="checkbox"/></p>































































ATEGO (1998/01-2004/10)

<p>712, 714, 714L 970 .001-003 .005 .011-013</p>	<p>9583170503 9583170603 9703171703 9703171803 9703174103 9703174203 A9583170503 A9583170603 A9703171703 A9703171803 A9703174103 A9703174203</p>	<p>CB0220⁰ <input type="checkbox"/></p>	
<p>714K, 717K 972 .011</p>		<p>CB0220⁰ <input type="checkbox"/></p>	
<p>715, 715L 970 .001-003 .005 .017 .203 .205</p>		<p>CB0220⁰ <input type="checkbox"/></p>	
<p>717, 717L 970 .011-013 .015 .017 .213 .215</p>		<p>CB0220⁰ <input type="checkbox"/></p>	
<p>812 970 .011-013 .015 .017</p>		<p>CB0220⁰ <input type="checkbox"/></p>	
<p>814K 972 .011 .021</p>		<p>CB0220⁰ <input type="checkbox"/></p>	
<p>814, 814L 970 .021-023 .025 .027 .223 .225</p>		<p>CB0220⁰ <input type="checkbox"/></p>	
<p>815F 976 .011-013</p>		<p>CB0220⁰ <input type="checkbox"/></p>	
<p>815K, 817K 972 .011-012 .021-022</p>		<p>CB0220⁰ <input type="checkbox"/></p>	
<p>815, 815L 970 .011-013 .015 .017 .021-023 .025 .027 .211-212 .223</p>		<p>CB0220⁰ <input type="checkbox"/></p>	



MERCEDES-BENZ ATEGO (1998/01-2004/10)

				
<i>i</i>			<i>i</i>	

817, 817L 970 .011-013 .015 .017 .021-023 .025 .027 .223 .225		CB0220⁰		
823K 972 .021-022		CB0220⁰		
823, 823L 970 .021-023 .025 .027 .221-222		CB0220⁰		
914, 914L 970 .235		CB0220⁰		
917 AF, 925AF 976 .332-334		CB0220⁰		
917K 972 .031-032 975 .031		CB0220⁰		
917, 917L, 923, 923L 970 .031-033 .035 .037 .233 .235		CB0220⁰		
923K 972 .031		CB0220⁰		
1017A, 1017AK, 1023AK 970 .342 972 .342		CB0220⁰		
1017, 1023K 972 .041-042		CB0220⁰		
1017KO, 1018KO 975 .041		CB0220⁰		
1017, 1017L, 1023, 1023L 970 .041-043 .045 .047 .243 .245		CB0220⁰		
1214K, 1215K, 1217KO 972 .052		CB0220⁰		
1214, 1214L 970 .053 .055 .057-058		CB0220⁰		
1215, 1215L 375 .101-102 970 .053 .055 .057-058 .253		CB0220⁰		
1217K, 1223K 972 .052-053		CB0220⁰		
1217, 1217L, 1223, 1223L 970 .050 .053 .055 .057-059 .083		CB0220⁰		
1225AF 976 .353-354		CB0220⁰		
1225F 976 .053-054		CB0220⁰		
1228, 1228L 970 .050 .053 .055 .057-059 .253		CB0220⁰		
1317A 970 .362-363		CB0220⁰		





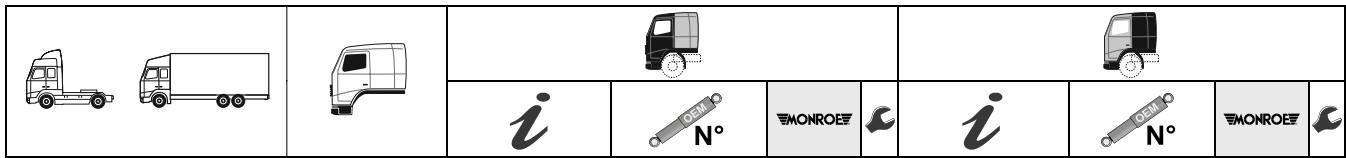













MERCEDES-BENZ ATEGO (1998/01-2004/10)







1317AK, 1323AK 972 .362		CB0220⁰			
1317K, 1323K 972 .062		CB0220⁰			
1317KO, 1317LKO, 1318KO, 1318LKO, 1323KO, 1323LKO 975 .062 .262		CB0220⁰			
1317, 1317L 970 .060 .063 .065 .067-068 .263 .265		CB0220⁰			
1323LS, 1328LS 974 .262-263		CB0220⁰			
1323, 1323L, 1328, 1328L 970 .063 .065 .067-068 .263 .265 .267		CB0220⁰			
135AF, 1328AF 976 .363-364		CB0220⁰			
1325F, 1328F 976 .063-065		CB0220⁰			
1517K, 1523K, 1528K 972 .072		CB0220⁰			
1517, 1517L 375 .121-122 970 .073 .075 .077-078 .273		CB0220⁰			
1523A 970 .373		CB0220⁰			
1523AK, 1528AK 972 .372		CB0220⁰			
1523KO 975 .072		CB0220⁰			
1523, 1523L, 1528, 1528L 970 .073 .075 .077-078 .273 .275 .277		CB0220⁰			
1525AF, 1528AF 976 .373-374		CB0220⁰			
1528F 976 .075 .077		CB0220⁰			

MERCEDES-BENZ ATEGO 2 (2004/10-2013/04)

			
<i>i</i>	 N°	 	<i>i</i>
 N°	 		

<p>1823AK, 1828A, 1828AK 952 .562-563</p> <p>1823, 1823L, 1828, 1828L 950 .501-509 .531-539 .544 .546-547</p> <p>1823K, 1828K 952 .502-503</p> <p>1823LS, 1828LS 954 .532</p>	<p>☒</p> <p>→ Ch. No. K794516</p> <p> L High Roof</p>	<p>942 890 0519 958 317 0703 A942 890 0519 A958 317 0703</p> <p>940 890 0519 940 890 1019 940 890 3719 A940 890 0519 A940 890 1019</p> <p>375 890 0819 940 890 4519 940 890 4619 958 317 1503 A375 890 0819 A940 890 4519 A940 890 4619 A958 317 1503</p>	<p>CB0148  L</p> <p>CB0162  L</p> <p>CB0163</p>	<p>375 890 0419 375 890 0919 940 890 3819 940 890 4719 958 317 1003 958 317 1103 A375 890 0419 A375 890 0919 A940 890 3819 A940 890 4719 A958 317 1003 A958 317 1103</p> <p>375 890 0519 940 890 3919 940 890 4119 958 317 2103 A375 890 0519 A940 890 3919 A940 890 4119 A958 317 2103</p>	<p>CB0150</p> <p>CB0097</p>
<p>1923L, 1928L, 2223L, 2228L</p>	<p>☒</p>	<p>↙ ↗</p> <p>↙ ↗</p>	<p>CB0148</p> <p>CB0162</p>		
<p>2523L 950 .624</p> <p>2528L 950 .602-605 .613-614 .623-626</p> <p>2628 950 .642-643</p> <p>2628B 953 .641 .643</p> <p>2628K 952 .641 .643</p>	<p>☒</p> <p>→ Ch. No. K794516</p> <p> L High Roof</p>	<p>↙ ↗</p> <p>↙ ↗</p> <p>↙ ↗</p>	<p>CB0148</p> <p>CB0162</p> <p>CB0163</p>	<p> L</p> <p> L</p>	<p>CB0150</p> <p>CB0097</p>







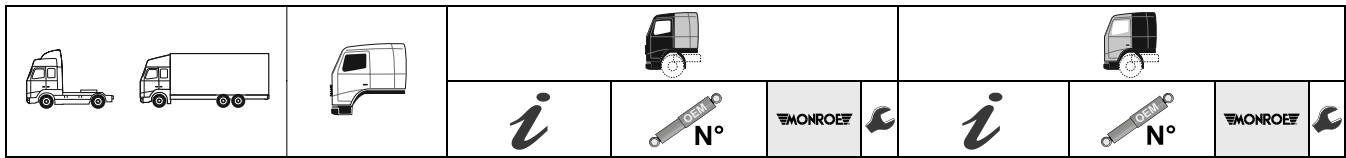



ATEGO 2 (2004/10-2013/04)



















































<p>712, 713 970 .001-003 .005 .011-013</p>		<p>9583170503 9583170603 9703171703 9703171803 9703174103 9703174203 A9583170503 A9583170603 A9703171703 A9703171803 A9703174103 A9703174203</p>	<p>CB0220⁰</p>	<p></p>	
<p>715, 715L, 716, 716L 970 .001-003 .005 .015 .017 .203</p>		<p>↙ ↗</p>	<p>CB0220⁰</p>	<p></p>	
<p>812, 813 970 .001 .011-013 .015 .017</p>		<p>↙ ↗</p>	<p>CB0220⁰</p>	<p></p>	
<p>815F 976 .011-013</p>		<p>↙ ↗</p>	<p>CB0220⁰</p>	<p></p>	
<p>815K, 816K, 818K, 822K 972 .011-012 .021-022</p>		<p>↙ ↗</p>	<p>CB0220⁰</p>	<p></p>	

MERCEDES-BENZ ATEGO 2 (2004/10-2013/04)



815, 815L, 816, 816L, 818, 818L, 822, 822L 970 .011-013 .015 .017 .021-022		CB0220⁰		
816, 816L 970 .011-012 .021-023 .025 .027 .223 .225		CB0220⁰		
818, 818L 970 .023 .025 .027 .223 .225		CB0220⁰		
822, 822L 970 .023 .025 .027		CB0220⁰		
823, 823L, 824, 824L 970 .021-023 .025 .027 .221-222		CB0220⁰		
824K 972 .021-022		CB0220⁰		
824, 824L 970 .021-023 .025 .027		CB0220⁰		
915, 915L, 916, 916L, 918, 918L, 922, 922L, 923, 923L, 924, 924L 970 .031-033 .035 .037 .233 .235		CB0220⁰		
916K, 918K, 922K, 924K 972 .031-032		CB0220⁰		
916, 916L, 924, 924L 970 .031-033 .035 .037		CB0220⁰		
918AF, 922AF, 926AF 976 .332-334		CB0220⁰		
1015K, 1016K, 1017K, 1018K, 1022K, 1024K 972 .041-042		CB0220⁰		
1016, 1016L, 1018, 1018L, 1022, 1022L, 1023, 1023L, 1024, 1024L 970 .041-043 .045 .047 .243 .245		CB0220⁰		
1017AK, 1018AK, 1022AK, 1024AK 972 .342		CB0220⁰		
1018A, 1022A, 1023A, 1024A 970 .342		CB0220⁰		
1024, 1024L 970 .043 .045 .047		CB0220⁰		

									
		<i>i</i>				<i>i</i>			

1215, 1215L, 1216, 1216L 970 .053 .055 .057-058 .083 .085 .087		CB0220⁰	 		
1216K 972 .052		CB0220⁰	 		
1218K, 1222K, 1224K 972 .052-053		CB0220⁰	 		
1218, 1218L, 1223, 1223L, 1224, 1224L, 970 .050 .053 .055 .057-059 .083		CB0220⁰	 		
1222, 1222L 970 .050 .053 .055 .057-058 .083 .085		CB0220⁰	 		
1226AF 976 .353-354		CB0220⁰	 		
1226F 976 .053-054		CB0220⁰	 		
1226, 1226L, 1228, 1228L, 1229, 1229L 970 .050 .053 .055 .057-059 .253		CB0220⁰	 		
1315 958 .026		CB0220⁰	 		
1318A, 1322A, 1323A, 1324A 970 .362-363		CB0220⁰	 		
1318AK, 1322AK, 1324AK 972 .362		CB0220⁰	 		
1318K, 1322K, 1324K 972 .062		CB0220⁰	 		
1318, 1318L 970 .060 .063 .065 .067-068 .263 .265		CB0220⁰	 		
1322LKO, 1324LKO 975 .262		CB0220⁰	 		
1322LS, 1323LS, 1324LS, 1326LS, 1328LS, 1329LS 974 .262-263		CB0220⁰	 		
1322, 1322LS 970 .060 .063 .065 .067-068 .263		CB0220⁰	 		
1323, 1323L, 1324, 1324L, 1326, 1326L, 1328, 1328L, 1329, 1329L 970 .063 .065 .067-068 .263 .265 .267		CB0220⁰	 		



MERCEDES-BENZ ATEGO 2 (2004/10-2013/04)



1324, 1324L, 1329, 1329L 970 .063 .065 .067-068		CB0220⁰		
1326AF, 1329AF 976 .364		CB0220⁰		
1326F, 1329F 976 .063-065		CB0220⁰		
1418 958 .030 .032 .034 .036		CB0220⁰		
1518A, 1522A 970 .373		CB0220⁰		
1518K, 1522K, 1523K, 1524K, 1526K, 1529K 972 .072		CB0220⁰		
1518, 1518L 958 .050 .052 .054 .056 970 .073 .075 .077		CB0220⁰		
1522, 1522L, 1523, 1523L, 1524, 1524L, 1526, 1526L, 1528, 1528L, 1529, 1529L 970 .073 .075 .077-078 .273 .275 .277		CB0220⁰		
1523A, 1524A 970 .372-373		CB0220⁰		
1524AK, 1526AK, 1529AK 972 .372		CB0220⁰		
1524, 1524L, 1529, 1529L 970 .073 .075 .077-078		CB0220⁰		
1526AF, 1529AF 976 .373-374		CB0220⁰		
1529F 976 .075 .077		CB0220⁰		
1718, 1725 958 .070 .072 .074 .076		CB0220⁰		
1719 958 .074		CB0220⁰		
1725A 958 .078		CB0220⁰		
1725S 958 .077		CB0220⁰		
1924L, 1926L, 1929L 970 .663 .665 .667		CB0220⁰		
2224L, 2226L, 2229L 970 .673 .675 .677		CB0220⁰		
2425 958 .090 .092 .094 .096		CB0220⁰		



MERCEDES-BENZ AXOR 2 (2004/10-)

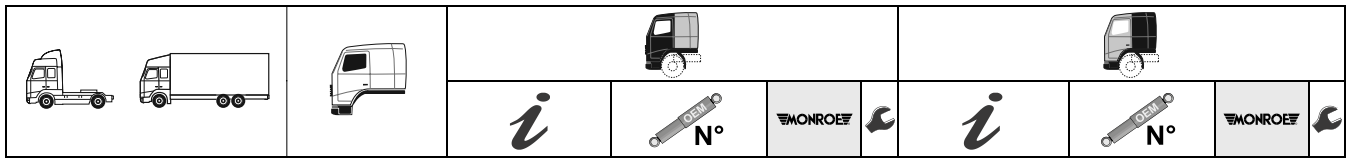

<p>1823K, 1823KL, 1824K, 1826K, 1828K, 1828KL, 1829K, 1833K 952 .502-503</p> <p>1823LS, 1824LS, 1826LS, 1829LS, 1833LS 954 .532</p>	<p>☒</p> <p>↪ Ch. No. K794516</p> <p>High Roof</p>	<p>CB0148</p> <p>CB0162</p> <p>CB0163</p>	<p>☐</p> <p>☐</p> <p>☐</p>	<p>CB0150</p> <p>CB0097</p>
<p>1836LLS, 1836LS, 1840LLS, 1840LS, 1843LLS, 1843LS 944 .032-033</p>	<p>☒</p> <p>High Roof</p> <p>9408904919 A9408904919</p>	<p>CB0148</p> <p>CB0163</p> <p>CB0236⁰</p>	<p>☐</p> <p>☐</p> <p>☐</p> <p>942 890 6119 A942 890 6119</p>	<p>CB0150</p> <p>CB0116</p> <p>CB0097</p>
<p>2436LS, 2440LS, 2443LS, 2536LS, 2540LS, 2543LS 944 .235</p>	<p>☒</p> <p>High Roof</p>	<p>CB0148</p> <p>CB0163</p>	<p>☐</p> <p>☐</p> <p>☐</p>	<p>CB0150</p> <p>CB0116</p> <p>CB0097</p>
<p>2528L, 2529L, 2533, 2533L 950 .602-605 .613-614</p>	<p>☒</p> <p>↪ Ch. No. K794516</p> <p>High Roof</p>	<p>CB0148</p> <p>CB0162</p> <p>CB0163</p>	<p>☐</p> <p>☐</p> <p>☐</p>	<p>CB0150</p> <p>CB0097</p>
<p>2535L, 2536L, 2536LL, 2540L, 2540LL, 2543L, 2543LL 940 .203-205</p>	<p>☒</p> <p>High Roof</p>	<p>CB0148</p> <p>CB0163</p> <p>CB0236⁰</p>	<p>☐</p> <p>☐</p> <p>☐</p>	<p>CB0150</p> <p>CB0097</p>
<p>2628, 2629, 2633 950 .642-643</p>	<p>☒</p> <p>↪ Ch. No. K794516</p> <p>High Roof</p>	<p>CB0148</p> <p>CB0162</p> <p>CB0163</p>	<p>☐</p> <p>☐</p> <p>☐</p>	<p>CB0150</p> <p>CB0097</p>
<p>2628B, 2629B, 2633B 953 .641 .643</p>	<p>☒</p> <p>↪ Ch. No. K794516</p> <p>High Roof</p>	<p>CB0148</p> <p>CB0162</p> <p>CB0163</p>	<p>☐</p> <p>☐</p> <p>☐</p>	<p>CB0150</p> <p>CB0097</p>



MERCEDES-BENZ LK/LN2 (1968/01-1988/12)

<i>i</i>			<i>i</i>	











2628K, 2629K, 2633K 952 . 641-643	<input checked="" type="checkbox"/>			CB0148			CB0150
		→ Ch. No. K794516		CB0162			CB0097
		High Roof		CB0163			
2636B, 2636K, 2640B, 2640K, 2643B, 2643K 942 . 141-142 943 . 142 . 143	<input checked="" type="checkbox"/>			CB0148			CB0097
				CB0163			
				CB0236⁰			
3236B, 3240B, 3243B 943 . 304-305	<input checked="" type="checkbox"/>			CB0148			
				CB0163			
				CB0236⁰			
3236K, 3240K, 3243K 942 . 307 943 . 304 . 305	<input checked="" type="checkbox"/>			CB0148			
				CB0163			
				CB0236⁰			
3240, 3243 940 . 365	<input checked="" type="checkbox"/>			CB0148			CB0150
				CB0163			CB0097
				CB0236⁰			
3335, 3340, 3343 940 . 163	<input checked="" type="checkbox"/>			CB0148			CB0150
				CB0163			CB0097
				CB0236⁰			
3340K, 3343B 940 . 162-163	<input checked="" type="checkbox"/>			CB0148			
				CB0163			
				CB0236⁰			





































ECONIC (1998/03-2013/04)							
1823L, 1823LL, 1828L, 1828LL, 2628LL	<input checked="" type="checkbox"/>					942 890 0519 958 317 0703 A942 890 0519 A958 317 0703	CB0148

LK/LN2 (1968/01-1988/12)							
709 673 . 001-003						673 317 0103 673 317 0203 673 317 0303	CB0080
709K 673 . 040							CB0080
809 673 . 010-014							CB0080
809K 673 . 042							CB0080







MERCEDES-BENZ LP (1963/02-1984/12)









			
<i>i</i>			
<i>i</i>			









814, 814L 674 .010-014 .210-214					CB0080	<input type="radio"/>
814F 674 .080-082 .090					CB0080	<input type="radio"/>
814K 674 .042	 				CB0080	<input type="radio"/>
814S 674 .042	 				CB0080	<input type="radio"/>
817, 817L 676 .001-004 .066-069 .201-209					CB0080	<input type="radio"/>
817F 676 .080-085					CB0080	<input type="radio"/>
817K 674 .040 .046	 				CB0080	<input type="radio"/>
817S, 817LS 676 .050-051 .060 .250-251 .258	 				CB0080	<input type="radio"/>
914 674 .021-024 678 .002 .003-008					CB0080	<input type="radio"/>
914AK 674 .144-145	 4x4 				CB0080	<input type="radio"/>
914K 674 .044	 				CB0080	<input type="radio"/>
914KO 674 .090					CB0080	<input type="radio"/>
1114, 1114L 675 .012-014 .212-214 678 .012 .013-018					CB0080	<input type="radio"/>
1114AK 675 .142-143 678 .116	 4x4 				CB0080	<input type="radio"/>
1114K 675 .042	 				CB0080	<input type="radio"/>
1114S 675 .052-053	 				CB0080	<input type="radio"/>
1117, 1117L 676 .012-019 .212-219 678 .022 .023-028					CB0080	<input type="radio"/>
1314 675 .032-034					CB0080	<input type="radio"/>
1314AK 675 .146-147	 4x4 				CB0080	<input type="radio"/>
1314K 675 .046	 				CB0080	<input type="radio"/>
1314KO 675 .093					CB0080	<input type="radio"/>

LP (1963/02-1984/12)





















334 37-32LPS				000 891 0305 000 891 0505 000 891 1005 001 323 1900	CB0057	<input type="radio"/>
338L, 338LP					CB0057	<input type="radio"/>
1118L					CB0057	<input type="radio"/>
1418L, 1418LP 338					CB0057	<input type="radio"/>
1518LAK 339					CB0057	<input type="radio"/>
1618L					CB0057	<input type="radio"/>



			
<i>i</i>			<i>i</i>
			

1620L, 1620LA, 1624L, 1624LA					CB0057	<input type="radio"/>
1626LP, 1626LPS, 1632LP, 1632LPK, 1632LPS				000 891 0705	CB0084	<input type="radio"/>
1918L, 1920L, 1920LA, 1921L, 1924L, 1924LA					CB0057	<input type="radio"/>
1926LP, 1926LPS, 1932LP, 1932LPK, 1932LPS					CB0084	<input type="radio"/>
2220LK, 2220LAK, 2620LK, 2620LAK 343					CB0057	<input type="radio"/>
2226LP, 2226LPS, 2232LP, 2232LPK, 2232LPS					CB0084	<input type="radio"/>
2621L 334					CB0057	<input type="radio"/>
2624L, 2624LA 335 336					CB0057	<input type="radio"/>























































































MK (1987/12-1996/09)						
1733LS, 1733S 652 .162				 S 620 890 0019 620 890 0119 A620 890 0019 A620 890 0119	CB0140	<input type="checkbox"/>
1824, 1824L, 2422L, 2427L, 2429, 2433L, 2433LS, 2433S, 2522L				 S 	CB0140	<input type="checkbox"/>
1827, 1827L, 1827LS, 1827S 652 .455-459 .551-553				 S 	CB0140	<input type="checkbox"/>
1831, 1831L, 1831LS, 1831S 652 .405-409 .495-498 .501-503 .508 .591-593				 S 	CB0140	<input type="checkbox"/>
1834, 1834L, 1834LS, 1834S 652 .162				 S 	CB0140	<input type="checkbox"/>
2420, 2420L 654 .411 .413				 S 	CB0140	<input type="checkbox"/>
2426, 2426L 654 .418 .422				 S 	CB0140	<input type="checkbox"/>
2524, 2524L 654 .416-418				 S 	CB0140	<input type="checkbox"/>
2527L 652 .416-418 .422 .455 .457-458				 S 	CB0140	<input type="checkbox"/>
2531, 2531L 652 .495-497 654 .012 .416 .418 .422 655 .405 .406 .408				 S 	CB0140	<input type="checkbox"/>
2534L, 2534LS, 2534S 655 .420-423				 S 	CB0140	<input type="checkbox"/>

MERCEDES-BENZ NG (1973/08-1996/09)























1635, 1635L 645 .026			CB0071				CB0140	
1635, 1635L 645 .076			CB0071				CB0071	
1635K							CB0140	
1635K 645 .127 86/02 → 89/07							CB0071	
1635LS, 1635S 645 .122-123							CB0140	
1635LS, 1635S 645 .172-173			CB0071				CB0071	
1636, 1636L 620 .026			CB0071				CB0140	
1636LS, 1636S 620 .122-123							CB0071	
1638 620 .086 .182-183 80/11 → 86/12			CB0071				CB0071	
1638LS, 1638S 620 .086 .182-183			CB0071				CB0071	
1644 645 .096 86/02 → 89/07			CB0071				CB0071	
1644LS, 1644S 645 .192-193			CB0071				CB0071	
1919, 1919AK, 1919K, 1919S, 1926, 1926A, 1926AK, 1926AS, 1926K, 1926LS, 1926S, 1932, 1932A, 1932AK, 1932AS, 1932K, 1932LS, 1932S 389							CB0104	
1922, 1922AK, 1922K, 1922S, 1928, 1928A, 1928AK, 1928AS, 1928K, 1928L, 1928S, 1936, 1936AK, 1936AS, 1936K, 1936LS, 1936S, 2428, 2528A, 2528AK, 2536AK 621							CB0142	
1933S 621 .142-143 .192			CB0071				CB0071	
1935 656 .025-026 .028							CB0140	

									
			<i>i</i>			<i>i</i>			
1935AK 656 . 327								CB0140	
1935AS, 2035S, 2038S, 3025B, 3025K, 3028, 3028B, 3028K, 3228B, 3228K, 3328B, 3328K, 3528, 3528B								CB0140	
1935S 656 . 122-123								CB0140	
1936K 621 . 127 81/10 → 91/03								CB0071	
1938S, 1938LS 621 . 182				000 891 1805 000 891 1905 000 891 2205	CB0071			CB0071	
2025S, 2219C, 2219CL, 2220, 2220L, 2222, 2222B, 2222K, 2222L, 3025B, 3025K 619								CB0104	
2026S, S 391								CB0142	
2026S, S 391								CB0142	
2026S, S 391								CB0081	
2036LS 622								CB0104	
2036LS 622								CB0142	
2036LS 622								CB0142	
2225, 2225B, 2225L 617 619								CB0104	
2225, 2225B, 2225L 617 619								CB0142	
2225, 2225B, 2225L 617 619								CB0142	
2226, 2226L, 2226LS, 2226S, 2232, 2232L, 2232LS, 2232S 393								CB0104	
2226, 2226L, 2226LS, 2226S, 2232, 2232L, 2232LS, 2232S 393								CB0142	
2226, 2226L, 2226LS, 2226S, 2232, 2232L, 2232LS, 2232S 393								CB0081	
2228								CB0140	
2228								CB0140	
2228, 2228L, 2228S 623								CB0104	
2228, 2228L, 2228S 623								CB0142	
2228, 2228L, 2228S 623								CB0142	
2626, 2626A, 2626AK, 2626AS, 2626B, 2626K, 2626S 395								CB0104	
2626, 2626A, 2626AK, 2626AS, 2626B, 2626K, 2626S 395								CB0142	
2626, 2626A, 2626AK, 2626AS, 2626B, 2626K, 2626S 395								CB0081	



































MERCEDES-BENZ SK (1987/07-1996/09)









			
<i>i</i>			<i>i</i>
			

















































2628, 2628A, 2628AK, 2628AS, 2628B, 2628K, 2628S, 3328, 3328B, 3336, 3336A, 3336AK, 3336K, 3336S 624			 S			 S Saudi Arabia	CB0104	
							CB0142	
2632, 2632A, 2632AK, 2632AS, 2632K, 2632S 395			 S			 S Saudi Arabia	CB0104	
							CB0142	
			 L				CB0081	
2633 624 .048 82/05 → 87/05	6x4							CB0071
2633S 624 .146 .196 82/05 → 87/05	6x4							CB0071
2638S 624 .191 81/01 → 86/12	6x4							CB0071
2650L 655 .182-183 .496	6x4	 L			CB0071			CB0071

SK (1987/07-1996/09)

1728, 1729, 1729L 655 .416 .418						 S	620 890 0019 620 890 0119 A620 890 0019 A620 890 0119	CB0140	
1729L 655.416/418 87/07 → 96/09						 L	000 891 1805 000 891 1905 000 891 2205	CB0071	
1729S, 1729LS, 2038S, 2435, 2538, 2538L, 2635AK, 2635AS, 2638AK, 2653AK, 2653K, 2653S, 3535AK, 3535B, 3535K, 3538AK, 3544LK, 4150K						 S	620 890 0019 620 890 0119 A620 890 0019 A620 890 0119	CB0140	
1735, 1735L 655 .426						 S		CB0140	
1735L 655 .476 87/07 → 96/09				000 891 1805 000 891 1905 000 891 2205	CB0071			CB0071	
1735S, 1735LS 655 .122-123 .522-523						 S		CB0140	
1735S, 1735LS 655 .172-173 .572-573 87/07 → 96/09		 S			CB0071	 S		CB0071	
1748 655 .096 87/07 → 96/09		 L			CB0071	 L		CB0071	
		 S							
1748L 655 .182-183 .494 .496 87/07 → 96/09		 L			CB0071	 L		CB0071	
1748LS 655 .182-183 .592-593 87/07 → 96/09		 L			CB0071	 L		CB0071	
1748S 655 .192-193 87/07 → 96/09		 S			CB0071	 L		CB0071	



			
<i>i</i>			<i>i</i>
			

1838 655 .035-038	 s		CB0071		 L		CB0071	
1838, 1838L 655 .035-038 .434 .436-437					 s		CB0140	
1838, 1838L 655 .086-087 87/07 → 96/09	 L		CB0071		 L		CB0071	
1838, 1838L 655 .182-183 87/07 → 96/09	 s		CB0071					
1838, 1838L 655 .182-183 .484 .486-487 87/07 → 96/09	 L		CB0071		 L		CB0071	
1838S, 1838LS 655 .132-133 .182-183 .532-533 .538					 s		CB0140	
1838S, 1838LS 655 .182-183 .582-583 .588 87/07 → 96/09	 L		CB0071		 L		CB0071	
1844 655 .035-037					 s		CB0140	
1844, 1844L 87/07 → 96/09	 s		CB0071					
1844, 1844L 655 .035-037 .093 87/07 → 96/09	 L		CB0071		 L		CB0071	
1844, 1844L 655 .182-183 .490 .492 87/07 → 96/09	 L		CB0071		 L		CB0071	
1844L, 1844LS 655 .182-183 .434 .436-437 .533					 s		CB0140	
1844S, 1844LS 655 .190-191 .590-591 87/07 → 96/09	 L		CB0071		 L		CB0071	
1850 655 .096 87/07 → 96/09	 L  s		CB0071		 L		CB0071	
1850L 655 .494 .496 87/07 → 96/09	 L		CB0071		 L		CB0071	
1850LS, 1850LAS 655 .592 87/07 → 96/09	 L		CB0071		 L		CB0071	
1850S 655 .133					 s		CB0140	
1850S 655 .192-193 87/07 → 96/09	 L  s		CB0071		 L		CB0071	
1935 656 .025-026 .028 89/05 → 94/08	 L		CB0071		 L		CB0071	
1935 656 .076 .078 89/05 → 94/08					 L		CB0071	
1935 656 .122-123 89/05 → 94/08	 L		CB0071		 L		CB0071	
1935 656 .172 89/05 → 94/08					 L		CB0071	



RENAULT TRUCKS KERAX (1997/06-)

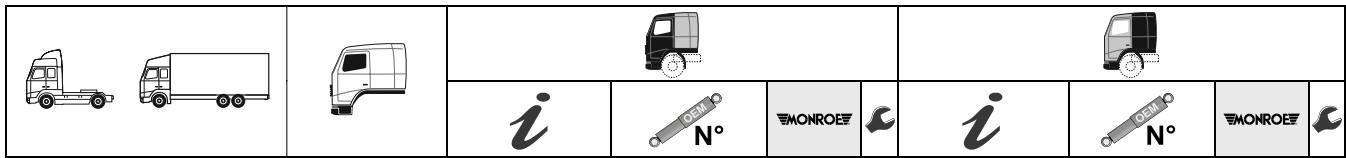

1935S 655 .122-123 89/05 → 94/08			CB0071				CB0071	
1948 655 .592 656 .095 .096 88/09 → 92/07							CB0071	
2544K, 2544L 655 .436-437 659 .144							CB0140	
2550L 655 .496 87/07 → 96/09			CB0071				CB0071	
2635AK 659 .338-339 90/02 → 94/08			CB0071					
2635AS 659 .336 90/02 → 96/08			CB0071					
2644, 2644AK 659 .142 .144							CB0140	
2650 659 .142 .144 .343							CB0140	
3235, 3235K 625 .018-019 .121 .128							CB0140	

RENAULT TRUCKS

KERAX (1997/06-)



















































Kerax 97/06 → 2006/05	Air Spring	5010269605 5010269605C 5010460113 5010615880 7420840318 5010130797 5010629414	CB0046			5010316210 5010316210B 5010316210C	CB0110	
			CB0075			5010460318 5010532897 5010629397	CB0109	
						5010228908 5010269674 5010316783 5010316783A 5010629398	CB0088	
Kerax 2006/05 →	Air Spring	5010629414 7482039600	CB0075			5010629471	CB0064	
			CB0133			20898055 5010552241 7420898055 7482052893 82052893	CB0118	
						5010629213 7482052895 82052895	CB0119	
						5010532895 7482052897	CB0131	

MAGNUM (1990/09-)

AE → 96/09		5000741013 5010052404 5010130534 5010137139 5010460115	CB0052			5000741014 5010052405 5010130535 5010460114	CB0051	
Magnum AE 96/04 → 2000/05	Air Spring	5010370630 5010460116 5000791271 5010320096	CB0053		Air Spring	5000791271 5010320096	CB0076	
			CB0076					



RENAULT TRUCKS PREMIUM (1996/04-2005/10)

										
			<i>i</i>				<i>i</i>			
Magnum DXi 2004/10 →		Air Spring	5010552370	CB0117				5010552010 5010629471	CB0064	
			5010491301	CB0135					CB0118	
									CB0119	
Magnum E-Tech 2000/05 → 2002/03				CB0052					CB0051	
Magnum E-Tech 2002/03 → 2004/10		Air Spring		CB0053					CB0076	
				CB0076						
MAJOR (1991/05-1996/10)										
R340Ti Series, R385Ti Series								5000787974 5010065311 5010130609	CB0069	
R350 Series 91/05 → 92/12			5000787975 5001863294 5010065310	CB0068				5000787974 5010065311 5010130609	CB0069	
MANAGER/MAXTER (1991/09-1996/10)										
G Series	4-point 						Air Spring	5010092916 5010266855 5010313619	CB0082	
MASCOTT										
Mascott 99/01 →	Crew Cab		5010435394	CB0050						
MIDLUM (2001/01-)										
Midlum 2000/01 →			5010460244 5010629761 20578877 25379081	CB0063				5010460198 7482052323	CB0061	
Midlum 2000/01 →			5010460244 5010629761 20578877 25379081	CB0063				5010460212 5010460238 5010552245 7482052324 7482052325 7482052326	CB0062	
PREMIUM (1996/04-2005/10)										
Premium I		Air Spring	5010269605 5010269605C 5010460113 5010615880 7420840318	CB0046				5010316210 5010316210B 5010316210C	CB0110	
			5010130797 5010629414	CB0075				5010460318 5010532897 5010629397	CB0109	
								5010228908 5010269674 5010316783 5010316783A 5010629398	CB0088	
								5010615879	CB0171 ⁰	



RENAULT TRUCKS PREMIUM 2 (2005/10-)

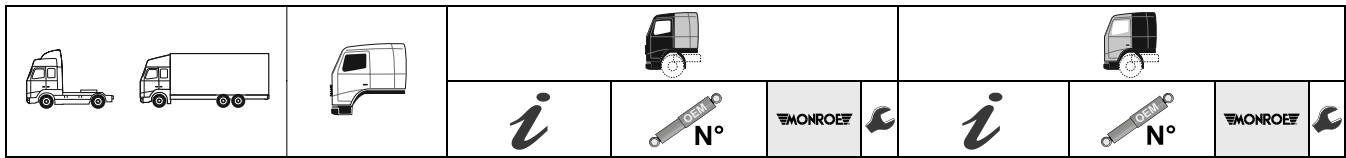

PREMIUM 2 (2005/10-)							
Premium II	Air Spring	5010269605 5010269605C 5010460113 5010615880 7420840318	CB0046	S	5010316210 5010316210B 5010316210C	CB0110	
		5010130797 5010629414	CB0075	L M	5010460318 5010532897 5010629397	CB0109	
				L	5010532895 7482052897	CB0131	
				S	5010228908 5010269674 5010316783 5010316783A 5010629398 5010615879	CB0088	
				L M		CB0171 ⁰	
				L	20898055 5010552241 7420898055 7482052893 82052893	CB0118	
				L	5010552010 5010629471	CB0064	
		R (1980/10-1996/12)					
		R Series 80/10 → 91/05	5000787975 5001863294 5010065310	CB0068	L	5000787974 5010065311 5010130609	CB0069

STEYR					
6, 8, 9, 10 S-SERIE					
6S10F, 6S16F, 8S10F, 8S15F, 8S16F, 9S15F, 9S16F, 10S15F, 10S16F			S	11 52004 40090 15 20044 0090 85 41722 6001	CB0139
			L	81 43701 6629	CB0103
11, 12, 15 S-SERIE					
11S15LL, 11S16LL, 12S15LL, 12S16LL, 15S15L, 15S15LL, 15S16L, 15S16LL, 15S22LLL, 15S26LLL			S		CB0139
			S w/Top sleeper		CB0103
			L		CB0103
19 S-SERIE					
19S29, 19S34			S w/Top sleeper	13 46416 50 81 41722 6010 81 41722 6013 81 41722 6017 81 41722 6045	CB0105
			L	13 46416 50 81 41722 6010 81 41722 6013 81 41722 6017 81 41722 6045	CB0105



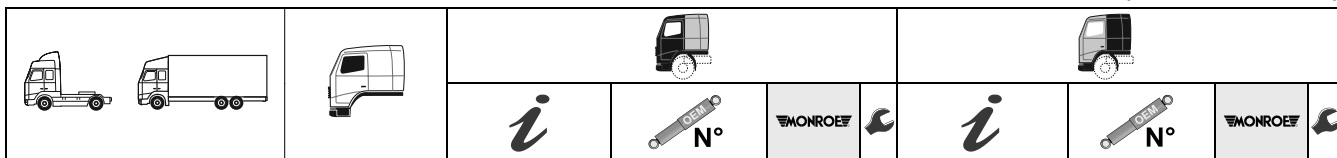

35, 41 S-SERIE									
35S36, 35S41, 41S36, 41S40, 41S41, 41S46							13 46416 50 81 41722 6010 81 41722 6013 81 41722 6017 81 41722 6045	CB0105	⊥ ○
							13 46416 50 81 41722 6010 81 41722 6013 81 41722 6017 81 41722 6045	CB0105	○ ○

SCANIA

P,G,R,T - SERIES (2003/01-)

G2xx, G3xx, G4xx, P2xx, P3xx, P4xx, P5xx, P620, R2xx, R3xx, R4xx, R5xx, R620, R730	2-point All OE=Sachs CP, Crew Cab					Unit without Air Spring	1495642 1505563	CB0134	⊥ ○
						High/Topline Bumper Kit	1444016 1349805 1349810 1923654	CB0130 MK801	
G2xx, G3xx, G4xx, P2xx, P3xx, P4xx, P5xx, P620, R2xx, R3xx, R4xx, R5xx, R620, R730	4-point All OE=Sachs CP, CR	Unit without Air Spring	1363120 1363122 1424227 1424228	CB0058	⊥ T	Unit without Air Spring	1363120 1363122 1424227 1424228	CB0134	⊥ ○
		Air Spring	1349840 1424231	CB0067		Air Spring	1349840 1424231	CB0067	
		Air Spring High/Topline + Crew Cab	1444016	CB0130		Air Spring High/Topline + Crew Cab	1444016	CB0130	
		Bumper Kit	1349805 1349810 1923654	MK801		Bumper Kit	1349805 1349810 1923654	MK801	
G2xx, G3xx, G4xx, P2xx, P3xx, P4xx, P5xx, P620, R2xx, R3xx, R4xx, R5xx, R620, R730	4-point All OE=Monroe CP, CR	Unit without Air Spring	1381904 1397396 1397400 1435859	CB0010	⊥ T	Unit without Air Spring	1502470 1502471 1502474	CB0078	⊥ ○
		Air Spring	1381919 1476415	CB0030		Unit without Air Spring	1502473	CB0160	⊥ ○
		Unit w/Air Spring	1381903 1381904/1381919 1381904/1476415 1397395 1397399 1397400/1381919 1397400/1476415 1435852 1435859/1381919	CB0172	⊥ T	Air Spring	1502468	CB0074	
		Bumper Kit	1435859/1381919	MK801		Bumper Kit	1435859/1381919	MK801	
						Unit without Air Spring	1910106	CB0182	⊥ ○
						Air Spring	1907301	CB0183	
						Unit with Air Spring	1873668 1907301/1910106	CB0194	⊥ ○
G2xx, G3xx, G4xx, P2xx, P3xx, P4xx, P5xx, R2xx, R3xx, R4xx, R5xx, R6xx	CP 19, CP 19F		1466184 1466185 1943267 1943268 2023668	CB0176	⊥ T		1741736 1761373	CB0177	⊥ ○

3 - SERIES (1998/01-1996/12)

T93, T113, T143						Unit without Air Spring	1117326 1331626 1348477	CB0060	⊥ ○
						Air Spring	1116535 1117320 1117326 1117334 1331620 1331621 1331626 1331634 1331635 1348117 1348118 1348121 370227 393257 550365	CB0066	
93						Unit without Air Spring	1340581	CB0014	⊥ ○
						Air Spring	1314278	CB0041	



SCANIA 4 - SERIES (1995/05-2004/09)

















93						370228 393208 393290	CB0015	$\frac{1}{O}$
113, 143	2-point					Unit without Air Spring 1340581 Air Spring 1314278	CB0014 CB0041	$\frac{1}{O}$ $\frac{1}{O}$
113, 143						$\leftarrow \uparrow$	CB0015	$\frac{1}{O}$
113, 143	4-point	Unit without Air Spring 1116535 1117320 1117334 1331620 1331621 1331634 1331635 1348117 1348118 1348119 1348120 370227 393257 550365	CB0065	$\frac{1}{O}$	Unit without Air Spring 1116535 1117320 1117334 1331620 1331621 1331634 1331635 1348117 1348118 1348119 1348120 370227 393257 550365	$\leftarrow \uparrow$	CB0065	$\frac{1}{O}$
		Air Spring 1116535 1117320 1117326 1117334 1331620 1331621 1331626 1331634 1331635 1348117 1348118 1348121 370227 393257 550365	CB0066		Air Spring $\leftarrow \uparrow$		CB0066	

4 - SERIES (1995/05-2004/09)

94, 114, 124, 144, 164 → 2003/07	2-point All OE=Sachs CP, CR					Unit without Air Spring 1349844 1382826 1382827 1382829 1424229 Air Spring 1349840 1424231 Bumper Kit 1349805 1349810 1923654	CB0059 CB0067 MK801	$\frac{1}{T}$
94, 114, 124, 144, 164 2003/08 →	2-point All OE=Sachs CP, Crew Cab					Unit without Air Spring 1495642 1505563 Air Spring 1444016 Bumper Kit 1349805 1349810 1923654	CB0134 CB0130 MK801	$\frac{1}{O}$
94, 114, 124, 144, 164 → 2003/07	4-point All OE=Sachs CP, CR	Unit without Air Spring 1363120 1363122 1424227 1424228 Air Spring 1349840 1424231 Air Spring High/Topline 1444016 Bumper Kit 1349805 1349810 1923654	CB0058	$\frac{1}{T}$	Unit without Air Spring 1349844 1382826 1382827 1382829 1424229 Air Spring 1349840 1424231 Air Spring High/Topline 1444016 Bumper Kit $\leftarrow \uparrow$	CB0059 CB0067 CB0130 MK801	$\frac{1}{T}$	
94, 114, 124, 144, 164 2003/08 →	4-point All OE=Sachs CP, CR	Unit without Air Spring $\leftarrow \uparrow$ Air Spring $\leftarrow \uparrow$ Air Spring High/Topline $\leftarrow \uparrow$ Bumper Kit $\leftarrow \uparrow$	CB0058 CB0067 CB0130 MK801	$\frac{1}{T}$	Unit without Air Spring 1495642 1505563 Air Spring 1349840 1424231 Air Spring High/Topline 1444016 Bumper Kit $\leftarrow \uparrow$	CB0134 CB0067 CB0130 MK801	$\frac{1}{O}$	



									
		<i>i</i>	 N°		<i>i</i>	 N°			
94, 114, 124, 144, 164 → 2003/07	2-point  All OE=Monroe CP, CR, Crew				Unit without Air Spring	1381906 1397394 1397398 1402271 1435856	CB0009	$\frac{1}{T}$	
					Air Spring	1381919 1476415	CB0030		
					Unit w/Air Spring	1381905 1381906/1381919 1381906/1476415 1397393 1397397 1397398/1381919 1397398/1476415 1435853 1435856/1381919 1435856/1476415 1390293	CB0173	$\frac{1}{T}$	
					Air Spring Crew Cab Bumper Kit		MK801		
94, 114, 124, 144, 164 2003/08 →	2-point  All OE=Monroe CP, CR				Unit without Air Spring	1502472	CB0079	$\frac{1}{O}$	
					Unit without Air Spring	1502473	CB0160	$\frac{1}{O}$	
					Air Spring	1502468	CB0074	$\frac{1}{O}$	
					Unit with Air Spring	1502472/1502468 1870893 1871658/1502468	CB0195	$\frac{1}{O}$	
					Bumper Kit		MK801		
94, 114, 124, 144, 164	2-point  All OE=Monroe CT14				Unit without Air Spring	1397386 1397388 1397390 1397392 1431745 1431746 1431747 1431748	CB0011	$\frac{1}{T}$	
					Air Spring		CB0030		
					Bumper Kit		MK801		
94, 114, 124, 144, 164	2-point  All OE=Monroe CT19				Unit without Air Spring	1381904 1397396 1397400 1435859	CB0010	$\frac{1}{T}$	
					Air Spring	1381919 1476415	CB0030		
					Unit w/Air Spring	1381903 1381904/1381919 1381904/1476415 1397395 1397399 1397400/1381919 1397400/1476415 1435852 1435859/1381919	CB0172	$\frac{1}{T}$	
					Bumper Kit	1349805 1349810 1923654	MK801		
94, 114, 124, 144, 164 2003/08 →	4-point  All OE=Monroe CP, CR				Unit without Air Spring	1381904 1397396 1397400 1435859	CB0010	$\frac{1}{T}$	
					Air Spring	1381919 1476415	CB0030		
					Unit w/Air Spring	1381903 1381904/1381919 1381904/1476415 1397395 1397399 1397400/1381919 1397400/1476415 1435852 1435859/1381919	CB0172	$\frac{1}{T}$	
					Bumper Kit	1349805 1349810 1923654	MK801		
94, 114, 124, 144, 164 2003/08 →	4-point  All OE=Monroe CP, CR				Unit without Air Spring	1502470 1502471 1502474	CB0078	$\frac{1}{O}$	
					Unit without Air Spring		CB0160	$\frac{1}{O}$	
					Air Spring		CB0074		
					Bumper Kit		MK801		



VOLVO F 6 (1975/03-1986/02)

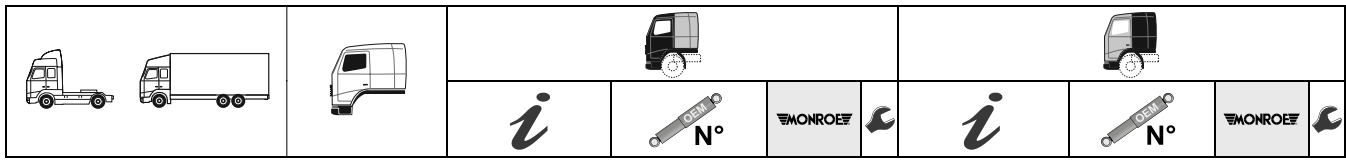

94, 114, 124, 144, 164 4-point All OE=Monroe CT	Unit without Air Spring 1397386 1397388 1397390 1397392 1431745 1431746 1431747 1431748 1397392/1381919 1397392/1476415 1432081 1432082 1432083 1432084	CB0011 CB0011/3 0 CB0030 MK801	Unit without Air Spring 1397392/1381919 1397392/1476415 1432081 1432082 1432083 1432084	CB0011 CB0011/3 0 CB0030 MK801
	Air Spring Bumper Kit	Air Spring Bumper Kit		
94, 114, 124, 164 CP 19, CP 19F	1466184 1466185 1943267 1943268 2023668	CB0176	1741736 1761373	CB0177

VOLVO

F 6 (1975/03-1986/02)

F6 Crew Cab			1505892 1588043 344574 353958	CB0020
-----------------------	--	--	--	---------------

F 7 (1978/08-1985/12)

F7			1580389 1587562	CB0021 CB0022
-----------	--	--	------------------------	--------------------------------

F 10 (1977/08-1994/12)

F10 → Ch.No.25000	1576443 1585586 1622085	CB0025	1586068 1622087 1599459 1622086 6794392	CB0016 CB0021 CB0026
F10 Ch.No.25001 → 40640	1599459 1622086 6794392	CB0026	1599459 1622086 6794392	CB0016 CB0021 CB0026
F10 Ch.No.314000 →		CB0025		CB0016 CB0021 CB0026

F 12 (1977/08-1994/12)

F12 → Ch.No.34000		CB0025		CB0016 CB0021 CB0026
F12 Ch.No.34001 → 65820		CB0026		CB0016 CB0021 CB0026
F12 Ch.No.314000 →		CB0025		CB0016 CB0021 CB0026



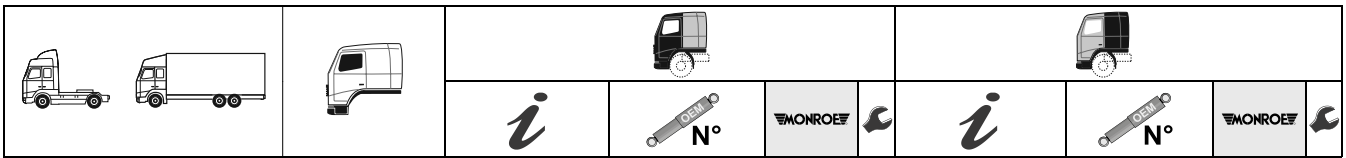

F 16 (1987-1994/12)									
F16			1576443 1585586 1622085	CB0025		1586068 1622087 1580389 1599459 1622086 6794392	CB0016 CB0021 CB0026		
F 80 (1965/08-1978/10)									
F88						1505892 1588043 344574 353958	CB0020		
F 80 (1965/08-1978/10)									
F89							CB0020		
FB88							CB0020		
FE (2006/05-2012/05)									
FE240 Series, FE260 Series, FE280 Series, FE300 Series, FE320 Series, FE340 Series		Air Spring	20721849 20840318 20591506 20906196	CB0046 CB0075		20593743 25379046 20757841	CB0110 CB0088		
FE240 Series, FE260 Series, FE280 Series, FE300 Series, FE320 Series, FE340 Series		Air Spring		CB0046 CB0075		20593746 	CB0109 CB0088		
FE240 Series, FE260 Series, FE280 Series, FE300 Series, FE320 Series, FE340 Series		Air Spring		CB0046 CB0075		20721512 82052897 25379070 20591650 82052893	CB0131 CB0064 CB0118		
FH 12/16 (1993/08-2009/04)									
FH12 → Ch.NoA544695 → Ch.NoB311773			1629722	CB0028		1622227 3198849 3986315 1099672	CB0007 CB0019		
FH12, FH16 → Ch.No2806854 → Ch.NoA257343 → Ch.NoB162550 → Ch.NoC754615 → Ch.NoD100895				CB0028			CB0007 CB0029		
FH12, FH16 → Ch.No2806854 → Ch.NoA257343 → Ch.NoB162550 → Ch.NoC754615 → Ch.NoD100895			1629722	CB0028			CB0004 CB0007 CB0204		
FH12, FH16 Ch.No.2806855 → Ch.No.A257344 → A544696 Ch.No.B162551 → B311774 Ch.No.C754616 → Ch.No.D111199 →				CB0028		1076860 20721166 20960913 21137458 3172986 3198859 	CB0004 CB0007 CB0204		

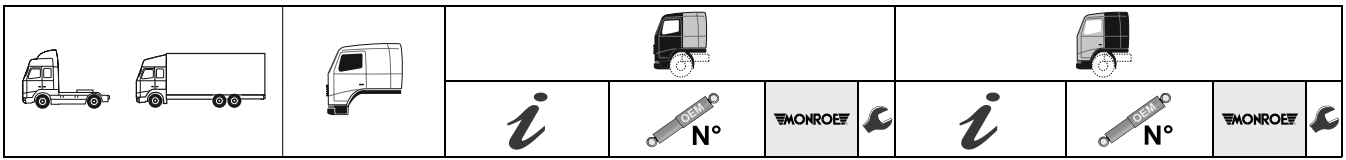

FL 6 (1985/09-2000/03)										
FL6	ex Crewcab							1599459 1622086 6794392	CB0026	○ ○
FL 7 (1985/09-1998/09)										
FL7			1594088		CB0023	○ ○		1089728 1593843 1594089	CB0017	⊥ ⊥
	→ Ch.No.377367 → Ch.No.561896 → Ch.No.904205									
FL7			↙↑		CB0027	○ ○		1089009	CB0018	⊥ ⊥
	Ch.No.377368 → Ch.No.561897 → Ch.No.904206 →									
FL7			↙↑		CB0027	○ ○		↙↑	CB0018	⊥ ⊥
	⊥									
FL 10 (1985/09-1998/09)										
FL10			↙↑		CB0023	○ ○		↙↑	CB0017	⊥ ⊥
	→ Ch.No.377367 → Ch.No.561896 → Ch.No.904205									
FL10			↙↑		CB0027	○ ○		↙↑	CB0018	⊥ ⊥
	⊥									
FL10			↙↑		CB0027	○ ○		↙↑	CB0018	⊥ ⊥
	Ch.No.377368 → Ch.No.561897 → Ch.No.904206 →									
FL 12 (1985/09-1998/09)										
FL12			↙↑		CB0027	○ ○		↙↑	CB0018	⊥ ⊥
FM (2005/09-)										
FM				21170510 21739591	CB0205	⊥ ○	↔	21430905 21171973	CB0209 CB0211	○ ○ ○ ○
	↻									
FM				21430900	CB0210	⊥ ○	↔	21430905 21880100	CB0209 CB0215	○ ○ ○ ○
	↻									
FM 7 (1998/08-2001/12)										
FM7				1075478	CB0008	⊥ ○	↔	1075445 1622227 3198849 3986315 1075444	CB0005 CB0007 CB0038	○ ○ ○ ○ ○ ○
	↻									
	→ Ch.No.A544695 → Ch.No.B311773									
FM 9 (2005/09-)										
FM9				21111925 3198836	CB0040	⊥ ○	↔	1076860 20721166 20960913 21137458 3172986 3198859 1622227 3198849 3986315	CB0004 CB0007	○ ○ ○ ○ ○ ○ ○ ○
	↻									
	Ch.No.0832497 → 0839081 Ch.No.2832815 → 2839005 Ch.No.8833484 → 8838289 Ch.No.A542185 → A572083 Ch.No.B312217 → B351629 Ch.No.D123488 → D124733 Ch.No.S832403 → S838741 Ch.No.T835790 → T839181 Ch.No.X832439 → X837957			Mounting Kit 20453256 20453258 20889132 20889136 21111925 21111932 21111942 3198836 3198837	MK800		↔			

VOLVO FM 10 (1999/04-2001/12)

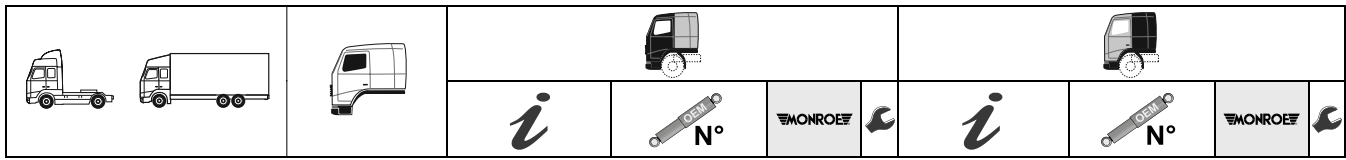

FM9 Ch.No.0832497 → 0839081 Ch.No.2832815 → 2839005 Ch.No.8833484 → 8838289 Ch.No.A542185 → A572083 Ch.No.B312217 → B351629 Ch.No.D123488 → D124732 Ch.No.S832403 → S838741 Ch.No.T835790 → T839181 Ch.No.X832439 → X837957	Unit without Air Spring 20453256 20453258 20889132 20889136 21111932 21111942 3198837	CB0039 ⊥ ○	20427897 20721167 20889138 21032337 21651229 3198850	CB0001 ○ ○			
					Mounting Kit ◀↗ ↖	MK800 ◀↗ ↖	CB0007 ○ ○
					Air Spring 20453258 20889136 21111942 3198837	CB0102	
					Unit with Air Spring 20453258 20889136 21111942 3198837	CB0212 ⊥ ○	

FM 10 (1999/04-2001/12)

FM10 → Ch.NoA544695 → Ch.NoB311773	1075478	CB0008 ⊥ ○	1075445 ↖ 1075444	CB0005 ○ ○ CB0007 ○ ○ CB0038 ○ ○
---	---------	-------------------------	-------------------------	---

FM 12 (1998/08-2005/09)

FM12 → Ch.NoA544695 → Ch.NoB311773	↖ ↖	CB0008 ⊥ ○	↖ ↖ ↖	CB0005 ○ ○ CB0007 ○ ○ CB0038 ○ ○
FM12 Ch.No.2832307 → 2839005 Ch.No.8833484 → 8838289 Ch.No.9839170 → 9839181 Ch.No.A544696 → A572083 Ch.No.B311774 → B351629 Ch.No.D123488 → D124732 Ch.No.H833790 → H838981 Ch.No.S832417 → S838741 Ch.No.W834538 → W838973 Ch.No.X832343 → X837957	↖ ↖	CB0040 ⊥ ○	1076860 20721166 20960913 21137458 3172986 3198859 ↖ ↖	CB0004 ○ ○ CB0007 ○
FM12 Ch.No.2832307 → 2839005 Ch.No.8833484 → 8838289 Ch.No.9839170 → 9839181 Ch.No.A544696 → A572083 Ch.No.B311774 → B351629 Ch.No.D123488 → D124732 Ch.No.H833790 → H838981 Ch.No.S832417 → S838741 Ch.No.W834538 → W838973 Ch.No.X832343 → X837957	↖ ↖ ↖ ↖ ↖	CB0039 ⊥ ○ MK800 ⊥ ○ CB0102 ⊥ ○ CB0212 ⊥ ○	↖ ↖ ↖	CB0001 ○ ○ CB0007 ○ ○

G88

G88			1505892 1588043 344574 353958	CB0020 ○ ○
------------	--	--	--	-------------------------

G89

G89			↖	CB0020 ○ ○
------------	--	--	---	-------------------------

N 7

N7 → Ch.No306000			1508429 1588042	CB0054 ○ ○
----------------------------	--	--	--------------------	-------------------------







N 10

N10 Ch.No.306000 →			1620658	CB0024 ⊥ ⊥
N10 → Ch.No306000			↖ ↖ ²	CB0054 ○ ○

N 12

















N12 → Ch.No306000			↖	CB0054 ○ ○
N12 Ch.No.306000 →			↖	CB0024 ⊥ ⊥





























































		
<i>i</i>	 MONROE 	<i>i</i>  MONROE 

DAF













CF 65 (2001/01-) 









4x2		1382703	T5227			1283735	T5181	
		1382704				1618608		
		1427903				1440457	T5357	
		1618606				1610800		
		1696291				1369711	T5180	
		1696292				1443695		
		1944418				1450885		
		1944419				1606742		

CF 75 (2001/01-) 































4x2		1205672	T5052			1283735	T5181				
		1283723				1618608					
		1283726									
		1327883				1369711			T5180		
		296305				1443695					
	92968	1450885									
		1606742									
		1443696	T5182								
		1606743									
		1649947									
		1382703	T5227			1924212	T5416				
	1382704										
	1427903										
	1618606										
	1696291										
	1696292										
	1944418										
	1944419										
		1205672				T5052			1369711	T5180	
	1283723	1443695									
	1283726	1450885									
	1327883	1606742									
	296305										
	92968										
			T5227			1332448	T5413				
											
6x2						1332448	T5413				
6x2/4											
6x4		1382703	T5227			1369711	T5180				
		1382704				1443695					
		1427903				1450885					
		1618606				1606742					
		1696291				1332448			T5413		
		1896599	T5415								
		1924212	T5416								
											
											
											

CF 75 (2001/01-) 



















4x2		1382703	T5227			1283735	T5181			
		1382704				1618608				
		1427903								
		1618606				1369711			T5180	
		1696291				1443695				
		1450885								
		1606742								
		1332448	T5413							
		1896599	T5415							
		1924212	T5416							
		1205672	T5052			1443696	T5182			
	1283723	1606743								
	1283726	1649947								
	1327883									
	296305									
	92968									

								
	<i>i</i>	 N°			<i>i</i>	 N°		

CF 85 (2001/01-) 

4x2		1205672	T5052			1283735	T5181	
		1283723				1618608		
4x2		1283726	T5227			1369711	T5180	
		1327883				1443695		
		296305				1450885		
		92968				1606742		
		1382703				1443696		
		1382704				1606743		
		1427903				1649947		
		1618606						
		1696291						
		1696292						
1944418								
1944419								
6x2		1205672	T5052			1369711	T5180	
		1283723				1443695		
		1283726				1450885		
		1327883				1606742		
		296305						
		92968						
6x4						1369711	T5180	
						1443695		
						1450885		
						1606742		
8x2			T5227			1369711	T5180	
						1443695		
						1450885		
						1606742		
8x4			T5227			1369711	T5180	
						1443695		
						1450885		
						1606742		

CF 85 (2001/01-) 

4x2		1382703	T5227			1283735	T5181	
		1382704				1618608		
		1427903				1369711		
		1618606				1443695		
		1696291				1450885		
		1696292				1606742		
1944418								
1944419								
6x2			T5227			1369711	T5180	
						1443695		
						1450885		
						1606742		
		1307056	T5288			1449271	T5169	
								
6x4						1282623	T5045	
						1328748		
						252620		
						360585		
						740021		
						755262		
						1369711		
						1443695		
						1450885		
						1606742		

F 1100 

4x2						291614	T5117¹	
-----	--	--	--	--	--	--------	--------------------------	---

F 1300 

4x2						291614	T5117¹	
-----	--	--	--	--	--	--------	--------------------------	---

F 1500 

4x2						291614	T5117¹	
-----	--	--	--	--	--	--------	--------------------------	---

F 1600 

4x2						256260	B1239	
-----	--	--	--	--	--	--------	--------------	---

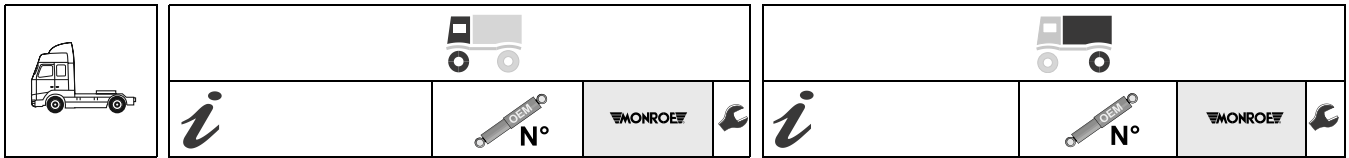

F 1600					
4x2	652722	T1099	⊥ ○	256260	B1239 ⊥ T
				617739 98923	T5143 ¹ ⊥ T

F 1600					
4x2	652722	T1099	⊥ ○	256260	B1239 ⊥ T
				617739 98923	T5143 ¹ ⊥ T

F 1700 (1987-1988)					
4x2	↔ 3650mm, 4000mm, 4450mm, 5550mm, 5050mm, 6100mm	086756 1283724 1283725 1283852 279245 378220 86756	T5053 ⊥ ○	394957	T5108 ⊥ T
				↔ 3650mm, 4000mm, 4450mm, 5550mm, 5050mm, 6100mm	

F 1800					
4x4				256260	B1239 ⊥ T

F 1800 (1970-1982)					
4x4				617739 98923	T5143 ¹ ⊥ T

F 1900 (1987-1993)					
4x2		086756 1283724 1283725 1283852 279245 378220 86756	T5053 ⊥ ○	394957	T5108 ⊥ T

F 1900 (1987-)					
4x2	↔ 3650mm, 4000mm, 4450mm, 5550mm, 5050mm, 6100mm	1283732 222773 086756 1283724 1283725 1283852 279245 378220 86756	T5046 ⊙ ○ T5053 ⊥ ○	394957	T5108 ⊥ T
				↔ 3650mm, 4000mm, 4450mm, 5550mm, 5050mm, 6100mm	

F 2000 (1970-1974)					
4x2				617739 98923	T5143 ¹ ⊥ T

F 2005					
4x2				617739 98923	T5143 ¹ ⊥ T

F 2005 (1970-1971)					
4x2				617739 98923	T5143 ¹ ⊥ T

F 2100					
4x2				617739 98923	T5143 ¹ ⊥ T

F 2105					
4x2	652722	T1099	⊥ ○		
6x2	652722	T1099	⊥ ○		

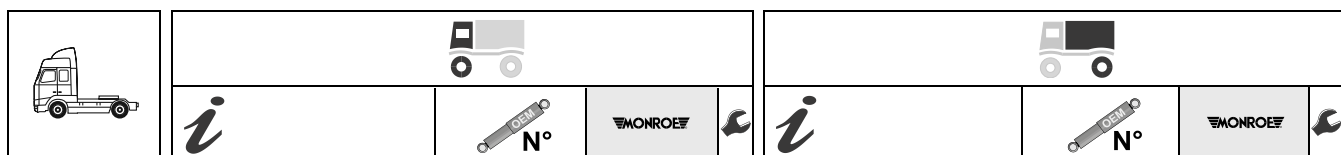

F 2105



4x2	652722	T1099	⊥ ○	617739 98923	T5143 ¹	⊥ T
-----	--------	-------	--------	-----------------	--------------------	--------

F 2300



4x2	652722	T1099	⊥ ○	617739 98923	T5143 ¹	⊥ T
-----	--------	-------	--------	-----------------	--------------------	--------

F 2335



6x4	652722	T1099	⊥ ○			
8x4	652722	T1099	⊥ ○			

F 2500



4x2	652722	T1099	⊥ ○			
6x2	652722	T1099	⊥ ○	617739 98923	T5143 ¹	⊥ T
		T5106 ¹	⊥ ○			
8x4	652722	T1099	⊥ ○	15 - 17 ton 1282623 1328748 252620 360585 740021 755262	T5045	○ ○

F 2500



4x2	652722	T1099	⊥ ○			
-----	--------	-------	--------	--	--	--

F 2505



6x2	652722	T1099	⊥ ○			
-----	--------	-------	--------	--	--	--

F 2525



8x4	652722	T1099	⊥ ○			
-----	--------	-------	--------	--	--	--

F 2535



8x4	652722	T1099	⊥ ○			
-----	--------	-------	--------	--	--	--

F 2700

(1990/01-1990/09)



8x4				15 - 17 ton 1282623 1328748 252620 360585 740021 755262	T5045	○ ○
-----	--	--	--	---	-------	--------

F 2800



4x2	652722	T1099	⊥ ○	617739 98923	T5143 ¹	⊥ T
		T5106 ¹	⊥ ○			
6x2	652722	T1099	⊥ ○			

F 2800



4x2	652722	T1099	⊥ ○	617739 98923	T5143 ¹	⊥ T
		T5106 ¹	⊥ ○			
6x4	652722	T1099	⊥ ○			

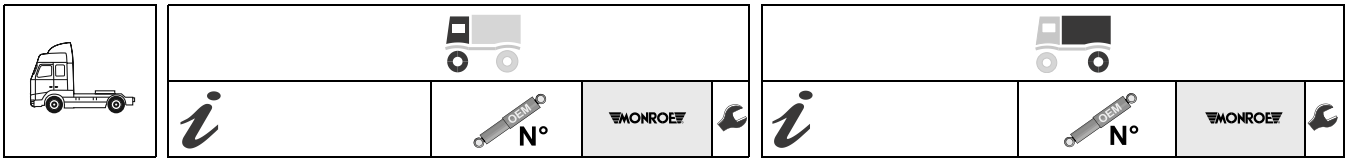

F 2805



4x2	652722	T1099	⊥ ○	617739 98923	T5143 ¹	⊥ T
6x4	652722	T1099	⊥ ○			

F 2805



4x2	652722	T1099	⊥ ○			
-----	--------	-------	--------	--	--	--

F 2825



6x4	652722	T1099	⊥ ○			
-----	--------	-------	--------	--	--	--

F 3300



4x2	652722	T1099	⊥ ○	⊗ ()	617739 98923	T5143 ¹	⊥ T
6x2	652722	T1099	⊥ ○	()	617739 98923	T5143 ¹	⊥ T

F 3300



4x2	652722	T1099	⊥ ○	()	617739 98923	T5143 ¹	⊥ T
		T5106 ¹	⊥ ○				

F 3305



6x2	652722	T1099	⊥ ○	⊗	617739 98923	T5143 ¹	⊥ T
-----	--------	-------	--------	---	-----------------	--------------------	--------

F 3305



4x2	652722	T1099	⊥ ○	⊗	617739 98923	T5143 ¹	⊥ T
-----	--------	-------	--------	---	-----------------	--------------------	--------

F 3600



4x2	652722	T1099	⊥ ○				
-----	--------	-------	--------	--	--	--	--

F 3600



4x2	652722	T1099	⊥ ○				
-----	--------	-------	--------	--	--	--	--

LF 45

(2001/01-)



4x2	1407069 1706888 1707348 AFRE002	V2141	⊥ T	⊗	1407075 AFRE008	T5364	⊥ ○
				8.5 ton	1407074 AFRE007	T1324	⊥ T
				5.5 ton	1407073 AFRE006	V2140	⊥ T

LF 45

(2006/05-)



4x2					1407075 AFRE008	T5364	⊥ ○
-----	--	--	--	--	--------------------	-------	--------

LF 45

(2006/05-)



4x2					1407075 AFRE008	T5364	⊥ ○
-----	--	--	--	--	--------------------	-------	--------



LF 55 (2001/01-)

4x2	☺	1382703	T5227	⊥ T	☺	8.5 ton	1407074	T1324	⊥ T	
		1382704				AFRE007				
		1427903				1407076	T5365			⊥ T
		1618606				1407077				
1696291	1706506	V2140	⊥ T							
1696292	1707385									
		1944418			5.5 ton	1407073			⊥ T	
		1944419				AFRE010			⊥ T	
		1407069	V2141	⊥ T		1369711	T5180	⊥ O		
		1706888								
		1707348				1443695				
		AFRE002				1450885				
		1407070	V2142	⊥ T		1606742				
		AFRE003								

LF 55 (2006/05-)

4x2		1407070	V2142	⊥ T		1407076	T5365	⊥ T
		AFRE003						
						1706506		
						1707385		
						AFRE010		

LF 55 (2006/05-)

4x2		1407070	V2142	⊥ T		1407076	T5365	⊥ T
		AFRE003						
						1706506		
						1707385		
						AFRE010		

XF 95 (1987/09-2006/12)

4x2	☺	1382703	T5227	⊥ T	☺	1283735	T5181	⊥ T		
		1382704				1618608				
		1427903								
		1618606				1369711			T5180	⊥ O
		1696291				1443695				
		1696292				1450885				
		1944418				1606742				
		1944419								
		7.5 ton				1398694			T5183	⊥ T
						1696290				
	1942781									
	1944417									
		1205672	T5052	⊥ O		1443696	T5182	⊥ O		
		1283723				1606743				
		1283726				1649947				
		1327883								
		296305								
		92968								
6x2					☺	1369711	T5180	⊥ O		
					●	1443695				
						1450885				
						1606742				

XF 95 (2002/09-2006/12)

4x2	☺	1205672	T5052	⊥ O	☺	1283735	T5181	⊥ T							
		1283723				1618608									
		1283726													
		1327883				1369711			T5180	⊥ O					
		296305				1443695									
		92968				1450885									
						1606742									
									1382703	T5227	⊥ T		1443696	T5182	⊥ O
						1382704						1606743			
						1427903						1649947			
	1618606														
		1696291													
		1696292													
		1944418													
		1944419													
		1398694	T5183	⊥ T											
		1696290													
		1942781													
		1944417													
6x2	☺		T5227	⊥ T		1369711	T5180	⊥ O							
		☺				1443695									
						1450885									
						1606742									
					☺	1449271	T5169	⊥ O							

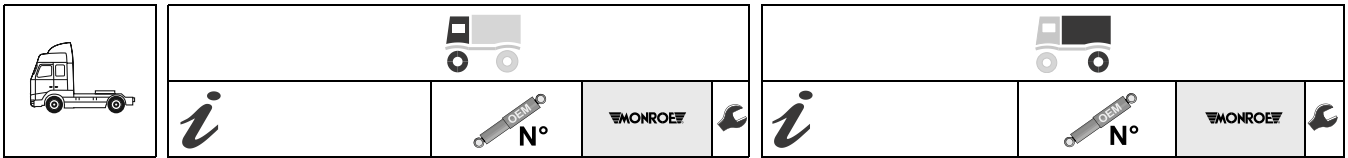

XF 105 (2005/10-)

4x2		086756	T5053			1283735	T5181	
		1283724				1618608		
		1283725						
		1283852						
		279245				1440457		
		378220				1610800		
		86756						
		1382703						
		1382704				1369711		
		1427903				1443695		
1618606	1450885							
1696291	1606742							
1696292								
1944418								
1944419								
	1398694	T5183			1443696	T5182		
	1696290				1606743			
	1942781				1649947			
	1944417							
	1205672							
	1283723							
	1283726							
	1327883							
	296305							
	92968							
6x2						1924212	T5416	
6x2/2/4						1924212	T5416	
6x4						1924212	T5416	
8x4/4						1924212	T5416	

XF 105 (2005/10-)

4x2		086756	T5053			1369711	T5180	
		1283724				1443695		
		1283725				1450885		
		1283852				1606742		
		279245						
		378220						
		86756						
		1382703						
		1382704						
		1427903						
1618606								
1696291								
1696292								
1944418								
1944419								
	1398694	T5183			1443696	T5182		
	1696290				1606743			
	1942781				1649947			
	1944417							
	1205672							
	1283723							
	1283726							
	1327883							
	296305							
	92968							
6x2/2/4						1924212	T5416	
6x2/4						1924212	T5416	
6x4						1924212	T5416	
8x4/4						1924212	T5416	

45

4x2		AMPC151	T1055¹			AMPC157	T1058			
		KAK9866								
		ACHB966				T1056				LAK7101
		ACHF113								LAK7107
		ACHF115								LAK9126
AMPC156		TAK9361								
AMPC158		TAK9362								
KAK9526										
LAK7099										
AMPC156	T1057									
WAK3806										

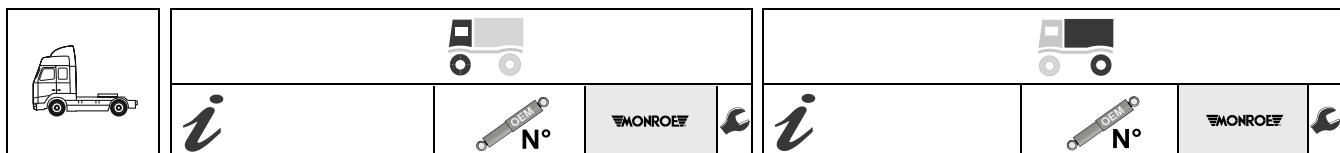

65 (1993/03-1998/02)



4x2	☺	086756 1283724 1283725 1283852 279245 378220 86756	T5053	⊥ ○	☺	1369711 1443695 1450885 1606742	T5180	○ ○
	☹	1382703 1382704 1427903 1618606 1696291 1696292 1944418 1944419	T5227	⊥ T				
4x4					☺	1369711 1443695 1450885 1606742	T5180	○ ○

65 CF (1998/02-2000/12)



4x2	☺	086756 1283724 1283725 1283852 279245 378220 86756	T5053	⊥ ○	☺	1282623 1328748 252620 360585 740021 755262	T5045	○ ○
	☹	1382703 1382704 1427903 1618606 1696291 1696292 1944418 1944419	T5227	⊥ T	☺	1369711 1443695 1450885 1606742	T5180	○ ○
4x4					☺	1369711 1443695 1450885 1606742	T5180	○ ○

75 (1992/07-1998/02)



4x2	☺	086756 1283724 1283725 1283852 279245 378220 86756	T5053	⊥ ○	☹	1283735 1618608	T5181	⊥ T
	☹	1382703 1382704 1427903 1618606 1696291 1696292 1944418 1944419	T5227	⊥ T	☺	1282623 1328748 252620 360585 740021 755262	T5045	○ ○
4x4					☺	1369711 1443695 1450885 1606742	T5180	○ ○
					☺	1443696 1606743 1649947	T5182	○ ○
6x2	☺	☹↗	T5053	⊥ ○	☹	1283729 379131	T5070	⊥ T
6x2	☹	☹↗	T5227	⊥ T	☺	1282623 1328748 252620 360585 740021 755262	T5045	○ ○
					☺	1283732 222773	T5046	○ ○
6x4					☺	1369711 1443695 1450885 1606742	T5180	○ ○
					☺	1286348	T1193	⊥ T
6x4	☺	☹↗	T5053	⊥ ○	☺	1369711 1443695 1450885 1606742	T5180	○ ○

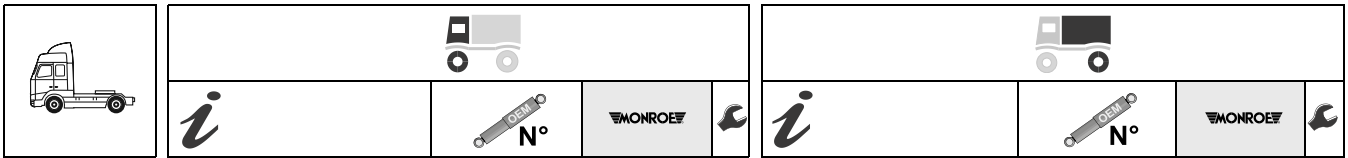

75 (1992/07-1998/02)

















4x2		086756 1283724 1283725 1283852 279245 378220 86756	T5053			1283735 1618608	T5181	
		1382703 1382704 1427903 1618606 1696291 1696292 1944418 1944419				T5227		
6x2			T5053			1282623 1328748 252620 360585 740021 755262	T5045	
			T5227			1369711 1443695 1450885 1606742		

75 CF (1998/02-2000/12)

4x2		086756 1283724 1283725 1283852 279245 378220 86756	T5053			1283735 1618608	T5181	
		1382703 1382704 1427903 1618606 1696291 1696292 1944418 1944419				T5227		
6x2			T5053			1440457 1610800	T5357	
			T5227			1282623 1328748 252620 360585 740021 755262 1369711 1443695 1450885 1606742		
6x4			T5053			1282623 1328748 252620 360585 740021 755262	T5045	
						1369711 1443695 1450885 1606742		































75 CF (1998/02-2000/12)

4x2		086756 1283724 1283725 1283852 279245 378220 86756	T5053			1283735 1618608	T5181	
		1382703 1382704 1427903 1618606 1696291 1696292 1944418 1944419				T5227		
6x2			T5053			1369711 1443695 1450885 1606742	T5180	
			T5227			1443696 1606743 1649947		

								
<i>i</i>	 N°			<i>i</i>	 N°			
6x2	 ↖ ↗	T5053			1282623 1328748 252620 360585 740021 755262	T5045		
	 ↖ ↗	T5227		 ○ ●	1369711 1443695 1450885 1606742	T5180		



















85 (1992/07-1998/02)



	4x2		086756 1283724 1283725 1283852 279245 378220 86756	T5053			1283735 1618608	T5181	
			1382703 1382704 1427903 1618606 1696291 1696292 1944418 1944419	T5227			1282623 1328748 252620 360585 740021 755262	T5045	
							1369711 1443695 1450885 1606742	T5180	
							1443696 1606743 1649947	T5182	
	6x2	 ↖ ↗		T5053			1283729 379131	T5070	
		 ↖ ↗		T5227			1282623 1328748 252620 360585 740021 755262	T5045	
							1369711 1443695 1450885 1606742	T5180	
	6x4	 ↖ ↗		T5053			1369711 1443695 1450885 1606742	T5180	
	8x4	 ↖ ↗		T5053			1369711 1443695 1450885 1606742	T5180	

85 (1992/07-1998/02)



	4x2		086756 1283724 1283725 1283852 279245 378220 86756	T5053			1283735 1618608	T5181	
			1382703 1382704 1427903 1618606 1696291 1696292 1944418 1944419	T5227			1369711 1443695 1450885 1606742	T5180	
							1443696 1606743 1649947	T5182	
	6x2	 ↖ ↗		T5053		 ○ ●	1369711 1443695 1450885 1606742	T5180	
		 ↖ ↗		T5227					
	6x4						1369711 1443695 1450885 1606742	T5180	

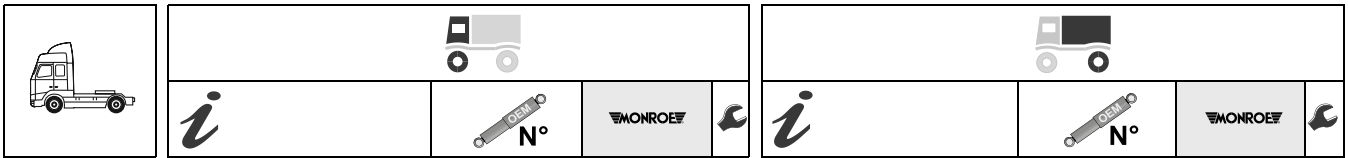

85 CF (1998/02-2000/12)

4x2	☺	1382703	T5227	⊥ ⊥	☺	1283735	T5181	⊥ ⊥	
		1382704				1618608			
6x2	☺	1427903	T5053	⊥ ○	☺	1282623	T5045	○ ○ ○	
		1618606				1328748			
		1696291				252620			
		1696292				360585			
		1944418				740021			
	☺	↗	1944419	T5227	⊥ ⊥	☺	755262	T5180	○ ○ ○
			1369711				1443695		
			1443696				1450885		
			1606742				1606742		
			1649947				1649947		
6x4	☺	086756	T5053	⊥ ○	☺	1282623	T5045	○ ○ ○	
		1283724				1328748			
		1283725				252620			
	☺	↗	1283852	T5227	⊥ ⊥	☺	360585	T5180	○ ○ ○
			279245				740021		
			378220				755262		
86756	1369711	1443695	1450885	1606742	1606742				
8x2	☺	↗	T5053	⊥ ○	☺	1369711	T5180	○ ○ ○	
						1443695			
						1450885			
						1606742			
8x4	☺	↗	T5053	⊥ ○	☺	1282623	T5045	○ ○ ○	
						1328748			
	☺	↗	↗	T5227	⊥ ⊥	☺	252620	T5180	○ ○ ○
							360585		
740021	755262	1369711	1443695	1450885	1606742				



85 CF (1998/02-2000/12)

4x2	☺	086756	T5053	⊥ ○	☺	1283735	T5181	⊥ ⊥	
		1283724				1618608			
		1283725				1282623			
		1283852				1328748			
		279245				252620			
	☺	↗	378220	T5227	⊥ ⊥	☺	360585	T5180	○ ○ ○
			86756				740021		
			1382703				755262		
			1382704				1369711		
			1427903				1443695		
6x2	☺	1618606	T5053	⊥ ○	☺	1282623	T5045	○ ○ ○	
		1696291				1328748			
		1696292				252620			
	☺	↗	1944418	T5227	⊥ ⊥	☺	360585	T5180	○ ○ ○
			1944419				740021		
			1307056				755262		
1369711	1443695	1450885	1606742	1606742					
6x4	☺	↗	T5288	⊥ ⊥	☺	1369711	T5180	○ ○ ○	
						1443695			
						1450885			
						1606742			
8x2	☺	↗	T5053	⊥ ○	☺	1282623	T5045	○ ○ ○	
						1328748			
						252620			
						360585			
8x4	☺	↗	T5227	⊥ ⊥	☺	740021	T5180	○ ○ ○	
						755262			
						1369711			
						1443695			
1450885	1606742	1606742							

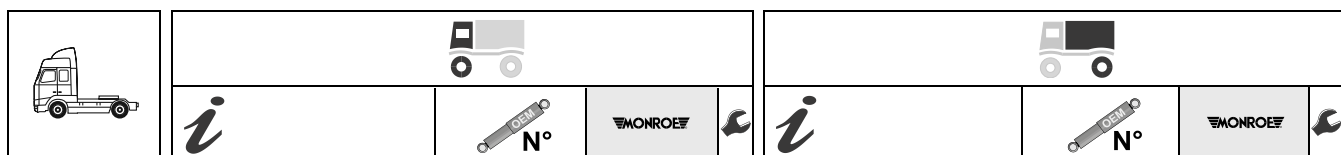

95 (1987/09-1997/02)









































































4x2		1205672	T5052			1283735	T5181	
		1283723				1618608		
		1283726				1369711		
		1327883	T5053			1443695	T5180	
		296305				1450885		
		92968				1606742		
	086756	T5053			1443696	T5182		
	1283724				1606743			
	1283725				1649947			
	1283852	T5227			1282623	T5045		
	279245				1328748			
	378220				252620			
6x2		1382703	T5227			360585	T5180	
		1382704				740021		
		1427903				755262		
		1618606	T5052			1283729	T5070	
		1696291				379131		
		1696292				1282623		
		1944418	T5053			1328748	T5045	
		1944419				252620		
		92968				360585		
		1205672	T5053			740021	T5046	
		1283723				755262		
		1283726				1283732		
	1327883	T5227			222773	T5180		
	296305				1369711			
	92968				1443695			
6x4		1283723	T5052			1450885	T5045	
		1327883				1606742		
		296305				1369711		
		92968	T5053			1443695	T5180	
		1205672				1450885		
		1283723				1606742		
8x2		1327883	T5052			1369711	T5180	
		296305				1443695		
		92968	T5053			1450885	T5180	
		1205672				1606742		
8x4		1327883	T5053			1282623	T5045	
		296305				1328748		
		92968	T5053			252620	T5180	
		1205672				360585		
8x4/4		1327883	T5053			740021	T5045	
		296305				1369711		
		92968	T5053			1443695	T5045	
		1205672				1450885		

95 (1987/09-1997/02)











































































4x2		1205672	T5052			1283735	T5181		
		1283723				1618608			
		1283726				1369711			
		1327883	T5053			1443695	T5180		
		296305				1450885			
		92968				1606742			
	086756	T5053			1443696	T5182			
	1283724				1606743				
	1283725				1649947				
	1283852	T5227			1282623	T5045			
	279245				1328748				
	378220				252620				
6x2		1382703	T5227			360585	T5180		
		1382704				740021			
		1427903				755262			
		1618606	T5052			1283729	T5070		
		1696291				379131			
		1696292				1282623			
		1944418	T5053			1328748	T5045		
		1944419				252620			
		92968				360585			
		1205672	T5053			740021	T5046		
		1283723				755262			
		1283726				1283732			
8x2		1327883	T5053			222773	T5180		
		296305				1369711			
		92968	T5053			1443695	T5180		
		1205672				1450885			
	8x4		1327883	T5053			1282623	T5045	
			296305				1328748		
		92968	T5053			252620	T5180		
		1205672				360585			
8x4/4		1327883	T5053			740021	T5045		
		296305				1369711			
		92968	T5053			1443695	T5045		
		1205672				1450885			

								
	<i>i</i>	 N°			<i>i</i>	 N°		
6x2		1205672 1283723 1283726 1327883 296305 92968	T5052		     	1283729 379131	T5070	
			T5053			1282623 1328748 252620 360585 740021 755262	T5045	     
			T5227			1283732 222773	T5046	    
6x2/4			T5053		   	1282623 1328748 252620 360585 740021 755262	T5045	   
			T5227			1282623 1328748 252620 360585 740021 755262	T5045	  
6x4		1205672 1283723 1283726 1327883 296305 92968	T5052		  	1369711 1443695 1450885 1606742	T5180	  
			T5053			1282623 1328748 252620 360585 740021 755262	T5045	 
			T5227			1369711 1443695 1450885 1606742	T5180	 



95 XF (1997/01-2002/09)



4x2		086756 1283724 1283725 1283852 279245 378220 86756	T5053		     	1283735 1618608	T5181	
		1382703 1382704 1427903 1618606 1696291 1696292 1944418 1944419	T5227			1282623 1328748 252620 360585 740021 755262	T5045	     
		1205672 1283723 1283726 1327883 296305 92968	T5052			1369711 1443695 1450885 1606742	T5180	    
6x2			T5053		  	1369711 1443695 1450885 1606742	T5180	  
			T5227			1282623 1328748 252620 360585 740021 755262	T5045	    
6x4			T5053		  	1369711 1443695 1450885 1606742	T5180	  
			T5227			1282623 1328748 252620 360585 740021 755262	T5045	   
8x2			T5227		 	1369711 1443695 1450885 1606742	T5180	 
8x4			T5227		 	1282623 1328748 252620 360585 740021 755262	T5045	   

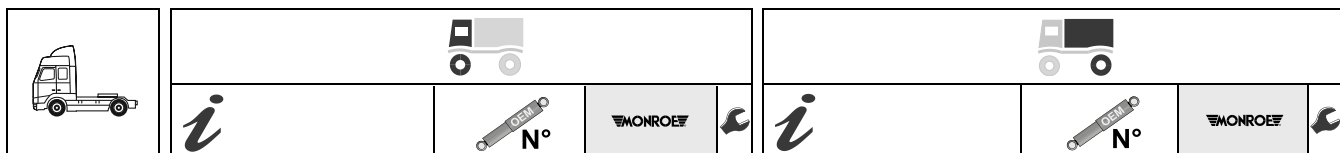

95 XF

(1997/01-2002/09)



4x2		086756 1283724 1283725 1283852 279245 378220 86756	T5053		1283735 1618608	T5181	
		1398694 1696290 1942781 1944417	T5183		1282623 1328748 1328748 252620 360585 740021 755262 1369711 1443695 1450885 1606742 1443696 1606743 1649947	T5045	T5180
6x2		1382703 1382704 1427903 1618606 1696291 1696292 1944418 1944419	T5053		1282623 1328748 252620 360585 740021 755262 1369711 1443695 1450885 1606742 1449271	T5045	
		1382703 1382704 1427903 1618606 1696291 1696292 1944418 1944419	T5227		1282623 1328748 252620 360585 740021 755262 1369711 1443695 1450885 1606742 1606742	T5045	T5180
6x4		1382703 1382704 1427903 1618606 1696291 1696292 1944418 1944419	T5053		1282623 1328748 252620 360585 740021 755262 1369711 1443695 1450885 1606742 1606742	T5045	
		1382703 1382704 1427903 1618606 1696291 1696292 1944418 1944419	T5227		1282623 1328748 252620 360585 740021 755262 1369711 1443695 1450885 1606742 1606742	T5045	T5180

ERF

ECT

(2003/06-)



















4x2			T1266			T5261	
			T1267			T5263	
			T1268			T5275	
			T1318				
			T1320				
6x2-2			T1267			T5261	
			T1268			T5266	
			T1320			T5275	
						T5276	

ECT

(2005/07-)





























































































4x2			T1266			T5261	
			T1267			T5263	
			T1318			T5275	
			T1320				

								
	<i>i</i>				<i>i</i>			
6x2/2			T1266				T5263	
			T1318				T5388	

IVECO

EUROCARGO 

4x2		98447153	T1128		98408701	V2108	
		98482579			98411159		
		99465084	V2104		98415100		
		98408700			99451732		
		98411160	V2105		99451740		
		99451729					
		4844580			4858811	V2109	
		504148140			98426866		
		98415098			99451738		
		98426865					
		99451736	V2107		500358167	T1356	
		99451739					
		98408702					
		98411158	T1242		Hendrickson 504105593	V2134	
		99451728					
		98480455	T1244				
		99473748					
		04859825					
		4859825					
		504148145			504197041	T1243	
		98408706			98436446		
		98408707			98438405		
		98408709			98447147		
		98411167			98482580		
		98411172			98482585		
		98415096			99431723		
		98419046			99465087		
		98445162			99476231		
		98482154			99485542		
		99465078					
		99465079					
		99465081					
		99465082	T1245 ¹				
							
		98480455	T1354		504117411	T1303	
		98493596					
		99473748					
		99473750					
		504120116	T1355		93163957	T1307	
		504147621			99458562		
		504197039					
		504083198	T5427		Hendrickson 504203651	V2133	
		504147774					
		504197043					
		504085814	T5428				
		504147773					
		504197042					
		504052221	V2106		04859825	T1244	
		504052222			4859825		
		504063456			504148145		
		504148138			98408706		
		98464210			98408707		
		99451744			98408709		
		500358166	V2137		98411167		
		504052219			98411172		
		504052220			98415096		
		504063454			98419046		
		504148139			98445162		
		504148143			98482154		
		98464211			99465078		
		99451745			99465079		
					99465081		
					99465082		
					98447155	T1309	
					99449219		
					99465080		
6x4		98480455	T1354				
		98493596					
		99473748					
		99473750					



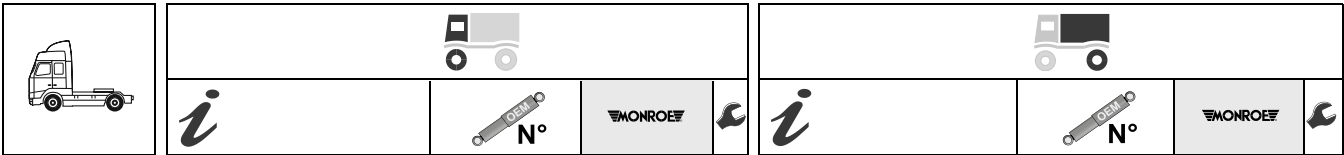

EUROCARGO



4x2		98447153 98482579 99465084	T1128		98408701 98411159 98415100 99451732 99451740	V2108		
		4844580 504148140 98415098 98426865 99451736 99451739	V2105		4858811 98426866 99451738	V2109		
4x2		98480455 99473748	T1242		500358167	T1356		
		04859825 4859825 504148145 98408706 98408707 98408709 98411167 98411172 98415096 98419046 98445162 98482154 99465078 99465079 99465081 99465082	T1244		Hendrickson 504105593	V2134		
4x2		98480455 98493596 99473748 99473750	T1245¹		504197041 98436446 98438405 98447147 98482580 98482585 99431723 99465087 99476231 99485542	T1243		
		504120116 504147621 504197039	T1354		504197041 93163957 99458562	T1303		
4x2		504083198 504147774 504197043	T1355		42565752 500379054	T1307		
		504085814 504147773 504197042	T5427		Hendrickson 504203651	T5389		
4x2		98408700 98411160 99451729	T5428		04859825 4859825 504148145 98408706 98408707 98408709 98411167 98411172 98415096 98419046 98445162 98482154 99465078 99465079 99465081 99465082 98447155 99449219 99465080	V2104	T1244	
		504052221 504052222 504063456 504148138 98464210 99451744	V2106		98408702 98411158 99451728	V2137	T1309	
4x4		504120116 504147621 504197039	T1355		98447155 99449219 99465080	T1243		
			V2137		98447155 99449219 99465080	T1309		
6x2			T1244			T1244		
			T1243			T1243		

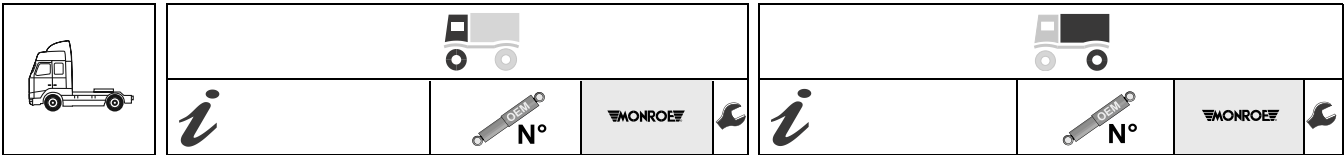









EUROFIRE (1991/01-)

4x2		504120116	T1355	⊥ ○			500358167	T1356	○ ○
		504147621							
		500358166	V2137	○ ○			98447155	T1309	⊥ ○
		504052219					99449219		
		504052220					99465080		
		504063454							
		504148139							
		504148143							
		98464211							
		99451745							

EUROSTAR























4x2	☺	41032334	T1137	⊥ ○	☺		98430151	T5252	⊥ T
		41218439					99474620		
		41218445							
		41218447							
		41272149							
		98414529							
		98414535							
		98430150							
		98432435							
		99474644							
99474655									
	☺	41218437	T1264	○ ○					
		41218443							
		98414527							
		98475501							
		98485037							
		98485038							
		99474645							
		99474649							
	☺	41006921	T1265	○ ○					
		41218440							
		41296756							
		99474646							
		41033038	T1261	⊥ ○					
		41214460							
		41214818							
6x2	☺	☺	T1137	⊥ ○	☺		41033239	T5267	○ ○
		☺					41218432		
		☺	41296212						
		☺	98498740						
			☺	98498741					
			☺	99474638					
				41033039			T5269	○ ○	
				41214461					
				41214700					
				41225418					
		41296211							
		41296216							
		41213451	T5426	○ ○					
		41214699							
6x2/2/4							41213451	T5426	○ ○
						41214699			
6x4	☺	☺	T1137	⊥ ○	☺		41033239	T5267	○ ○
		☺					41218432		
		☺	41296212						
		☺	98498740						
			☺	98498741					
			☺	99474638					
				41033039			T5269	○ ○	
				41214461					
				41214700					
				41225418					
		41296211							
		41296216							
		41006921	T1265	○ ○					
		41218440							
		41296756							
		99474646							

							
	<i>i</i>				<i>i</i>		

EUROSTAR









4x2		41032334 41218439 41218445 41218447 41272149 98414529 98414535 98430150 98432435 99474644 99474655	T1137		98430151 99474620	T5252	
			41218437 41218443 98414527 98475501 98485037 98485038 99474645 99474649	T1264		98414531 98485042 99474622 41033239 41218432 41296212 98498740 98498741 99474638	T1138
6x2		41033038 41214460 41214818	T1137		41033039 41214461 41214700 41225418 41296211 41296216	T5269	
				T1261		98488107 99432314 99474639	T5274
6x4		41033038 41214460 41214818	T1137		41033239 41218432 41296212 98498740 98498741 99474638	T5267	
				T1264		41033039 41214461 41214700 41225418 41296211 41296216	T5269
6x4		41033038 41214460 41214818	T1137		98488107 99432314 99474639	T5274	
				T1261			











EUROTECH MH























4x2					98430151 99474620	T5252	
					41033039 41214461 41214700 41225418 41296211 41296216	T5269	
					98447155 99449219 99465080	T1309	

EUROTECH MH





4x2		41006921 41218440 41296756 99474646	T1265		98430151 99474620	T5252	
					504197041 98436446 98438405 98447147 98482580 98482585 99431723 99465087 99476231 99485542	T1243	
		41033038 41214460 41214818	T1261		41033039 41214461 41214700 41225418 41296211 41296216	T5269	
					98447155 99449219 99465080	T1309	

								
	<i>i</i>	 N°			<i>i</i>	 N°		
6x2		41006921 41218440 41296756 99474646	T1265			41033239 41218432 41296212 98498740 98498741 99474638	T5267	
		41033038 41214460 41214818	T1261			41033039 41214461 41214700 41225418 41296211 41296216	T5269	
6x2/2/4						41213451 41214699	T5426	
6x4		41006921 41218440 41296756 99474646	T1265			41033039 41214461 41214700 41225418 41296211 41296216	T5269	















































EUROTECH MH



4x2		41033038 41214460 41214818	T1261			41033039 41214461 41214700 41225418 41296211 41296216	T5269	
-----	--	----------------------------------	--------------	---	---	--	--------------	---

EUROTECH MP



4x2		41032334 41218439 41218445 41218447 41272149 98414529 98414535 98430150 98432435 99474644 99474655	T1137			98430151 99474620	T5252	
		41218437 41218443 98414527 98475501 98485037 98485038 99474645 99474649	T1264			41033039 41214461 41214700 41225418 41296211 41296216	T5269	
		41006921 41218440 41296756 99474646	T1265			98447155 99449219 99465080	T1309	
		41033038 41214460 41214818	T1261					
6x2			T1137			98414531 98485042 99474622	T1138	
			T1264			41033239 41218432 41296212	T5267	
		41006921 41218440 41296756 99474646	T1265			98498740 98498741 99474638		
		41033038 41214460 41214818	T1261			41033039 41214461 41214700 41225418 41296211 41296216	T5269	
6x2/4						41213451 41214699	T5426	
6x4			T1137			98414531 98485042 99474622	T1138	
			T1264			41033039 41214461 41214700	T5269	
		41006921 41218440 41296756 99474646	T1265			41225418 41296211 41296216		

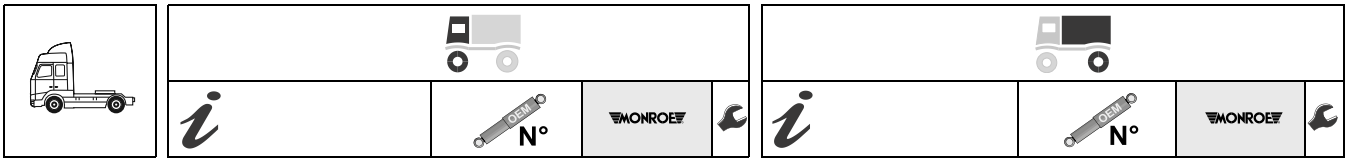

EUROTECH MP



4x2		41032334 41218439 41218445 41218447 41272149 98414529 98414535 98430150 98432435 99474644 99474655	T1137		98414531 98485042 99474622	T1138	
		41218437 41218443 98414527 98475501 98485037 98485038 99474645 99474649	T1264		41033039 41214461 41214700 41225418 41296211 41296216	T5269	
		41033038 41214460 41214818	T1261		98488107 99432314 99474639	T5274	
6x2		↗ 41033038 41214460 41214818	T1264		41033039 41214461 41214700 41225418 41296211 41296216	T5269	
		↗ 41033038 41214460 41214818	T1261		98414531 98485042 99474622	T1138	
6x4		↗ 41033038 41214460 41214818	T1137		41033039 41214461 41214700 41225418 41296211 41296216	T5269	
		↗ 41033038 41214460 41214818	T1264		98488107 99432314 99474639	T5274	
		↗ 41033038 41214460 41214818	T1261				



EUROTECH MT











4x2					504197041 98436446 98438405 98447147 98482580 98482585 99431723 99465087 99476231 99485542	T1243	
					98447155 99449219 99465080	T1309	

EUROTECH MT



























































































































































4x2		41032334 41218439 41218445 41218447 41272149 98414529 98414535 98430150 98432435 99474644 99474655	T1137		98430151 99474620	T5252	
		41218437 41218443 98414527 98475501 98485037 98485038 99474645 99474649	T1264		98414531 98485042 99474622	T1138	
		41033038 41214460 41214818	T1261		504197041 98436446 98438405 98447147 98482580 98482585 99431723 99465087 99476231 99485542	T1243	
		41033038 41214460 41214818	T1261		41033039 41214461 41214700 41225418 41296211 41296216	T5269	
					98447155 99449219 99465080	T1309	

								
	<i>i</i>	 N°			<i>i</i>	 N°		

EUROTRAKKER







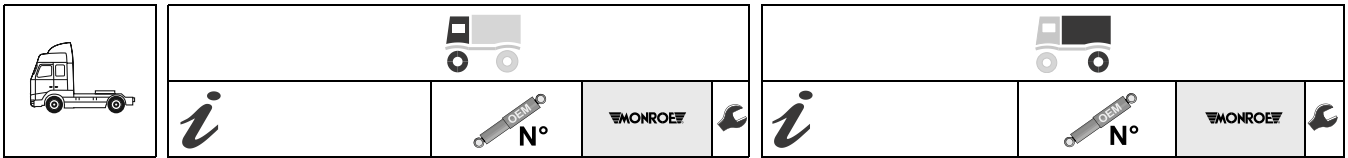

























































































(1993/01-)











4x2		41032334	T1137		98430151	T5252	
		41218439			99474620		
		41218445	T1264		41033039	T5269	
		41218447			41214461		
		41272149	T1265		41214700	T5267	
		98414529			41225418		
		98414535	T5435		41226700	T5267	
		98430150			41272902		
		98432435	T5435		41296211	T5267	
		99474644			41296210		
		99474655	T5435		98430151	T5252	
		41218437			99474620		
		41218443	T5269		41033039	T5269	
		98414527			41214461		
		98475501	T1265		41214700	T5267	
		98485037			41225418		
		98485038	T5435		41296211	T5267	
		99474645			41296216		
		99474649	T5435		41033239	T5267	
		41006921			41218432		
		41218440	T5435		41296212	T5267	
		41296756			98498740		
		99474646	T5435		98498741	T5267	
		41226700			99474638		
		41272902	T5435		98498741	T5267	
		41296210			99474638		
4x4		41226700	T5435		98430151	T5252	
		41272902	T5435		99474620	T5269	
		41296210	T5435		41033039	T5267	
			T5435		41214461	T5267	
			T5435		41214700	T5267	
			T5435		41225418	T5267	
			T5435		41296211	T5267	
			T5435		41296216	T5267	
			T5435		41033239	T5267	
			T5435		41218432	T5267	
			T5435		41296212	T5267	
			T5435		98498740	T5267	
			T5435		98498741	T5267	
			T5435		99474638	T5267	
6x2			T1137		41033039	T5269	
		41006921	T1265		41214461	T5267	
		41218440	T1265		41214700	T5267	
		41296756	T1265		41225418	T5267	
		99474646	T1265		41296211	T5267	
			T1137		41296216	T5267	
			T1137		41033239	T5269	
			T1137		41214461	T5269	
			T1137		41214700	T5269	
			T1137		41225418	T5269	
			T1137		41296211	T5269	
			T1137		41296216	T5269	
			T1137		41033239	T5267	
			T1137		41218432	T5267	
			T1137		41296212	T5267	
			T1137		98498740	T5267	
			T1137		98498741	T5267	
			T1137		99474638	T5267	
6x4			T1137		41033039	T5269	
		41006921	T1265		41214461	T5267	
		41218440	T1265		41214700	T5267	
		41296756	T1265		41225418	T5267	
		99474646	T1265		41296211	T5267	
			T1137		41296216	T5267	
			T1137		41033239	T5269	
			T1137		41214461	T5269	
			T1137		41214700	T5269	
			T1137		41225418	T5269	
			T1137		41296211	T5269	
			T1137		41296216	T5269	
			T1137		41033239	T5267	
			T1137		41218432	T5267	
			T1137		41296212	T5267	
			T1137		98498740	T5267	
			T1137		98498741	T5267	
			T1137		99474638	T5267	
6x6		41226700	T5435		41033239	T5267	
		41272902	T5435		41218432	T5267	
		41296210	T5435		41296212	T5267	
			T5435		98498740	T5267	
			T5435		98498741	T5267	
			T5435		99474638	T5267	
8x4			T1137		41033239	T5267	
			T1137		41218432	T5267	
			T1137		41296212	T5267	
			T1137				























EUROTRAKKER (1993/01-) 

4x2		41006921 41218440 41296756 99474646	T1265	  		98430151 99474620	T5252	  
		41226700 41272902 41296210	T5435	 		41033039 41214461 41214700 41225418 41296211 41296216 41033239 41218432 41296212 98498740 98498741 99474638	T5269	         
4x4		41226700 41272902 41296210	T5435	 		98430151 99474620	T5252	 
			T5269	         				
6x2		41006921 41218440 41296756 99474646	T1265	 		41033039 41214461 41214700 41225418 41296211 41296216	T5269	 
		41226700 41272902 41296210	T5435	 		41033239 41218432 41296212 98498740 98498741 99474638	T5267	     
6x4		41006921 41218440 41296756 99474646	T1265	 		41033039 41214461 41214700 41225418 41296211 41296216	T5269	 
		41226700 41272902 41296210	T5435	 		41033239 41218432 41296212 98498740 98498741 99474638	T5267	     
6x6		41226700 41272902 41296210	T5435	 		41033239 41218432 41296212 98498740 98498741 99474638	T5267	 
8x4		41032334 41218439 41218445 41218447 41272149 98414529 98414535 98430150 98432435 99474644 99474655	T1137	 		41033239 41218432 41296212 98498740 98498741 99474638	T5267	 
		41226700 41272902 41296210	T5435	 				
8x4/4		41226700 41272902 41296210	T5435	 		41033239 41218432 41296212 98498740 98498741 99474638	T5267	 
8x8			T1137	 		41033239 41218432 41296212 98498740 98498741 99474638	T5267	 
		41226700 41272902 41296210	T5435	 				
8x8/4		41226700 41272902 41296210	T5435	 				















		
<i>i</i>	 N°	 N°
		
		



EUROTRAKKER (1993/01-)

4x2		41032334	T1137			98430151	T5252	
		41218439				99474620		
4x4		41218445	T5435				T5269	
		41218447				41033039		
		41272149				41214461		
		98414529				41214700		
		98414535				41225418		
		98430150				41296211		
		98432435				41296216		
		99474644				41033239		
		99474655				41218432		
		41226700				41296212		
		41272902				98498740		
		41296210				98498741		
41296210	99474638							
6x2						41033239	T5267	
6x4			T1137			41033239	T5267	
						41218432		
						41296212		
						41296212		
6x6			T1137			98498740	T5267	
						98498741		
						99474638		
						99474638		

EUROTRAKKER (1999/09-)

6x2		41006921	T1265			41033039	T5269	
		41218440				41214461		
		41296756				41214700		
		99474646				41225418		
6x4		41006921	T1265			41296211	T5269	
		41218440				41296216		
		41296756				41033039		
		99474646				41214461		
8x4		41032334	T1137			41214700	T5267	
		41218439				98498740		
		41218445				98498741		
		41218447				99474638		
		41272149						
		98414529						
		98414535						
		98430150						
		98432435						
		99474644						
		99474655						

P/PA

4x2			42052987	T1131	
6x4			42052987	T1131	

P/PA (-1985)

4x2			42052987	T1131	
-----	--	--	----------	--------------	---

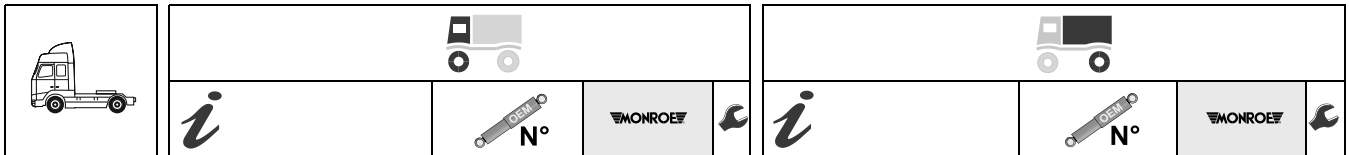

STRALIS (2002/02-)

4x2		41033038 41214460 41214818	T1261			98430151 99474620	T5252				
		41006921 41218440 41296756 99474646				T1265				41210787 41214698 99488018	T5264
										41033735 99488017	
6x2		41033038 41214460 41214818	T1261			41210787 41214698 99488018	T5264				
		41033735 99488017				T1270				41033239 41218432 41296212 98498740 98498741 99474638	T5267
										41033734 500310131	
6x2/2/4		41213451 41214699	T5426			41213451 41214699	T5426				
		6x2/4							41213451 41214699	T5426	
6x4			41033735 99488017	T1270				41210787 41214698 99488018	T5264		
		41033734 500310131	T5268					41213451 41214699		T5426	

STRALIS (2002/02-)

4x2		41033038 41214460 41214818	T1261			41033039 41214461 41214700 41225418 41296211 41296216	T5269	
6x2/4		41033038 41214460 41214818	T1261			41033039 41214461 41214700 41225418 41296211 41296216	T5269	
6x4		41033038 41214460 41214818	T1261			41033039 41214461 41214700 41225418 41296211 41296216	T5269	

TRAKKER (2004/09-)

4x2		41226700 41272902 41296210	T5435					
4x4		41226700 41272902 41296210	T5435					
6x4		41226700 41272902 41296210	T5435					
6x6		41226700 41272902 41296210	T5435					
8x4		41226700 41272902 41296210	T5435					
8x4/4		41226700 41272902 41296210	T5435					
8x8/4		41226700 41272902 41296210	T5435					

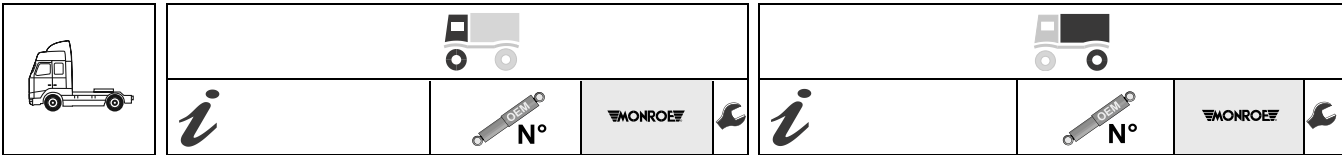

TRAKKER (2004/10-)

4x2	41226700 41272902 41296210	T5435	<input type="checkbox"/>	<input type="checkbox"/>		
4x4	41226700 41272902 41296210	T5435	<input type="checkbox"/>	<input type="checkbox"/>		







TRAKKER (2005/04-)

4x2	41226700 41272902 41296210	T5435	<input type="checkbox"/>	<input type="checkbox"/>		
4x4	41226700 41272902 41296210	T5435	<input type="checkbox"/>	<input type="checkbox"/>		
6x4	41226700 41272902 41296210	T5435	<input type="checkbox"/>	<input type="checkbox"/>		
6x6	41226700 41272902 41296210	T5435	<input type="checkbox"/>	<input type="checkbox"/>		



TRAKKER (2005/06-)

6x4	41226700 41272902 41296210	T5435	<input type="checkbox"/>	<input type="checkbox"/>		
8x4/4	41226700 41272902 41296210	T5435	<input type="checkbox"/>	<input type="checkbox"/>		











TURBOSTAR

4x2	  4400mm, 5005mm	42052982 4697041	T1130	<input type="checkbox"/>	<input type="checkbox"/>	 42052987	T1131	<input type="checkbox"/>	<input type="checkbox"/>
						 3800mm, 5005mm, 5700mm	T1133¹	<input type="checkbox"/>	<input type="checkbox"/>
6x2	 4200mm, 4800mm	42052982 4697041	T1130	<input type="checkbox"/>	<input type="checkbox"/>				
6x4	 4600mm	42052982 4697041	T1130	<input type="checkbox"/>	<input type="checkbox"/>	42052987	T1131	<input type="checkbox"/>	<input type="checkbox"/>





TURBOSTAR







4x2	 2480mm	42052982 4697041	T1130	<input type="checkbox"/>	<input type="checkbox"/>	42052987	T1131	<input type="checkbox"/>	<input type="checkbox"/>
						 3800mm	T1133¹	<input type="checkbox"/>	<input type="checkbox"/>
6x4	 3200mm	42052982 4697041	T1130	<input type="checkbox"/>	<input type="checkbox"/>				

TURBOTECH

4x2	  4000mm, 4400mm, 5005mm, 5700mm  4800mm, 5005mm, 5700mm	42052982 4697041	T1130	<input type="checkbox"/>	<input type="checkbox"/>	 42052987	T1131	<input type="checkbox"/>	<input type="checkbox"/>
						 3485mm, 4000mm, 4400mm, 5005mm, 5700mm, 6100mm  4000mm, 4400mm, 5005mm, 5700mm	T1133¹	<input type="checkbox"/>	<input type="checkbox"/>
6x2	 4210mm, 4610mm, 4800mm  4610mm	42052982 4697041	T1130	<input type="checkbox"/>	<input type="checkbox"/>				
6x4	 4610mm	42052982 4697041	T1130	<input type="checkbox"/>	<input type="checkbox"/>	42052987	T1131	<input type="checkbox"/>	<input type="checkbox"/>
						 4600mm	T1133¹	<input type="checkbox"/>	<input type="checkbox"/>



TURBOTECH

4x2	 3485mm, 3800mm  3485mm, 4000mm	42052982 4697041	T1130	<input type="checkbox"/>	<input type="checkbox"/>	 3485mm, 4000mm	T1133¹	<input type="checkbox"/>	<input type="checkbox"/>
6x4						 3200mm	T1133¹	<input type="checkbox"/>	<input type="checkbox"/>

						
	<i>i</i>	 N°		<i>i</i>	 N°	

ZETA









4x2	4726933	V2088	 
	4750776		
	4829308		
	4829310		
	8563333		
	8566311		
	8566312		
	8568999		
	8569000		
	8585538		

MAN

E 2000

(2000/05-)











6x4			81437016868	T5349	 
6x6			81437016868	T5349	 

E 2000

(2000/05-)









6x4		 ●	81437016926	T5277	 
			81437016868	T5349	 
6x6			81437016868	T5349	 



E 2000

(2000/05-)







6x4		 ●	81437016926	T5277	 
6x6			81437016868	T5349	 

F 8

	81437016097	T5056	 
	81437016128		
	81437016131		
	81437016132		
	81437016134		
	81437016186		
	81437016258		
	81437016345		
	81437016346		

F 8



4x2	19 ton	81437016442	T1028	 
		81437016444		
		81437016456		
		81437016457		
		81437016490		
		81437016491		
		81437016695		
		81437016097		
		81437016128		
		81437016131		
81437016132				
81437016134				
81437016186				
81437016258				
81437016345				
81437016346				
6x4		81437016347	T5041¹	 
		81437016348		

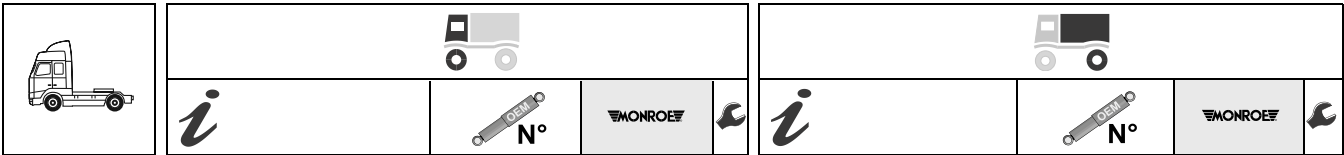

F 8



4x2	19 ton	81437016354	T1116	⊥	81437016253 81437016338 81437016452	T1117	⊙ ⊙
		81437016442	T1028	⊥			
		81437016444		⊥			
		81437016456		⊙			
		81437016457					
		81437016490					
		81437016491					
		81437016695					
		81437016391	T1209	⊥			
		81437016420		⊥			
81437016631		⊙					
81437016651		⊙					
81437016347	T5041 ¹	⊙					
81437016348		⊙					
81437016097	T5056	⊙					
81437016128		⊙					
81437016131							
81437016132							
81437016134							
81437016186							
81437016258							
81437016345							
81437016346							
4x4		81437016347	T5041 ¹	⊙			
		81437016348	T5056	⊙			
6x2		⊙	T1028	⊥	81437016431	T1036	⊥
		81437016347	T5041 ¹	⊙			
		81437016348	T5056	⊙			
6x4		81437016255	T1007	⊙			
		81437016279		⊙			
		81437016280	T1028	⊥			
		81437016426		⊙			
6x6		81437016347	T5041 ¹	⊙			
		81437016348	T5056	⊙			
		81437016255	T1007	⊙			
		81437016279		⊙			
8x4		81437016280	T5041 ¹	⊙			
		81437016426	T5056	⊙			
		81437016347		⊙			
		81437016348		⊙			

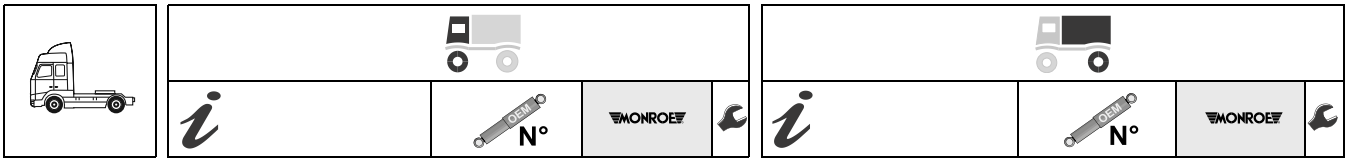

F 8



4x2	81437016442	T1028	⊥ ○	81437016634	T5048	○ ○	
	81437016444						
	81437016456						
	81437016457						
	81437016490						
	81437016491	T1142	⊥ T		81437016634	T5048	○ ○
	81437016695						
	631413031						
	81437016349						
	81437016365						
81437016392	T5041 ¹	○ ○ ○	81437016634	T5048		○ ○	
81437016410							
81437016665							
81437016789							
81437016347							
81437016348	T5056	○ ○ ○		81437016634	T5048	○ ○	
81437016097							
81437016128							
81437016131							
81437016132							
81437016134	T5056	○ ○ ○	81437016634		T5048	○ ○	
81437016186							
81437016258							
81437016345							
81437016346							
6x2	↗	T5056		○ ○			
6x4	↗	T1028		⊥ ○			
	81437016347	T5041 ¹		○ ○			
	81437016348	T5056		○ ○			



F 90





























































4x2				814307026132	T5429	○ ○	
6x4	81437016442	T1028	⊥ ○	81437016594	T5386	⊥ ○	
	81437016444			81437016757	T5429	○ ○ ○ ○ ○	
	81437016456			814307026132			
	81437016457			81437016149			T5069
	81437016490			81437016174			
	81437016491	81437016195					
	81437016695	81437016206					
		81437016218					
		81437016220					
		81437016244					
	81437016287						
	81437016288						
	81437016528						
	81437016710	T5119	○ ○				
	81437016711						
	81437016827						
	81437026131						

F 90























4x2	81437016632	T1043	⊥ T	814307026132	T5429	○ ○
	81437016633	T5080	⊥ T	81437016492	T1090	⊥ T
	81437016442	T1028	⊥ ○	81437016493		
	81437016444			81437016616		
	81437016456			81437016619		
	81437016457			81437016707		
	81437016490			81437016634	T5048	○ ○
	81437016491					
	81437016695	T1029	⊥ ○	81437016149	T5069	⊥ T
	81437016699	T1093	⊥ T	81437016174		
	T5056	○ ○	81437016195			
			81437016206			
			81437016218			
			81437016220			
			81437016244			
			81437016287			
			81437016288			
			81437016528			
			81437016710	T5119	○ ○	
			81437016711			
			81437016827			
			81437026131			

								
	<i>i</i>	 N°			<i>i</i>	 N°		
4x4						814307026132	T5429	
6x2		81437016633	T5080			814307026132	T5429	
			T1028			81437016568	T5047	
		81437016597 81437016598 81437016612	T1093				T5069	
			T5056			81437016710 81437016711 81437016827 81437026131	T5119	
6x2/2/4					814307026132	T5429		
6x2/4			T1028			814307026132	T5429	
		81437016597 81437016598 81437016612	T1093			81437016568 81437016605	T5047	
			T5119				T5069	
6x4			T1028			81437016594 81437016757	T5386	
		81437016597 81437016598 81437016612	T1093			81437016492 81437016493 81437016616 81437016619 81437016707	T1090	
			T5056			81437016568 81437016605	T5047	
			T5119				T5069	
8x4					81437016492 81437016493 81437016616 81437016619 81437016707	T1090		











F 90

























4x2						814307026132	T5429	
6x2/2/4						814307026132	T5429	
6x2/4						814307026132	T5429	
6x4		81437016442 81437016444 81437016456 81437016457 81437016490 81437016491 81437016695	T1028			81437016594 81437016757	T5386	
			T5429			81437016149 81437016174 81437016195 81437016206 81437016218 81437016220 81437016244 81437016287 81437016288 81437016528	T5069	
			T5119			81437016710 81437016711 81437016827 81437026131	T5119	
			T5119					

F 2000















































4x2		81437016793 81437016804	T1189			81437016634	T5048	
			81437016794	T1190				
			82437016017	T1203			814307026132	T5429

							
	<i>i</i>	 N°			<i>i</i>	 N°	

4x4		81437016794	T1190					
6x4						81437016926	T5277	
						81437016868	T5349	
						81437016594 81437016757	T5386	
						81437026132	T5429	
8x4						81437016934 81437026016	T5350	
8x4/4						81437016868	T5349	















F 2000



4x2	 //	81437016793 81437016804	T1189			81437016634	T5048	
		81437016794	T1190					
	 HD	82437016017	T1203			81437016796	T5121	
		81437016097 81437016128 81437016131 81437016132 81437016134 81437016186 81437016258 81437016345 81437016346	T5056			81437026132	T5429	
4x4		81437016794	T1190					
			T5056					
6x2			T5056			81437026132	T5429	
						81437016710 81437016711 81437016827 81437026131	T5119	
6x2/2/4						81437026132	T5429	
6x2/4						81437016796	T5121	
6x4			T5056			81437016926	T5277	
						81437016868	T5349	
						81437016594 81437016757	T5386	
						81437026132	T5429	
8x4						81437016934 81437026016	T5350	
8x4/4						81437016868	T5349	

F 2000



4x2	 //	81437016793 81437016804	T1189			81437016634	T5048	
		81437016794	T1190			81437016796	T5121	
	 HD	82437016017	T1203			81437026132	T5429	
4x4		81437016794	T1190					

	<i>i</i>	N°				<i>i</i>	N°		

6x2	81437016097 81437016128 81437016131 81437016132 81437016134 81437016186 81437016258 81437016345 81437016346	T5056						
6x2/2/4					814307026132	T5429		
6x2/4					81437016796	T5121		
6x4					81437016926	T5277		
					81437016868	T5349		
					81437016594 81437016757	T5386		
					814307026132	T5429		

F 2000 (2000/07-)

6x4					81437016926	T5277		
					81437016868	T5349		
8x4					81437016934 81437026016	T5350		
8x4/4					81437016868	T5349		

F 2000 (2001/05-)

6x2/4					81437016796	T5121		
-------	--	--	--	--	-------------	--------------	--	--

F 90 UNDERFLOOR

4x2		81437016597 81437016598 81437016612	T1093			81437016492 81437016493 81437016616 81437016619 81437016707	T1090	
		81437016632	T1043					
		81437016633	T5080			81437016149 81437016174 81437016195 81437016206 81437016218 81437016220 81437016244 81437016287 81437016288 81437016528	T5069	
		81437016442 81437016444 81437016456 81437016457 81437016490 81437016491 81437016695	T1028			81437016710 81437016711 81437016827 81437026131	T5119	
		81437016597 81437016598 81437016612	T1093			81437016710 81437016711 81437016827 81437026131	T5069	
						81437016710 81437016711 81437016827 81437026131	T5119	
6x4								

F 90 UNTERFLUR (1986/07-1994/05)

4x2					814307026132	T5429		
6x2					814307026132	T5429		

	<i>i</i>				<i>i</i>			

G							
4x2	631413031 81437016349 81437016365 81437016392 81437016410 81437016665 81437016789	T1142	\perp T		81437016253 81437016338 81437016452	T1117	O O

G								
4x2		81437016354 631413031 81437016349 81437016365 81437016392 81437016410 81437016665 81437016789	T1116 T1142	\perp T \perp T	 	81437016253 81437016338 81437016452	T1117	O O
4x4					81437016253 81437016338 81437016452	T1117	O O	

G							
4x2	631413031 81437016349 81437016365 81437016392 81437016410 81437016665 81437016789	T1142	\perp T		81437016253 81437016338 81437016452	T1117	O O









G 90								
4x2		81437016354	T1116	\perp T	 	81437016253 81437016338 81437016452	T1117	O O
4x4						81437016253 81437016338 81437016452	T1117	O O









G 90							
4x2	631413031 81437016349 81437016365 81437016392 81437016410 81437016665 81437016789	T1142	\perp T		81437016253 81437016338 81437016452	T1117	O O

L 2000								
4x2		81437016781 81437016821 81437016864 81437016751	T1334 T1185	\perp T \perp O	 	81437016782 81437016820	T1184	O O
4x4						81437016809	T1350	\perp T

L 2000								
4x2		81437016751	T1185	\perp O				

L 2000								
4x2	 	81437016354 81437016781 81437016821 81437016864 81437016751	T1116 T1334 T1185	\perp T \perp T \perp O	 	81437016253 81437016338 81437016452 81437016782 81437016820 81437016798 81437016860 81437016866	T1117 T1184 T1186 ¹ T1187 T5396	O O O O O O O O O O
4x4						81437016809	T1350	\perp T

							
	<i>i</i>	 N°			<i>i</i>	 N°	

6x4		81437016597	T1093		81437016492	T1090	
		81437016598					
		81437016612			81437016616		
					81437016619		
					81437016707		
					81437016568	T5047	
		81437016632	T1043		81437016605	T5069	
						T5119	
					81437016710		
					81437016711		
					81437016827		
					81437026131		

M 90







4x2					81437016796	T5121	
					81437016492	T1090	
					81437016493		
					81437016616		
					81437016619		
					81437016707		



M 2000 L

(1995/08-)







4x2					814307026132	T5429	
4x4					81437016809	T1350	
6x4/2					81437016890	T5430	

M 2000 L

(1995/08-)



4x2					814307026132	T5429	
4x4					81437016809	T1350	

M 2000 L

(1998/06-)

4x4					81437016809	T1350	
-----	--	--	--	---	-------------	-------	---

M 2000 L

(2001/05-)





6x4/2					81437016890	T5430	
-------	--	--	--	--	-------------	-------	---

M 2000 M

(1995/08-)



4x4					81437016809	T1350	
-----	--	--	--	---	-------------	-------	---

M 2000 M

(1995/08-)



4x4					81437016809	T1350	
-----	--	--	--	---	-------------	-------	---

M 2000 M





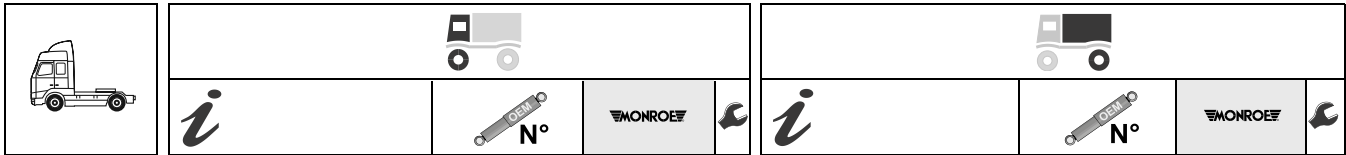



































































































(1998/06-)

4x4					81437016809	T1350	
-----	--	--	--	---	-------------	-------	---



























































































































































































































































TGA (2000/04-)

4x2		81437016902	T1266	⊥		81437016903	T5278	⊥	
		81437016949 81437016991	T1267	⊥		81437016930 81437016974	T5348	⊥	
		81437016897 81437016920 81437016948	T1268	⊥		81437026053 81437026114	T5437	⊥	
		81437026004 81437026005 81437026014 81437026078 81437026086	T1308	⊥		81437016796	T5121	⊥	
		81437016964	T1318	⊥		81437016904	T5261	⊥	
		81437026002 81437026003 81437026077 81437026085	T1320	⊥		81437016905 81437026100	T5263	⊥	
		81437026011 81437026012 81437026076 81437026058	T1321	⊥		81437016908 81437026037	T5275	⊥	
		81437026058	T1333	⊥		81437016926	T5277	⊥	
		81437026079	T1349	⊥		81437016868	T5349	⊥	
						81437016934 81437026016	T5350	⊥	
						81437016965 81437026055 81437026116	T5400	⊥	
		4x4		81437016983 81437016990 81437016992 81437026080 81437026084		T1347	⊥		81437026053 81437026114
4x4H		81437016949 81437016991	T1267	⊥		81437016796	T5121	⊥	
		81437016897 81437016920 81437016948	T1268	⊥		81437016904	T5261	⊥	
		81437026004 81437026005 81437026014 81437026078 81437026086	T1308	⊥		81437016905 81437026100	T5263	⊥	
		81437026002 81437026003 81437026077 81437026085	T1320	⊥		81437016908 81437026037	T5275	⊥	
		81437026079	T1349	⊥		81437016965 81437026055 81437026116	T5400	⊥	
6x2						81437026053 81437026114	T5437	⊥	
6x2/2, 6x2/4		81437016902	T1266	⊥		81437016904	T5261	⊥	
		81437016949 81437016991	T1267	⊥					
		81437016897 81437016920 81437016948	T1268	⊥					
		81437016964	T1318	⊥		81437016905 81437026100	T5263	⊥	
		81437026002 81437026003 81437026077 81437026085	T1320	⊥					
6x2/2,6x2/4						81437016904	T5261	⊥	
						81437016973 81437026108	T5388	⊥	
6x2/2/4						81437026053 81437026114	T5437	⊥	
6x2/4						81437026053 81437026114	T5437	⊥	









								
<i>i</i>					<i>i</i>			
6x2-2	      	81437016902 81437016897 81437016920 81437016948 81437016964 81437026002 81437026003 81437026077 81437026085 81437026011 81437026012 81437026076 81437026058	T1266 T1268 T1318 T1320 T1321 T1333	       	    	81437016904 81437016905 81437026100 81437016945 81437016981 81437026107 81437016965 81437026055 81437026116	T5261 T5263 T5399 T5400	    
6x2-2, 6x2-4		81437016902	T1266	 	     	81437016904 81437016905 81437026100 81437016944 81437016908 81437026037 81437016911 81437016912 81437026119	T5261 T5263 T5266 T5275 T5276	     
6x2-2, 6x2-4	       	81437016902 81437016949 81437016991 81437016897 81437016920 81437016948 81437016964 81437026002 81437026003 81437026077 81437026085 81437026011 81437026012 81437026076 81437026058	T1266 T1267 T1268 T1318 T1320 T1321 T1333	        	        	81437016904 81437016905 81437026100 81437016944 81437016908 81437026037 81437016911 81437016912 81437026119 81437016945 81437016981 81437026107 81437016965 81437026055 81437026116	T5261 T5263 T5266 T5275 T5276 T5399 T5400	        
6x2-4	   	81437016902 81437016949 81437016991 81437016897 81437016920 81437016948 81437026002 81437026003 81437026077 81437026085	T1266 T1267 T1268 T1320	   	       	81437016904 81437016905 81437026100 81437016944 81437016908 81437026037 81437016911 81437016912 81437026119 81437016945 81437016981 81437026107 81437016965 81437026055 81437026116	T5261 T5263 T5266 T5275 T5276 T5399 T5400	    































								
	<i>i</i>	 N°			<i>i</i>	 N°		
6x4		81437016902	T1266			81437016926	T5277	
		81437016949 81437016991	T1267			81437016868	T5349	
		81437016897 81437016920 81437016948	T1268			81437016934 81437026016	T5350	
		81437026004 81437026005 81437026014 81437026078 81437026086	T1308			81437026070	T5431	
		81437016964	T1318			81437026053 81437026114	T5437	
		81437026002 81437026003 81437026077 81437026085	T1320			81437016568 81437016605	T5047	
		81437026011 81437026012 81437026076	T1321			81437016796	T5121	
		81437026058	T1333			81437016905 81437026100	T5263	
		81437026079	T1349			81437016965 81437026055 81437026116	T5400	
						81430726109 81437016975	T5410	
6x4-4					81437016945 81437016981 81437026107	T5399		
6x4H/2, 6x4H/4		81437016897 81437016920 81437016948	T1268			81437016905 81437026100	T5263	
		81437026002 81437026003 81437026077 81437026085	T1320					
6x4H/2,6x4H/4					81437016973 81437026108	T5388		
6x4H-2,6x4H-4		81437016897 81437016920 81437016948	T1268			81437016904	T5261	
						81437016905 81437026100	T5263	
						81437016944	T5266	
						81437016908 81437026037	T5275	
						81437016911 81437016912 81437026119	T5276	
		81437026002 81437026003 81437026077 81437026085	T1320			81437016945 81437016981 81437026107	T5399	
						81437016965 81437026055 81437026116	T5400	
		81437016949 81437016991	T1267			81437016934 81437026016	T5350	
		81437016897 81437016920 81437016948	T1268			81437016901 81437026017	T5411	
		81437026004 81437026005 81437026014 81437026078 81437026086	T1308			81437026071	T5432	
	81437026002 81437026003 81437026077 81437026085	T1320			81437026053 81437026114	T5437		
	81437016983 81437016990 81437016992 81437026080 81437026084	T1347			81437016905 81437026100	T5263		
	81437026079	T1349						















































































































								
	<i>i</i>	 OEM N°	 MONROEE		<i>i</i>	 OEM N°	 MONROEE	
6x6H		81437016949 81437016991	T1267			81437016926	T5277	
		81437016897 81437016920 81437016948	T1268			81437016868	T5349	
		81437026004 81437026005 81437026014 81437026078 81437026086	T1308			81437016905 81437026100	T5263	
		81437026002 81437026003 81437026077 81437026085	T1320			81437016965 81437026055 81437026116	T5400	
		81437026079	T1349			81430726109 81437016975	T5410	
								
								
								
8x2-4		81437016897 81437016920 81437016948	T1268			81437016904	T5261	
		81437026002 81437026003 81437026077 81437026085 81437016995	T1320			81437016905 81437026100	T5263	
			T1353			81437016965 81437026055 81437026116	T5400	
								
8x2-4,8x2-6		81437016897 81437016920 81437016948	T1268			81437016904	T5261	
						81437016905 81437026100	T5263	
						81437016944	T5266	
		81437026002 81437026003 81437026077 81437026085	T1320			81437016908 81437026037	T5275	
						81437016911 81437016912 81437026119	T5276	
						81437016945 81437016981 81437026107	T5399	
						81437016965 81437026055 81437026116	T5400	
								
								
								
8x4		81437016949 81437016991	T1267			81437016926	T5277	
		81437016897 81437016920 81437016948	T1268			81437016868	T5349	
		81437026004 81437026005 81437026014 81437026078 81437026086	T1308			81437016934 81437026016	T5350	
		81437026002 81437026003 81437026077 81437026085	T1320			81437016965 81437026055 81437026116	T5400	
						81430726109 81437016975	T5410	
8x4/4		81437016949 81437016991	T1267			81437026070	T5431	
		81437016897 81437016920 81437016948	T1268					
		81437026004 81437026005 81437026014 81437026078 81437026086	T1308			81437016905 81437026100	T5263	
		81437026002 81437026003 81437026077 81437026085	T1320					
		81437016995	T1353					
								
8x4/6					81437026070	T5431		





































































































































8x4-4		81437016902	T1266						
		81437016897 81437016920 81437016948	T1268						
		81437026002 81437026003 81437026077 81437026085	T1320						
8x4H-6		81437016995	T1353						







































































































TGA (2000/04-) 

4x2		81437016902	T1266						
		81437016949 81437016991	T1267						
		81437016897 81437016920 81437016948	T1268						
		81437026004 81437026005 81437026014 81437026078 81437026086	T1308						
		81437016964	T1318						
		81437026002 81437026003 81437026077 81437026085	T1320						
		81437026011 81437026012 81437026076	T1321						
		81437026058	T1333						
		81437026079	T1349						
	4x4		81437016983 81437016990 81437016992 81437026080 81437026084	T1347					
4x4H		81437016949 81437016991	T1267						
		81437016897 81437016920 81437016948	T1268						
		81437026004 81437026005 81437026014 81437026078 81437026086	T1308						
		81437026002 81437026003 81437026077 81437026085	T1320						
		81437026079	T1349						
	6x2								

								
	<i>i</i>	 OEM N°	 MONROE		<i>i</i>	 OEM N°	 MONROE	
6x2/2, 6x2/4		81437016902	T1266	↑	 ●	81437016904	T5261	○
		81437016949 81437016991	T1267	↑				○
		81437016897 81437016920 81437016948	T1268	↑				○
		81437016964	T1318	↑	 ●	81437016905 81437026100	T5263	○
		81437026002 81437026003 81437026077 81437026085	T1320	○				○
6x2/2,6x2/4				 ●	81437016904	T5261	○	
6x2/2/4				 ●	81437016973 81437026108	T5388	○	
6x2/4					81437026053 81437026114	T5437	○	
6x2-2		81437016902	T1266	↑	 ●	81437016904	T5261	○
	81437016897 81437016920 81437016948	T1268	↑	 ●	81437016905 81437026100	T5263	○	
	81437016964	T1318	↑	 ●	81437016965 81437026055 81437026116	T5400	○	
	81437026002 81437026003 81437026077 81437026085	T1320	○				○	
	81437026011 81437026012 81437026076	T1321	○				○	
	81437026058	T1333	○				○	
6x2-2, 6x2-4		81437016902	T1266	↑	 ●	81437016904	T5261	○
					 ●	81437016905 81437026100	T5263	○
					 ○	81437016944	T5266	○
					 ●	81437016908 81437026037	T5275	○
					 ○	81437016911 81437016912 81437026119	T5276	○
6x2-2,6x2-4		81437016902	T1266	↑	 ●	81437016904	T5261	○
	81437016949 81437016991	T1267	↑	 ●	81437016905 81437026100	T5263	○	
	81437016897 81437016920 81437016948	T1268	↑	 ○	81437016944	T5266	○	
	81437016964	T1318	↑	 ●	81437016908 81437026037	T5275	○	
	81437026002 81437026003 81437026077 81437026085	T1320	○	 ○	81437016911 81437016912 81437026119	T5276	○	
	81437026011 81437026012 81437026076	T1321	○	 ○	81437016945 81437016981 81437026107	T5399	○	
	81437026058	T1333	○	 ●	81437016965 81437026055 81437026116	T5400	○	
6x2-4					 ●	81437016905 81437026100	T5263	○

























































































































































									
	<i>i</i>	 N°			<i>i</i>	 N°			
6x4		81437016902	T1266			81437016926	T5277		
		81437016949 81437016991	T1267			81437016868	T5349		
		81437016897 81437016920 81437016948	T1268			81437016934 81437026016	T5350		
		81437026004 81437026005 81437026014 81437026078 81437026086	T1308			81437016901 81437026017 81437026070	T5411 T5431		
		81437016964	T1318			81437026071	T5432		
		81437026002 81437026003 81437026077 81437026085	T1320			81437026053 81437026114 81437016568 81437016605 81437016796	T5437 T5047 T5121		
		81437026011 81437026012 81437026076 81437026058	T1321			81437016905 81437026100 81437016965 81437026055 81437026116	T5263 T5400		
		81437016983 81437016990 81437016992 81437026080 81437026084 81437026079	T1347			81430726109 81437016975	T5410		
		81437026059	T1349						
			T1357						
	6x4H/2, 6x4H/4		81437016897 81437016920 81437016948	T1268			81437016905 81437026100	T5263	
			81437026002 81437026003 81437026077 81437026085	T1320					
	6x4H/2,6x4H/4						81437016973 81437026108	T5388	
	6x4H-2,6x4H-4		81437016897 81437016920 81437016948	T1268			81437016796	T5121	
							81437016904	T5261	
						81437016905 81437026100	T5263		
						81437016944	T5266		
						81437016908 81437026037	T5275		
						81437016911 81437016912 81437026119	T5276		
						81437016945 81437016981 81437026107	T5399		
						81437016965 81437026055 81437026116	T5400		
									
									

									
	<i>i</i>	 N°			<i>i</i>	 N°			
6x6		81437016949 81437016991	T1267	 	 ●	81437016934 81437026016	T5350	 	
		81437016897 81437016920 81437016948	T1268	 	 ●	81437016901 81437026017	T5411	 	
		81437026004 81437026005 81437026014 81437026078 81437026086	T1308	   		81437026071	T5432	 	
		81437026002 81437026003 81437026077 81437026085	T1320	  		81437026053 81437026114	T5437	 	
		81437016983 81437016990 81437016992 81437026080 81437026084 81437026079	T1347	  	 ●	81437016905 81437026100	T5263	 	
			T1349	 					
	6x6H		81437016949 81437016991	T1267	 	 ●	81437016926	T5277	 
			81437016897 81437016920 81437016948	T1268	 	 ●	81437016868	T5349	 
			81437026004 81437026005 81437026014 81437026078 81437026086	T1308	  	 ●	81437016905 81437026100	T5263	 
		81437026002 81437026003 81437026077 81437026085 81437026079	T1320	  	 ●	81437016965 81437026055 81437026116	T5400	 	
			T1349	 	 ●	81430726109 81437016975	T5410	 	
8x4/4			81437016902	T1266	 	 ●	81437016905 81437026100	T5263	 
			81437026002 81437026003 81437026077 81437026085	T1320	  	 ●	81437016926	T5277	 
							81437026070	T5431	 
8x8					 ●	81437016901 81437026017	T5411	 	
8x8/4		81437026004 81437026005 81437026014 81437026078 81437026086	T1308	 					
		81437016983 81437016990 81437016992 81437026080 81437026084	T1347	 					













































































































































































































TGA (2000/10-) 

6x4		81437016902	T1266	 	 ●	81437016926	T5277	 
		81437016949 81437016991	T1267	 				
		81437016897 81437016920 81437016948	T1268	 	 ●	81437016868	T5349	 
		81437026004 81437026005 81437026014 81437026078 81437026086	T1308	  	 ●	81437016934 81437026016	T5350	 
		81437016964	T1318	 		81437026070	T5431	 
		81437026002 81437026003 81437026077 81437026085	T1320	  		81437026053 81437026114	T5437	 
		81437026011 81437026012 81437026076 81437026079	T1321	 	 ●	81437016905 81437026100	T5263	 
			T1349	 				





































































































								
	<i>i</i>	 N°			<i>i</i>	 N°		
6x6		81437016949 81437016991	T1267	  		81437016934 81437026016	T5350	 
		81437016897 81437016920 81437016948	T1268	  				
		81437026004 81437026005 81437026014 81437026078 81437026086	T1308	    		81437026053 81437026114	T5437	 
		81437026002 81437026003 81437026077 81437026085 81437026079	T1320	    				
			T1349	 				
6x6H						81437016926	T5277	 
						81437016868	T5349	 
8x4		81437016897 81437016920 81437016948	T1268	  		81437016926	T5277	 
		81437026004 81437026005 81437026014 81437026078 81437026086	T1308	    		81437016868	T5349	   
		81437026002 81437026003 81437026077 81437026085	T1320	   		81437016934 81437026016	T5350	  
		81437016949 81437016991	T1267	  				
		81437016897 81437016920 81437016948	T1268	  		81437026070	T5431	 
		81437026004 81437026005 81437026014 81437026078 81437026086	T1308	    				
		81437026002 81437026003 81437026077 81437026085 81437016995	T1320	    				
			T1353	 				
8x6H		81437016995	T1353	 		81437016868	T5349	 
						81437016934 81437026016	T5350	 





















TGA (2000/10-) 

4x2		81437016902	T1266	  		81437016903	T5278	 
		81437016949 81437016991	T1267	  		81437016930 81437016974	T5348	 
		81437016897 81437016920 81437016948	T1268	  		81437026053 81437026114	T5437	 
		81437026004 81437026005 81437026014 81437026078 81437026086	T1308	    		81437016796	T5121	   
		81437016964	T1318	  		81437016904	T5261	  
		81437026002 81437026003 81437026077 81437026085	T1320	   		81437016905 81437026100	T5263	  
			T1349	 		81437016908 81437026037	T5275	 
						81437016926	T5277	 
						81437016868	T5349	 
						81437016934 81437026016	T5350	 
		81437026079	T1349	 		81437016965 81437026055 81437026116	T5400	  
4x4		81437016983 81437016990 81437016992 81437026080 81437026084	T1347	   		81437026053 81437026114	T5437	 
						81437016905 81437026100	T5263	 





















































											
i	 N°			i	 N°			i	 N°		
4x4H	      	81437016949 81437016991 81437016897 81437016920 81437016948 81437026004 81437026005 81437026014 81437026078 81437026086 81437026002 81437026003 81437026077 81437026085 81437026079	T1267 T1268 T1308 T1320 T1349	      	81437016796 81437016904 81437016905 81437026100 81437016908 81437026037 81437016965 81437026055 81437026116	T5121 T5261 T5263 T5275 T5400	      				
6x2-4			81437016905 81437026100	T5263	 						
6x4	                	81437016902 81437016949 81437016991 81437016897 81437016920 81437016948 81437026004 81437026005 81437026014 81437026078 81437026086 81437016964 81437026002 81437026003 81437026077 81437026085 81437026011 81437026012 81437026076 81437016983 81437016990 81437016992 81437026080 81437026084 81437026079 81437026059	T1266 T1267 T1268 T1308 T1318 T1320 T1321 T1347 T1349 T1357	                	81437016926 81437016868 81437016934 81437026016 81437016901 81437026017 81437026070 81437026071 81437026053 81437026114 81437016568 81437016605 81437016796 81437016905 81437026100 81437016965 81437026055 81437026116 81430726109 81437016975	T5277 T5349 T5350 T5411 T5431 T5432 T5437 T5047 T5121 T5263 T5400 T5410	                				
6x4-4			81437016945 81437016981 81437026107	T5399	 						
6x6	         	81437016949 81437016991 81437016897 81437016920 81437016948 81437026004 81437026005 81437026014 81437026078 81437026086 81437026002 81437026003 81437026077 81437026085 81437016983 81437016990 81437016992 81437026080 81437026084 81437026079	T1267 T1268 T1308 T1320 T1347 T1349	        	81437016934 81437026016 81437016901 81437026017 81437026071 81437026053 81437026114 81437016905 81437026100	T5350 T5411 T5432 T5437 T5263	        				















								
	<i>i</i>	 N°			<i>i</i>	 N°		
6x6H		81437016949 81437016991	T1267			81437016926	T5277	
		81437016897 81437016920 81437016948	T1268			81437016868	T5349	
		81437026004 81437026005 81437026014 81437026078 81437026086	T1308			81437016905 81437026100	T5263	
		81437026002 81437026003 81437026077 81437026085 81437026079	T1320			81437016965 81437026055 81437026116	T5400	
			T1349			81430726109 81437016975	T5410	
8x4		81437016949 81437016991	T1267			81437016926	T5277	
		81437016897 81437016920 81437016948	T1268			81437016868	T5349	
		81437026004 81437026005 81437026014 81437026078 81437026086	T1308			81437016934 81437026016	T5350	
		81437026002 81437026003 81437026077 81437026085	T1320			81437016965 81437026055 81437026116	T5400	
						81430726109 81437016975	T5410	
8x4/4		81437016949 81437016991	T1267			81437026070	T5431	
		81437016897 81437016920 81437016948	T1268					
		81437026004 81437026005 81437026014 81437026078 81437026086	T1308			81437016905 81437026100	T5263	
		81437026002 81437026003 81437026077 81437026085 81437016995	T1320					
			T1353					
8x6		81437026004 81437026005 81437026014 81437026078 81437026086	T1308			81437016901 81437026017	T5411	
		81437016983 81437016990 81437016992 81437026080 81437026084	T1347			81437016905 81437026100	T5263	
8X6/4						81437026071	T5432	
						81437016905 81437026100	T5263	
8x6H		81437026004 81437026005 81437026014 81437026078 81437026086	T1308			81437016868	T5349	
						81437016934 81437026016	T5350	
						81437016965 81437026055 81437026116	T5400	
		81437016995	T1353			81430726109 81437016975	T5410	
8x8		81437016983 81437016990 81437016992 81437026080 81437026084	T1347			81437016901 81437026017	T5411	
						81437016905 81437026100	T5263	

								
	<i>i</i>	 N°			<i>i</i>	 N°		
8x8/4		81437026004 81437026005 81437026014 81437026078 81437026086	T1308	  		81437026071	T5432	 
		81437016983 81437016990 81437016992 81437026080 81437026084	T1347	  				













TGA (2000/12-)

6x2/2, 6x2/4		81437016902	T1266	  	 ●	81437016904	T5261	 
		81437016949 81437016991	T1267	 				
		81437016897 81437016920 81437016948	T1268	  				
		81437016964	T1318	 	 ●	81437016905 81437026100	T5263	 
		81437026002 81437026003 81437026077 81437026085	T1320	   				
					 ●	81437016904	T5261	 
6x2/2,6x2/4				 ●	81437016973 81437026108	T5388	 	
6x2/4					81437026053 81437026114	T5437	 	
6x4					81437026070	T5431	 	
					81437026053 81437026114	T5437	 	
6x4H/2, 6x4H/4		81437016897 81437016920 81437016948	T1268	 	 ●	81437016905 81437026100	T5263	 
		81437026002 81437026003 81437026077 81437026085	T1320	  				
6x4H/2,6x4H/4				 ●	81437016973 81437026108	T5388	 	



































TGL (2005/04-)

4x2		85437016006	T1322	 	 ●	85437016007	T1344	 
		85437016028	T1345	 	 ●	81437026000	T1313	 

TGL (2005/04-)

4x2		85437016006	T1322	 	 ●	85437016007	T1344	 
		85437016028	T1345	 	 ●	81437026000	T1313	 

TGM (2005/10-)

4x2		85437016014	T1346	 	 ●	81437016253 81437016338 81437016452	T1117	  
		85437016020	T1359	 	 ●	81437016965 81437026055 81437026116	T5400	  
4x4		85437016020	T1359	 	 ●	81437026030 81437026048 85437016035	T5406	  
6x4		85437016014	T1346	 	 ●	81437026030 81437026048 85437016035	T5406	  
		85437016020	T1359	 	 ●	81437016868	T5349	 

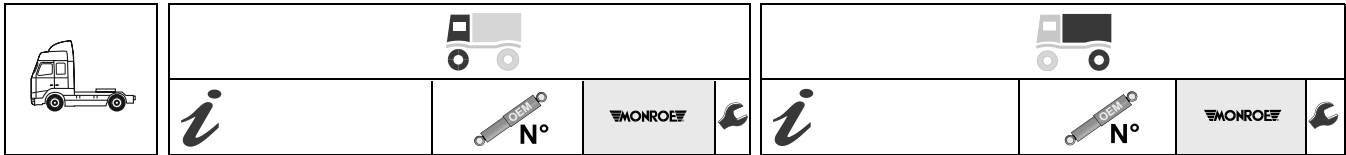

TGM (2005/10-)







































































































4x2		85437016014	T1346			81437016253	T1117	
		85437016016 85437016034	T1348			81437016338 81437016452	T5400	
		85437016020	T1359			81437016965 81437026055 81437026116	T5406	
4x4		85437016020	T1359			81437026030 81437026048 85437016035	T5406	
6x2/4		85437016020	T1359					
6x2-4		85437016014	T1346			81437026030 81437026048 85437016035	T5406	
6x4		85437016014	T1346			81437016868	T5349	
		85437016020	T1359					

TGM (2006/04-)





































6x4		85437016014	T1346			81437016868	T5349	
		85437016020	T1359					

TGS (2007/09-)

4x2		81437016949 81437016991	T1267			81437016903	T5278	
		81437026004 81437026005 81437026014 81437026078 81437026086	T1308			81437026053 81437026114 81437016796	T5437	
		81437026002 81437026003 81437026077 81437026085	T1320			81437016904 81437016950	T5261	
		81437026011 81437026012 81437026076	T1321			81437016905 81437026100	T5262	
		81437026058	T1333			81437016908 81437026037	T5275	
		81437026079	T1349			81437016965 81437026055 81437026116	T5400	
		81437016983 81437016990 81437016992 81437026080 81437026084	T1347			81437026053 81437026114 81437016905 81437026100	T5437	
		81437016949 81437016991	T1267			81437016796	T5121	
4x4		81437016897 81437016920 81437016948	T1268			81437016904	T5261	
		81437026004 81437026005 81437026014 81437026078 81437026086	T1308			81437016905 81437026100	T5263	
		81437026002 81437026003 81437026077 81437026085	T1320			81437016908 81437026037	T5275	
		81437026011 81437026012 81437026076	T1321			81437016965 81437026055 81437026116	T5400	
		81437026058	T1333					
		81437026079	T1349					
		81437016983 81437016990 81437016992 81437026080 81437026084	T1347					
		81437016949 81437016991	T1267					
6x2					81437026053 81437026114	T5437		

								
<i>i</i>					<i>i</i>			
6x2/2, 6x2/4	 	81437026002 81437026003 81437026077 81437026085 81437026011 81437026012 81437026076 81437026058	T1320 T1321 T1333	 	 ●	81437016905 81437026100	T5263	 
6x2/2,6x2/4		 ○ ○	81437016973 81437026108	T5388	 			
6x2/2/4			81437026053 81437026114	T5437	 			
6x2-2	  	81437016897 81437016920 81437016948 81437026002 81437026003 81437026077 81437026085 81437026011 81437026012 81437026076 81437026058	T1268 T1320 T1321 T1333	  	 ●  ●	81437016905 81437026100 81437016965 81437026055 81437026116	T5263 T5400	  
6x2-2, 6x2-4	  	81437026002 81437026003 81437026077 81437026085 81437026011 81437026012 81437026076 81437026058	T1320 T1321 T1333	  	 ●  ●	81437016904 81437016905 81437026100	T5261 T5263	  
6x2-2,6x2-4		 ○  ●  ○  ○  ●	81437016944 81437016908 81437026037 81437016911 81437016912 81437026119 81437016945 81437016981 81437026107 81437016965 81437026055 81437026116	T5266 T5275 T5276 T5399 T5400	    			
6x4	       	81437016949 81437016991 81437016897 81437016920 81437016948 81437026004 81437026005 81437026014 81437026078 81437026086 81437026002 81437026003 81437026077 81437026085 81437026011 81437026012 81437026076 81437026058 81437026079	T1267 T1268 T1308 T1320 T1321 T1333 T1349	       	 ●  ●  ●  ●  ●  ●  ●  ●	81437016926 81437016868 81437016934 81437026016 81437026070 81437016954 81437026053 81437026114 81437016905 81437026100 81437016965 81437026055 81437026116 81430726109 81437016975	T5277 T5349 T5350 T5431 T5436 T5437 T5263 T5400 T5410	       
6x4H/2, 6x4H/4	 	81437026002 81437026003 81437026077 81437026085 81437026011 81437026012 81437026076	T1320 T1321	 	 ●	81437016905 81437026100	T5263	 
6x4H/2,6x4H/4		 ○ ○	81437016973 81437026108	T5388	 			
6x4H-2, 6x4H-4	 	81437026002 81437026003 81437026077 81437026085 81437026011 81437026012 81437026076	T1320 T1321	 	 ●  ●	81437016904 81437016905 81437026100	T5261 T5263	 











































								
	<i>i</i>	 N°			<i>i</i>	 N°		
6x4H-2,6x4H-4		81437016897	T1268		 ○	81437016944	T5266	○
		81437016920				 ●		
81437016948	 ○	81437016911			T5276	○		
6x6		81437016983	T1347	○	 ●	81437016901	T5411	○
		81437016990				 ●		
81437016992	 ●	81437026071			T5437	○		
81437026080	 ●	81437026053			T5263	○		
81437026084	 ●	81437026114			T5263	○		
6x6H		81437016949	T1267		 ●	81437016905	T5263	○
		81437016991				 ●		
		81437026004	T1308	○	 ●	81437016965	T5400	○
		81437026005				 ●		
		81437026014	T1320	○	 ●	81430726109	T5410	○
		81437026078				 ●		
		81437026086	T1321	○	 ●		T5410	○
		81437026002				 ●		
		81437026003	T1349	○	 ●		T5410	○
		81437026077				 ●		
	81437026085							
	81437026011							
	81437026012							
	81437026076							
	81437026079							

TGS

(2007/10-)





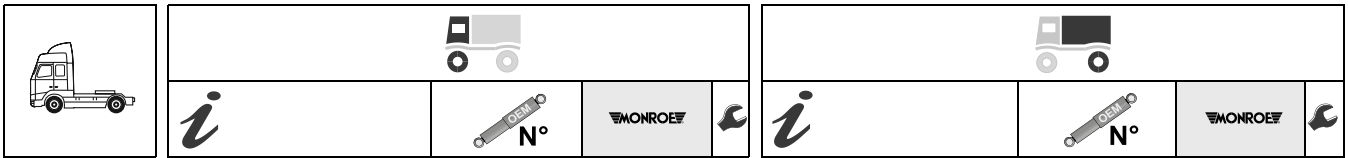













































6x4		81437016949	T1267		 ●	81437016926	T5277	○
		81437016991				 ●		
		81437016897	T1268		 ●	81437016934	T5350	○
		81437016920				 ●		
		81437016948	T1308	○	 ●	81437026070	T5437	○
		81437026004				 ●		
		81437026005	T1320	○	 ●	81437026011	T1321	○
		81437026014				 ●		
		81437026078	T1321	○	 ●	81437026058	T1333	○
		81437026086				 ●		
	81437026002	T1321	○	 ●		T1333	○	
	81437026003				 ●			
	81437026077	T1321	○	 ●		T1333	○	
	81437026085				 ●			
	81437026011	T1321	○	 ●		T1333	○	
	81437026012				 ●			
	81437026076	T1333	○	 ●		T1333	○	
	81437026058				 ●			
	81437026079	T1349	○	 ●		T1349	○	
					 ●			
8x4		81437026004	T1308	○	 ●	81437016868	T5349	○
		81437026005				 ●		
		81437026014	T1320	○	 ●	81437026016	T5431	○
		81437026078				 ●		
		81437026086	T1353	○	 ●	81437026071	T5432	○
		81437026002				 ●		
	81437026003							
	81437026077							



TGS (2007/10-)

Configuration	Part Number	MONROE Part Number	Notes	
4x2	81437016949 81437016991	T1267	○	
	81437026004 81437026005 81437026014 81437026078 81437026086	T1308	○	
	81437026002 81437026003 81437026077 81437026085	T1320	○	
	81437026011 81437026012 81437026076	T1321	○	
	81437026058	T1333	○	
	81437026079	T1349	○	
	4x4	81437016983 81437016990 81437016992 81437026080 81437026084	T1347	○
		81437026053 81437026114	T5437	○
		81437016905 81437026100	T5263	○
		81437016949 81437016991	T1267	○
	4x4H	81437016897 81437016920 81437016948	T1268	○
		81437026004 81437026005 81437026014 81437026078 81437026086	T1308	○
81437026002 81437026003 81437026077 81437026085		T1320	○	
81437026011 81437026012 81437026076 81437026058		T1321	○	
81437026079		T1349	○	
81437016926		T5277	○	
81437016868		T5349	○	
81437016934 81437026016		T5350	○	
81437026070		T5431	○	
81437016954		T5436	○	
81437026053 81437026114		T5437	○	
81437016905 81437026100		T5263	○	
81437016965 81437026055 81437026116	T5400	○		
81430726109 81437016975	T5410	○		
6x4	81437016949 81437016991	T1267	○	
	81437016897 81437016920 81437016948	T1268	○	
	81437026004 81437026005 81437026014 81437026078 81437026086	T1308	○	
	81437026002 81437026003 81437026077 81437026085	T1320	○	
81437026011 81437026012 81437026076 81437026058	T1321	○		
81437026079	T1349	○		
6x4-4	81437016983 81437016990 81437016992 81437026080 81437026084	T1347	○	
	81437016945 81437016981 81437026107	T5399	○	

	 <i>i</i>  N°  				 <i>i</i>  N°  				
6x6		81437016983 81437016990 81437016992 81437026080 81437026084	T1347	○ ○	 ●    ●	81437016901 81437026017 81437026071 81437026053 81437026114 81437016905 81437026100	T5411 T5432 T5437 T5263	○ ○ ○ ○ ○ ○ ○ ○ ○ ○ ○ ○	
6x6H	     	81437016949 81437016991 81437026004 81437026005 81437026014 81437026078 81437026086 81437026002 81437026003 81437026077 81437026085 81437026011 81437026012 81437026076 81437026079	T1267 T1308 T1320 T1321 T1349	I ○	 ●  ●  ●  ●  ●	81437016905 81437026100 81437016965 81437026055 81437026116 81430726109 81437016975	T5263 T5400 T5410	○ ○ ○ ○ ○ ○ ○ ○ ○ ○ ○ ○ ○ ○	
8x4	  	81437026004 81437026005 81437026014 81437026078 81437026086 81437026002 81437026003 81437026077 81437026085 81437016995	T1308 T1320 T1353	○ ○	 ●  ●    ●  ○  ●	81437016868 81437016934 81437026016 81437026070 81437026071 81437016905 81437026100 81437016945 81437016981 81437026107 81437016965 81437026055 81437026116	T5349 T5350 T5431 T5432 T5263 T5399 T5400	○ ○	
8x4/4		81437016995	T1353	○ ○ ○ ○	 	81437026070 81437026071	T5431 T5432	○ ○ ○ ○ ○ ○ ○ ○	
8x6		81437016983 81437016990 81437016992 81437026080 81437026084	T1347	○ ○ ○ ○	 ●  ●	81437016905 81437026100 81437016901 81437026017	T5263 T5411	○ ○ ○ ○ ○ ○ ○ ○	
8X6/4				○ ○ ○ ○		81437026071	T5432	○ ○ ○ ○	
8x6H		81437026004 81437026005 81437026014 81437026078 81437026086	T1308	○ ○ ○ ○	 ●  ●	81437016965 81437026055 81437026116 81437016901 81437026017	T5400 T5411	○ ○ ○ ○ ○ ○ ○ ○	
8x8		81437016983 81437016990 81437016992 81437026080 81437026084	T1347	○ ○ ○ ○	 ● 	81437016901 81437026017 81437026071	T5411 T5432	○ ○ ○ ○ ○ ○ ○ ○	
TGS		(2007/10-)							
6x2/4						81437026053 81437026114	T5437	○ ○ ○ ○	

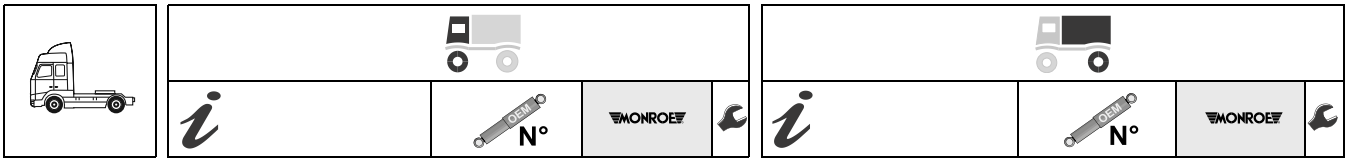



















































































































TGS

















































































(2007/10-)

































































4x2	☺	81437016949	T1267	⊥ ○ ○ ○ ○ ○ ○ ○ ○ ○	●	81437016903	T5278	⊥ ⊥ ○ ○ ○ ○ ○ ○ ○ ○
		81437016991				81437016930		
		81437026004	T1308			81437016974	T5348	
		81437026005				81437026053	T5437	
		81437026014	T1320			81437026114	T5121	
		81437026078				81437016796		
		81437026086	T1320			81437016904	T5261	
		81437026002				81437016905	T5263	
		81437026003	T1321			81437026100	T5275	
		81437026077				81437016908		
81437026085	T1321	81437026037	T5400					
81437026011		81437016965						
81437026012	T1333	81437026055	T5400					
81437026076		81437026116						
81437026058	T1333							
81437026079		T1349						
4x4	☺	81437016983	T1347	○ ○ ○ ○	☺	81437026053	T5437	○ ○
		81437016990				81437026114		
		81437016992						
		81437026080						
81437026084								
4x4H	☺	81437016949	T1267	⊥ ○ ○ ○ ○ ○ ○ ○ ○ ○ ○ ○ ○ ○	●	81437016796	T5121	○ ○ ○ ○ ○ ○ ○ ○ ○ ○ ○ ○ ○ ○
		81437016991				81437016904		
		81437016897	T1268			81437016905	T5263	
		81437016920				81437026100		
		81437016948	T1308			81437016908	T5275	
		81437026004				81437026037		
		81437026005	T1320			81437016965	T5400	
		81437026014				81437026055		
		81437026078	T1320			81437026116	T5400	
		81437026086						
		81437026002	T1321					
		81437026003				81437026058		
		81437026077	T1321					
		81437026085						
81437026011	T1321							
81437026012								
81437026076	T1333							
81437026058								
81437026079	T1349							
6x2					☺	81437026053	T5437	○ ○
6x2/2, 6x2/4	☺	81437026002	T1320	○ ○ ○ ○	●	81437016905	T5263	○ ○ ○ ○
		81437026003				81437026100		
		81437026077	T1321					
		81437026085				T1333		
81437026011	T1321							
81437026012		T1333						
81437026076	T1333							
81437026058								
6x2/2,6x2/4					○	81437016973	T5388	○ ○
6x2/2/4					☺	81437026108		○ ○
6x2-2	☺	81437026053	T5437	○ ○ ○ ○ ○ ○ ○ ○ ○ ○	☺	81437026114	T5437	○ ○ ○ ○ ○ ○ ○ ○ ○ ○
		81437016973				81437026108		
		81437016897	T1268			81437016905	T5263	
		81437016920				81437026100		
		81437016948	T1320			81437016945	T5399	
		81437026002				81437016981		
		81437026003	T1320			81437026107	T5400	
		81437026077				81437016965		
		81437026085	T1321			81437026055	T5400	
		81437026011				81437026116		
81437026012	T1321							
81437026076		T1333						
81437026058	T1333							
81437026079								



	 <i>i</i>  N°  				 <i>i</i>  N°  			
6x2-2, 6x2-4	  	81437026002 81437026003 81437026077 81437026085 81437026011 81437026012 81437026076 81437026058	T1320 T1321 T1333	  	  	81437016904 81437016905 81437026100	T5261 T5263	  
6x2-2,6x2-4		     	81437016944 81437016908 81437026037 81437016911 81437016912 81437026119 81437016945 81437016981 81437026107 81437016965 81437026055 81437026116	T5266 T5275 T5276 T5399 T5400	     			
6x2-4	 	81437016897 81437016920 81437016948 81437026002 81437026003 81437026077 81437026085	T1268 T1320	   	     	81437016904 81437016944 81437016908 81437026037 81437016945 81437016981 81437026107 81437016965 81437026055 81437026116	T5261 T5266 T5275 T5399 T5400	     
6x4	       	81437016949 81437016991 81437016897 81437016920 81437016948 81437026004 81437026005 81437026014 81437026078 81437026086 81437026002 81437026003 81437026077 81437026085 81437026011 81437026012 81437026076 81437026058 81437026079	T1267 T1268 T1308 T1320 T1321 T1333 T1349	          	          	81437016926 81437016868 81437016934 81437026016 81437026070 81437016954 81437026053 81437026114 81437016905 81437026100 81437016965 81437026055 81437026116 81430726109 81437016975	T5277 T5349 T5350 T5431 T5436 T5437 T5263 T5400 T5410	          
6x4-4			81437016983 81437016990 81437016992 81437026080 81437026084	T1347	 			
6x4H/2, 6x4H/4	 	81437026002 81437026003 81437026077 81437026085 81437026011 81437026012 81437026076	T1320 T1321	 	 	81437016905 81437026100	T5263	 
6x4H/2,6x4H/4			81437016973 81437026108	T5388				
6x4H-2, 6x4H-4	 	81437026002 81437026003 81437026077 81437026085 81437026011 81437026012 81437026076	T1320 T1321	 	 	81437016904 81437016905 81437026100	T5261 T5263	  

								
	<i>i</i>	 N°			<i>i</i>	 N°		
6x4H-2,6x4H-4		81437016897	T1268	 	 ○	81437016944	T5266	 
		81437016920 81437016948				 ●	81437016908 81437026037	T5275
6x4H-4		81437026002	T1320	 	 ○	81437016911 81437016912 81437026119	T5276	  
		81437026003 81437026077 81437026085				 ○	81437016945 81437016981 81437026107	T5399
6x6		81437016983	T1347	 	 ●	81437016965 81437026055 81437026116	T5400	  
		81437016990 81437016992 81437026080 81437026084				 ●	81437016904	T5261
6x6H	 	81437016983	T1347	 	 ●	81437016901 81437026017	T5411	 
		81437016991				 ●	81437026071	T5432
8x2-4, 8x2-6	 	81437026004	T1308	 	 ●	81437026053 81437026114	T5437	 
		81437026005 81437026014 81437026078 81437026086		 ●	81437016905 81437026100	T5263	 	
8x2-4, 8x2-6	 	81437026002	T1320	 	 ●	81437016905 81437026109 81437016975	T5410	  
		81437026003 81437026077 81437026085		 ●	81437016904	T5261	 	
8x2-4,8x2-6	 	81437026011	T1321	 	 ●	81437016905 81437026100	T5263	 
		81437026012 81437026076 81437026079		 ●	81437016995	T1353	 	
8x2-4,8x2-6	 	81437026011	T1321	 	 ●	81437016905 81437026100	T5263	 
		81437026012 81437026076 81437026079		 ●	81437016995	T1353	 	























































































								
	<i>i</i>	 N°			<i>i</i>	 N°		
8x4		81437026004 81437026005 81437026014 81437026078 81437026086	T1308	   	         	81437016868 81437016934 81437026016 81437026070 81437026071 81437016905 81437026100 81437016945 81437016981 81437026107 81437016965 81437026055 81437026116	T5349 T5350 T5431 T5432 T5263 T5399 T5400	         
8x4/4		81437016995	T1353	 	 	81437026070 81437026071	T5431 T5432	  
8x4/6						81437026070	T5431	 
8x4-4	 	81437016897 81437016920 81437016948 81437026002 81437026003 81437026077 81437026085	T1268 T1320	   	   	81437016945 81437016981 81437026107	T5399	   
8x4H-6		81437016995	T1353					

TGS

(2008/06-)





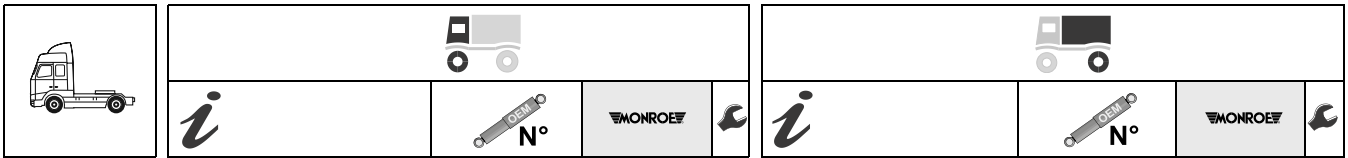











































6x6		81437016983 81437016990 81437016992 81437026080 81437026084	T1347	   	        	81437016901 81437026017 81437026053 81437026114 81437016905 81437026100 81437016965 81437026055 81437026116 81430726109 81437016975	T5411 T5437 T5263 T5263 T5400 T5410	        
6x6H	     	81437016949 81437016991 81437026004 81437026005 81437026014 81437026078 81437026086 81437026002 81437026003 81437026077 81437026085 81437026011 81437026012 81437026076 81437026079	T1267 T1308 T1320 T1321 T1349	         	         	81437016905 81437026100 81437016901 81437026017	T5263 T5411	         
8x6		81437016983 81437016990 81437016992 81437026080 81437026084	T1347	 	 	81437016905 81437026100 81437016901 81437026017	T5263 T5411	  
8x6H		81437026004 81437026005 81437026014 81437026078 81437026086	T1308	   	   	81437016965 81437026055 81437026116 81437016901 81437026017	T5400 T5411	   
8x8		81437016983 81437016990 81437016992 81437026080 81437026084	T1347			81437016901 81437026017	T5411	 



TGX (2007/09-)





























































4x2		81437026002 81437026003 81437026077 81437026085	T1320			81437026053 81437026114	T5437	
		81437026011 81437026012 81437026076	T1321			81437016796	T5121	
		81437026058	T1333			81437016904	T5261	
		81437026079	T1349			81437016905 81437026100	T5263	
		81437026032 81437026075	T1358			81437016908 81437026037	T5275	
4x4						81437026053 81437026114	T5437	
4x4H		81437026004 81437026005 81437026014 81437026078 81437026086	T1308			81437016796	T5121	
		81437026002 81437026003 81437026077 81437026085	T1320			81437016905 81437026100	T5263	
		81437026011 81437026012 81437026076	T1321			81437016908 81437026037	T5275	
		81437026058	T1333					
		81437026079	T1349					
6x2		81437026032 81437026075	T1358			81437026053 81437026114	T5437	
6x2-2		81437016897 81437016920 81437016948	T1268			81437016905 81437026100	T5263	
		81437026002 81437026003 81437026077 81437026085	T1320			81437016945 81437016981 81437026107	T5399	
		81437026011 81437026012 81437026076	T1321			81437016965 81437026055 81437026116	T5400	
		81437026058	T1333					
6x2-2,6x2-4		81437026002 81437026003 81437026077 81437026085	T1320			81437016904	T5261	
						81437016905 81437026100	T5263	
						81437016944	T5266	
						81437016908 81437026037	T5275	
		81437026011 81437026012 81437026076	T1321			81437016911 81437016912 81437026119	T5276	
81437026058	T1333		81437016945 81437016981 81437026107	T5399				
						81437016965 81437026055 81437026116	T5400	

































































































































































								
	<i>i</i>	 N°			<i>i</i>	 N°		
6x4		81437016949 81437016991	T1267			81437016926	T5277	
		81437016897 81437016920 81437016948	T1268			81437016868	T5349	
		81437026004 81437026005 81437026014 81437026078 81437026086	T1308			81437016934 81437026016 81437026070	T5350 T5431	
		81437026002 81437026003 81437026077 81437026085	T1320			81437016954	T5436	
		81437026011 81437026012 81437026076	T1321			81437026053 81437026114	T5437	
		81437026058	T1333			81437016905 81437026100	T5263	
		81437026079	T1349			81437016965 81437026055 81437026116 81430726109 81437016975	T5400 T5410	
6x6						81437026053 81437026114	T5437	
8x4/4						81437026070	T5431	
8x4-4		81437026002 81437026003 81437026077 81437026085	T1320			81437016945 81437016981 81437026107	T5399	

TGX

(2007/10-)



4x2		81437026002 81437026003 81437026077 81437026085	T1320			81437026053 81437026114	T5437	
		81437026011 81437026012 81437026076	T1321			81437016796	T5121	
		81437026058	T1333			81437016904	T5261	
		81437026079	T1349			81437016950	T5262	
		81437026032 81437026075	T1358			81437016905 81437026100	T5263	
4x4						81437016908 81437026037	T5275	
4x4H		81437026004 81437026005 81437026014 81437026078 81437026086	T1308			81437026053 81437026114	T5437	
		81437026002 81437026003 81437026077 81437026085	T1320			81437016796	T5121	
		81437026011 81437026012 81437026076	T1321			81437016905 81437026100	T5263	
		81437026058	T1333			81437016908 81437026037	T5275	
		81437026079	T1349					
6x2		81437026032 81437026075	T1358			81437026053 81437026114	T5437	
6x2/2,6x2/4		81437026002 81437026003 81437026077 81437026085	T1320			81437016905 81437026100	T5263	
		81437026011 81437026012 81437026076	T1321			81437016973 81437026108	T5388	
		81437026058	T1333					
6x2/2/4						81437026053 81437026114	T5437	

								
	<i>i</i>	 N°			<i>i</i>	 N°		
6x2-2		81437016897 81437016920 81437016948	T1268	 	 ●  ○	81437016905 81437026100	T5263	 
		81437026002 81437026003 81437026077 81437026085	T1320	 	 ○ 	81437016945 81437016981 81437026107	T5399	 
		81437026011 81437026012 81437026076	T1321	 	 ● 	81437016965 81437026055 81437026116	T5400	 
		81437026058	T1333	 				
6x2-2,6x2-4		81437026002 81437026003 81437026077 81437026085	T1320	 	 ●  ●  ○	81437016904 81437016905 81437026100 81437016944	T5261 T5263 T5266	    
		81437026011 81437026012 81437026076	T1321	 	 ○ 	81437016908 81437026037 81437016911 81437016912 81437026119	T5275 T5276	   
		81437026058	T1333	 	 ○ 	81437016945 81437016981 81437026107	T5399	 
				 	 ● 	81437016965 81437026055 81437026116	T5400	 
6x4		81437016949 81437016991	T1267	 	 ● 	81437016926	T5277	 
		81437016897 81437016920 81437016948	T1268	 	 ● 	81437016868	T5349	 
		81437026004 81437026005 81437026014 81437026078 81437026086	T1308	 	 ● 	81437016934 81437026016 81437026070	T5350 T5431	   
		81437026002 81437026003 81437026077 81437026085	T1320	 	 ● 	81437016954 81437026053 81437026114	T5436 T5437	   
		81437026011 81437026012 81437026076 81437026058	T1321	 	 ● 	81437016905 81437026100	T5263	 
		81437026079	T1349	 	 ● 	81437016965 81437026055 81437026116	T5400	 
				 	 ● 	81430726109 81437016975	T5410	 
		81437026002 81437026003 81437026077 81437026085	T1320	 	 ● 	81437016905 81437026100	T5263	 
6x4H/2,6x4H/4		81437026011 81437026012 81437026076	T1321	 	 ○ 	81437016973 81437026108	T5388	 
								
6x6						81437026053 81437026114	T5437	 
8x4/4		81437026002 81437026003 81437026077 81437026085	T1320	 	 ● 	81437016926	T5277	 
		81437026011 81437026012 81437026076	T1321	 	 ○ 	81437016973 81437026108	T5388	 
						81437026070	T5431	 
						81437026053 81437026114	T5437	 
						81437016905 81437026100	T5263	 

TGX (2007/12-) 



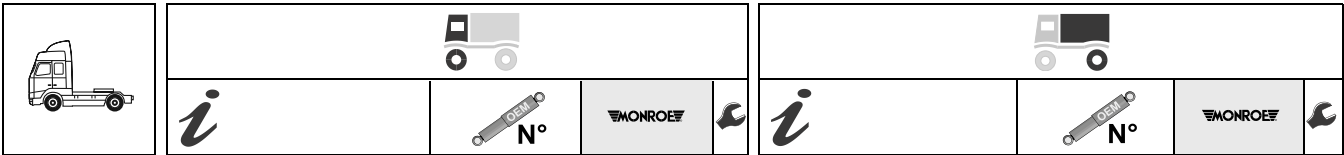









































































































































6x4		81437026070	T5431	 
		81437026053 81437026114	T5437	 



MERCEDES-BENZ

ACTROS (1996/04-2002/10)

4x2										
	☺	0033233200 0033233300 0043239200 0053239600 0063230900 0063237300 A0053239600 A0063230900	T1011	☺	☺	☺	☺	☺	☺	
	☺	0023231500 0023235300 0043234300 0043236100 0063233300 0063233900 0063234000 0063237400 A0063233300	T1197	☺	☺	☺	☺	☺	☺	
	☺	0013231100 0023231000 0023231100 0023231600 0023235400 0033231000 0043233600 0043234900 0043236500 0053239500 0063233700 0063236100 A0053239500	T1204	☺	☺	☺	☺	☺	☺	
	☺	0053239700 0063231600 0063232100 0063233800 0063236500 0063237100 0063237200 3753230100 9583230700 9583231000 9583231200 A0053239700 A0063236500 A0063237100 A9583230700 A9583231000 A9583231200	T1207	☺	☺	☺	☺	☺	☺	
	☺	0033232000 0033232100 0043235600 0063235100 0063236000 0063237800 0063237900 3573230000 3753230000 A0063235100	T1220	☺	☺	☺	☺	☺	☺	
	☺	0063234500	T1275	☺	☺	☺	☺	☺	☺	
	☺	0063235400 A0063235400	T1304	☺	☺	☺	☺	☺	☺	
	☺	0053239900 0063238300 A0053239900 A0063238300	T5360	☺	☺	☺	☺	☺	☺	
	4x4	☺	☺	T1011	☺	☺	☺	☺	☺	☺
		☺	☺	T1197	☺	☺	☺	☺	☺	☺
		☺	0063234500	T1275	☺	☺	☺	☺	☺	☺
		☺	0053263300 0053263400 9583260800 A0053263300 A0053263400 A9583260800	T1200	☺	☺	☺	☺	☺	☺
		☺	0053261000 A0053261000	T1210	☺	☺	☺	☺	☺	☺
		☺	0053262500 0063266000 A0053262500 A0063266000	T5414	☺	☺	☺	☺	☺	☺





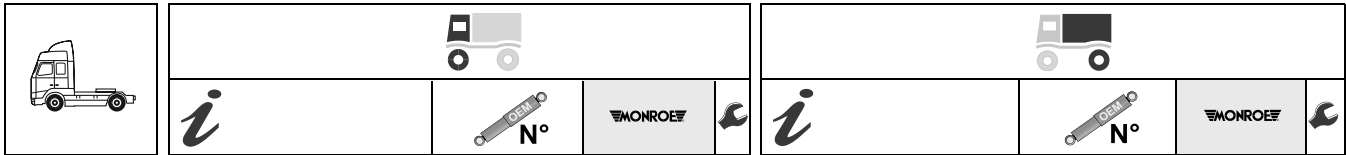



















































































































































								
	<i>i</i>	 N°			<i>i</i>	 N°		
6x2			T1197				T1201	
			T1204			0053261000 A0053261000	T1210	
			T1207			0053263300 0053263400 9583260800 A0053263300 A0053263400 A9583260800 0053262300	T1200	
			T1220			0053261200 0063265600 A0053261200	T5134	
			T5360			0053261300 0063260400 A0053261300 A0063260400	T5137	
						0053262500 0063260000 A0053262500 A0063266000	T5372	
6x2/2/4			T1197				T1201	
			T1204			0053261000 A0053261000	T1210	
			T1207			0053261200 0063265600 A0053261200	T5137	
			T1220			0053261300 0063260400 A0053261300 A0063260400	T5385	
			T5360			0053262500 0063260000 A0053262500 A0063266000	T5414	
						0053261400 0063260500 A0053261400	T5256	
6x4			T1011				T1201	
			T1197					
			T1204				T5372	
			T1207					
			T1220			0043269900 A0043269900	T5375	
			T1275			0053261200 0063265600 A0053261200	T5137	
			T1304					
			T5360					
6x6			T1011				T5372	
			T1197					
			T1275					
8x4/4			T1011				T1201	
			T1197					





ACTROS (1996/04-)

4x2		0033233200	T1011	Q		0053263300	T1200	Q
		0033233300		Q		0053263400		Q
		0043239200				9583260800		
		0053239600				A0053263300		
		0063230900				A0053263400		
		0063237300				A9583260800		
		A0053239600						
		A0063230900						
		0023231500	T1197	Q		0003201530	T1201	Q
		0023235300		Q		0053260900		Q
		0043234300				0053265700		
		0043236100				0053265800		
		0063233300				0053265900		
		0063233900				0053266300		
		0063234000				0063266700		
		0063237400				A0053260900		
		A0063233300						
		0013231100	T1204	Q				
		0023231000		Q				
		0023231100						
		0023231600						
		0023235400						
		0033231000				0053261000	T1210	Q
		0043233600				A0053261000		Q
		0043234900						
		0043236500				0043269900	T5375	Q
		0053239500				A0043269900		Q
		0063233700						
		0063236100						
		A0053239500						
		0053239700	T1207	Q		0053261200	T5137	Q
		0063231600		Q		A0053261200		Q
		0063232100						
		0063233800						
		0063236500						
		0063237100				0053261100	T5171	Q
		0063237200				0053267400		Q
		3753230100				0063260100		
		9583230700				A0053261100		
		9583231000				A0053267400		
9583231200			A0063260100					
A0053239700								
A0063236500								
A0063237100								
A9583230700								
A9583231000								
A9583231200								
0033232000	T1220	Q						
0033232100		Q						
0043235600								
0063235100								
0063236000			0053262200	T5287	Q			
0063237800			0053267300		Q			
0063237900			0063260000					
3573230000			0063263000					
3753230000								
A0063235100								
0033236700	T1232	Q						
0033236800		Q						
0043234100								
0043236800			0053268800	T5358	Q			
0043236900			0063260300		Q			
0053236000			0063261100					
0063239500			0063261200					
0053239100	T1251	Q	A0053268800					
A0053239100		Q	A0063260300					
		Q	A0063261100					
		Q	A0063261200					
0063234500	T1275	Q						
		Q						
		Q						
0063235400	T1304	Q						
A0063235400		Q						
		Q						
0053239900	T5360	Q						
0063238300		Q						
A0053239900		Q						
A0063238300		Q						
0063233400	T5361	Q						
0063238200		Q	0053266000	T5372	Q			
0063239700		Q	0053266400					
A0063233400		Q	0053266600					
A0063238200		Q	0063262400					
A0063239700		Q	0063266800					
		Q	9583260700					
0063238400	T5373	Q	A0053266000					
0063239800		Q	A0053266400					
A0063238400		Q	A0053266600					
A0063239800		Q	A0063262400					
		Q	A0063266800					
		Q	A9583260700					































































								
	<i>i</i>	 N°			<i>i</i>	 N°		
4x4			T1197	 		0053263300 0053263400 9583260800 A0053263300 A0053263400 A9583260800	T1200	 
		0063234500	T1275	 		0053261000 A0053261000	T1210	  
6x2						0053263300 0053263400 9583260800 A0053263300 A0053263400 A9583260800	T1200	  
							T5372	  
6x2/4			T1204	  			T1201	  
			T1207	  				
			T1220	  				
		0063235400 A0063235400	T1304	  				
		0063233400 0063238200 0063239700 A0063233400 A0063238200 A0063239700	T5361	   		0053261000 A0053261000	T1210	 
								
6x4			T1011	  			T1201	  
			T1197	  			T5372	  
			T1204	  				
			T1207	  				
			T1220	  		0043269900 A0043269900	T5375	  
			T1220	  		0053261200 0063265600 A0053261200	T5137	  
		0063234500	T1275	  			T5363	 
		0063235400 A0063235400	T1304	  		0053266800 0063262900 A0053266800 A0063262900		
		0053239900 0063238300 A0053239900 A0063238300	T5360	  			T1200	  
		0063233400 0063238200 0063239700 A0063233400 A0063238200 A0063239700	T5361	  				
6x6			T1197	  			T5372	 
		0063234500	T1275	  				













































































































































































ACTROS (1996/09-)

4x2	☺	0033233200	T1011	○	☺	0053263300	T1200	○
		0033233300		○		0053263400		○
	☺	0043239200				9583260800		
		0053239600				A0053263300		
	☺	0063230900				A0053263400		
		0063237300				A9583260800		
	☺	A0053239600						
		A0063230900						
	☺	0023231500	T1197	○				
		0023235300		○				
	☺	0043234300						
		0043236100						
	☺	0063233300						
		0063233900						
	☺	0063234000						
		0063237400						
	☺	A0063233300						
		0013231100	T1204	○				
	☺	0023231000						
		0023231100						
	☺	0023231600						
		0023235400						
	☺	0033231000						
		0043233600						
	☺	0043234900						
		0043236500						
	☺	0053239500						
		0063233700						
	☺	0063236100						
		A0053239500						
	☺	0053239700	T1207	○				
		0063231600						
	☺	0063232100						
		0063233800						
	☺	0063236500				0053261000	T1210	○
		0063237100				A0053261000		○
	☺	0063237200						
		3753230100						
	☺	9583230700						
		9583231000						
	☺	9583231200						
		A0053239700						
	☺	A0063236500						
		A0063237100						
	☺	A9583230700						
		A9583231000						
	☺	A9583231200						
		0063234500	T1275	○				
4x4	☺	☺↑	T1011	○	☺	0053263300	T1200	○
		☺↑		○		0053263400		○
	☺	☺↑	T1197	○		9583260800		
		☺↑		○		A0053263300		
	☺	0063234500	T1275	○		A0053263400		
				○		A9583260800		
6x4	☺	☺↑	T1011	○	☺	0003201530		
		☺↑		○		0053260900		
	☺	☺↑	T1197	○		0053265700		
		☺↑		○		0053265800		
	☺	☺↑	T1204	○		0053265900		
		☺↑		○		0053266300		
	☺	☺↑	T1207	○		0063266700		
		☺↑		○		A0053260900		
	☺	0063234500	T1275	○		0053266000	T5372	○
				○		0053266400		○
6x6	☺	☺↑	T1011	○	☺	0053266600		
		☺↑		○		0063262400		
	☺	☺↑	T1197	○		0063266800		
		☺↑		○		9583260700		
	☺	0063234500	T1275	○		A0053266000		
				○		A0053266400		
	☺					A0053266600		
						A0063262400		
	☺					A0063266800		
						A9583260700		
	☺					0053261200	T5137	○
						0063265600		○
	☺					A0053261200		

								
	<i>i</i>	 N°			<i>i</i>	 N°		
8x4/4			T1011				T1201	
			T1197					
			T1204					
			T1207					
8x6/4			T1011				T5372	
			T1197					
			T1204					
			T1207					
8x8/4			T1011				T5372	
			T1197					
			T1204					
			T1207					

ACTROS (1997/04-) 

6x4		0033233200 0033233300 00432339200 0053239600 0063230900 0063237300 A0053239600 A0063230900	T1011			0003201530 0053260900 0053265700 0053265800 0053265900 0053266300 0063266700 A0053260900	T1201		
		0023231500 0023235300 0043234300 0043236100 0063233300 0063233900 0063234000 0063237400 A0063233300	T1197						
		0013231100 0023231000 0023231100 0023231600 0023235400 0033231000 0043233600 0043234900 0043236500 0053239500 0063233700 0063236100 A0053239500	T1204			0053266000 0053266400 0053266600 0063262400 0063266800 9583260700 A0053266000 A0053266400 A0053266600 A0063262400 A0063266800 A9583260700	T5372		
		0053239700 0063231600 0063232100 0063233800 0063236500 0063237100 0063237200 3753230100 9583230700 9583231000 9583231200 A0053239700 A0063236500 A0063237100 A9583230700 A9583231000 A9583231200	T1207						
		0063234500	T1275						
	8x4/4			T1011				T1201	
				T1204					
				T1207					

								
	<i>i</i>	 OEM N°	 MONROE		<i>i</i>	 OEM N°	 MONROE	
6x4			T1011				T1201	
			T1197				T5372	
			T1204				T5372	
			T1207				T5137	
		0063234500	T1275			0053261200 0063265600 A0053261200	T5137	
		0073231400 A0073231400	T1352					
6x6			T1011				T5372	
			T1197					
		0063234500	T1275					
		0073231400 A0073231400	T1352					
8x4/4			T1011				T1201	
			T1197				T5372	
			T1204				T5372	
			T1207				T5372	
		0073231400 A0073231400	T1352					
8X6/4			T1011				T5372	
			T1197					
			T1204					
			T1207					
		0073231400 A0073231400	T1352					
8x8/4			T1011				T5372	
			T1197					
			T1204					
			T1207					
		0073231400 A0073231400	T1352					



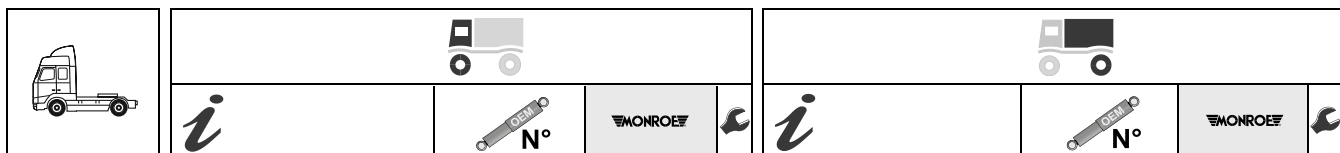



































































































































ACTROS MP2 / MP3

(2002/10-)



4x2		0033233200	T1011		0053263300	T1200				
		0033233300			0053263400					
		0043239200			9583260800					
		0053239600			A0053263300					
		0063230900			A0053263400					
		0063237300			A9583260800					
		A0053239600								
		A0063230900								
		0023231500			T1197					
		0023235300								
		0043234300								
		0043236100								
		0063233300								
		0063233900								
		0063234000								
0063237400										
A0063233300										
0013231100	T1204									
0023231000										
0023231100										
0023231600										
0023235400										
0033231000										
0043233600										
0043234900										
0043236500										
0053239500										
0063233700										
0063236100										
A0053239500										
0053239700			T1207							
0063231600										
0063232100										
0063233800										
0063236500										
0063237100										
0063237200										
3753230100										
9583230700										
9583231000										
9583231200										
A0053239700										
A0063236500										
A0063237100										
A9583230700										
A9583231000										
A9583231200										
0063234500	T1275									
0063235400										
A0063235400										
0073231400			T1304							
A0073231400										
0053239900					T1352					
0063238300										
A0053239900										
A0063238300										
0063238400							T5360			
0063239800										
A0063238400										
A0063239800										
0073231600									T5373	
A0073231600										
0053263300	T1200									
0053263400										
9583260800										
A0053263300										
A0053263400										
A9583260800										
0053261000			T1210							
A0053261000										
0053262500					T5414					
0063266000										
A0053262500										
A0063266000										
0073231400							T1352			
A0073231400										
0053239900									T5360	
0063238300										
A0053239900										
A0063238300										
0063238400	T5373									
0063239800										
A0063238400										
A0063239800										
0073231600			T1340							
A0073231600										
0053263300					T1200					
0053263400										
9583260800										
A0053263300										
A0053263400										
A9583260800										
0053261000							T1210			
A0053261000										
0053262500									T5414	
0063266000										
A0053262500										
A0063266000										
0073231400	T1352									
A0073231400										
0053239900			T5360							
0063238300										
A0053239900										
A0063238300										
0063238400					T5373					
0063239800										
A0063238400										
A0063239800										
0073231600							T1340			
A0073231600										
0053263300									T1200	
0053263400										
9583260800										
A0053263300										
A0053263400										
A9583260800										
0053261000	T1210									
A0053261000										
0053262500			T5414							
0063266000										
A0053262500										
A0063266000										
0073231400					T1352					
A0073231400										
0053239900							T5360			
0063238300										
A0053239900										
A0063238300										
0063238400									T5373	
0063239800										
A0063238400										
A0063239800										
0073231600	T1340									
A0073231600										

								
	<i>i</i>	 N°			<i>i</i>	 N°		
6x2/2/4			T1197			0053261200 0063265600 A0053261200	T5137	
			T1207			0053261300 0063260400 A0053261300 A0063260400	T5385	
		0063234500	T1275			0053261400 0063260500 A0053261400	T5256	
		0053239900 0063238300 A0053239900 A0063238300 0073231600 A0073231600	T5360					
6x2/4			T1197			0053261200 0063265600 A0053261200	T5137	
			T1207			0053261300 0063260400 A0053261300 A0063260400	T5385	
		0063234500	T1275			0053261400 0063260500 A0053261400	T5256	
		0053239900 0063238300 A0053239900 A0063238300 0073231600 A0073231600	T5360					
6x4			T1011			0003201530 0053260900 0053265700 0053265800 0053265900 0053266300 0063266700 A0053260900	T1201	
			T1197			0053266000 0053266400 0053266600 0063262400 0063266800 9583260700 A0053266000 A0053266400 A0053266600 A0063262400 A0063266800 A9583260700	T5372	
			T1204			0043269900 A0043269900	T5375	
			T1207			0053261200 0063265600 A0053261200	T5137	
		0063234500	T1275					
		0063235400 A0063235400	T1304					
		0073231400 A0073231400	T1352					
		0053239900 0063238300 A0053239900 A0063238300 0073231600 A0073231600	T5360					
6x6			T1011				T5372	
			T1197					
			T1207			0043269900 A0043269900	T5375	
		0063234500	T1275					
8x4/4			T1011				T1201	
			T1197					
			T1207				T5372	
		0063234500	T1275					
		0063235400 A0063235400	T1304					
		0073231400 A0073231400	T1352			0043269900 A0043269900	T5375	



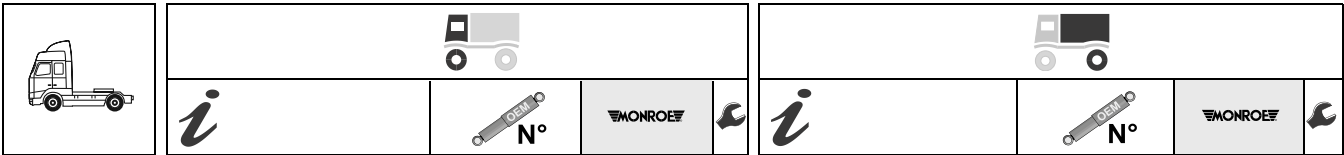





























ACTROS MP2 / MP3

(2002/10-)

































4x2		0033233200	T1011	00		0053263300	T1200	00
		0033233300		00		0053263400		00
		0043239200		00		9583260800		00
		0053239600		00		A0053263300		00
		0063230900		00		A0053263400		00
		0063237300		00		A9583260800		00
		A0053239600		00				
		A0063230900		00				
		0023231500	T1197	00				
		0023235300		00				
		0043234300		00				
		0043236100		00				
		0063233300		00				
		0063233900		00				
		0063234000		00				
0063237400		00						
A0063233300		00						
0013231100	T1204	00						
0023231000		00						
0023231100		00						
0023231600		00						
0023235400		00						
0033231000		00						
0043233600		00	0053261000	T1210	00			
0043234900		00	A0053261000		00			
0043236500		00						
0053239500		00						
0063233700		00						
0063236100		00						
A0053239500		00						
0053239700	T1207	00						
0063231600		00						
0063232100		00						
0063233800		00	0043269900	T5375	00			
0063236500		00	A0043269900		00			
0063237100		00						
0063237200		00						
3753230100		00						
9583230700		00						
9583231000		00						
9583231200		00						
A0053239700		00						
A0063236500		00						
A0063237100		00						
A9583230700		00						
A9583231000		00						
A9583231200		00						
0033232000	T1220	00	0053268800	T5358	00			
0033232100		00	0063260300		00			
0043235600		00	0063261100		00			
0063235100		00	0063261200		00			
0063236000		00	A0053268800		00			
0063237800		00	A0063260300		00			
0063237900		00	A0063261100		00			
3573230000		00	A0063261200		00			
3753230000		00						
A0063235100		00						
0033236700	T1232	00						
0033236800		00						
0043234100		00						
0043236800		00						
0043236900		00						
0053236000		00						
0063239500	T1275	00						
0063234500		00						
0063235400	T1304	00						
A0063235400		00						
0073231400	T1352	00						
A0073231400		00						
0063233400	T5361	00						
0063238200		00						
0063239700		00						
A0063233400		00						
A0063238200		00						
A0063239700		00						
0063238400	T5373	00						
0063239800		00						
A0063238400		00						
A0063239800		00						
0073231300	T1339	00						
A0073231300		00						
4x4		←↑	T1197	00		0053263300	T1200	00
		←↑	T1207	00		0053263400		00
		0063234500	T1275	00		9583260800		00
		0073231400	T1352	00		A0053263300		00
		A0073231400		00		A0053263400		00
				00		A9583260800		00
				00		0053261000	T1210	00
				00		A0053261000		00

























								
	<i>i</i>	 N°			<i>i</i>	 N°		
6x6			T1197				T5372	
			T1207					
		0063234500	T1275			0043269900	T5375	
		0073231400	T1352			A0043269900		
		A0073231400						

ACTROS MP2 / MP3

(2003/04-)

















	10x4/6					0003201530	T1201	
						0053260900		
						0053265700		
						0053265800		
						0053265900		
						0053266300		
						0063266700		
						A0053260900		
						0053266000	T5372	
						0053266400		
						0053266600		
						0063262400		
						0063266800		
						9583260700		
						A0053266000		
						A0053266400		
						A0053266600		
						A0063262400		
						A006326800		
						A9583260700		
6x4		0033233200	T1011				T1201	
		0033233300						
		0043239200						
		0053239600						
		0063230900						
		0063237300						
		A0053239600						
		A0063230900						
		0023231500	T1197					
		0023235300						
		0043234300						
		0043236100						
		0063233300						
		0063233900						
		0063234000						
		0063237400						
		A0063233300						
		0013231100	T1204				T5372	
		0023231000						
		0023231100						
		0023231600						
		0023235400						
		0033231000						
		0043233600						
		0043234900						
		0043236500						
		0053239500						
		0063233700						
		0063236100						
		A0053239500						
		0053239700	T1207					
		0063231600						
		0063232100						
		0063233800						
		0063236500						
		0063237100						
		0063237200						
		3753230100						
		9583230700						
		9583231000						
		9583231200						
		A0053239700						
		A0063236500						
		A0063237100						
		A9583230700						
		A9583231000						
		A9583231200						
		0063234500	T1275					
		0073231400	T1352					
		A0073231400						

								
	<i>i</i>	 N°			<i>i</i>	 N°		
8x4/4			T1011				T1201	
			T1204					
			T1207					
		0063234500	T1275					
		0073231400 A0073231400	T1352					

ACTROS MP2 / MP3

(2003/04-)



8x6/4		0033233200 0033233300 0043239200 0053239600 0063230900 0063237300 A0053239600 A0063230900	T1011		0003201530 0053260900 0053265700 0053265800 0053265900 0053266300 0063266700 A0053260900	T1201		
		0023231500 0023235300 0043234300 0043236100 0063233300 0063233900 0063234000 0063237400 A0063233300	T1197					
		0013231100 0023231000 0023231100 0023231600 0023235400 0033231000 0043233600 0043234900 0043236500 0053239500 0063233700 0063236100 A0053239500	T1204		0053266000 0053266400 0053266600 0063262400 0063266800 9583260700 A0053266000 A0053266400 A0053266600 A0063262400 A0063266800 A9583260700	T5372		
		0053239700 0063231600 0063232100 0063233800 0063236500 0063237100 0063237200 3753230100 9583230700 9583231000 9583231200 A0053239700 A0063236500 A0063237100 A9583230700 A9583231000 A9583231200 0073231400 A0073231400	T1207					
			T1352					











AROCS

(2013/01-)



4x2					0053263300 0053263400 9583260800 A0053263300 A0053263400 A9583260800	T1200	
4x4					0053263300 0053263400 9583260800 A0053263300 A0053263400 A9583260800	T1200	
8x4/4					0003201530 0053260900 0053265700 0053265800 0053265900 0053266300 0063266700 A0053260900	T1201	

								
	<i>i</i>	 N°			<i>i</i>	 N°		



















AROCS (2013/01-) 

4x2					0053263300 0053263400 9583260800 A0053263300 A0053263400 A9583260800	T1200	 
4x4					0053263300 0053263400 9583260800 A0053263300 A0053263400 A9583260800	T1200	 

AROCS (2013/01-) 

4x2					0053263300 0053263400 9583260800 A0053263300 A0053263400 A9583260800	T1200	 
4x4					0053263300 0053263400 9583260800 A0053263300 A0053263400 A9583260800	T1200	 

ATEGO (1998/01-2004/10) 

4x2				 Hendrickson	0063264200 0063264300 9463260000 9463260100 A0063264300 A9463260000 A9463260100	F5251	 
4x4		0023265000 0023265500 0033267400 0043262300 0043262400 0043264300 9723230100 9723230300 A9723230100 A9723230300	T1115		0063268100 9723260000 9723260200 A0063268100 A9723260000 A9723260200	T5374	 
		9703230000 9703230300 9703230700 9703231000 A9703230300	T1255				 
6x4		0023231500 0023235300 0043234300 0043236100 0063233300 0063233900 0063234000 0063237400 A0063233300	T1197		0003201530 0053260900 0053265700 0053265800 0053265900 0053266300 0063266700 A0053260900	T1201	 
		0053239700 0063231600 0063232100 0063233800 0063236500 0063237100 0063237200 3753230100 9583230700 9583231000 9583231200 A0053239700 A0063236500 A0063237100 A9583230700 A9583231000 A9583231200	T1207				 



ATEGO (1998/01-2004/10)

4x2										
	☺	0033233200 0033233300 0043239200 0053239600 0063230900 0063237300 A0053239600 A0063230900	T1011	☺ ☺	☺	0053263300 0053263400 9583260800 A0053263300 A0053263400 A9583260800	T1200	☺ ☺		
	☺	0023231500 0023235300 0043234300 0043236100 0063233300 0063233900 0063234000 0063237400 A0063233300	T1197	☺ ☺	☺	0053261000 A0053261000	T1210	☺ ☺		
	☺	0053239700 0063231600 0063232100 0063233800 0063236500 0063237100 0063237200 3753230100 9583230700 9583231000 9583231200 A0053239700 A0063236500 A0063237100 A9583230700 A9583231000 A9583231200	T1207	☺ ☺	☺	9703260400 9743260000 9743260400 A9743260400	T5178	☺ ☺ ☺		
	☺	0073230800 9583230400 9743230000 9743230400 9743230600 9743231300 9753230000 A0073230800 A9583230400 A9743230400 A9743230600 A9743231300 A9753230000	T1246	☺ ☺	☺	0063264200 0063264300 9463260000 9463260100 A0063264300 A9463260000 A9463260100	F5251	☺ ☺ ☺ ☺		
	☺	9703230000 9703230300 9703230700 9703231000 A9703230300	T1255	☺ ☺	☺	0063262000 0063267100 9743261000 A0063262000 A0063267100 A9743261000	T5403	☺ ☺ ☺		
	☺	0063234500	T1275	☺						
	☺	0073231400 A0073231400	T1352	☺ ☺						
		☺	0023265000 0023265500 0033267400 0043262300 0043262400 0043264300 9723230100 9723230300 A9723230100 A9723230300	T1115	☺ ☺	☺	0053263300 0053263400 9583260800 A0053263300 A0053263400 A9583260800	T1200	☺ ☺	
		☺	☺	T1197	☺	0053261000 A0053261000	T1210	☺		
		☺	☺	T1246	☺	0063268100 9723260000 9723260200 A0063268100 A9723260000 A9723260200	T5374	☺ ☺ ☺		
		☺	0063234500	T1275	☺					
		☺	0073231400 A0073231400	T1352	☺ ☺					
		☺	☺	T1197	☺	0003201530 0053260900 0053265700 0053265800 0053265900 0053266300 0063266700 A0053260900	T1201	☺		
		☺	☺	T1207	☺					



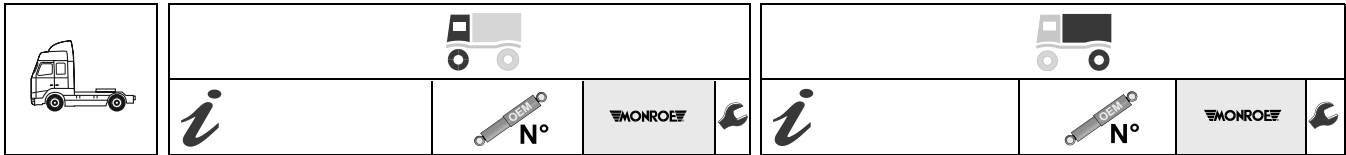

ATEGO 2 (2004/10-)































4x2	☺	0073230800	T1246	⊖ ⊖	☺	9703260000	T1256	⊖ ⊖
		9583230400				9703260200		
4x4	☺	9743230000	T1255	⊖ ⊖	☺	9703260700	T5178	⊖ ⊖
		9743230400				9743260400		
4x4	☺	9743230600	T1115	⊖ ⊖	☺	9743260000	T5403	⊖ ⊖
		9743230600				9743260400		
4x4	☺	9743231300	T1246	⊖ ⊖	☺	0063268100	T5374	⊖ ⊖
		9753230000				9723260000		
4x4	☺	A0073230800	T1255	⊖ ⊖	☺	9723260200	T5332	⊖ ⊖
		A9583230400				9743260400		
4x4	☺	A9743230400	T1115	⊖ ⊖	☺	9743260100	T5374	⊖ ⊖
		A9743230600				9723260200		
4x4	☺	A9743231300	T1246	⊖ ⊖	☺	A0063268100	T5374	⊖ ⊖
		A9753230000				A9723260000		
4x4	☺	9703230000	T1255	⊖ ⊖	☺	A9723260200	T5374	⊖ ⊖
		9703230300				A9723260200		
4x4	☺	9703230700	T1246	⊖ ⊖	☺	A9723260000	T5374	⊖ ⊖
		9703231000				A9723260200		
4x4	☺	A9703230300	T1246	⊖ ⊖	☺	A9723260000	T5374	⊖ ⊖
		☺				A9723260200		

ATEGO 2 (2004/10-)









4x2	☺	0073230800	T1246	⊖ ⊖	☺	9703260000	T1256	⊖ ⊖
		9583230400				9703260200		
4x4	☺	9743230000	T1255	⊖ ⊖	☺	9703260700	T5178	⊖ ⊖
		9743230400				9743260400		
4x4	☺	9743230600	T1115	⊖ ⊖	☺	9743260000	T5403	⊖ ⊖
		9743230600				9743260400		
4x4	☺	9743231300	T1246	⊖ ⊖	☺	0063267300	T5332	⊖ ⊖
		9753230000				9743260100		
4x4	☺	A0073230800	T1255	⊖ ⊖	☺	A0063267300	T5332	⊖ ⊖
		A9583230400				A9743260100		
4x4	☺	A9743230400	T1115	⊖ ⊖	☺	9743260100	T5374	⊖ ⊖
		A9743230600				9723260200		
4x4	☺	A9743231300	T1246	⊖ ⊖	☺	A0063268100	T5374	⊖ ⊖
		A9753230000				A9723260000		
4x4	☺	9703230000	T1255	⊖ ⊖	☺	A9723260200	T5374	⊖ ⊖
		9703230300				A9723260200		
4x4	☺	9703230700	T1246	⊖ ⊖	☺	A9723260000	T5374	⊖ ⊖
		9703231000				A9723260200		
4x4	☺	A9703230300	T1246	⊖ ⊖	☺	A9723260000	T5374	⊖ ⊖
		☺				A9723260200		

ATEGO 2 (2004/10-)









4x2	☺	0073230800	T1246	⊖ ⊖	☺	9703260000	T1256	⊖ ⊖
		9583230400				9703260200		
4x4	☺	9743230000	T1255	⊖ ⊖	☺	9703260700	T5178	⊖ ⊖
		9743230400				9743260400		
4x4	☺	9743230600	T1115	⊖ ⊖	☺	9743260000	T5403	⊖ ⊖
		9743230600				9743260400		
4x4	☺	9743231300	T1246	⊖ ⊖	☺	0063267300	T5332	⊖ ⊖
		9753230000				9743260100		
4x4	☺	A0073230800	T1255	⊖ ⊖	☺	A0063267300	T5332	⊖ ⊖
		A9583230400				A9743260100		
4x4	☺	A9743230400	T1115	⊖ ⊖	☺	9743260100	T5374	⊖ ⊖
		A9743230600				9723260200		
4x4	☺	A9743231300	T1246	⊖ ⊖	☺	A0063268100	T5374	⊖ ⊖
		A9753230000				A9723260000		
4x4	☺	9703230000	T1255	⊖ ⊖	☺	A9723260200	T5374	⊖ ⊖
		9703230300				A9723260200		
4x4	☺	9703230700	T1246	⊖ ⊖	☺	A9723260000	T5374	⊖ ⊖
		9703231000				A9723260200		
4x4	☺	A9703230300	T1246	⊖ ⊖	☺	A9723260000	T5374	⊖ ⊖
		☺				A9723260200		

								
<i>i</i>		N°		<i>i</i>		N°		
4x4		0023265000 0023265500 0033267400 0043262300 0043262400 0043264300 9723230100 9723230300 A9723230100 A9723230300	T1115	 		0063268100 9723260000 9723260200 A0063268100 A9723260000 A9723260200	T5374	 
			T1246	 		9703260100 A9703260100	T1273	 
6x2			T1246	 				
6x2/4			T1246	 		0063262000 0063267100 9743261000 A0063262000 A0063267100 A9743261000	T5403	 

ATEGO 2 (2004/10-) 

4x2		0073230800 9583230400 9743230000 9743230400 9743230600 9743231300 9753230000 A0073230800 A9583230400 A9743230400 A9743230600 A9743231300 A9753230000	T1246	 		9703260000 9703260200 9703260700 A9703260200	T1256	 
		9703230000 9703230300 9703230700 9703231000 A9703230300	T1255	 				

ATEGO 2 (2004/10-) 

4x2		0073230800 9583230400 9743230000 9743230400 9743230600 9743231300 9753230000 A0073230800 A9583230400 A9743230400 A9743230600 A9743231300 A9753230000	T1246	 		0063267300 9743260100 A0063267300 A9743260100	T5332	 
						0063262000 0063267100 9743261000 A0063262000 A0063267100 A9743261000	T5403	 

ATEGO 3 (2013/04-) 

4x2						9703260000 9703260200 9703260700 A9703260200	T1256	 
------------	--	--	--	--	---	---	--------------	--

ATEGO 3 (2013/04-)

4x2						9703260000 9703260200 9703260700 A9703260200	T1256	 
------------	--	--	--	--	---	---	--------------	--

ATEGO 3 (2013/04-) 

4x2						9703260000 9703260200 9703260700 A9703260200	T1256	 
------------	--	--	--	--	---	---	--------------	--

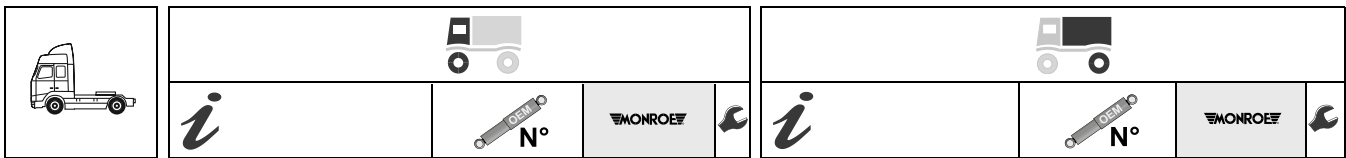

AXOR (2001/09-2004/10)



4x2	☺	0033232000	T1220	○	☺	0053263300	T1200	○
		0033232100				0053263400		
6x2	☺	0043235600	T1197	○	☺	9583260800	T5375	○
		0063235100				A0053263300		
6x2	☺	0063236000	T1207	○	☺	A0053263400	F5251	○
		0063237800				A9583260800		
6x2	☺	0063237900	T1207	○	☺	0043269900	T5375	○
		3573230000				A0043269900		
6x2	☺	3753230000	T1207	○	☺	A0053263300	F5251	○
		A0063235100				A0053264200		
6x2	☺	0023231500	T1197	○	☺	0063264300	F5251	○
		0023235300				9463260000		
6x2	☺	0043234300	T1207	○	☺	9463260100	F5251	○
		0043236100				A0063264300		
6x2	☺	0063233300	T1207	○	☺	A9463260000	F5251	○
		0063233900				A9463260100		
6x2	☺	0063234000	T1207	○	☺	A9463260000	F5251	○
		0063237400				A9463260100		
6x2	☺	A0063233300	T1207	○	☺	A9463260100	F5251	○
		0053239700						
6x2	☺	0063231600	T1207	○	☺		T5256	○
		0063232100						
6x2	☺	0063233800	T1207	○	☺		T5256	○
		0063236500						
6x2	☺	0063237100	T1207	○	☺		T5256	○
		0063237200						
6x2	☺	3753230100	T1207	○	☺		T5256	○
		9583230700						
6x2	☺	9583231000	T1207	○	☺		T5256	○
		9583231200						
6x2	☺	A0053239700	T1207	○	☺		T5256	○
		A0063236500						
6x2	☺	A0063237100	T1207	○	☺		T5256	○
		A9583230700						
6x2	☺	A9583230700	T1207	○	☺		T5256	○
		A9583231000						
6x2	☺	A9583231000	T1207	○	☺		T5256	○
		A9583231200						







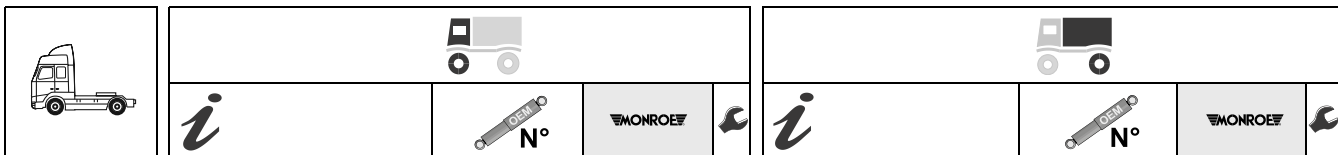









































































































AXOR (2001/09-2004/10)



4x2	☺	0033232000	T1220	○	☺	0053263300	T1200	○
		0033232100				0053263400		
6x2	☺	0043235600	T1197	○	☺	9583260800	T5375	○
		0063235100				A0053263300		
6x2	☺	0063236000	T1220	○	☺	A0053263400	F5251	○
		0063237800				A9583260800		
6x2	☺	0063237900	T1220	○	☺	0043269900	T5375	○
		3573230000				A0043269900		
6x2	☺	3753230000	T1220	○	☺	A0053263300	F5251	○
		A0063235100				A0053264200		
6x2	☺	0023231500	T1197	○	☺	0063264300	F5251	○
		0023235300				9463260000		
6x2	☺	0043234300	T1220	○	☺	9463260100	F5251	○
		0043236100				A0063264300		
6x2	☺	0063233300	T1220	○	☺	A9463260000	F5251	○
		0063233900				A9463260100		
6x2	☺	0063234000	T1220	○	☺	A9463260000	F5251	○
		0063237400				A9463260100		
6x2	☺	A0063233300	T1220	○	☺	A9463260100	F5251	○
		0053239700						
6x2	☺	0063231600	T1207	○	☺		T5256	○
		0063232100						
6x2	☺	0063233800	T1207	○	☺		T5256	○
		0063236500						
6x2	☺	0063237100	T1207	○	☺		T5256	○
		0063237200						
6x2	☺	3753230100	T1207	○	☺		T5256	○
		9583230700						
6x2	☺	9583231000	T1207	○	☺		T5256	○
		9583231200						
6x2	☺	A0053239700	T1207	○	☺		T5256	○
		A0063236500						
6x2	☺	A0063237100	T1207	○	☺		T5256	○
		A9583230700						
6x2	☺	A9583230700	T1207	○	☺		T5256	○
		A9583231000						
6x2	☺	A9583231000	T1207	○	☺		T5256	○
		A9583231200						



AXOR (2001/09-2004/10) 

4x2		0053239700 0063231600 0063232100 0063233800 0063236500 0063237100 0063237200 3753230100 9583230700 9583231000 9583231200 A0053239700 A0063236500 A0063237100 A9583230700 A9583231000 A9583231200	T1207	                       	T1207	                       	0053261100 0053267400 0063260100 A0053261100 A0053267400 A0063260100 0053262200 0053267300 0063260000 0063263000	T5171	                       	T5287	0053268800 0063260300 0063261100 0063261200 A0053268800 A0063260300 A0063261100 A0063261200	T5358	                       	6x2	    	  0063235400 A0063235400 0073231300 A0073231300	T1207 T1220 T1304 T1339	    	Hendrickson 0063264200 0063264300 9463260000 9463260100 A0063264300 A9463260000 A9463260100	F5251 T5358	    
-----	--	--	-------	---	-------	---	---	-------	---	-------	--	-------	---	-----	--	--	----------------------------------	--	--	----------------	--







































































AXOR 2 (2004/10-)

4x2	☺	0033233200 0033233300 0043239200 0053239600 0063230900 0063237300 A0053239600 A0063230900	T1011	○ ○	☺	0053263300 0053263400 9583260800 A0053263300 A0053263400 A9583260800	T1200	○ ○	
	☺	0023231500 0023235300 0043234300 0043236100 0063233300 0063233900 0063234000 0063237400 A0063233300	T1197	○ ○					
	☺	0053239700 0063231600 0063232100 0063233800 0063236500 0063237100 0063237200 3753230100 9583230700 9583231000 9583231200 A0053239700 A0063236500 A0063237100 A9583230700 A9583231000 A9583231200 0063234500	T1207	○ ○					
	☺	0073231400 A0073231400	T1275 T1352	○ ○ ○ ○	☺	0053261000 A0053261000	T1210	○ ○	
	4x4	☺	☺	T1197	○ ○	☺	0053263300 0053263400 9583260800 A0053263300 A0053263400 A9583260800	T1200	○ ○
		☺	0063234500	T1275	○ ○				
		☺	0073231400 A0073231400	T1352	○ ○	☺	0053261000 A0053261000	T1210	○ ○
	6x4	☺	☺	T1011	○ ○	☺	0003201530 0053260900 0053265700 0053265800 0053265900 0053266300 0063266700 A0053260900	T1201	○ ○
		☺	☺	T1197	○ ○				
		☺	0013231100 0023231000 0023231100 0023231600 0023235400 0033231000 0043233600 0043234900 0043236500 0053239500 0063233700 0063236100 A0053239500	T1204	○ ○	☺ ●	0053266000 0053266400 0053266600 0063262400 0063266800 9583260700 A0053266000 A0053266400 A0053266600 A0063262400 A0063266800 A9583260700	T5372	○ ○
☺		☺	T1207	○ ○					
☺		0063234500	T1275	○ ○					
☺		0063235400 A0063235400	T1304	○ ○					
☺		0073231400 A0073231400	T1352	○ ○					
8x4/4		☺	☺	T1011	○ ○	☺	☺	T1201	○ ○
		☺	☺	T1204	○ ○				
		☺	☺	T1207	○ ○	☺ ●	☺	T5372	○ ○
	☺	0073231400 A0073231400	T1352	○ ○					







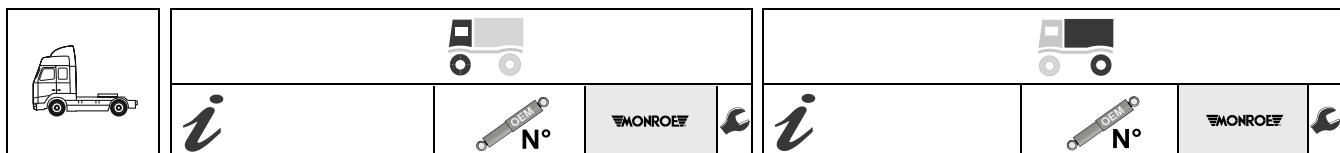































																			
<i>i</i>	 N°			6x2/2/4	      0053239900 0063238300 A0053239900 A0063238300 0073231600 A0073231600	T1197 T1204 T1207 T1220 T5360 T1340	       	6x2/4		  Hendrickson	0053261200 0063265600 A0053261200 0053261300 0063260400 A0053261300 A0063260400 0053261400 0063260500 A0053261400	T5137 T5385 T5256	  						
6x4	        0073231400 A0073231400 0053239900 0063238300 A0053239900 A0063238300 0073231600 A0073231600	T1011 T1197 T1204 T1207 T1220 T1352 T5360 T1340	         	8x2/4	  	T1197 T1207 T1220	  	8x4	  	T1197 T1207 T1220	  	8x4/4	 	T1011 T1197	 	  	 	T5372	 













































AXOR 2 (2004/10-)









Configuration	Part Number	Model	Notes	Part Number	Model	Notes
4x2	0023231500	T1197	○	0053263300	T1200	○
	0023235300		○	0053263400		○
	0043234300			9583260800		
	0043236100			A0053263300		
	0063233300			A0053263400		
	0063233900			A9583260800		
	0063234000					
	0063237400					
	A0063233300					
	0013231100	T1204	○			
	0023231000		○			
	0023231100					
	0023231600			0053261100	T5171	○
	0023235400			0053267400		○
	0033231000			0063260100		○
0043233600			A0053261100			
0043234900			A0053267400			
0043236500			A0063260100			
0053239500						
0063233700						
0063236100						
A0053239500						
0053239700	T1207	○				
0063231600						
0063232100						
0063233800						
0063236500						
0063237100			0053262200	T5287	○	
0063237200			0053267300		○	
3753230100			0063260000		○	
9583230700			0063263000			
9583231000						
9583231200						
A0053239700						
A0063236500						
A0063237100						
A9583230700						
A9583231000						
A9583231200						
0033232000	T1220	○				
0033232100		○				
0043235600						
0063235100			0053268800	T5358	○	
0063236000			0063260300		○	
0063237800			0063261100		○	
0063237900			0063261200			
3573230000			A0053268800			
3753230000			A0063260300			
A0063235100			A0063261100			
			A0063261200			
0063235400	T1304	○				
A0063235400		○				
0063233400	T5361	○				
0063238200		○				
0063239700						
A0063233400						
A0063238200						
A0063239700						
0073231300	T1339	○				
A0073231300		○				
6x2	0033233200	T1011	○	0003201530	T1201	○
	0033233300		○	0053260900		○
	0043239200			0053265700		
	0053239600			0053265800		
	0063230900			0053265900		
	0063237300			0053266300		
	A0053239600			0063266700		
	A0063230900			A0053260900		
	←↑	T1207	○	0053266000	T5372	○
	←↑		○	0053266400		○
	←↑	T1220	○	0053266600		○
	←↑		○	0063262400		○
	0063235400	T1304	○	0063266800		○
	A0063235400		○	9583260700		○
				A0053266000		○
			A0053266400		○	
			A0053266600		○	
			A0063262400		○	
			A0063266800		○	
			A9583260700		○	
0073231400	T1352	○				
A0073231400		○				
0073231300	T1339	○				
A0073231300		○	←↑	T5358	○	









									
	<i>i</i>	 N°			<i>i</i>	 N°			
6x4			T1011					T1201	
			T1197					T5372	
			T1207					T5358	
		0063235400 A0063235400	T1304						
		0073231400 A0073231400	T1352						





ECONIC (1998/01-)

4x2		0053239900 0063238300 A0053239900 A0063238300	T5360			0053262200 0053267300 0063260000 0063263000	T5287	
						0053261300 0063260400 A0053261300 A0063260400	T5385	
						0053262500 0063266000 A0053262500 A0063266000	T5414	
								
6x2/4		0053239900 0063238300 A0053239900 A0063238300	T5360			0053262200 0053267300 0063260000 0063263000	T5287	
						0053261300 0063260400 A0053261300 A0063260400	T5385	
						0053262500 0063266000 A0053262500 A0063266000	T5414	
								
6x4		0053239900 0063238300 A0053239900 A0063238300	T5360			0053262200 0053267300 0063260000 0063263000	T5287	
						0053261300 0063260400 A0053261300 A0063260400	T5385	
						0053262500 0063266000 A0053262500 A0063266000	T5414	
								
8x4/4		0053239900 0063238300 A0053239900 A0063238300	T5360			0053262200 0053267300 0063260000 0063263000	T5287	
						0053261300 0063260400 A0053261300 A0063260400	T5385	
						0053262500 0063266000 A0053262500 A0063266000	T5414	
								

ECONIC (1998/03-)









6x2/4		0053239900 0063238300 A0053239900 A0063238300	T5360			0053262200 0053267300 0063260000 0063263000	T5287	
						0053261300 0063260400 A0053261300 A0063260400	T5385	
						0053262500 0063266000 A0053262500 A0063266000	T5414	

								
	<i>i</i>	 OEM N°			<i>i</i>	 OEM N°		

6x4	0033233000	T1013	 	 
	0033233100			
	0033233400			
	0033236500			
	0033236600			
	0043233400			
	0043234700			
	0043236700			
A0043234700				
A0043236700				





LK/LN2



4x2		0063231700	T1072	 	 
		6753230600			
		6753230800			
		6753231000			
		0053264500	T5129	 	
		0063267800	T5250	 	
		0053264600			
		6753260500			
		6753260700			
		A0053264600			

LK/LN2

(1994/03-1998/12)

4x2		0013231100	T1204	 	 
		0023231000			
		0023231100			
		0023231600			
		0023235400			
		0033231000			
		0043233600			
		0043234900			
		0043236500			
		0053239500			
		0063233700			
		0063236100			
		A0053239500			



















LP



4x2			T5039 ¹	 
-----	--	--	--------------------	--

LP











4x2			Pub. Health Auth.	3183260000	T1018 ¹	              
				3183260500		
			Pub. Health Auth.		T5039 ¹	
					V2021	
				0013265700		
				0013268800		
				0023239400		
				0023239600		
				0023261900		
				0023262600		
				0023262700		
				0033235500		
				0033235800		
				0043263700		
	3143260100					
	3143260200					
	3143260400					
	3143260500					
	3143260600					
6x2				0013269300	T5033 ¹	
				3933260000		

LP



























4x2			3183260000	T1018 ¹	 
			3183260500		

								
	<i>i</i>				<i>i</i>			

MK





4x2		0033233000 0033233100 0033233400 0033236500 0033236600 0043233400 0043234700 0043236700 A0043234700 A0043236700	T1013	  		0053231800	T1002	 
		0033236700 0033236800 0043234100 0043236800 0043236900 0053236000 0063239500	T1232	      		0043265800 0043265900 0043267000 A0043265800 A0043265900 A0043267000	T1329	      
6x2/4		0053231800	T1002	 				

MK





(1987/12-1996/09)



6x4		0033233000 0033233100 0033233400 0033236500 0033236600 0043233400 0043234700 0043236700 A0043234700 A0043236700	T1013	 				
------------	---	--	--------------	--	--	--	--	--

MK

(1987/12-1996/09)

4x2		0033232000 0033232100 0043235600 0063235100 0063236000 0063237800 0063237900 3573230000 3753230000 A0063235100	T1220	  				
------------	--	---	--------------	--	--	--	--	--

NG





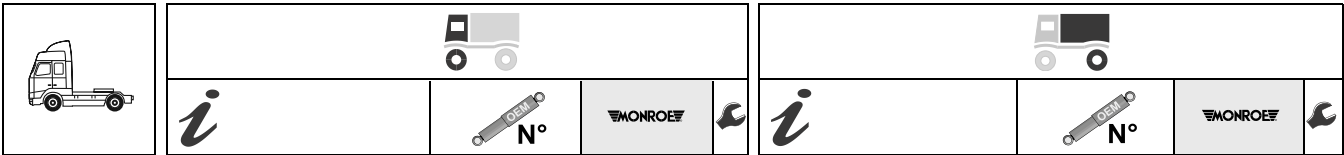



6x4		0033233200 0033233300 0043239200 0053239600 0063230900 0063237300 A0053239600 A0063230900	T1011	  		0023269200 0023269300 0033265000	T5031¹	  
		0033233000 0033233100 0033233400 0033236500 0033236600 0043233400 0043234700 0043236700 A0043234700 A0043236700	T1013	       				
	HD	0053234000 0053234100	T1012	  				
8x4/4			T1011	  				
	HD	0053234000 0053234100	T1012	 				



NG







4x2	☾	0033233200	T1011	OD	☾ ↔ 3500mm	T1151 ¹	⊥ T					
		0033233300										
		0043239200										
		0053239600										
		0063230900										
		0063237300										
		A0053239600										
		A0063230900										
		0033233000						T1013	OD	Pub. Health Auth.	T1056	⊥ T
		0033233100										
0033233400												
0033236500												
0033236600												
0043233400												
0043234700												
0043236700												
A0043234700												
A0043236700												
☾ Pub. Health Auth.	T1015 ¹	OD	Pub. Health Auth.	T5054	⊥ O							
☾ Pub. Health Auth.												
0023233200												
0023235800												
0023235900												
0023237200												
0023237300												
0023238600												
0023238700												
0023269500												
0033237100												
0033239700												
0033260200												
0033267700												
0043230000												
0043230100												
0043234400												
0043234500												
0043234600												
0043235200												
0043235900												
0043236400												
0043239700												
0043239800												
0063230700												
0063230800												
A0043234500												
☾	T1204	OD										
0013231100												
0023231000												
0023231100												
0023231600												
0023235400												
0033231000												
0043233600												
0043234900												
0043236500												
0053239500												
0063233700												
0063236100												
A0053239500												
☾	T1012	OD										
HD												
0053234000												
0053234100												
4x4	☾	↖ ↑	T1016	OD								
		↖ ↑	T1013	OD								
6x2	☾	↖ ↑	T1011	OD								
	HD	0053234000	T1012	OD								
		0053234100										
6x4	☾	↖ ↑	T1011	OD	☾	0023269200	T5031 ¹	OD				
	☾	↖ ↑	T1016	OD		0023269300						
	HD	0053234000	T1012	OD		0033265000						
		0053234100										
6x6	☾	↖ ↑	T1016	OD								
8x4/4	☾	↖ ↑	T1011	OD								
	HD	0053234000	T1012	OD								
		0053234100										







































































						
	<i>i</i>	 N°		<i>i</i>	 N°	

NG



4x2			T1015¹						
		0023233200 0023235800 0023235900 0023237200 0023237300 0023238600 0023238700 0023269500 0033237100 0033239700 0033260200 0033267700 0043230000 0043230100 0043234400 0043234500 0043234600 0043235200 0043235900 0043236400 0043239700 0043239800 0063230700 0063230800 A0043234500		T1016			0033261400 0033261500 0043266800 0043266900 6173260000 6523200031 A0033261400		T5030
						0023264600 0023264700 0033264500 0033269200 3853260100		T5054	



								
	<i>i</i>	 N°			<i>i</i>	 N°		
6x2			T1011			0023269200 0023269300 0033265000	T5031¹	
			T1013			0013269300 3933260000	T5033¹	
	 HD	0053234000 0053234100	T1012				T1115	
			T1016			0023264600 0023264700 0033264500 0033269200 3853260100	T5054	
6x2/2/4			T1013					
6x2/4						0023232500 0023235000 0023265200 3853260000	T1027	
6x4			T1011			0023269200 0023269300 0033265000	T5031¹	
			T1013					
			T1016					
	 HD	0053234000 0053234100	T1012					
6x6			T1013					
			T1016					
8x4			T1011					
	 HD	0053234000 0053234100	T1012					
8x4/4			T1011					
	 HD	0053234000 0053234100	T1012					



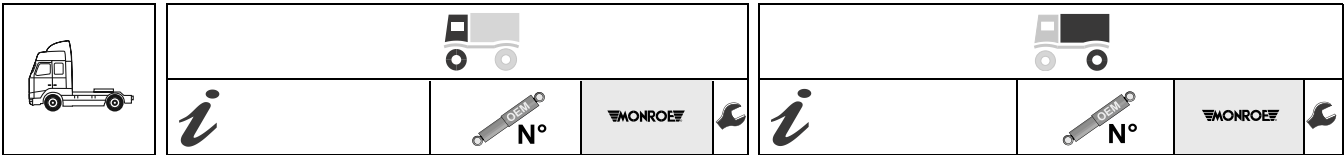







































NG



4x2			0033233200 0033233300 0043239200 0053239600 0063230900 0063237300 A0053239600 A0063230900	T1011		0033261400 0033261500 0043266800 0043266900 6173260000 6523200031 A0033261400	T5030	
				T1015 ¹			T1009 ¹	
			0023233200 0023235800 0023235900 0023237200 0023237300 0023238600 0023238700 0023269500 0033237100 0033239700 0033260200 0033267700 0043230000 0043230100 0043234400 0043234500 0043234600 0043235200 0043235900 0043236400 0043239700 0043239800 0063230700 0063230800 A0043234500	T1016		0023268800 0023268900 0033264400	T1027	
				T1204		002326200 0023266300 0033265800 0033268500 0053262000 0063265900 A0023266200 A0023266300 A0033265800 A0033268500 A0053262000 A0063265900	T5034	
				T1232				
				T1012				
4x4			0053234000 0053234100	T1012				
				T1016		0023233200 0023235800 0023235900 0023237200 0023237300 0023238600 0023238700 0023269500 0033237100 0033239700 0033260200 0033267700 0043230000 0043230100 0043234400 0043234500 0043234600 0043235200 0043235900 0043236400 0043239700 0043239800 0063230700 0063230800 A0043234500	T1016	
6x2			0053234000 0053234100	T1012		0023268800 0023268900 0033264400	T1009 ¹	
6x2/4			0053234000 0053234100	T1011		0023268800 0023268900 0033264400	T1009 ¹	
				T1012				





















								
	<i>i</i>	 N°			<i>i</i>	 N°		
6x4			T1011			0023268800 0023268900 0033264400	T1009¹	
			T1016			0023269200 0023269300 0033265000	T5031¹	
		0053234000 0053234100	T1012				T5034	
								
6x6			T1016				T1016	

NG (1973/08-1996/09)





4x2		0013231100 0023231000 0023231100 0023231600 0023235400 0033231000 0043233600 0043234900 0043236500 0053239500 0063233700 0063236100 A0053239500	T1204					
		0033232000 0033232100 0043235600 0063235100 0063236000 0063237800 0063237900 3573230000 3753230000 A0063235100	T1220					
6x6		0033233000 0033233100 0033233400 0033236500 0033236600 0043233400 0043234700 0043236700 A0043234700 A0043236700	T1013					



SK

								
4x2		0033233200 0033233300 0043239200 0053239600 0063230900 0063237300 A0053239600 A0063230900	T1011				T1151¹	
		0053234000 0053234100	T1012					
4x4			T1011					
		0053234000 0053234100	T1012					
6x2		0053234000 0053234100	T1012					
6x4			T1011					
		0053234000 0053234100	T1012					

SK

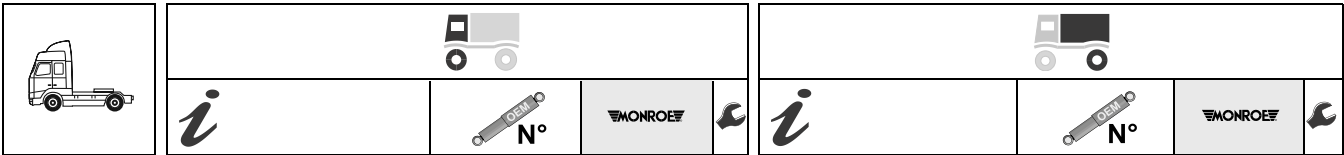

								
4x2		0053234000 0053234100	T1012					
4x4		0053234000 0053234100	T1012					
6x2		0053234000 0053234100	T1012					



SK















































































































































































































































































4x2		0033233200	T1011			0023265000	T1115	
		0033233300				0023265500		
		0043239200			0033267400			
		0053239600			0043262300			
		0063230900			0043262400			
		0063237300			0043264300			
		A0053239600			9723230100			
		A0063230900			9723230300			
		0023233200	T1016		A9723230100			
		0023235800			A9723230300			
		0023235900						
		0023237200						
		0023237300						
		0023238600						
		0023238700						
		0023269500						
		0033237100						
		0033239700						
		0033260200						
		0033267700						
		0043230000						
		0043230100						
		0043234400						
		0043234500						
		0043234600						
		0043235200						
		0043235900						
		0043236400						
		0043239700						
		0043239800						
		0063230700						
		0063230800						
		A0043234500						
		0053234000	T1012		0043266400	T5005		
		0053234100						
4x4			T1011					
		0053234000	T1012					
		0053234100						
6x2			T1011			0023269200	T5031 ¹	
						0023269300		
						0033265000		
			T1012				T1115	
							T5005	
6x2/4						0023268800	T1009 ¹	
						0023268900		
						0033264400		
6x4			T1011			0023269200	T5031 ¹	
			T1016			0023269300		
			T1012			0033265000		
6x6			T1013					
8x4/4			T1011					
			T1012					

								
	<i>i</i>	 N°			<i>i</i>	 N°		

SK



4x2		0053234000	T1012	 	 	0023268800	T1009 ¹	 
		0053234100				0033264400		
4x4		0033233200 0033233300 0043239200 0053239600 0063230900 0063237300 A0053239600 A0063230900	T1011	                                         	T1012	                                         	T5034	                                         
6x2		0023233200 0023235800 0023235900 0023237200 0023237300 0023238600 0023238700 0023269500 0033237100 0033239700 0033260200 0033267700 0043230000 0043230100 0043234400 0043234500 0043234600 0043235200 0043235900 0043236400 0043239700 0043239800 0063230700 0063230800 A0043234500	T1016	                                 	T1011	                                 	T5034	                                 
6x2/4		0053234000 0053234100	T1012	 	 	0023268800 0023268900 0033264400	T1009 ¹	  
6x4			T1016	 	      	0023269200 0023269300 0033265000	T5031 ¹	      
6x6				 	 		T1016	 



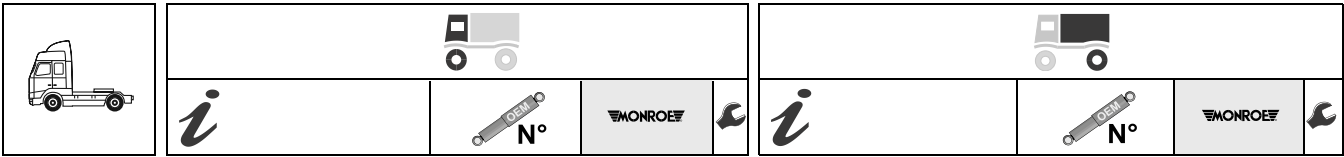

T2/L



4x2	HD	0023236900	T1143	○	Van	0013265700	V2021	○
	Van	0013268800	V2021	○		0013268800		
6x4		0023239400		○		0023239400		○
		0023239600		○		0023239600		○
		0023261900		○		0023261900		○
		0023262600		○		0023262600		○
		0023262700		○		0023262700		○
		0033235500		○		0033235500		○
		0033235800		○		0033235800		○
		0043263700		○		0043263700		○
		3143260100		○		3143260100		○
		3143260200		○		3143260200		○
		3143260400		○		3143260400		○
		3143260500		○		3143260500		○
		3143260600		○		3143260600		○
						HD	0023236900	T1143

T2/L

(0/00-)



6x4		0013231100	T1204	○				
		0023231000		○				
		0023231100		○				
		0023231600		○				
		0023235400		○				
		0033231000		○				
		0043233600		○				
		0043234900		○				
		0043236500		○				
		0053239500		○				
		0063233700		○				
		0063236100		○				
		A0053239500		○				

T2/LN1





4x2		6733230400	T1067 ¹	○			T1070 ¹	○
		6743230000		○				○
		6743230200		○				○
		6753230400		○				○
		0063231000		○				○
		0063231100		○		0053262900	T1111	○
		0063231200		○		0053263600		○
		6733230400		○		0053264200		○
		6733230800		○		6733260000		○
		6743230000		○		6733261100		○
		6743230200		○		6733261200		○
		6743230500		○		6733261300		○
		6743230600		○		6733261400		○
		6753230400		○		6743261200		○
	Pub. Health Auth.	0063232800	T1127	○	6743261300		○	
		6733230700		○	6743261400		○	
		6733230900		○	A0053263600		○	
		6743230100		○	A0053264200		○	
		6743230300		○				
		A0063232800		○				

T2/LN1























4x2		6733230400	T1067 ¹	○				
		6743230000		○				
		6743230200		○				
		6753230400		○				
		0063231000		○				
		0063231100		○				
		0063231200		○				
		6733230400		○				
		6733230800		○				
		6743230000		○				
		6743230200		○				
		6743230500		○				
		6743230600		○				
		6753230400		○				
	0063232800		T1127	○				
		6733230700		○				
		6733230900		○				
		6743230100		○				
		6743230300		○				
		A0063232800		○				

								
	<i>i</i>	 N°			<i>i</i>	 N°		











T2/LN1



4x2		Van	0063232800 6733230700 6733230900 6743230100 6743230300 A0063232800	T1127	 		Van	0053262900 0053263600 0053264200 6733260000 6733261100 6733261200 6733261300 6733261400 6743261200 6743261300 6743261400 A0053263600 A0053264200	T1070 ¹	   
		Van	0053230200 0053230300 0053230900 0053231900 A0053230900	T1064	  			Van	6733230400 6743230000 6743230200 6753230400	T1067 ¹
4x2		Van	0063231000 0063231100 0063231200 6733230400 6733230800 6743230000 6743230200 6743230500 6743230600 6753230400	T1069	   			Van	0043261300 A0043261300	T1194
		Van HD	0043238800 0043238900	V1089	 					

T2/LN1



4x2		Van	0063232800 6733230700 6733230900 6743230100 6743230300 A0063232800	T1127	 		Van	0053262900 0053263600 0053264200 6733260000 6733261100 6733261200 6733261300 6733261400 6743261200 6743261300 6743261400 A0053263600 A0053264200	T1111	 
		Van	6733230400 6743230000 6743230200 6753230400	T1067 ¹	  			Van	6743261400 6743261300 6743261300 6743261400 A0053263600 A0053264200	T1069

T2/LN1

(-1987/03)



4x2							0043261300 A0043261300	T1194	 
-----	--	--	--	--	--	--	---------------------------	-------	--

T2/LN1



4x2							0043261300 A0043261300	T1194	 
-----	--	--	--	--	--	--	---------------------------	-------	--

T2/LN1









4x2							0043261300 A0043261300	T1194	 
-----	--	--	--	--	--	--	---------------------------	-------	--

T2/LN1

(1987/11-1994/12)









4x4		Van	0053235000 A0053235000	V2145	 		Van	0043261400 0043265700 A0043261400 A0043265700	V2144	 
		Van								

T2/LN1

(1987/11-1994/12)



4x4		Van	0053235000 A0053235000	V2145	 		Van	0043261400 0043265700 A0043261400 A0043265700	V2144	 
		Van								

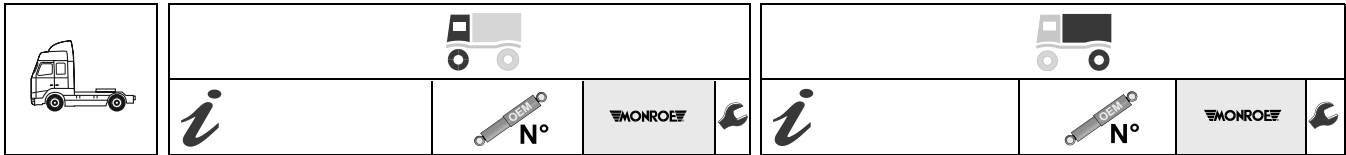

VARIO (1996/09-)

4x4	0053235000 A0053235000	V2145	○ ○	 	0043266700 A0043266700	V1189	○ ○ ○
					0043261400 0043265700 A0043261400 A0043265700	V2144	○ ○ ○

ZETROS (2008/09-)

4x4	0023231500 0023235300 0043234300 0043236100 0063233300 0063233900 0063234000 0063237400 A0063233300	T1197	○ ○	 	0053263300 0053263400 9583260800 A0053263300 A0053263400 A9583260800	T1200	○ ○

NISSAN

ATLEON (2000/09-)

4x2	561009X000 561009X401 561009X402	T1366⁰	⊥ ○	 	56200D8802	T1365	⊥ ○
	562009X403 56200LA20A	V1198	○ ○		562009X401 56200D9201	T1367⁰	⊥ ○
	561009X600 56100LA20A	V1199	⊥ ○		56200LA30A	T1368	⊥ ○

RENAULT TRUCKS

C









6x4	23512077 5000725485 5000725804 5000731913 5000790109 5000790852 5001857665	T1122	⊥ T	
-----	--	--------------	--------	--

C

4x2	23512077 5000725485 5000725804 5000731913 5000790109 5000790852 5001857665	T1122	⊥ T	
4x4	↙↑	T1122	⊥ T	
6x4	↙↑	T1122	⊥ T	

C

4x2	23512077 5000725485 5000725804 5000731913 5000790109 5000790852 5001857665	T1122	⊥ T	
4x4	↙↑	T1122	⊥ T	
6x4	↙↑	T1122	⊥ T	

								
	<i>i</i>	 N°			<i>i</i>	 N°		

C



4x2	23512077 5000725485 5000725804 5000731913 5000790109 5000790852 5001857665	T1122	⊥ T		
4x4		T1122	⊥ T		

KERAX



6x4	5010052921 5010060410 5010557642 7482293273	T5229	⊥ T	7421243060 7421909816	T5392	⊙ T
6x6				7421243060 7421909816	T5392	⊙ T
8x4	5010052921 5010060410 5010557642 7482293273	T5229	⊥ T	7421243060 7421909816	T5392	⊙ T



KERAX

(1997/06-)



6x2				 5010383909 5430050472 5430051681	T1214	⊙ ⊙
6x4				7421243060 7421909816	T5392	⊙ T
6x6				7421243060 7421909816	T5392	⊙ T

KERAX

(2001/01-)



6x4				7421243060 7421909816	T5392	⊙ T
8x4				7421243060 7421909816	T5392	⊙ T

KERAX

(2001/01-)



6x4				7421243060 7421909816	T5392	⊙ T
8x4				7421243060 7421909816	T5392	⊙ T

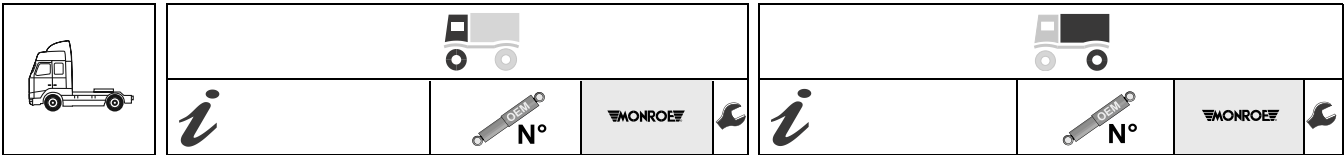

MAGNUM



4x2	18 - 19 ton 5000752729 5010052920 5010294412 5010294413 5010383049 5010383050 5010383693 5010383694	T1223		18 - 19 ton 5010052921 5010060410 5010557642 7482293273 5010130009 5010383701 7482293239 5000790689 5001863289 5010095871 5001863291 5010137052 5010380547 5010383687 5001863292 5010237285 For vehicles with Chassis 5010294158 5010383689 5010557482 5010600393 5010630386 5010239642 5010294528 5010294908 5010294909 5010383685 5010383686 5010557326 7482293198 7482293222 7482293227	T5229 T5354 T5016¹ T5068 T5078 T5147 T5153 T5154 T5258	
	18 - 19 ton 5010130401 5010383692 5010557487	T5179				
6x2	24 ton, 26 ton 5010130401 5010383692 5010557487	T1223		24 ton, 26 ton 5010130009 5010383701 7482293239 5010052921 5010060410 5010557642 7482293273 5001863289 5010095871 5001863291 5010137052 5010380547 5010383687 5001863292 5010237285 For vehicles with Chassis 5010294158 5010383689 5010557482 5010600393 5010630386 2376000200 5010095172 5010237338	T5354 T5229 T5068 T5078 T5147 T5153 T5154 T5258 V2097	
			T5179			

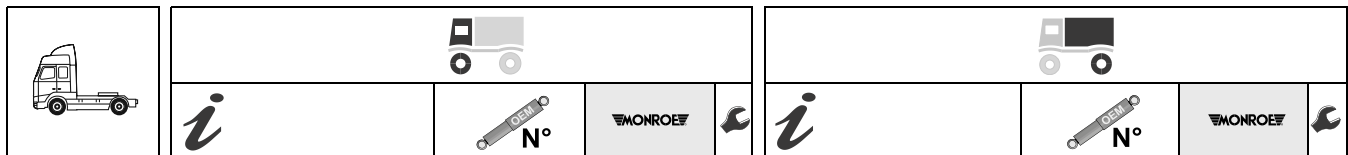

MAGNUM



Configuration	Weight	Part Number	Model	Accessories	Part Number	Model	Accessories			
4x2	18 - 19 ton	5000752729	T1223	⊥ ⊥	⌒	5010052921	T5229	⊥ ⊥		
		5010052920				5010060410				
		5010294412				5010557642				
		5010294413				7482293273				
		5010383049				5010130009				
	5010383050	5010383701	T5354	⊥ ⊥						
	5010383693	7482293239								
	5010383694	5001863289			T5068	⊖ ⊖				
		5010095871								
		5001863291					T5078	⊖ ⊖		
	5010137052									
	5010380547	T5147	⊖ ⊖							
	5010383687									
	5001863292			T5153	⊖ ⊖					
	5010237285									
	5010294158					T5154	⊖ ⊖			
	5010383689									
	5010557482									
	5010600393									
	5010630386									
	5010630602	T5309	⊖ ⊖							
	5010647062									
6x2	18 - 19 ton	5010130401	T5179	⊥ ⊥	⌒	5010239642	T5258	⊖ ⊖		
		5010383692				5010294528				
		5010557487				5010294908				
						5010294909				
						5010383685				
	24 ton, 26 ton	5010130401	T5179	⊥ ⊥	⌒	5010383686	T5354	⊥ ⊥		
		5010383692				5010383701				
		5010557487				7482293239				
						5001863289			T5068	⊖ ⊖
						5010095871				
	5001863291	T5078	⊖ ⊖							
	5010137052									
	Airtronic			T5147	⊖ ⊖					
	5010380547									
	5010383687									
	5001863292	T5153	⊖ ⊖							
	5010237285									
	5010294158			T5154	⊖ ⊖					
	5010383689									
	5010557482									
	5010600393									
	5010630386									
	5010630602	T5309	⊖ ⊖							
	5010647062									
		T2097	⊖ ⊖							
	2376000200									
	5010095172									
	5010237338									
	5010383909			T1214	⊖ ⊖					
	5430050472									
	5430051681									



	<i>i</i>	N°			<i>i</i>	N°			
6x4		←↑	T1223	 T		5010130009	T5354	 T	
			5010383701			7482293239			
		24 ton, 26 ton	5010130401 5010383692 5010557487	T5179	 T		5001863289	T5068	○ ○
				5010630602			5010647062	T5309	
	←↑	5010294158 5010383689 5010557482 5010600393 5010630386	T5154	 ○		5001863291	T5078	○ ○	
			5010137052			5001863292	T5153		○ ○
	SAF	2376000200 5010095172 5010237338	T5258	 ○		5010383909	V2097	○ ○	
			T1214			○ ○			

MAJOR



4x2		23512048 23512085 5010095719 5010130888	T1042	 T		5000788073	T5067 ¹	 T
			5001863283			5000790689	T5016 ¹	
6x2		5010383909 5430050472 5430051681	T1214	 ○		5001863291	T5078	○ ○
			5010137052			5000790689	T5016 ¹	
6x4		5001863291 5010137052	T5078	 ○		5001863291	T5078	○ ○
			5010137052			5010137052	T5078	

MAJOR

(1990-1994)



4x2						5001863291	T5078	○ ○
6x2						5001863291	T5078	○ ○
						5010137052		○ ○

MANAGER





4x2		23512077 5000725485 5000725804 5000731913 5000790109 5000790852 5001857665	T1122	 T				

MANAGER



4x2		23512077 5000725485 5000725804 5000731913 5000790109 5000790852 5001857665	T1122	 T		19 ton	T1228 ¹	 T
			4 x 26, 5 x 26			5000790689	T5016 ¹	
4x4	←↑	5001863289 5010095871	T5068	 ○		5001863291	T5078	○ ○
			5010137052			5010137052	T5078	
6x4	←↑		T1228 ¹	 T		Common Plate	T1228 ¹	 T
6x6	←↑	5010052921 5010060410 5010557642 7482293273	T5229	 T			T1228 ¹	 T

		
<i>i</i>	 N°	 N°
		
		

MANAGER



4x2			4 x 26, 5 x	T1228 ¹	⊥ T
			SAF - Variant No. 20804 5000790689	T5016 ¹	⊥ O O

MASCOTT (1999/01-2004/05)



4x2	5010383009 5010383679 5010557379	V1174	⊥ O O	01162016 5010383684 5010488467	V1175	⊥ O
				5010294929 5010557381 7420848708	V1176	⊥ O O

MASCOTT (1999/01-)



4x2	5010383009 5010383679 5010557379	V1174	⊥ O O	01162016 5010383684 5010488467	V1175	⊥ O O
				5010294929 5010557381 7420848708	V1176	⊥ O O

MASCOTT (1999/01-)



4x2	5010383009 5010383679 5010557379	V1174	⊥ O O	01162016 5010383684 5010488467	V1175	⊥ O O
				5010294929 5010557381 7420848708	V1176	⊥ O O

MAXTER



6x4	5010052921 5010060410 5010557642 7482293273	T5229	⊥ T			
8x4	5010052921 5010060410 5010557642 7482293273	T5229	⊥ T			



MAXTER



6x6	5010052921 5010060410 5010557642 7482293273	T5229	⊥ T			
-----	--	-------	--------	--	--	--

MIDLUM (2000/01-)



4x2		5010383497 5010557285	V2138	⊥ O O O)	5010383380	T1269	⊥ O T O
		7482052422	T1315	⊥ O O O)	5000452402 5000452403 5000453922 5001857660	V2103
		5010383496	T1337	⊥ O O O)		5010238077 5010294760 5010348438 5010488157	
		5010383498 5010488147 5010600336	V2099	⊥ O O O			5010488160 7482052754 91169135	
							5010383717 7482293280	T1258

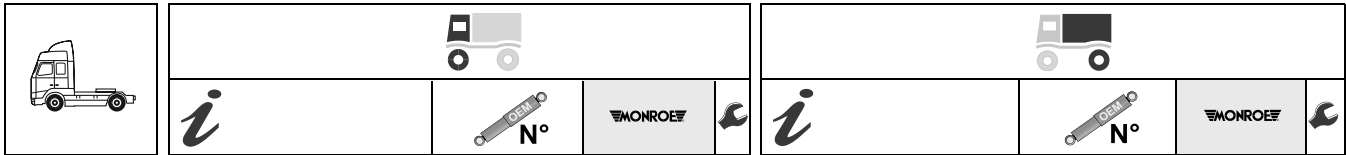

MIDLUM (2000/01-)

4x2)	7482053757	T1314	 O O)	5010383380	T1269	O T
		7420871960	T1338			5000452402	V2103	
)	5010383497	V2138	 O O)	5000452403		O T
		5010557285				5000453922		
)	7482052422	T1315	 O O)	5001857660		O T
		7420871963	T1335			5010238077		
)	5010557287	T1336	 O O)	5010294760		O T
		5010383496	T1337			5010348438		
)	5010383498	V2099	 O O)	5010488157		O T
		5010488147				5010488160		
)	5010600336		 O O)	7482052754		O T	
	5010600254	T1316			91169135			
)	7482052752		 O O)	5010383717	T1258	O T	
					7482293280			
)			 O O)	5010600333	T1341	O T	
					5010630003			
)			 O O)	5010348435	V2102	O T	
					5010488156			
)			 O O)	7482052758		O T	

MIDLUM (2000/01-)

























4x2)	5010383497	V2138	 O O)	5000452402	V2103	O T
		5010557285				5000452403		
)	7482052422	T1315	 O O)	5000453922		O T
		5010383498	V2099			5001857660		
)	5010488147		 O O)	5010238077		O T	
	5010600336				5010294760			
)			 O O)	5010348438		O T	
					5010488157			
)			 O O)	5010488160		O T	
					7482052754			
)			 O O)	91169135		O T	
					5010383717	T1258		
)			 O O)	7482293280		O T	

MIDLUM (2006/05-)























































4x2		7420871963	T1335	 O				
-----	--	------------	--------------	-------	--	--	--	--

PREMIUM (1996/04-)























4x2)	Refuse Collector B.O.M.	5000752729	T1223	 T)	Refuse Collector B.O.M.	7482293218	T5352	O T
			5010052920					5010380547	T5147	
)	5010294412		 O O)	5010383687		O T		
		5010294413				5010239642	T5258			
		5010383049				5010294528				
		5010383050				5010294908				
)	5010383693		 O O)	5010294909		O T			
	5010383694				5010383685					
)			 O O)	5010383686		O T			
					5010557326					
)			 O O)	7482293198		O T			
					7482293222					
)			 O O)	7482293227		O T			
)			 O O)	7482293218	T5352	O T			
					5010130554	T1257				
)			 O O)	5010383698		O T			
					7482293278					
)			 O O)	5010294158	T5154	O T			
					5010383689					
)			 O O)	5010557482		O T			
					5010600393					
)			 O O)	5010630386	T5258	O T			
)			 O O)	5010383909	T1214	O T			
					5430050472					
)			 O O)	5430051681		O T			



































































































								
	<i>i</i>	 N°			<i>i</i>	 N°		
6x2/4			T1223			7482293218	T5352	
		5010130401 5010383692 5010557487	T5179			5010130554 5010383698 7482293278	T1257	
						5010294158 5010383689 5010557482 5010600393 5010630386	T5154	
							T5258	
						5010383909 5430050472 5430051681	T1214	

PREMIUM (1996/04-) 





















































































































								
	<i>i</i>	 N°			<i>i</i>	 N°		
4x2		5000752729 5010052920 5010294412 5010294413 5010383049 5010383050 5010383693 5010383694	T1223			7482293218	T5352	
						5010380547 5010383687	T5147	
						5010239642 5010294528 5010294908 5010294909 5010383685 5010383686 5010557326 7482293198 7482293222 7482293227	T5258	
6x2			T1223			7482293218	T5352	
		5010130401 5010383692 5010557487	T5179			5010380547 5010383687	T5147	
						5010294158 5010383689 5010557482 5010600393 5010630386	T5154	
							T5258	
						5010383909 5430050472 5430051681 5010600329 5010630384 5010630388	T1214	
						5010600329 5010630384 5010630388	T5284	
6x2/4			T1223			7482293218	T5352	
		5010130401 5010383692 5010557487	T5179			5010380547 5010383687	T5147	
						5010294158 5010383689 5010557482 5010600393 5010630386	T5154	
							T5258	
						5010383909 5430050472 5430051681 5010600329 5010630384 5010630388	T1214	
						5010600329 5010630384 5010630388	T5284	

PREMIUM 2 (2005/10-) 

								
	<i>i</i>	 N°			<i>i</i>	 N°		
4x2		5010557974 5010630748 7420865132	T1271			5010630728	T5282	
		5010630208 7420900192	T5280			5010630865	T5306	
		5010630602 5010647062	T5309					
		5010647064	T5310					

								
	<i>i</i>	 N°			<i>i</i>	 N°		
6x2		5010557974 5010630748 7420865132	T1271	  	  	5010630728	T5282	  
		5010630208 7420900192	T5280	  	  	5010630867 5010630865	T5283 T5306	  
		5010647064	T5310	  	  	5010630941	T5307	  
6x2/4		5010557974 5010630748 7420865132	T1271	  	  	7420583421	T5091	  
		5010630208 7420900192	T5280	  	  	5010630728 5010630867	T5282 T5283	  
		5010647064	T5310	  	  	5010630865	T5306	  
6x4		5010557974 5010630748 7420865132	T1271	  	  	7420583421	T5091	  
		5010630208 7420900192	T5280	  	  	5010630728 5010630867	T5282 T5283	  
		5010647064	T5310	  	  	5010630865	T5306	  

PREMIUM 2 (2005/10-) 

4x2		5010557974 5010630748 7420865132	T1271	  	  	5010630728	T5282	  
		5010630702 7420867988	T1272	  	  	5010630865	T5306	  
		5010630133	T1294	  	  			  
		5010630208 7420900192	T5280	  	  	5010630863 7421251391	T5308	  
		5010630602 5010647062	T5309	  	  			  
6x2		5010557974 5010630748 7420865132	T1271	  	  	5010630728	T5282	  
		5010630208 7420900192	T5280	  	  	5010630867 5010630865	T5283 T5306	  
		5010647064	T5310	  	  	5010630941	T5307	  
6x4		5010557974 5010630748 7420865132	T1271	  	  	7420374543 7420854448	T5371	  
		5010630208 7420900192	T5280	  	  	7420583421	T5091	  
		5010647064	T5310	  	  	5010630728 5010630867	T5282 T5283	  
				  	5010630865	T5306	  	



SCANIA

P,G,R,T - SERIES (2003/01-)

4x2		1370267 1867874 1868263	T1330		1427423 1427424 2031227 2031228	T1296	
		1861118 1868265	T1331		1388416 1519629	T5356	
		1868264	T1332		1380426 1478508 1519632 1720604	T5351	
4x4					1380427 1478509 1519633	T5387	
6x2		1370267 1867874 1868263	T1330		1427423 1427424 2031227 2031228	T1296	
					1388416 1519629	T5356	
					1380426 1478508 1519632 1720604	T5351	
6x2/4					1380427 1478509 1519633	T5387	
6x4		1370267 1867874 1868263	T1330		1427423 1427424 2031227 2031228	T1296	
					1388416 1519629	T5356	
					1380426 1478508 1519632 1720604	T5351	
8x2					1380427 1478509 1519633	T5387	
8x2/6					1380427 1478509 1519633	T5387	
8x4					1380427 1478509 1519633	T5387	
8x4/4					1380427 1478509 1519633	T5387	
8x8					1380427 1478509 1519633	T5387	
AMD900, 901		1547113	T5439				



P,G,R,T - SERIES (2004/03-)

4x2		1370267 1867874 1868263	T1330			1427423 1427424 2031227 2031228	T1296	
		1861118 1868265	T1331			1388416 1519629	T5356	
		1868264	T1332			1380426 1478508 1519632 1720604	T5351	
4x4						1380427 1478509 1519633	T5362	
6x2		1370267 1867874 1868263	T1330			1427423 1427424 2031227 2031228	T1296	
		1861118 1868265	T1331			1388416 1519629	T5356	
		1868264	T1332			1380426 1478508 1519632 1720604	T5351	
6x2/2/4						1380427 1478509 1519633	T5387	
6x2/4		1370267 1867874 1868263	T1330			1427423 1427424 2031227 2031228	T1296	
		1861118 1868265	T1331			1388416 1519629	T5356	
		1868264	T1332			1380426 1478508 1519632 1720604	T5351	
6x2/4						1380427 1478509 1519633	T5387	
6x4		1370267 1867874 1868263	T1330			1427423 1427424 2031227 2031228	T1296	
		1861118 1868265	T1331			1388416 1519629	T5356	
		1868264	T1332			1380426 1478508 1519632 1720604	T5351	
AMD900, 901		1547113	T5439			1380427 1478509 1519633	T5387	
H		1868264	T1332					
M		1861118 1868265	T1331					

P,G,R,T - SERIES (2004/04-)

4x2						1380427 1478509 1519633	T5387	
6x2						1380427 1478509 1519633	T5387	
6x2/4						1380427 1478509 1519633	T5387	
6x4						1380427 1478509 1519633	T5387	

	<i>i</i>				<i>i</i>			
8x4						1380427 1478509 1519633	T5387	
8x4/4						1380427 1478509 1519633	T5387	
AMD900, 901		1547113	T5439					

P,G,R,T - SERIES (2004/04-)

4x2						1380427 1478509 1519633	T5387	
6x2/4						1380427 1478509 1519633	T5387	
6x4						1380427 1478509 1519633	T5387	
8x4						1380427 1478509 1519633	T5387	

PRE SERIES

4x2		1012046 1340253 1381808 258420	T5242			1012046 1340253 1381808 258420	T5242	
						1375832 1382062 1404864 216975	T5252	

1 SERIES

4x2		1012046 1340253 1381808 258420	T5242			1012046 1340253 1381808 258420	T5242	
						1375832 1382062 1404864 216975	T5252	

2 - SERIES

4x2		1110588 1111056 1356723 1388417 1421062 395063	T1101					
		1370267 1867874 1868263	T1330					
6x2		1110588 1111056 1356723 1388417 1421062 395063	T1101					
		1370267 1867874 1868263	T1330					
6x4		1110588 1111056 1356723 1388417 1421062 395063	T1101			1012046 1340253 1381808 258420	T5242	
						1340256 1481751 279927	T1148¹	
						1315960	T5060	
						1110531 1309129	T1105	
		1370267 1867874 1868263	T1330			1303235 1307332 1323476 1340251 1353371 1377056 1379487 1478502	T5059	

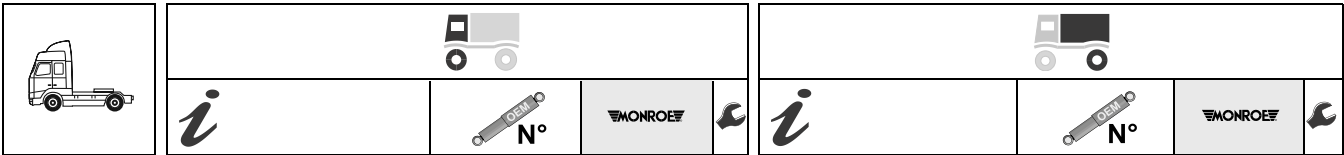

2 - SERIES



4x2		307111	T1100			1110589	T1044			
		1012044	T5241			395064				
		1340252				1303235				T5059
		1381807				1307332				
279011		1323476								
1110588	T1101	1340251								
1111056		1353371								
1356723		1377056								
1388417		1379487								
1421062		1478502								
395063		1012046		T5242						
		1340253								
		1381808								
		258420								
		1370267	T1330			1375832	T5252			
1867874						1382062				
1868263						1404864				
						216975				
		110531	T1105			1309129	T5243			
		1340254								
		1353105								
		1381809								
		272400								
6x2		307111	T1100			1110589	T1044			
		1012044	T5241			395064				
		1340252				↖				T5059
		1381807				↖				
279011		↖								
1110588	T1101					1012046	T5242			
1111056						19 ton			1340253	
1356723						↖			1381808	
1388417						↖			258420	
1421062						1340255	T5236			
395063					1381810					
					328111					
		1370267	T1330			1110531	T1105			
1867874						1309129				
1868263						↖				
						↖				
		1340254				1353105	T5243			
		↖				1381809				
		↖				272400				
		↖								
6x2/4		1340257	T5237			1340254	T5243			
		1481716				1353105				
		372291				1381809				
						272400				
6x4		1110588	T1101			1012046	T5242			
		1111056							1340253	
		1356723							1381808	
		1388417							258420	
1421062						1340256	T1148¹			
395063					1481751					
					279927					
					1315960					
		1370267	T1330			1110531	T1105			
1867874						1309129				
1868263						↖				
						↖				
						↖	T5059			
8x2						1340255	T5236			
						1381810				
						328111				



2 - SERIES





















































4x2)	307111	T1100	⊥ ○)	1110589	T1044	⊥ T			
		1012044	T5241	⊥ ○		395064	T5059	⊥ ○			
4x2)	1340252	T1101	⊥ ○)	1303235	T5242	⊥ T			
		1381807				1307332					
		279011				1323476					
		1110588				1340251					
		1111056				1353371					
		1356723	1377056								
		1388417	1379487								
		1421062	1478502								
		395063	1012046								
		1370267	1340253								
1867874	1381808										
1868263	258420										
6x2)	1370267	T1330	⊥ ○)	1375832	T5252	⊥ T			
						1382062					
						1404864					
						216975					
						1110531					
		1867874	110531	T1105		⊥ ○					
		1868263	1309129	T5243		⊥ ○					
		6x2)	307111		T1100	⊥ ○)	1110589	T1044	⊥ T
				1012044		T5241	⊥ ○		395064	T5059	⊥ ○
				1340252		T1101	⊥ ○)	1012046	T5242
1381807	1340253										
279011	1381808										
1110588	258420										
1111056	1340255										
1356723	1381810										
1388417	328111										
1421062	1110531			T1105	⊥ ○						
395063	1309129	T5243	⊥ ○								
1370267	1340254	T5236	⊥ T								
1867874	1353105										
1868263	1381809										
	272400										
	272400										
6x2/4	⊥ ○	1340257	T5237	⊥ ○							
6x4)	1110588	T1101	⊥ ○)	1012046	T5242	⊥ T			
		1111056				1340253					
		1356723				1381808					
		1388417				258420					
		1421062				1340256					
		395063	1481751								
			279927								
			1315960								
			1110531	T1148¹		⊥ T					
			1309129	T5060		⊥ T					
	⊥ ○	T1330	⊥ ○								
	⊥ ○	T1331	⊥ ○								
	⊥ ○	T1330	⊥ ○								
	⊥ ○	T1331	⊥ ○								
	⊥ ○	T1330	⊥ ○								
	⊥ ○	T1331	⊥ ○								



3 - SERIES













































































































































4x2)	1370267	T1330	⊥ ○				
		1867874						
		1868263						
		1861118						
		1868265						
4x4)	1370267	T1330	⊥ ○				
		1867874						
		1868263						
		1861118						
		1868265						

								
	<i>i</i>	 N°			<i>i</i>	 N°		
6x4	 AM 56  61 Axle	1315959	T1145	 		1012046 1340253 1381808 258420	T5242	 
		1110588 1111056 1356723 1388417 1421062 395063	T1101	 	 	1303235 1307332 1323476 1340251 1353371 1377056 1379487 1478502	T5059	 
		1370267 1867874 1868263	T1330	 				
		1861118 1868265	T1331	 				
6x6		1370267 1867874 1868263	T1330	 				
		1861118 1868265	T1331	 				
8x4/4		1370267 1867874 1868263	T1330	 				
		1861118 1868265	T1331	 				
HL		1861118 1868265	T1331	 				
MK8x4		1861118 1868265	T1331	 				
ML		1861118 1868265	T1331	 				

3 - SERIES

































































































4x2	 AM 56  61 Axle	1315959	T1145	 		1110589 395064	T1044	 
		1110588 1111056 1356723 1388417 1421062 395063	T1101	 	 	1012046 1340253 1381808 258420	T5242	 
		1370267 1867874 1868263	T1330	 	 	1375832 1382062 1404864 216975	T5252	 
	 AMA Axle	1327145 1327813 1331756	T5063	 	 	1303235 1307332 1323476 1340251 1353371 1377056 1379487 1478502	T5059	 
		1861118 1868265	T1331	 				
6x2	 AM 56  61 Axle	1315959	T1145	 		1110589 395064	T1044	 
		1110588 1111056 1356723 1388417 1421062 395063	T1101	 	 AMA Axle	1315960	T5060	 
		1370267 1867874 1868263	T1330	 	 	1012046 1340253 1381808 258420	T5242	 
		1370267 1867874 1868263	T1330	 	 	1340255 1381810 328111	T5236	 
		1861118 1868265	T1331	 	 	1375832 1382062 1404864 216975	T5252	 
		1370267 1867874 1868263	T1330	 	 	1340254 1353105 1381809 272400	T5059	 
		1861118 1868265	T1331	 			T5243	 
6x2/2/4		1370267 1867874 1868263	T1330	 				
		1861118 1868265	T1331	 				
6x2/4		1340257 1481716 372291	T5237	 		1340254 1353105 1381809 272400	T5243	 





































								
	<i>i</i>	 N°			<i>i</i>	 N°		
6x4		1370267 1867874 1868263	T1330	 	  	1012046 1340253 1381808 258420	T5242	  
		1861118 1868265	T1331	 		 		
8x2					 AMA Axle	1315960	T5060	 
8x2/4		1370267 1867874 1868263	T1330	 	  	1340255 1381810 328111	T5236	  
		1861118 1868265	T1331	 				
8x4/4		1370267 1867874 1868263	T1330	 				
		1861118 1868265	T1331	 				
HL		1861118 1868265	T1331	 				
MK8x4		1861118 1868265	T1331	 				
ML		1861118 1868265	T1331	 				









































3 - SERIES





























































4x2		AM 56 61 Axle	1315959	T1145	 	 	1110589 395064	T1044	 		
			1110588 1111056 1356723 1388417 1421062 395063	T1101	 		 	1012046 1340253 1381808 258420	T5242	  	
			1370267 1867874 1868263		T1330	 	 	1375832 1382062 1404864 216975	T5252	 	
			1122612 1354966		T1146	 		 	1303235 1307332 1323476 1340251 1353371 1377056 1379487 1478502	T5059	  
		 AMA Axle	1327145 1327813 1331756		T5063	 	 				
			1861118 1868265		T1331	 					
6x2		1110588 1111056 1356723 1388417 1421062 395063		T1101	 	    	1110589 395064	T1044	  		
		1370267 1867874 1868263		T1330	 		 	1012046 1340253 1381808 258420	T5242	  	
		1122612 1354966		T1146	 		 	1340255 1381810 328111	T5236	 	
		 AMA Axle	1327145 1327813 1331756		T5063		 	 	1375832 1382062 1404864 216975	T5252	 
			1861118 1868265		T1331		 		 		T5059
					 	1340254 1353105 1381809 272400	T5243	 			
6x2/2/4		1370267 1867874 1868263		T1330	 						
		1861118 1868265		T1331	 						
6x2/4	 	1340257 1481716 372291		T5237	 	 	1340257 1481716 372291	T5237	 		
					 		1340254 1353105 1381809 272400	T5243	 		

































































































































			
<i>i</i>	 N°		
<i>i</i>	 N°		
6x4	 1370267  1867874  1868263  1122612  1354966  1861118  1868265	T1330 T1146 T1331	         
HL	 1861118  1868265	T1331	 
MK8x4	 1861118  1868265	T1331	 
ML	 1861118  1868265	T1331	 

3 - SERIES (1990/01-1996/12) 



































































































































































6x4	 1370267  1867874  1868263  1861118  1868265	T1330 T1331	         
8x4/4	 1370267  1867874  1868263  1861118  1868265	T1330 T1331	     
HL	 1861118  1868265	T1331	 
MK8x4	 1861118  1868265	T1331	 
ML	 1861118  1868265	T1331	 









4 - SERIES 

4x2	 1370267  1867874  1868263  1861118  1868265  1868264   AMA 740 Axle, AMA 860 Axle  1371447  1371448  1438392  1438527  1478499  1478500  1478540  1478541  1861119  1390898  1478501	T1330 T1331 T1332 T1215 T1230	 AD 1300 Axle, AD1500 P Axle  1300 1500 P   ADA 1300 ELC Axle   	1012046 1340253 1381808 258420 1427423 1427424 2031227 2031228 1375832 1382062 1404864 216975 1388416 1519629 1370093 1380425 1397523 1478507 1519631 1377057 1478503 1380426 1478508 1519632 1380427 1478509 1519633 1854537	T5242 ¹ T1296 T5252 T5356 T5144 T5253 T5351 T5387 T5391	               
4x4	 1370267  1867874  1868263  1861118  1868265  1868264	T1330 T1331 T1332	  ADA 1300 ELC Axle   	1427423 1427424 2031227 2031228 1388416 1519629 1380426 1478508 1519632	T1296 T5356 T5351	     

								
	<i>i</i>	 N°			<i>i</i>	 N°		
6x2		1370267 1867874 1868263	T1330	 	 AD 1300 Axle, AD1500 P Axle	1012046 1340253 1381808 258420 1427423 1427424 2031227 2031228	T5242¹	 
		1861118 1868265	T1331	 	 AD 1500 Axle ADA 1300 ELC Axle	1377057 1478507 1478503	T5253	 
		1868264	T1332	 		1388416 1519629	T5356	 
	 AMA 740 Axle, AMA 860 Axle 		T1215	 	 	1370093 1380425 1397523 1478507 1519631	T5144	 
	1390898 1478501	T1230	 		1380426 1478508 1519632 1380427 1478509 1519633 1854537	T5351 T5387 T5391	  	
6x2/2/4		1370267 1867874 1868263	T1330	 		1427423 1427424 2031227 2031228	T1296	 
		1861118 1868265	T1331	 		1388416 1519629	T5356	 
		1868264	T1332	 		1380426 1478508 1519632	T5351	 
	1380427 1478509 1519633	T5387	 		1380427 1478509 1519633	T5387	 	
6x2/4		1370267 1867874 1868263	T1330	 		1427423 1427424 2031227 2031228	T1296	 
		1861118 1868265	T1331	 	 	1388416 1519629 1401877 1454753 1478511	T5356 T1216	 
	 AMA 740 Axle, AMA 860 Axle 		T1215	 	 	1370093 1380425 1397523 1478507 1519631	T5144	 
		1390898 1478501	T1230	 		1380426 1478508 1519632 1380427 1478509 1519633	T5351 T5387	  
6x4		1370267 1867874 1868263	T1330	 		1427423 1427424 2031227 2031228	T1296	 
		1861118 1868265	T1331	 	 Bal. Tandem Axle 	1388416 1519629 1370093 1380425 1397523 1478507 1519631	T5356 T5144	 
		1868264	T1332	 	 Bal. Tandem Axle 	1365211 1380424 1478506 1519630	T5145	 
	 AMA 740 Axle, AMA 860 Axle 		T1215	 		1380426 1478508 1519632	T5351	 
		1390898 1478501	T1230	 		1380427 1478509 1519633 1854537	T5387 T5391	  



								
	<i>i</i>	 N°			<i>i</i>	 N°		
6x6		1370267 1867874 1868263	T1330	 		1427423 1427424 2031227 2031228	T1296	 
		1861118 1868265	T1331	 		1388416 1519629	T5356	 
		1868264	T1332	 	 	1380426 1478508 1519632	T5351	  
8x2		1370267 1867874 1868263	T1330	 	 AD 1300 Axle, AD1500 P Axle	1012046 1340253 1381808 258420	T5242¹	 
						1427423 1427424 2031227 2031228	T1296	 
					 	1388416 1519629	T5356	 
8x2/4					 	1370093 1380425 1397523 1478507 1519631	T5144	   
					 	1401877 1454753 1478511	T1216	 
					 	1370093 1380425 1397523 1478507 1519631	T5144	  
8x2/4/6		1370267 1867874 1868263	T1330	 		1427423 1427424 2031227 2031228	T1296	 
		1868264	T1332	 		1388416 1519629	T5356	 
		1861118 1868265	T1331	 	 	1380426 1478508 1519632	T5351	  
8x2/6		1370267 1867874 1868263	T1330	 		1427423 1427424 2031227 2031228	T1296	 
					 	1388416 1519629	T5356	 
					 	1401877 1454753 1478511	T1216	 
8x4		1370267 1867874 1868263	T1330	 		1427423 1427424 2031227 2031228	T1296	 
		1861118 1868265	T1331	 	 	1388416 1519629	T5356	 
		1868264	T1332	 	 	Bal. Tandem Axle 	T5144	  
8x4/4		1370267 1867874 1868263	T1330	 		1370093 1380425 1397523 1478507 1519631	T5144	  
		1861118 1868265	T1331	 	 	1365211 1380424 1478506 1519630	T5145	  
		1868264	T1332	 	 	Bal. Tandem Axle 	T5351	  
8x4/4		1370267 1867874 1868263	T1330	 		1380426 1478508 1519632	T5351	  
		1861118 1868265	T1331	 	 	1427423 1427424 2031227 2031228	T1296	 
		1868264	T1332	 	 	1388416 1519629	T5356	 



















































































								
	<i>i</i>	 OEM N°			<i>i</i>	 OEM N°		
AM600,900,920	☺	1861118 1868265	T1331	⊥ ○				
AM620,900	☺	1868264	T1332	⊥ ○				
AM620,900,920	☺	1861118 1868265	T1331	⊥ ○				
AM620,920	☺	1868264	T1332	⊥ ○				
AM620,AM920	☺	1868264	T1332	⊥ ○				
AM620,900,920	☺	1861118 1868265	T1331	⊥ ○				
AM620,920	☺	1868264	T1332	⊥ ○				
AM620.,920	☺	1868264	T1332	⊥ ○				
AM900	☺	1868264	T1332	⊥ ○				
AM920,900,920	☺	1861118 1868265	T1331	⊥ ○				
AMD620,900,920	☺	1861118 1868265	T1331	⊥ ○				
AMD900	☺	1861118 1868265	T1331	⊥ ○				
	☺	1868264	T1332	⊥ ○				
AMS600,900,920	☺	1861118 1868265	T1331	⊥ ○				
AMS620,900,920	☺	1861118 1868265	T1331	⊥ ○				











4 - SERIES



4x2	☺	1370267 1867874 1868263	T1330	⊥ ○	☺	AD 1300 Axle, AD1500 P Axle	1012046 1340253 1381808 258420	T5242 ¹	⊥ T
	☺	1861118 1868265	T1331	⊥ ○	☺	1427423 1427424 2031227 2031228		T1296	○ ○
	☺	1868264	T1332	⊥ ○	●	1300 1500 P	1375832 1382062 1404864 216975	T5252	⊥ T
	☺	AMA 740 Axle, AMA 860 Axle	1371447 1371448 1438392 1438527 1478499 1478500 1478540 1478541 1861119	T1215	⊥ ○	●	1388416 1519629	T5356	⊥ T
	☺	1390898 1478501	T1230	⊥ ○	☺	1370093 1380425 1397523 1478507 1519631		T5144	○ ○
	☺				☺	ADA 1300 ELC Axle	1377057 1478503	T5253	⊥ ○
	☺				☺	1380426 1478508 1519632		T5351	⊥ ○
	☺				☺	1380427 1478509 1519633		T5387	○ ○
	☺				☺	1854537		T5391	○ ○
	4x4	☺	1370267 1867874 1868263	T1330	⊥ ○	☺	1427423 1427424 2031227 2031228		T1296
☺		1861118 1868265	T1331	⊥ ○	☺	1388416 1519629		T5356	⊥ T
☺		1868264	T1332	⊥ ○	☺	1380426 1478508 1519632		T5351	○ ○







								
	<i>i</i>	 N°			<i>i</i>	 N°		
6x2		1370267 1867874 1868263	T1330		 AD 1300 Axle, AD1500 P Axle	1012046 1340253 1381808 258420	T5242¹	
		1861118 1868265	T1331		 AD 1500 Axle	1427423 1427424 2031227 2031228	T1296	
		1868264	T1332			1377057 1478503	T5253	
		1390898 1478501	T1230			1388416 1519629	T5356	
6x2/2/4		1370267 1867874 1868263	T1330			1370093 1380425 1397523 1478507 1519631	T5144	
		1861118 1868265	T1331			1380426 1478508 1519632	T5351	
		1868264	T1332			1380427 1478509 1519633	T5387	
						1854537	T5391	
6x2/4		1370267 1867874 1868263	T1330			1427423 1427424 2031227 2031228	T1296	
		1861118 1868265	T1331			1388416 1519629	T5356	
		1868264	T1332			1401877 1454753 1478511	T1216	
	 AMA 740 Axle, AMA 860 Axle		T1215			1370093 1380425 1397523 1478507 1519631	T5144	
		1390898 1478501	T1230			1380426 1478508 1519632	T5351	
6x4		1370267 1867874 1868263	T1330			1427423 1427424 2031227 2031228	T1296	
		1861118 1868265	T1331		 Bal. Tandem Axle	1388416 1519629	T5356	
		1868264	T1332		 Bal. Tandem Axle	1370093 1380425 1397523 1478507 1519631	T5144	
		1390898 1478501	T1230			1365211 1380424 1478506 1519630	T5145	
						1380426 1478508 1519632	T5351	
8x2					1388416 1519629	T5356		
AM620		1868264	T1332					









								
	<i>i</i>	 N°			<i>i</i>	 N°		
AM620, 900	☺	1868264	T1332	⊥ ○				
AM620, 900,920	☺	1861118 1868265	T1331	⊥ ○				
AM620, 920	☺	1868264	T1332	⊥ ○				
AM620, AM920	☺	1868264	T1332	⊥ ○				
AM620,900, 920	☺	1861118 1868265	T1331	⊥ ○				
AM620,920	☺	1868264	T1332	⊥ ○				
AM620., 920	☺	1868264	T1332	⊥ ○				
AM900	☺	1868264	T1332	⊥ ○				
AMD900	☺	1861118 1868265	T1331	⊥ ○				
	☺	1868264	T1332	⊥ ○				



4 - SERIES (1995/09-)



4x2	☺	1370267 1867874 1868263	T1330	⊥ ○	☺	1427423 1427424 2031227 2031228	T1296	⊥ ○
					☺	1388416 1519629	T5356	⊥ T
	☺	1861118 1868265	T1331	⊥ ○		1380426 1478508 1519632	T5351	⊥ ○ ○
	☺	1868264	T1332	⊥ ○		1380427 1478509 1519633	T5387	○ ○
4x4	☺	1370267 1867874 1868263	T1330	⊥ ○	☺	1427423 1427424 2031227 2031228	T1296	○ ○
	☺	1861118 1868265	T1331	⊥ ○	☺	1388416 1519629	T5356	⊥ T
	☺	1868264	T1332	⊥ ○		1380426 1478508 1519632	T5351	⊥ ○ ○
6x2					☺	1388416 1519629	T5356	⊥ T
6x4	☺	1370267 1867874 1868263	T1330	⊥ ○	☺	1427423 1427424 2031227 2031228	T1296	○ ○
	☺	1861118 1868265	T1331	⊥ ○		1388416 1519629	T5356	⊥ T
	☺	1868264	T1332	⊥ ○		1380426 1478508 1519632	T5387	○ ○
6x6	☺	1370267 1867874 1868263	T1330	⊥ ○	☺	1427423 1427424 2031227 2031228	T1296	○ ○
	☺	1861118 1868265	T1331	⊥ ○	☺	1388416 1519629	T5356	⊥ T
	☺	1868264	T1332	⊥ ○		1380426 1478508 1519632	T5351	⊥ ○ ○
8x2					☺	1388416 1519629	T5356	⊥ T

								
	<i>i</i>	 N°			<i>i</i>	 N°		
8x4	☺	1370267	T1330	⊥ ○	☺	1427423	T1296	○ ○
		1867874				1427424		
8x4/4	☺	1868263	T1330	⊥ ○	☺	2031227	T5356	⊥ ○
		1861118				1388416		
AM620, 920	☺	1868265	T1331	⊥ ○	☺	1519629	T5351	○ ○
		1868264				1380426		
AMD900	☺	1861118	T1331	⊥ ○	☺	1478508	T5387	○ ○
		1868265				1380427		
		1868264	T1332	⊥ ○		1478509		○ ○
						1519632		
						1519633		

4 - SERIES (1996/05-) 

6x2					☺	1388416	T5356	⊥ ○
6x4	☺	1370267	T1330	⊥ ○	☺	1519629	T1296	○ ○
		1867874				1427423		
8x2		1868263	T1330	⊥ ○	☺	1427424	T5356	⊥ ○
						2031227		
8x4	☺		T1330	⊥ ○	☺	2031228	T5351	○ ○
						1388416		
					☺	1519629		○ ○
					☺	1380426		○ ○
					☺	1478508		○ ○
					☺	1519632		○ ○
					☺	1380427		○ ○
					☺	1478509		○ ○
					☺	1519633		○ ○

STEYR

18 S-SERIE

4x2							T5429	○ ○
-----	--	--	--	--	---	--	-------	--------

18 S-SERIE 

4x2	☺	81437016902	T1266	⊥ ○	☺		T5277	○ ○
		81437016949	T1267	⊥ ○		81437016868	T5349	○ ○
		81437016991	T1268	⊥ ○		81437016934	T5350	○ ○
		81437016897	T1308	⊥ ○		81437016904	T5261	○ ○
		81437016948	T1320	⊥ ○		81437016905	T5263	○ ○
			T1321	⊥ ○		81437016908	T5275	○ ○
			T1318	⊥ ○		81437026037		○ ○
	For vehicles with  Chassis							



18 S-SERIE



4x2	☐	81437016902	T1266	⊥	☐		T5277	⊥
	☐	81437016949 81437016991	T1267	⊥	☐	81437016868	T5349	⊥
	☐	81437016897 81437016948	T1268	⊥	☐	81437016934	T5350	⊥
	☐		T1308	⊥	☐	81437016904	T5261	⊥
	☐		T1320	⊥	☐	81437016905	T5263	⊥
	☐	For vehicles with Chassis	T1321	⊥	☐	81437016908 81437026037	T5275	⊥
	☐	7.5 ton	81437016964	T1318	⊥			⊥

19 S-SERIE

					☐		T5429	⊥
4x2					☐		T5429	⊥

26 S-SERIE



6x2/2/4	☐	81437016902	T1266	⊥	☐	81437016904	T5261	⊥
	☐	81437016949 81437016991	T1267	⊥	☐	81437016905	T5263	⊥
	☐	81437016897 81437016948	T1268	⊥	☐	81437016908 81437026037	T5275	⊥
	☐	81437016964	T1318	⊥				⊥

26 S-SERIE



6x2/2/4	☐	81437016902	T1266	⊥	☐	81437016904	T5261	⊥
	☐	81437016949 81437016991	T1267	⊥	☐	81437016905	T5263	⊥
	☐	81437016897 81437016948	T1268	⊥	☐	81437016908 81437026037	T5275	⊥
	☐	81437016964	T1318	⊥				⊥

28 S-SERIE



6x2/2/4	☐	81437016949 81437016991	T1267	⊥	☐	81437016904	T5261	⊥
					☐	81437016905	T5263	⊥
					☐	81437016908 81437026037	T5275	⊥

35 S-SERIE



8x4					☐	81437016934	T5350	⊥
					☐	81437016868	T5349	⊥
8x6					☐	81437016934	T5350	⊥

35 S-SERIE



8x4					☐	81437016934	T5350	⊥
8x6					☐	81437016934	T5350	⊥

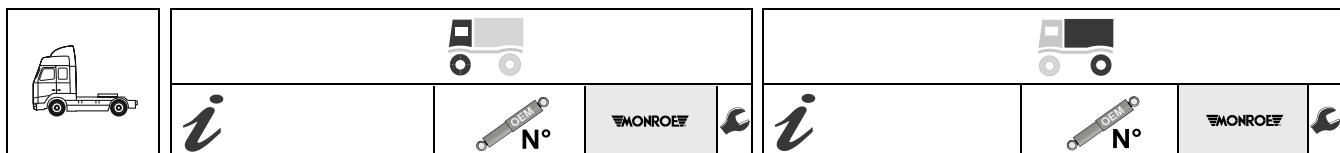

**35 S-SERIE**

8x4			81437016934	T5350	
-----	--	---	-------------	--------------	---

41 S-SERIE

8x4			81437016934	T5350	
			81437016868	T5349	

41 S-SERIE

8x4			81437016934	T5350	
			81437016868	T5349	





41 S-SERIE

8x4			81437016934	T5350	
			81437016868	T5349	

VOLVO**F 7 (-1986)**

4x2			1501501 1505190 1591501 1598814 1608678 1610919 8153538	T1048	
-----	--	---	---	--------------	---

F 7 (-1986)

4x2			1501501 1505190 1591501 1598814 1608678 1610919 8153538	T1048	
6x2				T1048	

F 7 (-1986)

4x2			1501501 1505190 1591501 1598814 1608678 1610919 8153538	T1048	
-----	--	---	---	--------------	---



F 10



4x2	 	1080654 1608949 1609000 1626057	T1025		 	1501501 1505190 1591501 1598814 1608678 1610919 8153538	T1048					
		1590161 1591735				T1102				1598105 1609005	T5066	
		1609603 70313746 70321019				T1183				1598106	T5155	
		1609001				T5095				1598106	T5155	
6x4	 	1590161 1591735	T1102			T Ride, B Ride 1612217 1628359 1629993	T5110					
		1609603 70313746 70321019	T1183			1598106	T5155					
8x4						T Ride, B Ride 1612217 1628359 1629993	T5110					



F 10



4x2	 	1080654 1608949 1609000 1626057	T1025		 	1501501 1505190 1591501 1598814 1608678 1610919 8153538	T1048					
		1590161 1591735				T1102				1598105 1609005	T5066	
		1609603 70313746 70321019				T1183				1598106	T5155	
		1609001				T5095				1598106	T5155	
6x2	 	1080654 1608949 1609000 1626057	T1025		 	S Ride 1599623 1609553 1609555 1610920 1610921 1613248	T1005					
		1590161 1591735				T1102					T1048	
		1609603 70313746 70321019				T1183					T5093	
		1609002				T5092				1598106	T5155	
6x4	 	1590161 1591735	T1102			T Ride, B Ride 1612217 1628359 1629993	T5110					
		1609603 70313746 70321019	T1183			1598106	T5155					

F 10



4x2	 	1080654 1608949 1609000 1626057	T1025		 	1501501 1505190 1591501 1598814 1608678 1610919 8153538	T1048					
		1590161 1591735				T1102				1598105 1609005	T5066	
		1609603 70313746 70321019				T1183				1598106	T5155	
		1609001				T5095				1598106	T5155	
6x2	 	1080654 1608949 1609000 1626057	T1025		 	S Ride 1599623 1609553 1609555 1610920 1610921 1613248	T1005					
		1590161 1591735				T1102					T1048	
		1609603 70313746 70321019				T1183					T5093	
		1609002				T5092				1598106	T5155	



6x4		6 - 10 ton	1590161 1591735	T1102	○ ○ ○ ○		T Ride, B Ride	1612217 1628359 1629993	T5110	○ T
			1609603 70313746 70321019	T1183				1598106	T5155	

F 12



4x2			1080654 1608949 1609000 1626057	T1025	○ ○ ○ ○			1501501 1505190 1591501 1598814 1608678 1610919 8153538	T1048	┌ T		
		FAT 6.7 ton	1609603 70313746 70321019	T1183					1629405		T5091	○ T
			1076717 1629478 20374545 20900497 3987957	T1177								
6x4		FAT 6.7 ton	1609603 70313746 70321019	T1183	○		T Ride, B Ride	1612217 1628359 1629993	T5110	○ T		
6x6								↕	T1048	┌ T		
8x4							B Ride, T Ride	1612217 1628359 1629993	T5110	○ T		

F 12













































4x2			1080654 1608949 1609000 1626057	T1025	○ ○ ○ ○			1501501 1505190 1591501 1598814 1608678 1610919 8153538	T1048	┌ T		
		FAT 6.7 ton	1609603 70313746 70321019	T1183					1598105 1609005 1629405		T5066	○ T ○
			1076717 1629478 20374545 20900497 3987957	T1177								
6x2			1080654 1608949 1609000 1626057	T1025	○ ○ ○ ○			1605163	T5093	○ T		
	FAT 6.7 ton	1609603 70313746 70321019	T1183									
		1609002	T5092									
6x4		FAT 6.7 ton	1609603 70313746 70321019	T1183	○		T Ride, B Ride	1612217 1628359 1629993	T5110	○ T		

F 12



















4x2			1080654 1608949 1609000 1626057	T1025	○ ○ ○ ○			1501501 1505190 1591501 1598814 1608678 1610919 8153538	T1048	┌ T		
			8152712	B1278					1598105 1609005 1598106		T5066	○ T ○
		6 - 10 ton	1590161 1591735	T1102								
	FAT 6.7 ton	1609603 70313746 70321019	T1183									
		1609001	T5095									
			1076717 1629478 20374545 20900497 3987957	T1177	○ ○ ○ ○					○ ○ ○ ○		

								
	<i>i</i>				<i>i</i>			

6x2		1080654 1608949 1609000 1626057 8152712	T1025	 		1599623 1609553 1609555 1610920 1610921 1613248	T1005	 
		1590161 1591735	B1278	 			1598106	T5155
6x4		1609603 70313746 70321019	T1183	 			1612217 1628359 1629993 1598106	T1048
		1609002	T5092	 			1598106	T5155
6x4		8152712	B1278	 			1612217 1628359 1629993 1598106	T1048
		1590161 1591735	T1102	 			1598106	T5110
6x4		1609603 70313746 70321019	T1183	 			1612217 1628359 1629993 1598106	T5110
		1609002	T5092	 			1598106	T5155











































F 16



6x6				 		1501501 1505190 1591501 1598814 1608678 1610919 8153538	T1048	 
				 			1612217 1628359 1629993	T5110
8x4				 			1612217 1628359 1629993	T5110
				 			1612217 1628359 1629993	T5110

F 16



4x2		1080654 1608949 1609000 1626057	T1025	 		1501501 1505190 1591501 1598814 1608678 1610919 8153538	T1048	 
		1609603 70313746 70321019	T1183	 			1598105 1609005	T5066
6x2		1609001	T5095	 			1598106	T5155
		1076717 1629478 20374545 20900497 3987957	T1177	 			1629405	T5091
6x2		1080654 1608949 1609000 1626057	T1025	 			1599623 1609553 1609555 1610920 1610921 1613248	T1005
		1609603 70313746 70321019	T1183	 			1605163	T5093
6x4		1609002	T5092	 			1598106	T5155
		1609603 70313746 70321019	T1183	 			1612217 1628359 1629993 1598106	T5110
6x4		1609603 70313746 70321019	T1183	 			1612217 1628359 1629993 1598106	T5110
		1609002	T5092	 			1598106	T5155

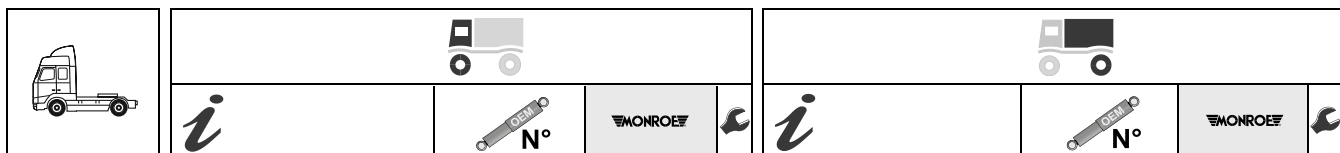

F 16



4x2	 FAT 6.7 ton	1080654 1608949 1609000 1626057	T1025	 	1501501 1505190 1591501 1598814 1608678 1610919 8153538	T1048	
		1590161 1591735 1609603 70313746 70321019 1609001	T1102	 	1598105 1609005 1598106 1629405	T5066	
6x2	 FAT 6.7 ton	1080654 1608949 1609000 1626057	T1025	 	1599623 1609553 1609555 1610920 1610921 1613248	T1005	
		1590161 1591735 1609603 70313746 70321019	T1102	 	1598106	T5155	
6x4	 FAT 6.7 ton	1590161 1591735	T1102	 	1612217 1628359 1629993 1598106	T1048	
		1609603 70313746 70321019	T1183	 	1598106	T5110	

FE (2006/05-)



6x4				21243048 21862164	T5392	
-----	--	--	--	----------------------	--------------	------

FE (2006/05-)



4x2	RH=310	20806286 20906911	T1271	 	RH=220, 240 20726482	T5282	
	RH=330, 350	20806287	T5280		RH=180, 200 20726480	T5306	
		20806288 21676912	T5310				
6x2	RH=310	20806286 20906911	T1271	 	RH=220, 240 20726482	T5282	
	RH=330, 350	20806287	T5280	 	RH=260 20726479	T5283	
		20806288 21676912	T5310		RH=180, 200 20726480	T5306	
6x2/4	RH=310	20806286 20906911	T1271	 	1629405	T5091	
	RH=330, 350	20806287	T5280	 	RH=220, 240 20726482	T5282	
		20806288 21676912	T5310		RH=260 20726479	T5283	
					RH=180, 200 20726480	T5306	

	<i>i</i>		MONROE		<i>i</i>		MONROE	
6x4		RH=310 20806286 20906911	T1271			21243048 21862164	T5392	
		RH=330, 350 20806287	T5280			1629405	T5091	
		20806288 21676912	T5310			RH=220, 240 20726482	T5282	
						RH=260 20726479	T5283	
						RH=180, 200 20726480	T5306	

FE (2006/05-)



















































4x2		RH=310 20806286 20906911	T1271			RH=220, 240 20726482	T5282	
		RH=310 20806285 20906906	T1272					
		RH=330, 350 20806289	T1294			RH=180, 200 20726480	T5306	
		RH=330, 350 20806287	T5280					
		20806288 21676912	T5310					

FH (2005/09-)

4x2		20766061 21232661	T5367			20766063 21232663	T5393	
						20766062 21232662	T5440 ⁰	
6x2		20766061 21232661	T5367			20709798 20883347	T1360	
						20766063 21232663	T5393	
						20766062 21232662	T5440 ⁰	
6x2/4		20766061 21232661	T5367			20709798 20883347	T1360	
						20766063 21232663	T5393	
						20766062 21232662	T5440 ⁰	
6x4		20766061 21232661	T5367			21243048 21862164	T5392	
						20766063 21232663	T5393	
						20766062 21232662	T5440 ⁰	
8x2					20766063 21232663	T5393		
8x2/4		20766061 21232661	T5367			20766063 21232663	T5393	
8x4		20766061 21232661	T5367			21243048 21862164	T5392	
						20766063 21232663	T5393	
						20766062 21232662	T5440 ⁰	
8x4/4						21243048 21862164	T5392	
						20766063 21232663	T5393	
						20766062 21232662	T5440 ⁰	





















































FH (2005/09-)

4x2		20766061 21232661	T5367			20766063 21232663	T5393	
						20766062 21232662	T5440 ⁰	

								
	<i>i</i>	 N°			<i>i</i>	 N°		
6x2		20766061 21232661	T5367	 	 ●  ○  ●  ○	20709798 20883347 20766063 21232663 20766062 21232662	T1360 T5393 T5440⁰	    
6x2/4					 ●  ○  ●  ○	20709798 20883347 20766063 21232663 20766062 21232662	T1360 T5393 T5440⁰	    
6x4		20766061 21232661	T5367	 	  	21243048 21862164 20766063 21232663 20766062 21232662	T5392 T5393 T5440⁰	     
8x4					  	21243048 21862164 20766063 21232663 20766062 21232662	T5392 T5393 T5440⁰	     

FH 12



6x4		1076717 1629478 20374545 20900497 3987957	T1177	 		1629405	T5091	 
	 FAL 8.0, FAL 13.0	1629485 3987958	T1178	 	 Without Anti Roll Bar, 	1612217 1628359 1629993	T5110	  
	 incl. Australia	20374546	T5184	 		20766063 21232663	T5393	 
		20374547	T5395	 		1628103 1628136 1629483	T5097	  
	 Chassis Height : Std.	1629481 1629920 3987961	T1179	  	 incl. Australia	1079151 20374543 20585556 21172387	T5170	  
	 Chassis Height 810mm, Chassis Height 850mm, Chassis Height 900mm	1629475 3987959	T1180	  	 ● (2nd. + 3rd.) Ride Height : 240mm →	1079150 20374544 20585555 21172388	T5177	  
		20367750	T1276	 	 ● (2nd. + 3rd.)			
		20766061 21232661	T5367	 		20766062 21232662	T5440⁰	 



FH 12



Configuration	Part Description	Part Number	Code	Icon	Part Description	Part Number	Code	Icon	
4x2		1080654	T1025	○		1629477	T5096	⌈	
		1608949		○				T	
		1609000		○				T	
		1626057		○		1628103	T5097	○	
		1076717	T1177	○	⌋	1628136		○	
		1629478		○	⌋	1629483		○	
		20374545		○	⌋	1629482	T5098	○	
		20900497		○	⌋	1629484	T5107	○	
		3987957		○	⌋	Chassis Height 900mm	1629484	T5177	○
		FAL 8.0, FAL 13.0	1629485	T1178	○	Chassis Height 810mm, Chassis Height 850mm	1629476	T5115	○
		3987958		○	⌋	Chassis Height : Std.	1079151	T5170	○
		incl. Australia	20374546	T5184	○	20374543		○	
		20374547	T5395	○	20585556		○		
				○	21172387		○		
	Chassis Height : Std.	1629481	T1179	○	Chassis Height : Low	1079150	T5177	○	
	1629920		○	⌋	20374544		○		
	3987961		○	⌋	20585555		○		
				○	21172388		○		
	Chassis Height 810mm, Chassis Height 850mm, Chassis Height 900mm	1629475	T1180	○	20766063	T5393	○		
		3987959		○	21232663		○		
		20367750	T1276	○		20399048	T5394	○	
				○				○	
		20766061	T5367	○		20766062	T5440 ⁰	○	
		21232661		○		21232662		○	
6x2		1080654	T1025	○		1629477	T5096	⌈	
		1608949		○				T	
		1609000		○				T	
		1626057		○		1628189	T1176	○	
		1076717	T1177	○	⌋	1629480		○	
		1629478		○	⌋	6 Air Bellows, Ride Height : 240mm →	1691617		○
		20374545		○	● (2nd.)	3987960		○	
		20900497		○	⌋	6 Air Bellows, Ride Height : → 180mm	1629475	T1180	○
		3987957		○	● (2nd.)	3987959		○	
		FAL 8.0, FAL 13.0	1629485	T1178	○	Chassis Height 810mm, Chassis Height 850mm, Chassis Height 900mm	1628103	T5097	○
		3987958		○	⌋	1628136		T	
			20374546	T5184	○	1629483		○	
		20374547	T5395	○	8 Air Bellows	1629476	T5115	○	
	Chassis Height : Std.	1629481	T1179	○	6 Air Bellows, Ride Height : 240mm →	1079151	T5170	○	
	1629920		○	● (3rd.)	20374543		○		
	3987961		○	8 Air Bellows, Ride Height : 240mm onw	20585556		○		
				○ (2nd. + 3rd.)	21172387		○		
	6 Air Bellows, Ride Height : → 180mm	1629475	T1180	○	6 Air Bellows, Ride Height : → 180mm	1079150	T5177	○	
	● (2nd.)	3987959		○	20374544		○		
	Chassis Height 810mm, Chassis Height 850mm, Chassis Height 900mm			○	20585555		○		
		20367750	T1276	○	21172388		○		
				○	8 Air Bellows, Ride Height : → 180mm			○	
		20766061	T5367	○	○ (2nd. + 3rd.)			○	
		21232661		○		20766063	T5393	○	
				○	21232663		○		
				○	20399048	T5394	○		
				○				○	
				○		20766062	T5440 ⁰	○	
				○		21232662		○	



FH 12



Configuration	Options	Part Numbers	Monroe Code	Icon	Part Numbers	Monroe Code	Icon
4x2		1080654 1608949 1609000 1626057	T1025		1629477	T5096	
		1076717 1629478 20374545 20900497 3987957	T1177		1628103 1628136 1629483 1629482	T5097 T5098	
		FAL 8.0, FAL 13.0 1629485 3987958	T1178		1629484	T5107	
		incl. Australia 20374546	T5184		Chassis Height 810mm, Chassis Height 850mm	T5115	
		20374547	T5395		Chassis Height : Std.	T5170	
		Chassis Height : Std. 1629481 1629920 3987961	T1179		1079151 20374543 20585556 21172387	T5177	
		Chassis Height 810mm, Chassis Height 850mm, Chassis Height 900mm	T1180		Chassis Height : Low	T5393	
		20367750	T1276		1079150 20374544 20585555 21172388	T5394	
		20766061 21232661	T5367		20766063 21232663	T5440⁰	
		6x2		1080654 1608949 1609000 1626057	T1025		1629477
1076717 1629478 20374545 20900497 3987957	T1177				1628189 1629480 6 Air Bellows, Ride Height : 240mm → 3987960 ● (2nd.)	T1176	
FAL 8.0, FAL 13.0 1629485 3987958	T1178				6 Air Bellows, Ride Height : → 180mm 1629475 3987959 ● (2nd.)	T1180	
20374546	T5184				Chassis Height 810mm, Chassis Height 850mm, Chassis Height 900mm	T5097	
20374547	T5395				1628103 1628136 1629483	T5115	
Chassis Height : Std. 1629481 1629920 3987961	T1179				8 Air Bellows	T5170	
6 Air Bellows, Ride Height : → 180mm 1629475 3987959 ● (2nd.) Chassis Height 810mm, Chassis Height 850mm, Chassis Height 900mm	T1180				6 Air Bellows, Ride Height : 240mm → 1079151 20374543 20585556 21172387 ● (3rd.)	T5177	
20367750	T1276				8 Air Bellows, Ride Height : 240mm onw ● (2nd. + 3rd.)	T5393	
20766061 21232661	T5367				6 Air Bellows, Ride Height : → 180mm 1079150 20374544 20585555 21172388 ● (3rd.)	T5394	
6x2/2/4				20374547	T5395		20766063 21232663
		20367750	T1276		20399048	T5440⁰	
		20766061 21232661	T5367		20766062 21232662	T5440⁰	





6x4								
		1076717 1629478 20374545 20900497 3987957	T1177			1629405	T5091	
		FAL 8.0, FAL 13.0	T1178			Without Anti Roll Bar,	T5110	
		incl. Australia	T5184			1612217 1628359 1629993	T5393	
			T5395			20766063 21232663	T5097	
		Chassis Height : Std.	T1179			1628103 1628136 1629483	T5170	
		Chassis Height 810mm, Chassis Height 850mm, Chassis Height 900mm	T1180			incl. Australia ● (2nd. + 3rd.) Ride Height : 240mm → 21172387	T5177	
			T1276			Ride Height : → 180mm ● (2nd. + 3rd.) 1079150 20374544 20585555 21172388	T5440⁰	
			T5367			20766062 21232662		

FH 16











































































4x2								
		1080654 1608949 1609000 1626057	T1025			1629477	T5096	
		incl. Australia	T5184			1629405	T5091	
			T5395			1628103 1628136 1629483	T5097	
			T5367			Chassis Height : Std. 1079151 20374543 20585556 21172387	T5170	
						Chassis Height : not Std. 1079150 20374544 20585555 21172388	T5177	
						20766063 21232663	T5393	
						20399048	T5394	
						20766062 21232662	T5440⁰	
						1629481 1629920 3987961	T1179	









































		
<i>i</i>	 N°	 N°
		

8x4/4			20766063 21232663	T5393	
			20766062 21232662	T5440⁰	



FH 16





4x2		1080654 1608949 1609000 1626057	T1025		1629477	T5096	
					1629405	T5091	
		incl. Australia 20374546	T5184		1628103 1628136 1629483	T5097	
					Chassis Height : Std. 1079151 20374543 20585556 21172387	T5170	
		20374547	T5395		Chassis Height : not Std. 1079150 20374544 20585555 21172388	T5177	
					20766063 21232663	T5393	
					20399048	T5394	
		20766061 21232661	T5367		20766062 21232662	T5440⁰	
					1629481 1629920 3987961	T1179	
6x2		1080654 1608949 1609000 1626057	T1025		1629477	T5096	
					1629405	T5091	
		20374546	T5184		6 Air Bellows, Ride Height : 1628189 240mm → 1629480 1691617 ● (2nd.) 3987960	T1176	
		20374547	T5395		6 Air Bellows, Ride Height : 1629475 → 180mm ● (2nd.)	T1180	
					1628103 1628136 1629483	T5097	
					6 Air Bellows, Ride Height : 1079151 240mm → 20374543 20585556 ● (3rd.) 21172387	T5170	
		20374547	T5395		8 Air Bellows, Ride Height : 240mm onw ○ (2nd. + 3rd.)	T5177	
		20374547	T5395		6 Air Bellows, Ride Height : 1079150 → 180mm 20374544 20585555 ● (3rd.) 21172388	T5177	
		20766061 21232661	T5367		8 Air Bellows, Ride Height : → 180mm ○ (2nd. + 3rd.)	T5393	
					20766063 21232663	T5394	
					20399048	T5394	
		20766061 21232661	T5367		20766062 21232662	T5440⁰	
6x2/2/4		20374547	T5395		20766063 21232663	T5393	
					20399048	T5394	
		20766061 21232661	T5367		20766062 21232662	T5440⁰	

								
	<i>i</i>	 N°			<i>i</i>	 N°		
6x2/4		20374547	T5395		 ○	20766063 21232663	T5393	
		20766061 21232661	T5367		 ○	20399048	T5394	
6x4	 Australia only	20374546	T5184			1629405	T5091	 T
		20374547	T5395		 1628103 1628136 1629483	T5097	 T	
		20766061 21232661	T5367		 Australia only ● (2nd. + 3rd.) Ride Height : 240mm → 1079151 20374543 20585556 21172387	T5170	 ○	
8x4					 Ride Height : → 180mm ● (2nd. + 3rd.) 1079150 20374544 20585555 21172388	T5177	 ○	
					 20766062 21232662	T5440⁰	 ○	
8x4/4					 20766063 21232663	T5393	 ○	
					 20766062 21232662	T5440⁰	 ○	
					 20766063 21232663	T5393	 ○	
					 20766062 21232662	T5440⁰	 ○	





FH II (2012/05-) 

6x4					21243048 21862164	T5392	 T
8x4/4					21243048 21862164	T5392	 T

























FH II (2012/05-) 

6x4					21243048 21862164	T5392	 T
8x4/4					21243048 21862164	T5392	 T

FL (2000/03-2006/05) 

4x2	 16 - 18 ton	1629475 3987959	T1180		 16 - 18 ton	20401856	T5265	 ○
------------	---	--------------------	--------------	---	---	----------	--------------	---

FL (2000/03-) 

4x2	 15 ton	20350489	T1252		 15 ton	3953648	T1164	 ○
	 15 ton 8 - 12 ton	20350040	T1254		 8 - 12 ton		T1165	 ○
	 16 - 18 ton	20350292	T1253		 15 ton	3953650	T1165	 ○
	 16 - 18 ton	1629475 3987959	T1180		 15 ton 8 - 12 ton	20386245 20400806 20571686 20717431	T1260	 ○
	 16 - 18 ton	21874256 82052423	T1315		 16 - 18 ton	20401856	T5265	 ○
6x2					 16 - 18 ton ○ (2nd. + 3rd.)	1079150 20374544 20585555 21172388	T5177	 ○
6x4						1629405	T5091	 T

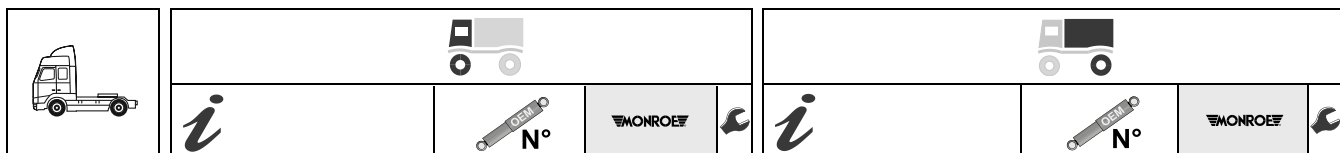

FL 6 (1980-2000/03)

4x2		11.2 ton 11.8 - 12.3 ton FAT 4.7 ton FAT 5.4 ton, FAT 6.0 ton, FAT 6.5 ton FAT 6.7 ton, FAT 7.1 ton	3953644 6775411 6775412 6794358	T1162		6771504	T1096	
		FAT 4.1 ton	3953642 6771500	T1160		3953651	T1163	
		FAT 4.7 ton	3953643	T1161		BAT 7.8 ton	3953648	T1164
			3953646	T1167		BAT 7.8 ton BAT 9.2 ton, BAT 10.0 ton	3953650	T1165
							3953652	T1168
							6790175 6794746	T5057
							1629405	T5091

FL 6 (1985/09-2000/03)

4x2		11.8 - 12.3 ton FAT 5.4 ton, FAT 6.0 ton, FAT 6.5 ton FAT 6.7 ton, FAT 7.1 ton	3953644 6775411 6775412 6794358	T1162		3953650	T1165	
		FAT 4.1 ton	3953642 6771500	T1160				
			3953643	T1161				
4x4		11 ton	3953644 6775411 6775412 6794358	T1162				

FL 6 (1985/09-2000/03)

4x2		11.8 - 12.3 ton FAT 4.7 ton	3953644 6775411 6775412 6794358	T1162		3953650	T1165	
		FAT 4.1 ton	3953642 6771500	T1160		6790175 6794746	T5057	
			3953643	T1161				

FL 7 (1985/09-1998/09)

4x2			1080654 1608949 1609000 1626057	T1025		1598105 1609005	T5066	
		P2 Suspension	1094523 20532767 20769819 8159833	T1149				
			1609603 70313746 70321019	T1183		1598106	T5155	
6x2			1080654 1608949 1609000 1626057	T1025		1599623 1609553 1609555 1610920 1610921 1613248	T1005	
		P2 Suspension	1094523 20532767 20769819 8159833	T1149				
			1609603 70313746 70321019	T1183		1598106	T5155	
6x4		P2 Suspension	1094523 20532767 20769819 8159833	T1149		1612217 1628359 1629993	T5110	
			1609603 70313746 70321019	T1183				
8x4						1612217 1628359 1629993	T5110	



FL 7 (1985/09-1998/09)



4x2		1080654 1608949 1609000 1626057	T1025			1598105 1609005	T5066		
	P2 Suspension	1094523 20532767 20769819 8159833	T1149						
		1609603 70313746 70321019	T1183		○	1598106	T5155		
		1609001	T5095						
6x2		1080654 1608949 1609000 1626057	T1025		○	1599623 1609553 1609555 1610920 1610921 1613248	T1005		
	P2 Suspension	1094523 20532767 20769819 8159833	T1149						
		1609603 70313746 70321019	T1183			1605163	T5093		
	○	1609002	T5092		○	1598106	T5155		



FL 7 (1985/09-1998/09)



4x2		1080654 1608949 1609000 1626057	T1025			1598105 1609005	T5066		
	P2 Suspension	1094523 20532767 20769819 8159833	T1149						
		1609603 70313746 70321019	T1183		○	1598106	T5155		
		1609001	T5095						

FL 10 (1985/09-1998/09)



4x2		1080654 1608949 1609000 1626057	T1025			1599623 1609553 1609555 1610920 1610921 1613248	T1005		
	FAT 6.7 ton, FAT 6.5 ton	1094523 20532767 20769819 8159833	T1149						
	FAT 7.5 ton	1609603 70313746 70321019	T1183		○	1598105 1609005	T5066		
		1609001	T5095		○	1598106	T5155		
6x2, 6x4		20766061 21232661	T5367						
6x4	FAT 6.7 ton, FAT 6.5 ton	1094523 20532767 20769819 8159833	T1149		○	1599623 1609553 1609555 1610920 1610921 1613248	T1005		
	FAT 7.5 ton	1609603 70313746 70321019	T1183		T Ride, B Ride	1612217 1628359 1629993	T5110		
8x4		1094523 20532767 20769819 8159833	T1149		○	1598106	T5155		
					B Ride, T Ride	1612217 1628359 1629993	T5110		

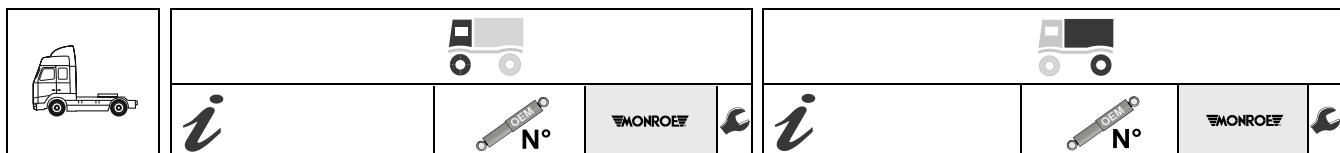

FL 10 (1985/09-1998/09)

4x2		1080654 1608949 1609000 1626057	T1025			1599623 1609553 1609555 1610920 1610921 1613248	T1005	
		1094523 20532767 20769819 8159833	T1149					
		1609603 70313746 70321019	T1183					
		1609001	T5095			1598105 1609005	T5066	
6x2		1080654 1608949 1609000 1626057	T1025			1599623 1609553 1609555 1610920 1610921 1613248	T1005	
		1094523 20532767 20769819 8159833	T1149					
		1609603 70313746 70321019	T1183			1598105 1609005	T5066	
		1609002	T5092			1605163	T5093	
6x2, 6x4		20766061 21232661	T5367					
6x4		1094523 20532767 20769819 8159833	T1149			1599623 1609553 1609555 1610920 1610921 1613248	T1005	
		1609603 70313746 70321019	T1183			T Ride, B Ride 1612217 1628359 1629993 1598106	T5110	
8x2		1609002	T5092			1598106	T5155	

FL 10 (1985/09-1998/09)

4x2		1080654 1608949 1609000 1626057	T1025			1599623 1609553 1609555 1610920 1610921 1613248	T1005	
		1094523 20532767 20769819 8159833	T1149					
		1609603 70313746 70321019	T1183					
		1609001	T5095			1598105 1609005	T5066	
6x2		1080654 1608949 1609000 1626057	T1025			1599623 1609553 1609555 1610920 1610921 1613248	T1005	
		1094523 20532767 20769819 8159833	T1149					
		1609603 70313746 70321019	T1183			1598105 1609005	T5066	
		1609002	T5092			1598106	T5155	
6x2, 6x4		20766061 21232661	T5367					

	<i>i</i>				<i>i</i>			
6x4	FAT 6.7 ton, FAT 6.5 ton	1094523 20532767 20769819 8159833	T1149			1599623 1609553 1609555 1610920 1610921 1613248	T1005	
	FAT 7.5 ton	1609603 70313746 70321019	T1183		T Ride, B Ride	1612217 1628359 1629993 1598106	T5110	
						T5155		

FL 12 (1985/09-1998/09)

6x2, 6x4		20766061 21232661	T5367					
6x4		1609603 70313746 70321019	T1183			1598106	T5155	
8x4		1094523 20532767 20769819 8159833	T1149		T Ride	1612217 1628359 1629993	T5110	

FL 12 (1985/09-1998/09)

4x2		1080654 1608949 1609000 1626057	T1025			1598106	T5155	
		1609603 70313746 70321019	T1183					
		1609001	T5095					
6x2		1080654 1608949 1609000 1626057	T1025			1598106	T5155	
		1609603 70313746 70321019	T1183					
		1609002	T5092					
6x2, 6x4		20766061 21232661	T5367					
6x4		1609603 70313746 70321019	T1183			1598106	T5155	

FL 12 (1985/09-1998/09)

4x2		1080654 1608949 1609000 1626057	T1025			1598106	T5155	
		1609603 70313746 70321019	T1183					
		1609001	T5095					
6x2, 6x4		20766061 21232661	T5367					
6x4		1609603 70313746 70321019	T1183			1598106	T5155	



















FM (2005/09-)

4x2		20766061 21232661	T5367			20766063 21232663	T5393				20766062 21232662	T5440⁰		
6x4		20766061 21232661	T5367			21243048 21862164	T5392				1629405	T5091		
8x4		20766061 21232661	T5367			1629405	T5091				20766063 21232663	T5393		

















































FM (2005/09-)

4x2		20766061 21232661	T5367			20766063 21232663	T5393				20766062 21232662	T5440⁰		
6x2		20766061 21232661	T5367			20766063 21232663	T5393				20766062 21232662	T5440⁰		
6x4		20766061 21232661	T5367			21243048 21862164	T5392				1629405	T5091		
8x2/6		20766061 21232661	T5367			20766063 21232663	T5393				1629405	T5091		

								
	<i>i</i>				<i>i</i>			
8x4/4		20766061 21232661	T5367	  	21243048 21862164 20766063 21232663 20766062 21232662	T5392 T5393 T5440⁰	   	

FM (2005/09-)





























4x2		20766061 21232661	T5367	 	20766063 21232663 20766062 21232662	T5393 T5440⁰	  
4x4		20766061 21232661	T5367		20766063 21232663	T5393	 
6x2		20766061 21232661	T5367	   	20709798 20883347 20766063 21232663 20766062 21232662	T1360 T5393 T5440⁰	    
6x2/4				   	20709798 20883347 20766063 21232663 20766062 21232662	T1360 T5393 T5440⁰	   
6x4		20766061 21232661	T5367	  	21243048 21862164 1629405 20766063 21232663 20766062 21232662	T5392 T5091 T5393 T5440⁰	     
6x6		20766061 21232661	T5367		20766063 21232663	T5393	 
8x4/4				  	21243048 21862164 20766063 21232663 20766062 21232662	T5392 T5393 T5440⁰	   











FM 7 (1998/08-2001/12)



4x2	   	20374546 20374547 20766061 21232661	T5184 T5395 T5367	     			     
6x4	  	20374546 20374547 20766061 21232661	T5184 T5395 T5367	  	1629405	T5091	 
8x4					1629405	T5091	

FM 7 (1998/08-2001/12)



4x2	  	20374546 20374547 20766061 21232661	T5184 T5395 T5367	  			  
------------	---	--	--	---	--	--	---

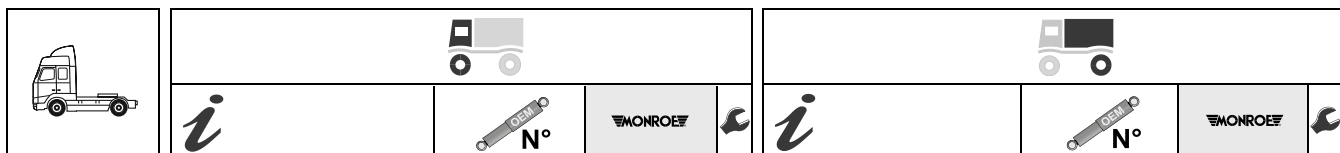

6x2		20374546	T5184	
		20374547	T5395	
		20766061 21232661	T5367	

FM 7 (1998/08-2001/12)

4x2		20374546	T5184	
		20374547	T5395	
		20766061 21232661	T5367	

FM 9 (2001/12-)

4x2		incl. Australia 20374546	T5184			Chassis Height : Std.	1079151 20374543 20585556 21172387	T5170	
		20374547	T5395			Chassis Height : not Std.	1079150 20374544 20585555 21172388	T5177	
		20367750	T1276				20766063 21232663	T5393	
		20766061 21232661	T5367				20399048	T5394	
		20766062 21232662	T5440⁰				20766062 21232662	T5440⁰	

6x2		20374546	T5184			6 Air Bellows, Ride Height : 240mm →	1628189 1629480 1691617 3987960	T1176	
		20374547	T5395			6 Air Bellows, Ride Height : → 180mm	1629475 3987959	T1180	
		20367750	T1276			6 Air Bellows, Ride Height : 240mm →	1079151 20374543 20585556 21172387	T5170	
		20766061 21232661	T5367			8 Air Bellows, Ride Height : 240mm onw	(2nd. + 3rd.)	T5177	
		20766063 21232663	T5393			6 Air Bellows, Ride Height : → 180mm	1079150 20374544 20585555 21172388	T5177	
		20399048	T5394			8 Air Bellows, Ride Height : → 180mm	(2nd. + 3rd.)	T5440⁰	
		20766062 21232662	T5440⁰					T5440⁰	

6x4		incl. Australia 20374546	T5184				1629405	T5091	
		20374547	T5395			incl. Australia	1079151 20374543 20585556 21172387	T5170	
		20367750	T1276			Ride Height : 240mm →		T5177	
		20766061 21232661	T5367			Ride Height : → 180mm	1079150 20374544 20585555 21172388	T5440⁰	
		20766062 21232662	T5440⁰			(2nd. + 3rd.)	20766062 21232662	T5440⁰	

	<i>i</i>				<i>i</i>				
8x4						1629405	T5091		
						Australia only ● (3rd. + 4th.) Ride Height : 240mm →	1079151 20374543 20585556 21172387	T5170	
						Ride Height : → 180mm ● (3rd. + 4th.)	1079150 20374544 20585555 21172388	T5177	
8x4/4		20367750	T1276			20766063 21232663	T5393		
		20766061 21232661	T5367			20766062 21232662	T5440⁰		

FM 9 (2001/12-)

4x2		incl. Australia	20374546	T5184			Chassis Height : Std.	1079151 20374543 20585556 21172387	T5170	
			20374547	T5395			Chassis Height : not Std.	1079150 20374544 20585555 21172388	T5177	
			20367750	T1276				20766063 21232663	T5393	
			20766061 21232661	T5367			20399048	T5394		
6x2			20374546	T5184			6 Air Bellows, Ride Height : 240mm → ● (2nd.)	1628189 1629480 1691617 3987960	T1176	
			20374547	T5395			6 Air Bellows, Ride Height : → 180mm ● (2nd.)	1629475 3987959	T1180	
			20367750	T1276			6 Air Bellows, Ride Height : 240mm → ● (3rd.)	1079151 20374543 20585556 21172387	T5170	
			20766061 21232661	T5367			8 Air Bellows, Ride Height : 240mm onw ○ (2nd. + 3rd.)			
							6 Air Bellows, Ride Height : → 180mm ● (3rd.)	1079150 20374544 20585555 21172388	T5177	
							8 Air Bellows, Ride Height : → 180mm ○ (2nd. + 3rd.)			
						20766063 21232663	T5393			
						20399048	T5394			
						20766062 21232662	T5440⁰			





FM 10 (1999/04-2001/12)

4x2		20374547	T5395						
6x2		20374547	T5395						

FM 12 (1998/08-)

8x4					1629405	T5091		
					Australia only ● (3rd. + 4th.) Ride Height : 240mm →	1079151 20374543 20585556 21172387	T5170	
					Ride Height : → 180mm ● (3rd. + 4th.)	1079150 20374544 20585555 21172388	T5177	
8x4/4		20367750	T1276				T5440⁰	

FM 12 (1998/08-)

4x2		incl. Australia	20374546	T5184		Chassis Height : Std.	1079151 20374543 20585556 21172387	T5170	
			20374547	T5395		Chassis Height : not Std.	1079150 20374544 20585555 21172388	T5177	
			20367750	T1276			20766063 21232663	T5393	
			20766061 21232661	T5367			20399048	T5394	
6x2			20374546	T5184		6 Air Bellows, Ride Height : 240mm →	1628189 1629480 1691617 3987960	T1176	
			20374547	T5395		6 Air Bellows, Ride Height : → 180mm	1629475 3987959	T1180	
			20367750	T1276		6 Air Bellows, Ride Height : 240mm →	1079151 20374543 20585556 21172387	T5170	
			20766061 21232661	T5367		8 Air Bellows, Ride Height : 240mm onw	● (2nd. + 3rd.)	T5177	
						6 Air Bellows, Ride Height : → 180mm	1079150 20374544 20585555 21172388	T5177	
						8 Air Bellows, Ride Height : → 180mm	● (3rd.)	T5393	
						● (2nd. + 3rd.)	20766063 21232663	T5394	
						● (3rd.)	20766062 21232662	T5440⁰	



ACERBI							
		449374	F1241	Q O	713	435	20x54 20x54
		431489 448397 449071 M001537	F5084	Q O	475	320	20x55 20x55
		431491	F5007	Q O	694	427	24x55 24x55
		431806	F5085	Q O	445	315	20x50 20x50

ACKERMAN							

ADR							
		7075	F5004	Q O	495	327	24x55 24x55

AUSTERAS							
		11048	F5015	Q O	428	303	24x58 24x58
		99391007	F5366	Q O	648	403	20x46 20x46

BANCE							
		8404174	F5020	Q O	466	316	24x62 24x62

BARTOLETTI							
		91610259 91610264 91610266 91610267 91610269 91610272 91610274 91610275 91610279	F5007	Q O	694	427	24x55 24x55

BATTAGLINO							
		126507007758 2604800 2607300	F5007	Q O	694	427	24x55 24x55
		126507007799 2607000	F5075	Q O	426	296	20x62 20x62
		2609000	F5004	Q O	495	327	24x55 24x55
		126507007758 2604800 2607300	F5007	Q O	694	427	24x55 24x55
		126502016770 2606800	F5366	Q O	648	403	20x46 20x46

BENALU							

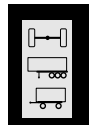

BERTOJA



BERTOJA							
		446421001	F5007		694	427	24x55 24x55
		44642100100	F5075		426	296	20x62 20x62
		423016002	F5075		426	296	20x62 20x62
		42301600200	F5075		426	296	20x62 20x62
		45101010	F5366		648	403	20x46 20x46
		45101013	F5366		648	403	20x46 20x46
		423016003	F5366		648	403	20x46 20x46
		42301600300	F5366		648	403	20x46 20x46

BOLGAN							
		30001002	F5075		426	296	20x62 20x62
		30001003	F5075		426	296	20x62 20x62

BPW							
		02 3722 0400	F5224		495	327	24x55 24x55
		02 3722 6200	F5188		906	536	32x55 32x55
		02 3722 7900	F5384		412	287	24x55 24x55
		02 3722 7902	F5384		412	287	24x55 24x55
		02 3702 8300	F5185		655	415	32x55 32x55
O		6 - 10 ton 02 3702 1000	F5126		789	477	24x55 24x55
O, OM, OT		6,5 - 13 ton 02 3702 1700	F5001		789	477	24x55 24x55
		3 - 13 ton 02 3702 1600	F5004		495	327	24x55 24x55
		6,5 - 13 ton 02 3702 1900	F5004		495	327	24x55 24x55
		02 3702 5200	F5004		495	327	24x55 24x55
		02 3722 8300	F5004		495	327	24x55 24x55
		02 3722 8302	F5004		495	327	24x55 24x55
		6 - 13 ton 02 3702 2000	F5007		694	427	24x55 24x55
		02 3702 2200	F5007		694	427	24x55 24x55
		02 3702 4800	F5008		692	429	24x55 24x55
		02 3702 5100	F5008		692	429	24x55 24x55
		02 3702 3600	F5073		495	327	24x55 24x55
		02 3722 1400	F5073		495	327	24x55 24x55
		02 3722 8300	F5073		495	327	24x55 24x55
O, OM, OT, ON, ONM, ONT		02 3702 1800	F5002		764	464	24x55 24x55
		02 3702 6700	F5002		764	464	24x55 24x55
O, ON, ONT		3,6 - 5,6 ton 02 3702 1400	F1113		679	413	20x55 20x55
OM		6,5 - 13 ton 02 3702 7000	F5011		429	294	24x55 24x55
		02 3722 8900	F5011		429	294	24x55 24x55
		02 3722 8900	F5190¹		424	291	24x55 24x55
		02 3722 8902	F5190¹		424	291	24x55 24x55
OM, OT		6,5 - 13 ton 02 3702 6000	F5010		794	477	24x55 24x55
OM, OT, ON, ONM, ONT		02 3702 1800	F5002		764	464	24x55 24x55
		02 3702 6700	F5002		764	464	24x55 24x55
OM, SL		6,5 - 13 ton 02 3702 9200	F5012		539	349	24x55 24x55
		02 3722 8800	F5012		539	349	24x55 24x55
		02 3722 8802	F5012		539	349	24x55 24x55
ZZONT/O.OM, OT, LL, SLO		3 - 13 ton 02 3702 3600	F5073		495	327	24x55 24x55
		02 3722 1400	F5073		495	327	24x55 24x55
		02 3722 8300	F5073		495	327	24x55 24x55

CALABRESE							
		128711209	F5007		694	427	24x55 24x55



CAR VENETA

	60030059	F5366	⊙ ⊙	648 403 20x46 20x46
--	----------	--------------	--------	---------------------

CARDI

	00501300	F5004	⊙	495 327 24x55 24x55
	00501310		⊙	
	00500600	F5007	⊙	694 427 24x55 24x55
	00501000		⊙	
	500600		⊙	
	00500900	F5075	⊙	426 296 20x62 20x62
	500900		⊙	

CHEREAU

CODER

	4050	F5205	⊙ ⊙	474 329 20x62 20x62
--	------	--------------	--------	---------------------

CORDERO

	1303007	F5007	⊙ ⊙	694 427 24x55 24x55
	1303006	F5366	⊙ ⊙	648 403 20x46 20x46

FILIA

	00361114P	F1118	⊙ ⊙	504 336 20x55 20x55
	0036114P			

FLOOR

	22532	F5022	⊥ T	652 392
	22632			
	4334			
	902417			
	917292	F5423	⊙ ⊙	696 436 24x58 24x58

FRUEHAUF

	6506635A	F5020	⊙ ⊙	466 316 24x62 24x62
	8404174			
	87001			
Flexair	921043	F5203	⊙ ⊙	679 436 25x51 25x51
	UJA895013			
NA, NA9	M0044020	F5166	⊙ ⊙	363 260 20x54 20x54
	M0044020H			
	M0078602			
	M078602			
SA9, SA10, SA11	M077800	F1241	⊙ ⊙	713 435 20x54 20x54
	UJB1147			
	152685	F5084	⊙ ⊙	475 320 20x55 20x55
	1526855			
	M001537			
	M007950			
	M076480			
	M200052			
	M200133			
	UJB0364			
	UJB0563			
	UJB0565			

GENERAL TRAILER



SA9, SA10 (185, 250)		196116	F5088		428 303 20x55 20x55
TA		UJB0315	F5021		460 308 20x50 20x50
		126502007352	F5085		445 315 20x50 20x50
		1518588			
		1521533			
		152786			
		1527867			
		23514			
		50370/0			
		680117			
		905180			
		BJB0180001			
		M007942			
		S09603030			
		S09605130			
		UCE1295			
UCE1295/1					
UJA0878001	F5089		375 280 20x45 20x45		
UJB0177					
UJB0177001					
UJB0179					
UJB0316					
UJB0562					
UJC0020					
UJC0020/01	F5089		375 280 20x45 20x45		
UJC0054					
UJZ7093					
W4012762					
1522341					
152787					
1527870					
UJC0027/001	F5089		375 280 20x45 20x45		
1522341					
152787					
1527870					
UJC0027/001					
1522341					
152787					

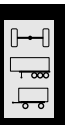

GENERAL TRAILER

← FRUEHAUF

GIGANT					
		196109	F5272		555 355 24x55 24x55
		196118	F5273		810 485 24x55 24x55
		196125			
		196116	F5002		764 464 24x55 24x55
		196107	F5004		495 327 24x55 24x55
		196111			
		196112	F5011		429 294 24x55 24x55
		196119			
		0237221400			
		196115	F5073		495 327 24x55 24x55
		196100			
		196103	F5083		489 324 24x55 24x55
		196105			
		196111			
		196131			
		451700112782			
		196102	F5192		694 426 24x55 24x55
		196133			
196121	F5190¹		424 291 24x55 24x55		



GIGANT (SMB)

NA9	99 → 2005		M078602	F5166		363 260 20x54 20x54
			M20007401			
SA9, SA10, SA11	91 →		M001537 M007950 UJB0364 UJB0565	F5084		475 320 20x55 20x55
			M001545 M007969 UJB0365 UJB0564			F5088
SA9, SA10, SA11	99 →		M077800 UJB1147	F1241		713 435 20x54 20x54
			M20008401			F1274
TA			UJB0315	F5021		460 308 20x50 20x50
			M007942	F5085		445 315 20x50 20x50
			UJC0027/001	F5089		375 280 20x45 20x45
ZA			M077932	F5407		421 313 24x55 20x55
ZA			M076022	F5408		421 313 24x55 20x55
ZA9	97 →		M001537 M007950 UJB0364 UJB0565	F5084		475 320 20x55 20x55
			M20016501			
ZA9	97 →		M001545 M007969 UJB0365 UJB0564	F5088		428 303 20x55 20x55
			M20016601			

GIRELLI

	0330560 03990560	F5366		648 403 20x46 20x46
--	---------------------	--------------	--	---------------------

GKN-FAD

	554FR004	F1113		679 413 20x55 20x55
	554FR001	F5004		495 327 24x55 24x55

GRANNING

	12740	F5075		426 296 20x62 20x62
--	-------	--------------	--	---------------------



HENDRICKSON							
		HS506711	F5196	Q O	484	323	20x50 20x50
		HS504933	F5311	Q O	750	470	20x45 20x45
		HS508390	T1303	L O	521	327	20x50
		HS322166	V2098	Q T	542	335	19x44
		HS508808	V2133	L O	581	357	20x50
		HS508386	V2134	Q O	666	410	20x50 20x50
	♀ ○	HS503038 HS505396	T1214	Q O	544	351	20x40 20x40
	♀ ○	HS503788	T5169	Q O	533	372	20x50 20x50
	≡	AM752999 NM2999	F1325	Q O	557	354	19x46 19x46
	≡	HS505091	F5198	Q O	616	406	20x50 20x50
	≡	HS505272	F1262 ¹	Q O	678	412	20x50 20x50
AA 230 T, AA 250 T	≡	A20002 A20126 A20889 B21832 B24125	65416	Q O	450	304	20x44 20x44
Discos HT250 MBE	≡	81108002 A9463260000 HS251084 QD100001	F5251	Q O	375	265	20x50 20x50
F01	≡	0237021700	F5001	Q O	789	477	24x55 24x55
HC 230	≡	A20002 A20126 A20889 B21832 B24125	65416	Q O	450	304	20x44 20x44
HT E	≡	506246 507172 AM757172	F5071 ¹	Q ⊖	435	305	22x49 21x84
INTRAAX	≡	A20002 A20126 A20889 B21832 B24125	65416	Q O	450	304	20x44 20x44
HT DOLLY	≡	A20002 A20126 A20889 B21832 B24125	65416	Q O	450	304	20x44 20x44
HT 230	≡	A20002 A20126 A20889 B21832 B24125	65416	Q O	450	304	20x44 20x44
HT 250 TE	≡	508571 AM758571 Y508571	F5015	Q O	428	303	24x58 24x58
HT 250 U	≡	A20002 A20126 A20889 B21832 B24125	65416	Q O	450	304	20x44 20x44
HT 300 T/U	≡	A20002 A20126 A20889 B21832 B24125	65416	Q O	450	304	20x44 20x44



KAISER							
		F01007650	F5013	Q	476	321	24x58 24x58
			F5075	Q	426	296	20x62 20x62
		509020	F5194	Q	426	296	20x62 20x62
		LEI16500500052		Q			
		LEI16500500052	F5221	Q	485	325	20x46 20x46
		4288		Q			
		2376001002	F5254	Q	477	319	20x62 20x62

KÄSSBOHRER							
TIRSAN							

KÖGEL							
		21229934	F5380	Q	380	270	20x68 20x68

LANGENDORF							
		7800	F5020	Q	466	316	24x62 24x62

LECINENA							
		196107	F5004	Q	495	327	24x55 24x55
		196103	F5083	Q	489	324	24x55 24x55
		196111		Q			
		451700112782		Q			
		120025000187	F5402	Q	449	305	20x62 20x62

LECITRAILER							
		0237025200	F5004	Q	495	327	24x55 24x55
		0237021400	F1113	Q	679	413	20x55 20x55
		196103	F5083	Q	489	324	24x55 24x55
		5180011	F5073	Q	495	327	24x55 24x55
		5180021	F5007	Q	694	427	24x55 24x55

LEGRAS INDUSTRIES							
		0036114P	F1022	Q	506	336	20x55 20x55
		21215742	F5075	Q	426	296	20x62 20x62

LEVEQUES (REMORQUES)							
	10-13 ton	902229	F5025	Q	476	321	20x62 20x62
	10-13 ton	921043	F5203	Q	679	436	25x51 25x51

LOHR



LOHR						
		06030510 A06030510	F5221	Q O	485 325 20x46	20x46
		06030509 A06030509	F5223	Q O	400 285 20x46	20x46
		06030508 A06030508	F5226	Q T	406 296 20x46	
		A06030528 A0603114	F5329	Q O	480 340 24x58	24x58

MASSO						
		112297	F5221	Q O	485 325 20x46	20x46

MENCI						
		2461	F5004	Q O	495 327 24x55	24x55

MERCEDES-BENZ						
Discos		006 326 4200 006 326 4300 946 326 0000 946 326 0100 A006 326 4300 A946 326 0000 A946 326 0100	F5251	Q O	375 265 20x50	20x50
DCA	TE 4/8, TE 5/8, TZ 4/8, TZ 5/8	946 326 0500 A946 326 0500	F5195	Q O	405 280 20x89	20x59
		946 326 0700 A946 326 0700	F5342	Q O	427 294 20x89	20x59
DLS		946 326 0200 A946 326 0200	F5025	Q O	476 321 20x62	20x62
		946 326 0300 A946 326 0300	F5194	Q O	426 296 20x62	20x62

MERITOR						
	R.O.R.					

MIELE						
		060AMM0505	F5004	Q O	495 327 24x55	24x55
		060AMM0506	F5007	Q O	694 427 24x55	24x55
		060AMM0504	F5075	Q O	426 296 20x62	20x62

MISTRALL						
		7302 7758	F5007	Q O	694 427 24x55	24x55
		11094	F5368	Q O	424 296 24x52	24x52



MONTENEGRO								
		050001668	F5077	Q	534	349	23x55	23x55
		050031668		O				
		050031668A						
		050041668	F5270	Q	534	354	23x55	23x55
				O				

NETAM								
	FRUEHAUF							

NEWAY								
		1752498	F1074	Q	744	451	20x44	20x44
		90044025		O				
		90044682						
		AR1654						
		M0044020	F5166	Q	363	260	20x54	20x54
		M0044020H		O				
		M0078602						
		4012289	F5071¹	Q	435	305	22x49	21x84
				⊕				
AR75		1752498	F1074	Q	744	451	20x44	20x44
		90044025		O				
		90044682						
		AR1654						
AR94		90045028	F1091	Q	544	363	20x44	26x48
				O				
AR95, AR120, AR125		90044012	F1140¹	Q	714	436	20x44	20x44
		90044625		O				
AR955, AR955A, HN HL/076		90044012	F1140¹	Q	714	436	20x44	20x44
		90044625		O				
ARD75, ARD244, AR85A		1752498	F1074	Q	744	451	20x44	20x44
		90044025		O				
		90044682						
		AR1654						
ARD120, ARD125, ARD238, ARD244		90044025	65416	Q	450	304	20x44	20x44
				O				
ARDST123, ARDST246		1752498	F1074	Q	744	451	20x44	20x44
		90044025		O				
		90044682						
		AR1654						
ART550	Tag Axle	90044012	F1140¹	Q	714	436	20x44	20x44
		90044625		O				

NOMEK								
		7799	F5075	Q	426	296	20x62	20x62
				O				

NUOVA MANARO								
		7075	F5004	Q	495	327	24x55	24x55
				O				

OMAR								
		013612	F5075	Q	426	296	20x62	20x62
				O				

OMT								
		22450420	F5075	Q	426	296	20x62	20x62
				O				



OTOKAR						
		16H0003615AB	F1118	Q O	504 336	20x55 20x55

PEZZAIOLI						
		70100000	F5004	Q O	495 327	24x55 24x55
		7758	F5007	Q O	694 427	24x55 24x55

PIACENZA						
		11066	F5004	Q O	495 327	24x55 24x55
		1201054	F5007	Q O	694 427	24x55 24x55
		1201048/45	F5221	Q O	485 325	20x46 20x46
		1201052	T5199	Q O	541 356	20x46 20x46

ROLFO						
		112319 S3363	F5004	Q O	495 327	24x55 24x55
		21215742 21215807 21221306 112297	F5075	Q O	426 296	20x62 20x62
			F5221	Q O	485 325	20x46 20x46
		112319 S3363	F5004	Q O	495 327	24x55 24x55
		112012	F5007	Q O	694 427	24x55 24x55
		112128	F5366	Q O	648 403	20x46 20x46
		112320	F5368	Q O	424 296	24x52 24x52

ROR						
		8404174	F5020	Q O	466 316	24x62 24x62
		21221348 902194	F5025	Q O	476 321	20x62 20x62
		21039042 21048043	F5381	Q O	383 267	20x58 16x58
CS-Series (Inter) CS9iL, CS10iL Euroflex 9i Low Mount, 10 Low Mount		21228392	F5379	Q O	337 254	24x58 24x58
CS-Series (Euro) CS9eL Euroflex 9e Low Mount		21229934	F5380	Q O	380 270	20x68 20x68
CS-Series (Euro) CS9eT Euroflex 9e Top Mount		21229935	F5378	Q O	423 291	20x68 20x68
CS-Series (Inter) CS9iT, CS10iT Euroflex 9i Top Mount, 10 Top Mount		21228930	F5409	Q O	383 280	24x58 24x58



Flexair FL041, FL131		21215442 21215607 21215742 21215751 21215807 21221306 21221306K	F5075		426 296 20x62 20x62
Flexair FL9000, FL9000H, FL9000HL, FL9000L		21222271 21224331 21224531 21224531B 21224745 902368 902404 912368	F5015		428 303 24x58 24x58
Flexair FL11000, FL11000/150, FL11000B, FL11000CS, FL11000CT, FL11000L, FL11000LB, FL11000LS, FL11000S			F5015		428 303 24x58 24x58
Flexair FL9000HLL, FL9000M		21208363 21216058 21224034	F5013		476 321 24x58 24x58
Flexair FL9000i, FL9000NB		21224778 21226989	F5164		376 273 24x57 24x57
Flexair FL11000D		21208363 21216058 21224034	F5013		476 321 24x58 24x58
Flexair FP11000		21224778 21226989	F5164		376 273 24x57 24x57
Flexair WFL041, WFL115, WFL128, WFL131			F5075		426 296 20x62 20x62
Flexair II WFL510, WFL520			F5075		426 296 20x62 20x62
FlexLite XL9000, XL9000H, XL9000HL, XL9000L		21225104	F5173		332 235 16x58 16x58
Indair		21208363 21216058 21224034	F5013		476 321 24x58 24x58
LM Universal Self Steer		21223345	F5343		552 353 20x50 20x50
TE Self Steer		21212534	F5344		632 407 20x50 20x50
TM Self Steer 6T-7T, TM20000, TM22500, TM25000		21212534	F5344		632 407 20x50 20x50
TM Self Steer 10T-12T, 420x180, 420x220		21223345	F5343		552 353 20x50 20x50

SAE					
		8404174	F5020		466 316 24x62 24x62
		8404174	F5254		477 319 20x62 20x62
		9302060	F5015		428 303 24x58 24x58



SAF							
		2 376 0022 00	F5083		489	324	24x55 24x55
		2 376 0030 00	F5187		474	316	24x55 24x55
		2 376 0039 00					
		2 376 4030 00					
		2 376 0032 00	F5192		694	426	24x55 24x55
		2 376 4032 00					
		2 376 0010 01	F5254		477	319	20x62 20x62
		2 376 0010 02					
		2 376 0014 00					
		2 376 0015 00					
		2 376 0029 00					
		2376001000					
		2376007301	F5401		460	300	20x78 20x68
AR112, AR113, AR418		2 376 0009 02	F5186		513	333	20x50 20x44
AR200		2 376 0003 00	F1068		616	383	20x44 20x44
		2 376 0003 01					
		2 376 0003 02					
		2 376 0017 00					
		2 376 1007 01					
		2 376 1007 52					
AR213, AR413, AR416, EU416		2 376 0010 01	F5254		477	319	20x62 20x62
		2 376 0010 02					
		2 376 0014 00					
		2 376 0015 00					
		2 376 0029 00					
		2376001000					
AR221		2 376 0016 00	F1119		714	436	20x44 20x44
AR 311, AR 314, AR 411, AR 414		2 376 0026 00	F5224		495	327	24x55 24x55
		2 376 0028 00					
		2 376 4026 00					
		4 017 0012 3247					
AR313		0 880 570	V2097		635	385	19x44 19x44
		2 376 0002 00					
AR316, EU316		2 376 0010 01	F5254		477	319	20x62 20x62
		2 376 0010 02					
		2 376 0014 00					
		2 376 0015 00					
		2 376 0029 00					
		2376001000					
AR413		2 376 0018 00	F1000		471	311	20x62 20x62
		2 376 0003 00	F1068		616	383	20x44 20x44
		2 376 0003 01					
		2 376 0003 02					
		2 376 0017 00					
		2 376 1007 01					
		2 376 1007 52					
		2 376 0005 00	F5020		466	316	24x62 24x62
		2 376 0006 00					
		2 376 0008 00					
		6 503 608P					
AR413 Special		2 376 0010 01	F5254		477	319	20x62 20x62
		2 376 0010 02					
		2 376 0014 00					
		2 376 0015 00					
		2 376 0029 00					
		2376001000					
AR421		2 376 0020 00	F5127		559	359	20x62 20x62
EM311, EO314, EM411, EO414		2 376 0026 00	F5224		495	327	24x55 24x55
		2 376 0028 00					
		2 376 4026 00					
		4 017 0012 3247					
Intraax, Intradisc Plus		2 376 0035 00	F5011		429	294	24x55 24x55
		2 376 0026 00	F5224		495	327	24x55 24x55
		2 376 0028 00					
		2 376 4026 00					
		4 017 0012 3247					



Intradisc Plus		2 376 0035 00 4 017 0012 3325 2 376 0031 00	F5011		429 294 24x55 24x55
			F5012		539 349 24x55 24x55
		2 376 0030 00 2 376 0039 00 2 376 4030 00	F5187		474 316 24x55 24x55
		2 376 0027 00	F5190 ¹		424 291 24x55 24x55
Intradisc Plus II		2 376 0070 00 2 376 0070 01 2 376 0071 00 2 376 0071 01	F5174		413 278 20x78 20x68
		2 376 0072 00 2 376 0072 01	F5175		491 315 20x78 20x68
			F5176		532 335 20x78 20x68
LF Series		196116	F5002		764 464 24x55 24x55

		Axle Nos. RLBM8442 RLSM8442 RLSM9042 RLSM9042/20 RSLM11242 SK RLS11242 SK RLS9042 SK RLS9042/20 WRLZM11030 WRLZM11035-10 WRLZM11035-8 WRLZM8130 WRLZM8435-10 WRLZM8435-8	2376100500	F5185		655 415 32x55 32x55
--	--	--	------------	--------------	--	---------------------

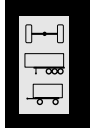

SAMRO						
		1752498 90044025	F1074		744 451 20x44 20x44	
		21208363 21216058	F5013		476 321 24x58 24x58	
		21215742	F5075		426 296 20x62 20x62	
		2500001 2500341 503100	F5201		474 329 20x62 20x62	
		2500002 2500342 371424 501400	F5205		474 329 20x62 20x62	

SCHMITZ CARGOBULL						
		012486 014134 1090122	F5254		477 319 20x62 20x62	
		012726	F5127		559 359 20x62 20x62	
		013290 016271 1079383	F5012		539 349 24x55 24x55	
		013506	F5007		694 427 24x55 24x55	
		014050	F5002		764 464 24x55 24x55	
		015531 015978 017090 902022 912022 912643	F5194		426 296 20x62 20x62	
		016008 017090 1028075	F5075		426 296 20x62 20x62	
		017641	V2097		635 385 19x44 19x44	



		017750	F5011		429 294 24x55 24x55
		017919	F5175		491 315 20x78 20x68
		018054 1020636	F5192		694 426 24x55 24x55
		075273 075278	F5126		789 477 24x55 24x55
		1012386	F5174		413 278 20x78 20x68
		1021298	F5176		532 335 20x78 20x68
		1048260	F5010		794 477 24x55 24x55
		1061555 1293079	F5381		383 267 20x58 16x58
MRH3 M30		1008054 1086690 1093977 912801	F5376		383 267 16x82 16x58
		1134526	F5164		376 273 24x57 24x57
Cargobull		016508 1086689 1093975 912565	F5172		383 268 16x58 16x58
Cargobull		013250 013961 1041843 017750	F5004		495 327 24x55 24x55
		196103	F5083		489 324 24x55 24x55
		075273 075278	F5126		789 477 24x55 24x55
		017370	F5187		474 316 24x55 24x55
		014118 014750 1055458	F5224		495 327 24x55 24x55
		012789 020044 028363 407620 408871	F5125 ¹		495 327 24x55 24x55
		013774 016270	F5190 ¹		424 291 24x55 24x55
Rotos		016508 1086689 1093975 912565	F5172		383 268 16x58 16x58
Weweler		014856 016007 016436 1113437 902398 912398 912637 015531 015978 017090 902022 912022 912643	F5025 F5194		476 321 20x62 20x62 426 296 20x62 20x62

S.M.B.

← GIGANT

TECMA

		7075	F5004		495 327 24x55 24x55
--	--	------	--------------	--	---------------------





TIRSAN (KÄSSBOHRER)

	8231092000 8231092000D 8231092000DG 8231276000 8231293000 8231293100	F5157	Q Q	560 360 16x49 16x49
--	---	--------------	--------	---------------------

TITAN

	4012899 4285 506246 507172	F5071¹	Q Q	435 305 22x49 21x84
--	-------------------------------------	--------------------------	--------	---------------------

TODD

	 2912002	F5084	Q Q Q	475 320 20x55 20x55
	 2914001	F1022	Q Q Q	506 336 20x55 20x55

TOUGHLINE

	12740	F5075	Q Q	426 296 20x62 20x62
--	-------	--------------	--------	---------------------

TRABOSA

	1700406850	F1068	Q Q	616 383 20x44 20x44
	 196103	F5083	Q Q Q	489 324 24x55 24x55

TRAILOR

→ 84	2376000800 6503123L 6503608P 6506635A	F5020	Q Q	466 316 24x62 24x62
	 2376003200	F5192	Q Q	694 426 24x55 24x55
AR211T, AR213T, SP413 → 84	2376000800 6503123L 6503608P 6506635A	F5020	Q Q	466 316 24x62 24x62
L200, N400	0036114 6505245	F1118	Q Q	504 336 20x55 20x55
L200, N400 86 →	2376001800 6504638G 6506636B	F1000	Q Q	471 311 20x62 20x62
L200, N400 88 →	0036114P 6505245X	F1022	Q Q	506 336 20x55 20x55
L200, N401	0036114 6505245	F1118	Q Q	504 336 20x55 20x55
SA	M077800	F1241	Q Q	713 435 20x54 20x54
	M001545 M007969 1526855 7000057L M001537 M007950 UJB0565	F5088	Q Q	428 303 20x55 20x55
		F5084	Q Q	475 320 20x55 20x55

TRAS CAR



TRAS CAR					
		03003106770C	F5366		648 403 20x46 20x46

TRAX					
		40050	F5201		474 329 20x62 20x62
		4050	F5205		474 329 20x62 20x62

TRENKAMP & GEHLE					
	GIGANT				

TROUILLET					
		01120012877200 0112007200 HA90750	F5202		575 382 20x55 20x55
		2376001001	F5254		477 319 20x62 20x62

VALX					
		D8A919524W	F5377		425 290 20x82 16x82

VIBERTI					
		0237021800	F5002		764 464 24x55 24x55
		128711209 128711216 178711204 178711207 178711209 7299	F5007		694 427 24x55 24x55
		127711219	F5370		584 374 24x52 24x52

WEWELER					
		20430004 902194 902229 902398 912194 912229 912398 912637	F5025		476 321 20x62 20x62
		20445015 50902 509020 50929 902022 902227 912022 912227 912643 912798 W2650 5106 91-2798 919522	F5194		426 296 20x62 20x62
			F5402		449 305 20x62 20x62
			F5381		383 267 20x58 16x58





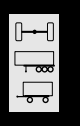





		D899531W 919531	F5377		425 290 20x82 16x82
Flexair FL 041, Schmitz		21215607 21215742 21215751 21221306 902022SP2 902023 902036 912036	F5075		426 296 20x62 20x62
Flexair FL131			F5075		426 296 20x62 20x62
Flexair FL 131, FL 134			F5075		426 296 20x62 20x62
Flexair FL 510, FL 520, FL 524, FL 530			F5075		426 296 20x62 20x62
Flexair FL11000		21216058 21224034	F5013		476 321 24x58 24x58
Indair		21216058 21224034	F5013		476 321 24x58 24x58
HD+			F5075		426 296 20x62 20x62
Mega		503075 503076	F5020		466 316 24x62 24x62
			F5025		476 321 20x62 20x62
Schmitz			F5025		476 321 20x62 20x62
Schmitz - Rotos		912565	F5172		383 268 16x58 16x58

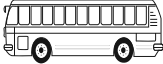

YORK					
HT E		506246 507172	F50711		435 305 22x49 21x84





ZORZI					
		1006610 1006611	F5075		426 296 20x62 20x62
		1006609	F5366		648 403 20x46 20x46
		1006619	F5368		424 296 24x52 24x52
		1006617 1006618	F5369		466 316 24x52 24x52
		1006613	F5002		425 290 20x82 16x82

ALEXANDER DENNIS DART



								
	<i>i</i>	 N°			<i>i</i>	 N°		

ALEXANDER DENNIS



DART

Dart I, Dart SLF		652516 652815 653517 653518 655730 655731 655871 656275 657351 657866 657867 657909 659900	B1238	$\frac{1}{T}$		652516 652815 653517 653518 655730 655731 655871 656275 657351 657866 657867 657909 659900	B1238	$\frac{1}{T}$
Dart II			B1238	$\frac{1}{T}$			B1238	$\frac{1}{T}$

DRAGON

Dragon Dominator		652815	B1238	$\frac{1}{T}$		652815	B1238	$\frac{1}{T}$
						652814		$\frac{1}{T}$





ENVIRO

Enviro 300		659307		$\frac{1}{T}$		659308		$\frac{1}{T}$
------------	--	--------	--	---------------	---	--------	--	---------------



JAVELIN

Javelin Midi Coach		659315	B1239	$\frac{1}{T}$				
--------------------	---	--------	--------------	---------------	--	--	--	--

LANCE

Lance						654397		$\frac{1}{O}$
						654398	T5252	$\frac{1}{T}$
Lance SLF		656505		$\frac{1}{T}$		656507		$\frac{1}{T}$

TRIDENT

Trident II		657610	B5162	$\frac{1}{T}$		657611	B5163	$\frac{1}{T}$
------------	---	--------	--------------	---------------	--	--------	--------------	---------------

AUTODROMO

BUSSOTTO

Bussotto		81 43701 6713	B5291	$\frac{1}{T}$		81 43701 6714	B1278	$\frac{1}{T}$
----------	--	---------------	--------------	---------------	--	---------------	--------------	---------------

BOVA

EUROPA

EL18, EL24, EL26, EL28, EL29				4 x 			B1289	$\frac{1}{T}$
---------------------------------	--	--	--	---	--	--	--------------	---------------

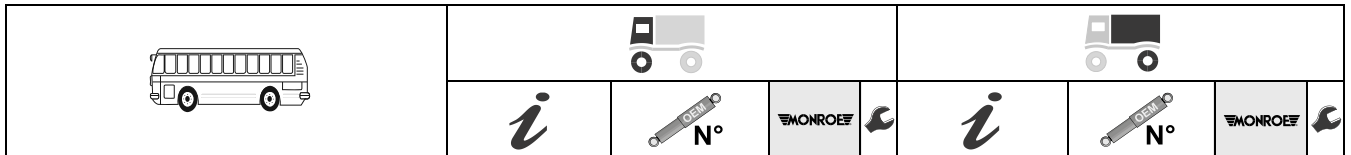

FUTURA									
FH12, FL12	82/01 → 90/12 → Ch.No6370		406694 410554	B5290		4 x	406694 410554	B5290	

DAF									
VDL BUS									
VDL BUS									

DENNIS									
ALEXANDER DENNIS									

ENASA									
PEGASO									
6420			1004876 81437016572	B5259			1004877 81437016578	B5260	

EVOBUS (KÄSSBOHRER, SETRA)									
SERIES 100									
S110-A	Ch.No.154298 →		8.231.103.000 8.231.103.000 E 8.231.204.000 8.231.204.000 C 8.231.267.000 8.231.267.000 D 8.231.268.000 8.231.268.000 D 8.231.344.000 8.231.344.000.0 8.231.355.000	B5300		4 x	8.231.116.000 8.231.116.000 E 8.231.270.000 8.231.270.000 D 8.231.346.000 8.231.346.000 D 8.231.346.000.0	B1289	
						4 x	8.231.171.000 8.231.187.000 8.231.351.000		
S110-H	Ch.No.154213 →			B5300		4 x		B1289	
						4 x	8.231.171.000 8.231.187.000 8.231.351.000		
S110-P	Ch.No.154801 →			B5300		4 x		B1289	
						4 x	8.231.171.000 8.231.187.000 8.231.351.000		
S120-A	Ch.No.156375 →			B5300		4 x		B1289	
						4 x	8.231.171.000 8.231.187.000 8.231.351.000		
S120-E	Ch.No.157510 →			B5300		4 x		B1289	
						4 x	8.231.171.000 8.231.187.000 8.231.351.000		
S120-H	Ch.No.152283 →			B5300		4 x		B1289	
						4 x	8.231.171.000 8.231.187.000 8.231.351.000		
S120-P	Ch.No.156911 →			B5300		4 x		B1289	
						4 x	8.231.171.000 8.231.187.000 8.231.351.000		



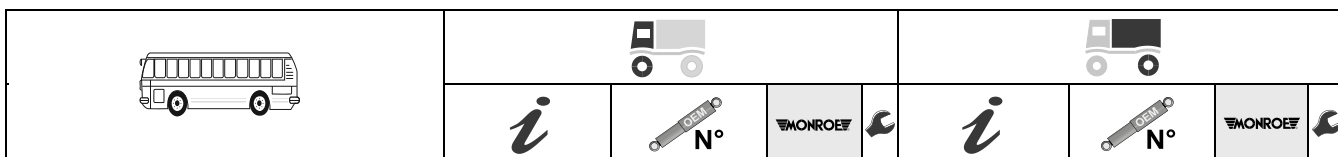





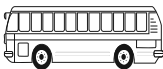

EVOBUS (Kässbohrer, Setra) SERIES 200



S130-E	Ch.No.159544 →		B5300		4 x		B1289	
					4 x	8.231.171.000 8.231.187.000 8.231.351.000	B5303	
S130-HK	Ch.No.158515 →		B5300		4 x		B1289	
					4 x	8.231.171.000 8.231.187.000 8.231.351.000	B5303	
S130-P	Ch.No.158921 →		B5300		4 x		B1289	
					4 x	8.231.171.000 8.231.187.000 8.231.351.000	B5303	
S130-S, S140-E, S140-ES, S140-P			B5300		4 x		B1289	
					4 x	8.231.171.000 8.231.187.000 8.231.351.000	B5303	
S150-E	Ch.No.161521 →		B5300		4 x		B1289	
					4 x	8.231.171.000 8.231.187.000 8.231.351.000	B5303	
S150-H	Ch.No.160315 →		B5300		4 x		B1289	
					4 x	8.231.171.000 8.231.187.000 8.231.351.000	B5303	
S150-P	Ch.No.160841 →		B5300		4 x		B1289	
					4 x	8.231.171.000 8.231.187.000 8.231.351.000	B5303	
SG180			B5300		4 x		B1289	
					4 x	8.231.171.000 8.231.187.000 8.231.351.000	B5303	

SERIES 200

S200, S209H, S209HD, S209HU, S210H, S210HD, S210HU, S211H, S211HD, S211HU, S212H, S212HD, S212HU, S213H, S213HD, S213HU, S213HR, S214H, S214HD, S214HU, S214HR		8.231.103.000 8.231.103.000 E 8.231.204.000 8.231.204.000 C 8.231.267.000 8.231.267.000 D 8.231.268.000 8.231.268.000 D 8.231.344.000 8.231.344.000.0 8.231.355.000	B5300		4 x	8.231.116.000 8.231.116.000 E 8.231.270.000 8.231.270.000 D 8.231.346.000 8.231.346.000 D 8.231.346.000.0	B1289	
					4 x	108108366 108123357	B1328	
					4 x	8.231.171.000 8.231.187.000 8.231.351.000	B5303	
S215H, S215HD, S215HU, S215HR, S215 SL, S215UL			B5300		4 x		B1289	
					4 x	8.231.171.000 8.231.187.000 8.231.351.000	B5303	
S215HDH			B5300					
S215HUL			B5300		4 x		B1289	
S216H, S216HDS	→ Ch. No. 025		B5300		4 x		B1289	
	Ch. No. 026 →	228189 8.231.220.000 8.231.220.000.C 8.231.269.000 8.231.269.000.D 8.231.367.000.0	B5319		4 x	8.231.171.000 8.231.187.000 8.231.351.000	B5303	
S217HDH		8.231.322.000 8.231.345.000 8.231.345.000.0	B5302			108108366 108123357	B1328	

S228DT	228189	B5319	O O	4 x		B1289	$\frac{1}{T}$
	8.231.220.000 8.231.220.000.C 8.231.269.000 8.231.269.000.D 8.231.367.000.0			4 x			

SERIES 300

S309HD, S312HD, S315HDH-BS, S317HDH-3	8.231.322.000 8.231.345.000 8.231.345.000.0	B5302	O O		108108366 108123357	B1328	$\frac{1}{T}$
S315GT-HD	8.231.322.000 8.231.345.000 8.231.345.000.0	B5302	O O		627 326 0100 8.231.347.000 8.231.323.000 8.231.323.000 B 8.231.323.000 D 8.231.348.000 8.231.348.000.0	B1288 B1293	$\frac{1}{T}$ $\frac{1}{T}$
S315HDH	8.231.322.000 8.231.345.000 8.231.345.000.0	B5302	O O		8.231.323.000 8.231.323.000 B 8.231.323.000 D 8.231.348.000 8.231.348.000.0	B1293	$\frac{1}{T}$
S315 NF, S319 NF	8.231.365.000 8.231.365.000 C 8.231.372.000 8.231.372.000.0	B5305	O O		8.231.366.000 8.231.366.000.0	B1292	$\frac{1}{T}$
S315UL, S315H, S315GT	8.231.322.000 8.231.345.000 8.231.345.000.0	B5302	O O		627 326 0100 8.231.347.000	B1288	$\frac{1}{T}$
S320, S328DT					108108366 108123357	B1328	$\frac{1}{T}$

SERIES 400

S411HD, S415HD, S415HDH, S417HDH	629 323 0000	B5286	O T	● 4 x ○	629 326 0000 629 326 0100	B1287	$\frac{1}{T}$
S415GT, S415GT-HD, S416GT-HD, S417GT-HD				4 x	629 326 0000 629 326 0100	B1287	$\frac{1}{T}$

HEULIEZ**GX**

GX327 Hybrid, GX337 DS T6 E6 Hybrid, GX427 Hybrid					5006172376 504124915 5801572582	B5424	$\frac{1}{O}$
---	--	--	--	--	---------------------------------------	--------------	---------------







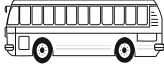

IKARBUS**IK**

IK103, IK104, IK105P, IK201, IK202, IK301, IK302	108108366 108123357	B1328	$\frac{1}{T}$		108108366 108123357	B1328	$\frac{1}{T}$
--	------------------------	--------------	---------------	--	------------------------	--------------	---------------

IRISBUS**CITELIS**

Citelis	5010531249	B5353	$\frac{1}{T}$		5006172492	B1317	$\frac{1}{O}$
Citelis 10M-CNG, 12M, 12M Trolley, 12M-CNG, 12M Hybrid, 12M Line CH, 18M Trolley, 18M-CNG, 18M-DS, 18M Hybrid					5006172376 504124915 5801572582	B5424	$\frac{1}{O}$





IRISBUS CITYBUS

								
	<i>i</i>	 N°			<i>i</i>	 N°		

CITYBUS							
Citybus	5006172375 5006172528 5010347902 5010347905	B5330	$\frac{1}{T}$ $\frac{1}{O}$		5006172376 504124915 5801572582 5010347903	B5424	$\frac{1}{O}$ $\frac{1}{O}$
		B5355	$\frac{1}{O}$			B5337¹	$\frac{1}{O}$

CREALIS							
Crealis 18M, 18M-CNG BU, 18M Hybrid BU					5006172376 504124915 5801572582	B5424	$\frac{1}{O}$



GX							
GX327 Hybrid, GX337 DS T6 E6 Hybrid, GX427 Hybrid					5006172376 504124915 5801572582	B5424	$\frac{1}{O}$







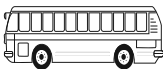

RECREO								
Recreo	97/01 → → Ch.No6345		42538567 5001840316 5801113772	B5341	$\frac{1}{O}$ 4 x $\frac{1}{O}$ 	42538556 5001840060 5801102621	B5382	$\frac{1}{O}$
Recreo	→ 2007/12 Ch.No.6344 →		42538567 5001840316 5801113772	B5341	$\frac{1}{O}$ 4 x $\frac{1}{O}$ 	5006019186	B5383	$\frac{1}{O}$

IVECO

BUS								
393.35 My Way			5006306262 5006306267 504023846 504023848 99432849 99432852 99469833 99469860	B5323	$\frac{1}{O}$ $\frac{1}{O}$	5006306266 504023849 99432850 99469861	B5322	$\frac{1}{O}$ $\frac{1}{O}$

CITYCLASS								
491.22, 491.22CNG, 491.24CNG, 491.27, 491.27CNG, 591.22, 591.22CNG, 591.24CNG, 591.27, 25, 29, 31, 35			5006228872	B5420	$\frac{1}{O}$ 4 x $\frac{1}{O}$	5006217618 5006228873 99432914 99477315	B5421	$\frac{1}{O}$

EURORIDER								
26, 26A, 31			5006306262 5006306267 504023846 504023848 99432849 99432852 99469833 99469860	B5323	$\frac{1}{O}$ $\frac{1}{O}$	5006306268 504023847 99432853 99469583 99469838 99469853	B5321	$\frac{1}{O}$ $\frac{1}{O}$
26, 27				B5323	$\frac{1}{O}$ $\frac{1}{O}$	5006306263 504023845	B5397	$\frac{1}{T}$
29, 29A, 35, 35A, 38				B5323	$\frac{1}{O}$ $\frac{1}{O}$	5006306268 504023847 99432853 99469583 99469838 99469853 5006306266 504023849 99432850 99469861	B5321	$\frac{1}{O}$ $\frac{1}{O}$
43				B5323	$\frac{1}{O}$ $\frac{1}{O}$	5006306266 504023849 99432850 99469861	B5322	$\frac{1}{O}$ $\frac{1}{O}$
393.29 My Way, 393.95 My Way, 399.35 My Way			500339897 5006306265 504023850	B5318	$\frac{1}{O}$ 4 x $\frac{1}{O}$	500396370 5006306264 504023851	B5315	$\frac{1}{O}$ $\frac{1}{O}$

								
	<i>i</i>	 N°	 	<i>i</i>	 N°	 		







URBANWAY

Urbanway E6 12M L2500, E6 12M T6 Hybrid, E6 18M L2500, E6 18M T6 Hybrid					5006172376 504124915 5801572582	B5424	$\frac{1}{0}$
--	--	--	--	--	---------------------------------------	--------------	---------------

480

480.10.21, 480.12.21	2997299 4823455 4866756	B5333	$\frac{1}{T}$	2997322 4823458	B5331	$\frac{1}{T}$
----------------------	-------------------------------	--------------	---------------	--------------------	--------------	---------------

KAROSA**C9**

C934, C934E, C935, C935E	→ 2001/12		5801113772	B5341	$\frac{0}{0}$ 4 x 	E4436211012 E5001840060 E5801102621	B5382	$\frac{1}{0}$
C954, C954E, C955, C955E	2001/01 →		5801113772	B5341	$\frac{0}{0}$ 4 x 	E5006019186	B5383	$\frac{1}{0}$
C956	2002/01 →		5801113772	B5341	$\frac{0}{0}$ 4 x 	E5006019186	B5383	$\frac{1}{0}$

CITYBUS

Citybus	5006172375 5006172528 5010347902 5010347905	B5330	$\frac{1}{T}$	5006172376 504124915 5801572582 5010347903	B5424	$\frac{1}{0}$
		B5355	$\frac{1}{0}$		B5337 ¹	$\frac{1}{0}$

KÄSSBOHRER

 EVOBUS						
--	--	--	--	--	--	--

LEYLAND

 VOLVO						
---	--	--	--	--	--	--

MAN**EL (1993/01-2001/01)**

EL202, EL222, EL262	A12 City Bus		81 43701 6670 81 43701 6688 81 43701 6713 81 43701 6729	B5291	$\frac{1}{T}$ 4 x	81 43701 6672 81 43701 6689 81 43701 6706 81 43701 6714 81 43701 6730 81 43701 6768 81 43701 6801 81 43701 6806	B1278	$\frac{1}{T}$
---------------------	-----------------	---	--	--------------	-------------------	--	--------------	---------------

F 8 (-1987/01)

15.200FOC		81 43701 6255 81 43701 6279 81 43701 6280 81 43701 6426	T1007	$\frac{0}{0}$		
-----------	---	--	--------------	---------------	--	--

FOCR





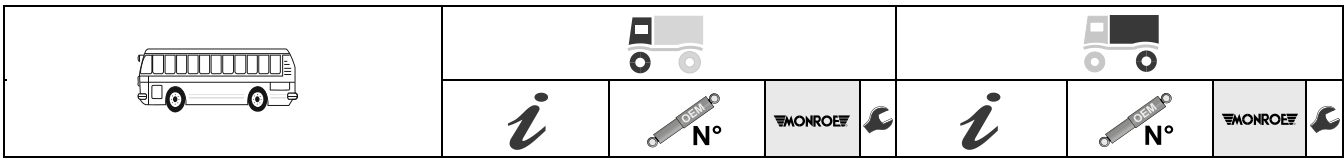

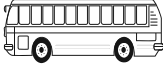

18.200FOCR		81 43701 6255 81 43701 6279 81 43701 6280 81 43701 6426	T1007	$\frac{0}{0}$	81 43701 6428	$\frac{1}{T}$
------------	---	--	--------------	---------------	---------------	---------------

MAN G 90 (1987/05-1995/05)









G 90 (1987/05-1995/05)							
8.136FOC, 8.136FOCR, 8.150FOC, 8.170FOC, 9.136FOC, 9.136FOCR, 9.150FOC, 9.170FOC	L05	81 4370 16665 81 4370 16789 81 4370 6349 81 4370 6385 81 4370 6392 81 4370 6410 81 4370 6781	T1142	⊥ T	↪	81 4370 6253 81 4370 6338 81 4370 6452	T1117 ⊙ ⊙

HOCL							
10.136HOCL/R, 10.150HOCL/R, 10.180HOCL/R	469	81 4370 6643 81 4370 6716		⊥ T		81 4370 6610	B1286 ⊙ ⊙
11.192HOCL/R	469	81 4370 6643 81 4370 6716		⊥ T		81 4370 6610	B1286 ⊙ ⊙
12.220HOCL-NL-CKD	2001/08 → A80	81 4370 6670 81 4370 6688 81 4370 6713 81 4370 6729	B5291	⊥ T		81 4370 6610	B1286 ⊙ ⊙
12.220HOCL/R	98/01 → A66	81 4370 6670 81 4370 6688 81 4370 6713 81 4370 6729	B5291	⊥ T		81 4370 6791	⊙ ⊖
12.220HOCL/SR	2002/02 → A77				→ 2003/06	81 4370 6610 81 4370 6885	B1286 ⊙ ⊙ ⊙ ⊙
14.220HOCL/R	98/01 → A66	81 4370 6670 81 4370 6688 81 4370 6713 81 4370 6729	B5291	⊥ T		81 4370 6791	⊙ ⊖
18.310HOCL/R-SKD, 18.313HOCL/R-SKD, 18.350HOCL/R-SKD, 18.370HOCL/R-SKD, 18.400HOCL/R-SKD, 18.420HOCL/R-SKD	95/01 → A55	81 4370 6767	B5299	⊥ T	⊕	81 4370 6787 81 4370 6830 81 4370 6892 81 4370 6924	B1290 ⊥ T
18.230HOCL/R, 18.250HOCL/R	A64	81 4370 6705 81 4370 6776 81 4370 6786 81 4370 6800 81 4370 6810	B5293	⊥ T	4 x	81 4370 6672 81 4370 6689 81 4370 6706 81 4370 6714 81 4370 6730 81 4370 6768 81 4370 6801 81 4370 6806	B1278 ⊥ T
18.310HOCL/R, 18.350HOCL/R, 18.370HOCL/R, 18.400HOCL/R, 18.420HOCL/R	→ 82/08 A51	81 4370 6705 81 4370 6776 81 4370 6786 81 4370 6800 81 4370 6810	B5293	⊥ T			
18.310HOCL/R, 18.350HOCL/R, 18.370HOCL/R, 18.400HOCL/R, 18.420HOCL/R, 18.460HOCL/R	92/01 → A51	81 4370 6705 81 4370 6776 81 4370 6786 81 4370 6800 81 4370 6810	B5293	⊥ T	4 x	81 4370 6787 81 4370 6830 81 4370 6892 81 4370 6924	B1290 ⊥ T
		81 4370 6785 81 4370 6855 81 4370 6856 81 4370 6923 81 4370 6940 81 4370 6008	B5299	⊥ T	4 x	↙ ↗	B1278 ⊥ T
		81 4370 6785 81 4370 6855 81 4370 6856 81 4370 6923 81 4370 6940 81 4370 6008	B5301	⊥ T			
18.310HOCL/R, 18.350HOCL/R, 18.360HOCL/R, 18.400HOCL/R, 18.410HOCL/R	2002/06 → A82	81 4370 6785 81 4370 6855 81 4370 6856 81 4370 6923 81 4370 6940 81 4370 6008	B5301	⊥ T	4 x	81 4370 6787 81 4370 6830 81 4370 6892 81 4370 6924	B1290 ⊥ T
24.310HOCLNR/NL-D D, 24.350HOCLNR/NL-D D	A59				● ○ → 1998/03	↙ ↗ 81 4370 6767	B1278 ⊥ T B5299 ⊥ T
24.350HOCLN, 24.400HOCLN	97/01 → A54	81 4370 6767	B5299	⊥ T	● ○ 4 x	↙ ↗ 81 4370 6767	B1278 ⊥ T B5299 ⊥ T

								
	<i>i</i>				<i>i</i>			

LION'S CITY									
Lion's City G	96/08 → A23		81 43701 6880	B5312	$\frac{1}{T}$		81 43701 6878	B1282	$\frac{1}{T}$
							81 43701 6881	B1297	$\frac{1}{T}$

LION'S COACH (1995/09-)									
RHC414	2002/06 → R07		81 43701 6785 81 43701 6855 81 43701 6856 81 43701 6923 81 43701 6940 81 43702 6008	B5301	$\frac{1}{T}$	4 x 	81 43701 6787 81 43701 6830 81 43701 6892 81 43701 6924	B1290	$\frac{1}{T}$
RH463, RHC464	2002/06 → R08		81 43701 6785 81 43701 6855 81 43701 6856 81 43701 6923 81 43701 6940 81 43702 6008	B5301	$\frac{1}{T}$	● 4 x 	81 43701 6787 81 43701 6830 81 43701 6892 81 43701 6924	B1290	$\frac{1}{T}$
						○ 	81 43701 6785 81 43701 6855 81 43701 6856 81 43701 6923 81 43701 6940 81 43702 6008	B5301	$\frac{1}{T}$
RH483, RHC484	2003/07 → R08		81 43701 6785 81 43701 6855 81 43701 6856 81 43701 6923 81 43701 6940 81 43702 6008	B5301	$\frac{1}{T}$	● ○	81 43701 6787 81 43701 6830 81 43701 6892 81 43701 6924	B1290	$\frac{1}{T}$
							81 43701 6785 81 43701 6855 81 43701 6856 81 43701 6923 81 43701 6940 81 43702 6008	B5301	$\frac{1}{T}$









LION'S STAR (1991/03-)									
FRH322, FRH422	A03		81 43701 6785 81 43701 6855 81 43701 6856 81 43701 6923 81 43701 6940 81 43702 6008	B5301	$\frac{1}{T}$		81 43701 6787 81 43701 6830 81 43701 6892 81 43701 6924	B1290	$\frac{1}{T}$

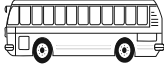





L 2000 (1993/10-)									
8.220FOC, 8.220FOCL, 10.220FOC, 10.220FOCL	L53		631 413 031 81 4370 16665 81 4370 16789 81 43701 6349 81 43701 6365 81 43701 6392 81 43701 6410 81 43701 6781	T1142	$\frac{1}{T}$		81 43701 6798	T1187	○ ○



N									
N4516 Centro-E			81 43701 6880	B5312	$\frac{1}{T}$				

NG (1992/08-)									
NG272, NG312	896A19 Low floor articulated bus		81 43701 6670 81 43701 6688 81 43701 6713 81 43701 6729	B5291	$\frac{1}{T}$	● 4 x ○ 4 x	81 43701 6672 81 43701 6689 81 43701 6706 81 43701 6714 81 43701 6730 81 43701 6768 81 43701 6801 81 43701 6806 81 43701 6715	B1278	$\frac{1}{T}$ $\frac{1}{T}$
NG262, NG263, NG312, NG313	A23		81 43701 6880	B5312	$\frac{1}{T}$	4 x	81 43701 6881	B1297	$\frac{1}{T}$











MAN NL (1988/09-)

								
	<i>i</i>	 N°			<i>i</i>	 N°		

NL (1988/09-)									
NL202	89/09 → 94/04 895 Low floor midi bus		81 43701 6670 81 43701 6688 81 43701 6713 81 43701 6729	B5291	$\frac{1}{T}$		81 43701 6672 81 43701 6689 81 43701 6706 81 43701 6714 81 43701 6730 81 43701 6768 81 43701 6801 81 43701 6806	B1278	$\frac{1}{T}$
NL202, NL262, NL263	91/04 → A10		81 43701 6670 81 43701 6688 81 43701 6713 81 43701 6729	B5291	$\frac{1}{T}$			B1278	$\frac{1}{T}$
NL202, NL222, NL223	92/08 → A10		81 43701 6670 81 43701 6688 81 43701 6713 81 43701 6729	B5291	$\frac{1}{T}$			B1278	$\frac{1}{T}$
NL262	97/06 → A10		81 43701 6670 81 43701 6688 81 43701 6713 81 43701 6729	B5291	$\frac{1}{T}$				
NL262, NL263	98/07 → A10		81 43701 6670 81 43701 6688 81 43701 6713 81 43701 6729	B5291	$\frac{1}{T}$				







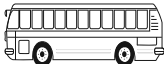

NM (1987/08-)									
NM152	A0500 Low floor midi bus		81 43701 6705 81 43701 6776 81 43701 6786 81 43701 6800 81 43701 6810	B5293	$\frac{1}{T}$		81 43701 6705 81 43701 6776 81 43701 6786 81 43701 6800 81 43701 6810	B5293	$\frac{1}{T}$

NMT (1998/04-)									
NMT222 M10	J30 Low floor midi bus		81 43701 6670 81 43701 6688 81 43701 6713 81 43701 6729	B5291	$\frac{1}{T}$		81 43701 6791		$\frac{1}{T}$







NÜ (1996/03-)									
NÜ223	96/09 → A20 Low floor intercity bus	 	81 43701 6670 81 43701 6688 81 43701 6713 81 43701 6729	B5291	$\frac{1}{T}$	→ 1997/06  + Standard Height	81 43701 6672 81 43701 6689 81 43701 6706 81 43701 6714 81 43701 6730 81 43701 6768 81 43701 6801 81 43701 6806	B1278	$\frac{1}{T}$
			Standard Chassis	81 43701 6880	B5312	$\frac{1}{T}$	1997/07 →  + Standard Height	81 43701 6878	B1282
NÜ263	96/09 → 98/07 A20 Low floor intercity bus	 	81 43701 6670 81 43701 6688 81 43701 6713 81 43701 6729	B5291	$\frac{1}{T}$	→ 1997/06  + Standard Height		B1278	$\frac{1}{T}$
			Standard Chassis	81 43701 6880	B5312	$\frac{1}{T}$	1997/07 →  + Standard Height	81 43701 6878	B1282
NÜ263, NÜ313	98/07 → A20 Low floor intercity bus	 	81 43701 6670 81 43701 6688 81 43701 6713 81 43701 6729	B5291	$\frac{1}{T}$	 + Standard Height	81 43701 6878	B1282	$\frac{1}{T}$
			Standard Chassis	81 43701 6880	B5312	$\frac{1}{T}$			

R (1985/05-1993/01)									
FR292, FRH292, R292			81 43701 6266 81 43701 6318 81 43701 6324 81 43701 6325 81 43701 6326 81 43701 6343 81 43701 6386 81 43701 6538 81 43701 6539 81 43701 6542 81 43701 6543 81 43701 6550 81 43701 6572 81 43701 6606 81 43701 6607	B5259	$\frac{1}{T}$		81 43701 6450 81 43701 6573 81 43701 6578	B5260	$\frac{1}{T}$

MAN SL (1972/06-1987/04)

								
	<i>i</i>	 N°			<i>i</i>	 N°		

SL (1972/06-1987/04)

SL40FT		81 43701 6266 81 43701 6318 81 43701 6324 81 43701 6325 81 43701 6326 81 43701 6343 81 43701 6386 81 43701 6538 81 43701 6539 81 43701 6542 81 43701 6543 81 43701 6550 81 43701 6572 81 43701 6606 81 43701 6607	B5259	$\frac{1}{T}$			
SL184			B5259	$\frac{1}{T}$	81 43701 6149 81 43701 6174 81 43701 6195 81 43701 6206 81 43701 6218 81 43701 6220 81 43701 6244 81 43701 6287 81 43701 6288 81 43701 6528	T5069	$\frac{1}{T}$
SL200	Mod. 192					T5069	$\frac{1}{T}$
SL200, SL200 ENASA, SL200F			B5259	$\frac{1}{T}$	81 43701 6450 81 43701 6573 81 43701 6578	B5260	$\frac{1}{T}$
SL200BVG						T5069	$\frac{1}{T}$
SL200FR			B5259	$\frac{1}{T}$	81 43701 6450 81 43701 6573 81 43701 6578	B5260	$\frac{1}{T}$
						T5069	$\frac{1}{T}$

SL II (1984/04-1996/05)

SL202		81 43701 6266 81 43701 6318 81 43701 6324 81 43701 6325 81 43701 6326 81 43701 6343 81 43701 6386 81 43701 6538 81 43701 6539 81 43701 6542 81 43701 6543 81 43701 6550 81 43701 6572 81 43701 6606 81 43701 6607	B5259	$\frac{1}{T}$	Mod. 791	81 43701 6149 81 43701 6174 81 43701 6195 81 43701 6206 81 43701 6218 81 43701 6220 81 43701 6244 81 43701 6287 81 43701 6288 81 43701 6528	T5069	$\frac{1}{T}$
-------	--	---	-------	---------------	----------	--	-------	---------------

SM

SM152, SM182, SM192	469	81 43701 6643 81 43701 6716		$\frac{1}{T}$		81 43701 6610	B1286	$\frac{1}{O}$
---------------------	-----	--------------------------------	--	---------------	--	---------------	-------	---------------

SR (1975/02-1994/08)

SR240		81 43701 6266 81 43701 6318 81 43701 6324 81 43701 6325 81 43701 6326 81 43701 6343 81 43701 6386 81 43701 6538 81 43701 6539 81 43701 6542 81 43701 6543 81 43701 6550 81 43701 6572 81 43701 6606 81 43701 6607	B5259	$\frac{1}{T}$	4 x Mod. 197	81 43701 6149 81 43701 6174 81 43701 6195 81 43701 6206 81 43701 6218 81 43701 6220 81 43701 6244 81 43701 6287 81 43701 6288 81 43701 6528	T5069	$\frac{1}{T}$
					Mod. 290 → '78/05	81 43701 6149 81 43701 6174 81 43701 6195 81 43701 6206 81 43701 6218 81 43701 6220 81 43701 6244 81 43701 6287 81 43701 6288 81 43701 6528	T5069	$\frac{1}{T}$

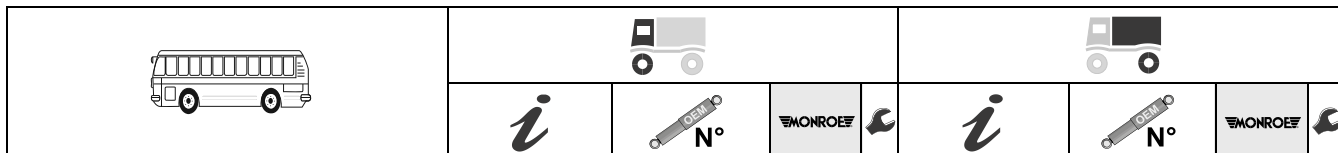







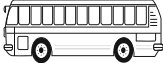

SR240F, SR280F		B5259	$\frac{1}{T}$	81 43701 6450 81 43701 6573 81 43701 6578 4 x Greece → '76/06	B5260	$\frac{1}{T}$
SR240R, SR280R		B5259	$\frac{1}{T}$	4 x	T5069	$\frac{1}{T}$
SR265, SR281		B5259	$\frac{1}{T}$			
SR280		B5259	$\frac{1}{T}$	4 x Mod. 288 Mod. 290 → '78/05	T5069	$\frac{1}{T}$
SR280H, SR321H, SR361H		B5259	$\frac{1}{T}$	4 x Mod. 288	T5069	$\frac{1}{T}$
SR292, SR292H, SR332H, SR362, SR362H		B5259	$\frac{1}{T}$	81 43701 6450 81 43701 6573 81 43701 6578	B5260	$\frac{1}{T}$

SÜ						
SU220		81 43701 6266 81 43701 6318 81 43701 6324 81 43701 6325 81 43701 6326 81 43701 6343 81 43701 6386 81 43701 6538 81 43701 6539 81 43701 6542 81 43701 6543 81 43701 6550 81 43701 6572 81 43701 6606 81 43701 6607	B5259	$\frac{1}{T}$		
SÜ220-SKD		B5259	$\frac{1}{T}$			
SÜ224, SÜ240F		B5259	$\frac{1}{T}$	81 43701 6149 81 43701 6174 81 43701 6195 81 43701 6206 81 43701 6218 81 43701 6220 81 43701 6244 81 43701 6287 81 43701 6288 81 43701 6528	T5069	$\frac{1}{T}$
SÜ240		B5259	$\frac{1}{T}$	81 43701 6450 81 43701 6573 81 43701 6578 → '83/12 Mod. 193 Mod. 789	B5260	$\frac{1}{T}$
SÜ240-SKD					T5069	$\frac{1}{T}$
SÜ242		B5259	$\frac{1}{T}$	81 43701 6450 81 43701 6573 81 43701 6578	B5260	$\frac{1}{T}$
SÜ280		B5259	$\frac{1}{T}$	81 43701 6450 81 43701 6573 81 43701 6578 → '82/07	B5260	$\frac{1}{T}$
					T5069	$\frac{1}{T}$

UEL							
UEL242, UEL272, UEL292	95/01 → 893	81 43701 6705 81 43701 6776 81 43701 6786 81 43701 6800 81 43701 6810	B5293	$\frac{1}{T}$	81 43701 6672 81 43701 6689 81 43701 6706 81 43701 6714 81 43701 6730 81 43701 6768 81 43701 6801 81 43701 6806	B1278	$\frac{1}{T}$

MAN ÜL (1989/08-)

								
	<i>i</i>	 N°			<i>i</i>	 N°		

ÜL (1989/08-)

ÜL242, ÜL272, ÜL292	893	81 43701 6705 81 43701 6776 81 43701 6786 81 43701 6800 81 43701 6810	B5293	⊥ T	81 43701 6672 81 43701 6689 81 43701 6706 81 43701 6714 81 43701 6730 81 43701 6768 81 43701 6801 81 43701 6806	B1278	⊥ T
---------------------	-----	---	--------------	--------	--	--------------	--------

MERCEDES-BENZ

LK/LN2 (1968/01-1988/12)

8140, 814LO	674 .272-273	ND	006 323 1000 006 323 1100 006 323 1200 673 323 0800 674 323 0500 674 323 0600	T1069	⊙ ⊙			
		ND	673 323 0400	T1067 ¹	⊙ ⊙ ⊙			
		HD	006 323 1100 006 323 2800 673 323 0700 673 323 0900 674 323 0100 674 323 0300 A006 323 2800	T1127	⊙ ⊙ ⊙ ⊙ ⊙ ⊙			
8140, 814LO	674 .072-073	ND	006 323 1000 006 323 1100 006 323 1200 673 323 0800 674 323 0500 674 323 0600	T1069	⊙ ⊙	005 326 2900 005 326 3600 005 326 4200 673 326 0000 673 326 1100 673 326 1200 673 326 1300 673 326 1400 674 326 1200 674 326 1300 674 326 1400 A005 326 3600 A005 326 4200	T1111	⊙ ⊙
		ND	673 323 0400	T1067 ¹	⊙ ⊙ ⊙			
		HD	↙↗	T1127	⊙ ⊙ ⊙ ⊙ ⊙ ⊙			
817LO	676 .464	ND	006 323 1000 006 323 1100 006 323 1200 673 323 0800 674 323 0500 674 323 0600	T1069	⊙ ⊙			
		ND	673 323 0400	T1067 ¹	⊙ ⊙ ⊙			
		HD	↙↗	T1127	⊙ ⊙ ⊙ ⊙ ⊙ ⊙			
8170, 817LO	676 .263	ND	006 323 1000 006 323 1100 006 323 1200 673 323 0800 674 323 0500 674 323 0600	T1069	⊙ ⊙			
		ND	673 323 0400	T1067 ¹	⊙ ⊙ ⊙			
		HD	↙↗	T1127	⊙ ⊙ ⊙ ⊙ ⊙ ⊙			
8170, 817LO	676 .063		006 323 3000 673 323 0500 675 323 0700 A006 323 3000	T1152	⊙ ⊙	↙↗	T1111	⊙ ⊙
8170, 817LO	676 .264	ND	006 323 1000 006 323 1100 006 323 1200 673 323 0800 674 323 0500 674 323 0600	T1069	⊙ ⊙	↙↗	T1111	⊙ ⊙
		ND	673 323 0400	T1067 ¹	⊙ ⊙ ⊙			
		HD	↙↗	T1127	⊙ ⊙ ⊙ ⊙ ⊙ ⊙			

MERCEDES-BENZ O 303

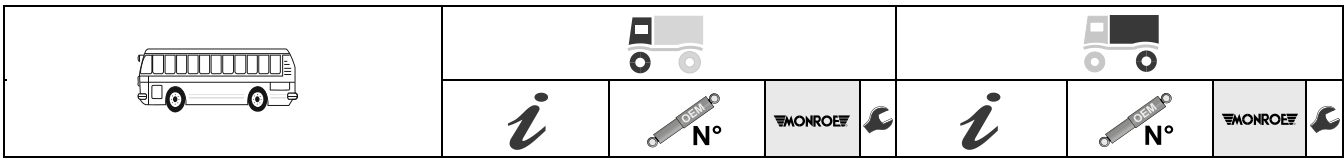

O302	64/01 → 75/11 302 .220 .230 .240 .250 .270 .280 .290 ↔ 4685mm	4 x ⊕	⬅↗ 003 323 4200 003 323 5300 003 323 7300 ⬅↗	B1259 ⊥ V2059 ⊥ 1300018 M □	4 x ⬅↗	B1327 ⊥
O30210R, O30211R, O30212R, O30213R	64/01 → 75/11	4 x ⊕	⬅↗ ⬅↗	B1259 ⊥ 1300018 M □	4 x ⬅↗	B1327 ⊥

O 303

O303	74/10 → 92/09 300 301 600	4 x ⊕ HD	001 326 2100 001 326 2800 002 326 2200 002 326 2300 002 326 4000 003 323 7400 003 326 3400 003 326 7500 300 326 0000 300 326 0200 300 326 0400 302 326 0200 302 326 0300 302 326 0500 373 320 0031 373 326 7300 000 463 5632 000 463 5932 000 463 6132 000 463 6162 000 463 6232 000 463 6432 000 463 6463	B1327 ⊥ 1300018 M □	4 x ⊕ HD	001 326 2100 001 326 2800 002 326 2200 002 326 2300 002 326 4000 003 323 7400 003 326 3400 003 326 7500 300 326 0000 300 326 0200 300 326 0400 302 326 0200 302 326 0300 302 326 0500 373 320 0031 373 326 7300	B1327 ⊥
-------------	------------------------------------	----------------	--	--------------------------------------	----------------	--	----------------

O 317

O317	317.201-204 317.206-209 317.214-222 317 .224				4 x	001 326 2100 001 326 2800 002 326 2200 002 326 2300 002 326 4000 003 323 7400 003 326 3400 003 326 7500 300 326 0000 300 326 0200 300 326 0400 302 326 0200 302 326 0300 302 326 0500 373 320 0031 373 326 7300	B1327 ⊥
-------------	---	--	--	--	-----	--	----------------

O 330

O330	600 .442 613 .455 .485				4 x	001 326 2100 001 326 2800 003 326 7500 302 326 0300	B1327 ⊥
-------------	------------------------------	--	--	--	-----	--	----------------

CONECTO (O 345) (2001/11-)

Conecto C, H, M, UE	671 .015 .020-021 .030 .042					628 326 0800 628 326 1100 628 326 1200 628 326 1600 628 326 1800 628 326 2300 628 326 2400 628 326 2500 628 326 2600 628 326 2700	B1283 ⊥
Conecto 12M, 18M			3823230100 6283230100 6283230200 6283230400	B5298 ⊥			

TOURISMO (O 350)

Tourismo, Turismo RHD, Turismo SHD	613 .355 .385 .455 .485		356 323 0200 356 323 0400 356 323 0500 613 323 0000 A356 323 0200 A356 323 0400 A356 323 0500	B5335 □	4 x	356 320 0031 356 326 0000 356 326 0700 A356 320 0031 A356 326 0000 A356 326 0700	B1305 ⊥
---	----------------------------------	--	---	----------------	-----	---	----------------

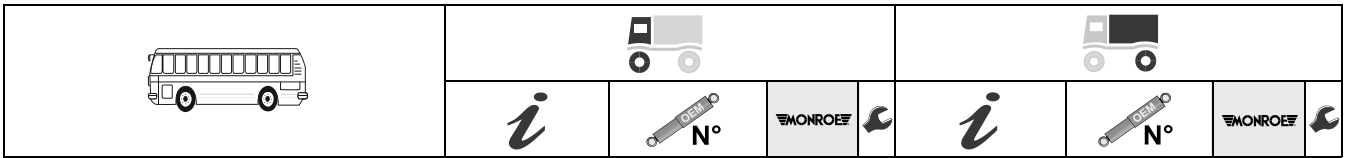







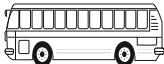

O 403							
403		356 323 0200 356 323 0400 356 323 0500 613 323 0000 A356 323 0200 A356 323 0400 A356 323 0500	B5335	○ ○	4 x	356 320 0031 356 326 0000 356 326 0700 A356 320 0031 A356 326 0000 A356 326 0700	B1305 ⊥ T



O 404							
O404	356 .105 .113 .323 .333 .335 .355 .363 .365 .415 .425 .435 .443 .445 .455 .465 .485 .495	356 323 0200 356 323 0400 356 323 0500 613 323 0000 A356 323 0200 A356 323 0400 A356 323 0500	B5335	○ ○	4 x	356 320 0031 356 326 0000 356 326 0700 A356 320 0031 A356 326 0000 A356 326 0700	B1305 ⊥ T
O404	614 .428 618 .203 .238				○ → Ch.No. 085595 ⊥	005 326 3500 A005 326 3500	B5347 ⊥ T
O404	618 .205 .215 .225 .235 .245 .335 .345					356 320 0031 356 326 0000 356 326 0700 A356 320 0031 A356 326 0000 A356 326 0700	B1305 ⊥ T

O 405 (1984/09-)							
O405 N-G, O405 NH, O405 NUE, O405 NUE-G, O405ST, O405N	357 .090 .416 .426 .436 .450 .454-455 .460-461 .464-466 .480 .484 .486 612 .400 .401-402 .410-413	4 x → Ch. No. 079427 4 x Ch. No. 079428 →	357 323 0300 357 323 0400 A357 323 0300 A357 323 0400 357 323 0500 357 323 0600 A357 323 0600	B5291 ⊥ T	4 x 4 x	005 326 8900 357 320 0431 357 326 0300 A005 326 8900 A357 320 0431 A357 326 0300	B1326 ⊥ T B1285 ¹ ⊥ T
O405ST, O405N	357 .400-402 .404 .406 .410 .412 .415		357 323 0300 357 323 0400 A357 323 0300 A357 323 0400	B5291 ⊥ T	4 x	356 326 0800 357 320 0331 357 326 0200	B1298 ⊥ T
O405ST, O405N	357 .470 .474 .476 612 .420 .422 .426	4 x → Ch. No. 079427 4 x Ch. No. 079428 →	357 323 0300 357 323 0400 A357 323 0300 A357 323 0400 357 323 0500 357 323 0600 A357 323 0600	B5291 ⊥ T B1291 ⊥ T	4 x ● ○ 4 x ● ○	005 326 8900 357 320 0431 357 326 0300 A005 326 8900 A357 320 0431 A357 326 0300	B1326 ⊥ T B1285 ¹ ⊥ T
O405G, O405GN, O405GTD, O405GN-G, O405GNTD, O405GNDE	357 .530 .532 .540 .542 .550 .552 .560 .562 .580 612 .512 .514 .522-525 .604 .608	4 x → Ch. No. 079427 4 x Ch. No. 079428 →	357 323 0300 357 323 0400 A357 323 0300 A357 323 0400 357 323 0500 357 323 0600 A357 323 0600	B5291 ⊥ T B1291 ⊥ T	4 x ● ○ 4 x ● ○	005 326 8900 357 320 0431 357 326 0300 A005 326 8900 A357 320 0431 A357 326 0300	B1326 ⊥ T B1285 ¹ ⊥ T

MERCEDES-BENZ CITARO (O 530) (1998/01-)

								
	<i>i</i>	 N°			<i>i</i>	 N°		

CITARO (O 530) (1998/01-)

Citaro N	628 .040 .043 .045 .047-048 .050	3823230100 6283230100 6283230200 6283230400	B5298	$\frac{1}{T}$	628 326 0800 628 326 1100 628 326 1200 628 326 1600 628 326 1800 628 326 2300 628 326 2400 628 326 2500 628 326 2600 628 326 2700 628 326 0700 A628 326 0700	B1283	$\frac{1}{T}$
Citaro N	628 .447					B1283	$\frac{1}{T}$
Citaro G, Citaro GNG, Citaro L, Citaro NG	628 .000-001 .010 .012 .200 .210 .212	3823230100 6283230100 6283230200 6283230400	B5298	$\frac{1}{T}$	628 326 0700 A628 326 0700	B1284	$\frac{1}{T}$
Citaro G	628 .200-202	3823230100 6283230100 6283230200 6283230400	B5298	$\frac{1}{T}$	628 326 0700 A628 326 0700	B1284	$\frac{1}{T}$
Citaro G	628 .240 .243 .245 .247-248 .250	3823230100 6283230100 6283230200 6283230400	B5298	$\frac{1}{T}$	 628 326 0700 A628 326 0700	B1283	$\frac{1}{T}$
Citaro L	628 .100-101	3823230100 6283230100 6283230200 6283230400	B5298	$\frac{1}{T}$	628 326 0700 A628 326 0700	B1284	$\frac{1}{T}$
Citaro L	628 .143 .145 .147-148	3823230100 6283230100 6283230200 6283230400	B5298	$\frac{1}{T}$	 628 326 0700 A628 326 0700	B1283	$\frac{1}{T}$
Citaro N	628 .000-002	3823230100 6283230100 6283230200 6283230400	B5298	$\frac{1}{T}$	628 326 0700 A628 326 0700	B1284	$\frac{1}{T}$

TOURO (O 500) (2001/01-)

O500GL, O500GLE, O500M, O500U		3823230100 6283230100 6283230200 6283230400	B5298	$\frac{1}{T}$			
--	--	--	--------------	---------------	--	--	--

TRAVEGO (O 580) (1999/10-)

580-17RHD	629 .012				4 x	629 326 0100	B1287	$\frac{1}{T}$
580-15RHD, 580-15RH/RHD	629 .001 .011	629 323 0000	B5286	$\frac{O}{T}$	4 x	629 326 0000	B1287	$\frac{1}{T}$

OH SERIES

OH1627L, OH1634L, OH1829L, OH1834L	396 .471 .473 .483 Ch.No.6901044 →	4 x	0023234200 0023236500 0033263600 004 323 5800 004 323 5900 005 323 1400 006 323 7500 3023230300 307 326 0200 357 326 0100 373 320 0030 373 320 0230 373 323 7200 396 320 0030 A005 323 1400	B1259	$\frac{1}{T}$			
---	---	-----	---	--------------	---------------	--	--	--

VIANO

639	 2003 →					639 326 0300 639 326 1000 639 326 2100 639 326 2500	V5007	$\frac{O}{O}$
------------	--	--	--	--	--	--	--------------	---------------

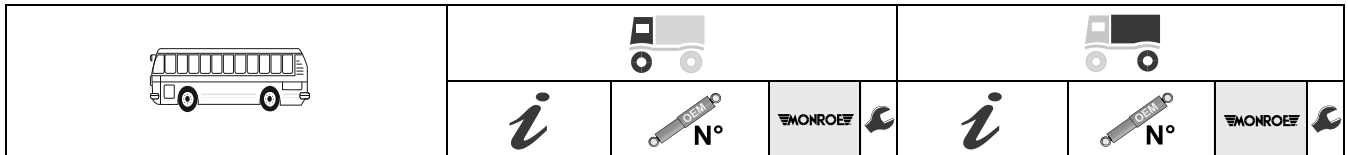

NEOPLAN

CENTROLINER

Centroliner	11070522 N1011070522	B5405⁰	$\frac{1}{T}$	
-------------	-------------------------	--------------------------	---------------	--

HIGHLINER

N120 Highliner	100210400 102200800 102200900 11016417 11016634 11016635 12106 36437016005 N1011016634 N1011016635	B5347	$\frac{1}{T}$	○	100210400 102200800 102200900 11016417 11016634 11016635 12106 36437016005 N1011016634 N1011016635	B5347	$\frac{1}{T}$
----------------	---	--------------	---------------	---	---	--------------	---------------

JETLINER

N209 Jetliner	100210200 11016414 12107 36437016003	B5313	$\frac{1}{T}$				
N212 Jetliner	100210200 11016414 12107 36437016003	B5313	$\frac{1}{T}$		100210200 11016414 12107 36437016003	B5313	$\frac{1}{T}$

JUMBOCRUISER

N138 Jumbocruiser	100210400 102200800 102200900 11016417 11016634 11016635 12106 36437016005 N1011016634 N1011016635	B5347	$\frac{1}{T}$	●	100210200 11016414 12107 36437016003	B5313	$\frac{1}{T}$
				○	100210300 102201000 11016416 12104 36437016004 N1011016636	B5314	$\frac{1}{T}$







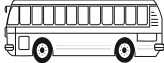

MEGALINER

N128/4 Megaliner	○ ○ ○ ○	100210200 11016414 12107 36437016003	B5313	$\frac{1}{T}$	●	100210200 11016414 12107 36437016003	B5313	$\frac{1}{T}$
					○	100210300 102201000 11016416 12104 36437016004 N1011016636	B5314	$\frac{1}{T}$

N-SERIE

N113, N116, N116H		100210300 102201000 11016416 12104 36437016004 N1011016636	B5314	$\frac{1}{T}$		100210200 11016414 12107 36437016003	B5313	$\frac{1}{T}$
N116/3H, N116/3HL		100210300 102201000 11016416 12104 36437016004 N1011016636	B5314	$\frac{1}{T}$	●	100210200 11016414 12107 36437016003	B5313	$\frac{1}{T}$
					○	100210300 102201000 11016416 12104 36437016004 N1011016636	B5314	$\frac{1}{T}$

NEOPLAN N-SERIE

								
	<i>i</i>	 N°			<i>i</i>	 N°		



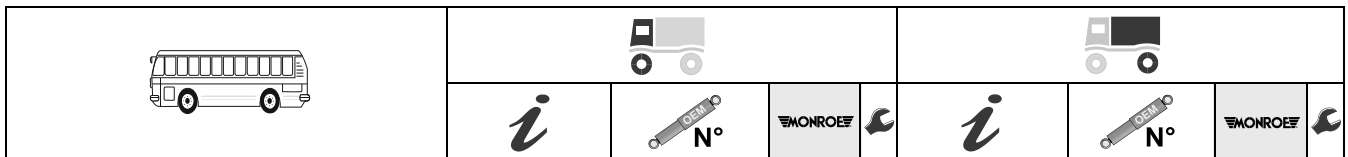





N117		100210300 102201000 11016416 12104 36437016004 N1011016636	B5314	⊥ T		100210200 11016414 12107 36437016003	B5313	⊥ T
N117/3		100210300 102201000 11016416 12104 36437016004 N1011016636	B5314	⊥ T ●	○	100210200 11016414 12107 36437016003 100210300 102201000 11016416 12104 36437016004 N1011016636	B5313	⊥ T
N118/3		100210400 102200800 102200900 11016417 11016634 11016635 12106 36437016005 N1011016634 N1011016635	B5347	⊥ T ●	○	100210200 11016414 12107 36437016003 100210300 102201000 11016416 12104 36437016004 N1011016636	B5313	⊥ T
N120 Highliner						100210300 102201000 11016416 12104 36437016004 N1011016636	B5314	⊥ T
N122		↙ ↗	B5347	⊥ T ●	○	100210300 102201000 11016416 12104 36437016004 N1011016636	B5314	⊥ T
N208, N212, N213H						100210200 11016414 12107 36437016003	B5313	⊥ T
N210		100210300 102201000 11016416 12104 36437016004 N1011016636	B5314	⊥ T				
N214, N214H, N216, N216H		100210300 102201000 11016416 12104 36437016004 N1011016636	B5314	⊥ T		100210200 11016414 12107 36437016003	B5313	⊥ T
N220 Longliner, N312, N313, N314, N314H		100210200 11016414 12107 36437016003	B5313	⊥ T		100210200 11016414 12107 36437016003	B5313	⊥ T
N312U, N312 K						100210200 11016414 12107 36437016003	B5313	⊥ T
N314U, N314K, N314L		100210300 102201000 11016416 12104 36437016004 N1011016636	B5314	⊥ T		100210200 11016414 12107 36437016003	B5313	⊥ T
N316, N316H		100210200 11016414 12107 36437016003	B5313	⊥ T		100210200 11016414 12107 36437016003	B5313	⊥ T
N316K, N316SHD		100210300 102201000 11016416 12104 36437016004 N1011016636	B5314	⊥ T		100210200 11016414 12107 36437016003	B5313	⊥ T

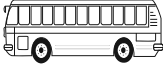

N316/3U, N316/3K, N316/3SHD, N318/3U, N318/3K, N318/3SHD		100210300 102201000 11016416 12104 36437016004 N1011016636	B5314	⊥ ⊥	●	100210200 11016414 12107 36437016003	B5313	⊥ ⊥
		⚡	B5347	⊥	○	100210300 102201000 11016416 12104 36437016004 N1011016636	B5314	⊥ ⊥
N321U, N321K		100210200 11016414 12107 36437016003	B5313	⊥	○	100210300 102201000 11016416 12104 36437016004 N1011016636	B5314	⊥ ⊥
N326/3	Kombi-Bus	⚡	B5347	⊥	●	100210300 102201000 11016416 12104 36437016004 N1011016636	B5314	⊥ ⊥
					○	100210200 11016414 12107 36437016003	B5313	⊥ ⊥
N412, N413	Public Transport	100210200 11016414 12107 36437016003	B5313	⊥	⊥	100210200 11016414 12107 36437016003	B5313	⊥ ⊥
N412, N413	76/06 →	100210300 102201000 11016416 12104 36437016004 N1011016636	B5314	⊥	⊥			
N414, N414H, N416, N416H	76/06 →	100210200 11016414 12107 36437016003	B5313	⊥	⊥	100210200 11016414 12107 36437016003	B5313	⊥ ⊥
N426		⚡	B5347	⊥	●	100210300 102201000 11016416 12104 36437016004 N1011016636	B5314	⊥ ⊥
					○			
N426/3	Public Transport	⚡	B5347	⊥	●	100210300 102201000 11016416 12104 36437016004 N1011016636	B5314	⊥ ⊥
					○	100210200 11016414 12107 36437016003	B5313	⊥ ⊥
N608, N612, N640		100210300 102201000 11016416 12104 36437016004 N1011016636	B5314	⊥	⊥	100210300 102201000 11016416 12104 36437016004 N1011016636	B5314	⊥ ⊥
		⚡	B5347	⊥	⊥			
N612, N640	Airport Bus					100210200 11016414 12107 36437016003	B5313	⊥ ⊥
N906, N907, N912	Airport Bus	100210300 102201000 11016416 12104 36437016004 N1011016636	B5314	⊥	⊥	100210200 11016414 12107 36437016003	B5313	⊥ ⊥
N922-2		100210300 102201000 11016416 12104 36437016004 N1011016636	B5314	⊥	⊥	100210300 102201000 11016416 12104 36437016004 N1011016636	B5314	⊥ ⊥
N940	Airport Bus	100210300 102201000 11016416 12104 36437016004 N1011016636	B5314	⊥	⊥	100210300 102201000 11016416 12104 36437016004 N1011016636	B5314	⊥ ⊥
N4021		100210720 11016642 N1011016429 N1011016642	B5346	⊥	⊥			



NEOPLAN SKYLINER

								
	<i>i</i>	 N°			<i>i</i>	 N°		

N4026, N4026L, N4026P, N4026PL		100210200 11016414 12107 36437016003	B5347	$\frac{1}{T}$ ●	100210200 11016414 12107 36437016003	B5313	$\frac{1}{T}$
				○	100210300 102201000 11016416 12104 36437016004 N1011016636	B5314	$\frac{1}{T}$
N4032/4	$\frac{\circ}{\circ}$	100210200 11016414 12107 36437016003	B5313	$\frac{1}{T}$ ○	100210300 102201000 11016416 12104 36437016004 N1011016636	B5314	$\frac{1}{T}$
N9010, N9012, N9022, N9040		100210300 102201000 11016416 12104 36437016004 N1011016636	B5314	$\frac{1}{T}$	100210200 11016414 12107 36437016003	B5313	$\frac{1}{T}$
N9044/2		100210300 102201000 11016416 12104 36437016004 N1011016636	B5314	$\frac{1}{T}$	100210300 102201000 11016416 12104 36437016004 N1011016636	B5314	$\frac{1}{T}$

SKYLINER

N122/3, N122/3L	Skyliner	100210400 102200800 102200900 11016417 11016634 11016635 12106 36437016005 N1011016634 N1011016635	B5347	$\frac{1}{T}$ ●	100210200 11016414 12107 36437016003	B5313	$\frac{1}{T}$
				○	100210300 102201000 11016416 12104 36437016004 N1011016636	B5314	$\frac{1}{T}$

SPACELINER

N121	Spaceliner	100210400 102200800 102200900 11016417 11016634 11016635 12106 36437016005 N1011016634 N1011016635	B5347	$\frac{1}{T}$ ●	100210300 102201000 11016416 12104 36437016004 N1011016636	B5314	$\frac{1}{T}$
				○			

PEGASO

ENASA

RENAULT TRUCKS

AGORA

Agora		5006172375 5006172528 5010347902 5010347905	B5330	$\frac{1}{T}$ ●	5006172376 504124915 5801572582 5010347903	B5424	$\frac{1}{O}$
	1994/09 → 1997/05		B5355	$\frac{1}{O}$		B5337¹	$\frac{1}{O}$
	2002/04 →	5010531249	B5353	$\frac{1}{T}$	2004/03 → 5006172492	B1317	$\frac{1}{O}$
Agora ETHEL	2000/07 → 2002/03	5006172375 5006172528 5010347902	B5330	$\frac{1}{T}$	2000/07 → 2001/03 5006172376 504124915 5801572582 5010347903	B5424	$\frac{1}{O}$
					2000/07 → 2001/03	B5337¹	$\frac{1}{O}$

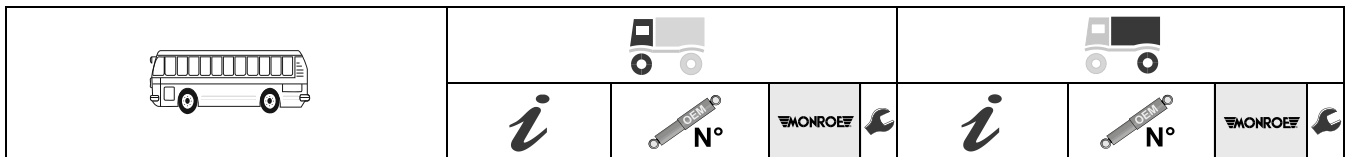

Agora GNV, GNV RATP	2002/01 → 2002/04	5006172375 5006172528 5010347902	B5330	⊥ T	2002/01 →	5006172376 504124915 5801572582	B5424	⊥ O
	2002/04 →	5010531249	B5353	⊥ T	2002/01 →	5010347903	B5337 ¹	⊥ O
Agora LINE	1998/05 → 2002/04	5006172375 5006172528 5010347902	B5330	⊥ T	1998/05 → 2002/04	5006172376 504124915 5801572582	B5424	⊥ O
	2002/04 →	5010531249	B5353	⊥ T	1998/05 → 2002/04	5010347903	B5337 ¹	⊥ O
Agora LINE AUTOCAR MOOVY	→ 2002/04	5006172375 5006172528 5010347902	B5330	⊥ T	→ 2002/04	5006172376 504124915 5801572582	B5424	⊥ O
	2002/04 →	5010531249	B5353	⊥ T	→ 2002/04	5010347903	B5337 ¹	⊥ O
Agora PKD KAROSA	Euro 2 12m	5006172375	B5330	⊥ T	Euro 2 12m	5006172376	B5424	⊥ O
	Euro 3 18m	5006172528 5010347902			Euro 3 18m	504124915 5801572582		
	Euro 3 12m	5010531249	B5353	⊥ T	Euro 2 12m Euro 3 18m	5010347903	B5337 ¹	⊥ O
Agora RATP		5006172375 5006172528 5010347902	B5330	⊥ T	→ 1996/07	5006172376 504124915 5801572582	B5424	⊥ O
	1996/07 → 1997/05	5010347905	B5355	⊥ O	→ 1996/07	5010347903	B5337 ¹	⊥ O
	2002/04 →	5010531249	B5353	⊥ T				







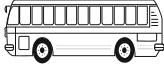

ARES								
Ares	98/07 →	5000790965 5010013183 5010151020 5010151151 5010151203 5010190151	B5422	⊥ O	ND	5000790966	B1301	⊥ O
					HD			
						5000790965 5010013183 5010151020 5010151151 5010151203 5010190151	B5422	⊥ O

FR1								
FR, FR1, FR1E, FR1G, FR1GT, FR1GTS, FR1GTX, FR1T	→ 99/12	5000790965 5010013183 5010151020 5010151151 5010151203 5010190151	B5422	⊥ O	ND	5000790966	B1301	⊥ O
					HD			
						5000790965 5010013183 5010151020 5010151151 5010151203 5010190151	B5422	⊥ O



ILIADE								
Iliade	→ 99/10	5000790965 5010013183 5010151020 5010151151 5010151203 5010190151	B5422	⊥ O	ND	5000790966	B1301	⊥ O
					HD			
						5000790965 5010013183 5010151020 5010151151 5010151203 5010190151	B5422	⊥ O





















R								
R332 Tracer		5010019952 5010151809	B5334	⊥ O	ND	5010019953 5010151811	B1306	⊥ O







RENAULT TRUCKS TRACER

								
	<i>i</i>	 N°			<i>i</i>	 N°		

TRACER			
Tracer			5010151812 B5398 $\frac{1}{O}$

SCANIA			
BR SERIES			
BR86, BR112, BR116, CR112		406694 410554 468191 470273	B5290 $\frac{1}{T}$ 4 x 
			403245 409707 410555 B1277 $\frac{1}{T}$

2 - SERIES			
AR112, BR112, CR112	Articulated Bus Ch.No.1801671 →		409720 411631 B5290 $\frac{1}{T}$ ● 4 x 
			403245 409707 410555 B1277 $\frac{1}{T}$
BR112, CR112, N112	Ch.No.1801671 →		406694 410554 468191 B5290 $\frac{1}{T}$ 4 x 
			403245 409707 410555 B1277 $\frac{1}{T}$
CN112AL, N112AL			426216 B5290 $\frac{1}{T}$ ● 4 x 
			403245 409707 410555 B1277 $\frac{1}{T}$
F82, K82, S82			409720 B5290 $\frac{1}{T}$ 4 x 
			403245 409707 410555 B1277 $\frac{1}{T}$
F92H			1012044 T5241 $\frac{1}{O}$
F112, S112			409720 B5290 $\frac{1}{T}$ 4 x 
			403245 409707 410555 B1277 $\frac{1}{T}$
F112H			1012044 T5241 $\frac{1}{O}$
K92			409720 B5290 $\frac{1}{T}$ 4 x 
			403245 409707 410555 B1277 $\frac{1}{T}$
K112 4x2			415848 429163 B5290 $\frac{1}{T}$ 4 x 
			403245 409707 410555 B1277 $\frac{1}{T}$
			415849 B1295 $\frac{1}{T}$
K112TL 6x2			426218 460081 468188 B5290 $\frac{1}{T}$ ● 4 x 
			466219 468189 B1277 $\frac{1}{T}$
			421280 468194 B1299 $\frac{1}{O}$
N112			426216 B5290 $\frac{1}{T}$ 4 x 
			403245 409707 410555 B1277 $\frac{1}{T}$
S82HR			1012044 T5241 $\frac{1}{O}$

3 - SERIES BUS (1989/01-1997/12)			
K93CL, K113, K113CLB, L113CLB		1523283 488823	B5419 $\frac{1}{T}$ 
			1523283 488823 B5419 $\frac{1}{T}$
K93CL, K113, L113CLB, N113	AMA axle 	1523282 468195 470265 470266	B5316 $\frac{1}{O}$ 
			415849 B1295 $\frac{1}{T}$
			421280 468194 B1299 $\frac{1}{O}$
K93CLB, L113CLL, N113CLB, N113CLL		475915 481967	B5290 $\frac{1}{T}$ 
			403245 409707 410555 470267 B1277 $\frac{1}{T}$

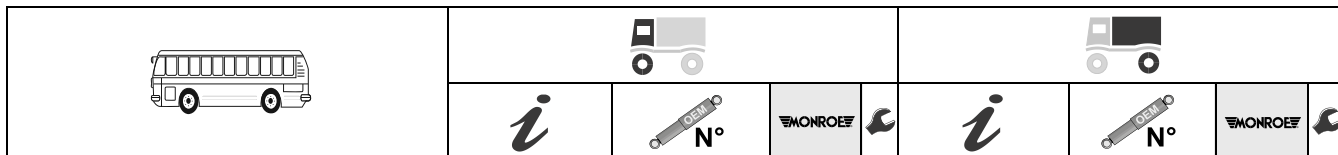









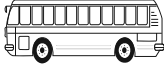

BN113ALB, BN113CLB, CN113ALB, CN113CLB, CN113CLL, K113TLB		470263 475915 481967	B5290	 ● 4 x ○ 	403245 409707 410555	B1277	
K113CLA, K113CRA, K113TLA		1523282 468195 470265 470266	B5316	 ○ ● 4 x	466219 468189	B1277	
K113CLB	 AMA axle 	475915 481967	B5290	 	403245 409707 410555 470267	B1277	
		1523282 468195 470265 470266	B5316	 ○ 	415849	B1295	
K113TL 6x2				○ 	421280 468194	B1299	
N113		1523283 488823	B5419	 	1523283 488823	B5419	

4 - SERIES BUS (1995/01-)

K94, L94	EB, IB	 AMA axle	1427406	B5292	 ○	ADA axle	468198	T1036	
			1480213			→ Ch. No. 1 829 819	470268		
			1480214 1480215 1523287 1523288 483550 489509			→ Ch. No. 1 843 282			
K94, L94, N94, 114, 124	UA	 AMI700 axle	1481358	B5340	 ┌ └	4 x ADA axle	1481359	B1310	
			481949			Ch. No. 1843283→			
K94, L94, N94, 114, 124	4x2 UB	 AMA axle	1462240	B5345	 ┌ └	4 x ADA axle	1542619	B1295	
			1488337 1920824			Ch. No. 1843283→			
K94, L94, N94, 114, 124	UB	 6x2 AMI700 axle	1481358	B5340	 ┌ └	6x2 ADA axle	1462241 488275 489751	B1311	
			481949						
K94, L94, N94, 114, 124	4x2 UB	 4x2 AMI700 axle	1523285	B5340	 ┌ └	4 x 4x2 ADA axle	1542619	B1295	
			489510						
K94, L94, N94, 114, 124	UB	 AMI700 axle	1481358	B5340	 ┌ └	ADA axle	1478317	B1351	
			481949						
N94, 114, 124	EB, IB	 AMI700 axle	1481358	B5340	 ┌ └	4 x ADA axle	1481359	B1310	
			481949			Ch. No. 1843283→			
N94, 114, 124	EB, IB	 AMI700 axle	1481358	B5340	 ┌ └	4 x ADA axle	1481359	B1310	
			481949			Ch. No. 1843283→			
N94, 114, 124	EB, IB	 AMI700 axle	1481358	B5340	 ┌ └	4 x ADA axle	1481359	B1310	
			481949			Ch. No. 1843283→			
N94, 114, 124	EB, IB	 AMI700 axle	1481358	B5340	 ┌ └	4 x ADA axle	1481359	B1310	
			481949			Ch. No. 1843283→			
N94, 114, 124	EB, IB	 AMI700 axle	1481358	B5340	 ┌ └	4 x ADA axle	1481359	B1310	
			481949			Ch. No. 1843283→			
N94, 114, 124	EB, IB	 AMI700 axle	1481358	B5340	 ┌ └	4 x ADA axle	1481359	B1310	
			481949			Ch. No. 1843283→			
N94, 114, 124	EB, IB	 AMI700 axle	1481358	B5340	 ┌ └	4 x ADA axle	1481359	B1310	
			481949			Ch. No. 1843283→			
N94, 114, 124	EB, IB	 AMI700 axle	1481358	B5340	 ┌ └	4 x ADA axle	1481359	B1310	
			481949			Ch. No. 1843283→			
N94, 114, 124	EB, IB	 AMI700 axle	1481358	B5340	 ┌ └	4 x ADA axle	1481359	B1310	
			481949			Ch. No. 1843283→			
N94, 114, 124	EB, IB	 AMI700 axle	1481358	B5340	 ┌ └	4 x ADA axle	1481359	B1310	
			481949			Ch. No. 1843283→			
N94, 114, 124	EB, IB	 AMI700 axle	1481358	B5340	 ┌ └	4 x ADA axle	1481359	B1310	
			481949			Ch. No. 1843283→			
K114, K124	IB	 AMA axle	468198	B5292	 ○	ADA axle	468198	T1036	
			470268			→ Ch. No. 1 829 819	470268		
						→ Ch. No. 1 843 282			

SETRA

								
	<i>i</i>	 N°			<i>i</i>	 N°		



K94, L94, N94, 114, 124	AMA axle 	1523283 488823	B5419	$\frac{1}{T}$			
N94 Double Decker					1494146	B5404⁰	$\frac{1}{T}$
94CL				ϕ \circ	489750	B1369⁰	\circ \circ

SETRA

◀ EVOBUS

SOLARIS

URBINO







10, 12, 12LE, 15, 15LE, 18		0820300100 100210720 102201800 11016642 11070522 820300100 11070522 N1011070522	B5346	$\frac{1}{T}$	4 x 	0820300110 0820300112 0820300125 P0820300196	B1312	$\frac{1}{T}$
			B5405⁰	$\frac{1}{T}$				

TRANSBUS

◀ ALEXANDER DENNIS

VDL BUS









DB

DB250	92/01 → Optare Body 	891165	T1090	$\frac{1}{T}$	   	1253399 41253399	B5328	$\frac{1}{T}$
						1253400 41253400	B5327	$\frac{1}{T}$
DB250RS		891165	T1090	$\frac{1}{T}$				

MB









MB230, MB203ESO		271025	B5304	$\frac{1}{T}$				
-----------------	---	--------	--------------	---------------	--	--	--	--

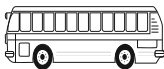



SB

SB120		1141379 41141379	B5359	$\frac{1}{T}$		1141380 41141380	B5324	$\frac{1}{T}$
SB220 <small>HD</small>		891165	T1090	$\frac{1}{T}$				
SB250		1194745 41194745	B5295	$\frac{1}{T}$		1196832 41196832	B5325	$\frac{1}{T}$
SB2300		271025 278249	B5304	$\frac{1}{T}$				
SB2750, SB3000		1196842 271025	B5304	$\frac{1}{T}$				
SB4000	 	271025	B5304	$\frac{1}{T}$				

SBR









SBR2300 Double Deck		1196842	B5304	$\frac{1}{T}$				
---------------------	---	---------	--------------	---------------	--	--	--	--

								
	<i>i</i>				<i>i</i>			





SBR3000, SBR3000 Interliner, SBR3000 Touring		1194210 1196842 271025	B5304			
SBR3015		1194210	B5304			

VOLVO







































B 5

B5LH	D-Deck				4 x 	20584310	B1362 ⁰	
B5LH	S-Deck		20584309 20726165	B5425 ⁰	 4 x 	20726168 70302100 9520277 9522179	B5289	
B5RH			21395046 21468510 70397058 70397060 70397084 70397094	B5434 ⁰				
B5RH	Low Floor Bus		20584309 20726165	B5425 ⁰				

B 6

B6BLE			3170104	B5320		3039244	B1364 ⁰	 
-------	--	---	---------	--------------	---	---------	---------------------------	---

B 7 (1992/01-)

B7L (Chassis)			3112260 70302099 70313745 70321619	B5295	 4 x 	20573647 20573649 3112261 70302101	B5294	
B7L	Low Floor Bus		20584309 20726165	B5425 ⁰				
B7LA (Chassis)			3112260 70302099 70313745 70321619	B5295	  4 x → Ch. No. 789  4 x  4 x Ch. No. 790 →  4 x  Ch. No. 790 → 	20726168 70302100 9520277 9522179 20573647 20573649 3112261 70302101 70302100 20726168 70302100 9520277 9522179	B5289 B5294	       
B7LDD	4x2				4 x 	20584310	B1362 ⁰	
B7LDD	Low Floor Bus		20584309 20726165	B5425 ⁰				
B7LLD			20564319 70302127	B5317	 4 x 	70302128	B1302	
B7R			20485166 70371252 70377034	B5433 ⁰				
B7R	4x2 Low Floor Bus		20584309 20726165	B5425 ⁰				
B7R	4x2 High Floor Bus 6x2 Mid Floor Bus		21395046 21468510 70397058 70397060 70397084 70397094	B5434 ⁰				
B7R, B7RLE			20385020 3159800	B5339	 			



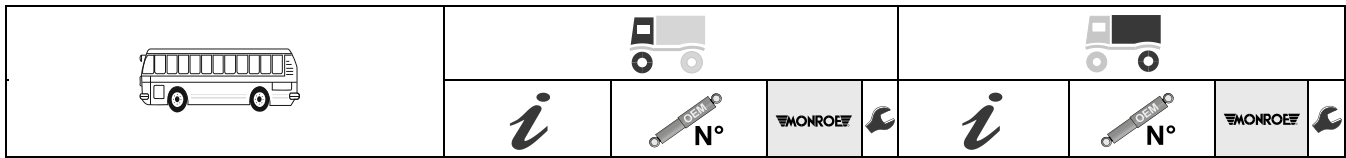





VOLVO B 8

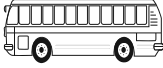





























B 8							
B8R	4x2		21395046 21468510 70397058 70397060 70397084 70397094	B5434⁰			
B8R	4x2	Low Floor Bus	20584309 20726165	B5425⁰			







B 9							
B9L Articulated Bus					● 4 x ○ Ch. No. 790 →	20726168 70302100 9520277 9522179	B5289
B9L			20584309 20726165	B5425⁰			
B9M	Ch.No.20001 →		3027113 3027423 3178737 1134748 1136643 1137026 1137027	B1280 B5339	 4 x 	1134749	
B9R			20485166 70371252 70377034 21395046 21468510 70397058 70397060 70397084 70397094	B5433⁰ B5434⁰	 		
B9R	6x2	Low Floor Bus	20584309 20726165	B5425⁰			
B9S					○ ● 4 x ⌋	3027422 3031623 70302128	B1281 B1302
B9S	Low Floor Bus		20584309 20726165	B5425⁰			
B9TL	4x2		20584309 20726165	B5425⁰	4 x 	20584310	B1362⁰
B9TL	6x2				○ 4 x Ch. No. 790 → ⌋	70302128	B1302

B 10							
B10B		4 x 	20540056 20543860 20568808 3037213 3178737 3178738	B1343	 4 x 	3031624 3031625 3031626 3031627 3036162	B1279
B10BLE		→ Ch. No. 2696	9516389	B5297	 4 x 	3031624 3031625 3031626 3031627 3036162	B1279
		Ch. No. 2697 →	3112260 70302099 70313745 70321619	B5295			
B10L			3112260 70302099 70313745 70321619	B5295	 4 x → Ch. No. 309	20573647 20573649 3112261 70302101	B5294
					4 x Ch. No. 310 →	20726168 70302100 9520277 9522179	B5289
B10L	Articulated Bus		3112260 70302099 70313745 70321619	B5295	 ● 4 x ○ Ch. No. 310 →	20726168 70302100 9520277 9522179	B5289

















































								
	<i>i</i>	 N°			<i>i</i>	 N°		

B10LA			3112260 70302099 70313745 70321619	B5295	  4 x	20726168 70302100 9520277 9522179	B5289	 
B10M	Articulated Bus → Ch.No20000	4 x 	1134748 1136643 1137026 1137027	B5339	  4 x 	1134748 1136643	B5339	 
B10M	Articulated Bus Ch.No.20001 →	4 x 	3027113 3027423 3178737	B1280	  4 x  	3031624 3031625 3031626 3031627 3036162	B1279	 
		4 x 	3027422 3031623	B1281	  4 x 	3027422 3031623	B1281	 
B10M	Coach		1134748 1136643 1137026 1137027	B5339	 			
B10TL	Super Olympian Ch.No.50000 →				 4 x	3193207	B5325	 

B 11

B11R	4x2 6x2	High Floor Bus Mid Floor Bus		21395046 21468510 70397058 70397060 70397084 70397094	B5434 ⁰	 		
B11R	4x2	Low Floor Bus		20584309 20726165	B5425 ⁰	 		

B 12 (1992/01-)

B12	4x2		4 x 	20540056 20543860 20568808 3037213 3178737 3178738	B1343	  4 x 	3031624 3031625 3031626 3031627 3036162	B1279	 
B12	6x2		4 x 	20540056 20543860 20568808 3037213 3178737 3178738	B1343	  4 x  	3031624 3031625 3031626 3031627 3036162 3193027	B1279	    
B12		S-5199		3027113 3027423 3178737	B1280	  4 x 	3031624 3031625 3031626 3031627 3036162	B1279	  
B12B (Chassis)	4x2	Low Floor Bus Mid Floor Bus	 	3112260 70302099 70313745 70321619	B5295	  4 x	1609603 70313746 70321019	T1183	 
B12B (Chassis)	4x2	Mid Floor Bus	 4 x	20540056 20543860 20568808 3037213 3178737 3178738	B1343	  4 x	1609603 70313746 70321019	T1183	 
B12B (Chassis)	6x2	High Floor Bus Mid Floor Bus	   4 x	70313740 70314310 70321020 70321611 20540056 20543860 20568808 3037213 3178737 3178738	B1343	  4 x  2 x	1609603 70313746 70321019 70313744 70313747 70321697 70377009	T1183	    
B12B (Chassis)		→ Ch.No13126	 4 x	20540056 20543860 20568808 3037213 3178737 3178738	B1343	 			

VOLVO B 13

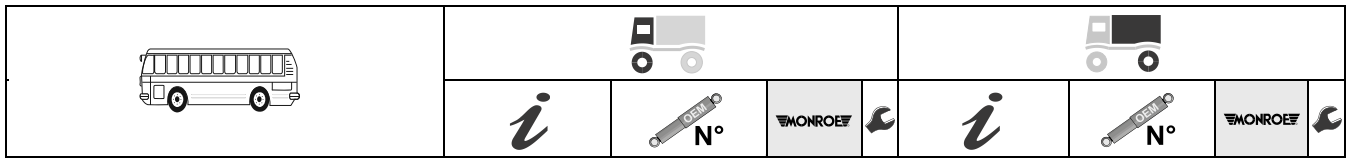

B12M (Chassis)	4x2	Low Floor Bus		70313740	B5296	○	●	3031624	B1279	○
	6x2			70314310 70321020 70321611		○	○	→ Ch. No. 291		3031625 3031626 3031627 3036162
				20549244	B5296	○	●	1609603	T1183	○
			4 x	3178737		○	○	Ch. No. 292 →		70313746 70321019
				3027113	B1280	○	○	3027113	B1280	○
			4 x	3027423 3178737 70321023		○	○	4 x		70321023
B12M (Chassis)	4x2	Low Floor Bus		20540056	B1343	○				
	6x2	Ch.No.292 →	4 x	20543860 20568808 3037213 3178737 3178738		○				
B12M (Chassis)	4x2	Mid Floor Bus		70313740	B5296	○	●	3031624	B1279	○
	6x2	→ Ch.No291		70314310 70321020 70321611		○	○	4 x		3031625 3031626 3031627 3036162
				20549244	B5296	○	○	3027113	B1280	○
			4 x	3178737		○	○	4 x		3027423 3178737 70321023
B12M (Chassis)	4x2	Mid Floor Bus		70313740	B1280	○	●	1609603	T1183	○
	6x2	Ch.No.292 →		70314310 70321020 70321611		○	○	4 x		70313746 70321019
				3027113	B1280	○	○	3027113	B1280	○
			4 x	3027423 3178737 70321023		○	○	4 x		3027423 3178737 70321023
B12M (Chassis)	4x2	High Floor Bus		20540056	B1343	○	●	3031624	B1279	○
	6x2	→ Ch.No291		20543860 20568808 3037213 3178737 3178738		○	○	4 x		3031625 3031626 3031627 3036162
				3027113	B1280	○	○	3027113	B1280	○
			4 x	3027423 3178737 70321023		○	○	4 x		3027423 3178737 70321023
B12M (Chassis)	4x2	High Floor Bus		70321022		○	●	3031624	B1279	○
	6x2	Ch.No.292 →	4 x			○	○	4 x		3031625 3031626 3031627 3036162
						○	○	3027113	B1280	○
			4 x			○	○	4 x		3027423 3178737 70321023
B12VDB		600/500H		3098121	B5338	⊥		3031624	B1279	○
		Ch.No.5000 →				⊥		3031625 3031626 3031627 3036162		○

B 13

B13R	4x2	High Floor Bus		21395046	B5434⁰	○				
	6x2	Mid Floor Bus		21468510 70397058 70397060 70397084 70397094		○	⊥			

OLYMPIAN

Olympian MKIII	Leyland			3116052 3116053 3193205		⊥	●	3193207	B5325	⊥
						○				
						○		3116809	B5326	⊥

7000

B7000				70313740 70314310 70321020 70321611		○	●	20726168	B5289	⊥
						○	○	70302100 9520277 9522179		⊥

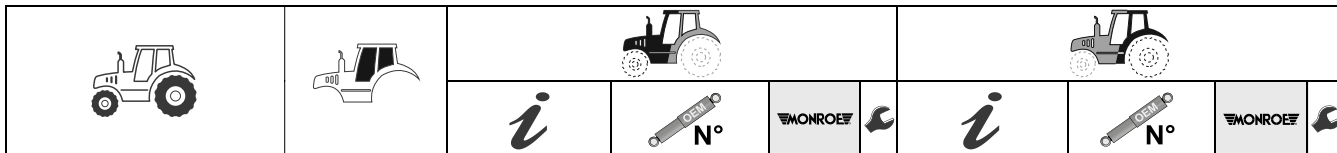

CASE IH

CVX										
130, 150, 170, 1135, 1145, 1155, 1170, 1190								134641650 47110917 134641645	CB0105 CB0174	○ ○ ○

MAXXUM										
MXM120, MXM130, MXM140, MXM150, MXM155, MXM165, MXM175, MXM180, MXM190	2002 → 2007							82018497 82021116 82029623 82031521 82032841 82033876	CB0168	○ T

DEUTZ-FAHR

AGROTON										
120, 130, 135, 140, 160, 175, 200, TTV1130, TTV1145, TTV1160								04426628 04426629	CB0105 CB0174	○ ○ ○
150, 155, 165								04426628	CB0105	○ ○
4.80, 210, 230, 235, 260, 265								04426629	CB0174	○ ○

NEW HOLLAND

TM										
TM115, TM120, TM125, TM130, TM135, TM140, TM150, TM155, TM165, TM175, TM190	2002 → 2007							82018497 82021116 82029623 82031521 82032841 82033876	CB0168	○ T

TS-A										
TS100 A, TS115 A, TS125 A, TS135 A	2003 → 2007							87301789	CB0166	○



T7										
T7.170, T7.185, T7.200, T7.210, T7.220, T7.235, T7.250, T7.260, T7.270	2011 →							84163866 84605258	CB0234	○ ○



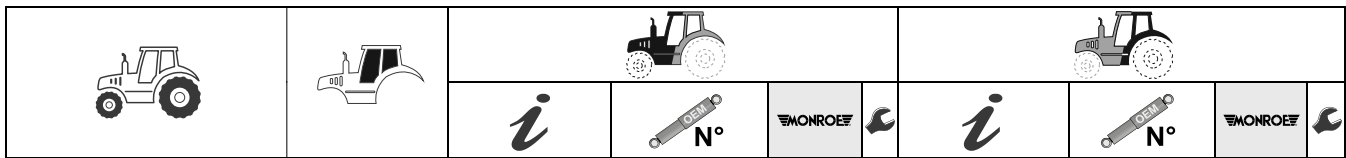

T8										
T8.275, T8.300, T8.330, T8.360, T8.380	2011/01 →							47630745 84141201	CB0170	○ ○

T6000										
T6010, T6020, T6030, T6040, T6050, T6060, T6070, T6080	2007 → 2012							84183931	CB0169	○ ○

NEW HOLLAND T7000



T7000									
T7030, T7040, T7050, T7060, T7070	2007 →				87591827	CB0167			

STEYR									
CVT									
120, 130, 150, 170, 6135, 6145, 6155, 6170, 6190					13 46416 50 81 41722 6010 81 41722 6013	CB0105			
					134641645	CB0174			





Reflex™ Twin Disc Technology
Sensa-Trac® Safe-Tech™ System

LL = Load-Leveler®
Level-Light®
MA/LA = Ride Leveler®

ALFA ROMEO

009002	35 AR 8		V1079		OIO		V1056		OIO
--------	---------	--	-------	--	-----	--	-------	--	-----

AVIA COMMERCIALS

1000, 2000, 3000 SERIES

041008	1600		V1071		OIO		V1045		OIO
041009	2000		V1027 ¹		OIO				OIO
041010	2000		V1044		OIO		V1045		OIO

1250

041004	1250	→ 1.78			OIO		V1028		OIO
266503	1250	1.78 → 1.83	V1027 ¹		OIO		V1028		OIO
041004	1250	1.78 → 1.83	V1027 ¹		OIO		V1028		OIO
266503	1250	1.83 →	V1027 ¹		OIO		V1028		OIO

2600

042001	2600		V1071		OIO		V1127		OIO
042002	2600		V1071		OIO				OIO

BEDFORD

050002	SA, SE, SL, SS SB NJM	57 → 60 72 → 72 →	V1029		OIO				OIO
055001	RLC, RLE, RLG, RLH, RLW	57 → 70	V2047		OIO		V2048		OIO
055002	RSC, RSH, RSW	57 → 70	V2047		OIO				OIO
050002	VAS	62 →	V1029		OIO				OIO

C, CF SERIES

050002	C 4, C 5, C 6	57 → 60	V1029		OIO				OIO
051001	CF Series 14, 18, 22, 25, 35 cwt	70 → 75	V2049		OIO				OIO
051004	CF 220, 250, 280 CF 340	76 → 82 76 →	V2049		OIO		V2048		OIO
051001	CF 350	76 →	V2049		OIO				OIO



051003	CF 230, 250, 280	83→		V2049	Orig. no 91095938			R1000			
					91105513						
051004	CF 35 cwt (035)	83→ 84		V2049				V2048			
051005	CF 18, 22, 25 cwt	84→		V2049	91095938			V1005			
					91105513						
051006	CF 35 cwt	84→						V2048			
051001	CF Electric			V2049							
051005	CF 97370, CF 97170			V2049	91095938			V1005			
					91105513						
051008	CF 97 K 60, CF 97760			V2049	91095938			V2048			
					91105513						

MIDI

058005	Midi (=) (4 x 2)	85→		V1038				V1012			
206002	Midi (=) (4 x 4)	85→						V1012			

RASCAL

411001	Rascal			V4001 				V1077			
				V4002 							
411004	Super Carry, TMDBM3			V4001 				V1096¹			
				V4002 							

CHEVROLET

VENTURE Van

960503	 (-) AWD (-)	97→ 05	71661				37156		MA824 AK029 146		
960504	 (+) (-) AWD	97→ 05	71661						MA824		
960506	 (=) AWD	02→ 05	71661								





LUMINA APV Van

960501	APV (-)	89→ 96	71820 AK030 !16		MC116		37071		MA809		
960502	APV (+)	89→ 96	71820 AK030 !16		MC116				MA809 AK016 !15		

S MODELS Light Duty

	S 10 Series (=) (4 x 2)	82→ 93		V1063			37021				
--	-----------------------------------	--------	--	--------------	--	--	--------------	--	--	--	--

SUBURBAN (4 x 2) 1/2 Ton

965103	1500 Series (=) (4 x 2) (-) Z 55 Autoride Suspension (-) ZW7 Premium Smooth Ride Suspension (Nivomat)	00→ 05	911178MM				911166MM				
--------	---	--------	-----------------	--	--	--	-----------------	--	--	--	--

SUBURBAN (4 x 4) 1/2 Ton

965103	1500 Series (=) (4 x 4) (-) Z 55 Autoride Suspension (-) ZW7 Premium Smooth Ride Susp. (Nivomat)	00→ 05	911178MM				911166MM				
965106	1500 Series (=) (4 x 4) (+) ZW7 Premium Smooth Ride Susp. (Nivomat) (-) Z 55 Autoride Suspension	00→	911178MM								

CHRYSLER US

VOYAGER Van Mini Van

900401	Voyager I (ES)	84→ 85			MK261		37065				
900302	Voyager I (ES) (+/-) AWD	86→ 2.95	72591ST AK037 !16		MK261		37065				
900303	Voyager II (GS) (-) (-) AWD	3.95→ 00	71964 AK071 !16		MK262		37123ST 911123MM ¹				
900304	Voyager II (GS) (+/-) AWD (+)	97→ 00	71964 AK071 !16		MK262						

CITROËN

BERLINGO (M_)

122015	Berlingo (+) (=) (4 x 2) (=) 475/600 kg (=) 765/800 kg (-) Electric Engine SA 18 (-)	5.96→ 11.02	E7062 (E7062R E7063L)	R8001 R8002 		 	43104				
--------	---	-------------	------------------------------------	--------------------------------------	--	------	--------------	--	--	--	--

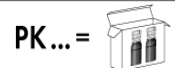



122025	Berlingo (+) (4 x 2) (-) 475/600 kg (-) 765/800 kg (-) Electric Engine sa 18 (-)	11.02→ 08		G8007 	MK001 MK097/098 !77 PK006					43104				OIO
			G8008 											
122026	Electric Engine SA 18	11.02→ 08		R8001 										OIO
				R8002 										

!77

MK001 =		MK001 =	
MK098 =		MK097 =	
TU, XU, XUD	->2.97	TU, XU, XUD	->2.97
HD,		HD,	
		ALL ex TU	2.97->
TU	2.97->	TU	2.97->

BERLINGO

122029	1.6i, 1.6 HDi (=) 600 kg (-)	4.08→		G7323 	MK196 PK124					G1117				OIO
				G7324 										
122028	1.6i, 1.6 HDi (=) 800 kg, 1000 kg (-)	4.08→		G7323 	MK196 PK124					G1118				OIO
				G7324 										

C 15

122005	C 15 (-) Diesel	85→ 5.88		11502	MC112 PK006			R6528		!52	
122006	C 15 Diesel C 15 Petrol	85→ 12.05 5.88→ 12.05		11522	MK009 PK006			R6528		!52	

C 25

125002	C 25 (-)	81→ 12.85			Orig. no 4434813 4439223 MK046			V2027		Orig. no 4434812 4439194 5965476 5983928 7534624	
125003	C 25 (-) 1800 kg	1.86→ 94		V4407	7569730 MK046 PK074			V2027		4434812 4439194 5965476 5983928 7534624	
125004	C 25 (-) 1800 kg	1.86→ 94		V4407	7569730 MK046 PK074			V2037		7576729	
160306	C 25 (=) 1800 kg	1.86→ 94						V2301		7562124	

C 32, C 35

125001	C 32, C 35	74→		V1065				V2023 ¹			
--------	-------------------	-----	--	--------------	--	--	--	--------------------	--	--	--

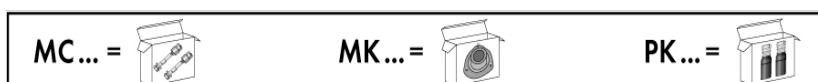

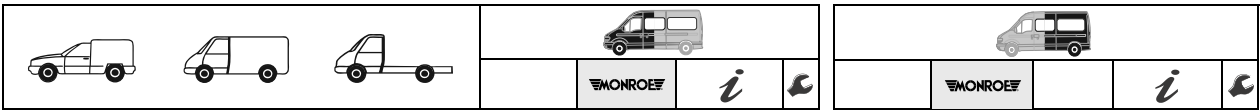









C-CROSSER

249009	2.4, 2.2 D	07→	72437ST			MK333		37310ST				C/O
			72438ST									

JUMPER, RELAY 94→ 06

125006	Jumper, Relay (=) (4 x 2) (=)  1000 kg	94→ 06	V4501	MK047 PK074 MK147R MK148L MK308R MK309L !44		V2506				C/O
125007	Jumper, Relay (=) (4 x 2) (=)  1400 kg	94→ 06	V4501	MK047 PK074 MK147R MK148L MK308R MK309L !44		V2507				C/O
125009	Jumper, Relay (=) (4 x 2) (=)  1800 kg	94→ 06	V4410			V2509				C/O
125008	 (=) (4 x 2)	94→ 06	V4501	MK047 PK074 MK147R MK148L MK308R MK309L !44		V2508				C/O

!44



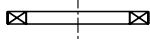
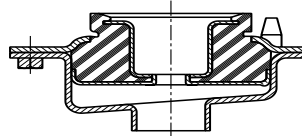

->12.01 :

MK047 = 



MK147R =  + 

1.02-> :

MK308R
MK309L

! MK147R =  MK148L =  : -> Ch. No. #15616153
MK147R =  MK148L =  : Ch. No. # 15616154 ->

JUMPER, RELAY 4.06→





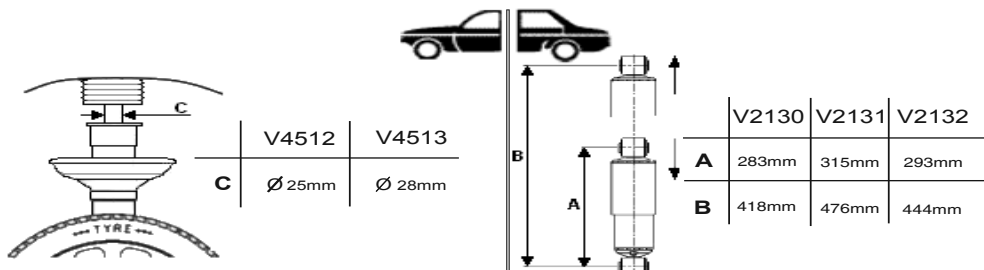

























125013	2.2 HDi, 3.0 HDi	4.06→	V4512	!69 MK308R MK309L PK285		V2130		!69	C/O
			V4513	!69 MK308R MK309L PK285		V2131		!69	C/O
						V2132		!69	C/O

!69







JUMPY, DISPATCH



125010	1580, 2000 16 V, 1867 D, 1905 D, 95→ 9.97 1905 TD, 2000 JTD (+)  → vet.no. 7609		V4201	MC112 MK048		V5006				
125012	1580, 2000 16 V, 1867 D, 1905 D, 9.97→ 10.03 1905 TD, 2000 JTD (+)  vet.no. 7609→ 9793		V4201	MC112 MK048		V2510				
125005	2000, 2000 JTD 10.03→ 06 (+)  , (+)  vet.no. 9793 →		V4202 	MC112		V2510				
		V4203 								
125005	1867 D 10.03→ 5.04 (+)  , (+)  vet.no. 9793→ 10408		V4202 	MC112		V2510				
		V4203 								
125012	1867 D 5.04→ 06 (+)  vet.no. 10408 →		V4201	MC112 MK048		V2510				
125011	2.0i, 1.6 HDi, 2.0 HDi  , 07→ 		G8167 	MK269R MK270L		V2517				
		G8168 								

DACIA

LOGAN VAN



326003	1.2, 1.4, 1.6, 1.5D 07→ 12 (+) 		G7369	MK300 PK286		G1137				
--------	---	--	-------	----------------	---	-------	--	--	--	---

LOGAN Pick-up

326012	1.2, 1.4, 1.6, 1.5D 07→ 12 (+) 		G7369	MK300 PK286		G1158				
--------	---	--	-------	----------------	---	-------	--	--	--	---









DAF COMMERCIALS

400 SERIES

133005	400 Series		V2068			V2071				
--------	------------	--	-------	--	---	-------	--	--	--	---

DODGE

CARAVAN, GRAND CARAVAN

970101	Caravan 84→ 85			MK261		37065				
900301	Caravan 86→ 2.95 (+/-) (4 x 4)	72591ST AK037 116		MK261		37065				
900303	Caravan 3.95→ 00 (-)  (-) Models w/height sensing brake prop. valve	71964 AK071 116		MK262		37123ST 911123MM ¹				
900304	Caravan 3.95→ 00 (+) 	71964 AK071 116		MK262						

MC... = 

MK... = 

PK... = 



900306	Caravan (-) (-) AWD (-) Models w/height sensing brake prop. valve	01→ 07	71572 AK071 !16		MK278		37123ST 911123MM ¹			
900305	Caravan (+) (-) AWD	01→ 05	71572 AK071 !16		MK278					
900305	Caravan (=) AWD	01→ 07	71572 AK071 !16		MK278					
900309	3.3, 3.6, 3.8, 4.0, 2.8 D (-)	08→ 14	71128ST				37290ST			
900311	3.3, 3.6, 3.8, 4.0, 2.8 D (+)	08→ 14	71128ST					58648ST		

DODGE TRUCK

D 50 Light Duty Pickup

	 (=) (4 x 2)	79→ 86		V1063			R1000			
	 (=) (4 x 2)	87→ 92		V1063			R1000			

EBRO

F SERIES, TRADE

041009	F 275	1.78→ 9.79		V1027 ¹						
041004	F 275	1.78→ 1.83					V1028			
266503	F 275 F 275 Trade 2.0	9.79→ 1.83→		V1027 ¹			V1028			
266504	Trade 2.8			V1044			V1028			
041010	F 350 Trade 2.8			V1044			V1045			
041009	F 350			V1027 ¹						

L SERIES

041008	L 35			V1071			V1045			
042001	L 45			V1071			V1127			
042002	L 35 F L 45 F			V1071						
266511	L 60 L 80 F , L 80	4.85→					V6019 ¹			

FIAT

242 Series

125001	1.6, 1.9, 2.2D, 2.5 D			V1065			V2023 ¹			
--------	------------------------------	--	--	--------------	--	--	--------------------	--	--	--

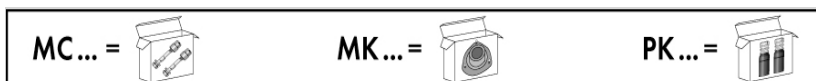



DOBLO, DOBLO CARGO (119) (223)

162250	1.2, 1.2 16 V, 1.6 16 V, 1.9 DS, 1.3 JTD, 1.9 JTD (-) HD	00→ 09		16470	MK374R PK109 MK350 ¹			25506	LA368		OIO
--------	--	--------	--	-------	---------------------------------------	--	--	-------	-------	--	-----

DOBLO CARGO (263)

162251	1.4, 1.4 Bio, 1.4 Gas, 1.3 JTD, 1.6 JTD, 2.0 JTD	10→		G8208 				G1171			OIO
				G8209 							

DOBLO WORKUP, DOBLO PRACTICO (263)

162251	1.4, 1.4 Bio, 1.4 Gas, 1.3 JTD, 1.6 JTD, 2.0 JTD	10→		G8208 				G1171			OIO
				G8209 							

DUCATO 81→ 5.86

160301	 → vet.no. 0284193	81→ 5.86			Orig. no 4434813 4439223 MK046						
160302	 vet.no. 0284194 →	81→ 5.86		V4407	7569730 MK046 PK074						

DUCATO 81→ 5.86

160304		81→ 5.84						V2027		Orig. no 4434812 4439194 5965476 5983928	OIO
160304	 (-) (-)	5.84→ 5.86						V2027		4434812 4439194 5965476 5983928	OIO
160304	 → vet.no. 0278758	5.84→ 5.86						V2027		7534624	OIO
160303	 vet.no. 0278758 →	→ 5.86						V2037		7576729	OIO

NUOVO DUCATO

125003	 (-) Maxi Ducato (1800 kg) (-) (-)	6.86→ 94		V4407	Orig. no 7569730 MK046 PK074			V2027		Orig. no 4434812 5983928	OIO
160306	Maxi Ducato (=) 1800 kg (-) (-)	6.86→ 94						V2301			OIO
125004	 (-) Maxi Ducato (1800 kg)	6.86→ 94		V4407	7569730 MK046 PK074			V2037		7576729	OIO
160308	Express 10-13-15	6.86→ 94		V4407	MK046 PK074			V2027		4434812 5983928	OIO
								V2037		7576729	OIO



125006	10 (=) 1000 kg	94 → 6.06	V4501	MK047 PK074 MK147R MK148L MK308R MK309L I44		V2506	1303682080	
125007	14 (=) 1400 kg	94 → 6.06	V4501	MK047 PK074 MK147R MK148L MK308R MK309L I44		V2507	1312314080 1314562080	
125009	18 (=) 1800 kg	94 → 6.06	V4410			V2509	1303816080	
125008	Panorama	94 → 6.06	V4501	MK047 PK074 MK147R MK148L MK308R MK309L I44		V2508	1312333080	

!44

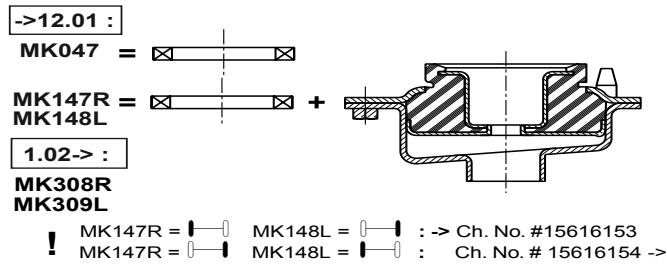

DUCATO **7.06** →

125013	Q 11, Q 15, Q 17, Q 20 (-)	7.06 →	V4512	I69 MK308R MK309L PK285		V2130	I69	
			V4513	I69 MK308R MK309L PK285		V2131	I69	
						V2132	I69	

!69

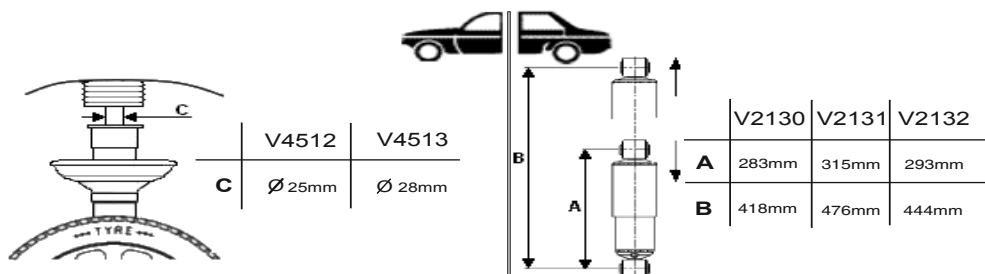

FIORINO 127

166001	Fiorino → vet.no. 7017071 (=)	77 → 6.82	R11025	Orig. no 4408213 4408227 4434916 MC110		R11001	Orig. no 4389825	
--------	--	-----------	---------------	---	--	---------------	---------------------	--

350

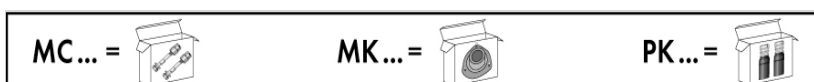



166003	Fiorino vet.no. 7017072 → (=) ORIG. (EUR)	7.82 → 84		R11025	4408213 4408227 4434916 MC110			4434966 4459272	
166002	Fiorino (=) ORIG. (BR)	7.82 → 87			4378176 7073397 MC110			4467262	
165401	Fiorino (=) ORIG. (BR)	87 → 88		11108	7514698 MC110		11530		

FIORINO NUOVO

165402	Fiorino vet.no. 8000001 → 8149536 (=) ORIG. (BR)	88 → 90		11108	Orig. no 7514698 7632212 MC110		11563	Orig. no 7585939 7632214	
165403	Fiorino vet.no. 8149537 → (=) ORIG. (BR)	91 → 7.93		11152	7519651 7687710 MC110		11567	639009 7722442	
165404	Fiorino (=) ORIG. (BR)	7.93 →		11152	7754834 MC110		25490		

FIORINO

122011	1,4, 1.3 D Multijet	2.08 →		G8107 	MC212 MK313R MK314L PK140		G1090	PK335	
				G8108 					

PENNY, DUNA FIORINO

165401	Fiorino (=) ORIG. (BR)	87 → 88		11108	Orig. no 7514698 MC110		11530		
165402	Fiorino vet.no. 8000001 → 8149536 (=) ORIG. (BR)	89 → 90		11108	7514698 7632212 MC110		11563	Orig. no 7585939 7632214	
165403	Fiorino vet.no. 8149537 → (=) ORIG. (BR)	91 → 7.93		11152	7519651 7687710 MC110		11567	639009 7722442	
165404	Fiorino (=) ORIG. (BR)	7.93 →		11152	7754834 MC110		25490		

SCUDO

125010	1580, 2000 16 V, 1867 D, 1905 D, 1905 TD, 2000 JTD (+) → vet.no. 7609	95 → 9.97		V4201	MC112 MK048 PK122		V5006		
125012	1580, 2000 16 V, 1867 D, 1905 D, 1905 TD, 2000 JTD (+) vet.no. 7609 → 9793	9.97 → 10.03		V4201	MC112 MK048 PK122		V2510		
125005	2000, 2000 JTD (+) , (+) vet.no. 9793 →	10.03 → 06		V4202 	MC112		V2510		
			V4203 						
125005	1867 D (+) , (+) vet.no. 9793 → 10408	10.03 → 5.04		V4202 	MC112		V2510		
			V4203 						
125012	1867 D (+) vet.no. 10408 →	5.04 → 06		V4201	MC112 MK048 PK122		V2510		



125011	1.6 D Multijet, 2.0 D Multijet ,	07→	G8167 	MK269R		V2517			
			G8168 						

TALENTO

125003			V4407	MK046 PK074		V2027			
125004			V4407	MK046 PK074		V2037			

UNO (CS)

165401	1.1 Berlina, 1.1 Van → vet.no. 3648341	88→ 91	11108	Orig. no 7626498 MC110		11530			
165405	1.4 Berlina, 1.1 Van vet.no. 3648341 →	88→ 91	11152	7649311 MC110		11530			
165401	1.7 D Van	88→ 91	11108	7716286 MC110		11530			

FORD

ESCORT 35, ESCORT 55, ESCORT 75

171016	Escort 35, Escort 55, Escort 75 (-)	80→ 5.83				R2642			
171017	Escort 35, Escort 55, Escort 75 (-)	6.83→ 90		PK013		R2642			
171032	Escort 35, Escort 55, Escort 75 (=) 500 kg	91→ 1.95	11138	MK014 PK022		R2689			
171033	Escort 35, Escort 55, Escort 75 (=) 700 kg	91→ 1.95	E4226	11136	MK014 PK022	R2689			
171056	Escort 35, Escort 55, Escort 75 (=) 500 kg/700 kg	1.95→	E4323	16221 16222 ¹		R2689			

FIESTA 76→ 2.96

170009		76→ 8.83	R11006	PK013		R11007			
170003		9.83→ 89	R11061 ¹	MK016 PK013		R11007			
170006	 (-) Courier	89→ 12.93	11117	MK016 PK022		E1010 ¹ R3756			
170012	Courier	8.91→ 12.93	11118	MK016 PK022		43078			
170017	Courier 1.3 Courier 1.8 D (-) HD	1.94→ 2.96	11196	MK016 PK013		43078			

FIESTA 11.95→ p. xxx

170021	Courier 1.3, 1.4 16 V (=)	11.95→	E4328	16226	MK055 PK022		43078		
170022	Courier 1.3 (=)	11.95→		16227	MK055 PK022		43078		





170021	Courier 1.8 D (=) (-)	11.95→	E4328	16226	MK055 PK022			43078				
170022	Courier 1.8 D (=) (-)	11.95→		16227	MK055 PK022			43078				

SIERRA

174008	PE 45	88→		11154								
--------	--------------	-----	--	--------------	--	--	--	--	--	--	--	--

TRANSIT

206002	FT 909, FT 1100	65→ 8.70						V1012				
206002	12, 17, 22 cwt (=) 106"	65→ 8.70						V1012				
179005	FT 125, FT 130, FT 150, FT 175 (=) 3 m (118")	9.70→ 77		V2019				V2018				
179004	FT 75, FT 100 (=) 2,69 m (106")	9.70→ 77		V2019				V2020				
179005	FT 75, FT 100, FT 125, FT 130, FT 150, FT 175	9.70→ 77		V2019				V2018				
179004	80, 100, 120 (=) 2,69 m (106")	78→ 85		V2019				V2020				
179005	100 L, 130, 160, 190 (=) 3 m (118")	78→ 85		V2019				V2018				
179005	100, 120 (=) 2,69 m (106")	78→ 85		V2019				V2018				
179004	 (=) 2,69 m (106") (=) 3 m (118")	9.70→ 77 78→ 10.85		V2019				V2020				
179005	 (=) 3 m (118") (=) 2,69 m (106")	9.70→ 77 78→ 10.85		V2019				V2018				
179006	80, 100, 115, 120 (=) 2,82 m	11.85→ 9.91		V4401				V1070				
179007	100 L, 130, 160, 190 (=) 3,02 m, 3,47 m	11.85→ 9.91		V1073				V1070				
179003	80, 100, 115, 120 (=) 2,835m	9.91→ 8.94		V4408	MK111			V2074				
179008	130 (=) 3,570 m	9.91→ 8.94		V4409	MK111			V2076				
179009	190 (=) 3,570 m	9.91→ 8.94		V4409	MK111			V2075				
179010	100 L, 150 L, 190 L (=) 3,570 m 150 S (=) 2,835m	9.91→ 8.94 9.91→ 8.94		V4409	MK111			V2073				









179003	80, 100 S, 120 (=) 2,835m (=) 800kg/1200 kg	8.94→ 3.00		V4408	MK111			V2074			
179012	150 S (=) 2,835m (=) 1500 kg	8.94→ 3.00		V4408	MK111			V2073			
179010	100 L, 150 L, 190 L (=) 3,570 m (=) 1000 kg, 1500 kg, 1900 kg	8.94→ 3.00		V4409	MK111			V2073			
179008	130 (=) 3,570 m (=) 1300 kg	8.94→ 3.00		V4409	MK111			V2076			
179009	190, 190 EF (=) 3,570 m (=) 1900 kg	8.94→ 3.00		V4409	MK111			V2075			

TRANSIT

179016	260, 280, 300, 330, 350 (=)	1.00→ 6.06		V4502	MK201 PK189 PK089 ¹			V1146			
179015	260, 280, 300, 330, 350 (=)	1.00→ 6.06		V4502	MK201 PK189 PK089 ¹			V1145			
179017	260, 280, 300, 330, 350 (=)	1.00→ 6.06		V4502	MK201 PK189 PK089 ¹			V1147			
179001	350 E (-) 3,2 L Engine	7.06→		V4509	MK318 PK293			V1181			
179021	260 S, 280 M, 280 S, 300 M, 300 S, 330 L, 330 M, 330 S, 350 L, 350 M (=) (-) 3,2 L Engine	7.06→		V4508	MK318 PK293			V1179			
179022	300 M, 300 S, 330 L, 330 M, 330 S, 350 E, 350 L (=) (-) 3,2 L Engine	7.06→		V4508	MK318 PK293			V1180			
179023	350 L Floor Cabin (=) (-) 3,2 L Engine	7.06→		V4509	MK318 PK293			V1179			
179002	300 L, 300 M, 330 L, 330 M, 350 E, 350 L, 350 M (=) (-) 3,2 L Engine	7.06→		V4509	MK318 PK293			V1147			
179001	300 S, 330 S, 430 E (=) (-) 3,2 L Engine	7.06→		V4509	MK318 PK293			V1181			
179001	350 L (=)	7.06→		V4509	MK318 PK293			V1181			
179001	300 M, 300 S, 330 L, 330 M, 330 S, 350 E, 350 L, 350 M, 430 E, 430 L, 430 M (=) (-) 3,2 L Engine	7.06→		V4509	MK318 PK293			V1181			









TRANSIT CONNECT



179018	65 Series, 700 Series (=)  550, 625 kg	9.02→ 13		V4302	MK306			V1168			
179019	80 Series, 900 Series (=)  725, 750, 825 kg	9.02→ 13		V4303	MK306			V1168			

FORD TRUCK US

AEROSTAR Mini Van









910101	Aerostar (=) (4 x 2)	86→ 88		37058							
910102	Aerostar (=) (4 x 2)	89→ 97		37058				37061			
910103	Aerostar (=) (4 x 4)	90→ 97						37061			

COURIER Light Duty

		72→ 82		V1063							
---	--	--------	--	--------------	--	---	--	--	--	--	--











FREIGHT ROVER COMMERCIALS

SHERPA





081005	200 Series  200-230-250-280	83→						V2036¹			
081007	300 Series 285-310-350 (=)  290 cm										
	300 Series 285-310 (=)  320 cm	83→									

GMC TRUCK

G MODELS Van 1/2 Ton (incl. Rally, Vandura)

	G 1000 Handi Van	64→ 66						34944			
	G 1500 Series	67→ 69						R1000			
965101	G 1500 Series (=) 	70		34839				R1000			
965102	G 1500 Series (=) I Beam Suspension	70						R1000			
965101	G 1500 Series	71→ 77		34839				R1000			
965104	G 1500 Series	78→ 95		34839				34910			

G MODELS Van 3/4 Ton (incl. Rally, Vandura)

	G 2500 Series	67→ 69						R1000			
965101	G 2500 Series (=)  (+/-) 	70		34839				R1000			



965102	G 2500 Series (=) I Beam Suspension	70																	
965101	G 2500 Series (+/-) HD	71→ 77		34839									R1000						
965104	G 2500 Series (+/-) HD	78→ 95		34839									34910						

G MODELS (incl. Rally, Vandura) Van 1 Ton

965101	G 3500 Series (-) Chopped Van	70→ 77		34839									R1000						
965109	G 3500 Series (=) Chopped Van	75→ 78		34839															
965104	G 3500 Series (-) Chopped Van	78→ 91		34839									34910						
965109	G 3500 Series (=) Chopped Van	79→ 95		34839															
965109	G 3500 Series (-) Chopped Van	92→ 95		34839															

MOTORHOME CHASSIS Class C

	G 3500 Series Motorhome Conversion (-) Chopped Van	70→ 77		34839									R1000						
--	---	--------	--	-------	--	--	--	--	--	--	--	--	-------	--	--	--	--	--	--

SAVANA (incl. Rally, Vandura) Van 3/4 Ton

965117	2500 Series (-) GVW 8600	96→ 02		34741									911086MM ¹	34763					
965116	2500 Series (=) GVW 8600	96→ 02		34741									911086MM ¹	34763					
965120	2500 Series	03→ 06											911086MM ¹	34763					

SAVANA (incl. Rally, Vandura) Van 1 Ton

965116	3500 Series (=)	96→ 02		34741										34763					
965113	3500 Series (=)	96→ 02		34741															
965120	3500 Series (=)	03→ 06											911086MM ¹	34763					
965010	3500 Series (=)	03→ 06																	

HANOMAG HENSCHEL COMMERCIALS

F SERIES

159003	F 40, F 46	71→		V2017									V2017						
--------	-------------------	-----	--	-------	--	--	--	--	--	--	--	--	-------	--	--	--	--	--	--

HYUNDAI

H 100, PORTER

192003	FD Series 2.4, 2.5 D, 2.5 TD, 2.6 D	93→		V1114									V1115						
--------	--	-----	--	-------	--	--	--	--	--	--	--	--	-------	--	--	--	--	--	--

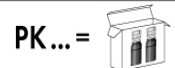



H 200/H 1

190012	 (=)	6.97→ 1.08		V1143		○ ⊥		V1149			○ ⊥
	 (=)	6.97→ 1.08									
190027		2.08→		V4304 ⁰ 		⊥ ⊥		V1192 ⁰			○ ⊥
				V4305 ⁰ 		⊥ ⊥					

SATELLITE/H 1/STAREX

190011	SWB 7 Seater SWB 9 Seater (=) (=) (4 x 2)	6.97→ 05		V1143		○ ⊥		V1144			○ ⊥
190012	LWB 9 Seater (=) (=) (4 x 2)	6.97→ 05		V1143		○ ⊥		V1149			○ ⊥

ISUZU

D-MAX, RODEO

204002	2.5 D 57, 74, 85, 100, 120 kW 3.0 D 120 kW (=) (4 x 2) (+) (+) (-) Hi-Lander, High Ride	6.03→ 6.12		D9009		○ ⊥		D9011			○ ⊥
204003	2.5 D Hi-Lander, High Ride 57, 85, 100, 120 kW 3.0 D Hi-Lander, High Ride 120 kW (=) (4 x 2) (+)	6.03→ 6.12		D9008		○ ⊥		D9010			○ ⊥
204001	2.5 85, 100 kW 3.0 100, 120 kW (=) (4 x 4) (+)	6.03→ 6.12		32336MM		○ ⊥		D9010			○ ⊥

ELF

202001	TL 20 Series	70→ 74		V1016		○ ⊥					
202001	TL 60 Series (=)	70→		V1016		○ ⊥					○ ⊥
202001	TL 10, TL 30 Series	70→		V1016		○ ⊥					
202001	TL 40, TL 50 Series (=)	70→		V1016		○ ⊥					○ ⊥
202001	TL 20 Series (=)	74→		V1016		○ ⊥					○ ⊥

LIGHT ELF

203001	KA 20, KA 40, KA 50	68→		V1016		○ ⊥		V1001			○ ⊥
--------	----------------------------	-----	--	-------	--	-------	--	-------	--	--	-------



MD 27

202004	MD 27		V2078		V1150		
--------	--------------	--	--------------	--	--------------	--	--

MIDI

058005	WFR Series (=) (4 x 2)	80 → 89	V1038		V1012		
206002	WSF Series (=) (4 x 4)	11.83 → 89			V1012		

NKR

202005	4HF1 & 4BE1 (=) (4 x 2)	94 → 12	V1193		V1194		
--------	---------------------------------------	---------	--------------	--	--------------	--	--

NPR

202003	4HF1 (=) (4 x 2)	94 → 12	V1160		V1161		
--------	----------------------------	---------	--------------	--	--------------	--	--

NPR77

202006	P35.04LE (=) (4 x 2)				V1196		
--------	--------------------------------	--	--	--	--------------	--	--

PICK UP

204004	TFR Series (=) (4 x 2)	4.88 → 00	V1087		V1088		
204005	TFS Series (=) (4 x 4)	4.88 → 96	V1053		V1088		

IVECO COMMERCIALS

DAILY I

209001	30-8, 35-8, 35-10, 40-8, 40-10, 45-10, 49-10	→ 12.89	V1055	Orig. no 8587219		V1056	Orig. no 4829235 8586273 93800199 93804339	
			V1079	4829233 93803675 93803892			4829235	
				93803675 93803892				

DAILY II

209004	30-8, 35-8, 35-10, 40-8 (=)	1.89 → 5.99	V1102	Orig. no 4829234 8574216 93826662		V1103	Orig. no 4835372 4835373 4835375 4850528	
209008	35.8, 35.10, 40.10 (=) ch.no. 5973717 →	1.89 → 5.99	V1102	4829234 8574216 93826662		V2110	93826664 98449030	

DAILY III

209015	35C12, 35C13, 35C14, 35C15 (=) (4x2) (=)	97 → 07	V1197	Orig. no 504110593 504118348 504195985 504198992 5801345771 5801345780		V2151	Orig. no 504170986	
209016	40C14, 40C15 (=) (4x2) (=)	97 → 07				V2151	504170986	



209017	50C14, 50C15 (=) (4x2) (=)	97→ 07					V2151		504170986	OIO
209018	65C14, 65C15 (=) (4x2) (=)	97→ 07					V2152		504190986	OIO

DAILY III

209019	35C15 (=) (4x2) (=)	97→ 07					V2151		Orig. no 504170986	OIO
--------	----------------------------------	--------	--	--	--	--	--------------	--	-----------------------	-----

DAILY III

209024	29L10, 29L12, 29L14 (=) (4x2)	97→ 07		V1195	Orig. no 504051656 5801345779	OIO		V2152	Orig. no 504190986	OIO
209025	35C9, 35C10, 35C11, 35C17 (=) (4x2)	97→ 07		V1195	504051656 5801345779	OIO		V2152	504190986	OIO
209020	35C12, 35C13, 35C14, 35C15 (=) (4x2) (=)	97→ 07		V1195	504051656 5801345779	OIO		V2151	504170986	OIO
209021	40C14, 40C15 (=) (4x2) (=)	97→ 07						V2151	504170986	OIO
209022	50C14, 50C15 (=) (4x2) (=)	97→ 07						V2151	504170986	OIO
209023	65C14, 65C15 (=) (4x2) (=)	97→ 07						V2152	504190986	OIO

DAILY IV

209030	29L10, 29L12, 29L14 (=) (4x2)	05.06→ 08.11		V1197	Orig. no 504110593 504118348 504195995 504198992 5801345771 5801345780	OIO		V1191	Orig. no 504118330 5801345772	OIO
209031	29L10, 29L12, 29L14 (=) (4x2)	05.06→ 08.11						V2135	2997280 500368633 500368634 500376000 500376001 500376002 500389135 500389838 500389841 500392353 500392553 504039594 504043881 504064549 504064551 5801345778	OIO
209032	35C10, 35C11, 35C12, 35C13, 35C14, 35C17, 35C18 (=) (4x2)	05.06→ 08.11		V1197	504110593 504115995 504118348 504198992 5801345771 5801345780	OIO		V1191	504118330 5801345772	OIO
209033	35S10, 35S11, 35S12, 35S13, 35S14, 35S17, 35S18 (=) (4x2)	05.06→ 08.11		V1197	504110593 504115995 504118348 504198992 5801345771 5801345780	OIO		V1191	504118330 5801345772	OIO
209034	35S10, 35S11, 35S12, 35S13, 35S14, 35S17 (=) (4x2) (=)	05.06→ 08.11						V2135	2997280 500368633 500368634 500376000 500376001 500376002 500389135 500389838 500389841 500392353 500392553 504039594 504043881 504064549 504064551 5801345778	OIO
209035	35C12, 35C13, 35C14, 35C17, 35C18 (=) (4x2) (=)	05.06→ 08.11						V2151	504170986	OIO

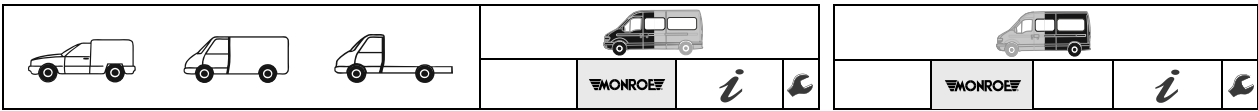

209036	40C12, 40C13, 40C14, 40C15, 40C17, 40C18 (=) (4x2) (=)	05.06→08.11						V2151		504170986	
209037	50C14, 50C15, 50C17, 50C18 (=) (4x2) (=)	05.06→08.11						V2151		504170986	
209038	60C15, 60C17 (=) (4x2) (=)	05.06→08.11						V2152		504190986	
209039	65C14, 65C15, 65C17, 65C18 (=) (4x2) (=)	05.06→08.11						V2152		504190986	
209040	70C14, 70C17 (=) (4x2) (=)	05.06→08.11						V2152		504190986	

DAILY IV

209041	35C12, 35C13, 35C14, 35C17, 35C18 (=) (4x2) (=)	05.06→08.11						V2151		Orig. no 504170986	
209042	35S11, 35S12, 35S13, 35S14, 35S17, 35S18 (=) (4x2)	05.06→08.11		V1197	Orig. no 504110593 504118348 504195995 5801345771 5801345780			V1191		504118330 5801345772	
209043	35S11, 35S12, 35S13, 35S14, 35S17 (=) (4x2) (=)	05.06→08.11						V2135		2997280 500368633 500368634 500376000 500376001 500376002 500389135 500389838 500389841 500392353 500392553 504038594 504043881 504064549 504064551 5801345778	
209044	40C14, 40C17 (=) (4x2) (=)	05.06→08.11						V2151		504170986	
209045	50C14, 50C15, 50C17, 50C18 (=) (4x2) (=)	05.06→08.11						V2151		504170986	
209046	60C15, 60C17 (=) (4x2) (=)	05.06→08.11						V2152		504190986	
209047	65C14, 65C17 (=) (4x2) (=)	05.06→08.11						V2152		504190986	
209048	70C14, 70C17 (=) (4x2) (=)	05.06→08.11						V2152		504190986	

DAILY IV

209050	29L10, 29L12, 29L14 (=) (4x2)	05.06→08.11		V1197	Orig. no 504110593 504115995 504118348 504198992 5801345771 5801345780			V1191		Orig. no 504118330 5801345772	
209051	29L10, 29L12, 29L14 (=) (4x2)	05.06→08.11						V2135		2997280 500368633 500368634 500376000 500376001 500376002 500389135 500389838 500389841 500392353 500392553 504038594 504043881 504064549 504064551 5801345778	

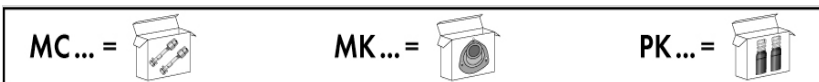



209052	35C11, 35C12, 35C13, 35C14 (=) (4x2)	05.06→08.11		V1197	504110593 504115995 504118348 504198992 5801345771 5801345780	OIO		V1191	504118330 5801345772	OIO
209053	35C12, 35C13, 35C14, 35C17, 35C18 (=) (4x2) =	05.06→08.11						V2151	204170986	OIO
209054	35S11, 35S12, 35S13, 35S14 (=) (4x2)	05.06→08.11		V1197	504110593 504115995 504118348 504198992 5801345771 5801345780	OIO		V1191	504118330 5801345772	OIO

DAILY V

209060	35C13, 35C14, 35C15, 35C17, 35C21 (=) (4x2) =	09.11→02.14						V2151	Orig. no 504170986	OIO
209061	40C13, 40C15, 40C17, 40C21 (=) (4x2) =	09.11→02.14						V2151	504170986	OIO
209062	50C14, 50C15, 50C17, 50C21 (=) (4x2) =	09.11→02.14						V2151	504170986	OIO
209063	65C14, 65C15, 65C17, 65C21 (=) (4x2) =	09.11→02.14						V2152	504190986	OIO
209064	70C14, 70C15, 70C17, 70C21 (=) (4x2) =	09.11→02.14						V2152	504190986	OIO

DAILY VI

209070	35C13, 35C15, 35C17, 35C21 (=) (4x2) =	02.14→						V2151	Orig. no 504170986	OIO
209071	40C15, 40C17, 40C21 (=) (4x2) =	02.14→						V2151	504170986	OIO
209072	50C14, 50C15, 50C17, 50C21 (=) (4x2) =	02.14→						V2151	504170986	OIO
209073	65C14, 65C15, 65C17, 65C21 (=) (4x2) =	02.14→						V2152	504190986	OIO
209074	70C14, 70C15, 70C17, 70C21 (=) (4x2) =	02.14→						V2152	504190986	OIO

DAILY S2000

209012	29 L Series, 35 S Series (=)	5.99→		V1502	Orig. no 500368632 500389134 500389136 500389837 500389839 504043715 504043879	OIO		V2135	Orig. no 500389135 500389841 504043881 504064549	OIO
209012	29 L Series, 35 S Series (=) (Parabolic)	5.99→		V1502	500368632 500389134 500389136 500389837 500389839 504043715 504043879	OIO		V2135	500368633 500368634 500376000 500376001	OIO
209003	29 L Series, 35 S Series (=)	5.99→		V1502	500368632 500389134 500389136 500389837 500389839 504043715 504043879	OIO		V2136	500378189 500378190 504043882	OIO
209013	35 C Series, 40 C Series (=) Triangle Susp.	5.99→		V1502	500368632 500389134 500389136 500389837 500389839 504043715 504043879	OIO		V2515	500368636 500368631 500389137 500398555 504043716 504043880	OIO

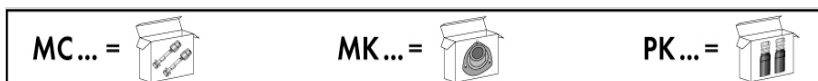



209014	35 C Series, 40 C Series (=) Multi Link Susp.	5.99→		V2516	500367642 500369632 504043717 504043883 504088408 504088409			V2515	500367032 500369633 504043718 504043884	
209014	50 C Series	5.99→		V2516	500367642 500369632 504043717 504043883 504088408 504088409			V2515	500367032 500369633 504043718 504043884	
209002	65 C Series	11.01→		V2518	500377618 504014873			V2515	500377620 500377633	

DAILY S2000

209012	40 C Series, 50 C Series (=) Multi Link Susp. (=)	5.99→		V2516	Orig. no 500367642 500369632 504043717 504043883 504088408 504088409			V2515	Orig. no 500367032 500369633 504043718 504043884	
--------	--	-------	--	--------------	--	--	--	--------------	--	--

TURBODAILY

209009	30-10, 35-10, 35-12 (=)	1.89→		V1102 ND	Orig. no 93826662			V1103	Orig. no 4835372 4835373 4835375 4850528	
209010	35-10, 35-12, 40-10, 40-12 (=) ch.no. 5973717 →	1.89→		V1102 ND	93826662			V2110	93826664 98449030	
209007	45-10, 45-12, 49-10, 49-12	1.89→		V1055	8587219			V1103	4835372 4835373 4835375 4850528	
209011	59-12			V1172	98415332			V2515	4854829 93826663	
								V2111	98415333 98445872 98445873	

LANCIA

VOYAGER

900309	3.6, 2.8 D (-)	9.11→	71128ST				37290ST			
900311	3.6, 2.8 D (+)	9.11→	71128ST					58648ST		

LDV COMMERCIALS

CUB

228001	2.3 D	9.98→		G16610 				V1002		
				G16611 	MC112					

MAZDA

B SERIES



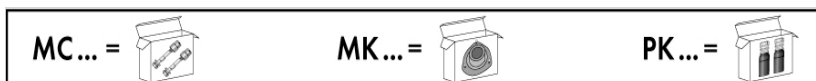





238001	B 1600 BNA	70→ 76		V1063						
238001	B 1600, B 1800, B 2000	→ 85		V1063						









238003	B 1600, B 2000, B 2200 (=) (4 x 2) 	85 → 3.96		V1053		⊥		V1035					⊥
238002	B Series (=) (4 x 2)	3.96 →		V1119		⊥		V1117					⊥
238009	B Series (=) (4 x 4)	3.96 →		V1119		⊥		V1118					⊥

E SERIES

238004	E 1600 Type BA 2 N 9	78 → 84		V1063		⊥		V1002					⊥
238005	E 2200	78 → 84		V1063		⊥		V1005					⊥
238006	E 1400 (=) (4 x 2)	84 → 97		V1021		⊥		V2503					⊥
238006	E 1800, E 2000, E 2200 (=) (4 x 2) (=) 	84 → 97		V1021		⊥		V2503					⊥
238006	E 1800, E 2000, E 2200  (=) (4 x 2)	84 → 97		V1021		⊥		V2503					⊥
238007	E 1400, E 1800, E 2000, E 2200 (=) (4 x 2) (=) 	84 → 97		V1021		⊥		V1005					⊥
238007	E 1400, E 1800, E 2000, E 2200 (=) (4 x 2) 	84 → 97		V1021		⊥		V1005					⊥
238010	E 2000, E 2200 (=) (4 x 2)	97 →		V1124		⊥		V1120					⊥
238011	E 2000, E 2200 (=)  (=) (4 x 2)	97 →		V1124		⊥							⊥
238012	E 2000, E 2200 (=)  (=) (4 x 2)	97 →		V1124		⊥		V1122					⊥
238013	E 2000, E 2200 (=) (4 x 4)	97 →		V1123		⊥		V1120					⊥
238014	E 2000, E 2200 (=)  (=) (4 x 4)	97 →		V1123		⊥							⊥
238015	E 2000, E 2200 (=)  (=) (4 x 4)	97 →		V1123		⊥		V1122					⊥

MERCEDES BENZ

MB SERIES

159106	MB 90 MB 100 (=) ORIG  MB 130 (=) ORIG 	→ 5.84 → 5.84		V1047¹		⊥							⊥
159107	MB 90, MB 100, MB 120 (=) ORIG 	5.84 →		V1051		⊥		V2042					⊥
159109	MB 140, MB 160, MB 180 (=) ORIG 	5.84 →		V1052		⊥		V2014¹					⊥

MC... = 

MK... = 

PK... = 



SPRINTER

157003	200 Series (B 901, B 902)		V4503	I67 MK277 PK123			V1116			
	300 Series (B 903)	95→ 06	V4507	I67 MK277 PK123						
461103	400 Series (B 904)	95→ 06	V4503	I67 MK277 PK123			V1166			
			V4507	I67 MK277 PK123						
461106	500 Series (B 906)	06→					V1188		Orig. no 9033260700 9063261500 9063261800 A9063261500 A9063261800	
461104	3 T, 3,5 T (B 906) (=) (4 x 2)	06→	V4510	MC114 MK287 PK302			V1177			
461105	5 T (=) (4 x 2)	06→	V4511	MC114 MK287 PK302			V1178			

!67

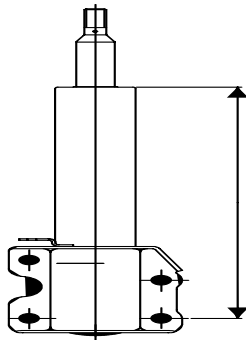

X=319,5 : V4503

OE

901 320 02 30	901 320 18 30	903 320 02 30
901 320 03 30	901 320 20 30	903 320 03 30
901 320 08 30	901 320 21 30	903 320 05 30
901 320 13 30	901 320 22 30	2D0 413 029
901 320 14 30	901 320 29 30	2D0 413 029 B
901 320 15 30	903 320 01 30	

X=345,5 : V4507

OE

904 320 07 30	904 320 16 30	904 320 25 30
904 320 08 30	904 320 18 30	904 320 26 30
904 320 13 30	904 320 19 30	2D0 413 029 A
904 320 14 30	904 320 23 30	

VARIO

156013	507 D 508D Type 667.001, .002, .302, .341, .342						V1190			
156014	510 512D Type 667.061, .061, .062, .361, .362						V1190			
156015	613D 614D Type 669.599, 669.899		V2145				V1189			
156016	814 DA Type 670.411, .412, .464, .465 (=) (4x4)		V2145				V1189			

VIANO (W 639)

156004	3.0, 3.2, 3.7, 2.0 CDi (80 kW, 85 kW), 2.2 CDi (110 kW), 3.0 CDi (150 kW) (=) (4 x 2) (+/-)	9.03→ 6.10	G8403				V5007			
156004	3.5 (=) (4 x 2) (+/-)	9.07→ 6.10	G8403				V5007			
	→ ch.no. 3603471									
156011	3.5 (=) (4 x 2) (+/-)	7.10→	V4516⁰				V5007			
	ch.no. 3603472 →									



156011	2.0 CDi (100 kW), 2.2 CDi (120 kW), 3.0 CDi (165 kW) (=) (4 x 2) (+/-)	7.10→		V4516 ⁰				V5007			OIO
156012	2.0 CDi 4-Matic, 2.2 CDi 4-Matic (=) (4 x 4) (+/-)	7.05→						V5007			OIO

VITO (W 638)

156007	638	96→ 03		V4301	MK112 PK006			V1501			OIO
--------	-----	--------	--	-------	----------------	--	--	-------	--	--	-----

VITO Bus, Familiar, VITO Mixto, Van (W 639)

156004	119, 122, 123, 109 CDi, 111 CDi, 115 CDi, 120 CDi (=) (4 x 2) (+/-)	9.03→ 8.10		G8403				V5007			OIO
156004	126 (3.5) (=) (4 x 2) (+/-)	9.03→ 8.10		G8403				V5007			OIO
	→ ch.no. 3603471										
156011	126 (3.5) (=) (4 x 2) (+/-)	8.10→		V4516 ⁰				V5007			OIO
	ch.no. 3603472 →										
156011	109 CDi, 110 CDi, 111 CDi, 113 CDi, 115 CDi, 116 CDi, 120 CDi, 122 CDi (=) (4 x 2) (+/-)	9.10→		V4516 ⁰				V5007			OIO
	ch.no. 3603472 →										
156012	109 CDi 4x4, 111 CDi 4x4, 113 CDi 4x4, 115 CDi 4x4, 116 CDi 4x4 (=) (4 x 4) (+/-)	9.07→						V5007			OIO
	ch.no. 3603472 →										

MERCEDES BENZ COMMERCIALS

BUS

159003	O 309, O 319 B, O 319 D		V2017					V2017			OIO
			1300018M	⊕	⊖						
	O 303		1300018M	⊕	⊖						
159004	O 302 Type 201, 202, 206, 207, 211, 212, 220, 222, 230 Type 231, 232, 240, 241, 250, 251, 252, 261, 262 Type 270, 271, 272, 280, 281, 282, 290, 291, 292 O 305 E City Bus O 305 G O 307 Type 050, 051, 055, 307		V2059 ¹		⊕			V2060			⊕
			1300018M	⊕	⊖						

MC... =

MK... =

PK... =



UNIMOG

159002	U 34/411, U 40/421, U 45/421		V2038			V2038				
159009	U 54/403, U 66/403, U 70/406, U 80/416, U 90/416, U 100/416, 404 S		V2058			V2058				
159110	MB Track 65/70 MB Track 700/800		V2058							
159007	L 207 D, L 208, L 209 D, L 210 Type 601 308, 310, L 307 D, L 309 D Type 602		V1036			V1066				
159003	L 319 D, L 319 B, L 405, L 406, L 406 D, L 408, L 409 61→ Type 309		V2017			V2017				
159001	L 407 D, L 409 D, L 410 Type 611		V1112			V1113				
159022	L 408 G, L 409, L 410 Type 309.000→.026 LK 408 G, LK 409, LK 410 Type 309.040, .041, .044 LKO 406 DG, LKO 407 D Type 309.130→.135 LKO 408 G, LKO 409 Type 309.030→.035 LF 408 G Type 309.054, .055 L 408 DG Type 309.300→.303, .311→.316, .324→.326		V1095			V1095				
159010	LF 408 G, LF 409, LF 410 ch.no. 309056..148037→309056..185439 ch.no. 309059..148037→309059..185439		V1095							
159022	LF 408 G, LF 409, LF 410 ch.no. 309056..185440→309056..275292 ch.no. 309059..185440→309059..275292		V1095			V1095				
159022	LF 408 G, LF 409, LF 410 ch.no. 309050..005094→309050..148036 ch.no. 309050..526087→		V1095			V1095				
159010	LF 408 G, LF 409, LF 410 ch.no. 309050..148037→309050..526086		V1095							
159008	LF 406 D, L 408 D, L 508 D, L 508 DG, L 613 Type 310		V2021			V2021				
159022	L 508 DG Type 309.400→.405, .411→.416, .424→.427, .429 LK 508 DG Type 309.440, .441, .442, .444, .445		V1095			V1095				
159022	L 608 D Type 310.300, .305, .311→.316, .324→.327, .329 Type 310.400, .405, .411→.416, .424→.427, .429 LK 608 D Type 310.340→.345, .440→.445		V1095			V1095				



159101	LP 608, LP 709 → ch.no. 314051.4282707 → ch.no. 314053.4282707								
	LP 608 → ch.no. 314055.4282707 → ch.no. 314060.4282707								
	LPS 608, LPS 709 → ch.no. 314063.4282707								
	LPK 608, LPK 709 → ch.no. 314072.4282707								
	LPKO 608, LPKO 709 → ch.no. 314077.4282707								
	LPKF 608, LPKF 709 → ch.no. 314081.4282707 → ch.no. 314083.4282707								
	LPO 608, LPO 709 → ch.no. 314085.4282707 → ch.no. 314087.4282707								

159102	LP 608, LP 709 ch.no. 314051.4282708 →								
	LP 608 ch.no. 314055.4282708 → ch.no. 314060.4282708 →								
	LPS 608, LPS 709 ch.no. 314063.4282708 →								
	LPK 608, LPK 709 ch.no. 314072.4282708 →								
	LPKO 608, LPKO 709 ch.no. 314077.4282708 →								
	LPKF 608, LPKF 709 ch.no. 314081.4282708 → ch.no. 314083.4282708 →								
	LPO 608, LPO 709 ch.no. 314085.4282708 → ch.no. 314087.4282708 →								

159013	LPS 608 ch.no. 314062.4282708 →								
	LT 608 D Type 310.100			V1095					
	LPL 608, LPL 709 Type 314.251, .252, .253 LPLS 608, LPLS 709 Type 314.263								

159011	LPS 709								
	609 D Type 668.001, .002, .003, .041, .042, Type 668.061, .062, .063								
	709 D Type 669.001, .002, .003, .041, .042 Type 669.061, .062, .063 711 D Type 669.302, .303, .362, .363 → 2.87			V1089					

159014	609 D Type 668.001, .002, .003, .041, .042 Type 668.061, .062, .063								
	709 D Type 669.001, .002, .003, .041, .042 Type 669.061, .062, .063 711 D Type 669.302, .303, .362, .363 3.87→			V1089					

159012	614 D			V1089					
--------	--------------	--	--	--------------	--	--	--	--	--

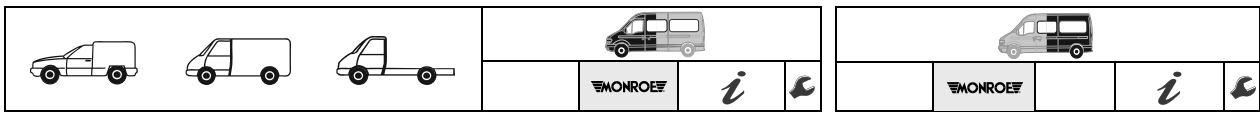

159012	609 D, 611 D, 614 D		V1089						
159011	809 D Type 670.001, .002, .003, .041, .042 811 D Type 670.061, .062, .063 → 2.87		V1089			V2302			
159014	809 D Type 670.001, .002, .003, .041, .042 Type 670.061, .062, .063 Type 669.001, .002, .003, .041, .042 Type 690.061, .062, .063 811 D Type 670.302, .303, .362, .363 3.87→		V1089			V2303			
159022	L 613 D Type 313		V1095			V1095			
159017	809 DT					V2303			

MITSUBISHI

CANTER

249503	FB, FE		V1084			V1085			
--------	---------------	--	--------------	--	--	--------------	--	--	--

L 200 (K_T)

249501	1600 K11T 2000 K12T 2000 K62T 2500 D K14T 2500 D K64T 86→ 96 (=) (4 x 2)		V1109			V1012			
--------	---	--	--------------	--	--	--------------	--	--	--

L 300

058004	1600 L032P, L062P 2300 D L068P 2300 D L038P → 10.86 (=) (4 x 2)		V1038			V1002			
058004	1600 L032P 2300 D L038P → 10.86 (=) (4 x 2)		V1038			V1002			
241503	1600 L032P (=) (4 x 2) → 10.86		V1038			R1000			
241507	1800 L035G (=) (4 x 4) 4.83→ 10.86 2000 L037G (=) (4 x 4) 5.85→ 10.86		V1038			V1001			
241504	1600 L032P (=) (4 x 2) 11.86→		V1038			V2502			
241505	2500 D L039P (=) (4 x 2) 11.86→		V1041			V2502			



241506	1600 P02V, P12V 2000 P03V, P13V 2000 P03W 2500 D P05V, P15V 2500 D P05W (=) (4 x 2) 11.86→			V1042							V2502								
241508	2000 P23V, P24V 2000 P23W 2400 D P24W (=) (4 x 4) 11.86→											V1029							

L 400

246013	2000 (PA 3 V, PB 3 V) 2500 (PA 5 V, PB 5 V) (=) (4 x 2) 95→ (=)			R3464								V1148							
--------	--	--	--	--------------	--	--	--	--	--	--	--	--------------	--	--	--	--	--	--	--

SPACE GEAR (L 400)

246013	2500 (PC 5 W) (=) (4 x 2) 95→ (=)			R3464								V1148							
--------	--	--	--	--------------	--	--	--	--	--	--	--	--------------	--	--	--	--	--	--	--

NISSAN

BUS

266517	60/6 D, 70/6 D 9.89→											V6019¹							
--------	-----------------------------	--	--	--	--	--	--	--	--	--	--	--------------------------	--	--	--	--	--	--	--

CABALL

264502	Caball C 240 67→ Caball H 240 W 69→ HQC 240 VWN GC 240 W GHQC 240 W											V1002							
--------	---	--	--	--	--	--	--	--	--	--	--	--------------	--	--	--	--	--	--	--

CAB, NAVARA, KING CAB

262503	520, 521, 620 65→ 78			D2113								D7561							
262505	720 Series 10.79→ 8.85 (=) (4 x 2) 720 Series 10.79→ 12.81 (=) (4 x 4) King Cab			D7648								D7561							
262506	720 Series 1.82→ 8.85 (=) (4 x 4) King Cab			D7648								D8004							
262504	GD 21 9.85→ 1.98 (=) (4 x 2)			D2113								D4463							
262510	MD 21 9.85→ 1.98 (=) (4 x 4)			D4462								D4463							
262504	D 22 2.98→ 7.05 (=) (4 x 2)			D2113								D4463							
262512	D 22 2.98→ 7.05 (=) (4 x 4)			D4486								D8487							



CABSTAR

241508	A 320, A 321	69→ 76					V1029				○/○
264505	F 22	83→		V1086		○/○	V2062				○/○

CABSTAR E (TL)

322011	75.28 (=)	10.98→10.06		V1108		○/○	V1133				○/○
264501	75.28 (=)	10.98→10.06		V1132		○/○	V1133				○/○
322012	90.32, 110.35, 120.35 (=)	10.98→10.06		V1108		○/○	V1183				○/○
322013	90.32, 110.35, 120.35 (=)	10.98→10.06		V1182		○/○	V1183				○/○
322013	110.45, 120.45 (=)	10.98→10.06		V1182		○/○	V1183				○/○

CABSTAR (F24M)

322011	28.11	10.06→		V1108		○/○	V1133				○/○
322012	32.11, 35.11, 35.13, 35.15, 45.13, 45.15	10.06→		V1108		○/○	V1183				○/○

CLIPPER

264504	Clipper 662 H, 663 H	69→					V1001				○/○
--------	-----------------------------	-----	--	--	--	--	--------------	--	--	--	-----

ECHO MICRO

264502	Echo Micro 	69→					V1002				○/○
--------	---	-----	--	--	--	--	--------------	--	--	--	-----







ECOT-T SERIES

266508	ECOT-T 100.35, 100.45	4.96→		V1136		○/○	V1127				○/○
266514	ECOT-T 100.56	4.96→		V1128		○/○	V1127				○/○
266515	ECOT-T 135.60, 135.75, 135.80	4.96→		V1138 ¹		○/○					○/○

F SERIES

041009	F 275	1.78→ 1.83		V1027 ¹		○/○					
266503	F 275	1.83→		V1027 ¹		○/○	V1028				○/○
041009	F 350			V1027 ¹		○/○					○/○
041010	F 350 Chassis			V1044		○/○	V1045				○/○

INTERSTAR

272504	Interstar  (=)  	02→		V2079		○/○	V2514				○/○
272503	Interstar  (=)  	02→		V2079		○/○	V2513				○/○



272502	Interstar (=)	02→		V2079			V2512				
272501	Interstar (=)	02→		V2079							

KUBISTAR

329301	1.2, 1.6 16V, 1.5 dCi (=) (4 x 2) (+) (=) (=) CUN	8.03→		11285	MC114 MK100 PK066			43107				
329302	1.2, 1.6 16V, 1.5 dCi (=) (4 x 2) (+) (=) (=) CU+	8.03→		11285	MC114 MK100			G55022				
329303	1.2, 1.6 16V, 1.5 dCi (=) (4 x 2) (+) (=)	8.03→		11285	MC114 MK100 PK066							

L SERIES

041008	L 35	1.79→ 2.86		V1071				V1045				
042001	L 35 L 45 L 35.08, L 35.09 L 50.09	2.86→ 10.82→ 5.88→ 5.88→ 7.95		V1071				V1127				
266508	L 45.08	7.93→ 7.95		V1136				V1127				
266508	L 45.08	7.95→		V1136				V1127				
042001	L 50.09	7.95→		V1071				V1127				
042002	L 35 F L 45 F L 35.08 F, L 45.08 F L 35.09 F, L 50.09 F	2.86→ 10.82→ 5.88→ 5.88→		V1071								
266511	L 60.09 L 80, L 80 F L 70.09, L 80.09 F L 80.09, L 80.14	5.88→ 4.96 4.85→ 5.88→ 6.88→ 4.96						V6019¹				

NAVARA

262515	2.5 dCi D40 (=) (4 x 2) (=) (4 x 4)	7.05→	D8070				D7017					
--------	--	-------	--------------	--	--	--	--------------	--	--	--	--	--

PRIMASTAR

265504	1.9 DCi, 2.0, 2.5 DCi	6.02→		V4504	MK181 PK116			V1167				
--------	------------------------------	-------	--	--------------	------------------------------	--	--	--------------	--	--	--	--



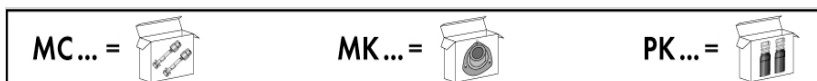

SUNNY

262004	1200 B110	70→ 74		MR834				R1004				
262011	120 Y, 140 Y B310 (=)	78→ 81		MR834				G21041 R1041				
262012	Sunny B11 (=)	83→ 91		R11039	MC212 PK024							



















CAMPO/BRAVA

204004	TFR Series (=) (4 x 2)	92 → 96		V1087				V1088		
204005	TFS Series (=) (4 x 4)	92 → 96		V1053				V1088		



CHEVETTE

271005	Chevette	76 → 84		G22609 R2609 ¹						
--------	-----------------	---------	--	-------------------------------------	--	---	--	--	--	---



COMBO

058003	Kadett E Combo	85 → 93		MG253 MR253	MK037 PK004			R2661		
270004	Corsa B Combo Van & Tour	94 → 01	E4364	G16203	MC212 MK017 PK004			R2661		
270009	Corsa C Combo Van, Tour (-) 	10.01 → 12	E4723 (E4723R E4724L)					23964		
270010	Corsa C Combo (+) 	10.01 → 12		G16329 	MK343 MK149 179 PK173			23964		
				G16330 						







179

MK001, MK202, MK342, MK343, MK344, MK345, MK346, MK347 = 
 MK149, MK208, MK263R, MK264L, MK271, MK321, MK322, MK376 = 
 MK067, MK068, MK077, MK156, MK194, MK326, MK332, MK334R, MK335L, MK337, MK372 = 





















KADETT E

058003	Combo	85 → 93		MG253 MR253	MK037 PK004			R2661		
--------	--------------	---------	--	------------------------------	------------------------------	---	--	--------------	--	---

MIDI

058005	Midi  (=) (4 x 2)	85 →		V1038				V1012		
206002	Midi  (=) (4 x 4)	85 →						V1012		

MOVANO

272504	Movano  (=)  	99 → 4.10		V2079				V2514		
272503	Movano  (=)  	99 → 4.10		V2079				V2513		
272502	Movano  (=)  	99 → 4.10		V2079				V2512		
272501	Movano  (+)  	99 → 4.10		V2079						

MC... = 

MK... = 

PK... = 



RASCAL

411001	Rascal		V4001 				V1077			
			V4002 							
411004	Super Carry, TMDBM3		V4001 				V1096 ¹			
			V4002 							

VIVARO

265504	2.0, 1.9 Di, 1.9 DCi, 1.9 DTi, 1.9 DTi, 2.5 DTi 2.00→ X 83		V4504	MK181 PK116			V1167			
--------	---	--	-------	----------------	--	--	-------	--	--	--

PEGASO COMMERCIALS

75 SERIES (J4)

550004	75.28, 75.32, 75.35, 75.40, 75.46, 75.50		V1026							
--------	---	--	-------	--	--	--	--	--	--	--

100 SERIES (J4)

550004	100.28, 100.32, 100.35, 100.40, 100.46, 100.50		V1026							
--------	---	--	-------	--	--	--	--	--	--	--

PEUGEOT

205 ENTREPRISE

382001	1.1, 1.4	83→ 90	11505	MK011 PK006			42041			
382008	1.8 D	83→ 90	11505	MK011 PK006			42053			

205 FOURGONNETTE

382009	1.8 D → ch.no. 25434222	3.94→	11522				42058			
383007	1.8 D ch.no. 25434223 →	3.94→					42058			

305 FOURGONNETTE

384005	305 → ch.no. 8987000	78→ 6.82	MR839				R6528		152	
384006	305 ch.no. 8987001 →	7.82→ 89	11504	MK011 PK006			R6528		152	

306

383014	306	2.97→ 02	E7062 (E7062R E7063L)	R8001 R8002 	MK097/098 139 PK006		42041			
--------	-----	----------	-----------------------------	------------------------	---------------------------	--	-------	--	--	--





139

MK098:		MK097:	
TU, XU, XUD	->2.97	TU, XU, XUD	->2.97
HD,		HD,	
ex Sport, Cabrio		Sport, Cabrio	->2.97
		ALL ex TU	2.97->
TU	2.97->	TU	2.97->
		Entreprise, Cabrio	2.97->

306

383008	Entreprise	94 → 02		R8001	MK097/098 139		42058			OIO
				R8002						

404 FAMILIAL, COMMERCIAL

386006		67 → 76		MR904						OIO
386007	U 8, U 10	66 → 76		MR904			R5433			OIO

504 FAMILIAL, COMMERCIAL

388007	L, LD, GL, GLD → ch.no. 2181356	72 → 76		MR916			R6616			OIO
388008	GL, GLD L, LD, GR, GRD ch.no. 2181357 → 2972015	76 → 80 76 → 85		MR205			R6616			OIO
388009	 ch.no. 3972016 →	85 →		MR999	PK024		R6616			OIO

504

388010	504 → ch.no. 3610000	79 → 82					R5433			OIO
388011	504 ch.no. 3610001 → 3972015	82 → 5.85		MR208			R5433			OIO
				MR261						
388012	504 ch.no. 3972016 →	5.85 →		MR261			R5433			OIO

BIPPER

122011	1,4, 1.4 HDi	12.07 →		G8107	MC212 MK313R MK314L PK140		G1090		PK335	OIO
				G8108						

BOXER 94 → 06

125006	Boxer (=) (4 x 2) (=) (4 x 4) (=) 1000 kg	94 → 06		V4501	MK047 PK074 MK147R MK148L MK308R !44		V2506			OIO
--------	---	---------	--	-------	---	--	-------	--	--	-----



125007	Boxer (=) (4 x 2) (=) (4 x 4) (=) 1400 kg	94→ 06	V4501	MK047 PK074 MK147R MK148L MK308R I44		V2507			
125009	Boxer (=) (4 x 2) (=) (4 x 4) (=) 1800 kg	94→ 06	V4410			V2509			
125008	Boxer (=) (4 x 2) (=) (4 x 4)	94→ 06	V4501	MK047 PK074 MK147R MK148L MK308R I44		V2508			

!44

->12.01 :

MK047 =

MK147R = +

1.02-> :

MK308R
MK309L

! MK147R = MK148L = : -> Ch. No. #15616153
MK147R = MK148L = : Ch. No. # 15616154 ->

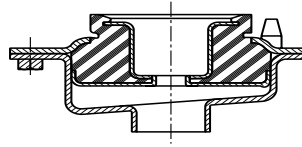

BOXER **4.06→**

125013	12 Q, 14 Q, 16 Q, 20 Q	4.06→	V4512	I69 MK308R MK309L PK285		V2130		I69	
			V4513	I69 MK308R MK309L PK285		V2131		I69	
						V2132		I69	

!69

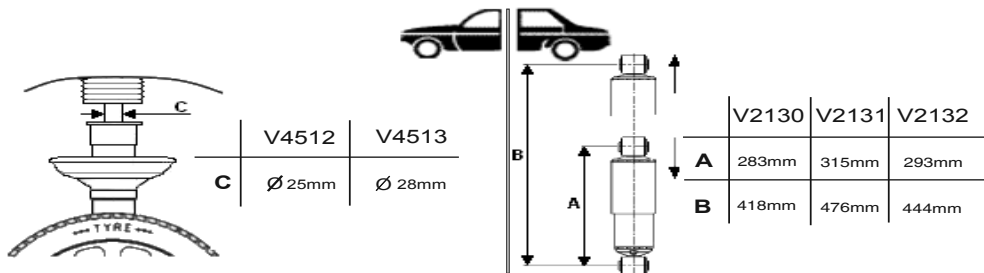

EXPERT

125010	1580, 2000 16 V, 1867 D, 1905 D, 1905 TD, 2000 JTD (+) → vet.no. 7609	95→ 9.97	V4201	MC112 MK048 PK122		V5006			
125012	1580, 2000 16 V, 1867 D, 1905 D, 1905 TD, 2000 JTD (+) vet.no. 7609→ 9793	9.97→ 10.03	V4201	MC112 MK048 PK122		V2510			

376

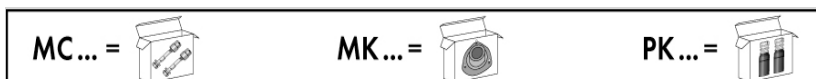



125005	2000, 2000 JTD (+) , (+) vef.no. 9793 →	10.03→ 06		V4202 	MC112		V2510				OIO
			V4203 								
125005	1867 D (+) , (+) vef.no. 9793→ 10408	10.03→ 5.04		V4202 	MC112		V2510				OIO
			V4203 								
125012	1867 D (+) vef.no. 10408 →	5.04→ 06		V4201 	MC112 MK048 PK122		V2510				OIO
125011	2.0 16 V, 1.6 HDi, 2.0 HDi Tepee, , 	07→		G8167 	MK269R MK270L		V2517				OIO
			G8168 								

J SERIES

125002	J 5 → ch.no. 0244300 (-)	81→ 85			Orig. no 520193 4439223		V2027		Orig. no 520629 520635		OIO
125003	J 5 ch.no. 0244301 → (-) (-) Fourgon 180	85→ 94		V4407	520313 7569730 PK074		V2027		520629 520635		OIO
160306	J 5 Fourgon 180 ch.no. 0244301 → (=) 1800 kg	85→ 94		∅			V2301		520663		OIO
125003	J 5 (-) 1800kg (180)	85→ 87		V4407	520313 7569730 PK074		V2027		520652		OIO
125004	J 5 (-) 1800 kg (180)	87→ 94		V4407	520313 7569730 PK074		V2037		520659		OIO
381101	J 7 Fourgon	66→ 80		V2041			V1030				⊥
381101	J 9 Fourgon → ch.no. 4161496	79→ 86		V2041			V1030				⊥
381102	J 9 Fourgon ch.no. 4161497 →	87→ 94		V2044			V1030				⊥

PARTNER, RANCH (5F), (5)

122015	1.1 TU1MF 1.4 TU3JP 1.8 D XUD7 1.9 D XUD9A 2.0 HDi DW10TD (+) (-) (4 x 2)	5.96→ 11.02		R8001 	MK001 MK097/098 !77 PK006		43104				OIO
			R8002 								
122025	1.6 TU5JP (+) (-) (4 x 2)	5.96→ 11.02		G8007 	MK001 MK097/098 !77 PK006		43104				OIO
			G8008 								



122025	1.1 TU1JP 1.4 TU3JP 1.6 TU5JP 1.6 TD DV6TED (+) (=) (4 x 2)	11.02 → 08	G8007 G8008 	MK001 MK097/098 177 PK006		43104	
122026	Electric Engine SA 18	11.02 → 08	R8001 R8002 				

!77

MK001 = MK098 =		MK001 = MK097 =	
TU, XU, XUD HD,	->2.97	TU, XU, XUD HD,	->2.97
TU	2.97->	ALL ex TU TU	2.97->

PARTNER Tepee

122027	1.6i, 1.6 HDi (-) (-) extra seat	4.08 →	G7323 G7324 	MK196 PK124		G1119	
122028	1.6i, 1.6 HDi (-) (+) extra seat	4.08 →	G7323 G7324 	MK196 PK124		G1118	

PARTNER

122029	1.6i, 1.6 HDi (=) 600 kg (-)	4.08 →	G7323 G7324 	MK196 PK124		G1117	
122028	1.6i, 1.6 HDi (=) 800 kg, 1000 kg (-)	4.08 →	G7323 G7324 	MK196 PK124		G1118	

305 FOURGONNETTE

384006	305 ch.no. 8987001 →	7.82 → 89	804177M M	MK011 PK006		330022M M		152	
--------	-------------------------	-----------	--------------	----------------	--	--------------	--	-----	--

PARTNER, RANCH (5F), (5)

122015	1.4 TU3JP (+) (=) (4 x 2)	5.96 → 11.02	804024M M 804023M M	MK001 MK097/098 177 PK006			
--------	---------------------------------	--------------	------------------------------	------------------------------------	--	--	--

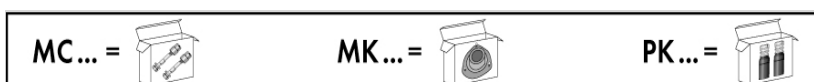



122025	1.9 D DW8B	11.02→ 08	G8007	MK001 MK097/098 177 PK006	OIO	43104				
	2.0 HDi DW10TD		G8008							
	(+) ND									
	(=) (4 x 2)									

PLYMOUTH TRUCK

ARROW Light Duty

	79→ 82	V1063				R1000				
--	--------	-------	--	--	--	-------	--	--	--	--

RENAULT

B SERIES

323501	B 70 B 90	1.83→ 9.95	V2313			V2314				OIO
--------	--------------	------------	-------	--	--	-------	--	--	--	-----

EXPRESS, EXTRA





322005	Utilitaire, Express, Extra, Rapid F 40 (-) CU+	85→ 10.96	11088	MC212 MK021 PK033		43058				OIO
322007	Utilitaire, Express, Extra, Rapid (=) CU+ (=) 775 kg	91→ 10.96	11088	MC212 MK021 PK033		G55014				OIO
322009	Utilitaire, Express, Extra, Rapid F 40 (-) CU+	10.96→ 8.98	11257	MC114 MK021 PK033		43058				OIO
322010	Utilitaire, Express, Extra, Rapid (=) CU+ (=) 775 kg	10.96→ 8.98	11257	MC114 MK021 PK033		G55014				OIO

KANGOO (KC0/1_)

329301	1.2, 1.2 16V, 1.4, 1.6 16 V, 1.5 dCi, 9.97→ 08 1.9 D 55, 1.9 D 65, 1.9 dCi, 1.9 dTi (=) (4 x 2) (=) 580 kg (-) CU+ (-) HD (-) Pampa (4 x 4)		11285	MC114 MK100 PK066		43107				OIO
329302	1.4, 1.6 16 V, 1.5 dCi, 1.9 D 55, 9.97→ 08 1.9 D 65, 1.9 dCi, 1.9 dTi (=) (4 x 2) (=) 750 kg (-) HD (-) Pampa (4 x 4)		11285	MC114 MK100 PK066		G55022				OIO
329303	1.2, 1.2 16V, 1.4, 1.6 16 V, 1.5 dCi, 9.97→ 08 1.9 D 55, 1.9 D 65, 1.9 dCi, 1.9 dTi (=) (4 x 2) (=) 750 kg (+) HD (-) Pampa (4 x 4)		11285	MC114 MK100 PK066						OIO



KANGOO (KW0/1_)

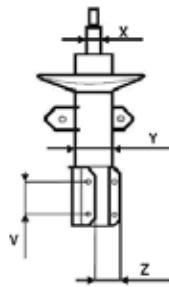

329304	1.6, 1.5 D (=)   2313mm	10.07→	R7612	I76 Z=27mm MK347 MK326 I79 PK315		G1105			
			G8173	I76 Z=35mm MK347 MK326 I79 PK315					
100000	Foot79								

I76





X	Y	Z	V	
20	47	27	57	R7612
22	52	35	72	G8173

LOGAN VAN

326003	1.2, 1.4, 1.6, 1.5D (+) 	07→ 12	G7369	MK300 PK286		G1137			
--------	--	--------	-------	----------------	---	-------	--	--	---

LOGAN Pick-up

326012	1.2, 1.4, 1.6, 1.5D (+) 	07→ 12	G7369	MK300 PK286		G1158			
--------	--	--------	-------	----------------	---	-------	--	--	---

MASCOTT

	TRUCK Section								
---	---------------	--	--	--	--	--	--	--	--

MASTER Q SERIES



327102	Master	→ 98	V5501	PK021					
--------	--------	------	-------	-------	---	--	--	--	---



MASTER R SERIES

327101	Master	5.80→ 2.89	V5501	PK021					
--------	--------	------------	-------	-------	---	--	--	--	---

327103	Master	2.89→ 97	V5502	PK021					
--------	--------	----------	-------	-------	---	--	--	--	---

MASTER R SERIES

327104	 	5.80→ 97				V5003			
	RL 7. RC 7.								

327105	 	5.80→ 97				V5005			
--------	---	----------	--	--	--	-------	--	--	---

327104	 	5.80→ 97				V5003			
	RH 9. RJ 9.								

380

MC... = 

MK... = 

PK... = 



MASTER

272504	Master (=)	10.97→ 10		V2079		OIO		V2514			OIO
272503	Master (=)	10.97→ 10		V2079		OIO		V2513			OIO
272502	Master (=)	10.97→ 10		V2079		OIO		V2512			OIO
272501	Master (=)	10.97→ 10		V2079		OIO					OIO

MASTER III

272505	 (=) incl. Motorhome	2.10→		V4517 ⁰				V2146			OIO
272506	 (=) (+/-) (+/-)	2.10→		V4517 ⁰				V2147			OIO

MAXITY

322011	110.28	3.07→		V1108				V1133			OIO
--------	--------	-------	--	-------	--	--	--	-------	--	--	-----

R 4 FOURGONNETTE ND, HD

320001	R 2102, R 2106	61→ 8.68						R2577			OIO
320002	R 2105, R 2106, R 2109 F 4	9.68→		23248 R3248				R2577			OIO
320003	R 2340, R 2370 F 6	75→		R3248				42006			OIO

R 4 EQUIPEMENT PISTES

320008	R 4 Equipement Pistes	61→						42006			OIO
--------	-----------------------	-----	--	--	--	--	--	-------	--	--	-----

TRAFIC P SERIES PROPULSION (4 × 2)

326105	P3.. → veh.no. 0003373	81→ 82		V4402 							OIO
	P5.. → veh.no. 000224			V4404 							
	P64. → veh.no. 000105			V4404 							
326106	P3.. veh.no. 0003374 →	82→ 2.89		V4402 				V2061			OIO
	P5.. veh.no. 0000225 →	82→ 85		V4404 							
	P64. veh.no. 0000106 →	82→ 2.89									
	P8..	82→ 86									
326107	P6C.	81→ 86						V2061			OIO
	PA..	81→ 86									
	PC..	84→									



TRAFIC T SERIES TRACTION (4 x 2)

326102	T1..	81 → 2.89		V4402			V2026		
	(-)								
	T1..	3.89 → 6.02							
	T2..	86 → 6.02							
	T3..	81 → 6.02							
326103	T4..	81 → 2.89		V4404			V2026		
	(-)								
	(-) T 42., (-) T 46.								
	T42.	81 → 12.82							
	→ veh.no. 0025720								
326101	T46.	1.83 → 2.89					V2030		
	veh.no. 0025721 →								
	T1..	81 → 2.89		V4402					
	T4..	81 → 2.89							
	T5..	81 → 2.89							
	T53.	3.89 → 6.02							
	T6..	83 → 86							
	T7..	86 → 6.02		V4404					
	T9..	83 → 89							
	TA..	81 → 86							
TB..	86 → 6.02								
TE..	3.89 → 6.02								

TRAFIC V SERIES (4 x 4)

326107	V2..	87 → 88					V2061		
	V3..	3.89 → 6.02							
	V4..	87 → 6.02							
	V5..	85 → 6.02							
	V9..	85 → 88							

TRAFIC

265504	1.9 DCi	6.02 →		V4504	MK181 PK116		V1167		
--------	---------	--------	--	-------	----------------	--	-------	--	--

TWINGO (C06_)

320011	1.1, 1.2	93 → 98	E4399	G16288	MC212 MK018 PK066		E1137	R3805	MK132 PK149	
	1.2	98 → 8.00	E4399	G16288	MC212 MK018 PK066		E1137	R3805	MK132 PK149	
	1.2 (+/-) HD	8.00 → 07	E4714	G16310	MC212 MK018 PK066		E1280	R3954	MK132 PK149	

VOLTIGEUR, GOELETTE

156002	R 2065, R 2086	59 → 65					R2030		
--------	----------------	---------	--	--	--	--	-------	--	--

MAXITY

322012	110.32, 110.35, 130.35, 150.35, 130.45, 150.45	3.07 →		V1108			V1183		
--------	--	--------	--	-------	--	--	-------	--	--

RENAULT V.I.

MESSENGER

326201	B 80, B 110, B 120	5.92 → 6.99		V2313	Orig. no 5000390683		V2314		Orig. no 5000393420	
--------	--------------------	-------------	--	-------	------------------------	--	-------	--	------------------------	--

MIDLINER M 140, M 150, M 160

326232	M 140, M 160 40D			V2307	Orig. no 5010391872		V2103		Orig. no 5010488160	
--------	---------------------	--	--	-------	------------------------	--	-------	--	------------------------	--

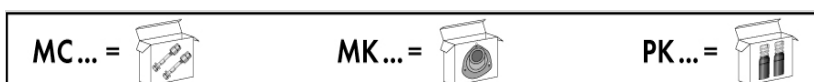



326204	<p>M 140 41C (-) 2 ch.no. VF640#20810</p> <p>M 140, M 160 40C (=) 1 ch.no. 20702</p> <p>M 140, M 160 40C (=) 2 ch.no. 20709</p> <p>M 150 41C (=) 1 ch.no. VF640#20505/20702</p> <p>M 150 41C (=) 2 ch.no. VF640#20101/20103/20709</p> <p>M 150 41C9 Tractor (=) 2 ch.no. VF640</p> <p>M 150 41D ch.no. 20101/03</p> <p>M 150 41Si CAM=12HV ch.no. VF640</p> <p>M 150 41Si CAM=12JV → 8.97</p> <p>M 160 40G (=) 1 ch.no. VF640</p>	V2307	5000453057	OT				
326226	<p>M 140, M 160 40C (+) ch.no. VF640</p> <p>M 140, M 160 40C (+) ch.no. VF640</p>				V2103	5010488160	OT	
326233	<p>M 150 41VC ch.no. VF640</p>	V2307	5010391872	OT	V2103	5010488160	OT	
326230	<p>M 150 41C CAM=13HV ch.no. VF640#20503/20802/20809</p>				V2103	5010488160	OT	
326226	<p>M 150 41C Rigid (=) 3 (2L32+1L40) ch.no. VF640#20101/20103/20505/20802/20809</p> <p>M 150 41C9 Tractor (=) 3 (2L28+1L36) ch.no. VF640#20505/20810</p>				V2103	5010488160	OT	
326230	<p>M 150 41D ch.no. VF640#20802/20809</p>				V2103	5010488160	OT	
326226	<p>M 150 41D (=) 2 ch.no. VF640#20810</p>				V2103	5010488160	OT	
326230	<p>M 150 41Si ch.no. VF640</p>				V2103	5010488160	OT	
326230	<p>M 160 40H</p>				V2103	5010488160	OT	
326224	<p>M 140, M 160 PA 160 </p>				V2310 ¹	5000542354	OT	
326226	<p>M 140, M 160 40C (+/-) Refuse Collector</p> <p>M 160 40G (=) 3 (+/-) Refuse Collector</p>				V2103	5010488160	OT	
326225	<p>M 140, M 160 PA 180 </p>				V2318 ¹	5000542355	OT	



326205	M 150 41A ch.no. VF640 M 150 41B (=) 2 ch.no. VF640#20702		V2308	5010348433					
326206	M 150 41B (=) 8 ch.no. VF640#20705		V2308 V2309 ¹	5010348433 5010348432					
326203	M 150 41C (=) 1 ch.no. VF640#20503/20702		V2306 ¹	5010294761					
326230	M 150 41C CAM=14HV ch.no. VF640#20503/20802/20809					V2103	5010488160		
326220	M 160 SE, SF 2		V2308	5010348433		V2311 ¹	5010391803		
326228	M 150 41A, 41B (=) 2, 4 ch.no. VF640#20802 M 160 SE, SF (=) 4					V2311 ¹	5010391803		
326208	M 160 SE (=) 6		V2315 ¹	5000542349					
326227	M 160 SE, SF (=) 10, 8+7					V2316 ¹	5000542352		

MIDLINER M 180, M 210, M 230 Ti

326204	M 230 Ti 40C (=) 1 ch.no. 20505/20702 M 180 41A/B (=) 2+2 ch.no. 20802 M 180 41C (=) 1 ch.no. VF640#20505/20702 M 180 41C (=) 2 HD ch.no. VF640#20101/20103/20709 M 180 41Si CAM=12HV ch.no. VF640 M 180, M 210, M 230 Ti 41C9 Tractor (=) 2 M 180, M 210, M 230 Ti 41D ch.no. 20101/03 M 180, M 210, M 230 Ti 41Si CAM=12JV → 8.97		V2307	Orig. no 5000453057 5010348430 5010391872					
326203	M 180 41Si CAM=15JV ch.no. VF640		V2306 ¹	5010294761					
326228	M 180, M 210, M 230 Ti 41A/B (=) (4 x 2) (=) 2, 4 ch.no. 20802					V2311 ¹	Orig. no 5010391803		
326205	M 180 41A (=) (4 x 2) ch.no. VF640 M 210, M 230 Ti 41A		V2308	5010348433					
326205	M 180 41B (=) 2 ch.no. VF640#20702		V2308	5010348433					

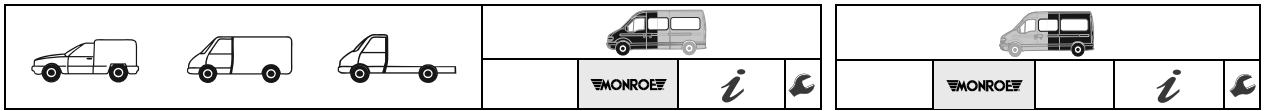

326206	M 180, M 210 41B (=) 8 ch.no. VF640#20705 M 230 Ti 41B (=) 8 ch.no. 20705			V2308 V2309 ¹	5010348433 5010348432				
326226	M 180, M 210, M 230 Ti 41C (=) 3 ch.no. 20101/03-20505-20802 M 180 41C5 Tractor (=) 3 (2L24+1L35) ch.no. VF640#20505/20802 M 230 Ti 41C9 Tractor (=) 3 ch.no. 20505, 20802						V2103	5010488160	
326230	M 180 41C CAM=14HV ch.no. VF640#20503/20802/20809						V2103	5010488160	
326230	M 180, M 210, M 230 Ti 41C CAM=13JV → 8.97 ch.no. 20503-20802-20809 M 180 41C CAM=13HV ch.no. VF640#20503/20802/20809						V2103	5010488160	
326226	M 180 41C9 Tractor (=) 3 (2L28+1L36) ch.no. VF640#20505/20810						V2103	5010488160	
326230	M 180 41D ch.no. VF640#20802/20809						V2103	5010488160	
326226	M 180 41D (=) 2 ch.no. VF640#20810						V2103	5010488160	
326230	M 180 41Si ch.no. VF640						V2103	5010488160	
326233	M 180 41VC ch.no. VF640			V2307	5010348430		V2103	5010488160	

MIDLINER **M 200, M 220, M 230, M 250**

326204	M 200 40C (=) 1 ch.no. 20505, 20702 M 200, M 220, M 230 40C (=) 2 ch.no. 20709 M 230 40D M 200 40G (=) 1 M 200 40G, 40H (=) 2 M 200 41D ch.no. VF640#20101/20103 M 250 41D ch.no. 20101/03 M 220, M 250 41Si CAM=12JV → 8.97			V2307	Orig. no 5010348430 5010391872				
326226	M 200 40C (+) ch.no. VF640						V2103	Orig. no 5010488160	
326230	M 200 40H						V2103	5010488160	
326232	M 200 40D			V2307	5010348430 5010391872		V2103	5010488160	

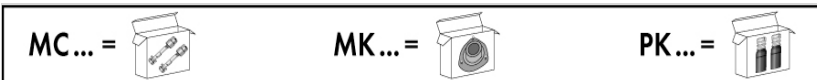



326226	M 200 40C (+/-) Refuse Collector M 200 40G (=) 3 Refuse Collector						V2103	5010488160	
326224	M 200, M 230 PA 160						V2310 ¹	5000542354	
326225	M 200, M 230 PA 180						V2318 ¹	5000542355	
326220	M 200 SE, SF 2		V2308	5010348433			V2311 ¹	5010391803	
326228	M 200 SE, SF (=) 4						V2311 ¹	5010391803	
326208	M 200 (=) 6		V2315 ¹	5000542349					
326206	M 200 SF (=) 8		V2308 V2309 ¹	5010348433 5010348432					
326227	M 200 SE, SF (=)						V2316 ¹	5000542352	

MIDLINER S 100, S 110

326221	S 100 SN		V2308 V2309 ¹	Orig. no 5010348432 5010348433			V2310 ¹	Orig. no 5000542354	
326220	S 100, S 110 2		V2308	5010348433			V2311 ¹	5010391803	
326208	S 100 SK S 110 (=) 6		V2315 ¹	5000542349					
326207	S 100, S 110 SK		V2312	5000437347					
326229	S 100 SK (=) 9 6 tonne						V2317 ¹	5000542350	
326227	S 100 SK 7T5 (=) 10 S 110 7T5 (=) 10 S 110 7T5 (=) 10 ch.no. VF6JK						V2316 ¹	5000542352	

MIDLINER S 130, S 150 Ti, S 170

326207	S 130 (=) 6		V2312	Orig. no 5000437347					
326227	S 130 7T5 (=) 10 ch.no. VF6JK S 130, S 150 Ti PS ch.no. VF6JN						V2316 ¹	Orig. no 5000542352	
326202	S 130, S 150 Ti, S 170 ch.no. VF6JP		V2305 ¹	5000546892					

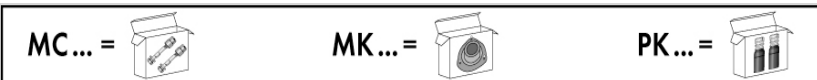



326224	S 130, S 150 Ti ch.no. VF6JN S 130, S 150 Ti, S 170 CAR PP ch.no. VF6JP 11 tonne, 13 tonne S 130, S 150 Ti PS10 (MA) PS150 (Venezuela) ch.no. VF6JN						V2310 ¹	5000542354	OT
326222	S 170 Tractor FAB=SH, CAM=LE → 11.84			V2305 ¹	5000546892	OT	V2310 ¹	5000542354	OT

MIDLINER S 120, S 135

326230	S 120 40H						V2103	Orig. no 5010488160	OT
326204	S 120 40G (=) 1 S 120 40G, 40H (=) 2 HD			V2307	Orig. no 5010348430 5010391872	OT			
326226	S 120 40G (=) 3 Refuse Collector						V2103	5010488160	OT
326229	S 135 40K (=) 9 ch.no. VF640AA#10005/20806 6 tonne						V2317 ¹	5000542350	OT
326227	S 120, S 135 40K 7T5 (=) 10 ch.no. 10006, 20806 S 135 40K 7T5 (=) 10 ch.no. VF640AA#10006/20806						V2316 ¹	5000542352	OT
326220	S 120 SE, SF 2			V2308	5010348433	OT	V2311 ¹	5010391803	OT
326228	S 120 SE, SF (=) 4						V2311 ¹	5010391803	OT
326208	S 120 SE (=) 6 S 135 40K CAM=HP → 8.93 (=) 6 ch.no. VF640AA#20706			V2315 ¹	5000542349	OT			
326206	S 120 SF (=) 8			V2308 V2309 ¹	5010348433 5010348432	OT			

MIDLINER S 140, S 150, S 160, S 180

326227	S 140, S 160 40K 7T5 (=) 10 S 140 SE, SF (=) 10, 8+7						V2316 ¹	Orig. no 5000542352	OT
326205	S 150 41A ch.no. VF640AC			V2308	Orig. no 5010348433	OT			
326228	S 150 41A/B (=) 2, 4 ch.no. 20802						V2311 ¹	5010391803	OT
326206	S 150 41B (=) 8 ch.no. VF640AC#20705			V2308 V2309 ¹	5010348433 5010348432	OT			



326203	S 150 41C (=) 1 ch.no. 20503, 20702		V2306 ¹	5010294761					
	S 150 40C (=) 1 ch.no. VF640#20505/20702								
	S 150 41C (=) 1 ch.no. 20505, 20702								
326204	S 150 41C (=) 2 ch.no. 20101/03, 20709		V2307	5010348430					
	S 150, S 180 41D ch.no. 20101/03								
	S 150, S 180 41Si CAM=12JV → 8.97								
326226	S 150 41C (=) 3					V2103		5010488160	
326230	S 150 41C CAM=13JV → 8.97 ch.no. VF640AC#20503 ch.no. VF640AC#20802/20809					V2103		5010488160	
	S 140 CAT 0096-B								
326230	S 150 41C CAM=15JV 9.97→ ch.no. VF640AC#20503/208					V2103		5010488160	

MIDLINER S 210, S 220, S 230 Ti, S 250

326204	S 210, S 220, S 230 Ti, S 250 41D ch.no. 20101/03		V2307	Orig. no. 5010391872					
	S 210, S 220, S 230 Ti, S 250 41Si CAM=12JV → 8.97								

SAVA

J 4

550004	J 4		V1026						
--------	------------	--	--------------	--	--	--	--	--	--

SAVIEM

SG SERIES

350002	SG 2, SG 3, SG 4 (+)		V2055 ¹						
--------	--------------------------------	--	--------------------	--	--	--	--	--	--

SEAT

TERRA, TRANS, INCA

161004	Terra Trans	87→ 3.89 85→ 12.96	R11038	MC210 MK029 PK012			R3292		
366001	Terra	4.89→ 12.96	R11121	MC210 MK027 PK012			R3292		
366004	Inca	96→	11250	MC212 MK067 I79 PK001 MK344 I79			R3462		

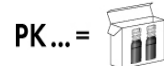
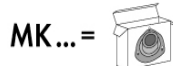
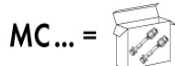



!79

MK001, MK202, MK342, MK343, MK344, MK345, MK346, MK347 =

MK149, MK208, MK263R, MK264L, MK271, MK321, MK322, MK376 =

MK067, MK068, MK077, MK156, MK194, MK326, MK332, MK334R, MK335L, MK337, MK372 =

SKODA

FABIA I, FABIA I PRAKTIK

361013	1.0, 1.2, 1.4, 1.4 16 V, 2.0, 1.4 TDi, 99→ 07 1.9 SDi, 1.9 TDi (+)	E4997	16451	MK345 MK156 !79 PK012		E1274	23950		MK118 PK095	
361015	1.0, 1.2, 1.4, 1.4 16 V, 2.0, 1.4 TDi, 99→ 07 1.9 SDi, 1.9 TDi (+)	E4998		MK345 MK156 !79 PK012		E1308			MK118 PK095	

FAVORIT

390504		8.91→ 7.95	E4288	G16130 MK069 PK056		E1119	23821			
				MG884 ¹ !10 MK069 PK056						

FELICIA

461029	1.3, 1.6, 1.9 D (+/-)	10.95→ 5.98	E4711	16296	MK069 PK071			R2702		
390514	1.3, 1.6, 1.9 D (+/-)	5.98→ 01	E4711	16296	MK069 PK071			23933		

SUZUKI

CARRY

411006	ST 90 V	80→ 82						V1077		
412001	ST 90 V	82→ 85						V1077		
411001	SK 408, SK 410	85→		V4001 				V1077		
411004	SK 408, SK 410 	85→		V4001 				V1096 ¹		
				V4002 						



TOYOTA

COASTER

436102	RU 19, BU 19	2.72 → 7.77		V1002		○ ○		V1012			○ ○
436103	RB 13 RB 10/11 BB 10	8.80 → 4.82 8.77 → 8.80 8.77 → 4.82		V1001		○ ○		V1012			○ ○

DYNA 100

432103	YH 81, LH 80	8.85 → 8.95		V1042		○ +		V1059			○ ○
--------	---------------------	-------------	--	--------------	--	-----	--	--------------	--	--	-----

DYNA 200, 250, 300, 350, 400

436101	RU 10/12/15 JU 10/12/15 BU 10/12/15	2.69 → 7.77 2.69 → 7.77 2.72 → 7.77		V1002		○ ○		V1001			○ ○
436102	RU 10 H, RU 15 H JU 10 H, JU 15 H BU 10 H, BU 15 H	2.69 → 7.77 2.69 → 7.77 2.72 → 7.77		V1002		○ ○		V1012			○ ○
436103	HU 15 H	2.72 → 7.77		V1001		○ ○		V1012			○ ○
436104	RU 20/30 JU 20 BU 20/30 HU 30 BU 35/36 HU 50	8.77 → 8.84 8.77 → 4.79 8.77 → 11.84 8.77 → 4.81 8.80 → 8.84 4.82 → 8.84		V1016		○ +		V1012			○ ○
436106	BU 85/75	8.87 → 5.95		V1080		○ +		V1081			○ ○

HI-ACE

430103	LH 10, RH 10 Series LH 20, LH 30, LH 40 Series RH 20, RH 30, RH 40 Series (-) RH 22/RH 24	10.67 → 1.77 2.77 → 11.82 2.77 → 11.82		V1041		○ +		V1005			○ ○
430105	RH 22	2.77 → 11.82		V1041		○ +					
432101	LH 50, LH 60, LH 70 Series YH 50, YH 60, YH 70 Series	12.82 → 1.84		V1037		○ +		V1002			○ ○
432102	LH 51, LH 61, LH 71 YH 50, YH 51, YH 60 YH 61, YH 71 (=) (4 x 2)	1.84 → 8.89		V1037		○ +		V1020 ¹			○ ○
432104	YH 56, YH 66 LH 56, LH 66 (=) (4 x 4)	8.86 → 8.89		V1100		○ +					○ ○
432105	LH 102, LH 112 RZH 102, RZH 103, RZH 112 RZH 113, RZH 115 (=) (4 x 2)	8.89 → 95		V1108		○ +		V1098			○ ○
432106	LH 108, LH 118 RZH 109, RZH 119 (=) (4 x 4)	8.89 → 95		V1100		○ +		V1099			○ ○
432107	LXH 12, LXH 22 RCH 12, RCH 13, RCH 22, RCH 23 (=) (4 x 2)	8.95 → 10.99		V1125		○ +		V1140			○ +

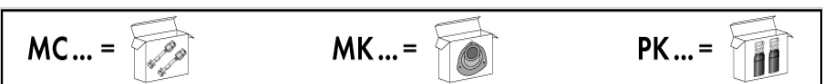



432108	LXH 18, LXH 28 RCH 18, RCH 19, RCH 28, RCH 29 (=) (4 x 4)	8.95 → 7.99	V1126				V1141				
432109	KLH 12, KLH 22 LXH 12, LXH 22 RCH 13, RCH 19, RCH 23 (=) (4 x 2)	10.99 →	V1125				V1171				
432110	KLH 18, KLH 28 LXH 18, LXH 28 RCH 18, RCH 28 (=) (4 x 4)	7.99 →	V1126				V1171				

HI-ACE/DYNA 100

















432103	YH 81, LH 80	8.85 → 8.95	V1042				V1059				
--------	--------------	-------------	-------	--	--	--	-------	--	--	--	--

HI-LUX









434101	RN 10/13/15/16 RN 20/22/25/27 (=) (4 x 2)	3.68 → 4.72 5.72 → 7.78	D2653								
434102	RN 30/31 LN 30 RN 40/41 LN 40 (=) (4 x 2)	8.78 → 3.84 9.79 → 3.84 8.78 → 3.84 9.79 → 3.84	D2653				R1000				
434103	LN 36/46 RN 36/46 (=) (4 x 4)	3.81 → 3.84 1.79 → 3.84	D8454				D8328				
434104	YN 50/51/52/55 YN 56/57/58 LN 50/51/55/56 RN 50/55 (=) (4 x 2)	8.83 → 7.98	D2653				D7606				
434105	YN 60/62/65/67 LN 60/65 (=) (4 x 4) (=) 	8.83 → 7.98	D8454				D4445				
434106	YN 85/90 LN 85/90 (=) (4 x 2)	8.88 → 2.97	D8468				D8004				
434107	YN 106 LN 105 (=) (4 x 4)	8.88 → 8.97	D5467				D8466				
434108	YN 110 LN 110, LN 108 RN 110/106 (=) (4 x 4)	8.88 → 8.97	D6432				D8467				
434111	LN 145, LN 150 (=) (4 x 2)	8.97 → 05	D8468				D8328				
434112	LN 165, LN 170 RZN 168, RZN 173 (=) (4 x 4)	8.97 → 05	D6432				D8488				
434116	KUN 15 (=) (4 x 2)	7.05 →	D9001 (D9001R D9002L)				D8064				
434117	KUN 25 (=) (4 x 4)	7.05 →	D8065				D8488				











LITE-ACE

430101	KM 10, KM 11 Series	5.71→ 9.79		V1063				V1001			
430102	KM 20, CM 20 Series (=) 	10.79→ 10.85		V1041				V1002			
430103	KM 20, CM 20 Series (=) 	10.79→ 10.85		V1041				V1005			
430108	KM 30, KM 31 (=) 	11.85→ 8.88		V1142 ¹							
430104	KM 36, CM 35 KM 36, CM 36 (=) 	11.85→ 8.88 8.88→ 1.92		V1142 ¹				V2504			
430106	CR 27, KR 27, YR 29 (=) 	1.92→		V1111				V1005			





LITE-ACE

430102	KM 20, CM 20 Series	10.79→ 10.85		V1041				V1002			
430108	KM 30, KM 31 KM 30, CM 30 (=) 	10.85→ 8.88 8.88→ 1.92		V1142 ¹							
430107	CR 21, KR 21, YR 22 (=) 	1.92→		V1111							

LITE-ACE



430101	KM 10, KM 11 Series	5.71→ 9.79		V1063				V1001			
430102	KM 20, CM 20 Series (=) 	10.79→ 10.85		V1041				V1002			
430103	KM 20, CM 20 Series (=) 	10.79→ 10.85		V1041				V1005			

STOUT









264504	RK 45/47/100/101	60→ 2.79						V1001			
430101	RK 40/40V/43	63→ 69		V1063				V1001			

VOLKSWAGEN

AMAROK

434114	2.0 TFSi, 2.0 TDi (=) (4 x 2) (=) (4 x 4) (+) 	9.10→	D0044					D9015			
--------	---	-------	--------------	--	--	---	--	--------------	--	--	---

CADDY I, II

461003	Pickup 	82→ 92		MR826	PK001			R2642			
366004	Caddy, Family 	96→ 04		11250	MC212 MK067			R3462			
461029	Pickup 	6.96→ 04	E4711	16296	MK067 PK001			R2702			

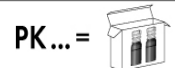



LT SERIES

461101	LT 28, LT 28 D, LT 31, LT 31 D, LT 35, LT 35 D → ch.no. 28 D 007273	75→11.82	V2024							
461102	LT 28, LT 28 D, LT 31, LT 31 D, LT 35, LT 35 D ch.no. 28 D 007274 →	12.82→12.96	V2024				V2050			
157003	LT 28, LT 32, LT 35	97→ 06	V4503	!67 MK277		V1116				
			V4507	!67 MK277						
461103	LT 45, LT 46	97→ 06	V4503	!67 MK277		V1166				
			V4507	!67 MK277						

!67

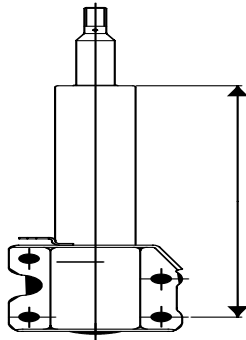

X=319,5 : V4503

OE		
901 320 02 30	901 320 18 30	903 320 02 30
901 320 03 30	901 320 20 30	903 320 03 30
901 320 08 30	901 320 21 30	903 320 05 30
901 320 13 30	901 320 22 30	2D0 413 029
901 320 14 30	901 320 29 30	2D0 413 029 B
901 320 15 30	903 320 01 30	

X=345,5 : V4507

OE		
904 320 07 30	904 320 16 30	904 320 25 30
904 320 08 30	904 320 18 30	904 320 26 30
904 320 13 30	904 320 19 30	2D0 413 029 A
904 320 14 30	904 320 23 30	

TARO (4 x 2)

434106	Taro, Taro CL Std. Cab. Taro CL, Taro GL Extra Cab. Taro, Taro CL Double Cab. 89→	D8468				D8004				
--------	---	-------	--	--	--	-------	--	--	--	--

TARO (4 x 4)

434107	Taro, Taro CL Std. Cab. Taro, Taro CL Double Cab. 89→ 3.97	D5467				D8466				
434108	Taro CL, Taro GL Extra Cab. 89→ 4.97	D6432				D8467				

TRANSPORTER, CARAVELLE

468007	T 4 (+/-) Syncro 90→ 93	V2065				V2077				
468009	T 4 (+/-) Syncro 94→ 03	V2065				V2077				

TRANSPORTER, MULTIVAN

468010	T 5 (+) (+/-) 4MOTION 03→	V4505	MK346 MK271 ¹ PK330 MK372 !79			V1169				
--------	------------------------------------	-------	--	--	--	-------	--	--	--	--

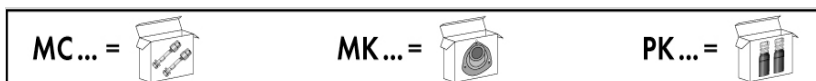



468012	T 5 (+) (+/-) 4MOTION	03→		V4506	MK346 MK271 ¹ MK372 !79			V1169				OIO
468011	T 5 (+) (+/-) 4MOTION	03→		V4505	MK346 MK271 ¹ MK372 !79			V1170				OIO

TRANSPORTER

468010	T 5 (+) (+/-) 4MOTION	03→		V4505	MK346 MK271 ¹ PK330 MK372 !79			V1169				OIO
468011	T 5 (+) (+/-) 4MOTION	03→		V4505	MK346 MK271 ¹ MK372 !79			V1170				OIO

!79

MK001, MK202, MK342, MK343, MK344, MK345, MK346, MK347 =





MK149, MK208, MK263R, MK264L, MK271, MK321, MK322, MK376 =

MK067, MK068, MK077, MK156, MK194, MK326, MK332, MK334R, MK335L, MK337, MK372 =



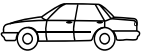

TYPE II, CARAVELLE TYPE II

468004	T 2	8.69→ 7.71		V1034								OIO
468005	T 2	8.71→ 79		V1034				V1018				OIO
468006	T 3 (-) Syncro	79→ 90		V2008				V2009				OIO
468008	T 3 Syncro (-)	85→ 90		V2401				V2505				OIO





NUMERICAL LISTING

Ref.			Ref.		
D0044	Volkswagen		G1137	Dacia	
D2113	Nissan	17.11.00.50	G1158	Dacia	17.11.09.10
D2653	Toyota	17.11.00.50		Renault	
D4445	Toyota	17.11.00.43	G1171	Fiat	-
D4462	Nissan	17.11.00.50	G16130	Skoda	17.13.00.21
D4463	Nissan	17.11.00.04	G16203	Opel, Vauxhall	17.11.03.95
D4486	Nissan	17.11.00.50	G16288	Renault	17.11.04.39
D5467	Toyota	17.11.00.50	G16310	Renault	17.11.04.39
	Volkswagen		G16329→	Opel, Vauxhall	17.11.06.81
D6432	Toyota	17.11.00.50	G16330→	Opel, Vauxhall	17.13.00.21
	Volkswagen		G16610→	LDV Commercials	17.11.04.91
D7017	Nissan	-		Nissan	
D7561	Nissan	17.11.00.09	G16611→	LDV Commercials	17.11.04.91
D7606	Toyota	17.11.00.04		Nissan	
D7648	Nissan	17.11.01.01	G16612→	Nissan	17.13.00.21
D8004	Nissan	17.11.00.04	G16613→	Nissan	17.13.00.21
	Toyota		G21041	Nissan	17.11.00.04
	Volkswagen		G22609	Opel, Vauxhall	17.11.00.05
D8064	Toyota	17.11.00.43	G55014	Renault	-
D8065	Toyota	17.11.08.20	G55022	Nissan	-
D8070	Nissan	17.11.08.23		Renault	
D8328	Toyota	17.11.00.04	G7323→	Citroën	17.13.00.47
D8454	Toyota	17.11.00.49		Peugeot	
D8466	Toyota	17.11.00.43	G7324→	Citroën	17.13.00.47
	Volkswagen			Peugeot	
D8467	Toyota	17.11.00.43	G7369	Dacia	
	Volkswagen			Renault	
D8468	Toyota	17.11.00.50	G8005	Volkswagen	17.11.07.53
	Volkswagen		G8006	Volkswagen	17.11.07.53
D8487	Nissan	17.11.00.04	G8007→	Citroën	17.11.04.36
D8488	Toyota	17.11.00.43		Peugeot	
D9001	Toyota	17.11.08.20	G8008→	Citroën	17.11.04.36
(D9001R→)				Peugeot	
D9002LI→)			G8107→	Fiat	17.11.07.35
D9008	Isuzu	-		Peugeot	
D9009	Isuzu	-	G8108→	Fiat	17.11.07.35
D9010	Isuzu	-		Peugeot	
D9011	Isuzu	-	G8167→	Citroën	
D9015	Volkswagen			Fiat	
E1010 ¹	Ford	-		Peugeot	
E1031	Nissan	17.11.00.04	G8173	Renault	17.11.09.14
E1119	Skoda	17.11.02.64	G8208→	Fiat	17.11.08.22
E1137	Renault	17.11.03.98	G8209→	Fiat	17.11.08.22
E1274	Skoda	17.11.04.97	G8403	Mercedes Benz	
E1280	Renault	17.11.03.98	LA368	Fiat	-
E1308	Skoda	17.11.04.97	MA809	Chevrolet Truck	-
E4226	Ford	17.11.04.12	MA824	Chevrolet	-
E4288	Skoda	17.13.00.21	MG253	Opel, Vauxhall	17.09.00.88
E4323	Ford	17.11.04.62	MG884 ¹	Skoda	17.09.01.73
E4328	Ford	17.11.04.65	MR205	Peugeot	17.09.01.67
E4364	Opel, Vauxhall	17.11.03.95	MR208	Peugeot	17.09.00.34
E4399	Renault	17.11.04.39	MR253	Opel, Vauxhall	17.09.00.88
E4452	Nissan	17.13.00.21	MR261	Peugeot	17.09.01.68
(E4452R→)			MR826	Volkswagen	17.11.05.14
E4453LI→)			MR834	Nissan	17.09.00.24
E4711	Skoda	17.13.00.21	MR839	Peugeot	17.09.01.63
	Volkswagen		MR904	Peugeot	17.09.01.65
E4714	Renault	17.11.04.39	MR916	Peugeot	17.09.00.34
E4723	Opel, Vauxhall	17.11.06.81	MR999	Peugeot	17.09.00.34
(E4723R→)			R1000	Bedford	17.11.00.04
E4724LI→)				Chevrolet Truck	
E4997	Skoda	17.13.00.24		Dodge Truck	
E4998	Skoda	17.13.00.24		GMC Truck	
E7062	Citroën	17.11.04.36		Mitsubishi	
	Peugeot			Plymouth Truck	
(E7062R→)				Toyota	
E7063LI→)			R1004	Nissan	17.11.00.04
G1090	Fiat	-	R1041	Nissan	-
	Peugeot		R11001	Fiat	17.11.03.85
G1105	Renault	-	R11006	Ford	17.13.00.21
G1117	Citroën	-	R11007	Ford	-
	Peugeot		R11025	Fiat	17.13.00.20
G1118	Citroën	-	R11038	Seat	-
	Peugeot		R11039	Nissan	17.11.04.90
G1119	Peugeot	-	R11061 ¹	Ford	17.11.04.15





NUMERICAL LISTING

Ref.			Ref.		
R11121	Seat	17.11.04.93	V1047 ¹	Mercedes Benz	-
R2030	Renault	17.11.00.78	V1051	Mercedes Benz Commer-	-
R2577	Renault	17.11.00.10		cial	
R2609 ¹	Opel, Vauxhall	17.11.00.05	V1052	Mercedes Benz Commer-	-
R2642	Ford	-		cial	
	Volkswagen		V1053	Isuzu	17.11.00.50
R2661	Opel, Vauxhall	-		Mazda	
R2689	Ford	-		Opel, Vauxhall	
R2702	Skoda	17.11.05.06	V1055	Iveco Commercials	-
	Volkswagen		V1056	Alfa Romeo	-
R3248	Renault	17.11.00.25		Iveco Commercials	
R3292	Seat	17.11.00.04	V1057	Nissan	17.11.00.03
R3462	Seat	-	V1058 ¹	Nissan	17.11.00.04
	Volkswagen		V1059	Toyota	-
R3464	Mitsubishi	17.11.00.24	V1060	Nissan	-
R3756	Ford	-	V1061	Nissan	17.11.02.50
R3805	Renault	17.11.03.98	V1062	Nissan	17.11.02.60
R3954	Renault	17.11.03.98	V1063	Chevrolet Truck	17.11.00.24
R5433	Peugeot	-		Dodge Truck	
R6528	Citroën	17.11.05.01		Ford Truck US	
	Peugeot			Mazda	
R6616	Peugeot	-		Plymouth Truck	
R7612	Renault	17.11.09.14	V1065	Toyota	-
R8001 ¹	Citroën	17.11.04.36		Citroën	-
	Peugeot			Fiat	
R8002 ¹	Citroën	17.11.04.36	V1066	Mercedes Benz Commer-	-
	Peugeot			cial	
V1001	Isuzu	17.11.00.04	V1070	Ford	17.05.01.54
	Mitsubishi				17.11.00.51
	Nissan		V1071	Avia Commercials	17.11.01.17
	Toyota			Ebro	
V1002	LDV Commercials	17.11.00.04		Nissan	
	Mazda		V1073	Ford	17.11.00.40
	Mitsubishi		V1077	Bedford	-
	Nissan			Opel, Vauxhall	
	Toyota			Suzuki	
V1005	Bedford	-	V1079	Alfa Romeo	-
	Mazda			Iveco Commercials	
	Toyota		V1080	Toyota	17.11.02.81
V1012	Bedford	17.11.00.04	V1081	Toyota	17.11.00.04
	Ford		V1084	Mitsubishi	17.11.00.50
	Isuzu		V1085	Mitsubishi	-
	Mitsubishi		V1086	Nissan	17.11.00.10
	Opel, Vauxhall		V1087	Isuzu	17.11.00.10
	Toyota			Opel, Vauxhall	
V1016	Isuzu	17.11.00.09	V1088	Isuzu	-
	Toyota			Opel, Vauxhall	
V1018	Volkswagen	-	V1089	Mercedes Benz Commer-	-
V1020 ¹	Toyota	17.05.01.54		cial	
		17.11.00.51	V1095	Mercedes Benz Commer-	-
V1021	Mazda	17.11.00.50		cial	
V1026	Pegaso Commercials	17.11.00.04	V1096 ¹	Bedford	-
	SAVA			Opel, Vauxhall	
V1027 ¹	Avia Commercials	17.11.01.17		Suzuki	
	Ebro		V1098	Toyota	17.11.02.99
	Nissan		V1099	Toyota	17.11.02.99
V1028	Avia Commercials	-	V1100	Toyota	17.11.01.01
	Ebro		V1102	Iveco Commercials	-
	Nissan		V1103	Iveco Commercials	-
V1029	Bedford	17.11.00.09	V1108	Nissan	17.11.01.01
	Mitsubishi			Renault	
	Nissan			Toyota	
V1030	Peugeot	17.11.00.10	V1109	Mitsubishi	17.11.00.10
V1034	Volkswagen	17.11.00.53	V1111	Toyota	17.11.02.26
V1035	Mazda	17.11.00.04	V1112	Mercedes Benz Commer-	-
V1036	Mercedes Benz Commer-			cial	
	cial		V1113	Mercedes Benz Commer-	-
V1037	Toyota	17.11.01.01		cial	
V1038	Bedford	17.11.00.10	V1114	Hyundai	17.11.00.50
	Isuzu		V1115	Hyundai	17.11.00.04
	Mitsubishi		V1116	Mercedes Benz	-
	Opel, Vauxhall			Volkswagen	
V1041	Mitsubishi	17.11.02.26	V1117	Mazda	17.11.00.04
	Toyota		V1118	Mazda	-
V1042	Mitsubishi	17.11.00.50	V1119	Mazda	17.11.01.01
	Nissan		V1120	Mazda	17.11.00.04
	Toyota		V1122	Mazda	17.11.00.04
V1044	Avia Commercials	17.11.01.17	V1123	Mazda	17.11.00.50
	Ebro		V1124	Mazda	17.11.00.10
	Nissan		V1125	Toyota	17.11.05.34
V1045	Avia Commercials	-	V1126	Toyota	17.11.05.34
	Ebro				
	Nissan				

NUMERICAL LISTING

Ref.			Ref.		
V1127	Avia Commercials	-	V2027	Citroën	-
	Ebro	-		Fiat	-
	Nissan	-		Peugeot	-
V1128	Nissan	-	V2030	Renault	17.11.00.16
V1130	Nissan	-	V2036 ¹	Freight Rover Commercials	-
V1131	Nissan	-	V2037	Citroën	-
V1132	Nissan	-		Fiat	-
V1133	Nissan	-		Peugeot	-
	Renault	-	V2038	Mercedes Benz Commercials	-
V1135	Nissan	-	V2041	Peugeot	17.11.01.37
V1136	Nissan	-	V2042	Mercedes Benz Commercials	-
V1138 ¹	Nissan	-	V2044	Peugeot	17.11.02.62
V1140	Toyota	17.11.05.37	V2047	Bedford	17.11.00.04
V1141	Toyota	17.11.05.37	V2048	Bedford	17.11.00.04
V1142 ¹	Toyota	17.11.02.26		Opel, Vauxhall	-
V1143	Hyundai	17.11.00.10	V2049	Bedford	17.11.00.52
V1144	Hyundai	17.11.00.10		Opel, Vauxhall	-
V1145	Ford	-	V2050	Volkswagen	-
V1146	Ford	-	V2055 ¹	Saviem	-
V1147	Ford	-	V2058	Mercedes Benz Commercials	-
V1148	Mitsubishi	-	V2060	Mercedes Benz Commercials	17.11.01.44
V1149	Hyundai	-	V2061	Renault	-
V1150	Isuzu	17.11.00.43	V2062	Nissan	17.11.00.04
<u>V1160</u>	Isuzu	17.11.06.35	V2065	Volkswagen	17.11.02.84
<u>V1161</u>	Isuzu	17.11.06.35	V2068	Daf Commercials	-
V1166	Mercedes Benz	-	V2071	Daf Commercials	-
	Volkswagen	-	V2073	Ford	-
V1167	Nissan	-	V2074	Ford	-
	Opel, Vauxhall	-	V2075	Ford	-
	Renault	-	V2076	Ford	-
V1168	Ford	-	V2077	Volkswagen	17.11.02.86
V1169	Volkswagen	-	V2078	Isuzu	17.11.06.38
V1170	Volkswagen	-	V2079	Nissan	-
V1171	Toyota	17.11.05.37		Opel, Vauxhall	-
V1172	Iveco Commercials	-		Renault	-
V1177	Mercedes Benz	-	V2103	Renault V.I.	17.11.07.65
	Volkswagen	-	V2110	Iveco Commercials	-
V1178	Mercedes Benz	-	V2111	Iveco Commercials	-
	Volkswagen	-	V2130	Citroën	-
V1179	Ford	-		Fiat	-
V1180	Ford	-		Peugeot	-
V1181	Ford	-	V2131	Citroën	-
V1182	Nissan	-		Fiat	-
V1183	Nissan	-		Peugeot	-
	Renault	-	V2132	Citroën	-
<u>V1188</u>	Mercedes Benz	-		Fiat	-
<u>V1189</u>	Mercedes Benz	-		Peugeot	-
<u>V1190</u>	Mercedes Benz	-	V2135	Iveco Commercials	-
<u>V1191</u>	Iveco Commercials	-	V2136	Iveco Commercials	-
V1192 ⁰	Hyundai	-	V2143	LDV Commercials	-
<u>V1193</u>	Isuzu	17.11.09.84	<u>V2145</u>	Mercedes Benz	-
<u>V1194</u>	Isuzu	17.11.09.86	V2146	Renault	-
<u>V1195</u>	Iveco Commercials	-	V2147	Renault	-
<u>V1196</u>	Isuzu	17.11.09.86	<u>V2151</u>	Iveco Commercials	-
<u>V1197</u>	Iveco Commercials	-	<u>V2152</u>	Iveco Commercials	-
V1501	Mercedes Benz	-	V2301	Citroën	-
V1502	Iveco Commercials	-		Fiat	-
V2008	Volkswagen	17.11.01.26		Peugeot	-
V2009	Volkswagen	-	V2302	Mercedes Benz Commercials	-
V2014 ¹	Mercedes Benz Commercials	-	V2303	Mercedes Benz Commercials	-
V2017	Hanomag Henschel Commercials	-	V2305 ¹	Renault V.I.	17.11.05.51
	Mercedes Benz Commercials	-	V2306 ¹	Renault V.I.	17.11.05.51
V2018	Ford	17.05.01.54 17.11.00.51	V2307	Renault V.I.	17.11.05.51
V2019	Ford	-	V2308	Renault V.I.	17.11.05.51
V2020	Ford	17.05.01.54 17.11.00.51	V2309 ¹	Renault V.I.	17.11.05.51
V2021	Mercedes Benz Commercials	-	V2310 ¹	Renault V.I.	17.11.05.51
V2023 ¹	Citroën	-	V2311 ¹	Renault V.I.	17.11.05.51
	Fiat	-	V2312	Renault V.I.	17.11.05.51
V2024	Volkswagen	17.11.01.32	V2313	Renault	17.11.05.56
V2026	Renault	17.11.00.16		Renault V.I.	-
			V2314	Renault	17.11.05.56
				Renault V.I.	-

NUMERICAL LISTING

Ref.			Ref.		
V2315 ¹	Renault V.I.	17.11.05.51	V4507	Mercedes Benz	17.11.06.60
V2316 ¹	Renault V.I.	17.11.05.51		Volkswagen	
V2317 ¹	Renault V.I.	17.11.05.51	V4508	Ford	17.11.04.61
V2318 ¹	Renault V.I.	17.11.05.51	V4509	Ford	17.11.04.61
V2401	Volkswagen	17.13.00.23	V4510	Mercedes Benz	17.11.06.60
V2501	Nissan	17.11.00.04		Volkswagen	
V2502	Mitsubishi	17.11.00.04	V4511	Mercedes Benz	17.11.06.60
V2503	Mazda	17.11.00.04		Volkswagen	
V2504	Toyota	17.11.00.04	V4512	Citroën	17.11.06.60
V2505	Volkswagen	-		Fiat	
V2506	Citroën	-	V4513	Peugeot	17.11.06.60
	Fiat			Peugeot	
V2507	Citroën	-	V4516 ⁰	Mercedes Benz	
	Fiat		V4517 ⁰	Renault	
	Peugeot		V5003	Renault	17.11.01.75
V2508	Citroën	-	V5005	Renault	17.11.01.75
	Fiat		V5006	Citroën	-
	Peugeot			Fiat	
V2509	Citroën	-		Peugeot	
	Fiat		V5007	Mercedes Benz	-
	Peugeot		V5501	Renault	17.11.02.95
V2510	Citroën	-	V5502	Renault	17.11.02.95
	Fiat		V6019 ¹	Ebro	-
	Peugeot			Nissan	
V2512	Nissan	-	V7007	LDV Commercials	
	Opel, Vauxhall		11088	Renault	17.11.03.83
	Renault		11108	Fiat	17.13.00.21
V2513	Nissan	-	11117	Ford	17.11.03.47
	Opel, Vauxhall				17.20.00.01
	Renault		11118	Ford	17.11.03.46
V2514	Nissan	-			17.20.00.01
	Opel, Vauxhall		11136	Ford	17.11.04.12
	Renault		11138	Ford	17.11.04.11
V2515	Iveco Commercials	-	11152	Fiat	17.13.00.21
V2516	Iveco Commercials	-	11154	Ford	17.13.00.21
V2517	Citroën	-	11196	Ford	17.11.03.47
	Fiat		11250	Seat	17.11.03.54
	Peugeot			Volkswagen	
V2518	Iveco Commercials	-	11257	Renault	17.11.03.83
V4001 ⁻¹	Bedford	17.13.00.24	11285	Nissan	17.11.05.27
	Opel, Vauxhall			Renault	
	Suzuki		11502	Citroën	17.11.03.88
V4002 ⁻¹	Bedford	17.13.00.24	11504	Peugeot	17.11.03.52
	Opel, Vauxhall		11505	Peugeot	17.11.03.52
	Suzuki		11522	Citroën	17.11.03.52
V4201	Citroën	17.13.00.24		Peugeot	
	Fiat		11530	Fiat	17.13.00.21
	Peugeot		11563	Fiat	17.13.00.21
V4202 ⁻¹	Citroën	17.11.07.18	11567	Fiat	17.13.00.21
	Fiat	17.13.00.24	1300018M	Mercedes Benz Commer-	-
	Peugeot			cials	
V4203 ⁻¹	Citroën	17.11.07.18	16221	Ford	17.11.04.62
	Fiat	17.13.00.24	16222 ¹	Ford	17.11.04.62
	Peugeot		16226	Ford	17.11.04.65
V4301	Mercedes Benz	17.11.04.86	16227	Ford	17.11.04.65
V4302	Ford	17.11.05.89	16296	Skoda	17.13.00.21
V4303	Ford	17.11.05.89		Volkswagen	
V4304 ⁰⁻¹	Hyundai		16451	Skoda	17.13.00.24
V4305 ⁰⁻¹	Hyundai		16470	Fiat	17.13.00.21
V4401	Ford	17.11.03.37	23248	Renault	17.11.00.25
V4402 ⁻¹	Renault	17.13.00.24	23443	Nissan	17.11.00.04
V4404 ⁻¹	Renault	17.13.00.24	23444	Nissan	17.05.01.54
V4407	Citroën	17.11.03.35	23821	Skoda	17.11.02.64
	Fiat		23933	Skoda	17.11.02.64
	Peugeot		23950	Skoda	17.11.04.97
V4408	Ford	17.13.00.43	23964	Opel, Vauxhall	-
V4409	Ford	17.13.00.43	23990	Volkswagen	-
V4410	Citroën	17.11.04.54	25490	Fiat	-
	Fiat		25506	Fiat	-
	Peugeot		32336MM	Isuzu	
V4501	Citroën	17.13.00.24	34741	Chevrolet Truck	-
	Fiat			GMC Truck	
	Peugeot		34763	Chevrolet Truck	-
V4502	Ford	17.11.00.40		GMC Truck	
V4503	Mercedes Benz	17.11.06.60	34839	Chevrolet Truck	-
	Volkswagen			GMC Truck	
V4504	Nissan	17.13.00.24			
	Opel, Vauxhall				
	Renault				
V4505	Volkswagen	17.13.00.24			
V4506	Volkswagen	17.13.00.24			

NUMERICAL LISTING

Ref.



34910	Chevrolet Truck GMC Truck	-
34944	Chevrolet Truck GMC Truck	-
37021	Chevrolet Truck	-
37058	Ford Truck US	-
37061	Ford Truck US	-
37065	Chrysler US Dodge	-
37071	Chevrolet Truck	-
37123ST	Chrysler US Dodge	-
37156	Chevrolet	-
37290ST	Dodge Lancia	-
37310ST	Citroën	-
42006	Renault	17.11.00.10
42041	Peugeot	-
42053	Peugeot	-
42058	Peugeot	-
43058	Renault	-
43078	Ford	-
43104	Citroën Peugeot	-
43107	Nissan Renault	-
58648ST	Dodge Lancia	-
71128ST	Dodge Lancia	-
71572	Dodge	-
71661	Chevrolet	-
71820	Chevrolet Truck	-
71964	Chrysler US Dodge	-
72437ST _→	Citroën	-
72438ST _→	Citroën	-
72591ST	Chrysler US Dodge	-
911086MM ¹	Chevrolet Truck GMC Truck	-
911123MM ¹	Chrysler US Dodge	-
911166MM	Chevrolet Truck	-
911178MM	Chevrolet Truck	-



DAF									
ISRI	Adjustable	ISRI 33734-55	1331727	SD0005	O O	184	139	16x19	16x19
	Air Spring		1331728	SD0009					

IRISBUS									
ISRI	Adjustable	ISRI 26960-01	42538424	SD0003	O O	213	153	16x19	16x19
	Air Spring		5001857902	SD0008					

IVECO									
ISRI	Adjustable	ISRI 35912-01	93161639	SD0001	O O	184	139	16x19	16x19
	Air Spring		425383268	SD0009					
	Adjustable	ISRI 26960-01	42538424	SD0003	O O	213	153	16x19	16x19
	Air Spring		5001857902	SD0008					

MAN									
ISRI	Adjustable	ISRI 26960-01	81 62385 6009	SD0001	O O	184	139	16x19	16x19
	Air Spring		81 62385 6003	SD0009					
	Adjustable	ISRI 27403-01	81 62385 6047	SD0003	O O	213	153	16x19	16x19
	Air Spring		81 62385 6048	SD0008					

MERCEDES-BENZ										
ISRI	Adjustable	ISRI 27403-01	000 919 8345	SD0001	O O	184	139	16x19	16x19	
			000 919 8545							
			000 919 8845							
			A000 919 8345							
			A000 919 8545							
			A000 919 8845							
	Air Spring	ISRI 38597-12	A000 800 0536	SD0009						
	Adjustable	ISRI 26960-03	A001 919 1245	SD0003	O O	213	153	16x19	16x19	
	Air Spring		A000 800 1236							
		ISRI 27403-01	A000 800 1236	SD0008						

RENAULT TRUCKS									
ISRI	Adjustable	ISRI 35611-12	5001836462	SD0001	O O	184	139	16x19	16x19
			5001836463						
	Air Spring		5001836461	SD0009					
	Adjustable	ISRI 35611-12	5001857903	SD0003	O O	213	153	16x19	16x19
Air Spring		5001857902	SD0008						

SCANIA ISRI SEAT



SCANIA								
ISRI	Adjustable	1391407	SD0001	Q	184	139	16x19	16x19
		1415638	SD0005	Q	184	139	16x19	16x19
	Air Spring	1377520	SD0009	Q				
		1440529						
		1448573						
	Adjustable	1498862	SD0003	Q	213	153	16x19	16x19
	ISRI 26960-01			Q				
	Air Spring	1498864	SD0008					
		1313003	SD0006¹¹	Q	198	146	12x24	12x24
		360109		Q				
ISRI 27396-03	1498861	SD0010⁰	Q	213	153	16x19	16x19	

VOLVO								
ISRI	Adjustable	1699212	SD0001	Q	184	139	16x19	16x19
	Air Spring	3090585	SD0009	Q				
	Adjustable	20443547	SD0003	Q	213	153	16x19	16x19
	ISRI 26960-03			Q				
	Air Spring	20443545	SD0008					
	ISRI 27403-01							
		3090587	SD0004	Q	184	139	16x19	16x19
		3091606		Q				
		3090144	SD0007	Q	198	146	12x24	12x24
		6212628		Q				
	1696541	SD0006¹¹	Q	198	146	12x24	12x24	
	3090570		Q					





ISRI	MONROE
0461-742-6688	SD0006 (*)
26960-01	SD0003
26960-03	SD0003
26960-05	SD0003
27396-01	SD0010
27396-03	SD0010
31141-02	SD0006 (*)
31141-03	SD0007 (*)
31141-04	SD0002
31141-05	SD0007 (*)
31141-06	SD0006 (*)
31141-12	SD0007 (*)
31141-12	SD0007
31141-22	SD0002
31141-33	SD0002
31141-42	SD0002
31141-44	SD0002
31141-44	SD0006
31141-49	SD0002
31141-54	SD0002
31141-56	SD0002
31141-69	SD0002
31141-76	SD0002
31141-76	SD0006
31141-78	SD0006 (*)
31141-87	SD0002
31141-99	SD0002
31166-01	SD0006 (*)
31166-74	SD0006 (*)
33144-01	SD0002
33144-33	SD0002
33144-33	SD0006
(*) Upon Request only (*) Nur auf Anfrage (*) Enkel op aanvraag (*) Uniquement sur demande (*) Solamente a petición (*) Soltanto su richiesta	

MONROE OE	MONROE
E10051	SD0006
E10052	SD0002
E10053	SD0002
E10054	SD0005
E10167	SD0005
E10168	SD0004
E10169	SD0004
E10170	SD0004
E10171	SD0006
E10172	SD0006
E10173	SD0002
E10174	SD0002
E10175	SD0002
E10176	SD0002
E10177	SD0002
E10178	SD0006
E10179	SD0002
E10180	SD0002
E10181	SD0006
E10182	SD0002
E10183	SD0007
E10184	SD0007
E11192	SD0010
E11193	SD0010
E19004	SD0003
E19005	SD0003
E19007	SD0001
E19008	SD0001
62308	SD0006 (*)
62320	SD0002
62325	SD0002
62329	SD0002
(*) Upon Request only (*) Nur auf Anfrage (*) Enkel op aanvraag (*) Uniquement sur demande (*) Solamente a petición (*) Soltanto su richiesta	

MONROE	MONROE OE	ISRI
SD0001	E19007	35912-01
SD0001	E19008	35912
SD0001	62465	34042
SD0001	62521	34042
SD0001	62569	35912
SD0001	62589	35912-01
SD0001	62616	35912-01
SD0001	62628	35912
SD0001	62642	35912-01
SD0001	67023	35912
SD0001	67040	35912
SD0002	E10052	33144-49
SD0002	E10053	33144-99
SD0002	E10173	33144-49
SD0002	E10174	31141-56
SD0002	E10175	33144-56
SD0002	E10176	31141-69
SD0002	E10177	31141-76
SD0002	E10179	31141-99
SD0002	E10180	33144-99
SD0002	E10182	31141-04
SD0002	62320	31141-99
SD0002	62325	31141-56
SD0002	62329	31141-87
SD0002	62346	31141-76
SD0002	62358	31141-42
SD0002	62363	31141-33
SD0002	62373	31141-42
SD0002	62423	33144-33
SD0002	62424	33144-54
SD0002	62428	31141-69
SD0002	62431	33144-36
(*) Upon Request only (*) Nur auf Anfrage (*) Enkel op aanvraag (*) Uniquement sur demande (*) Solamente a petición (*) Soltanto su richiesta		





*i*

MONROE OE	MONROE
62729	SD0010
62742	SD0003
62772	SD0002
62792	SD0010
62804	SD0006 (*)
67023	SD0001
(*) Upon Request only (*) Nur auf Anfrage (*) Enkel op aanvraag (*) Uniquement sur demande (*) Solamente a petición (*) Soltanto su richiesta	

MONROE	MONROE OE	ISRI
SD0010	E11192	27396-01
SD0010	E11193	27396-03
SD0010	62729	27396-01
SD0010	62792	27396-03
(*) Upon Request only (*) Nur auf Anfrage (*) Enkel op aanvraag (*) Uniquement sur demande (*) Solamente a petición (*) Soltanto su richiesta		



	ORIG. No. :	
--	-------------	--

ACERBI	
431489	F5084
431491	F5007
431806	F5085
448397	F5084
449071	F5084
449374	F1241
449751	F5343
M001537	F5084

ADR	
7075	F5004
99020001	F5344

ALEXANDER DENNIS	
652516	B1238
652815	B1238
653517	B1238
653518	B1238
654398	T5252
655730	B1238
655731	B1238
655871	B1238
656275	B1238
657351	B1238
657610	B5162
657611	B5163
657866	B1238
657867	B1238
657909	B1238
659315	B1239
659900	B1238
661284	B1371 ⁰
661285	B1373 ⁰
661286	B1371 ⁰

ASCA	
21224531	F5015

ASTRA V.I.	
115179	CB0073
121584	CB0073
99474620	T5252



AUSTERAS	
11048	F5015
9822	F5343
99391004	F5344
99391007	F5366

AUTODROMO	
81 43701 6713	B5291
81 43701 6714	B1278

BANCE	
8404174	F5020

BARTOLETTI	
91610259	F5007
91610264	F5007
91610266	F5007
91610267	F5007
91610269	F5007
91610272	F5007
91610274	F5007
91610275	F5007
91610279	F5007

BATTAGLINO	
126502016770	F5366
126507007758	F5007
126507007799	F5075

	ORIG. No. :	
--	-------------	---

2604800	F5007
2605100	F5344
2606800	F5366
2607000	F5075
2607300	F5007
2607400	F5343
2609000	F5004

BEDFORD	
91062025	T1028

BERTOJA	
423016002	F5075
42301600200	F5075
423016003	F5366
42301600300	F5366
445101010	F5075
445101013	F5075
446421001	F5007
44642100100	F5007

BOLGAN	
30000216	F5002
30001002	F5075
30001003	F5075



BOVA	
406694	B5290
410554	B5290

BPW	
02 3702 1000	F5126
02 3702 1400	F1113
02 3702 1600	F5004
02 3702 1700	F5001
02 3702 1800	F5002
02 3702 1900	F5004
02 3702 2000	F5007
02 3702 2200	F5007
02 3702 3600	F5073
02 3702 4800	F5008
02 3702 5100	F5008
02 3702 5200	F5004
02 3702 6000	F5010
02 3702 6700	F5002
02 3702 7000	F5011
02 3702 8300	F5185
02 3702 9200	F5012
02 3722 0400	F5224
02 3722 1400	F5073
02 3722 6200	F5188
02 3722 7900	F5384
02 3722 7902	F5384
02 3722 8300	F5073
02 3722 8300	F5004
02 3722 8302	F5004
02 3722 8800	F5012
02 3722 8802	F5012
02 3722 8900	F5190 ¹
02 3722 8900	F5011
02 3722 8902	F5190 ¹
02 3722 9000	F5004

CALABRESE	
128711209	F5007

CAR VENETA	
60030059	F5366

CARDI	
00500600	F5007

	ORIG. No. :	
--	-------------	--

00500900	F5075
00501000	F5007
00501300	F5004
00501310	F5004
500600	F5007
500900	F5075

CASE IH	
134641645	CB0174
134641650	CB0105
134641650	CB0105
47110917	CB0105
47110917	CB0105
82018497	CB0168
82021116	CB0168
82029623	CB0168
82031521	CB0168
82032841	CB0168
82033876	CB0168
84163866	CB0234
84605258	CB0234

CODER	
4050	F5205

CORDERO	
1303006	F5366
1303007	F5007

DAF	
086756	T5053
1141379	B5359
1141380	B5324
1196832	B5325
1205672	T5052
1253399	B5328
1253400	B5327
1260941	CB0187
1260942	CB0188 ⁰
1260942	CB0045 ¹
1265271	CB0187
1265272	CB0188 ⁰
1265272	CB0045 ¹
1265273	CB0031
1265274	CB0031
1265275	CB0048
1265276	CB0043
1265277	CB0048
1265281	CB0033
1265282	CB0034
1282623	T5045
1282624	T5255 ¹
1283723	T5052
1283724	T5053
1283725	T5053
1283726	T5052
1283729	T5070
1283732	T5046
1283735	T5181
1283852	T5053
1285393	CB0033
1285394	CB0034
1286348	T1193
1303516	CB0042
1307056	T5288
1319672	CB0235
1319672	CB0044 ¹
1319673	CB0237
1319673	CB0049 ¹



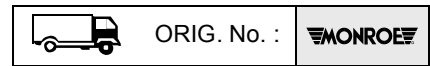
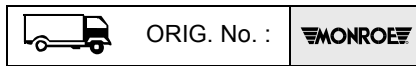
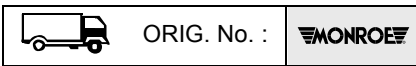

1321590	CB0033
1321591	CB0034
1327883	T5052
1328748	T5045
1331727	SD0005
1331728	<u>SD0009</u>
1332448	<u>T5413</u>
1336821	F5004
1336826	F5025
1337159	<u>CB0235</u>
1337159	CB0044 ¹
1353450	CB0033
1353451	CB0034
1353453	CB0033
1353454	CB0034
1369711	T5180
1371065	CB0033
1371066	CB0034
1377825	<u>CB0187</u>
1377826	CB0013
1377827	<u>CB0186</u>
1377828	<u>CB0188</u> ⁰
1377828	CB0045 ¹
1380606	CB0047
1382703	T5227
1382704	T5227
1387326	<u>CB0237</u>
1387326	CB0049 ¹
1387327	<u>CB0235</u>
1387327	CB0044 ¹
1398694	T5183
1407069	V2141
1407070	<u>V2142</u>
1407073	V2140
1407074	T1324
1407075	<u>T5364</u>
1407076	<u>T5365</u>
1407077	<u>T5365</u>
1407079	CB0124
1407080	CB0123
1407081	CB0125
1407082	CB0126
1407083	CB0132
1427903	T5227
1436055	CB0042
1436060	CB0047
1440457	T5357
1443695	T5180
1443696	T5182
1444147	CB0033
1449271	T5169
1450885	T5180
1451155	CB0013
1606742	T5180
1606743	T5182
1609020	CB0047
1610800	T5357
1618606	T5227
1618608	T5181
1622211	CB0033
1623464	<u>CB0235</u>
1623464	CB0044 ¹
1623465	<u>CB0237</u>
1623465	CB0049 ¹
1623477	CB0034
1649947	T5182
1696290	T5183
1696291	T5227

1696292	T5227
1706506	<u>T5365</u>
1707385	<u>T5365</u>
170835	T5106 ¹
1792419	CB0013
1792420	<u>CB0188</u> ⁰
1792420	CB0045 ¹
1792421	CB0034
1792422	<u>CB0237</u>
1792422	CB0049 ¹
1792423	CB0034
1817662	<u>CB0235</u>
1817663	<u>CB0237</u>
1818916	<u>CB0187</u>
1818918	<u>CB0186</u>
1818919	<u>CB0188</u> ⁰
1850676	<u>CB0224</u> ⁰
1850677	<u>CB0225</u> ⁰
1850682	<u>CB0221</u>
1850683	<u>CB0223</u>
1866162	<u>CB0233</u> ⁰
1868685	<u>CB0228</u> ⁰
1872954	<u>CB0232</u> ⁰
1896514	<u>CB0227</u> ⁰
1896599	<u>T5415</u>
1924212	<u>T5416</u>
1931023	<u>CB0221</u>
1931024	<u>CB0223</u>
1931026	<u>CB0223</u>
1936404	<u>CB0224</u> ⁰
1936405	<u>CB0225</u> ⁰
1936406	<u>CB0231</u> ⁰
1936407	<u>CB0228</u> ⁰
1936408	<u>CB0232</u> ⁰
1936409	<u>CB0226</u> ⁰
1936410	<u>CB0227</u> ⁰
1938640	<u>CB0231</u> ⁰
1938641	<u>CB0222</u>
1938642	<u>CB0232</u> ⁰
1938643	<u>CB0222</u>
1942781	T5183
1944417	T5183
1944418	T5227
1944419	T5227
1955773	<u>CB0229</u> ⁰
1955775	<u>CB0230</u> ⁰
222773	T5046
252620	T5045
256260	B1239
260035	CB0120
279245	T5053
284355	T5106 ¹
291614	T5117 ¹
296305	T5052
299862	CB0034
360585	T5045
375221	<u>CB0186</u>
375222	CB0048
375224	CB0033
377640	T5039 ¹
378220	T5053
379131	T5070
394957	T5108
41141379	B5359

41141380	B5324
41253400	B5327
617738	T5106 ¹
617739	T5143 ¹
652722	T1099
656395	CB0120
657274	T5106 ¹
740021	T5045
755262	T5045
762784	<u>CB0186</u>
86756	T5053
891165	T1090
92968	T5052
98923	T5143 ¹
ACHB966	T1056
ACHF113	T1056
ACHF115	T1056
AFRE002	V2141
AFRE003	<u>V2142</u>
AFRE006	V2140
AFRE007	T1324
AFRE008	<u>T5364</u>
AFRE010	<u>T5365</u>
AFRE011	CB0124
AFRE012	CB0123
AFRE013	CB0125
AFRE014	CB0126
AFRE015	CB0132
AFRU074	CB0132
AFRU075	CB0125
AFRU076	CB0126
AMPC151	T1055 ¹
AMPC156	T1057
AMPC156	T1056
AMPC157	T1058
AMPC158	T1056
AMPC159	T1056
KAK 9866	T1055 ¹
KAK9526	T1056
LAK7099	T1056
LAK7101	T1058
LAK7107	T1058
LAK9126	T1058
TAK9361	T1058
TAK9362	T1058
WAK3806	T1057

DEUTZ-FAHR	
04426628	CB0105
04426628	CB0105
04426629	CB0174

DRÖGMÖLLER	
320200190000100	B5347



ENASA	
1004876	B5259
1004877	B5260
81437016578	B5260

ERF	
81 43701 6631	T1209
81 43701 6633	T5080

ETA	
02 3722 1400	F5073



EVOBUS	
0043235900	B1259
0053268900	B1326



 ORIG. No. :	
--	--



0063237500	B1259
3573200431	B1326
3573230500	B1291
3573230600	B1291
3573260100	B1259
3573260300	B1326
3733200030	B1259
6273260100	B1288
6283260000	B1284
6283260200	B1284
6283260700	B1284
6283260800	B1283
6283261100	B1283
6283261200	B1283
6283261600	B1283
6283261800	B1283
6283262300	B1283
6283262400	B1283
6283262500	B1283
6283262600	B1283
6283262700	B1283
6293260000	B1287
6293260100	B1287
8231116000	B1289
8231116000E	B1289
82312420000	<u>B1328</u>
8231270000	B1289
8231270000D	B1289
8231323000	B1293
8231323000B	B1293
8231323000D	B1293
8231342000	<u>B1328</u>
8231346000	B1289
82313460000	B1289
82313460000D	B1289
8231347000	B1288
8231348000	B1293
82313480000	B1293
8231366000	B1292
82313660000	B1292
A0053231400	B1259
A0053268900	B1326
A3573200431	B1326
A3573230600	B1291
A3573260300	B1326
A6283260000	B1284
A6283260200	B1284
A6283260700	B1284

EVOBUS (Kässbohrer, Setra)	
228189	B5319
8.231.103.000	B5300
8.231.103.000 E	B5300
8.231.171.000	B5303
8.231.187.000	B5303
8.231.204.000	B5300
8.231.204.000 C	B5300
8.231.267.000	B5300
8.231.267.000 D	B5300
8.231.268.000	B5300
8.231.268.000 D	B5300
8.231.276.000	F5157
8.231.293.000	F5157
8.231.293.100	F5157
8.231.322.000	B5302
8.231.344.000	B5300
8.231.344.000.0	B5300
8.231.345.000	B5302
8.231.345.000.0	B5302

 ORIG. No. :	
--	---

8.231.351.000	B5303
8.231.355.000	B5300
8.231.365.000	B5305
8.231.365.000 C	B5305
8.231.372.000	B5305
8.231.372.0000	B5305
82.3122.0000 C	B5319
82.3122.0000	B5319
82.3126.9000	B5319
82.3126.9000 D	B5319
82.31367.0000	B5319
A005 326 8900	B1285 ¹

EVOBUS (Mercedes)	
000 463 5632	1300018M
000 463 5932	1300018M
000 463 6132	1300018M
000 463 6162	1300018M
000 463 6232	1300018M
000 463 6432	1300018M
000 463 6463	1300018M
0003200930	B5298
003 323 4200	V2059
003 323 5300	V2059
003 323 5900	V2021
003 323 6000	V2021
003 323 7300	V2059
004 323 8800	V1089
004 323 8900	V1089
005 326 2900	T1111
005 326 3500	B5347
005 326 3600	T1111
005 326 4600	T5250
005 326 8900	B1285 ¹
006 323 1700	T1072
006 323 2700	T1071
006 323 2800	T1127
006 323 3000	T1152
356 326 0000	B1305
356 320 0031	B1305
356 323 0200	B5335
356 323 0400	B5335
356 323 0500	B5335
356 326 0700	B1305
357 320 0431	B1285 ¹
357 326 0300	B1285 ¹
613 323 0000	B5335
628 323 0000	B5298
639 326 0300	V5007
639 326 1000	V5007
639 326 2100	V5007
639 326 2500	V5007
673 323 0000	T1071
673 323 0400	T1069
673 323 0600	T1071
673 323 0700	T1127
673 323 0900	T1127
673 326 1200	T1111
673 326 1400	T1111
674 323 0000	T1069
674 323 0000	T1067 ¹
674 323 0100	T1127
674 323 0200	T1069
674 323 0200	T1067 ¹
674 323 0300	T1127
674 326 1400	T1111
675 323 0400	T1069
675 323 0400	T1067 ¹

 ORIG. No. :	
--	--

675 323 0600	T1072
675 323 0700	T1152
675 323 0800	T1072
675 323 1000	T1072
675 326 0500	T5250
675 326 0700	T5250
823 110 3000	B5300
823 110 3000E	B5300
823 117 1000	B5303
823 118 7000	B5303
823 120 4000	B5300
823 120 4000C	B5300
823 126 7000	B5300
823 126 7000D	B5300
823 126 8000	B5300
823 126 8000D	B5300
823 127 6000	F5157
823 129 3000	F5157
823 129 3100	F5157
823 132 2000	B5302
823 134 4000	B5300
823 134 40000	B5300
823 134 5000	B5302
823 134 50000	B5302
823 135 1000	B5303
823 135 5000	B5300
823 136 5000	B5305
823 136 5000C	B5305
823 137 2000	B5305
823 137 20000	B5305
A005 326 3500	B5347
A005 326 3600	T1111
A005 326 4600	T5250
A356 323 0200	B5335
A356 323 0400	B5335
A356 323 0500	B5335
A356 326 0700	B1305
A382 323 0100	B5298
A628 323 0100	B5298
A628 323 0200	B5298
A628 323 0400	B5298

FIAT	
1004877	B5260

FLOOR	
22532	F5022
22632	F5022
4334	F5022
902417	F5022
917292	<u>F5423</u>

FODEN TRUCKS	
0500336000	CB0187

FRUEHAUF	
126502007352	F5085
1518588	F5085
1521533	F5085
1522341	F5089
152658	F5088
1526583	F5088
152685	F5084
1526855	F5084
152786	F5085
1527867	F5085
152787	F5089
1527870	F5089
23514	F5085
503700	F5085



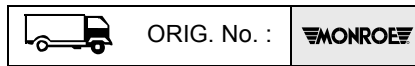
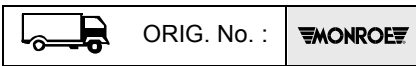

6506635A	F5020
6506636B	F1000
680117	F5085
8404174	F5020
87001	F5020
905180	F5085
921043	F5203
BJB0180001	F5085
CF153409	F5173
M001537	F5084
M001545	F5088
M0044020	F5166
M0044020H	F5166
M0078602	F5166
M007942	F5085
M007950	F5084
M007969	F5088
M076022	F5408
M076480	F5084
M077800	F1241
M077932	F5407
M078602	F5166
M200052	F5084
M200133	F5084
M200165	F5408
M20016501	F5408
M200166	F5407
M20016601	F5407
S09603030	F5085
S09605130	F5085
SR10368	F5201
UCE1295	F5085
UCE12951	F5085
UJA0878001	F5085
UJA895013	F5203
UJB0177	F5085
UJB0177001	F5085
UJB0179	F5085
UJB0315	F5021
UJB0316	F5085
UJB0364	F5084
UJB0365	F5088
UJB0562	F5085
UJB0563	F5084
UJB0564	F5088
UJB0565	F5084
UJB1147	F1241
UJB1179	F5166
UJC0020	F5085
UJC002001	F5085
UJC0027001	F5089
UJC0054	F5085
UJZ7093	F5085
W4012762	F5085

GIGANT	
0237221400	F5073
196100	F5083
196102	F5192
196103	F5083
196105	F5083
196107	F5004
196109	F5272
196111	F5083
196111	F5004
196112	F5004
196115	F5073
196116	F5002
196118	F5273

196119	F5011
196121	F5190 ¹
196125	F5273
196131	F5083
196133	F5192
451700112782	F5083
M076022	F5408
M077932	F5407
M200165	F5408
M20016501	F5408

GIGANT (SMB)	
23514	F5085
503700	F5085
680117	F5085
905180	F5085
BJB0180001	F5085
M001537	F5084
M001545	F5088
M0044020	F5166
M0044020H	F5166
M0078602	F5166
M007942	F5085
M007950	F5084
M007969	F5088
M077800	F1241
M078602	F5166
M20008401	F1274
M200166	F5407
M20016601	F5407
S09603030	F5085
UCE12951	F5085
UJA0878001	F5085
UJB0177	F5085
UJB0177001	F5085
UJB0179	F5085
UJB0315	F5021
UJB0316	F5085
UJB0364	F5084
UJB0365	F5088
UJB0562	F5085
UJB0565	F5084
UJB1147	F1241
UJC0020	F5085
UJC0027001	F5089
W4012762	F5085

GIRELLI	
01070460	F5344
0330560	F5366
03990560	F5366

GKN-FAD	
354F002	F5343
354F003	F5343
554FR001	F5004
554FR004	F1113

GRANNING	
12740	F5075

HANOMAG	
002 326 8900	T1009 ¹
314 326 0400	V2021



HENDRICKSON	
0237021700	F5001
508571	F5015
81108002	F5251
A20002	65416

A20126	65416
A20889	65416
A9463260000	F5251
AM752999	F1325
AM758571	F5015
B21832	65416
B24125	65416
HS251084	F5251
HS322166	V2098
HS503038	T1214
HS503788	T5169
HS504933	F5311
HS505091	F5198
HS505272	F1262 ¹
HS505396	T1214
HS506711	F5196
HS508386	V2134
HS508390	T1303
HS508808	V2133
NM2999	F1325
QD100001	F5251
Y508571	F5015

HEULIEZ	
23512158	F1068
5006172376	B5424
504124915	B5424
5801572582	B5424



IKARBUS	
108108366	B1328
108123357	B1328

IRISBUS	
1004877	B5260
228189	B5319
42538424	SD0003
42538426	SD0008
42538556	B5382
42538567	B5341
5000790965	B5422
5000790966	B1301
5001840060	B5382
5001840316	B5341
5001857902	SD0008
5006019186	B5383
5006172375	B5330
5006172376	B5424
5006172492	B1317
5006172528	B5330
5006228872	B5420
5006306262	B5323
5006306266	B5322
5006306267	B5323
5006306268	B5321
5010013183	B5422
5010013184	B5336
5010019952	B5334
5010019953	B1306
5010151020	B5422
5010151151	B5422
5010151203	B5422
5010151809	B5334
5010151811	B1306
5010151812	B5398
5010190151	B5422
5010347902	B5330
5010347903	B5424
5010347903	B5337 ¹



 ORIG. No. :	
--	--

5010347905	B5355
5010531249	B5353
503469463	<u>B5424</u>
503469877	<u>B5422</u>
504023846	B5323
504023847	B5321
504023848	B5323
504023849	B5322
504124915	<u>B5424</u>
5801102621	B5382
5801113772	B5341
5801572582	<u>B5424</u>
99432849	B5323
99432850	B5322
99432852	B5323
99432853	B5321
99469583	B5321
99469833	B5323
99469838	B5321
99469853	B5321
99469860	B5323
99469861	B5322
99485075	B5336

IVECO	
04859825	T1244
1004877	B5260
2997299	B5333
2997322	B5331
2997842	<u>CB0219</u>
41005917	CB0093
41005918	CB0093
41005984	CB0073
41006921	T1265
41015530	<u>CB0179</u>
41019150	<u>CB0179</u>
41028759	CB0095
41028760	CB0095
41028761	CB0095
41028762	CB0095
41028763	CB0099
41028764	CB0099
41032334	T1137
41033038	T1261
41033039	T5269
41033239	T5267
41033734	T5268
41033735	T1270
41210787	T5264
41213451	<u>T5426</u> ⁰
41214460	T1261
41214461	T5274
41214461	T5269
41214698	T5264
41214699	<u>T5426</u> ⁰
41214700	T5269
41214818	T1261
41218432	T5267
41218437	T1264
41218439	T1137
41218440	T1265
41218443	T1264
41218445	T1137
41218447	T1137
41225418	T5269
41226700	<u>T5435</u> ⁰
41272149	T1137
41272902	<u>T5435</u> ⁰



 ORIG. No. :	
--	---



41296210	<u>T5435</u> ⁰
41296211	T5269
41296212	T5267
41296216	T5269
41296756	T1265
41296758	T5267
42001826	CB0159
42001827	CB0159
42052982	T1130
42052987	T1131
42070286	CB0145
425383268	<u>SD0009</u>
42538424	SD0003
42538426	<u>SD0008</u>
42555627	CB0146
42555629	CB0073
42565752	<u>T5389</u> ⁰
4697041	T1130
4697212	T1133 ¹
4726933	V2088
4744675	T5199
4750776	V2088
4765759	T5199
4772444	T1133 ¹
4823455	B5333
4823458	B5331
4829308	V2088
4829310	V2088
4844580	V2105
4858811	V2109
4866756	B5333
5001857902	<u>SD0008</u>
500301936	T1245 ¹
500307338	CB0098
500307352	CB0093
500307353	CB0093
500307354	CB0093
500307355	CB0093
500310131	T5268
500332741	CB0095
500339897	B5318
500340705	CB0137
500340706	CB0136
500348789	CB0073
500348793	CB0099
500348797	CB0095
500352808	CB0098
500353511	CB0093
500353513	CB0093
500357351	CB0137
500357352	CB0136
500358167	<u>T1356</u>
500377859	CB0095
500377861	CB0095
500377878	CB0099
500379054	<u>T5389</u> ⁰
500379694	CB0093
500379696	CB0093
500379698	CB0098
500387621	CB0094
500392874	CB0154
500396370	B5315
5006172376	<u>B5424</u>
5006217618	<u>B5421</u>
5006228872	<u>B5420</u>
5006228873	<u>B5421</u>
5006306262	B5323
5006306263	<u>B5397</u>

 ORIG. No. :	
--	--

5006306264	B5315
5006306265	B5318
5006306266	B5322
5006306267	B5323
5006306268	B5321
504023845	<u>B5397</u>
504023846	B5323
504023847	B5321
504023848	B5323
504023849	B5322
504023850	B5318
504023851	B5315
504047432	CB0154
504049485	CB0073
504051670	CB0072
504052219	<u>V2137</u>
504055167	CB0152
504055168	CB0152
504057014	CB0151
504057016	CB0151
504060233	CB0149
504060241	CB0149
504063454	<u>V2137</u>
504068625	<u>CB0216</u>
504080348	CB0153
504080349	CB0154
504080440	CB0152
504080441	CB0151
504080540	<u>CB0219</u>
504083198	<u>T5427</u> ⁰
504084378	CB0153
504084379	CB0154
504084380	CB0152
504084381	CB0151
504085814	<u>T5428</u> ⁰
504105593	V2134
504115380	CB0153
504115381	CB0154
504115382	CB0152
504117334	<u>CB0238</u> ⁰
504117335	<u>CB0238</u> ⁰
504117411	T1303
504120116	<u>T1355</u>
504124915	<u>B5424</u>
504147621	<u>T1355</u>
504147773	<u>T5428</u> ⁰
504147774	<u>T5427</u> ⁰
504148140	V2105
504148143	<u>V2137</u>
504148145	T1244
504172337	<u>CB0238</u> ⁰
504187113	CB0138
504197039	<u>T1355</u>
504197041	T1243
504197042	<u>T5428</u> ⁰
504197043	<u>T5427</u> ⁰
504203651	V2133
504227725	CB0072
504228086	CB0073
504228332	CB0145
5801572582	<u>B5424</u>
8140869	CB0072
8141735	CB0146
8143658	CB0138
8169050	<u>CB0179</u>
8563333	V2088
8565060	V2088



	ORIG. No. :	
--	-------------	--

	ORIG. No. :	
--	-------------	--

	ORIG. No. :	
--	-------------	--

8566311	V2088
8566312	V2088
8568999	V2088
8569000	V2088
8585538	V2088
93161639	SD0001
93163957	T1307
98408700	V2104
98408701	V2108
98408702	V2107
98408706	T1244
98408707	T1244
98408709	T1244
98408733	CB0138
98408734	CB0072
98408735	CB0146
98411158	V2107
98411159	V2108
98411160	V2104
98411167	T1244
98411172	T1244
98414527	T1264
98414529	T1137
98414531	T1138
98414535	T1137
98415096	T1244
98415098	V2105
98415100	V2108
98419046	T1244
98426865	V2105
98426866	V2109
98430150	T1137
98430151	T5252
98432435	T1137
98436446	T1243
98438405	T1243
98445162	T1244
98445861	T1245 ¹
98447147	T1243
98447153	T1128
98447155	T1309
98461195	T1309
98464210	V2106
98472611	CB0073
98472734	CB0098
98473215	CB0093
98475501	T1264
98477778	CB0073
98480455	<u>T1354</u>
98480455	T1242 ¹
98482154	T1244
98482579	T1128
98482580	T1243
98482585	T1243
98485037	T1264
98485038	T1264
98485042	T1138
98487588	CB0093
98487589	CB0093
98487778	CB0073
98488107	T5274
98488520	T1309
98493596	<u>T1354</u>
98498740	T5267
98498741	T5267
99431373	CB0073
99431723	T1243
99432314	T5274
99432849	B5323

99432850	B5322
99432852	B5323
99432853	B5321
99432914	<u>B5421</u>
99433007	CB0073
99433008	CB0073
99433009	CB0073
99438144	CB0138
99438384	CB0093
99438387	CB0093
99438389	CB0093
99438514	CB0098
99449219	T1309
99449560	CB0138
99451728	V2107
99451729	V2104
99451732	V2108
99451736	V2105
99451738	V2109
99451739	V2105
99451740	V2108
99451744	V2106
99454195	CB0073
99454196	CB0073
99454197	CB0073
99455909	CB0093
99455910	CB0093
99455911	CB0093
99455912	CB0093
99455937	CB0098
99458562	T1307
99465078	T1244
99465079	T1244
99465080	T1309
99465081	T1244
99465082	T1244
99465083	T1245 ¹
99465084	T1128
99465087	T1243
99469583	B5321
99469833	B5323
99469838	B5321
99469853	B5321
99469860	B5323
99469861	B5322
99469924	CB0138
99473748	<u>T1354</u>
99473748	T1242 ¹
99473750	<u>T1354</u>
99474620	T5252
99474622	T1138
99474638	T5267
99474639	T5274
99474644	T1137
99474645	T1264
99474646	T1265
99474649	T1264
99474655	T1137
99476231	T1243
99477315	<u>B5421</u>
99485542	T1243
99488017	T1270
99488018	T5264
HS508386	V2134
HS508808	V2133

KAISER	
2376001002	F5254
4288	F5221

509020	F5194
F01007650	F5013
LE116500500052	F5194
LE116500500052	F5194

KAROSA	
5006172375	B5330
5006172376	<u>B5424</u>
5006172528	B5330
5010347902	B5330
5010347903	B5337 ¹
5010347905	B5355
504124915	<u>B5424</u>
5801113772	B5341
5801572582	<u>B5424</u>
E4436211011	B5341
E4436211012	B5382
E5001840060	B5382
E5006019186	B5383
E5801102620	B5341
E5801102621	B5382
E5801113772	B5341

KASSBOHRER	
8231092000	F5157
8231092000D	F5157
8231092000DG	F5157
8231276000	F5157
8231293000	F5157
8231293100	F5157

KÖGEL	
21229934	F5380

LANGENDORF	
7800	F5020



LECINENA	
120015200005	<u>F5343</u>
120015200079	<u>F5344</u>
120019500090	F5175
120025000005	F5025
120025000004	F5194
120025000134	F5015
120025000140	F5164
120025000141	F5175
120025000158	F5195
120025000169	F5342
120025000187	<u>F5402</u>
120025000313	F5164
196103	F5083
196107	F5004
196111	F5083
451700112782	F5083

LECITRAILER	
02 3702 5200	F5004
0237021400	F1113
196103	F5083
2376002200	F5083
5180011	F5073
5180021	F5007

LEGRAS INDUSTRIES	
0036114	F1118
0036114P	F1022
21215742	F5075

LEVEQUES (REMORQUES)	
902229	F5025
921043	F5203



 ORIG. No. :	
--	--



LEYLAND	
KAK 7541	T1055 ¹
LAK4519	T1208
TAK2977	T1208

LIEBHERR	
520901708	CB0084



LOHR	
06030508	F5226
06030509	F5223
06030510	F5221
A06030508	F5226
A06030509	F5223
A06030510	F5221
A06030528	F5329
A0603114	F5329

MAGIRUS	
99454196	CB0073
99454197	CB0073
99465087	T1243
99474646	T1265

MAN	
36 43701 6003	B5313
36 43701 6004	B5314
631 413 031	T1142
81 41722 6009	CB0106
81 41722 6010	CB0105
81 41722 6010	CB0105
81 41722 6012	CB0106
81 41722 6013	CB0105
81 41722 6013	CB0105
81 41722 6017	CB0105
81 41722 6017	CB0105
81 41722 6030	CB0087
81 41722 6033	CB0106
81 41722 6036	CB0087
81 41722 6037	CB0106
81 41722 6045	CB0105
81 41722 6045	CB0105
81 41722 6048	CB0092
81 41722 6049	CB0091
81 41722 6051	CB0092
81 41722 6052	CB0091
81 41722 6059	<u>CB0198</u>
81 41722 6060	<u>CB0201</u>
81 41722 6061	<u>CB0197</u>
81 41722 6068	<u>CB0200</u>
81 41722 6085	<u>CB0199</u>
81 41722 6090	<u>CB0198</u>
81 43072 6109	<u>T5410</u> ⁰
81 4370 16391	T1209
81 4370 16665	T1142
81 4370 16789	T1142
81 43701 6097	T5056
81 43701 6128	T5056
81 43701 6131	T5056
81 43701 6132	T5056
81 43701 6134	T5056
81 43701 6143	CB0086
81 43701 6149	T5069
81 43701 6149	T5069
81 43701 6174	T5069
81 43701 6174	T5069
81 43701 6185	CB0085
81 43701 6186	T5056
81 43701 6195	T5069
81 43701 6206	T5069

 ORIG. No. :	
--	---

81 43701 6218	T5069
81 43701 6220	T5069
81 43701 6241	CB0141
81 43701 6244	T5069
81 43701 6253	T1117
81 43701 6255	T1007
81 43701 6258	T5056
81 43701 6266	B5259
81 43701 6279	T1007
81 43701 6280	T1007
81 43701 6287	T5069
81 43701 6287	T5069
81 43701 6288	T5069
81 43701 6288	T5069
81 43701 6291	CB0141
81 43701 6318	B5259
81 43701 6324	B5259
81 43701 6325	B5259
81 43701 6326	B5259
81 43701 6331	CB0141
81 43701 6338	T1117
81 43701 6343	B5259
81 43701 6345	T5056
81 43701 6346	T5056
81 43701 6347	T5041 ¹
81 43701 6348	T5041 ¹
81 43701 6349	T1142
81 43701 6354	T1116
81 43701 6365	T1142
81 43701 6375	CB0086
81 43701 6379	CB0085
81 43701 6386	B5259
81 43701 6392	T1142
81 43701 6410	T1142
81 43701 6420	T1209
81 43701 6426	T1007
81 43701 6431	T1036
81 43701 6442	T1028
81 43701 6444	T1028
81 43701 6450	B5260
81 43701 6452	T1117
81 43701 6454	T1186 ¹
81 43701 6456	T1028
81 43701 6457	T1028
81 43701 6490	T1028
81 43701 6491	T1028
81 43701 6492	T1090
81 43701 6493	T1090
81 43701 6528	T5069
81 43701 6528	T5069
81 43701 6538	B5259
81 43701 6539	B5259
81 43701 6542	B5259
81 43701 6543	B5259
81 43701 6550	B5259
81 43701 6564	<u>T5429</u>
81 43701 6564	<u>T5044</u> ¹
81 43701 6568	T5047
81 43701 6572	B5259
81 43701 6573	B5260
81 43701 6578	B5260
81 43701 6584	<u>T5429</u>
81 43701 6584	<u>T5044</u> ¹
81 43701 6585	<u>T5429</u>
81 43701 6585	<u>T5044</u> ¹
81 43701 6594	<u>T5386</u>
81 43701 6597	T1093
81 43701 6598	T1093

 ORIG. No. :	
--	--

81 43701 6605	T5047
81 43701 6606	B5259
81 43701 6607	B5259
81 43701 6610	B1286
81 43701 6612	T1093
81 43701 6616	T1090
81 43701 6619	T1090
81 43701 6620	<u>T5429</u>
81 43701 6620	T5044 ¹
81 43701 6622	T1073
81 43701 6629	CB0103
81 43701 6630	T1208
81 43701 6631	T1209
81 43701 6632	T1043
81 43701 6633	T5080
81 43701 6634	T5048
81 43701 6650	T1208
81 43701 6651	T1209
81 43701 6670	B5291
81 43701 6672	B1278
81 43701 6688	B5291
81 43701 6689	B1278
81 43701 6695	T1028
81 43701 6699	T1029
81 43701 6705	B5293
81 43701 6706	B1278
81 43701 6707	T1090
81 43701 6710	<u>T5429</u>
81 43701 6710	T5119
81 43701 6711	<u>T5429</u>
81 43701 6711	T5119
81 43701 6713	B5291
81 43701 6714	B1278
81 43701 6729	B5291
81 43701 6730	B1278
81 43701 6749	T1198 ¹
81 43701 6751	T1185
81 43701 6752	T5121
81 43701 6757	<u>T5386</u>
81 43701 6767	B5299
81 43701 6768	B1278
81 43701 6776	B5293
81 43701 6781	<u>T1334</u> ⁰
81 43701 6781	T1142
81 43701 6782	T1184
81 43701 6784	T1186 ¹
81 43701 6785	B5301
81 43701 6786	B5293
81 43701 6787	B1290
81 43701 6793	T1189
81 43701 6794	T1190
81 43701 6796	T5121
81 43701 6798	T1187
81 43701 6800	B5293
81 43701 6801	B1278
81 43701 6804	T1189
81 43701 6806	B1278
81 43701 6809	<u>T1350</u>
81 43701 6810	B5293
81 43701 6820	T1184
81 43701 6821	<u>T1334</u> ⁰
81 43701 6825	T1073
81 43701 6827	<u>T5429</u>
81 43701 6827	T5119
81 43701 6830	B1290
81 43701 6855	B5301
81 43701 6856	B5301
81 43701 6860	<u>T5396</u>



81 43701 6864	<u>T1334</u> ⁰
81 43701 6866	<u>T5396</u>
81 43701 6868	T5349
81 43701 6878	B1282
81 43701 6880	B5312
81 43701 6881	B1297
81 43701 6890	<u>T5430</u> ⁰
81 43701 6892	B1290
81 43701 6897	T1268
81 43701 6901	<u>T5411</u> ⁰
81 43701 6902	T1266
81 43701 6903	T5278
81 43701 6904	T5261
81 43701 6905	T5263
81 43701 6908	T5275
81 43701 6911	T5276
81 43701 6912	T5276
81 43701 6920	T1268
81 43701 6923	B5301
81 43701 6924	B1290
81 43701 6926	T5277
81 43701 6930	<u>T5348</u>
81 43701 6934	T5350
81 43701 6940	B5301
81 43701 6944	T5266
81 43701 6945	<u>T5399</u> ⁰
81 43701 6948	T1268
81 43701 6949	T1267
81 43701 6950	T5262
81 43701 6954	<u>T5436</u> ⁰
81 43701 6964	T1318
81 43701 6965	<u>T5400</u>
81 43701 6973	<u>T5388</u>
81 43701 6974	<u>T5348</u>
81 43701 6975	<u>T5410</u> ⁰
81 43701 6981	<u>T5399</u> ⁰
81 43701 6983	<u>T1347</u>
81 43701 6990	<u>T1347</u>
81 43701 6991	T1267
81 43701 6992	<u>T1347</u>
81 43701 6594	<u>T5386</u> ⁰
81 43701 6757	<u>T5386</u> ⁰
81 43701 6995	<u>T1353</u>
81 43702 6000	T1313
81 43702 6002	T1320
81 43702 6003	T1320
81 43702 6004	T1308
81 43702 6005	T1308
81 43702 6008	B5301
81 43702 6011	T1321
81 43702 6012	T1321
81 43702 6014	T1308
81 43702 6016	T5350
81 43702 6017	<u>T5411</u> ⁰
81 43702 6030	<u>T5406</u>
81 43702 6032	<u>T1358</u>
81 43702 6037	T5275
81 43702 6042	<u>T5406</u>
81 43702 6048	<u>T5406</u>
81 43702 6055	<u>T5400</u>
81 43702 6058	<u>T1333</u> ⁰
81 43702 6059	<u>T1357</u> ⁰
81 43702 6070	<u>T5431</u> ⁰
81 43702 6071	<u>T5432</u> ⁰
81 43702 6075	<u>T1358</u>
81 43702 6076	T1321

81 43702 6077	T1320
81 43702 6078	T1308
81 43702 6079	<u>T1349</u>
81 43702 6080	<u>T1347</u>
81 43702 6084	<u>T1347</u>
81 43702 6085	T1320
81 43702 6086	T1308
81 43702 6100	T5263
81 43702 6107	<u>T5399</u> ⁰
81 43702 6108	<u>T5388</u>
81 43702 6116	<u>T5400</u>
81 43702 6119	T5276
81 43702 6131	<u>T5429</u>
81 43702 6132	<u>T5429</u>
81 62385 6003	<u>SD0009</u>
81 62385 6009	SD0001
81 62385 6033	<u>SD0009</u>
81 62385 6047	SD0003
81 62385 6048	<u>SD0008</u>
81 43702 6053	<u>T5437</u>
81 43702 6114	<u>T5437</u>
82 43701 6017	T1203
85 41722 6001	CB0139
85 41722 6010	<u>CB0199</u>
85 41722 6011	<u>CB0198</u>
85 41722 6017	<u>CB0199</u>
85 41722 6019	<u>CB0198</u>
85 41722 6025	<u>CB0181</u>
85 41722 6027	<u>CB0180</u>
85 41722 6028	<u>CB0180</u>
85 43701 6006	T1322
85 43701 6007	<u>T1344</u>
85 43701 6014	<u>T1346</u>
85 43701 6016	<u>T1348</u>
85 43701 6020	<u>T1359</u>
85 43701 6028	<u>T1345</u>
85 43701 6034	<u>T1348</u>
85 43701 6035	<u>T5406</u>
88 41701 0012	CB0141



MASSO	
112297	F5221

MENCI	
2461	F5004



MERCEDES-BENZ	
000 320 1530	T1201
000 463 5632	1300018M
000 463 5932	1300018M
000 463 6132	1300018M
000 463 6162	1300018M
000 463 6232	1300018M
000 463 6432	1300018M
000 463 6463	1300018M
000 800 0536	<u>SD0009</u>
000 800 1236	<u>SD0008</u>
000 891 0305	CB0057
000 891 0505	CB0057
000 891 0705	CB0084
000 891 1005	CB0057
000 891 1405	CB0081
000 891 1605	CB0081
000 891 1805	CB0071
000 891 1905	CB0071
000 891 2005	CB0081
000 891 2205	CB0071
000 919 8345	SD0001
000 919 8545	SD0001
000 919 8845	SD0001

001 323 1100	T1204
001 323 1100	T1015 ¹
001 323 1900	CB0057
001 326 0800	<u>B1327</u>
001 326 2100	<u>B1327</u>
001 326 2800	<u>B1327</u>
001 326 2900	<u>B1327</u>
001 326 3200	T5039 ¹
001 326 5700	V2021
001 326 6500	T5039 ¹
001 326 7400	T5039 ¹
001 326 7500	T5039 ¹
001 326 8500	T5039 ¹
001 326 8800	V2021
001 326 9300	T5033 ¹
001 919 1245	SD0003
002 323 1000	T1204
002 323 1000	T1015 ¹
002 323 1100	T1204
002 323 1100	T1015 ¹
002 323 1500	T1197
002 323 1600	T1204
002 323 1600	T1015 ¹
002 323 2500	T1027
002 323 3200	T1016
002 323 4200	B1259
002 323 5000	T1027
002 323 5300	T1197
002 323 5400	T1204
002 323 5400	T1015 ¹
002 323 5800	T1016
002 323 5900	T1016
002 323 6500	B1259
002 323 6900	T1143
002 323 7200	T1016
002 323 7300	T1016
002 323 8000	<u>B1327</u>
002 323 8600	T1016
002 323 8700	T1016
002 323 9400	V2021
002 323 9600	V2021
002 326 1100	T1151 ¹
002 326 1300	T1151 ¹
002 326 1900	V2021
002 326 2200	<u>B1327</u>
002 326 2300	<u>B1327</u>
002 326 2500	<u>B1327</u>
002 326 2600	V2021
002 326 2700	V2021
002 326 4000	<u>B1327</u>
002 326 4100	<u>B1327</u>
002 326 4600	T5054
002 326 4700	T5054
002 326 5000	T1115
002 326 5200	T1027
002 326 5500	T1115
002 326 6200	T5034
002 326 6300	T5034
002 326 8800	T1009 ¹
002 326 8900	T1009 ¹
002 326 9200	T5031 ¹
002 326 9300	T5031 ¹
002 326 9500	T1016
003 323 1000	T1204
003 323 1000	T1015 ¹
003 323 2000	T1220





 ORIG. No. :	
--	--

003 323 2100	T1220
003 323 3000	T1013
003 323 3100	T1013
003 323 3200	T1011
003 323 3300	T1011
003 323 3400	T1013
003 323 4200	V2059
003 323 5300	V2059
003 323 5500	V2021
003 323 5800	V2021
003 323 5900	V2021
003 323 6000	V2021
003 323 6500	T1013
003 323 6600	T1013
003 323 6700	T1232
003 323 6800	T1232
003 323 7100	T1016
003 323 7200	T1016
003 323 7300	V2059
003 323 7400	<u>B1327</u>
003 323 9700	T1016
003 326 0200	T1016
003 326 1400	T5030
003 326 1500	T5030
003 326 3400	<u>B1327</u>
003 326 3500	<u>B1327</u>
003 326 3600	B1259
003 326 4400	T1009 ¹
003 326 4500	T5054
003 326 5000	T5031 ¹
003 326 5800	T5034
003 326 7400	T1115
003 326 7500	<u>B1327</u>
003 326 7700	T1016
003 326 8300	T1151 ¹
003 326 8500	T5034
003 326 9200	T5054
003 326 9800	T5039 ¹
004 323 0000	T1016
004 323 0100	T1016
004 323 3400	T1013
004 323 3600	T1204
004 323 3600	T1015 ¹
004 323 4100	T1232
004 323 4300	T1197
004 323 4400	T1016
004 323 4500	T1016
004 323 4600	T1016
004 323 4700	T1013
004 323 4900	T1204
004 323 4900	T1015 ¹
004 323 5200	T1016
004 323 5600	T1220
004 323 5800	B1259
004 323 5900	T1016
004 323 5900	B1259
004 323 6100	T1197
004 323 6400	T1016
004 323 6500	T1204
004 323 6500	T1015 ¹
004 323 6700	T1013
004 323 6800	T1232
004 323 6900	T1232
004 323 8800	V1089
004 323 8900	V1089
004 323 9200	T1011
004 323 9700	T1016

 ORIG. No. :	
--	---

004 323 9800	T1016
004 326 1300	T1194
004 326 2300	T1115
004 326 2400	T1115
004 326 3700	V2021
004 326 4300	T1115
004 326 5800	<u>T1329</u>
004 326 5900	<u>T1329</u>
004 326 6400	T5005
004 326 6500	T5005
004 326 6800	T5030
004 326 6900	T5030
004 326 7000	<u>T1329</u>
004 326 9900	T5375
005 323 0200	T1064
005 323 0300	T1064
005 323 0900	T1064
005 323 1400	B1259
005 323 1800	T1002
005 323 1900	T1064
005 323 2800	T1143
005 323 4000	T1012
005 323 4100	T1012
005 323 6000	T1232
005 323 9100	T1251
005 323 9500	T1204
005 323 9600	T1011
005 323 9700	T1207
005 323 9900	<u>T5360</u>
005 326 0900	T1201
005 326 1000	T1210
005 326 1100	T5171
005 326 1200	T5137
005 326 1300	<u>T5385</u>
005 326 1400	T5256
005 326 2000	T5034
005 326 2200	T5287
005 326 2300	T5134
005 326 2500	<u>T5414</u> ⁰
005 326 2900	T1111
005 326 3300	T1200
005 326 3400	T1200
005 326 3500	B5347
005 326 3600	T1111
005 326 4200	T1111
005 326 4500	T5129
005 326 4600	T5250
005 326 5700	T1201
005 326 5800	T1201
005 326 5900	T1201
005 326 6000	T5372
005 326 6300	T1201
005 326 6400	T5372
005 326 6600	T5372
005 326 6800	T5363
005 326 7300	T5287
005 326 7400	T5171
005 326 8800	T5358
006 323 0700	T1016
006 323 0800	T1016
006 323 0900	T1011
006 323 1000	T1069
006 323 1100	T1127
006 323 1100	T1069
006 323 1200	T1069
006 323 1600	T1207
006 323 1700	T1072
006 323 2100	T1207
006 323 2700	T1071

 ORIG. No. :	
--	--

006 323 2800	T1127
006 323 3000	T1152
006 323 3300	T1197
006 323 3400	<u>T5361</u>
006 323 3700	T1204
006 323 3800	T1207
006 323 3900	T1197
006 323 4000	T1197
006 323 4500	T1275
006 323 5100	T1220
006 323 5400	T1304
006 323 6000	T1220
006 323 6100	T1204
006 323 6500	T1207
006 323 7100	T1207
006 323 7200	T1207
006 323 7300	T1011
006 323 7400	T1197
006 323 7500	B1259
006 323 7800	T1220
006 323 7900	T1220
006 323 8200	<u>T5361</u>
006 323 8300	<u>T5360</u>
006 323 8400	T5373
006 323 9500	T1232
006 323 9700	<u>T5361</u>
006 323 9800	T5373
006 326 0000	T5287
006 326 0100	T5171
006 326 0300	T5358
006 326 0400	<u>T5385</u>
006 326 0500	T5256
006 326 1100	T5358
006 326 1200	T5358
006 326 2000	<u>T5403</u> ⁰
006 326 2400	T5372
006 326 2900	T5363
006 326 3000	T5287
006 326 4200	F5251
006 326 4300	F5251
006 326 5600	T5137
006 326 5900	T5034
006 326 6000	<u>T5414</u> ⁰
006 326 6300	T5030
006 326 6700	T1201
006 326 6800	T5372
006 326 7100	<u>T5403</u> ⁰
006 326 7300	T5332
006 326 7800	T5129
006 326 8100	T5374
007 323 0800	T1246
007 323 1200	T1207
007 323 1300	<u>T1339</u> ⁰
007 323 1400	<u>T1352</u>
007 323 1600	<u>T1340</u> ⁰
300 326 0000	<u>B1327</u>
300 326 0100	<u>B1327</u>
300 326 0200	<u>B1327</u>
300 326 0300	<u>B1327</u>
300 326 0400	<u>B1327</u>
300 326 0500	<u>B1327</u>
301 323 0000	<u>B1327</u>
301 323 0100	<u>B1327</u>
302 323 0300	B1259
302 320 0230	<u>B1327</u>
302 326 0200	<u>B1327</u>
302 326 0300	<u>B1327</u>
302 326 0500	<u>B1327</u>



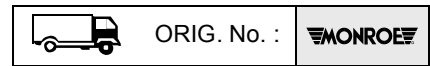
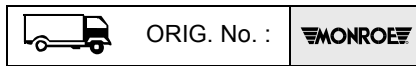
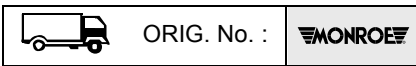



307 326 0200	B1259
314 326 0100	V2021
314 326 0200	V2021
314 326 0400	V2021
314 326 0500	V2021
314 326 0600	V2021
317 326 0100	<u>B1327</u>
318 326 0000	T1018 ¹
318 326 0500	T1018 ¹
345 326 7700	T5039 ¹
356 323 0200	B5335
356 323 0400	B5335
356 323 0500	B5335
356 326 0800	B1298
357 320 0331	B1298
357 323 0000	T1220
357 323 0300	B5291
357 323 0400	B5291
357 323 0500	B1291
357 323 0600	B1291
357 326 0100	B1259
357 326 0200	B1298
373 326 7300	<u>B1327</u>
373 320 0030	B1259
373 320 0031	<u>B1327</u>
373 320 0230	B1259
373 323 7200	B1259
375 323 0000	T1220
375 323 0100	T1207
375 890 0419	CB0150
375 890 0519	CB0097
375 890 0819	CB0163
375 890 0919	CB0150
375 890 1119	CB0150
381 890 0719	CB0104
381 890 0919	CB0104
382 323 0100	B5298
385 326 0000	T1027
385 326 0100	T5054
387 326 0000	T1151 ¹
387 890 1019	CB0104
387 890 1219	CB0142
387 890 1319	CB0104
387 890 1519	CB0142
387 890 1619	CB0104
393 326 0000	T5033 ¹
396 320 0030	B1259
613 323 0000	B5335
617 326 0000	T5030
620 890 0019	CB0140
620 890 0119	CB0140
628 323 0100	B5298
628 323 0200	B5298
628 323 0400	B5298
628 326 0700	B1284
628 326 0800	B1283
629 323 0000	B5286
629 326 0000	B1287
629 326 0100	B1287
639 326 0300	V5007
639 326 1000	V5007
639 326 2100	V5007
639 326 2500	V5007
652 320 0031	T5030
673 317 0103	CB0080
673 317 0203	CB0080
673 317 0303	CB0080
673 323 0000	T1071



673 323 0400	T1067 ¹
673 323 0500	T1152
673 323 0600	T1071
673 323 0700	T1127
673 323 0800	T1069
673 323 0900	T1127
673 326 0000	T1111
673 326 1100	T1111
673 326 1100	T1070 ¹
673 326 1200	T1111
673 326 1300	T1111
673 326 1400	T1111
674 323 0100	T1127
674 323 0300	T1127
674 323 0500	T1069
674 323 0600	T1069
674 326 1200	T1111
674 326 1300	T1111
674 326 1400	T1111
675 323 0500	T1075
675 323 0600	T1072
675 323 0700	T1152
675 323 0800	T1072
675 323 1000	T1072
675 326 0000	T5129
675 326 0400	T5129
675 326 0500	T5250
675 326 0600	T5129
675 326 0700	T5250
693 890 0519	CB0162
742 087 1960	<u>T1339</u> ⁰
940 890 0519	CB0162
940 890 1019	CB0162
940 890 3719	CB0162
940 890 3819	CB0150
940 890 3919	CB0097
940 890 4119	CB0097
940 890 4519	CB0163
940 890 4619	CB0163
940 890 4719	CB0150
940 890 4919	<u>CB0236</u> ⁰
942 890 0119	CB0089
942 890 0219	CB0090
942 890 0419	CB0147
942 890 0419	CB0147
942 890 0519	CB0148
942 890 1119	CB0165
942 890 1519	CB0147
942 890 1519	CB0147
942 890 2219	CB0100
942 890 2319	CB0101
942 890 2619	CB0127 ⁰
942 890 2819	CB0100
942 890 2919	CB0089
942 890 3119	CB0101
942 890 3519	CB0165
942 890 3619	CB0158
942 890 3619	CB0158
942 890 3619	CB0158
942 890 3819	CB0147
942 890 3819	CB0147
942 890 3919	CB0144
942 890 3919	CB0144
942 890 4019	CB0158
942 890 4019	CB0158
942 890 4019	CB0158
942 890 4019	CB0158
942 890 4719	CB0096
942 890 4919	CB0129 ⁰

942 890 5019	CB0129 ⁰
942 890 5119	CB0127 ⁰
942 890 5219	CB0108
942 890 5319	CB0115
942 890 5419	CB0122
942 890 5519	CB0128 ⁰
942 890 5619	CB0121
942 890 5919	CB0115
942 890 6019	CB0090
942 890 6119	CB0116
942 890 6919	CB0107
942 890 7019	CB0108
943 890 0119	CB0128 ⁰
943 890 0219	CB0121
943 890 0319	CB0122
943 890 0519	CB0165
943 890 0819	CB0101
943 890 0919	CB0101
943 890 1019	CB0158
943 890 1019	CB0158
943 890 1019	CB0158
943 890 1119	CB0158
943 890 1119	CB0158
943 890 1119	CB0158
943 890 1119	CB0158
943 890 1219	CB0147
943 890 1219	CB0147
943 890 1319	CB0144
943 890 1319	CB0144
943 890 1419	CB0101
943 890 1519	CB0101
943 890 1619	CB0158
943 890 1619	CB0158
943 890 1619	CB0158
943 890 1719	CB0158
943 890 1719	CB0158
943 890 1719	CB0158
943 890 2319	CB0165
943 890 2419	CB0147
943 890 2419	CB0147
943 890 2919	CB0161
943 890 3019	CB0161
943 890 3119	CB0156
943 890 3219	CB0156
943 890 3319	CB0157
943 890 3419	CB0155
943 890 3519	CB0155
943 890 3819	CB0115
943 890 3919	CB0090
943 890 4419	<u>CB0217</u> ⁰
943 890 4619	<u>CB0218</u> ⁰
943 890 4919	<u>CB0218</u> ⁰
943 890 5019	CB0164
946 326 0000	F5251
946 326 0100	F5251
946 326 0200	F5025
946 326 0300	F5194
946 326 0500	F5195
946 326 0700	F5342
958 317 0503	<u>CB0220</u> ⁰
958 317 0603	<u>CB0220</u> ⁰
958 317 0703	CB0148
958 317 1003	CB0150
958 317 1103	CB0150
958 317 1503	CB0163
958 317 2103	CB0097
958 323 0400	T1246
958 323 0700	T1207





 ORIG. No. :	
--	--

958 323 0800	T1011
958 323 0900	T1011
958 323 1000	T1207
958 323 1200	T1207
958 326 0700	T5372
958 326 0800	T1200
970 317 1703	<u>CB0220</u> ⁰
970 317 1803	<u>CB0220</u> ⁰
970 317 4103	<u>CB0220</u> ⁰
970 317 4203	<u>CB0220</u> ⁰
970 323 0000	T1255
970 323 0300	T1255
970 323 0700	T1255
970 323 1000	T1255
970 326 0000	T1256
970 326 0100	T1273
970 326 0200	T1256
970 326 0400	T5178
970 326 0700	T1256
972 323 0100	T1115
972 323 0300	T1115
972 326 0000	T5374
972 326 0200	T5374
974 323 0000	T1246
974 323 0400	T1246
974 323 0600	T1246
974 323 1300	T1246
974 326 0000	T5178
974 326 0100	T5332
974 326 0400	T5178
974 326 1000	<u>T5403</u> ⁰
975 323 0000	T1246
A00 5323 1400	B1259
A000 800 0536	<u>SD0009</u>
A000 800 1236	<u>SD0008</u>
A000 919 8345	SD0001
A000 919 8545	SD0001
A000 919 8845	SD0001
A001 326 0800	<u>B1327</u>
A001 326 2100	<u>B1327</u>
A001 326 2800	<u>B1327</u>
A001 326 2900	<u>B1327</u>
A001 919 1245	SD0003
A002 323 8000	<u>B1327</u>
A002 326 2200	<u>B1327</u>
A002 326 2500	<u>B1327</u>
A002 326 4000	<u>B1327</u>
A002 326 4100	<u>B1327</u>
A002 326 6200	T5034
A002 326 6300	T5034
A003 323 7400	<u>B1327</u>
A003 326 1400	T5030
A003 326 3400	<u>B1327</u>
A003 326 3500	<u>B1327</u>
A003 326 7500	<u>B1327</u>
A003 326 8500	T5034
A004 323 4500	T1016
A004 323 4700	T1013
A004 323 6700	T1013
A004 326 1300	T1194
A004 326 5800	<u>T1329</u>
A004 326 5900	<u>T1329</u>
A004 326 7000	<u>T1329</u>
A004 326 9900	T5375
A005 323 0900	T1064
A005 323 9100	T1251
A005 323 9500	T1204
A005 323 9600	T1011



 ORIG. No. :	
--	---

A005 323 9700	T1207
A005 323 9900	<u>T5360</u>
A005 326 0900	T1201
A005 326 1000	T1210
A005 326 1100	T5171
A005 326 1200	T5137
A005 326 1300	<u>T5385</u>
A005 326 1400	T5256
A005 326 2000	T5034
A005 326 2500	<u>T5414</u> ⁰
A005 326 3300	T1200
A005 326 3400	T1200
A005 326 3500	B5347
A005 326 3600	T1111
A005 326 4200	T1111
A005 326 4500	T5129
A005 326 4600	T5250
A005 326 6000	T5372
A005 326 6400	T5372
A005 326 6600	T5372
A005 326 6800	T5363
A005 326 7400	T5171
A005 326 8800	T5358
A006 323 0900	T1011
A006 323 2800	T1127
A006 323 3000	T1152
A006 323 3300	T1197
A006 323 3400	<u>T5361</u>
A006 323 4500	T1275
A006 323 5100	T1220
A006 323 5400	T1304
A006 323 6500	T1207
A006 323 7100	T1207
A006 323 8200	<u>T5361</u>
A006 323 8300	<u>T5360</u>
A006 323 8400	T5373
A006 323 9700	<u>T5361</u>
A006 323 9800	T5373
A006 326 0100	T5171
A006 326 0300	T5358
A006 326 0400	<u>T5385</u>
A006 326 1100	T5358
A006 326 1200	T5358
A006 326 2000	<u>T5403</u> ⁰
A006 326 2400	T5372
A006 326 2900	T5363
A006 326 4300	F5251
A006 326 5900	T5034
A006 326 6000	<u>T5414</u> ⁰
A006 326 6800	T5372
A006 326 7100	<u>T5403</u> ⁰
A006 326 7300	T5332
A006 326 8100	T5374
A007 323 0800	T1246
A007 323 1300	<u>T1339</u> ⁰
A007 323 1400	<u>T1352</u>
A007 323 1600	<u>T1340</u> ⁰
A300 326 0000	<u>B1327</u>
A300 326 0100	<u>B1327</u>
A300 326 0200	<u>B1327</u>
A300 326 0300	<u>B1327</u>
A300 326 0400	<u>B1327</u>
A300 326 0500	<u>B1327</u>
A301 323 0000	<u>B1327</u>
A301 323 0100	<u>B1327</u>
A302 320 0230	<u>B1327</u>
A302 326 0200	<u>B1327</u>
A302 326 0300	<u>B1327</u>

 ORIG. No. :	
--	--



A302 326 0500	<u>B1327</u>
A317 326 0100	<u>B1327</u>
A356 323 0200	B5335
A356 323 0400	B5335
A356 323 0500	B5335
A357 323 0600	B1291
A37 3320 0031	<u>B1327</u>
A37 3326 7300	<u>B1327</u>
A375 890 0419	CB0150
A375 890 0519	CB0097
A375 890 0819	CB0163
A375 890 0919	CB0150
A387 890 1219	CB0142
A387 890 1519	CB0142
A620 890 0019	CB0140
A620 890 0119	CB0140
A693 890 0519	CB0162
A742 087 1960	<u>T1339</u> ⁰
A940 890 0519	CB0162
A940 890 1019	CB0162
A940 890 3719	CB0162
A940 890 3819	CB0150
A940 890 3919	CB0097
A940 890 4119	CB0097
A940 890 4519	CB0163
A940 890 4619	CB0163
A940 890 4719	CB0150
A940 890 4919	<u>CB0236</u> ⁰
A942 890 0219	CB0090
A942 890 0419	CB0147
A942 890 0419	CB0147
A942 890 0519	CB0148
A942 890 1119	CB0165
A942 890 1519	CB0147
A942 890 1519	CB0147
A942 890 2619	CB0127 ⁰
A942 890 2819	CB0100
A942 890 2919	CB0089
A942 890 3519	CB0165
A942 890 3619	CB0158
A942 890 3619	CB0158
A942 890 3619	CB0158
A942 890 3819	CB0147
A942 890 3819	CB0147
A942 890 3919	CB0144
A942 890 3919	CB0144
A942 890 4019	CB0158
A942 890 4019	CB0158
A942 890 4019	CB0158
A942 890 4019	CB0158
A942 890 4719	CB0096
A942 890 5019	CB0129 ⁰
A942 890 5119	CB0127 ⁰
A942 890 5319	CB0115
A942 890 5519	CB0128 ⁰
A942 890 5919	CB0115
A942 890 6119	CB0116
A943 890 0119	CB0128 ⁰
A943 890 0519	CB0165
A943 890 1019	CB0158
A943 890 1019	CB0158
A943 890 1019	CB0158
A943 890 1119	CB0158
A943 890 1119	CB0158
A943 890 1119	CB0158
A943 890 1219	CB0147
A943 890 1219	CB0147
A943 890 1319	CB0144



	ORIG. No. :	
--	-------------	--

A943 890 1319	CB0144
A943 890 1619	CB0158
A943 890 1619	CB0158
A943 890 1619	CB0158
A943 890 1719	CB0158
A943 890 1719	CB0158
A943 890 1719	CB0158
A943 890 2319	CB0165
A943 890 2419	CB0147
A943 890 2419	CB0147
A943 890 2919	CB0161
A943 890 3019	CB0161
A943 890 3119	CB0156
A943 890 3219	CB0156
A943 890 3319	CB0157
A943 890 3419	CB0155
A943 890 3519	CB0155
A943 890 3819	CB0115
A943 890 4419	CB0217 ⁰
A943 890 4619	CB0218 ⁰
A943 890 4919	CB0218 ⁰
A943 890 5019	CB0164
A946 326 0000	F5251
A946 326 0100	F5251
A946 326 0200	F5025
A946 326 0300	F5194
A946 326 0500	F5195
A946 326 0700	F5342
A958 317 0503	CB0220 ⁰
A958 317 0603	CB0220 ⁰
A958 317 0703	CB0148
A958 317 1003	CB0150
A958 317 1103	CB0150
A958 317 1503	CB0163
A958 317 2103	CB0097
A958 323 0400	T1246
A958 323 0700	T1207
A958 323 0800	T1011
A958 323 0900	T1011
A958 323 1000	T1207
A958 323 1200	T1207
A958 323 1300	T1011
A958 326 0700	T5372
A958 326 0800	T1200
A960 310 5455	CB0239 ⁰
A970 317 1703	CB0220 ⁰
A970 317 1803	CB0220 ⁰
A970 317 4103	CB0220 ⁰
A970 317 4203	CB0220 ⁰
A970 323 0300	T1255
A970 326 0100	T1273
A970 326 0200	T1256
A972 323 0100	T1115
A972 323 0300	T1115
A972 326 0000	T5374
A972 326 0200	T5374
A974 323 0400	T1246
A974 323 0600	T1246
A974 323 1300	T1246
A974 326 0100	T5332
A974 326 0400	T5178
A974 326 1000	T5403 ⁰
A975 323 0000	T1246

MIELE	
060AMM0504	F5075
060AMM0505	F5004

	ORIG. No. :	
--	-------------	--



060AMM0506		F5007
MISTRALL		
11094	F5369	
11094	F5368	
7302	F5007	
7758	F5007	

MONTENEGRO		
050001668	F5077	
050031668	F5077	
050031668A	F5077	
050041668	F5270	

NEOPLAN		
100210200	B5313	
100210300	B5314	
100210400	B5347	
100210720	B5346	
100214400	T1197	
102200800	B5347	
102200900	B5347	
102201000	B5314	
11016414	B5313	
11016416	B5314	
11016417	B5347	
11016634	B5347	
11016635	B5347	
11016636	B5314	
11016642	B5346	
11070522	B5405 ⁰	
12104	B5314	
12106	B5347	
12107	B5313	
36437016003	B5313	
36437016004	B5314	
36437016005	B5347	
N1011016429	B5346	
N1011016448	T1197	
N1011016634	B5347	
N1011016635	B5347	
N1011016636	B5314	
N1011016642	B5346	
N1011070522	B5405 ⁰	

NEW HOLLAND		
47630745	CB0170	
82018497	CB0168	
82021116	CB0168	
82029623	CB0168	
82031521	CB0168	
82032841	CB0168	
82033876	CB0168	
84141201	CB0170	
84163866	CB0234	
84183931	CB0169	
84605258	CB0234	
87301789	CB0166	
87591827	CB0167	

NEWAY		
1752498	F1074	
90044025	F1074	
90044025	65416	
90044682	F1074	
90045028	F1091	
AR1654	F1074	
M0044020	F5166	
M0044020H	F5166	
M0078602	F5166	

	ORIG. No. :	
--	-------------	--

NISSAN		
561009X000	T1366 ⁰	
561009X401	T1366 ⁰	
561009X402	T1366 ⁰	
562009X401	T1367 ⁰	
56200D8802	T1365 ⁰	
56200D9201	T1367 ⁰	
56200LA30A	T1368 ⁰	

NOMECC		
7799	F5075	

NUOVA MANARO		
7075	F5004	

OMAR		
013612	F5075	

OMT		
22450420	F5075	
22450430	F5221	

OTOKAR		
16H0003615AB	F1118	

PEGASO		
1004876	B5259	
1004877	B5260	
81437016572	B5259	
81437016578	B5260	

PEZZAIOLI		
70100000	F5004	
7758	F5007	

PIACENZA		
11066	F5004	
1201048/45	F5221	
1201052	T5199	
1201054	F5007	

PRIM-BALL		
7075055	F5004	

RENAULT TRUCKS		
1152013	F1068	
20717436	T5258	
20898055	CB0118	
22313089	T1316	
23512048	T1042	
23512077	T1122	
23512085	T1042	
23512158	F1068	
2376000200	V2097	
2376000300	F1068	
2376000302	F1068	
2376001000	F5254	
5000356647	CB0025	
5000452402	V2103	
5000452403	V2103	
5000453922	V2103	
5000725485	T1122	
5000725804	T1122	
5000731913	T1122	
5000741013	CB0052	
5000741014	CB0051	
5000745958	T1228 ¹	
5000752729	T1223	
5000787062	T1056	
5000787974	CB0069	
5000787975	CB0068	

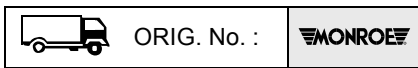

5000788073	T5067 ¹
5000790109	T1122
5000790689	T5016 ¹
5000790852	T1122
5000790965	<u>B5422</u>
5000791271	CB0076
5001836461	<u>SD0009</u>
5001836462	SD0001
5001836463	SD0001
5001857660	V2103
5001857665	T1122
5001857902	<u>SD0008</u>
5001857903	SD0003
5001863280	T1228 ¹
5001863283	T5067 ¹
5001863289	T5068
5001863291	T5078
5001863292	T5153
5001863294	CB0068
5006172375	B5330
5006172376	<u>B5424</u>
5006172528	B5330
5010013183	<u>B5422</u>
5010013184	B5336
5010019952	B5334
5010052404	CB0052
5010052405	CB0051
5010052920	T1223
5010052921	T5229
5010060410	T5229
5010063317	T1043
5010065310	CB0068
5010065311	CB0069
5010092916	CB0082
5010095172	V2097
5010095719	T1042
5010095871	T5068
5010095871	T5028 ⁴
5010130009	<u>T5354</u>
5010130009	T5227
5010130401	T5179
5010130534	CB0052
5010130535	CB0051
5010130554	T1257
5010130609	CB0069
5010130797	CB0075
5010130888	T1042
5010137052	T5078
5010137139	CB0052
5010151020	<u>B5422</u>
5010151151	<u>B5422</u>
5010151203	<u>B5422</u>
5010151809	B5334
5010151812	<u>B5398</u>
5010190151	<u>B5422</u>
5010228849	CB0070
5010228908	CB0088
5010237285	T5153
5010237338	V2097
5010238077	V2103
5010239642	T5258
5010266855	CB0082
5010269605	CB0046
5010269605C	CB0046
5010269674	CB0088
5010277261	CB0025
5010294158	T5154
5010294412	T1223

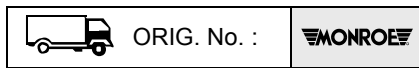

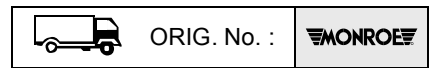

5010294413	T1223
5010294528	T5258
5010294760	V2103
5010294908	T5258
5010294909	T5258
5010294929	V1176
5010313619	CB0082
5010316210	CB0110
5010316210B	CB0110
5010316210C	CB0110
5010316783	CB0088
5010316783A	CB0088
5010320096	CB0076
5010347902	B5330
5010347903	B5337 ¹
5010347905	B5355
5010348438	V2103
5010370630	CB0053
5010380547	T5147
5010383009	V1174
5010383049	T1223
5010383050	T1223
5010383380	T1269
5010383496	<u>T1337</u> ⁰
5010383497	<u>V2138</u>
5010383498	V2099
5010383679	V1174
5010383684	V1175
5010383685	T5258
5010383686	T5258
5010383687	T5147
5010383689	T5154
5010383692	T5179
5010383693	T1223
5010383694	T1223
5010383698	T1257
5010383701	<u>T5354</u>
5010383701	T5227
5010383717	T1258
5010383909	T1214
5010435394	CB0050
5010460113	CB0046
5010460114	CB0051
5010460115	CB0052
5010460116	CB0053
5010460198	CB0061
5010460212	CB0062
5010460238	CB0062
5010460244	CB0063
5010460318	CB0109
5010488147	V2099
5010488156	V2102
5010488157	V2103
5010488160	V2103
5010488467	V1175
5010491301	CB0135
5010531249	B5353
5010532895	CB0131
5010532897	CB0109
5010552010	CB0064
5010552241	CB0118
5010552245	CB0062
5010552370	CB0117
5010557285	<u>V2138</u>
5010557287	<u>T1336</u> ⁰
5010557326	T5258
5010557379	V1174
5010557381	V1176



5010557482	T5154
5010557487	T5179
5010557642	T5229
5010557974	T1271
5010559508	CB0025
5010600254	<u>T1316</u>
5010600329	T5284
5010600333	<u>T1341</u> ⁰
5010600336	V2099
5010600393	T5154
5010600942	T5281
5010615879	CB0171 ⁰
5010615880	CB0046
5010629213	CB0119
5010629397	CB0109
5010629398	CB0088
5010629414	CB0075
5010629471	CB0064
5010629761	CB0063
5010630003	<u>T1341</u> ⁰
5010630004	T1260
5010630133	T1294
5010630208	T5280
5010630384	T5284
5010630386	T5154
5010630388	T5284
5010630602	<u>T5309</u>
5010630702	T1272
5010630728	T5282
5010630748	T1271
5010630782	V2099
5010630863	T5308
5010630865	T5306
5010630867	T5283
5010630941	T5307
5010647062	<u>T5309</u>
5010647064	T5310
5021171224	F5020
504124915	<u>B5424</u>
5430050472	T1214
5430051681	T1214
5801572582	<u>B5424</u>
7420374543	T5371
7420583421	T5091
7420840318	CB0046
7420848708	V1176
7420854448	T5371
7420865132	T1271
7420867988	T1272
7420871960	<u>T1338</u> ⁰
7420871963	<u>T1335</u> ⁰
7420898055	CB0118
7420900192	T5280
7421171977	<u>CB0240</u> ⁰
7421243060	<u>T5392</u> ⁰
7421251391	T5308
7421821030	<u>CB0240</u> ⁰
7421909816	<u>T5392</u> ⁰
7482039600	CB0133
7482052323	CB0061
7482052324	CB0062
7482052325	CB0062
7482052326	CB0062
7482052422	<u>T1315</u>
7482052752	<u>T1316</u>
7482052754	V2103
7482052758	V2102



	ORIG. No. :	
--	-------------	--



7482052893	CB0118
7482052895	CB0119
7482052897	CB0131
7482053757	T1314
7482087441	CB0088
7482293198	T5258
7482293218	T5352
7482293222	T5258
7482293227	T5258
7482293239	T5227
7482293273	T5229
7482293278	T1257
7482293280	T1258
82052893	CB0118
82052895	CB0119
82292981	T5258
99485075	B5336

ROCKWELL	
21039042	F5381
21048043	F5381
21224034S	F5013

ROLFO	
112012	F5007
112128	F5366
112297	F5221
112319	F5004
112320	F5369
112320	F5368
21215742	F5075
21215807	F5075
21221306	F5075
S3363	F5004

ROR	
21208363	F5013
21212534	F5344
21215442	F5075
21215607	F5075
21215742	F5075
21215751	F5075
21215807	F5075
21216058	F5013
21221306	F5075
21221306K	F5075
21221348	F5025
21222271	F5015
21223345	F5343
21224034	F5013
21224331	F5015
21224531	F5015
21224531B	F5015
21224745	F5015
21224778	F5164
21225104	F5173
21226989	F5164
21228392	F5379
21228930	F5409
21229934	F5380
21229935	F5378
8404174	F5020
902194	F5025
902368	F5015
902404	F5015
912368	F5015

SAE	
8404174	F5254



	ORIG. No. :	
--	-------------	--

8404174	F5020
9302060	F5015
M076022	F5408
M077932	F5407
M200165	F5408
M20016501	F5408
M200166	F5407
M20016601	F5407

SAF	
0 880 570	V2097
2 376 0002 00	V2097
2 376 0003 00	F1068
2 376 0003 01	F1068
2 376 0003 02	F1068
2 376 0005 00	F5020
2 376 0006 00	F5020
2 376 0008 00	F5020
2 376 0009 00	F5186
2 376 0009 02	F5186
2 376 0010 00	F5254
2 376 0010 01	F5254
2 376 0010 02	F5254
2 376 0014 00	F5254
2 376 0015 00	F5254
2 376 0016 00	F1119
2 376 0017 00	F1068
2 376 0018 00	F1000
2 376 0019 00	F5002
2 376 0020 00	F5127
2 376 0022 00	F5083
2 376 0026 00	F5224
2 376 0027 00	F5190 ¹
2 376 0028 00	F5224
2 376 0029 00	F5254
2 376 0030 00	F5187
2 376 0031 00	F5012
2 376 0032 00	F5192
2 376 0035 00	F5011
2 376 0039 00	F5187
2 376 0070 00	F5174
2 376 0070 01	F5174
2 376 0071 00	F5175
2 376 0071 01	F5175
2 376 0072 00	F5176
2 376 0072 01	F5176
2 376 0073 01	F5401
2 376 1005 00	F5185
2 376 1007 01	F1068
2 376 1007 52	F1068
2 376 4030 00	F5187
2 376 4032 00	F5192
2 3764 026 00	F5224
40 170 01233 25	F5011
40 170 01232 47	F5224
6 503 608P	F5020



SAME	
04426628	CB0105
04426629	CB0174

SAMRO	
1752498	F1074
21208363	F5013
21215742	F5075
21216058	F5013
2500001	F5201
2500002	F5205
2500341	F5201
2500342	F5205



	ORIG. No. :	
--	-------------	--

371424	F5205
501400	F5205
503100	F5201
90044025	F1074



SCANIA	
1012044	T5241
1012046	T5242
1110531	T1105
1110588	T1101
1110589	T1044
1111056	T1101
1116535	CB0066
1116535	CB0065
1117320	CB0066
1117320	CB0065
1117326	CB0066
1117326	CB0060
1117334	CB0066
1117334	CB0065
1122612	T1146
1303235	T5059
1307332	T5059
1309129	T1105
1313003	SD0006 ¹¹
1314278	CB0041
1315959	T1145
1315960	T5060
1323476	T5059
1327145	T5063
1327813	T5063
1331620	CB0066
1331620	CB0065
1331621	CB0066
1331621	CB0065
1331626	CB0066
1331626	CB0060
1331634	CB0066
1331634	CB0065
1331635	CB0066
1331635	CB0065
1331756	T5063
1340251	T5059
1340252	T5241
1340253	T5242
1340254	T5243
1340255	T5236
1340256	T1148 ¹
1340257	T5237
1340581	CB0014
1348117	CB0066
1348117	CB0065
1348118	CB0066
1348118	CB0065
1348119	CB0065
1348120	CB0065
1348121	CB0066
1348211	CB0066
1348211	CB0060
1348477	CB0060
1349805	MK801
1349810	MK801
1349840	CB0067
1349844	CB0059
1353105	T5243
1353371	T5059
1354966	T1146
1356723	T1101
1363120	CB0058

	ORIG. No. :	
--	-------------	--

1363122	CB0058
1365211	T5145
1370093	T5144
1370267	<u>T1330</u> ⁰
1371447	T1215
1371448	T1215
1375832	T5252
1377056	T5059
1377057	T5253
1377520	<u>SD0009</u>
1379487	T5059
1380424	T5145
1380425	T5144
1380426	<u>T5351</u>
1380427	<u>T5387</u>
1381807	T5241
1381808	T5242
1381809	T5243
1381810	T5236
1381903	CB0172
1381904	CB0010
1381904/1381919	CB0172
1381904/1476415	CB0172
1381905	CB0173
1381906	CB0009
1381906/1381919	CB0173
1381906/1476415	CB0173
1381919	CB0030
1382062	T5252
1382826	CB0059
1382827	CB0059
1382829	CB0059
1388416	<u>T5356</u>
1388416	T5060
1388417	T1101
1390898	T1230
1391407	SD0001
1397386	CB0011
1397388	CB0011
1397390	CB0011
1397392	CB0011
1397392/1381919	CB0011/30
1397392/1476415	CB0011/30
1397393	CB0173
1397394	CB0009
1397395	CB0172
1397396	CB0010
1397397	CB0173
1397398	CB0009
1397398/1381919	CB0173
1397398/1476415	CB0173
1397399	CB0172
1397400	CB0010
1397400/1381919	CB0172
1397400/1476415	CB0172
1397523	T5144
1397525	T5242
1397525	T5104 ¹
1401877	T1216
1402271	CB0009
1404864	T5252
1415638	SD0005
1420474	<u>T1332</u> ⁰
1421062	T5241
1421062	T1101
1424227	CB0058
1424228	CB0058
1424229	CB0059

	ORIG. No. :	
--	-------------	---

1424231	CB0067
1427406	B5292
1427423	<u>T1296</u>
1427424	<u>T1296</u>
1431745	CB0011
1431746	CB0011
1431747	CB0011
1431748	CB0011
1432081	CB0011/30
1432082	CB0011/30
1432083	CB0011/30
1432084	CB0011/30
1435852	CB0172
1435853	CB0173
1435856	CB0009
1435856/1381919	CB0173
1435856/1476415	CB0173
1435859	CB0010
1435859/1381919	CB0172
1438392	T1215
1438392	T1215
1438527	T1215
1440529	<u>SD0009</u>
1444016	CB0130
1448573	<u>SD0009</u>
1454753	T1216
1462240	B5345
1462241	B1311
1466184	<u>CB0176</u>
1466185	<u>CB0176</u>
1476415	CB0030
1478317	<u>B1351</u>
1478499	T1215
1478500	T1215
1478501	T1230
1478502	T5059
1478503	T5253
1478506	T5145
1478507	T5144
1478508	<u>T5351</u>
1478509	<u>T5387</u>
1478511	T1216
1478540	T1215
1478541	T1215
1480213	B5292
1480214	B5292
1480215	B5292
1481358	B5340
1481359	B1310
1481716	T5237
1481751	T1148 ¹
1488337	B5345
1494146	<u>B5404</u> ⁰
1495642	CB0134
1497641	<u>T1361</u> ⁰
1498861	<u>SD0010</u> ⁰
1498862	SD0003
1498864	<u>SD0008</u>
1502468	CB0074
1502470	CB0078
1502471	CB0078
1502472	CB0079
1502472/1502468	<u>CB0195</u>
1502473	CB0160
1502474	CB0078
1505563	CB0134
1519629	<u>T5356</u>
1519630	T5145

	ORIG. No. :	
--	-------------	--

1519631	T5144
1519632	<u>T5351</u>
1519633	<u>T5387</u>
1523282	B5316
1523283	<u>B5419</u>
1523287	B5292
1523288	B5292
1542619	B1295
1547113	<u>T5439</u>
1720604	<u>T5362</u>
1731203	<u>CB0178</u>
1731204	<u>CB0178</u>
1741736	<u>CB0177</u>
1761372	<u>CB0178</u>
1761373	<u>CB0177</u>
1761374	<u>CB0178</u>
1761375	<u>CB0178</u>
1761376	<u>CB0178</u>
1793982	<u>CB0202</u>
1802569	<u>CB0203</u>
1854537	<u>T5391</u> ⁰
1861117	<u>T1332</u> ⁰
1861118	<u>T1331</u> ⁰
1861119	T1215
1866129	<u>T5438</u>
1866131	<u>T5390</u> ⁰
1867874	<u>T1330</u> ⁰
1868263	<u>T1330</u> ⁰
1868264	<u>T1332</u> ⁰
1868265	<u>T1331</u> ⁰
1870615	<u>CB0196</u>
1870893	<u>CB0195</u>
1871658	CB0079
1871658/1502468	<u>CB0195</u>
1873668	<u>CB0194</u>
1907301	<u>CB0183</u>
1907301/1910106	<u>CB0194</u>
1908097	<u>CB0184</u>
1910106	<u>CB0182</u>
1920824	B5345
1923645	<u>CB0196</u>
1923646	<u>CB0203</u>
1923647	<u>CB0202</u>
1923654	MK801
1943267	<u>CB0176</u>
1943268	<u>CB0176</u>
2023668	<u>CB0176</u>
2023669	<u>CB0202</u>
2023670	<u>CB0203</u>
2023671	<u>CB0202</u>
2031227	<u>T1296</u>
2031228	<u>T1296</u>
2031229	<u>T1361</u> ⁰
2074020	<u>CB0178</u>
216975	T5252
258420	T5242
272400	T5243
279011	T5241
279927	T1148 ¹
307111	T1100
328111	T5236
346126	CB0036 ⁴
347934	CB0036 ⁴
350936	CB0035 ⁴
360109	SD0006 ¹¹
367241	CB0036 ⁴



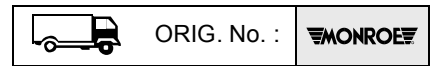
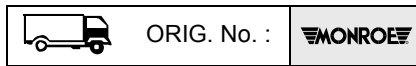
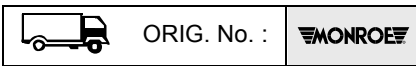

370227	CB0066
370227	CB0065
370228	CB0015
372291	T5237
393208	CB0015
393257	CB0066
393257	CB0065
393290	CB0015
395063	T1101
395064	T1044
403245	B1277
406694	B5290
409707	B1277
409720	B5290
410554	B5290
410555	B1277
411631	B5290
415848	B5290
415849	B1295
421280	B1299
426216	B5290
426218	B5290
426219	B1277
429163	B5290
460081	B5290
468188	B5290
468189	B1277
468191	B5290
468194	B1299
468195	B5316
468198	T1036
470263	B5290
470265	B5316
470266	B5316
470267	B1277
470268	T1036
470273	B5290
475915	B5290
481949	B5340
481967	B5290
483550	B5292
483551	B1310
488275	B1311
488823	<u>B5419</u>
489509	B5292
489750	<u>B1369</u> ⁰
489751	B1311
550365	CB0066
550365	CB0065

014856	F5025
015531	F5194
015978	F5194
016007	F5025
016008	F5075
016270	F5190 ¹
016270	F5011
016271	F5012
016436	F5025
016508	F5172
017090	F5194
017090	F5075
017370	F5187
017641	V2097
017750	F5011
017919	F5175
018054	F5192
020044	F5224
020044	F5125 ¹
028363	F5224
028363	F5125 ¹
075273	F5126
075278	F5126
1008054	F5376
1012386	F5174
1020636	F5192
1021298	F5176
1028075	F5075
1041843	F5004
1048260	F5010
1055458	F5224
1061555	F5381
1065667	F5015
1079383	F5012
1086689	F5172
1086690	F5376
1090122	F5254
1093975	F5172
1093977	F5376
1113437	F5025
1134526	F5164
1293079	F5381
196103	F5083
407620	F5125 ¹
408871	F5125 ¹
902022	F5194
902398	F5025
912022	F5194
912398	F5025
912565	F5172
912637	F5025
912643	F5194
912801	F5376
FAG0410191	F5075

SISU	
1550211821	CB0026

SNVI	
1090009	F1068



SOLARIS	
0820300100	B5346
0820300110	B1312
0820300112	B1312
0820300125	B1312
100210720	B5346
102201800	B5346
11016642	B5346

11070522	<u>B5405</u> ⁰
11070522	B5346
820300100	B5346
N1011070522	<u>B5405</u> ⁰
P0820300196	B1312

STEYR	
11 52004 40090	CB0139
13 46416 45	CB0174
13 46416 50	CB0105
13 46416 45	CB0174
15 20044 0090	CB0139
81 41722 6010	CB0105
81 41722 6010	CB0105
81 41722 6013	CB0105
81 41722 6013	CB0105
81 41722 6017	CB0105
81 41722 6017	CB0105
81 41722 6036	CB0087
81 41722 6045	CB0105
81 41722 6045	CB0105
81 41722 6049	CB0091
81 41722 6052	CB0091
81 41722 6059	<u>CB0198</u>
81 4370 16789	T1142
81 43701 6584	<u>T5429</u>
81 43701 6584	T5044 ¹
81 43701 6597	T1093
81 43701 6598	T1093
81 43701 6605	T5047
81 43701 6612	T1093
81 43701 6620	<u>T5429</u>
81 43701 6620	T5044 ¹
81 43701 6629	CB0103
81 43701 6629	CB0103
81 43701 6633	T5080
81 43701 6634	T5048
81 43701 6710	<u>T5429</u>
81 43701 6710	T5119
81 43701 6711	<u>T5429</u>
81 43701 6711	T5119
81 43701 6781	<u>T1334</u> ⁰
81 43701 6781	T1142
81 43701 6782	T1184
81 43701 6784	T1186 ¹
81 43701 6793	T1189
81 43701 6794	T1190
81 43701 6798	T1187
81 43701 6827	<u>T5429</u>
81 43701 6827	T5119
81 43701 6860	<u>T5396</u>
81 43701 6866	<u>T5396</u>
81 43701 6868	T5349
81 43701 6897	T1268
81 43701 6902	T1266
81 43701 6904	T5261
81 43701 6905	T5263
81 43701 6908	T5275
81 43701 6911	T5276
81 43701 6912	T5276
81 43701 6934	T5350
81 43701 6948	T1268
81 43701 6949	T1267
81 43701 6964	T1318
81 43701 6991	T1267
81 43702 6002	T1320
81 43702 6004	T1308
81 43702 6005	T1308



SCHMITZ CARGOBULL	
012486	F5254
012726	F5127
012789	F5125 ¹
012789	F5224
013250	F5073
013250	F5012
013250	F5004
013290	F5012
013506	F5007
013774	F5190 ¹
013774	F5011
013961	F5004
014050	F5002
014118	F5224
014134	F5254
014750	F5254
014750	F5224

	ORIG. No. :	
--	-------------	--

81 43702 6011	T1321
81 43702 6012	T1321
81 43702 6014	T1308
81 43702 6016	T5350
81 43702 6037	T5275
81 43702 6076	T1321
81 43702 6077	T1320
81 43702 6078	T1308
81 43702 6086	T1308
82 43701 6017	T1203
85 41722 6001	CB0139
85 41722 6011	<u>CB0198</u>
85 41722 6019	<u>CB0198</u>
85 41722 6010	<u>CB0199</u>
85 41722 6017	<u>CB0199</u>

TECMA	
11044001	F5343
7075	F5004

TIRSAN (KÄSSBOHRER)	
8231092000	F5157
8231092000D	F5157
8231092000DG	F5157
8231276000	F5157
8231293000	F5157
8231293100	F5157

TODD	
2912002	F5084
2914001	F1022



TOUGHLINE	
12740	F5075

TRABOSA	
1700406850	F1068
196103	F5083

TRAILOR	
0036114	F1118
0036114P	F1022
1526855	F5084
2376000800	F5020
2376001000	F5254
2376001800	F1000
2376003200	F5192
2376100500	F5185
6503123L	F5020
6503608P	F5020
6504638G	F1000
6505245	F1118
6505245X	F1022
6506635A	F5020
6506636B	F1000
7000057L	F5084
M001537	F5084
M001545	F5088
M007950	F5084
M007969	F5088
M076022	<u>F5408</u>
M077800	F1241
UJB0565	F5084

TRAS CAR	
03003106770C	F5366

TRAX	
40050	F5201
4050	F5205

	ORIG. No. :	
--	-------------	---

TROUILLET	
01120012877200	F5202
0112007200	F5202
2376001001	F5254
HA90750	F5202

VALTRA VALMET	
33139100	T1265
34147900P	CB0174



VALX	
D8A919524W	F5377

VDL BUS	
1141379	B5359
1141380	B5324
1194210	B5304
1194745	B5295
1196832	B5325
1196842	B5304
1253399	B5328
1253400	B5327
271025	B5304
278249	B5304
41141379	B5359
41141380	B5324
41194745	B5295
41196832	B5325
41253399	B5328
41253400	B5327
891165	T1090

VIBERTI	
02 3702 1800	F5002
127711219	F5370
128711209	F5007
128711216	F5007
178711204	F5007
178711207	F5007
178711209	F5007
7299	F5007

VOLKSWAGEN	
600 413 031 A	T1142
613 413 031	T1142

VOLVO	
1075076	CB0002
1075077	CB0002
1075444	CB0038
1075445	CB0005
1075478	CB0008
1076717	T1177
1076855	CB0006
1076860	CB0004
1079150	T5177
1079151	T5170
1080654	T1025
1089008	CB0027
1089009	CB0018
1089728	CB0017
1094523	T1149
1099672	CB0019
1134748	B5339
1136643	B5339
1137026	B5339
1137027	B5339
1501501	T1048
1505190	T1048
1505892	CB0020
1508429	CB0054

	ORIG. No. :	
--	-------------	--

1576443	CB0025
1580389	CB0021
1585586	CB0025
1586068	CB0016
1587562	CB0022
1588042	CB0054
1588043	CB0020
1590161	T1102
1591501	T1048
1591735	T1102
1593843	CB0017
1594088	CB0023
1594089	CB0017
1598105	T5066
1598106	T5155
1598814	T1048
1599459	CB0026
1599623	T1005
1605163	T5093
1608678	T1048
1608949	T1025
1609000	T1025
1609001	T5095
1609002	T5092
1609005	T5066
1609553	T1005
1609555	T1005
1609603	T1183
1610919	T1048
1610920	T1005
1610921	T1005
1612217	T5110
1613248	T1005
1620658	CB0024
1622085	CB0025
1622086	CB0026
1622087	CB0016
1622227	CB0007
1626057	T1025
1628103	T5097
1628136	T5097
1628189	T1176
1628359	T5110
1629405	T5091
1629475	T1180
1629476	T5115
1629477	T5096
1629478	T1177
1629480	T1176
1629481	T1179
1629482	T5098
1629483	T5097
1629484	T5107
1629485	T1178
1629719	CB0003
1629721	CB0029
1629722	CB0028
1629724	CB0003
1629920	T1179
1629992	T1149
1629993	T5110
1691617	T1176
1696541	SD0006 ¹¹
1699212	SD0001
1699225	<u>SD0009</u>
20350040	T1254
20350292	T1253
20350489	T1252
20367750	T1276





20374543	T5170
20374544	T5177
20374545	T1177
20374546	T5184
20374547	<u>T5395</u>
20374548	T1149
20385020	B5339
20386245	T1260
20399048	<u>T5394</u> ⁰
20400806	T1260
20401856	T5265
20427897	CB0006
20427897	CB0001
20443545	<u>SD0008</u>
20443547	SD0003
20453256	<u>CB0214</u>
20453256	MK800
20453256	CB0039
20453256	CB0055
20453258	<u>CB0212</u>
20453258	MK800
20453258	CB0039
20453258	CB0102
20485166	<u>B5433</u> ⁰
20512274	B5296
20532767	T1149
20540056	<u>B1343</u>
20543860	<u>B1343</u>
20549244	B5296
20564319	B5317
20568808	<u>B1343</u>
20568985	<u>B1370</u> ⁰
20571686	T1260
20573647	B5294
20573649	B5294
20578877	CB0063
20584309	<u>B5425</u> ⁰
20584310	<u>B1362</u> ⁰
20585555	T5177
20585556	T5170
20591506	CB0075
20591650	CB0119
20591650	CB0118
20593743	CB0110
20593746	CB0109
20709798	<u>T1360</u> ⁰
20709998	V2099
20710002	V2099
20710500	V2099
20717431	T1260
20717436	T5258
20721166	CB0004
20721167	CB0001
20721169	CB0006
20721512	CB0131
20721849	CB0046
20726165	<u>B5425</u> ⁰
20726168	B5289
20726168	B5289
20726479	T5283
20726480	T5306
20726482	T5282
20757841	CB0088
20766061	<u>T5367</u>
20766062	<u>T5440</u>
20766063	<u>T5393</u>
20769819	T1149
20775212	CB0006



20806285	T1272
20806286	T1271
20806287	T5280
20806288	T5310
20806289	T1294
20806291	<u>T5309</u>
20816502	B5289
20816502	B5289
20840318	CB0046
20871961	<u>T1338</u> ⁰
20871964	<u>T1335</u> ⁰
20878633	B5289
20878633	B5289
20883347	<u>T1360</u> ⁰
20889132	<u>CB0214</u>
20889132	MK800
20889132	CB0039
20889132	CB0055
20889134	CB0006
20889136	<u>CB0212</u>
20889136	MK800
20889136	CB0039
20889136	CB0102
20889138	CB0001
20900497	T1177
20906196	CB0075
20906906	T1272
20906911	T1271
20960913	CB0004
21032337	CB0001
21111925	MK800
21111925	CB0040
21111932	<u>CB0214</u>
21111932	MK800
21111932	CB0039
21111932	CB0055
21111942	<u>CB0212</u>
21111942	MK800
21111942	CB0039
21111942	CB0102
21137458	CB0004
21168663	<u>CB0204</u>
21170510	<u>CB0205</u>
21170611	<u>CB0207</u>
21171973	<u>CB0211</u>
21171975	<u>CB0208</u>
21171976	<u>CB0213</u>
21172387	T5170
21172388	T5177
21232661	<u>T5367</u>
21232662	<u>T5440</u>
21232663	<u>T5393</u>
21243048	<u>T5392</u> ⁰
21395046	<u>B5434</u>
21430900	<u>CB0210</u>
21430905	<u>CB0209</u>
21468510	<u>B5434</u>
21651229	CB0001
21651231	CB0006
21676912	T5310
21739591	<u>CB0205</u>
21739593	<u>CB0175</u>
21862164	<u>T5392</u> ⁰
21874256	<u>T1315</u>
21880100	<u>CB0215</u>
22040653	<u>CB0206</u>
22040662	<u>CB0207</u>
22040665	<u>CB0175</u>

22040666	<u>CB0213</u>
22128971	<u>CB0208</u>
22144200	CB0006
25379046	CB0110
25379070	CB0064
25379081	CB0063
3027113	B1280
3027422	B1281
3027423	B1280
3031623	B1281
3031624	B1279
3031625	B1279
3031626	B1279
3031627	B1279
3036162	B1279
3037213	<u>B1343</u>
3039244	<u>B1364</u>
3090128	<u>SD0009</u>
3090144	SD0007
3090570	SD0006 ¹¹
3090585	<u>SD0009</u>
3090587	SD0004
3091606	SD0004
3098121	B5338
3112260	B5295
3112261	B5294
3116809	B5326
3159800	B5339
3170104	B5320
3171962	T1149
3172984	CB0003
3172985	CB0006
3172986	CB0004
3178737	B5296
3178737	<u>B1343</u>
3178737	B1280
3178738	<u>B1343</u>
3193207	B5325
3198836	MK800
3198836	CB0040
3198837	<u>CB0212</u>
3198837	MK800
3198837	CB0039
3198837	CB0102
3198849	CB0007
3198850	CB0001
3198859	CB0004
344574	CB0020
353958	CB0020
3953641	T1168
3953642	T1160
3953643	T1161
3953644	T1162
3953646	T1167
3953648	T1164
3953650	T1165
3953651	T1163
3953652	T1168
3986315	CB0007
3987957	T1177
3987958	T1178
3987959	T1180
3987960	T1176
3987961	T1179
6212628	SD0007
6771500	T1160
6771504	T1096
6775411	T1162
6775412	T1162





	ORIG. No. :	
--	-------------	--

6790175	T5057
6794358	T1162
6794392	CB0026
6794746	T5057
70302099	B5295
70302100	B5289
70302100	B5289
70302101	B5294
70302127	B5317
70302128	B1302
70313744	<u>B1342</u>
70313745	B5295
70313746	T1183
70313747	<u>B1342</u>
70314331	<u>B5441</u> ⁰
70321019	T1183
70321023	B1280
70321619	B5295
70321697	<u>B1342</u>
70371252	<u>B5433</u> ⁰
70371256	B5296
70377009	<u>B1342</u>
70377024	B1280
70377034	<u>B5433</u> ⁰
70377050	B1280
70397058	<u>B5434</u>
70397060	<u>B5434</u>
70397084	<u>B5434</u>
70397094	<u>B5434</u>
8152712	B1278
8153538	T1048

	ORIG. No. :	
--	-------------	---

8159833	T1149
82052324	CB0062
82052423	<u>T1315</u>
82052425	<u>T1372</u> ⁰
82052893	CB0119
82052893	CB0118
82052897	CB0131
82292981	T5258
9516389	B5297
9520277	B5289
9520277	B5289
9522179	B5289
9522179	B5289

WEWELER	
20430004	F5025
20445015	F5194
21215607	F5075
21215742	F5075
21215751	F5075
21216058	F5013
21221306	F5075
21222271	F5015
21224034	F5013
503075	F5020
503076	F5020
50902	F5194
509020	F5194
50929	F5194
902022	F5194
902022SP2	F5075

	ORIG. No. :	
--	-------------	--

902023	F5075
902036	F5075
902194	F5025
902227	F5194
902229	F5025
902398	F5025
912022	F5194
912036	F5075
912194	F5025
912227	F5194
912229	F5025
912398	F5025
912565	F5172
912637	F5025
912643	F5194
912798	<u>F5402</u>
919522	F5381
919531	F5377
D899531W	F5377
W26505106912798	<u>F5402</u>

ZORZI	
1006604	<u>F5343</u>
1006609	F5366
1006610	F5075
1006611	F5075
1006613	F5002
1006617	F5369
1006618	F5369
1006619	F5368



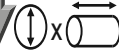
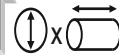
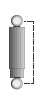
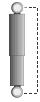

65416	450	304	Q	19x44	O	19x44	-	298, 301
B1238	517.4	316.3	L		T		17190572 (2x)	310
B1239	517	316	L		T		17190572 (2x)	8, 142, 143, 310
B1240			L		T		-	6
B1259	589.9	351.3	L		T		17190624 (2x)	323, 324, 326
B1263	594	356	L		T		17190619 (2x)	6
B1277	609.9	368.8	L		T		17190568 (2x)	332, 333
B1278	489.9	308.8	L		T		17190568 (2x)	9, 174, 270, 271, 310, 315, 316, 317, 318, 321, 322
B1279	656.3	415.2	Q	16x100	O	16x66	-	336, 337, 338
B1280	706.3	437.7	Q	16x100	O	20x50	-	336, 337, 338
B1281	631.3	402.7	Q	16x100	O	20x50	-	336, 337
B1282	442.4	273.8	L		T		17190568 (2x)	317, 318
B1283	507.4	306.3	L		T		17110045 (2x)	324, 326
B1284	472.4	288.8	L		T		17110045 (2x)	326
B1285¹	514	323	L		T		17190619 (2x)	6, 325
B1286	643.7	405.1	Q	16x50	O	16x50	-	316, 320
B1287	614.9	373.8	L		T		17110045 (2x)	313, 326
B1288	582.4	363.8	L		T		17190568 (2x)	313
B1289	602.4	356.3	L		T		17190568 (2x)	310, 311, 312, 313
B1290	489.9	308.8	L		T		17190568 (2x)	316, 317
B1291	547.4	343.8	L		T		17190624 (2x)	325
B1292	534	328	Q	16x40	T		17190584	313
B1293	589.9	361.3	L		T		17110045 (2x)	313
B1295	609.9	368.8	L		T		17190568 (2x)	332, 333
B1297	442	273	L		T		17190568 (2x)	317
B1298	474.9	306.3	L		T		17190624 (2x)	313, 325
B1299	778	467	L		O	22x46	17190568, 17190594	332, 333
B1301	671.1	405.0	L		O	20x45	17190568	331
B1302	507.4	316.3	L		T		17190568 (2x)	335, 336
B1305	609.9	368.8	L		T		17190624 (2x)	324, 325
B1306	688.9	415.3	L		O	20x45	17190568	331
B1310	602.4	361.3	L		T		17190568 (2x)	333
B1311	542.4	341.3	L		T		17190568 (2x)	333
B1312	447.4	278.8	L		T		17110045 (2x)	334
B1317	504.0	335.4	L		O	24x57	17190568	313, 330
B1326	514.9	323.8	L		T		17190624 (2x)	1, 6, 325
B1327	597.4	356.3	L		T		17190624 (2x)	1, 6, 323, 324
B1328	562.4	333.8	L		T		17190625 (2x)	1, 312, 313
B1342	686.2	485.1	Q	16x100	O	28x66	-	1, 337
B1343	706.3	437.7	Q	16x100	O	20x50	-	1, 336, 337, 338
B1351	599.9	461.3	L		T		17190625 (2x)	1, 333
B1362	487.4	316.3	L		T		17190625 (2x)	1, 335, 336
B1363⁰	889.9	508.8	L		T		17190625 (2x)	1
B1364⁰	611.6	394.1	Q	16x48	O	16x48	17190602	1, 335
B1369	542	341	L		T		17190625 (2x)	1, 334
B5162	514.5	315.0	L		T		17190569 (2x)	310



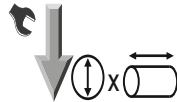
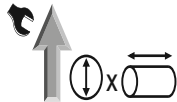
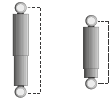

B5163	507.0	315.0	⊥	T	17190569 (2x)	310		
B5168			⊥	T	-	6		
B5259	527.0	320.0	⊥	T	17190570 (2x)	311, 318, 319, 320, 321		
B5260	692.0	410.0	⊥	T	17190570 (2x)	311, 318, 319, 320, 321		
B5286	566.0	356.0	⊙	20x62	T	17190570	313, 323, 326	
B5289	502.0	307.5	⊥	T	17190570 (2x)	335, 336, 337, 338		
B5290	587.0	352.5	⊥	T	17190570 (2x)	311, 332, 333		
B5291	542.0	327.5	⊥	T	17190570 (2x)	310, 315, 316, 317, 318, 325		
B5292	646.9	415.0	⊥	⊙	20x50	17190570	333	
B5293	537.0	327.5	⊥	T	17190570 (2x)	316, 318, 321, 322		
B5294	502.0	317.5	⊥	T	17190570 (2x)	335, 336		
B5295	487.0	307.5	⊥	T	17190570 (2x)	334, 335, 336, 337		
B5296	709.3	441.8	⊙	16x100	⊙	20x50	-	338
B5297	678	421	⊙	20x50	⊙	20x50	-	336
B5298	534.5	325.0	⊥	T	17190570 (2x)	324, 326		
B5299	544.5	332.5	⊥	T	17190570 (2x)	316		
B5300	550.9	370.9	⊙	20x62	⊙	20x62	-	311, 312
B5301	509.5	310.0	⊥	T	17190570 (2x)	316, 317		
B5302	550.9	370.9	⊙	20x62	⊙	20x62	-	312, 313
B5303	602.0	360.0	⊥	T	17190570 (2x)	311, 312, 313		
B5304	672.0	390.0	⊥	T	17190570 (2x)	334, 335		
B5305	560.9	363.4	⊙	20x62	⊙	20x62	-	313
B5312	494.5	312.5	⊥	T	17190570 (2x)	317, 318		
B5313	609.5	367.5	⊥	T	17190570 (2x)	327, 328, 329, 330		
B5314	609.5	367.5	⊥	T	17190570 (2x)	327, 328, 329, 330		
B5315	603.9	381.7	⊙	20x52	⊙	20x52	-	314
B5316	610.9	393.4	⊙	22x46	⊙	22x46	17190594 (2x)	332, 333
B5317	487.0	307.5	⊥	T	17190570 (2x)	335		
B5318	473.9	341.7	⊙	20x52	⊙	20x52	-	314
B5319	588.4	388.4	⊙	20x62	⊙	20x62	-	312, 313
B5320	477.0	295.0	⊥	T	17190570 (2x)	335		
B5321	603.9	381.7	⊙	20x52	⊙	20x52	-	314
B5322	603.9	381.7	⊙	20x52	⊙	20x52	-	314
B5323	603.9	381.7	⊙	20x52	⊙	20x52	-	314
B5324	534.5	325.5	⊥	T	17190570 (2x)	334		
B5325	572.0	343.0	⊥	T	17190570 (2x)	334, 337, 338		
B5326	549.5	330.0	⊥	T	17190570 (2x)	338		
B5327	549.5	330.5	⊥	T	17190570 (2x)	334		
B5328	459.5	288.0	⊥	T	17190570 (2x)	334		
B5330	504.5	342.5	⊥	T	17190570 (2x)	314, 315, 330, 331		
B5331	542.0	342.5	⊥	T	17190570 (2x)	315		
B5333	529.5	340.5	⊥	T	17190570 (2x)	315		
B5334	641.9	394.9	⊥	⊙	20x45	17190570	331	
B5335	666.4	434.2	⊙	20x62	⊙	20x62	-	324, 325
B5336	669.4	402.4	⊥	⊙	20x45	17190570	331	
B5337¹	494.4	334.9	⊥	⊙	24x58	17190569	6, 314, 315, 330, 331	
B5338	614.5	372.5	⊥	T	17190570 (2x)	338		



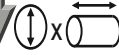
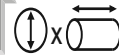
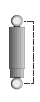
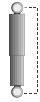

B5339	638.4	418.2	Q	28x100	○	28x66	-	335, 336, 337
B5340	537.0	327.5	⊥		⊥		17190570 (2x)	333
B5341	612	412	Q	24x49	○	24x49	-	314, 315
B5345	582.0	345.0	⊥		⊥		17190570 (2x)	333
B5346	467.0	297.5	⊥		⊥		17190570 (2x)	329, 334
B5347	609.5	360.0	⊥		⊥		17190570 (2x)	325, 327, 328, 329, 330
B5353	502.0	317.5	⊥		⊥		17190570 (2x)	313, 330, 331
B5355	497	348	⊥		○	24x58	17190570	314, 315, 330, 331
B5359	499.5	312.5	⊥		○	24x58	17190570 (2x)	334
B5382	685	407	⊥		○	24x49	-	314, 315
B5383	683	407	⊥		○	24x55	-	314, 315
B5397	687.0	397.5	⊥		⊥		17190627 (2x)	1, 314
B5398	696.9	422.4	⊥		○	20x45	17190627	1, 332
B5404	529.5	340.5	⊥		⊥		17190627 (2x)	1, 334
B5405	467.0	287.5	⊥		⊥		17190627 (2x)	1, 327, 334
B5419	584.5	360.0	⊥		⊥		17190627 (2x)	1, 332, 333, 334
B5420	535.1	340.6	⊥		○	20x52	17190627	1, 314
B5421	535.1	340.6	⊥		○	20x52	17190627	1, 314
B5422	490.1	323.1	⊥		○	24x58	17190627	1, 331
B5424	490.1	340.6	⊥		○	24x58	17190627	1, 6, 313, 314, 315, 330, 331
B5425	528.5	333.5	Q	16x100	⊥		17190627	1, 335, 336, 337
B5433	611.0	391.0	Q	16x100	⊥		17190627	1, 335, 336
B5434⁰	646.0	391.0	Q	16x100	⊥		17190627	1, 335, 336, 337, 338
CB0001	408	363	Q	14x45	○	14x45	-	138, 140
CB0002	398	353	Q	14x45	○	14x45	-	138
CB0003	430	300	Q	14x45	○	20x45	-	138
CB0004	411	360	Q	14x45	○	14x45	-	137, 138, 139, 140
CB0005	391	350	Q	14x45	○	14x45	-	139, 140
CB0006	408	363	Q	14x45	○	14x45	-	138
CB0007	256	235	Q	20x45	○	20x45	-	137, 138, 139, 140
CB0008	328	219	⊥		○	20x45	17110698	139, 140
CB0009	306	206	⊥		⊥		17110699	135
CB0010	306	206	⊥		⊥		17110699	133, 135
CB0011	289	246	⊥		⊥		17110701	135, 136
CB0012¹	329	277	Q	25x45	⊥		17110702	6, 11, 13
CB0013	308	270	Q	14x40	○	14x40	-	11
CB0014	322	222	⊥		○	14x50	17110703	133, 134
CB0015	330	232	⊥		○	14x50	-	134
CB0016	308	223	Q	14x32	○	14x32	-	6, 136, 137
CB0017	277	218	⊥		⊥		17110709	6, 139
CB0018	267	210	⊥		⊥		17110709	6, 139
CB0019	348	267	Q	14x45	○	14x45	-	6, 137
CB0020	227	172	Q	16x35	○	16x35	17110004	7, 136, 137, 140
CB0021	334	265	Q	14x32	○	14x32	-	7, 136, 137
CB0022	249	195	Q	14x32	○	14x32	-	7, 136
CB0023	266	213	Q	14x32	○	14x32	-	7, 139
CB0024	236	183	⊥		⊥		17110705	7, 140

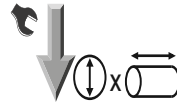
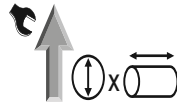
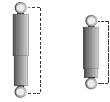

CB0025	245	186	Q	14x32	○	14x32	-	7, 136, 137
CB0026	245	186	Q	14x31	○	14x31	-	7, 136, 137, 139
CB0027	259	210	Q	14x32	○	14x32	-	7, 139
CB0028	428	299	Q	14x45	○	20x45	-	7, 137
CB0029	401	350	Q	14x45	○	14x45	-	7, 137
CB0030							17110720	133, 135, 136
CB0031	329	277	Q	25x45	T		17110702	11
CB0032 ¹	329	277	Q	25x45	T		17110702	6, 11, 13
CB0033	318	272	Q	25x46	T		17110704	11, 12, 13
CB0034	272	231	Q	14x40	T		17110704	11, 12, 13
CB0038	391	350	Q	14x45	○	14x45	-	139, 140
CB0039	335	222	⊥		○	20x46	17110829	138, 140
CB0040	336	226	⊥		○	20x46	17110828	138, 139, 140
CB0041							17110719	133, 134
CB0042	248	227	Q	14x40	○	14x40	-	12
CB0043	329	277	Q	25x46	T		17110702	13
CB0044 ¹	329	277	Q	25x46	T		17110702	6, 12
CB0045 ¹	283	245	Q	14x45	T		17110702	6, 11, 13
CB0046	266	211	Q	14x45	○	14x45	-	130, 131, 132, 137
CB0047	225	194	Q	14x40	○	14x40	-	11
CB0048	276	238	Q	14x40	T		17110702	13
CB0049 ¹	276	238	Q	14x40	T		17110702	6, 12
CB0050	228	172	Q	10x32	○	10x32	-	131
CB0051	292	202	⊥		T		-	130, 131
CB0052	368	247	Q	12x47	T		-	130, 131
CB0053	387	255	Q	12x32	○	12x32	-	130, 131
CB0054	227	172	Q	16x35	○	16x35	17110004	140
CB0055							17110771	138
CB0057	355	250	Q	12x32	○	12x32	-	122, 123
CB0058	306	206	⊥		T		17110847	133, 134
CB0059	306	206	⊥		T		17110847	134
CB0060	322	224	⊥		○	14x50	17110847	133
CB0061	233	194					-	131
CB0062	233	194					-	131
CB0063	227	190	Q	14x45	○	14x45	-	131
CB0064	241	210	Q	12x42	○	12x42	-	130, 131, 132, 137
CB0065	322	224	⊥		○	14x50	17110847	134
CB0066							-	133, 134
CB0067							17110785	133, 134
CB0068	254	206	⊥		○	50x35	17110757	131, 132
CB0069	298	251	Q	12x47	○	12x47	-	131, 132
CB0071	253	194	Q	18x34	○	18x34	-	125, 126, 127, 128, 129, 130
CB0072	260	188	Q	12x32	○	12x32	-	14
CB0073	268	196	Q	14x34	○	16x34	-	14, 15, 16
CB0074							17110720	133, 135
CB0075							-	130, 131, 132, 137
CB0076							-	130, 131



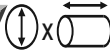
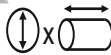
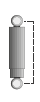
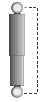

CB0078	335	235	⊥		○	14x50	17110699	133, 135
CB0079	335	235	⊥		○	14x50	17110699	135
CB0080	275	200	Q	12x32	○	12x32	-	121, 122
CB0081	256	200	Q	14x32	○	14x32	-	124, 125, 126, 127, 128
CB0082								131
CB0083								6
CB0084	247	181	Q	14x32	○	14x32	-	123
CB0085	249	183	Q	12x32	○	12x32	-	17, 18, 97, 98
CB0086	233	168	⊥		○	12x32	17110079	17, 18
CB0087	387	258	Q	12x32	○	12x32	-	19, 20
CB0088	308	262	Q	12x40	○	12x40	-	130, 131, 132, 137
CB0089	345	277	Q	14x40	○	25x40	-	98
CB0090	315	279	Q	14x40	○	14x40	-	98, 99
CB0091	288	252	Q	14x40	○	14x40	-	28
CB0092	315	254	Q	14x45	T		17110798	22, 23
CB0093	380	336	⊥		○	16x44	17110799	15, 16
CB0094	400	353	Q	16x65	○	16x44	-	15, 16
CB0095	400	353	Q	16x65	○	16x43	17110800	15, 16
CB0096	371	302	Q	12x39	○	12x32	-	98, 99
CB0097	371	302	Q	12x50	○	12x50	-	99, 100, 101, 102, 103, 104, 105, 106, 107, 108, 109, 110, 111, 115, 119, 120, 121
CB0098	380	305	⊥		○	16x44	17110799	14, 15
CB0099	415	324	Q	16x65	○	16x44	17110800	14, 15, 16
CB0100	338	274	Q	14x40	○	25x40	-	98
CB0101	321	279	Q	14x40	○	14x40	-	98, 99
CB0102							17110771	140
CB0103	263	225	Q	14x40	○	14x40	-	23, 24, 25, 26, 27, 28, 132
CB0104	289	254	⊥		□		-	124, 125, 126, 127, 128
CB0105	292	246	Q	14x40	○	14x40	-	19, 20, 21, 22, 23, 24, 132, 133, 339, 340
CB0106	314	252	Q	14x45	T		-	19, 20, 21, 22, 23, 24
CB0107	345	277	Q	14x40	○	25x40	-	98
CB0108	350	282	Q	14x50	○	25x40	-	98
CB0109	311	251	Q	12x40	○	12x40	-	130, 131, 132, 137
CB0110	311	251	Q	12x40	○	12x40	-	130, 131, 132, 137
CB0115	311	222	Q	14x50	○	25x38	-	98, 99, 100, 101, 102, 103, 104, 105, 106, 107, 108, 109, 110, 111
CB0116	323	283	Q	15x50	○	14x50	-	100, 101, 102, 103, 104, 105, 107, 108, 109, 111, 119, 120
CB0117	295	239	Q	14x45	○	14x45	-	131
CB0118	275	191	⊥		□		17110764	130, 131, 132, 137
CB0119	253	198	⊥		□		17110764	130, 131
CB0120	245	176	⊥		T		17110831 (2x)	13
CB0121	347	277	Q	14x50	○	25x38	-	99
CB0122	347	277	Q	14x50	○	25x38	-	99
CB0123	261	230	Q	12x80	○	12x40	-	11
CB0124	261	230	Q	12x80	○	12x40	-	11
CB0125	266	221	Q	12x40	○	12x40	-	11
CB0126	266	221	Q	12x40	○	12x40	-	11

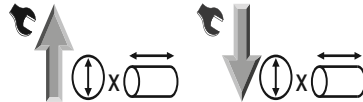
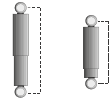

CB0130							-	133, 134
CB0131	258	203	⊥		□		17110764	130, 132, 137
CB0132	228	211	⊙	12x40	⊙	12x40	-	11
CB0133	266	211	⊙	14x45	⊙	14x45	-	130
CB0134	329	241	⊥		⊙	14x50	17110847	133, 134
CB0135							-	131
CB0136	330	296	⊙	20x46	⊙	20x46	-	16
CB0137	389	282	⊙	32x46	⊙	20x46	-	16
CB0138	380	339	⊥		⊙	25x44	-	14
CB0139	263	213	⊙	14x40	⊙	14x40	-	24, 25, 26, 27, 28, 132
CB0140	363	315	⊥		□		-	123, 125, 126, 127, 128, 129, 130
CB0141	263	216	⊙	14x40	⊙	14x40	-	17, 18, 24, 25, 27, 28
CB0142	362	321	⊥		□		-	124, 125, 126, 127, 128
CB0144	369	330	⊙	14x40	□		-	99, 100, 101, 102, 103, 104, 105, 106, 107, 108, 109, 110, 111
CB0145	272	200	⊙	14x34	⊙	16x50	-	16
CB0146	245	189	⊙	14x40	⊙	14x40	-	14
CB0147	369	325	⊙	14x40	□		-	99, 100, 101, 102, 103, 104, 105, 106, 107, 108, 109, 110, 111
CB0148	210	166	⊙	12x32	⊙	12x32	-	98, 99, 100, 101, 103, 104, 106, 107, 108, 109, 110, 111, 115, 119, 120, 121
CB0149	416	317	⊙	16x66	⊙	16x44	-	16, 17
CB0150	301	223	⊙	14x50	⊙	14x50	-	115, 119, 120, 121
CB0151	450	384	⊙	16x66	⊙	16x44	-	16, 17
CB0152	446	384	⊙	16x66	⊙	16x44	-	16, 17
CB0153	368	426	⊙	32x46	⊙	20x46	-	16, 17
CB0154	426	368	⊙	32x46	⊙	20x46	-	16, 17
CB0155	327	282	⊙	14x50	⊙	14x50	-	100, 101, 102, 103, 105, 108
CB0156	327	282	⊙	14x50	⊙	14x50	-	100, 101, 102, 103, 105, 108
CB0157	327	282	⊙	14x50	⊙	14x50	-	100, 101, 102, 103, 105, 108
CB0158	322	277	⊙	14x40	⊙	14x40	-	98, 99, 100, 101, 102, 103, 104, 105, 106, 107, 108, 109, 110, 111
CB0159	339	292	⊙	14x45	⊙	14x45	-	16
CB0160	315	275	⊥		⊙	14x50	17110701	133, 135
CB0161	327	282	⊙	14x50	⊙	14x50	-	100, 101, 102, 103, 105, 108, 109, 110
CB0162	343	274	⊙	14x40	⊙	14x40	-	115, 119, 120, 121
CB0163	349	277	⊙	14x50	⊙	14x40	-	115, 119, 120, 121
CB0164	228	210	⊙	12x40	⊙	12x40	-	100, 101, 102, 103, 105, 108
CB0165	369	330	⊙	14x40	□		-	98, 99, 100, 101, 102, 103, 104, 105, 106, 107, 108, 109, 110, 111
CB0166	421	324	⊙	14x45	⊙	14x45	-	339
CB0167	421	324	⊙	14x45	⊙	14x45	-	340
CB0168	384	272	⊙	12x35	T		-	339
CB0169	421	324	⊙	14x45	⊙	14x45	-	339
CB0170	421	324	⊙	14x45	⊙	14x45	-	339
CB0171⁰	350	307	□		⊙	12x40	-	131, 132
CB0172	315	215	⊥		T		17110915	133, 135
CB0173	306	206	⊥		T		17110915	135
CB0174	341	252	⊙	12x32	⊙	12x32	-	339, 340



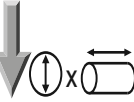
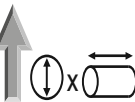
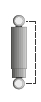
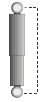

CB0175	378	333	Q	14x45	○	14x45	-	1, 138
CB0176	310	206	⊥		⊥		-	1, 133, 136
CB0177	321	243	⊥		○	14x50	NA	1, 133, 136
CB0178	340	236	⊥		○	14x50	NA	1
CB0179							-	1, 14, 15, 16
CB0180	274	247	Q	12x50	○	12x50	-	1, 81, 82, 83, 84, 85
CB0181	264	223	Q	12x40	○	12x40	-	1, 82, 83, 84, 85
CB0182	329	229	⊥		○	14x50	17110975	1, 133
CB0183							17110040	1, 133
CB0184	380	280	Q	14x47	□		-	1
CB0186	331	277	Q	25x45	⊥		17110702	1, 6, 11, 13
CB0187	331	277	Q	25x45	⊥		17110702	1, 6, 11, 13
CB0188	284.5	245	Q	14x40	⊥		17110702	1, 6, 11, 13
CB0194	344	244	⊥		○	14x50	17110040	1, 133
CB0195	344	244	⊥		○	14x50	17110040	1, 135
CB0196	380	285	Q	14x47	□		-	1
CB0197	346	286	Q	12x45	○	12x50	-	1, 33, 34, 35, 36, 39, 41, 46, 47, 48, 50, 51, 52, 53, 54, 55, 57, 58, 59, 60, 61, 63, 64, 65, 66, 67, 68, 69, 70, 71, 72, 73, 74, 76, 77, 78, 79, 80, 81, 87, 96
CB0198	350	284	Q	12x45	○	12x50	-	1, 29, 30, 31, 33, 34, 35, 36, 37, 38, 42, 43, 44, 45, 47, 49, 50, 53, 54, 57, 58, 59, 60, 61, 62, 65, 67, 68, 69, 71, 73, 74, 85, 86, 87, 88, 89, 90, 91, 92, 93, 94, 95, 96, 97
CB0199	380	314	Q	12x50	○	12x50	-	1, 13, 29, 30, 31, 32, 33, 34, 35, 36, 37, 38, 39, 40, 41, 42, 43, 44, 45, 46, 47, 48, 49, 50, 51, 52, 53, 54, 55, 56, 57, 58, 59, 60, 61, 62, 63, 64, 65, 66, 67, 68, 69, 70, 71, 72, 73, 74, 75, 76, 77, 78, 79, 80, 81, 85, 86, 87, 88, 89, 90, 91, 92, 93, 94, 95, 96, 97
CB0200	380	329	Q	12x50	○	12x50	-	1, 2, 13, 29, 30, 31, 32, 33, 34, 35, 36, 37, 38, 39, 40, 42, 43, 44, 45, 46, 47, 48, 49, 50, 51, 52, 53, 54, 56, 57, 58, 59, 60, 61, 62, 63, 64, 65, 66, 67, 68, 69, 70, 71, 72, 73, 74, 75, 76, 77, 78, 80, 81, 85, 86, 87, 88, 89, 90, 91, 92, 93, 94, 95, 96
CB0201	382	319	Q	12x50	○	12x50	-	2, 33, 34, 35, 36, 39, 41, 46, 47, 48, 50, 51, 52, 53, 54, 55, 57, 58, 59, 60, 61, 63, 64, 65, 66, 67, 68, 69, 70, 71, 72, 73, 74, 76, 78, 79, 80, 81, 87, 96
CB0202	378	280	Q	14x47	□		-	2
CB0203	378	280	Q	14x47	□		-	2
CB0204	254	237	Q	20x45	○	20x45	-	2, 137, 138
CB0205	336	219	⊥		○	14x67	17190628	2, 138, 139
CB0206	336	219	⊥		○	14x67	17190628	2, 138
CB0207	352	235	⊥		○	14x67	-	2, 138
CB0208	185	151	⊥		○	14x48	17190629	2, 138
CB0209	224	198	Q	14x48	○	14x48	-	2, 139
CB0210	352	235	⊥		○	14x67	-	2, 139
CB0211	378	333	Q	14x45	○	14x45	-	2, 139
CB0212	352	235	⊥		○	14x67	-	2, 140
CB0213	378	333	Q	14x45	○	14x45	-	2, 138
CB0214	352	235	⊥		○	14x67	-	2, 138
CB0215	378	333	Q	14x45	○	14x45	-	2, 139
CB0216	402	352	Q	16x66	○	16x44	-	2, 17



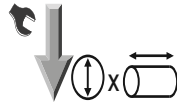
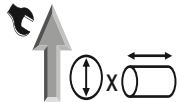
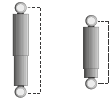

CB0217	370	327	□		○	14x50	-	2, 99, 100, 101, 103, 104, 105, 106, 107, 108, 109, 110, 111, 112
CB0218	312	243	□		○	14x50	-	2, 99, 100, 101, 103, 104, 105, 106, 107, 108, 109, 110, 111, 112
CB0219	426	372	○	32x46	○	20x46	-	2, 16, 17
CB0220⁰	247	214	○	50x25	○	14x45	-	2, 112, 113, 114, 115, 116, 117, 118, 119
CB0221	351	309	○	12x50	○	12x50	-	2, 12
CB0222	360	318	○	12x50	○	12x50	-	2, 11
CB0223	321	284	○	12x50	○	12x50	-	2, 11, 12
CB0224	351	309	○	12x50	○	12x50	-	2, 12
CB0225	321	284	○	12x50	○	12x50	-	2, 12
CB0226	366	329	○	12x50	T		17110702	2, 11
CB0227	296	259	○	12x50	T		17110702	2, 11
CB0228	321	284	○	12x50	○	12x50	-	2, 11
CB0229	261	229	○	12x40	○	12x114	-	2, 12
CB0230	261	229	○	12x40	○	12x40	-	2, 11
CB0231	360	318	○	12x50	○	12x50	-	2, 11
CB0232	360	318	○	12x50	○	12x50	-	2, 11
CB0233	225	193	○	12x40	○	12x40	-	2, 11
CB0234	421	324	○	14x45	○	14x45	-	2, 339
CB0235	331	277	○	25x45	T		17110702	2, 6, 12
CB0236	345	279	○	14x50	○	14x40	-	2, 119, 120, 121
CB0237	279	236.5	○	14x40	T		17110702	2, 6, 12
F1000	471.2	310.1	○	20x62	○	20x62	-	304, 307
F1022	506.2	335.1	○	20x55	○	20x55	-	299, 307
F1026	616	383	○	20x44	○	20x44	-	6
F1047	627	366	⊥		T		-	6
F1068	616.2	382.6	○	20x44	○	20x44	-	304, 307
F1074	743.7	450.1	○	20x44	○	20x44	-	301, 305
F1080	621	386	○	20x44	○	20x44	-	6
F1081	614	386	○	20x44	○	20x44	-	6
F1085	544	351	○	20x44	○	20x44	-	6
F1086	601	381	○	20x45	○	20x45	-	6
F1087	491	326	○	20x45	○	20x45	-	6
F1091	543.7	362.6	○	20x44	○	26x48	-	301
F1092	571	388	○	20x44	○	26x48	-	6
F1112	720	430	⊥		○	16x45	-	6
F1113	678.7	412.6	○	20x55	○	20x55	-	294, 297, 299
F1118	503.7	335.1	○	20x55	○	20x55	-	295, 302, 307
F1119	713.7	435.1	○	20x44	○	20x44	-	304
F1120	537	321	⊥		T		17190577, 17190585	6
F1139	429	291	○	20x44	○	20x44	-	6
F1140¹	714	436	○	20x44	○	20x44	-	301
F1141	544	351	○	20x44	○	20x44	-	6
F1241	713.7	435.1	○	20x55	○	20x55	-	293, 295, 297, 307
F1262¹	678	412	○	20x50	○	20x50	-	298
F1274	808.7	487.6	○	20x55	○	20x55	-	297



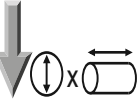
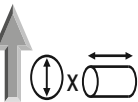
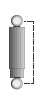
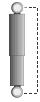

F1325	557	354	Q	19x46	○	19x46	-	298
F5001	788.9	476.6	Q	24x55	○	24x55	-	294, 298
F5002	763.9	464.2	Q	24x55	○	24x55	-	294, 296, 305, 308, 309
F5004	496.0	326.0	Q	24x55	○	24x55	-	293, 294, 295, 296, 297, 299, 300, 301, 302, 306
F5007	693.9	426.7	Q	24x55	○	24x55	-	293, 294, 295, 299, 300, 302, 305, 308
F5008	698.9	429.2	Q	24x55	○	24x55	-	6, 294
F5009	684	424	Q	24x55	○	24x55	-	6
F5010	793.9	476.7	Q	24x55	○	24x55	-	294, 306
F5011	432.0	292.0	Q	24x55	○	24x55	-	7, 294, 296, 304, 305, 306
F5012	541.0	351.0	Q	24x55	○	24x55	-	294, 305
F5013	475.9	320.9	Q	24x58	○	24x58	-	299, 303, 305, 309
F5015	428.4	303.4	Q	24x58	○	24x58	-	293, 298, 303
F5020	465.9	315.9	Q	24x62	○	24x62	-	293, 295, 299, 302, 303, 304, 307, 309
F5021	460.9	308.4	Q	20x50	○	20x50	-	296, 297
F5022	652.0	390.0	⊥		⊥		17190586 (2x)	295
F5025	475.9	320.9	Q	20x62	○	20x62	-	299, 300, 302, 306, 308, 309
F5026	689	421	⊥		○	28x66	-	6
F5027	425	293	Q	20x62	○	20x62	-	6
F5028	425	293	Q	20x62	○	20x62	-	6
F5029	879	517	⊥		○	28x66	-	6
F5071¹	435	305	Q	22x49	□		-	298, 301, 307, 309
F5073	496.0	326.0	Q	24x55	○	24x55	-	294, 296, 299
F5075	425.9	295.9	Q	20x62	○	20x62	-	6, 293, 294, 295, 297, 299, 300, 301, 302, 303, 305, 307, 309
F5077	533.9	349.2	Q	23x55	○	23x55	-	301
F5082	510	350	Q	25x50	○	25x50	-	6
F5083	488.9	324.2	Q	24x55	○	24x55	-	296, 299, 304, 306, 307
F5084	475.9	320.9	Q	20x55	○	20x55	-	293, 295, 297, 307
F5085	445.9	315.9	Q	20x50	○	20x50	-	293, 296, 297
F5086	445	315	Q	22x49	○	22x49	-	6
F5087	445	315	Q	25x50	○	25x50	-	6
F5088	428.4	303.4	Q	20x55	○	20x55	-	296, 297, 307
F5089	375.9	280.9	Q	20x45	○	20x45	-	296, 297
F5125¹	495	327	Q	24x55	○	24x55	-	6, 306
F5126	788.9	476.7	Q	24x55	○	24x55	-	294, 306
F5127	558.9	359.2	Q	20x62	○	20x62	-	304, 305
F5157	560.9	360.9	Q	16x50	○	16x50	-	307
F5161	824	489	⊥		○	28x66	-	6
F5164	375.9	273.4	Q	24x58	○	24x58	-	303, 306
F5166	363.4	260.9	Q	20x55	○	20x55	-	295, 297, 301
F5167	440.9	323.4	Q	20x55	○	20x55	-	6
F5172	383	267	Q	16x58	○	16x58	-	306, 309
F5173	332	235	Q	16x58	○	16x58	-	303
F5174	413	278	Q	20x78	○	20x68	-	305, 306
F5175	491	315	Q	20x78	○	20x68	-	305, 306
F5176	532	335	Q	20x78	○	20x68	-	305, 306

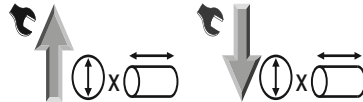
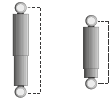

F5185	655	415	Q	24x55	○	24x55	-	294, 305
F5186	513	333	Q	20x50	○	20x44	-	304
F5187	473.9	316.7	Q	24x55	○	24x55	-	304, 305, 306
F5188	906	536	Q	24x55	○	24x55	-	294
F5190¹	424	291	Q	24x55	○	24x55	-	7, 294, 296, 305, 306
F5192	693.9	426.7	Q	24x55	○	24x55	-	296, 304, 306, 307
F5193	794	476	Q	24x55	○	24x55	-	7
F5194	426	296	Q	20x62	○	20x62	-	299, 300, 305, 306, 308
F5195	405	280	Q	20x89	○	20x59	-	300
F5196	485.9	323.4	Q	20x50	○	20x50	-	298
F5197	705	435	Q	20x50	○	20x50	-	7
F5198	616	406	Q	20x50	○	20x50	-	298
F5201	474.9	329.9	Q	20x62	○	20x62	-	305, 308
F5202	575.9	380.9	Q	20x55	○	20x55	-	308
F5203	678.9	436.7	Q	25x51	○	25x51	-	295, 299
F5204	525	382	Q	20x55	○	20x55	-	7
F5205	474.9	329.9	Q	20x62	○	20x62	-	295, 305, 308
F5220	445	315	Q	20x62	○	20x62	-	7
F5221	485.9	325.9	Q	20x46	○	20x46	-	299, 300, 302
F5223	400.9	285.9	Q	20x46	○	20x46	-	300
F5224	496.0	326.0	Q	24x55	○	24x55	-	6, 294, 304, 306
F5226	406.0	296.0	Q	20x46	T		17190570	300
F5251	385.9	270.9	Q	20x50	○	20x50	-	214, 215, 217, 218, 222, 223, 227, 298, 300
F5254	476.4	319.2	Q	20x62	○	20x62	-	299, 303, 304, 305, 308
F5270	533.9	354.2	Q	23x55	○	23x55	-	301
F5272	555	355	Q	24x55	○	24x55	-	296
F5273	810	485	Q	24x55	○	24x55	-	296
F5285	750	470	Q	20x45	○	20x45	-	7
F5311	715.0	435.0	Q	20x50	○	20x50	-	2, 298
F5329	480.9	340.9	Q	24x58	○	24x58	-	300
F5342	427	294	Q	20x89	○	20x59	-	300
F5343	552	353	Q	20x50	○	20x50	-	2, 303
F5344	632	407	Q	20x50	○	20x50	-	2, 303
F5366	648.4	403.4	Q	20x46	○	20x46	-	293, 294, 295, 297, 302, 308, 309
F5368	423.9	296.4	Q	24x52	○	24x52	-	300, 302, 309
F5369	466.4	316.4	Q	24x52	○	24x52	-	309
F5370	583.9	373.9	Q	24x52	○	24x52	-	308
F5376	383	267	Q	16x82	○	16x58	-	306
F5377	425	290	Q	20x82	○	16x82	-	308, 309
F5378	423	291	Q	20x68	○	20x68	-	302
F5379	337	254	Q	24x58	○	24x58	-	302
F5380	380	270	Q	20x68	○	20x68	-	299, 302
F5381	386	270	Q	20x58	○	16x58	-	302, 306, 308
F5384	412.0	287.0	Q	24x55	○	24x55	-	2, 294
F5401	460	300	Q	20x78	○	20x68	-	2, 304
F5402	449	305	Q	20x62	○	20x62	-	2, 299, 308
F5407	420.5	313.3	Q	24x55	○	20x55	-	2, 297



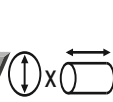
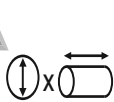
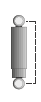
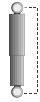

F5408	468.0	328.3	Q	24x55	○	20x55	-	2, 297
F5409	383	280	Q	24x58	○	24x58	-	2, 302
F5423	696.2	436.2	Q	24x58	○	24x58	-	3, 295
SD0001	184	138	Q	16x19	○	16x19	17110775	401, 402, 403, 404, 405, 406
SD0002	198	146	Q	16x19	○	16x19	17110788	403, 404, 405, 406
SD0003	213	153	Q	12x22	○	12x22	17110775	401, 402, 403, 404, 405, 406
SD0004	184	138	Q	12x22	○	12x22	17110775	402, 403, 404, 405
SD0005	184	138	Q	12x22	○	16x24	17110775	401, 402, 403, 404, 405
SD0006	198	146	Q	12x24	○	12x24	17110788	402, 403, 404, 405, 406
SD0007	198	146	Q	12x24	○	12x24	17110788	402, 403, 404, 405
SD0008							-	3, 401, 402
SD0009							-	3, 401, 402
SD0010	214	154	Q	12x22	○	12x22	17110775	3, 402, 403, 406
T1001	591	371	Q	20x46	○	20x46	-	7
T1002	618.7	390.1	Q	16x50	○	16x50	-	232, 233
T1003	631	396	Q	16x50	○	16x50	-	7
T1005	656.2	420.1	Q	16x100	○	16x66	-	9, 269, 271, 272, 282, 283, 284, 285
T1006	650	400					-	7
T1007	696	426	Q	16x50	○	16x50	-	168, 315
T1008	618	403					-	7
T1009¹	721	456	Q	16x50	○	16x50	-	236, 238, 239, 240, 241
T1010	969	549	⊥		T		-	7
T1011	798.7	477.6	Q	16x50	○	16x50	-	7, 200, 201, 202, 203, 204, 205, 206, 207, 208, 209, 210, 211, 212, 213, 215, 217, 224, 225, 226, 227, 228, 229, 233, 234, 236, 237, 238, 239, 240, 241
T1012	793.7	475.1	Q	16x50	○	16x50	-	232, 233, 234, 236, 237, 238, 239, 240, 241
T1013	806.2	490.1	Q	16x50	○	16x50	-	230, 231, 232, 233, 234, 236, 237, 239, 240
T1014	804	489	Q	16x50	○	16x50	-	7
T1015¹	806	491	Q	16x50	○	16x50	-	7, 234, 235, 236, 238
T1016	806.2	490.1	Q	16x50	○	16x50	-	7, 8, 234, 235, 236, 237, 238, 239, 240, 241
T1017	663	415					-	7
T1018¹	634	386	Q	14x40	○	14x40	-	231
T1019	821	488	Q	16x62	○	16x50	-	7
T1021	525	360	⊥		○	26x50	-	7
T1023	721	456	Q	16x100	○	16x66	-	7
T1024	886	531	Q	16x100	○	20x50	-	7
T1025	643.7	420.1	Q	16x100	○	16x66	-	269, 270, 271, 272, 275, 277, 278, 279, 280, 282, 283, 284, 285
T1027	628.9	387.8	⊥		○	16x50	17190572	232, 236, 237, 238
T1028	651.4	390.3	⊥		○	16x50	17190568	167, 168, 169, 170, 172, 174
T1029	671.4	397.8	⊥		○	16x50	17190572	169, 174
T1030	646	396	⊥		○	16x50	-	7
T1031	700	415	⊥		○	16x50	17190572	7
T1032	602	356	⊥		T		-	7
T1033	740	424	⊥		T		-	7
T1034	997	559	⊥		T		-	7

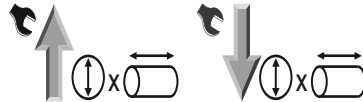
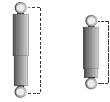

T1035	836	478	⊥		T		17190568 (2x)	7
T1036	609.9	368.8	⊥		T		17190568 (2x)	168, 333
T1037	670	410	⊥		○	16x50	-	7
T1038	627	366	⊥		T		-	7
T1039	743	438	⊥		T		-	7
T1042	844.9	481.3	⊥		T		17190606 (2x)	248
T1043	657.4	388.8	⊥		T		17190568 (2x)	169, 172, 175
T1044	602.4	353.8	⊥		T		17190585 (2x)	256, 257, 258, 259
T1045	518	310	⊥		T		-	8
T1046	622	386	⊥		T		-	8
T1048	712.4	418.8	⊥		T		17190568 (2x)	268, 269, 270, 271, 272
T1049	674	389	⊥		T		-	8
T1050	677	391	⊥		T		-	8
T1051	677	391	⊥		T		-	8
T1052	742	426	⊥		T		-	8
T1053	742	426	⊥		T		-	8
T1054	662	426	⊥		T		-	8
T1055 ¹	657	386	⊥		T		-	147
T1056	707.4	406.3	⊥		T		17190572 (2x)	8, 147, 234
T1057	692.4	401.7	⊥		T		17190572 (2x)	147
T1058	602.4	356.3	⊥		T		17190572 (2x)	7, 147
T1061	561	351	○	14x40	○	14x40	-	8
T1062	611	376	○	14x40	○	14x40	-	8
T1063	611	376	○	14x40	○	14x40	-	8
T1064	611.2	375.5	○	14x58	○	14x40	-	243
T1065	619	378	○	14x58	○	14x40	-	8
T1066	623	385	○	14x58	○	14x40	-	8
T1067 ¹	679	418	○	14x50	○	14x40	-	8, 242, 243, 322, 323
T1069	676.2	425.5	○	14x50	○	14x40	-	8, 230, 242, 243, 322, 323
T1070 ¹	704	431	○	14x62	○	16x50	-	8, 242, 243
T1071	711.2	430.5	○	14x50	○	14x40	-	230, 323
T1072	721.2	440.5	○	14x50	○	14x40	-	230, 231, 323
T1073	692.4	401.3	⊥		T		17190568 (2x)	174
T1075	722.2	441.5	○	14x50	○	14x40	-	230
T1076	651	401	○	16x45	○	16x45	-	8
T1077	656	403	○	12x80	○	14x40	-	8
T1078	636	396	○	16x45	○	16x45	-	8
T1079	631	391	○	16x45	○	16x45	-	8
T1082	616	386	○	16x45	○	16x45	-	8
T1083	589	376	○	14x45	○	14x45	-	8
T1084	591	378	○	16x45	○	16x45	-	8
T1088	625	380	⊥		○	16x44	-	8
T1089	610	385	⊥		○	16x45	-	8
T1090	677.4	391.3	⊥		T		17190585 (2x)	169, 170, 172, 174, 175, 334
T1093	692.4	401.3	⊥		T		17190585 (2x)	169, 170, 172, 174, 175
T1095	601	381	○	22x46	○	22x46	-	8
T1096	629	391	○	16x48	○	16x48	17190602	282



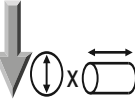
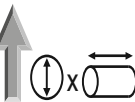
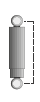
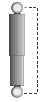

T1097	649	401	Q	16x48	○	16x48	-	8
T1098	546	351	Q	18x42	○	18x42	-	8
T1099	673	400	⊥		○	26x48	17190572, 17190594	143, 144, 145
T1100	691.4	410.3	⊥		○	16x44	17190585	256, 257
T1101	691.4	410.3	⊥		○	22x46	17190585, 17190594	255, 256, 257, 258, 259
T1102	713.7	450.1	Q	26x48	○	26x48	-	269, 270, 271, 272
T1104	784	468	Q	16x48	○	16x48	-	8
T1105	821.4	480.3	⊥		○	16x44	17190572	255, 256, 257
T1106	714	451					-	8
T1107	614	386	Q	20x45	○	20x45	-	8
T1108	675	399	⊥		T		-	8
T1109	749	476	Q	26x48	○	26x48	-	8
T1110	619	381	⊥		T		-	8
T1111	713.2	432.5	Q	14x62	○	16x50	-	8, 242, 243, 322, 323
T1115	676.2	412.6	Q	16x50	○	16x50	-	7, 214, 215, 216, 218, 220, 221, 236, 237, 240
T1116	597.4	354.2	⊥		T		17190572 (2x)	168, 173
T1117	651.2	400.1	Q	12x80	○	14x40	-	8, 168, 173, 187, 188, 316
T1122	759.9	433.8	⊥		T		17190568 (2x)	244, 245, 248
T1124	601	381	Q	22x46	○	22x46	-	8
T1125	601	381	Q	22x46	○	22x46	-	8
T1126	721	413	⊥		T		17190568 (2x)	8
T1127	688.7	420.1	Q	14x50	○	14x40	-	242, 243, 322, 323
T1128	701.4	415.3	⊥		○	20x46	17190568	155, 156
T1129	561	351	Q	16x38	○	16x38	-	8
T1130	758.7	452.6	Q	20x46	○	20x46	-	166
T1131	651.2	400.1	Q	20x46	○	20x46	-	164, 166
T1132	561	351	Q	16x38	○	16x38	-	8
T1133 ¹	651	401	Q	20x46	○	20x46	-	166
T1134	656	403	Q	20x46	○	20x46	-	8
T1135	606	381	Q	20x46	○	20x46	-	8
T1137	736.4	432.8	⊥		○	16x50	17190568	158, 159, 160, 161, 162, 163, 164
T1138	656.2	400.1	Q	20x55	○	20x55	-	158, 159, 160, 161
T1142	607.4	359.2	⊥		T		17190572 (2x)	169, 173, 316, 317
T1143	644	421	Q	20x55	○	20x55	-	242
T1144	821	488	Q	16x50	○	16x50	-	8
T1145	691.4	410.3	⊥		○	22x46	17190585, 17190594, 17190617	258, 259
T1146	738.9	440.3	⊥		○	22x46	17190585, 17190594	259, 260
T1147	705	425	⊥		○	22x46	-	8
T1148 ¹	722	411	⊥		T		17190585 (2x)	255, 256, 257
T1149	721.2	455.1	Q	16x100	○	16x66	-	282, 283, 284, 285
T1150	806	491	Q	16x50	○	16x50	-	8
T1151 ¹	830	469	⊥		T		17190568 (2x)	234, 239
T1152	711.2	430.1	Q	14x50	○	14x40	-	230, 322, 323
T1153	804	491	Q	16x62	○	20x62	-	9



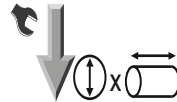
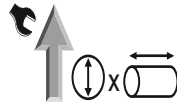
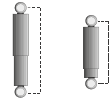

T1155	569	358	Q	18x42	○	18x42	-	9
T1157	806	491	Q	16x62	○	20x62	-	9
T1158	711	431	Q	16x50	○	16x50	-	9
T1159	711	441	Q	16x48	○	16x48	-	9
T1160	712.0	428.0	Q	16x48	○	16x48	17190602	282
T1161	784.0	466.0	Q	16x48	○	16x48	17190602	282
T1162	784.0	466.0	Q	16x48	○	16x48	17190602	8, 9, 282
T1163	824.0	486.0	Q	16x48	○	16x48	17190602	282
T1164	632.0	388.0	Q	16x48	○	16x48	17190602	281, 282
T1165	654.0	399.0	Q	16x48	○	16x48	17190602	281, 282
T1166	864	508	Q	16x48	○	16x48	17190602	9
T1167	864.0	506.0	Q	16x48	○	16x48	17190602	282
T1168	654.0	399.0	Q	16x48	○	16x48	17190602	282
T1169	629	391	Q	16x48	○	16x48	17190602	9
T1170	864	508	Q	16x48	○	16x48	17190602	9
T1176	781.2	480.1	Q	16x100	○	20x50	-	275, 276, 277, 279, 280, 288, 289, 290, 291
T1177	721.2	455.1	Q	16x100	○	16x66	-	7, 270, 271, 272, 274, 275, 276, 277, 278
T1178	721.2	455.1	Q	16x100	○	16x66	-	274, 275, 276, 277, 278
T1179	881.2	530.1	Q	16x100	○	20x50	-	7, 274, 275, 276, 277, 278, 280
T1180	716.2	450.1	Q	16x100	○	20x50	-	274, 275, 276, 277, 278, 279, 280, 281, 288, 289, 290, 291
T1181	656	421	Q	16x100	○	16x66	-	9
T1182	656	421	Q	16x100	○	16x66	-	9
T1183	656.2	420.1	Q	16x100	○	16x66	-	9, 269, 270, 271, 272, 282, 283, 284, 285, 337, 338
T1184	656.2	402.6	Q	12x80	○	14x45	-	173
T1185	646.4	395.3	⊥		○	16x50	17190568	7, 173, 174
T1186 ¹	591	371	Q	14x45	○	14x45	-	173, 174
T1187	593.7	370.1	Q	14x45	○	14x45	-	173, 174, 317
T1188	721	441	Q	16x50	○	16x50	-	9
T1189	646.4	395.3	⊥		○	16x50	17190585	170, 171
T1190	681.4	417.8	⊥		○	16x50	17190568	170, 171
T1191	630	387	⊥		○	20x50	-	9
T1192	806	491	Q	16x50	○	16x50	-	9
T1193	588	370	⊥		○	20x50	17190585	148, 152
T1194	613.7	402.6	Q	14x50	○	14x50	-	7, 243
T1197	771.2	460.1	Q	16x50	○	16x50	-	200, 201, 202, 203, 204, 205, 206, 207, 208, 209, 210, 211, 212, 213, 214, 215, 217, 218, 219, 222, 224, 225, 226, 227, 228, 229, 244
T1198 ¹	674	389	⊥		T		17190572 (2x)	174
T1199	677	391	⊥		T		-	9
T1200	766.2	465.1	Q	16x105	○	16x50	-	200, 201, 202, 203, 204, 206, 208, 210, 213, 214, 215, 217, 218, 222, 225, 226, 228, 244
T1201	856.2	515.1	Q	16x105	○	16x50	-	200, 201, 202, 203, 204, 205, 206, 207, 209, 211, 212, 213, 214, 215, 218, 224, 225, 227, 228, 229
T1202	753	437	⊥		○	16x50	-	9
T1203	721.4	430.3	⊥		○	16x50	17190585	170, 171



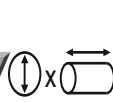
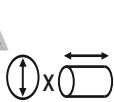
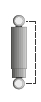
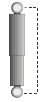

T1204	806.2	490.1	Q	16x50	○	16x50	-	7, 200, 201, 202, 203, 204, 205, 206, 207, 208, 209, 210, 211, 212, 213, 217, 218, 219, 224, 225, 226, 227, 228, 231, 234, 236, 238, 239, 242
T1205	806	491	Q	16x50	○	16x50	-	9
T1206	486	308	⊥		⊥		17190584 (2x)	9
T1207	856.2	505.1	Q	16x50	○	16x50	-	200, 201, 202, 203, 204, 205, 206, 207, 208, 209, 210, 211, 212, 213, 214, 215, 217, 218, 219, 222, 223, 224, 225, 226, 227, 228, 229
T1208	627.4	366.3	⊥		⊥		17190572 (2x)	174
T1209	627	366	⊥		⊥		17190572 (2x)	168, 174
T1210	766.2	465.1	Q	16x105	○	16x50	-	200, 201, 202, 203, 204, 208, 210, 215, 217, 218, 225, 226
T1211	896	536	Q	16x105	○	16x50	-	9
T1212	627	366	⊥		⊥		-	9
T1213	486	308	⊥		⊥		-	9
T1214	543.7	350.1	Q	20x40	○	20x40	-	245, 247, 248, 250, 251, 298
T1215	853.9	490.3	⊥		○	20x50	17190585, 17190616	260, 261, 263, 264
T1216	553.9	345.3	⊥		○	20x50	17190585	261, 262, 264
T1219	856	506					-	9
T1220	806.2	490.1	Q	16x50	○	16x50	-	200, 201, 202, 203, 210, 211, 217, 218, 219, 222, 223, 226, 227, 228, 233, 236, 239
T1221	886	531					-	9
T1223	627.4	366.3	⊥		⊥		17190606 (2x)	9, 246, 247, 248, 250, 251
T1224	743	438					-	9
T1225	743	438					-	9
T1226	602	356					-	9
T1227	791	448					-	9
T1228¹	692	401					-	248, 249
T1230	741.4	432.8	⊥		○	20x50	17190585	260, 261, 263, 264
T1232	806.2	490.1					-	9, 202, 210, 232, 233, 236, 238
T1242¹	816.4	470.3	⊥		○	16x50	17190568	9, 155, 156, 157
T1243	668.9	402.8	⊥		○	20x46	17190568	155, 156, 157, 159, 161
T1244	708.9	417.8	⊥		○	20x46	17190568	155, 156, 157
T1245¹	725	432	⊥		○	20x46	17190568	155, 156, 157
T1246	726.7	436.0	Q	14x50	○	14x40	-	215, 216, 217, 218, 219, 220, 221
T1251	856.2	505.1	Q	16x50	○	16x50	-	202
T1252	820	500	Q	25x50	○	14x40	17190618	281
T1253	760.0	452.0	Q	25x50	○	16x65	17190618	281
T1254	820.0	500.0	Q	25x50	○	14x40	17190618	281
T1255	691.1	411.0	Q	14x50	○	14x40	17190614	214, 215, 216, 217, 220, 221
T1256	725.8	431.0	Q	14x62	○	16x50	17190615	215, 216, 217, 220, 221
T1257	738.7	442.6	Q	20x45	○	20x45	-	250, 251
T1258	676.2	410.1	Q	20x54	⊥		171 10765	249, 250
T1260	722.0	435.0	Q	20x50	○	20x50	-	281
T1261	746.4	435.3	⊥		○	16x50	17190568	158, 159, 160, 161, 165
T1264	598.7	377.6	Q	16x50	○	16x50	-	158, 159, 160, 161, 162
T1265	493.7	322.6	Q	16x50	○	16x50	-	158, 159, 160, 162, 163, 164, 165
T1266	674.0	405.4	⊥		○	24x55	17190568	154, 155, 176, 177, 178, 180, 181, 182, 183, 184, 185, 187, 266, 267

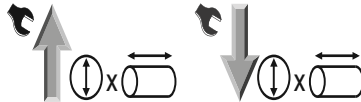
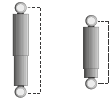

T1267	846.5	517.9	⊥		○	24x55	17190568	154, 176, 177, 178, 179, 180, 181, 182, 183, 184, 185, 186, 187, 188, 189, 190, 191, 192, 193, 194, 195, 196, 198, 199, 266, 267
T1268	674.0	405.4	⊥		○	24x55	17190568	154, 176, 177, 178, 179, 180, 181, 182, 183, 184, 185, 186, 187, 188, 189, 190, 191, 192, 193, 194, 195, 196, 197, 198, 199, 266, 267
T1269	631.5	401.5	○	20x45	⊥		17110551	249, 250
T1270	806.4	465.3	⊥		○	20x46	17190568	165
T1271	664.0	407.9	○	20x50	○	20x50	-	251, 252, 272, 273
T1272	664.0	407.9	○	20x50	○	20x50	-	252, 273
T1273	696.2	420.1	○	16x62	○	16x50	-	217, 218, 220, 221
T1275	671.2	420.1	○	16x50	○	16x50	-	200, 201, 202, 203, 204, 205, 206, 207, 208, 209, 210, 211, 212, 213, 215, 217, 218, 224, 225, 226
T1276	658.8	457.7	○	16x100	○	20x50	-	274, 275, 276, 277, 278, 288, 289, 290, 291, 292
T1294	713.5	432.4	○	20x50	○	20x50	-	252, 273
T1296	803.7	475.1	○	16x100	○	20x50	-	3, 253, 254, 260, 261, 262, 263, 264, 265, 266
T1303	521.6	327.2	⊥		○	20x50	17110045	155, 156, 298
T1304	803.7	480.1	○	16x50	○	16x50	-	200, 201, 202, 203, 208, 209, 210, 211, 219, 223, 224, 225, 228, 229
T1307	613.1	387.0	○	20x45	○	20x45	-	155, 156
T1308	868.8	540.2	○	20x105	○	24x55	-	176, 178, 179, 180, 182, 183, 184, 185, 186, 187, 188, 189, 190, 191, 192, 193, 194, 195, 196, 197, 198, 199, 266, 267
T1309	711.4	417.8	⊥		○	20x46	17190568	155, 156, 157, 158, 159, 160, 161
T1313	598.7	377.6	○	16x50	○	16x50	-	187
T1314	688.5	412.5	⊥		○	20x45	17110551	3, 250
T1315	520.0	335.0	○	20x45	○	20x45	-	3, 249, 250, 281
T1316	581.5	356.5	⊥		○	20x45	17110765	3, 250
T1318	674.0	405.4	⊥		○	24x55	17190568	154, 155, 176, 177, 178, 180, 181, 182, 183, 184, 185, 187, 266, 267
T1320	713.9	432.8	○	20x105	○	24x55	-	154, 176, 177, 178, 179, 180, 181, 182, 183, 184, 185, 186, 187, 188, 189, 190, 191, 192, 193, 194, 195, 196, 197, 198, 199, 266, 267
T1321	701.4	427.8	○	20x105	○	24x55	-	176, 177, 178, 180, 181, 182, 183, 185, 188, 189, 190, 191, 192, 193, 194, 195, 196, 197, 198, 199, 266, 267
T1322	701.4	415.3	⊥		○	20x50	17190584	187
T1324	607.4	356.3	⊥		⊥		17190568 (2x)	145, 146
T1329	706.7	430.6	○	16x50	○	16x50	-	3, 232, 233
T1330	687.7	413.7	⊥		○	22x50	17190626, 17110965	3, 253, 254, 255, 256, 257, 258, 259, 260, 261, 262, 263, 264, 265, 266
T1331	687.7	409.2	⊥		○	22x50	17190626, 17110965	3, 253, 254, 257, 258, 259, 260, 261, 262, 263, 264, 265, 266
T1332	687.7	409.2	⊥		○	22x50	17190626, 17110965	3, 253, 254, 260, 261, 262, 263, 264, 265, 266
T1333	661.4	430.3	○	20x105	○	24x55	-	3, 176, 177, 178, 180, 181, 182, 188, 189, 190, 191, 193, 194, 197, 198, 199
T1334	610.8	362.4	⊥		⊥		17110045 (2x)	3, 173, 174
T1335	703.5	468.5	⊥		○	20x45	17110551	3, 250
T1336	731.5	488.5	⊥		○	20x45	17110551	3, 250
T1337	680.5	429.5	⊥		○	20x45	17110551	3, 249, 250
T1338	703.5	468.5	⊥		○	20x45	17110551	3, 250



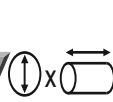
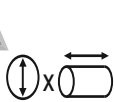
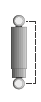
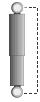

T1339	804.0	479.0	Q	16x50	○	16x50	-	3, 210, 211, 219, 223, 228
T1340	853	503	Q	16x50	○	16x50	-	3, 208, 209, 217, 218, 226, 227
T1341	722	435	Q	20x50	○	20x50	-	3, 250
T1344	636.4	392.8	Q	12x80	○	16x50	-	3, 187
T1345	699	416	⊥		○	20x50	17110045	3, 187
T1346	713.7	437.6	Q	16x50	○	16x50	-	3, 187, 188
T1347	768.9	460.3	Q	16x50	○	24x55	-	3, 176, 178, 180, 182, 183, 184, 185, 186, 187, 188, 190, 191, 192, 193, 194, 195, 196
T1348	753.9	462.8	⊥		○	20x50	17190625	3, 188
T1349	868.8	540.2	Q	20x105	○	24x55	-	3, 176, 178, 179, 180, 182, 183, 184, 185, 186, 188, 189, 190, 191, 192, 193, 194, 195, 196, 197, 198, 199
T1350	759.9	471.3	⊥		T		17190585 (2x)	3, 173, 175
T1352	804	479	Q	16x50	○	16x50	-	3, 206, 207, 208, 209, 210, 211, 212, 213, 215, 217, 218, 224, 225, 226, 227, 228, 229
T1353	711.2	435.1	Q	20x105	○	16x50	-	3, 179, 180, 184, 186, 190, 192, 195, 196
T1354	816.4	470.3	⊥		○	16x50	17190568	3, 9, 155, 156, 157
T1355	711.4	417.8	⊥		○	20x50	17190568	3, 155, 156, 158
T1356	669.9	406.0	Q	16x38	○	16x38	-	3, 155, 156, 158
T1357	766.2	465.1	Q	20x105	○	16x50	-	3, 182, 185
T1358	660.9	409.8	Q	20x55	○	16x50	-	3, 197, 198
T1359	573.9	357.8	⊥		○	16x50	17190625	3, 187, 188
T1360	841.0	499.9	Q	20x50	○	20x50	-	3, 273, 274, 286, 287
T1361⁰	888.7	577.6	Q	16x100	○	20x50	-	3
T1365	577	351	⊥		○	20x50	17110827	4, 244
T1366⁰	597	362	⊥		○	22x58	17111095	4, 244
T1367⁰	697	411	⊥		○	22x58	17110827	4, 244
T1368⁰	547.4	336.3	⊥		○	20x50	17111108	4, 244
T5005	720.9	440.9	Q	16x50	○	16x50	-	240
T5016¹	475	320	Q	24x62	○	24x62	-	246, 248, 249
T5019	819	484	⊥		○	20x55	-	9
T5024	686	403	⊥		T		17190586 (2x)	9
T5030	721.9	437.4	⊥		○	20x62	17190570	232, 235, 236, 238
T5031¹	840	515	Q	16x50	○	16x50	-	233, 234, 237, 239, 240, 241
T5033¹	926	521	⊥		T		17190570 (2x)	231, 237
T5034	668.4	413.4	Q	16x50	○	16x50	-	238, 239, 241
T5035	645	403	Q	16x50	○	16x50	-	9
T5036	650	410	Q	20x62	□		-	9
T5037	770	475	Q	20x62	□		-	9
T5039	790	478	Q	20x62	○	20x62	-	231
T5040	773	465	Q	16x50	○	16x50	-	9
T5041¹	705	435	Q	16x50	○	16x50	-	167, 168, 169
T5043	608	363	⊥		T		-	9
T5044¹	650.9	421.9	Q	20x62	○	30x62	-	9
T5045	675.9	425.9	Q	20x62	○	30x62	-	142, 144, 148, 149, 150, 151, 152, 153, 154
T5046	695.9	435.9	Q	20x62	○	30x62	-	143, 148, 152, 153
T5047	750.9	465.9	Q	20x62	○	20x62	-	170, 175, 178, 182, 185

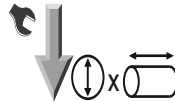
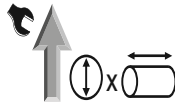
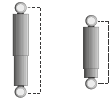

T5048	650.9	410.9	Q	20x62	○	30x62	-	167, 168, 169, 170, 171
T5049	670	428	Q	20x62	□		-	9
T5050	655	415	Q	16x50	○	16x50	-	9
T5051	668	413	Q	16x50	○	16x50	-	10
T5052	621.9	377.4	⊥		○	20x50	17190587	141, 142, 146, 147, 152, 153
T5053	621.9	377.4	⊥		○	20x50	17190587	9, 143, 147, 148, 149, 150, 151, 152, 153, 154
T5054	796.9	477.4	⊥		○	20x62	17190570	232, 234, 235, 236, 237
T5056	690.9	430.9	Q	16x50	○	16x50	-	10, 167, 168, 169, 170, 171, 172, 174
T5057	665.9	415.9	Q	16x50	○	16x50	-	282
T5059	816.9	477.4	⊥		○	20x50	17190569, 17190616	9, 255, 256, 257, 258, 259, 260
T5060	842.0	475.0	⊥		T		17190587 (2x)	255, 256, 257, 258, 259
T5061	632	384	⊥		○	22x55	-	10
T5062	665	415	Q	20x50	○	20x50	-	10
T5063	786.9	467.4	⊥		○	22x46	17190587, 17190594	258, 259
T5066	833.5	503.5	Q	16x50	T		17190570	10, 269, 270, 271, 272, 282, 283, 284
T5067 ¹	704	414	⊥		T		17190570 (2x)	248
T5068	720.9	440.9	Q	20x45	○	20x45	-	246, 247, 248
T5069	546	351	⊥		T		17190586 (2x)	169, 170, 172, 174, 175, 320, 321
T5070	834.5	475.0	⊥		T		17190587 (2x)	148, 150, 152, 153
T5072	650	410	Q	20x62	□		-	10
T5074	820	488	⊥		○	20x62	-	10
T5078	690.9	430.9	Q	20x45	○	20x45	-	246, 247, 248
T5079	665	415	Q	20x50	○	20x50	-	10
T5080	684.5	402.5	⊥		T		17190587 (2x)	169, 170, 172, 174
T5081	655	415	Q	20x50	○	20x50	-	10
T5090	900	540	Q	20x62	○	20x62	-	10
T5091	721.0	431.0	Q	16x100	T		17190570	252, 270, 271, 272, 273, 274, 276, 278, 279, 280, 281, 282, 286, 287, 288, 289, 290, 291, 292
T5092	883.4	530.9	Q	16x100	○	20x50	-	269, 270, 271, 282, 283, 284, 285
T5093	798.5	493.5	Q	16x50	T		17190570	269, 270, 271, 283, 284
T5094	859	559					-	10
T5095	893.4	530.9	Q	16x100	○	20x50	-	269, 270, 271, 272, 282, 283, 284, 285
T5096	724.5	417.5	⊥		T		17190570 (2x)	275, 276, 277, 278, 279, 280
T5097	801.0	488.5	Q	16x100	T		17190570	274, 275, 276, 277, 278, 279, 280, 281
T5098	821.0	481.0	Q	16x100	T		17190570	275, 277
T5101	682	422	⊥		○	26x48	-	10
T5103	698	418	⊥		○	26x48	-	10
T5104 ¹	608	363	⊥		T		17190570 (2x)	10
T5106 ¹	647	402	⊥		○	26x48	-	144, 145
T5107	763.5	478.5	Q	16x100	T		17190570	275, 276, 277
T5108	549.5	330.0	⊥		T		17190586 (2x)	143
T5109	760	485	Q	20x62	○	20x62	-	10
T5110	726.0	441.0	Q	16x100	T		17190570	269, 270, 271, 272, 274, 276, 278, 282, 283, 284, 285
T5112	780	480	Q	20x50	○	20x50	-	10



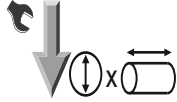
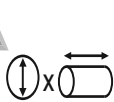
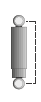
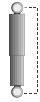

T5113	543	353	Q	16x50	○	16x50	-	10
T5115	721.0	431.0	Q	16x100	T		17190570	275, 277
T5117¹	528	321	L		T		17190586 (2x)	142
T5118	561	358	Q	20x62	T		-	10
T5119¹	650.9	421.9	Q	20x62	○	30x62	-	10, 169, 170, 171, 172, 174, 175
T5120	686	403	L		T		-	10
T5121	620.9	398.4	Q	20x62	○	30x62	-	171, 172, 175, 176, 178, 180, 182, 184, 185, 188, 191, 193, 197, 198
T5122	679	394					-	10
T5123	670	420	Q	26x48	○	26x48	17190609	10
T5124	670	430	Q	26x48	○	26x48	-	10
T5128	755	470	Q	20x55	○	20x55	-	10
T5129	695.9	435.9	Q	16x62	○	16x62	-	230, 231
T5130	685	430	Q	20x62	○	20x62	-	10
T5131	714	427	L		○	20x62	-	10
T5132	595	390	Q	20x62	○	30x62	-	10
T5133	672	392	L		T		-	10
T5134	730.9	465.9	Q	20x105	○	20x50	-	201
T5135	650	420	Q	20x62	□		-	10
T5136	650	420	Q	20x62	□		-	10
T5137	785.9	475.9	Q	20x105	○	20x50	-	200, 201, 202, 203, 204, 207, 208, 209, 218, 226, 227
T5138	679	394	L		T		-	10
T5139	679	394	L		T		-	10
T5140	728	485	Q	24x55	T		-	10
T5141	617	364	L		T		17190570 (2x)	10
T5142	627	369	L		T		-	10
T5143¹	624	369	L		T		17190570 (2x)	143, 144, 145
T5144	950.0	555.0	Q	20x50	○	20x50	-	260, 261, 262, 263, 264
T5145	873.4	523.4	Q	20x50	○	20x50	-	261, 262, 264
T5147	762.9	462.9					-	246, 247, 250, 251
T5148	590	380	L		○	20x62	17190586	10
T5153	585.9	375.9					-	246, 247, 248
T5154	858.0	510.8					-	246, 247, 248, 250, 251
T5155	840.9	515.9	Q	20x50	○	20x50	-	269, 270, 271, 272, 282, 283, 284, 285
T5169	553.4	373.4	Q	20x50	○	20x50	-	142, 146, 154, 298
T5170	841.8	501.8	Q	16x100	○	20x50	-	274, 275, 276, 277, 278, 279, 280, 281, 288, 289, 290, 291, 292
T5171	724.3	444.3	Q	20x105	○	20x50	-	202, 211, 219, 223, 228
T5177	751.8	459.3	Q	16x100	○	20x50	-	274, 275, 276, 277, 278, 279, 280, 281, 288, 289, 290, 291, 292
T5178	668.4	418.4	Q	16x62	○	20x62	-	215, 216, 217, 220
T5179	609.5	360.0	L		T		17190613 (2x)	246, 247, 248, 250, 251
T5180	669.3	419.3	Q	20x62	○	20x50	-	141, 142, 146, 147, 148, 149, 150, 151, 152, 153, 154
T5181	634.5	375.0	L		T		17190587 (2x)	141, 142, 146, 147, 148, 149, 150, 151, 152, 153, 154
T5182	644.3	414.3	Q	20x62	○	20x50	-	141, 142, 146, 147, 148, 149, 150, 151, 152, 153, 154
T5183	694.5	402.5	L		T		17190587 (2x)	146, 147, 154



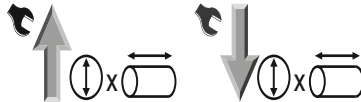
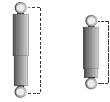

T5184	711.8	441.8	Q	16x100	○	16x66	-	274, 275, 276, 277, 278, 279, 280, 281, 287, 288, 289, 290, 291, 292
T5199	542.7	358.4	Q	20x46	○	20x46	-	302
T5211	787	462	⊥		○	26x48	-	10
T5225	668	413	Q	16x50	○	16x50	-	10
T5227	684.5	402.5	⊥		⊥		17190586 (2x)	141, 142, 146, 147, 148, 149, 150, 151, 152, 153, 154
T5229	642.0	380.0	⊥		⊥		17190570 (2x)	245, 246, 247, 248, 249
T5234	824	487	⊥		○	16x44	-	10
T5236	834	477	⊥		⊥		17190587 (2x)	256, 257, 258, 259
T5237	571.9	362.4	⊥		○	16x44	17190587	256, 257, 258, 259
T5238	664	407	⊥		○	16x44	17190587	10
T5239	724	419	⊥		⊥		-	10
T5240	652	397	⊥		⊥		-	10
T5241	689.4	419.9	⊥		○	22x46	17190587, 17190594	256, 257, 332
T5242	607.0	362.5	⊥		⊥		17190587 (2x)	10, 255, 256, 257, 258, 259, 260, 261, 262, 263, 264
T5243	819.4	484.9	⊥		○	16x44	17190587	10, 256, 257, 258, 259
T5250	730.9	465.9	Q	16x62	○	20x62	-	230, 231, 323
T5252	712.0	415.0					17190569 (2x)	10, 158, 159, 160, 161, 162, 163, 164, 165, 255, 256, 257, 258, 259, 260, 263, 310
T5253	816.9	477.4	⊥		○	20x50	17190587	260, 261, 263, 264
T5255¹	650	423	Q	20x62	○	30x62	-	152
T5256	875.9	520.9	Q	20x50	○	20x50	-	201, 209, 218, 222, 226, 227
T5257	795	480	Q	20x50	○	20x50	-	10
T5258	882.9	522.9					-	246, 247, 248, 250, 251
T5261	768.4	473.4	Q	20x69	○	30x69	-	154, 176, 177, 178, 179, 180, 181, 182, 184, 185, 187, 188, 189, 191, 193, 194, 195, 197, 198, 199, 266, 267
T5262	570.9	373.4	Q	20x62	○	30x62	-	180, 188, 198
T5263	678.4	428.4	Q	20x62	○	30x62	-	154, 155, 176, 177, 178, 179, 180, 181, 182, 183, 184, 185, 186, 187, 188, 189, 190, 191, 192, 193, 194, 195, 196, 197, 198, 199, 266, 267
T5264	773.4	468.4	Q	20x55	○	20x55	-	165
T5265	774	472	Q	16x100	○	20x50	-	281
T5266	848.4	530.9	Q	20x62	○	20x62	-	154, 177, 178, 179, 180, 181, 182, 189, 190, 194, 195, 197, 199
T5267	818.9	496.7	Q	24x54	○	24x54	17190623	158, 159, 160, 162, 163, 164, 165
T5268	923.9	551.7	Q	24x55	○	24x55	-	165
T5269	650.9	403.4	Q	20x55	○	20x55	-	158, 159, 160, 161, 162, 163, 164, 165
T5274	655.9	410.9	Q	20x54	○	20x54	-	159, 161
T5275	768.4	473.4	Q	20x62	○	30x62	-	154, 176, 177, 178, 179, 180, 181, 182, 184, 185, 188, 189, 190, 191, 193, 194, 195, 197, 198, 199, 266, 267
T5276	893.4	533.4	Q	20x62	○	20x62	-	154, 177, 178, 179, 181, 182, 189, 190, 194, 195, 197, 199
T5277	668.4	418.4	Q	20x62	○	20x62	-	167, 171, 172, 176, 178, 179, 180, 182, 183, 184, 185, 186, 189, 190, 191, 194, 198, 199, 266, 267
T5278	672.0	420.0	⊥		⊥		17190570 (2x)	176, 180, 184, 188, 191, 193
T5280	708.9	431.7	Q	20x50	○	20x50	-	251, 252, 272, 273
T5281	643.0	413.3	Q	20x55	○	20x62	-	4



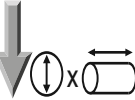
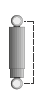
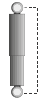

T5282	865.5	520.8	Q	20x55	○	20x62	-	251, 252, 272, 273
T5283	900.5	558.3	Q	20x55	○	20x62	-	252, 272, 273
T5284	875.5	523.3	Q	20x55	○	20x62	-	251
T5287	664.3	414.3	Q	20x105	○	20x50	-	202, 223, 228, 229, 230
T5288	629.5	370.0	⊥		⊥		17190587 (2x)	142, 151
T5306	853.0	515.8	Q	20x54	○	20x61	-	251, 252, 272, 273
T5307	875.5	523.3	Q	20x54	○	20x61	-	252
T5308	763.0	470.8	Q	20x55	○	20x62	-	252
T5309	678.9	421.7	Q	20x50	○	20x50	-	4, 247, 248, 251, 252
T5310	678.9	421.7	Q	20x50	○	20x50	-	251, 252, 272, 273
T5332	744.3	454.3	Q	20x62	○	20x50	-	216, 217, 219, 220, 221
T5348	684.5	460.0	⊥		⊥		17190570 (2x)	4, 176, 180, 184, 191, 193
T5349	668.4	420.9	Q	20x62	○	20x62	-	167, 171, 172, 176, 178, 179, 180, 182, 183, 184, 185, 186, 187, 188, 189, 190, 191, 192, 194, 196, 198, 199, 266, 267, 268
T5350	733.4	453.4	Q	20x62	○	20x62	-	171, 172, 176, 178, 179, 180, 182, 183, 184, 185, 186, 189, 190, 191, 192, 194, 196, 198, 199, 266, 267, 268
T5351	823.4	493.4	Q	20x50	○	20x50	-	4, 253, 254, 260, 261, 262, 263, 264, 265, 266
T5352	740.2	440.2	Q	20x55	⊥		17190569	250, 251
T5354	680.3	397.3	⊥		⊥		17190569 (2x)	4, 246, 247, 248
T5356	842.0	482.5	⊥		⊥		17190587 (2x)	4, 253, 254, 260, 261, 262, 263, 264, 265, 266
T5357	559.3	379.3	Q	20x62	○	20x50	-	141, 147, 149
T5358	711.8	436.8	Q	20x105	○	20x50	-	202, 210, 211, 219, 223, 228, 229
T5360	728.9	446.4	Q	16x105	○	16x50	-	4, 200, 201, 202, 203, 208, 209, 218, 226, 227, 229, 230
T5361	728.9	446.4	Q	20x50	○	20x50	-	4, 202, 203, 210, 211, 219, 228
T5362	810.9	485.9	Q	16x100	○	20x50	-	4, 253, 254
T5363	781.8	471.8	Q	20x105	○	20x50	-	203, 211
T5364	639.4	399.9	⊥		○	20x44	17190570	4, 145
T5365	654.5	392.5	⊥		⊥		17190570 (2x)	4, 146
T5367	879.3	531.8	Q	16x100	○	20x50	-	4, 273, 274, 275, 276, 277, 278, 279, 280, 281, 283, 284, 285, 286, 287, 288, 289, 290, 291, 292
T5371	763.9	471.4	Q	16x105	○	16x50	-	252
T5372	895.9	533.4	Q	16x105	○	16x50	-	9, 200, 201, 202, 203, 204, 205, 206, 207, 209, 211, 212, 213, 224, 225, 227, 228, 229
T5373	638.9	401.4	Q	20x50	○	20x50	-	202, 206, 208, 210
T5374	831.4	556.4	Q	16x62	○	20x50	-	214, 215, 216, 217, 218, 220, 221
T5375	765.9	465.9	Q	16x105	○	16x50	-	200, 201, 202, 203, 208, 209, 210, 211, 212, 217, 222, 226
T5385	798.9	481.4	Q	20x50	○	20x50	-	4, 10, 201, 209, 218, 227, 229, 230
T5386	672.8	423.3	⊥		○	20x62	17190570	4, 169, 170, 171, 172
T5387	913.5	543.5	Q	20x50	○	20x50	-	4, 253, 254, 255, 260, 261, 263, 264, 265, 266
T5388	758.9	473.9	Q	20x62	○	20x62	-	4, 155, 176, 178, 181, 182, 187, 189, 193, 194, 198, 199
T5389	495.3	326.0	Q	20x46	○	20x46	-	4, 156
T5390	869.3	521.8	Q	16x100	○	20x50	-	4
T5391	949.3	559.3	Q	16x100	○	20x50	-	4, 260, 261, 263, 264
T5392	771.0	456.0	Q	16x100	⊥		17190570	4, 245, 272, 273, 274, 281, 286, 287



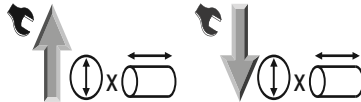
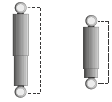

T5393	831.8	501.8	Q	16x100	○	20x50	-	4, 273, 274, 275, 276, 277, 278, 279, 280, 281, 286, 287, 288, 289, 290, 291, 292
T5394	674.3	424.3	Q	16x100	○	20x50	-	4, 275, 277, 278, 279, 280, 281, 288, 289, 290, 291
T5395	714.3	439.3	Q	16x66	○	16x66	-	4, 274, 275, 276, 277, 278, 279, 280, 281, 287, 288, 289, 290, 291, 292
T5396	598.5	378.5	Q	20x50	○	20x50	-	4, 173
T5399	846.4	528.9	Q	20x62	○	20x62	-	4, 177, 178, 179, 180, 181, 182, 185, 189, 190, 191, 192, 193, 194, 195, 196, 197, 198, 199
T5400	723.0	449.1	Q	20x62	○	30x62	-	4, 154, 176, 177, 178, 179, 180, 181, 182, 183, 184, 185, 186, 187, 188, 189, 190, 191, 192, 193, 194, 195, 196, 197, 198, 199
T5403	743.9	456.4	Q	20x62	○	20x50	-	4, 215, 217, 219, 220, 221
T5406	770.9	477.0	Q	20x62	○	30x62	-	4, 187, 188
T5410	720.5	526.6	Q	20x62	○	30x62	-	4, 178, 179, 182, 183, 185, 186, 189, 190, 191, 192, 194, 195, 196, 198, 199
T5411	808.7	483.7	Q	20x62	○	20x62	-	4, 178, 182, 183, 185, 186, 190, 192, 195, 196
T5413	650.5	421.6	Q	20x62	○	30x62	-	4, 141
T5414	721.8	446.8	Q	20x105	○	20x50	-	4, 200, 201, 208, 217, 218, 226, 229, 230
T5415	771.6	469.1	Q	16x105	○	20x50	-	4, 141
T5416	704.1	464.1	Q	16x105	○	20x50	-	4, 141, 147
T5426	726.0	438.5	Q	20x55	○	20x55	-	4, 158, 160, 165
T5427	661.9	394.9	⊥		○	20x46	17190570	4, 155, 156, 157
T5428	816.9	472.4	⊥		○	16x50	17190570	4, 155, 156, 157
T5429	648.0	411.6	Q	20x62	○	30x62	-	4, 9, 10, 169, 170, 171, 172, 175, 266, 267
T5430	672.8	423.3	⊥		○	20x62	17190627	4, 175
T5431⁰	733.4	453.4	Q	20x62	○	20x62	-	4, 178, 179, 182, 183, 184, 185, 186, 187, 189, 190, 191, 192, 194, 196, 198, 199
T5432	808.4	488.4	Q	20x62	○	20x62	-	4, 178, 182, 183, 185, 186, 187, 190, 192, 195, 196
T5435⁰	724	449	Q	20x52	○	20x52	-	4, 162, 163, 164, 165, 166
T5436⁰	733	453	Q	20x62	○	20x62	-	4, 189, 191, 194, 198, 199
T5437⁰	676	426	Q	20x62	○	30x62	-	176, 178, 180, 181, 182, 183, 184, 185, 187, 188, 189, 190, 191, 192, 193, 194, 195, 196, 197, 198, 199
T5439⁰	685	408	⊥		○	20x55	17190587	253, 254, 255
T5440⁰	749.3	459.3	Q	16x100	○	20x50	-	273, 274, 275, 276, 277, 278, 279, 280, 281, 286, 287, 288, 289, 290, 291, 292
V1089	623	378	Q	14x58	○	14x40	-	8, 243
V1160	594	351	⊥		○		17110635	4
V1161	556	341	⊥		○		17110636	4
V1174	561	341	Q	14x32	○	14x32	-	249
V1175	552	332	⊥		○	14x31	17110551	249
V1176	552	331	⊥		○	14x31	17110551	249
V1188	559	369	Q	14x40	○	14x40	-	4
V1189	654	401	Q	14x50	○	14x50	-	5, 244
V1190	581	451	Q	14x40	○	14x40	-	5
V1191	509	318	Q	16x38	○	16x38	-	5
V1193	595	350	⊥		○		17110984	5
V1194	508	318	⊥		○		17110986	5



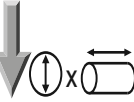
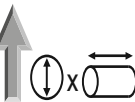
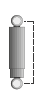
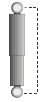

V1195⁰	415	393	Q	16x38	○	16x38	-	5
V1196	553	340	Q		○		17110986	5
V1197⁰	400	368	Q	16x44	○	16x44	-	5
V1198	554	339	Q	14x40	○	14x40	-	5, 244
V1199	645.2	369.8	⊥		○	14x40	17111097	5, 244
V1201⁰	401.2	322.2	Q	16x44	○	16x44	-	5
V2021	631	387	Q	14x40	○	14x40	-	8, 231, 242
V2059¹	571	347	⊥		T		17110144	10, 323, 324
V2088	570	355	Q	16x38	○	16x38	-	8, 167
V2097	635	385	Q	19x44	○	19x44	-	6, 246, 247, 248, 304, 305
V2099	698	463	⊥		○	20x45	17110551	249, 250
V2102	758	445	⊥		○	10x45	17110765	250
V2103	675	418	Q	20x45	T		17110765	249, 250
V2104	620	382	Q	16x38	○	16x38	-	155, 156, 157
V2105	655	399	Q	16x38	○	16x38	-	155, 156
V2106	655	399	Q	16x38	○	16x38	-	155, 156
V2107	655	395	Q	16x38	○	16x38	-	155, 156, 157
V2108	665	404	Q	16x38	○	16x38	-	155, 156, 157
V2109	695	424	Q	16x38	○	16x38	-	155, 156
V2133	581	357	⊥		○	20x50	17110045	155, 156, 298
V2134	666	410	Q	20x50	○	20x50	-	155, 156, 298
V2137	618	380	Q	16x38	○	16x38	-	5, 155, 156, 157, 158
V2138	684	413	⊥		○	20x45	17110551	5, 249, 250
V2140	593	353	⊥		T		17110045 (2x)	145, 146
V2141	613	365	⊥		T		17110045 (2x)	145, 146
V2142	618	380	⊥		T		17111027	5, 146
V2144	734	444	Q	14x50	○	14x50	-	5, 243, 244
V2145	621	376	Q	14x58	○	14x40	-	5, 243, 244
V2151⁰	462	360	Q	16x38	○	16x38	-	5
V2152	502	350	Q	16x38	○	16x38	-	5



CB0001		VOLVO	
OE N° 	1076855	21032337	
	3172985	21651229	
	3198850		
	20721167		
	20889138		
			
			
			
408	363	14x45	14x45

CB0002		VOLVO	
OE N° 	1075076		
	1075077		
			
			
			
398	353	14x45	14x45

CB0003		VOLVO	
OE N° 	1629719		
	1629724		
	3172984		
			
			
			
430	300	14x45	20x45

CB0004		VOLVO	
OE N° 	1076860	21137458	
	3172986		
	3198859		
	20721166		
	20960913		
			
			
			
411	360	14x45	14x45

CB0005		VOLVO	
OE N° 	1075445		
			
			
			
391	350	14x45	14x45

CB0006		VOLVO	
OE N° 	20427897		
	20721169		
	20775212		
	20889134		
	21651231		
			
			
			
408	363	14x45	14x45

CB0007		VOLVO	
OE N° 	1622227		
	3198849		
	3986315		
			
			
			
256	235	20x45	20x45

CB0008		VOLVO	
OE N° 	1075478		
			
			
			
328	219	20x45	20x45

CB0009		SCANIA	
OE N° 	1381906		
	1397394		
	1397398		
	1402271		
	1435856		
			
			
use with CB0030			
see also MK801			
			
306	206	L	T



CB0010		SCANIA	
OE N°	1381904		
	1397396		
	1397400		
	1435859		
 <p>use with CB0030</p>			
			
306	206		

CB0011		SCANIA	
OE N°	1397386	1431746	
	1397388	1431747	
	1397390	1431748	
	1397392	1431748	
 <p>use with CB0030</p>			
			
289	246		

CB0012		DAF	
OE N°	375221		
	1377827		
			
329	277		

CB0013		DAF	
OE N°	1377826		
	1451155		
	1792419		
			
308	270		

CB0014		SCANIA	
OE N°	1340581		
			
322	222		

CB0015		SCANIA	
OE N°	370228		
	393208		
	393290		
			
330	232		

CB0016		VOLVO	
OE N°	1586068		
	1622087		
			
308	223		









CB0017		VOLVO	
OE N°	1089728		
	1593843		
	1594089		
			
277	218		

CB0018		VOLVO	
OE N°	1089009		
			
267	210		







CB0019		VOLVO	
OE N° 	1099672		
	 		
		 	 
348	267	 14x45	 14x45

CB0020		VOLVO	
OE N° 	344574 353958 1505892 1588043		
	 		
		 	 
227	172	 16x35	 16x35

CB0021		VOLVO	
OE N° 	1580389		
	 		
		 	 
334	265	 14x32	 14x32

CB0022		VOLVO	
OE N° 	1587562		
	 		
		 	 
249	195	 14x32	 14x32

CB0023		VOLVO	
OE N° 	1594088		
	 		
		 	 
266	213	 14x32	 14x32

CB0024		VOLVO	
OE N° 	1620658		
	 		
		 	 
236	183	L	T

CB0025		VOLVO	
OE N° 	1576443 1585586 1622085		
	 		
		 	 
245	186	 14x32	 14x32

CB0026		VOLVO	
OE N° 	1599459 1622086 6794392 1550211821		
	 		
		 	 
245	186	 14x31	 14x31

CB0027		VOLVO	
OE N° 	1089008		
	 		
		 	 
259	210	 14x32	 14x32



CB0028		VOLVO	
OE N° 	1629722		
	 		
			
428	299	Q 14x45	O 20x45

CB0029		VOLVO	
OE N° 	1629721		
	 		
			
401	350	Q 14x45	O 14x45

CB0030		SCANIA	
OE N° 	1381919 1476415		
	 <p>use with CB0009 or CB0010 or CB0011</p> 		
see also MK801			
			

CB0031		DAF	
OE N° 	1265273 1265274		
	 		
			
329	277	Q 25x45	T

CB0032		DAF	
OE N° 	1260941 1265271 1377825		
	 		
			
329	277	Q 25x45	T

CB0033		DAF	
OE N° 	375224 1265281 1285393 1321590 1353450	1353453 1371065 1444147 1622211	
	 		
			
318	272	Q 25x45	T

CB0034		DAF	
OE N° 	299862 1265282 1285394 1321591 1353451	1353454 1371066 1623477 1792423	
	 		
			
272	231	Q 14x40	T

CB0038		VOLVO	
OE N° 	1075444		
	 		
			
391	350	Q 14x45	O 14x45

CB0039		VOLVO	
OE N° 	20453256 20453258 20889132 20889136 21111932	21111942 3198837	
	 <p>use with CB0055 or CB0102</p> 		
see also MK800			
			
335	222	L	O 20x45



CB0040		VOLVO	
OE N°	3198836		
	21111925		
			
<p>see also MK800</p>			
336	226		

CB0041		SCANIA	
OE N°	1314278		
			

CB0042		DAF	
OE N°	1303516		
	1436055		
			
248	227		

CB0043		DAF	
OE N°	1265276		
			
329	277		

CB0044		DAF	
OE N°	1319672		
	1337159		
	1387327		
	1623464		
			
329	277		

CB0045		DAF	
OE N°	1260942		
	1265272		
	1377828		
	1792420		
			
283	245		

CB0046		RENAULT, VOLVO	
OE N°	20721849	7420840318	
	20840318	5010269605	
	5010460113	5010269605C	
	5010615880		
			
266	211		

CB0047		DAF	
OE N°	1380606		
	1436060		
	1609020		
			
225	194		

CB0048		DAF	
OE N°	375222		
	1265275		
	1265277		
			
276	238		



CB0049		DAF	
OE N°	1319673		
	1387326		
	1623465		
	1792422		
			
			
276	238	Q 14x40	T

CB0050		RENAULT TRUCKS	
OE N°	5010435394		
			
			
228	172	Q 10x32	O 10x32

CB0051		RENAULT TRUCKS	
OE N°	5000741014		
	5010052405		
	5010130535		
	5010460114		
			
			
292	202	L	T





CB0052		RENAULT TRUCKS	
OE N°	5000741013		
	5010052404		
	5010130534		
	5010137139		
	5010460115		
			
			
368	247	Q 12x47	T

CB0053		RENAULT TRUCKS	
OE N°	5010370630		
	5010460116		
			
			
387	255	Q 12x32	O 12x32

CB0054		VOLVO	
OE N°	1508429		
	1588042		
			
			
227	172	Q 16x35	O 16x35

CB0055		VOLVO	
OE N°	20453256		
	20889132		
	21111932		
			
use with CB0039			
see also MK800			
			

CB0057		MERCEDES	
OE N°	000 891 0305		
	000 891 0505		
	000 891 1005		
	001 323 1900		
			
			
355	250	Q 12x32	O 12x32

CB0058		SCANIA	
OE N°	1363120		
	1363122		
	1424227		
	1424228		
			
use with CB0067 or CB0130			
see also MK801			
			
306	206	L	T



CB0059		SCANIA	
OE N°	1349844		
	1382826		
	1382827		
	1382829		
	1424229		
 <p>use with CB0067 or CB0130</p>			
 			
see also MK801			
			
306	206	L	T

CB0060		SCANIA	
OE N°	1348477		
	1117326		
	1331626		
 <p>use with CB0066</p>			
 			
			
322	224	L	O 14x50

CB0061		RENAULT TRUCKS	
OE N°	5010460198		
	7482052323		
			
 			
			
233	194		

CB0062		RENAULT TRUCKS	
OE N°	5010460212	7482052326	
	5010460238		
	5010552245		
	7482052324		
	7482052325		
			
   			
			
233	194		

CB0063		RENAULT TRUCKS	
OE N°	5010460244		
	5010629761		
			
   			
			
227	190	Q 14x45	O 14x45

CB0064		RENAULT, VOLVO	
OE N°	25379070		
	5010552010		
	5010629471		
			
   			
			
241	210	Q 12x42	O 12x42

CB0065		SCANIA	
OE N°	1116535	1331634	1348120
	1117320		
	1117334		
	1331620		
	1331621		
 <p>use with CB0066</p>			
 			
			
322	224	L	O 14x50

CB0066		SCANIA	
OE N°	1116535	1331621	1348118
	1117320		
	1117326		
	1117334		
	1331620		
 <p>use with CB0060 or CB0065</p>			
   			
			

CB0067		SCANIA	
OE N°	1349840		
	1424231		
 <p>use with CB0058 or CB0059 or CB0134</p>			
 			
see also MK801			
			



CB0068		RENAULT TRUCKS	
OE N° 	5000787975		
	5001863294 5010065310		
			
			
254	206		
			50x35

CB0069		RENAULT TRUCKS	
OE N° 	5000787974		
	5010065311 5010130609		
			
			
298	251		
		12x47	12x47

CB0070		RENAULT TRUCKS	
OE N° 	5010228849		
			
			
341	257		

CB0071		MERCEDES	
OE N° 	000 891 1805		
	000 891 1905 000 891 2205		
			
			
253	194		
		18x34	18x34

CB0072		IVECO	
OE N° 	8140869		
	98408734 504051670		
			
			
260	188		
		12x32	12x32

CB0073		IVECO	
OE N° 	115179	99431373	99454196
	121584	99433007	99454197
41005984	99433008	500348789	
98472611	99433009	504228086	
98487778	99454195		
			
			
268	196		
		14x34	16x34

CB0074		SCANIA	
OE N° 	1502468		
			
use with CB0078 or CB0079 or CB0160			
see also MK801			
			

CB0075		RENAULT, VOLVO	
OE N° 	20591506		
	20906196 5010130797 5010629414		
			
			

CB0076		RENAULT TRUCKS	
OE N° 	5000791271		
	5010320096		
			
			



CB0077		IVECO	
OE N°	8169050 41015530 41019150		
			

CB0078		SCANIA	
OE N°	1502470 1502471 1502474		
	 <p>use with CB0074</p>		
see also MK801			
335	235		

CB0079		SCANIA	
OE N°	1502472		
	 <p>use with CB0074</p>		
see also MK801			
335	235		

CB0080		MERCEDES	
OE N°	673 317 0103 673 317 0203 673 317 0303		
			
275	200		

CB0081		MERCEDES	
OE N°	000 891 1405 000 891 1605 000 891 2005		
			
256	200		

CB0082		RENAULT TRUCKS	
OE N°	5010092916		
			

CB0083		RENAULT TRUCKS	
OE N°	5010266845 5010313619		
			

CB0084		MERCEDES	
OE N°	000 891 0705		
			
247	181		

CB0085		MAN	
OE N°	81 43701 6185 81 43701 6379		
			
249	183		



CB0086		MAN	
OE N°	81 43701 6143		
	81 43701 6375		
			
233	168		12x32

CB0087		MAN	
OE N°	81 41722 6030		
	81 41722 6036		
			
387	258	12x32	12x32

CB0088		RENAULT, VOLVO	
OE N°	20757841	5010316783A	
	5010228908		
	5010269674		
	5010316783		
	5010629398		
			
308	262	12x40	12x40

CB0089		MERCEDES	
OE N°	942 890 0119		
	942 890 2919		
	A942 890 2919		
			
345	277	14x40	25x40

CB0090		MERCEDES	
OE N°	942 890 0219		
	942 890 6019		
	943 890 3919		
	A942 890 0219		
			
315	279	14x40	14x40

CB0091		MAN	
OE N°	81 41722 6049		
	81 41722 6052		
			
288	252	14x40	14x40

CB0092		MAN	
OE N°	81 41722 6048		
	81 41722 6051		
			
315	254	14x45	T

CB0093		IVECO	
OE N°	41005917	99438384	99455911
	41005918		
	98473215	99438389	500307352
	98487588	99455909	500307353
	98487589	99455910	500307354
			
380	336		16x44

CB0094		IVECO	
OE N°	500387621		
			
400	350	16x65	16x44



CB0095		IVECO	
OE N° 	41028759	500348797	
	41028760	500377859	
	41028761	500377861	
	41028762		
	500332741		
			
			
			
400	350	16x65	16x44

CB0096		MERCEDES	
OE N° 	942 890 4719		
	A942 890 4719		
			
			
			
371	302	12x38	12x32

CB0097		MERCEDES	
OE N° 	375 890 0519		
	940 890 3919		
	940 890 4119		
	958 317 2103		
			
			
			
371	302	12x50	12x50

CB0098		IVECO	
OE N° 	98472734	500379698	
	99438514		
	99455937		
	500307338		
	500352808		
			
			
			
380	305	16x44	16x44

CB0099		IVECO	
OE N° 	41028763		
	41028764		
	500348793		
	500377878		
			
			
			
415	324	16x65	16x44

CB0100		MERCEDES	
OE N° 	942 890 2219		
	942 890 2819		
	A942 890 2819		
			
			
			
338	274	14x40	25x40

CB0101		MERCEDES	
OE N° 	942 890 2319	9438901519	
	942 890 3119		
	943 890 0819		
	943 890 0919		
	9438901419		
			
			
			
321	279	14x40	14x40

CB0102		VOLVO	
OE N° 	3198837		
	20453258		
	20889136		
	21111942		
			
use with CB0039			
			
			

CB0103		MAN, STEYR	
OE N° 	81 43701 6629		
			
			
			
263	225	14x40	14x40



CB0104		MERCEDES	
OE N°	381 890 0719		
	381 890 0919 387 890 1019 387 890 1319 387 890 1619		
			
			
289	254		

CB0105		CASE, DEUTZ, MAN, STEYR	
OE N°	4426628	81 41722 6013	
	47110917 134641650 134641650 81 41722 6010	81 41722 6017 81 41722 6045	
			
			
292	246	 14x40	 14x40

CB0106		MAN	
OE N°	81 41722 6009		
	81 41722 6012 81 41722 6033 81 41722 6037		
			
			
314	252	 14x45	

CB0107		MERCEDES	
OE N°	942 890 6919		
			
			
345	277	 14x40	 25x40

CB0108		MERCEDES	
OE N°	942 890 5219		
	942 890 7019		
			
			
350	282	 14x50	 25x40

CB0109		RENAULT, VOLVO	
OE N°	20593746		
	5010460318 5010532897 5010629397		
			
			
311	251	 12x40	 12x40

CB0110		RENAULT, VOLVO	
OE N°	20593743		
	25379046 5010316210 5010316210B 5010316210C		
			
			
311	251	 12x40	 12x40

CB0115		MERCEDES	
OE N°	942 890 5319		
	942 890 5919 943 890 3819		
			
			
311	222	 14x50	 25x38

CB0116		MERCEDES	
OE N°	942 890 6119		
			
			
323	283	 14x50	 15x50



CB0117		RENAULT TRUCKS	
OE N°	5010552370		
			
295	239	14x45	14x45

CB0118		RENAULT, VOLVO	
OE N°	20591650 20898055 82052893 5010552241 7420898055	7482052893	
			
275	191		

CB0119		RENAULT TRUCKS	
OE N°	82052895 5010629213 7482052895		
			
253	198		

CB0120		DAF	
OE N°	260035 656395		
			
245	176		

CB0121		MERCEDES	
OE N°	942 890 5619 943 890 0219		
			
347	277	14x50	25x38

CB0122		MERCEDES	
OE N°	942 890 5419 943 890 0319		
			
347	277	14x50	25x38

CB0123		DAF	
OE N°	1407080 AFRE012		
			
261	230	12x80	12x40

CB0124		DAF	
OE N°	1407079 AFRE011		
			
261	230	12x80	12x40

CB0125		DAF	
OE N°	1407081 AFRE013 AFRU075		
			
266	221	12x40	12x40



CB0126		DAF	
OE N°	1407082 AFRE014 AFRU076		
			
			
266	221	12x40	12x40

CB0127		MERCEDES	
OE N°	942 890 2619 942 890 5119 A942 890 2619 A942 890 5119		
			
			
347	278	14x50	25x40

CB0128		MERCEDES	
OE N°	942 890 5519 943 890 0119 A942 890 5519 A943 890 0119		
			
			
347	278	14x50	25x38

CB0129		MERCEDES	
OE N°	942 890 5019 A942 890 5019		
			
			
347	278	14x50	25x40

CB0130		SCANIA	
OE N°	1444016		
	 <p>use with CB0058 or CB0059 or CB0134</p>		
			

see also MK801

CB0131		RENAULT, VOLVO	
OE N°	20721512 82052897 5010532895 7482052897		
			
			
258	203	L	□

CB0132		DAF	
OE N°	1407083 1407083 AFRE015 AFRU074		
			
			
228	211	12x40	12x40

CB0133		RENAULT TRUCKS	
OE N°	7482039600		
			
			
266	211	14x45	14x45

CB0134		SCANIA	
OE N°	1495642 1505563		
	 <p>use with CB0067 or CB0130</p>		
			
329	241	L	14x50

see also MK801



CB0135		RENAULT TRUCKS	
OE N° 	5010491301		
	 		
			

CB0136		IVECO	
OE N° 	500340706 500357352		
	 		
			
330	296	Q 20x46	O 20x46

CB0137		IVECO	
OE N° 	500340705 500357351		
	 		
			
389	282	Q 32x46	O 20x46

CB0138		IVECO	
OE N° 	8143658 98408733 99438144 99449560 99469924	504187113	
	 		
			
380	339	L	O 25x44

CB0139		MAN, STEYR	
OE N° 	15 20044 0090 85 41722 6001		
	 		
			
263	213	Q 14x40	O 14x40

CB0140		MERCEDES	
OE N° 	620 890 0019 620 890 0119		
	 		
			
363	315	L	□

CB0141		MAN	
OE N° 	81 43701 6241 81 43701 6291 81 43701 6331 88 41701 0012		
	 		
			
263	216	Q 14x40	O 14x40

CB0142		MERCEDES	
OE N° 	387 890 1219 387 890 1519		
	 		
			
362	321	L	□

CB0144		MERCEDES	
OE N° 	942 890 3919 943 890 1319		
	 		
			
369	330	Q 14x40	□



CB0145		IVECO	
OE N°	42070286		
	504228332		
			
			
272	200	14x34	16x50

CB0146		IVECO	
OE N°	8141735		
	42555627		
	98408735		
			
			
245	189	14x40	14x40

CB0147		MERCEDES	
OE N°	942 890 0419		
	942 890 1519		
	942 890 3819		
	943 890 1219		
	943 890 2419		
			
			
369	325	14x40	

CB0148		MERCEDES	
OE N°	942 890 0519		
	958 317 0703		
			
			
210	166	12x32	12x32

CB0149		IVECO	
OE N°	504060233		
	504060241		
			
			
416	317	16x66	16x44

CB0150		MERCEDES	
OE N°	357 890 0419	958 317 1103	
	357 890 0919		
	940 890 3819		
	940 890 4719		
	958 317 1003		
			
			
301	223	14x50	14x50

CB0151		IVECO	
OE N°	504057014		
	504057016		
	504080441		
	504084381		
			
			
450	384	16x66	16x44

CB0152		IVECO	
OE N°	504055167		
	504055168		
	504080440		
	504084380		
	504115382		
			
			
446	384	16x66	16x44

CB0153		IVECO	
OE N°	504080348		
	504084378		
	504084378		
	504115380		
			
			
426	368	32x46	20x46



CB0154		IVECO	
OE N°	500392874		
	504047432		
	504080349		
	504084379		
	504115381		
426	368	32x46	20x46

CB0155		MERCEDES	
OE N°	943 890 3419		
	943 890 3519		
327	282	14x50	14x50

CB0156		MERCEDES	
OE N°	943 890 3119		
	943 890 3219		
327	282	14x50	14x50

CB0157		MERCEDES	
OE N°	943 890 33 19		
327	282	14x50	14x50

CB0158		MERCEDES	
OE N°	942 890 3619	943 890 1719	
	942 890 4019		
	943 890 1019		
	943 890 1119		
	943 890 1619		
322	277	14x40	14x40

CB0159		IVECO	
OE N°	42001826		
	42001827		
339	292	14x45	14x45

CB0160		SCANIA	
OE N°	1502473		
use with CB0074			
see also MK801			
315	275	14x50	14x50

CB0161		MERCEDES	
OE N°	943 890 2919		
	943 890 3019		
327	282	15x50	14x50

CB0162		MERCEDES	
OE N°	940 890 0519		
	940 890 1019		
	940 890 3719		
343	274	14x40	14x40



CB0163		MERCEDES	
OE N° 	375 890 0819		
	940 890 4519		
	940 890 4619		
	958 317 1503		
			
			
			
349	277	 14x50	 14x40

CB0164		MERCEDES	
OE N° 	943 890 5019		
			
			
			
228	210	 12x40	 12x40

CB0165		MERCEDES	
OE N° 	942 890 1119		
	942 890 3519		
	943 890 0519		
	943 890 2319		
			
			
			
369	330	 14x40	

CB0166		CASE	
OE N° 	87301789		
			
			
			
421	324	 14x45	 14x45

CB0167		CASE	
OE N° 	87591827		
			
			
			
421	324	 14x45	 14x45

CB0168		CASE	
OE N° 	82018497	82029623	82033876
	82018497	82031521	82033876
	82021116	82031521	
	82021116	82032841	
	82029623	82032841	
			
			
			
385	273	 12x35	 T

CB0169		CASE	
OE N° 	84183931		
			
			
			
421	324	 14x45	 14x45

CB0170		CASE	
OE N° 	84141201		
			
			
			
421	324	 14x45	 14x45

CB0171		RENAULT TRUCKS	
OE N° 	5010615879		
			
			
			
350	307		 12x40



CB0172		SCANIA	
OE N°	1381904 + 1381919		
	1381904 + 1476415		
	1397400 + 1381919		
	1397400 + 1476415		
1435859 + 1381919			
			
see also MK801			
306	206		

CB0173		SCANIA	
OE N°	1381906 + 1381919	1435856 + 1476415	
	1381906 + 1476415		
	1397398 + 1381919		
	1397398 + 1476415		
1435856 + 1381919			
			
see also MK801			
306	206		

CB0174		CASE, DEUTZ, STEYR	
OE N°	4426629		
	134641645		
			
335	236		

MK800		VOLVO	
OE N°			
			

MK801		SCANIA	
OE N°	1349810 + 1923654		
			
use with CB0009 or CB0010 or CB0011 or CB0030 or CB0058 or CB0059 or CB0067 or CB0074 or CB0078 or CB0079 or CB0130 or CB0134			

CB0175		VOLVO	
OE N°	21739593		
	22040665		
			
378	333		

CB0176		SCANIA	
OE N°	1466184		
	1466185		
	1943267		
	1943268		
2023668			
			
310	206		

CB0177		SCANIA	
OE N°	1741736		
	1761373		
			
321	243		

CB0178		SCANIA	
OE N°	1731203	1761376	
	1731204	2074020	
	1761372		
	1761374		
1761375			
			
340	236		



CB0179		IVECO	
OE N°	8169050		
	41015530 41019150		
			

CB0180		MAN	
OE N°	85417226027		
	85417226028		
			
274	247	Q 12x50	O 12x50

CB0181		MAN	
OE N°	85417226025		
			
264	223	Q 12x40	O 12x40

CB0182		SCANIA	
OE N°	1910106		
 <p>used with CB0183</p>			
329	229	T	O 14x50

CB0183		SCANIA	
OE N°	1907301		
 <p>used with CB0182</p>			

CB0184		SCANIA	
OE N°	1908097		
			
380	280	Q 14x47	□

CB0185		NEW HOLLAND	
OE N°	87332268		
			
328	275	Q 14x50	O 14x50

CB0186		DAF	
OE N°	375221		
	1377827 1818918		
			
331	277	Q 25x45	T

CB0187		DAF, FODEN	
OE N°	1260941		
	1265271 1377825 1818916 500336000		
			
331	277	Q 25x45	T



CB0188		DAF	
OE N° 	1260942		
	1265272 1377828 1792420 1818919		
			
			
			
285	245	14x40	T

CB0194		SCANIA	
OE N° 	1873668		
			
			
			
344	244	14x50	

CB0195		SCANIA	
OE N° 	1870893		
			
			
			
344	244	14x50	

CB0196		SCANIA	
OE N° 	1870615		
	1923645		
			
			
			
380	285	14x47	

CB0197		MAN	
OE N° 	81417226061		
			
			
			
346	286	12x45	12x50

CB0198		MAN, STEYR	
OE N° 	81417226059		
	85417226011 85417226019		
			
			
			
350	284	12x45	12x50

CB0199		MAN, STEYR	
OE N° 	85417226010		
	85417226017		
			
			
			
380	314	12x50	12x50

CB0200		MAN	
OE N° 	81417226068		
			
			
			
380	329	12x50	12x50

CB0201		MAN	
OE N° 	81417226060		
			
			
			
382	319	12x50	12x50



CB0202		SCANIA	
OE N°	1793982		
	1923647		
	2023669		
	2023671		
			
			
378	280	14x47	

CB0203		SCANIA	
OE N°	1802569		
	1923646		
	2023670		
			
			
378	280	14x47	

CB0204		VOLVO	
OE N°	21168663		
			
			
254	237	20x45	20x45

CB0205		VOLVO	
OE N°	21170510		
	21739591		
			
			
336	219	14x67	

CB0206		VOLVO	
OE N°	22040653		
			
			
336	219	14x67	

CB0207		VOLVO	
OE N°	21170611		
	22040662		
			
			
352	235	14x67	

CB0208		VOLVO	
OE N°	21171975		
	22128971		
			
			
185	151	14x48	

CB0209		VOLVO	
OE N°	21430905		
			
			
224	199	14x48	14x48

CB0210		VOLVO	
OE N°	21430900		
			
			
352	235	14x67	



CB0211		VOLVO	
OE N° 	21171973		
	 		
			
378	333	 14x45	 14x45









CB0212		VOLVO	
OE N° 	20453258 20889136 21111942 3198837		
	 		
			
352	235		 14x67









CB0213		VOLVO	
OE N° 	22040666		
	 		
			
378	333	 14x45	 14x45







CB0214		VOLVO	
OE N° 	20453256 20889132 21111932		
	 		
			
352	235		 14x67

CB0215		VOLVO	
OE N° 	21880100		
	 		
			
378	333	 14x45	 14x45

CB0216		IVECO	
OE N° 	504068625		
	 		
			
402	352	 16x66	 16x44

CB0217		MERCEDES	
OE N° 	9438904419		
	 		
			
370	327		 14x50

CB0218		MERCEDES	
OE N° 	9438904619 9438904919		
	 		
			
370	327		 14x50

CB0219		IVECO	
OE N° 	2997842 504080540		
	 		
			
426	372	 32x46	 20x46



CB0220		MERCEDES	
OE N°	9583170503	9703174203	
	9583170603		
	9703171703		
	9703171803		
	9703174103		
302	284	Q 50x25	O 14x45

CB0221		DAF		
OE N°	1850682			
	1931023			
	351	309	Q 12x50	O 12x50

CB0222		DAF		
OE N°	1938641			
	1938643			
	360	318	Q 12x50	O 12x50

CB0223		DAF	
OE N°	1850683		
	1931024		
	1931026		
321	284	Q 12x50	O 12x50

CB0224		DAF		
OE N°	1850676			
	1936404			
	351	309	Q 12x50	O 12x50

CB0225		DAF		
OE N°	1850677			
	1936405			
	321	284	Q 12x50	O 12x50

CB0226		DAF		
OE N°	1936409			
	366	329	Q 12x50	T

CB0227		DAF		
OE N°	1896514			
	1936410			
	296	259	Q 12x50	T

CB0228		DAF		
OE N°	1868685			
	1936407			
	321	284	Q 12x50	O 12x50



CB0229		DAF	
OE N° 	1955773		
	 		
			
261	229	12x40	12x114

CB0230		DAF	
OE N° 	1955775		
	 		
			
261	229	12x40	12x114

CB0231		DAF	
OE N° 	1936406 1938640		
	 		
			
360	318	12x50	12x50

CB0232		DAF	
OE N° 	1872954 1936408 1938642		
	 		
			
360	318	12x50	12x50

CB0233		DAF	
OE N° 	1866162		
	 		
			
225	193	12x40	12x40

CB0234		NEW HOLLAND	
OE N° 	84163866 84605258		
	 		
			
421	324	14x45	14x45

CB0235		DAF	
OE N° 	1319672 1337159 1387327 1623464 1817662		
	 		
			
331	277	25x45	T

CB0236		MERCEDES	
OE N° 	9408904919 A9408904919		
	 		
			
345	279	14x50	14x40

CB0237		DAF	
OE N° 	1319673 1387326 1623465 1792422 1817663		
	 		
			
279	237	14x40	T



Warranty Terms

(valid in Europe only)

**MONROE® Europe warrants the listed
MONROE® products to the original retail purchaser
against functional and/or material defects:**



MONROE® Quick-Strut
MONROE® Reflex
MONROE® Springs
MONROE® CVSA
Continuously Variable Semi-Active Suspension

MONROE® Adventure
MONROE® Gas-Magnum
MONROE® Level-Light
MONROE® Load-Leveler
MONROE® Magic Camber
MONROE® Magnum
MONROE® Max Lift
MONROE® Mounting Kit



MONROE® Original
MONROE® Protection Kit
MONROE® Ride-Leveler
MONROE® Sensa-Trac
MONROE® Spheres
MONROE® Suspension parts
MONROE® Van-Magnum

MONROE® Europe provides a 2 year warranty without mileage limitation.
(3 year warranty for MONROE® Reflex, MONROE® Quick-Strut, MONROE® Springs)
The Warranty of MONROE® Europe is limited to the delivery of a new MONROE® product.
All claims are first handled by the MONROE® distributor and then honoured by MONROE®.

The reseller/installer will provide the MONROE® distributor with all relevant information such as:

- consumer's name and address
- fitting or sales dates
- MONROE® product part number
- vehicle identification data
- proof of purchase documents
- description of the defect.

Excluded from warranty are:

1. Regular wear-out.
2. MONROE® products fitted contrary to application information in the MONROE® catalogue or its subsequent amendments.
3. MONROE® products which have been modified or damaged by incorrect mounting or incorrect use of the vehicle, contrary to the car manufacturers' specifications or MONROE®'s.
4. MONROE® products damaged by mounting on another car than indicated in the MONROE® catalogue or its subsequent amendments.
5. Shock absorbers with damaged piston rod or damaged oil seal due to holding the piston rod with a wrench or pliers instead of the correct tool.
6. Premature wear-out caused by re-use of damaged mounting parts such as: rubber dirt shields, damaged bump stops, etc.
7. Damages caused by an accident.
8. MONROE® products damaged while used in rally or racing sports.
9. Ride-Levelers with air sleeve abrasion caused by incorrect mounting.
10. Reconditioned or recycled MONROE® products.
11. Defects caused by lack of maintenance or maintenance wrongly executed on the vehicle.

In addition: All MONROE® products are developed and manufactured according to original suspension specifications from car manufacturers. MONROE® indicates in its catalogue the originally lowered models on which its products fit.

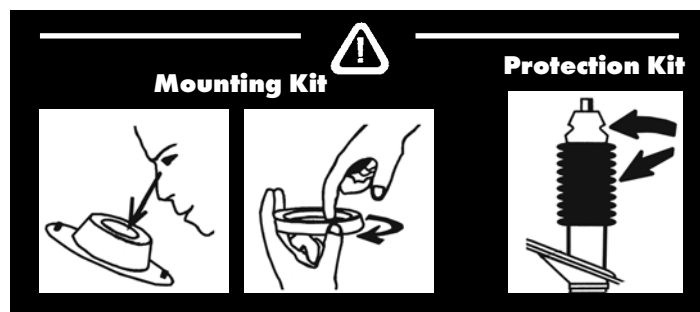
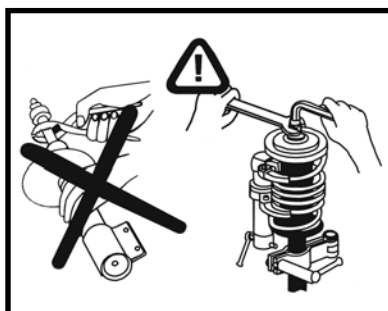

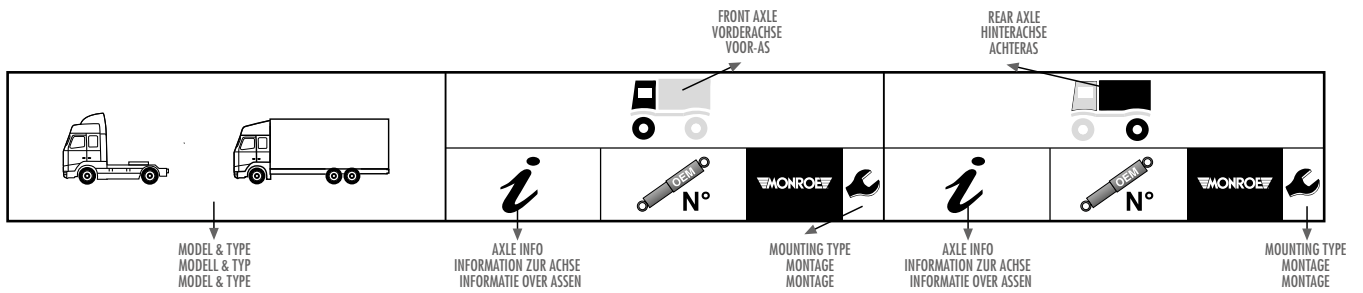

GB MODEL

- ex.** Excluding
- incl.** Including
- Rigid
- Tractor
- Cement mixer
- Tipper
- Fire engine
- Pick-up
- Delivery Van
- Minibus
- Ambulance
- Van Chassis Cabin
- Light Truck
- Camper
- 6x4/4 6x4/Twin steer
- 8x4/4 8x4/Twin steer
- Utility load "1000" kg
- Ch. n°** Chassis number
- Front wheel drive
- Rear wheel drive
- Short cab
- Medium cab
- Long cab
- ORIG. Vehicles built in Europe

SHOCK ABSORBERS

- Lateral damper
- Air levelling
- Non air levelling
- Steering damper

Due to the construction of the suspension system a replacement shock absorber is not available in this range.

- T1193 New part number
- T1009⁰ Part number available within 3 months
- V1090¹ Part number sold until depletion of stock but remains in the catalogue only for 1 year.

See OE listing above

Open & closed length

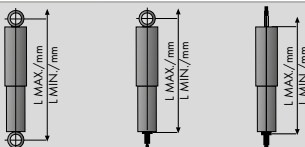

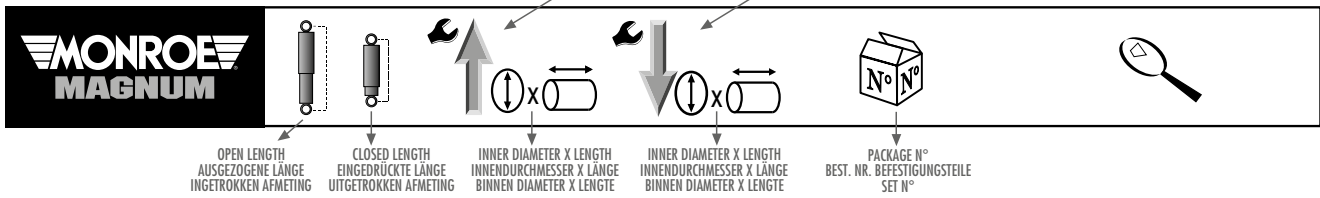

GB AXLES & WHEELS



Trailing axle



Steering axle



Driving axle



Steering and driving axle



Lift axle



First axle



Second axle



Mid lift axle



Front axle



Rear axle



Left



Right



Rigid Axle



Independent Axle



Single wheels



Twin wheels



Size of wheelbase



Disc brakes



Drum brakes

MOUNTING INFORMATION



Upper mounting with stem



Lower mounting with stem



Upper mounting with loop



Lower mounting with loop



Special mounting



Mounting with crosspin



Sealed strut



Replacement cartridge

SUSPENSION



Coil spring



Trapezoidal spring



Parabolic spring



Leaf, steel and parabolic spring



Air spring



2 Torsion Bar



Rubber Suspension



Normal Duty, Good Roads



Heavy Duty, Bad Roads



Original raised vehicles



Original lowered vehicles



MONROE[®]

SUSPENSION

WE HAVE ALL!

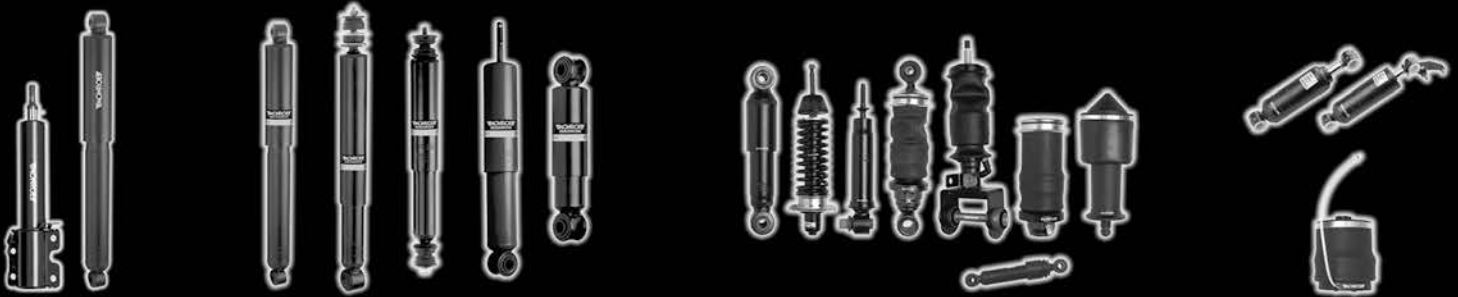

1916 **MONROE** 2016[®]
100
YEARS

TENNECO

MONROE

SHOCK ABSORBERS

Monroe Safety Ambassadors want you to be safe.
Inspect your shocks today!



Thierry NEUVILLE

WRC



Tiago MONTEIRO

WTCC
FIA World Touring Car
Championship



André LOTTERER

WEC
FIA WORLD ENDURANCE
CHAMPIONSHIP



DRIVEN BY INNOVATION AND QUALITY SINCE 1916
THANKS FOR BEING OUR CUSTOMER



100
1916 **MONROE** 2016
YEARS



DRIVEN BY INNOVATION AND
QUALITY SINCE 1916

MONROE
MAGNUM

THANKS FOR BEING OUR CUSTOMER

