

# 2015

## MASTER CATALOGUE



**EMEA**  
EUROPE, MIDDLE EAST, AFRICA



# MONROE



## EXPERIENCE THE MONROE® FULL PACK

# MONROE

## SUSPENSION





**REPLACE YOUR OLD GAS SPRINGS  
WITH MONROE® MAX-LIFT®,**



**DON'T WAIT ANY LONGER!**

**HATCH - BONNET - BOOT - REAR WINDOW - FOLDING TABLE - INDUSTRIAL EXTENSIONS\***

\* Available via our search function listing more than 50 end-fittings & ball studs.





Max-Lift® is a sealed, gas filled pressure cylinder that exerts an outward force. This force acts like a spring to lift and hold open hatches, bonnets and boots. An exact replacement fit for most applications.

**Features**

- Superior rod finish - increased seal durability.
- High strength piston seal - superior sealing strength.
- High pressure gas filled - smooth action.
- Two years warranty.

<b>MAX-LIFT</b>	Typical Part N° Series
<b>GAS SPRING</b>	ML-

# Monroe® quality and durability makes Max-Lift® the only choice.

Monroe® Max-Lift® gas charged lift supports are now available as exact replacement fits for most vehicles sold in Europe since 1980.

Max-Lift® is the market's premium replacement product. The highest quality, design and durability standards have been applied to their manufacture. And isn't that what your customers have a right to expect?



## installation guide

- Always replace both lift supports to ensure top performance and to prevent twisting caused by uneven loading.
- Gas charged lift supports typically store a gas charge of over 330 Newton and cannot be compressed by hand.
- Gas charge lift supports can be installed in minutes with no special tools required.
- Careful inspection of all hinges and connecting points should be made for wear and tear or stress fractures. These should be replaced or repaired before lift supports installation.

### Installation Instructions:

- Before removing old lift supports, examine any fittings supplied to determine which components must be re-used.
- Have someone hold the hatch, bonnet, boot or rear window open while replacing the lift supports.
- The new lift support must be installed in the same position as the old one which was removed.
- Do not remove both lift supports at the same time. Replace one, then remove and replace the second one.
- Gas spring orientation ie. It is important that the gas spring be mounted with the tube up in the closed position as this ensures lubrication and smooth operation.

### Important notes:

When ordering a gas spring, please consider the following:

- Overall length from centre to centre (Extended)
- Pressure
- Type of end fittings
- Year, Make and Model of vehicle

### How to measure a Gas Spring:

- Overall length is measured with strut fully extended and taken between the centre's of the fixing studs.
- Stroke is measured between top of strut barrel and end of shaft fitting.



# Standardized car description



HOW TO SELECT THE MONROE® GAS SPRING PRODUCT

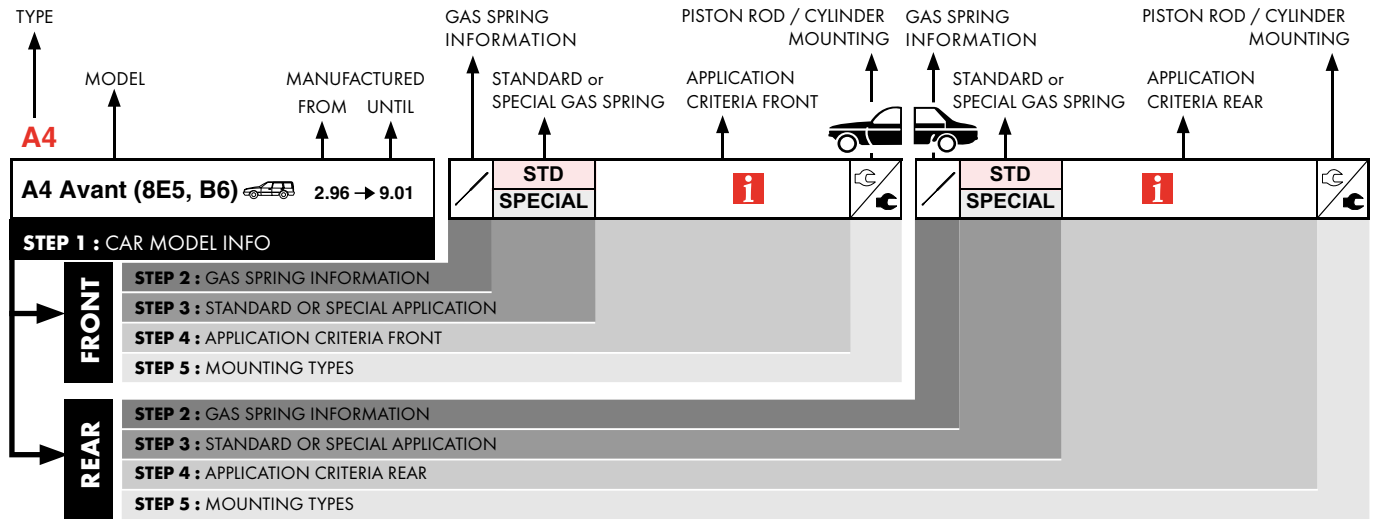

## MODEL

(=)	Only used for
(-)	Without
(+)	With
	Berline, Sedan, Saloon, 2/4 doors
	Berline, Sedan, Saloon, 3/5 doors
	Fastback, Hatchback, Liftback
	Coupé, Hardtop
	Break, Estate, Station, Wagon
	Cabriolet, Convertible
	Car derived Van
	Multi Purpose Vehicle (MPV)
	Sport Utility or Activity Vehicle
	Off Road
	Pick up
	Delivery Van
	Minibus
	Cargo
	2-3-4-5 doors
<b>OE n°</b>	Original Equipment number
<b>Ch. n°</b>	Chassis number
	...onwards
	up to...
	Only for Cars sold in Sweden

## STANDARD APPLICATIONS

	Gas spring
	Front
	Rear
	Spoiler
	Spoiler with additional stoplight
	Window wiper
	Loudspeaker
	Automatic closing
	Warning triangle
	Sunroof
	Left side
	Right side
	Folding top
	One piece tailgate
	Two piece tailgate
	Cars with fixed rear window
	Cars with opening rear window

## SPECIAL APPLICATIONS

	Opening rear window
	Folding table

## PARTNUMBER

<b>ML5001</b>	New available partnumber
<b>ML5853°</b>	Part number in process

## MOUNTING TYPES

	Piston rod mounting
	Cylinder mounting

Monroe® will only honour gas spring warranties when fitted in pairs.

**TIPS FOR EASY READING: 1. Check for car make 2. Check for car model 3. Look at the year 4. Look at the type**

### APPLICATION INFO

MAKE	MODEL	MONROE®	OEN°
AUDI	A1 2010	ML6154	8X0823359
AUDI	A1 Quattro 2012	ML6154	8X0823359
AUDI	A1 Sportback 2011	ML6154	8X0823359
AUDI	S1 Quattro 2014	ML6154	8X0823359
AUDI	S1 Sportback Quattro 2014	ML6154	8X0823359
AUDI	Q3 2011	ML6156	8A0823359B / 8U0823359B
AUDI	Q3 Quattro 2011	ML6156	8A0823359B / 8U0823359B
BMW	1 Series 2012	ML6158	51237239233
BMW	3 Series 2012	ML6160	51237255812
BMW	3 Series GT 2012	ML6160	51237255812
BMW	3 Series Touring 2012	ML6160	51237255812
BMW	X3 sDrive 2010	ML6163	51237210727
BMW	X3 xDrive 2010	ML6163	51237210727
MINI	Countryman 2010	ML6177	51239802054
MINI	Paceman 2012	ML6177	51239802054
VW	Passat 2010	ML6185	3AA823359A
VW	Passat Alltrack 2010	ML6185	3AA823359A
VW	Passat Estate/Variant 2010	ML6185	3AA823359A

### APPLICATION INFO

MAKE	MODEL	MONROE®	OEN°
AUDI	A1 2010	ML6153	8X3827552
AUDI	A1 Quattro 2012	ML6153	8X3827552
AUDI	A1 Sportback 2011	ML6155	8X4827552
AUDI	S1 Quattro 2014	ML6153	8X3827552
AUDI	S1 Sportback Quattro 2014	ML6155	8X4827552
AUDI	Q3 2011	ML6157	8U0827552A
AUDI	Q3 Quattro 2011	ML6157	8U0827552A
BMW	1 Series 2010	ML6159	51247239871
BMW	1 Series xDrive 2010	ML6159	51247239871
BMW	3 Series 2012	ML6161	51247259763
BMW	X3 2011	ML6162	51247211289
CITROEN	DS4 2010	ML6164	9676672180
FORD	C-Max 2010	ML6165	AM51R406A10AB
FORD	Focus 2011	ML6166	BM51A406A10AE
FORD	Focus Estate/Wagon 2011	ML6167	BM51N406A10AC
FORD	Grand C-Max 2010	ML6168	AM51U406A10AC
HYUNDAI	Santa Fe 2005	ML6169	81770-2B001 / 81770-2B000
KIA	Picanto 2011	ML6170	817701Y000 / 817701Y010
KIA	Venga 2010	ML6171	817701P000 / 817801P000
MERCEDES	B-Class 2013	ML6172	Q1A2469800264 / Q1A2469800564
MERCEDES	C-Class 2000	ML6173	2037400045
MINI	Countryman 2010	ML6176	51249801386
OPEL	Astra 2010	ML6178	132081 / 93867088
OPEL	Meriva 2010	ML6179	13338367
PEUGEOT	208 2012	ML6180	7000210271C0 / 9676494780
PEUGEOT	508 2010	ML6181	8731.W4
SEAT	Ibiza ST 2010	ML6183	6J8 827 550 B
TOYOTA	Yaris 2010	ML6184	68960-0W620
VW	Passat 2010	ML6186	3AE827550A
VW	Passat Alltrack 2010	ML6187	3AF827550A / 3AF827550C
VW	Passat Estate/Variant 2010	ML6187	3AF827550A / 3AF827550C
VW	Touran 2010	ML6188	1T0827550H
VW	E-Up 2013	ML6189	1S6827550D
VW	Up 2011	ML6189	1S6827550D

# MONROE® MAX-LIFT® CROSS REFERENCE LIST



## STABILUS

STABILUS	MONROE®	STABILUS	MONROE®	STABILUS	MONROE®	STABILUS	MONROE®	STABILUS	MONROE®
40873	ML6176	266250	ML6171	474902	ML6156	569070	ML6162	986604	ML6170
159421	ML6177	341059	ML6179	498324	ML6167	570749	ML6181	993536	ML6187
165876	ML6188	451250	ML6172	498563	ML6166	585798	ML6186	4013WV	ML6173
166832	ML6189	458650	ML6157	505741	ML6180	593440	ML6169		
193602	ML6161	459367	ML6154	547558	ML6159	620692	ML6164		
194558	ML6158	465581	ML6153	561183	ML6163	645070	ML6178		
194558	ML6160	466298	ML6155	568829	ML6185	775557	ML6183		

## LESJOFORS

LESJOFORS	MONROE®	LESJOFORS	MONROE®	LESJOFORS	MONROE®	LESJOFORS	MONROE®	LESJOFORS	MONROE®
8004230	ML6156	8104253	ML6155	8127582	ML6167	8163478	ML6179	8195082	ML6187
8008421	ML6158	8104258	ML6157	8137221	ML6169	8166764	ML6180	8195084	ML6188
8008421	ML6160	8108432	ML6159	8144241	ML6171	8166765	ML6181	8195085	ML6189
8008425	ML6163	8108433	ML6161	8156805	ML6173	8172937	ML6154		
8058702	ML6177	8108435	ML6162	8156832	ML6172	8182925	ML6183		
8095022	ML6185	8127579	ML6165	8158703	ML6176	8192585	ML6184		
8104251	ML6153	8127581	ML6166	8163474	ML6178	8195080	ML6186		

# MONROE® MAX-LIFT® OE CROSS REFERENCE LIST

	OE N°:	Ref.		OE N°:	Ref.		OE N°:	Ref.
<b>AUDI</b>			FORD	BM51A406A10AE	ML6166	OPEL	13338367	ML6179
AUDI	8A0823359B	ML6156	FORD	BM51N406A10AC	ML6167	OPEL	93867088	ML6178
<b>AUDI</b>			<b>HYUNDAI</b>			<b>PEUGEOT</b>		
AUDI	8U0823359B	ML6156	HYUNDAI	81770-2B001	ML6169	PEUGEOT	7000210271C0	ML6180
AUDI	8U0827552A	ML6157	HYUNDAI	81770-2B000	ML6169	PEUGEOT	9676494780	ML6180
AUDI	8X0823359	ML6154	<b>KIA</b>			PEUGEOT	8731.W4	ML6181
AUDI	8X3827552	ML6153	KIA	817701P000	ML6171	<b>SEAT</b>		
AUDI	8X4827552	ML6155	KIA	817801P000	ML6171	SEAT	6J8 827 550 B	ML6183
<b>BMW</b>			KIA	817701Y000	ML6170	<b>TOYOTA</b>		
BMW	51237210727	ML6163	KIA	817701Y010	ML6170	TOYOTA	68960-0W620	ML6184
BMW	51237239233	ML6158	<b>MERCEDES</b>			<b>VW</b>		
BMW	51237255812	ML6160	MERCEDES	2037400045	ML6173	VW	1S6827550D	ML6189
BMW	51247211289	ML6162	MERCEDES	Q1A2469800264	ML6172	VW	1T0827550H	ML6188
BMW	51247239871	ML6159	MERCEDES	Q1A2469800564	ML6172	VW	3AA823359A	ML6185
BMW	51247259763	ML6161	<b>MINI</b>			VW	3AE827550A	ML6186
<b>CITROEN</b>			MINI	51239802054	ML6177	VW	3AF827550A	ML6187
CITROEN	9676672180	ML6164	MINI	51249801386	ML6176	VW	3AF827550C	ML6187
<b>FORD</b>			<b>OPEL</b>					
FORD	AM51R406A10AB	ML6165	OPEL	132081	ML6178			
FORD	AM51U406A10AC	ML6168						





ALFA ROMEO

**MONROE**STD  
SPECIALSTD  
SPECIAL**ALFA ROMEO****33**

33 Sportwagon (907B)	1.90 → 9.94				<b>ML5597</b>	1.90 → 9.94 (-)	U/X1
----------------------	-------------	--	--	--	---------------	--------------------	------

**145**

145 (930)	7.94 → 1.01				<b>ML5335</b>		S1/S1
-----------	-------------	--	--	--	---------------	--	-------

**146**

146 (930)	12.94 → 1.01				<b>ML5271</b>		U/U
					<b>ML5272</b>	(+)	U/U

**147**

147 (937)	11.00 → 3.10	<b>ML5696</b>		P/U	<b>ML5222</b>		S1/U
-----------	--------------	---------------	--	-----	---------------	--	------

**155**

155 (167)	1.92 → 12.97	<b>ML5608</b>		N/N	<b>ML5531</b>		S1/T1
					<b>ML5532</b>	(+)	S1/T1

**156**

156 (932)	9.97 → 9.05	<b>ML5392</b>		S1/S1	<b>ML5215</b>		S1/S1
					<b>ML5216</b>	(+)	S1/S1
156 Sportwagon (932)	9.97 → 5.06	<b>ML5392</b>		S1/S1	<b>ML5442</b>		U/U

**159**

159 (939)	9.05 → 11.11	<b>ML5697</b>		U/U	<b>ML5698</b>		S1/U
159 Sportwagon (939)	3.06 → 11.11	<b>ML5697</b>		U/U	<b>ML6149<sup>0</sup></b>		G/G

**164**

164 (164)	6.87 → 9.98	<b>ML5919</b>		Y1/D	<b>ML5274</b>	(+) <sup>1</sup> / 6.87 → 8.91	U/U
					<b>ML5273</b>	(+) <sup>2</sup> / 9.91 → 9.98	U/U

**166**

166 (936)	9.98 → 6.07	<b>ML5414</b>		S1/S1	<b>ML5419</b>		S1/S1
-----------	-------------	---------------	--	-------	---------------	--	-------

**BRERA**

BRERA	1.06 →	<b>ML5697</b>		U/U	<b>ML5920</b>		U/U
-------	--------	---------------	--	-----	---------------	--	-----

**GT**

GT (937)	11.03 → 9.10	<b>ML5696</b>		P/U	<b>ML5855</b>		S1/S1
----------	--------------	---------------	--	-----	---------------	--	-------

**GTV**

GTV (916C_)	6.95 → 10.05	<b>ML6138</b>		U/U	<b>ML6137</b>		U/U
-------------	--------------	---------------	--	-----	---------------	--	-----

**MITO**

MITO (955)	9.08 →				<b>ML5655</b>		S1/U
------------	--------	--	--	--	---------------	--	------

**SPIDER**

SPIDER (916S_)	4.95 → 4.05	<b>ML6138</b>		U/U	<b>ML5272</b>		U/U
SPIDER (939)	9.06 →				<b>ML5921</b>		S1/S1

AUDI

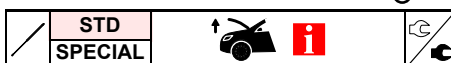

# AUDI

## 80

80 (89, 89Q, 8A, B3)	6.86 → 10.91	<b>ML5593</b>		Y1/D	<b>ML5417</b>		S1/S1
					<b>ML5533</b>	(+)	T1/T1
80 (8C, B4)	9.91 → 12.94	<b>ML5333</b>		Y1/D	<b>ML5376</b>		U/S1
					<b>ML5104</b>	(+)	U/S1
80 Avant (8C, B4)	9.91 → 1.96	<b>ML5333</b>		Y1/D	<b>ML5437</b>		S1/U

## 90

90 (89, 89Q, 8A, B3)	4.87 → 9.91	<b>ML5593</b>		Y1/D	<b>ML5417</b>		S1/S1
					<b>ML5533</b>	(+)	T1/T1

## CABRIOLET

CABRIOLET (8G7, B4)	5.91 → 8.00	<b>ML5333</b>		Y1/D	<b>ML5927</b>	Ch. n° 8G-P-003 612 →	U/T1
---------------------	-------------	---------------	--	------	---------------	-----------------------	------

## COUPE

COUPE (89, 8B)	10.88 → 12.96				<b>ML5534</b>		S1/U
----------------	---------------	--	--	--	---------------	--	------

## 100

100 (44, 44Q, C3)	8.82 → 7.91	<b>ML5420</b>	Ch. n° 44F 115 151 →	Y1/D			
100 Avant (44, 44Q, C3)	8.82 → 11.90	<b>ML5420</b>	Ch. n° 44F 115 151 →	Y1/D	<b>ML5428</b>		S1/S1
100 (4A, C4)	12.90 → 7.94	<b>ML5385</b>		U/X1	<b>ML5111</b>		U/C1
100 Avant (4A, C4)	12.90 → 7.94	<b>ML5385</b>		U/X1	<b>ML5418</b>		U/U

## 200

200 (44, 44Q)	8.83 → 12.91	<b>ML5420</b>	Ch. n° 44F 115 151 →	Y1/D			
200 Avant (44, 44Q)	9.83 → 12.91	<b>ML5420</b>	Ch. n° 44F 115 151 →	Y1/D	<b>ML5428</b>		S1/S1

## A2

A2 (8Z0)	2.00 → 8.05				<b>ML5370</b>		U/P
----------	-------------	--	--	--	---------------	--	-----

## A3

A3 (8L1)	9.96 → 5.03	<b>ML5261</b>		S1/U	<b>ML5197</b>	→ 8.00	S1/U
					<b>ML5198</b>	8.00 →	S1/U
A3 (8P1)	5.03 → 8.12	<b>ML5269</b>		P/U	<b>ML5459</b>		S1/S1
					<b>ML5460</b>	(+)	S1/S1
A3 Sportback (8PA)	9.04 →	<b>ML5269</b>		P/U	<b>ML5749</b>		U/P
A3 Convertible (8P7)	4.08 →	<b>ML5269</b>		P/U	<b>ML5922</b>		S1/S3

## A4

A4 (8D2, B5)	11.94 → 11.00	<b>ML5679</b>		L/L	<b>ML5135</b>		U/U
A4 Avant (8D5, B5)	11.94 → 9.01	<b>ML5679</b>		L/L	<b>ML5197</b>	→ 8.00	S1/U
A4 (8E2, B6)	10.00 → 12.04	<b>ML5386</b>		L/L	<b>ML5223</b>	5.00 → 12.04	U/U
A4 Avant (8E5, B6)	10.00 → 12.04	<b>ML5386</b>		L/L	<b>ML5227</b>		S1/S1
A4 Convertible (8H7, B6, 8HE, B7)	4.02 → 3.09	<b>ML5269</b>		P/U	<b>ML5844</b>		U/U
A4 (8EC, B7)	11.04 → 6.08	<b>ML5386</b>		U/U	<b>ML5745</b>		U/U
A4 Avant (8ED, B7)	11.04 → 6.08	<b>ML5386</b>		U/U	<b>ML5747</b>		T1/T1
A4 (8K2, B8)	11.07 →	<b>ML5741</b>		U/U			
A4 Avant (8K5, B8)	4.08 →	<b>ML5741</b>		U/U	<b>ML5918</b>		U/U
					<b>ML5923</b>	(+)	U/U
A4 Allroad (8KH, B8)	4.09 →	<b>ML5741</b>		U/U			



AUSTIN



/	STD			
	SPECIAL			

/	STD			
	SPECIAL			

### A5

A5 (8T3)	6.07 →	ML5741		U/U			
A5 Sportback (8TA)	9.09 →	ML5741		U/U	ML6102		U/P
A5 Convertible (8F7)	3.09 →	ML5741		U/U	ML6103		U/C1

### A6

A6 (4A, C4)	6.94 → 10.97	ML5385		U/X1	ML5111		U/C1
A6 Avant (4A, C4)	6.94 → 12.97	ML5385		U/X1	ML5418		U/U
A6 (4B, C5)	1.97 → 1.05	ML5678		U/L	ML5234	8.97 → 4.00	U/U
					ML5223	5.00 → 12.04	U/U
A6 Avant (4B, C5)	12.97 → 1.05	ML5678		U/L	ML5510	4B9827552D, 4B9827552H	U/U
					ML5240	4B9827552G	P/P
					ML5511	4B9827552J	U/U
					ML5238	→ 4.00 4B9827552A	S1/P
					ML5239	4.00 → 1.05 4B9827552L, 4B9827552M	P/U
ALLROAD (4BH, C5)	5.00 → 8.05	ML5266		U/C1	ML5512		U/U
A6 (4F2, C6)	5.04 → 3.11	ML5737		P/U	ML5744		U/U
A6 Avant (4F5, C6)	3.05 → 8.11	ML5737		P/U	ML6104	(+)	U/C1
A6 Allroad (4FH, C6)	5.06 → 8.11	ML5737		P/U	ML5746		U/P

### A8

A8 (4D2, 4D8)	3.94 → 9.02	ML5276		U/U	ML5275		U/U
A8 (4E_)	10.02 → 7.10	ML5924		U/C1	ML5926		U/C1
					ML5925		U/C1
A8 (4H_)	11.09 →	ML6106		U/C1	ML6105		S1/S1

### Q5

Q5 (8R)	11.08 →	ML5928		S1/S1	ML5856		U/U
					ML5857	(+)	P/P

### Q7

Q7 (4L)	3.06 →	ML5739		U/P	ML5774		T1/P
					ML5929	(-)	P/P

### TT

TT (8N3)	10.98 → 6.06	ML5135		U/U	ML5277		U/U
TT Roadster (8N9)	10.99 → 6.06	ML5135		U/U	ML5449	(+)	U/U
TT (8J3)	8.06 →	ML5740		S1/U	ML6150 <sup>o</sup>		U/U
TT Roadster (8J9)	3.07 →	ML5740		S1/U	ML5753		U/U
					ML5930		U/U

### V8

V8 (44_, 4C_)	10.88 → 2.94	ML5420	Ch. n° 44F 115 151 →	Y1/D			
---------------	--------------	--------	----------------------	------	--	--	--

## AUSTIN

### MAESTRO

MAESTRO (XC)	3.83 → 9.92				ML5362		U/U
--------------	-------------	--	--	--	--------	--	-----

### METRO

METRO	10.80 → 4.90				ML5041		U/U
-------	--------------	--	--	--	--------	--	-----

AUSTIN



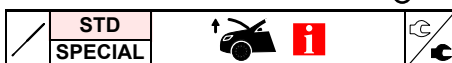

CHEVROLET

**7**

7 (E23)	5.77 → 8.86	<b>ML5600</b>	Y1/D			
7 (E32)	9.86 → 9.94	<b>ML5566</b>	10/10	<b>ML5934</b>		10/10
7 (E38)	10.94 → 11.01	<b>ML5441</b>	S1/S1	<b>ML5523</b>	reuse OE cyl. mount.	S1/12
7 (E65, E66)	11.01 →	<b>ML5565</b>	P/S1			
7 (F01, F02, F03, F04)	6.08 →	<b>ML6142</b>	U/C1			

**X1**

X1 (E84)	3.09 →	<b>ML6108</b>	S1/S1	<b>ML6109</b>		U/U
----------	--------	---------------	-------	---------------	--	-----

**X3**

X3 (E83)	1.04 →	<b>ML5769</b>	U/S1	<b>ML5693</b>		P/S1
----------	--------	---------------	------	---------------	--	------

**X5**

X5 (E53)	5.00 →	<b>ML5688</b>	S1/S1	<b>ML5690</b>		S1/S1
X5 (E70)	2.07 →	<b>ML5936</b>	P/U			

**X6**

X6 (E71, E72)	5.08 →	<b>ML5936</b>	P/U			
---------------	--------	---------------	-----	--	--	--

**Z3**

Z3 (E36)	10.95 → 1.03			<b>ML5860</b>		S1/S1
----------	--------------	--	--	---------------	--	-------

**Z4**

Z4 (E85)	2.03 →	<b>ML5938</b>	S1/U	<b>ML5861</b>		S1/S1
Z4 Coupe (E86)	3.06 →	<b>ML5938</b>	S1/U			
Z4 (E89)	5.09 →	<b>ML6111</b>	S1/C1	<b>ML6110</b>		S1/S3

**BMW (BRILLIANCE)****X1**

X1 (E84)	3.12 →	<b>ML6108</b>	S1/S1	<b>ML6109</b>		U/U
----------	--------	---------------	-------	---------------	--	-----

**CHEVROLET****CAPTIVA**

CAPTIVA (C100, C140)	6.06 →	<b>ML5939</b>	U/U	<b>ML5940</b>		S1/S1
----------------------	--------	---------------	-----	---------------	--	-------

**COMBO**

COMBO	4.01 →			<b>ML6057</b>		U/C1
-------	--------	--	--	---------------	--	------

**KALOS**

KALOS	3.05 →			<b>ML5714</b>		U/P
-------	--------	--	--	---------------	--	-----

**LACETTI**

LACETTI (J200)	3.05 →			<b>ML5794</b>		T1/T1
----------------	--------	--	--	---------------	--	-------

**MATIZ**

MATIZ (M200, M250)	3.05 →			<b>ML6140</b>		S1/U
--------------------	--------	--	--	---------------	--	------

**NUBIRA**

NUBIRA Estate	1.05 →			<b>ML5941</b>		S1/S1
---------------	--------	--	--	---------------	--	-------

CHEVROLET



	STD				STD			
	SPECIAL							

REZZO

REZZO	3.05 →				ML5446		T1/T1
-------	--------	--	--	--	--------	--	-------

SPARK

SPARK	9.00 → 12.04				ML5098		P/P
SPARK	5.05 →				ML5943		S1/S3
SPARK (M300)	3.10 →				ML5943		S1/S3

VECTRA

VECTRA	3.96 →	ML5085		U/U			
VECTRA	4.02 →	ML5085		U/U			

CHEVROLET (SGMW)

SPARK

SPARK	12.03 →				ML5943		S1/S3
-------	---------	--	--	--	--------	--	-------

CHRYSLER

300 C

300 C	9.04 → 11.12	ML5945		P/U	ML5946	→ 12.07	U/C
300 C Touring	9.04 → 12.10	ML5945		P/U	ML6112	1.08 →	U/C
300 C	9.11 →				ML5944		P/P
					ML6112		U/C

GRAND VOYAGER

GRAND VOYAGER V (RT)	10.07 →				ML5947		P/P
----------------------	---------	--	--	--	--------	--	-----

PT CRUISER

PT CRUISER (PT_)	6.00 → 12.10				ML6113		Q/Q
------------------	--------------	--	--	--	--------	--	-----

CHRYSLER (BBDC)

300C

300C	10.06 → 1.12	ML5945		P/U	ML5946	→ 12.07	U/C
					ML6112	1.08 →	U/C

CITROËN

AX

AX (ZA_)	7.86 → 12.98				ML5607		S1/S1
----------	--------------	--	--	--	--------	--	-------

BERLINGO

BERLINGO (MF)	7.96 →				ML5113		T1/T1
BERLINGO Box (M_)	7.96 →				ML5113		T1/T1
BERLINGO	4.08 →				ML5948		U/S1
					ML5954	→ OrgN. 118229	U/U
					ML5956	OrgN. 118230 →	S1/S3
					ML5948		U/S1
					ML5954	→ OrgN. 118229	U/U
					ML5956	OrgN. 118230 →	S1/S3

**BX**

BX (XB_)	10.82 → 6.94					<b>ML5603</b>	→ 10.86		Y1/D
BX Break (XB_)	4.83 → 12.94					<b>ML5605</b>	10.86 →		S1/D
						<b>ML5452</b>			U/U

**C1**

C1 (PM_, PN_)	6.05 →					<b>ML5687</b>			U/U
---------------	--------	--	--	--	--	---------------	--	--	-----

**C2**

C2 (JM_)	9.03 →					<b>ML5453</b>			U/U
----------	--------	--	--	--	--	---------------	--	--	-----

**C3**

C3 (FC_)	2.02 →					<b>ML5151</b>			U/U
C3 Pluriel (HB_)	5.03 →					<b>ML6114</b>			S1/H1
C3 Picasso	2.09 →					<b>ML5862</b>			S1/S1

**C4**

C4 (LC_)	11.04 →					<b>ML5668</b>			S1/U
C4 Saloon	7.06 →					<b>ML5962</b>			U/C1
C4 Coupe (LA_)	11.04 →					<b>ML5782</b>			T1/T1
						<b>ML5824</b>	(+)		S1/S1
C4 Picasso (UD_)	2.07 →					<b>ML5756</b>	(+)		U/P
						<b>ML5755</b>	(+)		U/P
						<b>ML5961</b>			S1/S3
C4 Grand Picasso (UA_)	10.06 →					<b>ML5783</b>	(+)		U/P
						<b>ML5958</b>	(+)		U/P
						<b>ML5959</b>			S1/S1
C4 (B7)	11.09 →					<b>ML6115</b>			U/C1

**C5**

C5 (DC_)	3.01 → 8.04	<b>ML5461</b>			S1/S1	<b>ML5391</b>			U/U
C5 Break (DE_)	6.01 → 8.04	<b>ML5461</b>			S1/S1	<b>ML5536</b>			U/Q
C5 (RC_)	9.04 →	<b>ML5461</b>			S1/S1	<b>ML5963</b>	(+)		S1/S1
C5 Break (RE_)	9.04 →	<b>ML5461</b>			S1/S1	<b>ML5536</b>			U/Q
C5 (RD_)	2.08 →					<b>ML5652</b>	(-)		J/S1
C5 Break (TD_)	2.08 →					<b>ML6143</b>	(-)		U/U

**C6**

C6 (TD_)	9.05 →	<b>ML5822</b>			S1/S1	<b>ML5967</b>			S1/S1
----------	--------	---------------	--	--	-------	---------------	--	--	-------

**C8**

C8 (EA_, EB_)	7.02 →					<b>ML5344</b>			U/U
---------------	--------	--	--	--	--	---------------	--	--	-----

**C-CROSSER**

C-CROSSER (EP_)	2.07 →					<b>ML5776</b>			U/P
-----------------	--------	--	--	--	--	---------------	--	--	-----

**CX**

CX I (MA)	9.74 → 8.85					<b>ML5606</b>			Y1/D
CX I Break (MA)	9.75 → 8.85					<b>ML5609</b>			W/D
CX II	7.85 → 12.92					<b>ML5606</b>			Y1/D

**EVASION**

EVASION (22, U6)	6.94 → 7.02					<b>ML5454</b>	→ 11.95		U/U
						<b>ML5456</b>	11.95 → 10.97		U/U
						<b>ML5455</b>	10.97 →		U/U

CITROËN

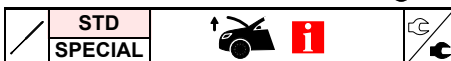

**GS**

GS	9.70 → 7.86					<b>ML5010</b>		Y6/X1
GS Break	7.71 → 7.86					<b>ML5011</b>		Y6/X1

**JUMPY**

JUMPY	1.07 →					<b>ML5950</b>	(+) Tailgate	U/U
JUMPY Box	1.07 →					<b>ML5950</b>	(+) Tailgate	U/U

**NEMO**

NEMO Estate	4.09 →					<b>ML5968</b>		U/U
-------------	--------	--	--	--	--	---------------	--	-----

**SAXO**

SAXO (S0, S1)	2.96 → 4.04					<b>ML5149</b>		U/U
---------------	-------------	--	--	--	--	---------------	--	-----

**VISA**

VISA	9.78 → 3.91					<b>ML5019</b>		Y6/X1
------	-------------	--	--	--	--	---------------	--	-------

**XANTIA**

XANTIA (X1)	3.93 → 1.98					<b>ML5504</b>		T1/T1
XANTIA Break (X1)	6.95 → 1.98					<b>ML5503</b>	(+)	T1/T1
XANTIA (X2)	1.98 → 4.03					<b>ML5430</b>		U/U
XANTIA Break (X2)	1.98 → 4.03					<b>ML5504</b>		T1/T1
						<b>ML5503</b>	(+)	T1/T1
						<b>ML5430</b>		U/U

**XM**

XM (Y3)	5.89 → 6.94	<b>ML5457</b>		U/U	<b>ML5504</b>		T1/T1
XM Break (Y3)	5.89 → 7.94	<b>ML5457</b>		U/U	<b>ML5505</b>		T1/T1
XM (Y4)	5.94 → 10.00	<b>ML5457</b>		U/U	<b>ML5504</b>		T1/T1
XM Break (Y4)	5.94 → 10.00	<b>ML5457</b>		U/U	<b>ML5505</b>		T1/T1

**XSARA**

XSARA (N1)	4.97 → 3.05	<b>ML5270</b>	→ 9.00	U/U	<b>ML5129</b>		S1/S1
		<b>ML5262</b>	9.00 →	U/U			
XSARA Break (N2)	10.97 → 8.05	<b>ML5270</b>	→ 9.00	U/U	<b>ML5435</b>		S1/S1
		<b>ML5262</b>	9.00 →	U/U			
XSARA Coupe (N0)	2.98 → 3.05	<b>ML5270</b>	→ 9.00	U/U	<b>ML5129</b>		S1/S1
		<b>ML5262</b>	9.00 →	U/U			
XSARA PICASSO (N68)	12.99 →	<b>ML5262</b>	9.00 →	U/U	<b>ML5162</b>		S1/S1

**ZX**

ZX (N2)	3.91 → 10.97					<b>ML5255</b>		U/U
ZX Break (N2)	10.93 → 2.98					<b>ML5506</b>		T1/T1

**DACIA**

**LOGAN**

LOGAN MCV (KS_)	2.07 →					<b>ML5864</b>		U/U
-----------------	--------	--	--	--	--	---------------	--	-----

**SANDERO**

SANDERO	6.08 →					<b>ML5864</b>		U/U
---------	--------	--	--	--	--	---------------	--	-----





FIAT



# DAEWOO

## KALOS

KALOS (KLAS)	9.02 →					ML5714		U/P
--------------	--------	--	--	--	--	--------	--	-----

## LACETTI

LACETTI Hatchback (KLAN)	2.04 →					ML5794		T1/T1
--------------------------	--------	--	--	--	--	--------	--	-------

## LANOS

LANOS (KLAT)	5.97 →					ML5087		U/C1
--------------	--------	--	--	--	--	--------	--	------

## MATIZ

MATIZ (KLYA)	9.98 →					ML5098		P/P
--------------	--------	--	--	--	--	--------	--	-----

## NEXIA

NEXIA (KLETN)	2.95 → 8.97					ML5031		U/U
---------------	-------------	--	--	--	--	--------	--	-----

## NUBIRA

NUBIRA (KLAJ)	4.97 →					ML5507	5 , (+)	T1/T1
NUBIRA Saloon (KLAJ)	4.97 →					ML5095	(+)	U/U
NUBIRA Wagon (KLAJ)	4.97 →					ML5096		U/U
NUBIRA Saloon (KLAN)	7.03 →					ML5095	(+)	U/U
NUBIRA Wagon (KLAN)	7.03 →					ML5941		S1/S1

## REXTON

REXTON (GAB_)	4.02 →		ML5355		U/U			
						ML5334		U/U
						ML5356		U/U

## REZZO

REZZO (KLAU)	9.00 →					ML5513		T1/T1
--------------	--------	--	--	--	--	--------	--	-------

## TICO

TICO (KLY3)	2.95 → 12.00					ML5051		S1/E1
-------------	--------------	--	--	--	--	--------	--	-------

# DAIHATSU

## SIRION

SIRION (M3_)	1.05 →					ML6084		T1/T1
--------------	--------	--	--	--	--	--------	--	-------

# FIAT

## 126

126 Special Design	9.87 → 6.96					ML5006		Y2/X2
--------------------	-------------	--	--	--	--	--------	--	-------

FIAT

FIAT



**127**

127	6.71 → 12.86					ML5010	5		Y6/X1
						ML5015	→ 3.77 3		Y6/X1
						ML5009	4.77 → 9.81 3		Y6/X1
						ML5034	9.81 → 3		Y6/X1
127 Panorama	1.77 → 12.86					ML5015	→ 3.77 3		Y6/X1

**128**

128	3.69 → 12.84					ML5003			U/U
128 Familiare	10.69 → 10.82					ML5011			Y6/X1

**131**

131 Familiare/Panorama	3.75 → 4.85					ML5042			Y6/X1
------------------------	-------------	--	--	--	--	--------	--	--	-------

**132**

132	4.72 → 12.82		ML5030		Y6/X1		ML5018		Y6/X1
-----	--------------	--	--------	--	-------	--	--------	--	-------

**147**

147	10.76 → 12.95		ML5030		Y6/X1		ML5018		Y6/X1
-----	---------------	--	--------	--	-------	--	--------	--	-------

**500**

500	10.07 →						ML5785		S1/S1
-----	---------	--	--	--	--	--	--------	--	-------

**BRAVA**

BRAVA (182)	10.95 → 12.02						ML5068		U/U
-------------	---------------	--	--	--	--	--	--------	--	-----

**BRAVO**

BRAVO I (182)	10.95 → 2.02						ML5069		U/U
BRAVO II (198)	11.06 →						ML5784		U/U

**CINQUECENTO**

CINQUECENTO (170)	7.91 → 7.99						ML5081		U/C1
-------------------	-------------	--	--	--	--	--	--------	--	------

**COUPE**

COUPE (FA/175)	11.93 → 8.00		ML5976		N/N				
----------------	--------------	--	--------	--	-----	--	--	--	--

**CROMA**

CROMA (154)	12.85 → 12.96						ML5043		Y1/X1
CROMA (194)	6.05 →						ML5795		U/U

**DOBLO**

DOBLO (119)	3.01 →						ML5448		U/U
DOBLO Cargo (223)	3.01 →						ML5404	(+) Panoramic	U/U
							ML5448		U/U

**DUCATO**

DUCATO Panorama (280)	7.82 → 8.90						ML5074		F1/Y3
DUCATO Box (280)	1.82 → 8.90						ML5074		F1/Y3
DUCATO Platform/Chassis (280)	7.82 → 8.90						ML5074		F1/Y3
DUCATO Panorama (290)	6.90 → 5.94						ML5074		F1/Y3



FIAT

	STD					STD				
	SPECIAL					SPECIAL				
DUCATO Box (290)	3.89	→ 5.94				ML5074				F1/Y3
DUCATO Platform/Chassis (290)	3.89	→ 5.94				ML5074				F1/Y3

**ELBA**

ELBA (146_)	4.86	→ 12.96				ML5064				U/U
-------------	------	---------	--	--	--	--------	--	--	--	-----

**FIORINO**

FIORINO Box Body / Estate (225)	1.07	→				ML5968				U/U
---------------------------------	------	---	--	--	--	--------	--	--	--	-----

**IDEA**

IDEA	12.03	→				ML5702				P/S1
------	-------	---	--	--	--	--------	--	--	--	------

**LINEA**

LINEA (323)	6.07	→				ML5975				S1/S3
-------------	------	---	--	--	--	--------	--	--	--	-------

**MAREA**

MAREA Weekend (185)	9.96	→ 8.02				ML5078				U/U
---------------------	------	--------	--	--	--	--------	--	--	--	-----

**MULTIPLA**

MULTIPLA (186)	4.99	→ 6.10			ML5389			S1/S1		ML5377				U/S1
----------------	------	--------	--	--	--------	--	--	-------	--	--------	--	--	--	------

**PALIO**

PALIO (178BX)	4.96	→				ML5462				S1/S1
PALIO Weekend (178DX)	4.96	→				ML5086				S1/S1

**PANDA**

PANDA (141A_)	10.80	→ 7.04				ML5016	→ Vet n° 6314421, 5370347			Y1/X2
PANDA (169)	9.03	→				ML5039	Vet n° 6314422, 5370348 →			Y1/X2
						ML5101				S1/S1

**PUNTO**

PUNTO (176)	9.93	→ 9.99				ML5079				U/U
PUNTO Convertible (176C)	4.94	→ 6.00				ML5974				T1/T1
PUNTO Van (176L)	4.96	→ 2.00				ML5973				S1/S1
PUNTO (188)	9.99	→				ML5079				U/U
						ML5164	3			U/U
						ML5165	5			U/U
PUNTO Van (188AX)	2.00	→ 10.09				ML5164	3			U/U
						ML5165	5			U/U
PUNTO / GRANDE PUNTO (199)	10.05	→				ML5775				S1/S1
PUNTO EVO	7.08	→ 2.12				ML5775				S1/S1
PUNTO (199)	3.12	→				ML5775				S1/S1

**QUBO**

QUBO (225)	9.08	→				ML5968				U/U
------------	------	---	--	--	--	--------	--	--	--	-----

**REGATA**

REGATA Weekend	1.84	→ 12.90				ML5041				U/U
----------------	------	---------	--	--	--	--------	--	--	--	-----

**RITMO**

RITMO Bertone Convertible	10.79	→ 7.89				ML5055				Y6/X1
RITMO I (138A)	1.78	→ 12.87				ML5010				Y6/X1

# FIAT



	STD				STD			
	SPECIAL							
RITMO II (138A)	10.82 → 12.88				ML5011			Y6/X1
					ML5501	(+)		Y2/D

## SCUDO

SCUDO Combinato (220P)	2.96 → 12.06				ML5950	(+) Tailgate		U/U
SCUDO Box (220L)	2.96 → 12.06				ML5950	(+) Tailgate		U/U
SCUDO (270_)	1.07 →				ML5950	(+) Tailgate		U/U
SCUDO Box (270_)	1.07 →				ML5950	(+) Tailgate		U/U

## SEDICI

SEDICI	6.06 →				ML5779			U/U
--------	--------	--	--	--	--------	--	--	-----

## SEICENTO

SEICENTO (187)	1.98 → 1.10				ML5081			U/C1
SEICENTO Van (187)	1.98 → 1.10				ML5081			U/C1

## STILO

STILO (192)	10.01 → 11.06	ML5038		U/U	ML5280	3		U/U
					ML5281	5		U/U
STILO Multi Wagon (192)	1.03 → 8.08	ML5038		U/U	ML5443	(+)		U/U
					ML5537	(+)		U/U
					ML5538	(+)  (+)		U/U
					ML5387			U/U

## TALENTO

TALENTO Bus (290)	3.89 → 3.94				ML5074			F1/Y3
TALENTO Box (290)	3.89 → 3.94				ML5074			F1/Y3
TALENTO Platform/Chassis (290)	3.89 → 3.94				ML5074			F1/Y3

## TEMPRA

TEMPRA S.W. (159)	3.90 → 8.96				ML5282			U/U
-------------------	-------------	--	--	--	--------	--	--	-----

## TIPO

TIPO (160)	7.87 → 8.96				ML5066	160.AE		U/U
					ML5013	→ 3.93		U/U
					ML5014	3.93 →		U/U

## ULYSSE

ULYSSE (220)	6.94 → 8.02				ML5283			U/U
ULYSSE (179AX)	8.02 → 6.11				ML5458			U/U

## UNO

UNO (146A/E)	1.83 → 8.00				ML5040	→ 8.89		U/U
UNO (146 A/E)	8.00 → 4.10				ML5065	9.89 →		U/U
					ML5065	9.89 →		U/U

# FORD

## C-MAX

C-MAX	2.07 →				ML5288			U/U
-------	--------	--	--	--	--------	--	--	-----

## ESCORT

ESCORT III (GAA)	9.80 → 7.86				ML5463	(+)		S1/S1
					ML5464	(+)		S1/S1
					ML5173	XR3i		U/U



FORD

MONROE	STD		↑ i	↺	STD		i	↑	↻
	SPECIAL				SPECIAL				
ESCORT III Estate (AWA)  9.80 → 2.86						ML5285 (-) ↘			U/U
						ML5286 (+) ↘			U/U
ESCORT IV (GAF, AWF, ABFT)  10.85 → 10.90						ML5463 (-) ↘			S1/S1
						ML5464 (+) ↘			S1/S1
						ML5200 (+) ↘			U/U
						ML5201 (+) ↘			U/U
ESCORT IV Estate (AWF, AVF)  10.85 → 10.90						ML5173 XR3i			U/U
						ML5285 (-) ↘			U/U
						ML5286 (+) ↘			U/U
ESCORT IV Convertible (ALF)  1.86 → 7.90						ML5173 XR3i			U/U
ESCORT V (GAL)  7.90 → 12.92						ML5171 (-) ↘			U/U
						ML5172 (+) ↘			U/U
ESCORT V Estate (GAL, AVL)  7.90 → 12.92						ML5161			U/U
ESCORT V Convertible (ALL)  7.90 → 12.92						ML5980			U/U
						ML5981			U/U
ESCORT VI (GAL)  9.92 → 1.95						ML5252			U/U
						ML5109 (+) ↘			U/U
ESCORT VI Estate (GAL)  9.92 → 1.95						ML5161			U/U
ESCORT VI Convertible (ALL)  12.92 → 1.95						ML5980			U/U
						ML5981			U/U
ESCORT VII (GAL, AAL, ABL)  1.95 → 10.98						ML5252			U/U
						ML5109 (+) ↘			U/U
ESCORT VII Estate (GAL, ANL)  1.95 → 2.99						ML5161			U/U
ESCORT VII Convertible (ALL)  2.95 → 8.00						ML5980			U/U
						ML5981			U/U

**FIESTA**

FIESTA II (FBD)  9.83 → 11.89						ML5465 (-) ↘			S1/S1
						ML5023 (+) ↘			U/U
FIESTA III (GFJ)  1.89 → 1.97						ML5141 → 4.93 (-) ↘			U/U
						ML5142 → 4.93 (+) ↘			U/U
						ML5143 4.93 → (-) ↘			U/U
						ML5147 4.93 → (+) ↘			U/U
FIESTA IV (JA_, JB_)  8.95 → 1.02						ML5147 4.93 →			U/U
FIESTA V (JH_, JD_)  11.01 →						ML5205 3			U/U
						ML5206 → 11.02 5			U/U
						ML5207 12.02 → 5			U/U
FIESTA VI  10.08 →						ML5651			P/U
FIESTA Box (JV_)  5.98 →						ML5147 4.93 →			U/U
FIESTA Van  10.03 →						ML5205 3			U/U
FIESTA Van  1.09 →						ML5651			P/U

**FOCUS**

FOCUS (DAW, DBW)  10.98 → 11.04						ML5415 (-) ↘			U/U
						ML5224 (+) ↘			U/K
FOCUS Saloon (DFW)  2.99 → 3.05						ML5466 → 10.01			S1/S1
						ML5467 10.01 →			S1/S1
FOCUS Estate (DNW)  2.99 → 1.05						ML5168 (-) ↘			U/U
						ML5169 (+) ↘			U/U
FOCUS C-MAX  10.03 → 3.07						ML5288			U/U
FOCUS II (DA_)  11.04 →						ML5416			U/U
FOCUS II Saloon (DA_)  4.05 →						ML5786			U/U

FORD

## FORD



	STD			/	STD			/
	SPECIAL							
FOCUS II Estate (DA_)  11.04 →					ML5664			U/U
FOCUS II Convertible  10.06 →					ML5979			U/U

## FUSION

FUSION (JU_)  8.02 →					ML5289			U/U
----------------------	--	--	--	--	--------	--	--	-----

## GALAXY

GALAXY (WGR)  3.95 → 5.06	ML5480		S1/S1		ML5127			U/U
GALAXY  5.06 →			S1/S1		ML5771			P/P

## KA

KA (RB_)  9.96 → 11.08					ML5136			U/U
KA  2.08 →					ML5977			S1/S1
KA  10.08 →					ML5977			S1/S1

## KUGA

KUGA  3.08 →	ML5650		P/U		ML5654			U/U
--------------	--------	--	-----	--	--------	--	--	-----

## MONDEO

MONDEO I (GBP)  2.93 → 8.96					ML5126			S1/U
MONDEO I Saloon (GBP)  2.93 → 8.96					ML5290			U/U
MONDEO I Estate (BNP)  1.93 → 8.96					ML5431 (+)			U/U
MONDEO II (BAP)  9.96 → 11.00					ML5332			U/U
MONDEO II Saloon (BFP)  9.96 → 11.00					ML5176			S1/U
MONDEO II Estate (BNP)  9.96 → 11.00					ML5290			U/U
MONDEO III (B5Y)  11.00 → 8.07	ML5330		U/U		ML5332			U/U
MONDEO III Saloon (B4Y)  11.00 → 8.07					ML5232 (+)			U/U
MONDEO III Estate (BWY)  11.00 → 8.07					ML5233 w. Automatic wiper			U/U
MONDEO IV  3.07 →					ML5231 → 12.01 (-)			U/U
MONDEO IV Saloon  3.07 →					ML5373 1.02 → (-)			U/U
MONDEO IV Turnier  3.07 →					ML5502			S1/S1
					ML5374			U/U
					ML5797			T1/T1
					ML5704			T1/T1
					ML5772			T1/P

## ORION

ORION I (AFD)  7.83 → 3.86					ML5611			Y1/D
ORION II (AFF)  12.85 → 8.90					ML5611			Y1/D

## PUMA

PUMA (EC_)  3.97 → 6.02					ML5399			U/U
-------------------------	--	--	--	--	--------	--	--	-----

## SCORPIO

SCORPIO I (GAE, GGE)  4.85 → 9.94					ML5110			U/U
SCORPIO I Estate (GGE)  10.90 → 9.94					ML5612 (+)  (+)			U/U
SCORPIO II (GFR, GGR)  10.94 → 8.98					ML5291 (+)			U/U
SCORPIO II Estate (GNR, GGR)  10.94 → 8.98	ML5292	4	U/U		ML5388			U/U
	ML5292	4	U/U		ML5388			U/U



HONDA



### SIERRA

SIERRA Hatchback (GBC)  8.82 → 2.87					ML5080 (-)	U/U
					ML5253 (+)	U/U
					ML5539 (+)	U/U
SIERRA Hatchback (GBC, GBG)	1.87 → 3.93				ML5080 (-)	U/U
					ML5253 (+)	U/U
					ML5539 (+)	U/U
SIERRA Estate (BNG)	1.87 → 2.93				ML5293 (-)	U/U
					ML5294 (+)	U/U

### S-MAX

S-MAX	5.06 →				ML5770	P/P
-------	--------	--	--	--	--------	-----

### STREETKA

STREET KA	5.03 → 7.05				ML5978	S1/S1
-----------	-------------	--	--	--	--------	-------

### TOURNEO

TOURNEO CONNECT	6.02 →				ML5295	U/U
-----------------	--------	--	--	--	--------	-----

### TRANSIT

TRANSIT Bus (T_)	11.85 → 9.92				ML5429 (-)	U/U
					ML5076 (+)	U/U
					ML5429 (-)	U/U
TRANSIT Bus (FD_, FB FS_, FZ_, FC_)	1.00 → 5.06				ML5514	U/U
TRANSIT Box (FA_)	1.00 → 5.06				ML5514	U/U
TRANSIT Bus	4.06 →				ML5514	U/U
TRANSIT Box	4.06 →				ML5514	U/U

### TRANSIT CONNECT

TRANSIT CONNECT (P65_, P70_, P80_)	6.02 →				ML5295	U/U
------------------------------------	--------	--	--	--	--------	-----

## FORD USA

### ESCORT

ESCORT Convertible	4.93 → 5.96				ML5980	U/U
					ML5981	U/U

## HOLDEN

### BARINA

BARINA SPARK (MJ)	10.10 →				ML5943	S1/S3
-------------------	---------	--	--	--	--------	-------

### COMBO

COMBO Box (XC)	9.02 →				ML6057	U/C1
----------------	--------	--	--	--	--------	------

## HONDA

### ACCORD

ACCORD VII Hatchback (CH)	12.99 → 12.02				ML5787	T1/T1
ACCORD VIII Tourer (CM_)	4.03 →				ML5982	1/1
					ML5983 (-)	U/P
					ML5984 (+)	U/P

HONDA

HONDA

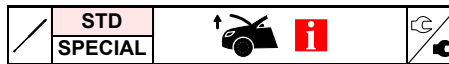

**CIVIC**

CIVIC IV Hatchback (EC, ED, EE)  9.87 → 10.93					ML5567	3	S1/S1
CIVIC V Hatchback (EG)  10.91 → 11.95					ML5568	3	S1/S1
CIVIC VI Hatchback (EJ, EK)  10.95 → 2.01					ML5405	5	U/U
CIVIC VI Aerodeck (MB, MC)  4.98 → 2.01					ML5214	5	S1/S1
CIVIC VII Hatchback (EU, EP, EV)  1.00 → 9.05					ML5122	5	U/U
CIVIC VIII Hatchback (FN, FK)  9.05 →					ML5396	3	U/U
					ML5371	5	U/U
					ML5615	5  D14Z5,D16V2/W7,D17A2	U/P
					ML5836		T1/T1

**CONCERTO**

CONCERTO (HW)  8.89 → 10.96					ML5508		T1/T1
					ML5192	(+)	U/U

**CR-V**

CR-V I (RD)  10.95 → 2.02					ML5447		T1/T1
CR-V II (RD_)  3.02 → 9.06					ML5910		U/S1
CR-V III  10.06 →					ML5866		U/P

**FR-V**

FR-V (BE)  8.04 →					ML5985		T1/T1
-------------------	--	--	--	--	--------	--	-------

**JAZZ**

JAZZ II (GD)  3.02 → 7.08					ML5911		T1/T1
---------------------------	--	--	--	--	--------	--	-------

**HYUNDAI**

**ACCENT**

ACCENT I (X-3)  10.94 → 1.00					ML5157		U/U
ACCENT II (LC)  1.00 → 11.05				ML6144		S1/C1	ML5986
							S1/C1

**ATOS**

ATOS PRIME (MX)  8.99 →					ML5987		U/S1
-------------------------	--	--	--	--	--------	--	------

**COUPE**

COUPE (RD)  7.96 → 4.02				ML5814		U/U	ML5379		U/S1
COUPE (GK)  8.01 → 8.09				ML5814		U/U	ML5378		U/S1
							ML5379	(+)	U/S1

**ELANTRA**

ELANTRA (XD)  6.00 → 7.06					ML5569		S1/S1
					ML5380	(+)	U/S1

**GETZ**

GETZ (TB)  9.02 → 6.09					ML5759		T1/T1
------------------------	--	--	--	--	--------	--	-------

**H-1**

H-1 Cargo  2.08 →					ML5989		U/K
H-1 Travel  2.08 →					ML5989		U/K

**i10**

i10  10.07 →					ML5867		U/U
--------------	--	--	--	--	--------	--	-----





INNOCENTI



STD		
SPECIAL		

STD		
SPECIAL		

**i20**

i20 (PB, PBT)	8.08 →				ML5868		U/P
---------------	--------	--	--	--	--------	--	-----

**i30**

i30 (FD)	10.07 → 11.11				ML5869		U/P
i30 CW (FD)	10.07 → 6.12				ML5990		U/U

**ix55**

ix55	1.07 →		ML5992		P/U	ML5991		U/U
------	--------	--	--------	--	-----	--------	--	-----

**LANTRA**

LANTRA II Wagon (J-2)	2.96 → 10.00				ML5296		U/U
-----------------------	--------------	--	--	--	--------	--	-----

**MATRIX**

MATRIX (FC)	6.01 → 8.10				ML5616		S1/U
-------------	-------------	--	--	--	--------	--	------

**SANTA FÉ**

SANTA FÉ I (SM)	11.00 → 3.06		ML5382		U/S1	ML5381		U/S1
SANTA FÉ II (CM)	8.04 →		ML5660		P/U	ML5297		U/U

**SONATA**

SONATA IV (EF)	3.98 → 5.05		ML5570		S1/S1	ML5154		U/U
SONATA V (NF)	1.05 →		ML5758		P/U	ML5761		U/U
SONATA VI (YF)	1.09 →		ML5758		P/U			

**TRAJET**

TRAJET (FO)	3.00 → 7.08					ML5816		T1/T1
-------------	-------------	--	--	--	--	--------	--	-------

**TUCSON**

TUCSON (JM)	8.04 → 3.10					ML5760		P/U
						ML5762		P/U

**XG**

XG (XG)	12.98 →					ML5994		U/C1
---------	---------	--	--	--	--	--------	--	------

**HYUNDAI (HUATAI)**

**SANTA FE**

SANTA FE Closed Off-Road Vehicle	10.06 →					ML5993		U/P
----------------------------------	---------	--	--	--	--	--------	--	-----

**INNOCENTI**

**ELBA**

ELBA (146)	8.91 → 12.96					ML5064		U/U
------------	--------------	--	--	--	--	--------	--	-----

**MINI**

MINI Special Design	5.74 → 2.82					ML5056		Y1/X1
---------------------	-------------	--	--	--	--	--------	--	-------

INNOCENTI

# JAGUAR



	STD				STD			
	SPECIAL							

## JAGUAR

### S-TYPE

S-TYPE (CCX)	1.99 → 10.07	<u>ML5995</u>			U/P		
--------------	--------------	---------------	--	--	-----	--	--

### X-TYPE

X-TYPE (CF1)	6.01 → 11.09					<u>ML5996</u>	U/C1
--------------	--------------	--	--	--	--	---------------	------

## JEEP

### CHEROKEE

CHEROKEE (XJ)	10.96 → 9.01					<u>ML5591</u>	U/Q
---------------	--------------	--	--	--	--	---------------	-----

### COMPASS

COMPASS (MK49)	8.06 →					<u>ML6117</u> (-)	U/C1
						<u>ML6116</u> (+)	U/C1

### GRAND CHEROKEE

GRAND CHEROKEE II (WJ, WG)	10.98 → 9.05	<u>ML6000</u>			U/U	<u>ML6001</u>	Q/Q
GRAND CHEROKEE III (WH)	6.05 → 12.10	<u>ML5999</u>			U/U	<u>ML5997</u>	P/S1
						<u>ML5998</u>	C/U

## KIA

### CARENS

CARENS II (FJ)	7.02 →					<u>ML5711</u>	U/U
CARENS III (UN)	9.06 →					<u>ML6002</u>	U/U

### CARNIVAL

CARNIVAL II (GQ)	10.01 →	<u>ML5706</u>			P/U	<u>ML5709</u>	U/U
CARNIVAL / GRAND CARNIVAL III (VQ)	9.05 →	<u>ML5706</u>			P/U	<u>ML6118</u>	U/C1

### CEE'D

CEE'D Hatchback (ED)	12.06 →					<u>ML5723</u>	S1/S1
CEE'D SW (ED)	9.07 →					<u>ML5839</u>	U/K

### CERATO

CERATO (LD)	4.04 →					<u>ML5713</u>	U/U
-------------	--------	--	--	--	--	---------------	-----

### MAGENTIS

MAGENTIS (GD)	5.01 →					<u>ML5710</u>	U/U
---------------	--------	--	--	--	--	---------------	-----

### PICANTO

PICANTO (BA)	4.04 →					<u>ML5708</u>	U/U
--------------	--------	--	--	--	--	---------------	-----

### RIO

RIO II (JB)	3.05 →					<u>ML5712</u>	P/U
-------------	--------	--	--	--	--	---------------	-----



LANCIA

**MONROE**STD  
SPECIALSTD  
SPECIAL**SORENTO**

SORENTO I (JC)	8.02 →	ML5705	S1/U	ML5707	U/U
SORENTO II (XM)	11.09 →			ML5823	S1/S1
				ML6119	U/C1

**SPORTAGE**

SPORTAGE (JE_)	9.04 →			ML5912	S1/U
----------------	--------	--	--	--------	------

**LADA****111**

111	1.95 →			ML5107	U/U
-----	--------	--	--	--------	-----

**112**

112	1.95 →			ML5108	U/U
-----	--------	--	--	--------	-----

**NADESCHDA**

NADESCHDA (2120)	12.97 →			ML5299	U/U
------------------	---------	--	--	--------	-----

**NIVA**

NIVA (2121)	12.76 →	ML5114	U/U	ML5025	U/U
-------------	---------	--------	-----	--------	-----

**NOVA**

NOVA Estate (2104)	9.85 →			ML5298	U/U
--------------------	--------	--	--	--------	-----

**SAMARA**

SAMARA (2108, 2109)	1.86 →			ML5024	U/C1
---------------------	--------	--	--	--------	------

**LANCIA****A 112**

A 112	3.78 → 12.86			ML5017	U/X2
-------	--------------	--	--	--------	------

**DEDRA**

DEDRA (835)	4.89 → 7.99			ML5617	N/N
DEDRA SW (835)	7.94 → 7.99			ML5300	U/U

**DELTA**

DELTA I (831AB0)	9.79 → 1.94			ML5618	N/N
DELTA II (836)	6.93 → 9.99			ML5303	S1/S1
				ML5540 (+)	S2/S2
DELTA III (844)	8.08 →			ML6003	U/P

**KAPPA**

KAPPA (838A)	8.94 → 10.01	ML5482	S1/S1	ML5483	S1/S1
KAPPA Coupe (838)	7.96 → 3.01	ML5482	S1/S1		
KAPPA SW (838B)	7.96 → 10.01	ML5482	S1/S1	ML5541	S1/S1

**LYBRA**

LYBRA (839AX)	7.99 → 10.05	ML5484	S1/S1	ML5301	U/U
LYBRA SW (839BX)	7.99 → 10.05	ML5484	S1/S1	ML5302	U/U

LANCIA





MERCEDES-BENZ

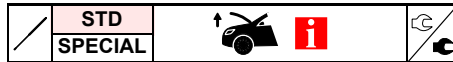

# MAZDA

## 2

2 (DY)	2.03 →					ML5765		T1/T1
2 (DE)	10.07 →					ML5873		U/P

## 3

3 (BK)	10.03 → 6.09					ML5763		T1/T1
3 Saloon (BK)	6.00 →					ML5764		U/U
3 (BL)	6.09 →					ML6120		U/U

## 6

6 Hatchback (GG)	8.02 → 8.07					ML5683		U/K	
6 (GG)	6.02 → 8.07					ML6014		P/U	
6 Station Wagon (GY)	8.02 → 12.07					ML5684		U/U	
6 (GH)	8.07 →				ML6011		U/U	ML6012	P/P
6 Estate (GH)	2.08 →				ML6011		U/U	ML6013	S1/S1

## 121

121 III (JASM, JBSM)	3.96 → 4.03					ML5147	4.93 →	U/U
----------------------	-------------	--	--	--	--	--------	--------	-----

## 323

323 III Hatchback (BF)	8.85 → 8.93					ML5542		U/U
						ML5403		U/U
323 F VI (BJ)	9.98 → 5.04					ML5843		S2/16
						ML5842		S2/15

## 626

626 V Hatchback (GF)	5.97 → 10.02					ML5847		B2/A2
						ML5848		B1/A1

## MX-5

MX-5 III (NC)	3.05 →					ML5810		U/U
---------------	--------	--	--	--	--	--------	--	-----

## RX-8

RX 8 (SE17)	10.03 → 6.12					ML6015		U/U
-------------	--------------	--	--	--	--	--------	--	-----

# MERCEDES-BENZ

## 190

190 (W201)	10.82 → 8.93				ML5102		Y1/V	
------------	--------------	--	--	--	--------	--	------	--

## A

A (W168)	7.97 → 8.04					ML5188		U/U
A (W169)	9.04 → 6.12					ML5717		P/U

## B

B (W245)	3.05 → 11.11					ML5718		U/U
----------	--------------	--	--	--	--	--------	--	-----

## C

C Estate (S202)	6.96 → 3.01					ML5307		U/U
-----------------	-------------	--	--	--	--	--------	--	-----

MERCEDES-BENZ

MERCEDES-BENZ



	STD				STD			
	SPECIAL				SPECIAL			
C (W203)  5.00 → 2.07	<b>ML5577</b>			U/13	<b>ML5468</b>			S1/S1
	<b>ML5560</b>			U/13				
C T-Model (S203)  3.01 → 8.07	<b>ML5577</b>			U/13				
	<b>ML5560</b>			U/13				
C Coupe (CL203)  3.01 → 5.08	<b>ML5577</b>			U/13	<b>ML5673</b>			U/U
	<b>ML5560</b>			U/13	<b>ML6017</b>			U/U
C CLASS (W204)  1.07 →	<b>ML5715</b>			U/C1				
C CLASS T-Model (S204)  8.07 →	<b>ML5715</b>			U/C1	<b>ML6016</b> (-)			U/S3
					<b>ML5719</b> (+)			U/P

**CLC**

CLC (CL203)  5.08 → 6.11					<b>ML6017</b>			U/U
--------------------------	--	--	--	--	---------------	--	--	-----

**CLK**

CLK (C208)  6.97 → 7.02	<b>ML5308</b>			U/U				
CLK Convertible (A208)  3.98 → 3.02	<b>ML5308</b>			U/U	<b>ML6019</b>			U/U
CLK (C209)  6.02 → 5.09	<b>ML5577</b>			U/13				
	<b>ML5560</b>			U/13				
CLK Convertible (A209)  2.03 → 3.10	<b>ML5577</b>			U/13	<b>ML5808</b>			S1/S1
	<b>ML5560</b>			U/13				

**CLS**

CLS (C219)  10.04 → 12.10	<b>ML5309</b>			U/U				
---------------------------	---------------	--	--	-----	--	--	--	--

**E**

E Convertible (A124)  6.93 → 3.98					<b>ML6020</b>			S1/10
E (W210)  6.95 → 3.02	<b>ML5438</b>			S1/S1				
E Estate (S210)  6.96 → 3.03	<b>ML5438</b>			S1/S1	<b>ML5674</b>			1/1
E (W211)  3.02 → 12.08	<b>ML5309</b>			U/U				
E T-Model (S211)  3.03 → 7.09	<b>ML5309</b>			U/U	<b>ML6021</b> (+)			1/1
E T-Model (S212)  8.09 →					<b>ML6016</b>			U/S3

**GLK**

GLK (X204)  6.08 →					<b>ML6023</b> (-)			U/C1
					<b>ML6022</b> (+)			U/C1

**M**

M (W163)  2.98 → 6.05	<b>ML5559</b>			U/S2	<b>ML5530</b>			U/P
M (W164)  7.05 →	<b>ML6024</b>			P/13	<b>ML5806</b>	(-)		U/P
	<b>ML6025</b>			P/13				

**R**

R (W251, V251)  1.06 →	<b>ML6027</b>			U/13	<b>ML6030</b>			M/M
	<b>ML6026</b>			U/13				

**S**

S (W220)  10.98 → 8.05	<b>ML5620</b>			U/U	<b>ML6028</b>			S1/12
S Coupe (C215)  3.99 → 3.06	<b>ML5561</b>			U/U				
S (W221)  10.05 →	<b>ML6029</b>			U/13	<b>ML5813</b>			S1/S1

**SL**

SL (R129)  3.89 → 12.01	<b>ML6031</b>			S1/10				
-------------------------	---------------	--	--	-------	--	--	--	--



MG

	STD			/	STD			/
	SPECIAL							
SL (R230)	10.01 → 1.12	ML5811		U/U	ML5800	Ch. n° → F 122820	U/U	
					ML5802	Ch. n° F 109966 → (+)	U/U	
					ML5801	Ch. n° F 109966 → (-)	U/U	

**SLK**

SLK (R170)	9.96 → 4.04	ML6032		U/13	ML5680		U/U
SLK (R171)	3.04 → 2.11	ML5799		U/U	ML5818		U/U
		ML5798		U/U			
SLK (R172)	2.11 →	ML5799		U/U	ML5818		U/U
		ML5798		U/U			

**VANEO**

VANEO (414)	2.02 → 7.05				ML5543		U/U
-------------	-------------	--	--	--	--------	--	-----

**V**

V (638/2)	9.96 → 7.03				ML5621	(-)	U/U
					ML5329	(+)	U/U

**VIANO**

VIANO (W639)	9.03 →				ML5716		U/U
--------------	--------	--	--	--	--------	--	-----

**VITO**

VITO Bus (638)	2.96 → 7.03				ML5328	(-)	U/U
					ML5329	(+)	U/U
VITO Box (638)	3.97 → 7.03				ML5328	(-)	U/U
					ML5329	(+)	U/U
VITO Bus (W639)	9.03 →				ML5716		U/U
VITO / MIXTO Box (W639)	9.03 →				ML5716		U/U

**MERCEDES-BENZ (BBDC)**

**GLK**

GLK Closed Off-Road Vehicle (X204)	4.12 →				ML6023	(-)	U/C1
					ML6022	(+)	U/C1

**MG**

**METRO**

METRO	5.82 → 9.90				ML5041		U/U
-------	-------------	--	--	--	--------	--	-----

**MG Z**

MG ZR	6.01 → 4.05				ML5434		U/U
MG ZS Hatchback	7.01 → 10.05				ML5410		S1/S1
					ML5622	(+)	S1/S1
MG ZT	6.01 → 7.05	ML6033		U/U	ML5411		S1/U
MG ZT- T	10.01 → 7.05	ML6033		U/U	ML5412		S1/U
					ML5623		S1/S1

MINI

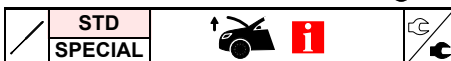

## MINI

### MINI

MINI (R50, R53)	6.01 → 9.06	<b>ML5564</b>		U/P	<b>ML5406</b>		U/U
MINI Convertible (R52)	7.04 → 11.07	<b>ML5564</b>		U/P			
MINI (R56)	10.06 →	<b>ML6037</b>		U/C1	<b>ML6036</b>		U/U
MINI Convertible (R57)	3.08 →	<b>ML6037</b>		U/C1			
MINI Roadster (R59)	2.12 →	<b>ML6037</b>		U/C1			
MINI CLUBMAN (R55)	10.07 →	<b>ML6037</b>		U/C1	<b>ML6035</b>		P/P
MINI CLUBVAN (R55)	12.12 →	<b>ML6037</b>		U/C1	<b>ML6035</b>		P/P
MINI Coupe (R58)	9.11 →	<b>ML6037</b>		U/C1			

## MITSUBISHI

### CARISMA

CARISMA (DA_)	7.95 → 6.06				<b>ML5278</b>		U/U
					<b>ML5354</b>	(+)	U/U

### COLT

COLT IV (CA_A)	4.92 → 4.96				<b>ML5587</b>		S1/S1
COLT VI (Z3_A, Z2_A)	6.04 →				<b>ML5661</b>	3	U/U
					<b>ML5662</b>	5	U/U

### GALANT

GALANT IV Saloon (E3_A)	11.87 → 3.93				<b>ML5578</b>		U/U
-------------------------	--------------	--	--	--	---------------	--	-----

### LANCER

LANCER CARGO I Estate (CS_W)	9.03 → 10.08				<b>ML5757</b>		U/U
------------------------------	--------------	--	--	--	---------------	--	-----

### OUTLANDER

OUTLANDER I (CU_W)	5.03 → 10.06				<b>ML5757</b>		U/U
OUTLANDER II (CW_W)	11.06 →				<b>ML5776</b>		U/P

### SPACE RUNNER

SPACE RUNNER (N6_W)	8.99 → 8.02				<b>ML6039</b>		T1/T1
---------------------	-------------	--	--	--	---------------	--	-------

### SPACE STAR

SPACE STAR (DG_A)	6.98 → 12.04				<b>ML5353</b>		U/U
-------------------	--------------	--	--	--	---------------	--	-----

### SPACE WAGON

SPACE WAGON (N9_W, N8_W)	10.98 → 12.04				<b>ML6038</b>		T1/T1
--------------------------	---------------	--	--	--	---------------	--	-------

## NISSAN

### ALMERA

ALMERA II Hatchback (N16)	1.00 →				<b>ML5672</b>		U/U
ALMERA II (N16)	7.00 →				<b>ML5672</b>		U/U
ALMERA TINO (V10)	8.00 →				<b>ML5579</b>		S1/S1





NISSAN



## KUBISTAR

KUBISTAR (X76)	8.03 →					<b>ML5837</b>			T1/T1
----------------	--------	--	--	--	--	---------------	--	--	-------

## MAXIMA

MAXIMA QX III (A32)	3.94 → 8.00					<b>ML5624</b>			P/T1
MAXIMA QX II (A33)	4.99 → 11.03					<b>ML5624</b>			P/T1

## MICRA

MICRA II (K11)	1.92 → 2.03					<b>ML6040</b>			U/U
MICRA III (K12)	1.03 → 6.10					<b>ML5360</b>			U/U

## NOTE

NOTE (E11)	3.06 →					<b>ML5701</b>			S1/U
------------	--------	--	--	--	--	---------------	--	--	------

## PATHFINDER

PATHFINDER (R50)	9.97 → 12.04					<b>ML5781</b>			U/S1
						<b>ML5700</b>			U/U

## PRIMASTAR

PRIMASTAR Bus (X83)	3.01 →					<b>ML5516</b>			T1/T1
PRIMASTAR Box (X83)	9.02 →					<b>ML5516</b>			T1/T1

## PRIMERA

PRIMERA Hatchback (P10)	6.90 → 6.96					<b>ML5317</b>			U/U
						<b>ML5318</b> (+)			U/U
						<b>ML5324</b> (+)			U/U
PRIMERA (P10)	6.90 → 6.96					<b>ML5524</b>			T1/T1
PRIMERA Traveller (W10)	7.90 → 3.98					<b>ML5525</b> (+)			T1/T1
PRIMERA Hatchback (P11)	9.96 → 7.02					<b>ML5588</b>			S1/S1
PRIMERA (P11)	6.96 → 12.01					<b>ML5433</b>			U/U
PRIMERA Traveller (WP11)	6.96 → 12.01					<b>ML5580</b> (+)			U/U
PRIMERA Hatchback (P12)	1.02 →					<b>ML5321</b>			U/U
PRIMERA (P12)	1.02 →					<b>ML5322</b> (+)			U/U
PRIMERA Estate (WP12)	1.02 →					<b>ML5581</b>			U/U
						<b>ML5086</b>			S1/S1
						<b>ML5352</b>			U/U
						<b>ML5413</b>			S1/U

## QASHQAI

QASHQAI / QASHQAI +2 (J10, JJ10)	2.07 →					<b>ML5890</b>			S1/S1
----------------------------------	--------	--	--	--	--	---------------	--	--	-------

## SERENA

SERENA (C23M)	11.92 → 9.01					<b>ML5582</b>			U/U
---------------	--------------	--	--	--	--	---------------	--	--	-----

## SUNNY

SUNNY II Traveller (B12)	1.86 → 6.91					<b>ML5409</b>			U/U
SUNNY III Traveller (Y10)	11.90 → 3.00					<b>ML6041</b>			T1/T1

## TERRANO

TERRANO II (R20)	10.92 →					<b>ML6121</b>			U/C1
------------------	---------	--	--	--	--	---------------	--	--	------

NISSAN



**X-TRAIL**

X-TRAIL (T30)	6.01 →					<b>ML5809</b>		S1/S1
X-TRAIL (T31)	3.07 →					<b>ML6042</b>		S1/S1

**OPEL**

**AGILA**

AGILA (A) (H00)	9.00 → 12.07					<b>ML5088</b>	→ 12.01	E2/E3
						<b>ML5089</b>	→ 12.01	E2/E3
						<b>ML6044</b>	1.02 →	S1/S1
AGILA (B) (H08)	4.08 →					<b>ML5078</b>		U/U

**ANTARA**

ANTARA	5.06 →		<b>ML6046</b>		U/U	<b>ML5888</b>		T1/T1
--------	--------	--	---------------	--	-----	---------------	--	-------

**ASCONA**

ASCONA C Hatchback (84_, 89_)	9.81 → 8.88					<b>ML5390</b>	(+)	U/U
						<b>ML5395</b>	(+)	U/U
						<b>ML5391</b>	(+)	U/U

**ASTRA**

ASTRA F Hatchback (53_, 54_, 58_, 59_)	9.91 → 1.98					<b>ML5077</b>		U/C1
ASTRA F Estate (51_, 52_)	9.91 → 1.98					<b>ML5077</b>		U/C1
						<b>ML5125</b>	(+)	U/U
						<b>ML5156</b>	(+)	P/P
ASTRA F Convertible (53_B)	3.93 → 3.01					<b>ML6047</b>		S1/S1
ASTRA F CLASSIC Hatchback	1.98 → 8.02					<b>ML5077</b>		U/C1
ASTRA F CLASSIC Estate	1.98 → 1.05					<b>ML5125</b>	(+)	U/U
						<b>ML5156</b>	(+)	P/P
ASTRA G Hatchback (F48_, F08_)	2.98 → 12.09					<b>ML5166</b>		U/C1
ASTRA G Estate (F35_)	2.98 → 12.09					<b>ML5167</b>	3 , (+)	U/U
ASTRA G Convertible	3.01 → 10.05					<b>ML5138</b>		U/U
ASTRA H	3.04 →		<b>ML5720</b>		U/U	<b>ML6146</b>		S1/S1
ASTRA H Saloon	2.07 →		<b>ML5720</b>		U/U	<b>ML5669</b>		U/U
ASTRA H GTC	3.05 →		<b>ML5720</b>		U/U	<b>ML5805</b>	3	P/U
ASTRA H Estate	8.04 →		<b>ML5720</b>		U/U	<b>ML5721</b>		U/U
ASTRA H TwinTop	9.05 →		<b>ML5720</b>		U/U	<b>ML5723</b>		S1/S1
ASTRA J	12.09 →					<b>ML6122</b>		P/P

**CALIBRA**

CALIBRA A (85_)	6.90 → 7.97					<b>ML5367</b>		U/U
-----------------	-------------	--	--	--	--	---------------	--	-----

**COMBO**

COMBO Tour	4.05 →					<b>ML6057</b>		U/C1
COMBO Box Body / Estate	4.05 →					<b>ML6057</b>		U/C1



OPEL



## CORSA

CORSA A Hatchback (93_, 94_, 98_, 99_)	9.82 → 3.93				ML5585 (-)	O/O
					ML5527 (+)	O/O
					ML5586 (+)	O/O
					ML5054 3 , (+) , (+)	U/U
CORSA B (73_, 78_, 79_)	3.93 → 9.00				ML5242 3 , (-)	U/U
					ML5054 3 , (+)	U/U
					ML5144 5	U/U
CORSA C (F08, F68)	9.00 →				ML5120	U/C1
CORSA D	7.06 →				ML5827 3	U/U
					ML5807 5	U/U
CORSA D Van	7.06 →				ML5827 3	U/U
					ML5807 5	U/U

## FRONTERA

FRONTERA B (6B_)	10.98 →				ML5825	S1/S1
					ML6043	U/U

## INSIGNIA

INSIGNIA	7.08 →	ML6049		U/U	ML6051	U/U
INSIGNIA Saloon	7.08 →	ML6049		U/U		
INSIGNIA Sports Tourer	7.08 →	ML6049		U/U	ML6053 (-)	U/C1
					ML6055 (+)	U/U

## KADETT

KADETT E Hatchback (33_, 34_, 43_, 44_)	9.84 → 8.91				ML5031 (+)	U/U
					ML5244 (+) , (+)	U/U
					ML5243 3 , (-)	U/U
KADETT E Estate (35_, 36_, 45_, 46_)	9.84 → 8.91				ML5528 Ch. n° → J2502492 (+)	M/O
					ML5835 Ch. n° → J2502492, JE100000 (-)	M/O
					ML5834 Ch. n° → J2502492, JE100000 (+)	M/O
					ML5407 Ch. n° J2502493, JE100001 →	U/U

## MERIVA

MERIVA	5.03 → 5.10				ML5119	U/U
--------	-------------	--	--	--	--------	-----

## OMEGA

OMEGA A (16_, 17_, 19_)	9.86 → 4.94				ML5366 Ch. n° → N1145948	U/U
OMEGA A Estate (66_, 67_)	9.86 → 4.94				ML5365 Ch. n° N1145949 →	U/U
OMEGA B (25_, 26_, 27_)	3.94 → 7.03				ML5408 Ch. n° → N1145948	U/U
OMEGA B Estate (21_, 22_, 23_)	3.94 → 7.03				ML5365 Ch. n° N1145949 →	U/U
					ML5210	U/U
					ML5103	U/U

## REKORD

REKORD E Estate (61_, 66_, 67_)	8.77 → 8.86				ML5398	U/U
---------------------------------	-------------	--	--	--	--------	-----

## SENATOR

SENATOR B (29_)	9.87 → 9.93				ML5366 Ch. n° → N1145948	U/U
					ML5365 Ch. n° N1145949 →	U/U

## SIGNUM

SIGNUM	5.03 →	ML5345		U/U	ML5817	P/U
--------	--------	--------	--	-----	--------	-----

OPEL

OPEL



	STD			STD		
	SPECIAL					

**SINTRA**

SINTRA	11.96 → 4.99				ML5515		U/U
--------	--------------	--	--	--	--------	--	-----

**TIGRA**

TIGRA (95_)	7.94 → 12.00				ML5369		U/U
-------------	--------------	--	--	--	--------	--	-----

**VECTRA**

VECTRA A Hatchback (88_ 89_)	4.88 → 11.95				ML5032		U/U
					ML5258	(+)	U/U
VECTRA B Hatchback (38_)	10.95 → 7.03	ML5085		U/U	ML5082	Ch. n° → -W5999999, -W7999999 5	U/U
VECTRA B (36_)	9.95 → 4.02	ML5085		U/U	ML5257	Ch. n° X1000001- →	U/U
VECTRA B Estate (31_)	11.96 → 7.03	ML5085		U/U	ML5179	Ch. n° X1000001 →	S1/S1
VECTRA C GTS	8.02 →	ML5345		U/U	ML5424		U/S1
VECTRA C	4.02 →	ML5345		U/U	ML5773		U/U
VECTRA C Estate	10.03 →	ML5345		U/U	ML5341		U/U
					ML5346		U/U

**VIVARO**

VIVARO Box (F7)	8.01 →				ML5516		T1/T1
-----------------	--------	--	--	--	--------	--	-------

**ZAFIRA**

ZAFIRA A (F75_)	4.99 → 6.05				ML5137		U/U
ZAFIRA B (A05)	7.05 →				ML5722		U/U

**PEUGEOT**

**106**

106 I (1A, 1C)	8.91 → 4.96				ML5133		U/U
106 II (1)	4.96 →	ML5268		U/U	ML5134		U/U

**107**

107	6.05 →				ML5687		U/U
-----	--------	--	--	--	--------	--	-----

**205**

205 I (741A/C)	2.83 → 10.87				ML5020		U/U
205 II (20A/C)	1.87 → 9.98				ML5020		U/U
205 Box	2.83 → 7.90				ML5020		U/U

**206**

206 Hatchback (2A/C)	8.98 →				ML5146		S1/S1
206 Saloon	3.07 →				ML6061		U/U
206 SW (2E/K)	7.02 →				ML5469		S1/S1
206 CC (2D)	9.00 →				ML5340		U/U
					ML5343		U/U

**206+**

206+ (T3E)	1.09 →				ML5146		S1/S1
------------	--------	--	--	--	--------	--	-------

**207**

207 (WA_, WC_)	2.06 →				ML5731		S1/P
207 CC (WD_)	2.07 →				ML5851		S1/S1
207 SW (WK_)	2.07 →				ML5732		S1/S1
					ML5733		S1/S1



PEUGEOT



### 305

305 I (581A)	11.77 → 9.82					<b>ML5628</b>		U/U
305 I Break (581D)	8.80 → 9.82					<b>ML5364</b>		U/U
305 II (581M)	10.82 → 7.90					<b>ML5628</b>		U/U
305 II Break (581E)	10.82 → 12.88					<b>ML5364</b>		U/U

### 306

306 Hatchback (7A, 7C, N3, N5)	4.93 → 5.01	<b>ML5267</b>		S1/S1	<b>ML5148</b>		U/U
306 (7B, N3, N5)	4.93 → 5.01	<b>ML5267</b>		S1/S1	<b>ML5323</b>		U/U
306 Break (7E, N3, N5)	2.97 → 4.02	<b>ML5267</b>		S1/S1	<b>ML5432</b>		S1/S1
306 Convertible (7D, N3, N5)	3.94 → 4.02	<b>ML5267</b>		S1/S1			

### 307

307 (3A/C)	8.00 →					<b>ML5160</b>		S1/S1
307 Break (3E)	3.02 →					<b>ML5425</b>		U/C1
307 SW (3H)	3.02 →					<b>ML5425</b>		U/C1

### 308

308 (4A_, 4C_)	9.07 →					<b>ML5734</b>		S1/S1
308 SW	9.07 →					<b>ML5889</b> (+)		S1/S1
						<b>ML6058</b> (+)		S1/S1
						<b>ML6060</b>		S1/S1

### 309

309 II (3C, 3A)	7.89 → 12.93					<b>ML5202</b>		U/U
-----------------	--------------	--	--	--	--	---------------	--	-----

### 405

405 I Break (15E)	6.87 → 8.92					<b>ML5426</b>		U/U
405 II Break (4E)	8.92 → 10.96					<b>ML5426</b>		U/U

### 406

406 (8B)	11.95 → 5.04	<b>ML5470</b>	F1 (N) : 200	S1/S1	<b>ML5180</b> → 3.99		U/U
					<b>ML5183</b> 4.99 →		U/U
406 Break (8E/F)	10.96 → 10.04	<b>ML5470</b>	F1 (N) : 200	S1/S1	<b>ML5319</b>		U/U
406 Coupe (8C)	3.97 → 12.04	<b>ML5517</b>	F1 (N) : 1100	U/U	<b>ML5471</b>		S1/S1

### 407

407 (6D_)	5.04 →					<b>ML5727</b>		U/U
407 SW (6E_)	5.04 →					<b>ML5728</b>		U/U
						<b>ML5729</b>		U/U

### 504

504 Break (D_, F_)	4.71 → 7.86					<b>ML5067</b>		Y1/X1
--------------------	-------------	--	--	--	--	---------------	--	-------

### 505

505 (551A)	5.79 → 12.93					<b>ML5625</b>		Y1/U
505 Break (551D)	4.82 → 12.93					<b>ML5311</b>		U/U

### 605

605 (6B)	6.89 → 9.99	<b>ML5583</b>		U/U	<b>ML5316</b>		U/U
----------	-------------	---------------	--	-----	---------------	--	-----

### 607

607 (9D, 9U)	2.00 →	<b>ML5788</b>		T1/T1	<b>ML5358</b>		U/U
--------------	--------	---------------	--	-------	---------------	--	-----

PEUGEOT

PEUGEOT



	STD				STD			
	SPECIAL							

806

806 (221)	6.94 → 8.02					<b>ML5626</b>	→ 11.95	U/U
						<b>ML5627</b>	11.95 → 10.97	U/U
						<b>ML5363</b>	10.97 →	U/U

807

807 (E)	6.02 →					<b>ML5344</b>		U/U
---------	--------	--	--	--	--	---------------	--	-----

1007

1007 (KM_)	4.05 →					<b>ML5730</b>		U/U
------------	--------	--	--	--	--	---------------	--	-----

3008

3008	6.09 →					<b>ML6123</b>		U/U
------	--------	--	--	--	--	---------------	--	-----

4007

4007 (GP_)	2.07 →					<b>ML5776</b>		U/P
------------	--------	--	--	--	--	---------------	--	-----

5008

5008	6.09 →					<b>ML6124</b>		U/P
------	--------	--	--	--	--	---------------	--	-----

BIPPER

BIPPER (AA_)	2.08 →					<b>ML5968</b>		U/U
BIPPER Tepee	4.08 →					<b>ML5968</b>		U/U

EXPERT

EXPERT Tepee (VF3V_)	1.07 →					<b>ML5950</b>	(+) Tailgate	U/U
EXPERT Box (VF3A_ VF3U_ VF3X_)	1.07 →					<b>ML5950</b>	(+) Tailgate	U/U

PARTNER

PARTNER Combispace (5F)	5.96 →					<b>ML5113</b>		T1/T1
PARTNER Box (5)	4.96 →					<b>ML5113</b>		T1/T1
PARTNER Tepee	4.08 →					<b>ML5948</b>		U/S1
						<b>ML5954</b>	→ OrgN. 118229	U/U
						<b>ML5956</b>	OrgN. 118230→	S1/S3
						<b>ML5948</b>		U/S1
						<b>ML5954</b>	→ OrgN. 118229	U/U
						<b>ML5956</b>	OrgN. 118230→	S1/S3

PEUGEOT (DF-PSA)

206

206	1.06 → 2.09					<b>ML5146</b>		S1/S1
-----	-------------	--	--	--	--	---------------	--	-------

207

207	3.09 →					<b>ML5731</b>		S1/P
-----	--------	--	--	--	--	---------------	--	------

3008

3008	1.13 →					<b>ML6123</b>		U/U
------	--------	--	--	--	--	---------------	--	-----

PONTIAC

MATIZ

MATIZ G2	2.06 →					<b>ML5943</b>		S1/S3
----------	--------	--	--	--	--	---------------	--	-------



RENAULT

**MONROE**STD  
SPECIALSTD  
SPECIAL**PORSCHE****911**

911	1.63 → 11.90	<b>ML5646</b>		Y5/X3	<b>ML5595</b>		Y5/X3
911 Targa	11.64 → 11.90	<b>ML5646</b>		Y5/X3	<b>ML5594</b> (+)		Y5/X3
911 (964)	12.88 → 9.93				<b>ML5595</b>		Y5/X3
911 (993)	10.93 → 9.97				<b>ML6062</b>		S1/D
911 Targa (993)	8.95 → 9.97				<b>ML6062</b>		S1/D
911 (996)	9.97 → 8.05	<b>ML6147</b>		S1/S1	<b>ML5594</b>		Y5/X3
911 Convertible (996)	2.98 → 8.05	<b>ML6147</b>		S1/S1	<b>ML6065</b>		U/C1
911 (997)	7.04 →				<b>ML5804</b>		U/U

**924**

924	11.75 → 8.89	<b>ML5846</b>		U/D			
-----	--------------	---------------	--	-----	--	--	--

**928**

928	9.77 → 11.95	<b>ML5676</b>		U/U			
-----	--------------	---------------	--	-----	--	--	--

**944**

944	6.81 → 7.91	<b>ML5846</b>		U/D			
944 Convertible	12.88 → 7.91	<b>ML5846</b>		U/D			

**BOXSTER**

BOXSTER (986)	9.96 → 12.04	<b>ML6147</b>		S1/S1	<b>ML6066</b>		S1/S1
BOXSTER (987)	11.04 →	<b>ML5803</b>		S1/S1	<b>ML6067</b>		S1/S1

**CAYENNE**

CAYENNE (955)	9.02 →	<b>ML6069</b>		U/P	<b>ML6068</b>		U/C1
---------------	--------	---------------	--	-----	---------------	--	------

**RENAULT****5**

SUPER 5 (B/C40_)	10.84 → 12.96				<b>ML5021</b>		U/U
					<b>ML5337</b> Baccara		U/U

**11**

11 (B/C37_)	3.83 → 12.88				<b>ML5630</b>		S1/S1
11 Box (S37_)	3.83 → 12.88				<b>ML5630</b>		S1/S1

**19**

19 I (B/C53_)	1.88 → 12.92				<b>ML5004</b>		U/U
19 I Chamade (L53_)	1.88 → 12.92				<b>ML5256</b> (+)		U/U
19 II (B/C53_)	1.92 → 12.95				<b>ML5310</b>		U/U
19 II Chamade (L53_)	4.92 → 12.95				<b>ML5094</b>		U/U
					<b>ML5256</b> (+)		U/U
					<b>ML5553</b>		U/U

**21**

21 (B48_)	7.89 → 6.94				<b>ML5631</b>		T1/T1
21 Estate (K48_)	3.86 → 9.95				<b>ML5632</b>		Y1/D

# RENAULT



## 25

25 (B29_)	4.84 → 12.93	<b>ML5633</b> → 8.86	Y1/D		
		<b>ML5549</b> 9.86 →	T1/D		

## AVANTIME

AVANTIME (DE0_)	9.01 → 5.03			<b>ML5351</b>	U/U
-----------------	-------------	--	--	---------------	-----

## CLIO

CLIO I (B/C57_, 5/357_)	5.90 → 9.98			<b>ML5093</b>	S1/S1
CLIO II (BB0/1/2_, CB0/1/2_)	9.98 →			<b>ML5254</b> Baccara-Williams	U/U
CLIO II Box (SB0/1/2_)	9.98 →			<b>ML5241</b>	U/U
CLIO III (BR0/1, CR0/1)	1.05 →			<b>ML5241</b>	U/U
CLIO III (BR0/1, CR0/1)	1.05 →			<b>ML5725</b>	S1/S1
CLIO Grandtour (KR0/1_)	2.08 →			<b>ML5656</b>	P/P

## ESPACE

ESPACE I (J11_)	7.84 → 12.92			<b>ML5320</b> 1.88 → 3.91	U/U
ESPACE II (J/S63_)	1.91 → 12.96			<b>ML5629</b>	R/R
ESPACE II (J/S63_)	1.91 → 12.96			<b>ML5313</b> → 11.93	U/U
ESPACE II (J/S63_)	1.91 → 12.96			<b>ML5314</b> 11.93 →	U/U
ESPACE II (J/S63_)	1.91 → 12.96			<b>ML5546</b>	R/R
ESPACE III (JE0_)	11.96 → 10.02			<b>ML5228</b> (+)	U/K
ESPACE III (JE0_)	11.96 → 10.02			<b>ML5229</b> (+)	U/U
ESPACE III (JE0_)	11.96 → 10.02			<b>ML5230</b>	S1/S1
ESPACE IV (JK0/1_)	11.02 →	<b>ML5472</b> → 7.04	S1/S1	<b>ML5518</b> (+)	U/U
ESPACE IV (JK0/1_)	11.02 →	<b>ML5473</b> 7.04 →	S1/S1	<b>ML5519</b> (+)	U/U
ESPACE IV (JK0/1_)	11.02 →			<b>ML5551</b>	S1/S1

## GRAND SCÉNIC

GRAND SCÉNIC II (JM0/1_)	4.04 →			<b>ML5826</b> (+)	U/C1
GRAND SCÉNIC II (JM0/1_)	4.04 →			<b>ML5475</b> (+)	U/U
GRAND SCÉNIC III (JZ0/1_)	2.09 →	<b>ML6127</b>	U/S1	<b>ML5552</b>	S1/S1
GRAND SCÉNIC III (JZ0/1_)	2.09 →			<b>ML6125</b>	S1/S1

## KANGOO

KANGOO (KC0/1_)	8.97 →			<b>ML5128</b>	S1/S1
KANGOO Express (FC0/1_)	8.97 →			<b>ML5128</b>	S1/S1
KANGOO / GRAND KANGOO (KW0/1_)	2.08 →			<b>ML5892</b>	S1/S1
KANGOO Express (FW0/1_)	2.08 →			<b>ML5892</b>	S1/S1
KANGOO BE BOP (KW0/1_)	2.09 →			<b>ML5892</b>	S1/S1

## KOLEOS

KOLEOS (HY_)	9.08 →			<b>ML6070</b>	U/C1
--------------	--------	--	--	---------------	------

## LAGUNA

LAGUNA I (B56_, 556_)	11.93 → 3.01			<b>ML5279</b> 5  (+/-) Side shield	S1/U
LAGUNA I (B56_, 556_)	11.93 → 3.01			<b>ML5544</b> 5  (-) Side shield	U/S1
LAGUNA I (B56_, 556_)	11.93 → 3.01			<b>ML5545</b> 5  (+) Side shield	U/S1
LAGUNA Grandtour (K56_)	9.95 → 3.01			<b>ML5383</b>	U/S1
LAGUNA Grandtour (K56_)	9.95 → 3.01			<b>ML5547</b>	S1/S1
LAGUNA II (BG0/1_)	3.01 →			<b>ML5189</b>	S1/S1
LAGUNA II (BG0/1_)	3.01 →			<b>ML5190</b> (+)	S1/S1





RENAULT

	STD				STD			
	SPECIAL				SPECIAL			
LAGUNA II Grandtour (KG0/1_)  3.01 →					ML5474 (+)			S1/S1
					ML5440 (+)			S1/S1
					ML5548			S1/S1
LAGUNA III (BT0/1)  10.07 →					ML5657			S1/S1
LAGUNA III Grandtour (KT0/1)  10.07 →					ML5893			S1/S1
					ML6063			S1/P
LAGUNA Coupe (DT0/1)  3.08 →					ML6126			S1/S1

## LOGAN

LOGAN MCV (KS_)  2.07 →					ML5864			U/U
-------------------------	--	--	--	--	--------	--	--	-----

## MEGANE

MEGANE I (BA0/1_)  1.96 → 8.03					ML5155 4			U/U
					ML5131 5			U/C1
MEGANE I Classic (LA0/1_)  9.96 → 8.03					ML5182			S1/S1
MEGANE I Grandtour (KA0/1_)  3.99 → 8.03					ML5158			U/U
MEGANE I Coach (DA0/1_)  3.96 → 8.03					ML5526			S1/14
MEGANE I Cabriolet (EA0/1_)  10.96 → 8.03					ML5686			U/U
MEGANE Scenic (JA0/1_)  1.97 → 10.99					ML5152 (+)			U/C1
					ML5130 (+)			U/C1
					ML5153			S1/S1
MEGANE II (BM0/1_, CM0/1_)  11.02 →					ML5212			U/U
MEGANE II Saloon (LM0/1_)  9.03 →					ML5789			U/U
MEGANE II Estate (KM0/1_)  8.03 →					ML5372 (+)			U/U
					ML5828 (+)			U/P
					ML5812			U/U
MEGANE II CoupJ-Cabriolet (EM0/1_)  9.03 →					ML5894			U/U
MEGANE III Hatchback (BZ0_)  11.08 →					ML6074			U/Q
MEGANE III Saloon  6.09 →					ML6074			U/Q
MEGANE III Grandtour (KZ0/1)  11.08 →					ML6074			U/Q
MEGANE III Coupe (DZ0/1_)  11.08 →					ML6074			U/Q
MEGANE CC (EZ0/1_)  6.10 →					ML6074			U/Q

## MODUS

MODUS (F/JP0_)  9.04 →					ML5724			S1/S1
					ML6075			U/K

## RAPID

RAPID Box (F40_, G40_)  7.85 → 11.98					ML5315			U/U
--------------------------------------	--	--	--	--	--------	--	--	-----

## SAFRANE

SAFRANE I (B54_)  4.92 → 7.96					ML5554			U/T1
					ML5555 Baccara			U/T1
SAFRANE II (B54_)  7.96 → 12.00					ML5477 620N			S1/S1
					ML5476 530N			S1/S1

## SANDERO

SANDERO  6.08 →					ML5864			U/U
-----------------	--	--	--	--	--------	--	--	-----

RENAULT



/	STD		
	SPECIAL		

/	STD		
	SPECIAL		

SCÉNIC

SCÉNIC I (JA0/1_)	9.99 → 8.03					ML5152	(+)  (-) RX4	U/C1
						ML5130	(+)  (-) RX4	U/C1
						ML5153	(-) RX4	S1/S1
SCÉNIC II (JM0/1_)	6.03 →					ML5826	(+)  (-)	U/C1
						ML5475	(+)  (-)	U/U
SCÉNIC III (JZ0/1_)	2.09 →				ML6127			S1/S1
						ML6128		S1/S1

TRAFIC

TRAFIC II Bus (JL)	3.01 →					ML5550		T1/T1
TRAFIC II Box (FL)	3.01 →					ML5550		T1/T1

TWINGO

TWINGO (C06_)	3.93 → 07					ML5331		U/K
TWINGO (CN0_)	3.07 →					ML5891		S1/S1

ROVER

25

25 (RF)	9.99 → 5.05					ML5434		U/U
---------	-------------	--	--	--	--	--------	--	-----

45

45 (RT)	2.00 → 5.05					ML5410		S1/S1
						ML5478	(+)	S1/S1

75

75 (RJ)	2.99 → 5.05		ML6033		U/U	ML5411		S1/U
75 Tourer (RJ)	8.01 → 5.05		ML6033		U/U	ML5412		S1/U
						ML5623		S1/S1

100

100 (METRO) (XP)	3.90 → 12.98					ML5208	(+)	U/U
						ML5209	(+)	U/U

200

200 Hatchback (XW)	10.89 → 10.95					ML5192		U/U
200 Coupe (XW)	10.92 → 6.99					ML5634	GTI	T1/T1
200 (RF)	11.95 → 3.00					ML6148		S1/S1
						ML5434		U/U

400

400 Hatchback (RT)	5.95 → 3.00					ML5410		S1/S1
						ML5478	(+)	S1/S1

800

800 Hatchback (XS)	10.86 → 2.99		ML5359		U/U	ML5384	Ch. n° → 230966	U/S1
800 (XS)	10.86 → 2.99		ML5359		U/U	ML5338	Ch. n° 230967 →	U/U
800 Coupe	8.92 → 2.99		ML5359		U/U			

MAESTRO

MAESTRO	9.90 → 1.95					ML5362		U/U
---------	-------------	--	--	--	--	--------	--	-----

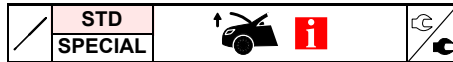

SEAT

**MINI**

MINI MK I	1.91 → 11.00				ML5041		U/U
-----------	--------------	--	--	--	--------	--	-----

**STREETWISE**

STREETWISE	8.03 → 5.05				ML5815 (+)		U/U
					ML5394 (+)		U/U

**SAAB****9-3**

9-3 (YS3D)	2.98 → 9.02	ML5349 (+) 1 /	U/U	ML5402 (+)	U/U
		ML5350 (+) 2 /	U/U	ML5375 (+) , (+)	U/U
9-3 Cabriolet (YS3D)	2.98 → 8.03	ML5349 (+) 1 /	U/U	ML5397 (+) , 4	U/U
9-3 (YS3F)	9.02 →	ML5350 (+) 2 /	U/U	ML6076	U/T1
9-3 Convertible (YS3F)	8.03 →	ML5790	P/S1	ML5766	S1/S1
9-3 Estate	3.05 →	ML5790	P/S1	ML5852	G/G

**9-3X**

9-3X	2.09 →	ML5790	P/S1	ML5852	G/G
------	--------	--------	------	--------	-----

**9-5**

9-5 (YS3E)	9.97 →	ML5638 → 12.05	U/U	ML5558	U/T1
9-5 Estate (YS3E)	10.98 →	ML5638 → 12.05	U/U	ML5637	O/O

**99**

99 Combi Coupe	8.68 → 1.84			ML5613	Y1/D
----------------	-------------	--	--	--------	------

**900**

900 I Combi Coupe	9.78 → 6.94			ML5613	Y1/D
900 II	7.93 → 2.98	ML5636	U/U	ML5635 (+)	Y1/D
900 II Coupe	12.93 → 2.98	ML5636	U/U	ML5400	U/U
900 II Convertible	12.93 → 2.98	ML5636	U/U	ML5401 (+)	U/U

**9000**

9000 Hatchback	9.84 → 12.98	ML5556	Y1/X1	ML5557 4006060, F1(N):710	U/U
9000	4.85 → 12.98	ML5556	Y1/X1	ML5495 4006078, F1(N):610	U/U
				ML5494 6956288, F1(N):400	Y1/D
				ML5499 9253964, 6956262/70, F1(N):345	Y1/D
				ML5496 6976369	Y1/D

**SEAT****ALHAMBRA**

ALHAMBRA (7V8, 7V9)	4.96 → 3.10	ML5480	S1/S1	ML5127	U/U
---------------------	-------------	--------	-------	--------	-----

**ALTEA**

ALTEA (5P1)	3.04 →			ML5100	S1/S1
ALTEA XL (5P5, 5P8)	10.06 →			ML5845	U/U

**AROSA**

AROSA (6H)	5.97 → 6.04	ML5195	S1/U	ML5284	S1/U
------------	-------------	--------	------	--------	------

SEAT

**CORDOBA**

CORDOBA (6K1, 6K2)	2.93 → 10.99					<b>ML5063</b>		U/U
CORDOBA Vario (6K5)	8.96 → 6.99					<b>ML5100</b>		S1/S1
CORDOBA (6K2)	6.99 → 10.02					<b>ML5259</b>		U/U
CORDOBA Vario (6K5)	6.99 → 12.02					<b>ML5100</b>		S1/S1
CORDOBA (6L2)	9.02 → 11.09					<b>ML5778</b>		S1/U

**EXEO**

EXEO (3R2)	12.08 →					<b>ML5386</b>		U/U
EXEO ST (3R5)	5.09 →					<b>ML5386</b>		U/U
						<b>ML5745</b>		U/U
						<b>ML6129</b>		U/U

**IBIZA**

IBIZA I (021A)	6.84 → 12.93					<b>ML5022</b>		Y6/X1
IBIZA II (6K1)	3.93 → 8.99					<b>ML5140</b>		U/U
IBIZA III (6K1)	8.99 → 2.02					<b>ML5211</b>		U/U
IBIZA IV (6L1)	2.02 → 11.09					<b>ML5225</b>		S1/U
IBIZA V (6J5)	3.08 →					<b>ML5850</b>		S1/P
IBIZA V SPORTCOUPE (6J1)	7.08 →					<b>ML6078</b>		S1/P

**LEON**

LEON (1M1)	11.99 → 6.06					<b>ML5342</b>		U/U
LEON (1P1)	5.05 →							
						<b>ML5181</b>		S1/U
						<b>ML5767</b>		S1/U

**MALAGA**

MALAGA (023A)	11.84 → 12.93					<b>ML5639</b>		Y1/D
---------------	---------------	--	--	--	--	---------------	--	------

**MARBELLA**

MARBELLA (28)	8.86 → 10.98					<b>ML5016</b>	→ Vet n° 6314421, 5370347	Y1/X2
---------------	--------------	--	--	--	--	---------------	---------------------------	-------

**PANDA**

PANDA (141A)	10.80 → 12.86					<b>ML5016</b>	→ Vet n° 6314421, 5370347	Y1/X2
--------------	---------------	--	--	--	--	---------------	---------------------------	-------

**RITMO**

RITMO (138)	7.78 → 9.83					<b>ML5010</b>		Y6/X1
-------------	-------------	--	--	--	--	---------------	--	-------

**RONDA**

RONDA (022A)	6.82 → 11.88					<b>ML5011</b>		Y6/X1
						<b>ML5501</b>	(+)	Y2/D

**TOLEDO**

TOLEDO I (1L)	5.91 → 3.99					<b>ML5124</b>		U/U
TOLEDO II (1M2)	4.99 → 5.06					<b>ML5342</b>		U/U
TOLEDO III (5P2)	4.04 → 5.09					<b>ML5584</b>		S1/U

**ŠKODA****FABIA**

FABIA (6Y2)	8.99 → 3.08					<b>ML5175</b>		U/C1
FABIA Saloon (6Y3)	10.99 → 12.07					<b>ML5135</b>		U/U
FABIA Combi (6Y5)	4.00 → 12.07					<b>ML5175</b>		U/C1
FABIA	12.06 →					<b>ML5681</b>		U/U
FABIA Combi	10.07 →					<b>ML5681</b>		U/U



SMART



STD				
SPECIAL				

STD				
SPECIAL				

### FAVORIT

FAVORIT (781)	5.89 → 9.94
FAVORIT Forman (785)	8.91 → 6.95
FAVORIT Pickup (787)	6.92 → 6.97

ML5048		U/U
ML5044	(+)	U/U
ML5005	Forman	U/U
ML5037	Forman Plus	U/P
ML5044	(+)	U/U
ML5036		Y6/X1
ML5026	(+) Panoramic	U/U

### FELICIA

FELICIA I (6U1)	10.94 → 3.98
FELICIA I Estate (6U5)	8.95 → 3.98
FELICIA I Fun (797)	10.95 → 4.02
FELICIA II (6U1)	1.98 → 6.01
FELICIA II Estate (6U5)	1.98 → 6.01

ML5061		U/C1
ML5061		U/C1
ML5099	F1(N):220	U/U
ML5057	F1(N):325	P/S1
ML5061		U/C1
ML5061		U/C1

### OCTAVIA

OCTAVIA (1U2)	9.96 → 12.10
OCTAVIA Combi (1U5)	7.98 → 12.10
OCTAVIA (1Z3)	2.04 →
OCTAVIA Combi (1Z5)	2.04 →

ML5218	(+)	U/U
ML5219	(+)	U/U
ML5217	4	U/U
ML5221	Sport RS	U/U
ML5045		U/C1
ML5665		U/U
ML5667		U/U

### ROOMSTER

ROOMSTER (5J)	5.06 →
---------------	--------

--	--	--	--

ML5682		U/U
--------	--	-----

### SUPERB

SUPERB (3U4)	12.01 → 3.08
SUPERB (3T4)	3.08 →
SUPERB Estate (3T5)	10.09 →

ML5768		U/U
ML6079		P/U
ML6079		P/U

ML5439		U/U
ML6080		U/U
ML6081	Lower	S1/S1

### YETI

YETI (5L)	5.09 →
-----------	--------

--	--	--	--

ML6130		P/U
--------	--	-----

## SMART

### CITY-COUPE

CITY-COUPE (450)	7.98 → 1.04
------------------	-------------

--	--	--	--

ML5640		T1/T1
--------	--	-------

### FORFOUR

FORFOUR (454)	1.04 → 6.06
---------------	-------------

--	--	--	--

ML5895		U/U
--------	--	-----

### FORTWO

FORTWO Coupe (450)	1.04 → 1.07
FORTWO Coupe (451)	1.07 →

ML6083		S1/S3
ML6083		S1/S3

### ROADSTER

ROADSTER Coupe (452)	4.03 → 11.05
----------------------	--------------

--	--	--	--

ML6082		S1/S1
--------	--	-------

SMART

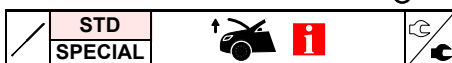

## SSANGYONG

### REXTON

REXTON (GAB_)  4.02 →	ML5355	U/U	ML5334	U/U
			ML5356	U/U

## SUBARU

### IMPREZA

IMPREZA Estate (GF)  8.92 → 12.00			ML5820	U/U
IMPREZA Estate (GD, GG)  12.00 →			ML5819	U/U

### JUSTY

JUSTY IV  1.07 →			ML6084	T1/T1
------------------	--	--	--------	-------

## SUZUKI

### ALTO

ALTO I (SS80)  6.82 → 12.85			ML5589	S1/S1
ALTO II (EC)  9.85 → 11.93			ML5589	S1/S1
ALTO III (EF)  9.94 → 6.02			ML5589	S1/S1
ALTO V (GF)  1.09 →			ML6131	U/U

### IGNIS

IGNIS II  9.03 →			ML5780	T1/T1
------------------	--	--	--------	-------

### JIMNY

JIMNY (FJ)  9.98 →		Y1/D	ML5386	Y1/D
--------------------	--	------	--------	------

### SAMURAI

SAMURAI (SJ)  11.88 → 12.04	ML5492	Y1/D		
-----------------------------	--------	------	--	--

### SJ

SJ 410  9.81 → 12.88	ML5492	Y1/D		
SJ 410 Cabrio  9.81 → 12.88	ML5492	Y1/D		
SJ 413  9.84 → 8.90	ML5492	Y1/D		

### SWIFT

SWIFT I (AA)  10.83 → 12.89	ML5492	Y1/D		
SWIFT II Hatchback (EA, MA)  3.89 → 12.03			ML5091	E4/T1
			ML5092	E4/T1
SWIFT III (MZ, EZ)  2.05 →			ML6086	U/U

### SX4

SX4 (GY)  6.06 →			ML5779	U/U
------------------	--	--	--------	-----

### VITARA

VITARA (ET, TA)  7.88 → 3.98			ML6085	11/11
			ML5493	(+) Panoramic  S1/S1
VITARA (ET)  12.03 → 12.05			ML6085	11/11
			ML5493	(+) Panoramic  S1/S1



TOYOTA

**WAGON R+**

WAGON R+ (MM)	5.00 →
---------------	--------

--	--	--	--

<b>ML5088</b>	→ 12.01	E2/E3
<b>ML5089</b>	→ 12.01	E2/E3
<b>ML6044</b>	1.02 →	S1/S1

**TOYOTA****AURIS**

AURIS (ZZE15_, ADE15_, ZRE15_, NDE15_)	10.06 →
--	---------

--	--	--	--

<b>ML5900</b>		S1/S1
---------------	--	-------

**AVENSIS**

AVENSIS (_T22_)	9.97 → 2.03
AVENSIS Liftback (_T22_)	9.97 → 2.03
AVENSIS Station Wagon (_T22_)	9.97 → 2.03
AVENSIS (T25_)	4.03 → 11.08
AVENSIS Estate (T25_)	4.03 → 11.08
AVENSIS Estate (ZRT27, ADT27)	2.09 →

<b>ML5592</b>		S1/S1
<b>ML5592</b>		S1/S1
<b>ML5121</b>		S1/S1
<b>ML5647</b>		P/S1
<b>ML5699</b>		P/S1
<b>ML6132</b>		S1/S1

**AYGO**

AYGO (WNB1_, KGB1_)	7.05 →
---------------------	--------

--	--	--	--

<b>ML6151<sup>0</sup></b>		S1/C1
---------------------------	--	-------

**CARINA E**

CARINA E (_T19_)	4.92 → 9.97
------------------	-------------

--	--	--	--

<b>ML6089</b>		T1/T1
---------------	--	-------

**COROLLA**

COROLLA Compact (_E11_)	4.97 → 1.02
COROLLA Liftback (_E11_)	4.97 → 1.02
COROLLA (ZZE12_, NDE12_, ZDE12_)	12.01 → 2.07
COROLLA Estate (_E12J_, E12T_)	1.02 → 2.07
COROLLA Verso (ZDE12_, CDE12_)	9.01 → 5.04
COROLLA Verso (ZER_, ZZE_, R1_)	3.04 → 3.09

<b>ML6087</b>	3  (-)	S1/S1
<b>ML5963</b>	3  (+)	S1/S1
<b>ML6087</b>	5  (-)	S1/S1
<b>ML5963</b>	5  (+)	S1/S1
<b>ML5485</b>		S1/U
<b>ML5486</b>		S1/S1
<b>ML5641</b>		S1/S1
<b>ML5666</b>		U/U

**IQ**

IQ (KGJ1_, NGJ1_)	1.09 →
-------------------	--------

--	--	--	--

<b>ML6133</b>		S1/S1
---------------	--	-------

**PRIUS**

PRIUS Hatchback (NHW20_)	8.03 → 3.09
PRIUS (ZVW3_)	4.09 →

<b>ML5917</b>		S1/S1
<b>ML6134</b>		S1/S3

**VERSO**

VERSO (_AUR2_, _ZGR2_)	4.09 →
VERSO S (NLP12_, NCP12_, NSP12_)	11.10 →

<b>ML6135</b>		S1/S3
<b>ML6135</b>		S1/S3

TOYOTA

TOYOTA

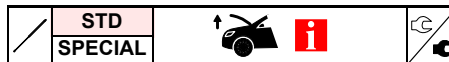

**YARIS**

YARIS (SCP1_, NLP1_, NCP1_)	4.99 → 9.05					ML5821		S1/U
YARIS (SCP9_, NSP9_, KSP9_, NCP9_, ZSP9_)	1.06 →					ML5777		U/U

**TOYOTA (GAC)**

**VERSO**

VERSO	6.11 →					ML6135		S1/S3
-------	--------	--	--	--	--	--------	--	-------

**VAUXHALL**

**AGILA**

AGILA Mk I (A)	2.00 → 3.08					ML5088	→ 12.01	E2/E3
						ML5089	→ 12.01	E2/E3
						ML6044	1.02 →	S1/S1

**ANTARA**

ANTARA (J26, H26)	8.06 →					ML6046		U/U
-------------------	--------	--	--	--	--	--------	--	-----

**ASTRA**

ASTRA Mk II Hatchback	9.84 → 8.91					ML5528	Ch. n° → -J2502492 (+)	M/O
						ML5835	Ch. n° → -J2502492, -JE100000 (-)	M/O
						ML5407	Ch. n° -JE100001, -J2502492 →	U/U
ASTRA Mk II Estate	9.84 → 8.91					ML5528	Ch. n° → -J2502492 (+)	M/O
						ML5835	Ch. n° → -J2502492, -JE100000 (-)	M/O
						ML5407	Ch. n° -JE100001, -J2502492 →	U/U
ASTRA Mk III (F) Hatchback	9.91 → 2.98					ML5077		U/C1
ASTRA Mk III (F) Estate	3.91 → 2.98					ML5156	(-)  (+)	P/P
						ML5125	(+)	U/U
ASTRA Mk III (F) Convertible	9.91 → 3.01					ML6047		S1/S1
ASTRA Mk IV (G) Hatchback	2.98 → 5.05					ML5166		U/C1
						ML5167	3 , (+)	U/U
ASTRA Mk IV (G) Estate	2.98 → 5.05					ML5138		U/U
ASTRA Mk IV (G) Convertible	3.01 → 7.06					ML6146		S1/S1
ASTRA Mk V (H) Sport Hatch	2.05 → 11.10					ML5720		U/U
ASTRA Mk V (H) Hatchback	1.04 → 9.09					ML5720		U/U
ASTRA Mk V (H) Estate	8.04 → 10.10					ML5720		U/U
ASTRA TwinTop Mk V (H)	9.05 → 11.10					ML5720		U/U

**ASTRAVAN**

ASTRAVAN Mk IV (G)	8.98 → 8.06					ML5138		U/U
ASTRAVAN Mk V (H)	3.05 →					ML5720		U/U

**CALIBRA**

CALIBRA	6.90 → 7.97					ML5367		U/U
---------	-------------	--	--	--	--	--------	--	-----





VAUXHALL

**MONROE**STD  
SPECIALSTD  
SPECIAL**CARLTON**

CARLTON Mk II Estate	9.77 → 8.86
CARLTON Mk III	9.86 → 3.94
CARLTON Mk III Estate	9.86 → 3.94

<b>ML5398</b>		U/U
<b>ML5366</b>	Ch. n° → N1145948	U/U
<b>ML5365</b>	Ch. n° N1145949 →	U/U
<b>ML5408</b>		U/U

**CAVALIER**

CAVALIER Mk II Hatchback	9.81 → 8.88
CAVALIER Mk III Hatchback	9.88 → 11.95

<b>ML5391</b>		U/U
<b>ML5390</b>	(-)	U/U
<b>ML5032</b>		U/U

**COMBO**

COMBO TOUR Mk II (C) (F25)	4.05 → 2.12
COMBO Mk II (C) Box Body / Estate (F25)	4.05 → 2.12

<b>ML6057</b>		U/C1
<b>ML6057</b>		U/C1

**CORSA**

CORSA Mk I (B)	3.93 → 9.00
CORSA Mk II (C) (W5L, F08)	8.00 → 10.06
CORSA Mk III (D) (L_8)	7.06 →

<b>ML5242</b>	3  (-)	U/U
<b>ML5054</b>	3  (+)	U/U
<b>ML5144</b>	5	U/U
<b>ML5827</b>	3	U/U
<b>ML5807</b>	5	U/U
<b>ML5827</b>	3	U/U
<b>ML5807</b>	5	U/U

**FRONTERA**

FRONTERA Mk II (B)	10.98 → 10.04
--------------------	---------------

<b>ML5825</b>		S1/S1
<b>ML6043</b>		U/U

**INSIGNIA**

INSIGNIA	7.08 →
INSIGNIA Saloon	7.08 →
INSIGNIA SPORTS TOURER	7.08 →

<b>ML6049</b>		U/U
<b>ML6049</b>		U/U
<b>ML6049</b>		U/U

<b>ML6051</b>		U/U
<b>ML6053</b>	(-)	U/C1
<b>ML6055</b>	(+)	U/U

**MERIVA**

MERIVA Mk I (A)	1.03 → 6.10
-----------------	-------------

<b>ML5119</b>		U/U
---------------	--	-----

**NOVA**

NOVA Hatchback	5.83 → 3.93
----------------	-------------

<b>ML5585</b>	(-)	O/O
---------------	-----	-----

**OMEGA**

OMEGA (B)	1.94 → 7.03
OMEGA (B) Estate	2.94 → 3.04

<b>ML5210</b>		U/U
<b>ML5103</b>		U/U

**SENATOR**

SENATOR Mk II (B)	9.87 → 9.93
-------------------	-------------

<b>ML5366</b>	Ch. n° → N1145948	U/U
<b>ML5365</b>	Ch. n° N1145949 →	U/U

**SIGNUM**

SIGNUM	1.02 → 10.08
--------	--------------

<b>ML5345</b>		U/U
---------------	--	-----

<b>ML5817</b>		P/U
---------------	--	-----

**SINTRA**

SINTRA	11.96 → 4.99
--------	--------------

<b>ML5515</b>		U/U
---------------	--	-----

VAUXHALL

VAUXHALL

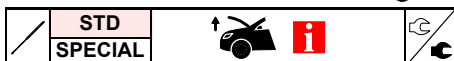

**SPEEDSTER**

SPEEDSTER (VX220)  10.03 → 9.06					ML5518	(+)	U/U
---------------------------------	--	--	--	--	--------	-----	-----

**TIGRA**

TIGRA Mk I (F07)  7.94 → 12.00					ML5369		U/U
--------------------------------	--	--	--	--	--------	--	-----

**VECTRA**

VECTRA (B)  8.95 → 3.02	ML5085				ML5179	Ch. n° X1000001 →	S1/S1
VECTRA (B) Hatchback  8.95 → 7.03	ML5085				ML5082	Ch. n° → -W5999999, -W7999999 5	U/U
VECTRA (B) Estate  8.95 → 3.02	ML5085				ML5257	Ch. n° X1000001- →	U/U
VECTRA Mk II (C) GTS  8.02 → 7.08	ML5345				ML5424		U/S1
VECTRA Mk II (C)  1.00 → 10.08	ML5345				ML5773		U/U
VECTRA Mk II (C) Estate  4.02 → 7.08	ML5345				ML5341		U/U
					ML5346		U/U

**VIVARO**

VIVARO Box (F7)  8.01 →					ML5516		T1/T1
-------------------------	--	--	--	--	--------	--	-------

**ZAFIRA**

ZAFIRA Mk I (A) (F75)  11.98 → 8.05					ML5137		U/U
ZAFIRA Mk II (B) (M75)  4.05 →					ML5722		U/U

**VOLVO**

**340-360**

340-360 (343, 345)  8.75 → 7.91					ML5642	(+)	T1/T1
340-360 Saloon (344)  8.82 → 7.91					ML5642	(+)	T1/T1

**440**

440 K (445)  8.88 → 12.96					ML5571		T1/T1
---------------------------	--	--	--	--	--------	--	-------

**460**

460 L (464)  9.88 → 7.96					ML5571		T1/T1
--------------------------	--	--	--	--	--------	--	-------

**480**

480 E  4.86 → 7.96					ML5509		T1/T1
--------------------	--	--	--	--	--------	--	-------

**740**

740 (744)  4.83 → 8.92					ML5906		I/H
740 Kombi (745)  5.85 → 8.92					ML5312		U/U

**760**

760 Kombi (704, 765)  1.82 → 7.92					ML5312		U/U
-----------------------------------	--	--	--	--	--------	--	-----

**780**

780  4.86 → 7.90					ML6090		I/H
------------------	--	--	--	--	--------	--	-----

**850**

850 (LS)  6.91 → 10.97					ML5840		I/H
850 Estate (LW)  8.92 → 10.97					ML5529	→ 8.00	O/M



VOLVO

**MONROE**STD  
SPECIALSTD  
SPECIAL**940**

940 (944)	8.90 → 12.94					<b>ML5347</b>		U/U
940 Kombi (945)	8.90 → 7.95					<b>ML5312</b>		U/U
940 II (944)	1.95 → 12.98					<b>ML5347</b>		U/U

**960**

960 (964)	8.90 → 7.94					<b>ML5347</b>		U/U
960 Kombi (965)	8.90 → 7.94					<b>ML5312</b>		U/U
960 II (964)	7.94 → 12.96					<b>ML5347</b>		U/U
960 II Estate (965)	8.94 → 12.96					<b>ML5312</b>		U/U

**C30**

C30	10.06 →	<b>ML5726</b>		U/U	<b>ML5907</b>		S1/S3
-----	---------	---------------	--	-----	---------------	--	-------

**C70**

C70 I Coupe	3.97 → 9.02				<b>ML5487</b>		S1/S1
C70 II Convertible	3.06 →	<b>ML5726</b>		U/U			

**S40**

S40 I (VS)	7.95 → 12.03	<b>ML5368</b>		S1/S1	<b>ML5154</b>		U/U
S40 II (MS)	1.04 →	<b>ML5726</b>		U/U	<b>ML5488</b>		S1/S1

**S60**

S60	7.00 → 4.10	<b>ML5643</b>		S1/S1	<b>ML5481</b>		S1/S1
-----	-------------	---------------	--	-------	---------------	--	-------

**S70**

S70 (P80_)	11.96 → 11.00				<b>ML5909</b>		I/U
------------	---------------	--	--	--	---------------	--	-----

**S80**

S80 I (TS, XY)	5.98 → 7.06	<b>ML5643</b>		S1/S1	<b>ML5489</b>		S1/S1
S80 II (AS)	3.06 →	<b>ML5663</b>		U/U	<b>ML5490</b> (+)		S1/S1
					<b>ML6091</b>		U/U

**S90**

S90	11.96 → 10.98				<b>ML5348</b>		U/U
-----	---------------	--	--	--	---------------	--	-----

**V40**

V40 Estate (VW)	7.95 → 6.04	<b>ML5368</b>		S1/S1	<b>ML5184</b>		S1/P
-----------------	-------------	---------------	--	-------	---------------	--	------

**V50**

V50 (MW)	4.04 →	<b>ML5726</b>		U/U	<b>ML5500</b>		S1/S1
----------	--------	---------------	--	-----	---------------	--	-------

**V70**

V70 I (P80_)	11.96 → 5.00				<b>ML5529</b>	→ 8.00	O/M
V70 II (P80_)	3.00 → 8.07	<b>ML5643</b>		S1/S1	<b>ML5685</b>	9.00 →	M/O
V70 III	8.07 →	<b>ML5663</b>		U/U	<b>ML6092</b> (+)		O/M
					<b>ML6094</b> (+)		S2/S2

**V90**

V90 Estate	11.96 → 12.98				<b>ML5312</b>		U/U
------------	---------------	--	--	--	---------------	--	-----

**XC60**



XC60	5.08 →	<b>ML6136</b>		U/C1			
------	--------	---------------	--	------	--	--	--

VOLVO

## VOLVO



## XC70



XC70 CROSS COUNTRY  11.97 → 8.07	<b>ML5643</b>		S1/S1	<b>ML5529</b>	→ 8.00	O/M
XC70 II  8.07 →	<b>ML5663</b>		U/U	<b>ML5685</b>	9.00 →	M/O

## XC90



XC90  10.02 →	<b>ML5361</b>		U/U	<b>ML5427</b>		S1/U
--	---------------	--	-----	---------------	--	------

## VW

## BORA

BORA (1J2)  10.98 → 7.05	<b>ML5261</b>		S1/U	<b>ML5135</b>		U/U
BORA Estate (1J6)  5.99 → 5.05	<b>ML5261</b>		S1/U	<b>ML5193</b>	(+) Δ	U/U
				<b>ML5132</b>		S1/U

## CADDY

CADDY I (14)  8.82 → 7.92				<b>ML5572</b>		Y1/U
CADDY III Estate (2KB, 2KJ, 2CB, 2CJ)  3.04 →	<b>ML5736</b>		S1/U	<b>ML5750</b>		U/U
	<b>ML6152<sup>0</sup></b>	8.10 →	S1/P			
CADDY III Box (2KA, 2KH, 2CA, 2CH)  3.04 →	<b>ML5736</b>		S1/U	<b>ML5750</b>		U/U
	<b>ML6152<sup>0</sup></b>	8.10 →	S1/P			

## CORRADO

CORRADO (53I)  9.88 → 12.95				<b>ML5573</b>		U/D
---	--	--	--	---------------	--	-----













## EOS

EOS (1F7, 1F8)  3.06 →	<b>ML5738</b>		P/U	<b>ML5752</b>		U/U
---	---------------	--	-----	---------------	--	-----

## FOX

FOX (5Z1, 5Z3)  10.03 →				<b>ML5796</b>		S1/U
--	--	--	--	---------------	--	------

## GOLF

GOLF I (17)  4.74 → 7.85				<b>ML5073</b>		Y1/X1
GOLF II (19E, 1G1)  8.83 → 12.92				<b>ML5574</b>	Ch. n° → 19E780000	U/D
				<b>ML5038</b>	Ch. n° 19E780001 →	U/U
GOLF III (1H1)  8.91 → 9.97				<b>ML5049</b>		U/C1
GOLF III Variant (1H5)  7.93 → 4.99				<b>ML5191</b>		U/U
GOLF III Cabriolet (1E7)  7.93 → 5.98	<b>ML5264</b>		S1/U	<b>ML5675</b>		U/U
GOLF IV (1J1)  8.97 → 10.05	<b>ML5261</b>		S1/U	<b>ML5132</b>		S1/U
GOLF IV Variant (1J5)  5.99 → 6.06	<b>ML5261</b>		S1/U	<b>ML5132</b>		S1/U
GOLF IV Cabriolet (1E7)  6.98 → 6.02	<b>ML5264</b>		S1/U	<b>ML5675</b>		U/U
GOLF V (1K1)  10.03 → 2.09	<b>ML5735</b>		P/U	<b>ML5742</b>		S1/U
GOLF V Variant (1K5)  6.07 →	<b>ML5735</b>		P/U	<b>ML5754</b>		U/P
GOLF VI (5K1)  10.08 → 11.13	<b>ML5648</b>		P/U	<b>ML5653</b>		S1/U
GOLF VI Variant (AJ5)  7.09 →	<b>ML5648</b>		P/U	<b>ML5754</b>		U/P
GOLF PLUS (5M1, 521)  1.05 →				<b>ML5792</b>		U/P

## JETTA

JETTA III (1K2)  8.05 → 10.10	<b>ML5735</b>		P/U	<b>ML5751</b>		T1/T1
--	---------------	--	-----	---------------	--	-------

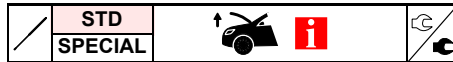

VW

**KOMBI**

KOMBI Bus (T2)	7.92 → 7.00
KOMBI Box (T2)	7.92 → 7.00

<b>ML6101</b>			S1/S1

<b>ML5251</b>	Ch. n° 70N151781 → (-)  "Trim" Version	P/P
<b>ML5249</b>	Ch. n° 70N151781 → (-)  F1(N):710	P/P
<b>ML5118</b>	Ch. n° 70N151781 → (+)	P/P
<b>ML5250</b>	Ch. n° 70N151781 → (+)  Heat insulating glass	P/P
<b>ML5248</b>	Ch. n° 70N151781 → M308 - Hydrolift	U/U
<b>ML5246</b>	Ch. n° → 70N151781 (-)  F1(N):660	U/U
<b>ML5105</b>	Ch. n° → 70N151781 (+)  Heat insulating glass	U/U
<b>ML5245</b>	Ch. n° → 70N151781 (+)  F1(N):750	U/U

**LUPO**

LUPO (6X1, 6E1)	9.98 → 7.05
-----------------	-------------

<b>ML5195</b>		S1/U
<b>ML5287</b>	GTI-FSI-TDI	S1/U
<b>ML5339</b>	Ch. n° 6X1049578 →	S1/U

<b>ML5261</b>		S1/U
<b>ML5199</b>	GTI-FSI-TDI	S1/U

**MULTIVAN**

MULTIVAN V (7HM, 7HN, 7HF, 7EF, 7EM, 7EN)	4.03 →
---	--------

--	--	--	--

<b>ML5576</b>		U/U
---------------	--	-----

**NEW BEETLE**

NEW BEETLE (9C1, 1C1)	1.98 →
NEW BEETLE Convertible (1Y7)	9.02 → 10.10

<b>ML5393</b>		U/U
<b>ML5393</b>		U/U

<b>ML5325</b>		U/U
<b>ML5791</b>		S1/U

**PASSAT**

PASSAT Variant (3A5, 35I)	2.88 → 5.97
PASSAT (3B2)	8.96 → 11.00
PASSAT Variant (3B5)	5.97 → 11.00
PASSAT (3B3)	11.00 → 5.05
PASSAT Variant (3B6)	11.00 → 8.05
PASSAT (3C2)	3.05 →
PASSAT Variant (3C5)	8.05 →
PASSAT CC (357)	5.08 →

<b>ML5266</b>			U/C1
<b>ML5266</b>			U/C1
<b>ML5266</b>			U/C1
<b>ML5266</b>			U/C1
<b>ML5829</b>			P/U
<b>ML5829</b>			P/U
<b>ML6096</b>			P/U

<b>ML5123</b>		S1/S1
<b>ML5135</b>		U/U
<b>ML5193</b>	(+)	U/U
<b>ML5185</b>		S1/U
<b>ML5439</b>		U/U
<b>ML5132</b>		S1/U
<b>ML5830</b>		U/P
<b>ML5831</b>		U/S1

**PHAETON**

PHAETON (3D_)	4.02 →
---------------	--------

<b>ML6097</b>		S1/S1
---------------	--	-------

<b>ML6099</b>	(+)	S1/U
<b>ML6098</b>	(+)	S1/U

**POLO**

POLO (86C, 80)	10.81 → 9.94
POLO Box (86CF)	8.92 → 7.94
POLO (6N1)	10.94 → 10.99
POLO CLASSIC (6KV2)	11.95 → 7.05
POLO Variant (6KV5)	5.97 → 9.01
POLO (6N2)	10.99 → 10.01
POLO (9N_)	10.01 → 11.09
POLO Saloon (9A4)	8.96 →
POLO (6R_)	6.09 →

<b>ML5265</b>			U/U
<b>ML5491</b>			S1/U

<b>ML5644</b>	→ 4.86	T1/D
<b>ML5177</b>	5.86 → 7.90	U/U
<b>ML5178</b>	8.90 →	U/U
<b>ML5178</b>	8.90 →	U/U
<b>ML5145</b>		U/C1
<b>ML5259</b>		U/U
<b>ML5100</b>		S1/S1
<b>ML5145</b>		U/C1
<b>ML5194</b>	(-)	S1/U
<b>ML5196</b>	(+)	S1/U
<b>ML5748</b>		S1/U
<b>ML5849</b>		U/U

VW

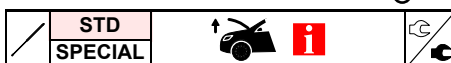

## SCIROCCO

SCIROCCO (53B)	8.80 → 7.92				<b>ML5677</b>		Y1/T1
SCIROCCO (137)	5.08 →				<b>ML6100</b>		U/U

## SHARAN

SHARAN (7M8, 7M9, 7M6)	9.95 → 3.10	<b>ML5480</b>		S1/S1	<b>ML5127</b>		U/U
------------------------	-------------	---------------	--	-------	---------------	--	-----

## TIGUAN

TIGUAN (5N_)	9.07 →				<b>ML5838</b>		P/P
--------------	--------	--	--	--	---------------	--	-----

## TOUAREG

TOUAREG (7LA, 7L6, 7L7)	10.02 → 5.10	<b>ML5357</b>		U/U	<b>ML5793</b>		S1/S1
-------------------------	--------------	---------------	--	-----	---------------	--	-------

## TOURAN

TOURAN (1T1, 1T2)	2.03 → 5.10	<b>ML5736</b>		S1/U	<b>ML5743</b>		U/P
TOURAN (1T3)	5.10 →	<b>ML5736</b>		S1/U			

## TRANSPORTER

KOMBI Bus (T2)	7.92 → 7.00				<b>ML5251</b>	Ch. n° 70N151781 → (-) , "Trim" Version	P/P
					<b>ML5249</b>	Ch. n° 70N151781 → (-) , F1(N):710	P/P
					<b>ML5118</b>	Ch. n° 70N151781 → (+)	P/P
					<b>ML5250</b>	Ch. n° 70N151781 → (+) , (+) Heat insulating glass	P/P
					<b>ML5248</b>	Ch. n° 70N151781 → M308 - Hydrolift	U/U
KOMBI Box (T2)	7.92 → 7.00	<b>ML6101</b>		S1/S1	<b>ML5246</b>	Ch. n° → 70N151781 (-) , F1(N):660	U/U
					<b>ML5105</b>	Ch. n° → 70N151781 (+) , (+) Heat insulating glass	U/U
					<b>ML5245</b>	Ch. n° → 70N151781 (+) , F1(N):750	U/U
TRANSPORTER III Bus	5.79 → 7.92				<b>ML5106</b>		U/D
TRANSPORTER III Box	5.79 → 7.92				<b>ML5645</b>	M308-Hydrolift	Y1/U
					<b>ML5106</b>		U/D
					<b>ML5832</b>	F1(N):360	U/P
TRANSPORTER IV Bus (70XB, 70XC, 7DB, 7DW)	9.90 → 4.03	<b>ML6101</b>		S1/S1	<b>ML5246</b>	Ch. n° → 70N151781 (-) , F1(N):660	U/U
					<b>ML5105</b>	Ch. n° → 70N151781 (+) , (+) Heat insulating glass	U/U
					<b>ML5245</b>	Ch. n° → 70N151781 (+) , F1(N):750	U/U
					<b>ML5247</b>	Ch. n° → 70N151781 F1(N):830	U/U
					<b>ML5251</b>	Ch. n° 70N151781 → (-) , "Trim" Version	P/P
					<b>ML5249</b>	Ch. n° 70N151781 → (-) , F1(N):710	P/P
					<b>ML5118</b>	Ch. n° 70N151781 → (+)	P/P
					<b>ML5250</b>	Ch. n° 70N151781 → (+) , (+) Heat insulating glass	P/P
					<b>ML5248</b>	Ch. n° 70N151781 → M308 - Hydrolift	U/U
TRANSPORTER IV Box (70XA)	7.90 → 4.03	<b>ML6101</b>		S1/S1	<b>ML5246</b>	Ch. n° → 70N151781 (-) , F1(N):660	U/U
					<b>ML5105</b>	Ch. n° → 70N151781 (+) , (+) Heat insulating glass	U/U
					<b>ML5245</b>	Ch. n° → 70N151781 (+) , F1(N):750	U/U
TRANSPORTER IV Platform/ Chassis (70XD)	7.90 → 4.03	<b>ML6101</b>		S1/S1			
TRANSPORTER V Bus (7HB, 7HJ, 7EB, 7EJ, 7EF)	4.03 →				<b>ML5833</b>	F1(N):1080	U/P
					<b>ML5832</b>	F1(N):360	U/P
					<b>ML5575</b>	F1(N):970	U/P



ZAZ



STD			
SPECIAL			

STD			
SPECIAL			

TRANSPORTER V Box (7HA, 7HH, 7EA, 7EH)	4.03 →			
--	--------	--	--	--

--	--	--	--

ML5833	F1(N):1080	U/P
ML5832	F1(N):360	U/P
ML5575	F1(N):970	U/P

### VENTO

VENTO (1H2)	11.91 → 9.98			
-------------	--------------	--	--	--

--	--	--	--

ML5226		U/S1
--------	--	------

## ZASTAVA

### 101

101 (1100)	6.73 → 12.93			
------------	--------------	--	--	--

--	--	--	--

ML5003		U/U
--------	--	-----

### YUGO

YUGO	4.80 → 6.95			
------	-------------	--	--	--

--	--	--	--

ML5028		U/U
--------	--	-----

YUGO FLORIDA	10.88 →			
--------------	---------	--	--	--

--	--	--	--

ML5008		Y1/X1
ML5097	Poly	U/U

## ZAZ

### TAVRIJA

TAVRIJA (1102)	1.89 →			
----------------	--------	--	--	--

--	--	--	--

ML5035	1102	U/U
ML5115	1103	U/U
ML5072	1105	U/U
ML5116	11055	U/U





# MONROE® MAX-LIFT® REPLACED & OBSOLETE PARTS

Ref	Ref	Ref	Ref	Ref	Ref	Ref	Ref
ML5001	-	ML5059	-	ML5186	ML5188	ML5601	ML5603
ML5002	-	ML5060	-	ML5187	ML5188	ML5602	ML5605
ML5007	-	ML5062	-	ML5203	ML5503	ML5604	ML5605
ML5012	-	ML5070	-	ML5204	ML5503	ML5610	ML5501
ML5027	-	ML5071	-	ML5220	ML5221	ML5614	ML5539
ML5029	-	ML5075	-	ML5304	-	ML5615	-
ML5033	ML5255	ML5083	-	ML5326	ML5202	ML5853	ML6149
ML5046	-	ML5084	-	ML5423	ML5433	ML5858	ML6150
ML5047	-	ML5090	-	ML5451	ML5235	ML5859	-
ML5050	-	ML5112	-	ML5479	-	ML5863	ML5864
ML5052	-	ML5117	-	ML5497	ML5499	ML5865	-
ML5053	-	ML5150	ML5152	ML5498	ML5499	ML5886	ML5078
ML5058	-	ML5174	ML5161	ML5520	ML5590	ML5887	ML5078

REPLACED

# MONROE® MAX-LIFT® NUMERICAL LISTING

**Ref.** 

ML5003 FIAT  
 ZASTAVA  
 ML5004 RENAULT  
 ML5005 ŠKODA  
 ML5006 FIAT  
 ML5008 ZASTAVA  
 ML5009 FIAT  
 ML5010 CITROËN  
 FIAT  
 SEAT  
 ML5011 CITROËN  
 FIAT  
 SEAT  
 ML5013 FIAT  
 ML5014 FIAT  
 ML5015 FIAT  
 ML5016 FIAT  
 SEAT  
 ML5017 AUTOBIANCHI  
 LANCIA  
 ML5018 FIAT  
 ML5019 CITROËN  
 ML5020 PEUGEOT  
 ML5021 RENAULT  
 ML5022 SEAT  
 ML5023 FORD  
 ML5024 LADA  
 ML5025 LADA  
 ML5026 ŠKODA  
 ML5028 ZASTAVA  
 ML5030 FIAT  
 ML5031 DAEWOO  
 OPEL  
 ML5032 OPEL  
 VAUXHALL  
 ML5034 FIAT  
 ML5035 ZAZ  
 ML5036 ŠKODA  
 ML5037 ŠKODA  
 ML5038 FIAT  
 VW  
 ML5039 FIAT  
 ML5040 FIAT  
 AUSTIN  
 FIAT  
 MG  
 ROVER  
 ML5042 FIAT  
 ML5043 FIAT  
 ML5044 ŠKODA  
 ML5045 ŠKODA  
 ML5048 ŠKODA  
 ML5049 VW  
 ML5051 DAEWOO  
 ML5054 OPEL  
 VAUXHALL  
 ML5055 FIAT  
 ML5056 INNOCENTI  
 ML5057 ŠKODA  
 ML5061 ŠKODA  
 ML5063 SEAT  
 ML5064 FIAT  
 INNOCENTI  
 ML5065 FIAT  
 ML5066 FIAT  
 ML5067 PEUGEOT  
 ML5068 FIAT  
 ML5069 FIAT  
 ML5072 ZAZ  
 ML5073 VW  
 ML5074 FIAT  
 ML5076 FORD  
 ML5077 OPEL  
 VAUXHALL  
 ML5078 FIAT  
 OPEL  
 ML5079 FIAT  
 ML5080 FORD  
 ML5081 FIAT  
 ML5082 OPEL  
 VAUXHALL  
 ML5085 CHEVROLET  
 OPEL  
 VAUXHALL

**Ref.** 

ML5086 FIAT  
 NISSAN  
 ML5087 DAEWOO  
 ML5088 OPEL  
 SUZUKI  
 VAUXHALL  
 ML5089 OPEL  
 SUZUKI  
 VAUXHALL  
 SUZUKI  
 ML5091 SUZUKI  
 ML5092 SUZUKI  
 ML5093 RENAULT  
 ML5094 RENAULT  
 ML5095 DAEWOO  
 ML5096 DAEWOO  
 ML5097 ZASTAVA  
 ML5098 CHEVROLET  
 DAEWOO  
 ML5099 ŠKODA  
 ML5100 SEAT  
 VW  
 ML5101 FIAT  
 ML5102 MERCEDES-BENZ  
 ML5103 OPEL  
 VAUXHALL  
 ML5104 AUDI  
 ML5105 VW  
 ML5106 VW  
 ML5107 LADA  
 ML5108 LADA  
 ML5109 FORD  
 ML5110 FORD  
 ML5111 AUDI  
 ML5113 CITROËN  
 PEUGEOT  
 ML5114 LADA  
 ML5115 ZAZ  
 ML5116 ZAZ  
 ML5118 VW  
 ML5119 OPEL  
 VAUXHALL  
 ML5120 OPEL  
 ML5121 TOYOTA  
 ML5122 HONDA  
 ML5123 VW  
 ML5124 SEAT  
 OPEL  
 VAUXHALL  
 ML5126 FORD  
 ML5127 FORD  
 SEAT  
 VW  
 ML5128 RENAULT  
 ML5129 CITROËN  
 ML5130 RENAULT  
 ML5131 RENAULT  
 ML5132 VW  
 ML5133 PEUGEOT  
 ML5134 PEUGEOT  
 ML5135 AUDI  
 ŠKODA  
 VW  
 ML5136 FORD  
 ML5137 OPEL  
 VAUXHALL  
 ML5138 OPEL  
 VAUXHALL  
 LANCIA  
 ML5139 VAUXHALL  
 ML5140 SEAT  
 ML5141 FORD  
 ML5142 FORD  
 ML5143 FORD  
 ML5144 OPEL  
 VAUXHALL  
 ML5145 VW  
 ML5146 PEUGEOT  
 PEUGEOT (DF-PSA)  
 ML5147 FORD  
 MAZDA  
 ML5148 PEUGEOT  
 ML5149 CITROËN  
 ML5151 CITROËN  
 ML5152 RENAULT  
 ML5153 RENAULT





**Ref.** 

ML5154 HYUNDAI  
 VOLVO  
 ML5155 RENAULT  
 ML5156 OPEL  
 VAUXHALL  
 ML5157 HYUNDAI  
 ML5158 RENAULT  
 ML5159 LANCIA  
 ML5160 PEUGEOT  
 ML5161 FORD  
 ML5162 CITROËN  
 ML5163 BMW  
 ML5164 FIAT  
 ML5165 FIAT  
 ML5166 OPEL  
 VAUXHALL  
 ML5167 OPEL  
 VAUXHALL  
 ML5168 FORD  
 ML5169 FORD  
 ML5170 BMW  
 ML5171 FORD  
 ML5172 FORD  
 ML5173 FORD  
 ML5175 ŠKODA  
 ML5176 FORD  
 ML5177 VW  
 ML5178 VW  
 ML5179 OPEL  
 VAUXHALL  
 PEUGEOT  
 ML5180 SEAT  
 ML5181 RENAULT  
 ML5182 RENAULT  
 ML5183 PEUGEOT  
 ML5184 VOLVO  
 ML5185 VW  
 ML5188 MERCEDES-BENZ  
 ML5189 RENAULT  
 ML5190 RENAULT  
 ML5191 VW  
 ML5192 HONDA  
 ROVER  
 SEAT  
 VW  
 ML5194 VW  
 ML5195 SEAT  
 VW  
 ML5196 VW  
 ML5197 AUDI  
 ML5198 AUDI  
 ML5199 VW  
 ML5200 FORD  
 ML5201 FORD  
 ML5202 PEUGEOT  
 ML5205 FORD  
 ML5206 FORD  
 ML5207 FORD  
 ML5208 ROVER  
 ML5209 ROVER  
 ML5210 OPEL  
 VAUXHALL  
 SEAT  
 ML5211 SEAT  
 ML5212 RENAULT  
 ML5213 BMW  
 ML5214 HONDA  
 ML5215 ALFA ROMEO  
 ML5216 ALFA ROMEO  
 ML5217 ŠKODA  
 ML5218 ŠKODA  
 ML5219 ŠKODA  
 ML5221 ŠKODA  
 ML5222 ALFA ROMEO  
 ML5223 AUDI  
 ML5224 FORD  
 ML5225 SEAT  
 ML5226 VW  
 ML5227 AUDI  
 ML5228 RENAULT  
 ML5229 RENAULT  
 ML5230 RENAULT  
 ML5231 FORD  
 ML5232 FORD  
 ML5233 FORD

**Ref.** 

ML5234 AUDI  
 ML5235 BMW  
 ML5236 BMW  
 ML5237 BMW  
 ML5238 AUDI  
 ML5239 AUDI  
 ML5240 AUDI  
 ML5241 RENAULT  
 ML5242 OPEL  
 VAUXHALL  
 ML5243 OPEL  
 ML5244 OPEL  
 ML5245 VW  
 ML5246 VW  
 ML5247 VW  
 ML5248 VW  
 ML5249 VW  
 ML5250 VW  
 ML5251 VW  
 ML5252 FORD  
 ML5253 FORD  
 ML5254 RENAULT  
 ML5255 CITROËN  
 ML5256 RENAULT  
 ML5257 OPEL  
 VAUXHALL  
 ML5258 OPEL  
 ML5259 SEAT  
 VW  
 ML5260 BMW  
 ML5261 AUDI  
 VW  
 ML5262 CITROËN  
 ML5263 BMW  
 ML5264 VW  
 ML5265 VW  
 ML5266 AUDI  
 VW  
 ML5267 PEUGEOT  
 ML5268 PEUGEOT  
 ML5269 AUDI  
 ML5270 CITROËN  
 ML5271 ALFA ROMEO  
 ML5272 ALFA ROMEO  
 ML5273 ALFA ROMEO  
 ML5274 ALFA ROMEO  
 ML5275 AUDI  
 ML5276 AUDI  
 ML5277 AUDI  
 ML5278 MITSUBISHI  
 ML5279 RENAULT  
 ML5280 FIAT  
 ML5281 FIAT  
 ML5282 FIAT  
 ML5283 FIAT  
 ML5284 SEAT  
 ML5285 FORD  
 ML5286 FORD  
 ML5287 VW  
 ML5288 FORD  
 ML5289 FORD  
 ML5290 FORD  
 ML5291 FORD  
 ML5292 FORD  
 ML5293 FORD  
 ML5294 FORD  
 ML5295 FORD  
 ML5296 HYUNDAI  
 ML5297 HYUNDAI  
 ML5298 LADA  
 ML5299 LADA  
 ML5300 LANCIA  
 ML5301 LANCIA  
 ML5302 LANCIA  
 ML5303 LANCIA  
 ML5305 LANCIA  
 ML5306 LAND ROVER  
 ML5307 MERCEDES-BENZ  
 ML5308 MERCEDES-BENZ  
 ML5309 MERCEDES-BENZ  
 ML5310 RENAULT  
 ML5311 PEUGEOT

# MONROE® MAX-LIFT® NUMERICAL LISTING

Ref.		Ref.		Ref.		Ref.	
ML5312	VOLVO	ML5384	ROVER	ML5456	CITROËN	ML5534	AUDI
ML5313	RENAULT	ML5385	AUDI	ML5457	CITROËN	ML5535	BMW
ML5314	RENAULT	ML5386	AUDI	ML5458	FIAT	ML5536	CITROËN
ML5315	RENAULT		SEAT	ML5459	AUDI	ML5537	FIAT
ML5316	PEUGEOT	ML5387	FIAT	ML5460	AUDI	ML5538	FIAT
ML5317	NISSAN	ML5388	FORD	ML5461	CITROËN	ML5539	FORD
ML5318	NISSAN	ML5389	FIAT	ML5462	FIAT	ML5540	LANCIA
ML5319	PEUGEOT	ML5390	OPEL	ML5463	FORD	ML5541	LANCIA
ML5320	RENAULT		VAUXHALL	ML5464	FORD	ML5542	MAZDA
ML5321	NISSAN	ML5391	CITROËN	ML5465	FORD	ML5543	MERCEDES-BENZ
ML5322	NISSAN		OPEL	ML5466	FORD	ML5544	RENAULT
ML5323	PEUGEOT		VAUXHALL	ML5467	FORD	ML5545	RENAULT
ML5324	NISSAN	ML5392	ALFA ROMEO	ML5468	MERCEDES-BENZ	ML5546	RENAULT
ML5325	VW	ML5393	VW	ML5469	PEUGEOT	ML5547	RENAULT
ML5327	RENAULT	ML5394	ROVER	ML5470	PEUGEOT	ML5548	RENAULT
ML5328	MERCEDES-BENZ	ML5395	OPEL	ML5471	PEUGEOT	ML5549	RENAULT
ML5329	MERCEDES-BENZ	ML5396	HONDA	ML5472	RENAULT	ML5550	RENAULT
ML5330	FORD	ML5397	SAAB	ML5473	RENAULT	ML5551	RENAULT
ML5331	RENAULT	ML5398	OPEL	ML5474	RENAULT	ML5552	RENAULT
ML5332	FORD		VAUXHALL	ML5475	RENAULT	ML5553	RENAULT
ML5333	AUDI	ML5399	FORD	ML5476	RENAULT	ML5554	RENAULT
ML5334	DAEWOO	ML5400	SAAB	ML5477	RENAULT	ML5555	RENAULT
	SSANGYONG	ML5401	SAAB	ML5478	ROVER	ML5556	SAAB
ML5335	ALFA ROMEO	ML5402	SAAB	ML5480	FORD	ML5557	SAAB
ML5336	BMW	ML5403	MAZDA		SEAT	ML5558	SAAB
ML5337	RENAULT	ML5404	FIAT	ML5481	VW	ML5559	MERCEDES-BENZ
ML5338	ROVER	ML5405	HONDA	ML5482	VOLVO	ML5560	MERCEDES-BENZ
ML5339	VW	ML5406	MINI	ML5483	LANCIA	ML5561	MERCEDES-BENZ
ML5340	PEUGEOT	ML5407	OPEL	ML5484	LANCIA	ML5562	BMW
ML5341	OPEL		VAUXHALL	ML5485	TOYOTA	ML5563	BMW
	VAUXHALL	ML5408	OPEL	ML5486	TOYOTA	ML5564	MINI
ML5342	SEAT		VAUXHALL	ML5487	VOLVO	ML5565	BMW
ML5343	PEUGEOT	ML5409	NISSAN	ML5488	VOLVO	ML5566	BMW
ML5344	CITROËN	ML5410	MG	ML5489	VOLVO	ML5567	HONDA
	PEUGEOT		ROVER	ML5490	VOLVO	ML5568	HONDA
ML5345	OPEL	ML5411	MG	ML5491	VW	ML5569	HYUNDAI
	VAUXHALL		ROVER	ML5492	SUZUKI	ML5570	HYUNDAI
ML5346	OPEL	ML5412	MG	ML5493	SUZUKI	ML5571	VOLVO
	VAUXHALL		ROVER	ML5494	SAAB	ML5572	VW
ML5347	VOLVO	ML5413	NISSAN	ML5495	SAAB	ML5573	VW
ML5348	VOLVO	ML5414	ALFA ROMEO	ML5496	LANCIA	ML5574	VW
ML5349	SAAB	ML5415	FORD		SAAB	ML5575	VW
ML5350	SAAB	ML5416	FORD	ML5499	SAAB	ML5576	VW
ML5351	RENAULT	ML5417	AUDI	ML5500	SAAB	ML5577	MERCEDES-BENZ
ML5352	NISSAN	ML5418	AUDI	ML5501	VOLVO	ML5578	MITSUBISHI
ML5353	MITSUBISHI	ML5419	ALFA ROMEO		FIAT	ML5579	NISSAN
ML5354	MITSUBISHI	ML5420	AUDI	ML5502	SEAT	ML5580	NISSAN
ML5355	DAEWOO	ML5421	BMW	ML5503	FORD	ML5581	NISSAN
	SSANGYONG	ML5422	BMW	ML5504	CITROËN	ML5582	NISSAN
ML5356	DAEWOO	ML5424	OPEL	ML5505	CITROËN	ML5583	PEUGEOT
	SSANGYONG		VAUXHALL	ML5506	CITROËN	ML5584	SEAT
ML5357	VW	ML5425	PEUGEOT	ML5507	DAEWOO	ML5585	OPEL
ML5358	PEUGEOT	ML5426	PEUGEOT		HONDA		VAUXHALL
ML5359	ROVER	ML5427	PEUGEOT	ML5508	HONDA	ML5586	OPEL
ML5360	NISSAN	ML5428	VOLVO	ML5509	VOLVO	ML5587	MITSUBISHI
ML5361	VOLVO	ML5429	AUDI	ML5510	AUDI	ML5588	NISSAN
ML5362	AUSTIN	ML5430	FORD	ML5511	AUDI	ML5589	SUZUKI
	ROVER	ML5431	CITROËN	ML5512	AUDI	ML5590	BMW
ML5363	PEUGEOT	ML5432	FORD	ML5513	DAEWOO	ML5591	JEEP
ML5364	PEUGEOT	ML5433	PEUGEOT	ML5514	FORD	ML5592	TOYOTA
ML5365	OPEL	ML5434	NISSAN	ML5515	OPEL	ML5593	AUDI
	VAUXHALL		MG		VAUXHALL	ML5594	PORSCHE
ML5366	OPEL	ML5435	ROVER	ML5516	NISSAN	ML5595	PORSCHE
	VAUXHALL	ML5436	CITROËN		OPEL	ML5596	BMW
ML5367	OPEL	ML5437	BMW	ML5517	VAUXHALL	ML5597	ALFA ROMEO
	VAUXHALL	ML5438	AUDI	ML5518	PEUGEOT	ML5598	AUTOBIANCHI
ML5368	VOLVO	ML5439	MERCEDES-BENZ		RENAULT	ML5599	BMW
ML5369	OPEL		ŠKODA	ML5519	VAUXHALL	ML5600	BMW
	VAUXHALL	ML5440	VW	ML5520	RENAULT	ML5601	CITROËN
ML5370	AUDI	ML5441	RENAULT	ML5521	RENAULT	ML5602	CITROËN
ML5371	HONDA	ML5442	BMW	ML5522	BMW	ML5603	CITROËN
ML5372	HONDA	ML5443	ALFA ROMEO	ML5523	BMW	ML5604	CITROËN
ML5373	RENAULT	ML5444	FIAT	ML5524	NISSAN	ML5605	CITROËN
ML5374	FORD	ML5445	BMW	ML5525	NISSAN	ML5606	CITROËN
ML5375	FORD	ML5446	BMW	ML5526	RENAULT	ML5607	ALFA ROMEO
ML5376	SAAB	ML5447	CHEVROLET	ML5527	RENAULT	ML5608	CITROËN
ML5377	AUDI	ML5448	HONDA	ML5528	OPEL	ML5609	CITROËN
ML5378	FIAT	ML5449	HONDA		OPEL	ML5610	FORD
ML5379	HYUNDAI	ML5450	FIAT	ML5529	VAUXHALL	ML5611	FORD
ML5380	HYUNDAI	ML5451	AUDI		VOLVO	ML5612	FORD
ML5381	HYUNDAI	ML5452	BMW	ML5530	VOLVO	ML5613	SAAB
ML5382	HYUNDAI	ML5453	CITROËN	ML5531	MERCEDES-BENZ	ML5614	HONDA
ML5383	RENAULT	ML5454	CITROËN	ML5532	ALFA ROMEO	ML5615	HYUNDAI
		ML5455	CITROËN	ML5533	ALFA ROMEO	ML5616	LANCIA
				ML5534	AUDI	ML5617	LANCIA
				ML5535		ML5618	LANCIA
				ML5536		ML5619	LANCIA

NUMERICAL LISTING

# MONROE® MAX-LIFT® NUMERICAL LISTING

**Ref.**



ML5620 MERCEDES-BENZ  
 ML5621 MERCEDES-BENZ  
 ML5622 MG  
 ML5623 MG  
 ROVER  
 ML5624 NISSAN  
 ML5625 PEUGEOT  
 ML5626 PEUGEOT  
 ML5627 PEUGEOT  
 ML5628 PEUGEOT  
 ML5629 RENAULT  
 ML5630 RENAULT  
 ML5631 RENAULT  
 ML5632 RENAULT  
 ML5633 RENAULT  
 ML5634 ROVER  
 ML5635 SAAB  
 ML5636 SAAB  
 ML5637 SAAB  
 ML5638 SAAB  
 ML5639 SEAT  
 ML5640 SMART  
 ML5641 TOYOTA  
 ML5642 VOLVO  
 ML5643 VOLVO  
 ML5644 VW  
 ML5645 VW  
 ML5646 PORSCHE  
 ML5647 TOYOTA  
 ML5648 VW  
 ML5649 LAND ROVER  
 ML5650 FORD  
 ML5651 FORD  
 ML5652 CITROËN  
 ML5653 VW  
 ML5654 FORD  
 ML5655 ALFA ROMEO  
 ML5656 RENAULT  
 ML5657 RENAULT  
 ML5658 BMW  
 ML5659 BMW  
 ML5660 HYUNDAI  
 ML5661 MITSUBISHI  
 ML5662 MITSUBISHI  
 ML5663 VOLVO  
 ML5664 FORD  
 ML5665 ŠKODA  
 ML5666 TOYOTA  
 ML5667 ŠKODA  
 ML5668 CITROËN  
 ML5669 OPEL  
 VAUXHALL  
 ML5670 BMW  
 ML5671 BMW  
 ML5672 NISSAN  
 ML5673 MERCEDES-BENZ  
 ML5674 MERCEDES-BENZ  
 ML5675 VW  
 ML5676 PORSCHE  
 ML5677 VW  
 ML5678 AUDI  
 ML5679 AUDI  
 ML5680 MERCEDES-BENZ  
 ML5681 ŠKODA  
 ML5682 ŠKODA  
 ML5683 MAZDA  
 ML5684 MAZDA  
 ML5685 VOLVO  
 ML5686 RENAULT  
 ML5687 CITROËN  
 PEUGEOT  
 ML5688 BMW  
 ML5689 BMW  
 ML5690 BMW  
 ML5691 BMW  
 ML5692 BMW  
 ML5693 BMW  
 ML5694 BMW  
 ML5695 BMW  
 ML5696 ALFA ROMEO  
 ML5697 ALFA ROMEO  
 ML5698 ALFA ROMEO

**Ref.**



ML5699 TOYOTA  
 ML5700 NISSAN  
 ML5701 NISSAN  
 ML5702 FIAT  
 LANCIA  
 ML5703 LANCIA  
 ML5704 FORD  
 ML5705 KIA  
 ML5706 KIA  
 ML5707 KIA  
 ML5708 KIA  
 ML5709 KIA  
 ML5710 KIA  
 ML5711 KIA  
 ML5712 KIA  
 ML5713 KIA  
 ML5714 CHEVROLET  
 DAEWOO  
 ML5715 MERCEDES-BENZ  
 ML5716 MERCEDES-BENZ  
 ML5717 MERCEDES-BENZ  
 ML5718 MERCEDES-BENZ  
 ML5719 MERCEDES-BENZ  
 ML5720 OPEL  
 VAUXHALL  
 ML5721 OPEL  
 ML5722 OPEL  
 VAUXHALL  
 ML5723 KIA  
 OPEL  
 ML5724 RENAULT  
 ML5725 RENAULT  
 ML5726 VOLVO  
 ML5727 PEUGEOT  
 ML5728 PEUGEOT  
 ML5729 PEUGEOT  
 ML5730 PEUGEOT  
 ML5731 PEUGEOT  
 PEUGEOT (DF-PSA)  
 ML5732 PEUGEOT  
 ML5733 PEUGEOT  
 ML5734 PEUGEOT  
 ML5735 VW  
 ML5736 VW  
 ML5737 AUDI  
 ML5738 VW  
 ML5739 AUDI  
 ML5740 AUDI  
 ML5741 AUDI  
 ML5742 VW  
 ML5743 VW  
 ML5744 AUDI  
 ML5745 AUDI  
 SEAT  
 ML5746 AUDI  
 ML5747 AUDI  
 ML5748 VW  
 ML5749 AUDI  
 ML5750 VW  
 ML5751 VW  
 ML5752 VW  
 ML5753 AUDI  
 ML5754 VW  
 ML5755 CITROËN  
 ML5756 CITROËN  
 ML5757 MITSUBISHI  
 ML5758 HYUNDAI  
 ML5759 HYUNDAI  
 ML5760 HYUNDAI  
 ML5761 HYUNDAI  
 ML5762 HYUNDAI  
 ML5763 MAZDA  
 ML5764 MAZDA  
 ML5765 MAZDA  
 ML5766 SAAB  
 ML5767 SEAT  
 ML5768 ŠKODA  
 ML5769 BMW  
 ML5770 FORD  
 ML5771 FORD  
 ML5772 FORD  
 ML5773 OPEL  
 VAUXHALL

**Ref.**







ML5774 AUDI  
 ML5775 FIAT  
 ML5776 CITROËN  
 MITSUBISHI  
 PEUGEOT  
 ML5777 TOYOTA  
 ML5778 SEAT  
 ML5779 FIAT  
 SUZUKI  
 ML5780 SUZUKI  
 ML5781 NISSAN  
 ML5782 CITROËN  
 ML5783 CITROËN  
 ML5784 FIAT  
 ML5785 FIAT  
 ML5786 FORD  
 ML5787 HONDA  
 ML5788 PEUGEOT  
 ML5789 RENAULT  
 ML5790 SAAB  
 ML5791 VW  
 ML5792 VW  
 ML5793 VW  
 ML5794 CHEVROLET  
 DAEWOO  
 ML5795 FIAT  
 ML5796 VW  
 ML5797 FORD  
 ML5798 MERCEDES-BENZ  
 ML5799 MERCEDES-BENZ  
 ML5800 MERCEDES-BENZ  
 ML5801 MERCEDES-BENZ  
 ML5802 MERCEDES-BENZ  
 ML5803 PORSCHE  
 ML5804 PORSCHE  
 ML5805 OPEL  
 ML5806 MERCEDES-BENZ  
 OPEL  
 ML5807 VAUXHALL  
 MERCEDES-BENZ  
 ML5808 MERCEDES-BENZ  
 ML5809 NISSAN  
 ML5810 MAZDA  
 ML5811 MERCEDES-BENZ  
 ML5812 RENAULT  
 ML5813 MERCEDES-BENZ  
 ML5814 HYUNDAI  
 ML5815 ROVER  
 ML5816 HYUNDAI  
 ML5817 OPEL  
 VAUXHALL  
 MERCEDES-BENZ  
 ML5818 MERCEDES-BENZ  
 ML5819 SUBARU  
 ML5820 SUBARU  
 ML5821 TOYOTA  
 ML5822 CITROËN  
 ML5823 KIA  
 ML5824 CITROËN  
 ML5825 OPEL  
 VAUXHALL  
 RENAULT  
 OPEL  
 VAUXHALL  
 RENAULT  
 OPEL  
 VAUXHALL  
 RENAULT  
 VW  
 ML5828 RENAULT  
 ML5829 OPEL  
 VAUXHALL  
 RENAULT  
 VW  
 ML5830 VW  
 ML5831 VW  
 ML5832 VW  
 ML5833 VW  
 ML5834 OPEL  
 ML5835 OPEL  
 VAUXHALL  
 HONDA  
 ML5836 HONDA  
 ML5837 NISSAN  
 ML5838 VW  
 ML5839 KIA  
 ML5840 VOLVO  
 ML5842 MAZDA  
 ML5843 MAZDA  
 ML5844 AUDI  
 ML5845 SEAT  
 ML5846 PORSCHE  
 ML5847 MAZDA  
 ML5848 MAZDA

**Ref.**





ML5849 VW  
 ML5850 SEAT  
 ML5851 PEUGEOT  
 ML5852 SAAB  
 ML5855 ALFA ROMEO  
 ML5856 AUDI  
 ML5857 AUDI  
 ML5860 BMW  
 ML5861 BMW  
 ML5862 CITROËN  
 ML5864 DACIA  
 RENAULT  
 ML5866 HONDA  
 ML5867 HYUNDAI  
 ML5868 HYUNDAI  
 ML5869 HYUNDAI  
 ML5870 LAND ROVER  
 ML5871 LAND ROVER  
 ML5872 LAND ROVER  
 ML5873 MAZDA  
 ML5888 OPEL  
 PEUGEOT  
 ML5889 NISSAN  
 ML5891 RENAULT  
 ML5892 RENAULT  
 ML5893 RENAULT  
 ML5894 RENAULT  
 ML5895 SMART  
 ML5900 TOYOTA  
 ML5906 VOLVO  
 ML5907 VOLVO  
 ML5909 VOLVO  
 ML5910 HONDA  
 ML5911 HONDA  
 ML5912 KIA  
 ML5917 TOYOTA  
 ML5918 AUDI  
ML5919 ALFA ROMEO  
ML5920 ALFA ROMEO  
ML5921 ALFA ROMEO  
ML5922 AUDI  
ML5923 AUDI  
ML5924 AUDI  
ML5925 AUDI  
ML5926 AUDI  
ML5927 AUDI  
ML5928 AUDI  
ML5929 AUDI  
ML5930 AUDI  
ML5932 BMW  
ML5934 BMW  
ML5936 BMW  
ML5938 BMW  
ML5939 CHEVROLET  
ML5940 CHEVROLET  
ML5941 CHEVROLET  
 DAEWOO  
ML5943 CHEVROLET  
 CHEVROLET (SGMW)  
 HOLDEN  
 PONTIAC  
ML5944 CHRYSLER  
ML5945 CHRYSLER  
 CHRYSLER (BBDC)  
ML5946 CHRYSLER  
 CHRYSLER (BBDC)  
ML5947 CHRYSLER  
ML5948 CITROËN  
 PEUGEOT  
ML5950 CITROËN  
 FIAT  
 PEUGEOT  
ML5954 CITROËN  
 PEUGEOT  
ML5956 CITROËN  
 PEUGEOT  
ML5958 CITROËN  
ML5959 CITROËN  
ML5961 CITROËN  
ML5962 CITROËN  
ML5963 CITROËN  
 TOYOTA  
ML5967 CITROËN



# MONROE® MAX-LIFT® NUMERICAL LISTING

Ref.		Ref.		Ref.		Ref.	
<u>ML5968</u>	CITROËN	<u>ML6047</u>	OPEL	<u>ML6128</u>	RENAULT		
	FIAT		VAUXHALL	<u>ML6129</u>	SEAT		
	PEUGEOT	<u>ML6049</u>	OPEL	<u>ML6130</u>	ŠKODA		
<u>ML5973</u>	FIAT		VAUXHALL	<u>ML6131</u>	SUZUKI		
<u>ML5974</u>	FIAT	<u>ML6051</u>	OPEL	<u>ML6132</u>	TOYOTA		
<u>ML5975</u>	FIAT		VAUXHALL	<u>ML6133</u>	TOYOTA		
<u>ML5976</u>	FIAT	<u>ML6053</u>	OPEL	<u>ML6134</u>	TOYOTA		
<u>ML5977</u>	FORD		VAUXHALL	<u>ML6135</u>	TOYOTA		
<u>ML5978</u>	FORD	<u>ML6055</u>	OPEL		TOYOTA (GAC)		
<u>ML5979</u>	FORD		VAUXHALL	<u>ML6136</u>	VOLVO		
<u>ML5980</u>	FORD	<u>ML6057</u>	CHEVROLET	<u>ML6137</u>	ALFA ROMEO		
	FORD USA		HOLDEN	<u>ML6138</u>	ALFA ROMEO		
<u>ML5981</u>	FORD		OPEL	<u>ML6140</u>	CHEVROLET		
	FORD USA		VAUXHALL	<u>ML6141</u>	BMW		
<u>ML5982</u>	HONDA	<u>ML6058</u>	PEUGEOT	<u>ML6142</u>	BMW		
<u>ML5983</u>	HONDA	<u>ML6060</u>	PEUGEOT	<u>ML6143</u>	CITROËN		
<u>ML5984</u>	HONDA	<u>ML6061</u>	PEUGEOT	<u>ML6144</u>	HYUNDAI		
<u>ML5985</u>	HONDA	<u>ML6062</u>	PORSCHE	<u>ML6145</u>	LEXUS		
<u>ML5986</u>	HYUNDAI	<u>ML6063</u>	RENAULT	<u>ML6146</u>	OPEL		
<u>ML5987</u>	HYUNDAI	<u>ML6065</u>	PORSCHE		VAUXHALL		
<u>ML5989</u>	HYUNDAI	<u>ML6066</u>	PORSCHE	<u>ML6147</u>	PORSCHE		
<u>ML5990</u>	HYUNDAI	<u>ML6067</u>	PORSCHE	<u>ML6148</u>	ROVER		
<u>ML5991</u>	HYUNDAI	<u>ML6068</u>	PORSCHE	<u>ML6149<sup>0</sup></u>	ALFA ROMEO		
<u>ML5992</u>	HYUNDAI	<u>ML6069</u>	PORSCHE	<u>ML6150<sup>0</sup></u>	AUDI		
<u>ML5993</u>	HYUNDAI (HUATAI)	<u>ML6070</u>	RENAULT	<u>ML6151<sup>0</sup></u>	TOYOTA		
<u>ML5994</u>	HYUNDAI	<u>ML6071</u>	RENAULT	<u>ML6152<sup>0</sup></u>	VW		
<u>ML5995</u>	JAGUAR	<u>ML6072</u>	RENAULT				
<u>ML5996</u>	JAGUAR	<u>ML6073</u>	RENAULT				
<u>ML5997</u>	JEEP	<u>ML6074</u>	RENAULT				
<u>ML5998</u>	JEEP	<u>ML6075</u>	RENAULT				
<u>ML5999</u>	JEEP	<u>ML6076</u>	SAAB				
<u>ML6000</u>	JEEP	<u>ML6077</u>	SEAT				
<u>ML6001</u>	JEEP	<u>ML6078</u>	ŠKODA				
<u>ML6002</u>	KIA	<u>ML6079</u>	ŠKODA				
<u>ML6003</u>	LANCIA	<u>ML6080</u>	ŠKODA				
<u>ML6004</u>	LAND ROVER	<u>ML6081</u>	SMART				
<u>ML6005</u>	LAND ROVER	<u>ML6082</u>	SMART				
<u>ML6006</u>	LAND ROVER	<u>ML6083</u>	DAIHATSU				
<u>ML6008</u>	LEXUS	<u>ML6084</u>	SUBARU				
<u>ML6009</u>	LEXUS		SUZUKI	<u>ML6085</u>	SUZUKI		
<u>ML6011</u>	MAZDA		SUZUKI	<u>ML6086</u>	SUZUKI		
<u>ML6012</u>	MAZDA		TOYOTA	<u>ML6087</u>	TOYOTA		
<u>ML6013</u>	MAZDA		TOYOTA	<u>ML6089</u>	TOYOTA		
<u>ML6014</u>	MAZDA		VOLVO	<u>ML6090</u>	VOLVO		
<u>ML6015</u>	MAZDA		VOLVO	<u>ML6091</u>	VOLVO		
<u>ML6016</u>	MERCEDES-BENZ		VOLVO	<u>ML6092</u>	VOLVO		
<u>ML6017</u>	MERCEDES-BENZ		VW	<u>ML6094</u>	VOLVO		
<u>ML6019</u>	MERCEDES-BENZ		VW	<u>ML6096</u>	VW		
<u>ML6020</u>	MERCEDES-BENZ		VW	<u>ML6097</u>	VW		
<u>ML6021</u>	MERCEDES-BENZ		VW	<u>ML6098</u>	VW		
<u>ML6022</u>	MERCEDES-BENZ		VW	<u>ML6099</u>	VW		
	MERCEDES-BENZ		VW	<u>ML6100</u>	VW		
	(BBDC)		VW	<u>ML6101</u>	VW		
<u>ML6023</u>	MERCEDES-BENZ		AUDI	<u>ML6102</u>	AUDI		
	MERCEDES-BENZ		AUDI	<u>ML6103</u>	AUDI		
	(BBDC)		AUDI	<u>ML6104</u>	AUDI		
<u>ML6024</u>	MERCEDES-BENZ		AUDI	<u>ML6105</u>	AUDI		
<u>ML6025</u>	MERCEDES-BENZ		AUDI	<u>ML6106</u>	AUDI		
<u>ML6026</u>	MERCEDES-BENZ		BMW	<u>ML6107</u>	BMW		
<u>ML6027</u>	MERCEDES-BENZ		BMW	<u>ML6108</u>	BMW		
<u>ML6028</u>	MERCEDES-BENZ		BMW (BRILLIANCE)		BMW (BRILLIANCE)		
<u>ML6029</u>	MERCEDES-BENZ	<u>ML6109</u>	BMW		BMW (BRILLIANCE)		
<u>ML6030</u>	MERCEDES-BENZ		BMW	<u>ML6110</u>	BMW		
<u>ML6031</u>	MERCEDES-BENZ		BMW	<u>ML6111</u>	BMW		
<u>ML6032</u>	MERCEDES-BENZ		CHRYSLER	<u>ML6112</u>	CHRYSLER		
<u>ML6033</u>	MERCEDES-BENZ		CHRYSLER (BBDC)		CHRYSLER (BBDC)		
	MG		CHRYSLER	<u>ML6113</u>	CHRYSLER		
	ROVER		CITROËN	<u>ML6114</u>	CITROËN		
<u>ML6035</u>	MINI		CITROËN	<u>ML6115</u>	CITROËN		
<u>ML6036</u>	MINI		JEEP	<u>ML6116</u>	JEEP		
<u>ML6037</u>	MINI		JEEP	<u>ML6117</u>	JEEP		
<u>ML6038</u>	MITSUBISHI		KIA	<u>ML6118</u>	KIA		
<u>ML6039</u>	MITSUBISHI		KIA	<u>ML6119</u>	KIA		
<u>ML6040</u>	NISSAN		MAZDA	<u>ML6120</u>	MAZDA		
<u>ML6041</u>	NISSAN		NISSAN	<u>ML6121</u>	NISSAN		
<u>ML6042</u>	NISSAN		OPEL	<u>ML6122</u>	OPEL		
<u>ML6043</u>	OPEL		PEUGEOT	<u>ML6123</u>	PEUGEOT		
	VAUXHALL		PEUGEOT (DF-PSA)		PEUGEOT (DF-PSA)		
<u>ML6044</u>	OPEL		PEUGEOT	<u>ML6124</u>	PEUGEOT		
	SUZUKI		RENAULT	<u>ML6125</u>	RENAULT		
	VAUXHALL		RENAULT	<u>ML6126</u>	RENAULT		
<u>ML6046</u>	OPEL		RENAULT	<u>ML6127</u>	RENAULT		
	VAUXHALL						

# MONROE® MAX-LIFT® OE CROSS REFERENCE LIST



	OE N°:	Ref.		OE N°:	Ref.		OE N°:	Ref.
<b>ALFA ROMEO</b>			AUDI	4D0823551B	ML5275	AUDI	8N8827552B	ML5449
ALFA ROMEO	46739202	ML5696	AUDI	4D0827551A	ML5275	AUDI	8P0823359	ML5269
ALFA ROMEO	46771551	ML5222	AUDI	4D0827551B	ML5275	AUDI	8P0823359A	ML5269
ALFA ROMEO	50508010	ML6149	AUDI	4E0823359C	ML5924	AUDI	8P0823359B	ML5269
ALFA ROMEO	50508060	ML5855	AUDI	4E0827551A	ML5316	AUDI	8P3827552A	ML5459
ALFA ROMEO	50508706	ML5655	AUDI	4E0827551B	ML5925	AUDI	8P3827552D	ML5460
ALFA ROMEO	50515442	ML5655	AUDI	4E0827552B	ML5926	AUDI	8P4827552B	ML5749
ALFA ROMEO	60505771	ML5597	AUDI	4E0827552C	ML5926	AUDI	8P7827552C	ML5922
ALFA ROMEO	60540532	ML5531	AUDI	4E827551C	ML5925	AUDI	8P7827552D	ML5922
ALFA ROMEO	60558222	ML5919	AUDI	4F0823359	ML5737	AUDI	8P7827552F	ML5922
ALFA ROMEO	60564112	ML5608	AUDI	4F0823359A	ML5737	AUDI	8R0823359A	ML5928
ALFA ROMEO	60566147	ML5274	AUDI	4F5827552	ML5744	AUDI	8R0827552	ML5856
ALFA ROMEO	60567794	ML5335	AUDI	4F5827552B	ML5744	AUDI	8R0827552A	ML5857
ALFA ROMEO	60577413	ML6138	AUDI	4F5827552B	ML6104	AUDI	8T0823359	ML5741
ALFA ROMEO	60583192	ML5532	AUDI	4F9827552B	ML5746	AUDI	8T8827552	ML6102
ALFA ROMEO	60591762	ML5273	AUDI	4F9827552C	ML5746	AUDI	8T8827552A	ML6102
ALFA ROMEO	60594694	ML6137	AUDI	4F9827552D	ML5746	AUDI	8Z0827552A	ML5370
ALFA ROMEO	60594694	ML6138	AUDI	4F9827552E	ML5746	AUDI	8Z0827552B	ML5370
ALFA ROMEO	60604174	ML5608	AUDI	4H0823359A	ML6106	AUDI	D0823354	ML5679
ALFA ROMEO	60604823	ML5271	AUDI	4H0823359B	ML6106	<b>AUSTIN</b>		
ALFA ROMEO	60612565	ML5272	AUDI	4H0823359D	ML6106	AUSTIN	AFP1282	ML5041
ALFA ROMEO	60622167	ML6137	AUDI	4H0827551B	ML6105	AUSTIN	BEP6628	ML5362
ALFA ROMEO	60622424	ML5419	AUDI	4L0823359	ML5739	<b>AUTOBIANCHI</b>		
ALFA ROMEO	60651067	ML5215	AUDI	4L0827552C	ML5774	AUTOBIANCHI	4480856	ML5017
ALFA ROMEO	60654724	ML5392	AUDI	4L0827552F	ML5774	AUTOBIANCHI	4484653	ML5017
ALFA ROMEO	60657685	ML5216	AUDI	4L0827552E	ML5929	AUTOBIANCHI	5970097	ML5598
ALFA ROMEO	60658924	ML5414	AUDI	893827552A	ML5533	AUTOBIANCHI	60617400	ML5598
ALFA ROMEO	60664833	ML5442	AUDI	895827552A	ML5534	<b>BMW</b>		
ALFA ROMEO	60680087	ML5698	AUDI	8A0823360A	ML5333	BMW	7060688	ML5691
ALFA ROMEO	60683933	ML6149	AUDI	8A5827552	ML5376	BMW	11811869147	ML5566
ALFA ROMEO	60688574	ML5697	AUDI	8A5827552A	ML5104	BMW	11811906286	ML5596
ALFA ROMEO	60689182	ML6138	AUDI	8A9827552D	ML5437	BMW	41612990344	ML6108
ALFA ROMEO	60694168	ML5921	AUDI	8D0823359	ML5679	BMW	41627166758	ML6141
ALFA ROMEO	60694616	ML5920	AUDI	8D0823359A	ML5679	BMW	51231868555	ML5599
ALFA ROMEO	605582220	ML5919	AUDI	8D0823359B	ML5679	BMW	51231869147	ML5600
ALFA ROMEO	606589240	ML5414	AUDI	8D5827552	ML5135	BMW	51231906286	ML5596
<b>AUDI</b>			AUDI	8D5827552A	ML5135	BMW	51231907962	ML5599
AUDI	441.827.551	ML5120	AUDI	8D5827552B	ML5135	BMW	51231908465	ML5566
AUDI	893823360	ML5593	AUDI	8D5827552C	ML5135	BMW	51231927129	ML5599
AUDI	893827552	ML5417	AUDI	8D5827552D	ML5135	BMW	51231944119	ML5522
AUDI	3B0823239A	ML5266	AUDI	8D5827552F	ML5135	BMW	51231960852	ML5421
AUDI	3B0823359	ML5266	AUDI	8D9827552	ML5197	BMW	51231869147	ML5600
AUDI	3B0823359B	ML5266	AUDI	8D9827552F	ML5198	BMW	51231906286	ML5596
AUDI	443823359B	ML5420	AUDI	8D9827552H	ML5198	BMW	51231907962	ML5599
AUDI	4A0823359B	ML5385	AUDI	8E0823359A	ML5386	BMW	51231908465	ML5566
AUDI	4A0823359C	ML5678	AUDI	8E5827552J	ML5745	BMW	51231927129	ML5599
AUDI	4A5827551	ML5428	AUDI	8E5827552K	ML5745	BMW	51231927129	ML5599
AUDI	4A5827552	ML5111	AUDI	8E5827552L	ML5745	BMW	51231944119	ML5522
AUDI	4A9827552	ML5418	AUDI	8E9827552E	ML5227	BMW	51231960852	ML5421
AUDI	4B0823359A	ML5266	AUDI	8E9827552G	ML5747	BMW	51231869147	ML5600
AUDI	4B0823359B	ML5266	AUDI	8E9827552H	ML5747	BMW	51231906286	ML5596
AUDI	4B0823359C	ML5266	AUDI	8F0827550A	ML6103	BMW	51231907962	ML5599
AUDI	4B5827552A	ML5234	AUDI	8G0827552C	ML5927	BMW	51231908465	ML5566
AUDI	4B5827552C	ML5234	AUDI	8G0827552B	ML5927	BMW	51231927129	ML5599
AUDI	4B5827552D	ML5234	AUDI	8H0823359	ML5269	BMW	51231944119	ML5522
AUDI	4B5827552F	ML5223	AUDI	8H0823359	ML5269	BMW	51231960852	ML5421
AUDI	4B5827552G	ML5223	AUDI	8H0827552B	ML5844	BMW	51233400352	ML5769
AUDI	4B9827552A	ML5238	AUDI	8J0823359C	ML5740	BMW	51237008745	ML5562
AUDI	4B9827552C	ML5239	AUDI	8J7827552	ML5930	BMW	51237016178	ML5938
AUDI	4B9827552D	ML5510	AUDI	8J8827552	ML5753	BMW	51237060550	ML5689
AUDI	4B9827552E	ML5239	AUDI	8K9827552	ML5918	BMW	51237070670	ML5932
AUDI	4B9827552G	ML5240	AUDI	8K9827552	ML5918	BMW	51237118370	ML5563
AUDI	4B9827552H	ML5510	AUDI	8K9827552	ML5923	BMW	51237148346	ML5936
AUDI	4B9827552I	ML5510	AUDI	8K9827552	ML5923	BMW	51.237.185.032	ML6142
AUDI	4B9827552J	ML5511	AUDI	8K9827552	ML5923	BMW	51237191528	ML6111
AUDI	4B9827552L	ML5239	AUDI	8K9827552	ML5923	BMW	51237191528	ML6111
AUDI	4B9827552M	ML5239	AUDI	8K9827552	ML5923	BMW	51238119558	ML5422
AUDI	4B9827552N	ML5512	AUDI	8K9827552A	ML5923	BMW	51238150077	ML5441
AUDI	4D0823359F	ML5276	AUDI	8L0823359	ML5261	BMW	51238174866	ML5336
			AUDI	8N0823359	ML5135	BMW	51238202688	ML5263
			AUDI	8N7827552A	ML6150	BMW	51238240596	ML5565
			AUDI	8N7827552C	ML6150	BMW	51238402551	ML5688
			AUDI	8N8827552	ML5277	BMW	51241908431	ML5934
			AUDI	8N8827552A	ML5449	BMW	51241934270	ML5444
						BMW	51241947096	ML5450
						BMW	51241960862	ML5170
						BMW	51242231663	ML5445
						BMW	51242264448	ML5260
						BMW	51242491349	ML5236
						BMW	51242990136	ML6109
						BMW	51243400379	ML5693
						BMW	51244212802	ML5163
						BMW	51244365788	ML5694
						BMW	51244394052	ML5694
						BMW	51247008754	ML5562

# MONROE® MAX-LIFT® OE CROSS REFERENCE LIST

	OE N°:	Ref.		OE N°:	Ref.		OE N°:	Ref.
BMW	51247008764	ML5695	CITROEN	792514	ML5461	CITROEN	8731.P2	ML5756
BMW	51247016186	ML5861	CITROEN	792520	ML5822	CITROEN	8731.P4	ML5755
BMW	51247038248	ML5671	CITROEN	873196	ML5503	CITROEN	8731.Q1	ML5776
BMW	51247060622	ML5691	CITROEN	873197	ML5503	CITROEN	8731.Q9	ML5950
BMW	51247060623	ML5694	CITROEN	949901	ML5204	CITROEN	8731.S0	ML5948
BMW	51247118885	ML5671	CITROEN	5429798	ML5606	CITROEN	8731.S1	ML5862
BMW	51247127875	ML5692	CITROEN	5459705	ML5609	CITROEN	8731.T0	ML5755
BMW	51247129194	ML5658	CITROEN	5490307	ML5609	CITROEN	8731.T1	ML5756
BMW	51247129215	ML5659	CITROEN	8,73E+06	ML5129	CITROEN	8731.V0	ML5968
BMW	51247191255	ML6110	CITROEN	75521825	ML5010	CITROEN	8731.A3	ML5454
BMW	51248110327	ML5444	CITROEN	8,73E+07	ML5435	CITROEN	8731.A8	ML5430
BMW	51248146290	ML5451	CITROEN	95492745	ML5011	CITROEN	8731.C0	ML5149
BMW	51248149327	ML5521	CITROEN	95496134	ML5019	CITROEN	8731.C1	ML5456
BMW	51248149328	ML5521	CITROEN	95568454	ML5601	CITROEN	8731.C2	ML5203
BMW	51248151579	ML5170	CITROEN	95568544	ML5604	CITROEN	8731.C3	ML5204
BMW	51248159239	ML5520	CITROEN	95598526	ML5603	CITROEN	8731.F1	ML5162
BMW	51248171158	ML5436	CITROEN	95631956	ML5607	CITROEN	8731.F5	ML5391
BMW	51248171480	ML5523	CITROEN	95635988	ML5602	CITROEN	8731.F6	ML5391
BMW	51248190688	ML5535	CITROEN	95635988	ML5604	CITROEN	8731.F7	ML5536
BMW	51248206652	ML5235	CITROEN	95635989	ML5605	CITROEN	8731.G3	ML5151
BMW	51248217305	ML5436	CITROEN	96026964	ML5505	CITROEN	8731.G6	ML5344
BMW	51248220075	ML5163	CITROEN	96027543	ML5033	CITROEN	8731.H8	ML5453
BMW	51248222913	ML5590	CITROEN	96095456	ML5504	CITROEN	8731.J4	ML6114
BMW	51248227895	ML5670	CITROEN	620915680	ML5430	CITROEN	8731.N1	ML5162
BMW	51248230070	ML5237	CITROEN	8,73E+08	ML5455	CITROEN	8731.P5	ML5950
BMW	51248230369	ML5521	CITROEN	1401103980	ML5950	CITROEN	8731.Q9	ML5950
BMW	51248230370	ML5521	CITROEN	1498071080	ML5950	CITROEN	8731.R6	ML6143
BMW	51248232873	ML5213	CITROEN	7552182580	ML5010	CITROEN	8731.R7	ML5652
BMW	51248251547	ML5671	CITROEN	7552182580	ML5011	CITROEN	96.618.151.80	ML5967
BMW	51248254281	ML5163	CITROEN	9556845480	ML5601	CITROEN	96472953808731.K0	ML5782
BMW	51248399087	ML5860	CITROEN	9558825480	ML5019	CITROEN	C101860033	ML5430
BMW	51248402405	ML5690	CITROEN	9559852680	ML5603	CITROEN	8731.K2	ML5963
BMW	51.327.200.197	ML6107	CITROEN	9560649080	ML5452	CITROEN	8731.L9	ML5962
<b>CHEVROLET</b>			CITROEN	9563195680	ML5607	CITROEN	8731.R8	ML5956
CHEVROLET	95962016	ML5943	CITROEN	9563598880	ML5602	CITROEN	8731.R9	ML5954
CHEVROLET	95962017	ML5943	CITROEN	9563598980	ML5605	CITROEN	8731.V6	ML5954
CHEVROLET	96306833	ML5096	CITROEN	9563914480	ML5457	CITROEN	8731.V8	ML6115
CHEVROLET	96306833	ML5941	CITROEN	9602754380	ML5033	CITROEN	8731.K1	ML5963
CHEVROLET	96310381	ML5446	CITROEN	9612212280	ML5506	<b>DACIA</b>		
CHEVROLET	96314606	ML5098	CITROEN	9612361280	ML5255	DACIA	8200735264	ML5864
CHEVROLET	96394240	ML5446	CITROEN	9618119180	ML5149	<b>DAEWOO</b>		
CHEVROLET	96507773	ML5098	CITROEN	9,62E+09	ML5435	DAEWOO	90159607	ML5031
CHEVROLET	96518910	ML5098	CITROEN	9,62E+09	ML5129	DAEWOO	96298318	ML5095
CHEVROLET	96540939	ML5714	CITROEN	9629618980	ML5270	DAEWOO	96301822	ML5507
CHEVROLET	96548931	ML5794	CITROEN	9637509380	ML5262	DAEWOO	96306157	ML5087
CHEVROLET	96557538	ML5096	CITROEN	9640894580	ML5536	DAEWOO	96306833	ML5096
CHEVROLET	96557538	ML5941	CITROEN	9641721980	ML5453	DAEWOO	96306833	ML5941
CHEVROLET	96557539	ML5098	CITROEN	9647295480	ML5668	DAEWOO	96310381	ML5513
CHEVROLET	96563503	ML5098	CITROEN	9650854180	ML5824	DAEWOO	96314606	ML5098
CHEVROLET	96598008	ML5098	CITROEN	9654433480	ML5756	DAEWOO	96324117	ML5087
CHEVROLET	96830123	ML5940	CITROEN	9654433580	ML5755	DAEWOO	96324119	ML5087
CHEVROLET	96830124	ML5939	CITROEN	9654433680	ML5961	DAEWOO	96394240	ML5513
CHEVROLET	96984466	ML5940	CITROEN	9654438680	ML5783	DAEWOO	96507773	ML5098
<b>CHRYSLER</b>			CITROEN	9654438780	ML5958	DAEWOO	96518910	ML5098
CHRYSLER	04589589AA	ML5946	CITROEN	9654438880	ML5959	DAEWOO	96540939	ML5714
CHRYSLER	04589607AA	ML5945	CITROEN	9682256580	ML5652	DAEWOO	96548931	ML5794
CHRYSLER	04589626AA	ML5944	CITROEN	10004215A	ML6114	DAEWOO	96557530	ML5095
CHRYSLER	04724743AD	ML6113	CITROEN	5802A007	ML5776	DAEWOO	96557538	ML5096
CHRYSLER	04724743AE	ML6113	CITROEN	5802A008	ML5776	DAEWOO	96557538	ML5941
CHRYSLER	05109605AC	ML5947	CITROEN	68950-0H020	ML5687	DAEWOO	96557539	ML5098
CHRYSLER	4589618AA	ML6112	CITROEN	7000510368CO	ML5862	DAEWOO	96563503	ML5098
CHRYSLER	5008938AA	ML5945	CITROEN	8731.J9	ML5824	DAEWOO	96598008	ML5098
CHRYSLER	5064659AA	ML5946	CITROEN	8731.K8	ML5967	DAEWOO	96601844	ML6140
CHRYSLER	G0004564	ML6113	CITROEN	8731.K99639853880	ML5151	DAEWOO	96666915	ML6140
CHRYSLER	KG004564	ML6113	CITROEN	8731.L0	ML5687	DAEWOO	81850A70802-000	ML5051
<b>CITROEN</b>			CITROEN	8731.N8	ML5959	DAEWOO-FSO	21273	ML5046
CITROEN	8,73E+03	ML5113	CITROEN	8731.N9	ML5783	DAEWOO-FSO	21331	ML5052
CITROEN	792511	ML5270	CITROEN	8731.P0	ML5958	DAEWOO-FSO	21333	ML5053
CITROEN	792513	ML5262	CITROEN	8731.P1	ML5961	DAEWOO-FSO	21377	ML5059



OE CROSS LIST

# MONROE® MAX-LIFT® OE CROSS REFERENCE LIST

	OE N°:	Ref.		OE N°:	Ref.		OE N°:	Ref.
DAEWOO-FSO	21408	ML5062	FIAT	46826216	ML5404	FORD	1219986	ML5233
DAEWOO-FSO	21457	ML5070	FIAT	46827091	ML5101	FORD	1224731	ML5207
DAEWOO-FSO	21458	ML5071	FIAT	46830389	ML5702	FORD	1225361	ML5978
DAEWOO-FSO	41190	ML5007	FIAT	46830389	ML5702	FORD	1232189	ML5373
DAEWOO-FSO	43882	ML5027	FIAT	46835404	ML5081	FORD	1251915	ML5205
DAEWOO-FSO	58084	ML5045	FIAT	51709681	ML5443	FORD	1252377	ML5288
DAEWOO-FSO	63397	ML5058	FIAT	51716995	ML5537	FORD	1252806	ML5288
DAEWOO-FSO	77187	ML5007	FIAT	51716996	ML5538	FORD	1313218	ML5415
DAEWOO-FSO	77187	ML5060	FIAT	51734960	ML5795	FORD	1321021	ML5416
DAEWOO-FSO	77763	ML5075	FIAT	51736743	ML5443	FORD	1336159	ML5786
DAEWOO-FSO	1171783	ML5027	FIAT	51736744	ML5443	FORD	1336230	ML5664
DAEWOO-FSO	4369120	ML5001	FIAT	51736745	ML5537	FORD	1349309	ML5664
<b>DAIHATSU</b>			FIAT	51736746	ML5538	FORD	1376673	ML5786
DAIHATSU	68950B1031	ML6084	FIAT	51778432	ML5775	FORD	1381555	ML5770
DAIHATSU	68960B1031	ML6084	FIAT	51785412	ML5785	FORD	1405189	ML5771
<b>FIAT</b>			FIAT	51801718	ML5975	FORD	1434296	ML5770
FIAT	21083	ML5030	FIAT	51812267	ML5784	FORD	1434313	ML5771
FIAT	4297742	ML5015	FIAT	71743352	ML5779	FORD	1453743	ML5979
FIAT	4392120	ML5011	FIAT	71743353	ML5779	FORD	1477988	ML5772
FIAT	4392129	ML5009	FIAT	75501720	ML5016	FORD	1484158	ML5704
FIAT	4392130	ML5010	FIAT	76063040	ML5282	FORD	1484371	ML5797
FIAT	4405569	ML5018	FIAT	82429686	ML5043	FORD	1496865	ML5704
FIAT	4418499	ML5042	FIAT	1354844080	ML5968	FORD	1650686	ML5285
FIAT	4424045	ML5074	FIAT	1489342080	ML5458	FORD	1661166	ML5110
FIAT	4483658	ML5016	FIAT	9622553680	ML5283	FORD	1666591	ML5980
FIAT	5975342	ML5011	FIAT	9626493880	ML5283	FORD	1666983	ML5388
FIAT	5981660	ML5041	FIAT	9630698380	ML5305	FORD	4346105	ML5514
FIAT	5993542	ML5012	FIAT	46720558P5	ML5973	FORD	4378216	ML5295
FIAT	5993542	ML5065	FIAT	46730681C3	ML5974	FORD	6151734	ML5539
FIAT	7516691	ML5064	FIAT	8731.P5	ML5950	FORD	6186916	ML5388
FIAT	7550172	ML5039	FIAT	8731.Q9	ML5950	FORD	6656800	ML5161
FIAT	7550938	ML5006	FIAT	SE14523200A	ML5016	FORD	6723080	ML5109
FIAT	7587706	ML5013	FIAT	XO-39401990	ML5010	FORD	6723080	ML5173
FIAT	7636049	ML5040	FIAT	XO-44836580	ML5016	FORD	6885988	ML5161
FIAT	7636049	ML5050	<b>FORD</b>			FORD	6900217	ML5109
FIAT	7636049	ML5112	FORD	108277	ML5147	FORD	6962811	ML5388
FIAT	7671700	ML5014	FORD	1008276	ML5147	FORD	7245797	ML5292
FIAT	7671700	ML5066	FORD	1009060	ML5127	FORD	7300069	ML5127
FIAT	7734566	ML5079	FORD	1025425	ML5136	FORD	9410495	ML5979
FIAT	7769737	ML5068	FORD	1034930	ML5399	FORD	1520777	ML5650
FIAT	7774707	ML5069	FORD	1047212	ML5127	FORD	1523356	ML5651
FIAT	39401990	ML5010	FORD	1070024	ML5224	FORD	1537538	ML5654
FIAT	39401990	ML5034	FORD	1071669	ML5168	FORD	1542413	ML5977
FIAT	39462450	ML5011	FORD	1071732	ML5466	FORD	1C15V406A10AD	ML5514
FIAT	39481770	ML5501	FORD	1072394	ML5466	FORD	1C15V406A10EA	ML5514
FIAT	46304290	ML5976	FORD	1074368	ML5224	FORD	1N31C406A10AB	ML5399
FIAT	46420780	ML5078	FORD	1079800	ML5168	FORD	1S7116C826AD	ML5330
FIAT	46453503	ML5081	FORD	1088369	ML5399	FORD	1S71A406A10AB	ML5232
FIAT	46514867	ML5377	FORD	1088369	ML5399	FORD	1S71A406A10CD	ML5233
FIAT	46524047	ML5086	FORD	1092108	ML5466	FORD	1S71A406AD10AC	ML5231
FIAT	46524049	ML5086	FORD	1093705	ML5168	FORD	1S71F406AD10AB	ML5502
FIAT	46524051	ML5086	FORD	1094814	ML5127	FORD	1S71N406A10AB	ML5374
FIAT	46524678	ML5165	FORD	1114031	ML5466	FORD	1S71N406A10AC	ML5373
FIAT	46530124	ML5462	FORD	1117046	ML5231	FORD	2N11N406A10AD	ML5289
FIAT	46559850	ML5389	FORD	1117246	ML5502	FORD	2S51B406A10AB	ML5205
FIAT	46559858	ML5389	FORD	1117394	ML5374	FORD	2S51B406A10AC	ML5205
FIAT	46720558	ML5973	FORD	1117690	ML5330	FORD	2S61B406A10AB	ML5206
FIAT	46730681	ML5974	FORD	1119688	ML5232	FORD	2S61B406A10AC	ML5207
FIAT	46744596	ML5164	FORD	1120812	ML5330	FORD	2T14V406A10AB	ML5295
FIAT	46762434	ML5443	FORD	1121248	ML5399	FORD	3M51R406A10AB	ML5288
FIAT	46773097	ML5404	FORD	1124003	ML5467	FORD	3S51B406A10-AA	ML5978
FIAT	46783650	ML5068	FORD	1136483	ML5169	FORD	4M51A406A10AB	ML5416
FIAT	46784590	ML5038	FORD	1141159	ML5206	FORD	4M51N406A10AA	ML5664
FIAT	46784994	ML5280	FORD	1146649	ML5169	FORD	4M51N406A10AB	ML5664
FIAT	46784995	ML5281	FORD	1150277	ML5224	FORD	51794232	ML5977
FIAT	46792437	ML5462	FORD	1150279	ML5224	FORD	5M51F406A10AA	ML5786
FIAT	46810696	ML5448	FORD	1211497	ML5289	FORD	5M51F406A10AB	ML5786
FIAT	46812168	ML5387	FORD	1212586	ML5289	FORD	6M21R406A10AB	ML5770
FIAT	46824070	ML5448	FORD	1218538	ML5205	FORD	6M21R406A10AD	ML5770





# MONROE® MAX-LIFT® OE CROSS REFERENCE LIST



	OE N°:	Ref.		OE N°:	Ref.		OE N°:	Ref.
FORD	6M21U406A10AB	ML5771	FORD	XS41F406A10AD	ML5466	HYUNDAI	81770-2L200	ML5990
FORD	6M21U406A10AC	ML5771	FORD	XS41F406A10AE	ML5466	HYUNDAI	81770-3J000	ML5991
FORD	6N41L406A10AA	ML5979	FORD	XS41F406A10AF	ML5467	HYUNDAI	81770-4H030	ML5989
FORD	7S71A406A10BA	ML5797	FORD	XS41N406A10AD	ML5168	HYUNDAI	817702B001	ML5993
FORD	7S71F406A10AF	ML5704	FORD	XS41N406A10AE	ML5168	HYUNDAI	81771-26010	ML5381
FORD	7S71N406A10AD	ML5772	FORD	XS41N406A10AH	ML5169	HYUNDAI	81771-2C010	ML5378
FORD	81ABD406A10BA	ML5286	FORD	XS41N406A10AJ	ML5169	HYUNDAI	81771-2C011	ML5378
FORD	81ABD406A10BB	ML5285	<b>HONDA</b>			HYUNDAI	81771-2C020	ML5379
FORD	83BBA406A10AD	ML5080	HONDA	04741-S10-000	ML5447	HYUNDAI	81771-2C021	ML5379
FORD	83BBA406A10BD	ML5253	HONDA	04741-S6A-000	ML5615	HYUNDAI	81771-2D210	ML5569
FORD	83BBA406A10CD	ML5614	HONDA	04741-SAA-000	ML5911	HYUNDAI	81771-2D220	ML5380
FORD	83BBN406A10AD	ML5293	HONDA	04741-SEG-900	ML5982	HYUNDAI	81771-2E000	ML5760
FORD	83BBN406A10BB	ML5294	HONDA	04746SJD000	ML5985	HYUNDAI	81771-38500	ML5994
FORD	84FBB406A10BB	ML5023	HONDA	74820-S1C-E01	ML5787	HYUNDAI	81771-39501	ML5994
FORD	84FBB406A10CB	ML5465	HONDA	74820-S1C-E018	ML5787	HYUNDAI	81771-3A001	ML5816
FORD	85GBA406A10BD	ML5291	HONDA	74820-S1E-E01	ML5122	HYUNDAI	81771-3D000	ML5154
FORD	85GBA406A10CD	ML5110	HONDA	74820-S5S-E01	ML5396	HYUNDAI	81771-3D001	ML5154
FORD	85GBA406A10DD	ML5612	HONDA	74820-S6D-E02	ML5371	HYUNDAI	81771-3D002	ML5154
FORD	86ABB406A10GA	ML5464	HONDA	74820-SH3-305	ML5567	HYUNDAI	81771-3K000	ML5761
FORD	86ABB406A10HA	ML5200	HONDA	74820-SK3-E20	ML5192	HYUNDAI	817711Z000	ML5869
FORD	86ABF406A10AA	ML5611	HONDA	74820-SK3-E20	ML5508	HYUNDAI	817712R000	ML5869
FORD	86ABW406A10CA	ML5286	HONDA	74820-SMG-E01	ML5836	HYUNDAI	81780-1J000	ML5868
FORD	86BBA406A10AA	ML5539	HONDA	74820-SMG-E010C1	ML5836	HYUNDAI	81780-22200	ML5157
FORD	86BBA406A10BA	ML5539	HONDA	74820-SMG-E02	ML5836	HYUNDAI	81780-25210	ML5986
FORD	86VBV406A10BA	ML5429	HONDA	74820-SMG-E021-M1	ML5836	HYUNDAI	81780-25220	ML5986
FORD	86VBV406A10CA	ML5076	HONDA	74820-SR3-003	ML5568	HYUNDAI	81780-2L200	ML5990
FORD	88BBA406A10BAD	ML5614	HONDA	74820-ST3-E01	ML5214	HYUNDAI	81780-4H030	ML5989
FORD	89ABB406A10HA	ML5201	HONDA	74820-ST3-E02	ML5214	HYUNDAI	817812R000	ML5869
FORD	89FBB406A10A1C	ML5141	HONDA	74820-ST3-E02	ML5214	HYUNDAI	817812R000	ML5869
FORD	89FBB406A10B1C	ML5142	HONDA	74820-ST3-E02	ML5214	HYUNDAI	87170-2E020	ML5762
FORD	8A61-A406A10-AB	ML5651	HONDA	74820-ST3-E51	ML5214	HYUNDAI	87171-26010	ML5297
FORD	8V41-S406A10-AD	ML5654	HONDA	74820-ST3-E52	ML5214	<b>INNOCENTI</b>		
FORD	8V41-S406A10-BB	ML5650	HONDA	74820-SWA-A01	ML5866	INNOCENTI	7516691	ML5064
FORD	91ABA406A10A1D	ML5171	HONDA	74820SCA003	ML5910	INNOCENTI	7636049	ML5040
FORD	91ABA406A10A1E	ML5171	HONDA	74820SCA0031	ML5910	INNOCENTI	7636049	ML5112
FORD	91ABA406A10C1	ML5172	HONDA	74820ST3E52	ML5622	INNOCENTI	53471007	ML5056
FORD	91ABA406A10C1E	ML5109	HONDA	74870-S5S-E01	ML5396	<b>IŽ</b>		
FORD	91ABW406A10A1C	ML5161	HONDA	74870-S6D-E02	ML5371	IŽ	2108-6308010	ML5114
FORD	91ABW406A10AF	ML5161	HONDA	74870-SWA-A01	ML5866	IŽ	2108-6308015	ML5024
FORD	91ABW406A10AG	ML5161	HONDA	74870S6DE01	ML5615	<b>JAGUAR</b>		
FORD	91ABW406A10C1C	ML5173	HONDA	BHE38017	ML5508	JAGUAR	1X4316C826AC	ML5832
FORD	93ABA406A10B1B	ML5252	HONDA	BHE38025	ML5192	JAGUAR	1X43F406A10AB	ML5996
FORD	93ABA406A10C1B	ML5109	HONDA	GTS120	ML5192	JAGUAR	C2S1687	ML5996
FORD	93BBA406A10AD	ML5126	HONDA	GTS122	ML5508	JAGUAR	C2S1927	ML5832
FORD	93BBA406A10AE	ML5126	HONDA	74820TL4G01	ML5983	JAGUAR	XR82401	ML5995
FORD	93BBA406A10BD	ML5176	HONDA	74820TL4G31	ML5984	JAGUAR	XR8316C826AA	ML5995
FORD	93BBF406A10AB	ML5290	<b>HYUNDAI</b>			JAGUAR	XR847319	ML5995
FORD	93BBF406A10BB	ML5431	HYUNDAI	8.177.025.550	ML6144	<b>JEEP</b>		
FORD	93BBN406A10AC	ML5332	HYUNDAI	8.177.025.560	ML6144	JEEP	55076208	ML5591
FORD	93FBB406A10AA	ML5143	HYUNDAI	8177129221	ML5296	JEEP	05109514AB	ML6116
FORD	93FBB406A10BA	ML5147	HYUNDAI	8.178.025.220	ML6144	JEEP	05109514AB	ML6117
FORD	9551-B460A10-AA	ML5977	HYUNDAI	8178025230	ML5986	JEEP	5109514AB	ML6117
FORD	95GB16C826AB	ML5292	HYUNDAI	8.178.025.230	ML6144	JEEP	5115226AB	ML6116
FORD	95VW442K08AE	ML5127	HYUNDAI	81160-2B010	ML5660	JEEP	55136764AA	ML6000
FORD	95VW442K08AG	ML5127	HYUNDAI	81160-3J000	ML5992	JEEP	55137022AB	ML6001
FORD	95VW442K08AH	ML5127	HYUNDAI	81161-26000	ML5382	JEEP	55137022AC	ML6001
FORD	96FBB406A10AA	ML5147	HYUNDAI	81161-2C000	ML5814	JEEP	55137023AB	ML6001
FORD	96FBB406A10BA	ML5147	HYUNDAI	81161-3D000	ML5570	JEEP	55352896AB	ML6000
FORD	96GBN406A10AF	ML5388	HYUNDAI	81161-3K000	ML5758	JEEP	55352897AB	ML6000
FORD	97KGB406A10AA	ML5136	HYUNDAI	8177-13-A00	ML5816	JEEP	55394472AA	ML5999
FORD	D83ABF406A10BA	ML5611	HYUNDAI	81770-06010	ML5987	JEEP	68025357AA	ML5998
FORD	V91ABL406A10AB	ML5980	HYUNDAI	81770-06011	ML5987	JEEP	68025359AA	ML5997
FORD	V91ABL50600AA	ML5981	HYUNDAI	81770-0X000	ML5867	<b>KIA</b>		
FORD	V97FBC406A10AB	ML5399	HYUNDAI	81770-17010	ML5616	KIA	0K2FB-62620	ML5711
FORD	V97FBC406A10AC	ML5399	HYUNDAI	81770-17030	ML5616	KIA	0K2FB-62620A	ML5711
FORD	V97FBC406A10AC	ML5399	HYUNDAI	81770-1C000	ML5759	KIA	0K2FB-62620B	ML5711
FORD	XS41A406A10AE	ML5224	HYUNDAI	81770-1C001	ML5759	KIA	0K2FB-63620	ML5711
FORD	XS41A406A10AF	ML5224	HYUNDAI	81770-1J000	ML5868	KIA	0K2FB-63620A	ML5711
FORD	XS41F406A10AC	ML5466	HYUNDAI	81770-22200	ML5157	KIA	0K2FB-63620B	ML5711
			HYUNDAI	81770-25220	ML5986	KIA	0K53Y-56620	ML5706

OE CROSS LIST

# MONROE® MAX-LIFT® OE CROSS REFERENCE LIST



	OE N°:	Ref.		OE N°:	Ref.		OE N°:	Ref.
KIA	0K53Y-56630	ML5706	LANCIA	82380453	ML5619	MAZDA	GS1M-63-620C	ML6012
KIA	0K53Y-62620	ML5709	LANCIA	82437256	ML5617	MAZDA	GS2A-63-620C	ML6013
KIA	0K53Y-63620	ML5709	LANCIA	82473205	ML5540	MAZDA	NF79-56-930B	ML5810
KIA	0K53Z-56620	ML5706	LANCIA	82486283	ML5482	MAZDA	NF80-56-930B	ML5810
KIA	0K53Z-56620A	ML5706	LANCIA	1479303080	ML5304	<b>MERCEDES</b>		
KIA	0K53Z-56620B	ML5706	LANCIA	1489342080	ML5458	MERCEDES	9802464	ML5102
KIA	0K53Z-56630	ML5706	LANCIA	9618278480	ML5304	MERCEDES	9802564	ML5102
KIA	0K53Z-56630A	ML5706	LANCIA	9630698380	ML5305	MERCEDES	9803764	ML5102
KIA	0K53Z-56630B	ML5706	<b>LAND ROVER</b>			MERCEDES	19808064	ML5674
KIA	0K53Z-62620	ML5709	LAND ROVER	393091	ML5306	MERCEDES	1637400345	ML5530
KIA	0K53Z-62620A	ML5709	LAND ROVER	32028398	ML5872	MERCEDES	1638800029	ML5559
KIA	0K53Z-63620	ML5709	LAND ROVER	32030482	ML5870	MERCEDES	1647400145	ML5806
KIA	0K53Z-63620A	ML5709	LAND ROVER	32030483	ML5870	MERCEDES	1647400245	ML5806
KIA	81161-4D000	ML6118	LAND ROVER	32031392	ML5871	MERCEDES	1648800029	ML6024
KIA	81181-3E000	ML5705	LAND ROVER	5H2216E610AA	ML5870	MERCEDES	1648800129	ML6025
KIA	81181-3E010	ML5705	LAND ROVER	5H22406A10BA	ML5871	MERCEDES	1689800164	ML5188
KIA	81181-3E011	ML5705	LAND ROVER	6H5216C826BD	ML6006	MERCEDES	1689800964	ML5188
KIA	81770-07000	ML5708	LAND ROVER	6H52406A10AF	ML6005	MERCEDES	1689801164	ML5188
KIA	81770-1D010	ML6002	LAND ROVER	ALR1050	ML5649	MERCEDES	1689801264	ML5188
KIA	81770-1G000	ML5712	LAND ROVER	BHE760020	ML5872	MERCEDES	1697400345	ML5717
KIA	81770-1H010	ML5723	LAND ROVER	BHE780012	ML5871	MERCEDES	1699800864	ML5718
KIA	81770-1H510	ML5839	LAND ROVER	BKK760010	ML6004	MERCEDES	1699800964	ML5718
KIA	81770-2F210	ML5713	LAND ROVER	BKK780010	ML5870	MERCEDES	1707500036	ML5680
KIA	81771-3C010	ML5710	LAND ROVER	LR001773	ML6006	MERCEDES	1708800229	ML6032
KIA	81771-3E011	ML5707	LAND ROVER	LR002104	ML6005	MERCEDES	1717500036	ML5818
KIA	81771-3E020	ML5707	LAND ROVER	LR009106	ML5870	MERCEDES	1718800129	ML5798
KIA	81780-07000	ML5708	LAND ROVER	MXC7833	ML5306	MERCEDES	1719800164	ML5799
KIA	81780-1D010	ML6002	LAND ROVER	XH4216E610AA	ML6004	MERCEDES	1719800164	ML5799
KIA	81780-1G000	ML5712	LAND ROVER	XH42406A10AA	ML5872	MERCEDES	2029800364	ML5307
KIA	81780-1H010	ML5723	<b>LEXUS</b>			MERCEDES	2037400045	ML5468
KIA	81780-1H510	ML5839	LEXUS	53440-0W090	ML6008	MERCEDES	2038800029	ML5577
KIA	81780-2F210	ML5713	LEXUS	53440-0W091	ML6008	MERCEDES	2038800429	ML5560
KIA	81780-2P000	ML6119	LEXUS	53440-0W100	ML6009	MERCEDES	2039800164	ML5673
KIA	817801H010	ML5723	LEXUS	53440-0W101	ML6009	MERCEDES	2039800764	ML6017
KIA	81781-3E011	ML5707	LEXUS	53450-0W070	ML6008	MERCEDES	2047400145	ML5719
KIA	81781-3E020	ML5707	LEXUS	53450-0W071	ML6008	MERCEDES	2048800029	ML5715
KIA	87170-1F100	ML5700	LEXUS	53450-0W080	ML6009	MERCEDES	2049800064	ML5715
KIA	87170-3E000	ML5823	LEXUS	53450-0W081	ML6009	MERCEDES	2079800564	ML5715
KIA	87170-3E010	ML5823	LEXUS	64530-0W090	ML6145	MERCEDES	2079801264	ML5715
KIA	87180-3E000	ML5823	LEXUS	64530-0W091	ML6145	MERCEDES	2087500036	ML6019
KIA	87180-3E010	ML5823	<b>MAZDA</b>			MERCEDES	2087500336	ML6019
KIA	OK01H-62-610E	ML5912	MAZDA	96FBB406A10BA	ML5147	MERCEDES	2087500336	ML6019
<b>LADA</b>			MAZDA	B1287F25	ML5403	MERCEDES	2088800029	ML5308
LADA	2108-6308010	ML5114	MAZDA	B1287F26	ML5542	MERCEDES	2099800064	ML5808
LADA	2108-6308015	ML5024	MAZDA	B28C62620B	ML5843	MERCEDES	2099800364	ML5808
LADA	2111-8231010	ML5107	MAZDA	B28C62620C	ML5843	MERCEDES	2099800564	ML5808
LADA	2111-8231015	ML5299	MAZDA	B28C63620B	ML5842	MERCEDES	2108800229	ML5438
LADA	2112-8231010	ML5108	MAZDA	B28C63620C	ML5842	MERCEDES	2108800429	ML5438
LADA	2121-6308010	ML5298	MAZDA	B28C63620C	ML5842	MERCEDES	2118800029	ML5309
LADA	2121-6308015	ML5025	MAZDA	BBM4-56-930A	ML6120	MERCEDES	2119800364	ML6021
LADA	21213-6308010	ML5114	MAZDA	BN8W-56-930	ML5764	MERCEDES	2119800464	ML6021
LADA	21213-6308015	ML5024	MAZDA	BN8W-56-930B	ML5764	MERCEDES	2158800029	ML5561
<b>LANCIA</b>			MAZDA	BP4K-62-620D	ML5763	MERCEDES	2207500136	ML6028
LANCIA	5970097	ML5139	MAZDA	BP4K-62-620F	ML5763	MERCEDES	2208800329	ML5620
LANCIA	7703325	ML5139	MAZDA	BP4K-63-620D	ML5763	MERCEDES	2217500216	ML5813
LANCIA	7792951	ML5159	MAZDA	BP4K-63-620F	ML5763	MERCEDES	2217500236	ML5813
LANCIA	46309135	ML5541	MAZDA	D651-62-620	ML5873	MERCEDES	2218800329	ML6029
LANCIA	46428438	ML5301	MAZDA	DD10-62-620	ML5765	MERCEDES	2307500036	ML5800
LANCIA	46429507	ML5483	MAZDA	DD10-63-620	ML5765	MERCEDES	2308800029	ML5811
LANCIA	46433702	ML5303	MAZDA	FE1556930C	ML6015	MERCEDES	2309800164	ML5801
LANCIA	46453835	ML5302	MAZDA	G21B62620A	ML5684	MERCEDES	2309800264	ML5802
LANCIA	46725028	ML5300	MAZDA	G21B63620A	ML5684	MERCEDES	2309800264	ML5802
LANCIA	46763101	ML5484	MAZDA	GE4V-62-620D	ML5847	MERCEDES	2517400045	ML6030
LANCIA	46817935	ML5703	MAZDA	GE4V-63-620D	ML5848	MERCEDES	2518800129	ML6026
LANCIA	46830389	ML5702	MAZDA	GE4V-63-620D	ML5848	MERCEDES	2518800229	ML6027
LANCIA	46830389	ML5702	MAZDA	GJ6A56930	ML6014	MERCEDES	2518800229	ML6027
LANCIA	51809199	ML6003	MAZDA	GJ6E56930	ML6014	MERCEDES	4149800064	ML5543
LANCIA	60617400	ML5139	MAZDA	GJ6J-62-620B	ML5683	MERCEDES	6389800364	ML5329
LANCIA	82336687	ML5618	MAZDA	GJ6J62620	ML5683	MERCEDES	6389800464	ML5328
			MAZDA	GJ6J63620	ML5683	MERCEDES	6389800464	ML5621
			MAZDA	GJ6J63620	ML5683	MERCEDES	6399800364	ML5716
			MAZDA	GS1D-56-930C	ML6011	MERCEDES	6399800364	ML5716
						MERCEDES	A1247500036	ML6020

# MONROE® MAX-LIFT® OE CROSS REFERENCE LIST



	OE N°:	Ref.		OE N°:	Ref.		OE N°:	Ref.
MERCEDES	A1299800664	ML6031	NISSAN	90450-AX000	ML5360	OPEL	132720	ML5156
MERCEDES	A2049801164	ML6016	NISSAN	90450-AX610	ML5360	OPEL	132721	ML5077
MERCEDES	A2049802264	ML6016	NISSAN	90450-BM400	ML5672	OPEL	132724	ML5054
MERCEDES	A2119800464	ML6021	NISSAN	90450-BM425	ML5672	OPEL	132725	ML5144
MERCEDES	A2127400045	ML6016	NISSAN	90450-BU000	ML5579	OPEL	132726	ML5369
MERCEDES	A2208800329	ML5620	NISSAN	90450-BU000	ML5579	OPEL	132727	ML5082
MERCEDES	A2049800764	ML6022	NISSAN	90450-EQ300	ML5809	OPEL	132729	ML5515
MERCEDES	A2049801564	ML6023	NISSAN	90450-EQ301	ML5809	OPEL	132730	ML5515
<b>MG</b>			NISSAN	90450-EQ30A	ML5809	OPEL	132731	ML5424
MG	AFP1282	ML5041	NISSAN	90450-EQ31A	ML5809	OPEL	132734	ML5835
MG	BHE140010	ML5410	NISSAN	90450-EQ325	ML5809	OPEL	132735	ML5407
MG	BHE140020	ML5622	NISSAN	90450-EQ325	ML5809	OPEL	132736	ML5515
MG	BHE45001	ML5434	NISSAN	90450-JD01B	ML5890	OPEL	132737	ML5515
MG	BHE450030	ML5434	NISSAN	90450-JG400	ML6042	OPEL	132739	ML5138
MG	BHE500050	ML5412	NISSAN	9045073R00	ML6041	OPEL	132741	ML5167
MG	BHE500070	ML5623	NISSAN	90450JG40A	ML6042	OPEL	132742	ML5137
MG	BKK500010	ML6033	NISSAN	90451-9C104	ML5582	OPEL	132749	ML5722
MG	BMH500010	ML5411	NISSAN	90451-9C130	ML5582	OPEL	132757	ML5721
<b>MINI</b>			NISSAN	90451-AX000	ML5360	OPEL	176105	ML6051
MINI	41626801258	ML5406	NISSAN	90451-EQ30A	ML5809	OPEL	176124	ML6051
MINI	41.626.801.258,00	ML6036	NISSAN	90451-EQ31A	ML5809	OPEL	176387	ML5179
MINI	41626801258	ML6037	NISSAN	90451-JG400	ML6042	OPEL	176413	ML5807
MINI	51237148864	ML6037	NISSAN	90451JG40A	ML6042	OPEL	176414	ML5827
MINI	51237175020	ML5564	NISSAN	90452-2F705	ML5433	OPEL	176541	ML6055
MINI	51.247.148.902,00	ML6036	NISSAN	90452-2F715	ML5580	OPEL	176601	ML5366
MINI	51247167442	ML6035	NISSAN	90452-2F725	ML5433	OPEL	176602	ML5366
<b>MITSUBISHI</b>			NISSAN	90452-2F726	ML5580	OPEL	176603	ML5365
MITSUBISHI	5802A007	ML5776	NISSAN	90452-3F200	ML5318	OPEL	176604	ML6047
MITSUBISHI	5802A008	ML5776	NISSAN	90452-3F201	ML5317	OPEL	176605	ML5210
MITSUBISHI	8731.Q1	ML5776	NISSAN	90452-3F202	ML5324	OPEL	176607	ML5341
MITSUBISHI	MB926947	ML5578	NISSAN	90452-6F100	ML5433	OPEL	176608	ML5773
MITSUBISHI	MB927791	ML5354	NISSAN	90452-6F126	ML5580	OPEL	176608	ML5773
MITSUBISHI	MR101555	ML5278	NISSAN	90452-8F825	ML5581	OPEL	176608	ML5773
MITSUBISHI	MR138596	ML5587	NISSAN	90452-98J26	ML5324	OPEL	176609	ML5817
MITSUBISHI	MR248939	ML5353	NISSAN	90452-9F725	ML5423	OPEL	176676	ML6053
MITSUBISHI	MR248940	ML5353	NISSAN	90452-AU200	ML5086	OPEL	176726	ML5119
MITSUBISHI	MR415171	ML6039	NISSAN	90452-AV700	ML5413	OPEL	1178224	ML5345
MITSUBISHI	MR415172	ML6039	NISSAN	90460-1W301	ML5700	OPEL	1180016	ML6049
MITSUBISHI	MR415173	ML6038	NISSAN	90460-6W560	ML5700	OPEL	1180402	ML5085
MITSUBISHI	MR415174	ML6038	<b>OPEL</b>			OPEL	1180405	ML5720
MITSUBISHI	MR959243	ML5661	OPEL	132020	ML6055	OPEL	4414419	ML5516
MITSUBISHI	MR959247	ML5662	OPEL	132.531,00	ML6146	OPEL	4705436	ML5088
MITSUBISHI	MR991807	ML5757	OPEL	132532	ML5805	OPEL	4705437	ML5089
MITSUBISHI	MR991808	ML5757	OPEL	132670	ML5120	OPEL	4705684	ML5088
<b>MOSKWICZ</b>			OPEL	132673	ML6043	OPEL	4705685	ML5089
MOSKWICZ	2141-6306206	ML5004	OPEL	132675	ML5103	OPEL	4808912	ML6046
<b>NISSAN</b>			OPEL	132677	ML5166	OPEL	4809275	ML5888
NISSAN	4414419	ML5516	OPEL	132681	ML5257	OPEL	5132262	ML5119
NISSAN	8465124	ML5837	OPEL	132682	ML5398	OPEL	5132267	ML6057
NISSAN	91168256	ML5516	OPEL	132691	ML5346	OPEL	9114311	ML5120
NISSAN	7700303186	ML5837	OPEL	132693	ML5391	OPEL	9152393	ML5257
NISSAN	7700308167	ML5837	OPEL	132694	ML5585	OPEL	9177081	ML5341
NISSAN	65470-40U10	ML5624	OPEL	132695	ML5586	OPEL	9180255	ML5773
NISSAN	65471-40U10	ML5624	OPEL	132696	ML5527	OPEL	9180256	ML5817
NISSAN	84430-2F000	ML5322	OPEL	132701	ML5390	OPEL	9.199.932,00	ML6146
NISSAN	84430-2F010	ML5321	OPEL	132702	ML5243	OPEL	9209569	ML5088
NISSAN	84430-90J00	ML5524	OPEL	132703	ML5244	OPEL	9209570	ML5089
NISSAN	84430-90J10	ML5525	OPEL	132704	ML5031	OPEL	9210307	ML5088
NISSAN	84430-9F500	ML5321	OPEL	132706	ML5834	OPEL	9210308	ML5089
NISSAN	84430-AV600	ML5352	OPEL	132708	ML5408	OPEL	10233372	ML5515
NISSAN	893020F600	ML6121	OPEL	132710	ML5407	OPEL	10233373	ML5515
NISSAN	90450-1W302	ML5781	OPEL	132712	ML5585	OPEL	10400854	ML5515
NISSAN	90450-1W312	ML5781	OPEL	132713	ML5527	OPEL	10400855	ML5515
NISSAN	90450-4F110	ML6040	OPEL	132714	ML5586	OPEL	13101335	ML5346
NISSAN	90450-4F111	ML6040	OPEL	132715	ML5258	OPEL	13122695	ML5721
NISSAN	90450-55A10	ML5409	OPEL	132716	ML5032	OPEL	13128759	ML5722
NISSAN	90450-79N02	ML5588	OPEL	132717	ML5367	OPEL	13182309	ML5807
NISSAN	90450-9C104	ML5582	OPEL	132718	ML5242	OPEL	13182537	ML5827
NISSAN	90450-9U00A	ML5701	OPEL	132719	ML5125	OPEL	13191401	ML5817

OE CROSS LIST

# MONROE® MAX-LIFT® OE CROSS REFERENCE LIST



	OE N°:	Ref.		OE N°:	Ref.		OE N°:	Ref.
OPEL	13220159	ML5805	OPEL	93193386	ML5078	PEUGEOT	9683207080	ML6123
OPEL	13241974	ML5773	OPEL	93193386	ML6044	PEUGEOT	9683422380	ML6060
OPEL	13241975	ML5119	OPEL	81860-83E10-X10	ML6044	PEUGEOT	8,73E+12	ML5183
OPEL	13243589	ML5723	OPEL	81860-84E00	ML6044	PEUGEOT	8,62214E+15	ML5625
OPEL	13246577	ML6051	<b>PAZ (ΠАЗ)</b>			PEUGEOT	5802A007	ML5776
OPEL	13247868	ML5817	PAZ (ΠАЗ)	2108-6308010	ML5114	PEUGEOT	5802A008	ML5776
OPEL	13247949	ML6053	<b>PEUGEOT</b>			PEUGEOT	68950-0H020	ML5687
OPEL	13252173	ML6049	PEUGEOT	8,73E+03	ML5113	PEUGEOT	7925.16	ML5788
OPEL	13.258.179	ML6122	PEUGEOT	8,73E+04	ML5432	PEUGEOT	8731.J3	ML5730
OPEL	13278257	ML6055	PEUGEOT	347040	ML5471	PEUGEOT	8731.J6	ML5728
OPEL	13332885	ML6055	PEUGEOT	792505	ML5583	PEUGEOT	8731.K4	ML5727
OPEL	24411022	ML5167	PEUGEOT	792506	ML5268	PEUGEOT	8731.K5	ML5729
OPEL	24454473	ML5345	PEUGEOT	792507	ML5517	PEUGEOT	8731.L0	ML5687
OPEL	24465295	ML5720	PEUGEOT	792508	ML5470	PEUGEOT	8731.L7	ML5731
OPEL	90043132	ML5398	PEUGEOT	792509	ML5267	PEUGEOT	8731.P8	ML5733
OPEL	90119276	ML5585	PEUGEOT	792510	ML5470	PEUGEOT	8731.P9	ML5732
OPEL	90127136	ML5585	PEUGEOT	792515	ML5160	PEUGEOT	8731.Q0	ML5732
OPEL	90127137	ML5527	PEUGEOT	862214	ML5625	PEUGEOT	8731.Q1	ML5776
OPEL	90127138	ML5586	PEUGEOT	862215	ML5628	PEUGEOT	8731.Q5	ML6060
OPEL	90138517	ML5527	PEUGEOT	873143	ML5067	PEUGEOT	8731.Q6	ML5734
OPEL	90138518	ML5586	PEUGEOT	873148	ML5364	PEUGEOT	8731.Q7	ML5889
OPEL	90158125	ML5391	PEUGEOT	873149	ML5364	PEUGEOT	8731.Q8	ML6058
OPEL	90159607	ML5031	PEUGEOT	873151	ML5311	PEUGEOT	8731.Q9	ML5950
OPEL	90159629	ML5834	PEUGEOT	873178	ML5202	PEUGEOT	8731.R8	ML5956
OPEL	90191627	ML5244	PEUGEOT	873179	ML5326	PEUGEOT	8731.T4	ML6123
OPEL	90191920	ML5243	PEUGEOT	873183	ML5426	PEUGEOT	8731.V6	ML5954
OPEL	90195260	ML5390	PEUGEOT	873185	ML5133	PEUGEOT	8731.VO	ML5968
OPEL	90195260	ML5395	PEUGEOT	873186	ML5133	PEUGEOT	8731A1	ML5316
OPEL	90196023	ML5835	PEUGEOT	873191	ML5134	PEUGEOT	8731A2	ML5323
OPEL	90227934	ML5258	PEUGEOT	873193	ML5148	PEUGEOT	8731A3	ML5626
OPEL	90227936	ML5032	PEUGEOT	5,10E+07	ML5146	PEUGEOT	8731A7	ML5180
OPEL	90241996	ML5407	PEUGEOT	8,73E+08	ML5363	PEUGEOT	8731C1	ML5627
OPEL	90246621	ML5408	PEUGEOT	7000510263	ML6058	PEUGEOT	8731C5	ML5319
OPEL	90275073	ML5366	PEUGEOT	7000510264	ML6060	PEUGEOT	8731C9	ML5471
OPEL	90275080	ML5366	PEUGEOT	7920062656	ML5067	PEUGEOT	8731F2	ML5343
OPEL	90275102	ML5365	PEUGEOT	7920071833	ML5364	PEUGEOT	8731F8	ML5425
OPEL	90341282	ML5077	PEUGEOT	8,73E+09	ML5146	PEUGEOT	8731F9	ML5358
OPEL	90341377	ML5156	PEUGEOT	9252280980	ML5625	PEUGEOT	8731G4	ML5340
OPEL	90341378	ML5125	PEUGEOT	9255607980	ML5628	PEUGEOT	8731G5	ML5469
OPEL	90346469	ML5367	PEUGEOT	9256119680	ML5020	PEUGEOT	8731G6	ML5344
OPEL	90379054	ML5210	PEUGEOT	9601430480	ML5180	PEUGEOT	8731G9	ML5358
OPEL	90379081	ML5103	PEUGEOT	9601430480	ML5426	PEUGEOT	8731S7	ML5851
OPEL	90388707	ML5144	PEUGEOT	9602673980	ML5583	PEUGEOT	8731V2	ML6124
OPEL	90463253	ML5179	PEUGEOT	9603762280	ML5202	PEUGEOT	8731.S0	ML5948
OPEL	90463721	ML5085	PEUGEOT	9603762380	ML5326	<b>PORSCHE</b>		
OPEL	90463749	ML5082	PEUGEOT	9605478880	ML5133	PORSCHE	9115113310	ML5646
OPEL	90463781	ML5424	PEUGEOT	9605478888	ML5133	PORSCHE	91151233101	ML5595
OPEL	90481180	ML5369	PEUGEOT	9610016680	ML5148	PORSCHE	91151233102	ML5594
OPEL	90481269	ML5242	PEUGEOT	9612504980	ML5180	PORSCHE	92851113903	ML5676
OPEL	90481270	ML5054	PEUGEOT	9612504980	ML5426	PORSCHE	94451135101	ML5846
OPEL	90486893	ML6047	PEUGEOT	9617046480	ML5323	PORSCHE	95551135900	ML6069
OPEL	90521517	ML5166	PEUGEOT	9619988380	ML5148	PORSCHE	95551255100	ML6068
OPEL	90559245	ML5138	PEUGEOT	9622165080	ML5316	PORSCHE	98651255101	ML6066
OPEL	90579440	ML5137	PEUGEOT	9,62E+09	ML5432	PORSCHE	99351133100	ML6062
OPEL	91163328	ML6057	PEUGEOT	9626771680	ML5319	PORSCHE	99651155101	ML6147
OPEL	91168256	ML5516	PEUGEOT	9628157780	ML5470	PORSCHE	99651255102	ML6065
OPEL	93386999	ML5119	PEUGEOT	9629219580	ML5267	PORSCHE	99651255103	ML6065
OPEL	96661403	ML5888	PEUGEOT	9630662480	ML5470	PORSCHE	99751155101	ML5803
OPEL	96664104	ML6046	PEUGEOT	9,64E+09	ML5183	PORSCHE	99751255100	ML5804
OPEL	96830123	ML5888	PEUGEOT	9637115080	ML5343	PORSCHE	7L5823359	ML6069
OPEL	97211748	ML6043	PEUGEOT	9638605280	ML5425	PORSCHE	7L5845587B	ML6068
OPEL	132709 90246620	ML5408	PEUGEOT	9642209980	ML5469	PORSCHE	928.511.139.05	ML5676
OPEL	90241995	ML5407	PEUGEOT	9642210080	ML5340	PORSCHE	987.512.551.01	ML6067
OPEL	132743	ML5669	PEUGEOT	9647261480	ML5727	PORSCHE	987.512.551.05	ML6067
OPEL	4708556	ML5078	PEUGEOT	9647487680	ML5728	<b>RENAULT</b>		
OPEL	4708557	ML5078	PEUGEOT	9647487880	ML5729	RENAULT	8453460	ML5724
OPEL	4708557	ML6044	PEUGEOT	9649587680	ML5730	RENAULT	8489348	ML5826
OPEL	24463829	ML5669	PEUGEOT	9656592980	ML5727	RENAULT	32062565	ML5725
OPEL	93193385	ML5078	PEUGEOT	9656593180	ML5729	RENAULT	6025001988	ML5629

# MONROE® MAX-LIFT® OE CROSS REFERENCE LIST



	OE N°:	Ref.		OE N°:	Ref.		OE N°:	Ref.
RENAULT	6025003919	ML5629	RENAULT	8200021975	ML5519	ROVER	GSA925	ML5192
RENAULT	6025005935	ML5320	RENAULT	8200025105	ML5551	ROVER	GSA930	ML5634
RENAULT	6025006621	ML5320	RENAULT	8200025317	ML5474	ROVER	GTS120	ML5192
RENAULT	6025100991	ML5546	RENAULT	8200051750	ML5212	ROVER	GTS122	ML5634
RENAULT	6025101952	ML5313	RENAULT	8200091749	ML5472	<b>SAAB</b>		
RENAULT	6025106762	ML5314	RENAULT	8200119497	ML5789	SAAB	4006060	ML5557
RENAULT	6025300735	ML5228	RENAULT	8200119498	ML5372	SAAB	4006078	ML5495
RENAULT	6025305941	ML5229	RENAULT	8200119500	ML5475	SAAB	4323994	ML5350
RENAULT	6025306563	ML5230	RENAULT	8200130187	ML5552	SAAB	4323994	ML5636
RENAULT	6025312658	ML5546	RENAULT	8200135264	ML5812	SAAB	4324307	ML5401
RENAULT	6025401711	ML5351	RENAULT	8200162697	ML5550	SAAB	4326468	ML5400
RENAULT	7700272026	ML5093	RENAULT	8200174571	ML5826	SAAB	4699260	ML5637
RENAULT	7700303139	ML5128	RENAULT	8200212598	ML5828	SAAB	4699260	ML5638
RENAULT	7700303186	ML5128	RENAULT	8200219322	ML5724	SAAB	4854717	ML5375
RENAULT	7700413083	ML5476	RENAULT	8200219323	ML6075	SAAB	4854733	ML5375
RENAULT	7700414002	ML5477	RENAULT	8200299546	ML5725	SAAB	4854741	ML6076
RENAULT	7700418621	ML5158	RENAULT	8200362400	ML5473	SAAB	4854758	ML6076
RENAULT	7700421906	ML5155	RENAULT	8200377199	ML5826	SAAB	4855094	ML5558
RENAULT	7700427547	ML5383	RENAULT	8200377789	ML5475	SAAB	5022082	ML5397
RENAULT	7700430022	ML5153	RENAULT	8200385560	ML5891	SAAB	5117015	ML5558
RENAULT	7700434465	ML5152	RENAULT	8200461349	ML6075	SAAB	5183017	ML5349
RENAULT	7700753540	ML5633	RENAULT	8200497806	ML5892	SAAB	5360821	ML5638
RENAULT	7700785587	ML5632	RENAULT	8200583852	ML5656	SAAB	5360839	ML5558
RENAULT	7700786247	ML5004	RENAULT	654700008R	ML6127	SAAB	6956262	ML5498
RENAULT	7700786248	ML5256	RENAULT	654710003R	ML6074	SAAB	6956270	ML5499
RENAULT	7700787749	ML5337	RENAULT	7000510521CO	ML6126	SAAB	6956288	ML5494
RENAULT	7700795698	ML5631	RENAULT	7000510523BO	ML6128	SAAB	6976369	ML5496
RENAULT	7700795731	ML5631	RENAULT	7000510524BO	ML6125	SAAB	9231796	ML5613
RENAULT	7700799026	ML5004	RENAULT	844300001R	ML5657	SAAB	9233727	ML5613
RENAULT	7700799027	ML5256	RENAULT	844300004R	ML5893	SAAB	9253964	ML5497
RENAULT	7700800311	ML5093	RENAULT	844300006R	ML6126	SAAB	9270240	ML5556
RENAULT	7700807057	ML5315	RENAULT	844300009R	ML6073	SAAB	9293580	ML5635
RENAULT	7700810554	ML5254	RENAULT	844310002R	ML5893	SAAB	12761582	ML5638
RENAULT	7700811019	ML5554	RENAULT	904500004R	ML6128	SAAB	12778556	ML5852
RENAULT	7700811570	ML5310	RENAULT	904505599R	ML6070	SAAB	12785021	ML5790
RENAULT	7700812193	ML5327	RENAULT	904510001R	ML6071	SAAB	12797509	ML5852
RENAULT	7700815135	ML5331	RENAULT	904510002R	ML6072	SAAB	12831543	ML5766
RENAULT	7700818237	ML5094	RENAULT	904510005R	ML6125	SAAB	30586552	ML5349
RENAULT	7700823271	ML5279	RENAULT	904513981R	ML6070	SAAB	104323994	ML5350
RENAULT	7700824817	ML5553	RENAULT	904600001R	ML6063	SAAB	104854733	ML5402
RENAULT	7700828451	ML5131	RENAULT	E84827465A	ML5894	SAAB	105183017	ML5349
RENAULT	7700828454	ML5130	RENAULT	7700848404	ML5686	SAAB	127850021	ML5790
RENAULT	7700829764	ML5279	RENAULT	7700848464	ML5686	SAAB	1012831543	ML5766
RENAULT	7700829825	ML5555	<b>ROVER</b>			<b>SEAT</b>		
RENAULT	7700831959	ML5554	ROVER	AFP1282	ML5041	SEAT	110827550	ML5124
RENAULT	7700832534	ML5555	ROVER	BEP6628	ML5362	SEAT	110827550A	ML5124
RENAULT	7700838005	ML5383	ROVER	BHE140010	ML5410	SEAT	1M0823359A	ML5342
RENAULT	7700838006	ML5547	ROVER	BHE140020	ML5478	SEAT	1M5827550B	ML5193
RENAULT	7700838487	ML5526	ROVER	BHE38017	ML5634	SEAT	1M6827550A	ML5181
RENAULT	7700838612	ML5182	ROVER	BHE38025	ML5192	SEAT	1P0827550	ML5767
RENAULT	7700838690	ML5526	ROVER	BHE39005	ML5208	SEAT	1P0827550A	ML5767
RENAULT	7700842152	ML5279	ROVER	BHE39006	ML5209	SEAT	3R9827550	ML6129
RENAULT	7700842153	ML5279	ROVER	BHE41003	ML5384	SEAT	5P0827550A	ML5100
RENAULT	7700842256	ML5241	ROVER	BHE41004	ML5384	SEAT	5P5827550	ML5584
RENAULT	7700843698	ML5131	ROVER	BHE45001	ML5434	SEAT	5P8827550	ML5845
RENAULT	7700846538	ML5383	ROVER	BHE45003	ML5394	SEAT	6E0827550C	ML5195
RENAULT	7700846772	ML5544	ROVER	BHE450030	ML5394	SEAT	6J3827550	ML6078
RENAULT	7700846773	ML5545	ROVER	BHE450030	ML5434	SEAT	6J4827550	ML5850
RENAULT	7701033344	ML5549	ROVER	BHE450030	ML5815	SEAT	6J4827550B	ML5850
RENAULT	770E+09	ML5894	ROVER	BHE500050	ML5412	SEAT	6K0827550	ML5100
RENAULT	7701057303	ML6073	ROVER	BHE500070	ML5479	SEAT	6K0827550A	ML5100
RENAULT	7702144629	ML5021	ROVER	BHM410040	ML5338	SEAT	6K5827550	ML5063
RENAULT	7702149568	ML5630	ROVER	BKK41003	ML5359	SEAT	6K5827550C	ML5259
RENAULT	7703024021	ML5548	ROVER	BKK500010	ML6033	SEAT	6K6827550	ML5140
RENAULT	8200000896	ML5548	ROVER	BMH38003	ML6148	SEAT	6K6827550A	ML5211
RENAULT	8200000902	ML5189	ROVER	BMH38004	ML6148	SEAT	6L5827550B	ML5778
RENAULT	8200000903	ML5440	ROVER	BMH500010	ML5411	SEAT	6L6827550B	ML5225
RENAULT	8200003020	ML5190	ROVER	GSA922	ML5208	SEAT	6R9827550	ML6129
RENAULT	8200021974	ML5518	ROVER	GSA923	ML5209	SEAT	6X0827550	ML5284

OE CROSS LIST



# MONROE® MAX-LIFT® OE CROSS REFERENCE LIST

	OE N°:	Ref.		OE N°:	Ref.		OE N°:	Ref.
SEAT	6X0827550A	ML5284	SMART	Q0009223V003000000	ML5813	TOYOTA	68950-09100	ML5963
SEAT	7M0827550D	ML5127	SMART	Q0009235V004000000	ML6082	TOYOTA	68950-09110	ML5821
SEAT	7M0827550F	ML5127	SMART	Q0009235V005000000	ML6082	TOYOTA	68950-09140	ML5647
SEAT	7M0827550G	ML5127	<b>SSANGYONG</b>			TOYOTA	68950-09140	ML5699
SEAT	7M3823359A	ML5480	SSANGYONG	7115008100	ML5355	TOYOTA	68950-09150	ML5699
SEAT	7M3827550A	ML5480	SSANGYONG	7140608100	ML5334	TOYOTA	68950-0D020	ML5777
SEAT	8E0823359A	ML5386	SSANGYONG	7140608110	ML5334	TOYOTA	68950-0D021	ML5777
SEAT	8L0823359	ML5284	SSANGYONG	7141608100	ML5334	TOYOTA	68950-0D022	ML5777
SEAT	SE021526200A	ML5022	SSANGYONG	7141608110	ML5334	TOYOTA	68950-0F010	ML5666
SEAT	SE02252620A	ML5011	SSANGYONG	7143608100	ML5356	TOYOTA	68950-0F011	ML5666
SEAT	SE023529200A	ML5639	SSANGYONG	7145009000	ML5889	TOYOTA	68950-0F012	ML5666
SEAT	SE028526200B	ML5016	SSANGYONG	7146009000	ML5889	TOYOTA	68950-0F030	ML6135
SEAT	W06K5827550	ML5063	<b>SUBARU</b>			TOYOTA	68950-0F031	ML6135
SEAT	W06K6827550	ML5140	SUBARU	60315FA010	ML5820	TOYOTA	68950-0H010	ML6151
SEAT	W1L0827550	ML5124	SUBARU	60335FA000	ML5820	TOYOTA	68950-0H020	ML6151
SEAT	XO-39303770	ML5042	SUBARU	60335FA100	ML5820	TOYOTA	68950-0Q010	ML6134
SEAT	XO-39401990	ML5010	SUBARU	60335FA120	ML5820	TOYOTA	68950-0W101	ML5641
SEAT	XO-39440480	ML5011	SUBARU	63269FE000	ML5819	TOYOTA	68950-0W140	ML5486
SEAT	XO-39462450	ML5011	SUBARU	68950B1031	ML6084	TOYOTA	68950-0W170	ML5485
SEAT	XO-39481770	ML5501	SUBARU	68960B1031	ML6084	TOYOTA	68950-0W251	ML5917
SEAT	XO-39503120	ML5022	SUBARU	81850-86G00	ML5780	TOYOTA	68950-0W541	ML6134
SEAT	XO-39507910	ML5022	SUBARU	81860-86G00	ML5780	TOYOTA	68960-02010	ML5963
SEAT	XO-39553290	ML5016	<b>SUZUKI</b>			TOYOTA	68960-02010	ML6087
SEAT	XO-42977420	ML5015	SUZUKI	4705436	ML6044	TOYOTA	68960-02020	ML5963
SEAT	XO39543290	ML5639	SUZUKI	4705437	ML6044	TOYOTA	68960-02030	ML5485
<b>SKODA</b>			SUZUKI	81800-62831	ML5091	TOYOTA	68960-02081	ML5900
SKODA	1U6827550	ML5217	SUZUKI	81800-62841	ML5092	TOYOTA	68960-02081	ML5900
SKODA	1U6827550A	ML5217	SUZUKI	81800-63811	ML6086	TOYOTA	68960-05050	ML5121
SKODA	1U6827550B	ML5217	SUZUKI	81801-62811-000	ML6086	TOYOTA	68960-05060	ML5699
SKODA	1U6827550C	ML5217	SUZUKI	81850-51810	ML5078	TOYOTA	68960-05072	ML5699
SKODA	1U6827550E	ML5218	SUZUKI	81850-62B20	ML5091	TOYOTA	68960-09050	ML5592
SKODA	1U6827550F	ML5219	SUZUKI	81850-62J00	ML6086	TOYOTA	68960-09060	ML5963
SKODA	1U6827550G	ML5220	SUZUKI	81850-83E10	ML5088	TOYOTA	68960-09060	ML6087
SKODA	1U6827550H	ML5221	SUZUKI	81850-84E00	ML5088	TOYOTA	68960-09080	ML5592
SKODA	1U9827550A	ML5045	SUZUKI	81850-84E00	ML5088	TOYOTA	68960-09090	ML5647
SKODA	1U9827550B	ML5045	SUZUKI	81850-86G-00-000	ML5780	TOYOTA	68960-09090	ML5699
SKODA	1Z5827550	ML5665	SUZUKI	81850-86G00-X10	ML5780	TOYOTA	68960-09100	ML5699
SKODA	1Z5827550B	ML5665	SUZUKI	81850-M68K00	ML6131	TOYOTA	68960-09120	ML5821
SKODA	1Z5827550C	ML5665	SUZUKI	81850-M76G20-A	ML5589	TOYOTA	68960-0D010	ML5777
SKODA	1Z5827550D	ML5665	SUZUKI	8185079J00	ML5779	TOYOTA	68960-0D011	ML5777
SKODA	1Z5827550E	ML5665	SUZUKI	8185185C00	ML6085	TOYOTA	68960-0D012	ML5777
SKODA	1Z5827550F	ML5665	SUZUKI	81860-51810	ML5078	TOYOTA	68960-0D012	ML5777
SKODA	1Z9827550	ML5667	SUZUKI	81860-62B20	ML5092	TOYOTA	68960-0F010	ML5666
SKODA	3B5827550E	ML5439	SUZUKI	81860-62B20	ML5092	TOYOTA	68960-0F011	ML5666
SKODA	3T0823359	ML6079	SUZUKI	81860-83E10	ML5089	TOYOTA	68960-0F012	ML5666
SKODA	3T5827550	ML6080	SUZUKI	81860-84E00	ML5089	TOYOTA	68960-0F030	ML6135
SKODA	3U0823359	ML5768	SUZUKI	81860-86G-00-000	ML5780	TOYOTA	68960-0F031	ML6135
SKODA	41-9.6442-047.6	ML5048	SUZUKI	81860-M68K00	ML6131	TOYOTA	68960-0Q010	ML6134
SKODA	441-9.6442-047.6	ML5061	SUZUKI	81860-M70F10-000	ML5589	TOYOTA	68960-0Q010	ML6134
SKODA	441-9.6442-048.6	ML5044	SUZUKI	81860-M76G20-A	ML5589	TOYOTA	68960-0W091	ML5641
SKODA	441-9.6492-038.6	ML5005	SUZUKI	8186079J00	ML5779	TOYOTA	68960-0W140	ML5486
SKODA	441.5.6442-006.6	ML5036	SUZUKI	8186079J01	ML5779	TOYOTA	68960-0W170	ML5485
SKODA	441.6.6442-007.6	ML5037	SUZUKI	8186079J01	ML5779	TOYOTA	68960-0W240	ML5917
SKODA	441.6.6442.008.6	ML5057	SUZUKI	81860A80100	ML5492	TOYOTA	68960-0W531	ML6134
SKODA	5J6827550B	ML5681	SUZUKI	9390085C00	ML5493	TOYOTA	689600W570	ML6133
SKODA	5J7827550	ML5682	<b>TOYOTA</b>			TOYOTA	689600W580	ML6133
SKODA	5L6827550	ML6130	TOYOTA	6895005080	ML6132	TOYOTA	8731.10	ML6151
SKODA	6U0827551A	ML5061	TOYOTA	6896005081	ML6132	<b>TWEKS (TB&amp;KC)</b>		
SKODA	6U0827551B	ML5061	TOYOTA	68940-05072	ML5699	TWEKS	2108-6308015	ML5024
SKODA	6Y0827550A	ML5175	TOYOTA	68950-02020	ML5963	<b>UAZ</b>		
SKODA	6Y5827550A	ML5135	TOYOTA	68950-02020	ML6087	UAZ	2121-6308015	ML5025
SKODA	3T5827552	ML6081	TOYOTA	68950-02030	ML5963	<b>VAUXHALL</b>		
<b>SMART</b>			TOYOTA	68950-02040	ML5485	VAUXHALL	132020	ML6055
SMART	113000013	ML5640	TOYOTA	68950-02091	ML5900	VAUXHALL	132670	ML5120
SMART	0000618V007	ML5640	TOYOTA	68950-02091	ML5900	VAUXHALL	132675	ML5103
SMART	0009223V	ML5813	TOYOTA	68950-05010	ML6089	VAUXHALL	132677	ML5166
SMART	0009223V005	ML5813	TOYOTA	68950-05020	ML6089	VAUXHALL	132677	ML5166
SMART	0009223V005	ML5813	TOYOTA	68950-05020	ML6089	VAUXHALL	132681	ML5257
SMART	A4519880004	ML6083	TOYOTA	68950-05050	ML5121	VAUXHALL	132681	ML5257
SMART	A4547400145	ML5895	TOYOTA	68950-05060	ML5699	VAUXHALL	132682	ML5398
			TOYOTA	68950-09050	ML5592	VAUXHALL	132691	ML5346
			TOYOTA	68950-09080	ML5592	VAUXHALL	132693	ML5391
			TOYOTA	68950-09090	ML5963	VAUXHALL	132694	ML5585
			TOYOTA	68950-09090	ML6087	VAUXHALL	132695	ML5586

# MONROE® MAX-LIFT® OE CROSS REFERENCE LIST

	OE N°:	Ref.		OE N°:	Ref.		OE N°:	Ref.
VAUXHALL	132696	ML5527	VAUXHALL	10233373	ML5515	VOLVO	1355263	ML5312
VAUXHALL	132701	ML5390	VAUXHALL	10400854	ML5515	VOLVO	1376115	ML6090
VAUXHALL	132702	ML5243	VAUXHALL	10400855	ML5515	VOLVO	3344245	ML5642
VAUXHALL	132703	ML5244	VAUXHALL	13101335	ML5346	VOLVO	3436644	ML5509
VAUXHALL	132704	ML5031	VAUXHALL	13128759	ML5722	VOLVO	3436644	ML5571
VAUXHALL	132706	ML5528	VAUXHALL	13182309	ML5807	VOLVO	3470348	ML5571
VAUXHALL	132708	ML5408	VAUXHALL	13182537	ML5827	VOLVO	3470350	ML5509
VAUXHALL	132710	ML5407	VAUXHALL	13191401	ML5817	VOLVO	3470350	ML5571
VAUXHALL	132712	ML5585	VAUXHALL	13241974	ML5773	VOLVO	3509482	ML5529
VAUXHALL	132713	ML5527	VAUXHALL	13246577	ML6051	VOLVO	3512998	ML5840
VAUXHALL	132714	ML5586	VAUXHALL	13247868	ML5817	VOLVO	3526575	ML5347
VAUXHALL	132715	ML5258	VAUXHALL	13247949	ML6053	VOLVO	3529925	ML5348
VAUXHALL	132716	ML5032	VAUXHALL	13252173	ML6049	VOLVO	6846014	ML5312
VAUXHALL	132717	ML5367	VAUXHALL	13278257	ML6055	VOLVO	8600233	ML5481
VAUXHALL	132718	ML5242	VAUXHALL	13321298	ML6051	VOLVO	8650233	ML5481
VAUXHALL	132719	ML5125	VAUXHALL	13332570	ML6051	VOLVO	9154605	ML5643
VAUXHALL	132720	ML5156	VAUXHALL	13332885	ML6055	VOLVO	9159604	ML5908
VAUXHALL	132721	ML5077	VAUXHALL	24411022	ML5167	VOLVO	9159605	ML5908
VAUXHALL	132724	ML5054	VAUXHALL	24454473	ML5345	VOLVO	9187315	ML5529
VAUXHALL	132725	ML5144	VAUXHALL	90043132	ML5398	VOLVO	9187795	ML5908
VAUXHALL	132726	ML5369	VAUXHALL	90119276	ML5585	VOLVO	9187796	ML5908
VAUXHALL	132727	ML5082	VAUXHALL	90127136	ML5585	VOLVO	9483297	ML5489
VAUXHALL	132729	ML5515	VAUXHALL	90127137	ML5527	VOLVO	9483299	ML5489
VAUXHALL	132730	ML5515	VAUXHALL	90127138	ML5586	VOLVO	9483570	ML5726
VAUXHALL	132731	ML5424	VAUXHALL	90138517	ML5527	VOLVO	9485546	ML5908
VAUXHALL	132734	ML5835	VAUXHALL	90138518	ML5586	VOLVO	9485547	ML5908
VAUXHALL	132735	ML5407	VAUXHALL	90158125	ML5391	VOLVO	9485548	ML5529
VAUXHALL	132736	ML5515	VAUXHALL	90159607	ML5031	VOLVO	9485706	ML5487
VAUXHALL	132737	ML5515	VAUXHALL	90159629	ML5528	VOLVO	30634580	ML5427
VAUXHALL	132739	ML5138	VAUXHALL	90191627	ML5244	VOLVO	30649439	ML5490
VAUXHALL	132741	ML5167	VAUXHALL	90191920	ML5243	VOLVO	30649516	ML5663
VAUXHALL	132742	ML5137	VAUXHALL	90195260	ML5390	VOLVO	30649736	ML5361
VAUXHALL	132749	ML5722	VAUXHALL	90195260	ML5395	VOLVO	30649836	ML6091
VAUXHALL	176387	ML5179	VAUXHALL	90196023	ML5835	VOLVO	30657235	ML5907
VAUXHALL	176413	ML5807	VAUXHALL	90227934	ML5258	VOLVO	30674203	ML5488
VAUXHALL	176414	ML5827	VAUXHALL	90227936	ML5032	VOLVO	30674494	ML5685
VAUXHALL	176541	ML6055	VAUXHALL	90241996	ML5407	VOLVO	30674718	ML5500
VAUXHALL	176601	ML5366	VAUXHALL	90246621	ML5408	VOLVO	30674836	ML6092
VAUXHALL	176602	ML5366	VAUXHALL	90275073	ML5366	VOLVO	30674971	ML5488
VAUXHALL	176603	ML5365	VAUXHALL	90275080	ML5366	VOLVO	30716189	ML5500
VAUXHALL	176604	ML6047	VAUXHALL	90275102	ML5365	VOLVO	30779837	ML6091
VAUXHALL	176605	ML5210	VAUXHALL	90341282	ML5077	VOLVO	30784935	ML6136
VAUXHALL	176607	ML5341	VAUXHALL	90341377	ML5156	VOLVO	30803472	ML5184
VAUXHALL	176608	ML5773	VAUXHALL	90341378	ML5125	VOLVO	30852059	ML5154
VAUXHALL	176608	ML5773	VAUXHALL	90346469	ML5367	VOLVO	30852060	ML5154
VAUXHALL	176608	ML5773	VAUXHALL	90379054	ML5210	VOLVO	31217640	ML6092
VAUXHALL	176609	ML5817	VAUXHALL	90379081	ML5103	VOLVO	31218478	ML5726
VAUXHALL	176676	ML6053	VAUXHALL	90388707	ML5144	VOLVO	31278323	ML5907
VAUXHALL	1178224	ML5345	VAUXHALL	90463253	ML5179	VOLVO	31335795	ML6094
VAUXHALL	1180016	ML6049	VAUXHALL	90463721	ML5085	<b>VW</b>		
VAUXHALL	1180402	ML5085	VAUXHALL	90463749	ML5082	VW	147827550	ML5572
VAUXHALL	4414419	ML5516	VAUXHALL	90463781	ML5424	VW	251829331	ML5645
VAUXHALL	4705436	ML5088	VAUXHALL	90481180	ML5369	VW	251829332	ML5106
VAUXHALL	4705437	ML5089	VAUXHALL	90481269	ML5242	VW	333827550	ML5123
VAUXHALL	4705684	ML5088	VAUXHALL	90481270	ML5054	VW	533827550	ML5677
VAUXHALL	4705685	ML5089	VAUXHALL	90486893	ML6047	VW	867827550	ML5644
VAUXHALL	4708556	ML5078	VAUXHALL	90521517	ML5166	VW	1918827550	ML5574
VAUXHALL	4708557	ML5078	VAUXHALL	90559245	ML5138	VW	171827550A	ML5073
VAUXHALL	5132262	ML5119	VAUXHALL	90579440	ML5137	VW	1918827550A	ML5038
VAUXHALL	9114311	ML5120	VAUXHALL	91168256	ML5516	VW	1C0823359B	ML5393
VAUXHALL	9152393	ML5257	VAUXHALL	93193385	ML5078	VW	1C0823359C	ML5393
VAUXHALL	9177081	ML5341	VAUXHALL	93193386	ML5078	VW	1C0823359D	ML5393
VAUXHALL	9180255	ML5773	VAUXHALL	93386999	ML5119	VW	1C0827550A	ML5325
VAUXHALL	9180256	ML5817	VAUXHALL	132709(90246620	ML5408	VW	1C0827550B	ML5325
VAUXHALL	9209569	ML5088	VAUXHALL	90241995	ML5407	VW	1C0827550C	ML5325
VAUXHALL	9209570	ML5089	<b>VOLVO</b>			VW	1C0827550D	ML5325
VAUXHALL	9210307	ML5088	VOLVO	180084	ML6090	VW	1E0827550	ML5675
VAUXHALL	9210308	ML5089	VOLVO	819865	ML5368	VW	1E0827550B	ML5675
VAUXHALL	10233372	ML5515	VOLVO	1334648	ML5906	VW	1H5827550A	ML5226

# MONROE® MAX-LIFT® OE CROSS REFERENCE LIST

	OE N°:	Ref.		OE N°:	Ref.		OE N°:	Ref.
VW	1H5827550B	ML5226	VW	5N0827550A	ML5838	ZAZ	12.6308506	ML5115
VW	1H6827550	ML5049	VW	5Z6827550B	ML5796	ZAZ	121.6308506	ML5072
VW	1H6827550A	ML5049	VW	6E0823359E	ML5287	ZAZ	132.6308506	ML5116
VW	1H9827550A	ML5191	VW	6E0827550B	ML5199			
VW	1J0823359	ML5261	VW	6E0827550C	ML5195			
VW	1J0823359C	ML5264	VW	6E0827550C	ML5195			
VW	1J6827550	ML5132	VW	6K0827550	ML5100			
VW	1J6827550	ML5132	VW	6K0827550A	ML5100			
VW	1J6827550C	ML5132	VW	6K5827550A	ML5063			
VW	1J6827550C	ML5132	VW	6K5827550C	ML5259			
VW	1J9827550	ML5132	VW	6N0823359	ML5265			
VW	1K0823359A	ML5735	VW	6N0827550A	ML5145			
VW	1K5827550C	ML5751	VW	6Q0823359	ML5491			
VW	1K6827550D	ML5742	VW	6Q0823359A	ML5491			
VW	1K6827550E	ML5742	VW	6Q5827550A	ML5748			
VW	1K6827550F	ML5742	VW	6Q5827550B	ML5748			
VW	1K8827550A	ML6100	VW	6Q6827550	ML5194			
VW	1K9827550A	ML5754	VW	6Q6827550	ML5196			
VW	1Q0823359	ML5738	VW	6Q6827550A	ML5196			
VW	1Q0827550A	ML5752	VW	6R6827550A	ML5849			
VW	1Q0827550B	ML5752	VW	6X0823359A	ML5195			
VW	1T0823359	ML5736	VW	6X0823359B	ML5287			
VW	1T0823359A	ML5736	VW	6X0823359C	ML5339			
VW	1T0823359D	ML6152	VW	6X0827550	ML5261			
VW	1T0827550A	ML5743	VW	6X0827550A	ML5261			
VW	1T0827550B	ML5743	VW	701829331AB	ML5250			
VW	1T0827550C	ML5743	VW	701829331F	ML5246			
VW	1T0827550D	ML5743	VW	701829331G	ML5245			
VW	1T0827550E	ML5743	VW	701829331H	ML5105			
VW	1Y0827550B	ML5791	VW	701829331J	ML5247			
VW	1Y0827550D	ML5791	VW	701829331Q	ML5249			
VW	1Y0827550F	ML5791	VW	701829331R	ML5118			
VW	251829331A	ML5645	VW	701829331S	ML5251			
VW	251829331B	ML5106	VW	7827550A	ML5644			
VW	2K0827550	ML5750	VW	7D0823359A	ML6101			
VW	2K0827550A	ML5750	VW	7H0823359A	ML5832			
VW	3A9827550	ML5123	VW	7H0823359B	ML5832			
VW	3B0823359	ML5266	VW	7H0823359C	ML5832			
VW	3B0823359A	ML5266	VW	7H0827550	ML5575			
VW	3B0823359B	ML5266	VW	7H0827550B	ML5576			
VW	3B0823359B	ML5266	VW	7H0827550B	ML5833			
VW	3B5827550	ML5135	VW	7H0827550C	ML5833			
VW	3B5827550A	ML5135	VW	7L6823359B	ML5357			
VW	3B5827550A	ML5193	VW	7L6845587	ML5793			
VW	3B5827550C	ML5193	VW	7L6845587A	ML5793			
VW	3B5827550E	ML5439	VW	7M0823359G	ML5127			
VW	3B5827550E	ML5439	VW	7M0827550D	ML5127			
VW	3B5827550G	ML5439	VW	7M0827550F	ML5127			
VW	3B9827550	ML5185	VW	7M0827550G	ML5127			
VW	3C0823359	ML5829	VW	7M3827550A	ML5480			
VW	3C0823359A	ML5829	VW	867827550C	ML5177			
VW	3C5827550A	ML5830	VW	867827550D	ML5178			
VW	3C5827550B	ML5830	VW	8B5827550C	ML5193			
VW	3C5827550C	ML5830	VW	8D5827550F	ML5193			
VW	3C8823359	ML6096	VW	8D5827552C	ML5193			
VW	3C9827550	ML5831	VW	8J0823359	ML5261			
VW	3C9827550A	ML5831	VW	8J0823359A	ML5261			
VW	3D0823359C	ML6097	VW	8L0823359	ML5261			
VW	3D5827550B	ML6099	VW	8L0823359	ML5261			
VW	3D5827550C	ML6098	VW	8L0823359	ML5261			
VW	3D5827550F	ML5193						
VW	3D5827552C	ML5193	<b>ZASTAVA</b>					
VW	533827550A	ML5677	ZASTAVA	46622166	ML5097			
VW	533827550A	ML5677	ZASTAVA	46635997	ML5008			
VW	535827550A	ML5573	ZASTAVA	46636020	ML5028			
VW	535827550A	ML5573	ZASTAVA	46636021	ML5028			
VW	5K0823359D	ML5648	ZASTAVA	46636022	ML5029			
VW	5K6827550B	ML5653	<b>ZAZ</b>					
VW	5M0827550	ML5792	ZAZ	13,6308506	ML5035			
VW	5M0827550A	ML5792	ZAZ	1102-6308016	ML5035			



# MONROE® MAX-LIFT® CROSS REFERENCE LIST

## STABILUS

STABILUS	MONROE®	STABILUS	MONROE®	STABILUS	MONROE®	STABILUS	MONROE®	STABILUS	MONROE®
920	ML5818	16618	ML6083	22869	ML6003	33035	ML5457	188579	ML6029
922	ML6144	16677	ML5496	22885	ML5921	33064	ML5663	192856	ML5546
1812	ML5806	16687	ML5776	22929	ML5222	33317	ML5788	195026	ML5867
1825	ML5806	16723	ML5890	23093	ML5920	33330	ML5727	199028	ML5501
1984	ML5727	16761	ML5765	23173	ML5698	33418	ML5682	214787	ML5420
2001	ML5728	16767	ML5743	23216	ML5975	33459	ML5515	220631	ML5851
2314	ML5697	16823	ML5831	23223	ML5750	33465	ML5813	238763	ML6123
2429	ML5802	16841	ML5553	23234	ML5977	33509	ML6016	239002	ML5962
2431	ML5801	16943	ML5665	23241	ML5697	33769	ML5741	239719	ML5961
2433	ML5309	16954	ML5357	23549	ML5277	33844	ML5653	239958	ML5967
2578	ML6143	16980	ML6008	23555	ML5234	33948	ML5648	240675	ML5344
6941	ML5760	16990	ML5763	23606	ML5240	34056	ML6097	240675	ML5458
6950	ML5987	17120	ML6014	23619	ML5924	34075	ML5838	241250	ML5113
6954	ML5758	17203	ML5667	23624	ML5844	34096	ML5738	241660	ML5106
6957	ML5761	17359	ML5829	23713	ML5749	34249	ML5694	248126	ML5625
6963	ML5762	17448	ML6081	23793	ML5100	34491	ML5088	248223	ML5364
7569	ML5518	17451	ML6080	23812	ML5269	34491	ML5089	248594	ML5511
7998	ML5502	17468	ML5220	23819	ML5269	34491	ML6044	249270	ML5635
8472	ML5637	17510	ML5735	23895	ML6078	34753	ML5830	249653	ML5585
11499	ML5692	17609	ML5661	23902	ML5767	34760	ML5316	253154	ML5497
11532	ML5976	17681	ML5832	23904	ML5753	34830	ML6129	274167	ML5654
11573	ML5668	17688	ML6145	23945	ML5449	34928	ML5866	274186	ML5286
11591	ML5782	17706	ML5779	23967	ML5239	35075	ML5928	274406	ML5650
11591	ML5824	17881	ML5684	24013	ML5845	42782	ML5869	283576	ML5452
12074	ML5330	17918	ML5665	24029	ML5752	43738	ML5842	286324	ML5816
12111	ML5702	17971	ML6086	24073	ML5850	43977	ML5843	291668	ML5644
12114	ML5387	17998	ML5736	24099	ML5778	44989	ML5011	291722	ML5073
12124	ML5784	18006	ML5683	24195	ML5774	47090	ML5067	291730	ML5574
12144	ML5664	18097	ML5122	24263	ML5927	49417	ML5017	291838	ML5572
12144	ML5416	18123	ML5194	24284	ML5929	52337	ML5011	291927	ML5645
12144	ML5664	18123	ML5196	24304	ML5750	60708	ML5081	292257	ML5677
12148	ML5785	18254	ML5701	24305	ML5744	68834	ML5358	303086	ML5473
12180	ML5703	18271	ML5354	24339	ML5679	82414	ML5629	308105	ML6063
12552	ML5232	18306	ML5045	24409	ML5740	83674	ML5024	317446	ML5628
12553	ML5233	18318	ML6022	24452	ML5959	83798	ML5632	318116	ML5593
12604	ML5514	18329	ML5757	24473	ML6100	84778	ML5606	324264	ML5463
12815	ML5755	18382	ML5764	24477	ML6066	93380	ML6000	341298	ML6073
12815	ML5756	18387	ML5581	24485	ML6047	105194	ML5774	341452	ML6090
13177	ML5790	18459	ML5575	24559	ML5746	105409	ML5448	343477	ML6125
13349	ML5716	18471	ML5836	26209	ML6102	105672	ML5926	347273	ML6130
13600	ML5713	18494	ML5787	26247	ML5235	105911	ML5925	348466	ML5870
13621	ML6002	18560	ML5318	26247	ML5236	106150	ML5857	348705	ML5871
13647	ML5873	18560	ML5324	26247	ML5237	106389	ML5856	348944	ML6035
13902	ML6009	18613	ML5889	26247	ML5451	106628	ML5746	351097	ML6132
14035	ML5700	18616	ML5284	26251	ML6016	106867	ML5665	352798	ML5548
14148	ML5708	18629	ML5768	26825	ML5687	107345	ML6096	354710	ML5551
14169	ML5712	18642	ML6121	26825	ML5730	109018	ML5849	361003	ML5011
14232	ML5912	18669	ML5287	27817	ML5860	109735	ML5922	361119	ML5618
15277	ML5405	18724	ML5480	30598	ML5907	110189	ML5729	361127	ML5619
15277	ML5410	18756	ML5277	30656	ML5772	113559	ML6079	361151	ML5015
15356	ML5852	18756	ML5449	30681	ML5771	118339	ML6103	361224	ML5010
15487	ML5777	18787	ML5413	30769	ML5723	123804	ML5945	361224	ML5034
15488	ML5900	18816	ML5687	30787	ML5658	127628	ML5944	361641	ML5158
15489	ML5485	18816	ML6151	31030	ML5895	128571	ML5478	362836	ML5383
15490	ML5486	19830	ML5979	31049	ML5770	129572	ML5796	376132	ML5074
15491	ML5666	19830	ML5747	31139	ML5681	130257	ML6116	381239	ML5440
15495	ML5647	19856	ML5584	31370	ML6091	130496	ML6117	385302	ML5724
15495	ML5699	19872	ML6108	31543	ML5958	135276	ML5999	394623	ML5537
15496	ML5699	20353	ML5958	31675	ML6016	136715	ML6134	394623	ML5538
15513	ML5917	20534	ML5864	31779	ML5783	137057	ML5527	395340	ML6075
15521	ML5592	20594	ML5227	31872	ML5307	138383	ML5997	397013	ML5474
15523	ML6087	20625	ML5891	31974	ML6082	138654	ML5751	407529	ML5021
15523	ML5963	20644	ML5833	31997	ML5797	140088	ML5791	416372	ML5725
15523	ML6087	20644	ML5576	32177	ML6092	141250	ML5113	419240	ML6128
15523	ML5963	20666	ML6152	32275	ML5839	141522	ML5754	425693	ML5893
15526	ML5963	20878	ML5745	32436	ML5439	146748	ML5680	426171	ML5101
15531	ML6089	20890	ML5792	32455	ML5930	151560	ML5777	430473	ML5582
15583	ML5183	22244	ML5696	32455	ML5753	153440	ML5946	437135	ML6092
15621	ML5536	22386	ML5165	32478	ML5715	155830	ML6112	437484	ML5906
16501	ML6009	22528	ML5968	32492	ML6083	167573	ML5923	444081	ML5177
16543	ML5662	22619	ML5655	32547	ML5715	167812	ML5918	444413	ML5607
16561	ML5214	22620	ML5855	32622	ML5704	168637	ML5031	450189	ML5934
16561	ML5622	22657	ML5795	32724	ML5719	168688	ML5243	450788	ML5652
16570	ML5500	22818	ML5775	32963	ML5659	170097	ML5390	457480	ML5516

CROSS LIST

# MONROE® MAX-LIFT® CROSS REFERENCE LIST

## STABILUS

STABILUS	MONROE®	STABILUS	MONROE®	STABILUS	MONROE®	STABILUS	MONROE®	STABILUS	MONROE®
457580	ML5550	768389	ML5847	0108IC	ML5602	0955QH	ML5434	1718NH	ML5511
463425	ML6133	770302	ML6106	0108IC	ML5604	0974DZ	ML6040	1758VF	ML5717
465240	ML5498	770331	ML5472	0108IC	ML5605	0999MG	ML5675	1765QH	ML5699
465240	ML5556	777230	ML5651	0174HL	ML5541	0999RN	ML5828	1773MA	ML6043
484726	ML5731	782281	ML5189	0197IH	ML5305	1026AW	ML5273	1791BP	ML5286
493302	ML5750	783925	ML6120	0197IH	ML5456	1035VA	ML5938	1793BF	ML5285
498588	ML5963	791148	ML5192	0197IH	ML5627	1036VW	ML5690	1793BF	ML5286
499514	ML6110	793159	ML5431	0244HW	ML5336	1041VO	ML5688	1796BR	ML5980
499783	ML5888	798428	ML5274	0259LC	ML5265	1043AX	ML5919	1800BN	ML5981
499783	ML5940	798436	ML5282	0261PU	ML6146	1047VL	ML5763	1806BK	ML5171
501695	ML5734	798444	ML5139	0261QQ	ML5564	1057VF	ML5763	1807BF	ML5172
512182	ML5490	798444	ML5598	0262QL	ML5564	1087PL	ML5370	1808BA	ML5173
513884	ML5369	810722	ML6115	0287QB	ML5631	1114WG	ML5749	1814AT	ML5081
522459	ML6022	817385	ML5656	0288RT	ML5799	1121FC	ML5974	1815BJ	ML5463
522459	ML6023	818341	ML6072	0316QO	ML5800	1128TT	ML5365	1819BQ	ML5252
524085	ML5012	819297	ML6071	0319VG	ML5699	1128TT	ML5366	1820BB	ML5109
524085	ML5065	820014	ML5998	0321VN	ML5699	1152RM	ML5168	1875DT	ML5426
524371	ML5160	831891	ML5094	0325VU	ML5699	1154PK	ML6004	1962RE	ML5459
527971	ML5320	835817	ML5190	0326VP	ML5699	1169PG	ML5872	1976BP	ML5429
529393	ML6032	836506	ML6135	0354KY	ML5159	1179KU	ML5499	1986BJ	ML5294
543968	ML5488	837458	ML5104	0421NL	ML5672	1187KY	ML5176	1987BE	ML5293
557757	ML5549	844392	ML5947	0421VG	ML5530	1193RK	ML5198	1990BG	ML5539
559502	ML6039	848581	ML5033	0438NY	ML5809	1194SB	ML5744	1990BG	ML5080
583880	ML5568	848581	ML5255	0442NV	ML5809	1196MP	ML5061	1996BD	ML5612
585314	ML5589	852518	ML6012	0482RI	ML5773	1207QO	ML5295	1997BZ	ML5110
591505	ML5133	853474	ML6013	0482RI	ML5341	1232VB	ML5776	1997BZ	ML5291
592484	ML5660	857270	ML5315	0488KG	ML5127	1242VW	ML5776	1997BZ	ML5110
593440	ML5993	859060	ML5384	0488VQ	ML5559	1262MT	ML6065	1997BZ	ML5291
608020	ML6136	859486	ML5825	0512RQ	ML5345	1263MO	ML5620	2001BC	ML5611
611843	ML5096	867843	ML5733	0519FC	ML5178	1273PX	ML5297	2008BV	ML5200
611843	ML5941	870950	ML5956	0552TL	ML5786	1275PN	ML5167	2008BV	ML5201
611844	ML5096	873072	ML6011	0592PD	ML5438	1277PD	ML5710	2008BV	ML5200
611844	ML5941	873790	ML6127	0593PZ	ML5561	1293BN	ML5846	2008BV	ML5201
611845	ML6111	874029	ML6074	0596PK	ML6147	1295BD	ML5142	2012BS	ML5464
612084	ML5995	875221	ML5936	0623BI	ML5253	1299KB	ML5238	2012BS	ML5463
612323	ML5613	881227	ML5162	0624KV	ML5184	1308PG	ML5137	2014BI	ML5023
613757	ML6107	882232	ML5825	0648KQ	ML5398	1311PI	ML5257	2038YT	ML5753
618101	ML5013	883589	ML6046	0681VK	ML5563	1313WY	ML5443	2065BA	ML5973
618101	ML5066	883589	ML5939	0685VR	ML5691	1325BL	ML5210	2189GW	ML5438
618102	ML5014	887064	ML5020	0691QY	ML5453	1381MF	ML5263	2211NP	ML5389
619016	ML5991	890146	ML5505	0698WT	ML6141	1383BM	ML5385	2232KK	ML5642
619491	ML5587	895534	ML5461	0704VJ	ML5932	1386BY	ML5111	2239NR	ML5164
622601	ML5992	896251	ML5862	0707VV	ML5695	1393BG	ML5417	2261NM	ML5449
627141	ML6030	905526	ML5141	0712PK	ML5670	1396BS	ML5533	2266UN	ML6150
639079	ML5202	907517	ML6058	0727PG	ML5163	1405BQ	ML5376	2268FJ	ML5517
643869	ML6094	907724	ML5428	0744VM	ML5693	1408BB	ML5534	2282NW	ML5152
643870	ML6094	911786	ML5794	0744VV	ML5564	1431EG	ML6140	2283NR	ML5130
655708	ML5022	911787	ML5794	0745VH	ML5565	1462BW	ML5599	2291TY	ML5744
656267	ML5617	917077	ML5948	0746VC	ML5406	1464BM	ML5596	2292NQ	ML5153
671363	ML5306	917284	ML5588	0751VV	ML5720	1477MB	ML5259	2315TS	ML5749
673986	ML5040	919913	ML5087	0752VQ	ML5669	1492RV	ML5381	2333BH	ML5578
673986	ML5050	920662	ML5822	0755VB	ML5088	1494RL	ML5994	2334BC	ML5421
673986	ML5112	925410	ML5567	0756VX	ML5721	1501RT	ML5759	2335QS	ML5154
686360	ML5208	931146	ML5714	0759VI	ML5817	1513BN	ML5600	2426FC	ML5069
686360	ML5209	931148	ML5714	0763VF	ML5562	1516RP	ML5707	2435QL	ML5699
688711	ML5524	935215	ML6032	0772VE	ML5769	1517RK	ML5711	2436FX	ML5482
688711	ML5525	946235	ML5296	0775KG	ML5154	1518QJ	ML5821	2442PY	ML5179
702694	ML5504	946919	ML5954	0786FP	ML5144	1525QS	ML5380	2446YW	ML6006
705084	ML5950	952449	ML5868	0789FA	ML5242	1525QS	ML5569	2449RI	ML5782
713210	ML6060	959347	ML5750	0792FC	ML5054	1529QZ	ML5570	2449RI	ML5824
717721	ML6122	962454	ML5990	0793KE	ML5368	1559BN	ML5573	2474LM	ML5161
720826	ML6049	996870	ML6113	0813MK	ML5226	1565TJ	ML5301	2479LO	ML6076
726084	ML6051	1376673	ML5786	0818MM	ML5241	1571DG	ML5271	2515TE	ML6083
732061	ML6142	0008SX	ML5206	0823NA	ML5129	1577BL	ML5522	2524BV	ML6020
732778	ML6055	0008SX	ML5207	0825MV	ML5123	1585BP	ML5422	2554NJ	ML5121
733495	ML6108	0009DY	ML5367	0833HS	ML5436	1589BW	ML5170	2561WJ	ML5671
734688	ML6053	0026DA	ML5258	0869SH	ML6138	1592BY	ML5019	2569LN	ML5138
735171	ML5091	0028DR	ML5032	0872NC	ML5909	1598PT	ML5412	2571WD	ML5812
735888	ML5092	0031DT	ML5077	0885SP	ML6137	1617MX	ML5640	2572WZ	ML5552
741173	ML5503	0033DJ	ML5125	0895QR	ML5705	1628NI	ML5468	2573WU	ML5372
759786	ML6105	0046SJ	ML5703	0933SV	ML5702	1646NG	ML5277	2574WP	ML5828
760579	ML5313	0093IH	ML5609	0955HQ	ML5136	1656NA	ML5100	2575WK	ML6131
766718	ML5943	0098IZ	ML5411	0955HQ	ML5815	1699NP	ML5514	2576WF	ML5894
766955	ML5848	0108IC	ML5601	0955QH	ML5394	1708TQ	ML5460	2584WJ	ML5789

# MONROE® MAX-LIFT® CROSS REFERENCE LIST

## STABILUS

STABILUS	MONROE®	STABILUS	MONROE®	STABILUS	MONROE®	STABILUS	MONROE®	STABILUS	MONROE®
2586XW	ML5746	3917NJ	ML5393	5821PQ	ML5467	7017TQ	ML5281	8139HA	ML5365
2593SY	ML5750	3937AM	ML5649	5836DG	ML6148	7021TN	ML5038	8166CR	ML5311
2614KL	ML5166	3958IA	ML5529	5904QC	ML5382	7022TI	ML5280	8205TK	ML5763
2616BK	ML6031	3958SO	ML5360	5905QY	ML5823	7041MC	ML5787	8218TQ	ML5763
2634LW	ML5239	3976SM	ML5215	5913QB	ML5814	7042MY	ML5787	8254BD	ML5465
2697LZ	ML5135	3987SB	ML5687	6007QP	ML5641	7043MT	ML5787	8306BQ	ML5418
2699UG	ML5744	3987SB	ML5730	6022MR	ML6019	7075HL	ML5267	8311BI	ML5147
2705RE	ML5800	3995SF	ML6151	6024MH	ML5484	7098VJ	ML5826	8312BD	ML5388
2745GY	ML5624	3995SF	ML5687	6052CM	ML5079	7167YN	ML5785	8322RO	ML5205
2765UK	ML5107	4013WV	ML5391	6054BG	ML5049	7168YI	ML5785	8333BN	ML5566
2765UK	ML5299	4027CV	ML5276	6061CL	ML5540	7187VN	ML5475	8337BU	ML5395
2769UR	ML5114	4038KF	ML5195	6062SX	ML5379	7189MM	ML5231	8339BK	ML5528
2778UQ	ML5025	4039KA	ML5132	6108DB	ML5494	7209HT	ML5303	8339BK	ML5834
2778UQ	ML5298	4043KY	ML5535	6124QL	ML5687	7266HZ	ML5140	8345BY	ML5527
2864UI	ML5780	4044WZ	ML5718	6124QL	ML5730	7266HZ	ML5211	8345BY	ML5586
2874GE	ML5082	4045WU	ML5718	6156HT	ML5630	7303DE	ML5016	8355KJ	ML5216
2877GQ	ML5085	4081FD	ML5678	6181SJ	ML5793	7303DE	ML5039	8358KV	ML5392
2894RC	ML5616	4126XQ	ML5564	6203BA	ML5102	7303DE	ML5016	8363KN	ML5335
2937ZL	ML5836	4147PE	ML5432	6241QH	ML5188	7373RO	ML5699	8413HV	ML5197
2943RD	ML5302	4209AR	ML5143	6252QX	ML5673	7374AL	ML5408	8413LF	ML5487
3011XI	ML5836	4279NE	ML5270	6253QS	ML5543	7377TN	ML5709	8429CF	ML5246
3061KD	ML5375	4348MY	ML5342	6315NK	ML5514	7378RQ	ML5699	8429DB	ML5532
3062KZ	ML5375	4412ML	ML5193	6324LR	ML5224	7378TI	ML5706	8432CH	ML5245
3062KZ	ML5402	4495VU	ML5718	6325MI	ML5544	7385RZ	ML5699	8432DD	ML5531
3161YV	ML5809	4636II	ML5308	6331QG	ML5269	7388RK	ML5699	8443BA	ML5031
3168YN	ML5809	4656NO	ML5218	6345QH	ML5817	7441FC	ML5229	8453BV	ML5407
3169SF	ML5288	4657IS	ML5571	6362LD	ML5128	7441FC	ML5228	8453CR	ML5247
3169SF	ML6109	4742NW	ML5203	6362LD	ML5837	7443NO	ML5063	8455CH	ML5105
3169SF	ML5288	4742NW	ML5204	6364LU	ML5086	7451NS	ML5832	8455LZ	ML5489
3169SF	ML6109	4742NW	ML5203	6371SB	ML5782	7456RE	ML5729	8456LU	ML5643
3177YF	ML5341	4751SB	ML5789	6371SB	ML5824	7463NC	ML5182	8467UA	ML5800
3183TT	ML5442	4756UW	ML5779	6389PV	ML5491	7469HX	ML5424	8468UW	ML5811
3187BR	ML5043	4927UV	ML6151	6391PB	ML5181	7509HZ	ML5093	8478CH	ML5249
3204DL	ML5483	4927UV	ML5687	6402QM	ML5526	7509HZ	ML5254	8482TR	ML5729
3211CY	ML5316	4932SV	ML5425	6467HO	ML5419	7557HF	ML5314	8484CV	ML5251
3211CY	ML5146	4958SG	ML5151	6467QF	ML5169	7587GS	ML5321	8487UP	ML5798
3216KV	ML6033	5001ZR	ML5737	6471QC	ML5638	7587GS	ML5322	8491UM	ML6021
3235YM	ML5634	5011ZL	ML5744	6474QO	ML5397	7628LW	ML5185	8498UE	ML5799
3235YM	ML5508	5037SY	ML5377	6479HZ	ML5478	7629LR	ML5191	8514CC	ML5126
3261XS	ML5817	5037SY	ML5732	6479HZ	ML5622	7631LY	ML5275	8516CT	ML5290
3269YB	ML6037	5073BH	ML5338	6482HA	ML5078	7638NI	ML5481	8523CB	ML5332
3271YI	ML6036	5086PL	ML5404	6492TA	ML5727	7642VA	ML5861	8534TD	ML5415
3277YF	ML5352	5105SS	ML5579	6518NI	ML5439	7653LC	ML5438	8539UB	ML5804
3278YA	ML5996	5114PC	ML5351	6543LX	ML5131	7656WY	ML5359	8541UI	ML5803
3286GW	ML5523	5126VQ	ML5699	6543NP	ML5199	7656WY	ML5361	8542CV	ML5333
3289YQ	ML5371	5132VD	ML5699	6556YE	ML5784	7691RP	ML5469	8542UD	ML6069
3289YQ	ML5615	5253VG	ML5699	6559YQ	ML5784	7734WM	ML5774	8551UC	ML5808
3293GE	ML5441	5262VF	ML5699	6566PH	ML5479	7739HU	ML5327	8552UY	ML6067
3309RE	ML5764	5279QL	ML5766	6566PH	ML5623	7739HU	ML5509	8584YH	ML6092
3339FH	ML5430	5336XP	ML5742	6576TM	ML5373	7762HK	ML5319	8613YU	ML5827
3347XU	ML5396	5353SL	ML5789	6576TM	ML5374	7764HA	ML5180	8628YQ	ML6057
3348SI	ML5757	5354SG	ML5799	6583WJ	ML5699	7819BW	ML5041	8637YP	ML5807
3354SW	ML5757	5371ZI	ML5269	6584WE	ML5699	7824VP	ML5805	8704YO	ML5777
3401UZ	ML5727	5399SL	ML5345	6591WN	ML5564	7825VK	ML5722	8711TQ	ML5779
3402UU	ML5727	5424QZ	ML5728	6615PI	ML5826	7856RD	ML5355	8715YD	ML5777
3442UX	ML5416	5427ZB	ML5737	6624PH	ML5826	7857RZ	ML5334	8722BX	ML5594
3445FO	ML5261	5435DM	ML5317	6649LN	ML5353	7858RU	ML5356	8771TH	ML5764
3445FO	ML5264	5435ZF	ML5739	6707DS	ML5350	7861DY	ML5145	8884HA	ML5450
3445FO	ML5261	5449ZG	ML5745	6707DS	ML5636	7865TV	ML5826	8899NR	ML5225
3445FO	ML5264	5454ZZ	ML6104	6711TF	ML6027	7891HR	ML5583	8906CY	ML5840
3445FO	ML5261	5537SQ	ML5703	6736AR	ML5347	7893HH	ML5326	8926CM	ML5278
3474XK	ML5577	5538SL	ML5702	6740AO	ML5348	7901GO	ML5068	8927UQ	ML6068
3477XW	ML5560	5563IT	ML5506	6743QT	ML5349	7906GQ	ML5272	8982NG	ML5343
3489US	ML5806	5593MY	ML5124	6787DY	ML5400	7958RN	ML5212	8985BM	ML5835
3493UP	ML5806	5642ZA	ML6042	6789DO	ML5401	7959RI	ML5340	8986IG	ML5435
3587SC	ML5044	5674MY	ML5331	6843RF	ML5773	7969MW	ML5175	8986NN	ML5262
3592SV	ML5826	5705XK	ML5223	6843RF	ML5341	8014RE	ML5986	8986TQ	ML5800
3658XP	ML6101	5724ZW	ML5416	6857LD	ML5217	8047NO	ML5386	8999NT	ML6099
3749WN	ML5809	5725ZR	ML5786	6858GS	ML5076	8069DF	ML5438	9003NX	ML6098
3781WC	ML5809	5754UY	ML5691	6886YT	ML5726	8082YZ	ML6149	9005XA	ML5810
3789WQ	ML5809	5768ZF	ML5685	6914LI	ML5148	8083GL	ML5471	9006XW	ML5810
3796WZ	ML5809	5783VH	ML5786	6927GH	ML5292	8113HP	ML5149	9084XL	ML6015
3798NY	ML5134	5796HP	ML5521	6927TJ	ML5817	8123DZ	ML5323	9093DJ	ML5608
3915PL	ML5511	5806SS	ML5828	6936AD	ML5312	8127KE	ML5437	9105EP	ML5444

# MONROE® MAX-LIFT® CROSS REFERENCE LIST

## STABILUS

STABILUS	MONROE®	STABILUS	MONROE®	STABILUS	MONROE®	STABILUS	MONROE®	STABILUS	MONROE®
9168MN	ML5219	9262QU	ML5824	9349XQ	ML5817	9517HN	ML5621	9714UQ	ML5777
9171HI	ML5423	9262UE	ML5810	9351XX	ML5723	9568UH	ML5745	9716UG	ML5777
9171HI	ML5433	9267UG	ML5810	9365BE	ML5595	9572UE	ML5745	9762HV	ML5329
9171MP	ML5221	9274NT	ML5269	9368BQ	ML5646	9582RK	ML5120	9767FE	ML5686
9176HK	ML5580	9283HM	ML5590	9371BS	ML5676	9588FB	ML5103	9778CF	ML5300
9213WV	ML5773	9284DX	ML5597	9378KB	ML6062	9605KK	ML5325	9783CY	ML5004
9213WV	ML5341	9288TU	ML5728	9391KY	ML6032	9618PX	ML5699	9789CV	ML5256
9219XO	ML5729	9338XA	ML5341	9410BZ	ML5391	9632TZ	ML5737	9829NG	ML5213
9227BZ	ML5120	9338XA	ML5773	9426NW	ML5118	9639BI	ML5244	9857CP	ML5156
9231BW	ML5362	9338XA	ML5341	9428NM	ML5250	9639UN	ML5813	9914WV	ML5809
9234HK	ML5260	9339XW	ML5346	9434HX	ML5520	9653HC	ML5399	9968GI	ML5266
9247ZZ	ML5427	9341XC	ML5119	9455ES	ML5445	9669ZC	ML5689	9991IR	ML5558
9262QU	ML5289	9341XC	ML6005	9494KC	ML5674	9677NA	ML5414		
9262QU	ML5782	9342BE	ML5495	9517HN	ML5328	9686IT	ML5470		

## LESJOFORS

LESJOFORS	MONROE®	LESJOFORS	MONROE®	LESJOFORS	MONROE®	LESJOFORS	MONROE®	LESJOFORS	MONROE®
8000700	ML5919	8026103	ML5976	8075703	ML6033	8100717	ML6137	8108409	ML5436
8000701	ML5608	8027500	ML5292	8075704	ML6006	8100719	ML5698	8108410	ML5235
8000702	ML5392	8027501	ML5330	8077601	ML5556	8100720	ML5855	8108410	ML5237
8000703	ML5414	8037200	ML5382	8077800	ML5636	8100721	ML5921	8108410	ML5451
8000704	ML5696	8037201	ML5660	8077802	ML5349	8100722	ML5920	8108411	ML5163
8000705	ML5697	8041402	ML5995	8077803	ML5350	8100723	ML5655	8108412	ML5213
8000706	ML6138	8042101	ML6000	8077803	ML5375	8104203	ML5417	8108414	ML5523
8004200	ML5593	8042102	ML5999	8077804	ML5638	8104204	ML5533	8108416	ML5520
8004201	ML5333	8042103	ML5997	8077805	ML5790	8104205	ML5376	8108416	ML5590
8004206	ML5420	8044200	ML5706	8082900	ML5195	8104206	ML5104	8108417	ML5535
8004207	ML5385	8044201	ML5705	8082901	ML5342	8104207	ML5437	8108418	ML5690
8004208	ML5678	8056800	ML5102	8082903	ML5386	8104209	ML5428	8108419	ML5860
8004209	ML5679	8056802	ML5438	8085700	ML5768	8104210	ML5111	8108420	ML5170
8004210	ML5261	8056803	ML5308	8085701	ML6079	8104211	ML5418	8108421	ML5691
8004212	ML5678	8056804	ML5309	8086000	ML5813	8104212	ML5534	8108422	ML6141
8004213	ML5135	8056805	ML5559	8095000	ML5266	8104214	ML5135	8108423	ML5694
8004214	ML5266	8056806	ML5577	8095001	ML5393	8104215	ML5197	8108424	ML5670
8004215	ML5276	8056807	ML5560	8095002	ML5195	8104217	ML5198	8108425	ML5671
8004216	ML5386	8056808	ML6024	8095003	ML5287	8104219	ML5238	8108426	ML5659
8004217	ML5269	8056809	ML6025	8095004	ML5266	8104219	ML5239	8108427	ML5658
8004218	ML5737	8056810	ML5620	8095005	ML5735	8104221	ML5277	8108428	ML5692
8004220	ML5741	8056811	ML6032	8095006	ML5832	8104222	ML6150	8108429	ML5695
8004221	ML5924	8056812	ML5798	8095007	ML5736	8104223	ML5449	8108430	ML5693
8004222	ML5740	8056813	ML5799	8095008	ML5491	8104224	ML5275	8108431	ML5861
8004223	ML5269	8056814	ML6029	8095009	ML5480	8104225	ML5370	8114200	ML5794
8004224	ML5928	8056819	ML5715	8095010	ML5261	8104226	ML5223	8114202	ML6140
8004225	ML5739	8056820	ML5715	8095010	ML5264	8104226	ML5234	8114203	ML5446
8008400	ML5596	8056822	ML5811	8095011	ML5829	8104227	ML5227	8114204	ML5714
8008401	ML5421	8056824	ML6026	8095012	ML5357	8104228	ML5459	8114205	ML5888
8008402	ML5599	8056825	ML6027	8095015	ML5738	8104229	ML5749	8114205	ML5940
8008403	ML5522	8058500	ML6033	8095017	ML6096	8104230	ML5744	8114900	ML6113
8008404	ML5600	8058700	ML5564	8095018	ML6097	8104231	ML5746	8115600	ML5607
8008405	ML5566	8058701	ML6037	8095019	ML5265	8104232	ML5745	8115601	ML5601
8008406	ML5441	8063402	ML5085	8095801	ML5368	8104233	ML5747	8115602	ML5603
8008407	ML5422	8063403	ML5345	8095802	ML5643	8104235	ML5844	8115603	ML5602
8008408	ML5336	8063404	ML5720	8095803	ML5361	8104236	ML5316	8115603	ML5604
8008409	ML5263	8063405	ML6046	8095804	ML5663	8104237	ML5753	8115604	ML5605
8008410	ML5688	8063406	ML6049	8095805	ML5726	8104238	ML5930	8115605	ML5452
8008412	ML5563	8066700	ML5583	8095807	ML6136	8104240	ML5922	8115606	ML5606
8008413	ML5689	8066701	ML5470	8100700	ML5597	8104241	ML5923	8115607	ML5609
8008414	ML5562	8066702	ML5267	8100702	ML5273	8104242	ML5918	8115608	ML5010
8008415	ML5932	8066703	ML5788	8100702	ML5274	8104243	ML6102	8115609	ML5011
8008416	ML5565	8069700	ML5646	8100705	ML5335	8104244	ML6103	8115611	ML5019
8008417	ML5769	8069701	ML5846	8100706	ML5335	8104245	ML5857	8115612	ML5504
8008418	ML5936	8069702	ML5676	8100707	ML5531	8104246	ML5856	8115613	ML5505
8008419	ML5938	8069703	ML6147	8100708	ML5532	8104247	ML5774	8115614	ML5255
8008420	ML6142	8069704	ML5803	8100709	ML5271	8104248	ML5929	8115615	ML5033
8014200	ML5939	8069705	ML6069	8100710	ML5272	8105800	ML5017	8115616	ML5506
8015600	ML5457	8072900	ML5472	8100711	ML5215	8108401	ML5450	8115617	ML5011
8015601	ML5270	8072901	ML5473	8100711	ML5216	8108402	ML5170	8115618	ML5203
8015602	ML5262	8072902	ML6074	8100712	ML5442	8108403	ML5444	8115618	ML5204
8015603	ML5461	8072903	ML6127	8100713	ML5419	8108404	ML5445	8115618	ML5503
8015604	ML5822	8075700	ML5359	8100714	ML5222	8108405	ML5521	8115619	ML5430
8026100	ML5038	8075701	ML5870	8100715	ML5335	8108406	ML5521	8115620	ML5129
8026102	ML5389	8075702	ML6004	8100716	ML6149	8108407	ML5934	8115622	ML5113

# MONROE® MAX-LIFT® CROSS REFERENCE LIST

## LESJOFORS

LESJOFORS	MONROE®	LESJOFORS	MONROE®	LESJOFORS	MONROE®	LESJOFORS	MONROE®	LESJOFORS	MONROE®
8115623	ML5454	8126123	ML5069	8127552	ML5374	8144220	ML5912	8159201	ML5354
8115623	ML5626	8126125	ML5078	8127553	ML5514	8144221	ML5700	8159202	ML5278
8115624	ML5456	8126126	ML5164	8127554	ML5466	8144222	ML6002	8159203	ML5587
8115624	ML5627	8126127	ML5081	8127554	ML5467	8144223	ML6002	8159215	ML5353
8115625	ML5363	8126128	ML5458	8127555	ML5289	8144224	ML5723	8159217	ML6038
8115625	ML5455	8126129	ML5377	8127556	ML5206	8144225	ML5723	8159220	ML5757
8115626	ML5149	8126130	ML5086	8127556	ML5207	8147000	ML5024	8159221	ML5757
8115627	ML5203	8126131	ML5281	8127557	ML5415	8147000	ML5114	8159222	ML5776
8115628	ML5204	8126132	ML5280	8127558	ML5288	8148400	ML5617	8159223	ML5776
8115629	ML5435	8126134	ML5462	8127559	ML5416	8148401	ML5139	8159224	ML5662
8115630	ML5151	8126135	ML5016	8127560	ML5664	8148401	ML5598	8159228	ML5661
8115631	ML5536	8126136	ML5165	8127561	ML5786	8148402	ML5159	8162004	ML5524
8115632	ML5391	8126137	ML5443	8127562	ML5205	8148404	ML5458	8162005	ML5525
8115633	ML5453	8126138	ML5448	8127563	ML5771	8155400	ML5403	8162006	ML5317
8115634	ML5344	8126139	ML5101	8127564	ML5770	8155401	ML5542	8162006	ML5324
8115635	ML5162	8126140	ML5702	8127565	ML5978	8155420	ML5843	8162007	ML5588
8115637	ML5668	8126141	ML5795	8127566	ML5797	8155421	ML5842	8162008	ML5423
8115638	ML5824	8126142	ML5537	8127567	ML5797	8155422	ML5684	8162008	ML5433
8115639	ML5782	8126143	ML5538	8127568	ML5704	8155423	ML5683	8162012	ML5409
8115640	ML5963	8126144	ML5387	8127569	ML5772	8155426	ML5847	8162015	ML6041
8115641	ML5967	8126145	ML5775	8127570	ML5295	8155427	ML5848	8162016	ML5580
8115642	ML5783	8126148	ML5784	8127571	ML5651	8155435	ML5147	8162017	ML5581
8115643	ML5958	8126150	ML5785	8127574	ML5979	8155436	ML5765	8162018	ML6040
8115644	ML5959	8126152	ML5779	8127575	ML5977	8155437	ML5763	8162025	ML5579
8115645	ML5755	8127500	ML5463	8127576	ML5654	8155437	ML5764	8162026	ML5579
8115646	ML5961	8127501	ML5464	8127577	ML5650	8155440	ML5873	8162028	ML5781
8115647	ML5950	8127503	ML5200	8135708	ML5568	8155442	ML6014	8162029	ML5700
8115648	ML5776	8127503	ML5201	8135712	ML5405	8155443	ML6014	8162030	ML5321
8115649	ML5776	8127504	ML5285	8135715	ML5911	8155444	ML6012	8162030	ML5322
8115650	ML6143	8127505	ML5286	8135716	ML5911	8155448	ML6011	8162031	ML5582
8115652	ML5687	8127506	ML5286	8135717	ML5787	8155450	ML6013	8162036	ML5086
8115653	ML5756	8127506	ML5285	8135718	ML5122	8155452	ML5810	8162037	ML5413
8115654	ML6114	8127508	ML5171	8135721	ML5567	8155453	ML5810	8162038	ML5360
8115655	ML5862	8127509	ML5172	8135722	ML5371	8155454	ML6015	8162039	ML5352
8115656	ML5968	8127510	ML5173	8135722	ML5615	8155600	ML5188	8162040	ML5672
8115658	ML5948	8127511	ML5161	8135723	ML5396	8156801	ML5307	8162041	ML5701
8115659	ML5956	8127512	ML5252	8135725	ML5192	8156802	ML5674	8162042	ML5809
8115660	ML5954	8127513	ML5109	8135725	ML5508	8156803	ML5328	8162043	ML5809
8115660	ML5956	8127514	ML5147	8135729	ML5836	8156803	ML5329	8162044	ML5809
8117000	ML5864	8127517	ML5465	8135730	ML5910	8156803	ML5621	8162045	ML5809
8117700	ML5087	8127518	ML5023	8135731	ML5982	8156805	ML5468	8162046	ML5837
8117701	ML5098	8127519	ML5141	8135734	ML5983	8156806	ML5560	8162047	ML5890
8117702	ML5096	8127520	ML5142	8135735	ML5984	8156807	ML5530	8162049	ML6042
8117704	ML5714	8127521	ML5143	8135736	ML5866	8156807	ML5577	8162050	ML6042
8117704	ML5941	8127522	ML5147	8137200	ML5157	8156808	ML5716	8163400	ML5390
8117705	ML5941	8127524	ML5126	8137205	ML5987	8156809	ML5543	8163401	ML5395
8117706	ML5513	8127525	ML5176	8137207	ML5296	8156810	ML5717	8163402	ML5391
8117707	ML5507	8127527	ML5332	8137208	ML5816	8156811	ML5718	8163403	ML5077
8119112	ML6084	8127529	ML5611	8137211	ML5986	8156812	ML5718	8163404	ML5156
8126101	ML5015	8127531	ML5110	8137217	ML5759	8156813	ML5808	8163405	ML5125
8126102	ML5011	8127531	ML5291	8137218	ML5616	8156814	ML5808	8163406	ML5367
8126102	ML5501	8127532	ML5612	8137219	ML5297	8156815	ML5806	8163407	ML5585
8126104	ML5043	8127533	ML5388	8137220	ML5382	8156816	ML5806	8163408	ML5527
8126105	ML5074	8127534	ML5080	8137221	ML5993	8156818	ML6028	8163409	ML5242
8126106	ML5016	8127535	ML5253	8137222	ML5760	8156819	ML5680	8163410	ML5054
8126106	ML5039	8127536	ML5614	8137223	ML5762	8156820	ML5818	8163411	ML5144
8126107	ML5079	8127537	ML5293	8137231	ML5379	8156821	ML5673	8163417	ML5243
8126108	ML5041	8127538	ML5294	8137232	ML5569	8156822	ML6017	8163418	ML5031
8126109	ML5010	8127539	ML5136	8137233	ML5380	8156823	ML6016	8163419	ML5244
8126109	ML5034	8127540	ML5980	8137234	ML5867	8156824	ML5719	8163420	ML5835
8126111	ML5013	8127541	ML5147	8137235	ML5868	8156826	ML5800	8163421	ML5834
8126111	ML5066	8127542	ML5290	8137236	ML5869	8156827	ML5801	8163421	ML5528
8126112	ML5014	8127543	ML5431	8137237	ML5990	8156829	ML5802	8163422	ML5407
8126113	ML5012	8127544	ML5429	8141405	ML5996	8156829	ML6030	8163423	ML5407
8126113	ML5065	8127545	ML5076	8142100	ML5591	8158505	ML5434	8163424	ML5408
8126114	ML5040	8127546	ML5399	8142102	ML6001	8158506	ML5410	8163425	ML5408
8126114	ML5050	8127547	ML5224	8142104	ML5998	8158506	ML5622	8163426	ML5210
8126114	ML5112	8127548	ML5168	8144209	ML5711	8158507	ML5411	8163427	ML5103
8126118	ML5042	8127548	ML5169	8144210	ML5709	8158508	ML5412	8163428	ML5398
8126119	ML5081	8127549	ML5127	8144211	ML5708	8158509	ML5623	8163429	ML5032
8126120	ML5282	8127550	ML5502	8144212	ML5708	8158700	ML5406	8163430	ML5258
8126121	ML5283	8127551	ML5231	8144213	ML5712	8158701	ML6036	8163432	ML5082
8126122	ML5068	8127551	ML5232	8144216	ML5707	8158705	ML5175	8163432	ML5257
		8127551	ML5233	8144217	ML5823	8159200	ML5578	8163435	ML5166

CROSS LIST

# MONROE® MAX-LIFT® CROSS REFERENCE LIST

## LESJOFORS

LESJOFORS	MONROE®	LESJOFORS	MONROE®	LESJOFORS	MONROE®	LESJOFORS	MONROE®	LESJOFORS	MONROE®
8163435	ML5167	8166749	ML5889	8172955	ML6063	8185702	ML5061	8195004	ML5038
8163435	ML5166	8166750	ML5344	8172957	ML6071	8185703	ML5217	8195005	ML5049
8163436	ML5138	8166750	ML5889	8172958	ML6072	8185703	ML5218	8195006	ML5191
8163437	ML5424	8166751	ML5340	8172959	ML6073	8185704	ML5045	8195011	ML5123
8163438	ML5515	8166753	ML5733	8172960	ML6128	8185705	ML5175	8195012	ML5123
8163439	ML5515	8166754	ML6058	8172961	ML6125	8185706	ML5681	8195014	ML5644
8163440	ML5369	8166755	ML6060	8172962	ML5891	8185707	ML5665	8195015	ML5644
8163442	ML5137	8166756	ML5968	8172963	ML5864	8185709	ML5667	8195016	ML5177
8163443	ML5120	8166757	ML5948	8172964	ML5550	8185710	ML5439	8195017	ML5178
8163444	ML5088	8166761	ML6123	8175701	ML5041	8185711	ML5135	8195020	ML5677
8163445	ML5089	8166762	ML6124	8175702	ML5192	8185712	ML5682	8195021	ML5677
8163446	ML6047	8168700	ML5595	8175703	ML5634	8185713	ML6080	8195022	ML5106
8163448	ML5366	8169700	ML5595	8175704	ML5338	8185715	ML6130	8195023	ML5246
8163449	ML5365	8169701	ML5594	8175705	ML5384	8185716	ML6081	8195024	ML5245
8163450	ML5341	8169705	ML6066	8175706	ML5384	8186000	ML5640	8195025	ML5118
8163451	ML5773	8169706	ML6067	8175707	ML5208	8186001	ML6082	8195026	ML5249
8163452	ML5516	8169707	ML5646	8175707	ML5209	8186002	ML5895	8195026	ML5250
8163453	ML5721	8172900	ML5021	8175708	ML5362	8186003	ML6083	8195026	ML5251
8163454	ML5669	8172901	ML5630	8175710	ML5306	8188304	ML5820	8195027	ML5226
8163455	ML5817	8172904	ML5310	8175712	ML5434	8188305	ML5819	8195029	ML5106
8163456	ML5119	8172905	ML5004	8175713	ML6148	8188308	ML6084	8195030	ML5127
8163457	ML6044	8172906	ML5093	8175715	ML5410	8188900	ML5589	8195031	ML5145
8163458	ML6044	8172907	ML5320	8175715	ML5478	8188901	ML5589	8195032	ML5675
8163459	ML6146	8172908	ML5331	8175716	ML5649	8188906	ML5091	8195033	ML5132
8163460	ML5827	8172909	ML5254	8175717	ML5871	8188907	ML5092	8195033	ML5185
8163461	ML5807	8172910	ML5279	8175718	ML5872	8188910	ML5780	8195035	ML5135
8163462	ML6043	8172910	ML5544	8175719	ML5411	8188911	ML5780	8195036	ML5193
8163462	ML5825	8172910	ML5545	8175721	ML6005	8188914	ML6086	8195037	ML5325
8163463	ML5346	8172911	ML5310	8175726	ML5479	8188915	ML6086	8195038	ML5135
8163464	ML5722	8172912	ML5256	8177800	ML5613	8188917	ML5088	8195038	ML5193
8163465	ML5078	8172913	ML5631	8177801	ML5635	8188922	ML5779	8195039	ML5132
8163466	ML5078	8172913	ML5632	8177802	ML5400	8192528	ML6089	8195040	ML5261
8163467	ML5805	8172914	ML5383	8177803	ML5401	8192529	ML6089	8195041	ML5199
8163470	ML5723	8172915	ML5131	8177804	ML5498	8192532	ML5592	8195042	ML5063
8163471	ML6051	8172916	ML5526	8177805	ML5499	8192533	ML5592	8195043	ML5100
8163472	ML6055	8172917	ML5241	8177806	ML5494	8192534	ML5121	8195044	ML5132
8163473	ML6122	8172918	ML5313	8177807	ML5496	8192541	ML5486	8195045	ML5742
8166701	ML5133	8172919	ML5314	8177808	ML5495	8192546	ML5485	8195046	ML5575
8166702	ML5020	8172920	ML5228	8177809	ML5557	8192547	ML6087	8195047	ML5743
8166704	ML5628	8172920	ML5229	8177810	ML5497	8192547	ML5963	8195048	ML5194
8166705	ML5364	8172921	ML5158	8177811	ML5402	8192548	ML6087	8195048	ML5196
8166706	ML5148	8172922	ML5130	8177812	ML5375	8192548	ML5963	8195050	ML5750
8166709	ML5202	8172922	ML5152	8177813	ML5558	8192549	ML5963	8195051	ML5796
8166710	ML5326	8172923	ML5094	8177814	ML5637	8192550	ML5641	8195053	ML5792
8166711	ML5426	8172924	ML5553	8177818	ML5766	8192555	ML5821	8195054	ML5754
8166712	ML5067	8172925	ML5128	8177820	ML6076	8192556	ML5821	8195055	ML5751
8166714	ML5625	8172926	ML5189	8177822	ML5852	8192557	ML5647	8195056	ML5831
8166715	ML5311	8172927	ML5440	8182900	ML5063	8192558	ML5699	8195057	ML5793
8166717	ML5180	8172927	ML5474	8182901	ML5140	8192561	ML5687	8195059	ML5830
8166719	ML5319	8172928	ML5190	8182901	ML5211	8192561	ML6151	8195060	ML5193
8166720	ML5146	8172929	ML5212	8182902	ML5124	8192566	ML5666	8195061	ML5259
8166720	ML5316	8172930	ML5518	8182903	ML5022	8192569	ML5900	8195062	ML5752
8166721	ML5134	8172931	ML5519	8182904	ML5127	8192570	ML6132	8195063	ML5742
8166723	ML5432	8172932	ML5551	8182905	ML5261	8192571	ML6133	8195064	ML5648
8166727	ML5113	8172933	ML5826	8182905	ML5264	8192572	ML6133	8195064	ML5653
8166728	ML5323	8172934	ML5475	8182905	ML5284	8192573	ML5917	8195065	ML6099
8166729	ML5469	8172935	ML5552	8182906	ML5100	8192574	ML5777	8195066	ML6098
8166730	ML5160	8172936	ML5725	8182907	ML5259	8192577	ML6135	8195067	ML6100
8166731	ML5425	8172937	ML5182	8182908	ML5181	8194602	ML5031	8195068	ML5838
8166732	ML5358	8172938	ML5894	8182909	ML5639	8194603	ML5244	8195070	ML5576
8166733	ML5183	8172939	ML5372	8182910	ML5016	8194604	ML5528	8195070	ML5833
8166734	ML5950	8172940	ML5828	8182911	ML5193	8194606	ML5077	8195071	ML5849
8166735	ML5776	8172941	ML5812	8182912	ML5778	8194607	ML5156	8195807	ML5642
8166736	ML5776	8172942	ML5789	8182913	ML5225	8194609	ML5365	8195808	ML5571
8166737	ML5687	8172943	ML5724	8182914	ML5100	8194635	ML5166	8195809	ML5571
8166738	ML5343	8172944	ML6075	8182915	ML5845	8194636	ML5138	8195810	ML5509
8166739	ML5730	8172946	ML5548	8182916	ML5767	8194637	ML5424	8195811	ML5906
8166740	ML5728	8172947	ML5230	8182917	ML5584	8194640	ML5369	8195813	ML5312
8166741	ML5727	8172948	ML5153	8182919	ML6129	8194642	ML5137	8195815	ML5840
8166742	ML5729	8172949	ML5656	8182920	ML5850	8194643	ML5120	8195816	ML5529
8166744	ML5731	8172950	ML5892	8182921	ML6078	8195000	ML5572	8195817	ML5347
8166746	ML5851	8172951	ML6070	8185700	ML5044	8195001	ML5573	8195818	ML5347
8166747	ML5732	8172952	ML5657	8185700	ML5048	8195002	ML5073	8195818	ML5348
8166748	ML5734	8172954	ML5893	8185701	ML5057	8195003	ML5574	8195819	ML5154

# MONROE® MAX-LIFT® CROSS REFERENCE LIST

## LESJOFORS

LESJOFORS	MONROE®
8195820	ML5154
8195821	ML5184
8195822	ML5909
8195823	ML5909

LESJOFORS	MONROE®
8195824	ML5489
8195825	ML5685
8195826	ML5481
8195827	ML5427

LESJOFORS	MONROE®
8195828	ML5488
8195829	ML5500
8195830	ML5907
8195831	ML6091

LESJOFORS	MONROE®
8195832	ML6092
8195832	ML6094
8195833	ML5487
8285710	ML5439

LESJOFORS	MONROE®
8772956	ML6126

## QH (LIP)

QH (LIP)	MONROE®
128002	ML5011
128003	ML5606
128007	ML5015
128022	ML5019
128024	ML5010
128029	ML5042
128052	ML5465
128053	ML5023
128056	ML5601
128062	ML5010
128062	ML5034
128065	ML5019
128066	ML5022
128069	ML5009
128069	ML5010
128069	ML5011
128070	ML5021
128071	ML5625
128073	ML5252
128074	ML5501
128075	ML5644
128076	ML5585
128078	ML5600
128083	ML5492
128086	ML5603
128088	ML5639
128089	ML5463
128090	ML5464
128092	ML5038
128096	ML5632
128097	ML5630
128098	ML5602
128099	ML5605
128106	ML5147
128108	ML5607
128113	ML5016
128114	ML5017
128118	ML5202
128119	ML5631
128123	ML5004
128124	ML5574
128125	ML6085
128131	ML5310
128132	ML5093
128133	ML5141
128134	ML5142
128135	ML5033
128140	ML5040
128140	ML5050
128140	ML5112
128141	ML5013
128141	ML5014
128141	ML5066
128146	ML5255
128147	ML5094
128148	ML5124
128149	ML5140
128150	ML5063
128152	ML5553
128153	ML5331
128155	ML5106
128156	ML5065
128157	ML5032
128158	ML5171
128159	ML5172

QH (LIP)	MONROE®
128160	ML5161
128161	ML5077
128162	ML5133
128170	ML5582
128174	ML5582
128178	ML5079
128178	ML5814
128179	ML5043
128180	ML5282
128182	ML5041
128182	ML5720
128183	ML5064
128185	ML5148
128190	ML5266
128191	ML5135
128223	ML5020
128244	ML5311
128245	ML5426
128249	ML5177
128252	ML5642
128254	ML5312
128255	ML5400
128256	ML5401
128257	ML5452
128261	ML5617
128262	ML5618
128264	ML5039
128272	ML5080
128273	ML5253
128282	ML5539
128283	ML5293
128284	ML5294
128287	ML5041
128288	ML5208
128289	ML5285
128289	ML5286
128290	ML5200
128291	ML5201
128293	ML5306
128294	ML5243
128295	ML5528
128295	ML5834
128296	ML5407
128297	ML5125
128297	ML5156
128298	ML5390
128298	ML5395
128299	ML5527
128300	ML5073
128301	ML5123
128302	ML5178
128304	ML5313
128305	ML5314
128319	ML5429
128320	ML5076
128321	ML5180
128323	ML5149
128324	ML5283
128324	ML5304
128324	ML5454
128324	ML5626
128325	ML5305
128325	ML5456
128325	ML5627
128327	ML5126

QH (LIP)	MONROE®
128328	ML5679
128331	ML5835
128335	ML5430
128336	ML5143
128337	ML5370
128338	ML5203
128339	ML5204
128340	ML5069
128341	ML5068
128342	ML5544
128343	ML5545
128344	ML5279
128345	ML5383
128348	ML5317
128349	ML5318
128350	ML5524
128351	ML5525
128352	ML5131
128353	ML5145
128354	ML5506
128356	ML5049
128357	ML5031
128358	ML5244
128362	ML5408
128363	ML5258
128363	ML5721
128365	ML5111
128366	ML5428
128367	ML5144
128368	ML5242
128369	ML5054
128371	ML5315
128372	ML5290
128373	ML5431
128374	ML5176
128375	ML5332
128376	ML5081
128377	ML5103
128379	ML5554
128380	ML5303
128381	ML5505
128382	ML5226
128383	ML5197
128384	ML5210
128385	ML5316
128387	ML5078
128388	ML5136
128389	ML5139
128389	ML5598
128390	ML5159
128391	ML5152
128391	ML5262
128392	ML5082
128393	ML5424
128394	ML5284
128395	ML5100
128396	ML5154
128397	ML5184
128398	ML5321
128399	ML5322
128401	ML5432
128402	ML5319
128405	ML5324
128406	ML5433
128407	ML5580

QH (LIP)	MONROE®
128412	ML5540
128413	ML5335
128414	ML5272
128415	ML5271
128416	ML5531
128417	ML5532
128418	ML5274
128419	ML5273
128420	ML5434
128421	ML5192
128422	ML5508
128422	ML5634
128423	ML5129
128424	ML5435
128426	ML5386
128428	ML5628
128429	ML5024
128429	ML5114
128430	ML5228
128431	ML5614
128432	ML5214
128432	ML5405
128433	ML5109
128433	ML5173
128434	ML5320
128435	ML5376
128436	ML5104
128438	ML5533
128439	ML5185
128440	ML5170
128441	ML5384
128442	ML5417
128444	ML5323
128445	ML5132
128446	ML5291
128447	ML5612
128448	ML5110
128449	ML5128
128449	ML5837
128450	ML5539
128451	ML5493
128457	ML5246
128458	ML5245
128459	ML5247
128460	ML5105
128498	ML5489
128499	ML5450
128500	ML5166
128501	ML5307
128502	ML5138
128503	ML5217
128504	ML5436
128505	ML5195
128506	ML5086
128507	ML5188
128510	ML5146
128511	ML5241
128512	ML5193
128513	ML5224
128514	ML5168
128515	ML5466
128516	ML5137
128517	ML5418
128518	ML5162
128519	ML5164

QH (LIP)	MONROE®
128521	ML5234
128522	ML5238
128523	ML5239
128524	ML5377
128525	ML5120
128526	ML5437
128527	ML5534
128528	ML5223
128529	ML5045
128530	ML5254
128531	ML5181
128532	ML5388
128533	ML5572
128534	ML5325
128536	ML5411
128537	ML5438
128538	ML5113
128539	ML5481
128542	ML5542
128543	ML5403
128551	ML5301
128561	ML5302
128562	ML5220
128563	ML5218
128564	ML5219
128565	ML5175
128566	ML5165
128567	ML5160
128568	ML5439
128569	ML5222
128570	ML5410
128571	ML5478
128571	ML5622
128573	ML5462
128575	ML5216
128576	ML5215
128577	ML5392
128579	ML5391
128580	ML5619
128581	ML5391
128582	ML5270
128583	ML5292
128584	ML5374
128585	ML5231
128586	ML5502
128588	ML5134
128589	ML5579
128591	ML5087
128592	ML5507
128593	ML5446
128593	ML5513
128594	ML5098
128595	ML5157
128596	ML5569
128597	ML5296
128598	ML5515
128599	ML5494
128600	ML5257
128601	ML5085
128602	ML5167
128603	ML5190
128604	ML5476
128605	ML5477
128606	ML5229
128607	ML5474

CROSS LIST

# MONROE® MAX-LIFT® CROSS REFERENCE LIST

## QH (LIP)

QH (LIP)	MONROE®	QH (LIP)	MONROE®	QH (LIP)	MONROE®	QH (LIP)	MONROE®	QH (LIP)	MONROE®
128608	ML5158	128702	ML5342	128783	ML5119	128922	ML5765	140260	ML5516
128609	ML5383	128703	ML5265	128783	ML6005	128924	ML5769	140260	ML5550
128610	ML5155	128704	ML5061	128784	ML5412	128925	ML5688	140261	ML5646
128611	ML5182	128705	ML5491	128785	ML5479	128928	ML5690	140262	ML5637
128612	ML5440	128706	ML5469	128785	ML5623	128929	ML5693	140299	ML5643
128613	ML5383	128707	ML5343	128786	ML5394	128930	ML5778	140300	ML5567
128614	ML5152	128708	ML5344	128786	ML5815	128931	ML5764	140301	ML5568
128615	ML5130	128709	ML5212	128787	ML5121	128934	ML5911	140303	ML5578
128616	ML5153	128710	ML5345	128788	ML5485	128938	ML5726	140304	ML5587
128617	ML5189	128711	ML5461	128789	ML5486	128939	ML5821	140305	ML5624
128618	ML5277	128712	ML5276	128790	ML5641	128940	ML5699	140310	ML5613
128619	ML5593	128714	ML5275	128791	ML5346	128941	ML5647	140312	ML5560
128620	ML5480	128715	ML5536	128792	ML5358	128960	ML5809	140312	ML5577
128621	ML5261	128719	ML5449	128793	ML5537	140021	ML5556	140313	ML5560
128622	ML5333	128720	ML5239	128805	ML5453	140024	ML5422	140313	ML5577
128623	ML5677	128721	ML6150	128806	ML5460	140025	ML5596	140320	ML5518
128624	ML5573	128722	ML5199	128808	ML5459	140046	ML5504	140321	ML5519
128625	ML5191	128723	ML5287	128809	ML5233	140074	ML5609	140322	ML5551
128626	ML5420	128724	ML5264	128810	ML5512	140075	ML5503	140324	ML5514
128628	ML5240	128725	ML5339	128810	ML5746	140080	ML5546	140325	ML5575
128630	ML5571	128726	ML5393	128811	ML5742	140084	ML5629	140326	ML5576
128632	ML5326	128727	ML5347	128812	ML5194	140114	ML5517	140326	ML5833
128633	ML5457	128728	ML5348	128813	ML5232	140115	ML5471	140327	ML5584
128636	ML5067	128729	ML5487	128814	ML5288	140116	ML5448	140329	ML5816
128637	ML5256	128732	ML5468	128815	ML5295	140121	ML5365	828125	ML5849
128638	ML5633	128733	ML5349	128821	ML5860	140122	ML5366	840132	ML5927
128639	ML5549	128733	ML5350	128826	ML5543	140123	ML5230	840134	ML5973
128640	ML5327	128734	ML5636	128831	ML5308	140124	ML5526	840251	ML6038
128642	ML5555	128735	ML5351	128833	ML5309	140125	ML5686	840270	ML6089
128643	ML5337	128736	ML5483	128843	ML5588	140126	ML5548	128087	ML5611
128644	ML5338	128737	ML5484	128850	ML5359	140127	ML5250	128699	ML5592
128645	ML5635	128738	ML5482	128851	ML5496	140128	ML5675		
128654	ML5399	128740	ML5096	128852	ML5495	140130	ML5511		
128655	ML5330	128741	ML5447	128853	ML5557	140131	ML5510		
128658	ML5336	128744	ML5297	128854	ML5497	140135	ML5118		
128659	ML5260	128745	ML5381	128855	ML5498	140136	ML5249		
128661	ML5840	128746	ML5382	128856	ML5499	140137	ML5251		
128661	ML5909	128747	ML5570	128859	ML5044	140144	ML5367		
128662	ML5535	128748	ML5378	128859	ML5048	140145	ML5547		
128663	ML5441	128749	ML5379	128860	ML5589	140154	ML5237		
128664	ML5263	128750	ML5380	128862	ML5509	140155	ML5235		
128665	ML5213	128751	ML5616	128865	ML5645	140156	ML5163		
128667	ML5280	128752	ML5352	128880	ML5490	140157	ML5444		
128668	ML5281	128753	ML5086	128881	ML5427	140158	ML5521		
128669	ML5458	128754	ML5413	128882	ML5361	140165	ML5102		
128670	ML5419	128755	ML5423	128883	ML5368	140169	ML5674		
128670	ML6047	128756	ML5581	128884	ML5373	140170	ML5089		
128671	ML5414	128757	ML5353	128885	ML5470	140171	ML5088		
128672	ML5467	128758	ML5354	128886	ML5500	140175	ML5685		
128673	ML5206	128759	ML5355	128887	ML5488	140176	ML5529		
128674	ML5169	128759	ML5729	128888	ML5387	140177	ML5127		
128675	ML5289	128760	ML5334	128889	ML5541	140180	ML5421		
128675	ML5782	128761	ML5356	128890	ML5727	140181	ML5522		
128676	ML5151	128762	ML5357	128890	ML5743	140182	ML5934		
128677	ML5211	128763	ML5583	128891	ML5728	140183	ML5566		
128678	ML5259	128764	ML5268	128892	ML5372	140184	ML5445		
128679	ML5341	128765	ML5267	128893	ML5812	140185	ML5520		
128680	ML5773	128766	ML6076	128895	ML5789	140186	ML5590		
128681	ML5196	128767	ML5558	128896	ML5826	140187	ML5523		
128682	ML5225	128768	ML5375	128897	ML5475	140190	ML5451		
128683	ML5198	128768	ML5402	128900	ML5472	140191	ML5236		
128684	ML5068	128769	ML5397	128901	ML5473	140192	ML5399		
128685	ML5207	128770	ML5442	128902	ML5744	140193	ML5179		
128686	ML5389	128771	ML5404	128903	ML5736	140194	ML5425		
128687	ML5209	128772	ML5702	128904	ML5832	140197	ML5599		
128689	ML5183	128773	ML5101	128905	ML5735	140224	ML5842		
128693	ML5221	128774	ML5443	128910	ML5669	140225	ML5843		
128694	ML5340	128775	ML5538	128911	ML5817	140228	ML5848		
128695	ML5205	128776	ML5122	128913	ML5559	140229	ML5847		
128696	ML5586	128777	ML5396	128914	ML5530	140238	ML5640		
128697	ML5608	128778	ML5371	128917	ML5711	140239	ML5329		
128698	ML5919	128778	ML5615	128918	ML5683	140240	ML5328		
128699	ML5227	128779	ML5406	128919	ML5684	140240	ML5621		
128701	ML5269	128782	ML5360	128920	ML5759	140259	ML5369		



# DIMENSION CHART

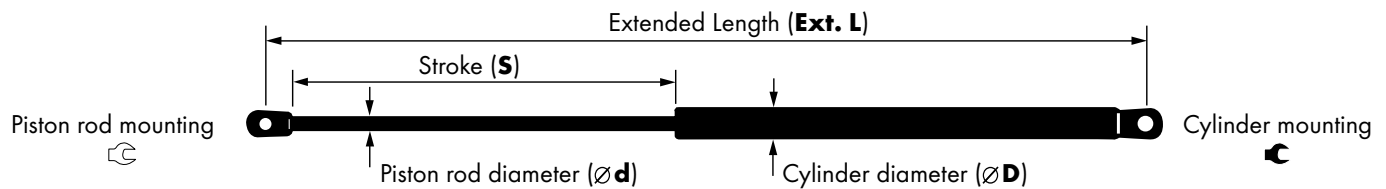

Monroe®	C	⌘	$\varnothing d$	$\varnothing D$	Ext. L	S	F1
ML5001	Y6	X1	8	18,5	405	160	390
ML5002	Y1	X1	8	18,5	509	200	400
ML5003	U	U	8	18,5	450	180	300
ML5004	U	U	8	18,5	502	200	400
ML5005	U	U	8	18,5	509	200	420
ML5006	Y2	X2	8	18,5	550	212	230
ML5007	Y6	X1	8	18,5	405	160	500
ML5008	Y1	X1	8	18,5	365	140	600
ML5009	Y6	X1	8	18,5	600	255	180
ML5010	Y6	X1	8	18,5	600	255	200
ML5011	Y6	X1	8	18,5	600	255	360
ML5012	U	U	8	18,5	600	245	410
ML5013	U	U	8	18,5	595	235	280
ML5014	U	U	8	18,5	584	234	280
ML5015	Y6	X1	8	18,5	549	229,5	350
ML5016	Y1	X2	8	18,5	549	229,5	240
ML5017	U	X2	8	18,5	362	135	190
ML5018	Y6	X1	8	18,5	256	86	280
ML5019	Y6	X1	8	18,5	600	250	500
ML5020	U	U	8	18,5	600	230	290
ML5021	U	U	8	18,5	700	251	200
ML5022	Y6	X1	8	18,5	696	278	220
ML5023	U	U	8	18,5	614	230	330
ML5024	U	C1	8	18,5	450	175	340
ML5025	U	U	8	18,5	450	175	260
ML5026	U	U	8	18,5	528	224	160
ML5027	U	U	8	18,5	586	236	280
ML5028	U	U	8	18,5	460	170	220
ML5029	U	U	8	18,5	589	239	310
ML5030	Y6	X1	8	18,5	256	86	180
ML5031	U	U	8	18,5	549	222	355
ML5032	U	U	8	18,5	473	188	530
ML5033	U	U	8	18,5	600	250	320
ML5034	Y6	X1	8	18,5	585	250	200
ML5035	U	U	8	18,5	450	175	280
ML5036	Y6	X1	8	18,5	518	209	220
ML5037	U	P	8	18,5	700	300	325
ML5038	U	U	8	18,5	500	200	280
ML5039	Y1	X2	8	18,5	550	229,5	380
ML5040	U	U	8	18,5	569	220	280
ML5041	U	U	8	18,5	542	210	300
ML5042	Y6	X1	8	18,5	600	255	310
ML5043	Y1	X1	8	18,5	490	180	480
ML5044	U	U	8	18,5	527	219	450
ML5045	U	C1	8	18,5	405	160	550
ML5046	U	U	8	18,5	700	300	260
ML5047	U	U	8	18,5	509	200	220
ML5048	U	U	8	18,5	527	219	420
ML5049	U	C1	8	18,5	500	212	350
ML5050	U	U	8	18,5	569	220	280
ML5051	S1	E1	10	22	726	280	420
ML5052	U	U	8	18,5	700	300	200
ML5053	U	U	8	18,5	550	212	350
ML5054	U	U	8	18,5	543,5	206	360
ML5055	Y6	X1	8	18,5	549,5	229,5	160
ML5056	Y1	X1	8	18,5	520	213	230
ML5057	P	S1	8	18,5	700	300	325
ML5058	Y1	X1	8	18,5	256	86	280
ML5059	Y2	X2	8	18,5	550	212	270
ML5060	Y1	X1	8	18,5	405	160	500
ML5061	U	C1	8	18,5	527	210	450
ML5062	U	U	8	18,5	586	236	200
ML5063	U	U	8	18,5	284	100	315
ML5064	U	U	8	18,5	527	219	520

Monroe®	C	⌘	$\varnothing d$	$\varnothing D$	Ext. L	S	F1
ML5065	U	U	8	18,5	600	245	430
ML5066	U	U	8	18,5	584	234	290
ML5067	Y1	X1	8	18,5	600	255	450
ML5068	U	U	8	18,5	515	202	370
ML5069	U	U	8	18,5	470	190	350
ML5070	Y1	D	8	18,5	405	160	500
ML5071	Y1	D	8	18,5	405	160	390
ML5072	U	U	8	18,5	502	200	280
ML5073	Y1	X1	8	18,5	501	207	480
ML5074	F1	Y3	10	22	798	350	500
ML5075	Y1	D	8	18,5	405	160	600
ML5076	U	U	10	22	550	235	850
ML5077	U	C1	8	18,5	591	240	350
ML5078	U	U	8	18,5	507	205	420
ML5079	U	U	8	18,5	445	180	300
ML5080	U	U	8	18,5	495	192	500
ML5081	U	C1	8	18,5	569	242	210
ML5082	U	U	8	18,5	469,5	171	560
ML5083	U	U	8	18,5	584	250	200
ML5084	U	U	8	18,5	685,5	300	200
ML5085	U	U	10	22	249	67	850
ML5086	S1	S1	8	18,5	526	207	570
ML5087	U	C1	8	18,5	473	172	420
ML5088	E2	E3	8	18,5	645	202,6	470
ML5089	E2	E3	8	18,5	645	202,6	470
ML5090	U	U	8	18,5	450	180	450
ML5091	E4	T1	8	18,5	613,8	248	190
ML5092	E4	T1	8	18,5	613,8	248	190
ML5093	S1	S1	8	18,5	471	191	360
ML5094	U	U	8	18,5	500	204	500
ML5095	U	U	8	18,5	324	115	290
ML5096	U	U	8	18,5	447	172	500
ML5097	U	U	8	18,5	460	170	270
ML5098	P	P	8	18,5	496	188	270
ML5099	U	U	8	18,5	528	224	220
ML5100	S1	S1	8	18,5	500	204	480
ML5101	S1	S1	8	18,5	502	199	280
ML5102	Y1	V	8	18,5	788	342	280
ML5103	U	U	8	18,5	510	202	620
ML5104	U	S1	8	18,5	280	95,5	630
ML5105	U	U	10	22	569	240	910
ML5106	U	D	8	18,5	514,5	217	610
ML5107	U	U	8	18,5	602	252	430
ML5108	U	U	8	18,5	450	170	460
ML5109	U	U	8	18,5	544	207	495
ML5110	U	U	8	18,5	500	170	635
ML5111	U	C1	8	18,5	402	160	390
ML5112	U	U	8	18,5	566,5	219	280
ML5113	T1	T1	8	18,5	700	300	670
ML5114	U	U	8	18,5	450	175	340
ML5115	U	U	8	18,5	500	200	400
ML5116	U	U	8	18,5	450	175	160
ML5117	S1	S1	8	18,5	440	175	175
ML5118	P	P	10	22	685	250	770
ML5119	U	U	8	18,5	540	196	540
ML5120	U	C1	8	18,5	475	195	350
ML5121	S1	S1	8	18,5	450	175	600
ML5122	U	U	8	18,5	570	232	520
ML5123	S1	S1	8	18,5	515	210	500
ML5124	U	U	8	18,5	515	195	500
ML5125	U	U	8	18,5	508	195	600
ML5126	S1	U	8	18,5	554	200	515
ML5127	U	U	10	22	591	200	830
ML5128	S1	S1	10	22	690	280	630

# DIMENSION CHART

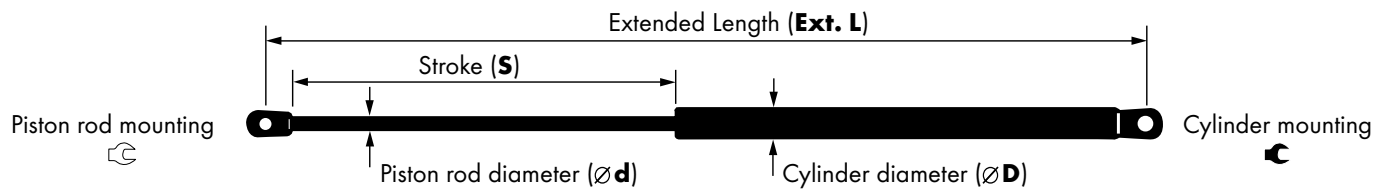

Monroe®	C	☉	$\varnothing d$	$\varnothing D$	Ext. L	S	F1
ML5129	S1	S1	8	18,5	622	240	360
ML5130	U	C1	8	18,5	596,5	212	515
ML5131	U	C1	8	18,5	440	160	450
ML5132	S1	U	8	18,5	502	205	500
ML5133	U	U	8	18,5	600	250	250
ML5134	U	U	8	18,5	585	222	280
ML5135	U	U	8	18,5	279	95	490
ML5136	U	U	8	18,5	448	180	310
ML5137	U	U	8	18,5	542	193	590
ML5138	U	U	8	18,5	566	204	500
ML5139	S1	S1	8	18,5	602	250	160
ML5140	U	U	8	18,5	526	206	320
ML5141	U	U	10	22	567	221	590
ML5142	U	U	10	22	567	221	650
ML5143	U	U	8	18,5	574	235	260
ML5144	U	U	8	18,5	565	216	360
ML5145	U	C1	8	18,5	431	173	380
ML5146	S1	S1	8	18,5	510	210	340
ML5147	U	U	8	18,5	574	235	310
ML5148	U	U	8	18,5	600	230	300
ML5149	U	U	8	18,5	611	230	355
ML5151	U	U	8	18,5	445	162	420
ML5152	U	C1	8	18,5	595	250	485
ML5153	S1	S1	8	18,5	460	169	100
ML5154	U	U	8	18,5	298	83	500
ML5155	U	U	8	18,5	440	160	520
ML5156	P	P	8	18,5	508	195	550
ML5157	U	U	10	22	540	200	450
ML5158	U	U	8	18,5	465	178	425
ML5159	S1	S1	8	18,5	485	190	320
ML5160	S1	S1	8	18,5	458	176	430
ML5161	U	U	8	18,5	534	216	410
ML5162	S1	S1	8	18,5	666,5	275	390
ML5163	S1	S1	8	18,5	350	100	320
ML5164	U	U	8	18,5	472	180	330
ML5165	U	U	8	18,5	455	164	380
ML5166	U	C1	8	18,5	536,5	205	430
ML5167	U	U	8	18,5	535	215	480
ML5168	U	U	8	18,5	512	200	550
ML5169	U	U	8	18,5	527	206	450
ML5170	U	U	8	18,5	295	80	480
ML5171	U	U	8	18,5	557	224	360
ML5172	U	U	8	18,5	557	224	425
ML5173	U	U	8	18,5	555	228	485
ML5175	U	C1	8	18,5	440	169	600
ML5176	S1	U	8	18,5	552	200	560
ML5177	U	U	8	18,5	515	210	550
ML5178	U	U	8	18,5	507	207	550
ML5179	S1	S1	6	15	305,5	121	45
ML5180	U	U	8	18,5	490	190	250
ML5181	S1	U	8	18,5	500	200	450
ML5182	S1	S1	8	18,5	300	100	410
ML5183	U	U	8	18,5	445	172	250
ML5184	S1	P	8	18,5	600,5	223	320
ML5185	S1	U	8	18,5	500	205	470
ML5188	U	U	8	18,5	540	214	400
ML5189	S1	S1	8	18,5	513	207	535
ML5190	S1	S1	8	18,5	513	207	585
ML5191	U	U	8	18,5	585	235	360
ML5192	U	U	8	18,5	680	270	360
ML5193	U	U	8	18,5	279	90	530
ML5194	S1	U	8	18,5	500	200	380
ML5195	S1	U	8	18,5	500	200	280
ML5196	S1	U	8	18,5	500	200	400

Monroe®	C	☉	$\varnothing d$	$\varnothing D$	Ext. L	S	F1
ML5197	S1	U	8	18,5	500	205	420
ML5198	S1	U	8	18,5	500	193	470
ML5199	S1	U	8	18,5	500	200	365
ML5200	U	U	8	18,5	577	226	415
ML5201	U	U	8	18,5	577	226	400
ML5202	U	U	8	18,5	566	230	440
ML5203	U	U	8	18,5	600	215	550
ML5204	U	U	8	18,5	600	215	600
ML5205	U	U	8	18,5	625	253	575
ML5206	U	U	8	18,5	599	190	425
ML5207	U	U	8	18,5	600	190	440
ML5208	U	U	8	18,5	552	205	370
ML5209	U	U	8	18,5	552	200	410
ML5210	U	U	8	18,5	440,5	158	370
ML5211	U	U	8	18,5	527	210	350
ML5212	U	U	8	18,5	417	155	500
ML5213	S1	S1	8	18,5	540	200	450
ML5214	S1	S1	8	18,5	517	200	460
ML5215	S1	S1	8	18,5	264	82	370
ML5216	S1	S1	8	18,5	264	82	460
ML5217	U	U	8	18,5	493	196	470
ML5218	U	U	8	18,5	495	198	500
ML5219	U	U	8	18,5	495	182	515
ML5220	U	U	8	18,5	495	182	550
ML5221	U	U	8	18,5	495	182	565
ML5222	S1	U	8	18,5	440	171	370
ML5223	U	U	10	22	298	95	650
ML5224	U	K	10	22	465	140	655
ML5225	S1	U	8	18,5	500	200	470
ML5226	U	S1	10	22	260	89	690
ML5227	S1	S1	8	18,5	502	200	530
ML5228	U	K	10	22	560	210	730
ML5229	U	U	10	22	560	210	800
ML5230	S1	S1	6	15	447	170	130
ML5231	U	U	8	18,5	535	198	485
ML5232	U	U	8	18,5	535	198	520
ML5233	U	U	8	18,5	535	198	585
ML5234	U	U	10	22	278	90	630
ML5235	U	U	8	18,5	596	190	380
ML5236	U	U	8	18,5	596	195	430
ML5237	U	U	8	18,5	596	190	420
ML5238	S1	P	8	18,5	500	200	635
ML5239	P	U	10	22	500	195	690
ML5240	P	P	10	22	500	200	635
ML5241	U	U	8	18,5	412	155	340
ML5242	U	U	8	18,5	543,5	206	320
ML5243	U	U	8	18,5	549	232	320
ML5244	U	U	8	18,5	549	232	410
ML5245	U	U	10	22	569	240	750
ML5246	U	U	10	22	569	240	660
ML5247	U	U	10	22	569	240	830
ML5248	U	U	10	22	567	225	460
ML5249	P	P	10	22	685	250	710
ML5250	P	P	10	22	685	250	910
ML5251	P	P	10	22	685	250	830
ML5252	U	U	8	18,5	544	210	440
ML5253	U	U	8	18,5	496,5	192	565
ML5254	U	U	8	18,5	476,5	184	420
ML5255	U	U	8	18,5	600	250	320
ML5256	U	U	8	18,5	505	190	520
ML5257	U	U	8	18,5	470	182	600
ML5258	U	U	8	18,5	471	184	570
ML5259	U	U	8	18,5	287	99	365
ML5260	U	U	8	18,5	293	80	610

# DIMENSION CHART

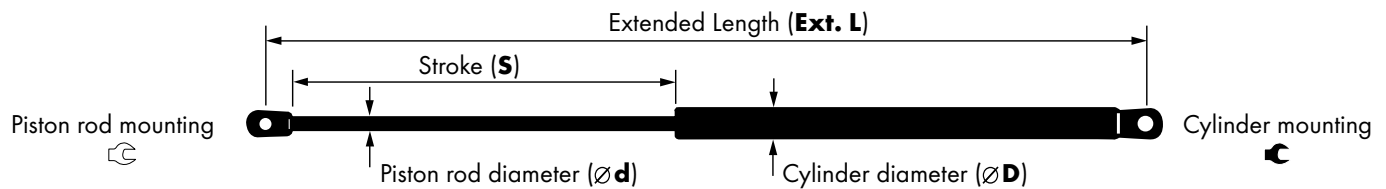

Monroe®	C	↺	$\varnothing d$	$\varnothing D$	Ext. L	S	F1
ML5261	S1	U	8	18,5	500	200	350
ML5262	U	U	8	18,5	595	250	450
ML5263	S1	S1	8	18,5	319	110	580
ML5264	S1	U	8	18,5	500	200	350
ML5265	U	U	8	18,5	585	235	250
ML5266	U	C1	8	18,5	722	306	280
ML5267	S1	S1	8	18,5	648	265	190
ML5268	U	U	8	18,5	685	285	180
ML5269	P	U	8	18,5	715	306	290
ML5270	U	U	8	18,5	460	160	300
ML5271	U	U	8	18,5	522	210	300
ML5272	U	U	8	18,5	522	210	400
ML5273	U	U	8	18,5	278	90	480
ML5274	U	U	8	18,5	278	90	430
ML5275	U	U	8	18,5	405	160	310
ML5276	U	U	8	18,5	529	215	245
ML5277	U	U	8	18,5	405	150	520
ML5278	U	U	8	18,5	570	240	520
ML5279	S1	U	8	18,5	595	210	470
ML5280	U	U	8	18,5	441,5	169	460
ML5281	U	U	8	18,5	506	200	380
ML5282	U	U	8	18,5	630	269	330
ML5283	U	U	8	18,5	627	230	570
ML5284	S1	U	8	18,5	500	200	320
ML5285	U	U	8	18,5	595	248	370
ML5286	U	U	8	18,5	591	239	400
ML5287	S1	U	8	18,5	500	200	190
ML5288	U	U	8	18,5	570	230	460
ML5289	U	U	8	18,5	556	205	500
ML5290	U	U	8	18,5	256	85	500
ML5291	U	U	8	18,5	501	175	595
ML5292	U	U	8	18,5	550	220	285
ML5293	U	U	8	18,5	485	196	460
ML5294	U	U	8	18,5	485	196	520
ML5295	U	U	8	18,5	678	282	480
ML5296	U	U	8	18,5	520	197	435
ML5297	U	U	8	18,5	435	160	100
ML5298	U	U	8	18,5	450	175	260
ML5299	U	U	8	18,5	602	252	430
ML5300	U	U	8	18,5	527	202	390
ML5301	U	U	8	18,5	295	100	380
ML5302	U	U	8	18,5	385	138	560
ML5303	S1	S1	8	18,5	365	135	620
ML5304	U	U	8	18,5	627	230	570
ML5305	U	U	8	18,5	610	200	560
ML5306	U	U	8	18,5	500	196	225
ML5307	U	U	8	18,5	485	189	450
ML5308	U	U	8	18,5	450	170	490
ML5309	U	U	8	18,5	675	285	260
ML5310	U	U	8	18,5	310	89	590
ML5311	U	U	8	18,5	640	190	470
ML5312	U	U	8	18,5	545	230	300
ML5313	U	U	8	18,5	526	206	560
ML5314	U	U	8	18,5	545	220	530
ML5315	U	U	8	18,5	675	275	440
ML5316	U	U	8	18,5	408	150	310
ML5317	U	U	8	18,5	590	215	410
ML5318	U	U	8	18,5	590	215	450
ML5319	U	U	8	18,5	558	200	550
ML5320	U	U	8	18,5	600	225	450
ML5321	U	U	8	18,5	315	100	420
ML5322	U	U	8	18,5	315	100	465
ML5323	U	U	8	18,5	285	95	290
ML5324	U	U	8	18,5	590	220	480

Monroe®	C	↺	$\varnothing d$	$\varnothing D$	Ext. L	S	F1
ML5325	U	U	8	18,5	600	244	330
ML5326	U	U	8	18,5	566	230	450
ML5327	U	U	8	18,5	540	220	250
ML5328	U	U	10	22	775	322	530
ML5329	U	U	10	22	772	322	630
ML5330	U	U	10	22	250	74	660
ML5331	U	K	10	22	450	162	740
ML5332	U	U	8	18,5	485	165	640
ML5333	Y1	D	8	18,5	668	280	375
ML5334	U	U	8	18,5	549,5	200	610
ML5335	S1	S1	8	18,5	310	110	580
ML5336	S1	S1	10	22	333	100	700
ML5337	U	U	8	18,5	691,5	285	270
ML5338	U	U	8	18,5	570	215	530
ML5339	S1	U	8	18,5	480	180	300
ML5340	U	U	8	18,5	525	210	140
ML5341	U	U	8	18,5	263	80	520
ML5342	U	U	8	18,5	575	235	330
ML5343	U	U	8	18,5	448	180	590
ML5344	U	U	8	18,5	632	230	510
ML5345	U	U	8	18,5	650	270	310
ML5346	U	U	8	18,5	571	208	570
ML5347	U	U	8	18,5	525	205	310
ML5348	U	U	8	18,5	525	205	350
ML5349	U	U	8	18,5	525	210	480
ML5350	U	U	8	18,5	525	210	240
ML5351	U	U	8	18,5	357	128	555
ML5352	U	U	8	18,5	268	78	510
ML5353	U	U	8	18,5	555	220	450
ML5354	U	U	8	18,5	570	230	490
ML5355	U	U	8	18,5	310	95	430
ML5356	U	U	8	18,5	352	110	150
ML5357	U	U	8	18,5	538	190	125
ML5358	U	U	8	18,5	500	171	400
ML5359	U	U	8	18,5	513	215	350
ML5360	U	U	8	18,5	500	190	360
ML5361	U	U	8	18,5	510	200	320
ML5362	U	U	8	18,5	507	208	436
ML5363	U	U	8	18,5	632	215	600
ML5364	U	U	8	18,5	635	248	360
ML5365	U	U	8	18,5	365	135	180
ML5366	U	U	8	18,5	365	135	240
ML5367	U	U	8	18,5	567,5	183	430
ML5368	S1	S1	8	18,5	750	315	300
ML5369	U	U	8	18,5	828	249	355
ML5370	U	P	8	18,5	510	200	370
ML5371	U	U	8	18,5	499	195	400
ML5372	U	U	8	18,5	546	215	500
ML5373	U	U	8	18,5	548	213	475
ML5374	U	U	8	18,5	556	225	475
ML5375	U	U	8	18,5	568	230	500
ML5376	U	S1	8	18,5	280	90	580
ML5377	U	S1	8	18,5	507	203	520
ML5378	U	S1	8	18,5	545	210	490
ML5379	U	S1	8	18,5	545	210	530
ML5380	U	S1	8	18,5	485	187	610
ML5381	U	S1	8	18,5	557	215	550
ML5382	U	S1	8	18,5	440	155	300
ML5383	U	S1	8	18,5	473,5	170	590
ML5384	U	S1	8	18,5	606,5	230	540
ML5385	U	X1	10	22	885	380	410
ML5386	U	U	8	18,5	722	315	325
ML5387	U	U	8	18,5	395	148	180
ML5388	U	U	8	18,5	565	215	480

DIMENSION CHART

# DIMENSION CHART

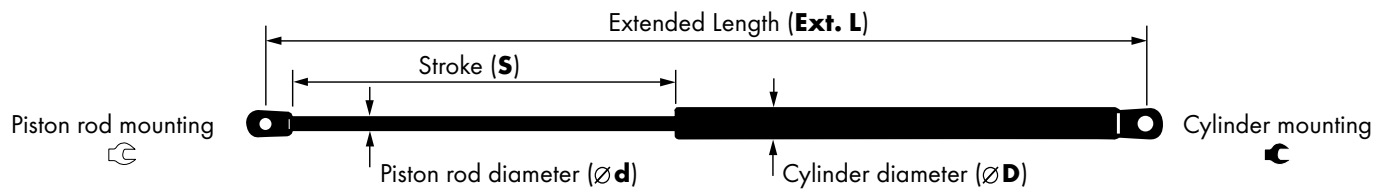

Monroe®	C	☞	$\varnothing d$	$\varnothing D$	Ext. L	S	F1
ML5389	S1	S1	8	18,5	215	48	420
ML5390	U	U	8	18,5	508	194	350
ML5391	U	U	8	18,5	510	208	470
ML5392	S1	S1	8	18,5	400	149	300
ML5393	U	U	8	18,5	678	270	270
ML5394	U	U	8	18,5	600	226	360
ML5395	U	U	8	18,5	510	208	390
ML5396	U	U	8	18,5	568	213	360
ML5397	U	U	8	18,5	568	230	560
ML5398	U	U	8	18,5	580	245	340
ML5399	U	U	8	18,5	570	230	215
ML5400	U	U	8	18,5	570	230	420
ML5401	U	U	8	18,5	570	230	520
ML5402	U	U	8	18,5	570	240	470
ML5403	U	U	8	18,5	668	215	375
ML5404	U	U	8	18,5	240	74	300
ML5405	U	U	8	18,5	516	205	425
ML5406	U	U	8	18,5	498	197	330
ML5407	U	U	8	18,5	700	257	320
ML5408	U	U	8	18,5	511	199	520
ML5409	U	U	8	18,5	765	325	235
ML5410	S1	S1	8	18,5	515	200	445
ML5411	S1	U	8	18,5	315	105	370
ML5412	S1	U	8	18,5	565	210	560
ML5413	S1	U	8	18,5	472	175	590
ML5414	S1	S1	8	18,5	438	170	480
ML5415	U	U	10	22	455	127	700
ML5416	U	U	8	18,5	481,5	199	530
ML5417	S1	S1	8	18,5	275	90	590
ML5418	U	U	8	18,5	645,5	275	450
ML5419	S1	S1	8	18,5	280	95	390
ML5420	Y1	D	8	18,5	465	187	320
ML5421	10	10	6	15	367	145	320
ML5422	10	10	6	15	410	166	280
ML5423	U	U	10	22	520	180	660
ML5424	U	S1	8	18,5	567	193	540
ML5425	U	C1	8	18,5	491	205	600
ML5426	U	U	10	22	418	148	700
ML5427	S1	U	8	18,5	471	185	380
ML5428	S1	S1	8	18,5	580	247	470
ML5429	U	U	10	22	550	235	810
ML5430	U	U	8	18,5	590,5	245	480
ML5431	U	U	8	18,5	256	85	630
ML5432	S1	S1	8	18,5	624	260	400
ML5433	U	U	10	22	520	180	665
ML5434	U	U	8	18,5	599	220	360
ML5435	S1	S1	8	18,5	656	260	400
ML5436	S1	S1	8	18,5	517	190	420
ML5437	S1	U	8	18,5	575	220	500
ML5438	S1	S1	8	18,5	459,5	180	535
ML5439	U	U	8	18,5	279	95	520
ML5440	S1	S1	8	18,5	534,5	220	480
ML5441	S1	S1	10	22	326	115	800
ML5442	U	U	8	18,5	348	120	620
ML5443	U	U	10	22	603	220	740
ML5444	10	10	8	18,5	365	145	410
ML5445	10	10	8	18,5	365	145	480
ML5446	T1	T1	10	22	382	140	660
ML5447	T1	T1	8	18,5	540	130	170
ML5448	U	U	10	22	866	350	370
ML5449	U	U	8	18,5	405	160	620
ML5450	U	U	8	18,5	635	259	290
ML5451	U	U	8	18,5	611	205	350
ML5452	U	U	8	18,5	653	260	460

Monroe®	C	☞	$\varnothing d$	$\varnothing D$	Ext. L	S	F1
ML5453	U	U	8	18,5	460	180	380
ML5454	U	U	8	18,5	627	230	630
ML5455	U	U	8	18,5	632	215	600
ML5456	U	U	8	18,5	610	200	600
ML5457	U	U	8	18,5	546	225	220
ML5458	U	U	8	18,5	631	230	440
ML5459	S1	S1	8	18,5	485	193	460
ML5460	S1	S1	8	18,5	494	185	490
ML5461	S1	S1	8	18,5	506	205	180
ML5462	S1	S1	8	18,5	477	188	360
ML5463	S1	S1	8	18,5	577	226	275
ML5464	S1	S1	8	18,5	577	226	320
ML5465	S1	S1	8	18,5	614	229	300
ML5466	S1	S1	8	18,5	280	80	465
ML5467	S1	S1	8	18,5	280	80	420
ML5468	S1	S1	8	18,5	512	200	470
ML5469	S1	S1	8	18,5	581,5	210	535
ML5470	S1	S1	8	18,5	685	265	200
ML5471	S1	S1	8	18,5	286	100	310
ML5472	S1	S1	8	18,5	395	150	230
ML5473	S1	S1	8	18,5	395	150	470
ML5474	S1	S1	8	18,5	535	220	425
ML5475	U	U	8	18,5	520	175	640
ML5476	S1	S1	8	18,5	574,5	230	530
ML5477	S1	S1	8	18,5	574,5	230	620
ML5478	S1	S1	8	18,5	515	200	490
ML5479	S1	S1	8	18,5	398	120	180
ML5480	S1	S1	8	18,5	452	177	350
ML5481	S1	S1	8	18,5	270	75	420
ML5482	S1	S1	8	18,5	575	230	440
ML5483	S1	S1	8	18,5	280	95	500
ML5484	S1	S1	8	18,5	400	150	280
ML5485	S1	U	8	18,5	468	163	440
ML5486	S1	S1	8	18,5	434	153	585
ML5487	S1	S1	8	18,5	298	90	600
ML5488	S1	S1	8	18,5	320	100	360
ML5489	S1	S1	8	18,5	364	132	310
ML5490	S1	S1	8	18,5	363	132	370
ML5491	S1	U	8	18,5	500	200	310
ML5492	Y1	D	8	18,5	465	169	113
ML5493	S1	S1	8	18,5	558	200	135
ML5494	Y1	D	8	18,5	700	295	400
ML5495	U	U	8	18,5	490	195	610
ML5496	Y1	D	8	18,5	226	63	100
ML5497	Y1	D	8	18,5	670	294	320
ML5498	Y1	D	8	18,5	670	294	345
ML5499	Y1	D	8	18,5	700	295	345
ML5500	S1	S1	8	18,5	430	160	470
ML5501	Y2	D	8	18,5	600	250	540
ML5502	S1	S1	8	18,5	300	99	560
ML5503	T1	T1	8	18,5	600	230	510
ML5504	T1	T1	8	18,5	837	315	365
ML5505	T1	T1	8	18,5	630	220	570
ML5506	T1	T1	8	18,5	540	220	490
ML5507	T1	T1	8	18,5	433	165	500
ML5508	T1	T1	8	18,5	680	270	390
ML5509	T1	T1	8	18,5	534	217	200
ML5510	U	U	10	22	483	175	740
ML5511	U	U	10	22	483	175	690
ML5512	U	U	10	22	480	173	690
ML5513	T1	T1	10	22	382	140	660
ML5514	U	U	10	22	850	340	670
ML5515	U	U	10	22	722	210	819
ML5516	T1	T1	10	22	905	307	730

# DIMENSION CHART

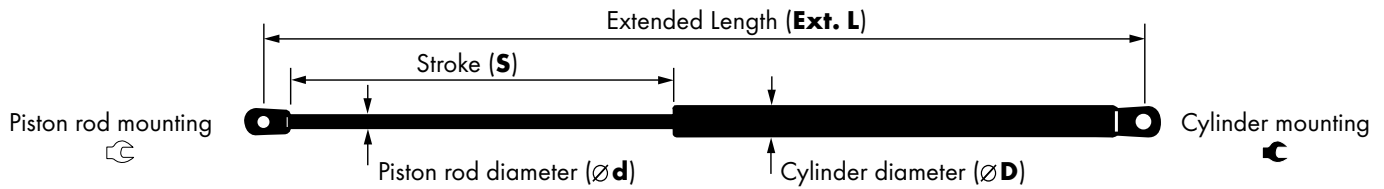

Monroe®	C	C	$\varnothing d$	$\varnothing D$	Ext. L	S	F1
ML5517	U	U	10	22	195	55	1100
ML5518	U	U	10	22	730	200	700
ML5519	U	U	10	22	730	200	760
ML5520	S1	12	8	18,5	336	100	520
ML5521	T1	Q	8	18,5	665	270	360
ML5522	10	10	8	18,5	242	84	380
ML5523	S1	12	8	18,5	312	100	640
ML5524	T1	T1	10	22	273	92	680
ML5525	T1	T1	10	22	273	92	720
ML5526	S1	14	8	18,5	178	55	480
ML5527	O	O	10	22	613,5	248	620
ML5528	M	O	10	22	697	257	610
ML5529	O	M	14	28	270	70	1600
ML5530	U	P	8	18,5	640	260	510
ML5531	S1	T1	8	18,5	280	90	500
ML5532	S1	T1	8	18,5	280	90	600
ML5533	T1	T1	10	22	272	90	670
ML5534	S1	U	8	18,5	605	247	340
ML5535	Y1	T1	8	18,5	241	70	560
ML5536	U	Q	8	18,5	288	95	250
ML5537	U	U	10	22	603	198	810
ML5538	U	U	10	22	603	198	850
ML5539	U	U	10	22	489	144	720
ML5540	S2	S2	10	22	364	130	800
ML5541	S1	S1	8	18,5	568	215	410
ML5542	U	U	8	18,5	667	215	375
ML5543	U	U	8	18,5	695	272	640
ML5544	U	S1	8	18,5	596	210	450
ML5545	U	S1	8	18,5	596	210	510
ML5546	R	R	6	15	185	55	100
ML5547	S1	S1	6	15	502	200	125
ML5548	S1	S1	6	15	530	213	110
ML5549	T1	D	8	18,5	270	90	540
ML5550	T1	T1	10	22	905	307	730
ML5551	S1	S1	6	15	547	190	170
ML5552	S1	S1	6	15	365	135	135
ML5553	U	U	10	22	310	89	650
ML5554	U	T1	10	22	573,5	215	580
ML5555	U	T1	10	22	573,5	215	670
ML5556	Y1	X1	6	15	547	214	225
ML5557	U	U	10	22	492	188	710
ML5558	U	T1	8	18,5	280	90	550
ML5559	U	S2	10	22	235	52	850
ML5560	U	13	8	18,5	525	200	280
ML5561	U	U	8	18,5	687	295	270
ML5562	S1	S1	8	18,5	313	112	330
ML5563	S1	S1	8	18,5	374	140	350
ML5564	U	P	8	18,5	577	225	270
ML5565	P	S1	8	18,5	715	303	160
ML5566	10	10	8	18,5	254	90	420
ML5567	S1	S1	8	18,5	635	225	200
ML5568	S1	S1	8	18,5	464	166	160
ML5569	S1	S1	8	18,5	485	185	580
ML5570	S1	S1	8	18,5	490	187	380
ML5571	T1	T1	8	18,5	550	222	475
ML5572	Y1	U	8	18,5	500	190	220
ML5573	U	D	8	18,5	640	235	390
ML5574	U	D	8	18,5	500	200	270
ML5575	U	P	10	22	755	210	970
ML5576	U	U	10	22	755	210	1080
ML5577	U	13	8	18,5	563	200	280
ML5578	U	U	8	18,5	650	250	460
ML5579	S1	S1	8	18,5	523	202	530
ML5580	U	U	10	22	520	185	730

Monroe®	C	C	$\varnothing d$	$\varnothing D$	Ext. L	S	F1
ML5581	U	U	10	22	527	200	660
ML5582	U	U	10	22	769	247	475
ML5583	U	U	10	22	195	50	760
ML5584	S1	U	10	22	870	370	370
ML5585	O	O	10	22	613,5	248	560
ML5586	O	O	10	22	613,5	248	640
ML5587	S1	S1	8	18,5	459	172	230
ML5588	S1	S1	8	18,5	559	220	330
ML5589	S1	S1	8	18,5	671,5	270	360
ML5590	S1	12	8	18,5	346	100	520
ML5591	U	Q	10	22	545	195	750
ML5592	S1	S1	8	18,5	498	225	540
ML5593	Y1	D	8	18,5	615	260	400
ML5594	Y5	X3	8	18,5	255	86	600
ML5595	Y5	X3	8	18,5	255	86	370
ML5596	Y4	X1	6	15	254	95	350
ML5597	U	X1	8	18,5	547	230	230
ML5598	S1	S1	8	18,5	600	250	160
ML5599	Y1	X1	6	15	440	142	380
ML5600	Y1	D	8	18,5	500	200	230
ML5601	Y1	D	8	18,5	650	275	240
ML5602	S1	D	8	18,5	650	275	240
ML5603	Y1	D	8	18,5	650	275	310
ML5604	S1	D	8	18,5	640	278	300
ML5605	S1	D	8	18,5	650	275	310
ML5606	Y1	D	8	18,5	579	235	320
ML5607	S1	S1	8	18,5	544	224	250
ML5608	N	N	8	18,5	675	279	210
ML5609	W	D	8	18,5	580	245	380
ML5611	Y1	D	8	18,5	245	76	330
ML5612	U	U	10	22	501	175	780
ML5613	Y1	D	8	18,5	500	201	600
ML5614	U	U	10	22	490	200	780
ML5615	U	P	8	18,5	502	195	400
ML5616	S1	U	8	18,5	570	200	630
ML5617	N	N	8	18,5	268	83,5	450
ML5618	N	N	8	18,5	505	180	430
ML5619	N	N	8	18,5	330	116	340
ML5620	U	U	8	18,5	580	205	230
ML5621	U	U	10	22	775	322	530
ML5622	S1	S1	8	18,5	515	187	490
ML5623	S1	S1	8	18,5	398	120	180
ML5624	P	T1	8	18,5	392	150	300
ML5625	Y1	U	8	18,5	419	165	360
ML5626	U	U	8	18,5	627	230	570
ML5627	U	U	8	18,5	610	200	560
ML5628	U	U	10	22	265	80	820
ML5629	R	R	6	15	225	80	100
ML5630	S1	S1	10	22	431	121	680
ML5631	T1	T1	8	18,5	677	274	340
ML5632	Y1	D	8	18,5	486	170	585
ML5633	Y1	D	8	18,5	268	90	540
ML5634	T1	T1	8	18,5	680	270	360
ML5635	Y1	D	8	18,5	500	195	650
ML5636	U	U	8	18,5	525	210	240
ML5637	O	O	14	28	396	108	1550
ML5638	U	U	8	18,5	765	324	200
ML5639	Y1	D	8	18,5	254	85	340
ML5640	T1	T1	6	15	305	109	130
ML5641	S1	S1	8	18,5	511,5	172	545
ML5642	T1	T1	8	18,5	550	200	460
ML5643	S1	S1	6	15	244	90	400
ML5644	T1	D	8	18,5	515	215	550
ML5645	Y1	U	8	18,5	512	200	300

# DIMENSION CHART

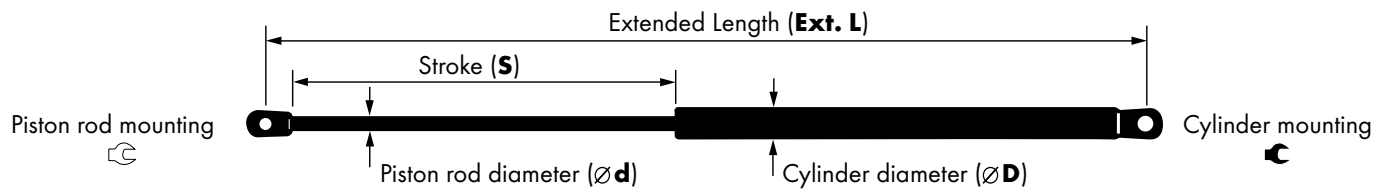

Monroe®	C	☞	$\varnothing d$	$\varnothing D$	Ext. L	S	F1
ML5646	Y5	X3	8	18,5	319	100	370
ML5647	P	S1	8	18,5	485	200	565
ML5648	P	U	8	18,5	728	310	265
ML5649	U	U	8	18,5	405	160	300
ML5650	P	U	8	18,5	484	190	200
ML5651	P	U	8	18,5	544	218	290
ML5652	J	S1	8	18,5	375	135	495
ML5653	S1	U	8	18,5	439,5	157	550
ML5654	U	U	8	18,5	657	275	480
ML5655	S1	U	8	18,5	456	165	320
ML5656	P	P	8	18,5	469,5	185	580
ML5657	S1	S1	8	18,5	495	205	610
ML5658	S1	S1	8	18,5	369	110	320
ML5659	S1	S1	8	18,5	553	225	220
ML5660	P	U	8	18,5	441	175	300
ML5661	U	U	8	18,5	440	170	470
ML5662	U	U	8	18,5	590	245	460
ML5663	U	U	8	18,5	283	101,5	450
ML5664	U	U	8	18,5	585	240	420
ML5665	U	U	8	18,5	585,5	245	405
ML5666	U	U	8	18,5	531	173	545
ML5667	U	U	8	18,5	490,5	200	480
ML5668	S1	U	8	18,5	545	195	425
ML5669	U	U	8	18,5	424,5	165	450
ML5670	S1	S1	8	18,5	366	117	280
ML5671	U	U	8	18,5	627	205	660
ML5672	U	U	8	18,5	540	210	385
ML5673	U	U	8	18,5	582	203	460
ML5674	1	1	14	28	325	100	1400
ML5675	U	U	10	22	175	45	700
ML5676	U	U	8	18,5	436	175	150
ML5677	Y1	T1	8	18,5	499	205	460
ML5678	U	L	10	22	943	417	380
ML5679	L	L	8	18,5	722	306	310
ML5680	U	U	8	18,5	350	130	440
ML5681	U	U	8	18,5	495	205	440
ML5682	U	U	8	18,5	420	162	600
ML5683	P	U	8	18,5	580	201	510
ML5684	U	U	8	18,5	515	190	490
ML5685	M	O	14	28	320	85	1200
ML5686	U	U	8	18,5	165	40	650
ML5687	U	U	8	18,5	555	228	305
ML5688	S1	S1	8	18,5	288	104	640
ML5689	S1	P	8	18,5	400	160	330
ML5690	S1	S1	8	18,5	530	175	530
ML5691	S1	U	8	18,5	412	163	400
ML5692	U	U	8	18,5	545	210	450
ML5693	P	S1	8	18,5	625	210	590
ML5694	S1	S1	8	18,5	370	110	320
ML5695	S1	U	8	18,5	425	165	350
ML5696	P	U	8	18,5	355	120	350
ML5697	U	U	8	18,5	604	253	250
ML5698	S1	U	8	18,5	291	107	380
ML5699	P	S1	8	18,5	445	183	550
ML5700	U	U	8	18,5	480	173	135
ML5701	S1	U	8	18,5	590	176	435
ML5702	P	S1	8	18,5	470	185	480
ML5703	P	U	8	18,5	480	190	420
ML5704	T1	T1	8	18,5	378	145	540
ML5705	S1	U	8	18,5	565	240	290
ML5706	P	U	8	18,5	395	158	440
ML5707	U	U	8	18,5	545	210	620
ML5708	U	U	8	18,5	480	195	335
ML5709	U	U	10	22	736,5	310	725

Monroe®	C	☞	$\varnothing d$	$\varnothing D$	Ext. L	S	F1
ML5710	U	U	8	18,5	299	109	550
ML5711	U	U	8	18,5	515	210	490
ML5712	P	U	8	18,5	490	200	380
ML5713	U	U	8	18,5	515	215	400
ML5714	U	P	8	18,5	386,5	150	350
ML5715	U	C1	8	18,5	650	270	350
ML5716	U	U	10	22	667	255	755
ML5717	P	U	8	18,5	497	200	430
ML5718	U	U	10	22	547	220	460
ML5719	U	P	8	18,5	475	175	510
ML5720	U	U	8	18,5	543	220	310
ML5721	U	U	8	18,5	474	190	570
ML5722	U	U	10	22	505	205	610
ML5723	S1	S1	8	18,5	405	160	480
ML5724	S1	S1	8	18,5	533	200	515
ML5725	S1	S1	8	18,5	451	185	385
ML5726	U	U	8	18,5	730	316	140
ML5727	U	U	8	18,5	320	105	470
ML5728	U	U	8	18,5	375	145	615
ML5729	U	U	8	18,5	310	110	400
ML5730	U	U	8	18,5	565	215	315
ML5731	S1	P	8	18,5	505	211	330
ML5732	S1	S1	8	18,5	505	195	490
ML5733	S1	S1	6	15	435	180	105
ML5734	S1	S1	8	18,5	460	180	440
ML5735	P	U	8	18,5	730	320	250
ML5736	S1	U	8	18,5	404,5	163	460
ML5737	P	U	8	18,5	720	300	180
ML5738	P	U	8	18,5	735	321	300
ML5739	U	P	8	18,5	485	200	170
ML5740	S1	U	8	18,5	315	120	440
ML5741	U	U	8	18,5	765	335	340
ML5742	S1	U	8	18,5	450	180	535
ML5743	U	P	10	22	505	170	770
ML5744	U	U	10	22	298	80	730
ML5745	U	U	10	22	298	80	700
ML5746	U	P	8	18,5	475	184	650
ML5747	T1	T1	8	18,5	490	198	530
ML5748	S1	U	8	18,5	255	85	600
ML5749	U	P	8	18,5	530	210	410
ML5750	U	U	10	22	720	280	870
ML5751	T1	T1	10	22	300	70	710
ML5752	U	U	8	18,5	500	208	375
ML5753	U	U	8	18,5	470	160	630
ML5754	U	P	8	18,5	528	212	420
ML5755	U	P	8	18,5	640	255	595
ML5756	U	P	8	18,5	640	255	565
ML5757	U	U	8	18,5	473	182	540
ML5758	P	U	8	18,5	726,5	310	360
ML5759	T1	T1	8	18,5	483	191	370
ML5760	P	U	8	18,5	515	196	585
ML5761	U	U	8	18,5	305	105	550
ML5762	P	U	8	18,5	385	150	140
ML5763	T1	T1	8	18,5	540	225	390
ML5764	U	U	8	18,5	252	85	425
ML5765	T1	T1	8	18,5	565	220	500
ML5766	S1	S1	8	18,5	318	120	380
ML5767	S1	U	8	18,5	500	195	340
ML5768	U	U	8	18,5	721,5	315	350
ML5769	U	S1	10	22	285	100	720
ML5770	P	P	8	18,5	605	242	655
ML5771	P	P	10	22	574	198	990
ML5772	T1	P	8	18,5	539	218	585
ML5773	U	U	8	18,5	475	195	640

# DIMENSION CHART

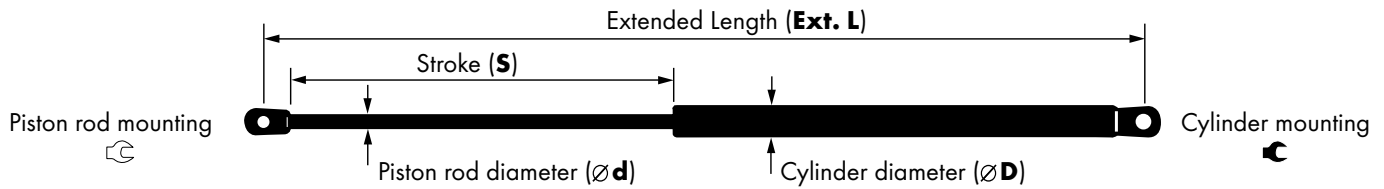

Monroe®	C	☞	$\varnothing d$	$\varnothing D$	Ext. L	S	F1
ML5774	T1	P	8	18,5	500	200	525
ML5775	S1	S1	8	18,5	437	173	350
ML5776	U	P	8	18,5	495	197	420
ML5777	U	U	8	18,5	430	170	370
ML5778	S1	U	8	18,5	285	105	600
ML5779	U	U	8	18,5	445	160	420
ML5780	T1	T1	8	18,5	550	235	280
ML5781	U	S1	10	22	535	183	710
ML5782	T1	T1	8	18,5	558	235	500
ML5783	U	P	8	18,5	585	190	625
ML5784	U	U	8	18,5	510	213	360
ML5785	S1	S1	8	18,5	460	170	350
ML5786	U	U	8	18,5	280	90	510
ML5787	T1	T1	10	22	550	160	710
ML5788	T1	T1	8	18,5	554	185	200
ML5789	U	U	8	18,5	345	122	350
ML5790	P	S1	8	18,5	740	310	290
ML5791	S1	U	8	18,5	201	52	250
ML5792	U	P	8	18,5	480	200	550
ML5793	S1	S1	8	18,5	315	100	550
ML5794	T1	T1	8	18,5	462,5	190	560
ML5795	U	U	8	18,5	628	272	440
ML5796	S1	U	8	18,5	463	185	360
ML5797	T1	T1	10	22	556	224	715
ML5798	U	U	8	18,5	674	293	300
ML5799	U	U	8	18,5	674	293	330
ML5800	U	U	8	18,5	333	117	650
ML5801	U	U	8	18,5	415	160	530
ML5802	U	U	8	18,5	418	163	490
ML5803	S1	S1	8	18,5	240	70	380
ML5804	U	U	8	18,5	314,5	116	330
ML5805	P	U	8	18,5	479	179	340
ML5806	U	P	10	22	560	178	725
ML5807	U	U	8	18,5	609,5	251,5	245
ML5808	S1	S1	8	18,5	256	58	560
ML5809	S1	S1	8	18,5	536	204	410
ML5810	U	U	8	18,5	238	62	165
ML5811	U	U	8	18,5	323	103	700
ML5812	U	U	8	18,5	520	208	130
ML5813	S1	S1	6	15	297	112,5	240
ML5814	U	U	8	18,5	447	175	300
ML5815	U	U	8	18,5	600	228	360
ML5816	T1	T1	10	22	570	240	650
ML5817	P	U	10	22	482	185,5	700
ML5818	U	U	8	18,5	282	98	560
ML5819	U	U	8	18,5	568	233	330
ML5820	U	U	8	18,5	613	260	300
ML5821	S1	U	8	18,5	500	203	245
ML5822	S1	S1	8	18,5	580	245	165
ML5823	S1	S1	6	15	362	138	100
ML5824	S1	S1	8	18,5	558	235	530
ML5825	S1	S1	8	18,5	500	230	135
ML5826	U	C1	8	18,5	520	180	625
ML5827	U	U	8	18,5	603	255	240
ML5828	U	P	8	18,5	547	220	550
ML5829	P	U	8	18,5	730	310	380
ML5830	U	P	8	18,5	375	140	390
ML5831	U	S1	8	18,5	450	180	550
ML5832	U	P	8	18,5	390	155	360
ML5833	U	P	10	22	755	210	1080
ML5834	M	O	10	22	699	257	610
ML5835	M	O	10	22	699	257	540
ML5836	T1	T1	8	18,5	639	258	465
ML5837	T1	T1	8	18,5	690	300	630

Monroe®	C	☞	$\varnothing d$	$\varnothing D$	Ext. L	S	F1
ML5838	P	P	8	18,5	494	172	500
ML5839	U	K	10	22	390	148	800
ML5840	I	H	6	15	465	190	335
ML5842	S2	15	8	18,5	585	235	310
ML5843	S2	16	8	18,5	585	235	310
ML5844	U	U	8	18,5	310	110	590
ML5845	U	U	8	18,5	419	165	510
ML5846	U	D	8	18,5	405	164	270
ML5847	B2	A2	10	22	610	240	500
ML5848	B1	A1	10	22	610	240	500
ML5849	U	U	8	18,5	526	220	325
ML5850	S1	P	8	18,5	559	230	290
ML5851	S1	S1	8	18,5	631	265	455
ML5852	G	G	14	28	399	86	1340
ML5855	S1	S1	8	18,5	400	139	400
ML5856	U	U	8	18,5	500	190	600
ML5857	P	P	8	18,5	500	190	500
ML5860	S1	S1	8	18,5	214	62	680
ML5861	S1	S1	8	18,5	296	95	250
ML5862	S1	S1	8	19	548	220	420
ML5864	U	U	8	18,5	519	184	370
ML5866	U	P	10	22	625	210	510
ML5867	U	U	8	18,5	460,5	174	350
ML5868	U	P	8	18,5	414	150	430
ML5869	U	P	8	18,5	569	240	310
ML5870	S1	S1	6	15	400	160	230
ML5871	S1	S1	8	18,5	480	185	480
ML5872	S1	S1	8	18,5	516,5	150	580
ML5873	U	P	8	18,5	514	180	335
ML5888	T1	T1	8	18,5	585,5	235	510
ML5889	S1	S1	8	18,5	527	188	620
ML5890	S1	S1	8	18,5	515	210	365
ML5891	S1	S1	8	18,5	383	137	455
ML5892	S1	S1	8	18,5	830	300	560
ML5893	S1	S1	8	18,5	569	240	670
ML5894	U	U	8	18,5	446	170	490
ML5895	U	U	8	18,5	532,5	190	360
ML5900	S1	S1	8	18,5	443,5	165	455
ML5906	I	H	6	15	365,5	150	290
ML5907	S1	S3	8	18,5	481	183	360
ML5909	I	U	8	18,5	496,5	195	340
ML5910	U	S1	8	18,5	355	135	115
ML5911	T1	T1	10	22	414	155	500
ML5912	S1	U	8	18,5	567	195	550
ML5917	S1	S1	8	18,5	493	195	445
ML5918	U	U	8	18,5	502	205	530
ML5919	Y1	D	8	18,5	615	243	240
ML5920	U	U	8	18,5	470	180	350
ML5921	S1	S1	8	18,5	270	82	380
ML5922	S1	S3	8	18,5	255	78	350
ML5923	U	U	8	18,5	502	205	450
ML5924	U	C1	8	18,5	375	144	280
ML5925	U	C1	8	18,5	408	152	390
ML5926	U	C1	8	18,5	408	152	265
ML5927	U	T1	8	18,5	274	90	740
ML5928	S1	S1	8	18,5	305	96	410
ML5929	P	P	10	22	498	191	630
ML5930	U	U	8	18,5	331	115	520
ML5932	S1	S1	8	18,5	291	65	540
ML5934	10	10	8	18,5	254	95	490
ML5936	P	U	8	18,5	410	155	390
ML5938	S1	U	8	18,5	672	240	180
ML5939	U	U	8	18,5	427	165	240
ML5940	S1	S1	8	18,5	585	246	500

# DIMENSION CHART

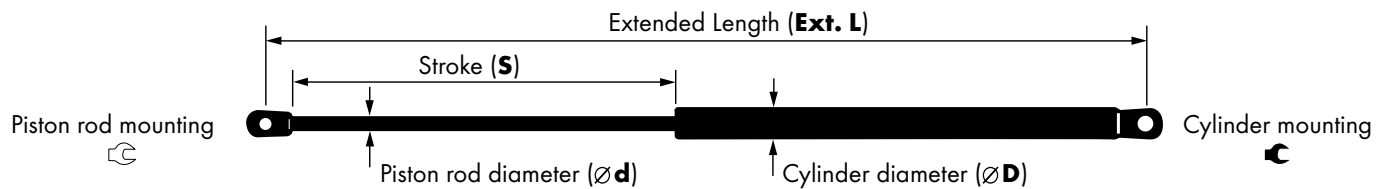

Monroe®	C	C	$\varnothing d$	$\varnothing D$	Ext. L	S	F1
ML5941	S1	S1	8	18,5	449	179	520
ML5943	S1	S3	8	18,5	376	145	390
ML5944	P	P	10	22	430,5	130	1050
ML5945	P	U	6	15	314	110	355
ML5946	U	C	8	18,5	293	104	280
ML5947	P	P	10	22	665	195	765
ML5948	U	S1	10	22	620	225	625
ML5950	U	U	10	22	700	172	1050
ML5954	U	U	8	18,5	543	220	200
ML5956	S1	S3	8	18,5	563	235	140
ML5958	U	P	8	18,5	588	198	645
ML5959	S1	S1	8	18,5	589	240	110
ML5961	S1	S3	8	18,5	526,5	208	125
ML5962	U	C1	8	18,5	313,5	78,5	495
ML5963	S1	S1	8	18,5	495	180,5	570
ML5967	S1	S1	8	18,5	387	139	465
ML5968	U	U	8	18,5	600	225	670
ML5973	S1	S1	8	18,5	565	200	200
ML5974	T1	T1	6	15	155	40	400
ML5975	S1	S3	8	18,5	288,5	100	380
ML5976	N	N	8	18,5	673	276	250
ML5977	S1	S1	8	18,5	418,5	155	390
ML5978	S1	S1	8	18,5	201	60	450
ML5979	U	U	8	18,5	490	189	560
ML5980	U	U	8	18,5	285	104	230
ML5981	U	U	8	18,5	431	100	400
ML5982	I	I	14	28	342	105	1200
ML5983	U	P	10	22	524	212	540
ML5984	U	P	10	22	524	212	585
ML5985	T1	T1	10	22	512	200	520
ML5986	S1	C1	8	18,5	577	190	530
ML5987	U	S1	8	18,5	449	160	470
ML5989	U	K	10	22	595	205	680
ML5990	U	U	8	18,5	512	198	460
ML5991	U	U	8	18,5	557	220	580
ML5992	P	U	8	18,5	436	154	245
ML5993	U	P	8	18,5	452	170	660
ML5994	U	C1	8	18,5	345	119	510
ML5995	U	P	8	18,5	494	194	250
ML5996	U	C1	8	18,5	300	106,5	460
ML5997	P	S1	8	18,5	505	205	585
ML5998	C	U	8	18,5	380	127	200
ML5999	U	U	6	15	346	136	340
ML6000	U	U	8	18,5	285	105	460
ML6001	Q	Q	10	22	429	136	838
ML6002	U	U	10	22	569,5	155	590
ML6003	U	P	8	18,5	644	265	300
ML6004	S1	S1	8	18,5	292	88	410
ML6005	S1	S1	8	18,5	538	220	510
ML6006	U	U	8	18,5	319,5	120	410
ML6008	S1	S1	8	18,5	516	184	160
ML6009	S1	S1	8	18,5	456	182	185
ML6011	U	U	8	18,5	273	85	420
ML6012	P	P	10	22	496	180	635
ML6013	S1	S1	10	22	515,5	205	610
ML6014	U	K	8	18,5	287	89	495
ML6015	U	U	8	18,5	232,5	65	305
ML6016	U	S3	8	18,5	479	174	580
ML6017	U	U	8	18,5	604	225	510
ML6019	U	U	8	18,5	222,5	71	500
ML6020	S1	10	6	15	289	113	350
ML6021	I	I	14	28	347,5	91,5	1300
ML6022	U	C1	8	18,5	506,5	186	485
ML6023	U	C1	8	18,5	506,5	186	515

Monroe®	C	C	$\varnothing d$	$\varnothing D$	Ext. L	S	F1
ML6024	P	13	8	18,5	533	216	330
ML6025	P	13	8	18,5	570	254	330
ML6026	U	13	8	18,5	394	149	400
ML6027	U	13	8	18,5	429	149	400
ML6028	S1	12	8	18,5	397	158	295
ML6029	U	13	10	22	301	92	730
ML6030	M	M	14	28	312,5	75,5	1450
ML6031	S1	10	6	15	242	74	325
ML6032	U	13	10	22	874	404	260
ML6033	U	U	8	18,5	338	119	420
ML6035	P	P	8	18,5	386,5	145	160
ML6036	U	U	8	18,5	495	190	370
ML6037	U	C1	8	18,5	241	76	700
ML6038	T1	T1	10	22	500	175	630
ML6039	T1	T1	10	22	742	277	400
ML6040	U	U	8	18,5	549	219	290
ML6041	T1	T1	10	22	600	220	325
ML6042	S1	S1	8	18,5	580	200	560
ML6043	U	U	8	18,5	499	145	150
ML6044	S1	S1	8	18,5	643	204	475
ML6046	U	U	8	18,5	431	173	320
ML6047	S1	S1	8	18,5	283	87	400
ML6049	U	U	8	18,5	721,5	313	180
ML6051	U	U	8	18,5	500	146	660
ML6053	U	C1	8	18,5	652	218	750
ML6055	U	U	10	22	661,5	260,5	800
ML6057	U	C1	10	22	598,5	186	700
ML6058	S1	S1	10	22	537	198	750
ML6060	S1	S1	8	18,5	584	250	150
ML6061	U	U	8	18,5	404	157	260
ML6062	S1	D	8	18,5	305	105	370
ML6063	S1	P	6	15	334	130	270
ML6065	U	C1	8	18,5	314,5	116	220
ML6066	S1	S1	6	15	195,5	60	350
ML6067	S1	S1	8	18,5	195,5	36	500
ML6068	U	C1	8	18,5	227	57	790
ML6069	U	P	8	18,5	585	246	260
ML6070	U	C1	8	18,5	585	250	430
ML6071	U	U	8	18,5	431	160	600
ML6072	U	U	8	18,5	664	275	265
ML6073	U	U	8	18,5	482,5	195	705
ML6074	U	Q	8	18,5	663,5	271	315
ML6075	U	K	10	22	533	220	750
ML6076	U	T1	10	22	282	100	680
ML6078	S1	P	8	18,5	452	144	455
ML6079	P	U	8	18,5	728	310	315
ML6080	U	U	8	18,5	538	205	650
ML6081	S1	S1	8	18,5	404,5	160	310
ML6082	S1	S1	8	18,5	435	175	170
ML6083	S1	S3	8	18,5	445	176	90
ML6084	T1	T1	8	18,5	414	160	410
ML6085	I1	I1	8	18,5	587	235	100
ML6086	U	U	8	18,5	439,5	155	410
ML6087	S1	S1	8	18,5	495	180,5	510
ML6089	T1	T1	8	18,5	611	228	420
ML6090	I	H	6	15	359	150	180
ML6091	U	U	8	18,5	291	91	600
ML6092	O	M	14	28	308	88	1190
ML6094	S2	S2	8	18,5	299,5	88	370
ML6096	P	U	8	18,5	690	280	380
ML6097	S1	S1	8	18,5	334	120	610
ML6098	S1	U	8	18,5	344,5	88,5	450
ML6099	S1	U	8	18,5	344,5	88,5	565
ML6100	U	U	8	18,5	457	167	320



# DIMENSION CHART

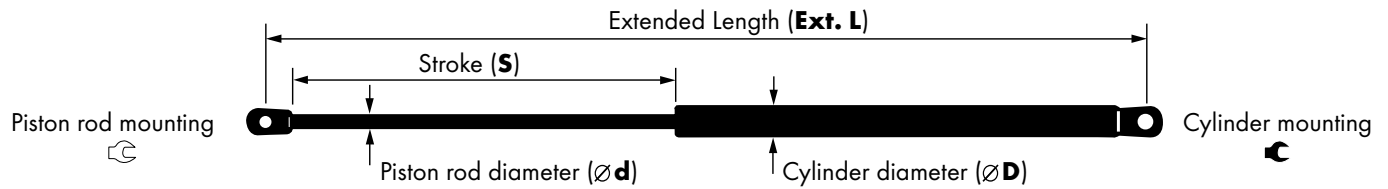

Monroe®	C	C	Ød	ØD	Ext. L	S	F1
ML6101	S1	S1	6	15	285	100	300
ML6102	U	P	10	22	483,5	148	750
ML6103	U	C1	8	19	319,5	91	480
ML6104	U	C1	8	18,5	299	65,5	670
ML6105	S1	S1	6	15	445	175	110
ML6106	U	C1	8	18,5	287	96	520
ML6107	S1	S3	8	19	290	102	395
ML6108	S1	S1	8	19	345	128	450
ML6109	U	U	8	19	567	228	460
ML6110	S1	S3	8	18,5	283	84	570
ML6111	S1	C1	8	18,5	694	294	220
ML6112	U	C	8	18,5	298	94	430
ML6113	Q	Q	10	22	539	163	690
ML6114	S1	H1	6	15	310	122	255
ML6115	U	C1	8	18,5	492	175	475
ML6116	U	C1	8	18,5	527	163	610
ML6117	U	C1	8	18,5	527	163	535
ML6118	U	C1	8	18,5	340	113	430
ML6119	U	C1	8	18,5	480	189	600
ML6120	U	U	8	18,5	280	95	395
ML6121	U	C1	8	18,5	285	100	580
ML6122	P	P	8	19	588	204	400
ML6123	U	U	8	19	450	181	395
ML6124	U	P	8	19	590	225	590
ML6125	S1	S1	8	19	665	238	535
ML6126	S1	S1	8	18,5	505	210	300
ML6127	U	S1	8	19	264	88	355
ML6128	S1	S1	8	19	523	200	600
ML6129	U	U	8	19	488	195	510
ML6130	P	U	8	19	522	210	490
ML6131	U	U	8	18,5	378	146	300
ML6132	S1	S1	8	19	441	166	530
ML6133	S1	S1	8	19	337,5	120	365
ML6134	S1	S3	8	18,5	503,5	187	450
ML6135	S1	S3	8	18,5	473,5	162	535
ML6136	U	C1	8	18,5	285	90	410
ML6137	U	U	8	18,5	393	150	170
ML6138	U	U	8	18,5	669	186	200
ML6140	S1	U	8	18,5	406	160	335
ML6141	S1	S1	8	18,5	362	112	260
ML6142	U	C1	8	18,5	278	70	470
ML6143	U	U	8	18,5	547	222	535
ML6144	S1	C1	8	18,5	587,5	167,5	590
ML6145	S1	S3	8	18,5	314	92	485
ML6146	S1	S1	6	15	375	118	180
ML6147	S1	S1	8	18,5	225	60	560
ML6148	S1	S1	8	18,5	274	95	320
ML6149	G	G	10	22	250	72	1180
ML6150	U	U	8	18,5	402,5	160	150
ML6151	S1	C1	8	18,5	517,5	191	295
ML6152	S1	P	8	18,5	361,5	121	540

# EXTENSION FORCE WITH EXTENDED PISTON ROD

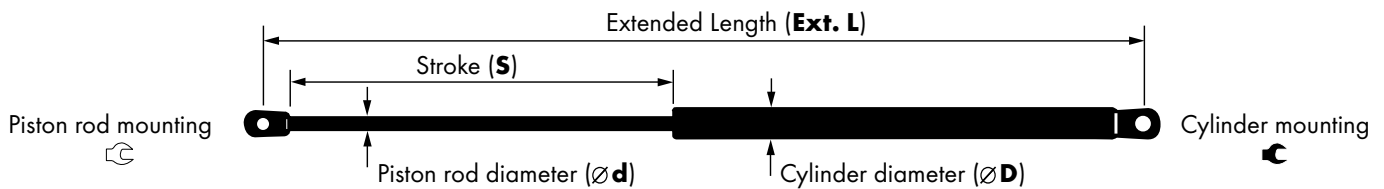
**F1**

F1	Monroe®	↻	↻	Ød	ØD	Ext. L	S
45	ML5179	S1	S1	6	15	305,5	121
90	ML6083	S1	S3	8	18,5	445	176
100	ML5153	S1	S1	8	18,5	460	169
100	ML5297	U	U	8	18,5	435	160
100	ML5496	Y1	D	8	18,5	226	63
100	ML5546	R	R	6	15	185	55
100	ML5629	R	R	6	15	225	80
100	ML5823	S1	S1	6	15	362	138
100	ML6085	11	11	8	18,5	587	235
105	ML5733	S1	S1	6	15	435	180
110	ML5548	S1	S1	6	15	530	213
110	ML5959	S1	S1	8	18,5	589	240
110	ML6105	S1	S1	6	15	445	175
113	ML5492	Y1	D	8	18,5	465	169
115	ML5910	U	S1	8	18,5	355	135
125	ML5357	U	U	8	18,5	538	190
125	ML5547	S1	S1	6	15	502	200
125	ML5961	S1	S3	8	18,5	526,5	208
130	ML5230	S1	S1	6	15	447	170
130	ML5640	T1	T1	6	15	305	109
130	ML5812	U	U	8	18,5	520	208
135	ML5493	S1	S1	8	18,5	558	200
135	ML5552	S1	S1	6	15	365	135
135	ML5700	U	U	8	18,5	480	173
135	ML5825	S1	S1	8	18,5	500	230
140	ML5340	U	U	8	18,5	525	210
140	ML5726	U	U	8	18,5	730	316
140	ML5762	P	U	8	18,5	385	150
140	ML5956	S1	S3	8	18,5	563	235
150	ML5356	U	U	8	18,5	352	110
150	ML5676	U	U	8	18,5	436	175
150	ML6043	U	U	8	18,5	499	145
150	ML6060	S1	S1	8	18,5	584	250
150	ML6150	U	U	8	18,5	402,5	160
160	ML5026	U	U	8	18,5	528	224
160	ML5055	Y6	X1	8	18,5	549,5	229,5
160	ML5116	U	U	8	18,5	450	175
160	ML5139	S1	S1	8	18,5	602	250
160	ML5565	P	S1	8	18,5	715	303
160	ML5568	S1	S1	8	18,5	464	166
160	ML5598	S1	S1	8	18,5	600	250
160	ML6008	S1	S1	8	18,5	516	184
160	ML6035	P	P	8	18,5	386,5	145
165	ML5810	U	U	8	18,5	238	62
165	ML5822	S1	S1	8	18,5	580	245
170	ML5447	T1	T1	8	18,5	540	130
170	ML5551	S1	S1	6	15	547	190
170	ML5739	U	P	8	18,5	485	200
170	ML6082	S1	S1	8	18,5	435	175
170	ML6137	U	U	8	18,5	393	150
175	ML5117	S1	S1	8	18,5	440	175
180	ML5009	Y6	X1	8	18,5	600	255
180	ML5030	Y6	X1	8	18,5	256	86
180	ML5268	U	U	8	18,5	685	285
180	ML5365	U	U	8	18,5	365	135
180	ML5387	U	U	8	18,5	395	148
180	ML5461	S1	S1	8	18,5	506	205
180	ML5479	S1	S1	8	18,5	398	120
180	ML5623	S1	S1	8	18,5	398	120
180	ML5737	P	U	8	18,5	720	300
180	ML5938	S1	U	8	18,5	672	240
180	ML6049	U	U	8	18,5	721,5	313
180	ML6090	I	H	6	15	359	150
180	ML6146	S1	S1	6	15	375	118

F1	Monroe®	↻	↻	Ød	ØD	Ext. L	S
185	ML6009	S1	S1	8	18,5	456	182
190	ML5017	U	X2	8	18,5	362	135
190	ML5091	E4	T1	8	18,5	613,8	248
190	ML5092	E4	T1	8	18,5	613,8	248
190	ML5267	S1	S1	8	18,5	648	265
190	ML5287	S1	U	8	18,5	500	200
200	ML5010	Y6	X1	8	18,5	600	255
200	ML5021	U	U	8	18,5	700	251
200	ML5034	Y6	X1	8	18,5	585	250
200	ML5052	U	U	8	18,5	700	300
200	ML5062	U	U	8	18,5	586	236
200	ML5083	U	U	8	18,5	584	250
200	ML5084	U	U	8	18,5	685,5	300
200	ML5470	S1	S1	8	18,5	685	265
200	ML5509	T1	T1	8	18,5	534	217
200	ML5567	S1	S1	8	18,5	635	225
200	ML5638	U	U	8	18,5	765	324
200	ML5650	P	U	8	18,5	484	190
200	ML5788	T1	T1	8	18,5	554	185
200	ML5954	U	U	8	18,5	543	220
200	ML5973	S1	S1	8	18,5	565	200
200	ML5998	C	U	8	18,5	380	127
200	ML6138	U	U	8	18,5	669	186
210	ML5081	U	C1	8	18,5	569	242
210	ML5608	N	N	8	18,5	675	279
215	ML5399	U	U	8	18,5	570	230
220	ML5022	Y6	X1	8	18,5	696	278
220	ML5028	U	U	8	18,5	460	170
220	ML5036	Y6	X1	8	18,5	518	209
220	ML5047	U	U	8	18,5	509	200
220	ML5099	U	U	8	18,5	528	224
220	ML5457	U	U	8	18,5	546	225
220	ML5572	Y1	U	8	18,5	500	190
220	ML5659	S1	S1	8	18,5	553	225
220	ML6065	U	C1	8	18,5	314,5	116
220	ML6111	S1	C1	8	18,5	694	294
225	ML5306	U	U	8	18,5	500	196
225	ML5556	Y1	X1	6	15	547	214
230	ML5006	Y2	X2	8	18,5	550	212
230	ML5056	Y1	X1	8	18,5	520	213
230	ML5472	S1	S1	8	18,5	395	150
230	ML5587	S1	S1	8	18,5	459	172
230	ML5597	U	X1	8	18,5	547	230
230	ML5600	Y1	D	8	18,5	500	200
230	ML5620	U	U	8	18,5	580	205
230	ML5870	S1	S1	6	15	400	160
230	ML5980	U	U	8	18,5	285	104
235	ML5409	U	U	8	18,5	765	325
240	ML5016	Y1	X2	8	18,5	549	229,5
240	ML5350	U	U	8	18,5	525	210
240	ML5366	U	U	8	18,5	365	135
240	ML5601	Y1	D	8	18,5	650	275
240	ML5602	S1	D	8	18,5	650	275
240	ML5636	U	U	8	18,5	525	210
240	ML5813	S1	S1	6	15	297	112,5
240	ML5827	U	U	8	18,5	603	255
240	ML5919	Y1	D	8	18,5	615	243
240	ML5939	U	U	8	18,5	427	165
245	ML5276	U	U	8	18,5	529	215
245	ML5807	U	U	8	18,5	609,5	251,5
245	ML5821	S1	U	8	18,5	500	203
245	ML5992	P	U	8	18,5	436	154
250	ML5133	U	U	8	18,5	600	250
250	ML5180	U	U	8	18,5	490	190

# EXTENSION FORCE WITH EXTENDED PISTON ROD

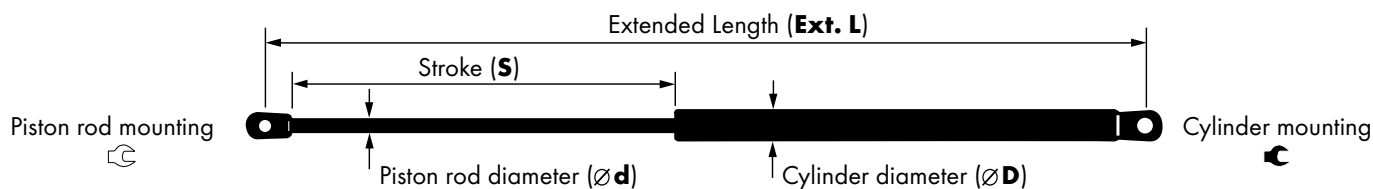
**F1**

F1	Monroe®	C	C	$\varnothing d$	$\varnothing D$	Ext. L	S
250	<b>ML5183</b>	U	U	8	18,5	445	172
250	<b>ML5265</b>	U	U	8	18,5	585	235
250	<b>ML5327</b>	U	U	8	18,5	540	220
250	<b>ML5536</b>	U	Q	8	18,5	288	95
250	<b>ML5607</b>	S1	S1	8	18,5	544	224
250	<b>ML5697</b>	U	U	8	18,5	604	253
250	<b>ML5735</b>	P	U	8	18,5	730	320
250	<b>ML5791</b>	S1	U	8	18,5	201	52
250	<b>ML5861</b>	S1	S1	8	18,5	296	95
250	<b>ML5976</b>	N	N	8	18,5	673	276
250	<b>ML5995</b>	U	P	8	18,5	494	194
255	<b>ML6114</b>	S1	H1	6	15	310	122
260	<b>ML5025</b>	U	U	8	18,5	450	175
260	<b>ML5046</b>	U	U	8	18,5	700	300
260	<b>ML5143</b>	U	U	8	18,5	574	235
260	<b>ML5298</b>	U	U	8	18,5	450	175
260	<b>ML5309</b>	U	U	8	18,5	675	285
260	<b>ML6032</b>	U	I3	10	22	874	404
260	<b>ML6061</b>	U	U	8	18,5	404	157
260	<b>ML6069</b>	U	P	8	18,5	585	246
260	<b>ML6141</b>	S1	S1	8	18,5	362	112
265	<b>ML5648</b>	P	U	8	18,5	728	310
265	<b>ML5926</b>	U	C1	8	18,5	408	152
265	<b>ML6072</b>	U	U	8	18,5	664	275
270	<b>ML5059</b>	Y2	X2	8	18,5	550	212
270	<b>ML5097</b>	U	U	8	18,5	460	170
270	<b>ML5098</b>	P	P	8	18,5	496	188
270	<b>ML5337</b>	U	U	8	18,5	691,5	285
270	<b>ML5393</b>	U	U	8	18,5	678	270
270	<b>ML5561</b>	U	U	8	18,5	687	295
270	<b>ML5564</b>	U	P	8	18,5	577	225
270	<b>ML5574</b>	U	D	8	18,5	500	200
270	<b>ML5846</b>	U	D	8	18,5	405	164
270	<b>ML6063</b>	S1	P	6	15	334	130
275	<b>ML5463</b>	S1	S1	8	18,5	577	226
280	<b>ML5013</b>	U	U	8	18,5	595	235
280	<b>ML5014</b>	U	U	8	18,5	584	234
280	<b>ML5018</b>	Y6	X1	8	18,5	256	86
280	<b>ML5027</b>	U	U	8	18,5	586	236
280	<b>ML5035</b>	U	U	8	18,5	450	175
280	<b>ML5038</b>	U	U	8	18,5	500	200
280	<b>ML5040</b>	U	U	8	18,5	569	220
280	<b>ML5050</b>	U	U	8	18,5	569	220
280	<b>ML5058</b>	Y1	X1	8	18,5	256	86
280	<b>ML5072</b>	U	U	8	18,5	502	200
280	<b>ML5101</b>	S1	S1	8	18,5	502	199
280	<b>ML5102</b>	Y1	V	8	18,5	788	342
280	<b>ML5112</b>	U	U	8	18,5	566,5	219
280	<b>ML5134</b>	U	U	8	18,5	585	222
280	<b>ML5195</b>	S1	U	8	18,5	500	200
280	<b>ML5266</b>	U	C1	8	18,5	722	306
280	<b>ML5422</b>	I0	I0	6	15	410	166
280	<b>ML5484</b>	S1	S1	8	18,5	400	150
280	<b>ML5560</b>	U	I3	8	18,5	525	200
280	<b>ML5577</b>	U	I3	8	18,5	563	200
280	<b>ML5670</b>	S1	S1	8	18,5	366	117
280	<b>ML5780</b>	T1	T1	8	18,5	550	235
280	<b>ML5924</b>	U	C1	8	18,5	375	144
280	<b>ML5946</b>	U	C	8	18,5	293	104
285	<b>ML5292</b>	U	U	8	18,5	550	220
290	<b>ML5020</b>	U	U	8	18,5	600	230
290	<b>ML5066</b>	U	U	8	18,5	584	234
290	<b>ML5095</b>	U	U	8	18,5	324	115
290	<b>ML5269</b>	P	U	8	18,5	715	306

F1	Monroe®	C	C	$\varnothing d$	$\varnothing D$	Ext. L	S
290	<b>ML5323</b>	U	U	8	18,5	285	95
290	<b>ML5450</b>	U	U	8	18,5	635	259
290	<b>ML5651</b>	P	U	8	18,5	544	218
290	<b>ML5705</b>	S1	U	8	18,5	565	240
290	<b>ML5790</b>	P	S1	8	18,5	740	310
290	<b>ML5850</b>	S1	P	8	18,5	559	230
290	<b>ML5906</b>	I	H	6	15	365,5	150
290	<b>ML6040</b>	U	U	8	18,5	549	219
295	<b>ML6028</b>	S1	I2	8	18,5	397	158
295	<b>ML6151</b>	S1	C1	8	18,5	517,5	191
300	<b>ML5003</b>	U	U	8	18,5	450	180
300	<b>ML5041</b>	U	U	8	18,5	542	210
300	<b>ML5079</b>	U	U	8	18,5	445	180
300	<b>ML5148</b>	U	U	8	18,5	600	230
300	<b>ML5270</b>	U	U	8	18,5	460	160
300	<b>ML5271</b>	U	U	8	18,5	522	210
300	<b>ML5312</b>	U	U	8	18,5	545	230
300	<b>ML5339</b>	S1	U	8	18,5	480	180
300	<b>ML5368</b>	S1	S1	8	18,5	750	315
300	<b>ML5382</b>	U	S1	8	18,5	440	155
300	<b>ML5392</b>	S1	S1	8	18,5	400	149
300	<b>ML5404</b>	U	U	8	18,5	240	74
300	<b>ML5465</b>	S1	S1	8	18,5	614	229
300	<b>ML5604</b>	S1	D	8	18,5	640	278
300	<b>ML5624</b>	P	T1	8	18,5	392	150
300	<b>ML5645</b>	Y1	U	8	18,5	512	200
300	<b>ML5649</b>	U	U	8	18,5	405	160
300	<b>ML5660</b>	P	U	8	18,5	441	175
300	<b>ML5738</b>	P	U	8	18,5	735	321
300	<b>ML5798</b>	U	U	8	18,5	674	293
300	<b>ML5814</b>	U	U	8	18,5	447	175
300	<b>ML5820</b>	U	U	8	18,5	613	260
300	<b>ML6003</b>	U	P	8	18,5	644	265
300	<b>ML6101</b>	S1	S1	6	15	285	100
300	<b>ML6126</b>	S1	S1	8	18,5	505	210
300	<b>ML6131</b>	U	U	8	18,5	378	146
305	<b>ML5687</b>	U	U	8	18,5	555	228
305	<b>ML6015</b>	U	U	8	18,5	232,5	65
310	<b>ML5029</b>	U	U	8	18,5	589	239
310	<b>ML5042</b>	Y6	X1	8	18,5	600	255
310	<b>ML5136</b>	U	U	8	18,5	448	180
310	<b>ML5147</b>	U	U	8	18,5	574	235
310	<b>ML5275</b>	U	U	8	18,5	405	160
310	<b>ML5316</b>	U	U	8	18,5	408	150
310	<b>ML5345</b>	U	U	8	18,5	650	270
310	<b>ML5347</b>	U	U	8	18,5	525	205
310	<b>ML5471</b>	S1	S1	8	18,5	286	100
310	<b>ML5489</b>	S1	S1	8	18,5	364	132
310	<b>ML5491</b>	S1	U	8	18,5	500	200
310	<b>ML5603</b>	Y1	D	8	18,5	650	275
310	<b>ML5605</b>	S1	D	8	18,5	650	275
310	<b>ML5679</b>	L	L	8	18,5	722	306
310	<b>ML5720</b>	U	U	8	18,5	543	220
310	<b>ML5842</b>	S2	I5	8	18,5	585	235
310	<b>ML5843</b>	S2	I6	8	18,5	585	235
310	<b>ML5869</b>	U	P	8	18,5	569	240
310	<b>ML6081</b>	S1	S1	8	18,5	404,5	160
315	<b>ML5063</b>	U	U	8	18,5	284	100
315	<b>ML5730</b>	U	U	8	18,5	565	215
315	<b>ML6074</b>	U	Q	8	18,5	663,5	271
315	<b>ML6079</b>	P	U	8	18,5	728	310
320	<b>ML5033</b>	U	U	8	18,5	600	250
320	<b>ML5140</b>	U	U	8	18,5	526	206
320	<b>ML5159</b>	S1	S1	8	18,5	485	190

EXTENSION FORCE

# EXTENSION FORCE WITH EXTENDED PISTON ROD

F1

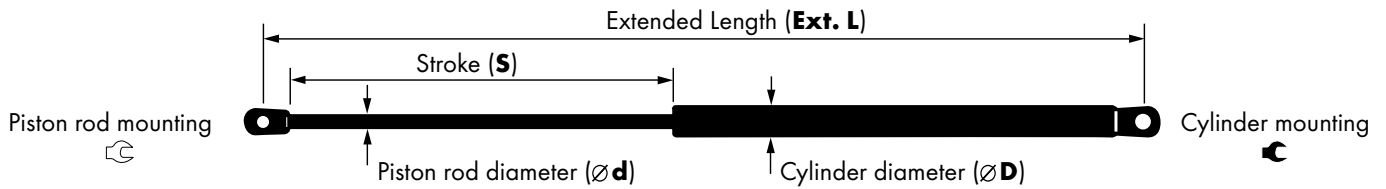

F1	Monroe®	C	C	Ød	ØD	Ext. L	S
320	ML5163	S1	S1	8	18,5	350	100
320	ML5184	S1	P	8	18,5	600,5	223
320	ML5242	U	U	8	18,5	543,5	206
320	ML5243	U	U	8	18,5	549	232
320	ML5255	U	U	8	18,5	600	250
320	ML5284	S1	U	8	18,5	500	200
320	ML5361	U	U	8	18,5	510	200
320	ML5407	U	U	8	18,5	700	257
320	ML5420	Y1	D	8	18,5	465	187
320	ML5421	10	10	6	15	367	145
320	ML5464	S1	S1	8	18,5	577	226
320	ML5497	Y1	D	8	18,5	670	294
320	ML5606	Y1	D	8	18,5	579	235
320	ML5655	S1	U	8	18,5	456	165
320	ML5658	S1	S1	8	18,5	369	110
320	ML5694	S1	S1	8	18,5	370	110
320	ML6046	U	U	8	18,5	431	173
320	ML6100	U	U	8	18,5	457	167
320	ML6148	S1	S1	8	18,5	274	95
325	ML5037	U	P	8	18,5	700	300
325	ML5057	P	S1	8	18,5	700	300
325	ML5386	U	U	8	18,5	722	315
325	ML5849	U	U	8	18,5	526	220
325	ML6031	S1	10	6	15	242	74
325	ML6041	T1	T1	10	22	600	220
330	ML5023	U	U	8	18,5	614	230
330	ML5164	U	U	8	18,5	472	180
330	ML5282	U	U	8	18,5	630	269
330	ML5325	U	U	8	18,5	600	244
330	ML5342	U	U	8	18,5	575	235
330	ML5406	U	U	8	18,5	498	197
330	ML5562	S1	S1	8	18,5	313	112
330	ML5588	S1	S1	8	18,5	559	220
330	ML5611	Y1	D	8	18,5	245	76
330	ML5689	S1	P	8	18,5	400	160
330	ML5731	S1	P	8	18,5	505	211
330	ML5799	U	U	8	18,5	674	293
330	ML5804	U	U	8	18,5	314,5	116
330	ML5819	U	U	8	18,5	568	233
330	ML6024	P	13	8	18,5	533	216
330	ML6025	P	13	8	18,5	570	254
335	ML5708	U	U	8	18,5	480	195
335	ML5840	I	H	6	15	465	190
335	ML5873	U	P	8	18,5	514	180
335	ML6140	S1	U	8	18,5	406	160
340	ML5024	U	C1	8	18,5	450	175
340	ML5114	U	U	8	18,5	450	175
340	ML5146	S1	S1	8	18,5	510	210
340	ML5241	U	U	8	18,5	412	155
340	ML5398	U	U	8	18,5	580	245
340	ML5534	S1	U	8	18,5	605	247
340	ML5619	N	N	8	18,5	330	116
340	ML5631	T1	T1	8	18,5	677	274
340	ML5639	Y1	D	8	18,5	254	85
340	ML5741	U	U	8	18,5	765	335
340	ML5767	S1	U	8	18,5	500	195
340	ML5805	P	U	8	18,5	479	179
340	ML5909	I	U	8	18,5	496,5	195
340	ML5999	U	U	6	15	346	136
345	ML5498	Y1	D	8	18,5	670	294
345	ML5499	Y1	D	8	18,5	700	295
350	ML5015	Y6	X1	8	18,5	549	229,5
350	ML5049	U	C1	8	18,5	500	212
350	ML5053	U	U	8	18,5	550	212

F1	Monroe®	C	C	Ød	ØD	Ext. L	S
350	ML5069	U	U	8	18,5	470	190
350	ML5077	U	C1	8	18,5	591	240
350	ML5120	U	C1	8	18,5	475	195
350	ML5211	U	U	8	18,5	527	210
350	ML5261	S1	U	8	18,5	500	200
350	ML5264	S1	U	8	18,5	500	200
350	ML5348	U	U	8	18,5	525	205
350	ML5359	U	U	8	18,5	513	215
350	ML5390	U	U	8	18,5	508	194
350	ML5451	U	U	8	18,5	611	205
350	ML5480	S1	S1	8	18,5	452	177
350	ML5563	S1	S1	8	18,5	374	140
350	ML5596	Y4	X1	6	15	254	95
350	ML5695	S1	U	8	18,5	425	165
350	ML5696	P	U	8	18,5	355	120
350	ML5714	U	P	8	18,5	386,5	150
350	ML5715	U	C1	8	18,5	650	270
350	ML5768	U	U	8	18,5	721,5	315
350	ML5775	S1	S1	8	18,5	437	173
350	ML5785	S1	S1	8	18,5	460	170
350	ML5789	U	U	8	18,5	345	122
350	ML5867	U	U	8	18,5	460,5	174
350	ML5920	U	U	8	18,5	470	180
350	ML5922	S1	S3	8	18,5	255	78
350	ML6020	S1	10	6	15	289	113
350	ML6066	S1	S1	6	15	195,5	60
355	ML5031	U	U	8	18,5	549	222
355	ML5149	U	U	8	18,5	611	230
355	ML5369	U	U	8	18,5	828	249
355	ML5945	P	U	6	15	314	110
355	ML6127	U	S1	8	19	264	88
360	ML5011	Y6	X1	8	18,5	600	255
360	ML5054	U	U	8	18,5	543,5	206
360	ML5093	S1	S1	8	18,5	471	191
360	ML5129	S1	S1	8	18,5	622	240
360	ML5144	U	U	8	18,5	565	216
360	ML5171	U	U	8	18,5	557	224
360	ML5191	U	U	8	18,5	585	235
360	ML5192	U	U	8	18,5	680	270
360	ML5360	U	U	8	18,5	500	190
360	ML5364	U	U	8	18,5	635	248
360	ML5394	U	U	8	18,5	600	226
360	ML5396	U	U	8	18,5	568	213
360	ML5434	U	U	8	18,5	599	220
360	ML5462	S1	S1	8	18,5	477	188
360	ML5488	S1	S1	8	18,5	320	100
360	ML5521	T1	Q	8	18,5	665	270
360	ML5589	S1	S1	8	18,5	671,5	270
360	ML5625	Y1	U	8	18,5	419	165
360	ML5634	T1	T1	8	18,5	680	270
360	ML5758	P	U	8	18,5	726,5	310
360	ML5784	U	U	8	18,5	510	213
360	ML5796	S1	U	8	18,5	463	185
360	ML5815	U	U	8	18,5	600	228
360	ML5832	U	P	8	18,5	390	155
360	ML5895	U	U	8	18,5	532,5	190
360	ML5907	S1	S3	8	18,5	481	183
365	ML5199	S1	U	8	18,5	500	200
365	ML5259	U	U	8	18,5	287	99
365	ML5504	T1	T1	8	18,5	837	315
365	ML5890	S1	S1	8	18,5	515	210
365	ML6133	S1	S1	8	19	337,5	120
370	ML5068	U	U	8	18,5	515	202
370	ML5208	U	U	8	18,5	552	205

# EXTENSION FORCE WITH EXTENDED PISTON ROD

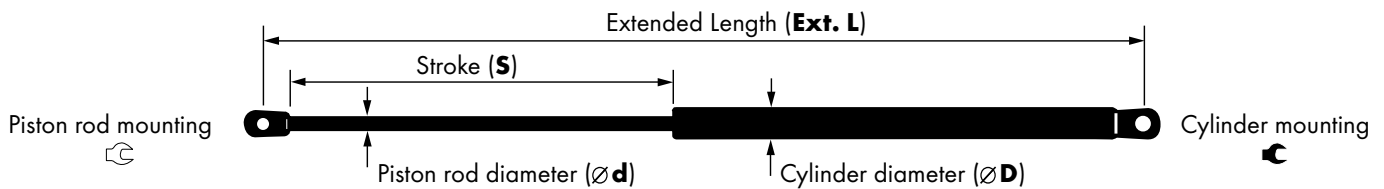
**F1**

F1	Monroe®	↺	↻	$\varnothing d$	$\varnothing D$	Ext. L	S
370	ML5210	U	U	8	18,5	440,5	158
370	ML5215	S1	S1	8	18,5	264	82
370	ML5222	S1	U	8	18,5	440	171
370	ML5285	U	U	8	18,5	595	248
370	ML5370	U	P	8	18,5	510	200
370	ML5411	S1	U	8	18,5	315	105
370	ML5448	U	U	10	22	866	350
370	ML5490	S1	S1	8	18,5	363	132
370	ML5584	S1	U	10	22	870	370
370	ML5595	Y5	X3	8	18,5	255	86
370	ML5646	Y5	X3	8	18,5	319	100
370	ML5759	T1	T1	8	18,5	483	191
370	ML5777	U	U	8	18,5	430	170
370	ML5864	U	U	8	18,5	519	184
370	ML6036	U	U	8	18,5	495	190
370	ML6062	S1	D	8	18,5	305	105
370	ML6094	S2	S2	8	18,5	299,5	88
375	ML5333	Y1	D	8	18,5	668	280
375	ML5403	U	U	8	18,5	668	215
375	ML5542	U	U	8	18,5	667	215
375	ML5752	U	U	8	18,5	500	208
380	ML5039	Y1	X2	8	18,5	550	229,5
380	ML5145	U	C1	8	18,5	431	173
380	ML5165	U	U	8	18,5	455	164
380	ML5194	S1	U	8	18,5	500	200
380	ML5235	U	U	8	18,5	596	190
380	ML5281	U	U	8	18,5	506	200
380	ML5301	U	U	8	18,5	295	100
380	ML5427	S1	U	8	18,5	471	185
380	ML5453	U	U	8	18,5	460	180
380	ML5522	10	10	8	18,5	242	84
380	ML5570	S1	S1	8	18,5	490	187
380	ML5599	Y1	X1	6	15	440	142
380	ML5609	W	D	8	18,5	580	245
380	ML5678	U	L	10	22	943	417
380	ML5698	S1	U	8	18,5	291	107
380	ML5712	P	U	8	18,5	490	200
380	ML5766	S1	S1	8	18,5	318	120
380	ML5803	S1	S1	8	18,5	240	70
380	ML5829	P	U	8	18,5	730	310
380	ML5921	S1	S1	8	18,5	270	82
380	ML5975	S1	S3	8	18,5	288,5	100
380	ML6096	P	U	8	18,5	690	280
385	ML5672	U	U	8	18,5	540	210
385	ML5725	S1	S1	8	18,5	451	185
390	ML5001	Y6	X1	8	18,5	405	160
390	ML5071	Y1	D	8	18,5	405	160
390	ML5111	U	C1	8	18,5	402	160
390	ML5162	S1	S1	8	18,5	666,5	275
390	ML5300	U	U	8	18,5	527	202
390	ML5395	U	U	8	18,5	510	208
390	ML5419	S1	S1	8	18,5	280	95
390	ML5508	T1	T1	8	18,5	680	270
390	ML5573	U	D	8	18,5	640	235
390	ML5763	T1	T1	8	18,5	540	225
390	ML5830	U	P	8	18,5	375	140
390	ML5925	U	C1	8	18,5	408	152
390	ML5936	P	U	8	18,5	410	155
390	ML5943	S1	S3	8	18,5	376	145
390	ML5977	S1	S1	8	18,5	418,5	155
395	ML6107	S1	S3	8	19	290	102
395	ML6120	U	U	8	18,5	280	95
395	ML6123	U	U	8	19	450	181
400	ML5002	Y1	X1	8	18,5	509	200

F1	Monroe®	↺	↻	$\varnothing d$	$\varnothing D$	Ext. L	S
400	ML5004	U	U	8	18,5	502	200
400	ML5115	U	U	8	18,5	500	200
400	ML5188	U	U	8	18,5	540	214
400	ML5196	S1	U	8	18,5	500	200
400	ML5201	U	U	8	18,5	577	226
400	ML5272	U	U	8	18,5	522	210
400	ML5286	U	U	8	18,5	591	239
400	ML5358	U	U	8	18,5	500	171
400	ML5371	U	U	8	18,5	499	195
400	ML5432	S1	S1	8	18,5	624	260
400	ML5435	S1	S1	8	18,5	656	260
400	ML5494	Y1	D	8	18,5	700	295
400	ML5593	Y1	D	8	18,5	615	260
400	ML5615	U	P	8	18,5	502	195
400	ML5643	S1	S1	6	15	244	90
400	ML5691	S1	U	8	18,5	412	163
400	ML5713	U	U	8	18,5	515	215
400	ML5729	U	U	8	18,5	310	110
400	ML5855	S1	S1	8	18,5	400	139
400	ML5974	T1	T1	6	15	155	40
400	ML5981	U	U	8	18,5	431	100
400	ML6026	U	13	8	18,5	394	149
400	ML6027	U	13	8	18,5	429	149
400	ML6039	T1	T1	10	22	742	277
400	ML6047	S1	S1	8	18,5	283	87
400	ML6122	P	P	8	19	588	204
405	ML5665	U	U	8	18,5	585,5	245
410	ML5012	U	U	8	18,5	600	245
410	ML5161	U	U	8	18,5	534	216
410	ML5182	S1	S1	8	18,5	300	100
410	ML5209	U	U	8	18,5	552	200
410	ML5244	U	U	8	18,5	549	232
410	ML5317	U	U	8	18,5	590	215
410	ML5385	U	X1	10	22	885	380
410	ML5444	10	10	8	18,5	365	145
410	ML5541	S1	S1	8	18,5	568	215
410	ML5749	U	P	8	18,5	530	210
410	ML5809	S1	S1	8	18,5	536	204
410	ML5928	S1	S1	8	18,5	305	96
410	ML6004	S1	S1	8	18,5	292	88
410	ML6006	U	U	8	18,5	319,5	120
410	ML6084	T1	T1	8	18,5	414	160
410	ML6086	U	U	8	18,5	439,5	155
410	ML6136	U	C1	8	18,5	285	90
415	ML5200	U	U	8	18,5	577	226
420	ML5005	U	U	8	18,5	509	200
420	ML5048	U	U	8	18,5	527	219
420	ML5051	S1	E1	10	22	726	280
420	ML5078	U	U	8	18,5	507	205
420	ML5087	U	C1	8	18,5	473	172
420	ML5151	U	U	8	18,5	445	162
420	ML5197	S1	U	8	18,5	500	205
420	ML5237	U	U	8	18,5	596	190
420	ML5254	U	U	8	18,5	476,5	184
420	ML5321	U	U	8	18,5	315	100
420	ML5389	S1	S1	8	18,5	215	48
420	ML5400	U	U	8	18,5	570	230
420	ML5436	S1	S1	8	18,5	517	190
420	ML5467	S1	S1	8	18,5	280	80
420	ML5481	S1	S1	8	18,5	270	75
420	ML5566	10	10	8	18,5	254	90
420	ML5664	U	U	8	18,5	585	240
420	ML5703	P	U	8	18,5	480	190
420	ML5754	U	P	8	18,5	528	212

**EXTENSION FORCE**

# EXTENSION FORCE WITH EXTENDED PISTON ROD

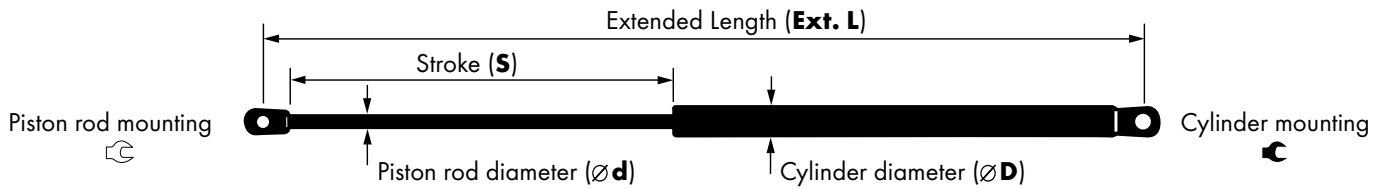
**F1**

F1	Monroe®	↺	↻	$\varnothing d$	$\varnothing D$	Ext. L	S
420	ML5776	U	P	8	18,5	495	197
420	ML5779	U	U	8	18,5	445	160
420	ML5862	S1	S1	8	19	548	220
420	ML6011	U	U	8	18,5	273	85
420	ML6033	U	U	8	18,5	338	119
420	ML6089	T1	T1	8	18,5	611	228
425	ML5158	U	U	8	18,5	465	178
425	ML5172	U	U	8	18,5	557	224
425	ML5206	U	U	8	18,5	599	190
425	ML5405	U	U	8	18,5	516	205
425	ML5474	S1	S1	8	18,5	535	220
425	ML5668	S1	U	8	18,5	545	195
425	ML5764	U	U	8	18,5	252	85
430	ML5065	U	U	8	18,5	600	245
430	ML5107	U	U	8	18,5	602	252
430	ML5160	S1	S1	8	18,5	458	176
430	ML5166	U	C1	8	18,5	536,5	205
430	ML5236	U	U	8	18,5	596	195
430	ML5274	U	U	8	18,5	278	90
430	ML5299	U	U	8	18,5	602	252
430	ML5355	U	U	8	18,5	310	95
430	ML5367	U	U	8	18,5	567,5	183
430	ML5618	N	N	8	18,5	505	180
430	ML5717	P	U	8	18,5	497	200
430	ML5868	U	P	8	18,5	414	150
430	ML6070	U	C1	8	18,5	585	250
430	ML6112	U	C	8	18,5	298	94
430	ML6118	U	C1	8	18,5	340	113
435	ML5296	U	U	8	18,5	520	197
435	ML5701	S1	U	8	18,5	590	176
436	ML5362	U	U	8	18,5	507	208
440	ML5202	U	U	8	18,5	566	230
440	ML5207	U	U	8	18,5	600	190
440	ML5252	U	U	8	18,5	544	210
440	ML5315	U	U	8	18,5	675	275
440	ML5458	U	U	8	18,5	631	230
440	ML5482	S1	S1	8	18,5	575	230
440	ML5485	S1	U	8	18,5	468	163
440	ML5680	U	U	8	18,5	350	130
440	ML5681	U	U	8	18,5	495	205
440	ML5706	P	U	8	18,5	395	158
440	ML5734	S1	S1	8	18,5	460	180
440	ML5740	S1	U	8	18,5	315	120
440	ML5795	U	U	8	18,5	628	272
445	ML5410	S1	S1	8	18,5	515	200
445	ML5917	S1	S1	8	18,5	493	195
450	ML5044	U	U	8	18,5	527	219
450	ML5061	U	C1	8	18,5	527	210
450	ML5067	Y1	X1	8	18,5	600	255
450	ML5090	U	U	8	18,5	450	180
450	ML5131	U	C1	8	18,5	440	160
450	ML5157	U	U	10	22	540	200
450	ML5169	U	U	8	18,5	527	206
450	ML5181	S1	U	8	18,5	500	200
450	ML5213	S1	S1	8	18,5	540	200
450	ML5262	U	U	8	18,5	595	250
450	ML5307	U	U	8	18,5	485	189
450	ML5318	U	U	8	18,5	590	215
450	ML5320	U	U	8	18,5	600	225
450	ML5326	U	U	8	18,5	566	230
450	ML5353	U	U	8	18,5	555	220
450	ML5418	U	U	8	18,5	645,5	275
450	ML5544	U	S1	8	18,5	596	210
450	ML5617	N	N	8	18,5	268	83,5

F1	Monroe®	↺	↻	$\varnothing d$	$\varnothing D$	Ext. L	S
450	ML5663	U	U	8	18,5	283	101,5
450	ML5669	U	U	8	18,5	424,5	165
450	ML5692	U	U	8	18,5	545	210
450	ML5923	U	U	8	18,5	502	205
450	ML5978	S1	S1	8	18,5	201	60
450	ML6098	S1	U	8	18,5	344,5	88,5
450	ML6108	S1	S1	8	19	345	128
450	ML6134	S1	S3	8	18,5	503,5	187
455	ML5851	S1	S1	8	18,5	631	265
455	ML5891	S1	S1	8	18,5	383	137
455	ML5900	S1	S1	8	18,5	443,5	165
455	ML6078	S1	P	8	18,5	452	144
460	ML5108	U	U	8	18,5	450	170
460	ML5214	S1	S1	8	18,5	517	200
460	ML5216	S1	S1	8	18,5	264	82
460	ML5248	U	U	10	22	567	225
460	ML5280	U	U	8	18,5	441,5	169
460	ML5288	U	U	8	18,5	570	230
460	ML5293	U	U	8	18,5	485	196
460	ML5452	U	U	8	18,5	653	260
460	ML5459	S1	S1	8	18,5	485	193
460	ML5578	U	U	8	18,5	650	250
460	ML5642	T1	T1	8	18,5	550	200
460	ML5662	U	U	8	18,5	590	245
460	ML5673	U	U	8	18,5	582	203
460	ML5677	Y1	T1	8	18,5	499	205
460	ML5718	U	U	10	22	547	220
460	ML5736	S1	U	8	18,5	404,5	163
460	ML5990	U	U	8	18,5	512	198
460	ML5996	U	C1	8	18,5	300	106,5
460	ML6000	U	U	8	18,5	285	105
460	ML6109	U	U	8	19	567	228
465	ML5322	U	U	8	18,5	315	100
465	ML5466	S1	S1	8	18,5	280	80
465	ML5836	T1	T1	8	18,5	639	258
465	ML5967	S1	S1	8	18,5	387	139
470	ML5088	E2	E3	8	18,5	645	202,6
470	ML5089	E2	E3	8	18,5	645	202,6
470	ML5185	S1	U	8	18,5	500	205
470	ML5198	S1	U	8	18,5	500	193
470	ML5217	U	U	8	18,5	493	196
470	ML5225	S1	U	8	18,5	500	200
470	ML5279	S1	U	8	18,5	595	210
470	ML5311	U	U	8	18,5	640	190
470	ML5391	U	U	8	18,5	510	208
470	ML5402	U	U	8	18,5	570	240
470	ML5428	S1	S1	8	18,5	580	247
470	ML5468	S1	S1	8	18,5	512	200
470	ML5473	S1	S1	8	18,5	395	150
470	ML5500	S1	S1	8	18,5	430	160
470	ML5661	U	U	8	18,5	440	170
470	ML5727	U	U	8	18,5	320	105
470	ML5987	U	S1	8	18,5	449	160
470	ML6142	U	C1	8	18,5	278	70
475	ML5373	U	U	8	18,5	548	213
475	ML5374	U	U	8	18,5	556	225
475	ML5571	T1	T1	8	18,5	550	222
475	ML5582	U	U	10	22	769	247
475	ML6044	S1	S1	8	18,5	643	204
475	ML6115	U	C1	8	18,5	492	175
480	ML5043	Y1	X1	8	18,5	490	180
480	ML5073	Y1	X1	8	18,5	501	207
480	ML5100	S1	S1	8	18,5	500	204
480	ML5167	U	U	8	18,5	535	215

# EXTENSION FORCE WITH EXTENDED PISTON ROD

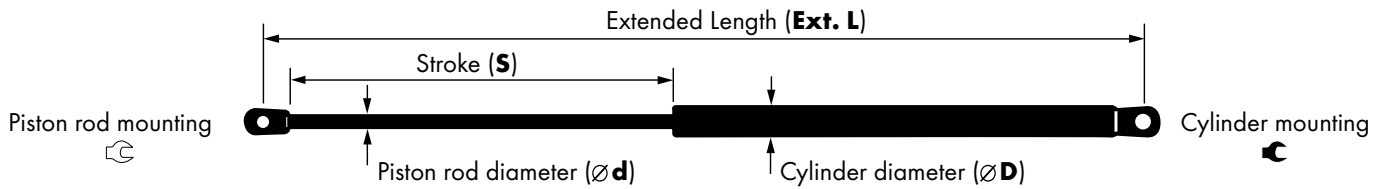
**F1**

F1	Monroe®	↺	↻	$\varnothing d$	$\varnothing D$	Ext. L	S
480	ML5170	U	U	8	18,5	295	80
480	ML5273	U	U	8	18,5	278	90
480	ML5295	U	U	8	18,5	678	282
480	ML5324	U	U	8	18,5	590	220
480	ML5349	U	U	8	18,5	525	210
480	ML5388	U	U	8	18,5	565	215
480	ML5414	S1	S1	8	18,5	438	170
480	ML5430	U	U	8	18,5	590,5	245
480	ML5440	S1	S1	8	18,5	534,5	220
480	ML5445	10	10	8	18,5	365	145
480	ML5526	S1	14	8	18,5	178	55
480	ML5654	U	U	8	18,5	657	275
480	ML5667	U	U	8	18,5	490,5	200
480	ML5702	P	S1	8	18,5	470	185
480	ML5723	S1	S1	8	18,5	405	160
480	ML5871	S1	S1	8	18,5	480	185
480	ML6103	U	C1	8	19	319,5	91
485	ML5152	U	C1	8	18,5	595	250
485	ML5173	U	U	8	18,5	555	228
485	ML5231	U	U	8	18,5	535	198
485	ML6022	U	C1	8	18,5	506,5	186
485	ML6145	S1	S3	8	18,5	314	92
490	ML5135	U	U	8	18,5	279	95
490	ML5308	U	U	8	18,5	450	170
490	ML5354	U	U	8	18,5	570	230
490	ML5378	U	S1	8	18,5	545	210
490	ML5460	S1	S1	8	18,5	494	185
490	ML5478	S1	S1	8	18,5	515	200
490	ML5506	T1	T1	8	18,5	540	220
490	ML5622	S1	S1	8	18,5	515	187
490	ML5684	U	U	8	18,5	515	190
490	ML5711	U	U	8	18,5	515	210
490	ML5732	S1	S1	8	18,5	505	195
490	ML5802	U	U	8	18,5	418	163
490	ML5894	U	U	8	18,5	446	170
490	ML5934	10	10	8	18,5	254	95
490	ML6130	P	U	8	19	522	210
495	ML5109	U	U	8	18,5	544	207
495	ML5652	J	S1	8	18,5	375	135
495	ML5962	U	C1	8	18,5	313,5	78,5
495	ML6014	U	K	8	18,5	287	89
500	ML5007	Y6	X1	8	18,5	405	160
500	ML5019	Y6	X1	8	18,5	600	250
500	ML5060	Y1	X1	8	18,5	405	160
500	ML5070	Y1	D	8	18,5	405	160
500	ML5074	F1	Y3	10	22	798	350
500	ML5080	U	U	8	18,5	495	192
500	ML5094	U	U	8	18,5	500	204
500	ML5096	U	U	8	18,5	447	172
500	ML5123	S1	S1	8	18,5	515	210
500	ML5124	U	U	8	18,5	515	195
500	ML5132	S1	U	8	18,5	502	205
500	ML5138	U	U	8	18,5	566	204
500	ML5154	U	U	8	18,5	298	83
500	ML5212	U	U	8	18,5	417	155
500	ML5218	U	U	8	18,5	495	198
500	ML5289	U	U	8	18,5	556	205
500	ML5290	U	U	8	18,5	256	85
500	ML5372	U	U	8	18,5	546	215
500	ML5375	U	U	8	18,5	568	230
500	ML5437	S1	U	8	18,5	575	220
500	ML5483	S1	S1	8	18,5	280	95
500	ML5507	T1	T1	8	18,5	433	165
500	ML5531	S1	T1	8	18,5	280	90

F1	Monroe®	↺	↻	$\varnothing d$	$\varnothing D$	Ext. L	S
500	ML5765	T1	T1	8	18,5	565	220
500	ML5782	T1	T1	8	18,5	558	235
500	ML5838	P	P	8	18,5	494	172
500	ML5847	B2	A2	10	22	610	240
500	ML5848	B1	A1	10	22	610	240
500	ML5857	P	P	8	18,5	500	190
500	ML5911	T1	T1	10	22	414	155
500	ML5940	S1	S1	8	18,5	585	246
500	ML6019	U	U	8	18,5	222,5	71
500	ML6067	S1	S1	8	18,5	195,5	36
510	ML5344	U	U	8	18,5	632	230
510	ML5352	U	U	8	18,5	268	78
510	ML5503	T1	T1	8	18,5	600	230
510	ML5530	U	P	8	18,5	640	260
510	ML5545	U	S1	8	18,5	596	210
510	ML5683	P	U	8	18,5	580	201
510	ML5719	U	P	8	18,5	475	175
510	ML5786	U	U	8	18,5	280	90
510	ML5845	U	U	8	18,5	419	165
510	ML5866	U	P	10	22	625	210
510	ML5888	T1	T1	8	18,5	585,5	235
510	ML5994	U	C1	8	18,5	345	119
510	ML6005	S1	S1	8	18,5	538	220
510	ML6017	U	U	8	18,5	604	225
510	ML6087	S1	S1	8	18,5	495	180,5
510	ML6129	U	U	8	19	488	195
515	ML5126	S1	U	8	18,5	554	200
515	ML5130	U	C1	8	18,5	596,5	212
515	ML5219	U	U	8	18,5	495	182
515	ML5724	S1	S1	8	18,5	533	200
515	ML6023	U	C1	8	18,5	506,5	186
520	ML5064	U	U	8	18,5	527	219
520	ML5122	U	U	8	18,5	570	232
520	ML5155	U	U	8	18,5	440	160
520	ML5232	U	U	8	18,5	535	198
520	ML5256	U	U	8	18,5	505	190
520	ML5277	U	U	8	18,5	405	150
520	ML5278	U	U	8	18,5	570	240
520	ML5294	U	U	8	18,5	485	196
520	ML5341	U	U	8	18,5	263	80
520	ML5377	U	S1	8	18,5	507	203
520	ML5401	U	U	8	18,5	570	230
520	ML5408	U	U	8	18,5	511	199
520	ML5439	U	U	8	18,5	279	95
520	ML5520	S1	12	8	18,5	336	100
520	ML5590	S1	12	8	18,5	346	100
520	ML5930	U	U	8	18,5	331	115
520	ML5941	S1	S1	8	18,5	449	179
520	ML5985	T1	T1	10	22	512	200
520	ML6106	U	C1	8	18,5	287	96
525	ML5774	T1	P	8	18,5	500	200
530	ML5032	U	U	8	18,5	473	188
530	ML5193	U	U	8	18,5	279	90
530	ML5227	S1	S1	8	18,5	502	200
530	ML5314	U	U	8	18,5	545	220
530	ML5328	U	U	10	22	775	322
530	ML5338	U	U	8	18,5	570	215
530	ML5379	U	S1	8	18,5	545	210
530	ML5416	U	U	8	18,5	481,5	199
530	ML5476	S1	S1	8	18,5	574,5	230
530	ML5579	S1	S1	8	18,5	523	202
530	ML5621	U	U	10	22	775	322
530	ML5690	S1	S1	8	18,5	530	175
530	ML5747	T1	T1	8	18,5	490	198

EXTENSION FORCE

# EXTENSION FORCE WITH EXTENDED PISTON ROD

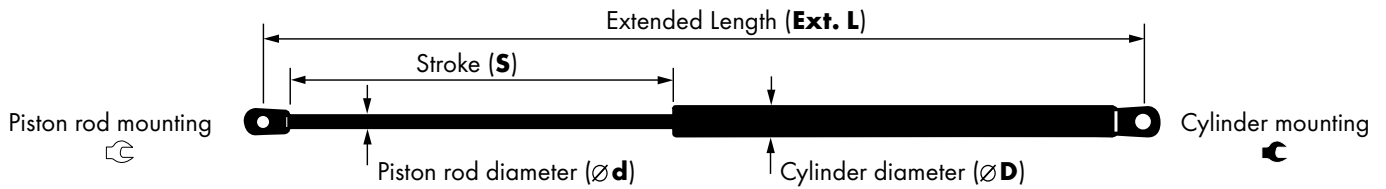
**F1**

F1	Monroe®	↺	↻	Ød	ØD	Ext. L	S
530	<b>ML5801</b>	U	U	8	18,5	415	160
530	<b>ML5824</b>	S1	S1	8	18,5	558	235
530	<b>ML5918</b>	U	U	8	18,5	502	205
530	<b>ML5986</b>	S1	C1	8	18,5	577	190
530	<b>ML6132</b>	S1	S1	8	19	441	166
535	<b>ML5189</b>	S1	S1	8	18,5	513	207
535	<b>ML5438</b>	S1	S1	8	18,5	459,5	180
535	<b>ML5469</b>	S1	S1	8	18,5	581,5	210
535	<b>ML5742</b>	S1	U	8	18,5	450	180
535	<b>ML6117</b>	U	C1	8	18,5	527	163
535	<b>ML6125</b>	S1	S1	8	19	665	238
535	<b>ML6135</b>	S1	S3	8	18,5	473,5	162
535	<b>ML6143</b>	U	U	8	18,5	547	222
540	<b>ML5119</b>	U	U	8	18,5	540	196
540	<b>ML5384</b>	U	S1	8	18,5	606,5	230
540	<b>ML5424</b>	U	S1	8	18,5	567	193
540	<b>ML5501</b>	Y2	D	8	18,5	600	250
540	<b>ML5549</b>	T1	D	8	18,5	270	90
540	<b>ML5592</b>	S1	S1	8	18,5	498	225
540	<b>ML5633</b>	Y1	D	8	18,5	268	90
540	<b>ML5704</b>	T1	T1	8	18,5	378	145
540	<b>ML5757</b>	U	U	8	18,5	473	182
540	<b>ML5835</b>	M	O	10	22	699	257
540	<b>ML5932</b>	S1	S1	8	18,5	291	65
540	<b>ML5983</b>	U	P	10	22	524	212
540	<b>ML6152</b>	S1	P	8	18,5	361,5	121
545	<b>ML5641</b>	S1	S1	8	18,5	511,5	172
545	<b>ML5666</b>	U	U	8	18,5	531	173
550	<b>ML5045</b>	U	C1	8	18,5	405	160
550	<b>ML5156</b>	P	P	8	18,5	508	195
550	<b>ML5168</b>	U	U	8	18,5	512	200
550	<b>ML5177</b>	U	U	8	18,5	515	210
550	<b>ML5178</b>	U	U	8	18,5	507	207
550	<b>ML5203</b>	U	U	8	18,5	600	215
550	<b>ML5220</b>	U	U	8	18,5	495	182
550	<b>ML5319</b>	U	U	8	18,5	558	200
550	<b>ML5381</b>	U	S1	8	18,5	557	215
550	<b>ML5558</b>	U	T1	8	18,5	280	90
550	<b>ML5644</b>	T1	D	8	18,5	515	215
550	<b>ML5653</b>	S1	U	8	18,5	439,5	157
550	<b>ML5699</b>	P	S1	8	18,5	445	183
550	<b>ML5710</b>	U	U	8	18,5	299	109
550	<b>ML5761</b>	U	U	8	18,5	305	105
550	<b>ML5792</b>	U	P	8	18,5	480	200
550	<b>ML5793</b>	S1	S1	8	18,5	315	100
550	<b>ML5828</b>	U	P	8	18,5	547	220
550	<b>ML5831</b>	U	S1	8	18,5	450	180
550	<b>ML5912</b>	S1	U	8	18,5	567	195
555	<b>ML5351</b>	U	U	8	18,5	357	128
560	<b>ML5082</b>	U	U	8	18,5	469,5	171
560	<b>ML5176</b>	S1	U	8	18,5	552	200
560	<b>ML5302</b>	U	U	8	18,5	385	138
560	<b>ML5305</b>	U	U	8	18,5	610	200
560	<b>ML5313</b>	U	U	8	18,5	526	206
560	<b>ML5397</b>	U	U	8	18,5	568	230
560	<b>ML5412</b>	S1	U	8	18,5	565	210
560	<b>ML5502</b>	S1	S1	8	18,5	300	99
560	<b>ML5535</b>	Y1	T1	8	18,5	241	70
560	<b>ML5585</b>	O	O	10	22	613,5	248
560	<b>ML5627</b>	U	U	8	18,5	610	200
560	<b>ML5794</b>	T1	T1	8	18,5	462,5	190
560	<b>ML5808</b>	S1	S1	8	18,5	256	58
560	<b>ML5818</b>	U	U	8	18,5	282	98
560	<b>ML5892</b>	S1	S1	8	18,5	830	300

F1	Monroe®	↺	↻	Ød	ØD	Ext. L	S
560	<b>ML5979</b>	U	U	8	18,5	490	189
560	<b>ML6042</b>	S1	S1	8	18,5	580	200
560	<b>ML6147</b>	S1	S1	8	18,5	225	60
565	<b>ML5221</b>	U	U	8	18,5	495	182
565	<b>ML5253</b>	U	U	8	18,5	496,5	192
565	<b>ML5647</b>	P	S1	8	18,5	485	200
565	<b>ML5756</b>	U	P	8	18,5	640	255
565	<b>ML6099</b>	S1	U	8	18,5	344,5	88,5
570	<b>ML5086</b>	S1	S1	8	18,5	526	207
570	<b>ML5258</b>	U	U	8	18,5	471	184
570	<b>ML5283</b>	U	U	8	18,5	627	230
570	<b>ML5304</b>	U	U	8	18,5	627	230
570	<b>ML5346</b>	U	U	8	18,5	571	208
570	<b>ML5505</b>	T1	T1	8	18,5	630	220
570	<b>ML5626</b>	U	U	8	18,5	627	230
570	<b>ML5721</b>	U	U	8	18,5	474	190
570	<b>ML5963</b>	S1	S1	8	18,5	495	180,5
570	<b>ML6110</b>	S1	S3	8	18,5	283	84
575	<b>ML5205</b>	U	U	8	18,5	625	253
580	<b>ML5263</b>	S1	S1	8	18,5	319	110
580	<b>ML5335</b>	S1	S1	8	18,5	310	110
580	<b>ML5376</b>	U	S1	8	18,5	280	90
580	<b>ML5554</b>	U	T1	10	22	573,5	215
580	<b>ML5569</b>	S1	S1	8	18,5	485	185
580	<b>ML5656</b>	P	P	8	18,5	469,5	185
580	<b>ML5872</b>	S1	S1	8	18,5	516,5	150
580	<b>ML5991</b>	U	U	8	18,5	557	220
580	<b>ML6016</b>	U	S3	8	18,5	479	174
580	<b>ML6121</b>	U	C1	8	18,5	285	100
585	<b>ML5190</b>	S1	S1	8	18,5	513	207
585	<b>ML5233</b>	U	U	8	18,5	535	198
585	<b>ML5486</b>	S1	S1	8	18,5	434	153
585	<b>ML5632</b>	Y1	D	8	18,5	486	170
585	<b>ML5760</b>	P	U	8	18,5	515	196
585	<b>ML5772</b>	T1	P	8	18,5	539	218
585	<b>ML5984</b>	U	P	10	22	524	212
585	<b>ML5997</b>	P	S1	8	18,5	505	205
590	<b>ML5137</b>	U	U	8	18,5	542	193
590	<b>ML5141</b>	U	U	10	22	567	221
590	<b>ML5310</b>	U	U	8	18,5	310	89
590	<b>ML5343</b>	U	U	8	18,5	448	180
590	<b>ML5383</b>	U	S1	8	18,5	473,5	170
590	<b>ML5413</b>	S1	U	8	18,5	472	175
590	<b>ML5417</b>	S1	S1	8	18,5	275	90
590	<b>ML5693</b>	P	S1	8	18,5	625	210
590	<b>ML5844</b>	U	U	8	18,5	310	110
590	<b>ML6002</b>	U	U	10	22	569,5	155
590	<b>ML6124</b>	U	P	8	19	590	225
590	<b>ML6144</b>	S1	C1	8	18,5	587,5	167,5
595	<b>ML5291</b>	U	U	8	18,5	501	175
595	<b>ML5755</b>	U	P	8	18,5	640	255
600	<b>ML5008</b>	Y1	X1	8	18,5	365	140
600	<b>ML5075</b>	Y1	D	8	18,5	405	160
600	<b>ML5121</b>	S1	S1	8	18,5	450	175
600	<b>ML5125</b>	U	U	8	18,5	508	195
600	<b>ML5175</b>	U	C1	8	18,5	440	169
600	<b>ML5204</b>	U	U	8	18,5	600	215
600	<b>ML5257</b>	U	U	8	18,5	470	182
600	<b>ML5363</b>	U	U	8	18,5	632	215
600	<b>ML5425</b>	U	C1	8	18,5	491	205
600	<b>ML5455</b>	U	U	8	18,5	632	215
600	<b>ML5456</b>	U	U	8	18,5	610	200
600	<b>ML5487</b>	S1	S1	8	18,5	298	90
600	<b>ML5532</b>	S1	T1	8	18,5	280	90

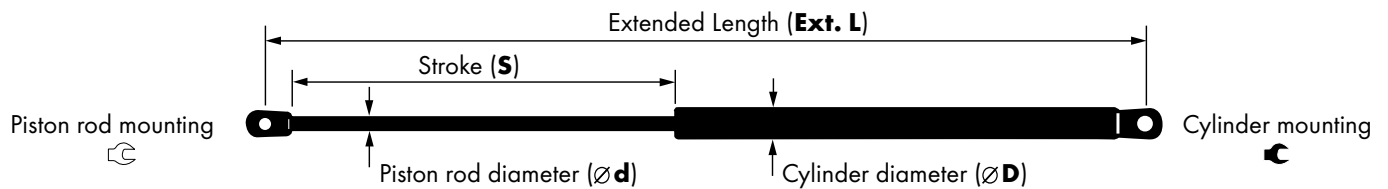

# EXTENSION FORCE WITH EXTENDED PISTON ROD

**F1**

F1	Monroe®	↺	↻	Ød	ØD	Ext. L	S
600	ML5594	Y5	X3	8	18,5	255	86
600	ML5613	Y1	D	8	18,5	500	201
600	ML5682	U	U	8	18,5	420	162
600	ML5748	S1	U	8	18,5	255	85
600	ML5778	S1	U	8	18,5	285	105
600	ML5856	U	U	8	18,5	500	190
600	ML6071	U	U	8	18,5	431	160
600	ML6091	U	U	8	18,5	291	91
600	ML6119	U	C1	8	18,5	480	189
600	ML6128	S1	S1	8	19	523	200
610	ML5106	U	D	8	18,5	514,5	217
610	ML5260	U	U	8	18,5	293	80
610	ML5334	U	U	8	18,5	549,5	200
610	ML5380	U	S1	8	18,5	485	187
610	ML5495	U	U	8	18,5	490	195
610	ML5528	M	O	10	22	697	257
610	ML5657	S1	S1	8	18,5	495	205
610	ML5722	U	U	10	22	505	205
610	ML5834	M	O	10	22	699	257
610	ML6013	S1	S1	10	22	515,5	205
610	ML6097	S1	S1	8	18,5	334	120
610	ML6116	U	C1	8	18,5	527	163
615	ML5728	U	U	8	18,5	375	145
620	ML5103	U	U	8	18,5	510	202
620	ML5303	S1	S1	8	18,5	365	135
620	ML5442	U	U	8	18,5	348	120
620	ML5449	U	U	8	18,5	405	160
620	ML5477	S1	S1	8	18,5	574,5	230
620	ML5527	O	O	10	22	613,5	248
620	ML5707	U	U	8	18,5	545	210
620	ML5889	S1	S1	8	18,5	527	188
625	ML5783	U	P	8	18,5	585	190
625	ML5826	U	C1	8	18,5	520	180
625	ML5948	U	S1	10	22	620	225
630	ML5104	U	S1	8	18,5	280	95,5
630	ML5128	S1	S1	10	22	690	280
630	ML5234	U	U	10	22	278	90
630	ML5329	U	U	10	22	772	322
630	ML5431	U	U	8	18,5	256	85
630	ML5454	U	U	8	18,5	627	230
630	ML5616	S1	U	8	18,5	570	200
630	ML5753	U	U	8	18,5	470	160
630	ML5837	T1	T1	8	18,5	690	300
630	ML5929	P	P	10	22	498	191
630	ML6038	T1	T1	10	22	500	175
635	ML5110	U	U	8	18,5	500	170
635	ML5238	S1	P	8	18,5	500	200
635	ML5240	P	P	10	22	500	200
635	ML6012	P	P	10	22	496	180
640	ML5332	U	U	8	18,5	485	165
640	ML5475	U	U	8	18,5	520	175
640	ML5523	S1	12	8	18,5	312	100
640	ML5543	U	U	8	18,5	695	272
640	ML5586	O	O	10	22	613,5	248
640	ML5688	S1	S1	8	18,5	288	104
640	ML5773	U	U	8	18,5	475	195
645	ML5958	U	P	8	18,5	588	198
650	ML5142	U	U	10	22	567	221
650	ML5223	U	U	10	22	298	95
650	ML5553	U	U	10	22	310	89
650	ML5635	Y1	D	8	18,5	500	195
650	ML5686	U	U	8	18,5	165	40
650	ML5746	U	P	8	18,5	475	184
650	ML5800	U	U	8	18,5	333	117

F1	Monroe®	↺	↻	Ød	ØD	Ext. L	S
650	ML5816	T1	T1	10	22	570	240
650	ML6080	U	U	8	18,5	538	205
655	ML5224	U	K	10	22	465	140
655	ML5770	P	P	8	18,5	605	242
660	ML5246	U	U	10	22	569	240
660	ML5330	U	U	10	22	250	74
660	ML5423	U	U	10	22	520	180
660	ML5446	T1	T1	10	22	382	140
660	ML5513	T1	T1	10	22	382	140
660	ML5581	U	U	10	22	527	200
660	ML5671	U	U	8	18,5	627	205
660	ML5993	U	P	8	18,5	452	170
660	ML6051	U	U	8	18,5	500	146
665	ML5433	U	U	10	22	520	180
670	ML5113	T1	T1	8	18,5	700	300
670	ML5514	U	U	10	22	850	340
670	ML5533	T1	T1	10	22	272	90
670	ML5555	U	T1	10	22	573,5	215
670	ML5893	S1	S1	8	18,5	569	240
670	ML5968	U	U	8	18,5	600	225
670	ML6104	U	C1	8	18,5	299	65,5
680	ML5524	T1	T1	10	22	273	92
680	ML5630	S1	S1	10	22	431	121
680	ML5860	S1	S1	8	18,5	214	62
680	ML5989	U	K	10	22	595	205
680	ML6076	U	T1	10	22	282	100
690	ML5226	U	S1	10	22	260	89
690	ML5239	P	U	10	22	500	195
690	ML5511	U	U	10	22	483	175
690	ML5512	U	U	10	22	480	173
690	ML6113	Q	Q	10	22	539	163
700	ML5336	S1	S1	10	22	333	100
700	ML5415	U	U	10	22	455	127
700	ML5426	U	U	10	22	418	148
700	ML5518	U	U	10	22	730	200
700	ML5675	U	U	10	22	175	45
700	ML5745	U	U	10	22	298	80
700	ML5811	U	U	8	18,5	323	103
700	ML5817	P	U	10	22	482	185,5
700	ML6037	U	C1	8	18,5	241	76
700	ML6057	U	C1	10	22	598,5	186
705	ML6073	U	U	8	18,5	482,5	195
710	ML5249	P	P	10	22	685	250
710	ML5557	U	U	10	22	492	188
710	ML5751	T1	T1	10	22	300	70
710	ML5781	U	S1	10	22	535	183
710	ML5787	T1	T1	10	22	550	160
715	ML5797	T1	T1	10	22	556	224
720	ML5525	T1	T1	10	22	273	92
720	ML5539	U	U	10	22	489	144
720	ML5769	U	S1	10	22	285	100
725	ML5709	U	U	10	22	736,5	310
725	ML5806	U	P	10	22	560	178
730	ML5228	U	K	10	22	560	210
730	ML5516	T1	T1	10	22	905	307
730	ML5550	T1	T1	10	22	905	307
730	ML5580	U	U	10	22	520	185
730	ML5744	U	U	10	22	298	80
730	ML6029	U	13	10	22	301	92
740	ML5331	U	K	10	22	450	162
740	ML5443	U	U	10	22	603	220
740	ML5510	U	U	10	22	483	175
740	ML5927	U	T1	8	18,5	274	90
750	ML5245	U	U	10	22	569	240

EXTENSION FORCE

# EXTENSION FORCE WITH EXTENDED PISTON ROD

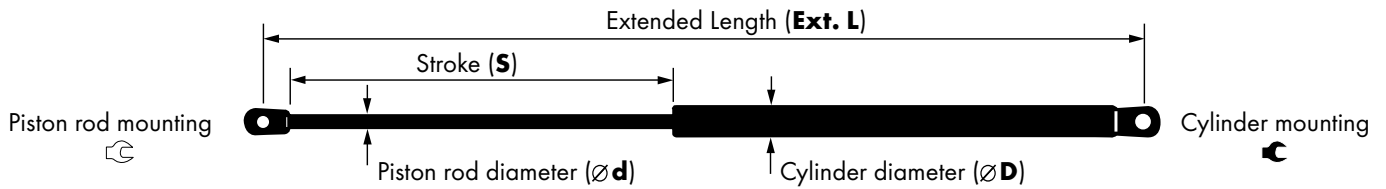
**F1**

F1	Monroe®	↶	↷	Ød	ØD	Ext. L	S
750	ML5591	U	Q	10	22	545	195
750	ML6053	U	C1	8	18,5	652	218
750	ML6058	S1	S1	10	22	537	198
750	ML6075	U	K	10	22	533	220
750	ML6102	U	P	10	22	483,5	148
755	ML5716	U	U	10	22	667	255
760	ML5519	U	U	10	22	730	200
760	ML5583	U	U	10	22	195	50
765	ML5947	P	P	10	22	665	195
770	ML5118	P	P	10	22	685	250
770	ML5743	U	P	10	22	505	170
780	ML5612	U	U	10	22	501	175
780	ML5614	U	U	10	22	490	200
790	ML6068	U	C1	8	18,5	227	57
800	ML5229	U	U	10	22	560	210
800	ML5441	S1	S1	10	22	326	115
800	ML5540	S2	S2	10	22	364	130
800	ML5839	U	K	10	22	390	148
800	ML6055	U	U	10	22	661,5	260,5
810	ML5429	U	U	10	22	550	235
810	ML5537	U	U	10	22	603	198
819	ML5515	U	U	10	22	722	210
820	ML5628	U	U	10	22	265	80
830	ML5127	U	U	10	22	591	200
830	ML5247	U	U	10	22	569	240
830	ML5251	P	P	10	22	685	250
838	ML6001	Q	Q	10	22	429	136
850	ML5076	U	U	10	22	550	235
850	ML5085	U	U	10	22	249	67
850	ML5538	U	U	10	22	603	198
850	ML5559	U	S2	10	22	235	52
870	ML5750	U	U	10	22	720	280
910	ML5105	U	U	10	22	569	240
910	ML5250	P	P	10	22	685	250
970	ML5575	U	P	10	22	755	210
990	ML5771	P	P	10	22	574	198
1050	ML5944	P	P	10	22	430,5	130
1050	ML5950	U	U	10	22	700	172
1080	ML5576	U	U	10	22	755	210
1080	ML5833	U	P	10	22	755	210
1100	ML5517	U	U	10	22	195	55
1180	ML6149	G	G	10	22	250	72
1190	ML6092	O	M	14	28	308	88
1200	ML5685	M	O	14	28	320	85
1200	ML5982	I	I	14	28	342	105
1300	ML6021	I	I	14	28	347,5	91,5
1340	ML5852	G	G	14	28	399	86
1400	ML5674	I	I	14	28	325	100
1450	ML6030	M	M	14	28	312,5	75,5
1550	ML5637	O	O	14	28	396	108
1600	ML5529	O	M	14	28	270	70

# EXTENDED LENGTH

**Ext. L**

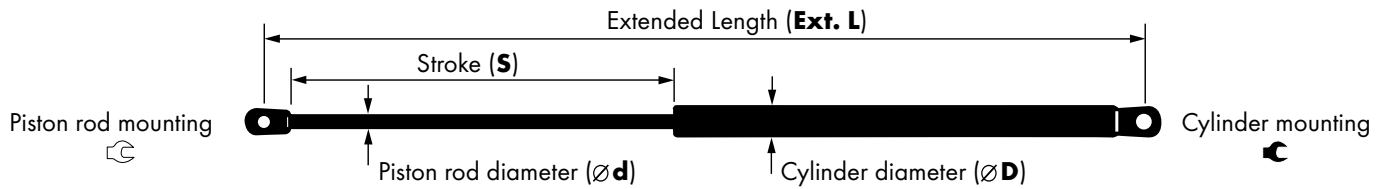

Ext. L	Monroe®	↶	↷	Ød	ØD	S	F1
155	ML5974	T1	T1	6	15	40	400
165	ML5686	U	U	8	18,5	40	650
175	ML5675	U	U	10	22	45	700
178	ML5526	S1	14	8	18,5	55	480
185	ML5546	R	R	6	15	55	100
195	ML5517	U	U	10	22	55	1100
195	ML5583	U	U	10	22	50	760
195,5	ML6066	S1	S1	6	15	60	350
195,5	ML6067	S1	S1	8	18,5	36	500
201	ML5791	S1	U	8	18,5	52	250
201	ML5978	S1	S1	8	18,5	60	450
214	ML5860	S1	S1	8	18,5	62	680
215	ML5389	S1	S1	8	18,5	48	420
222,5	ML6019	U	U	8	18,5	71	500
225	ML5629	R	R	6	15	80	100
225	ML6147	S1	S1	8	18,5	60	560
226	ML5496	Y1	D	8	18,5	63	100
227	ML6068	U	C1	8	18,5	57	790
232,5	ML6015	U	U	8	18,5	65	305
235	ML5559	U	S2	10	22	52	850
238	ML5810	U	U	8	18,5	62	165
240	ML5404	U	U	8	18,5	74	300
240	ML5803	S1	S1	8	18,5	70	380
241	ML5535	Y1	T1	8	18,5	70	560
241	ML6037	U	C1	8	18,5	76	700
242	ML5522	10	10	8	18,5	84	380
242	ML6031	S1	10	6	15	74	325
244	ML5643	S1	S1	6	15	90	400
245	ML5611	Y1	D	8	18,5	76	330
249	ML5085	U	U	10	22	67	850
250	ML5330	U	U	10	22	74	660
250	ML6149	G	G	10	22	72	1180
252	ML5764	U	U	8	18,5	85	425
254	ML5566	10	10	8	18,5	90	420
254	ML5596	Y4	X1	6	15	95	350
254	ML5639	Y1	D	8	18,5	85	340
254	ML5934	10	10	8	18,5	95	490
255	ML5594	Y5	X3	8	18,5	86	600
255	ML5595	Y5	X3	8	18,5	86	370
255	ML5748	S1	U	8	18,5	85	600
255	ML5922	S1	S3	8	18,5	78	350
256	ML5018	Y6	X1	8	18,5	86	280
256	ML5030	Y6	X1	8	18,5	86	180
256	ML5058	Y1	X1	8	18,5	86	280
256	ML5290	U	U	8	18,5	85	500
256	ML5431	U	U	8	18,5	85	630
256	ML5808	S1	S1	8	18,5	58	560
260	ML5226	U	S1	10	22	89	690
263	ML5341	U	U	8	18,5	80	520
264	ML5215	S1	S1	8	18,5	82	370
264	ML5216	S1	S1	8	18,5	82	460
264	ML6127	U	S1	8	19	88	355
265	ML5628	U	U	10	22	80	820
268	ML5352	U	U	8	18,5	78	510
268	ML5617	N	N	8	18,5	83,5	450
268	ML5633	Y1	D	8	18,5	90	540
270	ML5481	S1	S1	8	18,5	75	420
270	ML5529	O	M	14	28	70	1600
270	ML5549	T1	D	8	18,5	90	540
270	ML5921	S1	S1	8	18,5	82	380
272	ML5533	T1	T1	10	22	90	670
273	ML5524	T1	T1	10	22	92	680
273	ML5525	T1	T1	10	22	92	720
273	ML6011	U	U	8	18,5	85	420

Ext. L	Monroe®	↶	↷	Ød	ØD	S	F1
274	ML5927	U	T1	8	18,5	90	740
274	ML6148	S1	S1	8	18,5	95	320
275	ML5417	S1	S1	8	18,5	90	590
278	ML5234	U	U	10	22	90	630
278	ML5273	U	U	8	18,5	90	480
278	ML5274	U	U	8	18,5	90	430
278	ML6142	U	C1	8	18,5	70	470
279	ML5135	U	U	8	18,5	95	490
279	ML5193	U	U	8	18,5	90	530
279	ML5439	U	U	8	18,5	95	520
280	ML5104	U	S1	8	18,5	95,5	630
280	ML5376	U	S1	8	18,5	90	580
280	ML5419	S1	S1	8	18,5	95	390
280	ML5466	S1	S1	8	18,5	80	465
280	ML5467	S1	S1	8	18,5	80	420
280	ML5483	S1	S1	8	18,5	95	500
280	ML5531	S1	T1	8	18,5	90	500
280	ML5532	S1	T1	8	18,5	90	600
280	ML5558	U	T1	8	18,5	90	550
280	ML5786	U	U	8	18,5	90	510
280	ML6120	U	U	8	18,5	95	395
282	ML5818	U	U	8	18,5	98	560
282	ML6076	U	T1	10	22	100	680
283	ML5663	U	U	8	18,5	101,5	450
283	ML6047	S1	S1	8	18,5	87	400
283	ML6110	S1	S3	8	18,5	84	570
284	ML5063	U	U	8	18,5	100	315
285	ML5323	U	U	8	18,5	95	290
285	ML5769	U	S1	10	22	100	720
285	ML5778	S1	U	8	18,5	105	600
285	ML5980	U	U	8	18,5	104	230
285	ML6000	U	U	8	18,5	105	460
285	ML6101	S1	S1	6	15	100	300
285	ML6121	U	C1	8	18,5	100	580
285	ML6136	U	C1	8	18,5	90	410
286	ML5471	S1	S1	8	18,5	100	310
287	ML5259	U	U	8	18,5	99	365
287	ML6014	U	K	8	18,5	89	495
287	ML6106	U	C1	8	18,5	96	520
288	ML5536	U	Q	8	18,5	95	250
288	ML5688	S1	S1	8	18,5	104	640
288,5	ML5975	S1	S3	8	18,5	100	380
289	ML6020	S1	10	6	15	113	350
290	ML6107	S1	S3	8	19	102	395
291	ML5698	S1	U	8	18,5	107	380
291	ML5932	S1	S1	8	18,5	65	540
291	ML6091	U	U	8	18,5	91	600
292	ML6004	S1	S1	8	18,5	88	410
293	ML5260	U	U	8	18,5	80	610
293	ML5946	U	C	8	18,5	104	280
295	ML5170	U	U	8	18,5	80	480
295	ML5301	U	U	8	18,5	100	380
296	ML5861	S1	S1	8	18,5	95	250
297	ML5813	S1	S1	6	15	112,5	240
298	ML5154	U	U	8	18,5	83	500
298	ML5223	U	U	10	22	95	650
298	ML5487	S1	S1	8	18,5	90	600
298	ML5744	U	U	10	22	80	730
298	ML5745	U	U	10	22	80	700
298	ML6112	U	C	8	18,5	94	430
299	ML5710	U	U	8	18,5	109	550
299	ML6104	U	C1	8	18,5	65,5	670
299,5	ML6094	S2	S2	8	18,5	88	370
300	ML5182	S1	S1	8	18,5	100	410

EXTENDED LENGTH

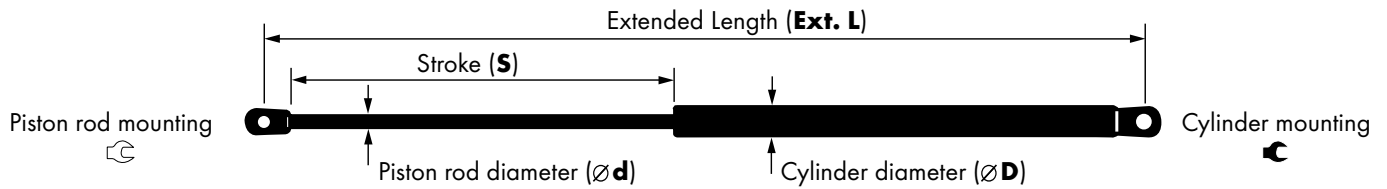

Ext. L	Monroe®	↺	↻	Ød	ØD	S	F1
300	ML5502	S1	S1	8	18,5	99	560
300	ML5751	T1	T1	10	22	70	710
300	ML5996	U	C1	8	18,5	106,5	460
301	ML6029	U	I3	10	22	92	730
305	ML5640	T1	T1	6	15	109	130
305	ML5761	U	U	8	18,5	105	550
305	ML5928	S1	S1	8	18,5	96	410
305	ML6062	S1	D	8	18,5	105	370
305,5	ML5179	S1	S1	6	15	121	45
308	ML6092	O	M	14	28	88	1190
310	ML5310	U	U	8	18,5	89	590
310	ML5335	S1	S1	8	18,5	110	580
310	ML5355	U	U	8	18,5	95	430
310	ML5553	U	U	10	22	89	650
310	ML5729	U	U	8	18,5	110	400
310	ML5844	U	U	8	18,5	110	590
310	ML6114	S1	H1	6	15	122	255
312	ML5523	S1	I2	8	18,5	100	640
312,5	ML6030	M	M	14	28	75,5	1450
313	ML5562	S1	S1	8	18,5	112	330
313,5	ML5962	U	C1	8	18,5	78,5	495
314	ML5945	P	U	6	15	110	355
314	ML6145	S1	S3	8	18,5	92	485
314,5	ML5804	U	U	8	18,5	116	330
314,5	ML6065	U	C1	8	18,5	116	220
315	ML5321	U	U	8	18,5	100	420
315	ML5322	U	U	8	18,5	100	465
315	ML5411	S1	U	8	18,5	105	370
315	ML5740	S1	U	8	18,5	120	440
315	ML5793	S1	S1	8	18,5	100	550
318	ML5766	S1	S1	8	18,5	120	380
319	ML5263	S1	S1	8	18,5	110	580
319	ML5646	Y5	X3	8	18,5	100	370
319,5	ML6006	U	U	8	18,5	120	410
319,5	ML6103	U	C1	8	19	91	480
320	ML5488	S1	S1	8	18,5	100	360
320	ML5685	M	O	14	28	85	1200
320	ML5727	U	U	8	18,5	105	470
323	ML5811	U	U	8	18,5	103	700
324	ML5095	U	U	8	18,5	115	290
325	ML5674	I	I	14	28	100	1400
326	ML5441	S1	S1	10	22	115	800
330	ML5619	N	N	8	18,5	116	340
331	ML5930	U	U	8	18,5	115	520
333	ML5336	S1	S1	10	22	100	700
333	ML5800	U	U	8	18,5	117	650
334	ML6063	S1	P	6	15	130	270
334	ML6097	S1	S1	8	18,5	120	610
336	ML5520	S1	I2	8	18,5	100	520
337,5	ML6133	S1	S1	8	19	120	365
338	ML6033	U	U	8	18,5	119	420
340	ML6118	U	C1	8	18,5	113	430
342	ML5982	I	I	14	28	105	1200
344,5	ML6098	S1	U	8	18,5	88,5	450
344,5	ML6099	S1	U	8	18,5	88,5	565
345	ML5789	U	U	8	18,5	122	350
345	ML5994	U	C1	8	18,5	119	510
345	ML6108	S1	S1	8	19	128	450
346	ML5590	S1	I2	8	18,5	100	520
346	ML5999	U	U	6	15	136	340
347,5	ML6021	I	I	14	28	91,5	1300
348	ML5442	U	U	8	18,5	120	620
350	ML5163	S1	S1	8	18,5	100	320
350	ML5680	U	U	8	18,5	130	440

Ext. L	Monroe®	↺	↻	Ød	ØD	S	F1
352	ML5356	U	U	8	18,5	110	150
355	ML5696	P	U	8	18,5	120	350
355	ML5910	U	S1	8	18,5	135	115
357	ML5351	U	U	8	18,5	128	555
359	ML6090	I	H	6	15	150	180
361,5	ML6152	S1	P	8	18,5	121	540
362	ML5017	U	X2	8	18,5	135	190
362	ML5823	S1	S1	6	15	138	100
362	ML6141	S1	S1	8	18,5	112	260
363	ML5490	S1	S1	8	18,5	132	370
364	ML5489	S1	S1	8	18,5	132	310
364	ML5540	S2	S2	10	22	130	800
365	ML5008	Y1	X1	8	18,5	140	600
365	ML5303	S1	S1	8	18,5	135	620
365	ML5365	U	U	8	18,5	135	180
365	ML5366	U	U	8	18,5	135	240
365	ML5444	I0	I0	8	18,5	145	410
365	ML5445	I0	I0	8	18,5	145	480
365	ML5552	S1	S1	6	15	135	135
365,5	ML5906	I	H	6	15	150	290
366	ML5670	S1	S1	8	18,5	117	280
367	ML5421	I0	I0	6	15	145	320
369	ML5658	S1	S1	8	18,5	110	320
370	ML5694	S1	S1	8	18,5	110	320
374	ML5563	S1	S1	8	18,5	140	350
375	ML5652	J	S1	8	18,5	135	495
375	ML5728	U	U	8	18,5	145	615
375	ML5830	U	P	8	18,5	140	390
375	ML5924	U	C1	8	18,5	144	280
375	ML6146	S1	S1	6	15	118	180
376	ML5943	S1	S3	8	18,5	145	390
378	ML5704	T1	T1	8	18,5	145	540
378	ML6131	U	U	8	18,5	146	300
380	ML5998	C	U	8	18,5	127	200
382	ML5446	T1	T1	10	22	140	660
382	ML5513	T1	T1	10	22	140	660
383	ML5891	S1	S1	8	18,5	137	455
385	ML5302	U	U	8	18,5	138	560
385	ML5762	P	U	8	18,5	150	140
386,5	ML5714	U	P	8	18,5	150	350
386,5	ML6035	P	P	8	18,5	145	160
387	ML5967	S1	S1	8	18,5	139	465
390	ML5832	U	P	8	18,5	155	360
390	ML5839	U	K	10	22	148	800
392	ML5624	P	T1	8	18,5	150	300
393	ML6137	U	U	8	18,5	150	170
394	ML6026	U	I3	8	18,5	149	400
395	ML5387	U	U	8	18,5	148	180
395	ML5472	S1	S1	8	18,5	150	230
395	ML5473	S1	S1	8	18,5	150	470
395	ML5706	P	U	8	18,5	158	440
396	ML5637	O	O	14	28	108	1550
397	ML6028	S1	I2	8	18,5	158	295
398	ML5479	S1	S1	8	18,5	120	180
398	ML5623	S1	S1	8	18,5	120	180
399	ML5852	G	G	14	28	86	1340
400	ML5392	S1	S1	8	18,5	149	300
400	ML5484	S1	S1	8	18,5	150	280
400	ML5689	S1	P	8	18,5	160	330
400	ML5855	S1	S1	8	18,5	139	400
400	ML5870	S1	S1	6	15	160	230
402	ML5111	U	C1	8	18,5	160	390
402,5	ML6150	U	U	8	18,5	160	150
404	ML6061	U	U	8	18,5	157	260

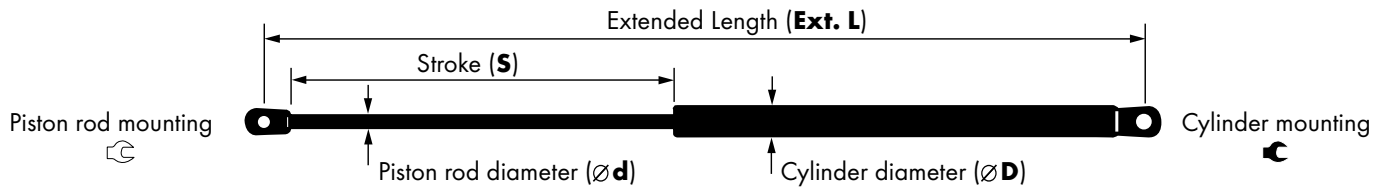

Ext. L	Monroe®	↙	↘	Ød	ØD	S	F1
404,5	ML5736	S1	U	8	18,5	163	460
404,5	ML6081	S1	S1	8	18,5	160	310
405	ML5001	Y6	X1	8	18,5	160	390
405	ML5007	Y6	X1	8	18,5	160	500
405	ML5045	U	C1	8	18,5	160	550
405	ML5060	Y1	X1	8	18,5	160	500
405	ML5070	Y1	D	8	18,5	160	500
405	ML5071	Y1	D	8	18,5	160	390
405	ML5075	Y1	D	8	18,5	160	600
405	ML5275	U	U	8	18,5	160	310
405	ML5277	U	U	8	18,5	150	520
405	ML5449	U	U	8	18,5	160	620
405	ML5649	U	U	8	18,5	160	300
405	ML5723	S1	S1	8	18,5	160	480
405	ML5846	U	D	8	18,5	164	270
406	ML6140	S1	U	8	18,5	160	335
408	ML5316	U	U	8	18,5	150	310
408	ML5925	U	C1	8	18,5	152	390
408	ML5926	U	C1	8	18,5	152	265
410	ML5422	10	10	6	15	166	280
410	ML5936	P	U	8	18,5	155	390
412	ML5241	U	U	8	18,5	155	340
412	ML5691	S1	U	8	18,5	163	400
414	ML5868	U	P	8	18,5	150	430
414	ML5911	T1	T1	10	22	155	500
414	ML6084	T1	T1	8	18,5	160	410
415	ML5801	U	U	8	18,5	160	530
417	ML5212	U	U	8	18,5	155	500
418	ML5426	U	U	10	22	148	700
418	ML5802	U	U	8	18,5	163	490
418,5	ML5977	S1	S1	8	18,5	155	390
419	ML5625	Y1	U	8	18,5	165	360
419	ML5845	U	U	8	18,5	165	510
420	ML5682	U	U	8	18,5	162	600
424,5	ML5669	U	U	8	18,5	165	450
425	ML5695	S1	U	8	18,5	165	350
427	ML5939	U	U	8	18,5	165	240
429	ML6001	Q	Q	10	22	136	838
429	ML6027	U	13	8	18,5	149	400
430	ML5500	S1	S1	8	18,5	160	470
430	ML5777	U	U	8	18,5	170	370
430,5	ML5944	P	P	10	22	130	1050
431	ML5145	U	C1	8	18,5	173	380
431	ML5630	S1	S1	10	22	121	680
431	ML5981	U	U	8	18,5	100	400
431	ML6046	U	U	8	18,5	173	320
431	ML6071	U	U	8	18,5	160	600
433	ML5507	T1	T1	8	18,5	165	500
434	ML5486	S1	S1	8	18,5	153	585
435	ML5297	U	U	8	18,5	160	100
435	ML5733	S1	S1	6	15	180	105
435	ML6082	S1	S1	8	18,5	175	170
436	ML5676	U	U	8	18,5	175	150
436	ML5992	P	U	8	18,5	154	245
437	ML5775	S1	S1	8	18,5	173	350
438	ML5414	S1	S1	8	18,5	170	480
439,5	ML5653	S1	U	8	18,5	157	550
439,5	ML6086	U	U	8	18,5	155	410
440	ML5117	S1	S1	8	18,5	175	175
440	ML5131	U	C1	8	18,5	160	450
440	ML5155	U	U	8	18,5	160	520
440	ML5175	U	C1	8	18,5	169	600
440	ML5222	S1	U	8	18,5	171	370
440	ML5382	U	S1	8	18,5	155	300

Ext. L	Monroe®	↙	↘	Ød	ØD	S	F1
440	ML5599	Y1	X1	6	15	142	380
440	ML5661	U	U	8	18,5	170	470
440,5	ML5210	U	U	8	18,5	158	370
441	ML5660	P	U	8	18,5	175	300
441	ML6132	S1	S1	8	19	166	530
441,5	ML5280	U	U	8	18,5	169	460
443,5	ML5900	S1	S1	8	18,5	165	455
445	ML5079	U	U	8	18,5	180	300
445	ML5151	U	U	8	18,5	162	420
445	ML5183	U	U	8	18,5	172	250
445	ML5699	P	S1	8	18,5	183	550
445	ML5779	U	U	8	18,5	160	420
445	ML6083	S1	S3	8	18,5	176	90
445	ML6105	S1	S1	6	15	175	110
446	ML5894	U	U	8	18,5	170	490
447	ML5096	U	U	8	18,5	172	500
447	ML5230	S1	S1	6	15	170	130
447	ML5814	U	U	8	18,5	175	300
448	ML5136	U	U	8	18,5	180	310
448	ML5343	U	U	8	18,5	180	590
449	ML5941	S1	S1	8	18,5	179	520
449	ML5987	U	S1	8	18,5	160	470
450	ML5003	U	U	8	18,5	180	300
450	ML5024	U	C1	8	18,5	175	340
450	ML5025	U	U	8	18,5	175	260
450	ML5035	U	U	8	18,5	175	280
450	ML5090	U	U	8	18,5	180	450
450	ML5108	U	U	8	18,5	170	460
450	ML5114	U	U	8	18,5	175	340
450	ML5116	U	U	8	18,5	175	160
450	ML5121	S1	S1	8	18,5	175	600
450	ML5298	U	U	8	18,5	175	260
450	ML5308	U	U	8	18,5	170	490
450	ML5331	U	K	10	22	162	740
450	ML5742	S1	U	8	18,5	180	535
450	ML5831	U	S1	8	18,5	180	550
450	ML6123	U	U	8	19	181	395
451	ML5725	S1	S1	8	18,5	185	385
452	ML5480	S1	S1	8	18,5	177	350
452	ML5993	U	P	8	18,5	170	660
452	ML6078	S1	P	8	18,5	144	455
455	ML5165	U	U	8	18,5	164	380
455	ML5415	U	U	10	22	127	700
456	ML5655	S1	U	8	18,5	165	320
456	ML6009	S1	S1	8	18,5	182	185
457	ML6100	U	U	8	18,5	167	320
458	ML5160	S1	S1	8	18,5	176	430
459	ML5587	S1	S1	8	18,5	172	230
459,5	ML5438	S1	S1	8	18,5	180	535
460	ML5028	U	U	8	18,5	170	220
460	ML5097	U	U	8	18,5	170	270
460	ML5153	S1	S1	8	18,5	169	100
460	ML5270	U	U	8	18,5	160	300
460	ML5453	U	U	8	18,5	180	380
460	ML5734	S1	S1	8	18,5	180	440
460	ML5785	S1	S1	8	18,5	170	350
460,5	ML5867	U	U	8	18,5	174	350
462,5	ML5794	T1	T1	8	18,5	190	560
463	ML5796	S1	U	8	18,5	185	360
464	ML5568	S1	S1	8	18,5	166	160
465	ML5158	U	U	8	18,5	178	425
465	ML5224	U	K	10	22	140	655
465	ML5420	Y1	D	8	18,5	187	320
465	ML5492	Y1	D	8	18,5	169	113

EXTENDED LENGTH

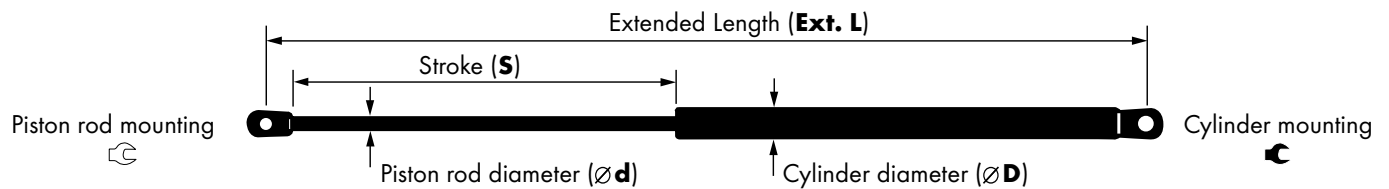

Ext. L	Monroe®	↙	↘	Ød	ØD	S	F1
465	ML5840	I	H	6	15	190	335
468	ML5485	S1	U	8	18,5	163	440
469,5	ML5082	U	U	8	18,5	171	560
469,5	ML5656	P	P	8	18,5	185	580
470	ML5069	U	U	8	18,5	190	350
470	ML5257	U	U	8	18,5	182	600
470	ML5702	P	S1	8	18,5	185	480
470	ML5753	U	U	8	18,5	160	630
470	ML5920	U	U	8	18,5	180	350
471	ML5093	S1	S1	8	18,5	191	360
471	ML5258	U	U	8	18,5	184	570
471	ML5427	S1	U	8	18,5	185	380
472	ML5164	U	U	8	18,5	180	330
472	ML5413	S1	U	8	18,5	175	590
473	ML5032	U	U	8	18,5	188	530
473	ML5087	U	C1	8	18,5	172	420
473	ML5757	U	U	8	18,5	182	540
473,5	ML5383	U	S1	8	18,5	170	590
473,5	ML6135	S1	S3	8	18,5	162	535
474	ML5721	U	U	8	18,5	190	570
475	ML5120	U	C1	8	18,5	195	350
475	ML5719	U	P	8	18,5	175	510
475	ML5746	U	P	8	18,5	184	650
475	ML5773	U	U	8	18,5	195	640
476,5	ML5254	U	U	8	18,5	184	420
477	ML5462	S1	S1	8	18,5	188	360
479	ML5805	P	U	8	18,5	179	340
479	ML6016	U	S3	8	18,5	174	580
480	ML5339	S1	U	8	18,5	180	300
480	ML5512	U	U	10	22	173	690
480	ML5700	U	U	8	18,5	173	135
480	ML5703	P	U	8	18,5	190	420
480	ML5708	U	U	8	18,5	195	335
480	ML5792	U	P	8	18,5	200	550
480	ML5871	S1	S1	8	18,5	185	480
480	ML6119	U	C1	8	18,5	189	600
481	ML5907	S1	S3	8	18,5	183	360
481,5	ML5416	U	U	8	18,5	199	530
482	ML5817	P	U	10	22	185,5	700
482,5	ML6073	U	U	8	18,5	195	705
483	ML5510	U	U	10	22	175	740
483	ML5511	U	U	10	22	175	690
483	ML5759	T1	T1	8	18,5	191	370
483,5	ML6102	U	P	10	22	148	750
484	ML5650	P	U	8	18,5	190	200
485	ML5159	S1	S1	8	18,5	190	320
485	ML5293	U	U	8	18,5	196	460
485	ML5294	U	U	8	18,5	196	520
485	ML5307	U	U	8	18,5	189	450
485	ML5332	U	U	8	18,5	165	640
485	ML5380	U	S1	8	18,5	187	610
485	ML5459	S1	S1	8	18,5	193	460
485	ML5569	S1	S1	8	18,5	185	580
485	ML5647	P	S1	8	18,5	200	565
485	ML5739	U	P	8	18,5	200	170
486	ML5632	Y1	D	8	18,5	170	585
488	ML6129	U	U	8	19	195	510
489	ML5539	U	U	10	22	144	720
490	ML5043	Y1	X1	8	18,5	180	480
490	ML5180	U	U	8	18,5	190	250
490	ML5495	U	U	8	18,5	195	610
490	ML5570	S1	S1	8	18,5	187	380
490	ML5614	U	U	10	22	200	780
490	ML5712	P	U	8	18,5	200	380

Ext. L	Monroe®	↙	↘	Ød	ØD	S	F1
490	ML5747	T1	T1	8	18,5	198	530
490	ML5979	U	U	8	18,5	189	560
490,5	ML5667	U	U	8	18,5	200	480
491	ML5425	U	C1	8	18,5	205	600
492	ML5557	U	U	10	22	188	710
492	ML6115	U	C1	8	18,5	175	475
493	ML5217	U	U	8	18,5	196	470
493	ML5917	S1	S1	8	18,5	195	445
494	ML5460	S1	S1	8	18,5	185	490
494	ML5838	P	P	8	18,5	172	500
494	ML5995	U	P	8	18,5	194	250
495	ML5080	U	U	8	18,5	192	500
495	ML5218	U	U	8	18,5	198	500
495	ML5219	U	U	8	18,5	182	515
495	ML5220	U	U	8	18,5	182	550
495	ML5221	U	U	8	18,5	182	565
495	ML5657	S1	S1	8	18,5	205	610
495	ML5681	U	U	8	18,5	205	440
495	ML5776	U	P	8	18,5	197	420
495	ML5963	S1	S1	8	18,5	180,5	570
495	ML6036	U	U	8	18,5	190	370
495	ML6087	S1	S1	8	18,5	180,5	510
496	ML5098	P	P	8	18,5	188	270
496	ML6012	P	P	10	22	180	635
496,5	ML5253	U	U	8	18,5	192	565
496,5	ML5909	I	U	8	18,5	195	340
497	ML5717	P	U	8	18,5	200	430
498	ML5406	U	U	8	18,5	197	330
498	ML5592	S1	S1	8	18,5	225	540
498	ML5929	P	P	10	22	191	630
499	ML5371	U	U	8	18,5	195	400
499	ML5677	Y1	T1	8	18,5	205	460
499	ML6043	U	U	8	18,5	145	150
500	ML5038	U	U	8	18,5	200	280
500	ML5049	U	C1	8	18,5	212	350
500	ML5094	U	U	8	18,5	204	500
500	ML5100	S1	S1	8	18,5	204	480
500	ML5110	U	U	8	18,5	170	635
500	ML5115	U	U	8	18,5	200	400
500	ML5181	S1	U	8	18,5	200	450
500	ML5185	S1	U	8	18,5	205	470
500	ML5194	S1	U	8	18,5	200	380
500	ML5195	S1	U	8	18,5	200	280
500	ML5196	S1	U	8	18,5	200	400
500	ML5197	S1	U	8	18,5	205	420
500	ML5198	S1	U	8	18,5	193	470
500	ML5199	S1	U	8	18,5	200	365
500	ML5225	S1	U	8	18,5	200	470
500	ML5238	S1	P	8	18,5	200	635
500	ML5239	P	U	10	22	195	690
500	ML5240	P	P	10	22	200	635
500	ML5261	S1	U	8	18,5	200	350
500	ML5264	S1	U	8	18,5	200	350
500	ML5284	S1	U	8	18,5	200	320
500	ML5287	S1	U	8	18,5	200	190
500	ML5306	U	U	8	18,5	196	225
500	ML5358	U	U	8	18,5	171	400
500	ML5360	U	U	8	18,5	190	360
500	ML5491	S1	U	8	18,5	200	310
500	ML5572	Y1	U	8	18,5	190	220
500	ML5574	U	D	8	18,5	200	270
500	ML5600	Y1	D	8	18,5	200	230
500	ML5613	Y1	D	8	18,5	201	600
500	ML5635	Y1	D	8	18,5	195	650

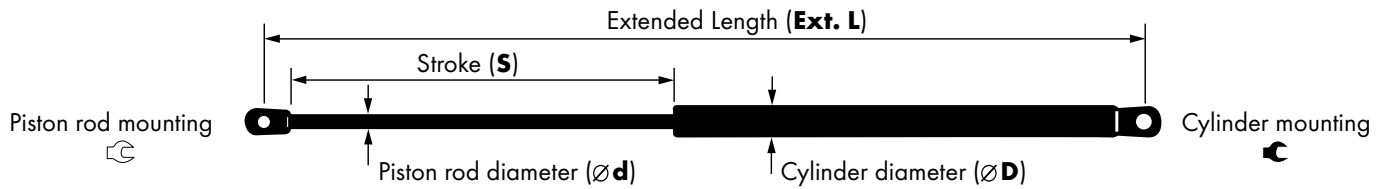

Ext. L	Monroe®	↺	↻	Ød	ØD	S	F1
500	ML5752	U	U	8	18,5	208	375
500	ML5767	S1	U	8	18,5	195	340
500	ML5774	T1	P	8	18,5	200	525
500	ML5821	S1	U	8	18,5	203	245
500	ML5825	S1	S1	8	18,5	230	135
500	ML5856	U	U	8	18,5	190	600
500	ML5857	P	P	8	18,5	190	500
500	ML6038	T1	T1	10	22	175	630
500	ML6051	U	U	8	18,5	146	660
501	ML5073	Y1	X1	8	18,5	207	480
501	ML5291	U	U	8	18,5	175	595
501	ML5612	U	U	10	22	175	780
502	ML5004	U	U	8	18,5	200	400
502	ML5072	U	U	8	18,5	200	280
502	ML5101	S1	S1	8	18,5	199	280
502	ML5132	S1	U	8	18,5	205	500
502	ML5227	S1	S1	8	18,5	200	530
502	ML5547	S1	S1	6	15	200	125
502	ML5615	U	P	8	18,5	195	400
502	ML5918	U	U	8	18,5	205	530
502	ML5923	U	U	8	18,5	205	450
503,5	ML6134	S1	S3	8	18,5	187	450
505	ML5256	U	U	8	18,5	190	520
505	ML5618	N	N	8	18,5	180	430
505	ML5722	U	U	10	22	205	610
505	ML5731	S1	P	8	18,5	211	330
505	ML5732	S1	S1	8	18,5	195	490
505	ML5743	U	P	10	22	170	770
505	ML5997	P	S1	8	18,5	205	585
505	ML6126	S1	S1	8	18,5	210	300
506	ML5281	U	U	8	18,5	200	380
506	ML5461	S1	S1	8	18,5	205	180
506,5	ML6022	U	C1	8	18,5	186	485
506,5	ML6023	U	C1	8	18,5	186	515
507	ML5078	U	U	8	18,5	205	420
507	ML5178	U	U	8	18,5	207	550
507	ML5362	U	U	8	18,5	208	436
507	ML5377	U	S1	8	18,5	203	520
508	ML5125	U	U	8	18,5	195	600
508	ML5156	P	P	8	18,5	195	550
508	ML5390	U	U	8	18,5	194	350
509	ML5002	Y1	X1	8	18,5	200	400
509	ML5005	U	U	8	18,5	200	420
509	ML5047	U	U	8	18,5	200	220
510	ML5103	U	U	8	18,5	202	620
510	ML5146	S1	S1	8	18,5	210	340
510	ML5361	U	U	8	18,5	200	320
510	ML5370	U	P	8	18,5	200	370
510	ML5391	U	U	8	18,5	208	470
510	ML5395	U	U	8	18,5	208	390
510	ML5784	U	U	8	18,5	213	360
511	ML5408	U	U	8	18,5	199	520
511,5	ML5641	S1	S1	8	18,5	172	545
512	ML5168	U	U	8	18,5	200	550
512	ML5468	S1	S1	8	18,5	200	470
512	ML5645	Y1	U	8	18,5	200	300
512	ML5985	T1	T1	10	22	200	520
512	ML5990	U	U	8	18,5	198	460
513	ML5189	S1	S1	8	18,5	207	535
513	ML5190	S1	S1	8	18,5	207	585
513	ML5359	U	U	8	18,5	215	350
514	ML5873	U	P	8	18,5	180	335
514,5	ML5106	U	D	8	18,5	217	610
515	ML5068	U	U	8	18,5	202	370

Ext. L	Monroe®	↺	↻	Ød	ØD	S	F1
515	ML5123	S1	S1	8	18,5	210	500
515	ML5124	U	U	8	18,5	195	500
515	ML5177	U	U	8	18,5	210	550
515	ML5410	S1	S1	8	18,5	200	445
515	ML5478	S1	S1	8	18,5	200	490
515	ML5622	S1	S1	8	18,5	187	490
515	ML5644	T1	D	8	18,5	215	550
515	ML5684	U	U	8	18,5	190	490
515	ML5711	U	U	8	18,5	210	490
515	ML5713	U	U	8	18,5	215	400
515	ML5760	P	U	8	18,5	196	585
515	ML5890	S1	S1	8	18,5	210	365
515,5	ML6013	S1	S1	10	22	205	610
516	ML5405	U	U	8	18,5	205	425
516	ML6008	S1	S1	8	18,5	184	160
516,5	ML5872	S1	S1	8	18,5	150	580
517	ML5214	S1	S1	8	18,5	200	460
517	ML5436	S1	S1	8	18,5	190	420
517,5	ML6151	S1	C1	8	18,5	191	295
518	ML5036	Y6	X1	8	18,5	209	220
519	ML5864	U	U	8	18,5	184	370
520	ML5056	Y1	X1	8	18,5	213	230
520	ML5296	U	U	8	18,5	197	435
520	ML5423	U	U	10	22	180	660
520	ML5433	U	U	10	22	180	665
520	ML5475	U	U	8	18,5	175	640
520	ML5580	U	U	10	22	185	730
520	ML5812	U	U	8	18,5	208	130
520	ML5826	U	C1	8	18,5	180	625
522	ML5271	U	U	8	18,5	210	300
522	ML5272	U	U	8	18,5	210	400
522	ML6130	P	U	8	19	210	490
523	ML5579	S1	S1	8	18,5	202	530
523	ML6128	S1	S1	8	19	200	600
524	ML5983	U	P	10	22	212	540
524	ML5984	U	P	10	22	212	585
525	ML5340	U	U	8	18,5	210	140
525	ML5347	U	U	8	18,5	205	310
525	ML5348	U	U	8	18,5	205	350
525	ML5349	U	U	8	18,5	210	480
525	ML5350	U	U	8	18,5	210	240
525	ML5560	U	13	8	18,5	200	280
525	ML5636	U	U	8	18,5	210	240
526	ML5086	S1	S1	8	18,5	207	570
526	ML5140	U	U	8	18,5	206	320
526	ML5313	U	U	8	18,5	206	560
526	ML5849	U	U	8	18,5	220	325
526,5	ML5961	S1	S3	8	18,5	208	125
527	ML5044	U	U	8	18,5	219	450
527	ML5048	U	U	8	18,5	219	420
527	ML5061	U	C1	8	18,5	210	450
527	ML5064	U	U	8	18,5	219	520
527	ML5169	U	U	8	18,5	206	450
527	ML5211	U	U	8	18,5	210	350
527	ML5300	U	U	8	18,5	202	390
527	ML5581	U	U	10	22	200	660
527	ML5889	S1	S1	8	18,5	188	620
527	ML6116	U	C1	8	18,5	163	610
527	ML6117	U	C1	8	18,5	163	535
528	ML5026	U	U	8	18,5	224	160
528	ML5099	U	U	8	18,5	224	220
528	ML5754	U	P	8	18,5	212	420
529	ML5276	U	U	8	18,5	215	245
530	ML5548	S1	S1	6	15	213	110

# EXTENDED LENGTH

Ext. L

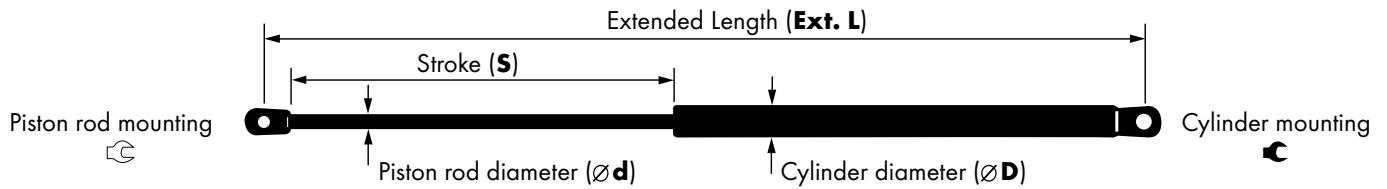

Ext. L	Monroe®	↙	↘	Ød	ØD	S	F1
530	ML5690	S1	S1	8	18,5	175	530
530	ML5749	U	P	8	18,5	210	410
531	ML5666	U	U	8	18,5	173	545
532,5	ML5895	U	U	8	18,5	190	360
533	ML5724	S1	S1	8	18,5	200	515
533	ML6024	P	I3	8	18,5	216	330
533	ML6075	U	K	10	22	220	750
534	ML5161	U	U	8	18,5	216	410
534	ML5509	T1	T1	8	18,5	217	200
534,5	ML5440	S1	S1	8	18,5	220	480
535	ML5167	U	U	8	18,5	215	480
535	ML5231	U	U	8	18,5	198	485
535	ML5232	U	U	8	18,5	198	520
535	ML5233	U	U	8	18,5	198	585
535	ML5474	S1	S1	8	18,5	220	425
535	ML5781	U	S1	10	22	183	710
536	ML5809	S1	S1	8	18,5	204	410
536,5	ML5166	U	C1	8	18,5	205	430
537	ML6058	S1	S1	10	22	198	750
538	ML5357	U	U	8	18,5	190	125
538	ML6005	S1	S1	8	18,5	220	510
538	ML6080	U	U	8	18,5	205	650
539	ML5772	T1	P	8	18,5	218	585
539	ML6113	Q	Q	10	22	163	690
540	ML5119	U	U	8	18,5	196	540
540	ML5157	U	U	10	22	200	450
540	ML5188	U	U	8	18,5	214	400
540	ML5213	S1	S1	8	18,5	200	450
540	ML5327	U	U	8	18,5	220	250
540	ML5447	T1	T1	8	18,5	130	170
540	ML5506	T1	T1	8	18,5	220	490
540	ML5672	U	U	8	18,5	210	385
540	ML5763	T1	T1	8	18,5	225	390
542	ML5041	U	U	8	18,5	210	300
542	ML5137	U	U	8	18,5	193	590
543	ML5720	U	U	8	18,5	220	310
543	ML5954	U	U	8	18,5	220	200
543,5	ML5054	U	U	8	18,5	206	360
543,5	ML5242	U	U	8	18,5	206	320
544	ML5109	U	U	8	18,5	207	495
544	ML5252	U	U	8	18,5	210	440
544	ML5607	S1	S1	8	18,5	224	250
544	ML5651	P	U	8	18,5	218	290
545	ML5312	U	U	8	18,5	230	300
545	ML5314	U	U	8	18,5	220	530
545	ML5378	U	S1	8	18,5	210	490
545	ML5379	U	S1	8	18,5	210	530
545	ML5591	U	Q	10	22	195	750
545	ML5668	S1	U	8	18,5	195	425
545	ML5692	U	U	8	18,5	210	450
545	ML5707	U	U	8	18,5	210	620
546	ML5372	U	U	8	18,5	215	500
546	ML5457	U	U	8	18,5	225	220
547	ML5551	S1	S1	6	15	190	170
547	ML5556	Y1	X1	6	15	214	225
547	ML5597	U	X1	8	18,5	230	230
547	ML5718	U	U	10	22	220	460
547	ML5828	U	P	8	18,5	220	550
547	ML6143	U	U	8	18,5	222	535
548	ML5373	U	U	8	18,5	213	475
548	ML5862	S1	S1	8	19	220	420
549	ML5015	Y6	X1	8	18,5	229,5	350
549	ML5016	Y1	X2	8	18,5	229,5	240
549	ML5031	U	U	8	18,5	222	355

Ext. L	Monroe®	↙	↘	Ød	ØD	S	F1
549	ML5243	U	U	8	18,5	232	320
549	ML5244	U	U	8	18,5	232	410
549	ML6040	U	U	8	18,5	219	290
549,5	ML5055	Y6	X1	8	18,5	229,5	160
549,5	ML5334	U	U	8	18,5	200	610
550	ML5006	Y2	X2	8	18,5	212	230
550	ML5039	Y1	X2	8	18,5	229,5	380
550	ML5053	U	U	8	18,5	212	350
550	ML5059	Y2	X2	8	18,5	212	270
550	ML5076	U	U	10	22	235	850
550	ML5292	U	U	8	18,5	220	285
550	ML5429	U	U	10	22	235	810
550	ML5571	T1	T1	8	18,5	222	475
550	ML5642	T1	T1	8	18,5	200	460
550	ML5780	T1	T1	8	18,5	235	280
550	ML5787	T1	T1	10	22	160	710
552	ML5176	S1	U	8	18,5	200	560
552	ML5208	U	U	8	18,5	205	370
552	ML5209	U	U	8	18,5	200	410
553	ML5659	S1	S1	8	18,5	225	220
554	ML5126	S1	U	8	18,5	200	515
554	ML5788	T1	T1	8	18,5	185	200
555	ML5173	U	U	8	18,5	228	485
555	ML5353	U	U	8	18,5	220	450
555	ML5687	U	U	8	18,5	228	305
556	ML5289	U	U	8	18,5	205	500
556	ML5374	U	U	8	18,5	225	475
556	ML5797	T1	T1	10	22	224	715
557	ML5171	U	U	8	18,5	224	360
557	ML5172	U	U	8	18,5	224	425
557	ML5381	U	S1	8	18,5	215	550
557	ML5991	U	U	8	18,5	220	580
558	ML5319	U	U	8	18,5	200	550
558	ML5493	S1	S1	8	18,5	200	135
558	ML5782	T1	T1	8	18,5	235	500
558	ML5824	S1	S1	8	18,5	235	530
559	ML5588	S1	S1	8	18,5	220	330
559	ML5850	S1	P	8	18,5	230	290
560	ML5228	U	K	10	22	210	730
560	ML5229	U	U	10	22	210	800
560	ML5806	U	P	10	22	178	725
563	ML5577	U	I3	8	18,5	200	280
563	ML5956	S1	S3	8	18,5	235	140
565	ML5144	U	U	8	18,5	216	360
565	ML5388	U	U	8	18,5	215	480
565	ML5412	S1	U	8	18,5	210	560
565	ML5705	S1	U	8	18,5	240	290
565	ML5730	U	U	8	18,5	215	315
565	ML5765	T1	T1	8	18,5	220	500
565	ML5973	S1	S1	8	18,5	200	200
566	ML5138	U	U	8	18,5	204	500
566	ML5202	U	U	8	18,5	230	440
566	ML5326	U	U	8	18,5	230	450
566,5	ML5112	U	U	8	18,5	219	280
567	ML5141	U	U	10	22	221	590
567	ML5142	U	U	10	22	221	650
567	ML5248	U	U	10	22	225	460
567	ML5424	U	S1	8	18,5	193	540
567	ML5912	S1	U	8	18,5	195	550
567	ML6109	U	U	8	19	228	460
567,5	ML5367	U	U	8	18,5	183	430
568	ML5375	U	U	8	18,5	230	500
568	ML5396	U	U	8	18,5	213	360
568	ML5397	U	U	8	18,5	230	560



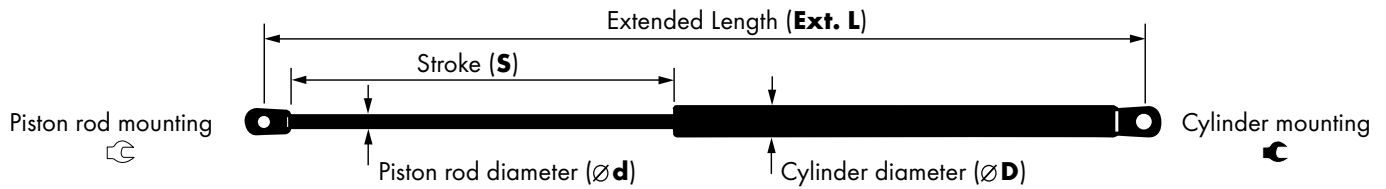

Ext. L	Monroe®	↺	↻	Ød	ØD	S	F1
568	ML5541	S1	S1	8	18,5	215	410
568	ML5819	U	U	8	18,5	233	330
569	ML5040	U	U	8	18,5	220	280
569	ML5050	U	U	8	18,5	220	280
569	ML5081	U	C1	8	18,5	242	210
569	ML5105	U	U	10	22	240	910
569	ML5245	U	U	10	22	240	750
569	ML5246	U	U	10	22	240	660
569	ML5247	U	U	10	22	240	830
569	ML5869	U	P	8	18,5	240	310
569	ML5893	S1	S1	8	18,5	240	670
569,5	ML6002	U	U	10	22	155	590
570	ML5122	U	U	8	18,5	232	520
570	ML5278	U	U	8	18,5	240	520
570	ML5288	U	U	8	18,5	230	460
570	ML5338	U	U	8	18,5	215	530
570	ML5354	U	U	8	18,5	230	490
570	ML5399	U	U	8	18,5	230	215
570	ML5400	U	U	8	18,5	230	420
570	ML5401	U	U	8	18,5	230	520
570	ML5402	U	U	8	18,5	240	470
570	ML5616	S1	U	8	18,5	200	630
570	ML5816	T1	T1	10	22	240	650
570	ML6025	P	I3	8	18,5	254	330
571	ML5346	U	U	8	18,5	208	570
573,5	ML5554	U	T1	10	22	215	580
573,5	ML5555	U	T1	10	22	215	670
574	ML5143	U	U	8	18,5	235	260
574	ML5147	U	U	8	18,5	235	310
574	ML5771	P	P	10	22	198	990
574,5	ML5476	S1	S1	8	18,5	230	530
574,5	ML5477	S1	S1	8	18,5	230	620
575	ML5342	U	U	8	18,5	235	330
575	ML5437	S1	U	8	18,5	220	500
575	ML5482	S1	S1	8	18,5	230	440
577	ML5200	U	U	8	18,5	226	415
577	ML5201	U	U	8	18,5	226	400
577	ML5463	S1	S1	8	18,5	226	275
577	ML5464	S1	S1	8	18,5	226	320
577	ML5564	U	P	8	18,5	225	270
577	ML5986	S1	C1	8	18,5	190	530
579	ML5606	Y1	D	8	18,5	235	320
580	ML5398	U	U	8	18,5	245	340
580	ML5428	S1	S1	8	18,5	247	470
580	ML5609	W	D	8	18,5	245	380
580	ML5620	U	U	8	18,5	205	230
580	ML5683	P	U	8	18,5	201	510
580	ML5822	S1	S1	8	18,5	245	165
580	ML6042	S1	S1	8	18,5	200	560
581,5	ML5469	S1	S1	8	18,5	210	535
582	ML5673	U	U	8	18,5	203	460
584	ML5014	U	U	8	18,5	234	280
584	ML5066	U	U	8	18,5	234	290
584	ML5083	U	U	8	18,5	250	200
584	ML6060	S1	S1	8	18,5	250	150
585	ML5034	Y6	X1	8	18,5	250	200
585	ML5134	U	U	8	18,5	222	280
585	ML5191	U	U	8	18,5	235	360
585	ML5265	U	U	8	18,5	235	250
585	ML5664	U	U	8	18,5	240	420
585	ML5783	U	P	8	18,5	190	625
585	ML5842	S2	15	8	18,5	235	310
585	ML5843	S2	16	8	18,5	235	310
585	ML5940	S1	S1	8	18,5	246	500

Ext. L	Monroe®	↺	↻	Ød	ØD	S	F1
585	ML6069	U	P	8	18,5	246	260
585	ML6070	U	C1	8	18,5	250	430
585,5	ML5665	U	U	8	18,5	245	405
585,5	ML5888	T1	T1	8	18,5	235	510
586	ML5027	U	U	8	18,5	236	280
586	ML5062	U	U	8	18,5	236	200
587	ML6085	I1	I1	8	18,5	235	100
587,5	ML6144	S1	C1	8	18,5	167,5	590
588	ML5958	U	P	8	18,5	198	645
588	ML6122	P	P	8	19	204	400
589	ML5029	U	U	8	18,5	239	310
589	ML5959	S1	S1	8	18,5	240	110
590	ML5317	U	U	8	18,5	215	410
590	ML5318	U	U	8	18,5	215	450
590	ML5324	U	U	8	18,5	220	480
590	ML5662	U	U	8	18,5	245	460
590	ML5701	S1	U	8	18,5	176	435
590	ML6124	U	P	8	19	225	590
590,5	ML5430	U	U	8	18,5	245	480
591	ML5077	U	C1	8	18,5	240	350
591	ML5127	U	U	10	22	200	830
591	ML5286	U	U	8	18,5	239	400
595	ML5013	U	U	8	18,5	235	280
595	ML5152	U	C1	8	18,5	250	485
595	ML5262	U	U	8	18,5	250	450
595	ML5279	S1	U	8	18,5	210	470
595	ML5285	U	U	8	18,5	248	370
595	ML5989	U	K	10	22	205	680
596	ML5235	U	U	8	18,5	190	380
596	ML5236	U	U	8	18,5	195	430
596	ML5237	U	U	8	18,5	190	420
596	ML5544	U	S1	8	18,5	210	450
596	ML5545	U	S1	8	18,5	210	510
596,5	ML5130	U	C1	8	18,5	212	515
598,5	ML6057	U	C1	10	22	186	700
599	ML5206	U	U	8	18,5	190	425
599	ML5434	U	U	8	18,5	220	360
600	ML5009	Y6	X1	8	18,5	255	180
600	ML5010	Y6	X1	8	18,5	255	200
600	ML5011	Y6	X1	8	18,5	255	360
600	ML5012	U	U	8	18,5	245	410
600	ML5019	Y6	X1	8	18,5	250	500
600	ML5020	U	U	8	18,5	230	290
600	ML5033	U	U	8	18,5	250	320
600	ML5042	Y6	X1	8	18,5	255	310
600	ML5065	U	U	8	18,5	245	430
600	ML5067	Y1	X1	8	18,5	255	450
600	ML5133	U	U	8	18,5	250	250
600	ML5148	U	U	8	18,5	230	300
600	ML5203	U	U	8	18,5	215	550
600	ML5204	U	U	8	18,5	215	600
600	ML5207	U	U	8	18,5	190	440
600	ML5255	U	U	8	18,5	250	320
600	ML5320	U	U	8	18,5	225	450
600	ML5325	U	U	8	18,5	244	330
600	ML5394	U	U	8	18,5	226	360
600	ML5501	Y2	D	8	18,5	250	540
600	ML5503	T1	T1	8	18,5	230	510
600	ML5598	S1	S1	8	18,5	250	160
600	ML5815	U	U	8	18,5	228	360
600	ML5968	U	U	8	18,5	225	670
600	ML6041	T1	T1	10	22	220	325
600,5	ML5184	S1	P	8	18,5	223	320
602	ML5107	U	U	8	18,5	252	430

EXTENDED LENGTH

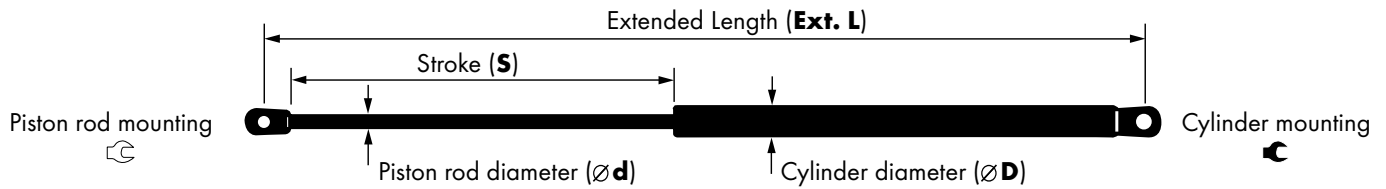

Ext. L	Monroe®	↺	↻	Ød	ØD	S	F1
602	ML5139	S1	S1	8	18,5	250	160
602	ML5299	U	U	8	18,5	252	430
603	ML5443	U	U	10	22	220	740
603	ML5537	U	U	10	22	198	810
603	ML5538	U	U	10	22	198	850
603	ML5827	U	U	8	18,5	255	240
604	ML5697	U	U	8	18,5	253	250
604	ML6017	U	U	8	18,5	225	510
605	ML5534	S1	U	8	18,5	247	340
605	ML5770	P	P	8	18,5	242	655
606,5	ML5384	U	S1	8	18,5	230	540
609,5	ML5807	U	U	8	18,5	251,5	245
610	ML5305	U	U	8	18,5	200	560
610	ML5456	U	U	8	18,5	200	600
610	ML5627	U	U	8	18,5	200	560
610	ML5847	B2	A2	10	22	240	500
610	ML5848	B1	A1	10	22	240	500
611	ML5149	U	U	8	18,5	230	355
611	ML5451	U	U	8	18,5	205	350
611	ML6089	T1	T1	8	18,5	228	420
613	ML5820	U	U	8	18,5	260	300
613,5	ML5527	O	O	10	22	248	620
613,5	ML5585	O	O	10	22	248	560
613,5	ML5586	O	O	10	22	248	640
613,8	ML5091	E4	T1	8	18,5	248	190
613,8	ML5092	E4	T1	8	18,5	248	190
614	ML5023	U	U	8	18,5	230	330
614	ML5465	S1	S1	8	18,5	229	300
615	ML5593	Y1	D	8	18,5	260	400
615	ML5919	Y1	D	8	18,5	243	240
620	ML5948	U	S1	10	22	225	625
622	ML5129	S1	S1	8	18,5	240	360
624	ML5432	S1	S1	8	18,5	260	400
625	ML5205	U	U	8	18,5	253	575
625	ML5693	P	S1	8	18,5	210	590
625	ML5866	U	P	10	22	210	510
627	ML5283	U	U	8	18,5	230	570
627	ML5304	U	U	8	18,5	230	570
627	ML5454	U	U	8	18,5	230	630
627	ML5626	U	U	8	18,5	230	570
627	ML5671	U	U	8	18,5	205	660
628	ML5795	U	U	8	18,5	272	440
630	ML5282	U	U	8	18,5	269	330
630	ML5505	T1	T1	8	18,5	220	570
631	ML5458	U	U	8	18,5	230	440
631	ML5851	S1	S1	8	18,5	265	455
632	ML5344	U	U	8	18,5	230	510
632	ML5363	U	U	8	18,5	215	600
632	ML5455	U	U	8	18,5	215	600
635	ML5364	U	U	8	18,5	248	360
635	ML5450	U	U	8	18,5	259	290
635	ML5567	S1	S1	8	18,5	225	200
639	ML5836	T1	T1	8	18,5	258	465
640	ML5311	U	U	8	18,5	190	470
640	ML5530	U	P	8	18,5	260	510
640	ML5573	U	D	8	18,5	235	390
640	ML5604	S1	D	8	18,5	278	300
640	ML5755	U	P	8	18,5	255	595
640	ML5756	U	P	8	18,5	255	565
643	ML6044	S1	S1	8	18,5	204	475
644	ML6003	U	P	8	18,5	265	300
645	ML5088	E2	E3	8	18,5	202,6	470
645	ML5089	E2	E3	8	18,5	202,6	470
645,5	ML5418	U	U	8	18,5	275	450

Ext. L	Monroe®	↺	↻	Ød	ØD	S	F1
648	ML5267	S1	S1	8	18,5	265	190
650	ML5345	U	U	8	18,5	270	310
650	ML5578	U	U	8	18,5	250	460
650	ML5601	Y1	D	8	18,5	275	240
650	ML5602	S1	D	8	18,5	275	240
650	ML5603	Y1	D	8	18,5	275	310
650	ML5605	S1	D	8	18,5	275	310
650	ML5715	U	C1	8	18,5	270	350
652	ML6053	U	C1	8	18,5	218	750
653	ML5452	U	U	8	18,5	260	460
656	ML5435	S1	S1	8	18,5	260	400
657	ML5654	U	U	8	18,5	275	480
661,5	ML6055	U	U	10	22	260,5	800
663,5	ML6074	U	Q	8	18,5	271	315
664	ML6072	U	U	8	18,5	275	265
665	ML5521	T1	Q	8	18,5	270	360
665	ML5947	P	P	10	22	195	765
665	ML6125	S1	S1	8	19	238	535
666,5	ML5162	S1	S1	8	18,5	275	390
667	ML5542	U	U	8	18,5	215	375
667	ML5716	U	U	10	22	255	755
668	ML5333	Y1	D	8	18,5	280	375
668	ML5403	U	U	8	18,5	215	375
669	ML6138	U	U	8	18,5	186	200
670	ML5497	Y1	D	8	18,5	294	320
670	ML5498	Y1	D	8	18,5	294	345
671,5	ML5589	S1	S1	8	18,5	270	360
672	ML5938	S1	U	8	18,5	240	180
673	ML5976	N	N	8	18,5	276	250
674	ML5798	U	U	8	18,5	293	300
674	ML5799	U	U	8	18,5	293	330
675	ML5309	U	U	8	18,5	285	260
675	ML5315	U	U	8	18,5	275	440
675	ML5608	N	N	8	18,5	279	210
677	ML5631	T1	T1	8	18,5	274	340
678	ML5295	U	U	8	18,5	282	480
678	ML5393	U	U	8	18,5	270	270
680	ML5192	U	U	8	18,5	270	360
680	ML5508	T1	T1	8	18,5	270	390
680	ML5634	T1	T1	8	18,5	270	360
685	ML5118	P	P	10	22	250	770
685	ML5249	P	P	10	22	250	710
685	ML5250	P	P	10	22	250	910
685	ML5251	P	P	10	22	250	830
685	ML5268	U	U	8	18,5	285	180
685	ML5470	S1	S1	8	18,5	265	200
685,5	ML5084	U	U	8	18,5	300	200
687	ML5561	U	U	8	18,5	295	270
690	ML5128	S1	S1	10	22	280	630
690	ML5837	T1	T1	8	18,5	300	630
690	ML6096	P	U	8	18,5	280	380
691,5	ML5337	U	U	8	18,5	285	270
694	ML6111	S1	C1	8	18,5	294	220
695	ML5543	U	U	8	18,5	272	640
696	ML5022	Y6	X1	8	18,5	278	220
697	ML5528	M	O	10	22	257	610
699	ML5834	M	O	10	22	257	610
699	ML5835	M	O	10	22	257	540
700	ML5021	U	U	8	18,5	251	200
700	ML5037	U	P	8	18,5	300	325
700	ML5046	U	U	8	18,5	300	260
700	ML5052	U	U	8	18,5	300	200
700	ML5057	P	S1	8	18,5	300	325
700	ML5113	T1	T1	8	18,5	300	670

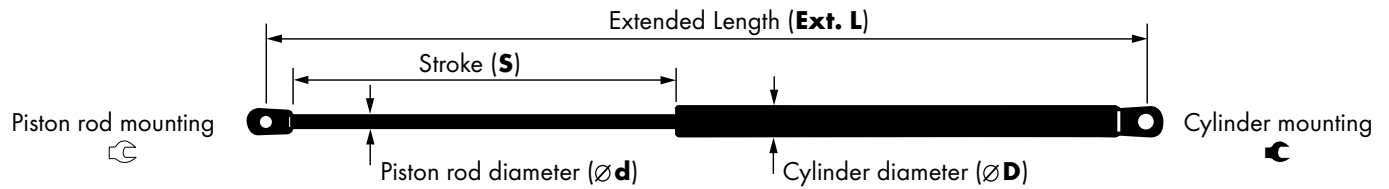

Ext. L	Monroe®	↺	↻	Ød	ØD	S	F1
700	ML5407	U	U	8	18,5	257	320
700	ML5494	Y1	D	8	18,5	295	400
700	ML5499	Y1	D	8	18,5	295	345
700	ML5950	U	U	10	22	172	1050
715	ML5269	P	U	8	18,5	306	290
715	ML5565	P	S1	8	18,5	303	160
720	ML5737	P	U	8	18,5	300	180
720	ML5750	U	U	10	22	280	870
721,5	ML5768	U	U	8	18,5	315	350
721,5	ML6049	U	U	8	18,5	313	180
722	ML5266	U	C1	8	18,5	306	280
722	ML5386	U	U	8	18,5	315	325
722	ML5515	U	U	10	22	210	819
722	ML5679	L	L	8	18,5	306	310
726	ML5051	S1	E1	10	22	280	420
726,5	ML5758	P	U	8	18,5	310	360
728	ML5648	P	U	8	18,5	310	265
728	ML6079	P	U	8	18,5	310	315
730	ML5518	U	U	10	22	200	700
730	ML5519	U	U	10	22	200	760
730	ML5726	U	U	8	18,5	316	140
730	ML5735	P	U	8	18,5	320	250
730	ML5829	P	U	8	18,5	310	380
735	ML5738	P	U	8	18,5	321	300
736,5	ML5709	U	U	10	22	310	725
740	ML5790	P	S1	8	18,5	310	290
742	ML6039	T1	T1	10	22	277	400
750	ML5368	S1	S1	8	18,5	315	300
755	ML5575	U	P	10	22	210	970
755	ML5576	U	U	10	22	210	1080
755	ML5833	U	P	10	22	210	1080
765	ML5409	U	U	8	18,5	325	235
765	ML5638	U	U	8	18,5	324	200
765	ML5741	U	U	8	18,5	335	340
769	ML5582	U	U	10	22	247	475
772	ML5329	U	U	10	22	322	630
775	ML5328	U	U	10	22	322	530
775	ML5621	U	U	10	22	322	530
788	ML5102	Y1	V	8	18,5	342	280
798	ML5074	F1	Y3	10	22	350	500
828	ML5369	U	U	8	18,5	249	355
830	ML5892	S1	S1	8	18,5	300	560
837	ML5504	T1	T1	8	18,5	315	365
850	ML5514	U	U	10	22	340	670
866	ML5448	U	U	10	22	350	370
870	ML5584	S1	U	10	22	370	370
874	ML6032	U	13	10	22	404	260
885	ML5385	U	X1	10	22	380	410
905	ML5516	T1	T1	10	22	307	730
905	ML5550	T1	T1	10	22	307	730
943	ML5678	U	L	10	22	417	380

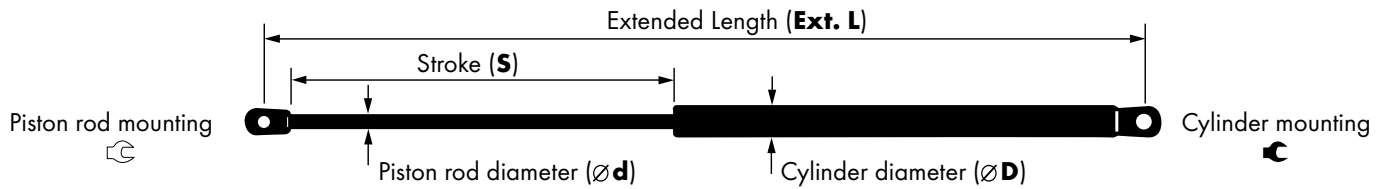

S	Monroe®	↺	↻	Ød	ØD	Ext. L	F1
36	ML6067	S1	S1	8	18,5	195,5	500
40	ML5686	U	U	8	18,5	165	650
40	ML5974	T1	T1	6	15	155	400
45	ML5675	U	U	10	22	175	700
48	ML5389	S1	S1	8	18,5	215	420
50	ML5583	U	U	10	22	195	760
52	ML5559	U	S2	10	22	235	850
52	ML5791	S1	U	8	18,5	201	250
55	ML5517	U	U	10	22	195	1100
55	ML5526	S1	14	8	18,5	178	480
55	ML5546	R	R	6	15	185	100
57	ML6068	U	C1	8	18,5	227	790
58	ML5808	S1	S1	8	18,5	256	560
60	ML5978	S1	S1	8	18,5	201	450
60	ML6066	S1	S1	6	15	195,5	350
60	ML6147	S1	S1	8	18,5	225	560
62	ML5810	U	U	8	18,5	238	165
62	ML5860	S1	S1	8	18,5	214	680
63	ML5496	Y1	D	8	18,5	226	100
65	ML5932	S1	S1	8	18,5	291	540
65	ML6015	U	U	8	18,5	232,5	305
65,5	ML6104	U	C1	8	18,5	299	670
67	ML5085	U	U	10	22	249	850
70	ML5529	O	M	14	28	270	1600
70	ML5535	Y1	T1	8	18,5	241	560
70	ML5751	T1	T1	10	22	300	710
70	ML5803	S1	S1	8	18,5	240	380
70	ML6142	U	C1	8	18,5	278	470
71	ML6019	U	U	8	18,5	222,5	500
72	ML6149	G	G	10	22	250	1180
74	ML5330	U	U	10	22	250	660
74	ML5404	U	U	8	18,5	240	300
74	ML6031	S1	10	6	15	242	325
75	ML5481	S1	S1	8	18,5	270	420
75,5	ML6030	M	M	14	28	312,5	1450
76	ML5611	Y1	D	8	18,5	245	330
76	ML6037	U	C1	8	18,5	241	700
78	ML5352	U	U	8	18,5	268	510
78	ML5922	S1	S3	8	18,5	255	350
78,5	ML5962	U	C1	8	18,5	313,5	495
80	ML5170	U	U	8	18,5	295	480
80	ML5260	U	U	8	18,5	293	610
80	ML5341	U	U	8	18,5	263	520
80	ML5466	S1	S1	8	18,5	280	465
80	ML5467	S1	S1	8	18,5	280	420
80	ML5628	U	U	10	22	265	820
80	ML5629	R	R	6	15	225	100
80	ML5744	U	U	10	22	298	730
80	ML5745	U	U	10	22	298	700
82	ML5215	S1	S1	8	18,5	264	370
82	ML5216	S1	S1	8	18,5	264	460
82	ML5921	S1	S1	8	18,5	270	380
83	ML5154	U	U	8	18,5	298	500
83,5	ML5617	N	N	8	18,5	268	450
84	ML5522	10	10	8	18,5	242	380
84	ML6110	S1	S3	8	18,5	283	570
85	ML5290	U	U	8	18,5	256	500
85	ML5431	U	U	8	18,5	256	630
85	ML5639	Y1	D	8	18,5	254	340
85	ML5685	M	O	14	28	320	1200
85	ML5748	S1	U	8	18,5	255	600
85	ML5764	U	U	8	18,5	252	425
85	ML6011	U	U	8	18,5	273	420
86	ML5018	Y6	X1	8	18,5	256	280

S	Monroe®	↺	↻	Ød	ØD	Ext. L	F1
86	ML5030	Y6	X1	8	18,5	256	180
86	ML5058	Y1	X1	8	18,5	256	280
86	ML5594	Y5	X3	8	18,5	255	600
86	ML5595	Y5	X3	8	18,5	255	370
86	ML5852	G	G	14	28	399	1340
87	ML6047	S1	S1	8	18,5	283	400
88	ML6004	S1	S1	8	18,5	292	410
88	ML6092	O	M	14	28	308	1190
88	ML6094	S2	S2	8	18,5	299,5	370
88	ML6127	U	S1	8	19	264	355
88,5	ML6098	S1	U	8	18,5	344,5	450
88,5	ML6099	S1	U	8	18,5	344,5	565
89	ML5226	U	S1	10	22	260	690
89	ML5310	U	U	8	18,5	310	590
89	ML5553	U	U	10	22	310	650
89	ML6014	U	K	8	18,5	287	495
90	ML5193	U	U	8	18,5	279	530
90	ML5234	U	U	10	22	278	630
90	ML5273	U	U	8	18,5	278	480
90	ML5274	U	U	8	18,5	278	430
90	ML5376	U	S1	8	18,5	280	580
90	ML5417	S1	S1	8	18,5	275	590
90	ML5487	S1	S1	8	18,5	298	600
90	ML5531	S1	T1	8	18,5	280	500
90	ML5532	S1	T1	8	18,5	280	600
90	ML5533	T1	T1	10	22	272	670
90	ML5549	T1	D	8	18,5	270	540
90	ML5558	U	T1	8	18,5	280	550
90	ML5566	10	10	8	18,5	254	420
90	ML5633	Y1	D	8	18,5	268	540
90	ML5643	S1	S1	6	15	244	400
90	ML5786	U	U	8	18,5	280	510
90	ML5927	U	T1	8	18,5	274	740
90	ML6136	U	C1	8	18,5	285	410
91	ML6091	U	U	8	18,5	291	600
91	ML6103	U	C1	8	19	319,5	480
91,5	ML6021	1	1	14	28	347,5	1300
92	ML5524	T1	T1	10	22	273	680
92	ML5525	T1	T1	10	22	273	720
92	ML6029	U	13	10	22	301	730
92	ML6145	S1	S3	8	18,5	314	485
94	ML6112	U	C	8	18,5	298	430
95	ML5135	U	U	8	18,5	279	490
95	ML5223	U	U	10	22	298	650
95	ML5323	U	U	8	18,5	285	290
95	ML5355	U	U	8	18,5	310	430
95	ML5419	S1	S1	8	18,5	280	390
95	ML5439	U	U	8	18,5	279	520
95	ML5483	S1	S1	8	18,5	280	500
95	ML5536	U	Q	8	18,5	288	250
95	ML5596	Y4	X1	6	15	254	350
95	ML5861	S1	S1	8	18,5	296	250
95	ML5934	10	10	8	18,5	254	490
95	ML6120	U	U	8	18,5	280	395
95	ML6148	S1	S1	8	18,5	274	320
95,5	ML5104	U	S1	8	18,5	280	630
96	ML5928	S1	S1	8	18,5	305	410
96	ML6106	U	C1	8	18,5	287	520
98	ML5818	U	U	8	18,5	282	560
99	ML5259	U	U	8	18,5	287	365
99	ML5502	S1	S1	8	18,5	300	560
100	ML5063	U	U	8	18,5	284	315
100	ML5163	S1	S1	8	18,5	350	320
100	ML5182	S1	S1	8	18,5	300	410

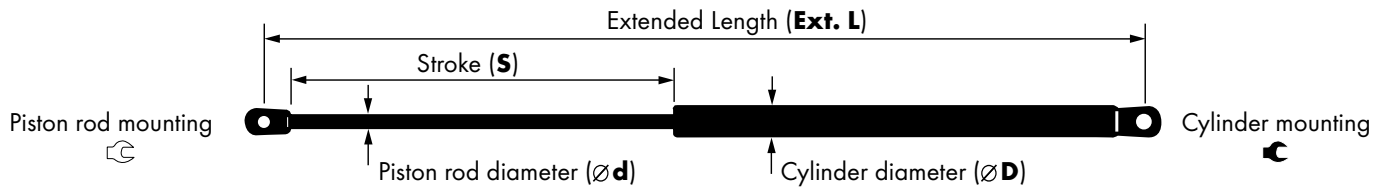

S	Monroe®	↺	↻	Ød	ØD	Ext. L	F1
100	ML5301	U	U	8	18,5	295	380
100	ML5321	U	U	8	18,5	315	420
100	ML5322	U	U	8	18,5	315	465
100	ML5336	S1	S1	10	22	333	700
100	ML5471	S1	S1	8	18,5	286	310
100	ML5488	S1	S1	8	18,5	320	360
100	ML5520	S1	12	8	18,5	336	520
100	ML5523	S1	12	8	18,5	312	640
100	ML5590	S1	12	8	18,5	346	520
100	ML5646	Y5	X3	8	18,5	319	370
100	ML5674	1	1	14	28	325	1400
100	ML5769	U	S1	10	22	285	720
100	ML5793	S1	S1	8	18,5	315	550
100	ML5975	S1	S3	8	18,5	288,5	380
100	ML5981	U	U	8	18,5	431	400
100	ML6076	U	T1	10	22	282	680
100	ML6101	S1	S1	6	15	285	300
100	ML6121	U	C1	8	18,5	285	580
101,5	ML5663	U	U	8	18,5	283	450
102	ML6107	S1	S3	8	19	290	395
103	ML5811	U	U	8	18,5	323	700
104	ML5688	S1	S1	8	18,5	288	640
104	ML5946	U	C	8	18,5	293	280
104	ML5980	U	U	8	18,5	285	230
105	ML5411	S1	U	8	18,5	315	370
105	ML5727	U	U	8	18,5	320	470
105	ML5761	U	U	8	18,5	305	550
105	ML5778	S1	U	8	18,5	285	600
105	ML5982	1	1	14	28	342	1200
105	ML6000	U	U	8	18,5	285	460
105	ML6062	S1	D	8	18,5	305	370
106,5	ML5996	U	C1	8	18,5	300	460
107	ML5698	S1	U	8	18,5	291	380
108	ML5637	O	O	14	28	396	1550
109	ML5640	T1	T1	6	15	305	130
109	ML5710	U	U	8	18,5	299	550
110	ML5263	S1	S1	8	18,5	319	580
110	ML5335	S1	S1	8	18,5	310	580
110	ML5356	U	U	8	18,5	352	150
110	ML5658	S1	S1	8	18,5	369	320
110	ML5694	S1	S1	8	18,5	370	320
110	ML5729	U	U	8	18,5	310	400
110	ML5844	U	U	8	18,5	310	590
110	ML5945	P	U	6	15	314	355
112	ML5562	S1	S1	8	18,5	313	330
112	ML6141	S1	S1	8	18,5	362	260
112,5	ML5813	S1	S1	6	15	297	240
113	ML6020	S1	10	6	15	289	350
113	ML6118	U	C1	8	18,5	340	430
115	ML5095	U	U	8	18,5	324	290
115	ML5441	S1	S1	10	22	326	800
115	ML5930	U	U	8	18,5	331	520
116	ML5619	N	N	8	18,5	330	340
116	ML5804	U	U	8	18,5	314,5	330
116	ML6065	U	C1	8	18,5	314,5	220
117	ML5670	S1	S1	8	18,5	366	280
117	ML5800	U	U	8	18,5	333	650
118	ML6146	S1	S1	6	15	375	180
119	ML5994	U	C1	8	18,5	345	510
119	ML6033	U	U	8	18,5	338	420
120	ML5442	U	U	8	18,5	348	620
120	ML5479	S1	S1	8	18,5	398	180
120	ML5623	S1	S1	8	18,5	398	180
120	ML5696	P	U	8	18,5	355	350

S	Monroe®	↺	↻	Ød	ØD	Ext. L	F1
120	ML5740	S1	U	8	18,5	315	440
120	ML5766	S1	S1	8	18,5	318	380
120	ML6006	U	U	8	18,5	319,5	410
120	ML6097	S1	S1	8	18,5	334	610
120	ML6133	S1	S1	8	19	337,5	365
121	ML5179	S1	S1	6	15	305,5	45
121	ML5630	S1	S1	10	22	431	680
121	ML6152	S1	P	8	18,5	361,5	540
122	ML5789	U	U	8	18,5	345	350
122	ML6114	S1	H1	6	15	310	255
127	ML5415	U	U	10	22	455	700
127	ML5998	C	U	8	18,5	380	200
128	ML5351	U	U	8	18,5	357	555
128	ML6108	S1	S1	8	19	345	450
130	ML5447	T1	T1	8	18,5	540	170
130	ML5540	S2	S2	10	22	364	800
130	ML5680	U	U	8	18,5	350	440
130	ML5944	P	P	10	22	430,5	1050
130	ML6063	S1	P	6	15	334	270
132	ML5489	S1	S1	8	18,5	364	310
132	ML5490	S1	S1	8	18,5	363	370
135	ML5017	U	X2	8	18,5	362	190
135	ML5303	S1	S1	8	18,5	365	620
135	ML5365	U	U	8	18,5	365	180
135	ML5366	U	U	8	18,5	365	240
135	ML5552	S1	S1	6	15	365	135
135	ML5652	J	S1	8	18,5	375	495
135	ML5910	U	S1	8	18,5	355	115
136	ML5999	U	U	6	15	346	340
136	ML6001	Q	Q	10	22	429	838
137	ML5891	S1	S1	8	18,5	383	455
138	ML5302	U	U	8	18,5	385	560
138	ML5823	S1	S1	6	15	362	100
139	ML5855	S1	S1	8	18,5	400	400
139	ML5967	S1	S1	8	18,5	387	465
140	ML5008	Y1	X1	8	18,5	365	600
140	ML5224	U	K	10	22	465	655
140	ML5446	T1	T1	10	22	382	660
140	ML5513	T1	T1	10	22	382	660
140	ML5563	S1	S1	8	18,5	374	350
140	ML5830	U	P	8	18,5	375	390
142	ML5599	Y1	X1	6	15	440	380
144	ML5539	U	U	10	22	489	720
144	ML5924	U	C1	8	18,5	375	280
144	ML6078	S1	P	8	18,5	452	455
145	ML5421	10	10	6	15	367	320
145	ML5444	10	10	8	18,5	365	410
145	ML5445	10	10	8	18,5	365	480
145	ML5704	T1	T1	8	18,5	378	540
145	ML5728	U	U	8	18,5	375	615
145	ML5943	S1	S3	8	18,5	376	390
145	ML6035	P	P	8	18,5	386,5	160
145	ML6043	U	U	8	18,5	499	150
146	ML6051	U	U	8	18,5	500	660
146	ML6131	U	U	8	18,5	378	300
148	ML5387	U	U	8	18,5	395	180
148	ML5426	U	U	10	22	418	700
148	ML5839	U	K	10	22	390	800
148	ML6102	U	P	10	22	483,5	750
149	ML5392	S1	S1	8	18,5	400	300
149	ML6026	U	13	8	18,5	394	400
149	ML6027	U	13	8	18,5	429	400
150	ML5277	U	U	8	18,5	405	520
150	ML5316	U	U	8	18,5	408	310

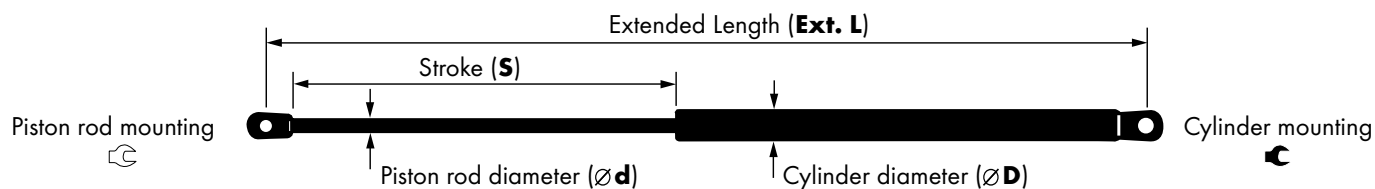

S	Monroe®	↺	↻	Ød	ØD	Ext. L	F1
150	ML5472	S1	S1	8	18,5	395	230
150	ML5473	S1	S1	8	18,5	395	470
150	ML5484	S1	S1	8	18,5	400	280
150	ML5624	P	T1	8	18,5	392	300
150	ML5714	U	P	8	18,5	386,5	350
150	ML5762	P	U	8	18,5	385	140
150	ML5868	U	P	8	18,5	414	430
150	ML5872	S1	S1	8	18,5	516,5	580
150	ML5906	I	H	6	15	365,5	290
150	ML6090	I	H	6	15	359	180
150	ML6137	U	U	8	18,5	393	170
152	ML5925	U	C1	8	18,5	408	390
152	ML5926	U	C1	8	18,5	408	265
153	ML5486	S1	S1	8	18,5	434	585
154	ML5992	P	U	8	18,5	436	245
155	ML5212	U	U	8	18,5	417	500
155	ML5241	U	U	8	18,5	412	340
155	ML5382	U	S1	8	18,5	440	300
155	ML5832	U	P	8	18,5	390	360
155	ML5911	T1	T1	10	22	414	500
155	ML5936	P	U	8	18,5	410	390
155	ML5977	S1	S1	8	18,5	418,5	390
155	ML6002	U	U	10	22	569,5	590
155	ML6086	U	U	8	18,5	439,5	410
157	ML5653	S1	U	8	18,5	439,5	550
157	ML6061	U	U	8	18,5	404	260
158	ML5210	U	U	8	18,5	440,5	370
158	ML5706	P	U	8	18,5	395	440
158	ML6028	S1	X2	8	18,5	397	295
160	ML5001	Y6	X1	8	18,5	405	390
160	ML5007	Y6	X1	8	18,5	405	500
160	ML5045	U	C1	8	18,5	405	550
160	ML5060	Y1	X1	8	18,5	405	500
160	ML5070	Y1	D	8	18,5	405	500
160	ML5071	Y1	D	8	18,5	405	390
160	ML5075	Y1	D	8	18,5	405	600
160	ML5111	U	C1	8	18,5	402	390
160	ML5131	U	C1	8	18,5	440	450
160	ML5155	U	U	8	18,5	440	520
160	ML5270	U	U	8	18,5	460	300
160	ML5275	U	U	8	18,5	405	310
160	ML5297	U	U	8	18,5	435	100
160	ML5449	U	U	8	18,5	405	620
160	ML5500	S1	S1	8	18,5	430	470
160	ML5649	U	U	8	18,5	405	300
160	ML5689	S1	P	8	18,5	400	330
160	ML5723	S1	S1	8	18,5	405	480
160	ML5753	U	U	8	18,5	470	630
160	ML5779	U	U	8	18,5	445	420
160	ML5787	T1	T1	10	22	550	710
160	ML5801	U	U	8	18,5	415	530
160	ML5870	S1	S1	6	15	400	230
160	ML5987	U	S1	8	18,5	449	470
160	ML6071	U	U	8	18,5	431	600
160	ML6081	S1	S1	8	18,5	404,5	310
160	ML6084	T1	T1	8	18,5	414	410
160	ML6140	S1	U	8	18,5	406	335
160	ML6150	U	U	8	18,5	402,5	150
162	ML5151	U	U	8	18,5	445	420
162	ML5331	U	K	10	22	450	740
162	ML5682	U	U	8	18,5	420	600
162	ML6135	S1	S3	8	18,5	473,5	535
163	ML5485	S1	U	8	18,5	468	440
163	ML5691	S1	U	8	18,5	412	400

S	Monroe®	↺	↻	Ød	ØD	Ext. L	F1
163	ML5736	S1	U	8	18,5	404,5	460
163	ML5802	U	U	8	18,5	418	490
163	ML6113	Q	Q	10	22	539	690
163	ML6116	U	C1	8	18,5	527	610
163	ML6117	U	C1	8	18,5	527	535
164	ML5165	U	U	8	18,5	455	380
164	ML5846	U	D	8	18,5	405	270
165	ML5332	U	U	8	18,5	485	640
165	ML5507	T1	T1	8	18,5	433	500
165	ML5625	Y1	U	8	18,5	419	360
165	ML5655	S1	U	8	18,5	456	320
165	ML5669	U	U	8	18,5	424,5	450
165	ML5695	S1	U	8	18,5	425	350
165	ML5845	U	U	8	18,5	419	510
165	ML5900	S1	S1	8	18,5	443,5	455
165	ML5939	U	U	8	18,5	427	240
166	ML5422	10	10	6	15	410	280
166	ML5568	S1	S1	8	18,5	464	160
166	ML6132	S1	S1	8	19	441	530
167	ML6100	U	U	8	18,5	457	320
167,5	ML6144	S1	C1	8	18,5	587,5	590
169	ML5153	S1	S1	8	18,5	460	100
169	ML5175	U	C1	8	18,5	440	600
169	ML5280	U	U	8	18,5	441,5	460
169	ML5492	Y1	D	8	18,5	465	113
170	ML5028	U	U	8	18,5	460	220
170	ML5097	U	U	8	18,5	460	270
170	ML5108	U	U	8	18,5	450	460
170	ML5110	U	U	8	18,5	500	635
170	ML5230	S1	S1	6	15	447	130
170	ML5308	U	U	8	18,5	450	490
170	ML5383	U	S1	8	18,5	473,5	590
170	ML5414	S1	S1	8	18,5	438	480
170	ML5632	Y1	D	8	18,5	486	585
170	ML5661	U	U	8	18,5	440	470
170	ML5743	U	P	10	22	505	770
170	ML5777	U	U	8	18,5	430	370
170	ML5785	S1	S1	8	18,5	460	350
170	ML5894	U	U	8	18,5	446	490
170	ML5993	U	P	8	18,5	452	660
171	ML5082	U	U	8	18,5	469,5	560
171	ML5222	S1	U	8	18,5	440	370
171	ML5358	U	U	8	18,5	500	400
172	ML5087	U	C1	8	18,5	473	420
172	ML5096	U	U	8	18,5	447	500
172	ML5183	U	U	8	18,5	445	250
172	ML5587	S1	S1	8	18,5	459	230
172	ML5641	S1	S1	8	18,5	511,5	545
172	ML5838	P	P	8	18,5	494	500
172	ML5950	U	U	10	22	700	1050
173	ML5145	U	C1	8	18,5	431	380
173	ML5512	U	U	10	22	480	690
173	ML5666	U	U	8	18,5	531	545
173	ML5700	U	U	8	18,5	480	135
173	ML5775	S1	S1	8	18,5	437	350
173	ML6046	U	U	8	18,5	431	320
174	ML5867	U	U	8	18,5	460,5	350
174	ML6016	U	S3	8	18,5	479	580
175	ML5024	U	C1	8	18,5	450	340
175	ML5025	U	U	8	18,5	450	260
175	ML5035	U	U	8	18,5	450	280
175	ML5114	U	U	8	18,5	450	340
175	ML5116	U	U	8	18,5	450	160
175	ML5117	S1	S1	8	18,5	440	175

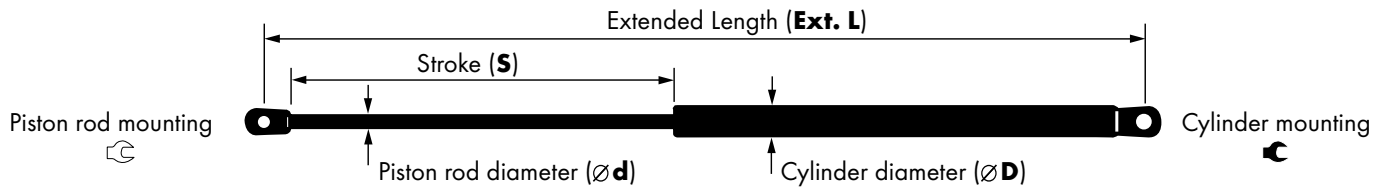

S	Monroe®	↺	↻	Ød	ØD	Ext. L	F1
175	ML5121	S1	S1	8	18,5	450	600
175	ML5291	U	U	8	18,5	501	595
175	ML5298	U	U	8	18,5	450	260
175	ML5413	S1	U	8	18,5	472	590
175	ML5475	U	U	8	18,5	520	640
175	ML5510	U	U	10	22	483	740
175	ML5511	U	U	10	22	483	690
175	ML5612	U	U	10	22	501	780
175	ML5660	P	U	8	18,5	441	300
175	ML5676	U	U	8	18,5	436	150
175	ML5690	S1	S1	8	18,5	530	530
175	ML5719	U	P	8	18,5	475	510
175	ML5814	U	U	8	18,5	447	300
175	ML6038	T1	T1	10	22	500	630
175	ML6082	S1	S1	8	18,5	435	170
175	ML6105	S1	S1	6	15	445	110
175	ML6115	U	C1	8	18,5	492	475
176	ML5160	S1	S1	8	18,5	458	430
176	ML5701	S1	U	8	18,5	590	435
176	ML6083	S1	S3	8	18,5	445	90
177	ML5480	S1	S1	8	18,5	452	350
178	ML5158	U	U	8	18,5	465	425
178	ML5806	U	P	10	22	560	725
179	ML5805	P	U	8	18,5	479	340
179	ML5941	S1	S1	8	18,5	449	520
180	ML5003	U	U	8	18,5	450	300
180	ML5043	Y1	X1	8	18,5	490	480
180	ML5079	U	U	8	18,5	445	300
180	ML5090	U	U	8	18,5	450	450
180	ML5136	U	U	8	18,5	448	310
180	ML5164	U	U	8	18,5	472	330
180	ML5339	S1	U	8	18,5	480	300
180	ML5343	U	U	8	18,5	448	590
180	ML5423	U	U	10	22	520	660
180	ML5433	U	U	10	22	520	665
180	ML5438	S1	S1	8	18,5	459,5	535
180	ML5453	U	U	8	18,5	460	380
180	ML5618	N	N	8	18,5	505	430
180	ML5733	S1	S1	6	15	435	105
180	ML5734	S1	S1	8	18,5	460	440
180	ML5742	S1	U	8	18,5	450	535
180	ML5826	U	C1	8	18,5	520	625
180	ML5831	U	S1	8	18,5	450	550
180	ML5873	U	P	8	18,5	514	335
180	ML5920	U	U	8	18,5	470	350
180	ML6012	P	P	10	22	496	635
180,5	ML5963	S1	S1	8	18,5	495	570
180,5	ML6087	S1	S1	8	18,5	495	510
181	ML6123	U	U	8	19	450	395
182	ML5219	U	U	8	18,5	495	515
182	ML5220	U	U	8	18,5	495	550
182	ML5221	U	U	8	18,5	495	565
182	ML5257	U	U	8	18,5	470	600
182	ML5757	U	U	8	18,5	473	540
182	ML6009	S1	S1	8	18,5	456	185
183	ML5367	U	U	8	18,5	567,5	430
183	ML5699	P	S1	8	18,5	445	550
183	ML5781	U	S1	10	22	535	710
183	ML5907	S1	S3	8	18,5	481	360
184	ML5254	U	U	8	18,5	476,5	420
184	ML5258	U	U	8	18,5	471	570
184	ML5746	U	P	8	18,5	475	650
184	ML5864	U	U	8	18,5	519	370
184	ML6008	S1	S1	8	18,5	516	160

S	Monroe®	↺	↻	Ød	ØD	Ext. L	F1
185	ML5427	S1	U	8	18,5	471	380
185	ML5460	S1	S1	8	18,5	494	490
185	ML5569	S1	S1	8	18,5	485	580
185	ML5580	U	U	10	22	520	730
185	ML5656	P	P	8	18,5	469,5	580
185	ML5702	P	S1	8	18,5	470	480
185	ML5725	S1	S1	8	18,5	451	385
185	ML5788	T1	T1	8	18,5	554	200
185	ML5796	S1	U	8	18,5	463	360
185	ML5871	S1	S1	8	18,5	480	480
185,5	ML5817	P	U	10	22	482	700
186	ML6022	U	C1	8	18,5	506,5	485
186	ML6023	U	C1	8	18,5	506,5	515
186	ML6057	U	C1	10	22	598,5	700
186	ML6138	U	U	8	18,5	669	200
187	ML5380	U	S1	8	18,5	485	610
187	ML5420	Y1	D	8	18,5	465	320
187	ML5570	S1	S1	8	18,5	490	380
187	ML5622	S1	S1	8	18,5	515	490
187	ML6134	S1	S3	8	18,5	503,5	450
188	ML5032	U	U	8	18,5	473	530
188	ML5098	P	P	8	18,5	496	270
188	ML5462	S1	S1	8	18,5	477	360
188	ML5557	U	U	10	22	492	710
188	ML5889	S1	S1	8	18,5	527	620
189	ML5307	U	U	8	18,5	485	450
189	ML5979	U	U	8	18,5	490	560
189	ML6119	U	C1	8	18,5	480	600
190	ML5069	U	U	8	18,5	470	350
190	ML5159	S1	S1	8	18,5	485	320
190	ML5180	U	U	8	18,5	490	250
190	ML5206	U	U	8	18,5	599	425
190	ML5207	U	U	8	18,5	600	440
190	ML5235	U	U	8	18,5	596	380
190	ML5237	U	U	8	18,5	596	420
190	ML5256	U	U	8	18,5	505	520
190	ML5311	U	U	8	18,5	640	470
190	ML5357	U	U	8	18,5	538	125
190	ML5360	U	U	8	18,5	500	360
190	ML5436	S1	S1	8	18,5	517	420
190	ML5551	S1	S1	6	15	547	170
190	ML5572	Y1	U	8	18,5	500	220
190	ML5650	P	U	8	18,5	484	200
190	ML5684	U	U	8	18,5	515	490
190	ML5703	P	U	8	18,5	480	420
190	ML5721	U	U	8	18,5	474	570
190	ML5783	U	P	8	18,5	585	625
190	ML5794	T1	T1	8	18,5	462,5	560
190	ML5840	I	H	6	15	465	335
190	ML5856	U	U	8	18,5	500	600
190	ML5857	P	P	8	18,5	500	500
190	ML5895	U	U	8	18,5	532,5	360
190	ML5986	S1	C1	8	18,5	577	530
190	ML6036	U	U	8	18,5	495	370
191	ML5093	S1	S1	8	18,5	471	360
191	ML5759	T1	T1	8	18,5	483	370
191	ML5929	P	P	10	22	498	630
191	ML6151	S1	C1	8	18,5	517,5	295
192	ML5080	U	U	8	18,5	495	500
192	ML5253	U	U	8	18,5	496,5	565
193	ML5137	U	U	8	18,5	542	590
193	ML5198	S1	U	8	18,5	500	470
193	ML5424	U	S1	8	18,5	567	540
193	ML5459	S1	S1	8	18,5	485	460

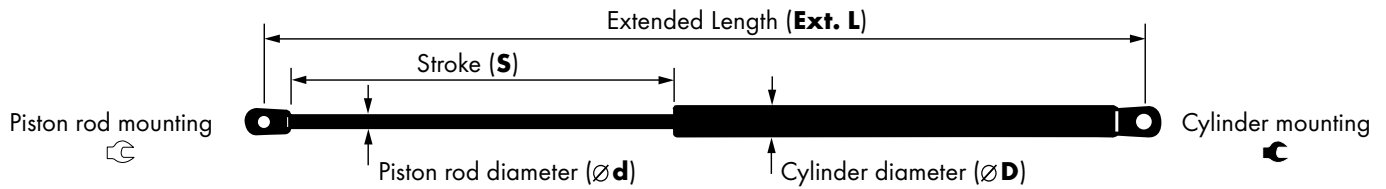

S	Monroe®	↺	↻	Ød	ØD	Ext. L	F1
194	ML5390	U	U	8	18,5	508	350
194	ML5995	U	P	8	18,5	494	250
195	ML5120	U	C1	8	18,5	475	350
195	ML5124	U	U	8	18,5	515	500
195	ML5125	U	U	8	18,5	508	600
195	ML5156	P	P	8	18,5	508	550
195	ML5236	U	U	8	18,5	596	430
195	ML5239	P	U	10	22	500	690
195	ML5371	U	U	8	18,5	499	400
195	ML5495	U	U	8	18,5	490	610
195	ML5591	U	Q	10	22	545	750
195	ML5615	U	P	8	18,5	502	400
195	ML5635	Y1	D	8	18,5	500	650
195	ML5668	S1	U	8	18,5	545	425
195	ML5708	U	U	8	18,5	480	335
195	ML5732	S1	S1	8	18,5	505	490
195	ML5767	S1	U	8	18,5	500	340
195	ML5773	U	U	8	18,5	475	640
195	ML5909	I	U	8	18,5	496,5	340
195	ML5912	S1	U	8	18,5	567	550
195	ML5917	S1	S1	8	18,5	493	445
195	ML5947	P	P	10	22	665	765
195	ML6073	U	U	8	18,5	482,5	705
195	ML6129	U	U	8	19	488	510
196	ML5119	U	U	8	18,5	540	540
196	ML5217	U	U	8	18,5	493	470
196	ML5293	U	U	8	18,5	485	460
196	ML5294	U	U	8	18,5	485	520
196	ML5306	U	U	8	18,5	500	225
196	ML5760	P	U	8	18,5	515	585
197	ML5296	U	U	8	18,5	520	435
197	ML5406	U	U	8	18,5	498	330
197	ML5776	U	P	8	18,5	495	420
198	ML5218	U	U	8	18,5	495	500
198	ML5231	U	U	8	18,5	535	485
198	ML5232	U	U	8	18,5	535	520
198	ML5233	U	U	8	18,5	535	585
198	ML5537	U	U	10	22	603	810
198	ML5538	U	U	10	22	603	850
198	ML5747	T1	T1	8	18,5	490	530
198	ML5771	P	P	10	22	574	990
198	ML5958	U	P	8	18,5	588	645
198	ML5990	U	U	8	18,5	512	460
198	ML6058	S1	S1	10	22	537	750
199	ML5101	S1	S1	8	18,5	502	280
199	ML5408	U	U	8	18,5	511	520
199	ML5416	U	U	8	18,5	481,5	530
200	ML5002	Y1	X1	8	18,5	509	400
200	ML5004	U	U	8	18,5	502	400
200	ML5005	U	U	8	18,5	509	420
200	ML5038	U	U	8	18,5	500	280
200	ML5047	U	U	8	18,5	509	220
200	ML5072	U	U	8	18,5	502	280
200	ML5115	U	U	8	18,5	500	400
200	ML5126	S1	U	8	18,5	554	515
200	ML5127	U	U	10	22	591	830
200	ML5157	U	U	10	22	540	450
200	ML5168	U	U	8	18,5	512	550
200	ML5176	S1	U	8	18,5	552	560
200	ML5181	S1	U	8	18,5	500	450
200	ML5194	S1	U	8	18,5	500	380
200	ML5195	S1	U	8	18,5	500	280
200	ML5196	S1	U	8	18,5	500	400
200	ML5199	S1	U	8	18,5	500	365

S	Monroe®	↺	↻	Ød	ØD	Ext. L	F1
200	ML5209	U	U	8	18,5	552	410
200	ML5213	S1	S1	8	18,5	540	450
200	ML5214	S1	S1	8	18,5	517	460
200	ML5225	S1	U	8	18,5	500	470
200	ML5227	S1	S1	8	18,5	502	530
200	ML5238	S1	P	8	18,5	500	635
200	ML5240	P	P	10	22	500	635
200	ML5261	S1	U	8	18,5	500	350
200	ML5264	S1	U	8	18,5	500	350
200	ML5281	U	U	8	18,5	506	380
200	ML5284	S1	U	8	18,5	500	320
200	ML5287	S1	U	8	18,5	500	190
200	ML5305	U	U	8	18,5	610	560
200	ML5319	U	U	8	18,5	558	550
200	ML5334	U	U	8	18,5	549,5	610
200	ML5361	U	U	8	18,5	510	320
200	ML5370	U	P	8	18,5	510	370
200	ML5410	S1	S1	8	18,5	515	445
200	ML5456	U	U	8	18,5	610	600
200	ML5468	S1	S1	8	18,5	512	470
200	ML5478	S1	S1	8	18,5	515	490
200	ML5491	S1	U	8	18,5	500	310
200	ML5493	S1	S1	8	18,5	558	135
200	ML5518	U	U	10	22	730	700
200	ML5519	U	U	10	22	730	760
200	ML5547	S1	S1	6	15	502	125
200	ML5560	U	I3	8	18,5	525	280
200	ML5574	U	D	8	18,5	500	270
200	ML5577	U	I3	8	18,5	563	280
200	ML5581	U	U	10	22	527	660
200	ML5600	Y1	D	8	18,5	500	230
200	ML5614	U	U	10	22	490	780
200	ML5616	S1	U	8	18,5	570	630
200	ML5627	U	U	8	18,5	610	560
200	ML5642	T1	T1	8	18,5	550	460
200	ML5645	Y1	U	8	18,5	512	300
200	ML5647	P	S1	8	18,5	485	565
200	ML5667	U	U	8	18,5	490,5	480
200	ML5712	P	U	8	18,5	490	380
200	ML5717	P	U	8	18,5	497	430
200	ML5724	S1	S1	8	18,5	533	515
200	ML5739	U	P	8	18,5	485	170
200	ML5774	T1	P	8	18,5	500	525
200	ML5792	U	P	8	18,5	480	550
200	ML5973	S1	S1	8	18,5	565	200
200	ML5985	T1	T1	10	22	512	520
200	ML6042	S1	S1	8	18,5	580	560
200	ML6128	S1	S1	8	19	523	600
201	ML5613	Y1	D	8	18,5	500	600
201	ML5683	P	U	8	18,5	580	510
202	ML5068	U	U	8	18,5	515	370
202	ML5103	U	U	8	18,5	510	620
202	ML5300	U	U	8	18,5	527	390
202	ML5579	S1	S1	8	18,5	523	530
202,6	ML5088	E2	E3	8	18,5	645	470
202,6	ML5089	E2	E3	8	18,5	645	470
203	ML5377	U	S1	8	18,5	507	520
203	ML5673	U	U	8	18,5	582	460
203	ML5821	S1	U	8	18,5	500	245
204	ML5094	U	U	8	18,5	500	500
204	ML5100	S1	S1	8	18,5	500	480
204	ML5138	U	U	8	18,5	566	500
204	ML5809	S1	S1	8	18,5	536	410
204	ML6044	S1	S1	8	18,5	643	475



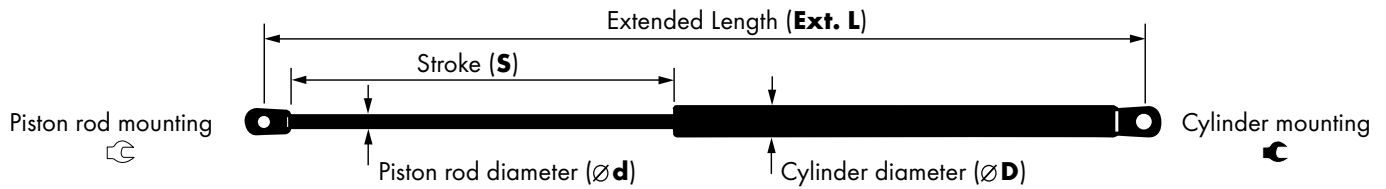

S	Monroe®	↺	↻	Ød	ØD	Ext. L	F1
204	ML6122	P	P	8	19	588	400
205	ML5078	U	U	8	18,5	507	420
205	ML5132	S1	U	8	18,5	502	500
205	ML5166	U	C1	8	18,5	536,5	430
205	ML5185	S1	U	8	18,5	500	470
205	ML5197	S1	U	8	18,5	500	420
205	ML5208	U	U	8	18,5	552	370
205	ML5289	U	U	8	18,5	556	500
205	ML5347	U	U	8	18,5	525	310
205	ML5348	U	U	8	18,5	525	350
205	ML5405	U	U	8	18,5	516	425
205	ML5425	U	C1	8	18,5	491	600
205	ML5451	U	U	8	18,5	611	350
205	ML5461	S1	S1	8	18,5	506	180
205	ML5620	U	U	8	18,5	580	230
205	ML5657	S1	S1	8	18,5	495	610
205	ML5671	U	U	8	18,5	627	660
205	ML5677	Y1	T1	8	18,5	499	460
205	ML5681	U	U	8	18,5	495	440
205	ML5722	U	U	10	22	505	610
205	ML5918	U	U	8	18,5	502	530
205	ML5923	U	U	8	18,5	502	450
205	ML5989	U	K	10	22	595	680
205	ML5997	P	S1	8	18,5	505	585
205	ML6013	S1	S1	10	22	515,5	610
205	ML6080	U	U	8	18,5	538	650
206	ML5054	U	U	8	18,5	543,5	360
206	ML5140	U	U	8	18,5	526	320
206	ML5169	U	U	8	18,5	527	450
206	ML5242	U	U	8	18,5	543,5	320
206	ML5313	U	U	8	18,5	526	560
207	ML5073	Y1	X1	8	18,5	501	480
207	ML5086	S1	S1	8	18,5	526	570
207	ML5109	U	U	8	18,5	544	495
207	ML5178	U	U	8	18,5	507	550
207	ML5189	S1	S1	8	18,5	513	535
207	ML5190	S1	S1	8	18,5	513	585
208	ML5346	U	U	8	18,5	571	570
208	ML5362	U	U	8	18,5	507	436
208	ML5391	U	U	8	18,5	510	470
208	ML5395	U	U	8	18,5	510	390
208	ML5752	U	U	8	18,5	500	375
208	ML5812	U	U	8	18,5	520	130
208	ML5961	S1	S3	8	18,5	526,5	125
209	ML5036	Y6	X1	8	18,5	518	220
210	ML5041	U	U	8	18,5	542	300
210	ML5061	U	C1	8	18,5	527	450
210	ML5123	S1	S1	8	18,5	515	500
210	ML5146	S1	S1	8	18,5	510	340
210	ML5177	U	U	8	18,5	515	550
210	ML5211	U	U	8	18,5	527	350
210	ML5228	U	K	10	22	560	730
210	ML5229	U	U	10	22	560	800
210	ML5252	U	U	8	18,5	544	440
210	ML5271	U	U	8	18,5	522	300
210	ML5272	U	U	8	18,5	522	400
210	ML5279	S1	U	8	18,5	595	470
210	ML5340	U	U	8	18,5	525	140
210	ML5349	U	U	8	18,5	525	480
210	ML5350	U	U	8	18,5	525	240
210	ML5378	U	S1	8	18,5	545	490
210	ML5379	U	S1	8	18,5	545	530
210	ML5412	S1	U	8	18,5	565	560
210	ML5469	S1	S1	8	18,5	581,5	535

S	Monroe®	↺	↻	Ød	ØD	Ext. L	F1
210	ML5515	U	U	10	22	722	819
210	ML5544	U	S1	8	18,5	596	450
210	ML5545	U	S1	8	18,5	596	510
210	ML5575	U	P	10	22	755	970
210	ML5576	U	U	10	22	755	1080
210	ML5636	U	U	8	18,5	525	240
210	ML5672	U	U	8	18,5	540	385
210	ML5692	U	U	8	18,5	545	450
210	ML5693	P	S1	8	18,5	625	590
210	ML5707	U	U	8	18,5	545	620
210	ML5711	U	U	8	18,5	515	490
210	ML5749	U	P	8	18,5	530	410
210	ML5833	U	P	10	22	755	1080
210	ML5866	U	P	10	22	625	510
210	ML5890	S1	S1	8	18,5	515	365
210	ML6126	S1	S1	8	18,5	505	300
210	ML6130	P	U	8	19	522	490
211	ML5731	S1	P	8	18,5	505	330
212	ML5006	Y2	X2	8	18,5	550	230
212	ML5049	U	C1	8	18,5	500	350
212	ML5053	U	U	8	18,5	550	350
212	ML5059	Y2	X2	8	18,5	550	270
212	ML5130	U	C1	8	18,5	596,5	515
212	ML5754	U	P	8	18,5	528	420
212	ML5983	U	P	10	22	524	540
212	ML5984	U	P	10	22	524	585
213	ML5056	Y1	X1	8	18,5	520	230
213	ML5373	U	U	8	18,5	548	475
213	ML5396	U	U	8	18,5	568	360
213	ML5548	S1	S1	6	15	530	110
213	ML5784	U	U	8	18,5	510	360
214	ML5188	U	U	8	18,5	540	400
214	ML5556	Y1	X1	6	15	547	225
215	ML5167	U	U	8	18,5	535	480
215	ML5203	U	U	8	18,5	600	550
215	ML5204	U	U	8	18,5	600	600
215	ML5276	U	U	8	18,5	529	245
215	ML5317	U	U	8	18,5	590	410
215	ML5318	U	U	8	18,5	590	450
215	ML5338	U	U	8	18,5	570	530
215	ML5359	U	U	8	18,5	513	350
215	ML5363	U	U	8	18,5	632	600
215	ML5372	U	U	8	18,5	546	500
215	ML5381	U	S1	8	18,5	557	550
215	ML5388	U	U	8	18,5	565	480
215	ML5403	U	U	8	18,5	668	375
215	ML5455	U	U	8	18,5	632	600
215	ML5541	S1	S1	8	18,5	568	410
215	ML5542	U	U	8	18,5	667	375
215	ML5554	U	T1	10	22	573,5	580
215	ML5555	U	T1	10	22	573,5	670
215	ML5644	T1	D	8	18,5	515	550
215	ML5713	U	U	8	18,5	515	400
215	ML5730	U	U	8	18,5	565	315
216	ML5144	U	U	8	18,5	565	360
216	ML5161	U	U	8	18,5	534	410
216	ML6024	P	I3	8	18,5	533	330
217	ML5106	U	D	8	18,5	514,5	610
217	ML5509	T1	T1	8	18,5	534	200
218	ML5651	P	U	8	18,5	544	290
218	ML5772	T1	P	8	18,5	539	585
218	ML6053	U	C1	8	18,5	652	750
219	ML5044	U	U	8	18,5	527	450
219	ML5048	U	U	8	18,5	527	420

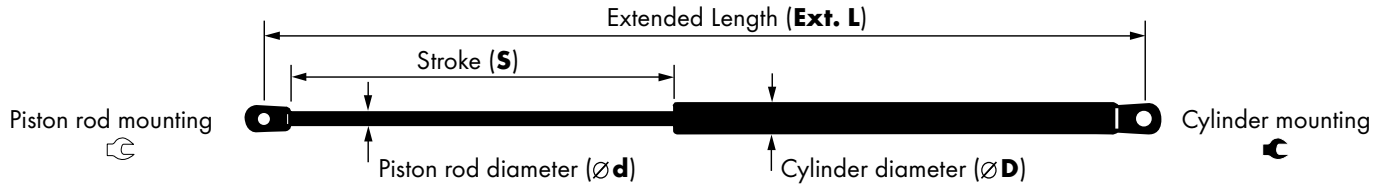

S	Monroe®	↺	↻	Ød	ØD	Ext. L	F1
219	ML5064	U	U	8	18,5	527	520
219	ML5112	U	U	8	18,5	566,5	280
219	ML6040	U	U	8	18,5	549	290
220	ML5040	U	U	8	18,5	569	280
220	ML5050	U	U	8	18,5	569	280
220	ML5292	U	U	8	18,5	550	285
220	ML5314	U	U	8	18,5	545	530
220	ML5324	U	U	8	18,5	590	480
220	ML5327	U	U	8	18,5	540	250
220	ML5353	U	U	8	18,5	555	450
220	ML5434	U	U	8	18,5	599	360
220	ML5437	S1	U	8	18,5	575	500
220	ML5440	S1	S1	8	18,5	534,5	480
220	ML5443	U	U	10	22	603	740
220	ML5474	S1	S1	8	18,5	535	425
220	ML5505	T1	T1	8	18,5	630	570
220	ML5506	T1	T1	8	18,5	540	490
220	ML5588	S1	S1	8	18,5	559	330
220	ML5718	U	U	10	22	547	460
220	ML5720	U	U	8	18,5	543	310
220	ML5765	T1	T1	8	18,5	565	500
220	ML5828	U	P	8	18,5	547	550
220	ML5849	U	U	8	18,5	526	325
220	ML5862	S1	S1	8	19	548	420
220	ML5954	U	U	8	18,5	543	200
220	ML5991	U	U	8	18,5	557	580
220	ML6005	S1	S1	8	18,5	538	510
220	ML6041	T1	T1	10	22	600	325
220	ML6075	U	K	10	22	533	750
221	ML5141	U	U	10	22	567	590
221	ML5142	U	U	10	22	567	650
222	ML5031	U	U	8	18,5	549	355
222	ML5134	U	U	8	18,5	585	280
222	ML5571	T1	T1	8	18,5	550	475
222	ML6143	U	U	8	18,5	547	535
223	ML5184	S1	P	8	18,5	600,5	320
224	ML5026	U	U	8	18,5	528	160
224	ML5099	U	U	8	18,5	528	220
224	ML5171	U	U	8	18,5	557	360
224	ML5172	U	U	8	18,5	557	425
224	ML5607	S1	S1	8	18,5	544	250
224	ML5797	T1	T1	10	22	556	715
225	ML5248	U	U	10	22	567	460
225	ML5320	U	U	8	18,5	600	450
225	ML5374	U	U	8	18,5	556	475
225	ML5457	U	U	8	18,5	546	220
225	ML5564	U	P	8	18,5	577	270
225	ML5567	S1	S1	8	18,5	635	200
225	ML5592	S1	S1	8	18,5	498	540
225	ML5659	S1	S1	8	18,5	553	220
225	ML5763	T1	T1	8	18,5	540	390
225	ML5948	U	S1	10	22	620	625
225	ML5968	U	U	8	18,5	600	670
225	ML6017	U	U	8	18,5	604	510
225	ML6124	U	P	8	19	590	590
226	ML5200	U	U	8	18,5	577	415
226	ML5201	U	U	8	18,5	577	400
226	ML5394	U	U	8	18,5	600	360
226	ML5463	S1	S1	8	18,5	577	275
226	ML5464	S1	S1	8	18,5	577	320
228	ML5173	U	U	8	18,5	555	485
228	ML5687	U	U	8	18,5	555	305
228	ML5815	U	U	8	18,5	600	360
228	ML6089	T1	T1	8	18,5	611	420

S	Monroe®	↺	↻	Ød	ØD	Ext. L	F1
228	ML6109	U	U	8	19	567	460
229	ML5465	S1	S1	8	18,5	614	300
229,5	ML5015	Y6	X1	8	18,5	549	350
229,5	ML5016	Y1	X2	8	18,5	549	240
229,5	ML5039	Y1	X2	8	18,5	550	380
229,5	ML5055	Y6	X1	8	18,5	549,5	160
230	ML5020	U	U	8	18,5	600	290
230	ML5023	U	U	8	18,5	614	330
230	ML5148	U	U	8	18,5	600	300
230	ML5149	U	U	8	18,5	611	355
230	ML5202	U	U	8	18,5	566	440
230	ML5283	U	U	8	18,5	627	570
230	ML5288	U	U	8	18,5	570	460
230	ML5304	U	U	8	18,5	627	570
230	ML5312	U	U	8	18,5	545	300
230	ML5326	U	U	8	18,5	566	450
230	ML5344	U	U	8	18,5	632	510
230	ML5354	U	U	8	18,5	570	490
230	ML5375	U	U	8	18,5	568	500
230	ML5384	U	S1	8	18,5	606,5	540
230	ML5397	U	U	8	18,5	568	560
230	ML5399	U	U	8	18,5	570	215
230	ML5400	U	U	8	18,5	570	420
230	ML5401	U	U	8	18,5	570	520
230	ML5454	U	U	8	18,5	627	630
230	ML5458	U	U	8	18,5	631	440
230	ML5476	S1	S1	8	18,5	574,5	530
230	ML5477	S1	S1	8	18,5	574,5	620
230	ML5482	S1	S1	8	18,5	575	440
230	ML5503	T1	T1	8	18,5	600	510
230	ML5597	U	X1	8	18,5	547	230
230	ML5626	U	U	8	18,5	627	570
230	ML5825	S1	S1	8	18,5	500	135
230	ML5850	S1	P	8	18,5	559	290
232	ML5122	U	U	8	18,5	570	520
232	ML5243	U	U	8	18,5	549	320
232	ML5244	U	U	8	18,5	549	410
233	ML5819	U	U	8	18,5	568	330
234	ML5014	U	U	8	18,5	584	280
234	ML5066	U	U	8	18,5	584	290
235	ML5013	U	U	8	18,5	595	280
235	ML5076	U	U	10	22	550	850
235	ML5143	U	U	8	18,5	574	260
235	ML5147	U	U	8	18,5	574	310
235	ML5191	U	U	8	18,5	585	360
235	ML5265	U	U	8	18,5	585	250
235	ML5342	U	U	8	18,5	575	330
235	ML5429	U	U	10	22	550	810
235	ML5573	U	D	8	18,5	640	390
235	ML5606	Y1	D	8	18,5	579	320
235	ML5780	T1	T1	8	18,5	550	280
235	ML5782	T1	T1	8	18,5	558	500
235	ML5824	S1	S1	8	18,5	558	530
235	ML5842	S2	15	8	18,5	585	310
235	ML5843	S2	16	8	18,5	585	310
235	ML5888	T1	T1	8	18,5	585,5	510
235	ML5956	S1	S3	8	18,5	563	140
235	ML6085	11	11	8	18,5	587	100
236	ML5027	U	U	8	18,5	586	280
236	ML5062	U	U	8	18,5	586	200
238	ML6125	S1	S1	8	19	665	535
239	ML5029	U	U	8	18,5	589	310
239	ML5286	U	U	8	18,5	591	400
240	ML5077	U	C1	8	18,5	591	350

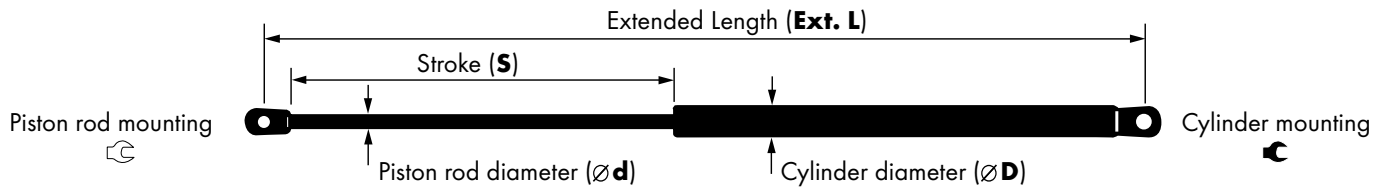

S	Monroe®	↺	↻	Ød	ØD	Ext. L	F1
240	ML5105	U	U	10	22	569	910
240	ML5129	S1	S1	8	18,5	622	360
240	ML5245	U	U	10	22	569	750
240	ML5246	U	U	10	22	569	660
240	ML5247	U	U	10	22	569	830
240	ML5278	U	U	8	18,5	570	520
240	ML5402	U	U	8	18,5	570	470
240	ML5664	U	U	8	18,5	585	420
240	ML5705	S1	U	8	18,5	565	290
240	ML5816	T1	T1	10	22	570	650
240	ML5847	B2	A2	10	22	610	500
240	ML5848	B1	A1	10	22	610	500
240	ML5869	U	P	8	18,5	569	310
240	ML5893	S1	S1	8	18,5	569	670
240	ML5938	S1	U	8	18,5	672	180
240	ML5959	S1	S1	8	18,5	589	110
242	ML5081	U	C1	8	18,5	569	210
242	ML5770	P	P	8	18,5	605	655
243	ML5919	Y1	D	8	18,5	615	240
244	ML5325	U	U	8	18,5	600	330
245	ML5012	U	U	8	18,5	600	410
245	ML5065	U	U	8	18,5	600	430
245	ML5398	U	U	8	18,5	580	340
245	ML5430	U	U	8	18,5	590,5	480
245	ML5609	W	D	8	18,5	580	380
245	ML5662	U	U	8	18,5	590	460
245	ML5665	U	U	8	18,5	585,5	405
245	ML5822	S1	S1	8	18,5	580	165
246	ML5940	S1	S1	8	18,5	585	500
246	ML6069	U	P	8	18,5	585	260
247	ML5428	S1	S1	8	18,5	580	470
247	ML5534	S1	U	8	18,5	605	340
247	ML5582	U	U	10	22	769	475
248	ML5091	E4	T1	8	18,5	613,8	190
248	ML5092	E4	T1	8	18,5	613,8	190
248	ML5285	U	U	8	18,5	595	370
248	ML5364	U	U	8	18,5	635	360
248	ML5527	O	O	10	22	613,5	620
248	ML5585	O	O	10	22	613,5	560
248	ML5586	O	O	10	22	613,5	640
249	ML5369	U	U	8	18,5	828	355
250	ML5019	Y6	X1	8	18,5	600	500
250	ML5033	U	U	8	18,5	600	320
250	ML5034	Y6	X1	8	18,5	585	200
250	ML5083	U	U	8	18,5	584	200
250	ML5118	P	P	10	22	685	770
250	ML5133	U	U	8	18,5	600	250
250	ML5139	S1	S1	8	18,5	602	160
250	ML5152	U	C1	8	18,5	595	485
250	ML5249	P	P	10	22	685	710
250	ML5250	P	P	10	22	685	910
250	ML5251	P	P	10	22	685	830
250	ML5255	U	U	8	18,5	600	320
250	ML5262	U	U	8	18,5	595	450
250	ML5501	Y2	D	8	18,5	600	540
250	ML5578	U	U	8	18,5	650	460
250	ML5598	S1	S1	8	18,5	600	160
250	ML6060	S1	S1	8	18,5	584	150
250	ML6070	U	C1	8	18,5	585	430
251	ML5021	U	U	8	18,5	700	200
251,5	ML5807	U	U	8	18,5	609,5	245
252	ML5107	U	U	8	18,5	602	430
252	ML5299	U	U	8	18,5	602	430
253	ML5205	U	U	8	18,5	625	575

S	Monroe®	↺	↻	Ød	ØD	Ext. L	F1
253	ML5697	U	U	8	18,5	604	250
254	ML6025	P	I3	8	18,5	570	330
255	ML5009	Y6	X1	8	18,5	600	180
255	ML5010	Y6	X1	8	18,5	600	200
255	ML5011	Y6	X1	8	18,5	600	360
255	ML5042	Y6	X1	8	18,5	600	310
255	ML5067	Y1	X1	8	18,5	600	450
255	ML5716	U	U	10	22	667	755
255	ML5755	U	P	8	18,5	640	595
255	ML5756	U	P	8	18,5	640	565
255	ML5827	U	U	8	18,5	603	240
257	ML5407	U	U	8	18,5	700	320
257	ML5528	M	O	10	22	697	610
257	ML5834	M	O	10	22	699	610
257	ML5835	M	O	10	22	699	540
258	ML5836	T1	T1	8	18,5	639	465
259	ML5450	U	U	8	18,5	635	290
260	ML5432	S1	S1	8	18,5	624	400
260	ML5435	S1	S1	8	18,5	656	400
260	ML5452	U	U	8	18,5	653	460
260	ML5530	U	P	8	18,5	640	510
260	ML5593	Y1	D	8	18,5	615	400
260	ML5820	U	U	8	18,5	613	300
260,5	ML6055	U	U	10	22	661,5	800
265	ML5267	S1	S1	8	18,5	648	190
265	ML5470	S1	S1	8	18,5	685	200
265	ML5851	S1	S1	8	18,5	631	455
265	ML6003	U	P	8	18,5	644	300
269	ML5282	U	U	8	18,5	630	330
270	ML5192	U	U	8	18,5	680	360
270	ML5345	U	U	8	18,5	650	310
270	ML5393	U	U	8	18,5	678	270
270	ML5508	T1	T1	8	18,5	680	390
270	ML5521	T1	Q	8	18,5	665	360
270	ML5589	S1	S1	8	18,5	671,5	360
270	ML5634	T1	T1	8	18,5	680	360
270	ML5715	U	C1	8	18,5	650	350
271	ML6074	U	Q	8	18,5	663,5	315
272	ML5543	U	U	8	18,5	695	640
272	ML5795	U	U	8	18,5	628	440
274	ML5631	T1	T1	8	18,5	677	340
275	ML5162	S1	S1	8	18,5	666,5	390
275	ML5315	U	U	8	18,5	675	440
275	ML5418	U	U	8	18,5	645,5	450
275	ML5601	Y1	D	8	18,5	650	240
275	ML5602	S1	D	8	18,5	650	240
275	ML5603	Y1	D	8	18,5	650	310
275	ML5605	S1	D	8	18,5	650	310
275	ML5654	U	U	8	18,5	657	480
275	ML6072	U	U	8	18,5	664	265
276	ML5976	N	N	8	18,5	673	250
277	ML6039	T1	T1	10	22	742	400
278	ML5022	Y6	X1	8	18,5	696	220
278	ML5604	S1	D	8	18,5	640	300
279	ML5608	N	N	8	18,5	675	210
280	ML5051	S1	E1	10	22	726	420
280	ML5128	S1	S1	10	22	690	630
280	ML5333	Y1	D	8	18,5	668	375
280	ML5750	U	U	10	22	720	870
280	ML6096	P	U	8	18,5	690	380
282	ML5295	U	U	8	18,5	678	480
285	ML5268	U	U	8	18,5	685	180
285	ML5309	U	U	8	18,5	675	260
285	ML5337	U	U	8	18,5	691,5	270

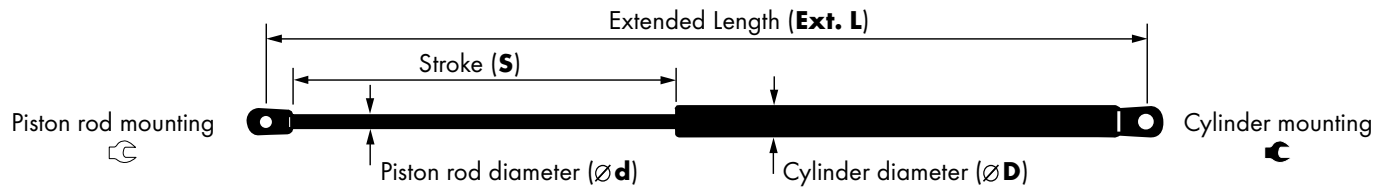

S	Monroe®	C	C	Ød	ØD	Ext. L	F1
293	ML5798	U	U	8	18,5	674	300
293	ML5799	U	U	8	18,5	674	330
294	ML5497	Y1	D	8	18,5	670	320
294	ML5498	Y1	D	8	18,5	670	345
294	ML6111	S1	C1	8	18,5	694	220
295	ML5494	Y1	D	8	18,5	700	400
295	ML5499	Y1	D	8	18,5	700	345
295	ML5561	U	U	8	18,5	687	270
300	ML5037	U	P	8	18,5	700	325
300	ML5046	U	U	8	18,5	700	260
300	ML5052	U	U	8	18,5	700	200
300	ML5057	P	S1	8	18,5	700	325
300	ML5084	U	U	8	18,5	685,5	200
300	ML5113	T1	T1	8	18,5	700	670
300	ML5737	P	U	8	18,5	720	180
300	ML5837	T1	T1	8	18,5	690	630
300	ML5892	S1	S1	8	18,5	830	560
303	ML5565	P	S1	8	18,5	715	160
306	ML5266	U	C1	8	18,5	722	280
306	ML5269	P	U	8	18,5	715	290
306	ML5679	L	L	8	18,5	722	310
307	ML5516	T1	T1	10	22	905	730
307	ML5550	T1	T1	10	22	905	730
310	ML5648	P	U	8	18,5	728	265
310	ML5709	U	U	10	22	736,5	725
310	ML5758	P	U	8	18,5	726,5	360
310	ML5790	P	S1	8	18,5	740	290
310	ML5829	P	U	8	18,5	730	380
310	ML6079	P	U	8	18,5	728	315
313	ML6049	U	U	8	18,5	721,5	180
315	ML5368	S1	S1	8	18,5	750	300
315	ML5386	U	U	8	18,5	722	325
315	ML5504	T1	T1	8	18,5	837	365
315	ML5768	U	U	8	18,5	721,5	350
316	ML5726	U	U	8	18,5	730	140
320	ML5735	P	U	8	18,5	730	250
321	ML5738	P	U	8	18,5	735	300
322	ML5328	U	U	10	22	775	530
322	ML5329	U	U	10	22	772	630
322	ML5621	U	U	10	22	775	530
324	ML5638	U	U	8	18,5	765	200
325	ML5409	U	U	8	18,5	765	235
335	ML5741	U	U	8	18,5	765	340
340	ML5514	U	U	10	22	850	670
342	ML5102	Y1	V	8	18,5	788	280
350	ML5074	F1	Y3	10	22	798	500
350	ML5448	U	U	10	22	866	370
370	ML5584	S1	U	10	22	870	370
380	ML5385	U	X1	10	22	885	410
404	ML6032	U	13	10	22	874	260
417	ML5678	U	L	10	22	943	380

# MOUNTING TYPES

## MOUNTING

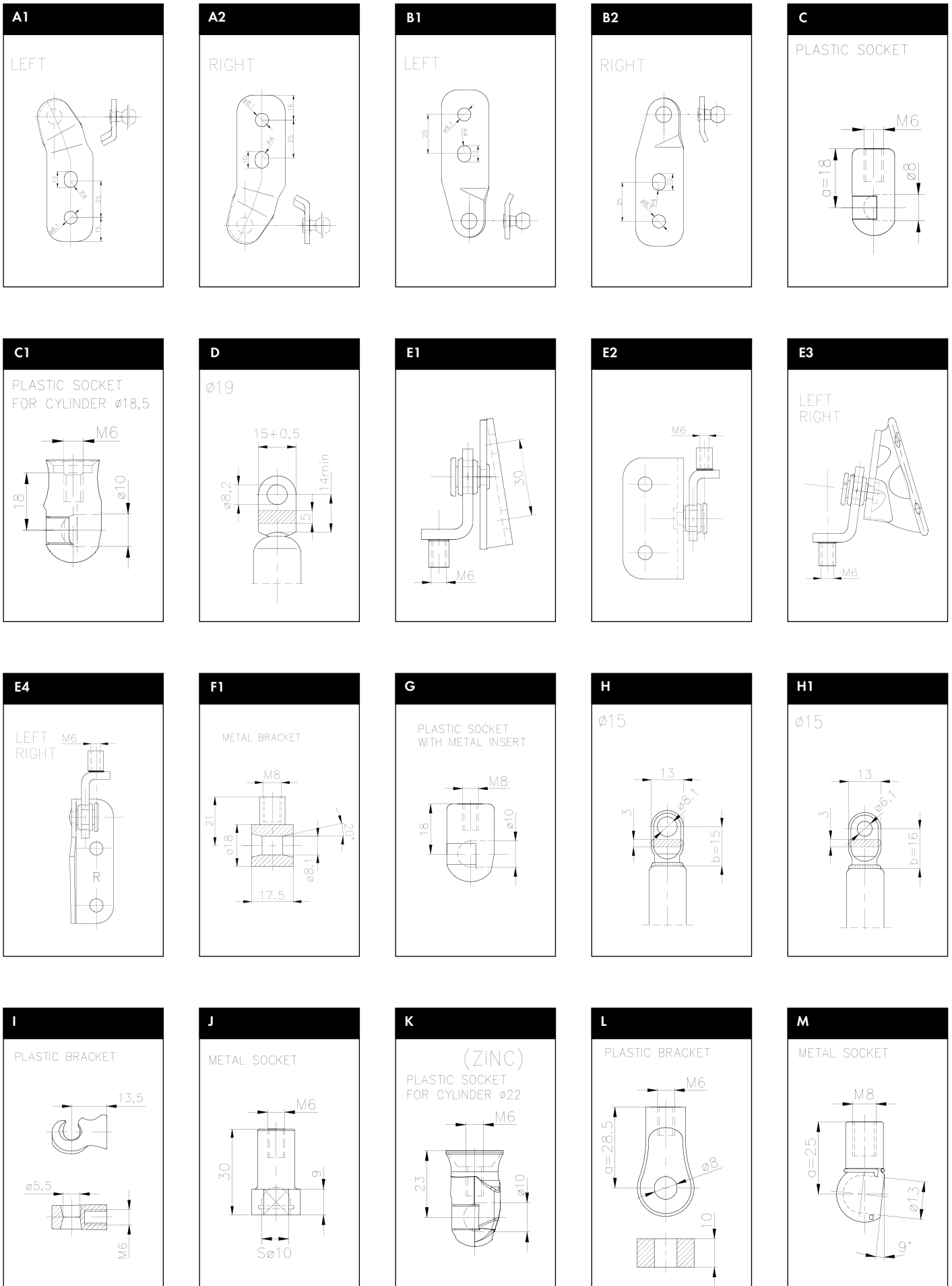

# MOUNTING TYPES

## MOUNTING

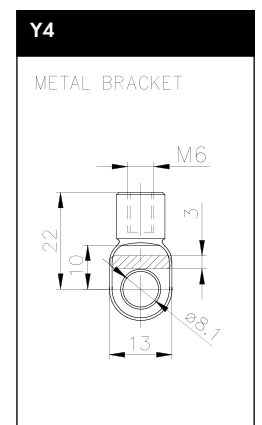
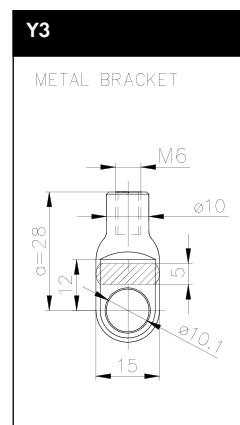
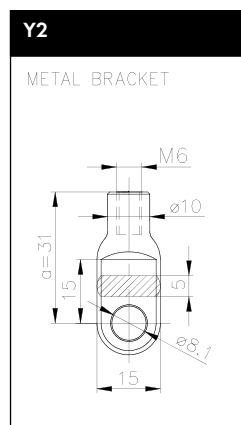
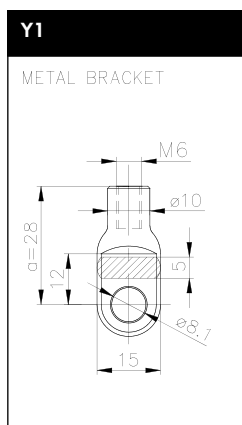
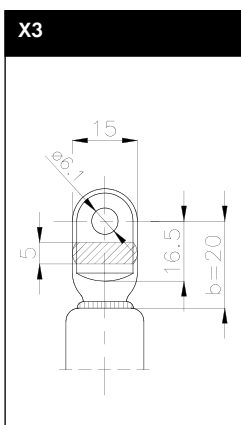
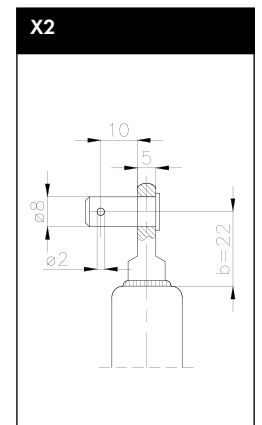
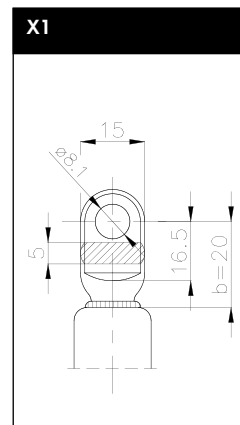
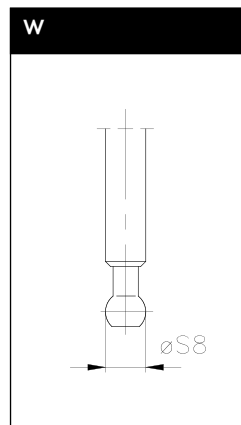
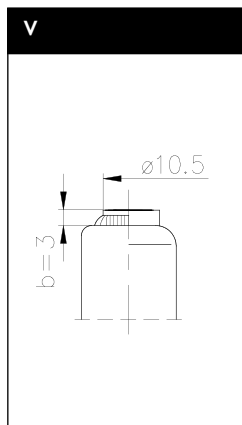
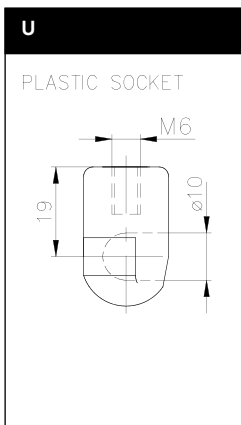
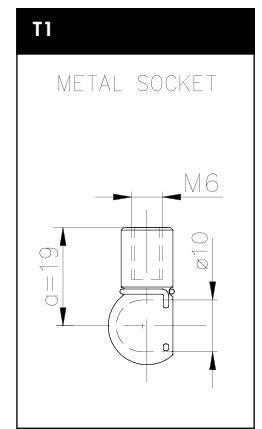
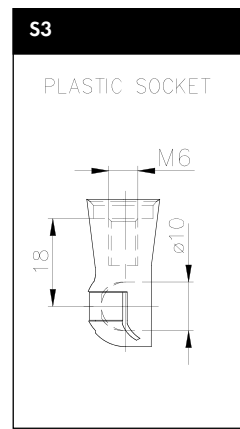
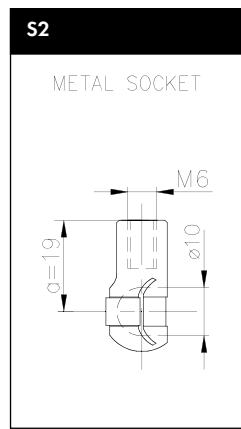
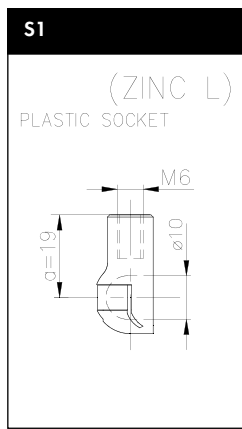
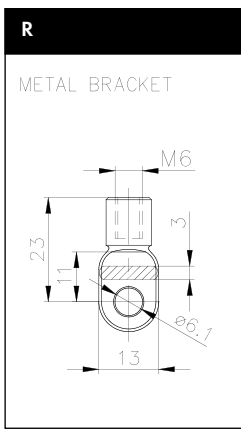
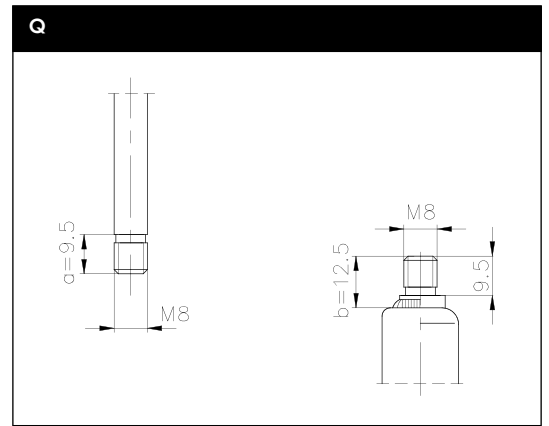
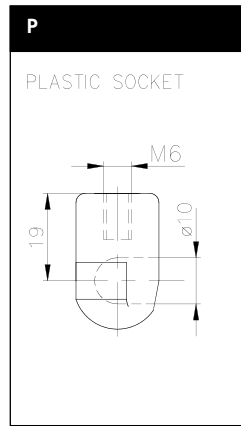
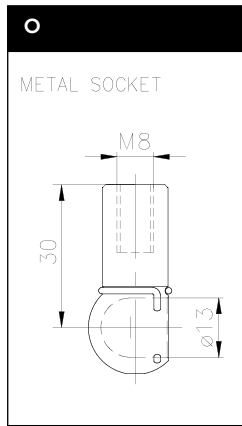
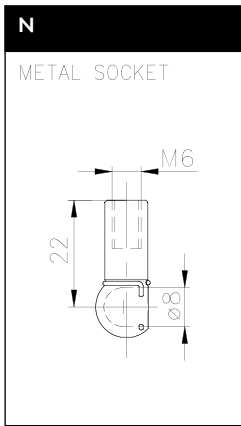

# MOUNTING TYPES

## MOUNTING

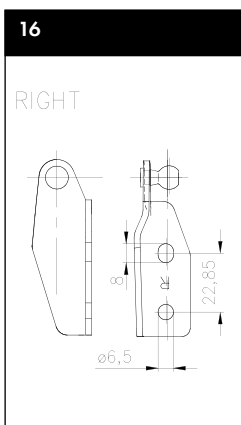
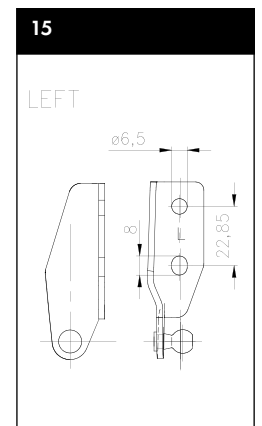
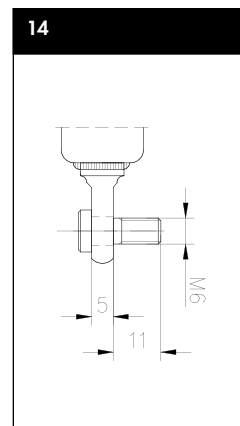
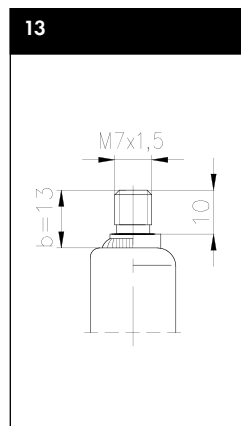
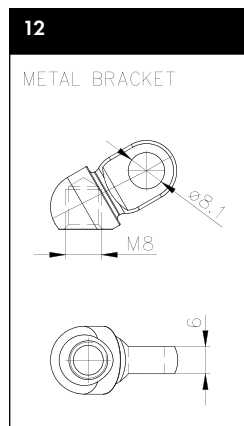
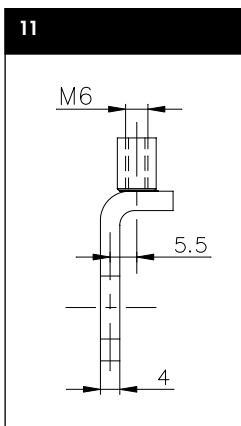
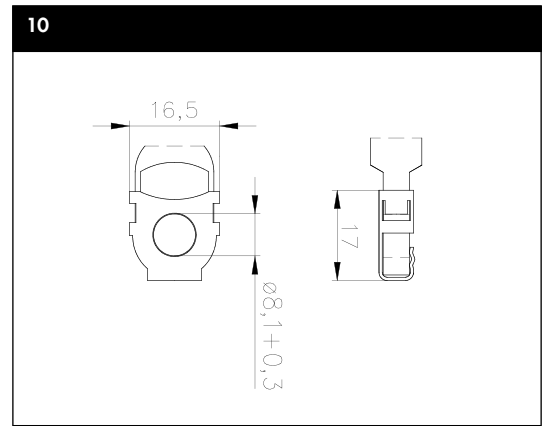
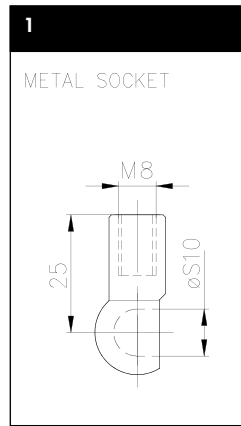
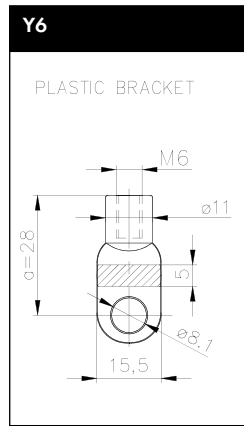
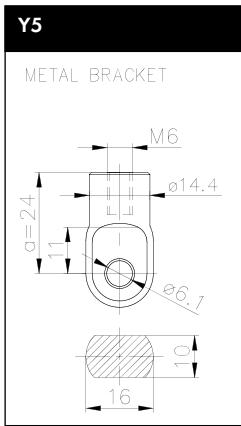

# GAS SPRINGS ON DEMAND

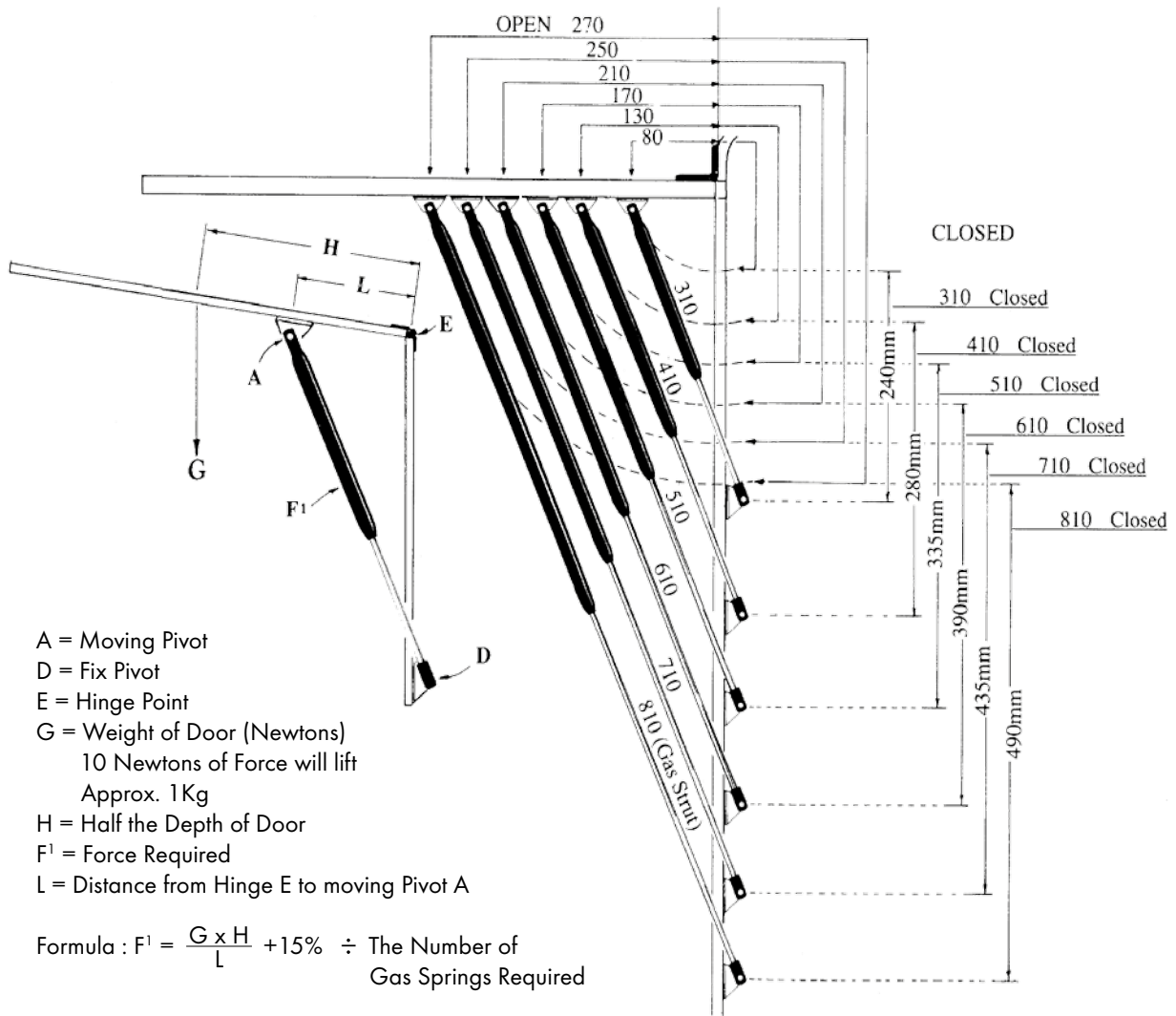

## Special Note.

By reducing the measurement from Point A to Hinge Point E by 20mm, this will give you an extra 10° (degrees) lift.





# BUILD TO ORDER - REQUEST FORM

Monroe® may be able to fulfill your need for special order applications.  
Use the following form to prepare information and accurate data.  
Please send this form to your  representative

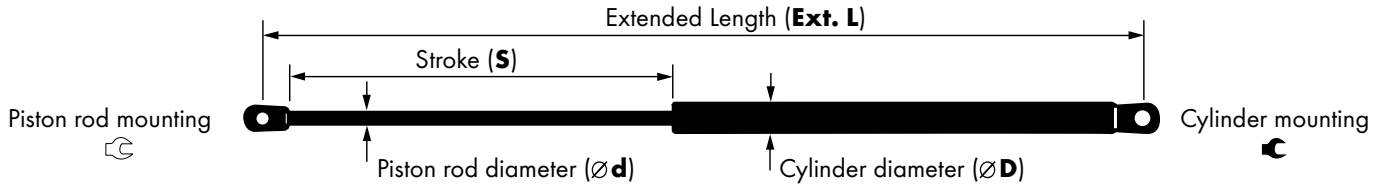

Piston rod mounting	<b>SPECIFICATIONS</b>		Cylinder mounting
	OE N°		
	Ød / ØD:	6/15 mm	
		8/19 mm	
		10/22 mm	
		14/28 mm	
	Ext. L	..... mm	
	S	..... mm	
	F1	..... N	
Annual Volumes			
Packaging Type	Carton box		
	Plastic bag		
	Bulk		

## CUSTOMER INFORMATION

Company name: \_\_\_\_\_ Phone: \_\_\_\_\_  
 Name: \_\_\_\_\_ Mobile: \_\_\_\_\_  
 Street: \_\_\_\_\_ Email: \_\_\_\_\_  
 Zip code: \_\_\_\_\_  
 City: \_\_\_\_\_  
 Country: \_\_\_\_\_

# Warranty Terms

(valid in Europe only)

**MONROE® Europe warrants the listed  
MONROE® products to the original retail purchaser  
against functional and/or material defects:**



**MONROE® Quick-Strut  
MONROE® Reflex  
MONROE® Springs**



**MONROE® Adventure  
MONROE® Gas-Magnum  
MONROE® Level-Light  
MONROE® Load-Leveler  
MONROE® Magic Camber  
MONROE® Max Lift  
MONROE® Mounting Kit**

**MONROE® Original  
MONROE® Protection Kit  
MONROE® Ride-Leveler  
MONROE® Sensa-Trac  
MONROE® Spheres  
MONROE® Steering & Suspension  
MONROE® Van-Magnum**

MONROE® Europe provides a 2 year warranty without mileage limitation.  
(3 year warranty for MONROE® Reflex, MONROE® Quick-Strut, MONROE® Springs)  
The Warranty of MONROE® Europe is limited to the delivery of a new MONROE® product.  
All claims are first handled by the MONROE® distributor and then honoured by MONROE®.

The reseller/installer will provide the MONROE® distributor with all relevant information such as:

- consumer's name and address
- fitting or sales dates
- MONROE® product part number
- vehicle identification data
- proof of purchase documents
- description of the defect.

Excluded from warranty are:

1. Regular wear-out.
2. MONROE® products fitted contrary to application information in the MONROE® catalogue or its subsequent amendments.
3. MONROE® products which have been modified or damaged by incorrect mounting or incorrect use of the vehicle, contrary to the car manufacturers' specifications or MONROE®s.
4. MONROE® products damaged by mounting on another car than indicated in the MONROE® catalogue or its subsequent amendments.
5. Shock absorbers with damaged piston rod or damaged oil seal due to holding the piston rod with a wrench or pliers instead of the correct tool.
6. Premature wear-out caused by re-use of damaged mounting parts such as: rubber dirt shields, damaged bump stops, etc.
7. Damages caused by an accident.
8. MONROE® products damaged while used in rally or racing sports.
9. Ride-Levelers with air sleeve abrasion caused by incorrect mounting.
10. Reconditioned or recycled MONROE® products.
11. Defects caused by lack of maintenance or maintenance wrongly executed on the vehicle.

In addition: All MONROE® products are developed and manufactured according to original suspension specifications from car manufacturers. MONROE® indicates in its catalogue the originally lowered models on which its products fit.

