

MONROE

SUSPENSION PARTS

2016

MASTER CATALOGUE



EMEA

TENNECO

MONROE[®]

SUSPENSION



SUSPENSION

Ball Joints

Bushings

Gaiters

Links

Mounting & Protection Kits

Shock Absorbers

Springs

Stabilizer Links

Tie Rods

Track Control Arms



» MASTERING

SAFE & COMFORTABLE DRIVING »



B-connected





GB

Ball joint

- Connects the suspension arm with the wheel carrier thanks to 2 or 3 bolts, depending on the application, and guides the wheel.
- Its pin, fitting the wheelhub and fixed with a nut or a bolt, must move freely in angular direction, although firmly to avoid noise in the passenger compartment, unclear alignment and unprecise steering.
- The sealing below keeps dirt and moisture out, but maintains grease inside for good lubrication.



Wishbone

- Guides the wheel while moving up and down and supports it against braking and cornering forces.
- Is fixed to the car body with special designed rubber mounts to absorb vibrations and small impacts of the road.
- Made out of sheet metal, forged iron or aluminium alloys.



Tie rod assembly

- Connects the wheel carrier to the steering box and its adjustable length determines the wheel alignment (Toe -in /Toe -Out).
- Made of two main parts, both equipped with a ball joint.
- Tie rod directly bolted into the steering rack and mounted with a bellow to keep dirt and moisture out and grease inside the joint.
- Tie rod end connected to the wheel carrier.



Stabilizer link

- Links the anti-roll bar end to the suspension.
- The pin of the ball joint must move freely in angular direction, although firmly to avoid noise in the passenger compartment and instability of the body.
- The sealing bellow keeps dirt and moisture out, but maintains grease inside for good lubrication.



Strut mount (MK)

- Connects the strut or shockabsorber to the car body while preventing vibrations from the wheel and supports the spring against the car body.
- Its bearing allows rotation of the front suspension strut during steering.
- Must be firm in horizontal directions for a straight steering feel, but vertically soft to assure good isolation.



Gaiters (Bellow kit)

- Protects the axial joint - steering rack linkage from corrosion, dirt, moisture and impact, and retains grease within the steering system to help prevent premature wear.
- Manufactured from high-grade nitrile rubber or thermoplastic compound, according to the OE design for each vehicle.
- Easy replacement and perfect seal with plastic strap or metal clamp.



Picto pages	
Gaiter (Universal type)	
Alfa Romeo	1
Audi	18
Autobianchi	195
BMW	196
Chevrolet	263
Chrysler	278
Citroen	285
Dacia	342
Daewoo	349
Daihatsu	361
Dodge	366
F.S.O	368
Fiat	369
Ford	432
GMC Truck	505
Honda	507
Hyundai	548
Isuzu	585
Iveco	589
Jaguar	592
Jeep	597
Kia	598
Lada	630
Lancia	632
Landrover	646

Lexus	657
Mazda	659
Mercedes	695
MG	784
Mini	785
Mitsubishi	795
Nissan	833
Opel/Vauxhall	889
Peugeot	956
Plymouth	1017
Pontiac	1018
Porsche	1021
Proton	1027
Renault	1028
Rover	1097
Saab	1105
Seat	1123
Skoda	1176
Smart	1204
Subaru	1209
Suzuki	1224
Talbot	1235
Toyota	1236
Vauxhall	1305
Volkswagen	1306
Volvo	1475
Zastava	1530

OVER 750
NEW suspension parts references
to cover **many**
new and existing
cars on the road

including
201 new references
for
Japanese/Korean cars

124
NEW references
for **Gaiters**

FULL RANGE
of Mounting Kits

TYPE	MANUFACTURED FROM	UNTIL	ALFA ROMEO		BRAND			
155 (167) 02.92 -> 09.05								
STEERING, FRONT/REAR SUSPENSION	PRODUCT DESCRIPTION	POSITION	APPLICATION CRITERIA	LEFT + RIGHT CENTER	THREAD SIZE	PART OF MONROE® PART NUMBER	QUANTITY PER AXLE	OE NUMBER
		←→	I	L1203 L1203	Thread	Part Of	OPA	I
		⊙		L29674			2 510915	1 102962

MODEL	
(=)	Only used for
(-)	Without
(+)	With
(+/-)	With or without
(+) (+)	OR Function
(+) & (+)	AND Function
	Berline, Sedan, Saloon, 2/4 doors
	Berline, Sedan, Saloon, 3/5 doors
	Fastback, Hatchback, Liftback
	Coupé, Hardtop
	Break, Estate, Station, Wagon
	Cabriolet, Convertible
	Car derived Van
	Multi Purpose Vehicle (MPV)
	Sport Utility or Activity Vehicle
	Off Road
	Pick up
	Delivery Van
	Minibus
	Ambulance
	Van Chassis Cabin
	Light Truck
	Utility load "1000" kg
	Increased payload
	2-3-4-5 doors
Ch. n°	Chassis number
	...onwards
	up to...
Petrol	Petrol
Diesel	Diesel
	Front wheel drive
	Rear wheel drive
	Automatic transmission
	Manual transmission
	Air conditioning

	Only for Cars sold in Portugal
	Only for Cars sold in Greece
	Only for Cars sold in Ireland
	Only for Cars sold in Sweden
	Only for Cars sold in Russia
	Additional heating
	Armoured Duty
	Cold Climate Countries
	Hot Climate Countries
	See
	See Above
	See page
	Sunroof
	Towing hook
	Driver
	Passenger
A.R.B.	Anti Roll Bar
LHD	Left Hand Drive vehicles
RHD	Right Hand Drive vehicles
Cyl.	Number of cylinders
	People carrier
	Cargo
Orig (Eur)	Cars built in Europe
	Part number in process

OTHER

	C-section (body = pressed)
	H-section (body = welded)
	Cast-iron (body = casted)
	Mounting hole
	Mounting bolts
	Special mounting
	Cone diameter
L29385	New available partnumber
L11A01	New partnumber, available within the year of the catalogue.
L1134 ¹	Partnumber sold until depletion of stock

AXLES & WHEELS

	Left
	Right
	Rigid Axle
	Independent Axle
	Single wheels
	Twin wheels
	Size of wheelbase
	13 inch ... 19 inch wheels
	Rear disc brakes
	Rear drum brakes
	Anti-lock brakes
	No power steering
	Power steering

SUSPENSION

	Coil spring
	Leaf spring
	Air suspension/springs
	2 torsion Bar
	4 torsion Bar
ND	Normal duty/standard suspension
CS	Comfort suspension
SP	Sport suspension
HD	Heavy duty suspension
	Lowered suspension
	Raised suspension
	Automatic leveling system
	Electronic adjustable suspension

TEXT

	Change in pairs
	Drag link
	For extended body
	Push
	Pull
	Rack and Pinion
	Stabilizer bar
	Steel
	Steering damper
	Stub axle pin
	Subframe
	Transverse/Longitudinal
	Wheel bearing housing
	Wheel/Hub carrier

**TIPS FOR EASY READING: 1. Check for car make 2. Check for car model
3. Look at the year 4. Look at the type**

ALFA ROMEO

155 (167) 02.92 -> 09.05

	STEERING, FRONT/REAR SUSPENSION	PRODUCT DESCRIPTION	POSITION	APPLICATION CRITERIA	LEFT + RIGHT ← CENTER →	Thread	Part Of	QUANTITY PER AXLE OPA	OE NUMBER
			↔	i	L1203 L1203			2	510915
			⊙		L29674			1	102962
STEP 1	STEP 2	STEP 3	STEP 4	STEP 5	STEP 6	STEP 7	STEP 8		

STEP 1: VEHICLE LOCATION	Check Component	<ul style="list-style-type: none"> Steering Front Suspension Rear Suspension 																																			
STEP 2: PRODUCT DESCRIPTION	Select Product	<table style="width: 100%; border: none;"> <tr> <td style="width: 50%; border: none;"> <ul style="list-style-type: none"> Tie Rod End Axial Joint Steering Rod Assembly Steering Rod Assembly-Center Gaiter Susp. Ball Joint Track Control Arm Bushing Stabilizer Link Bolt Kit Stabi Link Bushing Anti-Roll Bar Stabilizer Kit </td> <td style="width: 50%; border: none;"> <ul style="list-style-type: none"> Strut Mounting Bolt Kit Repair Kit Camber Rod Caster Rod Parallel Rod Coupling Idler Arm Pitman Arm Universal Joint Thread Tap </td> </tr> </table>	<ul style="list-style-type: none"> Tie Rod End Axial Joint Steering Rod Assembly Steering Rod Assembly-Center Gaiter Susp. Ball Joint Track Control Arm Bushing Stabilizer Link Bolt Kit Stabi Link Bushing Anti-Roll Bar Stabilizer Kit 	<ul style="list-style-type: none"> Strut Mounting Bolt Kit Repair Kit Camber Rod Caster Rod Parallel Rod Coupling Idler Arm Pitman Arm Universal Joint Thread Tap 																																	
<ul style="list-style-type: none"> Tie Rod End Axial Joint Steering Rod Assembly Steering Rod Assembly-Center Gaiter Susp. Ball Joint Track Control Arm Bushing Stabilizer Link Bolt Kit Stabi Link Bushing Anti-Roll Bar Stabilizer Kit 	<ul style="list-style-type: none"> Strut Mounting Bolt Kit Repair Kit Camber Rod Caster Rod Parallel Rod Coupling Idler Arm Pitman Arm Universal Joint Thread Tap 																																				
STEP 3: POSITION	Check detailed position	<table style="width: 100%; border: none;"> <tr> <td style="width: 33%; border: none;"> <ul style="list-style-type: none"> ↓ Lower ↑ Upper </td> <td style="width: 33%; border: none;"> <ul style="list-style-type: none"> ▲ Front Side ▼ Rear Side ▲▼ Front + Rear Side </td> <td style="width: 33%; border: none;"> <ul style="list-style-type: none"> →← Inner ↔ Outer → ← Center </td> </tr> </table>	<ul style="list-style-type: none"> ↓ Lower ↑ Upper 	<ul style="list-style-type: none"> ▲ Front Side ▼ Rear Side ▲▼ Front + Rear Side 	<ul style="list-style-type: none"> →← Inner ↔ Outer → ← Center 																																
<ul style="list-style-type: none"> ↓ Lower ↑ Upper 	<ul style="list-style-type: none"> ▲ Front Side ▼ Rear Side ▲▼ Front + Rear Side 	<ul style="list-style-type: none"> →← Inner ↔ Outer → ← Center 																																			
STEP 4: APPLICATION CRITERIA	Check Application Criteria*	<p>Picto's explanation: see left page</p> <p> </p> <p>*The indicated Monroe® part will only fit the vehicle that meets with all the correct data listed</p> <p> <input checked="" type="checkbox"/> Complete part <input type="checkbox"/> Without ball joint, incl. bushing <input type="checkbox"/> KIT Kit with more components </p>																																			
STEP 5: FITTING POSITION	Check where the part fits on the vehicle	<table style="width: 100%; border: none;"> <tr> <td style="width: 20%; text-align: center;">L12203</td> <td style="width: 20%; text-align: center;">← →</td> <td style="width: 20%; text-align: center;">OPA</td> <td style="width: 20%; text-align: center;">L12203</td> <td style="width: 20%; text-align: center;">L12203</td> </tr> <tr> <td></td> <td style="text-align: center;">L12203 L12203</td> <td style="text-align: center;">2</td> <td>LEFT/RIGHT</td> <td></td> </tr> <tr> <td style="text-align: center;">L10116</td> <td style="text-align: center;">L10115</td> <td style="text-align: center;">1</td> <td>RIGHT</td> <td style="text-align: center;">L10115</td> </tr> <tr> <td></td> <td style="text-align: center;">L10116</td> <td style="text-align: center;">1</td> <td>LEFT</td> <td></td> </tr> <tr> <td style="text-align: center;">L11829</td> <td style="text-align: center;">L11829</td> <td style="text-align: center;">1</td> <td>LEFT + RIGHT</td> <td></td> </tr> <tr> <td></td> <td style="text-align: center;">L2370</td> <td style="text-align: center;">1</td> <td>CENTER ONLY</td> <td></td> </tr> <tr> <td></td> <td></td> <td></td> <td></td> <td></td> </tr> </table>	L12203	← →	OPA	L12203	L12203		L12203 L12203	2	LEFT/RIGHT		L10116	L10115	1	RIGHT	L10115		L10116	1	LEFT		L11829	L11829	1	LEFT + RIGHT			L2370	1	CENTER ONLY						
L12203	← →	OPA	L12203	L12203																																	
	L12203 L12203	2	LEFT/RIGHT																																		
L10116	L10115	1	RIGHT	L10115																																	
	L10116	1	LEFT																																		
L11829	L11829	1	LEFT + RIGHT																																		
	L2370	1	CENTER ONLY																																		
STEP 6: THREAD	Check Thread info	<table style="width: 100%; border: none;"> <tr> <td style="width: 50%; border: none;"> <p>M 14x1,5 / M 18x1,5</p> <p>F 16x1,5</p> <p>M 14x1,5 ♂</p> <p>M 14x1,5 ♀</p> </td> <td style="width: 50%; border: none;"> <p>M = Male Thread</p> <p>F = Female Thread</p> <p>♂ = Right Turning Thread</p> <p>♀ = Left Turning Thread</p> </td> </tr> </table>	<p>M 14x1,5 / M 18x1,5</p> <p>F 16x1,5</p> <p>M 14x1,5 ♂</p> <p>M 14x1,5 ♀</p>	<p>M = Male Thread</p> <p>F = Female Thread</p> <p>♂ = Right Turning Thread</p> <p>♀ = Left Turning Thread</p>																																	
<p>M 14x1,5 / M 18x1,5</p> <p>F 16x1,5</p> <p>M 14x1,5 ♂</p> <p>M 14x1,5 ♀</p>	<p>M = Male Thread</p> <p>F = Female Thread</p> <p>♂ = Right Turning Thread</p> <p>♀ = Left Turning Thread</p>																																				
STEP 7: PART OF	Check for which Part Number this is a component	<p>The bushing L12800 fits to the Track Control Arm L12603</p> <p style="text-align: right;">Part Of</p> <p style="text-align: center;">L12800 L12603</p>																																			
STEP 8: OE NUMBER	Check indicative OE number	<p>! Only 1 OE is given, the Monroe Part Number might be equivalent to many OE numbers</p> <p>To know the complete list, check the OE-crosslist at the back of the Catalogue</p> <p>To know the most recent OE-cross updates, check TecDoc or on-line Catalogue</p>																																			

Universal type

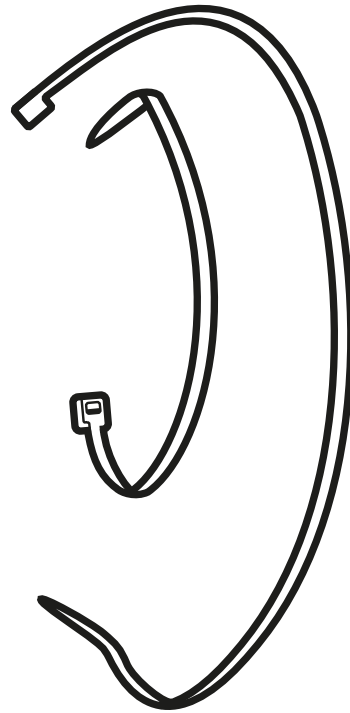
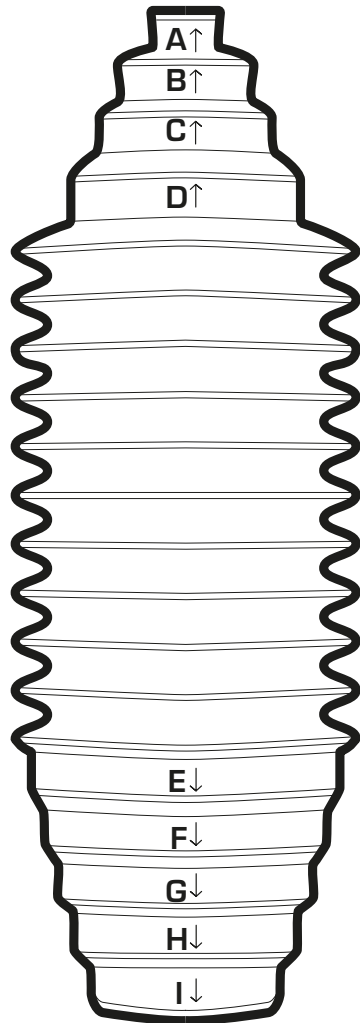

A	Ø 12 mm
B	Ø 24 mm
C	Ø 32 mm
D	Ø 42 mm
E	Ø 54 mm
F	Ø 48 mm
G	Ø 42 mm
H	Ø 38 mm
I	Ø 30 mm

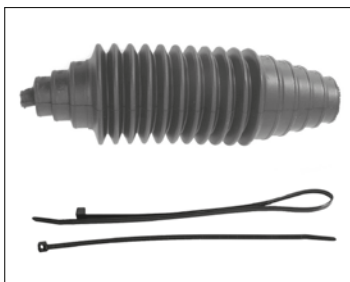

Monroe-Nr. L0001 = Universal type

Monroe-Nr. L.....

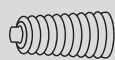

See catalogue

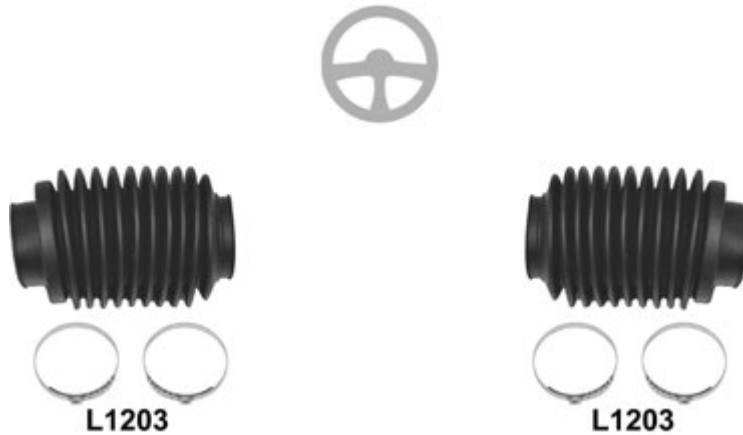
ALFA ROMEO
Alfasud 06.72 → 12.89

Thread

Part Of

QPA

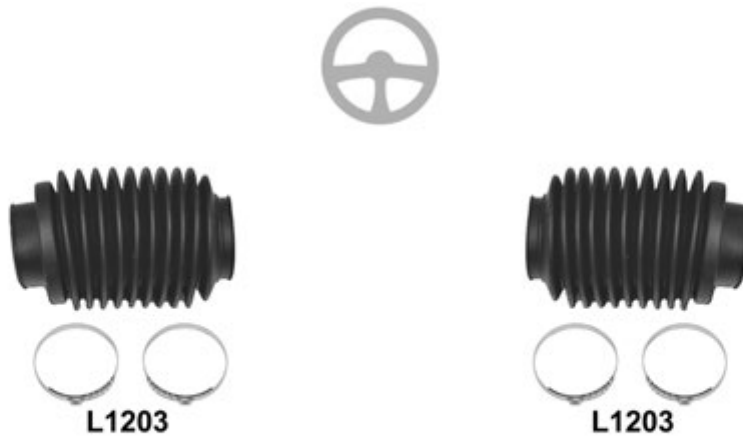

			L1203	L1203			2	102962
--	--	--	-------	-------	--	--	---	--------

Alfa 33 01.81 → 09.94
Arna 01.85 → 12.86

MK035

L1204

L1204

MK035

Thread

Part Of

QPA



			L1203	L1203			2	102962
		↓	L1204	L1204			2	545069
		Alfa 33 → 01.93, ch. → 5455777	KIT	MK035	MK035		2	60504729

Alfa 75 (162B) 05.85 → 02.92
 Alfa 90 05.85 → 09.92
 Alfetta (116) 1.6, 1.8, 2.0 → 12.84
 Alfona 1983 →
 Giulietta (116) 1.3, 1.6 10.77 → 12.85

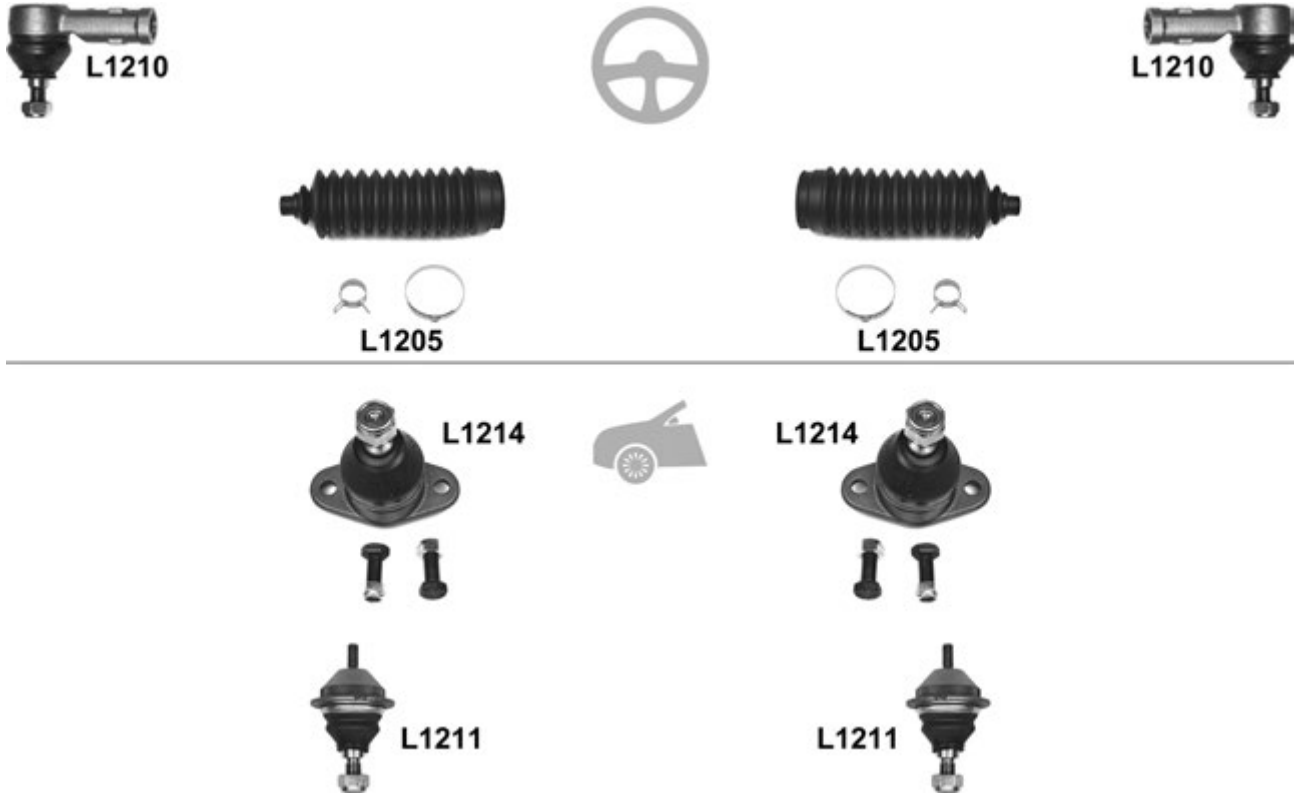

				←	→	Thread	Part Of	QPA	
		↔		L1210	L1210	F 14x1,5 ♂		2	116002404101
				L1205	L1205			2	1160023002
		↑	10.79 →	L1214	L1214			2	116462109700
		↓		L1211	L1211			2	116002101907

Brera 01.06 →

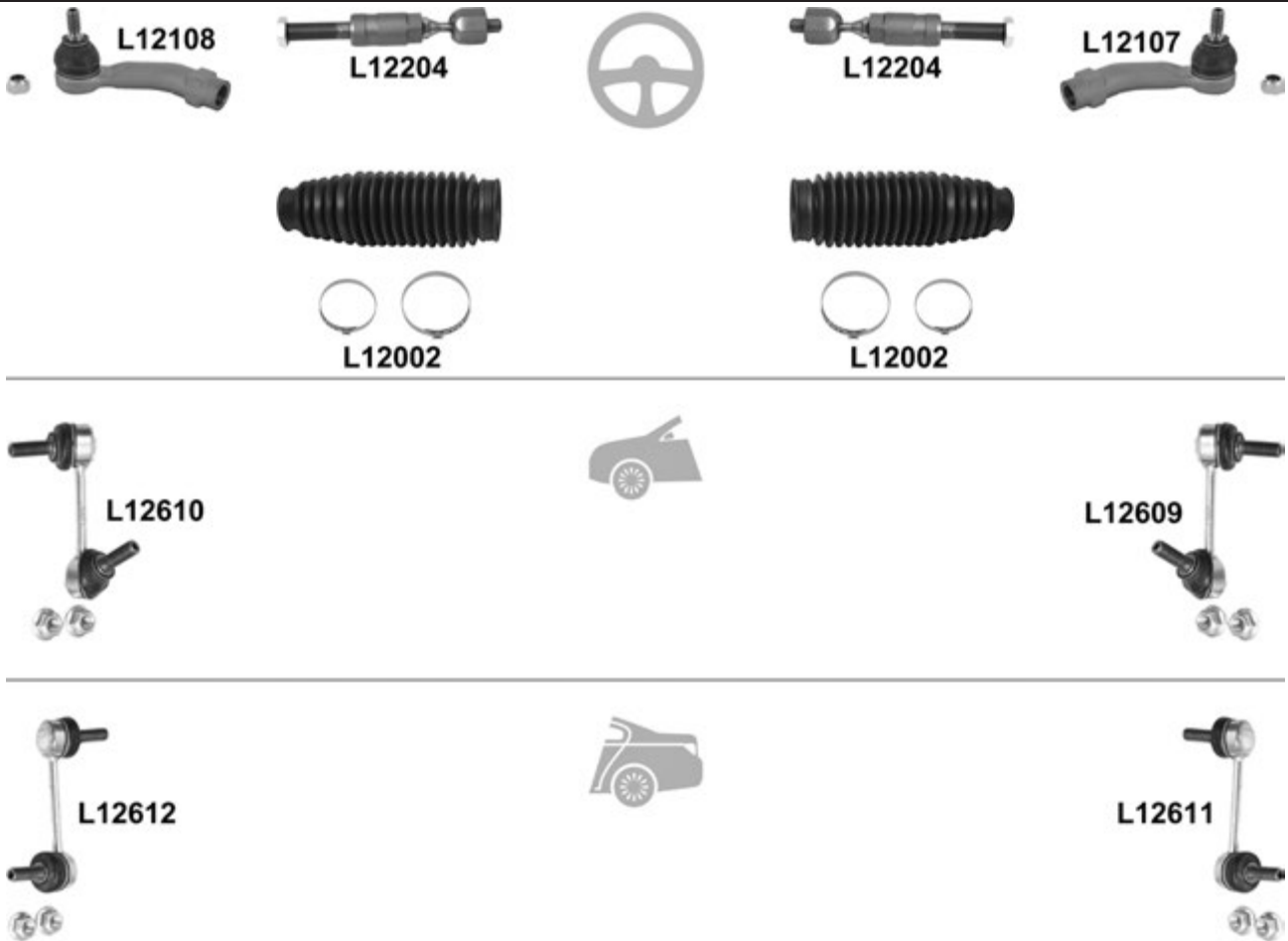

		i	←	→	Thread	Part Of	QPA	i
		↔		L12107	F 20x1,5 ∪		1	77363707
				L12108	F 20x1,5 ∪		1	77363706
		→ 09.08		L12204	L12204	M 20x1,5 / M 16x1,5 ∪	2	
				L12002	L12002		2	77363705
				L12609			1	50704362
				L12610			1	50704361
				L12611			1	51795704
				L12612			1	51795703

GT 11.03 →

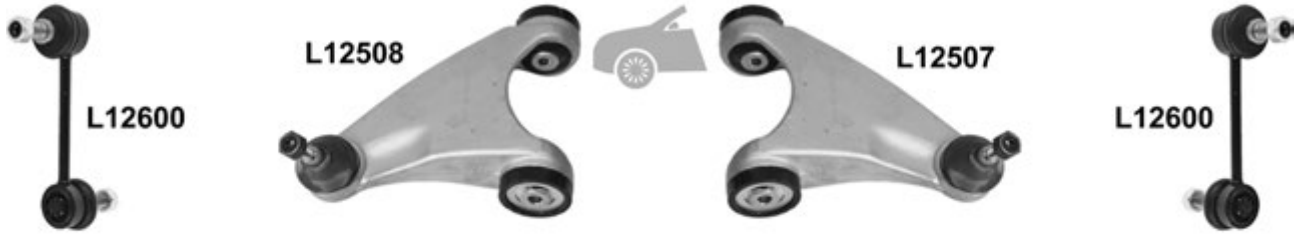

		i		←	→	Thread	Part Of	QPA	i
⊕		↔	→ 03.07		L12103	F 14x1,5 ∪		1	9947920
					L12104	F 14x1,5 ∪		1	9947919
					L12203	L12203	M 14x1,5 / M 16x1,5 ∪	2	9944452
		↑		<input checked="" type="checkbox"/>	L12507			1	60657246
					L12508			1	60657245
				<input checked="" type="checkbox"/>	L12505			1	60652466
			L12506			1	60652465		
			L12600	L12600		2	60625029		
			MK349	MK349		2			
		longitudinal			L12513			1	60651934
					L12514			1	60651935
		▼	L= 592mm	L12603	L12603		2	60652167	
		▲	L= 560mm	L12602	L12602		2	60629903	
				L12605	L12605		2	46843389	
			KIT	MK200	MK200		2	46791956	

GTV (916C) 09.94 →

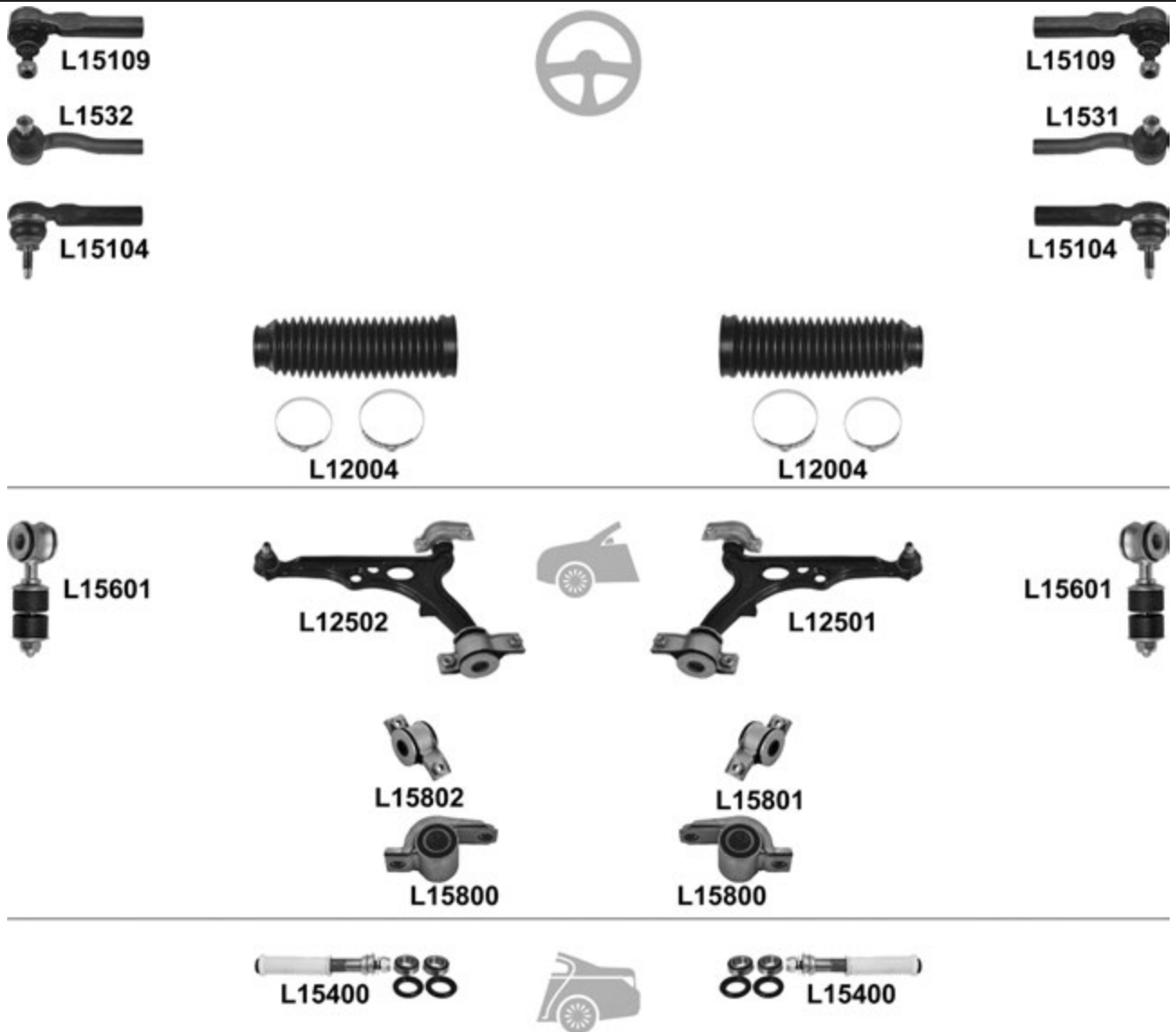

				←	→	Thread	Part Of	QPA			
		↔	(-) 2.0 V6 Turbo / 3.0 V6, L= 107mm	L15109	L15109	F 14x1,5 ♂		2	9947719		
			06.95 → 10.97, 2.0 V6 Turbo / 3.0 V6, L= 128mm		L1531	F 12x1,5 ♂		1	9947438		
				L1532	F 12x1,5 ♂		1	9947437			
			11.97 →, 2.0 V6 Turbo / 3.0 V6, L= 110mm	L15104	L15104	F 14x1,5 ♂		2	9947926		
			∅ 12mm, ∅ 61mm, L= 210mm	L12004	L12004 ^o			2	9947921		
		⊥		<input checked="" type="checkbox"/>		L12501		1	60809814		
					L12502		1	60809813			
		▼				L15801			L12501	1	
						L15802			L12502	1	
		▲				L15800	L15800		L12501/L12502	2	
			(-) 3.0 V6	L15601	L15601			2	60809242		
			3.0 V6 → 09.98	L15601	L15601			2	60809242		
				KIT	L15400	L15400		2			

Giulietta (940) 04.10 →



				←	→	Thread	Part Of	QPA		
⊕		↔			L12109	F 16x1,5 ∪		1	50520353	
					L12110	F 16x1,5 ∪		1	50520352	
				L12205	L12205	M 16x1,5 / M 16x1,5 ∪		2		
		⊥			L12521	L12521		L12523/L12524	2	
			ch. → 7034861	<input checked="" type="checkbox"/>		L12523			1	50513442
		⊥			L12524			1	50513444	
		▼			L12803	L12803		L12523/L12524	2	55700751
		▲			L12804	L12804		L12523/L12524	2	55703312
				L10620	L10620			2	50515276	
				L12613	L12613			2	50515275	
				L12614	L12614			2	50515274	

Mito 09.08 →

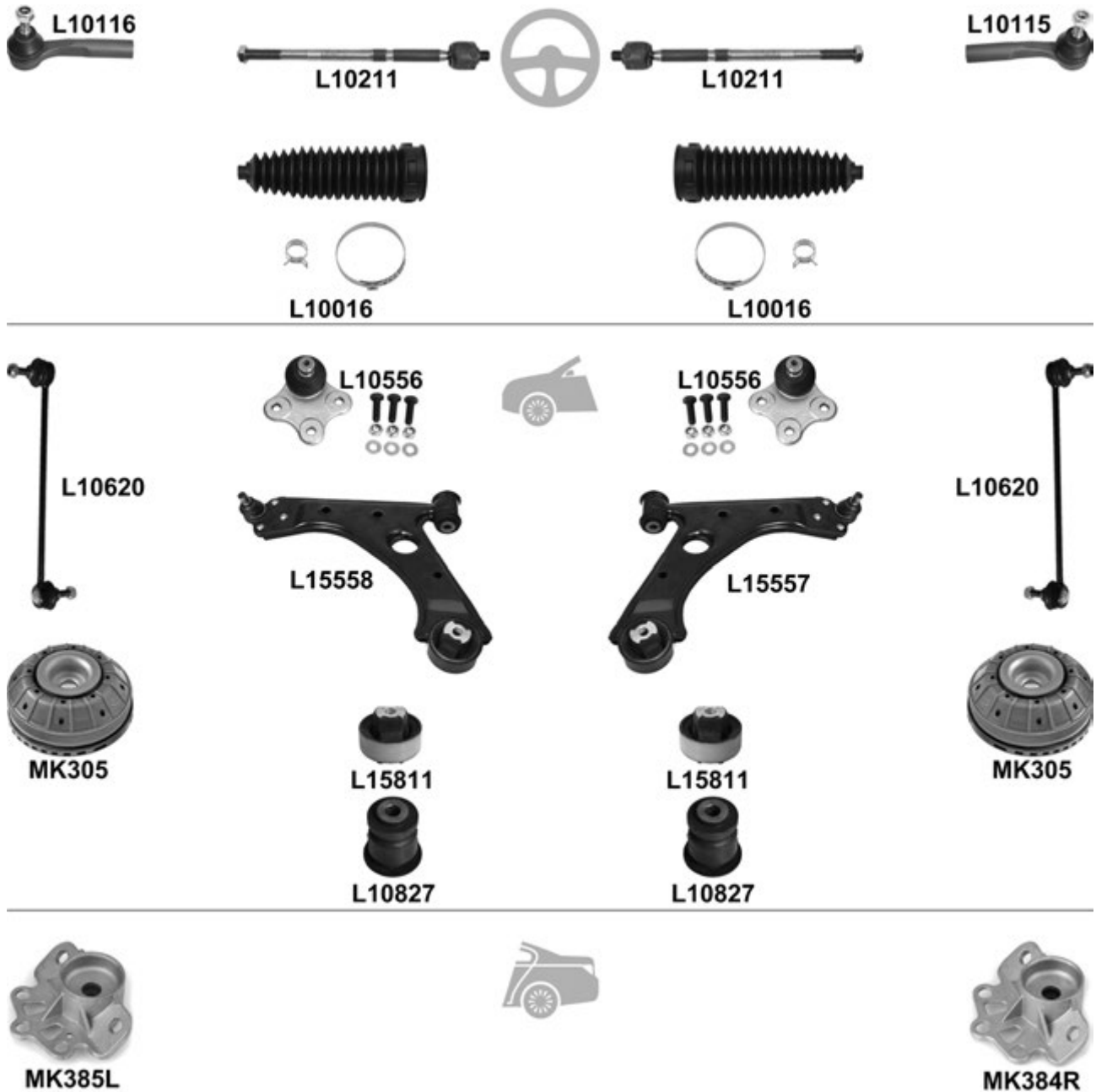

		i		←	→	Thread	Part Of	QPA	i
⊕		↔			L10115	F 14x1,5 ∪		1	77363830
					L10116	F 14x1,5 ∪		1	77363829
				L10211	L10211	M 14x1,5 / M 14x1,5 ∪		2	
					L10016	L10016			2
		↓			L10556	L10556		2	51783056
			<input checked="" type="checkbox"/>		L15557			1	55703627
		↓			L15558			1	55703629
			▼	L15811	L15811			2	55700751
		▲	L10827	L10827			2	55703312	
					L10620	L10620		2	55700753
	↻		KIT	MK305	MK305		2	50510134	
		→ 10.09			MK384R		1	55701901	
				MK385L			1	55701902	

Spider (916S) 09.94 → 04.05



		i		←	→	Thread	Part Of	QPA	i		
		↔	→ 04.95, (-) 3.0 V6		L1531	F 12x1,5 ∪		1	9947438		
				L1532	F 12x1,5 ∪		1	9947437			
			05.95 →, (-) 3.0 V6, L= 107mm	L15109	L15109	F 14x1,5 ∪		2	9947719		
		⊥		<input checked="" type="checkbox"/>		L12501			1	60809814	
						L12502			1	60809813	
						L15801			L12501	1	
						L15802			L12502	1	
						L15800	L15800		L12501/L12502	2	
		↕			L15601	L15601		2	60809242		
				KIT	L15400	L15400		2			

Spider 09.06 →

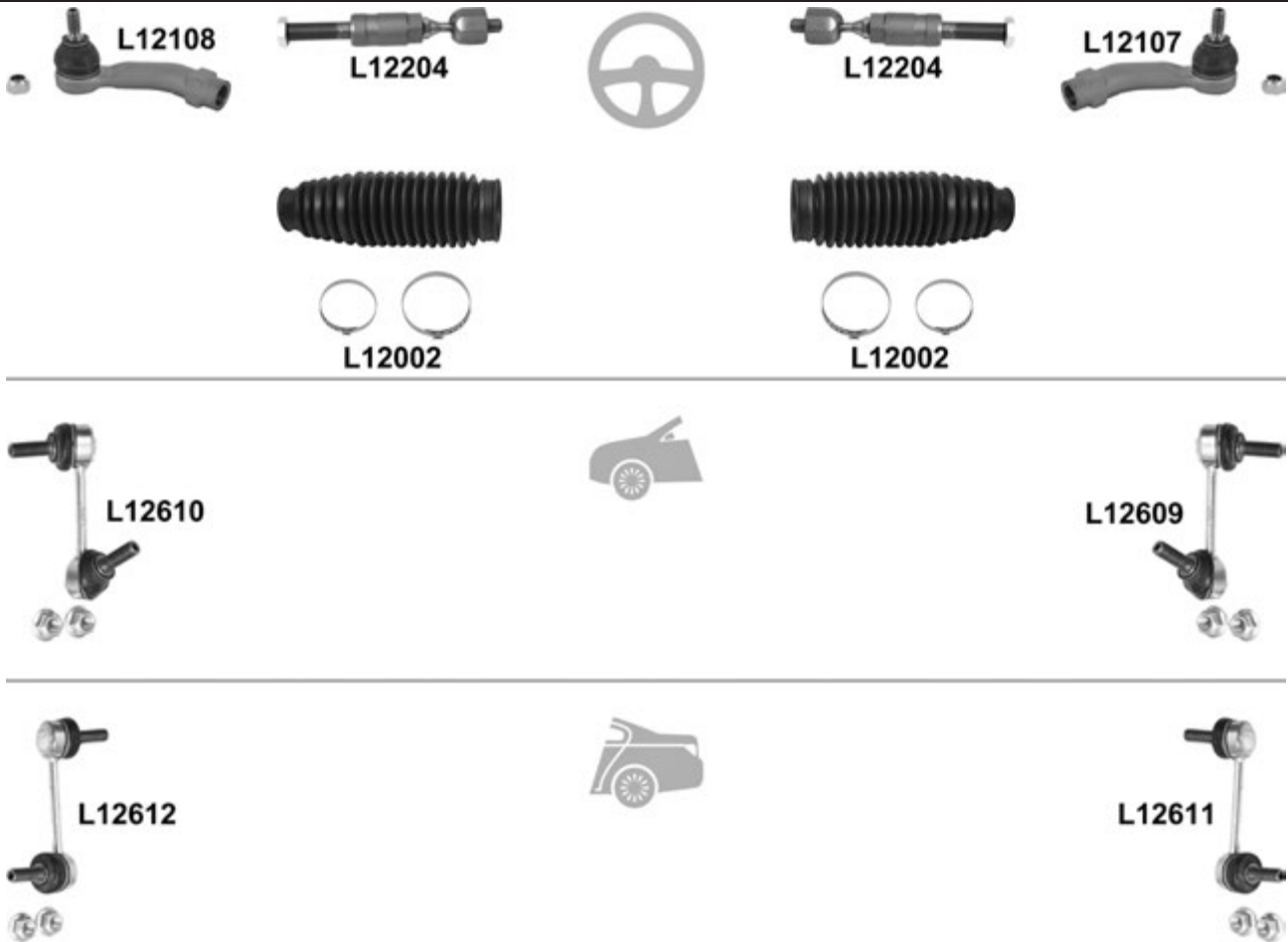

				←	→	Thread	Part Of	QPA		
⊕		↔			L12107	F 20x1,5 ∪		1	77363707	i
					L12108	F 20x1,5 ∪		1	77363706	
				L12204	L12204	M 20x1,5 / M 16x1,5 ∪		2		
			→ 09.08	L12002	L12002			2	77363705	
⊖					L12609			1	50704362	
					L12610			1	50704361	
⊖					L12611			1	51795704	
					L12612			1	51795703	

145 10.94 → 01.01
 146 08.95 → 01.01

				← → Thread		Part Of	QPA			
⊕	↔	↔	Boxer Engine 1.4, 1.6, 1.7, 1.8		L12101		1	60608980		
					L12102		1	60609979		
					L1531	F 12x1,5 ∪	1	7591216		
					L1532	F 12x1,5 ∪	1	7591215		
			1.7 T.S., 1.9 JTD, 2.0 T.S.	L15109	L15109	F 14x1,5 ∪	2	9947714		
⊖	⊖	⊖	☑		L12501		1	60809814		
					L12502		1	60809813		
					L15801			L12501	1	
					L15802			L12502	1	
					L15800	L15800		L12501/L12502	2	
				L15601	L15601		2	6057627		
				MK007	MK007		2	7601502		
⊖	⊖		KIT	L15400	L15400		2			

147 (937) 01.01 →

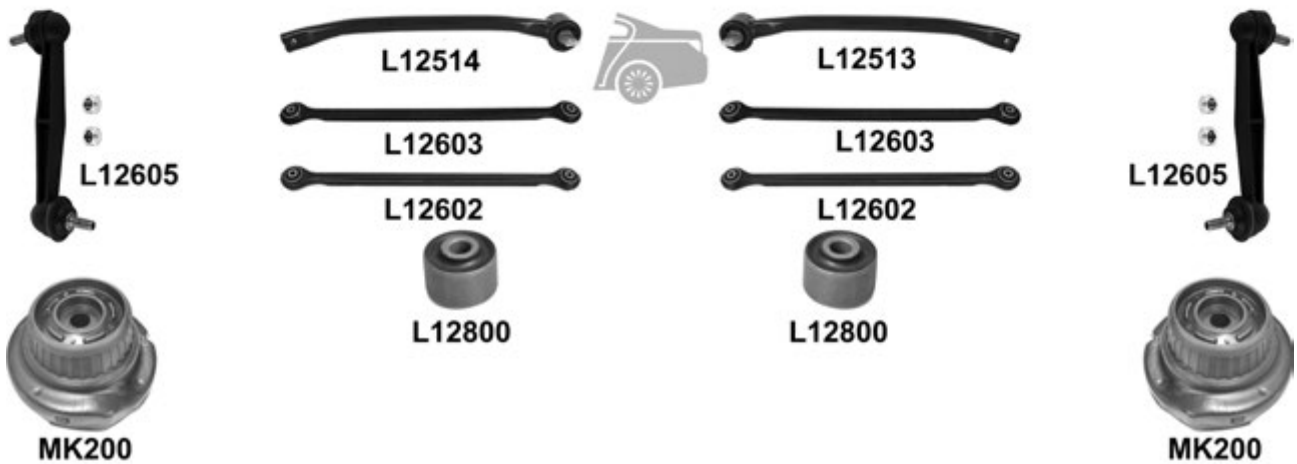
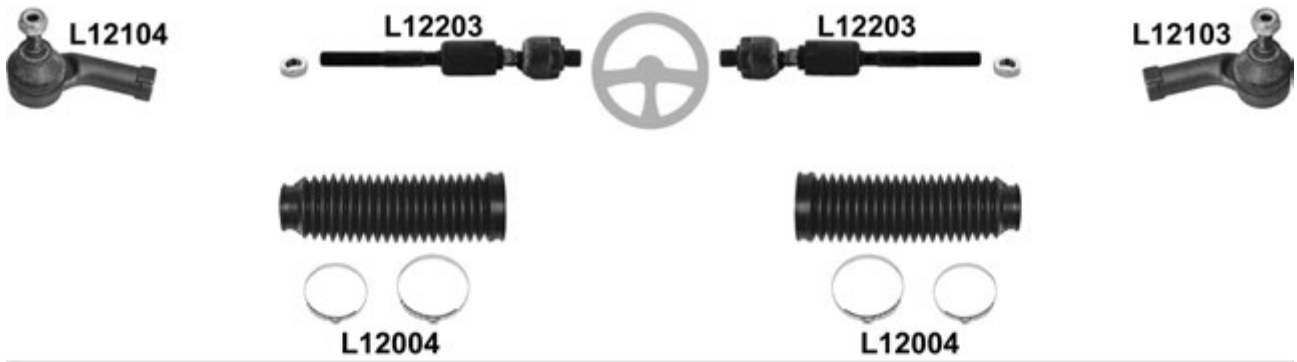

				← → Thread		Part Of	QPA			
⊕		↔		L12103	F 14x1,5 ∪		1	9947920		
				L12104	F 14x1,5 ∪		1	9947919		
		∅ 12mm, ∅ 61mm, L= 210mm		L12203	L12203	M 14x1,5 / M 16x1,5 ∪		2	9944452	
				L12004 ^o	L12004 ^o			2	9947921	
⊖		↑	<input checked="" type="checkbox"/>		L12507			1	60657246	
				L12508				1	60657245	
	↓	<input checked="" type="checkbox"/>		L12505				1	60652466	
			L12506				1	60652465		
				L12600	L12600			2	60625029	
				MK349	MK349			2		

147 (937) 01.01 →

			i	←	→	Thread	Part Of	QPA	i
		longitudinal		L12800	L12800		L12603	2	60652712
					L12513				1
			L12514					1	60651935
	▼	L= 592mm	L12603	L12603				2	60652167
	▲	(-) 3.2, L= 560mm	L12602	L12602				2	60629903
			L12605	L12605				2	46843389
		MK200	MK200				2	46791956	

155 (167) 02.92 → 09.05

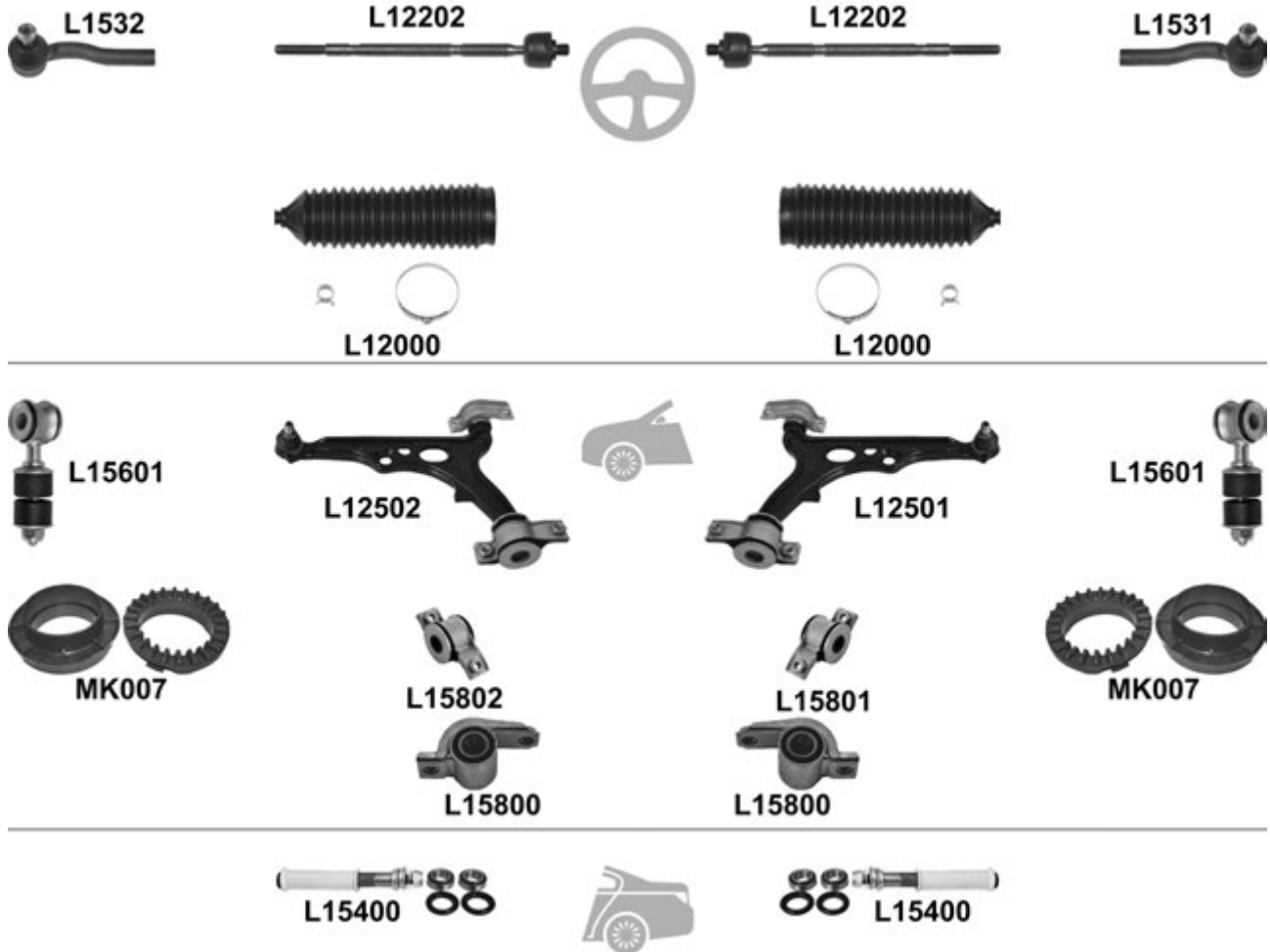

			i	←	→	Thread	Part Of	QPA	i	
		↔	(-) 2.0 16V Turbo Q4 / 2.5 V6 / 2.5 TD, L= 128mm		L1531	F 12x1,5 ∪		1	9947438	
					L1532	F 12x1,5 ∪		1	9947437	
					L12202	L12202	M 12x1,5 / M 14x1,5 ∪		2	9944452
					L12000°	L12000°			2	9944453
		↓		<input checked="" type="checkbox"/>	L12501			1	60586772	
					L12502			1	60586771	
		▼				L15801		L12501	1	
						L15802		L12502	1	
		▲				L15800	L15800	L12501/L12502	2	
						L15601	L15601		2	6057627
					MK007	MK007		2	7601502	
			KIT	L15400	L15400			2		

156 (932) 09.97 → 09.05

156 Sportswagon (932) 05.00 → 05.06

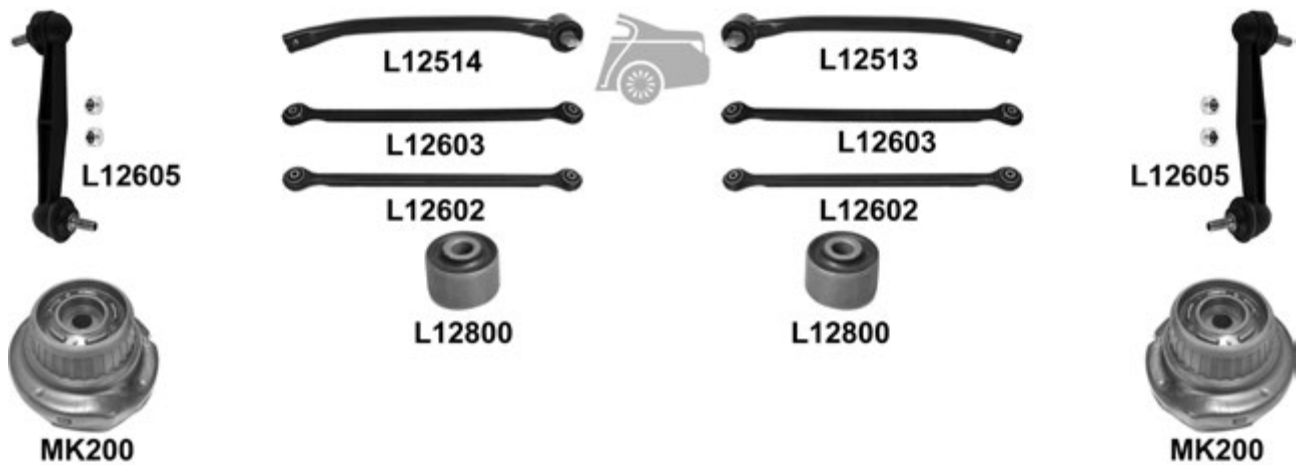
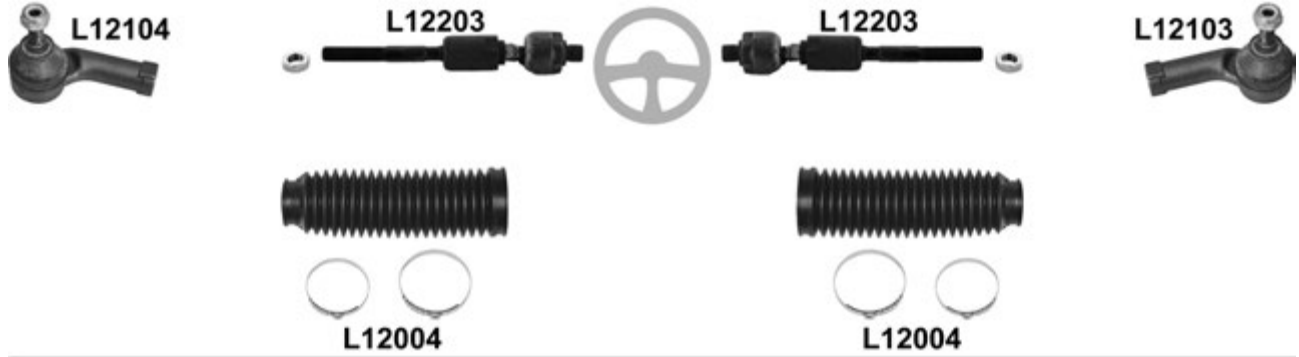

				←	→	Thread	Part Of	QPA				
		↔			L12103	F 14x1,5 ♂		1	9947920			
					L12104	F 14x1,5 ♂		1	9947919			
			∅ 12mm, ∅ 61mm, L= 210mm			L12203	L12203	M 14x1,5 / M 16x1,5 ♂		2	9944452	
						L12004 ⁰	L12004 ⁰			2	9947921	
		↑		<input checked="" type="checkbox"/>	L12507			1	60657246			
				<input checked="" type="checkbox"/>	L12508			1	60657245			
		↓		<input checked="" type="checkbox"/>	L12505			1	60652466			
					L12506			1	60652465			
				L12600	L12600			2	60625029			
					MK349	MK349		2				

156 (932) 09.97 → 09.05
156 Sportswagon (932) 05.00 → 05.06

				←	→	Thread	Part Of	QPA	i
		longitudinal		L12800	L12800		L12603	2	60652712
					L12513			1	60651934
				L12514			1	60651935	
		▼	L= 592mm	L12603	L12603			2	60652167
		▲	(-) 3.2, L= 560mm	L12602	L12602			2	60629903
				L12605	L12605			2	46843389
		(-) 156 Sportswagon	MK200	MK200			2	46791956	

159 (140) 09.05 →
159 (140) Sportswagon 03.06 →

				←	→	Thread	Part Of	QPA	i
		↔			L12107	F 20x1,5 ∪		1	77363707
				L12108		F 20x1,5 ∪		1	77363706
				L12204	L12204	M 20x1,5 / M 16x1,5 ∪		2	
			→ 12.06, ø 34mm, Ø 51mm, L= 196mm	L12002	L12002			2	77363705
					L12609			1	50704362
					L12610			1	50704361
					MK362	MK362		2	
					L12611			1	51795704
					L12612			1	51795703

164 06.87 → 09.98

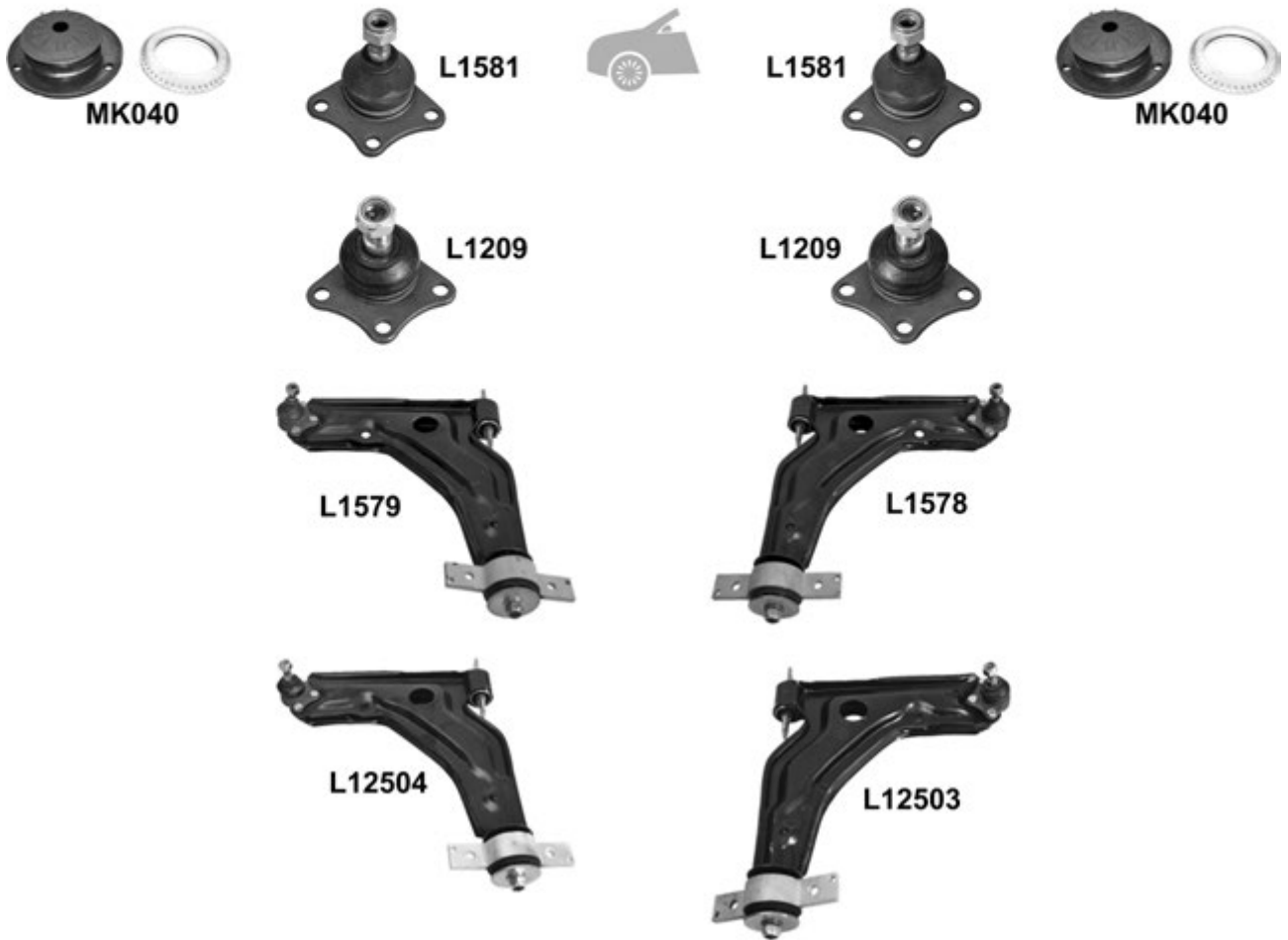
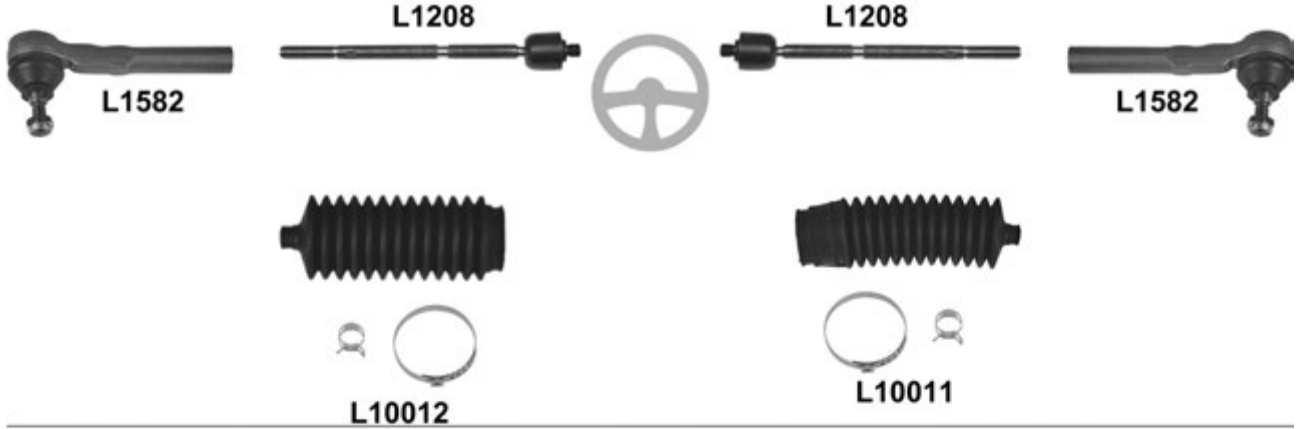

164 06.87 → 09.98



MK116



MK116

				← → Thread		Part Of	QPA	
⊕		↔		L1582	L1582	F 14x1,5 U	2	60511622
				L1208	L1208	M 14x1,5 / M 14x1,5	2	60507910
			⊕ → 12.90, * OE 9938779=set of 2		L10011		1	9938779*
				L10012			1	9938779*
🚗		⊥	Twin Spark / TD	L1581	L1581		2	82398170
			Turbo / 3000 6V	L1209	L1209		2	60510360
		⊥	Twin Spark / TD, → 12.91		L1578		1	60801529
					L1579		1	60801528
			3.0 V6 / Turbo, → 12.91		L12503		1	60510362
				L12504			1	60510363
		2.0 Twin Spark → 10.90, 2.0 Turbo 4 cyl. KIT	MK040	MK040		2	60501446	
		3.0 V6 → 04.90, ch. → T 6183988, (-) Quadrifoglio /						
				MK116	MK116		2	60507954

166 (936) 09.98 →

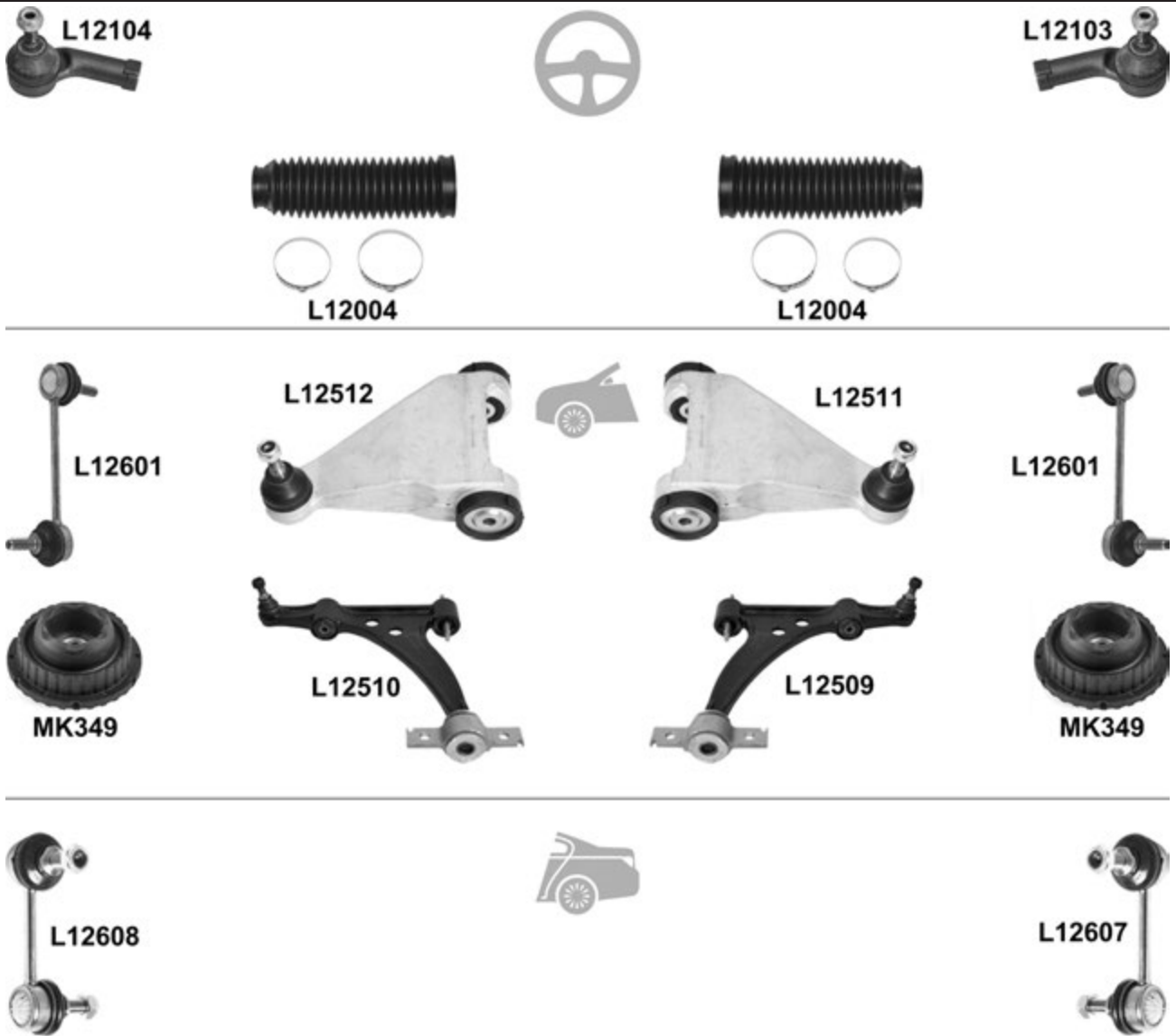

				←	→	Thread	Part Of	QPA	
		↔			L12103	F 14x1,5 ♂		1	9947920
					L12104	F 14x1,5 ♂		1	9947919
		↑	∅ 12mm, ∅ 61mm, L= 210mm		L12004 ^o	L12004 ^o		2	9947921
						L12511		1	60666020
						L12512		1	60666021
						L12509		1	60665805
						L12510		1	60665804
						L12601	L12601	2	60630757
		↓			MK349	MK349		2	
						L12607		1	60628255
						L12608		1	60628284

AUDI

Allroad (4BH) 05.00 → 08.05

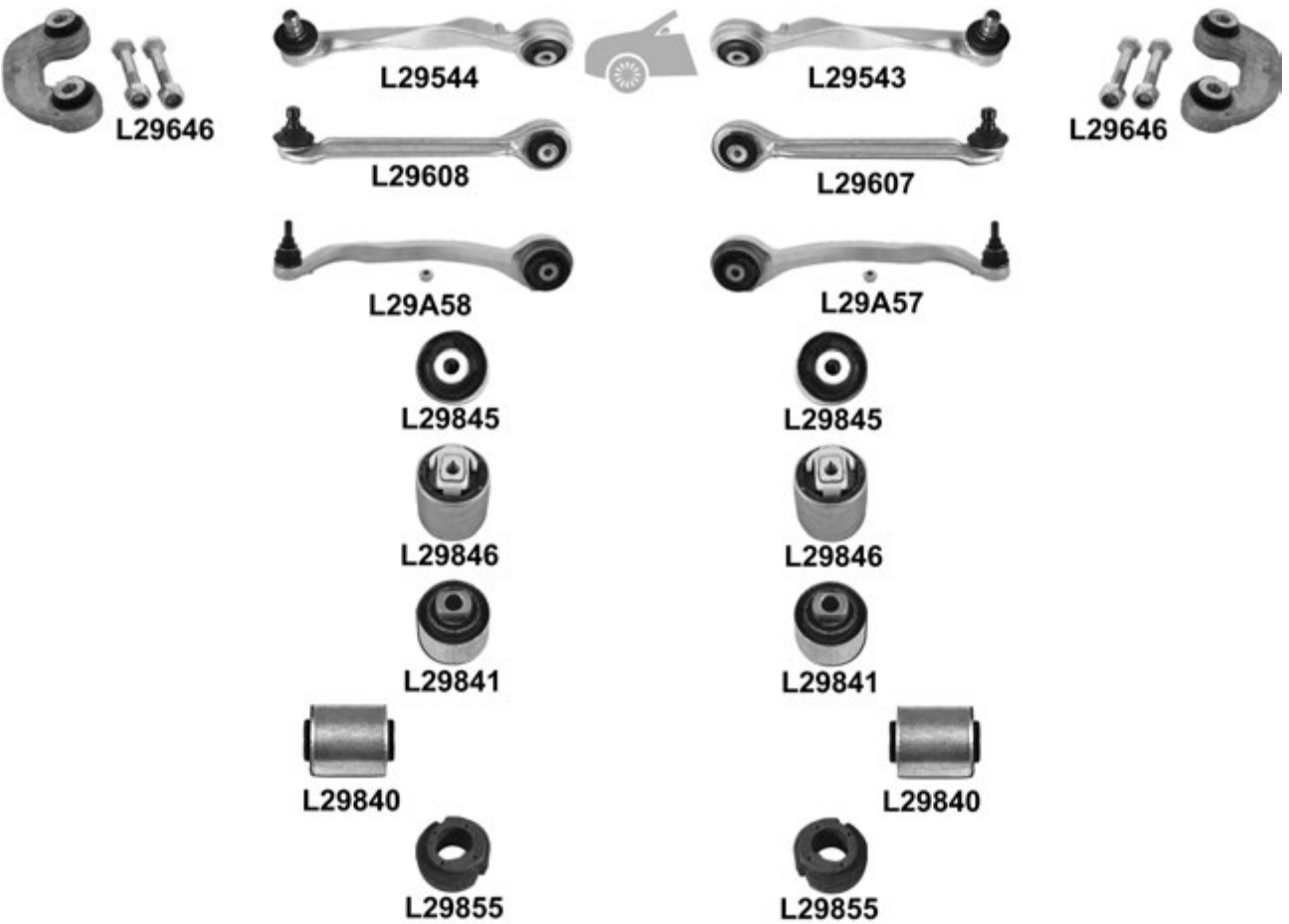
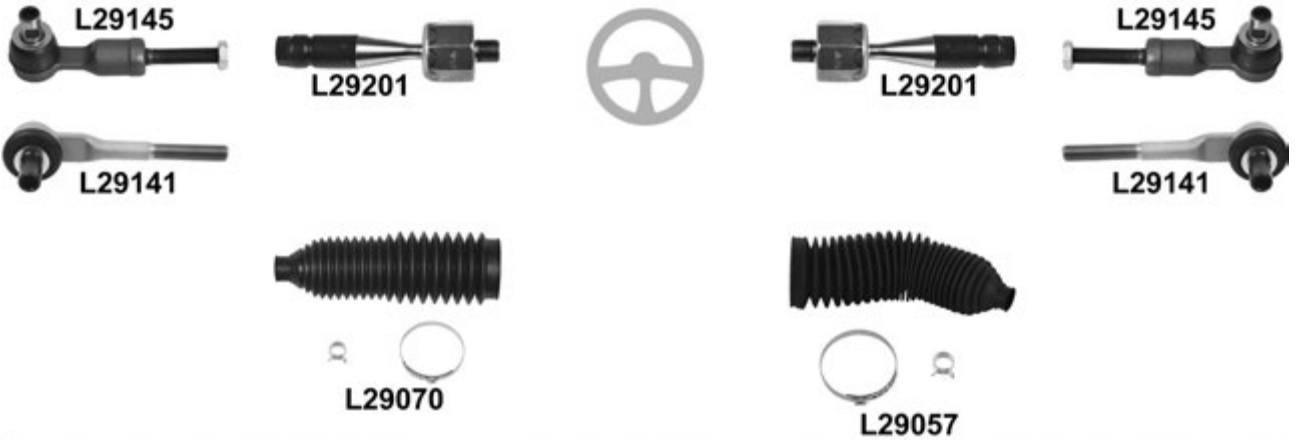

Allroad (4BH) 05.00 → 08.05

			←	→	Thread	Part Of	QPA		
		↔	→ 05.02, ch. → 4B 2 150 000	L29145	L29145	∪	2	4B0 419 811 E	
			06.02 →, ch. 4B 2 150 001 →	L29141	L29141	∪	2	4F0 419 811 C	
				L29201	L29201	F 14x1,5 / M 16x1,5 ∪	2	4B0 422 821	
			∅ 19mm, ∅ 63mm, L= 255mm		L29057			1	8D0 419 831 K
			∅ 20mm, ∅ 54mm, L= 205mm	L29070 ⁰				1	4D0 419 831 DE
		∩			L29543		1	8D0 407 510 C	
					L29544		1	8D0 407 509 C	
		∪				L29607		1	8E0 407 506 A
						L29608		1	8E0 407 505 A
		⊥				L29A57		1	4Z7 407 694 D
					L29A58		1	4Z7 407 693 D	
		∩	↔		L29845	L29845		4	4D0 407 515 C
			⊥		L29846	L29846		2	4D0 407 183 P
			↔		L29841	L29841		2	4D0 407 182 E
			↔		L29840	L29840		2	4D0 407 181 H
				L29646	L29646		2	4D0 411 317 K	
			∅ 27mm	L29855	L29855		Anti-roll bar	2	4D0 411 327 H
				L29663	L29663			2	8E0 505 465 D

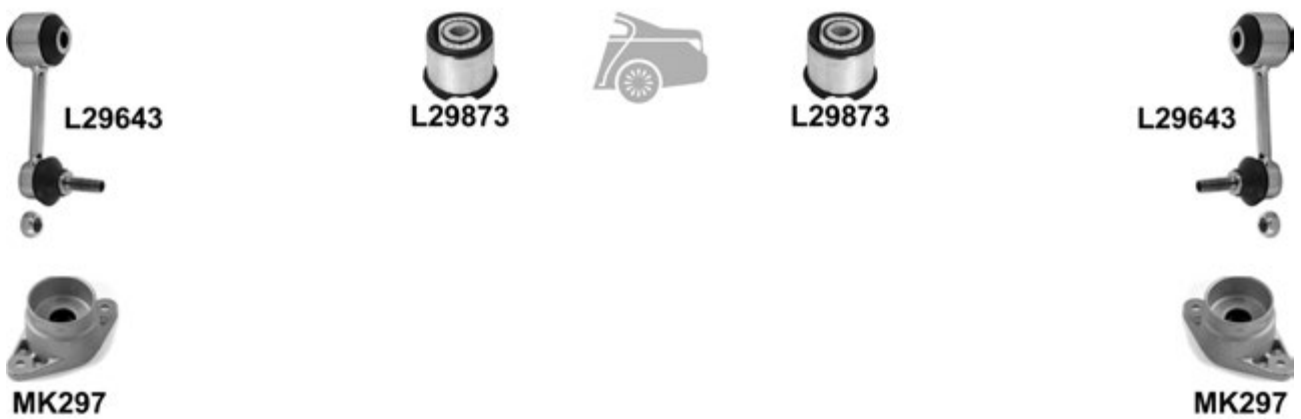
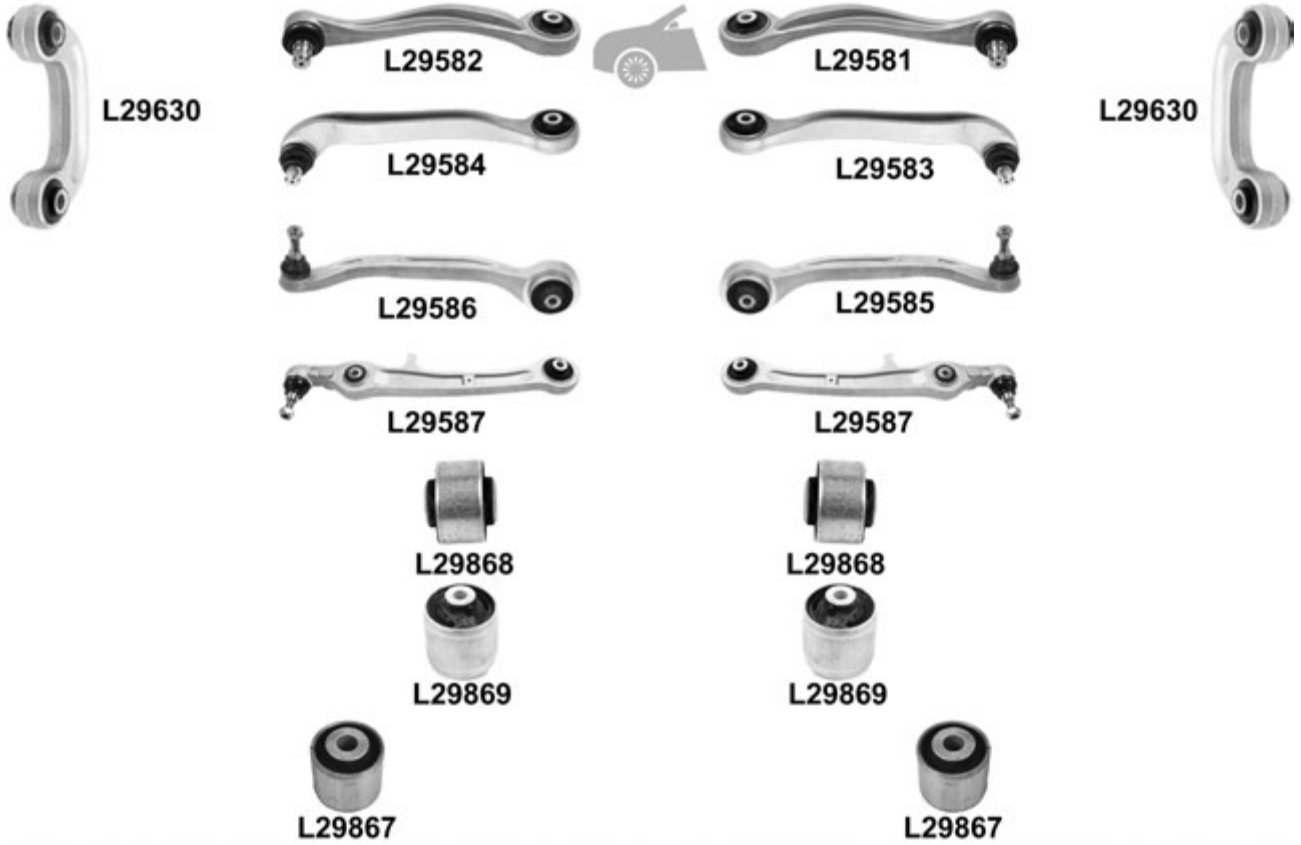
Allroad (4FH) 05.06 →

Allroad (4FH) 05.06 →

				←	→	Thread	Part Of	QPA		
		↔		L29141	L29141	⌀		2	4F0 419 811 C	
				L29218	L29218			2	4F0 422 821	
				L29061 °	L29061 °			2	4F0 422 831	
		ī ▼	→ 06.07, ch. → 4F8 018000		L29581			1	4E0 407 510 D	
				L29582				1	4E0 407 509 D	
		ī ▲			L29583			1	4E0 407 506 D	
				L29584				1	4E0 407 505 D	
		⊥ ▼			L29585			1	4F0 407 694 D	
			L29586				1	4F0 407 693 D		
			L29587	L29587			2	4F0 407 151		
		ī ▲ ▼ → ←			L29868	L29868		L29581/L29582/ L29583/L29584	4	8D0 407 515 C
		⊥ ▼ → ←			L29869	L29869			2	4F0 407 183 C
		⊥ ▲ → ←			L29867	L29867		L29587	2	4E0 407 181 B
				L29630	L29630			2	4E0 411 317 E	
		▼		L29873	L29873		Hub carrier	2	4F0 505 145 A	
				L29643	L29643			2	4F0 505 465 P	
				MK297	MK297			2	4F0 513 353 D	

A1 05.10 →
A1 Quattro 03.12 →

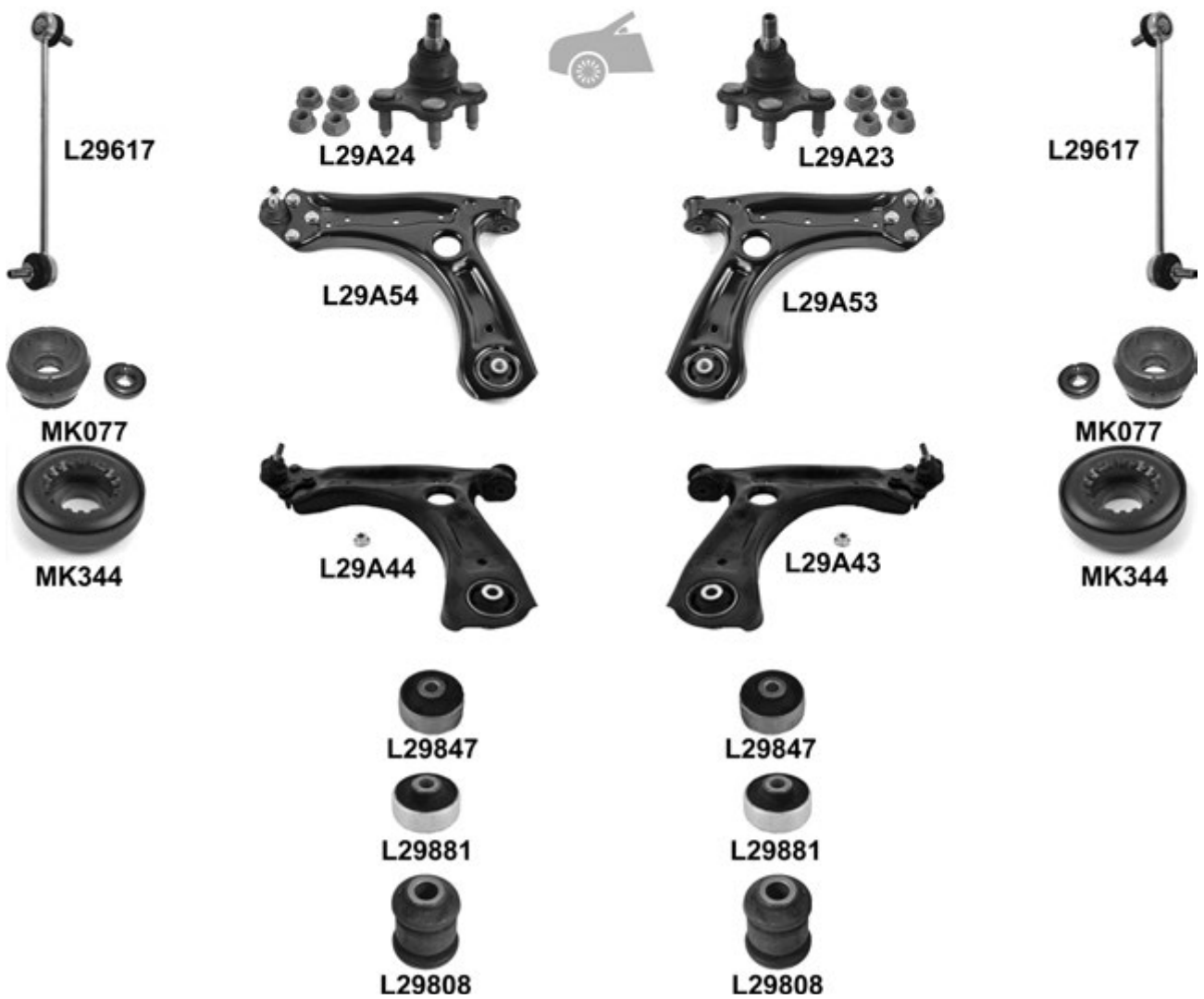
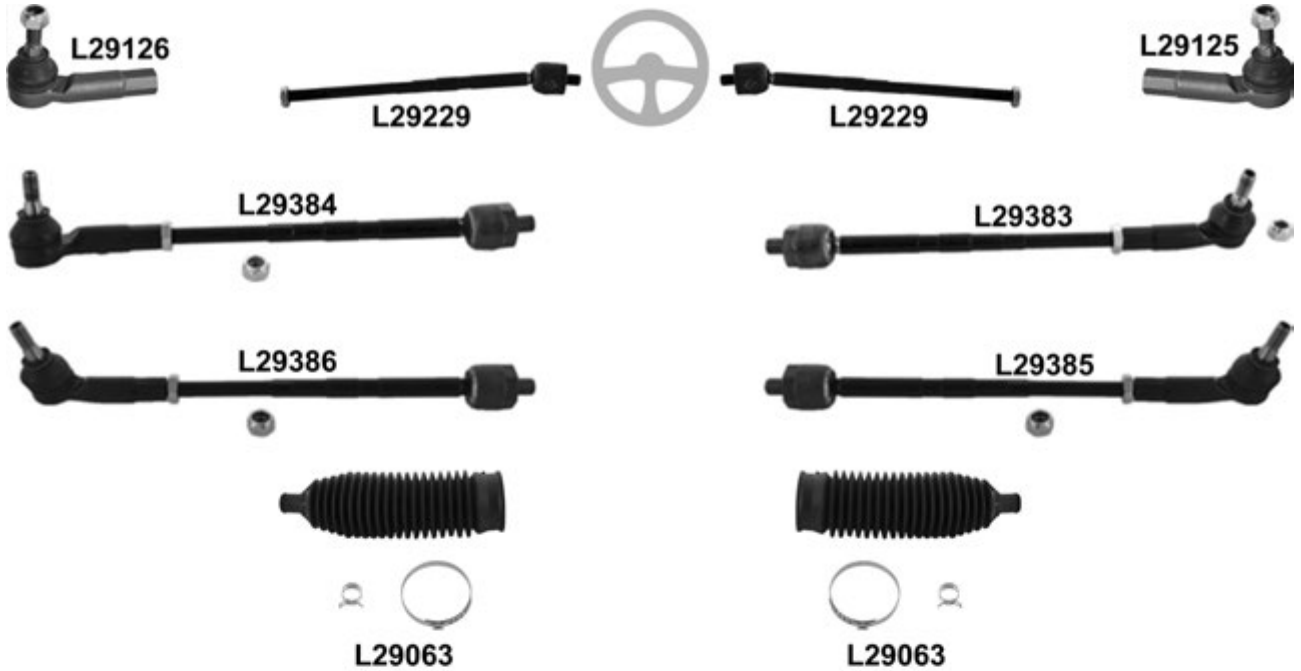

A1 05.10 →
 A1 Quattro 03.12 →

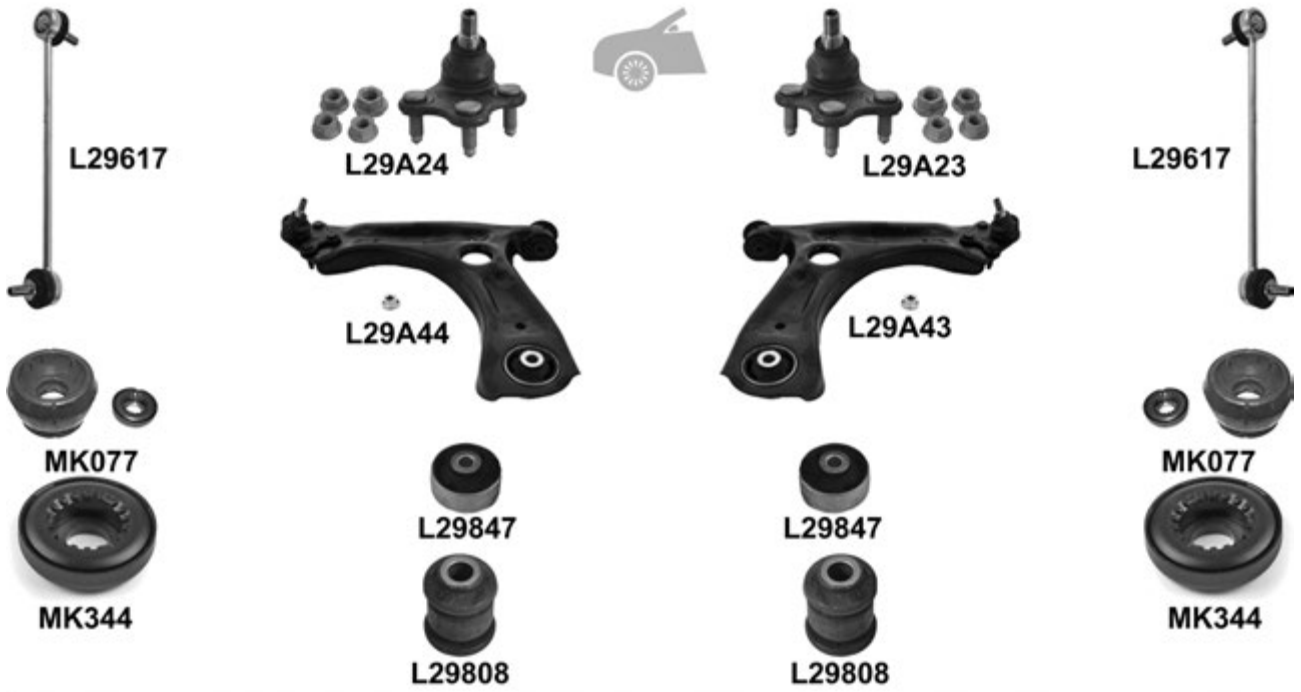
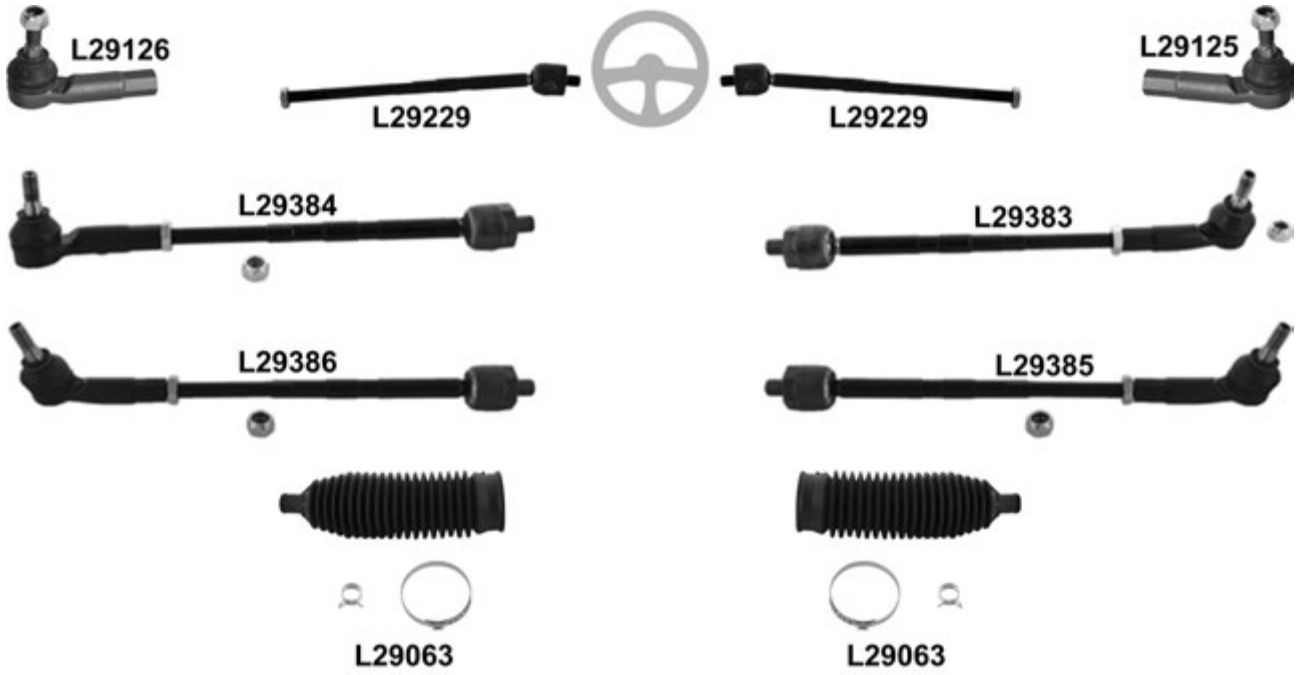

				← → Thread		Part Of	QPA					
⊕		↔			L29125		1	1J0 422 812 B				
					L29126		1	1J0 422 811 B				
					L29229	L29229	2	6R0 523 810				
						L29383	1	6R0 423 804 B				
						L29384	1	6R0 423 803 B				
				Quattro 2.0 TFSi		L29385 ⁰	1	6R0 423 804 D				
						L29386 ⁰	1	6R0 423 803 D				
				TRW, ø 14,5mm, Ø 47,5mm, L= 205mm		L29063 ⁰	L29063 ⁰	2	6Q0 423 831 D			
			🚗		⊥			L29A23		1	6R0 407 366	
								L29A24		1	6R0 407 365	
		L29A43					1	6R0 407 151 F				
	⊥	1.2 TFSi /1.4 TFSi G22/G23/G31/G32, 1.6 TDi Mot/Eng CAYB G22/G23/G26/G27/G31/G32 1.6 TDi Mot/Eng CAYC G22/G23/G31/G32 2.0 TDi G26/G27/G31/G32		<input checked="" type="checkbox"/>	L29A44		1	6R0 407 152 F				
				<input checked="" type="checkbox"/>	L29A53		1	6R0 407 151 B				
					L29A54		1	6R0 407 152 B				
				<input checked="" type="checkbox"/>	L29A43		1	6R0 407 151 F				
					L29A44		1	6R0 407 152 F				
					L29A43		1	6R0 407 151 F				
	⊥	(-) L 29A53/L29A54			L29847	L29847	2	1J0 407 181				
					L29881	L29881	2	8N0 407 181 B	L29A53/L29A54			
					L29808	L29808	2	357 407 182				
					L29617	L29617	2	6Q0 411 315 G				
		(+) MK344		KIT	MK077	MK077	2	1J0 412 331 BS				
					MK344	MK344	2	1J0 412 249				
🚗		⊥	Quattro	L29A11	L29A11	2	4K0 505 323 N					
			Quattro	L29A29	L29A29	2	1K0 505 311 AB					
			Quattro		L29A87 ⁰	1	1K0 505 224 K	Trailing Arm				
			L29A88 ⁰	1	1K0 505 222 K	Trailing Arm						
			Quattro	L29623	L29623	2	1K0 505 465 J					
			(-) Quattro		MK118	MK118	2	1J0 513 353 D				
				MK386	MK386	2	1K0 513 353 C					

A1 Sportback 11.11 →

A1 Sportback 11.11 →

				←	→	Thread	Part Of	QPA		
		↔			L29125			1	1J0 422 812 B	
					L29126			1	1J0 422 811 B	
					L29229	L29229		2	6R0 523 810	
					L29383			1	6R0 423 804 B	
					L29384			1	6R0 423 803 B	
		2.0 Tdi			L29385 ⁰			1	6R0 423 804 D	
					L29386 ⁰			1	6R0 423 803 D	
		TRW, ø 14,5mm, Ø 47,5mm, L= 205mm			L29063 ⁰	L29063 ⁰			2	6Q0 423 831 D
			⊥			L29A23			1	6R0 407 366
						L29A24			1	6R0 407 365
		⊥		<input checked="" type="checkbox"/>	L29A43			1	6R0 407 151 F	
					L29A44			1	6R0 407 152 F	
		⊥↘			L29847	L29847		2	1J0 407 181	
		⊥↗			L29808	L29808		2	357 407 182	
					L29617	L29617		2	6Q0 411 315 G	
		(+) MK344	KIT		MK077	MK077		2	1J0 412 331 BS	
					MK344	MK344		2	1J0 412 249	
				MK118	MK118		2	1J0 513 353 D		

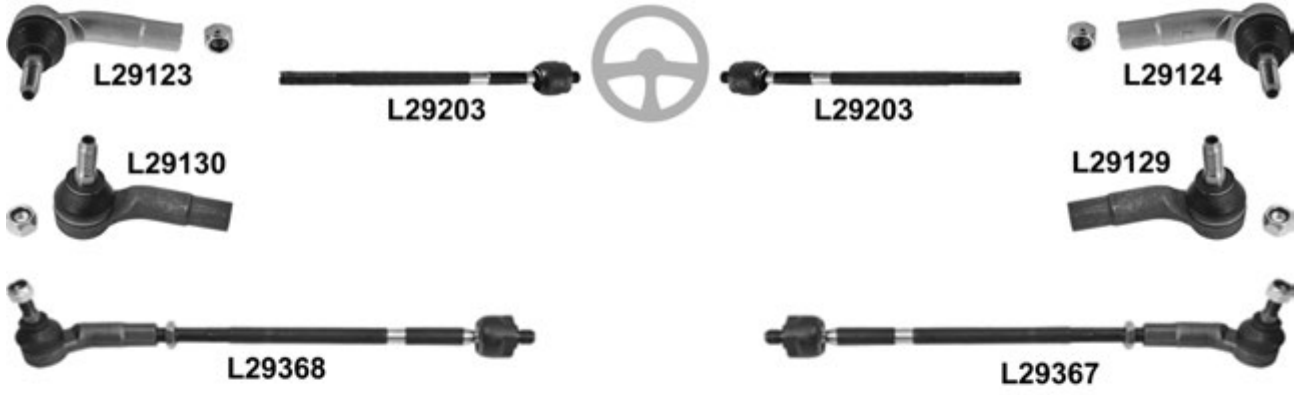
A2 (8Z0) 02.00 → 08.05



				←	→	Thread	Part Of	QPA		
⊕		↔	PR 1N6 / 1N8		L29124	F 14 x 1,5 ∪		1	820 419 812 A	
					L29123	F 14 x 1,5 ∪		1	820 419 811 A	
			PR 1N2		L29129	F 14x1,5 ∪		1	820 423 812 A	
					L29130	F 14x1,5 ∪		1	820 423 811 A	
			(-) 1.2 Tdi	L29203	L29203	M 14x1,5 / M 14x1,5 ∪		2	6N0 422 821 A	
			(-) 1.2 Tdi	L29367				1	6Q0 423 804 B	
		L29368				1	6Q0 423 803 B			
⊖		⊥	11.02 →, ch. 8Z 3 019 683 →, (-) 1.2 Tdi		L29563			1	6Q0 407 366 A	
					L29564			1	6Q0 407 365 A	
		⊥	(-) 1.2 Tdi/1.4 Tdi	L29887	L29887			2	1K0 407 183 E	
				L29858	L29858			2		
			(-) 1.2 Tdi	L29617	L29617			2	6Q0 411 315 D	
			1.4, Ø 18mm	L29883	L29883		Anti-roll bar	2	6Q0 411 314 R	
			(+) MK345	KIT	MK156	MK156		2	820 412 331	
			MK345	MK345		2	6N0 412 249 C			
			MK118	MK118		2	1J0 513 353 D			

A3 (8L1) 09.96 → 05.03

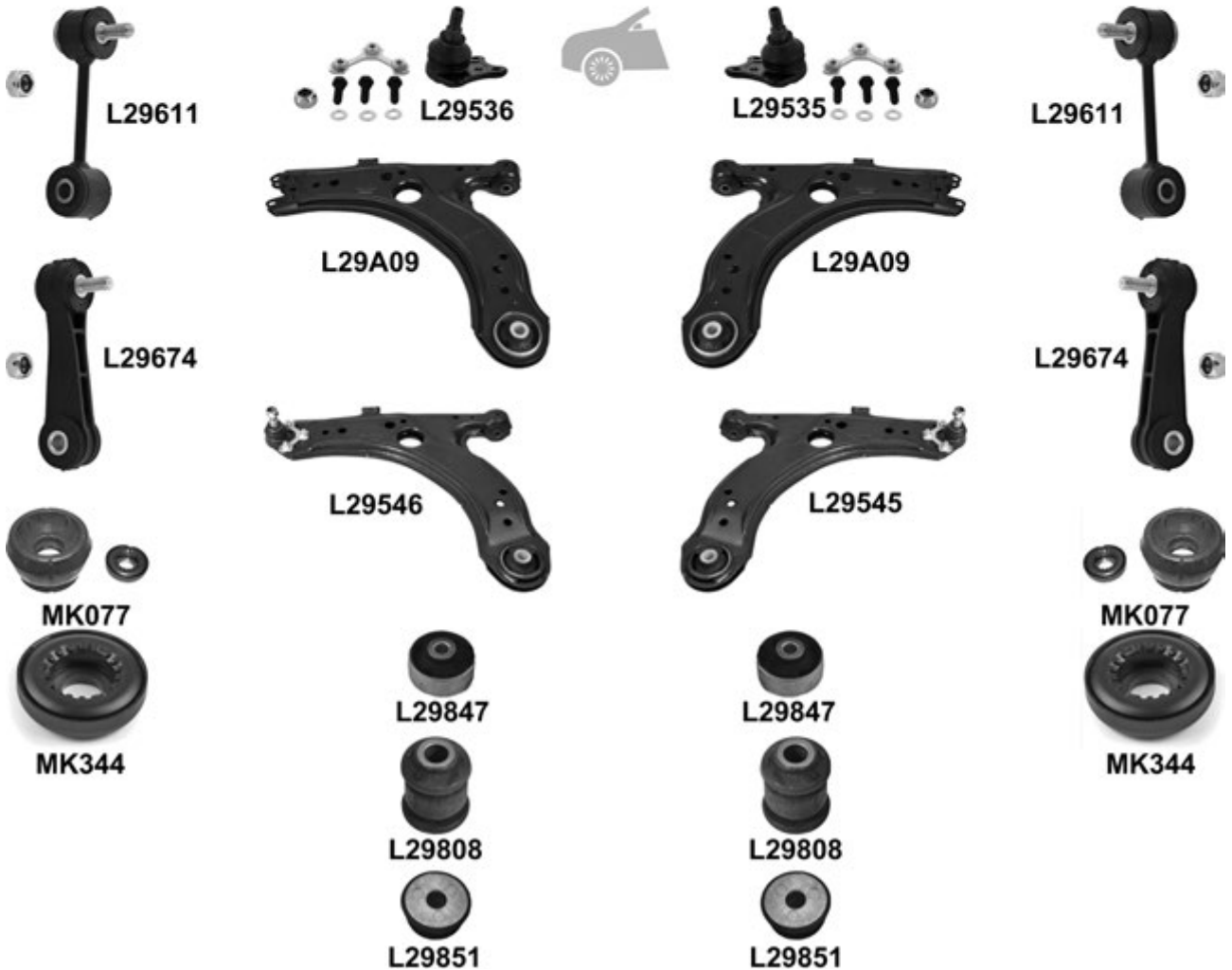
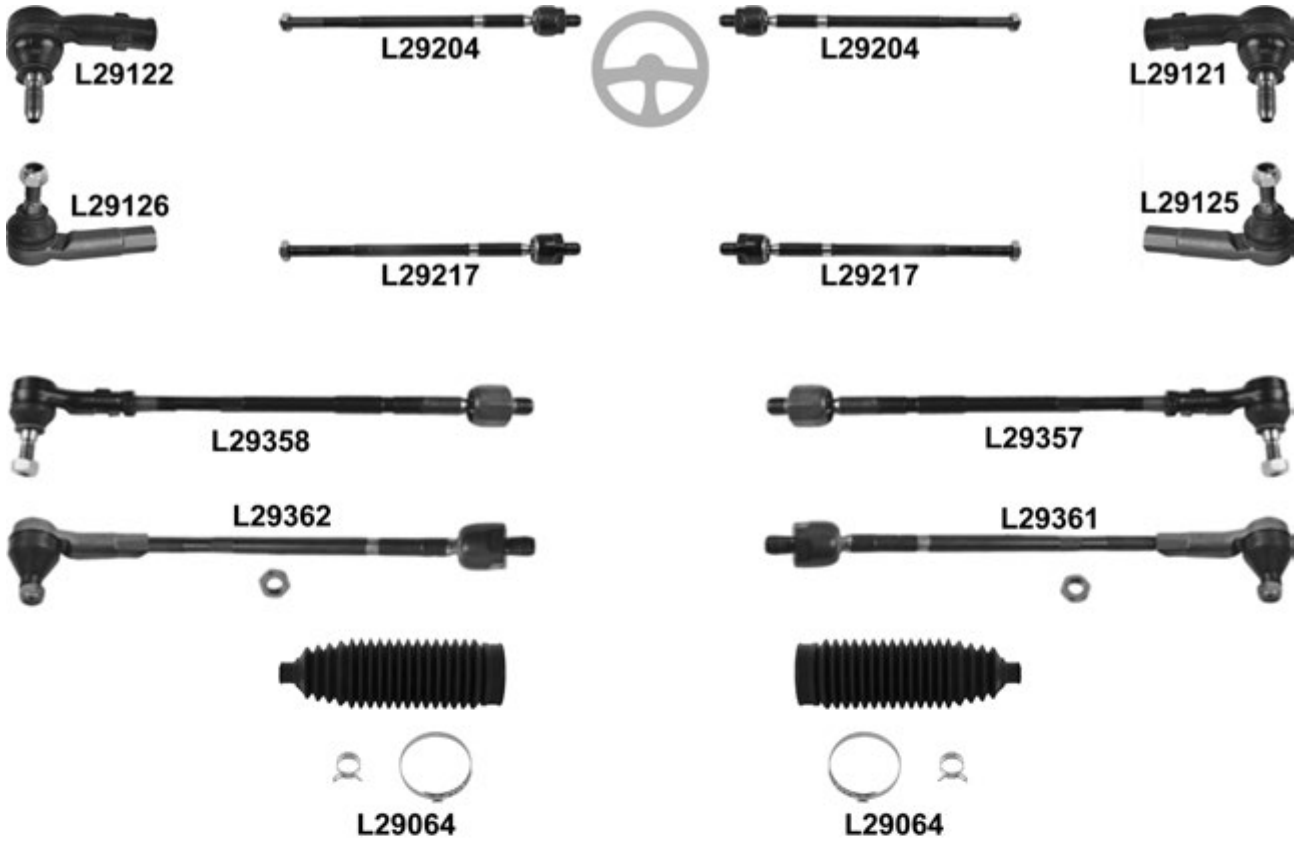

A3 (8L1) 09.96 → 05.03

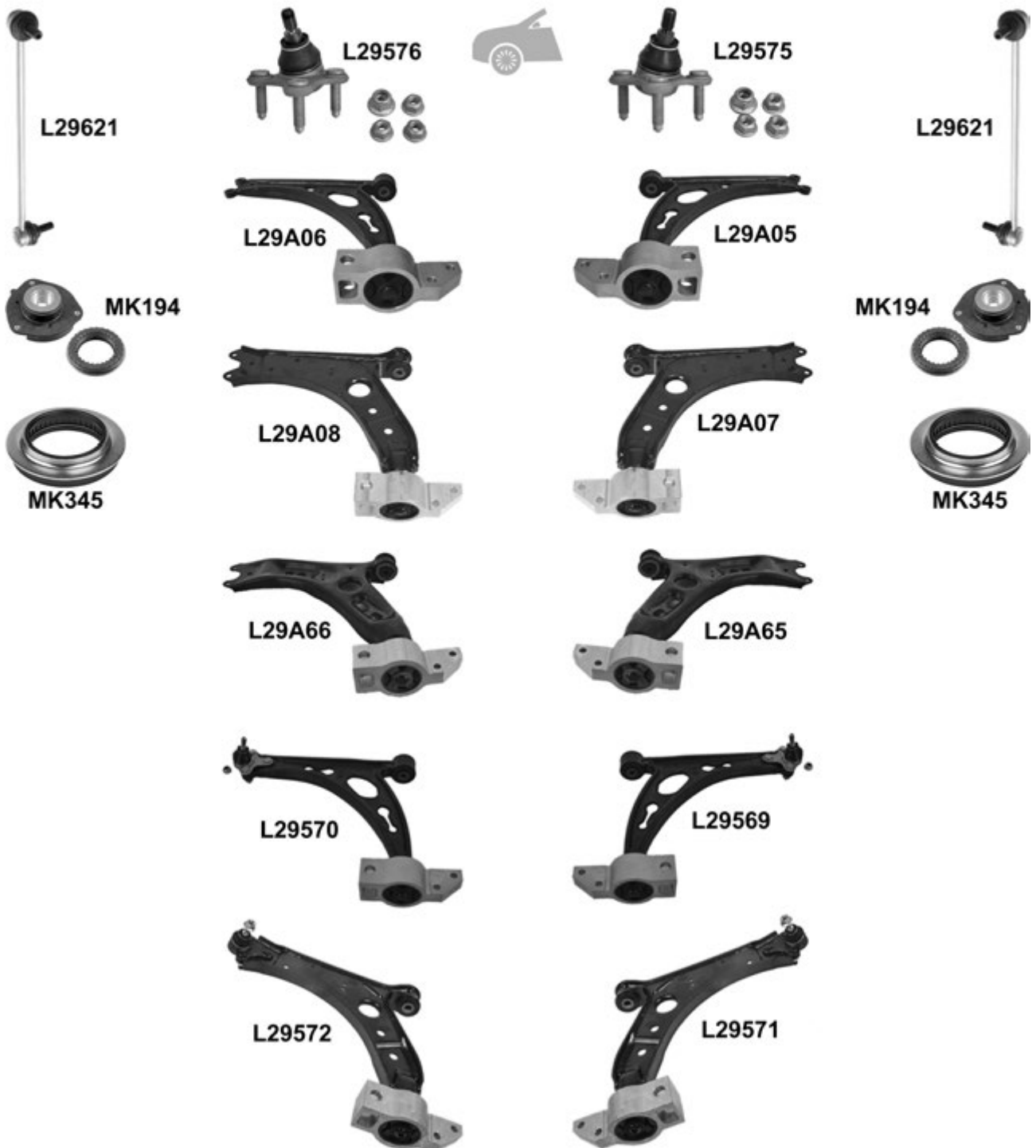
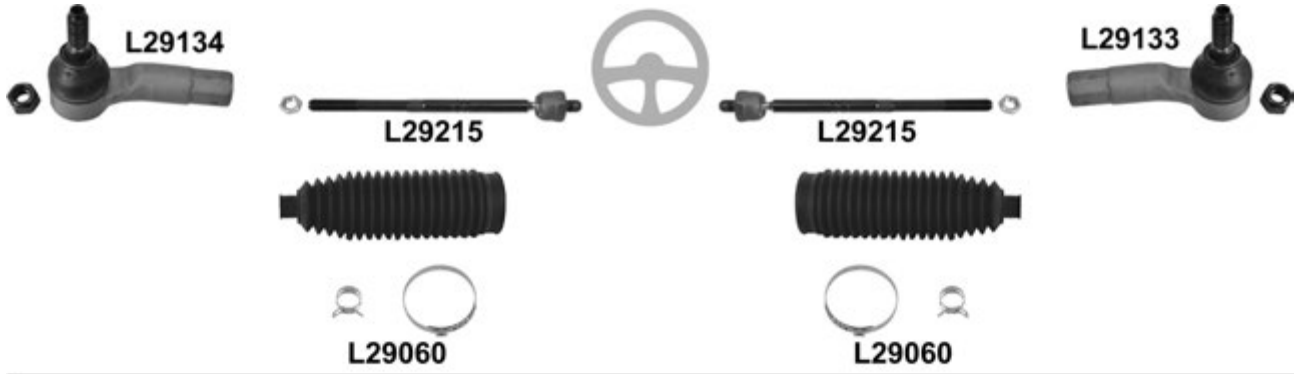

			←	→	Thread	Part Of	QPA		
	↔	→ 11.97, → 8L W 050 421		L29121			1	1J0 422 812 A	
				L29122			1	1J0 422 811 A	
		12.97 →, 8L W 050 422 →		L29125			1	1J0 422 812 B	
				L29126			1	1J0 422 811 B	
		→ 8L W 050 421		L29204	L29204		2	1J0 422 821 A	
		8L W 050 422 →		L29217	L29217		2	1J0 422 821 B	
		→ 11.97, → 8L W 050 421			L29357		1	1J0 422 804 A	
					L29358		1	1J0 422 803 A	
		12.97 →, 8L W 050 422 →			L29361		1	1J0 422 804 B	
				L29362			1	1J0 422 803 B	
			L29064 ⁰	L29064 ⁰		2	1J0 422 831 B		
		⊥			L29535		1	1J0 407 366 C	
					L29536		1	1J0 407 365 C	
		⊥	(-) (+)		L29A09	L29A09		2	1J0 407 151 C
				<input checked="" type="checkbox"/>		L29545		1	
				L29546			1		
		⊥	↘		L29847	L29847		2	1J0 407 181
			↗		L29808	L29808		2	357 407 182
					L29851	L29851	Hub carrier	2	1J0 199 429
			Metal		L29611	L29611		2	1J0 411 315 G
			Plastic		L29674	L29674		2	1J0 411 315 C
			PR OAG, ø 17mm/Ø 19mm		L29853	L29853	Anti-roll bar	2	1J0 411 314 B
			(+) MK344	KIT	MK077	MK077		2	1J0 412 331 BS
				MK344	MK344		2	1J0 412 249	
		69mm	KIT	L29874		Hub carrier	1	1J0 501 541 D	
		74mm	KIT	L29849		Hub carrier	1	1J0 501 541 C	
			ch. 8LV 113 396 →		MK118	MK118		2	1J0 513 353 B



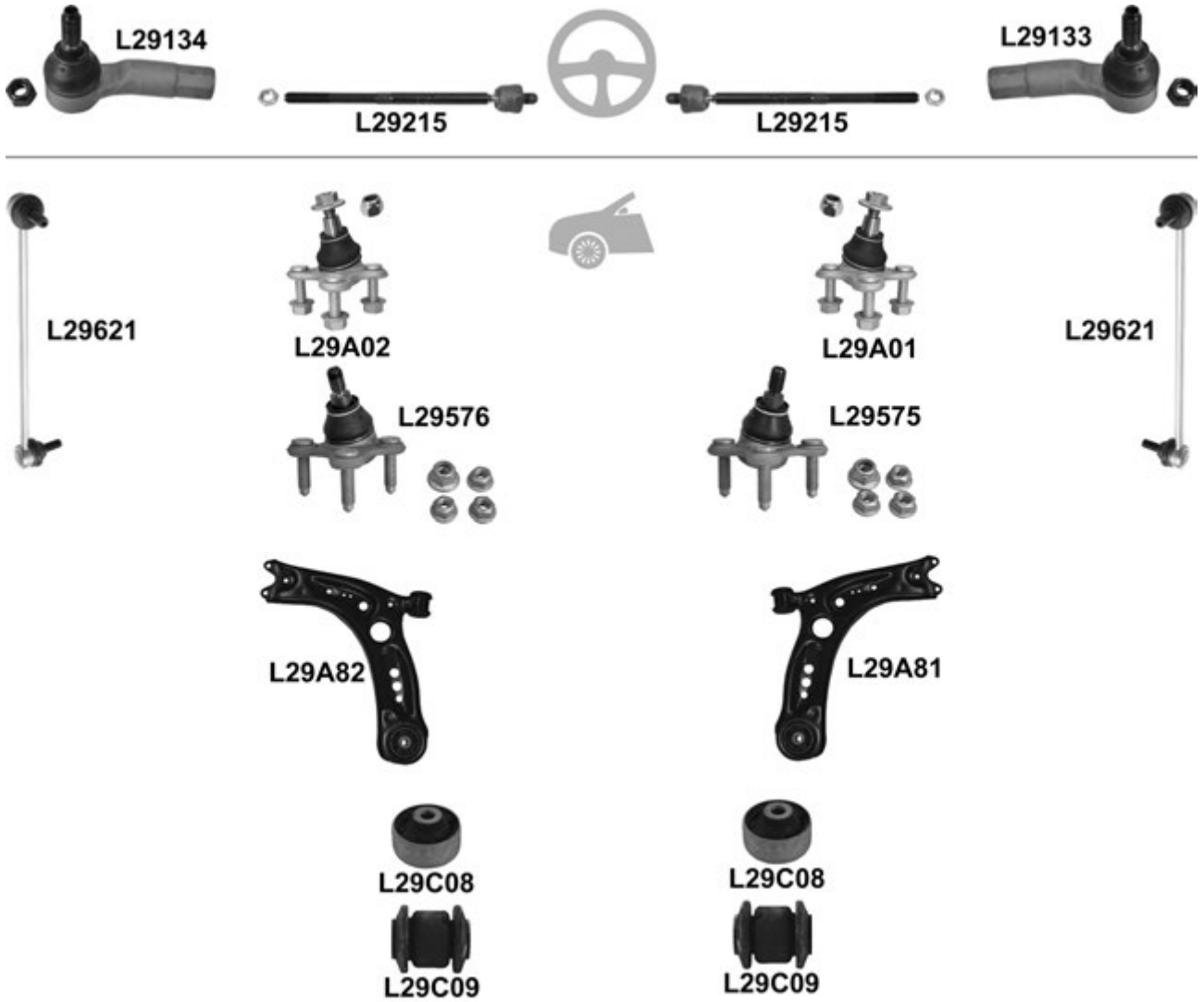

A3 (8P1) 05.03 →

			←	→	Thread	Part Of	QPA			
		↔		L29133	F 16x1,5 ∪		1	1K0 423 812 E		
			L29134		F 16x1,5 ∪		1	1K0 423 811 E		
				L29215	L29215	M 16x1,5 / M 16x1,5 ∪	2	1K0 423 810 A		
			Electric	L29060	L29060		2	1K0 423 831 A		
		↓		L29575			1	1K0 407 366 C		
			L29576				1	1K0 407 365 C		
		↓	→ 05.09, (-) (+)		L29A05			1	1K0 407 152 M	
				L29A06				1	1K0 407 151 M	
			→ 05.09, (-) (+)		L29A07				1	1K0 407 152 P
				L29A08					1	1K0 407 151 P
			06.09 →, (-) (+)		L29A65				1	1K0 407 152 BC
				L29A66					1	1K0 407 151 BC
			→ 05.09,	<input checked="" type="checkbox"/>	L29569				1	1K0 407 152 M
				L29570					1	1K0 407 151 M
			→ 05.09,	<input checked="" type="checkbox"/>	L29571				1	1K0 407 152 P
				L29572					1	1K0 407 151 P
	06.09 →,	<input checked="" type="checkbox"/>	L29A67				1	1K0 407 152 BC		
		L29A68					1	1K0 407 151 BC		
		<input checked="" type="checkbox"/>	L29A49 ⁰				1	1K0 407 152 BD		
			L29A50 ⁰				1	1K0 407 151 BD		
		↓	▼		L29861			1	1K0 199 232 G	
				L29876				1	1K0 199 231 G	
		↓	▲	L29862	L29862			2	1K0 407 182	
				L29621	L29621			2	1K0 411 315 D	
		(+) MK345	KIT	MK194	MK194		2	1K0 412 331 B		
			MK345	MK345			2	6N0 412 249 C		
		↑	→ 05.12	L29A11	L29A11		2	4K0 505 323 N		
		↓		L29A29	L29A29		2	1K0 505 311 AB		
		↓	▲		L29A87 ⁰		Trailing Arm	1	1K0 505 224 K	
	L29A88 ⁰					Trailing Arm	1	1K0 505 222 K		
		▲	→ 05.09		L29637			1	1K0 501 530 C	
				L29638				1	1K0 501 529 F	
				L29623	L29623			2	1K0 505 465 J	
			→ 08.09, (-) PR UA6/UA7/U5B/4P0	MK203	MK203			2	1K0 513 353 H	
MK386				MK386			2	1K0 513 353 C		

A3 (8V1) 04.12 →

				← → Thread		Part Of	QPA	i		
⊕		↔		L29133	F 16x1,5 ∪		1	1K0 423 812 E		
				L29134	F 16x1,5 ∪		1	1K0 423 811 E		
				L29215	L29215	M 16x1,5 / M 16x1,5 ∪		2	1K0 423 810 A	
🚗		⊥	PR 1LC/1LJ/1ZA/1ZD		L29A01			1	3C0 407 366 A	
					L29A02			1	3C0 407 365 A	
			PR 1ZE/1ZF/1ZP		L29575			1	5Q0 407 366 A	
					L29576			1	5Q0 407 365 A	
	⊥	(-) (+)		L29A81 ⁰			1	5Q0 407 152 J		
				L29A82 ⁰			1	5Q0 407 151 J		
	⊥	PR 1ZE/1ZF/1ZP		L29C08	L29C08		2	5Q0 407 183 E		
				L29C09	L29C09		2	5Q0 407 182		
				L29621	L29621		2	1K0 411 315 D		

A3 Cabriolet (8P7) 04.08 →

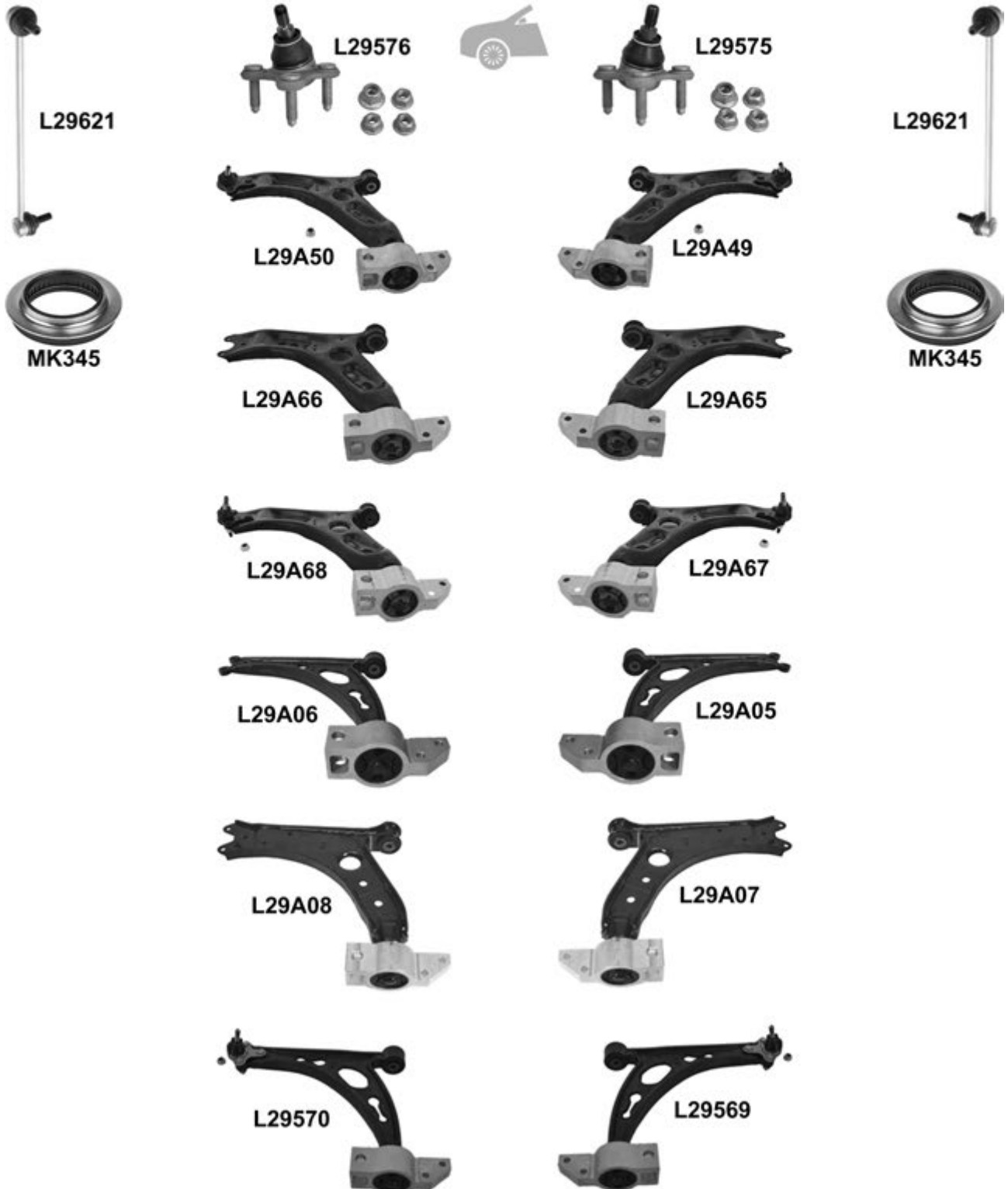
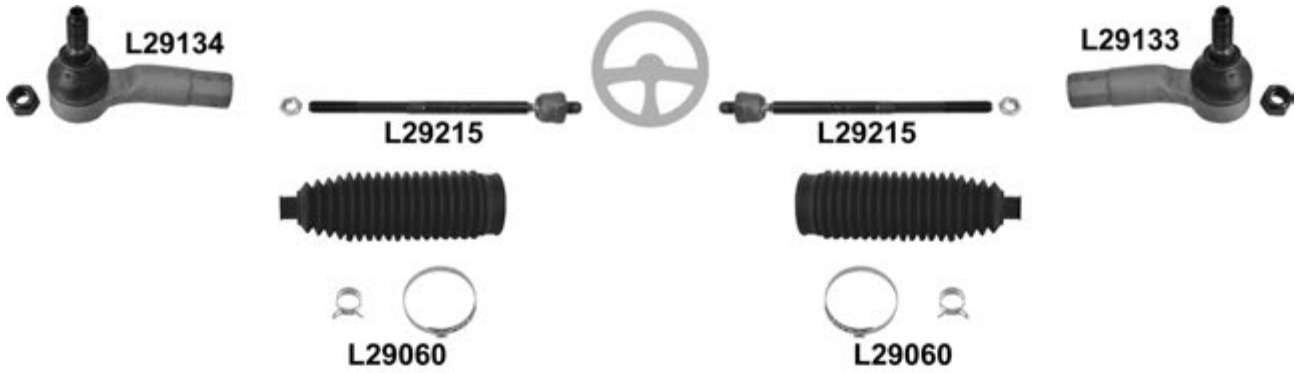

A3 Cabriolet (8P7) 04.08 →



L29572



L29571



L29876



L29861



L29862



L29862



L29638



L29A11



L29A11



L29637



L29A29



L29A29



L29623



L29A88



L29A87



L29623

A3 Cabriolet (8P7) 04.08 →

			←	→	Thread	Part Of	QPA			
		↔		L29133	F 16x1,5 U		1	1K0 423 812 E		
				L29134	F 16x1,5 U		1	1K0 423 811 E		
				L29215	L29215	M 16x1,5 / M 16x1,5 U		2	1K0 423 810 A	
			Electronic	L29060	L29060			2	1K0 423 831 A	
		↓			L29575			1	1K0 407 366 C	
					L29576			1	1K0 407 365 C	
		↓	1.2 TFSi/1.4 TFSi,	<input checked="" type="checkbox"/>		L29A49 ⁰			1	1K0 407 152 BD
					L29A50 ⁰			1	1K0 407 151 BD	
		1.6 8V/1.6 TDi, (-) , (+) ,				L29A65			1	1K0 407 152 BC
					L29A66			1	1K0 407 151 BC	
		1.6 8V/1.6 TDi,	<input checked="" type="checkbox"/>			L29A67			1	1K0 407 152 BC
					L29A68			1	1K0 407 151 BC	
		1.8 Fsi/TFSi, → 12.09, (-) , (+)				L29A65			1	1K0 407 152 BC
					L29A66			1	1K0 407 151 BC	
		1.8 Fsi/TFSi, → 12.09,	<input checked="" type="checkbox"/>			L29A67			1	1K0 407 152 BC
					L29A68			1	1K0 407 151 BC	
		1.8 Fsi/TFSi, 01.10 →,	<input checked="" type="checkbox"/>			L29A49 ⁰			1	1K0 407 152 BD
					L29A50 ⁰			1	1K0 407 151 BD	
		1.9 Tdi, (-) , (+) ,				L29A05			1	1K0 407 152 M
					L29A06			1	1K0 407 151 M	
		1.9 TDi, (-) , (+) ,				L29A07			1	1K0 407 152 P
					L29A08			1	1K0 407 151 P	
		1.9 TDi, (-) , (+) ,				L29A65			1	1K0 407 152 BC
					L29A66			1	1K0 407 151 BC	
		1.9 Tdi,	<input checked="" type="checkbox"/>			L29569			1	1K0 407 152 M
					L29570			1	1K0 407 151 M	
		1.9 TDi,	<input checked="" type="checkbox"/>			L29571			1	1K0 407 152 P
					L29572			1	1K0 407 151 P	
		1.9 TDi,	<input checked="" type="checkbox"/>			L29A67			1	1K0 407 152 BC
					L29A68			1	1K0 407 151 BC	
		2.0 TFSi, → 12.09, (-) , (+) ,				L29A65			1	1K0 407 152 BC
					L29A66			1	1K0 407 151 BC	
		2.0 TFSi, → 12.09,	<input checked="" type="checkbox"/>			L29A67			1	1K0 407 152 BC
					L29A68			1	1K0 407 151 BC	
		2.0 TFSi, 01.10 →,	<input checked="" type="checkbox"/>			L29A49 ⁰			1	1K0 407 152 BD
					L29A50 ⁰			1	1K0 407 151 BD	
	2.0 Tdi, → 12.09, (-) , (+) ,				L29A05			1	1K0 407 152 M	
				L29A06			1	1K0 407 151 M		
	2.0 Tdi, 01.10 →, , (-) , (+)				L29A65			1	1K0 407 152 BC	
				L29A66			1	1K0 407 151 BC		
	2.0 Tdi, → 12.09,	<input checked="" type="checkbox"/>			L29569			1	1K0 407 152 M	
				L29570			1	1K0 407 151 M		
	2.0 Tdi, 01.10 →,	<input checked="" type="checkbox"/>			L29A67			1	1K0 407 152 BC	
				L29A68			1	1K0 407 151 BC		
	↓	▼			L29861			1	1K0 199 232 G	
					L29876			1	1K0 199 231 G	
	↓	▲			L29862	L29862		2	1K0 407 182	
					L29621	L29621		2	1K0 411 315 D	
					MK345	MK345		2	6N0 412 249 C	

A3 Cabriolet (8P7) 04.08 →

		i		←	→	Thread	Part Of	QPA	i
		↕		L29A11	L29A11			2	4K0 505 323 N
		⊥		L29A29	L29A29			2	1K0 505 311 AB
		↕↗			L29A87 ⁰		Trailing Arm	1	1K0 505 224 K
				L29A88 ⁰			Trailing Arm	1	1K0 505 222 K
	↗	↗	→ 05.09		L29637			1	1K0 501 530 C
				L29638			1	1K0 501 529 F	
				L29623	L29623			2	1K0 505 465 J

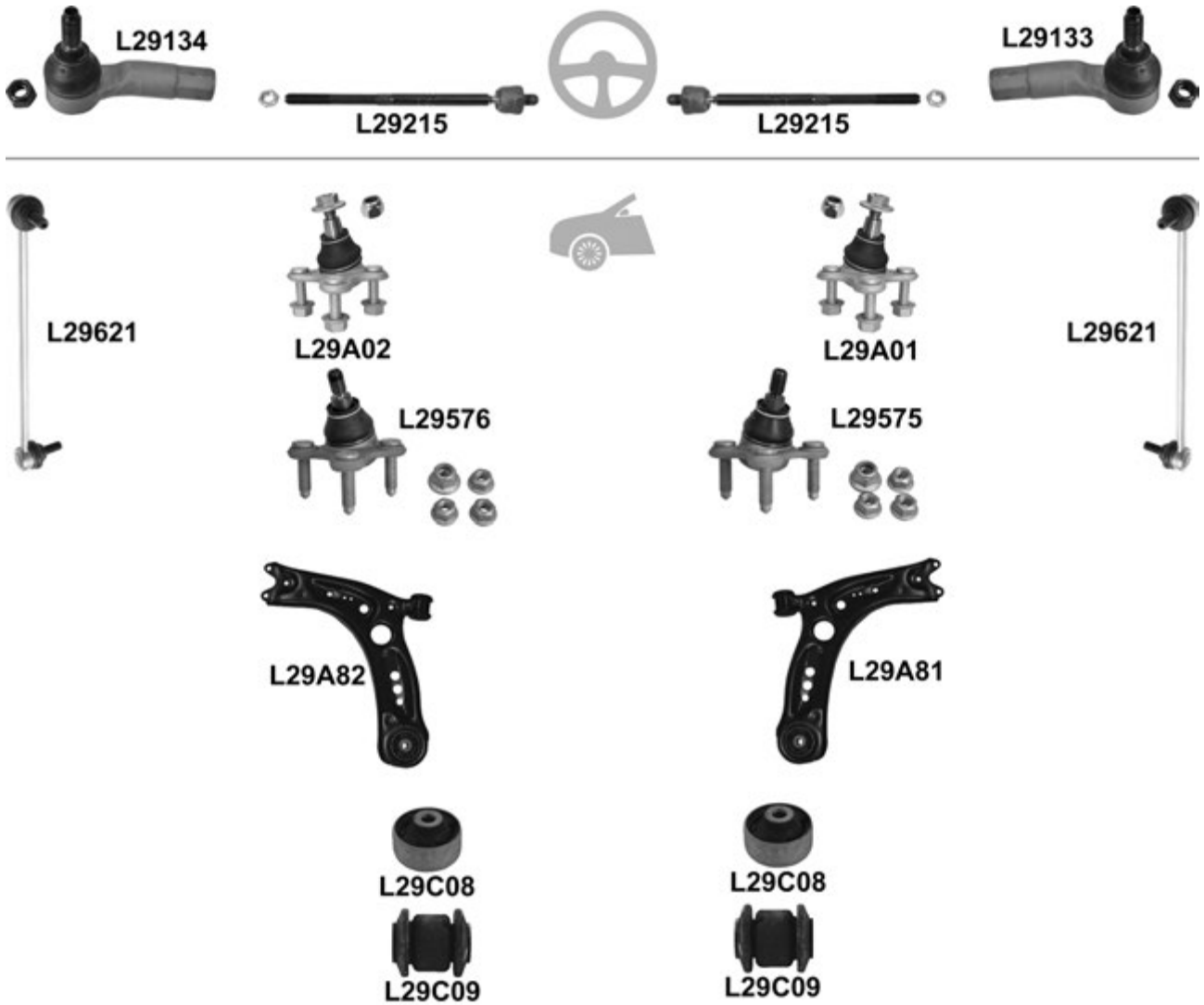
A3 Cabriolet (8V7) 10.13 →
A3 Cabriolet Quattro (8V7) 03.14 →

A3 Cabriolet (8V7) 10.13 →
A3 Cabriolet Quattro (8V7) 03.14 →

		i		←	→	Thread	Part Of	QPA	i	
		↔			L29133	F 16x1,5 ∪		1	1K0 423 812 E	
					L29134	F 16x1,5 ∪		1	1K0 423 811 E	
				L29215	L29215	M 16x1,5 / M 16x1,5 ∪		2	1K0 423 810 A	
		⊥	PR 1LC/1LJ/1ZA/1ZD		L29A01			1	3C0 407 366 A	
				L29A02			1	3C0 407 365 A		
		PR 1ZE/1ZP		L29575			1	5Q0 407 366 A		
			L29576			1	5Q0 407 365 A			
		⊥	(-) (+)			L29A81⁰			1	5Q0 407 152 J
						L29A82⁰			1	5Q0 407 151 J
	⊥▼			L29C08	L29C08			2	5Q0 407 183 E	
				L29C09	L29C09			2	5Q0 407 182	
	⊥▲		L29621	L29621				2	1K0 411 315 D	

A3 Quattro (81L) 12.96 → 05.03

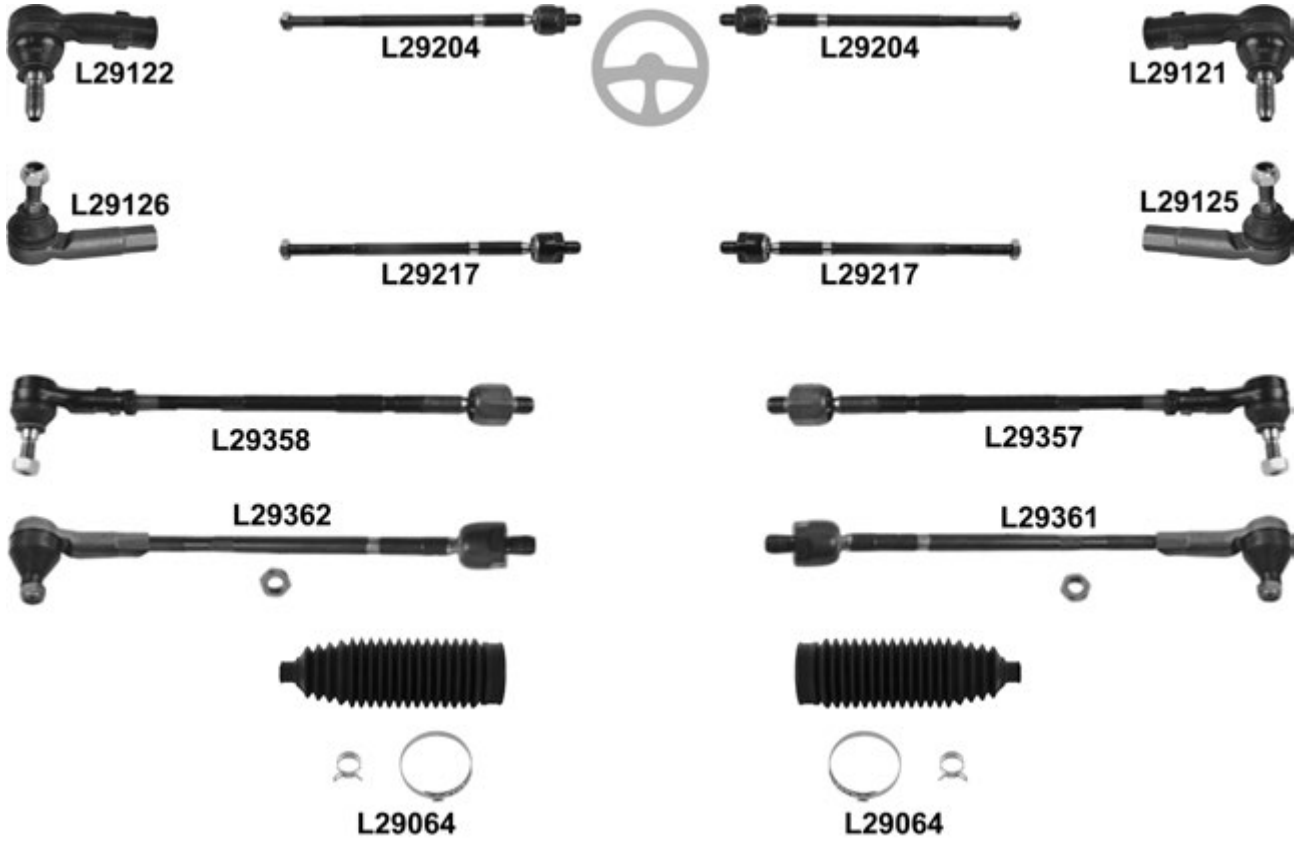

A3 Quattro (81L) 12.96 → 05.03

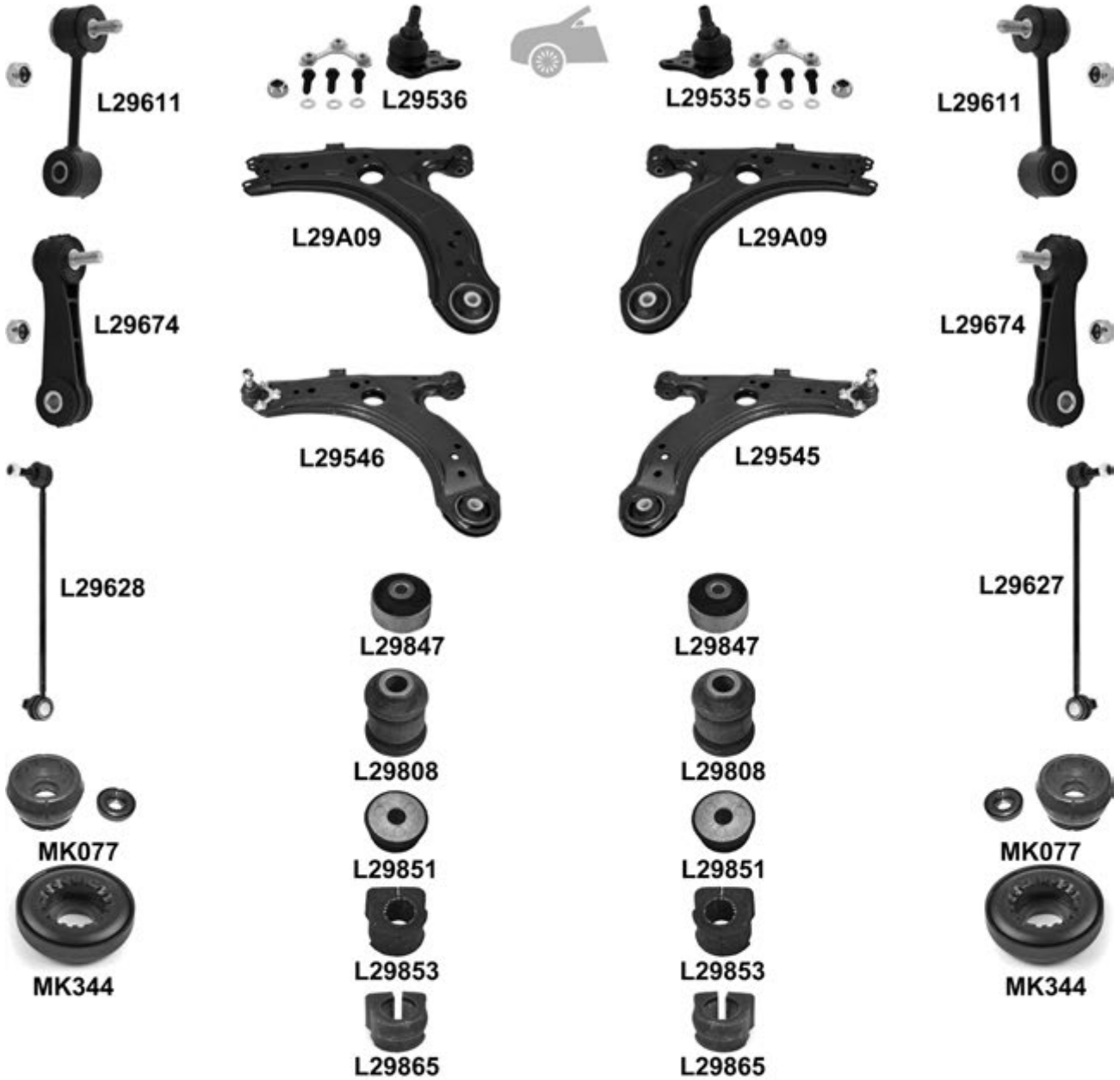

A3 Quattro (81L) 12.96 → 05.03

			←	→	Thread	Part Of	QPA		
		↔	→ 11.97 , ch. → 8L W 050 421		L29121		1	1J0 422 812 A	
				L29122			1	1J0 422 811 A	
		↔	→ 12.97 →, ch. 8L W 050 422 →		L29125			1	1J0 422 812 B
				L29126			1	1J0 422 811 B	
			ch. → 8L W 050 421	L29204	L29204		2	1J0 422 821 A	
			ch. 8L W 050 422 →	L29217	L29217		2	1J0 422 821 B	
			→ 11.97 , ch. → 8L W 050 421		L29357		1	1J0 422 804 A	
					L29358		1	1J0 422 803 A	
			→ 12.97 →, ch. 8L W 050 422 →		L29361		1	1J0 422 804 B	
					L29362		1	1J0 422 803 B	
			L29064	L29064 ^o		2	1J0 422 831 B		
		↓			L29535		1	1J0 407 366 C	
				L29536		1	1J0 407 365 C		
		↓	(-) (+)		L29A09	L29A09		2	1J0 407 151 C
				<input checked="" type="checkbox"/>	L29545		1		
				L29546		1			
		↓	▼		L29847	L29847		2	1J0 407 181
					L29808	L29808		2	357 407 182
					L29851	L29851	Hub carrier	2	1J0 199 429
				→ 05.99 , → 8L X 140 000, Metal	L29611	L29611		2	1J0 411 315 G
				→ 05.99 , → 8L X 140 000, Plastic	L29674	L29674		2	1J0 411 315 C
				06.99 →, 8L X 140 001 →		L29627		1	1J0 411 316 D
						L29628		1	1J0 411 315 D
				PR 0AG/0AN/0AR, ø 17mm/Ø 19mm	L29853	L29853	Anti-roll bar	2	1J0 411 314 B
				PR 0AN/0AS, ø 23mm	L29865	L29865	Anti-roll bar	2	1J0 411 314 G
			(+) MK344	KIT	MK077	MK077	2	1J0 412 331 BS	
					MK344	MK344	2	1J0 412 249	
			(-) , PR 1JF/1JU/1JV	L29641	L29641		2	1J0 505 466 B	
			, PR 1JW	L29661	L29661		2	1J0 505 466 C	
			69mm	KIT	L29874		1	1J0 501 541 D	
			74mm	KIT	L29849		1	1J0 501 541 C	

A3 Quattro (8P3L) 07.03 →

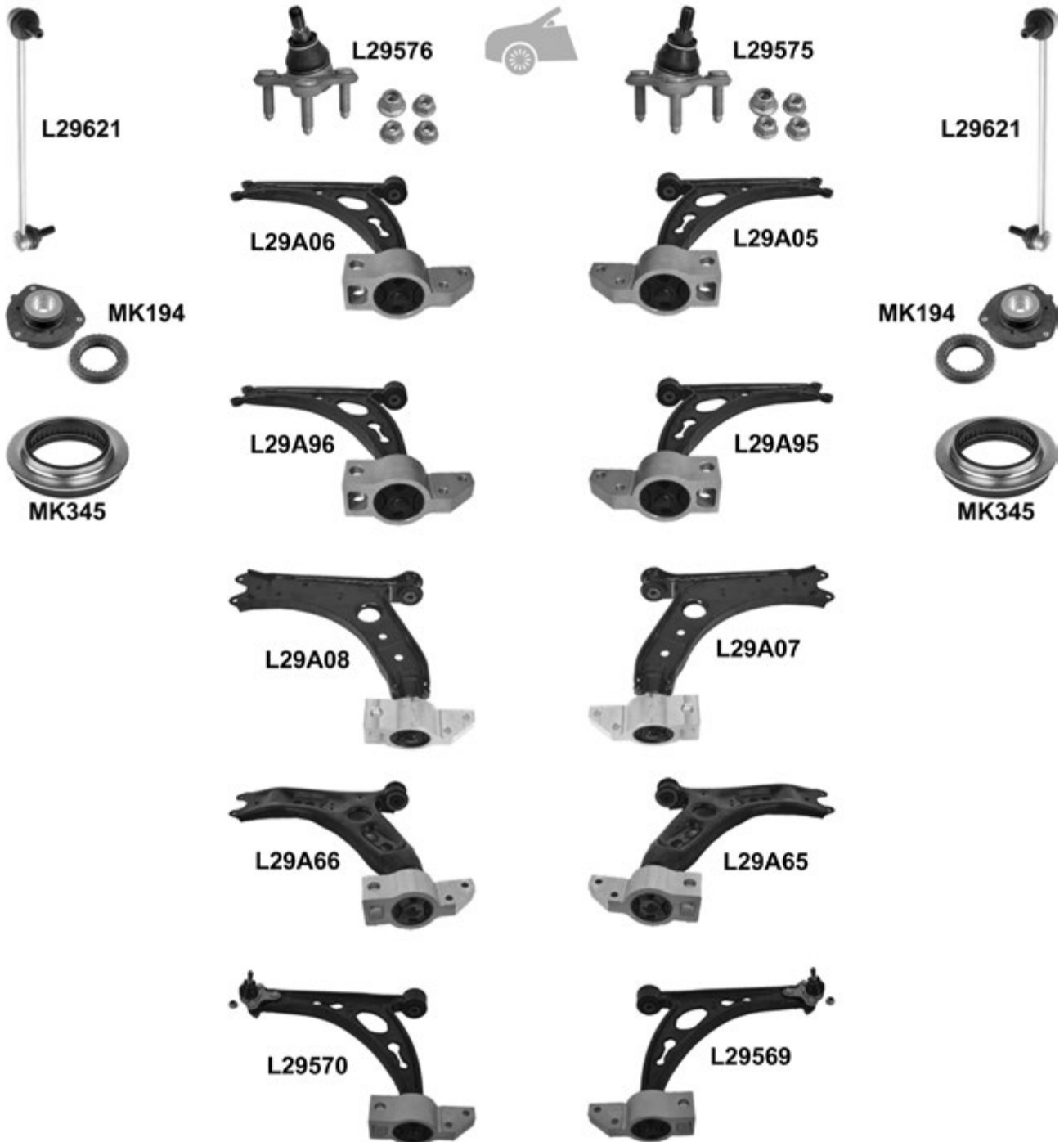
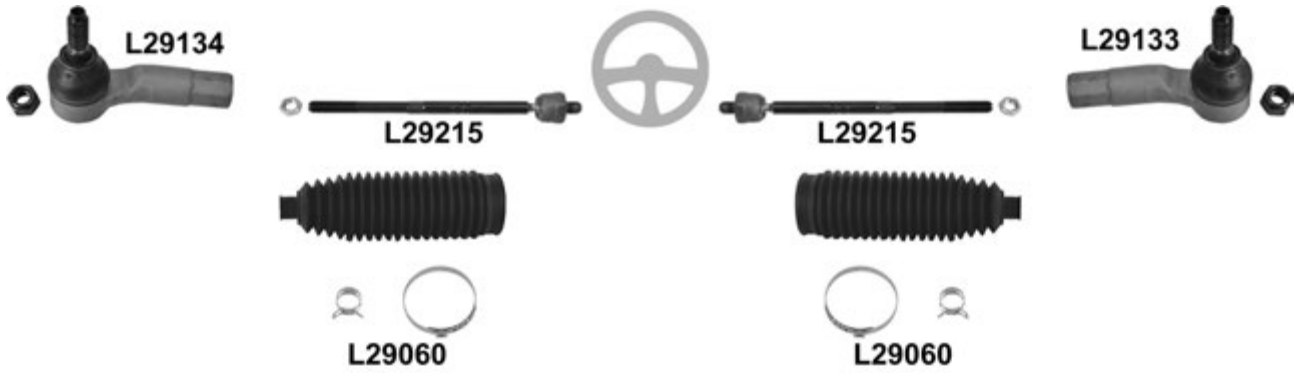

A3 Quattro (8P3L) 07.03 →



A3 Quattro (8P3L) 07.03 →

			←	→	Thread	Part Of	QPA		
		↔		L29133	F 16x1,5 ∪		1	1K0 423 812 E	
			L29134		F 16x1,5 ∪		1	1K0 423 811 E	
				L29215	L29215	M 16x1,5 / M 16x1,5 ∪		2	1K0 423 810 A
			Electronic	L29060	L29060			2	1K0 423 831 A
		⊥		L29575			1	1K0 407 366 C	
			L29576				1	1K0 407 365 C	
		⊥	→ 05.09, (-) (+)		L29A05			1	1K0 407 152 M
				L29A06			1	1K0 407 151 M	
			06.09 →, (-) (+)		L29A95 ⁰		1	1K0 407 152 BF	
				L29A96 ⁰		1	1K0 407 151 BF		
			→ 05.09, (-) (+)		L29A07		1	1K0 407 152 P	
				L29A08		1	1K0 407 151 P		
			(-) (+)		L29A65		1	1K0 407 152 BC	
				L29A66		1	1K0 407 151 BC		
			→ 05.09,	<input checked="" type="checkbox"/>	L29569		1	1K0 407 152 M	
				L29570		1	1K0 407 151 M		
	→ 05.09,	<input checked="" type="checkbox"/>	L29571		1	1K0 407 152 P			
		L29572		1	1K0 407 151 P				
		<input checked="" type="checkbox"/>	L29A67		1	1K0 407 152 BC			
		L29A68		1	1K0 407 151 BC				
	SP ,	<input checked="" type="checkbox"/>	L29A49 ⁰		1	1K0 407 152 BD			
		L29A50 ⁰		1	1K0 407 151 BD				
		⊥ ▼			L29861			1	1K0 199 232 G
			L29876				1	1K0 199 231 G	
⊥ ▲			L29862	L29862			2	1K0 407 182	
			L29621	L29621			2	1K0 411 315 D	
			(+) MK345	KIT	MK194	MK194		2	1K0 412 331 B
					MK345	MK345		2	6N0 412 249 C
	⊥		L29A11	L29A11			2	4K0 505 323 N	
			L29A29	L29A29			2	1K0 505 311 AB	
	⊥ ▲			L29A87 ⁰		Trailing Arm	1	1K0 505 224 K	
				L29A88 ⁰		Trailing Arm	1	1K0 505 222 K	
		▲	→ 05.09		L29637			1	1K0 501 530 C
			L29638			1	1K0 501 529 F		

A3 Quattro (8V1) 10.12 →
 A3 Quattro (8VS) 09.13 →

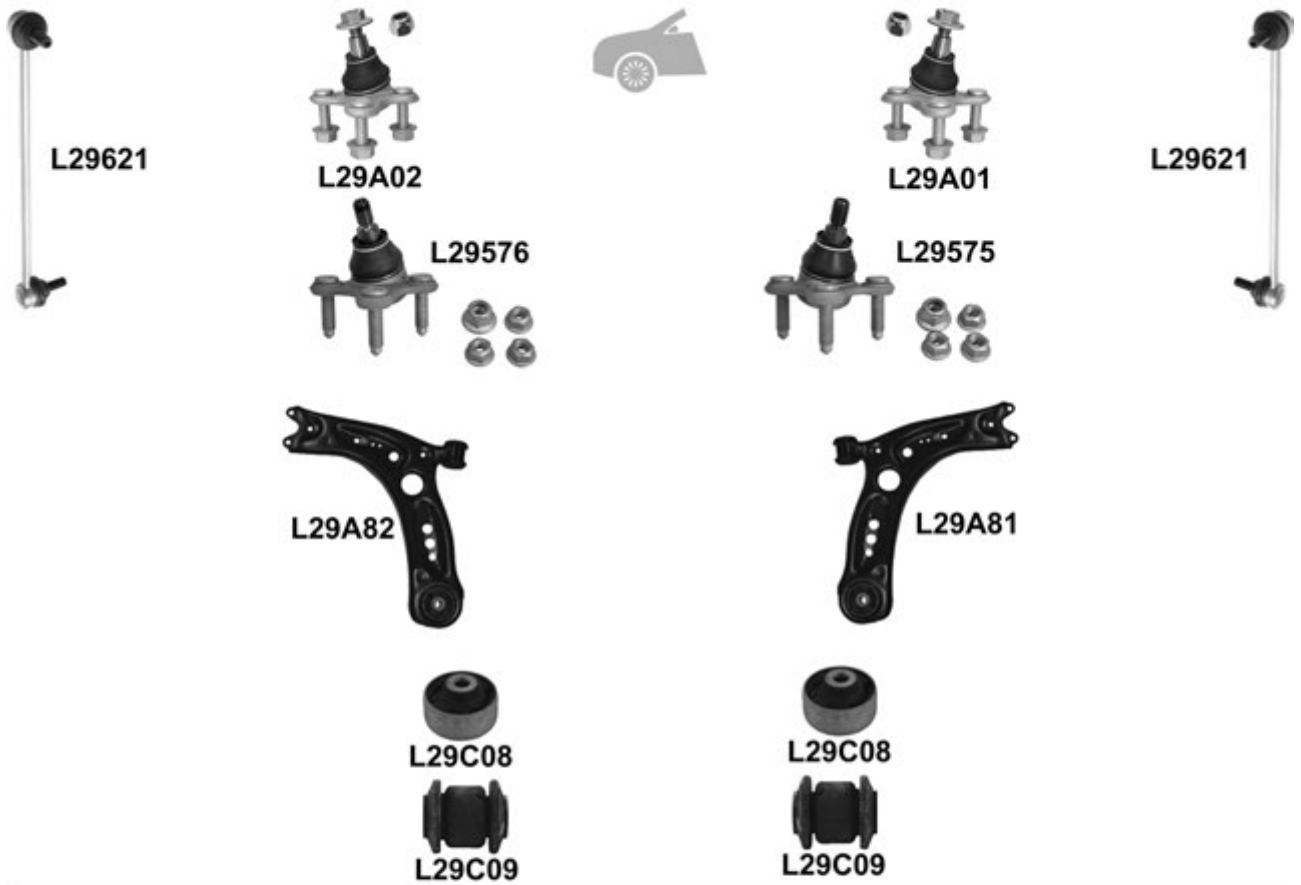

A3 Quattro (8V1) 10.12 →
A3 Quattro (8VS) 09.13 →

				←	→	Thread	Part Of	QPA		
		↔			L29133	F 16x1,5 ♂		1	1K0 423 812 E	
					L29134	F 16x1,5 ♂		1	1K0 423 811 E	
					L29215	L29215	M 16x1,5 / M 16x1,5 ♂		2	1K0 423 810 A
		⊥	PR 1LC/1LJ/1ZA/1ZD		L29A01			1	3C0 407 366 A	
					L29A02			1	3C0 407 365 A	
					L29575			1	5Q0 407 366 A	
					L29576			1	5Q0 407 365 A	
		⊥	(-) (+)		L29A81 ⁰			1	5Q0 407 152 J	
					L29A82 ⁰			1	5Q0 407 151 J	
		⊥	PR 1ZE/1ZF/1ZP		L29C08	L29C08			2	5Q0 407 183 E
					L29C09	L29C09			2	5Q0 407 182
		L29621	L29621			2	1K0 411 315 D			
				L29623	L29623			2	1K0 505 465 J	
				MK203	MK203			2	1K0 513 353 H	
				MK386	MK386			2	1K0 513 353 C	

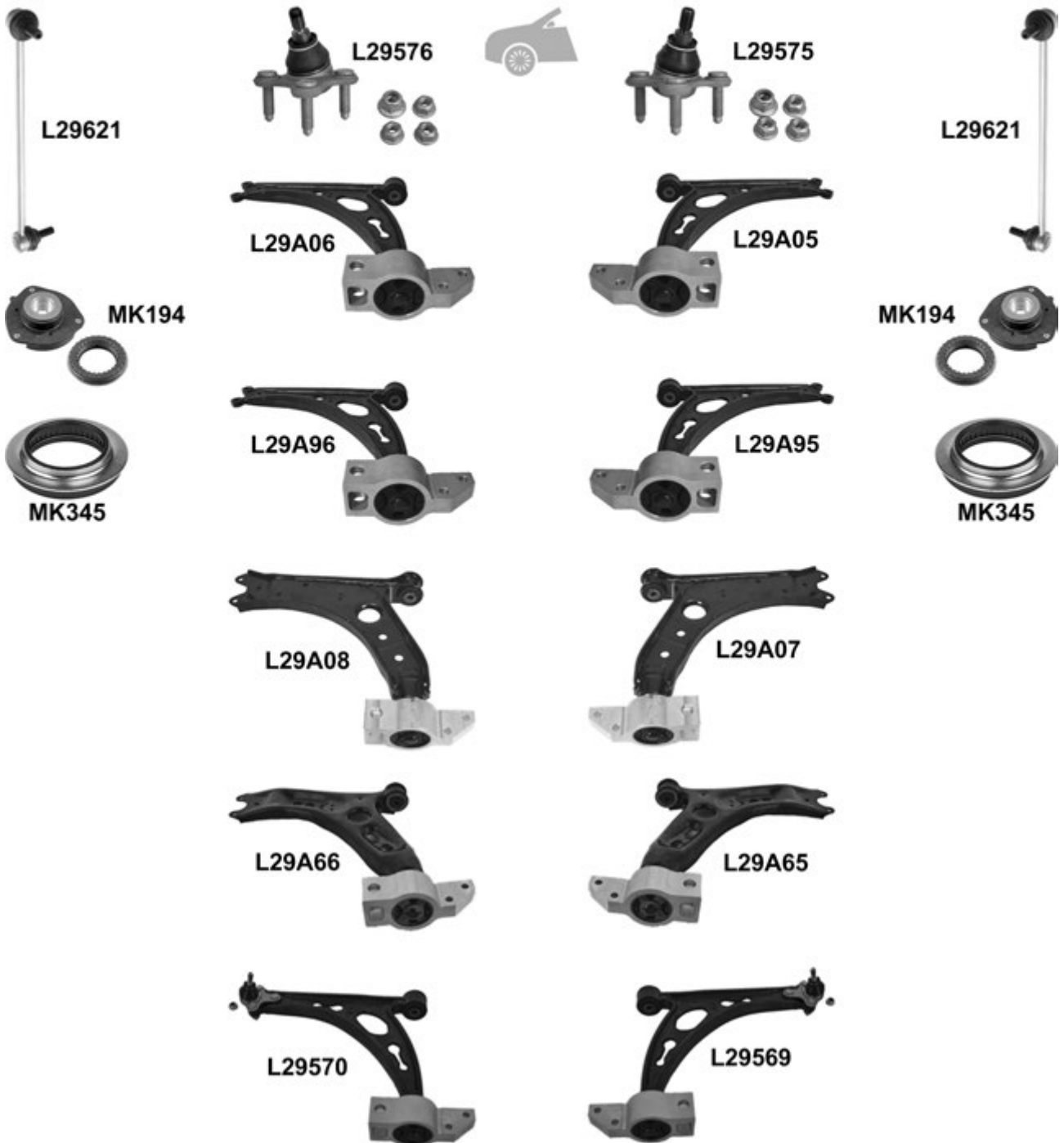
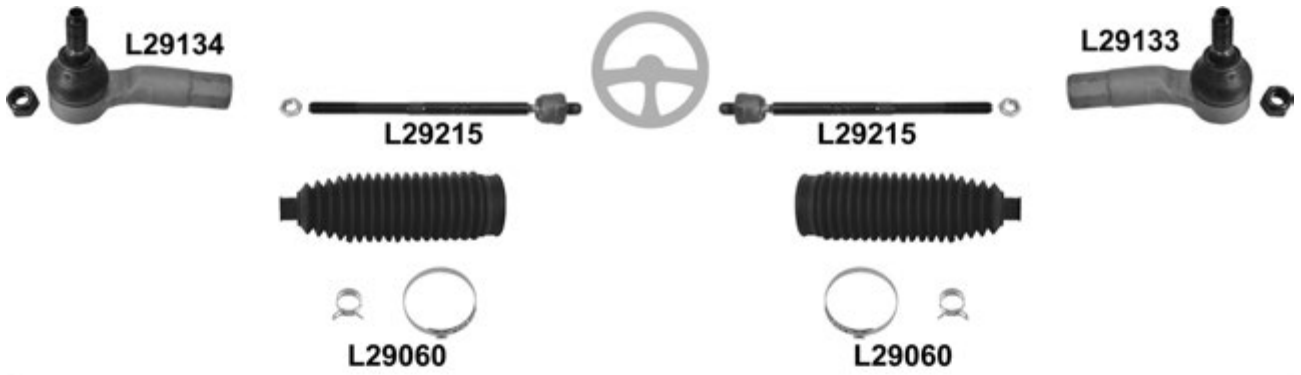
A3 Sportback (8PA) 09.04 →

A3 Sportback (8PA) 09.04 →



A3 Sportback (8PA) 09.04 →

			←	→	Thread	Part Of	QPA			
		↔		L29133	F 16x1,5 ∩		1	1K0 423 812 E		
				L29134	F 16x1,5 ∩		1	1K0 423 811 E		
				L29215	L29215	M 16x1,5 / M 16x1,5 ∩		2	1K0 423 810 A	
		Electronic			L29060	L29060			2	1K0 423 831 A
		⊥			L29575			1	1K0 407 366 C	
					L29576			1	1K0 407 365 C	
		⊥	→ 05.09, (-) (+)		L29A05			1	1K0 407 152 M	
				L29A06			1	1K0 407 151 M		
			06.09 →, (-) (+)		L29A95 ⁰		1	1K0 407 152 BF		
				L29A96 ⁰		1	1K0 407 151 BF			
			→ 05.09, (-) (+)		L29A07		1	1K0 407 152 P		
				L29A08		1	1K0 407 151 P			
			(-) (+)		L29A65		1	1K0 407 152 BC		
				L29A66		1	1K0 407 151 BC			
			→ 05.09,	<input checked="" type="checkbox"/>	L29569		1	1K0 407 152 M		
				L29570		1	1K0 407 151 M			
	→ 05.09,	<input checked="" type="checkbox"/>	L29571		1	1K0 407 152 P				
		L29572		1	1K0 407 151 P					
		<input checked="" type="checkbox"/>	L29A67		1	1K0 407 152 BC				
		L29A68		1	1K0 407 151 BC					
	SP ,	<input checked="" type="checkbox"/>	L29A49 ⁰		1	1K0 407 152 BD				
		L29A50 ⁰		1	1K0 407 151 BD					
			⊥ ▼			L29861			1	1K0 199 232 G
						L29876			1	1K0 199 231 G
		⊥ ▲			L29862	L29862		2	1K0 407 182	
				L29621	L29621		2	1K0 411 315 D		
		(+) MK345	KIT	MK194	MK194		2	1K0 412 331 B		
				MK345	MK345		2	6N0 412 249 C		
		⊥		L29A11	L29A11		2	4K0 505 323 N		
				L29A29	L29A29		2	1K0 505 311 AB		
		⊥ ▲			L29A87 ⁰		Trailing Arm	1	1K0 505 224 K	
					L29A88 ⁰		Trailing Arm	1	1K0 505 222 K	
		▲	→ 05.09		L29637			1	1K0 501 530 C	
					L29638			1	1K0 501 529 F	
					L29623	L29623		2	1K0 505 465 J	
		→ 08.09, (-) PR UA6/UA7/U5B/4P0	MK203	MK203		2	1K0 513 353 H			
		09.09 →, PR UA0/UA1/UA3/UA6/UA7/UA9/UB5/4P0	MK386	MK386		2	1K0 513 353 C			

A3 Sportback (8VA) 09.12 →

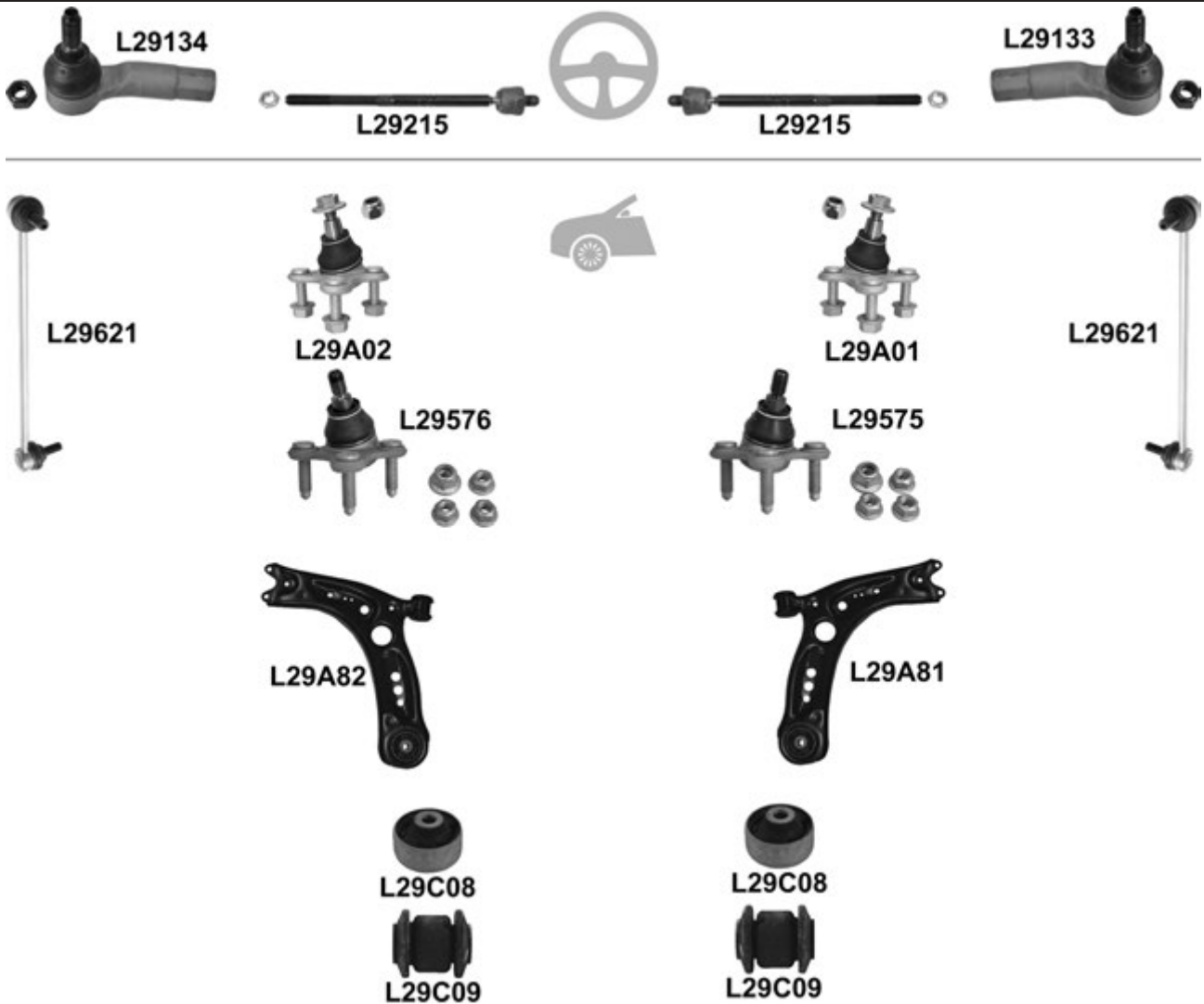

				←	→	Thread	Part Of	QPA	i	
⊕		↔				L29133	F 16x1,5 ∪	1	1K0 423 812 E	
						L29134	F 16x1,5 ∪	1	1K0 423 811 E	
						L29215	L29215	M 16x1,5 / M 16x1,5 ∪	2	1K0 423 810 A
🚗		⊥	1LC/1LJ/1ZA/1ZD			L29A01		1	3C0 407 366 A	
						L29A02		1	3C0 407 365 A	
					PR 1ZE/1ZP	L29575		1	5Q0 407 366 A	
						L29576		1	5Q0 407 365 A	
			⊥	(-) (+)	L29A81 ⁰		1	5Q0 407 152 J		
			L29A82 ⁰		1	5Q0 407 151 J				
🚗		⊥	PR 1ZE/1ZF/1ZP			L29C08	L29C08		2	5Q0 407 183 E
						L29C09	L29C09		2	5Q0 407 182
					L29621	L29621		2	1K0 411 315 D	

A3 Sportback Quattro (8PA) 09.04 →

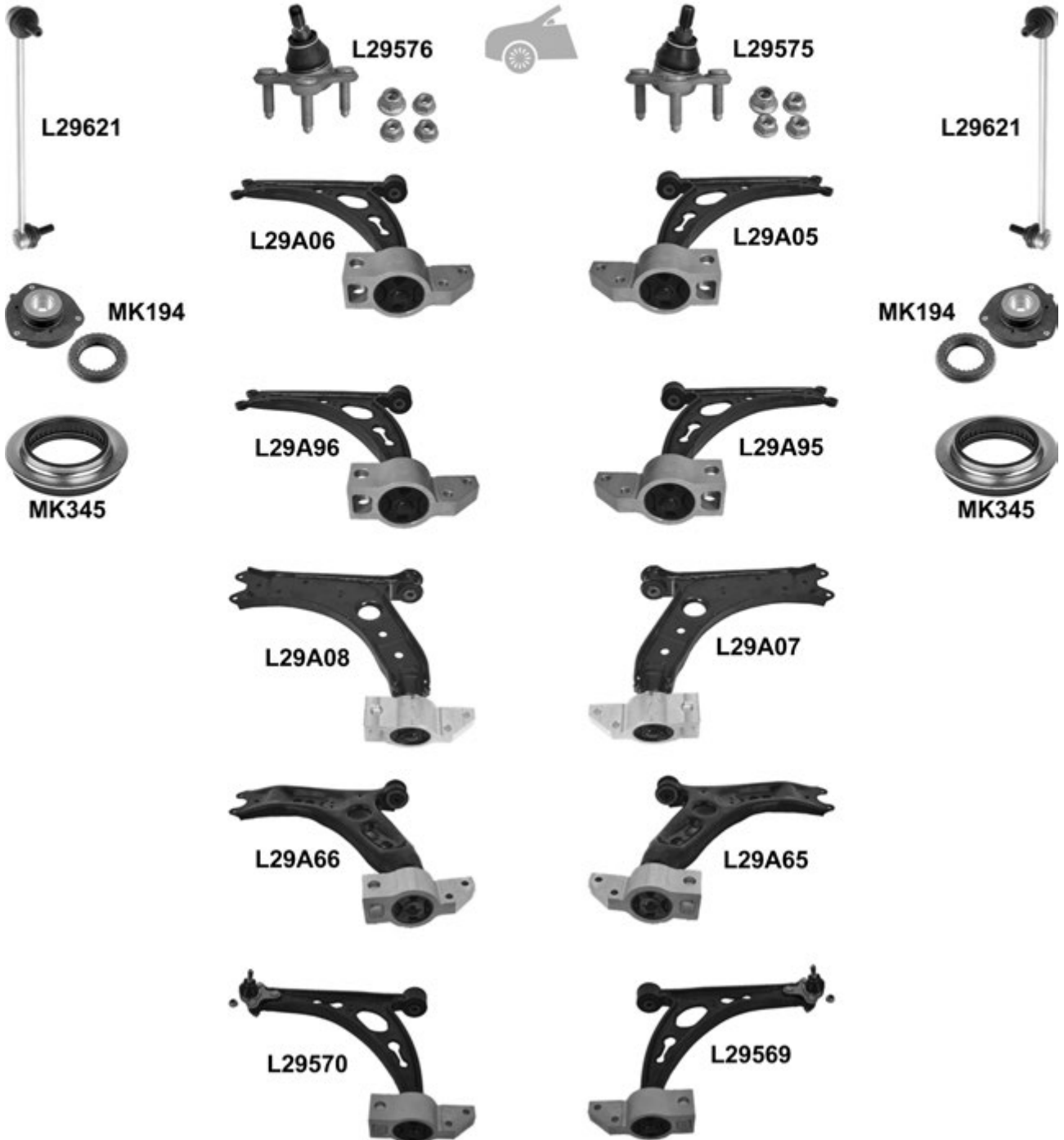
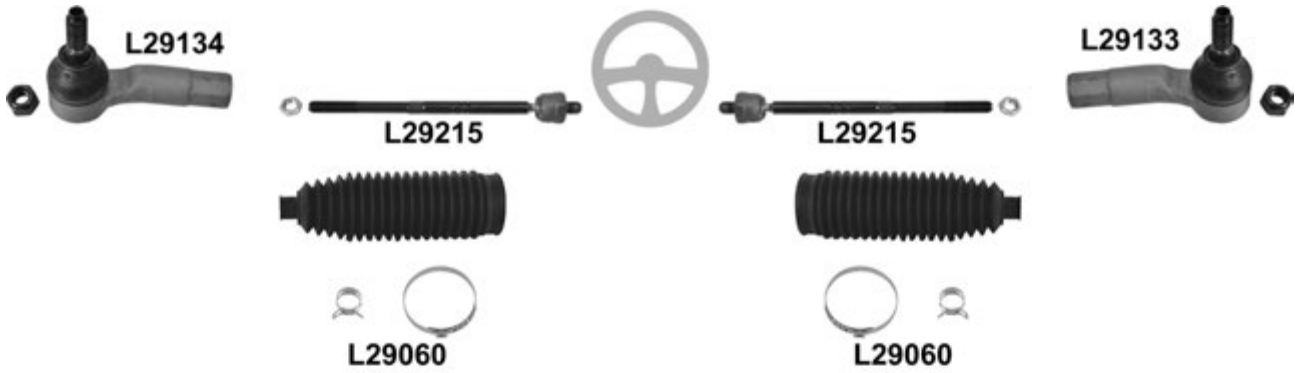

A3 Sportback Quattro (8PA) 09.04 →



A3 Sportback Quattro (8PA) 09.04 →

			←	→	Thread	Part Of	QPA		
		↔		L29133	F 16x1,5 ∪		1	1K0 423 812 E	
			L29134		F 16x1,5 ∪		1	1K0 423 811 E	
		Electronic		L29215	L29215	M 16x1,5 / M 16x1,5 ∪		2	1K0 423 810 A
			L29060	L29060			2	1K0 423 831 A	
		⊥		L29575			1	1K0 407 366 C	
			L29576				1	1K0 407 365 C	
		⊥	→ 05.09, (-) (+)		L29A05			1	1K0 407 152 M
			L29A06				1	1K0 407 151 M	
			06.09 →, (-) (+)		L29A95 ⁰			1	1K0 407 152 BF
			L29A96 ⁰				1	1K0 407 151 BF	
			→ 05.09, (-) (+)		L29A07			1	1K0 407 152 P
			L29A08				1	1K0 407 151 P	
			(-) (+)		L29A65			1	1K0 407 152 BC
			L29A66				1	1K0 407 151 BC	
			→ 05.09,	<input checked="" type="checkbox"/>	L29569			1	1K0 407 152 M
			L29570				1	1K0 407 151 M	
	→ 05.09,	<input checked="" type="checkbox"/>	L29571			1	1K0 407 152 P		
	L29572				1	1K0 407 151 P			
		<input checked="" type="checkbox"/>	L29A67			1	1K0 407 152 BC		
	L29A68				1	1K0 407 151 BC			
	SP ,	<input checked="" type="checkbox"/>	L29A49 ⁰			1	1K0 407 152 BD		
	L29A50 ⁰				1	1K0 407 151 BD			
		⊥ ▼			L29861			1	1K0 199 232 G
			L29876				1	1K0 199 231 G	
⊥ ▲			L29862	L29862			2	1K0 407 182	
		L29621	L29621				2	1K0 411 315 D	
		(+) MK345	KIT	MK194	MK194			2	1K0 412 331 B
			MK345	MK345			2	6N0 412 249 C	
		L29A11	L29A11				2	4K0 505 323 N	
	⊥		L29A29	L29A29				2	1K0 505 311 AB
		⊥ ▲		L29A87 ⁰		Trailing Arm	1	1K0 505 224 K	
	L29A88 ⁰				Trailing Arm	1	1K0 505 222 K		
		⊥	→ 05.12	L29A11	L29A11			2	4K0 505 323 N
			→ 05.09		L29637			1	1K0 501 530 C
			L29638				1	1K0 501 529 F	
			L29623	L29623			2	1K0 505 465 J	
		↔	→ 08.09, (-) PR UA6/UA7/USB/4P0	MK203	MK203			2	1K0 513 353 H
09.09 →, PR UA0/UA1/UA3/UA6/UA7/UA9/UB5/4P0			MK386	MK386			2	1K0 513 353 C	

A3 Sportback Quattro (8VA) 11.12 →

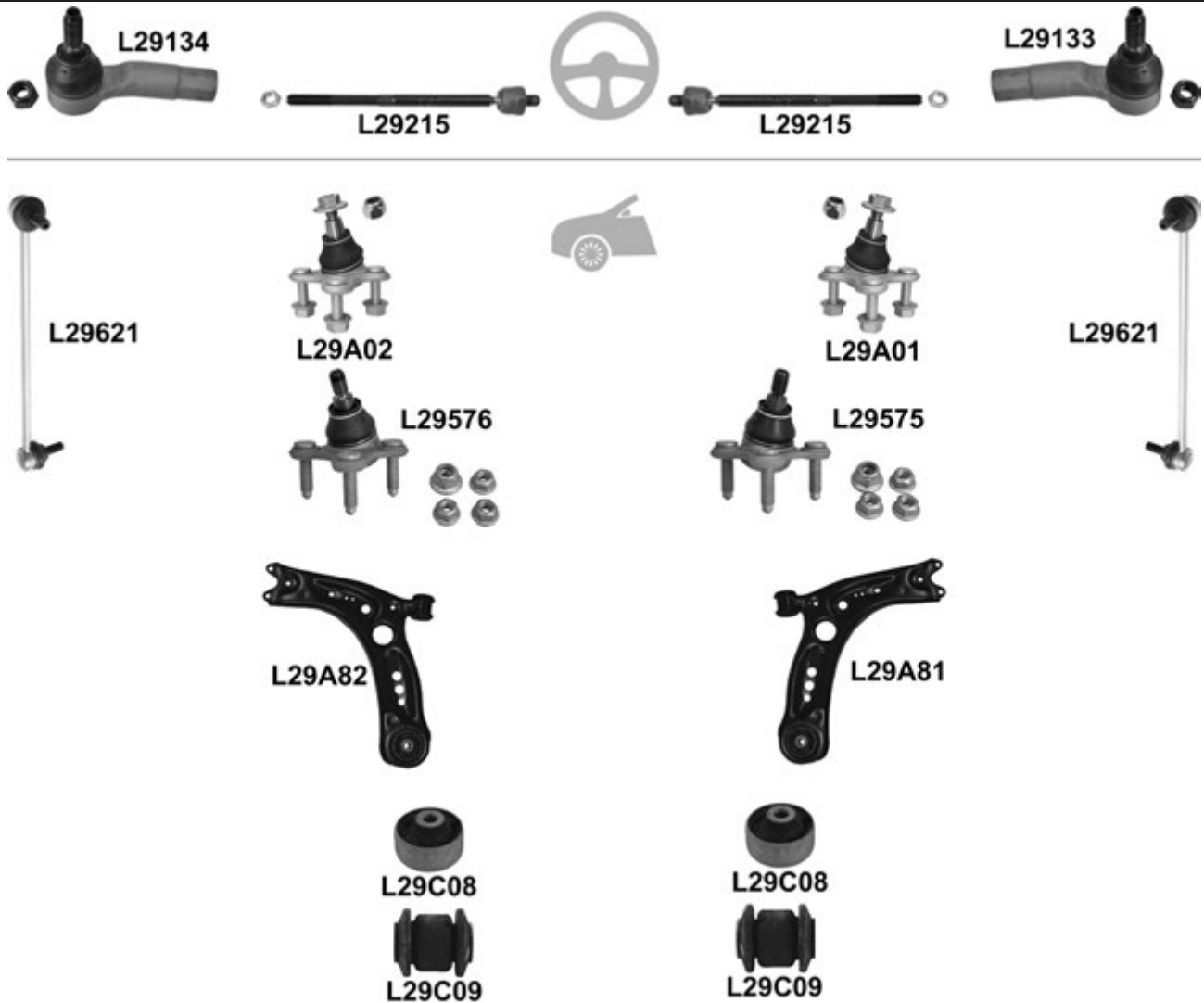

				←	→	Thread	Part Of	QPA	i	
⊕		↔				L29133	F 16x1,5 ∪	1	1K0 423 812 E	
						L29134	F 16x1,5 ∪	1	1K0 423 811 E	
						L29215	L29215	M 16x1,5 / M 16x1,5 ∪	2	1K0 423 810 A
🚗		⊥	1LC/1LJ/1ZA/1ZD			L29A01		1	3C0 407 366 A	
						L29A02		1	3C0 407 365 A	
				PR 1ZE/1ZP			L29575		1	5Q0 407 366 A
							L29576		1	5Q0 407 365 A
	⊥	(-) (+)			L29A81 ⁰		1	5Q0 407 152 J		
					L29A82 ⁰		1	5Q0 407 151 J		
	⊥	PR 1ZE/1ZF/1ZP			L29C08	L29C08		2	5Q0 407 183 E	
					L29C09	L29C09		2	5Q0 407 182	
					L29621	L29621		2	1K0 411 315 D	

A4 (8D2, B5) 01.95 → 11.00
 A4 Avant (8D5, B5) 02.96 → 09.01

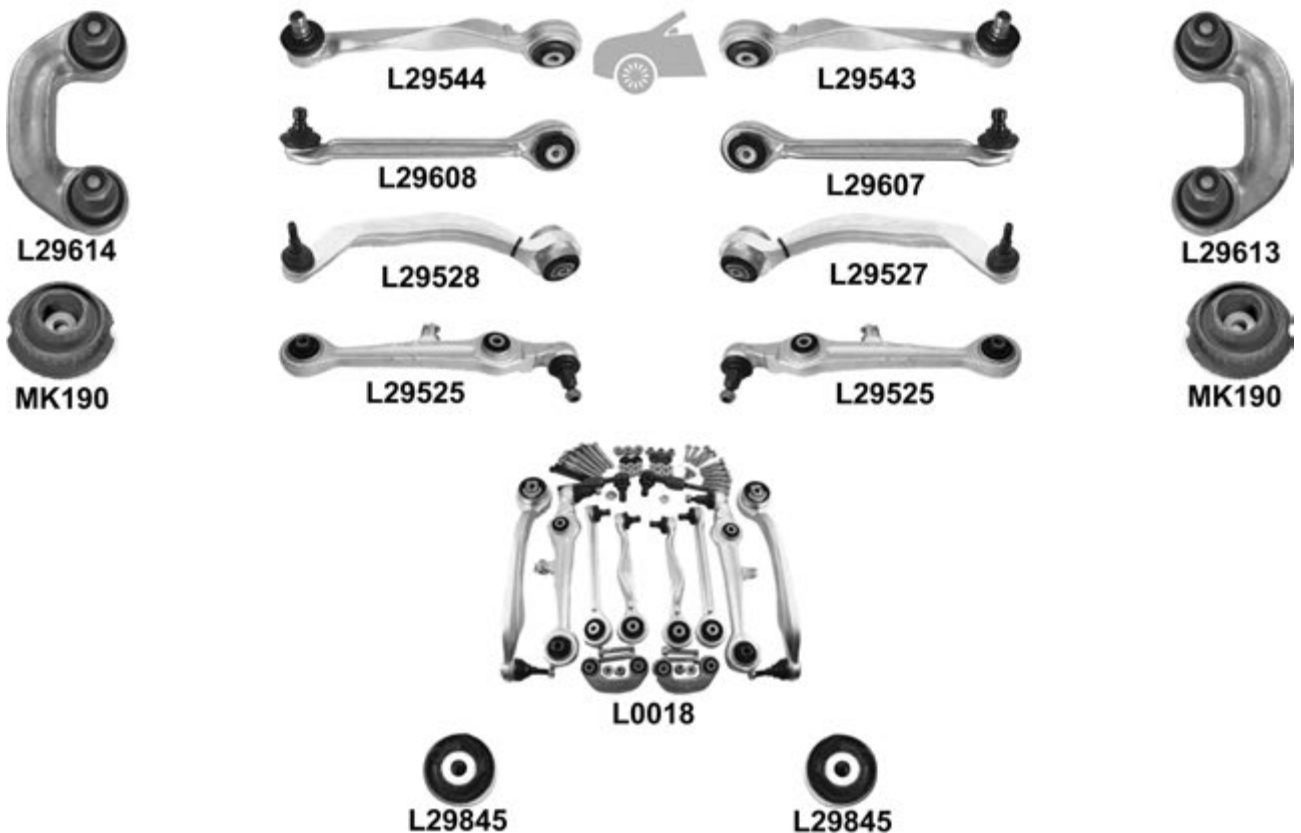
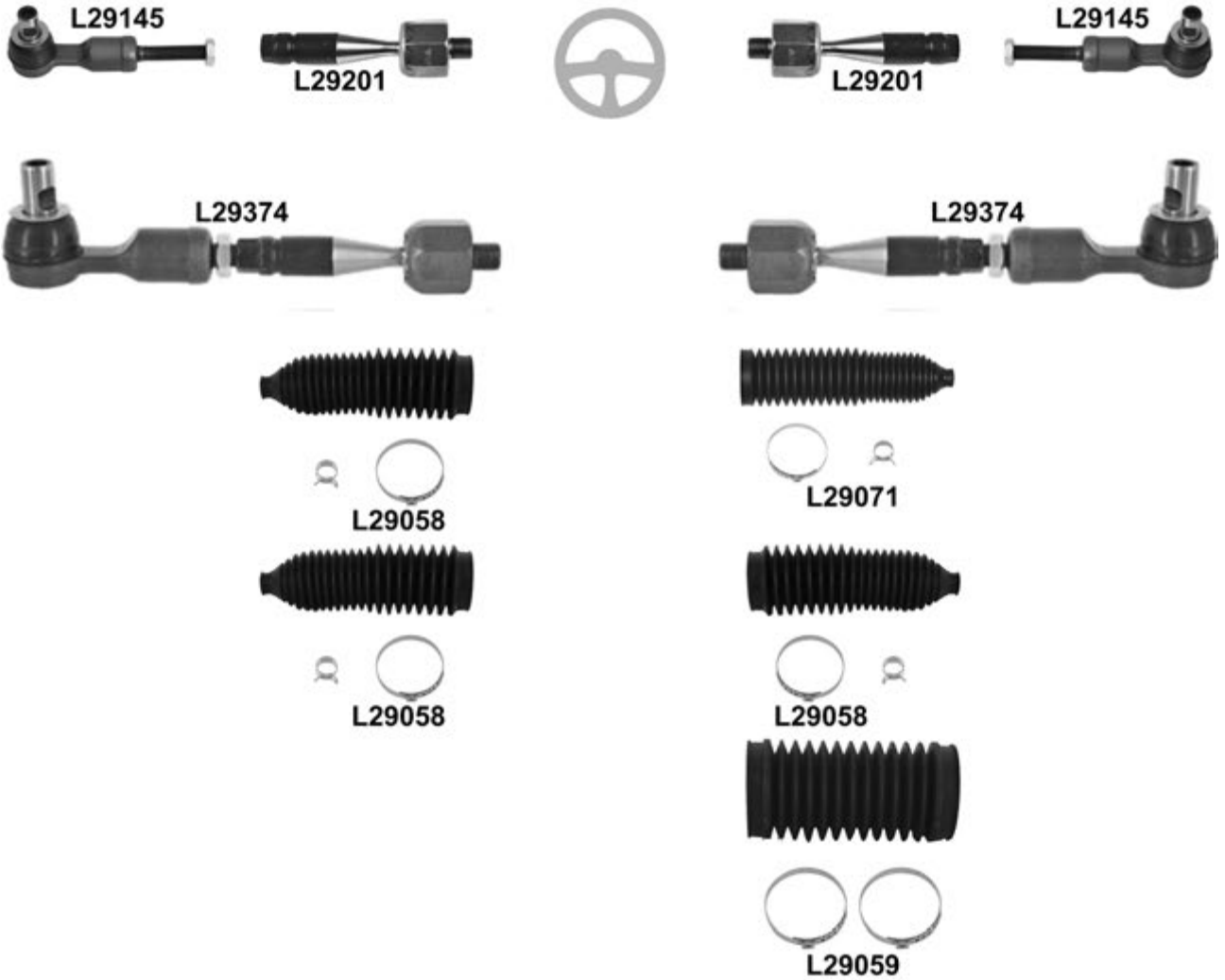

A4 (8D2, B5) 01.95 → 11.00
 A4 Avant (8D5, B5) 02.96 → 09.01

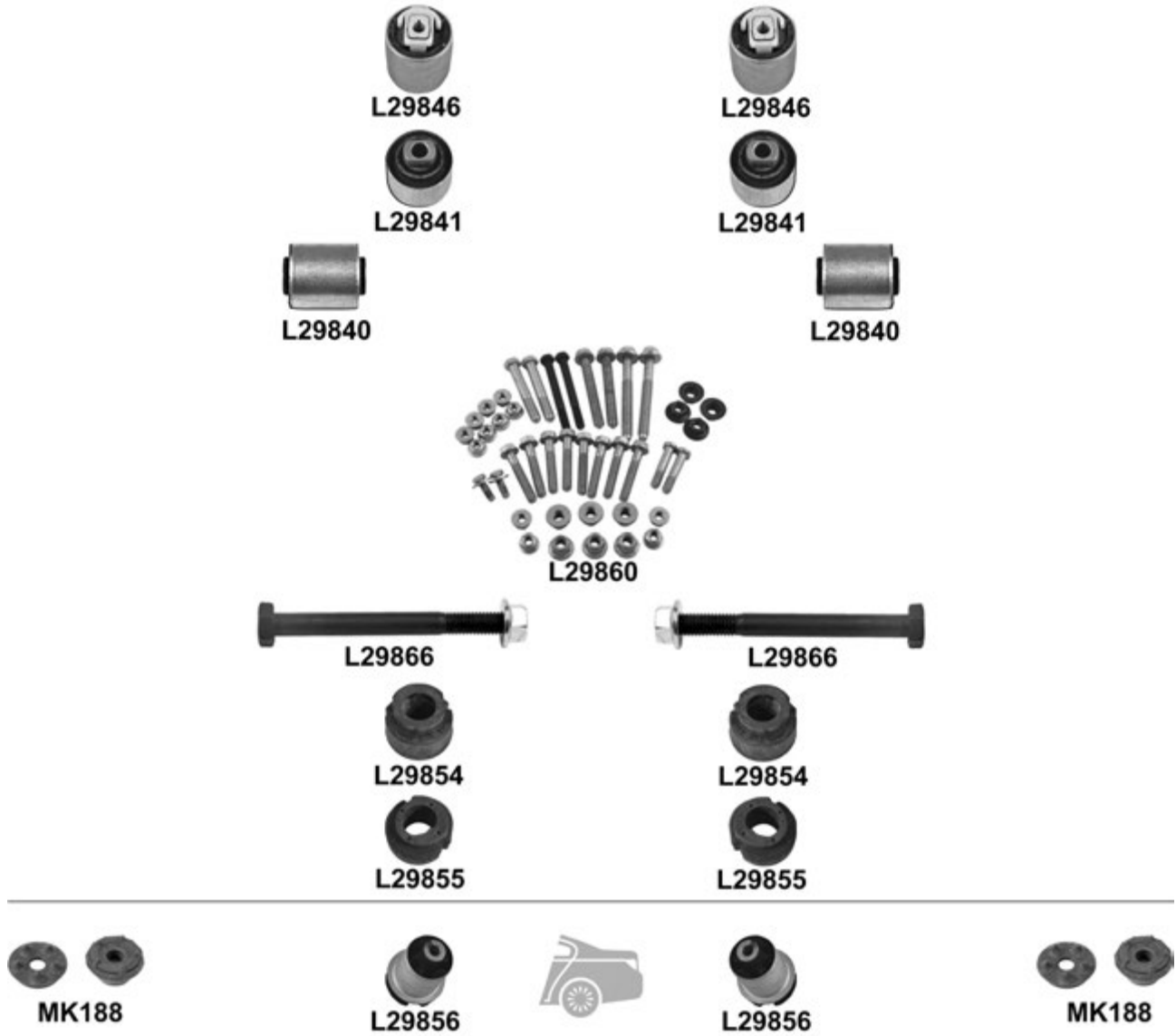

A4 (8D2, B5) 01.95 → 11.00
A4 Avant (8D5, B5) 02.96 → 09.01

		i		← → Thread		Part Of	QPA	i	
		↔	(-) 1.8 Turbo 132KW/S4 195KW	L29145	L29145	M 14x1,5 ☺	2	4B0 419 811 E	
			(-) 1.8 Turbo 132KW/S4 195KW	L29201	L29201	F 14x1,5 / M 16x1,5 ☺	2	4B0 422 821	
			(-) 1.8 Turbo 132KW/S4 195KW	L29374	L29374	M 14x1,5	2	4B0 419 801 E	
				4 cyl., ø 17,5mm, Ø 63mm, L= 255mm		L29071 0		1	8D0 419 831 J
				4 cyl., ø 18mm, Ø 54mm, L= 205mm	L29058			1	4D0 419 831 D
		↔		6 cyl., ø 18mm, Ø 54mm, L= 205mm	L29058	L29058		2	4D0 419 831 D
		→ ←		1.8 20V, Mot/Eng AJL, 6 cyl. cars with bracket for Steering damper ø 65mm, Ø 65mm, L= 141mm		L29059		1	4D0 419 831 A
		↕			L29543		1	8D0 407 510 C	
					L29544		1	8D0 407 509 C	
		↕				L29607		1	8E0 407 506 A
						L29608		1	8E0 407 505 A
		↕				L29527		1	8E0 407 694 K
						L29528		1	8E0 407 693 K
		↕			L29525	L29525		2	4D0 407 151 K
				2 x L 29145/2 x L 29525/29527/29528/29543/29544/ 29607/29608/29613/29614/29860	KIT	L0018		1	8D0 498 998
			↕		L29845	L29845		2	4D0 407 515 C L29543/L29544/ L29607/L29608
			↕		L29846	L29846		2	4D0 407 183 P L29527/L29528
			↕		L29841	L29841		2	4D0 407 182 E L29525
			↕		L29840	L29840		2	4D0 407 181 H L29525
				L 29525/29527/29528/29543/29544/29607/ 29608/29613/29614	KIT	L29860		1	
↕			L 29607/29608	KIT	L29866	L29866		2	
		↕			L29613		1	8D0 411 318 D	
					L29614		1	8D0 411 317 D	
			(-) Sport, Ø 24.8mm	L29854	L29854		2	4D0 411 327 G Anti-roll bar	
			Avant/Sport, Ø 27mm	L29855	L29855		2	4D0 411 327 H Anti-roll bar	
				KIT	MK190	MK190	2	4D0 412 377 F	
			(-) HD	L29856	L29856		2	8D0 501 541 D Hub carrier	
				MK188	MK188		2		

A4 Quattro (8D, B5) 01.95 → 11.00
 A4 Avant Quattro (8D, B5) 01.96 → 09.01

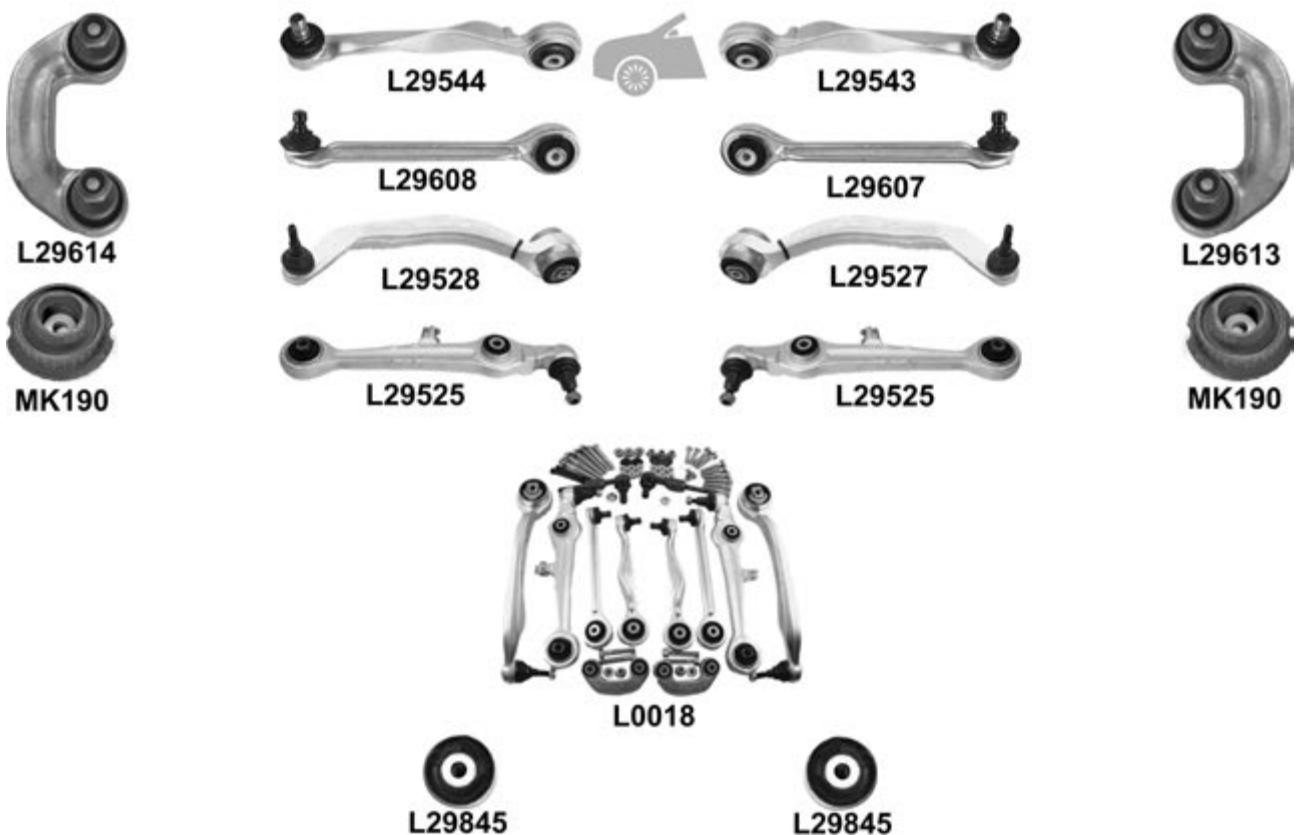
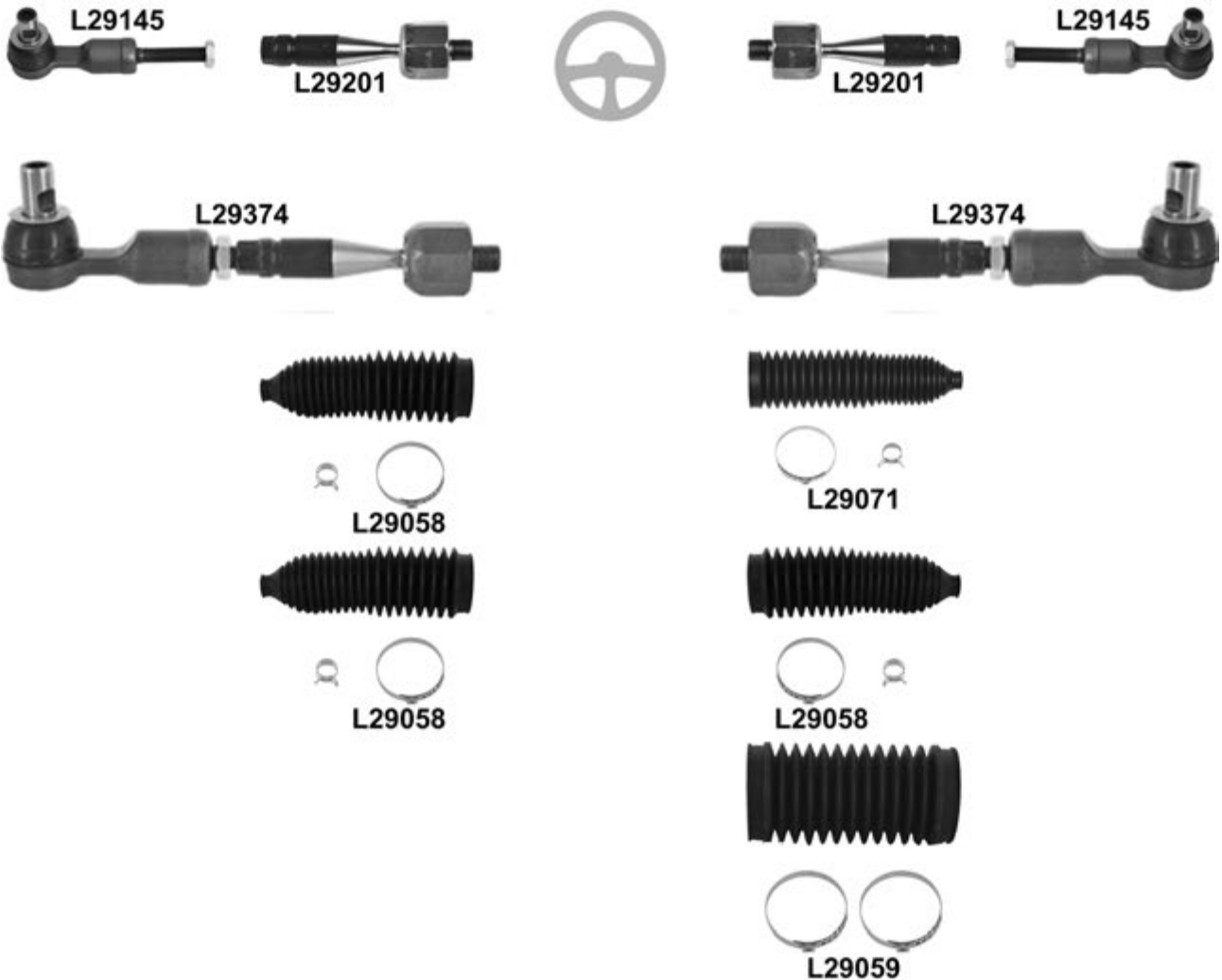

A4 Quattro (8D, B5) 01.95 → 11.00
 A4 Avant Quattro (8D, B5) 01.96 → 09.01

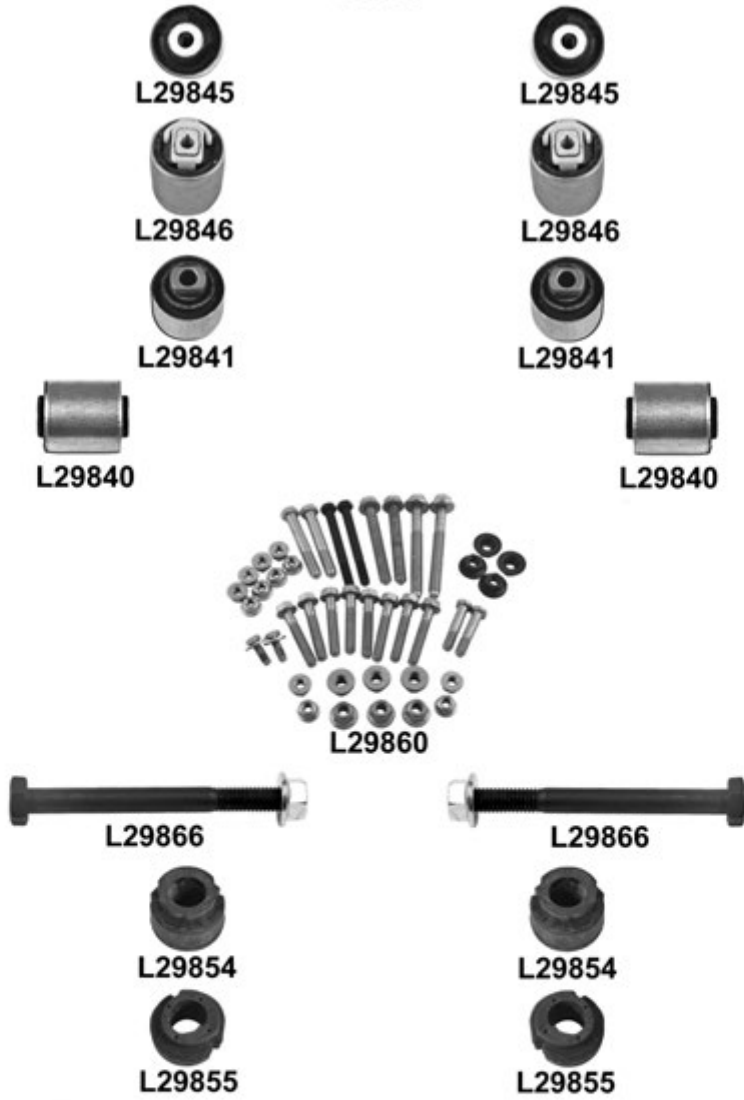

A4 Quattro (8D, B5) 01.95 → 11.00
A4 Avant Quattro (8D, B5) 01.96 → 09.01

			←	→	Thread	Part Of	QPA		
		↔	L29145	L29145	M 14x1,5 U		2	4B0 419 811 E	
			L29201	L29201	F 14x1,5 / M 16x1,5 U		2	4B0 422 821	
			L29374	L29374	M 14x1,5		2	4B0 419 801 E	
				L29071 ⁰			1	8D0 419 831 J	
		4 cyl., ø 17,5mm, Ø 63mm, L= 255mm		L29058			1	4D0 419 831 D	
		4 cyl., ø 18mm, Ø 54mm, L= 205mm		L29058	L29058		2	4D0 419 831 D	
		6 cyl., ø 18mm, Ø 54mm, L= 205mm			L29059		1	4D0 419 831 A	
	1.8 20V, Mot/Eng AJL, 6 cyl. cars with bracket for Steering damper ø 65mm, Ø 65mm, L= 141mm								
		↑		L29543			1	8D0 407 510 C	
			L29544				1	8D0 407 509 C	
		↑		L29607			1	8E0 407 506 A	
			L29608				1	8E0 407 505 A	
		↓		L29527			1	8E0 407 694 K	
			L29528				1	8E0 407 693 K	
		↓	L29525	L29525			2	4D0 407 151 K	
		2 x L 29145/2 x L 29525/29527/29528/29543/ 29544/29607/29608/29613/29614/29860	KIT	L0018				1	8D0 498 998
		↑	↖↗↘↙	L29845	L29845		L29543/L29544/ L29607/L29608	2	4D0 407 515 C
		↓	↖↗↘↙	L29846	L29846		L29527/L29528	2	4D0 407 183 P
		↓	↖↗↘↙	L29841	L29841		L29525	2	4D0 407 182 E
		↓	↖↗↘↙	L29840	L29840		L29525	2	4D0 407 181 H
			L 29525/29527/29528/29543/29544/29607/29608/29613/29614	KIT		L29860		1	
		↑	L 29607/29608	KIT		L29866	L29866		2
		↓			L29613			1	8D0 411 318 D
				L29614			1	8D0 411 317 D	
		Ø 24,8mm	L29854	L29854		Anti-roll bar	2	4D0 411 327 G	
		Ø 27mm	L29855	L29855		Anti-roll bar	2	4D0 411 327 H	
			KIT		MK190	MK190	2	4D0 412 377 F	
					L29671		1	8D0 505 466	
				L29672			1	8D0 505 465	

A4 (8E2, B6) 11.00 → 12.04
 A4 Avant (8E5, B6) 09.01 → 12.04

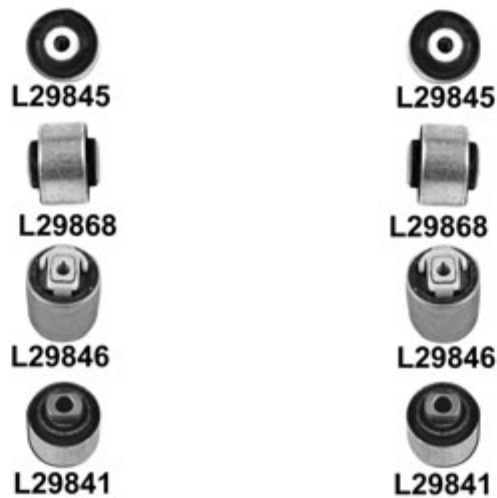
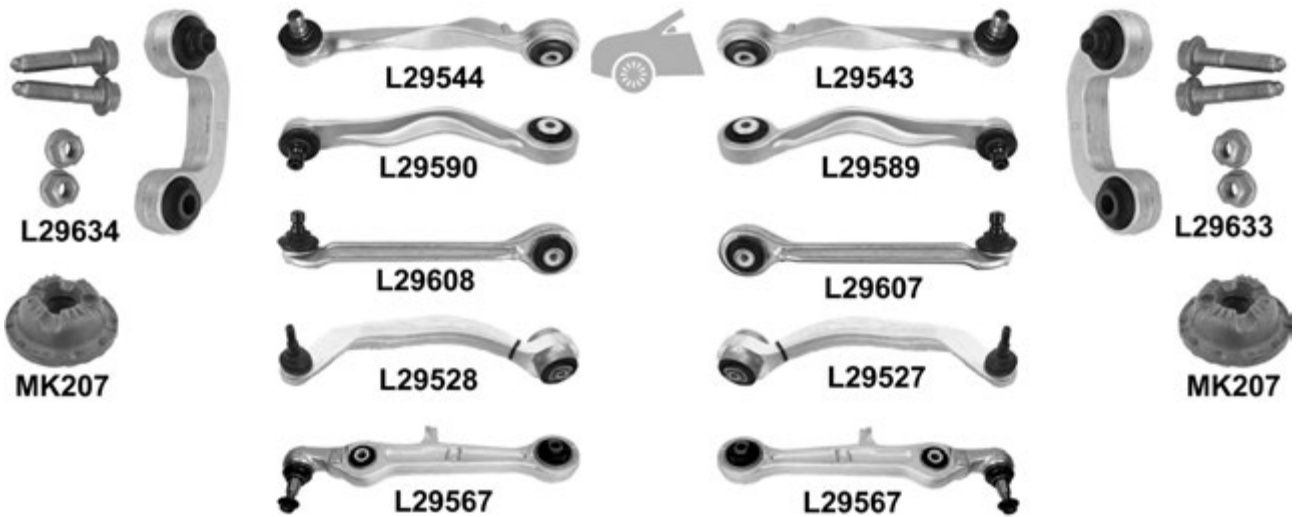
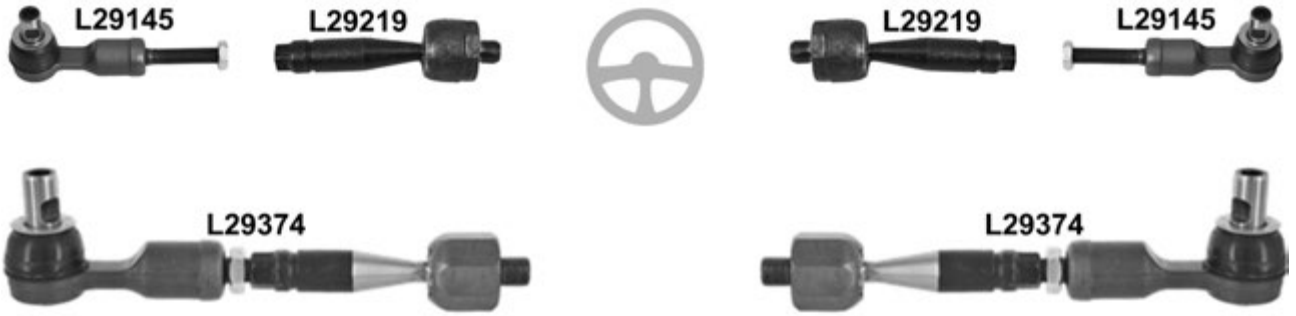

A4 (8E2, B6) 11.00 → 12.04
 A4 Avant (8E5, B6) 09.01 → 12.04



				← → Thread		Part Of	QPA			
⊕		↔		L29145	L29145	↻	2	8E0 419 811 B		
				L29219	L29219		2	8E0 422 821		
				L29374	L29374		2	8E0 418 801 B		
🔧		↕	(-) PR 1BV		L29543		1	8D0 407 510 C		
				L29544		1	8D0 407 509 C			
		PR 1BV		L29589		1	8E0 407 510 P			
			L29590		1	8E0 407 509 P				
	↕	↗			L29607		1	8E0 407 506 A		
				L29608		1	8E0 407 505 A			
	↕	↘			L29527		1	8E0 407 694 K		
				L29528		1	8E0 407 693 K			
	↕	↗			L29567	L29567		2	8E0 407 151 N	
			2 x L 29145/2 x L 29567/29527/29528/29543/29544/29607/29608/29633/29634/29875	KIT	L0019			1		
	🌀	↕	↗↖↗↖↗↖↗↖	(-) PR 1BV	L29845	L29845		4	4D0 407 515 C	🔧 L29543/L29544/L29607/L29608
				PR 1BV, (+) S4 Quattro	L29868	L29868		4	8D0 407 515 C	🔧 L29589/L29590
					L29846	L29846		2	4D0 407 183 P	🔧 L29527/L29528
					L29841	L29841		2	4D0 407 182 E	🔧 L29567
				L29870	L29870		2	8E0 407 181 C	🔧 L26567	
🔧	↕		L 29567/29527/29528/29543/29544/29607/29608/29633/29634	KIT	L29875		1		🔧	
					L29633		1	8E0 411 318		
					L29634		1	8E0 411 317		
🌀	↕	KIT		MK207	MK207		2	8E0 412 377		
				L29871	L29871		2	8E0 505 145 AP	Hub carrier	
			L29872	L29872		2	8E0 505 145 AR	Hub carrier		
			L29635	L29635		2	8E0 505 465 AC			
					MK297	MK297		2	4F0 513 353 D	

↕ = Upper ↕ = Lower ↗ = Front ↘ = Rear ↗↖ = Inner ↖↗ = Outer ↗↖↗↖ = Center

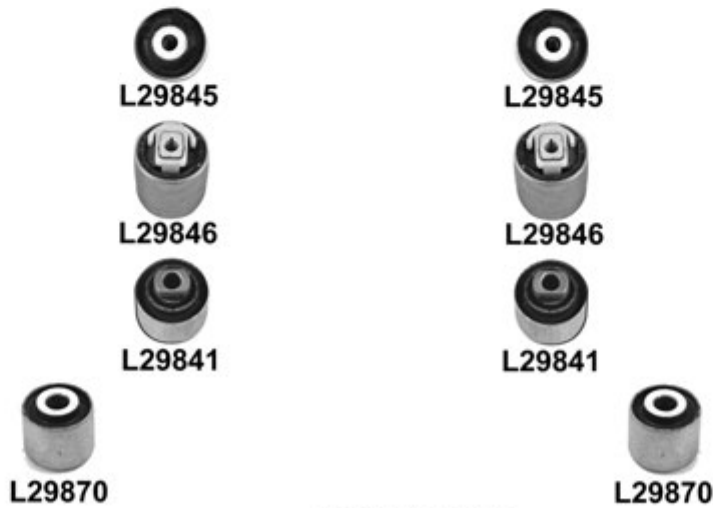
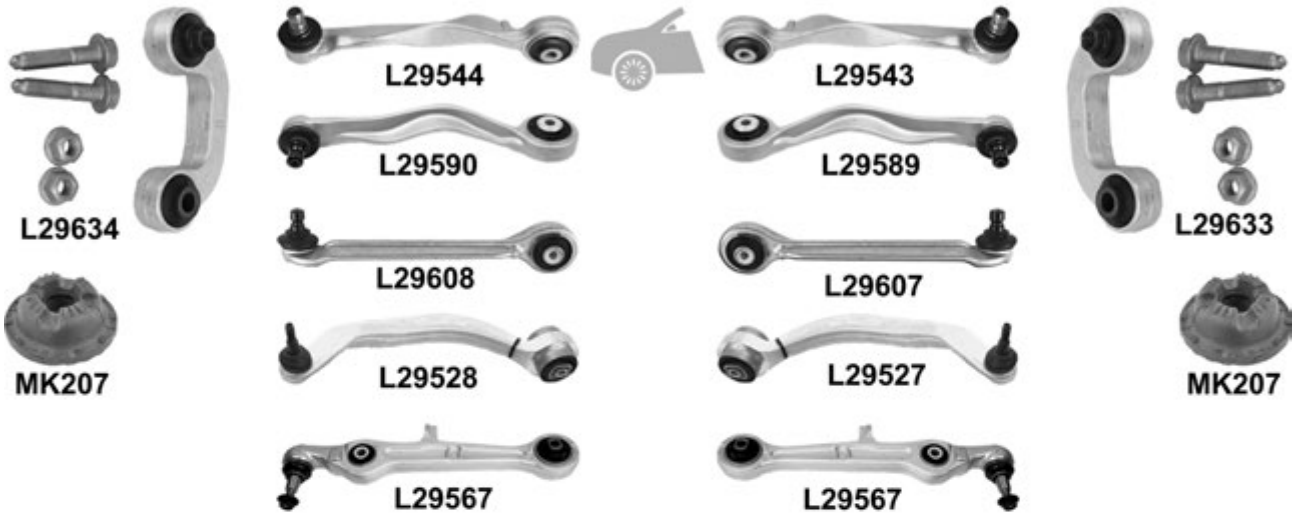
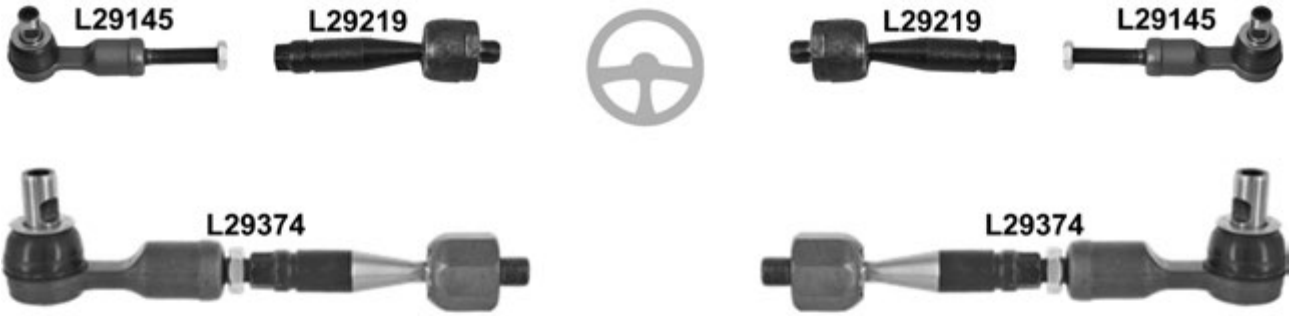
A4 Quattro (8E2, B6) 11.00 → 12.04
A4 Avant Quattro (8E5, B6) 09.01 → 12.04

A4 Quattro (8E2, B6) 11.00 → 12.04
A4 Avant Quattro (8E5, B6) 09.01 → 12.04



		i		←	→	Thread	Part Of	QPA	i	
				L29145	L29145	⌋		2	8EO 419 811 B	
				L29219	L29219			2	8EO 422 821	
				L29374	L29374			2	8EO 418 801 B	
		HD			L29543			1	8D0 407 510 C	
				L29544				1	8D0 407 509 C	
		(-) HD			L29589			1	8EO 407 510 P	
				L29590				1	8EO 407 509 P	
						L29607			1	8EO 407 506 A
				L29608				1	8EO 407 505 A	
						L29527			1	8EO 407 694 K
				L29528				1	8EO 407 693 K	
					L29567	L29567			2	8EO 407 151 N
			2 x L 29145/2 x L 29567/29527/29528/29543/29544/ 29607/29608/29633/29634/29875	KIT	L0019				1	
		(-) HD		L29845	L29845		L29543/L29544/ L29607/L29608	4	4D0 407 515 C	
				L29846	L29846		L29527/L29528	2	4D0 407 183 P	
				L29841	L29841		L29567	2	4D0 407 182 E	
				L29870	L29870		L26567	2	8EO 407 181 C	
		L 29567/29527/29528/29543/29544/29607/29608/29633/29634	KIT	L29875			1			
					L29633			1	8EO 411 318	
				L29634				1	8EO 411 317	
			KIT	MK207	MK207			2	8EO 412 377	
		Hydraulic		L29871	L29871		Hub carrier	2	8EO 505 145 AP	
		Hydraulic		L29872	L29872		Hub carrier	2	8EO 505 145 AR	
					L29635	L29635			2	8EO 505 465 AC
					MK297	MK297			2	4FO 513 353 D

A4 (8EC) 11.04 →
 A4 Avant (8ED) 11.04 →

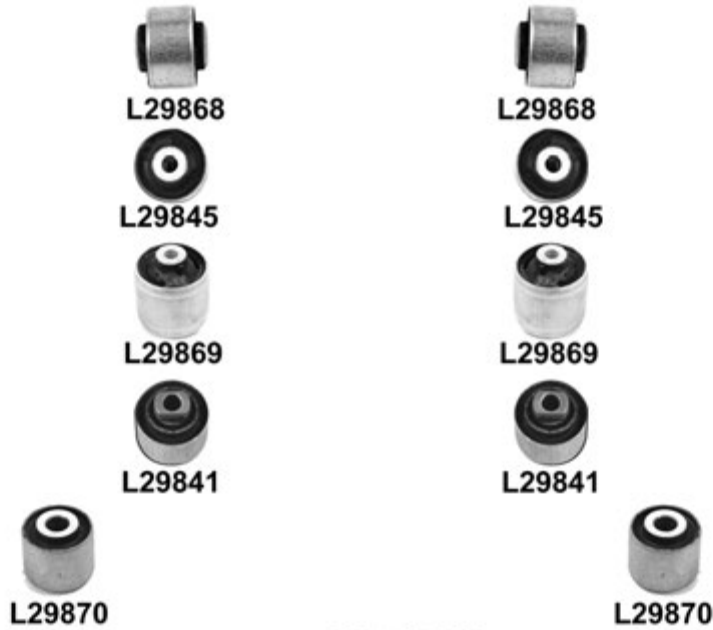
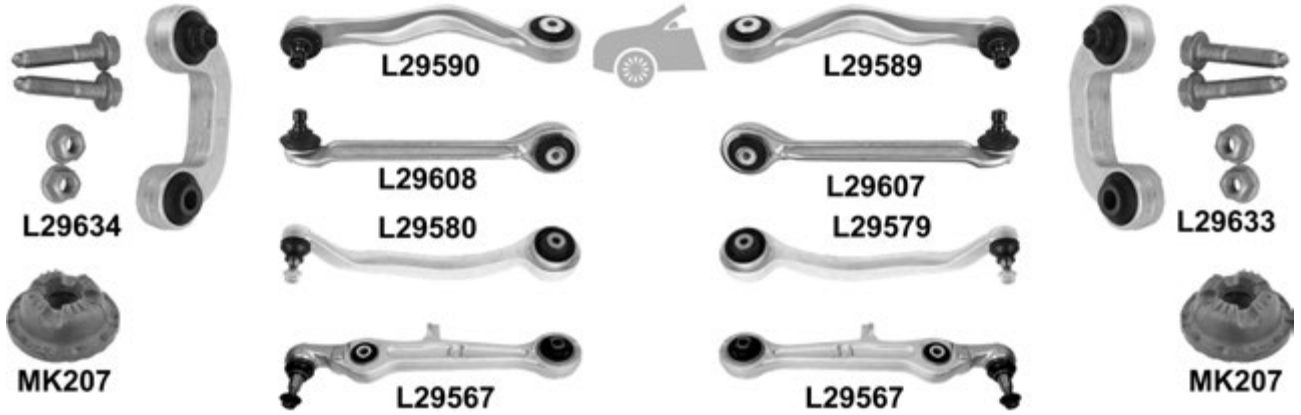

A4 (8EC) 11.04 →
A4 Avant (8ED) 11.04 →



		i		←	→	Thread	Part Of	QPA	i	
		↔		L29141	L29141	↻		2	4F0 419 811 C	
				L29219	L29219			2	8E0 422 821	
		↕↓			L29589			1	8E0 407 510 C	
				L29590				1	8E0 407 509 C	
		↕↑			L29607			1	8E0 407 506 C	
				L29608				1	8E0 407 505 C	
		⊥↓			L29579			1	8E0 407 694 T	
				L29580				1	8E0 407 693 T	
		⊥↑			L29567	L29567			2	8E0 407 151 N
		↕↓↔↔			L29868	L29868		L29589/L29590	4	8D0 407 515 B
		↕↑↔↔			L29845	L29845		L29543/L29544/ L29607/L29608	4	4D0 407 515 C
		⊥↓↔↔			L29869	L29869		L29579/L29580	2	4F0 407 183 C
		⊥↑↔↔			L29841	L29841		L29567	2	4D0 407 182 E
		⊥↑↔↔			L29870	L29870		L29567	2	8E0 407 181 C
			L 29567/29579/29580/29589/29590/29607/29608/29633/29634	KIT	L29875			1		
		⊥				L29633			1	8E0 411 318
				L29634				1	8E0 411 317	
				L29854	L29854		Anti-roll bar	2	4D0 411 327 G	
	KIT			MK207	MK207			2	8E0 412 377	
				L29635	L29635			2	8E0 505 465 AC	
			MK297	MK297			2	4F0 513 353 D		

A4 Quattro (8EC) 11.04 →
 A4 Avant Quattro (8ED) 11.04 →

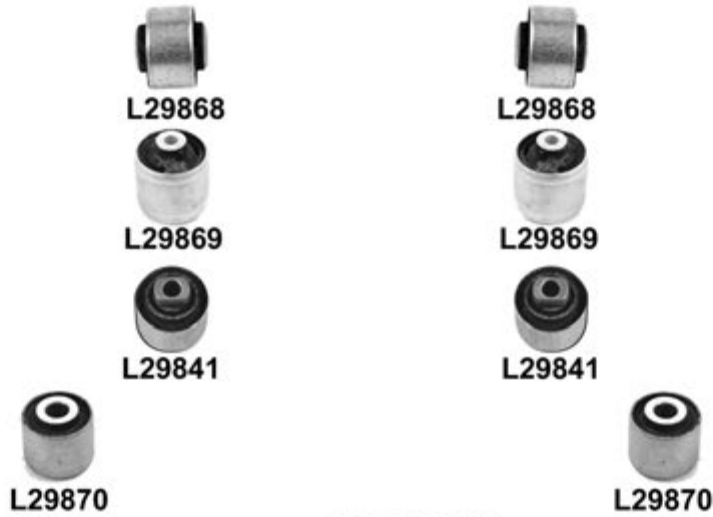
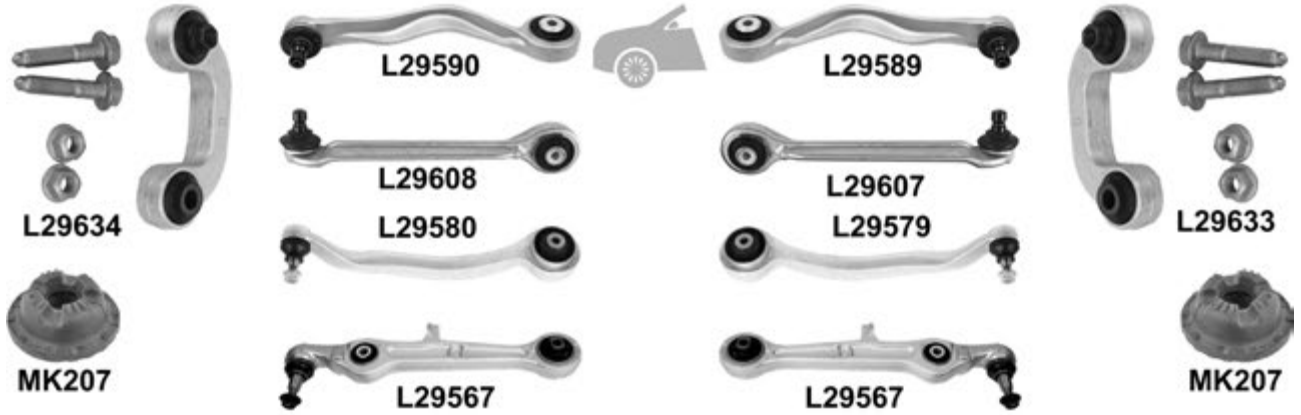

A4 Quattro (8EC) 11.04 →
A4 Avant Quattro (8ED) 11.04 →

			←	→	Thread	Part Of	QPA		
		↔	L29141	L29141	↻		2	4F0 419 811 C	
			L29219	L29219			2	8E0 422 821	
		ī ▼		L29589			1	8E0 407 510 C	
			L29590				1	8E0 407 509 C	
		ī ▲		L29607			1	8E0 407 506 C	
			L29608				1	8E0 407 505 C	
		⊥ ▼		L29579			1	8E0 407 694 T	
			L29580				1	8E0 407 693 T	
		⊥ ▲	L29567	L29567			2	8E0 407 151 N	
		ī ▼ → ←		L29868	L29868		L29589/L29590	4	8D0 407 515 B
		⊥ ▼ → ←		L29869	L29869		L29579/L29580	2	4F0 407 183 C
		⊥ ▲ → ←		L29841	L29841		L29567	2	4D0 407 182 E
		⊥ ▲ ← →		L29870	L29870		L29567	2	8E0 407 181 C
			L 29567/29579/29580/29589/29590/29607/29608/29633/29634 KIT		L29875			1	
		⊥			L29633			1	8E0 411 318
				L29634				1	8E0 411 317
			L29854	L29854		Anti-roll bar	2	4D0 411 327 G	
		KIT	MK207	MK207			2	8E0 412 377	
			L29635	L29635			2	8E0 505 465 AC	
			MK297	MK297			2	4F0 513 353 D	

A4 (8K2) 11.07 →
 A4 Avant (8K5) 04.08 →

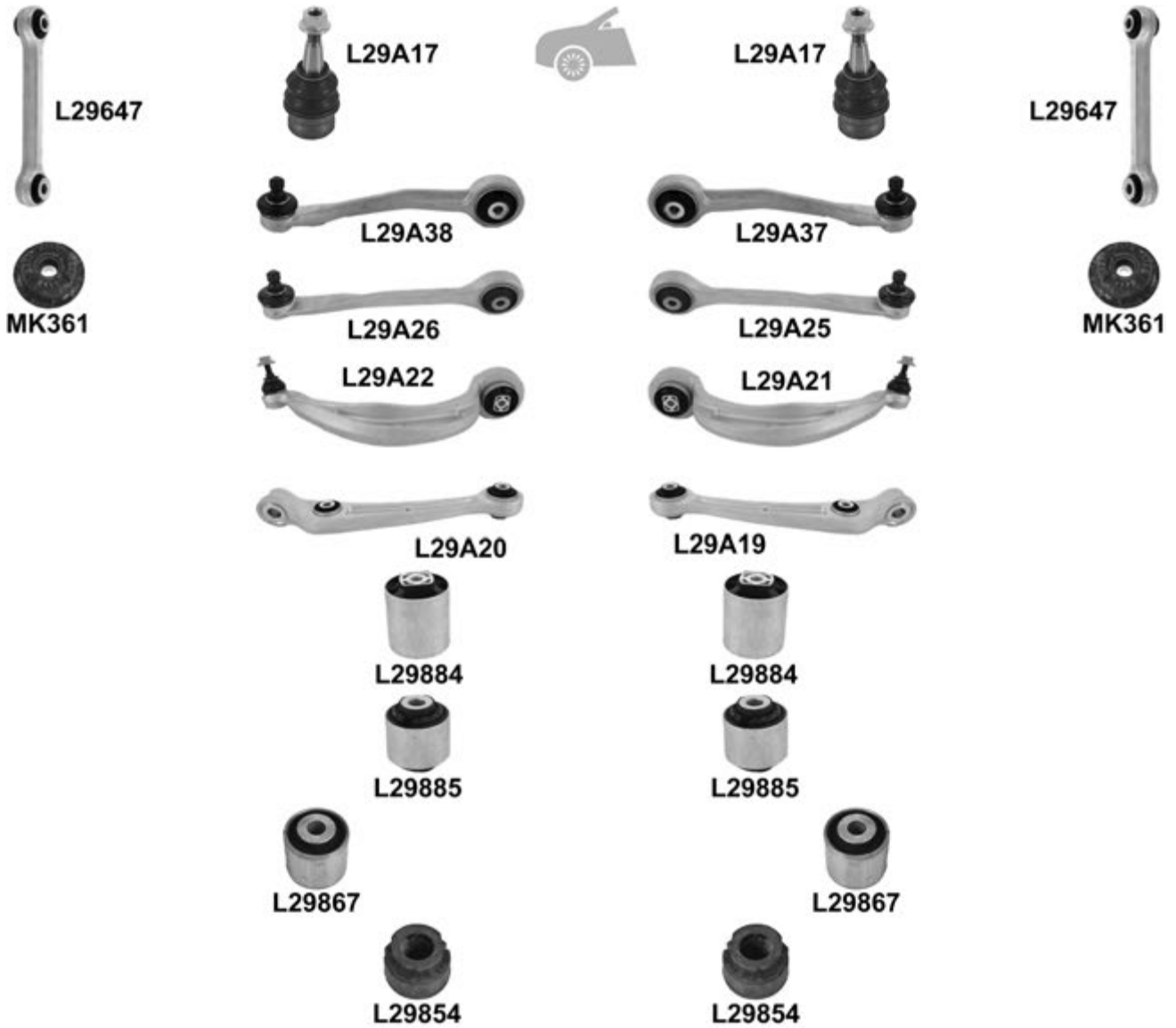

A4 (8K2) 11.07 →
A4 Avant (8K5) 04.08 →

			←	→	Thread	Part Of	QPA							
		↔		L= 208mm	L29151	F 16x1,5 ∪	1	8K0 422 818 B						
					L29152	F 16x1,5 ∪	1	8K0 422 817 B						
					L29224	L29224	M 16x1,5 / M 16x1,5 ∪	2	8J0 423 810					
					L29062 ⁰	L29062 ⁰		2	8K0 422 831					
		↓	→ 12.11	(-) 1.8 Tsi, Mot/Eng CABB/CDHB/2.0 Tdi, Mot/Eng CAGA/CAGC/CAHA/CAHB/CMEA (-) 2.7 Tdi, Mot/Eng CAMA/CAMB/CGKA/CGKB	L29A17	L29A17		2	8K0 407 689 F					
					L29A17	L29A17		2	8K0 407 689 F					
						↖	L29A37		1	8K0 407 510 A				
							L29A38		1	8K0 407 509 A				
						↗	L29A25		1	8K0 407 506 A				
							L29A26		1	8K0 407 505 A				
						↘	→ 10.09, 65mm	L29A21		1	8K0 407 694 N			
							L29A22		1	8K0 407 693 N				
						↙	→ 12.11	L29A19		1	8K0 407 152 C			
							L29A20		1	8K0 407 151 C				
						↕↔	L29884	L29884		L29A21/L29A22	2	8K0 407 183 A		
							L29885 ⁰	L29885 ⁰		L29A19/L29A20	2	8K0 407 182 B		
							L29867	L29867		L29A19/L29A20	2	4E0 407 181 B		
								L29647	L29647		2	8K0 411 317 E		
							PR 1BD/1BE/1BP/1BV with SP /Allroad, Ø 24.8mm	L29854	L29854	Anti-roll bar	2	4D0 411 327 G		
							PR 1BA/1BD/1BE/1BR/1BV, (-)	KIT MK361	MK361		2	8K0 412 377 C		
							↕↗	1.8 TFSi, Mot/Eng CABB/CDHB/CCUA	L29A61			1	8K0 501 530 N	
									L29A62			1	8K0 501 529 N	
									1.8 FSi/TFSi/2.0 R, Mot/Eng CABA/CDHA/CFKA → 12.11	L29A61			1	8K0 501 530 N
										L29A62			1	8K0 501 529 N
2.0 TFSi, Mot/Eng CADA/CAEA/CAEB/CDNB/CDNC/CDZA → 12.11	L29A61			1					8K0 501 530 N					
	L29A62			1					8K0 501 529 N					
2.0 Tdi, Mot/Eng CAGA/CAGC/CAHA/CAHB/CMEA	L29A61			1					8K0 501 530 N					
	L29A62			1					8K0 501 529 N					
2.0 Tdi, Mot/Eng CAGB/CJCB → 12.11	L29A61			1					8K0 501 530 N					
	L29A62			1					8K0 501 529 N					
2.7 Tdi, Mot/Eng CAMA/CAMB/CGKA/CGKB	L29A61			1					8K0 501 530 N					
	L29A62			1					8K0 501 529 N					
			L29645	L29645		2	8K0 505 465 E							
	↕↗	→ 12.11	MK388 ⁰	MK388 ⁰		2	8K0 513 353 E							
		Mot/Eng CAGA/CAGC/CAHB/CAKA/CMEA	MK388 ⁰	MK388 ⁰		2	8K0 513 353 E							
		Allroad Quattro/S4 Quattro	MK388 ⁰	MK388 ⁰		2	8K0 513 353 E							

A4 Allroad (8KH) 04.09 →

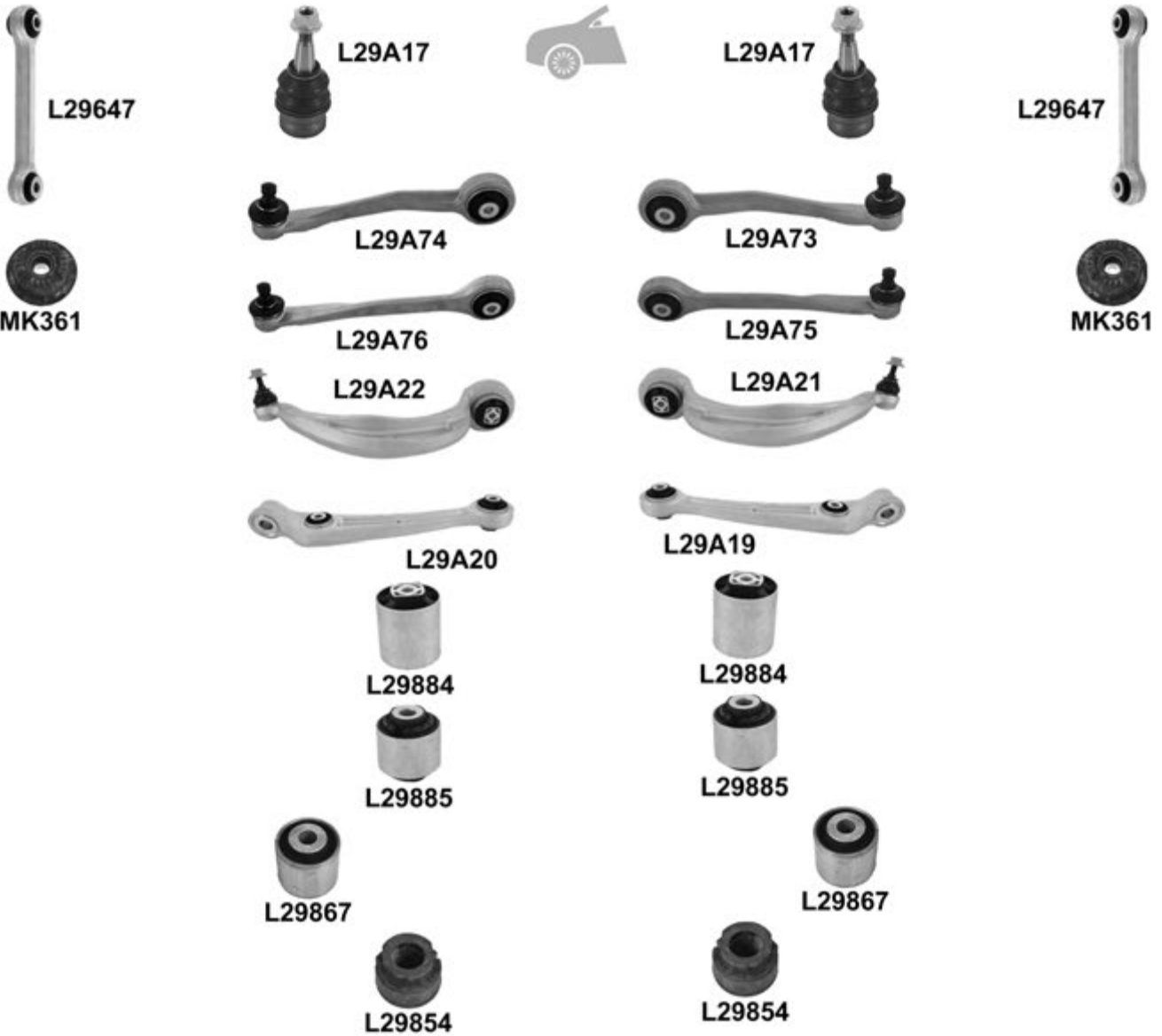

A4 Allroad (8KH) 04.09 →

				←	→	Thread	Part Of	QPA	
		↔	Hydraulic , L= 208mm		L29151	F 16x1,5 ♂		1	8K0 422 818 B
					L29152	F 16x1,5 ♂		1	8K0 422 817 B
			Thermoplast		L29224	M 16x1,5 / M 16x1,5 ♂		2	8J0 423 810
					L29062 ⁰	L29062 ⁰		2	8K0 422 831
		⊥			L29A17	L29A17		2	8K0 407 689 F
					L29A73 ⁰		1	8K0 407 510 B	
		↕			L29A74 ⁰		1	8K0 407 509 B	
					L29A75 ⁰		1	8K0 407 506 B	
		⊥	→ 10.09, 65mm		L29A76 ⁰		1	8K0 407 505 B	
					L29A21		1	8K0 407 694 N	
		⊥			L29A22		1	8K0 407 693 N	
					L29A19		1	8K0 407 152 C	
		↕	→ 10.09		L29A20		1	8K0 407 151 C	
					L29884	L29884	L29A21/L29A22	2	8K0 407 183 A
					L29885 ⁰	L29885 ⁰	L29A19/L29A20	2	8K0 407 182 B
		↕	↔		L29867	L29867	L29A19/L29A20	2	4E0 407 181 B
					L29647	L29647		2	8K0 411 317 E
		∅ 24.8mm		L29854	L29854	Anti-roll bar	2	4D0 411 327 G	
				MK361	MK361	KIT	2	8K0 412 377 C	
		⊥	2.0 TFSi, Mot/Eng CDNC → 07.09		L29A61		1	8K0 501 530 N	
					L29A62		1	8K0 501 529 N	
		↕	2.0 Tdi, Mot/Eng CAHA/CAHB/CGLD → 07.09		L29A61		1	8K0 501 530 N	
					L29A62		1	8K0 501 529 N	
					L29645	L29645		2	8K0 505 465 E
					MK388 ⁰	MK388 ⁰		2	8K0 513 353 E

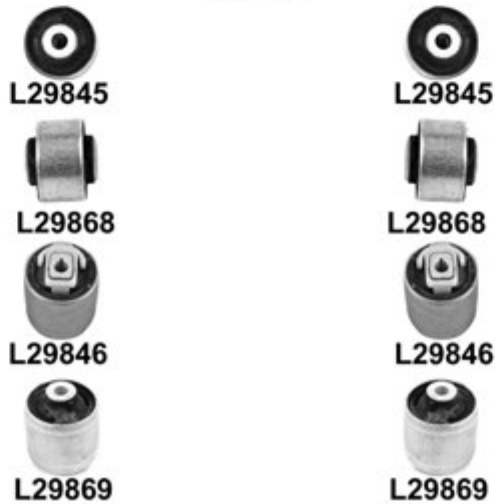
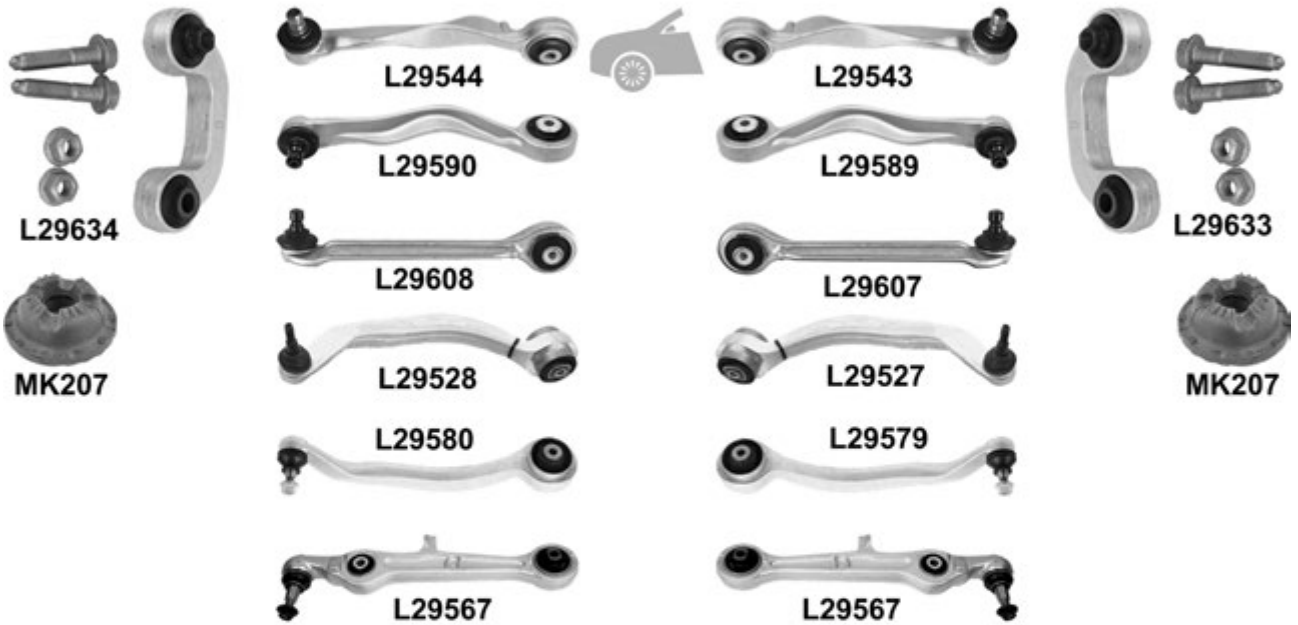
A4 Cabriolet (8H7, 8HE) 04.02 →

A4 Cabriolet (8H7, 8HE) 04.02 →

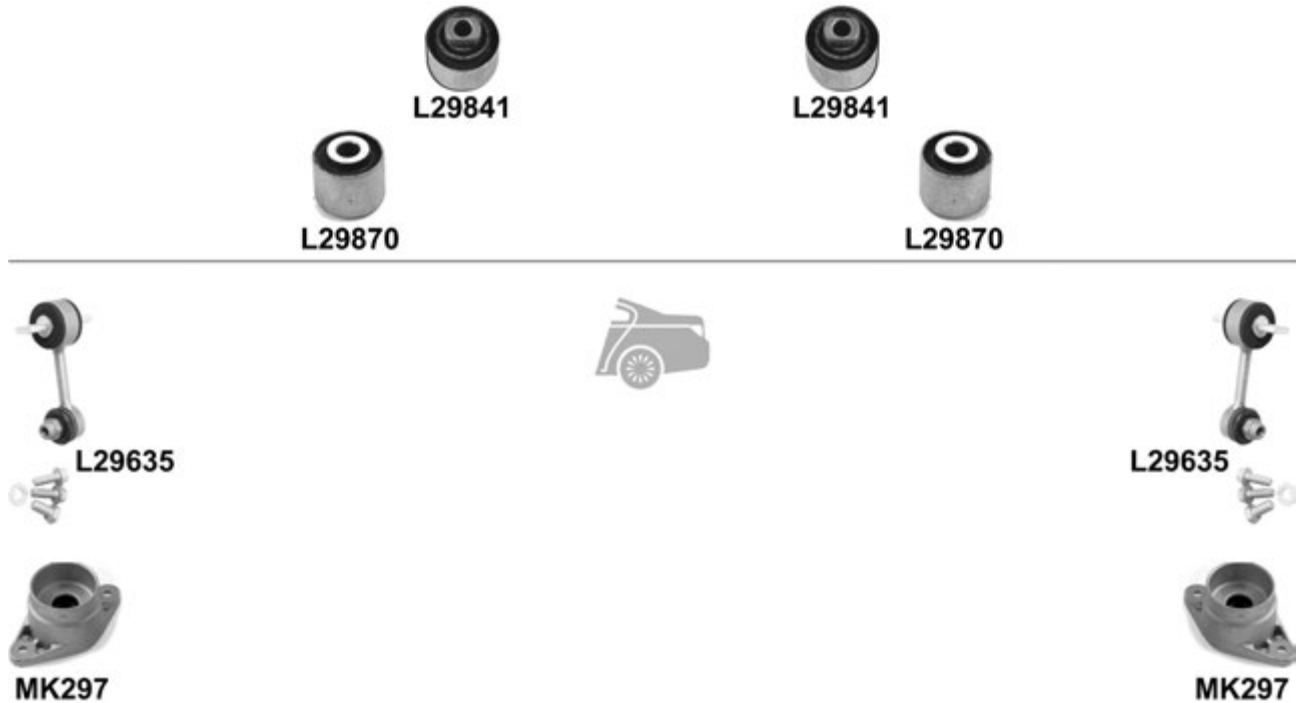

		← → Thread		Part Of	QPA			
⊕	↔	Model 8H7, → 10.04 , ch. → 8H 5 014 475	L29145	L29145	∪	2	8EO 419 811 B	
		Model 8H7, 11.04 →, ch. 8H 5 014 476 →	L29141	L29141	∪	2	4FO 419 811 C	
		Model 8HE	L29141	L29141	∪	2	4FO 419 811 C	
	↔		L29219	L29219		2	8EO 422 821	
		Model 8H7, → 10.04 , ch. → 8H 5 014 475	L29374	L29374		2	4FO 419 801 B	
🔧	↕	Model 8H7, (-) HD		L29543		1	8DO 407 510 C	
			L29544			1	8DO 407 509 C	
		Model 8H7, HD		L29589		1	8EO 407 510 C	
			L29590			1	8EO 407 509 C	
		Model 8HE		L29589		1	8EO 407 510 C	
			L29590			1	8EO 407 509 C	
		↕			L29607		1	8EO 407 506 A
				L29608			1	8EO 407 505 A
		↕	Model 8H7		L29527		1	8EO 407 694 K
				L29528			1	8EO 407 693 K
	Model 8HE			L29579		1	8EO 407 694 T	
			L29580			1	8EO 407 693 T	
	↕		L29567	L29567		2	8EO 407 151 N	
	🔧	🔧	L 29567/29579/29580/29589/29590/29607/29608/29633/29634 KIT	L29875			1	
			↕↔↔	L29845	L29845		4	L29607/L29608 4DO 407 515 C
↕↔↔			L29868	L29868		4	L29589/L29590 8DO 407 515 C	
↕↔↔			L29846	L29846		2	L29527/L29528 4DO 407 183 P	
			L29869	L29869		2	L29579/L29580 4FO 407 183 C	
↕↔↔			L29841	L29841		2	L29567 4DO 407 182 E	
↕↔↔			L29870	L29870		2	L29567 8EO 407 181 C	
↕					L29633		1	8EO 411 318
					L29634		1	8EO 411 317
🔧			🔧	KIT	MK207	MK207		2
		L29635		L29635		2	8EO 505 465 AC	
🔧	🔧	PR GP1	MK297	MK297		2	4FO 513 353 D	

A4 Cabriolet Quattro (8H7, 8HE) 04.02 →

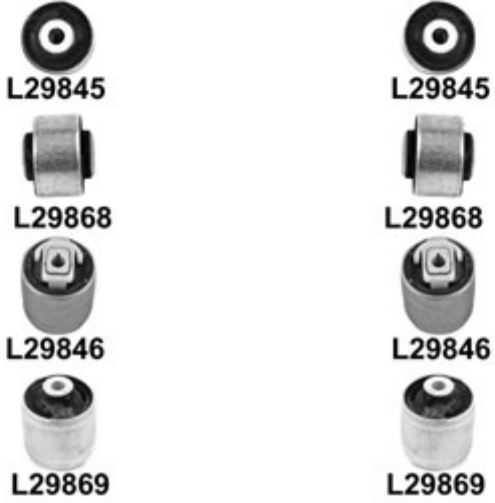
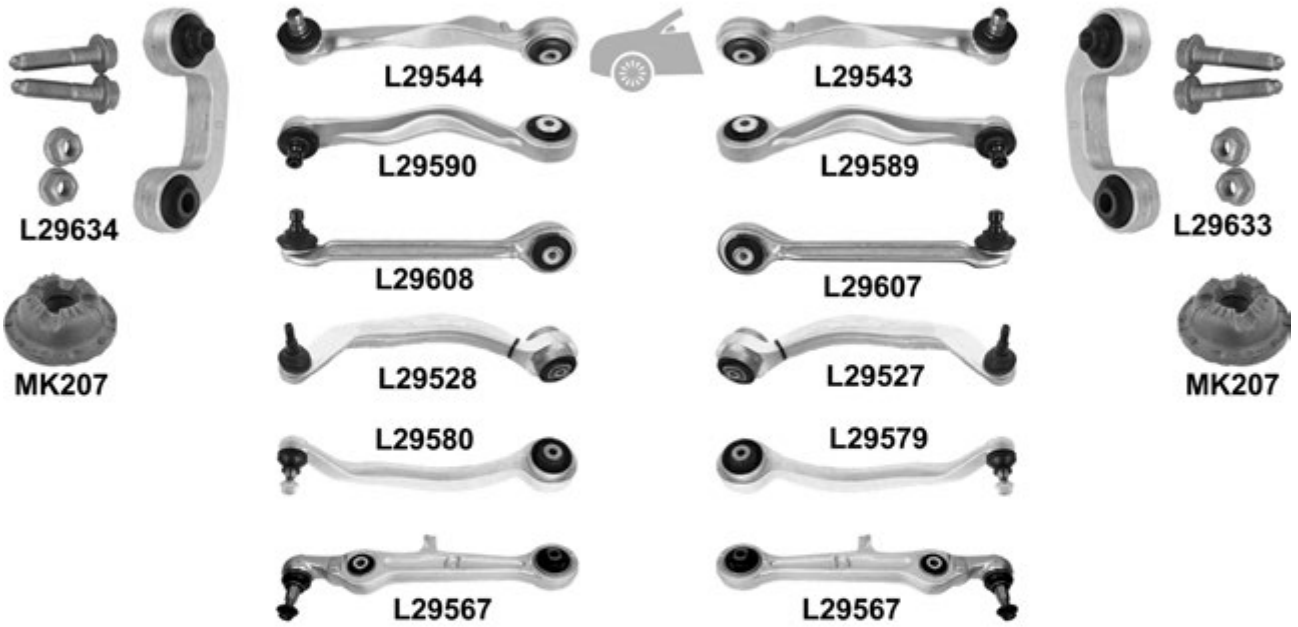
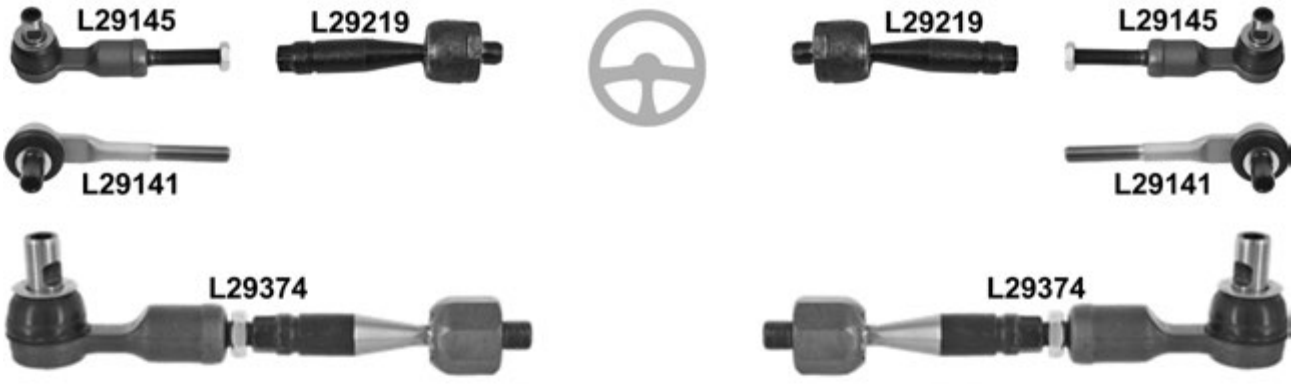

A4 Cabriolet Quattro (8H7, 8HE) 04.02 →

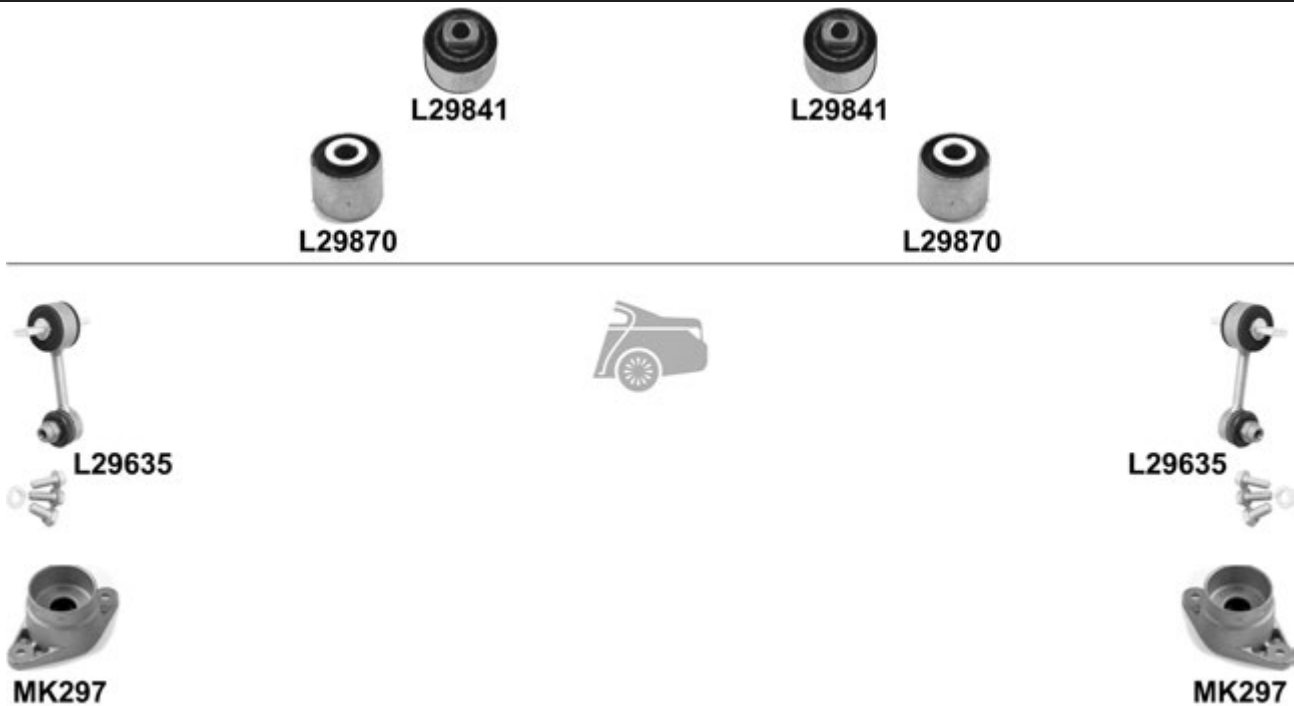

			←	→	Thread	Part Of	QPA		
⊕	↔	Model 8H7, → 10.04 , ch. → 8H 5 014 475	L29145	L29145	∪		2	8EO 419 811 B	
		Model 8H7, 11.04 →, ch. 8H 5 014 476 →	L29141	L29141	∪		2	4FO 419 811 C	
		Model 8HE	L29141	L29141	∪		2	4FO 419 811 C	
			L29219	L29219			2	8EO 422 821	
		ch. → 8H 5 013 000	L29374	L29374			2	4FO 419 801 B	
🚗	🔧	↕	Model 8H7, → 10.04 , ch. → 8H 5 014 475		L29543		1	8DO 407 510 C	
				L29544		1	8DO 407 509 C		
				Model 8H7, 11.04 →, ch. 8H 5 014 476 →		L29589		1	8EO 407 510 C
					L29590		1	8EO 407 509 C	
		Model 8HE		L29589		1	8EO 407 510 C		
			L29590		1	8EO 407 509 C			
		↕			L29607		1	8EO 407 506 A	
				L29608		1	8EO 407 505 A		
		↕	Model 8H7			L29527		1	8EO 407 694 K
				L29528		1	8EO 407 693 K		
			Model 8HE			L29579		1	8EO 407 694 T
				L29580		1	8EO 407 693 T		
		↕		L29567	L29567		2	8EO 407 151 N	
		🔧		L 29567/29579/29580/29589/29590/29607/29608/29633/29634 KIT	L29875			1	
🔧	↕		L29845	L29845		L29607/L29608	4	4DO 407 515 C	
			L29868	L29868		L29589/L29590	4	8DO 407 515 C	
			L29846	L29846		L29527/L29528	2	4DO 407 183 P	
			L29869	L29869		L29579/L29580	2	4FO 407 183 C	
			L29841	L29841		L29567	2	4DO 407 182 E	
			L29870	L29870		L29567	2	8EO 407 181 C	
🔧	↕			L29633			1	8EO 411 318	
			L29634				1	8EO 411 317	
		KIT	MK207	MK207			2	8EO 412 377	
🚗	🔧		L29635	L29635			2	8EO 505 465 AC	
		PR GP1	MK297	MK297			2	4FO 513 353 D	

A5 (8T3) 06.07 →

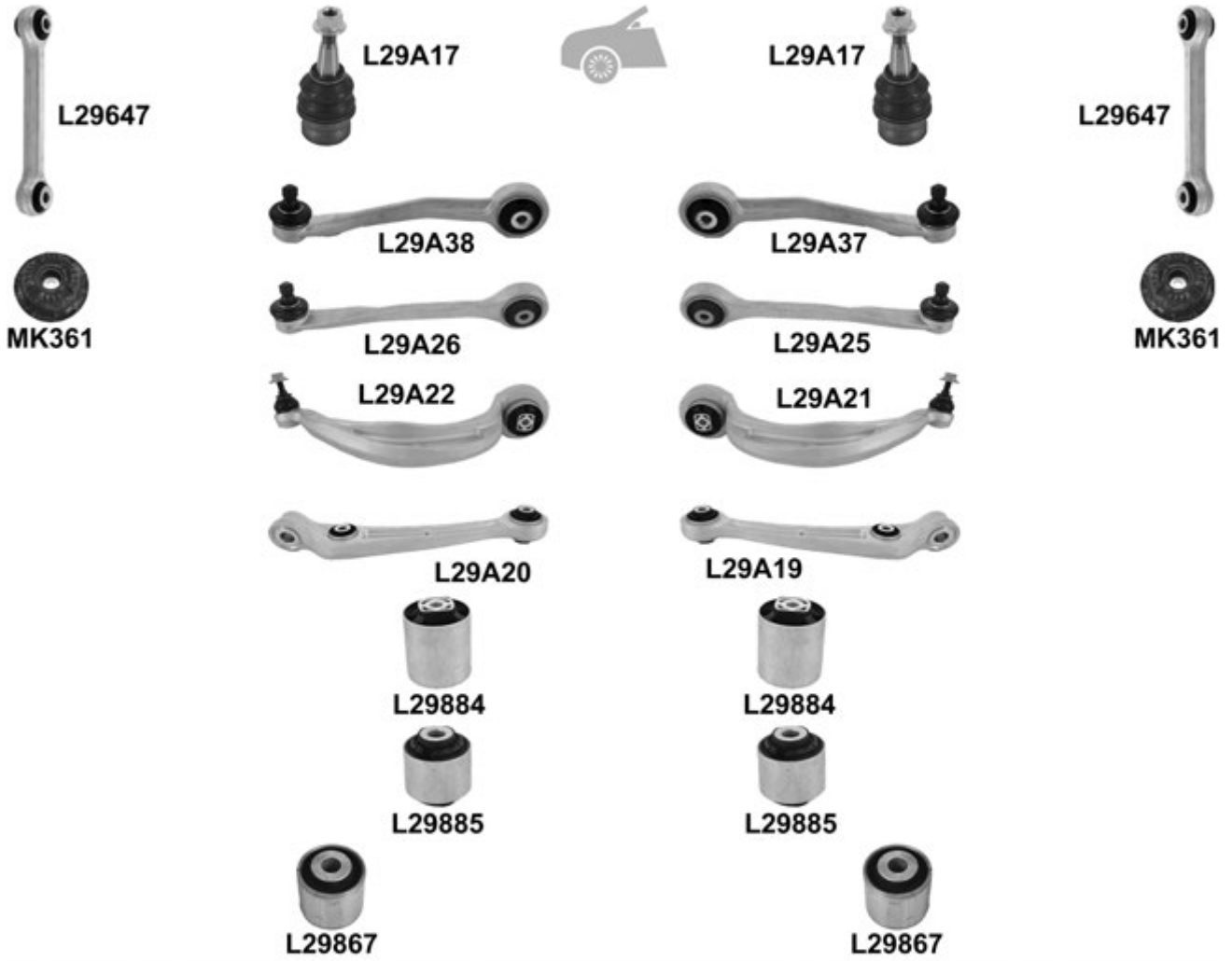
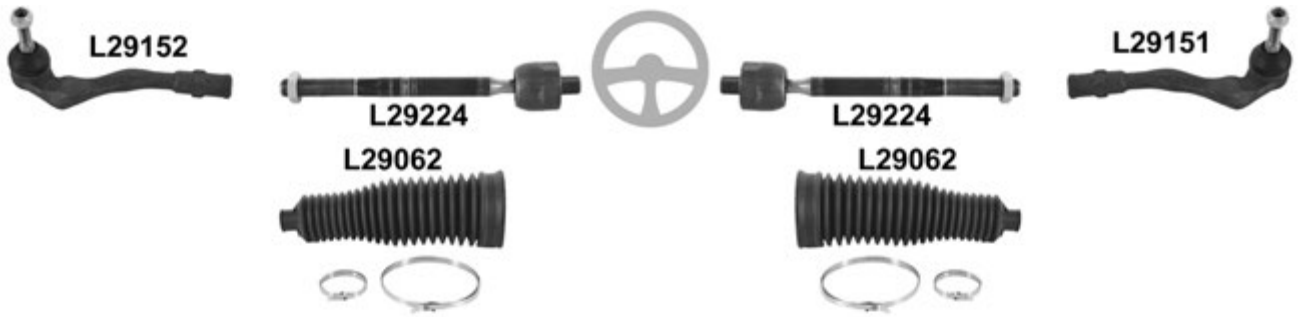

A5 (8T3) 06.07 →

				←	→	Thread	Part Of	QPA		
		↔	Hydraulic , L= 208mm		L29151	F 16x1,5 ∩		1	8K0 422 818 B	
					L29152	F 16x1,5 ∩		1	8K0 422 817 B	
			Thermoplast		L29224	M 16x1,5 / M 16x1,5 ∩		2	8J0 423 810	
					L29062 ⁰	L29062 ⁰		2	8K0 422 831	
		⊥	1.8 TFSi, Mot/Eng CABD/CDHB, 2.0 Fsi, Mot/Eng CDNB	L29A17	L29A17			2	8K0 407 689 F	
			2.0 Fsi, Mot/Eng CDNC, → 10.11	L29A17	L29A17			2	8K0 407 689 F	
			2.0 Tdi, Mot/Eng CAHB/CAHA, 2.7 Tdi, Mot/Eng CAMA/CAMB/CGKA/CGKB	L29A17	L29A17			2	8K0 407 689 F	
			3.2 Tdi, Mot/Eng CALA							
		ī	▼			L29A37			1	8K0 407 510 A
					L29A38			1	8K0 407 509 A	
		ī	▲			L29A25			1	8K0 407 506 A
					L29A26			1	8K0 407 505 A	
		⊥	▼	1.8 TFSi, Mot/Eng CABD/CDHB/2.0 TFSi, Mot/Eng CDNB/CDNC 2.0 Tdi, Mot/Eng CAHA/CAHB/2.7 Tdi, Mot/Eng CAMA/CAMB/CGKA/CGKB 3.2 Fsi, Mot/Eng CALA → 10.09, with 65mm		L29A21			1	8K0 407 694 N
					L29A22			1	8K0 407 693 N	
		⊥	▲	1.8 TFSi, Mot/Eng CABD/CDHB/2.0 TFSi, Mot/Eng CDNB/2.0 Tdi, Mot/Eng CAHA/CAHB		L29A19			1	8K0 407 152 C
					L29A20			1	8K0 407 151 C	
	2.0 TFSi, Mot/Eng CDNC, → 10.11				L29A19			1	8K0 407 152 C	
				L29A20			1	8K0 407 151 C		
		⊥	▲	2.7 Tdi, Mot/Eng CAMA/CAMB/CGKA/CGKB/3.2 Tsi, Mot/Eng CALA		L29A19			1	8K0 407 152 C
						L29A20			1	8K0 407 151 C
						L29884	L29884	L29A21/L29A22	2	8K0 407 183 A
						L29885 ⁰	L29885 ⁰	L29A19/L29A20	2	8K0 407 182 B
		⊥	▲	↔		L29867	L29867	L29A19/L29A20	2	4E0 407 181 B
						L29647	L29647		2	8K0 411 317 E
						L29647	L29647		2	8K0 411 317 E
			⊥	▲	→ 07.09		L29A61		1	8K0 501 530 N
						L29A62			1	8K0 501 529 N
						L29645	L29645		2	8K0 505 465 E
						L29645	L29645		2	8K0 505 465 E
					1.8 TFSi, Mot/Eng CABD/CDHB/2.0 Fsi, Mot/Eng CDNB	MK388 ⁰	MK388 ⁰		2	8K0 513 353 E
					2.0 Fsi, Mot/Eng CDNC, → 10.11	MK388 ⁰	MK388 ⁰		2	8K0 513 353 E
					2.0 Tdi, Mot/Eng CAHB/CAHA/2.7 Tdi, Mot/Eng CAMA/CAMB/CGKA/CGKB	MK388 ⁰	MK388 ⁰		2	8K0 513 353 E
						MK361	MK361		2	8K0 412 377 C
						MK361	MK361		2	8K0 412 377 C

A5 Cabriolet (8F7) 03.09 →

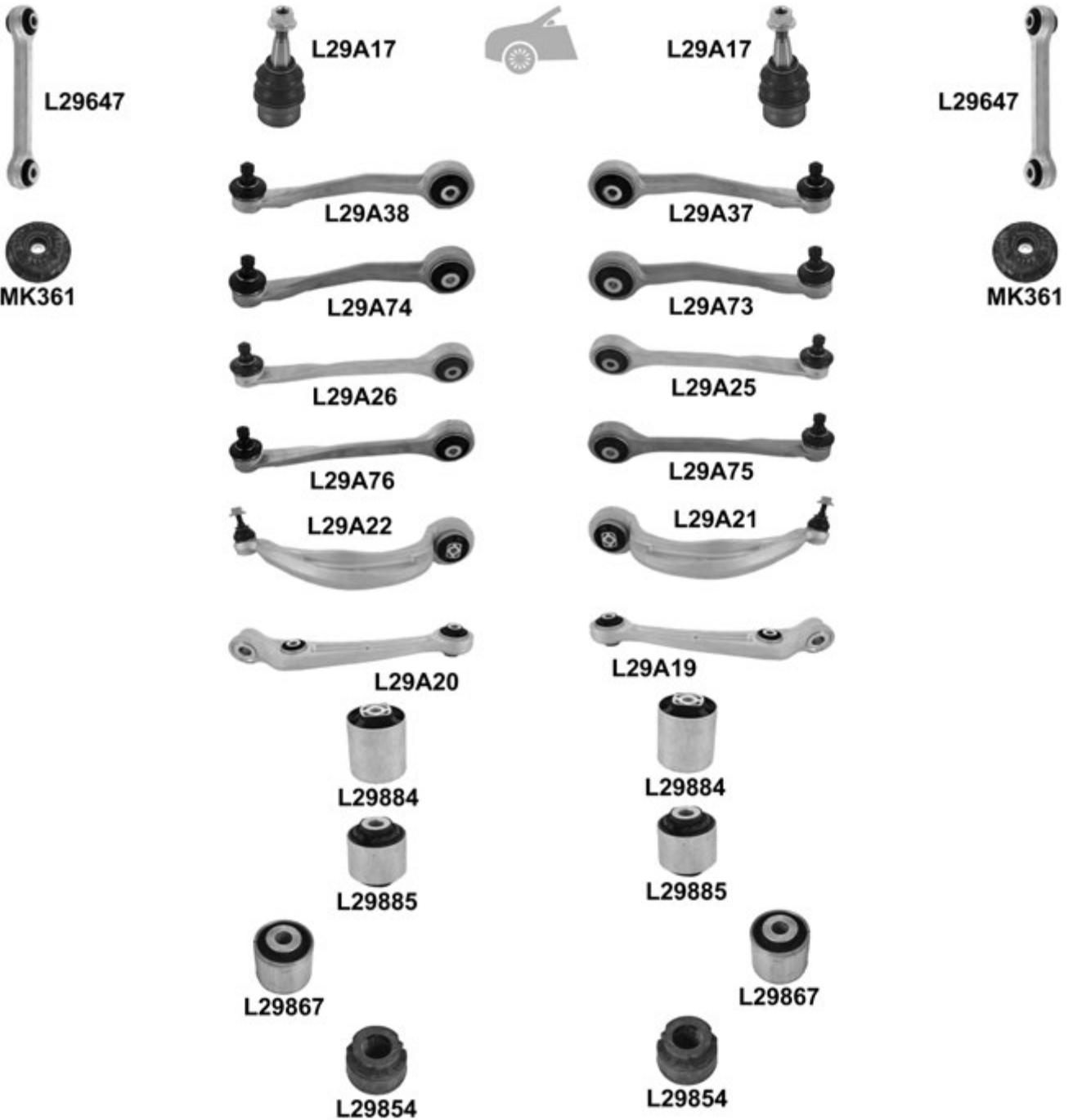

A5 Cabriolet (8F7) 03.09 →



L29645

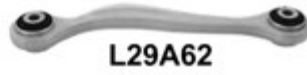

L29A62



L29A61



L29645



MK388



MK388

		i		←	→	Thread	Part Of	QPA	i		
		Hydraulic L= 208mm			L29151	F 16x1,5 ∪		1	8K0 422 818 B		
					L29152	F 16x1,5 ∪		1	8K0 422 817 B		
					L29224	L29224	M 16x1,5 / M 16x1,5 ∪		2	8J0 423 810	
					L29062 ⁰	L29062 ⁰			2	8K0 422 831	
		1.8 TFSi, Mot/Eng CDHB/2.0 TFSi, Mot/Eng CAEA/CDNB 2.0 Tdi, Mot/Eng CAHA/CAHB/CGLD 2.0 TFSi, Mot/Eng CAEB/CDNC, → 10.11 2.7 Tdi, Mot/Eng CGKA/CGKB/3.2 Fsi, Mot/Eng CALA			L29A17	L29A17		2	8K0 407 689 F		
					L29A17	L29A17		2	8K0 407 689 F		
					L29A17	L29A17		2	8K0 407 689 F		
				1.8 TFSi, Mot/Eng EJEB/2.0 Tdi, Mot/Eng CGLC/CGLD 1.8 TFSi, Mot/Eng CDHB/2.0 Tdi, Mot/Eng CAHB 2.0 TFSi, Mot/Eng CAEB/CDNC, → 10.11 2.0 TFSi, Mot/Eng CAEB/CDNC, 11.11 → 2.7 TDi, Mot/Eng CGKA/CGKB 3.0 Tdi, Mot/Eng CLAB 3.2 FSi, Mot/Eng CALA			L29A37			1	8K0 407 510 A
							L29A38			1	8K0 407 509 A
							L29A73 ⁰			1	8K0 407 510 B
							L29A74 ⁰			1	8K0 407 509 B
							L29A73 ⁰			1	8K0 407 510 B
							L29A74 ⁰			1	8K0 407 509 B
							L29A37			1	8K0 407 510 A
					L29A38			1	8K0 407 509 A		
		1.8 TFSi, Mot/Eng EJEB /2.0 Tdi, Mot/Eng CGLD 1.8 TFSi, Mot/Eng CDHB/2.0 Tdi, Mot/Eng CAHB 2.0 TFSi, Mot/Eng CAEB/CDNC, → 10.11 2.0 TFSi, Mot/Eng CAEB/CDNC, 11.11 → 2.7 TDi, Mot/Eng CGKA/CGKB 3.0 Tdi, Mot/Eng CLAB 3.2 FSi, Mot/Eng CALA			L29A25			1	8K0 407 506 A		
					L29A26			1	8K0 407 505 A		
					L29A75 ⁰			1	8K0 407 506 B		
					L29A76 ⁰			1	8K0 407 505 B		
					L29A75 ⁰			1	8K0 407 506 B		
					L29A76 ⁰			1	8K0 407 505 B		
					L29A25			1	8K0 407 506 A		
					L29A26			1	8K0 407 505 A		
					L29A75 ⁰			1	8K0 407 506 B		
				L29A76 ⁰			1	8K0 407 505 B			

A5 Cabriolet (8F7) 03.09 →

			←	→	Thread	Part Of	QPA	
		↓ ▾	1.8 TFSi, Mot/Eng CDHB/2.0 Tdi, Mot/Eng CAHA/CAHB	L29A21			1	8K0 407 694 N
			L29A22				1	8K0 407 693 N
			2.0 TFSi, Mot/Eng CAEB/CDNC, → 10.09	L29A21			1	8K0 407 694 N
			L29A22				1	8K0 407 693 N
		2.7 TDi, Mot/Eng CGKA/CGKB/3.2 Fsi, Mot/Eng CALA, → 10.09	L29A21			1	8K0 407 694 N	
		L29A22				1	8K0 407 693 N	
		↓ ▲	1.8 TFSi, Mot/Eng CDHB/2.0 Tdi, Mot/Eng CAHA/CGLD	L29A19			1	8K0 407 152 C
			L29A20				1	8K0 407 151 C
	2.0 TFSi, Mot/Eng CAEB/CDNC, → 10.11		L29A19			1	8K0 407 152 C	
	L29A20					1	8K0 407 151 C	
	2.7 Tdi, Mot/Eng CGKA/CGKB/3.2 Fsi, Mot/Eng CALA	L29A19			1	8K0 407 152 C		
	L29A20				1	8K0 407 151 C		
		↓ ▾ → ←	L29884	L29884		L29A21/L29A22	2	8K0 407 183 A
		↓ ▲ → ←	L29885 ^o	L29885 ^o		L29A19/L29A20	2	8K0 407 182 B
↓ ▲ ↔		L29867	L29867		L29A19/L29A20	2	4E0 407 181 B	
		L29647	L29647			2	8K0 411 317 E	
		PR 1BA/1BD/1BE/1BV, Ø 24.8mm	L29854	L29854		Anti-roll bar	2	4D0 411 327 G
		PR 1BA/1BB/1BD/1BE/1BR/1BV, (-)	KIT MK361	MK361			2	8K0 412 377 C
		↓ ▲	2.0 TFSi, Mot/Eng CAEB/CDNB/CDNC/2.0 Tdi, Mot/Eng CAHA/CAHB/CGLD	L29A61			1	8K0 501 530 N
			2.7 Tdi, Mot/Eng CGKA/CGKB/3.2 Fsi, Mot/Eng CALA → 07.09	L29A62			1	8K0 501 529 N
			L29645	L29645			2	8K0 505 465 E
			MK388 ^o	MK388 ^o			2	8K0 513 353 E

A5 Cabriolet Quattro (8F7) 03.09 →

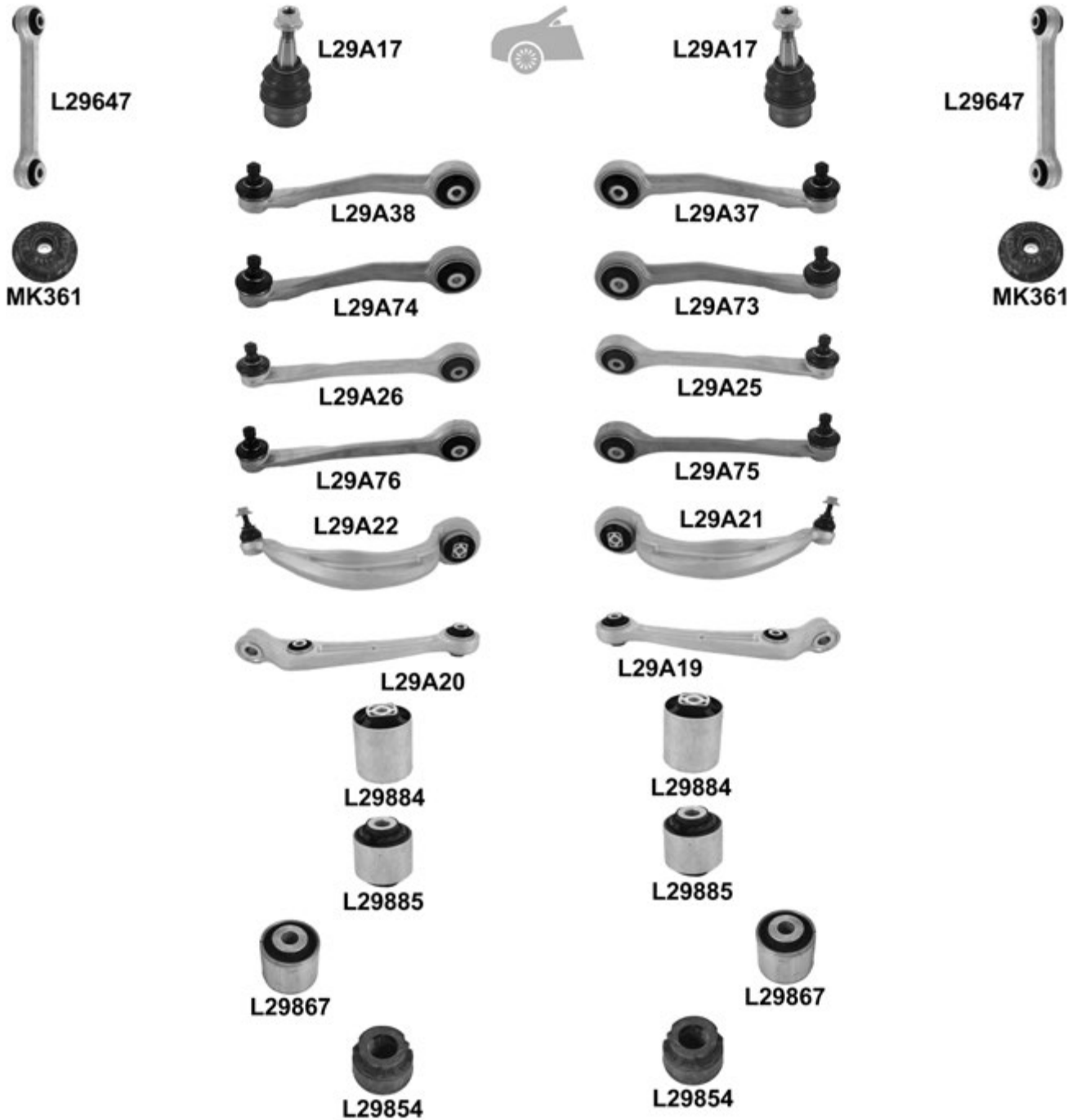

A5 Cabriolet Quattro (8F7) 03.09 →

			← →	Thread	Part Of	QPA					
			↔	Hydraulic , L= 208mm	L29151	F 16x1,5 ♂	1	8K0 422 818 B			
				L29152	F 16x1,5 ♂	1	8K0 422 817 B				
				L29224	L29224	M 16x1,5 / M 16x1,5 ♂	2	8J0 423 810			
				L29062 °	L29062 °		2	8K0 422 831			
			↕	2.0 TFSi, Mot/Eng CAEB/CDNC, → 10.11	L29A17	L29A17		2	8K0 407 689 F		
				3.0 Tdi, Mot/Eng CCWA/3.2 Fsi, Mot/Eng CALA	L29A17	L29A17		2	8K0 407 689 F		
				↕	2.0 Tdi, Mot/Eng CGLC		L29A37		1	8K0 407 510 A	
						L29A38		1	8k0 407 509 A		
					2.0 TFSi, Mot/Eng CAEB/CDNC, → 10.11		L29A73 °		1	8K0 407 510 B	
						L29A74 °		1	8K0 407 509 B		
					2.0 TFSi, Mot/Eng CAEB/CDNC, 11.11 →		L29A37		1	8K0 407 510 A	
						L29A38		1	8K0 407 509 A		
					3.0 Fsi, Mot/Eng CMUA		L29A37		1	8K0 407 510 A	
						L29A38		1	8K0 407 509 A		
					3.0 Tdi, Mot/Eng CCWA		L29A73 °		1	8K0 407 510 B	
						L29A74 °		1	8K0 407 509 B		
					3.0 Tdi, Mot/Eng CDUC		L29A37		1	8K0 407 510 A	
						L29A38		1	8K0 407 509 A		
					3.2 Tdi, Mot/Eng CALA		L29A73 °		1	8K0 407 510 B	
						L29A74 °		1	8K0 407 509 B		
					↕	2.0 Tdi, Mot/Eng CGLC		L29A25		1	8K0 407 506 A
							L29A26		1	8K0 407 505 A	
				2.0 TFSi, Mot/Eng CAEB/CDNC, → 10.11			L29A75 °		1	8K0 407 506 B	
						L29A76 °		1	8K0 407 505 B		
				2.0 TFSi, Mot/Eng CAEB/CDNC, 11.11 →			L29A25		1	8K0 407 506 A	
						L29A26		1	8K0 407 505 A		
				3.0 Fsi, Mot/Eng CMUA			L29A25		1	8K0 407 506 A	
						L29A26		1	8K0 407 505 A		
				3.0 Tdi, Mot/Eng CCWA			L29A75 °		1	8K0 407 506 B	
						L29A76 °		1	8K0 407 505 B		
				3.0 Tdi, Mot/Eng CDUC			L29A25		1	8K0 407 506 A	
						L29A26		1	8K0 407 505 A		
↕	2.0 TFSi, Mot/Eng CAEB/CDNC/3.0 Tdi, Mot/Eng CCWA/3.2 Tdi, Mot/Eng CALA → 10.09		L29A21		1	8K0 407 694 N					
		L29A22		1	8K0 407 693 N						
↕	2.0 TFSi, Mot/Eng CAEB/CDNC, → 10.11		L29A19		1	8K0 407 152 C					
			L29A20		1	8K0 407 151 C					

A5 Cabriolet Quattro (8F7) 03.09 →

				←	→	Thread	Part Of	QPA	
		⊥ ▲	3.0 TDi, Mot/Eng CCWA/3.2 Tdi, Mot/Eng CALA			L29A19		1	8K0 407 152 C
				L29A20				1	8K0 407 151 C
		⊥ ▼ → ←		L29884	L29884		L29A21/L29A22	2	8K0 407 183 A
				L29885 ⁰	L29885 ⁰		L29A19/L29A20	2	8K0 407 182 B
				L29867	L29867		L29A19/L29A20	2	4E0 407 181 B
				L29647	L29647			2	8K0 411 317 E
			PR 1BA/1BD/1BE/1BV, Ø 24.8mm	L29854	L29854		Anti-roll bar	2	4D0 411 327 G
		PR 1BA/1BD/1BE/1BV, (-) KIT	MK361	MK361			2	8K0 412 377 C	
		⊥ ▲	2.0 TFSi, Mot/Eng CAEB/CDNC/3.0 Tdi, Mot/Eng CCWA/3.2 Fsi, Mot/Eng CALA			L29A61		1	8K0 501 530 N
				L29A62				1	8K0 501 529 N
				L29645	L29645			2	8K0 505 465 E
				MK388 ⁰	MK388 ⁰			2	8K0 513 353 E

A5 Quattro (8F3) 03.09 →

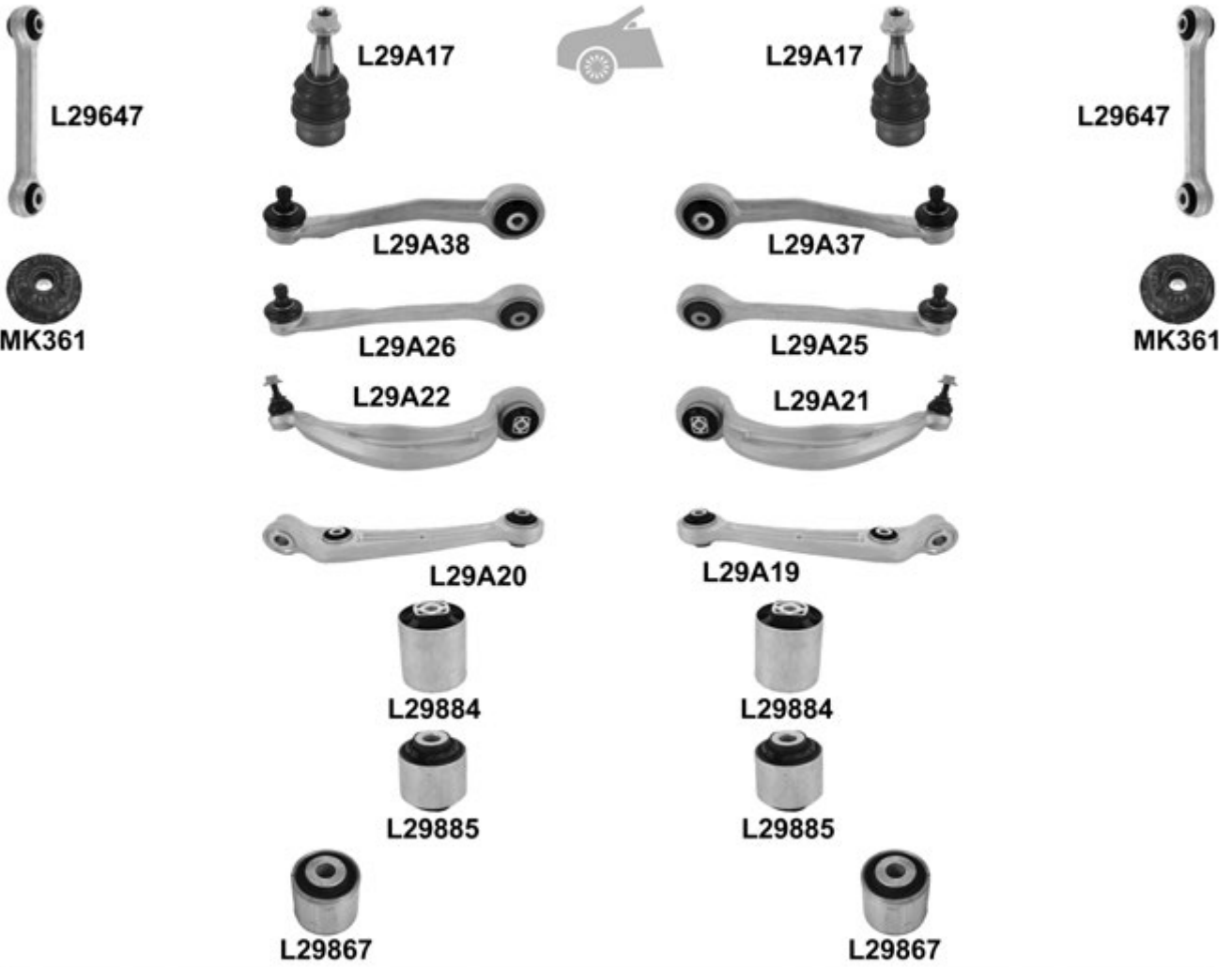
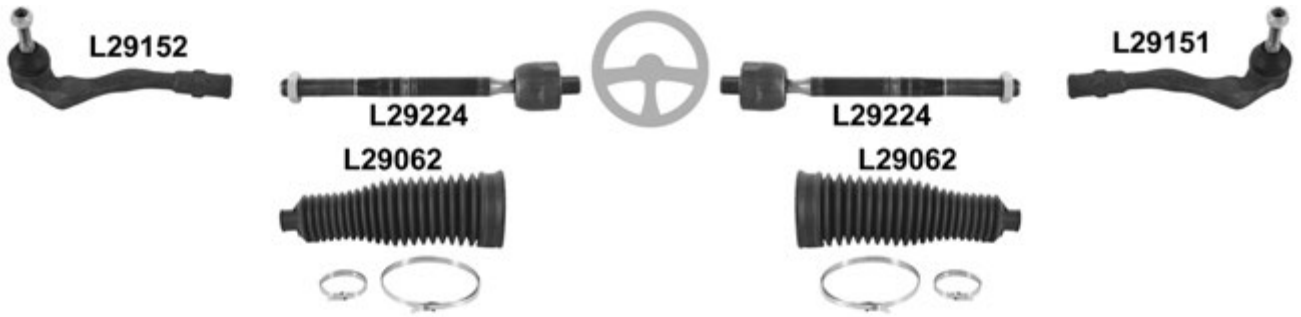

A5 Quattro (8F3) 03.09 →

				←	→	Thread	Part Of	QPA				
		↔	Hydraulic , L= 208mm		L29151	F 16x1,5 ∩		1	8K0 422 818 B			
					L29152	F 16x1,5 ∩		1	8K0 422 817 B			
					L29224	L29224	M 16x1,5 / M 16x1,5 ∩		2	8J0 423 810		
					L29062 ⁰	L29062 ⁰			2	8K0 422 831		
		⊥	2.0 Tdi, Mot/Eng CAHA	L29A17	L29A17			2	8K0 407 689 F			
			2.0 TFSi, Mot/Eng CAEB/CDNC, → 10.11	L29A17	L29A17			2	8K0 407 689 F			
			3.0 TDi, Mot/Eng CAPA/CCWA/CCWB/3.2 Fsi, Mot/Eng CALA	L29A17	L29A17			2	8K0 407 689 F			
		↖	⊥	2.0 TFSi, Mot/Eng CAEB/CDNC/2.0 Tdi, Mot/Eng CAHA/CGLC		L29A37			1	8K0 407 510 A		
				3.0 Tdi, Mot/Eng CAPA/CCWA/CCWB/CDUC/CKVB	L29A38				1	8K0 407 509 A		
		↗	⊥	2.0 TFSi, Mot/Eng CAEB/CDNC/2.0 Tdi, Mot/Eng CAHA/CGLC		L29A25			1	8K0 407 506 A		
					3.0 Tdi, Mot/Eng CAPA/CCWA/CCWB/CDUC/CKVB	L29A26			1	8K0 407 505 A		
		⊥	↘	2.0 TFSi, Mot/Eng CAEB/CDNC/2.0 Tdi, Mot/Eng CAHA		L29A21			1	8K0 407 694 N		
					3.0 Tdi, Mot/Eng CAPA/CCWA/CCWB/3.2 Fsi, Mot/Eng CALA	L29A22			1	8K0 407 693 N		
		⊥	↗	2.0 Tdi, Mot/Eng CAHA		L29A19			1	8K0 407 152 C		
						L29A20			1	8K0 407 151 C		
					2.0 TFSi, Mot/Eng CAEB/CDNC, → 10.11		L29A19		1	8K0 407 152 C		
						L29A20			1	8K0 407 151 C		
		⊥	↘	3.0 TDi, Mot/Eng CAPA/CCWA/CCWB/3.2 Fsi, Mot/Eng CALA		L29A19			1	8K0 407 152 C		
						L29A20			1	8K0 407 151 C		
					L29884	L29884	L29A21/L29A22	2	8K0 407 183 A			
					L29885 ⁰	L29885 ⁰	L29A19/L29A20	2	8K0 407 182 B			
		↖	↔		L29867	L29867	L29A19/L29A20	2	4E0 407 181 B			
					↖	⊥	2.0 TFSi, Mot/Eng CAEB/CDNC/2.0 Tdi, Mot/Eng CGLC/CAHA	L29647	L29647		2	8K0 411 317 E
							3.0 Tdi, Mot/Eng CCWB/CDUC/CKVB					
3.0 Tdi, Mot/Eng CAPA/CCWA, 10.07 →	L29647	L29647					2	8K0 411 317 E				
3.0 TFSi, Mot/Eng CMUA	L29647	L29647					2	8K0 411 317 E				
	↖	⊥	3.2 Fsi, Mot/Eng CALA, 10.07 →	L29647	L29647		2	8K0 411 317 E				
			PR 1BA/1BD/1BE/1BV, (-)	KIT	MK361	MK361		2	8K0 412 377 C			
		⊥	2.0 TFSi, Mot/Eng CAEB/CDNC/2.0 Tdi, Mot/Eng CAHA		L29A61			1	8K0 501 530 N			
			3.0 Tdi, Mot/Eng CAPA/CCWA/CCWB/3.2 Fsi, Mot/Eng CALA	L29A62			1	8K0 501 529 N				
		↖	⊥		L29645	L29645		2	8K0 505 465 E			
				2.0 Tdi, Mot/Eng CAHA	MK388 ⁰	MK388 ⁰		2	8K0 513 353 E			
				2.0 TFSi, Mot/Eng CAEB/CDNC, → 10.11	MK388 ⁰	MK388 ⁰		2	8K0 513 353 E			
				3.0 TDi, Mot/Eng CAPA/CCWA/CCWB/3.2 Fsi, Mot/Eng CALA	MK388 ⁰	MK388 ⁰		2	8K0 513 353 E			

A5 Sportback (8T3) 06.07 →

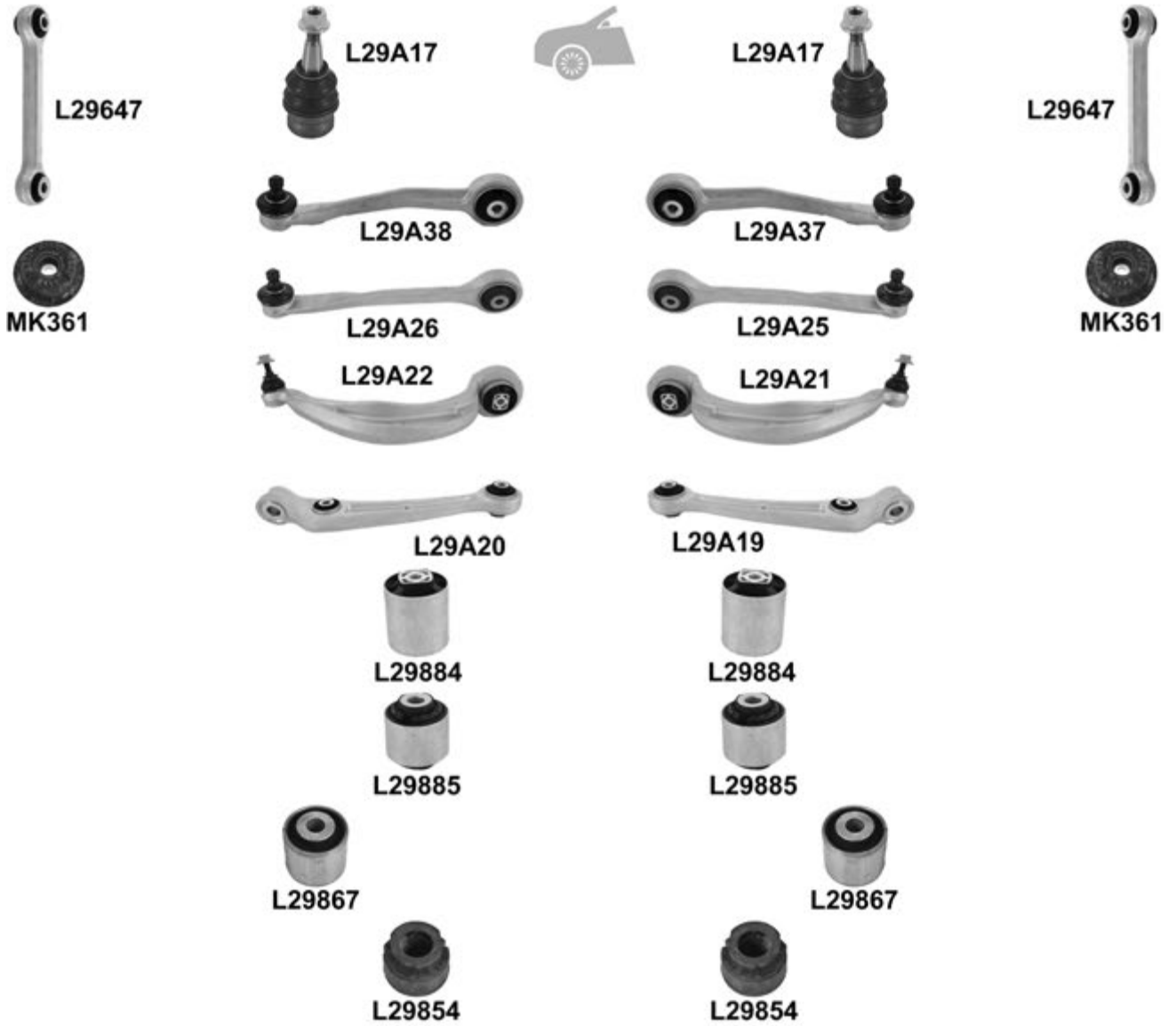

A5 Sportback (8T3) 06.07 →

				←	→	Thread	Part Of	QPA		
		↔	Hydraulic , L= 208mm		L29151	F 16x1,5		1	8K0 422 818 B	
					L29152	F 16x1,5		1	8K0 422 817 B	
					L29224	L29224	M 16x1,5 / M 16x1,5		2	8J0 423 810
					L29062 ⁰	L29062 ⁰			2	8K0 422 831
		↓	1.8 TFSi, Mot/Eng CDHB/2.0 Tdi, Mot/Eng CAGA/CAGB/CAHA/CAHB/CMEA	L29A17	L29A17			2	8K0 407 689 F	
			2.0 Fsi, Mot/Eng CDNB/CDNC, → 08.11	L29A17	L29A17			2	8K0 407 689 F	
			2.7 TDi, Mot/Eng CGKA/CGKB	L29A17	L29A17			2	8K0 407 689 F	
		↑	↓			L29A37			1	8K0 407 510 A
					L29A38			1	8K0 407 509 A	
		↑	↓			L29A25			1	8K0 407 506 A
					L29A26			1	8K0 407 505 A	
	↓	↓	2.0 TFSi, Mot/Eng CDNB/CDNC/2.0 Tdi, Mot/Eng CAHA/CAHB 2.7 Tdi, Mot/Eng CGKA/CGKB, → 10.09 , 65mm		L29A21			1	8K0 407 694 N	
					L29A22			1	8K0 407 693 N	
	↑	↓	1.8 TFSi, Mot/Eng CDHB/2.0 Tdi, Mot/Eng CAGA/CAHA/CAHB/CMEA		L29A19			1	8K0 407 152 C	
					L29A20			1	8K0 407 151 C	
				2.0 TFSi, Mot/Eng CDNB/CDNC, → 08.11		L29A19			1	8K0 407 152 C
					L29A20			1	8K0 407 151 C	
	2.7 TDi, Mot/Eng CGKA/CGKB		L29A19			1	8K0 407 152 C			
			L29A20			1	8K0 407 151 C			
		↓	↔		L29884	L29884		L29A21/L29A22	2	8K0 407 183 A
					L29885 ⁰	L29885 ⁰		L29A19/L29A20	2	8K0 407 182 B
					L29867	L29867		L29A19/L29A20	2	4E0 407 181 B
					L29647	L29647			2	8K0 411 317 E
				PR 1BA/1BD/1BE/1BV, Ø 24.8mm	L29854	L29854		Anti-roll bar	2	4D0 411 327 G
				PR 1BA/1BB/1BD/1BE/1BV, (-)	KIT MK361	MK361			2	8K0 412 377 C
					L29645	L29645			2	8K0 505 465 E
1.8 TFSi, Mot/Eng CDHB				MK388 ⁰	MK388 ⁰			2	8K0 513 353 E	
2.0 Fsi, Mot/Eng CDNB/CDNC, → 10.11				MK388 ⁰	MK388 ⁰			2	8K0 513 353 E	
2.0 Tdi, Mot/Eng CAGA/CAHA/CAGB/CAHB/CMEA/2.7 Tdi, Mot/Eng CGKA/CGKB				MK388 ⁰	MK388 ⁰			2	8K0 513 353 E	

A5 Sportback Quattro (8TA) 03.09 →

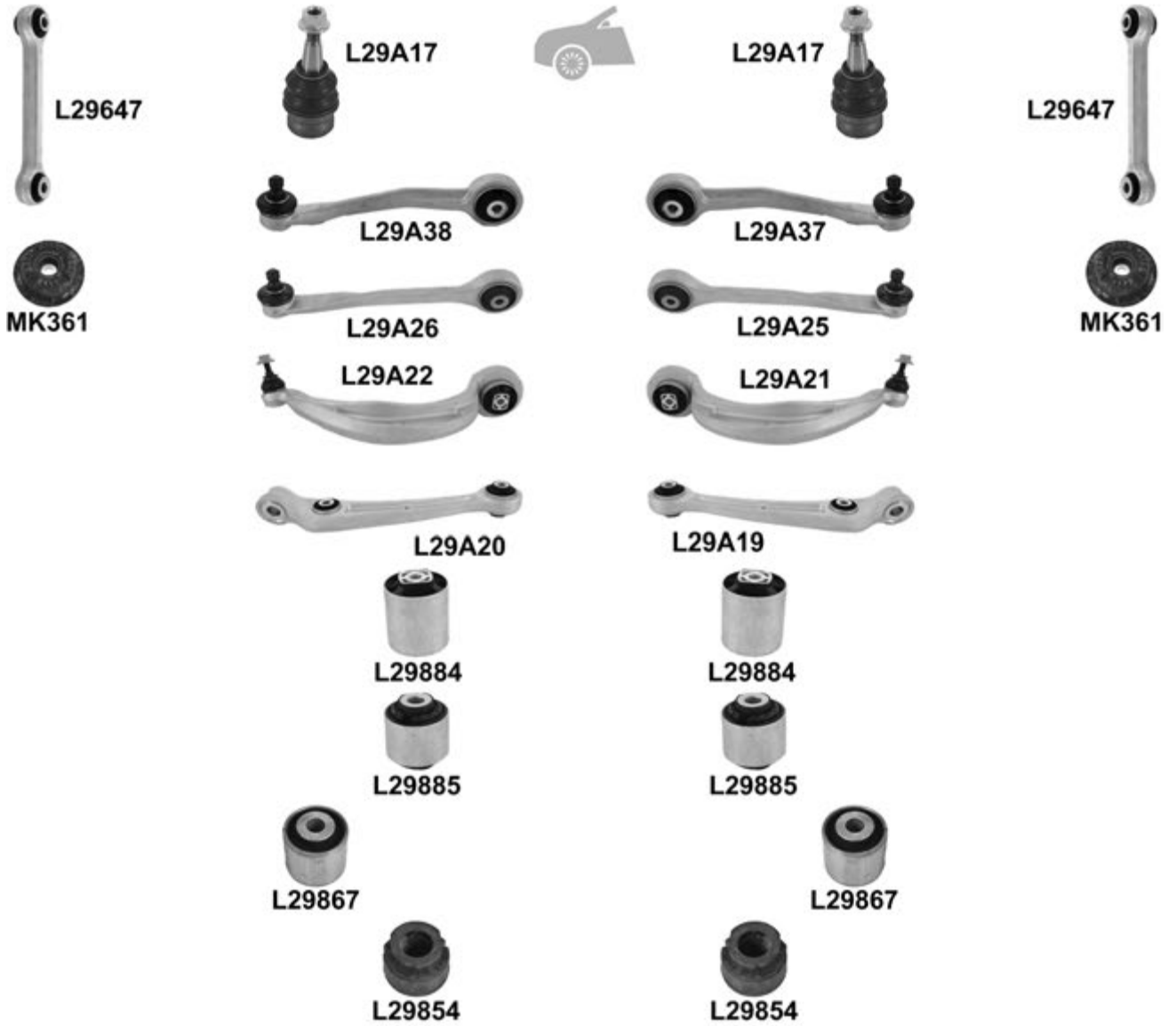

A5 Sportback Quattro (8TA) 03.09 →

				←	→	Thread	Part Of	QPA		
		↔	Hydraulic , L= 208mm		L29151	F 16x1,5 ∩		1	8K0 422 818 B	
					L29152	F 16x1,5 ∩		1	8K0 422 817 B	
					L29224	L29224	M 16x1,5 / M 16x1,5 ∩		2	8J0 423 810
					L29062 ⁰	L29062 ⁰			2	8K0 422 831
		⊥	2.0 Tdi, Mot/Eng CAHA/2.0 TFSi, Mot/Eng CDNC/3.0 TDi, Mot/Eng CCWA	L29A17	L29A17			2	8K0 407 689 F	
			2.0 TFSi, Mot/Eng CDNC, → 08.11	L29A17	L29A17			2	8K0 407 689 F	
			3.0 Tdi, Mot/Eng CCWA/3.2 Fsi, Mot/Eng CALA	L29A17	L29A17			2	8K0 407 689 F	
		⌈	▼	2.0 TFSi, Mot/Eng CDNC/2.0 Tdi, Mot/Eng CAHA/CGLC		L29A37			1	8K0 407 510 A
				3.0 Tdi, Mot/Eng CCWA/CDUC/CKVB	L29A38				1	8K0 407 509 A
				3.0 TFSi, Mot/Eng CMUA/3.2 Fsi, Mot/Eng CALA						
		⌈	▲	2.0 TFSi, Mot/Eng CDNC/2.0 Tdi, Mot/Eng CAHA/CGLC		L29A25			1	8K0 407 506 A
				3.0 Tdi, Mot/Eng CCWA/CDUC/CKVB	L29A26				1	8K0 407 505 A
		⊥	▼	2.0 TFSi, Mot/Eng CDNC/2.0 Tdi, Mot/Eng CAHA		L29A21			1	8K0 407 694 N
				3.0 TFSi, Mot/Eng CMUA/3.0 Tdi, Mot/Eng CCWA/3.2 Fsi, Mot/Eng CALA	L29A22				1	8K0 407 693 N
		⊥	▲	2.0 Tdi, Mot/Eng CAHA		L29A19			1	8K0 407 152 C
						L29A20			1	8K0 407 151 C
					2.0 TFSi, Mot/Eng CDNC, → 08.11		L29A19			1
					L29A20			1	8K0 407 151 C	
	⊥	▲	3.0 Tdi, Mot/Eng CCWA/3.2 Fsi, Mot/Eng CALA		L29A19			1	8K0 407 152 C	
					L29A20			1	8K0 407 151 C	
		⊥	▼	↔	L29884	L29884		L29A21/L29A22	2	8K0 407 183 A
					L29885 ⁰	L29885 ⁰		L29A19/L29A20	2	8K0 407 182 B
					L29867	L29867		L29A19/L29A20	2	4E0 407 181 B
						L29647	L29647			2
				PR 1BD/1BE/1BV, Ø 24.8mm	L29854	L29854		Anti-roll bar	2	4D0 411 327 G
				PR 1BA/1BD/1BE/1BV, (-) KIT	MK361	MK361			2	8K0 412 377 C
		⊥	▲	3.0 Tdi, Mot/Eng CCWA, → 07.09		L29A61		1	8K0 501 530 N	
					L29A62			1	8K0 501 529 N	
					L29645	L29645			2	8K0 505 465 E
				2.0 Tdi, Mot/Eng CAHA	MK388 ⁰	MK388 ⁰			2	8K0 513 353 E
				2.0 TFSi, Mot/Eng CDNC, → 10.11	MK388 ⁰	MK388 ⁰			2	8K0 513 353 E
				3.0 Tdi, Mot/Eng CCWA/3.2 Fsi, Mot/Eng CALA	MK388 ⁰	MK388 ⁰			2	8K0 513 353 E

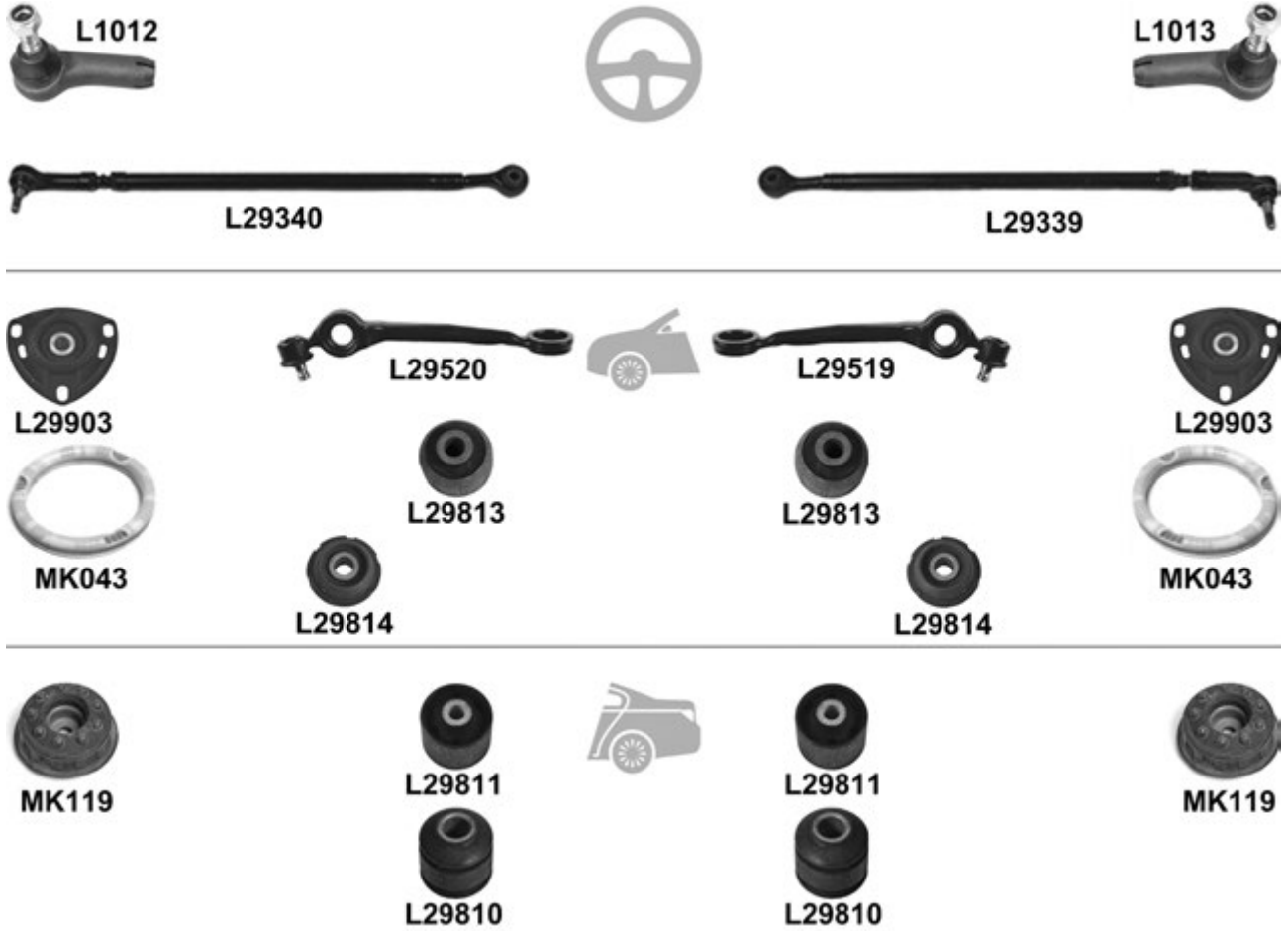
A6, A6 Avant (4A, C4) 06.94 → 12.97, ch. 4A S 000 001 → 4A V 200 000

		i	←	→	Thread	Part Of	QPA	i
⊕		↔		L1013	F 16x1,5		1	443 419 812 D
				L1012	F 16x1,5		1	443 419 811 D
				L29339			1	4A0 419 802 A
				L29340			1	4A0 419 801 A
⊖		⊥		<input checked="" type="checkbox"/>	L29519		1	4A0 407 152
					L29520		1	4A0 407 151
		→←		L29813	L29813	L29519/L29520	2	4A0 407 183 D
		↔		L29814	L29814	L29519/L29520	4	4A0 407 181 A
			(+) MK043	KIT	L29903	L29903	2	4A0 412 377 C
				MK043	MK043		2	4A0 4412 249
⊖		transverse		L29810	L29810		2	431 505 172
				L29811	L29811	Hub carrier	2	4A0 511 247
				MK119	MK119		2	

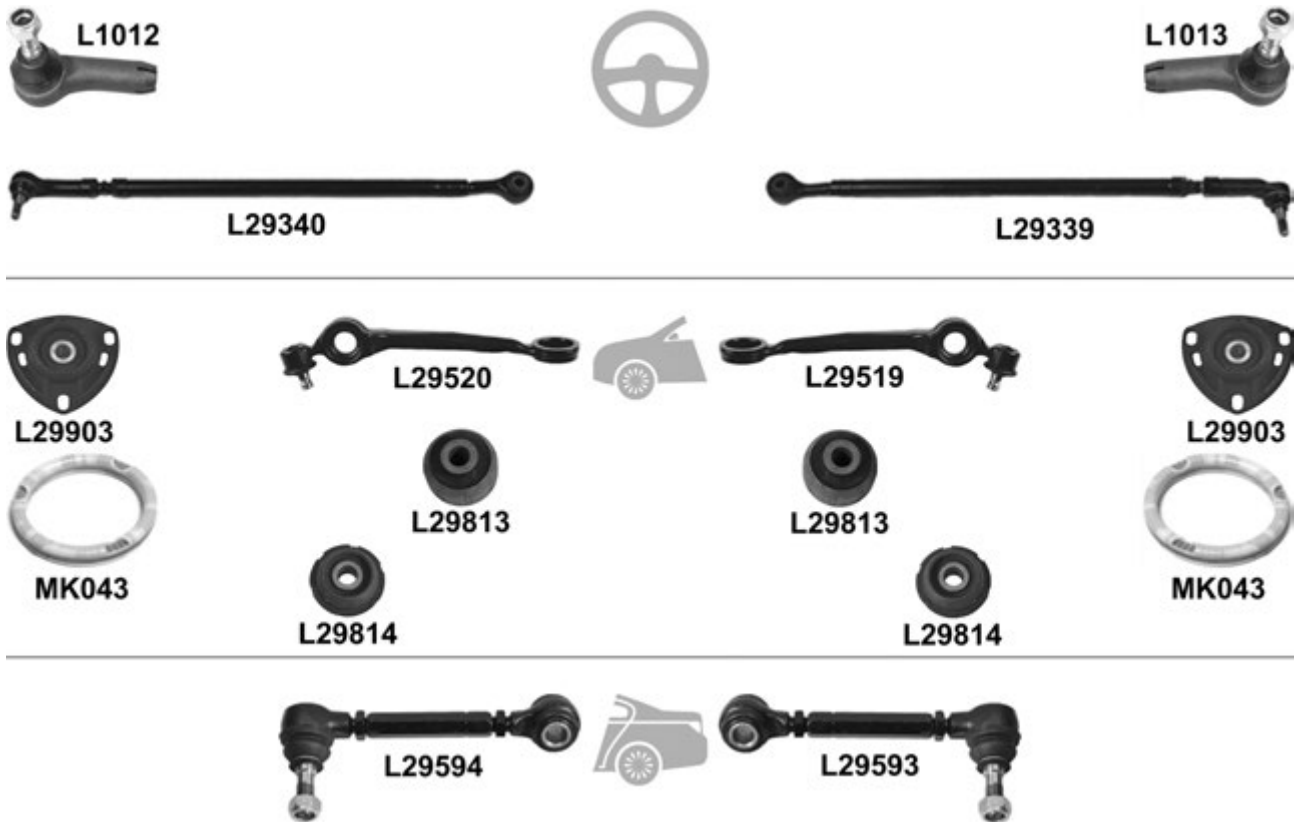
A6 Quattro, A6 Avant Quattro (4A, C4) 06.94 → 12.97

						←	→	Thread	Part Of	QPA			
								F 16x1,5		1	443 419 812 D		
									F 16x1,5		1	443 419 811 D	
											1	4A0 419 802 A	
											1	4A0 419 801 A	
				<input checked="" type="checkbox"/>						1	4A0 407 152		
										1	4A0 407 151		
											L29519/L29520	2	4A0 407 183 D
											L29519/L29520	4	4A0 407 181 A
												2	4A0 412 377 C
										2	4A0 412 249		
											1	443 505 352 P	
											1	443 505 351 P	

A6, A6 Avant (4B, C5) 01.97 → 01.05

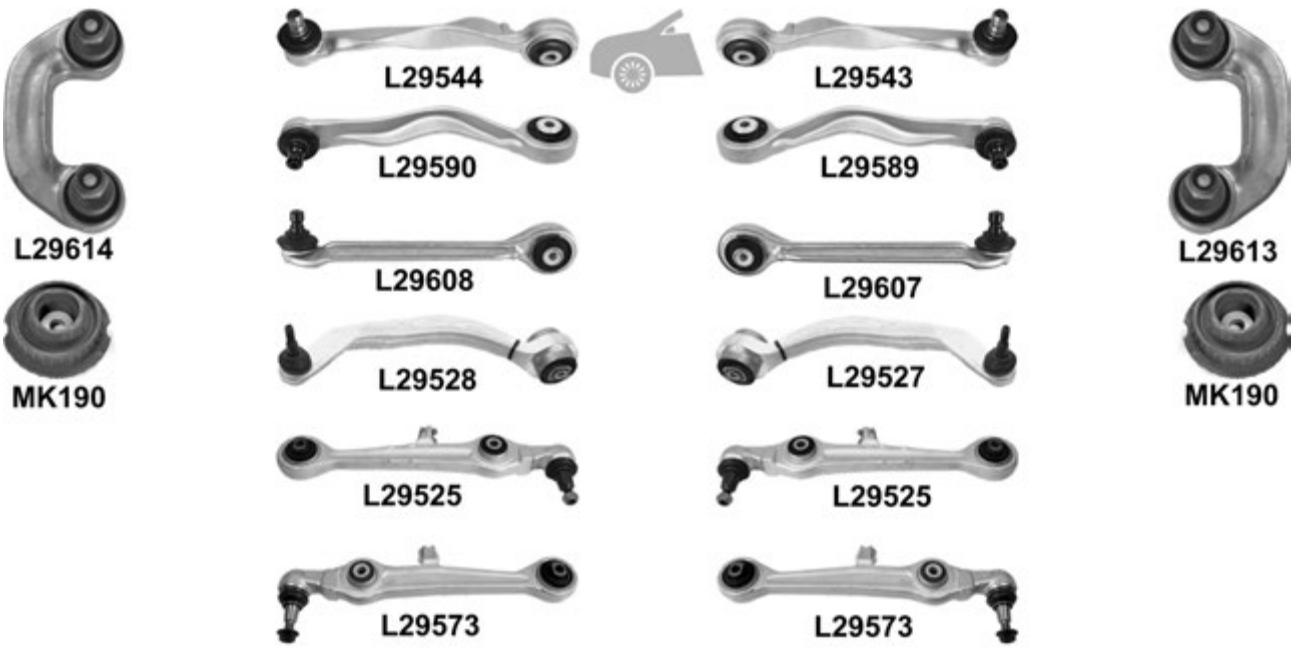
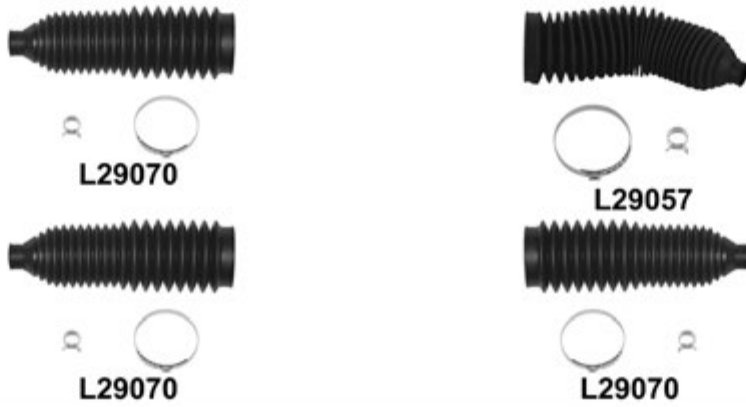



L0018



L0020



L29868



L29845



L29846



L29841



L29840



L29866



L29855



L29868



L29845



L29846



L29841



L29840



L29866



L29855



MK187



L29864



L29863



MK187

A6, A6 Avant (4B, C5) 01.97 → 01.05

			←	→	Thread	Part Of	QPA		
		↔	→ 07.02, ch. → 4B 3 011 544	L29145	L29145	∩	2	4B0 419 811 E	
			07.02 →, ch. 4B 3 011 545 →	L29141	L29141	∩	2	4F0 419 811 C	
			→ 07.02, ch. → 4B 3 011 544	L29201	L29201	F 14x1,5 / M 16x1,5 ∩		2	4B0 422 821
			07.02 →, ch. 4B 3 011 545 →	L29219	L29219			2	8E0 422 821
			→ 07.02, ch. → 4B 3 011 544	L29374	L29374			2	4B0 419 801 E
			4 cyl., ø 19mm, Ø 63mm, L= 255mm		L29057			1	8D0 419 831 K
			4 cyl., ø 20mm, Ø 54mm, L= 205mm	L29070 ⁰				1	4D0 419 831 DE
			6 cyl., ø 20mm, Ø 54mm, L= 205mm	L29070 ⁰	L29070 ⁰			2	4D0 419 831 DE
			↕	(-) SP		L29543		1	8D0 407 510 C
					L29544			1	8D0 407 509 C
			SP		L29589		1	8E0 407 510 C	
				L29590			1	8E0 407 509 C	
		↕			L29607		1	8E0 407 506 A	
					L29608		1	8E0 407 505 A	
		⊥			L29527		1	8E0 407 694 K	
					L29528		1	8E0 407 693 K	
		⊥	→ 08.01, ch. → 4B 2 031 500	L29525	L29525		2	4D0 407 151 K	
			09.01 →, ch. 4B 2 031 501 →	L29573	L29573		2	4B3 407 151 E	
			→ 08.01, ch. → 4B 2 031 500, (-) 3.7 2 x L 29145/2 x L 29525/29527/29528/29543/29544/ 29607/29608/29613/29614/29860 KIT	L0018			1	8D0 498 998	
			09.01 → 07.02, ch. 4B 2 031 501 → 4B 3 011 544, (-) 3,7 2 x L 29145/2 x L 29573/29527/29528/29543/29544/29607/ 29608/29613/29614/29860 KIT	L0020			1	8D0 498 998	
			↕↔	SP	L29868	L29868	L29589/L29590	4	8D0 407 515 C
	↕↔			L29845	L29845	L29607/L29608	2	4D0 407 515 C	
	⊥↔			L29846	L29846	L29527/L29528	2	4D0 407 183 P	
	⊥↔			L29841	L29841	L29525	2	4D0 407 182 E	
	⊥↔			L29840	L29840	L29525	2	4D0 407 181 H	
		↕	KIT	L29866	L29866	L29607/L29608	2		
		⊥			L29613			1	8D0 411 318 D
					L29614			1	8D0 411 317 D
			ø 27mm	L29855	L29855	Anti-roll bar	2	4D0 411 327 H	
			KIT	MK190	MK190		2	4D0 412 377 F	
					L29863	Hub carrier	1	4B0 501 522 E	
					L29864	Hub carrier	1	4B0 501 521 E	
				MK187	MK187		2		

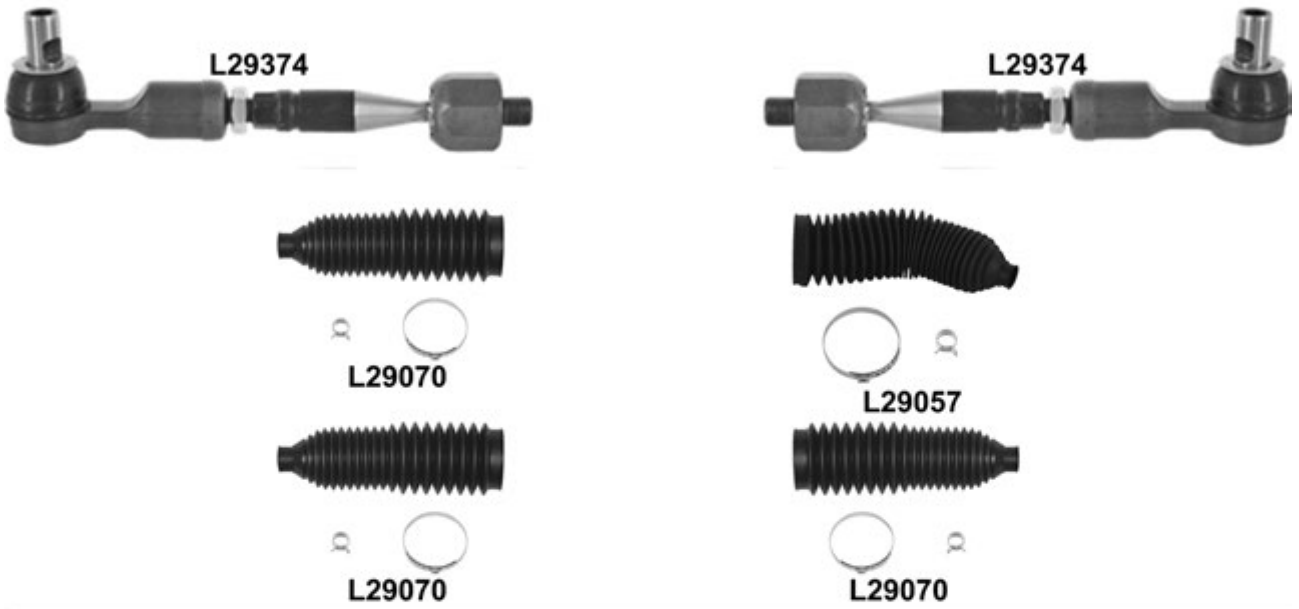
A6 Quattro, A6 Avant Quattro (4B, C5) 01.97 → 01.05

A6 Quattro, A6 Avant Quattro (4B, C5) 01.97 → 01.05



L0018



L0020

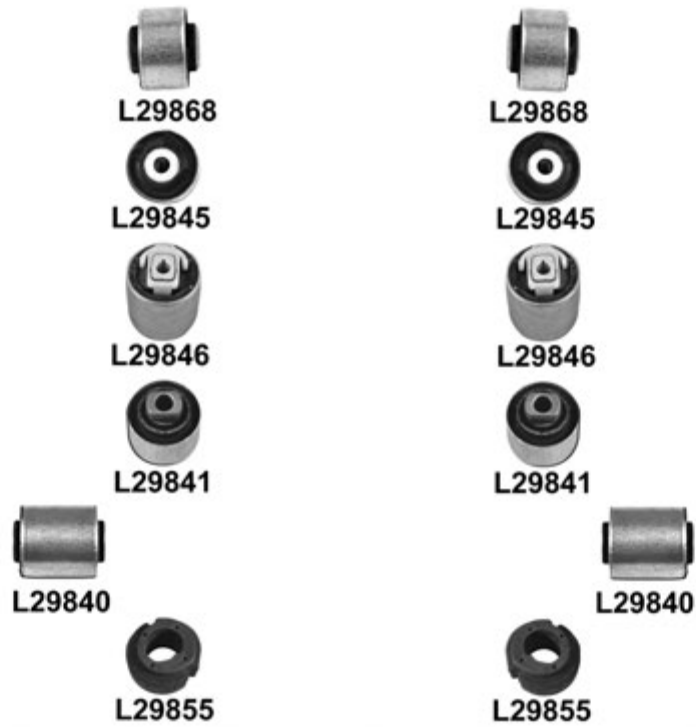

A6 Quattro, A6 Avant Quattro (4B, C5) 01.97 → 01.05

			←	→	Thread	Part Of	QPA		
		↔	ch. → 4B X 065 000	L29145	L29145	∪	2	4B0 419 811 E	
			ch. 4B X 065 001 →	L29141	L29141	∪	2	4F0 419 811 C	
			ch. → 4B X 065 000	L29201	L29201	F 14x1,5 / M 16x1,5 ∪	2	4B0 422 821	
			ch. 4B X 065 001 →	L29219	L29219		2	8E0 422 821	
				L29374	L29374		2	4B0 419 801 E	
			4 cyl., ø 19mm, Ø 63mm, L= 255mm		L29057		1	8D0 419 831 K	
			4 cyl., ø 20mm, Ø 54mm, L= 205mm	L29070 ⁰			1	4D0 419 831 DE	
			6 cyl., ø 20mm, Ø 54mm, L= 205mm	L29070 ⁰	L29070 ⁰		2	4D0 419 831 DE	
			î ▼	(-) SP		L29543		1	8D0 407 510 C
					L29544		1	8D0 407 509 C	
SP				L29589		1	8E0 407 510 C		
			L29590		1	8E0 407 509 C			
î ▲				L29607		1	8E0 407 506 A		
				L29608		1	8E0 407 505 A		
⊥ ▼				L29527		1	8E0 407 694 K		
				L29528		1	8E0 407 693 K		
⊥ ▲		→ 08.01 , ch. → 4B 2 031 500, (-) 3.7/Quattro/4.2 Quattro	L29525	L29525		2	4D0 407 151 K		
			L29573	L29573		2	4B3 407 151 E		
			L29573	L29573		2	4B3 407 151 E		
		→ 08.01 , ch. → 4B 2 031 500, (-) 3.7/Quattro/4.2 Quattro KIT 2 x L 29145/2 x L 29525/29527/29528/29543/29544/29607/ 29608/29613/29614/29860	L0018			1	8D0 498 998		
		09.01 →, ch. 4B 2 031 501 →, (-) 3.7/Quattro/4.2 Quattro KIT 2 x L 29145/2 x L 29573/29527/29528/29543/29544/ 29607/29608/29613/29614/29860	L0020			1			
		î ▼ ↔	SP	L29868	L29868		L29589/L29590	4	8D0 407 515 C
				L29845	L29845		L29607/L29608	2	4D0 407 515 C
			L29846	L29846		L29527/L29528	2	4D0 407 183 P	
			L29841	L29841		L29525	2	4D0 407 182 E	
			L29840	L29840		L29525	2	4D0 407 181 H	
				L29613			1	8D0 411 318 D	
	⊥		L29614				1	8D0 411 317 D	
			L29855	L29855		Anti-roll bar	2	4D0 411 327 H	
		Ø 27mm	L29855	L29855			2	4D0 411 327 H	
			KIT	MK190	MK190		2	4D0 412 377 F	
			L29663	L29663			2	8E0 505 465 D	

A6, A6 Avant (4F2, 4F5) 05.04 →

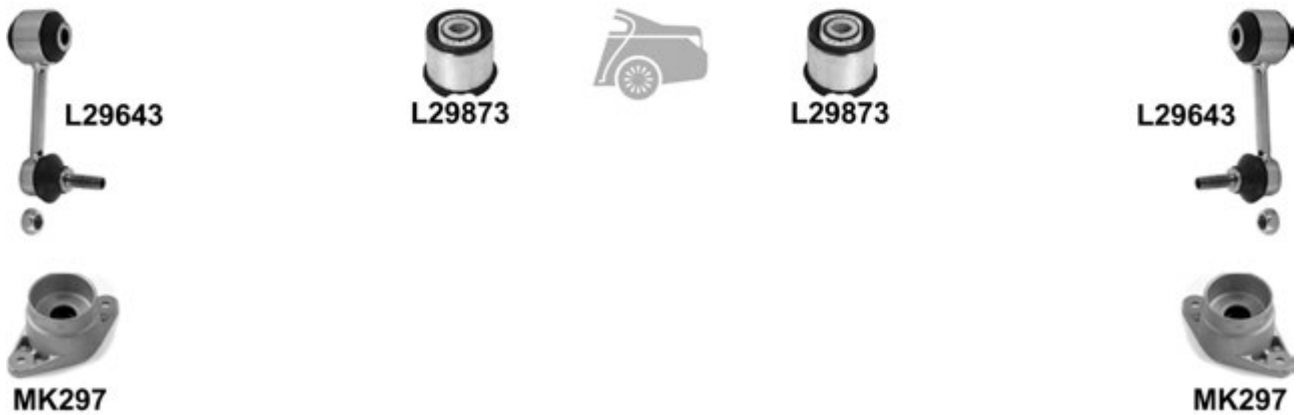
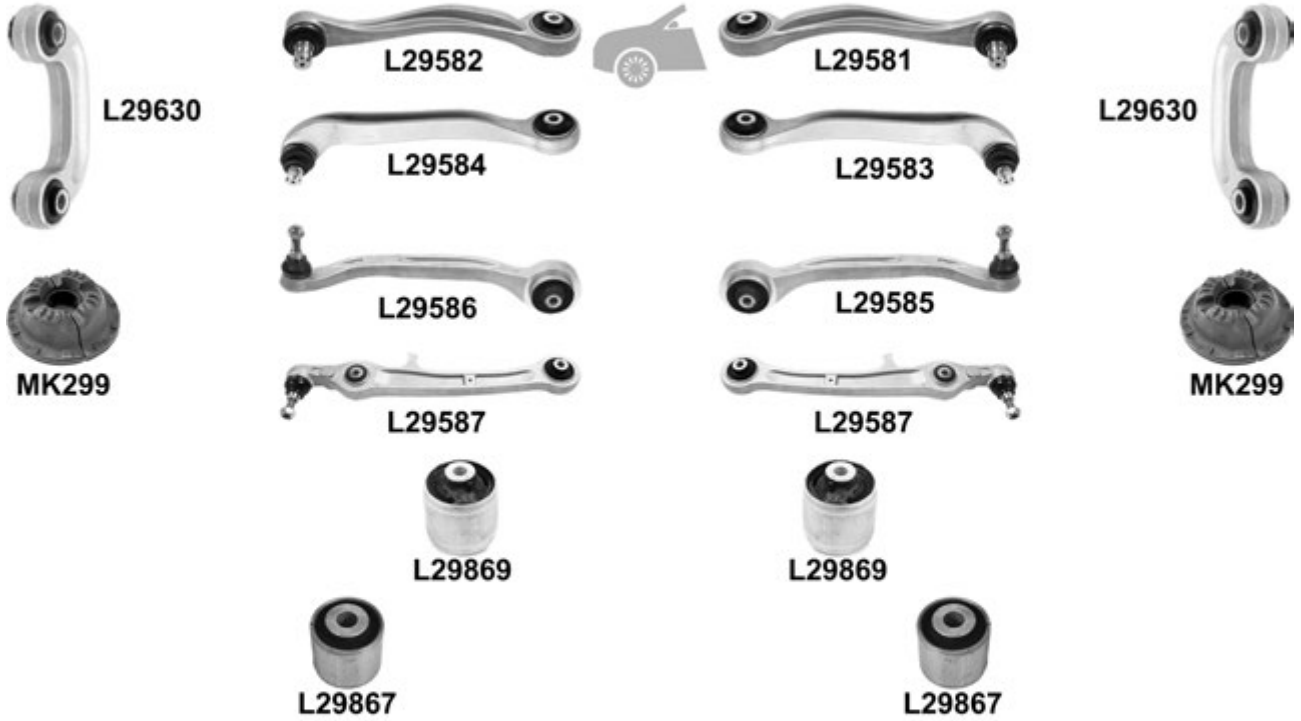

A6, A6 Avant (4F2, 4F5) 05.04 →

		i		←	→	Thread	Part Of	QPA	i	
		↔		L29141	L29141	⌚		2	4F0 419 811 C	
				L29218	L29218			2	4F0 422 821	
				L29061 °	L29061 °			2	4F0 422 831	
		↑	▼		L29581			1	4E0 407 510 D	
				L29582			1	4E0 407 509 D		
		↓	▲		L29583			1	4E0 407 506 D	
				L29584			1	4E0 407 505 D		
		⊥	▼		L29585			1	4F0 407 694 D	
	⊥	▲		L29586			1	4F0 407 693 D		
		⊥	▼	↔	L29869	L29869			2	4F0 407 183 C
			▲	↔	L29867	L29867		L29587	2	4E0 407 181 B
			↔		L29630	L29630			2	4E0 411 317 E
					MK299	MK299			2	
		▼		L29873	L29873		Hub carrier	2	4F0 505 145 A	
				L29643	L29643			2	4F0 505 465 P	
				MK297	MK297			2	4F0 513 353 D	

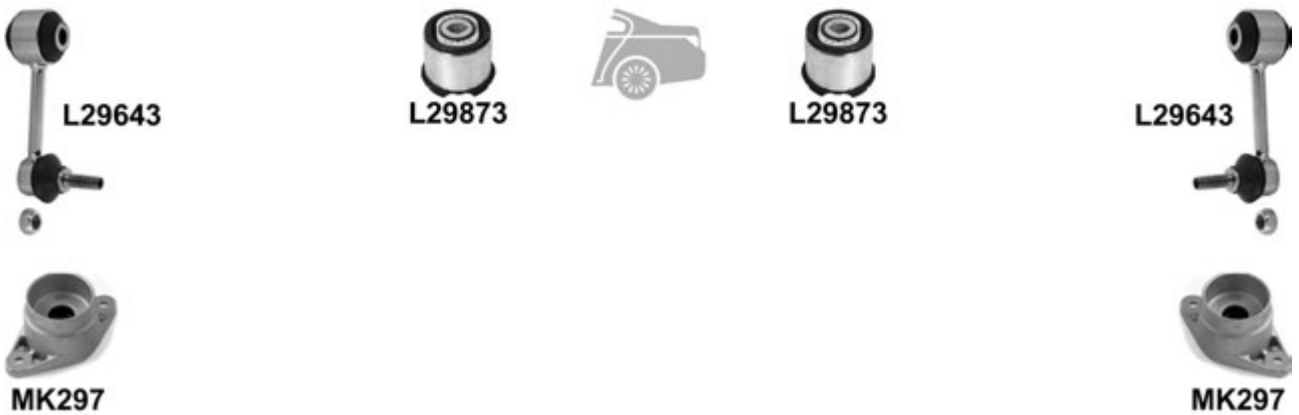
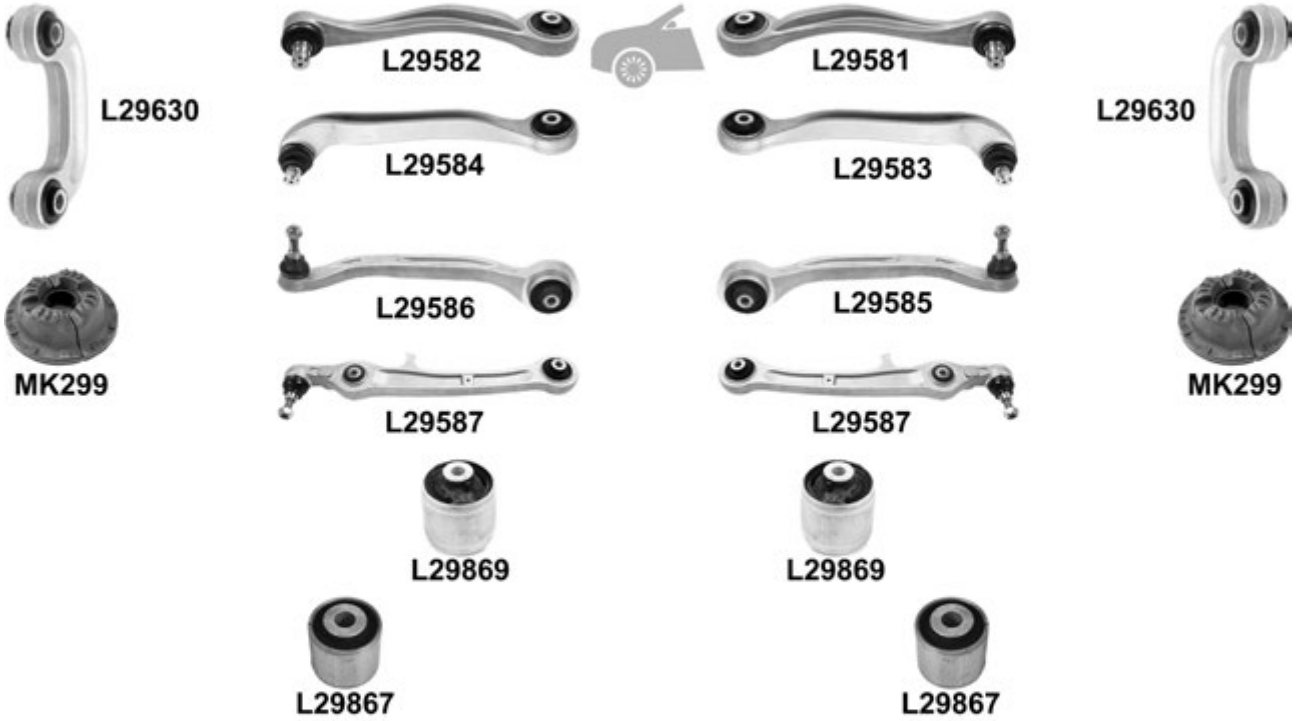
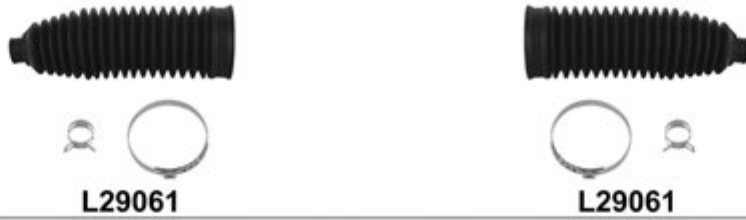
A6 Quattro, A6 Avant Quattro (4F2, 4F5) 05.04 →

A6 Quattro, A6 Avant Quattro (4F2, 4F5) 05.04 →

		i		←	→	Thread	Part Of	QPA	i	
		↔		L29141	L29141	☺		2	4F0 419 811 C	
				L29218	L29218			2	4F0 422 821	
				L29061 °	L29061 °			2	4F0 422 831	
		↑	▼	(-) RS6 Quattro	L29581			1	4E0 407 510 D	
					L29582			1	4E0 407 509 D	
		↑	▲	(-) RS6 Quattro	L29583			1	4E0 407 506 D	
					L29584			1	4E0 407 505 D	
		⊥	▼	(-) RS6 Quattro	L29585			1	4F0 407 694 D	
					L29586			1	4F0 407 693 D	
		⊥	▲		L29587	L29587			2	4F0 407 151
		⊥	▼	↔	L29869	L29869			2	4F0 407 183 C
		⊥	▲	↔	L29867	L29867		L29587	2	4E0 407 181 B
					L29630	L29630			2	4E0 411 317 E
				MK299	MK299			2		
		▼		L29873	L29873		Hub carrier	2	4F0 505 145 A	
			≡	L29643	L29643			2	4F0 505 465 P	
				MK297	MK297			2	4F0 513 353 D	

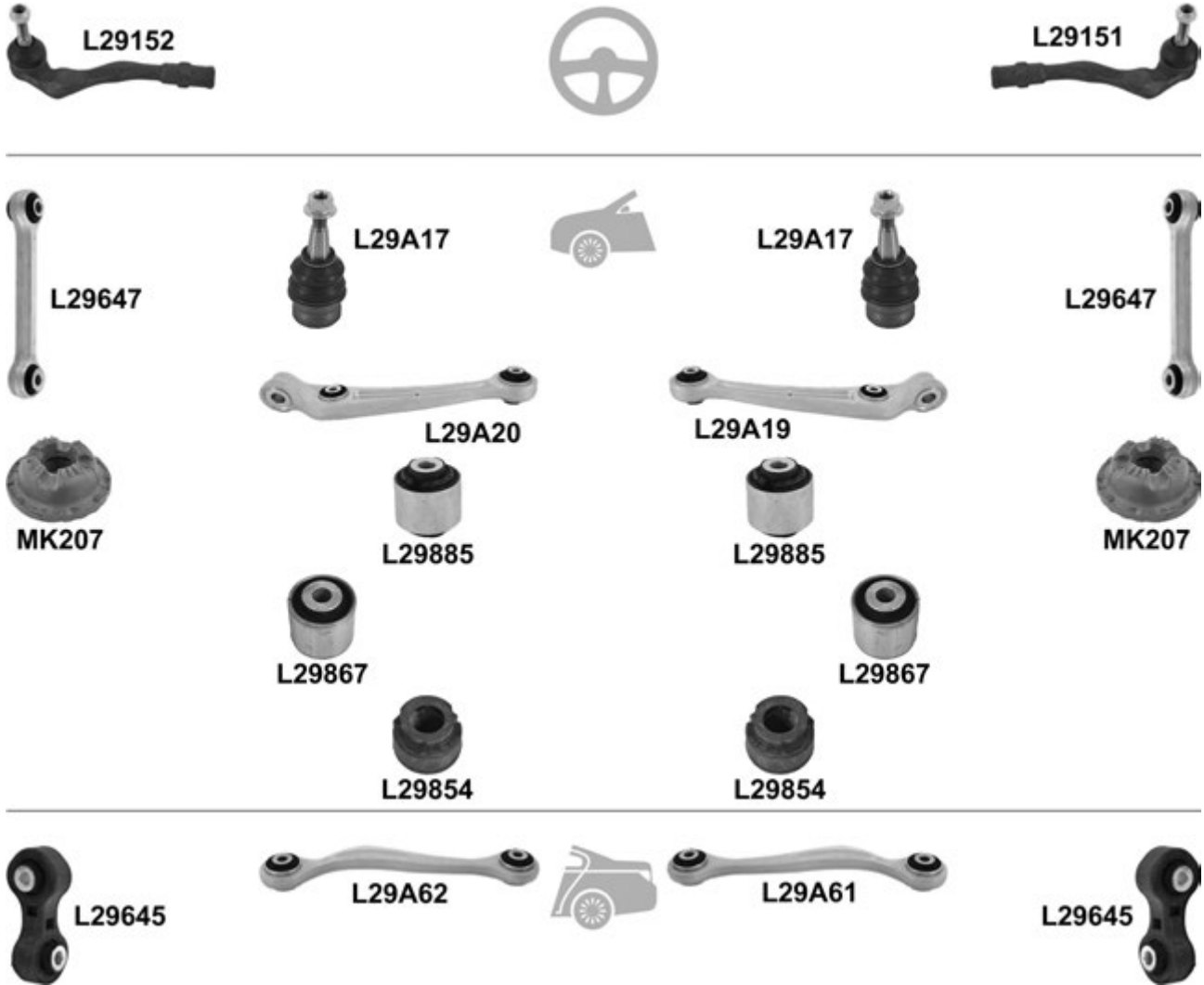
**A6 / A6 Quattro (4G2, C7) 10.10 →
A6 Avant / A6 Avant Quattro (4G5, C7) 05.11 →**

		i		←	→	Thread	Part Of	QPA	i
		↔				L29151	F 16x1,5 U	1	8K0 422 818 B
						L29152	F 16x1,5 U	1	8K0 422 817 B
		⊥	→ 08.11			L29A17	L29A17	2	8K0 407 689 F
			→ 08.11			L29A19		1	8K0 407 152 C
		⊥ ▲ ↔	(+) 09.11 →/Allroad			L29A20		1	8K0 407 151 C
			(+) 09.11 →/Allroad			L29885 ⁰	L29885 ⁰	2	8K0 407 182 B
		⊥ ▲ ↔	(+) 09.11 →/Allroad			L29867	L29867	2	4E0 407 181 B
			PR 1BA/ABE/1BR/1BV			L29647	L29647	2	8K0 411 317 E
			→ 01.11, PR 1BA/ABE/1BK/1BV, Ø 24.8mm			L29854	L29854	2	4D0 411 327 G
			KIT		MK207	MK207	2	8E0 412 377	
		⊥ ▲	1BK/1BS			L29A61		1	8K0 501 530 N
						L29A62		1	8K0 501 529 N
			(+) Allroad			L29645	L29645	2	8K0 505 465 E

A7 Sportback (4GA) 10.10 →

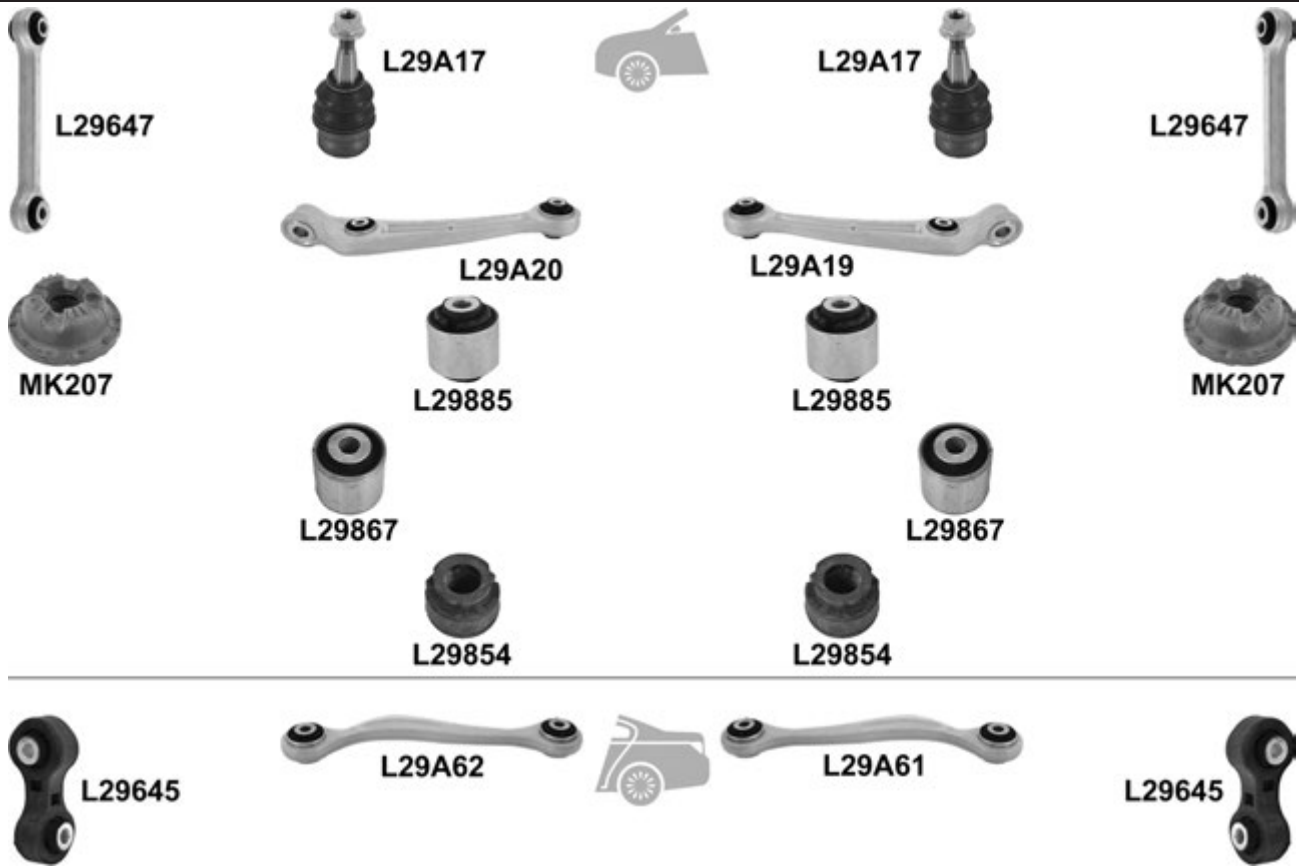

		i		←	→	Thread	Part Of	QPA	i
		↓	→ 07.11	L29A17	L29A17			2	8K0 407 689 F
		↓ ▲	→ 07.11		L29A19			1	8K0 407 152 C
				L29A20				1	8K0 407 151 C
		↓ ▲ → ←	(+) 07.11 →	L29885 ^o	L29885 ^o		L29A19/L29A20	2	8K0 407 182 B
		↓ ▲ ← →	(+) 07.11 →	L29867	L29867		L29A19/L29A20	2	4E0 407 181 B
			PR 1BA/1BB/1BE/1BV	L29647	L29647			2	8K0 411 317 E
			PR 1BA/1BE/1BK/1BV, Ø 24.8mm	L29854	L29854		Anti-roll bar	2	4D0 411 327 G
			KIT	MK207	MK207			2	8E0 412 377
		↓ ▲	1BK/2MB		L29A61			1	8K0 501 530 N
				L29A62				1	8K0 501 529 N
				L29645	L29645			2	8K0 505 465 E

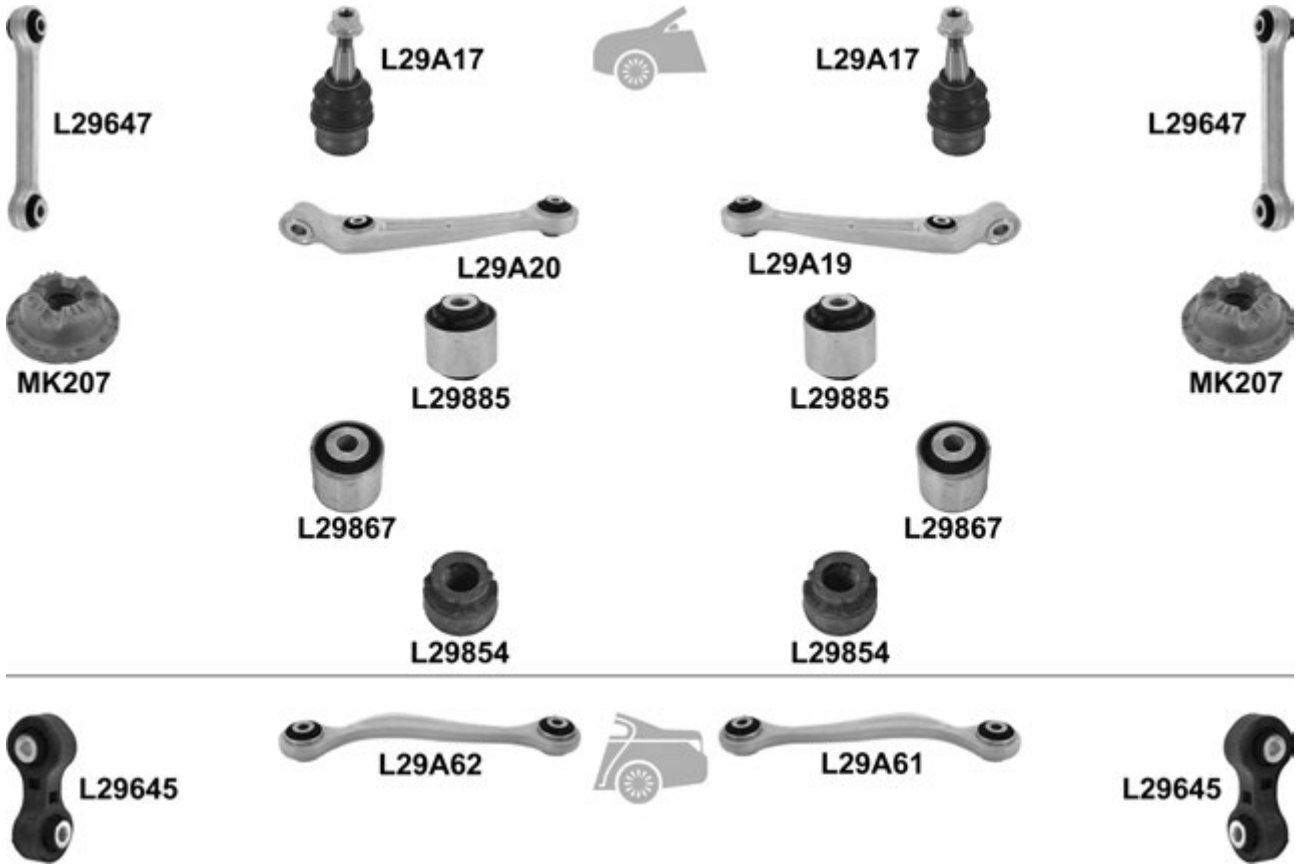
A7 Sportback Quattro (4GA) 10.10 →

		i		←	→	Thread	Part Of	QPA	i
		↓	→ 08.11	L29A17	L29A17			2	8K0 407 689 F
		↓ ▲	→ 08.11		L29A19			1	8K0 407 152 C
				L29A20				1	8K0 407 151 C
		↓ ▲ → ←	(+) 08.11 →	L29885 ^o	L29885 ^o		L29A19/L29A20	2	8K0 407 182 B
		↓ ▲ → ←	(+) 08.11 →	L29867	L29867		L29A19/L29A20	2	4E0 407 181 B
			PR 1BA/1BB/1BE/1BV	L29647	L29647			2	8K0 411 317 E
			PR 1BA/1BE/1BK/1BV, Ø 24.8mm	L29854	L29854		Anti-roll bar	2	4D0 411 327 G
			KIT	MK207	MK207		2	8E0 412 377	
		↓ ▲	☰, 1BK/2MB		L29A61			1	8K0 501 530 N
				L29A62				1	8K0 501 529 N
				L29645	L29645			2	8K0 505 465 E

A8 (4D2, 4D8) 03.94 → 12.02
 A8 Quattro (4D2, 4D8) 03.94 → 12.02

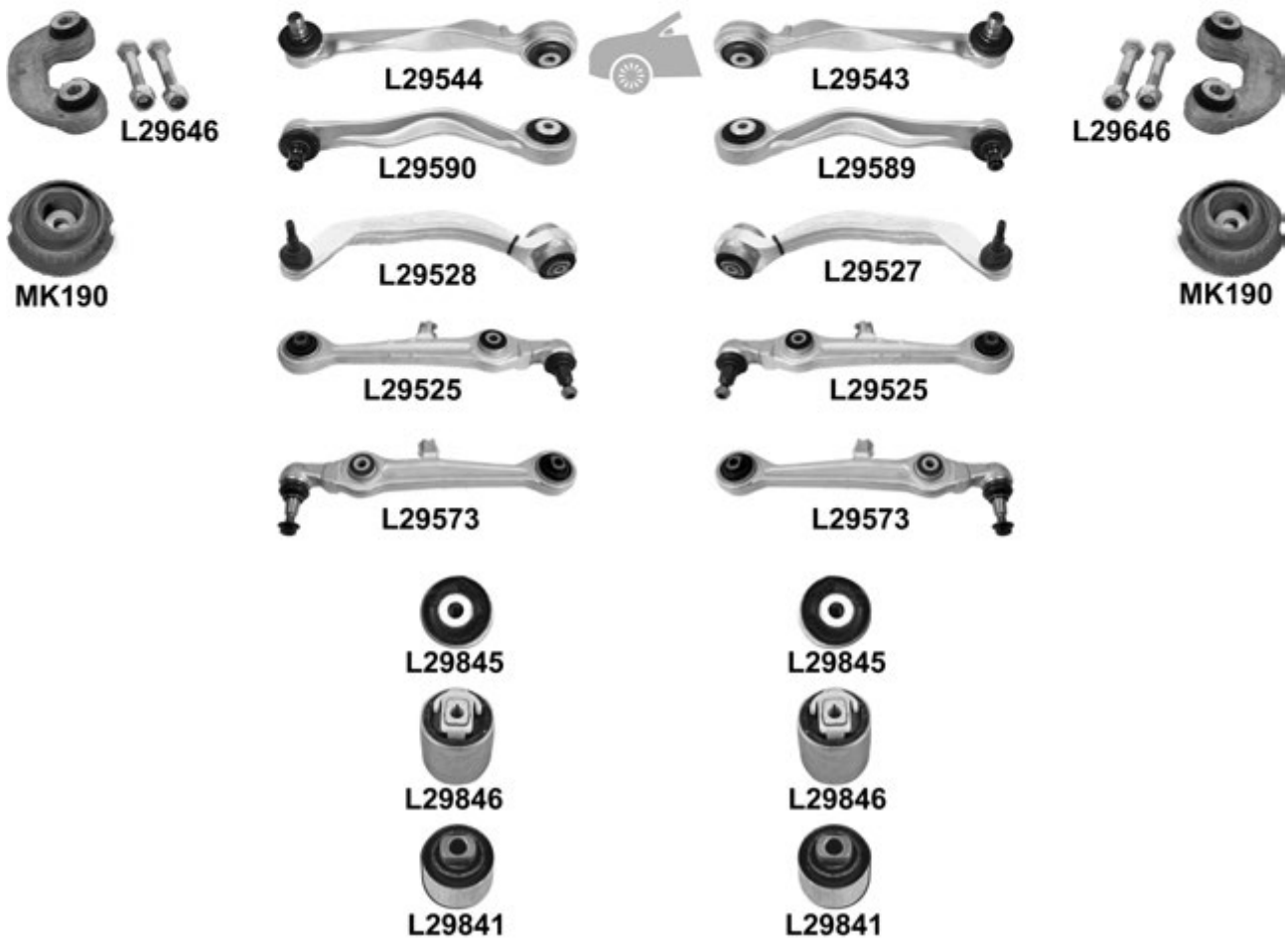
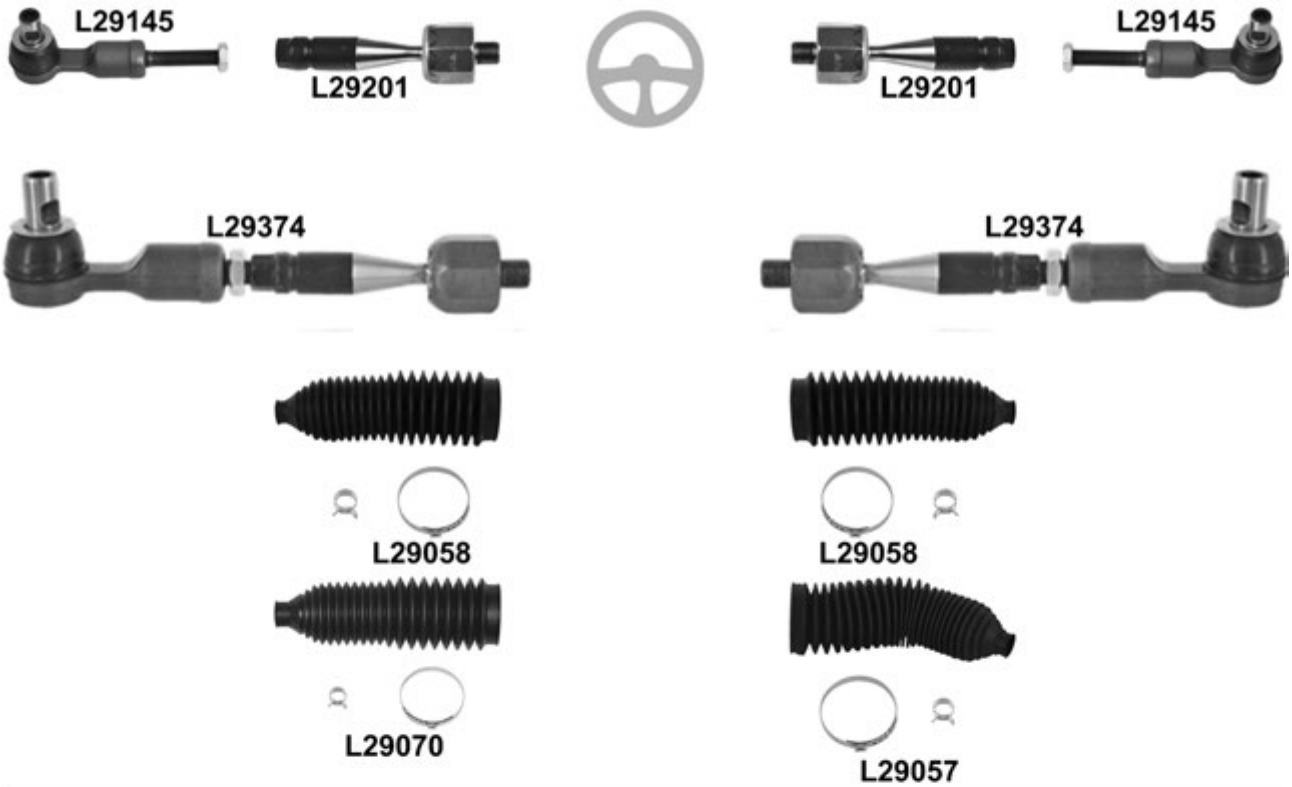

A8 (4D2, 4D8) 03.94 → 12.02
A8 Quattro (4D2, 4D8) 03.94 → 12.02

				← → Thread		Part Of	QPA				
⊕		↔		L29145	L29145	M 14x1,5 ⌢	2	4D0 419 811 B			
				L29201	L29201	⌢	2	4D0 422 821			
				L29374	L29374		2	4D0 419 801 B			
				L29058	L29058		2	4D0 419 831 D			
		↔	(-) Quattro, ø 18mm, Ø 54mm, L= 205mm		L29057		1	8D0 419 831 K			
			Quattro, ø 19mm, Ø 63mm, L= 255mm				1	4D0 419 831 DE			
			Quattro, ø 20mm, Ø 54mm, L= 205mm	L29070 ⁰			1				
🚗		↕	(-) SP		L29543		1	8D0 407 510 C			
					L29544		1	8D0 407 509 C			
					L29589		1	8E0 407 510 C			
					L29590		1	8E0 407 509 C			
					L29527		1	8E0 407 694 K			
					L29528		1	8E0 407 693 K			
		↕	↕	→ 12.98 , ch. → 4D X 004 999	L29525	L29525		2	4D0 407 151 E		
				01.99 →, ch. 4D X 005 501 →	L29573	L29573		2	4B3 407 151 E		
		🌀	↕	↔		L29845	L29845		2	4D0 407 515 C	L29543/L29544
						L29846	L29846		2	4D0 407 183 P	L29527/L29528
						L29841	L29841		2	4D0 407 182 E	L29525
						L29840	L29840		2	4D0 407 181 H	L29525
🌀	↕	↔	(-) AD	L29646	L29646		2	4D0 411 317 K			
			Height adjustment, Ø 24.8mm	L29854	L29854		2	4D0 411 327 G	Anti-roll bar		
			(-) Height adjustment, Ø 27mm	L29855	L29855		2	4D0 411 327 H	Anti-roll bar		
🌀	↕	↔	KIT	MK190	MK190		2	4D0 412 377 F			
				L29651	L29651		2	4D0 505 465 D			

A8 (4E_) 07.03 → 07.10

A8 Quattro (4E_) 10.02 → 07.10

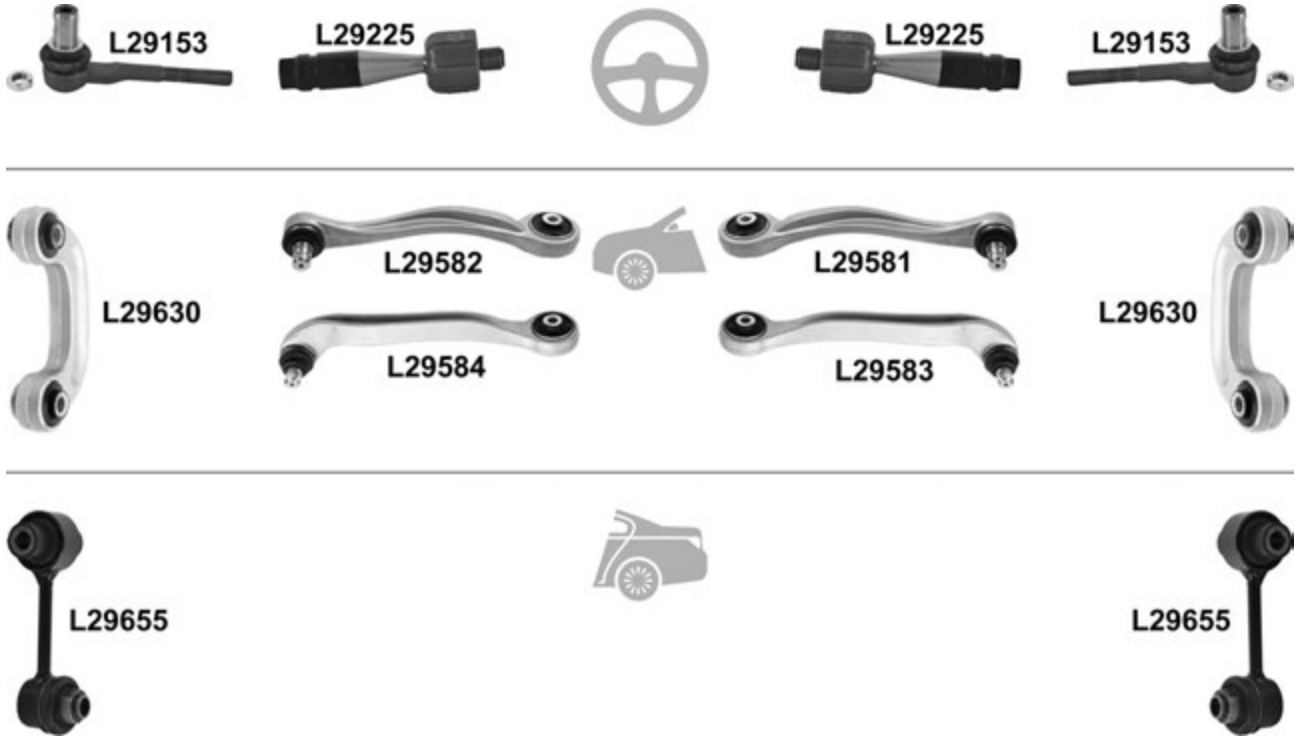

				←	→	Thread	Part Of	QPA	
		↔		L29153	L29153	↻		2	4E0 419 811 E
				L29225	L29225	↻		2	4E0 419 821 A
		↑			L29581			1	4E0 407 510 D
				L29582				1	4E0 407 509 D
		↓			L29583			1	4E0 407 506 D
				L29584				1	4E0 407 505 D
				L29630	L29630			2	4E0 411 317 E
				L29655	L29655			2	4E0 505 765 G

A8 (4H) 09.11 →
A8 Quattro (4H) 11.09 →

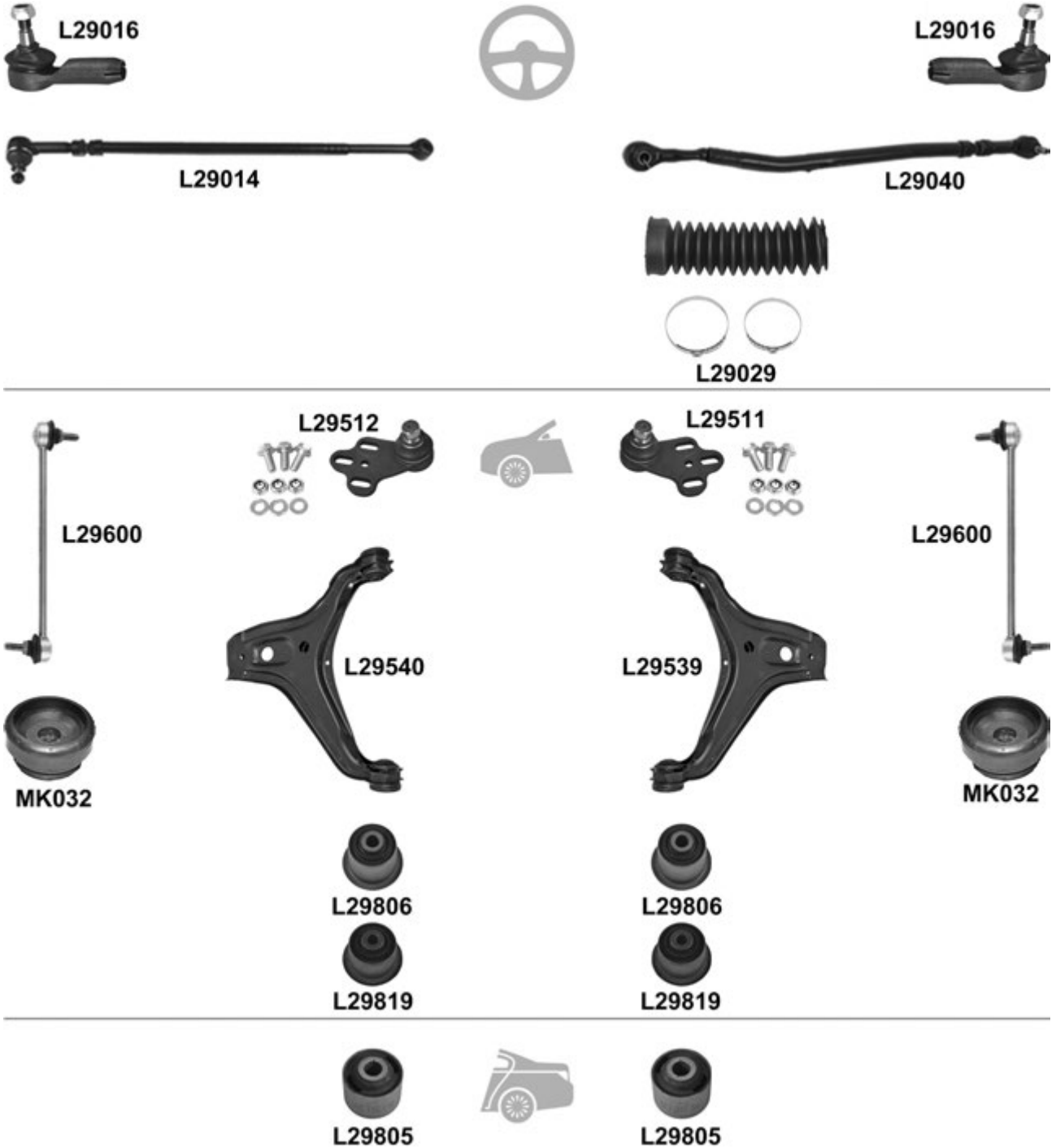

		i	←	→	Thread	Part Of	QPA	i
		Hydraulic PR 1N3/1N7	L29224	L29224	M 16x1,5 / M 16x1,5 ☺		2	8J0 423 810
		Thermoplast	L29062 ⁰	L29062 ⁰			2	8K0 422 831
		(+) 08.11 →	L29867	L29867		L29A19/L29A20	2	4E0 407 181 B
		PR 1BK/1BY, HD , PR 2MA, Electronic Suspension, Ø 27mm	L29855	L29855		Anti-roll bar	2	4D0 411 327 H
		4.2 Fsi, Mot/Eng CDRA, → 06.10	L29A62	L29A61			1	8K0 501 530 N
			L29A62				1	8K0 501 529 N
		4.2 Tdi, Mot/Eng CDSB → 06.10		L29A61			1	8K0 501 530 N
			L29A62				1	8K0 501 529 N
			L29645	L29645			2	8K0 505 465 E

Cabriolet (8G7, B4) 05.91 → 08.00

Cabriolet (8G7, B4) 05.91 → 08.00

				←	→	Thread	Part Of	QPA	
		↔		L29016	L29016	F 14x1,5 U		2	811 419 812 A
				L29014	L29040			1	893 419 802
				L29014				1	811 419 801 E
				L29014	L29029			1	811 419 831 B
		↓	(-) 2.6 110kw/2.8	L29512	L29511			1	8A0 407 366
				L29512	L29511			1	8A0 407 365
				L29512	L29511			1	8A0 407 366
				L29512	L29511			1	8A0 407 365
		↓	(-) 2.8	L29539	L29539			1	895 407 148 A
				L29540	L29540			1	895 407 147 A
				L29539	L29539			1	895 407 148 A
				L29540	L29540			1	895 407 147 A
		↓ ▲ ▼	2.3 E/2.6 110kw/2.8	L29806	L29806			4	8A0 407 181
				L29819	L29819			4	893 407 181
				L29806	L29806			4	8A0 407 181
				L29600	L29600			2	8A0 407 465 C
			KIT	MK032	MK032		2	8A0 412 323 B	
			(-) Quattro	L29805	L29805		Hub carrier	2	811 511 247

Coupe (81, 85) 07.80 → 10.88

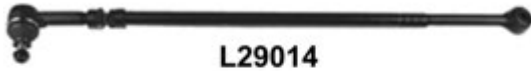
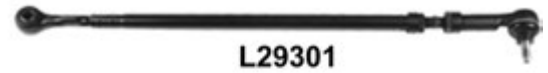
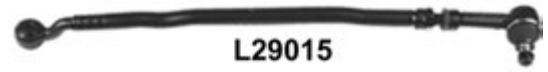

L29029



Coupe (81, 85) 07.80 → 10.88

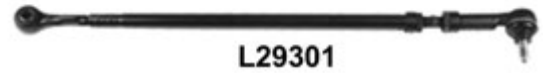

				← → Thread		Part Of	QPA		
				L29016	L29016	F 14x1,5 U	2	811 419 812 A	
			ch. → 85 G 160 000		L29015		1	811 419 802 J	
			ch. 85 G 160 001 →		L29301		1	811 419 802 K	
					L29014		1	811 419 801 E	
						L29029		1	811 419 831 B
		↓	, (-) 2.1 GT 96 KW, (-) Quattro, 17mm	L1076	L1076		2	823 407 365 E	
			, 2.1 GT 96 KW, ch. → 85 E 220 000, (-) Quattro		L29503		1	855 407 366	
			17mm		L29504		1	855 407 365	
			, (-) 2.1 GT 96 KW, 17mm		L29501		1	855 407 366 A/B	
					L29502		1	855 407 365 A/B	
			, 2.1 GT 96 KW, ch. → 85 D 094 983, (-) Quattro	L1076	L1076		2	823 407 365 E	
			17mm						
			, 2.1 GT 96 KW, ch. 85 D 094 984 →, (-) Quattro		L29501		1	855 407 366 A/B	
	17mm								
	, 2.1 GT 96 KW, ch. 85 D 094 984 →, (-), Quattro	L29502			1	855 407 365 A/B			
	17mm								
		↓	4 cyl., (-) Quattro	L29530	L29530		2	893 407 147 G	
			5 cyl., (-) Quattro		L29531		1	893 407 148 C	
			L29532		1	893 407 147 C			
		, (-) Quattro	L29804	L29804		4	811 407 181 A		
		, 5 cyl., (-) Quattro	L29806	L29806		4	857 407 181		
			L29837	L29837	Anti-roll bar	2	823 411 313 A		
			KIT	MK032	MK032		2	8A0 412 323 B	
		↓	Quattro	L29529	L29529		2	857 505 365	
			(-) Quattro	L29805	L29805	Hub carrier	2	811 511 247	

Coupe (89, 8B) 10.88 → 12.96

			i	←	→	Thread	Part Of	QPA	i
⊕		↔		L29016	L29016	F 14x1,5 ♂		2	811 419 812 A
					L29015			1	811 419 802 J
					L29301			1	811 419 802 K

Quattro (85) 07.80 → 07.91

			i	←	→	Thread	Part Of	QPA	i
⊕		↔		L29016	L29016	F 14x1,5 ♂		2	811 419 812 A

Q3 06.11 →
Q3 Quattro 06.11 →

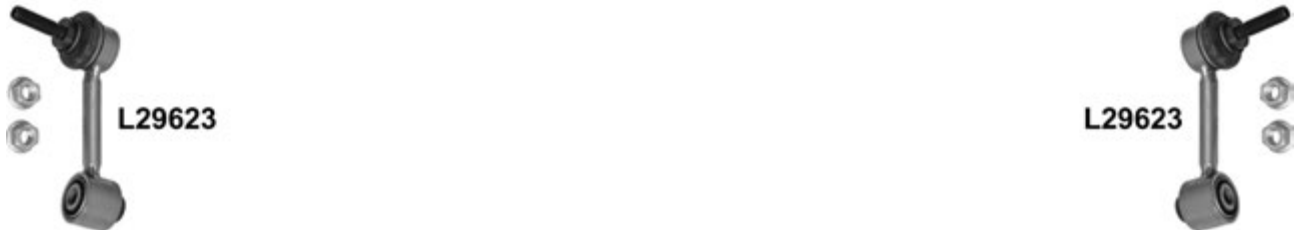
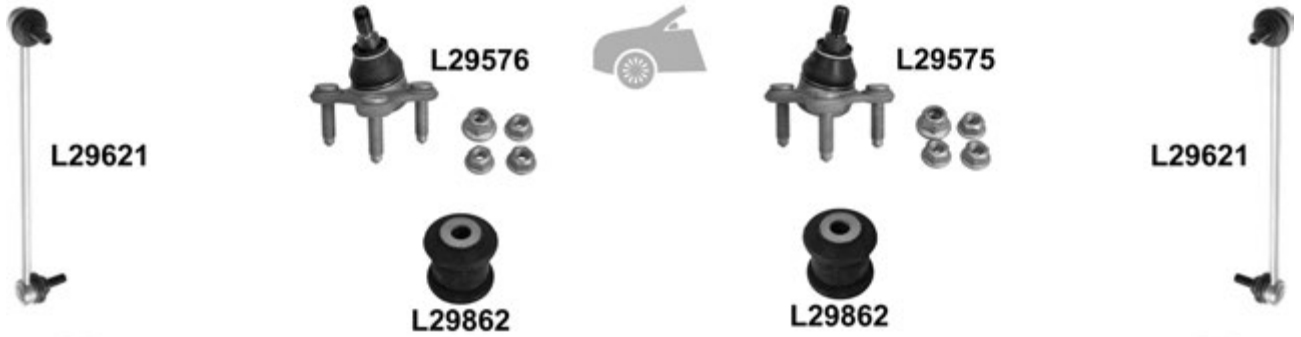

Q3 06.11 →
 Q3 Quattro 06.11 →

		i		←	→	Thread	Part Of	QPA	i		
		↔			L29135	F 16x1,5 ♂		1	1K0 423 812 G		
						L29136	F 16x1,5 ♂		1	1K0 423 811 G	
						L29215	L29215	M 16x1,5 / M 16x1,5 ♂		2	1K0 423 810 A
		⊥				L29575				1	1K0 407 366 C
						L29576				1	1K0 407 365 C
		⊥ ▲				L29862	L29862			2	1K0 407 182
						L29621	L29621			2	1K0 411 315 D
						MK345	MK345			2	6N0 412 249 C
		⊥ ▲	→ 05.12			L29A11	L29A11			2	4K0 505 323 N
			⊥			L29A29	L29A29			2	1K0 505 311 AB
		▲					L29637			1	1K0 501 530 C
						L29638				1	1K0 501 529 F
						L29623	L29623			2	1K0 505 465 J
				PR UA0/UC3			MK386	MK386		2	1K0 513 353 C

Q5 (8RB) 11.10 →
Q5 Quattro (8RB) 11.08 →

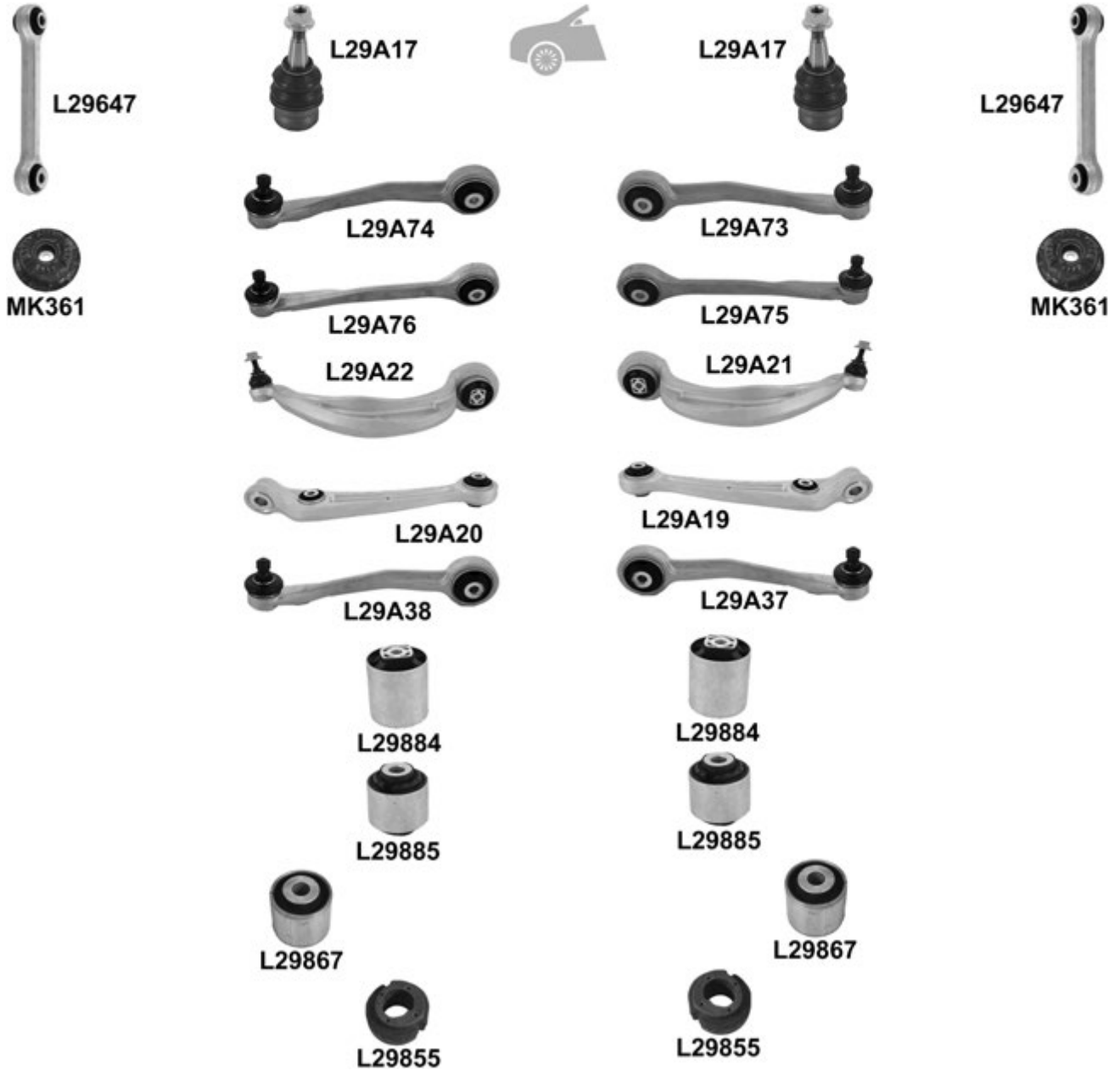

Q5 (8RB) 11.10 →
 Q5 Quattro (8RB) 11.08 →

L29645

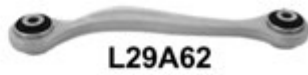

L29A62

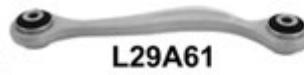

L29A61



L29645



MK388



MK388

			←	→	Thread	Part Of	QPA	
			L29224	L29224	M 16x1,5 / M 16x1,5 U		2	8J0 423 810
		Thermoplast	L29062 ⁰	L29062 ⁰			2	8K0 422 831
		↓	L29A17	L29A17			2	8K0 407 689 F
		↖		L29A73 ⁰			1	8K0 407 510 B
		↖		L29A74 ⁰			1	8K0 407 509 B
		↗		L29A75 ⁰			1	8K0 407 506 B
	↓	→ 07.09		L29A21			1	8K0 407 694 N
				L29A22			1	8K0 407 693 N
	↓			L29A19			1	8K0 407 152 C
				L29A20			1	8K0 407 151 C
	↖	06.12 → 2.0 TFSI/2.0 Tdi/3.0 TFSI/3.0 Tdi Mot/Eng CNCD/CGLC/CMGB/CTUC/CTVA/CDUD		L29A37			1	8K0 407 510 A
		↓↖↗	→ 07.09	L29884	L29884		L29A21/L29A22	2
↓↗↖			L29885 ⁰	L29885 ⁰		L29A19/L29A20	2	8K0 407 182 B
↓↖↗			L29867	L29867		L29A19/L29A20	2	4E0 407 181 B
			L29647	L29647			2	8K0 411 317 E
	PR QJA/QJB/QJC/QJD/QJE, Ø 27mm		L29855	L29855		Anti-roll bar	2	4D0 411 327 H
	PR 1BA/1BV, (-)	KIT	MK361	MK361			2	8K0 412 377 C
		↓		L29A61			1	8K0 501 530 N
				L29A62			1	8K0 501 529 N
	↓	2.0 Tdi, Mot/Eng CAHA/CAHB/CGLA/CGLB/CMGA → 11.10		L29A61			1	8K0 501 530 N
				L29A62			1	8K0 501 529 N
	↓	3.0 Tdi, Mot/Eng CCWA/CCWB → 11.10		L29A61			1	8K0 501 530 N
				L29A62			1	8K0 501 529 N
	↓	3.2 Fsi, Mot/Eng CALB → 11.10		L29A61			1	8K0 501 530 N
				L29A62			1	8K0 501 529 N
			L29645	L29645			2	8K0 505 465 E
			MK388 ⁰	MK388 ⁰			2	8K0 513 353 E

Q7 03.06 →

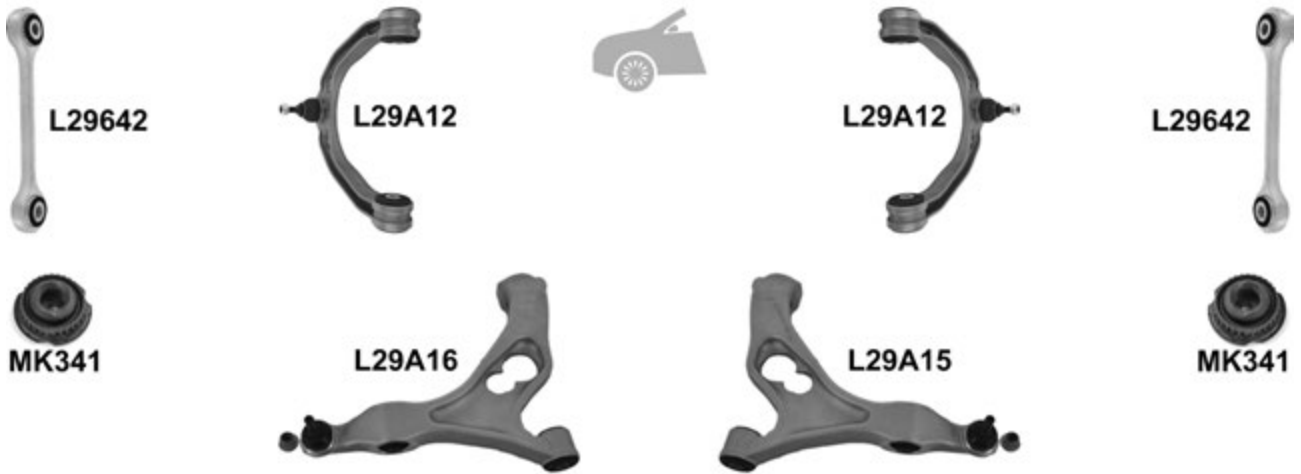
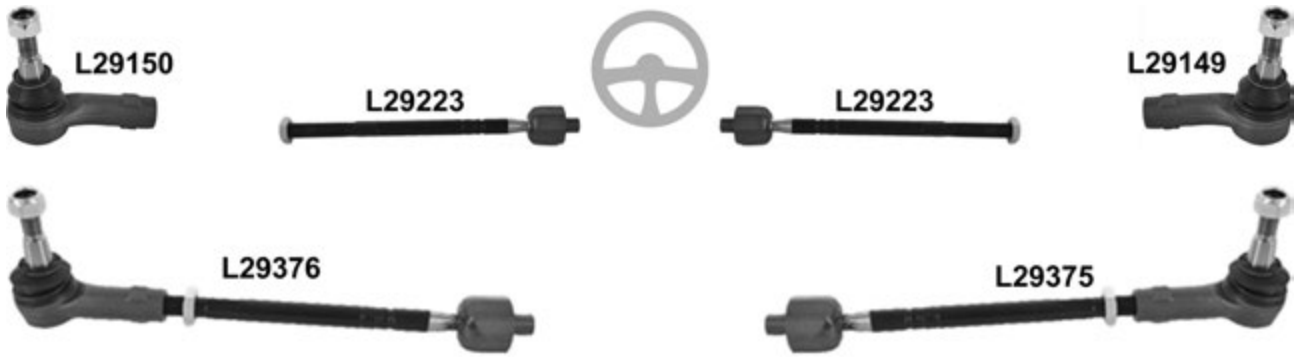

				←	→	Thread	Part Of	QPA			
								1	7L0 422 818 D		
									1	7L0 422 817 D	
									2	7L0 422 821	
									1	7L0 422 804 D	
									1	7L0 422 803 D	
			→ 12.10	<input checked="" type="checkbox"/>	L29A12	L29A12		2	7L0 407 021 B		
			→ 02.07, 60mm rear	<input checked="" type="checkbox"/>		L29A15			1	7L8 407 152 E	
						L29A16			1	7L8 407 151 E	
						L29642	L29642		2	7L0 411 317	
						MK341	MK341		2		
								1	7L0 505 466 D		
								1	7L0 505 465 D		

RS3 Sportback Quattro (8PA) 04.11 →

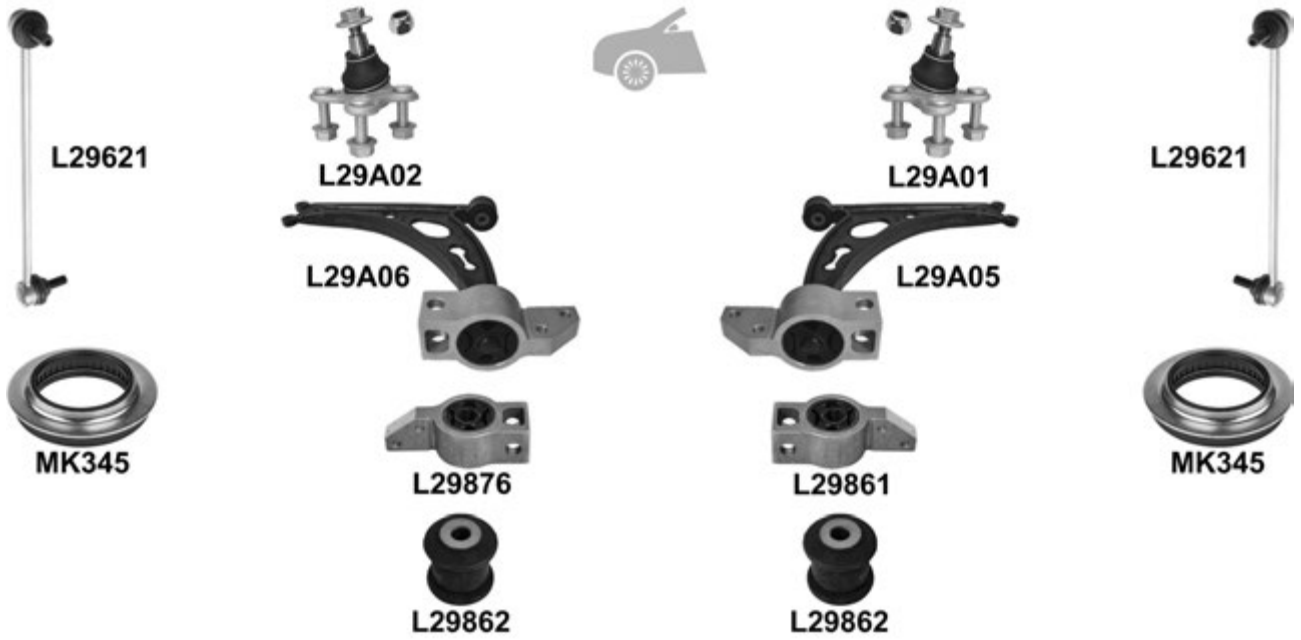
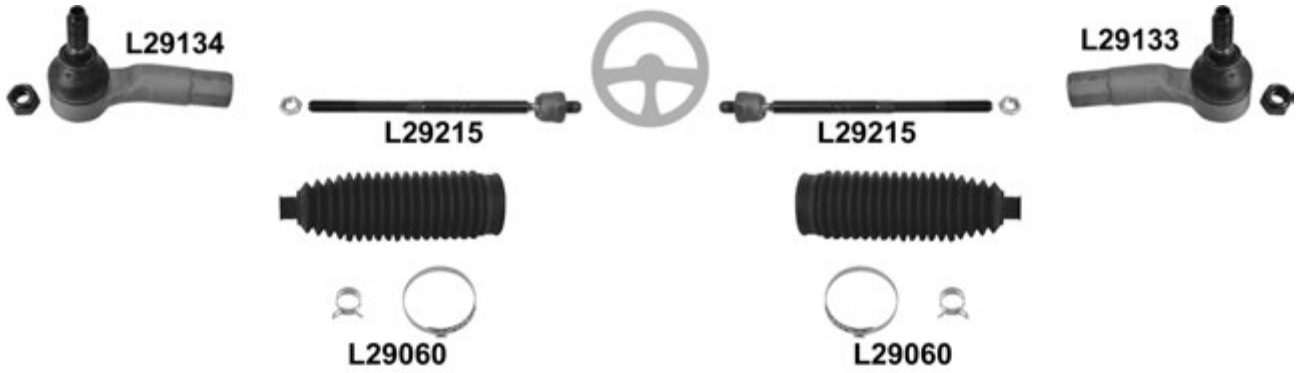

RS3 Sportback Quattro (8PA) 04.11 →

				←	→	Thread	Part Of	QPA	
		↔			L29133	F 16x1,5 ∪		1	1K0 423 812 E
					L29134	F 16x1,5 ∪		1	1K0 423 811 E
			Electronic		L29215	M 16x1,5 / M 16x1,5 ∪		2	1K0 423 810 A
					L29060			2	1K0 423 831 A
		⊥			L29A01			1	3C0 407 366 A
					L29A02			1	3C0 407 365 A
		⊥			L29A05			1	1K0 407 152 M
					L29A06			1	1K0 407 151 M
		⊥↘			L29861			1	1K0 199 232 G
					L29876			1	1K0 199 231 G
		⊥↗		L29862	L29862			2	1K0 407 182
					L29621	L29621		2	1K0 411 315 D
					MK345	MK345		2	6N0 412 249 C
			↕	→ 05.12	L29A11	L29A11			2
				L29A29	L29A29			2	1K0 505 311 AB
				L29A87 ⁰		Trailing Arm	1	1K0 505 224 K	
				L29A88 ⁰		Trailing Arm	1	1K0 505 222 K	
		↗		L29637			1	1K0 501 530 C	
				L29638			1	1K0 501 529 F	
				L29623	L29623		2	1K0 505 465 J	
			MK386	MK386			2	1K0 513 353 C	

RS4 Cabriolet Quattro (8HE) 06.06 → 03.09

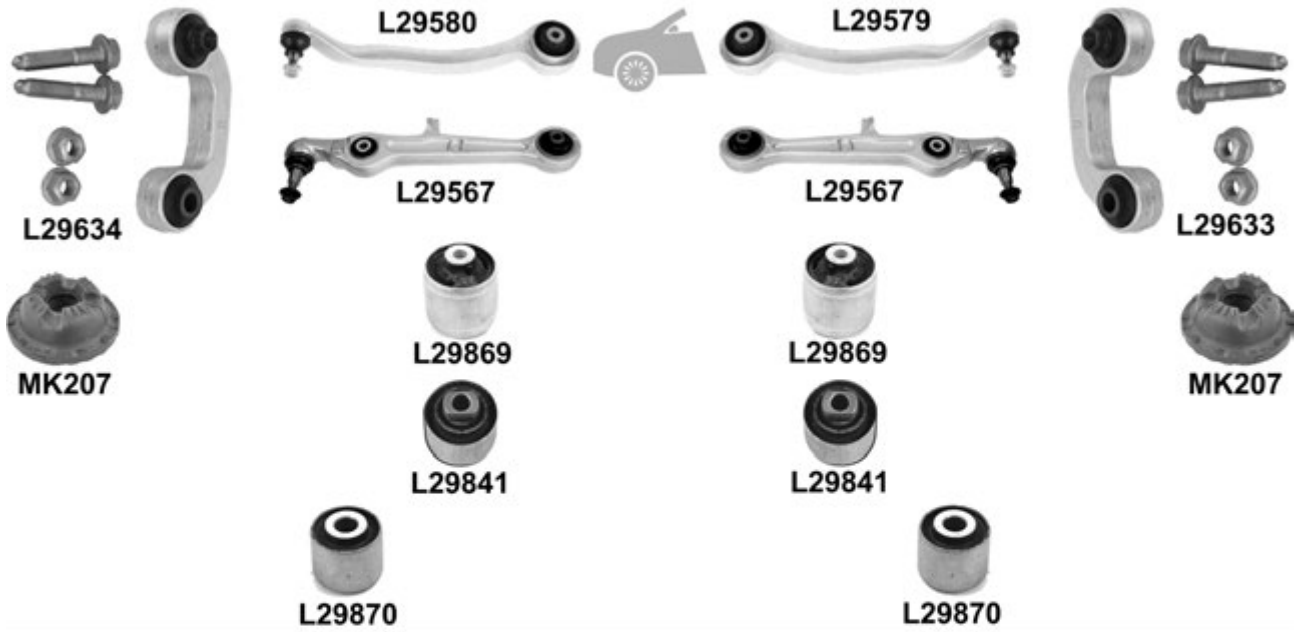

		i		←	→	Thread	Part Of	QPA	i
				L29141	L29141	U		2	4FO 419 811 C
				L29219	L29219			2	8EO 422 821
		⊥▼			L29579			1	8EO 407 694 T
				L29580				1	8EO 407 693 T
		⊥▲		L29567	L29567			2	8EO 407 151 N
		⊥▼→←		L29869	L29869			2	4FO 407 183 C
		⊥▲→←		L29841	L29841		L29567	2	4DO 407 182 E
		⊥▲→←		L29870	L29870		L29567	2	8EO 407 181 C
		⊥				L29633			1
				L29634				1	8EO 411 317
			KIT	MK207	MK207			2	8EO 412 377
				L29635	L29635			2	8EO 505 465 AC
				MK297	MK297			2	4FO 513 353 D

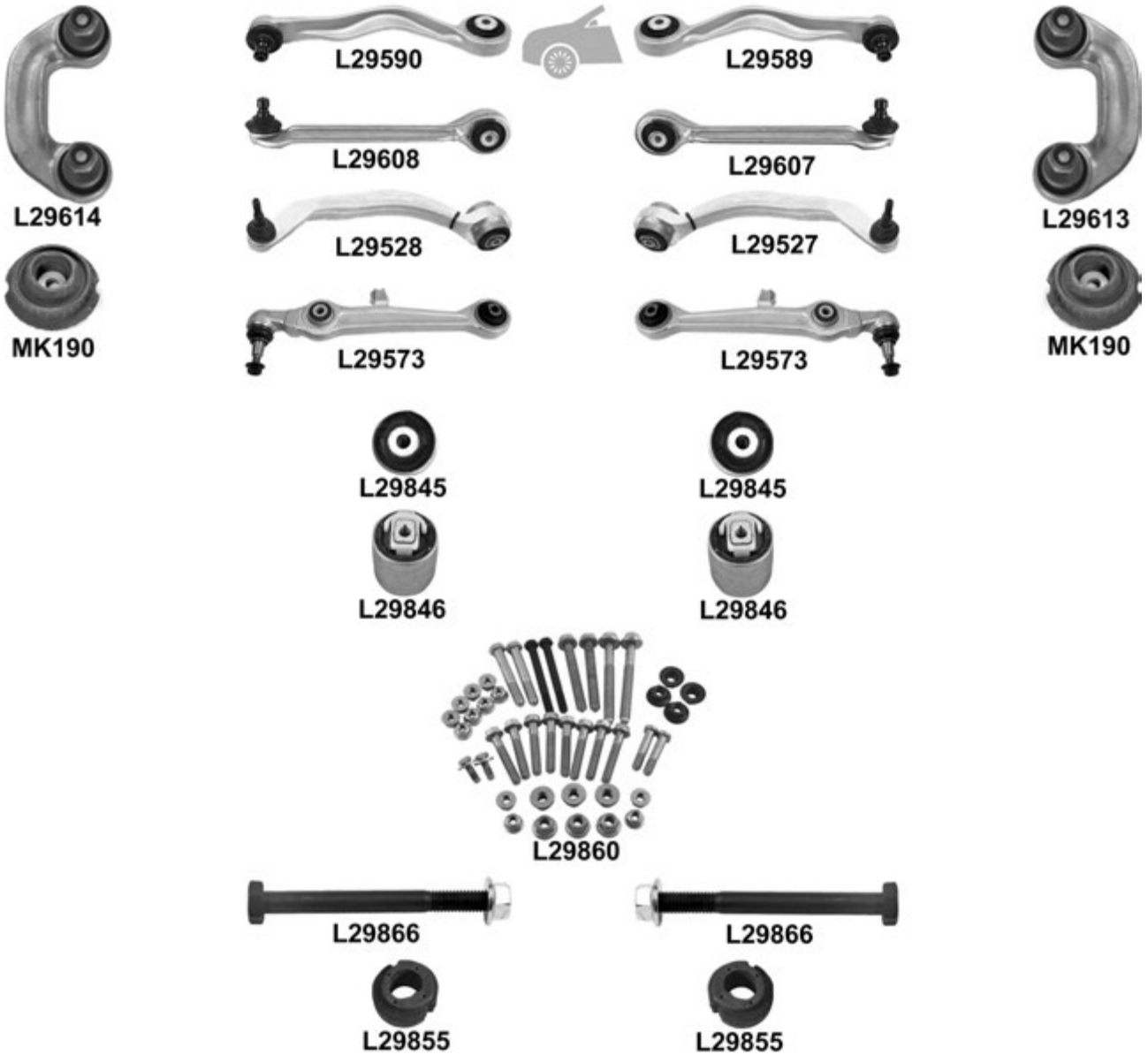
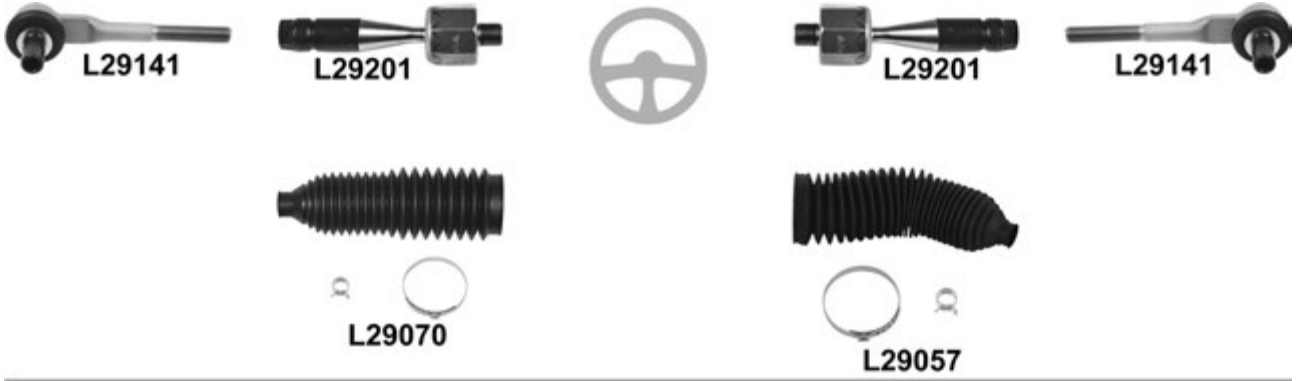
RS4 Quattro (8D, B5) 06.00 → 09.01

RS4 Quattro (8D, B5) 06.00 → 09.01

				←	→	Thread	Part Of	QPA			
⊕		↔		L29141	L29141	M 14x1,5 ♂		2	4F0 419 811 C		
				L29201	L29201	♂		2	4B0 422 821		
			∅ 19mm, ∅ 63mm, L= 255mm		L29057				1	8D0 419 831 K	
			∅ 20mm, ∅ 54mm, L= 205mm		L29070 ⁰				1	4D0 419 831 DE	
🚗		↑↓			L29589			1	8E0 407 510 P		
					L29590			1	8E0 407 509 P		
		↑▲			L29607			1	8E0 407 506 A		
					L29608			1	8E0 407 505 A		
	⊥↓			L29527			1	8E0 407 694 K			
				L29528			1	8E0 407 693 K			
	⊥▲			L29573	L29573		2	4B3 407 151 E			
		⊥▲↘↙↔			L29845	L29845			2	4D0 407 515 C	
				L29846	L29846			2	4D0 407 183 P		
			L 29573/29527/29528/29589/29590/29607/29608/29613/29614 KIT		L29860				1		
			L 29607/29608	KIT	L29866	L29866			2		
		⊥				L29613			1	8D0 411 318 D	
						L29614			1	8D0 411 317 D	
			∅ 27mm		L29855	L29855		Anti-roll bar	2	4D0 411 327 H	
			KIT	MK190	MK190			2	4D0 412 377 F		
🚗					L29671			1	8D0 505 466		
					L29672			1	8D0 505 465		

RS4 Quattro (8EC) 09.05 →
RS4 Avant Quattro (8ED) 09.05 →

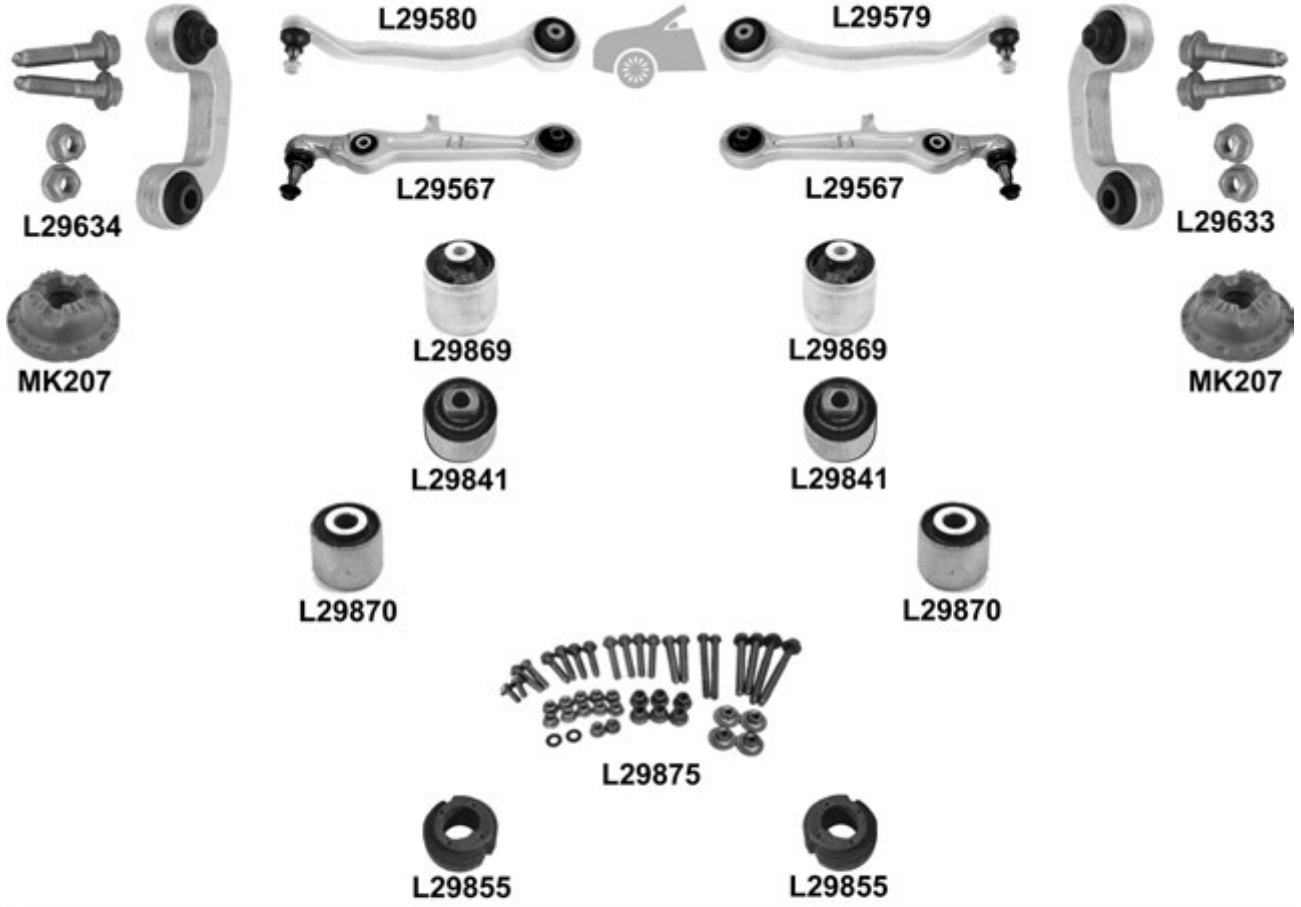

RS4 Quattro (8EC) 09.05 →
 RS4 Avant Quattro (8ED) 09.05 →

		i		←	→	Thread	Part Of	QPA	i	
		↔		L29141	L29141	↻		2	4F0 419 811 C	
				L29219	L29219			2	8E0 422 821	
		↓ ↓			L29579			1	8E0 407 694 T	
				L29580				1	8E0 407 693 T	
		↓ ▲		L29567	L29567			2	8E0 407 151 N	
		↓ ↓ → ←		L29869	L29869			2	4F0 407 183 C	
		↓ ▲ → ←		L29841	L29841		L29567	2	4D0 407 182 E	
		↓ ▲ ↔		L29870	L29870		L29567	2	8E0 407 181 C	
			L 29567/29579/29580/29633/29634	KIT	L29875			1		
		↓				L29633			1	8E0 411 318
					L29634				1	8E0 411 317
			∅ 27mm		L29855	L29855		Anti-roll bar	2	4D0 411 327 H
			KIT	MK207	MK207			2	8E0 412 377	
				L29635	L29635			2	8E0 505 465 AC	
				MK297	MK297			2	4F0 513 353 D	

RS5 Quattro (8T3) 03.10 →

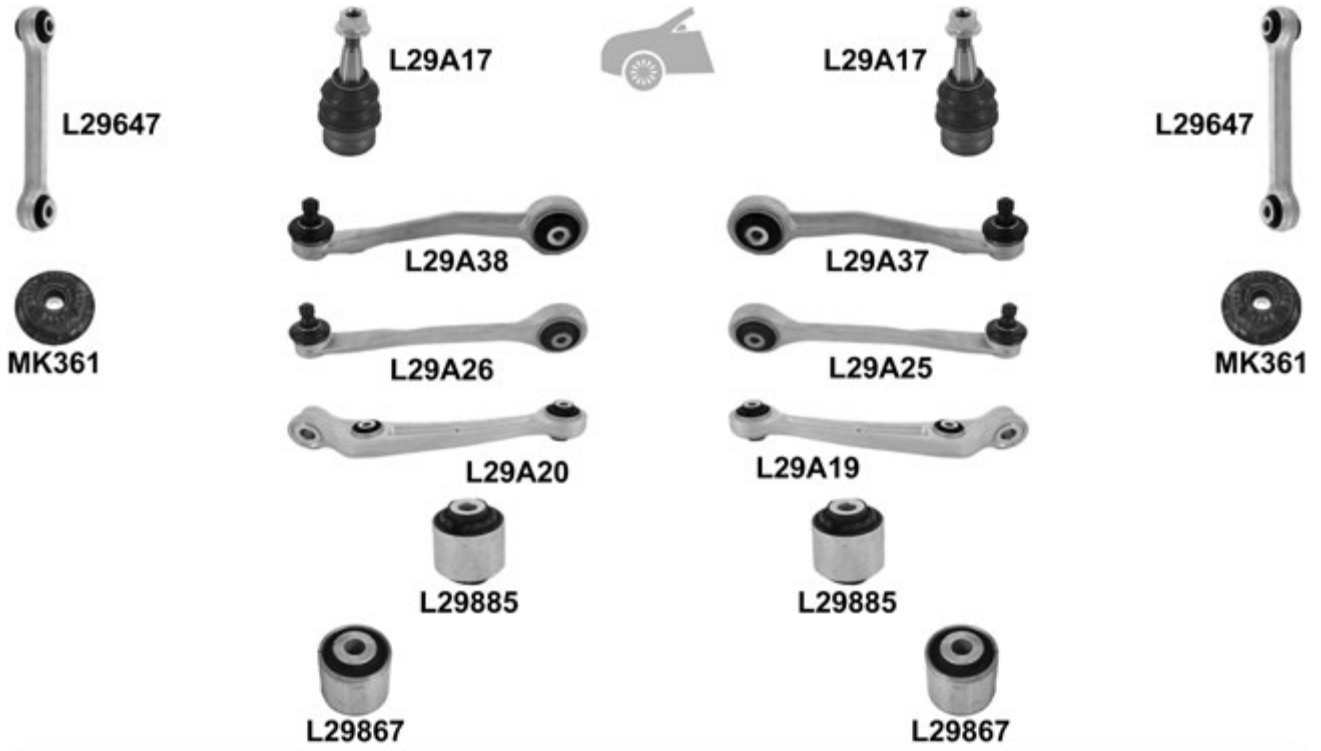

RS5 Quattro (8T3) 03.10 →

			←	→	Thread	Part Of	QPA		
		↔		L29151	F 16x1,5 ∪		1	8K0 422 818 B	
				L29152	F 16x1,5 ∪		1	8K0 422 817 B	
				L29224	L29224	∪	2	8J0 423 810	
		Thermoplast		L29062 ⁰	L29062 ⁰		2	8K0 422 831	
		⊥		L29A17	L29A17		2	8K0 407 689 F	
		↕			L29A37		1	8K0 407 510 A	
		↕			L29A38		1	8K0 407 509 A	
		↕			L29A25		1	8K0 407 506 A	
		↕			L29A26		1	8K0 407 505 A	
		↕			L29A19		1	8K0 407 152 C	
		↕			L29A20		1	8K0 407 151 C	
		↕↗↖			L29885 ⁰	L29885 ⁰	L29A19/L29A20	2	8K0 407 182 B
		↕↖↗			L29867	L29867	L29A19/L29A20	2	4E0 407 181 B
					L29647	L29647		2	8K0 411 317 E
		KIT	MK361	MK361			2	8K0 412 377 C	
				L29645	L29645		2	8K0 505 465 E	
		→ 10.11		MK388 ⁰	MK388 ⁰		2	8K0 513 353 E	

RS6 Quattro, RS6 Avant Quattro (4B, C5) 07.02 → 01.05

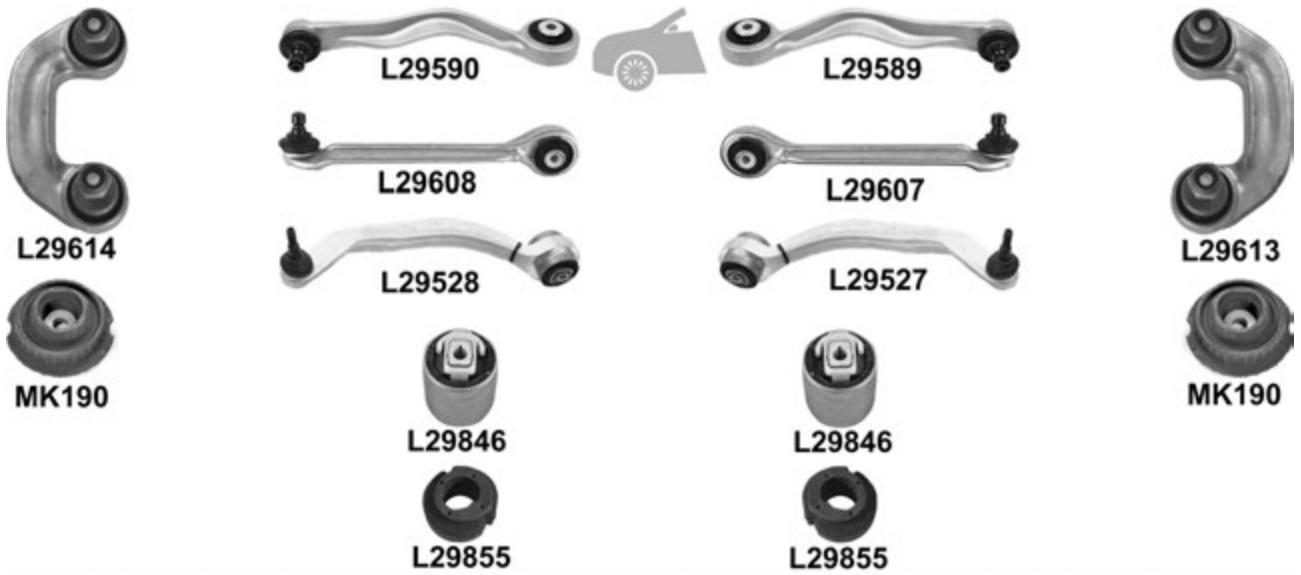
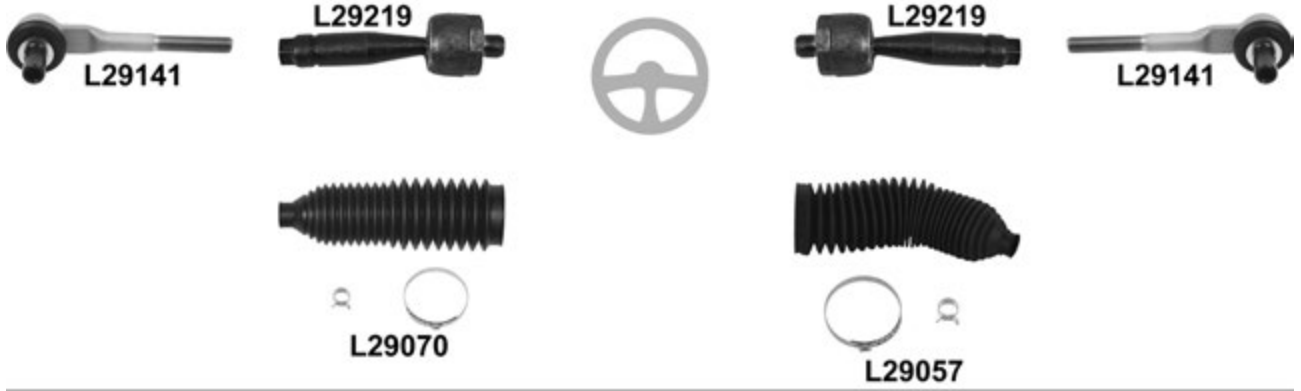

		i		←	→	Thread	Part Of	QPA	i	
				L29141	L29141	☺		2	4FO 419 811 C	
				L29219	L29219			2	8EO 422 821	
		∅ 19mm, ∅ 63mm, L= 255mm			L29057			1	8D0 419 831 K	
		∅ 20mm, ∅ 54mm, L= 205mm		L29070 ⁰				1	4D0 419 831 DE	
	 ↑▼				L29589			1	8EO 407 510 C	
				L29590				1	8EO 407 509 C	
	 ↑▲				L29607			1	8EO 407 506 A	
				L29608				1	8EO 407 505 A	
	 ⊥▼				L29527			1	8EO 407 694 K	
				L29528				1	8EO 407 693 K	
		 ⊥▼→←			L29846	L29846		L29527/L29528	2	4D0 407 183 P
						L29613			1	8D0 411 318 D
		∅ 27mm		L29614				1	8D0 411 317 D	
				L29855	L29855		Anti-roll bar	2	4D0 411 327 H	
			KIT	MK190	MK190			2	4D0 412 377 F	
				L29663	L29663			2	8EO 505 465 D	

RS6 Quattro (4F2, 4F5) 04.08 → 08.10

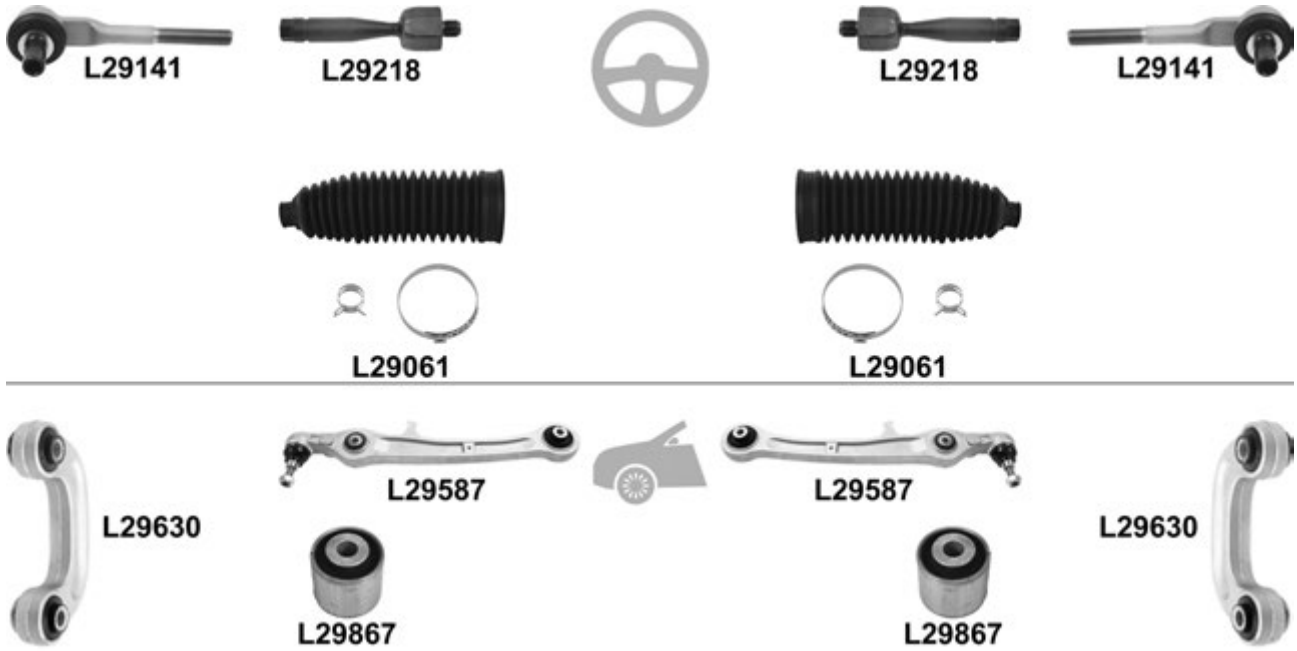

		i		←	→	Thread	Part Of	QPA	i
⊕		↔		L29141	L29141	↻		2	4F0 419 811 C
				L29218	L29218			2	4F0 422 821
				L29061 ⁰	L29061 ⁰			2	4F0 422 831
⊖		↕		L29587	L29587			2	4F0 407 151
		↕↔↔		L29867	L29867		L29587	2	4E0 407 181 B
				L29630	L29630			2	4E0 411 317 E

SQ5 Quattro (8RB) 12.12 →

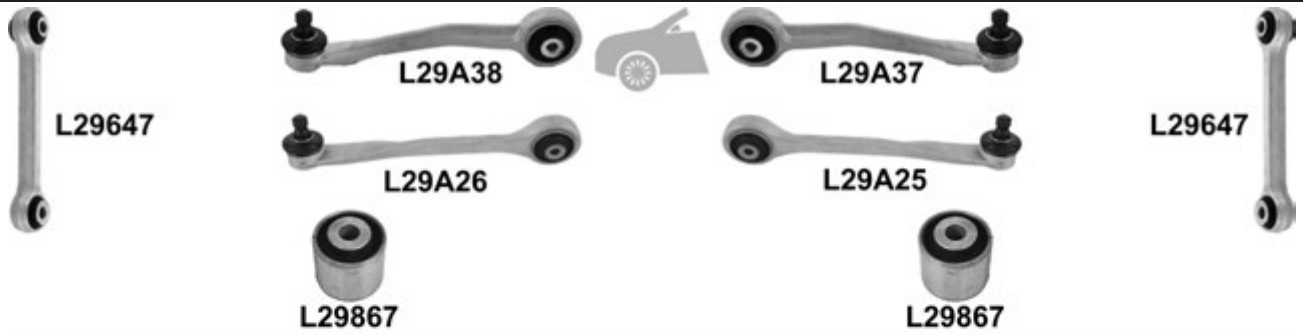

		i		←	→	Thread	Part Of	QPA	i
		$\bar{\uparrow}\downarrow$			L29A37			1	8K0 407 510 A
					L29A38			1	8K0 407 509 A
		$\bar{\uparrow}\uparrow$			L29A25			1	8K0 407 506 A
					L29A26			1	8K0 407 505 A
		\perp	$\uparrow\leftarrow\rightarrow$	L29867	L29867		L29A19/L29A20	2	4E0 407 181 B
				L29647	L29647			2	8K0 411 317 E
				L29645	L29645			2	8K0 505 465 E
				MK388 ⁰	MK388 ⁰			2	8K0 513 353 E

S3 Quattro (8L1) 11.98 →

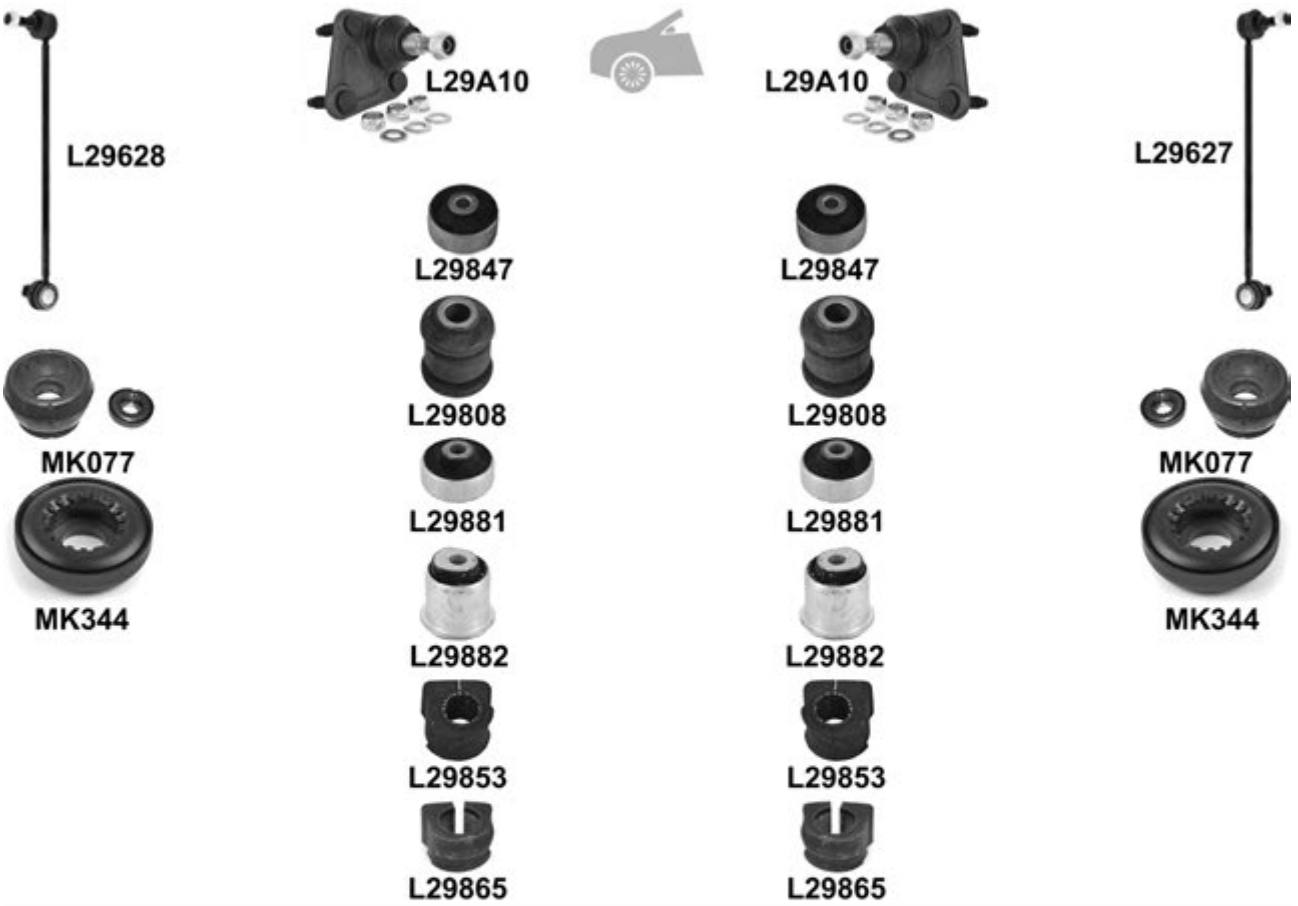
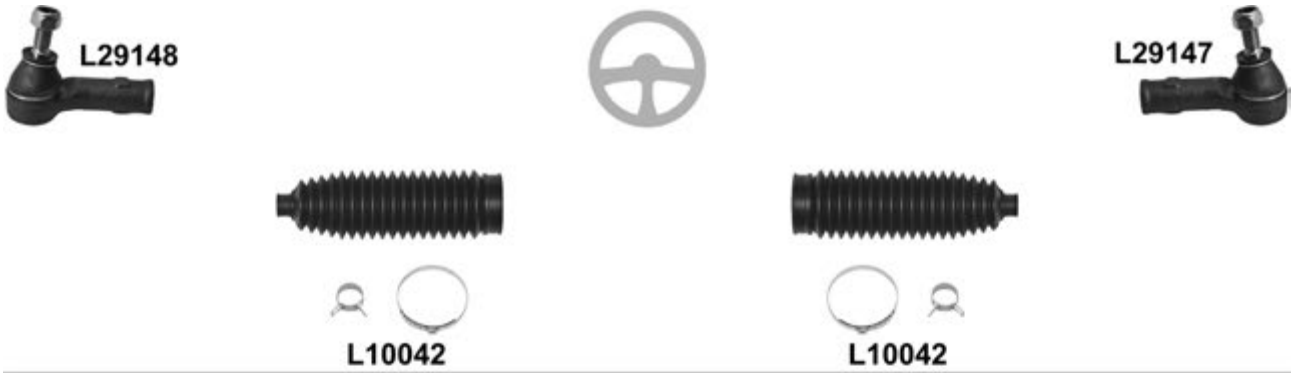

↑ = Upper ↓ = Lower ▲ = Front ▼ = Rear →← = Inner ←→ = Outer →← = Center

S3 Quattro (8L1) 11.98 →

		i		←	→	Thread	Part Of	QPA	i		
		↔			L29147	F 16x1,5 U		1	8N0 422 812 A		
					L29148	F 16x1,5 U		1	8N0 422 811 A		
			Hydraulic , Ø 16mm, Ø 49mm, L= 190mm	L10042 ^o	L10042 ^o			2	8N0 422 831		
		⊥		L29A10	L29A10			2	8N0 407 365 C		
		⊥▼	→ 04.00 , ch. → 8LY117500	L29847	L29847			2	1J0 407 181		
		⊥▲	→ 04.00 , ch. → 8LY117500	L29808	L29808			2	357 407 182		
		▼	05.00 →, ch. 8LY117501 →	L29881	L29881			2	8N0 407 181 B		
		▲	05.00 →, ch. 8LY117501 →	L29882	L29882			2	8N0 407 182 A		
						L29627			1	1J0 411 316 D	
						L29628			1	1J0 411 315 D	
					PR OAN/OAR, Ø 17mm	L29853	L29853		Anti-roll bar	2	1J0 411 314 B
					PR OAS, 09.00 →, ch. 8LY200001 →, Ø 23mm	L29865	L29865		Anti-roll bar	2	1J0 411 314 G
					(+) MK344 KIT	MK077	MK077			2	1J0 412 331 BS
				MK344	MK344			2	1J0 412 249		
			PR 1JF/1JU/1JV	L29641	L29641			2	1J0 505 466 B		
			PR 1JW, HD	L29661	L29661			2	1J0 505 466 C		

S3 Quattro (8V1) 11.12 →
 S3 Quattro (8VS) 05.13 →
 S3 Cabrio Quattro (8V7) 05.14 →

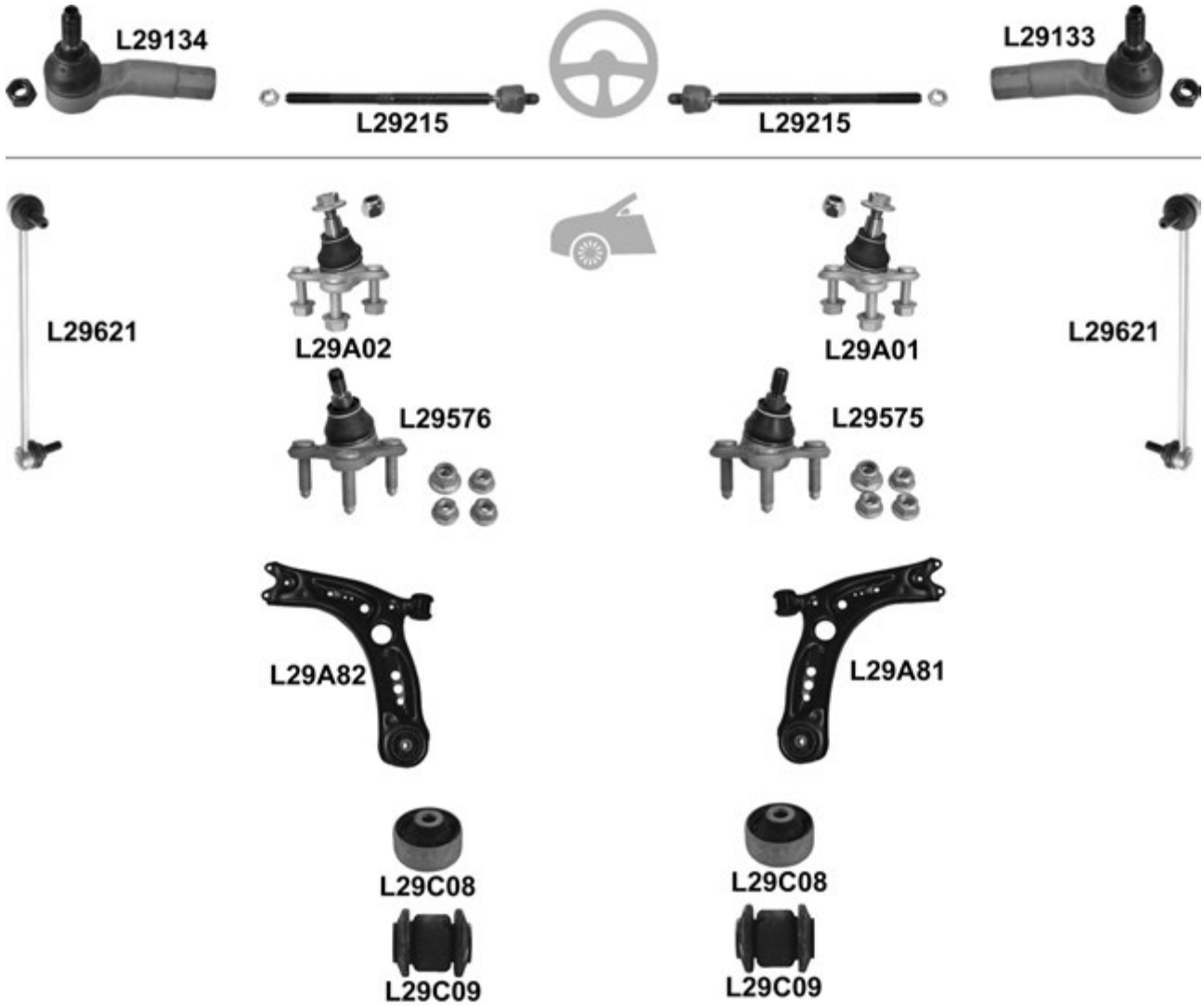

		i		←	→	Thread	Part Of	QPA	i	
		↔				L29133	F 16x1,5 ♂	1	1K0 423 812 E	
						L29134	F 16x1,5 ♂	1	1K0 423 811 E	
						L29215	L29215	M 16x1,5 / M 16x1,5 ♂	2	1K0 423 810 A
		⊥	PR 1LC/1LJ/1ZA/1ZD			L29A01		1	3C0 407 366 A	
						L29A02		1	3C0 407 365 A	
						L29575		1	5Q0 407 366 A	
						L29576		1	5Q0 407 365 A	
	⊥	→ 11.13, (-) (+)				L29A81 ⁰		1	5Q0 407 152 J	
						L29A82 ⁰		1	5Q0 407 151 J	
	⊥	PR 1ZE/1ZF/1ZP				L29C08	L29C08		2	5Q0 407 183 E
						L29C09	L29C09		2	5Q0 407 182
						L29621	L29621		2	1K0 411 315 D

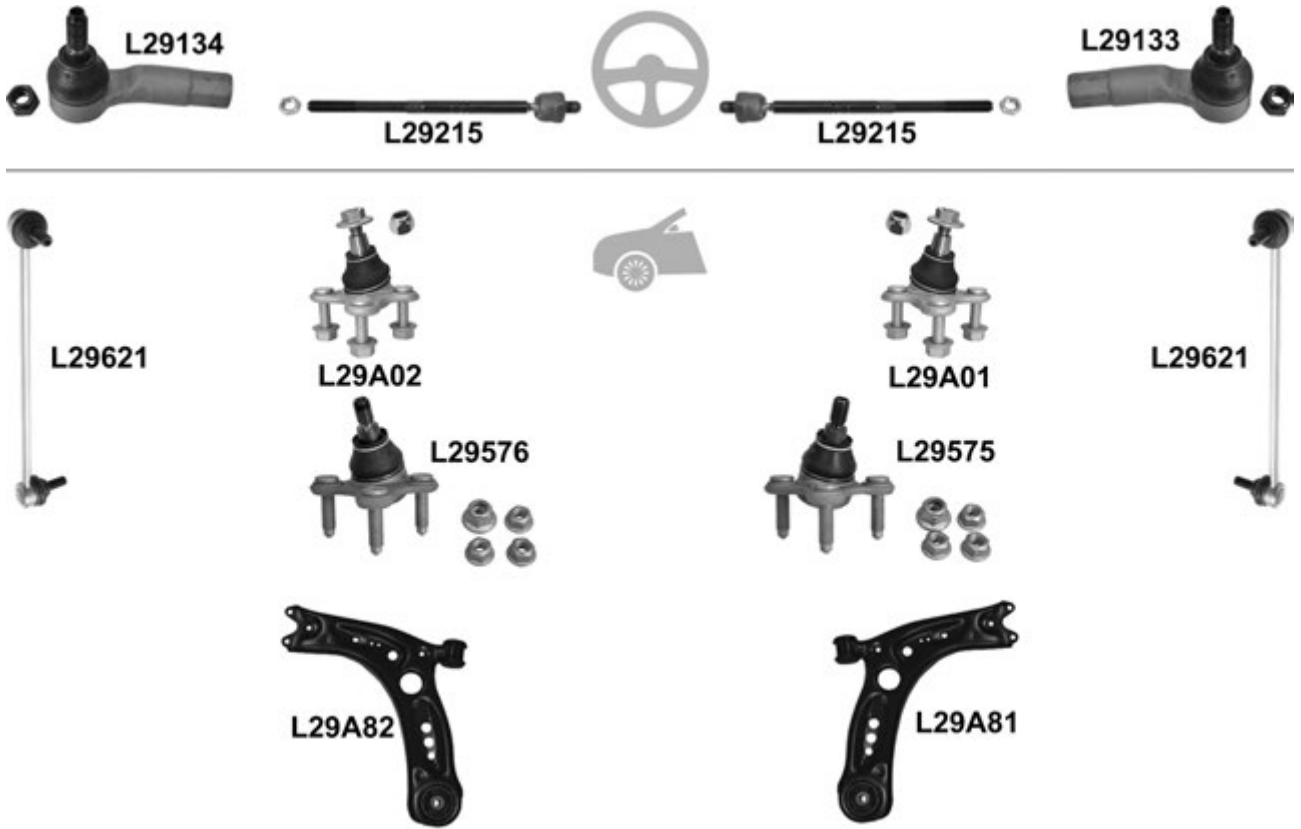
S3 Sportback Quattro (8VA) 11.12 →

				←	→	Thread	Part Of	QPA		
					L29133	F 16x1,5 ∪		1	1K0 423 812 E	
					L29134	F 16x1,5 ∪		1	1K0 423 811 E	
			PR 1LC/1LJ/1ZA/1ZD/1ZK		L29215	M 16x1,5 / M 16x1,5 ∪		2	1K0 423 810 A	
					L29A01			1	3C0 407 366 A	
					L29A02			1	3C0 407 365 A	
					L29575			1	5Q0 407 366 A	
			PR 1ZE/1ZP		L29576			1	5Q0 407 365 A	
					L29A81 ^o			1	5Q0 407 152 J	
					L29A82 ^o			1	5Q0 407 151 J	
				L29621	L29621			2	1K0 411 315 D	

S4 Cabriolet Quattro (8H7, 8HE) 03.04 →

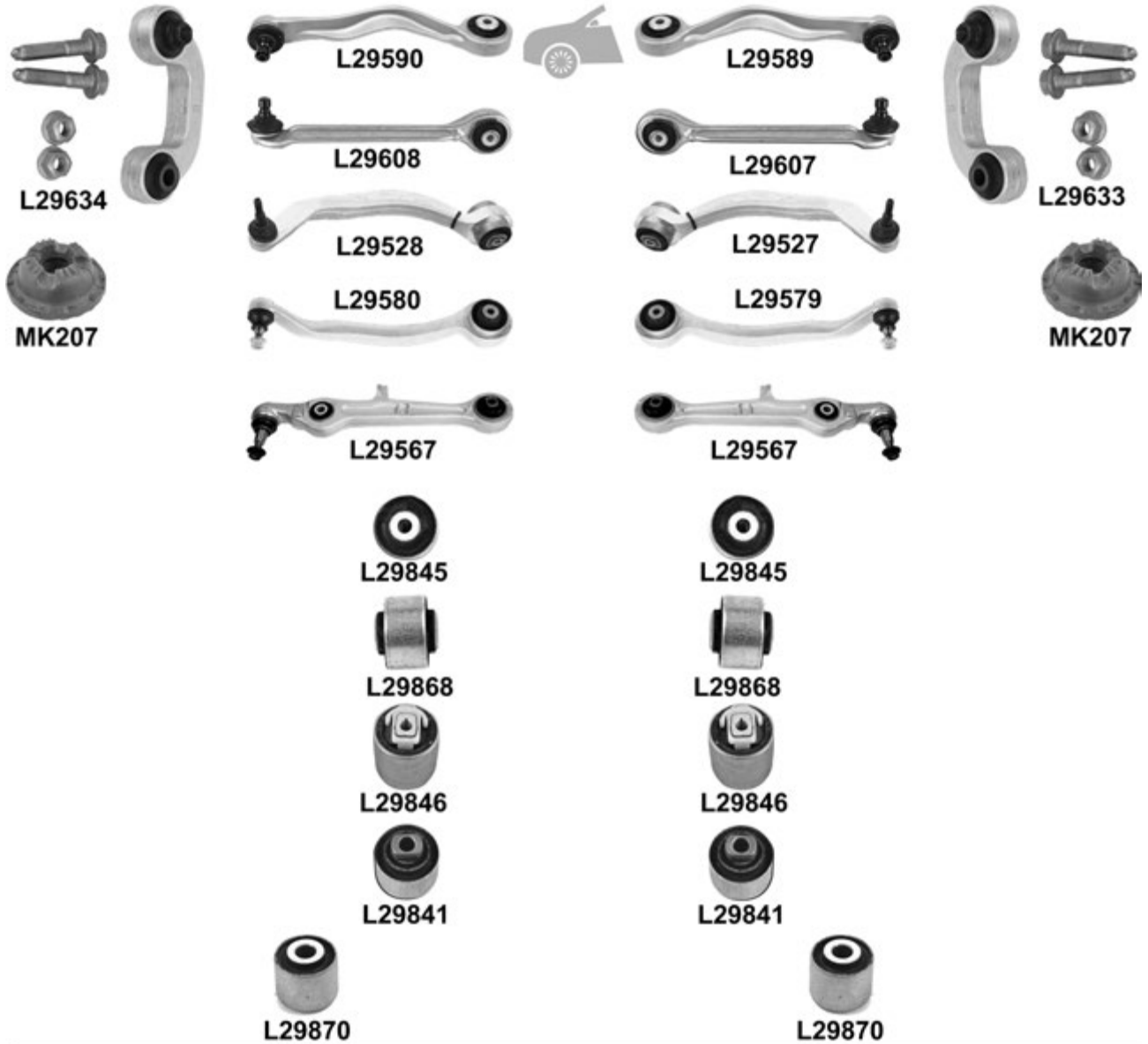

S4 Cabriolet Quattro (8H7, 8HE) 03.04 →

				←	→	Thread	Part Of	QPA		
		↔		L29141	L29141	⊖		2	4F0 419 811 C	
				L29219	L29219			2	8E0 422 821	
		ī ▼			L29589			1	8E0 407 510 C	
				L29590			1	8E0 407 509 C		
		ī ▲			L29607		1	8E0 407 506 A		
				L29608			1	8E0 407 505 A		
		⊥ ▼	8H7		L29527		1	8E0 407 694 K		
				L29528			1	8E0 407 693 K		
	8HE			L29579		1	8E0 407 694 T			
			L29580			1	8E0 407 693 T			
	⊥ ▲		L29567	L29567		2	8E0 407 151 N			
			ī ▼ → ←		L29845	L29845		L29607/L29608	4	4D0 407 515 C
			ī ▲ → ←		L29868	L29868		L29587/L29590	4	8D0 407 515 C
			⊥ ▼ → ←		L29846	L29846		L29527/L29528	2	4D0 407 183 P
⊥ ▲ → ←				L29841	L29841		L29567	2	4D0 407 182 E	
⊥ ▲ ↔				L29870	L29870		L29567	2	8E0 407 181 C	
↔			⊥		L29633				1	8E0 411 318
			L29634				1	8E0 411 317		
			KIT	MK207	MK207			2	8E0 412 377	
				L29635	L29635			2	8E0 505 465 AC	
		PR GP1		MK297	MK297			2	4F0 513 353 D	

S4 Quattro (8D, B5) 09.97 → 11.00

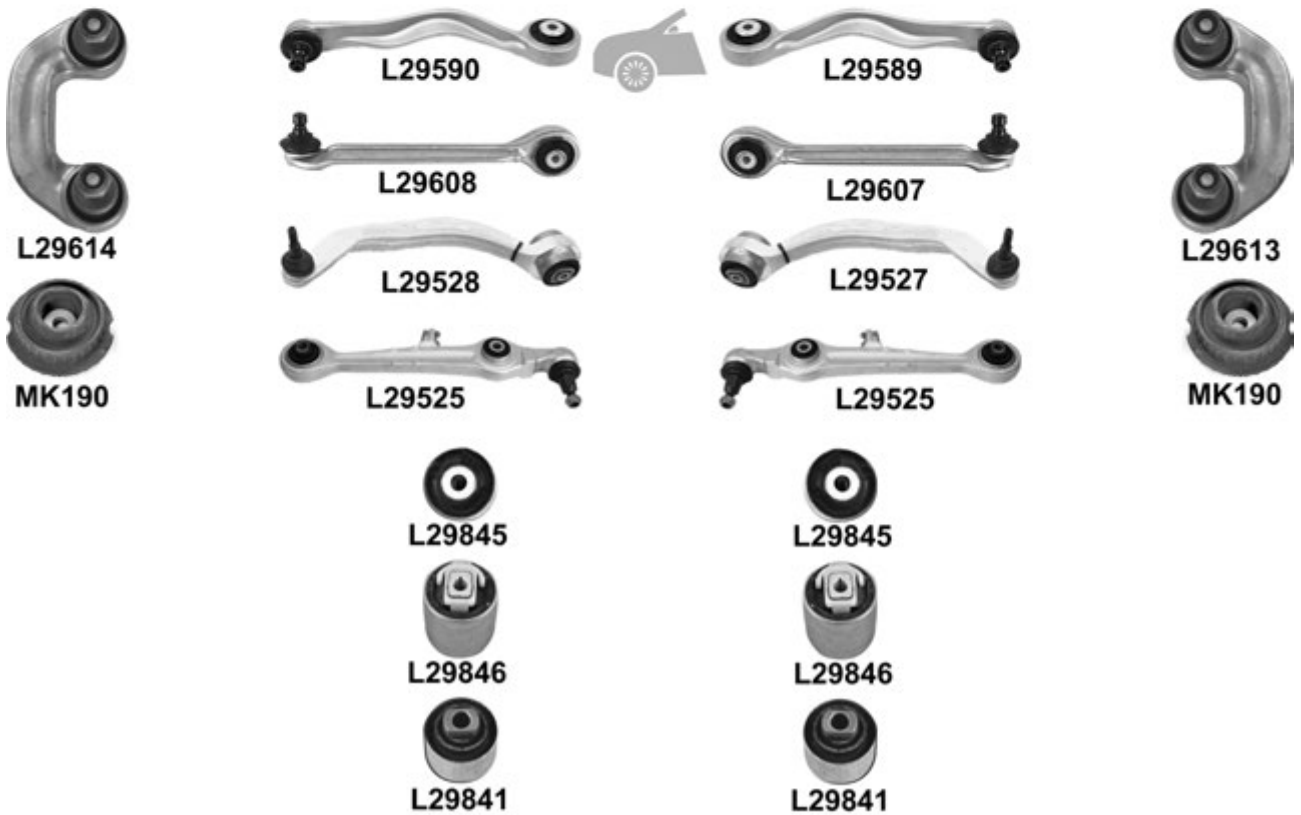
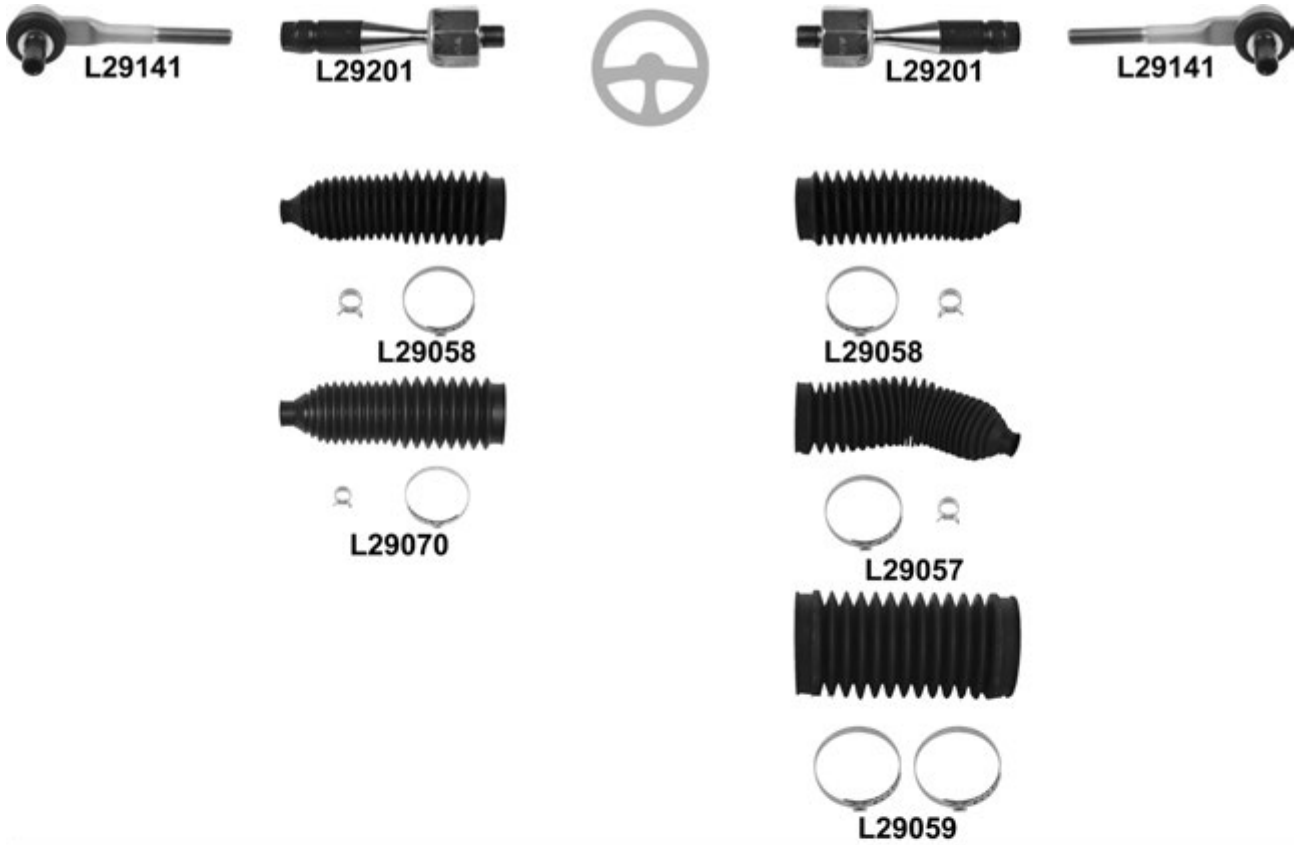

S4 Quattro (8D, B5) 09.97 → 11.00



S4 Quattro (8D, B5) 09.97 → 11.00

			←	→	Thread	Part Of	QPA			
		↔	L29141	L29141	M 14x1,5 ☺		2	4F0 419 811 C		
			L29201	L29201	☺		2	4B0 422 821		
		↔	ch. → 8DX 053 000, ø 18mm, Ø 54mm, L= 205mm	L29058	L29058			2	4D0 419 831 D	
			ch. 8DX 053 001 →, ø 19mm, Ø 63mm, L= 255mm		L29057			1	8D0 419 831 K	
			ch. 8DX 053 001 →, ø 20mm, Ø 54mm, L= 205mm	L29070 ⁰				1	4D0 419 831 DE	
		→←	cars with bracket for Steering damper ø 65mm, Ø 65mm, L= 141mm		L29059			1	4D0 419 831 A	
			↑↓		L29589			1	8E0 407 510 P	
				L29590				1	8E0 407 509 P	
			↑			L29607			1	8E0 407 506 A
				L29608					1	8E0 407 505 A
		↓			L29527			1	8E0 407 694 K	
			L29528					1	8E0 407 693 K	
		↓		L29525	L29525			2	4D0 407 151 K	
		↑↑↓↓↔		L29845	L29845			2	4D0 407 515 C	
		↓↓↑↑↔		L29846	L29846			2	4D0 407 183 P	
		↓↑↔		L29841	L29841		L29525	2	4D0 407 182 E	
		↓↑↔		L29840	L29840		L29525	2	4D0 407 181 H	
			L 29525/29527/29528/29589/29590/29607/29608/29613/29614 KIT	L29860				1		
			L 29607/29608 KIT	L29866	L29866			2		
		↓			L29613			1	8D0 411 318 D	
				L29614				1	8D0 411 317 D	
	∅ 27mm		L29855	L29855		Anti-roll bar	2	4D0 411 327 H		
			KIT	MK190	MK190			2	4D0 412 377 F	
				L29671			1	8D0 505 466		
			L29672				1	8D0 505 465		

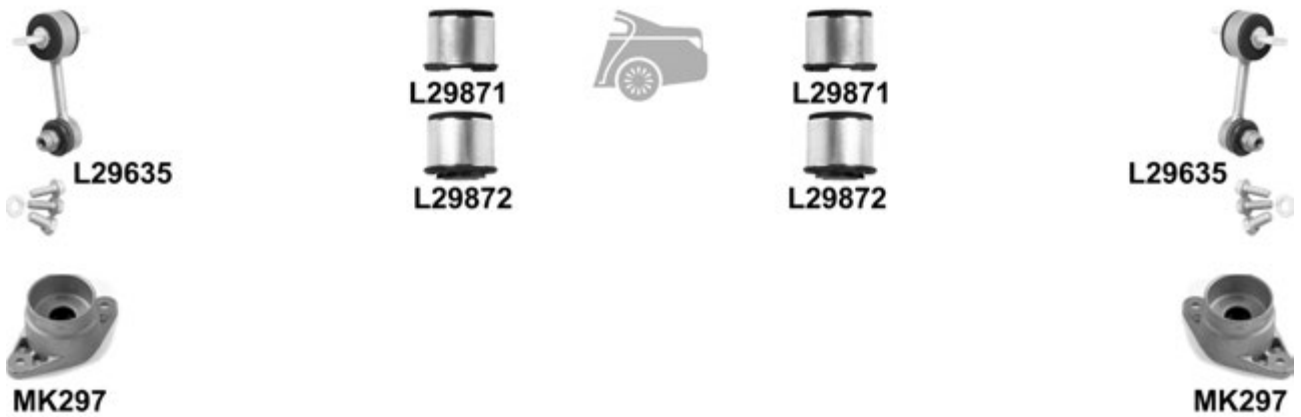
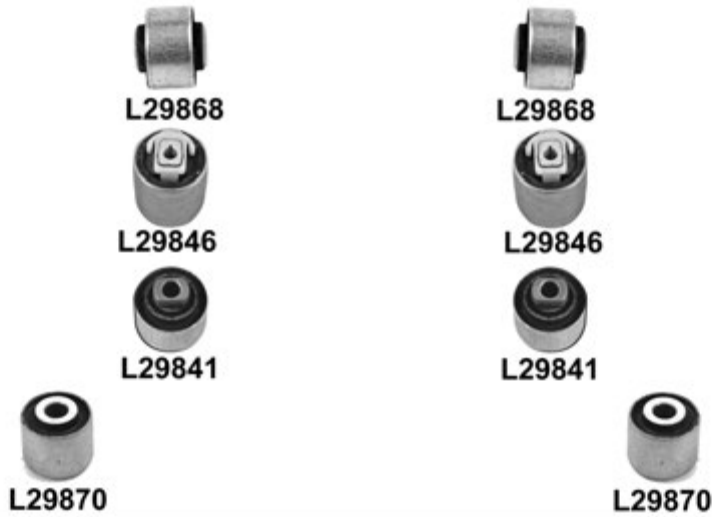
S4 Avant Quattro (8E5, B6) 09.01 → 06.08

S4 Avant Quattro (8E5, B6) 09.01 → 06.08

				←	→	Thread	Part Of	QPA		
		↔		L29141	L29141	⌚		2	4F0 419 811 C	
				L29219	L29219			2	8E0 422 821	
		⌄	(-) HD		L29589			1	8E0 407 510 P	
				L29590				1	8E0 407 509 P	
		⌄			L29607			1	8E0 407 506 A	
				L29608				1	8E0 407 505 A	
		⌄			L29527			1	8E0 407 694 K	
				L29528				1	8E0 407 693 K	
		⌄		L29567	L29567			2	8E0 407 151 N	
		⌄↔			L29868	L29868		L29589/L29590	4	8D0 407 515 C
		⌄↔			L29846	L29846		L29527/L29528	2	4D0 407 183 P
		⌄↔			L29841	L29841		L29567	2	4D0 407 182 E
		⌄↔			L29870	L29870		L29567	2	8E0 407 181 C
		⌄				L29633			1	8E0 411 318
					L29634				1	8E0 411 317
				KIT	MK207	MK207			2	8E0 412 377
▼			Hydraulic	L29871	L29871		Hub carrier	2	8E0 505 145 AP	
▲		Hydraulic	L29872	L29872		Hub carrier	2	8E0 505 145 AR		
				L29635	L29635			2	8E0 505 465 AC	
					MK297	MK297			2	4F0 513 353 D

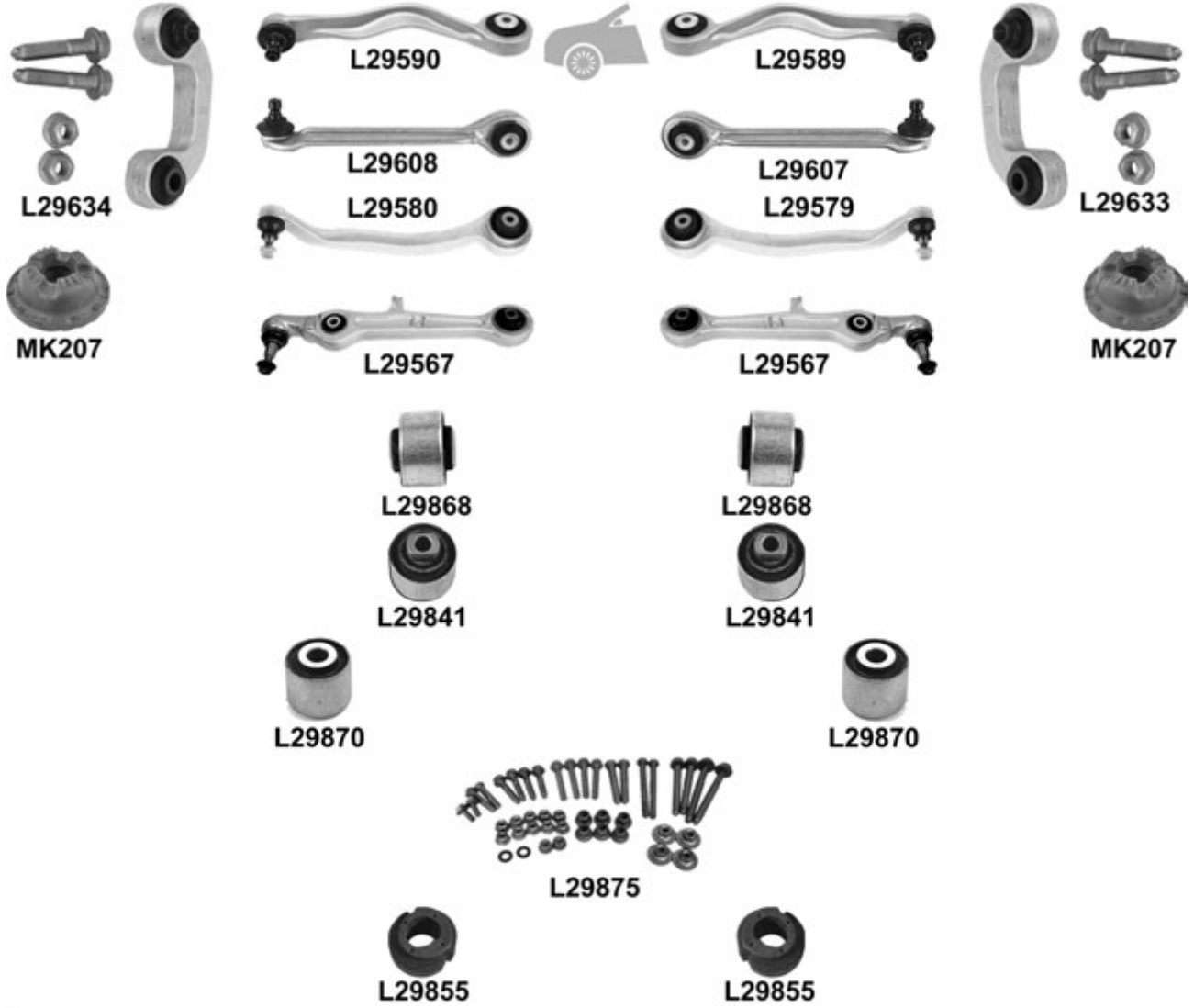
S4 Quattro (8EC) 11.04 → 10.07

S4 Quattro (8EC) 11.04 → 10.07

				←	→	Thread	Part Of	QPA	
		↔		L29141	L29141	∅		2	4F0 419 811 C
				L29219	L29219			2	8E0 422 821
		↑	→ 12.05		L29589			1	8E0 407 510 P
				L29590				1	8E0 407 509 P
	↓	→ 12.05		L29607				1	8E0 407 506 A
			L29608				1	8E0 407 505 A	
	↓			L29579				1	8E0 407 694 T
				L29580				1	8E0 407 693 T
	↓		L29567	L29567				2	8E0 407 151 N
		↑↔↔		L29868	L29868		L29589/L29590	4	8D0 407 515 C
	↓↔↔		L29841	L29841			L29567	2	4D0 407 182 E
		↑↔↔		L29870	L29870		L29567	2	8E0 407 181 C
		L 29567/29579/29580/29633/29634	KIT	L29875				1	
		↓		L29633				1	8E0 411 318
				L29634				1	8E0 411 317
			∅ 27mm	L29855	L29855		Anti-roll bar	2	4D0 411 327 H
		KIT	MK207	MK207			2	8E0 412 377	
			L29635	L29635			2	8E0 505 465 AC	
			MK297	MK297			2	4F0 513 353 D	

S4 Avant Quattro (8K2/8K5) 11.08 →

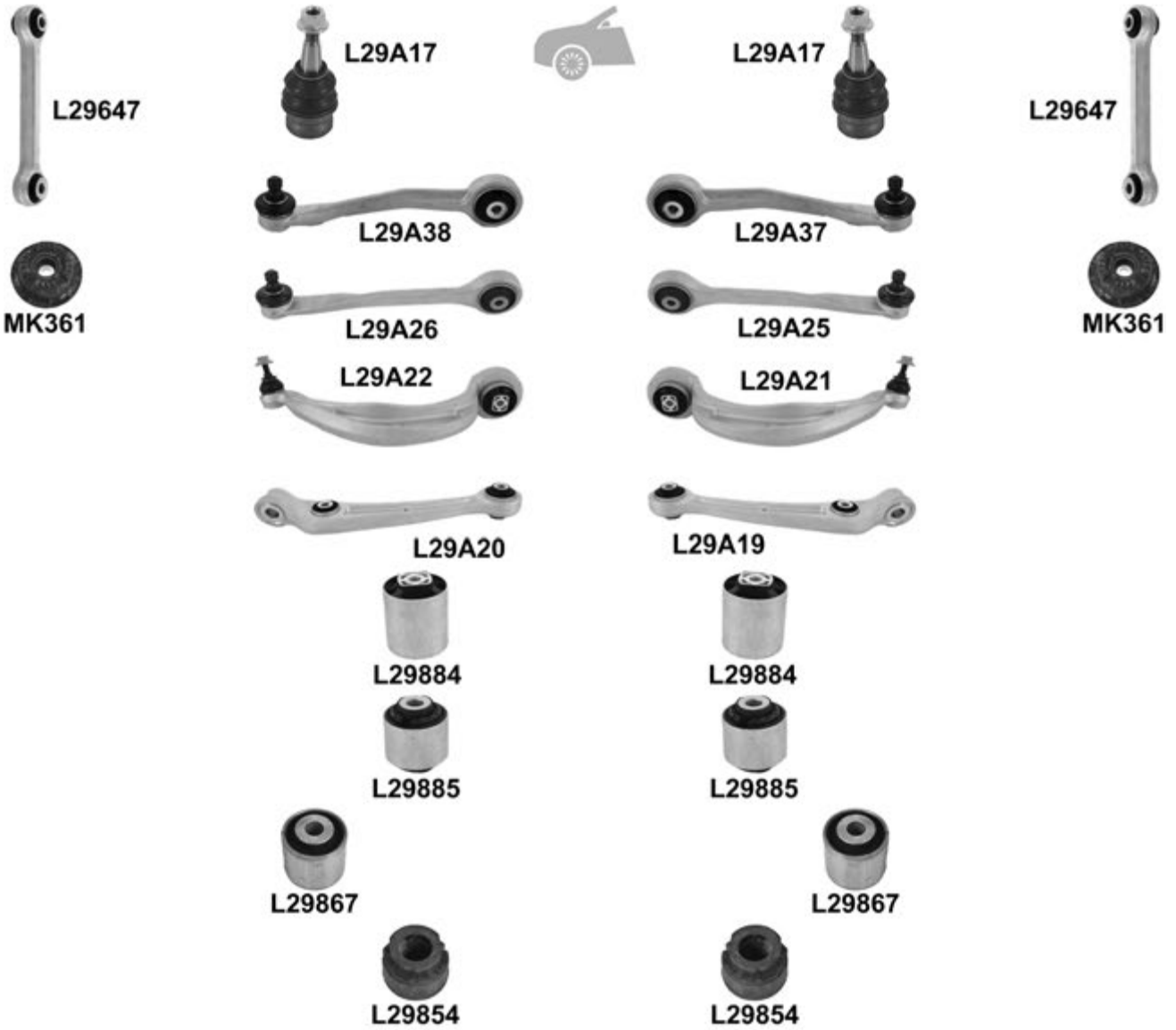

S4 Avant Quattro (8K2/8K5) 11.08 →

				←	→	Thread	Part Of	QPA		
		↔			L29151	F 16x1,5 U		1	8K0 422 818 B	
				L29152		F 16x1,5 U		1	8K0 422 817 B	
				L29224	L29224	M 16x1,5 / M 16x1,5 U		2	8J0 423 810	
		Thermoplast	L29062 ⁰	L29062 ⁰				2	8K0 422 831	
		↓	3.0 TFSi, Model 8K2, Mot/Eng CAKA	L29A17	L29A17			2	8K0 407 689 F	
			3.0 TFSi, Model 8K5, Mot/Eng CAKA/CGWC	L29A17	L29A17			2	8K0 407 689 F	
		↖	3.0 TFSi, Mot/Eng CAKA/CGWC/CGXC		L29A37			1	8K0 407 510 A	
				L29A38			1	8K0 407 509 A		
		↗	3.0 TFSi, Mot/Eng CAKA/CGWC/CGXC		L29A25			1	8K0 407 506 A	
				L29A26			1	8K0 407 505 A		
	↓	↖	3.0 TFSi, Model 8K2, Mot/Eng CAKA, → 10.09, 65mm		L29A21			1	8K0 407 694 N	
				L29A22			1	8K0 407 693 N		
			3.0 TFSi, Model 8K5, Mot/Eng CAKA/CGWC, → 10.09, 65mm		L29A21			1	8K0 407 694 N	
				L29A22			1	8K0 407 693 N		
	↓	↗	3.0 TFSi, Model 8K2, Mot/Eng CAKA		L29A19			1	8K0 407 152 C	
					L29A20			1	8K0 407 151 C	
				3.0 TFSi, Model 8K5, Mot/Eng CAKA/CGWC		L29A19			1	8K0 407 152 C
				L29A20			1	8K0 407 151 C		
		↓	↖↗↔	3.0 TFSi, Mot/Eng CAKA	L29884	L29884		L29A21/L29A22	2	8K0 407 183 A
				3.0 TFSi, Mot/Eng CAKA/CGWC/CGXC	L29885 ⁰	L29885 ⁰		L29A19/L29A20	2	8K0 407 182 B
				3.0 TFSi, Mot/Eng CAKA/CGWC/CGXC	L29867	L29867		L29A19/L29A20	2	4E0 407 181 B
			L29647	L29647			2	8K0 411 317 E		
			L29854	L29854		Anti-roll bar	2	4D0 411 327 G		
			MK361	MK361			2	8K0 412 377 C		
		↓	↗	→ 07.09		L29A61		1	8K0 501 530 N	
					L29A62			1	8K0 501 529 N	
				L29645	L29645			2	8K0 505 465 E	
			3.0 TFSi, Model 8K2, Mot/Eng CAKA	MK388 ⁰	MK388 ⁰			2	8K0 513 353 E	
		3.0 TFSi, Model 8K5, Mot/Eng CAKA/CGWC	MK388 ⁰	MK388 ⁰			2	8K0 513 353 E		

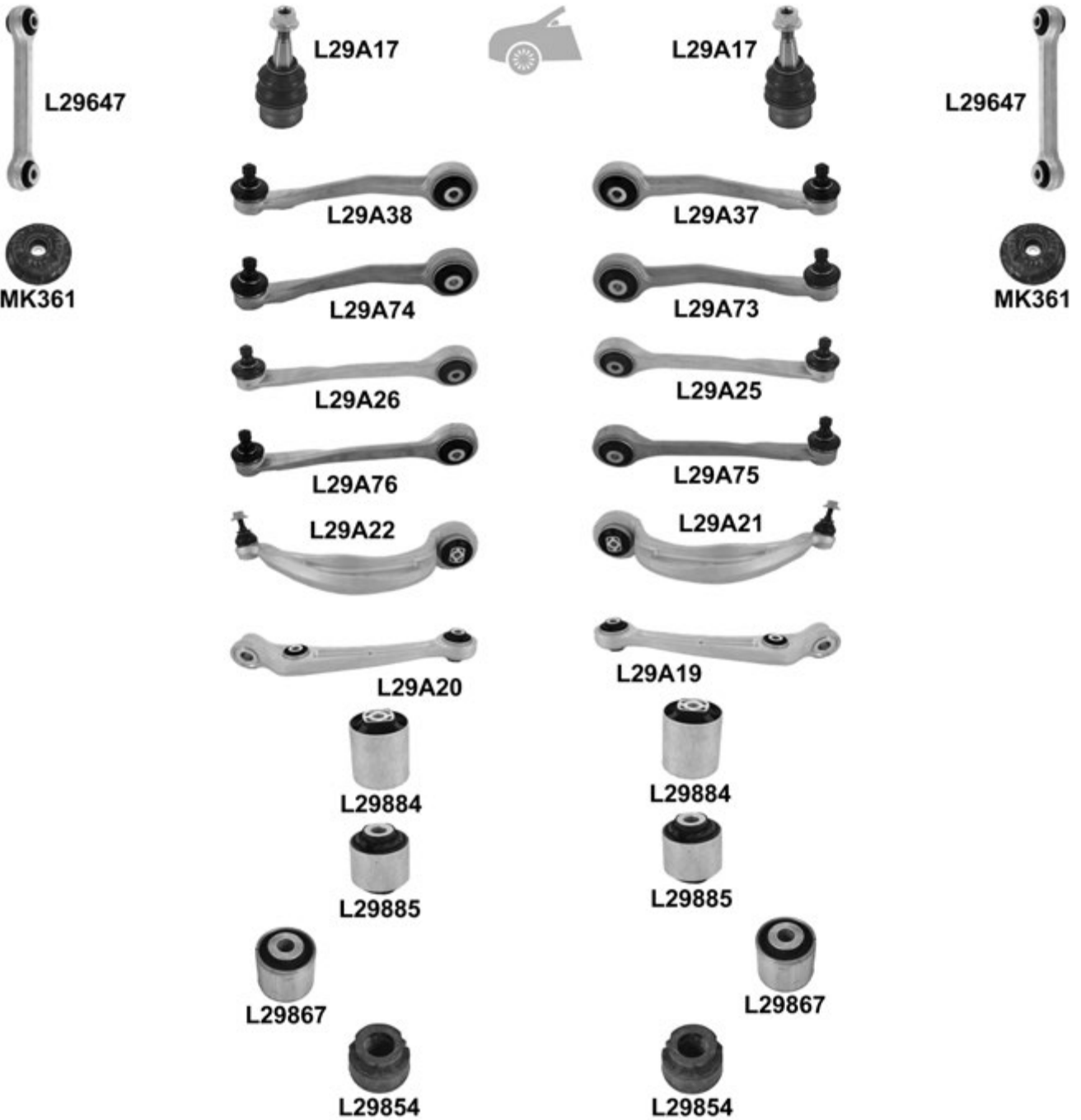
S5 Cabriolet Quattro (8F7) 03.09 →

S5 Cabriolet Quattro (8F7) 03.09 →



L29645

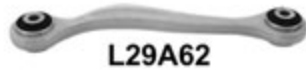

L29A62

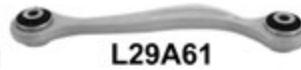

L29A61



L29645



MK388



MK388

			←	→	Thread	Part Of	QPA		
		↔		L29151	F 16x1,5 U		1	8KO 422 818 B	
				L29152	F 16x1,5 U		1	8KO 422 817 B	
				L29224	L29224	M 16x1,5 / M 16x1,5 U		2	8JO 423 810
		Thermoplast		L29062 ⁰	L29062 ⁰		2	8KO 422 831	
		↓ Mot/Eng CAKA/CCBA ↖ Mot/Eng CGWC ↗ Mot/Eng CAKA/CCBA ↖ Mot/Eng CGWC ↗ Mot/Eng CAKA/CCBA ↓ Mot/Eng CAKA/CCBA, → 10.09 , 65mm ↓ Mot/Eng CAKA/CCBA ↓ ↖ ↗ ↓ ↗ ↖ ↓ ↖ ↗ ↖ ↗ PR 1BA/1BD/1BE/1BV, Ø 24.8mm PR 1BA/1BD/1BE /1BV, (-) KIT		L29A17	L29A17			2	8KO 407 689 F
				L29A37				1	8KO 407 510 A
				L29A38				1	8KO 407 509 A
				L29A73 ⁰				1	8KO 407 510 B
				L29A74 ⁰				1	8KO 407 509 B
				L29A25				1	8KO 407 506 A
				L29A26				1	8KO 407 505 A
				L29A75 ⁰				1	8KO 407 506 B
				L29A76 ⁰				1	8KO 407 505 B
				L29A21				1	8KO 407 694 N
				L29A22				1	8KO 407 693 N
				L29A19				1	8KO 407 152 C
				L29A20				1	8KO 407 151 C
				L29884	L29884			L29A21/L29A22	2
	L29885 ⁰	L29885 ⁰			L29A19/L29A20	2	8KO 407 182 B		
	L29867	L29867			L29A19/L29A20	2	4EO 407 181 B		
	L29647	L29647				2	8KO 411 317 E		
	L29854	L29854			Anti-roll bar	2	4DO 411 327 G		
	MK361	MK361				2	8KO 412 377 C		
		↖ → 07.09 ↗ ↖ ↗ ↖ ↗		L29A61			1	8KO 501 530 N	
				L29A62			1	8KO 501 529 N	
				L29645	L29645			2	8KO 505 465 E
				MK388 ⁰	MK388 ⁰			2	8KO 513 353 E

S5 Sportback Quattro (8F7) 03.09 →

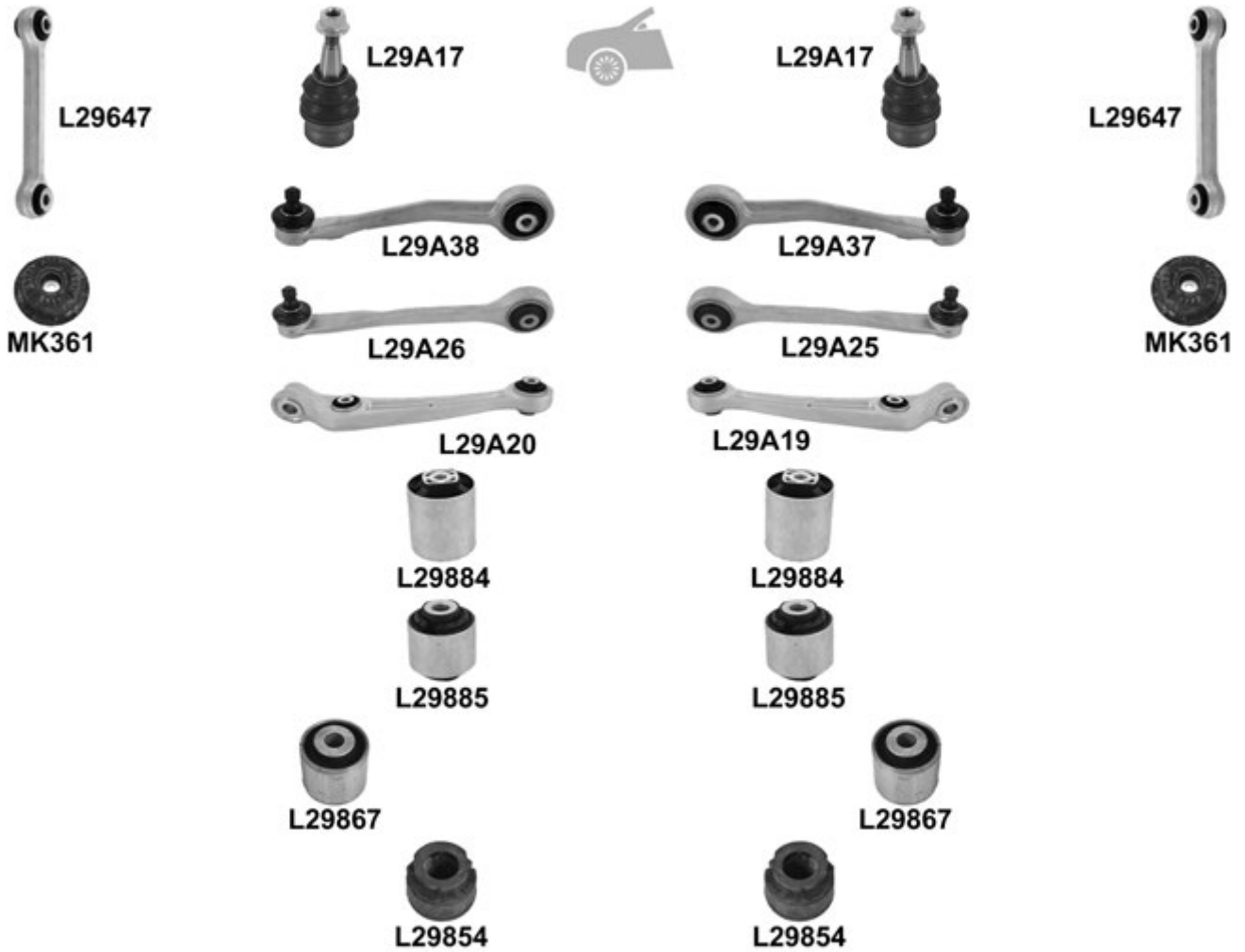

S5 Sportback Quattro (8F7) 03.09 →

		i		←	→	Thread	Part Of	QPA	i		
		↔				L29151 F 16x1,5 U		1	8K0 422 818 B		
						L29152 F 16x1,5 U		1	8K0 422 817 B		
					L29224 L29224 M 16x1,5 / M 16x1,5 U		2	8J0 423 810			
			Thermoplast			L29062 ⁰ L29062 ⁰		2	8K0 422 831		
		⊥	Mot/Eng CAKA			L29A17 L29A17		2	8K0 407 689 F		
		↕				L29A37		1	8K0 407 510 A		
		↕				L29A38		1	8K0 407 509 A		
		↕				L29A25		1	8K0 407 506 A		
		↕				L29A26		1	8K0 407 505 A		
	⊥	Mot/Eng CAKA				L29A19		1	8K0 407 152 C		
	⊥					L29A20		1	8K0 407 151 C		
		⊥↕↔					L29884 L29884		L29A21/L29A22	2	8K0 407 183 A
		⊥↕↔					L29885 ⁰ L29885 ⁰		L29A19/L29A20	2	8K0 407 182 B
		⊥↕↔					L29867 L29867		L29A19/L29A20	2	4E0 407 181 B
						L29647 L29647		2	8K0 411 317 E		
			Mot/Eng CAKA, PR 1BD/1BE/1BV, Ø 24.8mm			L29854 L29854		Anti-roll bar	2	4D0 411 327 G	
			PR 1BA/1BD/1BE /1BV, (-)	KIT			MK361 MK361		2	8K0 412 377 C	
						L29645 L29645		2	8K0 505 465 E		
			Mot/Eng CAKA			MK388 ⁰ MK388 ⁰		2	8K0 513 353 E		

S6 Quattro (C5) 09.99 → 01.05
 S6 Avant Quattro (4B, C5) 09.99 → 01.05

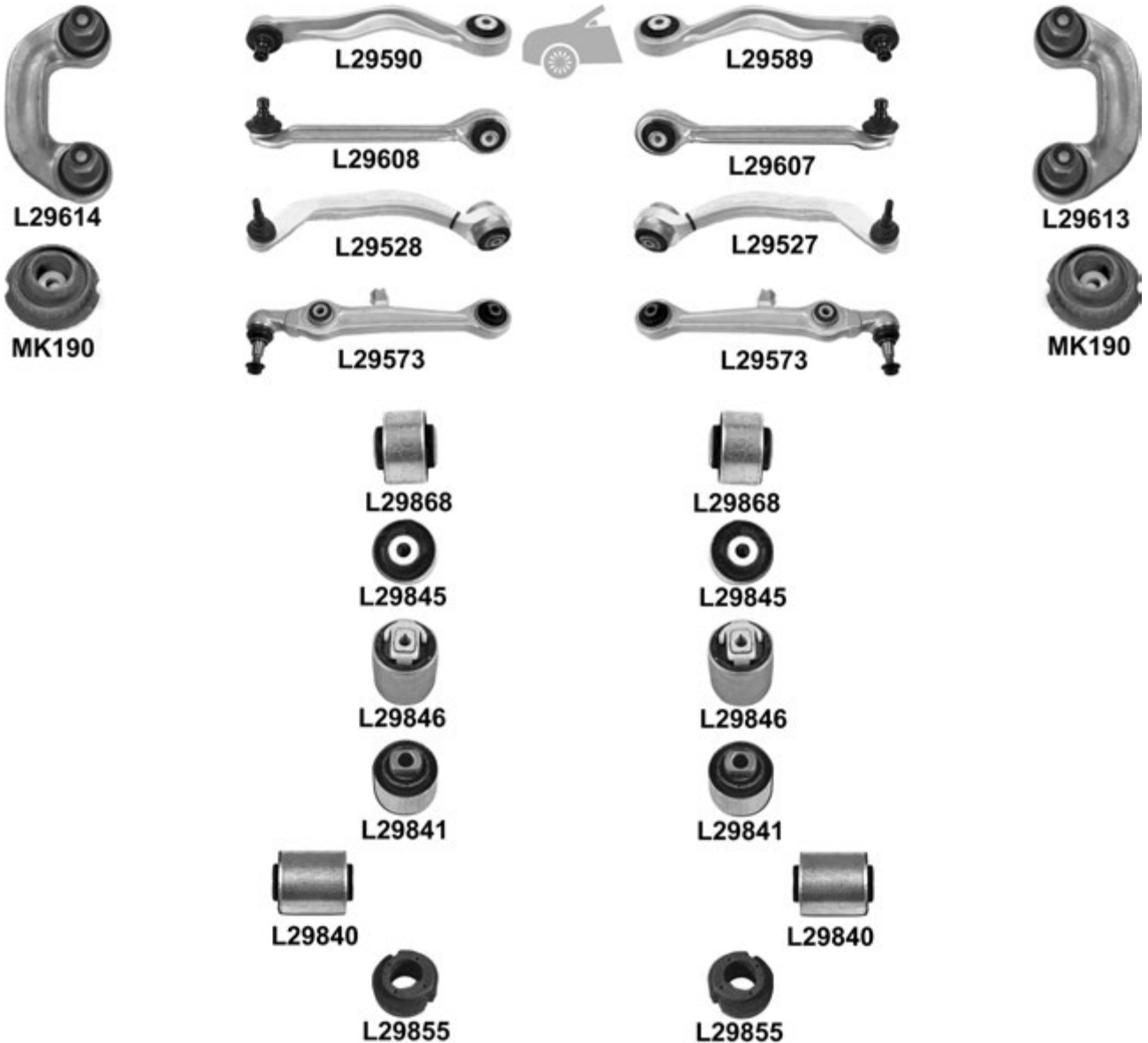
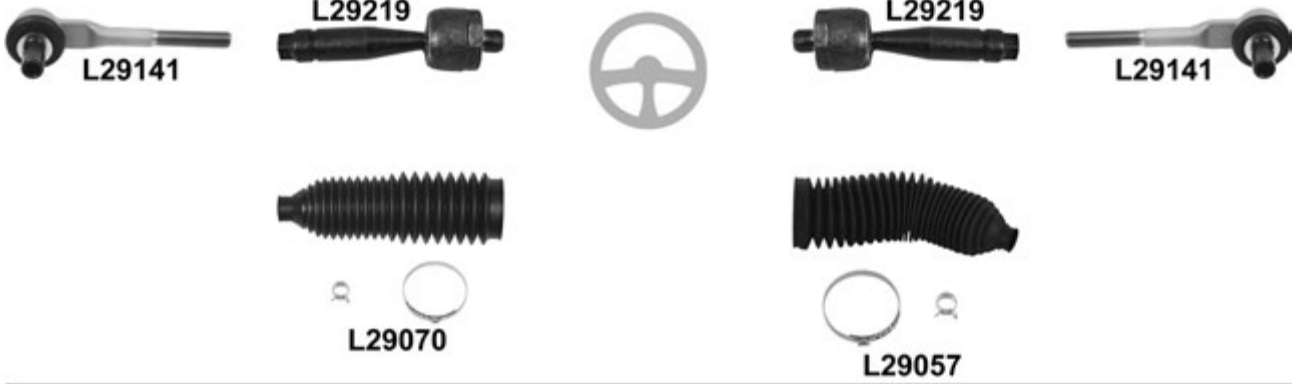

S6 Quattro (C5) 09.99 → 01.05
S6 Avant Quattro (4B, C5) 09.99 → 01.05

		i		←	→	Thread	Part Of	QPA	i	
		↔		L29141	L29141	↻		2	4F0 419 811 C	
				L29219	L29219			2	8E0 422 821	
			∅ 19mm, ∅ 63mm, L= 255mm			L29057			1	8D0 419 831 K
			∅ 20mm, ∅ 54mm, L= 205mm		L29070 ⁰				1	4D0 419 831 DE
		↑			L29589			1	8E0 407 510 C	
				L29590				1	8E0 407 509 C	
		↑			L29607			1	8E0 407 506 A	
				L29608				1	8E0 407 505 A	
		↓			L29527			1	8E0 407 694 K	
				L29528				1	8E0 407 693 K	
		↓	09.03 →, ch. 4B 4 030 101 →		L29573	L29573			2	4B3 407 151 E
		↑	↔		L29868	L29868		L29589/L29590	4	8D0 407 515 C
			↔		L29845	L29845		L29607/L29608	2	4D0 407 515 C
		↓	↔		L29846	L29846		L29527/L29528	2	4D0 407 183 P
			↔		L29841	L29841		L29573	2	4D0 407 182 E
		↓	↔		L29840	L29840		L29573	2	4D0 407 181 H
		↓				L29613			1	8D0 411 318 D
					L29614				1	8D0 411 317 D
		∅ 27mm		L29855	L29855		Anti-roll bar	2	4D0 411 327 H	
			KIT	MK190	MK190			2	4D0 412 377 F	
				L29663	L29663			2	8E0 505 465 D	

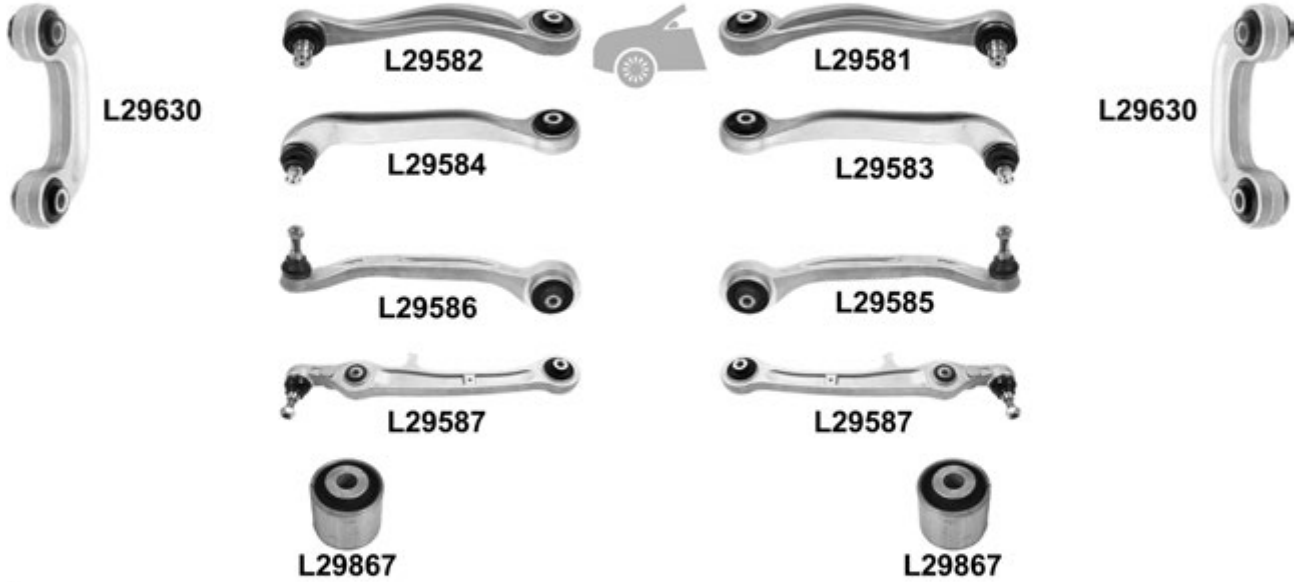
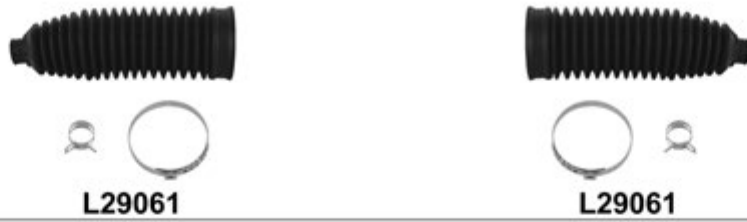
S6 Quattro, S6 Avant Quattro (4F2, 4F5) 06.06 → 08.11

S6 Quattro, S6 Avant Quattro (4F2, 4F5) 06.06 → 08.11

		i	←	→	Thread	Part Of	QPA	i
		↔					2	4FO 419 811 C
							2	4FO 422 821
							2	4FO 422 831
		↕					1	4EO 407 510 D
							1	4EO 407 509 D
	↕						1	4EO 407 506 D
							1	4EO 407 505 D
	↕						1	4FO 407 694 D
							1	4FO 407 693 D
		↕					2	4FO 407 151
							L29587	2
							2	4EO 411 317 E
							2	4FO 505 465 P
							2	4FO 513 353 D

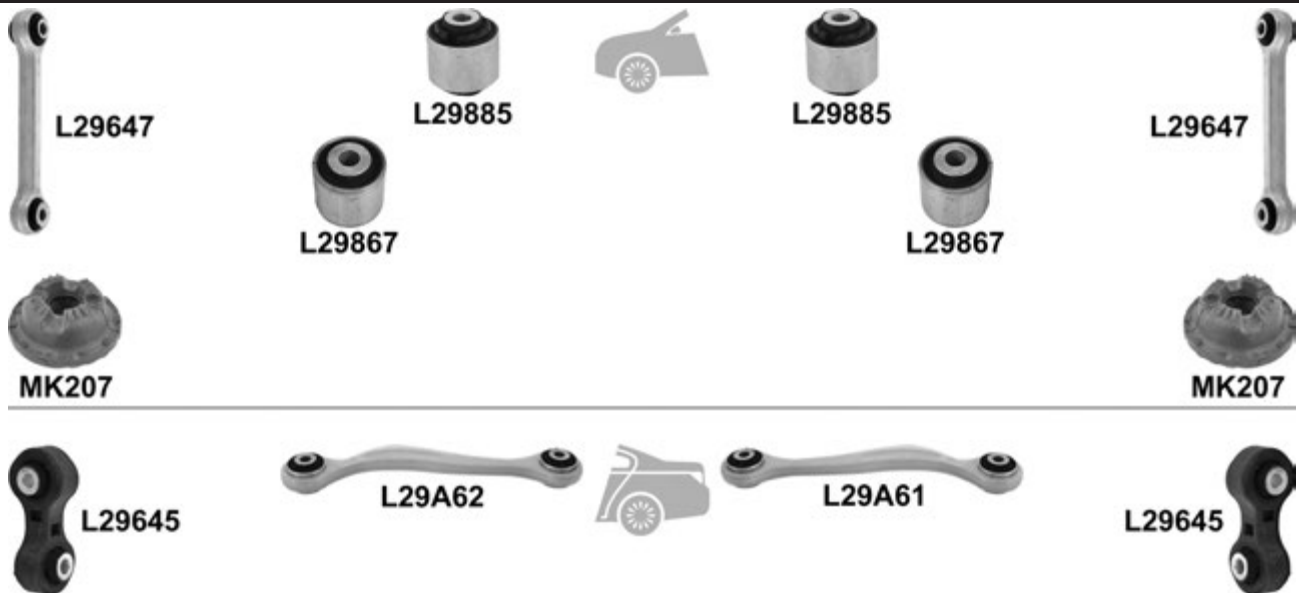
S6 Quattro (4G2, 4G5) 04.12 →

		i	←	→	Thread	Part Of	QPA	i
		↕					2	8KO 407 182 B
							2	4EO 407 181 B
							2	8KO 411 317 E
			KIT					2
		↕	1BK/1BS				1	8KO 501 530 N
							1	8KO 501 529 N
							2	8KO 505 465 E

S7 Sportback Quattro (4GA) 02.12 →

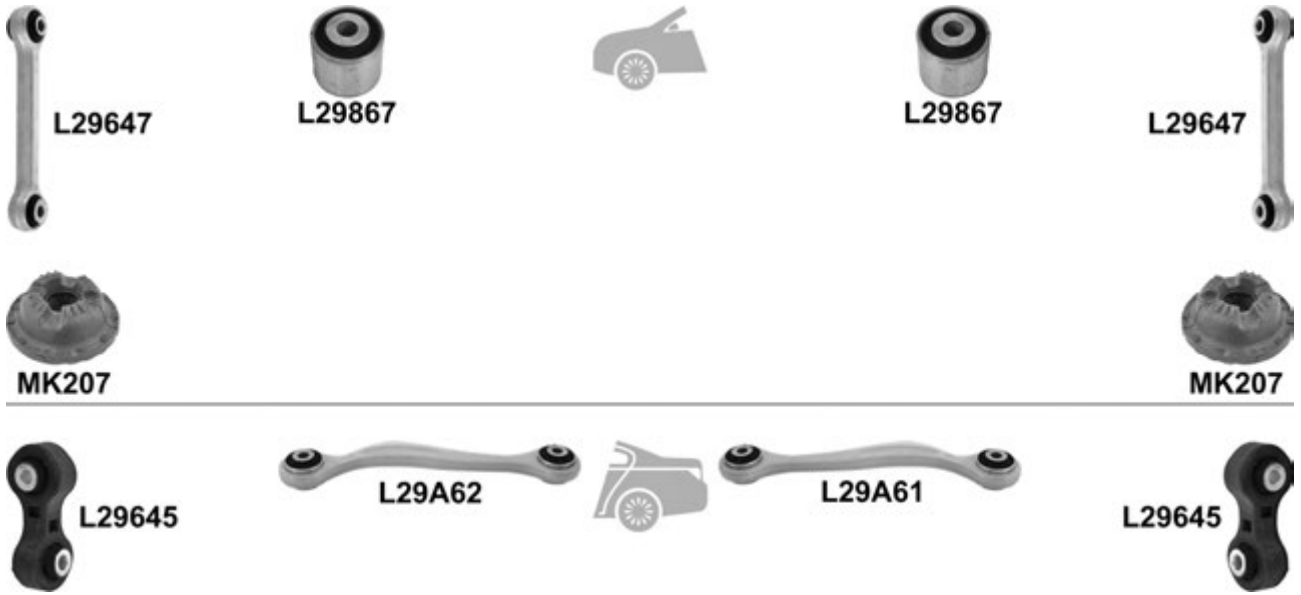

		i		← → Thread		Part Of		QPA		i		
			(+) 08.11 →	L29867	L29867	L29A19/L29A20	2	4E0 407 181 B				
			PR 1BA/1BB/1BE/1BV	L29647	L29647			2	8K0 411 317 E			
			KIT	MK207	MK207			2	8E0 412 377			
			, 1BK/2MB		L29A61		1	8K0 501 530 N				
				L29A62			1	8K0 501 529 N				
				L29645	L29645		2	8K0 505 465 E				

S8 Quattro (4D2) 09.96 → 09.02

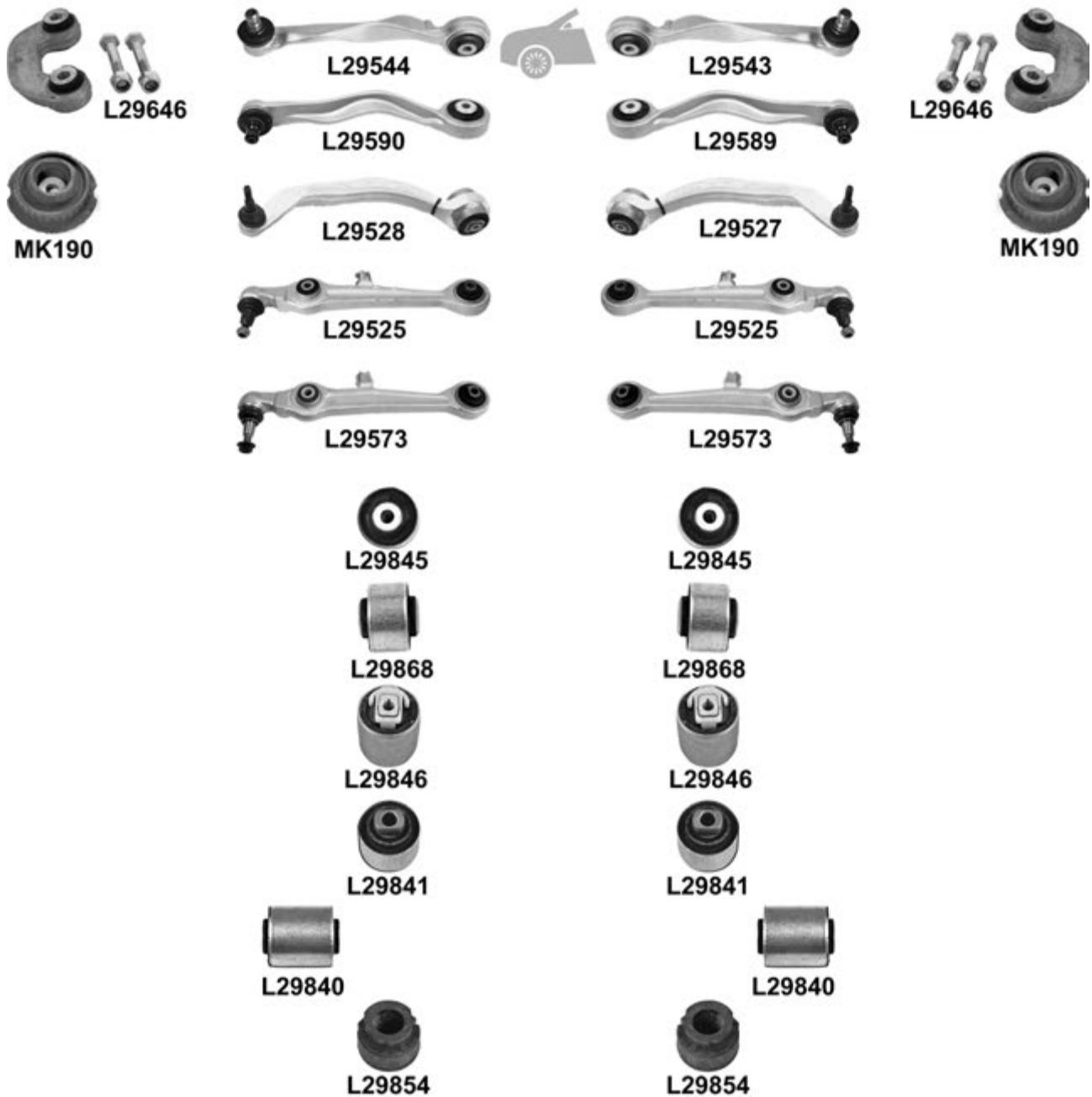
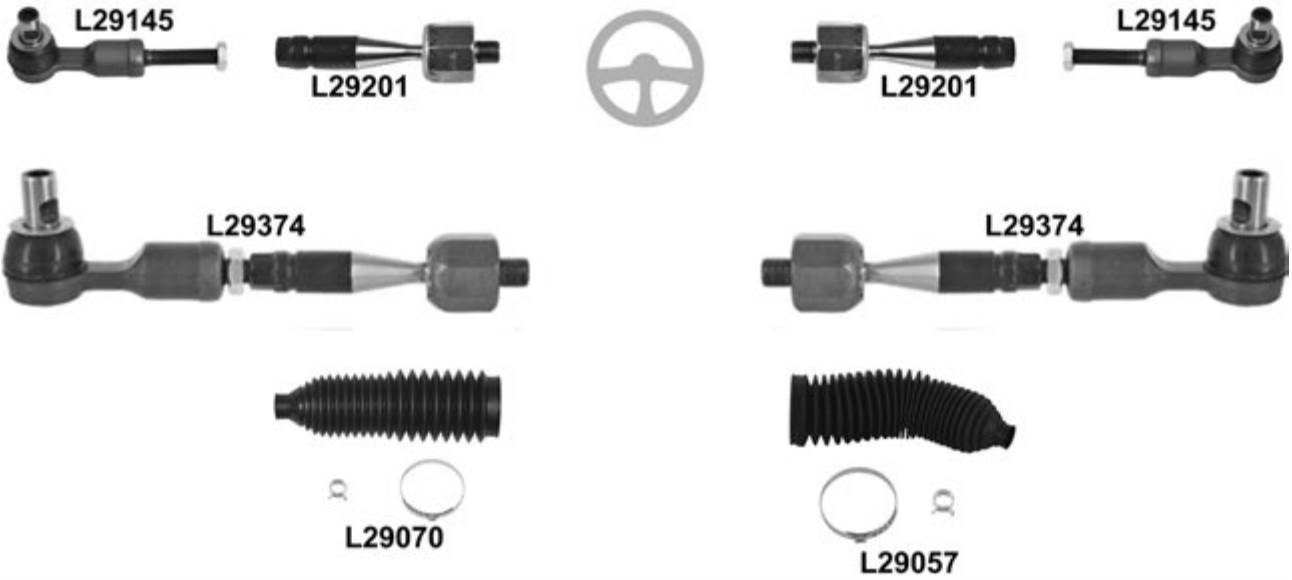

S8 Quattro (4D2) 09.96 → 09.02

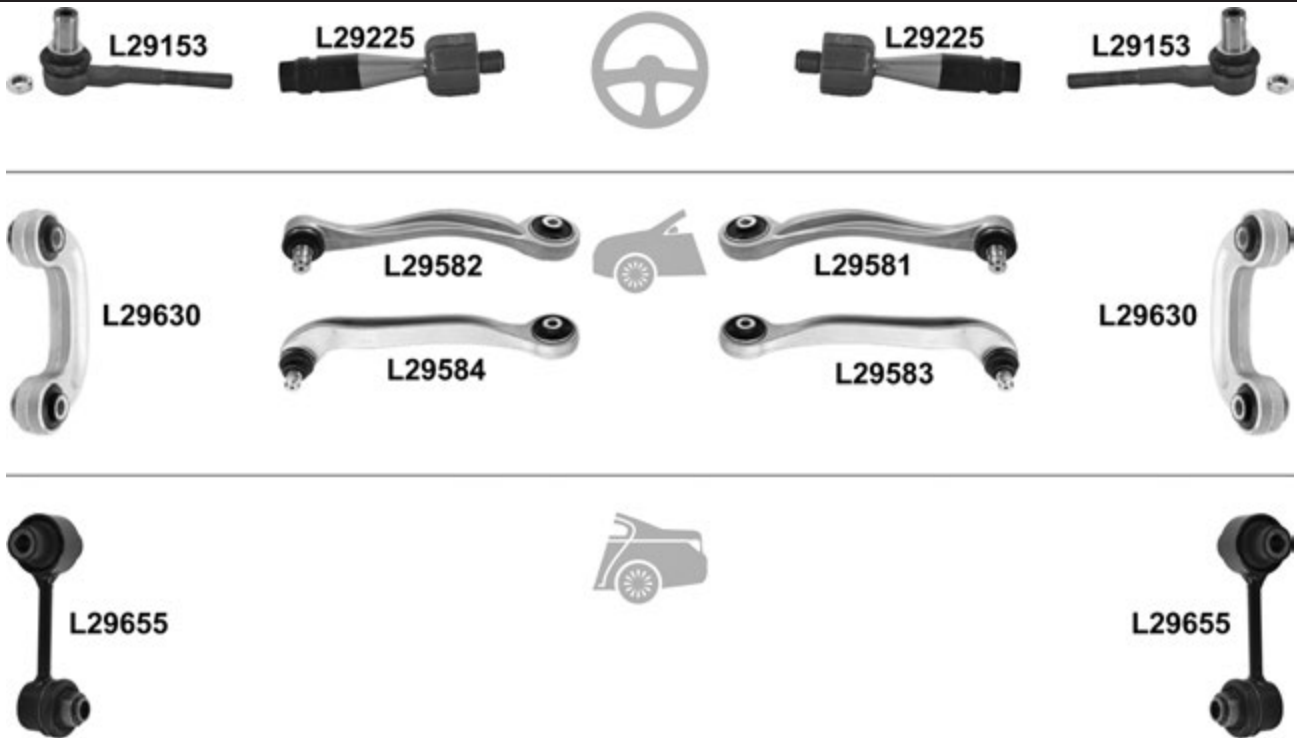

			←	→	Thread	Part Of	QPA		
		↔	L29145	L29145	M 14x1,5 U		2	4D0 419 811 B	
			L29201	L29201	F 14x1,5 / M 16x1,5 U		2	4D0 422 821	
			L29374	L29374			2	4D0 419 801 B	
				L29057			1	8D0 419 831 K	
		∅ 19mm, ∅ 63mm, L= 255mm ∅ 20mm, ∅ 54mm, L= 205mm		L29070 ⁰			1	4D0 419 831 DE	
		↑	Mot/Eng AHC/AKH, → 12.98		L29543		1	8D0 407 510 C	
				L29544			1	8D0 407 509 C	
		↓	Mot/Eng AQH/AVP, 05.99 →		L29589		1	8E0 407 510 C	
				L29590			1	8E0 407 509 C	
		±			L29527		1	8E0 407 694 K	
				L29528			1	8E0 407 693 K	
		±	Mot/Eng AHC/AKH, → 12.98	L29525	L29525		2	4D0 407 151 E	
			Mot/Eng AQH/AVP, 05.99 →	L29573	L29573		2	4B3 407 151 E	
			↑	L29845	L29845		L29543/L29544	2	4D0 407 515 C
			↑	L29868	L29868		L29589/L29590	4	8D0 407 515 C
↓			L29846	L29846		L29527/L29528	2	4D0 407 183 P	
±			L29841	L29841		L29525/L29573	2	4D0 407 182 E	
±			L29840	L29840		L29525/L29573	2	4D0 407 181 H	
		(-) AD	L29646	L29646			2	4D0 411 317 K	
		Height adjustment, ∅ 24.8mm	L29854	L29854		Anti-roll bar	2	4D0 411 327 G	
		(-) Height adjustment, ∅ 27mm	L29855	L29855		Anti-roll bar	2	4D0 411 327 H	
		KIT	MK190	MK190			2	4D0 412 377 F	
			L29651	L29651			2	4D0 505 465 D	

S8 Quattro (4E2, 4E8) 06.06 → 07.10

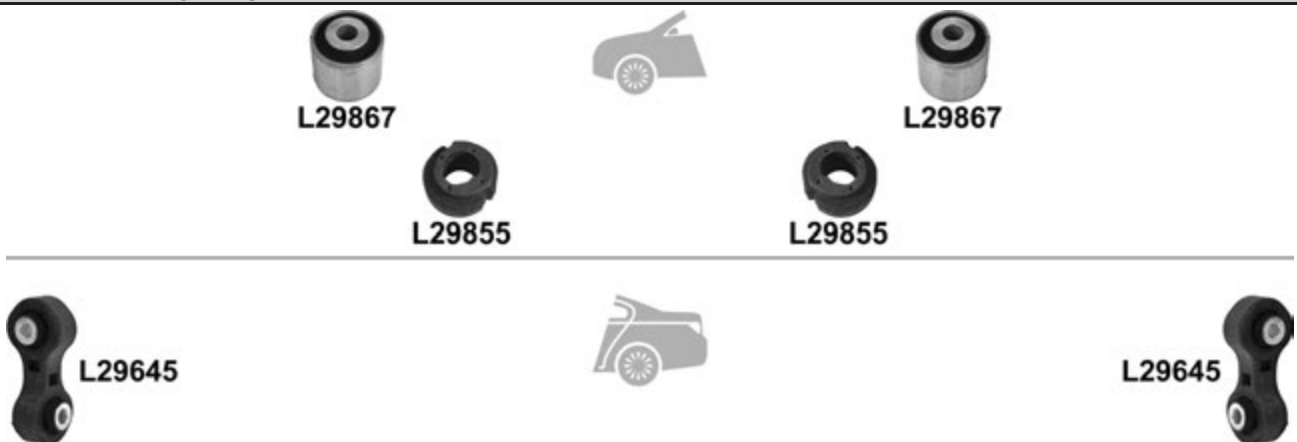
		i	←	→	Thread	Part Of	QPA	i	
		↔	L29153	L29153	∪		2	4E0 419 811 E	
			L29225	L29225	∪		2	4E0 419 821 A	
		↑↓		L29581			1	4E0 407 510 D	
			L29582				1	4E0 407 509 D	
				L29583				1	4E0 407 506 D
			L29584					1	4E0 407 505 D
			L29630	L29630			2	4E0 411 317 E	
			L29655	L29655			2	4E0 505 765 G	

S8 Quattro (4H2) 02.12 →

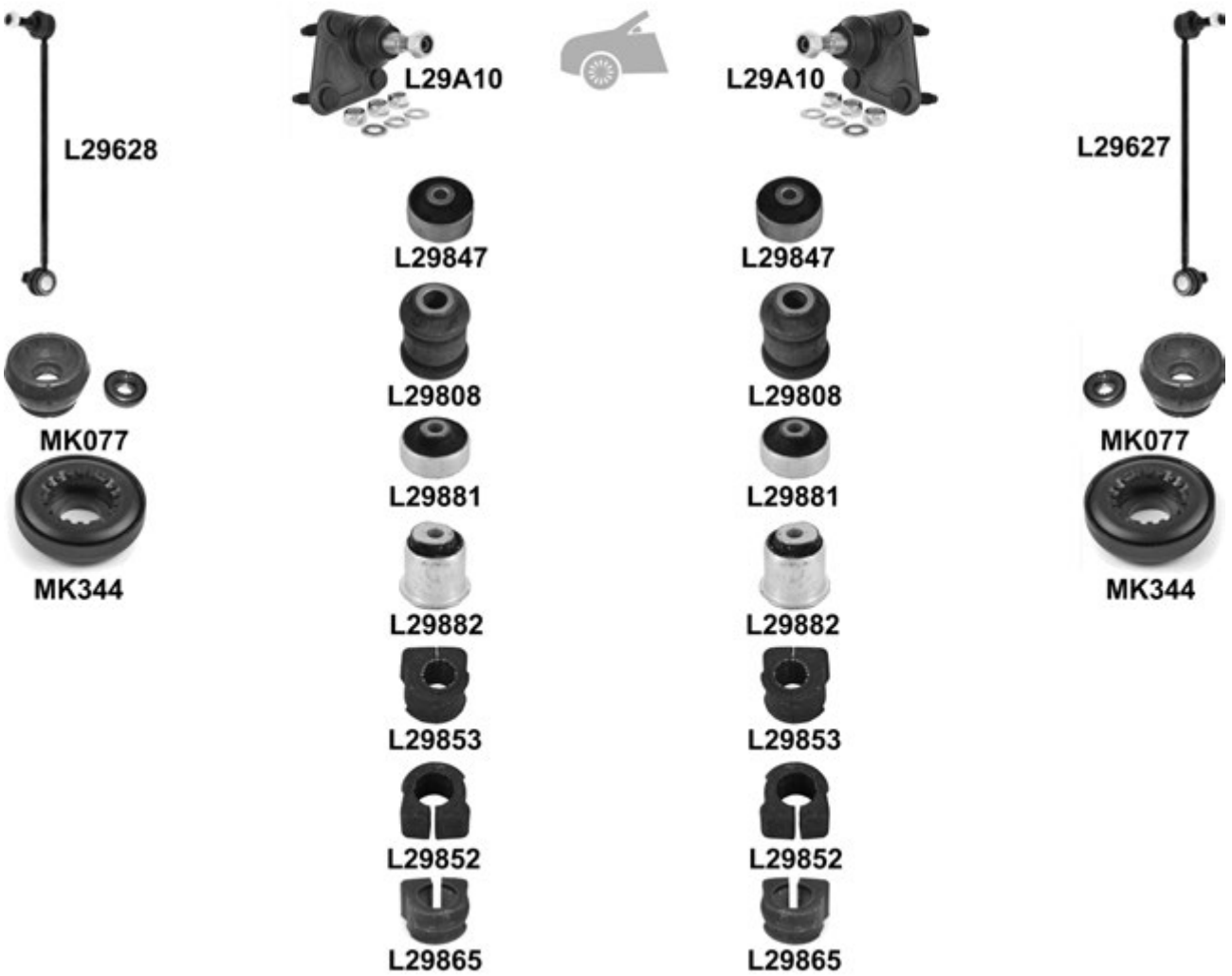
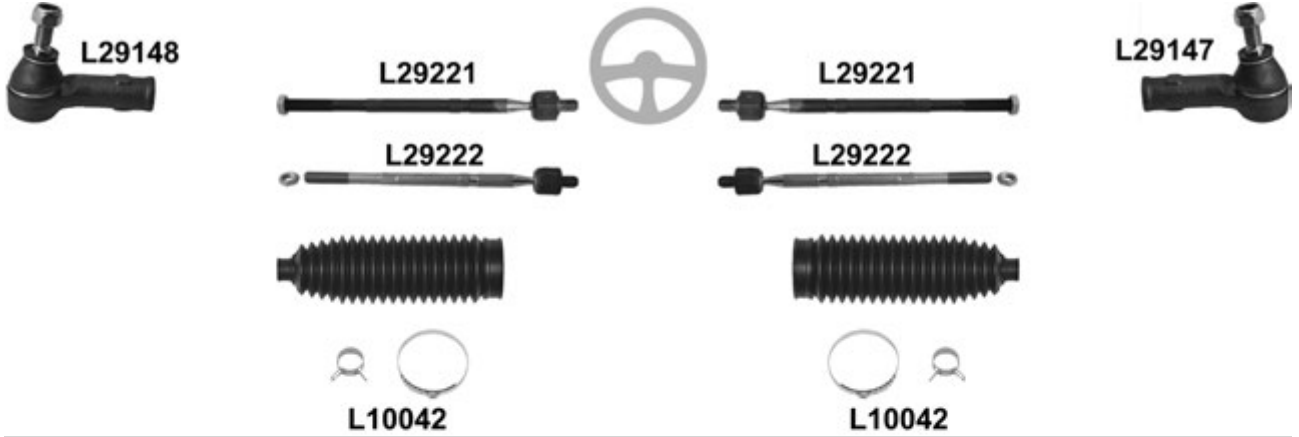
		i	←	→	Thread	Part Of	QPA	i
		↓↑↔	(+) 08.11 →	L29867	L29867		2	4E0 407 181 B
			PR 1BK/1BY, HD, PR 2MA Electronic Suspension, Ø 27mm	L29855	L29855	Anti-roll bar	2	4D0 411 327 H
				L29645	L29645		2	8K0 505 465 E

TT / TT Quattro (8N3) 10.98 → 06.06
TT Roaster / TT Roaster Quattro (8N9) 10.99 → 06.06

TT / TT Quattro (8N3) 10.98 → 06.06

TT Roaster / TT Roaster Quattro (8N9) 10.99 → 06.06

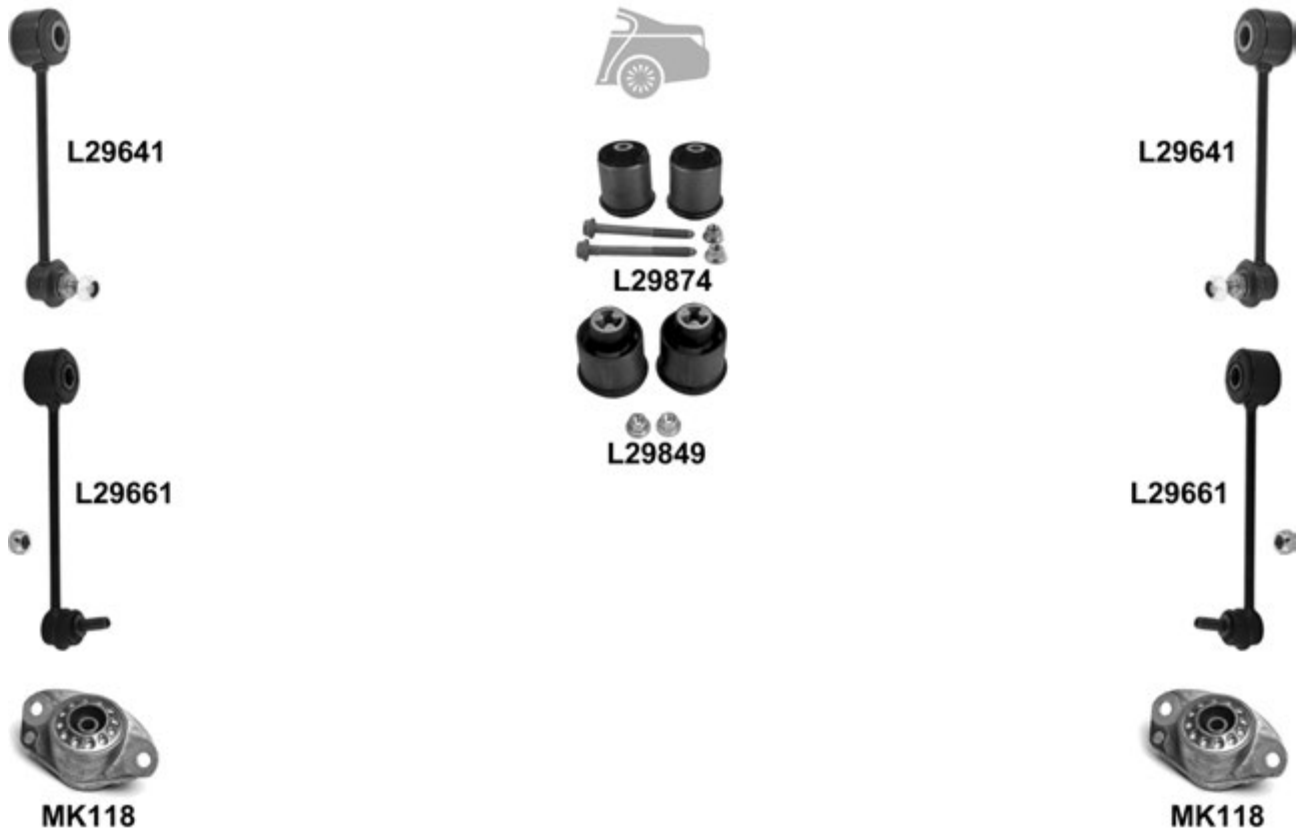

			←	→	Thread	Part Of	QPA		
		↔		L29147	F 16x1,5 U		1	8N0 422 812 A	
				L29148	F 16x1,5 U		1	8N0 422 811 A	
			(-) SP & (18°)	L29221	L29221	M 16x1,5 / M 16x1,5 U		2	8N0 422 807 C
			SP & (18°)	L29222	L29222	U		2	8N0 422 807 D
			∅ 16mm, ∅ 49mm, L= 190mm	L10042 ^o	L10042 ^o			2	8N0 422 831
		↓		L29A10	L29A10		2	8N0 407 365 C	
		↓↘	→ 11.99, ch. → 8N Y 060 000	L29847	L29847			2	1J0 407 181
		↓↗	→ 11.99, ch. → 8N Y 060 000	L29808	L29808			2	357 407 182
		↘	12.99 →, ch. 8N Y 060 001 →	L29881	L29881			2	8N0 407 181 B
		↗	12.99 →, ch. 8N Y 060 001 →	L29882	L29882			2	8N0 407 182 A
					L29627			1	1J0 411 316 D
					L29628			1	1J0 411 315 D
			(-) Quattro, ∅ 17mm	L29853	L29853		Anti-roll bar	2	1J0 411 314 B
			(-) Quattro, ∅ 21mm	L29852	L29852		Anti-roll bar	2	1J0 411 314 C
			Quattro, ∅ 23mm	L29865	L29865		Anti-roll bar	2	1J0 411 314 G
			1.8/3.2 (+) MK344	KIT	MK077	MK077		2	1J0 412 331 BS
		1.8/3.2		MK344	MK344		2	1J0 412 249	
			(-) Quattro, ∅ 69mm	KIT	L29874		Hub carrier	1	1J0 501 541 D
			(-) Quattro, ∅ 74mm	KIT	L29849		Hub carrier	1	1J0 501 541 C
			09.05 →, (-)Quattro/ HD	L29641	L29641			2	1J0 505 466 B
			HD	L29661	L29661			2	1J0 505 466 C
			Quattro, (-) HD	L29641	L29641			2	1J0 505 466 B
			Quattro/ HD	L29661	L29661			2	1J0 505 466 C
		1.8	MK118	MK118			2	1J0 513 353 B	

TT / TT Quattro (8J3) 10.06 →
TT Roaster (8J9) 02.07 →



TT / TT Quattro (8J3) 10.06 →
TT Roaster (8J9) 02.07 →

			i	←	→	Thread	Part Of	QPA	i		
		↔				L29155	F 16x1,5 ∪	1	8J0 423 812		
						L29156	F 16x1,5 ∪	1	8J0 423 811		
						L29224	L29224	M 16x1,5 / M 16x1,5 ∪	2	8J0 423 810	
				Electronic		L29060	L29060		2	1K0 423 831 A	
		⊥				L29A27		1	8J0 407 366		
						L29A28		1	8J0 407 365		
		▲				L29862	L29862		2	1K0 407 182	
						L29621	L29621		2	1K0 411 315 D	
			PR 1BL/1BV/1BQ, Electronic SP , (+) MK345	KIT		MK194	MK194		2	1K0 412 331 B	
						MK345	MK345		2	6N0 412 249 C	
		⊥				L29A11	L29A11		2	4K0 505 323 N	
						L29A29	L29A29		2	1K0 505 311 AB	
		⊥▲				L29A87 ⁰		Trailing Arm	1	1K0 505 224 K	
						L29A88 ⁰		Trailing Arm	1	1K0 505 222 K	
		▲	→ 05.09				L29637			1	1K0 501 530 C
							L29638			1	1K0 501 529 F
							L29623	L29623		2	1K0 505 465 J
							MK386	MK386		2	1K0 513 353 C

V8 10.91 → 02.94

L1012

L1013

L29542

L29541

L29594

L29593

			i	←	→	Thread	Part Of	QPA	i
		↔				L1013	F 16x1,5	1	443 419 812 D
						L1012	F 16x1,5	1	443 419 811 D
		⊥	, ch. 44 M 002 674 →, 19mm	<input checked="" type="checkbox"/>		L29541		1	441 407 156
						L29542		1	441 407 155
		⊥		<input checked="" type="checkbox"/>		L29593		1	443 505 352 P
						L29594		1	443 505 351 P

50 08.74 → 07.78, ch. 865 1500 001 → 868 2600 000

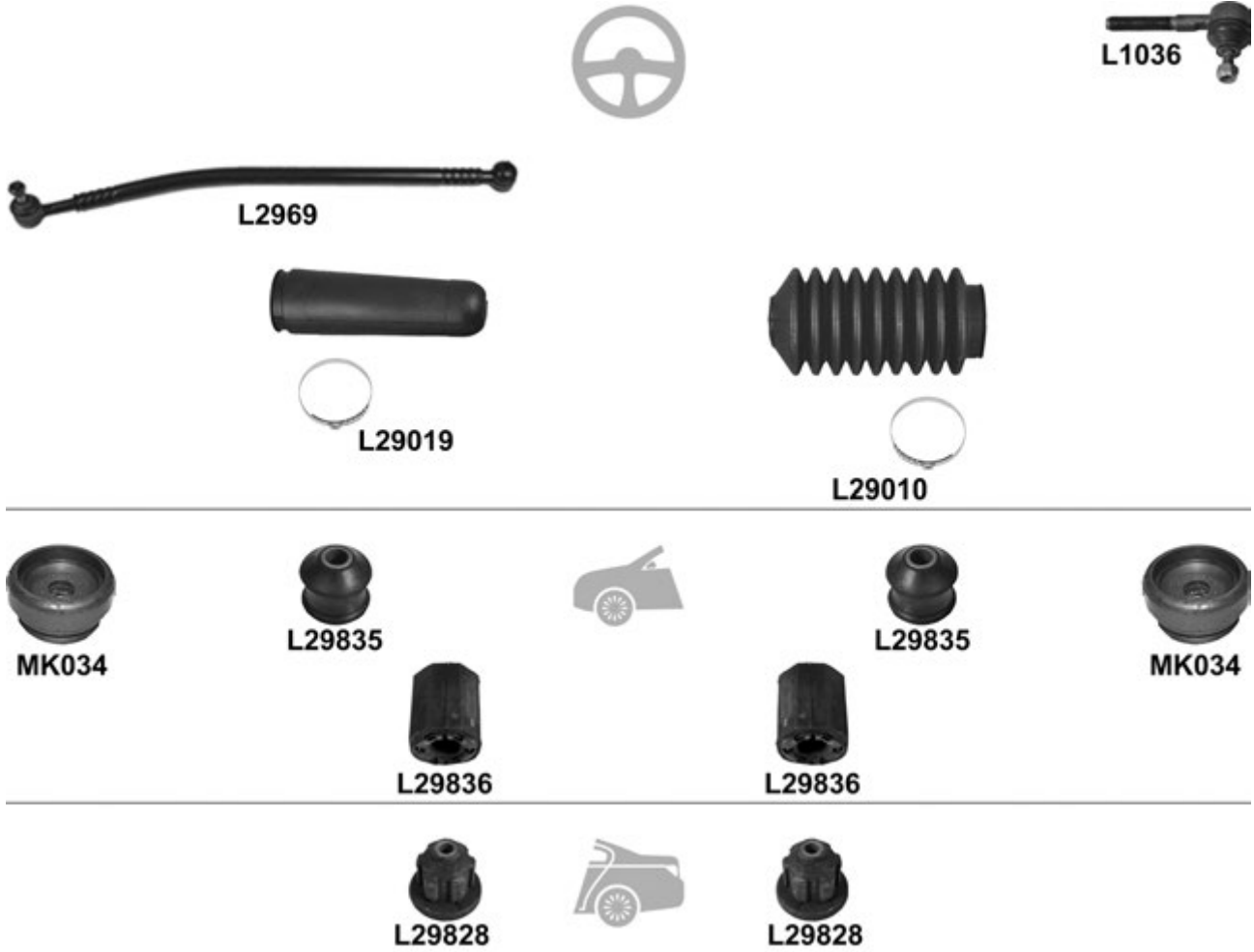

			←	→	Thread	Part Of	QPA	
		↔		L1036	M 14x1,5 ☺		1	861 419 812
				L2969			1	861 419 801 C
				L29010			1	861 419 831 B
				L29019			1	861 419 287 A
		↕ ↔		L29835	L29835		2	861 407 183
				L29836	L29836	Anti-roll bar	2	867 411 313
			KIT	MK034	MK034		2	871 412 323 A
				L29828	L29828	Hub carrier	2	861 511 271

80 I / II 05.72 → 07.78, ch. 865 1500 001 → 868 2600 000 Sedan
 80 I / II 05.72 → 07.78, ch. 335 2900 274 → 338 2903 669 Variant



Thread

Part Of

QPA



		↔		L1036	M 14x1,5 U		1	861 412 812
		⊥	09.77 →, ↗ 17mm	L1076	L1076		2	823 407 365 E
				L29837	L29837	Anti-roll bar	2	823 411 313 A

80 09.78 → 04.80, ch. 819 2100 001 → 81 A 0173 588



Thread

Part Of

QPA



		↔		L1036	M 14x1,5 U		1	861 412 812
		⊥		L1076	L1076		2	823 407 365 E
				L29837	L29837	Anti-roll bar	2	823 411 313 A
				L29805	L29805	Hub carrier	2	811 511 247

80 04.80 → 08.84, ch. 81 A 173 589 → 81 E 220 000

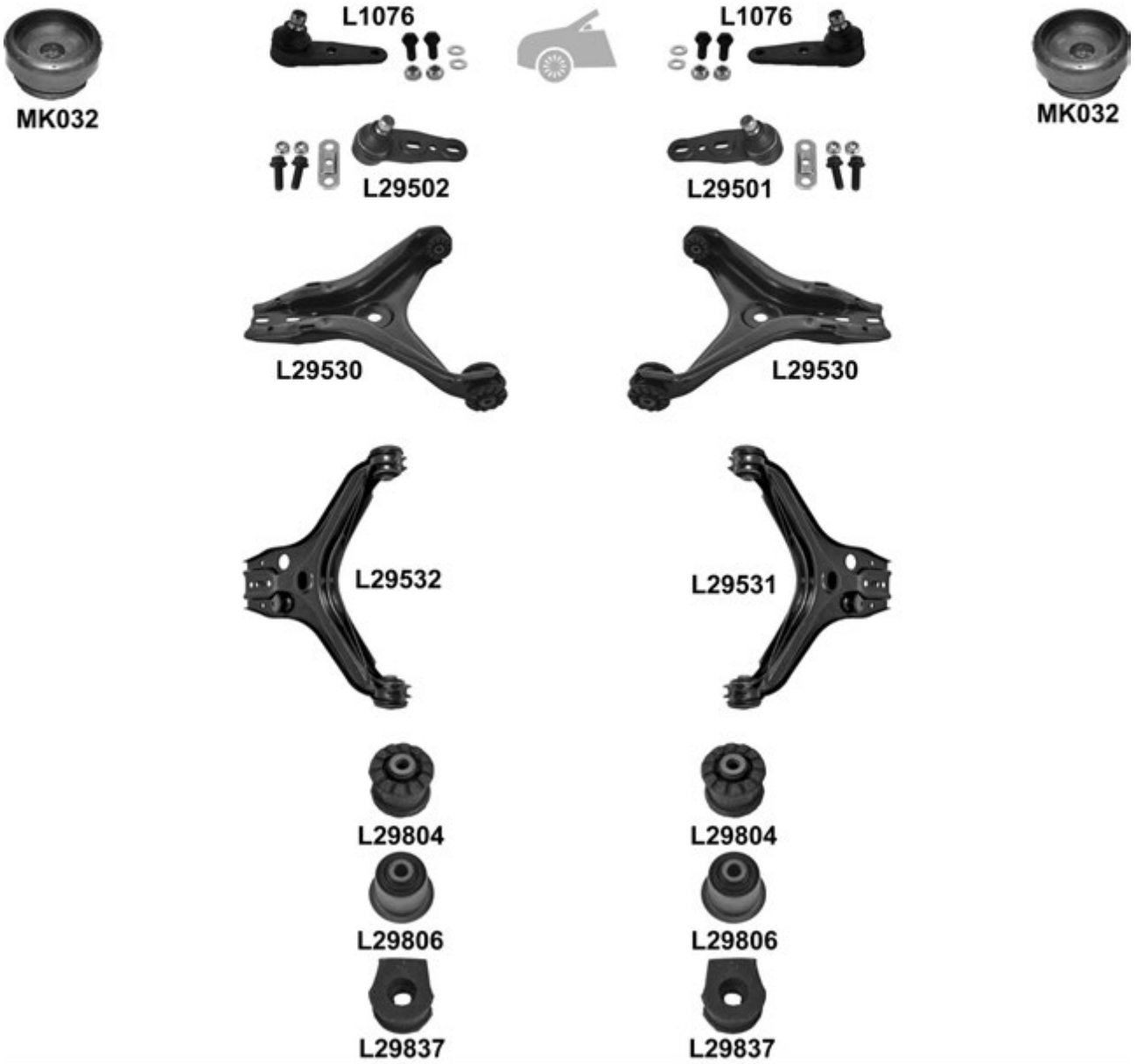

80 04.80 → 08.84, ch. 81 A 173 589 → 81 E 220 000

			←	→	Thread	Part Of	QPA		
		↔			F 14x1,5 U		2	811 419 812 A	
							1	811 419 802 J	
							1	811 419 801 E	
							1	811 419 831 B	
		↓					2	823 407 365 E	
				, ch. 81 D 077 974 →, 17mm				1	855 407 366 A/B
								1	855 407 365 A/B
		↓		4 cyl., (-)				2	893 407 147 G
				5 cyl. ch. → 81 D 077 973, (-)				2	893 407 147 G
				5 cyl. ch. 81 D 077 974 →,				1	893 407 148 C
								1	893 407 147 C
		↓ ▲ ▼						4	811 407 181 A
				, ch. → 81 D 077 973				4	811 407 181 A
				, ch. 81 D 077 974 →				4	857 407 181
							2	823 411 313 A	
							2	8A0 412 323 B	
							2	811 511 247	

80 06.84 → 04.87, ch. 81 F 000 001 → 81 H 299 000

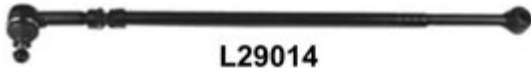
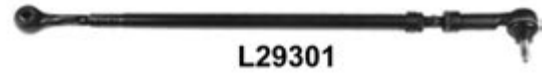
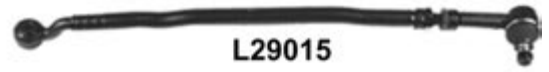

L29029



80 06.84 → 04.87, ch. 81 F 000 001 → 81 H 299 000



Thread

Part Of

QPA



				L29016	L29016	F 14x1,5 ♂		2	811 419 812 A
			ch. → 81 G 160 000		L29015			1	811 419 802 J
			ch. 81 G 160 001 → 81 H 299 000		L29301			1	811 419 802 K
					L29014			1	811 419 801 E
					L29029			1	811 419 831 B
				L1076	L1076			2	823 407 365 E
			, 17mm		L29501			1	855 407 366 A/B
				L29502			1	855 407 365 A/B	
			4 cyl.	L29530	L29530			2	893 407 147 G
			5 cyl.,		L29531			1	893 407 148 C
				L29532			1	893 407 147 C	
				L29804	L29804			4	811 407 181 A
			, 5 cyl.	L29806	L29806			4	857 407 181
				L29837	L29837		Anti-roll bar	2	823 411 313 A
			KIT	MK032	MK032			2	8A0 412 323 B
		transverse		L29810	L29810			2	431 505 172
				L29805	L29805		Hub carrier	2	811 511 247

80 09.86 → 08.89, ch. 89 H 300 001 → 89 K 520 000

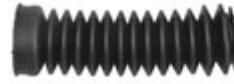
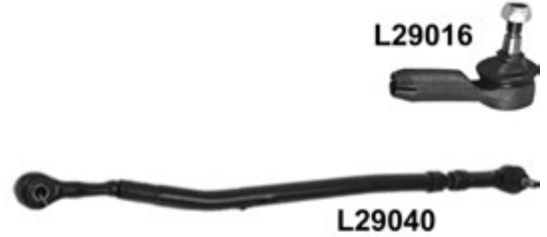
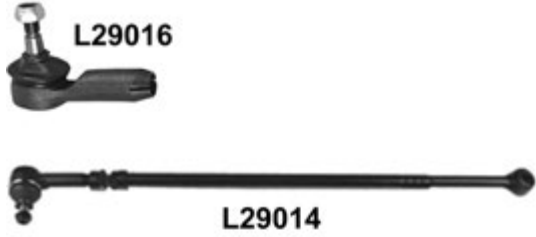

L29029



80 09.86 → 08.89, ch. 89 H 300 001 → 89 K 520 000



				← → Thread		Part Of	QPA			
		↔		L29016	L29016	F 14x1,5 ♂	2	811 419 812 A		
					L29040		1	893 419 802		
					L29014		1	811 419 801 E		
		⊥		ch. → 89 J 373 598, ↗ 17mm		L29029		1	811 419 831 B	
						L29503		1	855 407 366	
						L29504		1	855 407 365	
						L29505		1	893 407 366 A	
						L29506		1	893 407 365 A	
						L29501		1	855 407 366 A/B	
						L29502		1	855 407 365 A/B	
						L29507		1	893 407 366 F	
						L29508		1	893 407 365 F	
						L29509		1	893 407 366 E	
						L29510		1	893 407 365 E	
		⊥		4 cyl.	L29530	L29530		2	893 407 147 G	
					5 cyl., Ⓢ	L29531		1	893 407 148 C	
						L29532		1	893 407 147 C	
		⊥ ▲ ▼			L29804	L29804		4	811 407 181 A	
					L29806	L29806		4	857 407 181	
					L29837	L29837		Anti-roll bar	2	823 411 313 A
				KIT	MK032	MK032			2	8A0 412 323 B
			transverse		L29810	L29810		2	431 505 172	
					L29805	L29805		2	811 511 247	Hub carrier

80 08.89 → 09.91, ch. 8A L 000 001 → 8A M 500 000

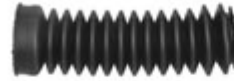
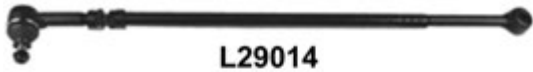

L29029

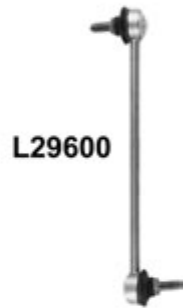
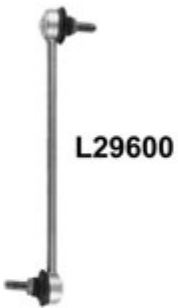

80 08.89 → 09.91, ch. 8A L 000 001 → 8A M 500 000

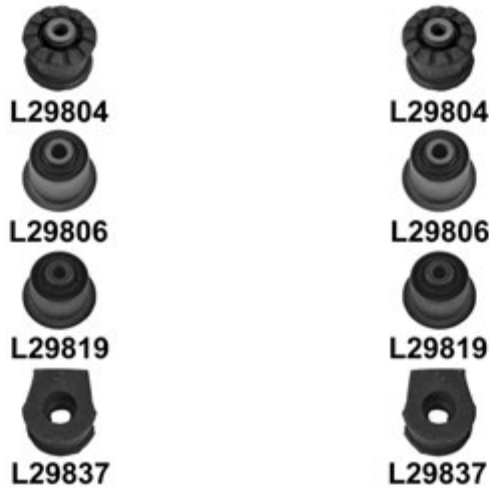

			←	→	Thread	Part Of	QPA		
				L29016	L29016	F 14x1,5 U	2	811 419 812 A	
					L29040		1	893 419 802	
					L29014		1	811 419 801 E	
					L29029		1	811 419 831 B	
					L29505		1	893 407 366 A	
				L29506		1	893 407 365 A		
					L29507		1	893 407 366 F	
				L29508		1	893 407 365 F		
			2.3 ltr.		L29509		1	893 407 366 E	
		L29510		1	893 407 365 E				
					L29530	L29530		2	893 407 147 G
					L29531		1	893 407 148 C	
				L29532		1	893 407 147 C		
					L29804	L29804		4	811 407 181 A
				L29806	L29806		4	857 407 181	
2.3 E 125 kw, Mot/Eng 7A				L29819	L29819		4	893 407 181	
		L29837	L29837		Anti-roll bar	2	823 411 313 A		
		ch. 8A L 038 758 →	L29600	L29600			2	8A0 407 465 C	
			KIT	MK032	MK032		2	8A0 412 323 B	
		transverse		L29810	L29810		2	431 505 172	
				L29805	L29805		Hub carrier	2	811 511 247

80, 80 Avant (8C / B4) 09.91 → 01.96, ch. 8C N 000 001 → 8C T 010 000

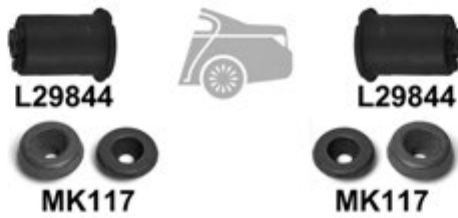
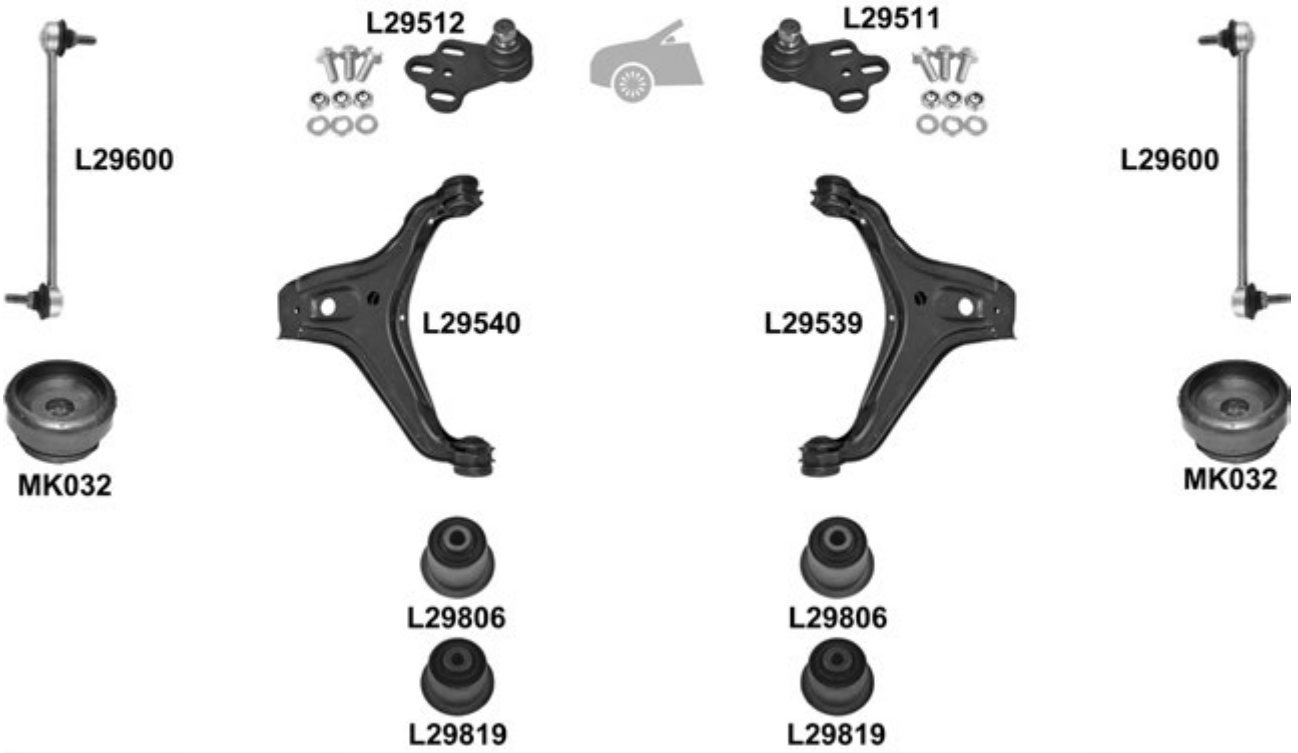
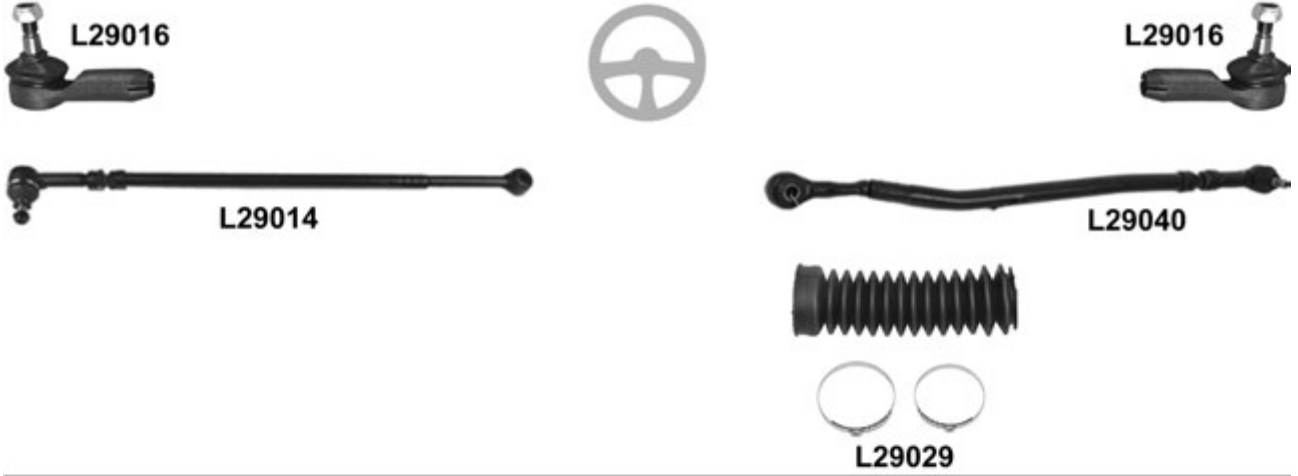

80, 80 Avant (8C / B4) 09.91 → 01.96, ch. 8C N 000 001 → 8C T 010 000

			←	→	Thread	Part Of	QPA		
		↔			F 14x1,5 U		2	811 419 812 A	
							1	893 419 802	
							1	811 419 801 E	
							1	811 419 831 B	
		⊥	(-) 2.8 V6, Mot/Eng AAH, 19mm		L29511			1	8A0 407 366
					L29512			1	8A0 407 365
					L29511			1	8A0 407 366
					L29512			1	8A0 407 365
		⊥	(-) 2.8 V6, Mot/Eng AAH, ch. 8CN 000 352 → 8CN 175 591		L29539			1	895 407 148 A
					L29540			1	895 407 147 A
					L29539			1	895 407 148 A
					L29540			1	895 407 147 A
		⊥ ▲ ▼	(-) 2.8V6, Mot/Eng AAH		L29806	L29806		4	857 407 181
					L29819	L29819		4	893 407 181
					L29806	L29806		4	857 407 181
					L29600	L29600		2	8A0 407 465 C
				KIT	MK032	MK032		2	8A0 412 323 B
			transverse		MK117	MK117		2	8A0 512 335 S
				L29844	L29844	Hub carrier	2	8A0 501 541	

80 Quattro 08.82 → 08.84, ch. 85 D 000 001 → 81 E 810 000

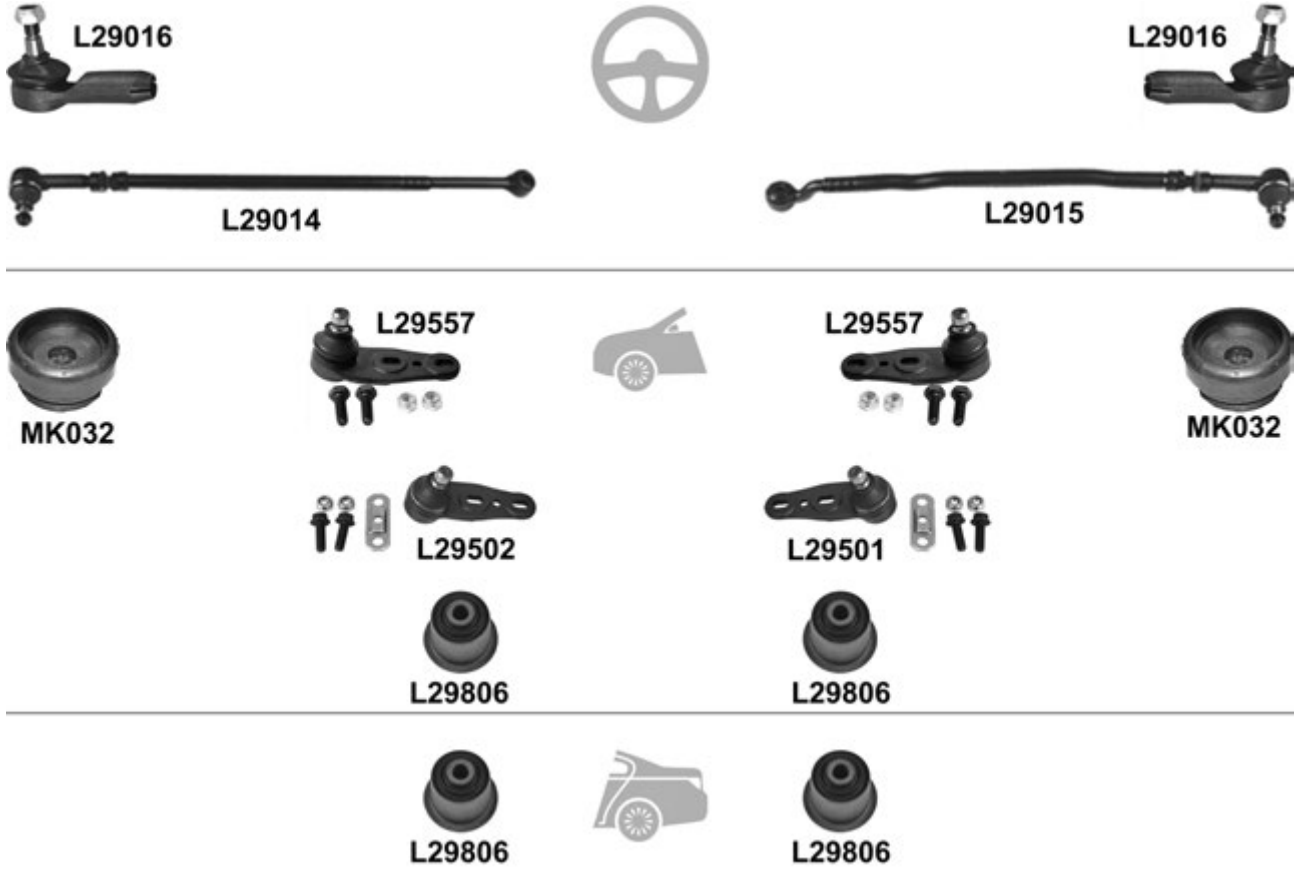

				← → Thread		Part Of	QPA		
		↔		L29016	L29016	F 14x1,5 ♂	2	811 419 812 A	
					L29015		1	811 419 802 J	
				L29014			1	811 419 801 E	
		↓	(-)	L29557	L29557		2	857 407 365	
					L29501		1	855 407 366 A/B	
				L29502		1	855 407 365 A/B		
		↓ ▲ ▼		L29806	L29806		4	857 407 181	
			KIT	MK032	MK032		2	8A0 412 323 B	
		↓ ▲ ▼		L29806	L29806		4	857 407 181	

80 Quattro 08.84 → 08.86, ch. 81 F 000 001 → 81 G 220 000

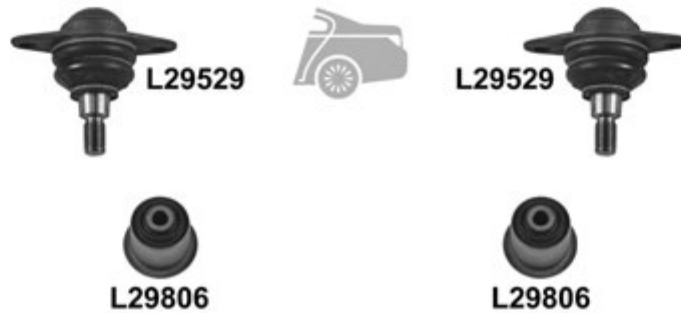
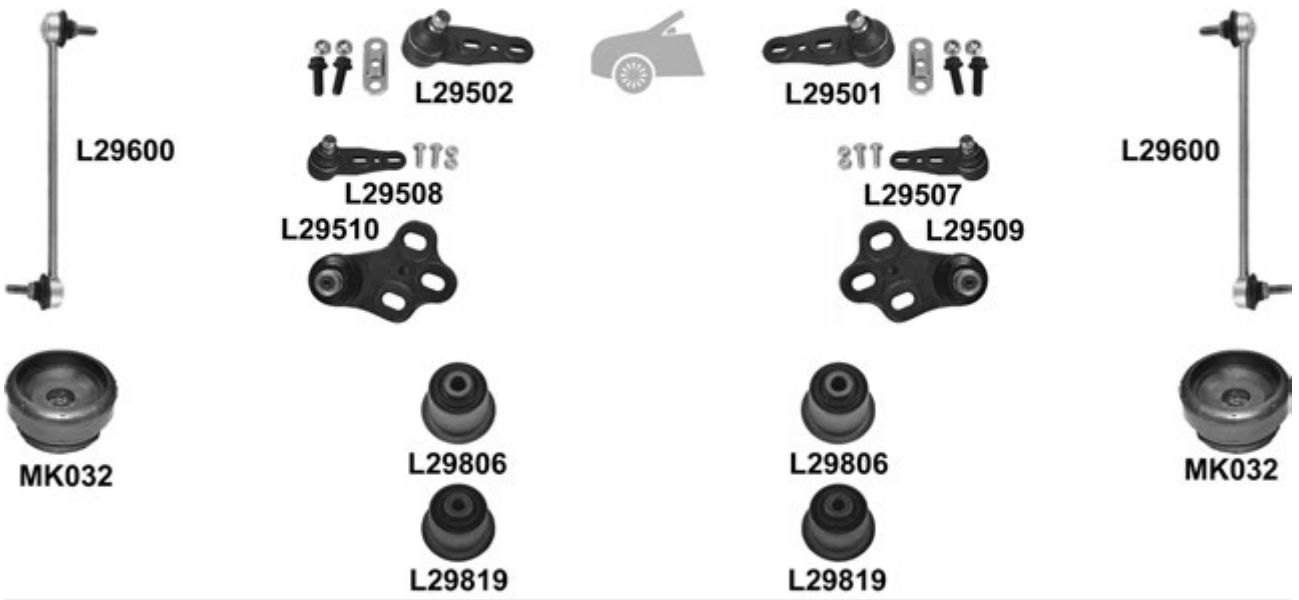
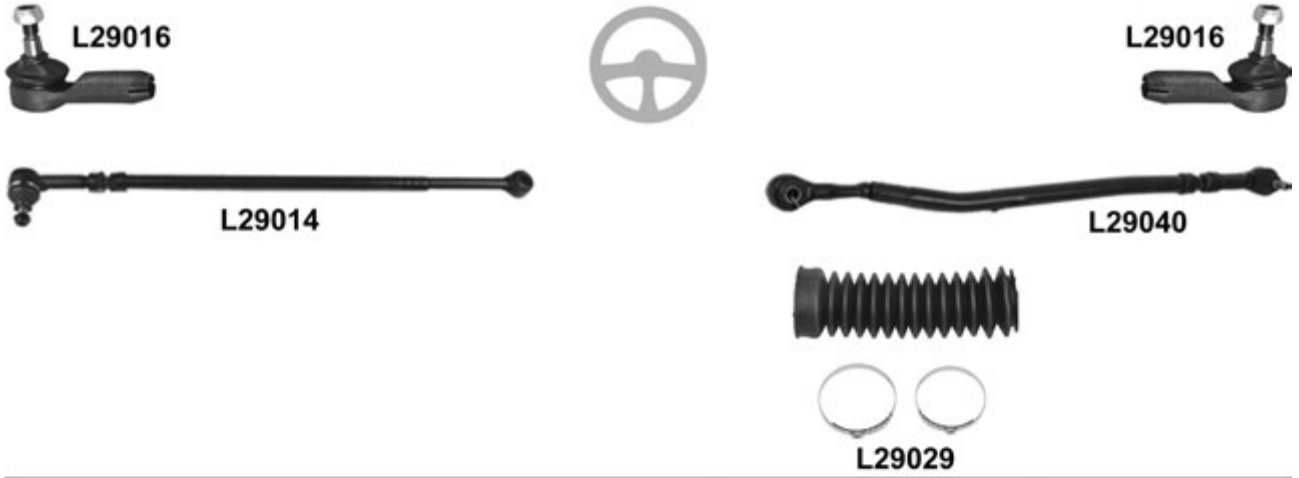

				← → Thread		Part Of	QPA	i	
				L29016	L29016	F 14x1,5 ♂		2	811 419 812 A
			ch. → 81 G 160 000		L29015			1	811 419 802 J
			ch. 81 G 160 001 →		L29301			1	811 419 802 K
				L29014				1	811 419 801 E
			(-)	L29557	L29557			2	857 407 365
					L29501			1	857 407 366 A/B
				L29502			1	857 407 365 A/B	
				L29806	L29806			4	857 407 181
			KIT	MK032	MK032			2	8A0 412 323 B
				L29806	L29806			4	857 407 181
				L29529	L29529			2	857 505 365

80 Quattro 09.86 → 10.91, ch. 89 H 300 001 → 8A N 200 000

80 Quattro 09.86 → 10.91, ch. 89 H 300 001 → 8A N 200 000

				←	→	Thread	Part Of	QPA	
		↔		L29016	L29016	F 14x1,5 U		2	811 419 812 A
					L29040			1	893 419 802
				L29014				1	811 419 801 E
					L29029			1	811 419 831 B
		↓	ch. → 89 J 351 000, (-) AC/5 cyl./Mot/Eng 7A		L29501			1	855 407 366 A/B
				L29502			1	855 407 365 A/B	
			5 cyl., ch.89 H 450 000 → 89 J 351 000, (-) Mot/Eng 7A		L29507		1	893 407 366 F	
				L29508		1	893 407 365 F		
			ch. 89 J 351 001 →, (-) Mot/Eng 7A		L29507		1	893 407 366 F	
				L29508		1	893 407 365 F		
		Mot/Eng 7A, ch. 8A L 045 001 →		L29509		1	893 407 366 E		
			L29510		1	893 407 365 E			
		↓ ▲ ▼	(-) Mot/Eng 7A	L29806	L29806			4	857 407 181
			Mot/Eng 7A	L29819	L29819			4	893 407 181
			ch. 8A L 045 001 →	L29600	L29600			2	8A0 407 465 C
			KIT	MK032	MK032		2	8A0 412 323 B	
		↓ ▲ ▼		L29806	L29806			4	857 407 181
		↓		L29529	L29529			2	857 505 365

80, 80 Avant Quattro (8C / B4) 09.91 → 07.95, ch. 8C N 000 001 → 8C T 010 000

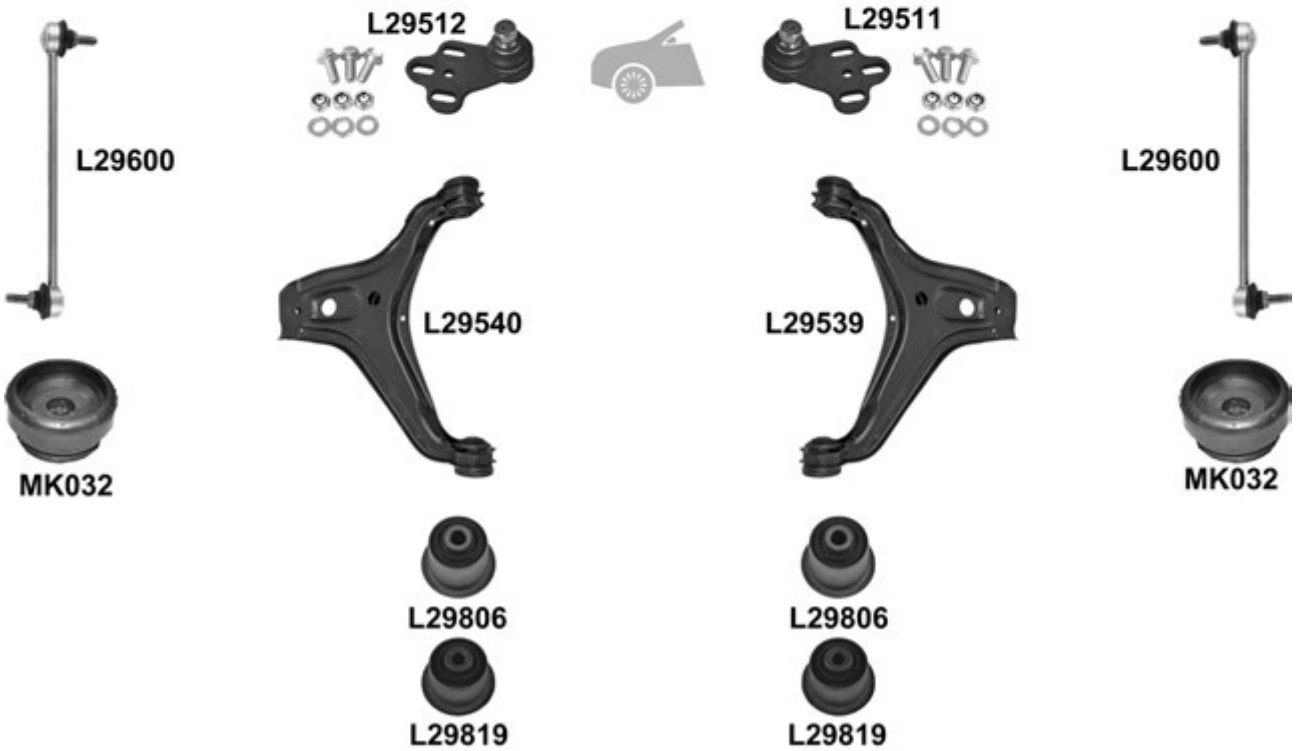
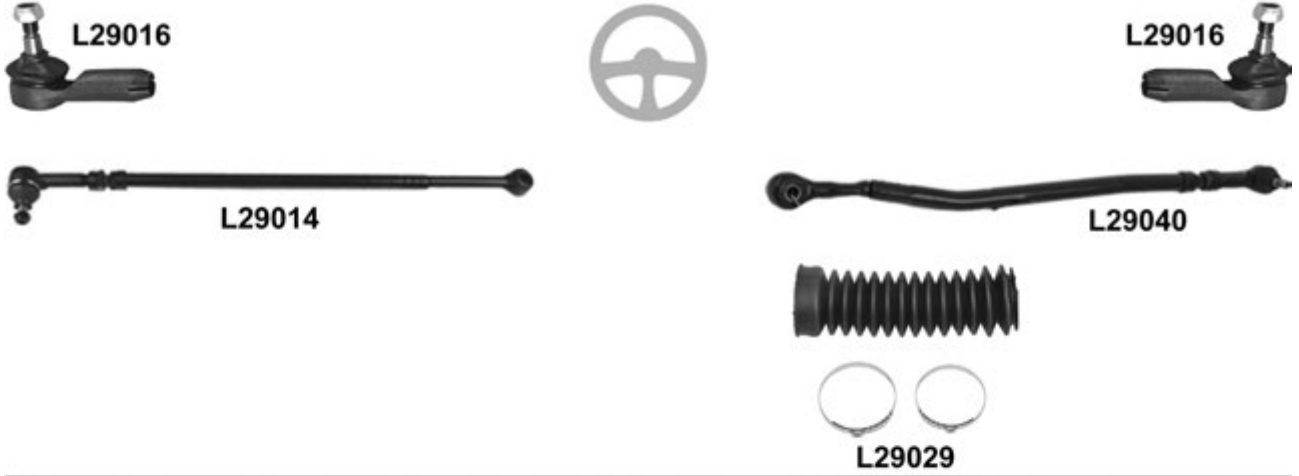

				←	→	Thread	Part Of	QPA		
⊕		↔		L29016	L29016	F 14x1,5 U		2	811 419 812 A	
					L29040			1	893 419 802	
				L29014				1	811 419 801 E	
					L29029			1	811 419 831 B	
⊖		⊥	(-) Mot/Eng ABY		L29511			1	8A0 407 366	
				L29512			1	8A0 407 365		
			Mot/Eng ABY, ch. 8C R 125 001 →		L29511			1	8A0 407 366	
		L29512			1	8A0 407 365				
		⊥	(-) Mot/Eng ABY, ch. → 8C R 125 000		L29539			1	895 407 148 A	
				L29540			1	895 407 147 A		
			Mot/Eng ABY, ch. 8C R 125 001 →		L29539			1	895 407 148 A	
		L29540			1	895 407 147 A				
	⊥ ▲ ▼	(+) Mot/Eng ABY, ch. → 8C R 125 0000	L29806	L29806			4	857 407 181		
		Mot/Eng ABY, ch. 8C R 125 001 →	L29819	L29819			4	893 407 181		
				L29600	L29600			2	8A0 407 465 C	
			(-) Mot/Eng ABY	KIT	MK032	MK032		2	8A0 412 323 B	

80 Avant RS2 Quattro 03.94 → 08.95, ch. 8C R 000 001 → 8C T 001 000



				←	→	Thread	Part Of	QPA	
		↔		L29016	L29016	F 14x1,5 ♂		2	811 419 812 A
					L29040			1	893 419 802
				L29014				1	811 419 801 E
					L29029			1	811 419 831 B
				L29819	L29819			4	893 407 181
				L29600	L29600			2	8A0 407 465 C

90 06.84 → 04.87, ch. 81 F 000 001 → 81 H 299 000

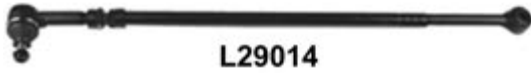
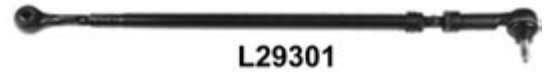
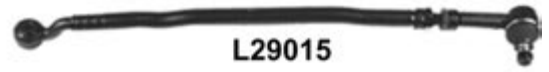

L29029



90 06.84 → 04.87, ch. 81 F 000 001 → 81 H 299 000



Thread

Part Of

QPA



		↔		L29016	L29016	F 14x1,5 U		2	811 419 812 A	
			ch. → 81 G 160 000		L29015			1	811 419 802 J	
			ch. 81 G 160 001 → 81 H 299 000		L29301			1	811 419 802 K	
					L29014			1	811 419 801 E	
						L29029			1	811 419 831 B
		↓		L1076	L1076			2	823 407 365 E	
				17mm		L29501			1	855 407 366 A/B
						L29502			1	855 407 365 A/B
		↓	, 4 cyl.		L29530	L29530			2	893 407 147 G
			, 5 cyl.,		L29531			1	893 407 148 C	
						L29532			1	893 407 147 C
		↓ ▲ ▼			L29804	L29804			4	811 407 181 A
, 5 cyl., Turbo diesel				L29806	L29806			4	857 407 181	
				L29837	L29837		Anti-roll bar	2	823 411 313 A	
			KIT	MK032	MK032			2	8A0 412 323 B	
		transverse		L29810	L29810			2	431 505 172	
				L29805	L29805		Hub carrier	2	811 511 247	

90 09.86 → 08.89, ch. 89 H 300 001 → 89 K 520 000

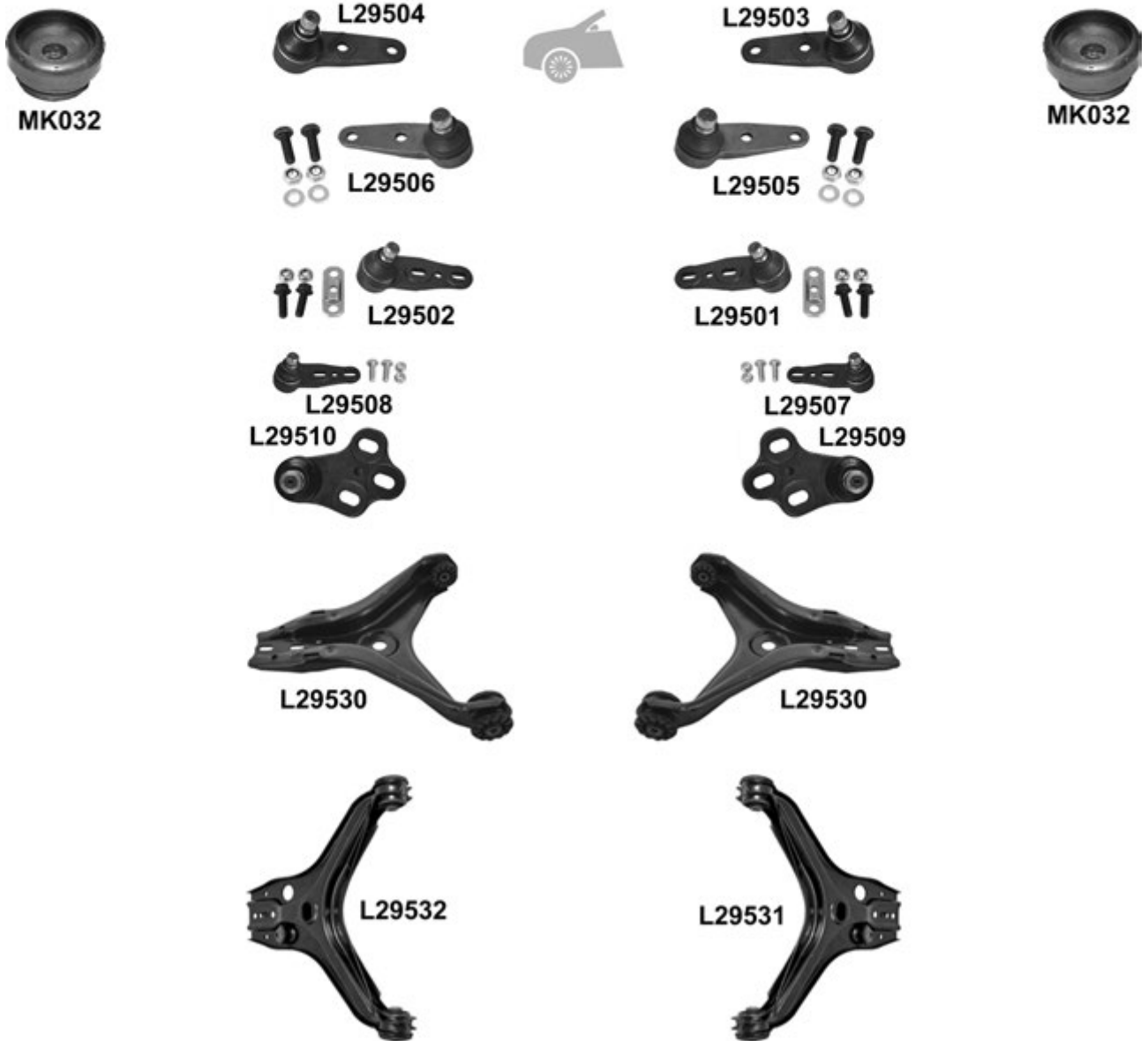

90 09.86 → 08.89, ch. 89 H 300 001 → 89 K 520 000



L29804



L29806



L29837



L29804



L29806



L29837



L29805



L29810



L29805



L29810

				← → Thread		Part Of	QPA			
⊕		↔		L29016	L29016	F 14x1,5 U	2	811 419 812 A		
					L29040		1	893 419 802		
					L29014		1	811 419 801 E		
🚗		⊥		ch. → 89 J 373 598, 17mm		L29029		1	811 419 831 B	
					L29503		1	855 407 366		
					L29504		1	855 407 365		
				ch. 89 J 373 599 →, 19mm		L29505		1	893 407 366 A	
					L29506		1	893 407 365 A		
				ch. → 89 J 373 598, 17mm		L29501		1	855 407 366 A/B	
					L29502		1	855 407 365 A/B		
				ch. 89 J 373 599 →, 19mm, (-) 2.3 Ltr.		L29507		1	893 407 366 F	
					L29508		1	893 407 365 F		
				2.3 ltr., ch. 89 J 373 599 →, 19mm		L29509		1	893 407 366 E	
					L29510		1	893 407 365 E		
				🔫	⊥		4 cyl.	L29530	L29530	
5 cyl.,		L29531					1	893 407 148 C		
	L29532		1				893 407 147 C			
🔫	⊥			L29804	L29804		4	811 407 181 A		
				L29806	L29806		4	857 407 181		
🔫				L29837	L29837	Anti-roll bar	2	823 411 313 A		
			KIT	MK032	MK032		2	8A0 412 323 B		
🔫	⊥	transverse		L29810	L29810		2	431 505 172		
				L29805	L29805	Hub carrier	2	811 511 247		

90 08.89 → 09.91, ch. 8A L 000 001 → 8A M 500 000

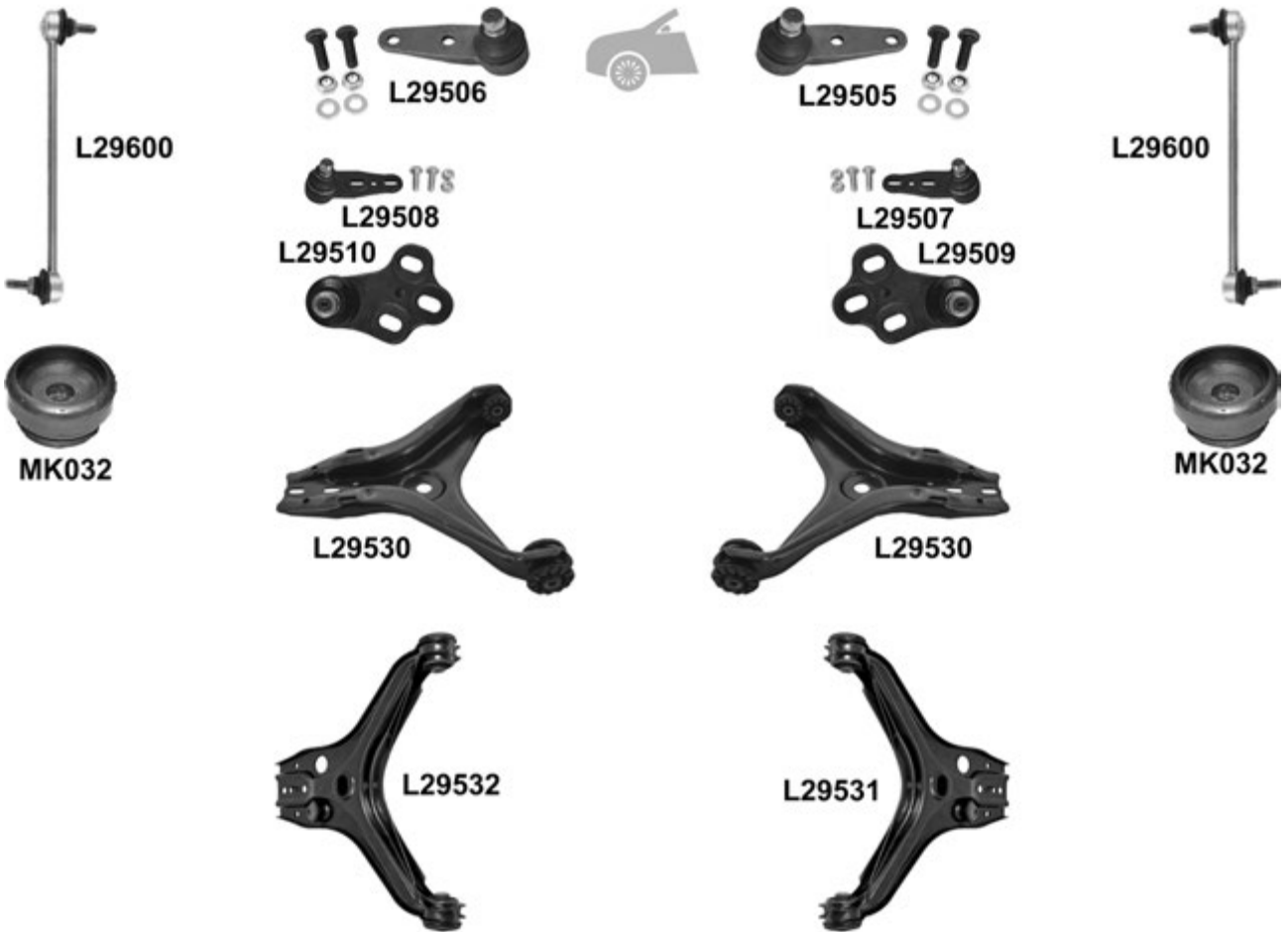
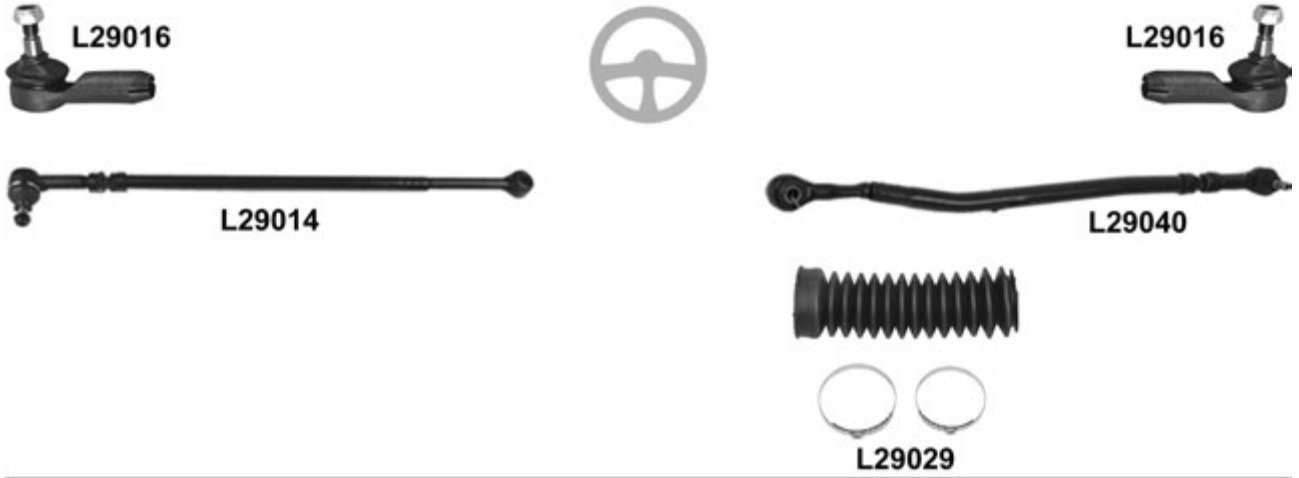

90 08.89 → 09.91, ch. 8A L 000 001 → 8A M 500 000

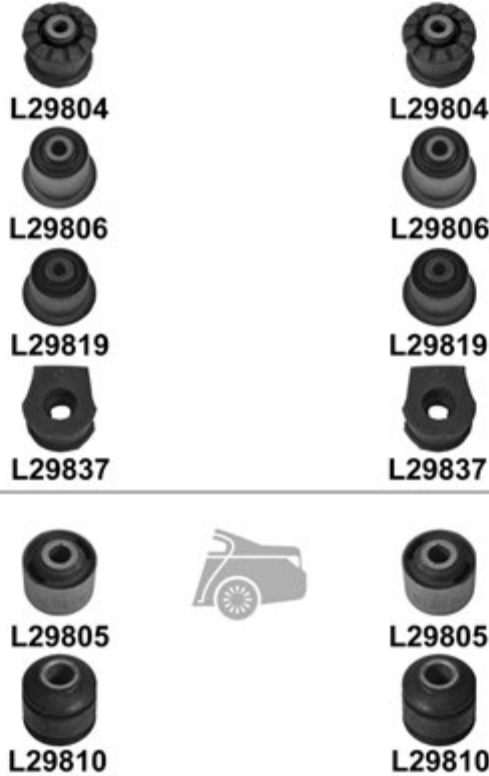

			←	→	Thread	Part Of	QPA		
				L29016	L29016	F 14x1,5 ⌀	2	811 419 812 A	
					L29040		1	893 419 802	
					L29014		1	811 419 801 E	
						L29029		1	811 419 831 B
					L29505		1	893 407 366 A	
					L29506		1	893 407 365 A	
				(-) 2.3 ltr.,	L29507		1	893 407 366 F	
					L29508		1	893 407 365 F	
				2.3 ltr.	L29509		1	893 407 366 E	
			L29510		1	893 407 365 E			
				4 cyl.	L29530	L29530		2	893 407 147 G
				5 cyl.,		L29531		1	893 407 148 C
					L29532		1	893 407 147 C	
				4 cyl.	L29804	L29804		4	811 407 181 A
			5 cyl., (-) 2.3 E 125 kw, Mot/Eng 7A	L29806	L29806		4	857 407 181	
			2.3 E 125 kw, Mot/Eng 7A	L29819	L29819		4	893 407 181	
				L29837	L29837	Anti-roll bar	2	823 411 313 A	
			ch. 8A L 038 758 →	L29600	L29600		2	8A0 407 465 C	
			KIT	MK032	MK032		2	8A0 412 323 B	
			transverse	L29810	L29810		2	431 505 172	
				L29805	L29805	Hub carrier	2	811 511 247	

90 Quattro 08.84 → 04.87, ch. 85 F 000 001 → 85 H 030 215

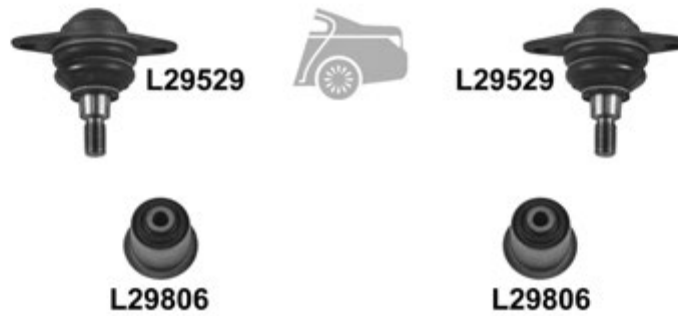

		i		←	→	Thread	Part Of	QPA	i
		↔		L29016	L29016	F 14x1,5 ♂		2	811 419 812 A
			ch. → 81 G 160 000		L29015			1	811 419 802 J
			ch. 81 G 160 001 →		L29301			1	811 419 802 K
				L29014			1	811 419 801 E	
		↓	(-)	L29557	L29557			2	857 407 365
					L29501			1	857 407 366 A/B
				L29502			1	857 407 365 A/B	
		↓ ▲ ▼		L29806	L29806			4	857 407 181
			KIT	MK032	MK032			2	8A0 412 323 B
		↓ ▲ ▼		L29806	L29806			4	857 407 181
		↓		L29529	L29529			2	857 505 365

90 Quattro 09.86 → 10.91, ch. 89 H 300 001 → 8A N 200 000

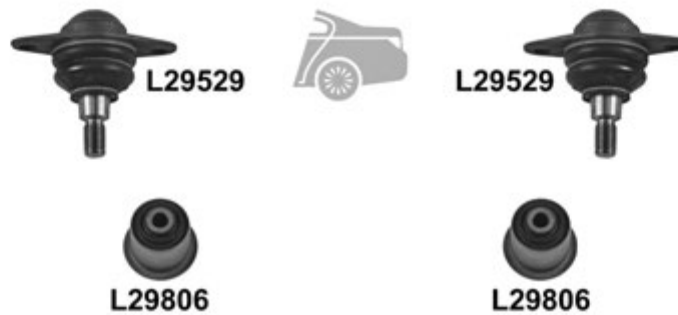
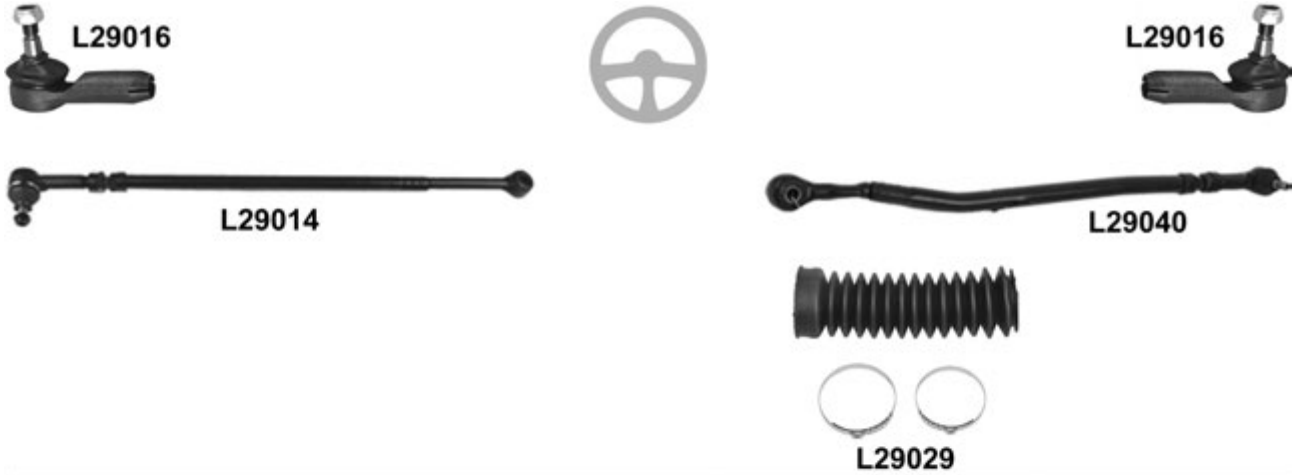

90 Quattro 09.86 → 10.91, ch. 89 H 300 001 → 8A N 200 000

			i	←	→	Thread	Part Of	QPA	i	
				L29016	L29016	F 14x1,5 U		2	811 419 812 A	
					L29040				1	893 419 802
				L29014					1	811 419 801 E
					L29029				1	811 419 831 B
					L29501			1	855 407 366 A/B	
				L29502			1	855 407 365 A/B		
					L29507		1	893 407 366 F		
				L29508		1	893 407 365 F			
				L29509		1	893 407 366 E			
				L29510		1	893 407 365 E			
					L29806	L29806			4	857 407 181
					L29819	L29819			4	893 407 181
			L29600	L29600			2	8A0 407 465 C		
			KIT	MK032	MK032			2	8A0 412 323 B	
				L29806	L29806			4	857 407 181	
				L29529	L29529			2	857 505 365	

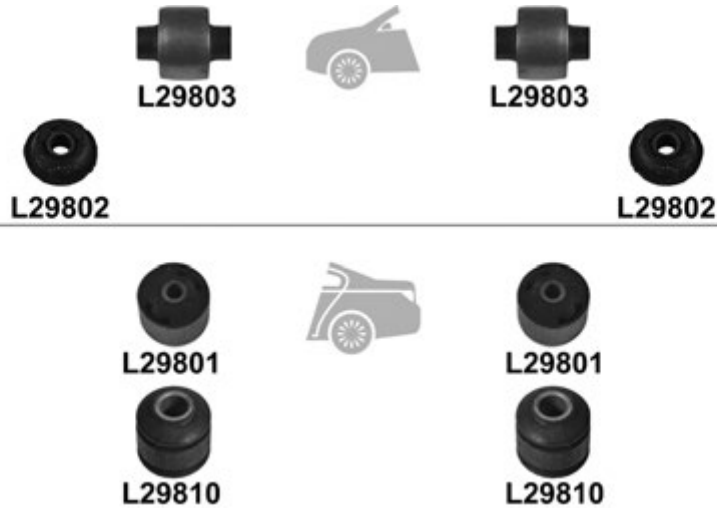
100, 100 Avant 06.76 → 08.82, ch. 43 7 2000 001 → 43 C 100 000

			i	←	→	Thread	Part Of	QPA	i
				L29803	L29803			2	431 407 183 A
				L29802	L29802			4	431 407 181 F
			transverse	L29810	L29810			2	431 505 172
				L29801	L29801		Hub carrier	2	431 511 247 C

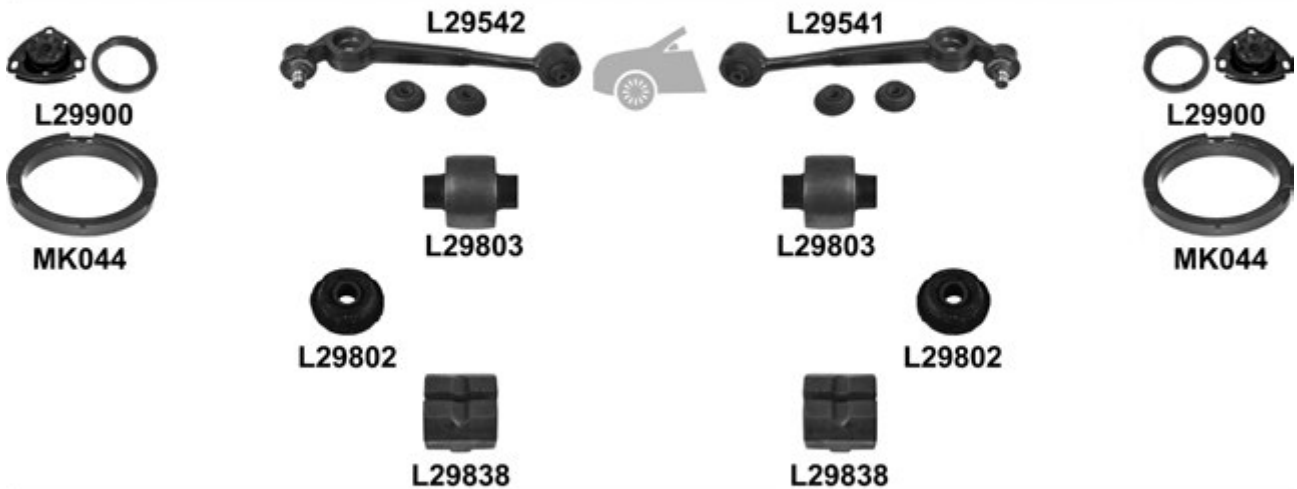
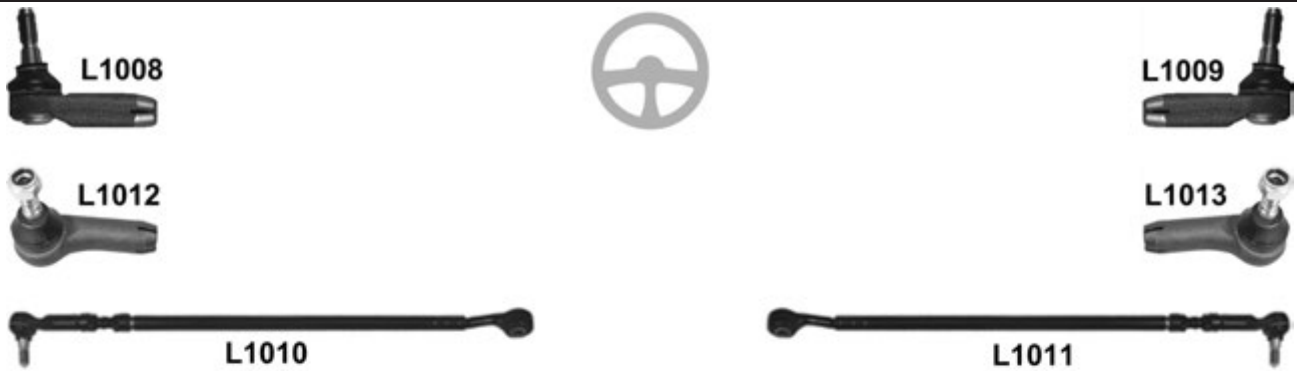
100, 100 Avant (44) 08.82 → 11.90, ch. 44 D 000 001 → 44 M 050 000

				← → Thread		Part Of	QPA				
⊕		↔	ch. → 44 E 068 500		L1009	F 14x1,5 ∪		1	443 419 812 C		
			If steering rod is replaced by a new version, use L 1012 / 1013	L1008		F 14x1,5 ∪		1	443 419 811 C		
			ch. 44 E 068 501 →		L1013		F 16x1,5 ∪		1	443 419 812 D	
					L1012		F 16x1,5 ∪		1	443 419 811 D	
						L1011			1	443 419 802 E	
		ch. 44 D 068 501 →		L1010			1	443 419 801 E			
⊖		⊥	⊕, ch. 44 M 002 674 →, 19mm	<input checked="" type="checkbox"/>	L29541			1	441 407 156		
					L29542			1	441 407 155		
				↕↔		L29803	L29803		L1004/L1005	2	431 407 183 A
				↕↔		L29802	L29802		L1004/L1005	4	431 407 181 F
					ch. 44 H 180 001 →, (-) Taxi/HD Springs/100 Sport		L29838	L29838	Anti-roll bar	2	443 411 327
					(+) MK044	KIT	L29900	L29900		2	443 412 377
							MK044	MK044		2	441 412 249 D
⊖		⊥	transverse		L29810	L29810		2	431 505 172		
					L29801	L29801	Hub carrier	2	431 511 247 C		
					MK119	MK119		2			

100, 100 Avant 12.90 → 08.94, ch. F 4A M 000 001 → F 4A R 120 000



				← → Thread		Part Of	QPA	i		
⊕	↔	ch. → 4AP 001 983	L29107	F 18x1,5		1	4A0 419 812 A			
			L29108	F 18x1,5		1	4A0 419 811 A			
	↔	ch. 4AP 001 984 →	L1013	F 16x1,5		1	443 419 812 D			
			L1012	F 16x1,5		1	443 419 811 D			
	↔	ch. 4AP 001 984 →	L29339	F 16x1,5		1	4A0 419 802 A			
			L29340	F 16x1,5		1	4A0 419 801 A			
⊖	⊥	☑	L29519			1	4A0 407 152			
			L29520			1	4A0 407 151			
	⊥ ↔		L29813	L29813		2	4A0 407 183 D	L29519/L29520		
			L29814	L29814		4	4A0 407 181 A	L29519/L29520		
	⊥ ↔			L29842	L29842		2	4A0 411 327 A	Anti-roll bar	
		Mot/Eng AAH/AAR/AAS/AAT/ABC/ABP/ACE, (-) 100 Sport, 25mm	KIT	L29903	L29903		2	4A0 412 377 C		
		(+) MK043		MK043	MK043		2	4A0 4412 249		
⊖	⊥	transverse	L29810	L29810		2	431 505 172			
			L29811	L29811		2	4A0 511 247	Hub carrier		
				MK119	MK119		2			

100 Quattro, 100 Avant Quattro (44Q) 08.84 → 11.90

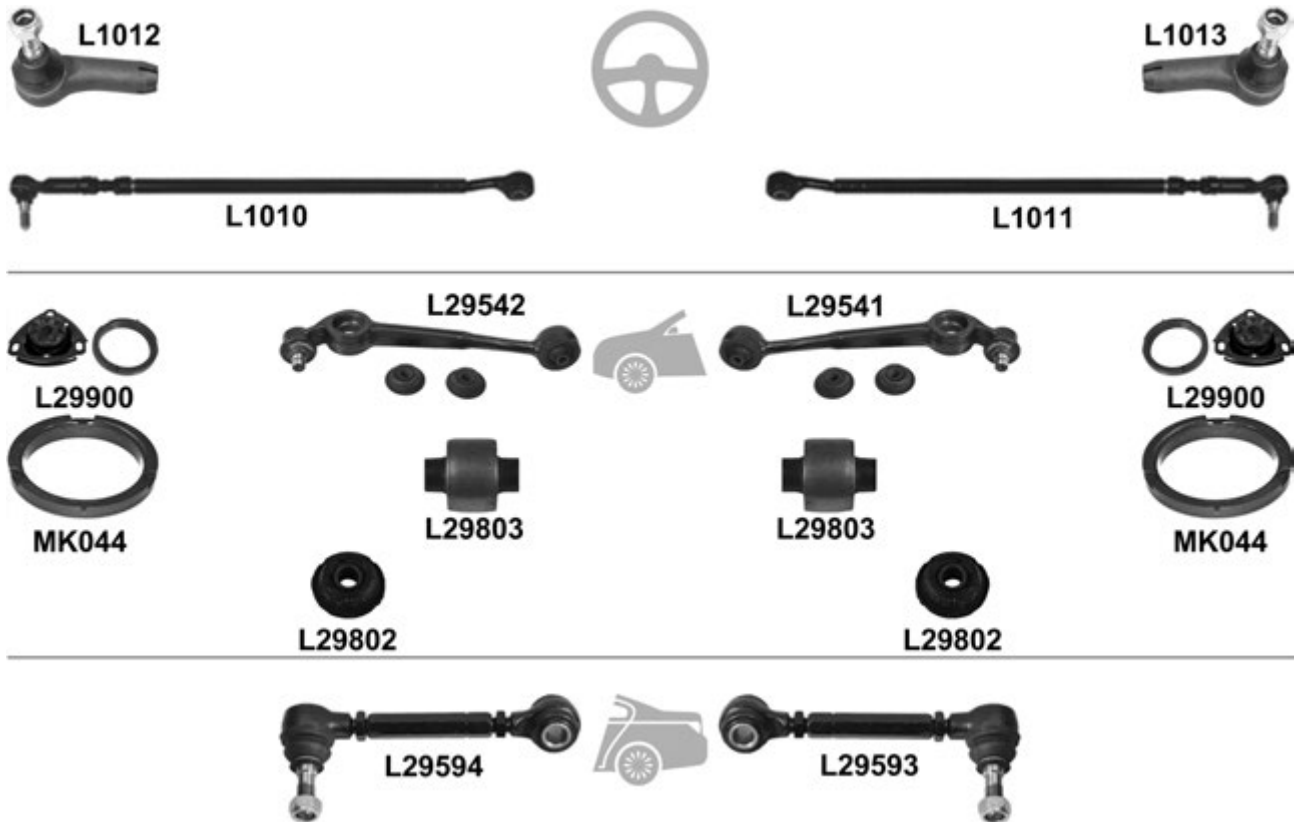

						←	→	Thread	Part Of	QPA		
⊕		↔					L1013	F 16x1,5		1	443 419 812 D	i
							L1012	F 16x1,5		1	443 419 811 D	
							L1011			1	443 419 802 E	
							L1010			1	443 419 801 E	
⊖		⊥	Mot/Eng MC/1B ch. 44 L 111 381 →, 19mm	<input checked="" type="checkbox"/>		L29541				1	441 407 156	
						L29542			1	441 407 155		
						L29803	L29803		L1004/L1005	2	431 407 183 A	
						L29802	L29802		L1004/L1005	4	431 407 181 F	
						L29900	L29900	KIT		2	443 412 377	
						MK044	MK044			2	441 412 249 D	
⊖		⊥	ch. 44 G 073 363 →	<input checked="" type="checkbox"/>		L29593				1	443 505 352 P	
						L29594				1	443 505 351 P	

100 Quattro / 100 Avant Quattro (4A, C4) 12.90 → 06.94

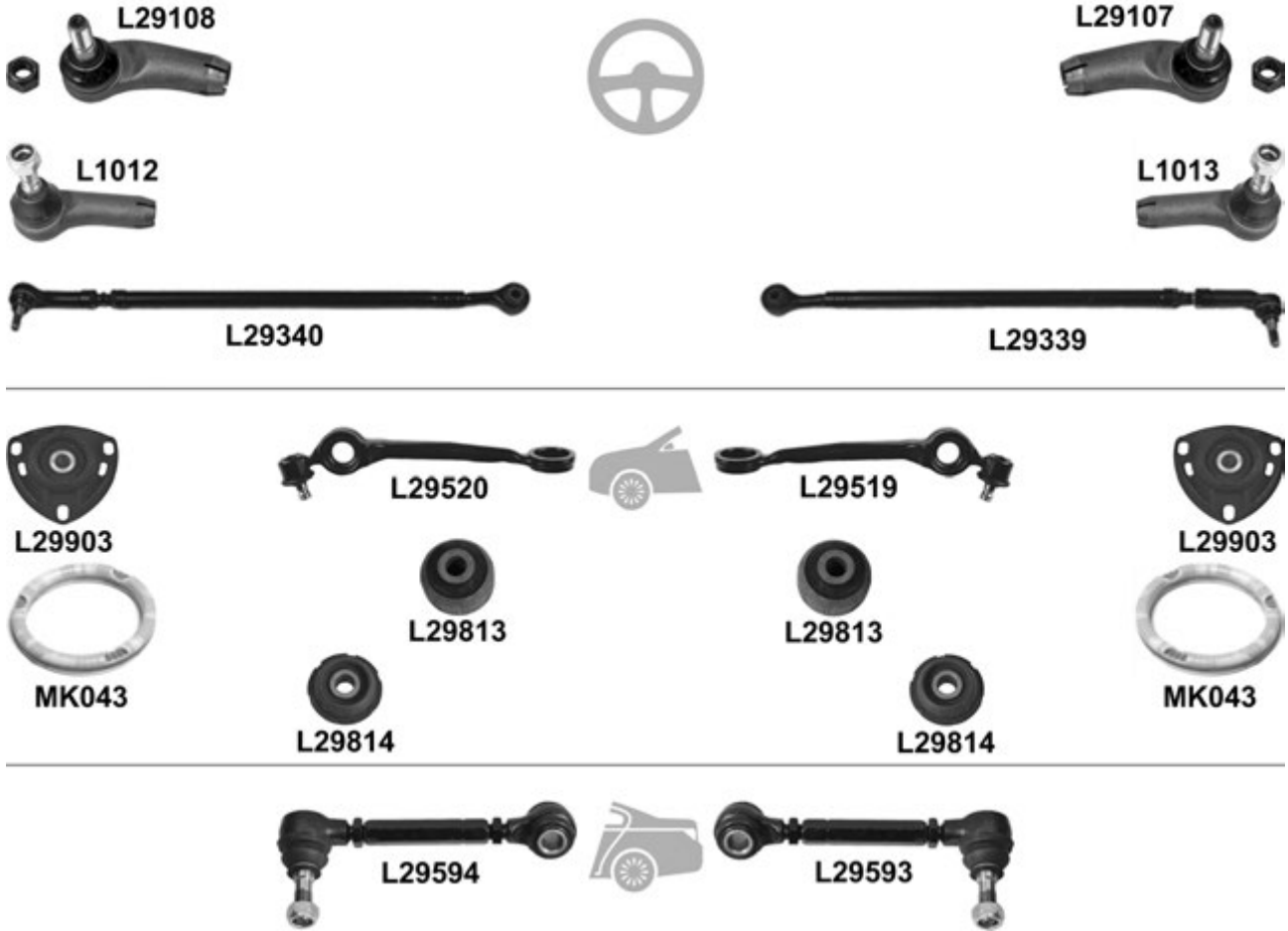

				←	→	Thread	Part Of	QPA			
		↔	ch. → 4AP 001 983		L29107	F 18x1,5		1	4A0 419 812 A		
					L29108	F 18x1,5		1	4A0 419 811 A		
		↔	ch. 4AP 001 984 →		L1013	F 16x1,5		1	443 419 812 D		
					L1012	F 16x1,5		1	443 419 811 D		
						L29339	F 16x1,5		1	4A0 419 802 A	
						L29340	F 16x1,5		1	4A0 419 801 A	
		⊥		<input checked="" type="checkbox"/>	L29519			1	4A0 407 152		
					L29520			1	4A0 407 151		
		↕ ↔				L29813	L29813		L29519/L29520	2	4A0 407 183 D
						L29814	L29814		L29519/L29520	4	4A0 407 181 A
			(+) MK043	KIT	L29903	L29903			2	4A0 412 377 C	
					MK043	MK043			2	4A0 4412 249	
	⊥			<input checked="" type="checkbox"/>	L29593			1	443 505 352 P		
					L29594			1	443 505 351 P		

200 09.79 → 10.82, ch. 43 A 0045 129 → 43 D 033 670



Thread

Part Of

QPA



				←	→	Thread	Part Of	QPA	
				L29803	L29803			2	431 407 183 A
				L29802	L29802			4	431 407 181 F
		transverse		L29810	L29810			2	431 505 172
				L29801	L29801		Hub carrier	2	431 511 247 C

200, 200 Avant (44) 08.83 → 12.90, ch. 44 E 001 001 → 44 J 200 099

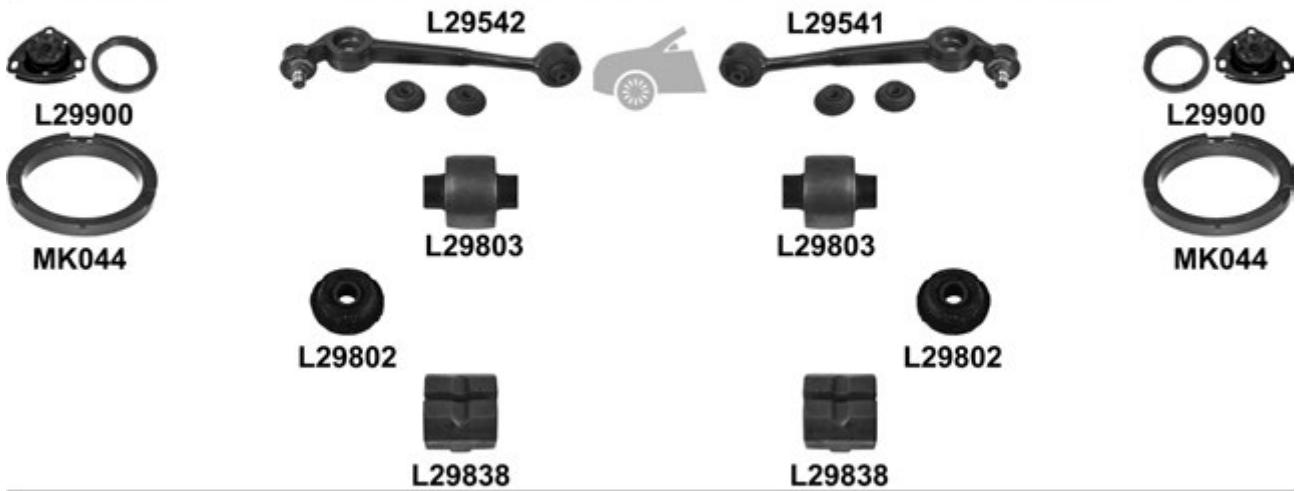
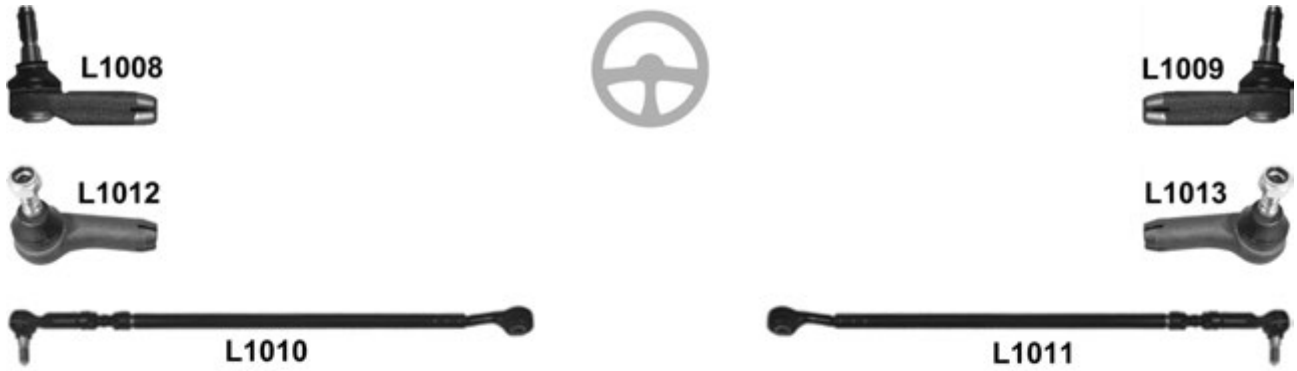

				← → Thread		Part Of	QPA					
⊕		↔	ch. → 44 E 068 500		L1009	F 14x1,5 ∪		1	443 419 812 C			
			If steering rod is replaced by a new version, use L 1012 / 1013	L1008		F 14x1,5 ∪		1	443 419 811 C			
			ch. 44 E 068 501 →		L1013		F 16x1,5 ∪		1	443 419 812 D		
					L1012		F 16x1,5 ∪		1	443 419 811 D		
				L1011					1	443 419 802 E		
		ch. 44 D 068 501 →	L1010				1	443 419 801 E				
⊖		⊥	19mm	<input checked="" type="checkbox"/>	L29541			1	441 407 156			
					L29542			1	441 407 155			
					↕↔	L29803	L29803		L1004/L1005	2	431 407 183 A	
					↕↔	L29802	L29802		L1004/L1005	4	431 407 181 F	
						ch. 44 H 180 001 →, (-) Taxi/HD Springs	L29838	L29838		Anti-roll bar	2	443 411 327
						(+) MK044	KIT	L29900	L29900		2	443 412 377
							MK044	MK044			2	441 412 249 D
⊖		⊥	transverse	L29810	L29810			2	431 505 172			
				L29801	L29801		Hub carrier	2	431 511 247 C			
				MK119	MK119			2				

AUTOBIANCHI

A 112 → 10.82



				← → Thread		Part Of	QPA		
⊕					L1564		1	4371156	i
				L1563			1	4371155	
🚗		⊥	☑	L6001	L6001		2	4364095	

A 112 11.82 → 12.86

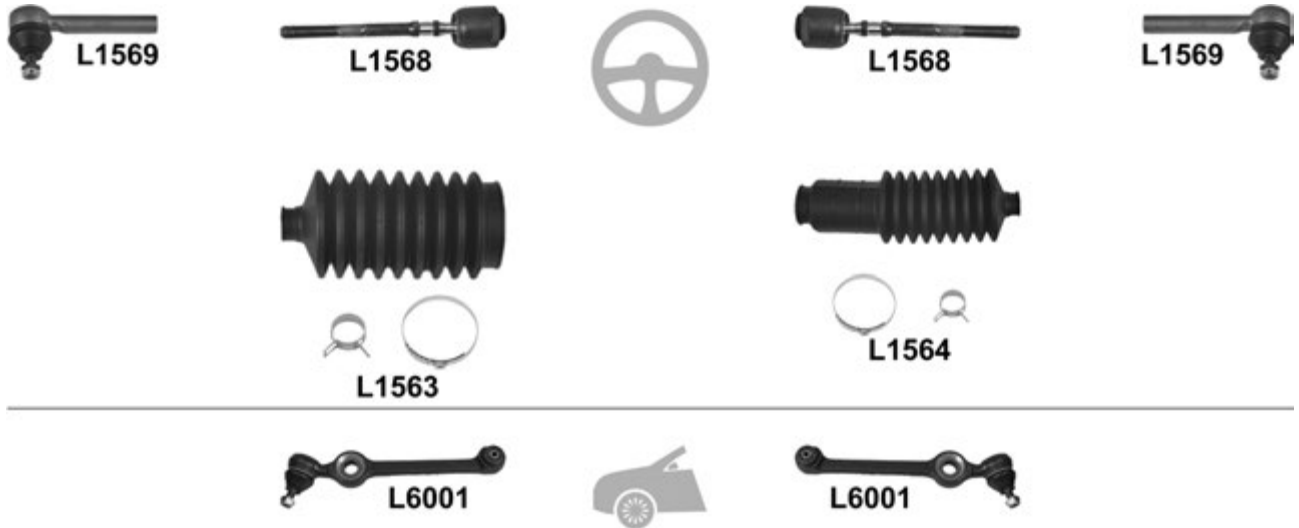

				← → Thread		Part Of	QPA		
⊕		↔		L1569	L1569	F 12x1,5 ∪	2	5960036	i
				L1568	L1568	M 12x1,5 / F 14x1,5 ∪	2	5960321	
					L1564		1	4371156	
				L1563			1	4371155	
🚗		⊥	☑	L6001	L6001		2	4364095	

BMW

X1 E84 10.09 →

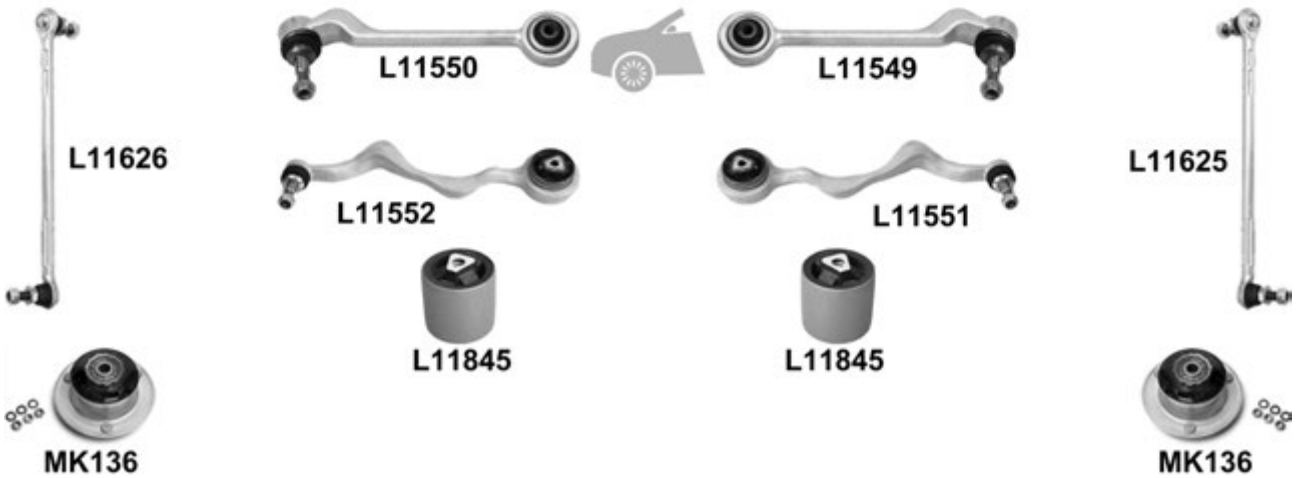
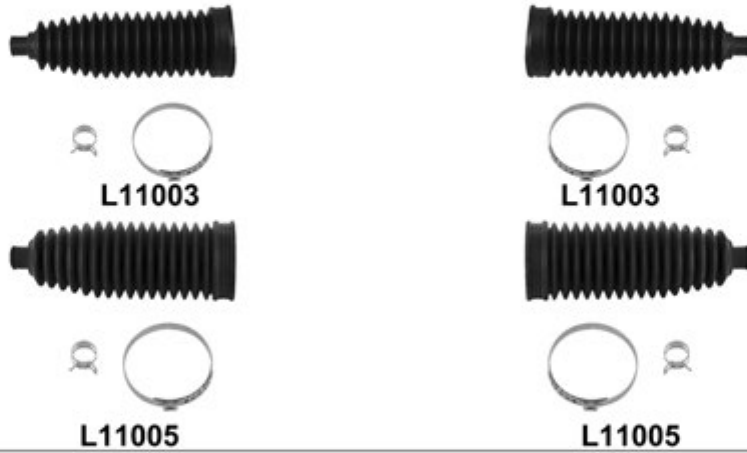
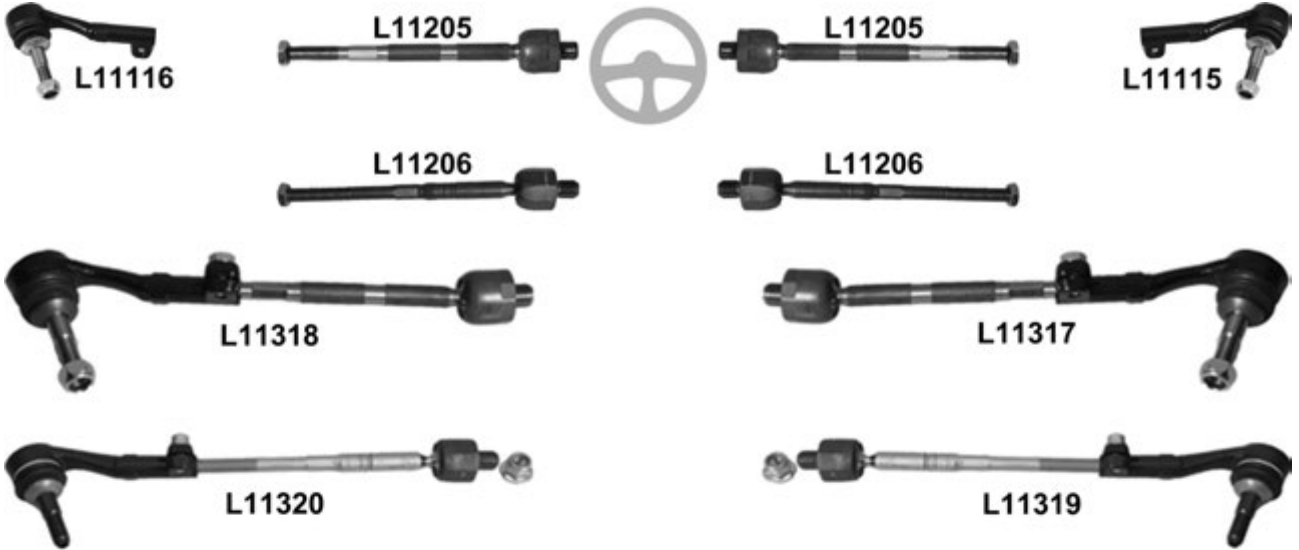

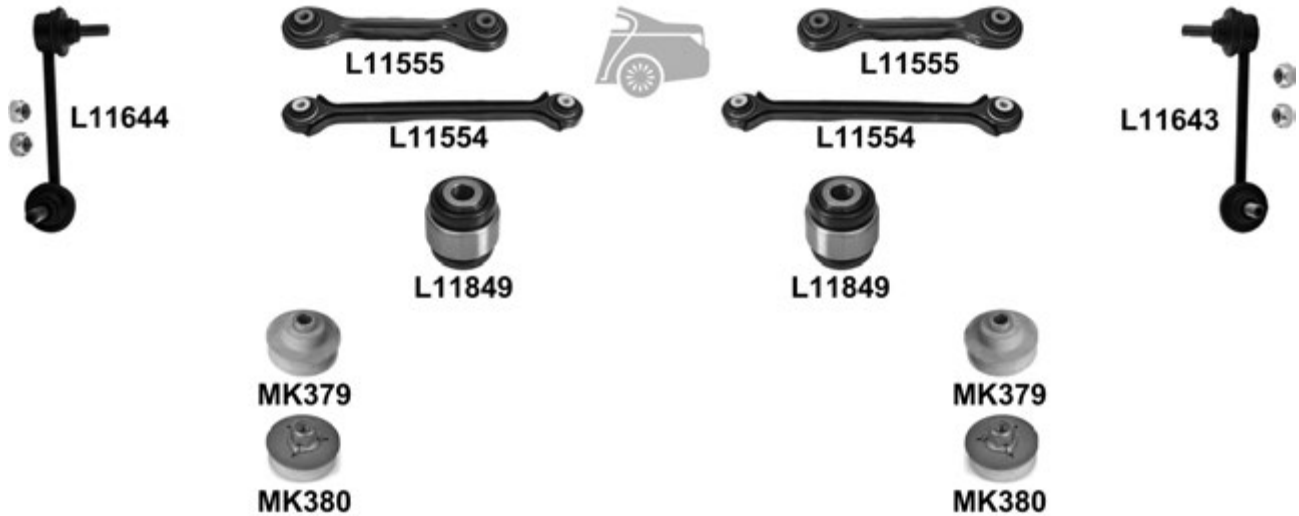
X1 E84 10.09 →

			←	→	Thread	Part Of	QPA		
		↔	sDrive	L11115	F 14x1,5 ∪		1	32 10 6 765 090	
				L11116	F 14x1,5 ∪		1	32 10 6 765 089	
			sDrive, TRW	L11205	L11205	M 14x1,5 / M 18x1,5 ∪		2	
			sDrive, ZF	L11206	L11206	M 14x1,5 / M 18x1,5 ∪		2	
			sDrive, Hydraulic .TRW		L11317			1	32 21 6 762 244
					L11318			1	32 21 6 762 243
					L11319			1	32 10 6 765 236
			Hydraulic .TRW	L11320				1	32 10 6 765 235
				L11003	L11003			2	32 10 6 765 079
			Electric .ZF	L11005 ⁰	L11005 ⁰			2	32 10 6 765 234
		⊥ ▼	sDrive	<input checked="" type="checkbox"/>	L11549			1	31 12 6 763 700
			L11550			1	31 12 6 763 699		
	⊥ ▲	sDrive	<input checked="" type="checkbox"/>	L11551				1	31 12 6 769 802
		L11552			1	31 12 6 769 801			
		↔ → ←	sDrive		L11845	L11845	L11551/L11552	2	31 12 0 393 540
			sDrive		L11625			1	31 35 6 765 934
				L11626			1	31 35 6 765 933	
			KIT	MK136	MK136		2	31 33 6 760 943	
		↕ ▲	<input checked="" type="checkbox"/>	L11555	L11555		2	33 32 6 765 425	
			<input checked="" type="checkbox"/>	L11554	L11554		2	33 32 6 763 471	
				L11849	L11849		Hub carrier	2	33 32 6 756 249
				L11643 ⁰			1	33 50 6 785 608	
				L11644 ⁰				1	33 50 6 785 607
				MK379	MK379		2		
	⊥		MK380	MK380			2		

X3 E83 01.04 →



L11004

L11004



L10034

L10034



L11820

L11820



L11815

L11815



L11816

L11816

X3 E83 01.04 →

				← → Thread		Part Of	QPA	i		
⊕		↔		L11117	L11117	F 14x1,5 ∪	2	32 30 3 418 202		
				L11207	L11207	M 14x1,5 / M 18x1,5 ∪	2			
				L11327	L11327		2	32 10 3 444 999		
				(-) Servotronic	L11004	L11004		2	32 12 6 751 026	
				Servotronic	L10034 ⁰	L10034 ⁰		2	32 10 6 765 782	
🚗		↕↔		L11556	L11556		2	31 10 3 418 341		
		↕↘		☑		L11559		1	31 10 3 451 882	
				L11560				1	31 10 3 451 881	
		↕↗		☑		L11561		1	31 10 3 443 128	
				L11562				1	31 10 3 443 127	
		↘↔		L11820	L11820		2	31 12 1 124 622		
						L11627		1	31 30 3 414 300	
				L11628				1	31 30 3 414 299	
				KIT	MK136	MK136		2	31 33 6 752 735	
	🚗		→←		L11814	L11814		2	33 32 1 137 571	
			longitudinal	L11830	L11830		2	33 32 1 097 009		
		→←		L11815	L11815		2	33 32 1 138 383		
		↔↔		L11816	L11816		2	33 32 1 136 311		
				L11624	L11624		2	33 50 3 414 297		
				MK206	MK206		2	33 50 3 450 542		

X3 F25 09.10 →

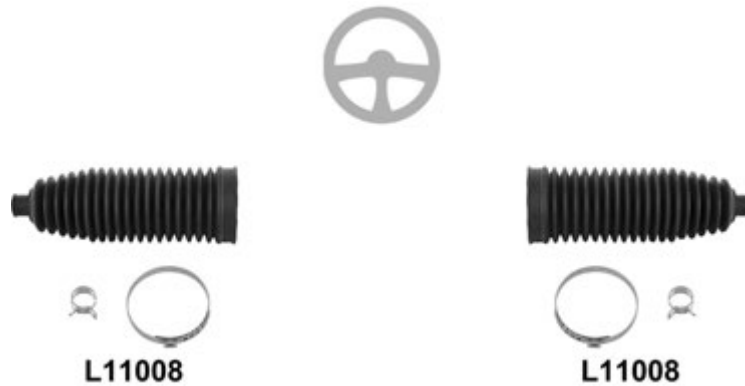

				← → Thread		Part Of	QPA	i	
⊕			ThyssenKrupp, ø 16mm, Ø 63mm, L= 204mm	L11008 ⁰	L11008 ⁰		2	32 10 6 795 845	

X4 F26 04.14 →

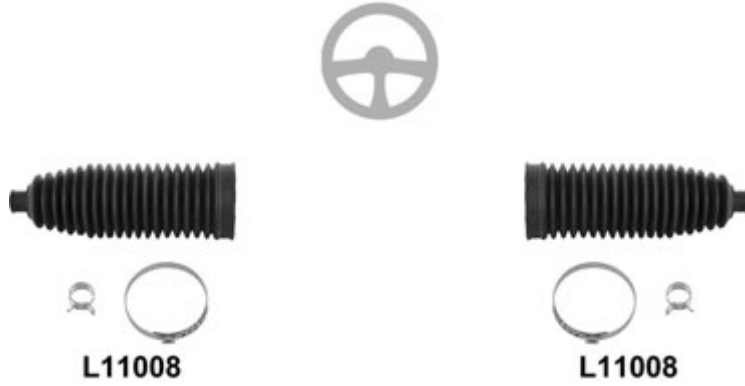

Thread

Part Of

QPA



		ThyssenKrupp, ø 16mm, Ø 63mm, L= 204mm	L11008 ⁰	L11008 ⁰			2	32 10 6 795 845
--	--	--	---------------------	---------------------	--	--	---	-----------------

X5 E53 05.00 →

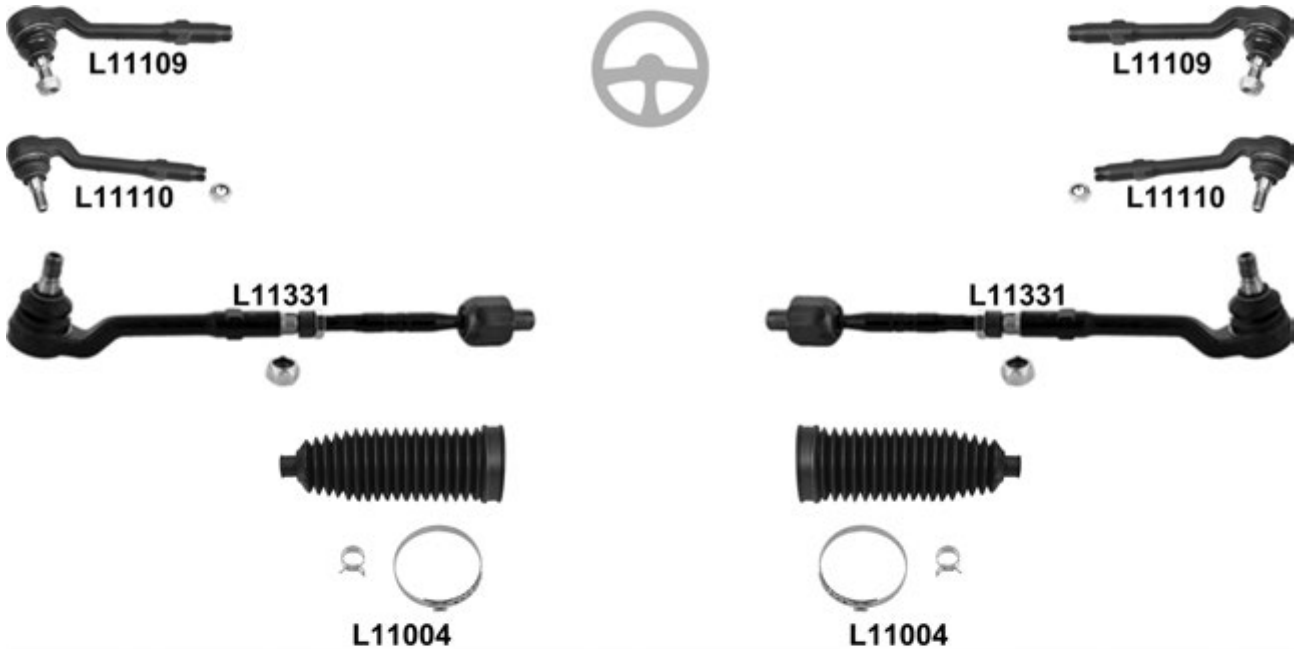

X5 E53 05.00 →



		i		←	→	Thread	Part Of	QPA	i	
		↔	→ 10.03	L11109	L11109	F 14x1,5 U		2	32 21 1 096 327	
			11.03 →	L11110	L11110	F 14x1,5 U		2	32 21 6 760 354	
			→ 10.03	L11331	L11331			2	32 21 6 751 277	
			(-) Servotronic	L11004	L11004			2	32 12 6 751 026	
		↕ ↔		L11557	L11557			2	31 10 3 418 341	
		↕ ▼		<input checked="" type="checkbox"/>	L11545			1	31 12 6 760 276	
				L11546				1	31 12 6 760 275	
		↕ ▲		<input checked="" type="checkbox"/>	L11547			1	31 12 1 096 170	
			↕ ▼ ↔		L11820	L11820			2	31 12 1 124 622
			↕ ▲ ↔		L11837	L11837			2	31 12 1 096 372
					L11615				1	31 35 6 750 704
					L11616				1	31 35 6 750 703
				MK273	MK273			2		
		↕ ▲		L11563	L11563			2	33 32 6 770 749	
				L11842	L11842		Hub carrier	2	33 32 6 767 748	
				L11614	L11614			2	33 55 1 096 735	
				MK274	MK274			2		

X5 E70 02.07 →



L11008

L11008

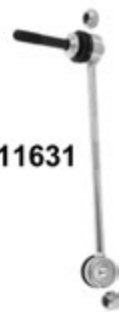

L11632

L11574

L11573

L11631



L11634

L11576

L11575

L11633



L11578

L11577



L11851

L11851



L11852

L11852



L11635

L11635

X5 E70 02.07 →

			←	→	Thread	Part Of	QPA		
		↔			L11123 L11123	F 14x1,5 U		2 32 10 6 780 984	
					L11328 L11328		2	32 10 6 780 985	
			ThyssenKrupp, ø 16mm, Ø 63mm, L= 204mm		L11008° L11008°		2	32 10 6 779 622	
		↑	(-) X5M	<input checked="" type="checkbox"/>		L11573		1 31 12 6 776 418	
					L11574		1	31 12 6 776 417	
	↓			<input checked="" type="checkbox"/>		L11575		1 31 12 6 771 894	
					L11576		1	31 12 6 771 893	
	↑	(-) X5M	<input checked="" type="checkbox"/>		L11577		1	31 12 6 773 950	
					L11578		1	31 12 6 773 949	
		↔→←				L11851 L11851	L11573/L11574	2	
		↓↑↔→←				L11852 L11852	L11577/L11578	2	31 10 6 778 015
		(-)					L11631		1 31 35 6 773 024
						L11632		1	31 35 6 773 023
						L11633		1 37 11 6 771 930	
					L11634		1	37 11 6 771 929	
					L11635 L11635		2 33 55 6 771 937		

X6 E71 05.08 →

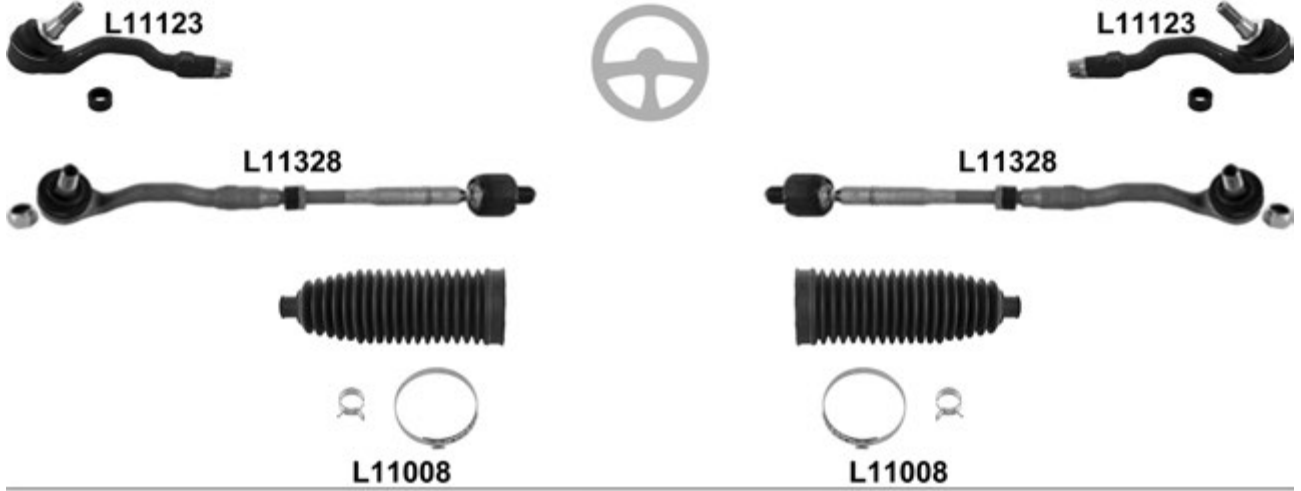

X6 E71 05.08 →

		i		←	→	Thread	Part Of	QPA	i	
		↔				L11123 L11123 F 14x1,5 U		2	32 10 6 780 984	
						L11328 L11328		2	32 10 6 780 985	
						L11008° L11008°		2	32 10 6 779 622	
		↑	(-) X6 M	<input checked="" type="checkbox"/>		L11573		1	31 12 6 776 418	
					L11574		1	31 12 6 776 417		
		↓		<input checked="" type="checkbox"/>		L11575		1	31 12 6 771 894	
					L11576		1	31 12 6 771 893		
		↓	(-) X6 M	<input checked="" type="checkbox"/>		L11577		1	31 12 6 773 950	
					L11578		1	31 12 6 773 949		
		↑→←				L11851 L11851	L11573/L11574	2		
		↓↑→←				L11852 L11852	L11577/L11578	2	31 10 6 778 015	
				(-) Dynamic Drive/X6M			L11631		1	31 35 6 773 024
						L11632		1	31 35 6 773 023	
			Dynamic Drive/X6M			L11633		1	37 11 6 771 930	
					L11634		1	37 11 6 771 929		
					L11635 L11635		2	33 55 6 771 937		

Z1 06.88 → 06.91

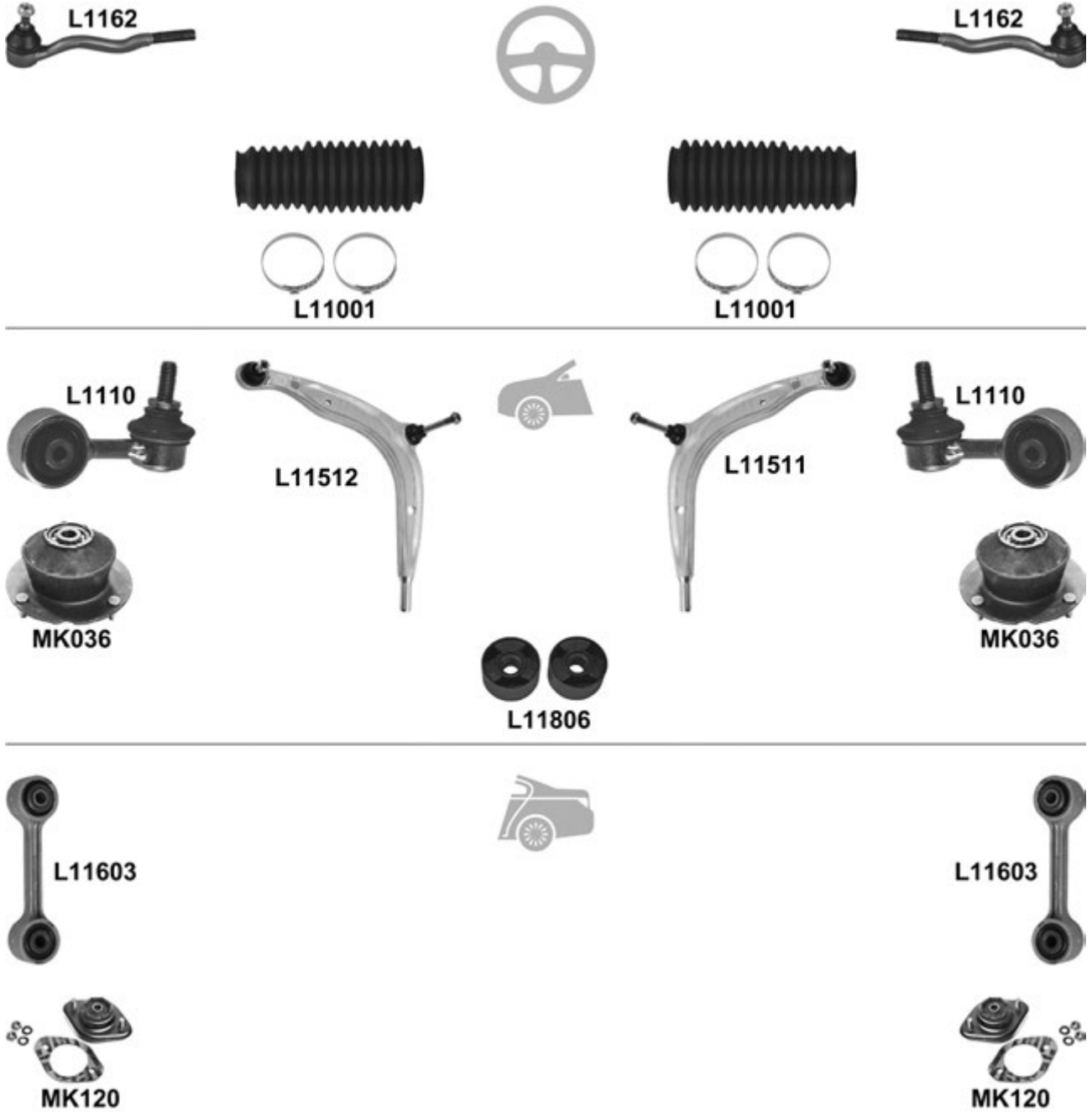

		i		←	→	Thread	Part Of	QPA	i
⊕		↔		L1162	L1162	F 14x1,5 U		2	32 11 1 126 757
				L11001	L11001			2	32 11 1 127 104
⊖		⊥	(-) L11806		L11511			1	31 12 1 130 824
				L11512				1	31 12 1 130 823
				KIT L11806				1	31 12 9 058 931
				L1110	L1110			2	31 35 1 128 737
⊖				KIT MK036 MK036				2	31 33 1 139 452
				L11603	L11603			2	33 55 1 126 932
				MK120	MK120			2	33 52 1 128 819

Z3 10.95 → 01.03

Z3 Coupe 04.97 → 06.03

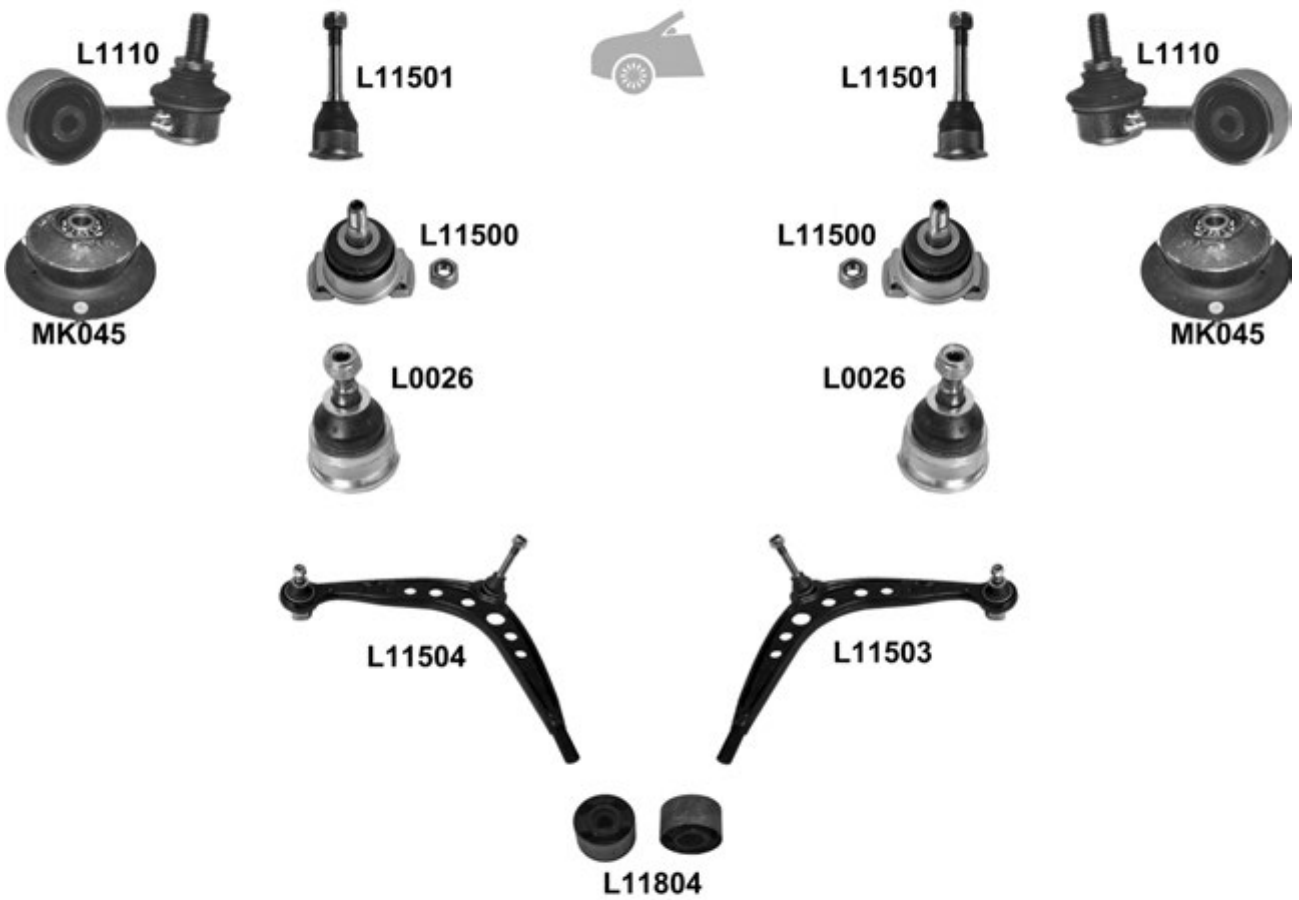
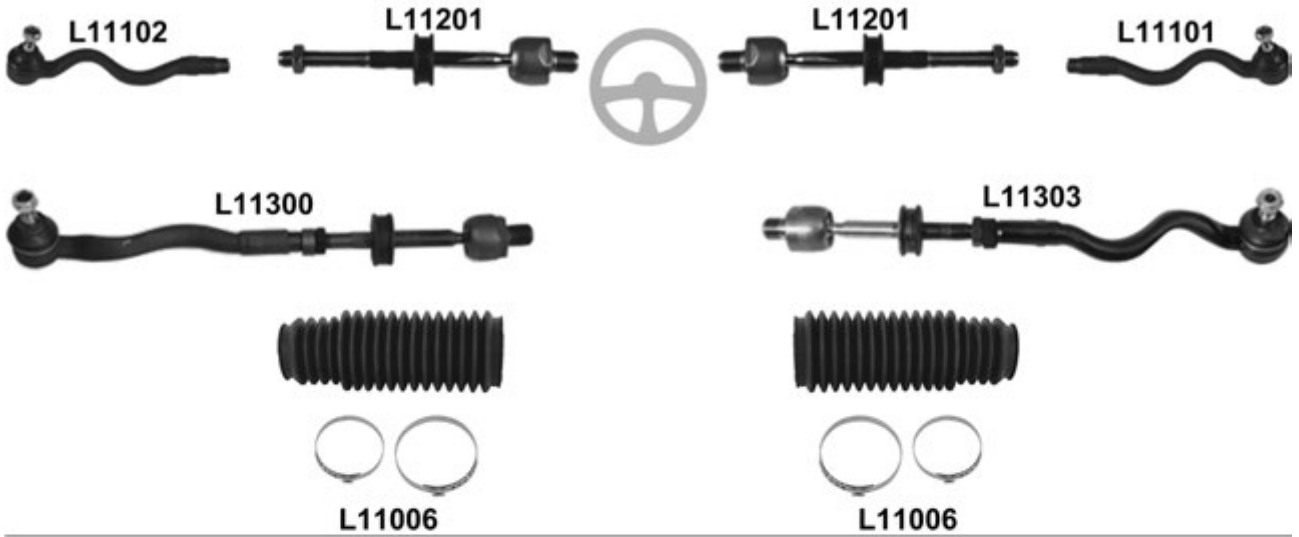

Z3 10.95 → 01.03
 Z3 Coupe 04.97 → 06.03

		i		←	→	Thread	Part Of	QPA	i
		↔			L11101	F 14x1,5 ∪		1	32 11 1 139 314
					L11102	F 14x1,5 ∪		1	32 11 1 139 313
				L11201	L11201	M 14x1,5 / M 18x1,5		2	
					L11303			1	3211 1139 316
				L11300				1	3211 1139 315
			L11006 ⁰	L11006 ⁰			2	32 21 1 139 786	
		↕↔	(-) M 3.2	L11501	L11501			2	31 12 1 139 131
		↕↔	(-) M 3.2	L11500	L11500			2	31 12 1 140 398
			HD Version, (-) M 3.2	L0026	L0026			2	31 12 1 140 398
		⊥	(-) M 3.2		L11503			1	31 12 6 758 514
					L11504			1	31 12 6 758 513
			(-) M 3.2	KIT	L11804			1	31 12 9 059 288
			(-) M 3.2		L1110	L1110		2	31 35 1 091 764
			(-) M 3.2	KIT	MK045	MK045		2	31 33 1 092 885
			KIT	L11810	L11810			2	33 32 9 061 945
				L11604	L11604			2	33 55 1 135 307
				MK121	MK121			2	33 52 1 092 362

Z4, E85 02.03 →

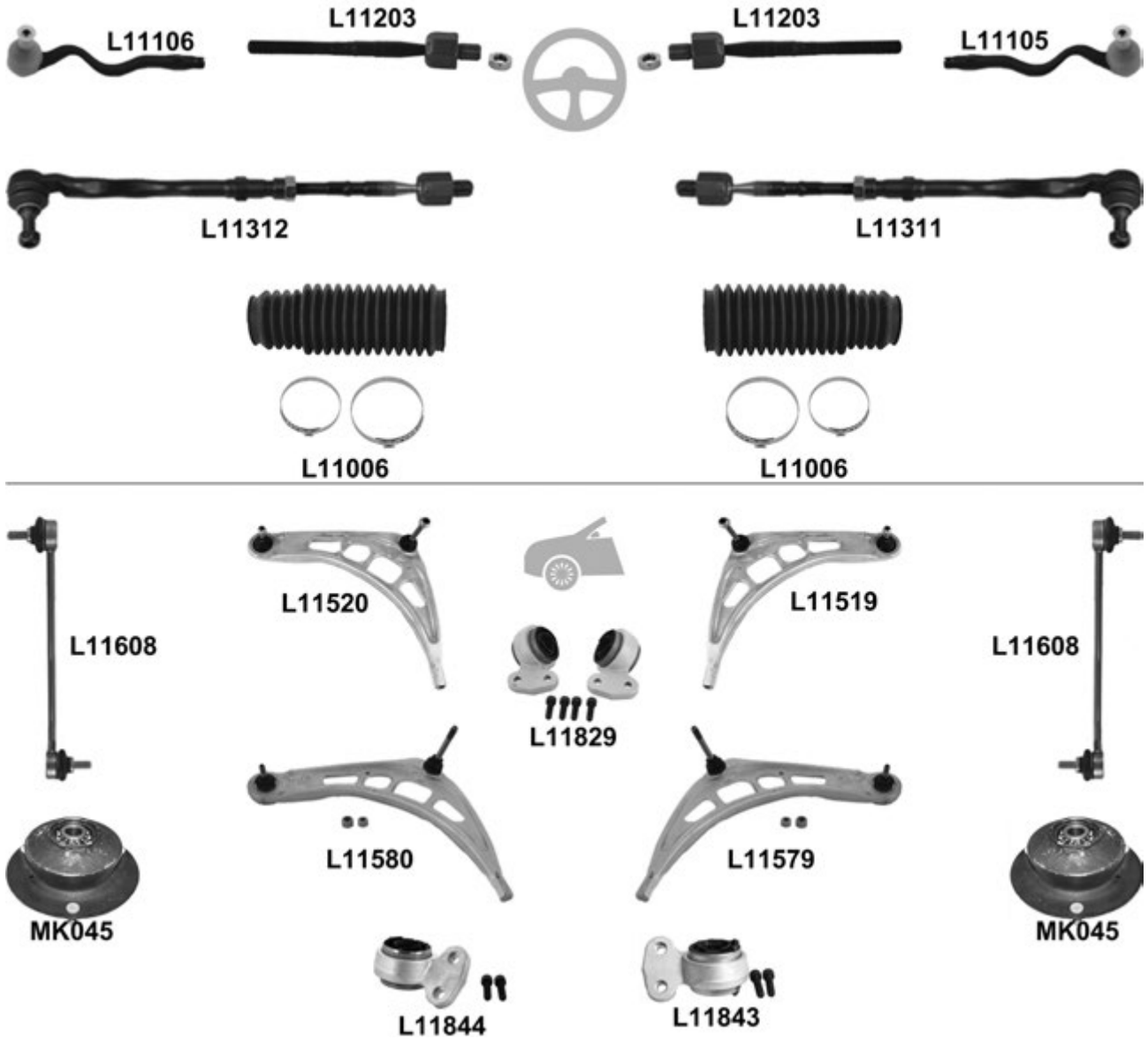

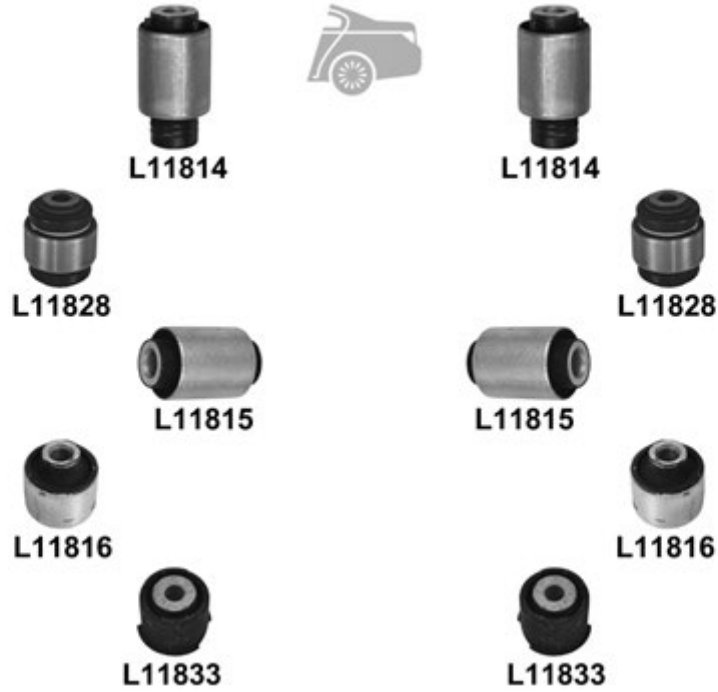

				←	→	Thread	Part Of	QPA			
		↔			L11105	F 14x1,5		1	32 21 1 095 958		
					L11106	F 14x1,5		1	32 21 1 095 957		
					L11203	L11203	M 14x1,5 / M 18x1,5		2	32 11 1 096 898	
						L11311			1	32 21 1 096 898	
						L11312			1	32 21 1 096 897	
		⊥			L11519			1	31 12 6 758 520		
					L11520			1	31 12 6 759 519		
			3.2M		L11579			1	31 12 2 282 122		
					L11580			1	31 12 2 282 121		
		⊥			L11843			1	31 12 6 753 060		
					L11844			1	31 12 6 753 059		
				KIT	L11829			1	31 12 6 757 623		
						L11608	L11608		2	31 35 1 095 694	
					KIT	MK045	MK045		2	3133 1092 885	
						→ ←		L11814	L11814		2
↔	→ 03.06, (-) 3.2	L11828	L11828				2	33 32 1 138 722			
→ ←		L11815	L11815				2	33 32 1 138 383			
↔	(-) 3.2	L11816	L11816				2	33 32 1 136 311			
▼		L11833	L11833			Hub carrier	2	33 31 1 092 517			

Z4 E89 05.09 →

BMW

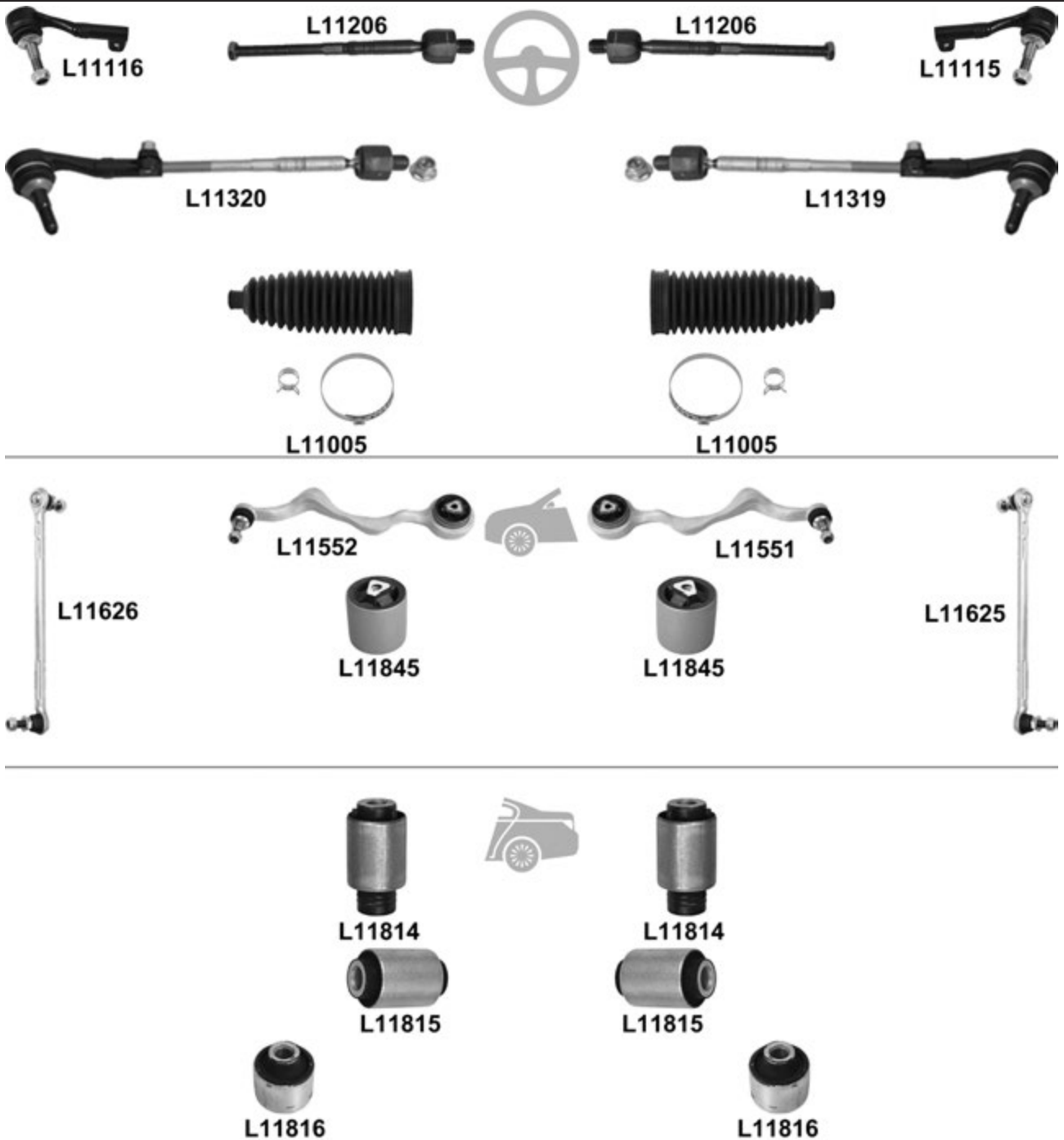

				←	→	Thread	Part Of	QPA	i
⊕		↔			L11115	F 14x1,5 ∪		1	32 10 6 765 090
					L11116	F 14x1,5 ∪		1	32 10 6 765 089
				L11206	L11206	M 14x1,5 / M 18x1,5 ∪		2	
		ZF			L11319			1	32 10 6 765 236
		ZF		L11320				1	32 10 6 765 235
⊖				L11005 ⁰	L11005 ⁰			2	32 10 6 765 234
					L11551			1	31 12 6 769 802
		⊥ ▲		<input checked="" type="checkbox"/>	L11552			1	31 12 6 769 801
		▲ → ←			L11845	L11845		2	31 12 0 393 540
					L11625			1	31 35 6 765 934
⊖				L11626			1	31 35 6 765 933	
				L11814	L11814		2	33 32 1 137 571	
		→ ←			L11815	L11815		2	33 32 1 138 383
		↔			L11816	L11816		2	33 32 1 136 311

⊕ = Upper ⊥ = Lower ▲ = Front ▼ = Rear → ← = Inner ↔ = Outer → ← = Center

Z8 06.00 → 06.03

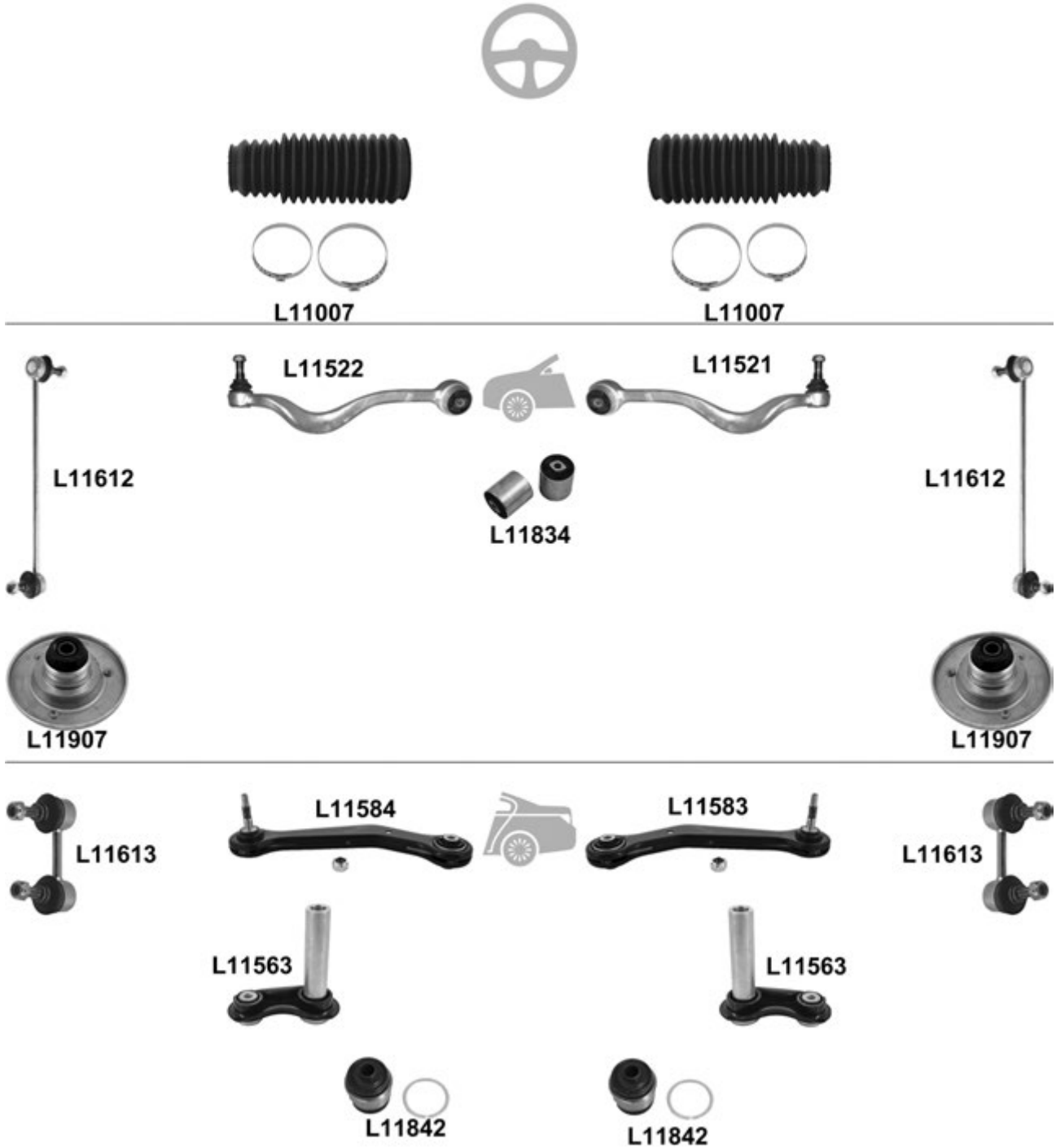

				← → Thread		Part Of	QPA		
				L11007 ⁰	L11007 ⁰		2	32 13 1 092 876	
		↓ ▲	<input checked="" type="checkbox"/>		L11521		1	31 12 1 092 024	
				L11522			1	31 12 1 092 023	
		↓ ▲	KIT	L11834			1	31 12 9 068 753	
				L11612	L11612		2	31 35 1 091 496	
		↓ ▲		KIT	L11907	L11907	2	31 33 1 091 708	
						L11583		1	33 32 6 770 060
		↓ ▲			L11584		1	33 32 6 770 059	
					L11563	L11563		2	33 32 6 770 749
					L11842	L11842	Hub carrier	2	33 32 6 767 748
				L11613	L11613		2	33 55 1 091 497	

1 E81, E87 09.04 →
 1 Coupe E82 10.07 →
 1 Cabriolet E88 03.08 →

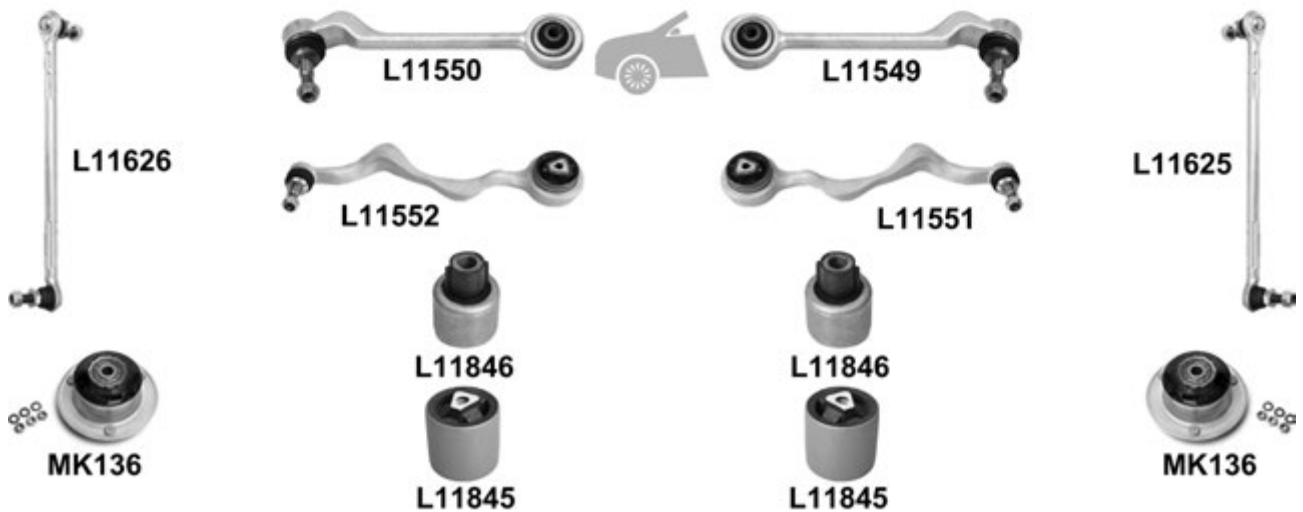
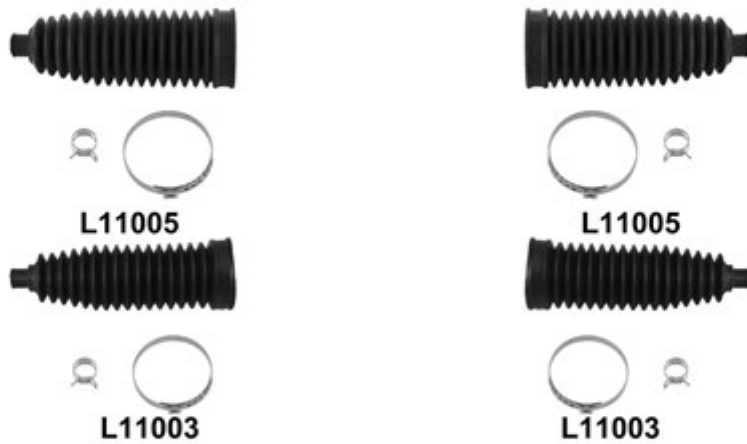
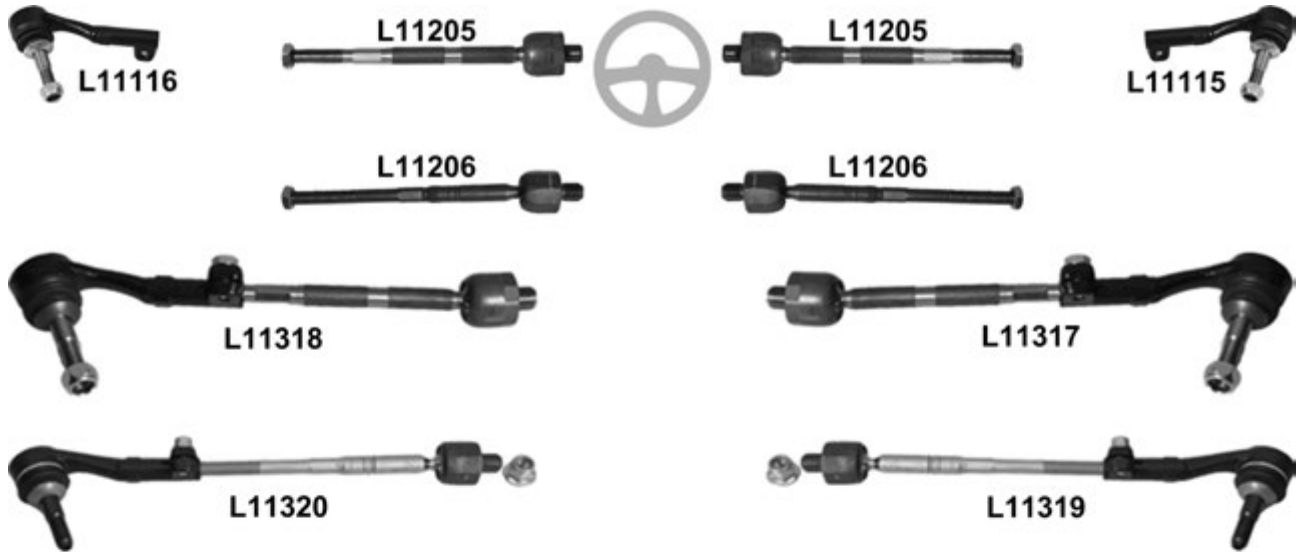

1 E81, E87 09.04 →
 1 Coupe E82 10.07 →
 1 Cabriolet E88 03.08 →

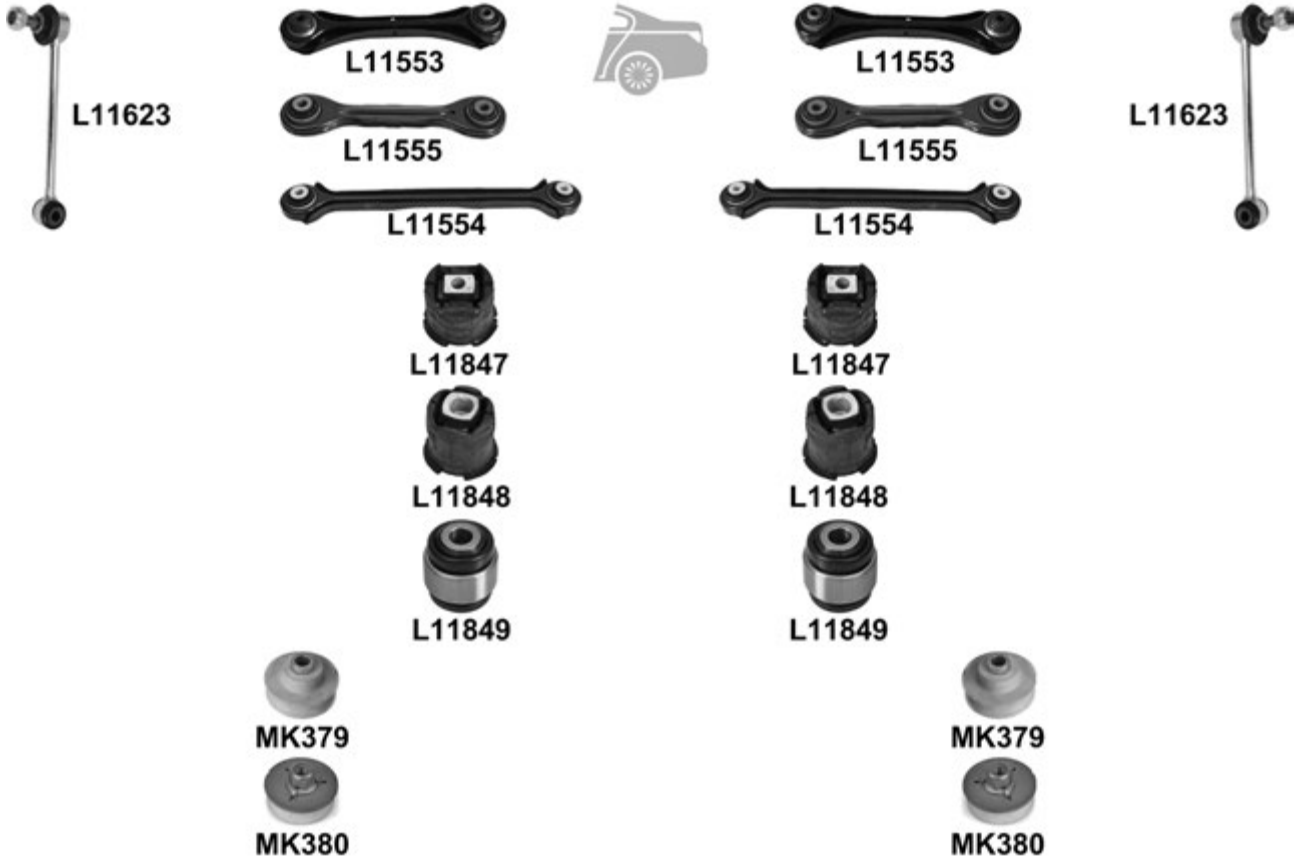

1 E81, E87 09.04 →
 1 Coupe E82 10.07 →
 1 Cabriolet E88 03.08 →

				←	→	Thread	Part Of	OPA			
		↔			L11115	F 14x1,5 ♂		1	32 10 6 765 090		
					L11116	F 14x1,5 ♂		1	32 10 6 765 089		
			TRW		L11205	L11205	M 14x1,5 / M 18x1,5 ♂	L11317/L11318	2		
			ZF		L11206	L11206	M 14x1,5 / M 18x1,5 ♂	L11319/L11320	2		
			TRW			L11317			1	32 21 6 762 244	
						L11318			1	32 21 6 762 243	
			ZF			L11319			1	32 10 6 765 236	
						L11320			1	32 10 6 765 235	
			ZF		L11005 ^o	L11005 ^o			2	32 10 6 765 234	
			TRW		L11003	L11003			2	32 10 6 765 079	
		⊥▼	(-) M Coupé	<input checked="" type="checkbox"/>		L11549			1	31 12 6 763 700	
						L11550			1	31 12 6 763 699	
		⊥▲	(-) M Coupé	<input checked="" type="checkbox"/>		L11551				1	31 12 6 769 802
						L11552				1	31 12 6 769 801
		▼→←			L11846	L11846		L11549/L11550	2		
		▲→←			L11845	L11845		L11551/L11552	2	31 12 0 393 540	
						L11625			1	31 35 6 765 934	
						L11626			1	31 35 6 765 933	
				KIT	MK136	MK136			2	31 33 6 760 943	
			⊥▼		<input checked="" type="checkbox"/>	L11553	L11553			2	33 32 6 777 980
⊥▲				<input checked="" type="checkbox"/>	L11555	L11555			2	33 32 6 765 425	
⊥▼				<input checked="" type="checkbox"/>	L11554	L11554			2	33 32 6 763 471	
		▼			L11847	L11847		Hub carrier	2	33 31 6 758 260	
		▲			L11848	L11848		Hub carrier	2	33 31 6 758 259	
					L11849	L11849		Hub carrier	2	33 32 6 756 249	
					L11623	L11623			2	33 55 6 764 428	
		⊥			MK379	MK379			2		
		⊥			MK380	MK380			2		

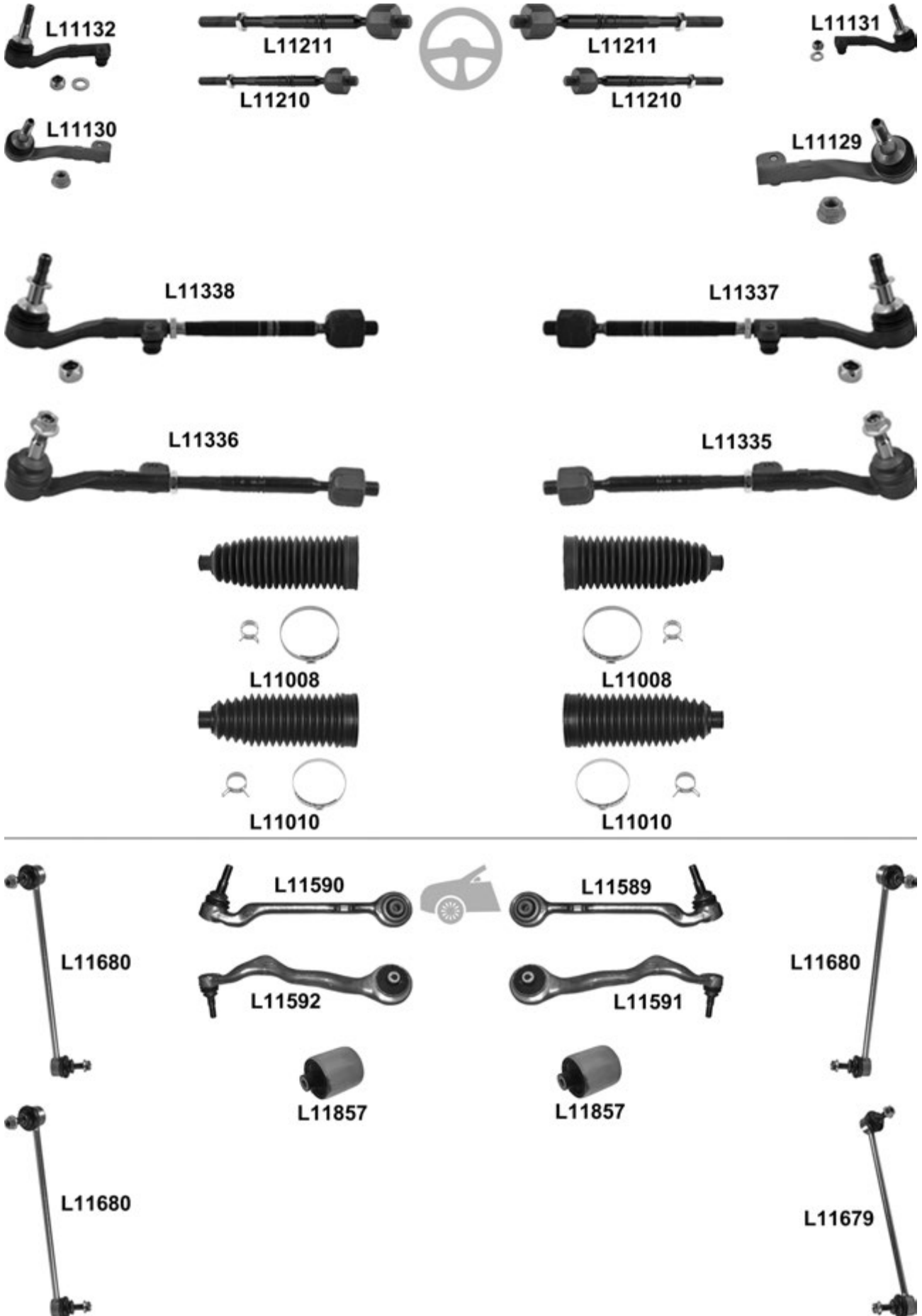
1 F20, F21 06.11 →

1 F20, F21 06.11 →



		i		←	→	Thread	Part Of	QPA	i	
		↔	(-) xDrive		L11131	F 14x1,5		1	32 10 6 799 967	
				L11132		F 14x1,5		1	32 10 6 788 966	
				xDrive		L11129			1	32 10 6 797 618
						L11130			1	32 10 6 797 617
			(-) xDrive		L11211	L11211		L11337/L11338	2	
				xDrive		L11210	L11210		L11335/L11336	2
			(-) xDrive			L11337			1	32 10 6 799 965
						L11338			1	32 10 6 799 960
			xDrive			L11335			1	32 10 6 792 030
						L11336			1	32 10 6 792 029
		ThyssenKrupp, ø 16mm, Ø 63mm, L= 204mm		L11008 ⁰	L11008 ⁰			2	32 10 6 795 845	
			ZF, ø 16mm, Ø 56mm, L= 186mm		L11010 ⁰	L11010 ⁰			2	32 10 6 854 893
		↓	(-) M135i/xDrive	<input checked="" type="checkbox"/>		L11589 ⁰		1	31 12 6 852 992	
					L11590 ⁰		1	31 12 6 852 991		
	↑	(-) xDrive	<input checked="" type="checkbox"/>		L11591 ⁰		1	31 12 6 855 742		
				L11592 ⁰		1	31 12 6 855 741			
		↔	(-) xDrive		L11857	L11857		L11591/L11592	2	31 12 6 855 743
				(-) /M-Technik/xDrive		L11680	L11680		2	31 30 6 792 211
		/M-Technik/xDrive			L11679		1	31 30 6 792 212		
				L11680			1	31 30 6 792 211		
					L11849	L11849	Hub carrier	2	33 32 6 756 249	
		(+) M135i/120d xDrive				L11643 ⁰		1	33 50 6 785 608	
						L11644 ⁰		1	33 50 6 785 607	

2 Coupe F22 10.13 →

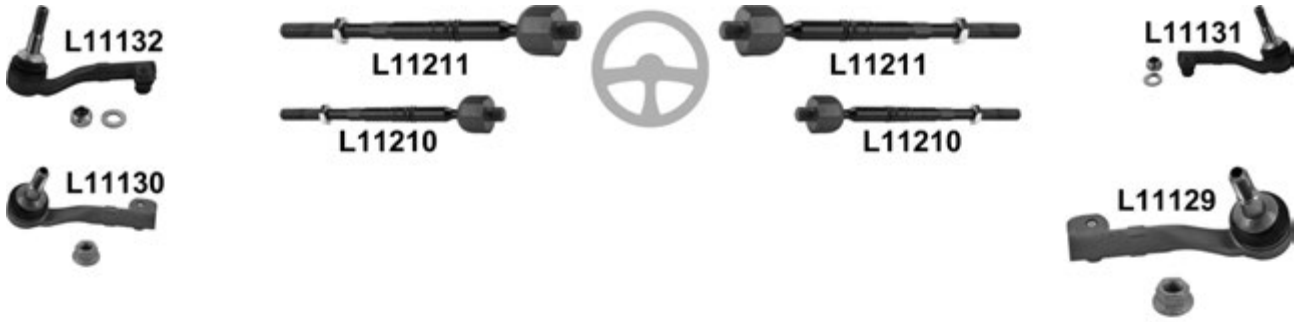

2 Coupe F22 10.13 →



		i		←	→	Thread	Part Of	QPA	i		
		↔	(-) xDrive		L11131	F 14x1,5		1	32 10 6 799 967		
				L11132		F 14x1,5		1	32 10 6 788 966		
		↔	xDrive		L11129				1	32 10 6 797 618	
				L11130					1	32 10 6 797 617	
			(-) xDrive	L11211	L11211		L11337/L11338	2			
			xDrive	L11210	L11210		L11335/L11336	2			
		↔	(-) xDrive		L11337			1	32 10 6 799 965		
				L11338				1	32 10 6 799 960		
			xDrive		L11335			1	32 10 6 792 030		
			ThyssenKrupp, ø 16mm, Ø 63mm, L= 204mm	L11008 ⁰	L11008 ⁰			2	32 10 6 795 845		
		ZF, ø 16mm, Ø 56mm, L= 186mm	L11010 ⁰	L11010 ⁰			2	32 10 6 854 893			
		⊥▼	(-) M235i/xDrive	<input checked="" type="checkbox"/>		L11589 ⁰		1	31 12 6 852 992		
				L11590 ⁰			1	31 12 6 852 991			
	⊥▲	(-) xDrive	<input checked="" type="checkbox"/>		L11591 ⁰			1	31 12 6 855 742		
			L11592 ⁰				1	31 12 6 855 741			
		↔	(-) /M-Technik/xDrive		L11680	L11680		2	31 30 6 792 211		
			/M-Technik/xDrive		L11679			1	31 30 6 792 212		
			L11680				1	31 30 6 792 211			
				L11849	L11849		Hub carrier	2	33 32 6 756 249		
		(+) M135i/120d xDrive			L11643 ⁰			1	33 50 6 785 608		
				L11644 ⁰				1	33 50 6 785 607		

315 - 323 i E21 06.75 → 03.84

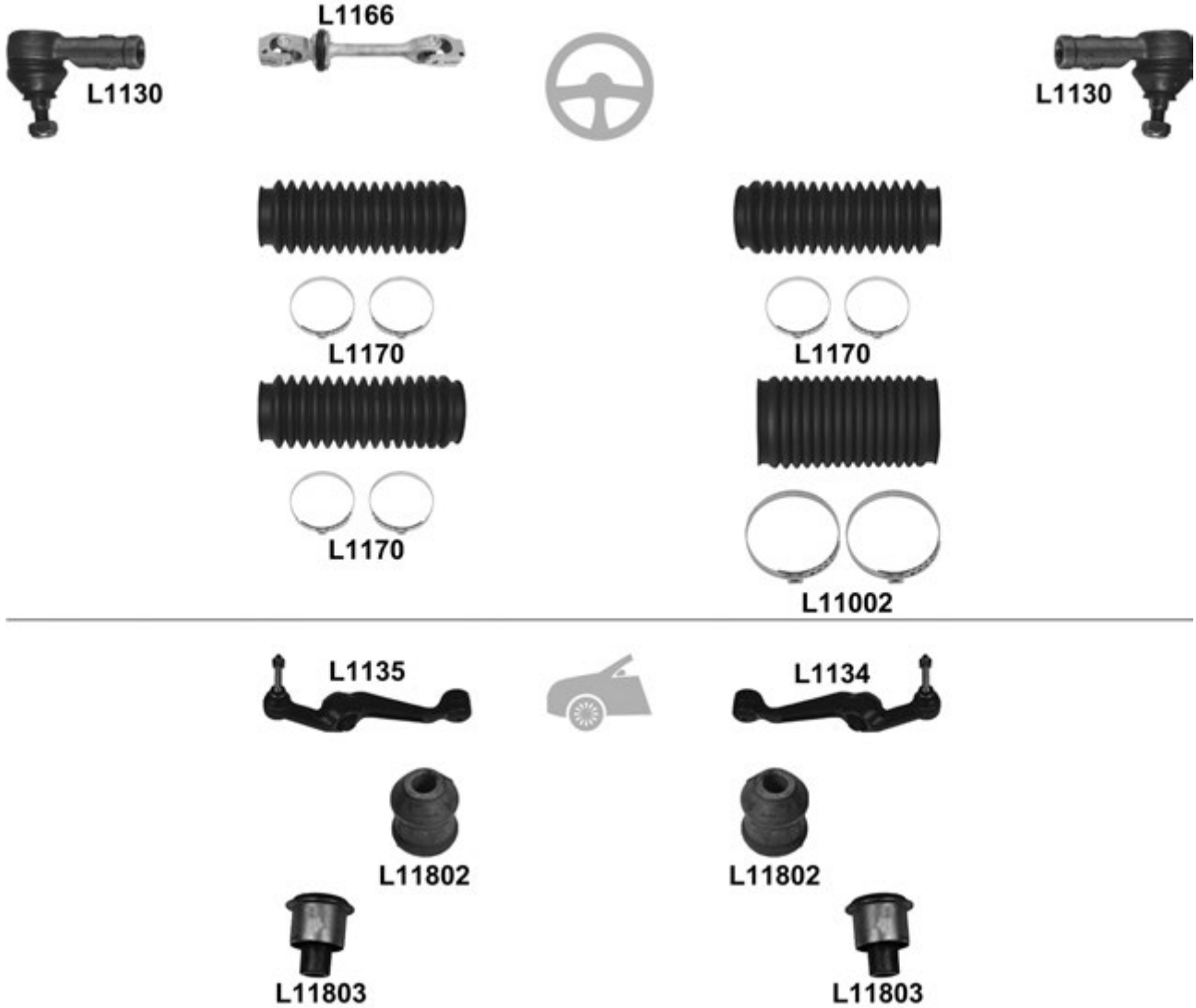

						←	→	Thread	Part Of	QPA			
				<input checked="" type="checkbox"/>	L1130	L1130		F 14x1,5 U		2	3211 1116 463		
					L1166					1	3231 1121 790		
					L1170	L1170				2	3211 1118 688		
						L11002				1	3211 1117 426		
					L1170					1	3211 1118 688		
				<input checked="" type="checkbox"/>	11.78 →	L1134 ¹				1	3112 1123 026		
						L1135 ¹			1	3112 1123 025			
					→←	11.78 →	L11802	L11802		L1134/L1135	2	3112 1119 260	
					↔	11.78 →	L11803	L11803		L1134/L1135	2	3112 1123 037	

316 - M3 E30 09.82 → 08.91
 318 i - 325 i E30 12.85 → 10.93
 316 i - 325 i Touring E30 07.87 → 06.94

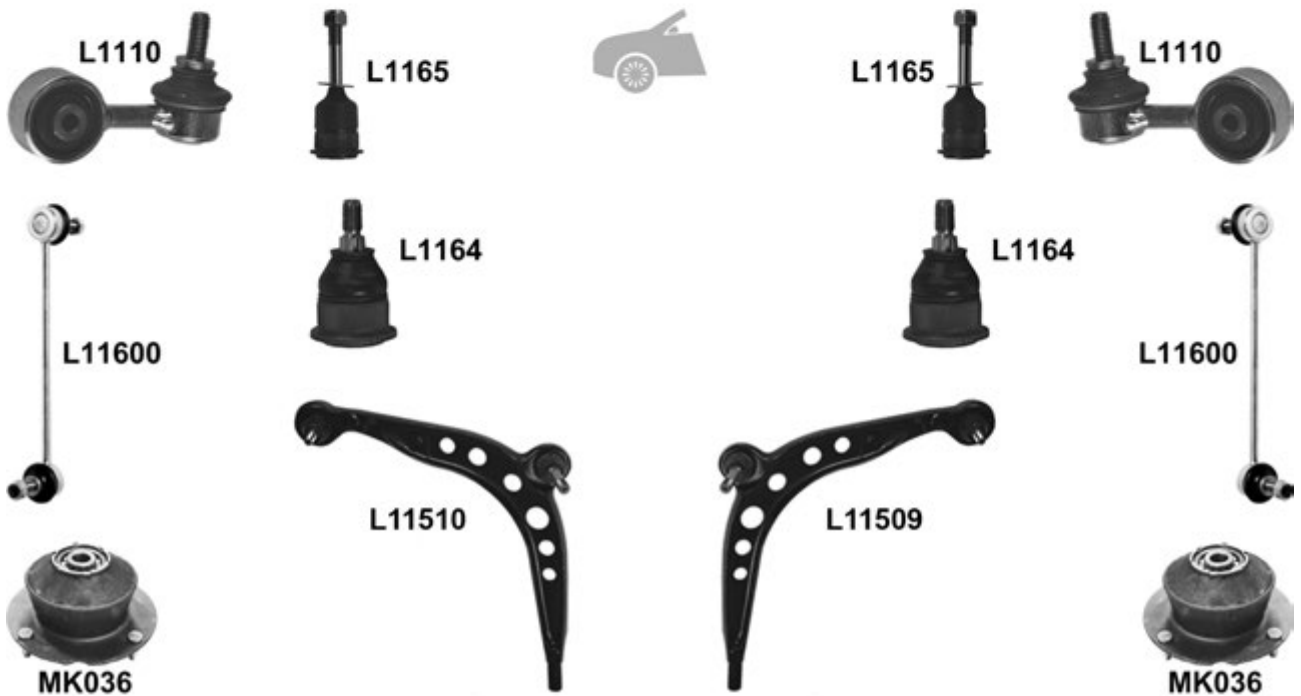
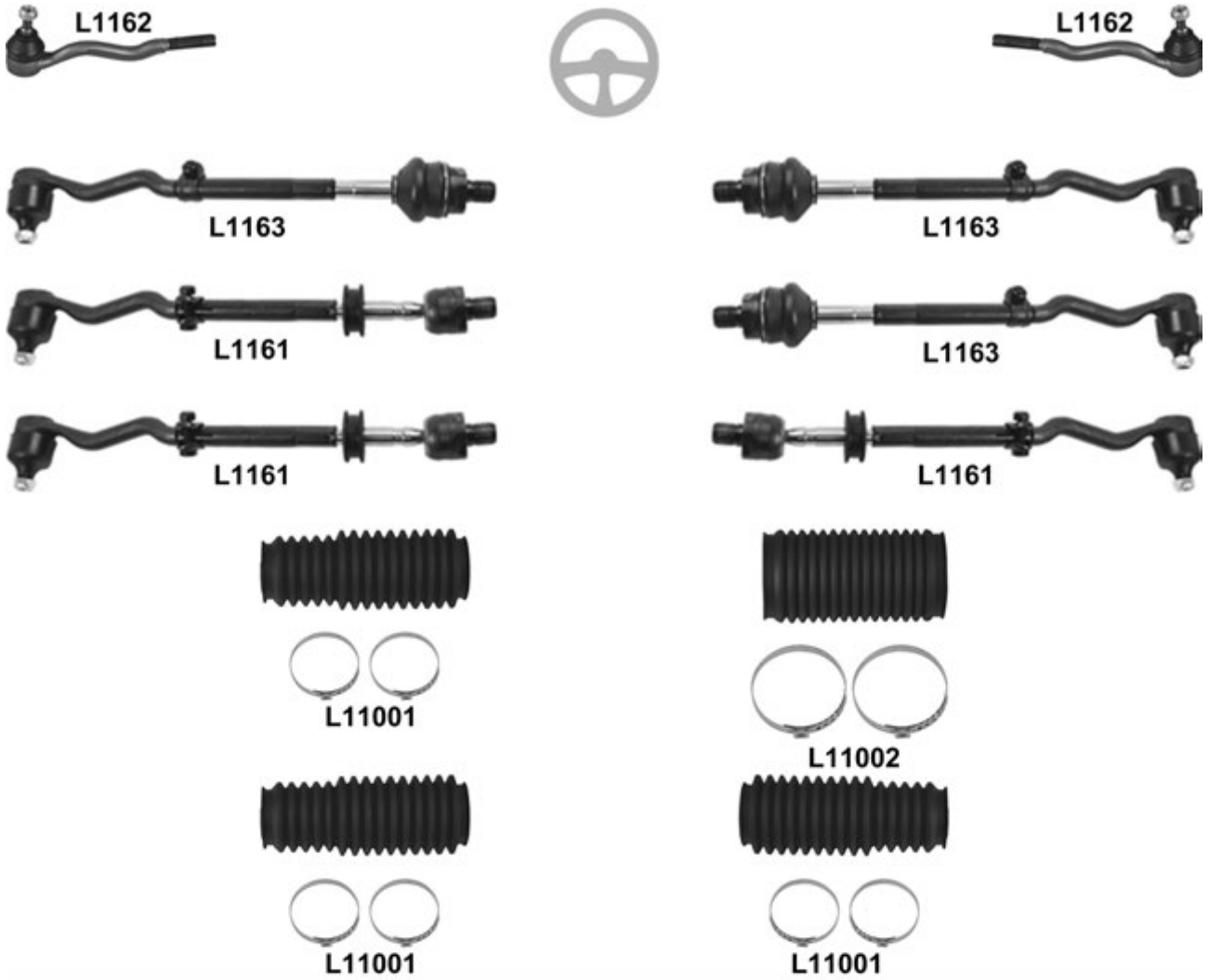

316 - M3 E30 09.82 → 08.91
 318 i - 325 i E30 12.85 → 10.93
 316 i - 325 i Touring E30 07.87 → 06.94



L11512

L11511



L11806



L11808



L11808



L11809



L11809



L11603



L11810



L11810



L11811



L11811



L11603



MK120



MK120

316 - M3 E30 09.82 → 08.91
318 i - 325 i E30 12.85 → 10.93
316 i - 325 i Touring E30 07.87 → 06.94

			←	→	Thread	Part Of	OPA			
		↔	L1162	L1162	F 14x1,5 U		2	3211 1126 757		
			(-) 325 ix,	L1163	L1163			2	3211 1125 187	
			(-) 325 ix, Steering damper/Airbag		L1163			1	3211 1125 187	
				L1161				1	3211 1125 186	
			(-) 325 ix,	L1161	L1161			2	3211 1125 186	
			Steering damper/Airbag		L11002			1	3211 1117 426	
				L11001				1	3211 1127 104	
				L11001	L11001			2	3211 1127 104	
			↓↔↔	(+) 325 i Touring/M3 → 09.88 , (-) 325 ix	L1165	L1165		2	3112 1126 253	
			↔↔	(+) 325 i Touring/M3 → 09.88 , (-) 325 ix	L1164	L1164		2	3112 1126 254	
		↓	(+) 325 i Touring/M3 → 09.88 , (-) 325 ix		L11509		1	3112 1127 726		
				L11510		1	3112 1127 725			
			325i Touring/M3 09.88 →, (-) 325 ix		L11511		1	3112 1130 824		
				L11512		1	3112 1130 823			
			KIT	L11806			1	3112 9058 815		
			(-) M3/M3C	L1110	L1110			2	3135 1128 737	
			M3/M3C	L11600	L11600			2	3135 1134 582	
			ø 18,5mm	L11808	L11808		Anti-roll bar	2	31 35 1 127 414	
			ø 20mm	L11809	L11809		Anti-roll bar	2	3135 1129 139	
			(-) 325 iX/325 iX Touring	KIT	MK036	MK036		2	3133 1139 452	
				KIT	L11810	L11810			2	3332 9061 945
					L11811	L11811		Hub carrier	2	3331 1129 144
				L11603	L11603			2	3355 1126 932	
				MK120	MK120			2	3352 1128 819	

316 i - M3 E36 09.90 → 02.98
 316 i - M3 Coupé E36 03.92 → 04.99
 318 - 328 i Touring E36 01.95 → 10.99
 320 i - M3 Cabriolet E36 03.93 → 04.99

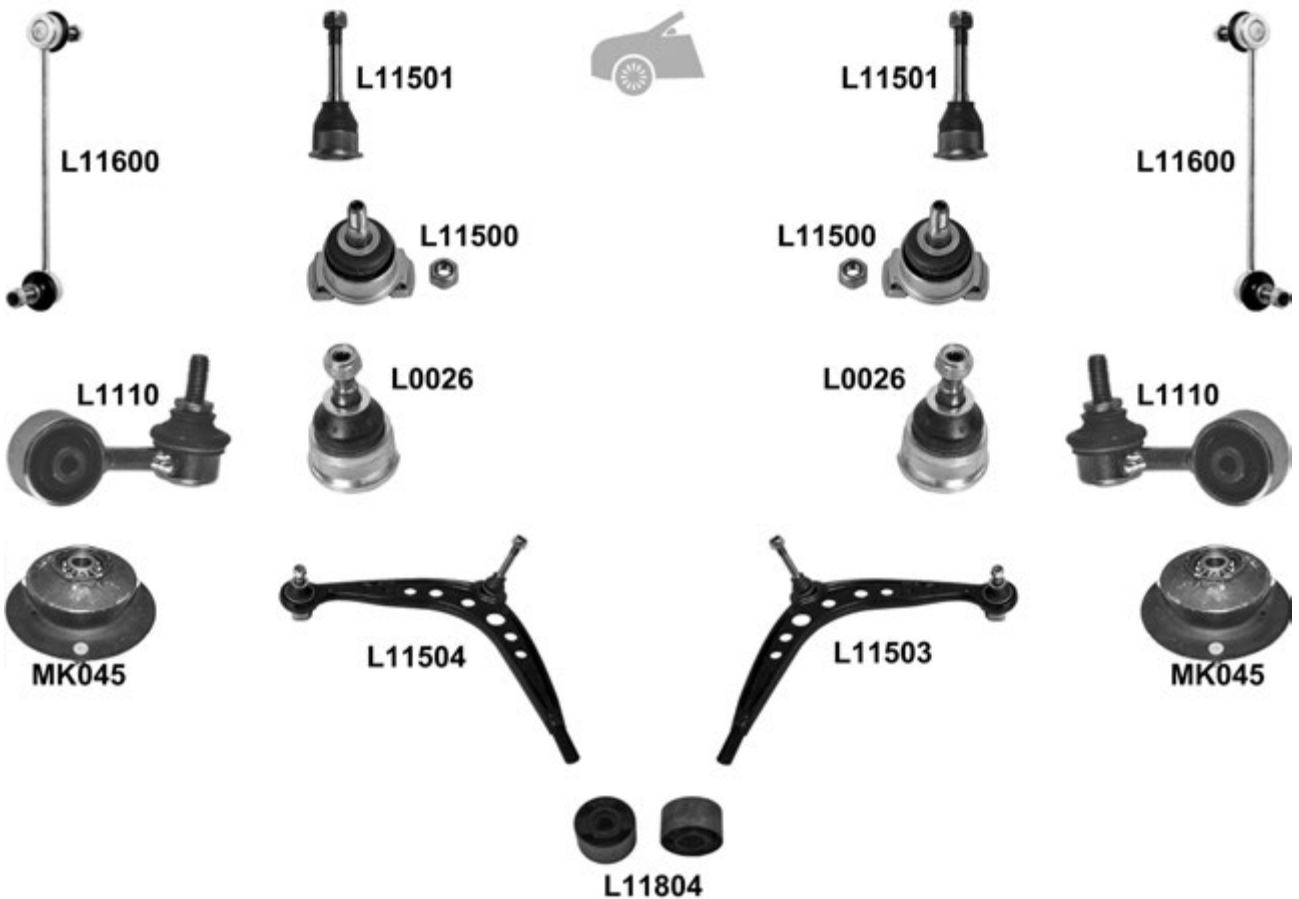
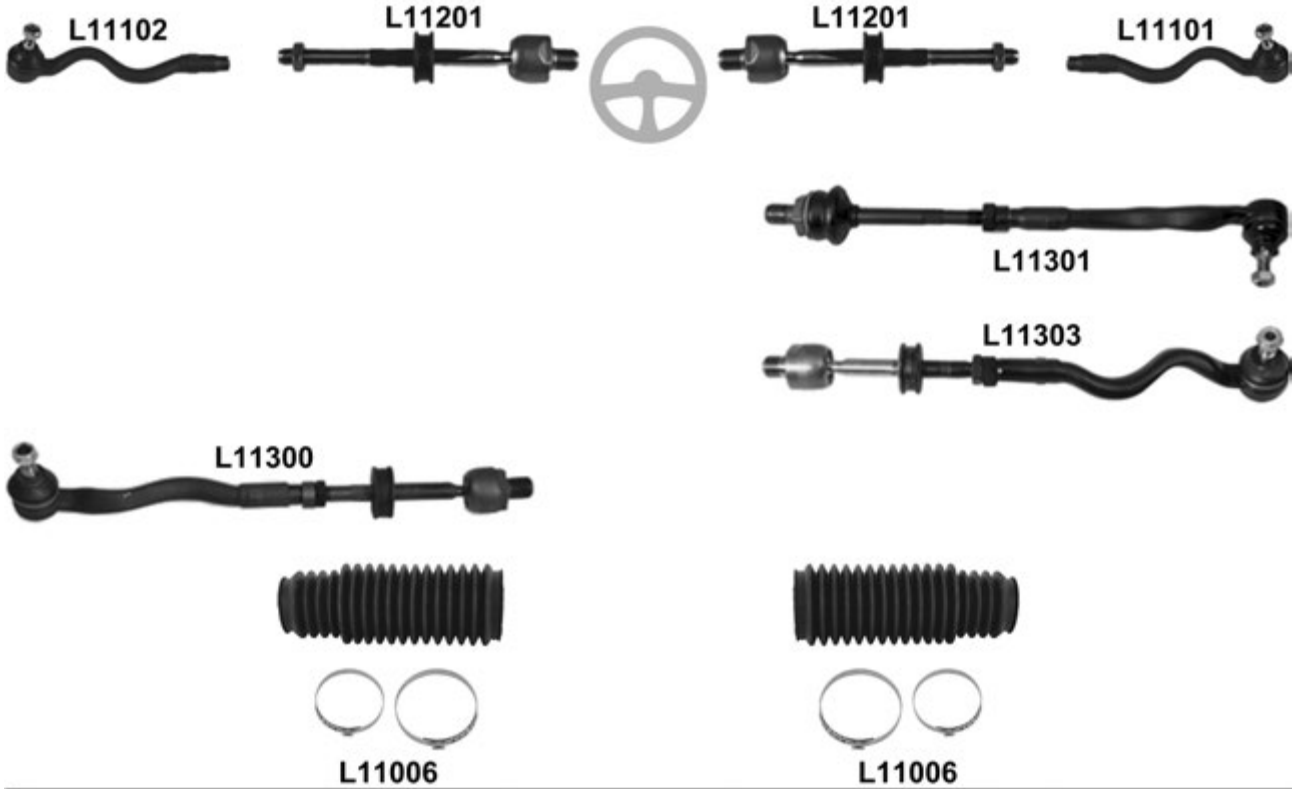

316 i - M3 E36 09.90 → 02.98
 316 i - M3 Coupé E36 03.92 → 04.99
 318 - 328 i Touring E36 01.95 → 10.99
 320 i - M3 Cabriolet E36 03.93 → 04.99

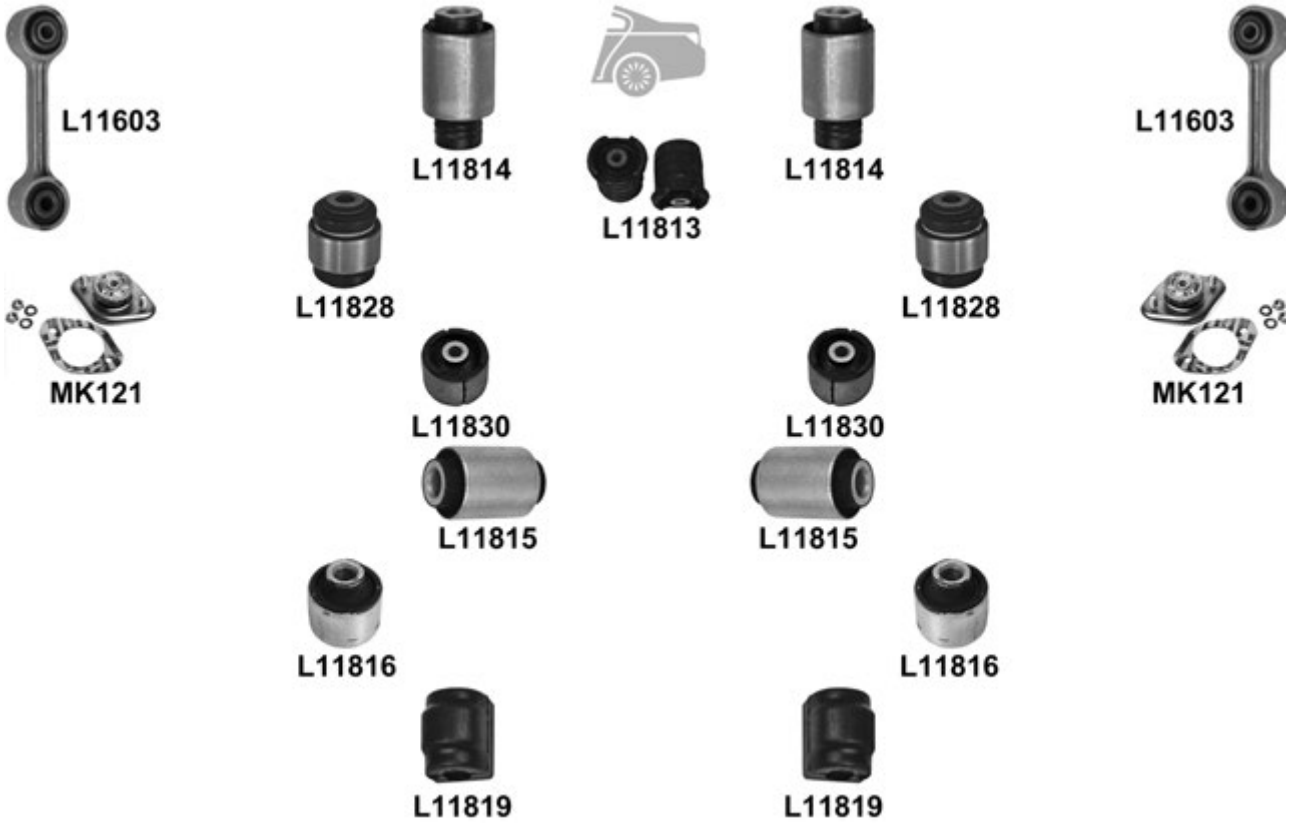

316 i - M3 E36 09.90 → 02.98
 316 i - M3 Coupé E36 03.92 → 04.99
 318 - 328 i Touring E36 01.95 → 10.99
 320 i - M3 Cabriolet E36 03.93 → 04.99

		← →		← →		Thread	Part Of	QPA		
		↔		L11101		F 14x1,5 ♂		1	3211 1139 314	
				L11102		F 14x1,5 ♂		1	3211 1139 313	
			, Steering damper		L11201	L11201			2	
						L11301			1	3211 1139 318
						L11303			1	3211 1139 316
					L11300				1	3211 1139 315
				L11006 ⁰	L11006 ⁰			2	32 21 1 139 786	
		↓ ↔	(-) M3	L11501	L11501			2	3112 1139 131	
			(-) M3	L11500	L11500		2	3112 1140 398		
			(-) M3, HD Version	L0026	L0026		2	3112 1140 398		
		↓	(-) M3		L11503			1	3112 6758 514	
				L11504			1	3112 6758 513		
				(-) M3	KIT	L11804			1	3112 9059 288
				→ 10.91, (-) M3	L11600	L11600			2	3135 1134 582
				10.91 →, (-) M3	L1110	L1110		2	3135 1091 764	
				(-) M3	KIT	MK045	MK045		2	3133 1092 885
			↔		L11814	L11814			2	33 32 1 137 571
				L11828	L11828			2	33 32 1 138 722	
		↔		07.99 → longitudinal	L11830	L11830			2	33 32 1 097 009
					L11815	L11815			2	33 32 1 138 383
		↔			L11816	L11816			2	33 32 1 136 311
					KIT	L11813		Hub carrier	KIT	1
					L11603	L11603			2	33 55 1 126 932
				06.92 →, ø 15mm	L11819	L11819		Anti-roll bar	2	33 55 1 131 155
			(-) M3	MK121	MK121			2	33 52 1 092 362	

316 i - 318 ti Compact E36 03.94 → 08.00

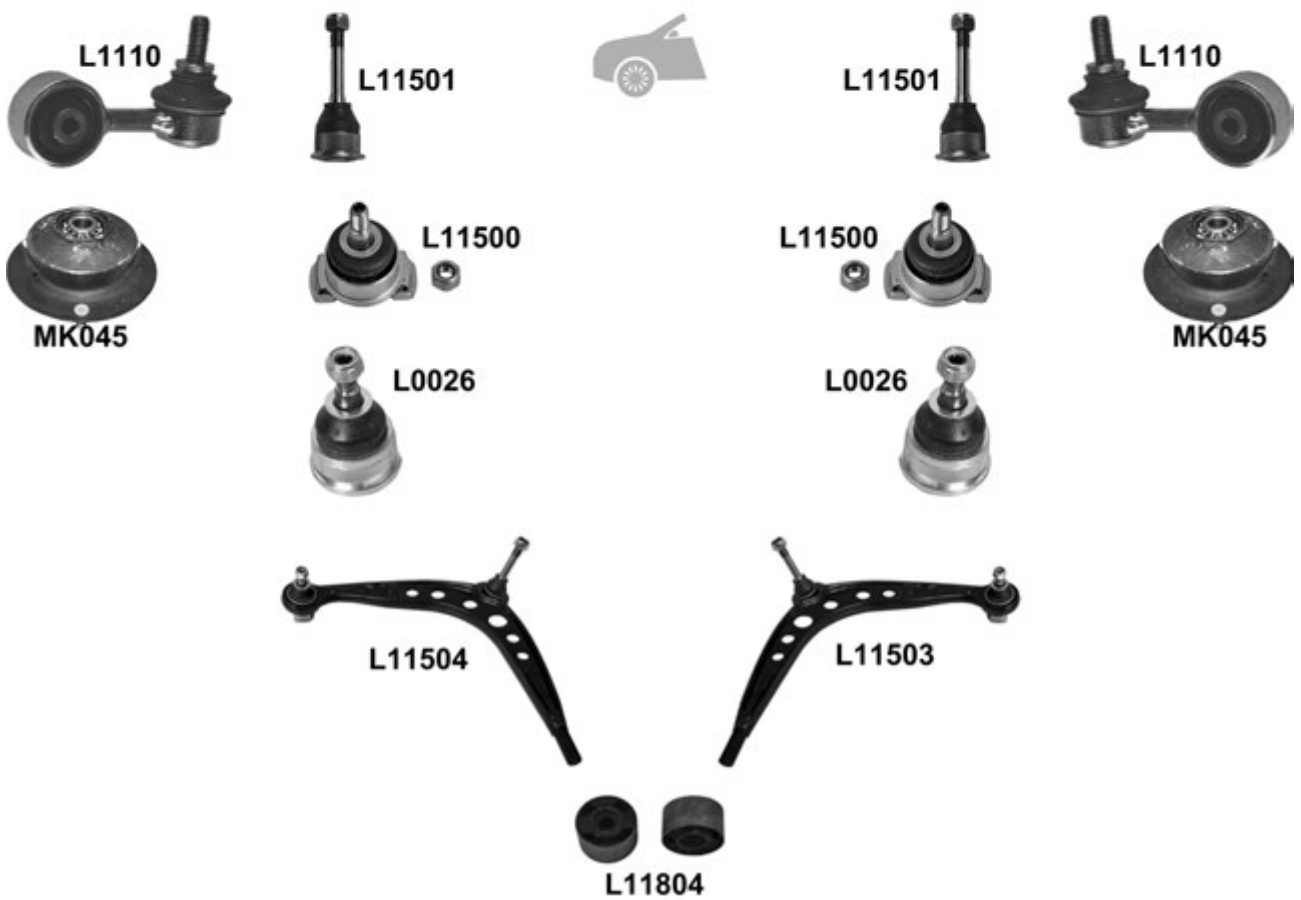
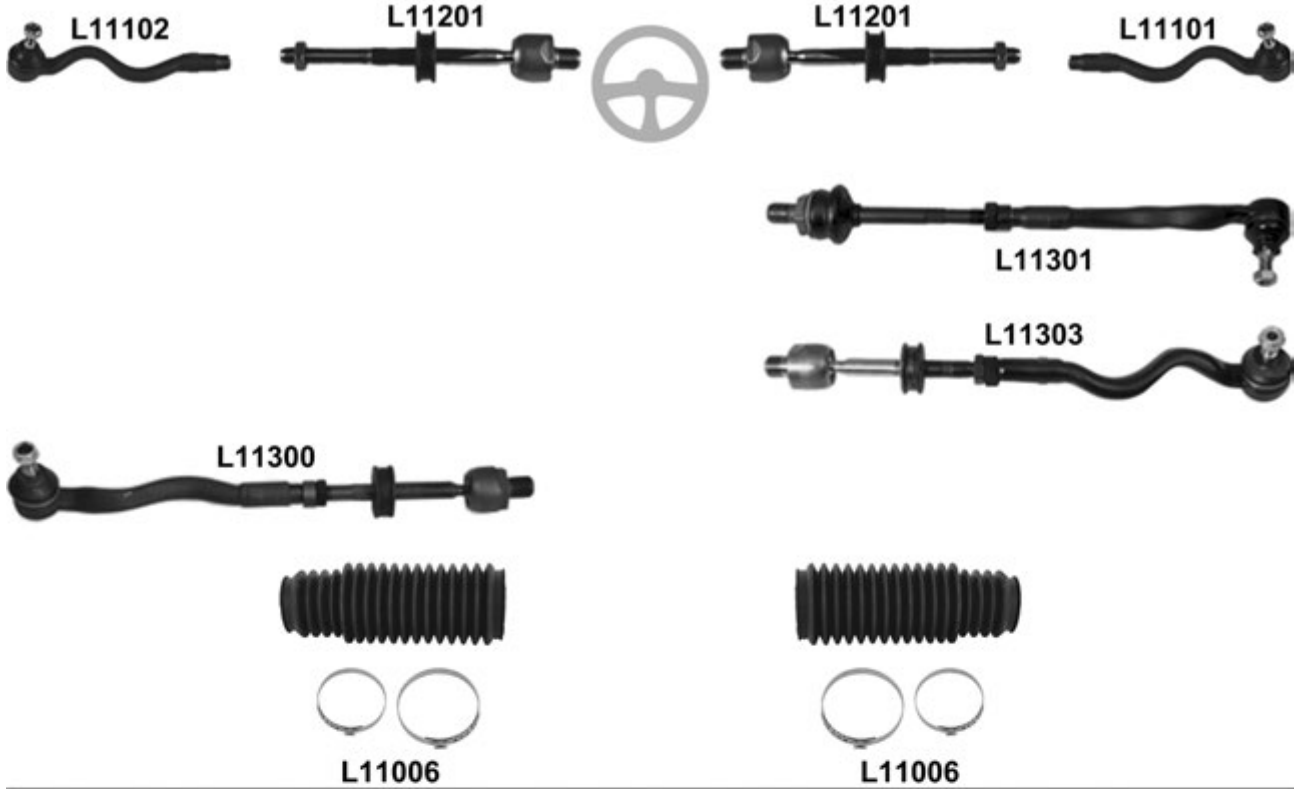

316 i - 318 ti Compact E36 03.94 → 08.00



L11604



L11810



L11810



L11604



MK121



MK121

				← → Thread		Part Of	QPA			
⊕	🔧	↔		L11101	F 14x1,5 ♂		1	3211 1139 314		
				L11102	F 14x1,5 ♂		1	3211 1139 313		
	🔧	⊕		L11201	L11201		2			
			🔧, Steering damper		L11301		1	3211 1139 318		
			🔧		L11303		1	3211 1139 316		
		🔧/🔧		L11300			1	3211 1139 315		
	🌀		L11006 ⁰	L11006 ⁰		2	32 21 1 139 786			
🚗	🔧	⊥ → ⊥ ←		L11501	L11501		2	3112 1139 131		
				L11500	L11500		2	3112 1140 398		
			(-) M3/HD Version	L0026	L0026		2	3112 1140 398		
	🔧	⊥			L11503		1	3112 6758 514		
					L11504		1	3112 6758 513		
		🔧		KIT	L11804		🔧	1	3112 9059 288	
		🔧			L1110	L1110		2	3135 1091 764	
		🔧		KIT	MK045	MK045		2	3133 1092 885	
🚗	🔧	⊕		KIT	L11810	L11810		🔧	2	3332 9061 945
					L11604	L11604		2	33 55 1 135 307	
		🔧			MK121	MK121		2	3352 1092 362	

316 i - 328 i E46 2.1998 →

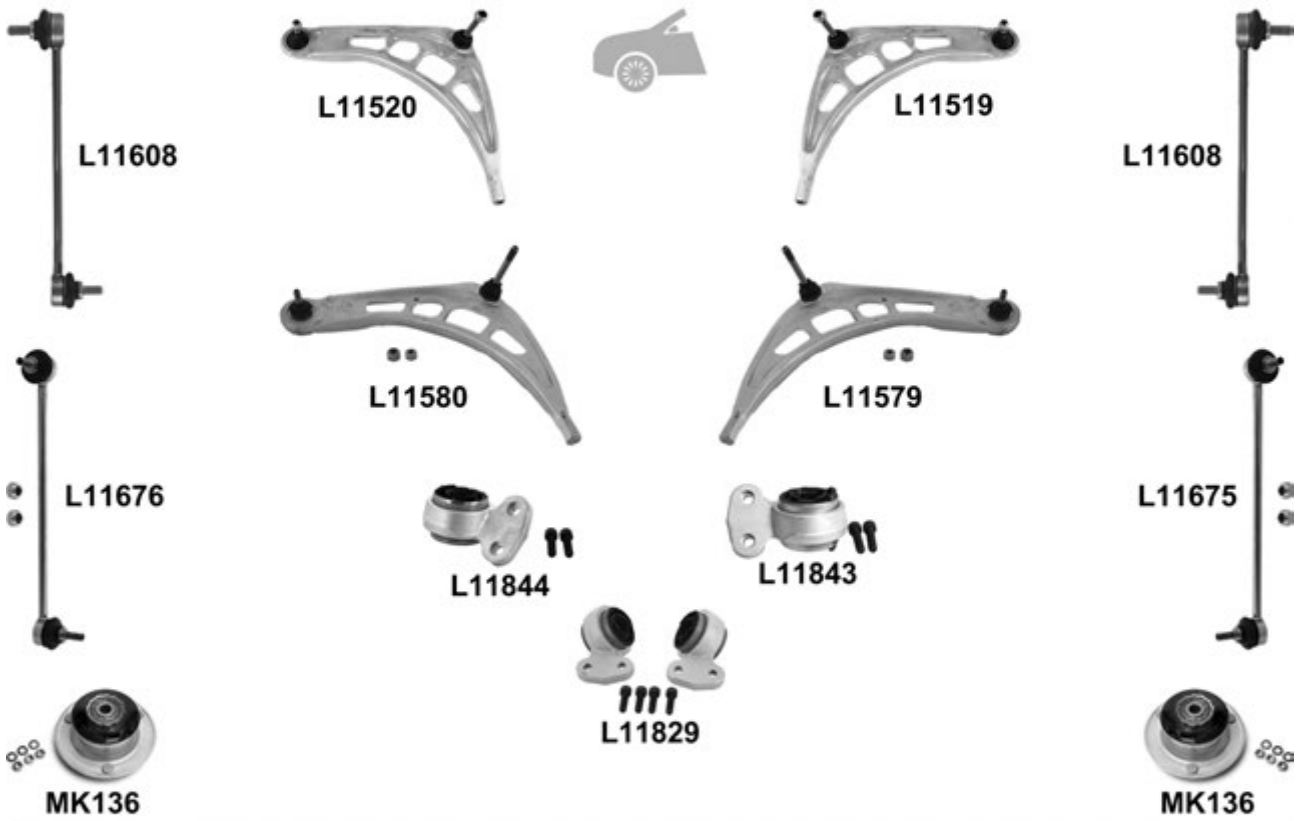
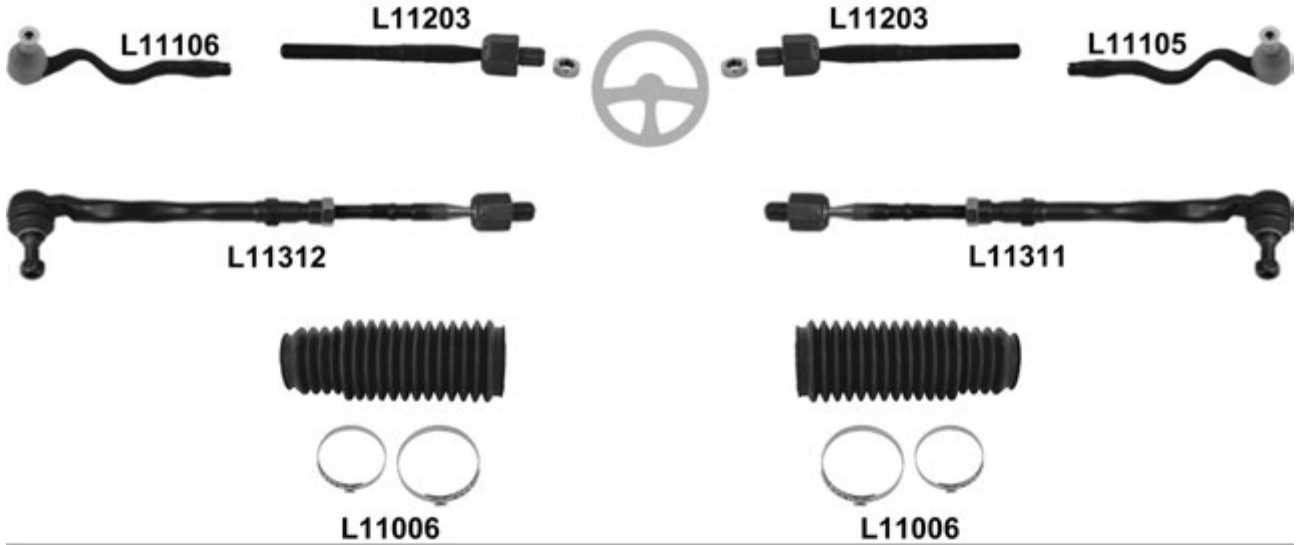

316 i - 328 i E46 2.1998 →

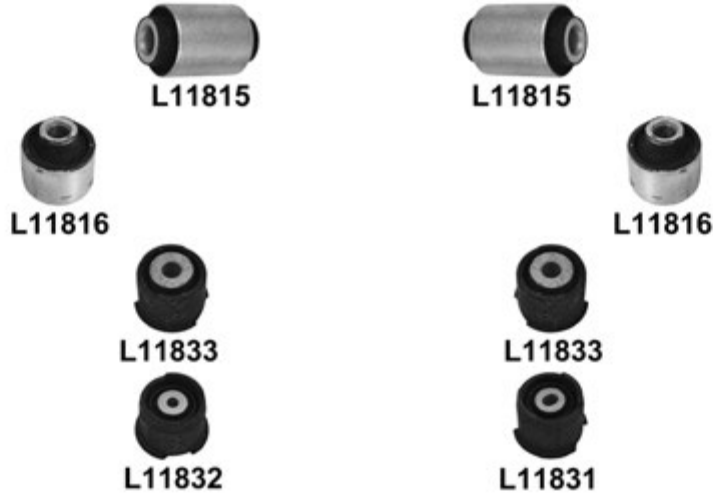

				← → Thread		Part Of	QPA				
⊕		↔		L11105	F 14x1,5		1	32 21 1 095 958			
				L11106	F 14x1,5		1	32 21 1 095 957			
					L11203	L11203	M 14x1,5 / M 18x1,5		2	32 11 1 096 898	
						L11311			1	32 21 1 096 898	
						L11312			1	32 21 1 096 897	
		10.98 →, (+) M3		L11006 ^o	L11006 ^o		2	32 21 1 139 786			
🚗		⊥	(-) SP /xi/xd		L11519		1	31 12 6 758 520			
					L11520		1	31 12 6 759 519			
			SP /xi/xd		L11579		1	31 12 2 282 122			
					L11580		1	31 12 2 282 121			
					L11843			1	31 12 6 753 060		
					L11844			1	31 12 6 753 059		
			KIT	L11829				1	31 12 6 757 623		
			(+) M3		L11608	L11608		2	31 35 1 095 694		
			xi/xd			L11675		1	31 35 6 751 080		
					L11676			1	31 35 6 751 079		
			KIT	MK136	MK136		2	31 33 6 760 943			
🚗		→ ←	(+) M3	L11814	L11814			2	33 32 1 137 571		
		↔		L11828	L11828			2	33 32 1 138 722		
			(+) M3 longitudinal	L11830	L11830			2	33 32 1 097 009		
		→ ←	(+) M3	L11815	L11815			2	33 32 1 138 383		
		↔		L11816	L11816			2	33 32 1 136 311		
		▼		L11833	L11833		Hub carrier	2	33 31 1 092 517		
		▲			L11831		Hub carrier	1	33 31 6 753 394		
				L11832			Hub carrier	1	33 31 6 757 393		
		(-) M3		L11611	L11611		2	33 55 1 094 619			
		(-)		MK121	MK121		2	33 52 1 092 362			

3 E90, (-) M3 01.05 →
 3 Touring E91 01.05 →
 3 Coupe E92, (-) M3 09.05 →
 3 Cabriolet E93, (-) M3 08.06 →

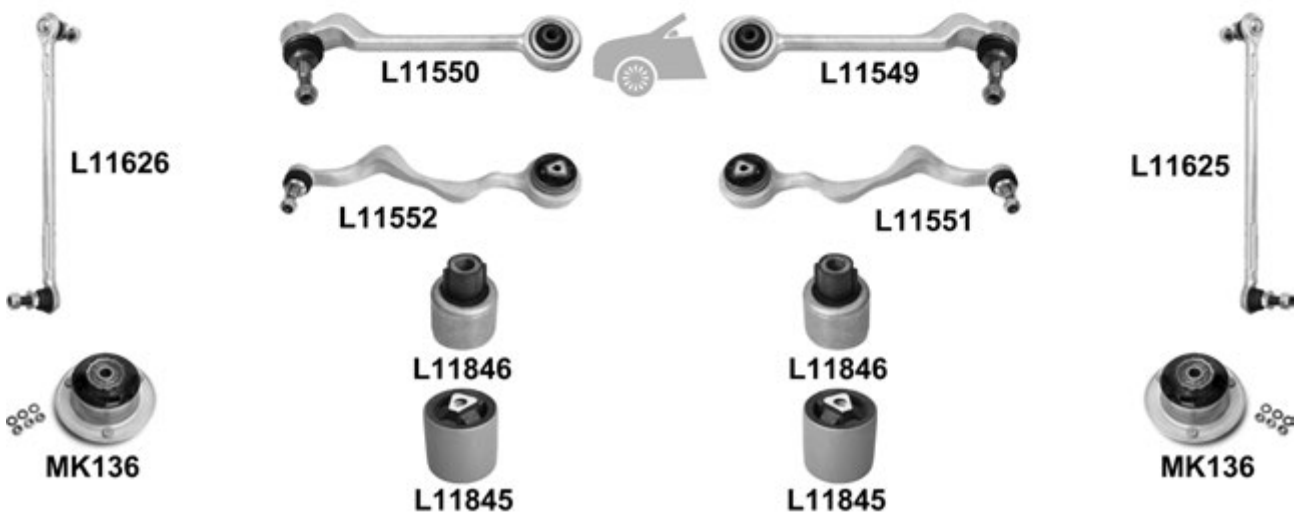
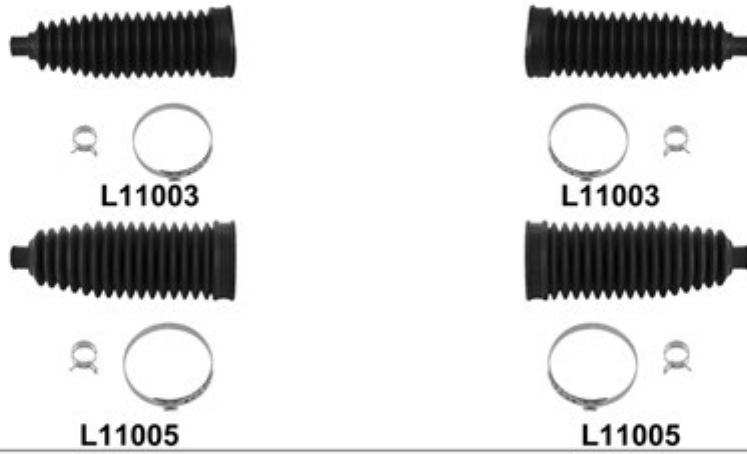
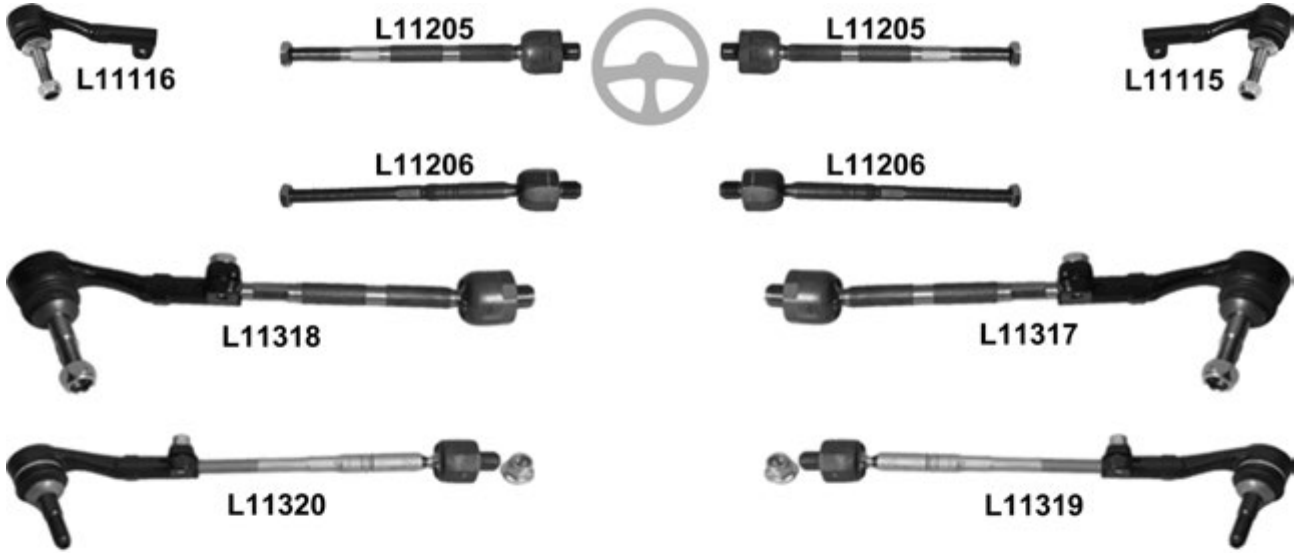

3 E90, (-) M3 01.05 →
 3 Touring E91 01.05 →
 3 Coupe E92, (-) M3 09.05 →
 3 Cabriolet E93, (-) M3 08.06 →

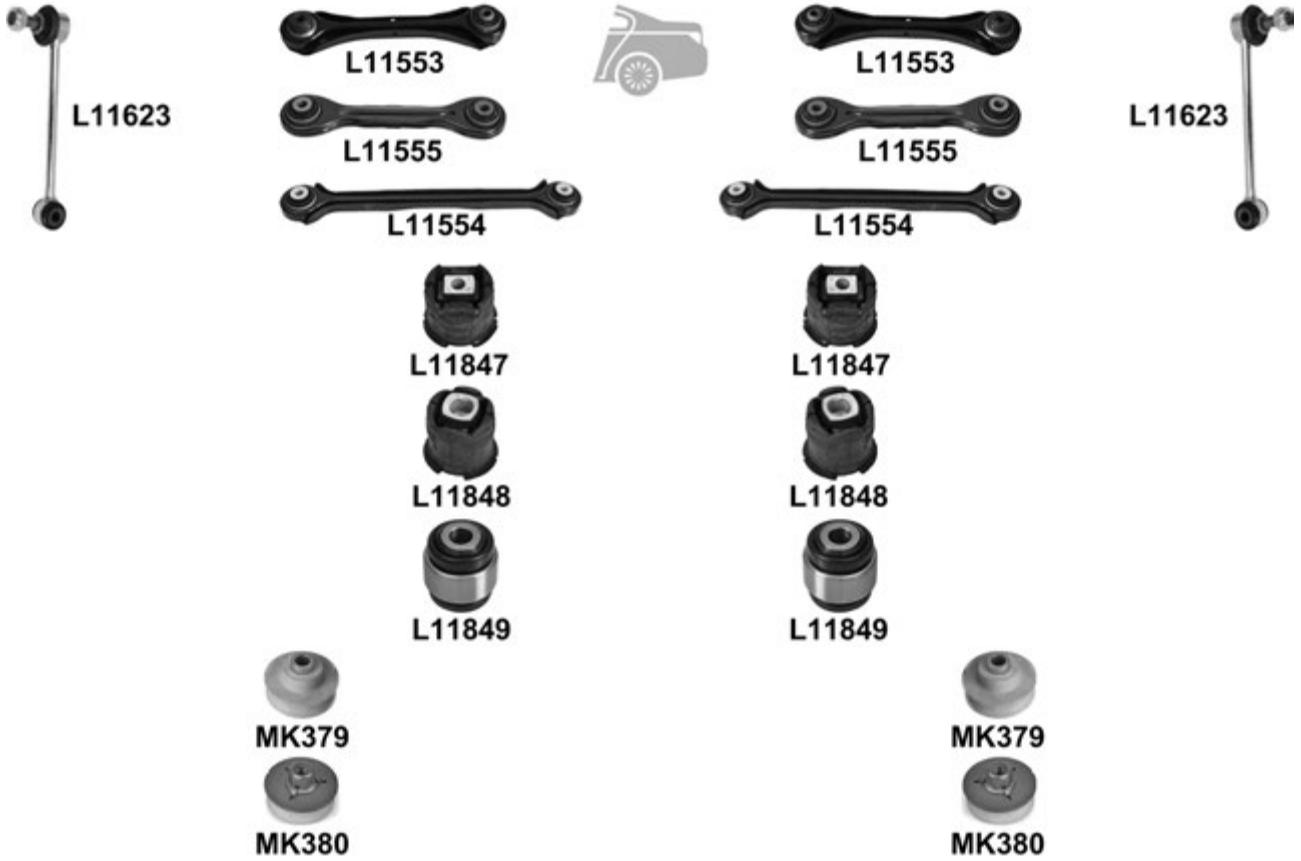

3 E90, (-) M3 01.05 →
3 Touring E91 01.05 →
3 Coupe E92, (-) M3 09.05 →
3 Cabriolet E93, (-) M3 08.06 →

			←	→	Thread	Part Of	QPA				
		↔	(-) xd/xDrive, (+) M3		L11115	F 14x1,5 ∪		1	32 10 6 765 090		
					L11116	F 14x1,5 ∪		1	32 10 6 765 089		
			TRW		L11205	L11205	M 14x1,5 / M 18x1,5 ∪	L11317/L11318	2		
			ZF		L11206	L11206	M 14x1,5 / M 18x1,5 ∪	L11319/L11320	2		
			(-) xi/xd/xDrive, TRW			L11317			1	32 21 6 762 244	
						L11318			1	32 21 6 762 243	
			(-) xd/xDrive, ZF			L11319			1	32 10 6 765 236	
						L11320			1	32 10 6 765 235	
			TRW		L11003	L11003			2	32 10 6 765 079	
			(+) M3, ZF		L11005 ^o	L11005 ^o			2	32 10 6 765 234	
		⊥▼		<input checked="" type="checkbox"/>		L11549			1	31 12 6 763 700	
					<input checked="" type="checkbox"/>		L11550			1	31 12 6 763 699
		⊥▲		<input checked="" type="checkbox"/>			L11551			1	31 12 6 769 802
				<input checked="" type="checkbox"/>			L11552			1	31 12 6 769 801
		▼→←			L11846	L11846		L11549/L11550	2		
		▲→←			L11845	L11845		L11551/L11552	2	31 12 0 393 540	
			(-) xi/xd/xDrive			L11625			1	31 35 6 765 934	
						L11626			1	31 35 6 765 933	
				KIT	MK136	MK136			2	31 33 6 760 943	
			ī▼		<input checked="" type="checkbox"/>	L11553	L11553			2	33 32 6 777 980
ī▲				<input checked="" type="checkbox"/>	L11555	L11555			2	33 32 6 765 425	
⊥▼				<input checked="" type="checkbox"/>	L11554	L11554			2	33 32 6 763 471	
		▼			L11847	L11847		Hub carrier	2	33 31 6 758 260	
		▲	(+) ix/ix/M3		L11848	L11848		Hub carrier	2	33 31 6 758 259	
			(+) M3		L11849	L11849		Hub carrier	2	33 32 6 756 249	
			(+) M3		L11623	L11623			2	33 55 6 764 428	
		⊥			MK379	MK379			2		
		ī			MK380	MK380			2		

3 F30 10.11 →
 3 Touring F31 06.12 →
 3 Gran Turismo F34 03.13 →

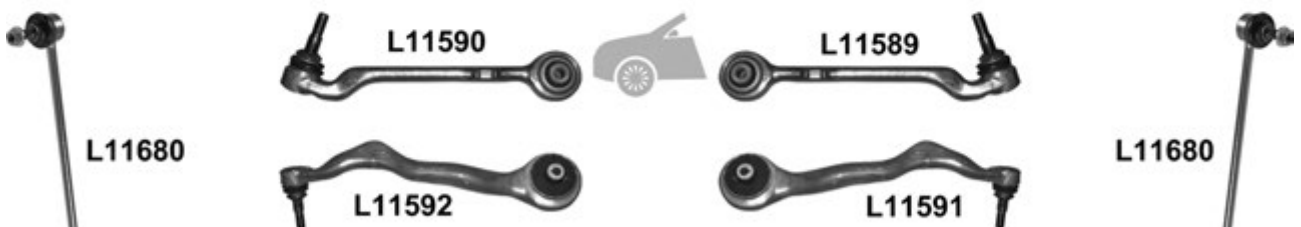
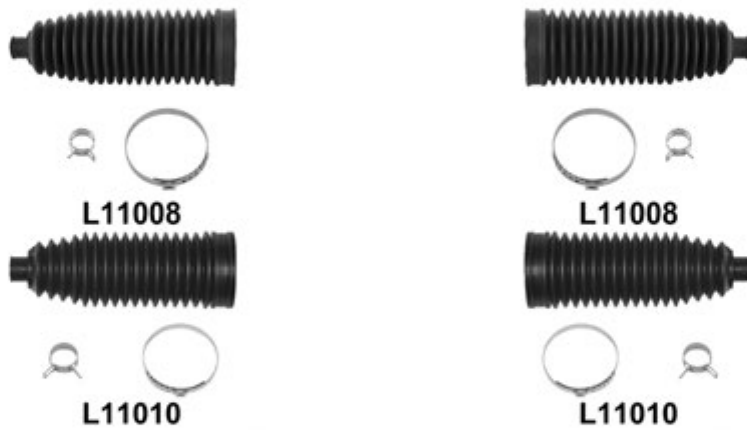
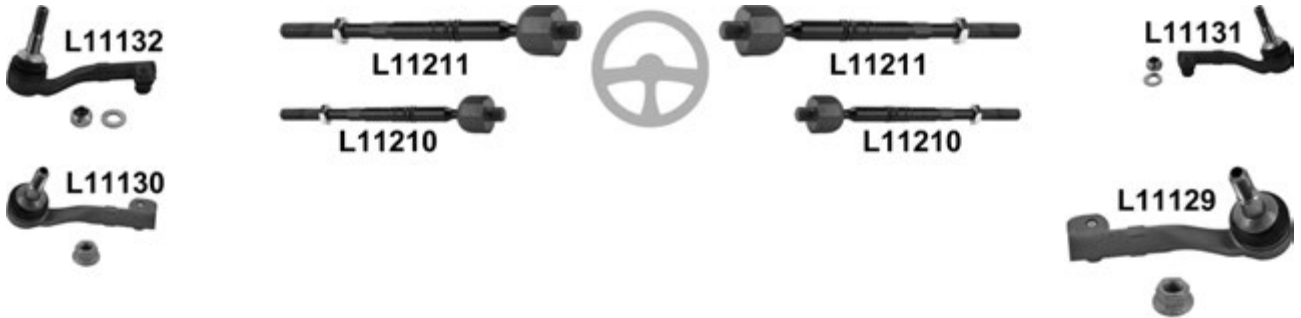

3 F30 10.11 →
 3 Touring F31 06.12 →
 3 Gran Turismo F34 03.13 →



				← → Thread		Part Of	QPA		
⊕	↔	(-) xDrive		L11131	F 14x1,5		1	32 10 6 799 967	i
				L11132	F 14x1,5		1	32 10 6 788 966	
		xDrive		L11129			1	32 10 6 797 618	
				L11130			1	32 10 6 797 617	
	⊖	(-) xDrive		L11211	L11211		L11337/L11338	2	
			xDrive	L11210	L11210		L11335/L11336	2	
	↔	(-) xDrive			L11337			1	32 10 6 799 965
				L11338				1	32 10 6 799 960
		xDrive			L11335			1	32 10 6 792 030
				L11336				1	32 10 6 792 029
⊖	ThyssenKrupp, ø 16mm, Ø 63mm, L= 204mm		L11008 ⁰	L11008 ⁰			2	32 10 6 795 845	
		ZF, ø 16mm, Ø 56mm, L= 186mm	L11010 ⁰	L11010 ⁰			2	32 10 6 854 893	
⊖	⊖	(-) M135i/xDrive	<input checked="" type="checkbox"/>		L11589 ⁰		1	31 12 6 852 992	
				L11590 ⁰		1	31 12 6 852 991		
	⊖	(-) xDrive	<input checked="" type="checkbox"/>		L11591 ⁰		1	31 12 6 855 742	
				L11592 ⁰		1	31 12 6 855 741		
	⊖	(-) M-Technik/xDrive		L11680	L11680			2	31 30 6 792 211
			M-Technik/xDrive			L11679		1	31 30 6 792 212
			L11680				1	31 30 6 792 211	
⊖	⊖	(+)		L11849	L11849	Hub carrier	2	33 32 6 756 249	
					L11643 ⁰		1	33 50 6 785 608	
					L11644 ⁰		1	33 50 6 785 607	

4 Coupe F32 07.13 →

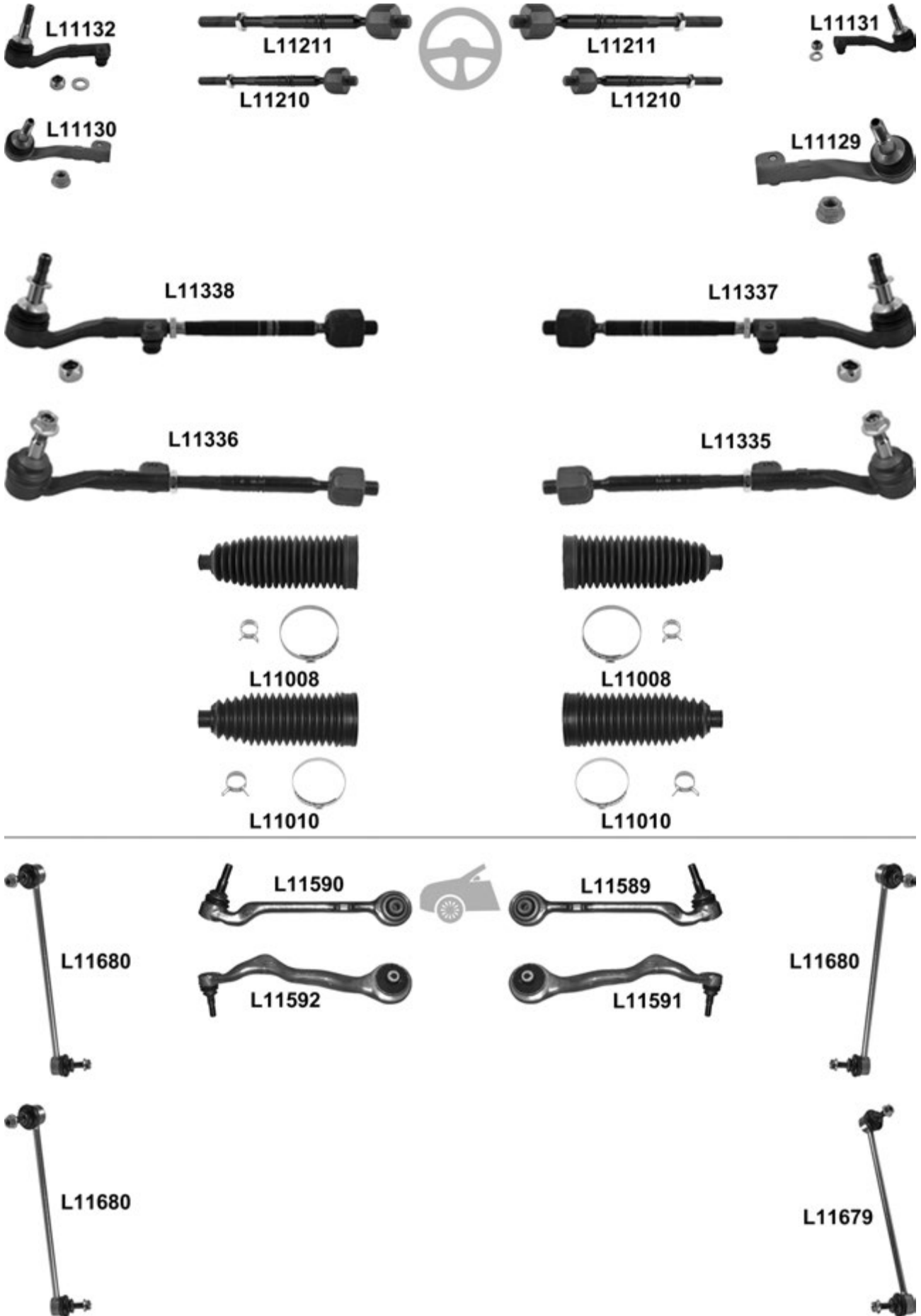

4 Coupe F32 07.13 →



				← → Thread		Part Of	QPA		
⊕	↔	(-) xDrive		L11131	F 14x1,5		1	32 10 6 799 967	
			L11132		F 14x1,5		1	32 10 6 788 966	
		xDrive		L11129			1	32 10 6 797 618	
			L11130				1	32 10 6 797 617	
	⊖	(-) xDrive	L11211	L11211		L11337/L11338	2		
			L11210	L11210		L11335/L11336	2		
	↕	(-) xDrive		L11337			1	32 10 6 799 965	
			L11338				1	32 10 6 799 960	
		xDrive		L11335			1	32 10 6 792 030	
			L11336				1	32 10 6 792 029	
⊖	ThyssenKrupp, ø 16mm, Ø 63mm, L= 204mm		L11008 ⁰	L11008 ⁰		2	32 10 6 795 845		
	ZF, ø 16mm, Ø 56mm, L= 186mm		L11010 ⁰	L11010 ⁰		2	32 10 6 854 893		
⊖	⊖	(-) M135i/xDrive	<input checked="" type="checkbox"/>	L11589 ⁰			1	31 12 6 852 992	
			<input type="checkbox"/>	L11590 ⁰			1	31 12 6 852 991	
		(-) xDrive	<input checked="" type="checkbox"/>	L11591 ⁰			1	31 12 6 855 742	
			<input type="checkbox"/>	L11592 ⁰			1	31 12 6 855 741	
	⊖	(-) M-Technik/xDrive		L11680	L11680		2	31 30 6 792 211	
				L11679			1	31 30 6 792 212	
⊖	(-) M-Technik/xDrive		L11680			1	31 30 6 792 211		
			L11849	L11849		Hub carrier	2	33 32 6 756 249	
⊖	(+)	xDrive		L11643 ⁰			1	33 50 6 785 608	
				L11644 ⁰			1	33 50 6 785 607	

518 - 528 i E12 08.72 → 08.81



				← → Thread		Part Of	QPA		
⊖	⊖	⊖		L11802	L11802	L1120/L1121	2	3112 1119 260	

518 - 535 i E28 06.80 → 06.90



518 - 535 i E28 06.80 → 06.90

			←	→	Thread	Part Of	QPA	
			L1150	L1150	M 14x1,5		2	3221 1135 820
			L1151	L1151	M 14x1,5		2	3221 1135 819
			L1152	L1152			2	3221 1135 666
		→ ←	L1153				1	3221 1129 014
		↑		L1160 ¹			1	3112 1132 354
			L1159 ¹			1	3112 1132 353	
		↓	Steel version <input checked="" type="checkbox"/>		L1157		1	3112 1139 992
			L1156			1	3112 1139 991	
		↑	KIT L11821			L1159 / 1160	1	3112 9058 826
		↓	L11820	L11820		L1156/L1157	2	3112 1124 622
			L11600	L11600			2	3135 1134 582
			KIT MK036 MK036				2	3133 1124 508
		518/518 i/520 i/525 E/524 TD/525 i/525 i, , → 04.86 KIT	L11810	L11810			2	3332 9061 945
		524 D, 09.86 →	L11610	L11610			2	33 32 1 126 476
			L11823	L11823		Hub carrier	2	3331 1130 488

518 i - M5 E34, (-) 525 ix, 12.87 → 11.95
 518 i - M5 Touring E34, (-) 525 ix, 11.91 → 01.97

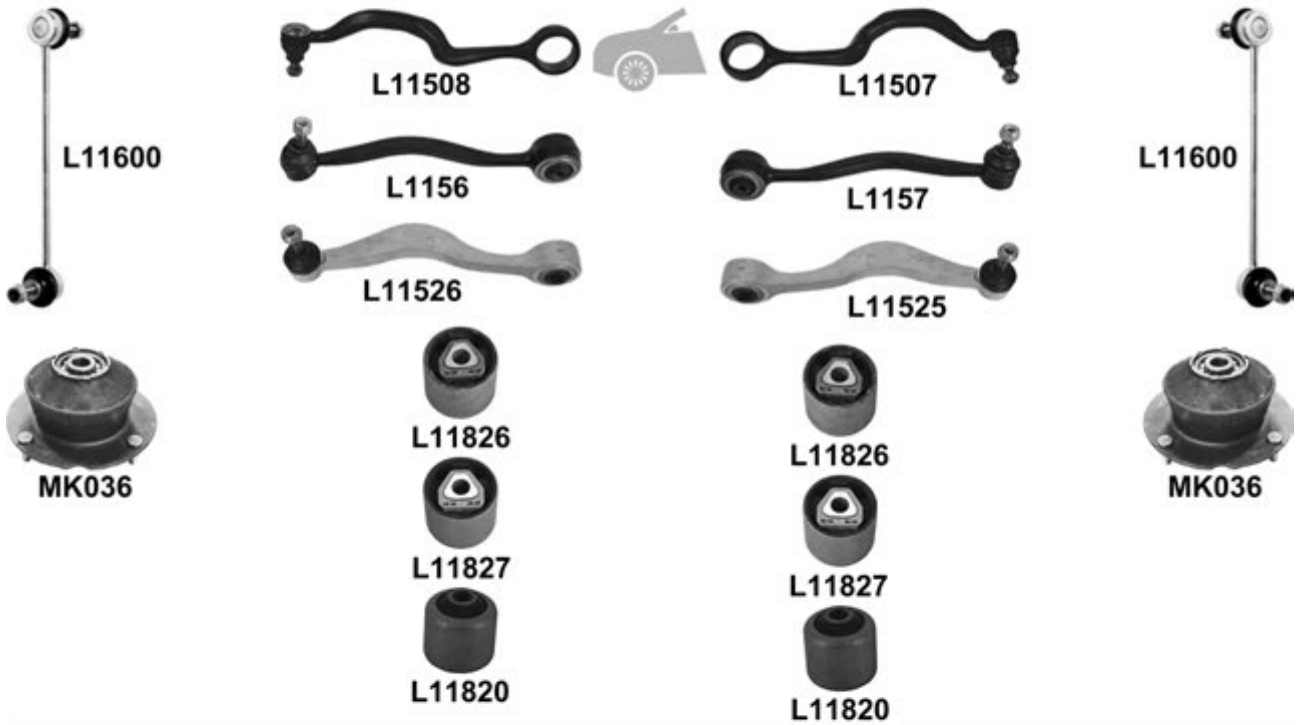

518 i - M5 E34, (-) 525 ix, 12.87 → 11.95
 518 i - M5 Touring E34, (-) 525 ix, 11.91 → 01.97

			←	→	Thread	Part Of	QPA		
			L1150	L1150	M 14x1,5 U		2	3221 1135 820	
			L1151	L1151	M 14x1,5 U		2	3221 1135 819	
			L1152	L1152			2	3221 1135 666	
		→ ←	(-) 518 i/518 i Touring	L11304				1	3221 1138 854
			(+) 518 i/518 i Touring	L11305				1	3221 1138 852
		↑	(-)	L11507			1	3112 1141 098	
				L11508			1	3112 1141 097	
		↓	(-) 530 i, Mot/Eng M60/540 i/M5 Touring, Steel version <input checked="" type="checkbox"/>	L1157			1	3112 1139 992	
				L1156			1	3112 1139 991	
			(-) M5 3.8/M5 Touring, ALU version <input checked="" type="checkbox"/>	L11525			1	31 12 1 139 988	
				L11526			1	31 12 1 139 987	
			M5 3.8/M5 Touring, → 06.94, ALU version <input checked="" type="checkbox"/>	L11525			1	31 12 1 139 988	
			L11526			1	31 12 1 139 987		
		↑	520 i, Mot/Eng M20/M50/525 i, Mot/Eng M20/M50	L11826	L11826			2	31 12 1 136 605
			518 i/518 G/524 td/525 td/tds/530 i/535 i/540 i	L11827	L11827			2	31 12 1 139 456
		↓		L11820	L11820		L1156/L1157	2	3112 1124 622
				L11600	L11600			2	3135 1134 582
			518i Mot/Eng M40/520i, Mot/Eng M20/M50, → 07.90 KIT	MK036	MK036			2	3133 1124 508
			L11604	L11604			2	33 55 1 135 307	
			L11825	L11825		Hub carrier	2	3331 1129 760	
			L11610	L11610			2	33 32 1 126 476	
			(-) 525 ix/M-Technik/Sport	L11819	L11819		Anti-roll bar	2	3355 1131 155
				MK122	MK122			2	33 52 1 132 270

520 i - 528 i (E39) 11.95 → 06.03
 520 i - 528 i Touring (E39) 01.97 → 05.04

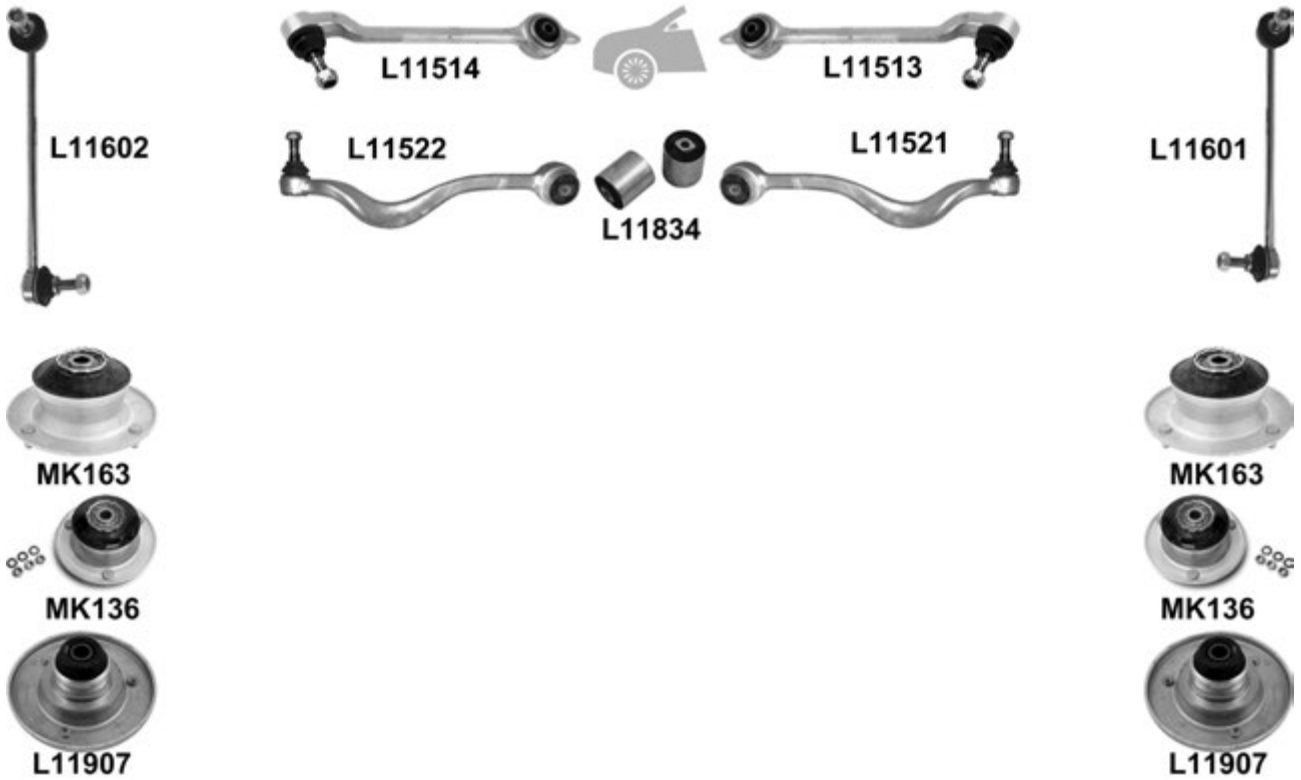
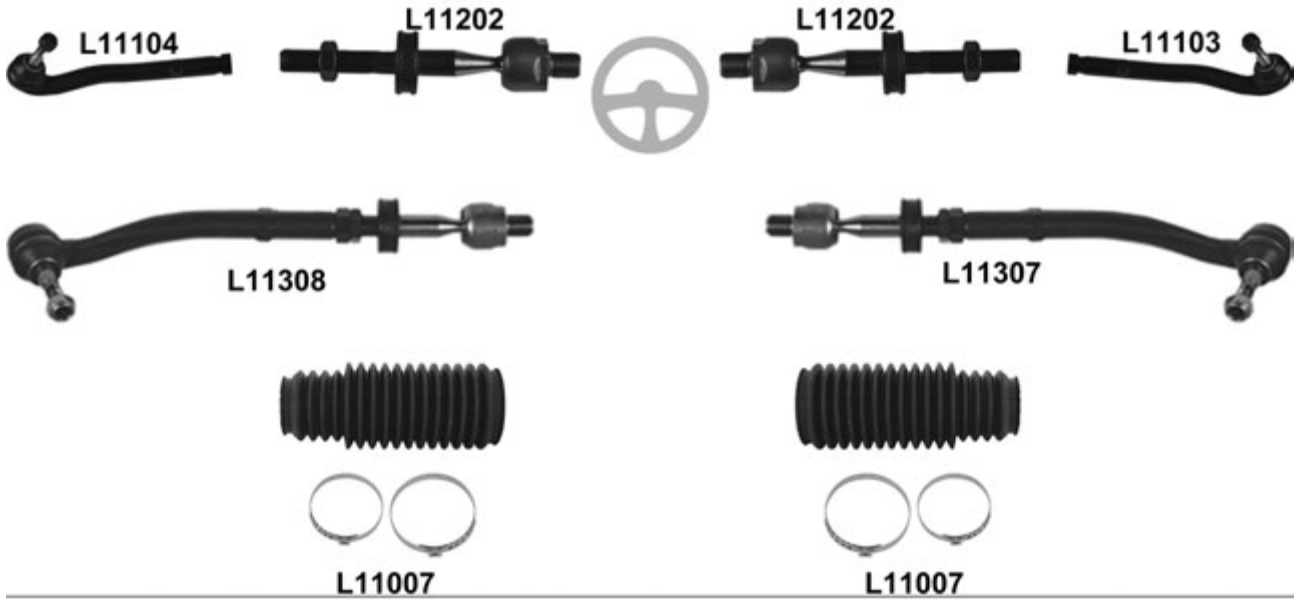

520 i - 528 i (E39) 11.95 → 06.03
 520 i - 528 i Touring (E39) 01.97 → 05.04

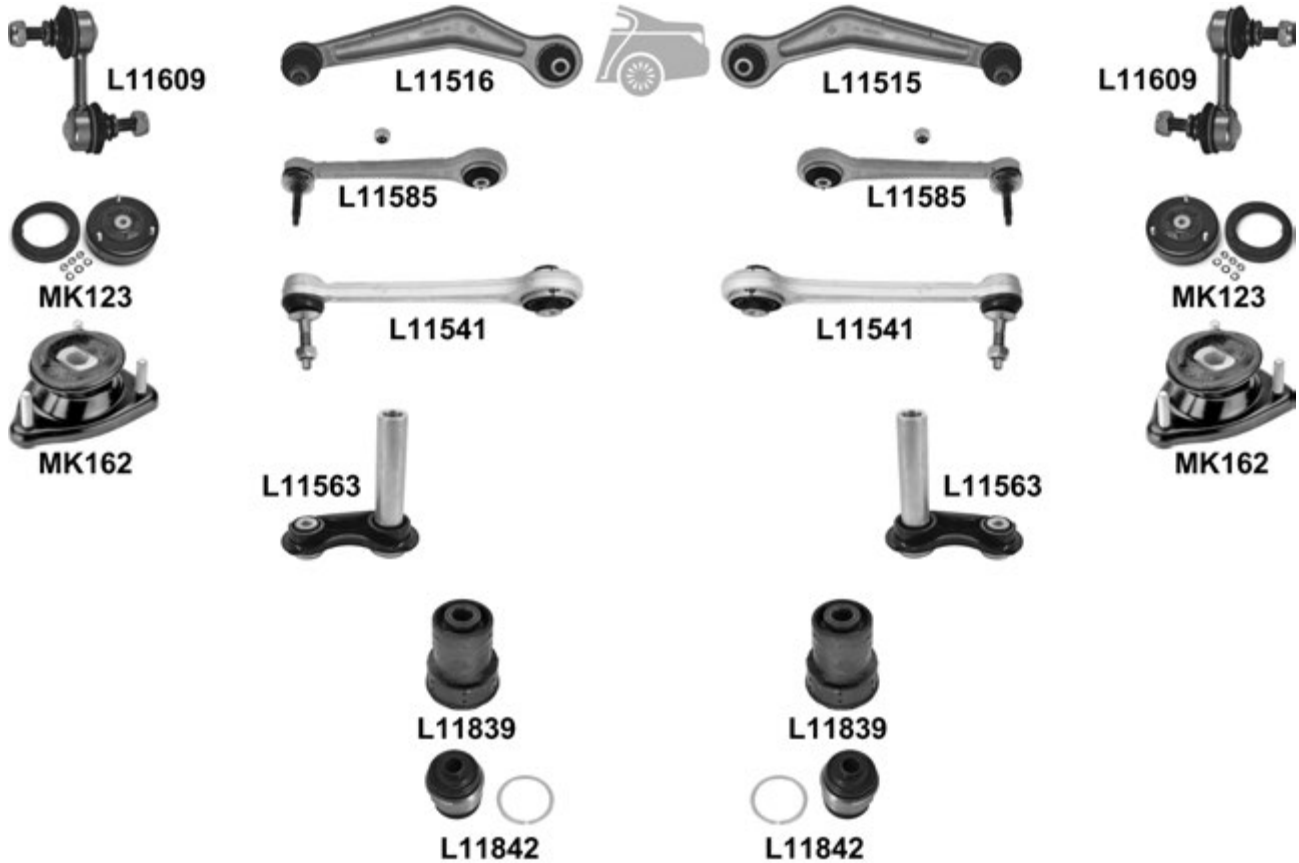

				← → Thread		Part Of	QPA			
⊕		↔		L11103	F 16x1 ♂		1	32 11 1 093 772		
				L11104	F 16x1 ♂		1	32 11 1 093 771		
				L11202	L11202	M 16x1 / M 18x1,5		2		
				L11307				1	32 21 1 094 674	
				L11308				1	32 21 1 094 673	
⊖		⊥▼	<input checked="" type="checkbox"/>		L11513		1	31 12 1 094 234		
				L11514		1	31 12 1 094 233			
		⊥▲	<input checked="" type="checkbox"/>		L11521		1	31 12 1 092 024		
				L11522		1	31 12 1 092 023			
		⊥▲		KIT	L11834		L11521/L11522	1	31 12 9 068 753	
					L11601		1	31 35 1 095 662		
					L11602		1	31 35 1 095 661		
				→ 09.97, (-) Electronic shock absorber, EDC	KIT	MK163	MK163	2	31 33 1 091 709	
				09.97 →, (-) Electronic shock absorber, EDC	KIT	MK136	MK136	2	31 33 6 752 735	
				530 D//M5, Electronic shock absorber, EDC	KIT	L11907	L11907	2	31 33 1 091 708	
⊖		⊥▼			L11515		1	33 32 1 094 210		
				L11516		1	33 32 1 094 209			
		⊥▲	→ 12.01		L11585	L11585	2	33 32 6 768 791		
			01.02 →		L11541	L11541	2	33 32 6 770 753		
		⊥▲			L11563	L11563	2	33 32 6 770 749		
			530 D, → 03.99/All Touring		L11839	L11839	Hub carrier	4	33 31 1 094 036	
					L11842	L11842	Hub carrier	2	33 32 6 767 748	
					L11609	L11609		2	33 55 1 095 532	
				(-) EDC/Touring		MK123	MK123	2	33 52 1 091 710	
				HD suspension, (-) Touring		MK123	MK123	2	33 52 1 094 977	
			Touring		MK162	MK162	2			

⊥ = Upper ⊥ = Lower ▲ = Front ▼ = Rear → ← = Inner ↔ = Outer ↔ = Center

535 i, 540 i, M5 (E39) 04.96 → 06.03
 540 i Touring (E39) 01.97 → 05.04

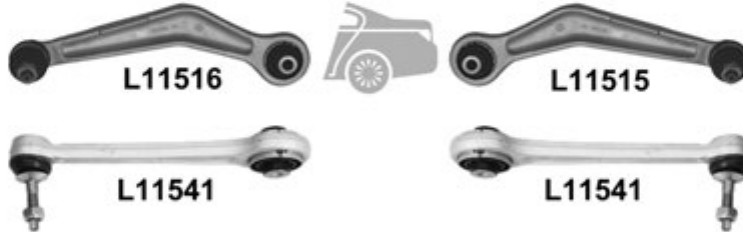
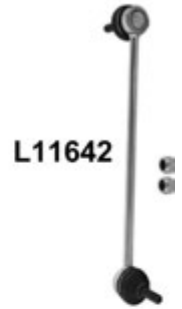
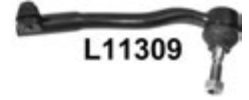

535 i, 540 i, M5 (E39) 04.96 → 06.03
 540 i Touring (E39) 01.97 → 05.04

		i		←	→	Thread	Part Of	QPA	i	
		↔			L11309	F 16x1,5 ♂		1	3221 1 091 724	
					L11310	F 16x1,5 ♂		1	3221 1 091 723	
		⊥▼	<input checked="" type="checkbox"/>		L11523			1	3112 1 092 820	
			<input checked="" type="checkbox"/>		L11524			1	3112 1 092 819	
		⊥▲	<input checked="" type="checkbox"/>		L11517			1	3112 1 141 962	
			<input checked="" type="checkbox"/>		L11518			1	3112 1 141 961	
		⊥▲		KIT	L11835		L11517/L11518	1	31 12 0 006 482	
					L11642	L11642		2	31 35 1 095 664	
				KIT	L11907	L11907		2	31 33 1 091 708	
		⌈▼			L11515			1	33 32 1 094 210	
					L11516			1	33 32 1 094 209	
		⌈▲			L11541	L11541			2	33 32 6 770 753
					L11563	L11563			2	33 32 6 770 749
			540 i Touring		L11839	L11839		Hub carrier	4	33 31 1 094 036
					L11842	L11842		Hub carrier	2	33 32 6 767 748
					L11609	L11609		2	3355 1 092 292	
				(-) HD / SP , (-) M5/Touring	MK123	MK123			2	33 52 1 091 710
				HD , (-) SP / M5/Touring	MK123	MK123			2	33 52 1 094 977
			Touring		MK162	MK162			2	

520 i - M5 (E60) 7.2003 →
 520 i Touring - 535 d Touring (E61) 06.04 →

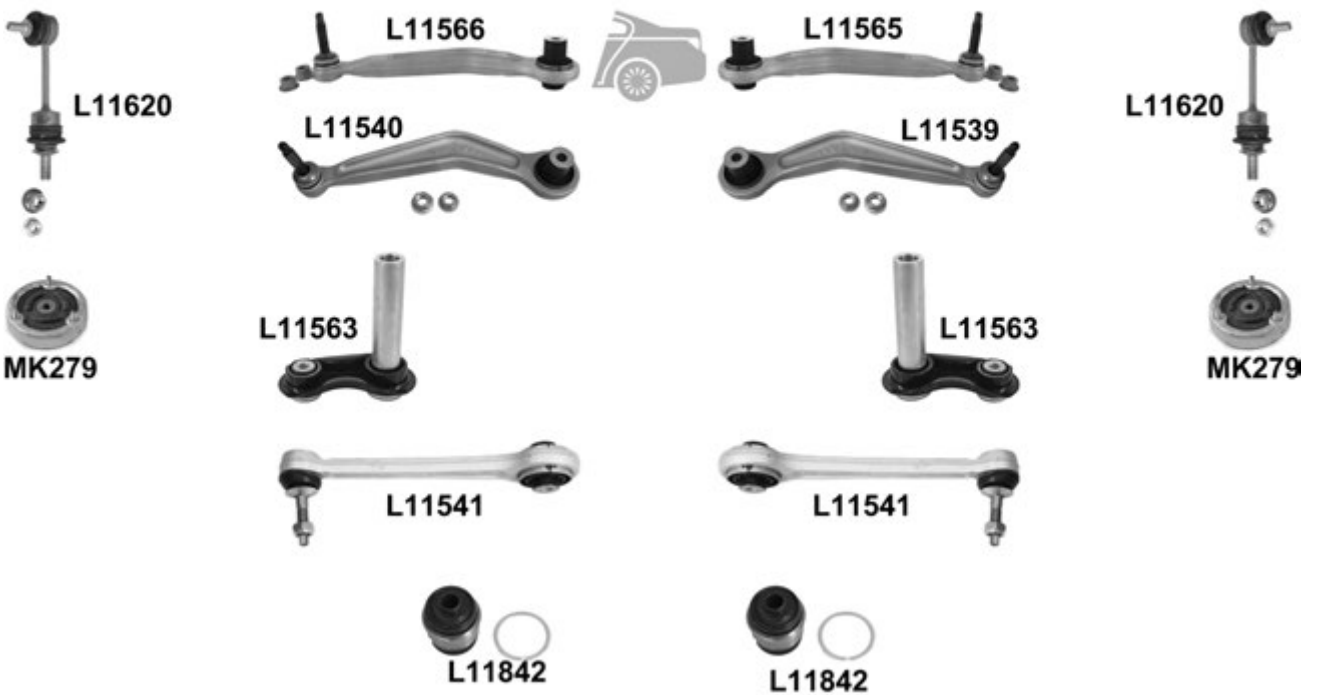
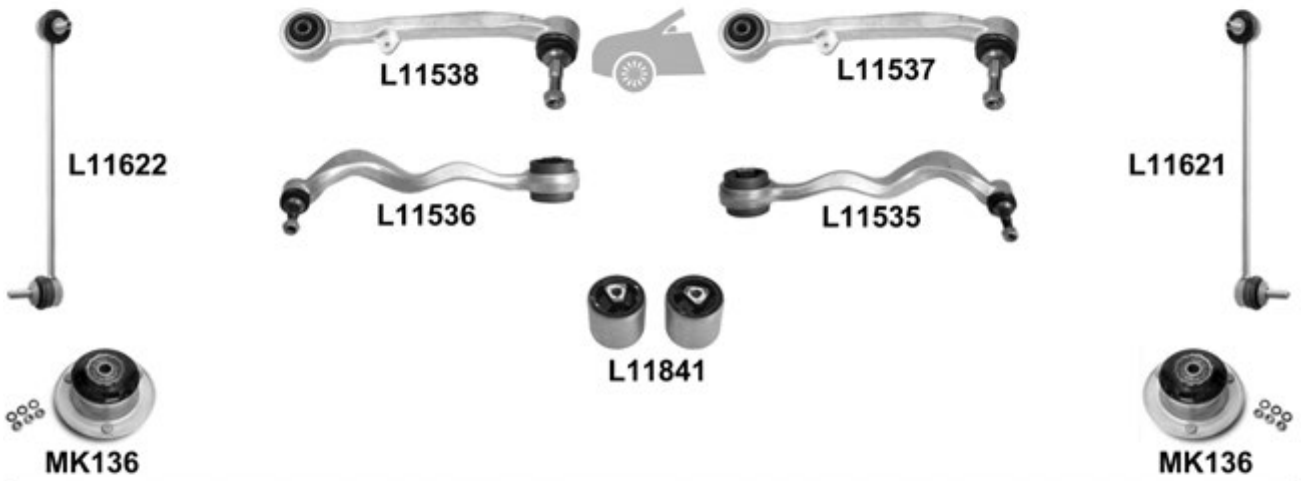
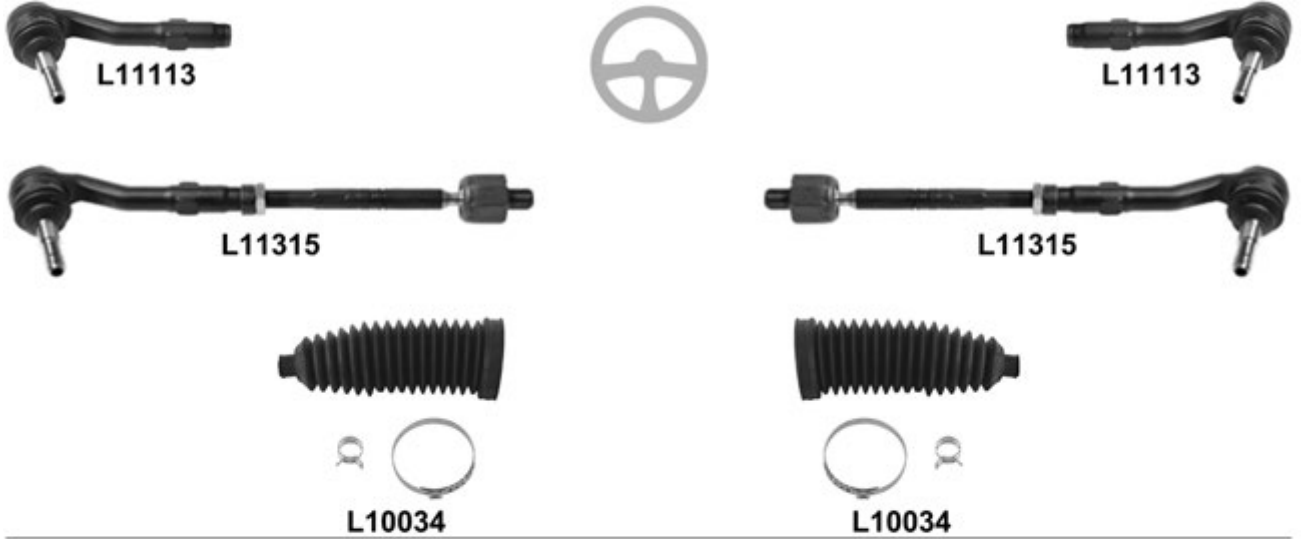

520 i - M5 (E60) 7.2003 →
 520 i Touring - 535 d Touring (E61) 06.04 →

			←	→	Thread	Part Of	QPA			
		↔	(-) xi/xd	L11113	L11113	F 16x1,5 ∪	2	32 21 6 756 369		
			(-) xi/xd	L11315	L11315	∪	2	32 21 6 762 403		
			(+) dx/ix/M5	L10034 ⁰	L10034 ⁰		2	32 10 6 765 782		
		⊥▼			L11537		1	31 12 6 760 182		
				L11538			1	31 12 6 760 181		
		⊥▲			L11535		1	31 10 4 026 720		
				L11536			1	31 10 4 026 719		
		⊥▲		L11841		L11535/L11536	1	31 12 0 305 612		
					L11621		1	31 35 4 014 532		
				L11622			1	31 35 4 014 531		
			(+) dx/ix, (-) M5	KIT	MK136	MK136	2	31 33 6 752 735		
		▼	→ 01.05	<input checked="" type="checkbox"/>		L11565	1	33 32 6 777 426		
					L11566		1	33 32 6 777 425		
		02.05 →, (+) dx/ix/M5	<input checked="" type="checkbox"/>		L11539		1	33 30 6 772 242		
				L11540		1	33 30 6 772 241			
		⊥▲	(+) dx/ix/M5		L11563	L11563	2	33 32 6 770 749		
		⊥▲	(+) dx/ix, (-) M5		L11541	L11541	2	33 32 6 770 753		
			(+) dx/ix/M5		L11842	L11842		Hub carrier	2	33 32 6 767 748
			(+) dx/ix/M5, (-) Electronic Drive Dynamic		L11620	L11620	2	33 55 6 761 000		
			(+) dx/ix, (-) M5		MK279	MK279	2	33 52 6 779 611		

520 D - 550 i F10 / F11 / F18 03.10 →
 530 D - 550 i Grand Tourismo F07GT 10.09 →

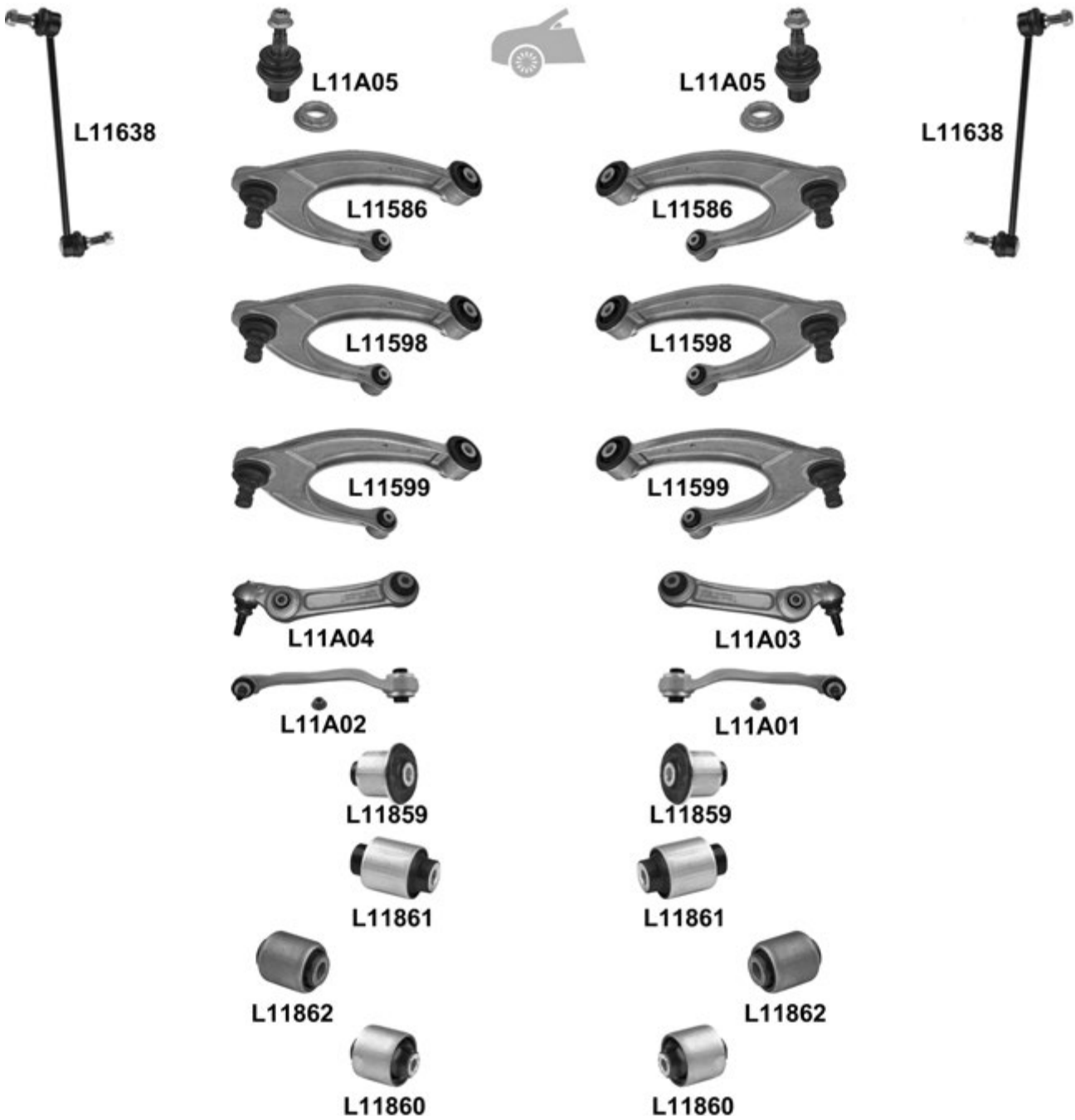
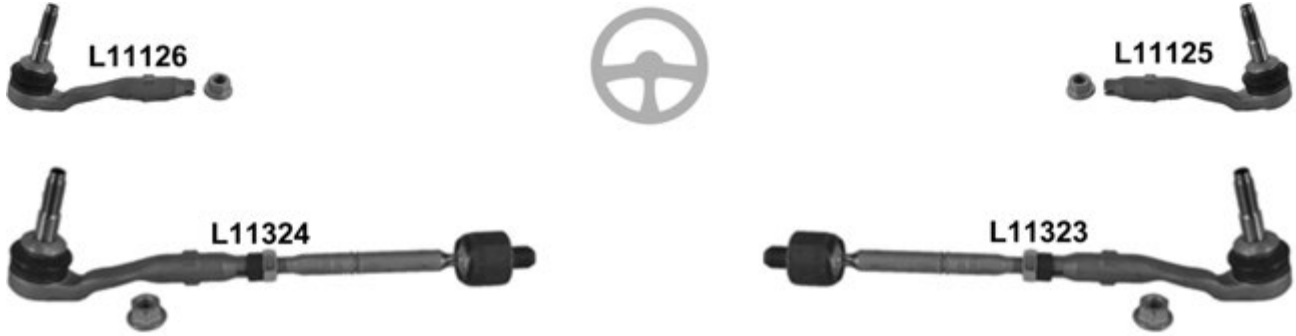

520 D - 550 i F10 / F11 / F18 03.10 →
 530 D - 550 i Grand Tourismo F07GT 10.09 →



L11639



L11639



L11640



L11640



L11641



L11641

		i		← →		Thread	Part Of	QPA	i			
		↔			L11125	F 14x1,5 ♂		1	32 10 6 784 796			
					L11126	F 14x1,5 ♂		1	32 10 6 784 790			
					L11323			1	32 10 6 784 719			
					L11324			1	32 10 6 784 719			
		⊥	xDrive	L11A05	L11A05			2	31 12 6 777 753			
			↕	L11586	L11586			2	31 12 6 775 667			
				Camber -30'	L11598	L11598			2	31 12 6 779 908		
				Camber +30'	L11599	L11599			2	31 12 6 779 871		
			⊥↘	(-) xDrive/Grand Tourismo F07	L11A03 ⁰				1	31 12 6 794 204		
					L11A04 ⁰				1	31 12 6 794 203		
			⊥↗	(-) xDrive/Grand Tourismo F07	L11A01 ⁰				1	31 12 6 775 972		
					L11A02 ⁰				1	31 12 6 775 971		
					↕↔		L11859	L11859		L11598/L11599	4	
							L11861	L11861		L11A03/L11A04	4	
	L11862	L11862					L11A03/L11A04	4				
	L11860	L11860					L11A01/L11A02	4				
		↔		L11638	L11638			2	31 35 6 777 319			
			F10, (-) Electronic Drive Dynamic	L11639 ⁰	L11639 ⁰			2	33 55 6 777 635			
			F10, Electronic Drive Dynamic	L11640	L11640			2	37 10 6 775 189			
			F11/F07GT	L11641	L11641			2	33 55 6 786 429			

628 - M635 E24 04.76 → 05.82



		i		←	→	Thread	Part Of	QPA	i
		±	▼	L11802	L11802		L1120/L1121	2	3112 1119 260
		628 Csi/630 CS/633 Csi/635 CSi		KIT	L11810	L11810		2	3332 9061 945

628 - M635 E24 05.82 → 09.90



628 - M635 E24 05.82 → 09.90

				←	→	Thread	Part Of	QPA	
		↔↔		L1150	L1150	M 14x1,5 ☺		2	3221 1135 820
		→←		L1151	L1151	M 14x1,5 ☺		2	3221 1135 819
				L1152	L1152			2	3221 1135 666
		→ ←		L1153				1	3221 1129 014
		↑	(-) ☺		L1160 ¹			1	3112 1132 354
				L1159 ¹				1	3112 1132 353
		↓	Steel version <input checked="" type="checkbox"/>		L1157			1	3112 1139 992
				L1156				1	3112 1139 991
		↓▼		L11820	L11820		L1156/L1157	2	3112 1124 622
		↓		L11600	L11600			2	3135 1134 582
				KIT	MK036	MK036		2	3133 1124 508
				L11610	L11610			2	33 32 1 126 476
				L11823	L11823		Hub carrier	2	3331 1130 488
				L11603	L11603			2	3355 1126 932

630 i - 645 ci E63 01.04 →

630 i Cabriolet - 645 ci Cabriolet E64 04.04 →



L11113



L11113



L11315



L11315



L10034



L10034



MK136



L11588



L11587



MK136



L11841



L11620



L11540



L11539



L11620

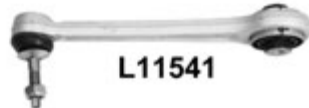

L11541

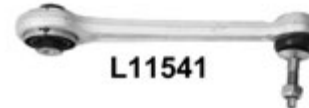

L11541



MK279



L11563



L11563



MK279



L11842



L11842

630 i - 645 ci E63 01.04 →

630 i Cabriolet - 645 ci Cabriolet E64 04.04 →

		i		←	→	Thread	Part Of	QPA	i	
		↔		L11113	L11113	F 16x1,5 ♂		2	32 21 6 756 369	
				L11315	L11315	♂		2	32 21 6 792 403	
				L10034 ⁰	L10034 ⁰			2	32 10 6 765 782	
		⊥▼	<input checked="" type="checkbox"/>		L11587			1	31 12 6 777 940	
				L11588			1	31 12 6 777 939		
		⊥▲		KIT	L11841				1	31 12 0 305 612
					MK136	MK136		2	31 33 6 752 735	
		⌈▼	<input checked="" type="checkbox"/>		L11539			1	33 30 6 772 242	
				L11540			1	33 30 6 772 241		
				L11541	L11541		2	33 32 6 770 753		
		⊥▲	07.06 → 10.06, (-) M6		L11563	L11563			2	33 32 6 770 749
					L11842	L11842		Hub carrier	2	33 32 6 767 748
					L11620	L11620			2	33 55 6 761 000
					MK279	MK279			2	33 52 6 779 611

640 D - 650 i xDrive Cabriolet F12 03.11 →
 640 D - 650 i xDrive Coupe F13 06.11 →
 640 D Gran Coupe - 650 i xDrive Grand Coupe F06 01.12 →

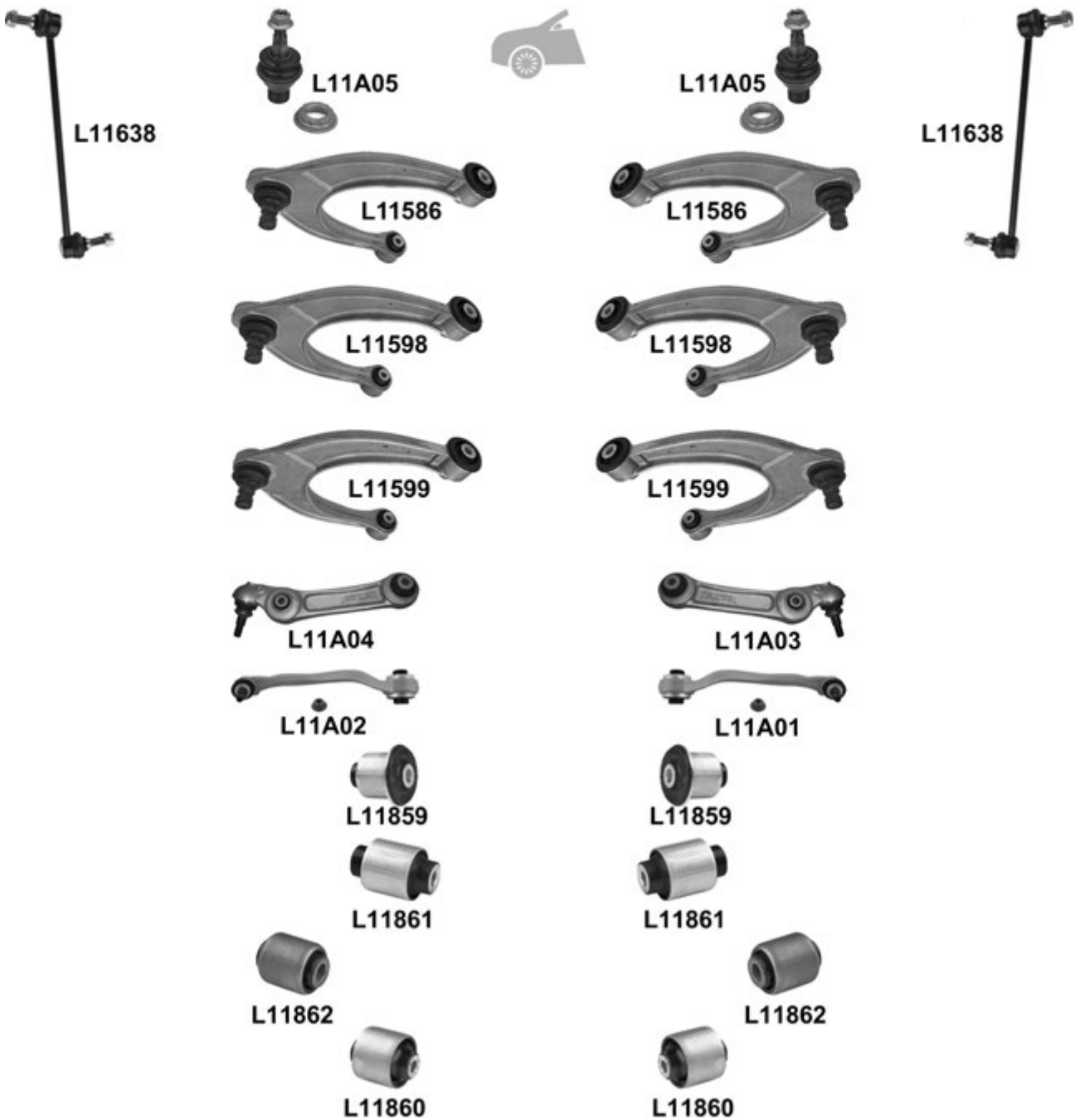
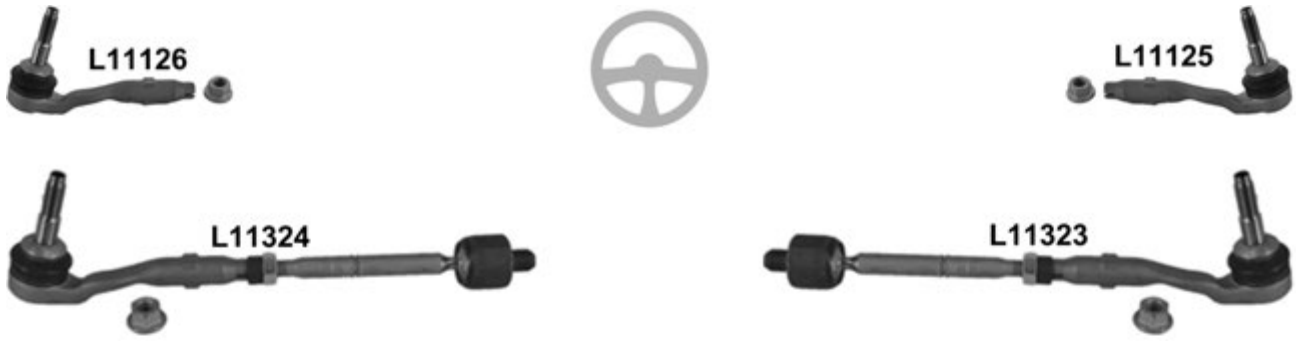

640 D - 650 i xDrive Cabriolet F12 03.11 →
 640 D - 650 i xDrive Coupe F13 06.11 →
 640 D Gran Coupe - 650 i xDrive Grand Coupe F06 01.12 →



L11639



L11639



L11640



L11640

						←	→	Thread	Part Of	QPA				
⊕		↔			L11125		F 14x1,5 U		1	32 10 6 784 796				
					L11126		F 14x1,5 U		1	32 10 6 784 790				
					L11323				1	32 10 6 784 719				
					L11324				1	32 10 6 784 719				
⊖		⊥	xDrive		L11A05	L11A05			2	31 12 6 777 753				
			⌈	(-) M6		L11586	L11586			2	31 12 6 775 667			
				(-) M6, Camber -30°		L11598	L11598			2	31 12 6 779 908			
				(-) M6, Camber +30°		L11599	L11599			2	31 12 6 779 871			
			⊥▼	(-) xDrive/M6		L11A03 ⁰				1	31 12 6 794 204			
						L11A04 ⁰				1	31 12 6 794 203			
			⊥▲	(-) xDrive/M6		L11A01 ⁰				1	31 12 6 775 971			
						L11A02 ⁰				1	31 12 6 775 972			
			⊖		⌈▲▼→←		L11859	L11859			L11598/L11599	4		
							L11861	L11861			L11A03/L11A04	4		
	L11862	L11862						L11A03/L11A04	4					
	L11860	L11860						L11A01/L11A02	4					
⊖		↔	(-) M6		L11638	L11638			2	31 35 6 777 319				
			(-) Electronic Drive Dynamic/M6		L11639 ⁰	L11639 ⁰			2	33 55 6 777 635				
⊖		↔	Electronic Drive Dynamic		L11640	L11640			2	37 10 6 775 189				

730 - 750 i E32 09.86 → 09.94

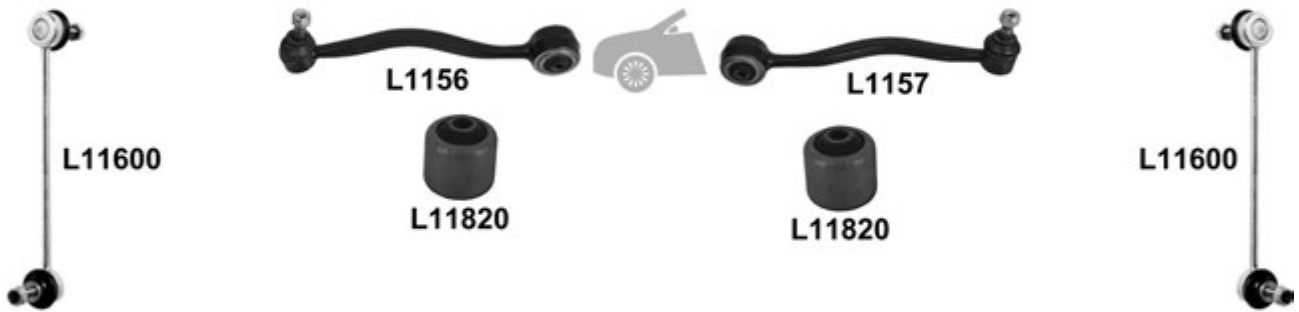

						←	→	Thread	Part Of	QPA	
		↔		L1150	L1150			M 14x1,5 U		2	3221 1135 820
		→←		L1151	L1151			M 14x1,5 U		2	3221 1135 819
				L1152	L1152					2	3221 1135 666
		⊥	Steel version		L1157					1	3112 1139 992
				L1156						1	3112 1139 991
		⊥↘		L11820	L11820				L1156/L1157	2	3112 1124 622
				L11600	L11600					2	3135 1134 582
				L11604	L11604					2	33 55 1 135 307
				L11825	L11825				Hub carrier	2	33 31 1 129 760
				L11610	L11610					2	33 32 1 126 476
				L11819	L11819				Anti-roll bar	2	33 55 1 131 155
				MK124	MK124					2	

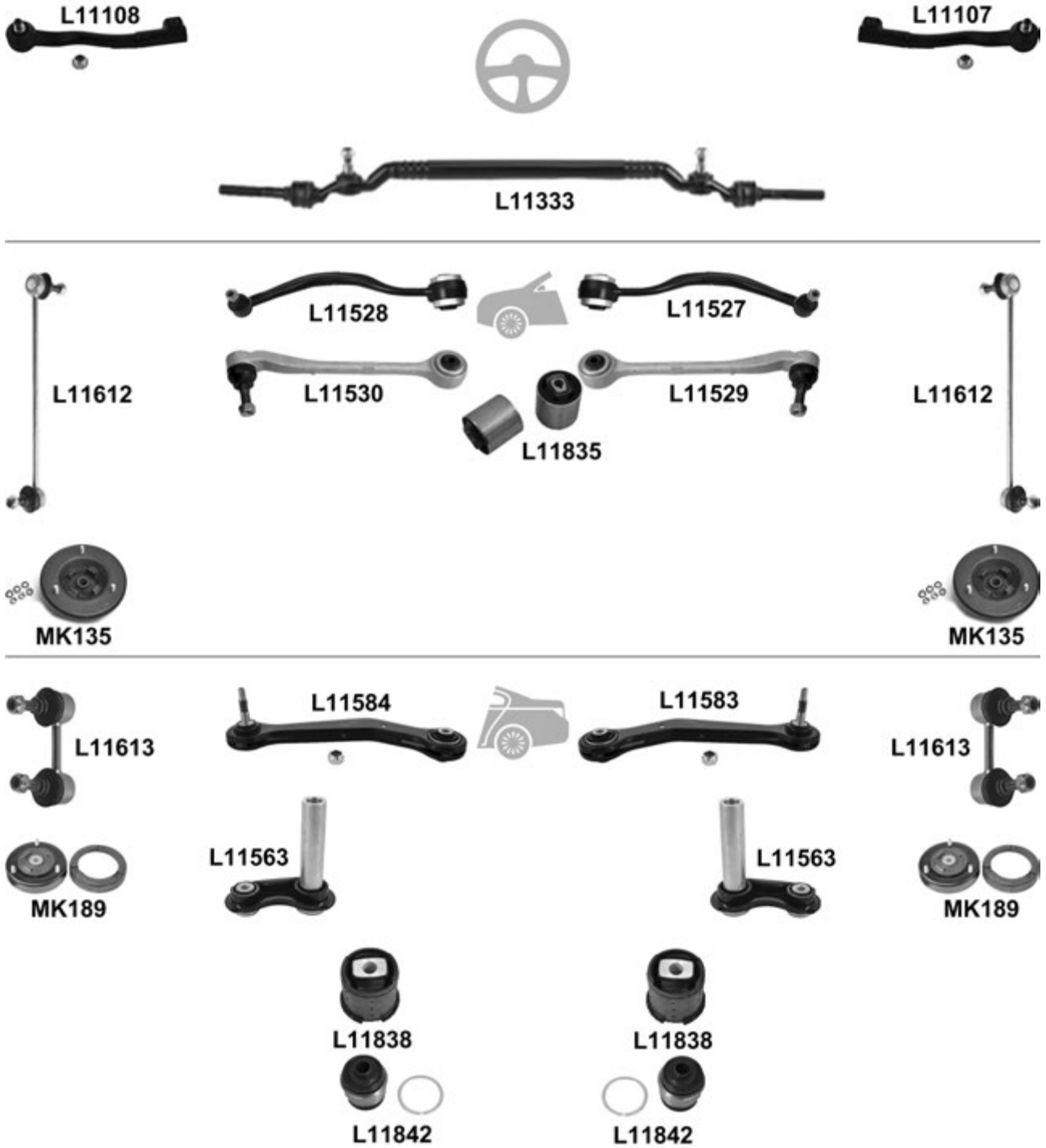
728 i - 750 il E38 (-) 728 ix 10.94 → 11.01

728 i - 750 il E38 (-) 728 ix 10.94 → 11.01

				←	→	Thread	Part Of	QPA		
		\leftrightarrow			L11107			1	32 21 1 141 346	
					L11108			1	32 21 1 141 345	
		$\rightarrow\leftarrow$		L11333				1	32 21 1 096 057	
		$\bar{\uparrow}$	<input checked="" type="checkbox"/>		L11527			1	31 12 1 141 724	
					L11528			1	31 12 1 141 723	
			<input checked="" type="checkbox"/>		L11529			1	31 12 1 142 088	
		\perp		<input checked="" type="checkbox"/>		L11530			1	31 12 1 142 087
		$\bar{\uparrow}$	KIT		L11835			1	31 12 0 006 482	
					L11612	L11612		2	31 35 1 091 496	
					MK135	MK135		2		
		$\bar{\uparrow}\blacktriangledown$			L11583			1	33 32 6 770 060	
					L11584			1	33 32 6 770 059	
					L11563	L11563		2	33 32 6 770 749	
					L11838	L11838	Hub carrier	4	33 31 1 090 956	
					L11842	L11842	Hub carrier	2	33 32 6 767 748	
					L11613	L11613		2	33 55 1 091 497	
					MK189	MK189		2		

730 i - 745 d E65, E66 11.01 →

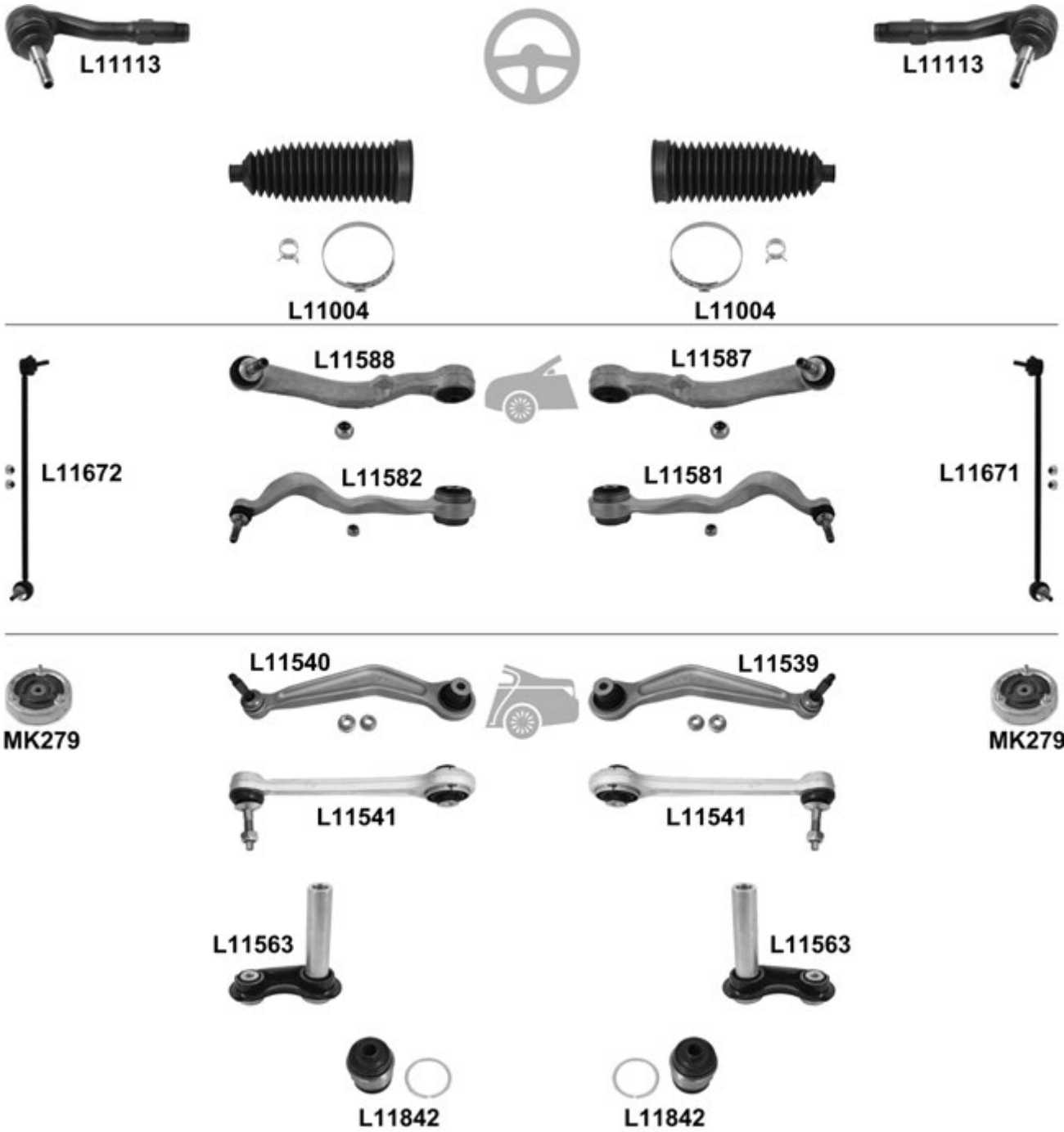

				← → Thread		Part Of	QPA		
		↔		L11113	L11113	F 16x1,5 U	2	32 21 6 756 369	
			ZF	L11004	L11004		2	32 12 6 751 026	
		⊥▼		<input checked="" type="checkbox"/>	L11587		1	31 12 6 777 940	
				<input checked="" type="checkbox"/>	L11588		1	31 12 6 777 939	
	⊥▲		<input checked="" type="checkbox"/>	L11581		1	31 12 6 774 832		
				L11582		1	31 12 6 774 831		
					L11671		1	31 35 6 781 546	
					L11672		1	31 35 6 781 545	
		↔		<input checked="" type="checkbox"/>	L11539		1	33 32 6 767 968	
				L11540		1	33 32 6 767 967		
	↔	→ 09.06		L11541	L11541		2	33 32 6 770 753	
				L11563	L11563		2	33 32 6 770 749	
				L11842	L11842		2	33 32 6 767 748	
			MK279	MK279		2	33 52 6 779 611		

730 D - 760 i F01, F02 10.08 →

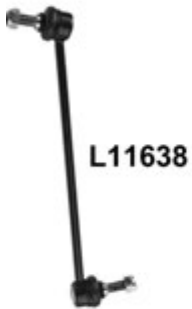

730 D - 760 i F01, F02 10.08 →

		i		←	→	Thread	Part Of	QPA	i	
		↔			L11125	F 14x1,5 ♂		1	32 10 6 784 796	
					L11126	F 14x1,5 ♂		1	32 10 6 784 790	
					L11323			1	32 10 6 784 719	
					L11324			1	32 10 6 784 719	
		⊥	xDrive		L11A05	L11A05		2	31 12 6 777 753	
					L11586	L11586		2	31 12 6 775 667	
			Camber -30°		L11598	L11598		2	31 12 6 779 908	
			Camber +30°		L11599	L11599		2	31 12 6 779 871	
		↕	↔			L11859	L11859		4	
						L11638	L11638		2	31 35 6 777 319
			(-) Electronic Drive Dynamic		L11639°	L11639°		2	33 55 6 777 635	
			Electronic Drive Dynamic		L11640	L11640		2	37 10 6 775 189	

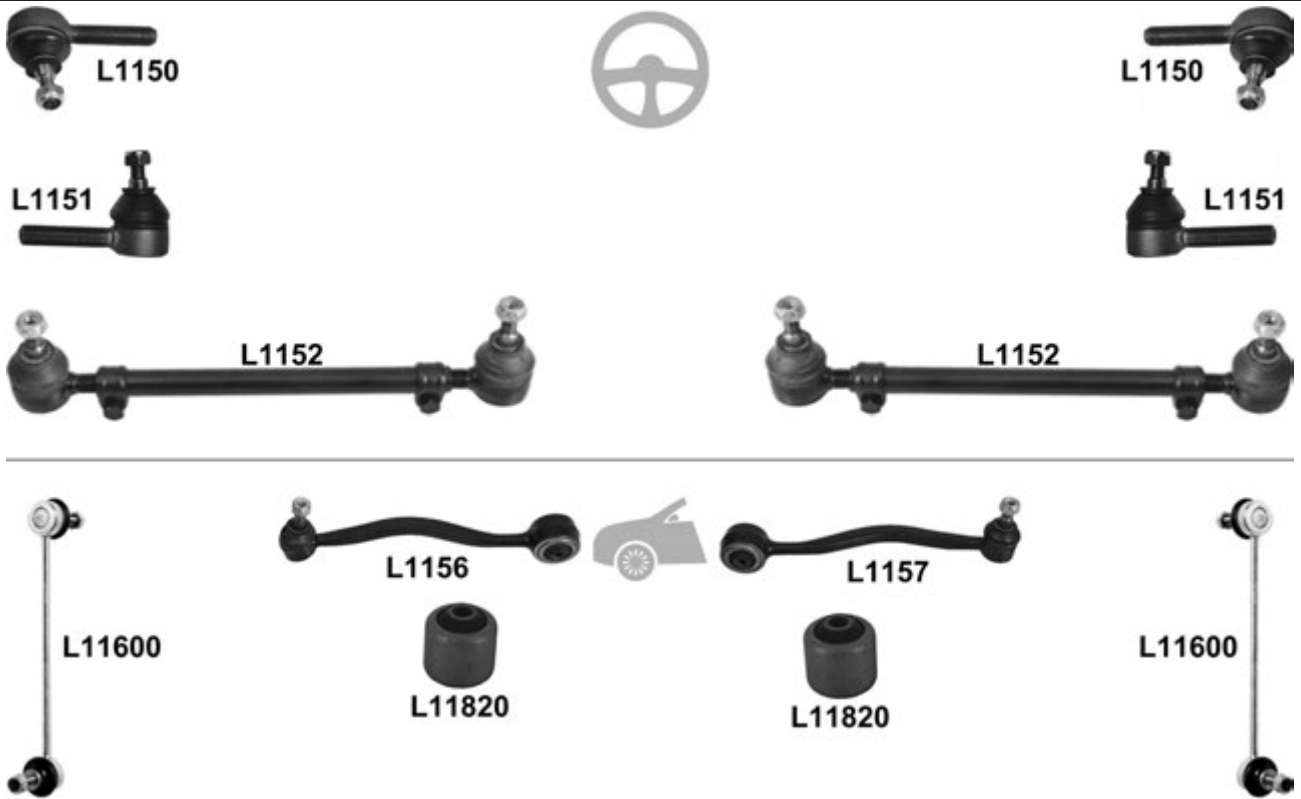
840 i - 850 csi E31 04.90 → 12.99

		i		←	→	Thread	Part Of	QPA	i
		↔			L1150	L1150	M 14x1,5 ♂	2	3221 1135 820
					L1151	L1151	M 14x1,5 ♂	2	3221 1135 819
					L1152	L1152		2	3221 1135 666
		⊥	Steel version	<input checked="" type="checkbox"/>		L1157		1	3112 1139 992
					L1156		1	3112 1139 991	
		⊥			L11820	L11820		2	3112 1124 622
					L11600	L11600		2	3135 1134 582

CHEVROLET

All 1971 → 1996



L80601



L80601



Thread

Part Of

QPA



			L80601	L80601			2	
--	--	--	--------	--------	--	--	---	--

Aveo 05.05 →

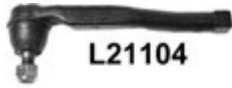

L21104

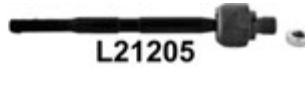

L21205

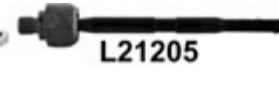

L21205



L21103



L24036



L24036



L21606



L21505



L21505



L21606



L21514



L21513



MK275



L21800



L21801



L21800



L21801



MK275

Aveo 05.05 →

				←	→	Thread	Part Of	QPA		
⊕		↔			L21103	F 12x1,5		1	9374-0723	
					L21104	F 12x1,5		1	9374-0722	
					L21205	L21205	M 12x1,5 / M 16x1,5 ⤴	2		
					L24036 ^o	L24036 ^o		2	9374-2565	
⊖		⊥			L21505	L21505		2	9653-5089	
				<input checked="" type="checkbox"/>	L21513			1	9635-5082	
		⊥			L21514			1	9635-5081	
					L21800	L21800		2	9665-3381	
		⊥	▲			L21801	L21801		2	9653-5087
						L21606	L21606		2	9639-1875
				KIT	MK275	MK275		2	9665-3239	
				MK276	MK276		2	9645-6713		

Aveo (T300) 06.11 →

				←	→	Thread	Part Of	QPA	
					L21611	L21611		2	9594-1670

Blazer, C10 Pickup/Suburban, R10 Pickup/Surburban (2WD) 1971 → 1991

				←	→	Thread	Part Of	QPA	
		⊥			L80514	L80514		2	09.12

Blazer 4WD 09.82 →

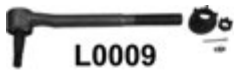

L0009



L0009



L0022



L0022



L80512



L80512



L80513



L80513

				← → Thread		Part Of	QPA		
		↔		L0009	L0009		2		
		↑	01.84 → 12.97	L0022	L0022		2		
		↓	01.84 → 12.96	L80512	L80512		2		
			01.97 →	L80513	L80513		2	09.12	

Camaro 01.70 → 12.92



L80601



L80601

				← → Thread		Part Of	QPA		
				L80601	L80601		2		

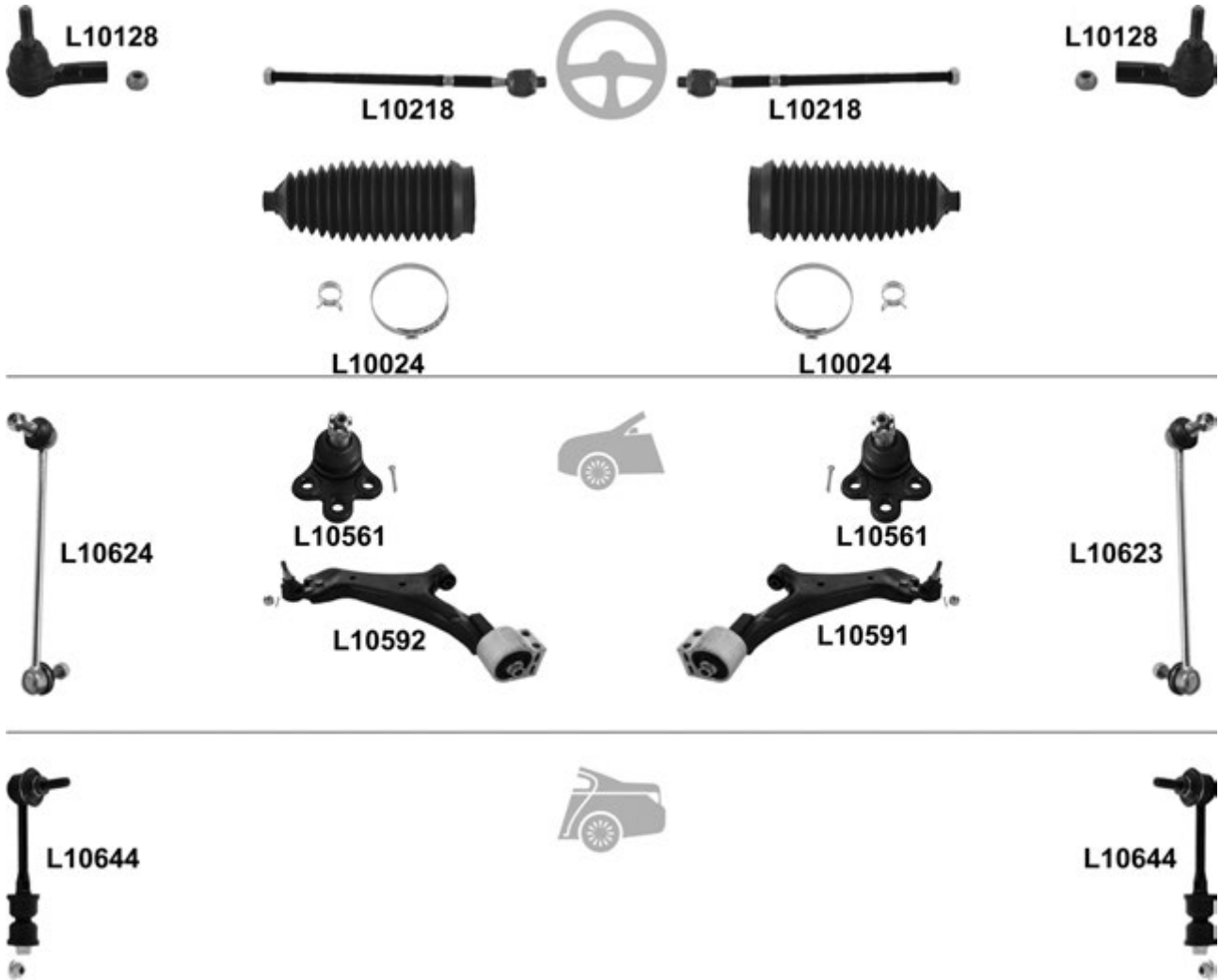
Captiva 06.06 →

		i	←	→	Thread	Part Of	QPA	i	
⊕		↔			L10128	L10128	F 14x1,5 ∪	2	9662-6667
					L10218	L10218	M 14x1,5 / M 16x1,5 ∪	2	
					L10024°	L10024°		2	9374-3434
🚗		⊥			L10561	L10561		2	9685-2964
		⊥		☑		L10591		1	9681-9162
					L10592			1	9681-9161
						L10623		1	9699-6451
					L10624			1	9699-6450
🚗					L10644	L10644		2	9662-6150

Chevelle, El Camino, Malibu, Monte Carlo 1973 → 1977

		i	←	→	Thread	Part Of	QPA	i	
🚗					L80601	L80601		2	

Corsica 01.87 → 12.96

		i	←	→	Thread	Part Of	QPA	i
			L80601	L80601			2	

Cruze 05.09 →

		i	←	→	Thread	Part Of	QPA	i
		↔	L24155	L24155	F 16x1,5 ∪		2	1327-8359
			L24236	L24236	M 16x1,5 / M 16x1,5 ∪		2	1328-6687
			L10042 ⁰	L10042 ⁰			2	13278357
			L24035 ⁰	L24035 ⁰			2	13354440
		⊥		L21515			1	13313750
			L21516				1	13313749
		⊥ ▲	L24848 ⁰	L24848 ⁰			2	13219090
			L10648	L10648			2	13219141
			KIT	MK381	MK381		2	13505131

Epica 01.05 →



				←	→	Thread	Part Of	QPA	
⊕		↔		L21100	L21100	↻		2	9620-5809
			→ 12.06	L21201	L21201	↻		2	9374-0701
⊙			→ 12.06		L21603			1	9622-5859
				L21604				1	9622-5858

Evanda 03.05 →

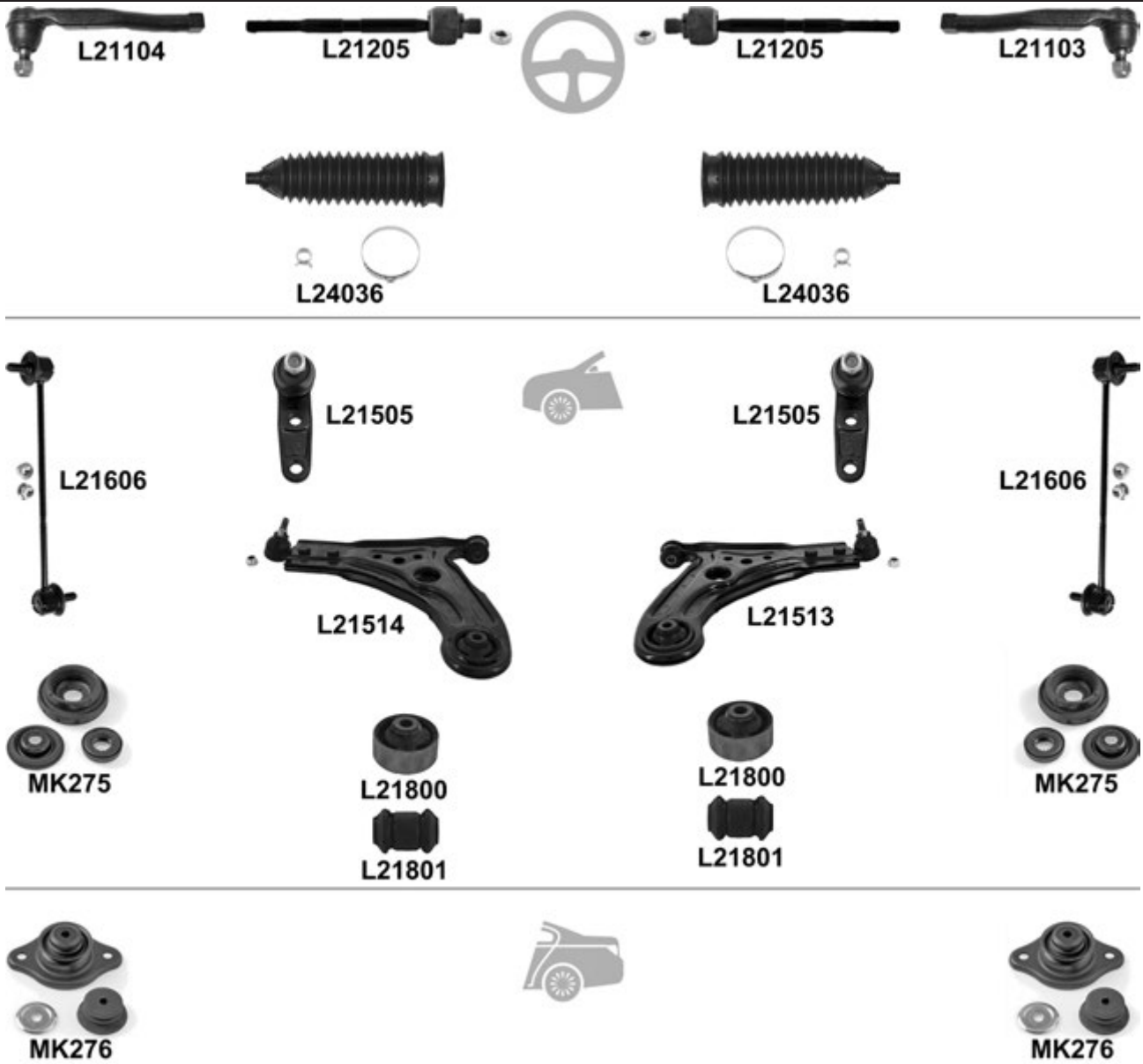

				←	→	Thread	Part Of	QPA	
⊕		↔		L21100	L21100	↻		2	9620-5809
				L21201	L21201	↻		2	9374-0701
⊙					L21603			1	9622-5859
			L21604				1	9622-5858	

Kalos 03.05 →

		i		←	→	Thread	Part Of	QPA	i
		↔			L21103	F 12x1,5		1	9374-0723
					L21104	F 12x1,5		1	9374-0722
				L21205	L21205	M 12x1,5 / M 16x1,5 ∪		2	
			∅ 11mm, ∅ 45mm, L= 203mm	L24036 ^o	L24036 ^o			2	9374-2565
		⊥			L21505	L21505		2	9653-5089
				<input checked="" type="checkbox"/>		L21513			1
		⊥			L21514			1	9635-5081
					L21800	L21800			2
			L21801	L21801			2	9653-5087	
				L21606	L21606			2	9639-1875
			KIT	MK275	MK275			2	9665-3239
			KIT	MK276	MK276			2	9645-6713

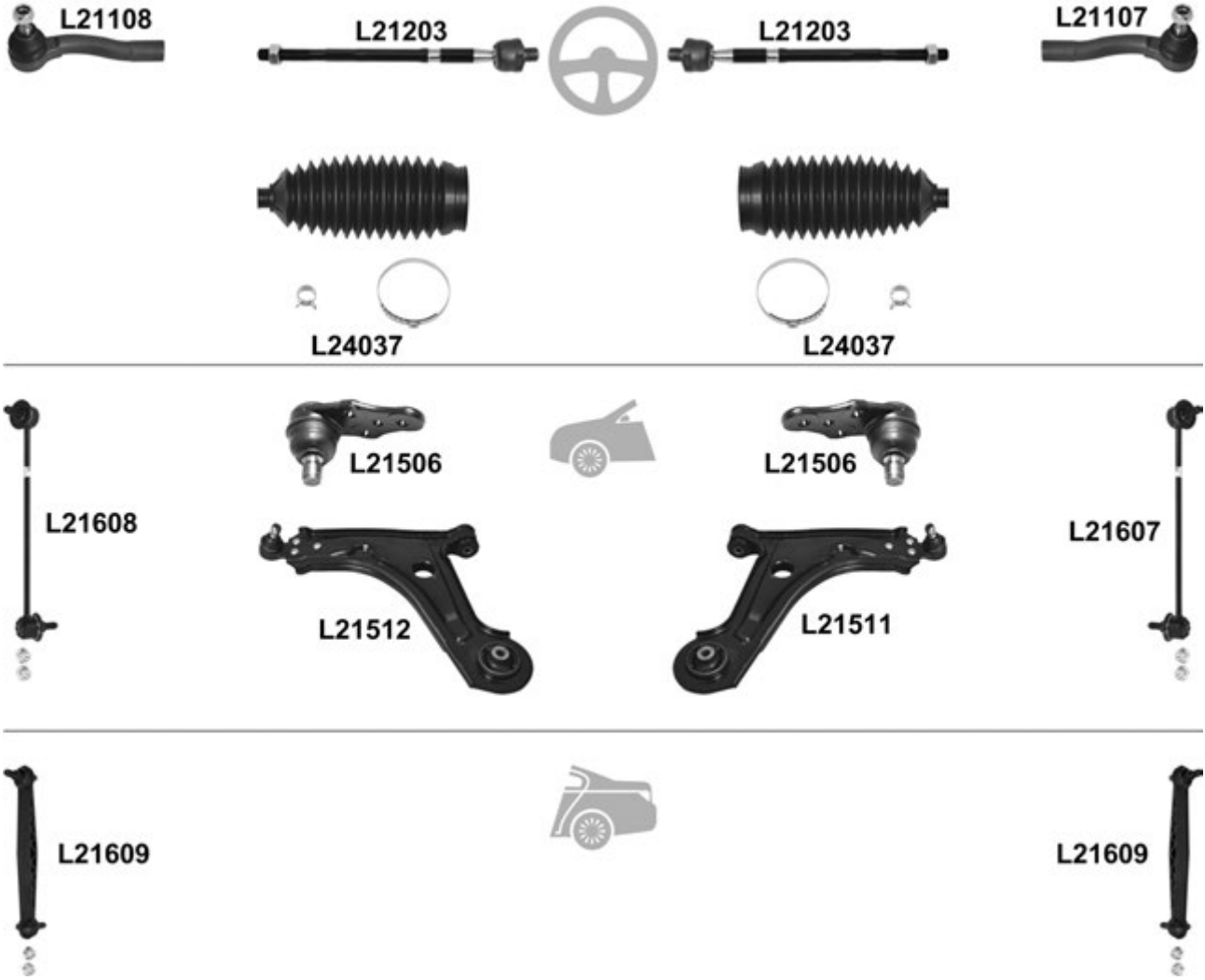
Lacetti 03.05 →

				← → Thread		Part Of	QPA	i	
⊕		↔		L21107	F 14x1,5 ∪		1	9640-7486	
				L21108	F 14x1,5 ∪		1	9640-7585	
				L21203	L21203	M 14x1,5 / M 16x1,5 ∪	2		
			∅ 13mm, ∅ 49mm, L= 173mm	L24037 ^o	L24037 ^o		2	9374-2552	
⊖		⊥		L21506	L21506		2	9649-0218	
		⊥	→ 12.07	<input checked="" type="checkbox"/>	L21511		1	9641-5064	
				L21512			1	9641-5063	
			01.08 →, (-)	<input checked="" type="checkbox"/>	L21511		1	9641-5064	
				L21512			1	9641-5063	
					L21607		1	9640-3100	
⊖				L21608			1	9640-3099	
				L21609	L21609		2	9656-1754	

Malibu (V300) 01.12 →

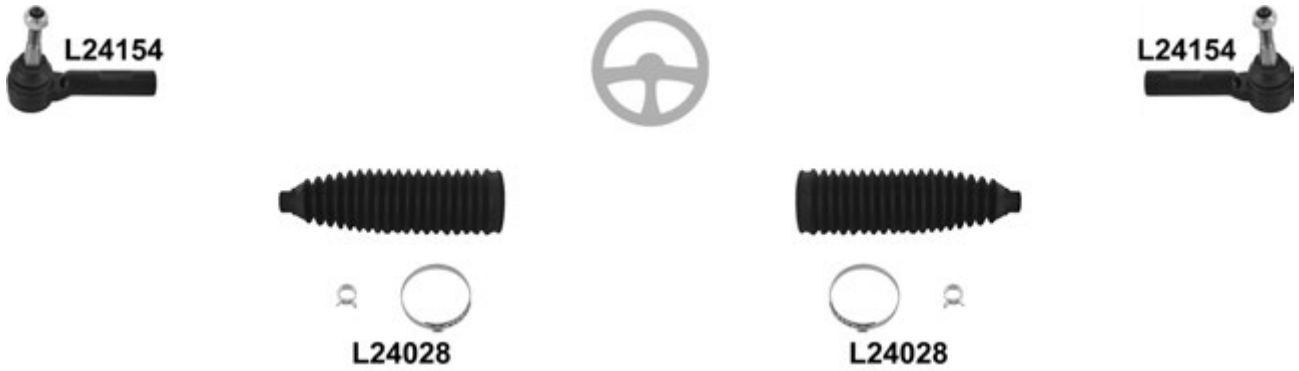

				←	→	Thread	Part Of	QPA	i
⊕		↔		L24154	L24154	F 16x1,5 U		2	13272000
			Hydraulic ⊕	L24028	L24028			2	1609357

Matiz (KLYA) 09.98 →

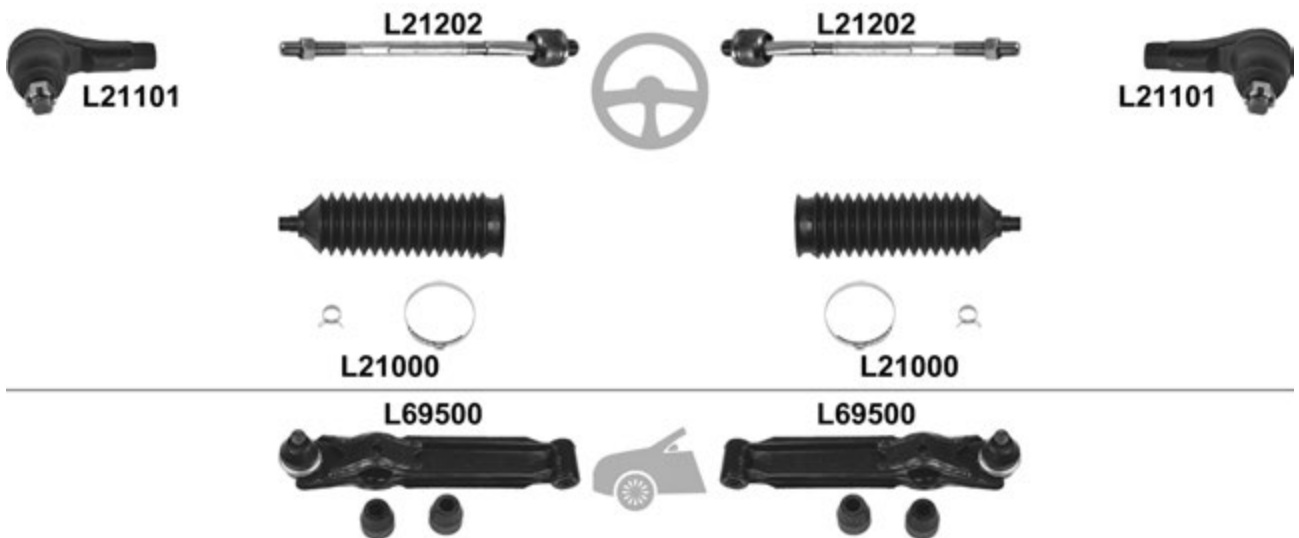

				←	→	Thread	Part Of	QPA	i
⊕		↔		L21101	L21101	F 12x1,5 U		2	521136
			(-) ⊕	L21202	L21202	M 12x1,5 / M 16x1,5 U		2	521255
			∅ 11mm, ∅ 45mm, L= 197mm	L21000 ⁰	L21000 ⁰			2	9374-1087
		⊥		<input checked="" type="checkbox"/>	L69500	L69500		2	96316765

Matiz (M200) 03.05 →



Thread

Part Of

QPA



		↔			L21101	L21101	F 12x1,5 ♂		2	9374-1077
		⊥		<input checked="" type="checkbox"/>	L6950	L6950			2	9631-6765
				KIT	MK275	MK275			2	9665-3239

Nubira 01.05 →

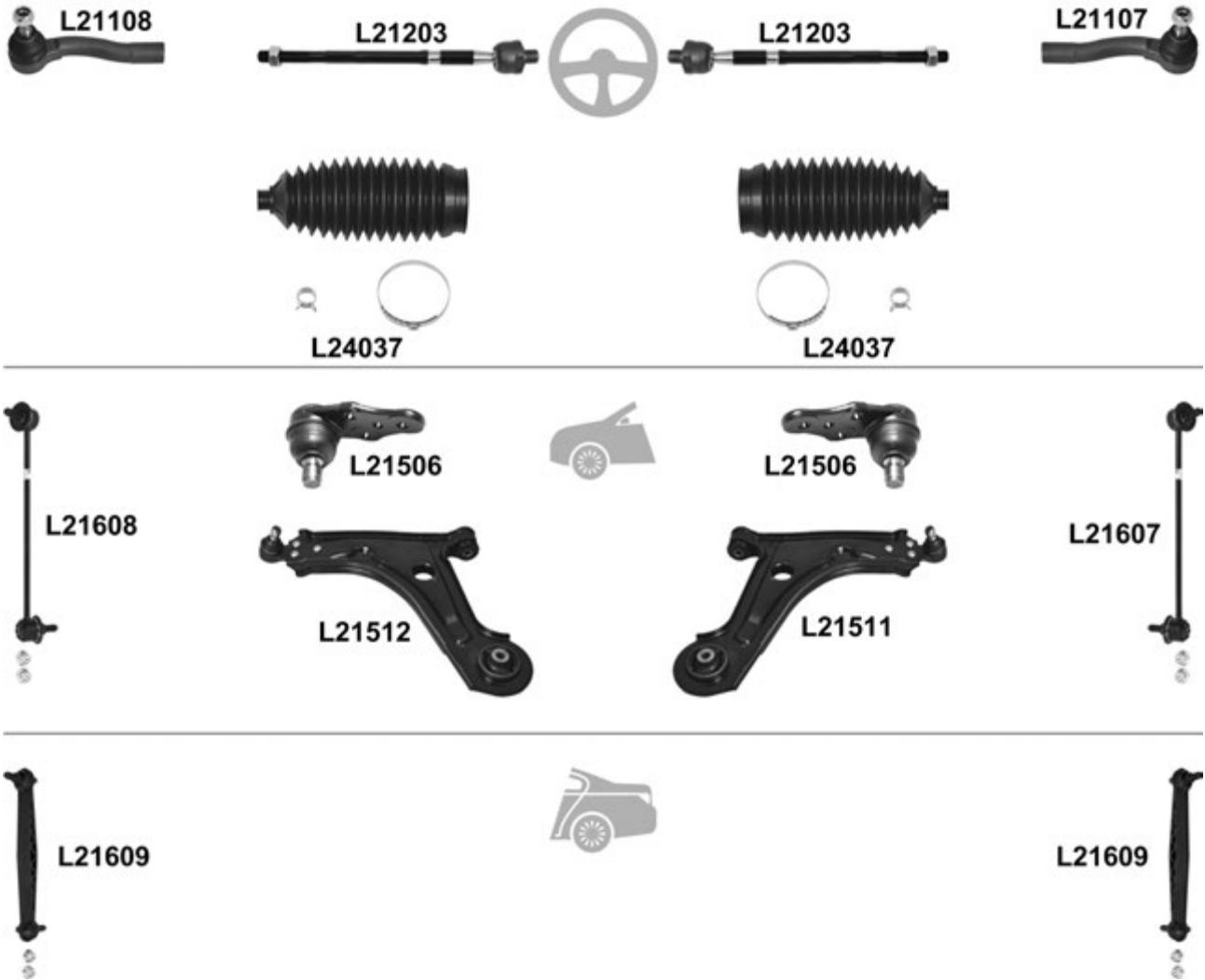

				← → Thread		Part Of	QPA		
⊕		↔		L21107	F 14x1,5 U		1	9640-7486	
				L21108	F 14x1,5 U		1	9640-7585	
			L21203	L21203	M 14x1,5 / M 16x1,5 U		2		
			∅ 13mm, ∅ 49mm, L= 173mm	L24037 ^o	L24037 ^o			2	9374-2552
⊖		⊥		L21506	L21506		2	9649-0218	
			→ 12.07	<input checked="" type="checkbox"/>	L21511		1	9641-5064	
	01.08 →, (-) AUT	<input checked="" type="checkbox"/>	L21512		1	9641-5063			
		<input checked="" type="checkbox"/>	L21511		1	9641-5064			
					L21607		1	9640-3100	
					L21608		1	9640-3099	
			L21609	L21609		2	9656-1754		

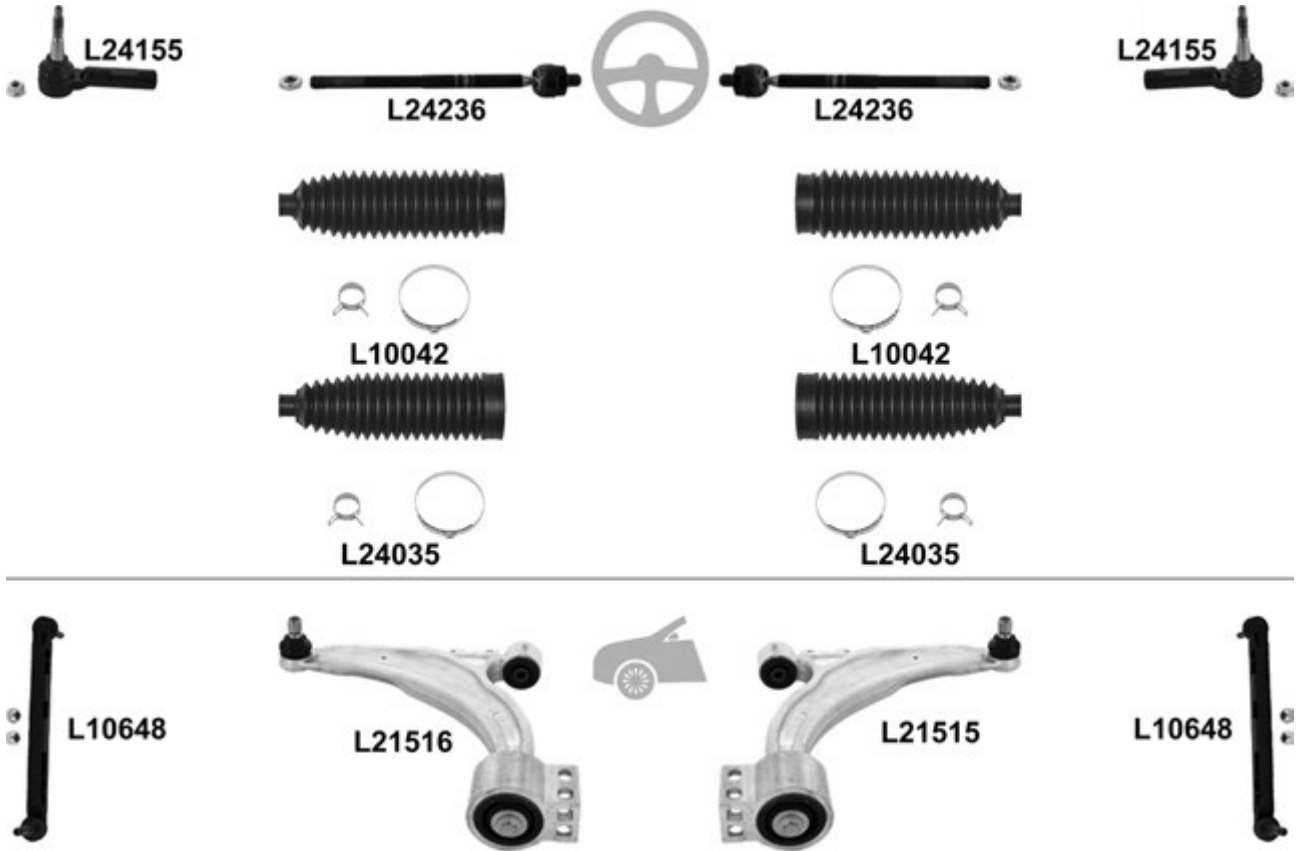
Orlando 12.10 →

		i		←	→	Thread	Part Of	QPA	i
		↔		L24155	L24155	F 16x1,5 U		2	1327-8359
			Electric	L24236	L24236	M 16x1,5 / M 16x1,5 U		2	1328-6687
			Hydraulic , ø 16mm, Ø 49mm, L= 190mm	L10042 ^o	L10042 ^o			2	1327-8357
			Electric , ø 16mm, Ø 53,5mm, L= 194mm	L24035 ^o	L24035 ^o			2	1335-4440
		⊥			L21515			1	1331-3750
				L21516				1	1331-3749
				L10648	L10648			2	1321-9141

Rezzo / Tacoma 03.05 →

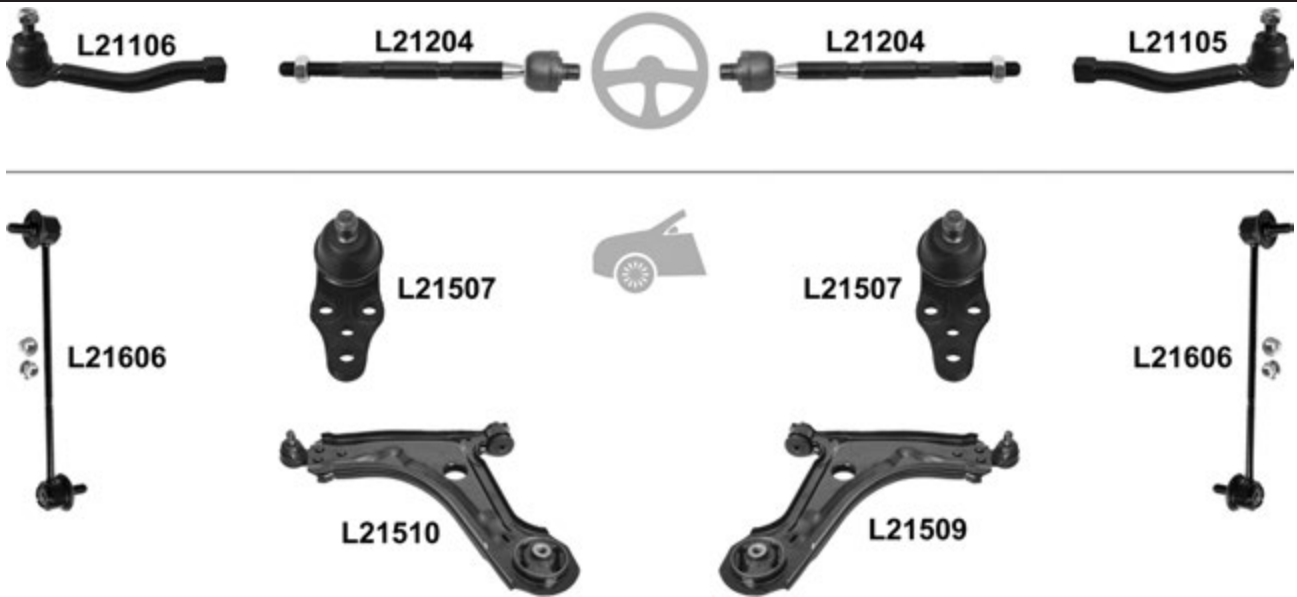

				← → Thread		Part Of	QPA		
⊕		↔		L21105	F 14x1,5 ∪		1	9626-1379	i
				L21106	F 14x1,5 ∪		1	9626-1378	
				L21204	L21204	M 14x1,5 / M 16x1,5 ∪		2	
⊖		⊥		L21507	L21507		2	9626-1108	i
			<input checked="" type="checkbox"/>	L21509			1	9637-8348	
				L21510			1	9639-8347	
				L21606	L21606		2	9639-1875	

Spark (1MD48, 1MJ48, M200) 05.05 →

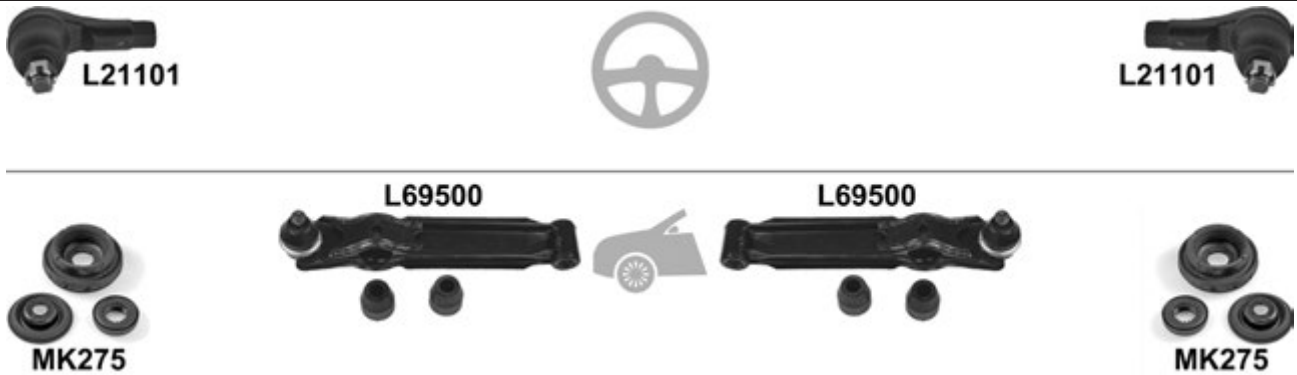

				← → Thread		Part Of	QPA		
⊕		↔		L21101	L21101	∪		2	521136
⊖		⊥	<input checked="" type="checkbox"/>	L6950	L6950			2	96316765
			KIT	MK275	MK275			2	9665-3239

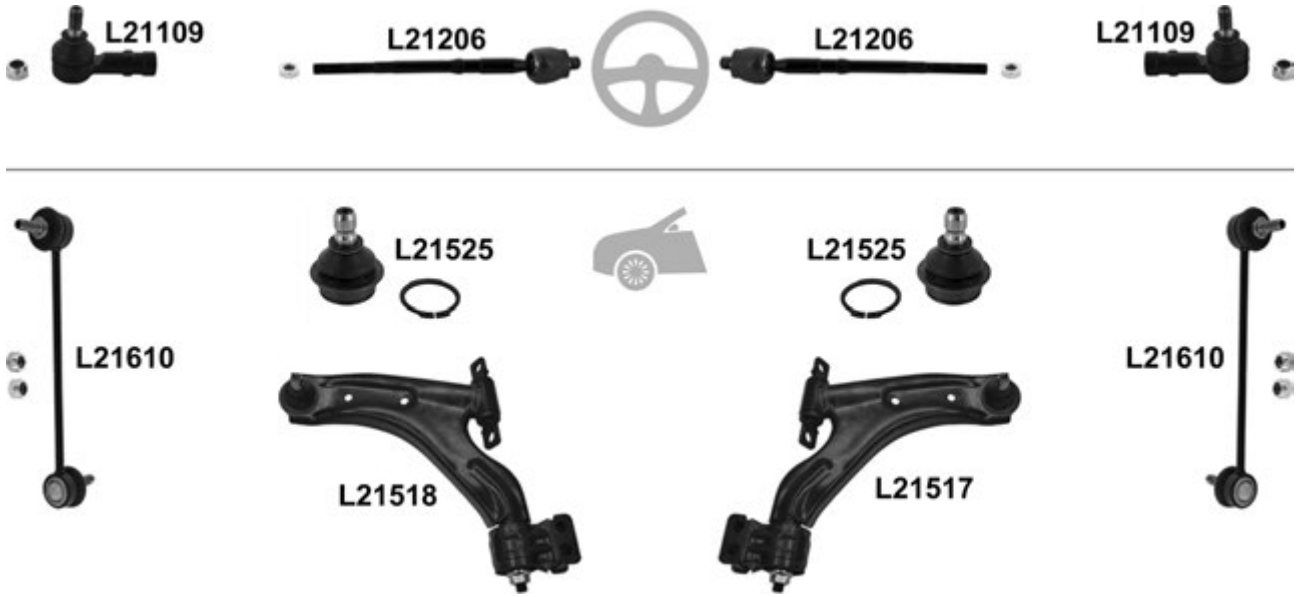
Spark (M300) 03.10 →

				←	→	Thread	Part Of	QPA		
⊕		↔		L21109	L21109	∪		2	9596-7285	
				L21206	L21206	M 12x1,25 / M 14x1,5 ∪		2	9596-7294	
⊖		⊥		L21525	L21525			2		
		⊥		<input checked="" type="checkbox"/>	L21517			1	9595-2783	
				L21518				1	9595-2782	
				L21610	L21610			2	9594-7829	

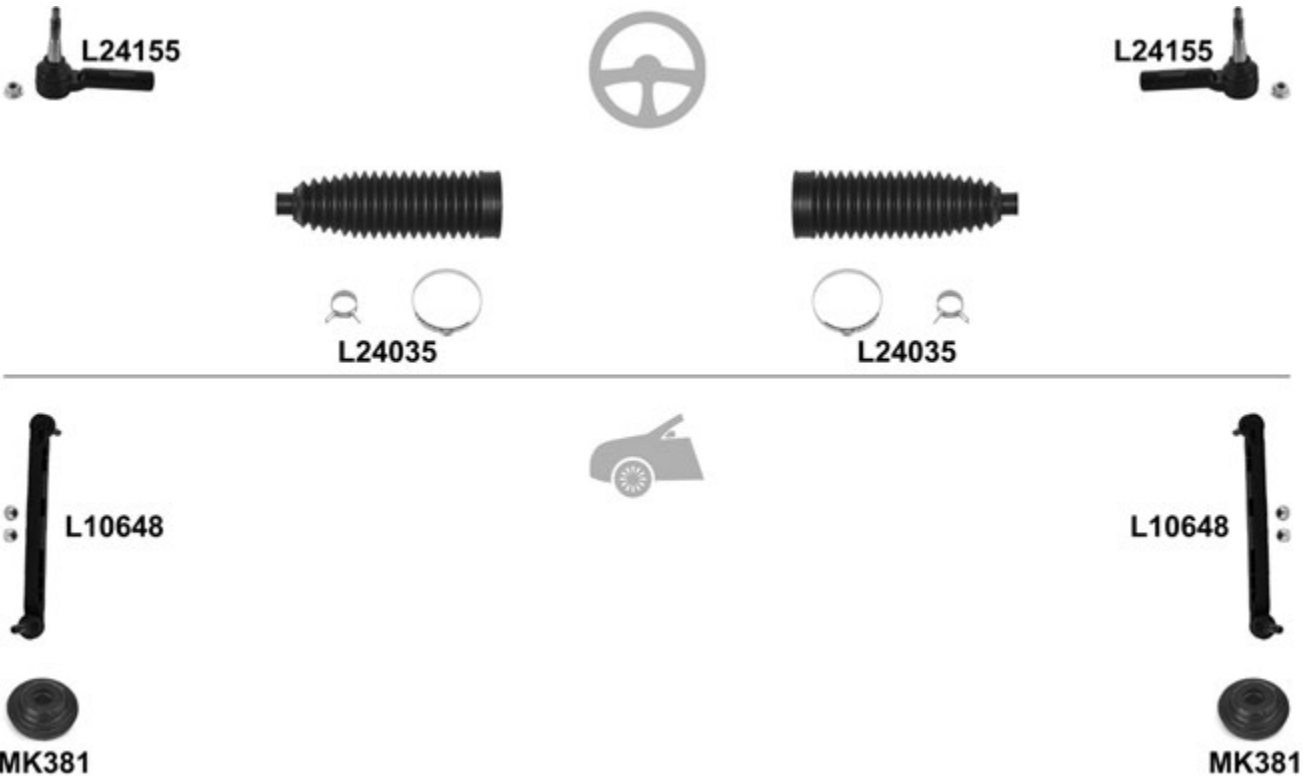
Volt (EV150) 10.11 →

				←	→	Thread	Part Of	QPA		
⊕		↔		L24155	L24155	F 16x1,5 ∪		2	1327-8359	
			∅ 16mm, ∅ 53,5mm, L= 194mm	L24035 ^o	L24035 ^o			2	13354440	
⊖				L10648	L10648			2	1321-9141	
				KIT	MK381	MK381		2	13505131	

Astro Mini Van 1985 → 12.95

Thread

Part Of

QPA



				L80601	L80601			2	
--	--	--	--	--------	--------	--	--	---	--

C1500, C2500, C3500 (Pickup) 1988 → 1999

Thread

Part Of

QPA



				L80601	L80601			2	
--	--	--	--	--------	--------	--	--	---	--

C1500, C2500 (Suburban) 1992 → 1996

Thread

Part Of

QPA



				L80601	L80601			2	
--	--	--	--	--------	--------	--	--	---	--

G10 (1/2 Ton), G20 (3/4 Ton), G30 (1 Ton) 01.71 → 1995

Thread

Part Of

QPA



		↓	G10, 01.73 →	L80514	L80514			2	09.12
			G20 (-) Diesel, 01.73 →	L80514	L80514			2	09.12

G10 (1/2 Ton), G20 (3/4 Ton), G30 (1 Ton) 01.83 →

Thread

Part Of

QPA



		↔		L80108	L80108			2	09.12
--	--	---	--	--------	--------	--	--	---	-------

CHRYSLER
Crossfire 07.03 →
Crossfire Roadster 05.04 →

Thread
Part Of
QPA

				L23103	L23103	F 12x1,5 U		2	001 330 77 35
				L23505	L23505			2	5099237 AA

Neon 05.94 → 02.00

Thread
Part Of
QPA

				L80105	L80105			2	04762861AA
				L80202	L80202			2	#04626890AA
				L0024	L0024			2	4443405
				KIT	L80903	L80903		2	04626100AB
				L80900	L80900			2	4626182

Neon 10.99 → 09.05

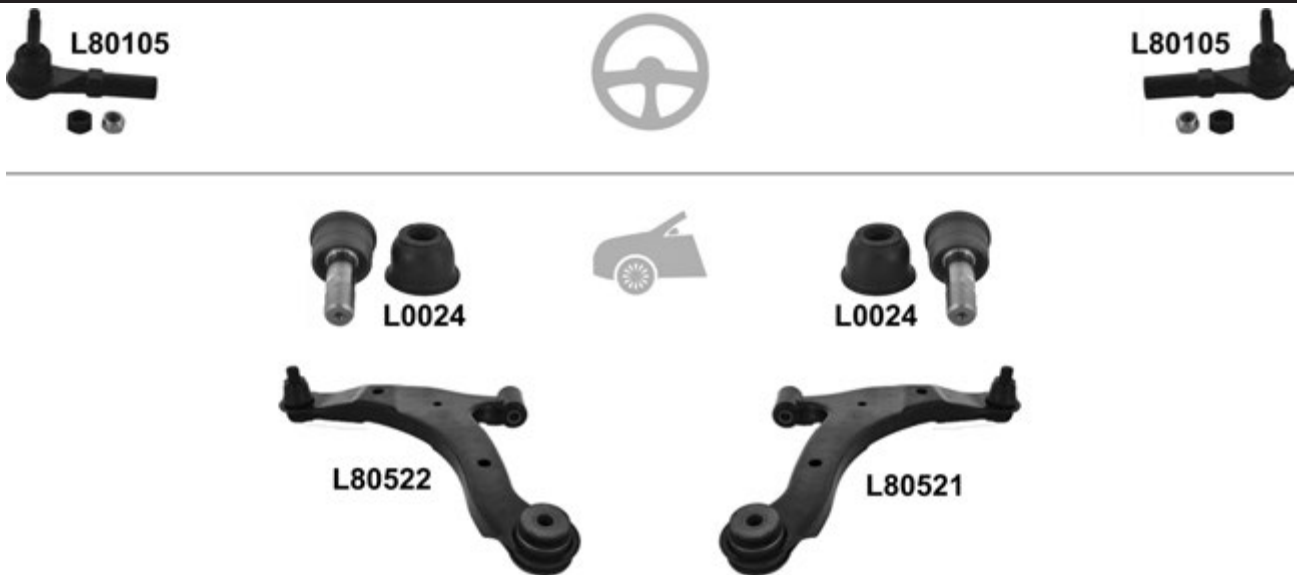

			i	←	→	Thread	Part Of	QPA	i
		↔		L80105	L80105			2	04762861AA
		⊥		L0024	L0024			2	4656010
		⊥	<input checked="" type="checkbox"/>		L80521			1	4656730AE
				L80522				1	4656731AE

 PT Cruiser 06.00 →
 PT Cruiser Cabriolet 03.04 →

			i	←	→	Thread	Part Of	QPA	i
		↔		L80105	L80105			2	04762861AA
		⊥		L0024	L0024			2	4443405
		⊥	<input checked="" type="checkbox"/>	06.02 →	L80521			1	4656730AE
					L80522			1	4656731AE

Sebring (JR) 09.00 → 06.07

Thread
Part Of
QPA

					L80103			1	05094006AA
					L80104			1	05093857AA
				<input checked="" type="checkbox"/>	L80505			1	4616922
					L80506			1	4616923

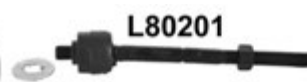
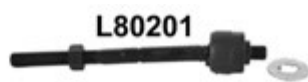
Stratus (JA) 12.95 → 04.01
Stratus Cabriolet (JX) 04.96 → 04.01

Thread
Part Of
QPA

					L80103			1	05094006AA
					L80104			1	05093857AA
					L80201	L80201		OE no. 04897091AA Power Rack	2
				<input checked="" type="checkbox"/>	L80505			1	4616922
					L80506			1	4616923

Vision 09.93 →

Thread
Part Of
QPA

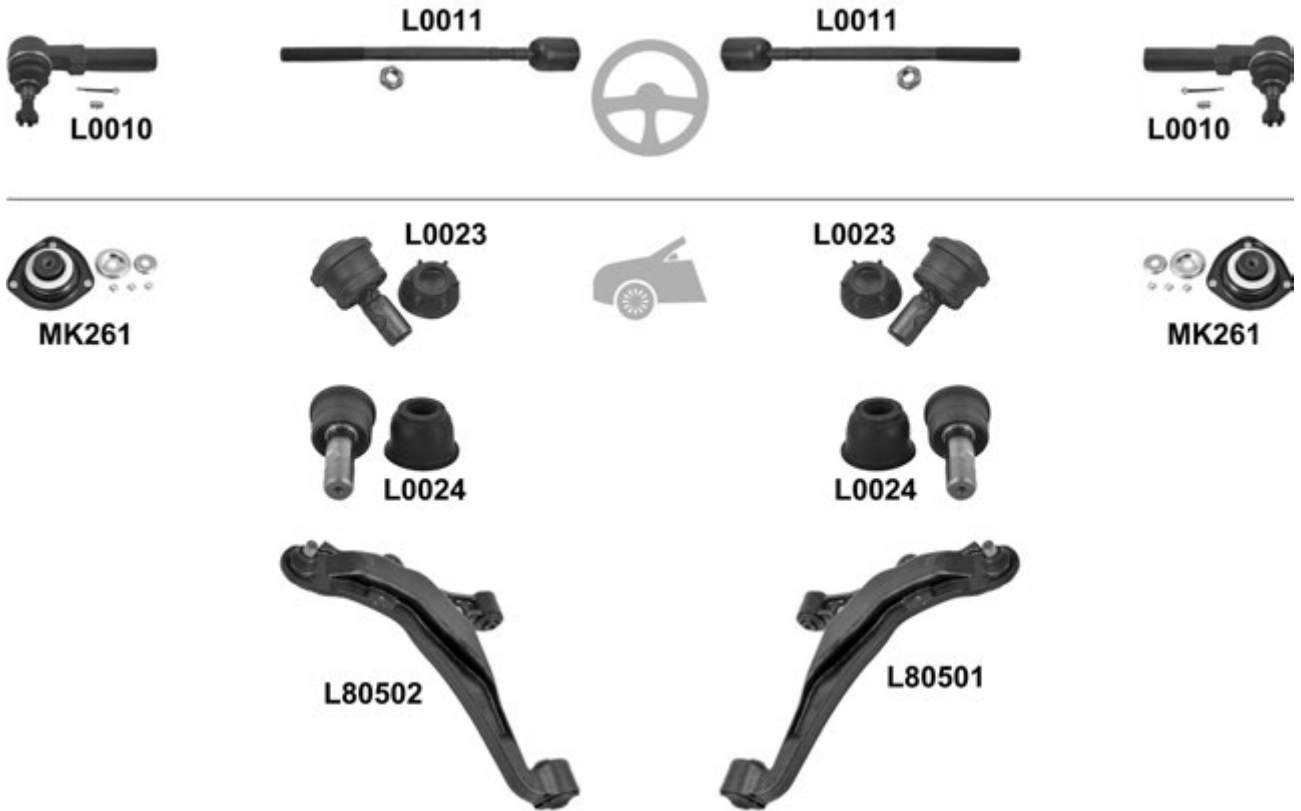
					L80109	L80109		2	04762861AA
--	--	--	--	--	--------	--------	--	---	------------

Voyager I (ES) 08.84 → 01.95

				← → Thread		Part Of	QPA		
⊕		↔		L0010	L0010		2	5274470	
				L0011	L0011		2	4333450	
🚗		⊥	→ 08.90	L0023	L0023		2	4364782	
			08.90 →	L0024	L0024		2	4449553	
		⊥		<input checked="" type="checkbox"/>	L80501		1	4728884	
				<input type="checkbox"/>	L80502		1	4728885	
			KIT	MK261	MK261		2	4684643	

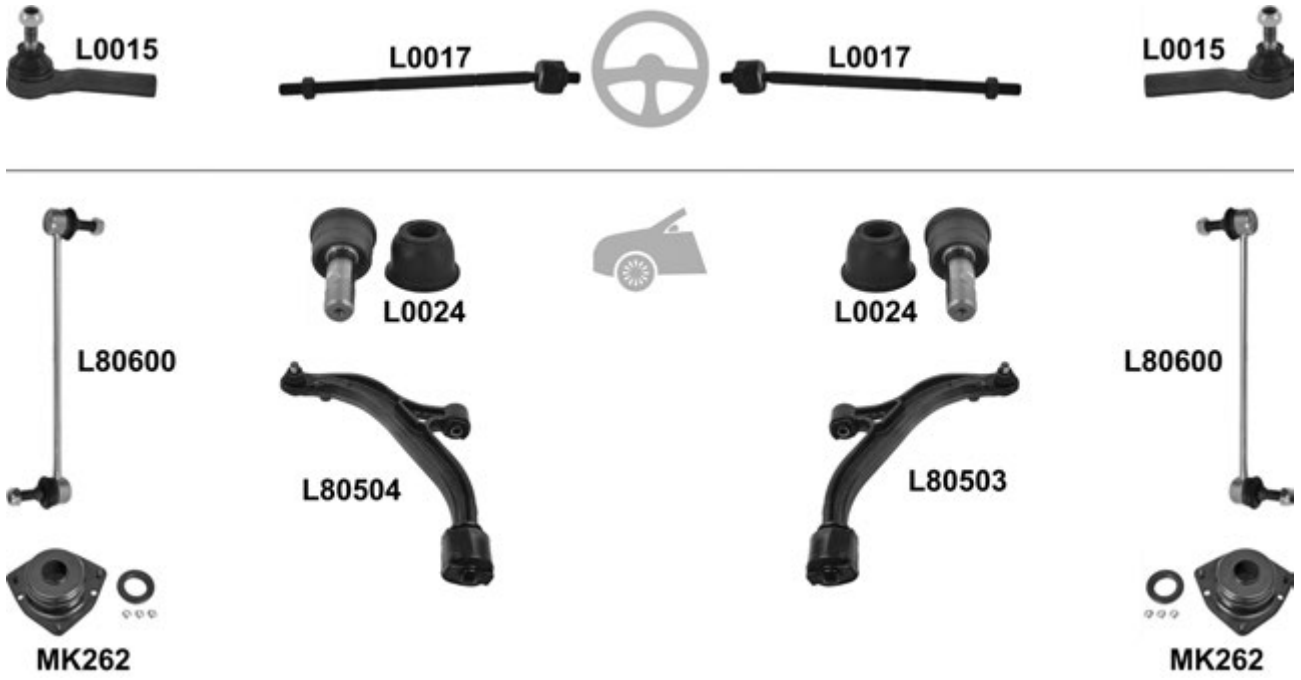
Voyager II (GS) 01.95 → 03.01

				←	→	Thread	Part Of	QPA	
		↔		L0015	L0015			2	4797706
				L0017	L0017			2	
		↓		L0024	L0024			2	4449553
		↓			L80503			1	4694760
			<input checked="" type="checkbox"/>	L80504				1	4694761
				L80600	L80600			2	4743669AA
			KIT	MK262	MK262			2	4694870

Voyager III (RG) 02.00 →

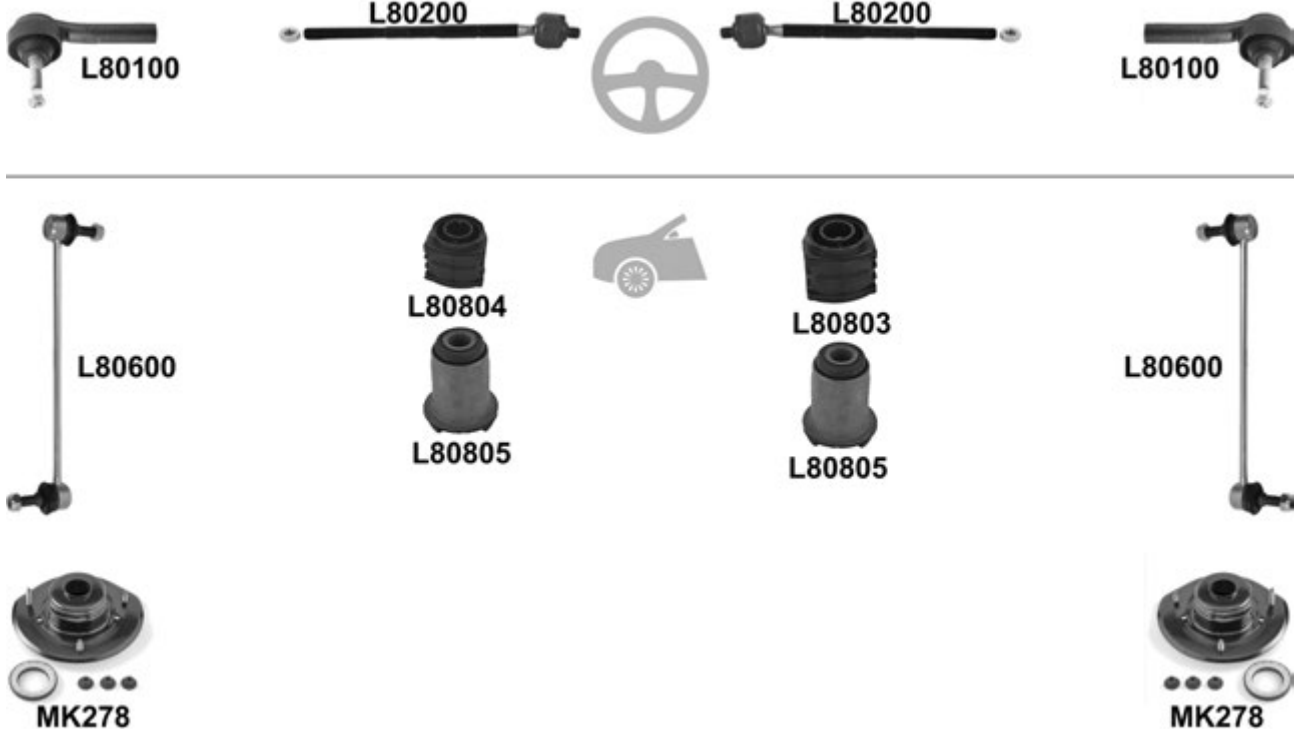

		i		←	→	Thread	Part Of	QPA	i
		↔		L80100	L80100			2	05066373AA
				L80200	L80200			2	04743935AD
		↓			L80803			1	04743094AA
				L80804				1	04743095AA
		↑		L80805	L80805			2	5272084
				L80600	L80600			2	4743669AA
			KIT	MK278	MK278			2	04766116AB

Voyager IV 10.07 →



		i		←	→	Thread	Part Of	QPA	i
				L80600	L80600			2	4743669AA

300 C 09.04 →
300 C Touring 09.04 →



		i	←	→	Thread	Part Of	QPA	i
		↔		L80110	L80110		2	5201-3468AC
				L80205	L80205		2	6802-8831AC
		→ 12.09			L80603		1	4895-482AA
				L80604			1	4895-483AA
		01.10 →		L80612	L80612		2	4766866AA
				L80612	L80612		2	4766866AA

CITROËN

AX (ZA-_) 07.86 → 12.98



AX (ZA-_) 07.86 → 12.98



						←	→	Thread	Part Of	QPA	
⊕		↔			L3871			F 14x1,5 ♂		1	3817.42
					L3870			F 14x1,5 ♂		1	3817.41
		→←			L38200	L38200				2	3817.33
					L38800	L38800				2	3817.A0
		⊥	→ 04.91, PR → 5277, 14mm		L2860	L2860				2	95 608 843
			04.91 →, PR 5278 →, 16mm		L38500	L38500				2	3640.36
		⊥	→ 04.91, PR → 5277, 14mm, (-) 1.4 Gti	<input checked="" type="checkbox"/>		L38505				1	96 133 609
				<input checked="" type="checkbox"/>	L38506			1	96 133 608		
			04.91 →, PR 5278 →, 16mm, (-) 1.4 Gti	<input checked="" type="checkbox"/>		L10501		1	3520.79		
				<input checked="" type="checkbox"/>	L10502		1	3520.78			
		⊥	1.4 Gti	<input checked="" type="checkbox"/>		L28539			1	3520.93	
				<input checked="" type="checkbox"/>	L28540		1	3520.92			
		⊥	⌵			L28806	L28806		L10501/L10502	2	3523.51
						L28805	L28805		L10501/L10502	2	3523.50
				KIT	MK008	MK008			2	95 603 783 S	
					MK001	MK001			2	5035.27	
			1.4 Gti, 11 4x4, 14, 14 4x4		L28809	L28809		Hub carrier	2	5131.63	
			08.90 →, 10, 11, 14 D, 15D		L28810	L28810		Hub carrier	2	5131.65	

Berlingo (MF) 10.96 →
Berlingo Van (M_) 10.96 →

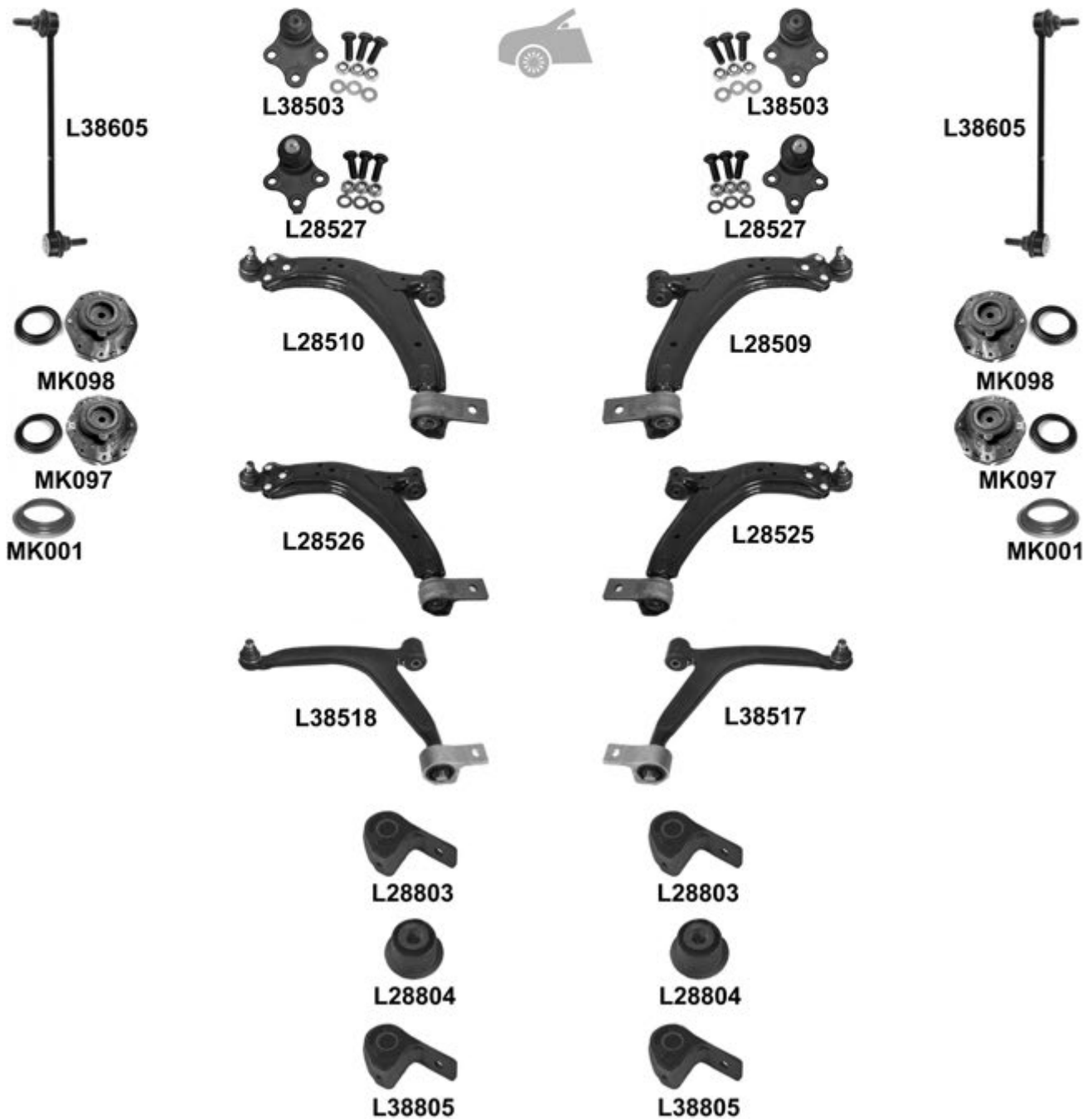
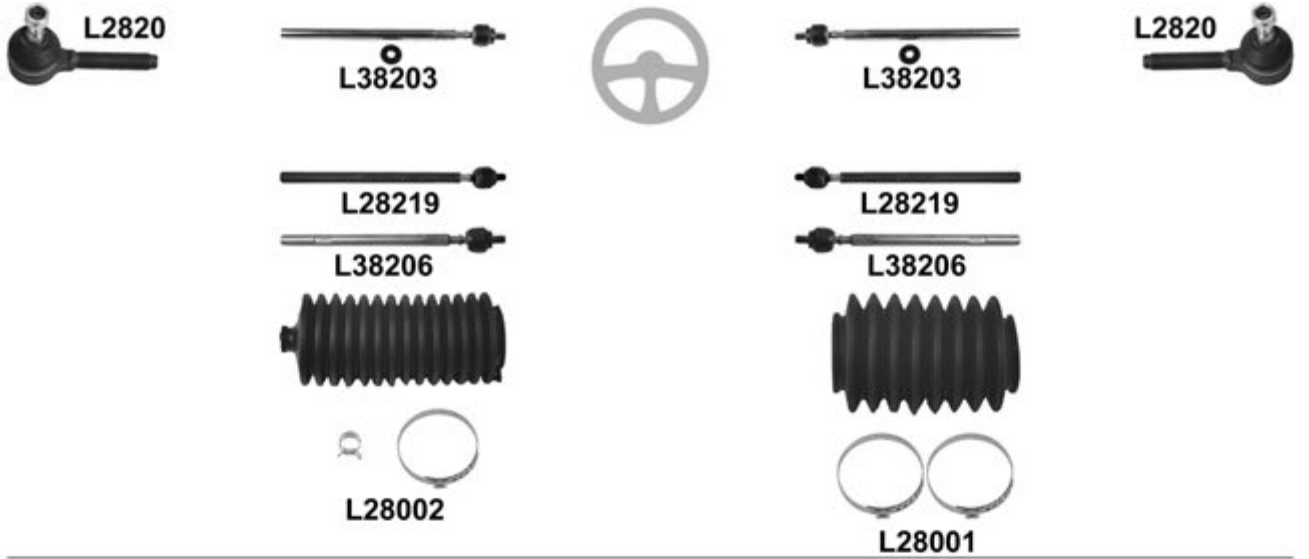

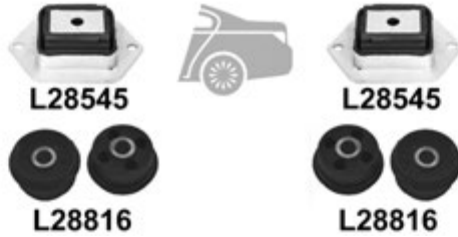
Berlingo (MF) 10.96 →
 Berlingo Van (M_) 10.96 →

				←	→	Thread	Part Of	QPA	
⊕	🔧	↔		L2820	L2820	M 14x1,5 U		2	3817.18
			(-) Hdi	L38203	L38203	F 14x1,5 / M 12x1 U		2	3812.C0
			1.6 Hdi Mot/Eng DV6ATED4 / DV6BTED4	L28219	L28219	M 14x1,5 / M 12x1 U		2	3812.E4
			2.0 Hdi Mot/Eng DW10TD, → 03.04, PR. → 10017, L= 336mm	L38206	L38206	F 14x1,5 / M 12x1 U		2	3812.C6
			2.0 Hdi Mot/Eng DW10TD, 04.04 →, PR. 10017 →	L28219	L28219	M 14x1,5 / M 12x1 U		2	3812.E4
		🌀	11.02 →, ⊕		L28001			1	4066.22
				L28002				1	4066.20
🚗	🔧	↓	→ PR 7969, ⊕, ↗ 16mm, (-) HD /Hdi	L38503	L38503			2	3640.39
			→ PR 7969, ⊕, ↗ 16mm, (-) HD /Hdi	L38503	L38503			2	3640.38
			PR 7970 →, ⊕ / ⊕, ↗ 18mm (-) HD /Hdi	L28527	L28527			2	3640.51
	🔧	↓	→ PR 7969, ⊕, ↗ 16mm, (-) HD /Hdi	<input checked="" type="checkbox"/>	L28509			1	3521.E5
				L28510				1	3520.H5
			PR 7970 →, ⊕ / ⊕, ↗ 18mm, (-) HD /Hdi	<input checked="" type="checkbox"/>	L28525			1	3521.E6
				L28526				1	3520.H6
			HD /Hdi	<input checked="" type="checkbox"/>	L38517			1	3521.F3
				L38518				1	3520.J3
	🔧	↓	(-) Hdi	L28803	L28803			2	L28509/L28510/ L28525/L28526
		↑	(-) Hdi	L28804	L28804			4	L28509/L28510/ L28525/L28526
		↓	HD /Hdi	L38805	L38805			2	L38517/L38518
		↑	HD /Hdi	L28804	L28804			4	L38517/L38518
	🔧			L38605	L38605			2	5087.39
		🌀		⊕ / (-) HD	KIT	MK098	MK098		2
			⊕ / HD		MK097	MK097		2	5038.21 S
🌀				MK001	MK001		2	5035.27	
🔧		↓		L28545	L28545		Hub carrier	2	5152.62
	↑		KIT	L28816	L28816		Hub carrier	2	5131.47

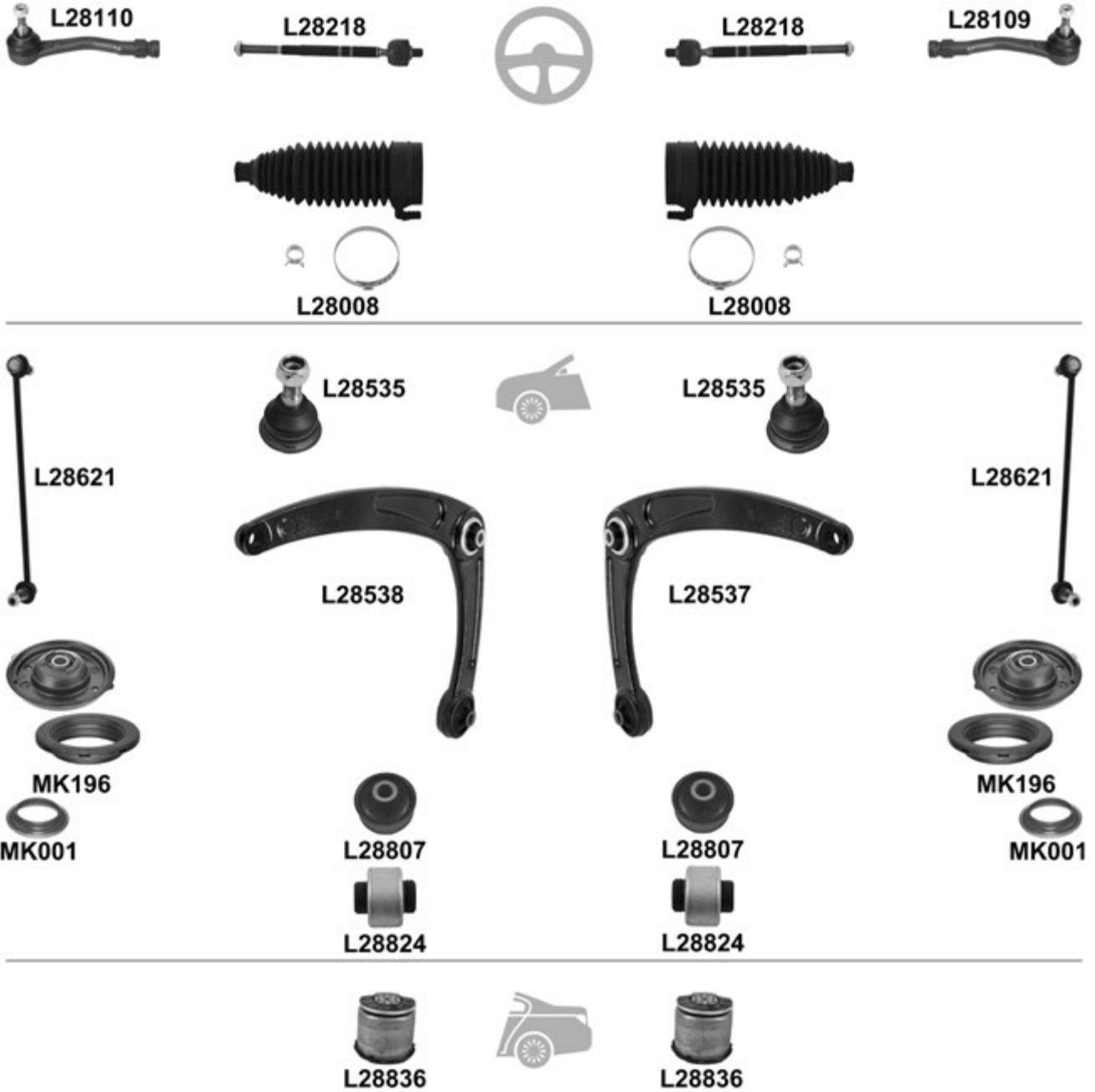
Berlingo 04.08 →
 Berlingo Van 04.08 →

				←	→	Thread	Part Of	QPA			
⊕		↔				L28109	F 14x1,5 ∪	1	3817.88		
						L28110	F 14x1,5 ∪	1	3817.89		
						L28218	L28218	M 14x1,5 / M 14x1,5 ∪	2	3812.F4	
						L28008 ⁰	L28008 ⁰		2	4066.85	
🚗		↓				L28535	L28535	2	3640.68		
					☑	L28537		1	3521.P3		
						L28538		1	3520.S2		
					↓ ▾	L28807	L28807		2	3523.92	
					↓ ▲	L28824	L28824		2	3523.91	
						L28621	L28621		2	5087.57	
					(+) MK001	KIT	MK196	MK196	2	5038.G0	
			MK001	MK001		2	5035.58				
🚚						L28836	L28836	2	5131.F2	Hub carrier	

BX (XB-) 10.82 → 09.93
BX Break (XB-) 04.83 → 12.94

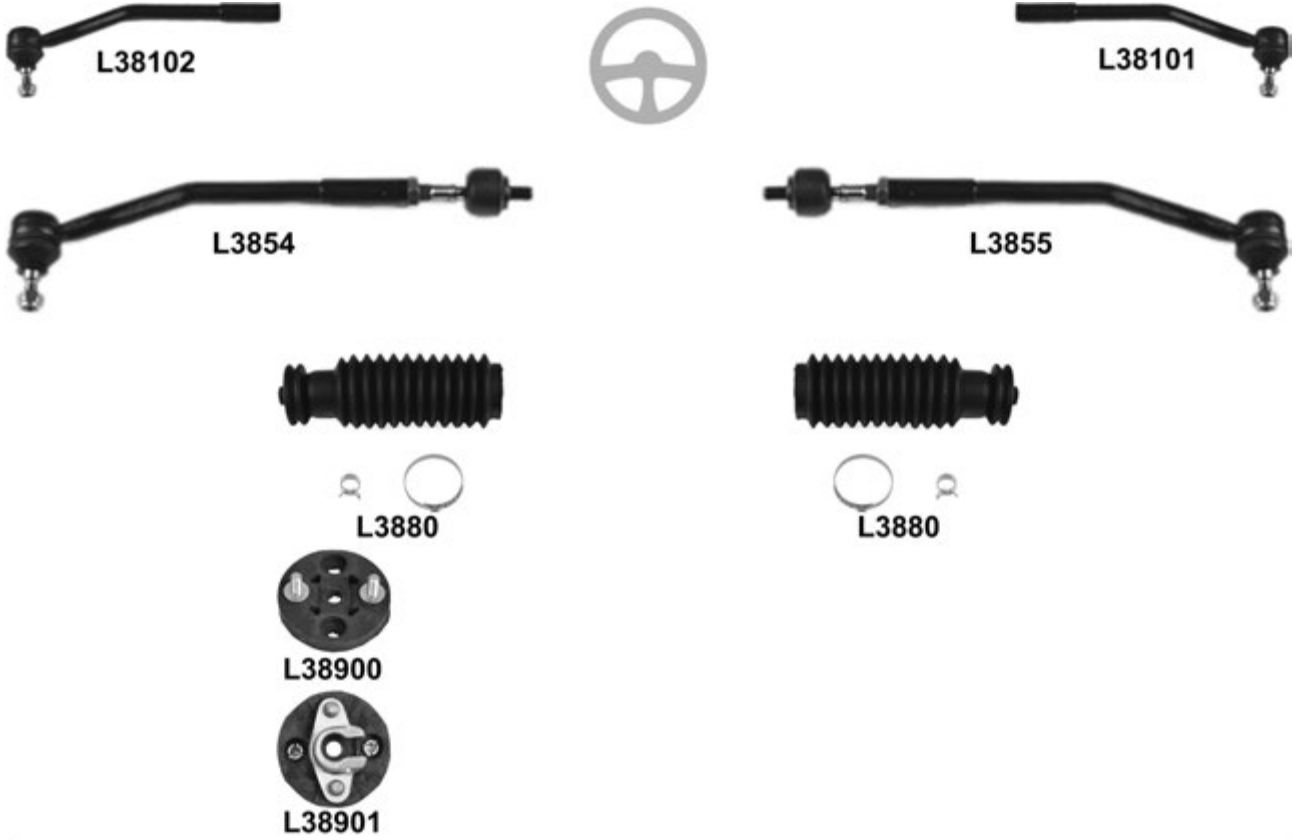

BX (XB-) 10.82 → 09.93
BX Break (XB-) 04.83 → 12.94

		i		←	→	Thread	Part Of	QPA	i
		↔			L38101	F 14x1,5 U		1	95 496 045
					L38102	F 14x1,5 U		1	95 496 044
					L3855			1	
					L3854			1	
					L3880	L3880		2	95 495 914
					L38900			1	3XB95631286
				L38901			1	95 630 094	
		↓		L3856	L3856			2	96 041 652
		↓▼		L38810	L38810			2	96 070 064
		↓▲		L38811	L38811			2	95 637 690
				L3857	L3857			2	95 597 955
			KIT	L38400	L38400			2	

C-Crosser (EP_) 02.07 →

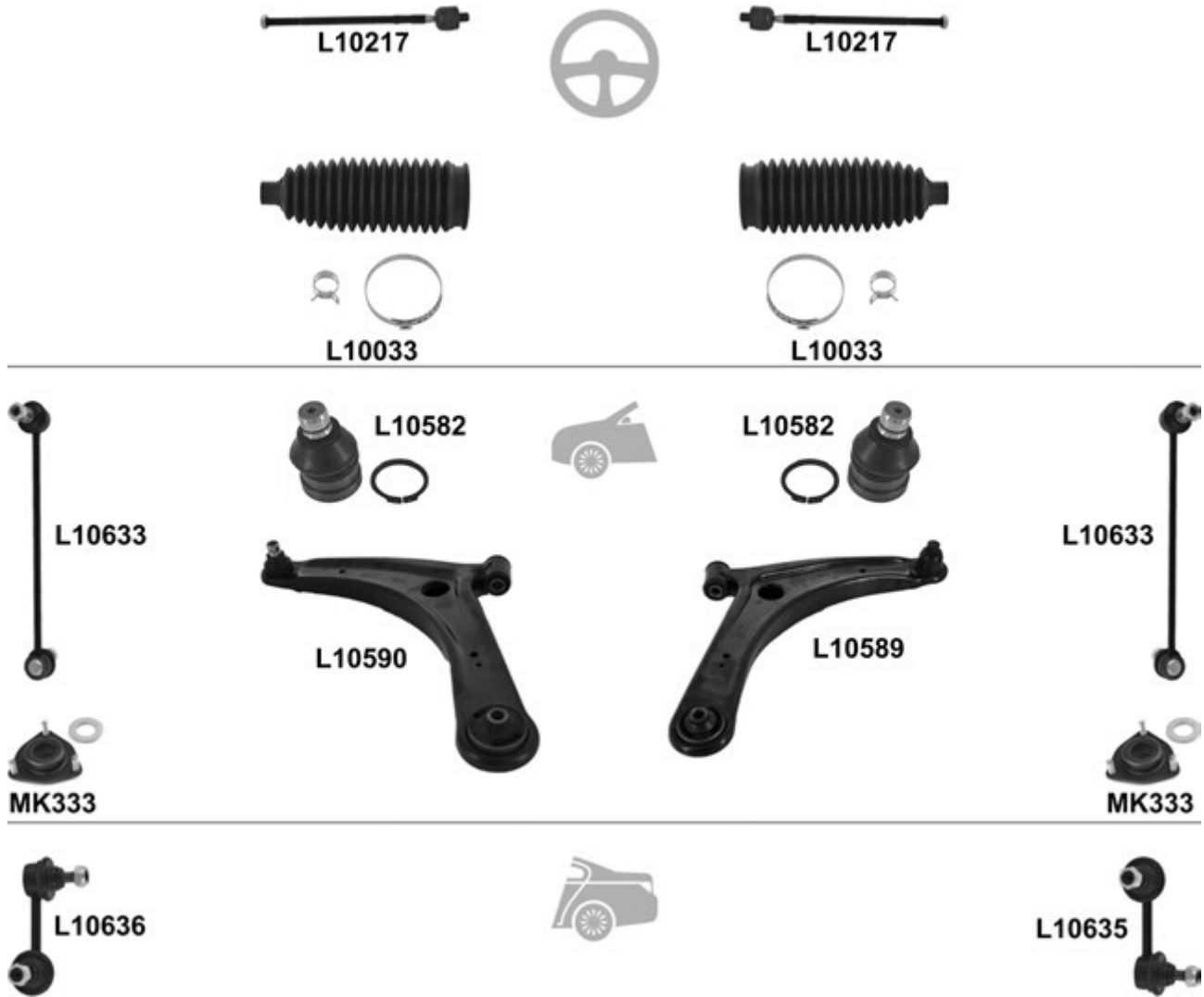

				←	→	Thread	Part Of	QPA		
				L10217 ⁰	L10217 ⁰	U		2	3812.F1	
		→ 09.09		L10033 ⁰	L10033 ⁰			2	4066.84	
		↓		L10582	L10582			2		
		↓		<input checked="" type="checkbox"/>	L10589			1	3521.R1	
				L10590				1	3520.V0	
				L10633	L10633			2	5087.58	
				MK333	MK333			2		
					L10635			1	5178.49	
				L10636				1	5178.48	

C-ELYSEE 11.12 →



				← → Thread		Part Of	QPA		
⊕		↔		L28107	F 16x1,5 ♂		1	1608652380	
				L28108		F 16x1,5 ♂		1	1608652280
🚗		⊥		L38521	L38521		2	3640.77	
			<input checked="" type="checkbox"/>	L28563 ⁰			1	9675028880	
		⊥		L28564 ⁰			1	9675031880	
				L28615			1	5087.68	
	↔		L28616			1	5087.69		
			MK001	MK001			2	5035.27	

C1 (PM_, PN_) 06.05 →



				←	→	Thread	Part Of	QPA		
⊕		↔			L10111	F 12x1,25 ∪		1	3817.64	
					L10112	F 12x1,25 ∪		1	3817.63	
					L10207	L10207	M 12x1,25 / M 14x1,5 ∪		2	
					L10041 ⁰	L10041 ⁰			2	4066.A3
⊖		⊥			L13537	L13537		2		
					L10553			1	3521.L3	
					L10554			1	3520.Q2	
					L10615	L10615		2	5091.10	
			KIT	MK351	MK351		2	5035.57		

C1 (PA_, PS_) 04.14 →



				←	→	Thread	Part Of	QPA	
⊕		↔			L10111	F 12x1,25 ∪		1	3817.64
					L10112	F 12x1,25 ∪		1	3817.63
					L10041 ⁰	L10041 ⁰			2

C2 (JM_) 09.03 →

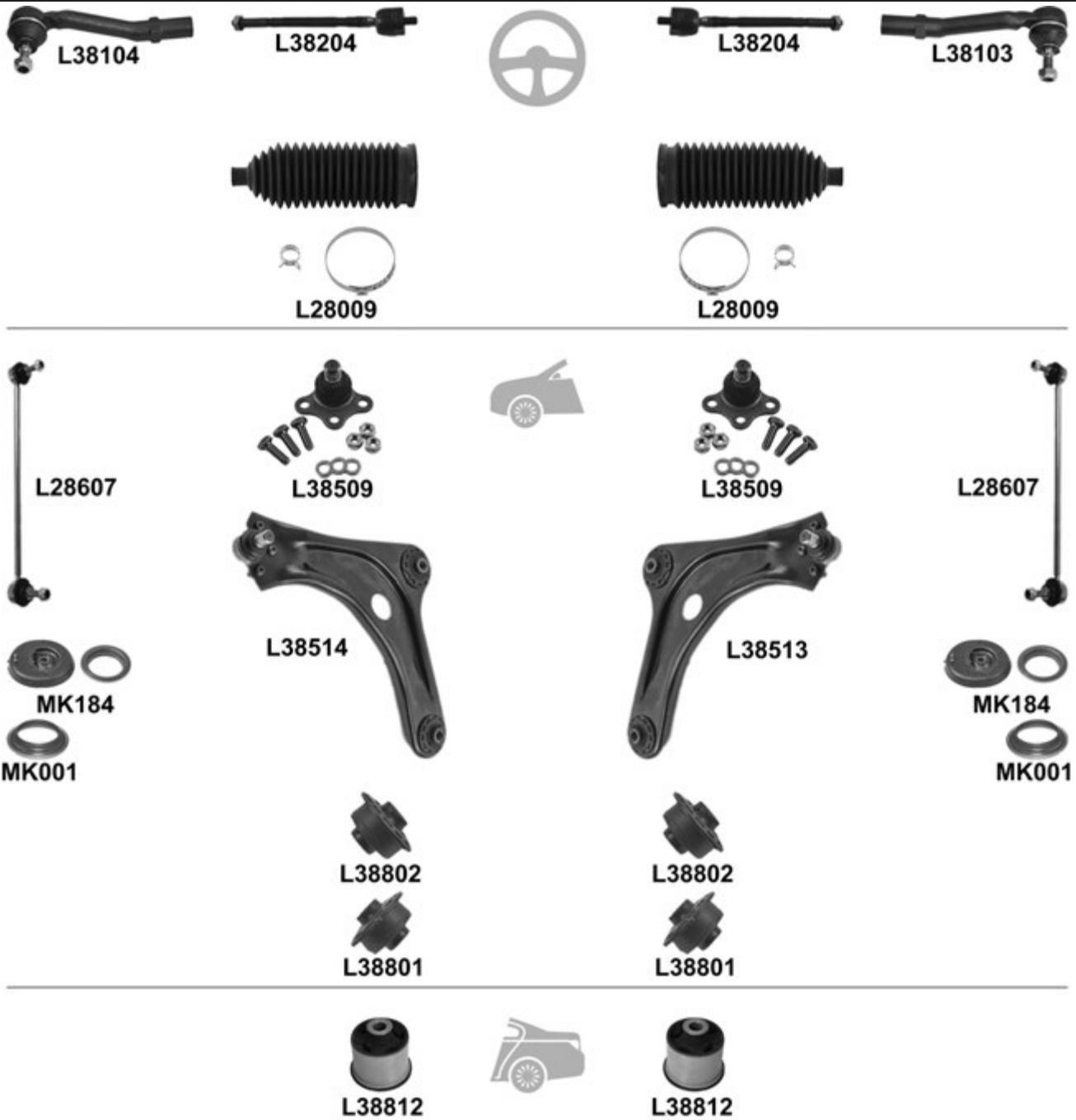

		i	←	→	Thread	Part Of	QPA	i	
⊕		↔		L38103	F 14x1,5 ∪		1	3817.56	
				L38104	F 14x1,5 ∪		1	3817.55	
			L38204	L38204	M 14x1,5 / M 12x1 ∪		2	3812.E1	
				L28009°	L28009°			2	4066.69
🚗		⊥		L38509	L38509		2	3640.56	
			<input checked="" type="checkbox"/>		L38513		1	3521.H6	
		⊥		L38514			1	3520.L4	
				L38802	L38802		2	3523.AA	
		⊥	▼	L38801	L38801		2	3523.98	
			▲	L28607	L28607		2	5087.45	
			→ 09.04, PR → 10156, (+) MK001	KIT	MK184	MK184		2	5038.91
					MK001	MK001		2	5035.27
🚗		▲		L38812	L38812	Hub carrier	2	5131.C2	

C3 (FC_) 02.02 → 11.09
 C3 Pluriel (HB_) 05.03 → 11.09

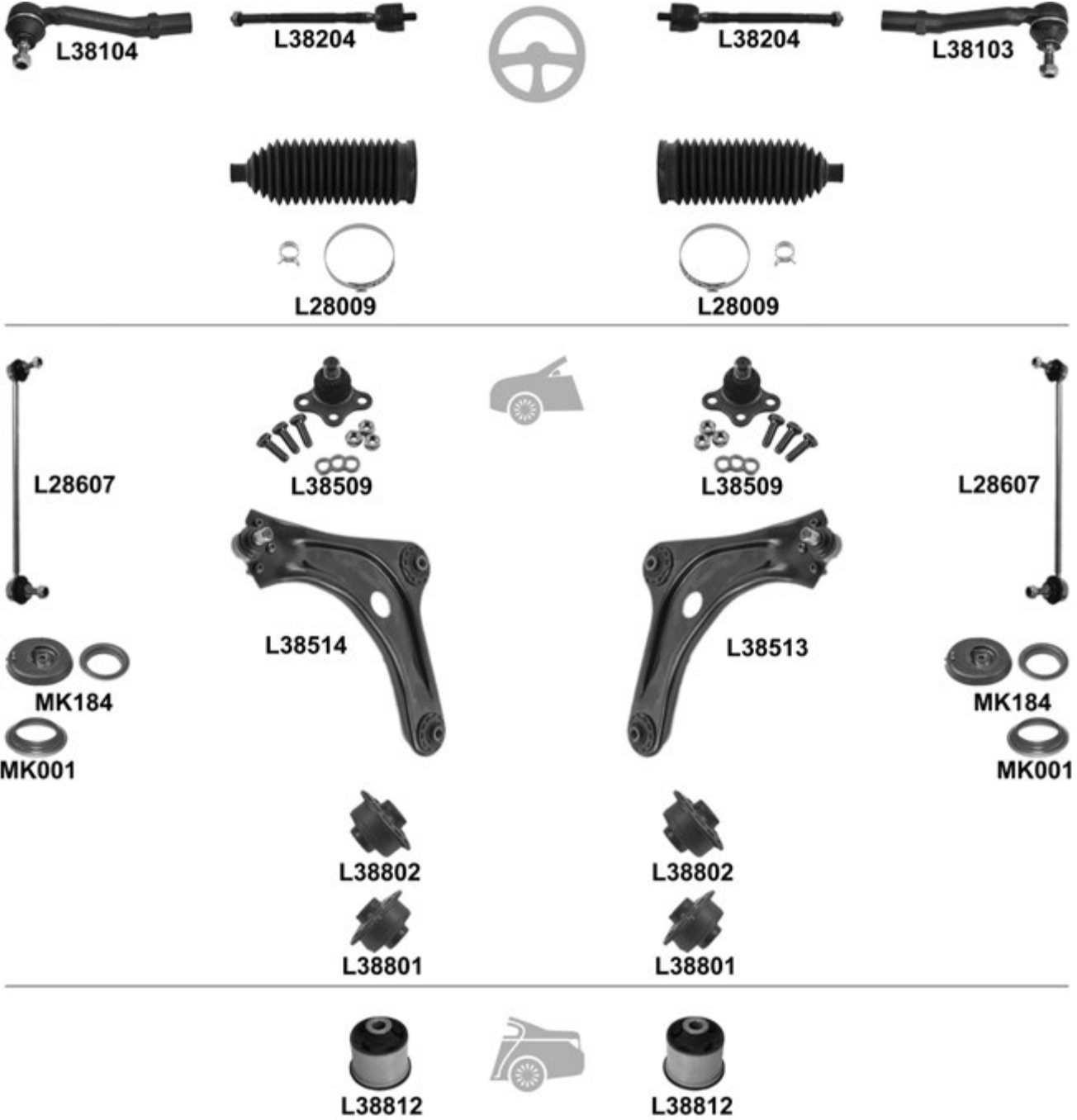

			←	→	Thread	Part Of	QPA			
		↔	(-) 1.6 16V		L38103	F 14x1,5 ∪	1	3817.56		
					L38104	F 14x1,5 ∪	1	3817.55		
			L= 234mm		L38204	L38204	M 14x1,5 / M 12x1 ∪	2	3812.E1	
					L28009⁰	L28009⁰		2	4066.69	
		⊥			L38509	L38509		2	3640.56	
				<input checked="" type="checkbox"/>		L38513			1	3521.H6
		⊥			L38514			1	3520.L4	
					L38802	L38802		2	3523.AA	
		⊥	▼			L38801	L38801		2	3523.98
						L28607	L28607		2	5087.45
				→ 08.04, (+) MK001	KIT	MK184	MK184		2	5038.91
						MK001	MK001		2	5035.27
		▲			L38812	L38812	Hub carrier	2	5131.C2	

C3 11.09 →

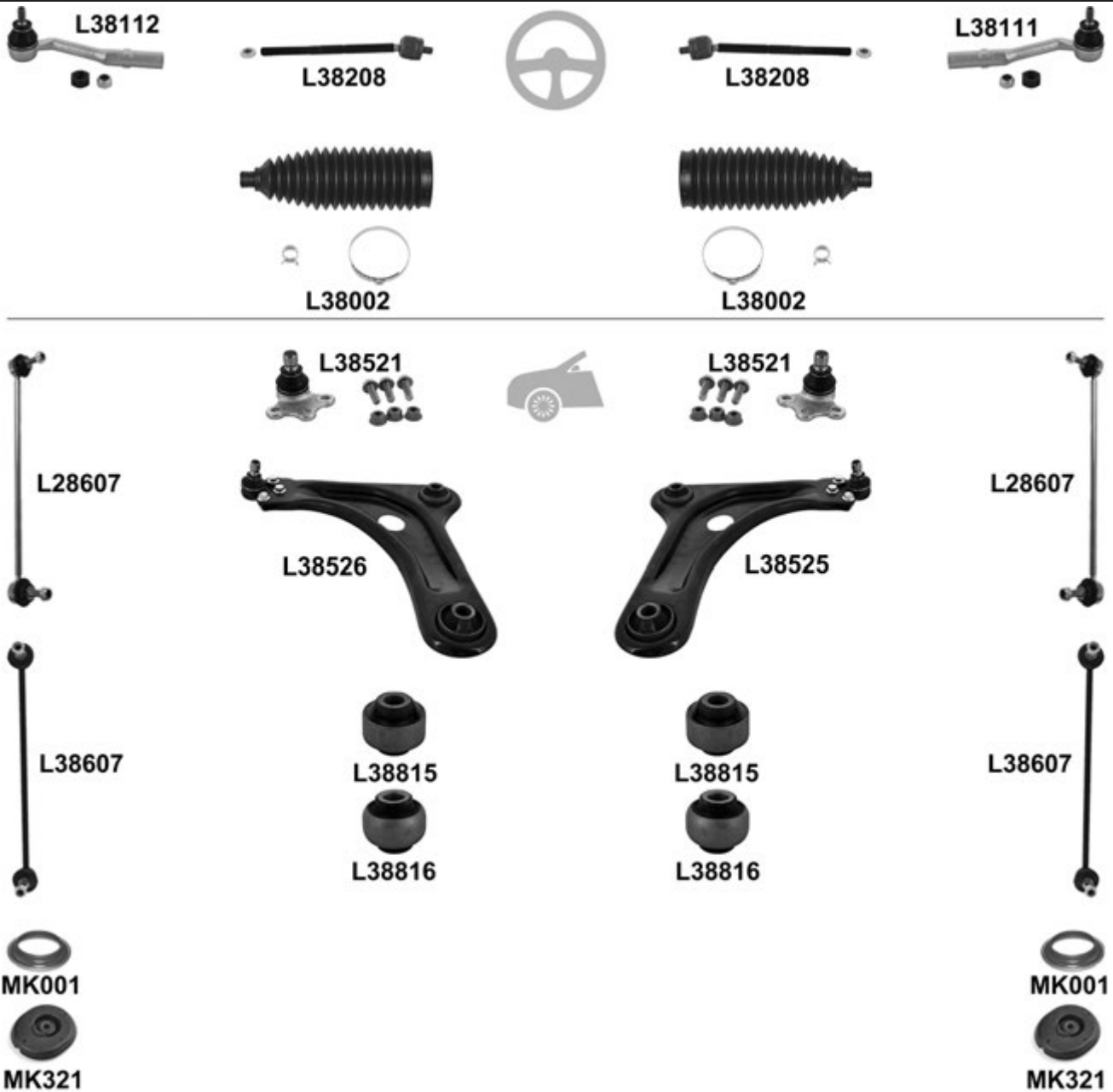

			←	→	Thread	Part Of	QPA		
		↔		L38111	F 14x1,5 U		1	3817.91	
				L38112	F 14x1,5 U		1	3817.92	
		L= 245mm		L38208	L38208	M 14x1,5 / M 12x1 U		2	3812.F6
				L38002 ^o	L38002 ^o			2	4066.79
		↓		L38521	L38521			2	3640.77
				L38525				1	3521.S9
		↓	→ 09.11, PR → 12739, (-) HD		L38526			1	3520.W7
				L38815	L38815			2	3523.EC
		↓ ▲	(-) HD	L38816	L38816			2	3523.CZ
			(-) HD	L38816	L38816			2	3523.CZ
		↔	→ 10.10, PR → 12389	L38607	L38607			2	5087.71
			11.10 →, PR 12390 →	L28607	L28607			2	5087.45
(-)			L38607	L38607			2	5087.71	
			MK001	MK001			2	5035.27	
			MK321	MK321			2		

C3 Picasso 02.09 →

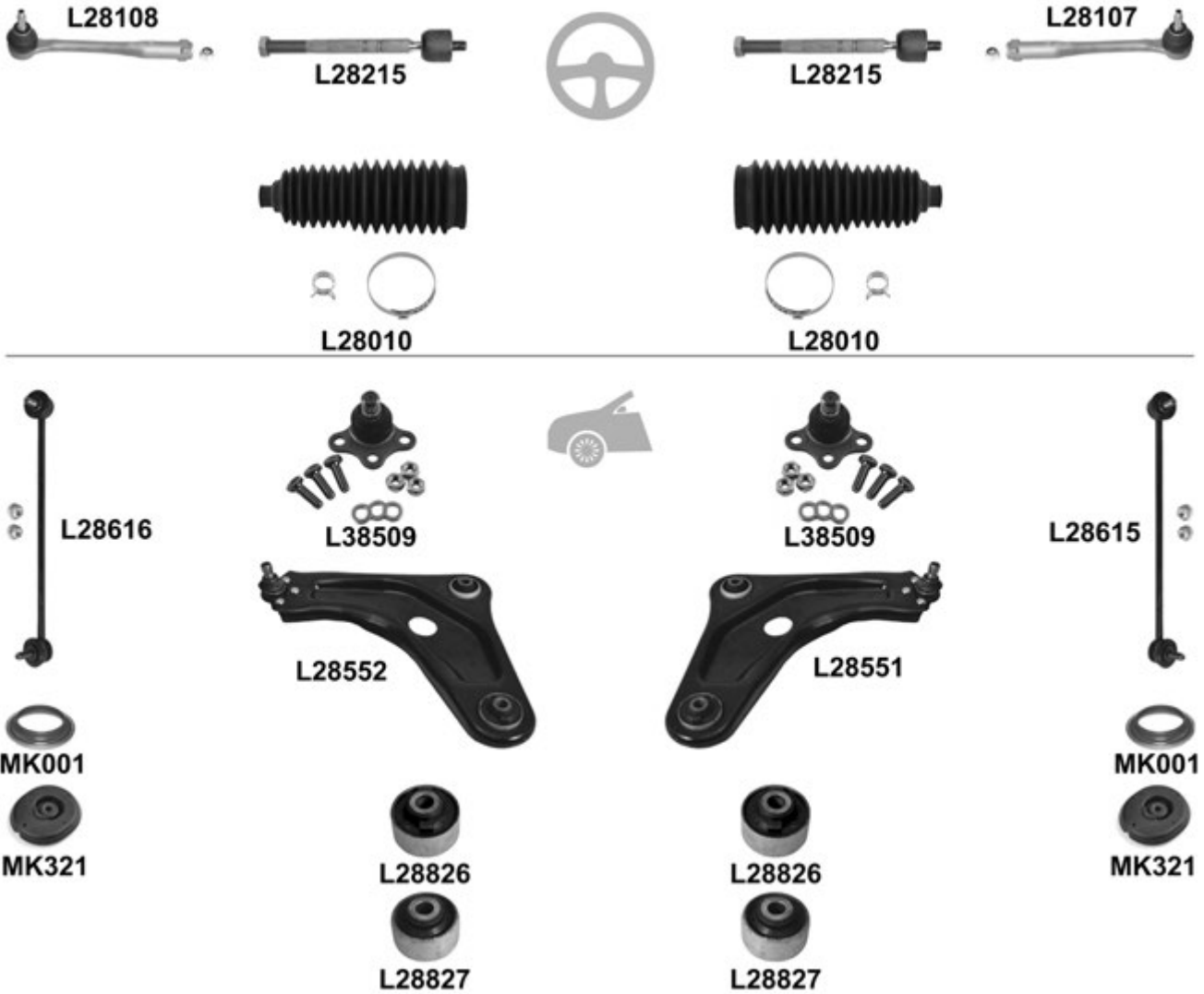

				←	→	Thread	Part Of	QPA	i		
⊕		↔				L28107	F 16x1,5 ∪	1	3817.68		
						L28108	F 16x1,5 ∪	1	3817.67		
						L28215	L28215	M 16x1,5 / M 12x1 ∪	2	3812.E8	
						L28010 ^o	L28010 ^o		2	4066.80	
⊖		↓				L38509	L38509		2	3640.56	
				HD	<input checked="" type="checkbox"/>		L28551			1	3521.N8
		↓					L28552			1	3520.R7
							L28826	L28826		2	3523.CC
		↓	↘				L28827	L28827		2	3523.CE
			↙					L28615			1
							L28616			1	5087.69
							MK001	MK001		2	5035.27
						MK321	MK321		2		

C4 (LC_) 11.04 →
C4 Coupe (LA_) 11.04 →

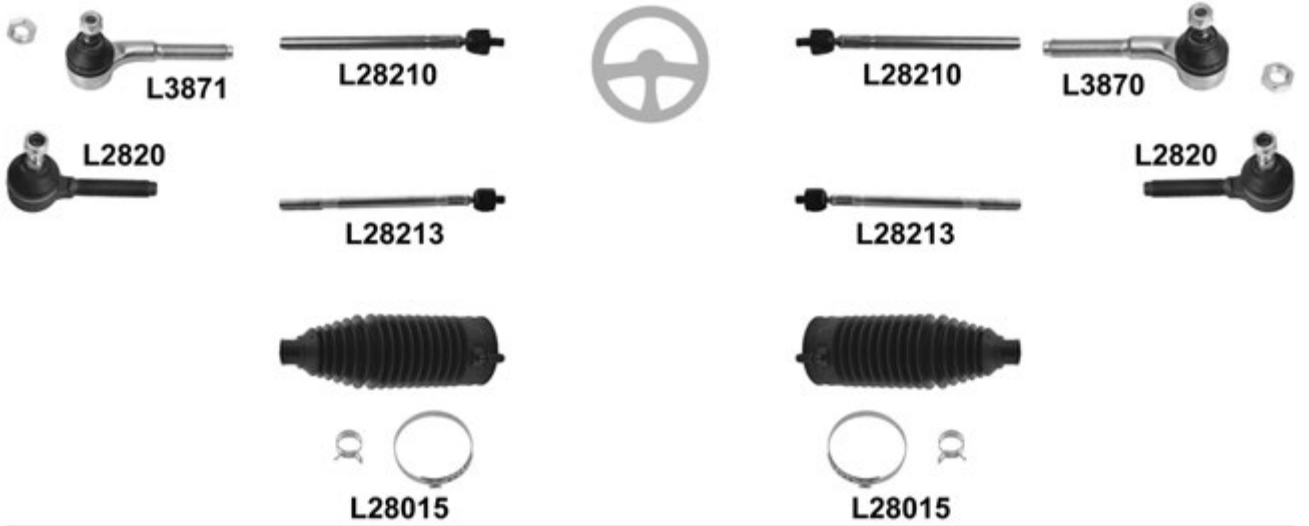

C4 (LC_) 11.04 →
 C4 Coupe (LA_) 11.04 →

		i		←	→	Thread	Part Of	QPA	i
		↔	PR. → 10310, → 02.05		L3870	M 14x1,5 ♂		1	3817.41
				L3871		M 14x1,5 ♂		1	3817.42
			PR. 10311 →, 03.05 →	L2820	L2820	M 14x1,5 ♂		2	3817.18
			PR. → 10310, → 02.05 , L= 322mm	L28210	L28210	F 14x1,5 / M 14x1,5 ♂		2	3812.E0
			PR. 10311 →, 03.05 →, L= 340mm	L28213	L28213	F 14x1,5 / M 14x1,5 ♂		2	3812.E5
		(-)	L28015 ⁰	L28015 ⁰			2	4066.73	
		↓		L28535	L28535			2	3640.68
		↓		L28537				1	3521.P3
			<input checked="" type="checkbox"/>	L28538				1	3520.S2
		↓ ▾		L28807	L28807			2	3523.92
		↓ ▲		L28824	L28824			2	3523.91
				L28609	L28609			2	5087.50
			→ 08.06 , PR → 10853, (+) MK001	KIT	MK196	MK196			2
			MK001	MK001			2	5035.27	
				MK205	MK205			2	5142.34

C4 (B7_) 10.10 →

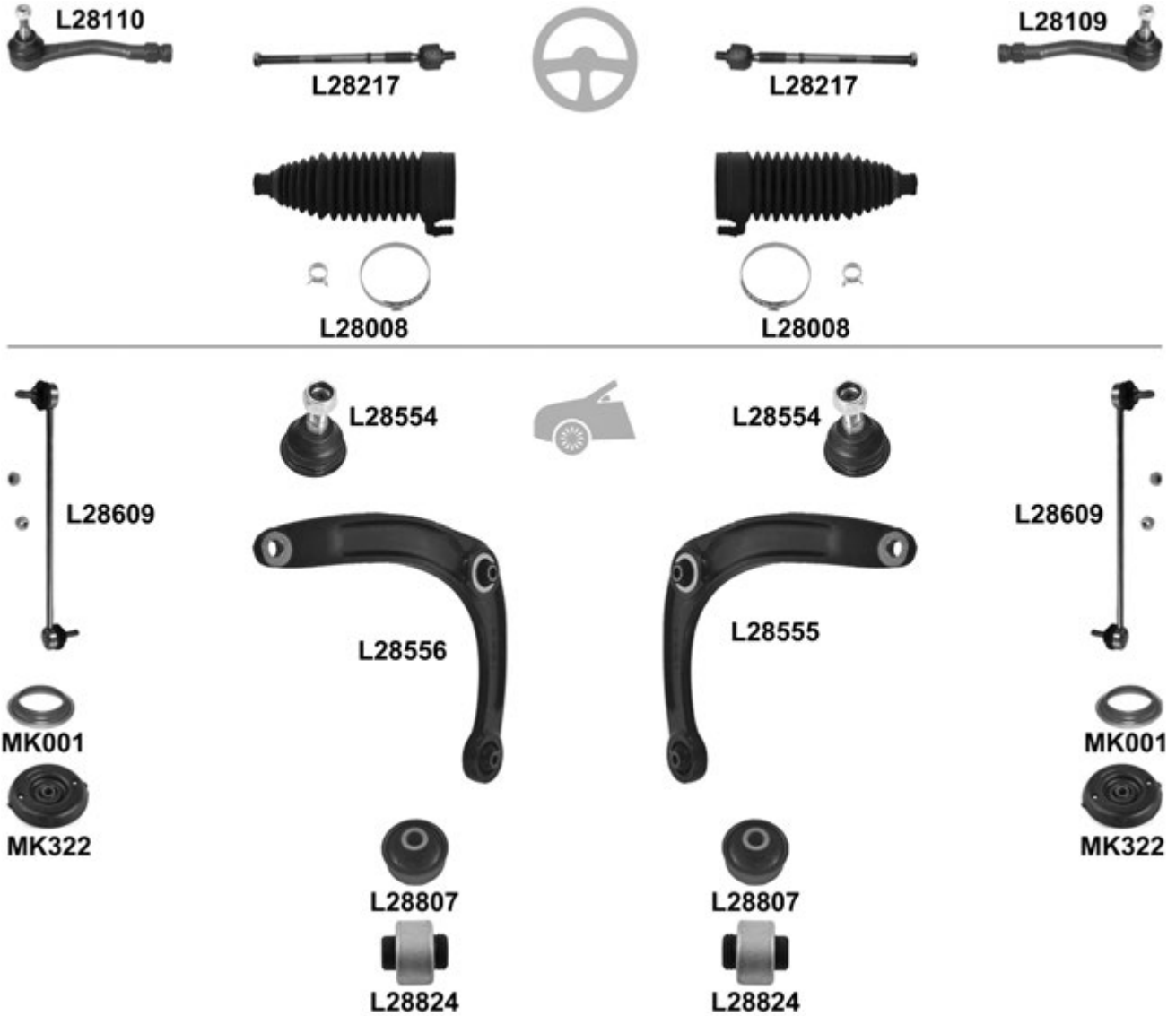

			←	→	Thread	Part Of	QPA		
		↔		L28109	F 14x1,5 ∪		1	3817.88	
				L28110	F 14x1,5 ∪		1	3817.89	
				L28217	L28217	M 14x1,5 / M 14x1,5 ∪	2	3812.F2	
					L28008 ⁰	L28008 ⁰		2	4066.85
		⊥		L28554	L28554		2	3640.73	
				⊥	(-)		L28555		1
		L28556						1	3520.V2
		⊥			L28807	L28807		2	3523.92
					L28824	L28824		2	3523.91
					L28609	L28609		2	5087.50
					MK001	MK001		2	5035.27
					MK322	MK322		2	

C4 Grand Picasso (UA_) 10.06 →



C4 Grand Picasso (UA_) 10.06 →

		i		←	→	Thread	Part Of	QPA	i	
		↔			L38107	F 16x1,5 ☺		1	3817.72	
					L38108	F 16x1,5 ☺		1	3817.71	
					L38207	L38207	M 16x1,5 / M 14x1,5 ☺		2	3812.E9
					L28008 ⁰	L28008 ⁰			2	4066.85
		↓			L28535	L28535			2	3640.68
		↓		<input checked="" type="checkbox"/>	L28537				1	3521.P3
					L28538				1	3520.S2
		↓▼			L28807	L28807			2	3523.92
		↓▲			L28824	L28824			2	3523.91
					L28621	L28621			2	5087.57
			(+)	MK001	KIT	MK196	MK196		2	5038.85
					MK001	MK001			2	5035.27
			(-)	HD	L28836	L28836	Hub carrier	2	5131.F2	
				HD	L28837	L28837	Hub carrier	2	5131.H2	

C4 Picasso (UD_) 02.07 →



C4 Picasso (UD_) 02.07 →

		i		←	→	Thread	Part Of	QPA	i
		↔				L38107 F 16x1,5 U		1	3817.72
						L38108 F 16x1,5 U		1	3817.71
						L38207 L38207 M 16x1,5 / M 14x1,5 U		2	3812.E9
						L28008 ⁰ L28008 ⁰		2	4066.85
		↓				L28535 L28535		2	3640.68
		↓		<input checked="" type="checkbox"/>		L28537		1	3521.P3
						L28538		1	3520.S2
		↓▼				L28807 L28807		2	3523.92
		↓▲				L28824 L28824		2	3523.91
						L28621 L28621		2	5087.57
			(+)	MK001	KIT	MK196 MK196		2	5038.85
						MK001 MK001		2	5035.27
			(-)	HD		L28836 L28836	Hub carrier	2	5131.F2
				HD		L28837 L28837	Hub carrier	2	5131.H2

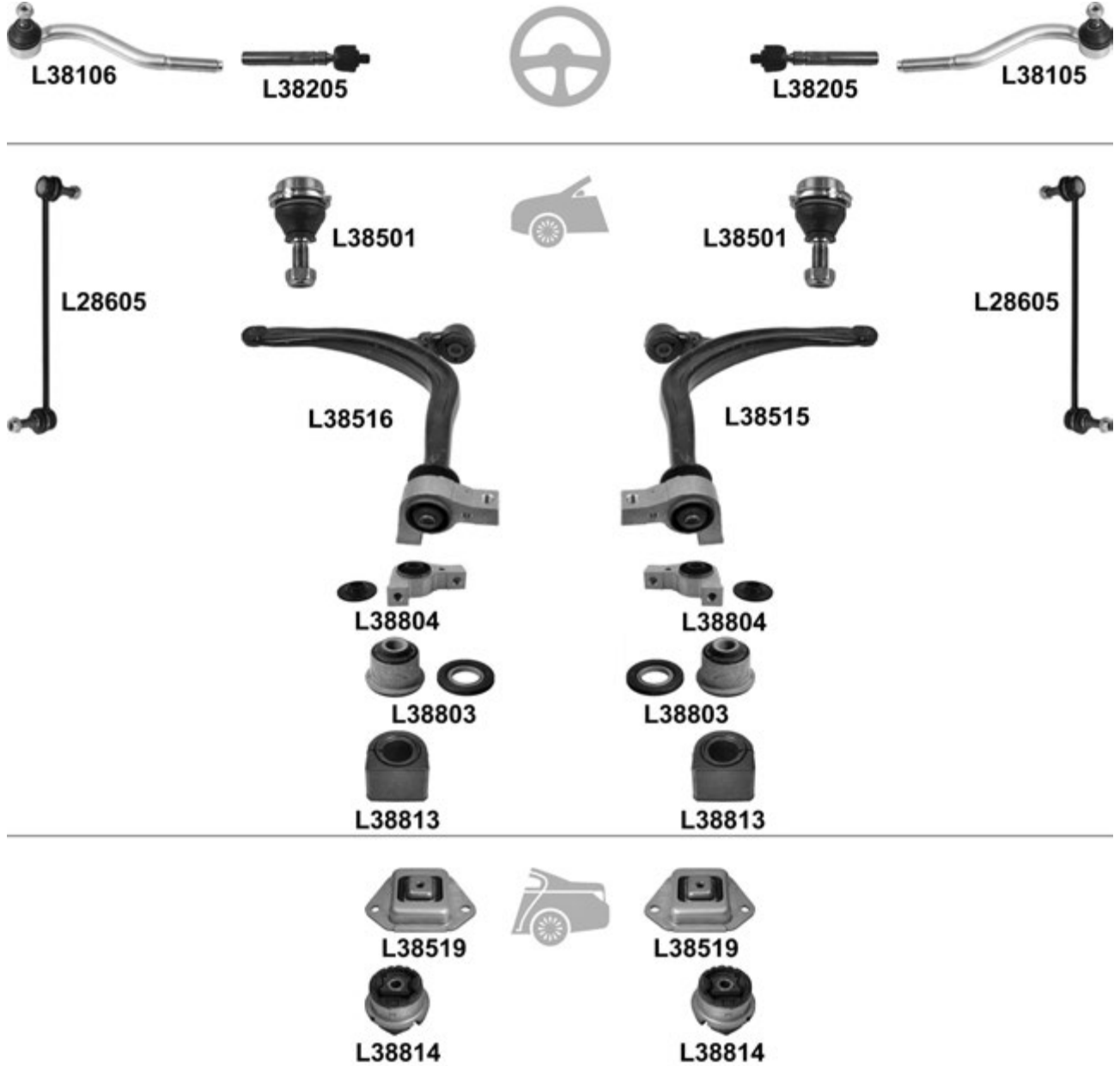
C5 (DC_) 03.01 → 08.04
 C5 Break (DE_) 06.01 → 08.04

			←	→	Thread	Part Of	QPA			
				L38105	M 16x1,5 ∪		1	3817.60		
				L38106	M 16x1,5 ∪		1	3817.59		
				L38501			2	3640.34		
				L38515			1	3521.G3		
					L38516			1	3520.K3	
					L38804	L38804			2	3523.95
					L38803	L38803			2	3523.84
					L28605	L28605			2	5087.48
				L38813	L38813		Anti-roll bar	2	5094.83	
				L38519	L38519		Hub carrier	2	5131.C8	
				L38814	L38814		Hub carrier	2	5131.C7	
						∅ 23.5mm				

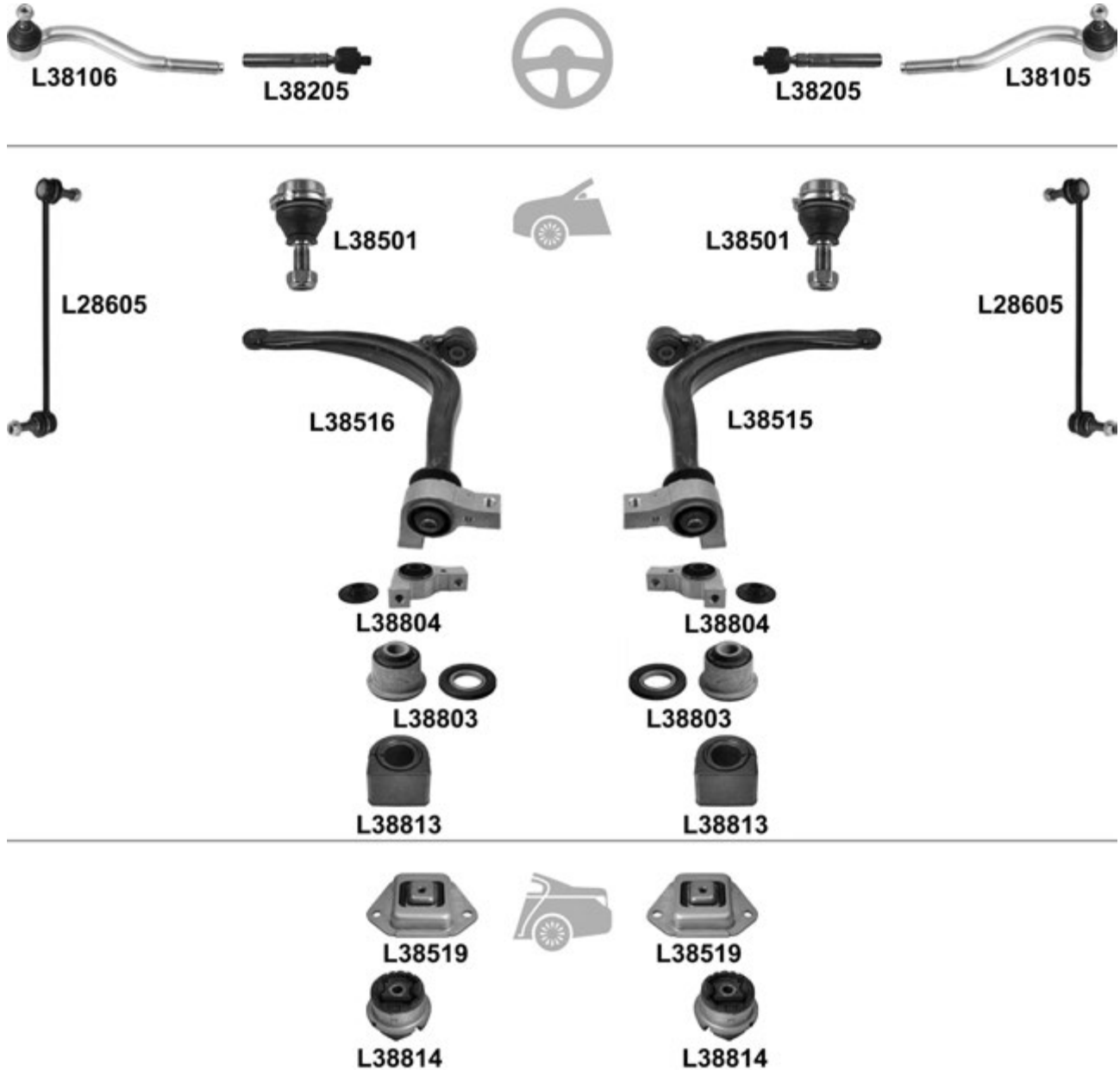
C5 (RC_) 09.04 →
 C5 Break (RE_) 09.04 →

				←	→	Thread	Part Of	QPA		
⊕		↔			L38105	M 16x1,5 ∪		1	3817.60	
				L38106		M 16x1,5 ∪		1	3817.59	
⊖		⊥		L38205	L38205	F 16x1,5 / M 16x1,5 ∪		2	3812.C8	
					L38501	L38501			2	3640.34
					L38515				1	3521.G3
					L38516				1	3520.K3
				⊥↘	L38804	L38804			2	3523.84
				⊥↗	L38803	L38803			2	3523.95
⊖				L28605	L28605			2	5087.48	
			∅ 23.5mm	L38813	L38813		Anti-roll bar	2	5094.83	
⊖		∇		L38519	L38519		Hub carrier	2	5131.C8	
			▲	L38814	L38814		Hub carrier	2	5131.C7	

C5 (RD_) 02.08 →
C5 Break (TD_) 02.08 →

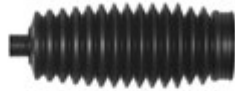

L28011

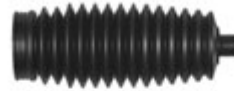

L28011



L28612



L28553



L28553



L28611



L28834



L28834



L28835



L28835



L28613



L28613

				←	→	Thread	Part Of	QPA	
				L28011 ⁰	L28011 ⁰			2	4066.88
		↓		L28553	L28553			2	3640.72
		↓ ▾		L28834	L28834		L38523/L38524	2	
		↓ ▲		L28835	L28835		L38523/L38524/ L38527/L38528	2	3523.AQ
					L28611			1	5087.53
				L28612				1	5087.52
				L28613	L28613			2	5178.46

C6 (TD_) 09.05 →



C6 (TD_) 09.05 →

		← →		Thread	Part Of	QPA	
		↔		L28111	M 14x1,5 ♂	1	3817.66
				L28112	M 14x1,5 ♂	1	3817.65
				L28212	L28212	2	3812.E3
				L28013 ⁰	L28013 ⁰	2	4066.71
		↑		L28541	L28541	2	3640.57
		↓		L28553	L28553	2	3640.72
		↓	→ 02.07, PR → 11039, (-)		L28543	1	3521.L2
				L28544		1	3520.Q1
		↓▼		L28834	L28834	2	
		↓▲		L28835	L28835	2	L38523/L38524
					L28611	1	5087.53
				L28612		1	5087.52
				L28613	L28613	2	5178.46

C8 (EA_, EB_) 07.02 →

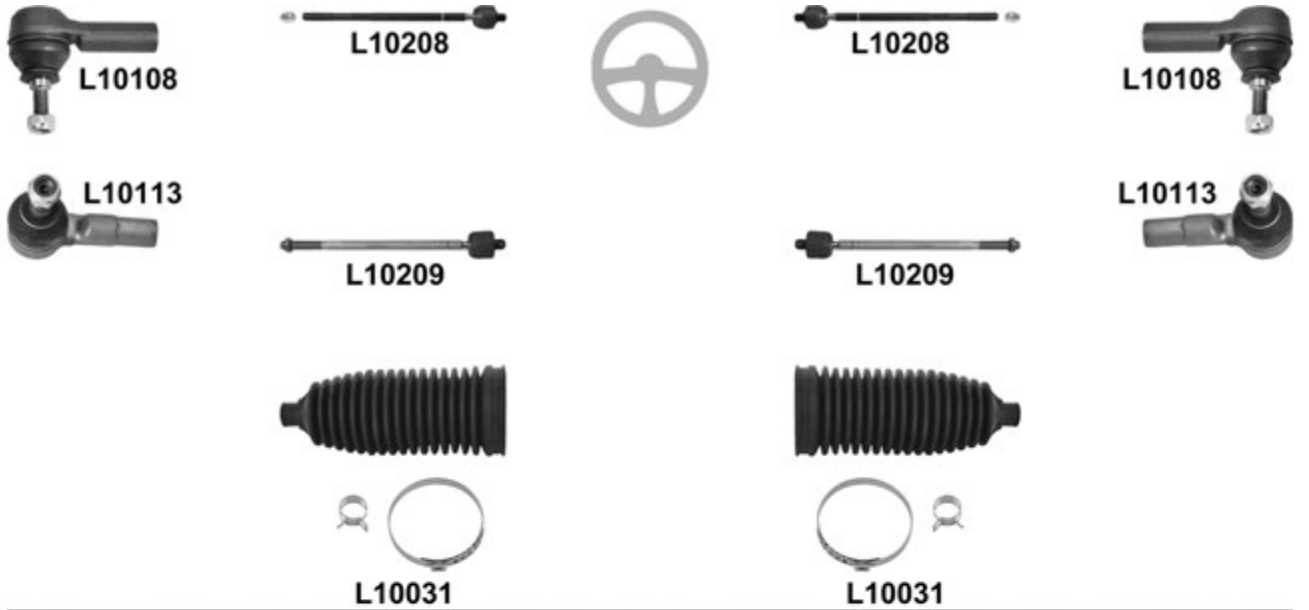

				←	→	Thread	Part Of	QPA		
⊕	↔	(-) 2.0 Hdi DW10CTED4 / 2.2 Hdi DW12BTED4		L10108	L10108	F 14x1,5 ∪		2	4059.12	
				L10108	L10108	F 14x1,5 ∪		2	4059.12	
				L10113	L10113	F 14x1,5 ∪		2	3817.73	
	↔	(-) 2.0 Hdi DW10CTED4 / 2.2 Hdi DW12BTED4		L10208	L10208	M 14x1,5 / M 14x1,5 ∪		2	3812.E2	
				L10208	L10208	M 14x1,5 / M 14x1,5 ∪		2	3812.E2	
				L10209	L10209	M 14x1,5 / M 14x1,5 ∪		2	3812.F0	
			L10031 °	L10031 °			2	4066.70		
⊖	⊥	PR → 10823, → 07.06, ↕ 12mm	<input checked="" type="checkbox"/>		L10529			1	3521.P6	
				L10530			1	3520.P6		
		PR 10824 →, 08.06 →, ↗ 17mm, ↘ 14mm	<input checked="" type="checkbox"/>		L10577			1	3521.T2	
				L10578			1	3520.X0		
	↗ 19mm	<input checked="" type="checkbox"/>		L10571			1	3521.N9		
			L10572			1	3520.R8			
				L10608	L10608			2	5087.51	
	⊕		(+) MK048	KIT		MK269R			1	5038.70
						MK270L			1	5038.68
				MK048	MK048			2	5035.38	

C15 (VD-_) 10.84 → 12.05

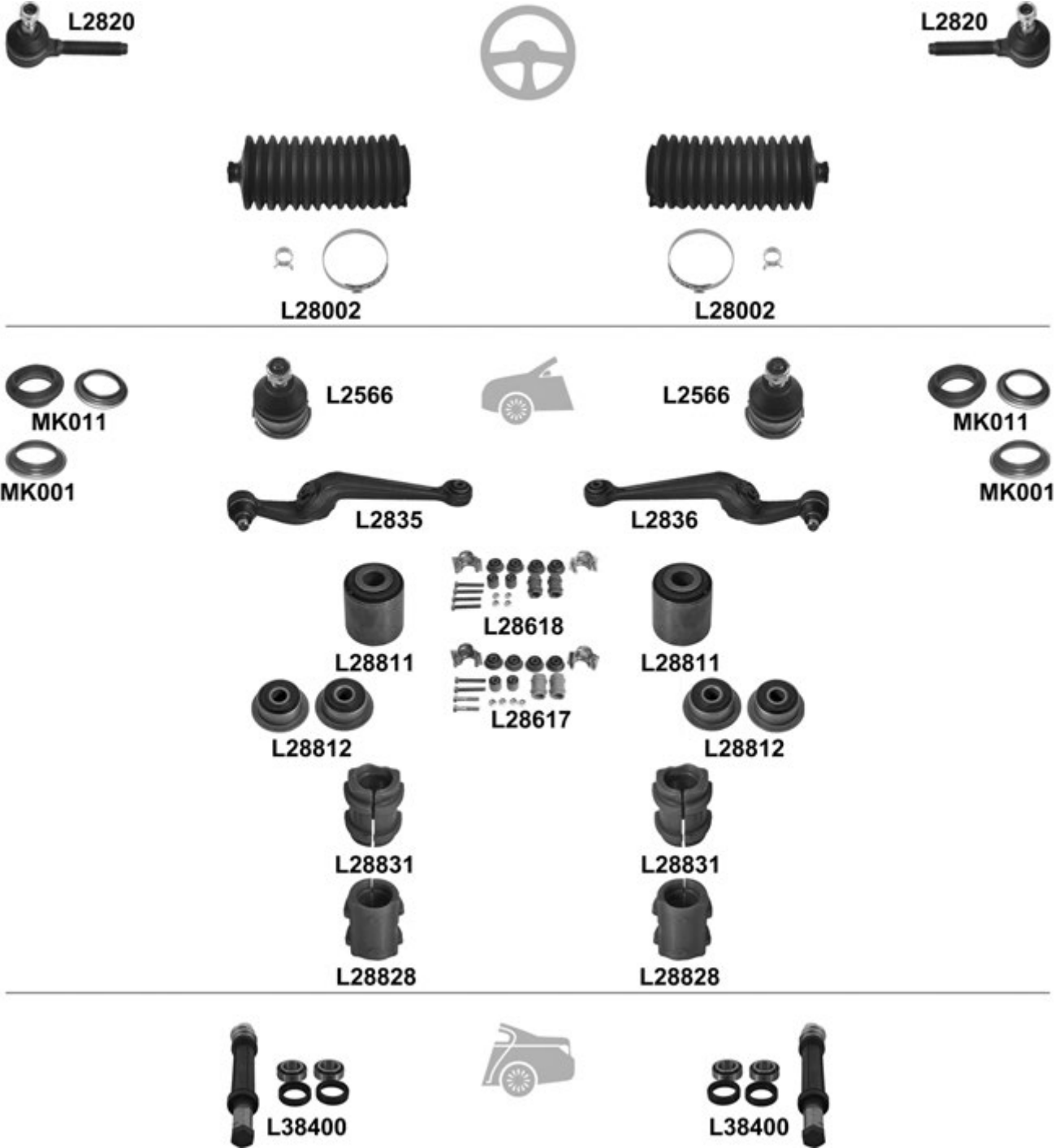

C15 (VD-_) 10.84 → 12.05

				←	→	Thread	Part Of	QPA		
		↔		L2820	L2820	M 14x1,5		2	3817.18	
				L28002	L28002			2	4066.15	
		↓	(-) diesel	L2566	L2566			2	91 504 248	
		↓	954cc / 1124 cc / 1360 cc, ch. 4196 → <input checked="" type="checkbox"/>	L2835	L2836			1	3521.34	
			1769 cc Diesel <input checked="" type="checkbox"/>	L2835	L2836			1	3520.51	
				L2835				1	3520.51	
		↓→←	954cc / 1124 cc / 1360 cc, ch. 4196 →, (+) 1769 cc Diesel		L28811	L28811			2	3523.49
		↓←→	954cc / 1124 cc / 1360 cc, ch. 4196 →, (+) 1769 cc Diesel		L28812	L28812			2	3523.20
			1124 cc / 1360 cc, ch. → 4195, Ø 22mm, Green		L28831	L28831		Anti-roll bar	2	5094.37
			Ø 23mm, blue, (-) 760		L28828	L28828		Anti-roll bar	2	5094.40
			Ø 22mm, green KIT		L28618			Anti-roll bar	1	
			Ø 23mm, blue, (-) 760 KIT		L28617			Anti-roll bar	1	
			954 cc / 1124 cc / 1360 cc, 05.88 → KIT		MK011	MK011			2	5035.18
Diesel			MK011	MK011			2	5035.18		
				MK001	MK001			2	5035.27	
		KIT		L38400	L38400			2		

C25 (280 / 290) 09.81 → 03.94

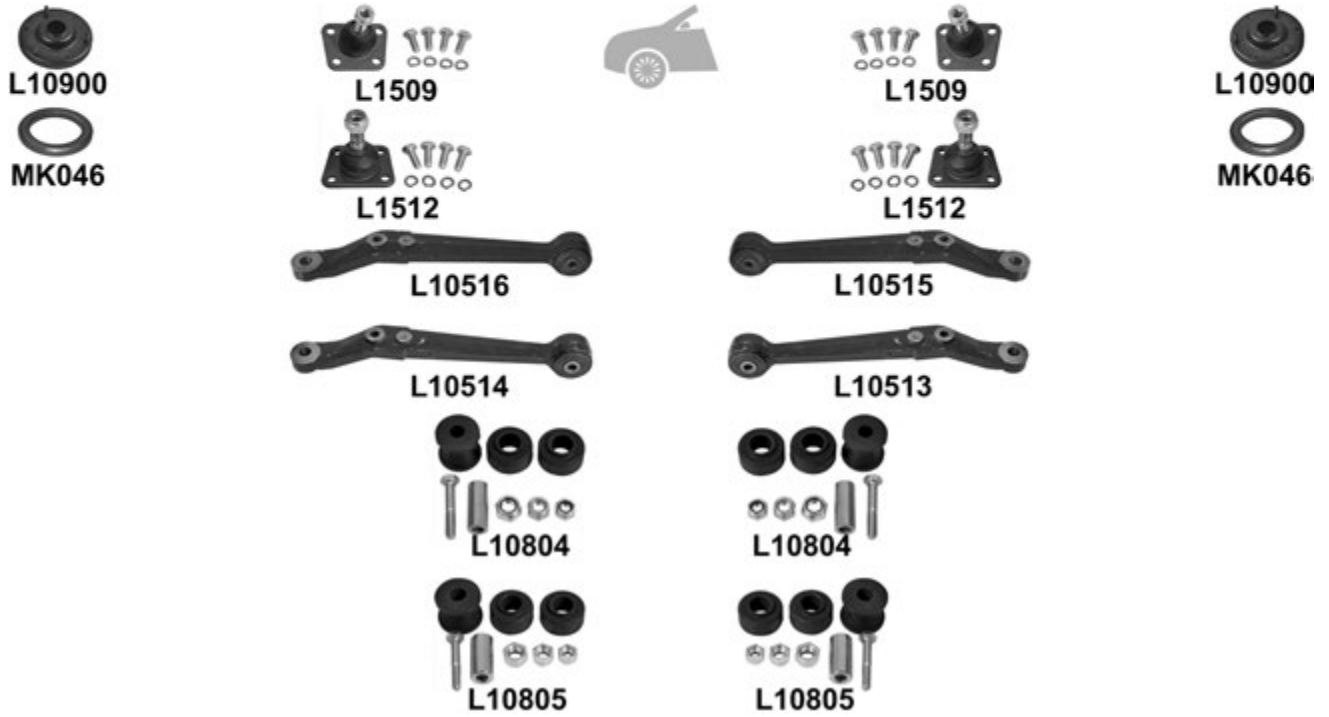

				← → Thread		Part Of	QPA			
⊕		↔		L1508	L1508	F 16x1,5 ♂	2	9750 079 800		
				L1513	L1513	M 16x1,5 / F 16x1,5 ♂	2	9750 001 180		
		⊙			L3890		1	4066.19		
				L3891			1	4066.18		
🚗		⊥	→ 09.85	L1509	L1509		2	3640.18		
			10.85 →, ch. 289711 →	L1512	L1512		2	3640.29		
		⊥	10.85 →, (-) 1800		L10515		1	3521.52		
				L10516		1	3520.76			
			10.85 →, 1800		L10513 ¹		1	3521.53		
				L10514 ¹		1	3520.77			
			(-) 1800	KIT	L10804	L10804		2		
			1800		L10805	L10805		2		
				KIT	L10900	L10900		2	5210.20 S	
					MK046	MK046		2	5035.17	

DS3 04.10 →

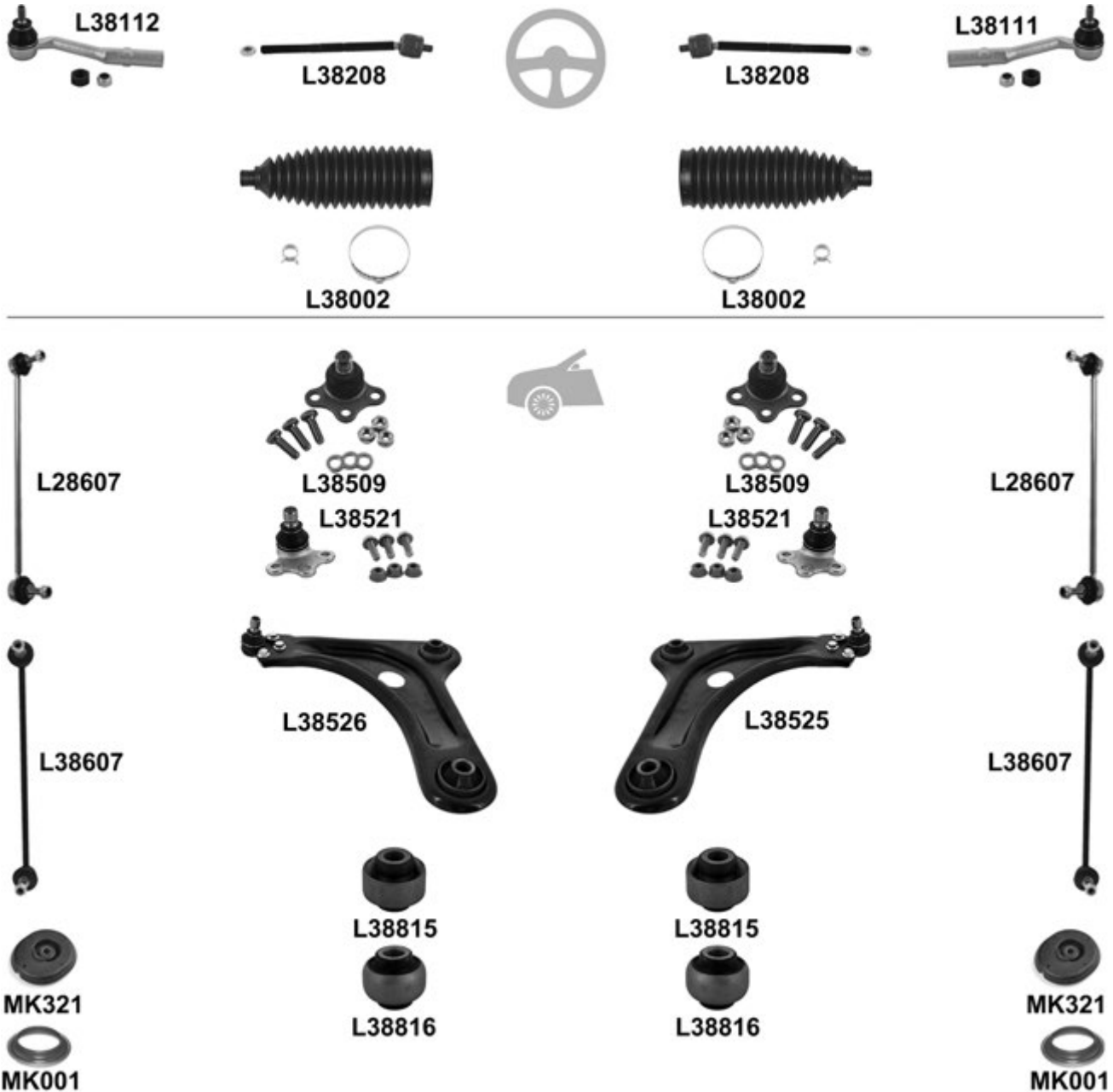

				←	→	Thread	Part Of	QPA		
⚙️	↔️				L38111	F 14x1,5 U		1	3817.91	
					L38112	F 14x1,5 U		1	3817.92	
	🌀			L38208	L38208	M 14x1,5 / M 12x1 U		2	3812.F6	
				L38002 ⁰	L38002 ⁰			2	4066.79	
🚗	⬇️	MAN		L38509	L38509			2	3640.78	
		AUT		L38521	L38521			2	3640.77	
	🔧	⬇️	(-) HD	<input checked="" type="checkbox"/>	L38525			1	3521.S9	
					L38526			1	3520.W7	
	🌀	⬇️	(-) HD		L38815	L38815		2	3523.EC	🔧
			(-) HD		L38816	L38816		2	3523.CZ	🔧
	🔧		🌀, → 10.10, PR → 12389		L38607	L38607		2	5087.71	
			🌀, 11.10 →, PR 12390 →		L28607	L28607		2	5087.45	
			(-) 🌀		L38607	L38607		2	5087.71	
	🌀				MK321	MK321		2		
🌀				MK001	MK001		2	5035.27	🌀	

DS4 04.11 →

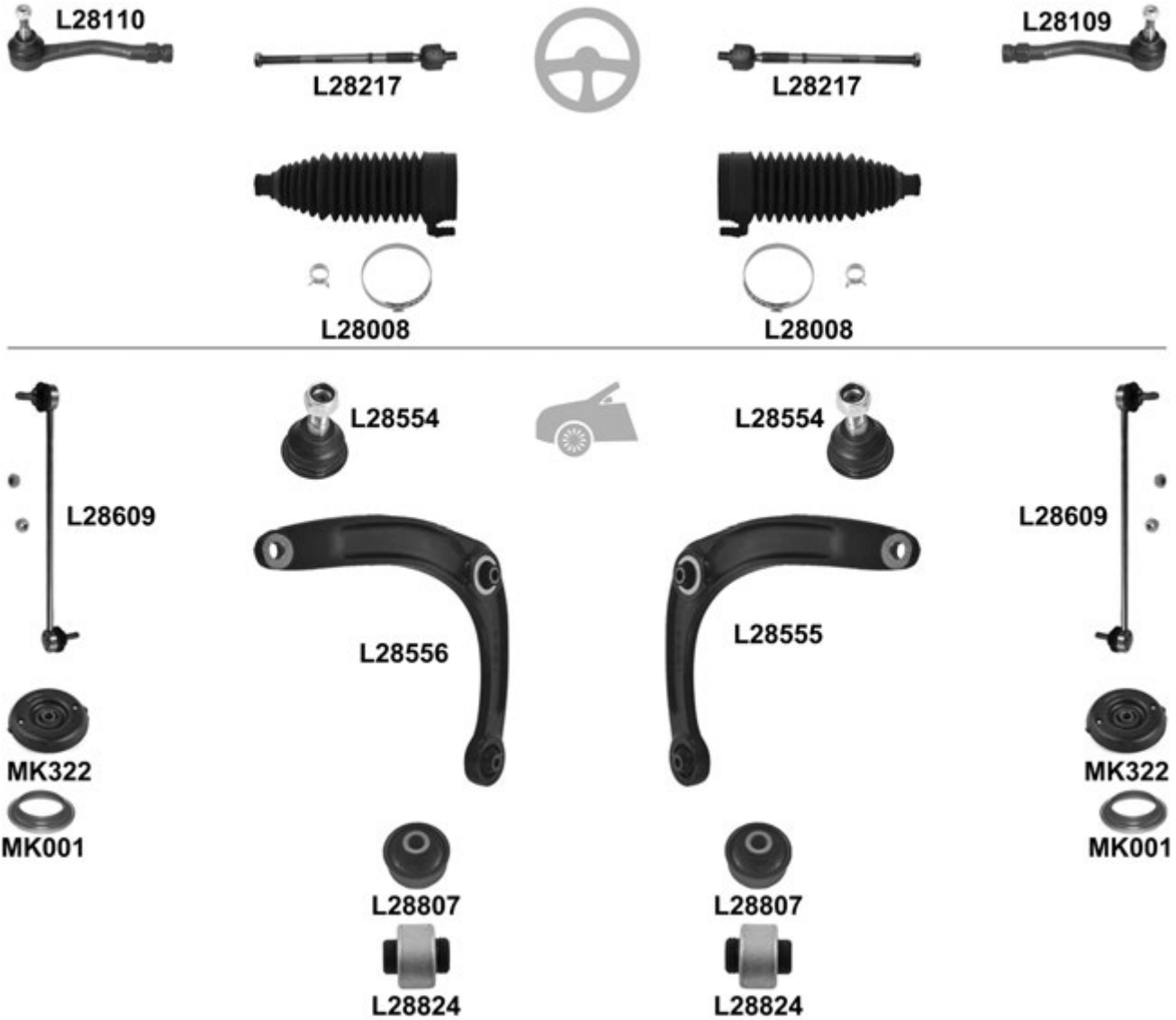

			←	→	Thread	Part Of	QPA	
		↔		L28109	F 14x1,5 ∪		1	3817.88
				L28110	F 14x1,5 ∪		1	3817.89
			L28217	L28217	M 14x1,5 / M 14x1,5 ∪		2	3812.F2
			L28008 ⁰	L28008 ⁰			2	4066.85
		⊥		L28554	L28554		2	3640.73
					L28555		1	3521.R3
		⊥		L28556			1	3520.V2
				L28807	L28807		2	3523.92
		⊥	↕	L28824	L28824		2	3523.91
				L28609	L28609		2	5087.50
			MK322	MK322		2		
			MK001	MK001			2	5035.27

DS5 11.11 →

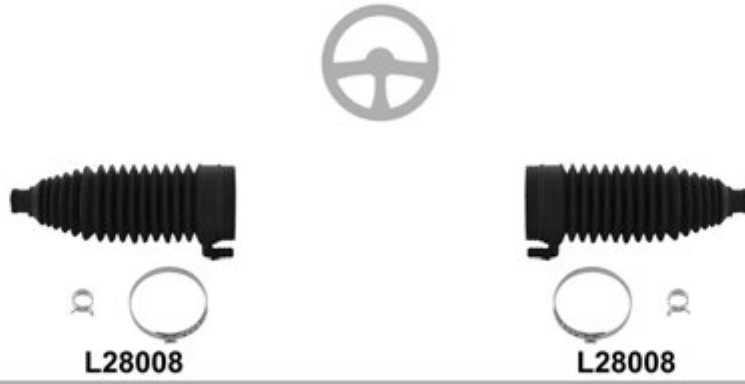

Thread

Part Of

QPA

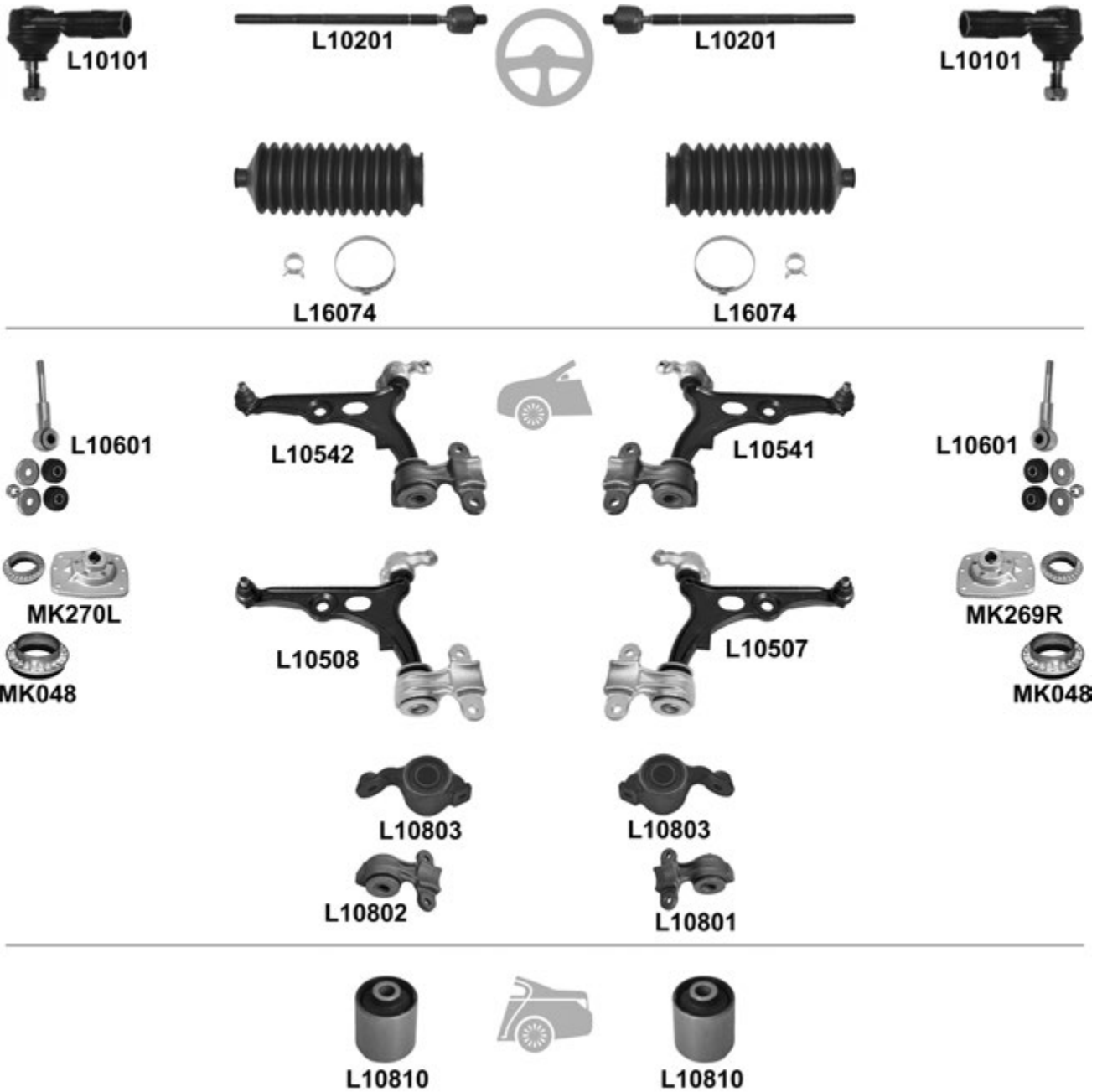

				L28008 ^o	L28008 ^o			2 4066.85
				MK001	MK001			2 5035.27

Evasion / Synergie (22 / U6U) 06.94 → 07.02

		i		←	→	Thread	Part Of	QPA	i	
⊕		↔				L10101 L10101	F 14x1,5 ∪	2	4059.09	
						L10201 L10201	M 14x1,5 / M 14x1,5 ∪	2	3812.A4	
						L16074 L16074		2	4066.41	
⊖		⊥	Petrol	<input checked="" type="checkbox"/>		L10541		1	3521.L0	
				<input checked="" type="checkbox"/>		L10542		1	3520.P8	
		Diesel	<input checked="" type="checkbox"/>		L10507		1	3521.K4		
			<input checked="" type="checkbox"/>		L10508		1	3520.P4		
		⊥↘				L10803 L10803		2	L10507/L10508/ L10541/L10542	
		⊥↗				L10801		1	L10507/L10541	
						L10802		1	L10508/L10542	
						L10601 L10601		2	5038.35 S	
							KIT MK269R		1	5038.70
							MK270L		1	5038.68
						MK048 MK048		2	5035.43	
						L10810 L10810	Hub carrier	2	5152.61	

Jumper (230P / 230L) 02.94 → 04.02

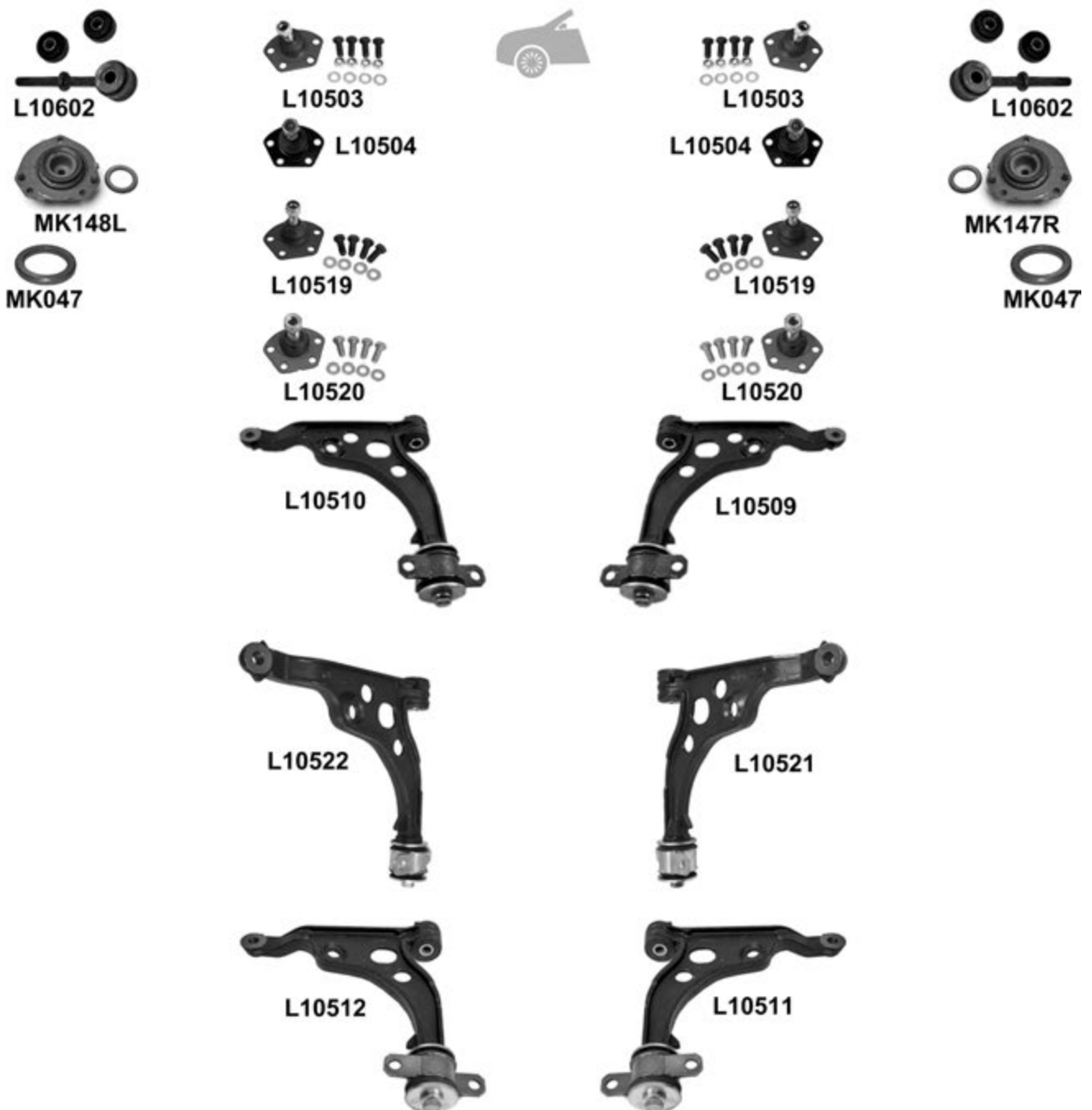
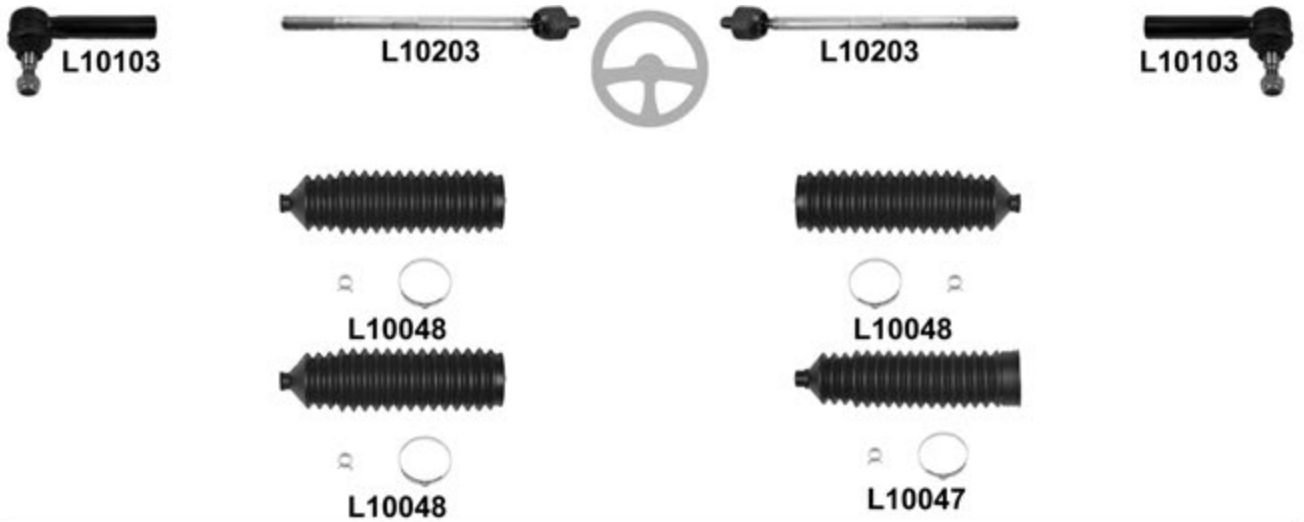

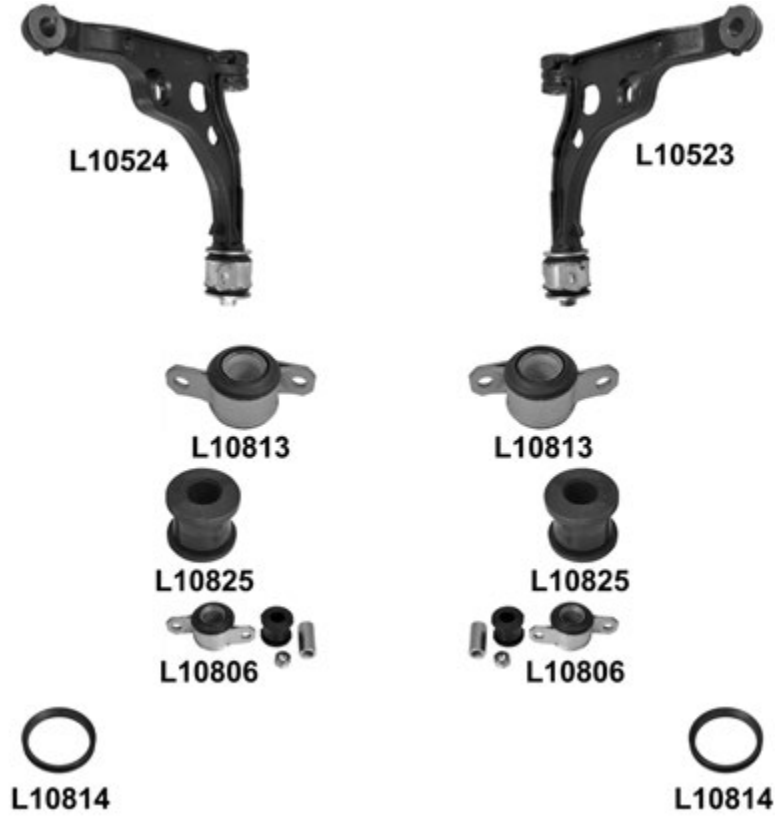
Jumper (230P / 230L) 02.94 → 04.02

						←	→	Thread	Part Of	QPA		
		↔		L10103	L10103			F 16x1,5 ∪		2	4018.H4	
				L10203	L10203			M 16x1,5 / M 16x1,5 ∪		2	4018.A4	
					L10048 ^o	L10048 ^o					2	4066.31
				⊗, *: OE no. 4006.22=set of 2							1	4006.22*
					L10048 ^o						1	4006.22*
		⊥	→ 01.01, 10 - 14 Q,	L10503	L10503					2	3640.32	
			→ 01.01, 18 Q,	L10504	L10504					2	3640.33	
			02.01 →, 10 - 14 Q,	L10519	L10519					2	3640.55	
			02.01 →, 18 Q,	L10520	L10520					2	3640.54	
		⊥		→ 01.01, 10 - 14 Q,		L10509					1	3520.95
					L10510					1	3521.65	
				02.01 →, 10 - 15 Q,		L10521				1	3521.J3	
					L10522					1	3520.N3	
				→ 01.01, 18 Q,		L10511				1	3521.66	
					L10512					1	3520.96	
				02.01 →, 18 Q,		L10523				1	3521.J4	
					L10524					1	3520.N4	
		⊥			L10813	L10813				2	3523.94	
				(+) metal sleeve	L10825	L10825				2	3523.93	
				KIT	L10806	L10806				2		
				L10602	L10602				2	13007 16080 S		
			(+) MK047 / L10814	KIT		MK147R			1	5038.19 S		
					MK148L			1	5038.18 S			
				MK047	MK047				2	5035.39		
RUBBER				L10814	L10814				2	5035.50		

Jumper / Relay (244) 04.02 →

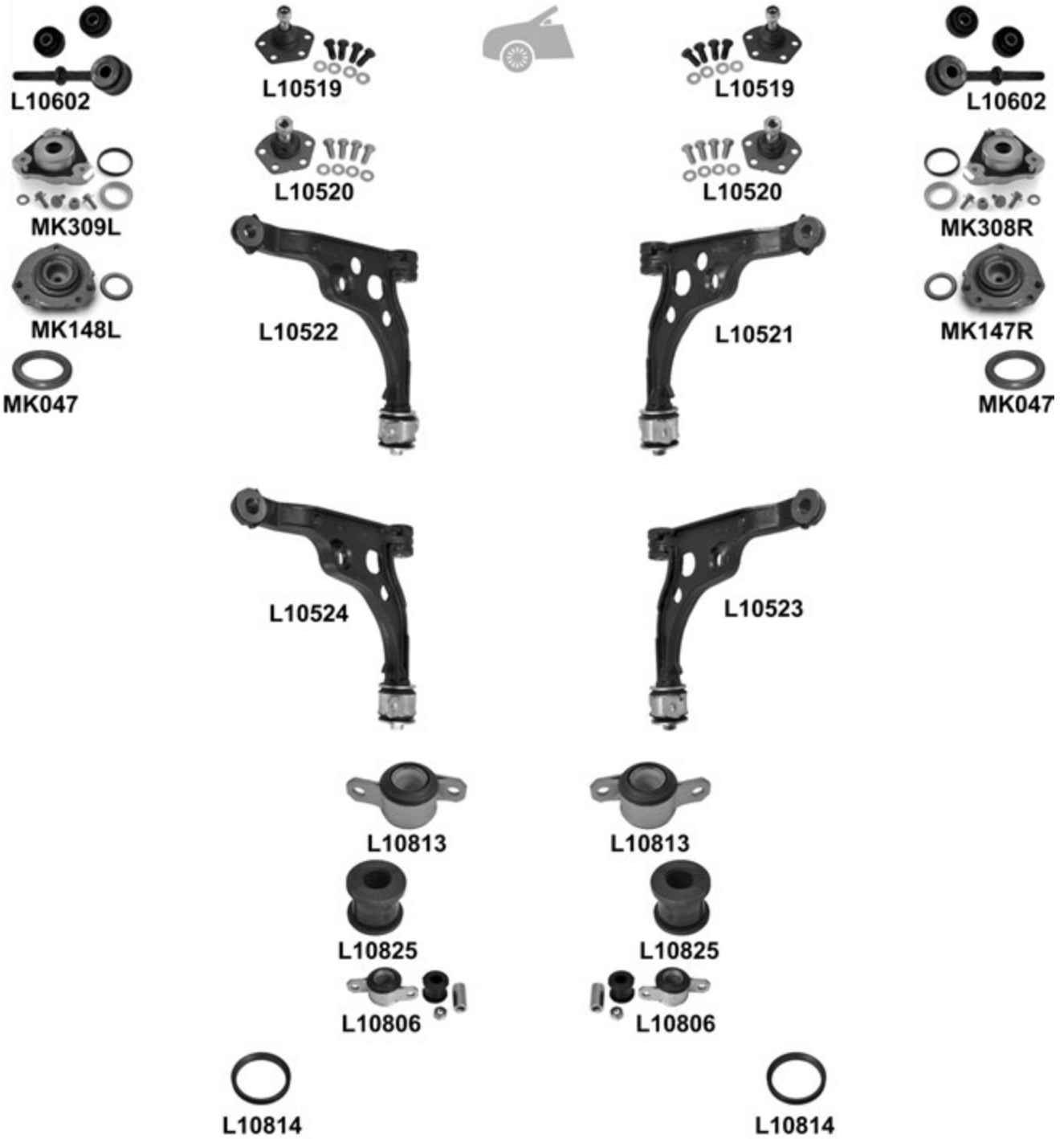

Jumper / Relay (244) 04.02 →

				←	→	Thread	Part Of	QPA		
		↔	→ 12.02 , ch. → 17175290, 14.4mm	L10103	L10103	F 16x1,5 ∩		2	4018.H4	
			12.02 →, ch. 17175291 →, 16.7mm	L10107	L10107	F 16x1,5 ∩		2	4018.E0	
			/	L10203	L10203	M 16x1,5 / M 16x1,5 ∩		2	4018.A4	
		⊥	10 - 15 Q, 20mm	L10519	L10519			2	3640.55	
			18 Q, 24mm	L10520	L10520			2	3640.54	
		⊥	10 - 15 Q, 20mm			L10521			1	3521.J3
						L10522			1	3520.N3
						L10523			1	3521.J4
						L10524			1	3520.N4
		⊥		L10813	L10813			2	3523.94	
			(+) metal sleeve	L10825	L10825			2	3523.93	
				KIT	L10806	L10806			2	
					L10602	L10602			2	
			(-) Off-Road, (+) MK047 / L 10814	KIT		MK308R		1	5038.C9	
					MK309L		1	5038.E3		
			Off-Road, (+) MK047 / L 10814	KIT		MK147R		1	5038.29	
					MK148L		1	5038.28		
				MK047	MK047			2	5035.39	
RUBBER				L10814	L10814			2	5035.50	

Jumper / Relay 04.06 →

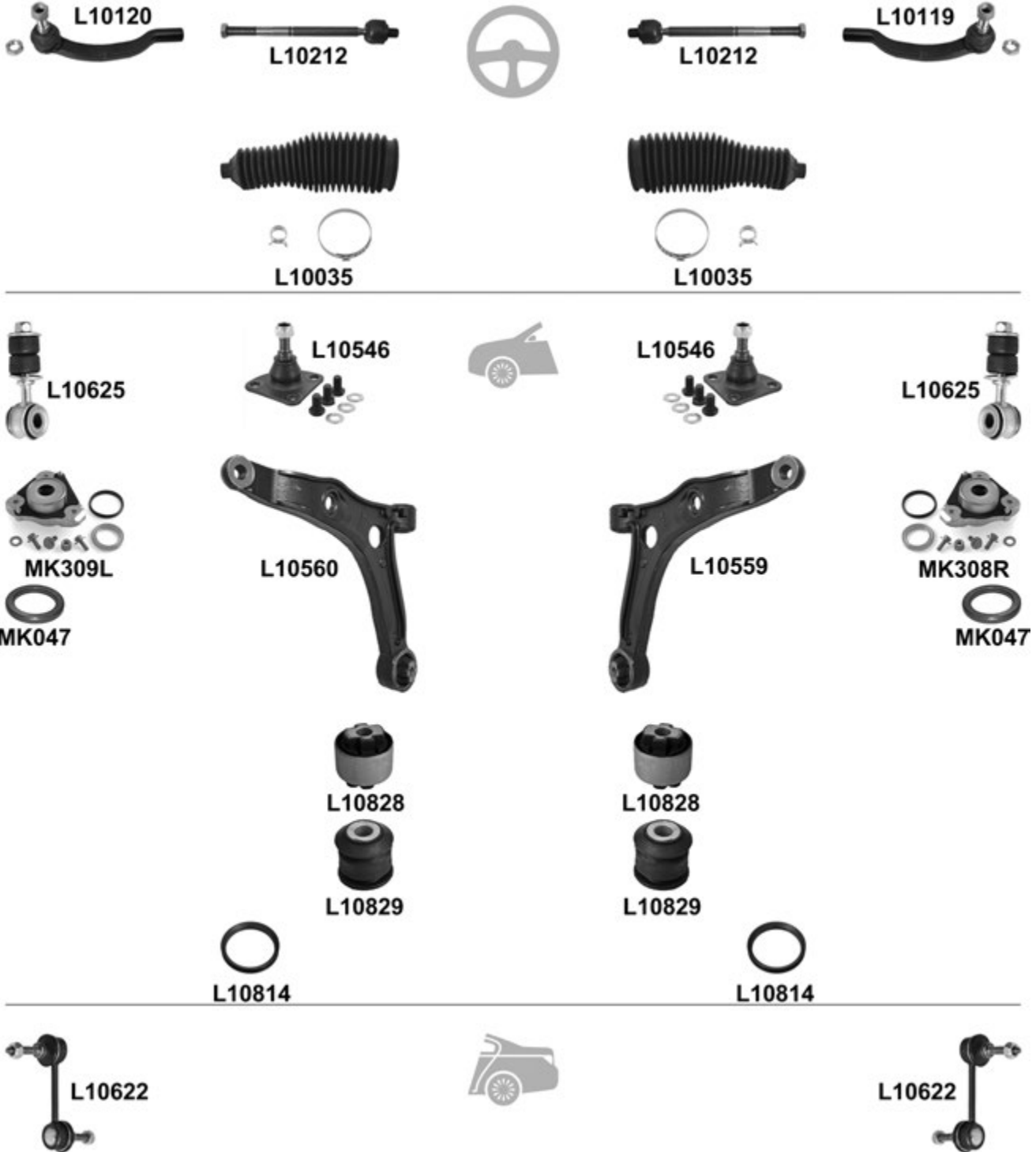

Jumper / Relay 04.06 →

		← →		Thread	Part Of	QPA			
			L10119	F 16x1,5 U		1	3817.70		
		L10120		F 16x1,5 U		1	3817.77		
			L10212	L10212	M 16x1,5 / M 16x1,5 U		2		
				L10035 ⁰	L10035 ⁰		2	77364254	
			L10546	L10546		2	3640.67		
				L10559		1	3521.P2		
			L10560				1	3520.S1	
			L10828	L10828			L10559/L10560	2	51705198
			L10829	L10829			L10559/L10560	2	51705197
			L10625	L10625			2		
				KIT	MK308R		1	5038.C9	
				MK309L			1	5038.87	
			MK047	MK047			2	5035.47	
RUBBER		L10814	L10814			2	5035.50		
		L10622	L10622			2	5170.F6		

Jumpy / Dispatch (U6U) 10.95 →

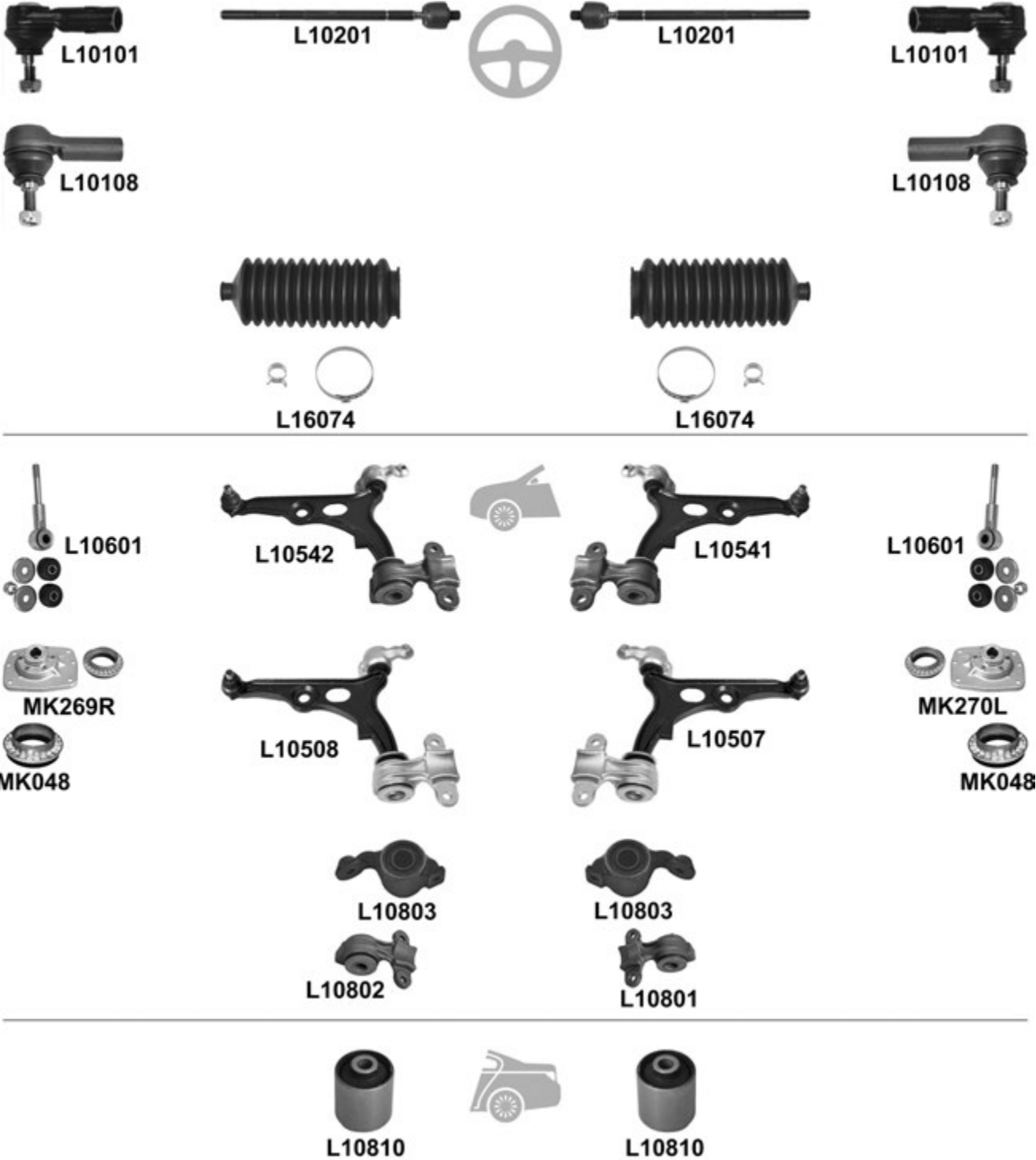

Jumpy / Dispatch (U6U) 10.95 →

		i		←	→	Thread	Part Of	QPA	i	
		↔	→ 09.03, ch. → PR 9792	L10101	L10101	F 14x1,5 ∪		2	4059.09	
			10.03 →, ch. PR 9793 →	L10108	L10108	F 14x1,5 ∪		2	4059.12	
				L10201	L10201	M 14x1,5 / M 14x1,5 ∪		2	3812.A4	
					L16074	L16074			2	4066.41
		⊥	Petrol, → PR 10829, → 06.06	<input checked="" type="checkbox"/>		L10541			1	3521.L0
				L10542				1	3520.P8	
		Diesel, → PR 10829, → 06.06	<input checked="" type="checkbox"/>		L10507			1	3521.K4	
				L10508				1	3520.P4	
		⊥↘			L10803	L10803		L10507/L10508/ L10541/L10542	2	
			⊥↗			L10801		L10507/L10541	1	
					L10802		L10508/L10542	1		
				L10601	L10601			2	5038.35 S	
				KIT		MK270L			1	5038.16 S
					MK269R				1	5038.17 S
			MK048	MK048			2	5035.38		
				L10810	L10810		Hub carrier	2	5152.68	

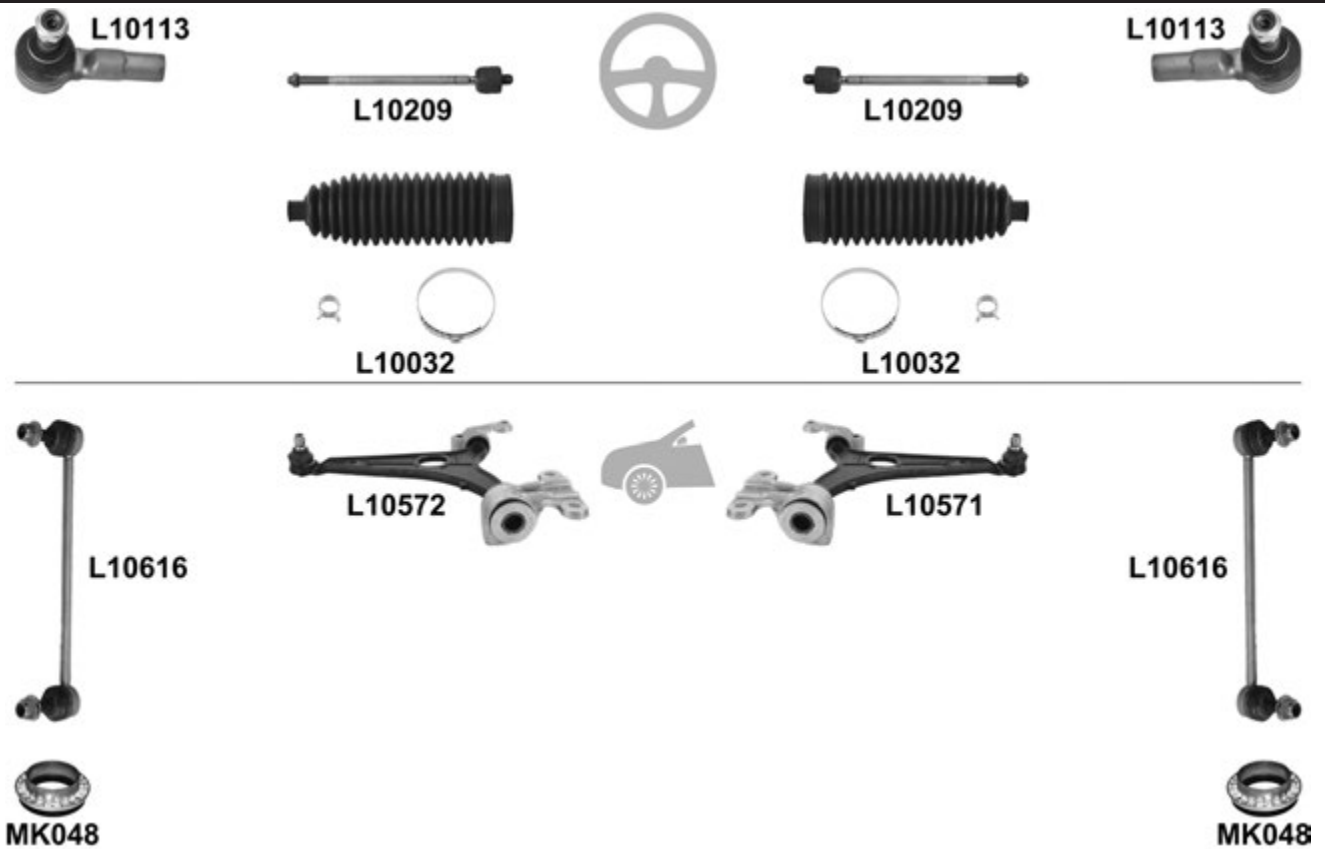
Jumpy / Dispatch 01.07 →

		i		←	→	Thread	Part Of	QPA	i	
		↔		L10113	L10113	F 14x1,5 ∪		2	3817.73	
				L10209	L10209	M 14x1,5 / M 16x1,5 ∪		2	3812.F0	
				L10032 ^o	L10032 ^o			2	4066.83	
		⊥	↗ 19mm	<input checked="" type="checkbox"/>		L10571			1	3521.N9
					L10572			1	3520.R8	
					L10616	L10616		2	5087.56	
					MK048	MK048			2	5035.55

LN 07.76 → 05.79



L2566



L2566



Thread

Part Of

QPA



		↓		L2566	L2566			2	91504248
--	--	---	--	-------	-------	--	--	---	----------

LN 06.79 →



L2820



L2820



L2566



L2566



Thread

Part Of

QPA



		↔		L2820	L2820	M 14x1,5 U		2	9471000965
		↓		L2566	L2566			2	91504248

Nemo (AA_) 02.08 →

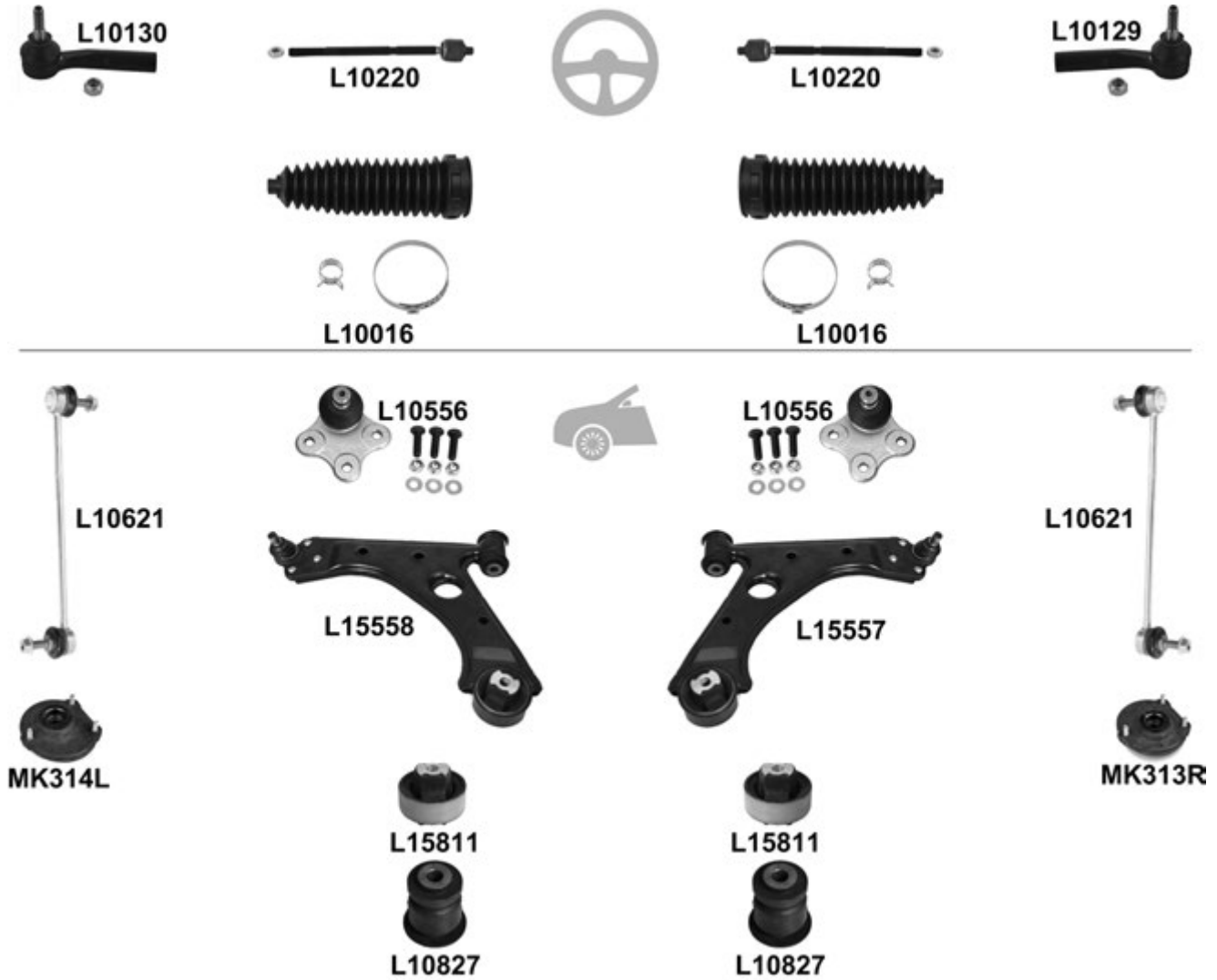

				← → Thread		Part Of	QPA		
		↔		L10129	F 14x1,5 ∪		1	3817.87	
				L10130	F 14x1,5 ∪		1	3817.86	
				L10220	L10220	∪		2	
					L10016	L10016			2
		⊥		L10556	L10556			2	3520.W3
			☑		L15557				1
		⊥		L15558				1	3520.W3
				L15811	L15811			2	
		⊥	▼	L10827	L10827			2	
			▲	L10827	L10827			2	
				L10621	L10621			2	5087.70
			KIT				1	5038.J8	
					MK313R			1	5038.J7
					MK314L			1	5038.J7

Saxo 02.96 → 04.04

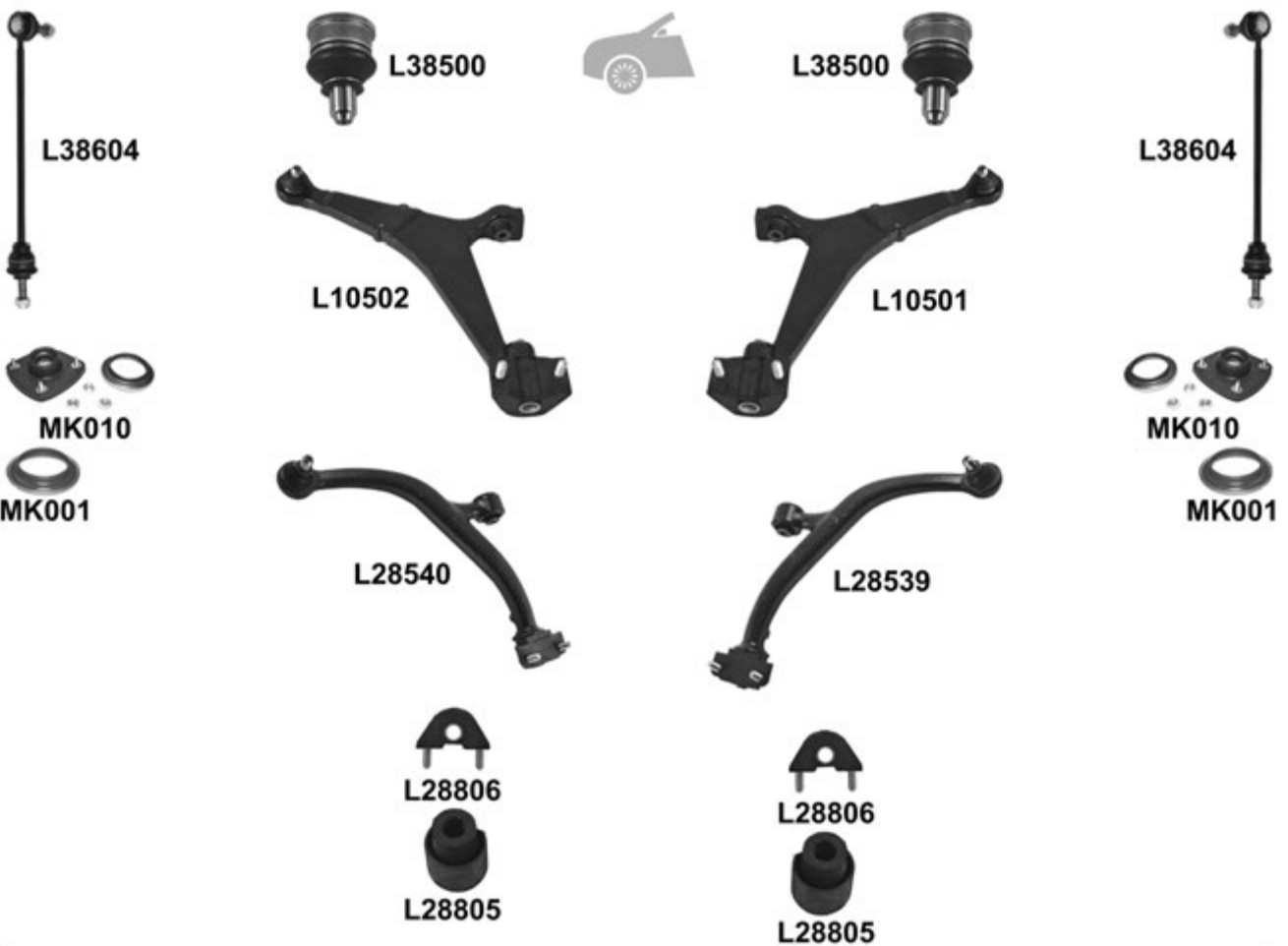

Saxo 02.96 → 04.04

				← → Thread		Part Of	QPA				
					L3871	F 14x1,5 ♂		1	3817.42		
					L3870	F 14x1,5 ♂		1	3817.41		
					L28003			1	4066.34		
					L28004			1	4066.32		
				PR 07084 →,	L28018 ^o			1	4066.50		
					L38500	L38500		2	3640.36		
				1.0 X, 1.1 X / SX, (-) Sport, 1.4 VTS (-) Sport, 1.5 D <input checked="" type="checkbox"/>	L10501			1	3520.79		
					L10502			1	3520.78		
				1.1 X / SX Sport, 1.4 VTS Sport, 1.6 VTL / VTR, 1.6 16V VTS <input checked="" type="checkbox"/>	L28539			1	3520.93		
					L28540			1	3520.92		
					⬇	(-) 1.4 VTS, 1.6 VTL/VTR/16V VTS	L28806	L28806	L10501/L10502	2	3523.51
					⬆	(-) 1.4 VTS, 1.6 VTL/VTR/16V VTS	L28805	L28805	L10501/L10502	2	3523.50
						1.4 VTS, 1.6 VTL / VTR / VTS	L38604	L38604		2	5087.40
						(+) MK001 KIT	MK010	MK010		2	5038.15 S
							MK001	MK001		2	5035.27
						1.0 X, 1.1 X / SX, 1.4 VTS, 1.5 D, 1.6 VTL / VTR / VTS	L28809	L28809	Hub carrier	2	5131.63

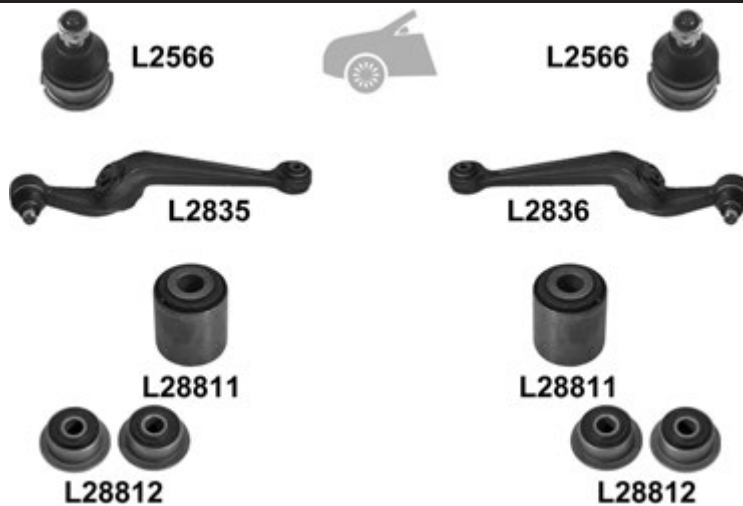
Visa → 09.79

				← → Thread		Part Of	QPA		
			(-) diesel		L2566	L2566		2	91 504 248
			Diesel <input checked="" type="checkbox"/>		L2836			1	91 516 337
					L2835			1	91 516 336
				⬇←	Diesel		L28811	L28811	
		⬆←	Diesel		L28812	L28812		2	3523.20

Visa 10.79 → 03.91

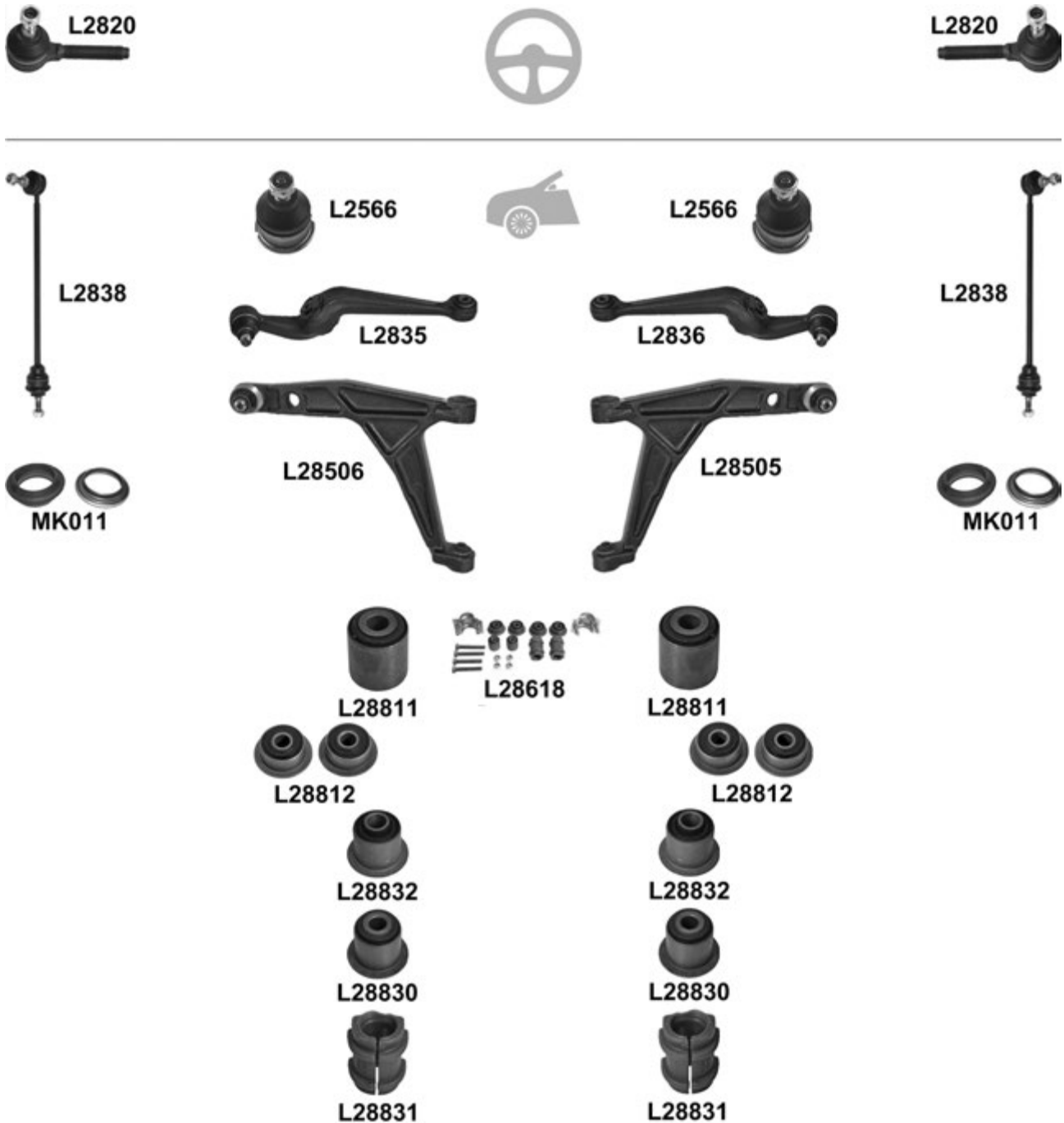

				← → Thread		Part Of	QPA	i	
		↔		L2820	L2820	M 14x1,5 U	2	95 493 208	
		⊥	(-) diesel	L2566	L2566		2	91 504 248	
		⊥	Diesel	<input checked="" type="checkbox"/>	L2836		1	91 516 337	
			GTi	<input checked="" type="checkbox"/>	L28505		1	3521.37	
					L28506		1	3520.54	
			⊥↔←	Diesel	L28811	L28811		2	3523.49
⊥↔→			Diesel	L28812	L28812		2	3523.20	
⊥↘			GTi	L28832	L28832		2	3523.23	
⊥↗			GTi	L28830	L28830		2	3523.31	
			GTi	L2838	L2838		2	5087.32	
			1.7 D, Ø 22mm, Green	L28831	L28831		2	5094.37	Anti-roll bar
			1.7 D, Ø 22mm, Green	KIT	L28618		1		Anti-roll bar
				KIT	MK011	MK011	2	5035.18	

⊥ = Upper ⊥ = Lower ▲ = Front ▼ = Rear ↔ = Inner ↔ = Outer ↔ = Center

Xantia (X1 / X2) 03.93 → 04.03
 Xantia Break (X1 / X2) 06.95 → 04.03

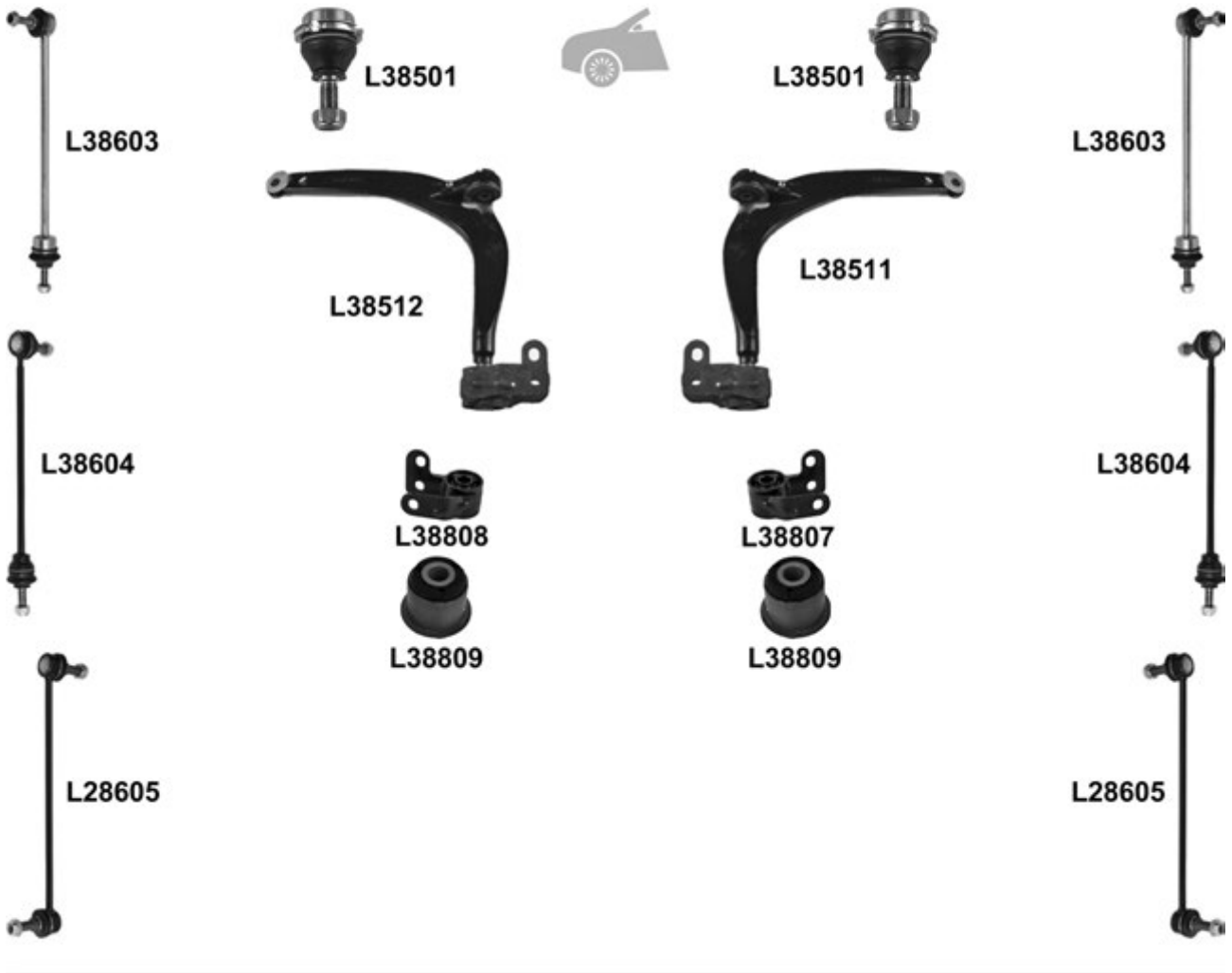
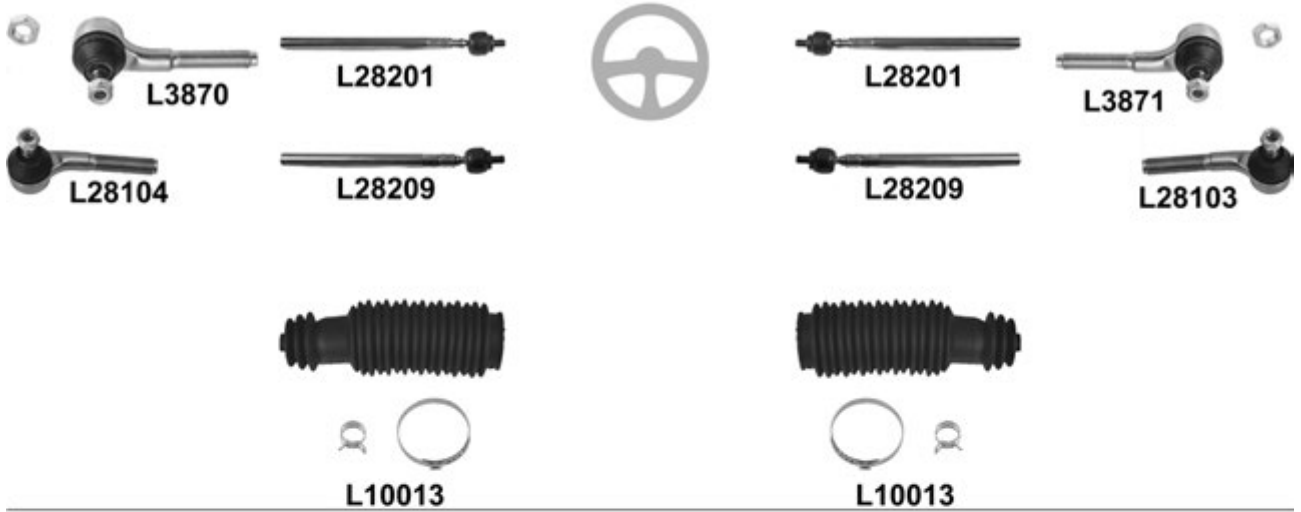

Xantia (X1 / X2) 03.93 → 04.03
Xantia Break (X1 / X2) 06.95 → 04.03

			←	→	Thread	Part Of	QPA		
		↔	(-) 2.0 Turbo, 3.0 V6, 2.1 TD, Hdi	L3871	M 14x1,5 U		1	3817.42	
			L3870	M 14x1,5 U		1	3817.41		
		↔	2.0 Turbo, 3.0 V6, 2.1 TD, Hdi	L28103	M 16x1,5 U		1	3817.44	
			L28104	M 16x1,5 U		1	3817.43		
		(-) 2.0 Turbo, 3.0 V6, 2.1 TD, Hdi	L28201	L28201	F 16x1,5 / M 12x1 U		2	96 136 394	
		2.0 Turbo, 3.0 V6, 2.1 TD, Hdi	L28209	L28209	F 16x1,5 / M 12x1		2	3812.A9	
			L10013	L10013			2	961127397	
		↓	L38501	L38501			2	95 028 039	
		↓	(+) Xantia Activa	L38511			1	3521.82	
			L38512			1	3520.C2		
		↓ ▾		L38807			L38511	1	3523.82
			L38808			L38512	1	3523.81	
		↓ ▲		L38809	L38809		L38511/L38512	2	96083570
			→ 12.94	L38603	L38603			2	96 145 457
			01.95 → 03.99	L38604	L38604			2	5087.40
		04.99 →	L28605	L28605			2	5087.48	
			(-) Break	KIT	L38400	L38400		2	

XM 03.89 → 10.00
 XM Break 11.91 → 10.00

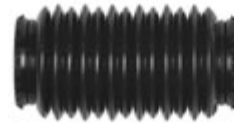
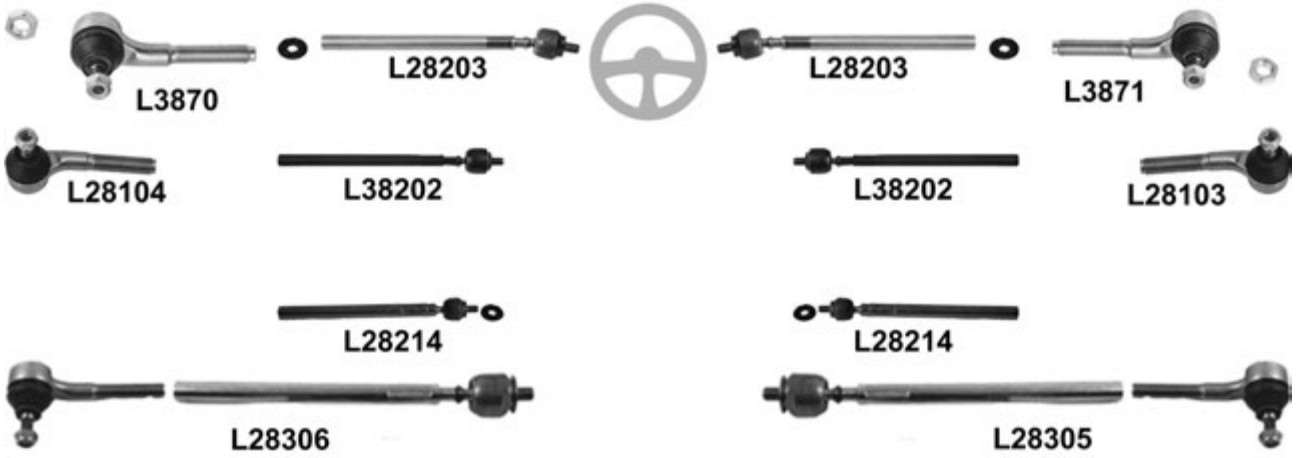

L10014



L28005



L38001



XM 03.89 → 10.00

XM Break 11.91 → 10.00

			←	→	Thread	Part Of	QPA		
		↔	(-) 2.0 16V, 2.0 Turbo, 3.0 V6, 2.1 TD, 2.5 TD	L3871	M 14x1,5 ♂		1	3817.42	
				L3870	M 14x1,5 ♂		1	3817.41	
			2.0 16V, 2.0 Turbo, 3.0 V6, 2.1 TD, 2.5 TD	L28103	M 16x1,5 ♂		1	3817.44	
				L28104	M 16x1,5 ♂		1	3817.43	
			(-) DIRAVI, (-) 2.0 16V, 2.0 Turbo, 3.0 V6, 2.1 TD, 2.5 TD L= 315mm	L28203	L28203	F 14x1,5 / M 12x1		2	96 032 460
				L38202	L38202	F 14x1,5 / M 12x1		2	3812.A7
				L28214	L28214	F 16x1,5 / M 12x1		2	3812.A6
			(-) 2.0 16V, 2.0 Turbo, 3.0 V6, 2.1 TD, 2.5 TD, L 3871 + L 28203 (-) DIRAVI	L28305		♂		1	3812.80
				L28306		♂		1	3812.81
		→←		L10014				1	4066.30
				L28005 ^o				1	4066.21
				L38001				1	4066.29
			↓	L38501	L38501			2	95 028 039
				L38600	L38600			2	5087.30

Xsara (N1) 04.97 → 04.05
 Xsara Break (N2) 10.97 → 08.05
 Xsara Coupé (N0) 02.98 → 04.05

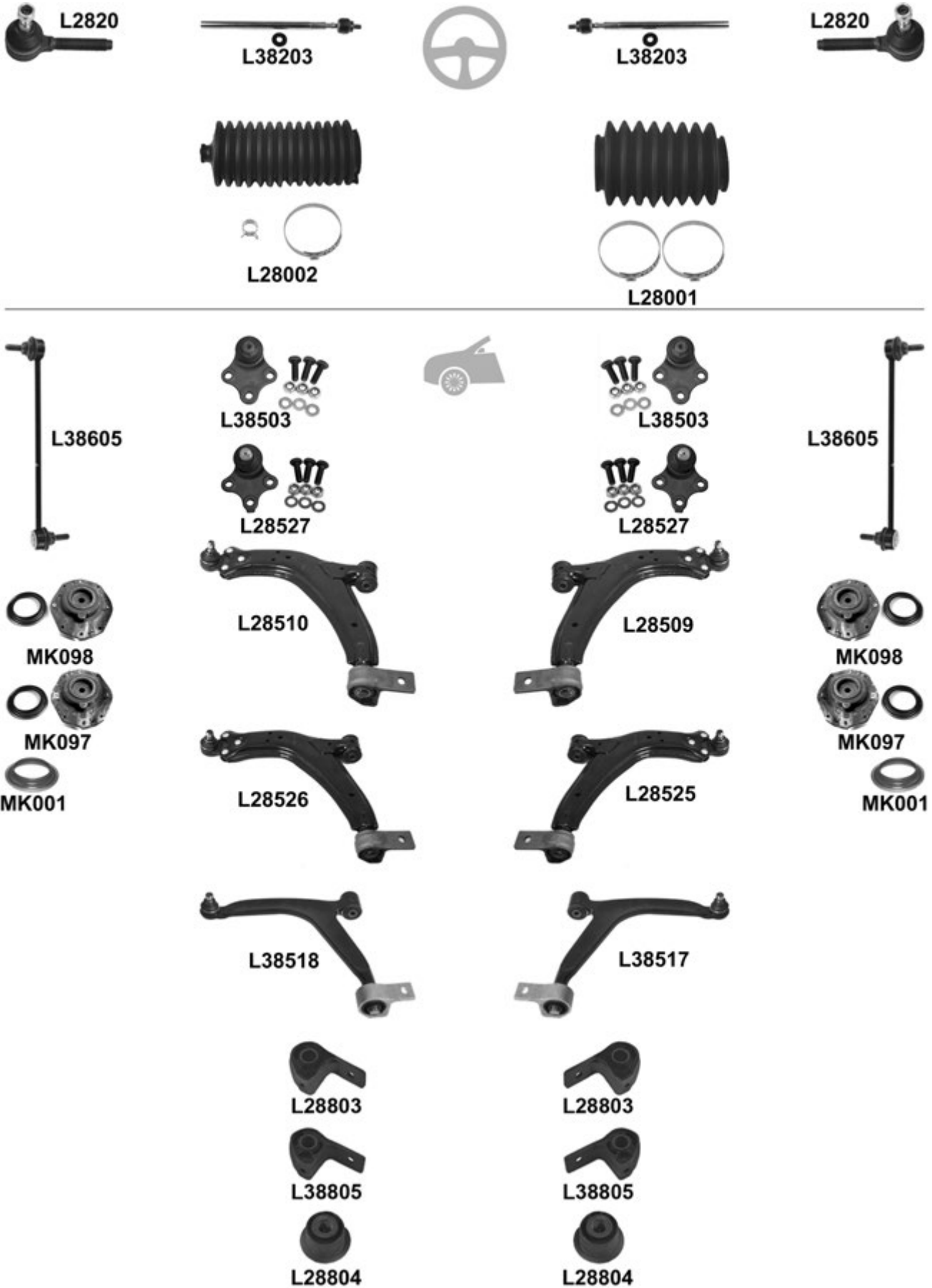

Xsara (N1) 04.97 → 04.05
Xsara Break (N2) 10.97 → 08.05
Xsara Coupé (N0) 02.98 → 04.05

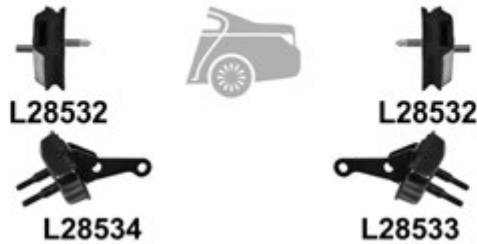

		i	←	→	Thread	Part Of	QPA	i				
		↔		L2820	L2820	M 14x1,5 U		2	3817.50			
				L38203	L38203	F 14x1,5 / M 12x1 U		2	3812.00			
					L28001				1	4066.22		
				L28002					1	4066.20		
		↓		L38503	L38503			2	3640.43			
			Mot/Eng DW / XU / XUD PR → 7966	L38503	L38503			2	3640.42			
			Mot/Eng TU / TUD / TUJ5D / TU3JP / TUD5 PR → 7870									
			16mm, (-) HD									
			Mot/Eng DW / XU / XUD PR 7967 →	L28527	L28527			2	3640.51			
			Mot/Eng TU / TUD / TUJ5D / TU3JP / TUD5 PR 7871 →									
			Mot/Eng DW8									
			18mm (-) HD									
				↓	Mot/Eng DW / XU / XUD PR → 7966	<input checked="" type="checkbox"/>		L28509			1	3521.E5
					Mot/Eng TU / TUD / TUJ5D / TU3JP / TUD5 PR → 7870		L28510				1	3520.H5
16mm, (-) HD												
Mot/Eng DW / XU / XUD PR 7967 →	<input checked="" type="checkbox"/>				L28525			1	3521.E6			
Mot/Eng TU / TUD / TUJ5D / TU3JP / TUD5 PR 7871 →		L28526						1	3520.H6			
Mot/Eng DW8												
	<input checked="" type="checkbox"/>				L38517			1	3521.F3			
			L38518					1	3520.J3			
		↓		L28803	L28803		L28509/L28510/ L28525/L28526	2	3523.75			
				L38805	L38805		L38517/L38518	2	3523.83			
		↑		L28804	L28804		L28509/L28510/ L28525/L28526	4	96110483			
				L28804	L28804		L38517/L38518	4				
			L38605	L38605			2	5087.46				
			→ 04.99, PR → 8189(-) <input type="checkbox"/> HD	KIT	MK098	MK098		2	5038.76			
			05.99 →, PR 8190 →, (-) <input type="checkbox"/> HD	KIT	MK097	MK097		2	5038.21 S			
			→ 08.00, <input type="checkbox"/> HD		MK098	MK098		2	5038.76			
		↓						2	5035.27			
		↑		L28532	L28532		Hub carrier	2	5131.71			
					L28533			Hub carrier	1	5131.70		
				L28534				Hub carrier	1	5131.69		

Xsara Picasso N68 02.00 →

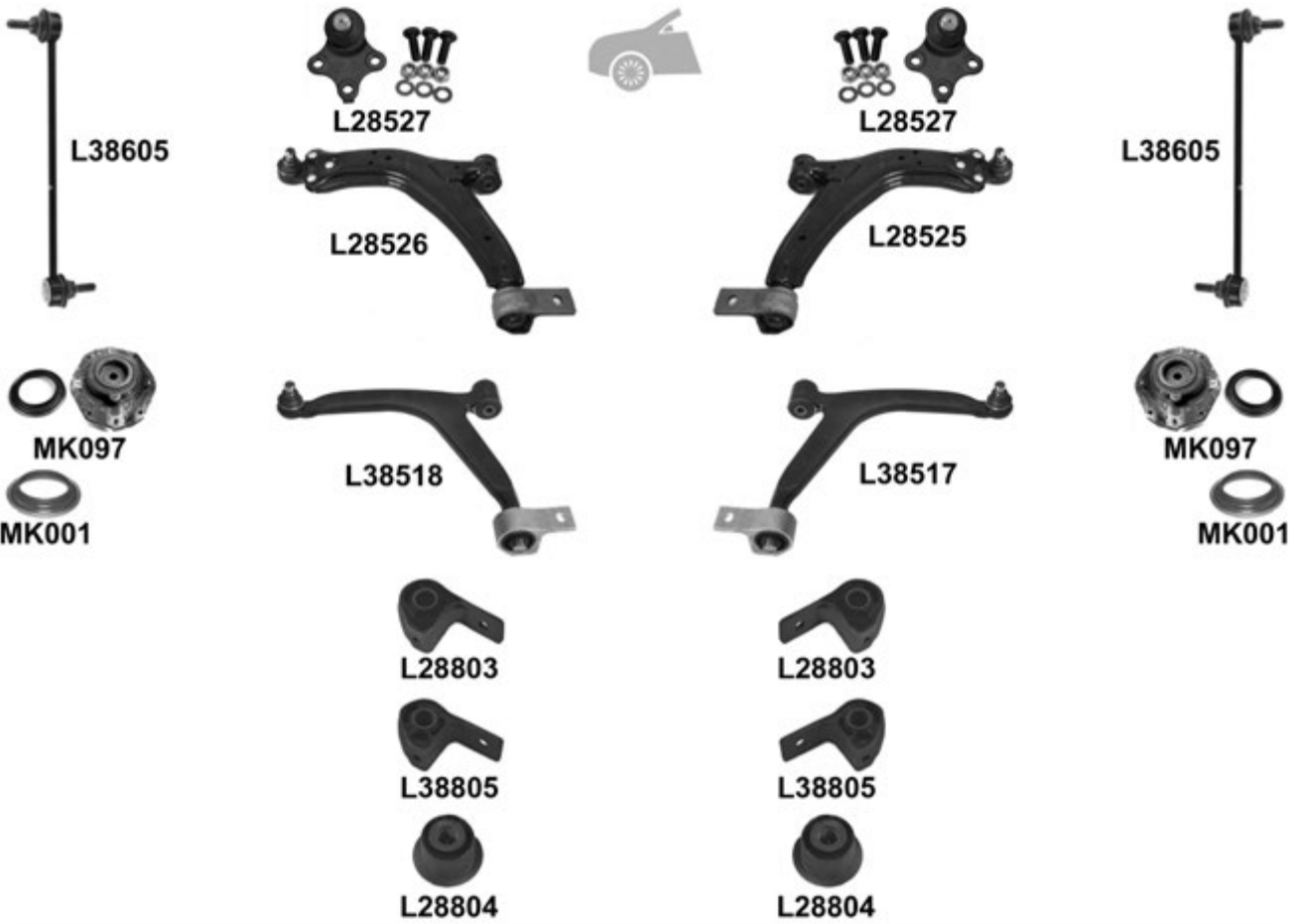
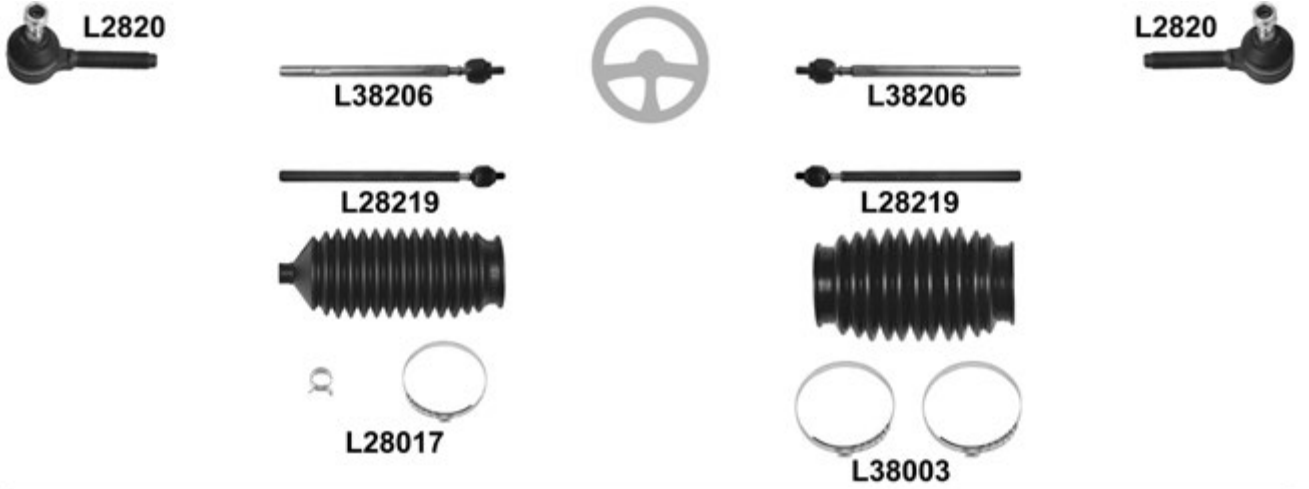

Xsara Picasso N68 02.00 →

			←	→	Thread	Part Of	QPA		
		↔		L2820	L2820	M 14x1,5 ⤴	2	3817.50	
				L38206	L38206	F 14x1,5 / M 12x1 ⤴	2	3812.C6	
				L28219	L28219	M 14x1,5 / M 12x1 ⤴	2	3812.E4	
			⌀42mm, Ø 44mm, L= 115mm		L38003 ⁰		1	4066.62	
			⌀ 11mm, Ø 43mm, L= 150mm		L28017 ⁰		1	4066.43	
		⊥	18mm, (-) HD		L28527	L28527		2	3640.51
			18mm, (-) HD <input checked="" type="checkbox"/>		L28525		1	3521.E6	
		⊥	HD <input checked="" type="checkbox"/>		L28526			1	3520.H6
					L38517		1	3521.F3	
					L38518		1	3520.J3	
		⊥▼	(-) HD		L28803	L28803	L28525/L28526	2	3523.75
					L38805	L38805	L38517/L38518	2	3523.83
		⊥▲	(-) HD		L28804	L28804	L28525/L28526	4	96110483
					L28804	L28804	L38517/L38518	4	
				L38605	L38605		2	5087.46	
			→ 09.01	KIT	MK097	MK097		2	5038.21 S
				MK001	MK001			2	5035.27
			▼		L28545	L28545	Hub carrier	2	5152.64

ZX (N2) 03.91 → 10.97
 ZX Break (N2) 06.93 → 08.05

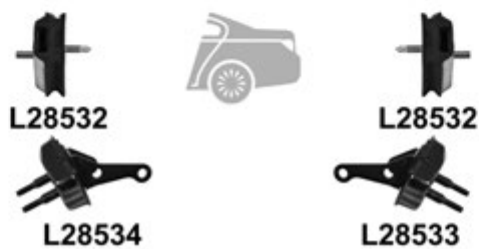
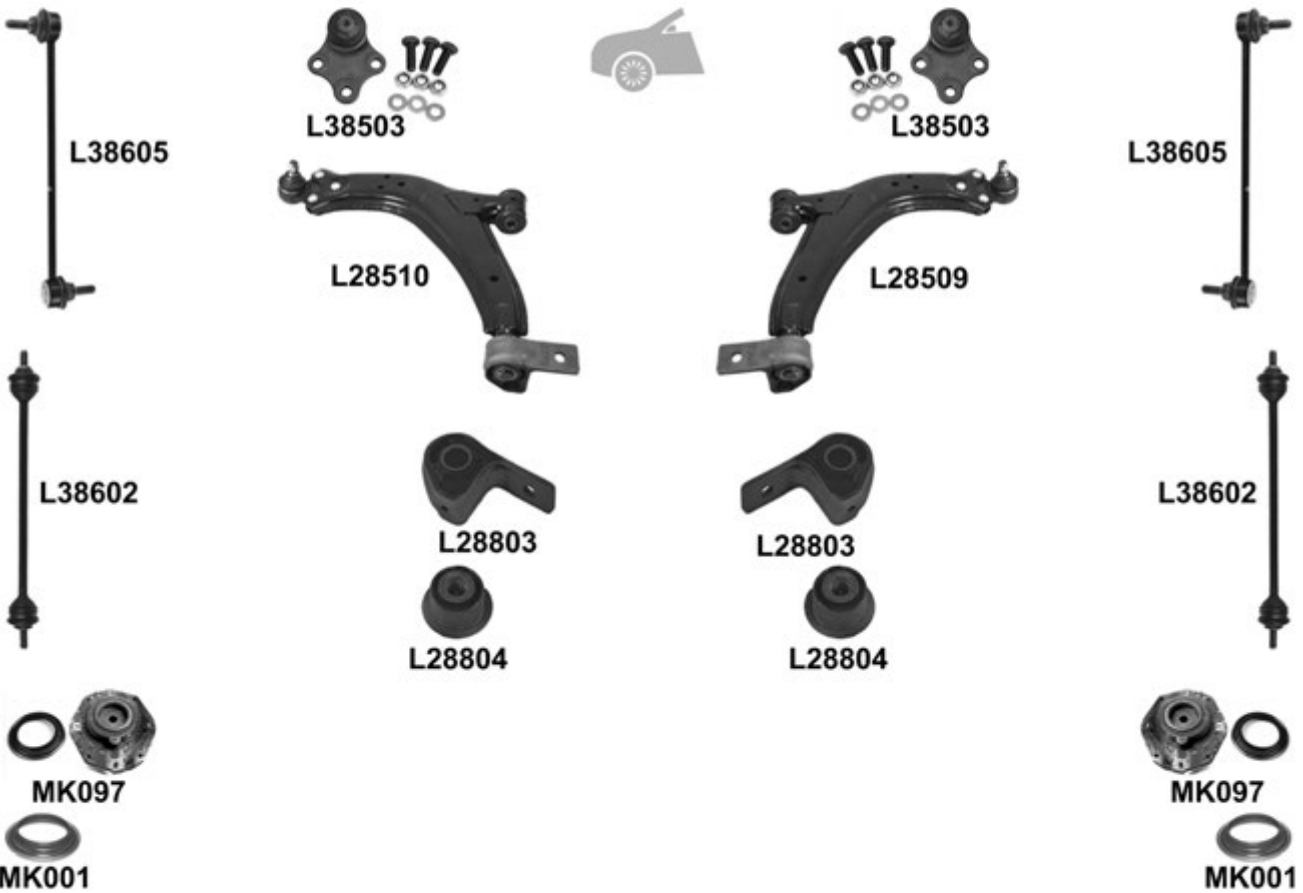
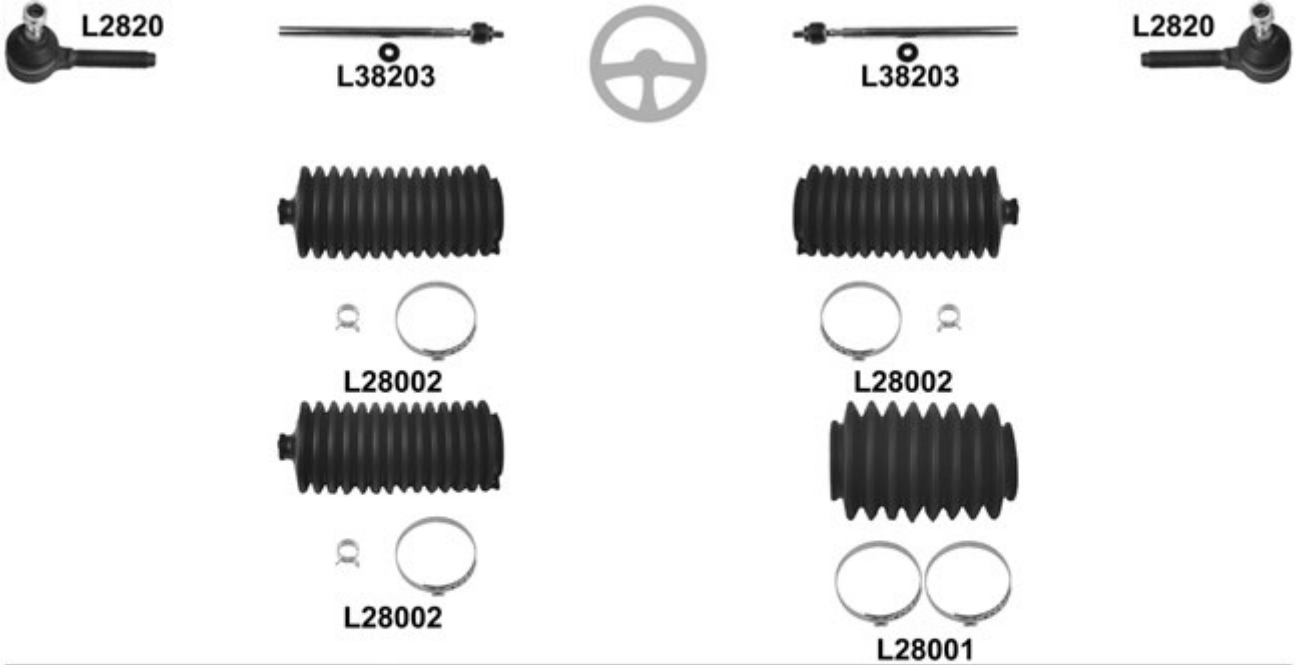

ZX (N2) 03.91 → 10.97
ZX Break (N2) 06.93 → 08.05

		i		←	→	Thread	Part Of	QPA	i			
		↔				M 14x1,5 ☺		2	3817.18			
						F 14x1,5 / M 12x1 ☺		2	3812.C0			
									2	4066.15		
									1	4066.22		
										1	4066.20	
		⊥						2	3640.38			
		⊥			<input checked="" type="checkbox"/>			1	3521.E5			
								1	3520.H5			
		⊥▼						L28509/L28510	2			
		⊥▲						L28509/L28510	4			
									2	5087.39		
									1.9 i → 06.92		2	96 111 480
									1.9 i 07.92 →		2	5087.39
					KIT	MK097	MK097		2	5038.21 S		
						MK001	MK001		2	5035.27		
		▼						Hub carrier	2	5131.71		
		▲						Hub carrier	1	5131.70		
									Hub carrier	1	5131.69	

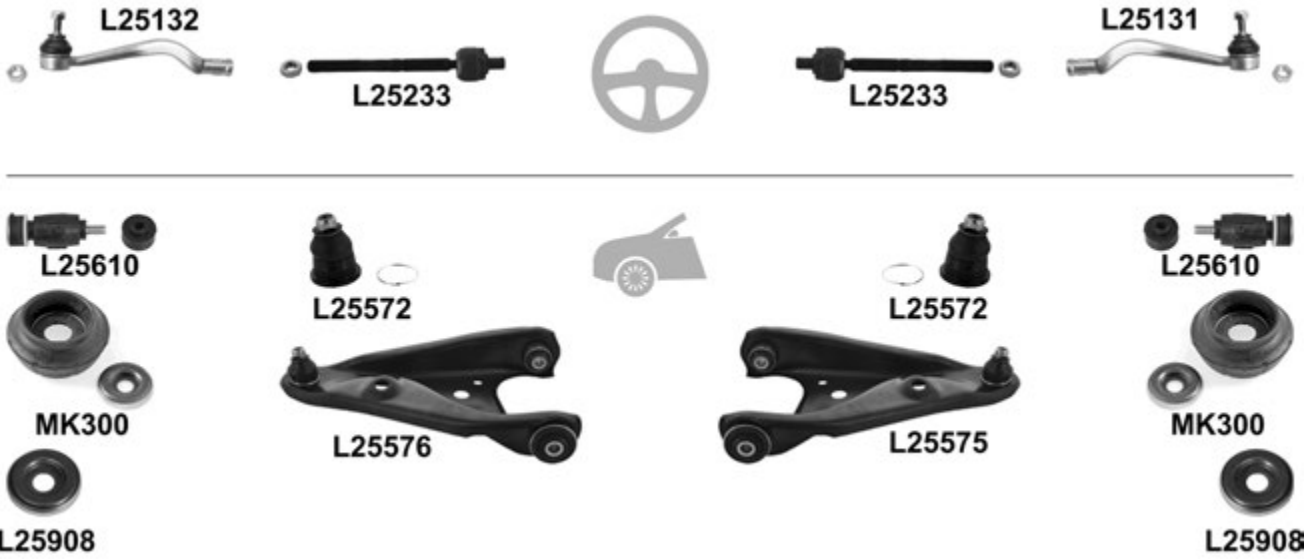
DACIA
Dokker 11.12 →
Dokker Express 12.12 →

		← →		Thread	Part Of	QPA			
⊕		↔		L25131	F 14x1,5 ∪	1	6001 550 443		
				L25132	F 14x1,5 ∪	1	6001 550 442		
⊖		⊥		L25233 ⁰	M 14x1,5 / M 14x1,5 ∪	2	48521-3172R		
				L25572	L25572		L25575/L25576	2	
			<input checked="" type="checkbox"/>	L25575 ⁰			1	54500-7106R	
				L25576 ⁰			1	54501-0294R	
				L25610	L25610		2	6001 547 138	
			KIT	MK300	MK300		2	6001 547 499	
	L25908 ¹	L25908 ¹		2	6001 025 850				

Duster 04.10 →

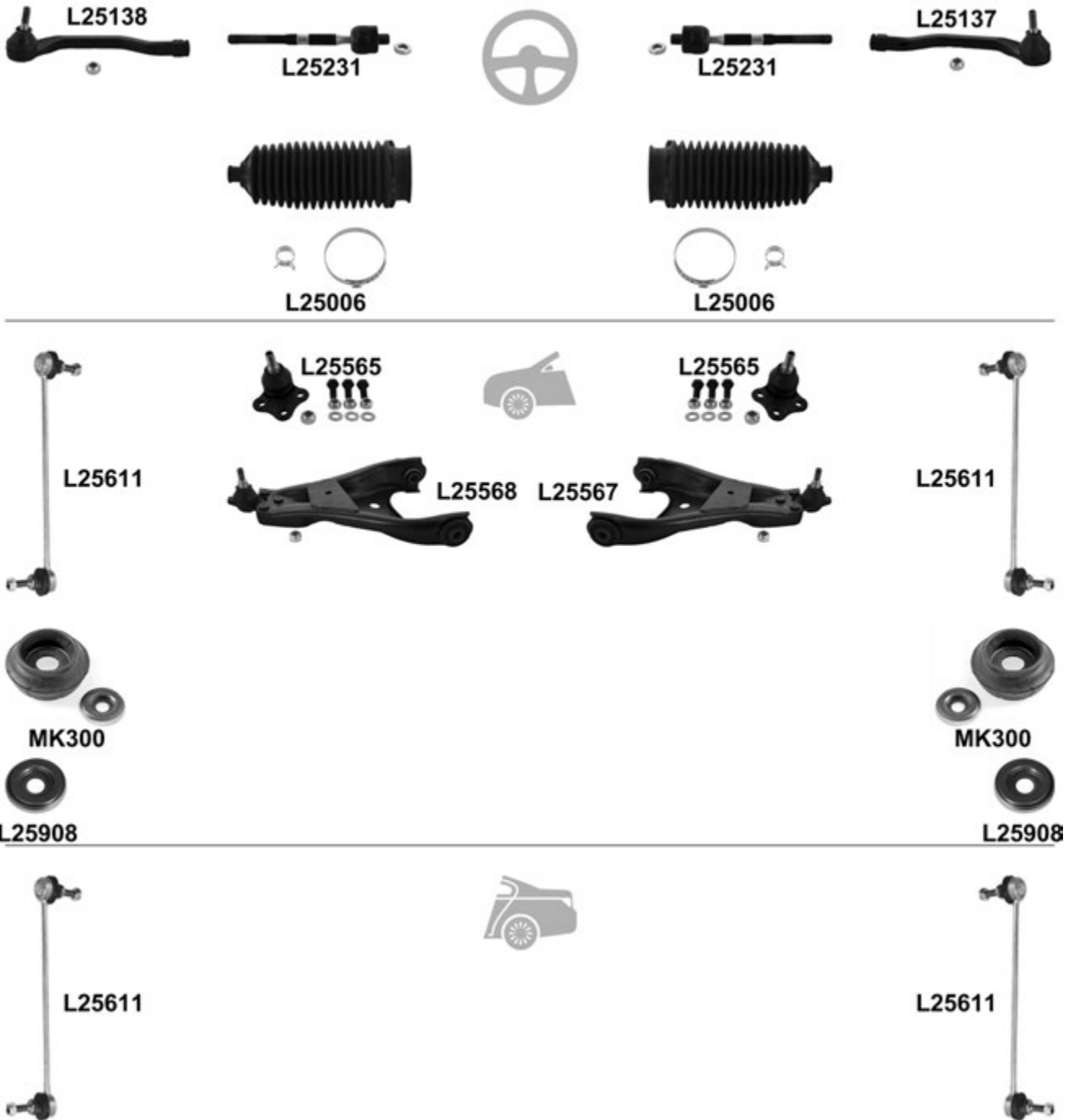

			←	→	Thread	Part Of	QPA	
		↔		L25137	F 14x1,5 ∪		1	8201 108 332
				L25138	F 14x1,5 ∪		1	8201 108 339
			L25231	L25231	M 14x1,5 / M 16x1,5 ∪		2	8201 108 350
			L25006 ⁰	L25006 ⁰			2	8201 108 358
		⊥		L25565	L25565		2	40160-2308R
			<input checked="" type="checkbox"/>	L25567			1	54500-1535R
				L25568			1	54501-9969R
			L25611	L25611			2	8200 814 411
			KIT	MK300	MK300		2	6001 547 499
			L25908 ¹	L25908 ¹			2	6001 025 850
			L25611	L25611		2	8200 814 411	

Lodgy 06.10 →

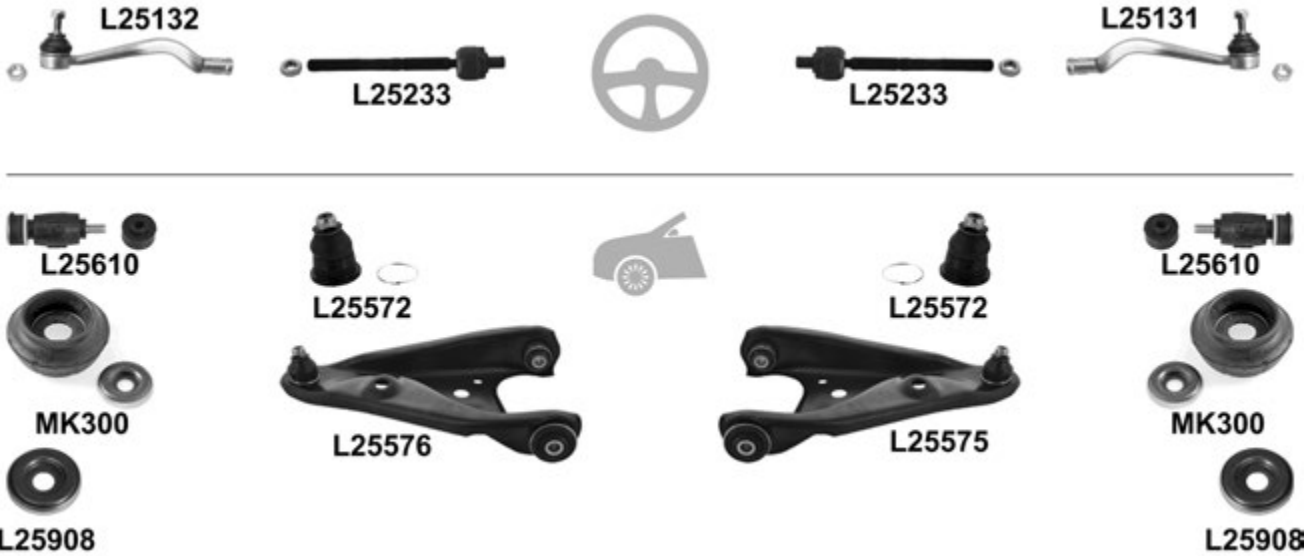

		← →		Thread	Part Of	QPA				
				L25131	F 14x1,5 ♂		1	6001 550 443		
				L25132	F 14x1,5 ♂		1	6001 550 442		
				L25233 ⁰	L25233 ⁰	M 14x1,5 / M 14x1,5 ♂		2	48521-3172R	
				L25572	L25572	L25575/L25576	2			
					L25575 ⁰			1	54500-7106R	
					L25576 ⁰			1	54501-0294R	
					L25610	L25610		2	6001 547 138	
					KIT	MK300	MK300		2	6001 547 499
						L25908 ¹	L25908 ¹		2	6001 025 850

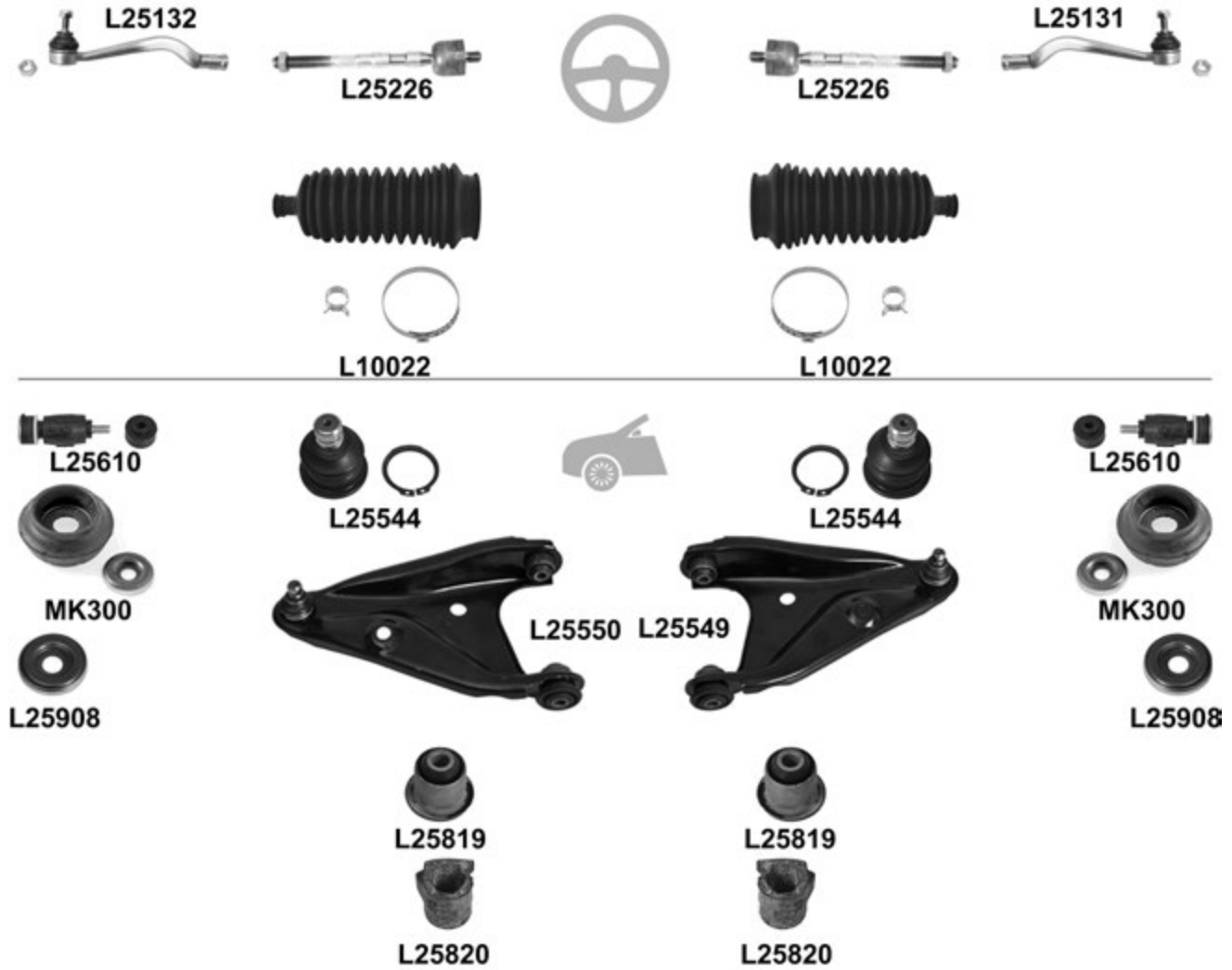
Logan 09.04 →
 Logan MCV 02.07 →

				←	→	Thread	Part Of	QPA		
⊕		↔			L25131	F 14x1,5 ∪		1	6001 550 443	
					L25132	F 14x1,5 ∪		1	6001 550 442	
				L25226	L25226	M 14x1,5 / M 12x1 ∪		2	6001 550 441	
				L10022 ⁰	L10022 ⁰			2	6001 547 607	
⊖		⊥			L25544	L25544		2	40160-4793R	
		⊥		<input checked="" type="checkbox"/>	L25549			1	6001 547 520	
					L25550			1	6001 547 519	
		▲▼			L25819	L25819		4	6040 096 299	L25549/L25550
					L25610	L25610		2	6001 547 138	
					L25820	L25820	Anti-roll bar	2	6001 547 140	
					KIT	MK300	MK300	2	6001 547 499	
				L25908 ¹	L25908 ¹		2	6001 025 850		

Logan II 10.12 →
Logan MCV II 02.13 →

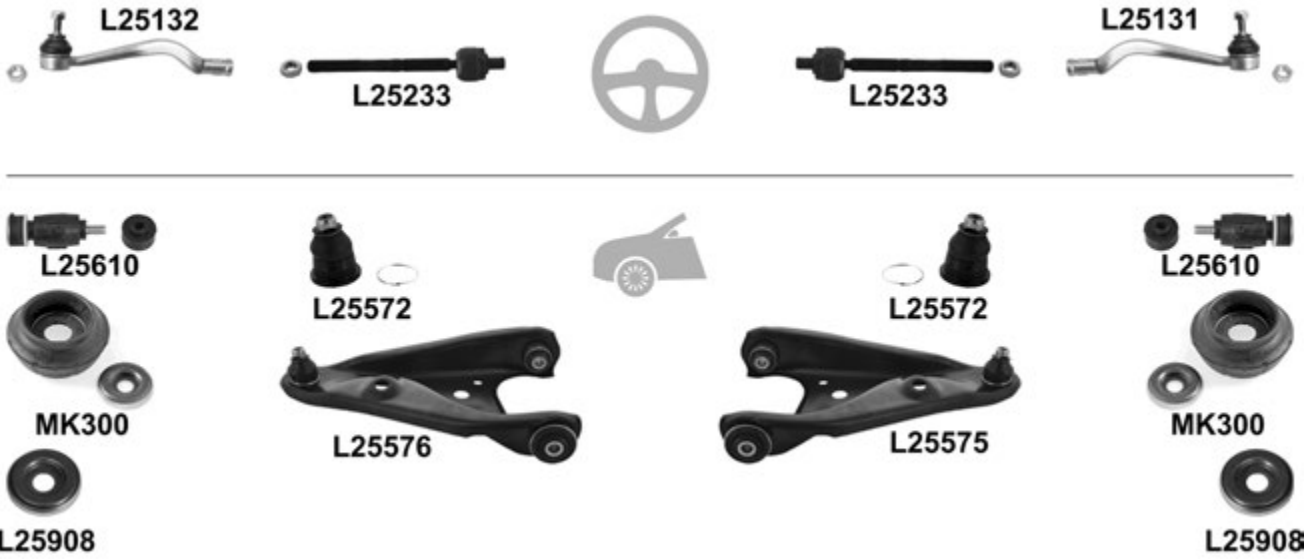

				← → Thread		Part Of	QPA			
		↔		L25131	F 14x1,5 ∪		1	48520-0410R		
				L25132	F 14x1,5 ∪		1	48520-2867R		
				L25233 ⁰	L25233 ⁰	M 14x1,5 / M 14x1,5 ∪		2	48521-3172R	
		⊥		L25572	L25572			L25575/L25576	2	
					L25575 ⁰				1	54500-4529R
					L25576 ⁰				1	54501-0529R
					L25610	L25610			2	8200 277 960
				KIT	MK300	MK300			2	8200 757 150
			L25908 ¹	L25908 ¹			2	8200 651 172		

Sandero 06.08 →

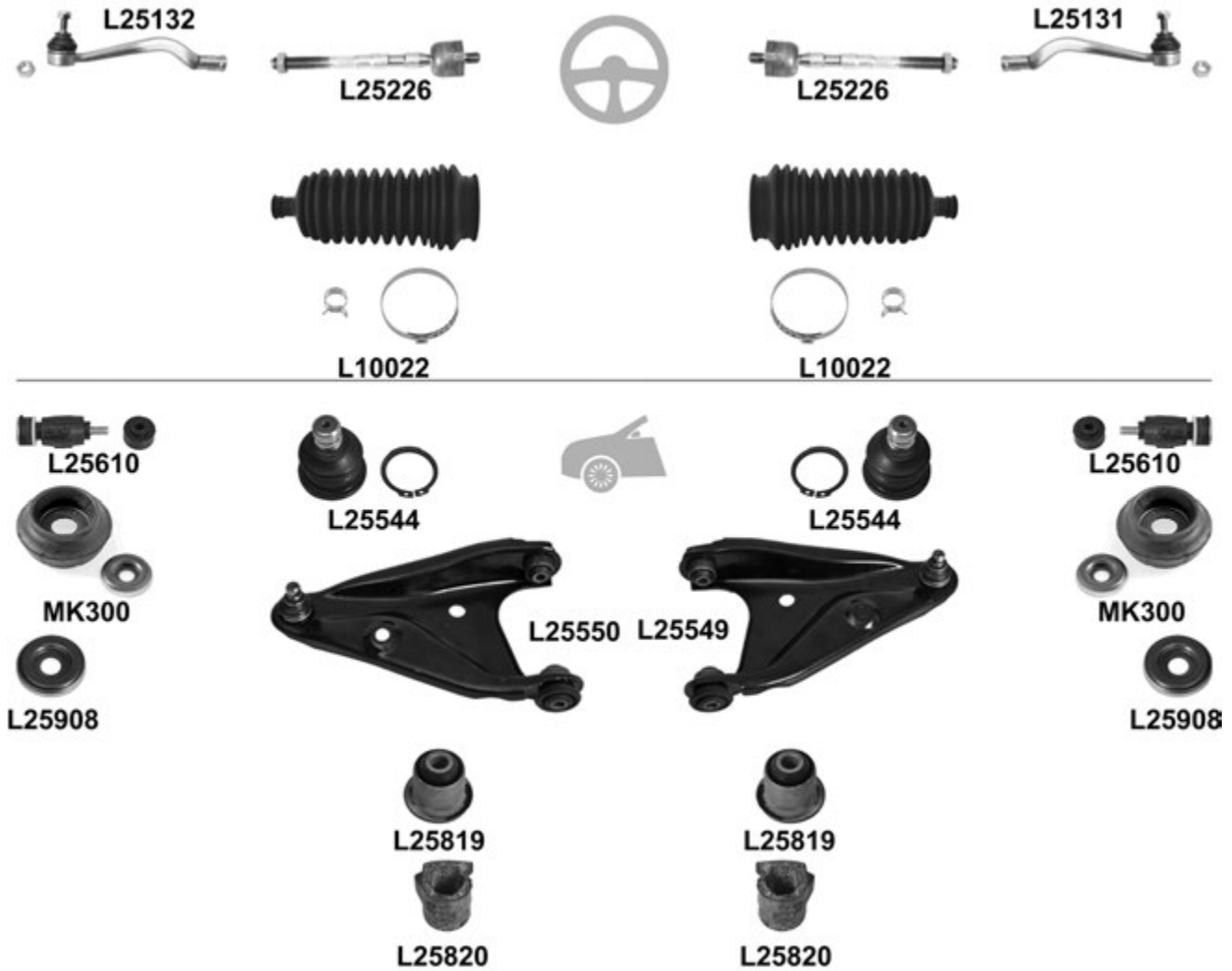

				←	→	Thread	Part Of	QPA	i
⊕		↔		L25131		F 14x1,5 ∪		1	6001 550 443
				L25132		F 14x1,5 ∪		1	6001 550 442
				L25226	L25226	M 14x1,5 / M 12x1 ∪		2	6001 550 441
				L10022°	L10022°			2	6001 547 607
⊖		⊥		L25544	L25544			2	40160-4793R
				L25549				1	6001 547 520
			<input checked="" type="checkbox"/>	L25550				1	6001 547 519
				L25819	L25819		L25549/L25550	4	6040 096 299
				L25610	L25610			2	6001 547 138
				L25820	L25820		Anti-roll bar	2	6001 547 140
			KIT	MK300	MK300			2	6001 547 499
	L25908 ¹	L25908 ¹			2	6001 025 850			

Sandero II 01.13 →
Sandero Stepway II 01.13 →

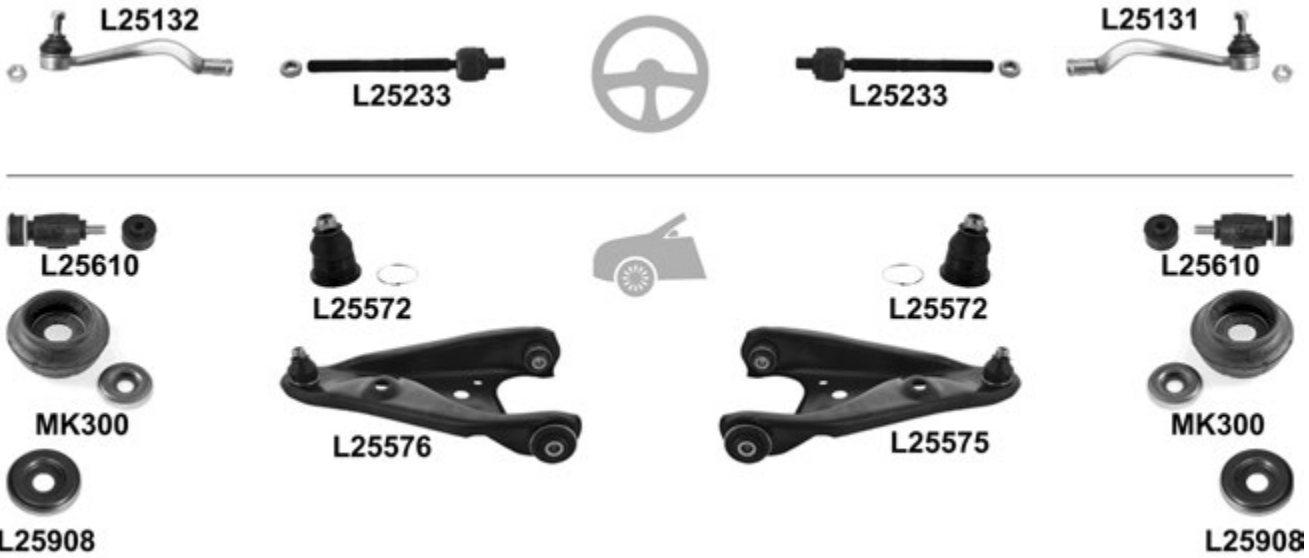

				←	→	Thread	Part Of	QPA					
		↔				L25131	F 14x1,5 ♂	1	48520-0410R				
							L25132	F 14x1,5 ♂	1	48520-2867R			
							L25233 ⁰	L25233 ⁰	M 14x1,5 / M 14x1,5 ♂	2	48521-3172R		
		↓				L25572	L25572		L25575/L25576	2			
							L25575 ⁰				1	54500-4529R	
							L25576 ⁰					1	54501-0529R
							L25610	L25610				2	8200 277 960
							KIT	MK300	MK300			2	8200 757 150
						L25908 ¹	L25908 ¹			2	8200 651 172		

1210
1310



				←	→	Thread	Part Of	QPA		
						L2539		1		

DAEWOO

Aveo 05.05 →

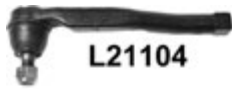

L21104



L21103

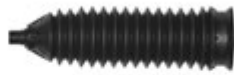

L24036

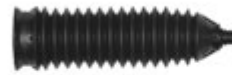

L24036



L21606



L21505



L21505



L21606



L21514



L21513



MK275



L21800

L21801



L21800

L21801



MK275



MK276



MK276

						←	→	Thread	Part Of	QPA						
		↔						F 12x1,5		1	9374-0723					
								F 12x1,5		1	9374-0722					
		↓	∅ 11mm, ∅ 45mm, L= 203mm					L24036 ⁰	L24036 ⁰		2	9374-2565				
										L21505	L21505		2	9653-5089		
											L21513			1	9635-5082	
											L21514			1	9635-5081	
											L21800	L21800		2	9665-3381	
											L21801	L21801		2	9653-5087	
											L21606	L21606		2	9639-1876	
							KIT	MK275	MK275		2	9665-3239				
								MK276	MK276		2	9645-6713				

Espero / Aranos (KLEJ) 02.95 → 06.97

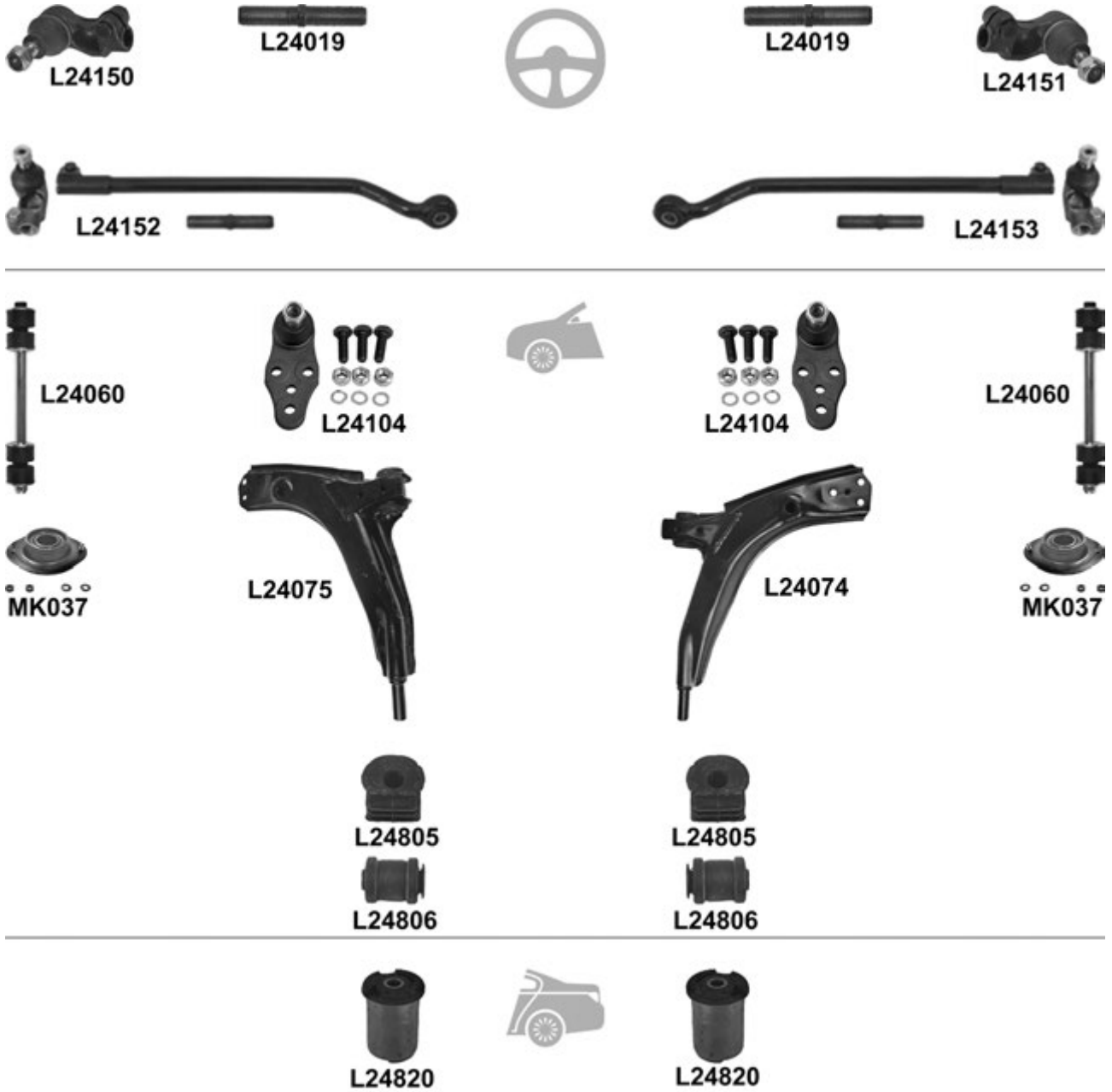

		i	←	→	Thread	Part Of	QPA	i	
				L24151	F 16x1,5 U		1	0784-8282	
				L24150	F 16x1,5 U		1	0784-8281	
				L24019	L24019			2	
				L24153				1	
				L24152				1	
				L24104	L24104		2	9037-5506	
				L24074			1	9621-8398	
				L24075			1	9621-8397	
				L24805	L24805			2	352335
				L24806	L24806			2	352349
				L24060	L24060			2	1603148
				KIT	MK037	MK037		2	9018-4756
				L24820	L24820		Hub carrier	2	402642

Evanda / Magnus / Tosca 08.02 →

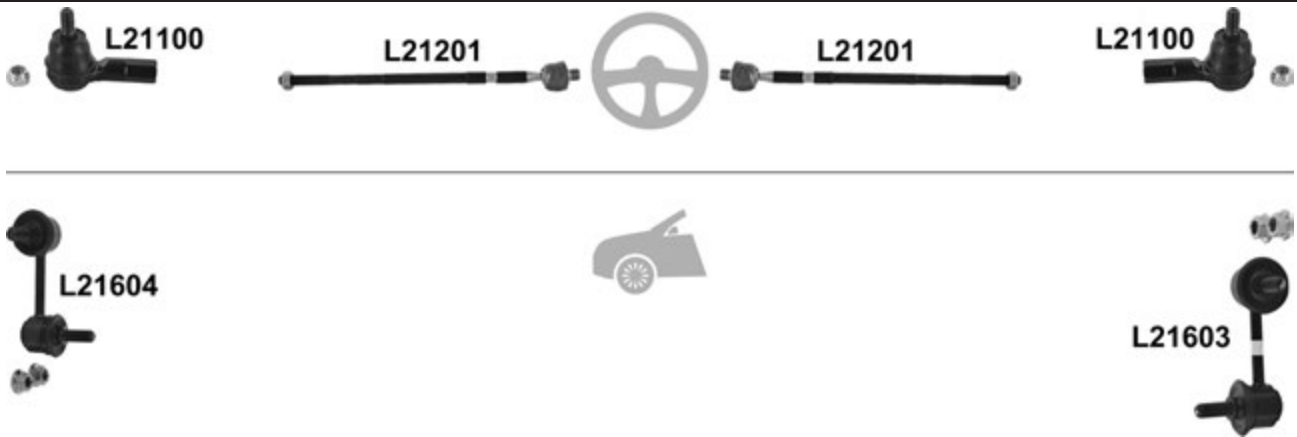

				← →		Thread	Part Of	QPA	
⊕		↔		L21100	L21100	∪		2	9374-0710
				L21201	L21201	∪		2	9374-0701
⊖					L21603			1	9622-5859
				L21604			1	9622-5858	

Kalos (KLAS) 09.02 →



			←	→	Thread	Part Of	QPA		
		↔		L21103	F 12x1,5 U		1	9374-0723	
				L21104	F 12x1,5 U		1	9374-0722	
				L21205	L21205	M 12x1,5 / M 16x1,5 U		2	
			∅ 11mm, ∅ 45mm, L= 203mm	L24036 ⁰	L24036 ⁰			2	9374-2565
		↓		L21505	L21505		2	9653-5089	
			<input checked="" type="checkbox"/>		L21513		1	9635-5082	
		↓		L21514			1	9635-5081	
				L21800	L21800		2	9665-3381	
		↓	▲	L21801	L21801		2	9653-5087	
			▼	L21606	L21606		2	9639-1876	
	↓		KIT	MK275	MK275		2	9665-3239	
				MK276	MK276		2	9645-6713	

Lacetti (KLAN) 08.03 →

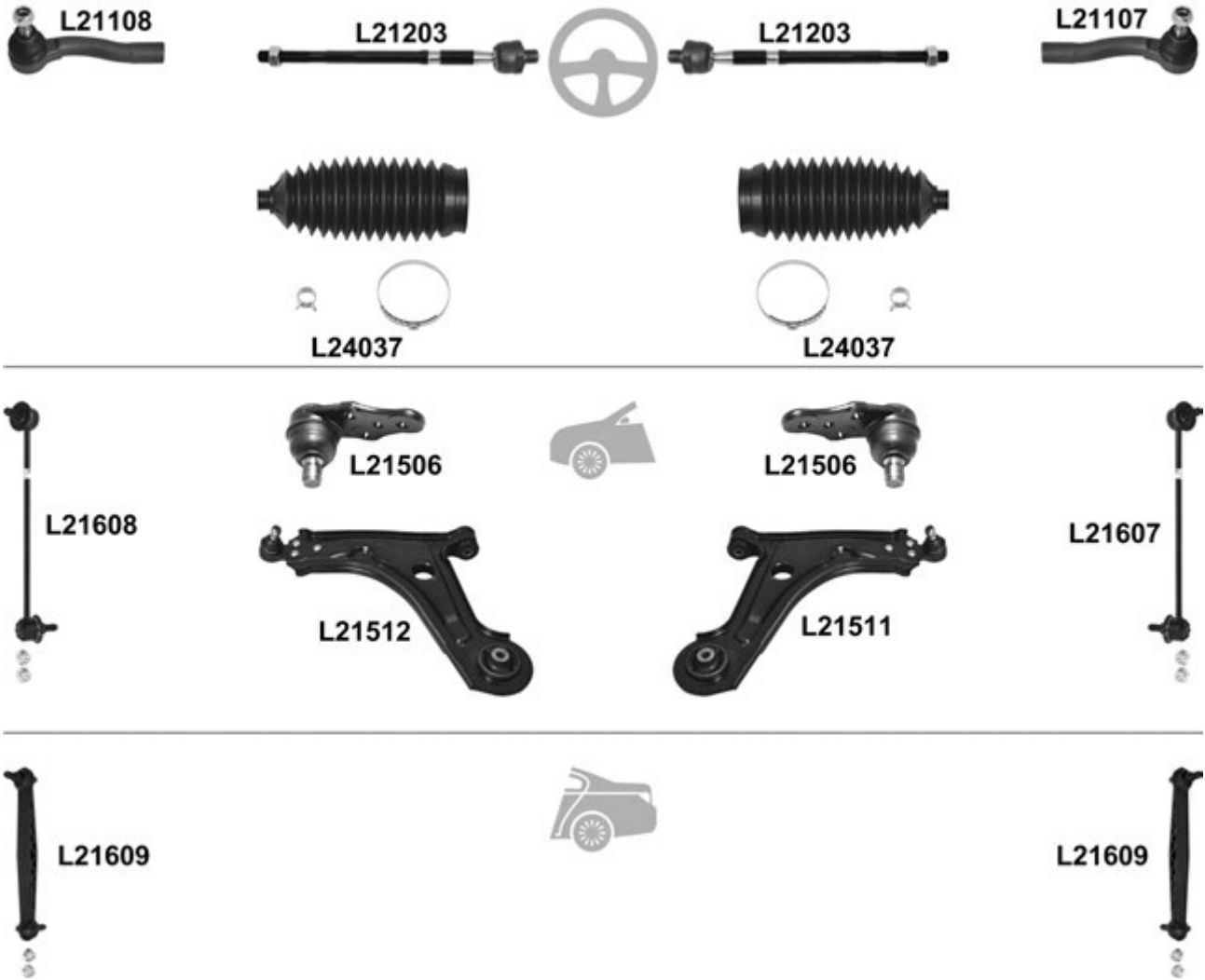

				← → Thread		Part Of	QPA	i	
⊕		↔		L21107	F 14x1,5 ∪		1	9640-7486	
				L21108	F 14x1,5 ∪		1	9640-7585	
				L21203	L21203	M 14x1,5 / M 16x1,5 ∪	2		
			∅ 13mm, ∅ 49mm, L= 173mm	L24037 ^o	L24037 ^o		2	9374-2552	
		⊥		L21506	L21506		2	9649-0218	
			→ 12.07	<input checked="" type="checkbox"/>	L21511		1	9641-5064	
		⊥		<input checked="" type="checkbox"/>	L21512		1	9641-5063	
			01.08 →, (-)	<input checked="" type="checkbox"/>	L21511		1	9641-5064	
					L21512		1	9641-5063	
					L21607		1	9640-3100	
				L21608		1	9640-3099		
				L21609	L21609	2	9656-1754		

Lanos / Assol (KLAT) 05.97 →

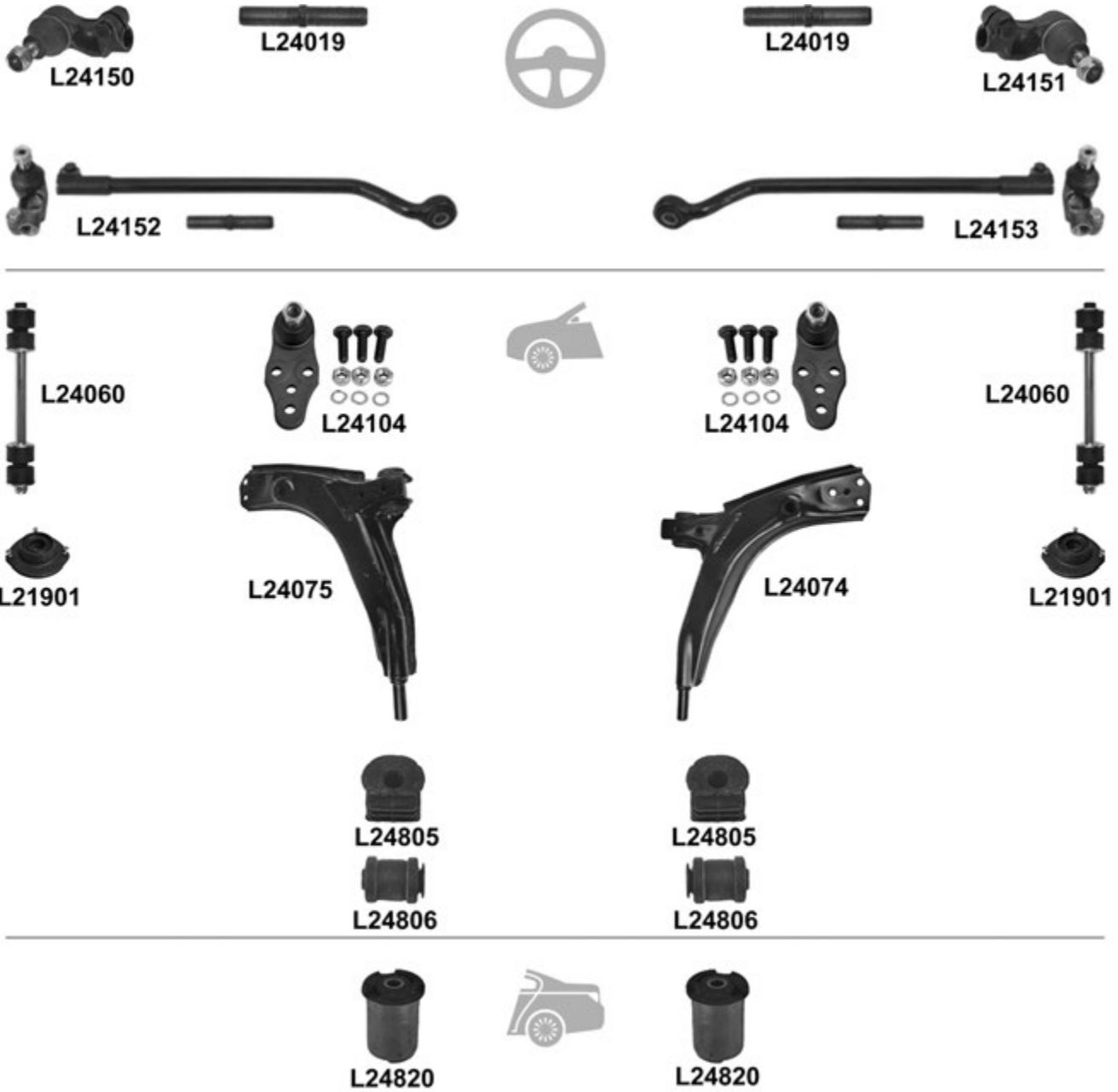

				← → Thread		Part Of	QPA		
				L24151	F 16x1,5 U		1	0784-8282	
				L24150	F 16x1,5 U		1	0784-8281	
				L24019	L24019		2		
				L24153			1		
				L24152			1		
				L24104	L24104		2	9478-8122	
				L24074		1	9621-8398		
				L24075			1	9621-8397	
				L24805	L24805		2	9023-5040	
			→ ch. 447 433	L24806	L24806		2	352349	
				L24060	L24060		2	9450-0776	
			KIT	L21901	L21901		2	96225638	
		→ ch. 447 433	L24820	L24820		2	402642		
						Hub carrier	2	402642	

Leganza (KLAV) 06.97 → 02.02

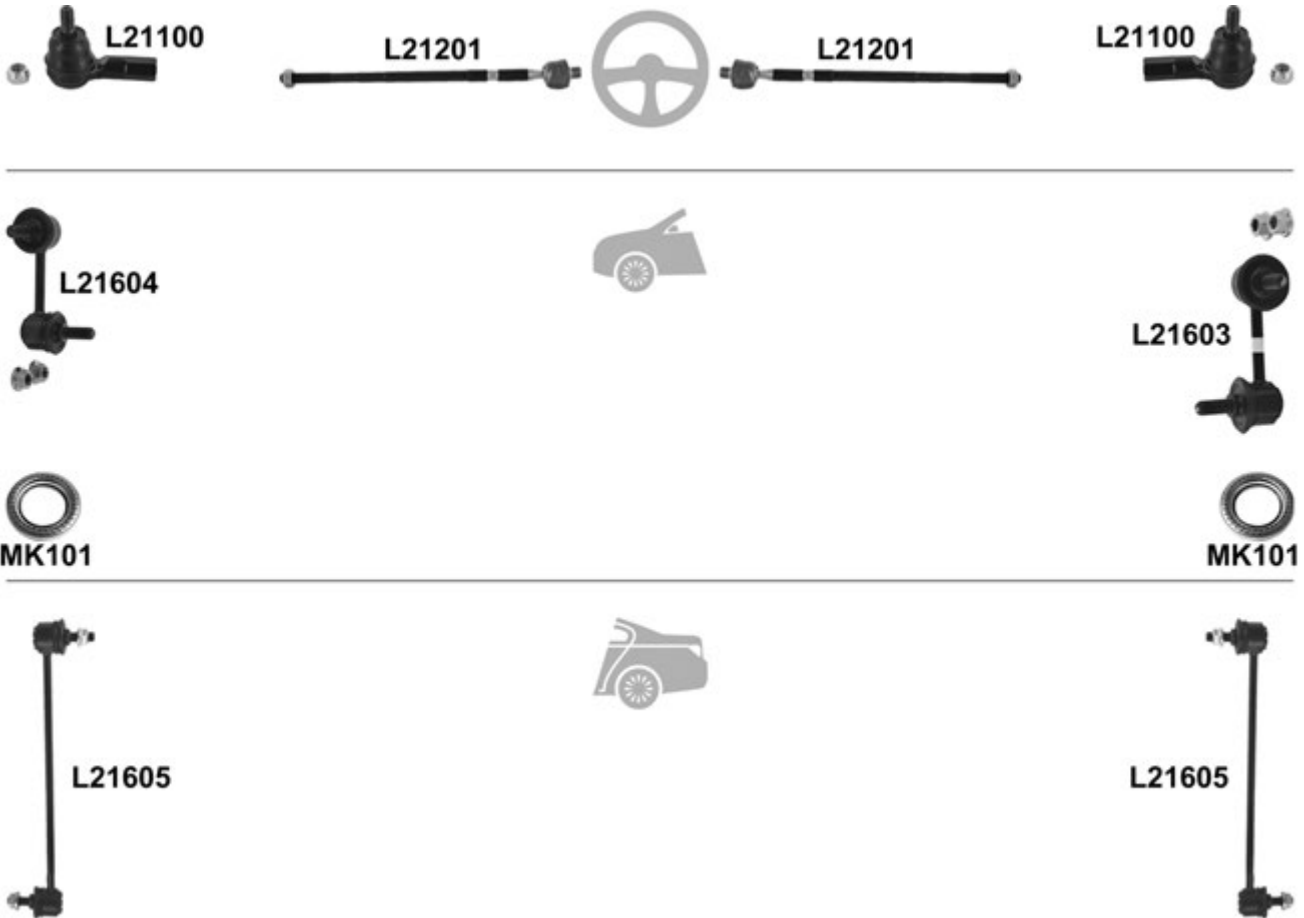

				←	→	Thread	Part Of	QPA		
		↔		L21100	L21100	↻		2	9620-5809	
				L21201	L21201	↻		2	520808	
					L21603			1	9622-5859	
				L21604				1	9622-5858	
				MK101	MK101			2		
				L21605	L21605			2	9620-7628	

Matiz (KLYA) 09.98 →

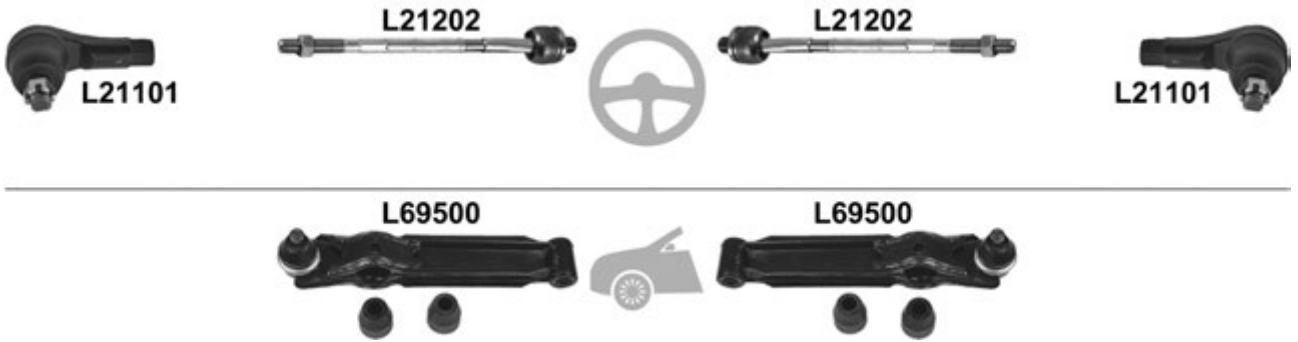

						←	→	Thread	Part Of	QPA	i
		↔				L21101	L21101	↺		2	9374-1091
						L21202	L21202	↺		2	9374-1074
		⊥		<input checked="" type="checkbox"/>		L69500	L69500			2	9631-6765

Matiz (M200) 03.05 →



						←	→	Thread	Part Of	QPA	i
						KIT	MK275	MK275		2	9665-3239

Nexia / Cielo (KLETN) 02.95 → 08.97

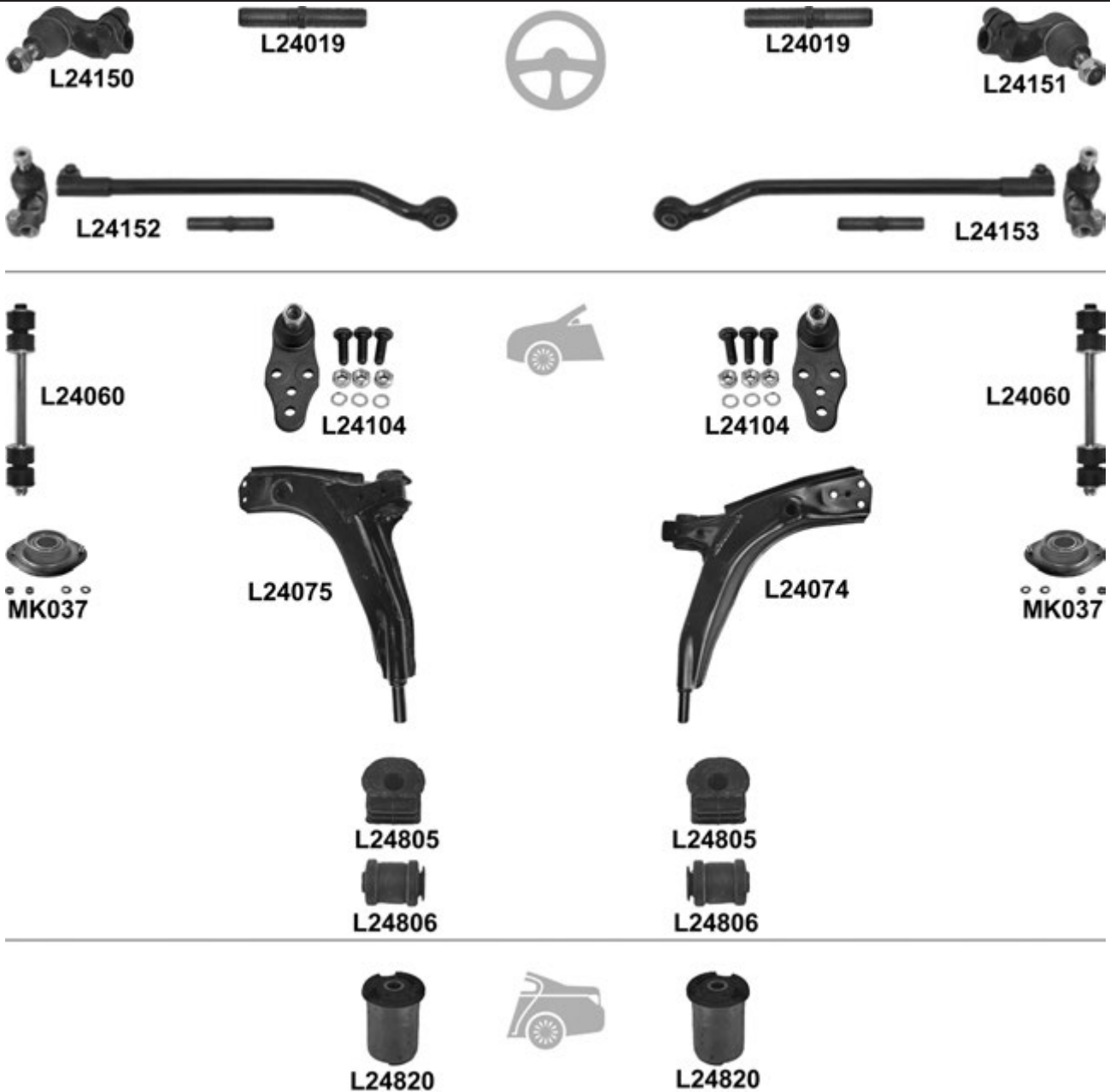

				← → Thread		Part Of	QPA	i		
⊕		↔		L24151	F 16x1,5 U		1	0784-8282		
				L24150	F 16x1,5 U		1	0784-8281		
				L24019	L24019			2		
				L24153				1		
				L24152				1		
⊖		↓		L24104	L24104		2	9478-8122		
				L24074			1	9621-8398		
		↓		L24075			1	9621-8397		
				L24805	L24805		2	9023-5040		
		L24806	L24806		2	352349				
				L24060	L24060		2	1603148		
⊖			KIT	MK037	MK037		2	9018-4756		
			L24820	L24820		2	402642	Hub carrier		

Nubira (KLAJ) 02.97 →

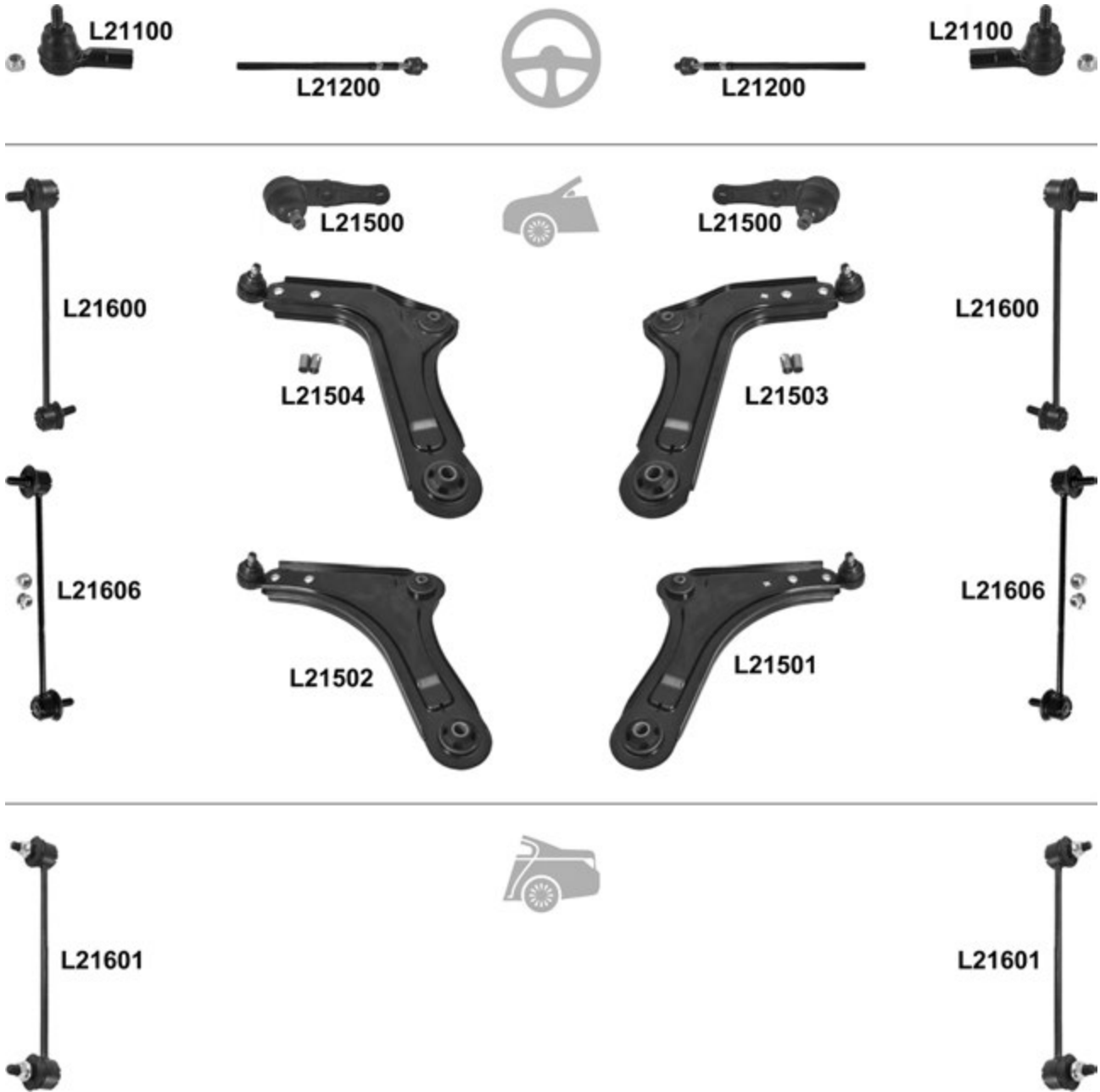

						←	→	Thread	Part Of	QPA	
		↔		L21100	L21100			∩		2	9620-5809
				L21200	L21200			∩		2	520672
		↓		L21500	L21500					2	9630-0048
		↓	→ 12.99	<input checked="" type="checkbox"/>		L21503				1	9630-5975
				<input checked="" type="checkbox"/>	L21504					1	9630-5974
			01.00 →	<input checked="" type="checkbox"/>		L21501				1	9626-8455
					L21502				1	9626-8454	
			→ 12.98		L21600	L21600				2	9630-0627
			01.99 →		L21606	L21606				2	9639-1875
				L21601	L21601					2	9639-1876

Nubira (KLAN) 07.03 →

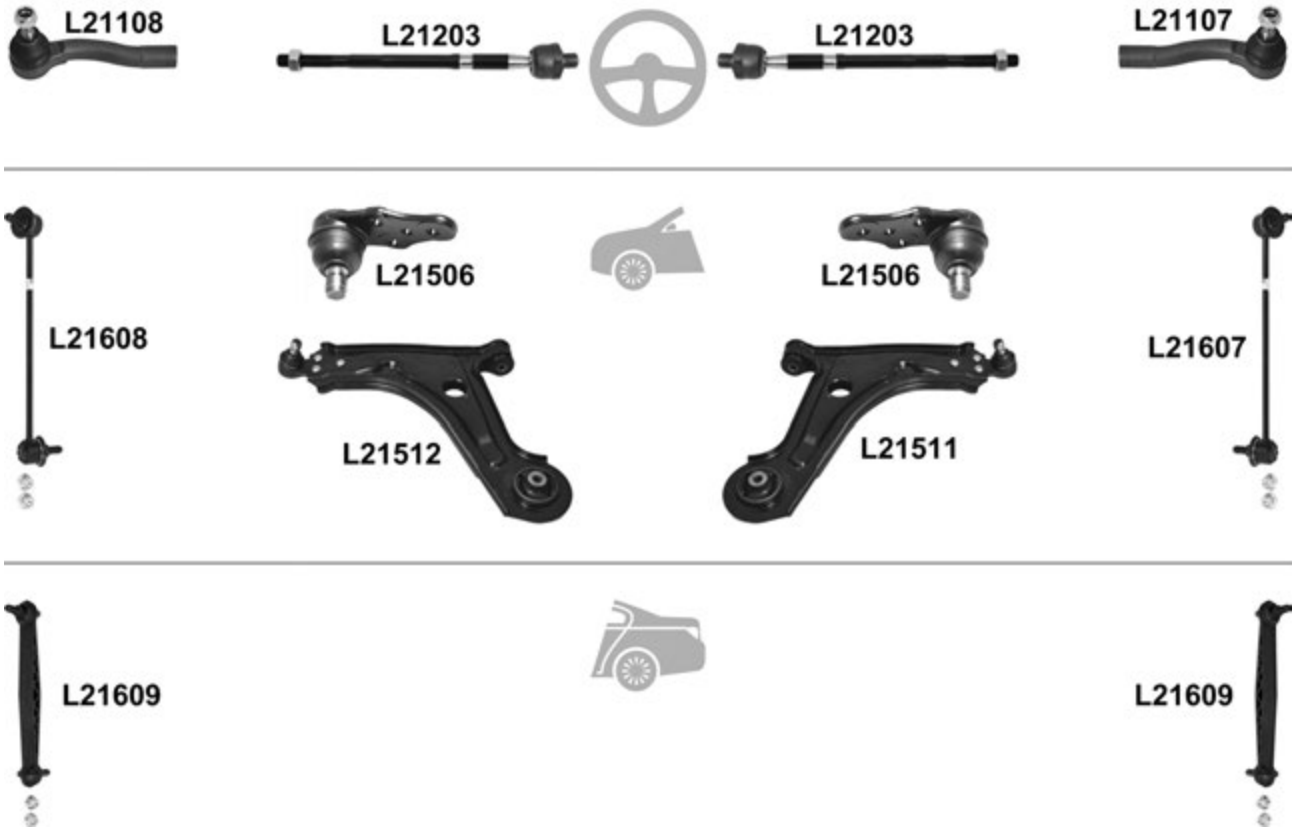

		i		←	→	Thread	Part Of	QPA	i		
⊕		↔			L21107	F 14x1,5 ∪		1	9640-7486		
					L21108	F 14x1,5 ∪		1	9640-7585		
🚗		⊥			L21203	M 14x1,5 / M 16x1,5 ∪		2			
					L21506	L21506			2	9649-0218	
				☑	L21511				1	9641-5064	
					L21512				1	9641-5063	
🚗		⊥			L21607			1	9640-3100		
					L21608			1	9640-3099		
					L21609	L21609			2	9656-1754	

Rezzo / Tacoma (KLAU) 09.00 →

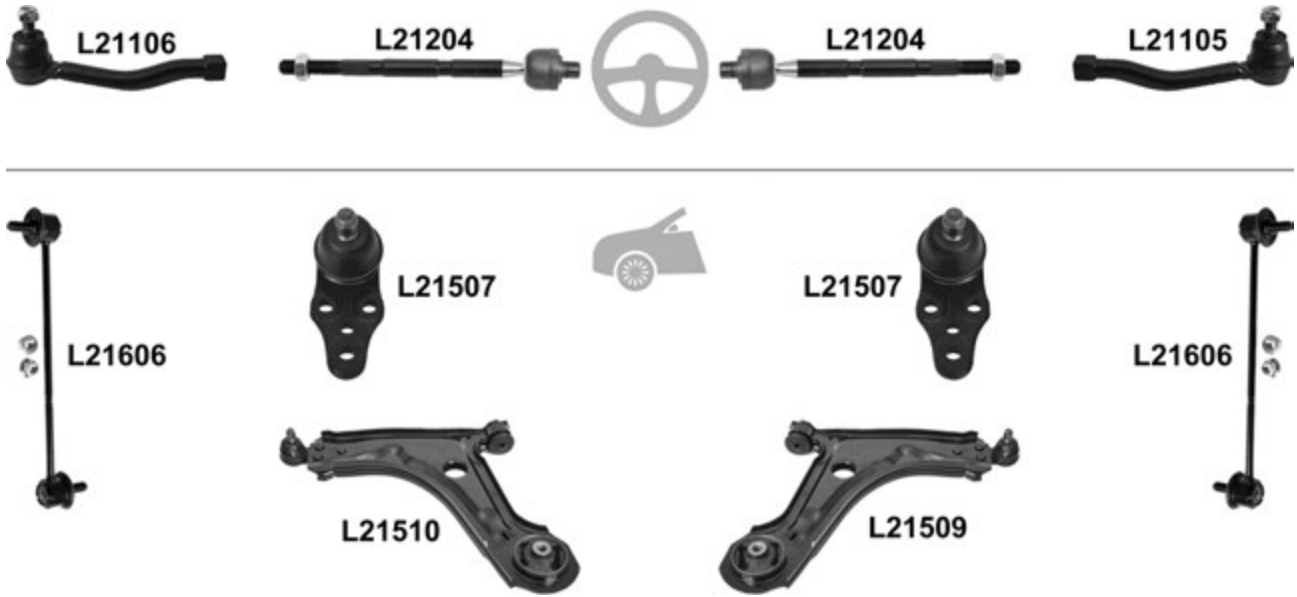

				← → Thread		Part Of	QPA			
⊕		↔		L21105	F 14x1,5 ∪		1	9626-1379	i	
				L21106	F 14x1,5 ∪		1	9626-1378		
⊖		⊥		L21204	L21204	M 14x1,5 / M 16x1,5 ∪		2	521564	i
				L21507	L21507			2	9626-1108	
					L21509			1	9637-8348	
					L21510			1	9639-8347	
				L21606	L21606		2	9639-1875		

DAIHATSU
Applause A101, A111 06.89 →

L4121

L4120

Thread
Part Of
QPA

⊕	🔧	↔				Thread	Part Of	QPA	i
				←	→				
					L4120	F 12x1,25 ∪		1	45046-87784
					L4121	F 12x1,25 ∪		1	45047-87784

Charade G11, G30 01.83 → 05.87

L4102

L4101

L4106

L4106

Thread
Part Of
QPA

⊕	🔧	↔				Thread	Part Of	QPA	i
				←	→				
					L4101	F 12x1,25 ∪		1	45046-87780
					L4102	F 12x1,25 ∪		1	45047-87780
🚗	🔧	⊥			L4106	L4106		2	48068-87705

Charade G100, G101, G102 01.87 → 07.93

L4121

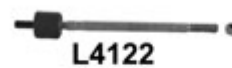
L4122

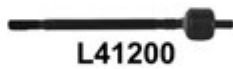
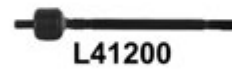
L4122

L4120

L41200

L41200

L41502

L41501

Thread
Part Of
QPA

⊕	🔧	↔				Thread	Part Of	QPA	i
				←	→				
					L4120	F 12x1,25 ∪		1	45046-87784
					L4121	F 12x1,25 ∪		1	45047-87784
			→ 12.88, (-) ⊕		L4122	L4122	M 12x1,25 / M 11x1,5 ∪	2	45503-87705
			01.89 →, (-) ⊕		L41200	L41200	∪	2	45503-87711
🚗	🔧	⊥		☑		L41501		1	48068-87706
					L41502			1	48069-87706

Charade G200 01.93 →



				←	→	Thread	Part Of	QPA	
⊕	🔧	↔			L4120	F 12x1,25 ∪		1	45046-87784
					L4121	F 12x1,25 ∪		1	45047-87784
			(-) ⊕	L41200	L41200	∪		2	45503-87711

Charade L2 03.03 →



				←	→	Thread	Part Of	QPA	
⊕	🔧	↔			L4101	F 12x1,25 ∪		1	45046-97203-000
					L4102	F 12x1,25 ∪		1	45047-97203-000

Charade NSP90 05.11 →

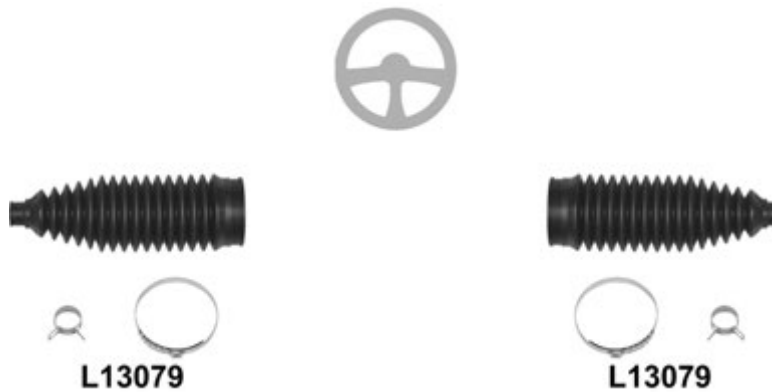

				←	→	Thread	Part Of	QPA	
⊕	🌀		∅ 15mm, ∅ 51,5mm, L= 200mm	L13079 ⁰	L13079 ⁰			2	45535-09130

Charmant A35, A55, A60 11.81 → 07.87

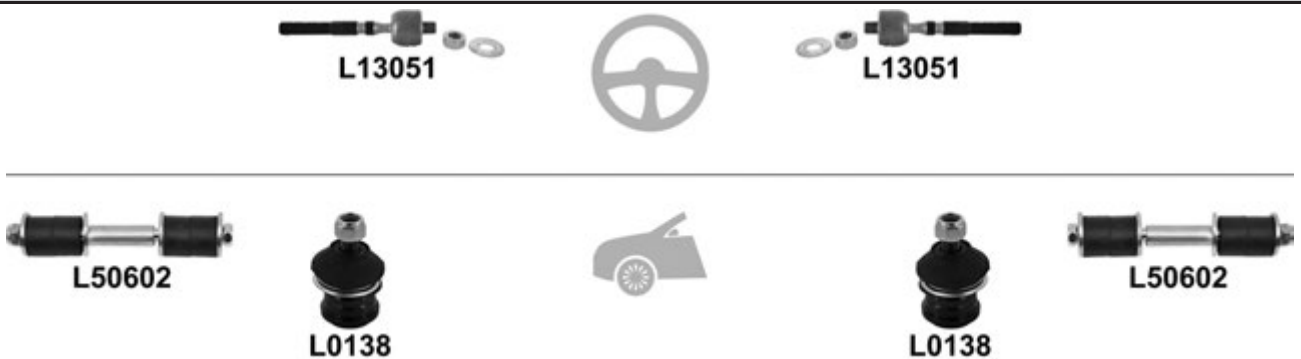

				←	→	Thread	Part Of	QPA	
⊕	🔧			L13051	L13051	M 14x1,5 / M 14x1,5 ∪		2	45503-19015
🚗	🔧	↓		L0138	L0138			2	43308-12030
				L50602	L50602			2	

Copen 09.03 →

Thread
Part Of
QPA

⊕	🔧	↔							1	45046-87285-000
				L4101	F 12x1,25 ∪					
				L4102	F 12x1,25 ∪				1	45047-87282-000

Cuore II (L80 / L81) 09.85 → 12.90

Thread
Part Of
QPA

⊕	🔧	↔							1	45046-87780
				L4101	F 12x1,25 ∪					
				L4102 <th>F 12x1,25 ∪</th> <td></td> <td></td> <td></td> <td>1</td> <td>45047-87780</td>	F 12x1,25 ∪				1	45047-87780

Cuore IV / Domino (L501) 12.94 → 10.98

Thread
Part Of
QPA

⊕	🔧	↔							1	45046-87285-000
				L4101	F 12x1,25 ∪					
				L4102 <th>F 12x1,25 ∪</th> <td></td> <td></td> <td></td> <td>1</td> <td>45047-87282-000</td>	F 12x1,25 ∪				1	45047-87282-000

Cuore VI (L701) 10.98 → 05.03

Thread
Part Of
QPA

⊕	🔧	↔							1	45046-87285-000
				L4101	F 12x1,25 ∪					
				L4102 <th>F 12x1,25 ∪</th> <td></td> <td></td> <td></td> <td>1</td> <td>45047-87282-000</td>	F 12x1,25 ∪				1	45047-87282-000

Cuore VII (L251) 03.03 →

Thread
Part Of
QPA

⊕	🔧	↔							1	45046-87285-000
				L4101	F 12x1,25 ∪					
				L4102 <th>F 12x1,25 ∪</th> <td></td> <td></td> <td></td> <td>1</td> <td>45047-87282-000</td>	F 12x1,25 ∪				1	45047-87282-000

Move (L6, L9) 06.94 →



L4102



L4101

			i	←	→	Thread	Part Of	QPA	i	
						L4101	F 12x1,25 ∪		1	45046-87285-000
						L4102	F 12x1,25 ∪		1	45047-87282-000

Sirion (M1__) 04.98 → 04.05



L4121



L4120

			i	←	→	Thread	Part Of	QPA	i	
						L4120	F 12x1,25 ∪		1	45046-B9150
						L4121	F 12x1,25 ∪		1	45047-B9150

Sirion (M3) 01.05 →



L4121



L4120

			i	←	→	Thread	Part Of	QPA	i	
						L4120	F 12x1,25 ∪		1	45046-B9150
						L4121	F 12x1,25 ∪		1	45047-B9150

Terios (J1) 05.97 → 10.05

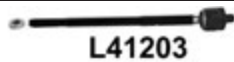

L41203

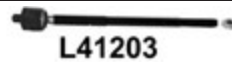

L41203



L41504



L41503

			i	←	→	Thread	Part Of	QPA	i	
						L41203	L41203 ∪		2	45460-87401-000
				<input checked="" type="checkbox"/>		L41503			1	48068-87405-000
						L41504			1	48069-87405-000

Terios (J2) 11.05 →

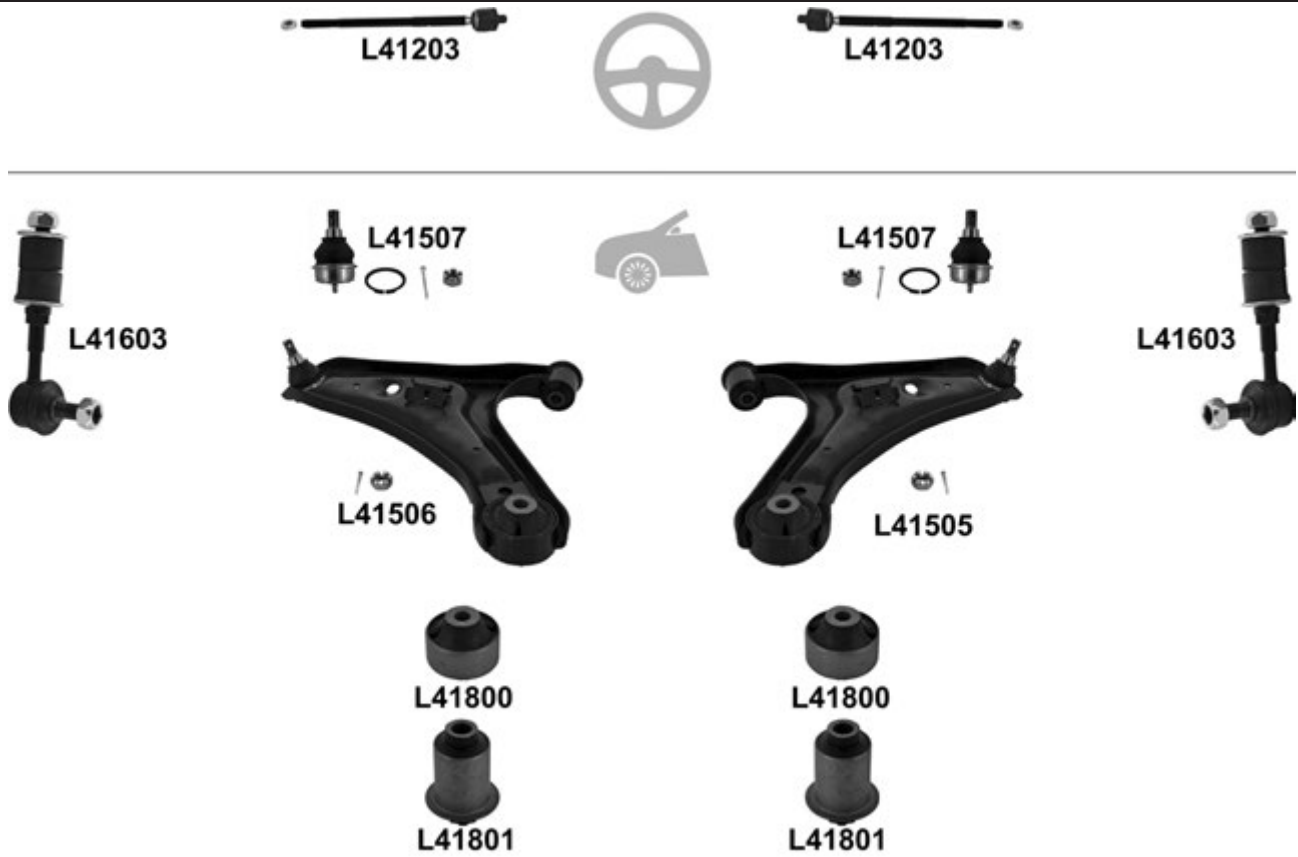

				←	→	Thread	Part Of	QPA	
				L41203	L41203	↻		2	45460-87401-000
		⊥		L41507	L41507		L41505/L41506	2	
		⊥		<input checked="" type="checkbox"/>	L41505			1	48068-B4011
				L41506				1	48069-B4011
		⊥▼		L41800	L41800		L41505/L41506	2	
		⊥▲		L41801	L41801		L41505/L41506	2	
				L41603	L41603			2	48822-97503

DODGE

Caravan II 01.95 → 03.01

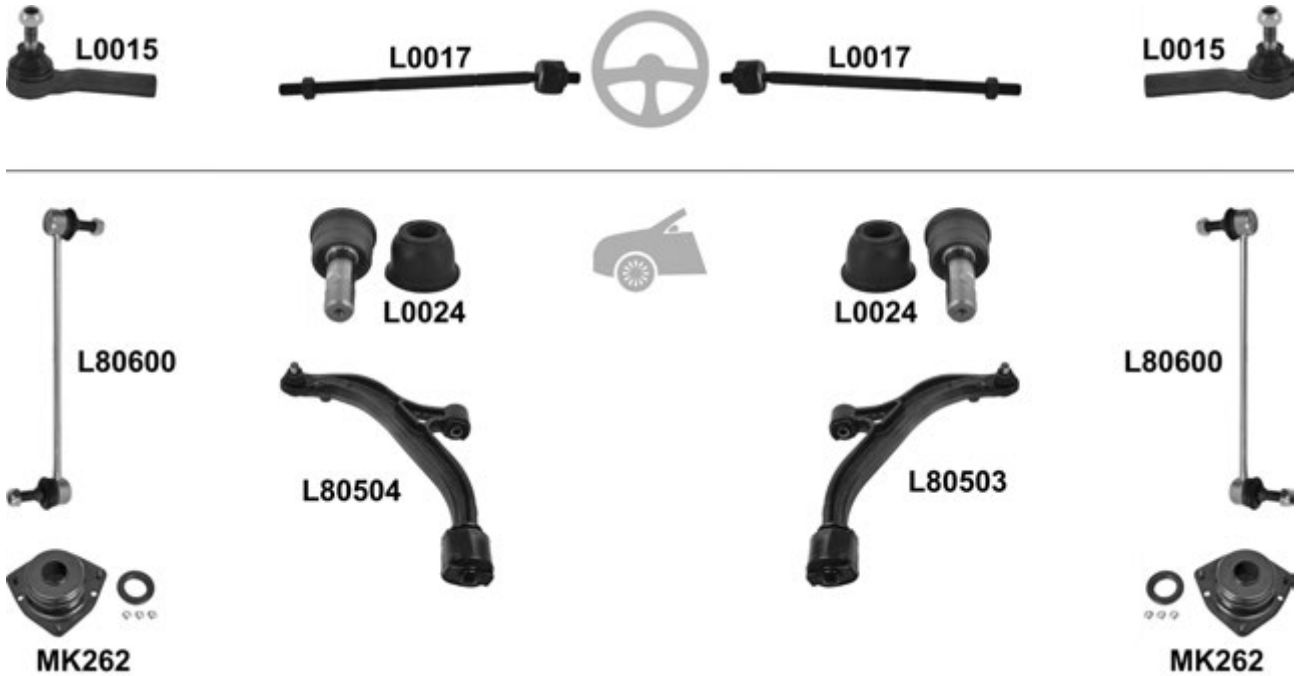

			←	→	Thread	Part Of	QPA	
⊕		↔					2	4797706
							2	
⊖		↓					2	4449553
		↓	<input checked="" type="checkbox"/>				1	4694760
							1	4694761
							2	4743669AA
			KIT				2	4694870

Caravan III 02.00 →

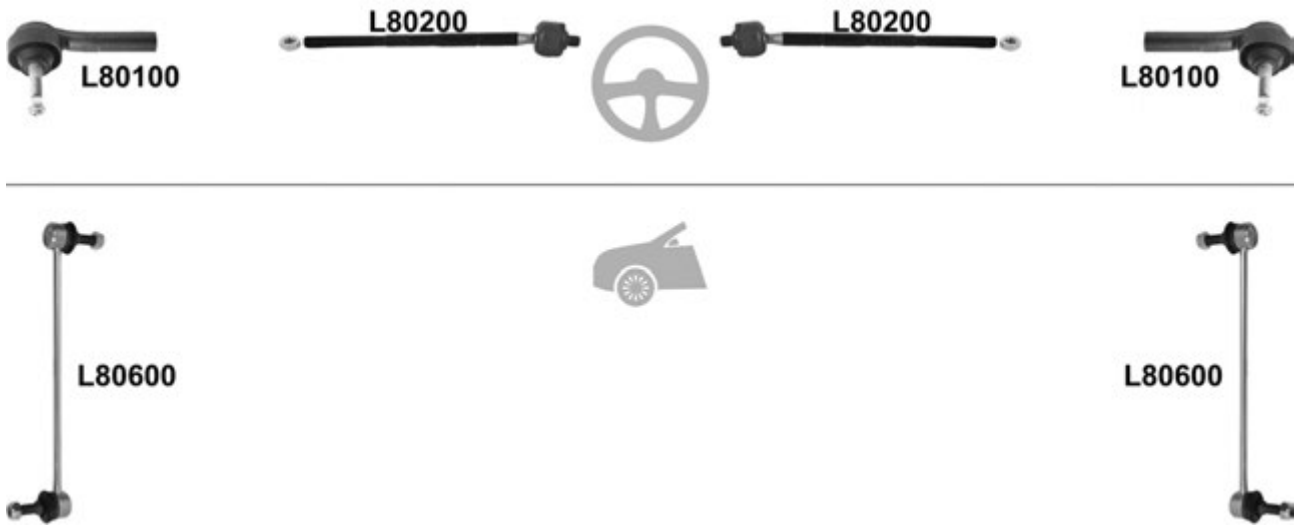

			←	→	Thread	Part Of	QPA	
⊕		↔					2	05066373AA
							2	04743935AD
⊖						OE no. 04743935AD Power Rack	2	04743935AD
							2	4743669AA

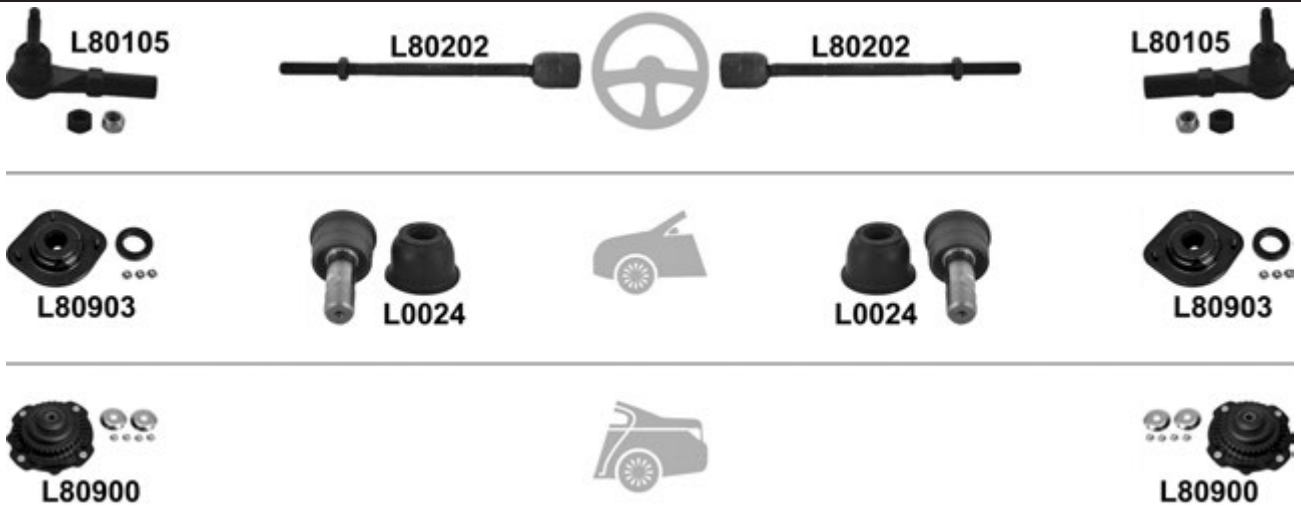
Neon 05.94 → 08.99

			i	←	→	Thread	Part Of	QPA	i
				L80105	L80105			2	04762861AA
				L80202	L80202			2	#04626890AA
				L0024	L0024			2	4443405
			KIT	L80903	L80903			2	04626100AB
				L80900	L80900			2	4626182

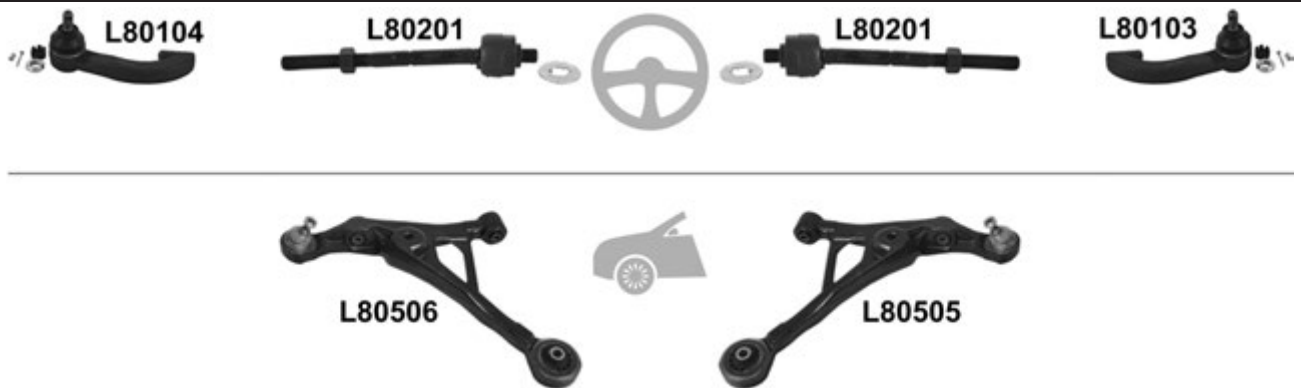
Stratus 12.95 → 04.01

			i	←	→	Thread	Part Of	QPA	i
					L80103			1	05094006AA
				L80104				1	05093857AA
				L80201	L80201	OE no. 04897091AA Power Rack	2	04897091AA	
			<input checked="" type="checkbox"/>		L80505			1	4616922
				L80506			1	4616923	

F.S.O

Polski Fiat



				←	→	Thread	Part Of	QPA	
		↔		L1526	L1526	M 16x1 ♂		2	43 43 762
		↑		L1527	L1527			2	41 04 861

FIAT

Argenta 05.77 → 03.87



			←	→	Thread	Part Of	QPA	
		↔	L1526	L1526	M 16x1 ♂		2	5995268
		↑	L1527	L1527			2	5880794

Albea (178) 09.01 →

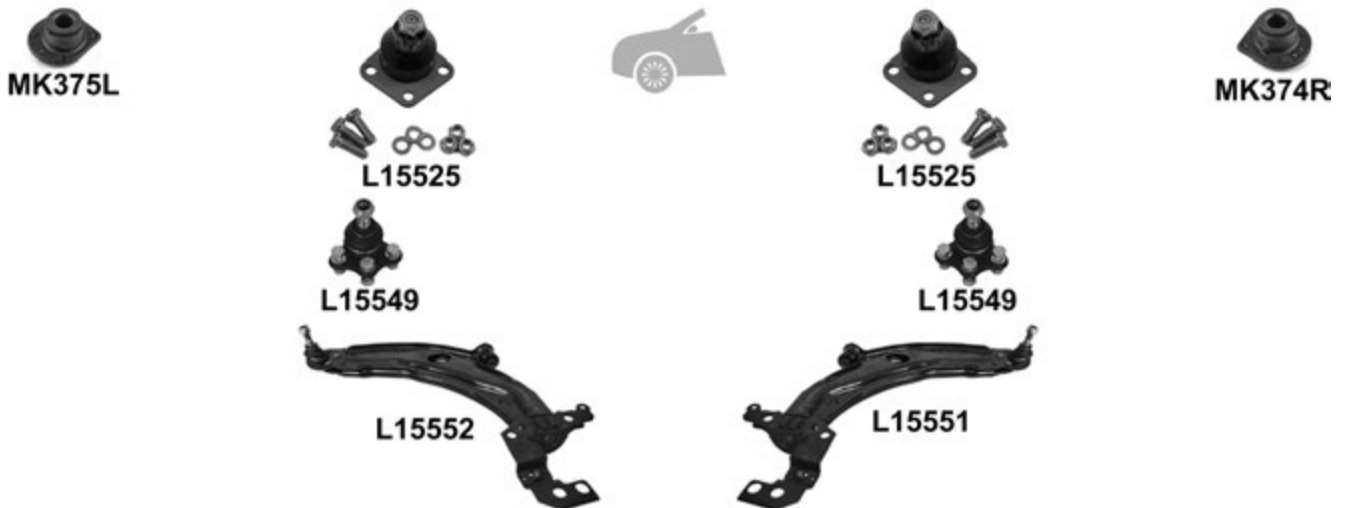

			←	→	Thread	Part Of	QPA		
		↔		L15113	F 14x1,5 ♂		1	98845031	
				L15114	F 14x1,5 ♂		1	98845032	
		↓	→ 09.02	L15525	L15525		2	46543045	
				10.02 →	L15549	L15549		2	46842581
			10.02 →	<input checked="" type="checkbox"/>	L15551			1	51714207
					L15552			1	51714208
						KIT		MK374R	
	MK375L						1	82491441	

Barchetta 03.95 →

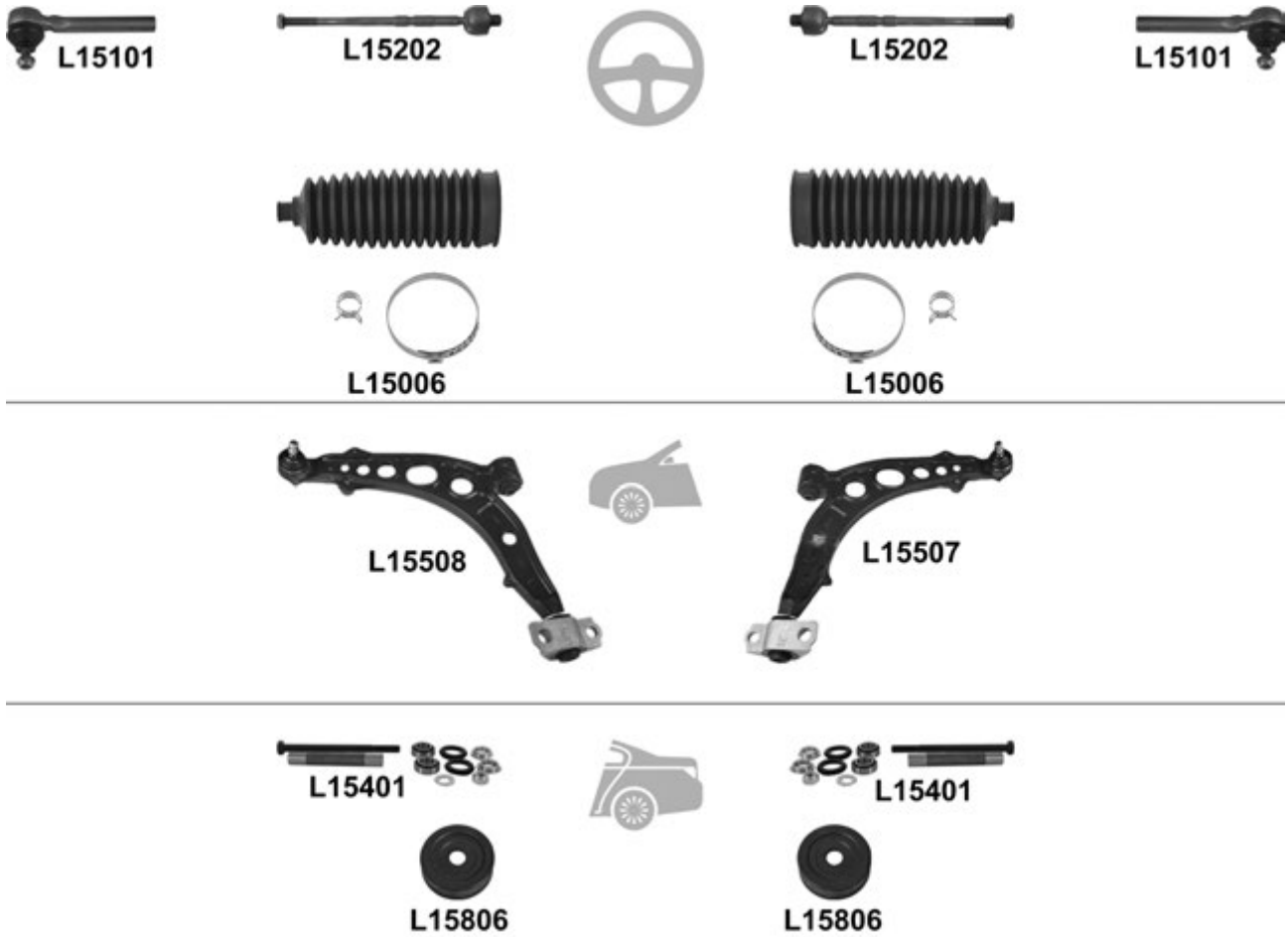

				← → Thread		Part Of	QPA		
		↔		L15101	L15101	F 12x1,5 ∪		2	7752285
				L15202	L15202	M 12x1,5 / M 16x1,5 ∪		2	9945562
				L15006 ^o	L15006 ^o			2	9945564
		⊥			L15507			1	46430002
					L15508			1	46430003
				KIT	L15401	L15401		2	
					L15806	L15806	Hub carrier	2	46476755

Brava (182) 10.95 → 12.02

Bravo (182) 10.95 → 10.01

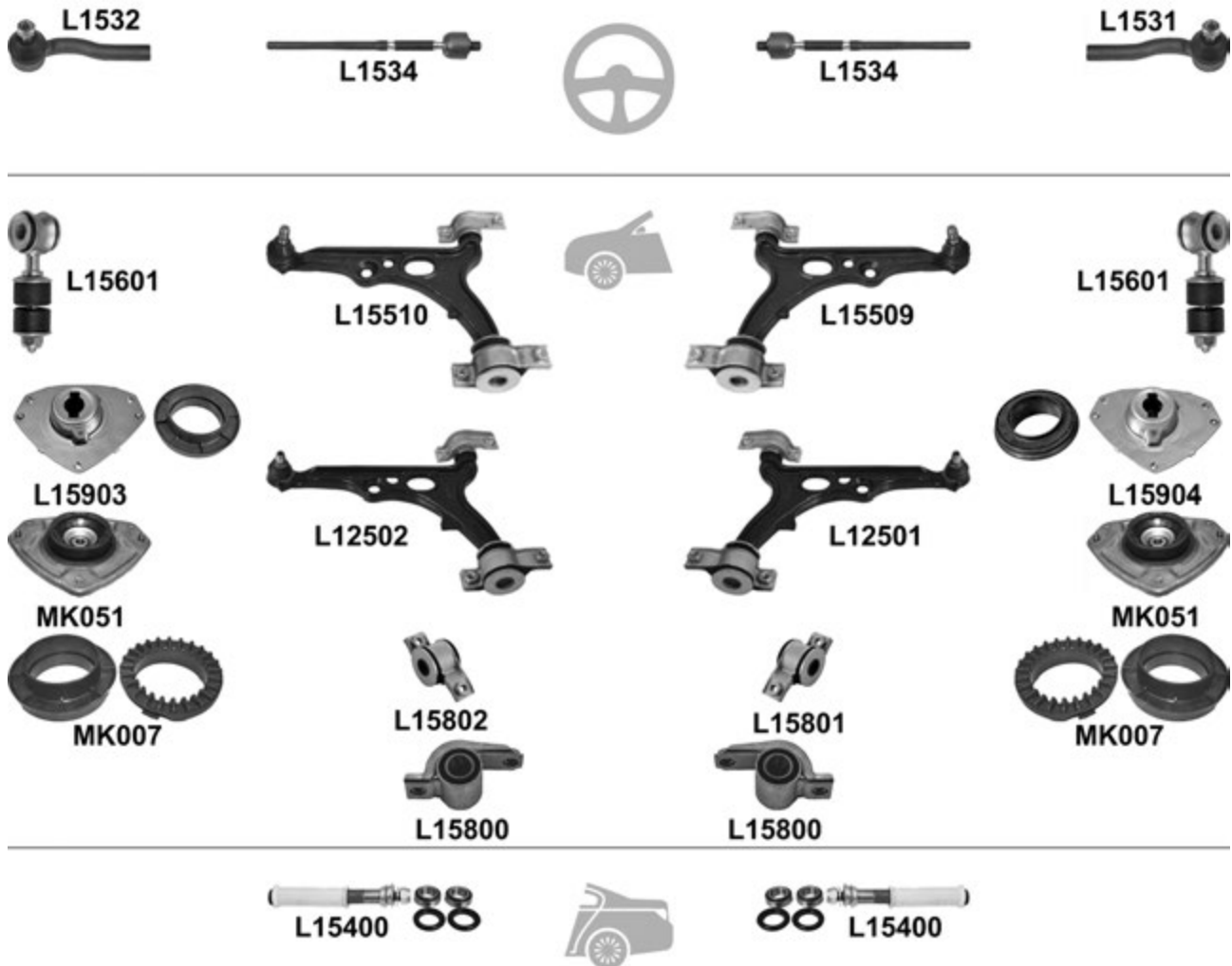

				← → Thread		Part Of	QPA			
⊕	↔	(-) 2.0 HGT 20V, L= 128mm		L1531	F 12x1,5 ♂		1	9947438		
				L1532	F 12x1,5 ♂		1	9947437		
⊖	⊥	(-) 2.0 HGT 20V, Steel	☉	L1534	L1534	M 12x1,5 / M 14x1,5 ♂		2	9941625	
				L15509				1	46423823	
			L15510				1	46423822		
			L12501				1	7780444		
		L12502				1	7780443			
	↙				L15801		↳ L15509	1	7601068	
					L15802		↳ L15510	1	7601065	
	↘			L15800	L15800		↳ L15509/L15510	2	7601064	
				L15601	L15601			2	60809242S	
	☉		☉, → 01.96, ch. → 4085697, (+) MK007	KIT		L15904 ¹		1	60811372S	
				L15903 ¹		1	60811373S			
☉, 02.96 →, ch. 4085698 →			KIT	MK051	MK051		2	46469709		
☉		☉		MK051	MK051		2	46469709		
				MK007	MK007		2	7601502		
⊖	⚙️		KIT	L15400	L15400		2			

Bravo 04.07 →



L15005



L15005

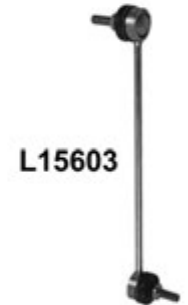
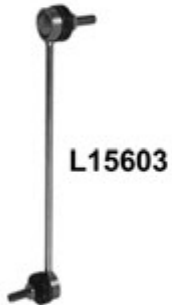

Thread

Part Of

QPA



		↔		L15110	L15110	F 14x1,5 U		2	9949218
				L15005 ⁰	L15005 ⁰			2	77364341
		↓		L15569	L15569			2	
		↓		<input checked="" type="checkbox"/>	L15567			1	51827737
					L15568			1	51827736
		↓		L15809	L15809			2	50700778
		↓	14,2mm x 43mm x 67,5mm	L15818	L15818			2	50704262
				L15603	L15603			2	51801136
				KIT	MK302	MK302		2	50702841

Cinquecento 07.91 → 07.99



L1569



L15201

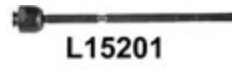

L15201



L1569



MK049



L15506



L15505



MK049

				← → Thread		Part Of	QPA		
		↔		L1569	L1569	M 12x1,5 U	2	7669756	
				L15201	L15201	M 12x1,5 / F 12x1,5 U	2	7658273	
		⊥			L15505		1	7636996	
					L15506		1	7636995	
			(-) 1.1 Sport	KIT	MK049	MK049	2	7667087	

Coupé (FA / 175) 11.93 → 08.00

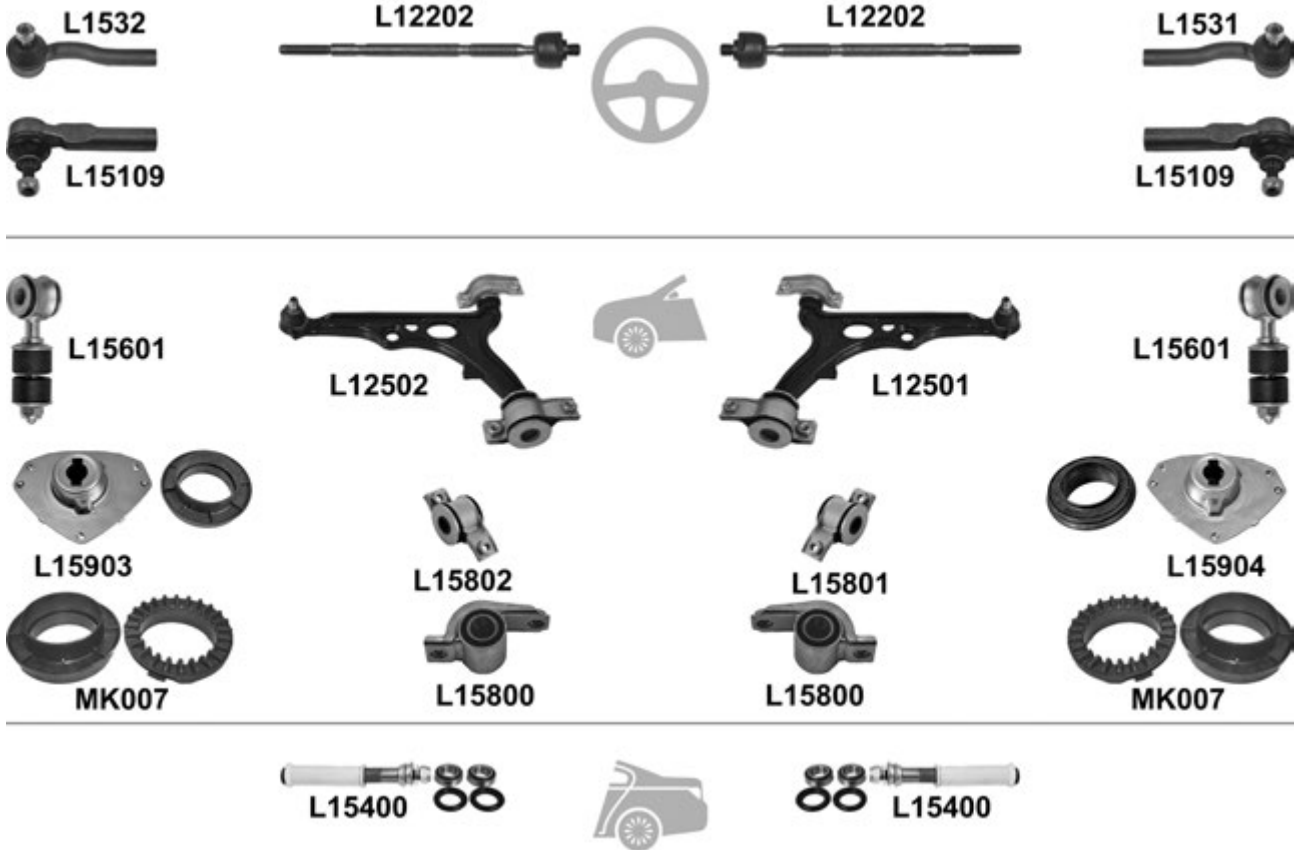

						←	→	Thread	Part Of	QPA	
⊕		↔	1.8 16V → 12.96 , 2.0 16V, (-) 2.0 Turbo 16V / 20 V, L= 128mm		L1531			F 12x1,5 ∪		1	9947438
					L1532			F 12x1,5 ∪		1	9947437
					L15109	L15109		F 14x1,5 ∪		2	9947714
					L12202	L12202		M 12x1,5 / M 14x1,5 ∪		2	9950452
⊖		⊥	<input checked="" type="checkbox"/>		L12501					1	7780444
					L12502					1	7780443
		⊥↘			L15801			L12501	1	7601068	
					L15802			L12502	1	7601065	
		⊥↗		L15800	L15800			L12501/L12502	2	7601064	
					L15601	L15601				2	60809242S
			(+) MK007	KIT		L15904 ¹			1	60811372S	
				L15903 ¹					1	60811373S	
				MK007	MK007				2	7601502	
				KIT	L15400	L15400			2		

Croma (154) 12.85 → 12.96

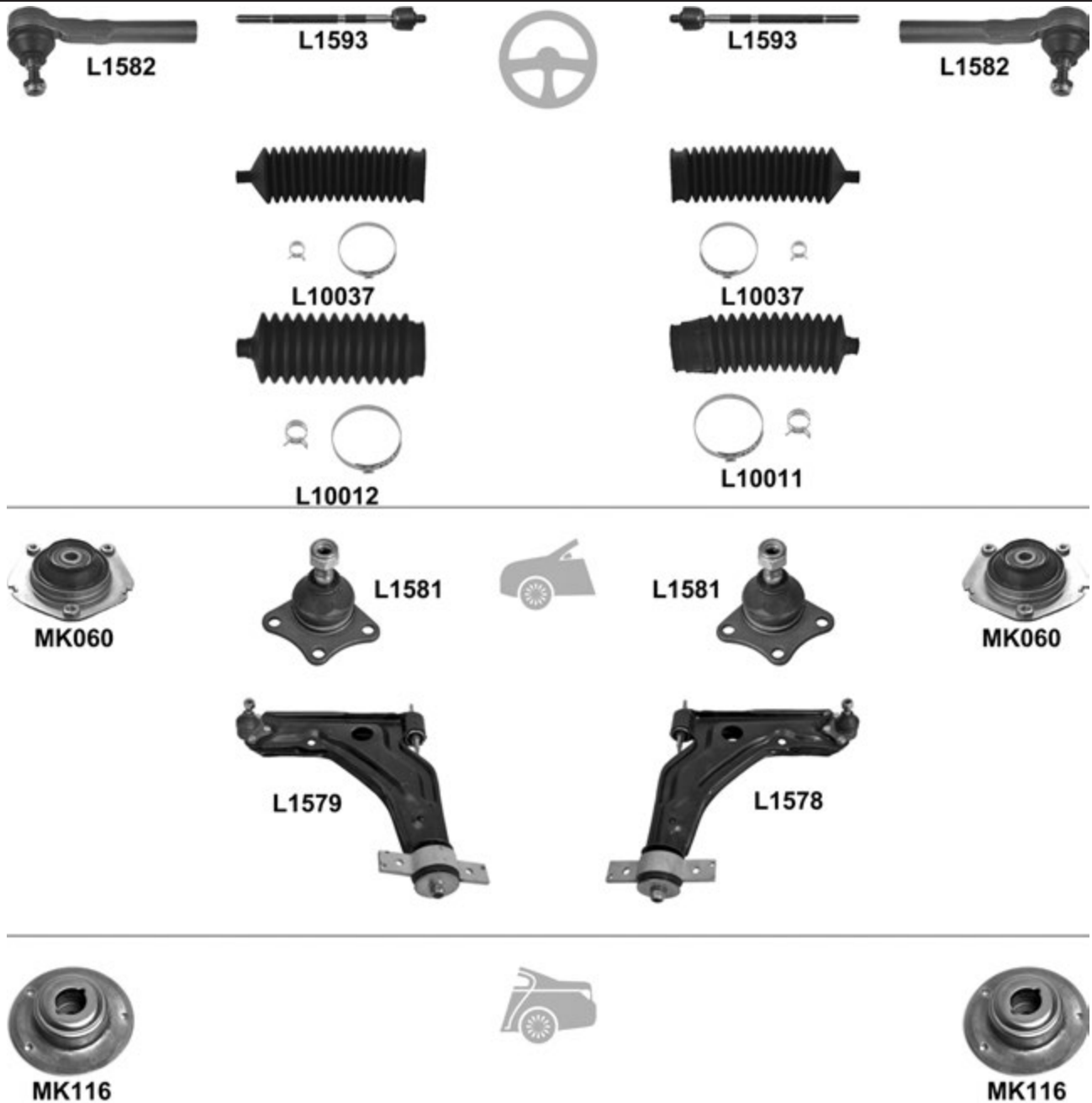

		i		←	→	Thread	Part Of	QPA	i
⊕		↔	04.86 →	L1582	L1582	F 14x1,5 ∪		2	82387676
			04.86 →	L1593	L1593	M 14x1,5 / M 14x1,5 ∪		2	9940260
				L10037 ^o	L10037 ^o			2	9939555
			→ 12.93, *, OE 9938779=set of 2	L10012	L10011			1	9938779*
🚗		⊥		L1581	L1581			2	82446499
		⊥	→ 12.91	<input checked="" type="checkbox"/>	L1578			1	82406868
				L1579				1	82406867
🚗				MK060	MK060			2	
				MK116	MK116			2	82430666

Croma (194) 06.05 →

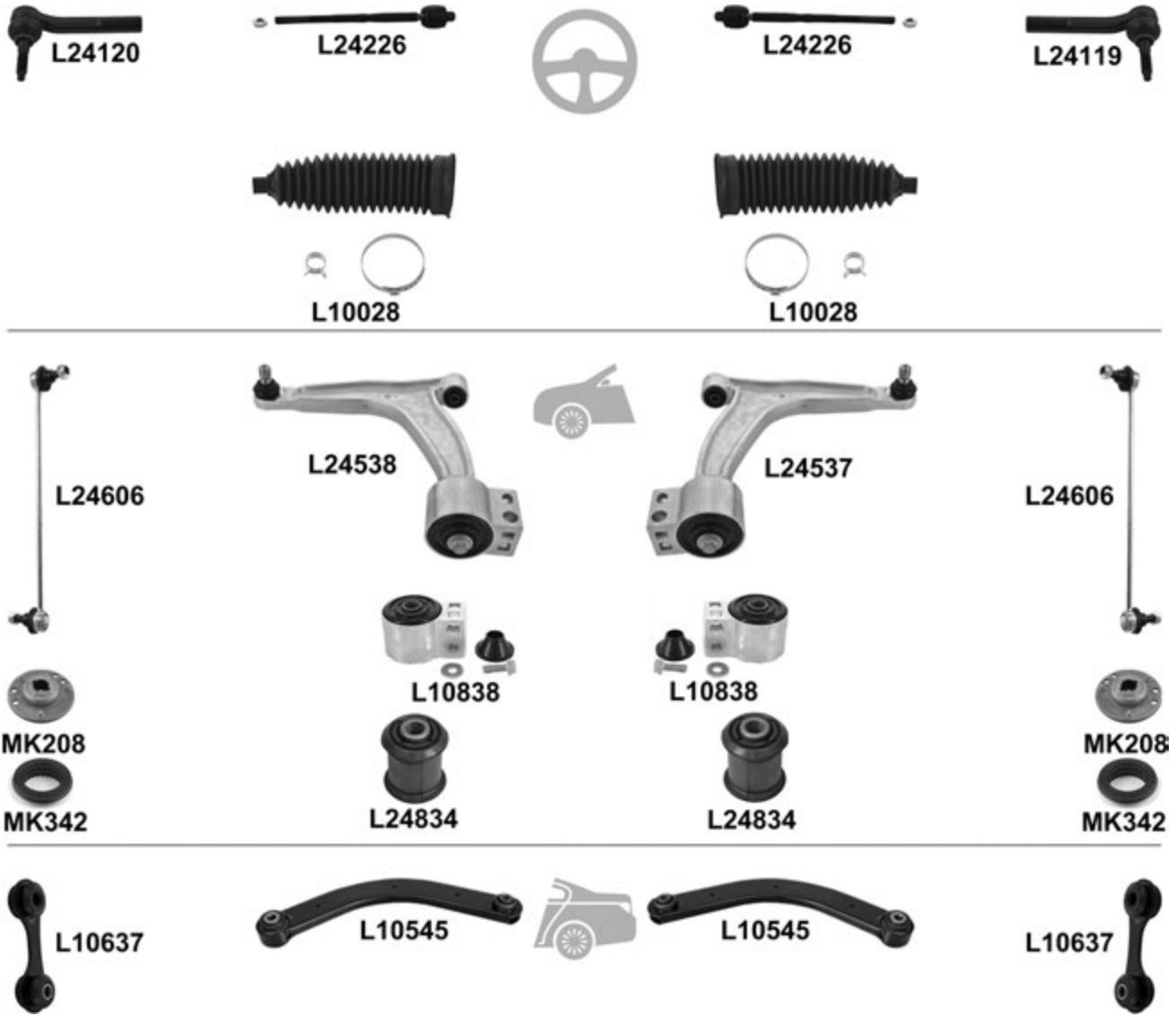

		← → Thread		Part Of		QPA			
⊕		↔		L24119			1 77363712		
				L24120			1 77363713		
				L24226	L24226		2		
				L10028 ^o	L10028 ^o		2	1609558	
⊖		⊥	<input checked="" type="checkbox"/>	L24537			1 51748652		
				L24538			1 51748653		
				L10838	L10838		2	71740107	
				L24834	L24834		2		
				L24606	L24606		2	51741130	
				(+) MK342	KIT	MK208	MK208		2 51755688
						MK342	MK342		2 51755689
⊖		⊥	<input checked="" type="checkbox"/>	L10545	L10545		2 51783009		
				L10637 ^o	L10637 ^o		2 71740112		

Doblo (119) 03.01 →
 Doblo Cargo (223) 03.01 →

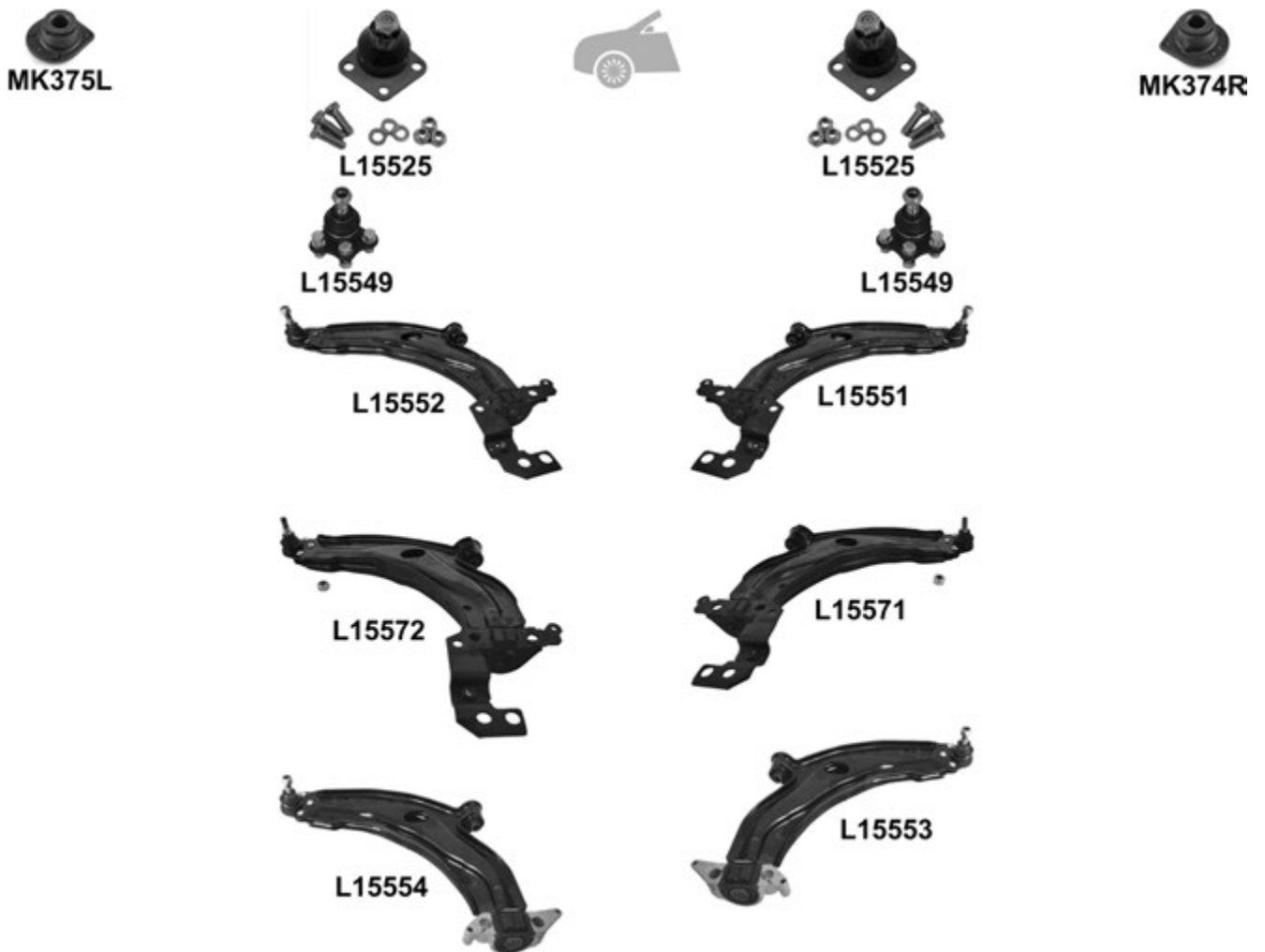
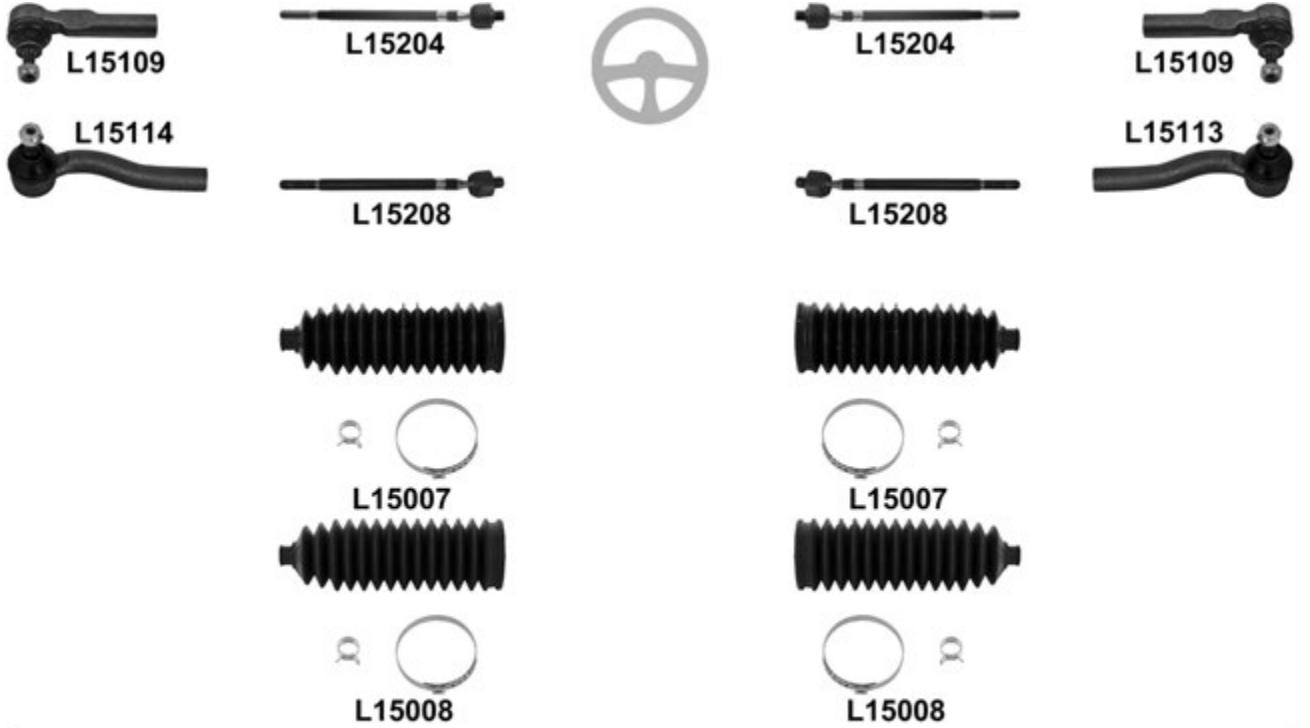

Doblo (119) 03.01 →
 Doblo Cargo (223) 03.01 →

				←	→	Thread	Part Of	QPA		
⊕	↔	⊕		L15109	L15109	F 14x1,5 ∪		2	98845030	
			⊕, ch. → 5120134	L15109	L15109	F 14x1,5 ∪		2	98845030	
			⊕, ch. 5120135 →		L15113	F 14x1,5 ∪		1	98845031	
				L15114		F 14x1,5 ∪		1	98845032	
	⊖	⊕, ch. → 5120134	L15204	L15204	M 14x1,5 / M 16x1,5 ∪		2	98845024		
			⊕, ch. 5120135 →	L15208	L15208	M 14x1,5 / M 16x1,5 ∪		2	98845026	
	⊖	→ 09.05, ∅ 14, ∅ 53, L= 188mm	L15007 ^o	L15007 ^o			2	98845034		
			10.05 →, ∅ 12, ∅ 53, L= 196mm	L15008 ^o	L15008 ^o			2	98845882	
	⊖	⊖	→ 07.01, → ch. 5023342	L15525	L15525			2	46543045	
				08.01 →, ch. 5023343 →	L15549	L15549			2	46842581
⊖		08.01 →, ch. 5023343 →, (-) HD	<input checked="" type="checkbox"/>		L15551		1	51714207		
				L15552		1	51714208			
			<input checked="" type="checkbox"/>		L15571		1	51722992		
				L15572		1	51722988			
⊖		HD	<input checked="" type="checkbox"/>		L15553		1	51727863		
				L15554		1	51727865			
⊖		KIT			MK374R		1	82491440		
					MK375L		1	82491441		
⊖	⊖		L15602	L15602			2	46767267		

Doblo (152) 02.10 →
 Doblo Cargo (263) 02.10 →

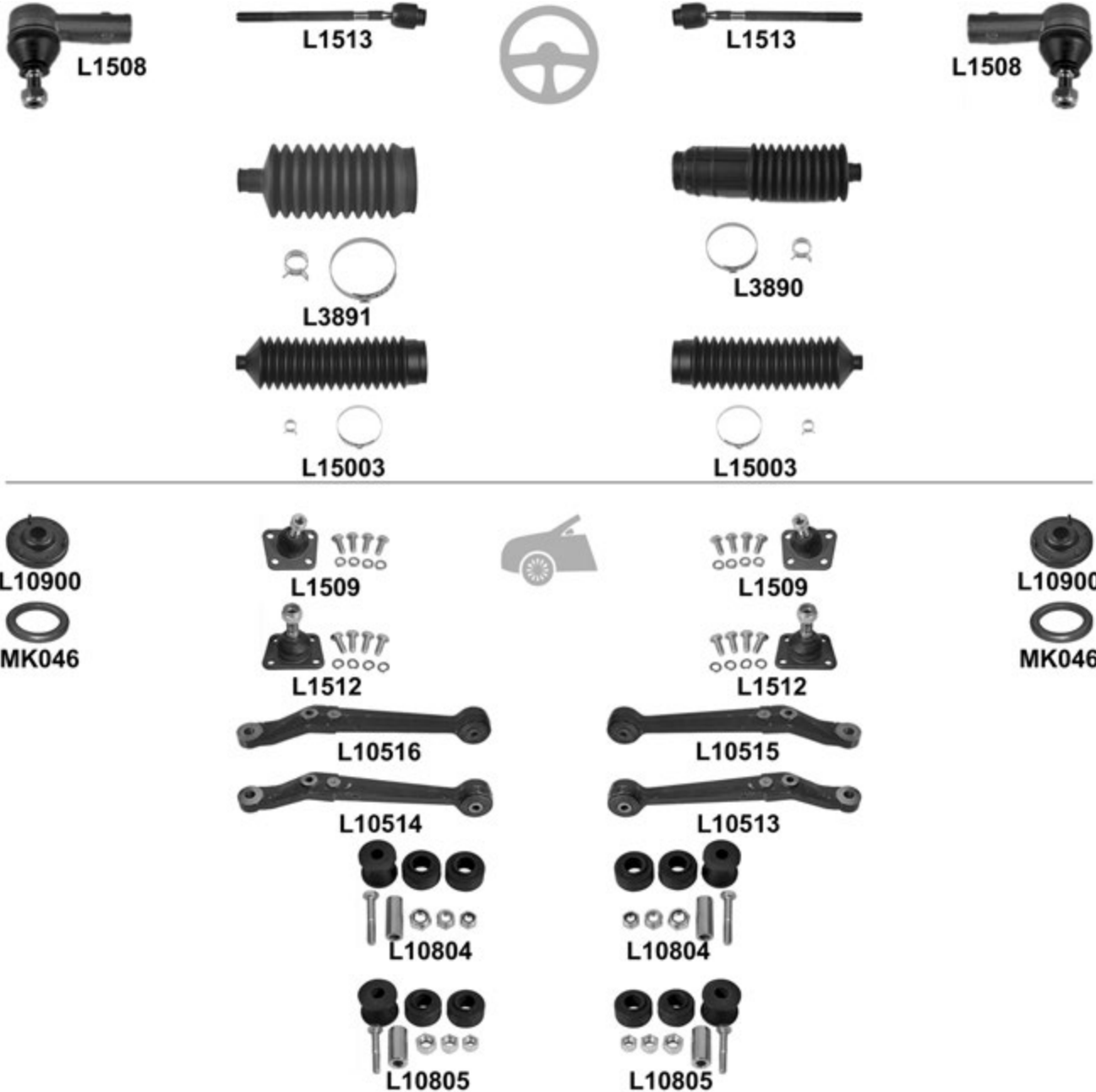

						←	→	Thread	Part Of	QPA				
		↔						F 14x1,5 U		1	77365224			
									F 14x1,5 U		1	77365223		
		⊥		<input checked="" type="checkbox"/>						1	51810664			
											1	51810665		
					Old type							2		
												2		
		↔								2	51848645			
											2			

Ducato / Talento (280 / 290) 01.82 → 03.94

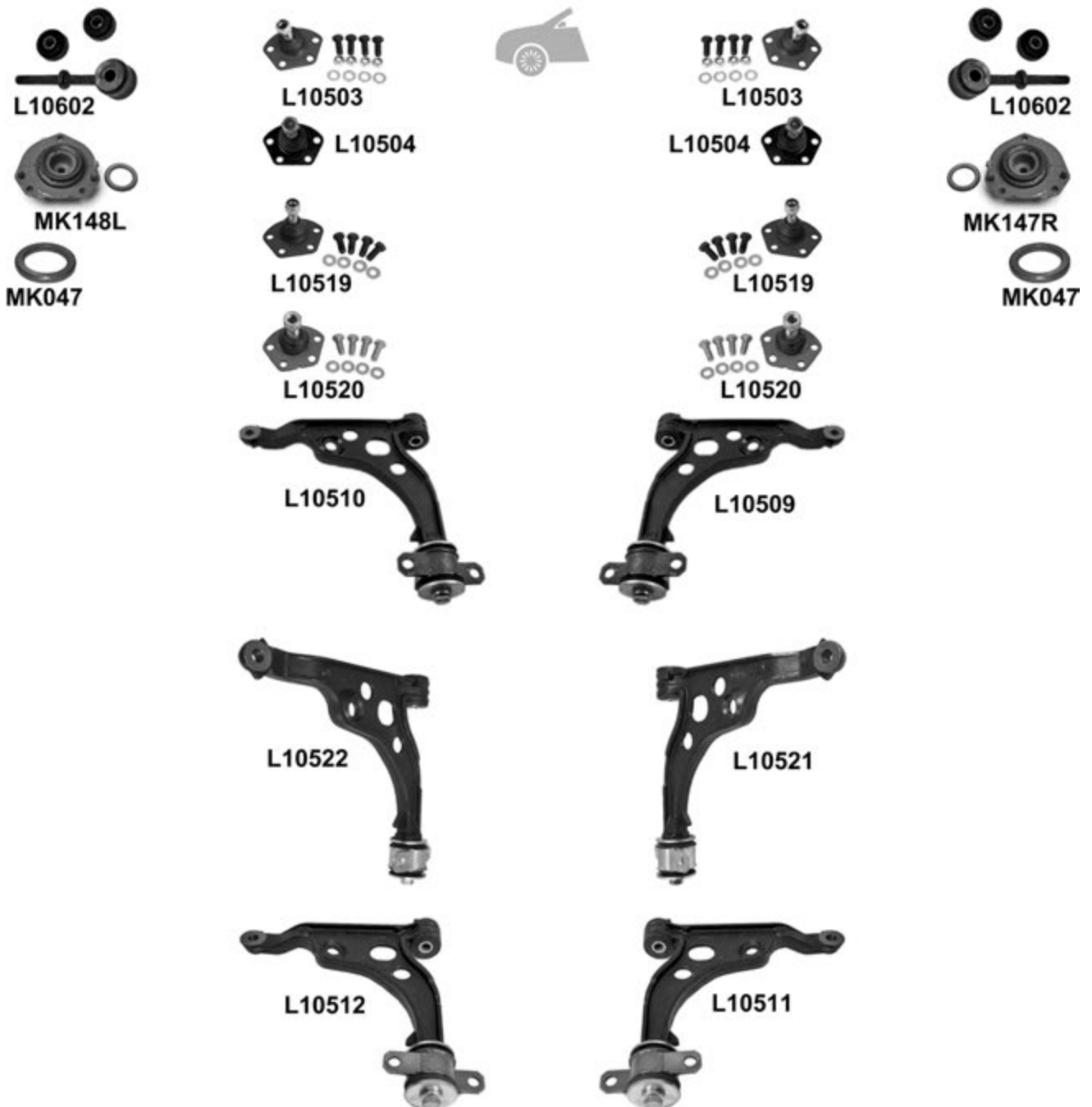
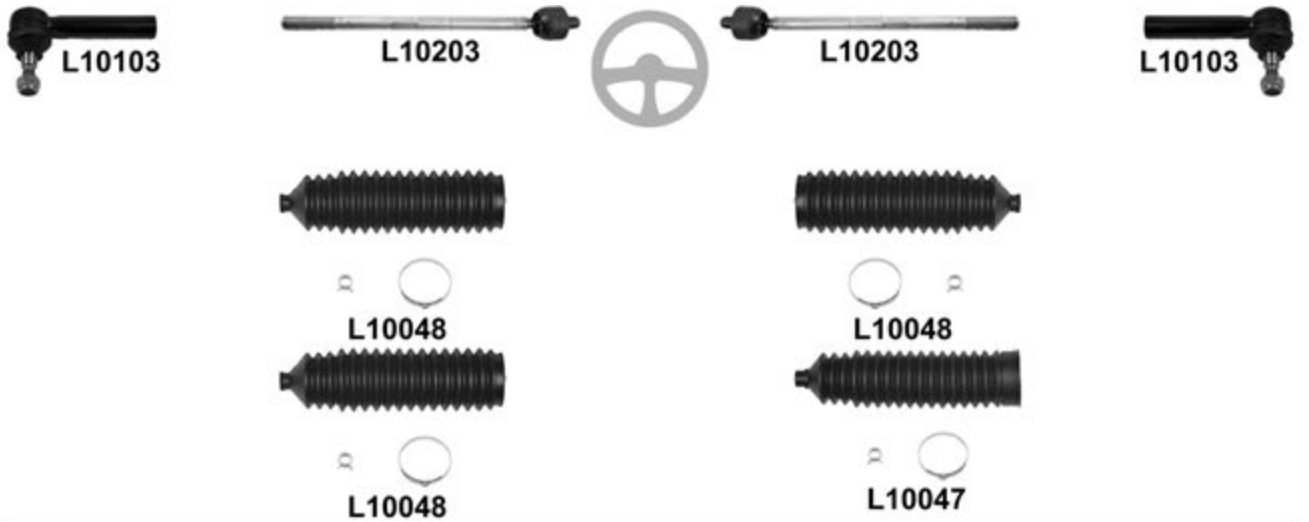

				← → Thread		Part Of	QPA			
⊕		↔		L1508	L1508	F 16x1,5 ∪		2	4336779	
				L1513	L1513	M 16x1,5 / F 16x1,5 ∪		2	9750001180	
						L3890			1	9750000380
						L3891			1	9750000280
					L15003	L15003			2	9941077
🚗		↓	→ 09.85	L1509	L1509			2	4388159	
			10.85 →	L1512	L1512			2	7567284	
		↓	10.85 →, (-) 1800			L10515		1	7695190	
					L10516			1	7695191	
					10.85 →, 1800		L10513 ¹		1	7695185
				L10514 ¹			1	7695186		
			(-) 1800	KIT	L10804	L10804			2	
			1800		L10805	L10805			2	
				KIT	L10900	L10900			2	4466980S
					MK046	MK046			2	4390179

Ducato (230 / 230L) 03.94 → 04.02



Ducato (230 / 230L) 03.94 → 04.02

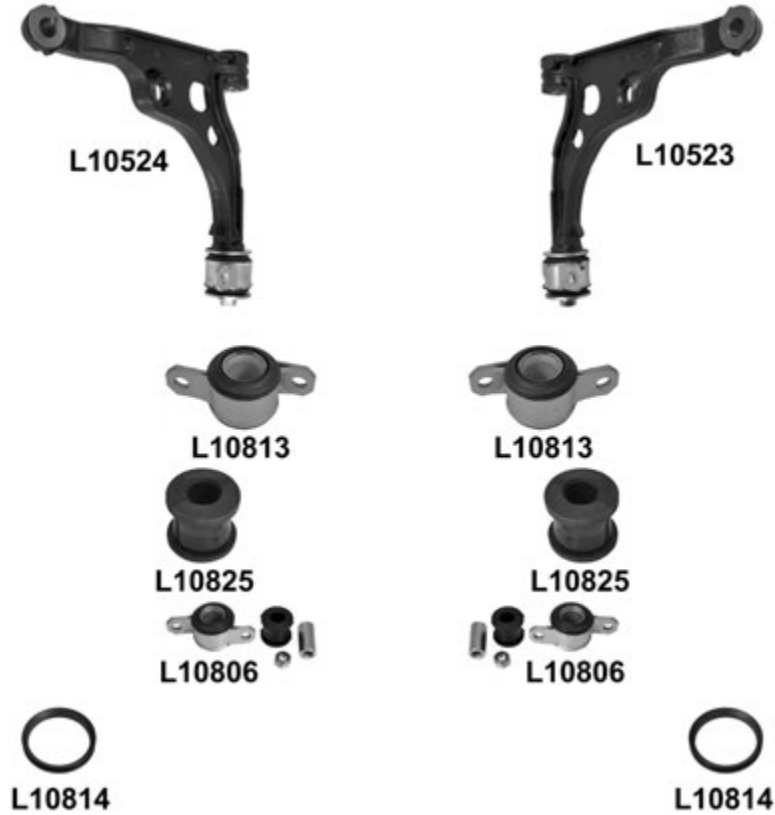

		i		← → Thread		Part Of	QPA	i	
		14.4mm	L10103	L10103	F 16x1,5 U		2	1471655080	
			L10203	L10203	M 16x1,5 / F 16x1,5 U		2	9945836	
				L10048 ^o	L10048 ^o			2	9946982
			, OE no. 9945837=set of 2		L10047 ^o			1	9945837
				L10048 ^o				1	9945837*
		↓ → 01.01, 10 - 14 Q, 16,2mm	L10503	L10503			2	1302368080	
		↓ → 01.01, 18 Q, 19,2mm, (16°)	L10504	L10504			2	1300473080	
		↓ 02.01 →, 10 - 15 Q, 20mm	L10519	L10519			2	1331640080	
		↓ 02.01 →, 18 Q, 24mm	L10520	L10520			2	1331641080	
		↓ → 01.01, 10 - 14 Q, 16,2mm		L10509			1	1317240080	
			L10510				1	1317241080	
		↓ 02.01 →, 10 - 15 Q, 20mm		L10521			1	1331940080	
			L10522				1	1331938080	
		↓ → 01.01, 18 Q, 19,2mm, (16°)		L10511			1	1317239080	
			L10512				1	1317238080	
		↓ 02.01 →, 18 Q, 24mm		L10523			1	1331939080	
			L10524				1	1331937080	
	↓ ▼		L10813	L10813			2	1338373080	
	↓ ▲ (+) metal sleeve		L10825	L10825			2	1320756080	
		KIT	L10806	L10806			2		
			L10602	L10602			2	1300716080S	
		(+) MK047 / L10814	KIT		MK147R		1	1307241080S	
				MK148L			1	1307242080S	
			MK047	MK047			2	1318573080	
RUBBER			L10814	L10814			2	1320987080	

Ducato (244) 04.02 →

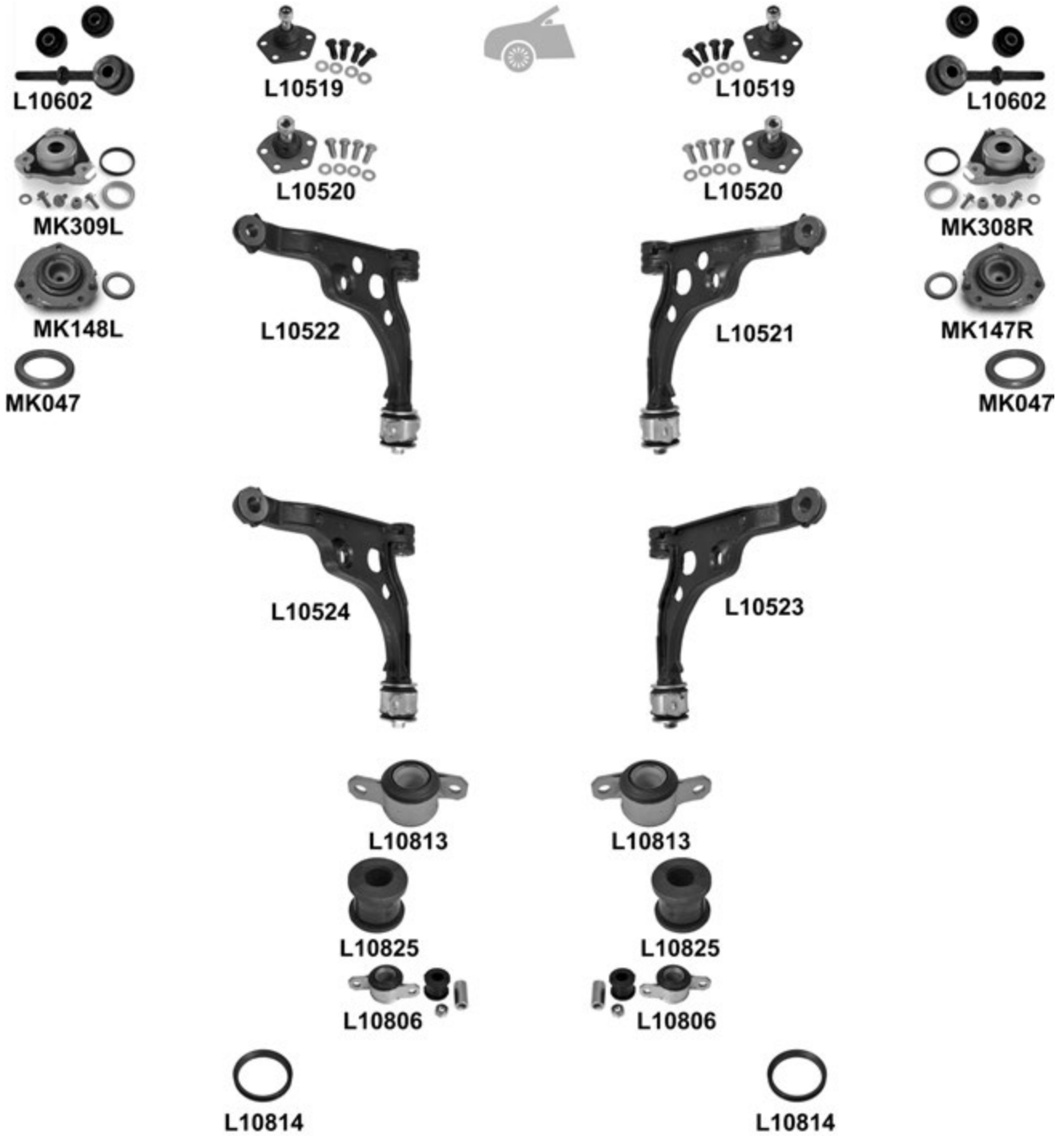

Ducato (244) 04.02 →

			←	→	Thread	Part Of	QPA		
		↔	→ 12.02, ch. → 17175291, 14.4mm	L10103	L10103	F 16x1,5 ∪	2	1306716080	
			12.02 →, ch. 17175292 →, 16.7mm	L10107	L10107	F 16x1,5 ∪	2	77362278	
				L10203	L10203	M 16x1,5 / F 16x1,5 ∪	2	9945836	
		⊥	10 - 15 Q, 20mm	L10519	L10519		2	1331640080	
			18 Q, 24mm	L10520	L10520		2	1331641080	
		⊥	10 - 15 Q, 20mm		L10521		1	1331940080	
					L10522		1	1331938080	
			18 Q, 24mm		L10523		1	1331939080	
					L10524		1	1331937080	
		⊥		L10813	L10813			2	1338373080
		⊥	(+) metal sleeve	L10825	L10825			2	1320756080
			KIT	L10806	L10806			2	
				L10602	L10602			2	1300716080S
			→ 03.03, (+) MK047 / L 10814	KIT		MK308R		1	1345896080
					MK309L		1	1345897080	
		04.03 → 07.04, (+) MK047 / L 10814	KIT		MK147R		1	1339628080	
					MK148L		1	1339629080	
		08.04 →, (+) MK047 / L 10814	KIT		MK308R		1	1345896080	
				MK309L		1	1345897080		
				MK047	MK047			2	1318573080
RUBBER				L10814	L10814			2	1320987080

Ducato 07.06 →

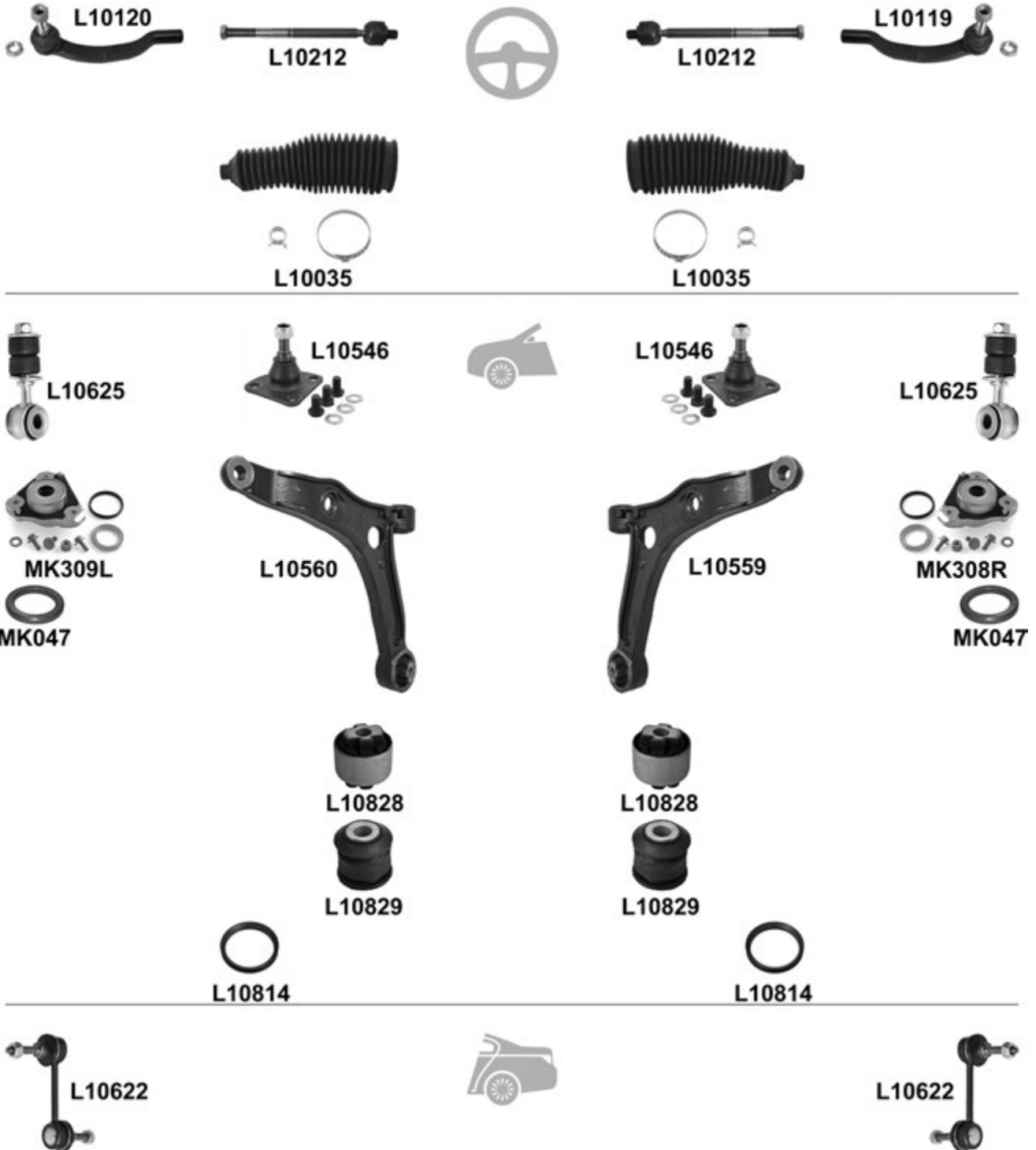

Ducato 07.06 →

				←	→	Thread	Part Of	QPA		
		↔		L10119		F 16x1,5 ∪		1	77364009	
			L10120		F 16x1,5 ∪		1	77364253		
				L10212	L10212	∪		2		
				L10035 ⁰	L10035 ⁰			2	77364254	
		⊥		L10546	L10546			2	50705629	
		⊥			L10559			1	1352226080	
				L10560				1	1352228080	
		⊥▼		L10828	L10828			L10559/L10560	2	51705198
		⊥▲		L10829	L10829			L10559/L10560	2	51705197
				L10625	L10625			2		
			(+) MK047 / L10814	KIT		MK308R			1	1350788080
					MK309L				1	1350789080
			MK047	MK047				2	1318573080	
RUBBER			L10814	L10814				2	1320987080	
			L10622	L10622				2	1355449080	

Duna 01.87 →

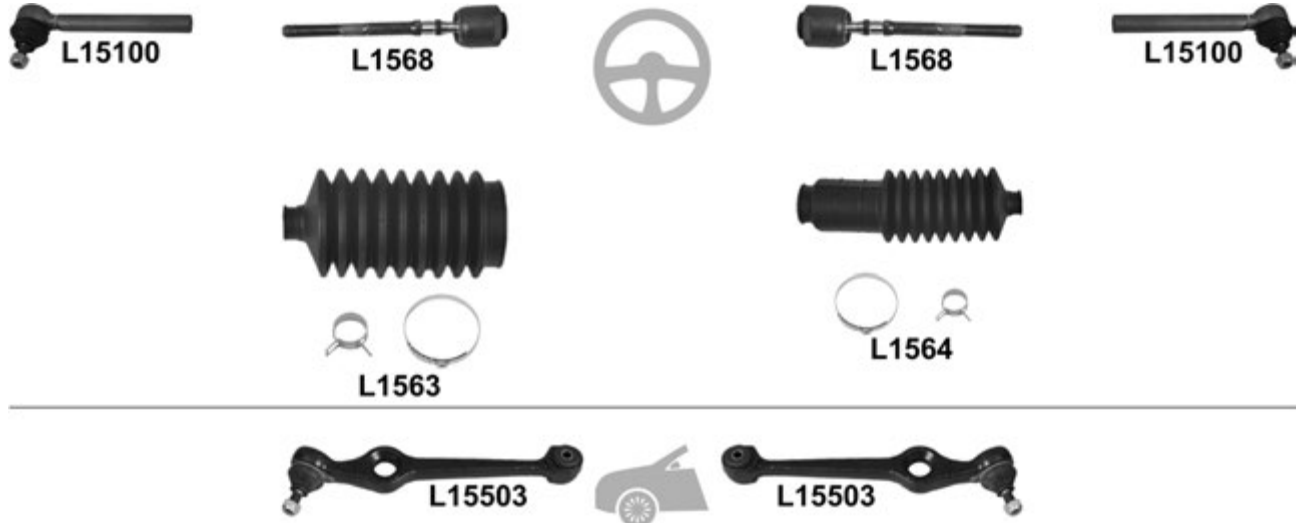

				←	→	Thread	Part Of	QPA	
		↔		L15100	L15100	F 12x1,5 ∪		2	7584628
			L1568	L1568	M 12x1,5 / F 14x1,5 ∪		2	5960321	
					L1564			1	4371156
				L1563				1	4371155
		⊥	<input checked="" type="checkbox"/>	L15503	L15503			2	7591277

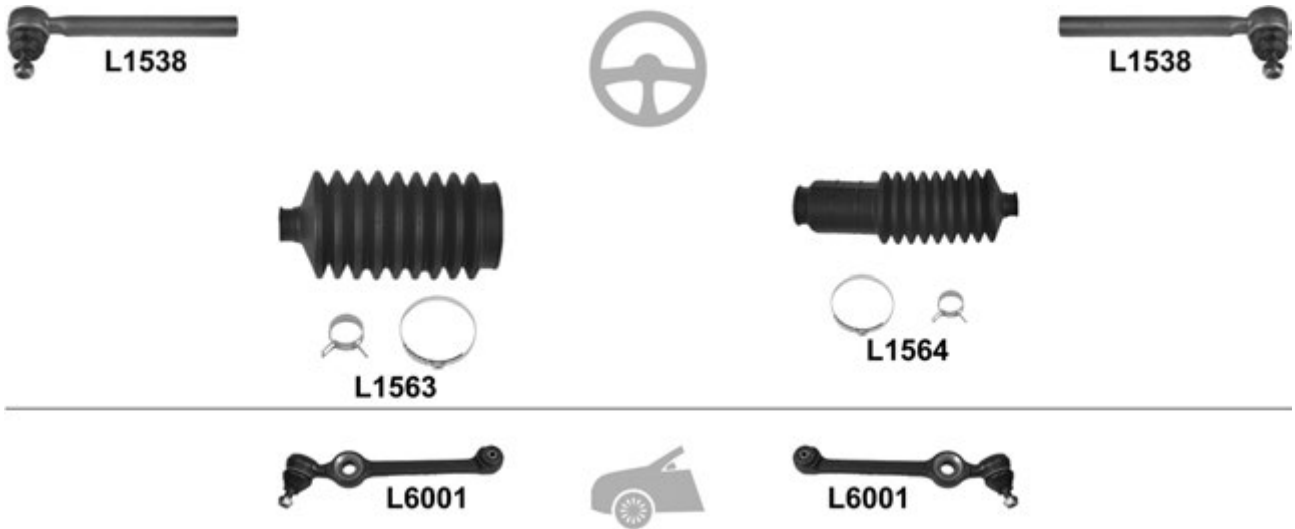
Fiorino (127, 147) 10.77 → 10.82

			i	←	→	Thread	Part Of	QPA	i	
⊕		↔		L1538	L1538	F 14x1 ∪		2	4257066	
					L1564			1	4371156	
				L1563				1	4371155	
⊖		⊥		<input checked="" type="checkbox"/>	L6001	L6001			2	4364095

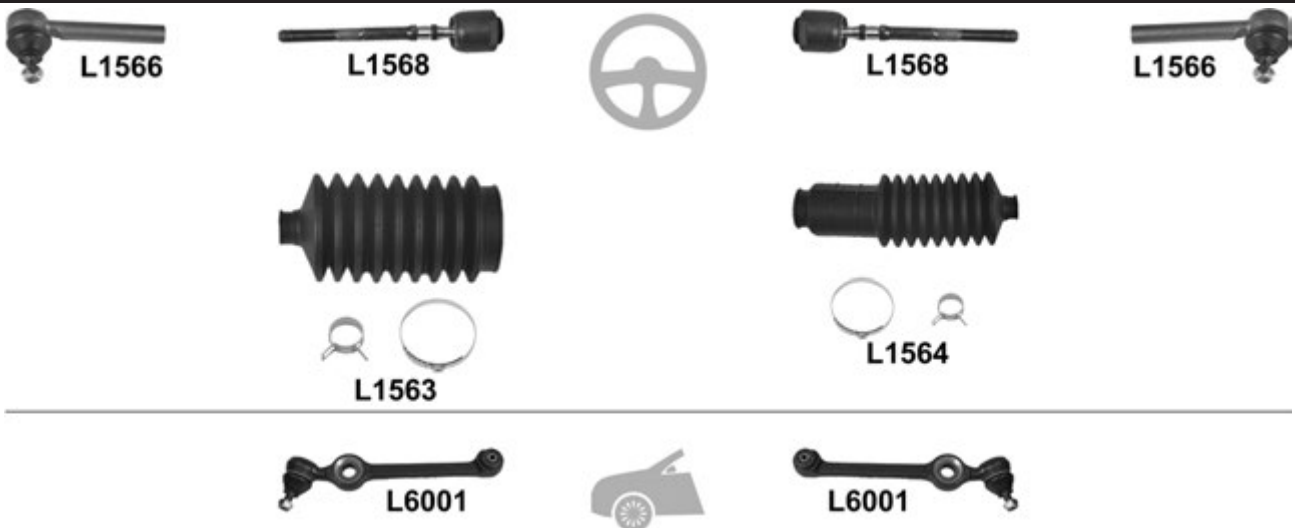
Fiorino (127, 147) 10.82 → 12.88

			i	←	→	Thread	Part Of	QPA	i	
⊕		↔		L1566	L1566	F 12x1,5 ∪		2	5983406	
				L1568	L1568	M 12x1,5 / F 14x1,5 ∪		2	5960321	
					L1564			1	4371156	
				L1563				1	4371155	
⊖		⊥		<input checked="" type="checkbox"/>	L6001	L6001			2	4364095

Fiorino (146 / Uno) 01.88 → 10.92

				←	→	Thread	Part Of	QPA	
⊕		↔		L15100	L15100	F 12x1,5 ∪		2	7584628
				L1568	L1568	M 12x1,5 / F 14x1,5 ∪		2	5960321
					L1564			1	4371156
				L1563				1	4371155
↙		⊥		<input checked="" type="checkbox"/>	L15503	L15503		2	7591277
				L15116	L15116	F 16x1,5 ∪		2	7693816

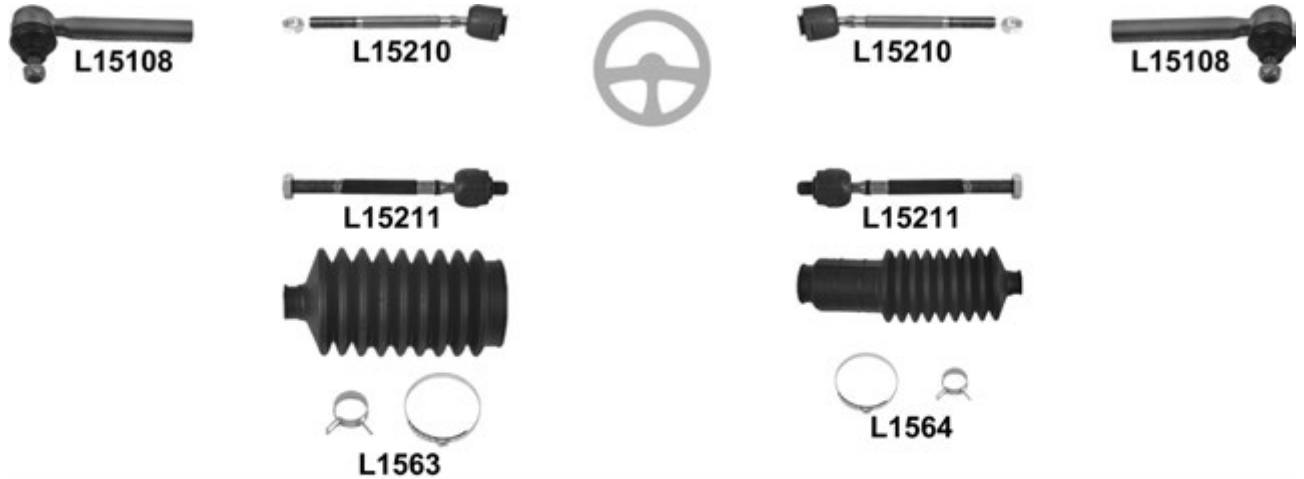
Fiorino (146 / Uno) 11.92 → 05.01

				←	→	Thread	Part Of	QPA	
⊕		↔		L15108	L15108	F 14x1,5 ∪		2	7690960
			⊕	L15210	L15210	M 14x1,5 / F 14x1,5 ∪		2	7076231
			⊕	L15211	L15211	M 14x1,5 / M 14x1,5 ∪		2	7077206
			⊕		L1564			1	4371156
				L1563				1	4371155
↙		⊥		<input checked="" type="checkbox"/>	L15503	L15503		2	7674825
				L15117	L15117	F 18x1,5 ∪		2	7524715

Fiorino 02.08 →

				← → Thread		Part Of	QPA		
⊕	↔			L10129	F 14x1,5 ⊕		1	77364569	
				L10130	F 14x1,5 ⊕		1	77364568	
	↔			L10220	L10220	M 14x1,5 / M 14x1,5 ⊕		2	
				L10016	L10016			2	77364571
⊖	⊥	→ 05.10	<input checked="" type="checkbox"/>		L15557			1	55703627
				L15558			1	55703629	
	⊥	↕		L15811	L15811			2	55700751
				L10827	L10827			2	55703312
	↔			L10621	L10621			2	51815480
			→ 06.13	KIT		MK313R		1	51839931
			MK314L				1	51839975	

Freemont 08.11 →

				← → Thread		Part Of	QPA		
⊕	↔			L80100	L80100	F 14x1,5 ⊕	1	K68141058AA	

Grande Punto (199) 10.05 →

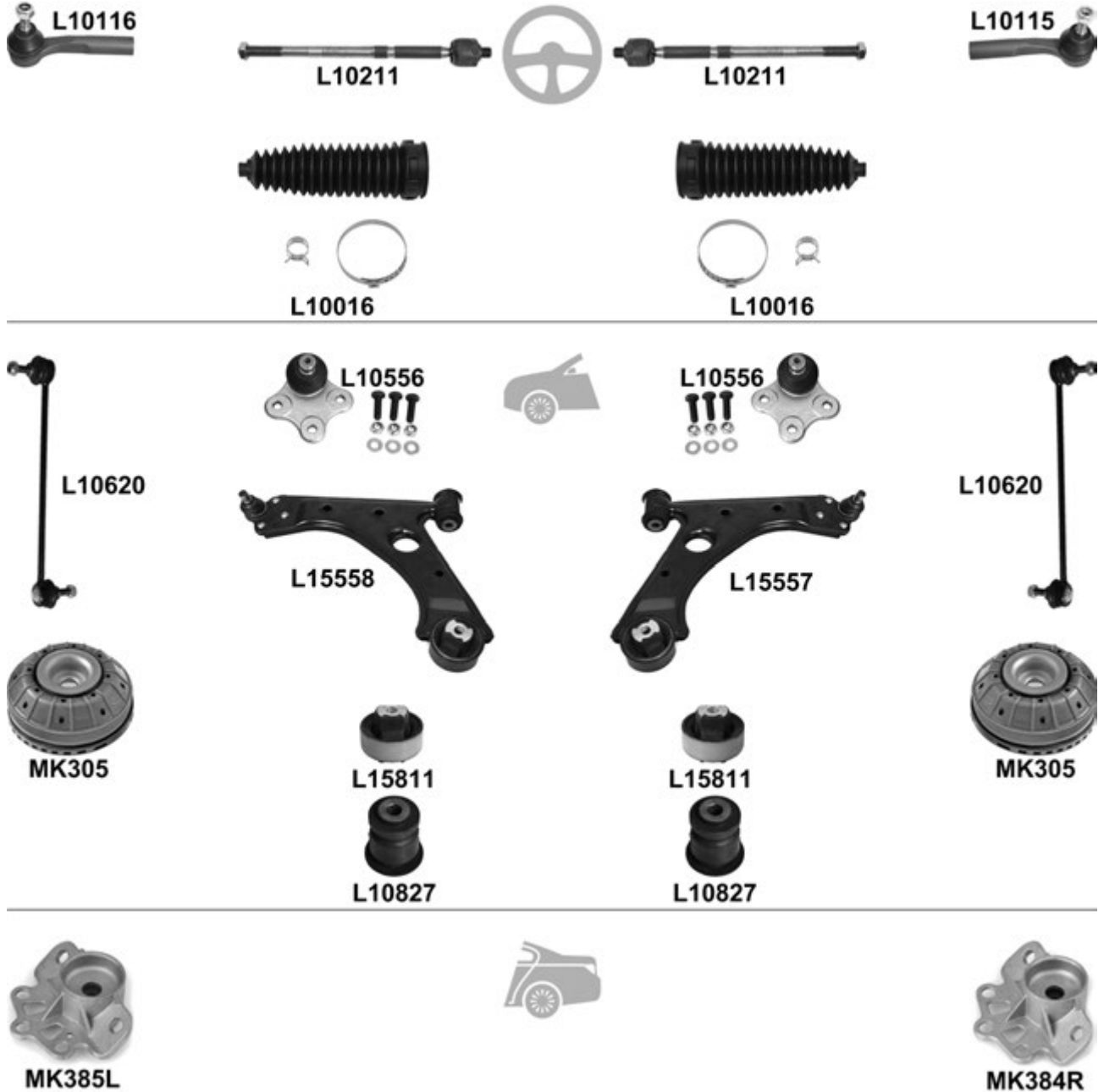

			←	→	Thread	Part Of	QPA		
		↔		L10115	F 14x1,5 U		1	77363830	
				L10116	F 14x1,5 U		1	77363829	
				L10211	L10211	M 14x1,5 / M 14x1,5 U		2	
				L10016	L10016			2	77363828
		⊥		L10556	L10556		2	51783056	
			<input checked="" type="checkbox"/>		L15557		1	55703627	
				L15558			1	55703629	
				L15811	L15811		2	55700751	
				L10827	L10827		2	55703312	
				L10620	L10620		2	55700753	
				KIT	MK305	MK305	2	51831016	
						MK384R	1	55701901	
						MK385L	1	55701902	

Idea 12.03 →

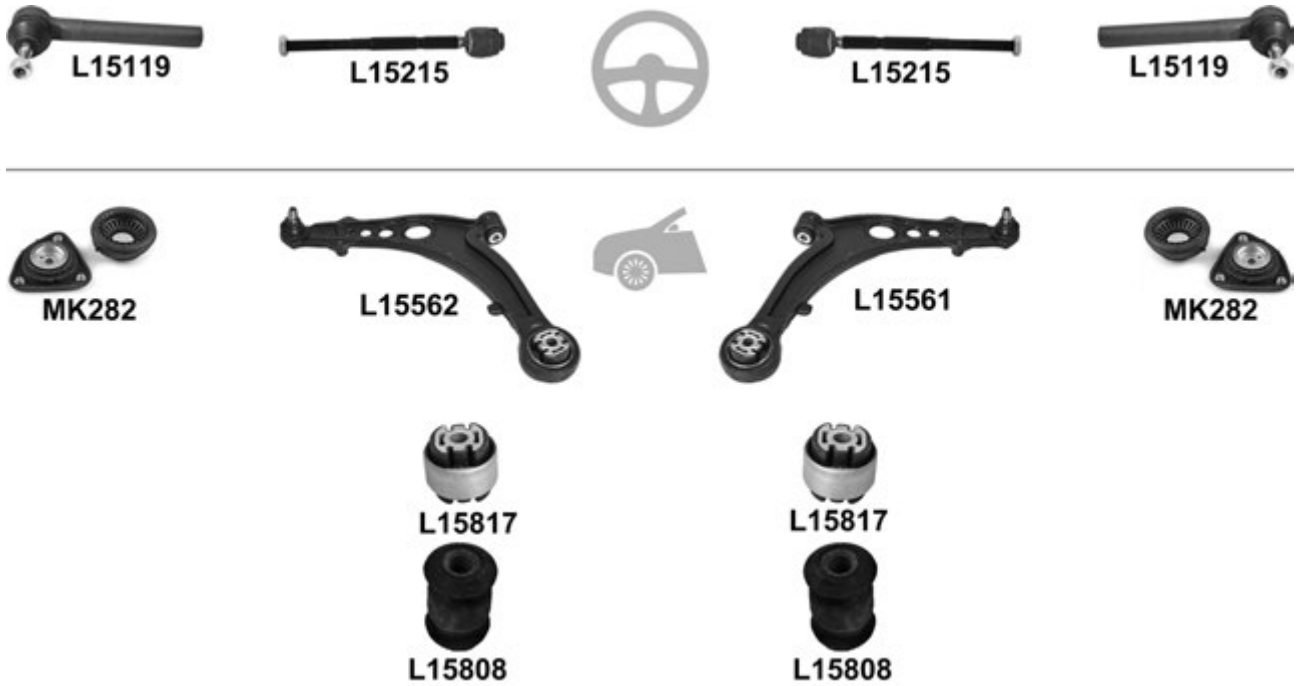

				← → Thread		Part Of	QPA		
⊕		↔		L15119	L15119	F 14x1,5 ∪		2	77362503
				L15215	L15215	M 14x1,5 / F 14x1,5 ∪		2	77362502
🚗		⊥			L15561			1	50703231
			<input checked="" type="checkbox"/>		L15562			1	50703232
		⊥▼		L15817	L15817			2	
		⊥▲		L15808	L15808			2	
			ch. → 0117995	KIT	MK282	MK282		2	51830518

Linea 06.07 →

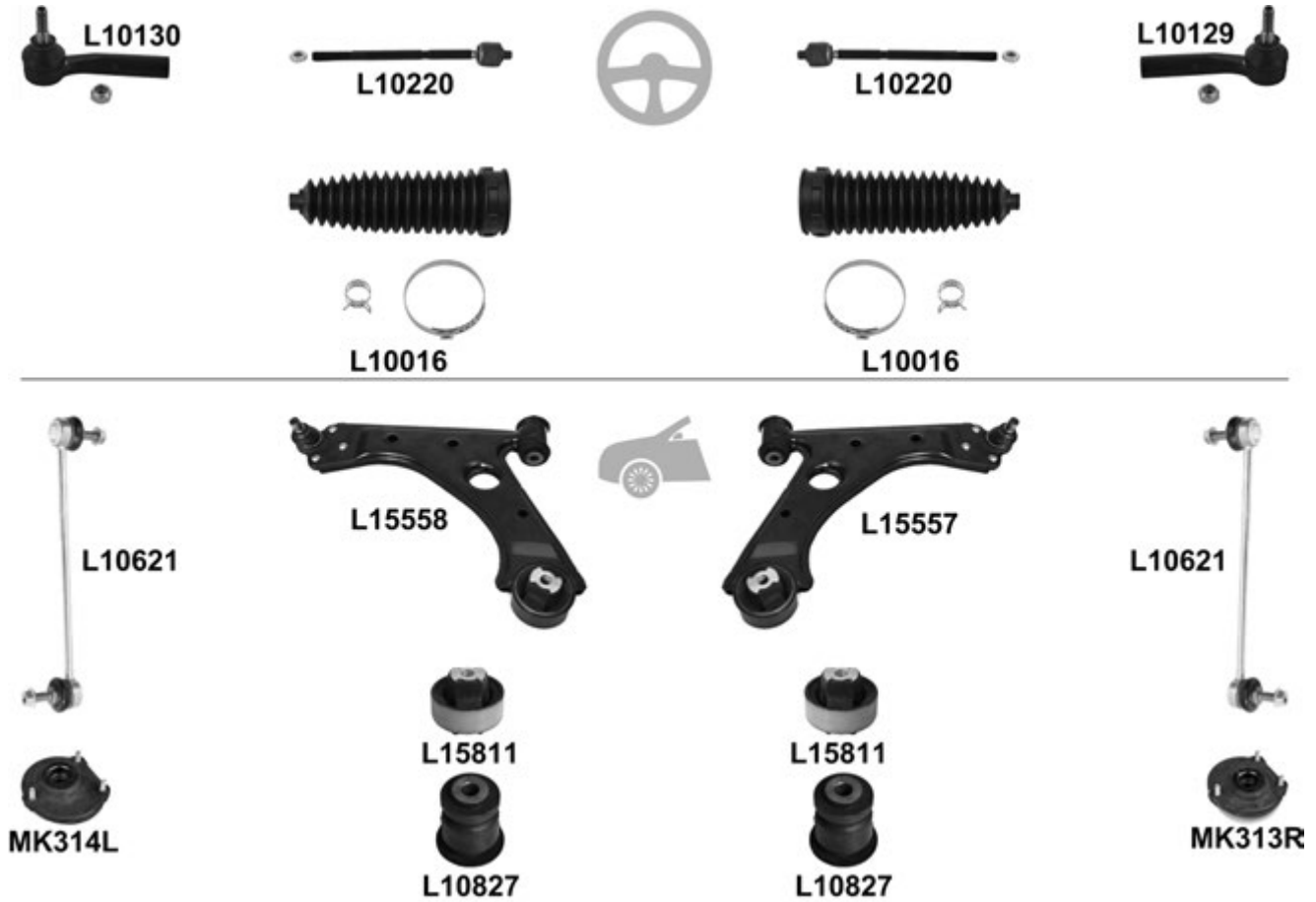

						←	→	Thread	Part Of	QPA		
⊕		↔			L10129			F 14x1,5 ∪		1	77364569	
					L10130			F 14x1,5 ∪		1	77364568	
					L10220	L10220		M 14x1,5 / M 14x1,5 ∪		2		
					L10016	L10016				2	77364571	
⊖		⊥		<input checked="" type="checkbox"/>				L15557		1	55703627	
						L15558				1	55703629	
						L15811	L15811			2	55700751	
		⊥					L10827	L10827			2	55703312
							L10621	L10621			2	51815480
				→ 06.13	KIT			MK313R			1	51839931
						MK314L			1	51839975		

Marea (185) 09.96 →
Marea Weekend (185) 09.96 →

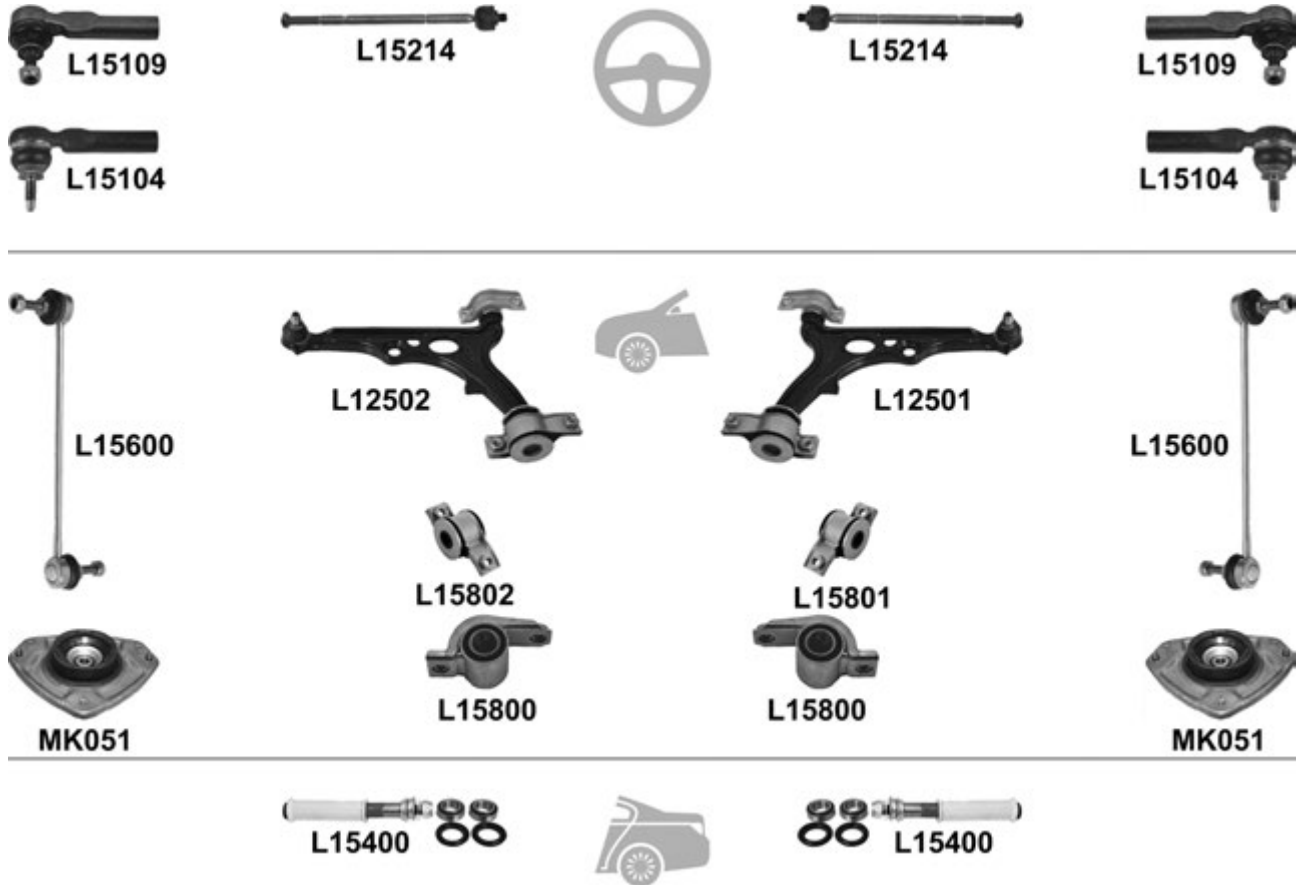

		i	←	→	Thread	Part Of	QPA	i	
⊕		↔	(-) 2.0, 2.4 TD, 2.4 JTD, 12mm	L15109	L15109	∪	2	9947714	
			2.0, 2.4 TD, 2.4 JTD, 12,5mm	L15104	L15104	∪	2	9947926	
				L15214	L15214	M 14x1,5 / M 14x1,5 ∪	2	9947713	
		⊥		<input checked="" type="checkbox"/>	L12501		1	60809814	
					L12502		1	60809813	
		⊥↘			L15801	L12501	1	7601068	
		⊥↙			L15802	L12502	1	7601065	
		⊥↗			L15800	L15800	L12501/L12502	2	7601064
					L15600	L15600		2	46413122
			KIT	MK051	MK051		2	46469709	
			KIT	L15400	L15400		2		

Multipla (186) 04.99 →

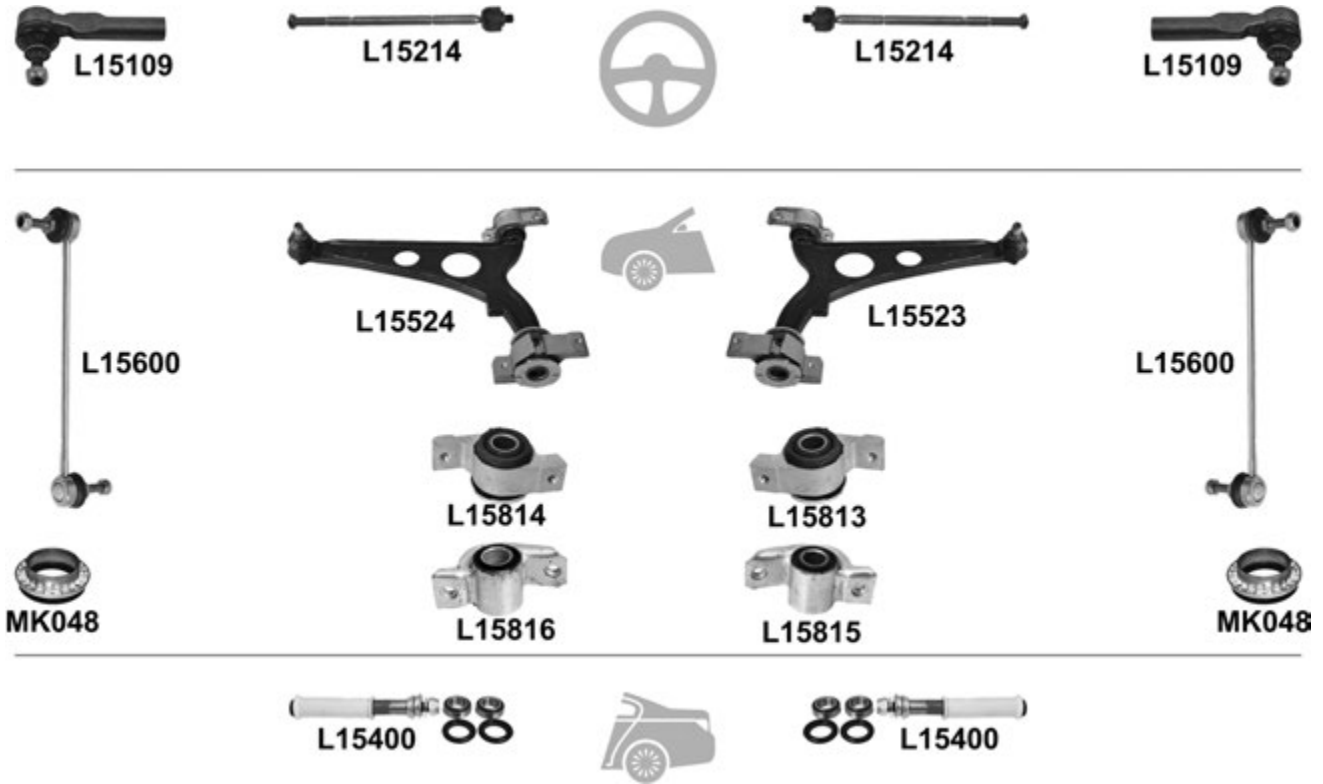

						←	→	Thread	Part Of	QPA			
		↔		L15109	L15109			F 14x1,5 U		2	9947714		
				L15214	L15214			M 14x1,5 / M 14x1,5 U		2	9947713		
		⊥	<input checked="" type="checkbox"/>		L15523				L15523	1	46522142		
				L15524					L15524	1	46525407		
		⊥▼				L15813				L15523	1		
						L15814				L15524	1		
		⊥▲				L15815				L15523	1		
						L15816				L15524	1		
				L15600	L15600					2	46413122		
				MK048	MK048					2	1303672080		
			KIT	L15400	L15400					2			

Palio / Albea 04.96 →
 Palio Weekend (178DX) 04.96 →



L15006

L15006



L15008

L15008

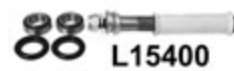

Palio / Albea 04.96 →
Palio Weekend (178DX) 04.96 →

		i		← →		Thread	Part Of	QPA i		
		↔		L15113		M 12x1,5 ☺		1	46456660	
				L15114		M 12x1,5 ☺		1	46456189	
			∅12mm, ∅ 55mm, L= 170mm	L15006 ⁰	L15006 ⁰			2	7079340	
			∅ 13,5mm, ∅ 53mm, L= 193mm	L15008 ⁰	L15008 ⁰			2	98845882	
		⊥	→ 02.01	L15511	L15511			2	46437959	
			03.01 →	L15549	L15549			2	46842581	
		⊥		<input checked="" type="checkbox"/>	L15513				1	46454596
				<input checked="" type="checkbox"/>	L15514				1	46454595
				<input checked="" type="checkbox"/>	L15515				1	46454598
				<input checked="" type="checkbox"/>	L15516				1	46454597
				<input checked="" type="checkbox"/>	L15515				1	46454598
				<input checked="" type="checkbox"/>	L15516				1	46454597
				<input checked="" type="checkbox"/>	L15551				1	51714207
				<input checked="" type="checkbox"/>	L15552				1	51714208
				<input checked="" type="checkbox"/>	L15551				1	51714207
				<input checked="" type="checkbox"/>	L15552				1	51714208
			KIT	MK374R				1	82491440	
				MK375L				1	82491441	
			KIT	L15400	L15400			2		

Panda 10.80 → 07.04

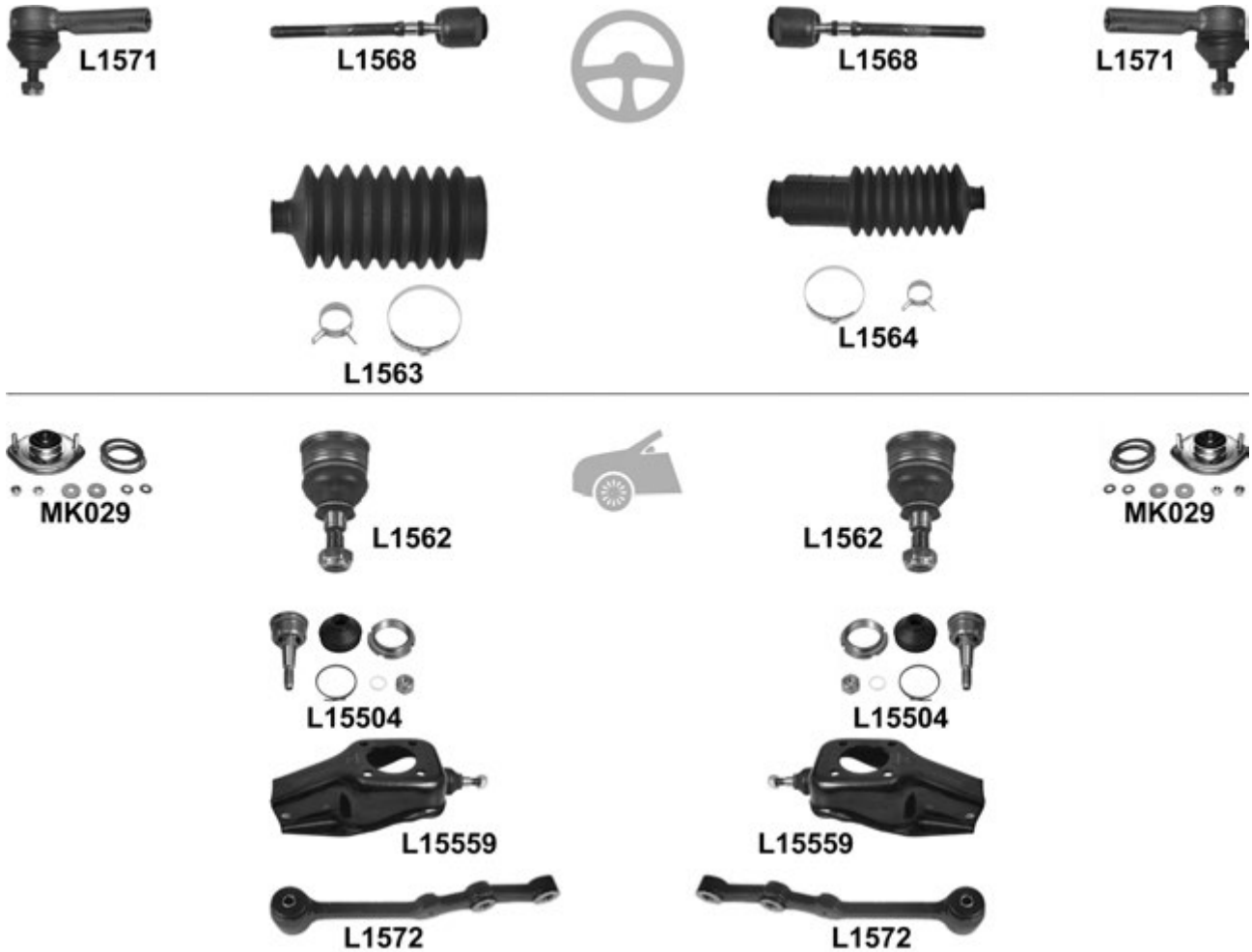

				← → Thread		Part Of	QPA	i
⊕		↔	10.82 →	L1571	L1571	F 12x1,5 U	2	5960835
			10.82 →	L1568	L1568	M 12x1,5 / F 14x1,5 U	2	5960321
					L1564		1	4371156
					L1563		1	4371155
⊖		⊥		L1562	L1562		2	4402649
		⊥		KIT L15504 L15504			2	
		⊥	(+) 4WD, (+) L 1562	L15559	L15559		2	5995503
			(+) 4WD	L1572	L1572		2	7601261
				MK029	MK029		2	

Panda (169) 09.03 →

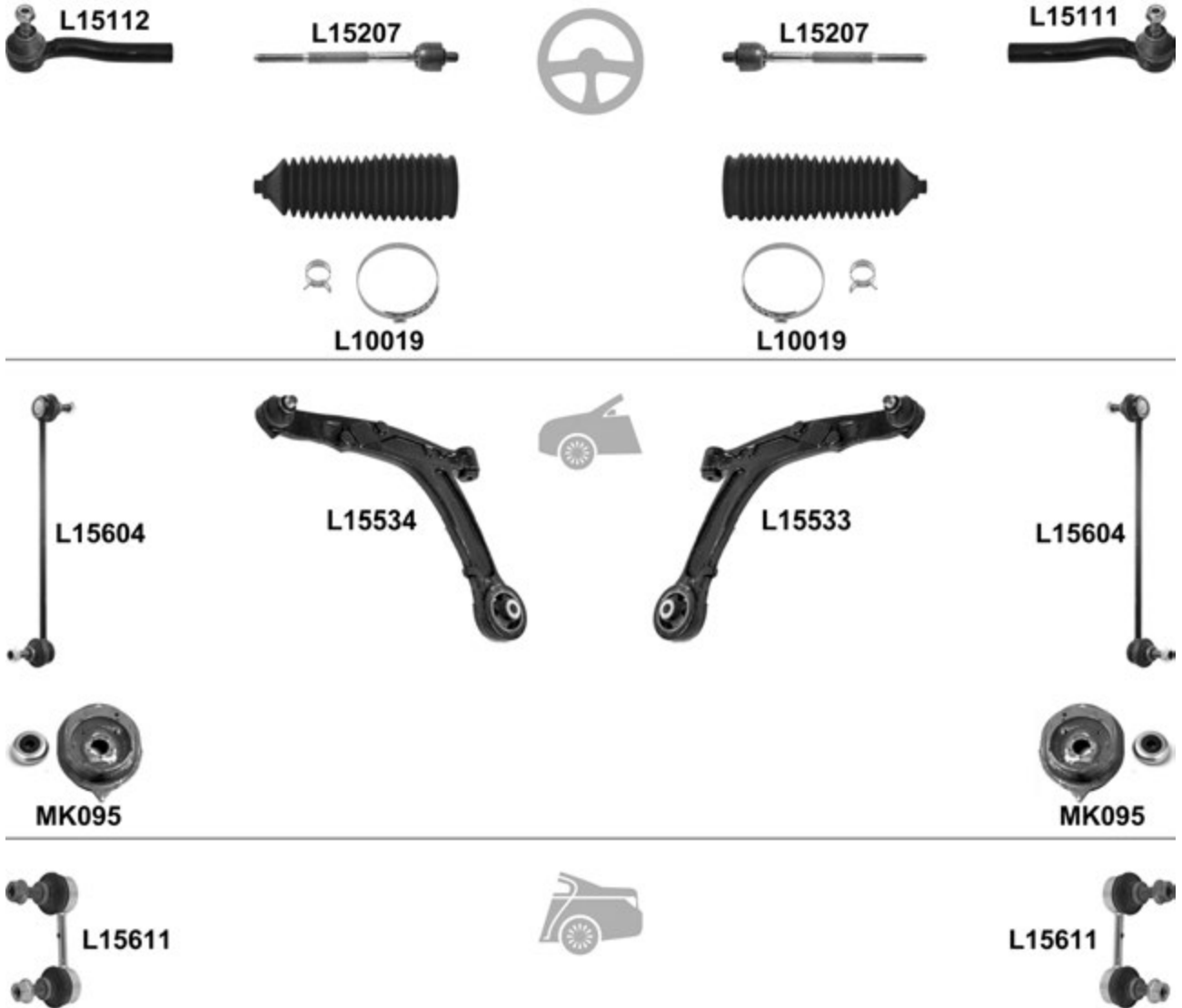

				← → Thread		Part Of	QPA		
		↔		L15111	F 12x1,5 ∪		1	77362508	
				L15112	F 12x1,5 ∪		1	77362507	
				L15207	L15207	M 12x1,5 / M 14x1,5 ∪	2	77362506	
			Thermoplast	L10019	L10019		2	77362509	
		⊥	(-) Abarth	<input checked="" type="checkbox"/>	L15533		1	50703129	
				L15534			1	50703128	
			(-) Abarth	L15604	L15604		2	50703296	
				KIT	MK095	MK095	2	46746544	
			4x4	L15611	L15611		2	50704671	

Panda (312, 323) 02.12 →

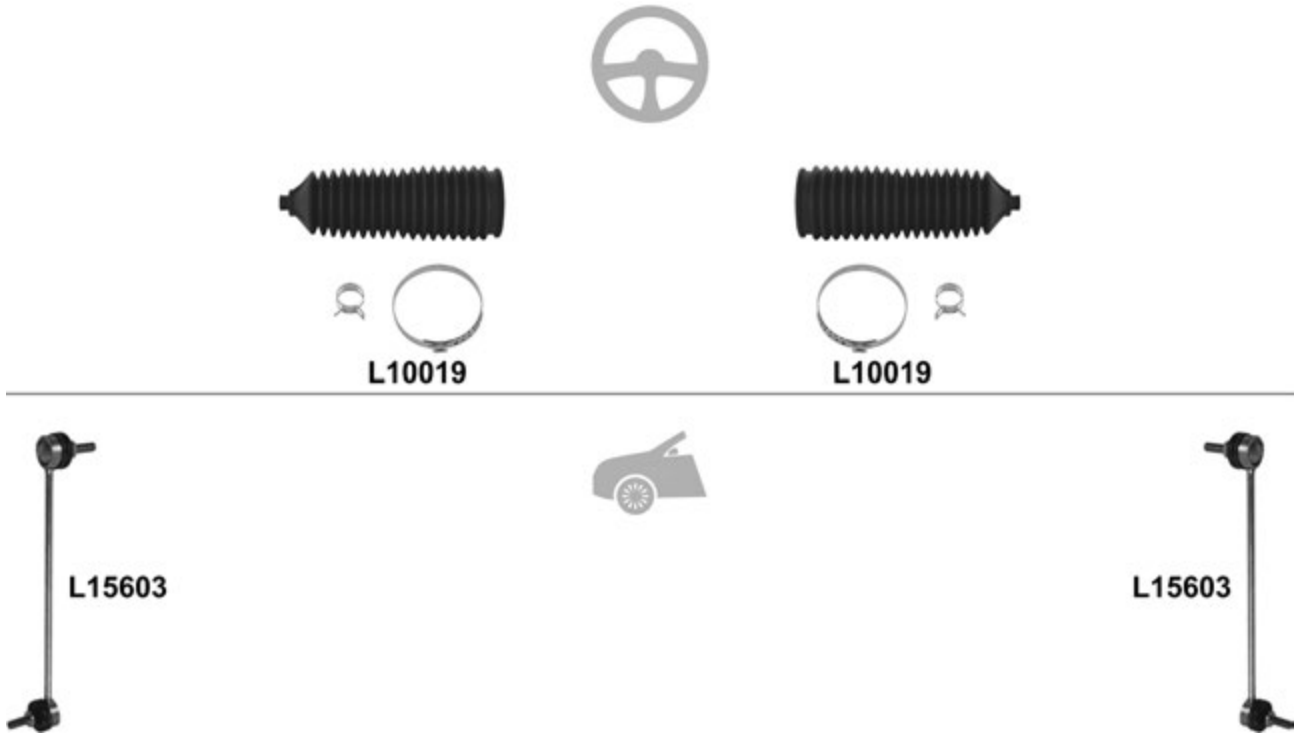

		i	←	→	Thread	Part Of	QPA	i
		Thermoplast	L10019	L10019			2	77362509
			L15603	L15603			2	50700464

Punto (176) 09.93 → 09.99
 Punto Cabrio (176C) 04.94 → 06.00
 Punto Van (176L) 04.96 → 02.00

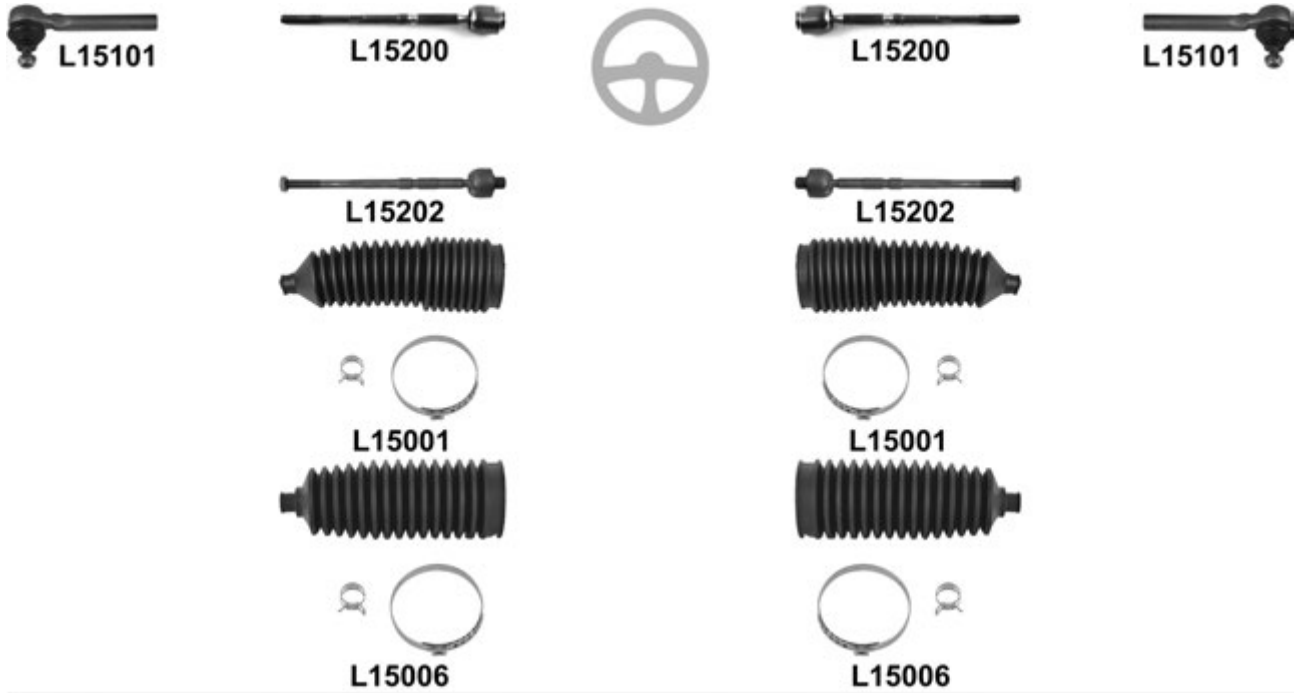

Punto (176) 09.93 → 09.99
 Punto Cabrio (176C) 04.94 → 06.00
 Punto Van (176L) 04.96 → 02.00

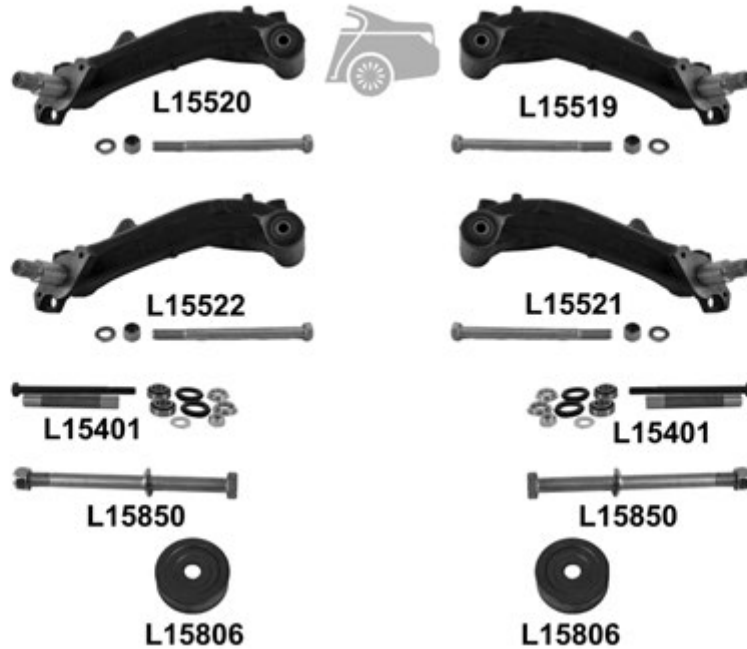

				← → Thread		Part Of	QPA				
⊕		↔		L15101	L15101	F 12x1,5 U		2	7752285		
				L15200	L15200	M 12x1,5 / F 14x1,5 U		2	7701491		
				L15202	L15202	M 12x1,5 / M 16x1,5 U		2	9945562		
				L15001	L15001			2	7645160		
				L15006 ⁰	L15006 ⁰			2	9945564		
		⊥			L15507			1	46430003		
					L15508			1	46430002		
						L15803		L15507	1	7775343	
						L15804		L15508	1	7775344	
						L15805	L15805	L15507/L15508	2	7673581	
		⊥		KIT	MK050	MK050		2	7775940		
				KIT	L15401	L15401			2		
				KIT	L15850	L15850			2	7719062	
					(-)		L15519			1	7736515
							L15520			1	7736514
					(+)		L15521			1	7769901
							L15522			1	7769900
				L15806	L15806		Hub carrier	2	46476755		

Punto (188) 09.99 →

Punto Van (188AX) 02.00 →



L15101

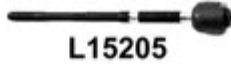

L15205

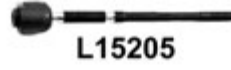

L15205



L15101



L15006

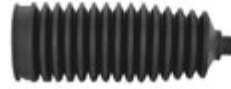

L15006



MK095



L15530



L15529



MK095



L15807



L15807



L15808



L15808



Thread

Part Of

QPA

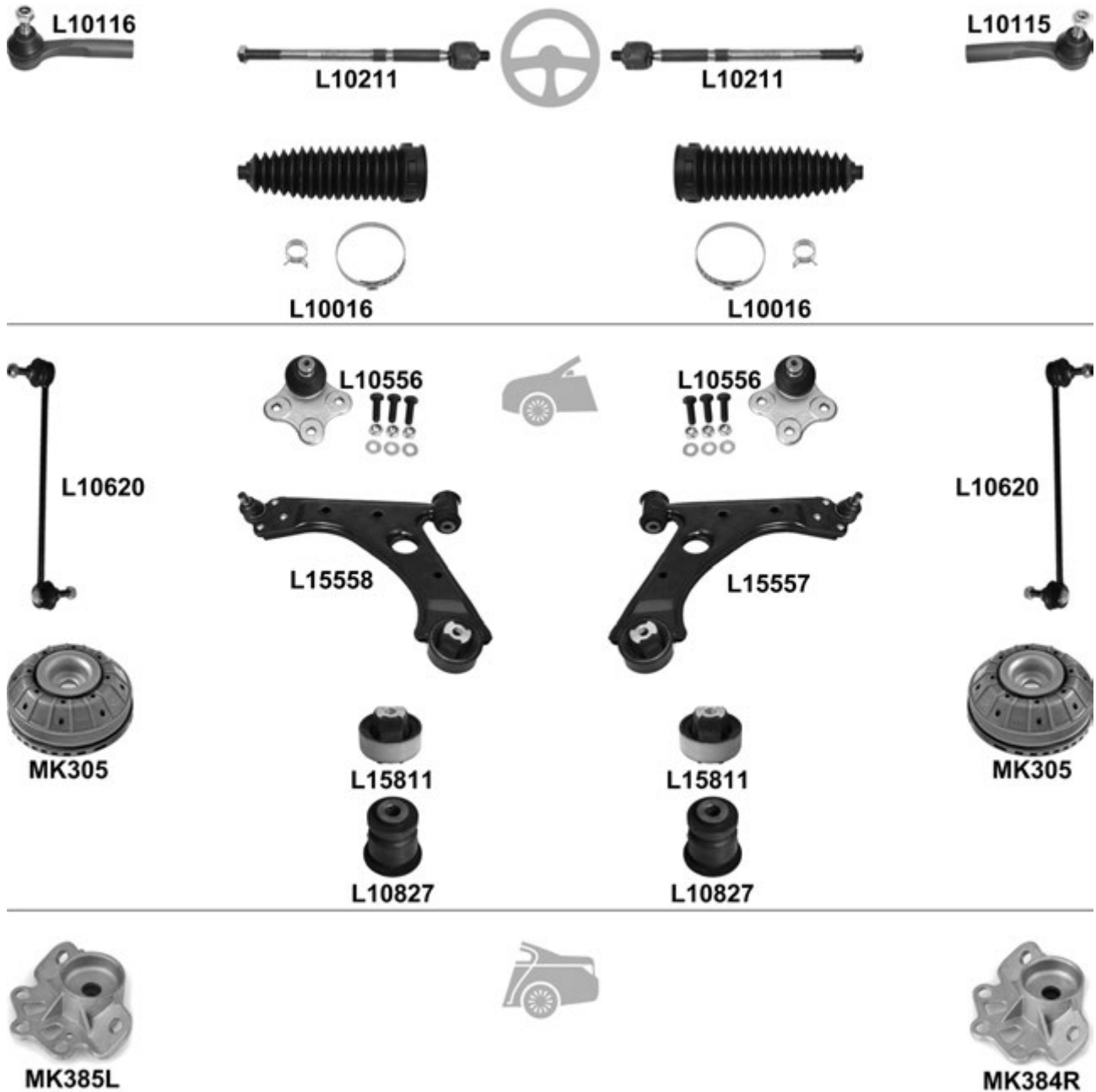

		←	→	Thread	Part Of	QPA	
		↔		L15101 L15101 F 12x1,5 ♂		2	9946949
				L15205 L15205 M 12x1,5 / M 14x1,5 ♂		2	9948343
		Electric		L15006 ^o L15006 ^o		2	9945564
		⊥	<input checked="" type="checkbox"/>	L15529		1	46551790
		⊥		L15530		1	46551732
		⊥▼		L15807 L15807		2	
		⊥▲		L15808 L15808		2	
				KIT MK095 MK095		2	46746544

Punto (199_) 03.12 →

		i	←	→	Thread	Part Of	QPA	i
⊕		↔		L10115	F 14x1,5 U		1	77363830
				L10116	F 14x1,5 U		1	77363829
			L10211	L10211	M 14x1,5 / M 14x1,5 U		2	
				L10016	L10016			2
🚗		⊥		L10556	L10556		2	51783056
			<input checked="" type="checkbox"/>		L15557		1	55703627
		⊥		L15558			1	55703629
			↙	L15811	L15811		2	55700751
		↗		L10827	L10827		2	55703312
				L10620	L10620		2	55700753
			KIT	MK305	MK305		2	51831016
		1.2, 1.4 Van Model 199AXB1A/199BXB1A			MK384R		1	55701901
				MK385L		1	55701902	

Punto Evo (199_) 09.09 →

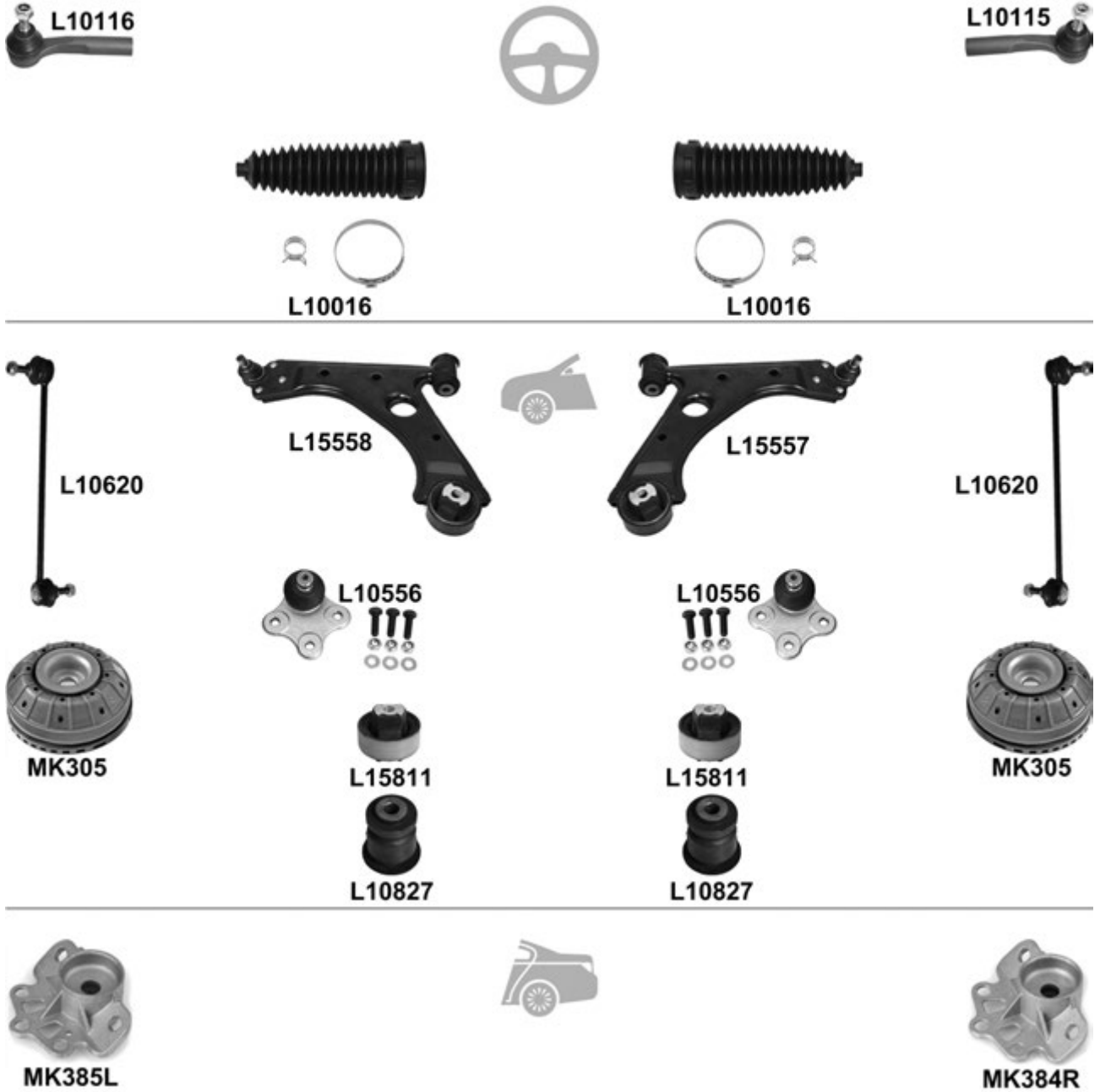

			←	→	Thread	Part Of	QPA	
		↔		L10115	F 14x1,5 U		1	77363830
				L10116	F 14x1,5 U		1	77363829
		↓		L10016	L10016		2	77363828
			<input checked="" type="checkbox"/>	L15557			1	55703627
				L15558			1	55703629
				L10556	L10556		2	51783056
				L15811	L15811		2	55700751
				L10827	L10827		2	55703312
				L10620	L10620		2	55700753
			KIT	MK305	MK305		2	51831016
				MK385L	MK384R		1	55701901
			1.2, 1.4 Van Model 199AXB1A/199BxB1A		MK385L		1	55701902

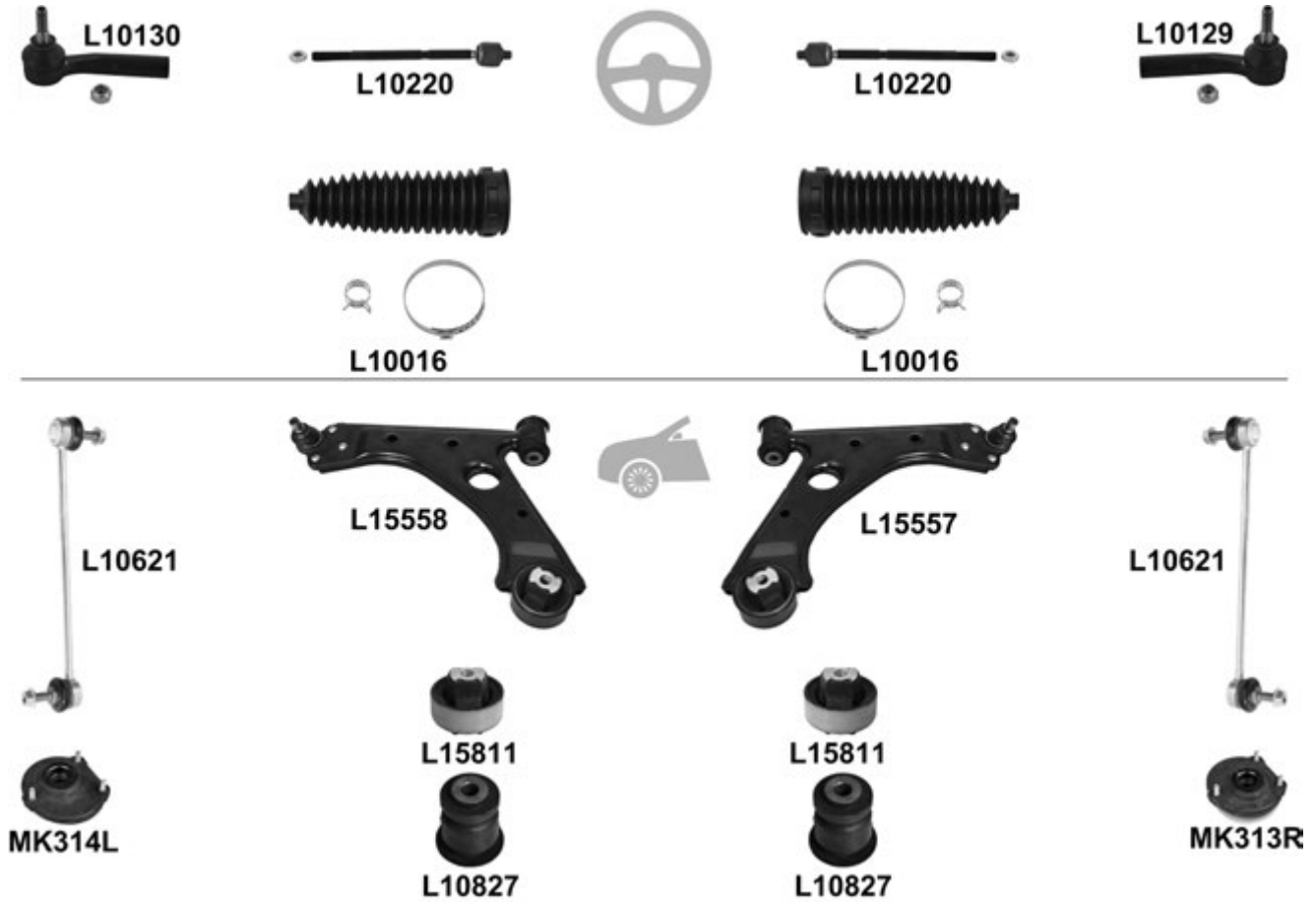
Qubo 09.08 →

				← → Thread		Part Of	QPA			
⊕		↔		L10129	F 14x1,5 ⊕		1	77364569		
				L10130	F 14x1,5 ⊕		1	77364568		
				L10220	L10220	M 14x1,5 / M 14x1,5 ⊕		2		
					L10016	L10016			2	77364571
🚗		⊥	(-) 1.4 G	<input checked="" type="checkbox"/>	L15557			1	55703627	
				<input checked="" type="checkbox"/>	L15558			1	55703629	
			1.4 G, → 05.10	<input checked="" type="checkbox"/>	L15557			1	55703627	
				<input checked="" type="checkbox"/>	L15558			1	55703629	
		⊥▼		L15811	L15811			2	55700751	
		⊥▲		L10827	L10827			2	55703312	
				L10621	L10621			2	51815480	
				KIT	MK313R			1	51839931	
			MK314L				1	51839975		

Regata 09.83 → 06.91

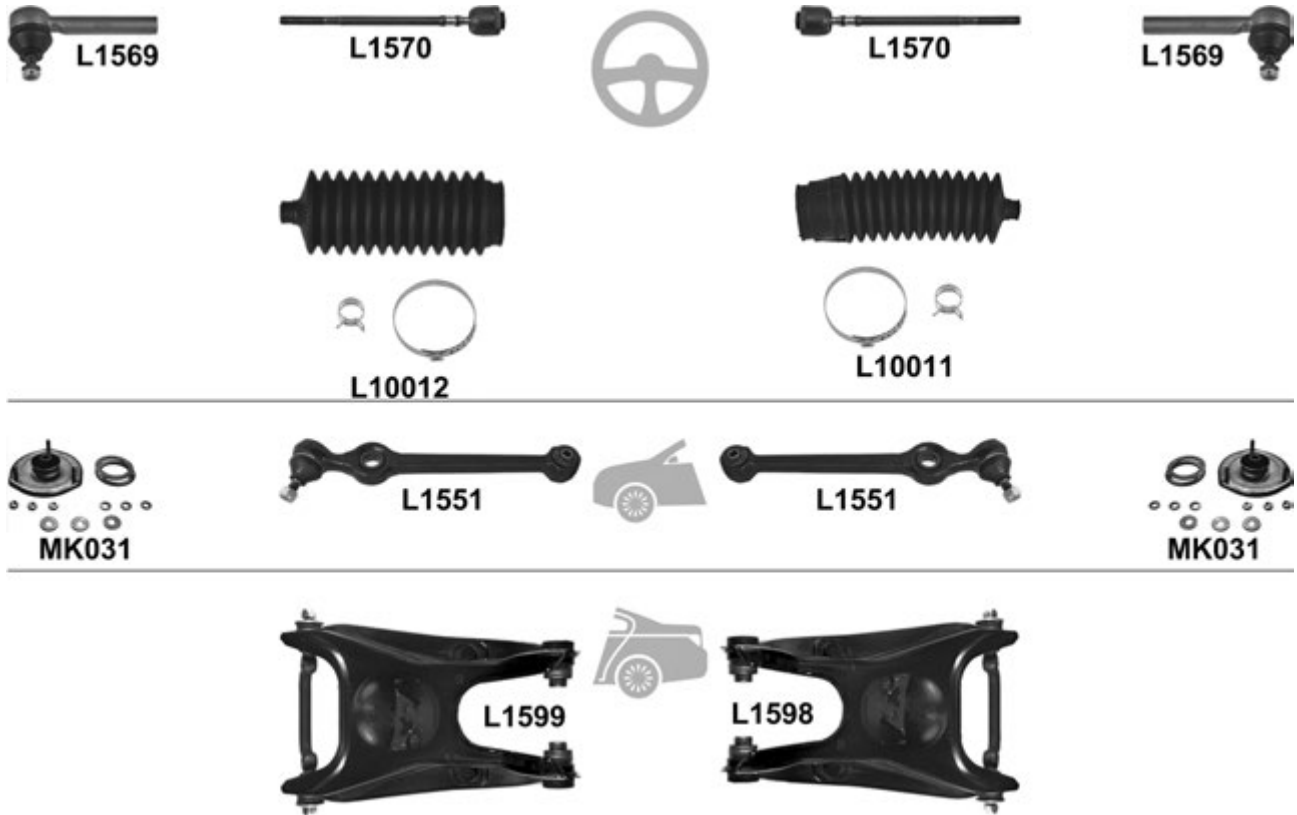

				← → Thread		Part Of	QPA		
⊕		↔		L1569	L1569	F 12x1,5 U	2	5960036	
				L1570	L1570	M 12x1,5 / F 14x1,5 U	2	7633721	
		⊕, *: OE 9938779=set of 2			L10011		1	9938779*	
				L10012			1	9938779*	
		⊥	<input checked="" type="checkbox"/>	L1551	L1551		2	4402361	
				MK031	MK031		2		
					L1598		1	7537989	
				L1599			1	7537988	

Ritmo (138A) 01.78 → 09.82

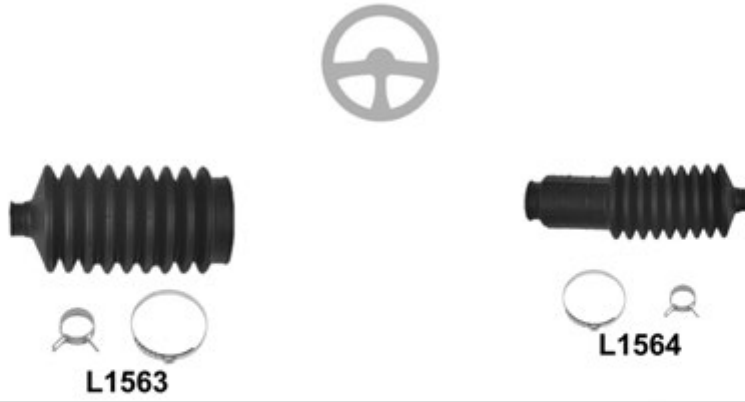

				← → Thread		Part Of	QPA	
					L1564		1	4371156
					L1563		1	4371155
		↓	<input checked="" type="checkbox"/>	L1551	L1551		2	4402361
				MK029	MK029		2	

Ritmo (138A) 10.82 → 12.88

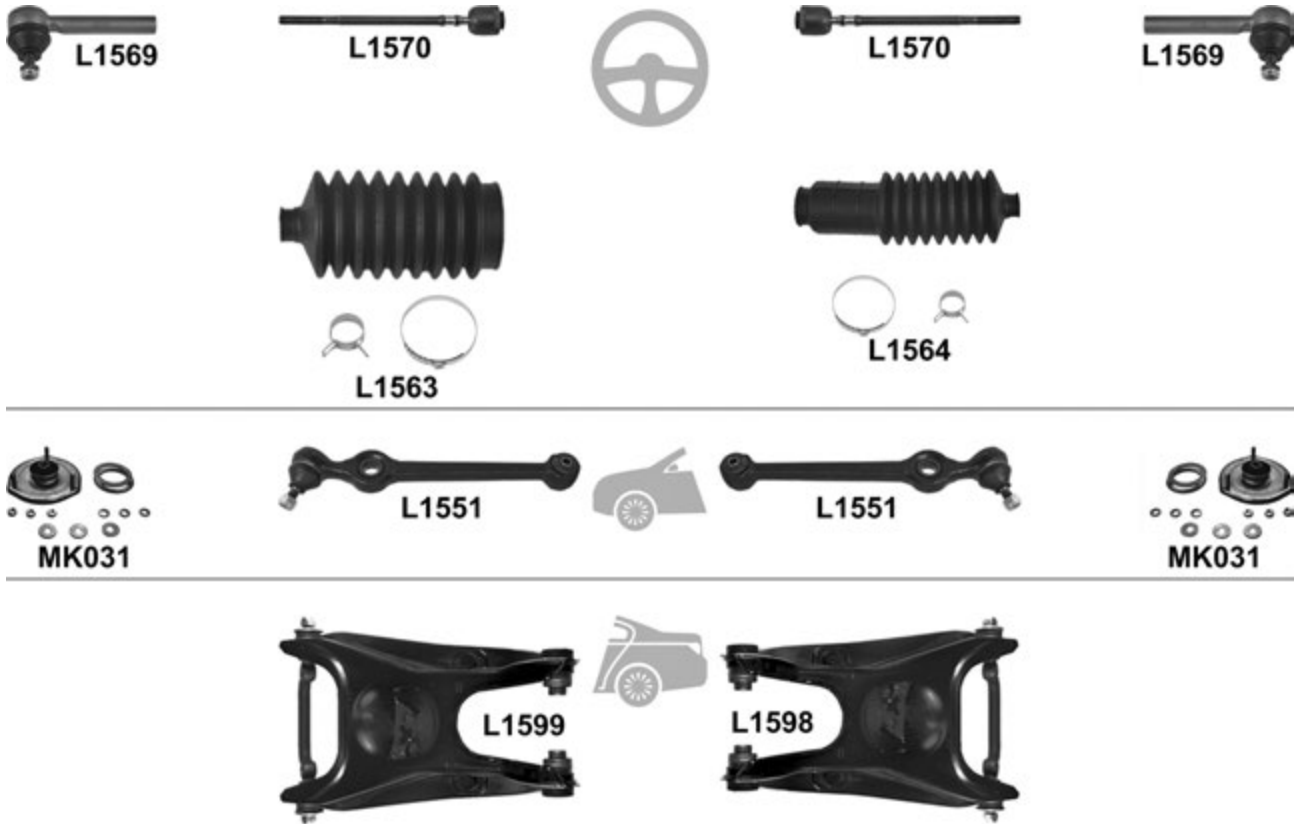

						← → Thread		Part Of		QPA	
⊕		↔		L1569	L1569	F 12x1,5 U		2	5960036		
				L1570	L1570	M 12x1,5 / F 14x1,5 U		2	7633721		
					L1564			1	4371156		
				L1563				1	4371155		
🚗		⊥		<input checked="" type="checkbox"/>	L1551	L1551			2	4402361	
					MK031	MK031			2		
🚗						L1598			1	7537989	
					L1599				1	7537988	

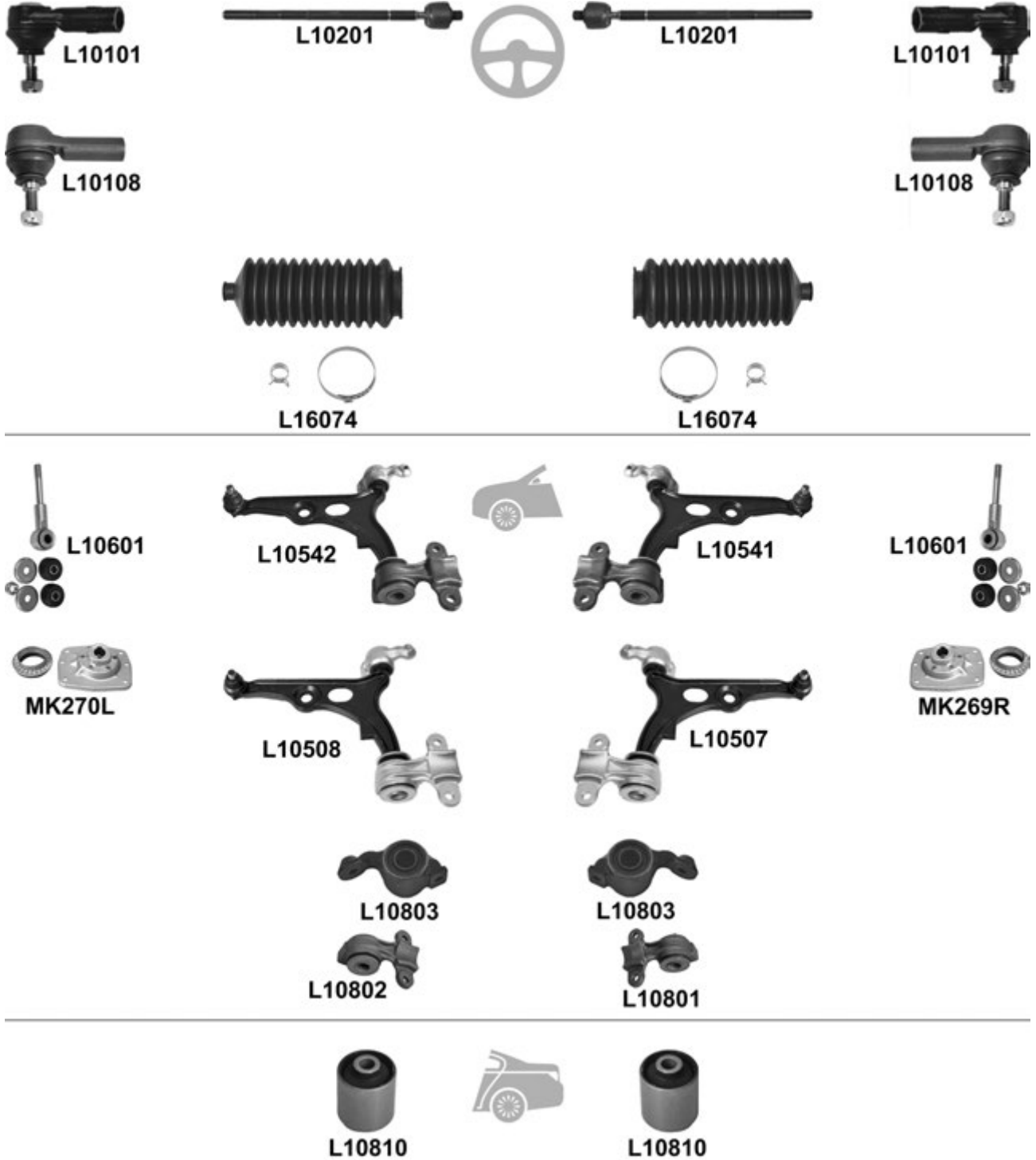
Scudo 02.96 →

Scudo 02.96 →

		i		←	→	Thread	Part Of	QPA	i
		↔	→ 06.03	L10101	L10101	F 14x1,5 ∪		2	9404059080
			07.03 →	L10108	L10108	F 14x1,5 ∪		2	7736279
				L10201	L10201	M 14x1,5 / M 14x1,5 ∪		2	9566950880
					L16074	L16074			2
		⊥	Petrol, → 06.06 <input checked="" type="checkbox"/>	L10541				1	1316736080
				L10542				1	1316735080
		Diesel, → 06.06 <input checked="" type="checkbox"/>	L10507				1	1333755080	
			L10508				1	1333754080	
		⊥▼		L10803	L10803		L10507/L10508/ L10541/L10542	2	
		⊥▲		L10801			L10507/L10541	1	
				L10802			L10508/L10542	1	
				L10601	L10601			2	1317425080S
				KIT	MK269R			1	1311931080S
				MK270L				1	1311930080S
				L10810	L10810		Hub carrier	2	1479759080

Scudo 01.07 →

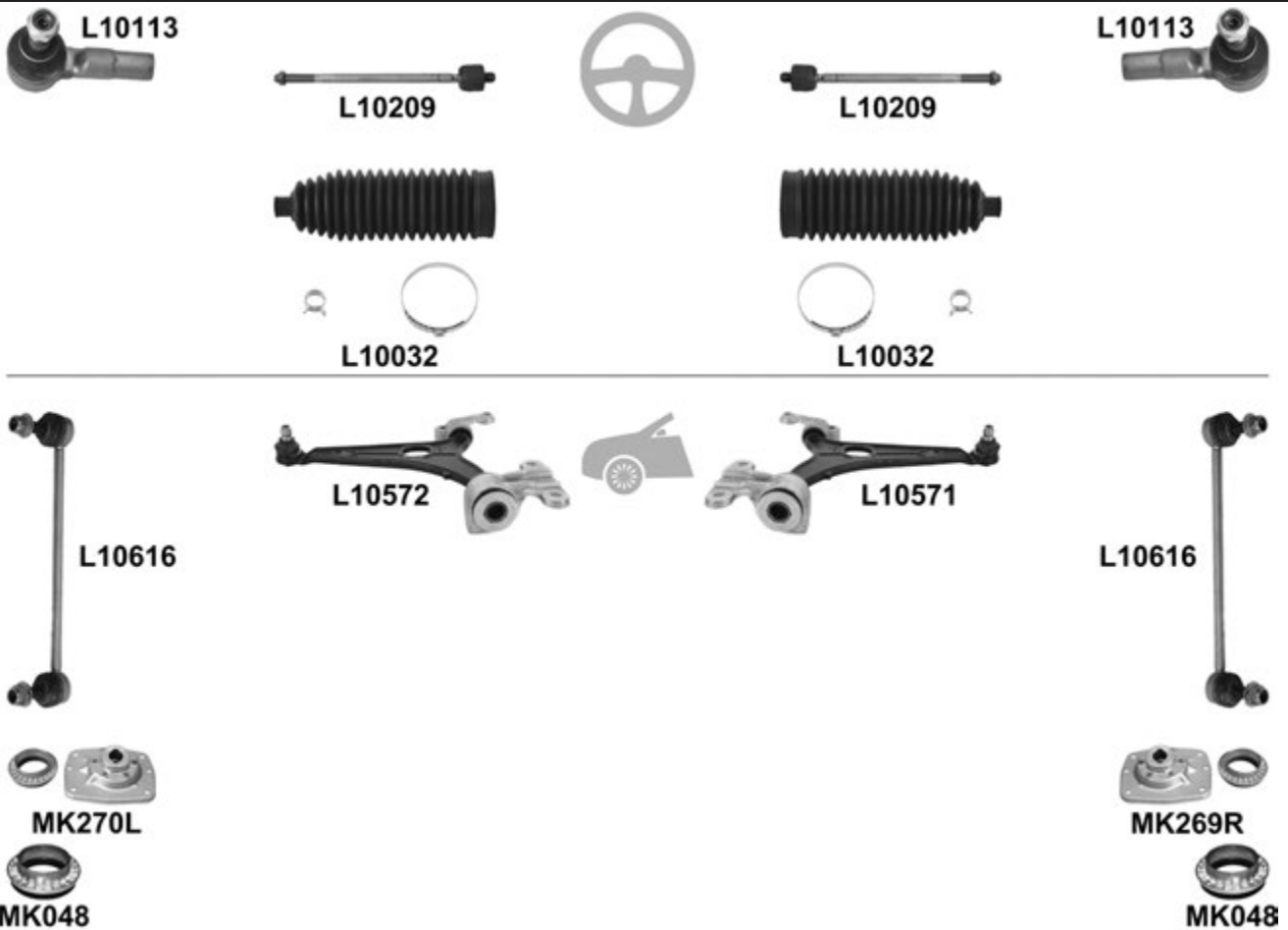

						←	→	Thread	Part Of	QPA	
⊕		↔		L10113	L10113	↺				2	9403817738
				L10209	L10209	↺				2	
				L10032 ^o	L10032 ^o					2	9404066838
⊖		⊥	19mm		L10571					1	1497407080
				L10572						1	1497408080
				L10616	L10616					2	1400099680
				KIT	MK269R					1	1311931080S
				MK270L						1	1311930080S
				MK048	MK048					2	1303672080

Sedici 06.06 →



				← → Thread		Part Of	QPA		
⊕		↔		L10123	L10123	F 14x1,5 ∪	2	71742770	
					L10215 ⁰	M 14x1,5 / M 16x1 ∪	1		
					L10216 ⁰	M 14x1,5 / M 16x1 ∪	1		
🚗		⊥		<input checked="" type="checkbox"/>	L10593 ⁰		1	71742731	
					L10594 ⁰		1	71742732	
				⊥▼	L10842 ⁰	L10842 ⁰		2	81742733
				⊥▲	L10841 ⁰	L10841 ⁰		2	71742733
			L10627	L10627		2	71742688		

Seicento (187) 01.98 →

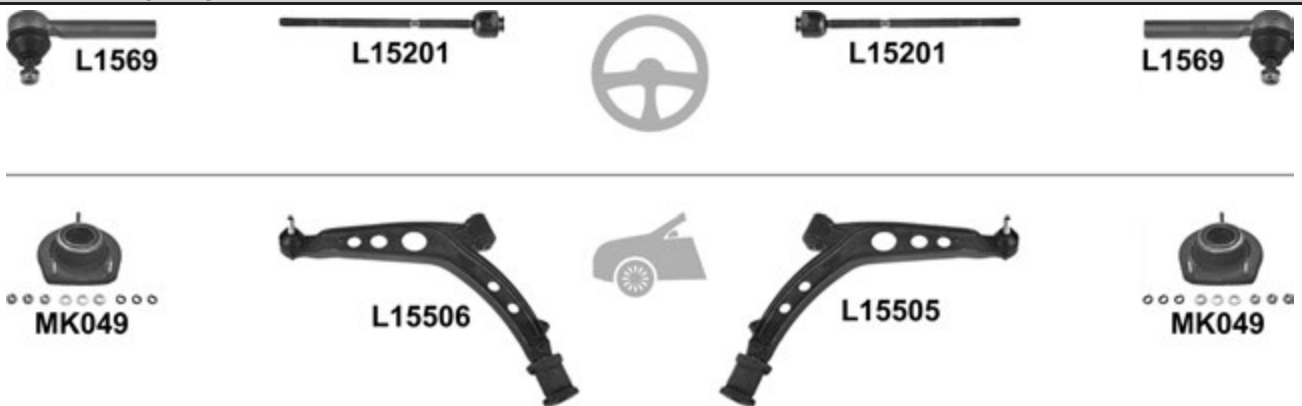

				← → Thread		Part Of	QPA	
⊕		↔		L1569	L1569	M 12x1,5 ∪	2	7669756
					L15201	L15201	M 12x1,5 / F 12x1,5 ∪	2
🚗		⊥		<input checked="" type="checkbox"/>	L15505		1	7636996
					L15506		1	7636995
			KIT	MK049	MK049		2	7667087

Siena (178) 04.96 → 09.01

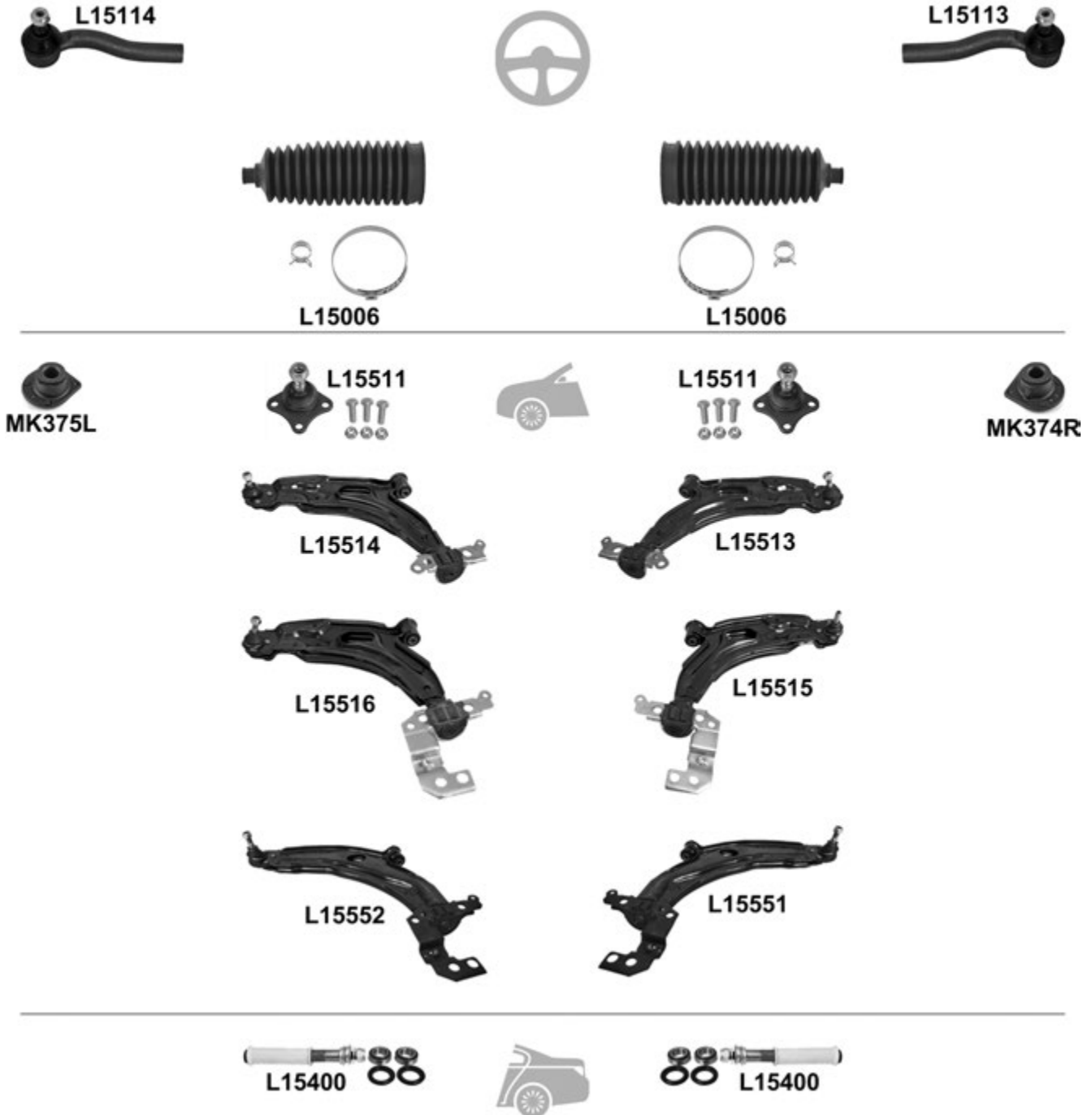

				← → Thread		Part Of	QPA			
		↔		L15113	M 12x1,5 ♂		1	46456660		
				L15114	M 12x1,5 ♂		1	46456189		
		↓		L15006 ^o	L15006 ^o		2	7079340		
				L15511	L15511		2	46437959		
			<input checked="" type="checkbox"/>	L15513			1	46454596		
			<input checked="" type="checkbox"/>	L15514			1	46454595		
			<input checked="" type="checkbox"/>	L15515			1	46454598		
			<input checked="" type="checkbox"/>	L15516			1	46454597		
			<input checked="" type="checkbox"/>	L15551			1	51714207		
	Model178CYCAAT		L15552			1	51714208			
				KIT	MK374R		1	82491440		
				KIT	MK375L		1	82491441		
				KIT	L15400	L15400			2	

Siena 09.01 →



L15114



L15113



L15008



L15008



L15549



L15549



L15514



L15513



L15516



L15515



L15552



L15551



Thread

Part Of

QPA



					L15113	M 12x1,5 ♂		1	46456660
					L15114	M 12x1,5 ♂		1	46456189
					L15008 ^o	L15008 ^o		2	7081850
					L15549	L15549		2	46842581
			, Model 178CXG1AMM / 178CXG1AAP / 178CXG1AAT	<input checked="" type="checkbox"/>		L15513		1	46454596
					L15514		1	46454595	
			, Model 178CXG1AMM / 178CXG1AAP / 178CXG1AAT	<input checked="" type="checkbox"/>		L15515		1	46454598
					L15516		1	46454597	
			Model 178CXCAAE/178CXCAAP/178CXCAT/178CXD1AEE	<input checked="" type="checkbox"/>		L15515		1	46454598
			178CXD1AAP/178CXD1AAT			L15516		1	46454597
			Model 178BYA1AAT/178CYA1AAT/178CYE1AAT	<input checked="" type="checkbox"/>		L15551		1	51714207
					L15552		1	51714208	

Stilo (192) 10.01 →
Stilo Multi Wagon (192) 01.03 →

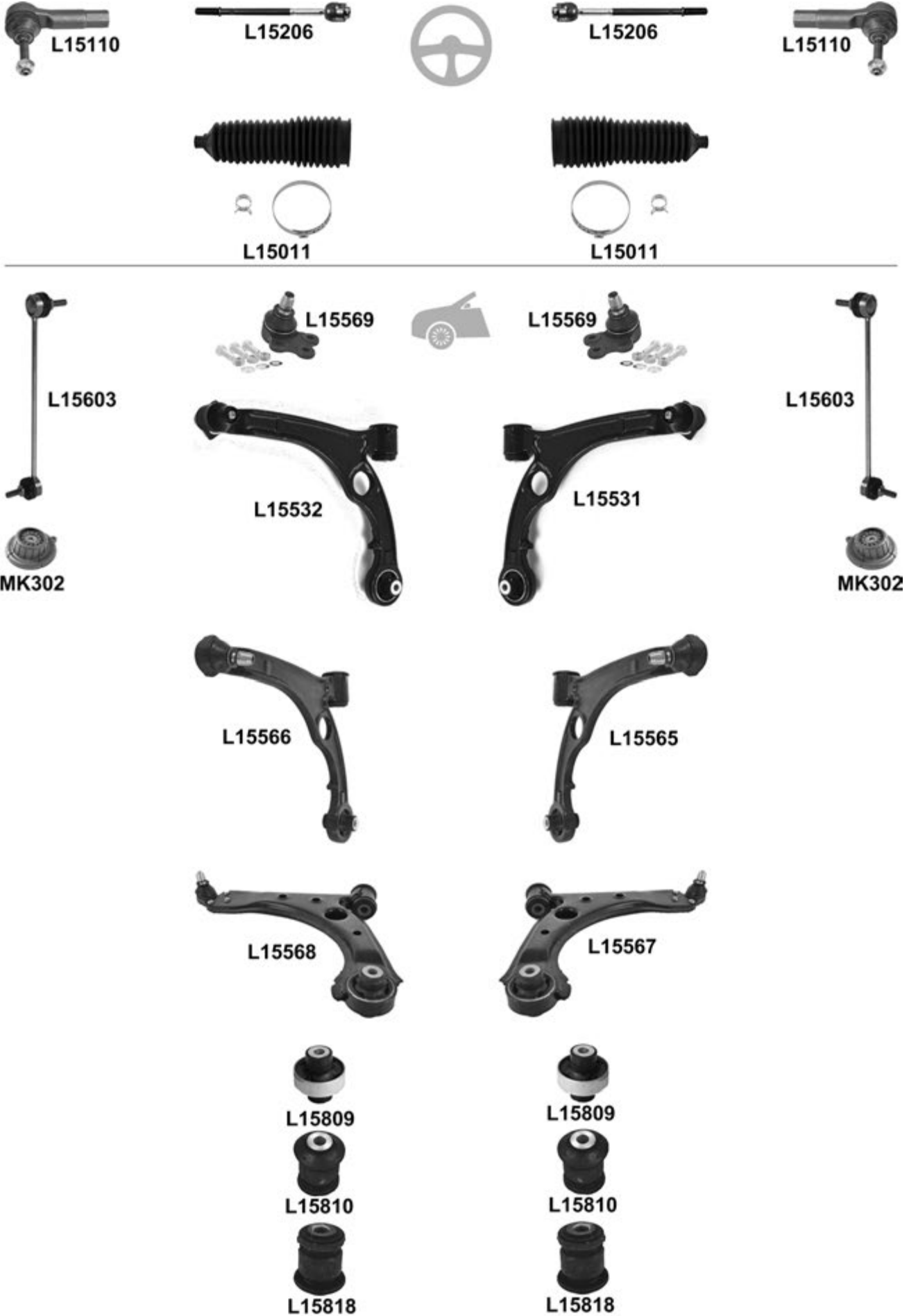

Stilo (192) 10.01 →
 Stilo Multi Wagon (192) 01.03 →

		i		←	→	Thread	Part Of	QPA	i	
		↔		L15110	L15110	F 14x1,5 U		2	9949218	
				L15206	L15206	M 14x1,5 / F 14x1,5 U		2	9949217	
				L15011 ⁰	L15011 ⁰			2	9949216	
		⊥	10.06 →	L15569	L15569			2		
		⊥	→ 08.03, ch. → 495306,	<input checked="" type="checkbox"/>	L15531				1	50700779
					L15532				1	50700797
			09.03, → 10.06, ch. 495307 →,	<input checked="" type="checkbox"/>	L15565				1	50705084
					L15566				1	50705083
			11.06 →,	<input checked="" type="checkbox"/>	L15567			1	51827737	
					L15568			1	51827736	
		⊥▼			L15809	L15809			2	50700778
		⊥▲	→ 01.03, ch. → 495306, 12,5 x 43 x 67,5mm		L15810	L15810			2	50700443
			01.03 →, ch. 495307 →, 14,2 x 43 x 67,5		L15818	L15818			2	50704262
				L15603	L15603			2	50700464	
			KIT	MK302	MK302			2	50702841	

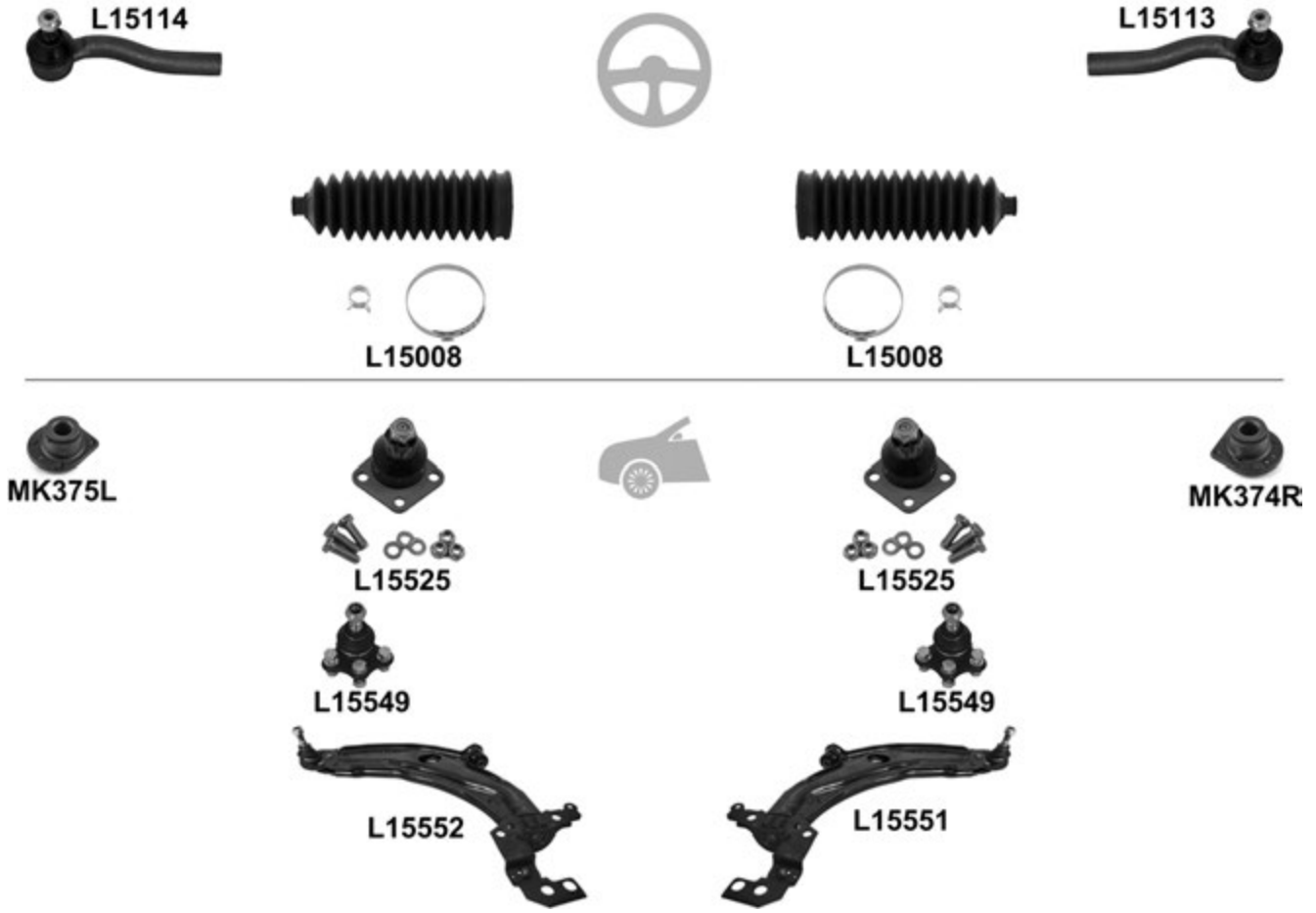
Strada (178E) 06.99 →

				←	→	Thread	Part Of	QPA	
		↔			L15113	M 12x1,5 U		1	46456660
					L15114	M 12x1,5 U		1	46456189
					L15008 ^o	L15008 ^o		2	7081850
		↕	→ 09.02		L15525	L15525		2	46543045
	10.02 →			L15549	L15549		2	46842581	
		↕	10.02 →		<input checked="" type="checkbox"/>	L15551		1	51714207
						L15552		1	51714208
					KIT		MK374R		1
						MK375L		1	82491441

Tempra (159) 02.90 → 08.96
 Tempra SW (159) 03.90 → 08.96

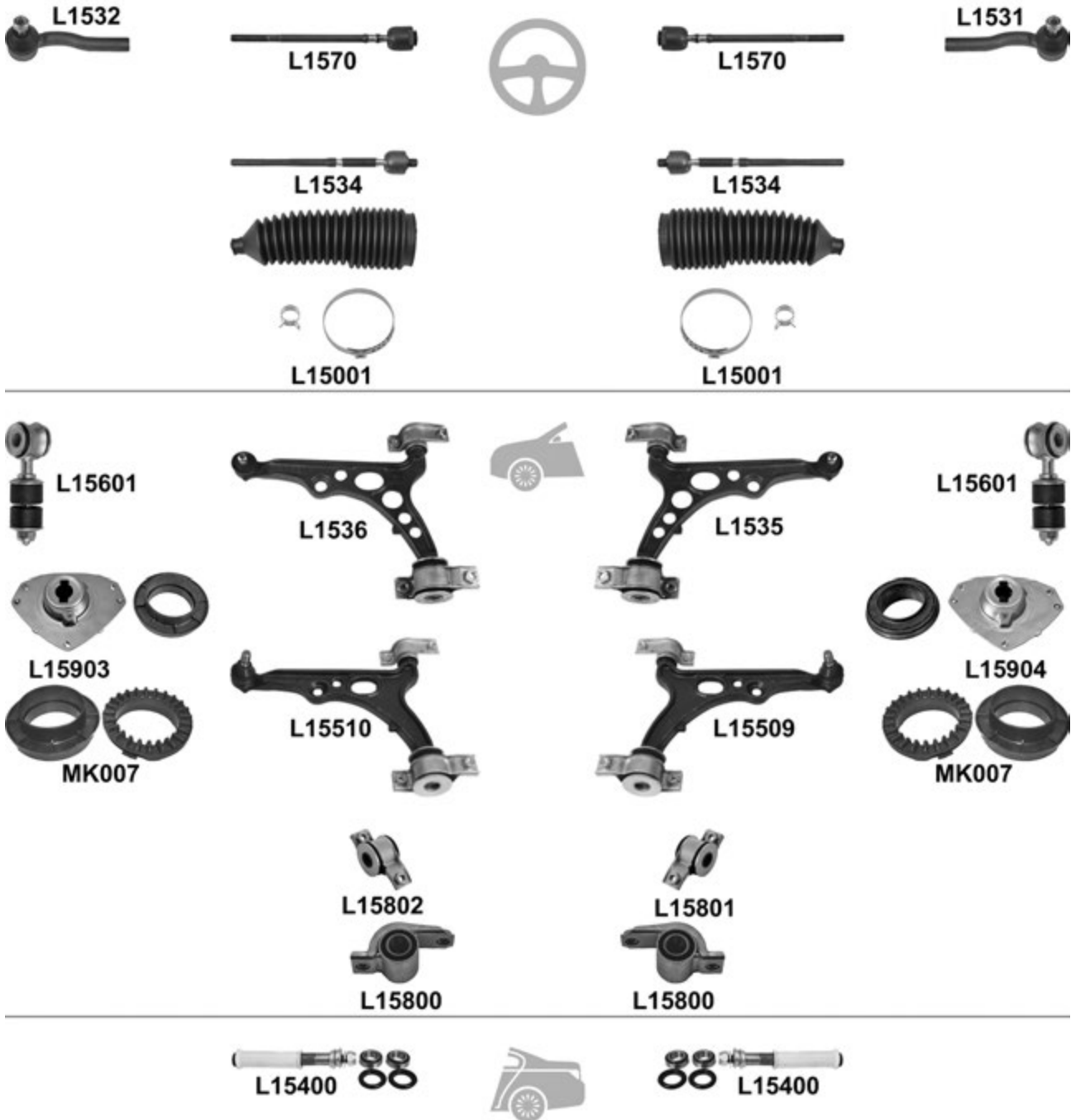

Tempra (159) 02.90 → 08.96
 Tempra SW (159) 03.90 → 08.96

		i		←	→	Thread	Part Of	QPA	i	
		↔				L1531 F 12x1,5 U		1	7591215	
						L1532 F 12x1,5 U		1	7591216	
						L1570 L1570	M 12x1,5 / F 14x1,5 U		2	7633721
						L1534 L1534	M 12x1,5 / M 14x1,5 U		2	9941625
						L15001 L15001			2	7645160
		⊥	→ 06.90, 15mm	<input checked="" type="checkbox"/>		L1535		1	76010373	
					L1536		1	76010372		
				<input checked="" type="checkbox"/>		L15509		1	7777240	
					L15510		1	7777239		
		⊥	▼	07.90 →			L15801	L15509	1	7601068
							L15802	L15510	1	7601065
							L15800 L15800	L15509/L15510	2	7601064
							L15601 L15601		2	60809242S
							L15903 ¹		1	60811372S
					1.4 / ie, 1.6 / ie	KIT	L15904 ¹		1	60811373S
							L15903 ¹		1	60811372S
						KIT	L15904 ¹		1	60811373S
						L15903 ¹		1	60811372S	
				1.8 ie, 1.9 D / TD, 2.0 ie	KIT	L15904 ¹		1	60811373S	
						L15903 ¹		1	60811372S	
						MK007 MK007		2	7601502	
				KIT	L15400 L15400			2		

Tipo (160) 07.87 → 08.96

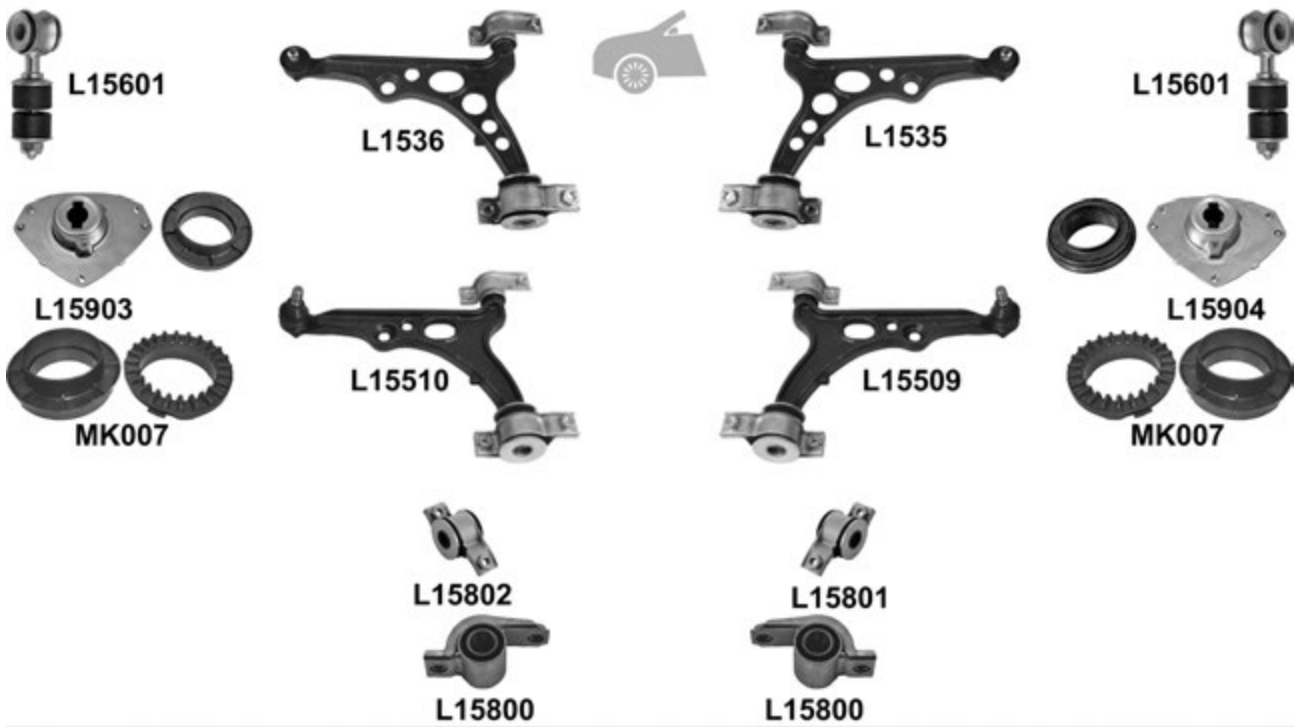
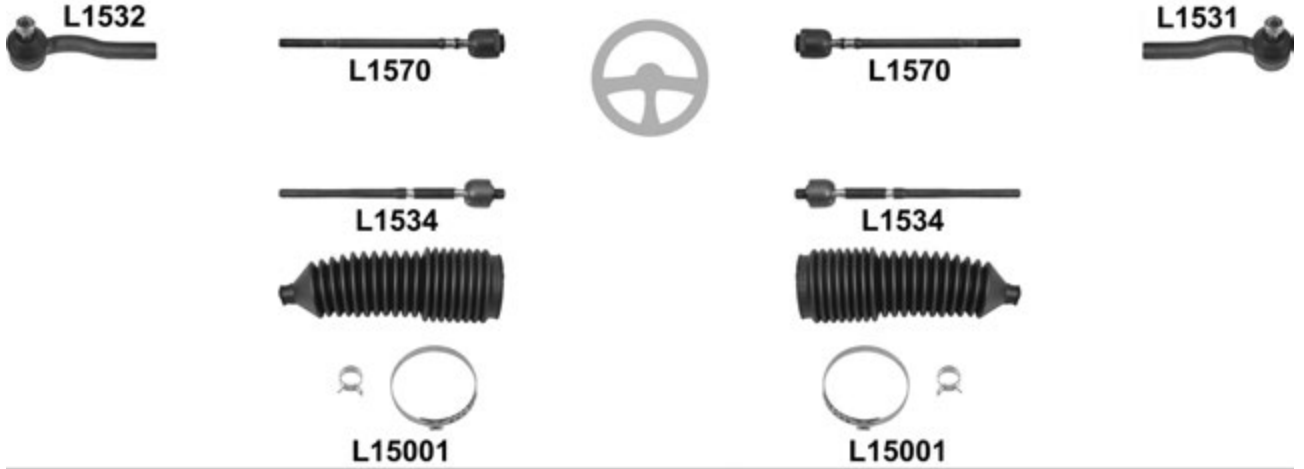

Tipo (160) 07.87 → 08.96

				←	→	Thread	Part Of	QPA					
		↔			L1531	F 12x1,5 U		1	7591215				
				L1532		F 12x1,5 U		1	7591216				
				L1570	L1570	M 12x1,5 / F 14x1,5 U		2	7633721				
				L1534	L1534	M 12x1,5 / M 14x1,5 U		2	9941625				
		⊥	→ 06.90 , 15mm <input checked="" type="checkbox"/>		L1535			1	76010373				
					L1536				1	76010372			
					→ 07.90 , 17mm <input checked="" type="checkbox"/>		L15509			1	7777240		
							L15510			1	7777239		
					⊥	→ 07.90		L15801		L15509	1	7601068	
								L15802		L15510	1	7601065	
					⊥	→ 07.90		L15800	L15800	L15509/L15510	2	7601064	
								L15601	L15601		2	60809242S	
							1.1, 1.4 / ie, 1.6 / ie, (+) MK007 KIT		L15903 ¹			1	60811372S
									L15904 ¹			1	60811373S
	L15904 ¹							1	60811373S				
	L15903 ¹							1	60811372S				
	L15904 ¹							1	60811372S				
	L15903 ¹							1	60811373S				
			1.7 D, 1.8 ie / ie 16V / 1.9 D / TD, 2.0 ie / 16V, (+) MK007 KIT		L15904 ¹			1	60811372S				
					L15903 ¹			1	60811373S				
			KIT	MK007	MK007		MK051	2	7601502				
				L15400	L15400			2					

Ulysse (220) 06.94 → 08.02

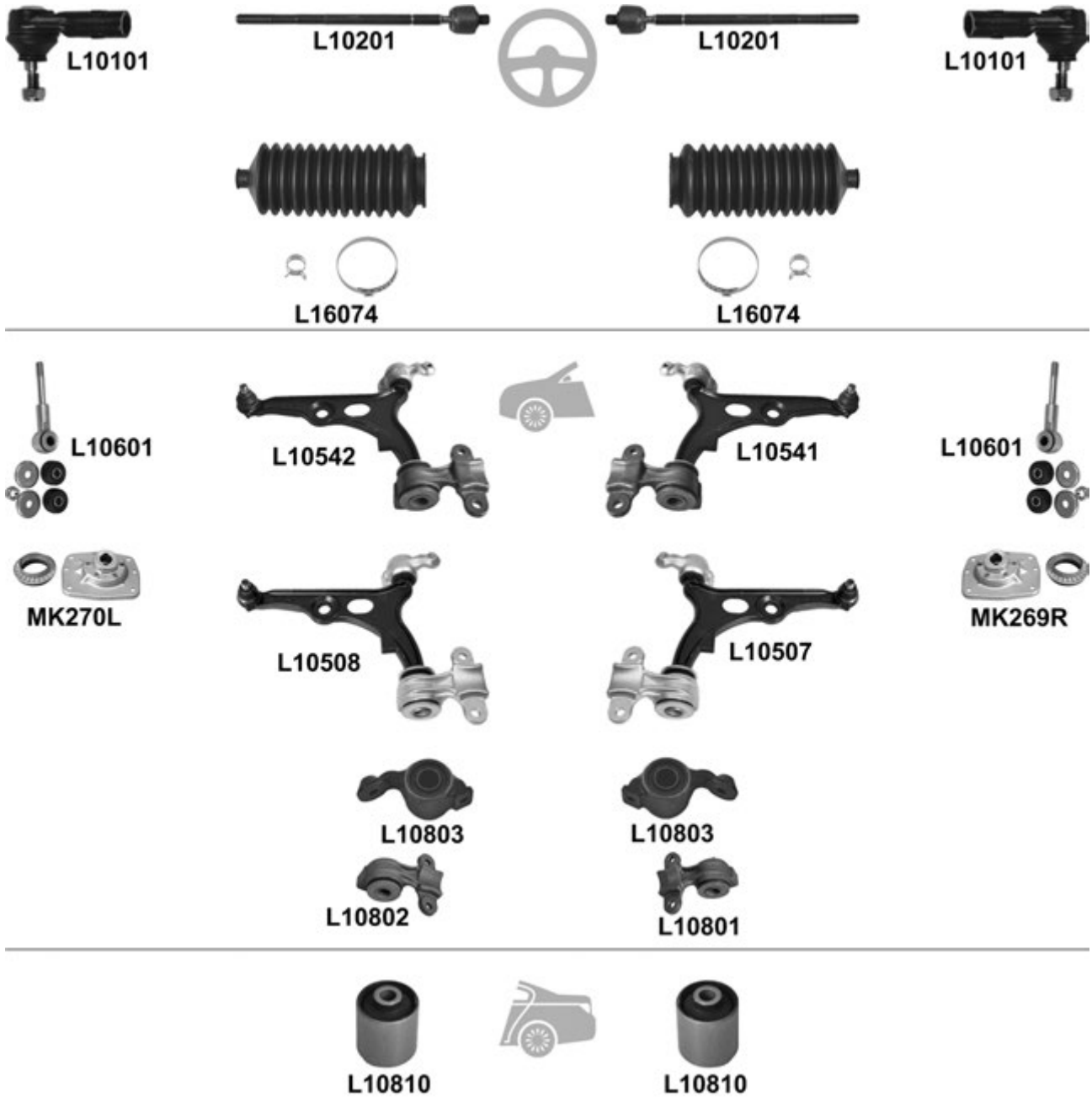

				← → Thread		Part Of	QPA		
⊕		↔		L10101	L10101	F 14x1,5 ∪	2	9404059080	
				L10201	L10201	M 14x1,5 / M 14x1,5 ∪	2	9566950880	
				L16074	L16074		2	9404066418	
⊖		⊥	Petrol	<input checked="" type="checkbox"/>		L10541		1	1316736080
				<input type="checkbox"/>	L10542		1	1316735080	
			Diesel	<input checked="" type="checkbox"/>		L10507		1	1333755080
		<input type="checkbox"/>	L10508		1	1333754080			
		⊥▼			L10803	L10803	L10507/L10508/ L10541/L10542	2	
		⊥▲				L10801	L10507/L10541	1	
					L10802		L10508/L10542	1	
				L10601	L10601		2		
			KIT			MK269R	1	1311931080	
						MK270L	1	1311930080	
				L10810	L10810	Hub carrier	2	1479759080	

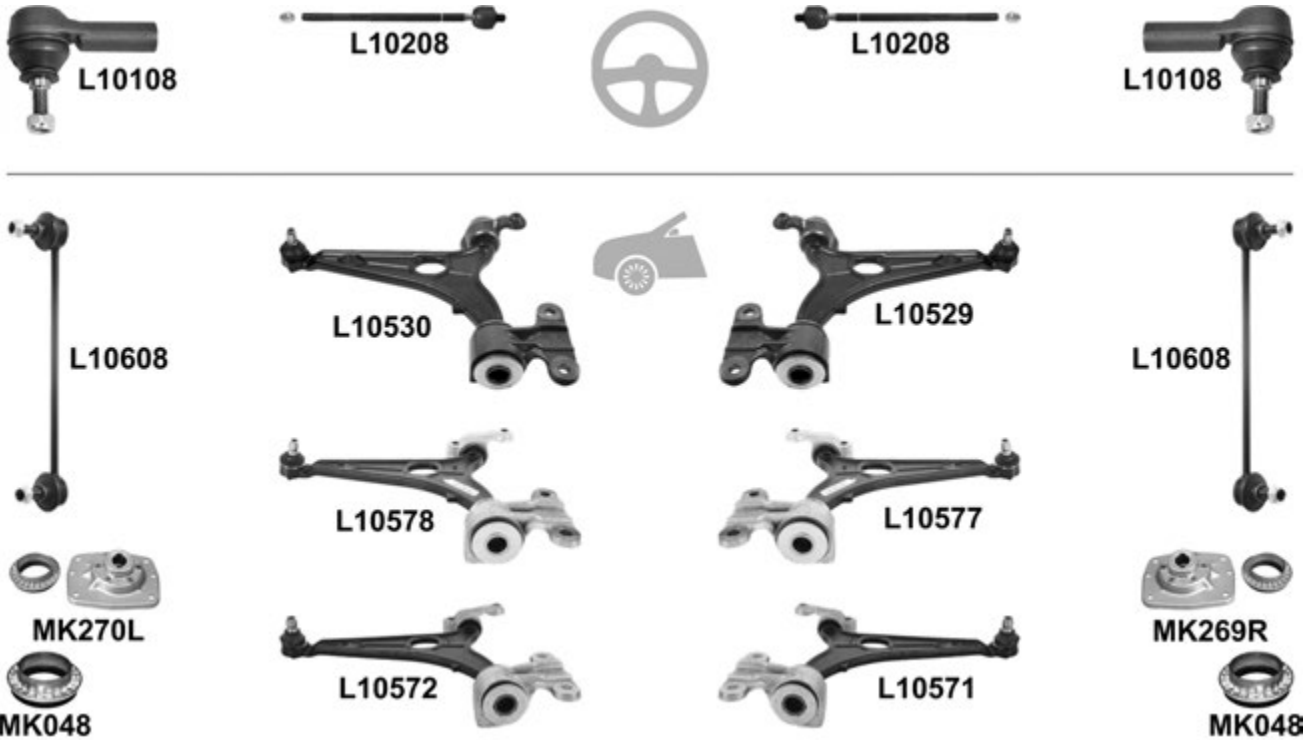
Ulysse (179AX) 08.02 →

				← → Thread		Part Of	QPA			
		↔		L10108	L10108	F 14x1,5 ♂	2	7736279		
				L10208	L10208	M 14x1,5 / M 14x1,5 ♂	2	77362280		
		↓	→ 07.06, 12mm	<input checked="" type="checkbox"/>		L10529		1	93501488	
					L10530		1	35011487		
			08.06 →, 17mm, 14mm	<input checked="" type="checkbox"/>		L10577		1	1356061080	
					L10578		1	1356060080		
			19mm	<input checked="" type="checkbox"/>		L10571		1	3521.N9	
					L10572		1	3520.R8		
			08.06 →, 14mm	<input checked="" type="checkbox"/>		L10577		1	1356061080	
					L10578		1	1356060080		
				L10608	L10608		2	1331209080		
		(+) L 28911		KIT		MK269R		1	1311931080	
				MK270L			1	1311930080		
				MK048	MK048		2	1303672080		

Uno 01.83 →

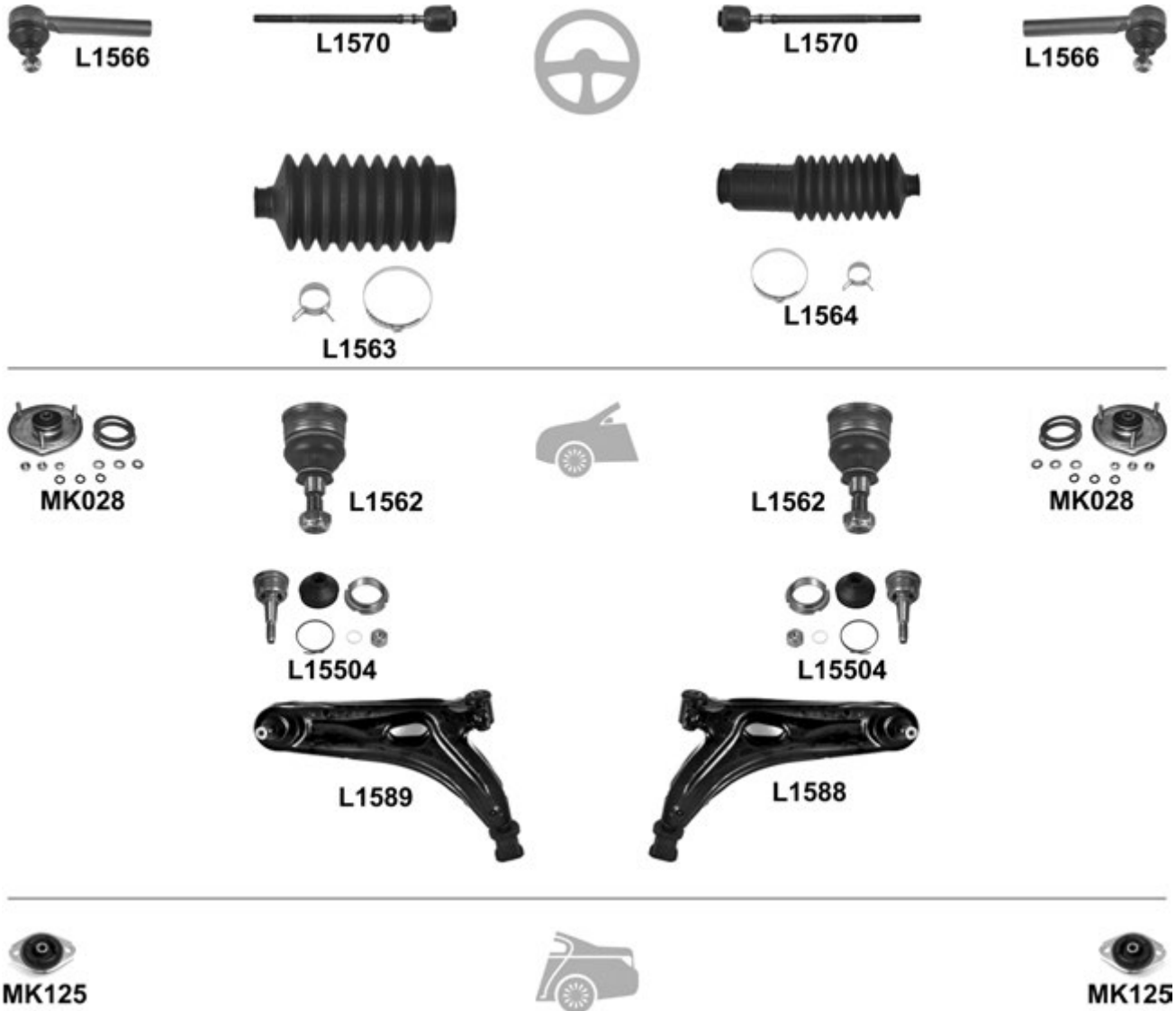

				← → Thread		Part Of	QPA		
⊕		↔		L1566	L1566	F 12x1,5 ∪	2	5983406	
				L1570	L1570	M 12x1,5 / F 14x1,5 ∪	2	7633721	
					L1564		1	4371156	
				L1563			1	4371155	
⊖		⊥	(-) Turbo ie	L1562	L1562		2	4402649	
		⊥	(-) Turbo ie	KIT	L15504	L15504	2		
		⊥	(-) Turbo ie	<input checked="" type="checkbox"/>		L1588	1	7705616	
					L1589		1	7705615	
⊖				KIT	MK028	MK028	2	4400895S	
			(-) Turbo		MK125	MK125	2	5960254	

125
125 Special
1300 / 1500 ch. 299501 →



			i	←	→	Thread	Part Of	QPA	i
		↔		L1526	L1526	↺		2	4193224
		↑		L1527	L1527			2	5880794

127 06.71 → 10.82



			i	←	→	Thread	Part Of	QPA	i
		↔		L1538	L1538	↺		2	4257066
					L1564			1	4371156
				L1563				1	4371155
		↓	<input checked="" type="checkbox"/>	L6001	L6001			2	4364095

127 10.82 → 12.86

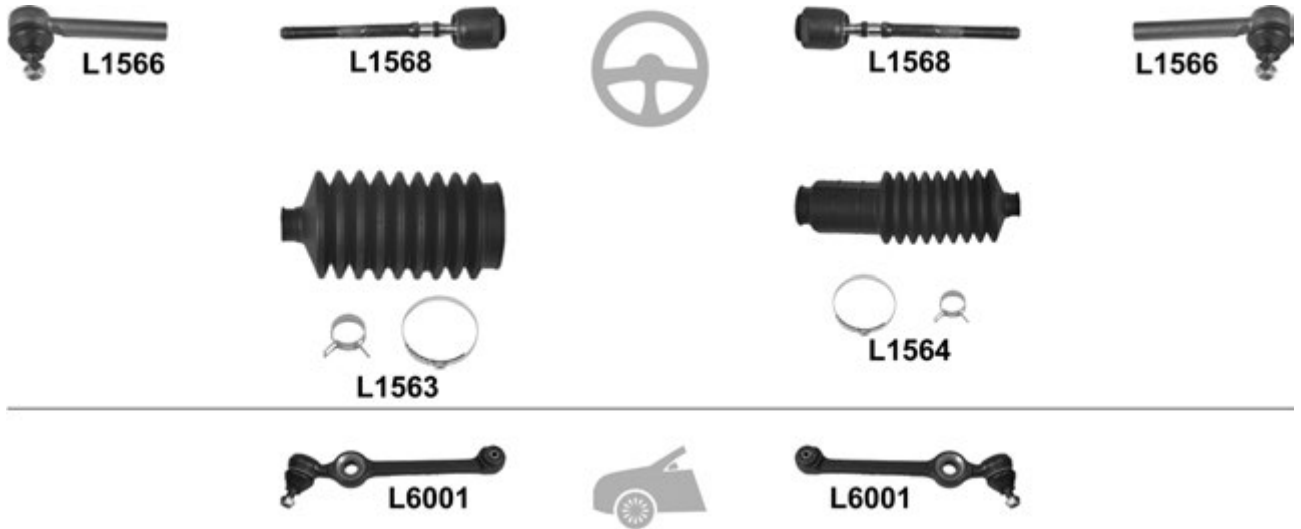

				← → Thread		Part Of	QPA		
⊕	↔	↔		L1566	L1566	∪		2	5983406
				L1568	L1568	M 12x1,5 / F 14x1,5 ∪		2	5960321
	⌊	⌊			L1564			1	4371156
				L1563				1	4371155
⊖	⊖	⌊	☑	L6001	L6001			2	4364095

128 03.69 → 10.82

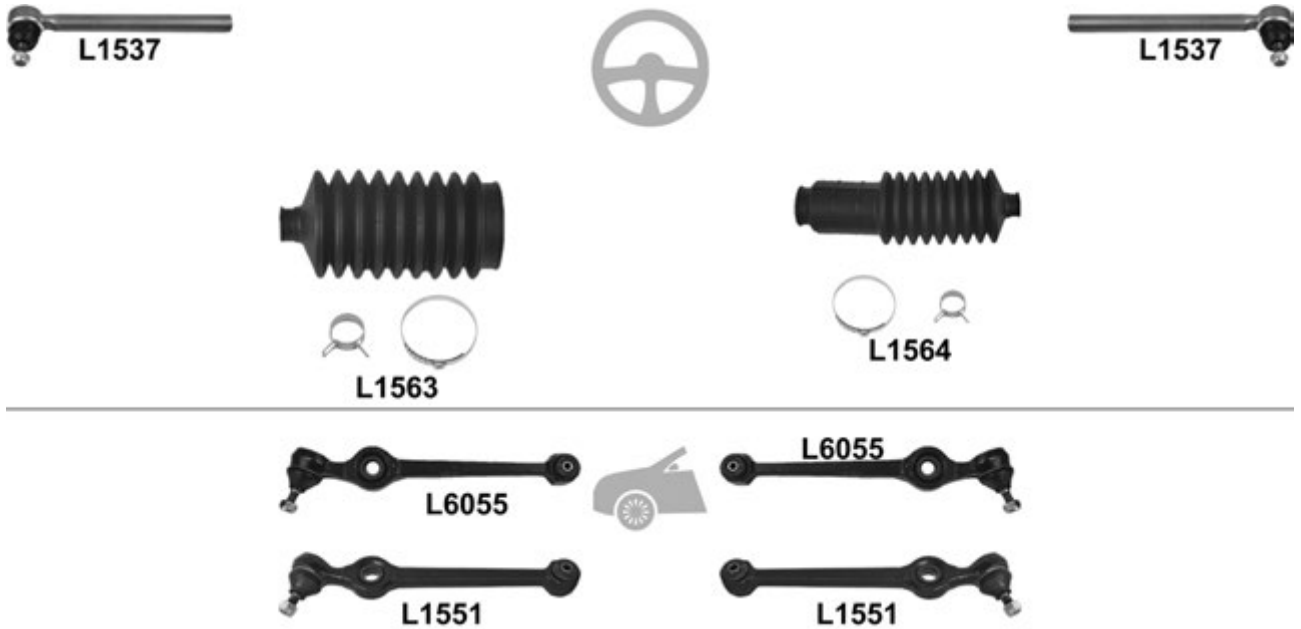

				← → Thread		Part Of	QPA			
⊕	↔	↔	ch. → 2511997	L1537	L1537	∪		2	4254278	
					L1564			1	4371156	
				L1563				1	4371155	
⊖	⊖	⌊	→ 03.78, Ø 8mm	☑	L6055	L6055			2	5882282
			04.78 →, Ø 10mm		L1551	L1551			2	4402361

128 11.82 → 12.84

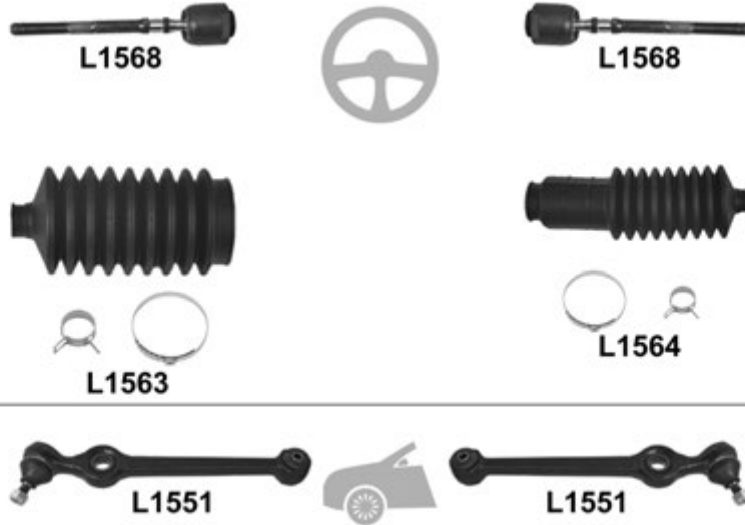

				← → Thread		Part Of	QPA		
⊕				L1568	L1568	M 12x1,5 / F 14x1,5 ∪	2	5960321	i
					L1564		1	4371156	
				L1563			1	4371155	
		⊥	☑	L1551	L1551		2	7558962	

128 Coupé 09.69 → 02.81

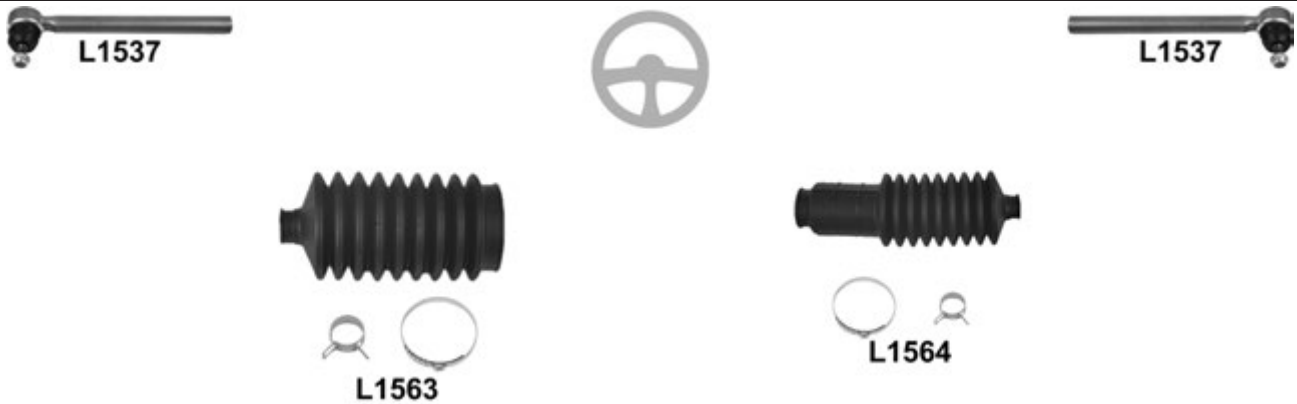

				← → Thread		Part Of	QPA		
⊕		↔		L1537	L1537	∪	2	4254278	i
					L1564		1	4371156	
				L1563			1	4371155	

132 04.72 → 12.82



L1526



L1526



L1527



L1527

			i	←	→	Thread	Part Of	QPA	i
		↔		L1526	L1526	↺		2	5995268
		↑		L1527	L1527			2	5880794

147 → 10.82

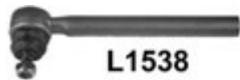

L1538

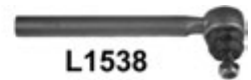

L1538



L1563



L1564



L6001



L6001

			i	←	→	Thread	Part Of	QPA	i
		↔		L1538	L1538	↺		2	4257066
					L1564			1	4371156
				L1563				1	4371155
		↓	<input checked="" type="checkbox"/>	L6001	L6001			2	4364095

147 11.82 →

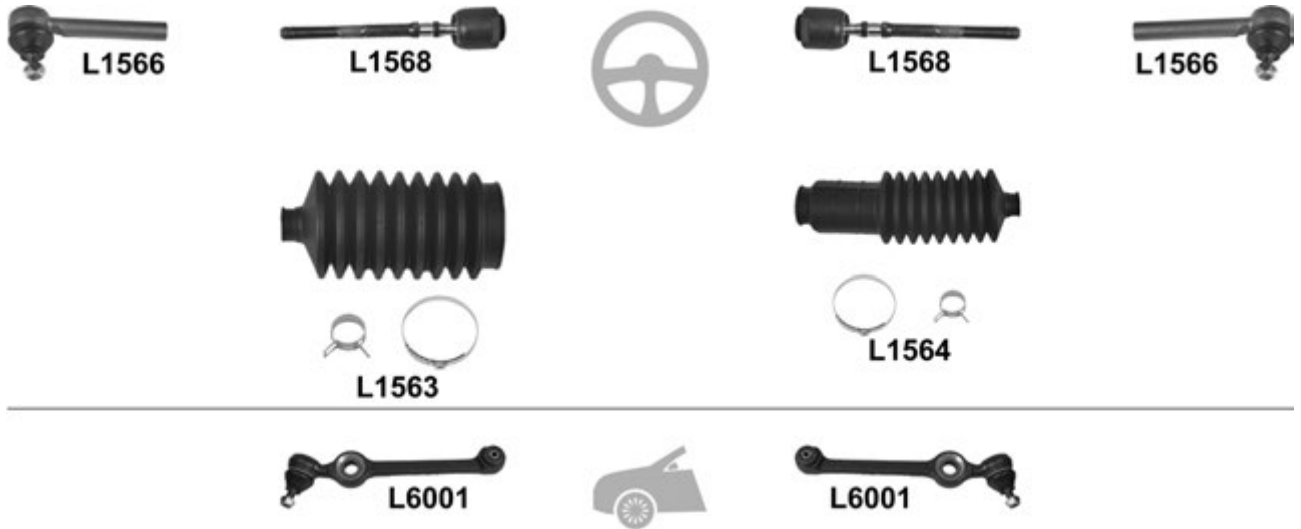

						←	→	Thread	Part Of	QPA	
⊕		↔		L1566	L1566			∩		2	5983406
				L1568	L1568			M 12x1,5 / F 14x1,5 ∩		2	5960321
						L1564				1	4371156
				L1563						1	4371155
		⊥	<input checked="" type="checkbox"/>	L6001	L6001				2	4364095	

238 09.66 → 06.82



						←	→	Thread	Part Of	QPA	
⊕		↔		L15121	L15121			∩		2	4113746

500 10.07 →

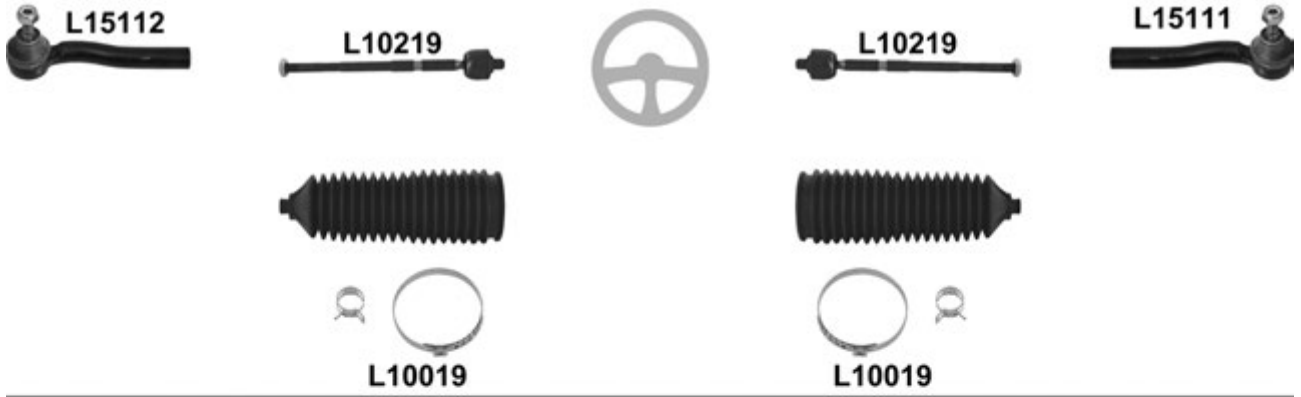

				←	→	Thread	Part Of	QPA		
⊕		↔			L15111	∩		1	77362508	
					L15112	∩		1	77362507	
				L10219	L10219	M 12x1,5 / F 14x1,5 ∩		2		
				Thermoplast	L10019	L10019			2	77362509
⊖		⊥	(-) Abarth <input checked="" type="checkbox"/>		L15563			1	51857022	
			(-) Abarth/cars with Xenon light		L15564			1	51857021	
		⊥▼		L15822 ^o	L15822 ^o		L15563/L15564	2		
		⊥▲		L15823 ^o	L15823 ^o		L15563/L15564	2		
				L15603	L15603			2	51801136	
			1.2/1.2L/1.3D/1.4, ch. 418097 →	KIT	MK282	MK282		2	51830518	

500L 09.12 →

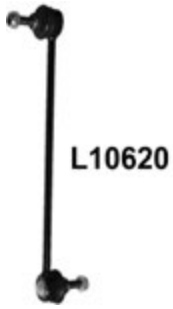

L10620

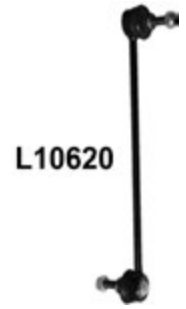

L10620



Thread

Part Of

QPA



			L10620	L10620			2	55700753
--	--	--	--------	--------	--	--	---	----------

600 03.55 → 02.71



L15121



L15121



Thread

Part Of

QPA



			L15121	L15121	M 16x1 ↻		2	4113746
--	--	--	--------	--------	----------	--	---	---------

900 T/E 01.78 → 01.86



L15121



L15121



Thread

Part Of

QPA



			L15121	L15121	M 16x1 ↻		2	4113746
--	--	--	--------	--------	----------	--	---	---------

FORD

B-Max (JK) 08.12 →

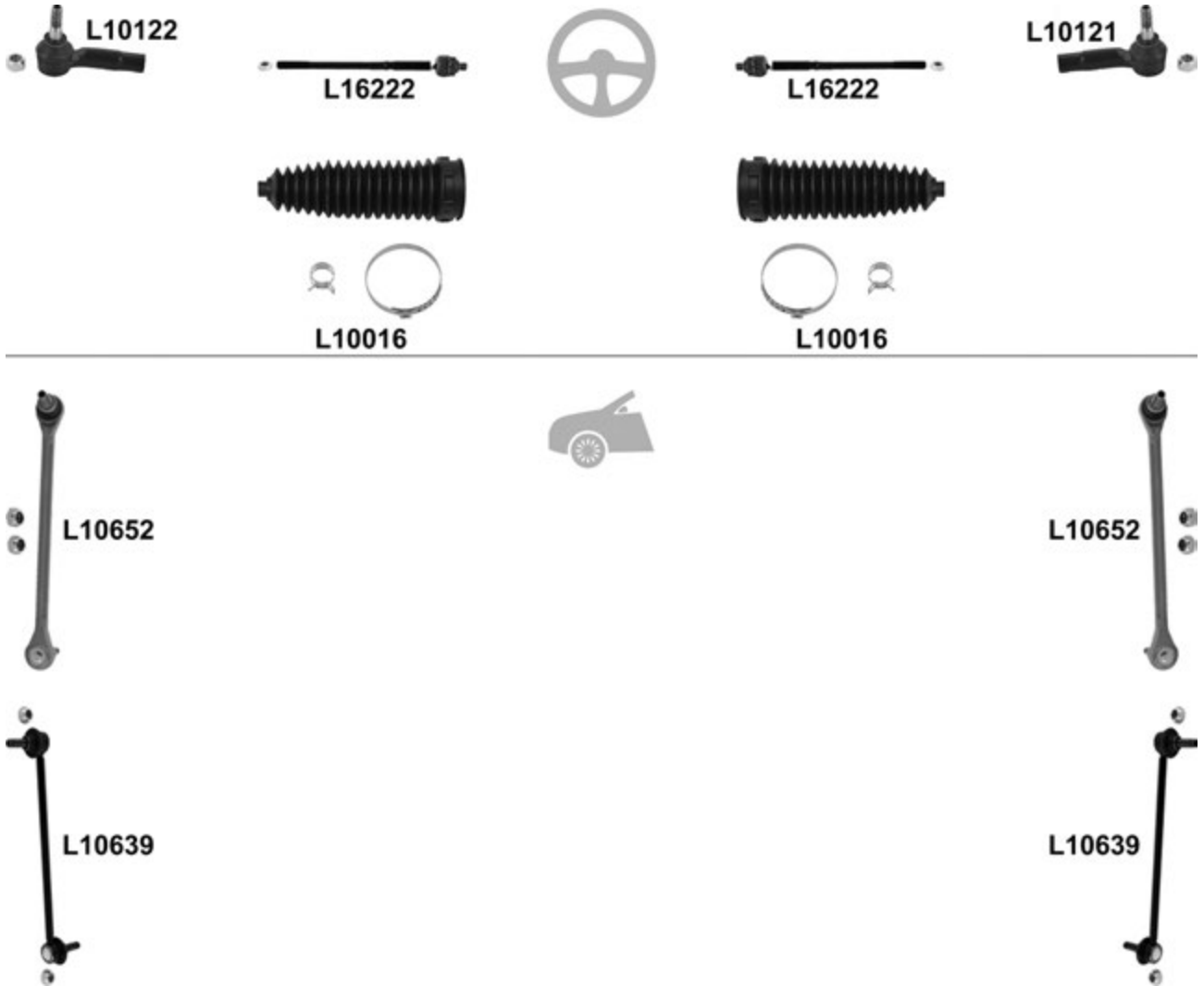

		← →		Thread	Part Of	QPA	i	
⊕	↔		L10121	F 14x1,5 ∪		1	1545338	
			L10122	F 14x1,5 ∪		1	1545339	
	↔		L16222	L16222	M 14x1,5 / M 14x1,5 ∪		2	1545457
	⌀		L10016	L10016			2	1545456
⊖	↔	ALU	L10652	L10652		2	1513343	
		Metal	L10639	L10639		2	1513343	

C-Max 02.07 →

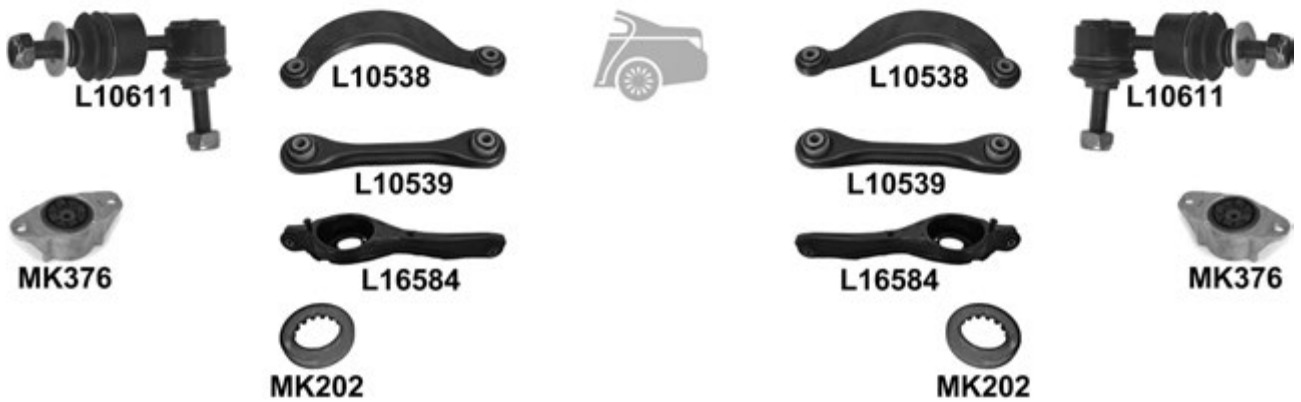

C-Max 02.07 →

				←	→	Thread	Part Of	QPA	
		↔			L10109	F 16x1,5 ∪		1	1328877
				L10110		F 16x1,5 ∪		1	1328881
				L16216	L16216	M 16x1,5 / M 14x1,5 ∪		2	1251937
				L10023	L10023			2	1334215
		⊥			L10575	L10575		2	1470387
		⊥		<input checked="" type="checkbox"/>		L10573		1	1570285
				L10574				1	1570284
		⊥▼		L10832	L10832			2	
		⊥▲		L10830	L10830			2	
				L16613	L16613			2	1230909
			KIT	MK282	MK282		2	1381605	
	RUBBER			MK202	MK202			2	
		⊥		L10538	L10538			2	1329730
		⊥▲		L10539	L10539			2	1061668
		⊥		L16584 ⁰	L16584 ⁰			2	1357317
				L10611	L10611			2	1335548
				MK376	MK376			2	1300459

C-Max 12.10 →
Grand C-Max 12.10 →



**C-Max 12.10 →
Grand C-Max 12.10 →**

		i		←	→	Thread	Part Of	QPA	i			
		↔	Electric		L16173	F 16x1,5 ♂		1	1748237			
					L16174	F 16x1,5 ♂		1	1748239			
			Electric		L16216	L16216	M 16x1,5 / M 14x1,5 ♂		2	1714484		
					L10023	L10023			2	1334215		
		↓			L16595			L16591	1			
					L16596			L16592	1			
		↓	C-Max 1.6 Ti/EcoBoost/LPG/FlexiFuel, 2.0 TDCi, Sheet Metal <input checked="" type="checkbox"/>		L16591				1	1709457		
					L16592				1	1709466		
				C-Max 1.6 TDCi, ALU, (+/-) Xenon light, (-)	<input checked="" type="checkbox"/>	L16593				1	1749991	
					<input checked="" type="checkbox"/>	L16594				1	1749992	
			Grand C-Max, Sheet Metal <input checked="" type="checkbox"/>		L16591				1	1709457		
					L16592				1	1709466		
			↓ ▾			L16834	L16834			L16591/L16592	2	
						L16837				L16593	1	
					L16838				L16594	1		
↓ ▲			L16835	L16835			L16591/L16592	2				
			L50815	L50815			L16593/L16594	2				
			L16613	L16613				2	1230909			
	RUBBER				MK202	MK202				2		
					↑		L16A02 ⁰	L16A02 ⁰			2	1752736
							L16639	L16639			2	1714891
		Horizontal Mounting										

Capri MK I, MK II, MK III 12.68 → 04.87

		i		←	→	Thread	Part Of	QPA	i
		↔		L0003	L0003	F 1/2"x20 UNF ♂		2	5021410

Cougar (EC) 08.98 → 12.01



L16078



L16078

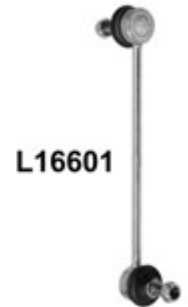
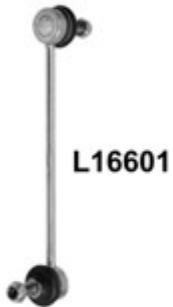

Cougar (EC) 08.98 → 12.01

		i		←	→	Thread	Part Of	QPA	i
		↔				F 16x1,5 U		1	1097316
						F 16x1,5 U		1	1097323
			∅ 17mm, ∅ 55mm, L= 206mm					2	4780137
			Steel					2	6960036
			ALU					2	1106269
			(+) L 16916	KIT				2	6799585S1
								2	1103725
		⊥						2	6867577
								2	1054209
									2

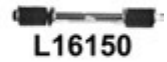
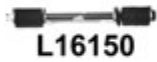
Econovan 03.86 → 03.92

		i		←	→	Thread	Part Of	QPA	i
		↔				F 14x1,5 U		2	3251449
		↑						2	3252249
		⊥						2	3252250
								2	

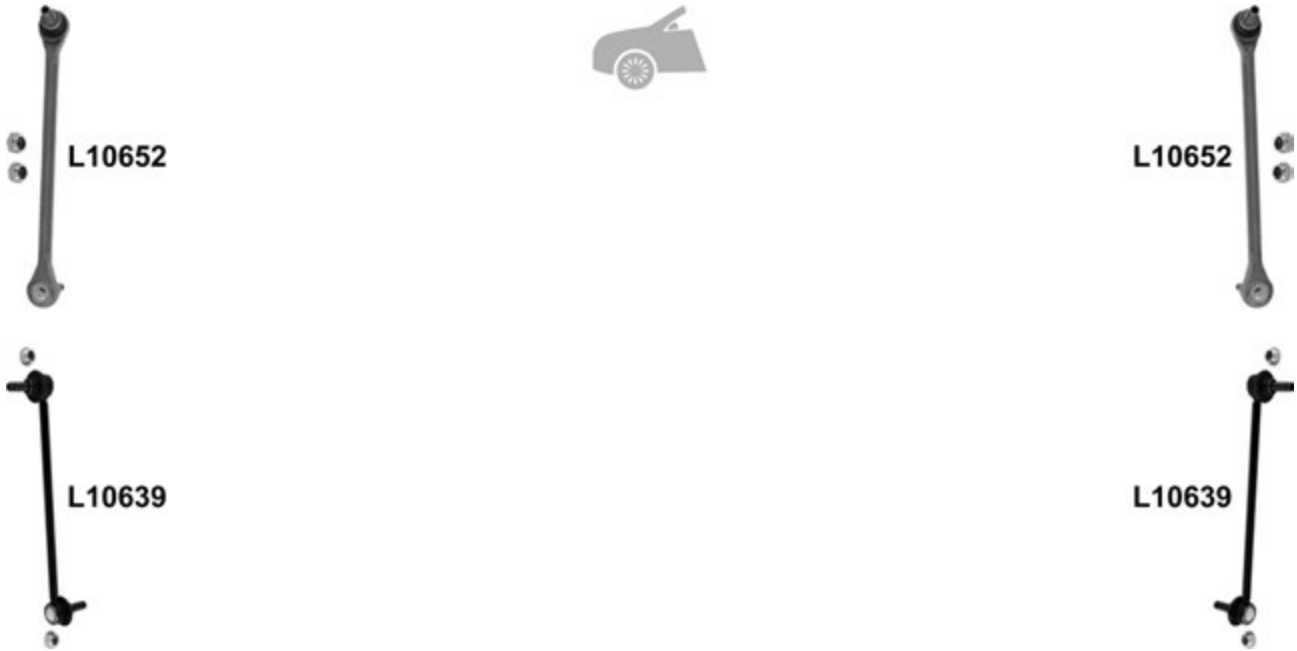
Ecosport (KB) 10.13 →

			←	→	Thread	Part Of	QPA	
				L10121	F 14x1,5 ♂		1	1545338
			L10122		F 14x1,5 ♂		1	1545339
			L10016	L10016			2	1545456
			L10652	L10652			2	1513343
			L10639	L10639			2	1513343

Escort → 1968



			←	→	Thread	Part Of	QPA	
			L0003	L0003	F 1/2"x20 UNF ♂		2	5021410

Escort MK I 1969 → 12.74

			←	→	Thread	Part Of	QPA	
			L0003	L0003	F 1/2"x20 UNF ♂		2	5021410

Escort MK II 12.74 → 08.80

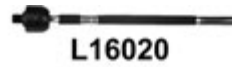
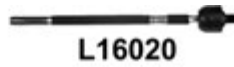
				←	→	Thread	Part Of	QPA		
						F 14x2		2	1476246	

Escort MK III 09.80 → 12.85
Orion I (AFD) 07.83 → 03.86

				←	→	Thread	Part Of	QPA		
						F 1/2"x20 UNF		2	5021410	
						M 1/2"x20 UNF / M 14x1,5		2	6185334	
			→ 05.83					1	6079916	
			05.83 →					2	6935233	
			05.83 →	<input checked="" type="checkbox"/>				1	6087888	
								1	6087889	
			05.83 →					2	1619120	
			05.83 →					4	1652910	
			Mounting of on Wheels suspension		KIT			2	6080625	
			12.84 →		KIT			2	6150277S2	

Escort MKIV (GAF / AWF / ABFT) 10.85 → 10.90
 Escort MKIV Turnier (AWF / AVF) 10.85 → 10.90
 Escort MKIV Cabrio (ALF) 01.86 → 07.90
 Escort MKIV Express (AVF) 04.84 → 07.90
 Orion II (AFF) 12.85 → 07.90

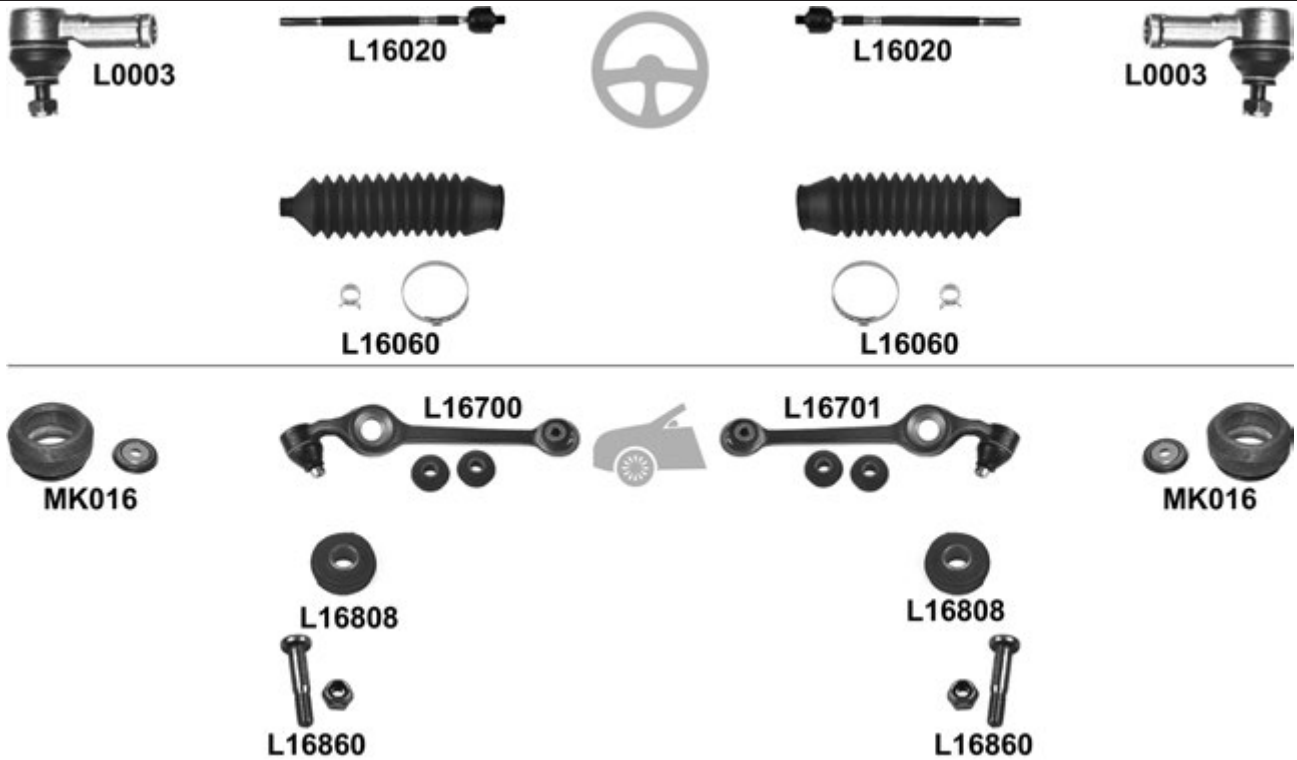

			←	→	Thread	Part Of	QPA		
		↔	L0003	L0003	F 1/2"x20 UNF ↻		2	5021410	
			L16020	L16020	M 1/2"x20 UNF / M 14x1,5		2	6127726	
			L16060	L16060			2	6935233	
		⊥		L16701			1	5021458	
			L16700				1	5021459	
		↔	L16808	L16808			4	1652910	
			Mounting of on Wheels suspension		KIT	L16860	L16860	2	6080625
			Mounting of on Wheels suspension		KIT	MK016	MK016	2	6150277S2

Escort MKV / MKVI (GAL) 07.90 → 01.95
 Escort MKV / MKVI Turnier (GAL / AVL) 07.90 → 01.95
 Escort MKV / MKVI Cabrio (ALL) 07.90 → 01.95
 Escort MKV / MKVI Express (AVL) 07.90 → 12.94
 Orion MKIII (GAL) 07.90 → 12.93

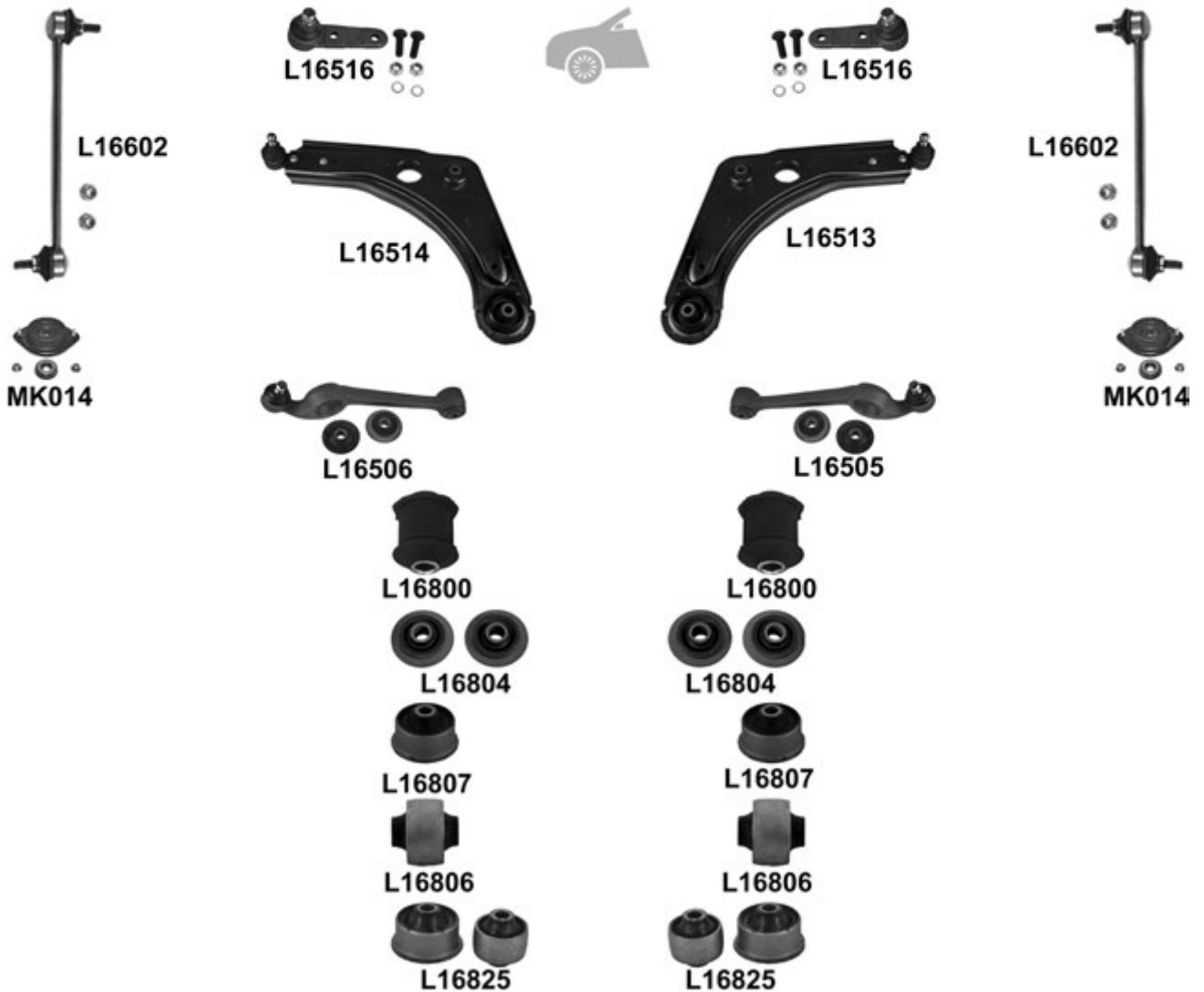
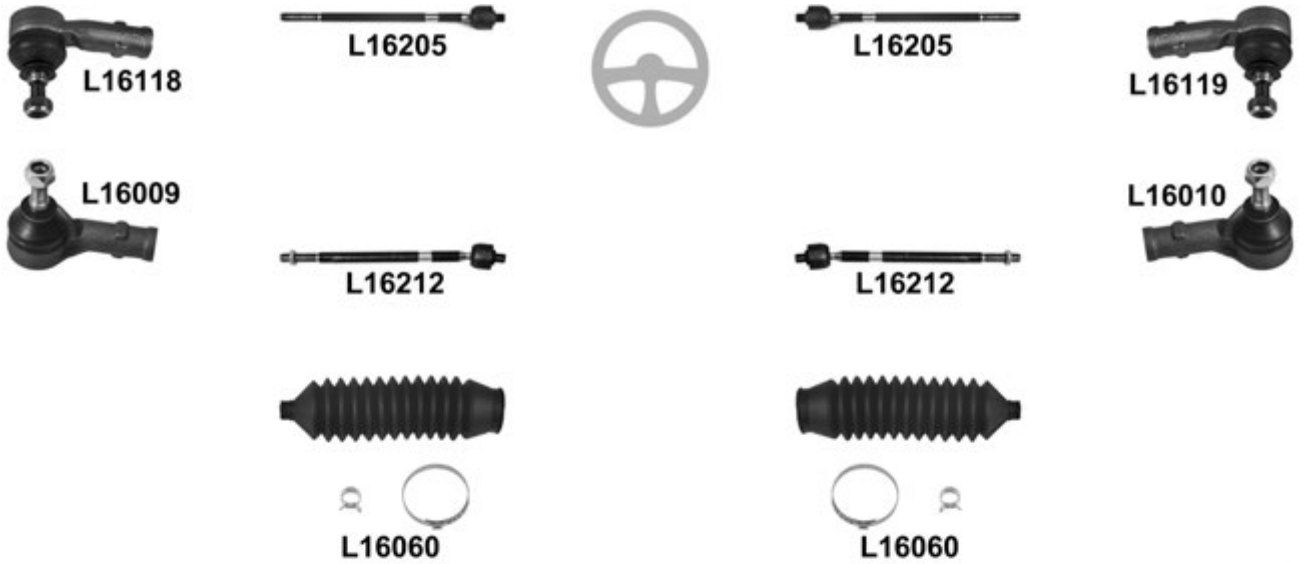

Escort MKV / MKVI (GAL) 07.90 → 01.95
Escort MKV / MKVI Turnier (GAL / AVL) 07.90 → 01.95
Escort MKV / MKVI Cabrio (ALL) 07.90 → 01.95
Escort MKV / MKVI Express (AVL) 07.90 → 12.94
Orion MKIII (GAL) 07.90 → 12.93



		i	←	→	Thread	Part Of	QPA	i	
		↔	(-) Cosworth		L16119	F 14x2 U		1	5024332
					L16118	F 14x2 U		1	5024333
			Cosworth		L16010	F 14x2 U		1	5021413
					L16009	F 14x2 U		1	5021414
			(Wuelfrath), (-) Cosworth	L16205	L16205	M 14x2 / M 14x1,5		2	6180350
			(TRW), (-) Cosworth	L16212	L16212	M 14x2 / M 14x1,5		2	6197238
		(-) Cosworth	L16060	L16060			2	6935233	
		↓	(-) Cosworth, 2... ↔		L16516	L16516		2	1047853
			(-) Cosworth		<input checked="" type="checkbox"/>	L16513			1
	Cosworth, 03.92 →		<input checked="" type="checkbox"/>	L16514			1	1058280	
			<input checked="" type="checkbox"/>	L16505			1	5021462	
			<input checked="" type="checkbox"/>	L16506			1	5021463	
		↓↔←	Cosworth	L16800	L16800		L16505/L16506	2	6192705
		↓↔→	Cosworth	L16804	L16804		L16505/L16506	2	5021729
		↓▼	(-) Cosworth	L16807	L16807		L16513/L16514	2	1035929
		↓▲	(-) Cosworth	L16806	L16806		L16513/L16514	2	1000445
		↓▲▼	(-) Cosworth	L16825	L16825		L16513/L16514	2	
			Mounting of on Wheels suspension	L16860	L16860			2	6080625
			(-) Cosworth	L16602	L16602			2	1661237
				L16823	L16823		Anti-roll bar	2	7102392
				MK014	MK014			2	6495311S1

Escort MKVII (GAL/ AAL / ABL / AFL) 01.95 → 02.99

Escort MKVII Turnier (GAL/ ANL) 01.95 → 02.99

Escort MKVII Cabrio (ALL) 02.95 →

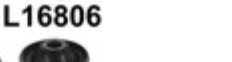
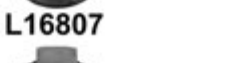
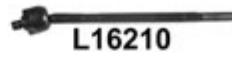
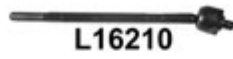
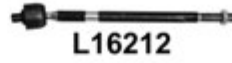
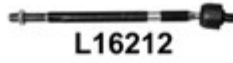
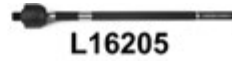
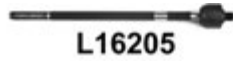

Escort MKVII (GAL/ AAL / ABL / AFL) 01.95 → 02.99
Escort MKVII Turnier (GAL/ ANL) 01.95 → 02.99
Escort MKVII Cabrio (ALL) 02.95 →



			←	→	Thread	Part Of	QPA			
		↔	(-) Cosworth		L16119	F 14x2 ⤷	1	5024332		
					L16118	F 14x2 ⤷	1	5024333		
					L16010	F 14x2 ⤷	1	5021413		
					L16009	F 14x2 ⤷	1	5021414		
					(Wuelfrath), (-) Cosworth	L16205	L16205	M 14x2 / M 14x1,5	2	6180350
					(TRW), (-) Cosworth	L16212	L16212	M 14x2 / M 16x1,5	2	6197238
					Cosworth, TRW	L16210	L16210		2	6185338
					, ø 14mm, Ø 37mm, L= 228mm	L16062 ^o	L16062 ^o		2	6935233
					TRW, ø 13mm, Ø 47mm, L= 200mm	L10036 ^o	L10036 ^o		2	6182818
					Wuelfrath, ø 14mm, Ø 56mm, L= 185mm	L16030 ^o	L16030 ^o		2	1012814
		⊥	(-) Cosworth	<input checked="" type="checkbox"/>	L16513		1	1058279		
					L16514		1	1058280		
				<input checked="" type="checkbox"/>	L16505		1	5021462		
					L16506		1	5021463		
		⊥	(-) Cosworth		L16807	L16807	L16513/L16514	2	1035929	
					L16806	L16806	L16513/L16514	2	1000445	
		⊥	(-) Cosworth	KIT	L16825	L16825	L16513/L16514	2		
				Mounting of on Wheels suspension	KIT	L16860	L16860		2	6080625
				(-) Cosworth		L16602	L16602		2	1661237
						L16823	L16823	Anti-roll bar	2	7102392
					MK053	MK053		2	7350847S1	
					L16815	L16815	Hub carrier	2	7371059	
					L16823	L16823	Anti-roll bar	2	7102392	
		→ 01.98		L16815	L16815		2	7371059		
				L16823	L16823		2	7102392		
			(-) / 4WD	MK127	MK127		2	7234730		

Explorer 4WD 11.94 →

				←	→	Thread	Part Of	QPA	
⊕		↔		L80106	L80106			2	F5TZ-3A131-A
				L80203	L80203		OE no. 04038762 Power Rack	2	4038762
		⊥		L80507	L80507			2	2L3Z-3050-AA

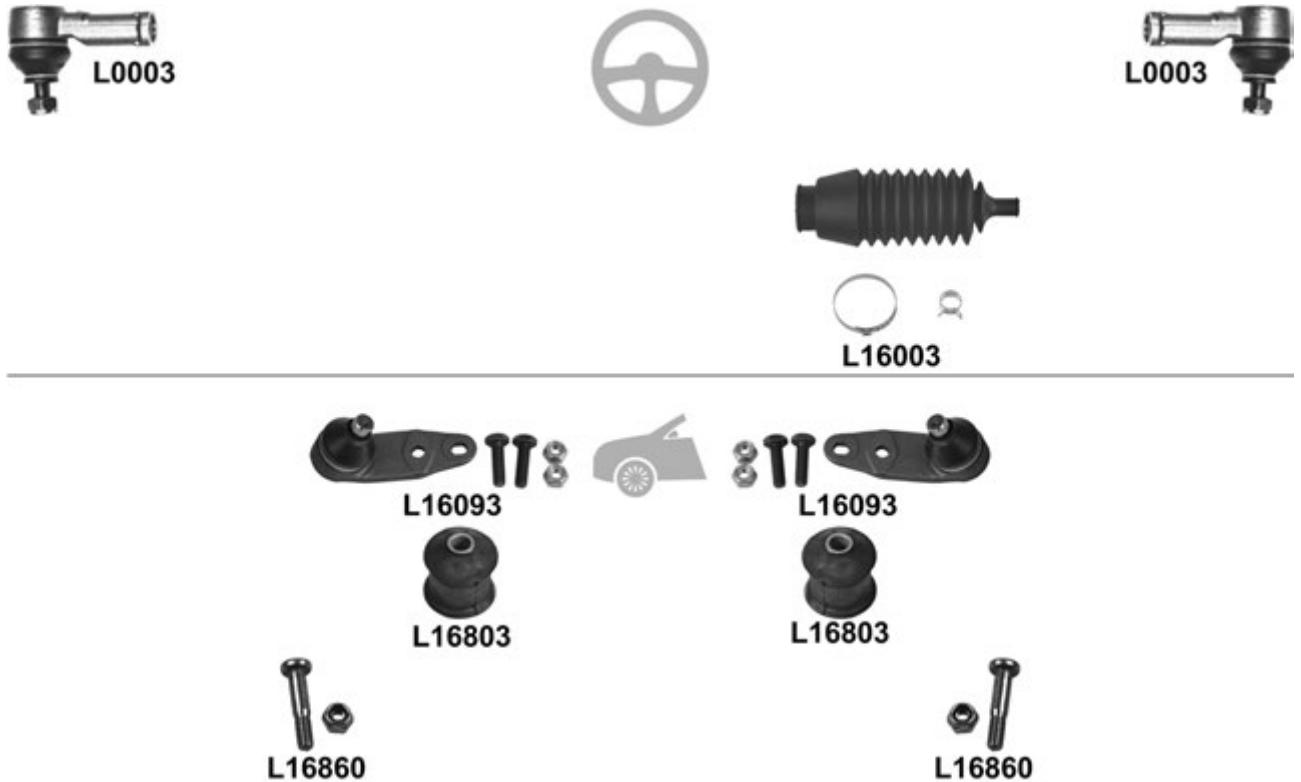
Fiesta I 05.76 → 08.83

				←	→	Thread	Part Of	QPA	
⊕		↔		L0003	L0003	F 1/2"x20 UNF ⌀		2	5021410
			⊕		L16003			1	6079917
		⊥		L16093	L16093			2	5021425
		⊥↔		L16803	L16803			2	1619120
			Mounting of on Wheels suspension	KIT	L16860	L16860		2	6080625

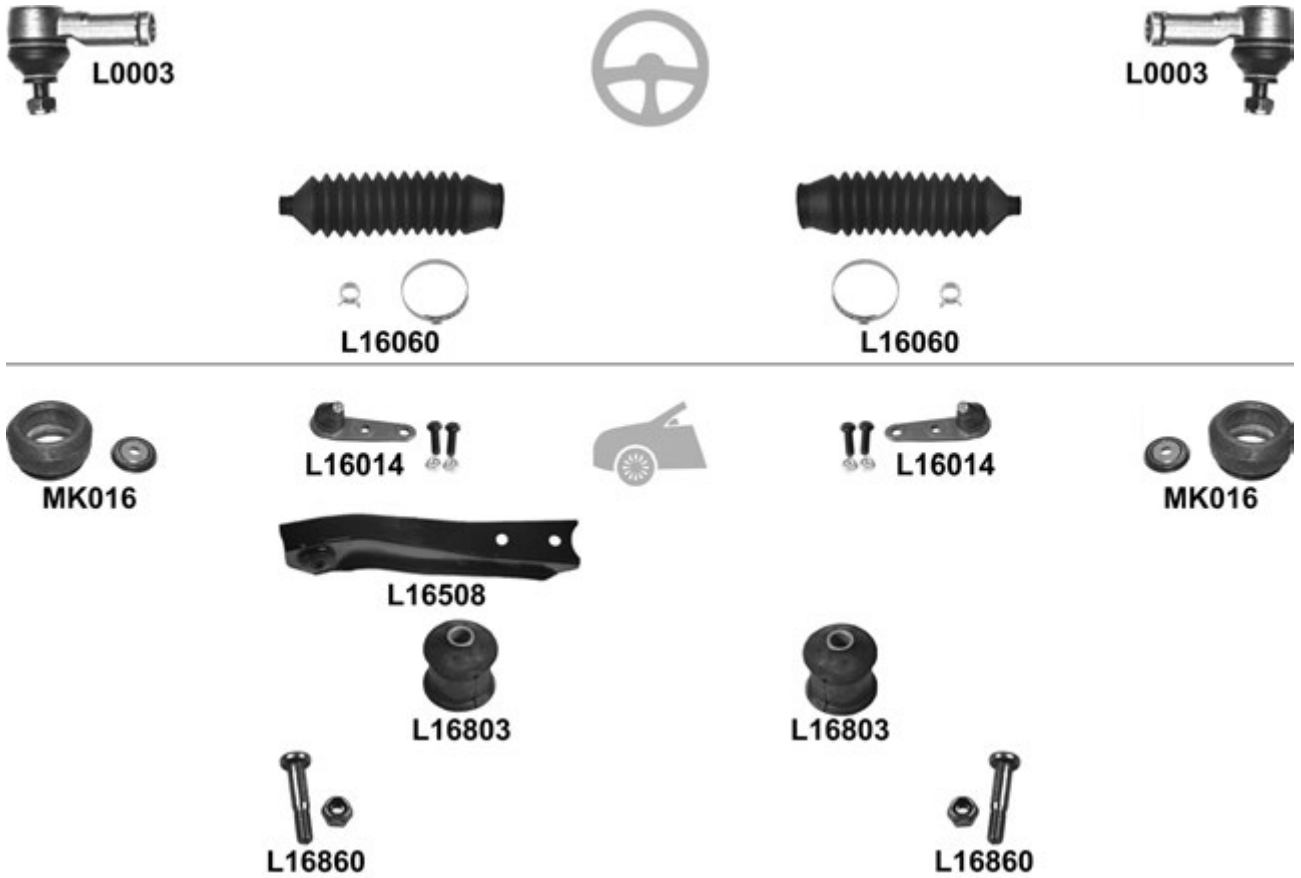
Fiesta II (FBD) 09.83 → 11.89

		i		←	→	Thread	Part Of	QPA	i	
		↔		L0003	L0003	F 1/2"x20 UNF ♂		2	5021410	
				L16060	L16060			2	6935233	
		↓		L16014	L16014			2	5021426	
		↓	<input checked="" type="checkbox"/>	L16508 ¹				1	6133850	
		↕↔		L16803	L16803		L16508	2	1619120	
			Mounting of on Wheels suspension	KIT	L16860	L16860			2	6080625
			12.84 →	KIT	MK016	MK016			2	6150277S2

Fiesta III (GFJ) 01.89 → 12.95

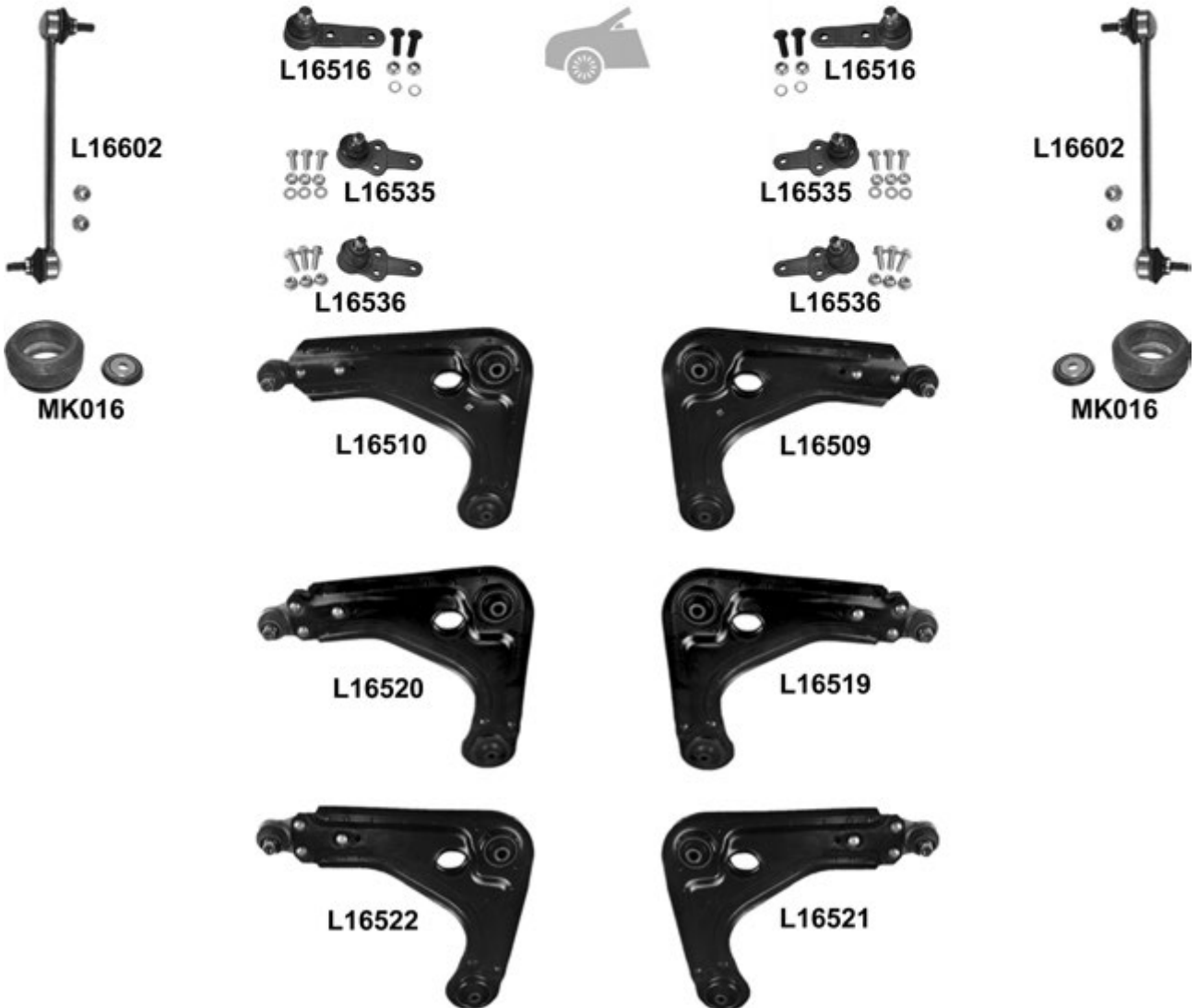
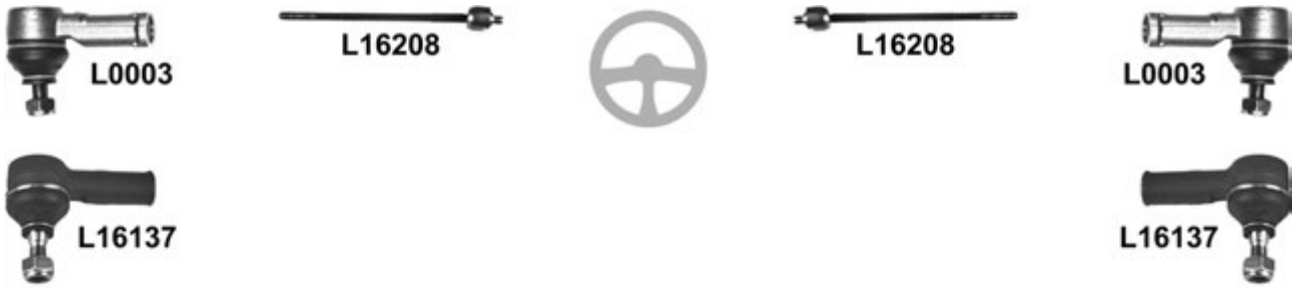

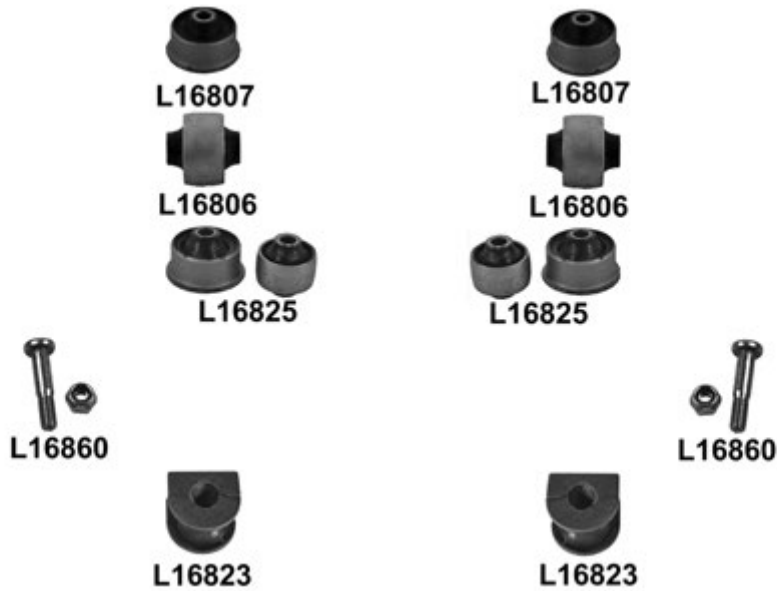
Fiesta III (GFJ) 01.89 → 12.95

		i	←	→	Thread	Part Of	QPA	i	
		↔	→ 12.93	L0003	L0003	F 1/2"x20 UNF ∪	2	5021410	
			01.94 →	L16137	L16137	∪	2	1032567	
				L16208	L16208		2	1659374	
				L16750			1	7257202	
				L16060	L16060		2	6935233	
		⊥	→ 12.93, 2x	L16516	L16516		2	1047853	
			→ 12.93, 17mm, 3x	L16535	L16535		2		
			01.94 →, 16,5mm, 3x	L16536	L16536		2	1030025	
		⊥	→ 01.94, (-) XR2i, RS Turbo	<input checked="" type="checkbox"/>		L16509		1	1054988
				L16510			1	1054989	
			XR2i, 04.89 → 10.90	<input checked="" type="checkbox"/>		L16509		1	1054988
				<input checked="" type="checkbox"/>	L16510			1	1054989
			01.94 →	<input checked="" type="checkbox"/>		L16519		1	7152271
				<input checked="" type="checkbox"/>	L16520			1	7152269
		01.94 →	<input checked="" type="checkbox"/>		L16521		1	7152270	
			<input checked="" type="checkbox"/>	L16522			1	7152272	
		⊥▼			L16807	L16807		2	1035929
⊥▲				L16806	L16806		2	1000445	
	⊥▲▼		KIT	L16825	L16825		2		
		Mounting of on Wheels suspension	KIT	L16860	L16860		2	6080625	
				L16602	L16602		2	1661237	
				L16823	L16823	Anti-roll bar	2	7102392	
			KIT	MK016	MK016		2	6150277S2	

Fiesta IV (JAS/JBS) 01.96 →

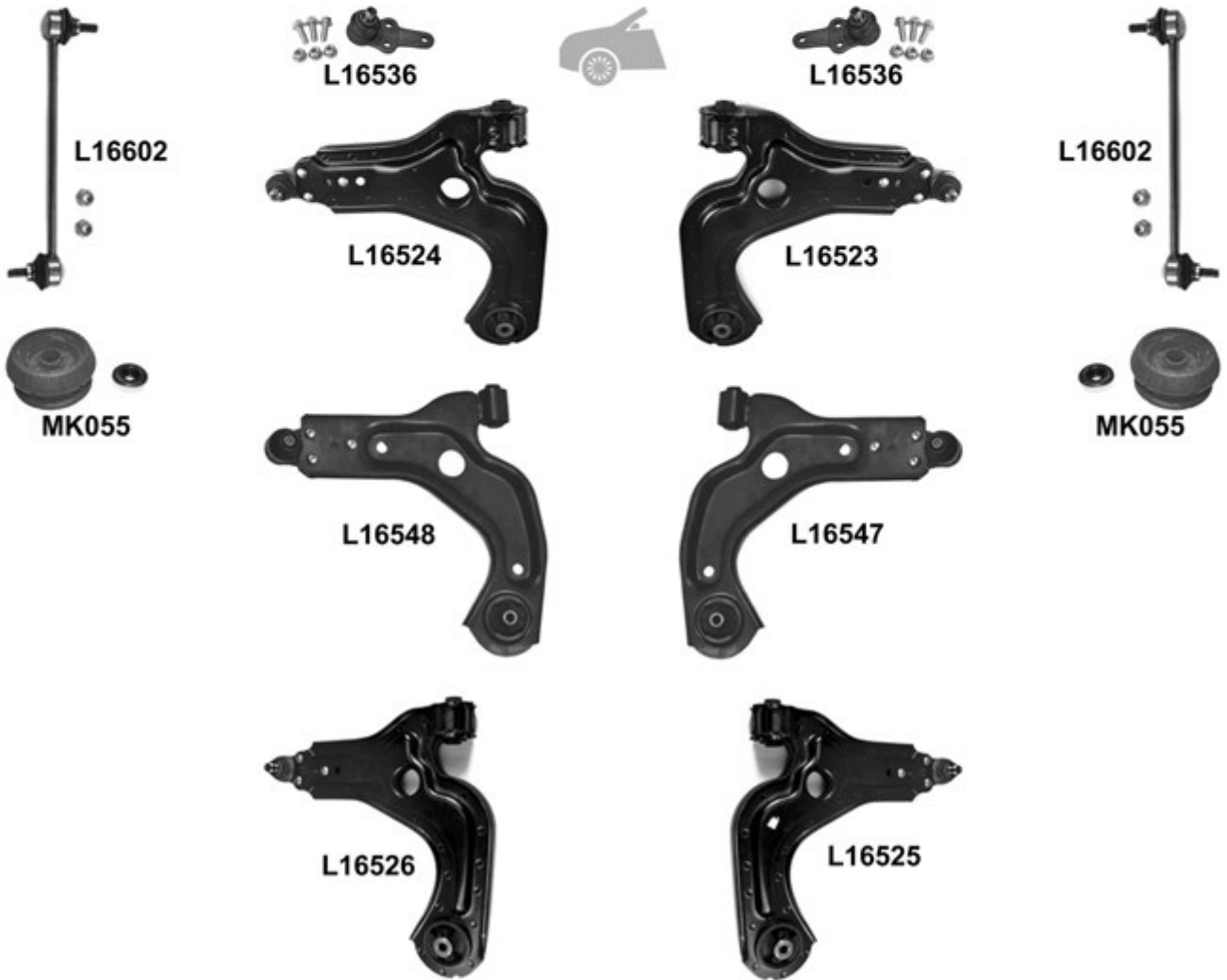
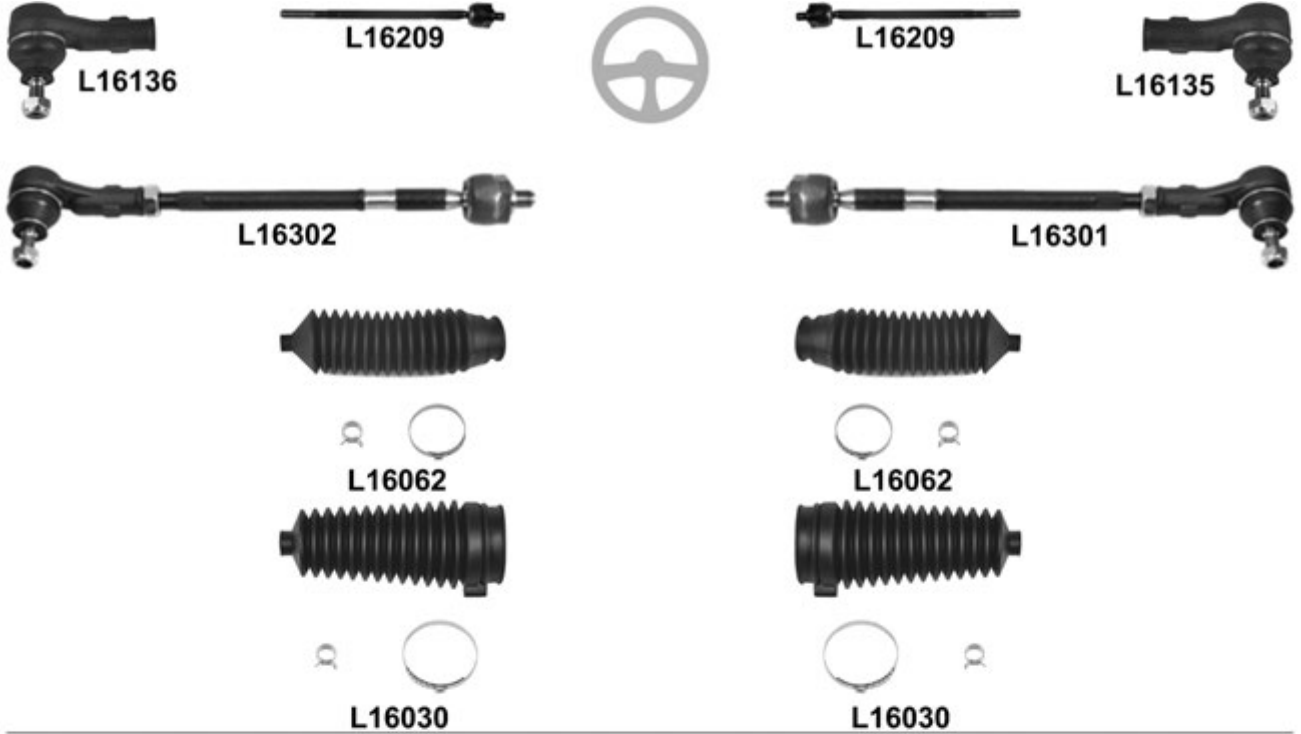

Fiesta IV (JAS/JBS) 01.96 →



Fiesta IV (JAS/JBS) 01.96 →

			←	→	Thread	Part Of	QPA			
		↔		L16135	F 14x2 ♂		1	1020174		
			L16136		F 14x2 ♂		1	1020175		
				L16209	L16209			2	1044014	
				L16301				1		
					L16302				1	
				L16062 ^o	L16062 ^o			2	6935233	
		Wuelfrath, ø 14mm, Ø 56mm, L= 185mm	L16030 ^o	L16030 ^o			2	4045250		
		⊥		16,5mm				2	1030025	
					L16536	L16536				
		⊥	→ 05.98, , Double Sheet <input checked="" type="checkbox"/>		L16523			1	1063226	
				L16524				1	1063248	
				06.98 →, , Single Sheet <input checked="" type="checkbox"/>	L16547			1	1071683	
				L16548			1	1071701		
				→ 05.98, , Double Sheet <input checked="" type="checkbox"/>	L16525			1	1063236	
				L16526			1	1063255		
				06.98 →, , Single Sheet <input checked="" type="checkbox"/>	L16549			1	1071694	
	L16550			1	1072279					
		⊥	▼		L16809	L16809		2	1014654	
				L16810	L16810		2	1010037		
			Mounting of on Wheels suspension	KIT	L16860	L16860		2	6080625	
				L16602	L16602		2	1661237		
		ø 16mm		L16823	L16823	Anti-roll bar	2	7102392		
		→ 02.00	KIT	MK055	MK055		2	1013794S		
			(-) HD	L16822	L16822	Hub carrier	2	1016439		
			HD	L16815	L16815	Hub carrier	2	7371059		
					MK126	MK126		2	1023587	

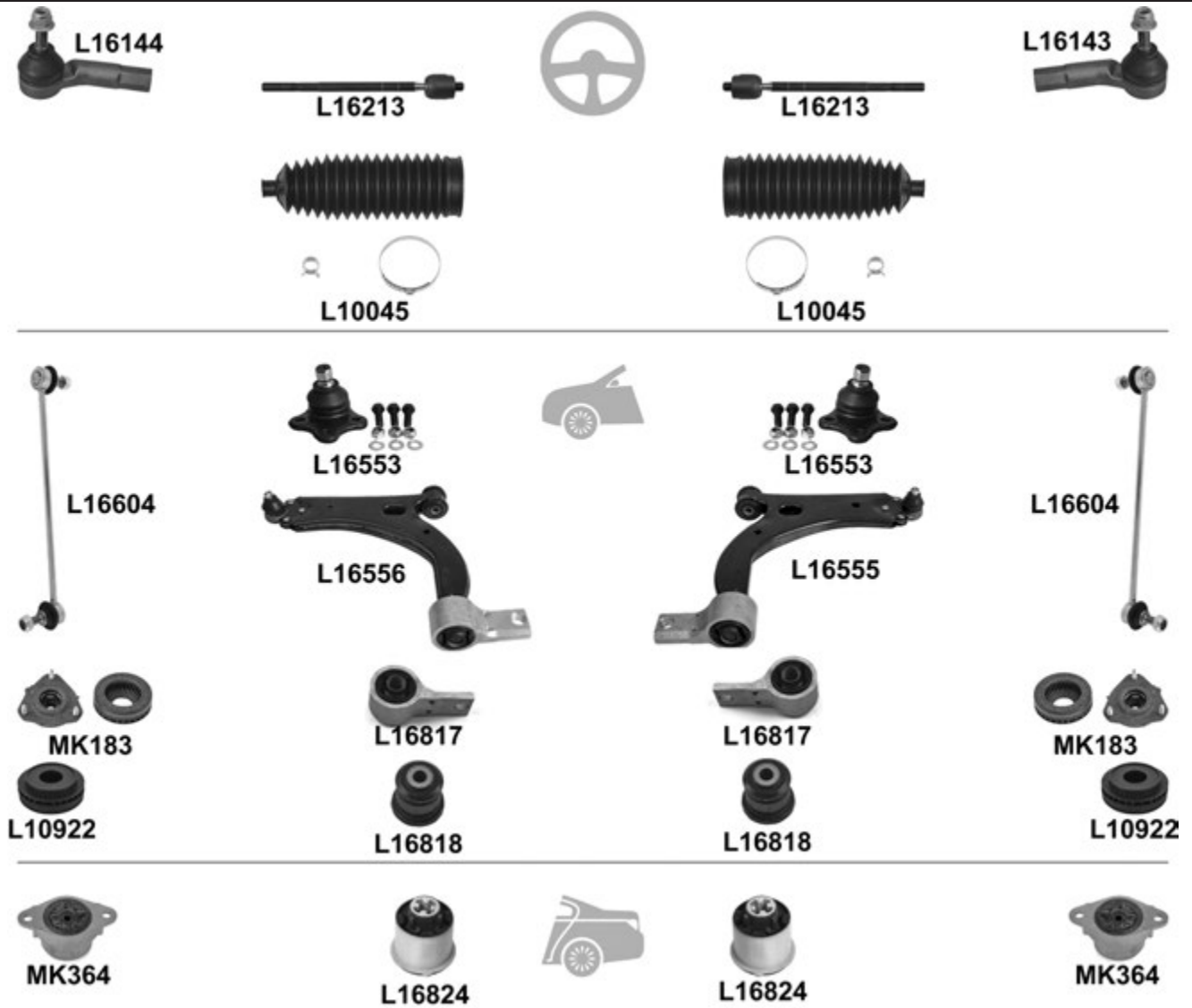
Fiesta V (JH_) 11.01 →

					←	→	Thread	Part Of	QPA			
		↔					L16143	F 14x1,5 ∪	1	1202548		
								L16144	F 14x1,5 ∪	1	1202549	
								L16213	L16213	M 14x1,5 / M 14x1,5 ∪	2	4342539
									L10045 ⁰	L10045 ⁰		2
		↓						L16553	L16553		2	2S613395AB
			<input checked="" type="checkbox"/>						L16555			1
		↓						L16556			1	1146131
									L16817	L16817		2
		↕	↙					L16818	L16818		2	1212807S1
			↘						L16604	L16604		2
				(-) L10922	KIT			MK183	MK183		2	1146153
								L10922	L10922		2	1198235
								L16824	L16824	Hub carrier	2	1146160
									MK364	MK364		2

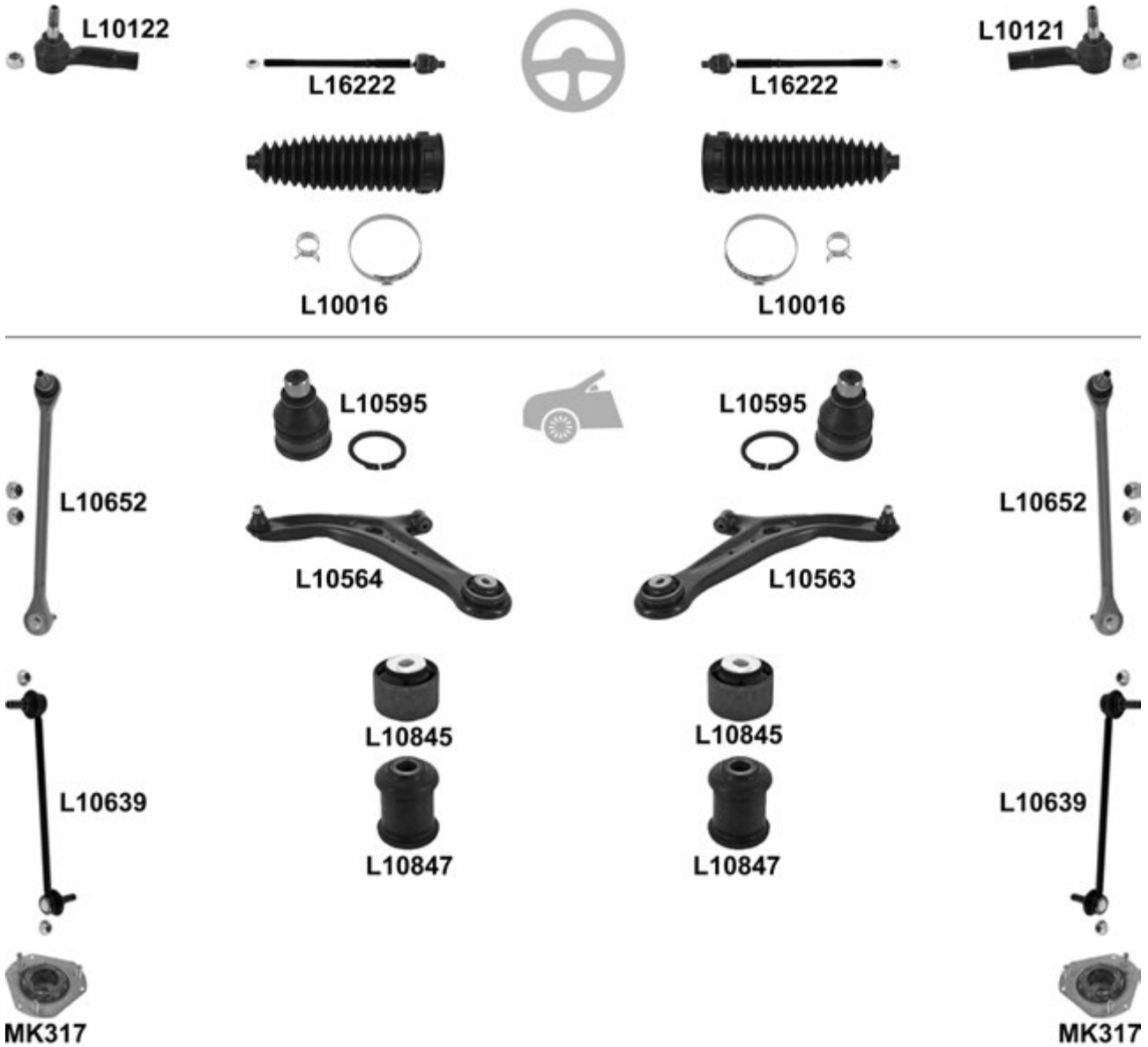
Fiesta VI (JC) 10.08 →

				←	→	Thread	Part Of	QPA		
⊕		↔			L10121	F 14x1,5 ∪		1	1545338	
					L10122	F 14x1,5 ∪		1	1545339	
					L16222	L16222	M 14x1,5 / M 14x1,5 ∪		2	1545457
					L10016	L10016			2	1545456
⊖		⊥			L10595	L10595		2		
					L10563			1	1540724	
		⊥		<input checked="" type="checkbox"/>	L10564			1	1540725	
		⊥▼			L10845	L10845		2		
		⊥▲			L10847	L10847		2		
			ALU		L10652	L10652		2	1513343	
			Metal		L10639	L10639		2	1513343	
		(-)	KIT	MK317	MK317		2			

Fiesta Courier II (F3L, 5FL) 09.91 → 02.96

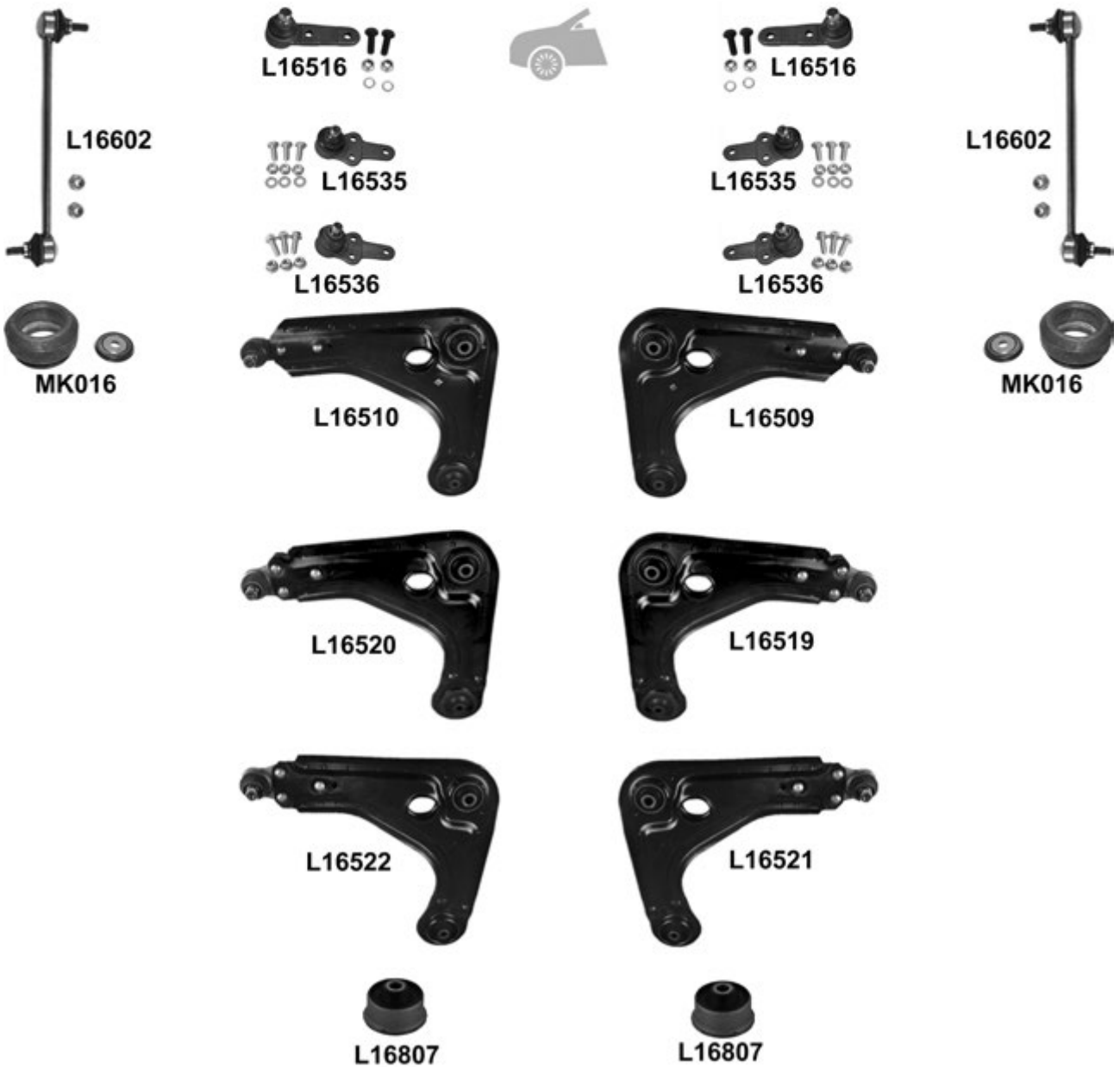
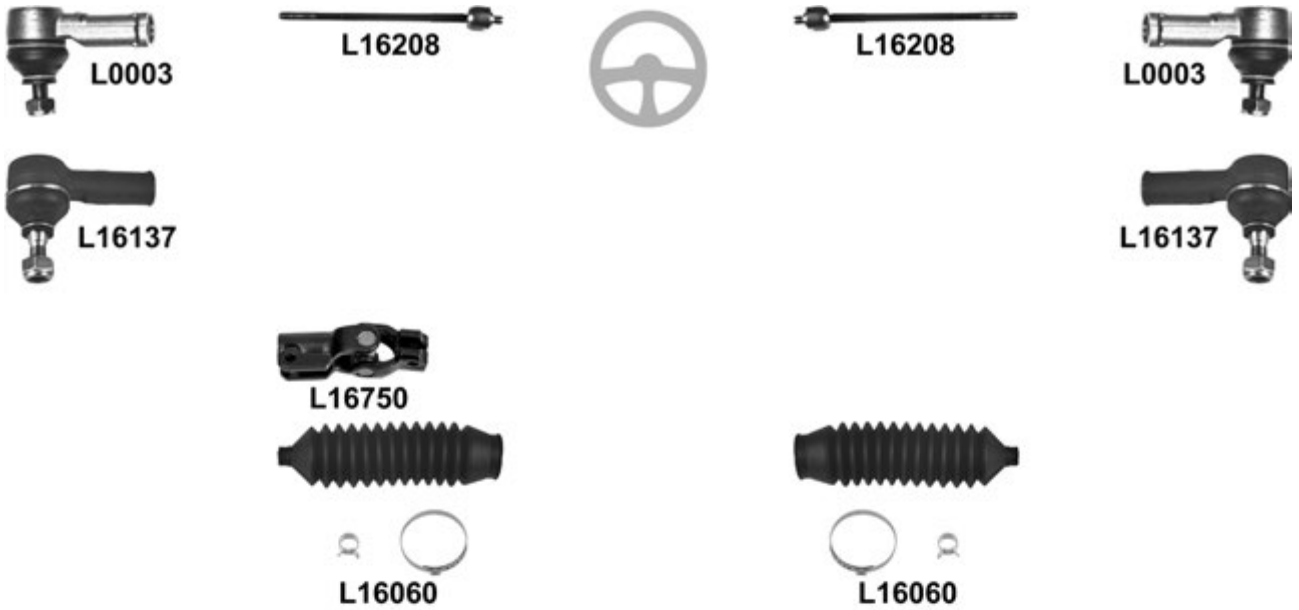

Fiesta Courier II (F3L, 5FL) 09.91 → 02.96

			←	→	Thread	Part Of	QPA		
		↔	→ 12.93	L0003	L0003	F 1/2"x20 UNF ⤷	2	5021410	
			01.94 →	L16137	L16137	⤷	2	1032567	
				L16208	L16208		2	1659374	
				L16750			1	7257202	
				L16060	L16060		2	6935233	
		⊥	→ 12.93, 2x	L16516	L16516		2	1047853	
			→ 12.93, 17mm, 3x	L16535	L16535		2		
			01.94 →, 16,5mm, 3x	L16536	L16536		2	1030025	
		⊥	→ 01.94	<input checked="" type="checkbox"/>	L16510	L16509		1	1054988
			01.94 →	<input checked="" type="checkbox"/>	L16520	L16519		1	1054989
			01.94 →	<input checked="" type="checkbox"/>	L16522	L16521		1	7152271
								1	7152270
		⊥			L16807	L16807	L16509/L16510/ L16519/L16520	2	7152272
		⊥			L16806	L16806	L16509/L16510/ L16519/L16520	2	1035929
		⊥		KIT	L16825	L16825	L16509/L16510/ L16519/L16520	2	1000445
		Mounting of on Wheels suspension	KIT	L16860	L16860		2	6080625	
				L16602	L16602		2	1661237	
				L16823	L16823	Anti-roll bar	2	7102392	
			KIT	MK016	MK016		2	6150277S2	

Fiesta Courier II (J5S / J3S) 02.96 →

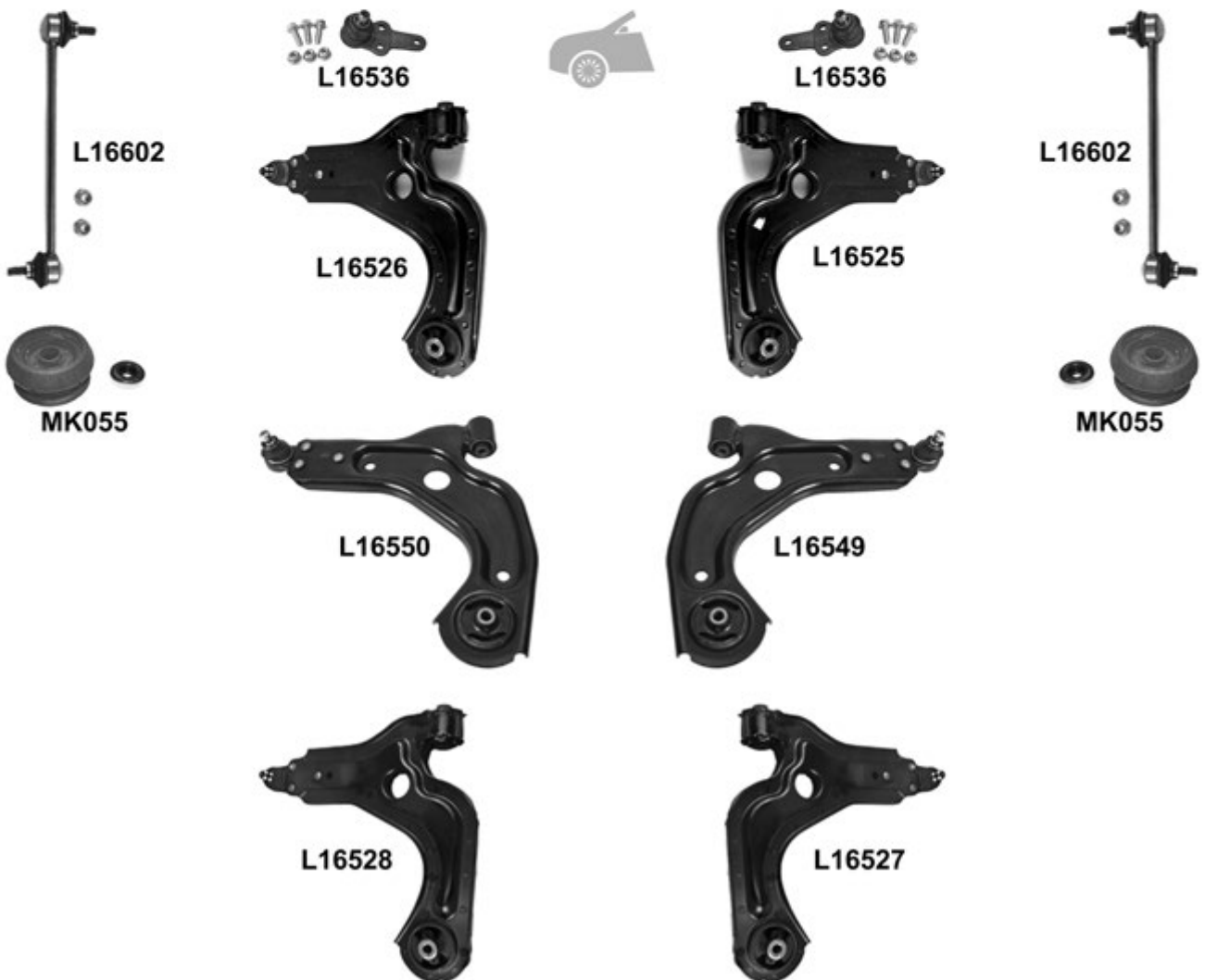
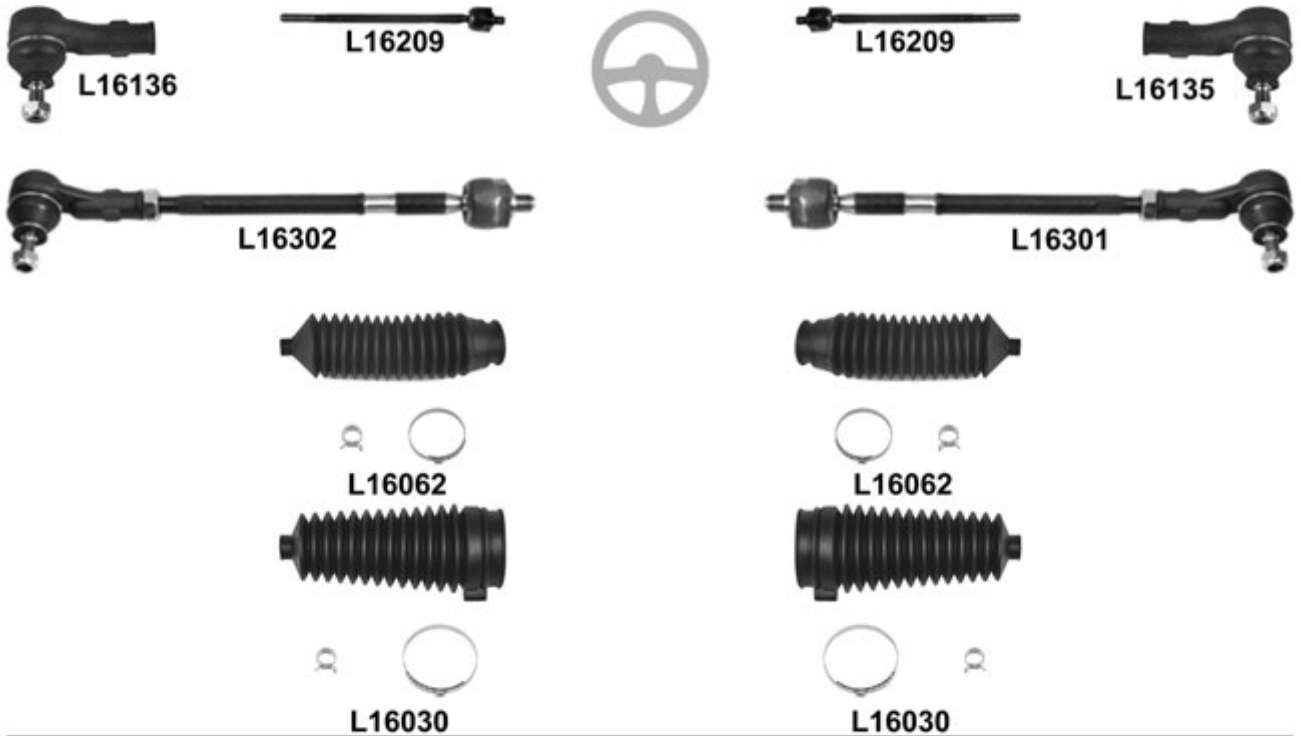

Fiesta Courier II (J5S / J3S) 02.96 →



Fiesta Courier II (J5S / J3S) 02.96 →

			←	→	Thread	Part Of	QPA			
		↔		L16135	F 14x2 ☺		1	1020174		
			L16136		F 14x2 ☺		1	1020175		
				L16209	L16209			2	1044014	
				L16301				1		
				L16302				1		
				L16062 ⁰	L16062 ⁰			2	6935233	
			☺, Wuelfrath, ø 14mm, Ø 56mm, L= 185mm	L16030 ⁰	L16030 ⁰			2	4045250	
			⊥		L16536	L16536			2	1030025
					L16525			1	1063236	
			⊥	Courier, → 05.98 , ☺, Double Sheet <input checked="" type="checkbox"/>	L16526				1	1063255
can be replaced by L 16549/16550, if they are replaced in pairs!				L16549				1	1071694	
Courier, 06.98 →, ☺, Single Sheet <input checked="" type="checkbox"/>				L16550				1	1072279	
Courier, → 05.98 , (-) ☺, Double Sheet <input checked="" type="checkbox"/>				L16527				1	1063223	
can be replaced by L 16551/16552, if they are replaced in pairs!				L16551				1	1071690	
Courier, 06.98 →, (-) ☺, Single Sheet <input checked="" type="checkbox"/>				L16552				1	1071702	
		⊥	▼	L16809	L16809			2	1014654	
			▲	L16810	L16810			2	1010037	
			Mounting of on Wheels suspension	KIT	L16860	L16860			2	6080625
					L16602	L16602			2	1661237
			ø 16mm		L16823	L16823		Anti-roll bar	2	7102392
			→ 02.00	KIT	MK055	MK055			2	1013794S
			(-) HD	L16822	L16822		Hub carrier	2	1016439	
			HD	L16815	L16815		Hub carrier	2	7371059	
				MK126	MK126			2	1023587	

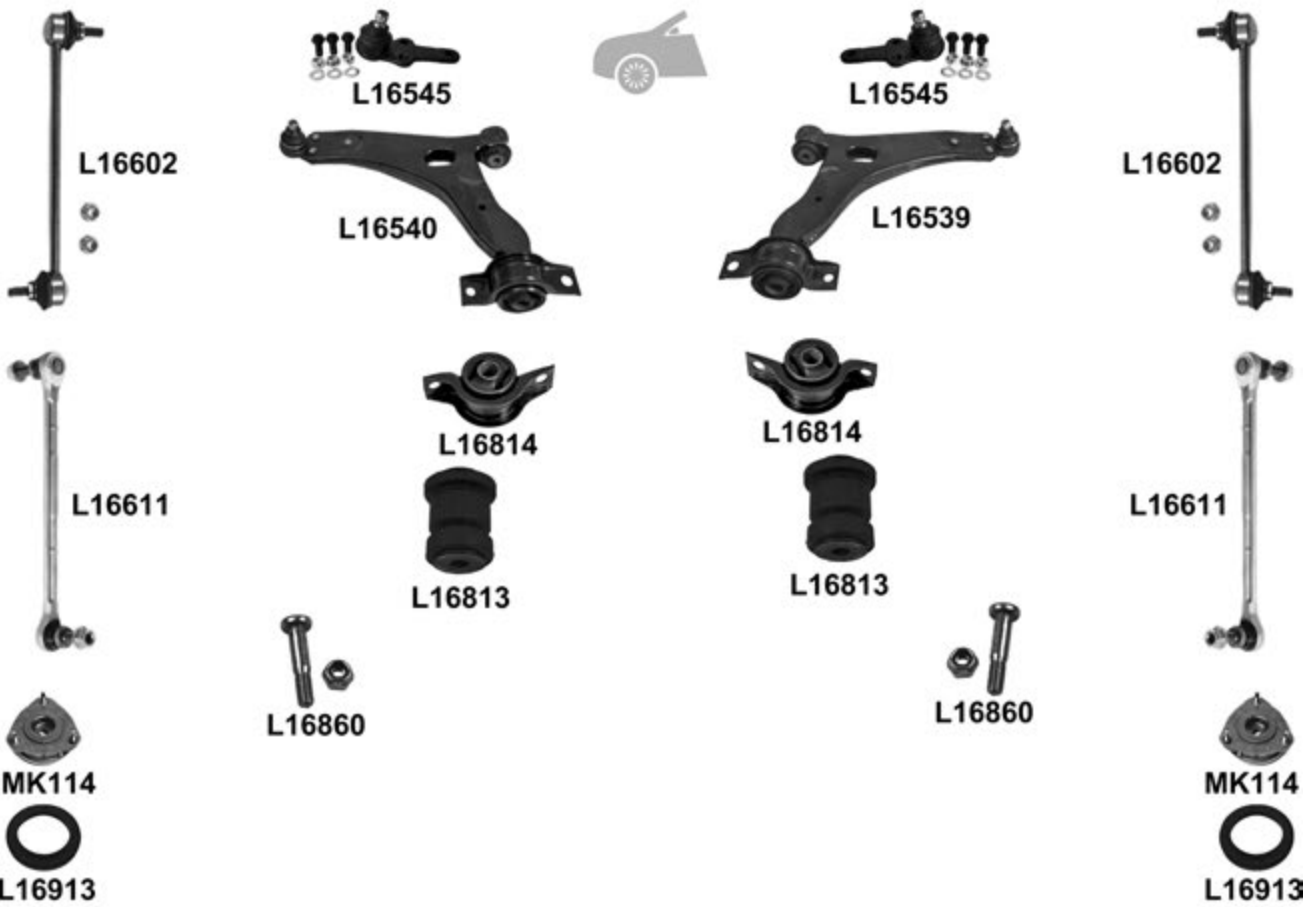
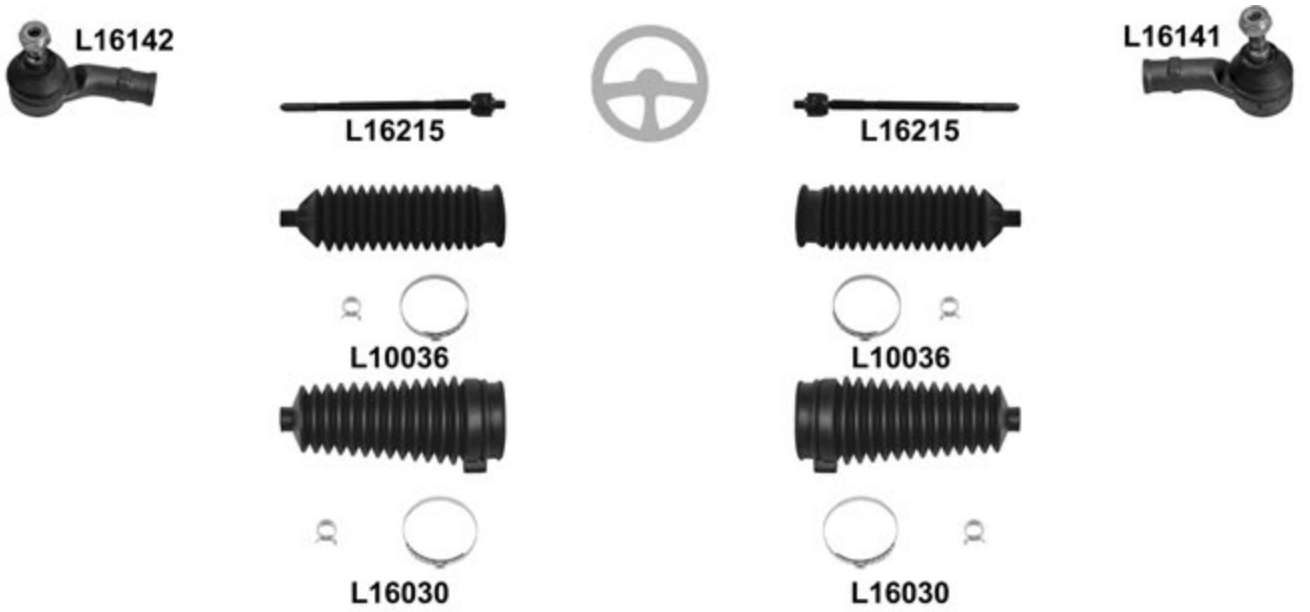
Focus (DAW / DBW / DFW / DNW) 10.98 → 03.05

Focus (DAW / DBW / DFW / DNW) 10.98 → 03.05

			←	→	Thread	Part Of	QPA		
		↔		L16141	F 14x2 ♂		1	1074305	
			L16142		F 14x2 ♂		1	1074306	
			L16215	L16215	M 14x2 / M 14x2 ♂		2	3707533	
		LHD, TRW, ø13mm, Ø 47mm, L= 200mm	L10036 ⁰	L10036 ⁰			2	6182818	
		RHD, Wuelfrath ø 14mm, Ø 56mm, L= 185mm	L16030 ⁰	L16030 ⁰			2	1012814	
		⊥	L16545	L16545			2	1679401	
		⊥	(-) ST170 / RS <input checked="" type="checkbox"/>	L16539			1	1090730	
			L16540				1	1090738	
		⊥▼	(-) ST170 / RS	L16814	L16814			2	1097918
		⊥▲	(-) ST170 / RS	L16813	L16813			2	1061570
		Mounting of on Wheels suspension	KIT	L16860	L16860			2	6080625
			Steel	L16602	L16602			2	1661237
			ALU	L16611	L16611			2	1209035
		(-) ST170 / RS, (-)	KIT	MK114	MK114			2	1087177S1
	(-) ST170 / RS, (-)		L16913	L16913			2	1061721	
		⊥	L10538	L10538			2	1329730	
		⊥▲	L10539	L10539			2	1061668	
		⊥	L16571	L16571			2	1064128	
		→ 06.01	L16638	L16638			2	1061702	
		07.01 →	KIT	L16612			1	1203093	

Focus II 11.04 →

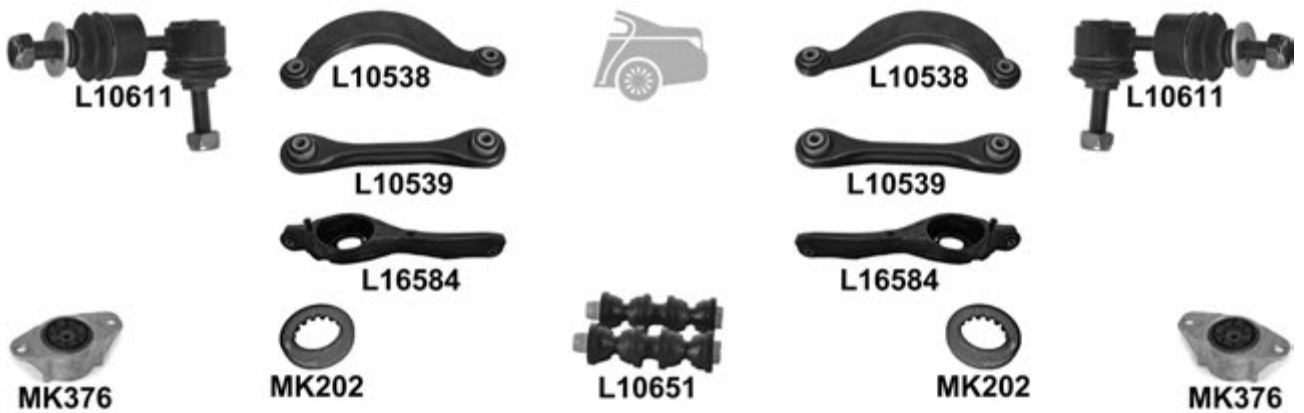
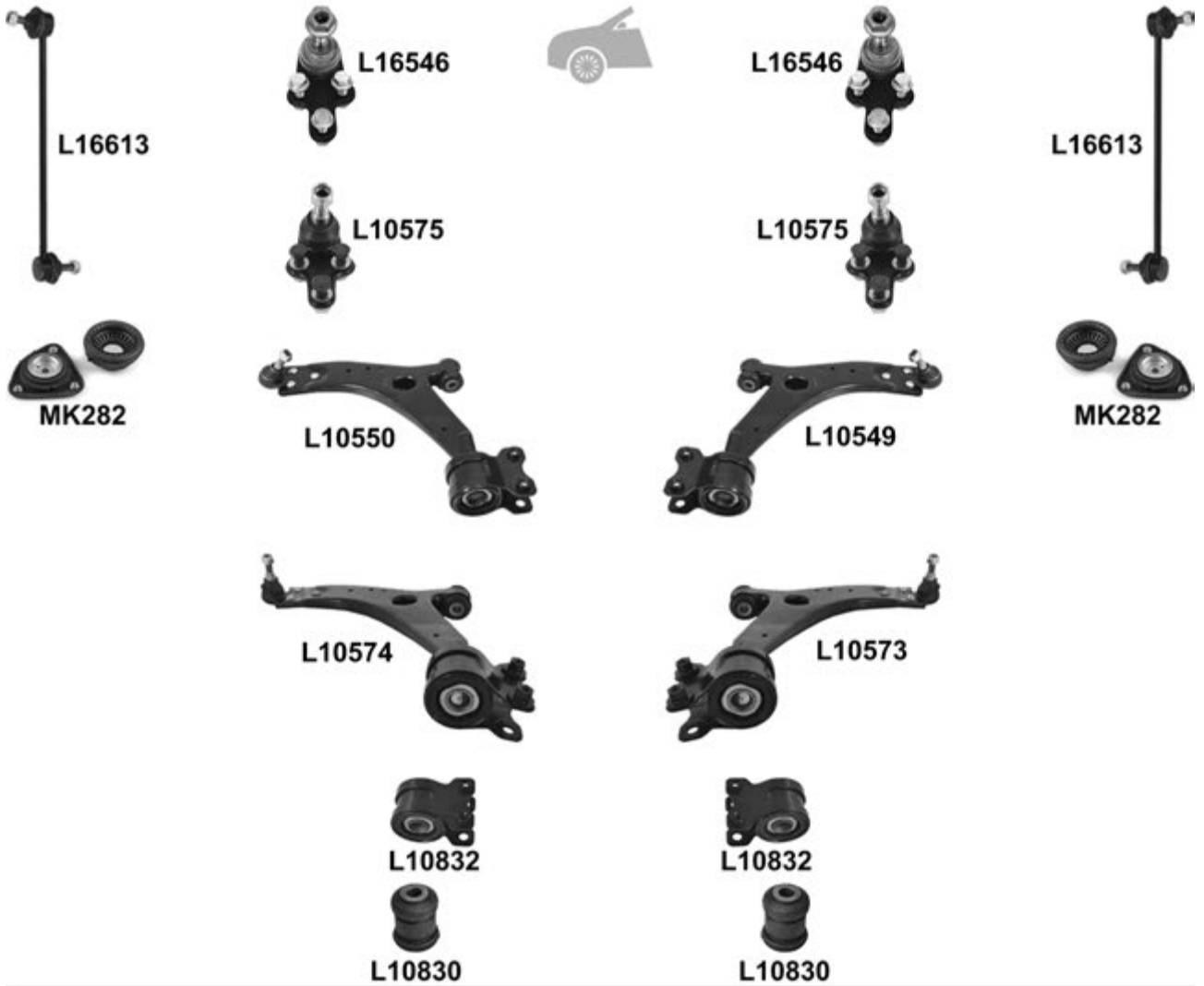

Focus II 11.04 →

				←	→	Thread	Part Of	QPA	
		↔			L10109	F 16x1,5 U		1	1328877
				L10110		F 16x1,5 U		1	1328881
				L16217	L16217	M 16x1,5 / M 14x1,5 U		2	1377655
				L16075	L16075			2	1377499
		↓	→ 02.06, 18mm		L16546	L16546		2	1234382
			03.06 →, 21mm		L10575	L10575		2	1470387
		↓	→ 02.06, 18mm	<input checked="" type="checkbox"/>		L10549		1	1420795
				<input checked="" type="checkbox"/>	L10550			1	1420858
			03.06 →, 21mm	<input checked="" type="checkbox"/>		L10573		1	1570285
				<input checked="" type="checkbox"/>	L10574			1	1570284
		↓▼			L10832	L10832		2	
		↓▲			L10830	L10830		2	
					L16613	L16613		2	1230909
				KIT	MK282	MK282		2	1381605
	RUBBER				MK202	MK202		2	
		↑			L10538	L10538		2	1329730
		↓▲	→ 11.04		L10539	L10539		2	1061668
		↓	(-) /Van		L16584 ⁰	L16584 ⁰		2	1357317
			Horizontal Mounting		L10611	L10611		2	1335548
			Vertical mounting	KIT	L10651			1	1500682
			(-) /Wagon		MK376	MK376		2	1300459

Focus III 04.11 →
Focus III Turnier 05.11 →

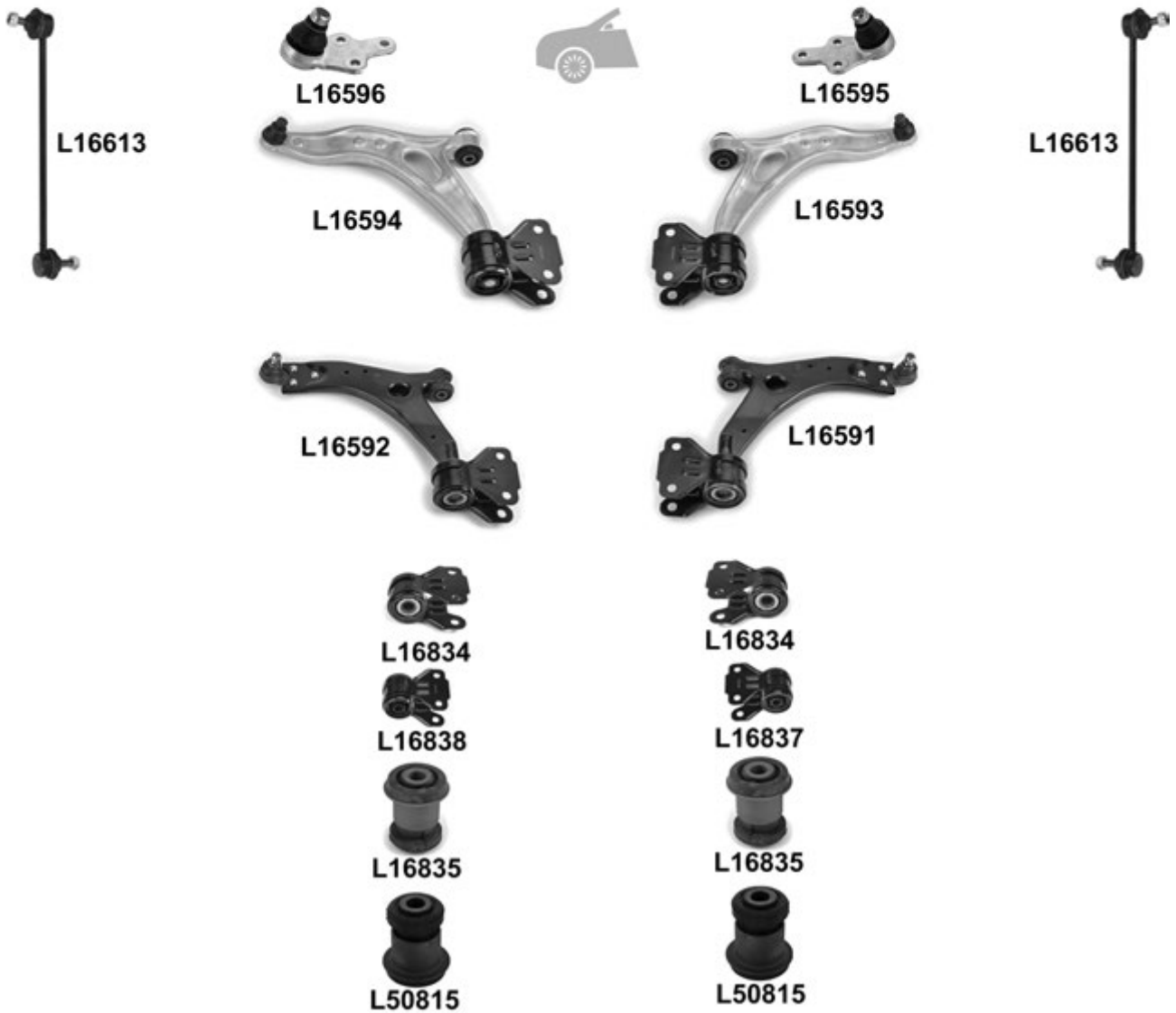
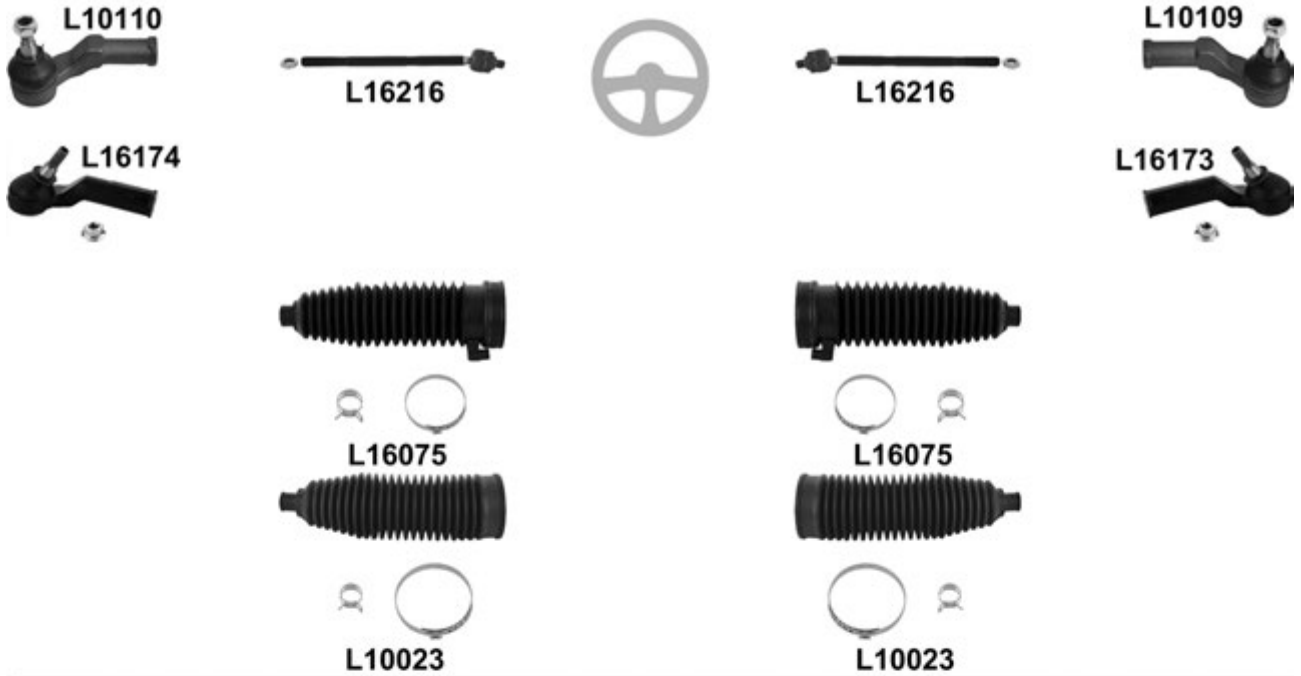

Focus III 04.11 →
Focus III Turnier 05.11 →

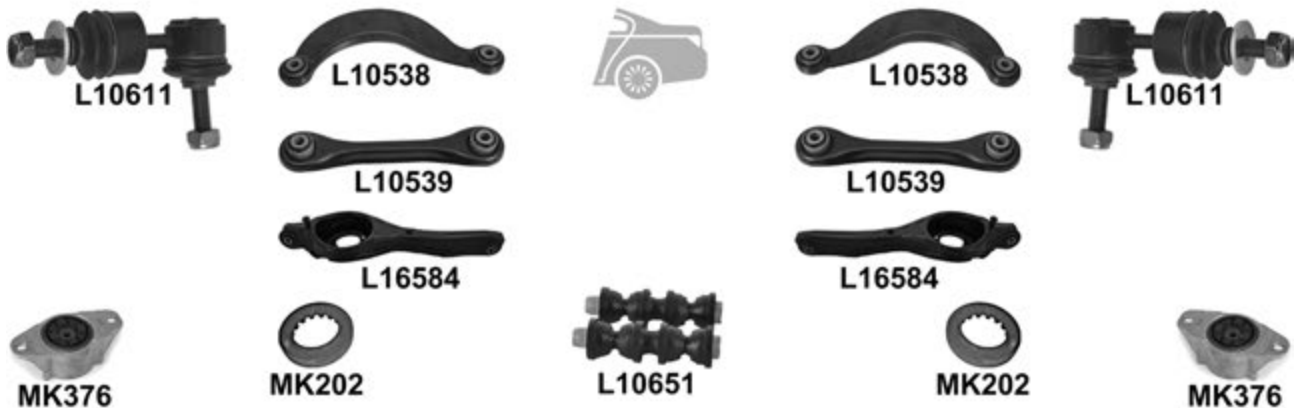
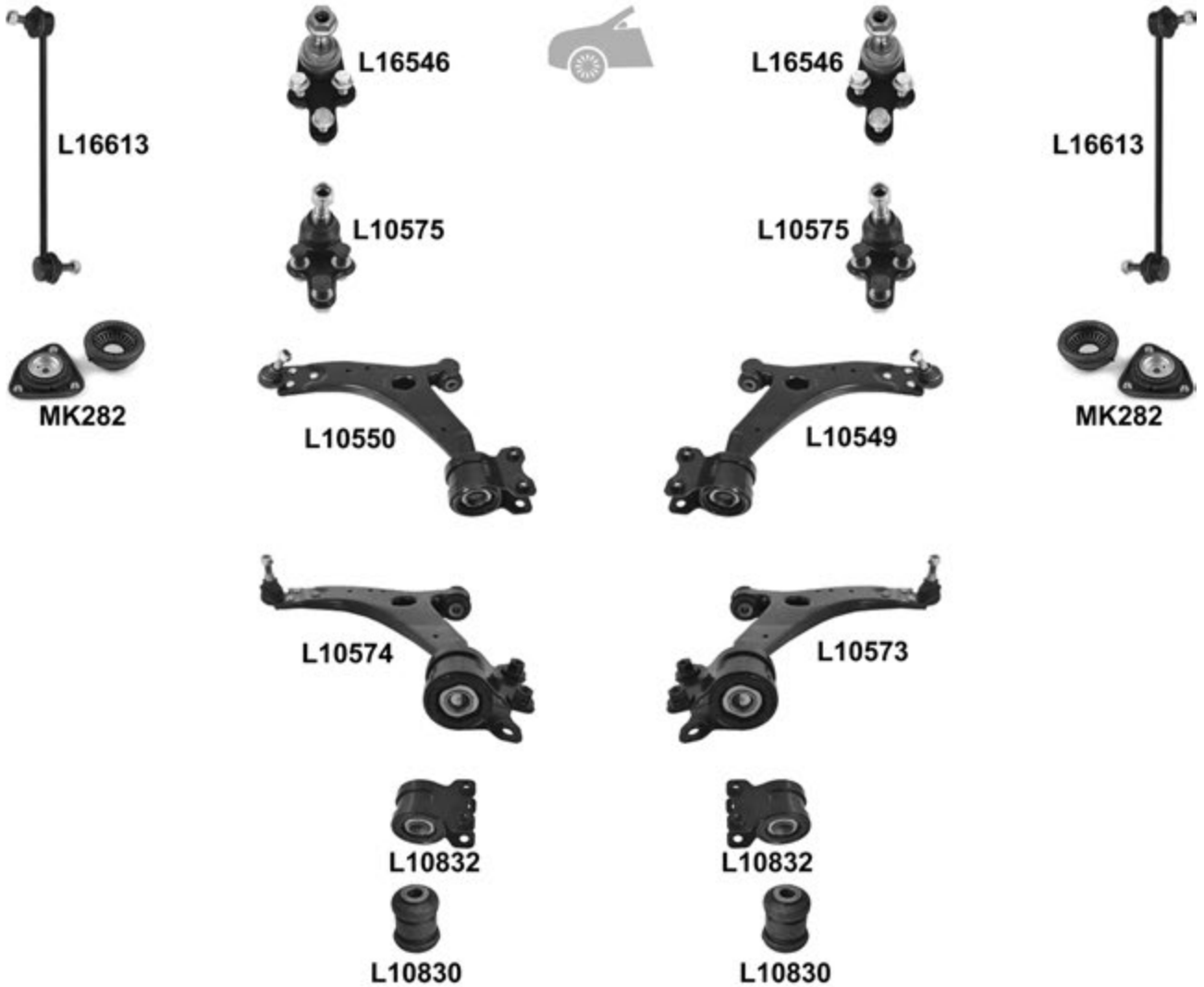

				←	→	Thread	Part Of	QPA		
		↔	(-) Electric	L10109		∪		1	1328877	
				L10110		∪		1	1328881	
			Electric		L16173		∪		1	1714576
				L16174		∪		1	1714700	
			Electric	L16216	L16216	∪		2	1714484	
			(-) Electric	L16075	L16075			2	1377499	
			Electric	L10023	L10023			2	1334215	
		⊥			L16595		L16591	1		
					L16596		L16592	1		
		⊥	1.0 EcoBoost, 1.6 FlexiFuel, 1.6 LPG, 1.6 Ti Mot/Eng 1QDB/PNDA <input checked="" type="checkbox"/> ALU, (+/-) Xenon light, (-)		L16593				1	1749991
			1.6 EcoBoost, 1.6 TDCi, 1.6 Ti Mot/Eng XTDA, 2.0 TDCi, Sheet Metal <input checked="" type="checkbox"/>		L16594				1	1749992
					L16591			1	1702970	
					L16592			1	1702983	
		⊥	▼		L16834	L16834		L16591/L16592	2	
					L16837			L16593	1	
					L16838			L16594	1	
					L16835	L16835		L16591/L16592	2	
				L50815	L50815		L16593/L16594	2		
			D, → 05.14, RUS, → 02.14	L16613	L16613			2	1230909	
	RUBBER		(-)	MK202	MK202			2		
		↑		L16A02 ⁰	L16A02 ⁰			2	1752736	
			Vertical mounting	KIT		L10651		1	1500682	
			(+) Horizontal mounting	L16639	L16639			2	1517891	

Focus C-Max 10.03 → 03.07

Focus C-Max 10.03 → 03.07

		i		←	→	Thread	Part Of	QPA	i	
		↔			L10109	F 16x1,5 ∪		1	1328877	
			L10110			F 16x1,5 ∪		1	1328881	
				L16216	L16216	M 16x1,5 / M 14x1,5 ∪		2	1251937	
					L10023	L10023			2	1334215
		⊥	→ 02.06, 18mm		L16546	L16546			2	1234382
			03.06 →, 21mm		L10575	L10575			2	1470387
		⊥	→ 02.06, 18mm	<input checked="" type="checkbox"/>		L10549			1	1420795
				<input checked="" type="checkbox"/>	L10550				1	1420858
			03.06 →, 21mm	<input checked="" type="checkbox"/>		L10573			1	1570285
				<input checked="" type="checkbox"/>	L10574			1	1570284	
		⊥	▼		L10832	L10832			2	
			▲		L10830	L10830			2	
					L16613	L16613			2	1230909
				KIT	MK282	MK282			2	1381605
	RUBBER			MK202	MK202			2		
		⏊		L10538	L10538			2	1329730	
		⊥ ▲		L10539	L10539			2	1061668	
		⊥		L16584 ⁰	L16584 ⁰			2	1357317	
			Horizontal Mounting	L10611	L10611			2	1335548	
			Vertical mounting	KIT	L10651			1	1500682	
				MK376	MK376			2	1300459	

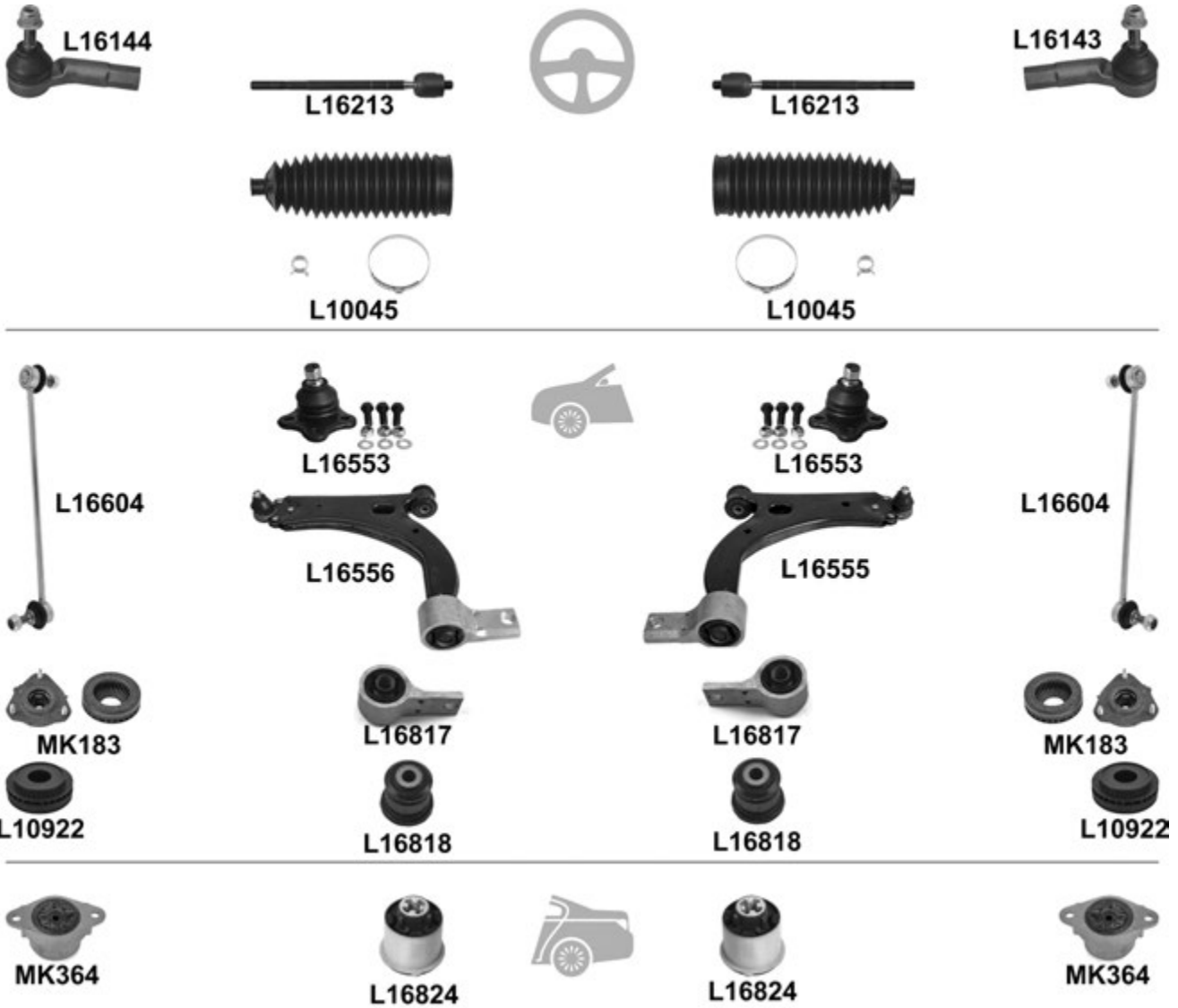
Fusion 08.02 →

			←	→	Thread	Part Of	QPA	
		↔		L16143	F 14x1,5 ♂		1	1202548
				L16144	F 14x1,5 ♂		1	1202549
			L16213	L16213	M 14x1,5		2	4342539
			∅ 14mm, ∅ 54mm, L= 198mm	L10045 ⁰	L10045 ⁰			2
		↓		L16553	L16553		2	2S613395AB
			<input checked="" type="checkbox"/>	L16555			1	1214911
		L16556			1	1214912		
		↓ ▾	L16817	L16817			2	1212807S2
		↓ ▲	L16818	L16818			2	1212807S1
			L16604	L16604			2	1146150
		(-) L10922	KIT	MK183	MK183		2	1146153
		L10922	L10922			2	1198235	
			L16824	L16824		Hub carrier	2	1146160
			MK364	MK364			2	1330706

Galaxy (WGR) 11.95 →

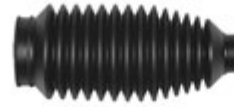
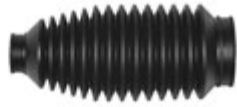

L10046

L10046

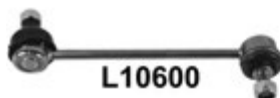

L10518

L10517



MK344

MK344



L10800

L10800



L10812

L10812



L10833

L10833



L10834

L10834

Galaxy (WGR) 11.95 →

		i		←	→	Thread	Part Of	QPA	i	
		↔				L29119		1	1092377	
						L29120		1	1092380	
						L10204	L10204	M 14x1,5 / M 14x1,5	2	
						L29355		1	1092376	
						L29356		1	1092382	
			ø 10mm, Ø 49mm, L= 178mm			L10046 ^o	L10046 ^o		2	7398680
		↓				L10505	L10505		2	7200946
		↓				L10517			1	1012632
						L10518			1	1007602
		↓↘				L10800	L10800		2	7396830
		↓↗				L10812	L10812		2	7201717
						L10600	L10600		2	1009591
				ø 17mm			L10833	L10833	Anti-roll bar	2
			(+) MK344	KIT		MK067	MK067		2	7201848S1
						MK344	MK344		2	1J0412249
			(-) HD , ø 20mm			L10834	L10834	Anti-roll bar	2	1001713

Galaxy 05.06 →

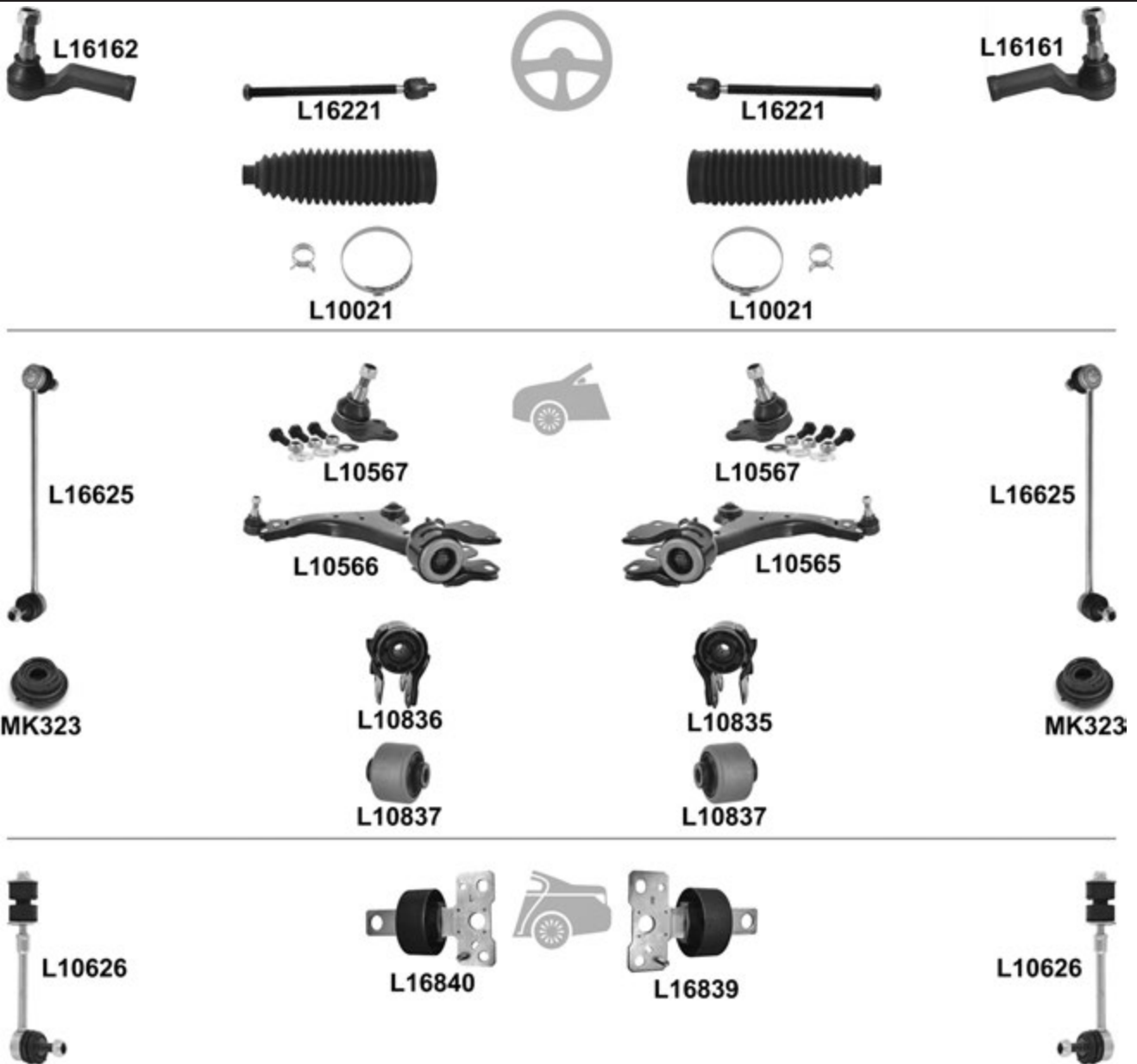

		i		←	→	Thread	Part Of	QPA	i		
⊕		↔			L16161	⊖		1	1433274		
					L16162	⊖		1	1433273		
		L= 315mm			L16221	L16221	⊖		2	1596574	
					L10021 ^o	L10021 ^o			2	1433372	
		⊥			L10567	L10567			2		
			<input checked="" type="checkbox"/>		L10565				1	1507181	
		⊥			L10566				1	1507182	
					L10835				1		
		⊥	↘		L10836				1		
			↗		L10837	L10837			2		
		⊥	↔			L16625	L16625			2	1377849
					MK323	MK323			2	1539863	
		⊥	longitudinal			L16839			1	1566836	
						L16840				1	1566838
						L10626	L10626			2	1425853

Granada 03.72 → 08.85
Consul



Thread

Part Of

QPA



		↔		L0004	L0004	F 14x2 ∅		2	1476246
				L16160	L16160			2	5021729

Ka (RBT) 09.96 → 11.08

FORD

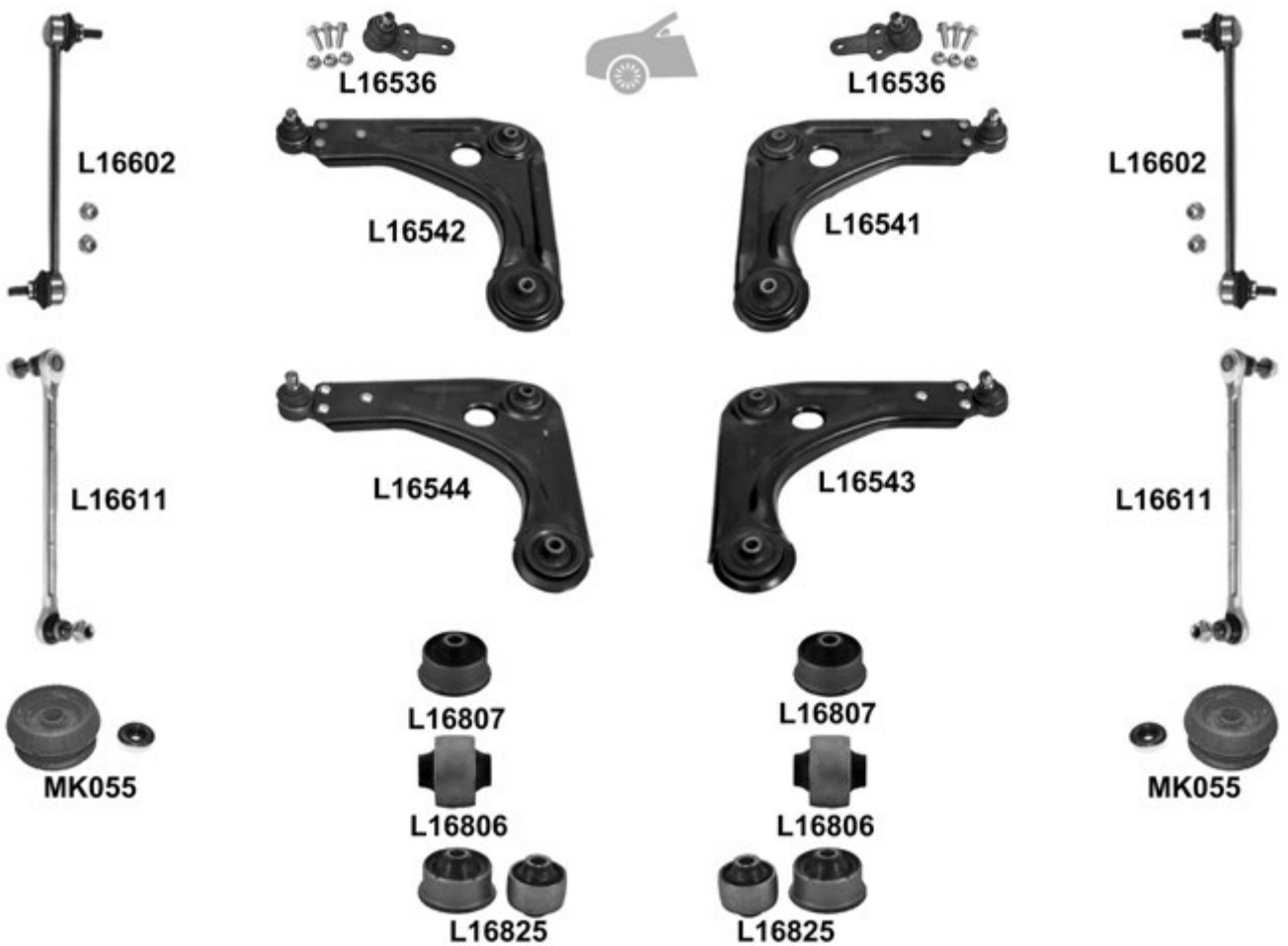
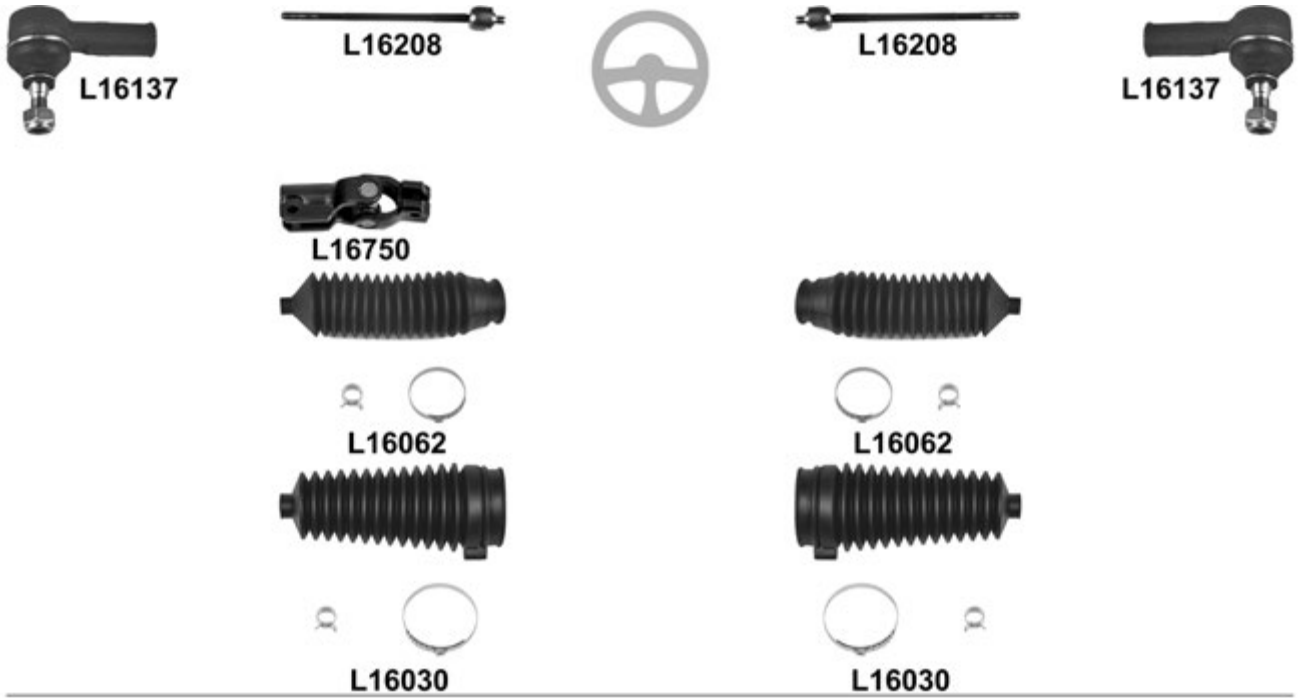

Ka (RBT) 09.96 → 11.08

			←	→	Thread	Part Of	QPA			
		↔			F 1/2"x20 UNF		2	1034417		
							2	6790700		
							1	7257202		
			∅ 14mm, ∅ 37mm, L= 228mm				2	6935233		
			∅ 14mm, ∅ 56mm, L= 185mm				2	4045250		
		↓		16,5mm			2	1030025		
		↓		<input checked="" type="checkbox"/>		L16541		1	1063987	
				<input checked="" type="checkbox"/>	L16542			1	1063988	
		↓		<input checked="" type="checkbox"/>		L16543		1	1063985	
				<input checked="" type="checkbox"/>	L16544			1	1063986	
		↓					L16541/L16542/ L16543/L16544	2	1035929	
		↑					L16541/L16542/ L16543/L16544	2	1000445	
		↓			KIT	L16825	L16825		2	
			→ 10.00, Steel			L16602	L16602		2	1661237
			11.00 →, ALU			L16611	L16611		2	1209035
		→ 03.03			KIT	MK055	MK055		2	1013794S
					L16822	L16822		Hub carrier	2	1016439
					MK126	MK126			2	1023587

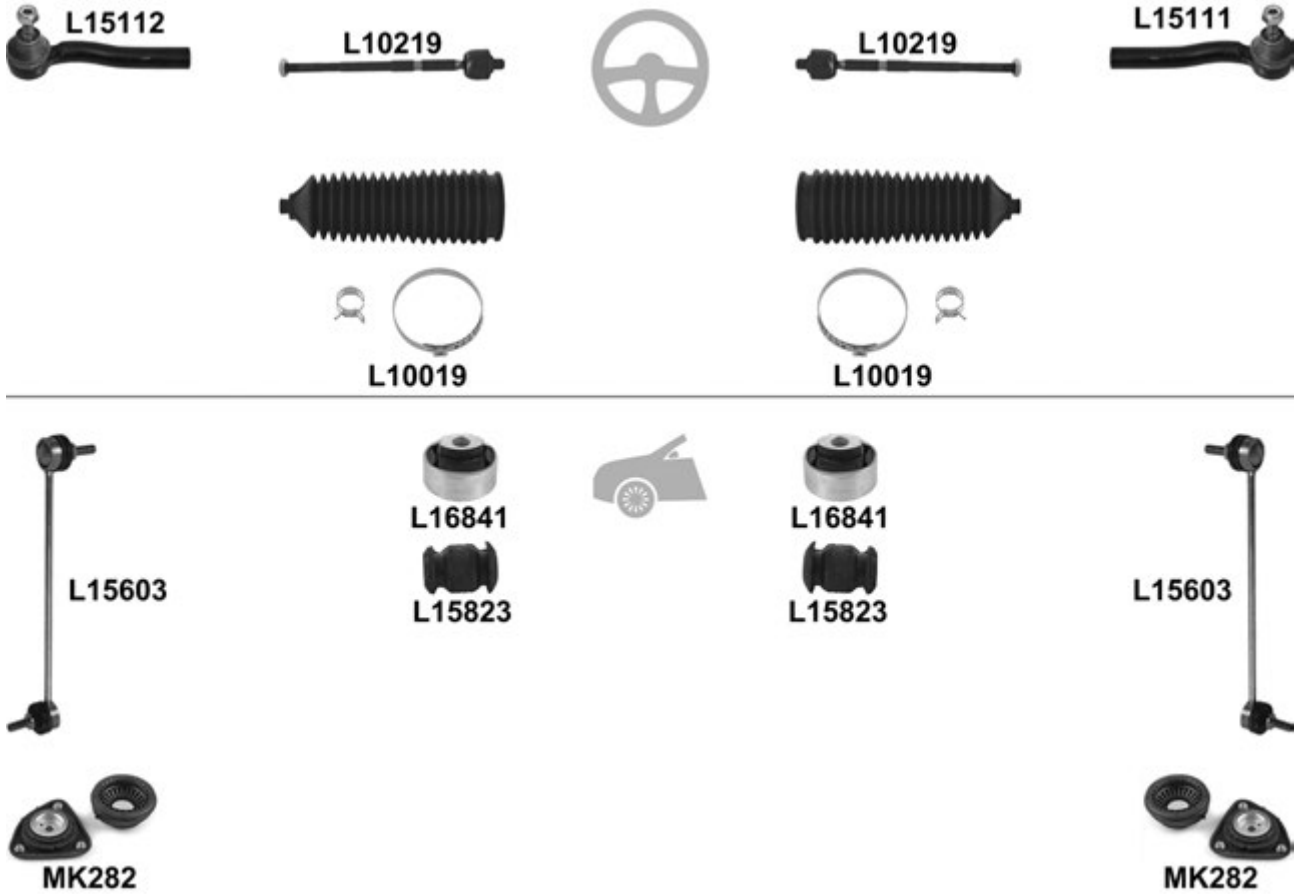
Ka 02.09 →

				←	→	Thread	Part Of	QPA		
⊕		↔			L15111	F 12x1,5 ♂		1	1546260	
					L15112	F 12x1,5 ♂		1	1546259	
				L10219	L10219	M 12x1,5 / F 14x1,5 ♂		2		
				Thermoplast	L10019	L10019			2	1546265
⊙		⊥▼		L16841 ⁰	L16841 ⁰		L16A03/L16A04	2		
		⊥▲		L15823 ⁰	L15823 ⁰		L16A03/L16A04	2		
				L15603	L15603			2	1580517	
			01.06 →	KIT	MK282	MK282		2	51830518	

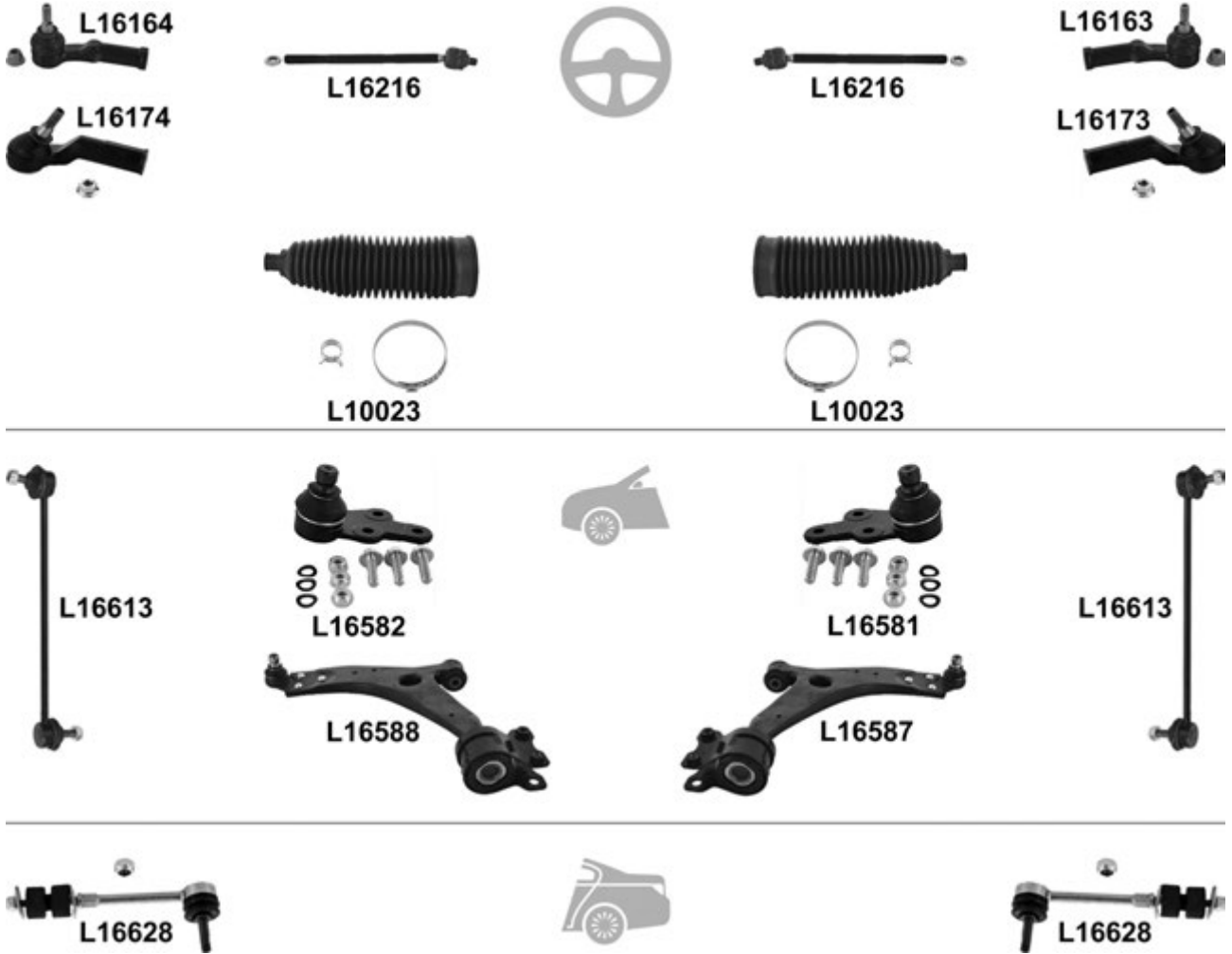
Kuga 03.08 →

				← → Thread		Part Of	QPA				
		↔		L16163	∩		1	1541485			
				L16164	∩		1	1541488			
			11.12 →, Electric	L16173	∩		1	1748237			
				L16174	∩		1	1748239			
				L16216 L16216	∩		2	1510270			
				L10023 L10023			2	1334215			
				↓		L16581		L16587		1	
						L16582		L16588		1	
				↓	<input checked="" type="checkbox"/>	L16587				1	1723323
						L16588				1	1723324
			(-) 1.6 EcoBoost	L16613 L16613			2	1230909			
			1.6 EcoBoost, → 02.14	L16613 L16613			2	1230909			
				L16628 L16628			2	1502681			

Maverick (UDS, UNS) 02.93 → 04.98

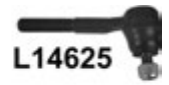
L14626

L14625

Thread
Part Of
QPA

				L14625	L14625	M 16x1,5 ⌀		1 1960077
				L14626		M 16x1,5 ⌀		1 1962367

Maverick 02.01 →

L50153

L50153

L16078

L16078

L50040

L50040

L50812

L50812

L50813

L50813

Thread
Part Of
QPA

				L50153	L50153	F 16x1,5 ⌀		2 4546412
			∅ 17mm, ∅ 55mm, L= 206mm	L16078⁰	L16078⁰			2 4780137
				L50040	L50040			2 G030-99-356
				L50812	L50812			2
				L50813	L50813			2

Mondeo I (GBP/BNP) 02.93 → 08.96

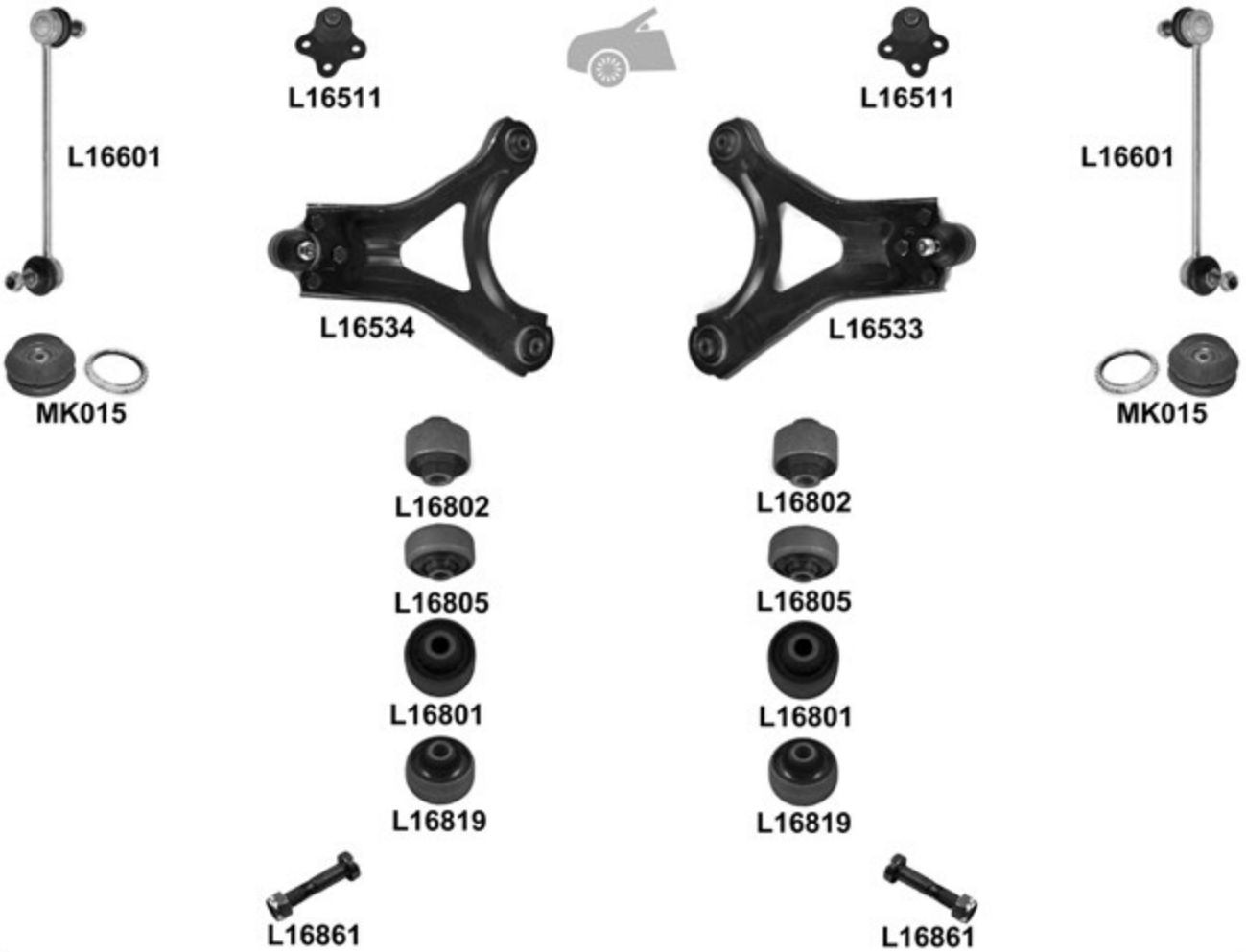
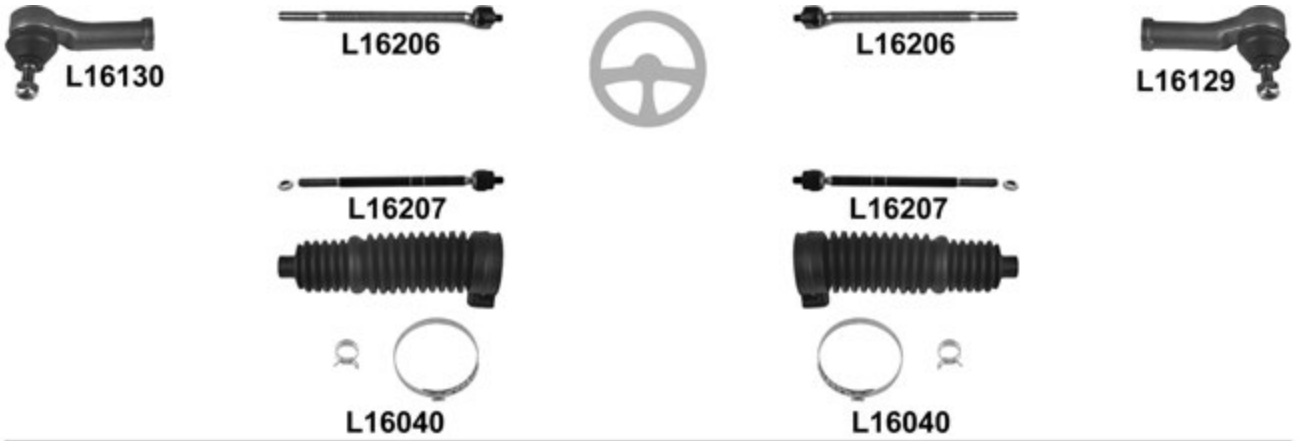

Mondeo I (GBP/BNP) 02.93 → 08.96

			←	→	Thread	Part Of	QPA		
		↔		L16129	F 16x1,5 ⤴		1	5027452	
			L16130		F 16x1,5 ⤴		1	5027451	
				L16206	L16206	M 16x1,5 / M 14x1,5		2	7294415
			L16207	L16207	M 16x1,5 / M 14x1,5		2	7294416	
			∅ 17mm, ∅ 58mm, L= 215mm	L16040	L16040		2	3904122	
		↓		L16511	L16511		2	93BB3395AC	
		↓			L16533		1	1102948	
			<input checked="" type="checkbox"/>	L16534			1	1102994	
		↓	▼	Old type, 12 x 46 x 45,5mm	L16802	L16802		2	6870549
				New type, 12 x 60 x 45,5mm	L16805	L16805	L16533/L16534	2	1074282
		↓	▲	Old type, 12 x 48 x 45,5mm	L16801	L16801		2	6790115
				New type, 12 x 54 x 45,5mm	L16819	L16819	L16533/L16534	2	1102950
				Mounting of on Wheels suspension	KIT	L16861	L16861	2	1138220
					L16601	L16601		2	6960036
					KIT	MK015	MK015	2	6799585S1
		▼	(-)	L16566	L16566		2	6867577	
		↓		L16565	L16565		2	1214290	
			→ 10.94	L16607	L16607		2	7014210	
			10.94 →	L16608	L16608		2	1054209	
			(-)	MK128	MK128		2	6838725	

Mondeo II (BAP/BFP/BNP) 09.96 → 11.00

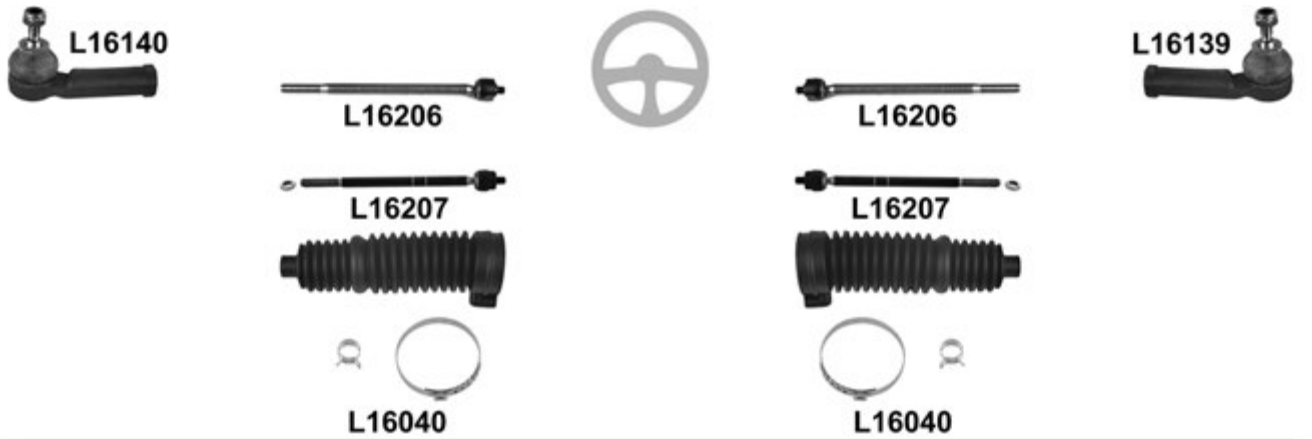

Mondeo II (BAP/BFP/BNP) 09.96 → 11.00

		i		← →		Thread	Part Of	QPA	i		
		↔		L16139		F 16x1,5 U		1	1035690		
				L16140		F 16x1,5 U		1	1035691		
				L16206	L16206	M 16x1,5 / M 14x1,5		2	7294415		
				L16207	L16207	M 16x1,5 / M 14x1,5		2	7294416		
			∅ 17mm, ∅ 58mm, L= 215mm	L16040	L16040			2	3904122		
		↓		L16511	L16511			2	93BB3395AC		
		↓			L16533			1	1102948		
			<input checked="" type="checkbox"/>		L16534			1	1102994		
		↓	12 x 60 x 45,5mm		L16805	L16805			L16533/L16534	2	1074282
		↕	Old type, 12 x 48 x 45,5mm		L16801	L16801			2	6790115	
		↕	New type, 12 x 54 x 45,5mm		L16819	L16819			L16533/L16534	2	1102950
			Mounting of on Wheels suspension	KIT	L16861	L16861			2	1138220	
			→ 12.99 , steel		L16601	L16601			2	6960036	
			01.00 →, ALU		L16623	L16623			2	1106269	
			(+) L 16916	KIT	MK015	MK015			2	6799585S1	
				L16916	L16916			2	1103725		
		▼	(-)	L16566	L16566			2	6867577		
		↓		L16565	L16565			2	1214290		
			→ 07.98	L16608	L16608			2	1054209		
			08.98 →	L16622	L16622			2	1072446		
			(-)	MK128	MK128			2	6838725		

Mondeo III Hatchback (B5Y) 11.00 → 08.07
Mondeo III Sedan (B4Y) 11.00 → 08.07
Mondeo III Kombi (BWY) 11.00 → 08.07

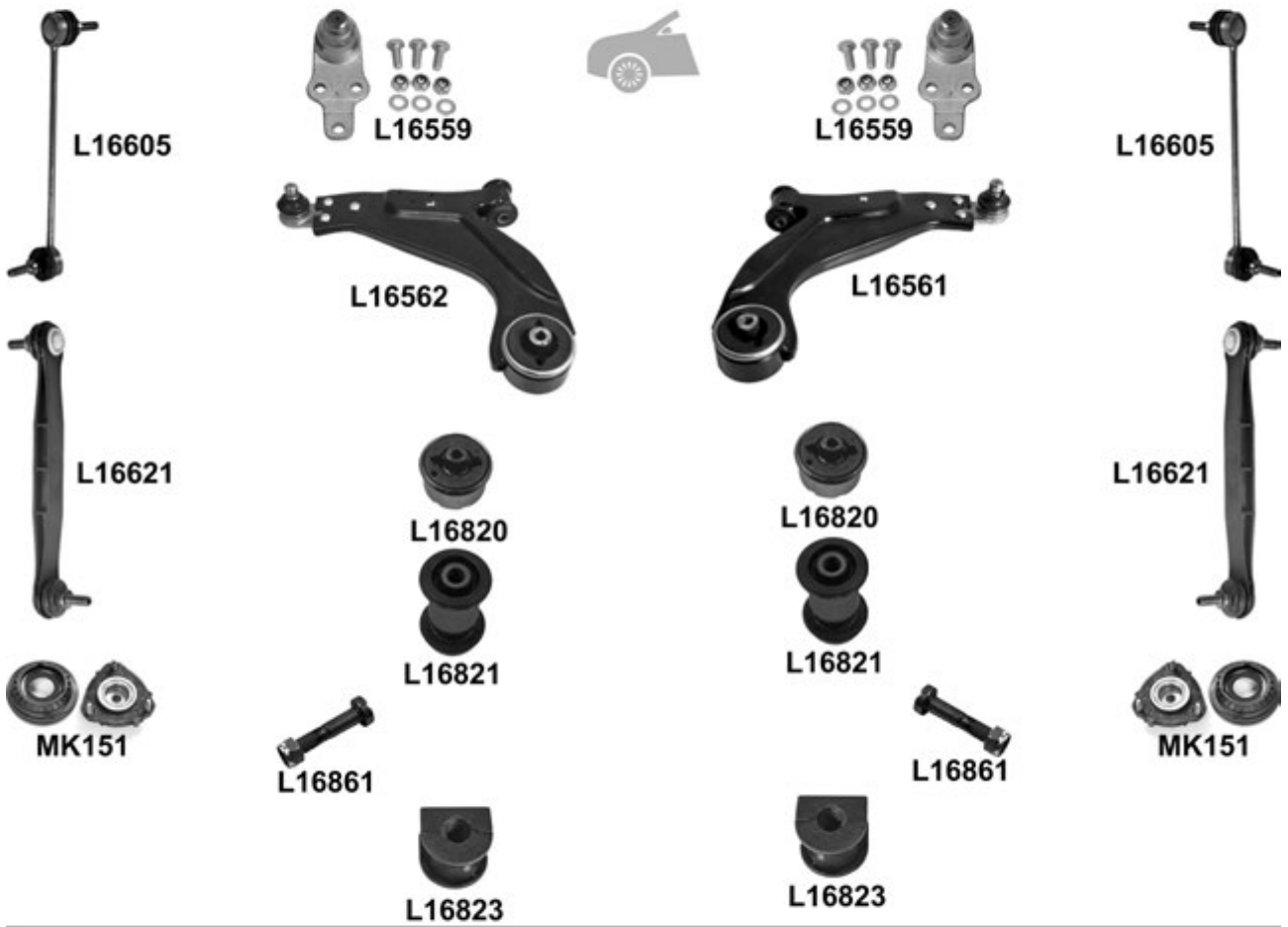
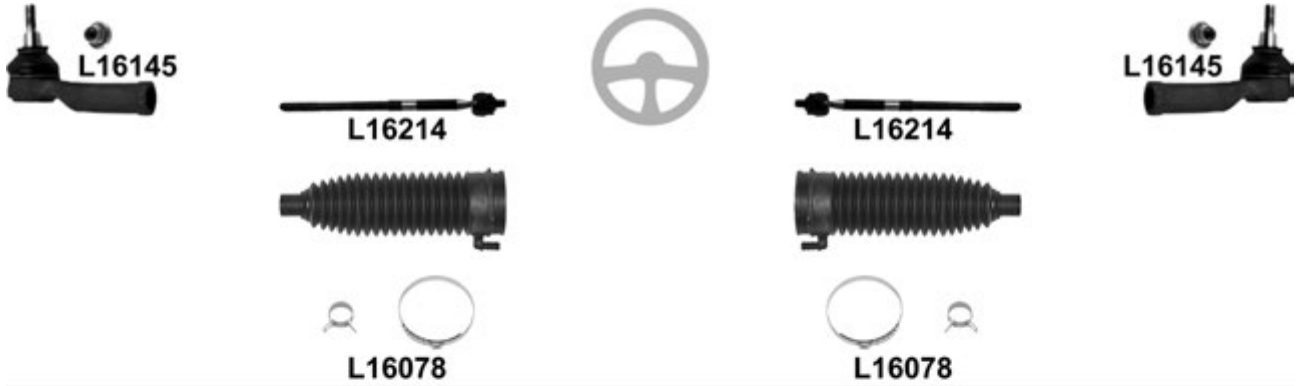

Mondeo III Hatchback (B5Y) 11.00 → 08.07
Mondeo III Sedan (B4Y) 11.00 → 08.07
Mondeo III Kombi (BWY) 11.00 → 08.07



		i	←	→	Thread	Part Of	QPA	i	
⊕		↔			F 16x1,5 U		2	1138313	
					M 16x1,5 / M 14 x1,5		2	4111327	
					∅ 17mm, ∅ 55mm, L= 206mm		2	4780137	
🚗		↓			L16559 L16559		2	1679376	
		↓		☑	L16561		1	1203923	
					L16562		1	1203924	
		↓ ▼			L16820 L16820		2	1311416S2	
		↓ ▲			L16821 L16821		2	1311416S1	
			Mounting of on Wheels suspension		KIT	L16861 L16861	2	1138220	
			→ 09.02, Metal			L16605 L16605	2	1127646	
			Plastic			L16621 L16621	2	1219697	
			∅ 19mm			L16823 L16823	Anti-roll bar	2	7102392
				KIT	MK151 MK151		2	4609099	
🚗			(-)		L16610 L16610		2	1127648	
					L16609 L16609		2	1130452	
			(-) Pull longitudinal		L16616 L16616		2	1206474	
		↓ ▼	(-)		L16618 L16618		2	1118920	
		↓ ▲	(-)		L16617 L16617		2	1118921	
		↓			L16565 L16565		2	1214290	
			(-)		MK311 MK311		2		

Mondeo IV Hatchback 03.07 →
 Mondeo IV Sedan 03.07 →
 Mondeo IV Kombi 03.07 →

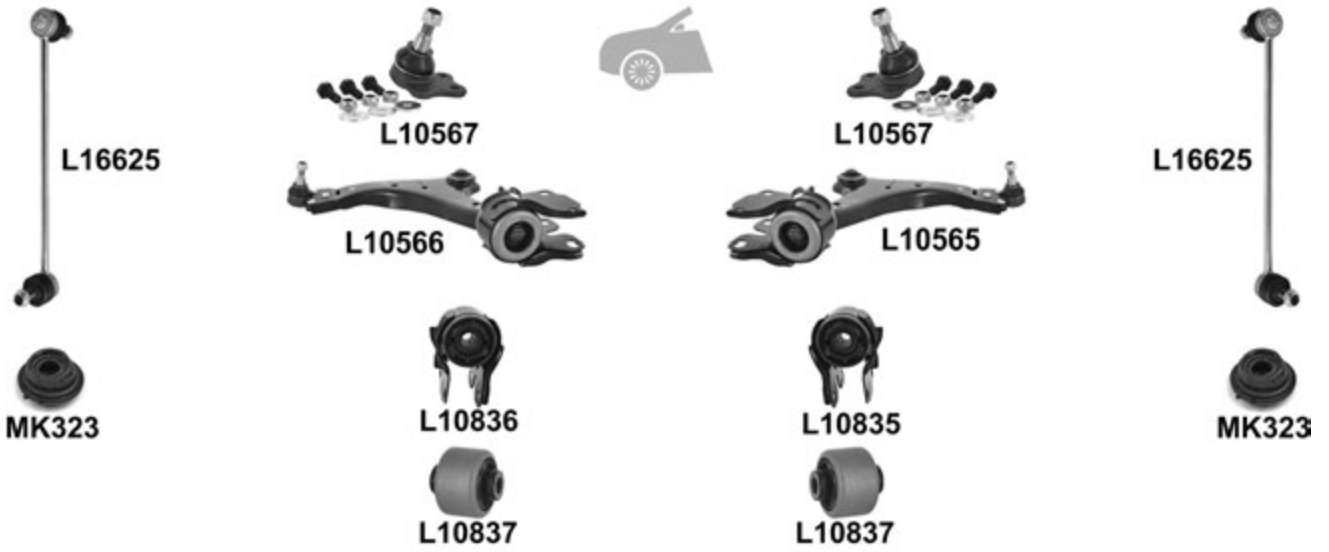

Mondeo IV Hatchback 03.07 →
Mondeo IV Sedan 03.07 →
Mondeo IV Kombi 03.07 →

			←	→	Thread	Part Of	QPA		
		↔		L16161	∩		1	1433274	
				L16162	∩		1	1433273	
		↔	L= 315mm	L16221	L16221	∩		2	1596574
				L10021 ^o	L10021 ^o			2	1433372
		⊥		L10567	L10567			2	
		⊥		<input checked="" type="checkbox"/>	L10565			1	1507181
				L10566			1	1507182	
		⊥▼			L10835			1	
				L10836				1	
		⊥▲			L10837	L10837		2	
					L16625	L16625		2	1377849
				MK323	MK323		2	1539863	
		⊥▲	longitudinal		L16839			1	1566836
				L16840			1	1566838	
		⊥▲			L16583 ^o	L16583 ^o		2	1426770
					L10626	L10626		2	1425853

Probe (ECP) 10.93 → 03.98

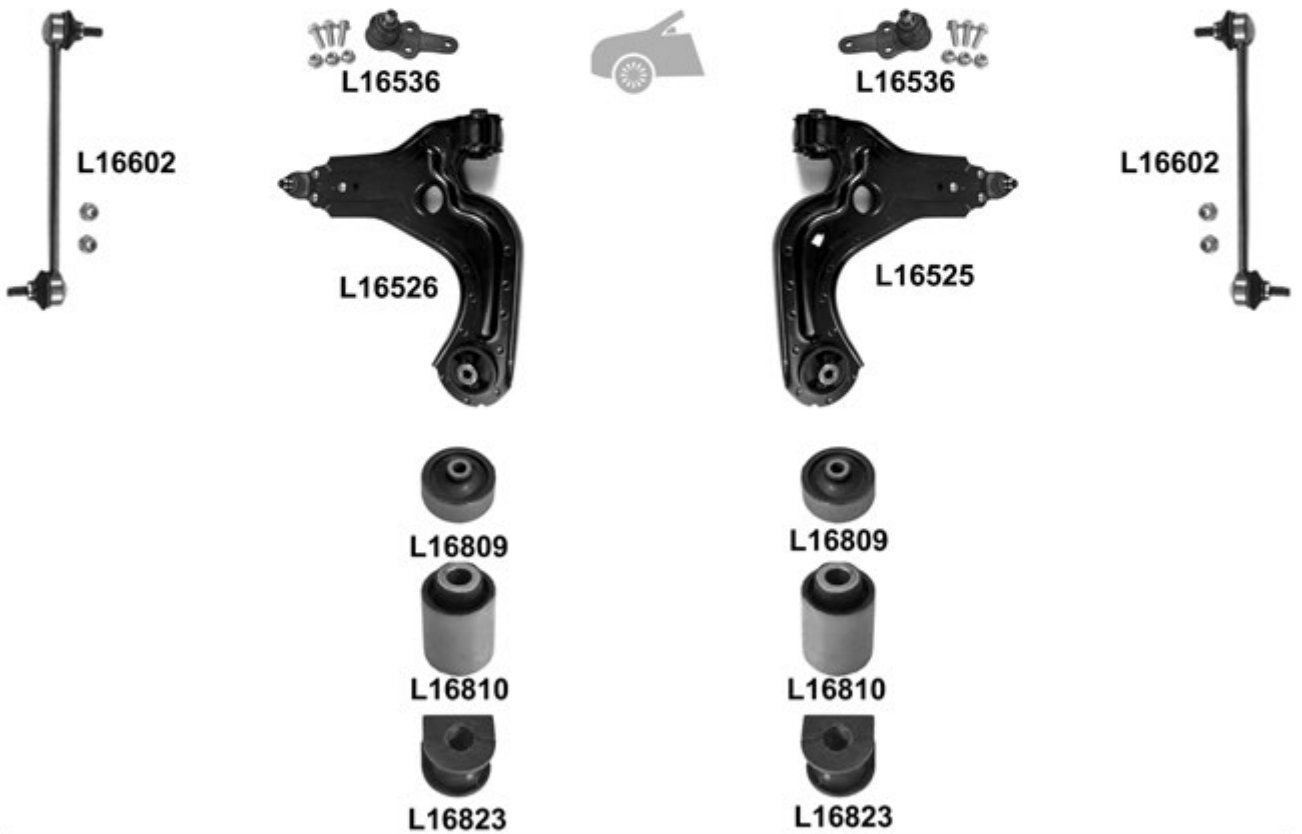
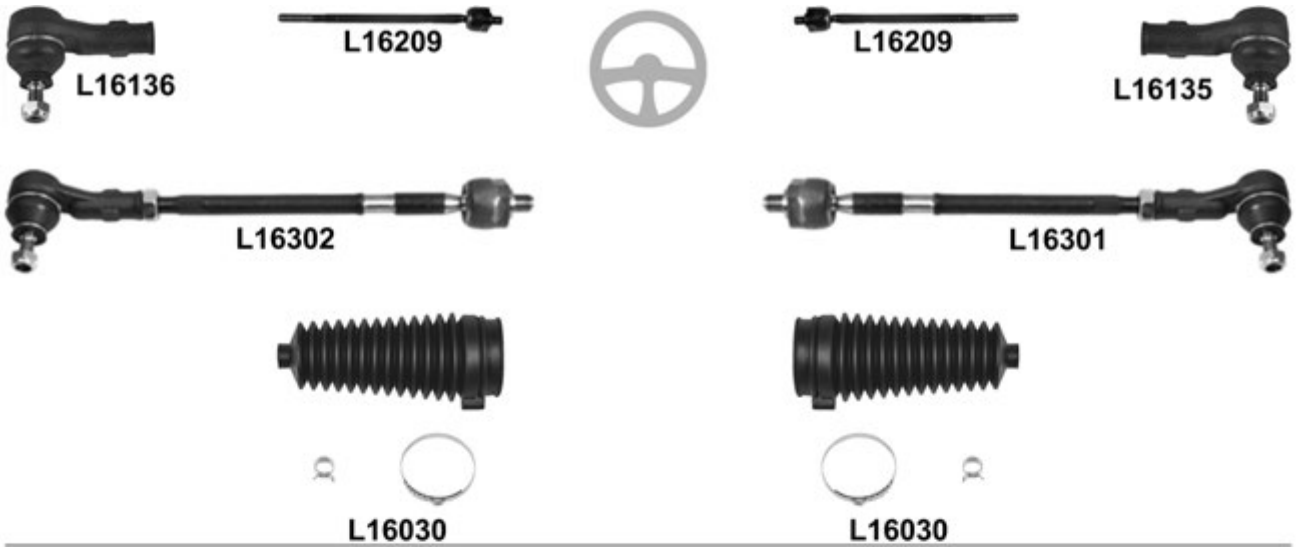

			i	←	→	Thread	Part Of	QPA	i
		↔		L50107	L50107	F 14x1,5 ⌀		2	3405915
		↓		L50040	L50040			2	
		↓	<input checked="" type="checkbox"/>		L50513			1	3707090
				L50514				1	3703255
					L50603			1	3410591
				L50604				1	3410592
			KIT	MK254	MK254			2	3405806
				L50605	L50605			2	3799085
					MK173R			1	3405826
				MK174L				1	3405827

Puma (ECT) 03.97 → 06.02

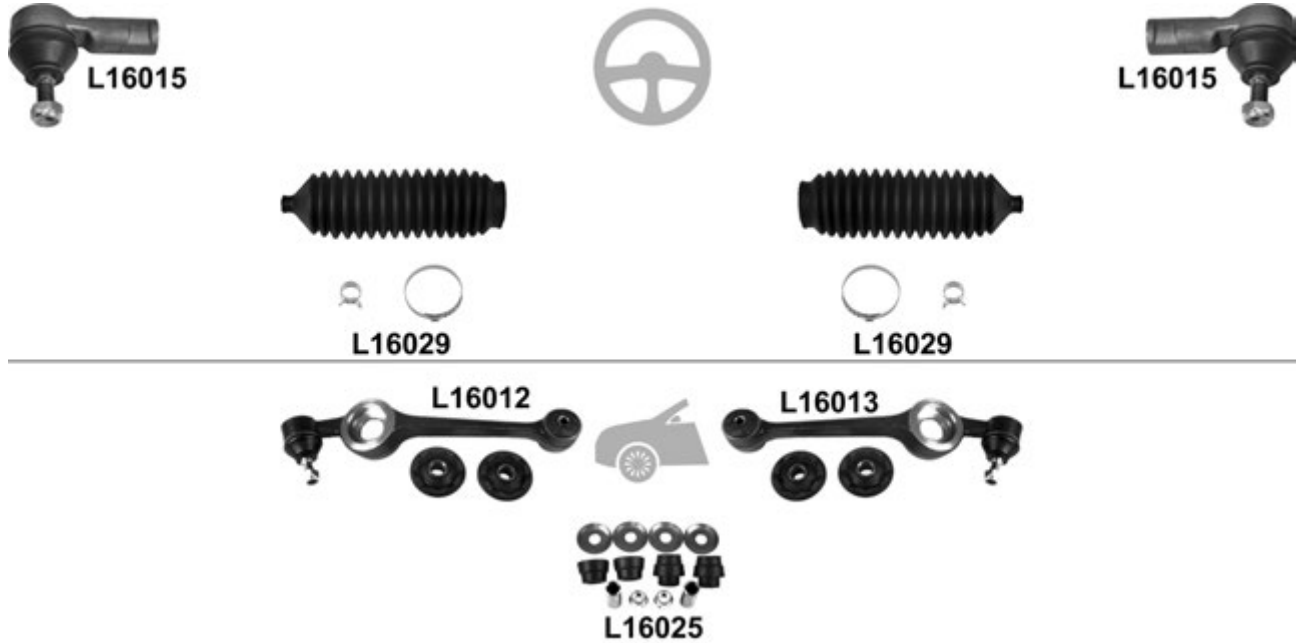

Puma (ECT) 03.97 → 06.02

		i	←	→	Thread	Part Of	QPA	i
⊕		↔		L16135	F 14x2 ⊕		1	1020174
				L16136	F 14x2 ⊕		1	1020175
				L16209	L16209		2	1044014
				L16301			1	
				L16302			1	
		⊕, Wuefrath, ø 14mm, Ø 56mm, L= 185mm		L16030 ^o	L16030 ^o		2	4045250
⊖		⊕, 16,5mm		L16536	L16536		2	1030025
		⊕	<input checked="" type="checkbox"/>	L16525			1	1063236
				L16526			1	1063255
		⊕↘		L16809	L16809	L16525/L16526	2	1014654
		⊕↗		L16810	L16810	L16525/L16526	2	1010037
				L16602	L16602		2	1661237
		ø 16mm		L16823	L16823	Anti-roll bar	2	7102392
⊖				L16822	L16822	Hub carrier	2	1016439
				MK126	MK126		2	1023587

P100 10.87 → 12.92

		i	←	→	Thread	Part Of	QPA	i
⊕		↔	(-) 4WD	L16015	L16015	F 14x2 ⊕	2	6160988
		⊕		L16029	L16029		2	1619061
⊖		⊕	(-) 4WD, L 16025=option HD ⊕	<input checked="" type="checkbox"/>	L16013		1	5021460
				L16012			1	5021461
		⊕↔	HD ⊕	KIT	L16025		1	

Ranger (TU_) 10.99 → 06.06

						←	→	Thread	Part Of	QPA		
		↔	2WD, (-) 2WD Highrider	L50101	L50101	F 14x1,5	↺			2	UB39-99-324	
		→←	2WD Highrider/4WD	L50104	L50104	F 14x1,5	↺			2	8AU2-32-270	
			2WD/4WD	L50103	L50103		↻			2	8AU1-32-280	
		↑		L50505	L50505					2	3665732	
		↓	2WD	L50506	L50506					2	3665782	
			4WD	L50507	L50507					2	3665787	

Ranger 05.06 →

						←	→	Thread	Part Of	QPA		
		↑		L50505	L50505					2	3665732	

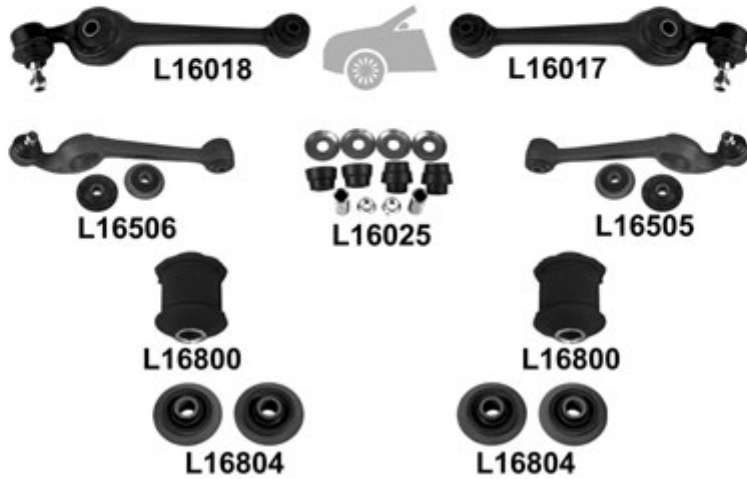
Scorpio (GAE/GGE) 04.85 → 12.94

						←	→	Thread	Part Of	QPA		
⊕		↔	(-) 4WD		L16015	L16015	F 14x2	∩		2	5021415	
			4WD			L16010	F 14x2	∩		1	5021413	
					L16009	F 14x2	∩		1	5041414		
					L16210	L16210			2	6185338		
⊖		⊥	(-) 4WD	☑		L16017				1	5021464	
					L16018					1	5021465	
			4WD	☑		L16505				1	5021462	
					L16506					1	5021463	
							L16800	L16800				L16505/L16506
		⊥ ↔		KIT	L16804	L16804				L16017/L16018	2	5021729
			HD	KIT	L16025						1	

Scorpio II (GFR/GGR/GNR) 10.94 → 08.98

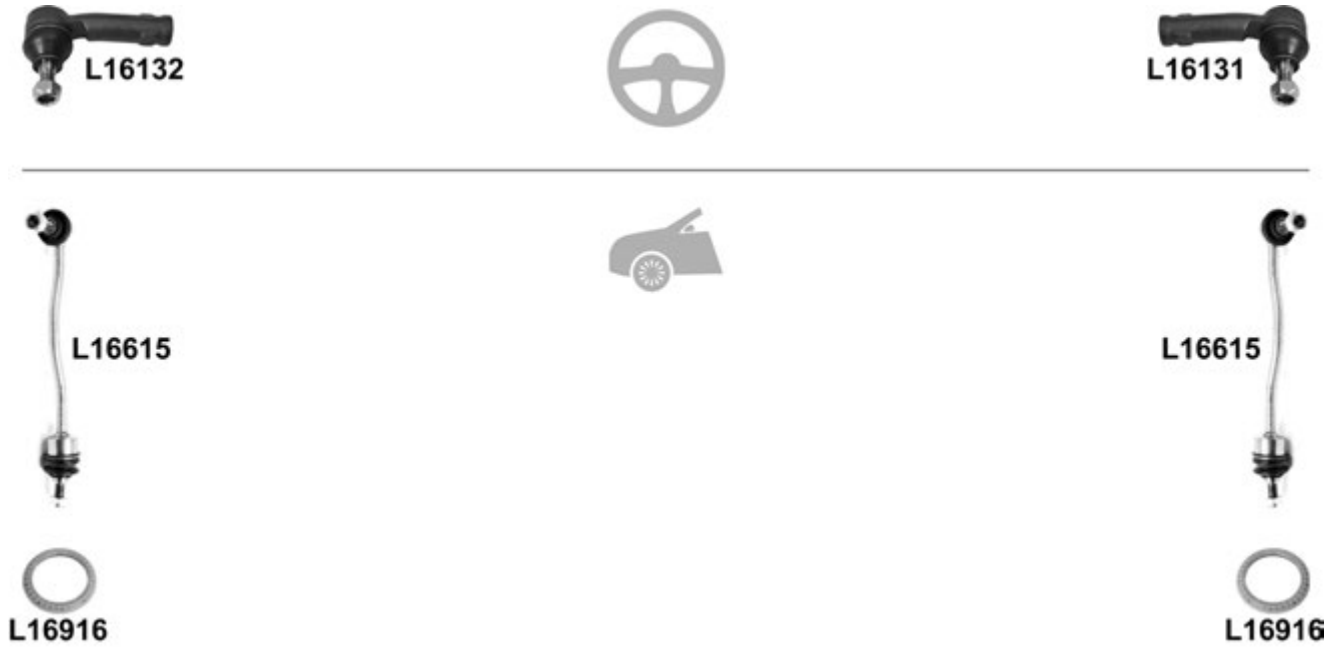

				←	→	Thread	Part Of	QPA		
		↔			L16131	F 16x1,5 ♂		1	5030221	
				L16132		F 16x1,5 ♂		1	5030222	
				L16615	L16615			2	1045413	
				L16916	L16916			2	1103725	

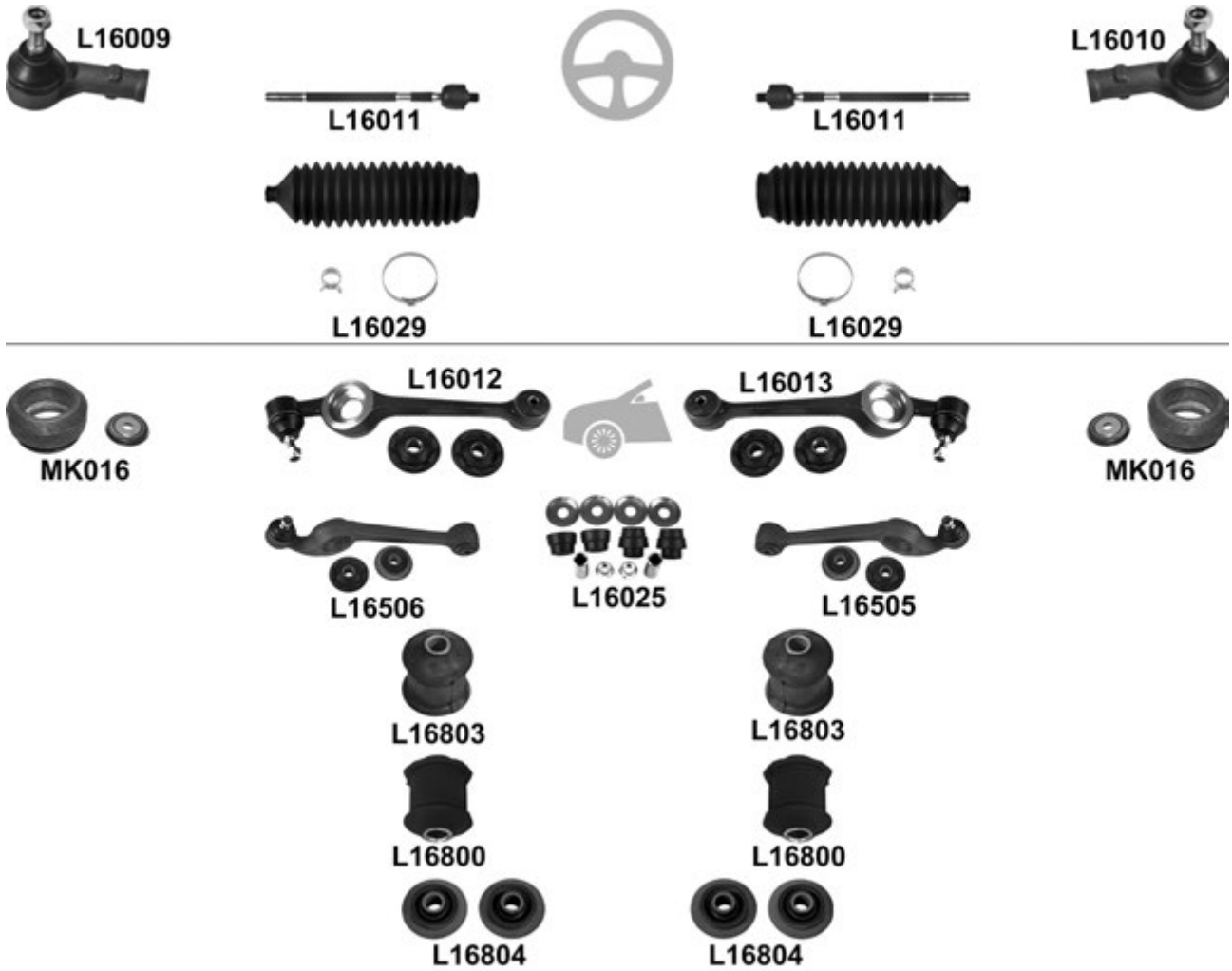
Sierra 08.82 → 03.93

		i		←	→	Thread	Part Of	QPA	i	
⊕		↔			L16010	F 14x2 ⤴		1	5021413	
				L16009	F 14x2 ⤴		1	5021414		
				L16011	L16011	M 14x2 / M 14x1,5 ⤴		2	6185336	
					L16029	L16029			2	1619061
⊖		⊥	(-) 4WD, L 16025=option HD	<input checked="" type="checkbox"/>		L16013		1	5021460	
				<input checked="" type="checkbox"/>	L16012		1	5021461		
		4WD	<input checked="" type="checkbox"/>		L16505		1	5021462		
			<input checked="" type="checkbox"/>	L16506		1	5021463			
		⊥↔			L16803	L16803		L16012/L16013	2	1619120
					L16800	L16800		L16505/L16506	2	6192705
		⊥↔		KIT	L16804	L16804		L16012/L16013	2	5021729
			HD	KIT	L16025				1	
		11.84 →	KIT	MK016	MK016			2	6150277S2	

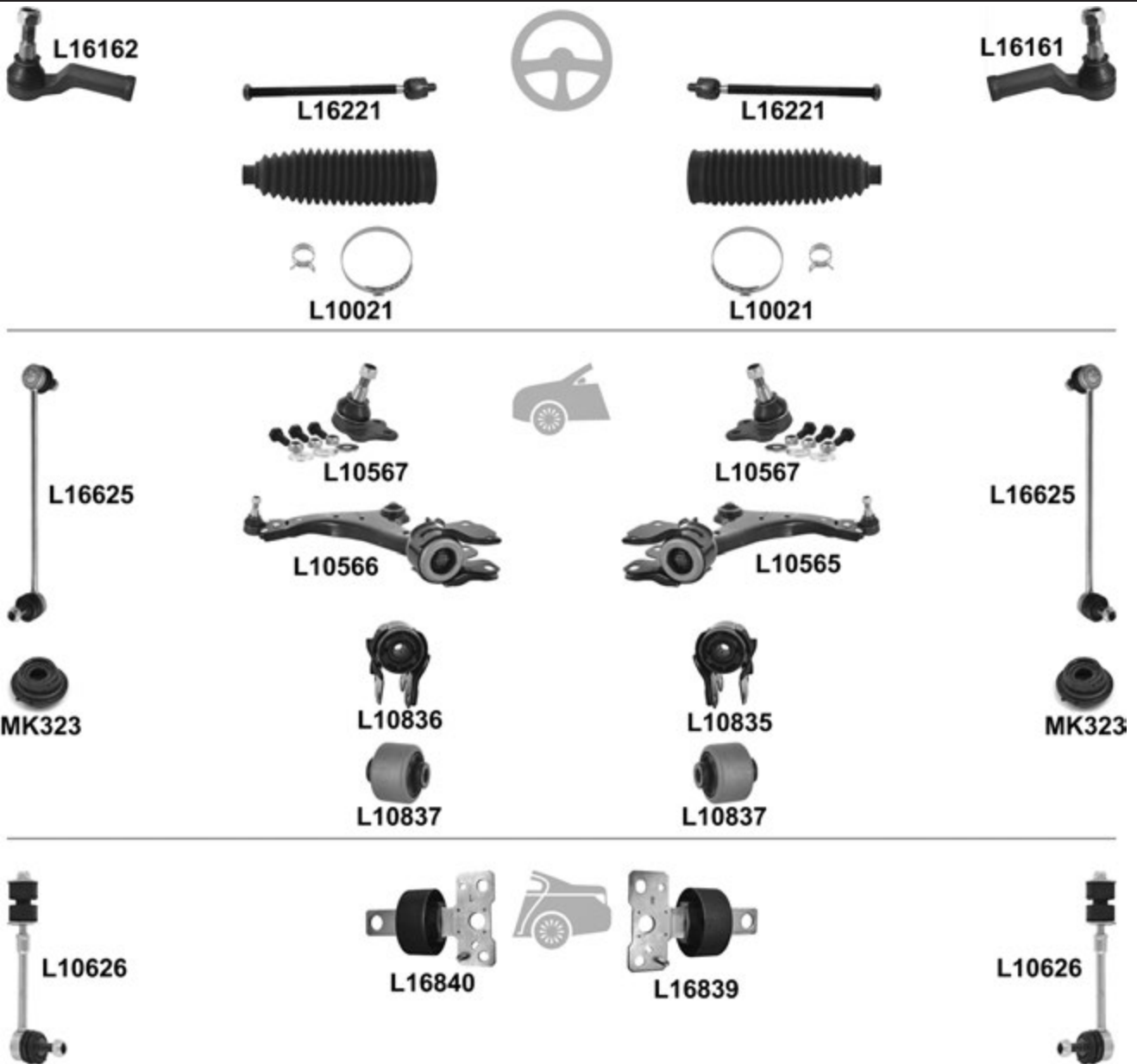
S-Max 05.06 →

		i	←	→	Thread	Part Of	QPA	i
⊕		↔		L16161	∩		1	1433274
			L16162		∩		1	1433273
		L= 315mm	L16221	L16221	∩		2	1596574
			L10021 ^o	L10021 ^o			2	1433372
⊖		⊥		L10567	L10567		2	
			<input checked="" type="checkbox"/>	L10565			1	1507181
		⊥		L10566			1	1507182
			⊥↘	L10835			1	
		⊥↗		L10836			1	
			⊥↖	L10837	L10837		2	
		↔		L16625	L16625		2	1377849
			MK323	MK323		2	1539863	
⊖		⊥↖	longitudinal	L16839			1	1566836
				L16840			1	1566838
		↔	L10626	L10626		2	1425853	

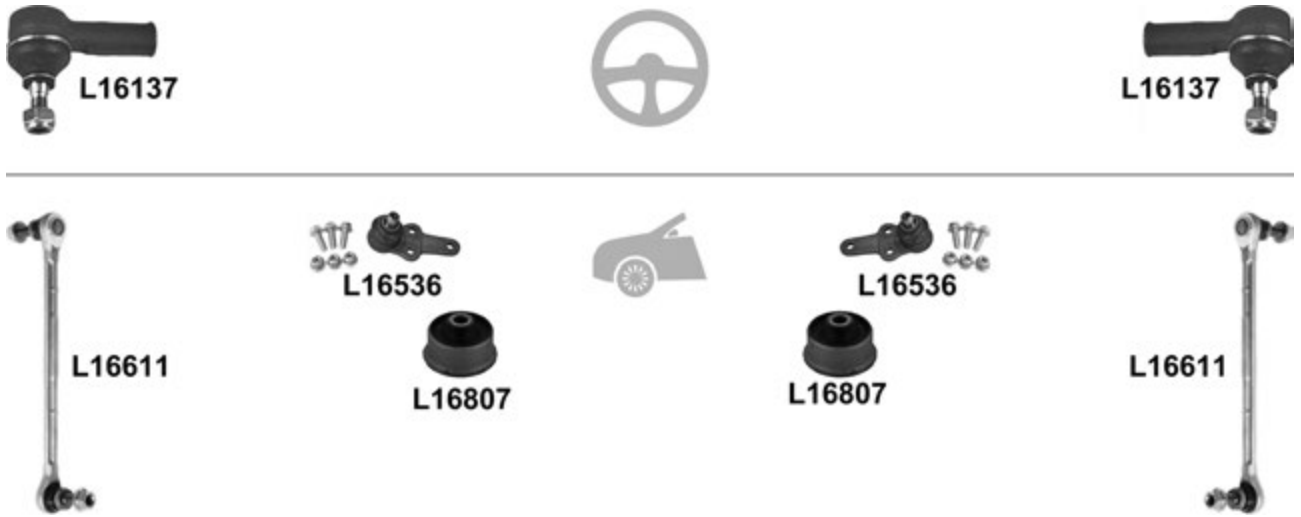
Street Ka 05.03 → 07.05

				←	→	Thread	Part Of	QPA		
		↔		L16137	L16137	F 1/2"x20 UNF ⤴		2	1034417	
		⌄	↗ 16,5mm	L16536	L16536			2	1030025	
		⌄		L16807	L16807			2	1035929	
			ALU	L16611	L16611			2	1209035	

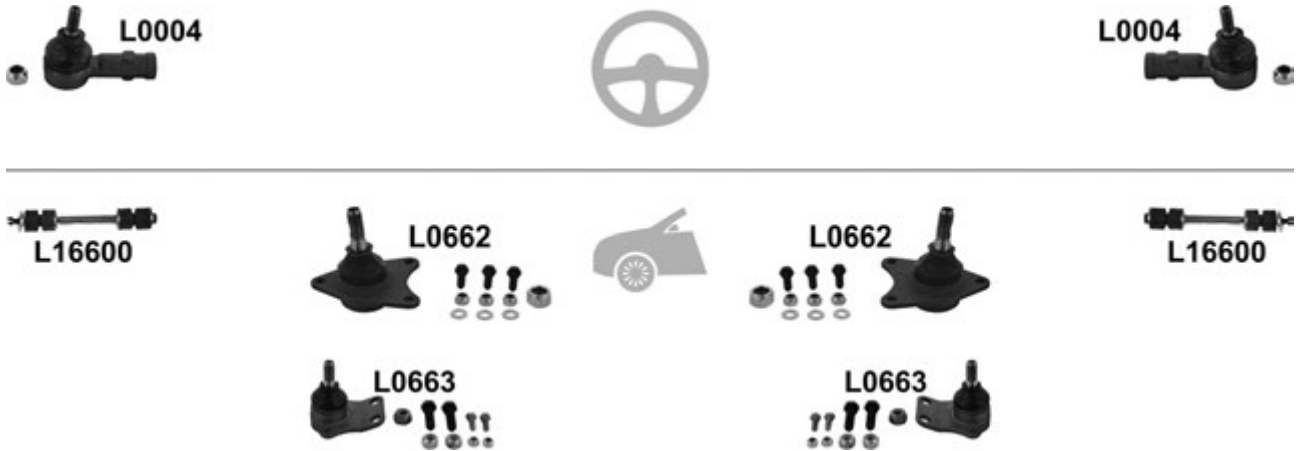
**Taurus MKIV 1970 → 07.82
Cortina MKIII 1970 → 1976**

				←	→	Thread	Part Of	QPA		
		↔		L0004	L0004	⤴		2	1476246	
		⌈		L0662 ¹	L0662 ¹			2	6010076	
		⌄		L0663	L0663			2	6009974	
				L16600	L16600			2	1481464	

Transit (VLS/VZS) 1964 → 02.86



				←	→	Thread	Part Of	QPA		
⊕		▲	longitudinal	L16053		M 18x1,5 ⤴	Steering rod	1	1796515	
		▼	longitudinal	L16054		M 18x1,5 ⤴	Steering rod	1	1796516	
		→ ←			L16051		M 20x1,5 ⤴	_center	1	6148439
					L16050		M 20x1,5 ⤴	_center	1	6148436

Transit / Tourneo 80 - 120 11.85 → 03.00
 Transit / Tourneo 130 - 190 / 100L / 150S 08.91 → 03.00

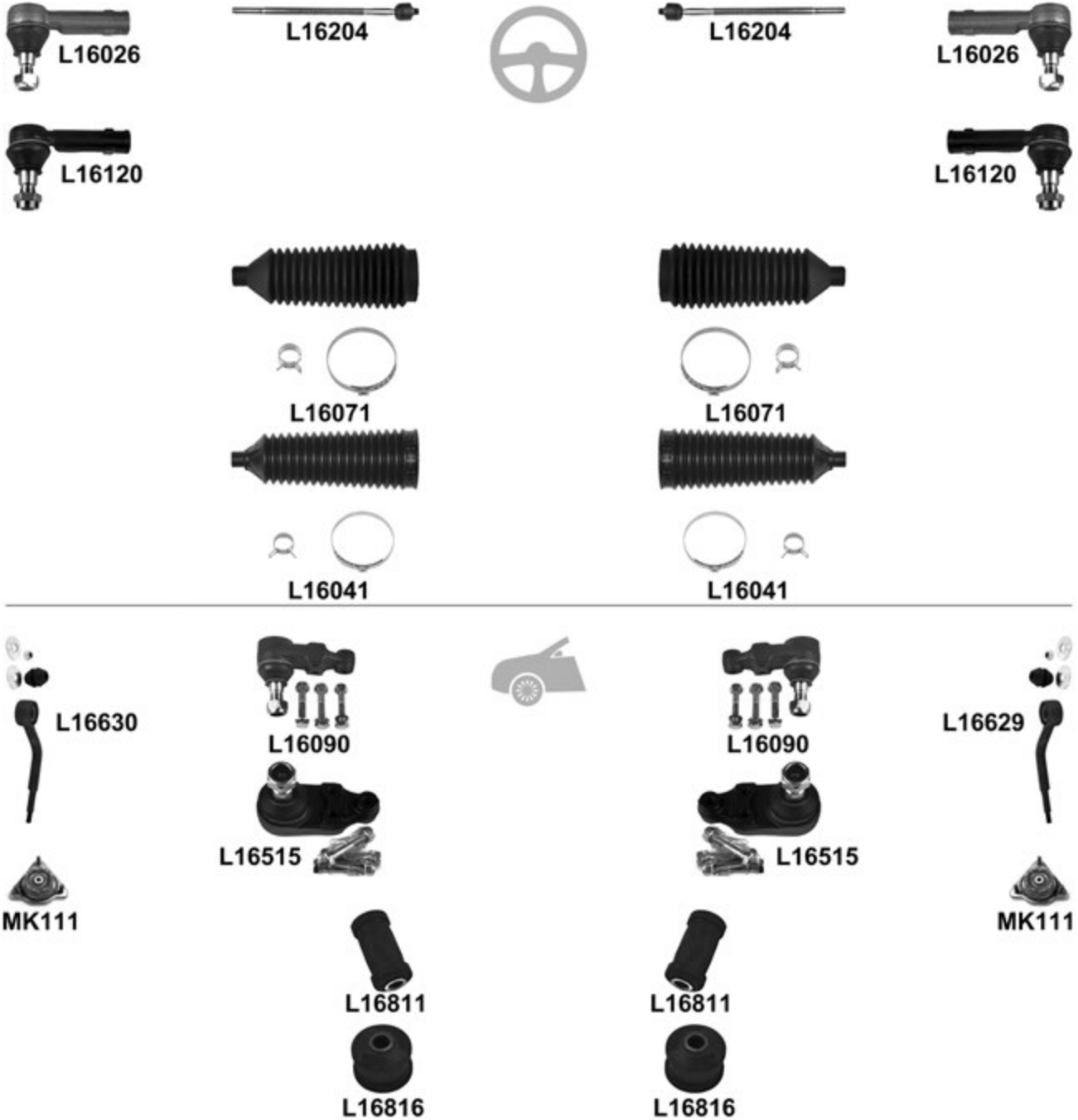

		i	←	→	Thread	Part Of	QPA	i	
⊕	↔	→ 09.91	L16026	L16026	F 16x1,5 U		2	5021442	
		09.91 →	L16120	L16120	F 16x1,5 U		2	6687191	
	⌄		L16204	L16204	M 16x1,5 U		2	6869951	
		⊙, ø 15mm, Ø 49mm, L= 185mm	L16071	L16071			2	6160070	
		⊙, ø 15mm, Ø 60mm, L= 205mm	L16041 ^o	L16041 ^o			2	6869950	
⊖	⊥	→ 09.91	L16090	L16090			2	5021430	
		09.91 →	L16515	L16515			2	5025676	
	⊥	↙	09.91 →	L16811	L16811		⌄	2	6517356
		↘	09.91 →	L16816	L16816		⌄	2	6608818
	⌄				L16629			1	6150970
				L16630				1	6150971
	⊙	08.91 →	KIT	MK111	MK111			2	6763456

Transit 130 - 190A, 100L 10.85 → 08.94

				← → Thread		Part Of	QPA	
⊕	↔	→ 08.87	L16081		M 20x1,5 ∪		1	5021443
		08.87 →	L16123		∪		1	5021446
				L16124		∪		1
	▲	→ 08.87 longitudinal	L16026		F 16x1,5 ∪	Steering rod	1	5021442
		08.87 → longitudinal	L16125		∪	Steering rod	1	5021448
	▼	⊕ longitudinal	L16086		F 16x1,5 ∪	Steering rod	1	5021445
		08.87 → 11.90, ⊕ longitudinal	L16127		∪	Steering rod	1	5025558
🚗	⊥	→ 08.91	L16090	L16090			2	5021430
		08.91 →	L16515	L16515			2	5025676
	⊥▼	09.91 →	L16816	L16816			2	6608818
		08.91 →	L16811	L16811			2	6517356
	⊕	08.91 →	KIT	MK111	MK111		2	6763456

Transit 01.00 → 05.06

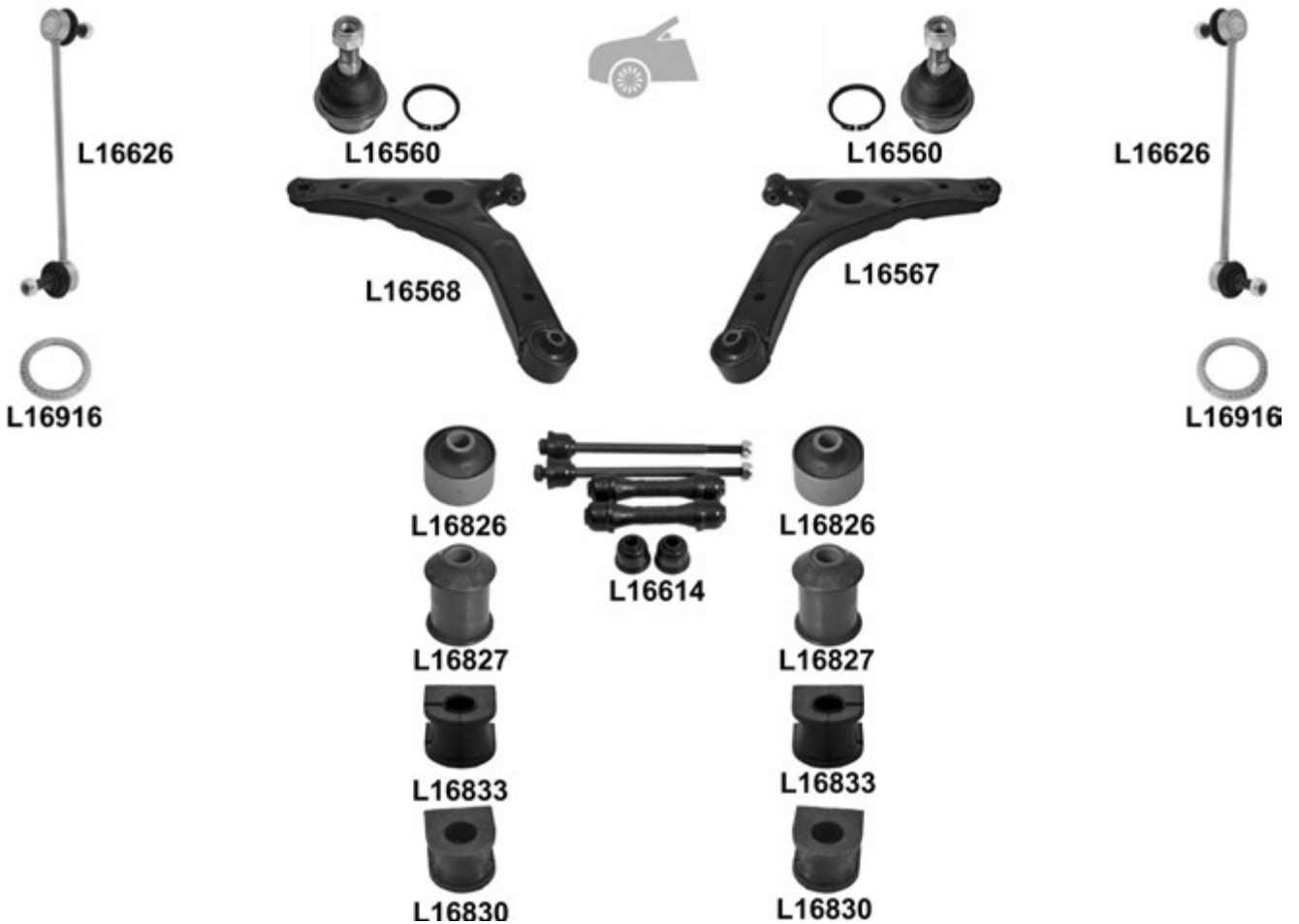
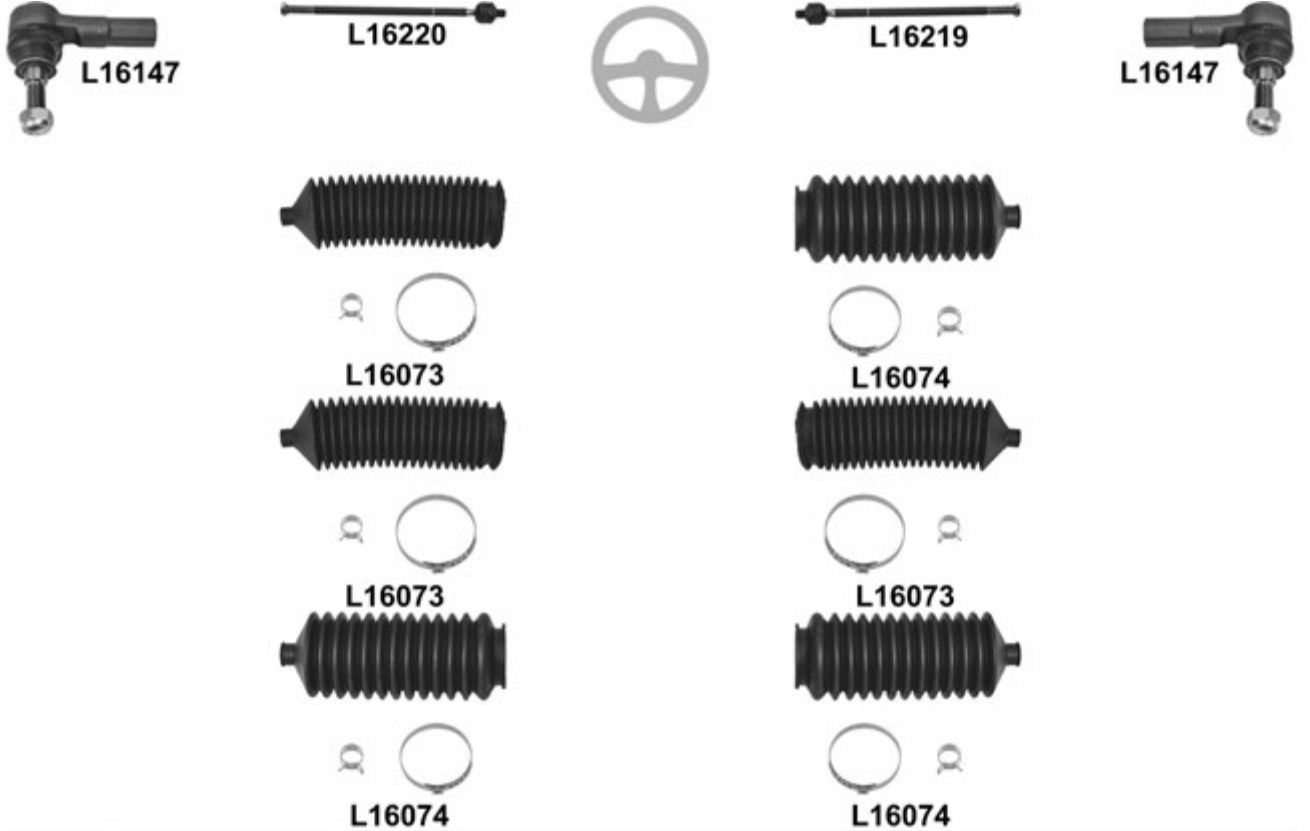

Transit 01.00 → 05.06



L16624



L16624

				←	→	Thread	Part Of	QPA	
⊕		↔		L16147	L16147	F 16x1,5 U		2	1138275
					L16219	M 16x1,5 / M 20x1,5 U		1	4059924
				L16220		M 16x1,5 / M 16x1,5 U		1	4059923
			→ 04.04		L16074			1	4602026
				L16073				1	4602027
			→ 04.04,	L16073	L16073			2	4602027
			→ 04.04,	L16074	L16074			2	4602026
🚐		⊥		L16560	L16560			2	4173761
		⊥			L16567			1	1438315
				L16568				1	1438350
		⊥▼		L16826	L16826			2	4540787
		⊥▲		L16827	L16827			2	4131788
				KIT L16614				1	3736028
				L16626	L16626			2	4519467
			∅ 20mm	L16833	L16833		Anti-roll bar	2	4671720
			∅ 23,5mm	L16830	L16830		Anti-roll bar	2	4041489
				L16916	L16916			2	1103725
			L16624	L16624			2	4042068	

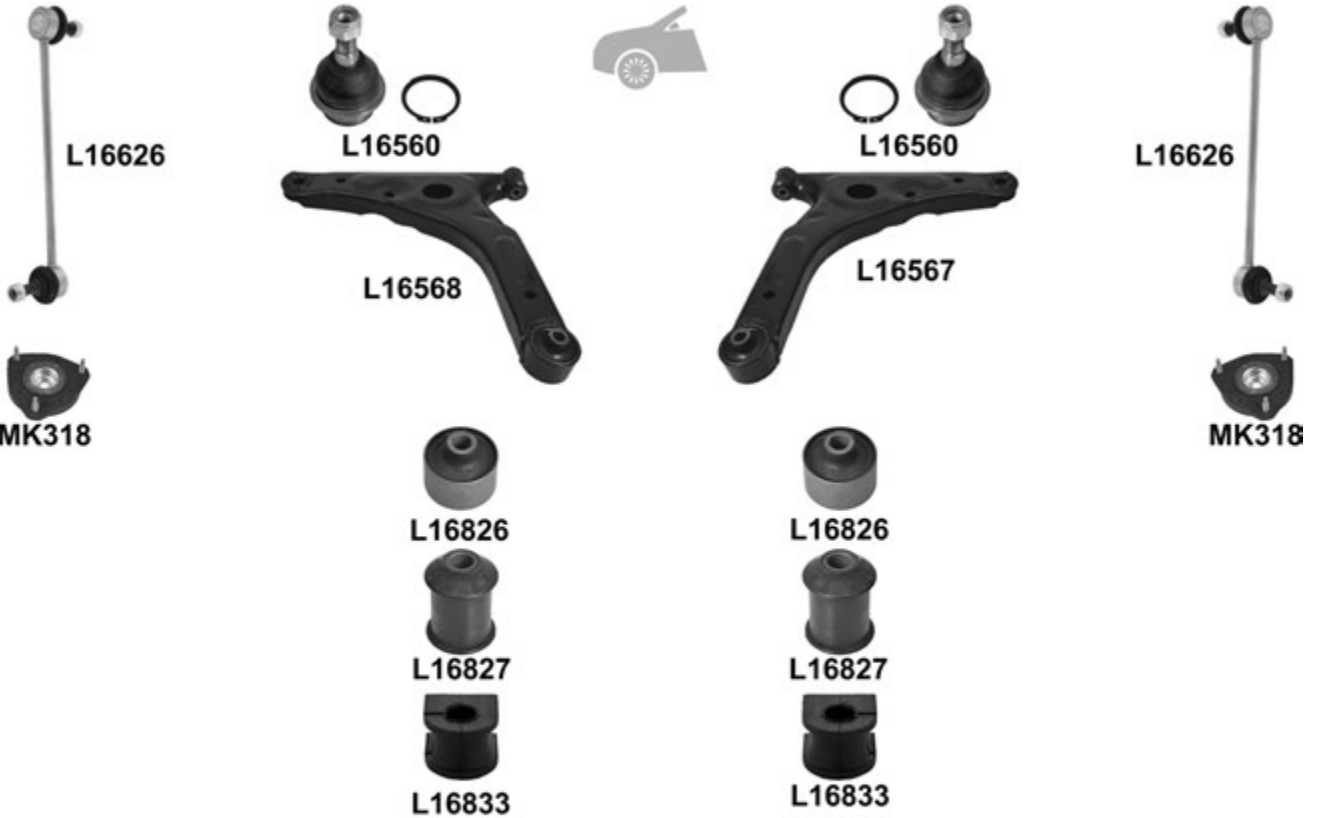
Transit 07.06 →

				←	→	Thread	Part Of	QPA	
⊕		↔		L16147	L16147	F 16x1,5 ∪		2	1490759
					L16219	M 16x1,5 / M 20x1,5 ∪		1	1370710
				L16220		M 16x1,5 / M 16x1,5 ∪		1	1370709
🚗		⊥		L16560	L16560			2	4173761
		⊥	→ 09.08		L16567			1	1438315
				L16568				1	1438350
		⊥▼		L16826	L16826			2	4540787
		⊥▲		L16827	L16827			2	4131788
				L16626	L16626			2	1495685
			∅ 20mm	L16833	L16833		Anti-roll bar	2	4671720
			KIT	MK318	MK318			2	
🚗				L16627	L16627			2	4709303

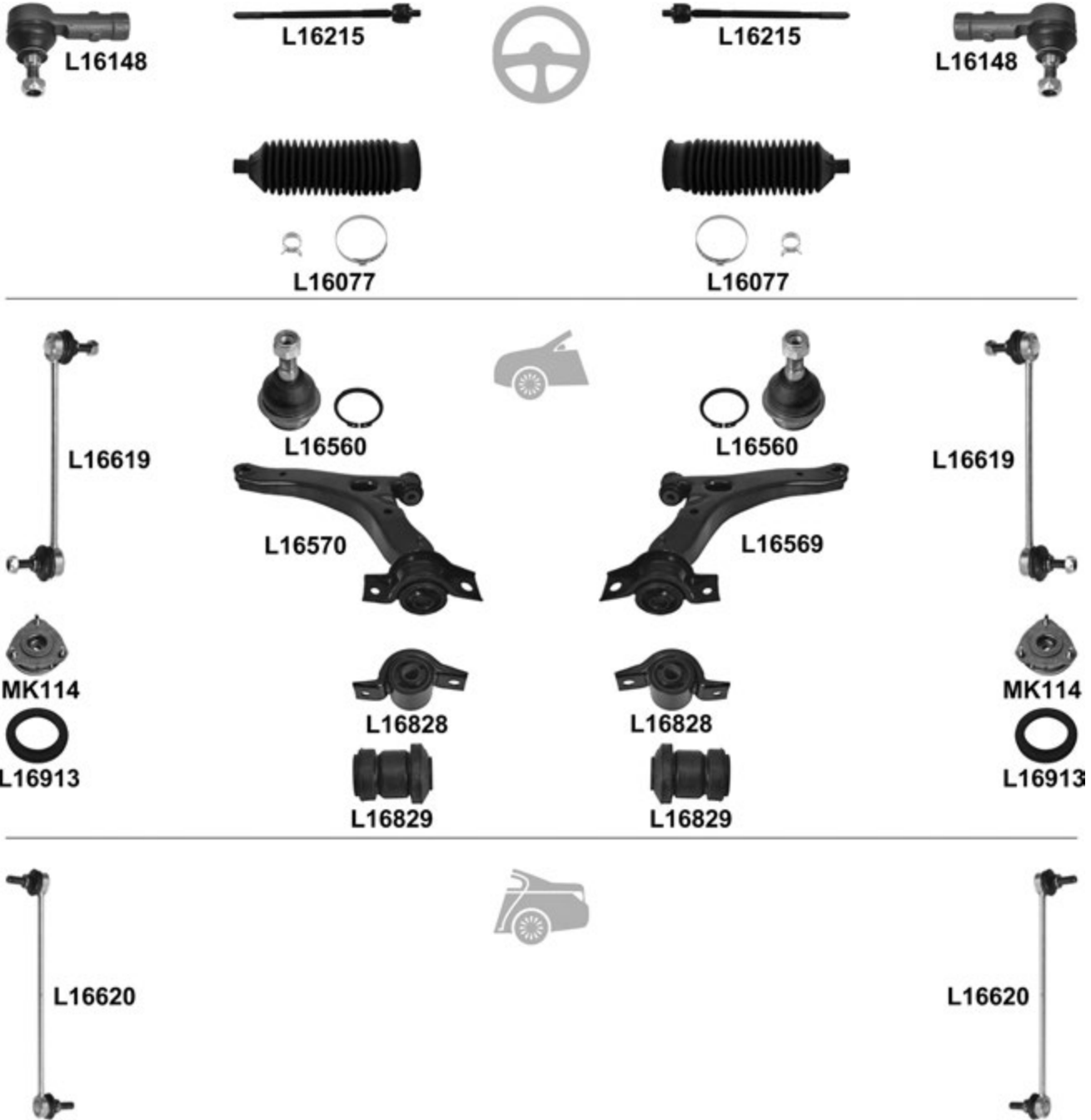
Transit Connect 06.02 →
Tourneo Connect 06.02 →

				← → Thread		Part Of	QPA		
⊕		↔		L16148	L16148	F 14x2 ⊂	2	4381840	
				L16215	L16215	M 14x2 / M 14x2 ⊂	2	3707333	
				L16077 ^o	L16077 ^o		2	4381841	
⊖		⊥		L16560	L16560		2	4173761	
		⊥	(-)		L16569		1	4371925	
				L16570			1	4371926	
		⊥↘		L16828	L16828		2		
		⊥↗		L16829	L16829		2	4366976	
			→ 08.09	L16619	L16619		2	1332453	
				KIT		MK114	MK114	2	1087177
			L16913	L16913		2	1061721		
			L16620	L16620		2	1332463		

Transit Connect (GCD) 09.13 →
 Tourneo Connect (GAD) 06.13 →
 Grand Tourneo Connect (GAD) 06.13 →

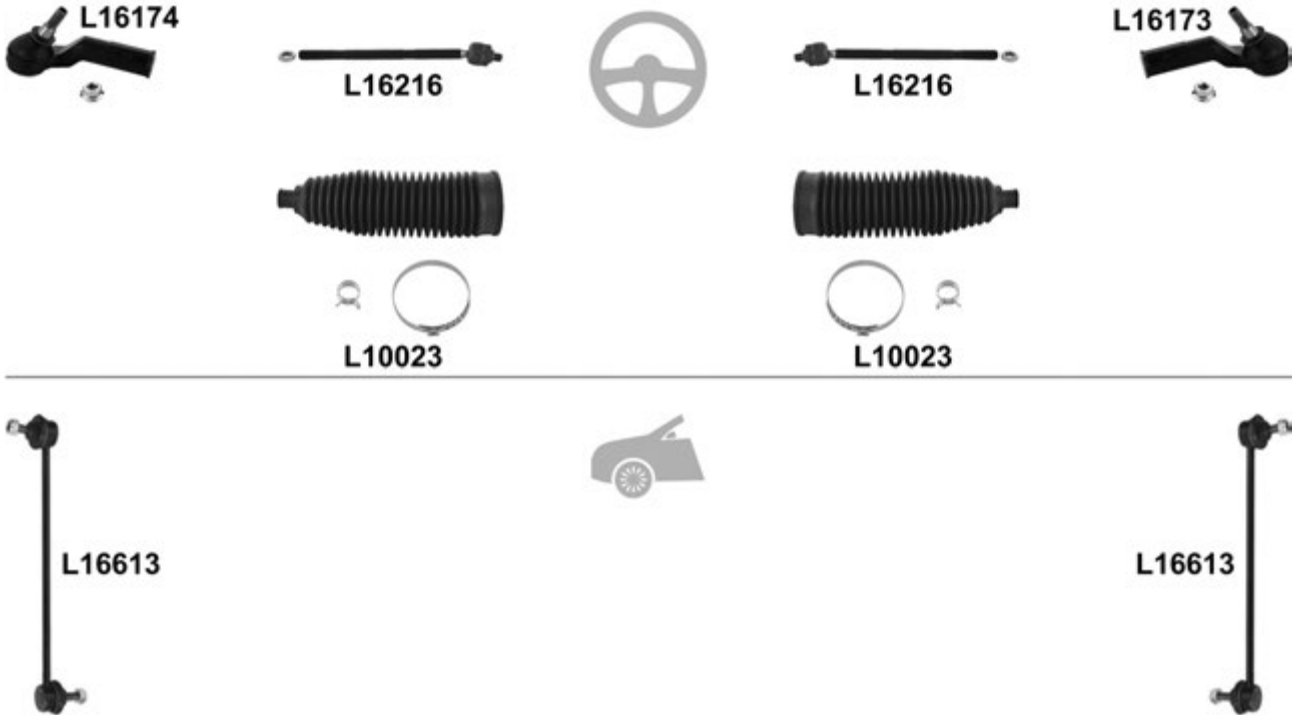

				←	→	Thread	Part Of	QPA		
		↔	11.12 →, Electric		L16173	∩		1	1748237	
					L16174	∩		1	1748239	
					L16216	L16216	∩		2	1510270
					L10023	L10023			2	1334215
			→ 05.14	L16613	L16613			2	1762149	

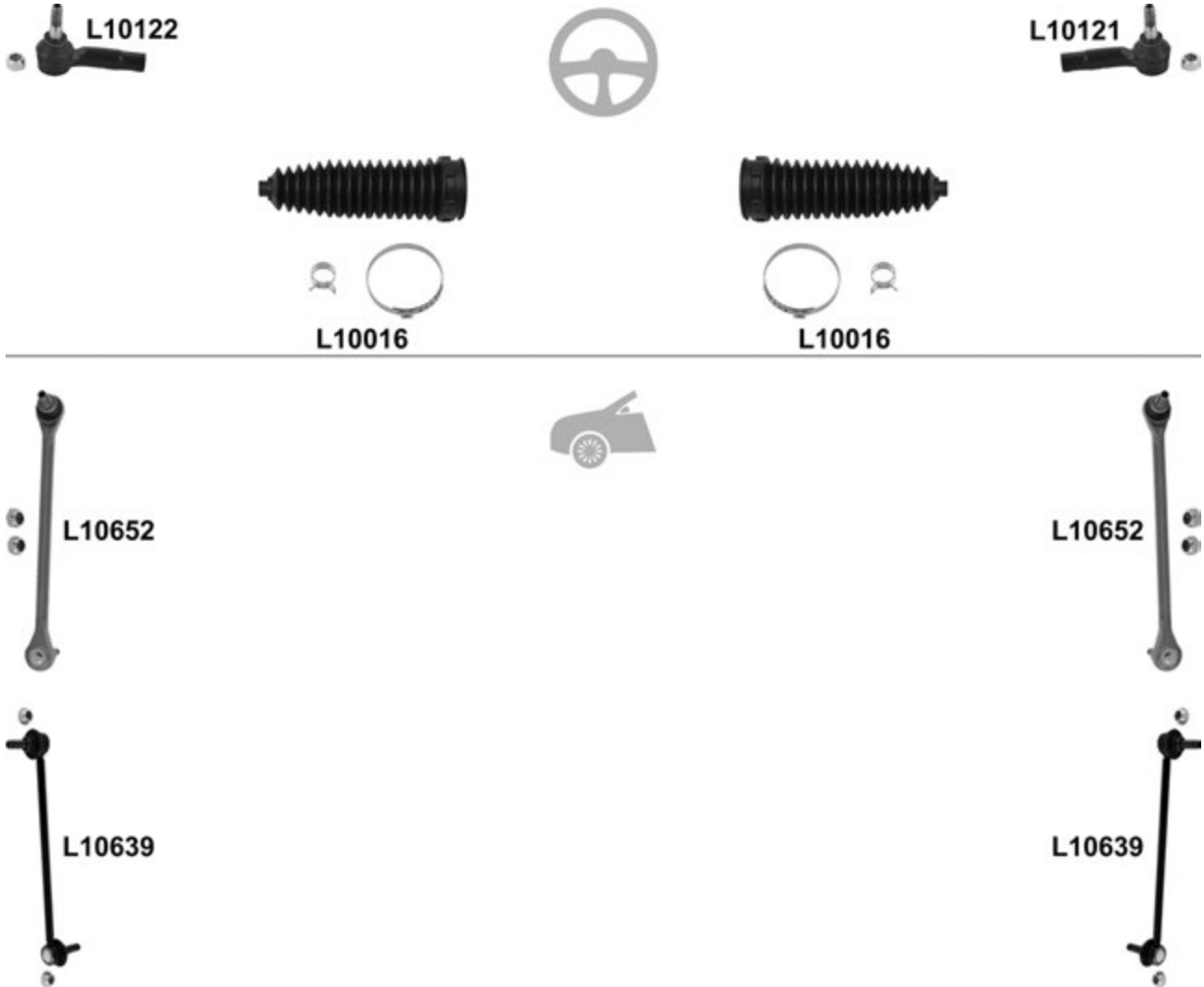
Transit Courier (CM/CW) 02.14 →
Tourneo Courier (CM/CW) 02.14 →

		i		←	→	Thread	Part Of	QPA	i
		↔				L10121	F 14x1,5 ∩	1	1545338
						L10122	F 14x1,5 ∩	1	1545339
						L10016	L10016	2	1545456
			ALU			L10652	L10652	2	1513343
			Metal			L10639	L10639	2	1513343

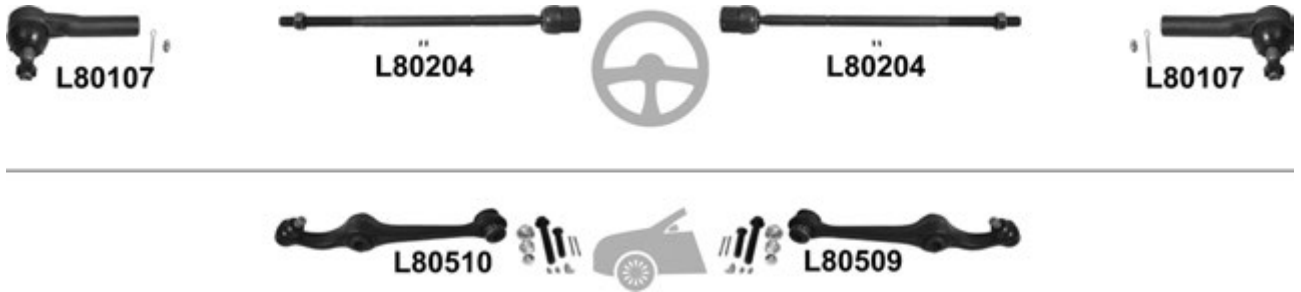
Windstar (A3) 01.95 →

				←	→	Thread	Part Of	QPA		
						L80107	L80107		2	4508182
						L80204	L80204		2	
				<input checked="" type="checkbox"/>			L80509		1	
						L80510			1	

(TRUCK) F150, F250 (4WD) 1997 → 1998

				←	→	Thread	Part Of	QPA		
						L80507	L80507		2	

GMC TRUCK

C1500, C2500, C3500 (Pickup) 1988 → 1999



L80601



L80601



Thread

Part Of

QPA



				L80601	L80601				2	
--	--	--	--	--------	--------	--	--	--	---	--

C1500, C2500 (Suburban) 1992 → 1996



L80601



L80601



Thread

Part Of

QPA



				L80601	L80601				2	
--	--	--	--	--------	--------	--	--	--	---	--

G1500 (1/2 Ton), G2500 (3/4 Ton), G3500 (1 Ton) 01.83 →



L80108

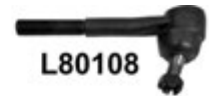

L80108



Thread

Part Of

QPA



		↔		L80108	L80108				2	
		⊥	G1500, 73 →	L80514	L80514				2	
			G2500 (-) Diesel, 73 →	L80514	L80514				2	



L80514



L80514



Jimmy, Sonoma, Syclone, Typoon (4WD) 1984 → 12.96



Thread

Part Of

QPA



		↓	84 → 96	L80512	L80512			2	09.12
			97 →	L80513	L80513			2	09.12

HONDA
Accord SJ, SM, SV 05.76 → 08.81

Thread

Part Of

QPA



				L40001	L40001	F 12x1,25 ∪		2	53540-SC2-004
--	--	--	--	--------	--------	-------------	--	---	---------------

Accord SY, SZ 09.81 → 09.83

Thread

Part Of

QPA



				L40001	L40001	F 12x1,25 ∪		2	53540-SC2-004
				L40004	L40004	M 12x1,25 / M 12x1,25 ∪		2	53521-SAO-003

Accord AC, AD 09.83 → 10.85

Thread

Part Of

QPA



				L40001	L40001	F 12x1,25 ∪		2	53540-SC2-004
--	--	--	--	--------	--------	-------------	--	---	---------------

Accord CA1, CA2, CA3, CA5 11.85 → 12.89

		i		←	→	Thread	Part Of	QPA	i
		↔		L40001	L40001	F 12x1,25 ∪		2	53540-SC2-004
				L40004	L40004	M 12x1,25 / M 12x1,25 ∪		2	53521-SE0-951
		↑			L40501			1	51459-SE0-003
				L40502				1	51469-SE0-003
		↓		L40040	L40040			2	51220-SK7-013
				L40160	L40160			2	90112-SE0-000
				L40512	L40512			2	52390-SE0-043
			KIT	MK226			1	52631-SF0-004	

Accord IV CB1, CB3, CB4, CB5 01.90 → 12.93

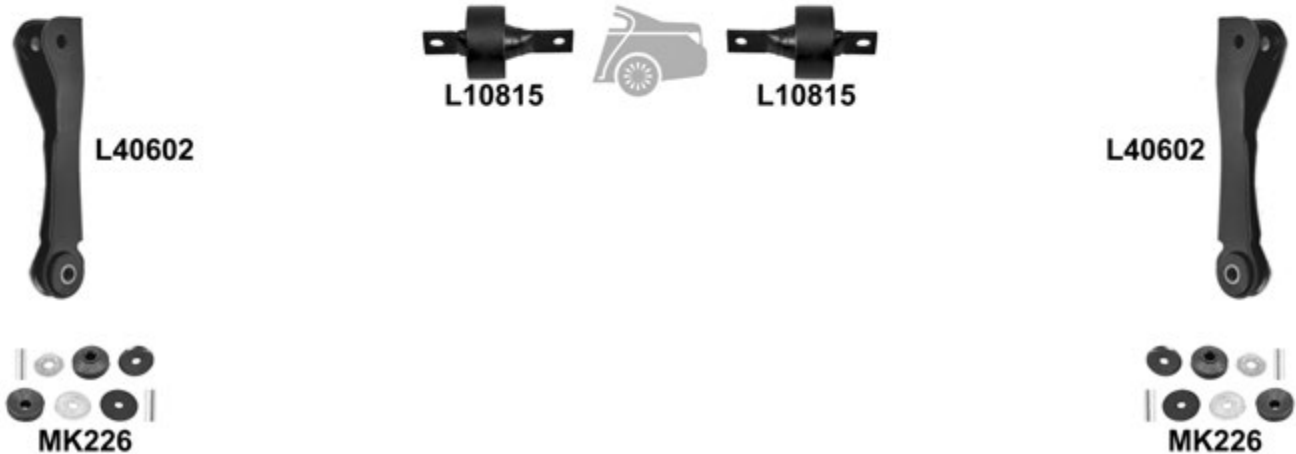
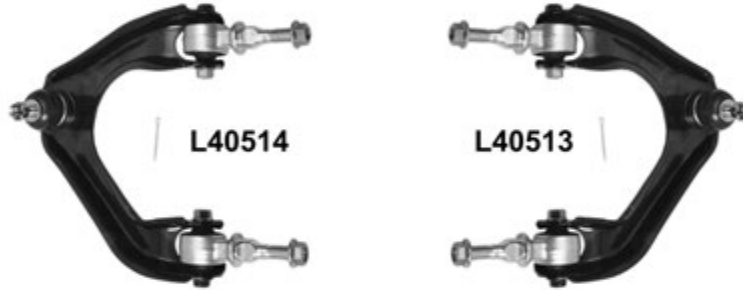

Accord IV CB1, CB3, CB4, CB5 01.90 → 12.93

				← → Thread		Part Of	QPA		
		↔		L40107			1	53540-SM4-004	
				L40108			1	53560-SM4-004	
				L40202	L40202		2	53521-SM4-013	
		⌈	∅ 33,4mm	L10537	L10537	L40513/L40514	2		
		⌋		L40509	L40509		2	51220-SM4-013	
		⌈		<input checked="" type="checkbox"/>	L40513			1	51450-SM4-A03
					L40514			1	51460-SM4-A03
		⌋			L40515			1	51355-SM4-040
					L40516			1	51365-SM4-040
		⌋ → ←			L10818	L10818		2	51393-SN7-003
		⌋ ↔			L40800	L40800		2	51810-SV4-004
				L40601	L40601		2	90112-SM4-020	
				MK129	MK129		2		
		⌋ ▲	longitudinal	L10815	L10815		2	52385-SR3-003	
				L40602	L40602		2	52306-SEO-030	
			KIT	MK226			1	52631-SF0-004	

Accord Aerodeck CE1 09.1993 →

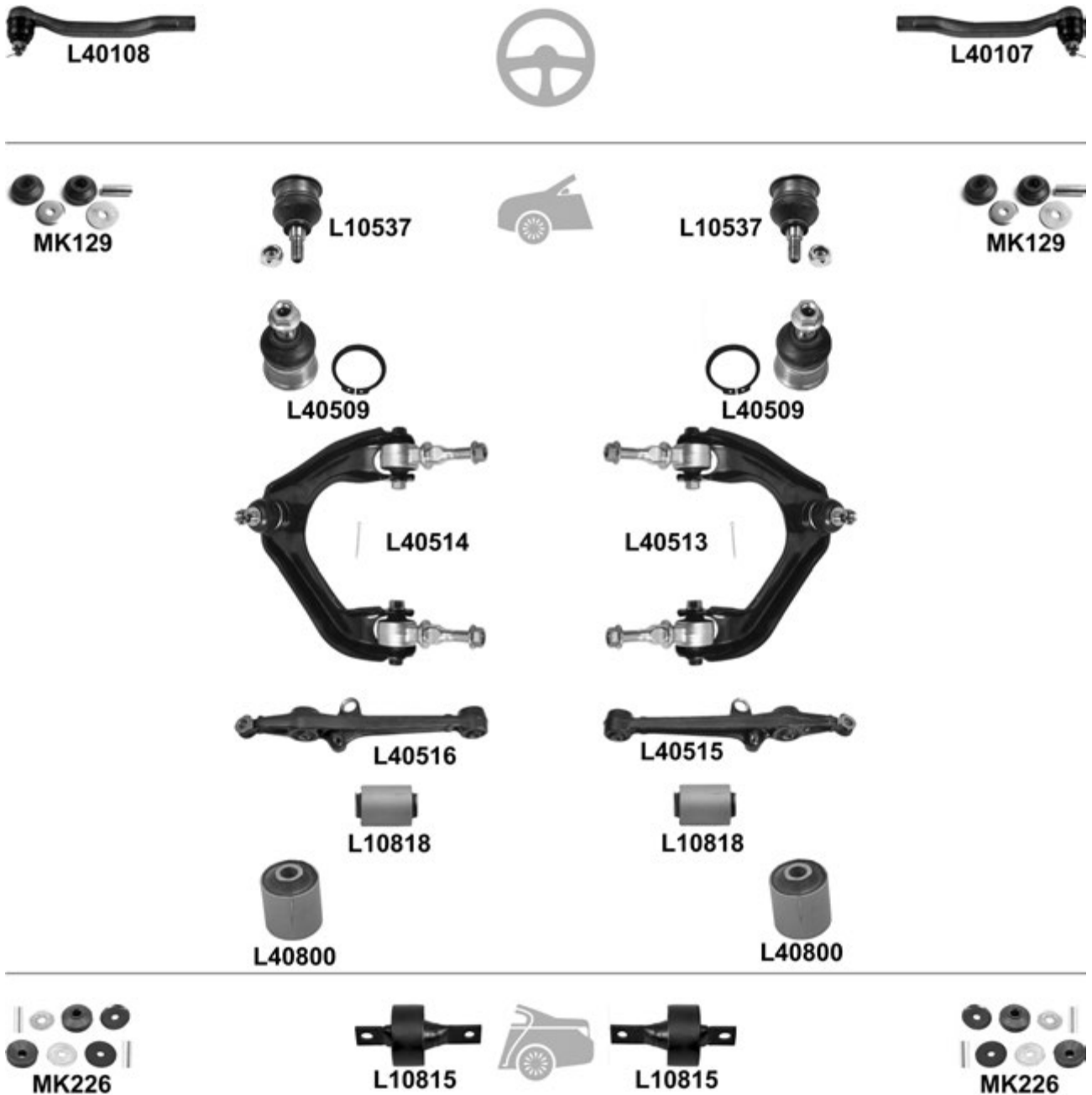

		← → Thread		Part Of	QPA					
		↔			1	53540-SM4-004				
				L40107		1	53560-SM4-004			
		↑	∅ 33,4mm	L10537	L10537		L40513/L40514	2		
		↓		L40509	L40509			2	51220-SM4-013	
		↑		<input checked="" type="checkbox"/>		L40513			1	51450-SM4-A03
		↓				L40514			1	51460-SM4-A03
		↓				L40515			1	51355-SM4-040
						L40516			1	51365-SM4-040
		↓ → ←			L10818	L10818			2	51393-SN7-003
		↓ ← →			L40800	L40800			2	51810-SV4-004
				MK129	MK129			2		
		↓ ▲	longitudinal	L10815	L10815			2	52385-SR3-003	
				KIT	MK226			1	52631-SF0-004	

Accord V CC7, CE, CD7, CD9E1 03.93 → 02.98



Accord V CC7, CE, CD7, CD9E1 03.93 → 02.98

				←	→	Thread	Part Of	QPA		
		↔			L40107			1	53540-SM4-004	
			L40108					1	53560-SM4-004	
		↑	∅ 33,4mm	L10537	L10537		L40513/L40514	2		
		↓		L40509	L40509			2	51220-SM4-013	
		↑		<input checked="" type="checkbox"/>		L40513			1	51450-SM4-A03
					L40514			1	51460-SM4-A03	
			↓			L40515		1	51355-SM4-040	
					L40516			1	51365-SM4-040	
		↓↔←			L10818	L10818			2	51393-SN7-003
					L40800	L40800			2	51810-SV4-004
					L40601	L40601			2	90112-SM4-020
					MK129	MK129			2	
		↑↔←		L10826	L10826			2	52370-SR3-J00	
				L40602	L40602			2	52306-SEO-030	
				KIT	MK226			1	52631-SF0-004	

Accord VI CE, CF 02.96 → 10.98



Accord VI CE, CF 02.96 → 10.98

		i		← → Thread		Part Of	QPA	i	
		↔		L40107			1	53540-SM4-004	
			L40108				1	53560-SM4-004	
		↑	∅ 33,4mm	L10537	L10537	L40513/L40514	2		
		↓		L40509	L40509		2	51220-SM4-013	
		↑		☑	L40513			1	51450-SM4-A03
			L40514				1	51460-SM4-A03	
		↓			L10535			1	51355-SX0-000
			L10536				1	51365-SX0-000	
		↓↔←			L10818	L10818		2	51393-SN7-003
			↓↔→			L10822	L10822		2
					L40601	L40601		2	90112-SM4-020
					MK129	MK129		2	
		↑↔←		L10826	L10826		2	52370-SR3-J00	
				L40602	L40602		2	52306-SEO-030	
				KIT	MK226		1	52631-SF0-004	

Accord Hatchback VII (CG6, CG7, CG8, CH7, CH8, CL3) 12.99 → 12.02
Accord Sedan VII (CG7, CG8, CG9, CH1, CH2, CL3) 10.98 → 12.02
Accord Coupe (CG2, CG4) 12.97 → 06.03



		i		←	→	Thread	Part Of	QPA	i	
		↑	∅ 35,2mm	L40517	L40517			2		
		↓		L40509	L40509			2	51220-SM4-013	
		↑	ORIG.	<input checked="" type="checkbox"/>		L40523			1	51450-S1A-E01
					L40524				1	51460-S1A-E01
		↓	ORIG.			L40525			1	51355-SX0-000
					L40526				1	51365-SX0-000
						L40603			1	51320-S84-A01
				L40604				1	51321-S84-A01	
		(-)	(CG2, CG4)	MK129	MK129			2		
					L40605			1	52320-S84-A01	
					L40606			1	52325-S84-A01	
		(-)	(CG2, CG4)	MK129	MK129			2		

Accord Sedan VIII (CL7, CL9, CN1) 02.03 →
 Accord Estate/Wagon VIII (CM1, CM2) 04.03 →

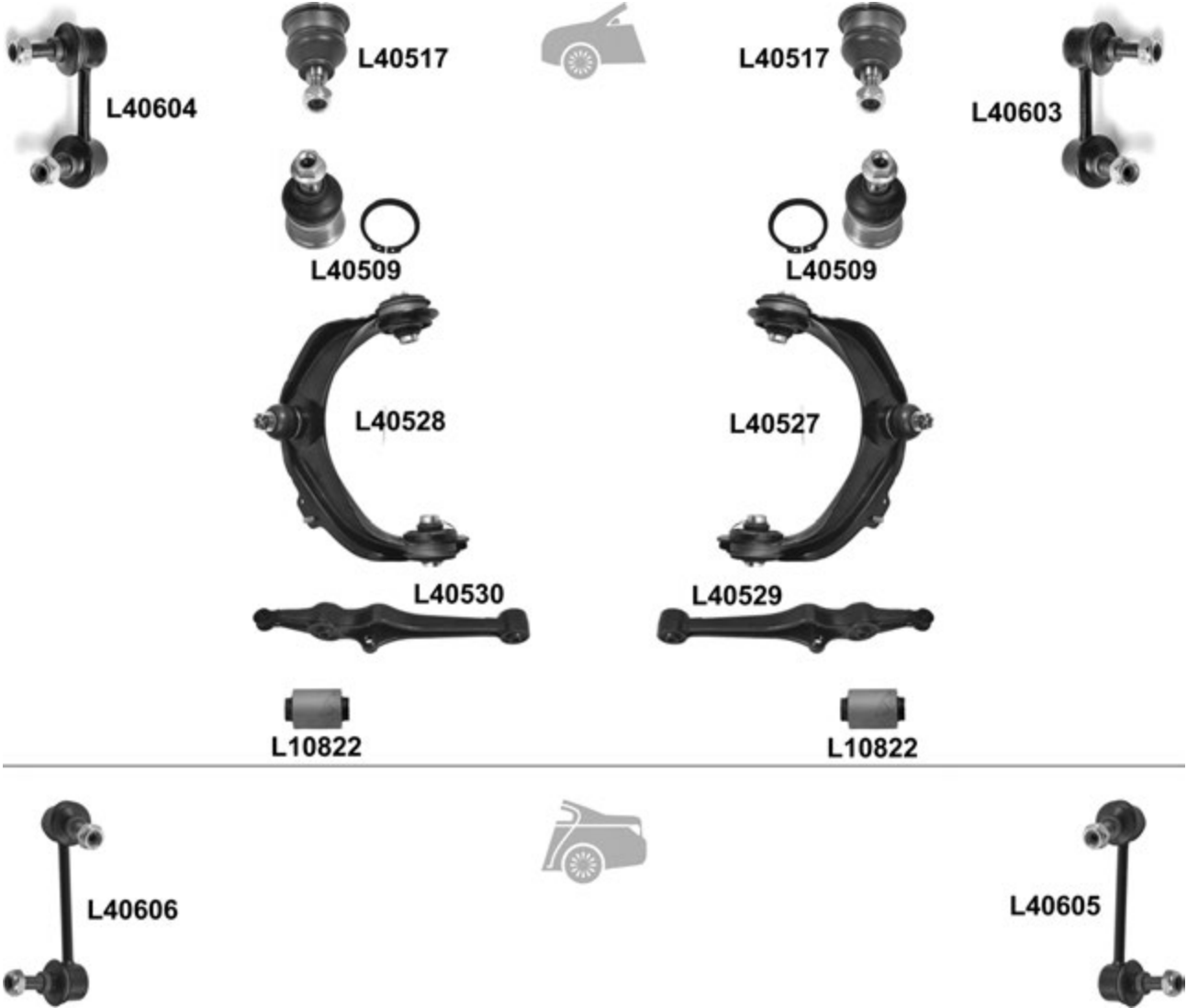

		i	←	→	Thread	Part Of	QPA	i
⊕		↔		L40121	F 14x1,5 ∪		1	53540-SDA-A01
				L40122	F 14x1,5 ∪		1	53560-SDA-A01
				L40207	L40207	F 14x1,5 / M 18x1,5		2
🚗		⌈	→ 09.05	<input checked="" type="checkbox"/>	L40549		1	51450-SDA-A01
					L40550		1	51460-SDA-A01
		⌋	(-)		L40547		1	51350-SEA-E01
					L40548		1	51350-SEA-E01
					L40631		1	51320-SEA-E01
					L40632		1	51321-SEA-E01
🚗					L40605		1	52320-S84-A01
					L40606		1	52325-S84-A01
					MK129	MK129	2	

**Accord Aerodeck VII 02.98 →
Accord Coupe (CG2, CG4) 12.97 → 06.03**

		i		←	→	Thread	Part Of	QPA	i
		↑		L40517	L40517			2	
		↓		L40509	L40509			2	51220-SM4-013
		↑	ORIG (USA) <input checked="" type="checkbox"/>		L40527			1	51450-S84-A01
				L40528				1	51460-S84-A01
		↓	ORIG (USA)		L40529			1	51355-S84-A00
				L40530				1	51365-S84-A00
	↕↔←		L10822	L10822			2	51393-SV1-A01	
			(-) Aerodeck		L40603			1	51320-S84-A01
				L40604				1	51321-S84-A01
			(-) Aerodeck		L40605			1	52320-S84-A01
					L40606			1	52325-S84-A01

Accord IX 07.08 →
 Accord IX Tourer 07.08 →

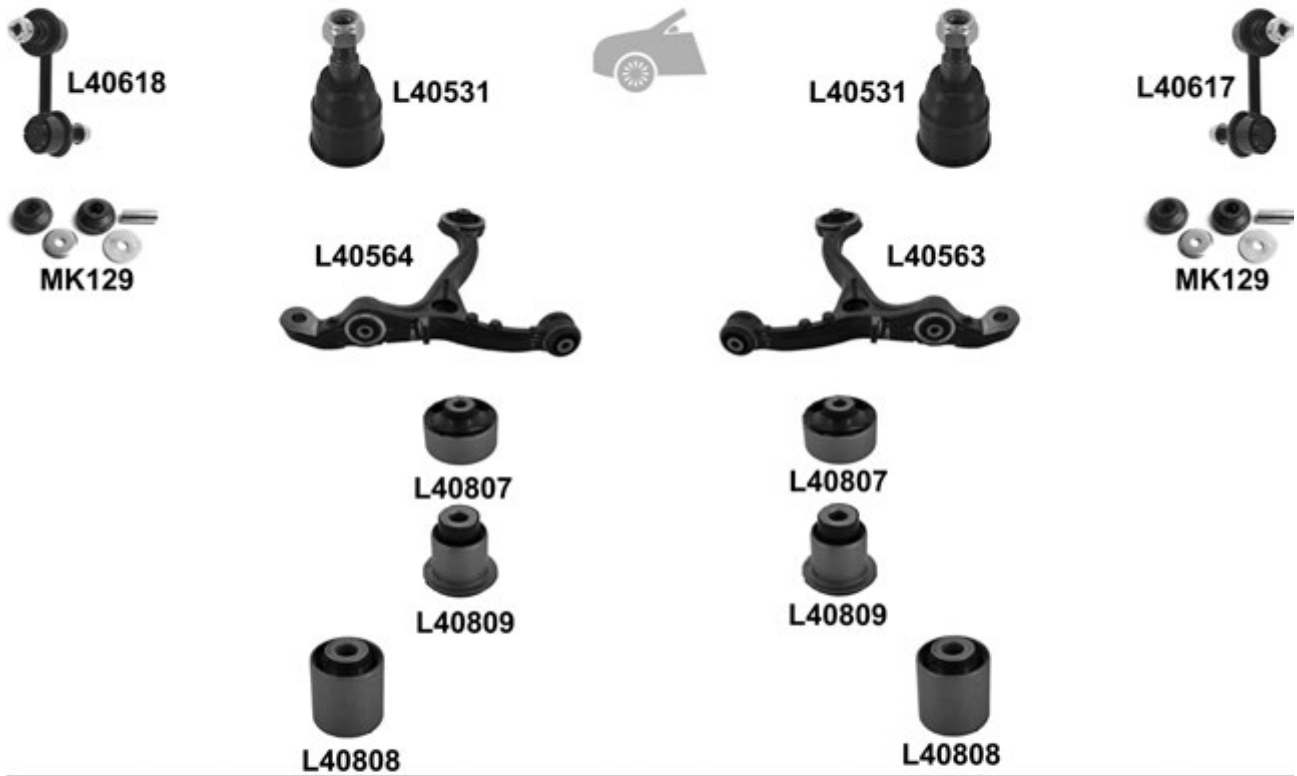

Accord IX 07.08 →
Accord IX Tourer 07.08 →

			i	←	→	Thread	Part Of	QPA	i			
		↔				L40111	F 14x1,5	1	53540-TA0-A01			
						L40112	F 14x1,5	1	53560-TA0-A01			
		↔				L40204	M 14x1,5 / M 20x1,5	2	53010-TA0-A01			
						L40531	L40531		2	51220-TA0-A02		
				⊥				L40563		1	51350-TA0-A00	
				⊥	(-) L40531			L40564		1	51360-TA0-A00	
				⊥	⌵			L40807	L40807		2	51392-S5A-004
				⊥	⌵			L40809	L40809		2	51391-S5A-024
				⊥	⌵			L40808	L40808		2	51391-S5A-024
								L40617			1	51320-TA0-A01
		↔				L40618		1	51325-TA0-A01			
						MK129	MK129		2			
								L40619 ^o		1	52320-TA0-A01	
								L40620 ^o		1	52325-TA0-A01	
		↔				MK129	MK129		2			

City (GM15, GM16) 08.08 →



			i	←	→	Thread	Part Of	QPA	i
		↔				L40135	M 14x1,5 ∪	1	53540-TF0-003
						L40136	M 14x1,5 ∪	1	53560-TF0-003

Civic SB 09.72 → 1975
Civic SC, SF, SG 1975 → 06.79
Civic SH, SK, SP 1975 → 06.79

			i	←	→	Thread	Part Of	QPA	i	
		↔				L40001	L40001	F 12x1,25 ∪	2	53540-SC2-004

Civic SL, SR, SS, ST 09.79 → 09.83
Civic VC, VE, WD 09.79 → 09.83

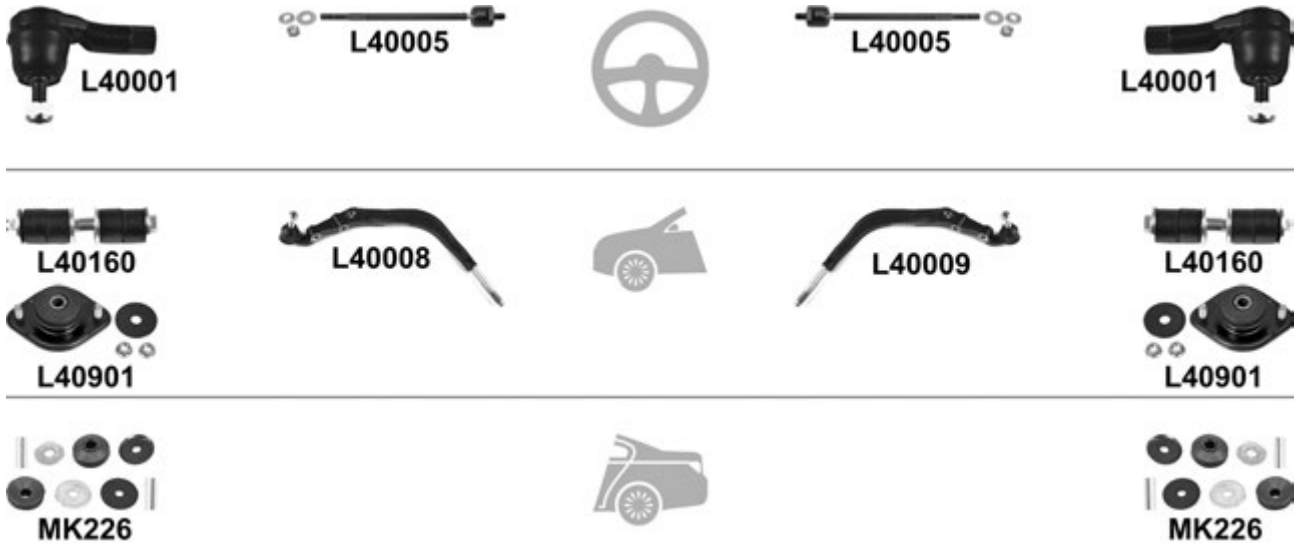
				←	→	Thread	Part Of	QPA	i
⊕		↔		L40001	L40001	F 12x1,25 ∪		2	53540-SC2-004
				L40004	L40004	M 12x1,25 / M 12x1,25 ∪		2	53521-SE0-951
			KIT	MK226				1	52631-SF0-004

Civic AG, AH, AJ, AK 10.83 → 10.87
Civic AR, AT, AU, VJ 09.83 → 1987

				←	→	Thread	Part Of	QPA	i
⊕		↔		L40001	L40001	F 12x1,25 ∪		2	53540-SC2-004
				L40005	L40005	M 12x1,25 / M 12x1,25 ∪		2	53521-SB2-013
		⊥			L40009			1	51351-SB6-931
				L40008				1	51361-SB6-931
				L40160	L40160			2	90112-SE0-000
			KIT	L40901	L40901			2	
			KIT	MK226				1	52631-SF0-004

Civic EF1, EF2, EF3, EF4, EF 10.87 → 09.91
 Civic EY2 10.87 → 09.91



						←	→	Thread	Part Of	QPA			
								F 14x1,5 Ъ		1	53540-SH3-013		
									F 14x1,5 Ъ		1	53560-SH3-013	
								M 14x1,5 / M 12x1,25 Ъ		2	53521-SH3-003		
											1	51450-SH3-010	
												1	51460-SH3-010
												2	51220-SB0-003
										2	90112-SE0-000		
											2	52385-SR3-003	

Civic IV (EG, EH, EJ) 10.91 → 11.95

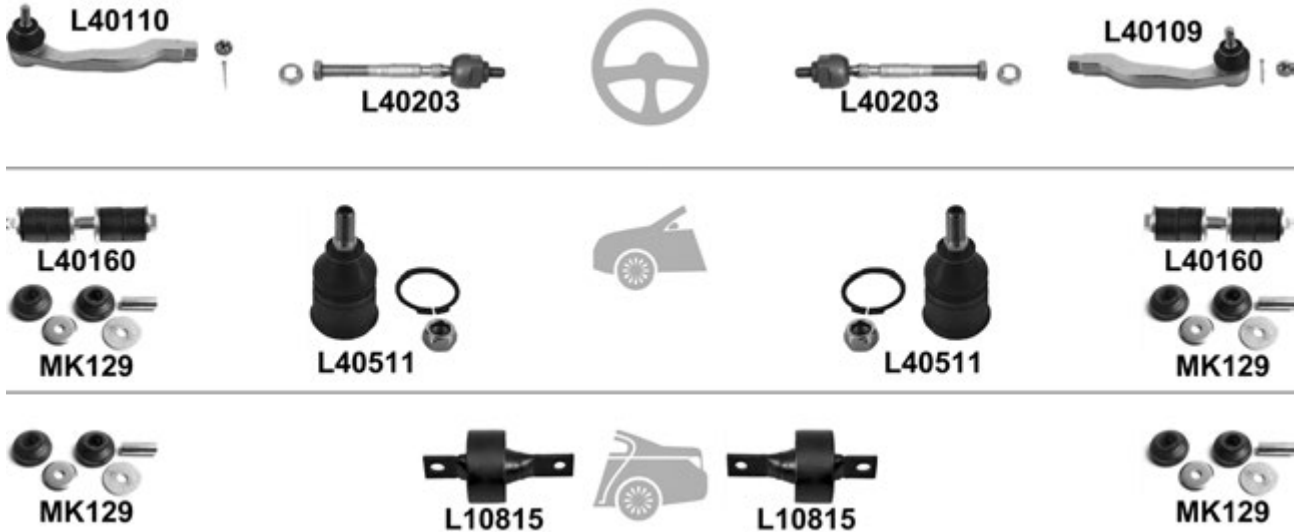

						←	→	Thread	Part Of	QPA	
⊕		↔		L40109	F 14x1,5 ♂					1	53540-SR3-003
				L40110	F 14x1,5 ♂					1	53560-SR3-003
⊖		⊥		L40203	L40203					2	53010-SR3-010
				L40511	L40511					2	51220-SR3-003
				L40160	L40160					2	90112-SEO-000
⊖		↕	longitudinal	L10815	L10815				2	52385-SR3-003	
				MK129	MK129				2		

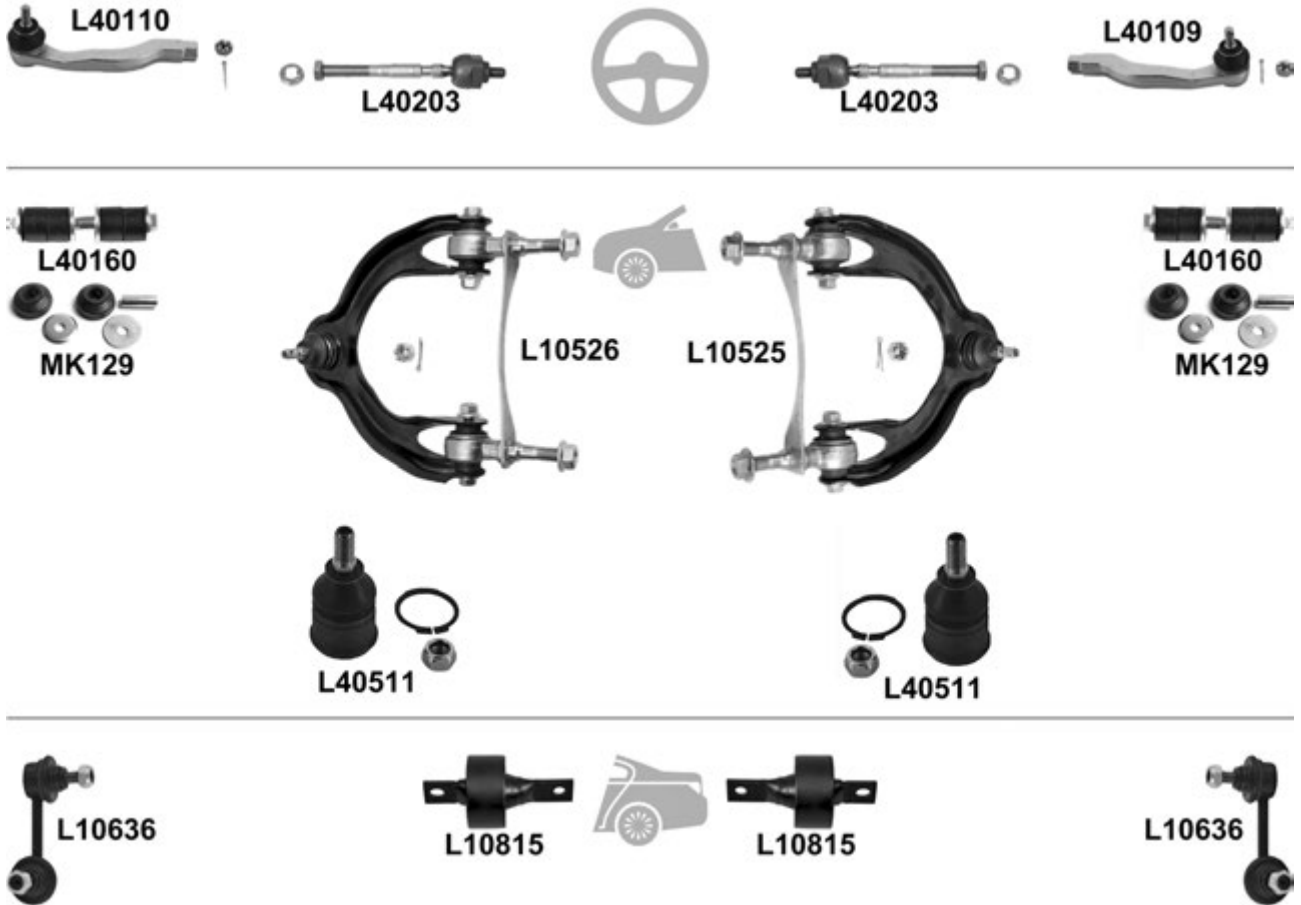
Civic IV (MA, MB) 09.94 → 01.97

				← → Thread		Part Of	QPA		
⊕		↔		L40109	F 14x1,5 ∪		1	53540-SR3-003	
				L40110	F 14x1,5 ∪		1	53560-SR3-003	
				L40203	L40203		2	53010-SR3-010	
⊖		↑		L10525			1	51450-ST3-E10	☑
				L10526			1	51460-ST3-E10	
		↓		L40511	L40511		2	51220-SR3-003	
				L40160	L40160		2	90112-SE0-000	
				MK129	MK129		2		
⊖		↓ ▲	longitudinal	L10815	L10815		2	52385-SR3-003	
				L10636	L10636		2	52303-SK3-010	

Civic V (EJ, EK) 11.95 → 02.01

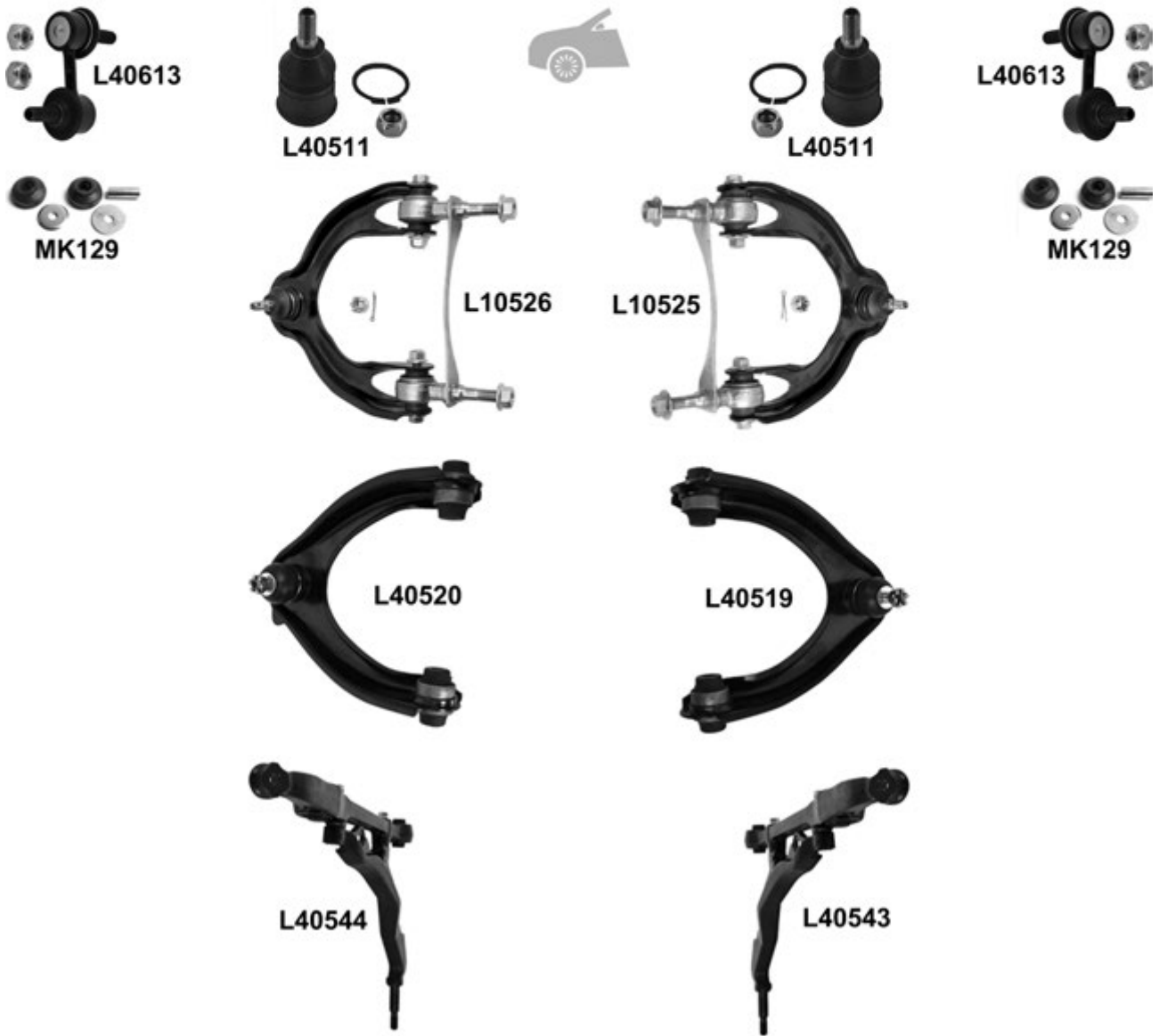
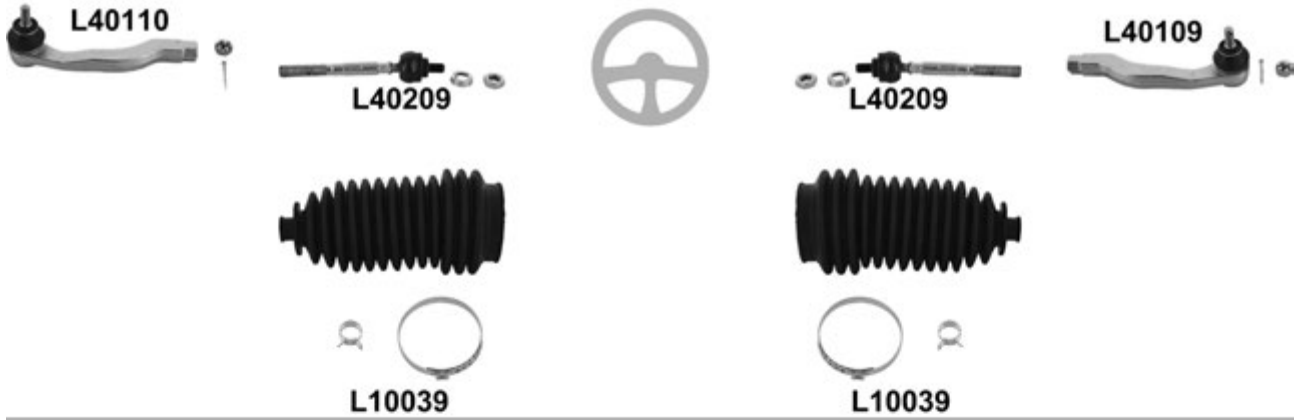

Civic V (EJ, EK) 11.95 → 02.01

				← → Thread		Part Of	QPA					
⊕		↔		L40109	F 14x1,5 ♂		1	53540-SR3-003				
				L40110	F 14x1,5 ♂		1	53560-SR3-003				
				L40209	L40209	M 14x1,5 / M 12x1,25		2	53010-S04-000			
				L10039 ⁰	L10039 ⁰			2	53535-ST3-305			
🚗		⊥		L40511	L40511			2	51220-SR3-003			
			↕	EJ9, (-) (ABS) <input checked="" type="checkbox"/>	L10525			1	51450-ST3-E10			
					L10526			1	51460-ST3-E10			
			↕	EJ9/EK1/EK3/EK4 <input checked="" type="checkbox"/>	L40519			1	51450-S01-023			
					L40520			1	51460-S01-023			
			⊥	EJ9		L40543			1	51350-ST3-E01		
						L40544			1	51360-ST3-E01		
						L40613	L40613			2	51320-S04-003	
						MK129	MK129			2		
			🚗		⊥ ▲	longitudinal	L10815	L10815			2	52385-SR3-003
		L40607						1	52320-S04-003			
		L40608						1	52321-S04-003			

Civic Coupe V (EJ6, EJ7, EJ8, EM1) 01.96 → 12.00

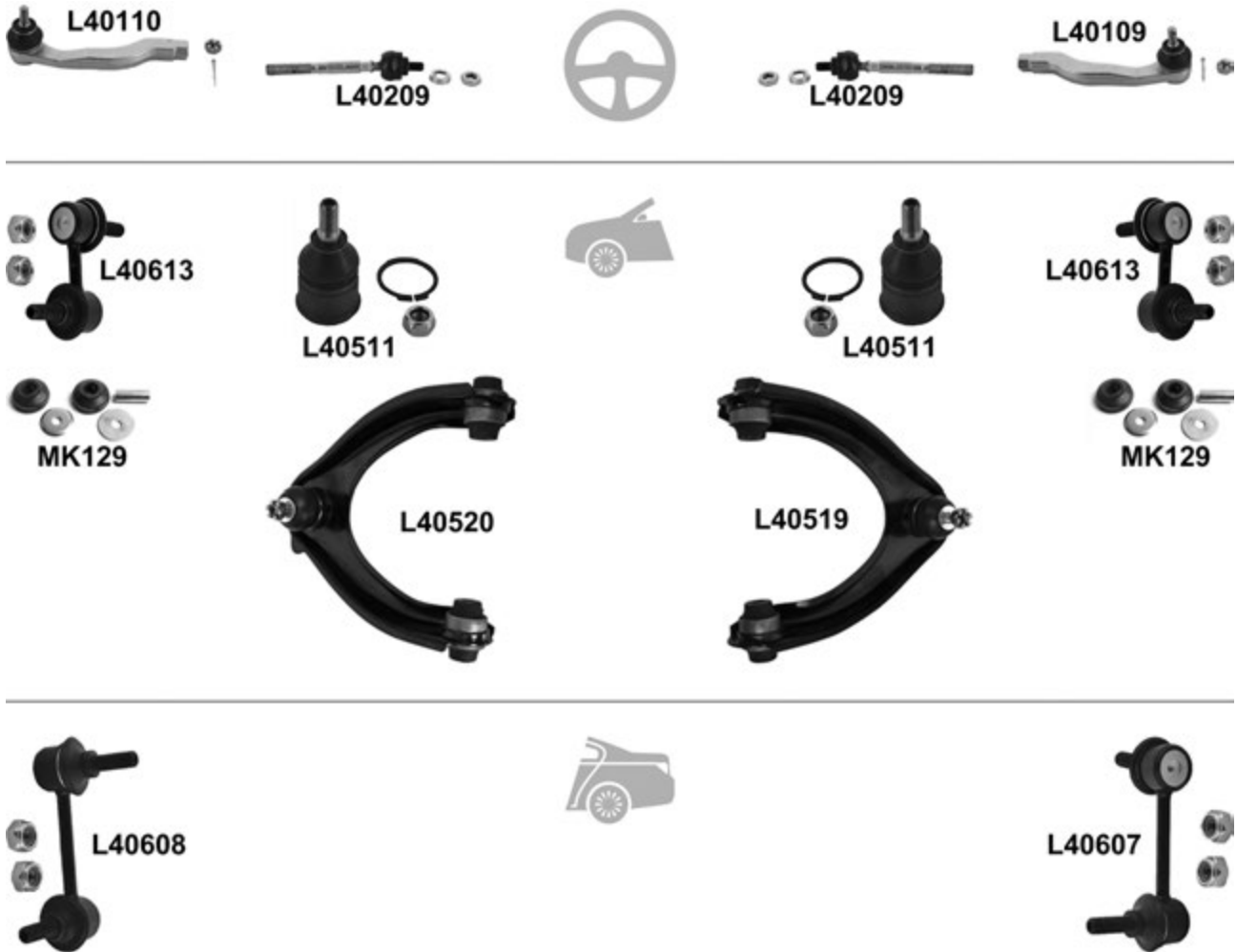

				←	→	Thread	Part Of	QPA			
⊕		↔			L40109	F 14x1,5 ♂		1	53540-SR3-003		
					L40110	F 14x1,5 ♂		1	53560-SR3-003		
⊖		⊥			L40209	L40209	M 14x1,5 / M 12x1,25		2	53010-S04-000	
					L40511	L40511			2	51220-SR3-003	
				<input checked="" type="checkbox"/>	L40519				1	51450-S01-023	
					L40520				1	51460-S01-023	
					L40613	L40613			2	51320-S04-003	
⊖					MK129	MK129		2			
					L40607			1	52320-S04-003		
					L40608			1	52321-S04-003		

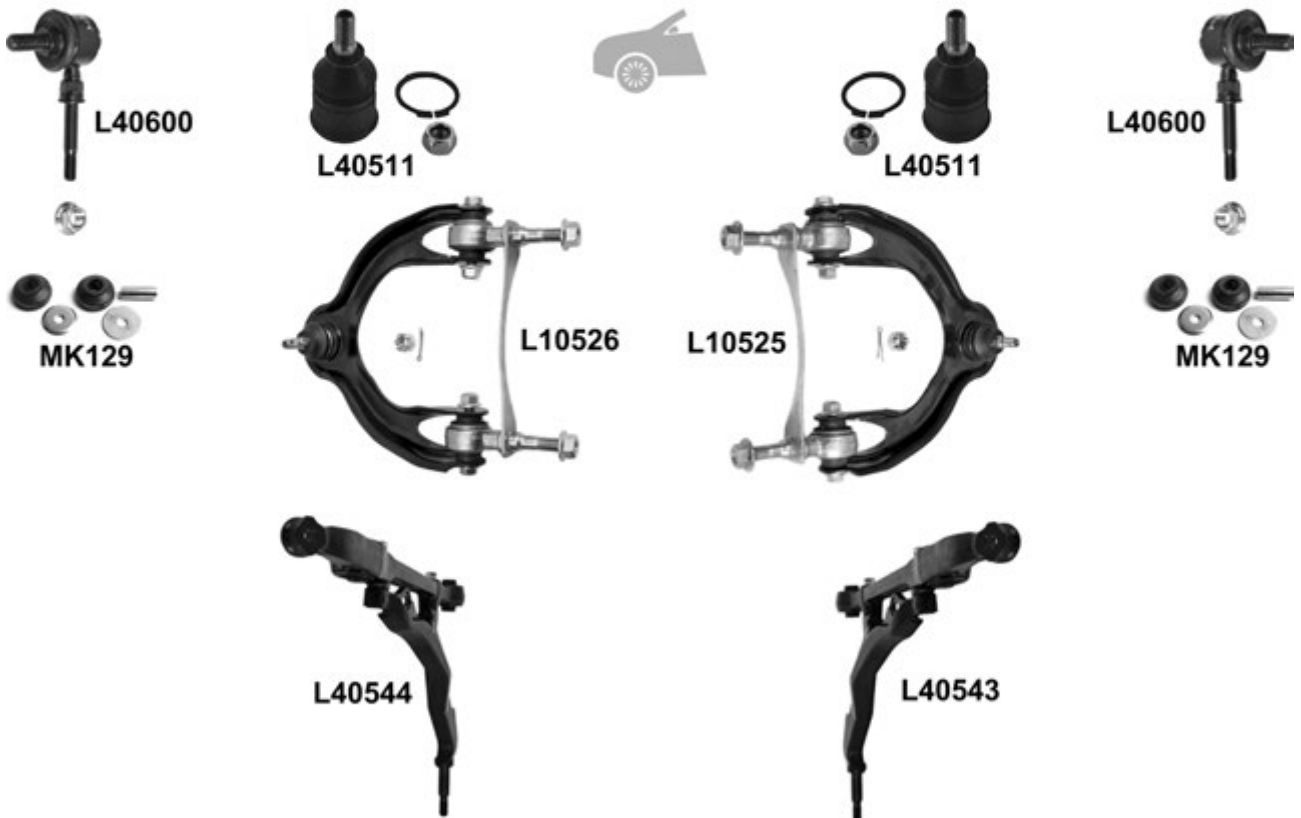
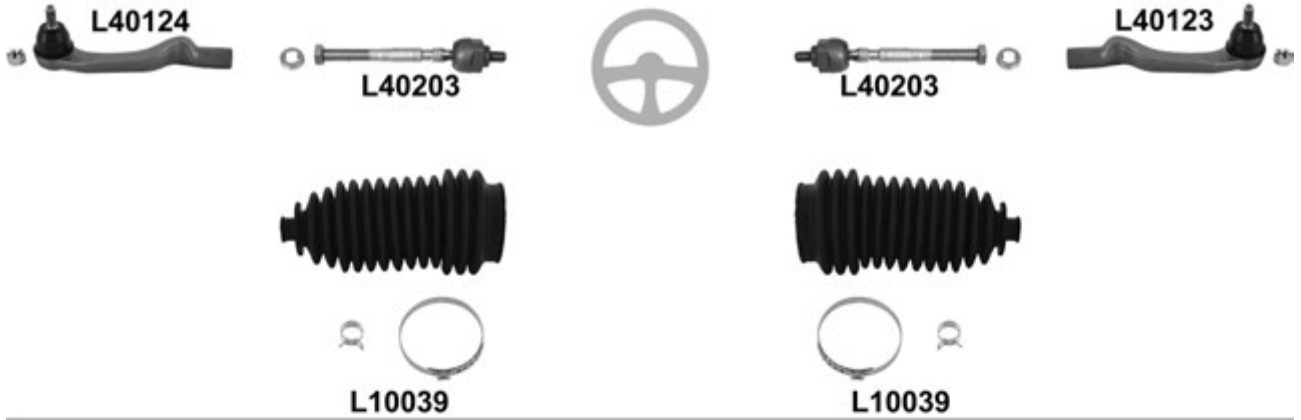
Civic V (MA8, MB1, MB2, MB3, MB4, MB6, MB7, MB8) 01.97 → 02.01

				←	→	Thread	Part Of	QPA		
⊕		↔				L40123	F 14x1,5 ♂	1	53540-ST3-E03	
						L40124	F 14x1,5 ♂	1	53560-ST3-E03	
						L40203	L40203		2	53010-SR3-010
						L10039 ⁰	L10039 ⁰		2	53535-ST3-305
⊖		⊥				L40511	L40511	2	51220-SR3-003	
							L10525		1	51450-ST3-E10
						L10526			1	51460-ST3-E10
							L40543		1	51350-ST3-E01
						L40544			1	51360-ST3-E01
						L40600	L40600		2	51320-ST7-003
⊖		⊥				MK129	MK129	2		
						L10815	L10815		2	52385-SR3-003
		⊥	longitudinal					2		

Civic Aerodeck V (MB, MC) 04.1998 → 02.2001

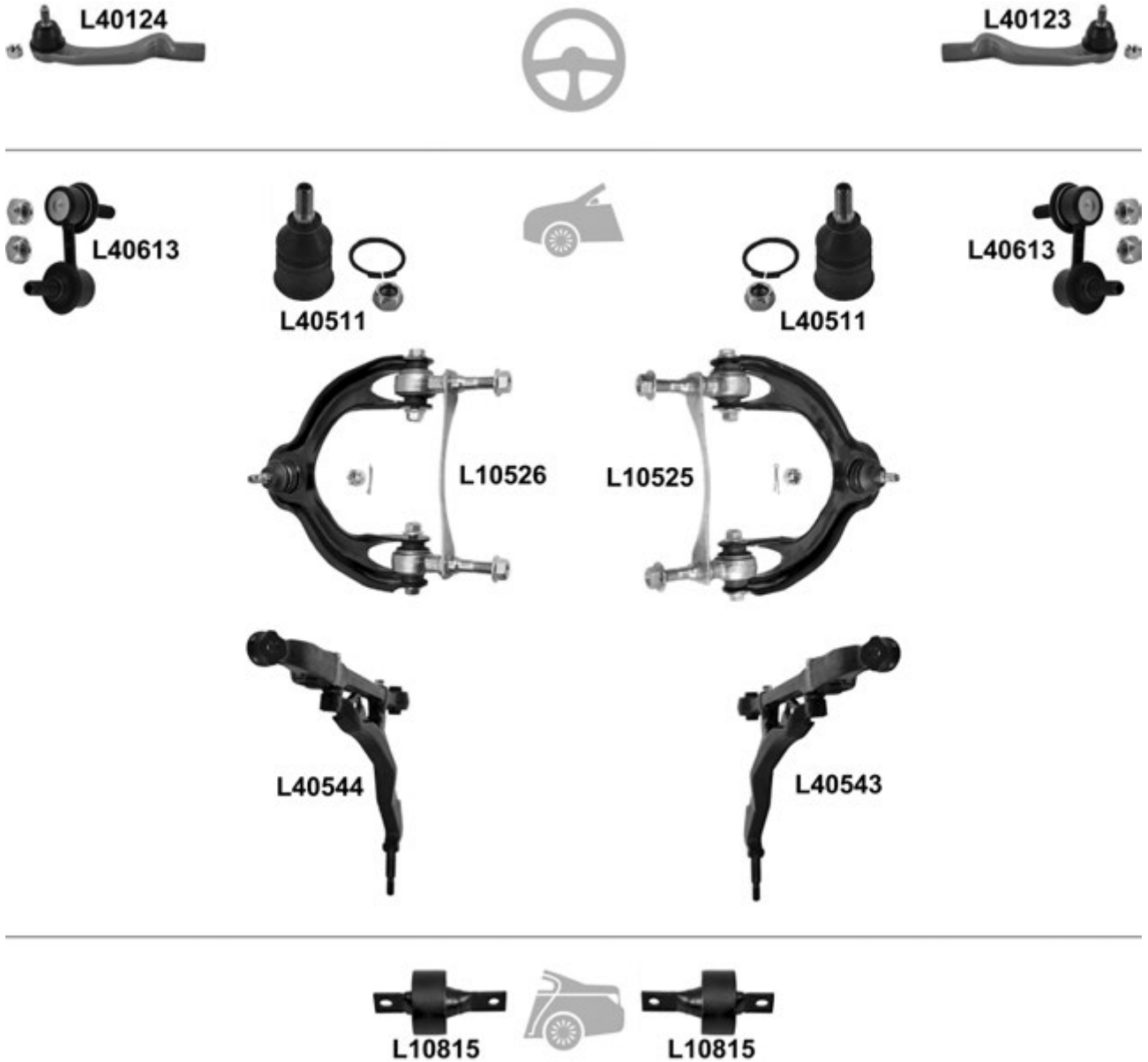

				← → Thread		Part Of	QPA	i	
⊕	↔			L40123	F 14x1,5 ♂		1	53540-ST3-E03	
				L40124	F 14x1,5 ♂		1	53560-ST3-E03	
🚗	⊥	↔		L40511	L40511		2	51220-SR3-003	
				L10525		<input checked="" type="checkbox"/>	1	51450-ST3-E10	
	⊥			L10526			1	51460-ST3-E10	
				L40543			1	51350-ST3-E01	
	L40544			1	51360-ST3-E01				
↔			L40613	L40613		2	51320-S04-003		
🚗	⊥	↔	longitudinal	L10815	L10815		2	52385-SR3-003	

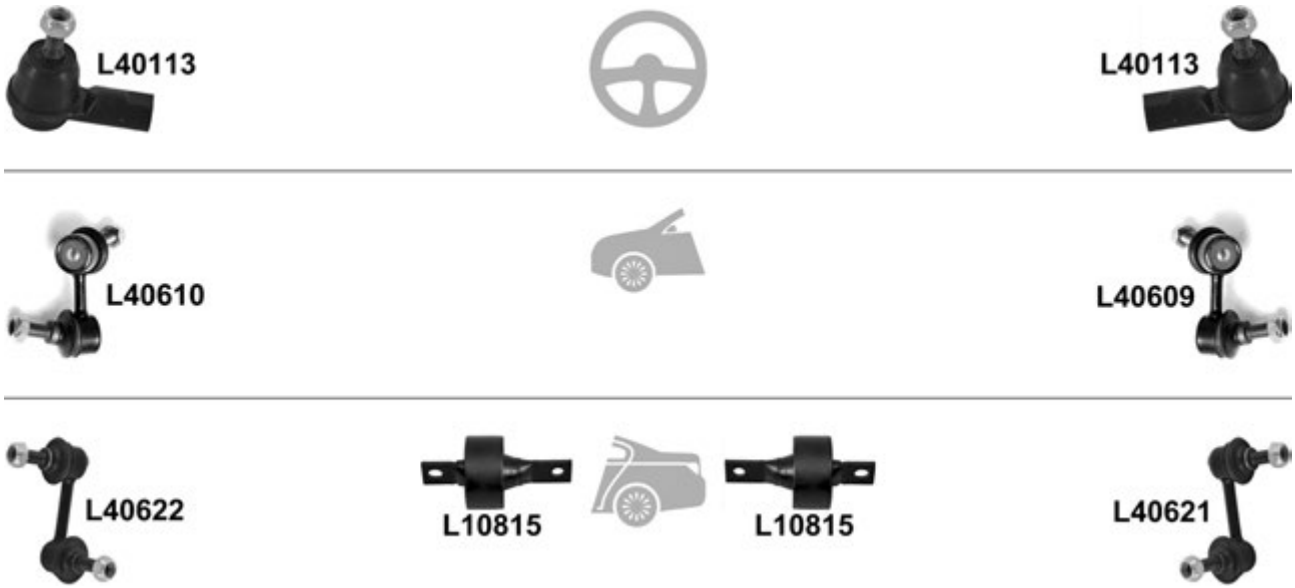
Civic Coupe VI (EM2) 01.00 → 12.05

		i		←	→	Thread	Part Of	QPA	i
		↔		L40113	L40113	F 14x1,5 U		2	53541-S5A-003
					L40609			1	51320-S5A-003
				L40610				1	51321-S5A-003
		⊥	longitudinal	L10815	L10815			2	52385-SR3-003
					L40621			1	52320-S5A-013
				L40622				1	52321-S5A-013

Civic VI (EU_, EM_, EP_ES_EV_) 01.00 → 12.05

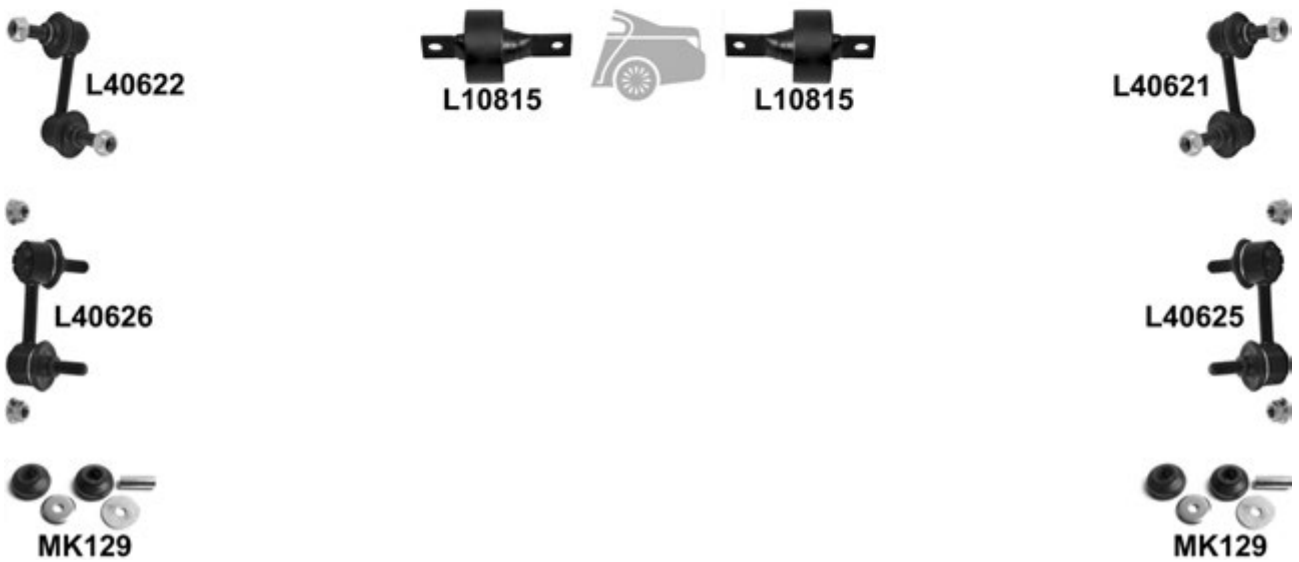
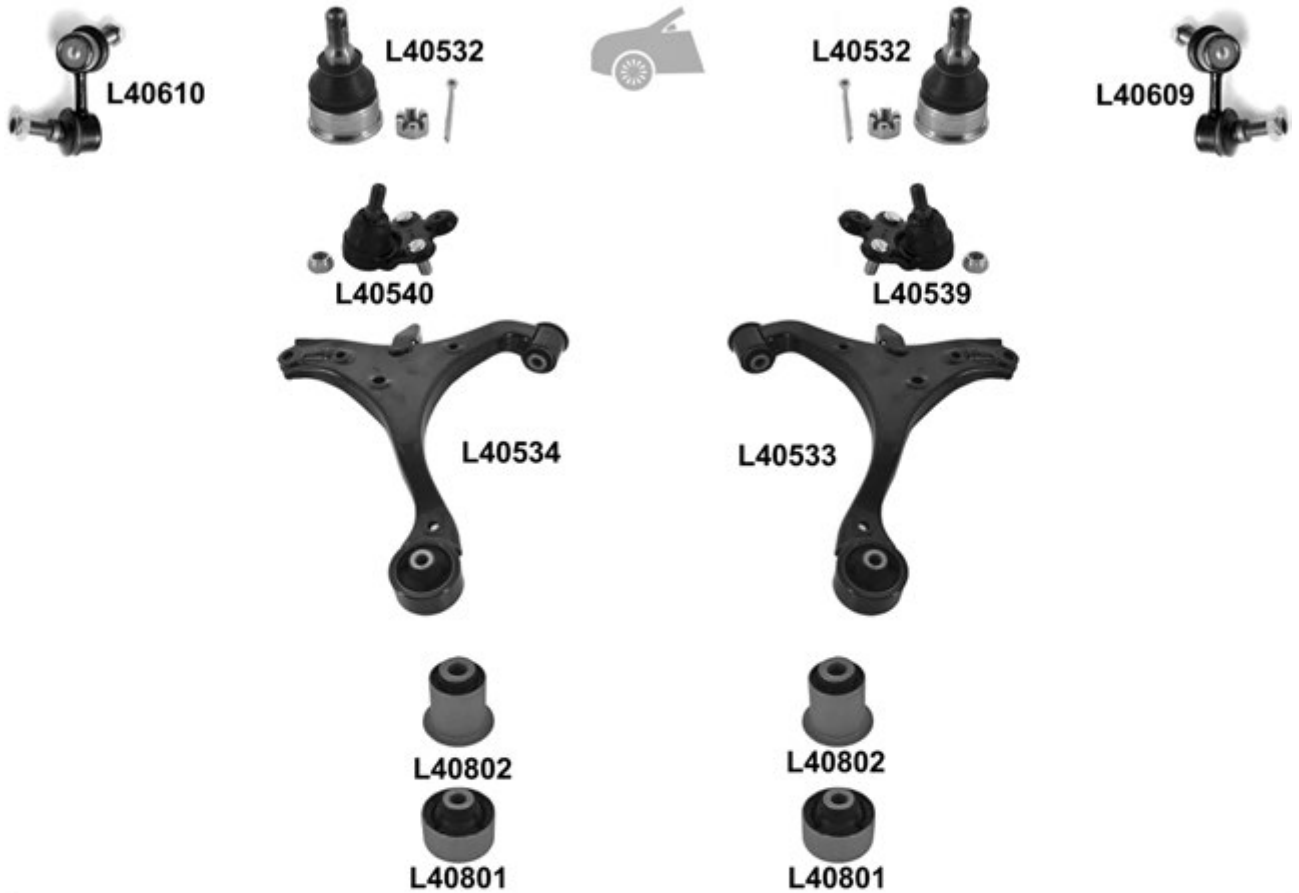

Civic VI (EU_, EM_, EP_ES_EV_) 01.00 → 12.05

			i	←	→	Thread	Part Of	QPA	i		
		↔		L40113	L40113	F 14x1,5 ♂		2	53541-S5A-003		
			ES9		L40117	F 14x1,5 ♂		1	53540-SNA-A02		
				L40118	F 14x1,5 ♂		1	53560-SNA-A02			
				L40205	L40205	M 14x1,5 / M 12x1,25 ♂		2	53521-S5A-003		
		⊥		L40532	L40532			2	51220-S5A-J10		
			ES9		L40539			1	51220-SNA-A03		
				L40540			1	51230-SNA-A03			
		⊥	(-) L40532		L40533			1	51350-S6D-G00		
			L40534			1	51360-S6D-G00				
		⊥	↘		L40802	L40802			2	51392-S5A-004	
			↗		L40801	L40801			2	51391-S5A-024	
				(-) EU7/EU9		L40609			1	51320-S5A-003	
						L40610			1	51321-S5A-003	
			⊥	↗	longitudinal	L10815	L10815			2	52385-SR3-003
						L40621			1	52320-S5A-013	
						L40622			1	52321-S5A-013	
					EP3/ES9/EV1		L40625			1	52320-SNA-A01
						L40626			1	52321-SNA-A01	
					MK129	MK129			2		

Civic VIII (FD_, FK_, FN_) 09.05 →



Civic VIII (FD_, FK_, FN_) 09.05 →

		i		←	→	Thread	Part Of	QPA	i	
		↔	Model FD		L40117	F 14x1,5 ∪		1	53540-SNA-A02	
				L40118	F 14x1,5 ∪		1	53560-SNA-A02		
			FK 1.3 iDS/iVEC, 1.8 FK1, 2.2 CDTi FK3 FN 1.3 iVEC FN4, 1.8, FN1, 2.0 FN2, 2.2 CDTi FN3		L40125	F 14x1,5 ∪		1	53540-SMG-003	
					L40126	F 14x1,5 ∪		1	53560-SMG-003	
				Model FK/FN		L40211	M 14x1,5 / M 20x1,5 ∪		1	53011-SMG-E01
						L40212	M 14x1,5 / M 20x1,5 ∪		1	53010-SMG-E01
		⊥	Model FD		L40539			1	51220-SNA-A03	
				L40540			1	51230-SNA-A03		
		⊥	Model FK1/2/3, FN1/3/4	<input checked="" type="checkbox"/>		L40555			1	51350-SMG-E07
				L40556			1	51360-SMG-E07		
			Model FD1/3/4/6/7, (-) Xenon light, (-) , (+)		L40567		1	51350-SNA-A03		
			Model FD1/3/4/6/7, (-) , (+)		L40568		1	51360-SNA-A03		
		⊥▼				L40803			1	
		⊥▲				L40804			1	
			Model FD			L40647			1	52320-SNA-A02
					L40648			1	52321-SNA-A02	
			Model FK/FN		L40629	L40629		2	51320-SMG-E01	
			Model FD	KIT	MK354	MK354		2	51920-SVB-A03	
		Model FD			L40625			1	52320-SNA-A01	
				L40626			1	52321-SNA-A01		

Civic IX (FK) 01.12 →

		i		←	→	Thread	Part Of	QPA	i
					L40625			1	52320-SNA-A01
					L40626			1	52321-SNA-A01

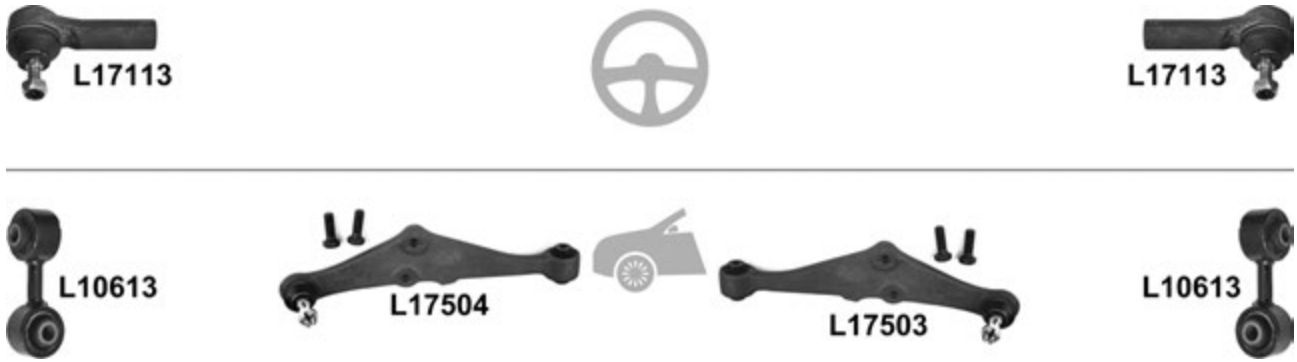
Concerto (HW) 8.1989 → 03.95

			i	←	→	Thread	Part Of	QPA	i
		↔		L17113	L17113	F 12x1,25 ♂		2	53540-SK3-E01
		⊥	<input checked="" type="checkbox"/>	L17503				1	51355-SK3-000
				L17504				1	51365-SK3-000
				L10613	L10613			2	51320-SK3-000

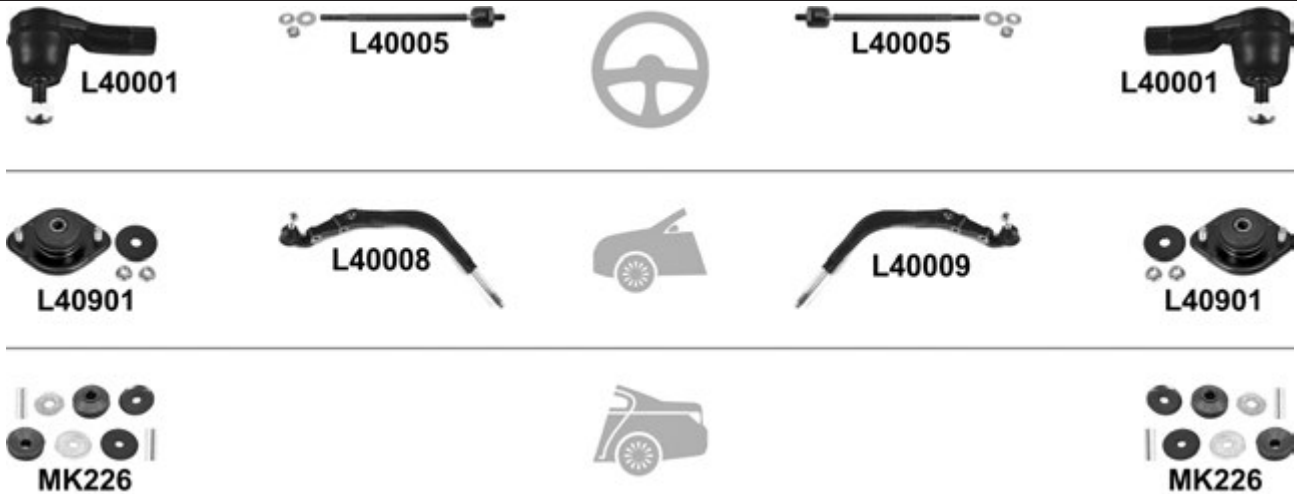
CRX AE, AF, AS 10.1983 → 10.1987

			i	←	→	Thread	Part Of	QPA	i
		↔		L40001	L40001	F 12x1,25 ♂		2	53540-SC2-004
				L40005	L40005	M 12x1,25 / M 12x1,25 ♂		2	53521-SB2-013
		⊥			L40009			1	51351-SB6-931
				L40008				1	51361-SB6-931
				KIT	L40901	L40901		2	
				KIT	MK226			1	52631-SF0-004

CRX EF6, EF7 10.87 → 02.92

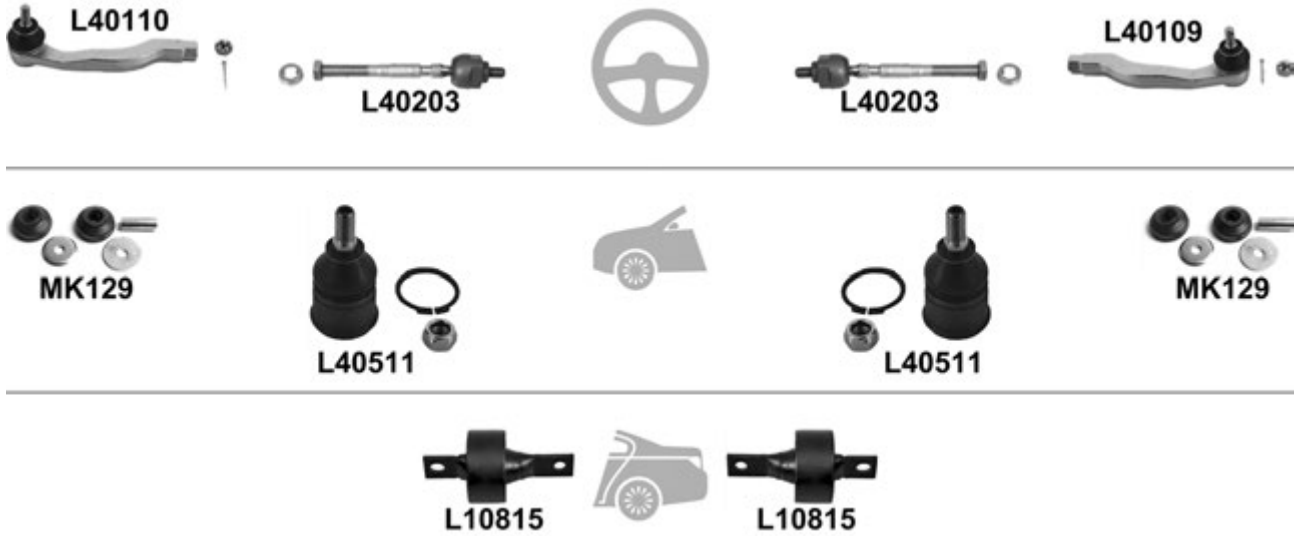

		i		←	→	Thread	Part Of	QPA	i	
		↔				L40105	F 14x1,5 ∪	1	53540-SH3-013	
						L40106	F 14x1,5 ∪	1	53560-SH3-013	
		↑		<input checked="" type="checkbox"/>		L40507		1	51450-SH3-030	
						L40508		1	51460-SH3-030	
					⊥		L40040	L40040	2	51220-SB0-003
							MK129	MK129	2	
		⊥ ▲	longitudinal			L10815	L10815	2	52385-SR3-003	
						MK129	MK129	2		

CRX (EG / EH) 03.92 →

			←	→	Thread	Part Of	QPA	
				L40109	F 14x1,5 ♂		1	53540-SR3-003
			L40110		F 14x1,5 ♂		1	53560-SR3-003
				L40203	L40203		2	53010-SR3-010
			L40511	L40511		2	51220-SR3-013	
				MK129	MK129		2	
			longitudinal	L10815	L10815			2

CR-V I (RD1) 10.95 → 02.02



CR-V I (RD1) 10.95 → 02.02

				←	→	Thread	Part Of	QPA	
		\leftrightarrow			L40109	F 14x1,5 \cup		1	53540-SR3-003
			L40110			F 14x1,5 \cup		1	53560-SR3-003
				L40213	L40213	M 14x1,5 / M 12x1,25		2	53010-S10-000
		\perp		L40511	L40511			2	51220-SR3-003
		$\bar{\uparrow}$	<input checked="" type="checkbox"/>		L40521			1	51450-S10-020
					L40522			1	51460-S10-020
		\perp			L40553			1	51350-S10-G00
					L40554			1	51360-S10-G00
		$\bar{\uparrow}$ $\bar{\downarrow}$			L40810	L40810		L40521/L40522	4
				L40613	L40613			2	51320-S04-003
					L40611			1	52320-S10-003
					L40612			1	52321-S10-003
				MK129	MK129			2	

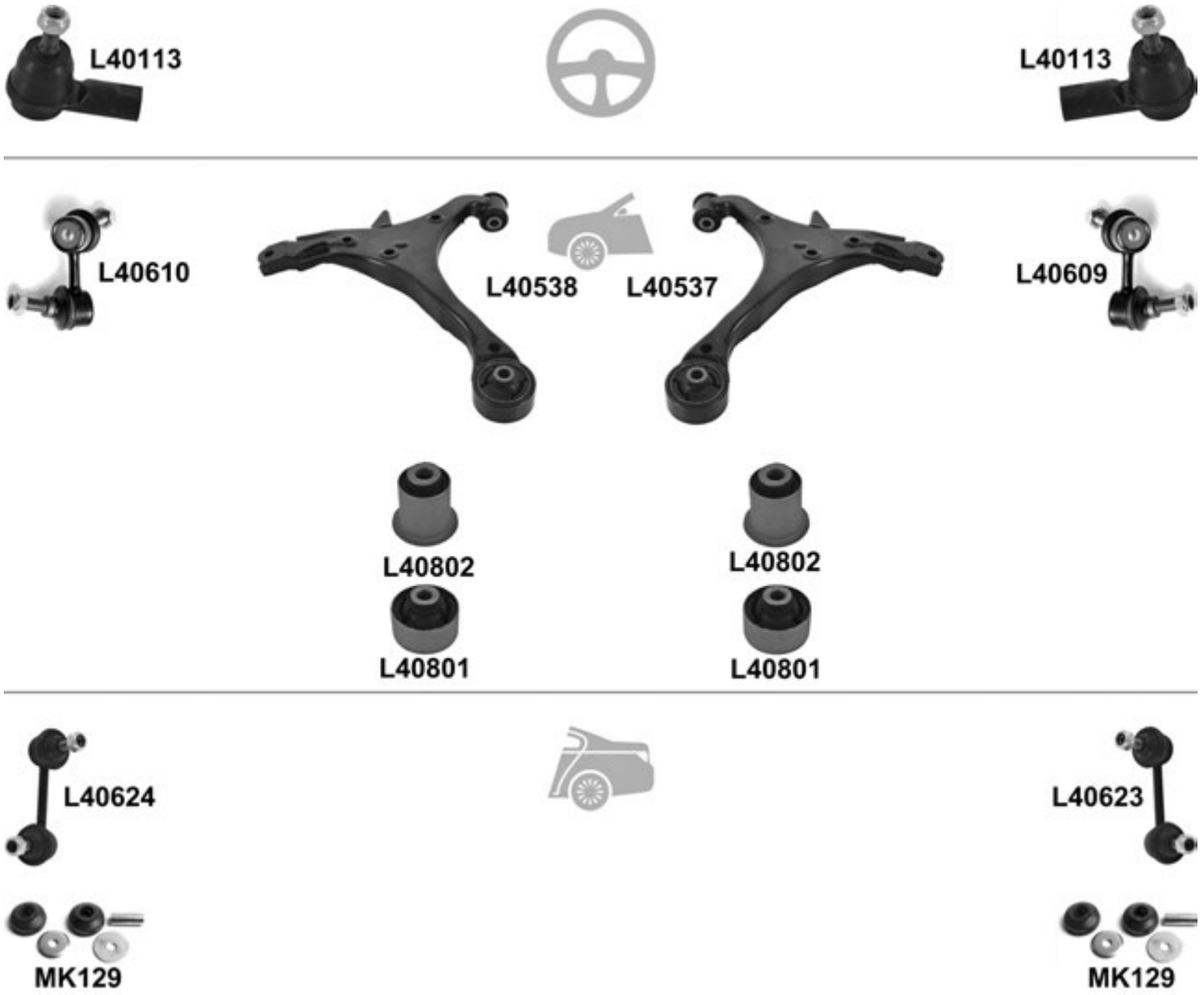
CR-V II (RD) 12.01 → 09.06

		i		←	→	Thread	Part Of	QPA	i
		↔		L40113	L40113	F 14x1,5 U		2	53541-S5A-003
		⊥	(-)		L40537			1	51350-S9A-010
					L40538			1	51360-SA9-010
		⊥	▼		L40802	L40802		2	51392-S5A-004
					L40801	L40801		2	51391-S5A-024
						L40609			1
					L40610			1	51321-S5A-003
					L40623			1	52320-S9A-003
					L40624			1	52321-S9A-003
				MK129	MK129			2	

CR-V III (RE) 10.06 →

			←	→	Thread	Part Of	QPA	
		↔	L40137 ⁰	L40137 ⁰	F 14x1,5 ♂		2	53540-SWA-A02
		⊥	L40541	L40541			2	51220-STK-A01
		⊥	<input checked="" type="checkbox"/>	L40569 ⁰			1	51350-SWA-E01
		⊥		L40570 ⁰			1	51360-SWA-E01
		⊥ ▾		L40811 ⁰		L40569	1	
		⊥ ▲		L40812 ⁰		L40570	1	
				L40813 ⁰	L40813 ⁰	L40569/L40570	2	
			L40635	L40635			2	51320-STK-A01
		KIT	MK360	MK360		2	51920-SWA-A01	
				L40633			1	52320-SWA-A01
			L40634				1	52321-SWA-A01
			MK129	MK129			2	

CR-Z (ZF1) 06.10 →

			i	←	→	Thread	Part Of	QPA	i
		↔		L40137 ^o	L40137 ^o	F 14x1,5 U		2	53540-SWA-A02
			KIT	MK336	MK336			2	51920-SAA-015

FR-V (BE) 02.05 →



			i	←	→	Thread	Part Of	QPA	i
		↓		L40801	L40801			2	51391-S7A-005
					L40609			1	51320-S5A-003
				L40610				1	51321-S5A-003

Insight (ZE2) 04.09 →

			i	←	→	Thread	Part Of	QPA	i
		↔		L40135	L40135	F 14x1,5 U		1	53540-TF0-003
				L40136		F 14x1,5 U		1	53560-TF0-003
		↓		L40561	L40561		L40559/L40560	2	
		↓	→ 12.11, (-) Xenon light	<input checked="" type="checkbox"/>	L40559			1	51350-TH9-000
				L40560				1	51360-TH9-000
			KIT	MK336	MK336			2	51920-SAA-015

Integra (DC) 10.97 → 08.01

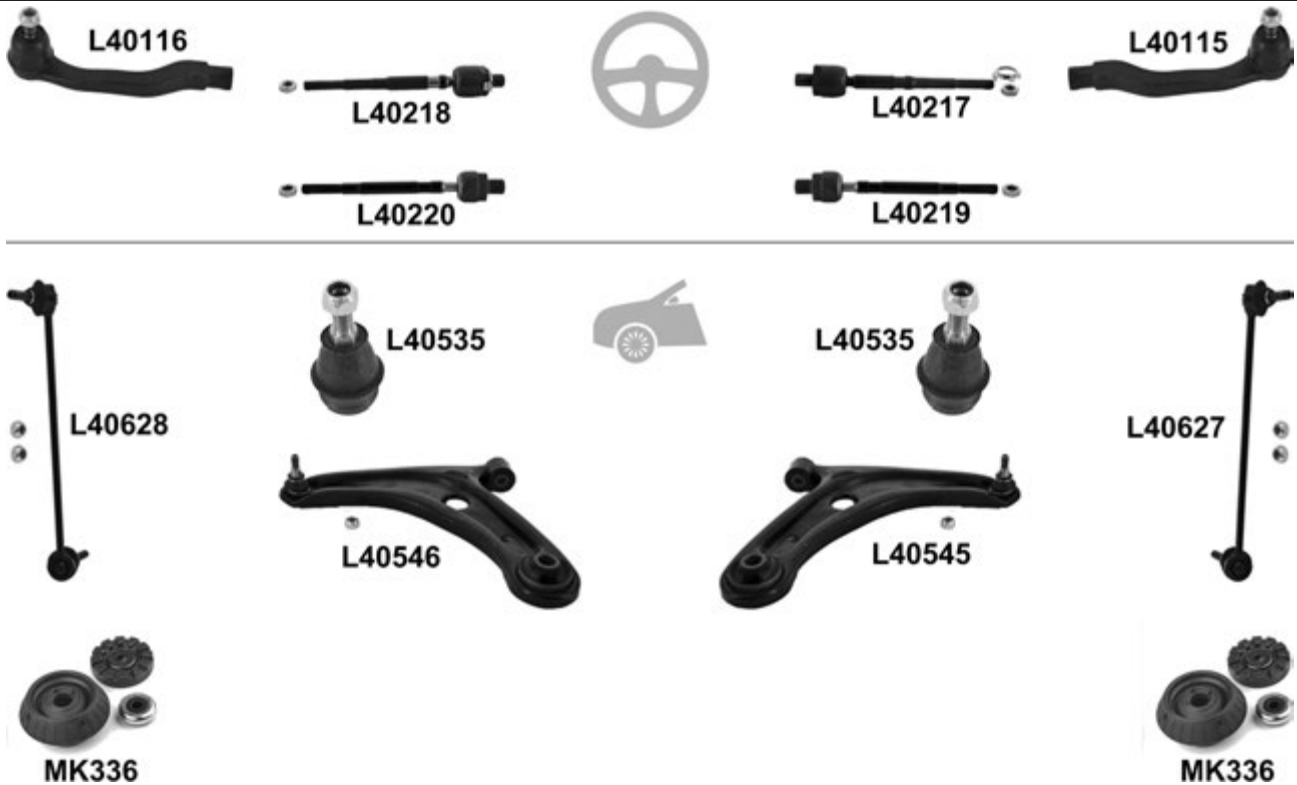
			i	←	→	Thread	Part Of	QPA	i
						L40109	F 14x1,5 ∪	1	53540-SR3-003
						L40110	F 14x1,5 ∪	1	53560-SR3-003
						L40600	L40600	2	51320-ST7-003

Jazz (GD) 03.02 → 07.08

			i	←	→	Thread	Part Of	QPA	i		
						L40115	F 12x1,25 ∪	1	53540-SAA-003		
						L40116	F 12x1,25 ∪	1	53560-SAA-003		
					→ 12.04			L40217	M 12x1,25 / M 16x1	1	53011-SAA-J01
					01.05 →			L40218	M 12x1,25 / M 16x1	1	53010-SAA-J01
								L40219	M 12x1,25 / M 18x1,5	1	53011-SEL-003
						L40535	L40535	2			
					<input checked="" type="checkbox"/>	L40545		1	51350-SAA-E11		
						L40546		1	51360-SAA-E11		
			1.3 8V, → 12.04, L= 301mm			L40627		1	51320-SAD-P01		
						L40628		1	51321-SAD-P01		
						KIT	MK336	MK336	2	51920-SAA-015	

Jazz (GE_/GG_/GP1) 07.08 →

L40136

L40135

MK336

L40561

L40561

MK336

L40560

L40559

						←	→	Thread	Part Of	QPA			
			GE6 / GG1 / GP1					L40135	F 14x1,5 ∪		1	53540-TF0-003	
								L40136	F 14x1,5 ∪		1	53560-TF0-003	
			GE6/GG1/GG2/GG3/GG5/GP1	<input type="checkbox"/>				L40561	L40561		L40559/L40560	2	
				<input checked="" type="checkbox"/>				L40559				1	51350-TH9-000
								L40560				1	51360-TH9-000
					KIT			MK336	MK336		2	51920-SAA-015	

Legend I (HS, KA) 01.86 → 12.90

L17112

L17111

L17502

L17502

MK226

MK226

						←	→	Thread	Part Of	QPA		
								L17111	F 12x1,25 ∪		1	53540-SD4-003
								L17112	F 12x1,25 ∪		1	53560-SD4-003
								L17502	L17502		2	GSJ295
								KIT		MK226		1

Prelude SN 11.78 → 10.82
 Prelude AB 11.83 → 04.87
 Prelude BA1 06.85 → 04.87

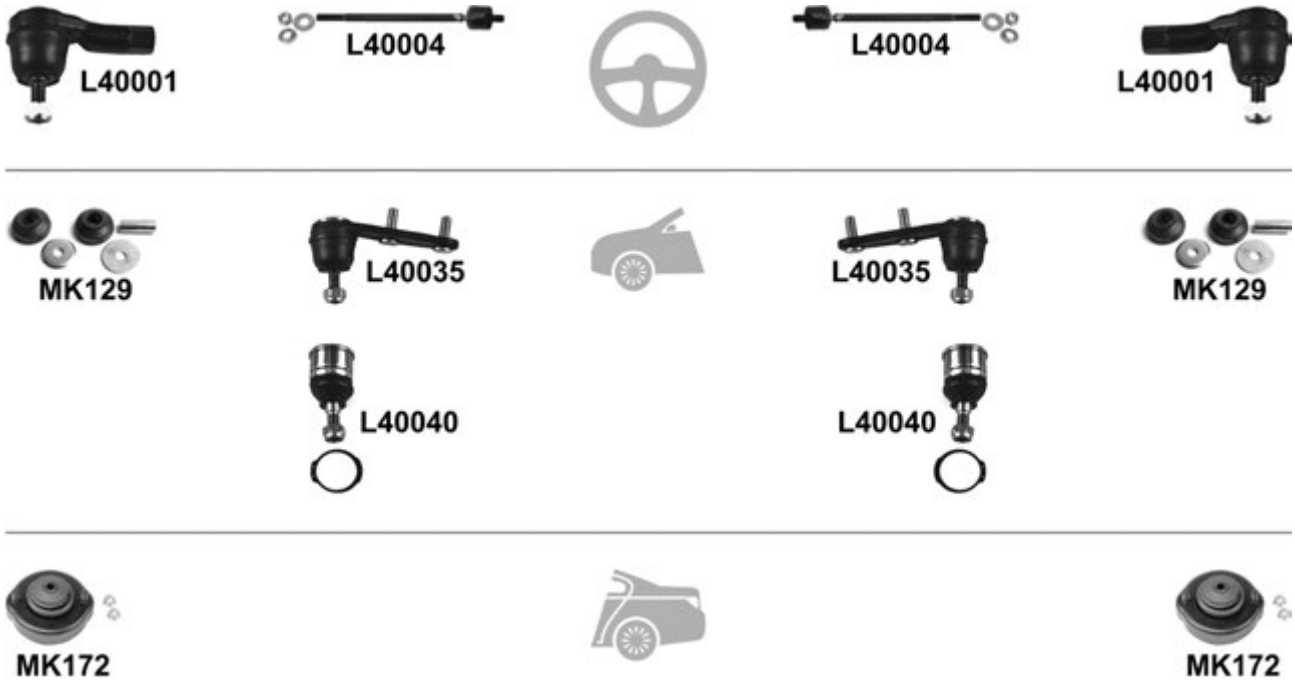

		i		←	→	Thread	Part Of	QPA	i
		↔		L40001	L40001	F 12x1,25 ♂		2	53540-SC2-004
			SN	L40004	L40004	M 12x1,25 / M 12x1,25 ♂		2	53521-SA0-003
		↑	AB, BA1	L40035	L40035			2	51270-SB0-013
		↓	AB, BA1	L40040	L40040			2	51220-SB0-003
				MK129	MK129			2	
				MK172	MK172			2	

Prelude BA4 04.86 → 01.92
Prelude BA5 4WS 04.86 → 01.92

			i	←	→	Thread	Part Of	QPA	i
		↔		L40104	L40104	F 12x1,25 ∪		2	53540-SF1-004
		↑		L40503	L40503			2	51270-SF1-003
		↓		L40040	L40040			2	51220-SB0-003
				L40160	L40160			2	90112-SE0-000
				MK129	MK129			2	
				MK172	MK172			2	

Prelude V (BB) 10.96 → 10.00

			i	←	→	Thread	Part Of	QPA	i
				MK129	MK129			2	

Quintet SU 02.80 → 12.84

			i	←	→	Thread	Part Of	QPA	i
		↔		L40001	L40001	F 12x1,25 ∪		2	53540-SC2-004
				L40004	L40004	M 12x1,25 / M 12x1,25 ∪		2	53521-SAO-003

Shuttle (RA) 06.94 → 06.02

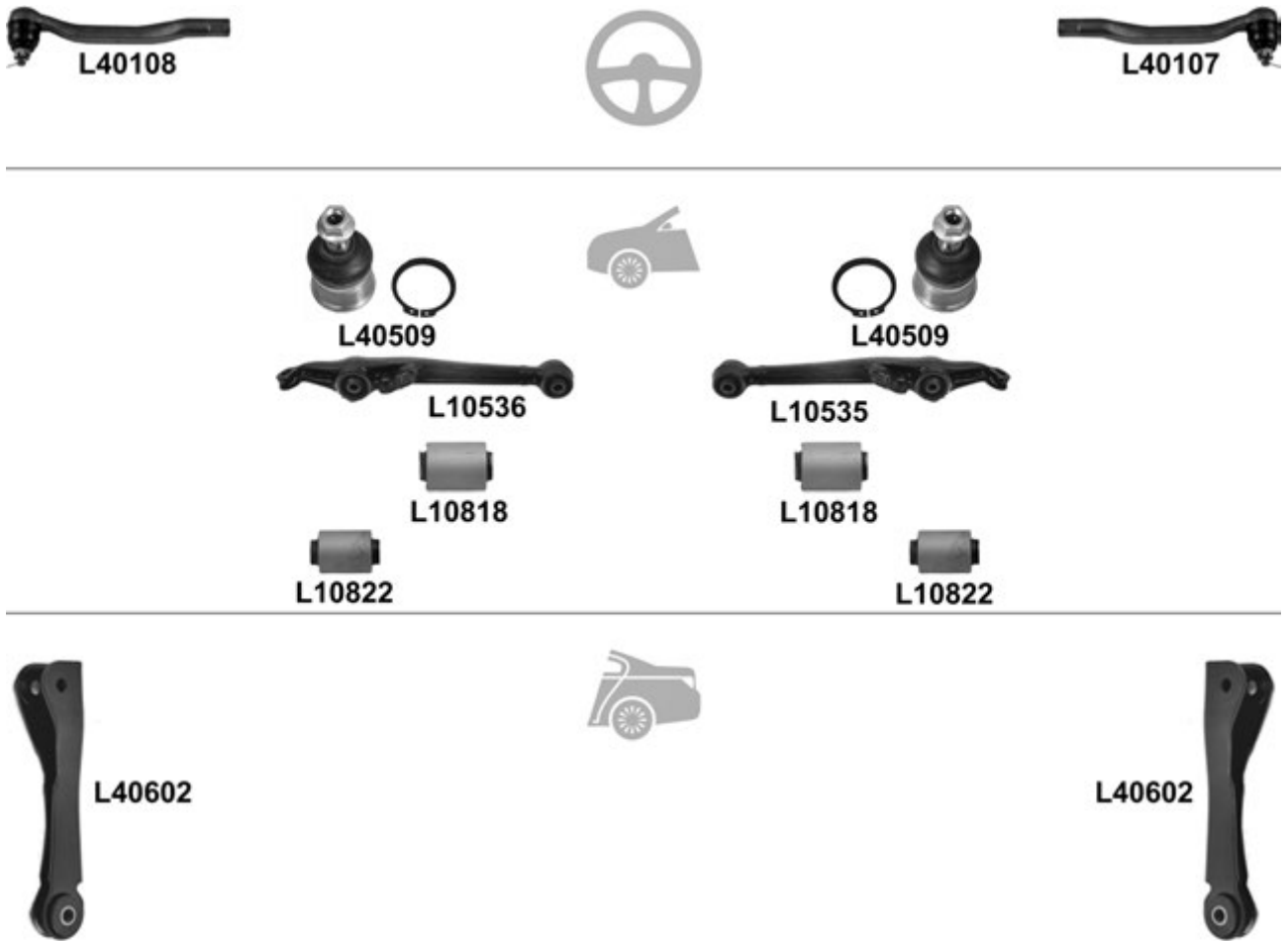

				← → Thread		Part Of	QPA		
		↔	12.99 →	L40107	↺		1	53540-SM4-004	
				L40108	↻		1	53560-SM4-004	
		⊥		L40509	L40509		2	51220-SM4-013	
				L10536			1	51355-SX0-000	
		↕↔		L10818	L10818		2	51393-SN7-003	
				L10822	L10822		2	51393-SV1-A01	
				L40602	L40602		2	52306-SE0-030	

Stream (RN) 05.01 →



				← → Thread		Part Of	QPA		
				L40609			1	51320-S5A-003	
				L40610			1	51321-S5A-003	

HYUNDAI

Accent Excel (X3) 10.94 → 01.00

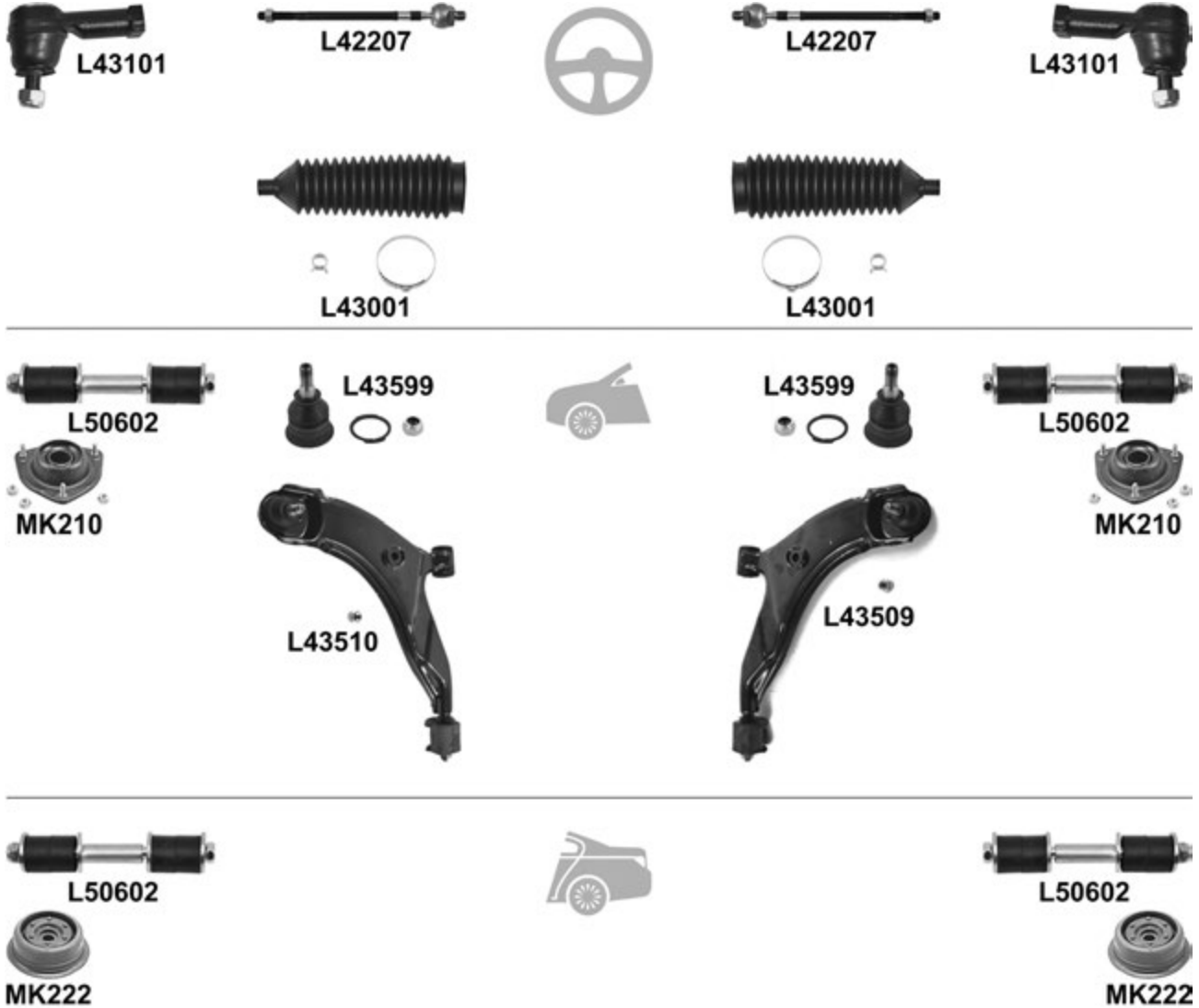

			←	→	Thread	Part Of	QPA	
		↔	L43101	L43101	F 14x1,5 ☺		2	56820-22000
			L42207	L42207	M 14x1,5 / M 16x1,5 ☺		2	57755-22000
		∅ 15mm, ∅ 48mm, L= 208mm	L43001 ⁰	L43001 ⁰			2	56528-24000
		⊥	L43599 ⁰	L43599 ⁰			2	54530-31600
		⊥	<input checked="" type="checkbox"/>	L43509			1	54501-22200
			L43510				1	54500-22200
			L50602	L50602			2	54825-22000
			KIT	MK210	MK210		2	54610-22000
			L50602	L50602			2	54825-22000
			MK222	MK222			2	

Accent / Excel (LC) 01.00 →

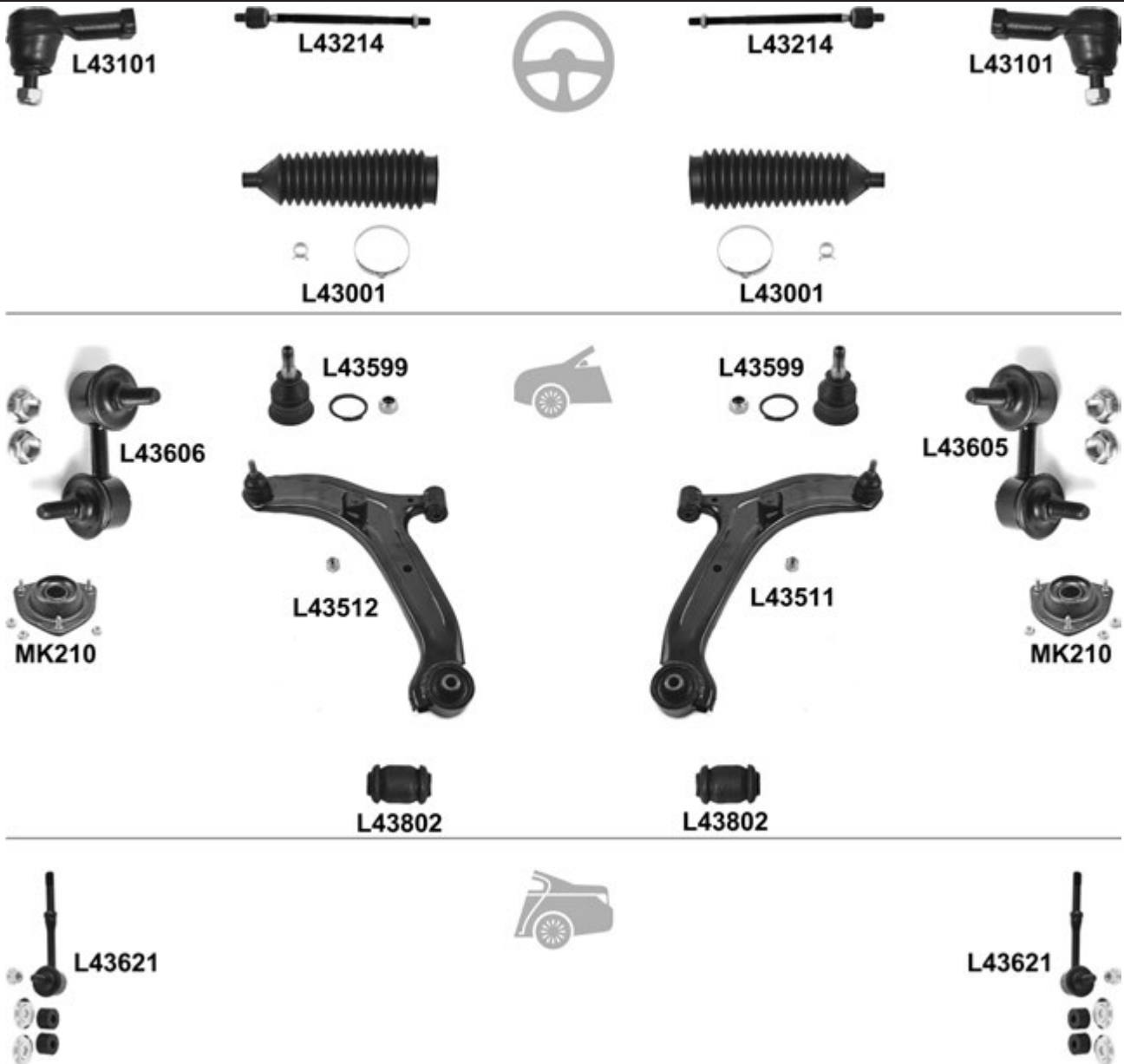

				← → Thread		Part Of	QPA		
⊕		↔		L43101	L43101		2	56820-25000	
				L43214	L43214	M 14x1,5 / M 16x1,5 U	2	57755-25000	
			∅ 15mm, ∅ 48mm, L= 208mm	L43001 ⁰	L43001 ⁰		2	56528-24000	
⊖		⊥		L43599 ⁰	L43599 ⁰		2	54503-25A00	
		⊥		<input checked="" type="checkbox"/>	L43511		1	54501-25000	
				L43512			1	54500-25000	
		⊥↘		L43802	L43802		2	54551-1E000	
					L43605		1	54830-25020	
				L43606			1	54830-25010	
				KIT	MK210	MK210		2	54610-25000
			L43621	L43621		2	55830-25000		

Accent / Verna (MC) 11.05 →

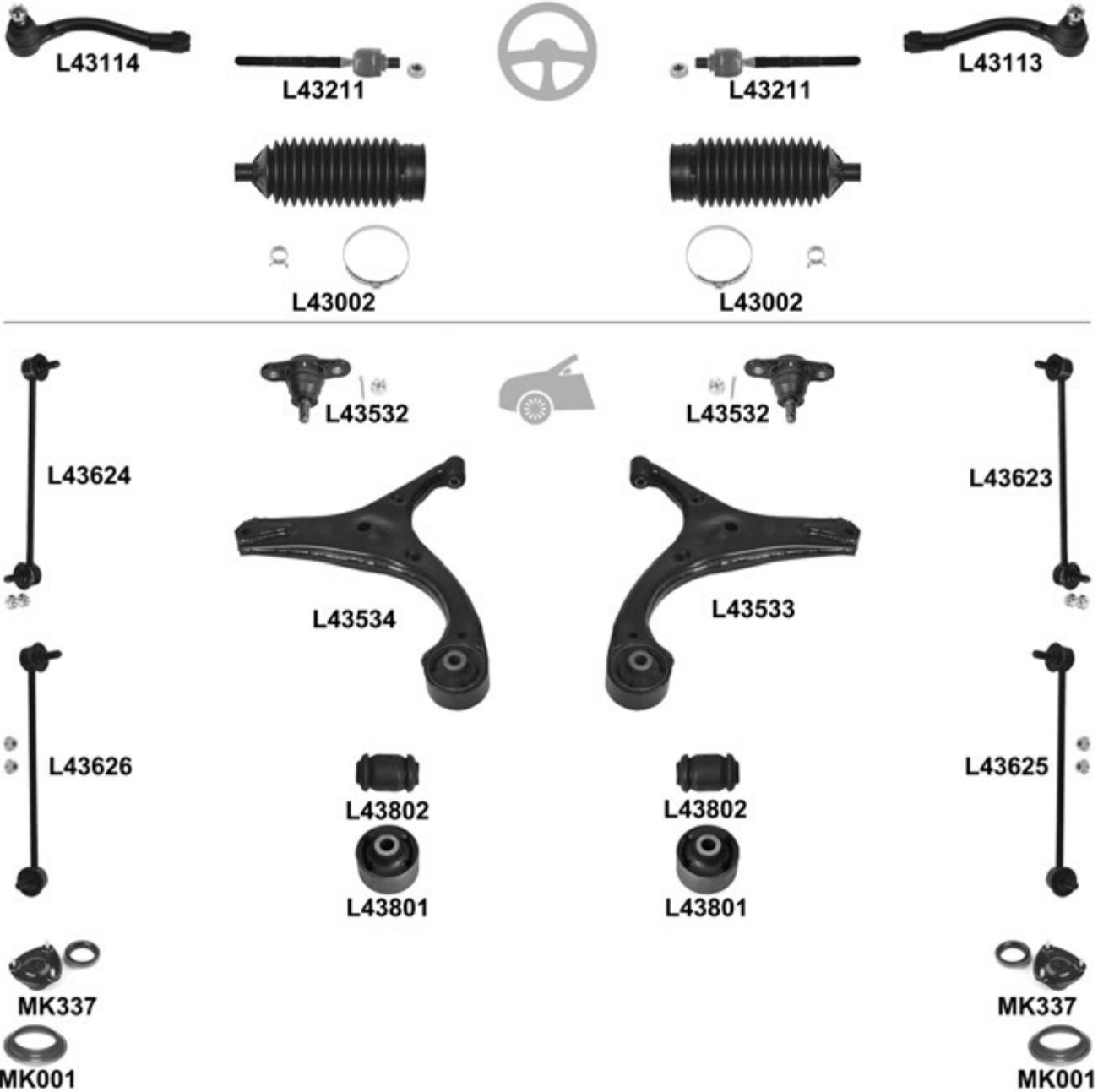

		i	←	→	Thread	Part Of	QPA	i
⊕		↔		L43113	F 14x1,5 ∪		1	56820-1E900
				L43114	F 14x1,5 ∪		1	56820-1E000
			L43211	L43211	M 14x1,5 / M 16x1,5 ∪		2	57724-1E000
				L43002 ^o	L43002 ^o		2	57728-17000
⊖		⊥		L43532	L43532		2	51760-1G000
				L43533			1	54501-1E000
		⊥		L43534			1	54500-1E000
				L43802	L43802		2	54551-1E000
		⊥		L43801	L43801		2	54584-1G000
				L43623			1	54840-1G000
		↔	→ 04.06, 90°, L= 285,9		L43624		1	54830-1G000
			05.06 →, 75°		L43625		1	54840-1E000
		↔		L43626			1	54830-1E000
				KIT	MK337	MK337		2
			MK001	MK001		2	54612-1G010	

Accent (RB) 11.10 →



				←	→	Thread	Part Of	QPA		
		↓				L43599 ⁰	L43599 ⁰		2	54530-0U000
			→ 05.12			L43647 ⁰	L43647 ⁰		2	54830-2S200

Atos (MX) 02.98 →

Atos Prime/Amica (MX) 08.99 →

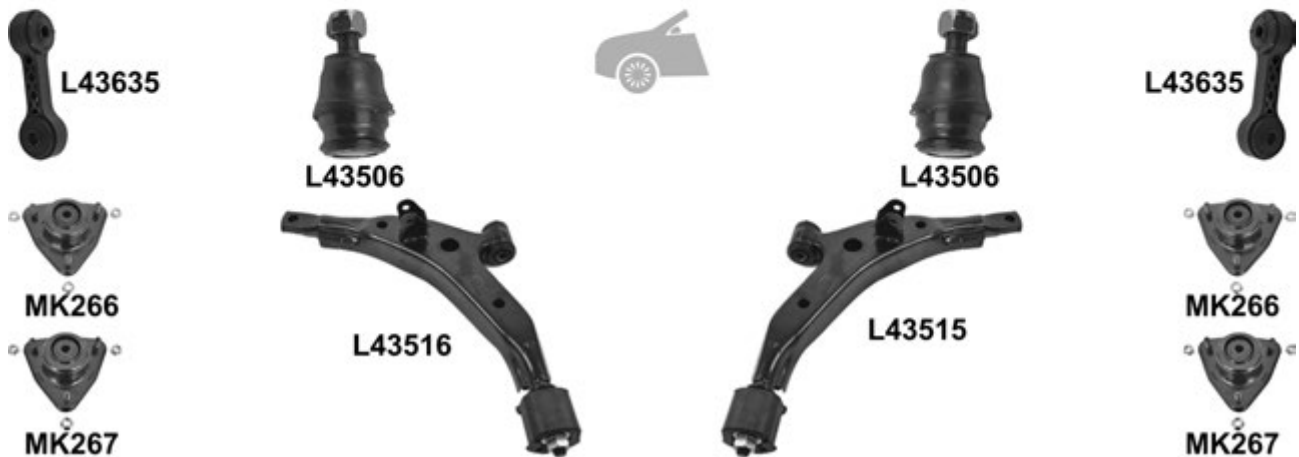

				←	→	Thread	Part Of	QPA			
		↔				L43104	L43104	F 12x1,25 ∪	2	56820-02500	
						L43203	L43203	M 12x1,25 / M 14x1,5 ∪	2	56540-02000	
						L43209	L43209	M 12x1,25 / M 14x1,5	2	57755-02000	
		↓				L43506	L43506		2	54530-02000	
			↓		☑		L43515			1	54501-02051
							L43516			1	54500-02051
						L43635	L43635		2	54820-02000	
				→ 10.98 O-hole	KIT		MK266	MK266		2	54610-02000
	11.98 →, D-hole				MK267	MK267		2	54610-02000		

Centennial 10.99 →



		← →		Thread	Part Of	QPA	
		↔		L43101	L43101		2 56820-3B000
		⊥		L43521	L43521		2 54530-3B000

Coupé / Tiburon (RD) 08.96 → 04.02

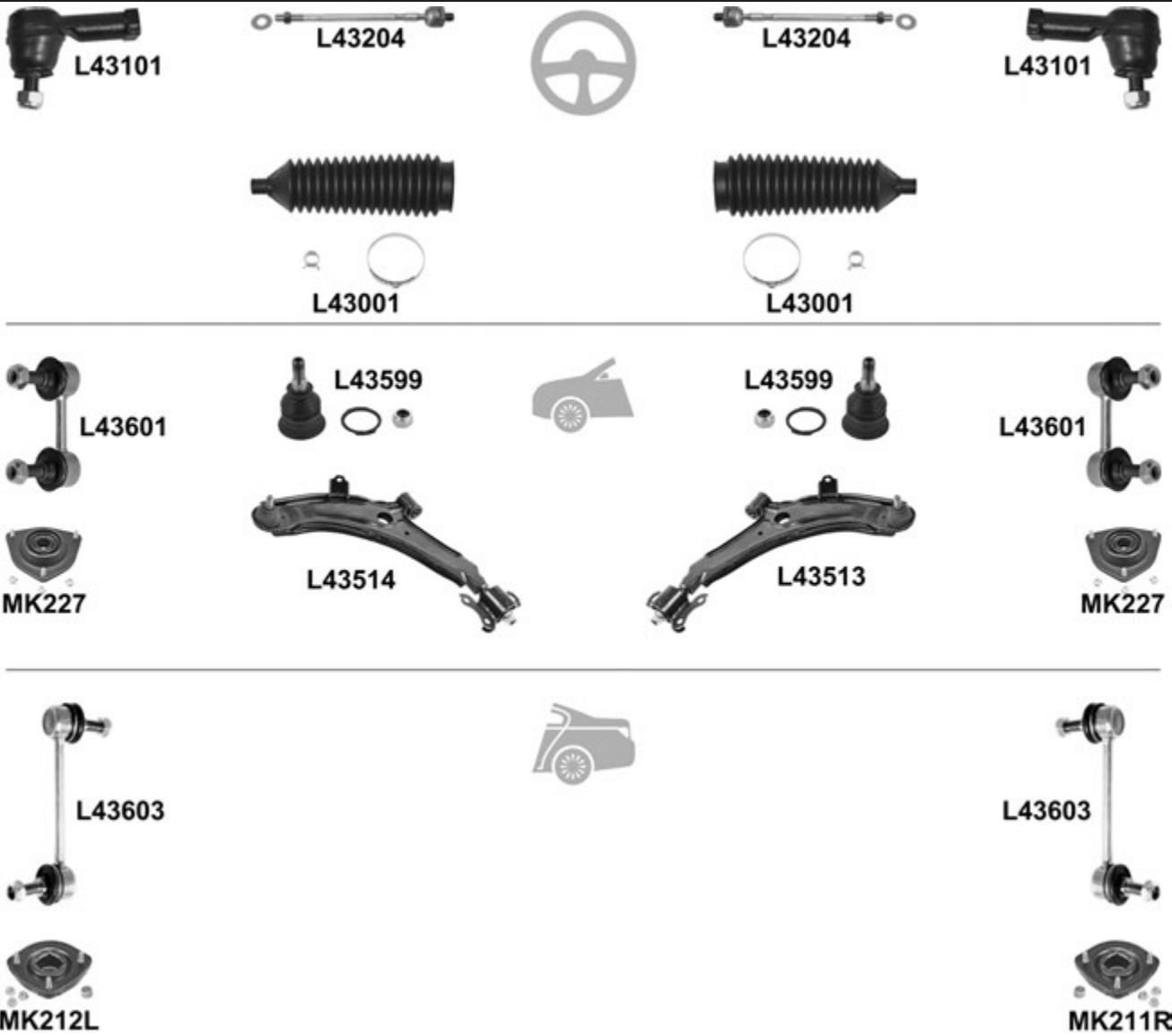

		i	←	→	Thread	Part Of	QPA	i
		↔	L43101	L43101	F 14x1,5 ∪		2	56820-22000
			L43204	L43204	∪		2	57730-29000
		∅ 15mm, ∅ 48mm, L= 208mm	L43001 ⁰	L43001 ⁰			2	56528-24000
		⊥	L43599 ⁰	L43599 ⁰			2	54530-31600
		⊥		L43513			1	54501-29000
			L43514				1	54500-29000
			L43601	L43601			2	54830-29000
			KIT	MK227	MK227		2	54610-2D000
			L43603	L43603			2	55530-29500
					MK211R		1	55320-2D000
			MK212L				1	55310-2D000

Coupé / Tiburon / Tuscani (GK) 08.01 →

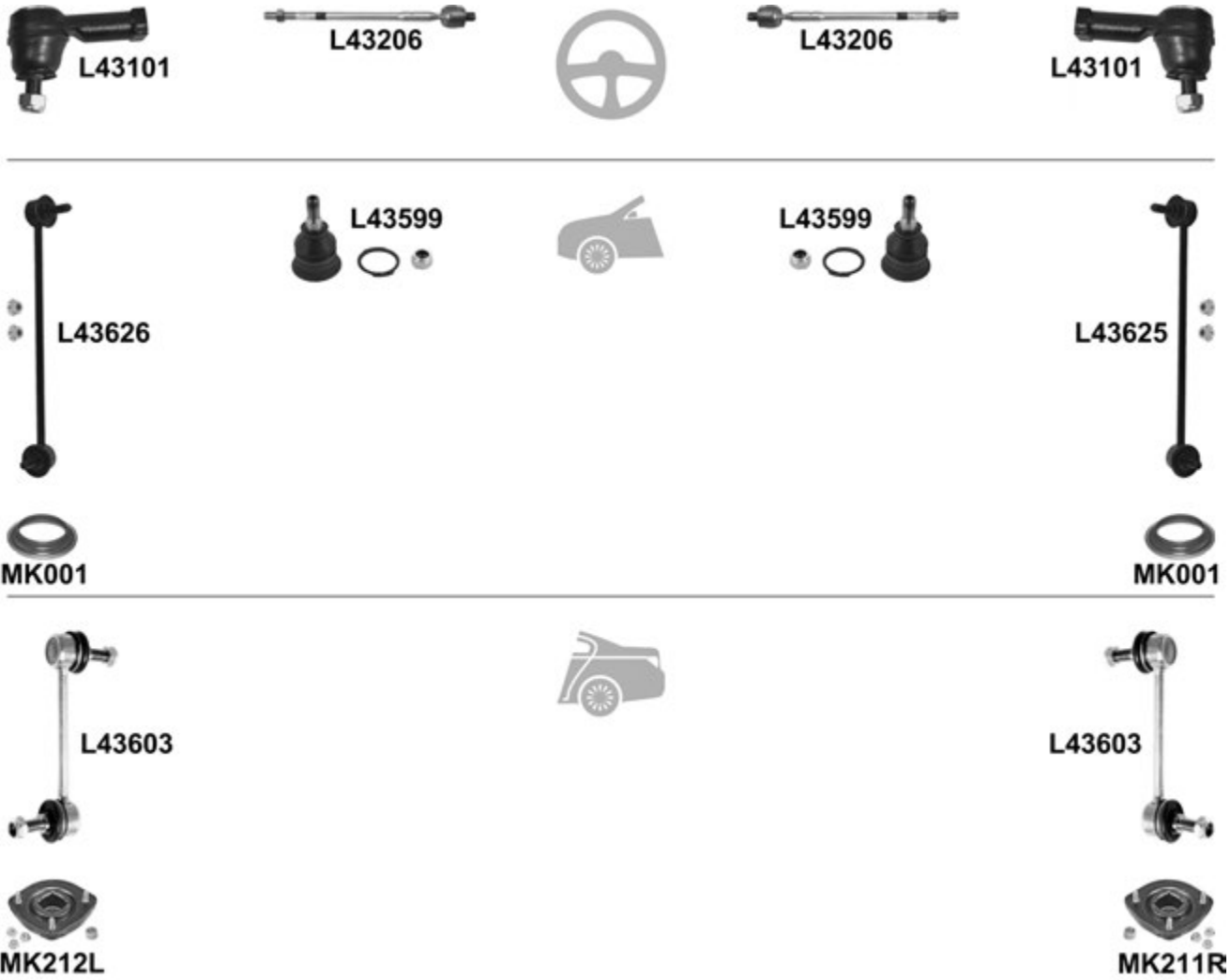

			←	→	Thread	Part Of	QPA	
		↔	L43101	L43101	F 14x1,5		2	56820-25000
			L43206	L43206	M 14x1,5 / M 16x1,5		2	57724-2D000
		↓	L43599 ^o	L43599 ^o			2	54503-38A00
				L43625			1	54840-1E000
			L43626				1	54830-1E000
			MK001	MK001			2	54612-1G010
			L43603	L43603			2	55530-29500
				MK211R			1	55320-2D000
			MK212L				1	55310-2D000

Elantra (XD) 06.00 →

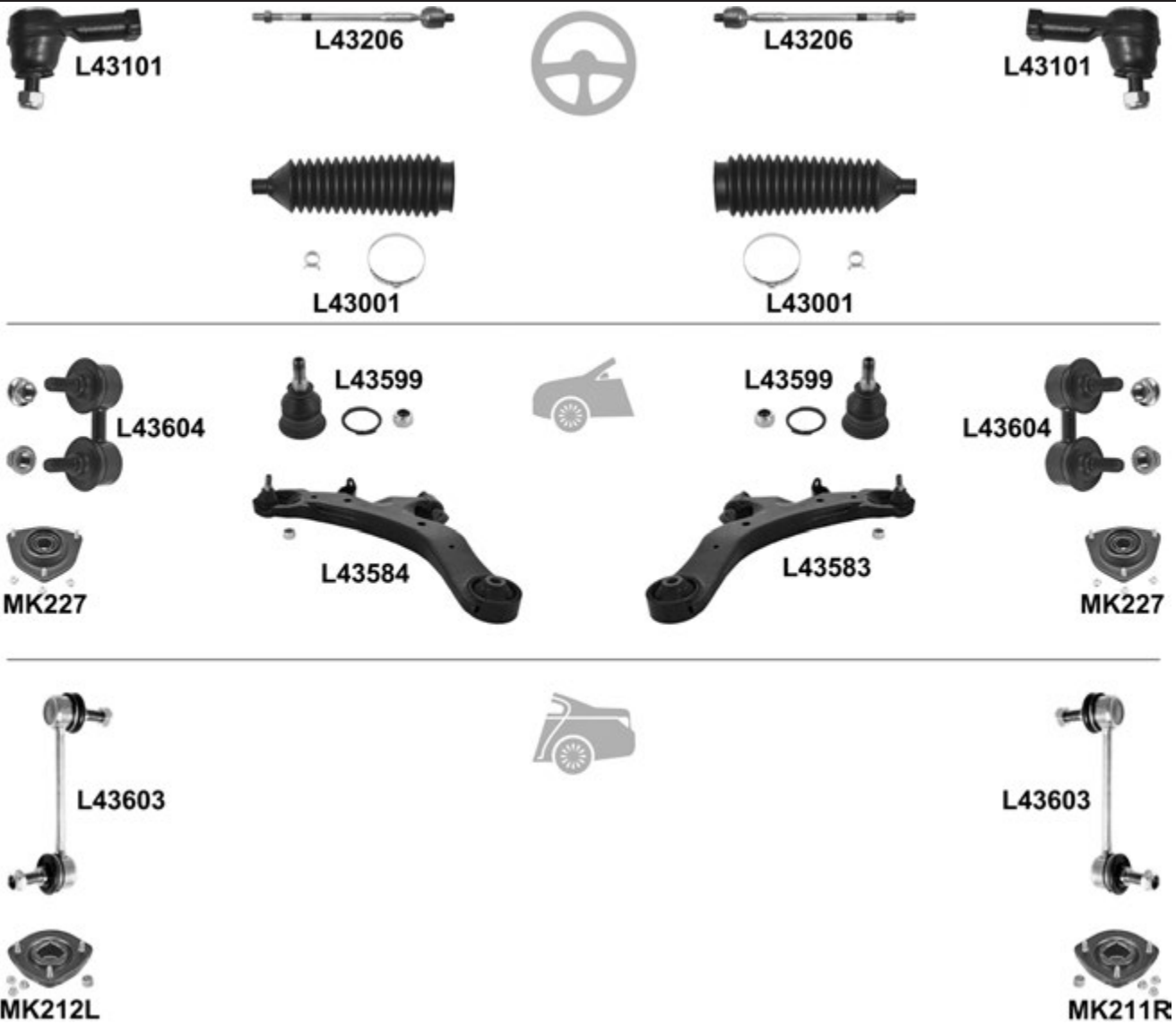

		← → Thread		Part Of	QPA		
		↔	L43101	L43101		2	56820-25000
			L43206	L43206	↻	2	57724-2D000
		∅ 15mm, ∅ 48mm, L= 208mm	L43001 ^o	L43001 ^o		2	56528-24000
		⊥	L43599 ^o	L43599 ^o		2	54503-38A00
		⊥	<input checked="" type="checkbox"/>	L43583		1	54501-2D002
			L43584			1	54500-2D002
			L43604	L43604		2	54830-34500
		KIT	MK227	MK227		2	54610-2D000
			L43603	L43603		2	55530-29500
				MK211R		1	55320-2D000
			MK212L			1	55310-2D000

Elantra 06.06 →

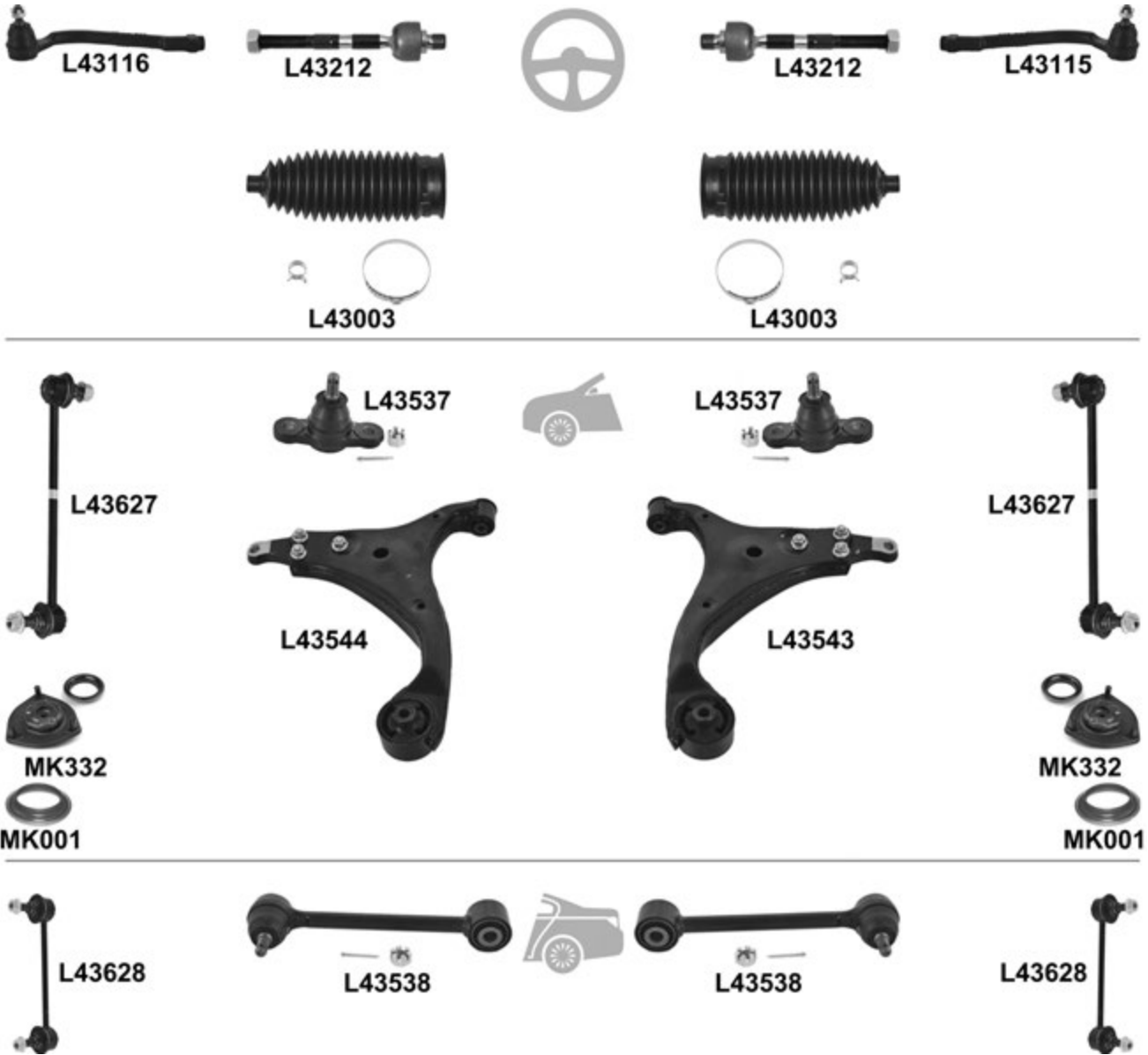

				← → Thread		Part Of	QPA			
⊕		↔		L43115	F 14x1,5 ♂		1	56820-2H090		
				L43116	F 14x1,5 ♂		1	56820-2H000		
			L43212	L43212	M 14x1,5 / M 16x1,5 ♂		2	56240-2H000		
			∅ 12mm, ∅ 49mm, L= 170mm	L43003 ⁰	L43003 ⁰			2	57740-1H000	
		⊥		L43537	L43537		2	51760-2H000		
				(-) L43537	<input checked="" type="checkbox"/>	L43543		1	54501-2H000	
		⊥		L43544			1	54500-2H000		
				L43627	L43627		2	54830-2H100		
			(+) MK001	KIT	MK332	MK332		2	54610-3H000	
					MK001	MK001		2	54612-1G010	
		↗		L43538	L43538		2	55250-2H000		
				L43628	L43628		2	55530-2H000		

Elantra (MD) 01.11 →



Thread

Part Of

QPA



		→ 02.12	L43647 ⁰	L43647 ⁰			2	54830-0U000
--	--	---------	---------------------	---------------------	--	--	---	-------------

Galloper II (JK-01) 08.98 →

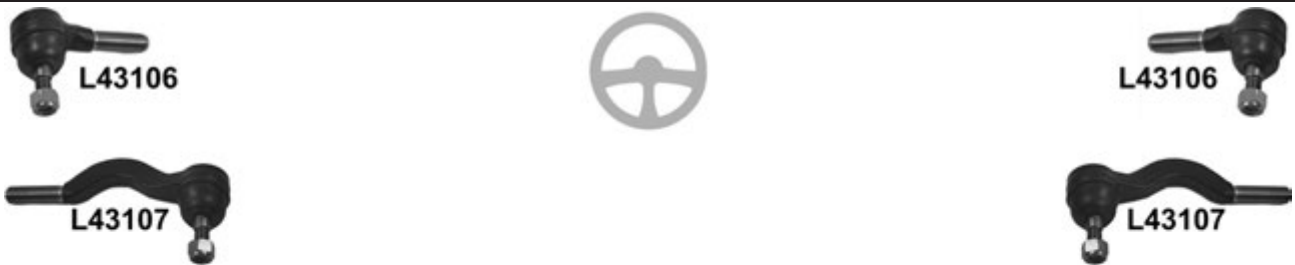

Thread

Part Of

QPA



		↔↔	L43106	L43106	M 16x1,5 ∩		2	MB166765
		→←	L43107	L43107	M 16x1,5 ∩		2	MB166766
		↑	L43507	L43507			2	54431-44000
		↓	L42503	L42503			2	MB527352
			L42600	L42600			2	MB892982

Getz / Click (TB) 09.02 →

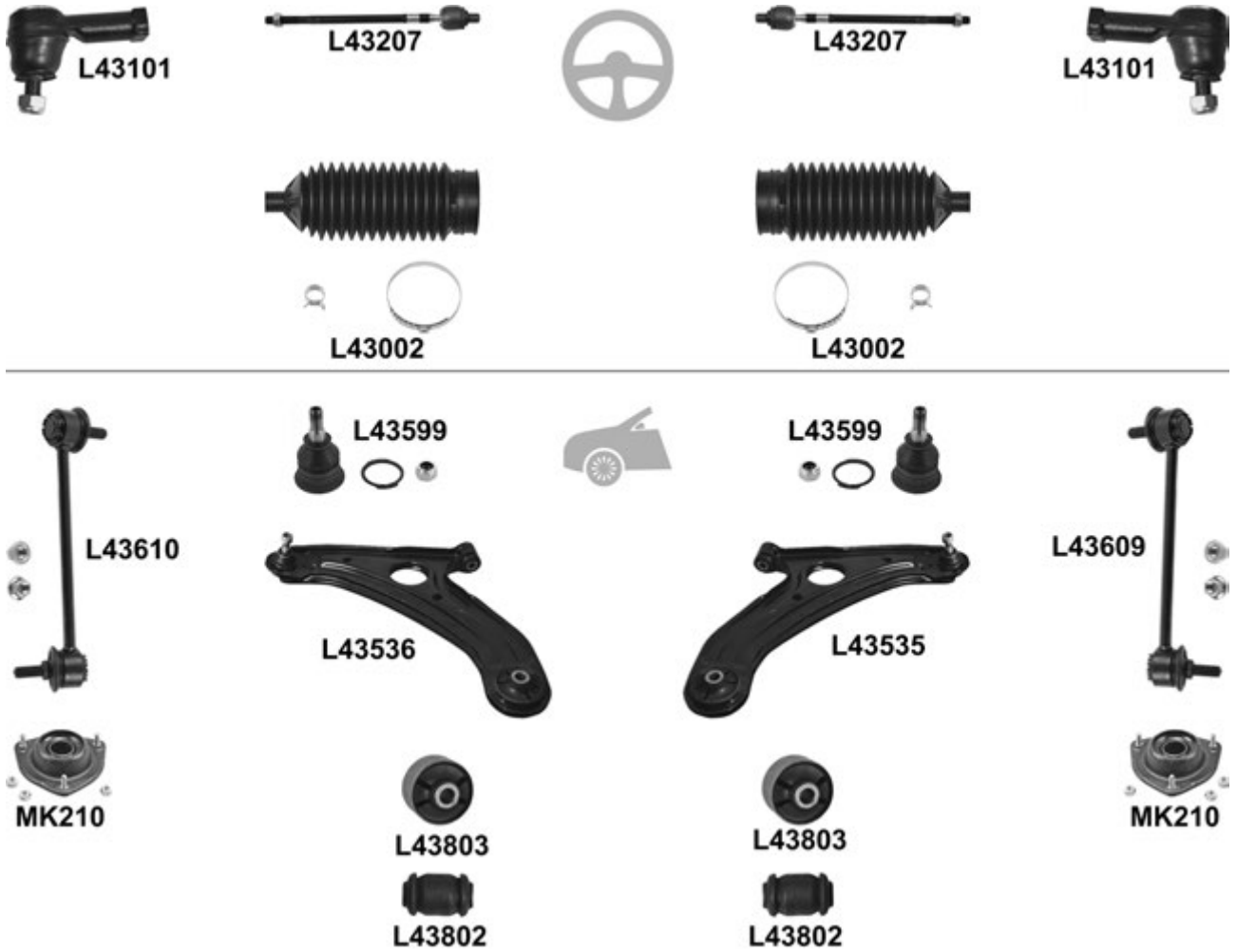

		i		←	→	Thread	Part Of	QPA	i	
		↔		L43101	L43101	F 14x1,5		2	56820-3B000	
				L43207	L43207	M 14x1,5 / M 16x1,5 U		2	57755-1C000	
			ø 14mm, Ø 47mm, L= 178mm	L43002 ⁰	L43002 ⁰			2	57728-17000	
		⊥		L43599 ⁰	L43599 ⁰			2	54503-25A00	
		⊥			L43535			1	54501-1C010	
				☑	L43536				1	54500-1C010
		⊥▼		L43803	L43803			2	54584-1C300	
		⊥▲		L43802	L43802			2	54551-25000	
					L43609			1	54840-1C000	
					L43610			1	54830-1C000	
			KIT	MK210	MK210			2	54610-25000	

Grandeur 06.99 → 05.05



			←	→	Thread	Part Of	QPA		
		↔		L43109	F 14x1,5 ♂		1	57780-38010	
				L43110	F 14x1,5 ♂		1	57780-38000	
		⊥		L43210	L43210	M 14x1,5 / M 16x1,5		2	57724-38010
				L43599 ⁰	L43599 ⁰			2	54503-38A00
					L43525			1	54501-38000
					L43526			1	54500-38000
					L43529			1	54501-38011
		⊥	→ 11.99		L43529		1	54501-38011	
					L43530		1	54500-38011	
					L43612	L43612		2	54830-38100
			→ 04.00	L43613	L43613		2	55530-38000	

Grandeur (TG) 04.05 →



Thread

Part Of

QPA



				L43612	L43612			2	54830-38100
--	--	--	--	--------	--------	--	--	---	-------------

H1 / Satellite / Starex 10.97 →

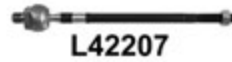

Thread

Part Of

QPA



		↔		L42102	L42102	F 14x1,5 ∪		2	57705-56820B
				L42207	L42207	M 14x1,5 / M 16x1,5 ∪		2	57729-4A000
		↑	(-) 4WD	L42500	L42500			2	54417-4AA00
		↓	(-) 4WD	L43504	L43504			2	54530-4AA00
				L43607	L43607			2	54830-4A000
				L43608	L43608			2	55530-4A001

H1 / i800 / Starex 02.08 →



Thread

Part Of

QPA

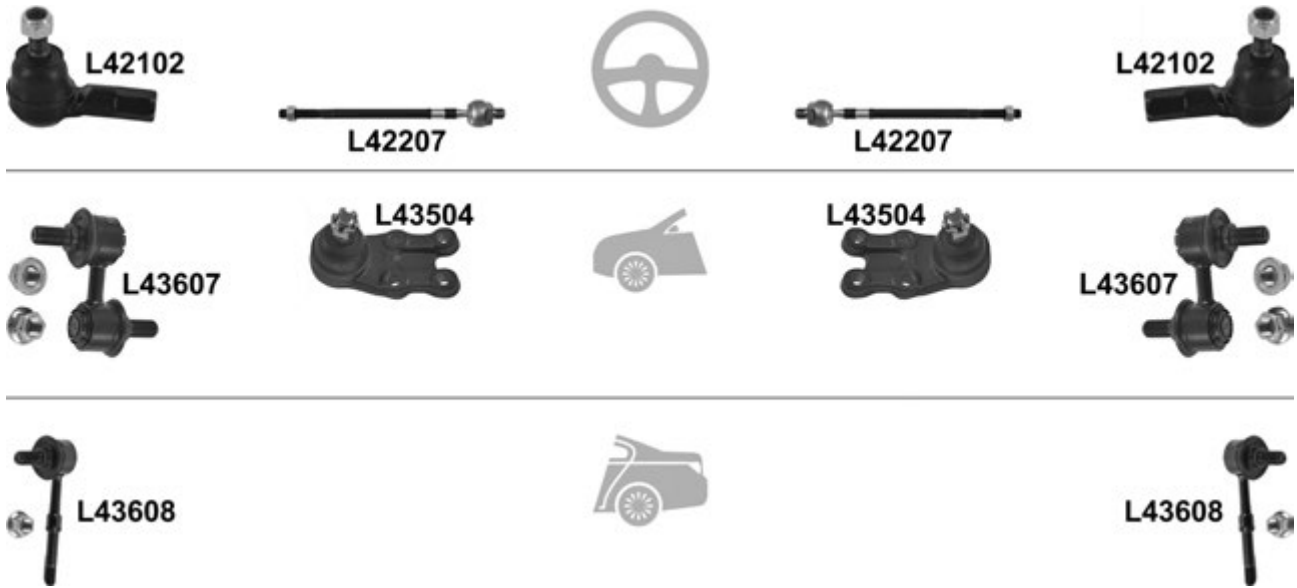

		↕		L43805	L43805			L43567/L43568	2
--	--	---	--	--------	--------	--	--	---------------	---

H200 10.97 →

				← → Thread		Part Of	QPA		
⊕		↔		L42102	L42102		2	57705-56820B	
				L42207	L42207	M 14x1,5 / M 16x1,5 U	2	57729-4A000	
⊖		⊥	(-) 4WD	L43504	L43504		2	54530-4AA00	
				L43607	L43607		2	54830-4A000	
				L43608	L43608		2	55530-4A001	

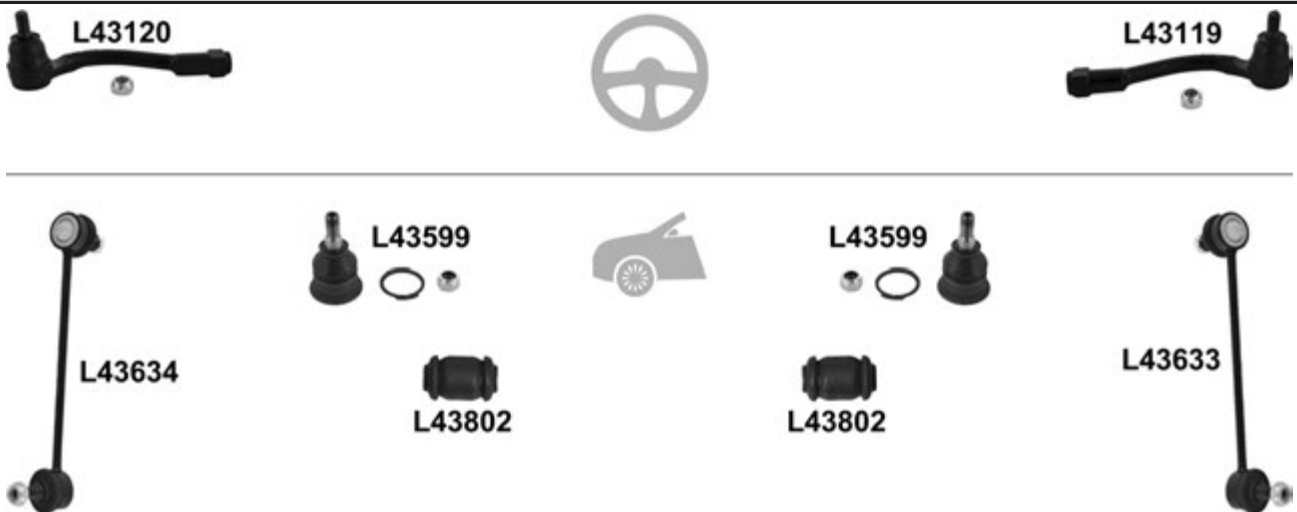
iX20 11.10 →

				← → Thread		Part Of	QPA		
⊕		↔		L43119	F 16x1,5 U		1	56820-2K050	
				L43120		F 16x1,5 U		1	56820-2K000
⊖		⊥		L43599°	L43599°		2	54530-25000	
				L43802	L43802			2	54551-1E000
		↕		L43633			1	54840-1J000	
				L43634				1	54830-1J000

iX35 (LM) 01.10 →

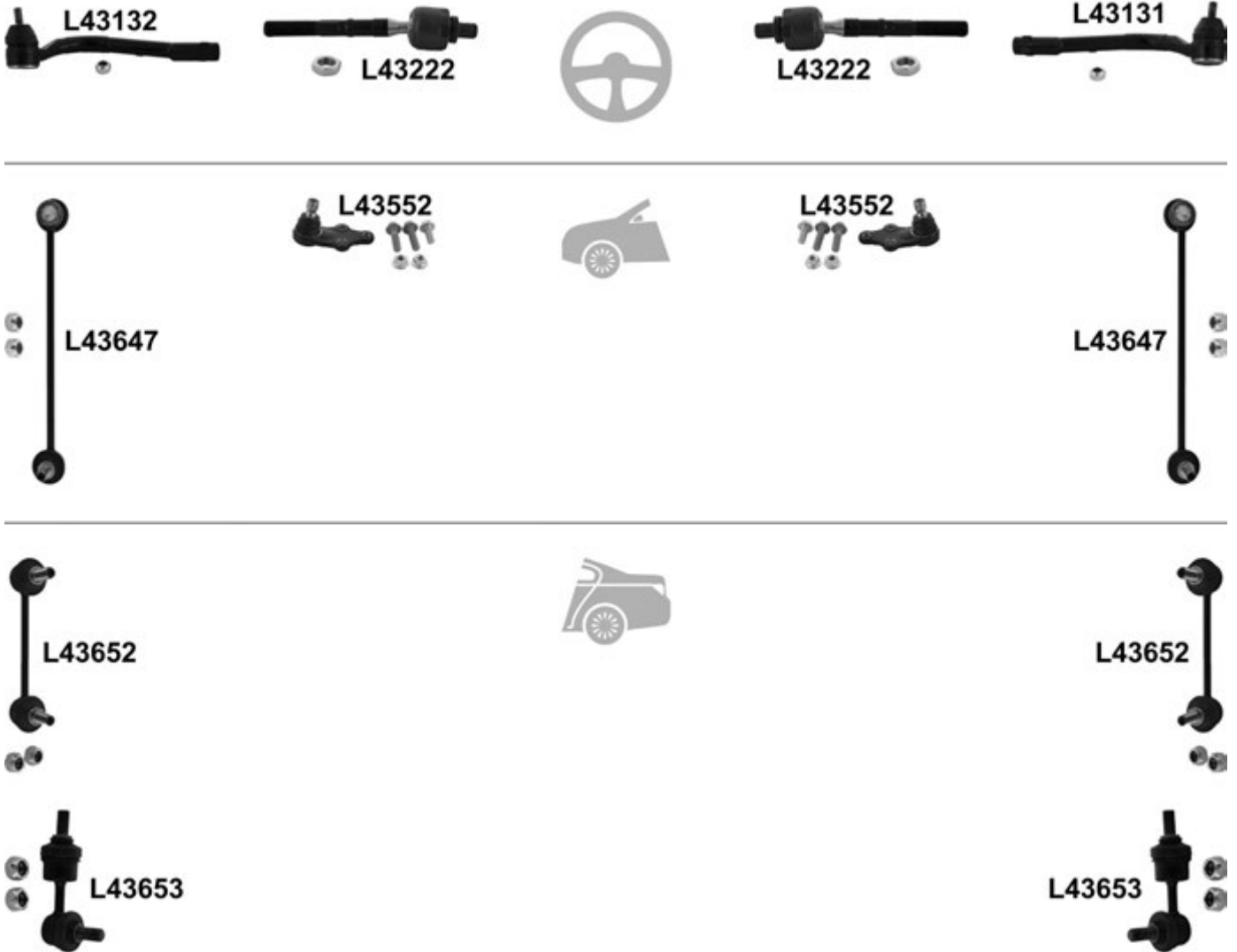

			←	→	Thread	Part Of	QPA		
				L43131	F 16x1,5 ♂		1	56820-2S050	
				L43132	F 16x1,5 ♂		1	56820-2S000	
				L43222	L43222	M 16x1,5 / M 16x1,5		2	57724-2S000
				L43552	L43552		2	54530-3S000	
				L43647	L43647 ^o		2	54830-2S200	
			(-) 1.6 Gdi, 1.7 CRDi , 2.0 CWT KW110/120	L43652	L43652		2	55530-2S200	
			(-) 2.0 CRDi , 2.0 CWT KW122						
			1.6 Gdi, 1.7 CRDi , 2.0 CWT KW110/120	L43653 ^o	L43653 ^o		2	55530-3R000	
			2.0 CRDi , 2.0 CWT KW122						

iX55 / Veracruz 09.08 →

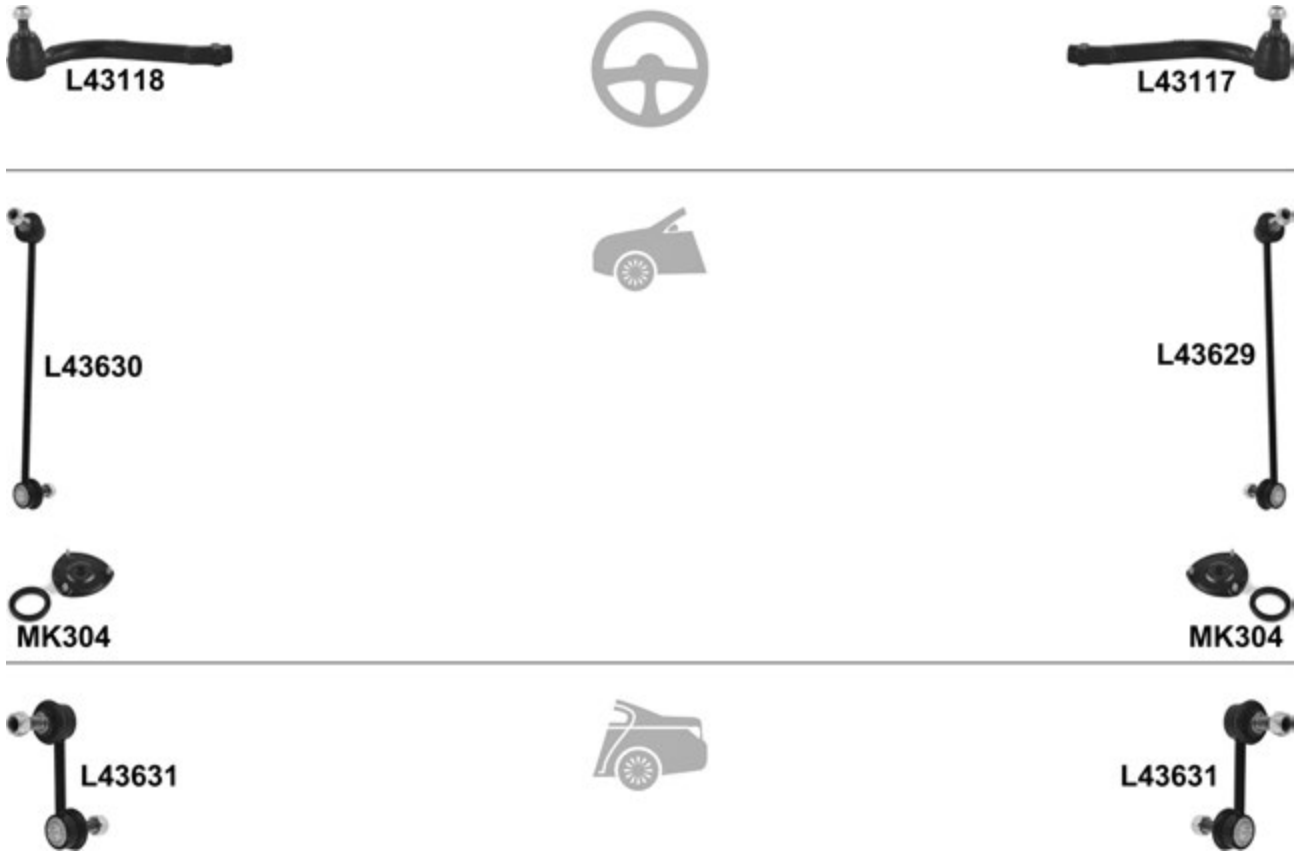

				←	→	Thread	Part Of	QPA	
		↔		L43117	F 16x1,5 ♂		1	53821-2B900	
				L43118	F 16x1,5 ♂		1	53821-2B000	
				L43629			1	54840-2B000	
			L43630			1	54830-2B000		
			KIT	MK304	MK304		2	54610-2B100	
				L43631	L43631		2	55530-2B000	

i10 10.07 →

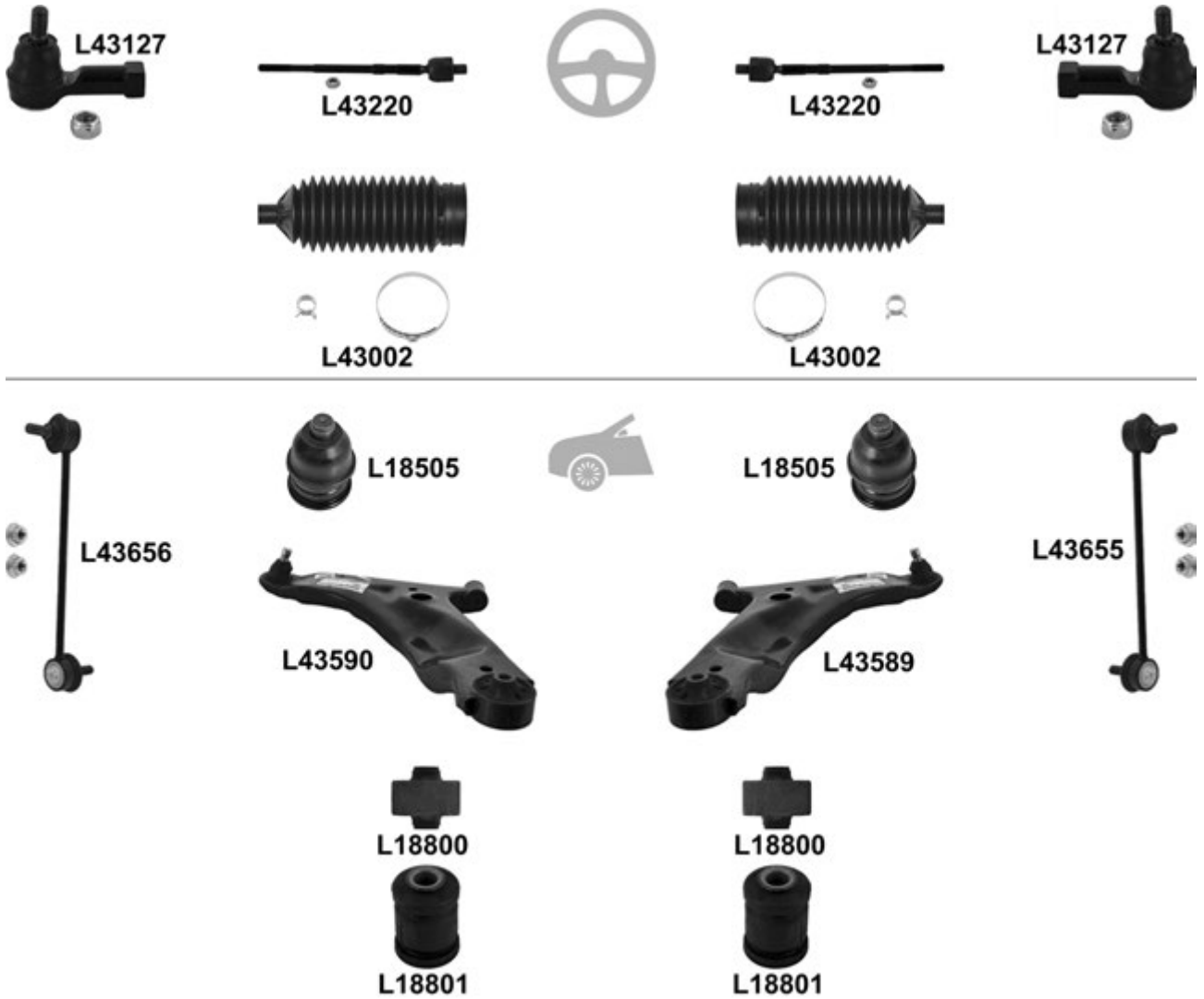

		i		←	→	Thread	Part Of	QPA	i
⊕		↔		L43127	L43127	F 12x1,25		2	56820-0X000
				L43220	L43220	M 12x1,25 / M 16x1,5		2	57724-0X000
			∅ 14mm, ∅ 47mm, L= 178mm	L43002 ⁰	L43002 ⁰			2	57728-17000
⊖		⊥		L18505	L18505			2	54530-07000
		⊥		<input checked="" type="checkbox"/>	L43589			1	54501-0X000
				L43590				1	54500-0X000
		⊥▼		L18800 ⁰	L18800 ⁰			2	54584-0X000
		⊥▲		L18801 ⁰	L18801 ⁰			2	54551-07000
					L43655 ⁰			1	54840-0X000
				L43656 ⁰			1	54830-0X000	

i20 08.08 →

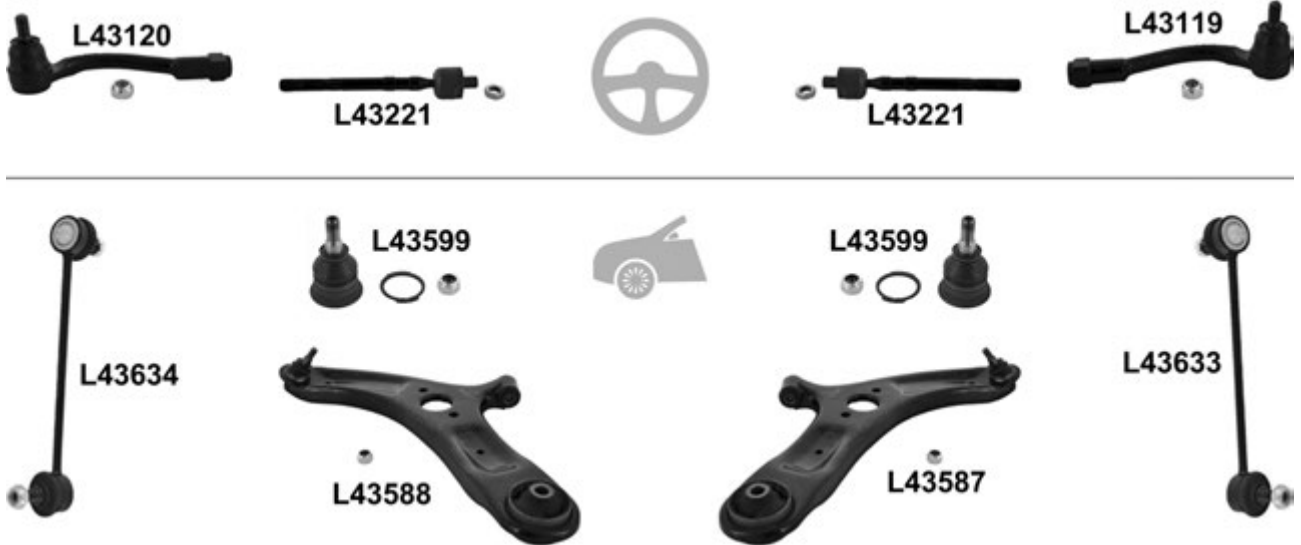

				←	→	Thread	Part Of	QPA				
		↔				L43119	F 16x1,5 ∪	1	56820-2K050			
							L43120	F 16x1,5 ∪	1	56820-2K000		
		⊥				L43221	L43221	M 16x1,5 / M 16x1,5 ∪	2	57724-1J000		
							L43599 ⁰	L43599 ⁰		2	54530-25000	
					<input checked="" type="checkbox"/>			L43587		1	54501-1J500	
								L43588		1	54500-1J500	
								L43633		1	54840-1J000	
						L43634		1	54830-1J000			

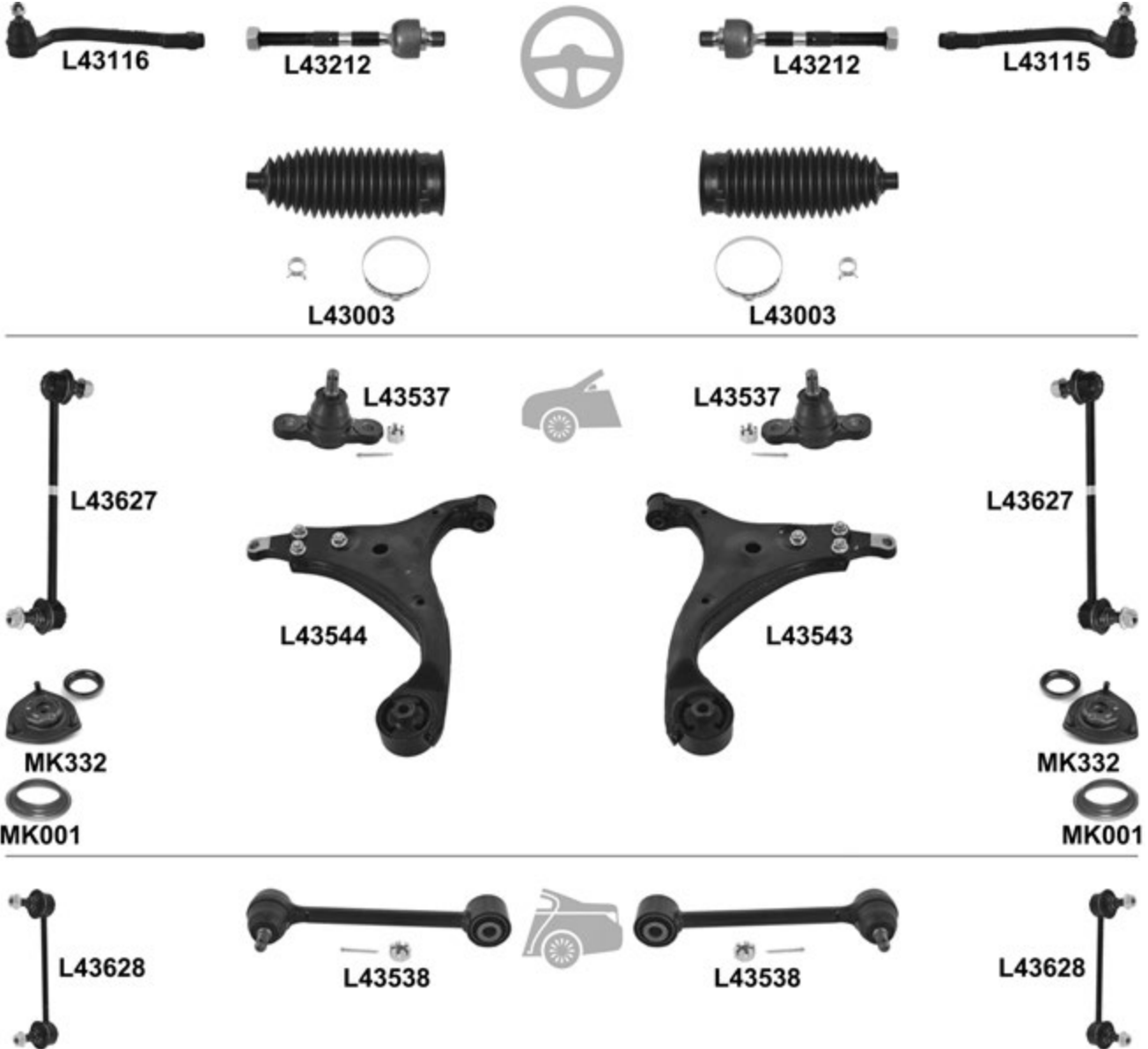
i30 10.07 →
 i30 CW Kombi 02.08 →

				← → Thread		Part Of	QPA			
⊕		↔		L43115	F 14x1,5 ∪		1	56820-2H090		
				L43116	F 14x1,5 ∪		1	56820-2H000		
				L43212	L43212	M 14x1,5 / M 16x1,5 ∪	2	56240-2H000		
			∅ 12mm, ∅ 49mm, L= 170mm	L43003 ⁰	L43003 ⁰		2	57740-1H000		
⊖		⊥		L43537	L43537		2	51760-2H000		
		⊥	→ 08.10, (-) L 43537		L43543		1	54501-2H000	<input checked="" type="checkbox"/>	
				L43544			1	54500-2H000		
				L43627	L43627		2	54830-2H100		
			(+) MK001	KIT	MK332	MK332		2	54610-3H000	
				MK001	MK001		2	54612-1G010		
⊖		↗		L43538	L43538		2	55250-2H000		
				L43628	L43628		2	55530-2H000		

i30 GD 11.11 →

i30 CW Kombi GD 06.12 →



				← → Thread		Part Of	QPA		
		↓		L43592 ⁰	L43592 ⁰		2	54530-3S100	
		↓	☑	L43A03 ⁰			1	54501-A6200	
				L43A04 ⁰			1	54500-A6200	
			→ 11.12	L43647 ⁰	L43647 ⁰		2	54830-2S200	
				L43653 ⁰	L43653 ⁰		2	55530-3R000	

i40 07.11 →



				← → Thread		Part Of	QPA		
		↔		L43131	F 16x1,5 ∪		1	56820-2T190	
				L43132		F 16x1,5 ∪		1	56820-2T100

Lantra I (J-1) 10.90 → 11.95

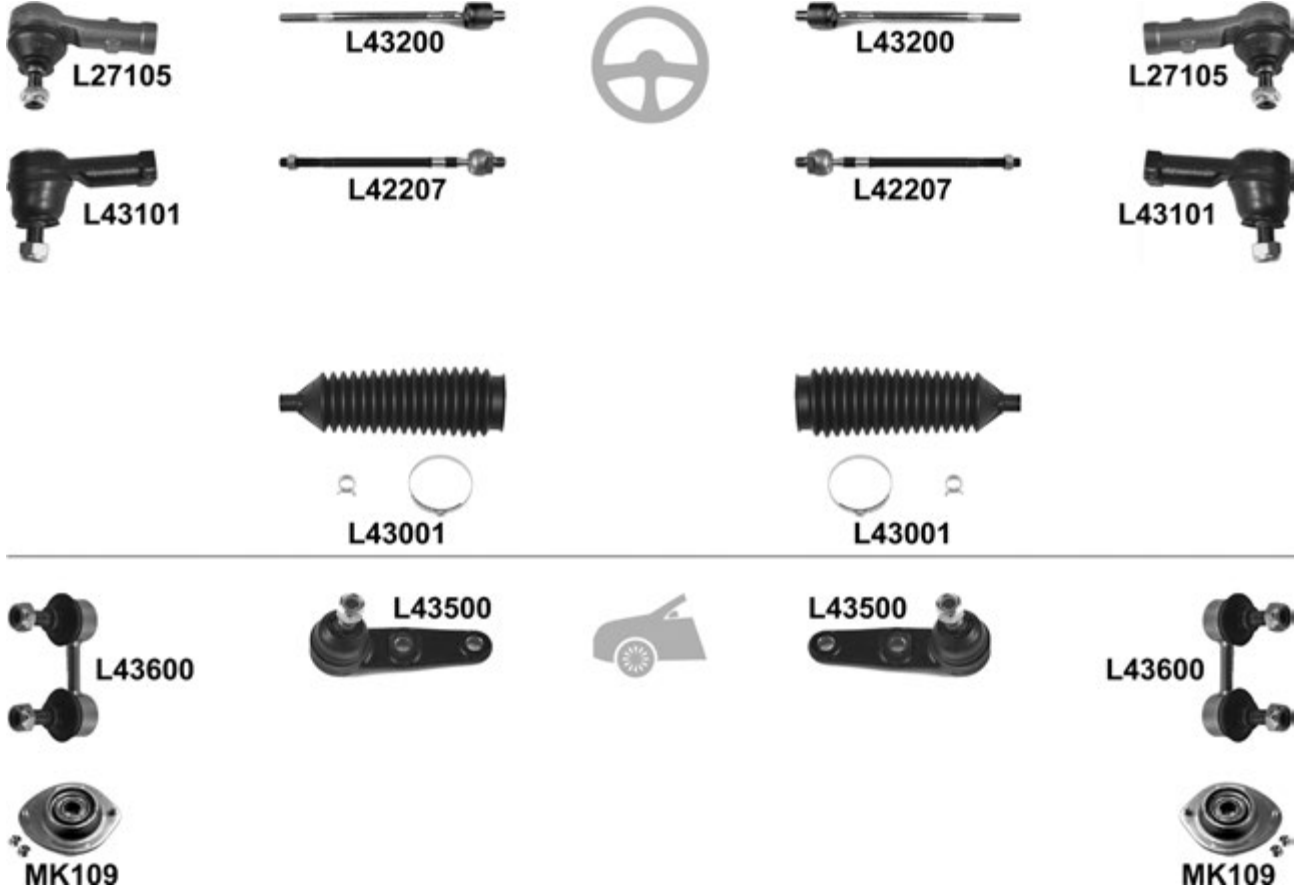

						←	→	Thread	Part Of	QPA	
⊕		↔		L27105	L27105			F 12x1,25 ∪		2	56820-28000
				L43101	L43101			F 14x1,5 ∪		2	56820-28500
				L43200	L43200			M 12x1,25 / M 16x1,5 ∪		2	57730-28000
				L42207	L42207			M 14x1,5 / M 16x1,5 ∪		2	57730-28500
			∅ 15mm, ∅ 48mm, L= 208mm	L43001 °	L43001 °					2	56528-24000
⊖		⊥		L43500	L43500					2	54530-28A00
				L43600	L43600					2	54830-37020
				KIT	MK109	MK109				2	

Lantra II (J-2) 11.95 →

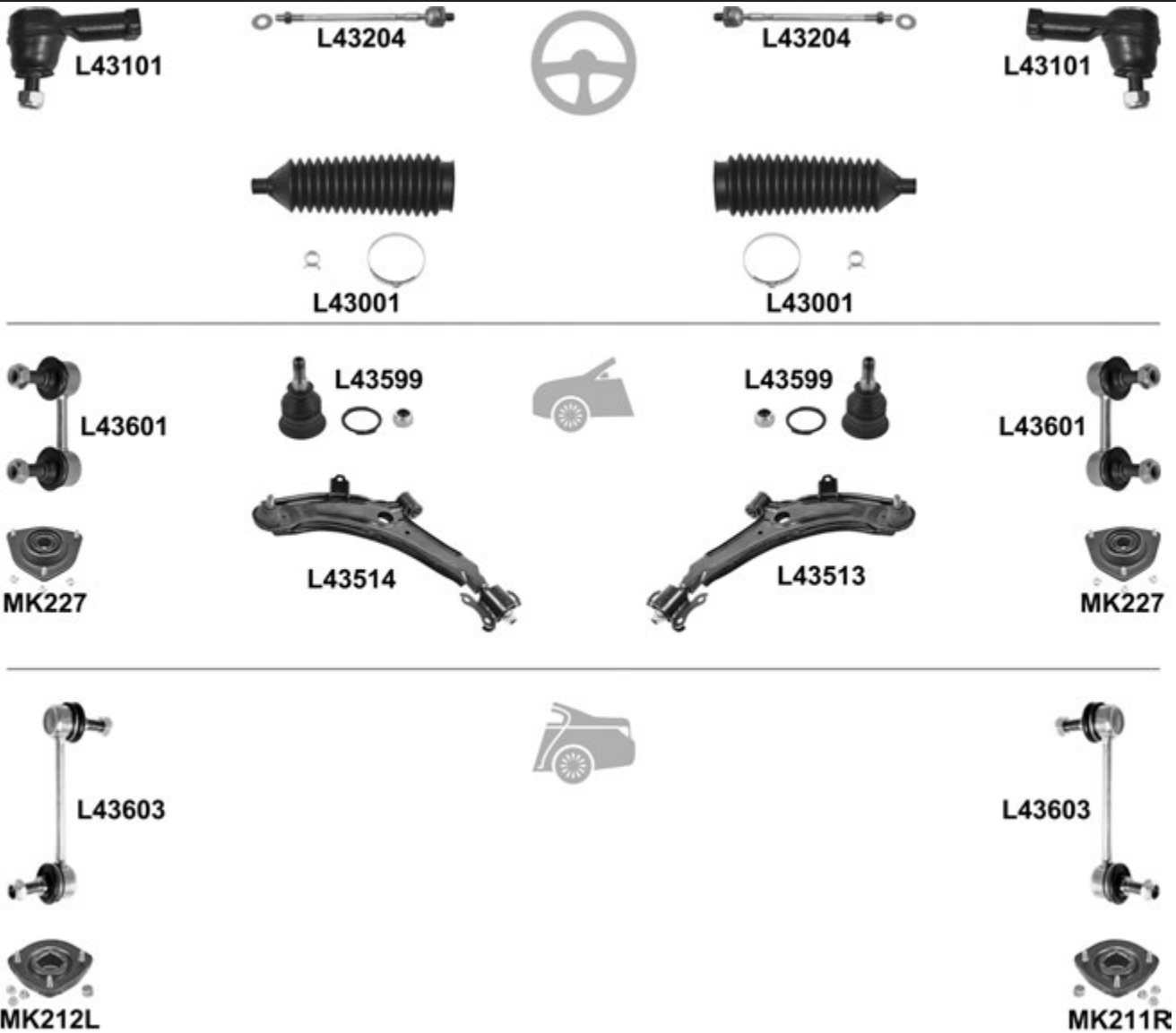

		i	←	→	Thread	Part Of	QPA	i
		↔	L43101	L43101	F 14x1,5 ∪		2	56820-28500
			L43204	L43204	∪		2	57730-29000
		∅ 15mm, ∅ 48mm, L= 208mm	L43001 ⁰	L43001 ⁰			2	56528-24000
		⊥	L43599 ⁰	L43599 ⁰			2	54530-31600
		⊥		L43513		<input checked="" type="checkbox"/>	1	54501-29000
			L43514				1	54500-29000
			L43601	L43601			2	54830-29000
			KIT	MK227	MK227		2	54610-2D000
			L43603	L43603			2	55530-29000
					MK211R		1	55320-2D000
			MK212L				1	55310-2D000

Matrix (FC) 06.01 → 12.05



Matrix (FC) 06.01 → 12.05

				←	→	Thread	Part Of	QPA	i
⊕		↔		L43101	L43101	∪		2	56820-25000
				L43208	L43208	∪		2	57755-17000
			∅ 14mm, ∅ 47mm, L= 178mm	L43002 ⁰	L43002 ⁰			2	57728-17000
⊖		⊥		L43599 ⁰	L43599 ⁰			2	54530-31600
		⊥↗		L43802	L43802			2	54551-1E000
					L43605			1	54830-25020
				L43606				1	54830-25010
			KIT	MK227	MK227			2	54610-2D000
⊖			(-) (ABS)	L18617	L18617			2	55530-17000
			(+) (ABS)	L43603	L43603			2	55530-17010
					MK211R			1	55320-2D000
				MK212L				1	55310-2D000

Pony (X1) 10.85 → 09.89



				←	→	Thread	Part Of	QPA	i
⊕		↔		L4203	L4203	F 14x1,5 ∪		2	56820-21100

Pony (X2) 10.89 → 01.95



L43001



L43001



L43520



L43519

				←	→	Thread	Part Of	QPA	i
⊕		↔		L4203	L4203	F 14x1,5 ∪		2	56820-21100
			∅ 15mm, ∅ 48mm, L= 208mm	L43001 ⁰	L43001 ⁰			2	56528-24000
⊖		⊥		L43502	L43502			2	54530-24A00
		⊥		<input checked="" type="checkbox"/>	L43519			1	54503-24001
				L43520				1	54502-24001
			KIT	MK230	MK230			2	54610-23001

Pony (X3) 10.94 → 01.00

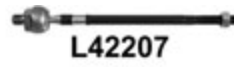
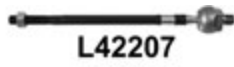

Thread

Part Of

QPA



				L43101	L43101	F 14x1,5 ∪		2	56820-25000
				L42207	L42207	M 14x1,5 / M 16x1,5 ∪		2	57755-22000
				L50602	L50602			2	54825-22000
			KIT	MK210	MK210			2	54610-22000
				MK222	MK222			2	

Santa Fé (SM) 02.01 →

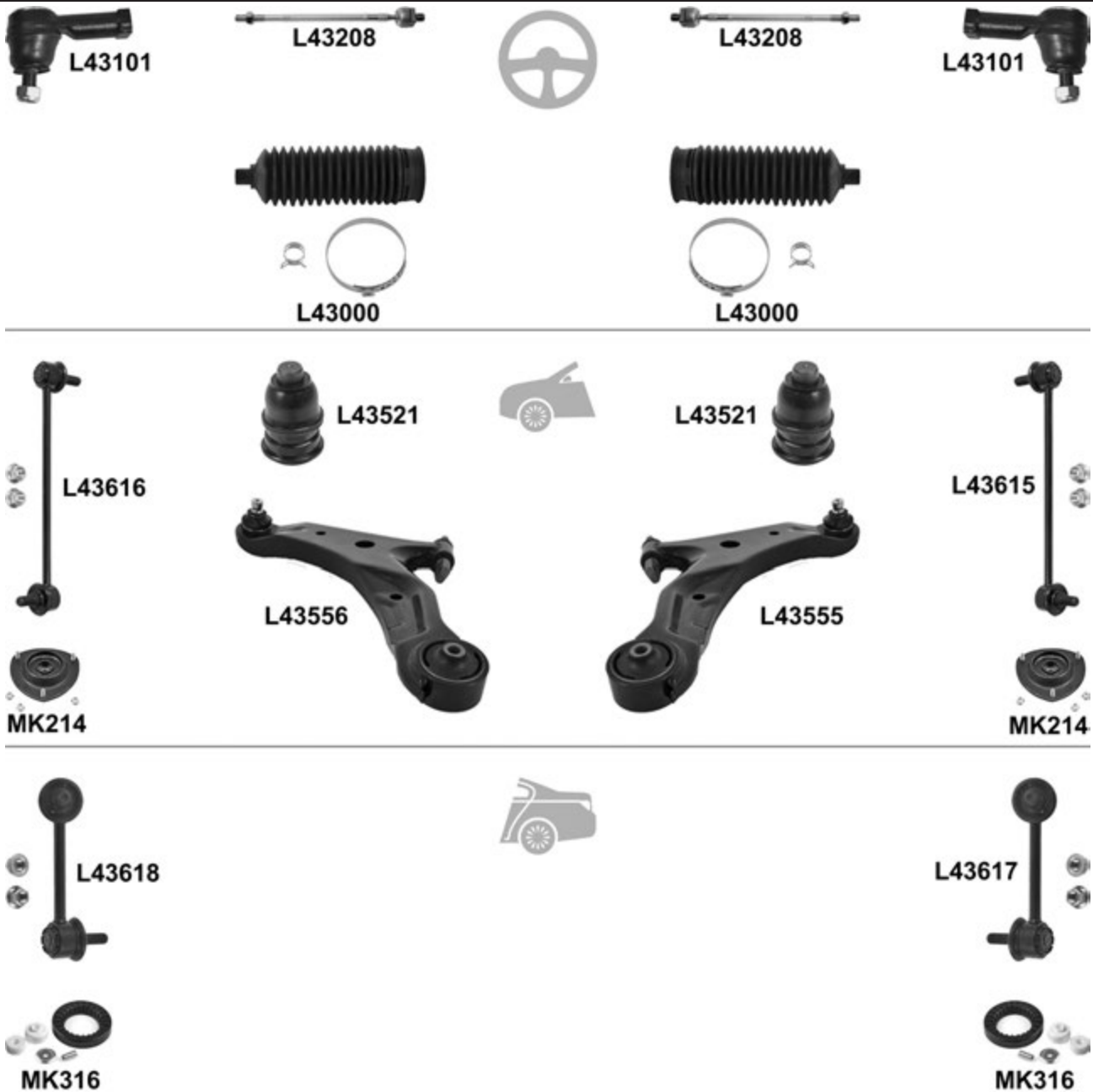

		i		←	→	Thread	Part Of	QPA	i
		↔		L43101	L43101			2	56820-3B000
				L43208	L43208			2	57785-26200
				L43000 ⁰	L43000 ⁰			2	57740-26000
		↓		L43521	L43521			2	54530-3B000
		↓			L43555			1	54501-26000
				L43556				1	54500-26000
					L43615			1	54840-26000
				L43616				1	54830-26000
			KIT	MK214	MK214			2	54610-34010
					L43617			1	55540-26600
			KIT	MK316	MK316			2	

Santa Fe (CM) 03.06 →

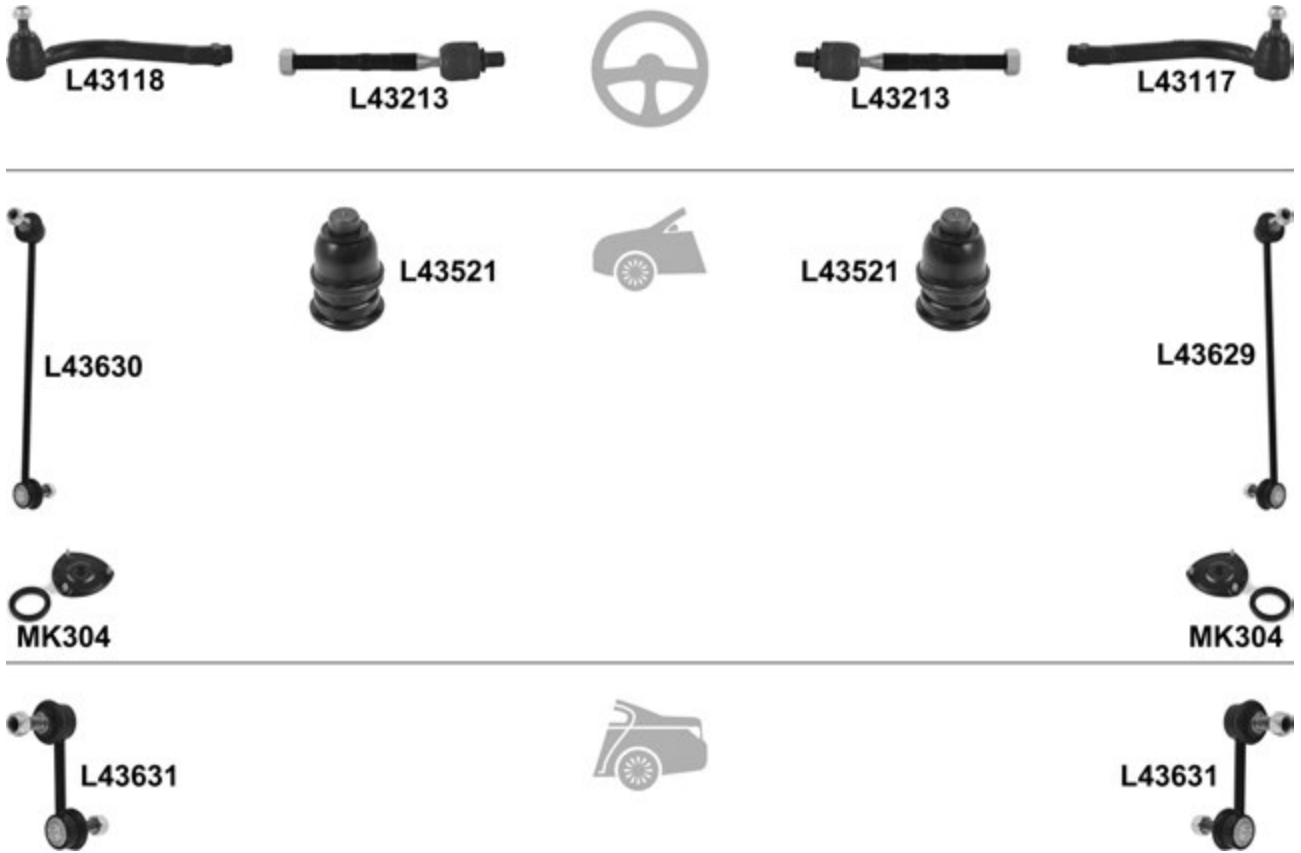

			←	→	Thread	Part Of	QPA	
				L43117	F 16x1,5 ∪		1	53821-2B900
				L43118	F 16x1,5 ∪		1	53821-2B000
				L43213	L43213	M 16x1,5 / M 16x1,5 ∪	2	57724-2B000
				L43521	L43521		2	54530-3B000
				L43629		1	54840-2B000	
				L43630			1	54830-2B000
			KIT	MK304	MK304		2	54610-2B100
				L43631	L43631		2	55530-2B000

Santa Fe III (DM12) 09.12 →



			←	→	Thread	Part Of	QPA	
				L43592 ⁰	L43592 ⁰		2	54530-3S100

Scoupe (SLC) 02.90 → 05.96

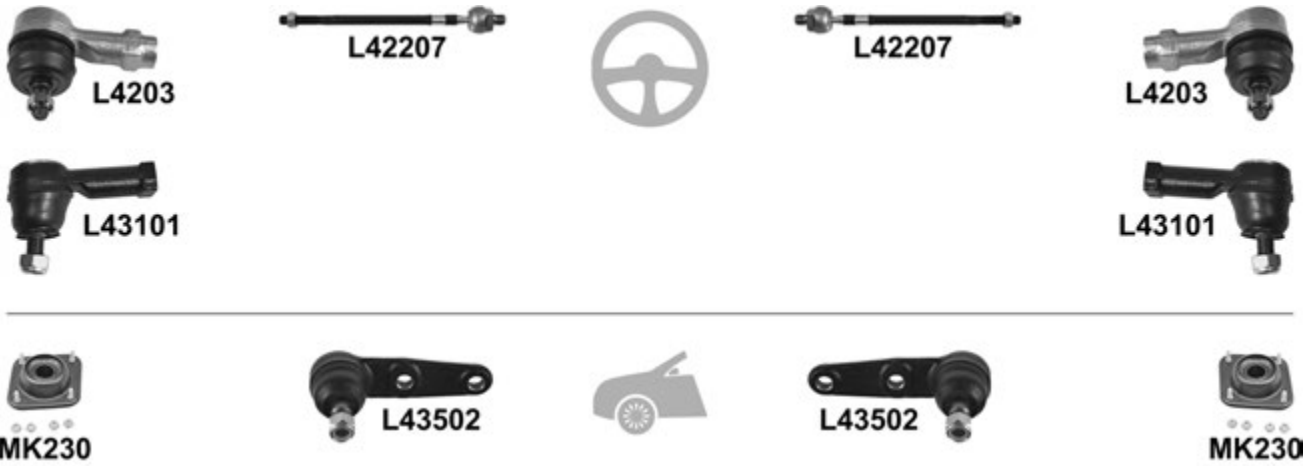

				←	→	Thread	Part Of	QPA	
				L4203	L4203	∪		2	56820-21100
				L43101	L43101			2	56820-28500
				L42207	L42207	M 14x1,5 / M 16x1,5		2	57730-28500
				L43502	L43502			2	54530-24A00
			KIT	MK230	MK230			2	54610-23001

Solaris (RB) 11.10 →

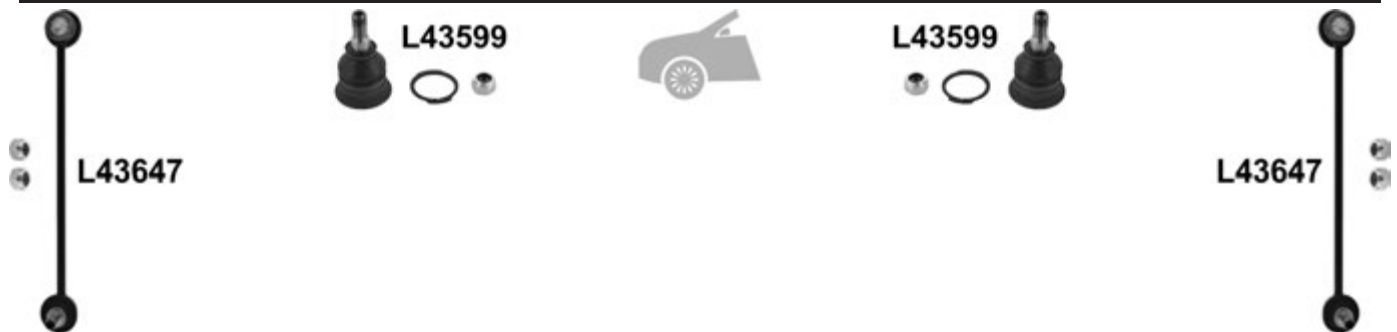

				←	→	Thread	Part Of	QPA	
				L43599 ⁰	L43599 ⁰			2	54530-31600
				L43647 ⁰	L43647 ⁰			2	54830-2S200

Sonata II (Y-2) 09.88 → 10.93



L42023



L42023



L42601



L43599



L43599



L42601



MK247



MK247



MK281



MK281



Thread

Part Of

QPA



				L42023	L42023			2	56820-36000
				L43599 ⁰	L43599 ⁰			2	54530-31600
				L42601	L42601			2	54830-36000
				KIT	MK247	MK247		2	
				KIT	MK281	MK281		2	

Sonata III (Y-3) 05.93 → 08.98



				Thread	Part Of	QPA		
		↔		L43101	L43101	↻	2	56820-37000
				L43202 ¹	L43202 ¹		2	57716-34000
		⊥		L43503	L43503		2	54530-37000
		⊥		<input checked="" type="checkbox"/>	L43523		1	54501-34010
				L43524			1	54500-34010
				L43602	L43602		2	54830-34000
				KIT	MK214	MK214		2
				L43611	L43611		2	55530-29000
				KIT	MK281	MK281		2

Sonata IV / Sonica / NF (EF) 03.98 → 12.04

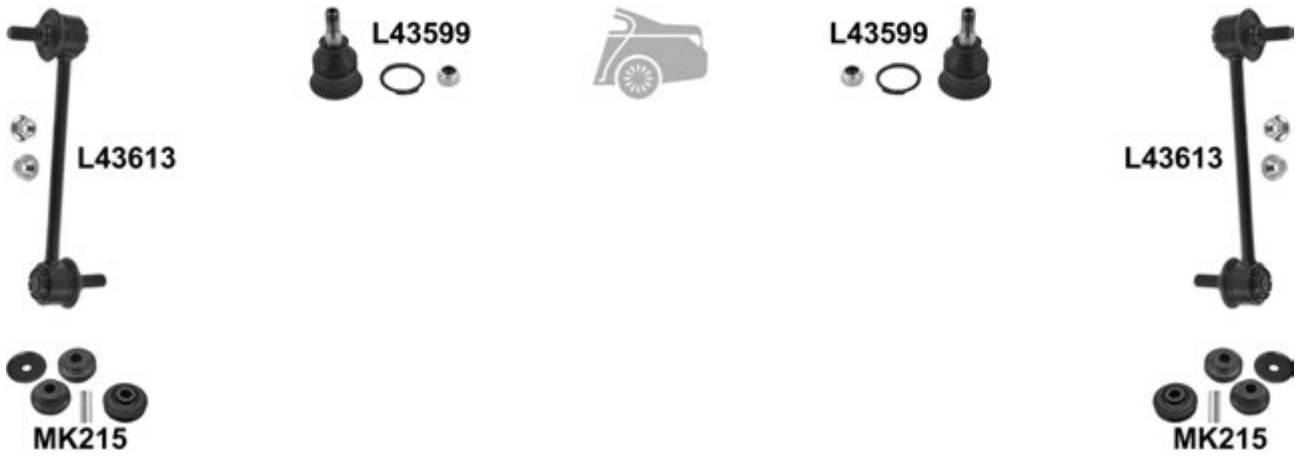

Sonata IV / Sonica / NF (EF) 03.98 → 12.04

			i	←	→	Thread	Part Of	QPA	i	
		↔			L43109	∩		1	57780-38010	
					L43110	∩		1	57780-38000	
					L43210	L43210	M 14x1,5 / M 16x1,5	2	57724-38010	
		↓			L43531	L43531		2	51760-38000	
				→ 10.99	☑	L43525			1	54501-38000
		↓			L43526			1	54500-38000	
				11.99 →	☑	L43529			1	54501-38011
					L43530			1	54500-38011	
					L43612	L43612		2	54830-38100	
				KIT	MK215	MK215		2		
		↑			L43599°	L43599°		2	54530-31600	
				→ 05.01, L= 180,5mm		L43613	L43613		2	55530-38000
				04.00 →	KIT	MK215	MK215		2	

Sonata V / Sonica / NF 01.05 →

			i	←	→	Thread	Part Of	QPA	i
				KIT	MK338	MK338		2	54830-3L100

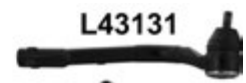
Sonata VI / Sonica YF 06.09 →

			i	←	→	Thread	Part Of	QPA	i
		↔			L43131	F 16x1,5 ∩		1	56820-2T500
					L43132	F 16x1,5 ∩		1	56820-2T000
		↓			L43592°	L43592°		2	54530-3S100
					L43653°	L43653°		2	55530-3R000
					1.6 Gdi, 1.7 CRDi 2.0 CWT KW110/120				
					2.0 CRDi 2.0 CWT KW122				

Trajet (FO) 03.00 →

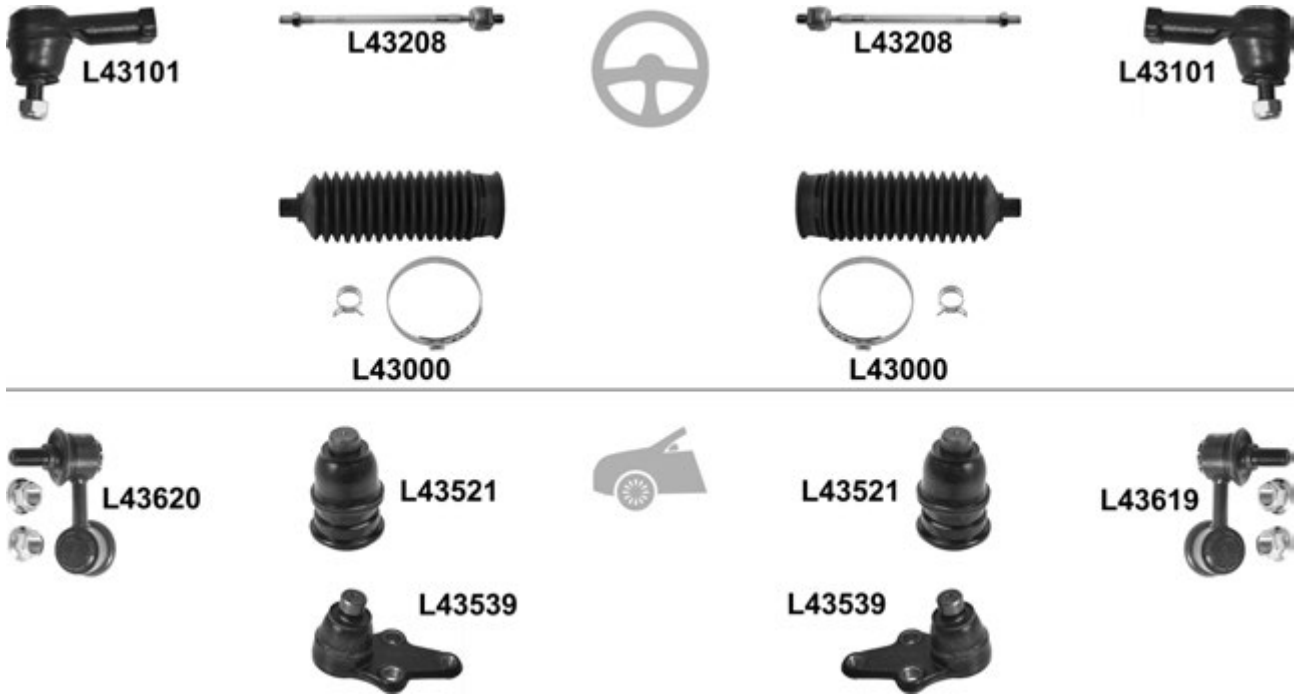

				←	→	Thread	Part Of	QPA		
⊕		↔		L43101	L43101	F 14x1,5 ♂		2	56820-3B000	
				L43208	L43208	M 14x1,5 / M 16x1,5 ♂		2	57785-26200	
				L43000 ^o	L43000 ^o			2	57740-26000	
⊖		⊥	→ 02.04	L43521	L43521			2	54530-3B000	
			03.04 →	L43539	L43539			2	54530-3A200	
					L43619			1	54840-3A000	
					L43620				1	54830-3A000

Tucson (JM) 08.04 →



Tucson (JM) 08.04 →

			i	←	→	Thread	Part Of	QPA	i	
		↔			L43111	F 16x1,5 ♂		1	56820-2E900	
					L43112	F 16x1,5 ♂		1	56820-2E000	
		↔			L43219	L43219	M 16x1,5 / M 16x1,5		2	57724-2E000
			∅ 16mm, ∅ 51mm, L= 186mm		L43004 ⁰	L43004 ⁰			2	57740-2E000
		⊥			L43545	L43545			2	51760-2E000
			<input checked="" type="checkbox"/>		L43553				1	54501-2E100
			L43554					1	54500-2E100	
		⊥			L43804	L43804			2	54551-2E000
					L18619	L18619			2	54830-2E000
				L18620	L18620			2	55530-2E000	
					MK211R			1	55320-2E000	
				MK212L				1	55310-2E000	

Tucson (LM) 08.09 →



			i	←	→	Thread	Part Of	QPA	i	
		↔			L43131	F 16x1,5 ♂		1	56820-2S050	
					L43132	F 16x1,5 ♂		1	56820-2S000	
		↔			L43222	L43222	M 16x1,5 / M 16x1,5		2	57724-2S000
				L43552	L43552			2	54530-3S000	
		⊥			L43650	L43650			2	54830-2S200
			→ 01.12		L43652	L43652			2	55530-2S200

XG 12.98 →



			←	→	Thread	Part Of	QPA	
		↔		L43109	F 14x1,5 ♂		1	57780-38010
				L43110	F 14x1,5 ♂		1	57780-38000
		⊥		L43210	M 14x1,5 / M 16x1,5		2	57724-38010
				L43531	L43531		2	51760-38000
			→ 08.00	<input checked="" type="checkbox"/>	L43525		1	54501-38000
				<input type="checkbox"/>	L43526		1	54500-38000
			09.00 →	<input checked="" type="checkbox"/>	L43529		1	54501-38011
			<input type="checkbox"/>	L43530		1	54500-38011	
		⊥		L43612	L43612		2	54830-38100
				L43599 ⁰	L43599 ⁰		2	54530-31600
			→ 04.00	<input type="checkbox"/>	L43613	L43613		2

Veloster (FS) 01.11 →



		i	←	→	Thread	Part Of	QPA	i	
		→ 03.12			L43647 ⁰	L43647 ⁰		2	54830-0U000

ISUZU

D-Max 8DH 05.02 →



Thread

Part Of

QPA



		↑		L20501	L20501			2	8-94472-255-2
		↓		L20502	L20502			2	8-94459-464-2

Pick-up KB 21 - KB 27 06.81 →



Thread

Part Of

QPA



		↔		L20000	L20000	F 14x1,5 U		2	8-94237-351-1
		↑		L20501	L20501			2	8-94472-255-2
		↓		L20010	L20010			2	8-94452-104-0/1

Pick-up KB 41-47 4WD 06.81 →

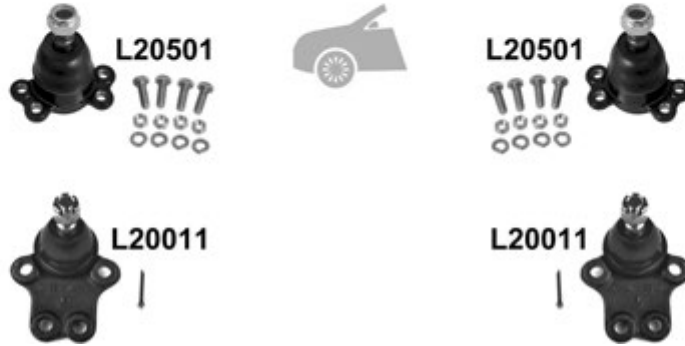

				←	→	Thread	Part Of	QPA		
				L20000	L20000	F 14x1,5 ∪		2	8-94237-351-1	
				L20002	L20002	M 14x1,5 / F 14x1,5 ∪		2	5-44352-095-2	
				L20501	L20501			2	8-94472-255-0	
				L20011	L20011			2	9-51227-704-1	

Pick-up TFR 04.88 →

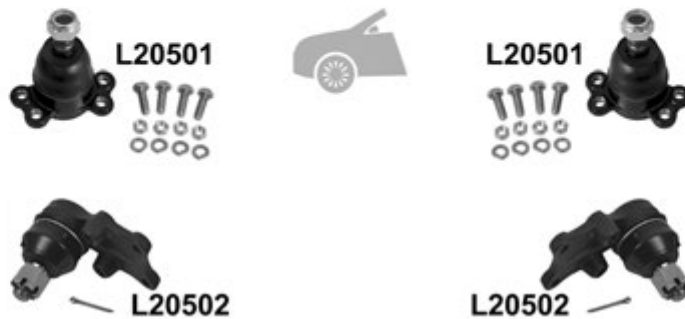

				←	→	Thread	Part Of	QPA		
					L20103	∪		1	8-97020-953-1	
				L20104		∪		1	8-97020-954-2	
				L20501	L20501			2	8-94459-453-3	
				L20502	L20502			2	8-94459-464-2	

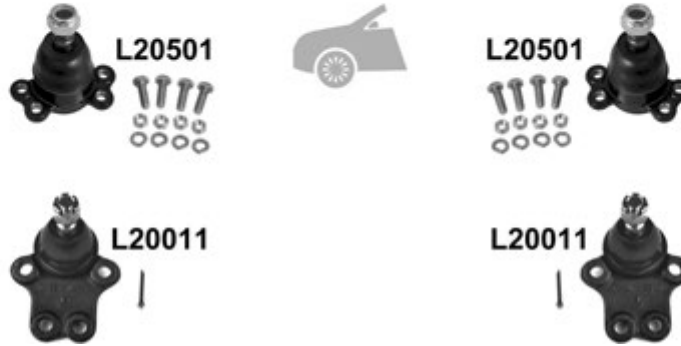
Trooper UBS 1981 → 10.86

			i	←	→	Thread	Part Of	QPA	i
		↔		L20000	L20000	F 14x1,5 ∪		2	8-94237-351-1
				L20002	L20002	M 14x1,5 / F 14x1,5 ∪		2	5-44352-095-2
		↑		L20501	L20501			2	8-94472-255-0
		↓		L20011	L20011			2	9-51227-704-1

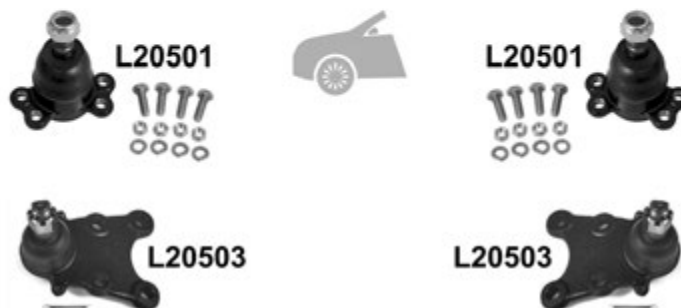
Trooper UBS 11.86 → 1991

			i	←	→	Thread	Part Of	QPA	i
		↔		L20103				1	8-94459-480-2
				L20104				1	8-94459-481-2
		↑		L20501	L20501			2	8-94472-255-0
		↓		L20503	L20503			2	8-94452-102-1

Trooper 04.00 →

			i	←	→	Thread	Part Of	QPA	i
		↓	STD. Chassis	L20503	L20503			2	8-94452-102-1

Van WFR 2WD 1981 →



L20005



L20005



L20004



L20004



L20501



L20501



L20012



L20012

				←	→	Thread	Part Of	QPA	
		↔		L20005	L20005	M 16x1,5 ∪		2	8-94233-476-1
		→←		L20004	L20004	M 16x1,5 ∪		2	8-94369-925-0
		↑		L20501	L20501			2	8-94472-255-0
		↓		L20012	L20012			2	8-94452-110-1/2

Van WFS 4WD 11.83 →



L20501



L20501

				←	→	Thread	Part Of	QPA	
		↑		L20501	L20501			2	8-94472-255-0

IVECO

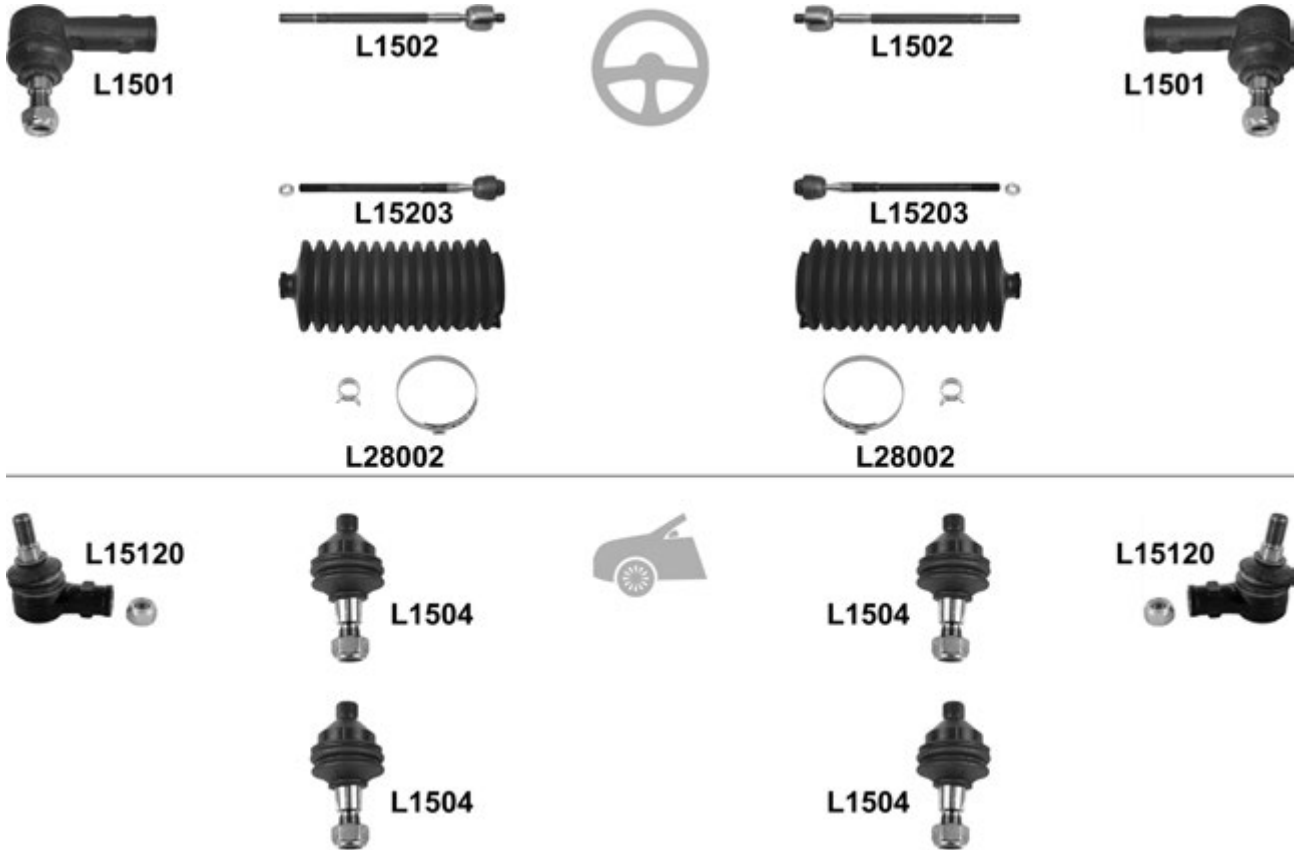
 Daily I 01.78 → 04.99
 Turbo Daily 4WD 1987 →

				←	→	Thread	Part Of	QPA	
		↔		L1501	L1501	F 16x1,5 ♂		2	93800662
				L1502	L1502	M 16x1,5 / M 16x1,5		2	9983325
				L15203	L15203	M 16x1,5 / F 16x1,5		2	
				L28002	L28002			2	4066 15
		↑		L1504	L1504			2	93802242
		↓		L1504	L1504			2	93802242
				L15120	L15120	F 20x1,5 ♂		2	93802209

Daily II 05.99 →

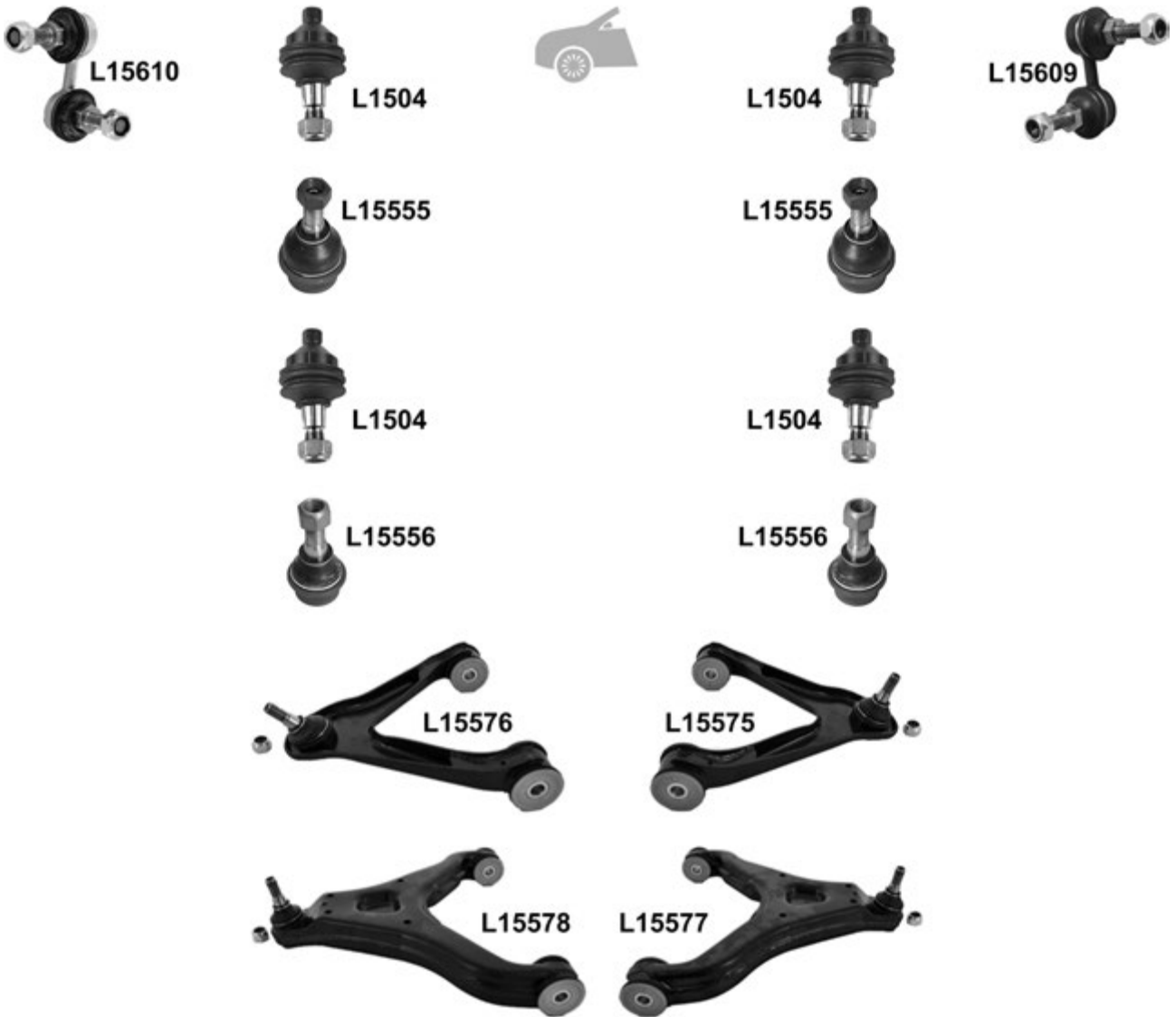
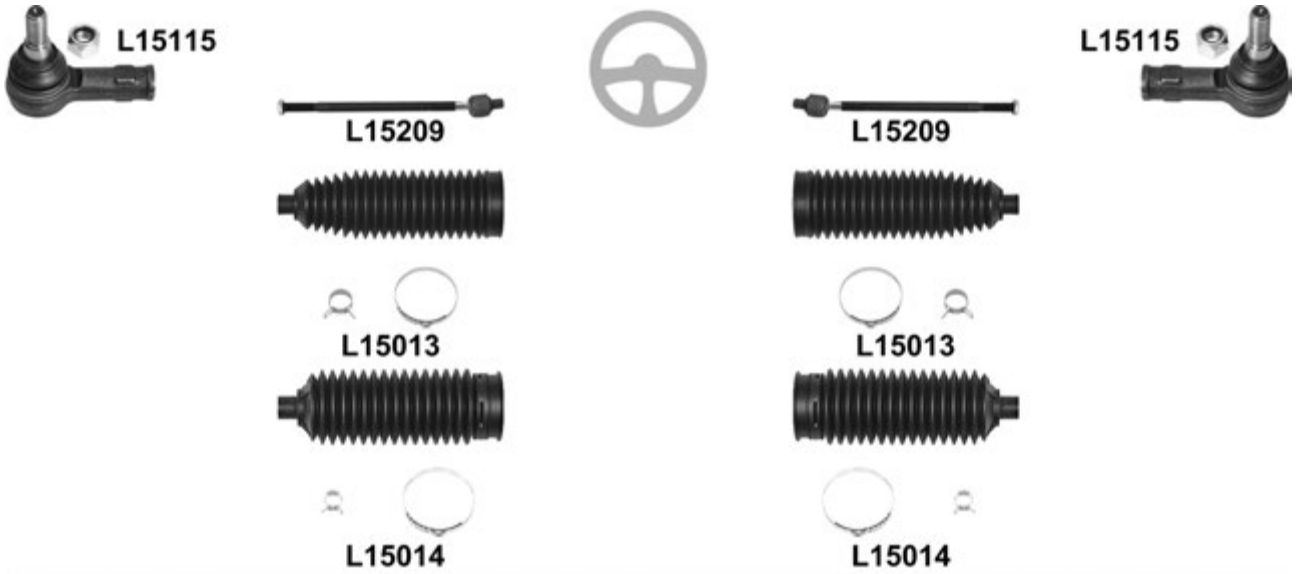

Daily II 05.99 →

				← → Thread		Part Of	QPA			
		↔		L15115	L15115	↺		2	4253 4911	
				L15209	L15209	↺		2		
			ZF, ø 16mm, Ø 61mm, L= 215mm	L15013 ^o	L15013 ^o			2	2992592	
			TRW, ø 14,5mm, Ø 54mm, L= 196mm	L15014 ^o	L15014 ^o			2	42556992	
		↑		L1504	L1504			2	93802242	
				L15555	L15555			L15575/L15576	2	
		↓		L1504	L1504				2	93802242
				L15556	L15556			L15577/L15578	2	
		↑		<input checked="" type="checkbox"/>		L15575			1	500379802
				<input checked="" type="checkbox"/>		L15576			1	500379801
		↓		<input checked="" type="checkbox"/>		L15577			1	500334716
				<input checked="" type="checkbox"/>		L15578			1	500334717
					L15609			1	500 383 976	
					L15610			1	500 383 975	

Maxus 10.05 →

				← → Thread		Part Of	QPA		
		↓		L10504	L10504			2	

JAGUAR

S-Type (CCX) 01.99 →



				← → Thread		Part Of	QPA		
		↑	ch. M45255 →		L16589		1	C2Z2278	
				L16590		1	C2Z2279		
		↔	ch. → M45254	L16636	L16636		2	C2C10793	
			ch. M45255 →	L16632	L16632		2	C2C10793	
				L16633			1	XR81692	
				L16634			1	XR81693	

Sovereign 10.97 → 04.03



				← → Thread		Part Of	QPA		
				L16608	L16608		2	MNA3505AE	

X-Type (CF1) 06.01 →

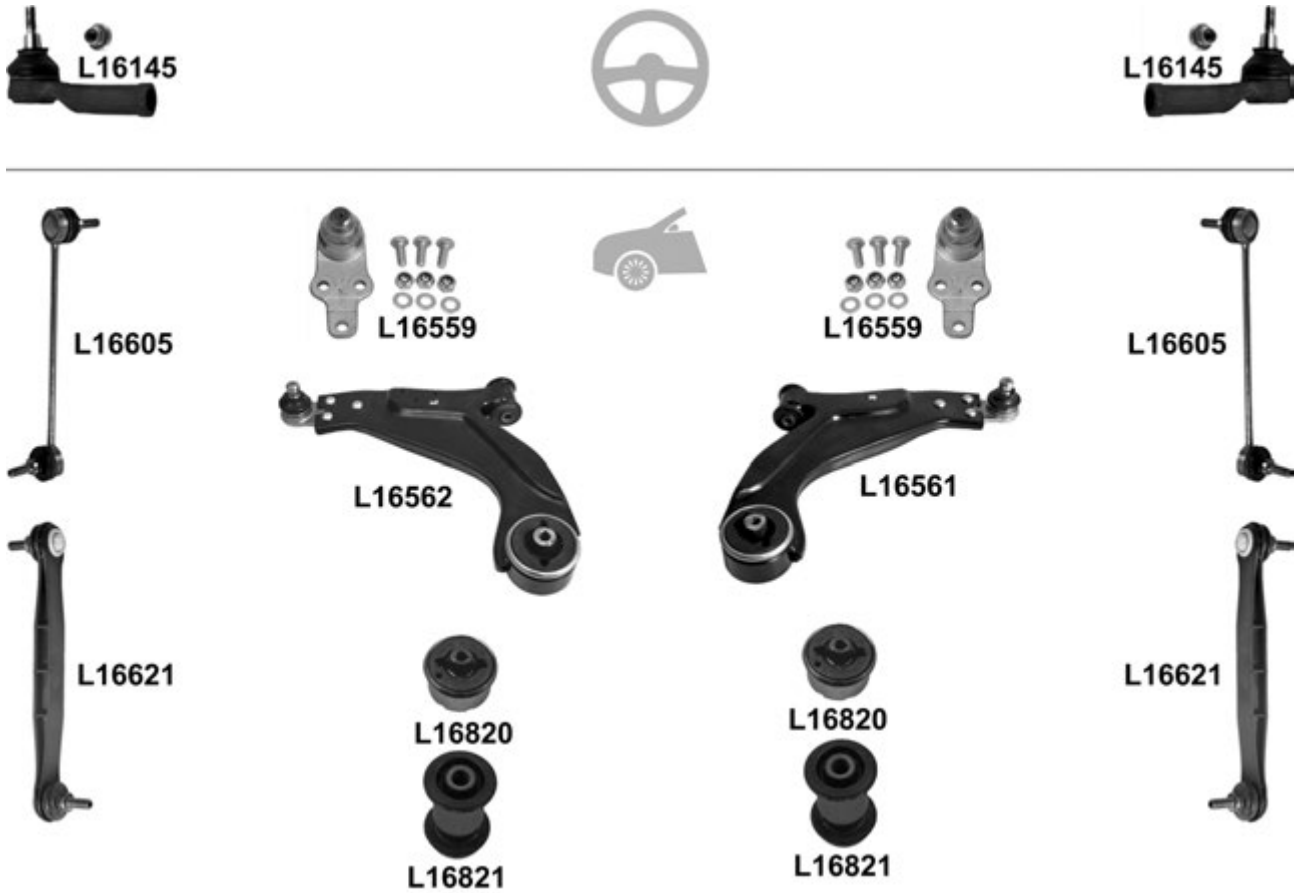

				← → Thread		Part Of	QPA		
		↔		L16145	L16145	F 16x1,5 ♂		2	C2S 12013
		⊥		L16559	L16559			2	C2S20964
		⊥	<input checked="" type="checkbox"/>		L16561			1	C2S20963
				L16562				1	
		⊥↘		L16820	L16820			2	
		⊥↗		L16821	L16821			2	
			ch. → D14965, Metal	L16605	L16605			2	1127646
			ch. D14966 →, Plastic	L16621	L16621			2	1219697

XF 03.08 →
 XF Sportsbrake 09.12 →
 XFR 01.09 →

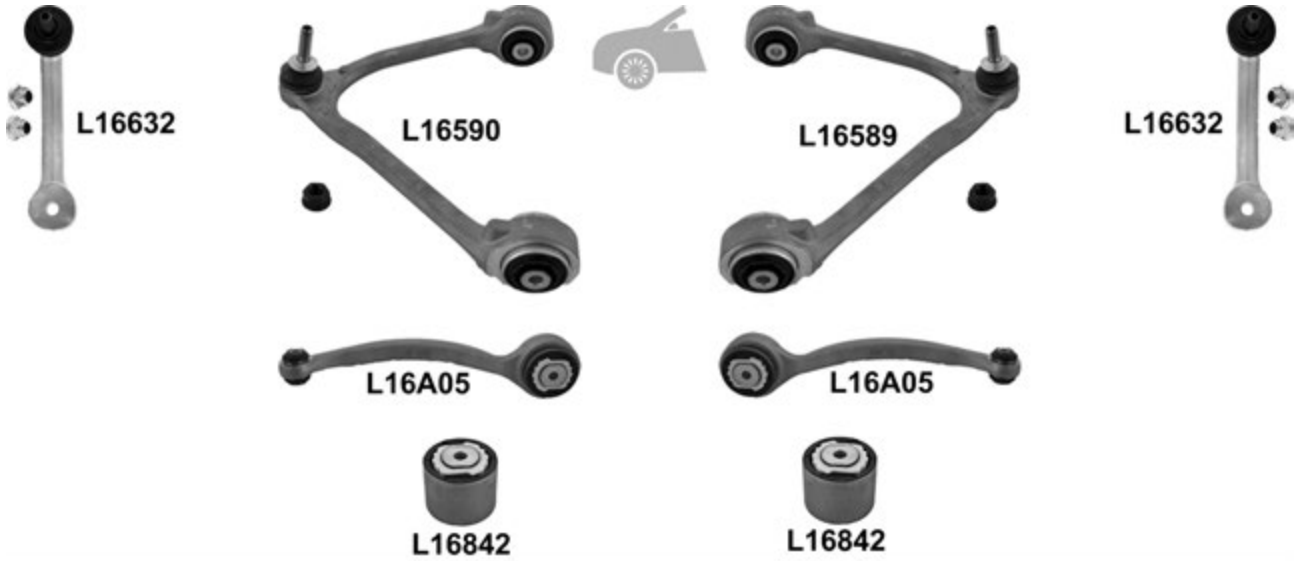

				←	→	Thread	Part Of	QPA		
		$\bar{\uparrow}$	<input checked="" type="checkbox"/>		L16589			1	C2Z2278	
				L16590			1	C2Z2279		
		\perp	<input checked="" type="checkbox"/>	L16A05	L16A05			2	C2Z10052	
				L16842	L16842		L16A05	2		
				L16632	L16632			2	C2C10793	
					L16633			1	C2C18571	
					L16634			1	C2C18572	

XJ (NAW, NBW) 07.97 → 05.03



				←	→	Thread	Part Of	QPA		
				L16608	L16608			2	MNA3505AE	

XJ (X350, X358) 05.03 →

				←	→	Thread	Part Of	QPA	i
						L16632	L16632	2	C2C10793
							L16633	1	C2C18571
						L16634		1	C2C18572

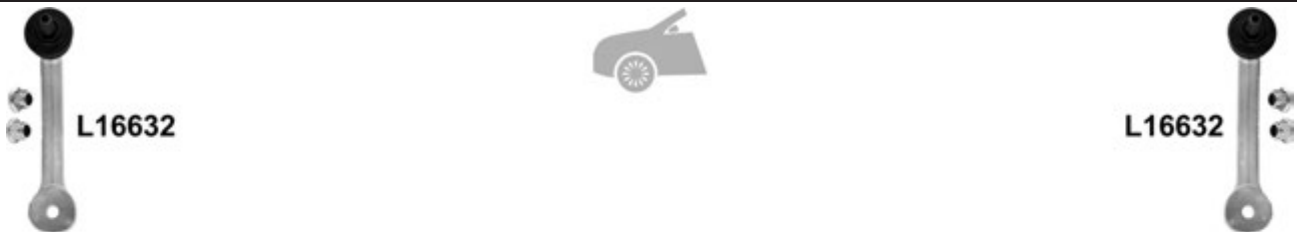
XJ (X351) 01.10 →

				←	→	Thread	Part Of	QPA	i
						L16632	L16632	2	C2C10793
							L16633	1	C2C18571
						L16634		1	C2C18572

XK 8 Coupe (QEV) 03.96 →
XK 8 Convertible (QDV) 03.96 →

				←	→	Thread	Part Of	QPA	i
						L16608	L16608	2	MNA3505AE

XK Coupe 03.06 →
 XK Cabriolet 03.06 →

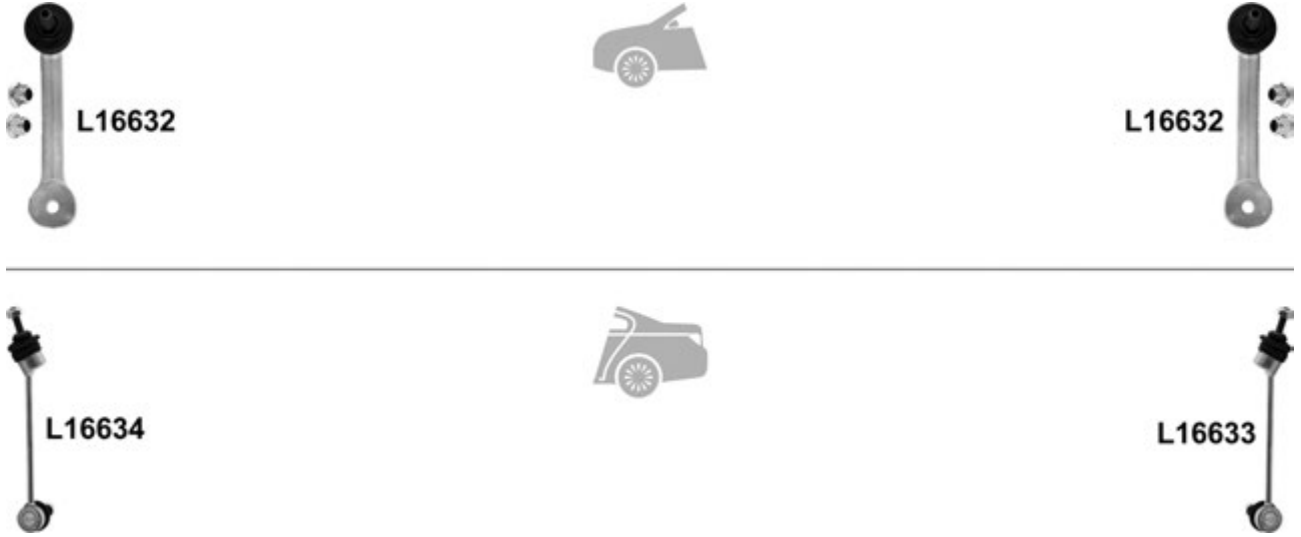

		i		←	→	Thread	Part Of	QPA	i
				L16632	L16632			2	C2C10793
					L16633			1	C2C18571
				L16634				1	C2C18572

JEEP

Compass (MK49) 08.06 →



		←	→	Thread	Part Of	QPA	
		↔		L80100	L80100		2 68141058AA

Patriot (MK74) 01.08 →



		←	→	Thread	Part Of	QPA	
		↔		L80100	L80100		2 68141058AA

KIA

Carens I (FC) 11.00 → 07.02



			i	←	→	Thread	Part Of	QPA	i
		↔		L18100	L18100			2	OK9A2-32-280
		⌞		L18506	L18506			2	K2A1-34-550A
		⌞	<input checked="" type="checkbox"/>		L18517			1	OK2NA-34-300B
				L18518				1	OK2NA-34-350B
					L18613			1	OK2N1-34-150A
				L18614				1	OK2N1-34-170A
				L18612	L18612			2	OK2A1-34-150A

Carens II (FJ) 07.02 →

Thread

Part Of

QPA



				L18100	L18100			2	OK9A2-32-280
				L18506	L18506			2	K2A1-34-550A
				L18612	L18612			2	OK2A1-34-150A

Carens IV (A4) 03.13 →



Thread

Part Of

QPA

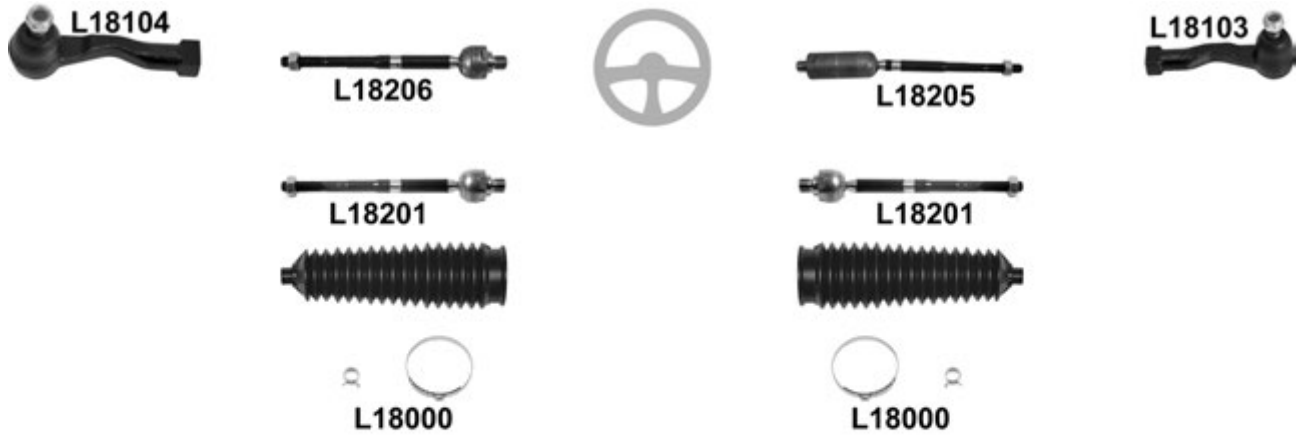

				L43592 ⁰	L43592 ⁰			2	54530-3S100

Carnival (UP) 08.99 → 10.01

			i	←	→	Thread	Part Of	QPA	i				
						L18103	F 14x1,5 ∪	1	OK552-32-280				
						L18104	F 14x1,5 ∪	1	OK552-32-240				
						L= 308mm			L18205	M 14x1,5 / M 17x1 ∪	1	OK552-32-250A	
						L= 245,5mm			L18206	M 14x1,5 / M 17x1 ∪	1	OK552-32-270	
									L18201	L18201	M 14x1,5 / M 18x1,5 ∪	2	OK552-32-270B
								L18000 ^o	L18000 ^o	2	OK552-32-125		
										L18503		1	OK552-34-300A
										L18504		1	OK552-34-350A
						L18603	L18603			2	OK552-34-150B		

Carnival II (GQ) 10.01 →

			i	←	→	Thread	Part Of	QPA	i		
						L18103	F 14x1,5 ∪	1	OK552-32-280		
						L18104	F 14x1,5 ∪	1	OK552-32-240		
						L18201	L18201	M 14x1,5 / M 18x1,5 ∪	2	OK552-32-270B	
								L18503		1	OK552-34-300A
								L18504		1	OK552-34-350A
								L18603	L18603		2

Carnival III / Sedona (UVP) 09.05 →

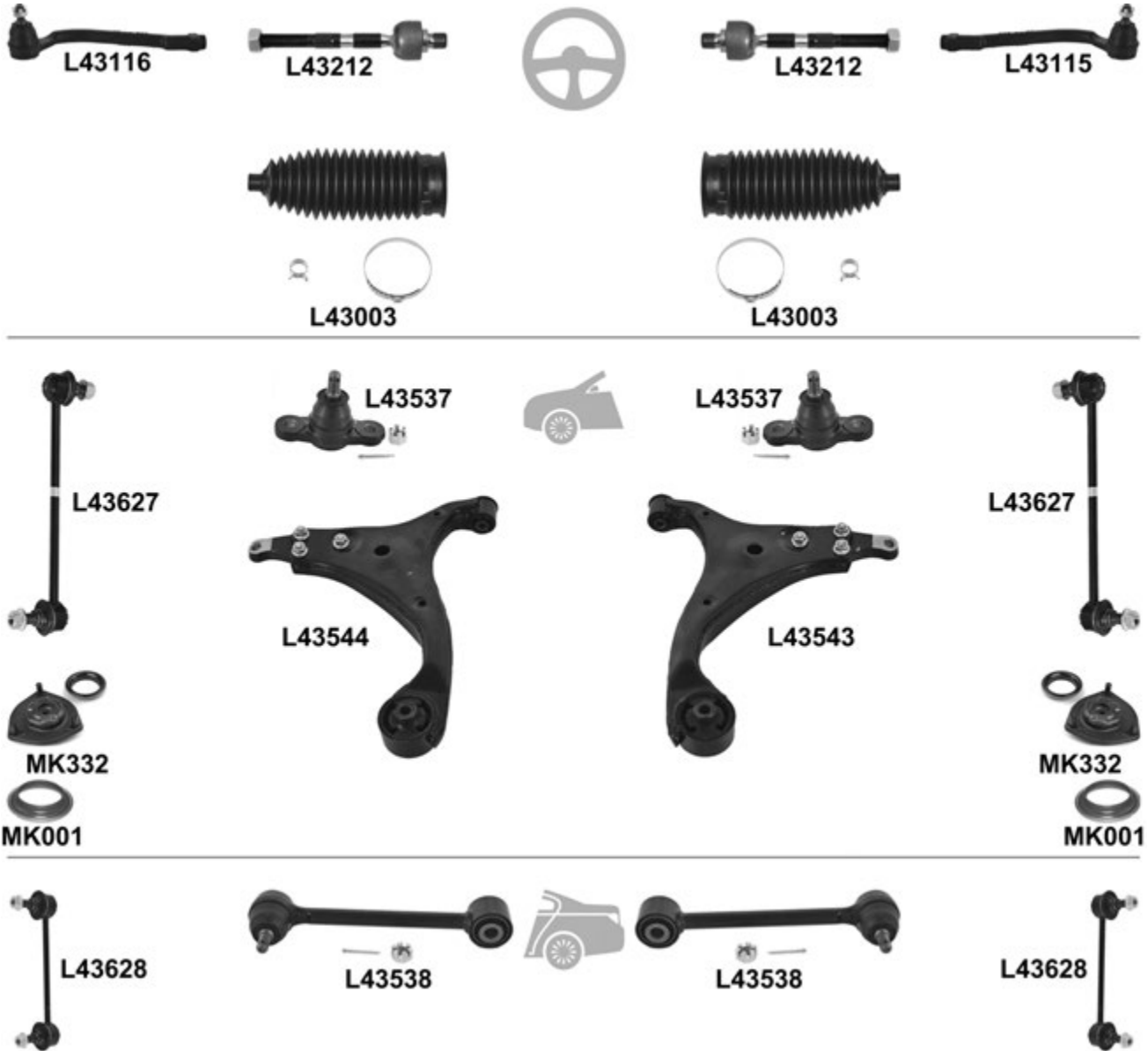

				← → Thread		Part Of		QPA ⓘ	
			KIT	MK304	MK304			2	54610-2B100

Ceed 12.06 →
 Ceed Kombi 09.07 →

		i	←	→	Thread	Part Of	QPA	i
⊕		↔		L43115	F 14x1,5 ∪		1	56820-2H090
				L43116	F 14x1,5 ∪		1	56820-2H000
				L43212	L43212	M 14x1,5 / M 16x1,5 ∪	2	56240-2H000
			∅ 12mm, ∅ 49mm, L= 170mm	L43003 ^o	L43003 ^o		2	57740-1H000
		⊥	→ 10.09	L43537	L43537		2	51760-2H000
			(-) L43537	L43543		1	54501-2H000	
		⊥		L43544		1	54500-2H000	
			L43627	L43627		2	54830-2H100	
		(+) MK001	KIT	MK332	MK332		2	54610-3H000
				MK001	MK001		2	54612-1G010
			↗		L43538	L43538		2
				L43628	L43628		2	55530-2H000

Ceed 05.12 →
Ceed SW 09.12 →



				← → Thread		Part Of	QPA		
		↓		L43592 ⁰	L43592 ⁰		2	54530-3S100	
		↓	→ 04.14	<input checked="" type="checkbox"/>	L43A03 ⁰		1	54501-A6200	
					L43A04 ⁰		1	54500-A6200	
			→ 01.13		L43647 ⁰	L43647 ⁰	2	54830-0U000	
					L43653 ⁰	L43653 ⁰	2	55530-3R000	

Cerato 04.04 →



		← →		Thread	Part Of	QPA			
		↔		L43101	L43101	F 14x1,5 U		2	56820-25000
				L43206	L43206	U		2	57724-2D000
		⊥		L43599 ⁰	L43599 ⁰			2	54530-2F000
					L18615			1	54840-2F000
				L18616			1	54830-2F000	
				L18617	L18617			2	55530-17000

Cerato (TD) 06.09 →

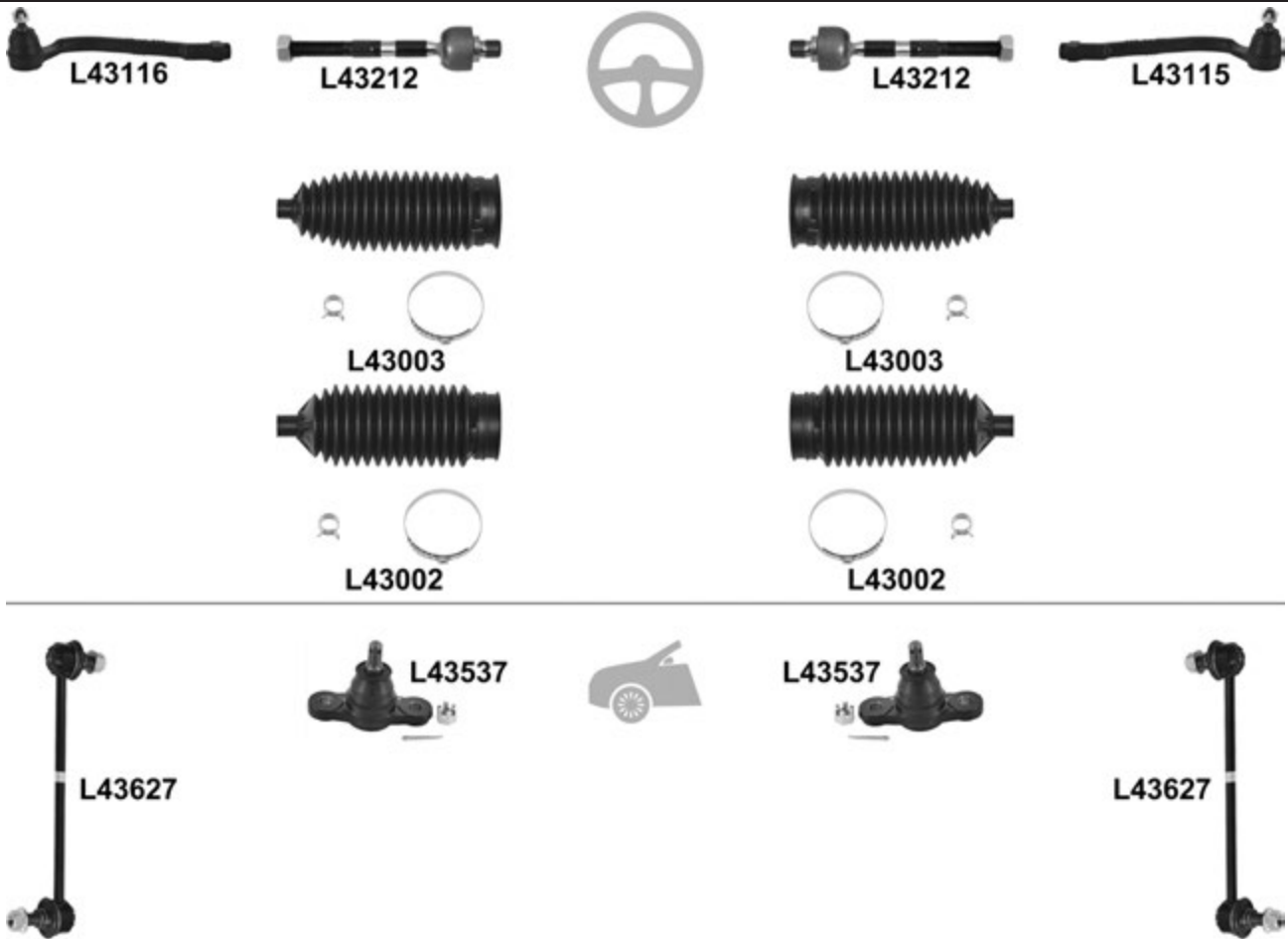

				i		←	→	Thread	Part Of	QPA	i
					L43115			F 14x1,5 U		1	56820-2H090
					L43116			F 14x1,5 U		1	56820-2H000
				, ø 12mm, ø 49mm, L= 170mm	L43212	L43212		M 14x1,5 / M 16x1,5 U		2	56240-2H000
				, ø 14mm, ø 47mm, L= 178mm	L43003 ⁰	L43003 ⁰				2	57740-1H000
					L43002 ⁰	L43002 ⁰				2	57728-17000
					L43537	L43537				2	51760-2H000
				→ 07.10	L43627	L43627				2	54830-2H100

Clarus (K9A) 07.96 →

L18100

L18100

L50604

L50040
L18514

L50040
L18513

L50603

L18600

L18600

			i	←	→	Thread	Part Of	QPA	i
		↔		L18100	L18100			2	OK9A2-32-280
		⊥		L50040	L50040			2	OG030-34-550B
		⊥	→ 05.98		L18513			1	OK9A2-34-300
				L18514				1	OK9A2-34-350
					L50603			1	KGA2A-34-170A
				L50604				1	KGA2A-34-150A
				L18600	L18600			2	K9A3-28-170A

Clarus Kombi (GC) 05.98 →



L18100



L18100



L50604



L50040

L18514



L50040

L18513



L50603



L18600



L18600

			i	←	→	Thread	Part Of	QPA	i
		↔		L18100	L18100			2	OK9A2-32-280
		⊥		L50040	L50040			2	OG030-34-550B
		⊥	<input checked="" type="checkbox"/>		L18513			1	OK9A2-34-300
				L18514				1	OK9A2-34-350
					L50603			1	KGA2A-34-170A
				L50604				1	KGA2A-34-150A
				L18600	L18600			2	K9A3-28-170A

Credos (FE) 06.96 →

			i	←	→	Thread	Part Of	QPA	i
		↔		L18100	L18100			2	OK9A2-32-280
		↓		L50040	L50040			2	OG030-34-550B
					L50603			1	KGA2A-34-170A
				L50604				1	KGA2A-34-150A
				L18600	L18600			2	K9A3-28-170A

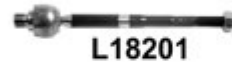
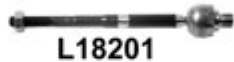
Grand Sedona (UP) 08.99 → 10.01

			i	←	→	Thread	Part Of	QPA	i
		↔			L18103	F 14x1,5 ∪		1	OK552-32-280
				L18104		F 14x1,5 ∪		1	OK552-32-240
			L= 308mm		L18205	M 14x1,5 / M 17x1 ∪		1	OK552-32-250A
			L= 245,5mm		L18206	M 14x1,5 / M 17x1 ∪		1	OK552-32-270
		↓		L18201	L18201	M 14x1,5 / M 18x1,5 ∪		2	OK552-32-270B
			L= 245,5mm		L18503	M 14x1,5 / M 18x1,5		1	OK552-34-300A
				L18504				1	OK552-34-350A
				L18603	L18603			2	OK552-34-150B

Grand Sedona II (GQ) 10.01 →



			←	→	Thread	Part Of	QPA	
⊕		↔		L18103	F 14x1,5 ∪		1	OK552-32-280
				L18104	F 14x1,5 ∪		1	OK552-32-240
⊖		⊥	L= 245,5mm	L18201	M 14x1,5 / M 18x1,5 ∪		2	OK552-32-270B
				L18503			1	OK552-34-300A
				L18504			1	OK552-34-350A

Magentis (GD) 05.01 →

			←	→	Thread	Part Of	QPA	
⊕		↔		L43109	∪		1	56820-38900
				L43110	∪		1	56820-38000
⊖		⊥		L43210	M 14x1,5 / M 16x1,5		2	57724-38010
				L43531	L43531		2	51760-38000
			<input checked="" type="checkbox"/>	L43529			1	54501-38011
				L43530			1	54500-38011
			L43612	L43612		2	54830-38100	

Magentis (MG) 11.05 →

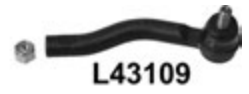
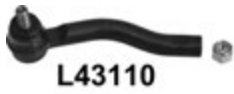
			←	→	Thread	Part Of	QPA	
		⊥		L43537	L43537		2	51760-2H000

Opus (EH) 06.03 →

				←	→	Thread	Part Of	QPA	
		↔	→ 09.06		L43109	↺		1	56820-38900
					L43110	↺		1	56820-38000
		⊥			L43531	L43531		2	51760-38000

Opus (EH) 10.06 →

				←	→	Thread	Part Of	QPA	
		⊥	→ 09.06	<input checked="" type="checkbox"/>	L43529			1	54501-38011
					L43530			1	54500-38011

Opus (EH) 06.03 →

				←	→	Thread	Part Of	QPA	
			→ 09.06		L43612	L43612		2	54830-38100

Optima (FS) 02.01 →

			←	→	Thread	Part Of	QPA	
⊕		↔		L43109	∩		1	56820-38900
			L43110		∩		1	56820-38000
⊖		↔		L43210	L43210	M 14x1,5 / M 16x1,5	2	57724-38010
				L43529			1	54501-38011
				L43530			1	54500-38011
⊖		⊥		L43612	L43612		2	54830-38100

Optima (MG) 10.05 →

			←	→	Thread	Part Of	QPA	
⊖		⊥		L43537	L43537		2	51760-2H000

Optima (TF) 06.10 →

			←	→	Thread	Part Of	QPA	
⊕		↔		L43131	F 16x1,5 ∩		1	56820-2T500
			L43132		F 16x1,5 ∩		1	56820-2T000
⊖				L43653 ^o	L43653 ^o		2	55530-3R000

Picanto / Morning 04.04 →



L43002



L43002

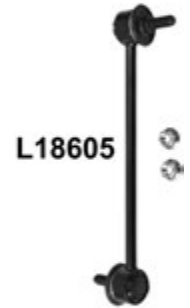

Picanto / Morning 04.04 →

			←	→	Thread	Part Of	QPA		
		↔	→ 07.07	L18105	L18105	F 12x1,25 ♂	2	56820-07000	
			08.07 →	L43127	L43127	F 12x1,25	2	56820-0X000	
			08.07 →, ø 14mm, Ø 47mm, L= 178mm	L43002 ⁰	L43002 ⁰			2	57728-17000
		↓	→ 08.08, (-) 1.1 Diesel	L18505	L18505		2	54830-07000	
			09.08 →, (-) 1.1 Diesel	L43599 ⁰	L43599 ⁰		2	54530-2F000	
			1.1 Diesel, → 06.07	L18506	L18506		2	0K2A1-34-550A	
			1.1 Diesel, 07.07 →	L18505	L18505		2	54830-07000	
		↓	(-) 1.1 Diesel	<input checked="" type="checkbox"/>		L18527		1	54501-07250
					L18528		1	54500-07250	
		↓	↕		L18800 ⁰	L18800 ⁰		2	54584-07000
					L18801 ⁰	L18801 ⁰		2	54581-1G000
	↕				L18605		1	54840-07000	
					L18606		1	54830-07000	
				MK363	MK363		2		

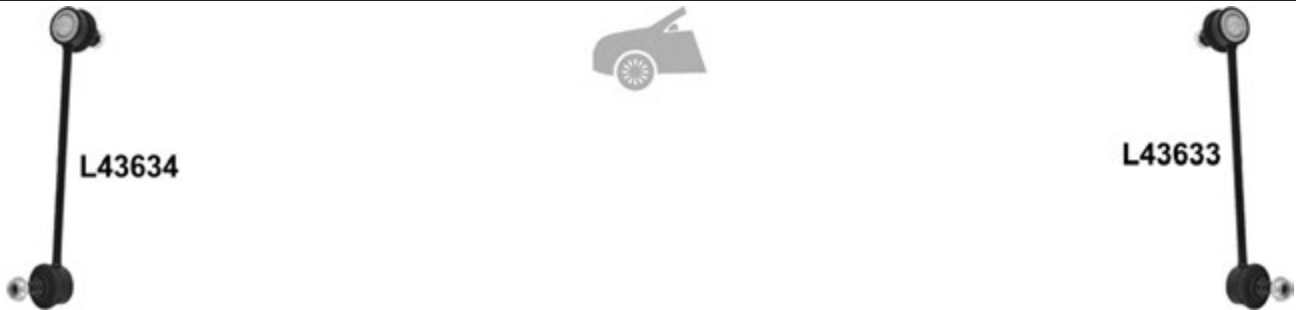
Picanto (TA) 05.11 →

			←	→	Thread	Part Of	QPA	
				L43633			1	54840-1J000
			L43634				1	54830-1J000

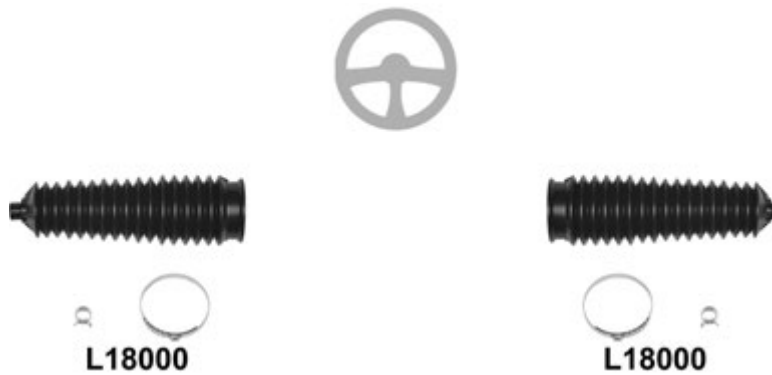
Pregio (FP) 11.95 →

			←	→	Thread	Part Of	QPA	
			ø 15mm, Ø 54mm, L= 237mm	L18000 ⁰	L18000 ⁰		2	0K552-32-125

Pride (DA) 01.90 →



			i	←	→	Thread	Part Of	QPA	i
		↔				L50018 [†] L50018 [†]		2	KKY01-32-280
		⊥				L18502 L18502		2	KKY01-34-310A

Pride Kombi 08.99 →



			i	←	→	Thread	Part Of	QPA	i
		↔				L50018 [†] L50018 [†]		2	KKY01-32-280

ProCeed 02.08 →

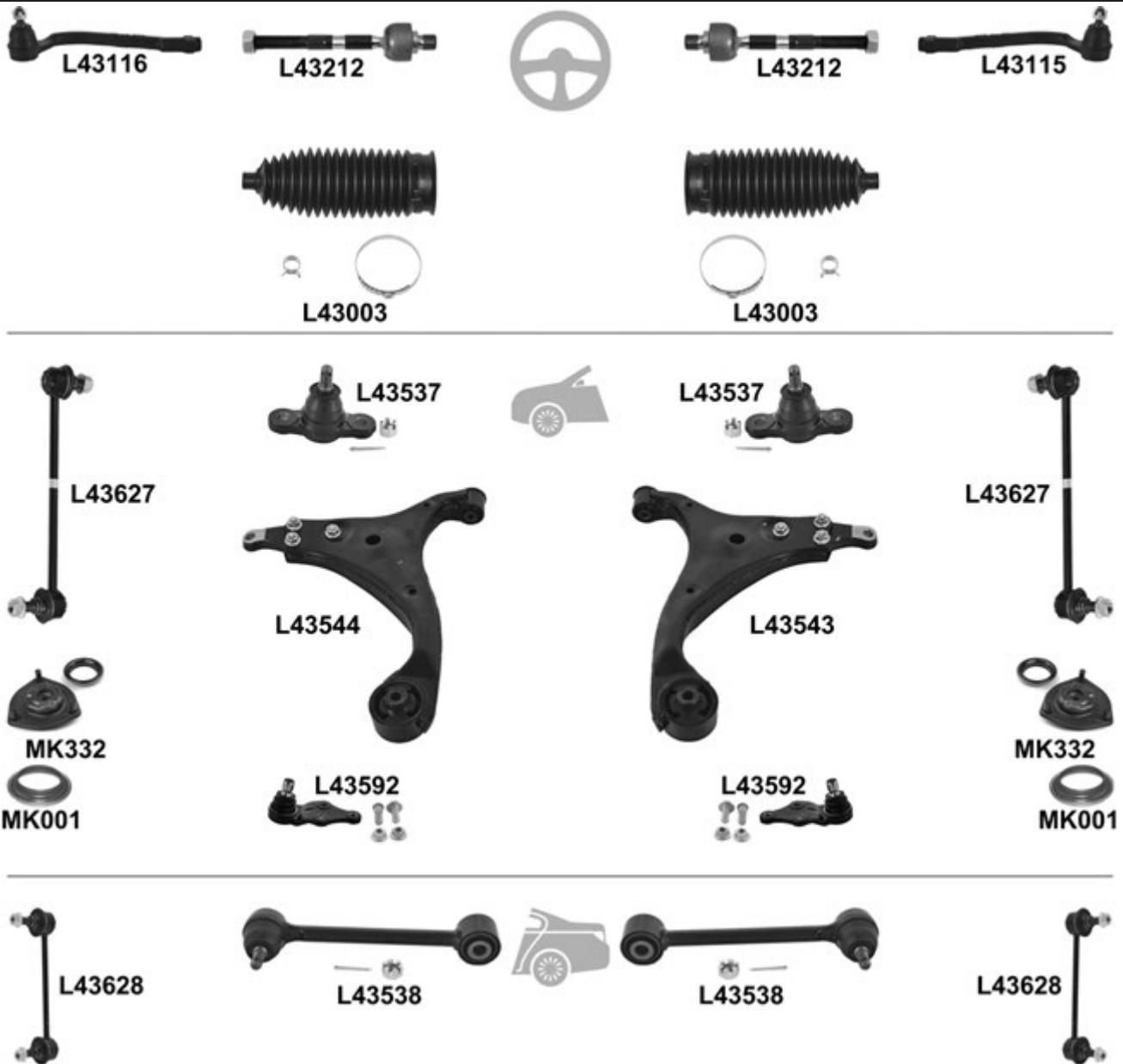

			←	→	Thread	Part Of	QPA		
		↔		L43115	F 14x1,5 U		1	56820-2H090	
				L43116	F 14x1,5 U		1	56820-2H000	
				L43212	M 14x1,5 / M 16x1,5 U		2	56240-2H000	
				∅ 12mm, ∅ 49mm, L= 170mm	L43003 ^o		2	57740-1H000	
		↓	→ 10.09	L43537	L43537		2	51760-2H000	
		↓	(-) L43537		L43543		1	54501-2H000	
				L43544			1	54500-2H000	
				L43627	L43627		2	54830-2H100	
			(+) MK001	KIT	MK332	MK332		2	54610-3H000
					MK001	MK001		2	54612-1G010
		↓			L43592 ^o	L43592 ^o		2	54530-3S100
		↗		L43538	L43538		2	55250-2H000	
				L43628	L43628		2	55530-2H000	

ProCeed 10.12 →



				←	→	Thread	Part Of	QPA			
		↓						2	54530-3S100		
			→ 04.14	<input checked="" type="checkbox"/>	L43592 ⁰	L43592 ⁰			1	54501-A6200	
					L43A04 ⁰				1	54500-A6200	
		↓	1.6 Gdi, Mot/Eng G4FD, → 01.13			L43647 ⁰	L43647 ⁰			2	54830-0U000
			1.6 Gdi, Mot/Eng G4FB, → 06.13			L43647 ⁰	L43647 ⁰			2	54830-0U000
		↓				L43653 ⁰	L43653 ⁰			2	55530-3R000

Retona (CE) 06.99 →



				←	→	Thread	Part Of	QPA		
		↔				L18107	F 18x1,5 ∪		1	OK011-32-240A
						L18108	F 18x1,5 ∪		1	OK011-32-250A
			→ ←			L18109	F 18x1,5 ∪		1	OK011-32-280
						L18110	F 18x1,5 ∪		1	OK011-32-230
		↓				L18501	L18501		2	OK011-34-510B

Rio 08.00 → 02.05

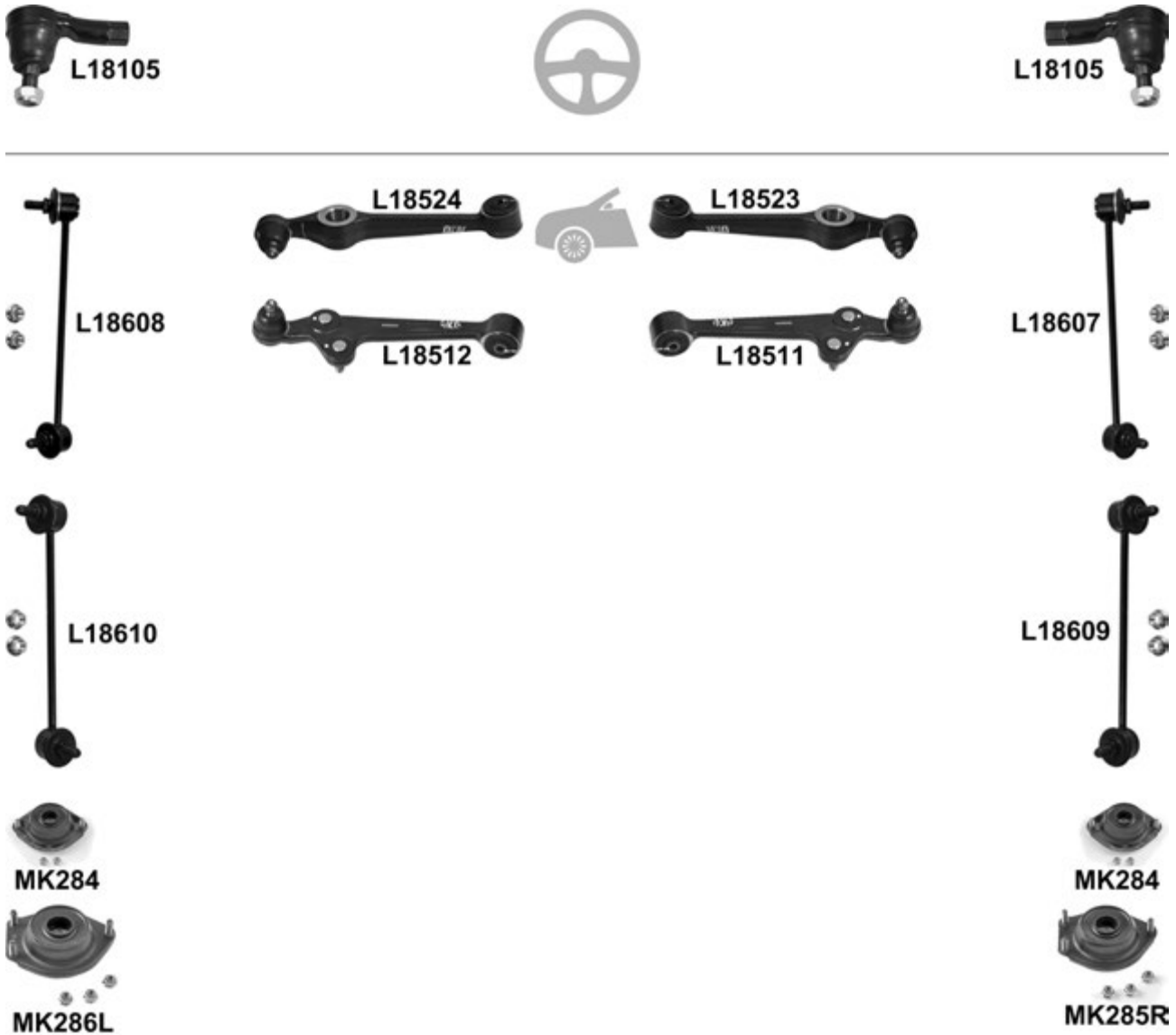

				← → Thread		Part Of	QPA			
		↔		L18105	L18105	F 12x1,25 ☺	2	MDX50-32-280		
		⊥	→ 06.02	<input checked="" type="checkbox"/>		L18523		1	OK30B-34-300B	
					L18524			1	OK30B-34-350B	
			07.02 →	<input checked="" type="checkbox"/>		L18511			1	54501-FD000
					L18512			1	54500-FD000	
		↔	→ 06.02				L18607		1	OK33C-34-150A
						L18608			1	OK33C-34-160A
07.02 →						L18609			1	54830-FD000
	↻	→ 07.02		KIT	MK284	MK284		2		
			07.02 →	KIT		MK285R		1	54615-FD000	
					MK286L			1	54610-FD000	

Rio II 03.05 →

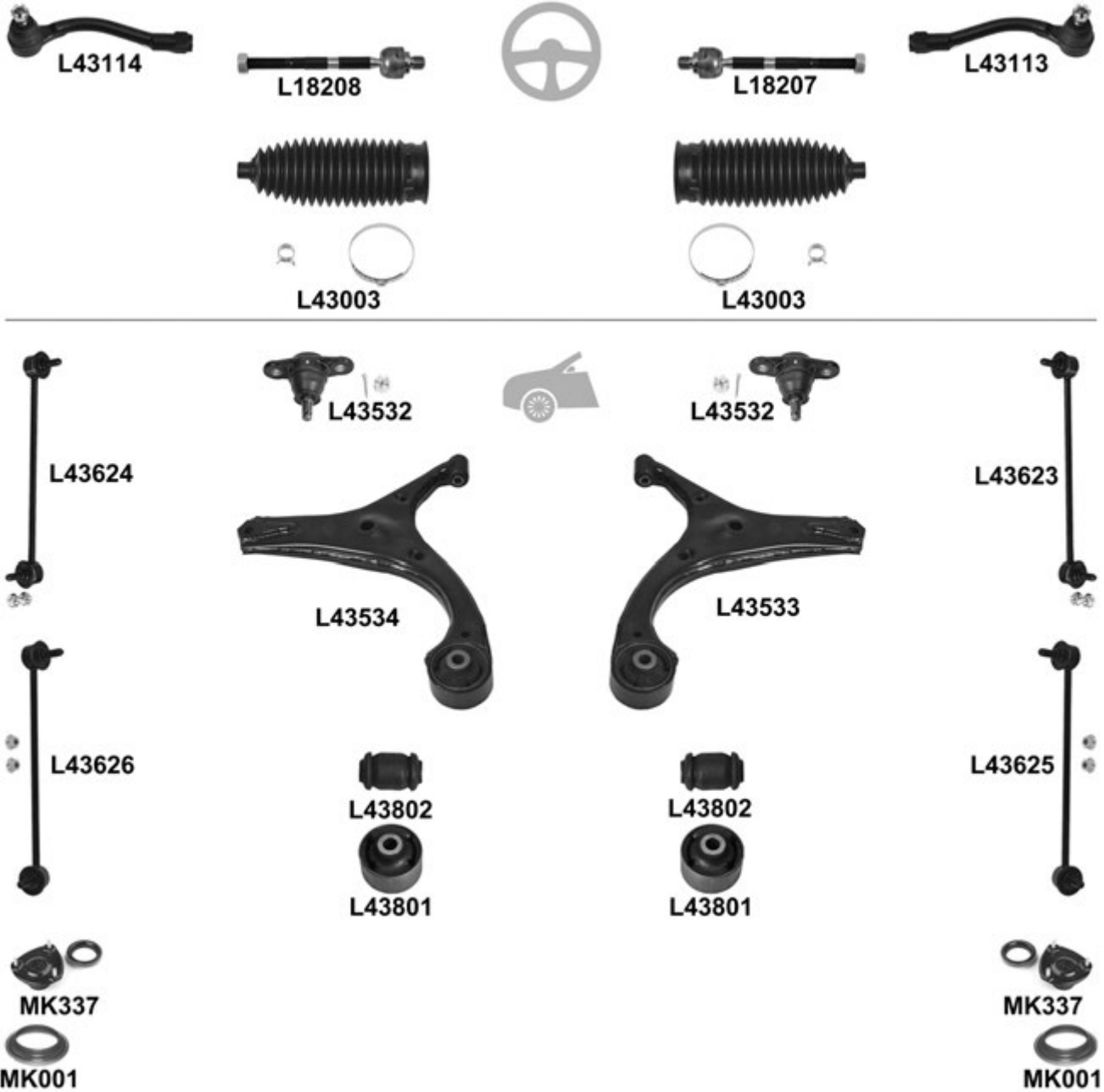

		i	←	→	Thread	Part Of	QPA	i	
⊕		↔		L43113	F 14x1,5 ∪		1	56820-3E900	
				L43114	F 14x1,5 ∪		1	56820-3E000	
				L18207	M 14x1,5 / M 18x1,5		1	57724-1G100	
				L18208	M 14x1,5 / M 18x1,5		1	57724-1G000	
		∅ 12mm, ∅ 49mm, L= 170mm	L43003 ⁰	L43003 ⁰			2	57740-1H000	
⊖		⊥	L43532	L43532			2	51760-1G000	
		⊥	(-) L43532	L43533			1	54501-1E000	
			L43534				1	54500-1E000	
		⊥▼	L43802	L43802			2	54551-1E000	
		⊥▲	L43801	L43801			2	54584-1G000	
			→ 08.06, 90°, L= 285,9		L43623			1	54840-1G000
					L43624			1	54830-1G000
			09.06 →, 75°		L43625			1	54840-1E000
			L43626				1	54830-1E000	
		KIT	MK337	MK337			2	54610-1G550	
			MK001	MK001			2	54612-1G010	

Rio (UB) 06.11 →

				← → Thread		Part Of	QPA		
		↓	1.6 16V	L43599 ⁰	L43599 ⁰		2	54530-2F000	
			02.12 →	L43647 ⁰	L43647 ⁰		2	54830-0U000	

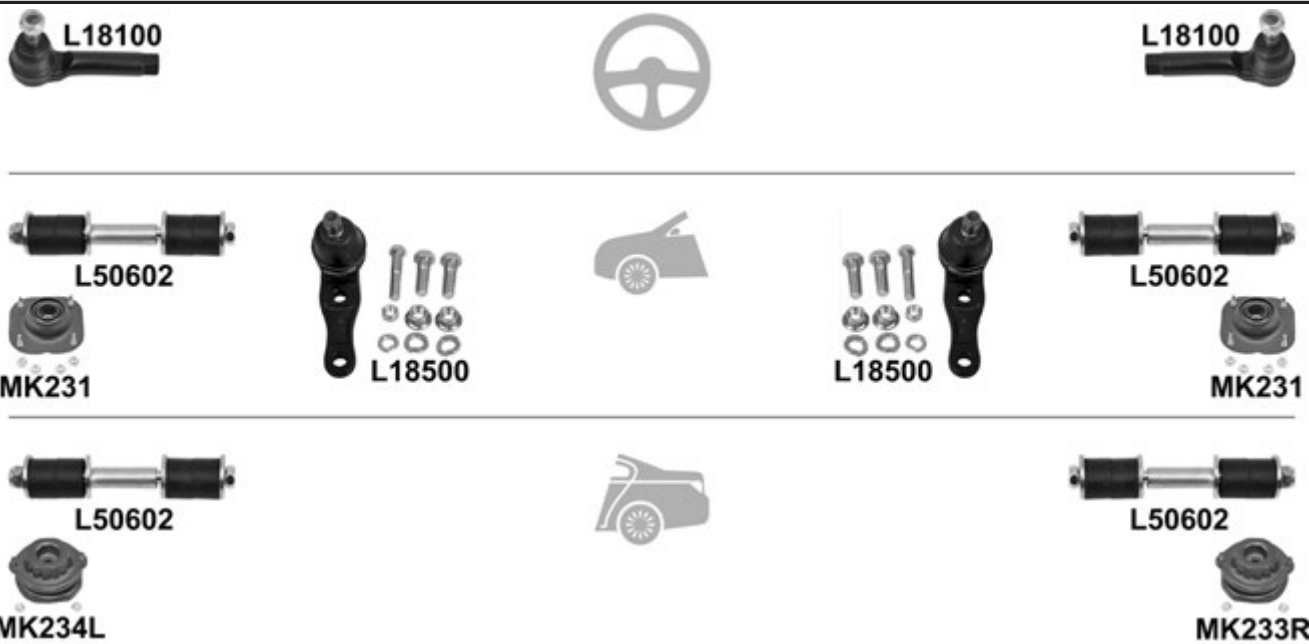
Sephia (FA) 09.93 → 10.97

				← → Thread		Part Of	QPA		
		↔		L18100	L18100		2	0K201-32-280	
		↓	↗ 16mm	L18500	L18500		2	0K201-34-550C	
				L50602	L50602		2		
				MK231	MK231		2		
				L50602	L50602		2		
					MK233R		1		
				MK234L			1		

Sephia (FB) 10.97 → 03.01

Thread
Part Of
QPA



				L18100	L18100			2	OK9A2-32-280
				L18506	L18506			2	K2A1-34-550A
				L18611	L18611			2	OK2A5-34-150B
				MK231	MK231			2	
				L50602	L50602			2	
				L18612	L18612			2	OK2A1-34-150A
					MK233R			1	
				MK234L				1	

Sephia II (FB) / Spectra 04.01 → 06.05

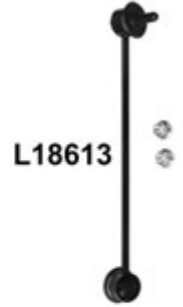
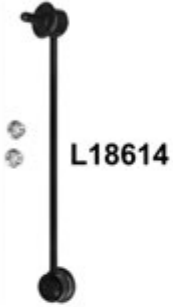

			i	←	→	Thread	Part Of	QPA	i
		↔		L18100	L18100			2	OK9A2-32-280
		⊥		L18506	L18506			2	K2A1-34-550A
		⊥	<input checked="" type="checkbox"/>		L18517			1	OK2NA-34-300B
				L18518				1	OK2NA-34-350B
					L18613			1	OK2N1-34-150A
				L18614				1	OK2N1-34-170A
			→ 06.03	L18612	L18612			2	OK2A1-34-150A

Shuma I (FB, FX) 03.96 →



Shuma I (FB, FX) 03.96 →

		i	←	→	Thread	Part Of	QPA	i	
		↔			L18100	L18100		2	OK9A2-32-280
		↓	→ 10.97,		L18500	L18500		2	OK201-34-550C
			10.97 →,		L18506	L18506		2	OK2A1-34-550A
		↓	10.97 → 09.00,	<input checked="" type="checkbox"/>		L18515		1	OK2A1-35-300G
					L18516		1	OK2A1-35-350G	
			10.00 →,	<input checked="" type="checkbox"/>		L18517		1	OK2NA-34-300B
				L18518		1	OK2NA-34-350B		
	↔	→ 09.00			L18611	L18611		2	OK2A5-34-150B
		10.00 →				L18613		1	OK2N1-34-150A
					L18614		1	OK2N1-34-170A	
					MK232	MK232		2	
		→ 06.03			L18612	L18612		2	OK2A1-34-150A
						MK233R		1	
					MK234L		1		

Shuma II / Mentor (FB) 05.01 →

		i	←	→	Thread	Part Of	QPA	i	
		↔			L18100	L18100		2	OK9A2-32-280
		↓			L18506	L18506		2	K2A1-34-550A
						L18517		1	OK2NA-34-300B
		↓		<input checked="" type="checkbox"/>		L18518		1	OK2NA-34-350B
							L18613		1
					L18614		1	OK2N1-34-170A	
		→ 06.03			L18612	L18612		2	OK2A1-34-150A

Sorento (JC) 08.02 →



Sorento (JC) 08.02 →

			←	→	Thread	Part Of	QPA		
		↔		L18111	↺		1	56820-3E900	
				L18112	↺		1	56820-3E000	
				L18203			1	57731-3E010	
				L18204			1	57732-3E010	
			ø 15mm, Ø 54mm, L= 237mm				2	0K552-32-125	
		↓		L18521	L18521		2	54570-3E001	
			<input checked="" type="checkbox"/>		L18519		1	54420-3E002	
		↑	<input checked="" type="checkbox"/>		L18520		1	54410-3E002	
			<input checked="" type="checkbox"/>		L18525		1	54520-3E003	
			→ 02.04	KIT		L18621	L18621	2	54810-3E000
							L18623		1
			03.04 →			L18624		1	54811-3E010
							MK216	MK216	2
		03.04 →				L18625	1	55580-3E050	
						L18626		1	55580-3E000

Sorento (XM) 11.09 →

			←	→	Thread	Part Of	QPA	
		↔		L43117	↺		1	53821-2B900
				L43118	↺		1	53821-2B000
		↓		L43521	L43521		2	54530-3B000
					L43629		1	54840-2B000
			(-) 2.4 Gdi		L43630		1	54830-2B000
			(-) 2.4 Gdi, L= 99,4mm		L43631	L43631	2	55530-2B000

Soul 02.09 →



L43120



L43119



L43802



L43802



Thread

Part Of

QPA



				L43119	↺			1	56820-2K000
				L43120	↻			1	56820-2K050
			(-) 1.6 CRDi	L43802	L43802			2	54551-1E000
			1.6 CRDi → 12.09	L43802	L43802			2	54551-1E000

Sportage (KOO) 04.94 →



L18108



L18107



L18110



L18109



L18618



L18501



L18501



L18618



MK217



MK217



Thread

Part Of

QPA



				L18107	↺			1	OK011-32-240A
				L18108	↻			1	OK011-32-250A
				L18109	↺			1	OK011-32-280
				L18110	↻			1	OK011-32-230
				L18501	L18501			2	OK011-34-510B
				L18618	L18618			2	OK011-34-160A
			04.00 →	KIT	MK217	MK217		2	

Sportage 09.04 →



Sportage 09.04 →

			i	←	→	Thread	Part Of	QPA	i
		↔			L43111	∩		1	56820-2E900
					L43112	∩		1	56820-2E000
					L43219	L43219		2	57724-2E000
				∅ 16mm, ∅ 51mm, L= 186mm	L43004 ^o	L43004 ^o		2	57740-2E000
		⊥			L43545	L43545		2	51760-2E000
				<input checked="" type="checkbox"/>		L43553		1	54501-1F100
		⊥			L43554			1	54500-1F100
					L43804	L43804		2	54551-2E000
					L18619	L18619		2	54830-2E000
					L18620	L18620		2	55530-2E000
						MK211R		1	55320-2E000
					MK212L		1	55310-2E000	

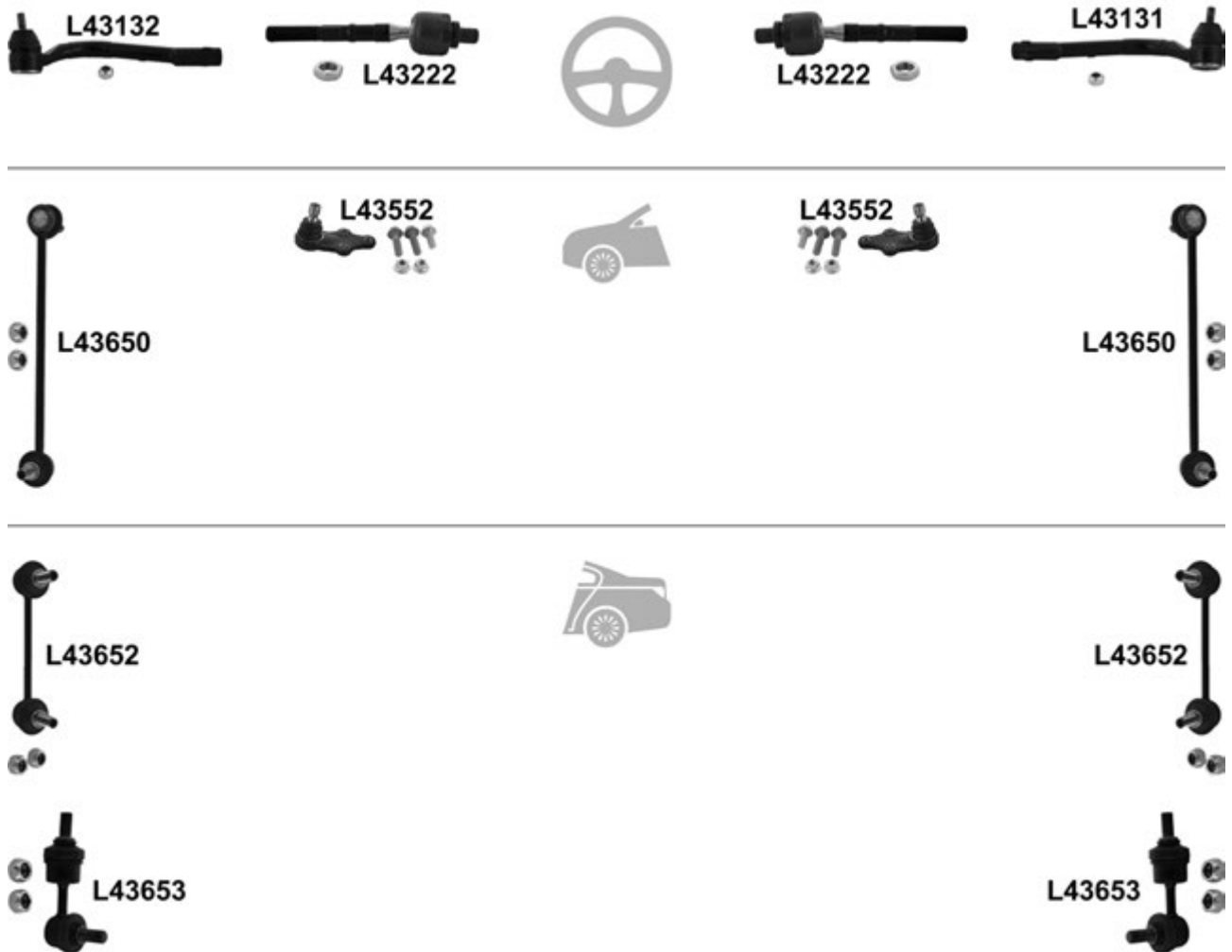
Sportage (SL) 07.10 →

			i	←	→	Thread	Part Of	QPA	i
		↔			L43131	F 16x1,5 ∩		1	56820-2S050
					L43132	F 16x1,5 ∩		1	56820-2S000
					L43222	L43222	M 16x1,5 / M 16x1,5	2	57724-2S000
		⊥			L43552	L43552		2	54530-3S000
				Prod. KR → 10.11	L43650	L43650		2	54830-2S200
			Prod. SK → 08.12		L43650	L43650		2	54830-2S200
				(-) 1.6 Gdi/1.7 CRdi KW110/120/2.0 Crdi KW122, L= 140mm	L43652	L43652		2	55530-3R000
				1.6 Gdi/1.7 CRdi KW110/120/2.0 Crdi KW122, L= 88mm	L43653 ^o	L43653 ^o		2	55530-3R000

Venga (YN) 02.10 →

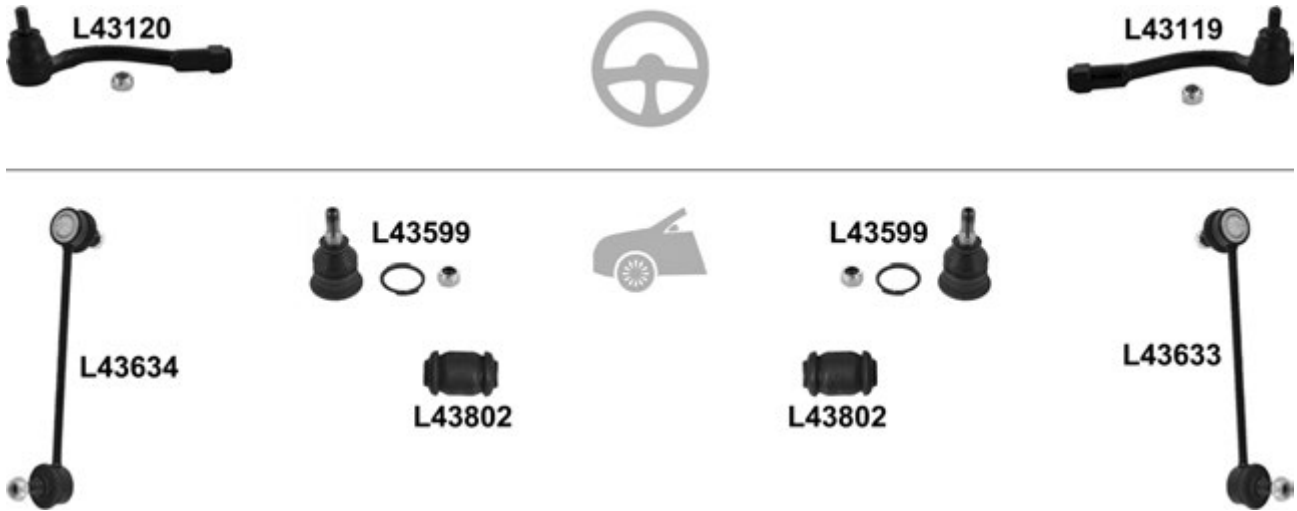

			i	←	→	Thread	Part Of	QPA	i
		↔			L43119	F 16x1,5 ∪		1	56820-2K000
				L43120		F 16x1,5 ∪		1	56820-2K050
		⊥		L43599 ^o	L43599 ^o			2	54530-0U000
				L43802	L43802			2	54551-1E000
					L43633			1	54840-1J000
				L43634			1	54830-1J000	

LADA
Kalina (1117, 1118, 1119) 10.04 →

Thread
Part Of
QPA

				L70003	L70003			2	2108 290 4185
--	--	--	--	---------------	---------------	--	--	---	---------------

Niva 12.76 →

Thread
Part Of
QPA

				L1526	L1526	M 16x1 ⤴		2	2101 300 3057
				L7020	L7020	M 16x1 ⤴		2	2121 341 4116
				L0705	L0705			2	2101 290 4192
				L0705	L0705			2	2101 290 4192

Samara 01.86 →

Thread
Part Of
QPA

					L70001	M 16x1 ⤴		1	2108 341 4056
				L70002		M 16x1 ⤴		1	2108 341 4057
				L70003	L70003			2	2108 290 4185
				MK191	MK191			2	

110, 111, 112 01.95 →



MK192



L70003



L70003



MK192



Thread

Part Of

QPA



		↓		L70003	L70003			2	2108 290 4185
				MK192	MK192			2	

1200 - 1600 01.70 →



L1526



L1526



L0705



L0705



L0704



L0704



Thread

Part Of

QPA



		↔		L1526	L1526	M 16x1 ☺		2	2101 300 3057
		↑		L0705	L0705			2	2101 290 4192
		↓		L0704	L0704			2	2101 290 4082

LANCIA

Dedra (835) 08.89 → 07.99
 Dedra SW (835) 07.94 → 07.99



Dedra (835) 08.89 → 07.99
Dedra SW (835) 07.94 → 07.99

			←	→	Thread	Part Of	QPA		
		↔	→ 12.97		L1531	F 12x1,5 ♂	1	9947438	
			(-) 1.6 16V / 1.8 16V LE / GT 16V / iE						
			(-) 2.0 16V / Integrale, L= 128mm	L1532		F 12x1,5 ♂		1	9947437
			↔	01.98 →	L15109	L15109	F 12x1,5 ♂	2	9947714
	(-) 1.6 16V / 1.8 16V LE / GT 16V / iE								
	(-) 2.0 16V / Integrale, L= 128mm								
			→ 12.97	L1570	L1570	M 12x1,5 / F 14x1,5 ♂	2	7633721	
			→ 12.97 ,	L1534	L1534	♂	2	9941625	
				L15001	L15001		2	7645160	
		⊥	→ 06.90	<input checked="" type="checkbox"/>	L1535		1	7601062	
					L1536		1	7601057	
			07.90 →	<input checked="" type="checkbox"/>	L15509		1	7777240	
					L15510		1	7777239	
			⊥	→ 07.90 →		L15801	L15509	1	
					L15802		L15510	1	
			⊥	→ 07.90 →	L15800	L15800	L15509/L15510	2	
				(-) 1.6 16V / 2.0 16V / 1.9 TD	L15601	L15601		2	60809242S
				1.6 16V / 2.0 16V / 1.9 TD	L15600	L15600		2	46413122
				→ 12.97 , (+) MK007	KIT	L15903 ¹		1	60811372S
						L15904 ¹		1	60811373S
	01.98 →			MK051	MK051		2	46469709	
			→ 12.97	MK007	MK007	MK051	2	7601502	

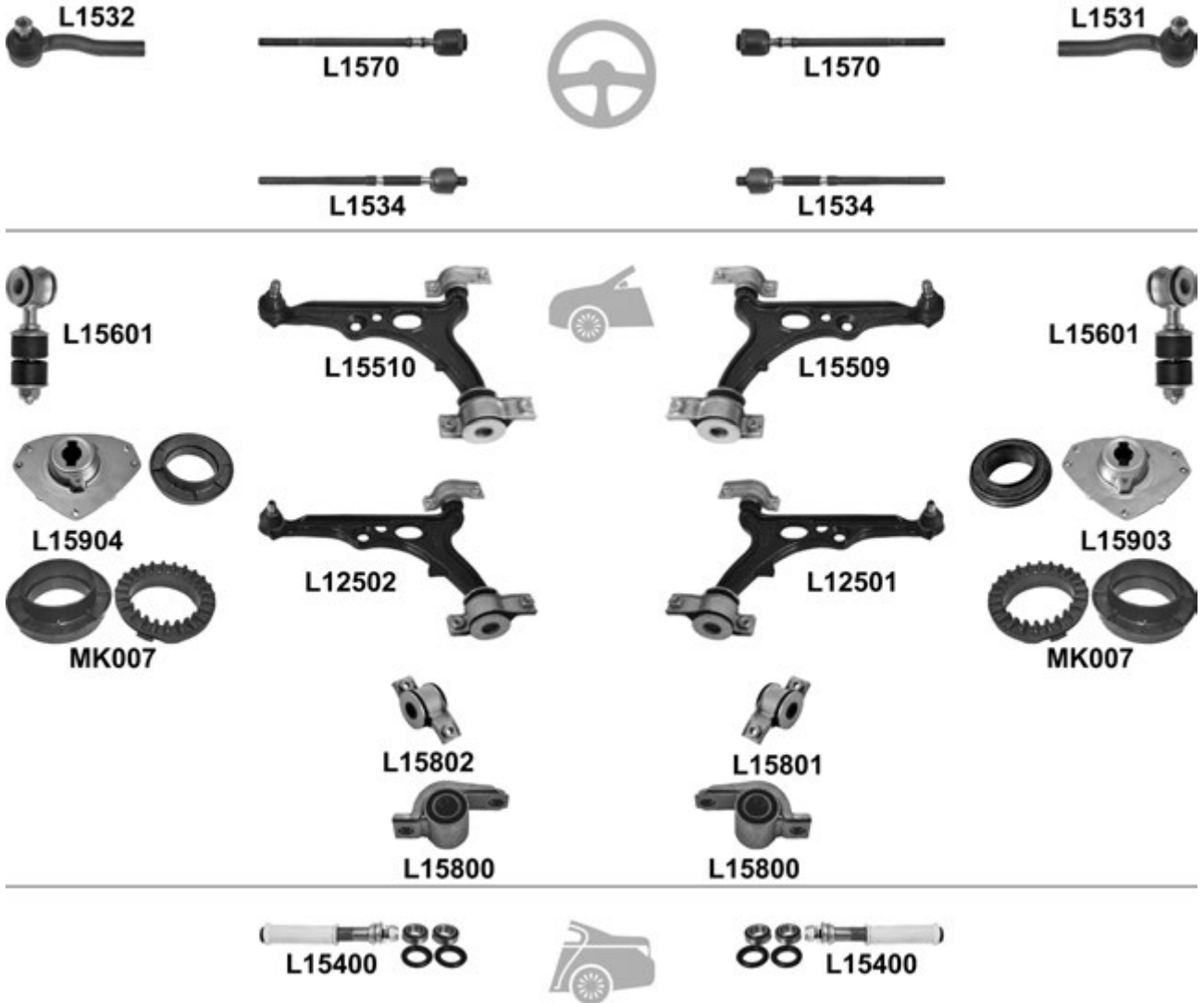
Delta II (836) 06.93 → 08.99

				← → Thread		Part Of	QPA				
⊕		↔	(-) 2.0 16V Turbo, L= 128mm	L1531	F 12x1,5 ∪		1	7591215			
				L1532	F 12x1,5 ∪		1	7591216			
				L1570	L1570	M 12x1,5 / F 14x1,5 ∪		2	7633721		
				L1534	L1534	∪		2	9941625		
⊖		⊥	(-) 2.0 16V, 2.0 16V Turbo, 1.9 TD	<input checked="" type="checkbox"/>	L15509			1	7777240		
				<input checked="" type="checkbox"/>	L15510			1	7777239		
				<input checked="" type="checkbox"/>	L12501			1	7780444		
				<input checked="" type="checkbox"/>	L12502			1	7780443		
		⊥	↙			L15801		L15509	1		
						L15802		L15510	1		
		⊥	↗			L15800	L15800		L15509/L15510	2	
						L15601	L15601		2	60809242S	
				(+) MK007	KIT		L15903 ¹		1	60811372S	
							L15904 ¹		1	60811373S	
						MK007	MK007		MK051	2	7601502
				KIT	L15400	L15400		2			

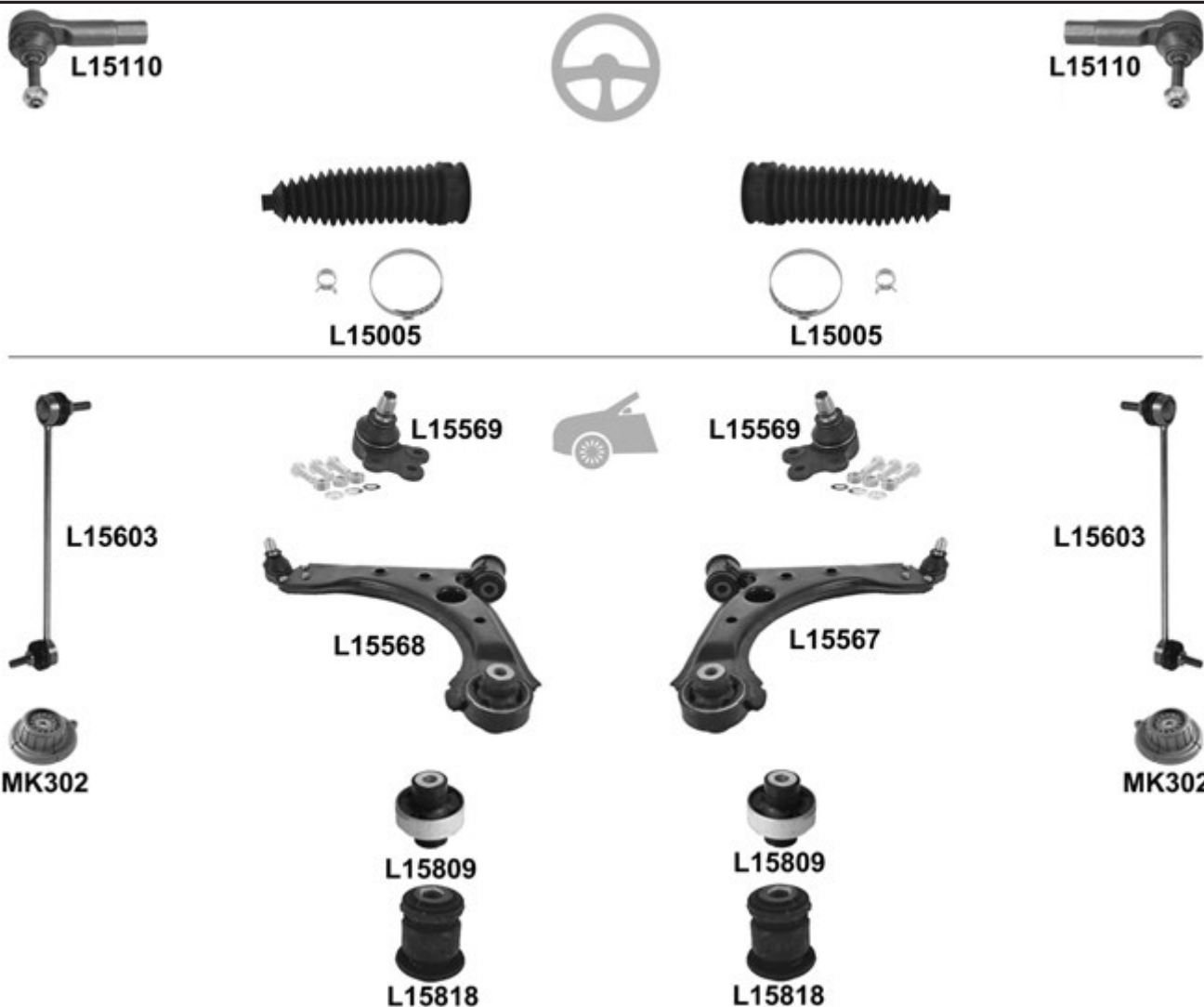
Delta III 09.08 →

		i	←	→	Thread	Part Of	QPA	i
		↔	L15110	L15110	F 14x1,5 U		2	9949218
			L15005 ^o	L15005 ^o			2	77364341
		↓	L15569	L15569			2	
		↓	<input checked="" type="checkbox"/>	L15567			1	51827737
			L15568				1	51827736
		↓	L15809	L15809			2	50700778
		↓	L15818	L15818			2	50704262
			L15603	L15603			2	51801136
			KIT	MK302	MK302		2	50702841

Kappa (838A) 08.94 → 10.01
 Kappa SW (838B) 07.96 → 10.01
 Kappa Coupe (838) 07.96 → 03.01



L1582



L1582



L15605



L15605

					←	→	Thread	Part Of	QPA	
		↔			L1582	L1582	F 14x1,5 ♂		2	82460439
					L15605	L15605			2	46462049

Lybra (839AX) 07.99 →
 Lybra SW (839BX) 07.99 →

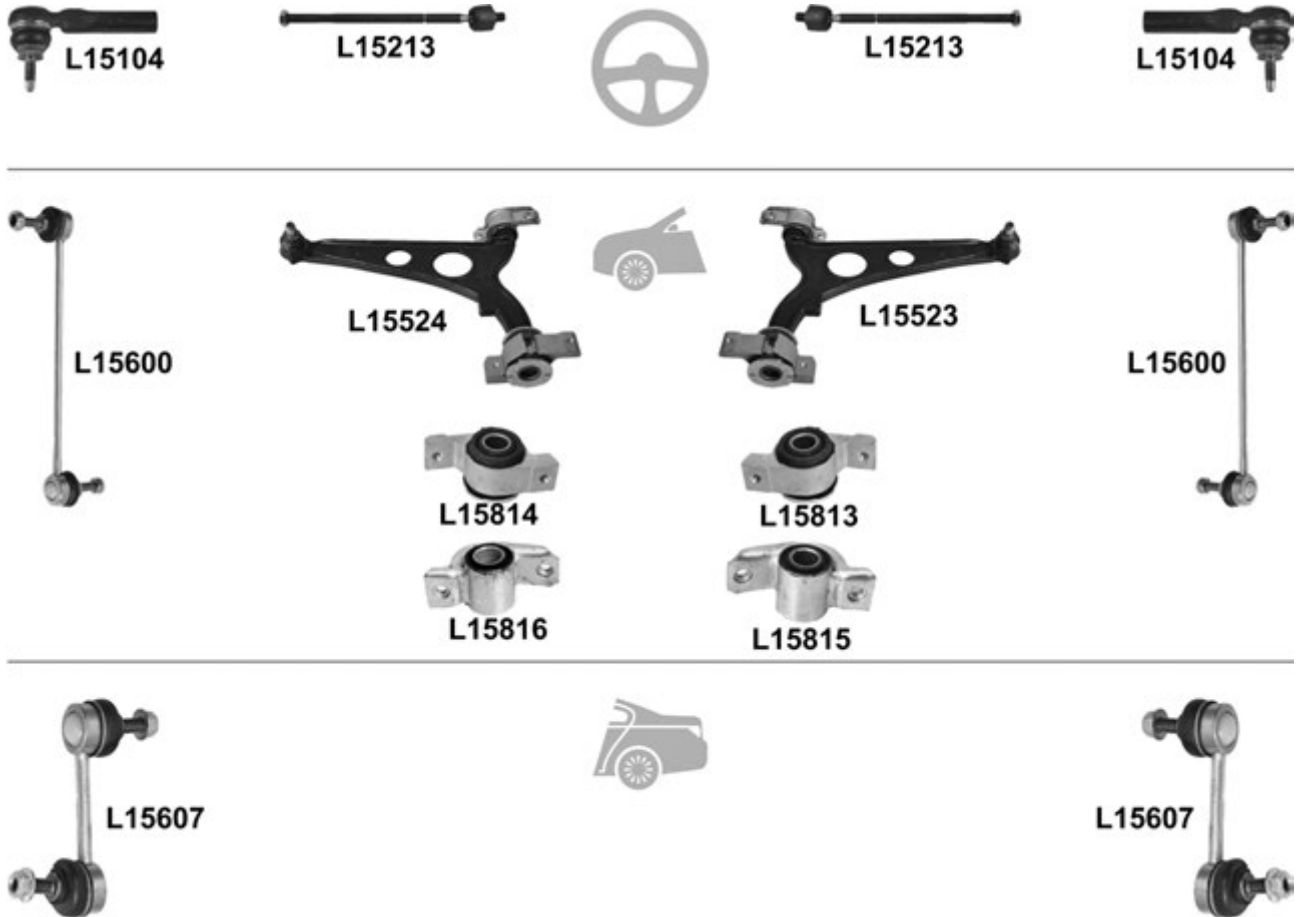

				← → Thread		Part Of	QPA		
		↔		L15104	L15104	F 14x1,5 U	2	9947926	
				L15213	L15213	M 14x1,5 / M 14x1,5 U	2	9948296	
		⊥	<input checked="" type="checkbox"/>		L15523			1	46764747
				L15524				1	46764746
		⊥ ▾			L15813		L15523	1	
				L15814			L15524	1	
		⊥ ▲			L15815		L15523	1	
				L15816			L15524	1	
				L15600	L15600			2	51701045
				L15607	L15607			2	46545749

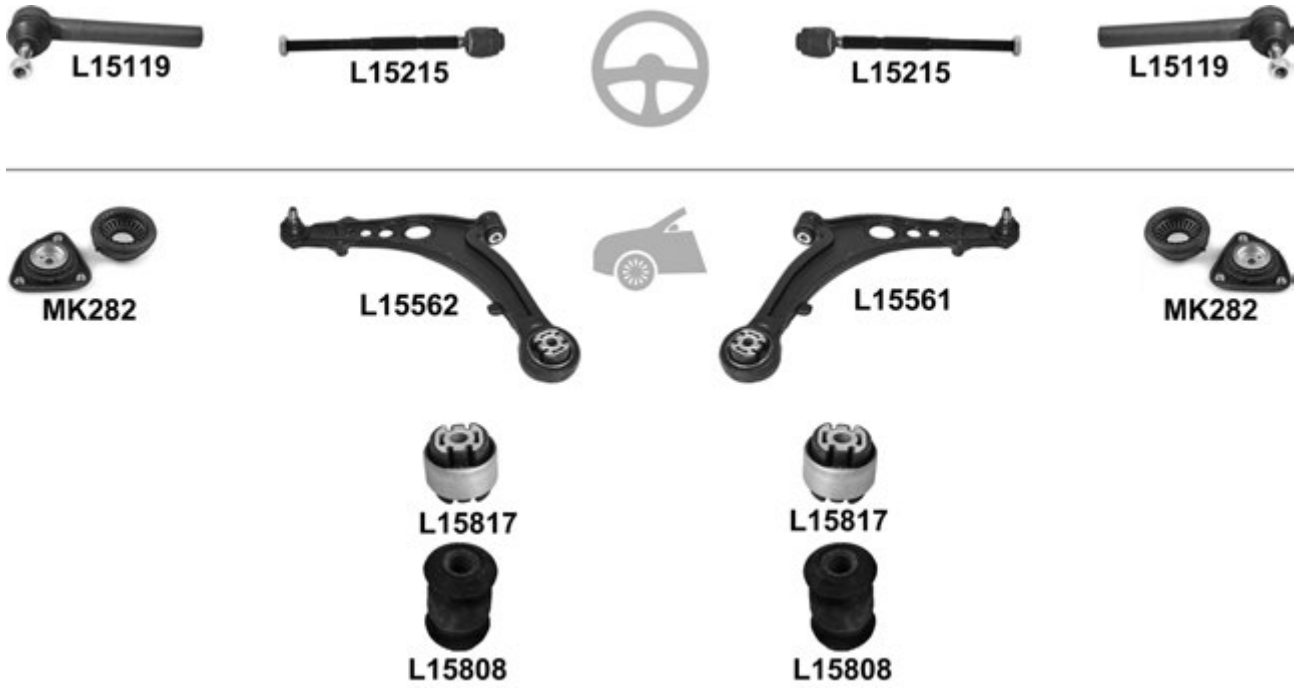
Musa 10.04 →

						←	→	Thread	Part Of	QPA	
		↔		L15119	L15119			F 14x1,5 ∪		2	77362503
				L15215	L15215			M 14x1,5 / F 14x1,5 ∪		2	77362502
		⊥				<input checked="" type="checkbox"/>		L15561		1	50703231
					L15562						1
		⊥▼			L15817	L15817				2	
		⊥▲			L15808	L15808				2	
			01.06 →	KIT	MK282	MK282				2	51830518

Phedra (179) 09.02 →

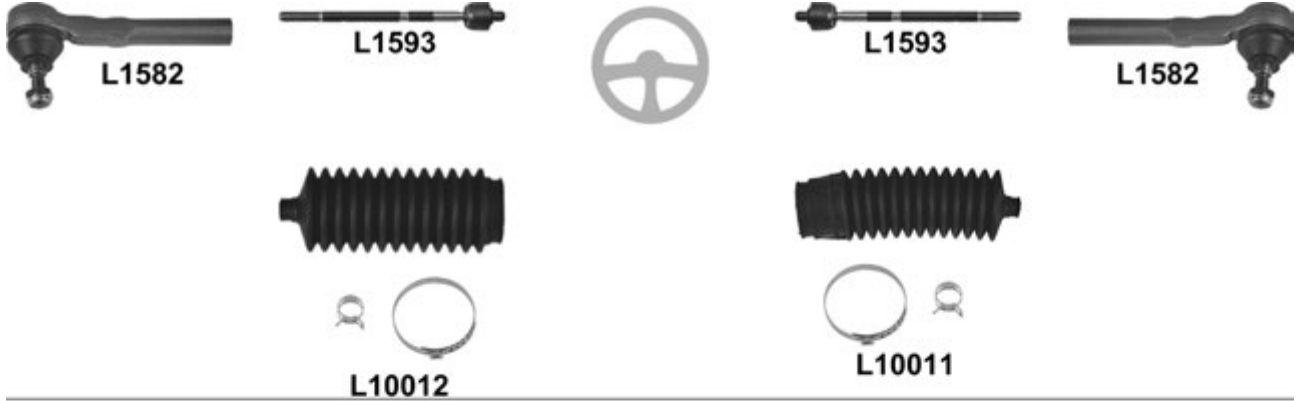

				← → Thread		Part Of	QPA	
		↔		L10108	L10108	F 14x1,5 ♂	2	7736279
		⊥	→ 05.07, 12mm ↔	<input checked="" type="checkbox"/>	L10529		1	93501488
				<input checked="" type="checkbox"/>	L10530		1	35011487
			06.07 →, ↗ 17mm, 14mm ↔	<input checked="" type="checkbox"/>	L10577		1	1356061080
				<input checked="" type="checkbox"/>	L10578		1	1356060080
			↖ 19mm	<input checked="" type="checkbox"/>	L10571		1	3521.N9
				<input checked="" type="checkbox"/>	L10572		1	3520.R8
				L10608	L10608		2	1331209080
			(+) MK048	KIT	MK269R		1	1311931080
				MK270L			1	1311930080
				MK048	MK048		2	1303672080

Thema (834), (-) 8.32 11.84 → 07.94
Thema SW (834) 03.87 → 07.94

		i		←	→	Thread	Part Of	QPA	i
		↔	04.86 →	L1582	L1582	F 14x1,5 ∪		2	9941186
			04.86 →	L1593	L1593	M 14x1,5 / M 14x1,5 ∪		2	9940260
			: OE 9938779=set of 2		L10011			1	9938779
				L10012				1	9938779*
		⊥		L1581	L1581			2	82446499
		⊥	→ 12.91	<input checked="" type="checkbox"/>	L1578			1	82406868
				L1579				1	82406867
				MK060	MK060			2	
				MK116	MK116			2	82430666

Thesis (841AX) 07.02 →

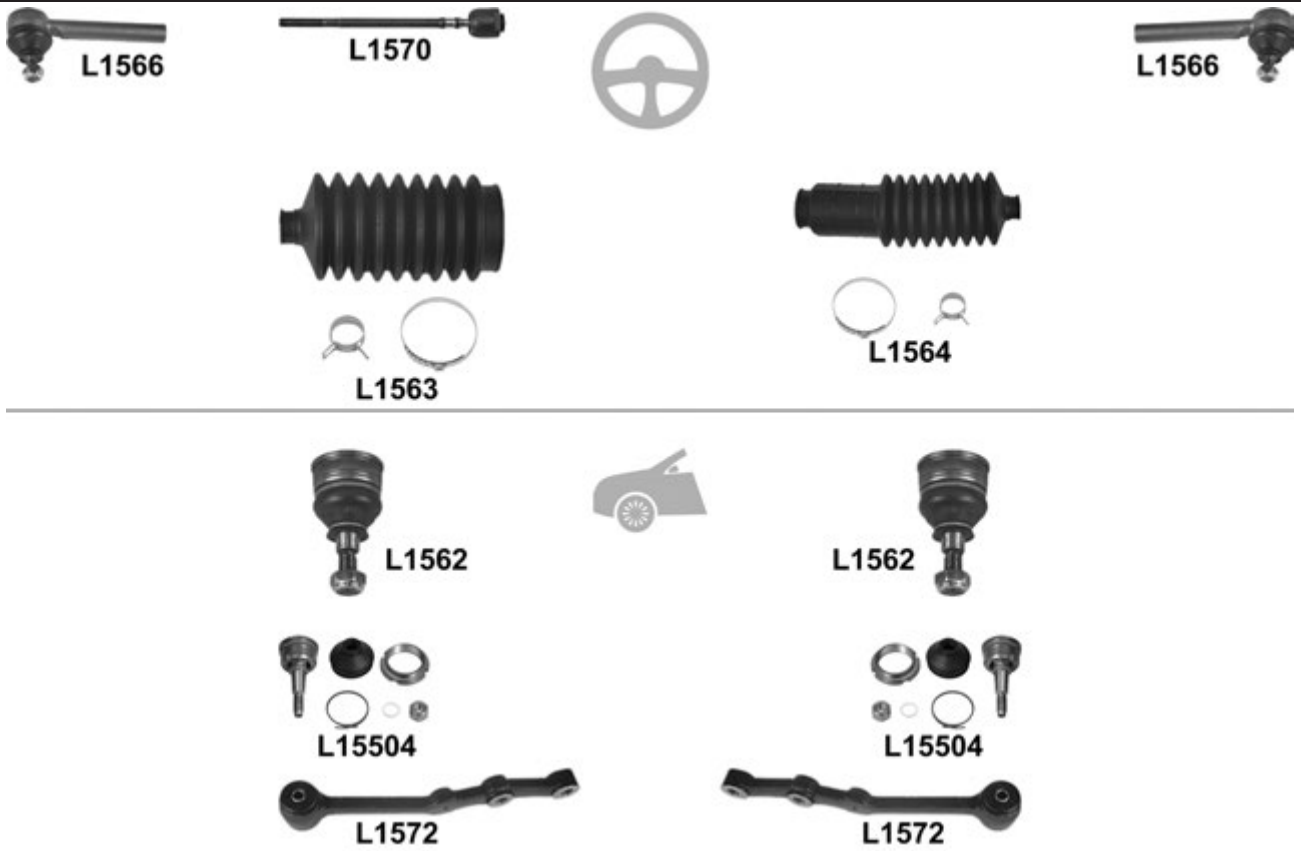

		i		←	→	Thread	Part Of	QPA	i
		↔			L12103	F 14x1,5 ∪		1	9947920
				L12104		F 14x1,5 ∪		1	9947919

Y10 03.85 →

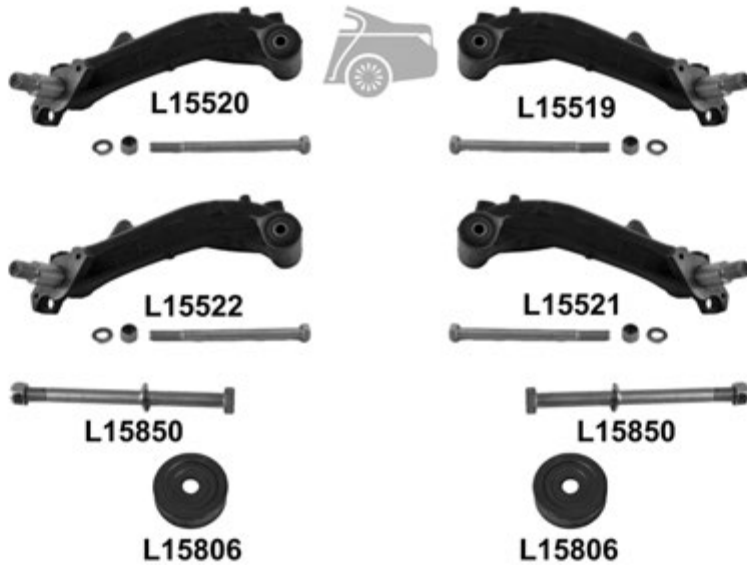
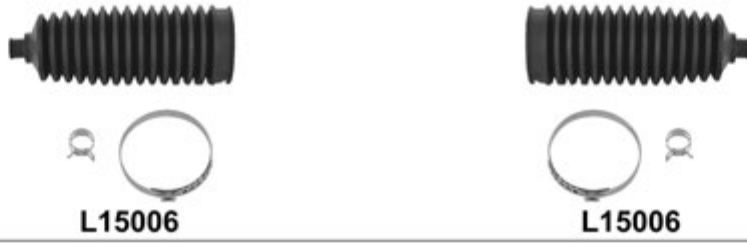

						←	→	Thread	Part Of	QPA	
⊕		↔		L1566	L1566			F 12x1,5 U		2	5958247
				L1570				M 12x1,5 / F 14x1,5 U		1	7633721
					L1564					1	4371156
				L1563						1	4371155
⊖		↓		L1562	L1562					2	4402649
		↓	KIT	L15504	L15504					2	
		↓		L1572	L1572					2	7601261

Y (840A) 11.95 →



Y (840A) 11.95 →

			i	←	→	Thread	Part Of	QPA	i		
		↔		L15101	L15101	F 12x1,5 ∪		2	7752285		
				L15202	L15202	M 12x1,5 / M 16x1,5 ∪		2	9945562		
				L15006 ^o	L15006 ^o			2	9945564		
		⊥		<input checked="" type="checkbox"/>		L15507		1	46430002		
					L15508			1	46430003		
		⊥↘				L15803		L15507	1		
					L15804				L15508	1	
		⊥↗			L15805	L15805			L15507/L15508	2	
			KIT	MK050	MK050			2	7775940		
				KIT	L15850	L15850				2	7719062
			(-)			L15519			1	7736515	
					L15520			1	7736514		
			(+)			L15521			1	7769901	
					L15522			1	7769900		
				L15806	L15806		Hub carrier	2	46476755		

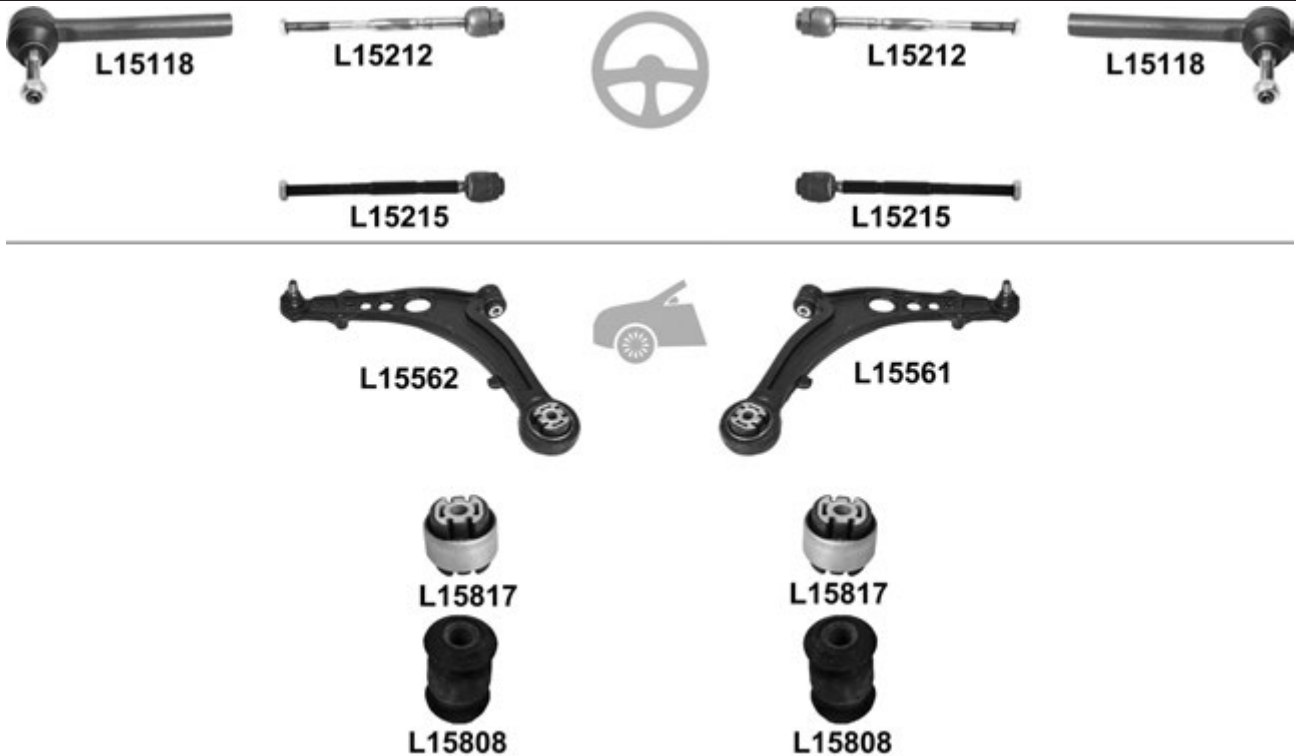
Ypsilon (843) 10.03 →

			i	←	→	Thread	Part Of	QPA	i	
		↔		L15118	L15118	F 12x1,5 ∪		2	77362381	
				L15212	L15212	M 12x1,5 / M 14x1,5 ∪		2	77362380	
				L15215	L15215	M 14x1,5 / F 14x1,5 ∪		2	77362502	
		⊥		<input checked="" type="checkbox"/>		L15561		1	50703231	
					L15562			1	50703232	
		⊥↘			L15817	L15817			2	
					L15808	L15808			2	

Ypsilon (846) 05.11 →



L10019

L10019



L15603



L15603



MK305



MK305



Thread

Part Of

QPA



				L10019	L10019			2 77362509
				L15603	L15603			2 51801136
			KIT	MK305	MK305			2 51831016

Zeta (220) 05.95 → 09.02



				← → Thread		Part Of	QPA	i	
⊕		↔		L10101	L10101	F 14x1,5 U	2	1306003080	
				L16074	L16074		2	9404066418	
⊖		⊥	☑		L10541		1	1316736080	
				L10542			1	1316735080	
					L10507		1	1333755080	
				L10508		1	1333754080		
				L10601	L10601		2	1317425080S	

LAND ROVER

Defender LD 09.90 →
 Defender Station Wagon LD 09.90 →
 Defender Pick-up 10.95 →



		i		←	→	Thread	Part Of	QPA	i
		↔		L17115		M 11/16 "x20 UNF ☺		1	RTC 5869
					L17116		M 11/16 "x20 UNF ☺		1
				L17601	L17601			2	NTC 1888
		↓	ch. KA930264 →	L17505	L17505			2	ANR 1799
				L17601	L17601			2	NTC 1888

Discovery I 09.89 → 06.94



			i	←	→	Thread	Part Of	QPA	i
		↔		L17115		M 11/16 "x20 UNF ♂		1	RTC 5869
					L17116	M 11/16 "x20 UNF ♂		1	RTC 5870
				L17601	L17601			2	NTC 1888
		↓		L17505	L17505			2	ANR 1799
				L17601	L17601			2	NTC 1888

Discovery II LJ, LT 06.94 →



			i	←	→	Thread	Part Of	QPA	i
		↓		L17505	L17505			2	ANR 1799

Discovery III TAA 10.04 →

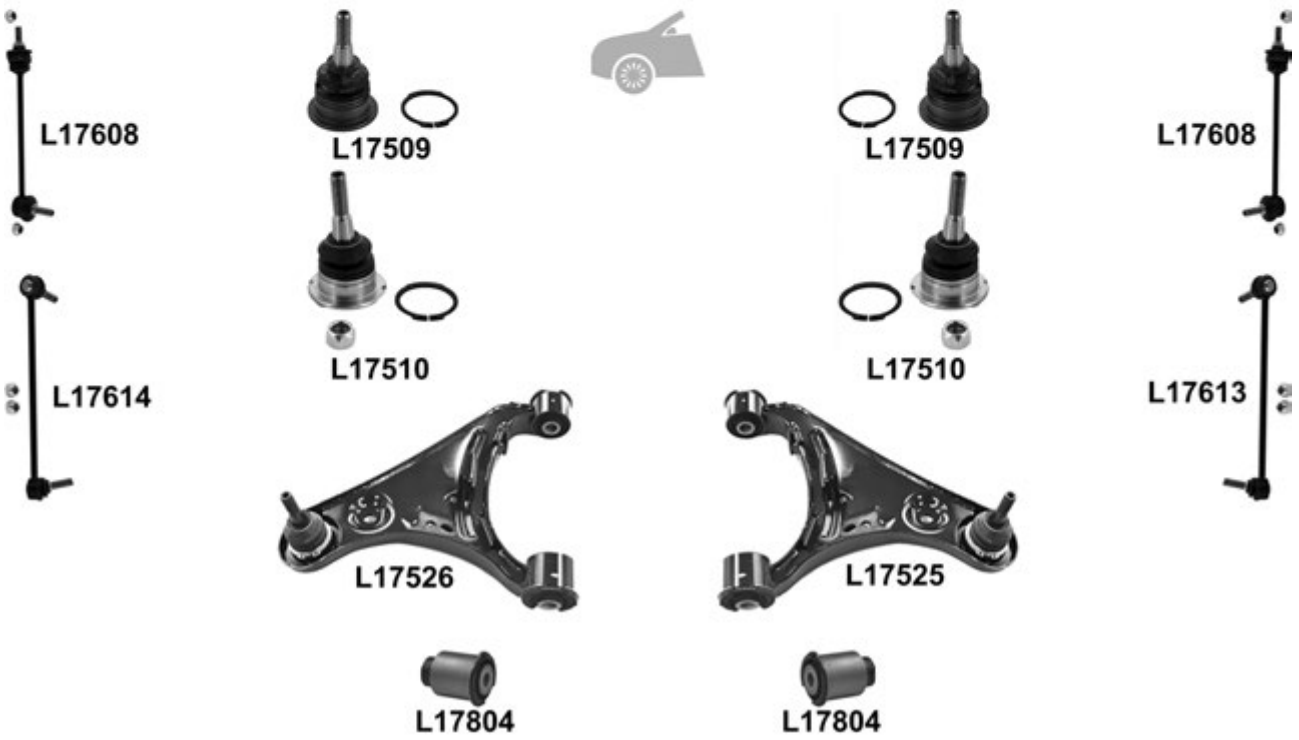
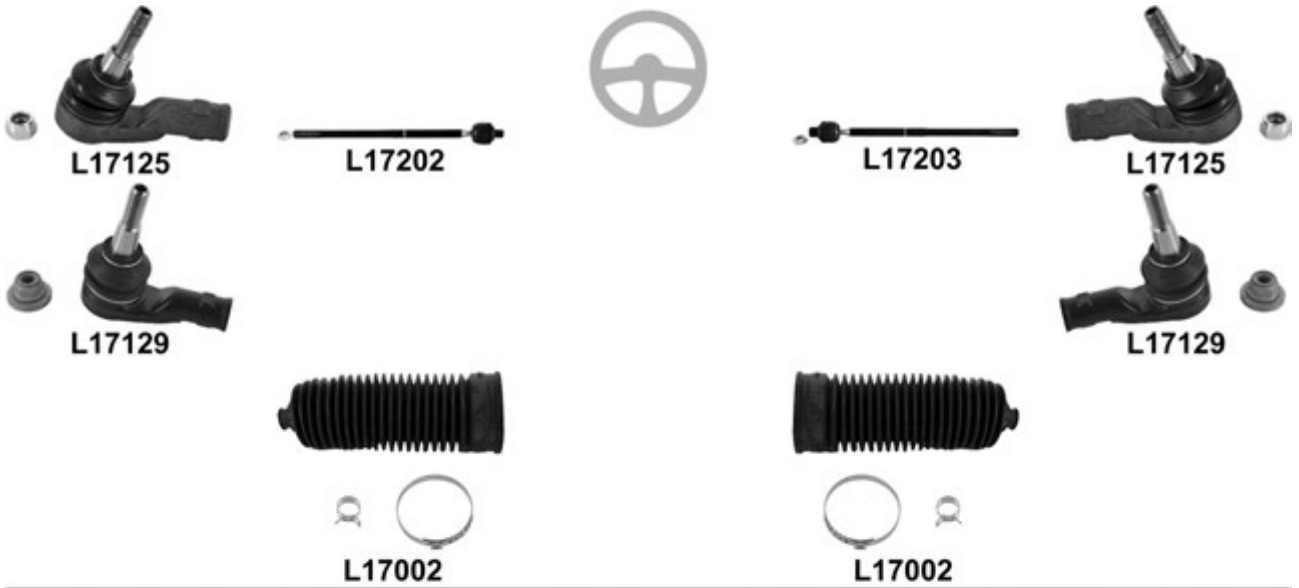

Discovery III TAA 10.04 →



Discovery III TAA 10.04 →

		i		← →		Thread	Part Of	QPA	i
		↔	ch. → 9A496359	L17125	L17125	F 16x1,5 ∪		2	LR010671
			ch. 9A496360 →	L17129	L17129	F 16x1,5 ∪		2	LR010672
					L17203	M 16x1,5 / M 20x1,5 ∪		1	QFK500020
					L17202	M 16x1,5 / M 16x1,5 ∪		1	QFK500010
					L17002 ^o	L17002 ^o		2	QFW500010
		↑	(-) AD	L17509 ^o	L17509 ^o			2	RBK500030
			AD	L17510	L17510			2	RBK500170
		↑			L17525 ^o			1	RBJ500222
					L17526 ^o			1	RBJ500232
		⊥ ↗ ↖ ↔	(-) AD	L17804	L17804		L17527/L17528/ L17529/L17530	2	RBX500311
			(-) AD	L17608	L17608			2	RBM500190
			AD		L17613 ^o			1	RBM500140
				L17614 ^o			1	RBM500150	
		⊥	(-) AD		L17527			1	RBJ501560
					L17528			1	RBJ501570
			, (-) AD		L17529			1	RBJ501540
					L17530			1	RBJ501550
		ch. → 6A999999, (-) AD	L17605	L17605			2	RGD000312	

Discovery IV (LA) 09.09 →

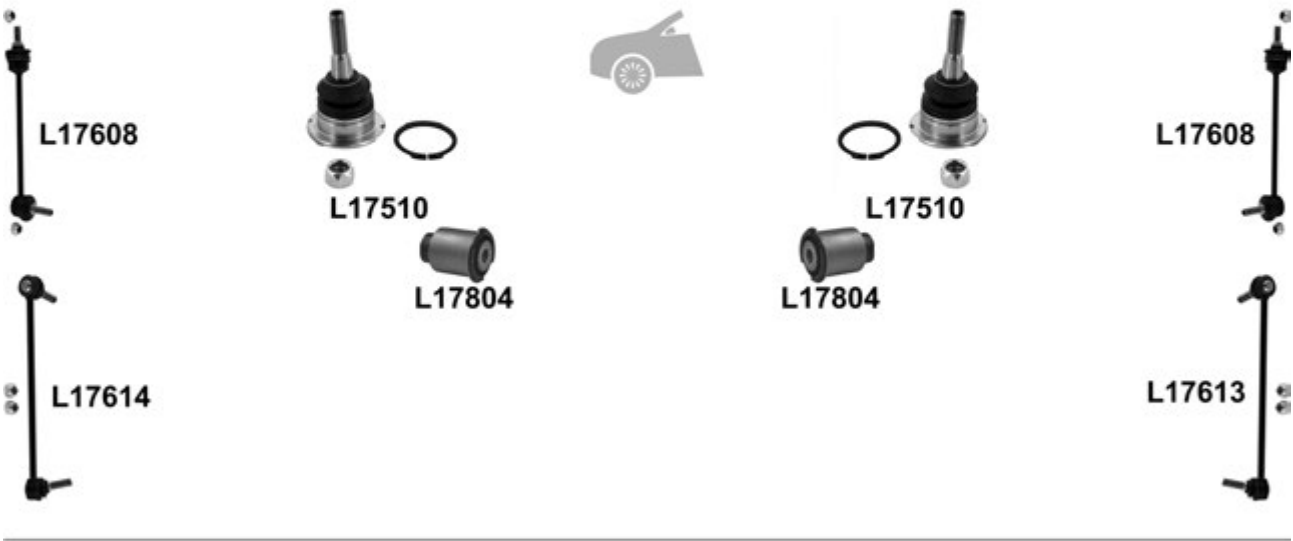
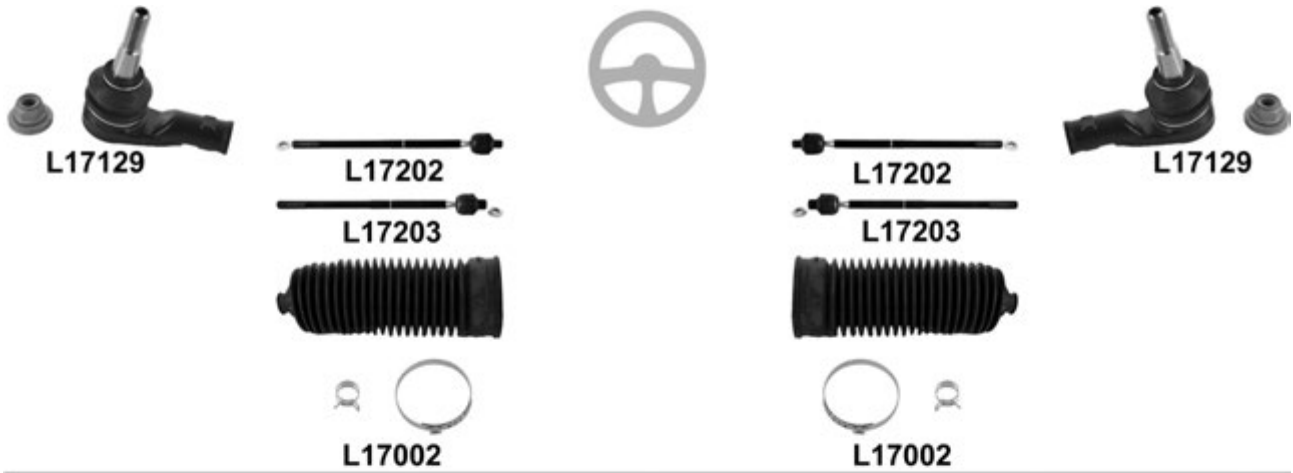

			←	→	Thread	Part Of	QPA	
		↔	L17129	L17129	∪		2	LR010672
			L17202	L17202	M 16x1,5 / M 16x1,5 ∪		2	QFK500010
			L17203	L17203	M 16x1,5 / M 20x1,5 ∪		2	QFK500020
			L17002 ⁰	L17002 ⁰			2	QFW500010
		↑	L17510	L17510			2	RBK500170
		↓ ↗ ↘ ↔	(-) AD	L17804	L17804	OE no. LR014137 / 14139 / 25610 / 25611 / 25613 / 25616	2	RBX500311
			(-) AD	L17608	L17608		2	RBM500190
			AD		L17613 ⁰		1	RBM500140
			L17614 ⁰				1	RBM500150
		(-) Active Roll	L17605	L17605			2	RGD000311

Freelander 02.98 →



			i	←	→	Thread	Part Of	QPA	i
		↔			L17119	↻		1	JQB 100220
				L17120		↻		1	JQB 100230
				L17600	L17600			2	RBM100171
				MK312	MK312			2	
				MK310	MK310			2	

Freelander 2 10.06 →

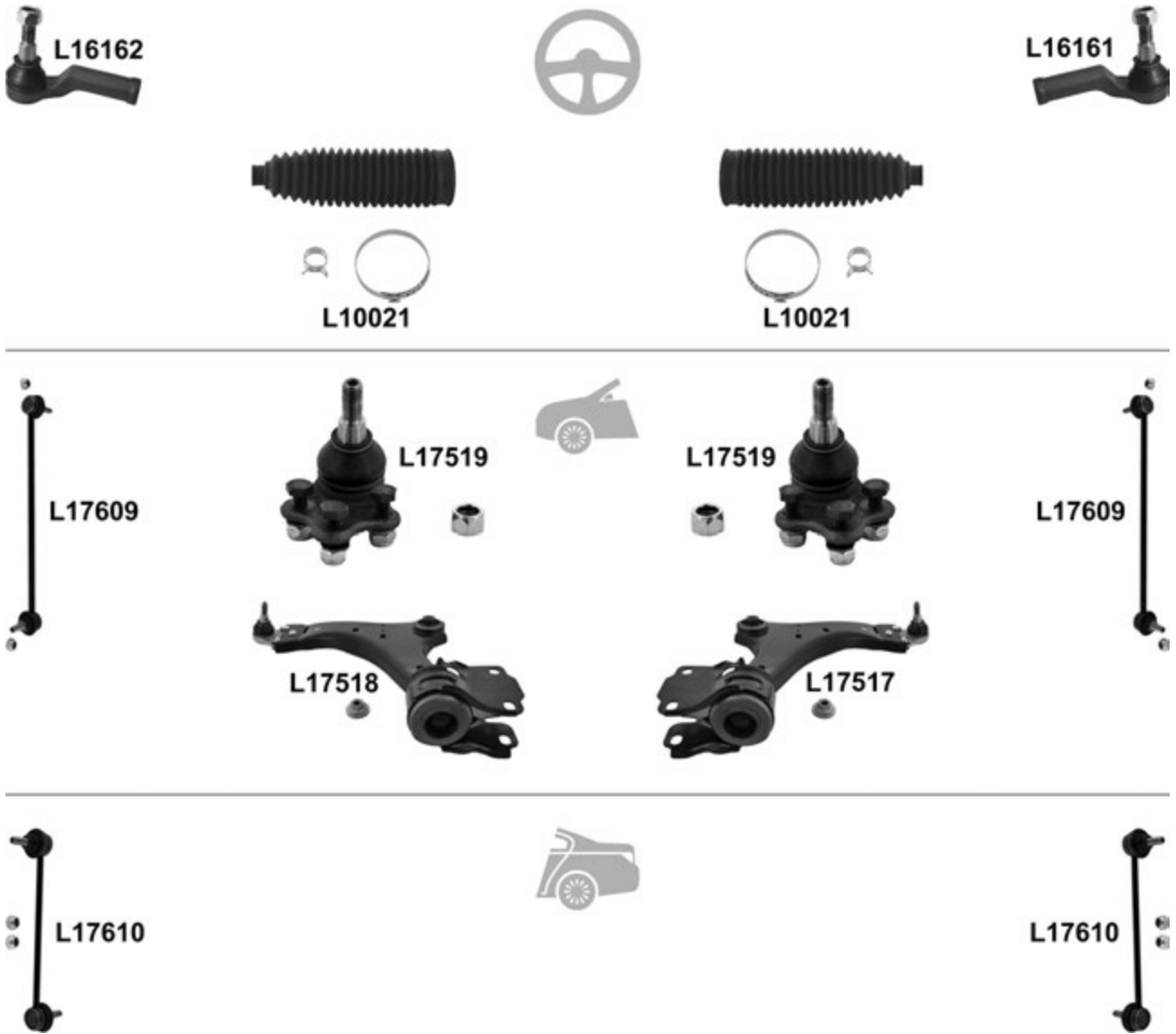

			←	→	Thread	Part Of	QPA		
				L16161	F 18x1,5 ∪		1	LR0 02609	
				L16162	F 18x1,5 ∪		1	LR0 02610	
				L10021 °	L10021 °		2	LR0 02682	
				L17519	L17519		L17517/L17518	2	
			<input checked="" type="checkbox"/>	L17517				1	LR007205
				L17518			1	LR007206	
				L17609	L17609		2	LR002626	
			L17610	L17610		2	LR002876		

Range Rover III (LM) 03.02 → 12.06

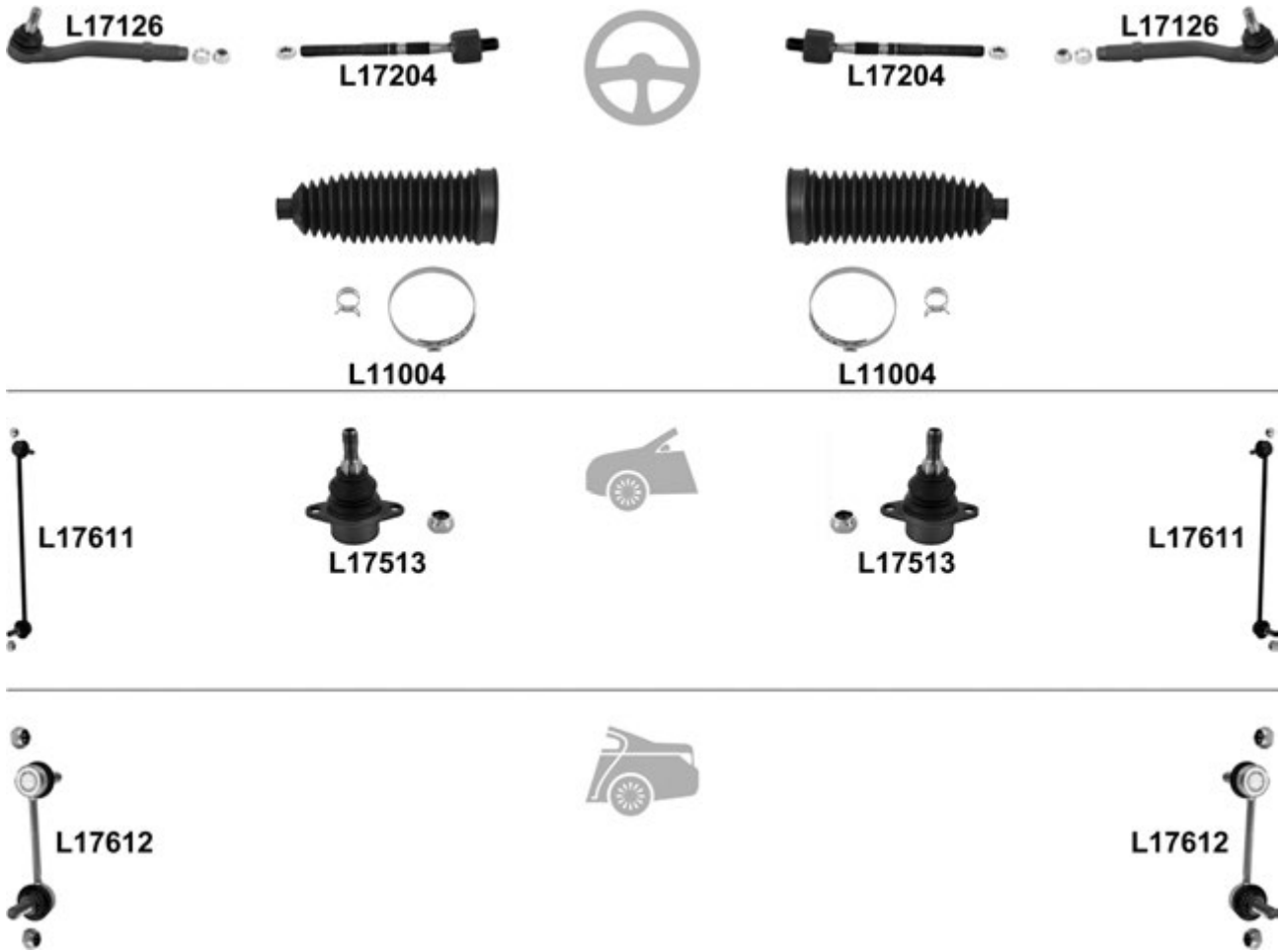

		i	←	→	Thread	Part Of	QPA	i
⊕		↔	L17126	L17126	F 16x1,5 U		2	QJB500050
			L17204	L17204	M 16x1,5 / M 18x1,5 U		2	QJB500060
			L11004	L11004			2	QFW000010
🚗		⌈	L17513	L17513			2	RBK500150
		(-) AD	L17611	L17611			2	RBM500200
🚗			L17612	L17612			2	RGD500150

Range Rover Evoque (SAL) 06.11 →



L17128



L17127

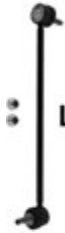

L17615

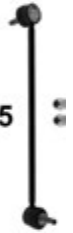

L17615



L17610



L17610



Thread

Part Of

QPA



					L17127 ⁰	F 18x1,5 U		1	LR026267
					L17128 ⁰	F 18x1,5 U		1	LR027570
					L17615 ⁰	L17615 ⁰		2	LR024474
					L17610	L17610		2	LR002876

Range Rover Sport 02.2005



Range Rover Sport 02.2005

		i		←	→	Thread	Part Of	QPA	i	
		↔	ch. → 9A191791	L17122	L17122	∩		2	QJB500040	
			ch. 9A191792 →	L17121	L17121	∩		2	QJB500070	
			07.09 →	L17126	L17126	F 16x1,5 ∩		2	QJB500050	
				ch. → 9A191791	L17200	L17200	∩		2	QFK500030
				07.09 →	L17204	L17204	M 16x1,5 / M 18x1,5 ∩		2	QJB500060
					L11004	L11004			2	QFW000010
		↑		L17510	L17510			2	RBK500170	
		↓	<input checked="" type="checkbox"/>	L17516	L17515			1	LR029304	
				L17516				1	LR029306	
				ch. → 9A191791	L17614 ^o	L17613 ^o			1	RBM500140
					L17614 ^o				1	RBM500150
				07.09 →	L17611	L17611			2	RBM500200
				ch. → 6A999999, (-) Active Roll/Stability Control System (ESP/DSC)	L17605	L17605			2	RGD000311

LEXUS

CT 200H 12.2010

L13078

L13078

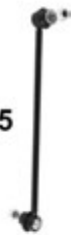
L13625

L13625

L13641

L13641

Thread

Part Of

QPA



		ORIG , ϕ 15,5mm, \emptyset 59,5mm, L= 178mm	L13078 ⁰	L13078 ⁰			2	45535-49015
			L13625	L13625			2	48820-02070
			L13641	L13641			2	48830-12070

GX470 (UZJ120) 11.02 → 12.09

L13147

L13248

L13248

L13147

L13628

L13627

Thread

Part Of

QPA



				L13147	L13147	F 15x1,5		2	45046-39505
				L13248	L13248	M 15x1,5 / M 22x1,5		2	45503-39265
					L13627			1	48820-60050
				L13628				1	48810-60040

RX (XU1) 08.97 → 05.03



Thread

Part Of

QPA



				L13125	L13125	F 15x1,5 U		2	45046-29255
--	--	--	--	--------	--------	------------	--	---	-------------

RX (MCU_) 04.03 →

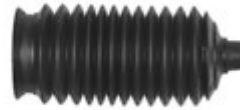

L13080



L13080



Thread

Part Of

QPA



			ø 14mm, Ø 47,5mm, L= 148mm	L13080 ⁰	L13080 ⁰			2	45535-12060
--	--	--	----------------------------	---------------------	---------------------	--	--	---	-------------

MAZDA
B-Serie 2WD (UN) 02.99 → 03.05

				← → Thread		Part Of	QPA		
⊕		↔		L50101	L50101		2	UB39-99-324	i
		→←		L50104	L50104		2	8AU2-32-270	
⊙		↑		L50505	L50505		2	8AU1-34-540	i
		↓		L50506	L50506		2	8AU2-34-510	

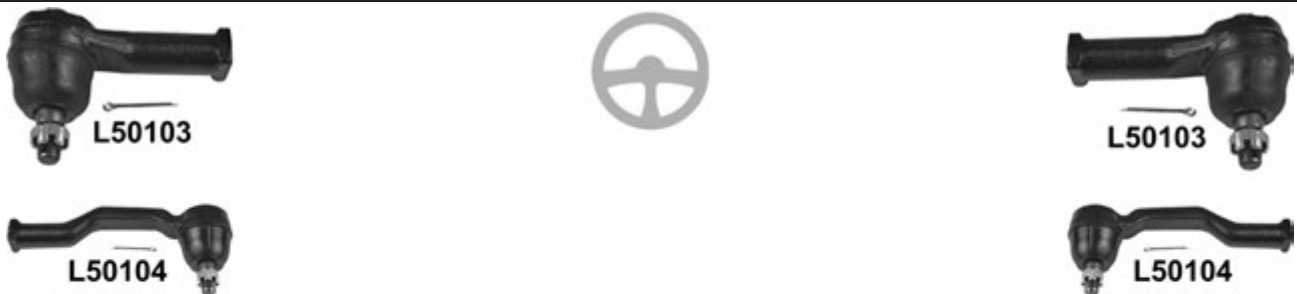
B-Serie 4WD (UN) 02.99 → 03.05

				← → Thread		Part Of	QPA		
⊕		↔		L50103	L50103		2	8AU1-32-280	i
		→←		L50104	L50104		2	8AU2-32-270	
⊙		↑		L50505	L50505		2	8AU1-34-540	i
		↓		L50506	L50506		2	8AU2-34-510	

BT50 12.06 →

Thread
Part Of
QPA

		↑		L50505	L50505			2	8AU1-34-540
--	--	---	--	--------	--------	--	--	---	-------------

CX7 (ER) 11.06 →

Thread
Part Of
QPA

				L50603			1	L206-34-150A
				L50604			1	L206-34-170A
				L50604			1	F151-34-150
				L50603			1	F151-34-170

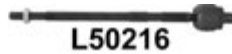
Demio DW 08.98 →

Thread
Part Of
QPA

		↔		L50105	L50105	∪		2	8AB2-32-280
					L50215	M 12x1,25 / M 16x1,5 ∪		1	D102-32-250
					L50216	M 12x1,25 / M 16x1,5 ∪		1	D102-32-240
		↓			L50537			1	D201-34-300E
					L50538			1	D201-34-350A
					L50617	L50617			2

E2000, E2200 SR1 / SR2 01.84 →



				← → Thread		Part Of	QPA		
		↔	→ 08.99, (-) 4WD	L16200	L16200	F 14x1,5 U		2	S083-99-324
		↑		L16202	L16202			2	S083-99-354
		↓	(-) 4WD	L16203	L16203			2	S083-99-356
			(-) 4WD	L16150	L16150			2	

MPV II (LW) 09.99 →

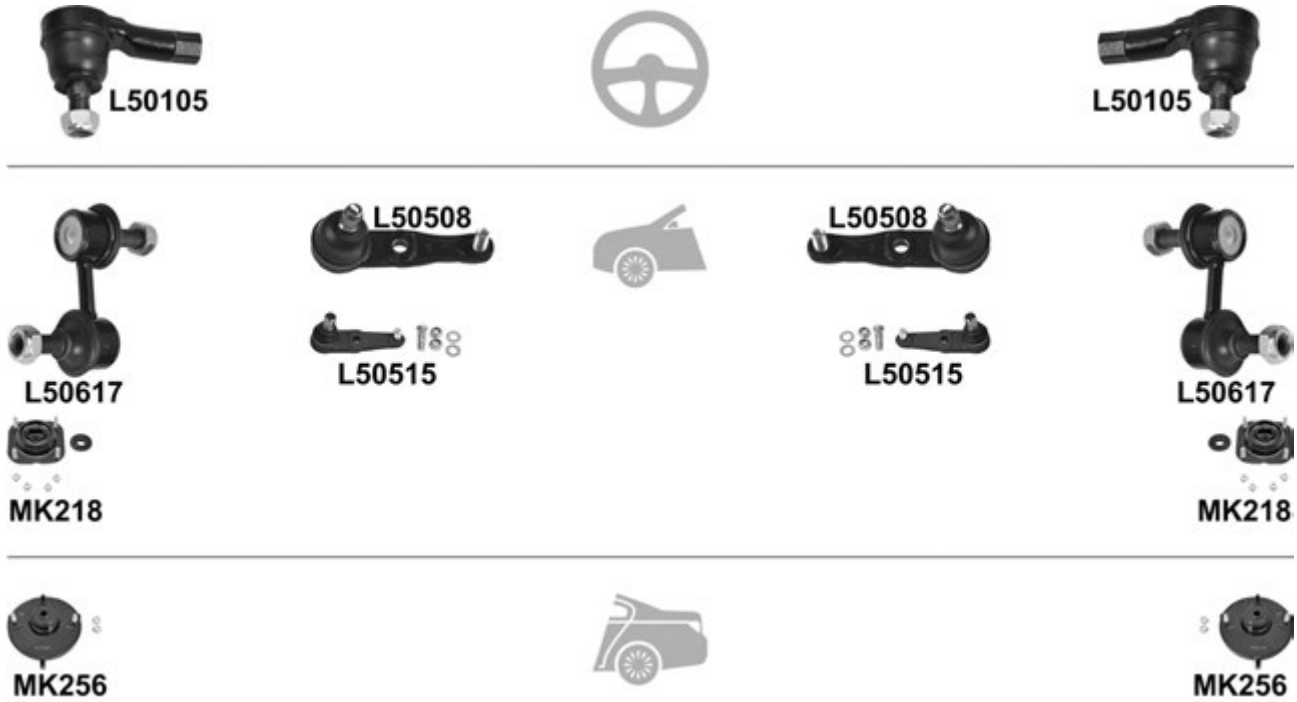

				← → Thread		Part Of	QPA			
		↔		L50107	L50107	F 14x1,5		2	8AG4-32-280	
		↓		L50040	L50040			2	G030-99-356	
		↓		<input checked="" type="checkbox"/>	L50529			1	LC62-34-300C	
				L50530				1	LC62-34-350C	
		↓ ▾			L50805	L50805			2	LC62-34-460B
		↓ ▲			L50806	L50806			2	LC62-34-470
			→ 10.00, 265mm	L50614	L50614			2	LC62-34-170B	
		11.00 →, 325mm	L50616	L50616			2	LC70-34-170		

MX3 (EC) 07.91 → 10.97

				←	→	Thread	Part Of	QPA		
				L50105	L50105	F 12x1,25 ♂		2	B455-32-280	
				L50508	L50508			2	B455-34-550	
				L50515	L50515			2	B01A-34-550A	
				L50617	L50617			2	EA03-34-170A	
				KIT	MK218	MK218		2	B455-34-380D	
				MK256	MK256			2	B595-28-390A	

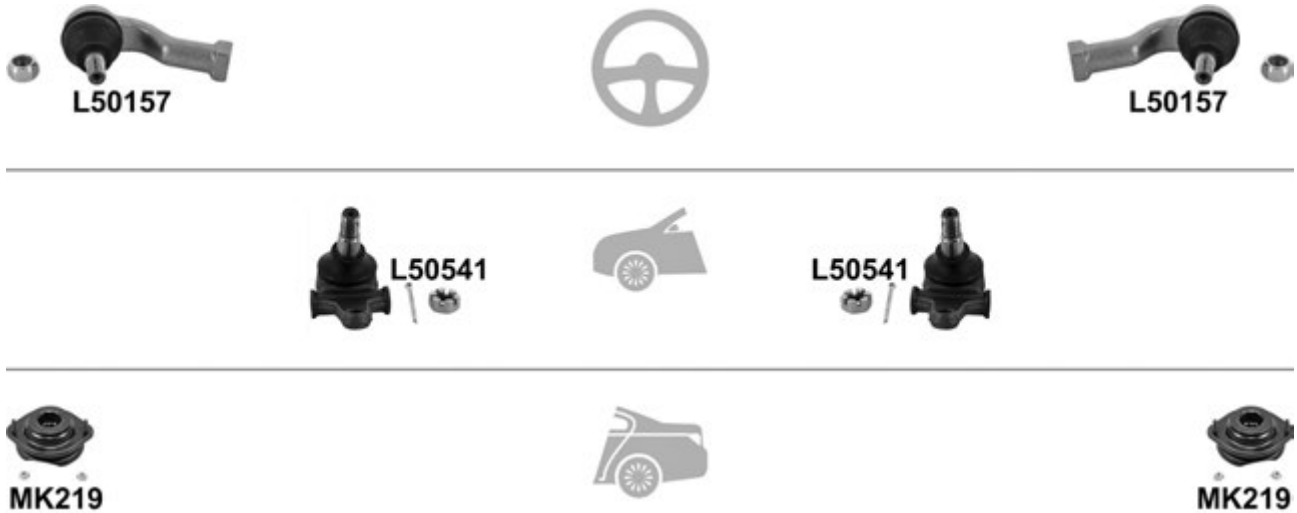
MX5 I (NA) 10.89 → 04.98

				←	→	Thread	Part Of	QPA		
				L50157	L50157	F 12x1,25 ♂		2	NA01-32-280	
				L50541	L50541			2	NA01-35-550A	
				MK219	MK219			2		

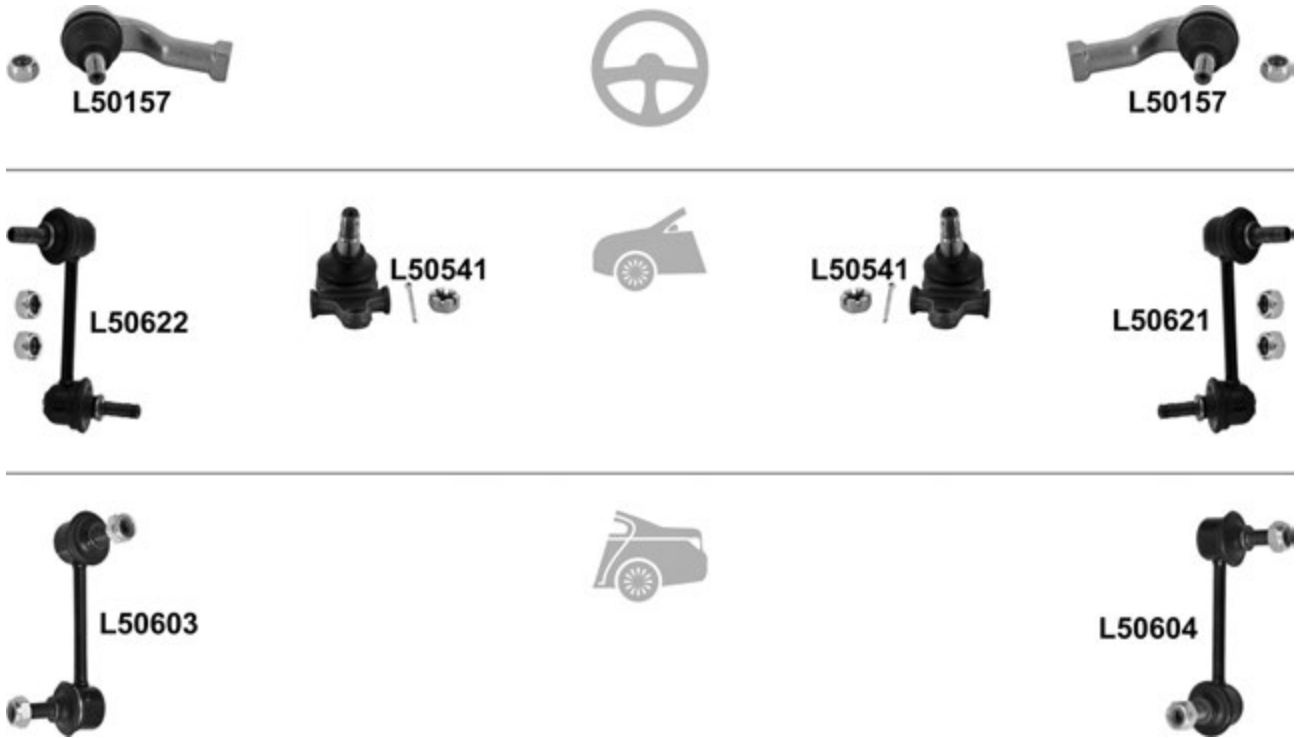
MX5 II (NB) 01.98 → 10.05

			i	←	→	Thread	Part Of	QPA	i
		↔		L50157	L50157	F 12x1,25 ♂		2	8AN1-32-280
		↓		L50541	L50541			2	NA01-35-550A
					L50621			1	NC10-34-150
				L50622				1	NC10-34-170
					L50604			1	GA2A-34-170A
				L50603			1	GA2A-34-150A	

MX5 III (NC) 03.05 →

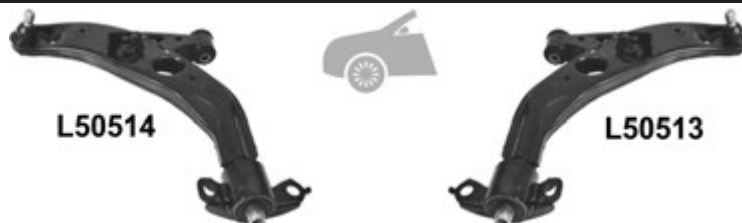

			i	←	→	Thread	Part Of	QPA	i
		→ 08.08			L50604			1	F151-34-150
				L50603				1	F151-34-170

MX6 (GE6) 02.92 →

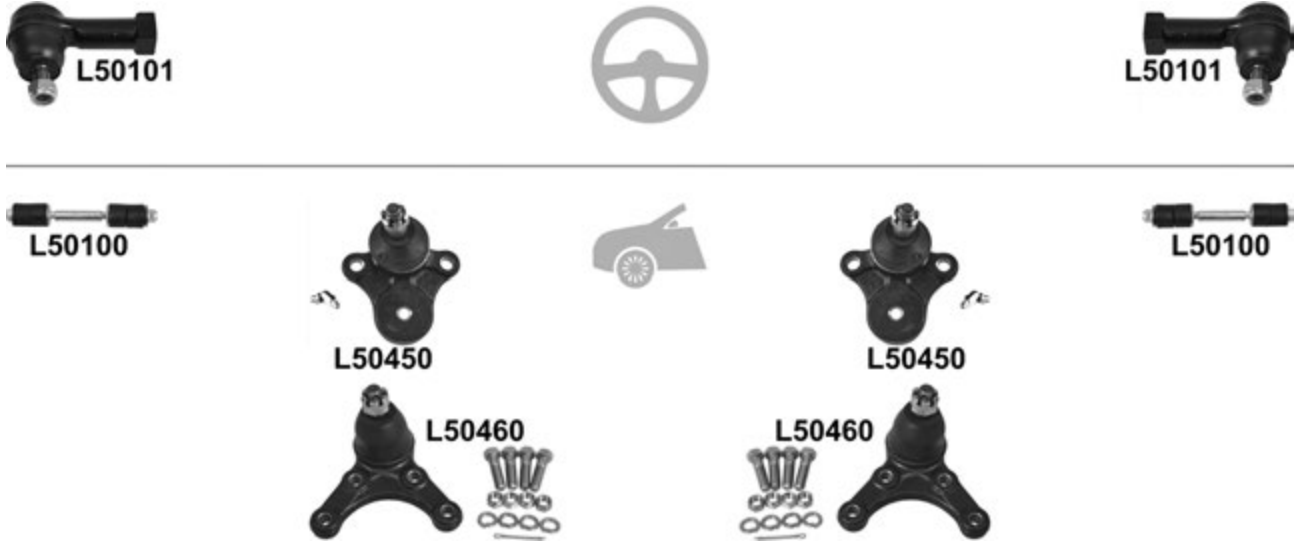
			i	←	→	Thread	Part Of	QPA	i
		↓	<input checked="" type="checkbox"/>		L50513			1	GA6B-34-300
				L50514				1	GA6B-34-350

Pick-Up B1800, B2000, B2200 11.80 →

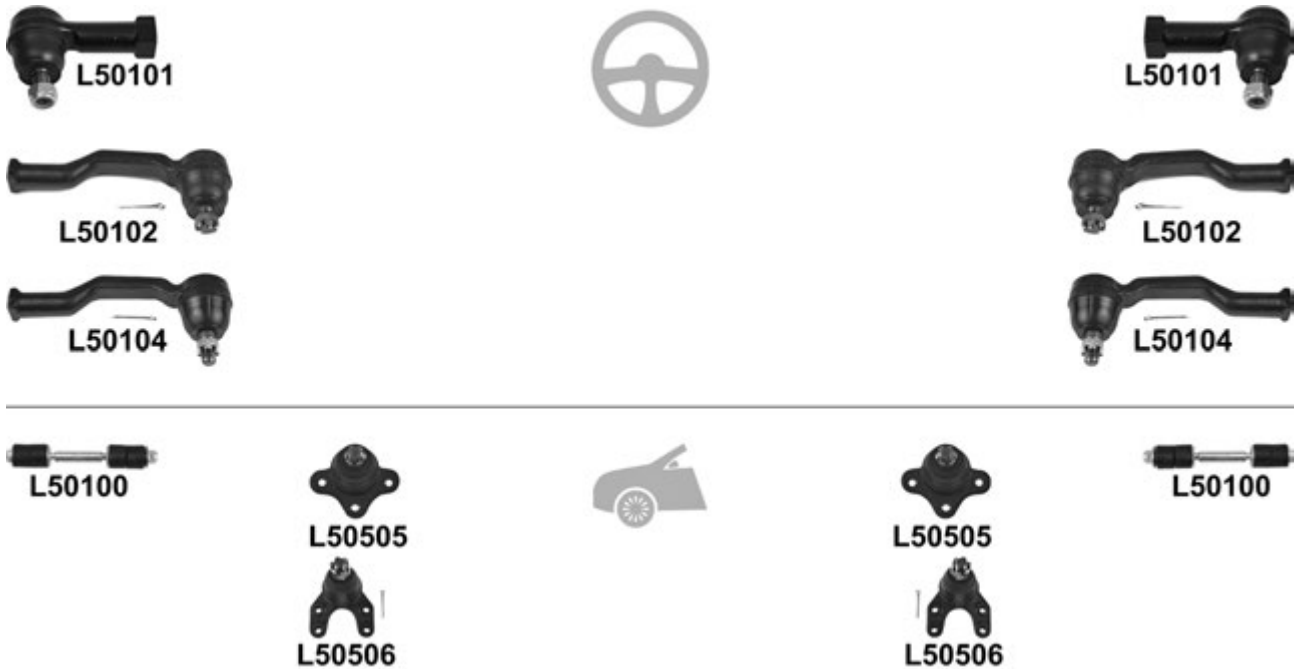
				←	→	Thread	Part Of	QPA	
		↔		L50101	L50101	F 14x1,5 ⌀		2	UA01-99-324
		↑		L50450	L50450			2	UA01-99-354
		↓		L50460	L50460			2	UA01-99-356
				L50100	L50100			2	

Pick-Up B2000, B2200 UF 1984 →

				←	→	Thread	Part Of	QPA	
		↔		L50101	L50101			2	UB39-99-324
		↔	→ 12.86	L50102	L50102			2	UB39-99-322
			01.87 →	L50104	L50104			2	8AU2-32-270
		↑		L50505	L50505			2	8AU1-34-540
		↓		L50506	L50506			2	8AU2-34-510
				L50100	L50100			2	

Pick-Up B2600 4WD UF 1987 →

Thread

Part Of

QPA



		↔		L50103	L50103			2 8AU1-32-280
		→←		L50104	L50104			2 8AU2-32-270
		↑		L50505	L50505			2 8AU1-34-540
		↓		L50507	L50507			2 8AU3-34-510

Premacy (CP) 07.99 →

			i	←	→	Thread	Part Of	QPA	i	
		↔		L50107	L50107	F 14x1,5 ∪		2	8AG3-32-280	
					L50217		M 14x1,5 / M 16x1 ∪		1	B25D-32-250
				L50218		M 14x1,5 / M 16x1 ∪		1	B25D-32-240	
		↓		L50040	L50040			2	G030-99-356	
					L50521				1	B25D-34-300B
				L50522					1	B25D-34-350B
				↓▼	L50800	L50800			2	C100-34-470A
				↓▲	L50801	L50801			2	C100-34-460B
		↔	→ 08.00	L50608	L50608			2	B26R-34-170	
			09.00 →	L50614	L50614			2	LC62-34-170B	
			→ 07.01	L50609	L50609			2	B26R-28-170	
			08.01 →	L50615	L50615			2	B30H-28-170B	

Premacy (CR) 02.05 →

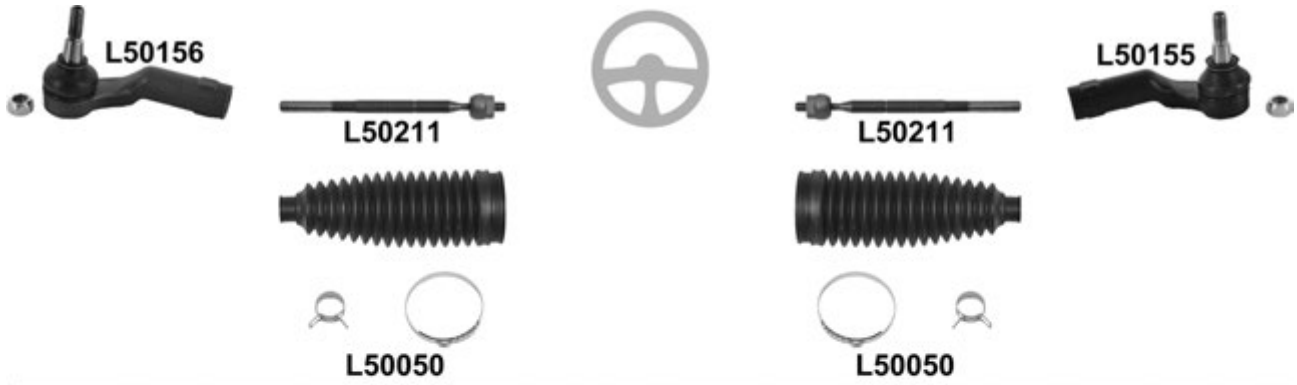

Premacy (CR) 02.05 →

				← → Thread		Part Of	QPA		
		↔		L50155	F 17x1,5 U		1	BP4L-32-280	
				L50156	F 17x1,5 U		1	BP4L-32-290	
				L50211	L50211		2	BP4L-32-240	
			∅ 15,5mm, ∅ 51mm, L= 170mm	L50050 ⁰	L50050 ⁰		2	BP4L-32-125	
		⊥		L50551	L50551		2		
		⊥		L50531			1	B32H-34-300A	
			<input checked="" type="checkbox"/>	L50532			1	B32H-34-350A	
		⊥▼		L50814	L50814			2	
		⊥▲		L50815	L50815			2	
				L50627 ⁰	L50627 ⁰			2	BP4K-34-170D
			KIT	MK282	MK282			2	BP4K-34-38XA
		⊥		L10538	L10538		2	BP4K-28-C10B	
		⊥▲		L10539	L10539		2	C236-28-500E	
				L10611	L10611		2	BP4K-28-170E	

RX8 (SE17) 10.03 →

L50603

L50604

				← → Thread		Part Of	QPA	
		→ 08.08		L50604			1	F151-34-150
				L50603			1	F151-34-170

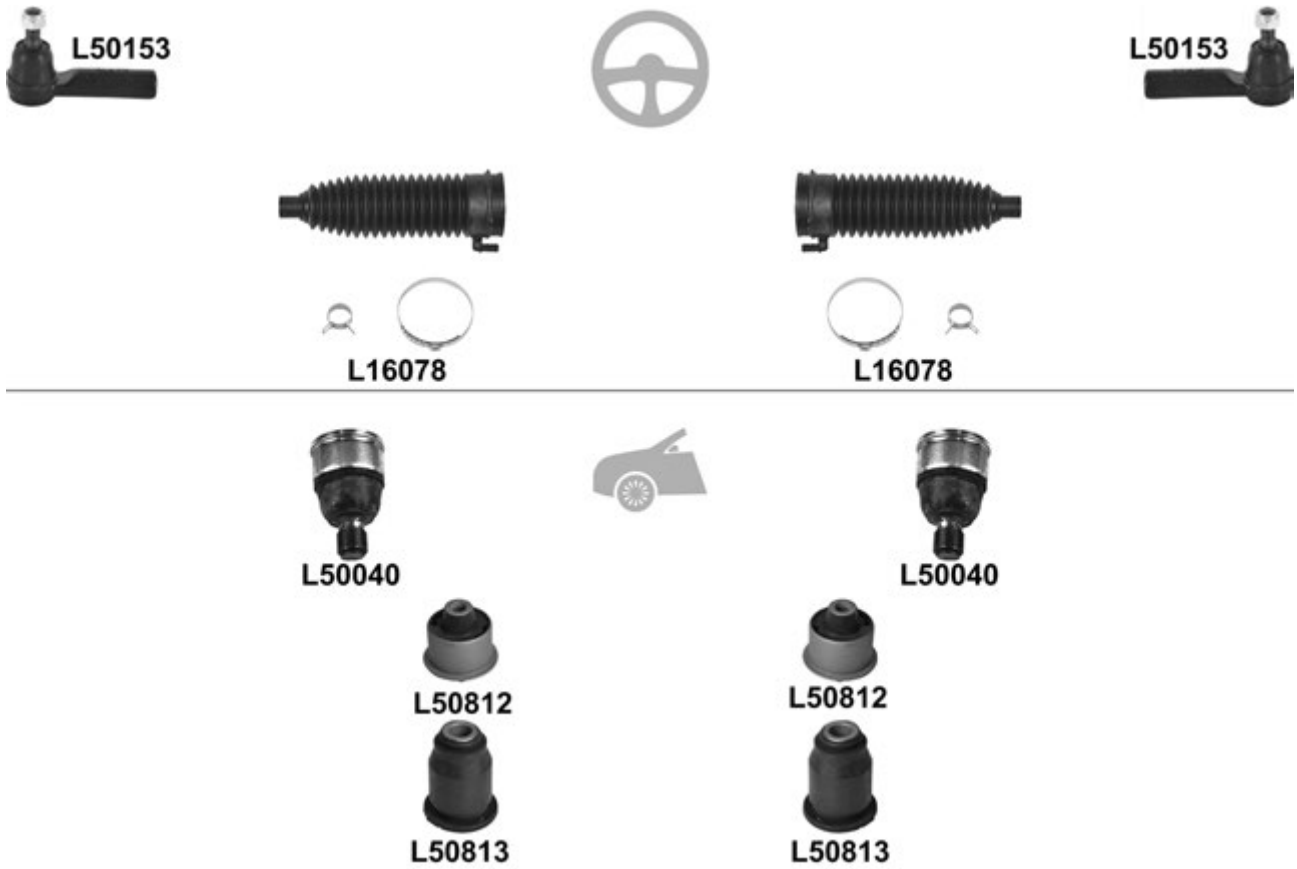
Tribute EP 03.00 →

				←	→	Thread	Part Of	QPA	
		↔		L50153	L50153	F 16x1,5 ⌚		2	EC01-32-280A
			∅ 17mm, ∅ 55mm, L= 206mm	L16078 ^o	L16078 ^o			2	4780137
		⊥		L50040	L50040			2	G030-99-356
		⊥↘		L50812	L50812			2	
		⊥↗		L50813	L50813			2	

2 04.03 →

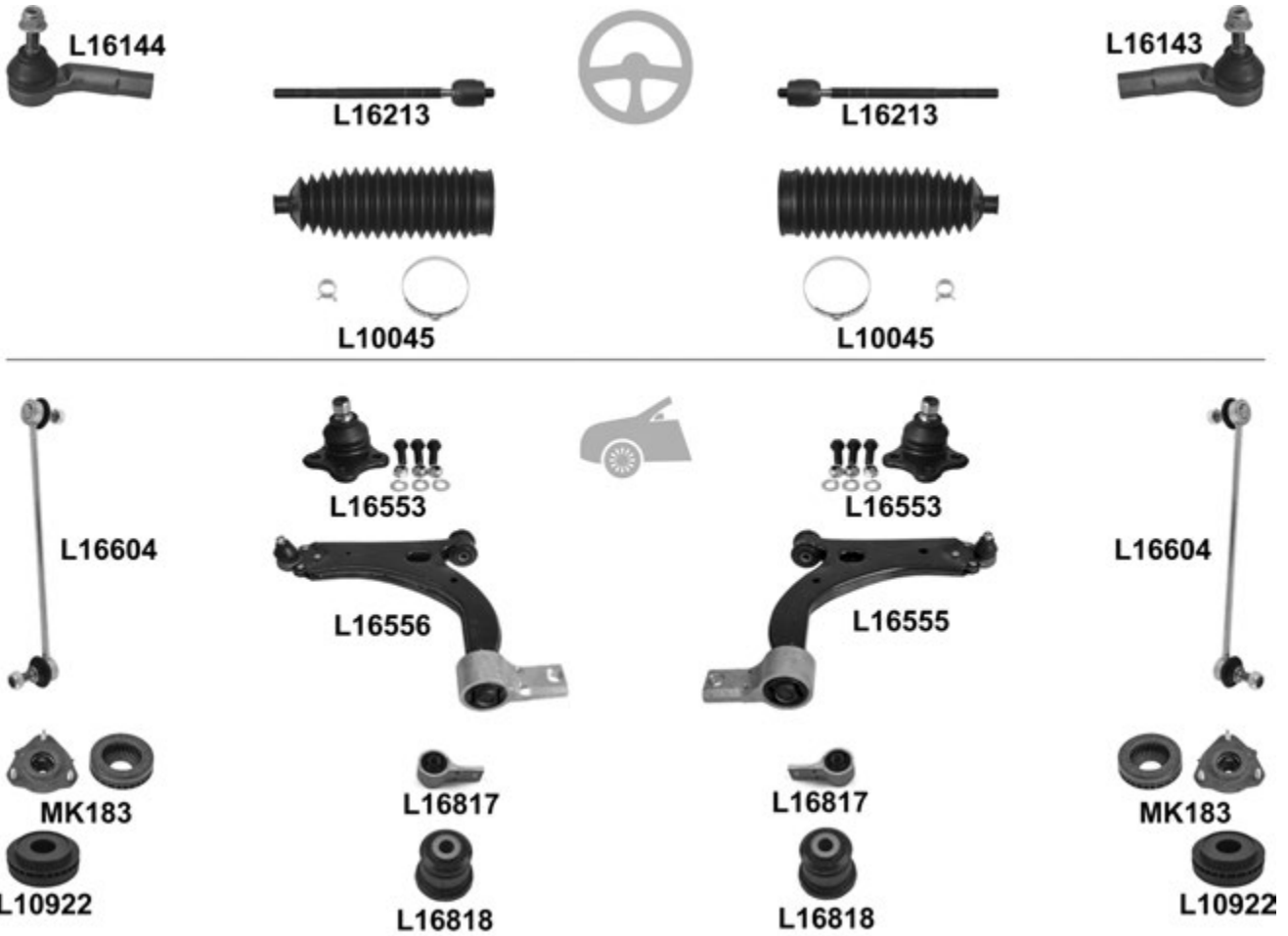

				←	→	Thread	Part Of	QPA	i	
⊕		↔			L16143	F 14x1,5 ∪		1	DE90-32-280	
					L16144	F 14x1,5 ∪		1	DE90-32-290	
				L16213	L16213	M 14x1,5 / M 14x1,5		2	DE90-32-240	
				∅ 14mm, ∅ 54mm, L= 198mm	L10045 ^o	L10045 ^o			2	DE90-32-125
🚗		⊥			L16553	L16553			2	
			<input checked="" type="checkbox"/>		L16555				1	DD32-34-300
		⊥			L16556				1	DD32-34-350
			<input type="checkbox"/>		L16817	L16817			2	
		⊥	↙		L16818	L16818			2	
			↘		L16604	L16604			2	DD32-34-170
				KIT	MK183	MK183			2	DD32-34-380A
				L10922	L10922			2	DD32-34-380A	

2 10.07 →

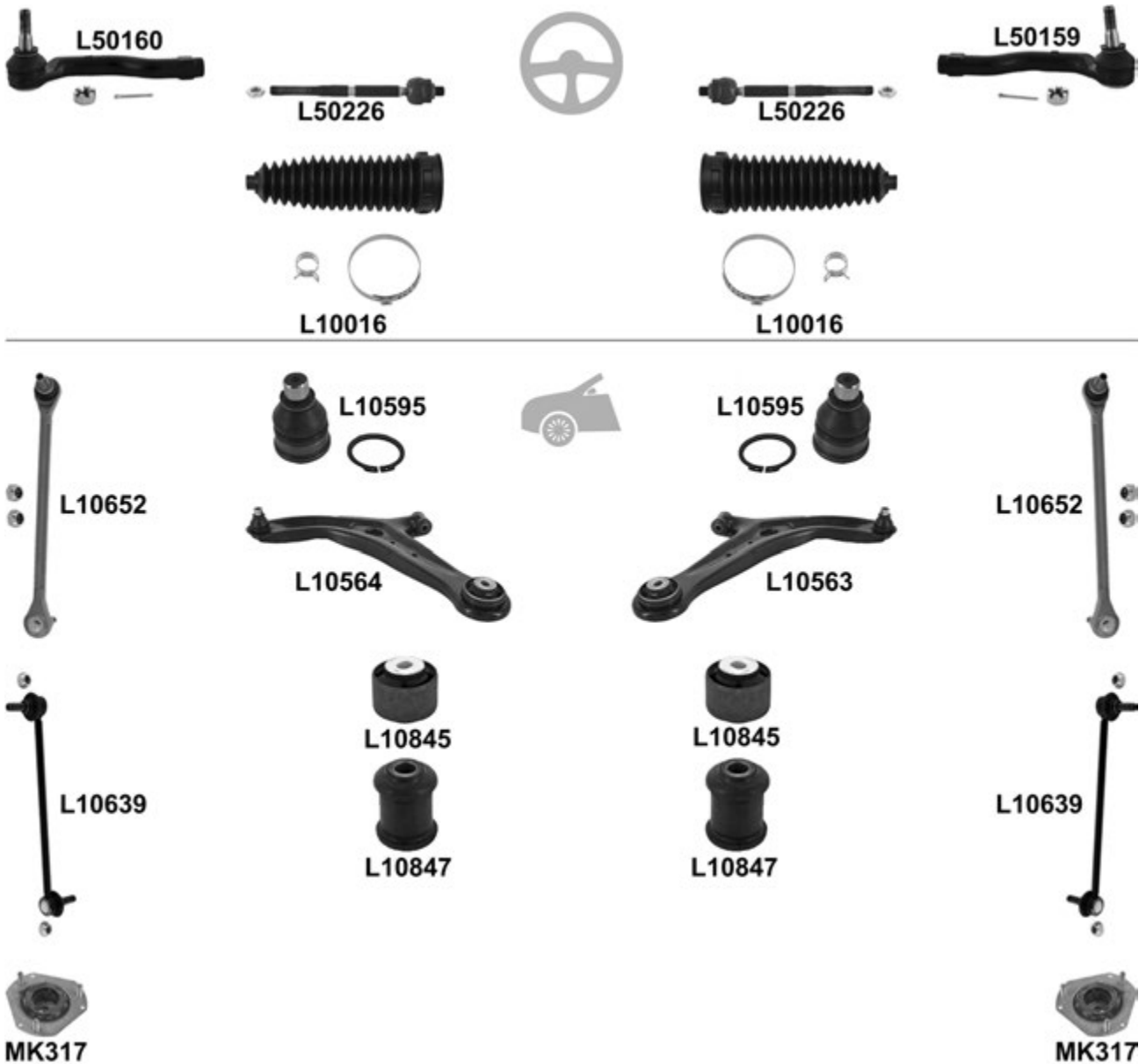

				← → Thread		Part Of	QPA			
⊕		↔		L50159	F 14x1,5 U		1	D651-32-280		
				L50160	F 14x1,5 U		1	D651-32-290		
				L50226	L50226	M 14x1,5 / M 14x1,5 U		2	D651-32-240	
				L10016	L10016			2	1545456	
⊖		⊥		L10595	L10595		2			
			<input checked="" type="checkbox"/>		L10563		1	D651-34-300B		
		↕↖		L10845	L10845		2			
				L10847	L10847		2	D651-34-470		
			ALU	L10652	L10652		2	D651-34-170A		
			Metal	L10639	L10639		2	D651-34-170A		
			MK317	MK317		2				

3 (BK) 10.03 →

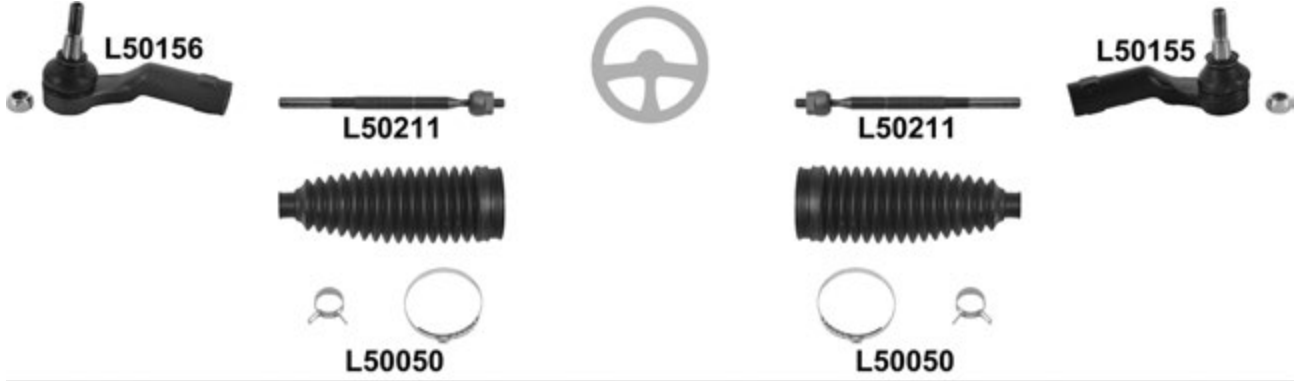

3 (BK) 10.03 →

		i		←	→	Thread	Part Of	QPA	i	
		↔				L50155 F 17x1,5 U		1	BP4L-32-280	
						L50156 F 17x1,5 U		1	BP4L-32-290	
					L50211 L50211		2	BP4L-32-240		
			∅ 15,5mm, ∅ 51mm, L= 170mm			L50050 ⁰ L50050 ⁰		2	BP4L-32-125	
		⊥	(-) 2.3 16V			L50551 L50551		2		
			2.3 16V, → 01.06			L50551 L50551		2		
		⊥	(-) 2.3 16V	<input checked="" type="checkbox"/>			L50531		1	B32H-34-300A
			2.3 16V, → 01.06	<input checked="" type="checkbox"/>			L50531		1	B32H-34-300A
							L50532		1	B32H-34-350A
							L50532		1	B32H-34-350A
		⊥	▼	(-) 2.3 16V			L50814 L50814		2	
				2.3 16V, → 01.06			L50814 L50814		2	
		⊥	▲	(-) 2.3 16V			L50815 L50815		2	
				2.3 16V, → 01.06			L50815 L50815		2	
							L50627 ⁰ L50627 ⁰		2	BP4K-34-170C
					KIT		MK282 MK282		2	BBM2-34-380
			↑				L10538 L10538		2	BP4K-28-C10B
			⊥▲				L10539 L10539		2	C236-28-500E
						L10611 L10611		2	BP4K-28-170E	
						MK376 MK376		2		

3 (BL) 06.09 →

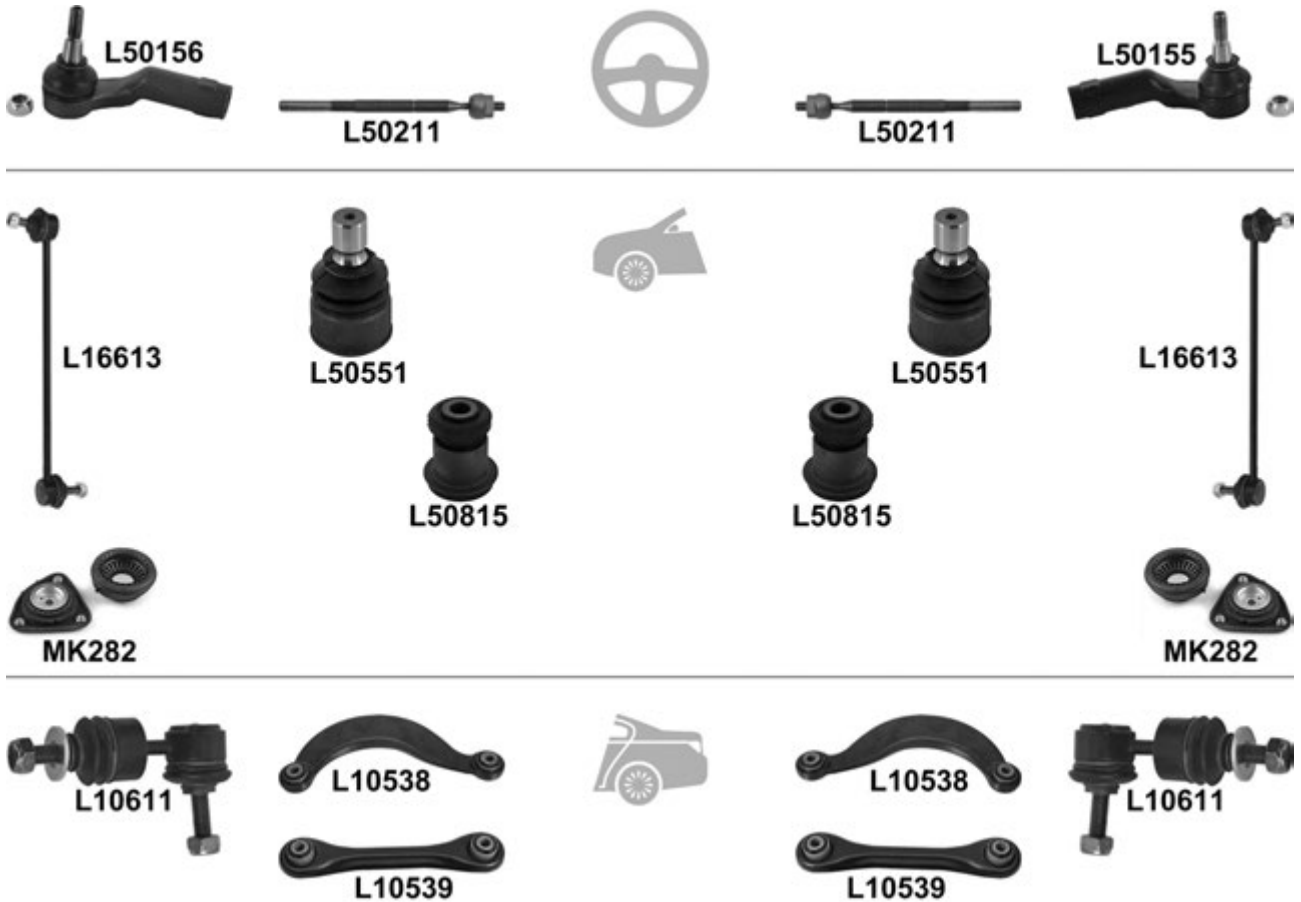

			←	→	Thread	Part Of	QPA	i
		↔		L50155	F 17x1,5 ∪		1	BP4L-32-280
				L50156	F 17x1,5 ∪		1	BP4L-32-290
				L50211	L50211		2	BP4L-32-240
		↓		L50551	L50551		2	
		↓ ▲		L50815	L50815		2	
		↔		L16613	L16613		2	BBM2-34-170A
			KIT	MK282	MK282		2	BBM2-34-380
		↔		L10538	L10538		2	BP4K-28-C10B
		↓ ▲	(-) Quick start system	L10539	L10539		2	C236-28-500E
		→ 01.06		L10611	L10611		2	BP4K-28-170E

5 (CR19) 03.05 →

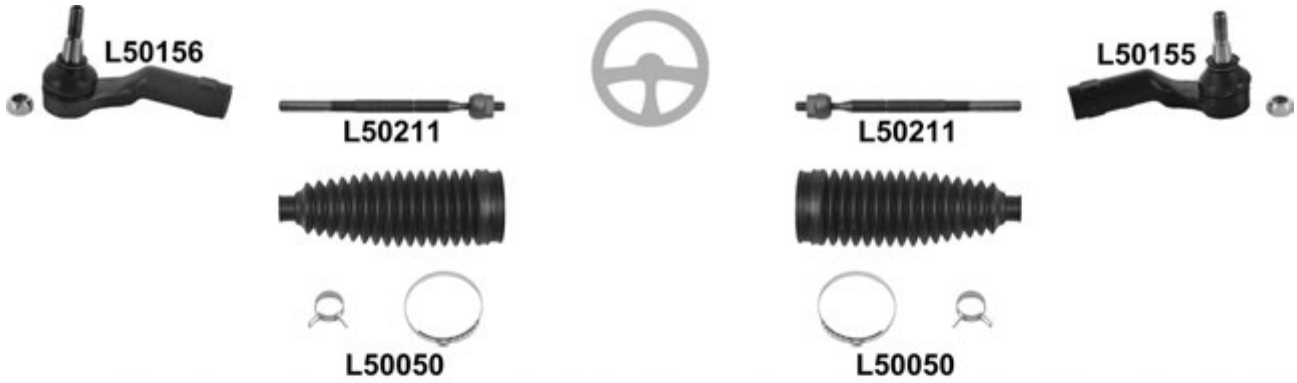

				←	→	Thread	Part Of	QPA		
⊕		↔			L50155	F 17x1,5 ♂		1	BP4L-32-280	
				L50156	F 17x1,5 ♂		1	BP4L-32-290		
			L50211	L50211		2	BP4L-32-240			
			∅ 15,5mm, ∅ 51mm, L= 170mm	L50050 ⁰	L50050 ⁰		2	BP4L-32-125		
⊖		⊥		<input checked="" type="checkbox"/>	L50531			1	B32H-34-300A	
				L50532			1	B32H-34-350A		
		⊥↘	L50814	L50814		2				
		⊥↗	L50815	L50815		2				
⊖		↔	L50627 ⁰	L50627 ⁰		2	BP4K-34-170C			
		↔	L10538	L10538		2	BP4K-28-C10B			
	⊥↗	L10539	L10539		2	C236-28-500E				
			L10611	L10611		2	BP4K-28-170E			
			MK376	MK376		2				

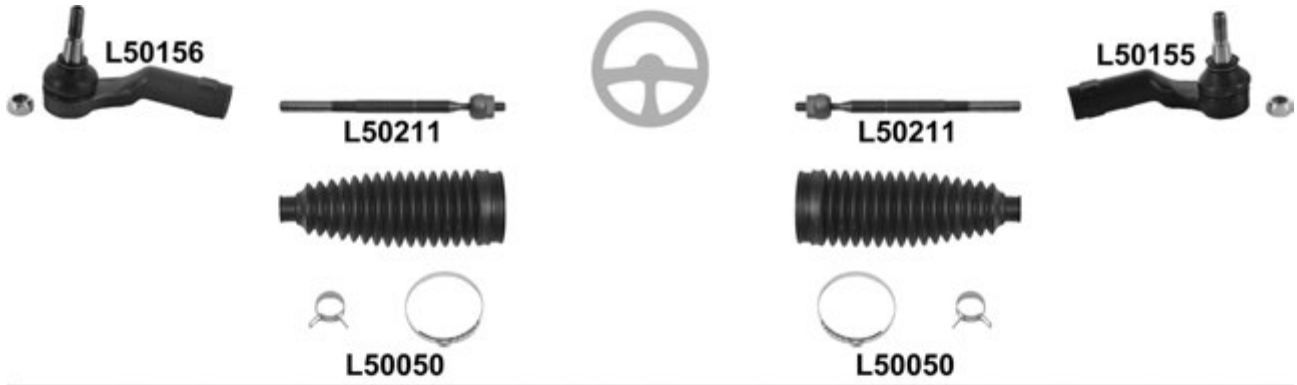
5 (CW01) 06.10 →

				← → Thread		Part Of	QPA			
⊕		↔		L50155	F 17x1,5 ♂		1	BP4L-32-280		
				L50156	F 17x1,5 ♂		1	BP4L-32-290		
			L50211	L50211			2	BP4L-32-240		
			∅ 15,5mm, ∅ 51mm, L= 170mm	L50050 ⁰	L50050 ⁰			2	BP4L-32-125	
⊖		↓		L50551	L50551			2		
			<input checked="" type="checkbox"/>		L50531				1	C513-34-300
		↓		L50532				1	C513-34-350	
			<input type="checkbox"/>		L50814	L50814			2	
	<input type="checkbox"/>		L50815	L50815			2			
		L16613	L16613			2	BP4K-34-170C			
⊖		↑	L10538	L10538			2	BP4K-28-C10B		
		↓	L10539	L10539			2	C236-28-500E		
			L10611	L10611			2	BP4K-28-170E		

6 GG, GY 6.2002 →

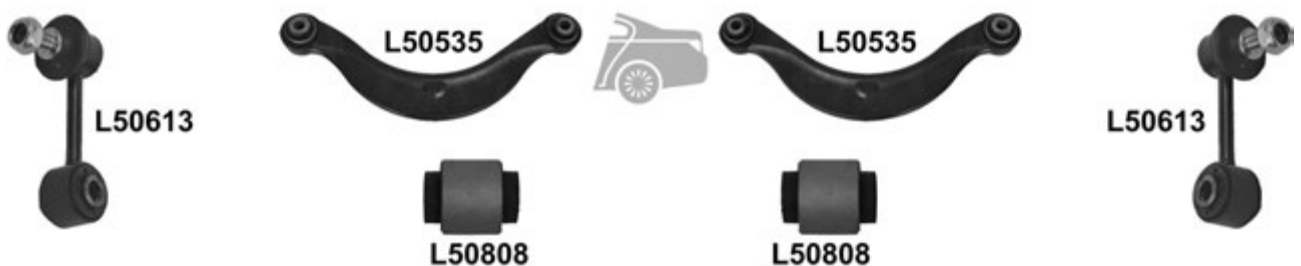
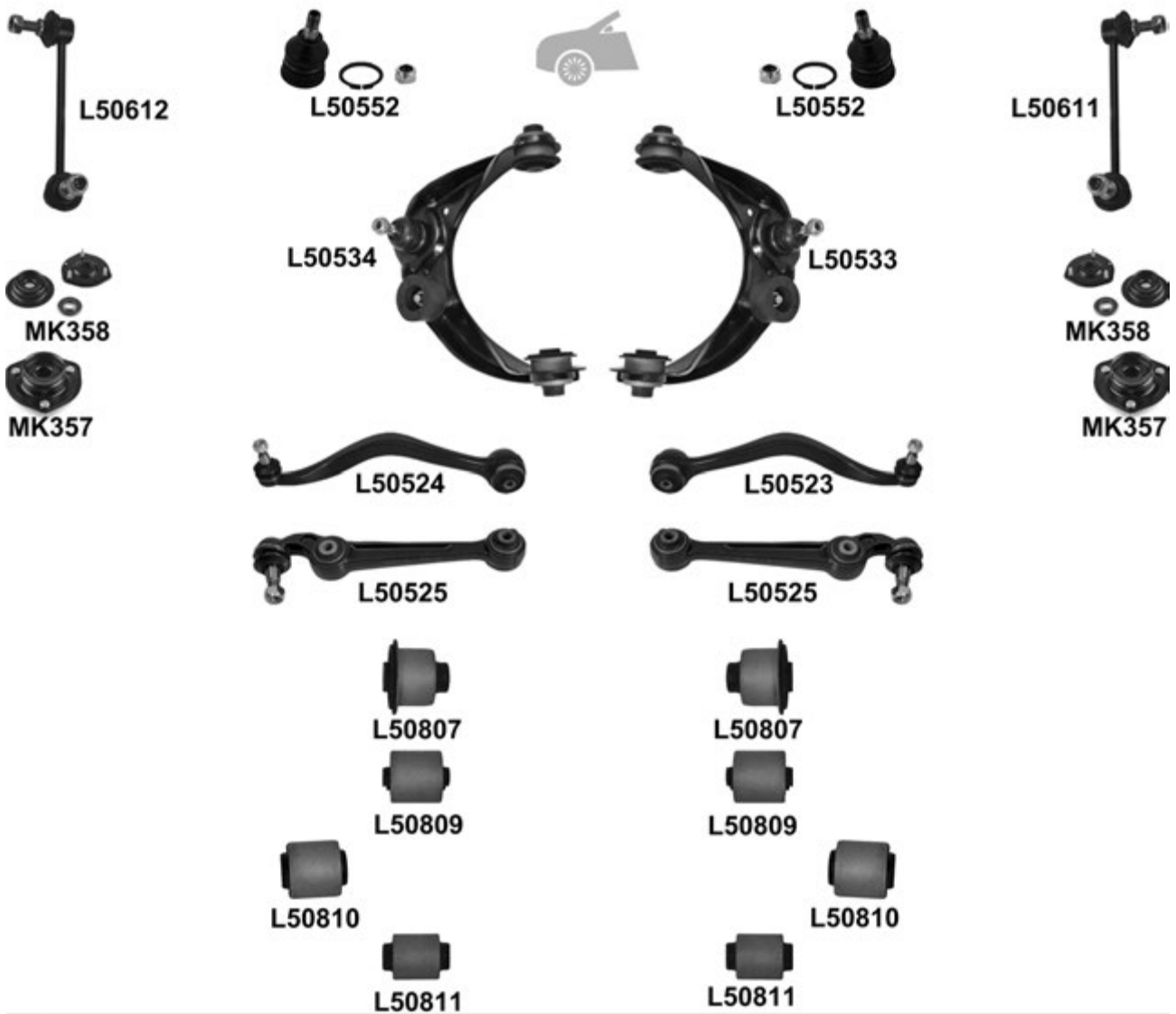

6 GG, GY 6.2002 →

				←	→	Thread	Part Of	QPA			
		↔			L50151	↻		1	GJ6E-32-280		
					L50152	↻		1	GJ6E-32-290		
				L50212	L50212			2	GJ6E-32-240		
				L50049	L50049			2	GJ6A-32-12X		
		↑			L50552	L50552		L50533/L50534	2		
				<input checked="" type="checkbox"/>		L50533			1	GJ6A-34-200B	
		↓				L50534			1	GJ6A-34-250B	
			→ 09.06			L50523			1	GJ6A-34-J00C	
					L50524				1	GJ6A-34-J050C	
		↑				L50525	L50525		2	GJ6A-34-300c	
			→ 09.06			L50807	L50807		L50533/L50534	4	
			↕↔↔	62 x 12.1 x 79mm		L50809	L50809		L50523/L50524	2	
			↕↔↔	44 x 12,1 x 50mm		L50810	L50810		L50525	2	GJ6A-34-710A
		↕↔↔	40 x 12,1 x 58mm			L50811	L50811		L50525	2	GJ6A-34-470A
							L50611			1	GJ6A-34-150A
						L50612			1	GJ6A-34-170A	
					KIT	MK358	MK358			2	GJ6E-34-380B
→ 02.04					MK357	MK357			2		
04.04 →				KIT	MK358	MK358			2		
		↑			L50808	L50808		L50535	4		
			→ 09.06			L50535	L50535			2	GJ6A-28-C10
					L50613	L50613			2	GJ6A-28-170A	

6 GH 08.07 →

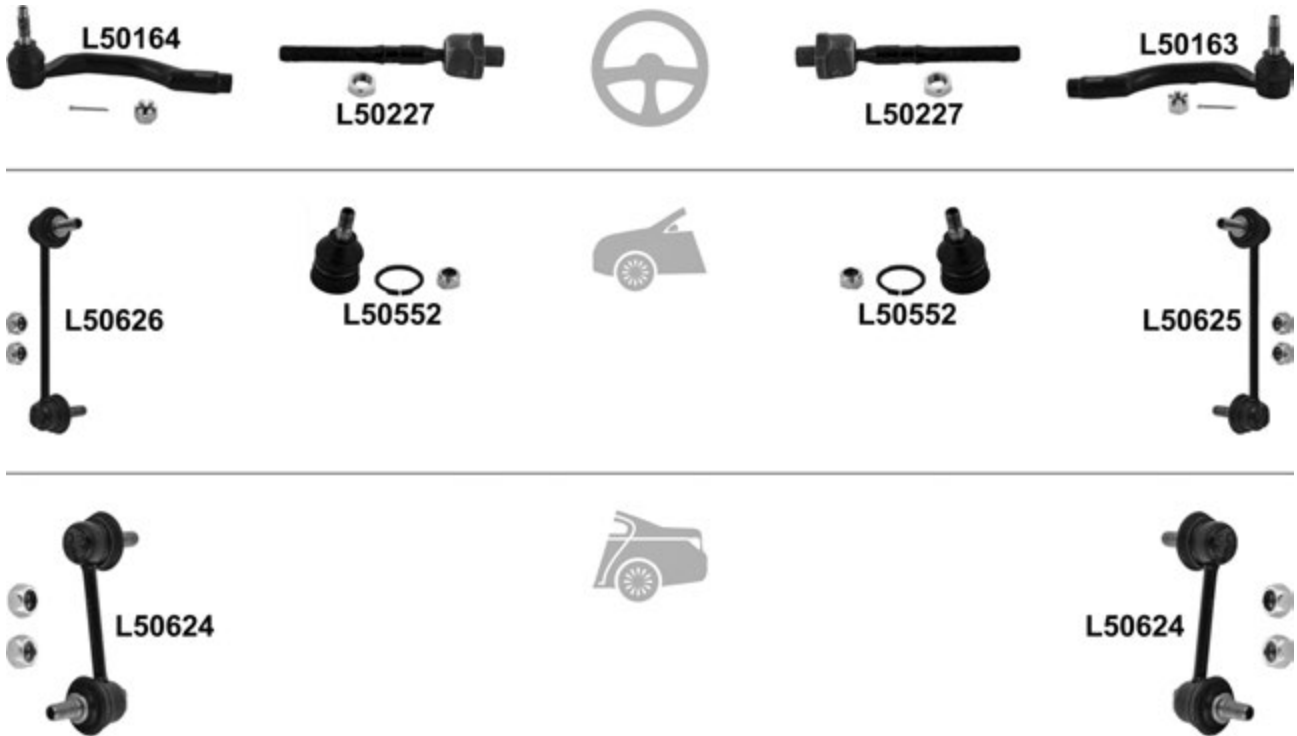

				←	→	Thread	Part Of	QPA		
⊕		↔	L=165mm		L50163	F 14x1,5 ∪		1	GS1D-32-280	
					L50164	F 14x1,5 ∪		1	GS1D-32-290	
🚗		↑		L50552	L50552	M 14x1,5 / M 18x1,5,	L50549/L50550	2		
								1	GS1D-34-150	
🚗				L50626				1	GS1D-34-170	
				L50624	L50624			2	GS1D-28-170	

121 I (DA) 10.87 → 11.90

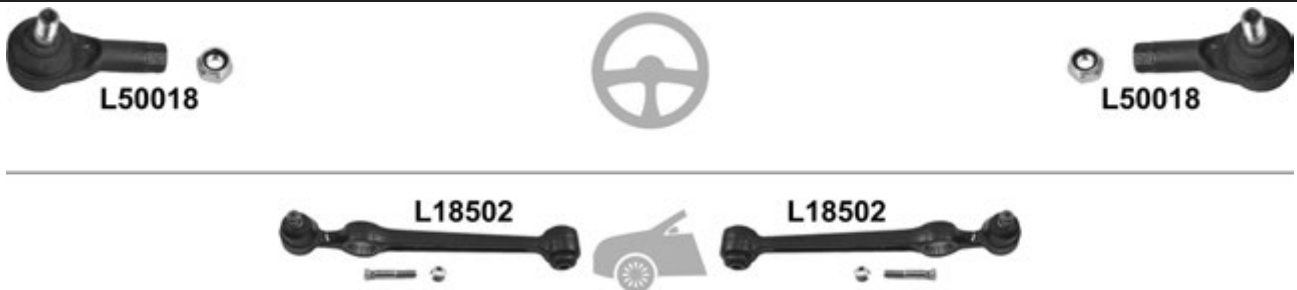

				←	→	Thread	Part Of	QPA		
⊕		↔		L50018 ¹	L50018 ¹	F 12x1,25		2	8AB1-32-280	
🚗		⊥		L18502	L18502			2	D031-34-310A	

121 II (DB) 11.90 → 03.96



Thread

Part Of

QPA



		↔		L50105	L50105	F 12x1,25		2	8AB2-32-280
		⊥			L50517			1	D061-34-300
				L50518				1	D061-35-350

121 III (JASM/JBSM) 03.96 →

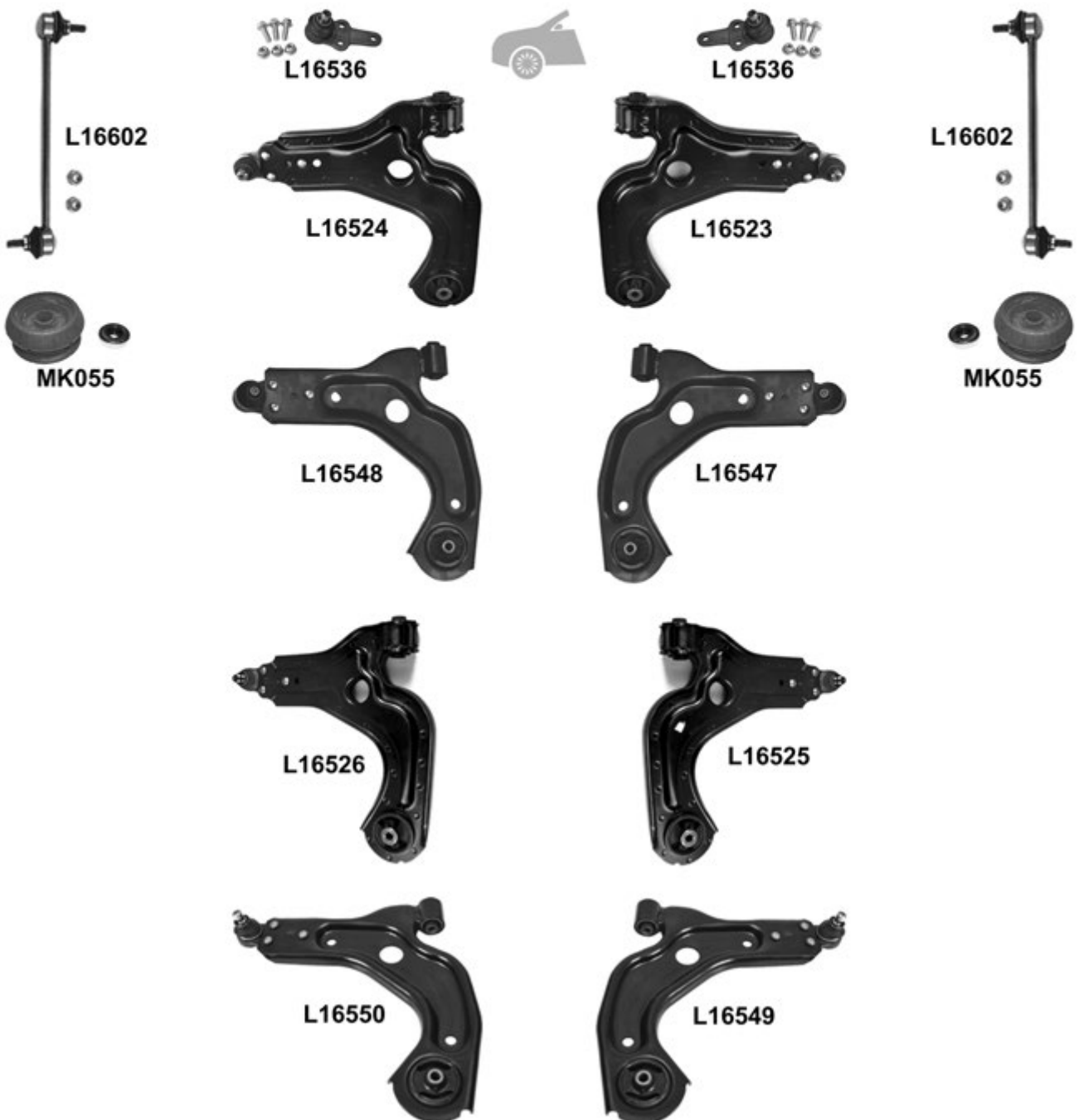
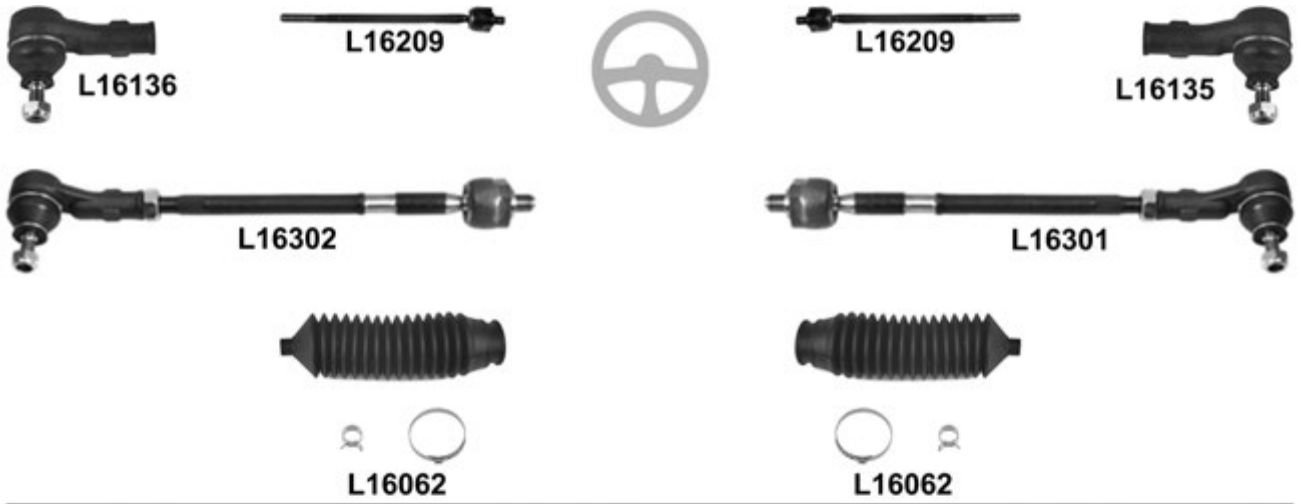

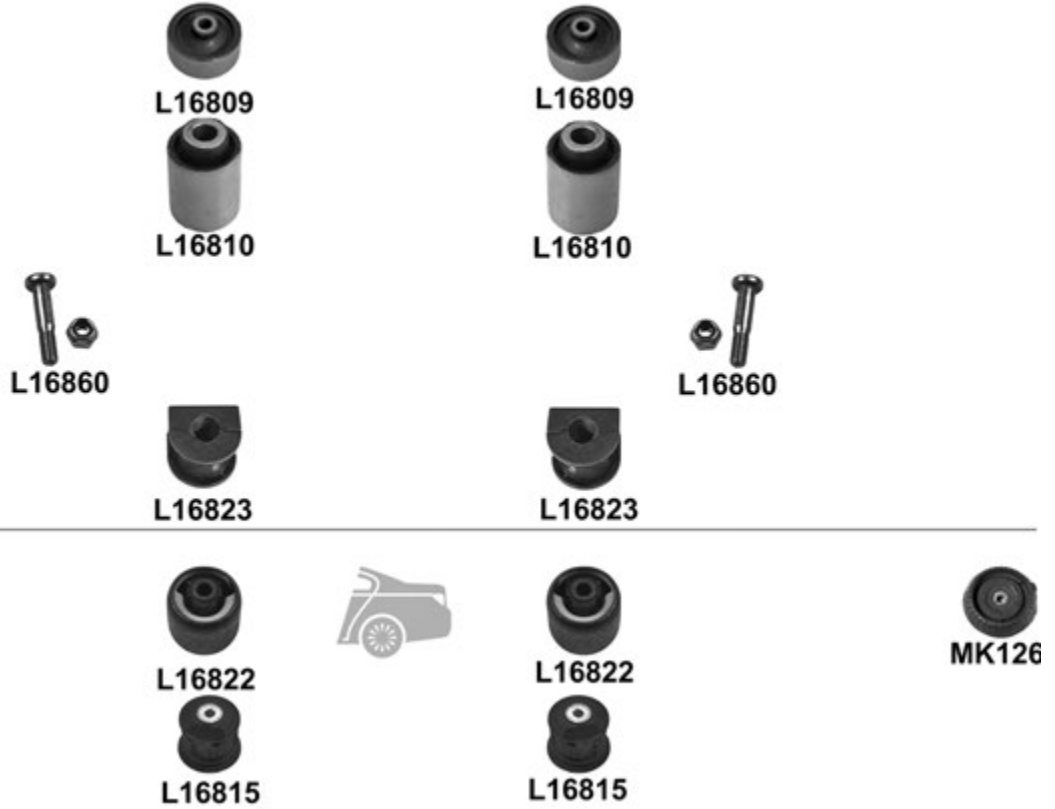
121 III (JASM/JBSM) 03.96 →

		i	←	→	Thread	Part Of	QPA	i				
⊕		↔		L16135	F 14x2 U		1	1E00-32-280A				
				L16136	F 14x2 U		1	1E01-32-280A				
				L16209	L16209			2	1E00-32-240			
				L16301				1				
				L16302				1				
🚗		⊥	16,5mm	L16536	L16536			2				
				→ 01.98	<input checked="" type="checkbox"/>	L16523			1	1E00-34-300C		
				02.98 →	<input checked="" type="checkbox"/>	L16524			1	1E00-34-350C		
				→ 01.98	<input checked="" type="checkbox"/>	L16547			1	1E00-34-300E		
				02.98 →	<input checked="" type="checkbox"/>	L16548			1	1E00-34-350E		
				→ 01.98	<input checked="" type="checkbox"/>	L16525			1	1E01-34-300C		
				02.98 →	<input checked="" type="checkbox"/>	L16526			1	1E01-34-350C		
				→ 01.98	<input checked="" type="checkbox"/>	L16549			1	1E01-34-300E		
				02.98 →	<input checked="" type="checkbox"/>	L16550			1	1E01-34-350E		
				⊥		L16809	L16809			2	1E01-34-153A	
				⊥		L16810	L16810			2	1E00-34-153A	
					Mounting of on Wheels suspension	KIT	L16860	L16860			2	6080625
							L16602	L16602			2	1E00-34-170
							L16823	L16823		Anti-roll bar	2	1E00-34-156
						KIT	MK055	MK055			2	1E00-34-380
🚗			(-) Reinforced chassis	L16822	L16822		Hub carrier	2	1016439			
			Reinforced chassis	L16815	L16815		Hub carrier	2	7371059			
				MK126	MK126			2	1023587			

323 FA4TS, FA4TV 01.77 → 05.80

Thread

Part Of

QPA



			L50110	L50110			2	8AB2-34-100B
--	--	--	--------	--------	--	--	---	--------------

323 BD 11.80 → 10.85

Thread

Part Of

QPA



		↔		L50106	L50106	F 12x1,25 ⌀		2	B037-99-324
		⊥		L50003	L50003			2	B092-34-550
				L50110	L50110			2	8AB2-34-100B
			KIT	MK248	MK248			2	B029-34-390D
				MK249	MK249			2	

323 BF 08.85 → 10.89

				← → Thread		Part Of	QPA		
		↔		L50018 ¹	L50018 ¹	F 12x1,25 ♂	2	8AB1-32-280	
			323 BF	L50046	L50046		2	H002-32-125	
		↓		L50030	L50030		2	B092-34-550	
		↓		L50510	L50509		1	B092-34-310A	
				L50110	L50110		2	8AB2-34-100B	
			323 BF	KIT	MK248	MK248	2	B029-34-390D	
				L50602	L50602		2	8AB2-34-100A	
				MK249	MK249		2		

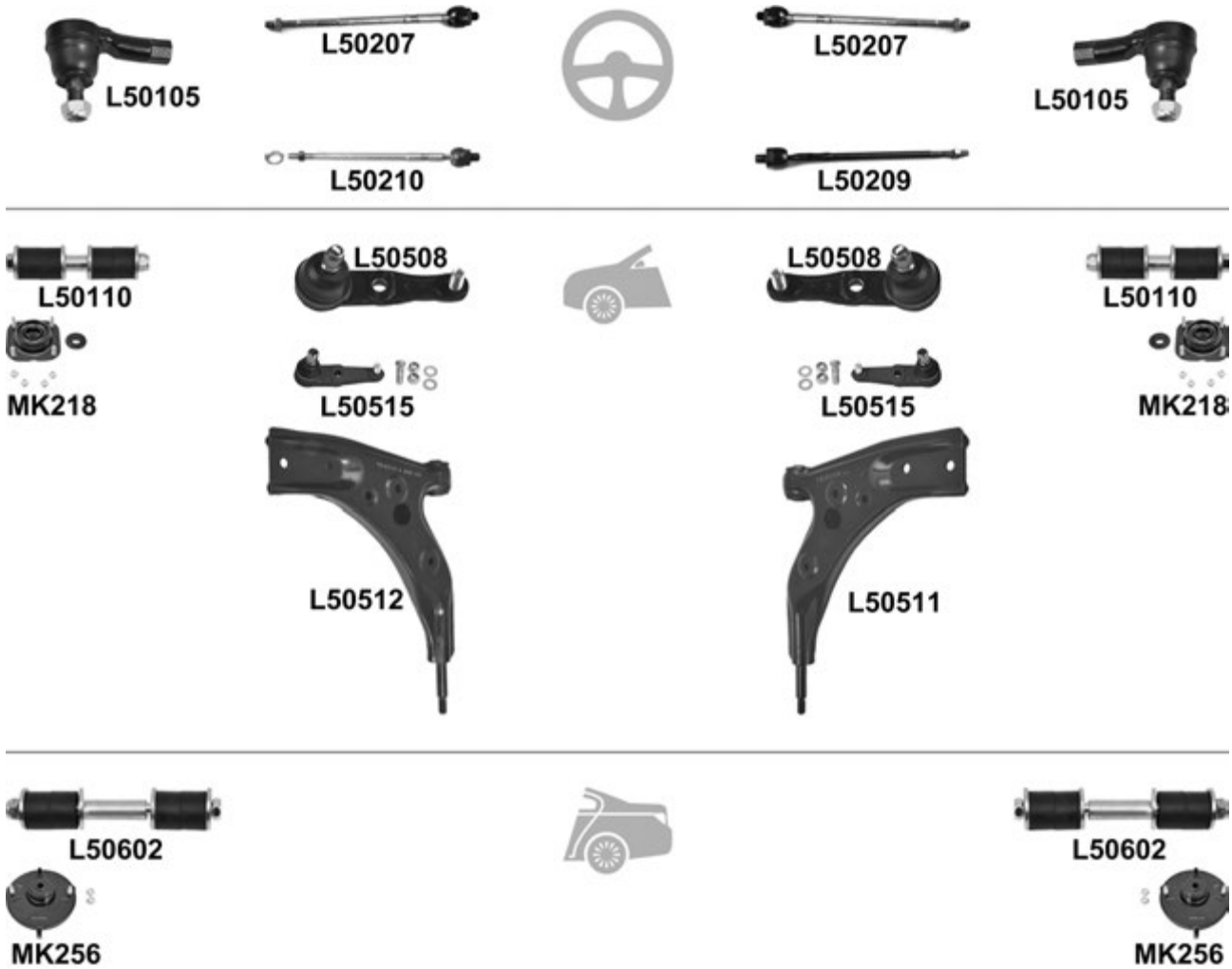
323 BG 08.89 → 10.94

		← → Thread		Part Of	QPA			
			L50105	L50105	F 12x1,25	2	8AB2-32-280	
			L50207	L50207	M 12x1,25 / M 16x1	2	B455-32-24X	
				L50209	M 12x1,25 / M 16x1	1	B456-32-24X	
			L50210		M 12x1,25 / M 16x1	1	B456-32-25X	
			ch. → 1-630911, 16mm	L50508	L50508		2	B455-34-550
			ch. 1-630912 →, 18mm	L50515	L50515		2	B01A-34-550A
					L50511		1	B455-34-300E
					L50512		1	B455-34-350E
				L50110	L50110		2	8AB2-34-100B
				KIT		MK218	MK218	2
			L50602	L50602		2	8AB2-34-100A	
			MK256	MK256		2	B595-28-390A	

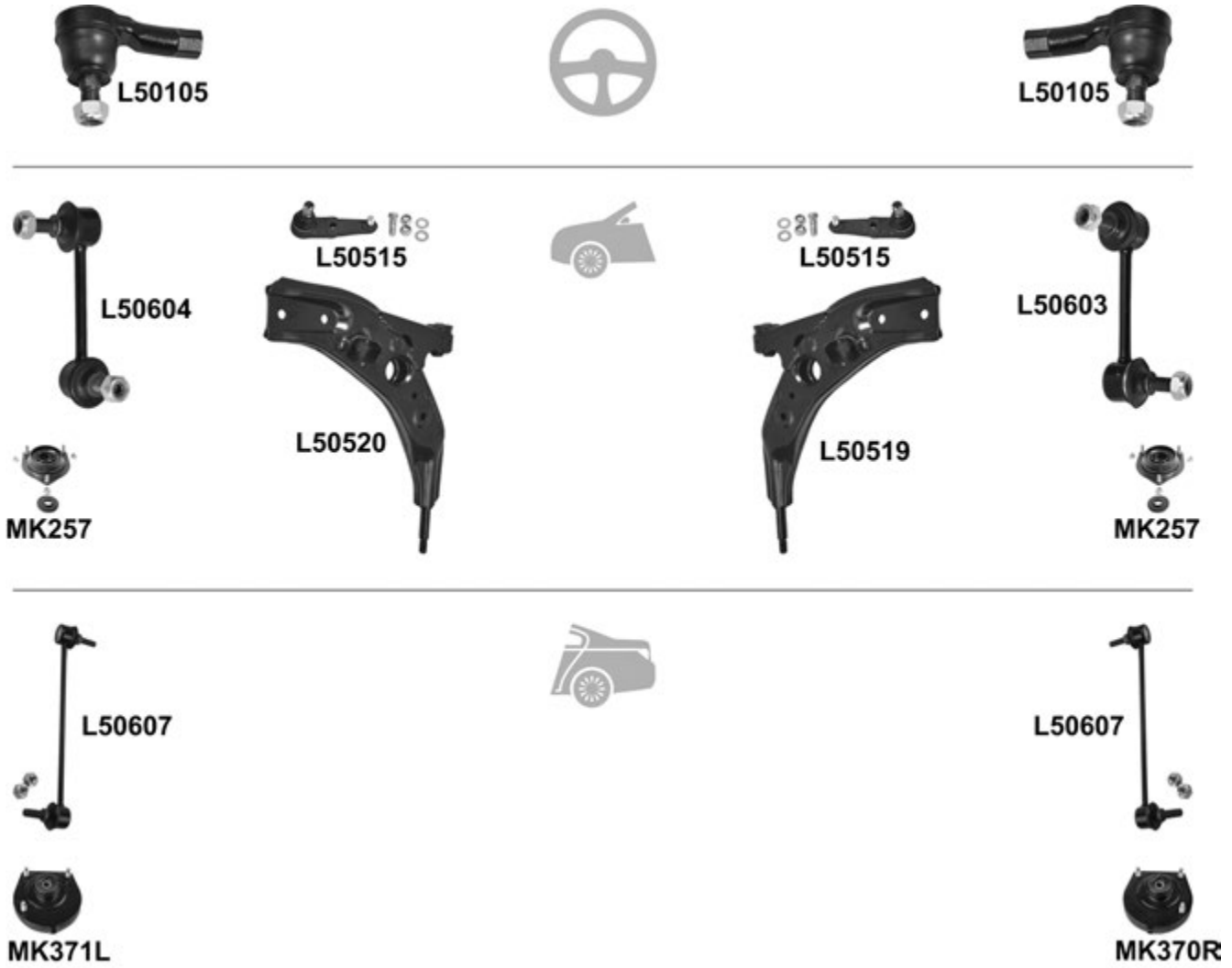
323 BA 08.94 → 09.98

				←	→	Thread	Part Of	QPA	
		↔		L50105	L50105	F 12x1,25		2	8AB2-32-280
		⊥		L50515	L50515			2	B01A-34-550A
		⊥			L50519			1	BE7B-34-300A
					L50520			1	BE7B-34-3350A
						L50603		1	GA2A-34-150A
					L50604			1	GA2A-34-170A
			KIT	MK257	MK257			2	B01C-34-380
				L50607	L50607			2	BC1D-28-170A
					MK370R ⁰			1	BC1D-28-380
				MK371L ⁰				1	BC1D-28-390

323 BJ 09.98 →



323 BJ 09.98 →

				←	→	Thread	Part Of	QPA	
		↔		L50107	L50107	F 14x1,5 ∪		2	8AG3-32-280
					L50217	M 14x1,5 / M 16x1 ∪		1	B25D-32-250
					L50218		M 14x1,5 / M 16x1 ∪		1
		↓		L50040	L50040			2	G030-99-356
		↓			L50521			1	B25D-34-300B
		↕	- TCA/lower/rear	L50522				1	B25D-34-350B
		↕		L50800	L50800			2	B25D-34-460
		↕		L50801	L50801			2	B25D-34-470
			→ 08.00 , → ch. 304194	L50608	L50608			2	B26R-34-170
			09.00 →, ch. 304195 →	L50614	L50614			2	LC62-34-170B
			→ 11.01	KIT	MK315	MK315		2	CB01-34-380
			→ 12.01 →	KIT	MK315	MK315		2	C145-34-380C
			4 , → ch.310769	L50609	L50609			2	B26R-28-170
			5 , → ch.308943	L50609	L50609			2	B26R-28-170
			4 , ch. 310770 →	L50615	L50615			2	B30H-28-170B
			5 , ch. 308944 →	L50615	L50615			2	B30H-28-170B

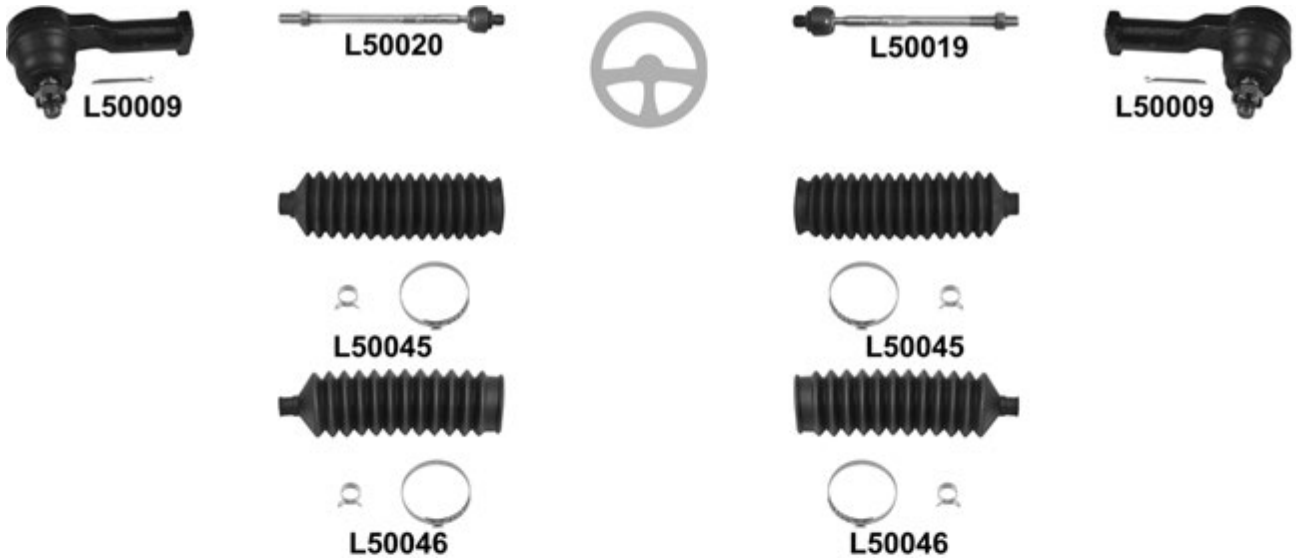
626 GC 11.82 → 09.87

626 GC 11.82 → 09.87

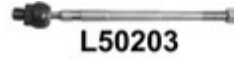
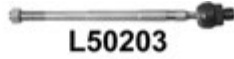
				← → Thread		Part Of	QPA		
⊕		↔		L50009	L50009	F 14x1,5 ∪	2	8AH1-32-280	
			(-) ⊕		L50019	M 14x1,5 / M 16x1 ∪	1	G030-32-240A	
				L50020		M 14x1,5 / M 16x1 ∪	1	G030-32-250A	
			⊕	L50045	L50045		2	G030-32-125	
			⊕	L50046	L50046		2	H002-32-125	
⊖		⊥		L50040	L50040		2	G030-99-356	
		⊥			L50004		1	G030-34-300F	
				L50005			1	G030-34-350F	
				L50140	L50140		2	G030-34-100	
⊖			(-) AUT	KIT	MK103	MK103	2		
				L50602	L50602		2	8AB2-34-100A	
					MK250R		1		
				MK251L			1		

626 (GD) 06.87 → 05.92

Thread
Part Of
QPA

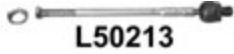

		↔	→ ch. 561648	L50009	L50009	F 14x1,5 ∪		2 8AH1-32-280
			ch. 561649 →	L50107	L50107	F 14x1,5 ∪		2 8AG3-32-280
				L50203	L50203	M 14x1,5 / M 18x1,5 ∪		2 GJ22-32-240
		↓		L50040	L50040			2 G030-99-356
		↓		L50503				1 GF22-34-300A
				L50504				1 GF22-34-350A
				L50600	L50600			2 8AG1-34-100
			(-)	KIT	MK252	MK252		2
				L50601	L50601			2 8AB1-28-100
				MK253	MK253			2 GJ21-28-380A

626 Van / St.car (GV) 09.87 → 11.96

		i		←	→	Thread	Part Of	QPA	i
		↔	→ ch. 205496	L50009	L50009	F 14x1,5 U		2	8AH1-32-280
			ch. 205497 →	L50107	L50107	F 14x1,5		2	8AG4-32-280
		⊥			L50503			1	GF22-34-300A
				L50504				1	GF22-34-350A
				L50600	L50600			2	8AG1-34-100
				MK253	MK253			2	GJ21-28-380A

626 (GE) excl. 4WD 08.91 → 04.97

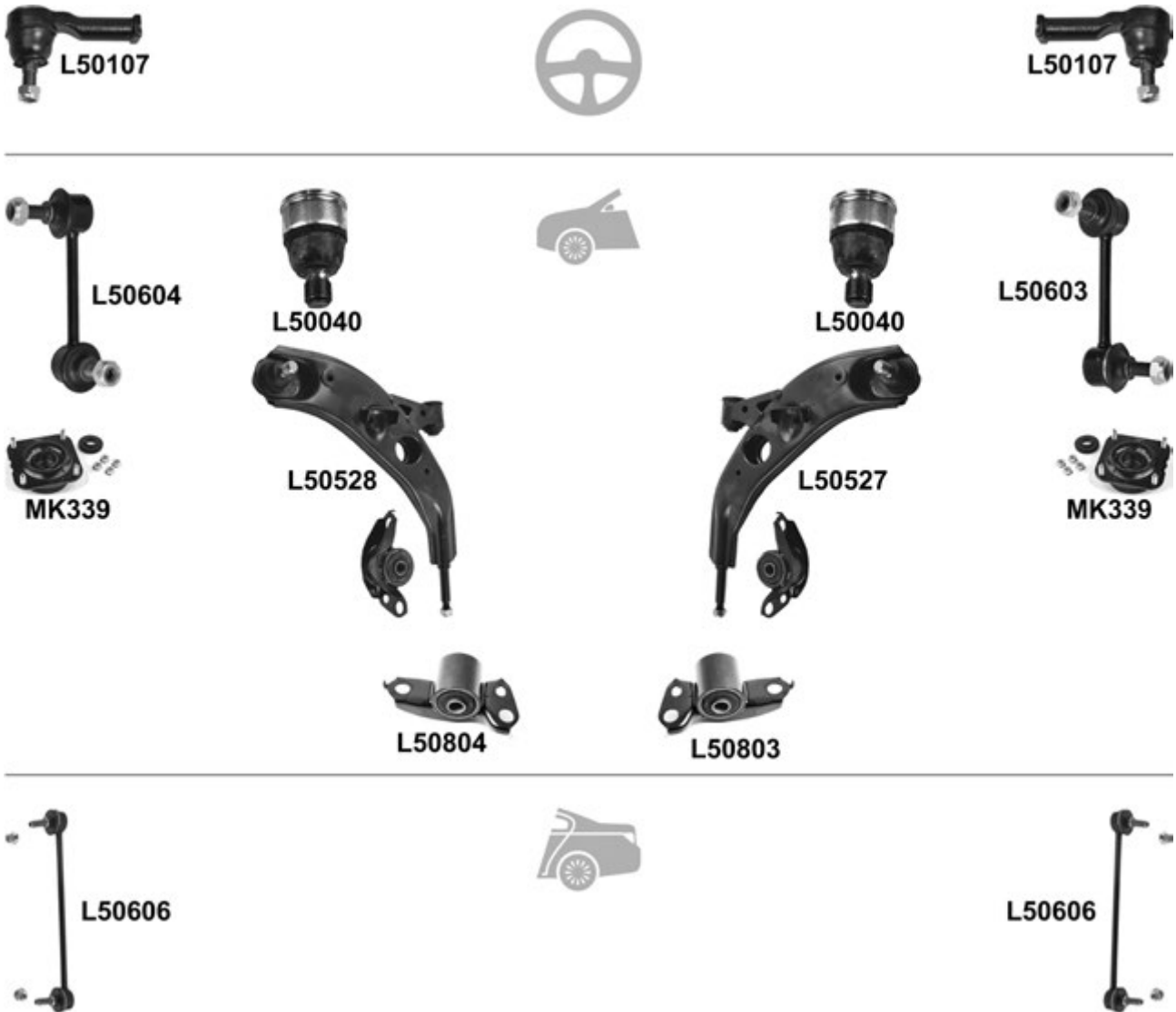
			←	→	Thread	Part Of	QPA	
		↔	L50107	L50107	F 14x1,5		2	8AG4-32-280
			L50213	L50213	M 14x1,5 / M 18x1,5 ☺		2	GA2A-32-240
		⊥	L50040	L50040			2	G030-99-356
		⊥		L50513			1	GA6B-34-300
				L50514			1	GA6B-34-350
					L50603		1	GA2A-34-150A
				L50604			1	GA2A-34-170A
			KIT	MK254	MK254		2	GA2A-34-380
			L50605	L50605			2	GA2C-28-170B
				MK173R			1	GA2A-28-380A
			MK174L				1	GA2A-28-390A

626 (GF / GW) 05.97 →

			i	←	→	Thread	Part Of	QPA	i
		↔		L50107	L50107	F 14x1,5		2	8AG4-32-280
		↓		L50040	L50040			2	G030-99-356
		↓	<input checked="" type="checkbox"/>		L50527			1	GE4T-34-300E
				L50528				1	GE4T-34-350E
		↓			L50803			1	GE4T-34-46XD
				L50804				1	GE4T-34-46YD
					L50603			1	GA2A-34-150A
				L50604			1	GA2A-34-170A	
			KIT	MK339	MK339			2	
				L50606	L50606			2	GE4T-28-170

929 HB 05.82 → 07.87

			i	←	→	Thread	Part Of	QPA	i
		↔		L50009	L50009	F 14x1,5		2	8AH1-32-280

929 (HC) 09.87 →



Thread

Part Of

QPA



				L50009	L50009	F 14x1,5			2	8AH1-32-280
--	--	--	--	--------	--------	----------	--	--	---	-------------

MERCEDES

A-Class (W168) 07.97 → 08.04



A-Class (W168) 07.97 → 08.04

		i		←	→	Thread	Part Of	QPA	i
		↔				F 12x1,5 U		1	168 330 15 35
						F 12x1,5 U		1	168 330 14 35
						M 12x1,5 / M 14x1,5 U		2	168 330 13 35
								2	168 460 23 00
		↓						2	168 333 01 27
		↓		<input checked="" type="checkbox"/>				1	168 330 12 07
								1	168 330 11 07
			Metal					2	168 320 10 89
			Plastic					2	168 320 03 89
				KIT	MK150	MK150			2
			KIT	L23406	L23406			2	168 981 05 18

A-Class (W169) 09.04 →



A-Class (W169) 09.04 →

				←	→	Thread	Part Of	QPA	
		↔				L23125 F 14x1,5 U		1	169 330 06 03
						L23126 F 14x1,5 U		1	169 330 05 03
						L23209 L23209 M 14x1,5 U		2	169 330 07 03
						L23211 L23211 M 14x1,5 U		2	169 330 07 03
						L23007 ⁰		1	169 460 03 96
						L23008 ⁰		1	169 460 01 96
		⊥				L23551 L23551		2	169 333 01 27
		⊥	<input checked="" type="checkbox"/>			L23553		1	169 333 08 07
						L23554		1	169 333 07 07
		⊥↘		KIT		L23824 L23824		2	169 333 01 14
		⊥↗				L23825 L23825		2	169 333 00 14
						L23626 L23626		2	169 320 09 89
						MK378 ⁰ MK378 ⁰		2	
					L23627 L23627		2	169 320 05 89	

A-Class (W176) 06.12 →



						←	→	Thread	Part Of	QPA			
⊕		↔						L23147	F 14x1,5 U	1	246 330 18 00		
									L23148	F 14x1,5 U	1	246 330 17 00	
									L23221	L23221	M 14x1,5 / M 14x1,5 U	2	246 338 00 00
🚗		⊥	(-) A45 AMG	<input checked="" type="checkbox"/>					L23577		1	246 330 48 00	
											L23578		1
		⊥▼	(-) A45 AMG							L23829		1	246 333 02 14
										L23830		1	246 333 00 14
🚗		⊥▲	(-) A45 AMG					L23831	L23831		2	246 333 01 14	
		⊥	(-) A45 AMG					L23583 ⁰	L23583 ⁰		2	246 350 10 06	
		⊥▲						L23582 ⁰	L23582 ⁰		2	246 350 00 53	
			(-) SP					L23676 ⁰	L23676 ⁰		2	246 320 04 89	

B-Class (W245) 03.05 →



		i	←	→	Thread	Part Of	QPA	i	
⊕		↔		L23125	F 14x1,5 U		1	169 330 06 03	
				L23126	F 14x1,5 U		1	169 330 05 03	
				L23211	L23211	M 14x1,5 U		2	169 330 07 03
				L23007 ^o				1	169 460 03 96
				L23008 ^o				1	169 460 01 96
⊖		⊥		L23551	L23551		2	169 333 01 27	
			<input checked="" type="checkbox"/>	L23553			1	169 333 08 07	
				L23554			1	169 333 07 07	
				KIT	L23824	L23824		2	169 333 01 14
				L23825	L23825		2	169 333 00 14	
				L23626	L23626		2	169 320 09 89	
⊖			MK378 ^o	MK378 ^o		2			
			L23627	L23627		2	169 320 05 89		

B-Class (W246) 11.11 →



				←	→	Thread	Part Of	QPA	
⊕		↔			L23147	F 14x1,5 ∪		1	246 330 18 00
					L23148	F 14x1,5 ∪		1	246 330 17 00
					L23221	L23221	M 14x1,5 / M 14x1,5 ∪	2	246 338 00 00
🚗		⊥	☑		L23577			1	246 330 48 00
					L23578			1	246 330 47 00
					L23829			1	246 333 02 14
					L23830			1	246 333 00 14
🚗		⊥	↗		L23831	L23831		2	246 333 01 14
					L23583 ⁰	L23583 ⁰		2	246 350 10 06
					L23582 ⁰	L23582 ⁰		2	246 350 00 53
					L23676 ⁰	L23676 ⁰		2	246 320 04 89

W108 / 109 (250 S - 300 SEL 6.3) 01.66 → 08.72
 W110 (190 C - 230) 08.59 → 02.68
 W111 (220 B - 280 SE 3.5) 08.59 → 12.71
 W113 (230 SL - 280 SL) 01.63 → 03.71



L2321



L2321



L2320



L2320

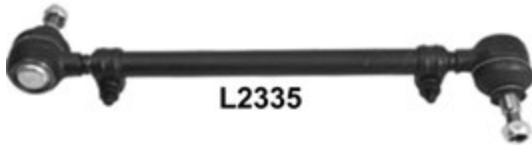

L2335



L2335

		i		←	→	Thread	Part Of	QPA	i
⊕		↔		L2321	L2321	M 14x1,5 ♂		2	000 338 50 10
		→←		L2320	L2320	M 14x1,5 ♂		2	000 338 52 10
			L2335	L2335			2	115 330 08 03	

W114 (230.6 - 280 E "8") 01.68 → 11.76
 W114 Coupé (250 C - 280 CE "8") 04.69 → 02.77
 W115 (200 D - 230.4 "8") 01.68 → 01.77

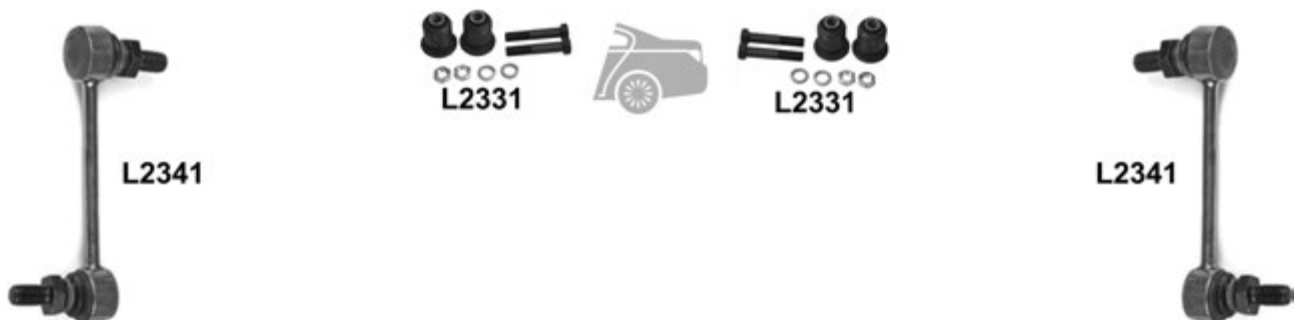

				←	→	Thread	Part Of	QPA	
		↔		L2321	L2321	M 14x1,5 U		2	000 338 50 10
		→←		L2320	L2320	M 14x1,5 U		2	000 338 52 10
				L2335	L2335			2	115 330 08 03
		→←	KIT	L23402				1	126 460 08 19
			KIT	L2332			Anti-roll bar	1	115 320 00 47
			KIT	L2331	L2331			2	126 352 01 65 S
				L2341	L2341			2	115 320 15 89

W116 (280 S - 450 SEL 6.9) 08.72 → 7.80

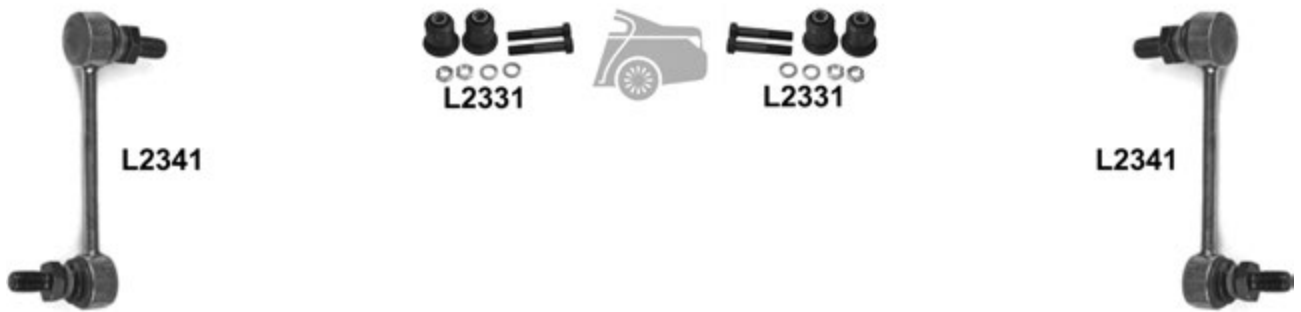

				←	→	Thread	Part Of	QPA	
		↔		L2321	L2321	M 14x1,5 U		2	000 338 50 10
		→←		L2320	L2320	M 14x1,5 U		2	000 338 52 10
		⊥		L2344	L2344			2	116 333 09 27
		↑			L2360			1	123 330 53 07
				L2361				1	123 330 52 07
			KIT	L2331	L2331			2	126 352 01 65 S
				L2341	L2341			2	115 320 15 89

W123 (200 - 280 E) 01.76 → 12.85
 W123 Coupé (230 CE - 280 CE) 03.77 → 12.85
 W123 T (200 T - 300 TE) 09.77 → 12.85

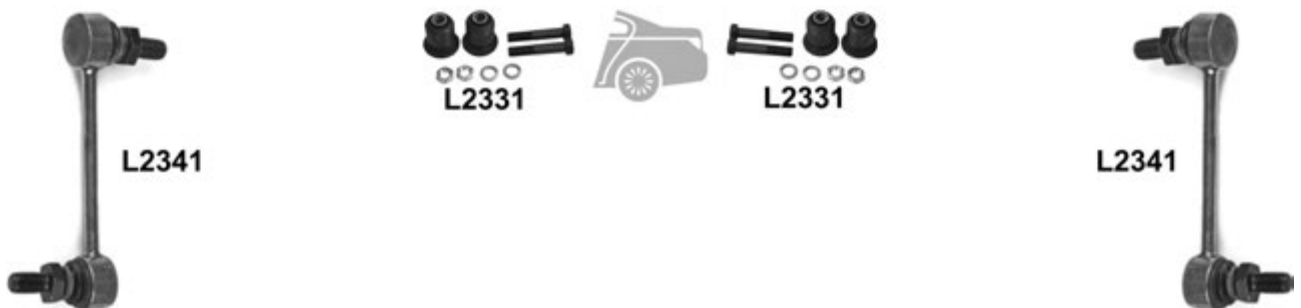

W123 (200 - 280 E) 01.76 → 12.85
 W123 Coupé (230 CE - 280 CE) 03.77 → 12.85
 W123 T (200 T - 300 TE) 09.77 → 12.85

L23600

L23600

		i		←	→	Thread	Part Of	QPA	i
		↔	→ 09.77	L2321	L2321	M 14x1,5 U		2	000 338 50 10
			→ 08.82	L2359	L2359	M 16x1,5 U		2	123 338 02 10
			08.82 →	L2321	L2321	M 14x1,5 U		2	000 338 50 10
			→ ← 08.82 →	L2304	L2304	M 14x1,5 U		2	000 338 51 10
			14mm	L2365	L2365			2	123 330 18 03
		→ ←	KIT	L23402				1	124 460 08 19
		⊥		L2344	L2344			2	116 333 09 27
			∩		L2360			1	123 330 53 07
				L2361				1	123 330 52 07
		⊥→←	Model 123.003/007/028/102/103/105/125/132/200	KIT	L23401	L23401		2	126 330 00 75
				KIT	L2331	L2331		2	126 352 01 65 S
					L2341	L2341		2	115 320 15 89
			New type		L23600	L23600		2	123 320 09 89

W124 (200 - 400 E) 12.84 → 06.93
 W124 (E-Class) 06.93 → 06.95
 (-) 4-MATIC model



W124 (200 - 400 E) 12.84 → 06.93
 W124 (E-Class) 06.93 → 06.95
 (-) 4-MATIC model

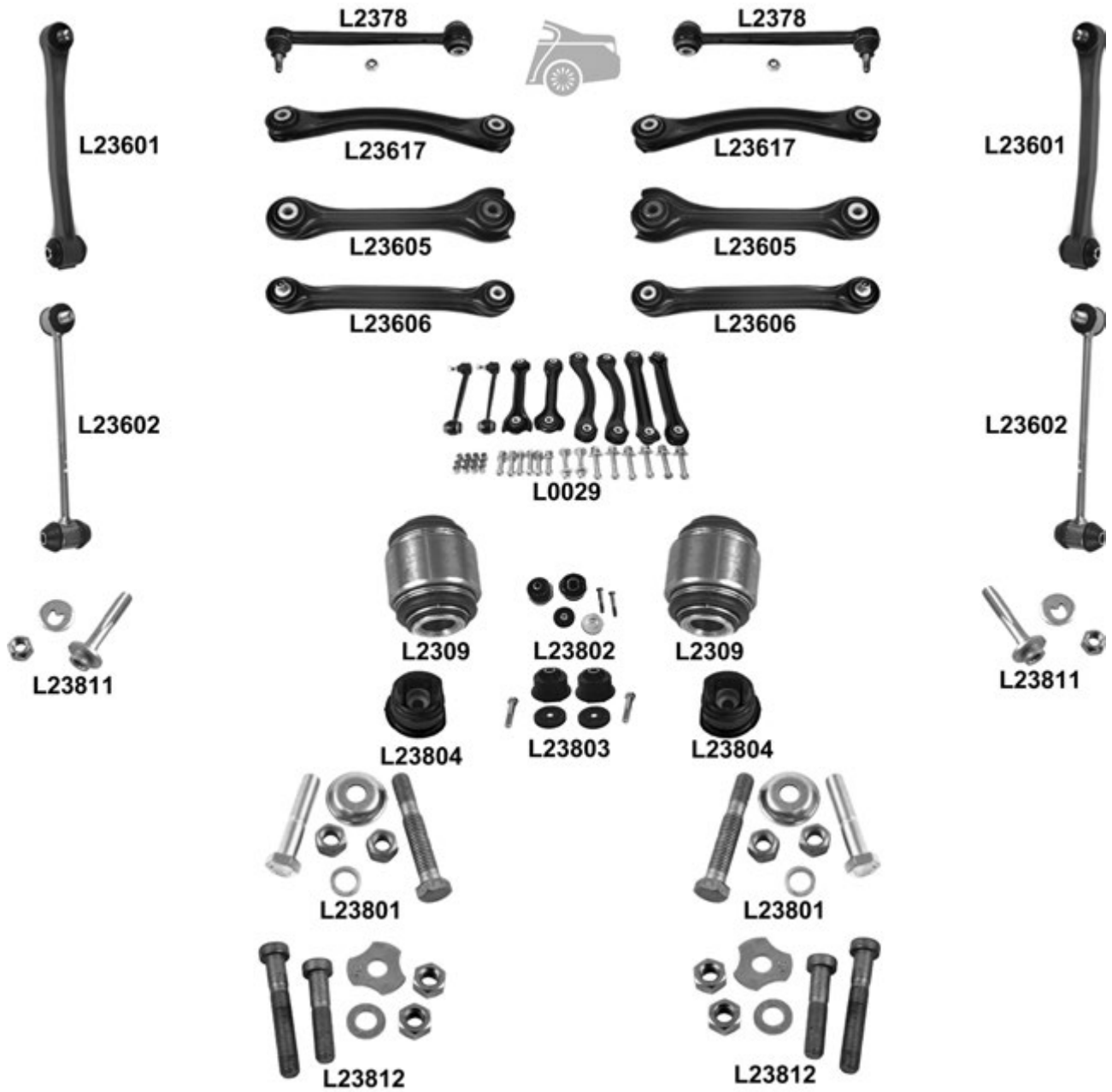

W124 (200 - 400 E) 12.84 → 06.93
W124 (E-Class) 06.93 → 06.95
(-) 4-MATIC model

			←	→	Thread	Part Of	QPA		
		↔	(-) E-Klasse Mot/Eng 119.###	L2304	L2304	M 14x1,5 U	2	000 338 51 10	
		→←	(-) E-Klasse Mot/Eng 119.###	L2303	L2303	M 14x1,5 U	2	000 338 56 10	
			(-) E-Klasse Mot/Eng 119.###	L2301	L2301		2	124 330 08 03	
		↔	→ 08.89 , Ident. → 1B022104 / → 2B051198	L2300			1	124 460 08 05	
		08.89 →, Ident. 1B022105 → / 2B051199 →	L23301			1	124 460 12 05		
		↔	KIT		L23402		1	124 460 01 19	
		↓		L2377	L2377		2	124 333 03 27	
		↓	(-) SP <input checked="" type="checkbox"/>		L23501		1	124 330 31 07	
			E280 Model124.028, SP <input checked="" type="checkbox"/>		L23501		1	124 330 31 07	
					L23502		1	124 330 30 07	
			500/E500 Model124.036, Ident. → 927760 <input checked="" type="checkbox"/>		L23501		1	124 330 31 07	
					L23502		1	124 330 30 07	
		Old Version	KIT	L23801	L23801	L23605	2	124 350 68 06	
		New version		L23812	L23812	L23605/ L23606/L23617	2	210 350 45 06	
				L2378	L2378		2	210 350 06 53	
			New type	L23617	L23617		2	210 350 34 06	
		↑	Pull	L23605	L23605		2	201 350 56 06	
		↓	Push	L23606	L23606		2	124 350 01 29	
			L 2378x2, L 23605x2, L 23606x2, L 23617x2, L 23811x2, L 23812x6 <input checked="" type="checkbox"/>	L0029			1	210 350 30 38 06 S	
			Plastic	L23601	L23601		2	124 320 02 89	
			Metal	L23602	L23602		2	124 320 04 89	
		↓		L2309	L2309		Wheel bearing housing	2	204 352 00 27
		▼		L23804	L23804		Hub carrier	2	124 351 02 42
▲		(-) Taxi	L23802			Hub carrier	1	124 350 64 08	
		Taxi	L23803			Hub carrier	1	124 350 00 41	
			L23811	L23811		Hub carrier, L2378	2	140 350 11 70	

W124 Coupé (230CE - 300 CE) 03.87 → 05.93
 W124 Coupé (E-Class) 06.93 →
 W124 Cabriolet 04.92 →



W124 Coupé (230CE - 300 CE) 03.87 → 05.93
 W124 Coupé (E-Class) 06.93 →
 W124 Cabriolet 04.92 →

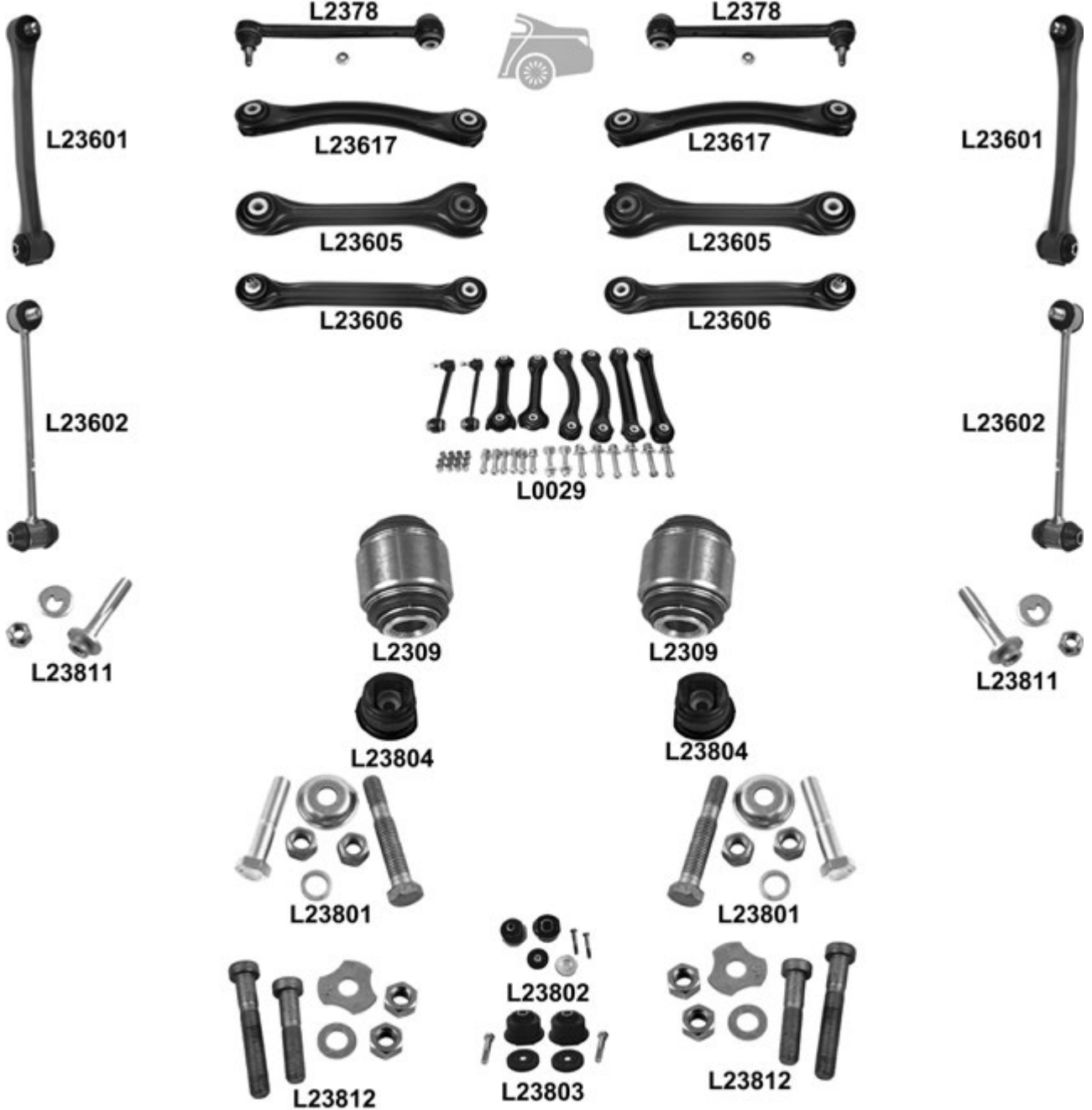

W124 Coupé (230CE - 300 CE) 03.87 → 05.93
W124 Coupé (E-Class) 06.93 →
W124 Cabriolet 04.92 →

			←	→	Thread	Part Of	QPA		
		↔	L2304	L2304	M 14x1,5 U		2	000 338 51 10	
		→←	L2303	L2303	M 14x1,5 U		2	000 338 56 10	
			L2301	L2301			2	124 330 08 03	
		→ ←	→ 08.89, Ident. → 1B022104 / → 2B051198 09.89 →, Ident. 1B022105 → / 2B051199 →	L2300			1	124 460 08 05	
			L23301			1	124 460 12 05		
		→ ←	KIT		L23402		1	124 460 01 19	
		⊥	L2377	L2377			2	124 333 03 27	
		⊥	A124 : E 200, E 220 <input checked="" type="checkbox"/> C124 : 220 CE, 230 CE, 300 CE, E 200, E 220 (-) SP	L23501			1	124 330 31 07	
		SP , A124 : E 200, C124 : E 200 <input checked="" type="checkbox"/>	L23502			1	124 330 30 07		
			L23503			1	124 330 39 07		
			L23504			1	124 330 38 07		
			L2309	L2309			2	210 350 06 53	
		Old Version	KIT L23801 L23801			CAS L23605	2	124 350 68 06	
		New version	L23812	L23812		CAM L23605/ L23606/L23617	2	210 350 45 06	
			L2378	L2378			2	210 350 06 53	
			L23617	L23617			2	210 350 34 06	
		↑	Pull	L23605	L23605		2	201 350 56 06	
		⊥	Push	L23606	L23606		2	201 350 00 29	
			L 2378x2, L 23605x2, L 23606x2, L 23617x2, L 23811x2, L 23812x6	KIT L0029			1	210 350 30 38 06 S	
			Plastic	L23601	L23601			2	124 320 02 89
			Metal	L23602	L23602			2	124 320 04 89
		▼		L23804	L23804		Hub carrier	2	124 351 02 42
		▲	(-) Taxi	L23802			Hub carrier	1	124 350 68 06
		Taxi	L23803			Hub carrier	1	124 350 00 41	
			L23811	L23811		Hub carrier, L2378	2	140 350 11 70	

W124 T (200T - 300 TE) 09.85 → 06.93
 W124 T (E-Class) 06.93 →
 (-) 4-MATIC model



W124 T (200T - 300 TE) 09.85 → 06.93
 W124 T (E-Class) 06.93 →
 (-) 4-MATIC model

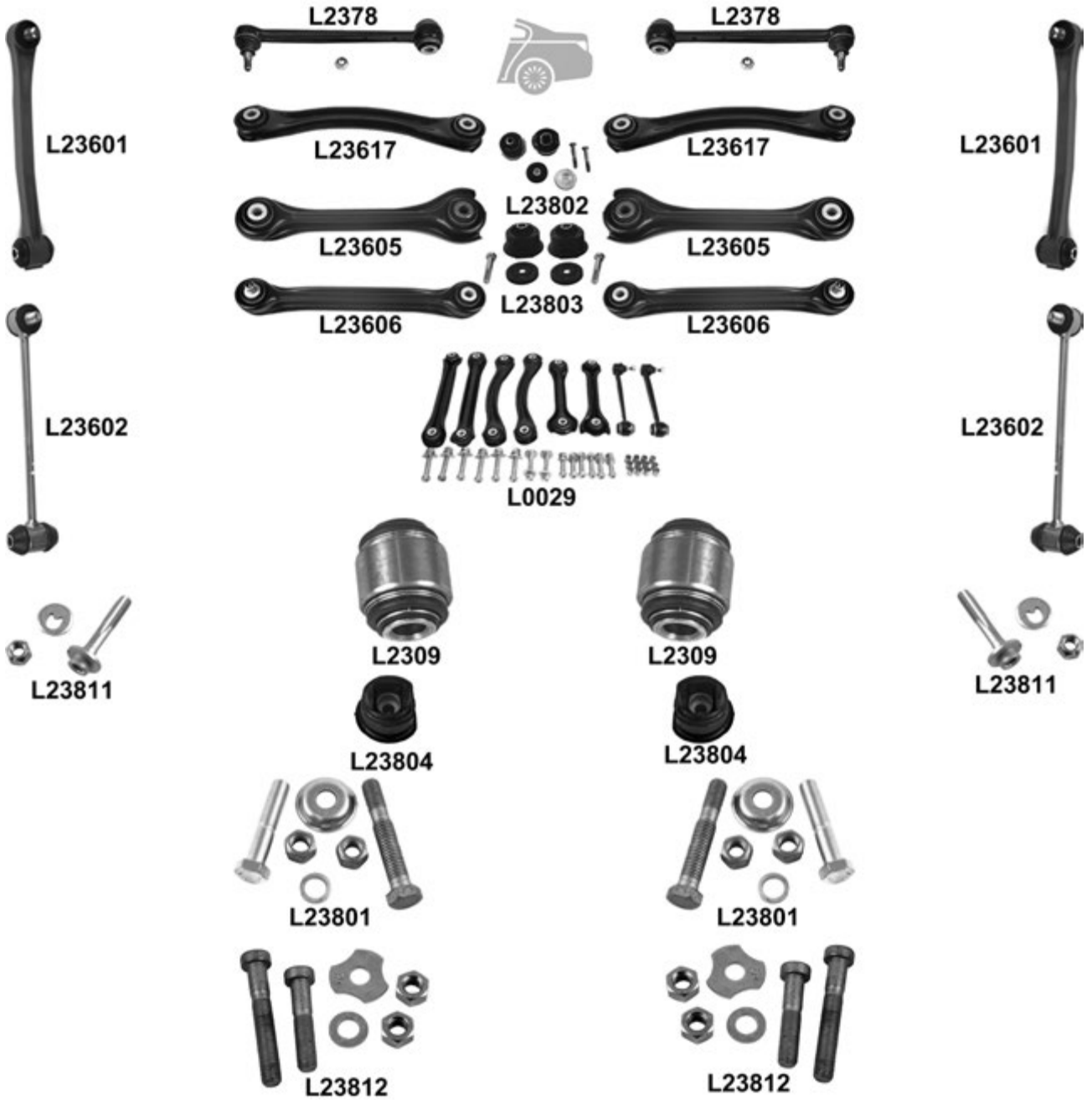

W124 T (200T - 300 TE) 09.85 → 06.93
W124 T (E-Class) 06.93 →
(-) 4-MATIC model

			←	→	Thread	Part Of	QPA		
		↔	L2304	L2304	M 14x1,5 U		2	000 338 51 10	
		→←	L2303	L2303	M 14x1,5 U		2	000 338 56 10	
			L2301	L2301			2	124 330 08 03	
		→ ←	→ 12.88 , Ident. → 1F114568 / → 2F120743	L2300			1	124 460 08 05	
		→ 01.89 , Ident. 1F114569 → / 2F120744 →	L23301			1	124 460 12 05		
		→ ←	KIT		L23402		1	124 460 01 19	
		↓	L2377	L2377			2	124 333 03 27	
		↓	200 T, 200 TD, 200 TE, 220 TE, 230 TE, 250 TD, 250 TD Turbo, 260 TE, 280 TE 300 TD 300 T Turbo-D, 300 TE, 300 TE-24 E 200 T, E 220 T, E 250, E 250 TD, E 280 T, E 300 TD, E 300 T, E 320 T (-) SP	L23502			1	124 330 31 07	
				L23501					
			L2309	L2309			2	210 350 06 53	
		Old Version	KIT	L23801	L23801		L23605	2	124 350 68 06
	New version		L23812	L23812		L23605/ L23606/L23617	2	210 350 45 06	
			L2378	L2378			2	210 350 06 53	
		New type		L23617	L23617			2	210 350 34 06
		↑	Pull	L23605	L23605			2	201 350 56 06
		↓	Push	L23606	L23606			2	201 350 00 29
			L 2378x2, L 23605x2, L 23606x2, L 23617x2, L 23811x2, L 23812x6	KIT		L0029		1	210 350 30 38 06 S
			Plastic	L23601	L23601			2	124 320 02 89
			Metal	L23602	L23602			2	124 320 04 89
			▼	L23804	L23804		Hub carrier	2	124 351 02 42
			▲	(-) Taxi	L23802			Hub carrier	1
Taxi			L23803			Hub carrier	1	124 350 00 41	
			L23811	L23811		Hub carrier, L2378	2	140 350 11 70	

W126 (260 SE - 560 SEL) 10.79 → 6.91
 W126 Coupé (380 SEC - 560 SEC) 10.81 → 6.91

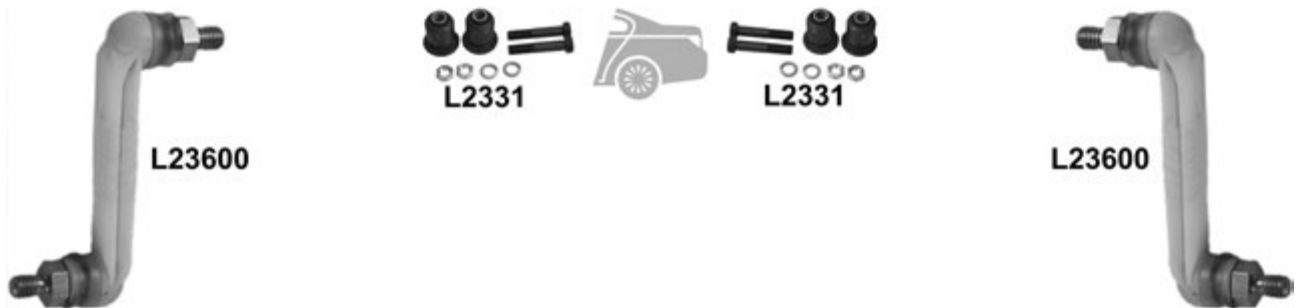

				← → Thread		Part Of	QPA	i	
⊕		↔		L2321	L2321	M 14x1,5 U		2	000 338 50 10
		→←		L2320	L2320	M 14x1,5 U		2	000 338 52 10
		↔↔	KIT	L23402				1	124 460 08 19
⊖		⊥		L2344	L2344			2	116 333 09 27
		↕			L23519			1	126 330 07 07
				L23520				1	126 330 06 07
		↕↔	KIT	L23401	L23401			2	126 330 00 75
			KIT	L2331	L2331			2	126 352 01 65 S
				L23600	L23600			2	123 320 09 89

W201 (190 - 190 E) 10.82 → 08.93

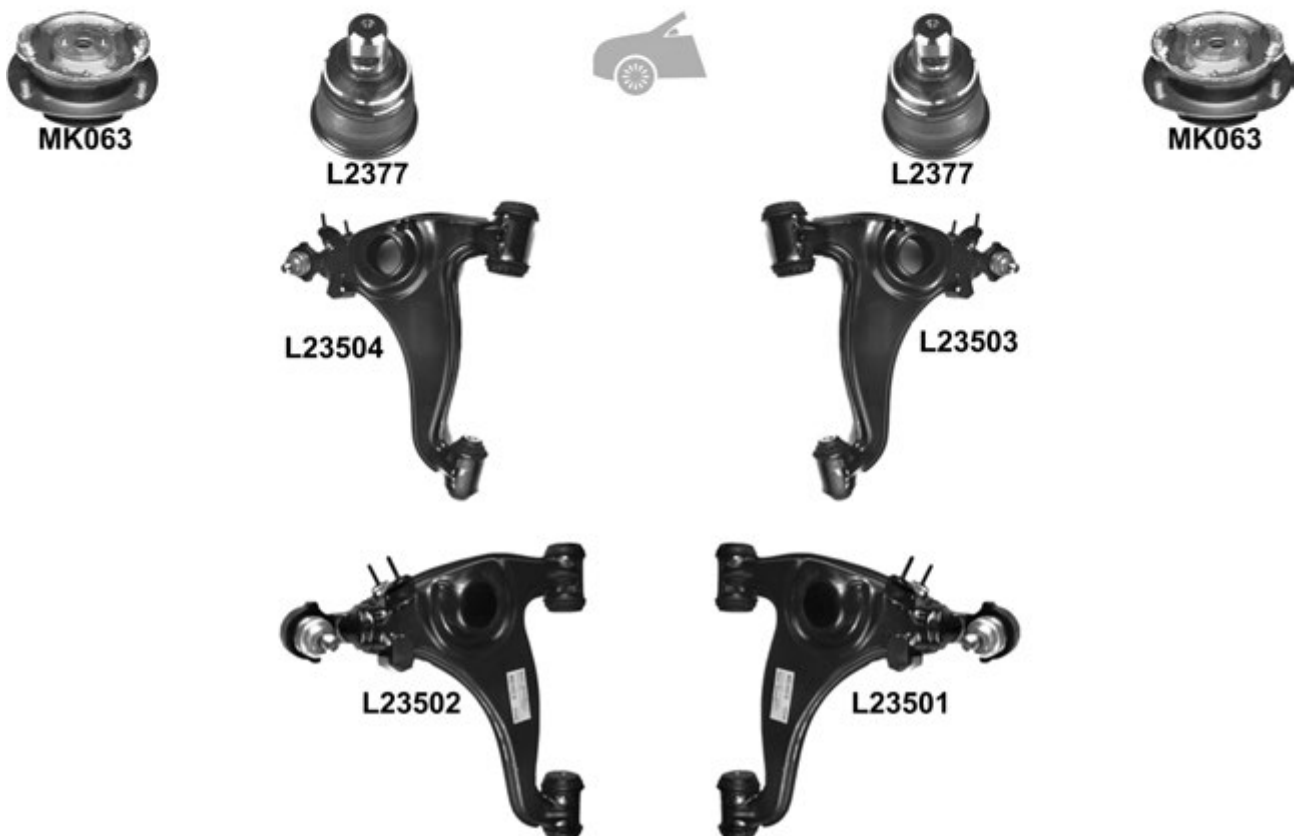
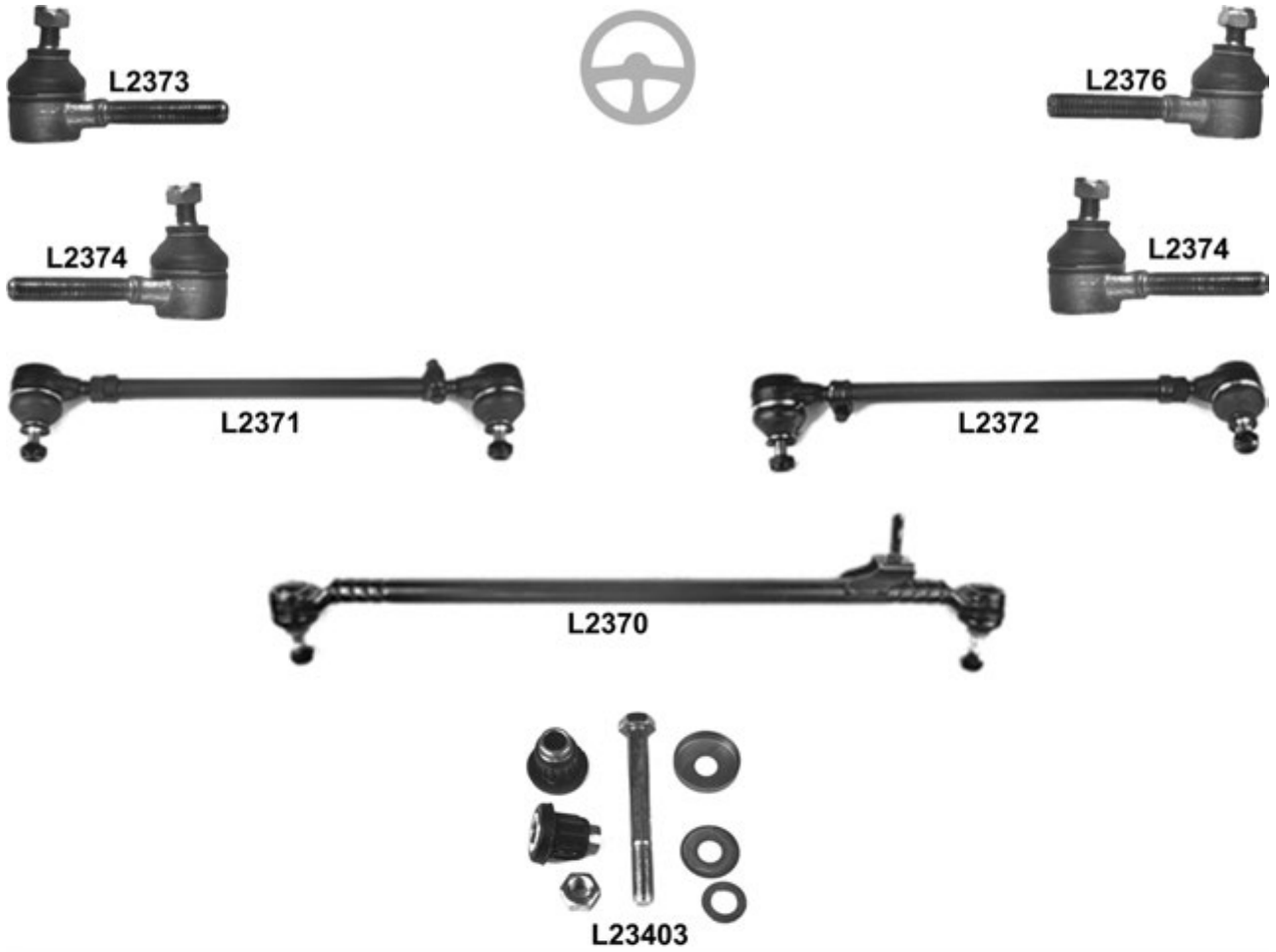

W201 (190 - 190 E) 10.82 → 08.93



L23508



L23507



L23601



L2378



L2378



L23617



L23617



L23605



L23605



L23606



L23606



L23601



L23811



L23811



L0029



L2309



L2309



L23801



L23801



L23812



L23802



L23812

W201 (190 - 190 E) 10.82 → 08.93

		i		←	→	Thread	Part Of	QPA	i		
		↔↔			L2376	M 12x1,5 U	L2372	1	000 338 63 10		
		→←			L2374	M 12x1,5 U	L2372	1	000 338 60 10		
		↔↔			L2373	M 12x1,5 U	L2371	1	000 338 61 10		
		→←			L2374	M 12x1,5 U	L2371	1	000 338 60 10		
						L2372			1	201 330 16 03	
						L2371			1	201 330 15 03	
		→ ←			L2370				1	201 460 15 05	
		→ ←		KIT		L23403			1	201 460 00 50	
		⊥			L2377	L2377		2	124 333 03 27		
		⊥	(-) SP , 190 E 2.3 / 2.6, 190 D 2.5 Turbo	<input checked="" type="checkbox"/>		L23503			1	124 330 39 07	
					L23504			1	124 330 38 07		
		⊥	SP , (-) 190 E 2.3 / 2.6, 190 D 2.5 Turbo	<input checked="" type="checkbox"/>		L23501			1	124 330 31 07	
				L23502			1	124 330 30 07			
		⊥	190 E 2.3 / 2.6, 190 D 2.5 Turbo, (-) SP	<input checked="" type="checkbox"/>		L23507			1	124 330 19 07	
				L23508			1	124 330 18 07			
					MK063	MK063			2	201 320 24 44	
					L2309	L2309			2	210 350 06 53	
			Old Version	KIT	L23801	L23801			L23605	2	124 350 68 06
			New version		L23812	L23812			L23605/ L23606/L23617	2	210 350 45 06
					L2378	L2378			2	210 350 06 53	
			New type		L23617	L23617			2	210 350 34 06	
		↕	Pull		L23605	L23605			2	201 350 56 06	
			Push		L23606	L23606			2	201 350 00 29	
			L 2378x2, L 23605x2, L 23606x2, L 23617x2, L 23811x2, L 23812x6	KIT	L0029				1	210 350 30 38 06 S	
					L23601	L23601			2	124 320 02 89	
					L23802			Hub carrier	1	124 350 64 08	
				L23811	L23811		Hub carrier, L2378	2	140 350 11 70		

C-Class W202 (C180 - C280) 06.93 → 05.00
 C-Class Kombi S202 (C180 - C250 TD) 06.96 → 03.01

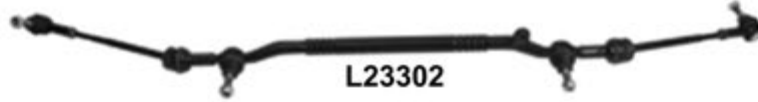

C-Class W202 (C180 - C280) 06.93 → 05.00
 C-Class Kombi S202 (C180 - C250 TD) 06.96 → 03.01

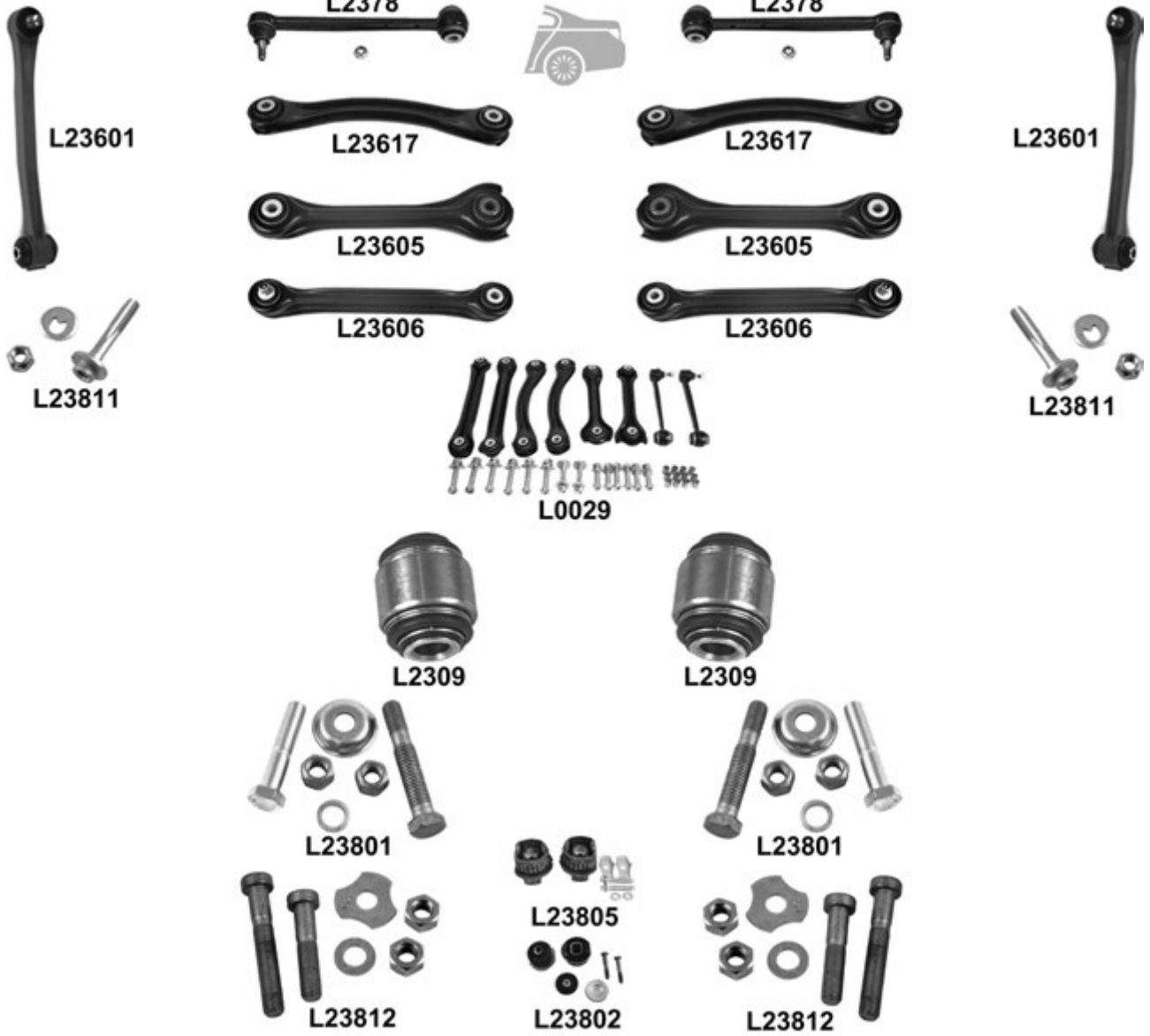

C-Class W202 (C180 - C280) 06.93 → 05.00
C-Class Kombi S202 (C180 - C250 TD) 06.96 → 03.01

		i		← → Thread		Part Of	QPA	i	
		↔		L23103	L23103	F 12x1,5 ⌀	2	001 330 77 35	
		→ ←		L23302			1	202 460 04 05	
			6 / 8 cyl. Petrol Models	L23310			1	202 460 05 05	
		→ ←		KIT L23405			1	202 460 03 19	
		⊥		L23505	L23505		2	210 330 00 35	
		↑	<input checked="" type="checkbox"/>		L23521		1	210 330 88 07	
				L23522			1	210 330 87 07	
		⊥	<input checked="" type="checkbox"/>		L23511		1	202 330 27 07	
				L23512			1	202 330 26 07	
		⊥ ▲		L23821	L23821	L23511/L23512	4	202 338 87 14	
		⊥	ch. → A 443812 ch → F 500865	KIT	L23806	L23806		2	202 330 00 75
			ch. A 443813 → ch. F 500866 →	KIT	L23807	L23807		2	170 330 00 75
				L2309	L2309		2	210 350 06 53	
			Old Version	KIT	L23801	L23801	CAS L23605	2	124 350 68 06
			New version		L23812	L23812	CAM L23605/ L23606/L23617	6	210 350 45 06
				L2378	L2378		2	210 350 06 53	
			New type	L23617	L23617		2	210 350 34 06	
		↑	Pull	L23605	L23605		2	201 350 56 06	
		⊥	Push	L23606	L23606		2	201 350 00 29	
			L 2378x2, L 23605x2, L 23606x2, L 23617x2, L 23811x2, L 23812x6	KIT	L0029			1	210 350 30 38 06 S
				L23601	L23601		2	124 320 02 89	
		▼		KIT L23805		Hub carrier	1	202 350 34 08	
		▲		L23802		Hub carrier	1	124 350 64 08	
			L23811	L23811	Hub carrier, L2378	2	140 350 11 70		

C-Class W203 (C180 - C30 CDi) 05.00 →
 C-Class Kombi S203 (C180 - C30 CDi) 03.01 →
 C-Class Sportcoupe SL203 (C180 - C30 CDi) 03.01 →

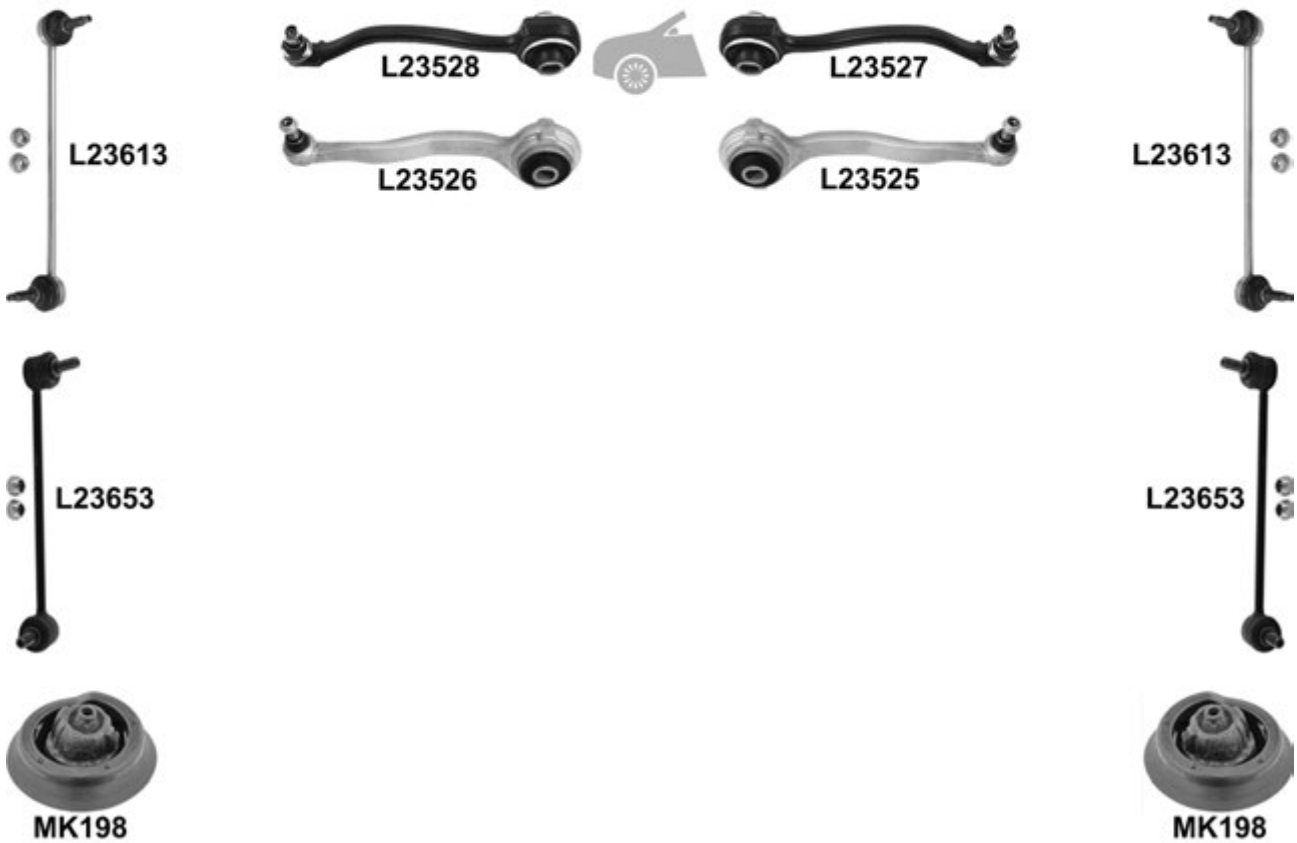
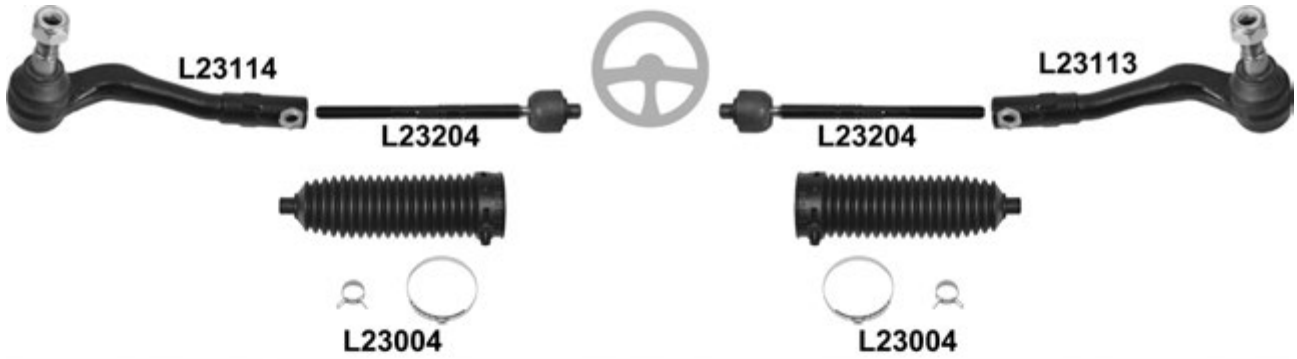

C-Class W203 (C180 - C30 CDi) 05.00 →
 C-Class Kombi S203 (C180 - C30 CDi) 03.01 →
 C-Class Sportcoupe SL203 (C180 - C30 CDi) 03.01 →

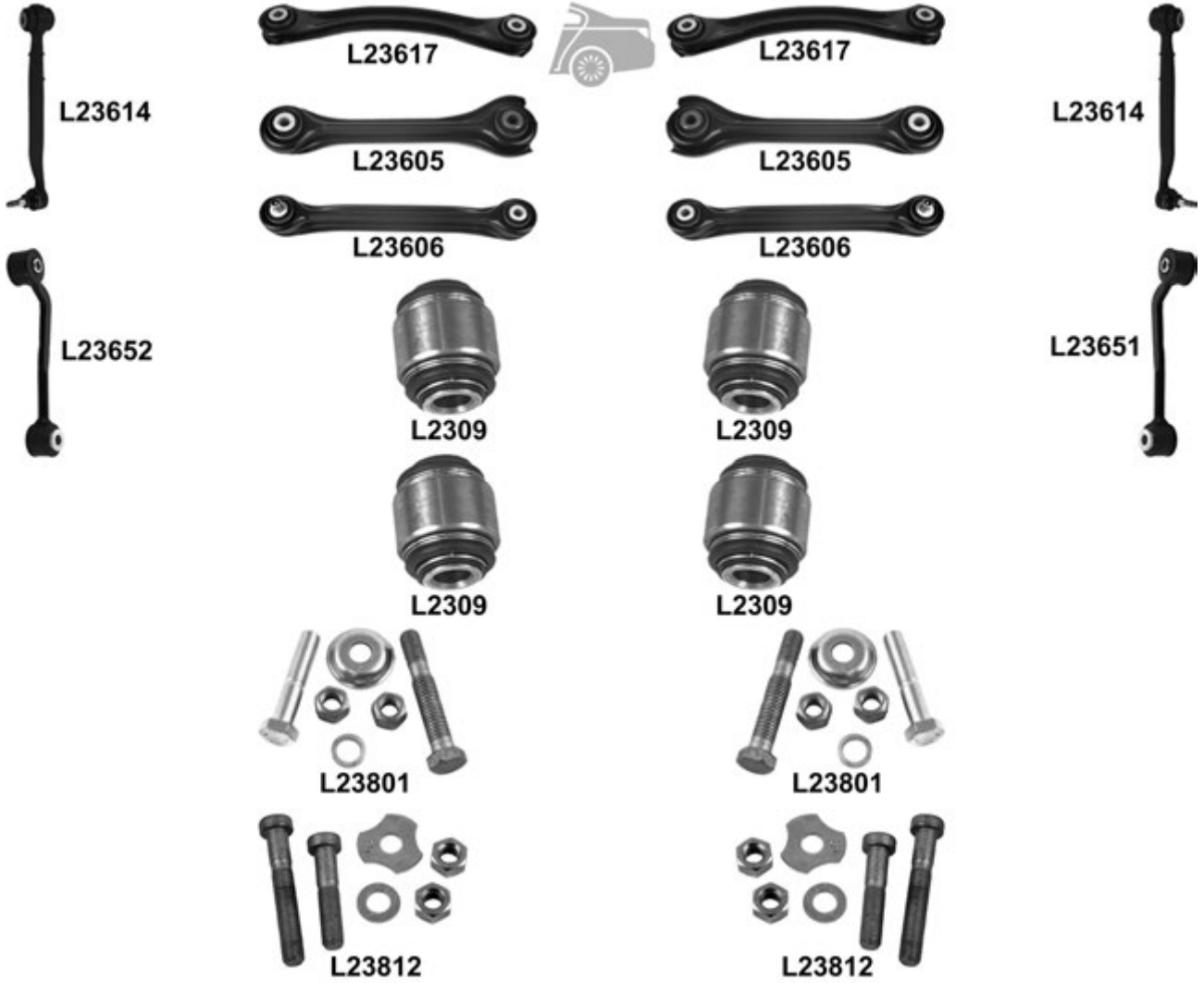

C-Class W203 (C180 - C30 CDi) 05.00 →
C-Class Kombi S203 (C180 - C30 CDi) 03.01 →
C-Class Sportcoupe SL203 (C180 - C30 CDi) 03.01 →

			←	→	Thread	Part Of	QPA			
		↔		L23113	F 14x1,5 ♂		1	203 330 20 03		
				L23114	F 14x1,5 ♂		1	203 330 19 03		
				L23204	L23204	M 14x1,5 / M 16x1,5 ♂		2	230 338 00 15	
			(-) 4-Matic	L23004 ^o	L23004 ^o			2	204 463 02 96	
		↓			L23527			1	203 330 20 11	
					L23528			1	203 330 19 11	
		↑	ALU		L23525			1	203 330 02 11	
					L23526			1	203 330 01 11	
				L23613	L23613			2	203 320 25 89	
			(-) SP /4-Matic, 10mm / 10mm	L23613	L23613			2	203 320 25 89	
			SP /AMG/4-Matic, 12mm / 12mm	L23653	L23653			2	203 320 29 89	
				MK198	MK198			2		
					L2309	L2309			2	220 352 02 27
				L 23605, Old Version	KIT	L23801	L23801			2
		L 23605 / 23606 / 23617, New version		L23812	L23812			6	210 350 45 06	
			New type	L23617	L23617			2	210 350 34 06	
		↑	Pull		L23605	L23605			2	201 350 56 06
					L23606	L23606			2	210 350 38 06
					L23614	L23614			2	203 350 03 53
						L23651			1	203 320 08 89
					L23652				1	203 320 07 89
		↓			L2309	L2309		Wheel bearing housing	2	204 352 00 27

C-Class W204 (C 180 - C 63 AMG) 01.07 →
 C-Class Coupe C204 (C 180 - C 63 AMG) 06.11 →
 C-Class Kombi S204 (C 180 - C 63 AMG) 08.07 →

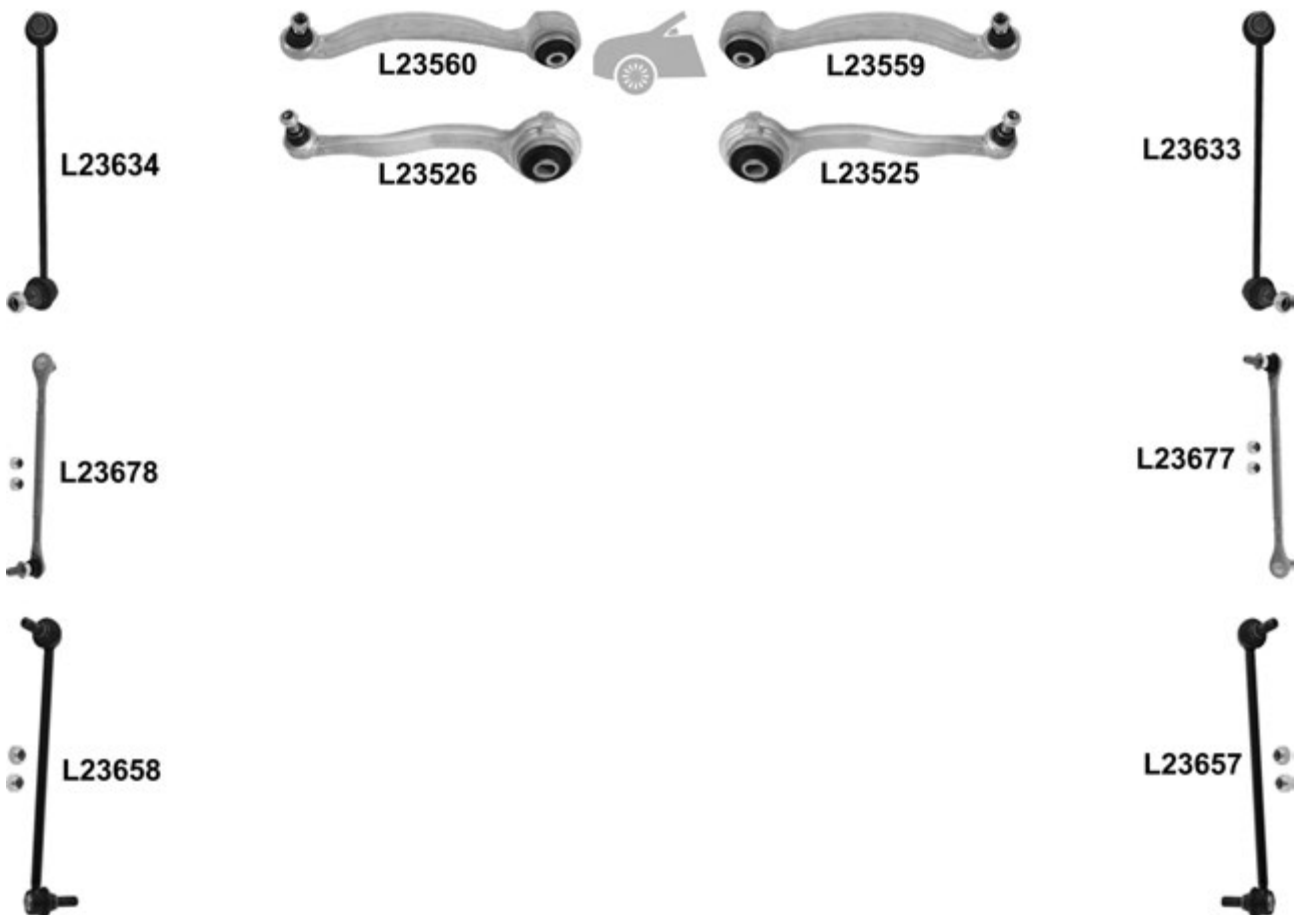
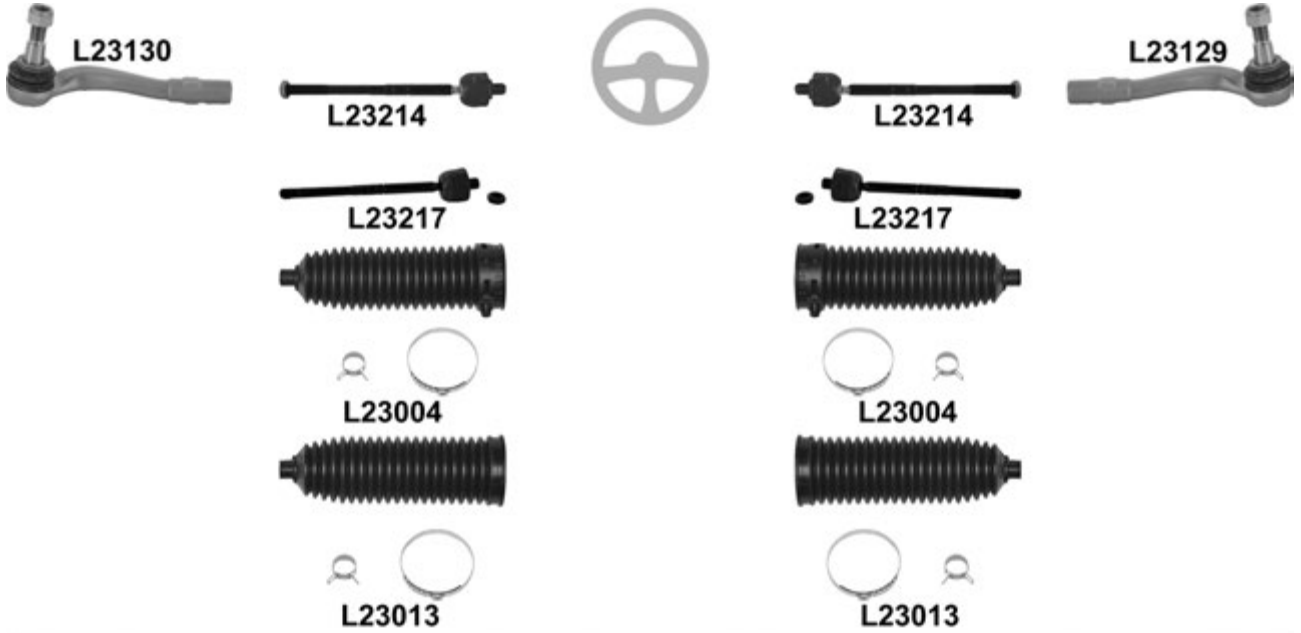

C-Class W204 (C 180 - C 63 AMG) 01.07 →
 C-Class Coupe C204 (C 180 - C 63 AMG) 06.11 →
 C-Class Kombi S204 (C 180 - C 63 AMG) 08.07 →

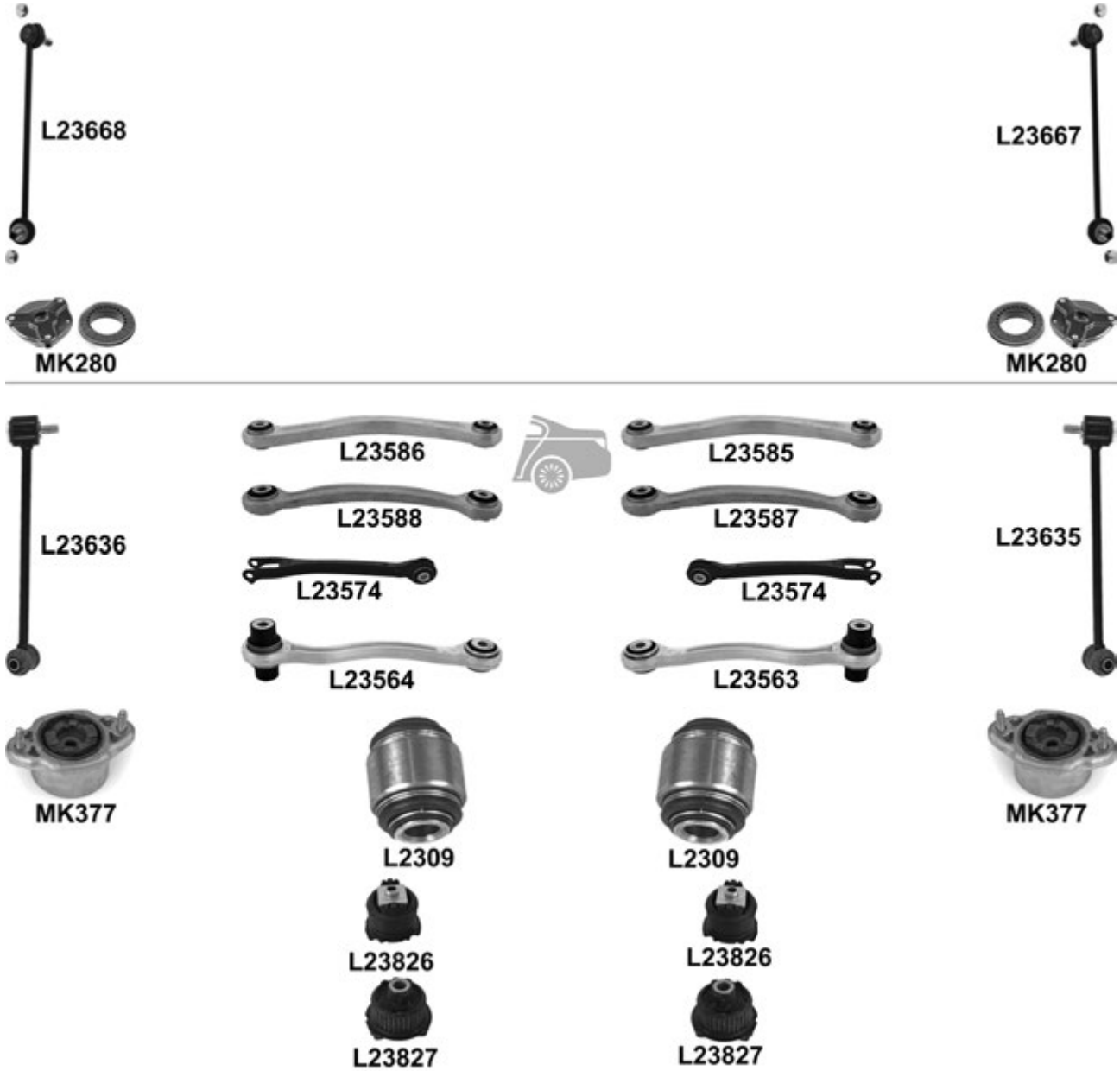

C-Class W204 (C 180 - C 63 AMG) 01.07 →
C-Class Coupe C204 (C 180 - C 63 AMG) 06.11 →
C-Class Kombi S204 (C 180 - C 63 AMG) 08.07 →

			←	→	Thread	Part Of	QPA		
		↔	(-) 4-Matic	L23129	F 14x1,5 ♂		1	204 330 10 03	
				L23130	F 14x1,5 ♂		1	204 330 09 03	
			(-) 4-Matic	L23214	L23214	M 14x1,5 / M 16x1,5 ♂		2	204 338 04 15
				L23217	L23217	M 14x1,5 / M 16x1,5 ♂		2	204 338 05 15
			(-) Model 204047/204202/204203/204207/204208 (-) Model 204222/204225/204241/204245/204248 (-) Model 204252/204256/204277/204282/204289 (-) Model 204292 ø 14mm, Ø 60mm, L= 115mm	L23004 ⁰	L23004 ⁰			2	204 463 02 96
				L23013 ⁰	L23013 ⁰			2	203 463 03 96
			⊥▼	(-) 4-Matic	L23559			1	204 330 68 11
					L23560			1	204 330 67 11
			⊥▲	(-) 4-Matic, ALU	L23525			1	204 330 44 11
					L23526			1	204 330 43 11
			(-) SP / 4-Matic, Metal	L23633			1	204 320 38 89	
				L23634			1	204 320 37 89	
		(-) SP / 4-Matic, ALU	L23677 ⁰		1	204 320 38 89			
			L23678 ⁰		1	204 320 37 89			
		SP (-) 4-Matic	L23657		1	204 320 38 89			
			L23658		1	204 320 37 89			
4-Matic	L23667		1	204 320 22 89					
	L23668		1	204 320 07 89					
		→ 01.09 , (-) Stability Control/Electronic Drive Dynamic KIT	MK280	MK280		2	204 320 00 73		
		↔		L2309	L2309		2	221 352 00 27	
				L23585 ⁰		1	204 350 16 06		
		↔		L23586 ⁰		1	204 350 15 06		
				L23587 ⁰		1	204 350 22 06		
		⊥▲	Push	L23574	L23574		2	204 350 27 06	
				L23563		1	204 350 06 53		
				L23564		1	204 350 05 53		
				L23826	L23826	Hub carrier	2	A 204 350 00 75	
				L23827	L23827	Hub carrier	2	A 204 351 03 42	
				L23635		1	204 320 04 89		
			L23636		1	204 320 05 89			
			MK377	MK377		2	204 320 09 73		

CLA-Class (C117) 01.13 →



			←	→	Thread	Part Of	QPA		
		↔		L23147	F 14x1,5 U		1	246 330 18 00	
				L23148	F 14x1,5 U		1	246 330 17 00	
				L23221	L23221	M 14x1,5 / M 14x1,5 U		2	246 338 00 00
		⊥		<input checked="" type="checkbox"/>	L23577		1	246 330 48 00	
					L23578		1	246 330 47 00	
					L23829			1	246 333 02 14
					L23830			1	246 333 00 14
		⊥			L23831	L23831		2	246 333 01 14
					L23583 ⁰	L23583 ⁰		2	246 350 10 06
					L23582 ⁰	L23582 ⁰		2	246 350 00 53
					L23676 ⁰	L23676 ⁰		2	246 320 04 89

CLC-Class 203 (160 - 350) 05.08 →

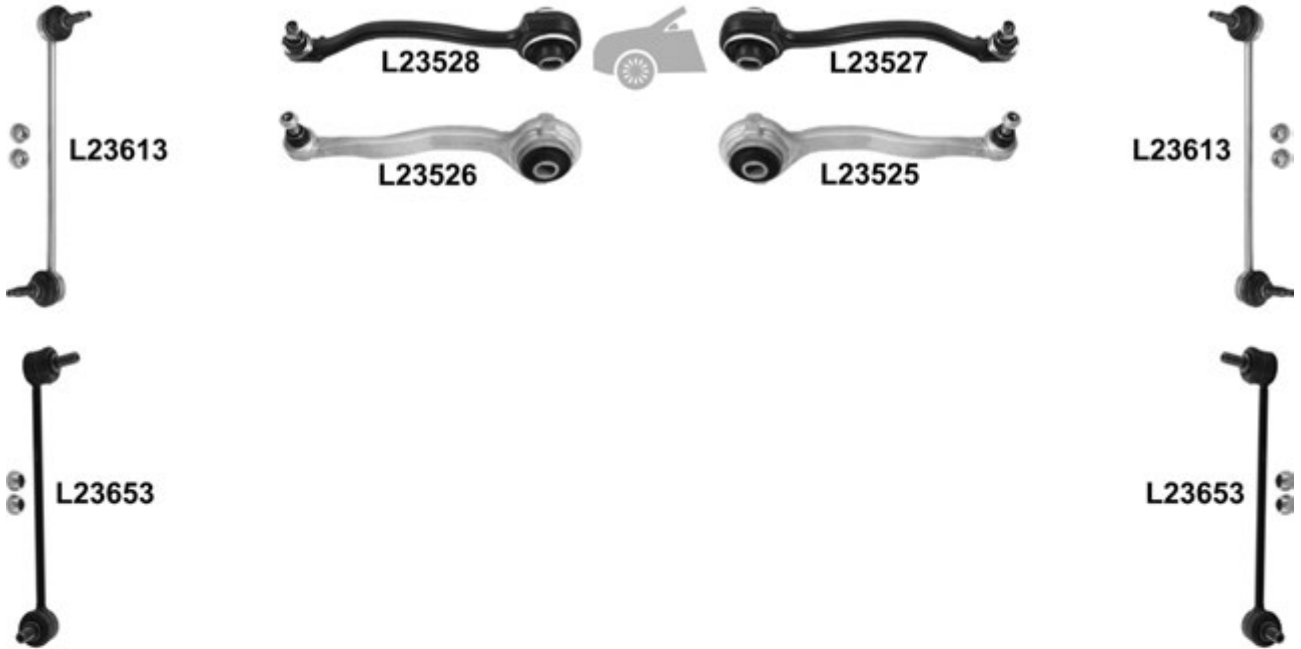

CLC-Class 203 (160 - 350) 05.08 →

		i		←	→	Thread	Part Of	QPA	i		
		↔			L23113	F 14x1,5 ☺		1	203 330 20 03		
						L23114	F 14x1,5 ☺		1	203 330 19 03	
		↓			L23527			1	203 330 20 11		
					L23528			1	203 330 19 11		
		↓	ALU		L23525			1	203 330 02 11		
					L23526			1	203 330 01 11		
			(-) SP		L23613	L23613			2	203 320 25 89	
				SP	L23653	L23653			2	203 320 29 89	
				L2309	L2309			2	220 352 02 27		
				L23801	L23801		CAS L23605	2	124 350 68 06		
			Old Version	KIT	L23812	L23812		CAM L23605/ L23606/L23617	6	210 350 45 06	
			New version								
			New type		L23617	L23617			2	210 350 34 06	
			↑	Pull		L23605	L23605			2	210 350 33 06
				Push		L23606	L23606			2	210 350 38 06
			↑			L23614	L23614			2	203 350 03 53
						L23651			1	203 320 08 89	
				L23652				1	203 320 07 89		

CLK-Class 208 06.97 → 07.02
 CLK Cabriolet A208 03.98 → 03.02

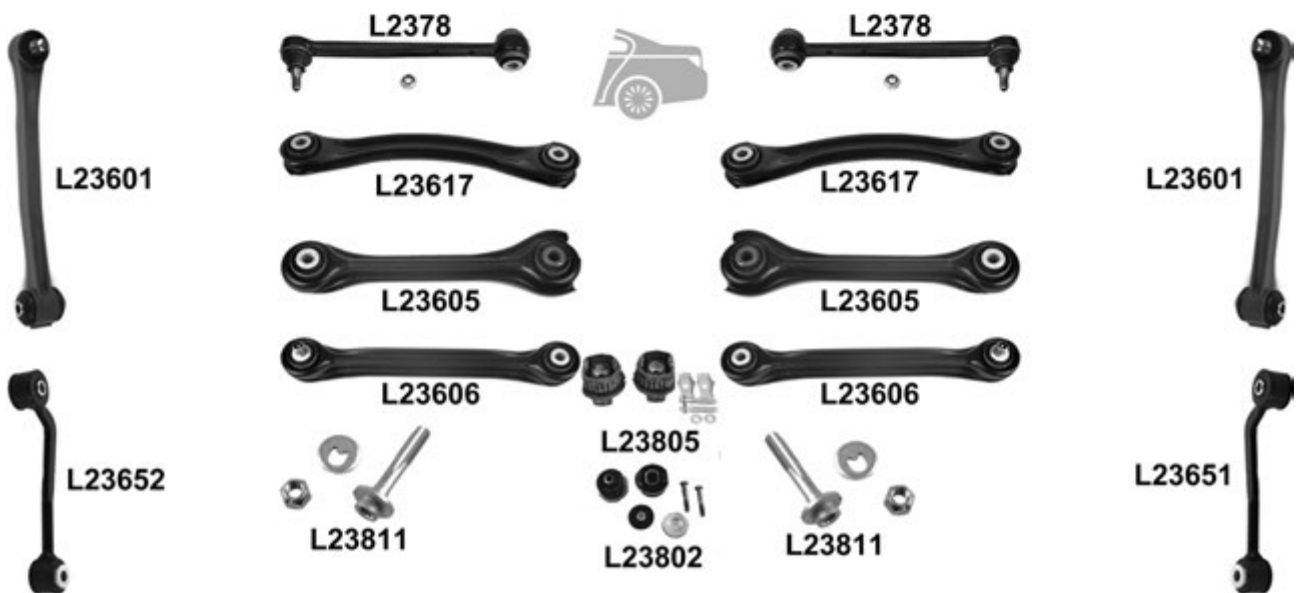

CLK-Class 208 06.97 → 07.02
CLK Cabriolet A208 03.98 → 03.02

		i		←	→	Thread	Part Of	QPA	i	
		↔		L23103	L23103	F 12x1,5 U		2	001 330 77 35	
		→ ←	(-) 6 / 8 cyl. Petrol Models	L23302				1	202 460 04 05	
			6 / 8 cyl. Petrol Models	L23310				1	202 460 05 05	
		⊥		L23505	L23505			2	210 330 00 35	
		↑	SP <input checked="" type="checkbox"/>		L23521			1	210 330 88 07	
				L23522				1	210 330 87 07	
		⊥▲	(-) 55 AMG	L23821	L23821			4	202 338 87 14	
				L2378	L2378			2	210 350 06 53	
			New type	L23617	L23617			2	210 350 34 06	
		↑	Pull	L23605	L23605			2	210 350 33 06	
		⊥	Push	L23606	L23606			2	210 350 38 06	
				L23601	L23601			2	124 320 02 89	
			AMG		L23651			1	203 320 08 89	
				L23652				1	203 320 07 89	
		▼		KIT		L23805		Hub carrier	1	202 350 34 08
		▲				L23802		Hub carrier	1	124 350 64 08
			L23811	L23811			Hub carrier, L2378	2	140 350 11 70	

CLK-Class 209 06.02 →
 CLK Cabriolet A209 02.03 →

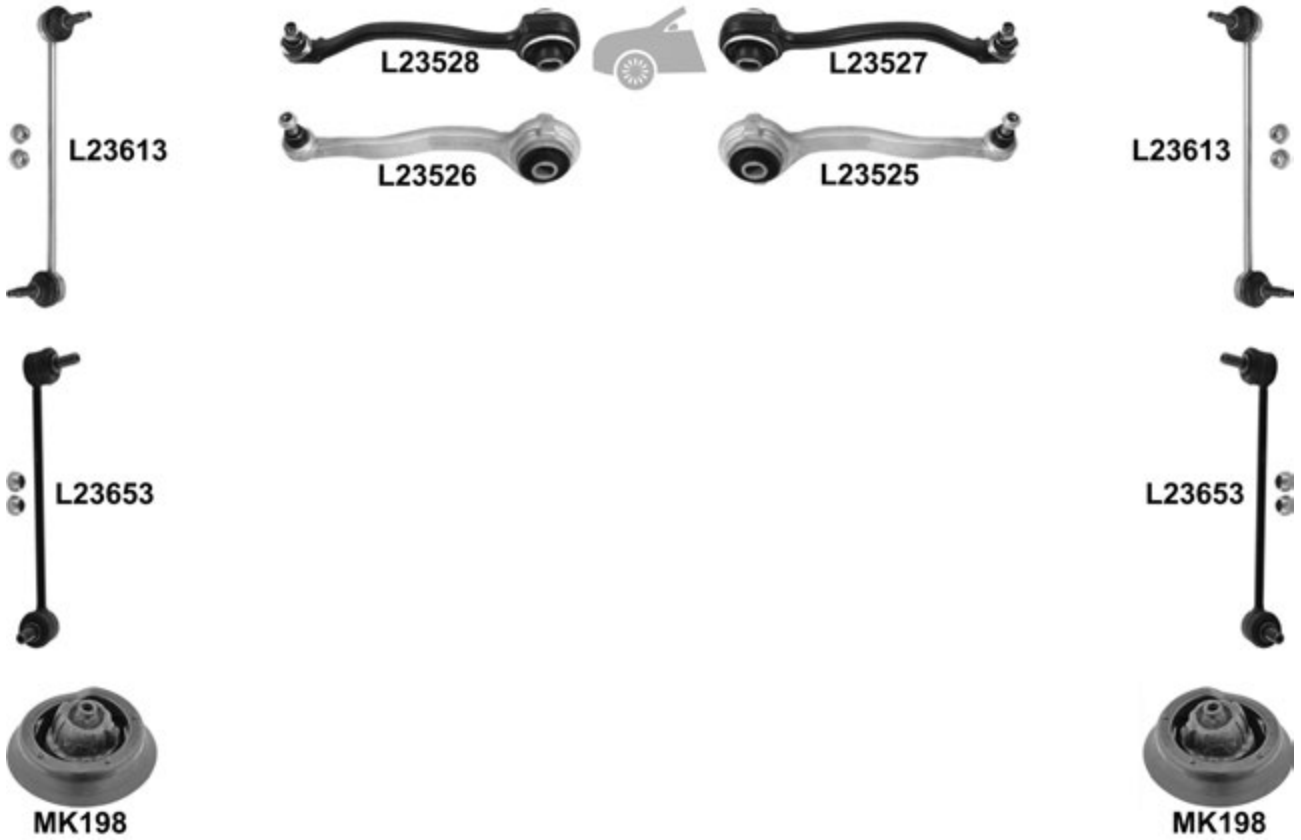

CLK-Class 209 06.02 →
 CLK Cabriolet A209 02.03 →

				←	→	Thread	Part Of	QPA	i	
⊕		↔			L23113	F 14x1,5 U		1	203 330 20 03	
					L23114	F 14x1,5 U		1	203 330 19 03	
					L23204	L23204	M 14x1,5 / M 16x1,5 U		2	230 338 00 15
						ø 14mm, Ø 63mm, L= 230mm	L23004 °	L23004 °		2
		↓			L23527			1	203 330 20 11	
					L23528			1	203 330 19 11	
					L23525			1	203 330 02 11	
					L23526			1	203 330 01 11	
			ALU		L23525			1	203 330 02 11	
				(-) SP / 10mm / 10mm	L23613	L23613		2	203 320 25 89	
			SP / AMG, 12mm / 12mm	L23653	L23653		2	203 320 29 89		
					MK198	MK198		2		
					L2309	L2309		2	220 352 02 27	
				KIT		L23812	L23812		6	210 350 45 06
						L23617	L23617		2	210 350 34 06
					L23605	L23605		2	201 350 56 06	
		↑	Pull		L23606	L23606		2	210 350 38 06	
		↓	Push		L23614	L23614		2	203 350 03 53	
		↑				L23651		1	203 320 08 89	
					L23652		1	203 320 07 89		

CLS C219 (CLS 280 - CLS 63 AMG) 10.04 →

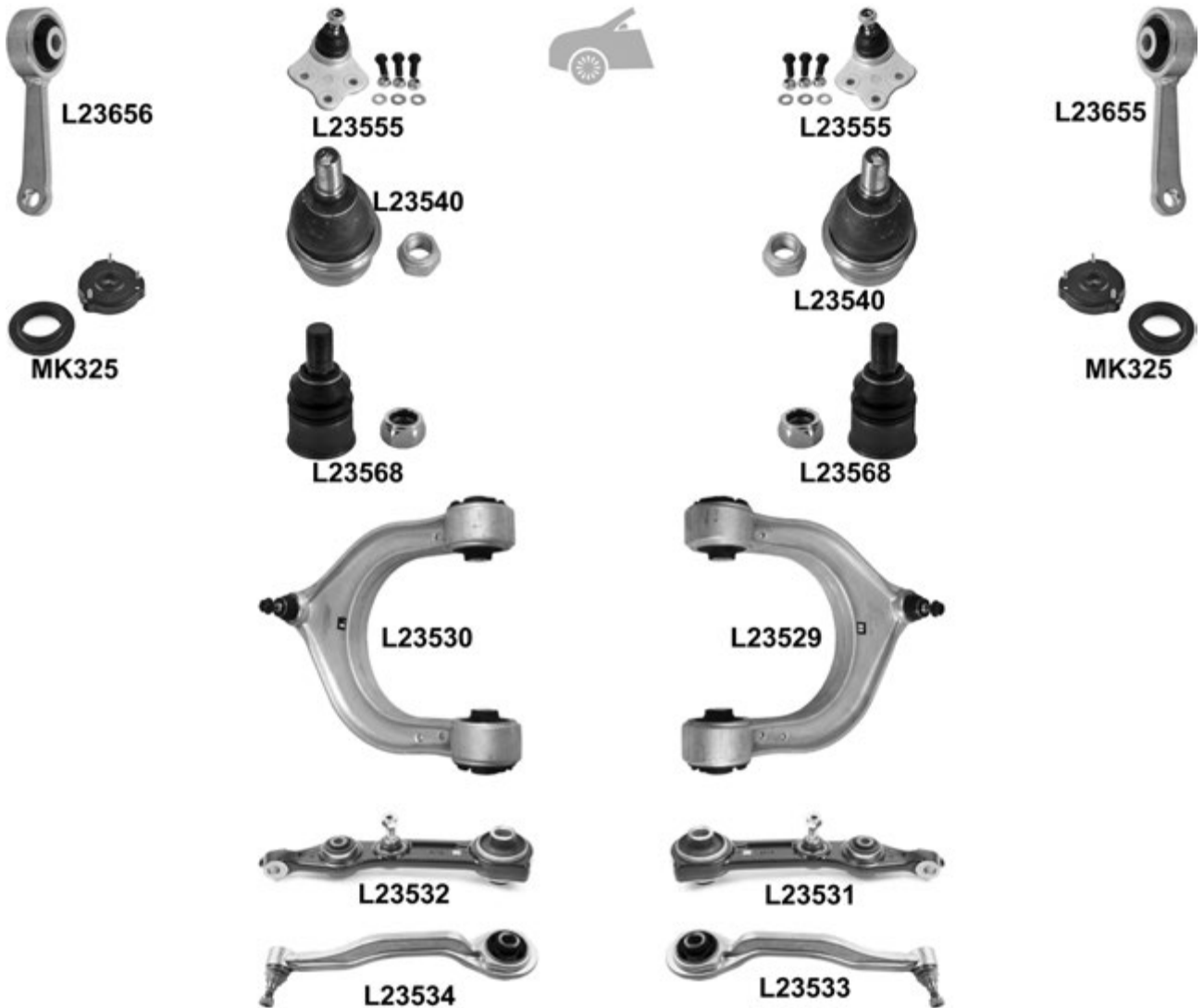
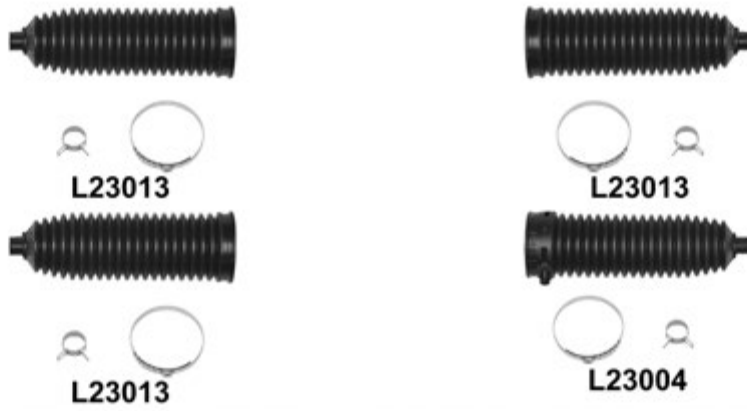

CLS C219 (CLS 280 - CLS 63 AMG) 10.04 →

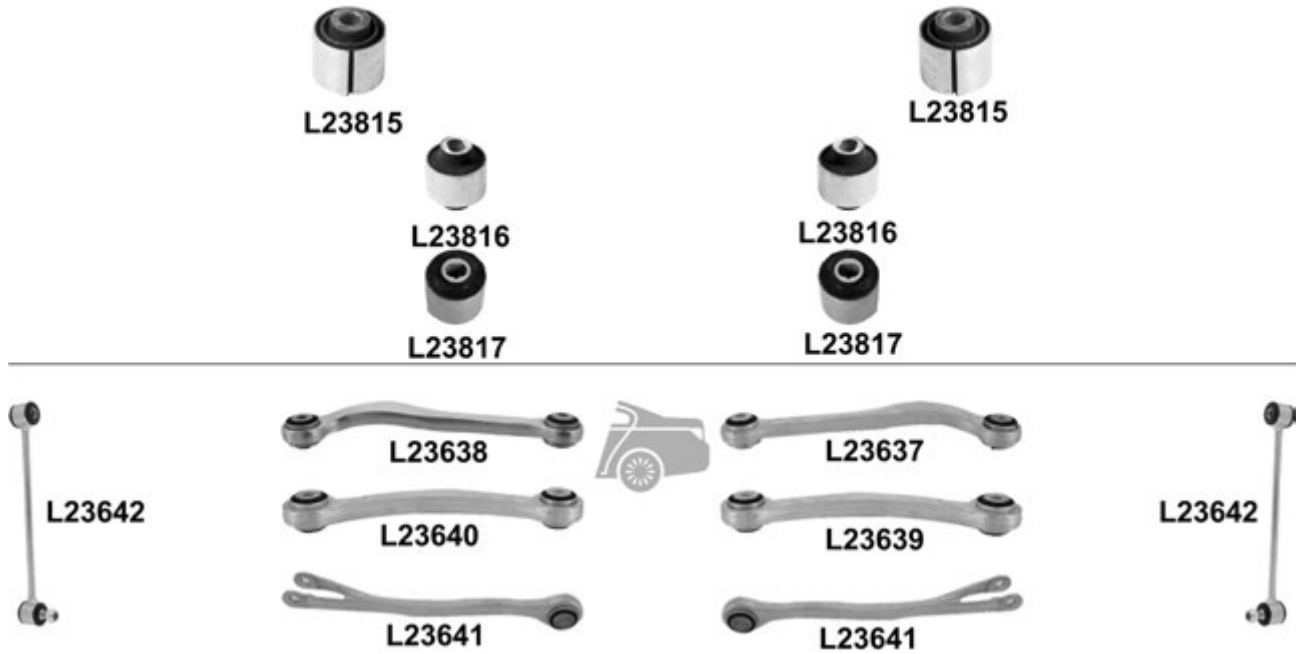

				←	→	Thread	Part Of	QPA			
⊕		↔			L23119	F 14x1,5		1	211 330 24 03		
					L23120	F 14x1,5		1	211 330 23 03		
			→ 10.05 →, ø 14mm, Ø 60mm, L= 215mm		L23204	L23204	M 14x1,5 / M 16x1,5		2	230 338 00 15	
			11.05 →, ø 14mm, Ø 63mm, L= 230mm		L23013 ⁰	L23013 ⁰			2	203 463 03 96	
			11.05 →, ø 14mm, Ø 60mm, L= 215mm		L23004 ⁰				1	204 463 02 96	
				L23013 ⁰				1	203 463 03 96		
🚗		↑			L23555	L23555			2	211 330 99 07	
		↓ ↔			L23540	L23540			2	211 330 02 35	
		↓ → ←			L23568	L23568			2	211 323 00 68	
		↑		<input checked="" type="checkbox"/>		L23529			1	211 330 68 07	
		↓ ↓				L23530			1	211 330 67 07	
		↓ ↓				L23531			1	211 330 82 07	
		↓ ↓				L23532			1	211 330 81 07	
		↓ ↑				L23533			1	211 330 30 11	
		↓ ↑				L23534			1	211 330 29 11	
		↓ ↓ ↔				L23815	L23815		2	211 333 19 14	
		↓ ↓ →←				L23816	L23816		2	211 333 11 14	
		↓ ↑ →←				L23817	L23817		2	211 333 25 14	
		↔				L23655			1	211 320 38 89	
	↔				L23656			1	211 320 39 89		
				KIT	MK325	MK325		2	211 320 00 26		
🚗	CAM	↑ ↓			L23637			1	295		
		↑ ↓			L23638			1	230 350 27 06		
	CAS	↑ ↑	Pull			L23639			1	230 350 36 06	
		↑ ↑				L23640			1	230 350 35 06	
		↓ ↑	Push			L23641	L23641		2	230 350 20 06	
	↔			L23642	L23642		2	211 320 33 89			

CLS C218 (CLS 350 - CLS 63 AMG) 01.11 →



				←	→	Thread	Part Of	QPA			
		⊥		L23567	L23567			2	212 330 01 35		
			(-) 4-Matic			L23665			1	212 320 12 89	
				L23666					1	212 320 11 89	
		⌈▼			L23585 ⁰			1	204 350 16 06		
				L23586 ⁰				1	204 350 15 06		
		⌈▲			L23587 ⁰			1	204 350 22 06		
				L23588 ⁰				1	204 350 21 06		
		⊥▲	Push	L23574	L23574			2	204 350 27 06		
		⊥→ ←				L23563			1	204 350 06 53	
	L23564					1	204 350 05 53				
					L23635			1	204 320 04 89		
			L23636				1	204 320 05 89			

E-Class Cabriolet A207 (E 200 CGI - E 500) 01.10 →
 E-Class Coupe C207 (E 200 CGI - E 500) 01.09 →

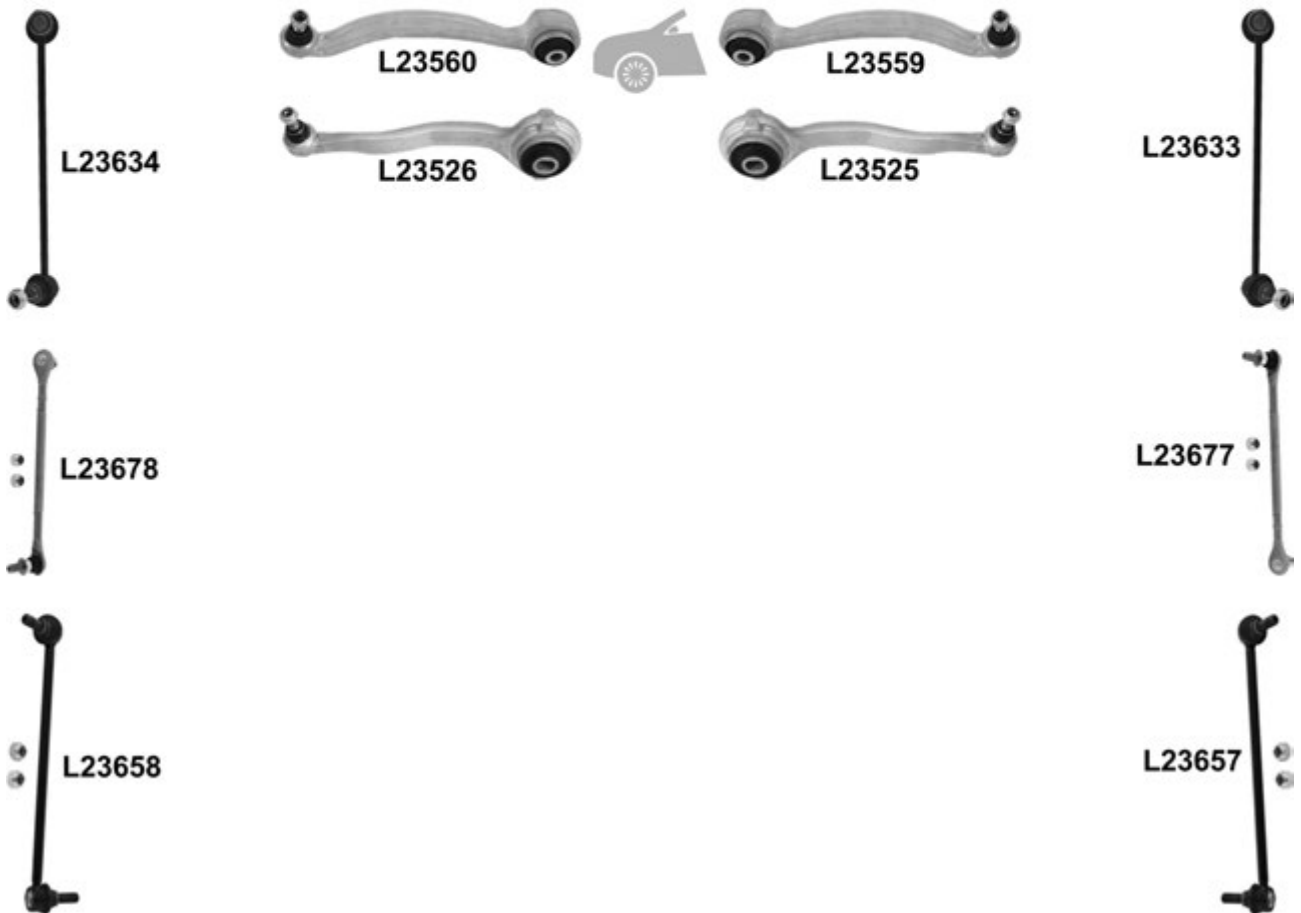
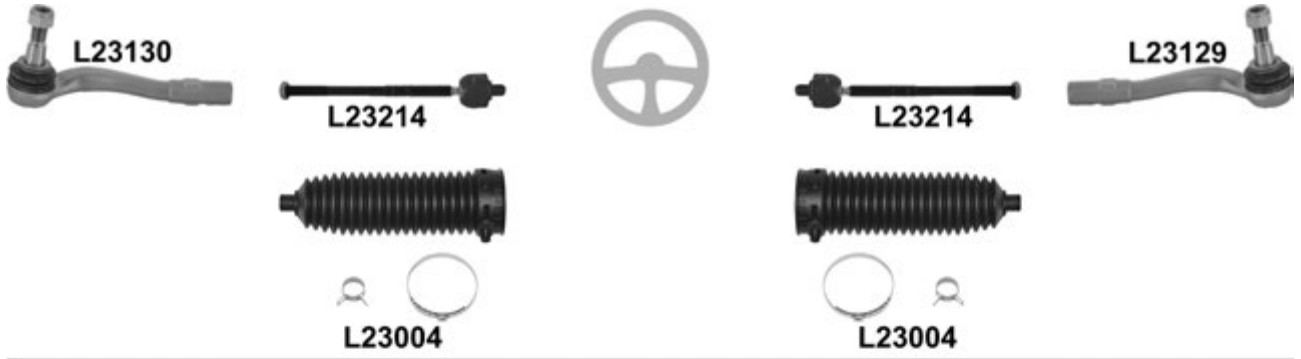

E-Class Cabriolet A207 (E 200 CGI - E 500) 01.10 →

E-Class Coupe C207 (E 200 CGI - E 500) 01.09 →



				← → Thread		Part Of	QPA			
⊕		↔		L23129	∩		1	204 330 10 03		
				L23130	∩		1	204 330 09 03		
				L23214	L23214	∩		2	204 338 04 15	
				L23004 ⁰	L23004 ⁰			2	204 463 02 96	
		⊥▼		L23559			1	204 330 68 11		
				L23560			1	204 330 67 11		
		⊥▲	ALU		L23525			1	204 330 44 11	
				L23526			1	204 330 43 11		
		⊥	(-) SP / 4-Matic, Metal		L23633			1	204 320 38 89	
				L23634			1	204 320 37 89		
			(-) SP / 4-Matic, ALU		L23677 ⁰			1	204 320 38 89	
			L23678 ⁰			1	204 320 37 89			
	SP		L23657			1	204 320 38 89			
			L23658			1	204 320 37 89			
				L2309	L2309		2	221 352 00 27		
				L23585 ⁰			1	204 350 16 06		
			L23586 ⁰			1	204 350 15 06			
		⊥▲			L23587 ⁰			1	204 350 22 06	
					L23588 ⁰			1	204 350 21 06	
		⊥▲	Push		L23574	L23574		2	204 350 27 06	
						L23563			1	204 350 06 53
		⊥→ ←			L23564			1	204 350 05 53	
						L23635			1	204 320 04 89
			L23636			1	204 320 05 89			

E-Class W210 (E 200 - E 55 AMG / E 200 D - 320 CDi) 06.95 →
 E-Class Kombi S210 (E 200 T - E 55 T AMG / E 220 CDi - E 320 CDi) 06.96 →

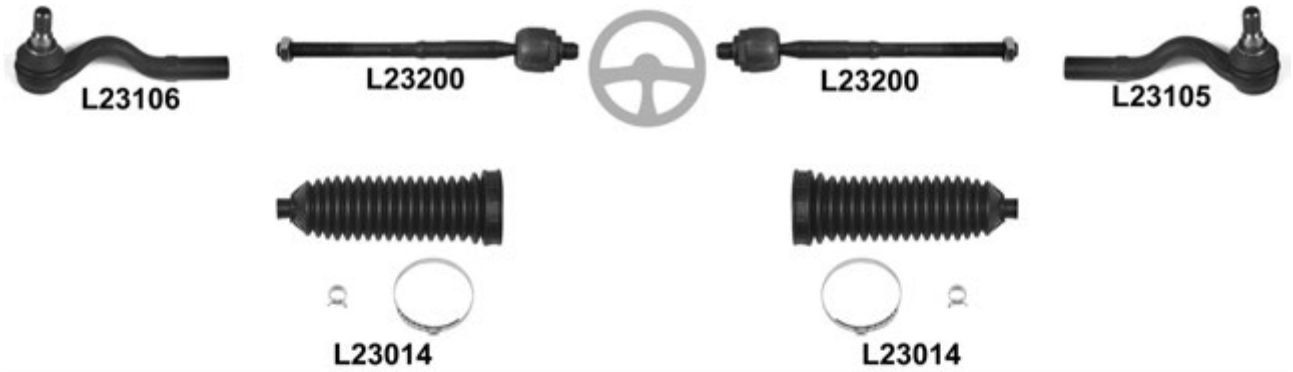

E-Class W210 (E 200 - E 55 AMG / E 200 D - 320 CDi) 06.95 →
 E-Class Kombi S210 (E 200 T - E 55 T AMG / E 220 CDi - E 320 CDi) 06.96 →

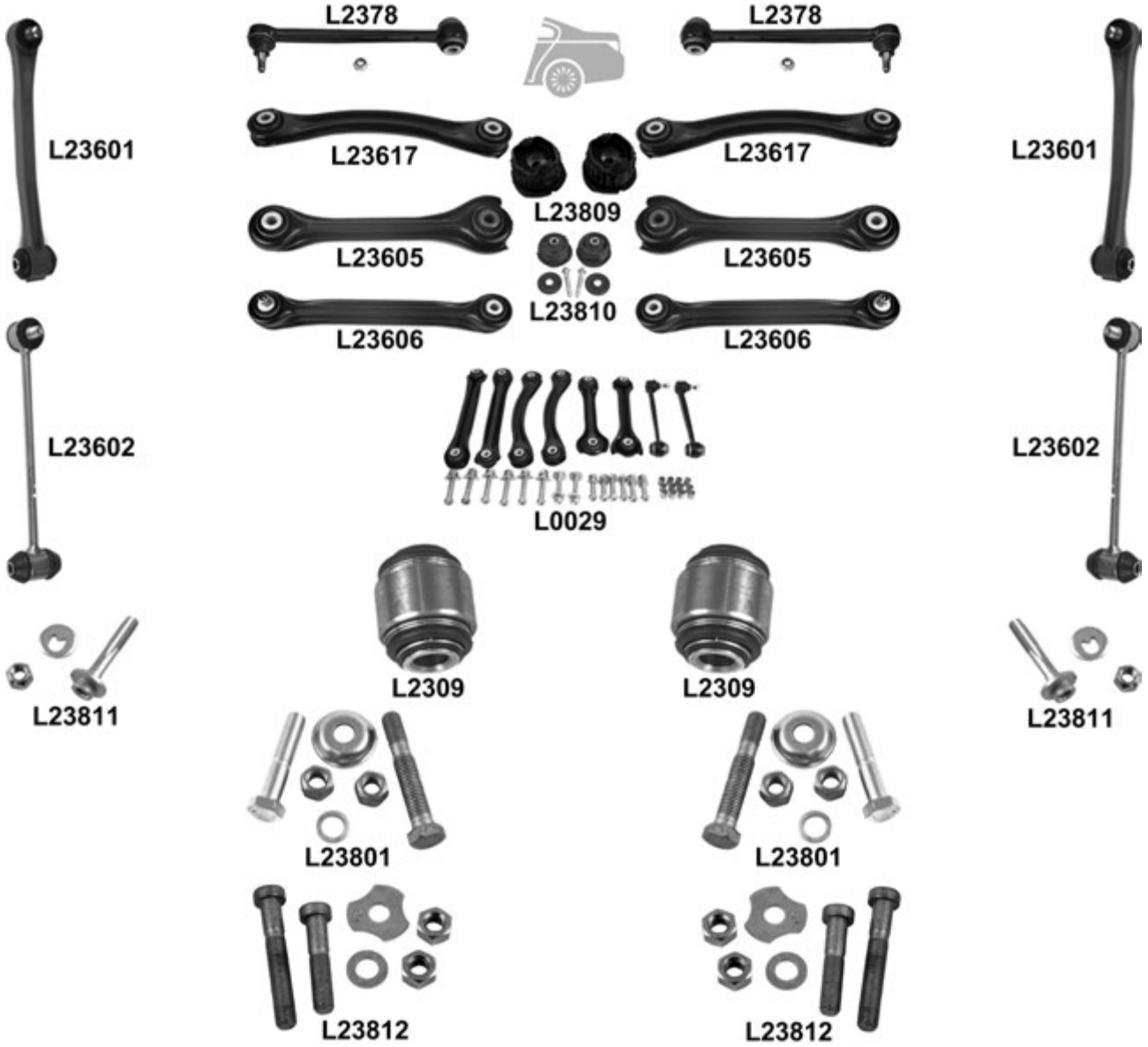

E-Class W210 (E 200 - E 55 AMG / E 200 D - 320 CDi) 06.95 →
E-Class Kombi S210 (E 200 T - E 55 T AMG / E 220 CDi - E 320 CDi) 06.96 →

		i		←	→	Thread	Part Of	QPA	i	
		↔	(-) 4-Matic		L23105	F 14x1,5 ♂		1	210 338 06 15	
					L23106	F 14x1,5 ♂		1	210 338 05 15	
			(-) 4-Matic		L23200	L23200	M 14x1,5 / M 16x1,5 ♂	2	210 338 04 15	
					L23014 ^o	L23014 ^o		2	210 460 23 00	
		↓			L23505	L23505		2	210 330 00 35	
					L23521			1	210 330 88 07	
		↑		☑		L23522			1	210 330 87 07
						L23515			1	210 330 62 07
		↓		☑		L23516			1	210 330 61 07
						L23607			1	210 320 37 89
		↓		KIT		L23808	L23808		2	210 330 04 75
						L23608			1	210 320 36 89
				Old Version	KIT	L23801	L23801	L23605	2	124 350 68 06
				New version		L23812	L23812	L23605/ L23606/L23617	6	210 350 45 06
						L2378	L2378		2	210 350 06 53
						L23617	L23617		2	210 350 34 06
		↑							2	201 350 56 06
									2	201 350 00 29
		↓							2	201 350 00 29
									2	201 350 00 29
					KIT	L0029			1	210 350 30 38 06 S
							L23601	L23601		2
								2	124 320 04 89	
								2	124 320 04 89	
	↓							2	204 352 00 27	
								1	210 350 59 08	
								1	210 350 58 08	
				KIT	L23809			1	210 350 59 08	
					L23810			1	210 350 58 08	
								2	140 350 11 70	
								2	140 350 11 70	

E-Class W211 03.02 →
E-Class Kombi S211 03.03 →

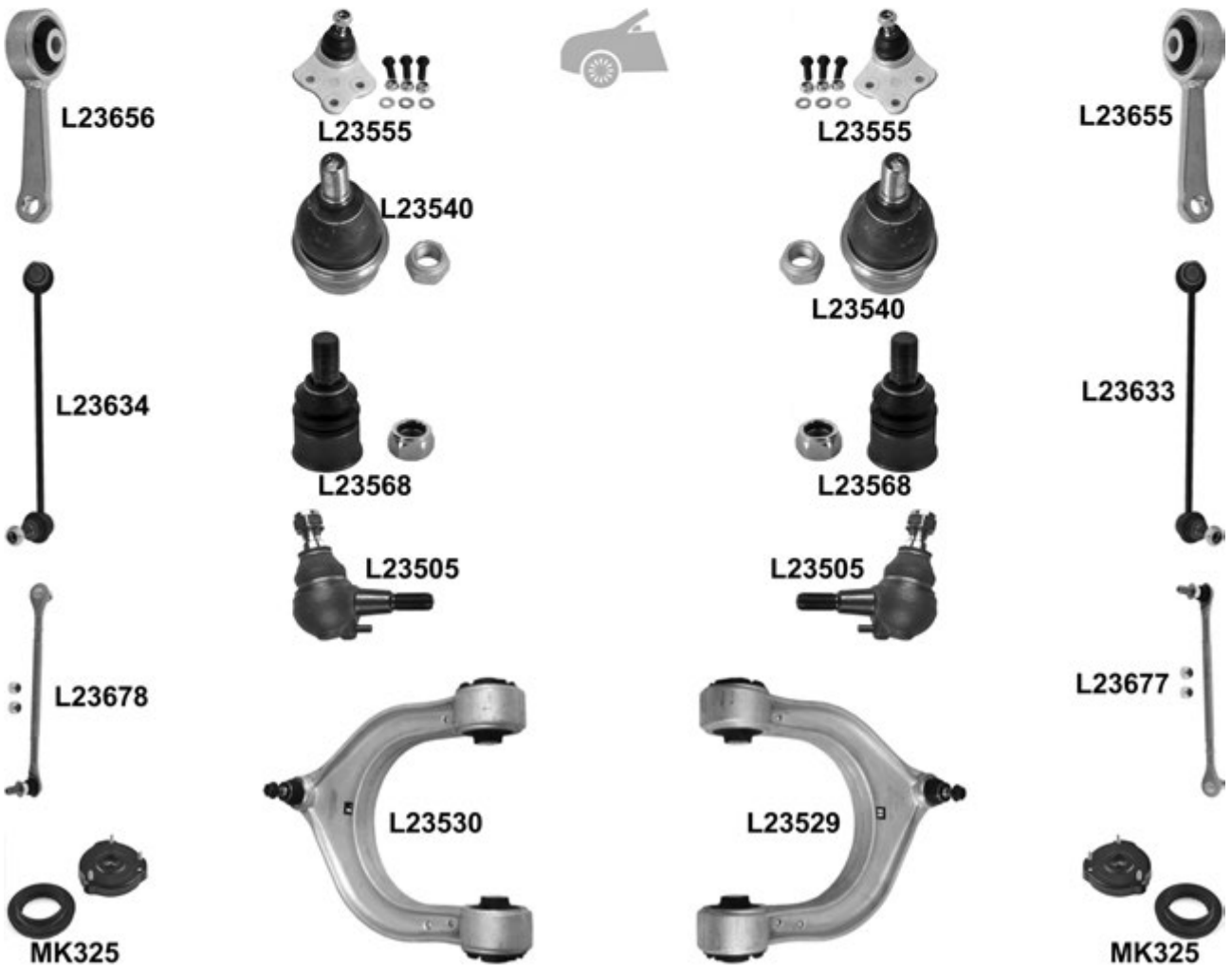
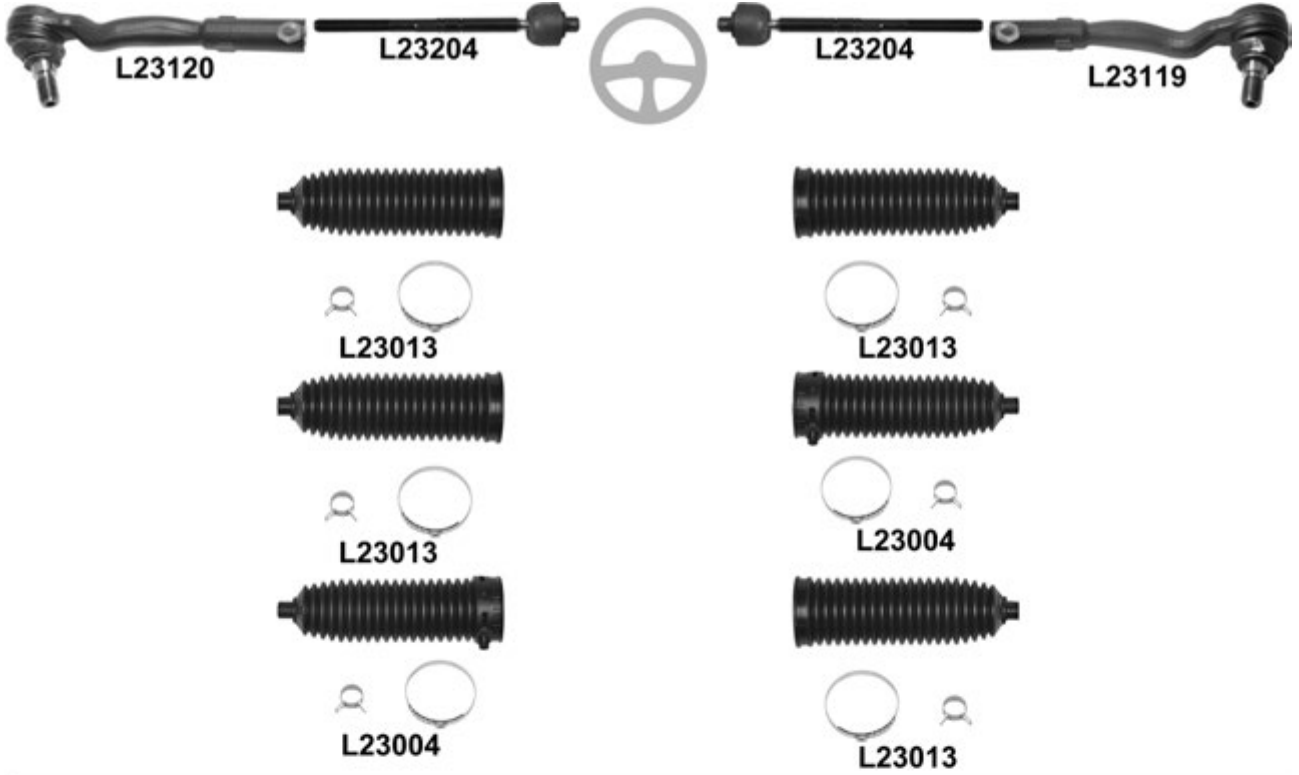

E-Class W211 03.02 →
 E-Class Kombi S211 03.03 →

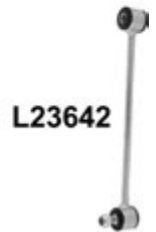
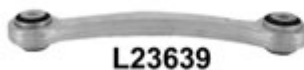
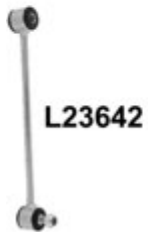

E-Class W211 03.02 →
E-Class Kombi S211 03.03 →

		i	←	→	Thread	Part Of	QPA	i			
⊕		↔	(-) 4-Matic	L23119		F 14x1,5		1	211 330 24 03		
				L23120		F 14x1,5		1	211 330 23 03		
			→ 01.07 , ø 14mm, Ø 60mm, L= 115mm	L23204	L23204	M 14x1,5 / M 16x1,5		2	230 338 00 15		
			LHD, 02.07 →, ø 14mm, Ø 63mm, L= 230mm	L23013 ⁰	L23013 ⁰			2	203 463 03 96		
			LHD, 02.07 →, ø 14mm, Ø 60mm, L= 215mm		L23004 ⁰			1	204 463 02 96		
			RHD, 02.07 →, ø 14mm, Ø 60mm, L= 215mm	L23013 ⁰				1	203 463 03 96		
			RHD, 02.07 →, ø 14mm, Ø 63mm, L= 230mm		L23013 ⁰			1	203 463 03 96		
			L23004 ⁰			1	204 463 02 96				
		↑		L23555	L23555			2	211 330 99 07		
		↕↔	(-) 4-Matic	L23540	L23540			2	211 330 02 35		
		↕↔↔	(-) 4-Matic	L23568	L23568			2	211 323 00 68		
		↕	4- Matic	L23505	L23505			2	210 330 00 35		
		↑	(-) 4-Matic	<input checked="" type="checkbox"/>	L23529				1	211 330 68 07	
					L23530				1	211 330 67 07	
		↕▼	(-) 4-Matic		L23531				1	211 330 82 07	
					L23532				1	211 330 81 07	
					L23533				1	211 330 30 11	
				L23534				1	211 330 29 11		
		↕↔↔		L23815	L23815			2	211 333 19 14		
				L23816	L23816			2	211 333 11 14		
				L23817	L23817			2	211 333 25 14		
					L23655				1	211 320 38 89	
					L23656				1	211 320 39 89	
					(-) SP / 4-Matic, Metal	L23633				1	204 320 38 89
					L23634				1	204 320 37 89	
					(-) SP / 4-Matic, ALU	L23677 ⁰				1	204 320 38 89
				L23678 ⁰				1	204 320 37 89		
			↑▼	(-) 4-Matic	KIT	MK325	MK325		2	211 320 00 26	
					L23637				1	230 350 28 06	
		↑▲	(-) AD Pull		L23639				1	230 350 36 06	
					L23640				1	230 350 35 06	
		↕▲	(-) AD Push		L23641	L23641			2	230 350 20 06	
					L23642	L23642			2	211 320 33 89	

E-Class W212 (E 200 CGI - E 500) 01.09 →
 E-Class Kombi S212 (E 200 CGI - E 63 AMG) 11.09 →

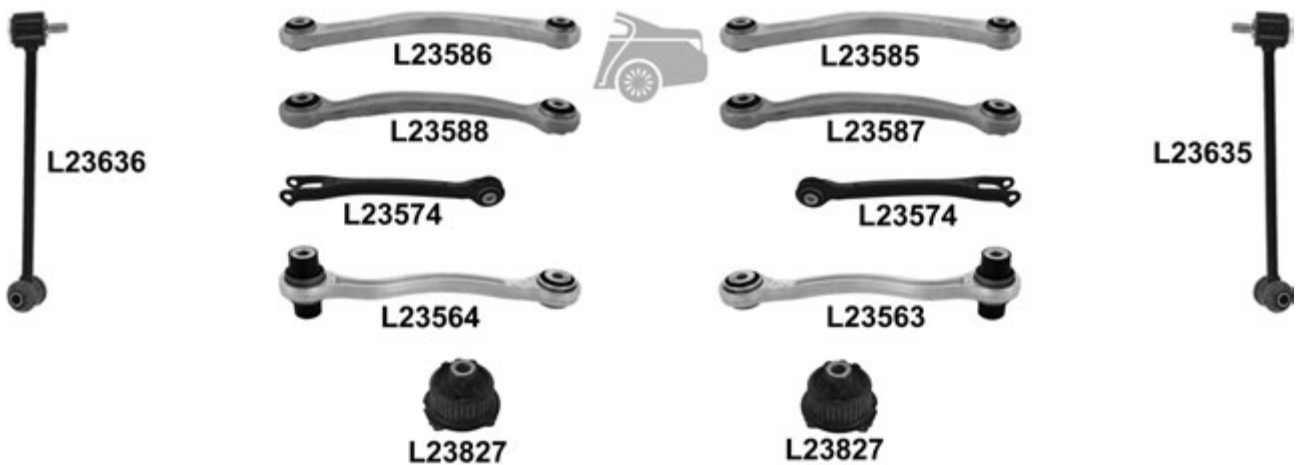
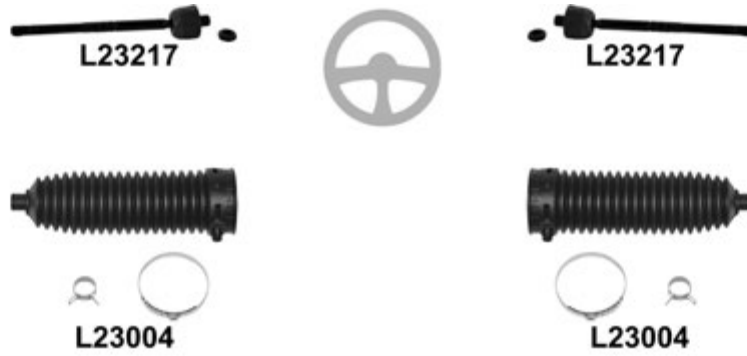

				←	→	Thread	Part Of	QPA		
			4-Matic	L23217	L23217	M 14x1,5 / M 16x1,5 U		2	204 338 05 15	
			ø 14mm, ø 63mm, L= 230mm	L23004 ⁰	L23004 ⁰			2	204 463 02 96	
		↓		L23567	L23567			2	212 330 01 35	
			(-) 4-Matic		L23665			1	212 320 12 89	
		↕			L23585 ⁰			1	204 350 16 06	
					L23586 ⁰			1	204 350 15 06	
						L23587 ⁰			1	204 350 22 06
						L23588 ⁰			1	204 350 21 06
		↕	Push		L23574	L23574		2	204 350 27 06	
		↕↔				L23563		1	204 350 06 53	
					L23564			1	204 350 05 53	
			▲		L23827	L23827		Hub carrier	2	A 204 351 03 42
					L23635			1	204 320 04 89	
					L23636			1	204 320 05 89	

GL-Class X164 09.06 →

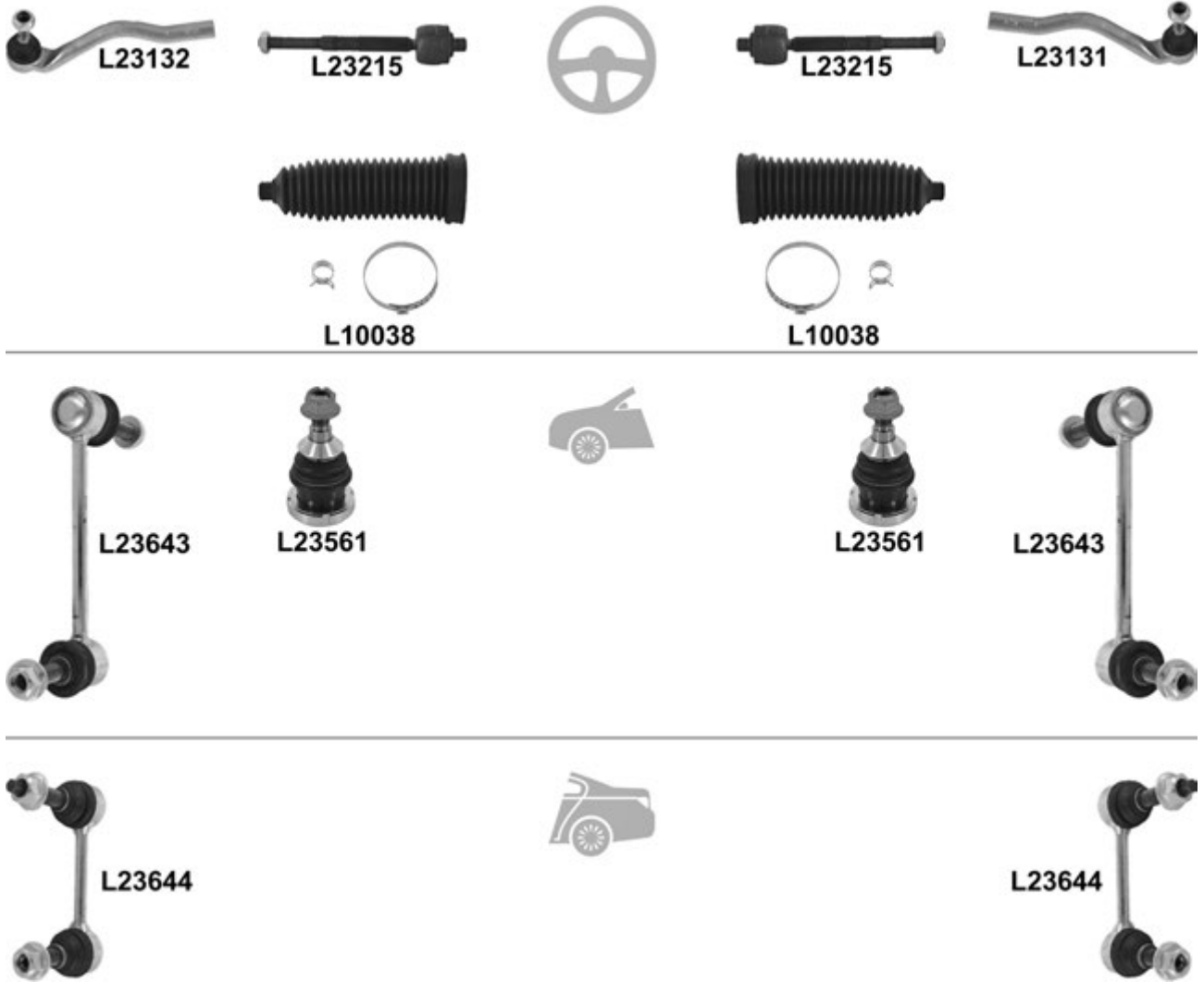

		i	←	→	Thread	Part Of	QPA	i
		↔		L23131	F 14x1,5		1	A 164 330 12 03
				L23132	F 14x1,5		1	A 164 330 11 03
				L23215	L23215	M 14x1,5 / M 16x1,5	2	A 164 460 00 05
				L10038 ^o	L10038 ^o		2	164 460 00 96
		⊥		L23561	L23561		2	A 164 330 09 35
				L23643	L23643		2	164 320 21 32
				L23644	L23644		2	164 320 12 32

GLK-Class X204 06.08 →

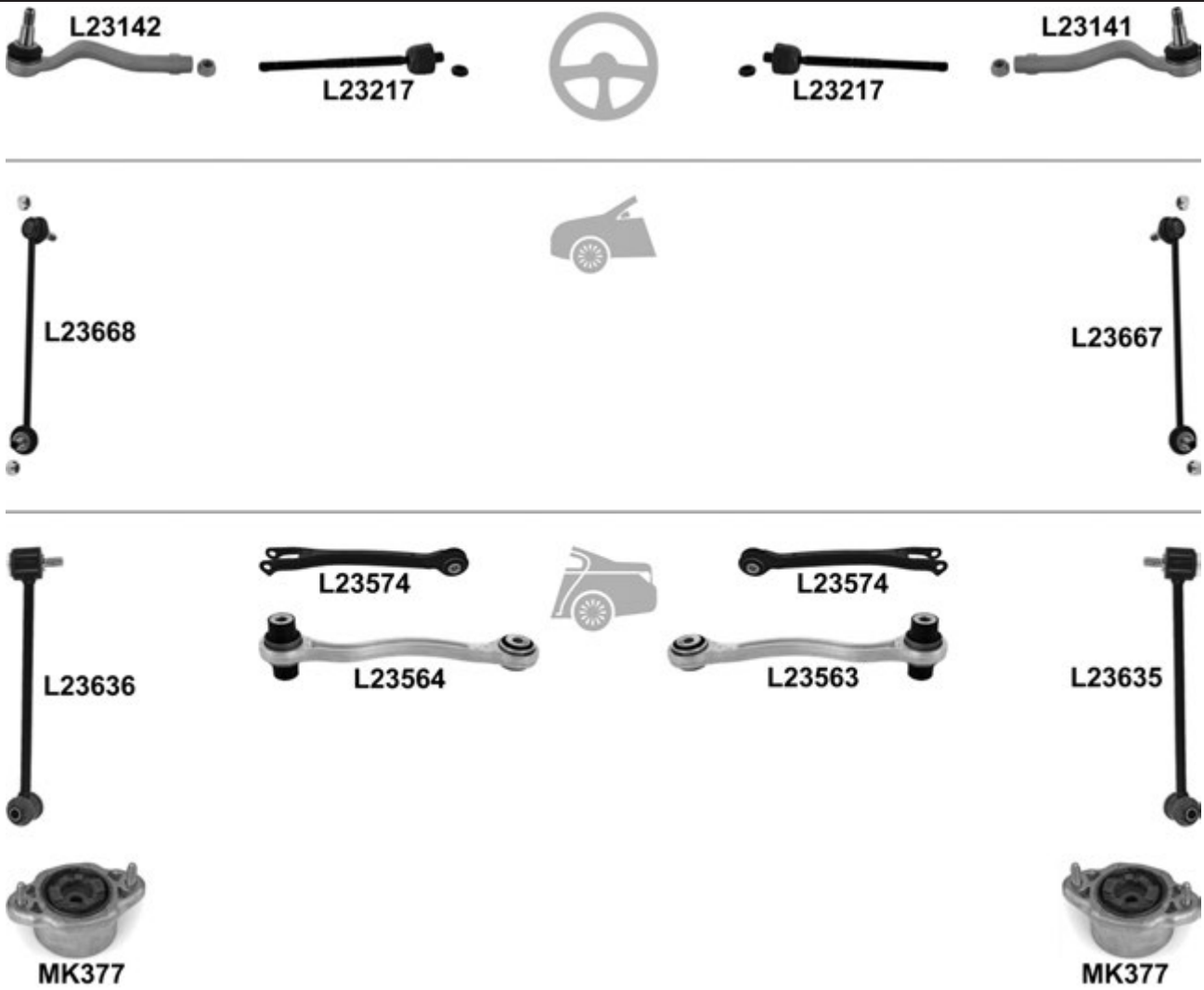

				←	→	Thread	Part Of	QPA		
⊕		↔			L23141	F 14x1,5 ♂		1	204 330 20 03	
					L23142	F 14x1,5 ♂		1	204 330 19 03	
					L23217	M 14x1,5 / M 16x1,5 ♂		2	204 338 05 15	
					L23667			1	204 320 22 89	
		⊥ ▲ Push ⊥ → ←			L23574	L23574		2	204 350 27 06	
					L23563			1	204 350 06 53	
					L23564			1	204 350 05 53	
					L23635			1	204 320 04 89	
					L23636			1	204 320 05 89	
				KIT	MK377	MK377		2	204 320 09 73	

L406
L408
L508



L2369



Thread

Part Of

QPA



			L2369				1	309 460 13 05
--	--	--	-------	--	--	--	---	---------------

M-Class (W163) 02.98 →



L23124

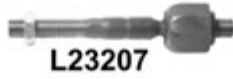

L23207



L23207



L23123



L23009



L23009



L23547



L23547



L23306



L23305



L23548



L23548



Thread

Part Of

QPA

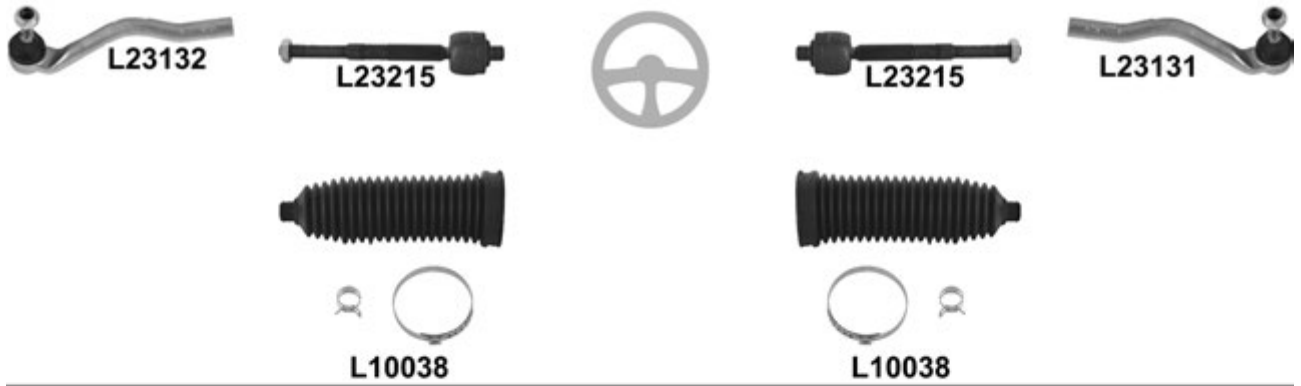

		↔		L23123	F 16x1,5		1	163 330 02 03		
				L23124	F 16x1,5		1	163 330 00 03		
					L23207	L23207	M 16x1,5 / M 16x1,5		2	163 338 02 15
						L23009 ^o	L23009 ^o			2
		↓		L23547	L23547			2	163 330 01 35	
					L23305				1	A 163 350 06 53
					L23306				1	A 163 350 05 53
		↓		L23548	L23548			2	163 350 01 13	

M-Class (W164) 07.05 →

		i	←	→	Thread	Part Of	QPA	i	
					L23131	F 14x1,5	1	A 164 330 12 03	
					L23132	F 14x1,5	1	A 164 330 11 03	
					L23215	L23215	M 14x1,5 / M 16x1,5	2	A 164 460 00 05
					L10038 ^o	L10038 ^o		2	164 460 00 96
					L23561	L23561	2	A 164 330 09 35	
					L23643	L23643	2	A 164 320 21 32	
					L23562	L23562	2	A 164 352 03 27	
					L23644	L23644	2	A 164 320 12 32	

M-Class (W166) 06.11 →

		i	←	→	Thread	Part Of	QPA	i
					L23644	L23644	2	A 164 320 12 32

MB 100 02.88 →



L23506



L23506



L23506



L23506



Thread

Part Of

QPA

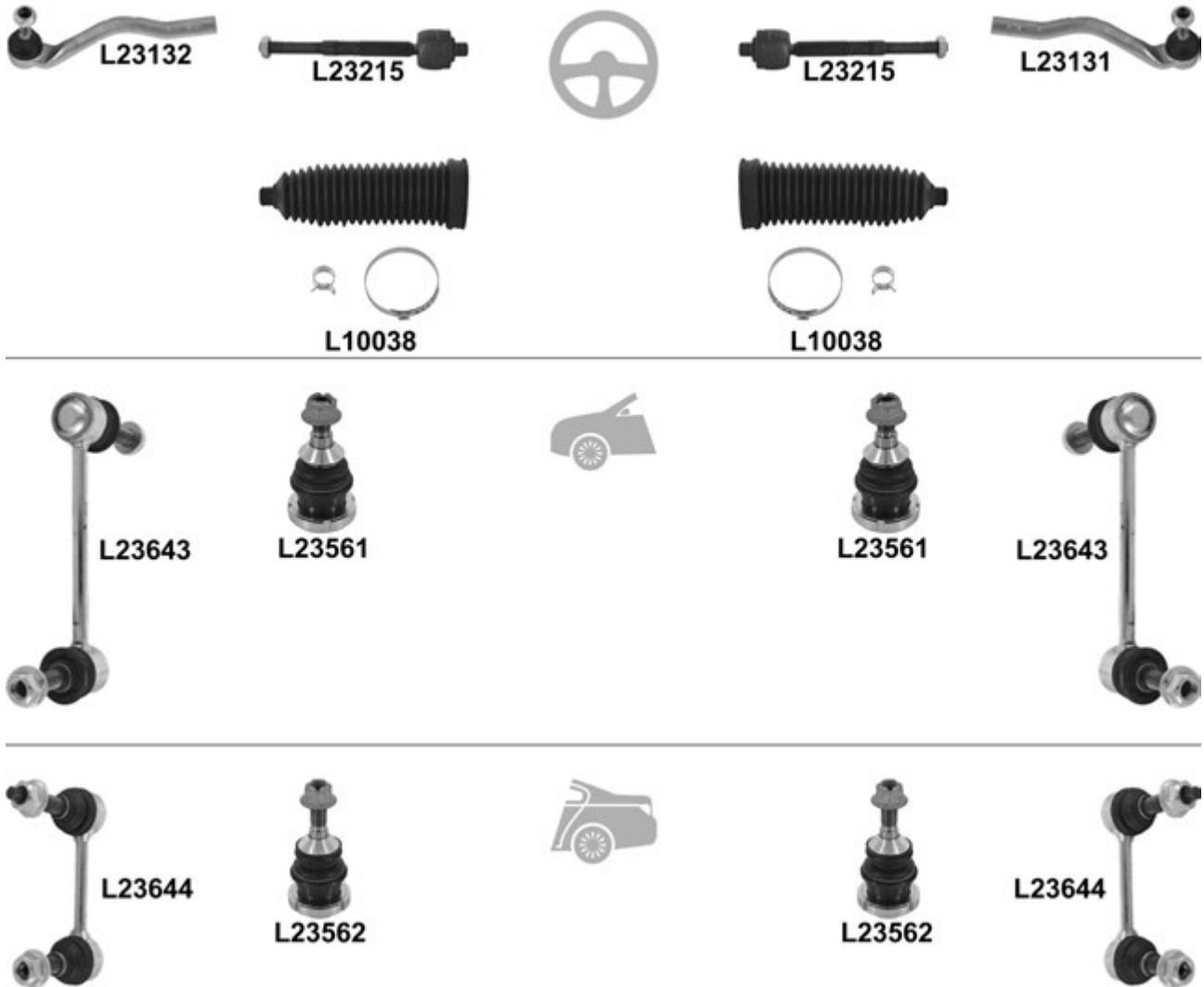

		↑		←	→	Thread	Part Of	QPA	
				L23506	L23506				
		↓		L23506	L23506			2	631 320 02 28
		↓		L23506	L23506			2	631 320 02 28

R-Class (W251, V251) 01.06 →

		i	←	→	Thread	Part Of	QPA	i
		↔		L23131	F 14x1,5		1	A 164 330 12 03
				L23132	F 14x1,5		1	A 164 330 11 03
				L23215	M 14x1,5 / M 16x1,5		2	A 164 460 00 05
				L10038 ^o	L10038 ^o		2	164 460 00 96
		⊥		L23561	L23561		2	A 164 330 09 35
				L23643	L23643		2	A 164 320 21 32
		⊥		L23562	L23562		2	A 164 352 03 27
				L23644	L23644		2	A 164 320 12 32

S-Class W140 (300 SE - 600 SEL) 02.91 → 10.98

SL-Class 140 (420 CL - 600 CL) 10.92 → 02.99



		i		←	→	Thread	Part Of	QPA	i
		↔		L23108	L23108	↻		2	001 330 62 35
		→←		L23107	L23107	↻		2	001 330 63 35
				L23303	L23303			2	140 330 00 03
		→←		L23304				1	140 460 08 05
		→←		KIT	L23404			1	140 460 08 19
		⊥		L23509	L23509			2	140 333 03 27
				KIT	L23800	L23800		2	140 330 82 07
				L23620	L23620			2	140 320 35 89

S-Class (W220) 10.98 →

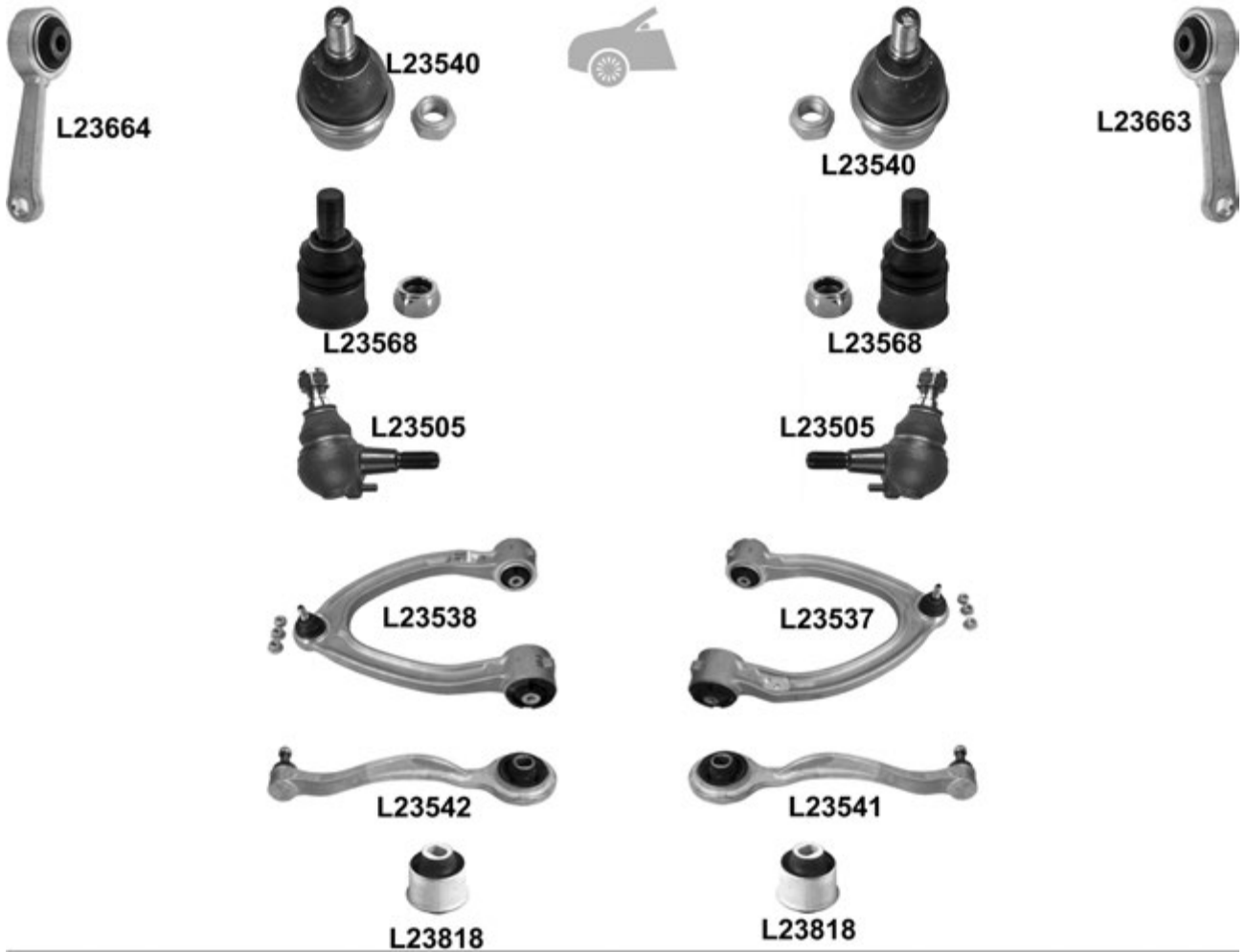
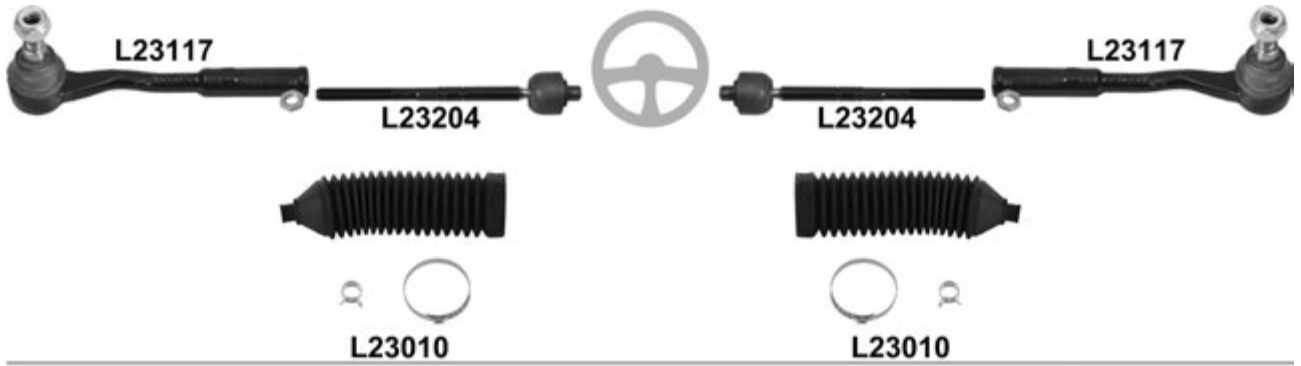

S-Class (W220) 10.98 →

				←	→	Thread	Part Of	QPA		
		↔	(-) 4-Matic	L23117	L23117	⊖		2	220 338 05 15	
			(-) 4-Matic	L23204	L23204	M 14x1,5 / M 16x1,5		2	230 338 00 15	
				L23010 ^o	L23010 ^o			2	220 460 10 00	
		⊥↔	(-) 4-Matic	L23540	L23540			2	220 333 07 27	
		⊥↔↔	(-) 4-Matic	L23568	L23568			2	211 323 00 68	
		⊥	4-Matic	L23505	L23505			2	210 330 00 35	
		⌈	(-) 4-Matic	<input checked="" type="checkbox"/>		L23537			1	220 330 94 07
					L23538			1	220 330 93 07	
		⊥▲	(-) 4-Matic			L23541			1	220 330 58 11
				L23542			1	220 330 57 11		
		⊥▲↔	(-) 4-Matic		L23818	L23818			2	220 333 18 14
			(-) 4-Matic			L23663			1	220 320 15 89
				L23664			1	220 320 16 89		
		▼	KIT	L23813			Hub carrier	1	215 350 01 08	
		▲		L23814			Hub carrier	1	215 350 00 08	
			(-) 4-Matic	L23620	L23620			2	140 320 35 89	

S-Class W221 (S 320 CDI - S 65 AMG), (-) . 4-Matic 10.05 →



		i		←	→	Thread	Part Of	QPA	i	
			(-) AD /4-Matic	L23213	L23213	M 14x1,5 / M 16x1,5 U		2	221 330 16 03	
			4-Matic, (-) AD	L23217	L23217	M 14x1,5 / M 16x1,5 U		2	204 338 05 15	
		±▼	(-) AD /4-Matic <input checked="" type="checkbox"/>		L23571			1	221 330 82 07	
				L23572				1	221 330 81 07	
			(-) AD /4-Matic		L23629			1	221 320 02 89	
		±▲		L23630				1	221 320 01 89	
				L2309	L2309			2	221 352 00 27	
			CAM			L23645			1	A 221 350 06 06
					L23646				1	A 221 350 04 06
			CAS	Pull		L23647			1	A 221 350 10 06
					L23648				1	A 221 350 02 06
				Push		L23649			1	A 221 350 08 06
				L23650				1	A 221 350 07 06	
					L23631			1	221 320 22 89	
			L23632					1	221 320 19 89	

S-Class Coupé C215 (CL 500 - CL65 AMG) 03.99 →

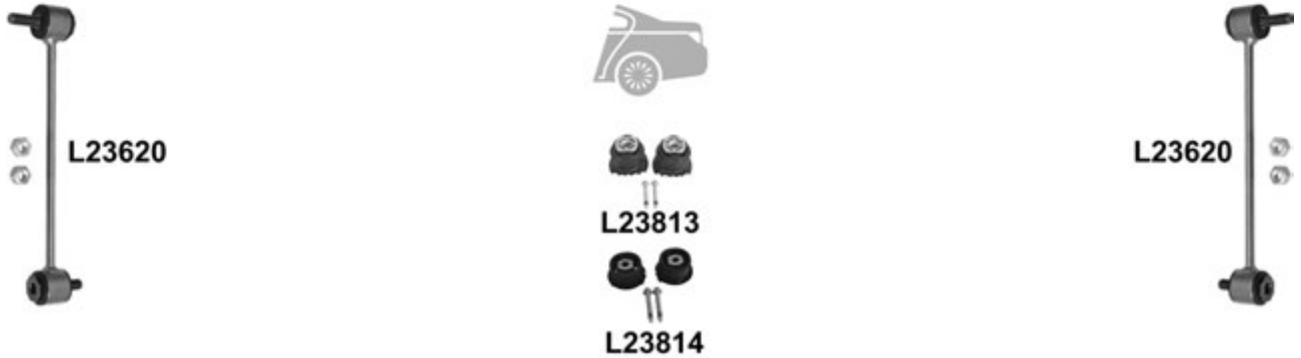
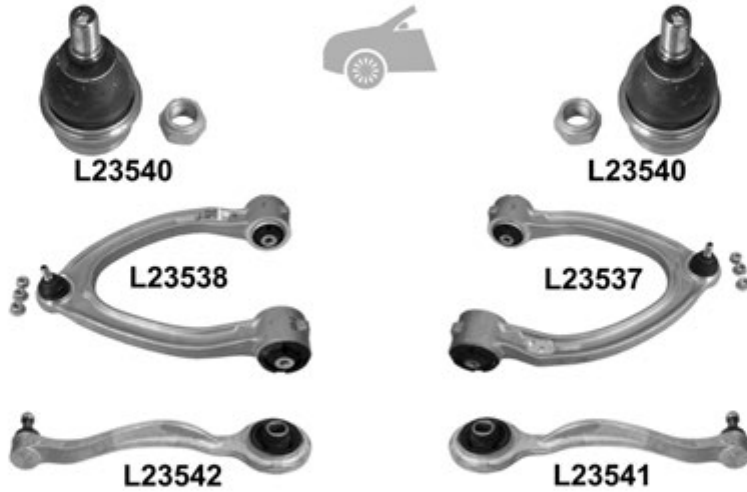
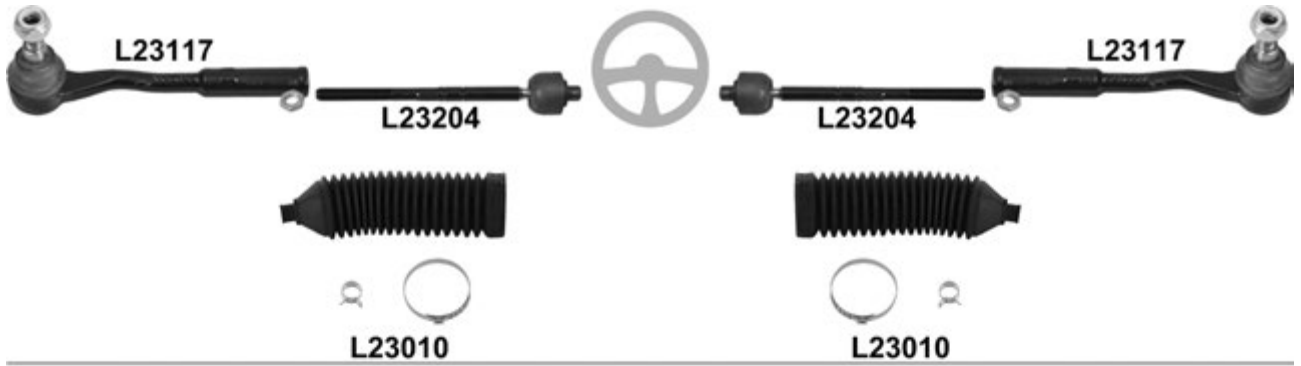

			←	→	Thread	Part Of	QPA	
		↔	L23117	L23117	∪		2	220 338 05 15
			L23204	L23204	M 14x1,5 / M 16x1,5		2	230 338 00 15
			L23010 ^o	L23010 ^o			2	220 460 10 00
		↓	L23540	L23540			2	220 333 07 27
		↑		L23537			1	220 330 94 07
				L23538				1
		↓ ▲		L23541			1	220 330 58 11
			L23542				1	220 330 57 11
		▼	KIT		L23813	Hub carrier	1	215 350 01 08
		▲			L23814	Hub carrier	1	215 350 00 08
			L23620	L23620			2	140 320 35 89

S-Class Coupe C216 (CL 500 - CL 65 AMG) 06.06 →



				←	→	Thread	Part Of	QPA	i
⊕	🔑	(-) 4-Matic	L23213	L23213	M 14x1,5 / M 16x1,5 ∪		2	221 330 16 03	
		4-Matic	L23217	L23217	M 14x1,5 / M 16x1,5 ∪		2	204 338 05 15	
🚗	🔑				L23629			1	221 320 02 89
					L23630			1	221 320 01 89
🚗	🌀		L2309	L2309		🔑	2	221 352 00 27	
		CAM	↕ ↓		L23645			1	A 221 350 06 06
					L23646			1	A 221 350 04 06
		CAS	↕ ↑	Pull		L23647		1	A 221 350 10 06
					L23648			1	A 221 350 02 06
			↕ ↑	Push		L23649		1	A 221 350 08 06
					L23650			1	A 221 350 07 06
🔑	🔑				L23631			1	221 320 22 89
					L23632			1	221 320 19 89

SL-Class R129 03.89 → 12.01
 W124 (E-Class) 06.93 → 06.95
 (-) 4-MATIC model



				←	→	Thread	Part Of	QPA	
		↓	(-) AMG <input checked="" type="checkbox"/>		L23501			1	124 330 31 07
				L23502			1	124 330 30 07	
			SL280 Model 129.058, SL280 Model 129.059, Ident. → F 187941 <input checked="" type="checkbox"/>		L23501			1	124 330 31 07
			SL320 Model 129.063, SL320 Model 129.064, Ident → F 187941		L23502			1	124 330 30 07
			(-) ESP/AMG						

SL-Class R230 08.02 →

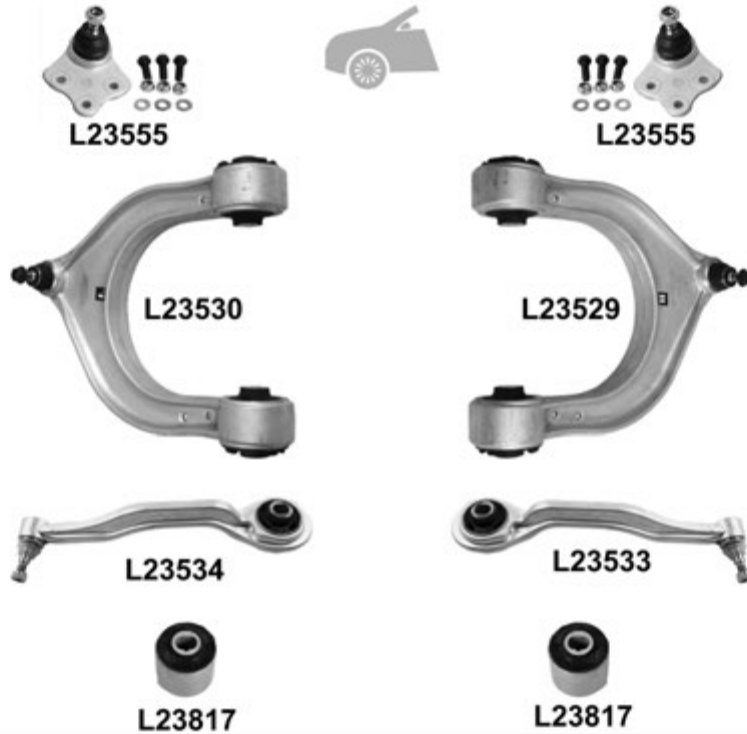

			i	←	→	Thread	Part Of	QPA	i
		↔		L23117	L23117	F 14x1,5 U		2	220 338 05 15
				L23204	L23204	M 14x1,5 / M 16x1,5 U		2	230 338 00 15
		↑		L23555	L23555			2	211 330 99 07
		↑	<input checked="" type="checkbox"/>		L23529			1	211 330 68 07
					L23530			1	211 330 67 07
		⊥▲				L23533		1	211 330 30 11
					L23534			1	211 330 29 11
		⊥▲↔		L23817	L23817			2	211 333 25 14
		↑▼			L23637			1	230 350 28 06
					L23638			1	230 350 27 06
		↑	Pull			L23639		1	230 350 36 06
					L23640			1	230 350 35 06
		⊥▲	Push		L23641	L23641		2	230 350 20 06
					L23642	L23642		2	211 320 33 89

SLK R170 (200 - 32 AMG) 04.96 → 04.04



SLK R170 (200 - 32 AMG) 04.96 → 04.04

		i		←	→	Thread	Part Of	QPA	i	
		↔		L23103	L23103	F 12x1,5 U		2	001 330 77 35	
		↓		L23505	L23505			2	210 330 00 35	
		↑		<input checked="" type="checkbox"/>		L23521			1	210 330 88 07
		↓		<input checked="" type="checkbox"/>		L23511			1	202 330 27 07
		↓		<input checked="" type="checkbox"/>		L23512			1	202 330 26 07
				L2378	L2378			2	210 350 06 53	
				L23617	L23617			2	210 350 34 06	
		↑	Pull		L23605	L23605			2	201 350 56 06
		↓ ▲	Push		L23606	L23606			2	201 350 00 29
			L 2378x2, L 23605x2, L 23606x2, L 23617x2, L 23811x2, L 23812x6 KIT	L0029				1	210 350 30 38 06 S	
				L23601	L23601			2	124 320 02 89	

SLK R171 (200 Kompressor - 55 AMG) 03.04 →



SLK R171 (200 Kompressor - 55 AMG) 03.04 →

		i		←	→	Thread	Part Of	QPA	i
		↔			L23113	F 14x1,5 ∪		1	203 330 20 03
					L23114	F 14x1,5 ∪		1	203 330 19 03
		↕	∩		L23004 ^o			2	204 463 02 96
					L23527			1	203 330 20 11
					L23528			1	203 330 19 11
					L23525			1	203 330 02 11
		↕	∩	ALU	L23526			1	203 330 01 11
					L23816	L23816		2	211 333 11 14
		↕	∩		L2309	L2309		2	220 352 02 27
					L23812	L23812		6	210 350 45 06
				KIT	L23617	L23617		2	210 350 34 06
					L23605	L23605		2	201 350 56 06
					L23606	L23606		2	210 350 38 06
					L23601	L23601		2	124 320 02 89
					L23614	L23614		2	203 350 03 53

SLK R172 (200 - 350) 02.11 →

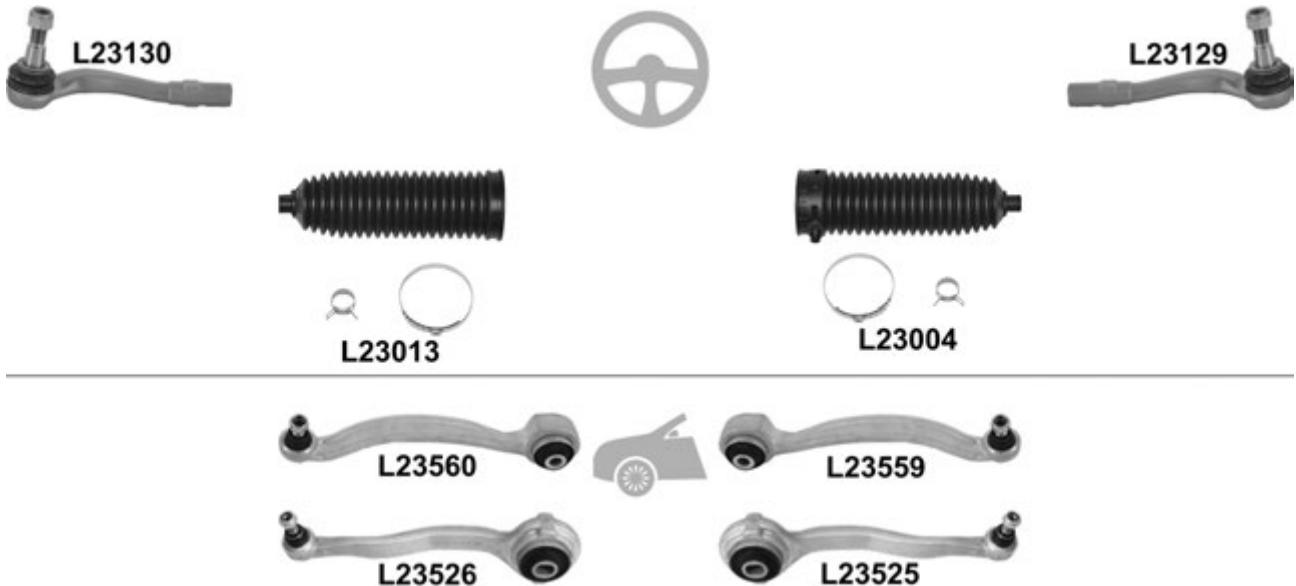

		i		←	→	Thread	Part Of	QPA	i
		↔			L23129	F 14x1,5 ∪		1	204 330 10 03
					L23130	F 14x1,5 ∪		1	204 330 09 03
		↕	∩		L23004 ^o			1	204 463 02 96
					L23013 ^o			1	203 463 03 96
					L23559			1	204 330 68 11
					L23560			1	204 330 67 11
		↕	∩	ALU	L23525			1	204 330 44 11
					L23526			1	204 330 43 11

Sprinter 901, 902, 903, 904 01.95 →

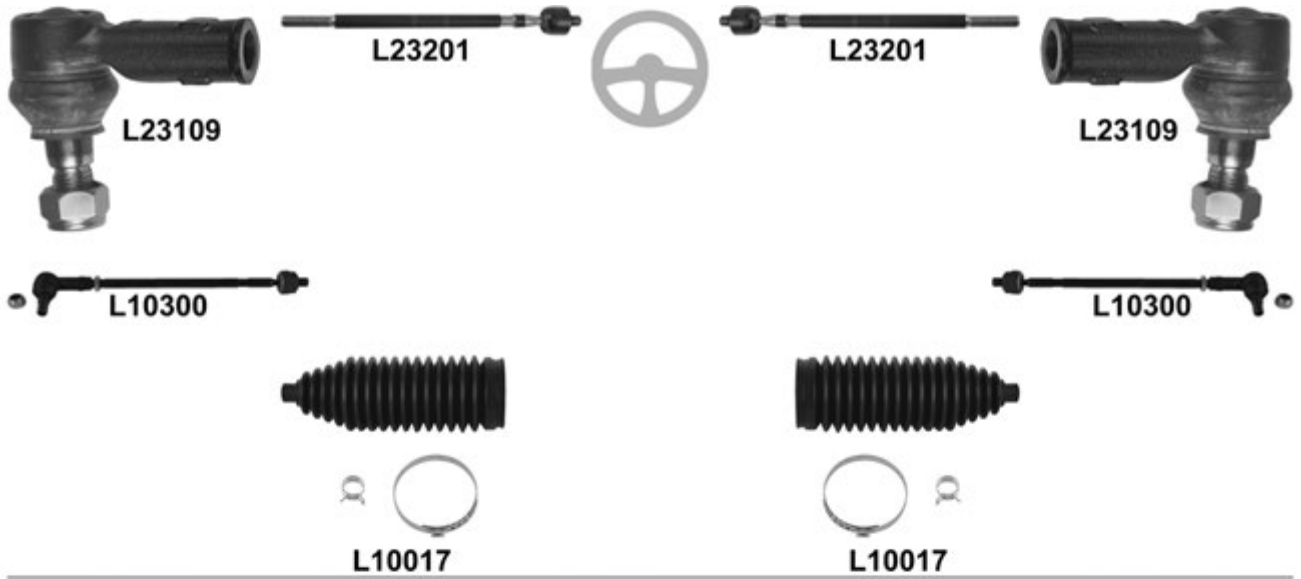

Sprinter 901, 902, 903, 904 01.95 →

		i		←	→	Thread	Part Of	QPA	i		
		↔↔				F 16x1,5 ∪		2	901 460 01 48		
						M 16x1,5 / M 16x1,5 ∪		2	901 460 04 55		
								2	901 460 02 05		
								2	901 460 55 00		
		⊥						2	901 333 11 27		
		⊥		<input checked="" type="checkbox"/>		L10543		1	901 330 25 07		
						L10544		1	901 330 24 07		
						L10603		1	901 320 03 89		
						L10604		1	901 320 02 89		
			(-) 904			L10811	L10811			4	601 321 03 50
			(-) 904			L10605	L10605			2	901 320 00 89
			904			L10641	L10641			2	906 320 13 89

Sprinter 3t (906) 06.06 →
 Sprinter 5t (906) 06.06 →



Sprinter 3t (906) 06.06 →
 Sprinter 5t (906) 06.06 →

		i		←	→	Thread	Part Of	QPA	i
		↔		L10114	L10114	F 16x1,5 ♂		2	906 460 00 48
				L10210	L10210	M 16x1,5 / M 18x1,5		2	906 460 00 55
				L10038 ⁰	L10038 ⁰			2	164 460 00 96
		⊥		L10555	L10555			2	
		⊥	(-) HD	<input checked="" type="checkbox"/>	L10587			1	906 330 40 07
				L10588				1	906 330 41 07
			(-) HD		L10617			1	906 320 18 89
				L10618				1	906 320 17 89
				MK287	MK287			2	906 323 05 20
				L10641	L10641			2	906 320 13 89

V-Class (638/2) 09.96 →

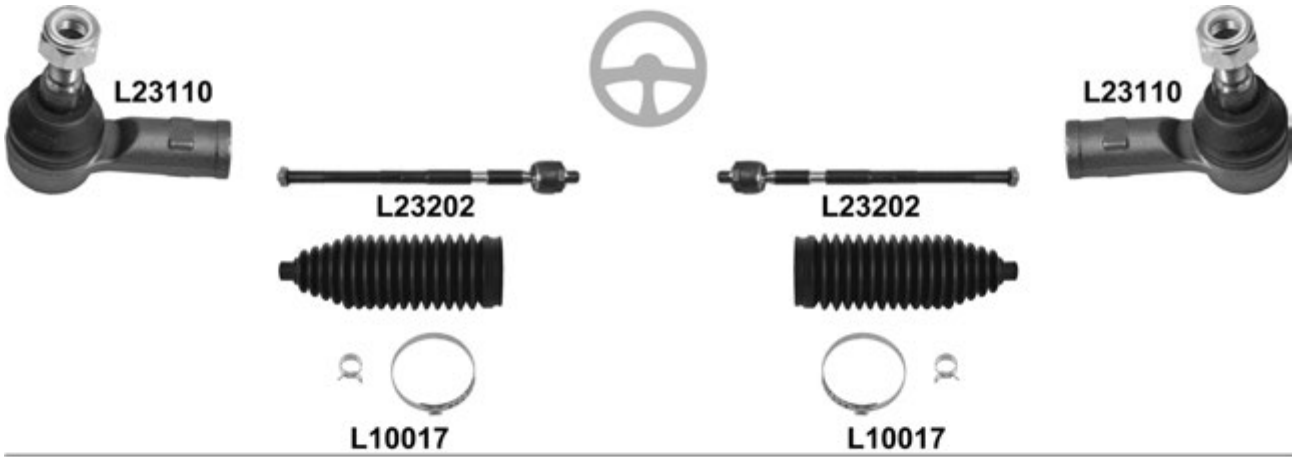

V-Class (638/2) 09.96 →

			i	←	→	Thread	Part Of	QPA	i
		↔		L23110	L23110	F 16x1,5 ∩		2	638 460 00 48
				L23202	L23202	M 16x1,5 / M 16x1,5 ∩		2	638 460 02 55
				L10017	L10017			2	901 460 55 00
		⊥		L23523	L23523			2	638 333 00 27
		⊥	☑		L23549			1	638 330 01 10
				L23550				1	638 330 00 10
		⊥↘		L23820	L23820			2	638 333 08 14
		⊥↗		L23819	L23819			2	639 333 02 14
			(-) Cdi		L23611			1	638 323 03 68
				L23612				1	638 323 02 68
			Cdi		L23615			1	638 323 05 68
			L23616				1	638 323 04 68	
				MK112	MK112			2	
				L23628	L23628			2	638 326 01 16

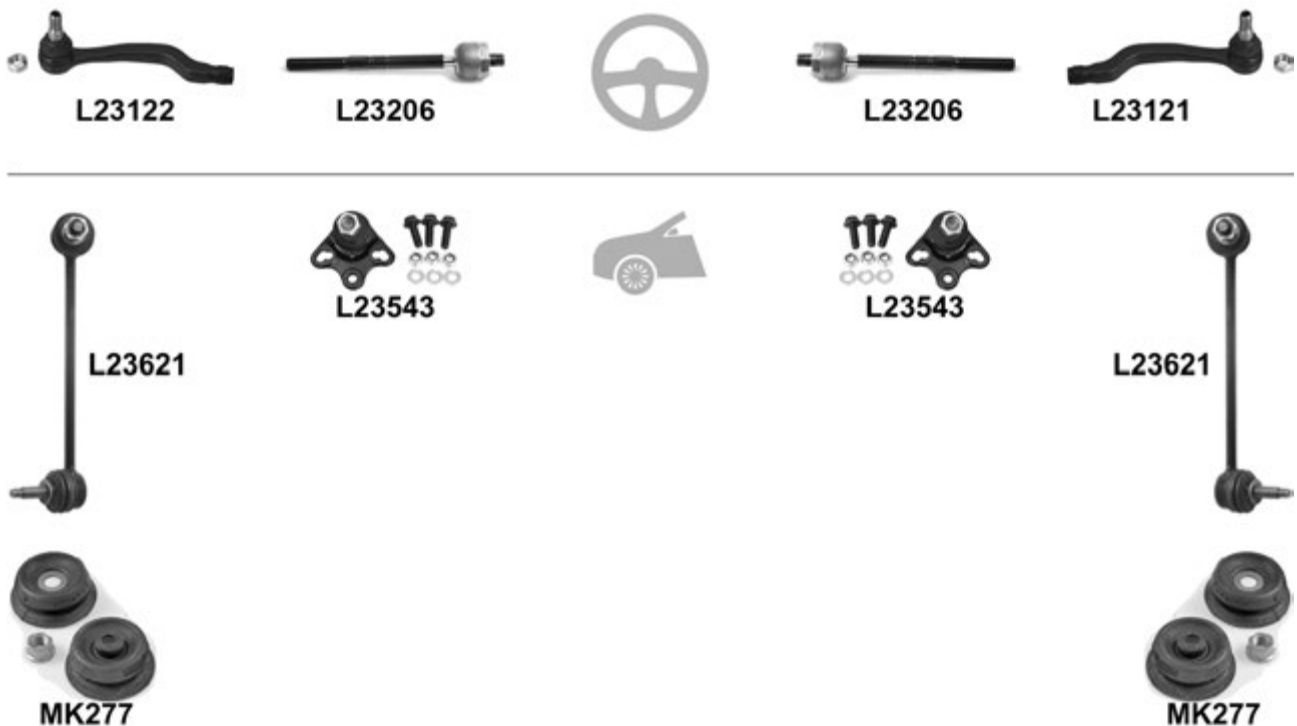
Vaneo (414) 02.02 →

			i	←	→	Thread	Part Of	QPA	i
		↔			L23121	F 14x1,5		1	414 333 01 35
				L23122		F 14x1,5		1	414 333 02 35
				L23206	L23206	M 14x1,5 / M 14x1,5		2	414 330 00 35
		⊥		L23543	L23543			2	414 333 01 27
				L23621	L23621			2	414 320 01 89
				MK277	MK277			2	

Viano (W639) 09.03 →

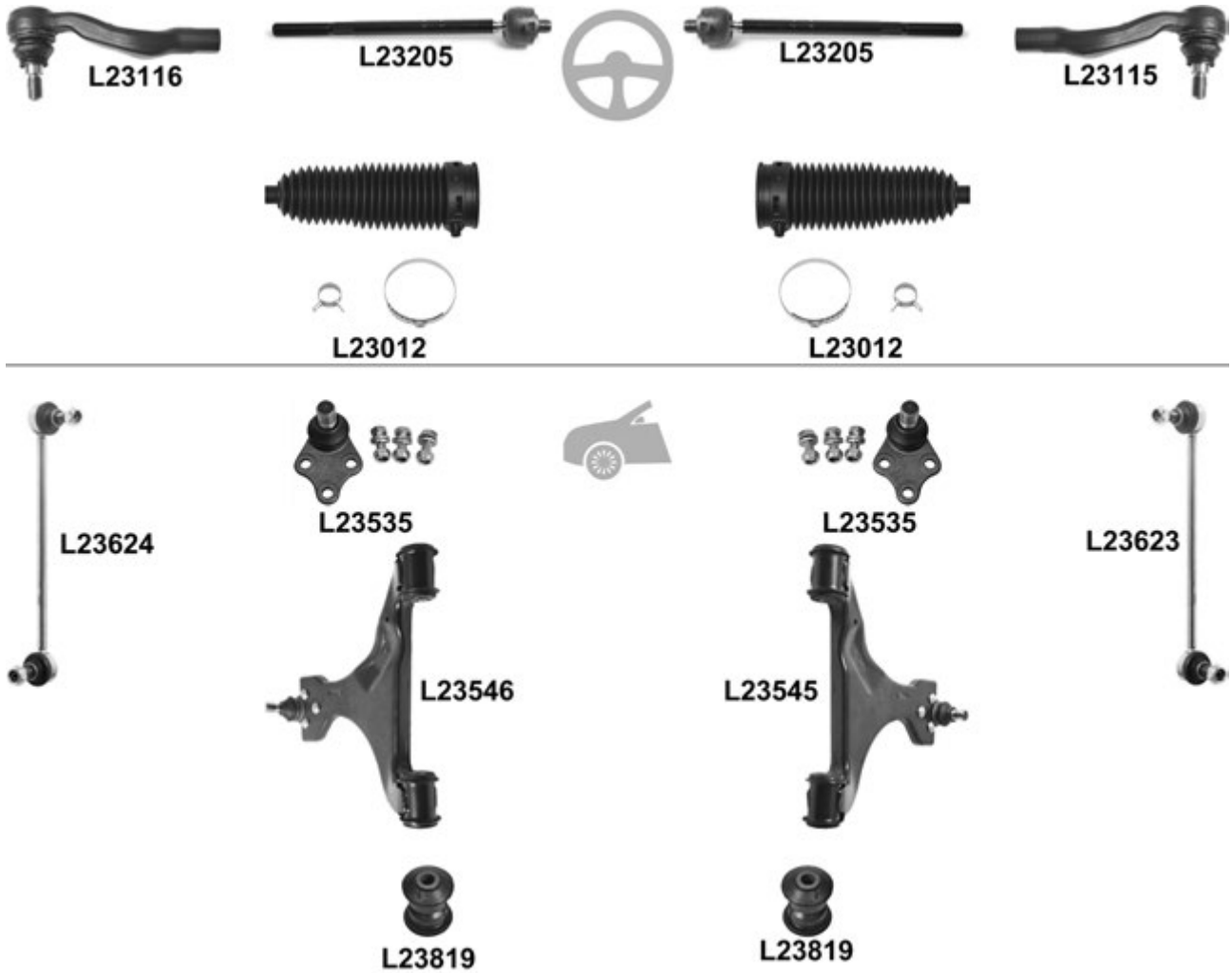

				←	→	Thread	Part Of	QPA		
⊕		↔			L23115	F 16x1,5 ♂		1	639 460 03 48	
				L23116		F 16x1,5 ♂		1	639 460 00 48	
				L23205	L23205	M 16x1,5 / M 16x1,5 ♂		2	639 460 00 55	
				L23012 ⁰	L23012 ⁰			2	639 460 01 96	
⊖		⊥		L23535	L23535			2	639 333 02 27	
				L23545				1	639 330 05 10	
		⊥		L23546				1	639 330 04 10	
				L23819	L23819			4	639 333 02 14	
					L23623			1	639 320 03 89	
			L23624				1	639 320 00 89		

Vito (638) 113, 114, 108 CDI, 110 CDI, 112 CDI, 108 D, 110 TD 02.96 →

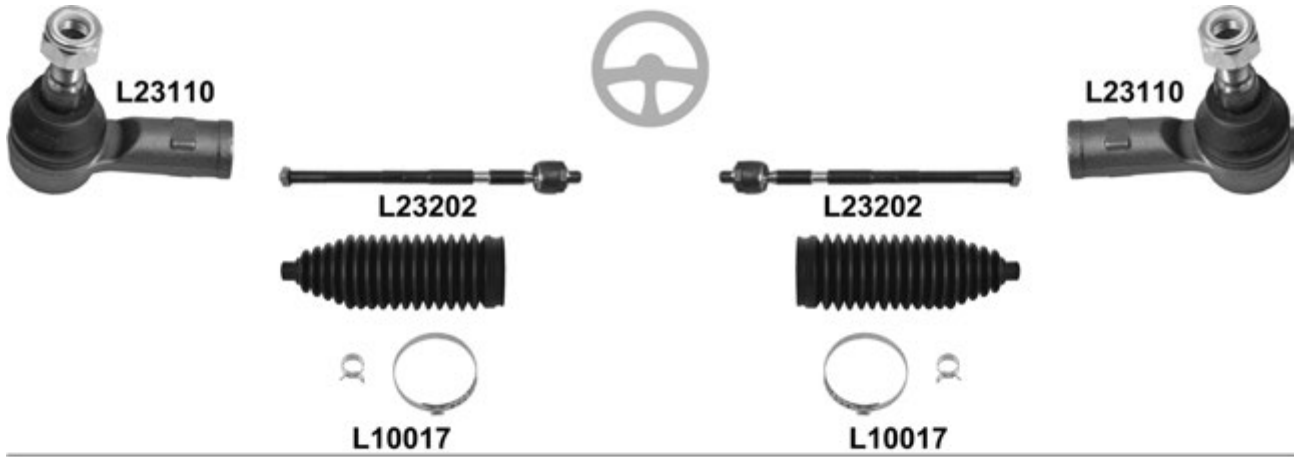

Vito (638) 113, 114, 108 CDI, 110 CDI, 112 CDI, 108 D, 110 TD 02.96 →

			←	→	Thread	Part Of	QPA	
		↔	L23110	L23110	F 16x1,5 ♂		2	638 460 00 48
			L23202	L23202	M 16x1,5 / M 16x1,5 ♂		2	638 460 02 55
			L10017	L10017			2	901 460 55 00
		⊥	L23523	L23523		L23549/L23550	2	
		⊥		L23549			1	638 330 01 10
		⊥	<input checked="" type="checkbox"/>	L23550			1	638 330 00 10
		⊥		L23820	L23820		2	638 333 08 14
		⊥		L23819	L23819		2	639 333 02 14
			(-) Cdi		L23611		1	638 323 03 68
			Cdi		L23612		1	638 323 02 68
					L23615		1	638 323 05 68
				L23616			1	638 323 04 68
			MK112	MK112			2	
			L23628	L23628			2	638 326 01 16

Vito (W639) 119, 122, 109 CDi, 111 CDi, 115 CDi 09.03 →

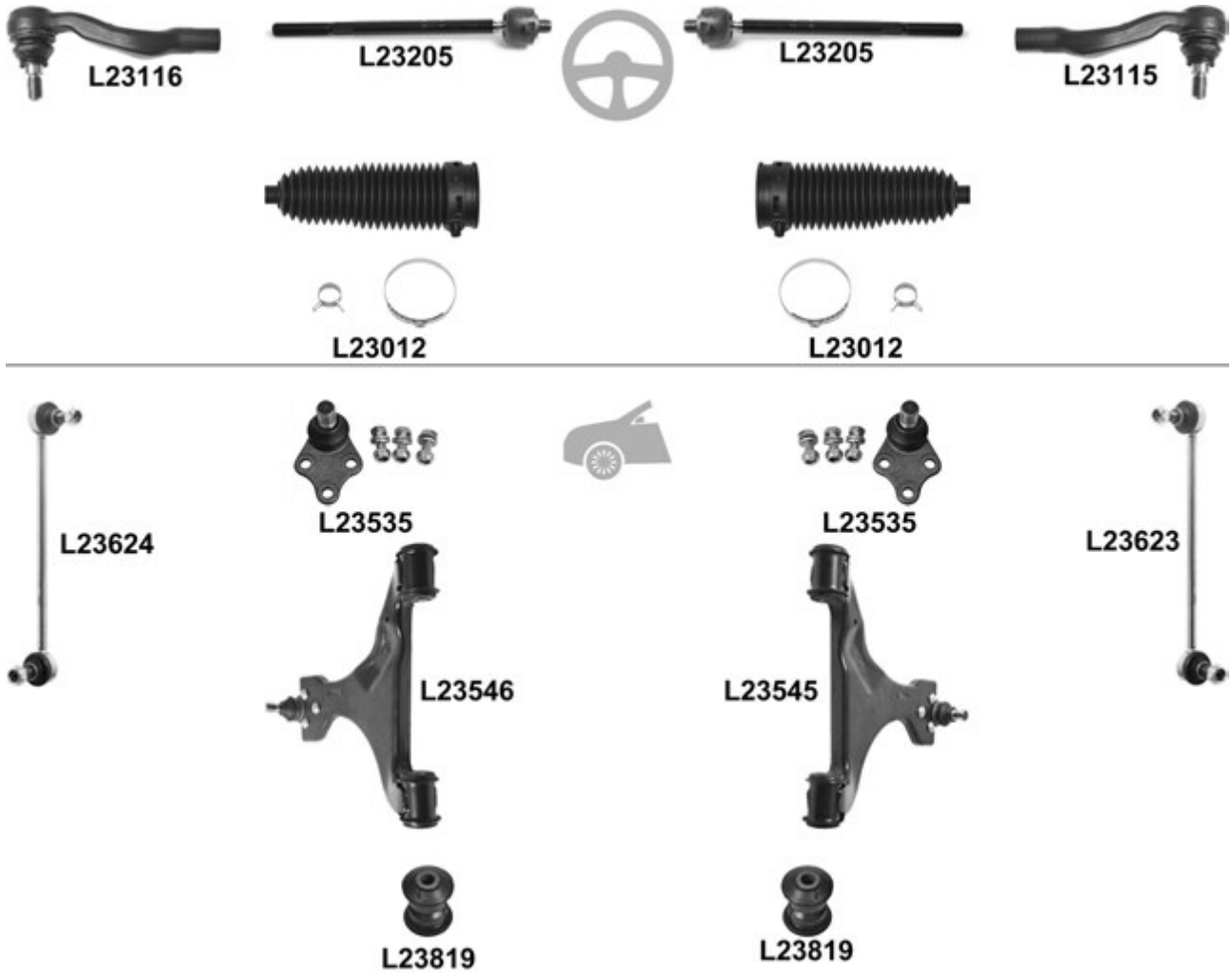

				←	→	Thread	Part Of	QPA		
⊕		↔		L23115		F 16x1,5 ∪		1	639 460 03 48	
			L23116		F 16x1,5 ∪		1	639 460 00 48		
				L23205	L23205	M 16x1,5 / M 16x1,5 ∪		2	639 460 00 55	
			L23012 ⁰	L23012 ⁰			2	639 460 01 96		
⊖		↓		L23535	L23535			2	639 333 02 27	
				L23545			1	639 330 05 10		
		↓		L23546			1	639 330 04 10		
				↕	L23819	L23819			4	639 333 02 14
					L23623			1	639 320 03 89	
				L23624				1	639 320 00 89	

207 D, 208 / D, 210 / D Type 601



L2367



L2368



L2382



L2381



L23101

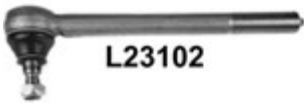

L23102

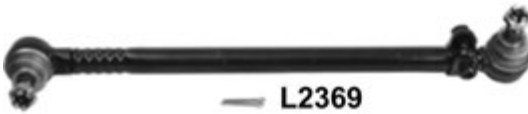

L2369



L23300

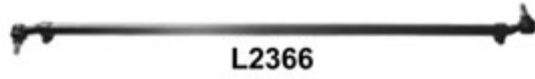

L2366



L2362



L2362



L2350

207 D, 208 / D, 210 / D Type 601

			←	→	Thread	Part Of	QPA			
		↔	Axle 730.403/730.445	L2367		M 24x1,5 ⤴		1	602 330 58 35	
					L2368		M 24x1,5 ⤴		1	602 330 57 35
		↔	Axle 730.404/730.446		L2381		M 20x1,5 ⤴		1	601 330 52 35
					L2382		M 20x1,5 ⤴		1	601 330 53 35
	▼		ch. → 152919	L23101		M 22x1,5 ⤴	Steering rod	1	000 460 85 48	
			ch. → 152683 longitudinal							
			ch. 152920 →	L23101		M 22x1,5 ⤴	Steering rod	1	000 460 85 48	
			ch. 152684 → longitudinal							
	▲		ch. 152920 →	L23102		M 22x1,5 ⤴	Steering rod	1	000 460 86 48	
			ch. 152684 → longitudinal							
				ch. → 152919	L2369				1	309 460 31 05
				ch. → 152683 longitudinal						
			ch. 152920 →	L23300				1	601 460 13 05	
			ch. 152684 → longitudinal							
	↔	Axle 730.403/730.445, 1355mm	L2366				1	602 330 09 03		
			→ A 280963	KIT	L2362	L2362		Stub axle pin	2	601 330 00 19
		30mm	KIT	L2350			Torsion rod	1	601 320 01 83	

209 D Type 601

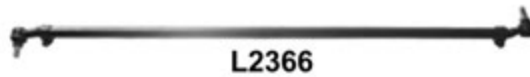
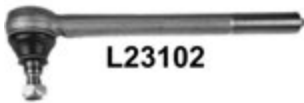

				←	→	Thread	Part Of	QPA			
		↔	Axle 730.403/730.445	L2367		M 24x1,5 ∪		1	602 330 58 35		
					L2368		M 24x1,5 ∪		1		602 330 57 35
		▼	Axle 730.404/730.446		L2381		M 20x1,5 ∪		1		601 330 52 35
			longitudinal		L2382		M 20x1,5 ∪		1		601 330 53 35
		▲	longitudinal		L23101		M 22x1,5 ∪	Steering rod	1		000 460 41/45 48
			longitudinal		L23102		M 22x1,5 ∪	Steering rod	1		000 460 42/46 48
	↔	longitudinal		L23300				1	601 460 11/13 05		
	↔	Axle 730.403/730.445, 1355mm		L2366				1	602 330 09/10 03		
		→ A 280963	KIT	L2362	L2362		Stub axle pin	2	601 330 00 19		
		30mm	KIT	L2350			Torsion rod	1	601 320 01 83		

307 D Type 602



L2382



L2381



L23101

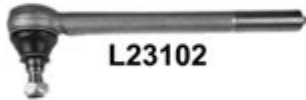

L23102

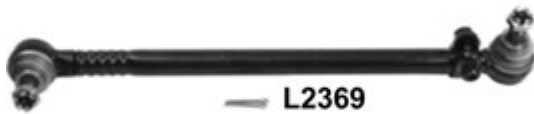

L2369



L23300



L2362



L2362

				←	→	Thread	Part Of	QPA		
		↔			L2381	M 20x1,5 ∪		1	601 330 05/07 35	
					L2382	M 20x1,5 ∪		1	601 330 04/06 35	
		▼	, ch. → 152645		L23101	M 22x1,5 ∪	Steering rod	1	000 460 41/45 48	
			, ch. → 152683 longitudinal		L23101	M 22x1,5 ∪	Steering rod	1	000 460 41/45 48	
		▲	, ch. 152646 →		L23102	M 22x1,5 ∪	Steering rod	1	000 460 42/46 48	
			, ch. 152684 → longitudinal		L23102	M 22x1,5 ∪	Steering rod	1	000 460 42/46 48	
			, ch. → 152645		L2369			1	309 460 31 05	
			, ch. → 152683 longitudinal		L2369			1	309 460 31 05	
	, ch. 152646 →		L23300			1	601 460 11/13 05			
	, ch. 152684 → longitudinal		L23300			1	601 460 11/13 05			
		→ A 280963	KIT	L2362	L2362		Stub axle pin	2	601 330 00 19	

308 / D, 310 / D Type 602

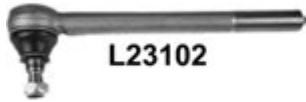

				←	→	Thread	Part Of	QPA		
		↔			L2381	M 20x1,5 ♂		1	601 330 05/07 35	
					L2382	M 20x1,5 ♂		1	601 330 04/06 35	
		▼	, ch. → 152919 , ch. → 152683 longitudinal		L23101	M 22x1,5 ♂	Steering rod	1	000 460 85 48	
			, ch. 152920 → , ch. 152684 → longitudinal		L23101	M 22x1,5 ♂	Steering rod	1	000 460 85 48	
		▲	, ch. 152920 → , ch. 152684 → longitudinal		L23102	M 22x1,5 ♂	Steering rod	1	000 460 86 48	
			, ch. → 152919 , ch. → 152683 longitudinal		L2369			1	309 460 31 05	
			, ch. 152920 → , ch. 152684 → longitudinal		L23300			1	601 460 13 05	
				→ A 280963	KIT	L2362	L2362	Stub axle pin	2	601 330 00 19

309 D Type 602



L2382



L2381



L23300



L23101

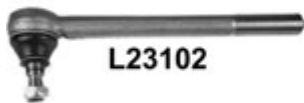

L23102



L2362



L2362

						←	→	Thread	Part Of	QPA		
			Axle 730.404/730.446		L2381			M 20x1,5 ⌀		1	601 330 05/07 35	
					L2382			M 20x1,5 ⌀		1	601 330 04/06 35	
			Axle 730.404/730.446 longitudinal		L23300			M 22x1,5		1	601 460 11/13 05	
			Axle 730.404/730.446 longitudinal		L23101			M 22x1,5 ⌀	Steering rod	1	000 460 41/45 48	
			Axle 730.404/730.446 longitudinal		L23102			M 22x1,5 ⌀	Steering rod	1	000 460 42/46 48	
			Axle 730.404/730.446, → A 280963	KIT	L2362	L2362		Stub axle pin	2	601 330 00 19		

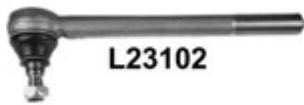
407 D, 409 D, 410 D Type 611

				← → Thread		Part Of	QPA		
⊕	↔	↔	Axle 730.405	L2381	M 20x1,5 ⤴		1	601 330 05/07 35	
				L2382	M 20x1,5 ⤴		1	601 330 04/06 35	
	↕	↕	Axle 730.405 longitudinal	L23300	M 22x1,5		1	601 460 11/13 05	
			Axle 730.405 longitudinal	L23101	M 22x1,5 ⤴	Steering rod	1	000 460 41/45 48	
		▲	Axle 730.405 longitudinal	L23102	M 22x1,5 ⤴	Steering rod	1	000 460 42/46 48	
🚗	🔧		Axle 730.405, → A 280946	KIT	L23400 L23400	Stub axle pin	2	611 330 00 19	

507 D Type 667

				← → Thread		Part Of	QPA		
⊕	↔	↔	Axle 730.407	L2381	M 20x1,5 ⤴		1	601 330 05/07 35	
				L2382	M 20x1,5 ⤴		1	601 330 04/06 35	
🚗	🔧		Axle 730.407, → A 280946	KIT	L23400 L23400	Stub axle pin	2	611 300 00 19	

O 309 B / D Type 309 / 310
 O 310 D Type 310
 L / LK 406 DG Type 309
 L / LK 407 D Type 309
 L / LK / 408 G Type 309
 L / LF / LK / LKO 408 G Type 309
 L / LK / LKO 409 Type 309
 L / LK 410 Type 309
 L 508 DG Type 309
 L / LK 608 D Type 310
 L 613 Type 313



Thread

Part Of

QPA



				KIT	L2363	L2363		Stub axle pin	2	310 330 03 19
--	--	--	--	-----	-------	-------	--	---------------	---	---------------

MG

MG F 04.95 → 02.02



		← →		Thread	Part Of	QPA		
		$\bar{\uparrow}$		L17107	L17107		2	GSJ269

MG ZR 06.01 →



		← →		Thread	Part Of	QPA		
		\leftrightarrow		L17113	L17113	F 14x1,5 ∪	2	GSJ288
		\perp	ch. 770231 →	<input checked="" type="checkbox"/>	L17503		1	GSJ414
					L17504		1	GSJ413
					L10613	L10613	2	EGP 1662

MG ZS 07.01 →



		← →		Thread	Part Of	QPA		
		\leftrightarrow		L40105	L40105	F 14x1,5 ∪	1	GSJ496
				L40106	L40106	F 14x1,5 ∪	1	GSJ495

MG ZT 06.01 → MG ZT-T 10.01 →



		← →		Thread	Part Of	QPA		
		\leftrightarrow		L17117	L17117	∪	1	QSJ878
				L17118	L17118	∪	1	QSJ877

MINI

Mini (R50, R52, R53) 06.01 →

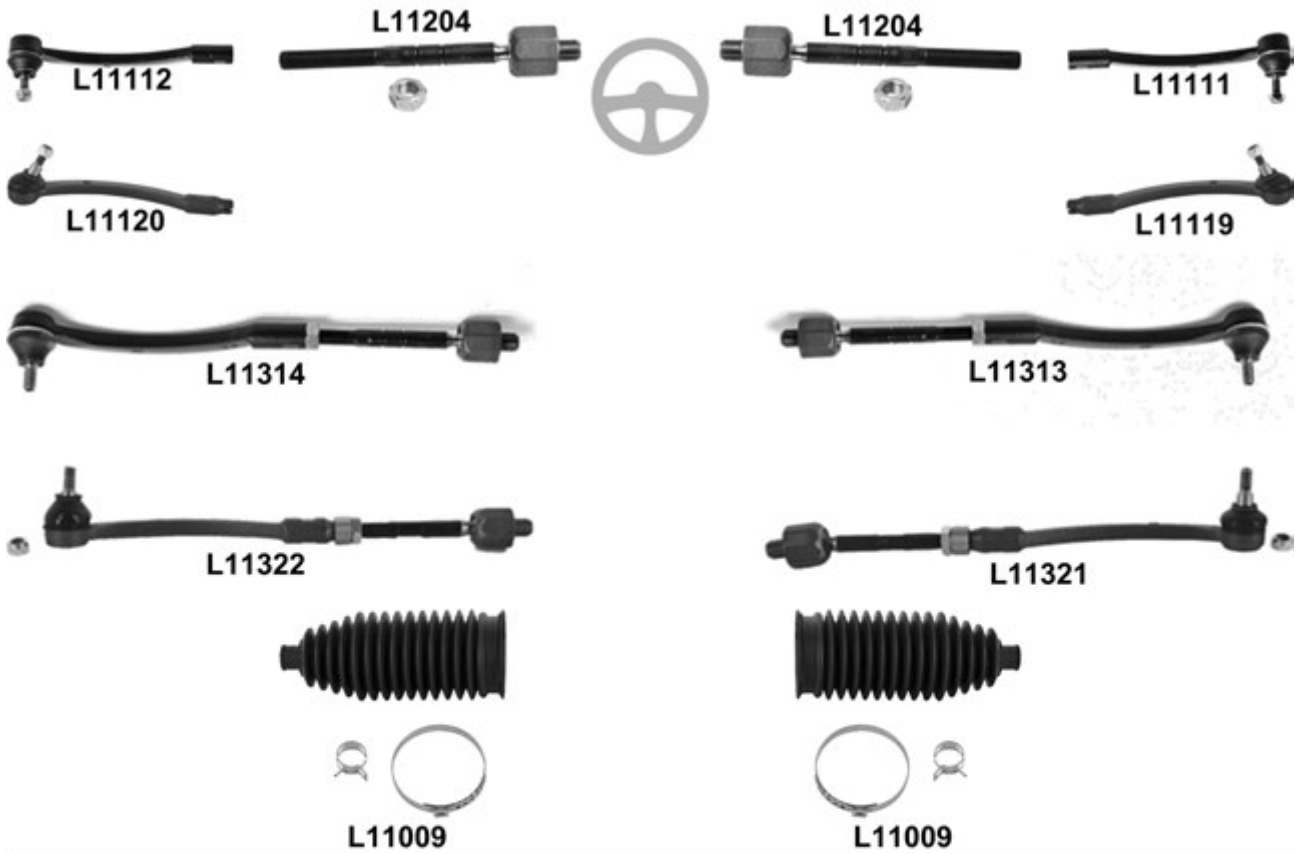

Mini (R50, R52, R53) 06.01 →

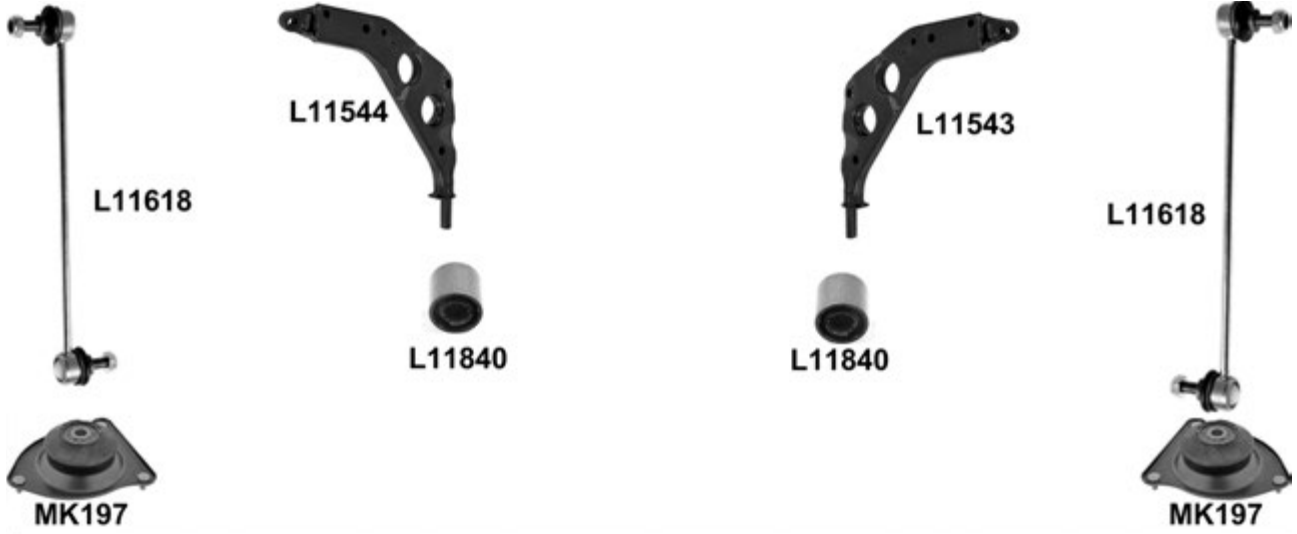

Mini (R50, R52, R53) 06.01 →

		i		←	→	Thread	Part Of	QPA	i
		↔	→ 05.03		L11111			1	32 21 6 754 566
				L11112			1	32 21 6 754 565	
			06.03 →		L11119			1	32 11 6 761 560
				L11120			1	32 13 6 761 559	
					L11204	L11204		2	
		↔	→ 05.03		L11313			1	32 21 6 754 564
				L11314			1	32 21 6 754 563	
			06.03 →		L11321			1	32 11 6 777 522
				L11322			1	32 11 6 777 521	
					L11009 ⁰	L11009 ⁰		2	32 10 6 778 560
		↕↔↔			L11531			1	31 12 6 753 992
				L11532			1	31 12 6 753 991	
		↕↔		L11533	L11533			2	31 12 6 756 309
		⊥	(-) (-)		L11543			1	31 12 6 761 410
				L11544			1	31 12 6 761 409	
		⊥↘		L11840	L11840			2	31 12 6 757 561
		↔	→ 03.02	L11617	L11617			2	31 35 1 507 989
			04.02 →	L11618	L11618			2	31 35 6 759 537
					MK197	MK197			2
		↔	→ 07.07	L11619	L11619			2	33 55 1 507 999
08.07 →			L11629	L11629			2	33 50 6 772 789	

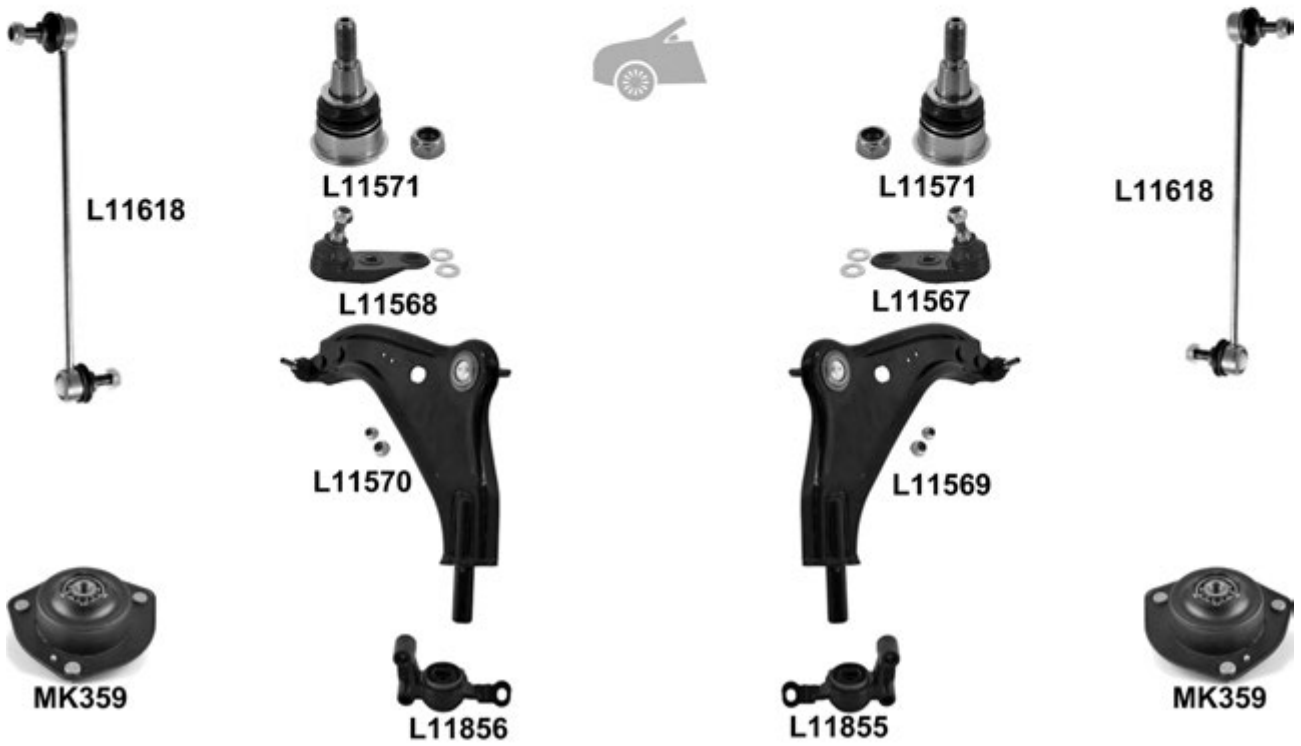
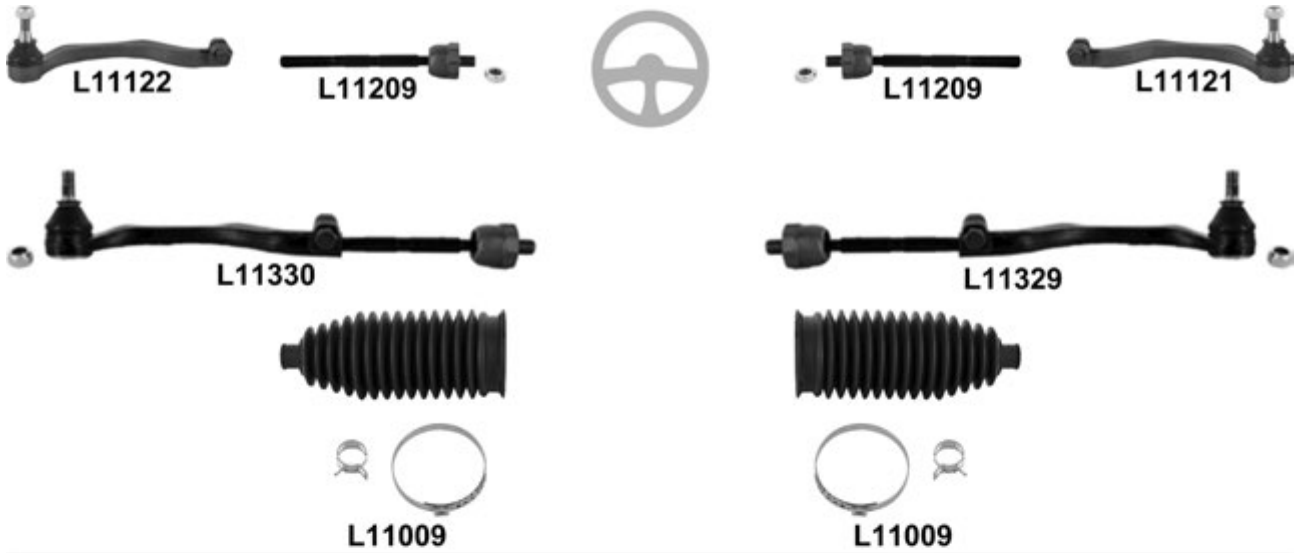
Mini (R55, R56, R57) 09.06 →

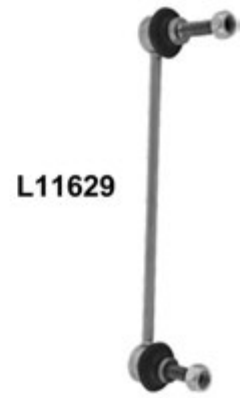
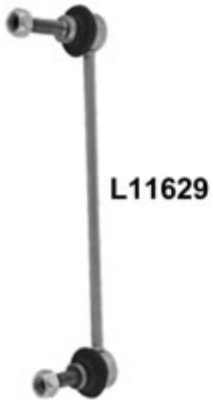
Mini (R55, R56, R57) 09.06 →

				←	→	Thread	Part Of	QPA			
⊕		↔			L11121	F 14x1,5		1	32 10 6 778 438		
					L11122	F 14x1,5		1	32 10 6 778 437		
				L11209	L11209	M 14x1,5 / M 14x1,5		2			
						L11329			1	32 10 6 778 548	
					L11330			1	32 10 6 778 547		
🚗		↕↔↔			L11571	L11571		2			
		↕↔				L11567		1	31 12 6 772 304		
		↕	(+) L 11571			L11569		1	31 12 6 772 302		
						L11570		1	31 12 6 772 301		
		↕↙				L11855			1	31 12 6 772 236	
						L11856			1	31 12 6 772 235	
					L11618	L11618		2	31 35 6 778 831		
				KIT	MK359	MK359		2	31 30 6 772 749		
					L11629	L11629		2	33 50 6 772 789		

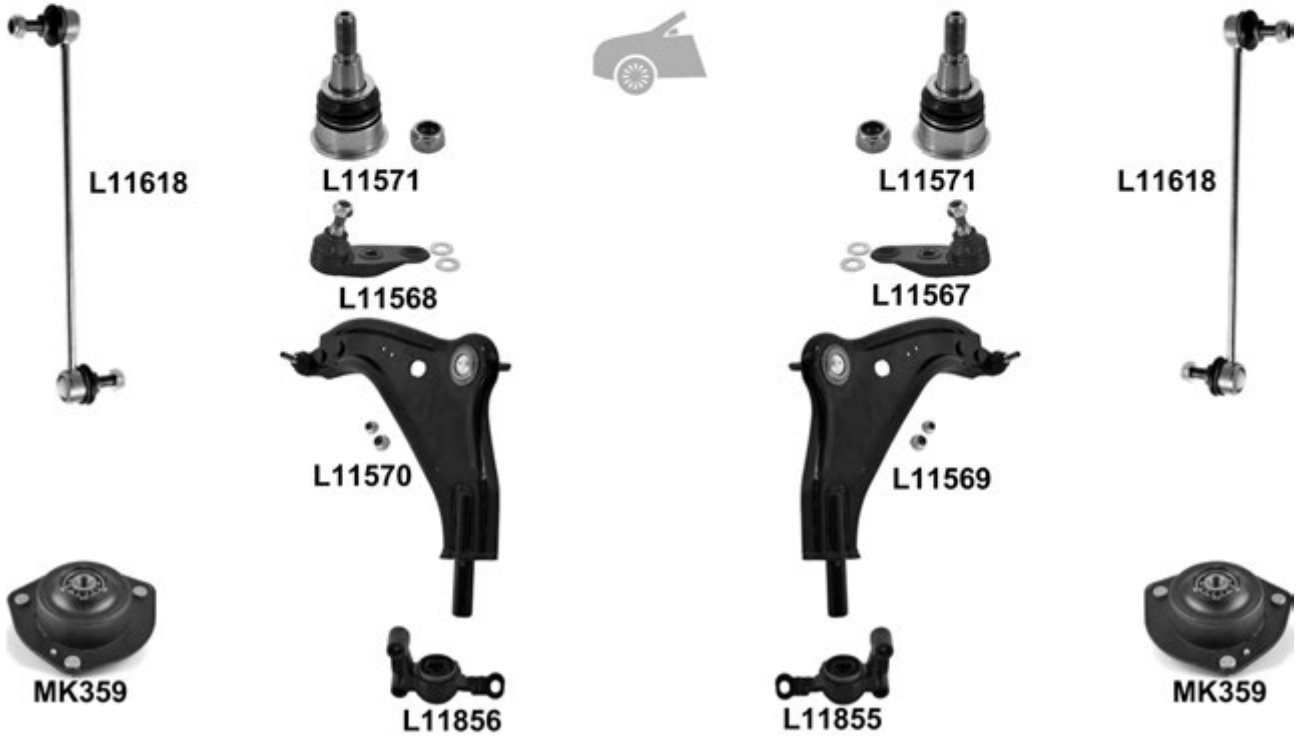
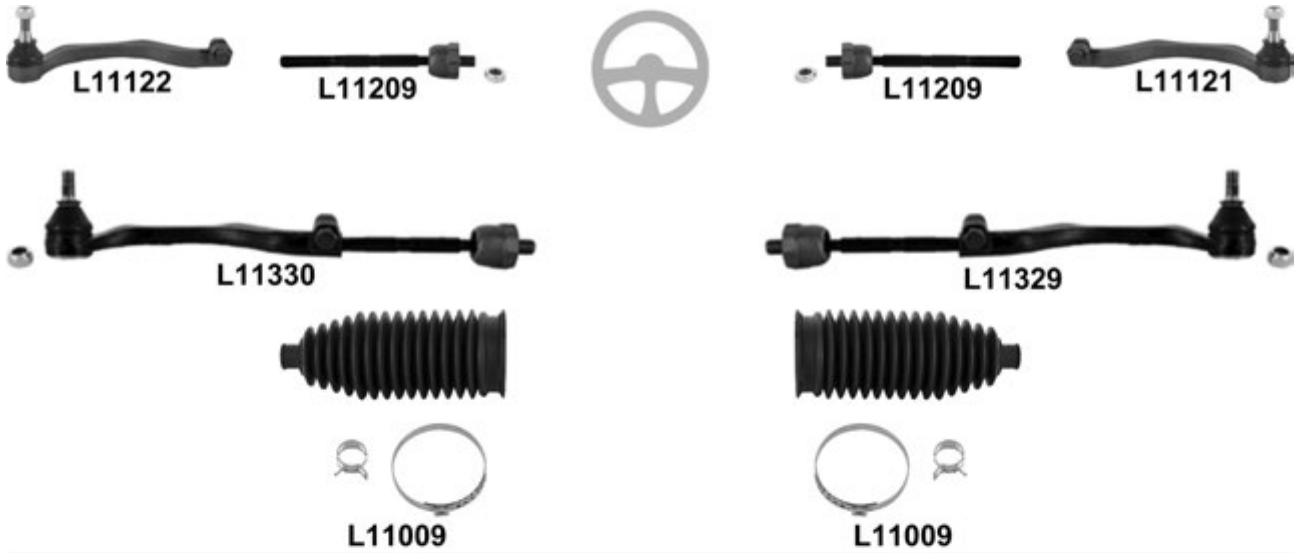
Mini Coupe (R58) 09.11 →

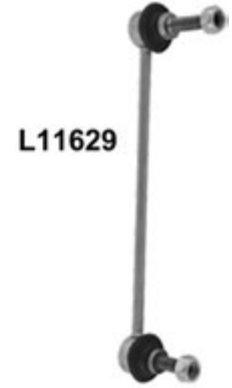
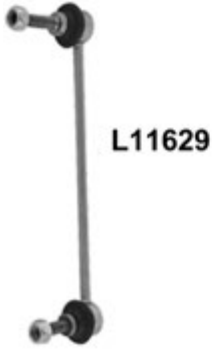
Mini Coupe (R58) 09.11 →

		i		←	→	Thread	Part Of	QPA	i	
⊕		↔			L11121	F 14x1,5		1	32 10 6 778 438	
					L11122	F 14x1,5		1	32 10 6 778 437	
					L11209	L11209	M 14x1,5 / M 14x1,5		2	
					L11329				1	32 10 6 778 548
					L11330				1	32 10 6 778 547
					L11009 ⁰	L11009 ⁰			2	32 10 6 778 560
🚗		↓→↔		L11571	L11571			2		
		↓↔→		L11567			1	31 12 6 772 304		
		↓	(+) L 11571	L11569			1	31 12 6 772 302		
				L11570			1	31 12 6 772 301		
		↓▼		L11855			1	31 12 6 772 236		
				L11856			1	31 12 6 772 235		
				L11618	L11618		2	31 35 6 778 831		
				KIT	MK359	MK359		2	31 30 6 772 749	
			L11629	L11629		2	33 50 6 772 789			

Mini Countryman (R60) 06.10 →



L11009



L11009



MK359



MK359

				←	→	Thread	Part Of	QPA	i
						L11009 ⁰	L11009 ⁰	2	32 10 6 778 560
				KIT		MK359	MK359	2	31 30 6 772 749

Mini Paceman (R61) 01.13 →



L11009



L11009



MK359



MK359

				←	→	Thread	Part Of	QPA	i
						L11009 ⁰	L11009 ⁰	2	32 10 6 778 560
				KIT		MK359	MK359	2	31 30 6 772 749

Mini Roadster (R59) 02.12 →

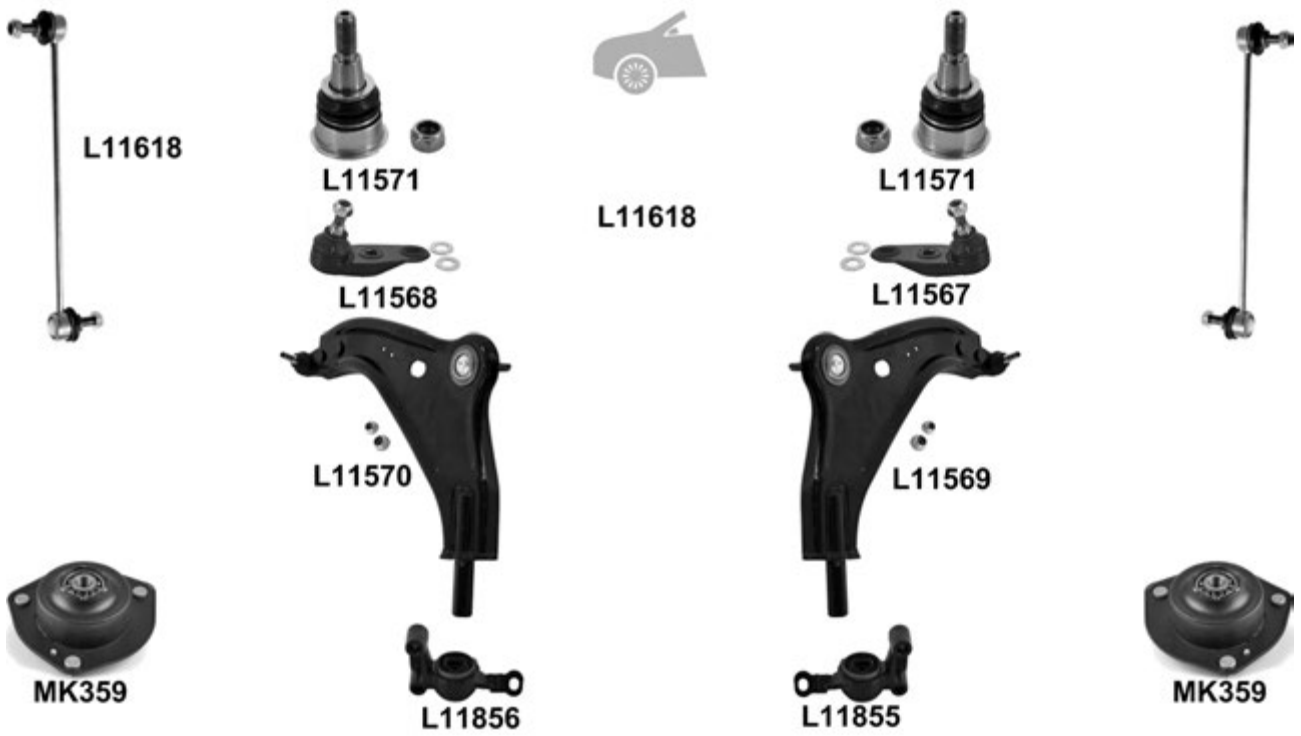
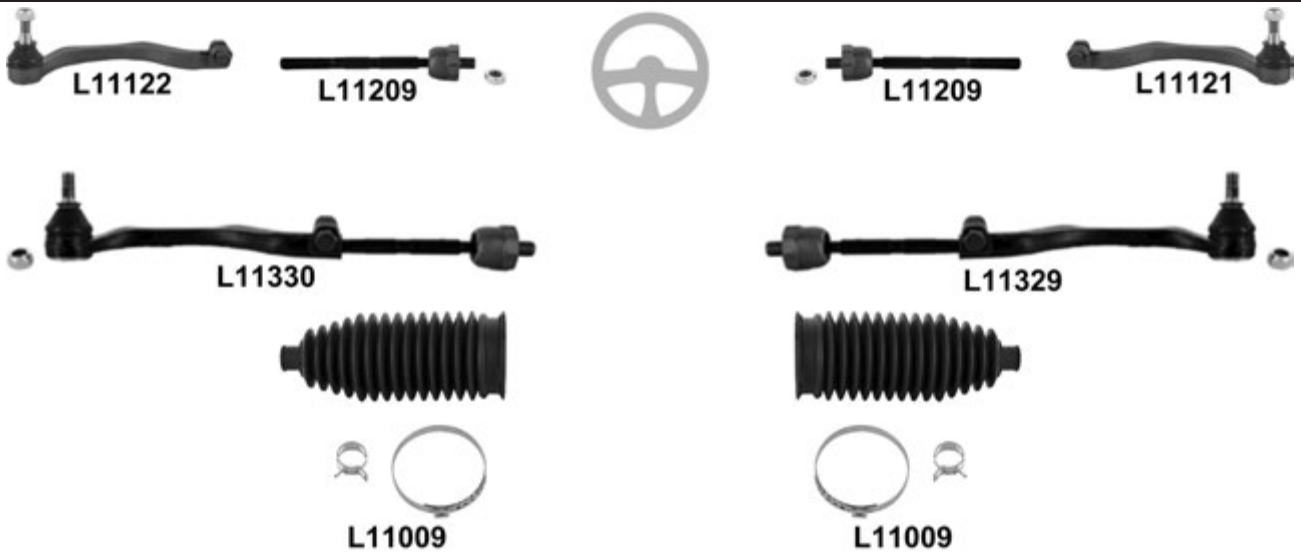

Mini Roadster (R59) 02.12 →

				←	→	Thread	Part Of	QPA	
		↔			L11121	F 14x1,5		1	32 10 6 778 438
				L11122		F 14x1,5		1	32 10 6 778 437
				L11209	L11209	M 14x1,5 / M 14x1,5		2	
					L11329			1	32 10 6 778 548
				L11330				1	32 10 6 778 547
				L11009°	L11009°			2	32 10 6 778 560
		↕↔		L11571	L11571			2	
		↕↔			L11567			1	31 12 6 772 304
				L11568				1	31 12 6 772 303
		↕	(+) L 11571		L11569			1	31 12 6 772 302
				L11570				1	31 12 6 772 301
		↕↙			L11855			1	31 12 6 772 236
				L11856				1	31 12 6 772 235
				L11618	L11618			2	31 35 6 778 831
			KIT	MK359	MK359		2	31 30 6 772 749	
				L11629	L11629			2	33 50 6 772 789

MITSUBISHI

ASX 06.10 →



				← → Thread		Part Of	QPA	
				L10582	L10582		2	
			<input checked="" type="checkbox"/>		L10589		1	4013A010
				L10590			1	4013A009
				L42804	L42804		2	MR403441
				L10633	L10633		2	MN101368
			KIT	MK333	MK333		2	MR101372
					L10635		1	MN184194
				L10636			1	4156A014

Carisma (DAO) 07.95 → 06.06

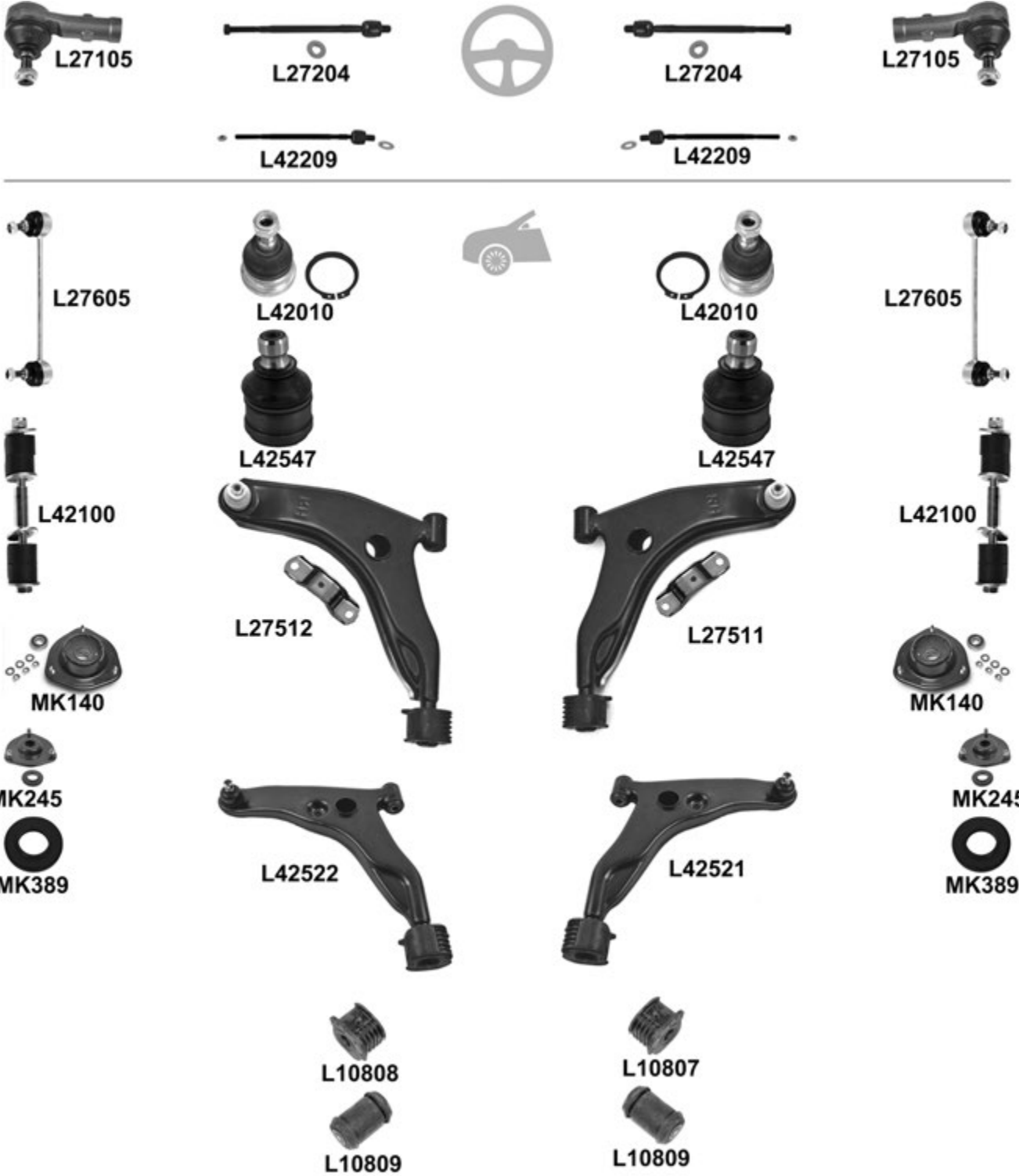

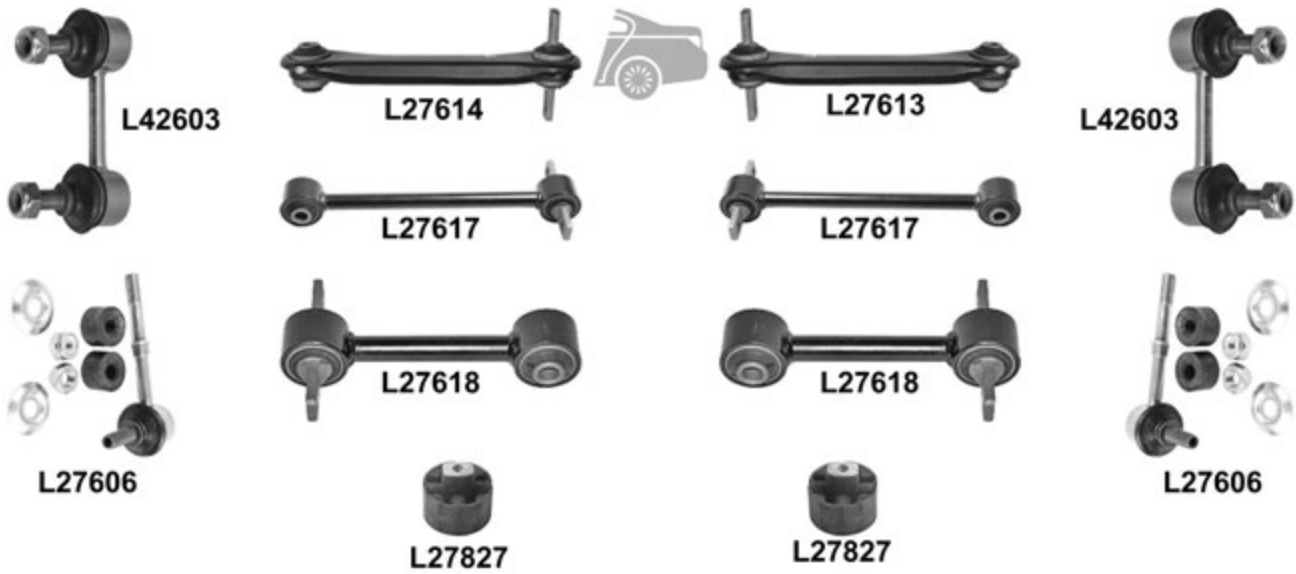
Carisma (DAO) 07.95 → 06.06

				←	→	Thread	Part Of	QPA			
⊕		↔		L27105	L27105	F 12x1,25 U		2	MB912076		
				L27204	L27204	M 12x1,25 / M 16x1,5 U		2	MR244901		
				L42209	L42209	M 12x1,25 / M 16x1,5 U		2	MR403027		
🚗		⊥	→ 02.99	L42010	L42010			2	MB430351		
			03.99 →, 18mm	L42547°	L42547°			2			
		⊥	→ 02.99	<input checked="" type="checkbox"/>		L27511			1	MR179480	
				<input type="checkbox"/>	L27512				1	MR179479	
			03.99 →	<input checked="" type="checkbox"/>		L42521			1	MR911569	
				<input type="checkbox"/>	L42522				1	MR911568	
		⊥▼				L10807			1	MB808910	
						L10808			1	MB808909	
		⊥▲			L10809	L10809			2	MR130982	
			→ 02.99		L27605	L27605			2	30884358	
			03.99 →		L42100	L42100			2	MR392730	
			→ 02.99		KIT	MK140	MK140			2	MR130519
03.99 →					MK245	MK245			2	MR316528	
03.99 →				MK389°	MK389°			2	MR316535		
			⊥	12 x 70 x 75mm longitudinal		L27827	L27827			2	MR911439
				CAS ↑	→ 04.97 Pull		L27613			1	MR491346
							L27614			1	MR491345
	05.97 → Pull				L27617	L27617		2	MR130180		
	↓	Push			L27618	L27618		2	MR491348		
		→ 02.99		L42603	L42603		2	MR272117			
		03.99 →		L27606	L27606		2	MR272118			

Challenger (K96) 09.99 →



L42103



L42103



L43107



L43107



L42505



L42505



L42508



L42507



L42526



L42525

				←	→	Thread	Part Of	QPA	
		↔		L42103	L42103	M 16x1,5 ∪		2	MR296275
		↔		L43107	L43107	M 16x1,5 ∪		2	MR296274
		↑		L42505	L42505			2	MB860830
		↓			L42507			1	MB831038
				L42508				1	MB831037
		↑		<input checked="" type="checkbox"/>	L42525			1	MB831036
				L42526				1	MB831035

Colt (A151A - A157A) 12.78 → 01.84



L4203



L4203



L42100



L42100

				←	→	Thread	Part Of	QPA	
		↔		L4203	L4203	F 14x1,5 ∪		2	MB315629
				L42100	L42100			2	MR954888

Colt (C11A - C37W) 02.84 → 04.88

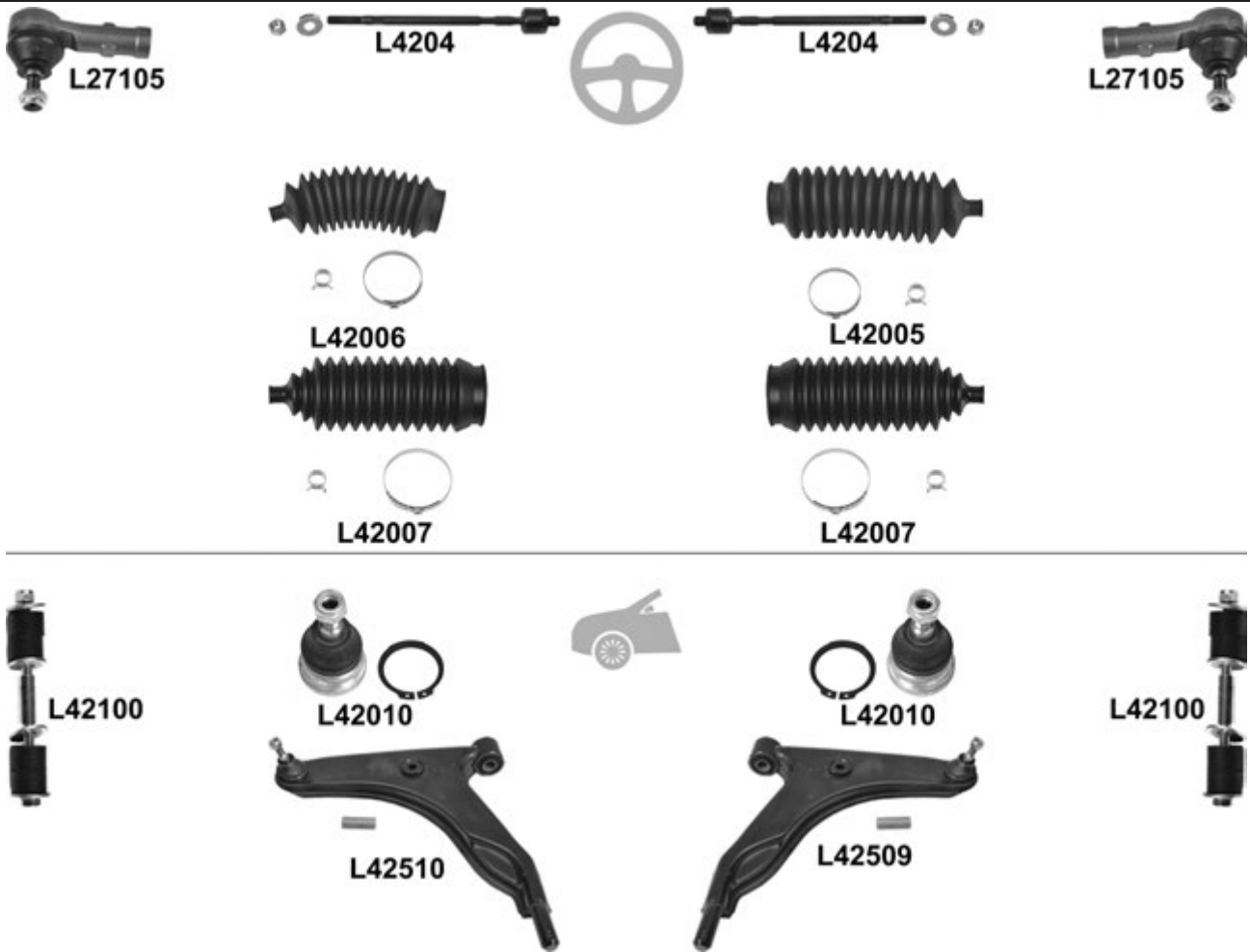

				← → Thread		Part Of	QPA			
⊕		↔		L27105	L27105	F 12x1,25 ♂	2	MB912076		
			(-) ⊕	L4204	L4204	M 12x1,25 / M 14x1,5 ♂	2	MB532046		
			⊕			L42005		1	MB347365	
				⊕	L42006			1	MB347364	
			⊕	L42007	L42007		2	MB501711		
⊖		↓		L42010	L42010		2	MB430351		
		↓			L42509		1	MB349446		
					L42510			1	MB349445	
		→ 01.86	L42100	L42100		2	MR954888			

Colt (C50 serie) 04.88 → 05.92

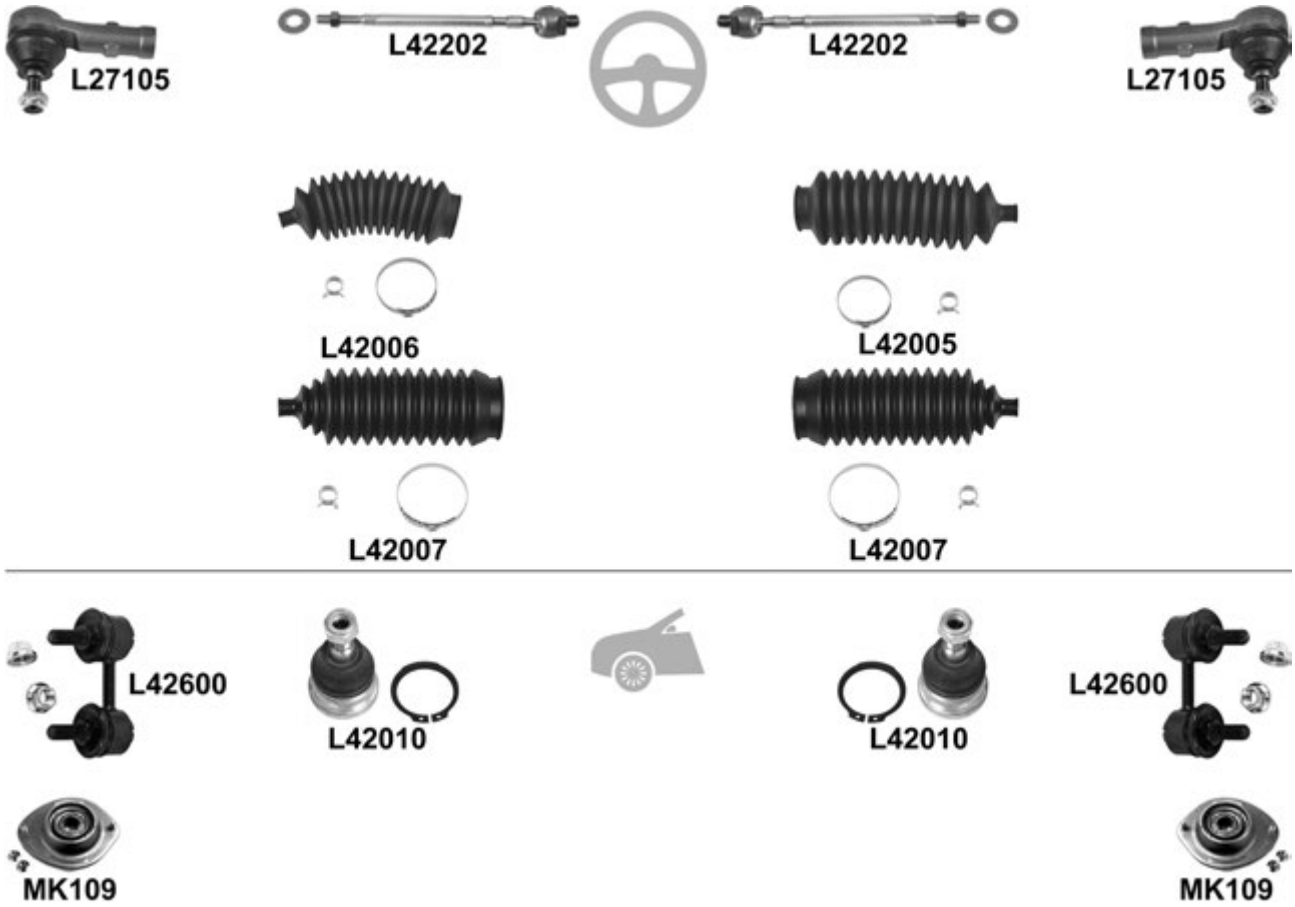

		← →		Thread	Part Of	QPA	
⊕	↔	↔		L27105 L27105	F 12x1,25 ∪	2	MB912076
	↔			L42202 L42202	M 12x1,25 / M 16x1,5 ∪	2	MB553249
	↔	⊖		L42006 L42005		1	MB347365
	↔	⊕		L42007 L42007		2	MB501711
⊖	⊥			L42010 L42010		2	MB303375
	↔			L42600 L42600		2	MB892982
	↺		KIT	MK109 MK109		2	

Colt (CA serie) 04.92 → 08.95

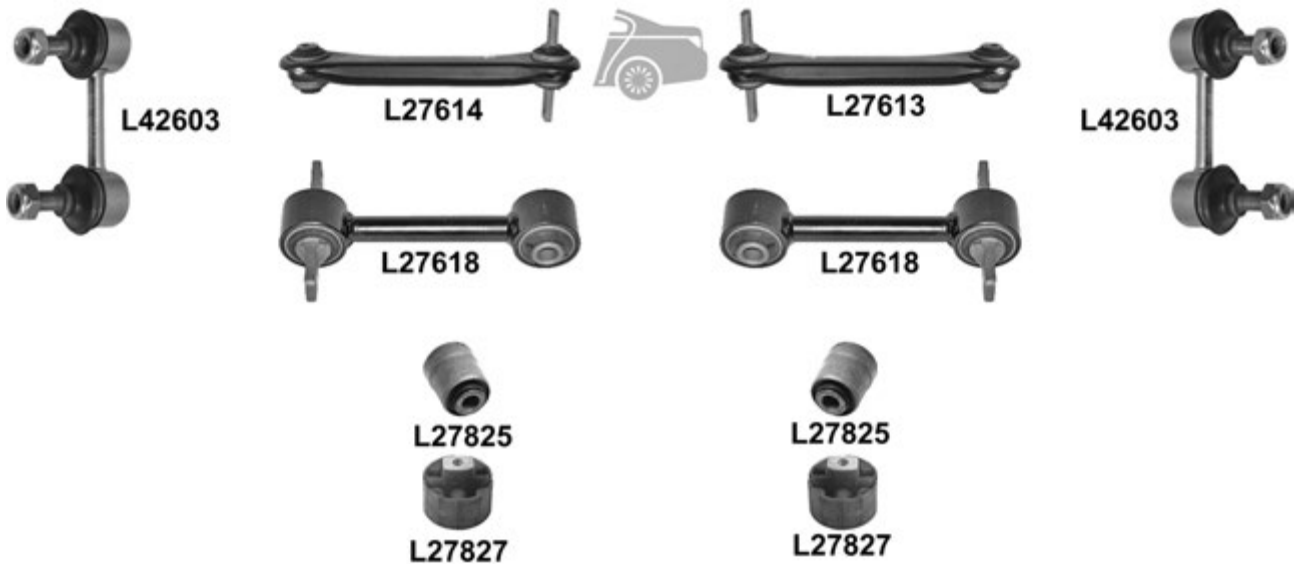

				← → Thread		Part Of	QPA	i	
		↔		L27105	L27105	F 12x1,25 ♂	2	MB598023	
				L42205	L42205	M 12x1,25 / M 16x1,5	2	MB910961	
		⊥		L42010	L42010		2	MB430351	
		⊥			L42513		1	MB912078	<input checked="" type="checkbox"/>
				L42514			1	MB912077	
				L42601	L42601		2	MB518780	
			→ 05.95	KIT	MK091	MK091		2	MB808306
		↔↔↔	transverse	L27825	L27825		4		
		▲	longitudinal	L27827	L27827		2	MR102063	
		↑	Pull		L27613		1	MB809220	
				L27614			1	MB809221	
		⊥	Push	L27618	L27618		2	MR491348	
				L42603	L42603		2	MB809354	

Colt (CJO serie) 09.95 →

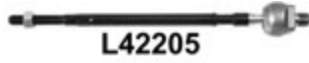

Colt (CJO serie) 09.95 →

			←	→	Thread	Part Of	QPA	
		↔	L27105	L27105	F 12x1,25 U		2	MB598023
			L42205	L42205	M 12x1,25 / M 16x1,5		2	MB910961
		↓	L42010	L42010			2	MB430351
		↓	<input checked="" type="checkbox"/>	L42523			1	MR241342
			L42524				1	MR241341
		↓ ▾		L10807			1	MB102654
			L10808				1	MB102653
		06.97 →	KIT	MK245	MK245		2	MR316457
		↔ ↔ ↔	transverse	L27825	L27825		4	
		▲	longitudinal	L27827	L27827		2	MR102063
		↑	→ 12.97 Pull		L27613		1	MB809220
				L27614			1	MB809221
		↓	Push	L27618	L27618		2	MR491348

Colt VI 06.04 →

Colt CZC Cabriolet 05.06 →

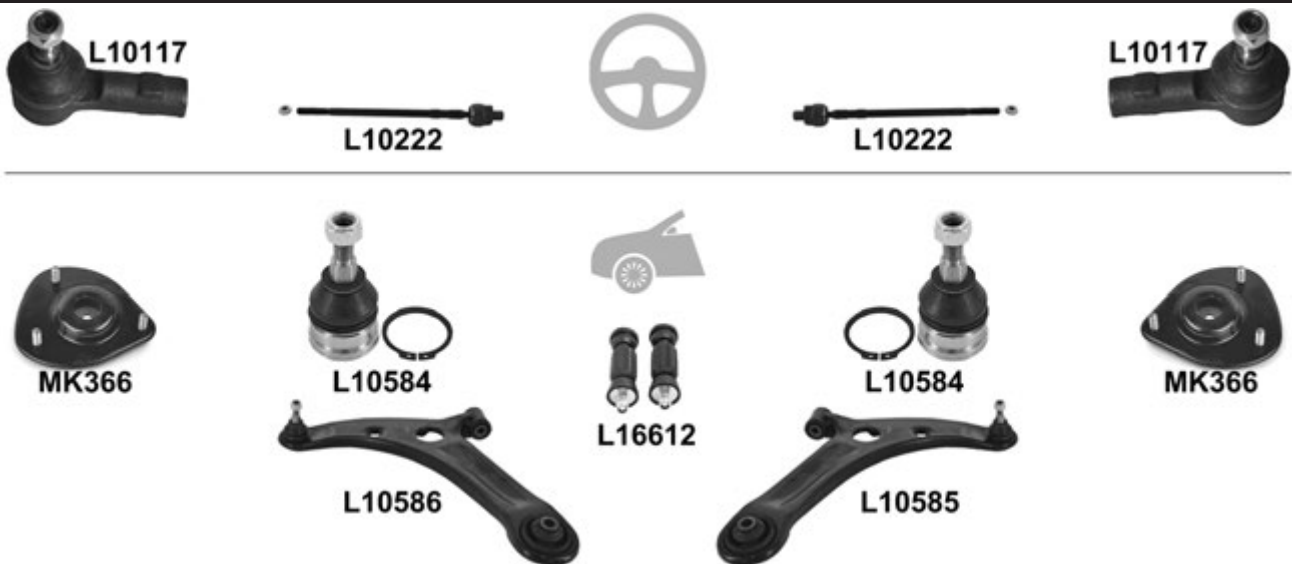

			←	→	Thread	Part Of	QPA	
		↔	L10117	L10117	F 12x1,25 U		2	MR977606
			L10222 ⁰	L10222 ⁰	M 12x1,25 / M 16x1 U	OE no. MR594094 / 4410A410 / 4410A055	2	
		↓	L10584	L10584			2	
		↓	<input checked="" type="checkbox"/>	L10585			1	4013A150
			L10586				1	4013A135
			KIT	L16612			1	4013A052
			MK366	MK366			2	

Eclipse I / II (D2#A / D3) 04.91 →

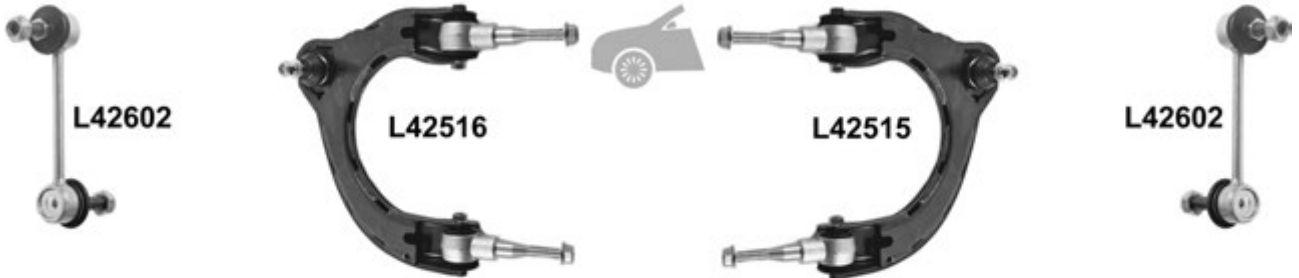

Eclipse I / II (D2#A / D3) 04.91 →

		i		←	→	Thread	Part Of	QPA	i		
		↔		L42023	L42023	F 14x1,5 ∪		2	MB192430		
			→ 08.94	L42201	L42201	M 14x1,5 / M 16x1,5 ∪		2	MB532281		
		08.95 →		L42208	L42208	M 14x1,5 / M 16x1,5 ∪		2	MB949343		
		↑		<input checked="" type="checkbox"/>		L42515			1	MR162804	
				<input checked="" type="checkbox"/>	L42516				1	MR162803	
				<input checked="" type="checkbox"/>		L42517				1	MR296320
				<input checked="" type="checkbox"/>	L42518				1	MR296319	
				<input checked="" type="checkbox"/>		L42519			1	MR325577	
					L42520			1	MR325576		
		↑↗			L42803	L42803			4		
		↓↗↔			L42800	L42800			2		
		↓↗↔			L42801	L42801			2		
		↓↗↔			L42802	L42802			2		
				L42602	L42602			2	MB892981		
		(-) 4WD		L42600	L42600			2	MB892982		

Galant E12A, E13A, E15A 06.84 → 12.87

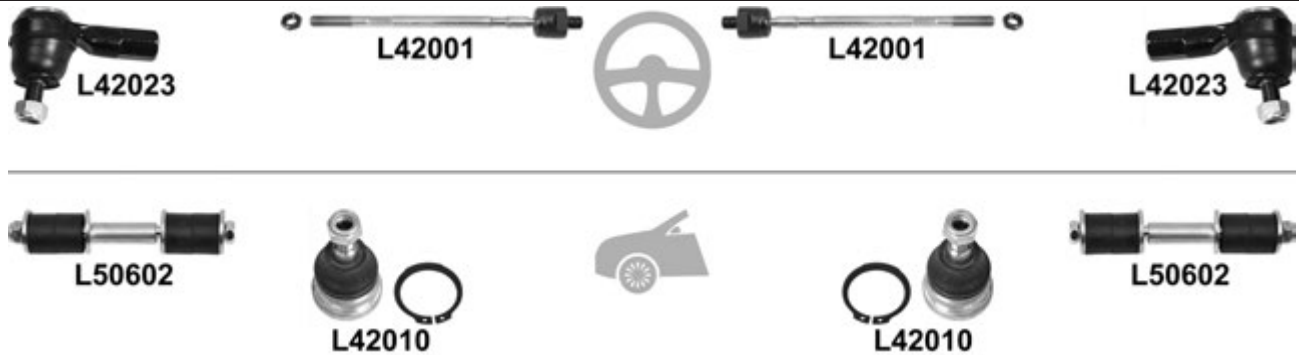

		i		←	→	Thread	Part Of	QPA	i
		↔		L42023	L42023	F 14x1,5 ∪		2	MB192430
				L42001	L42001	M 14x1,5 / M 16x1,5 ∪		2	MB315160
		↓		L42010	L42010			2	MB303375
				L50602	L50602			2	MB241908

Galant E31A, E32A, E33A, E38A, E39A 11.87 → 10.92

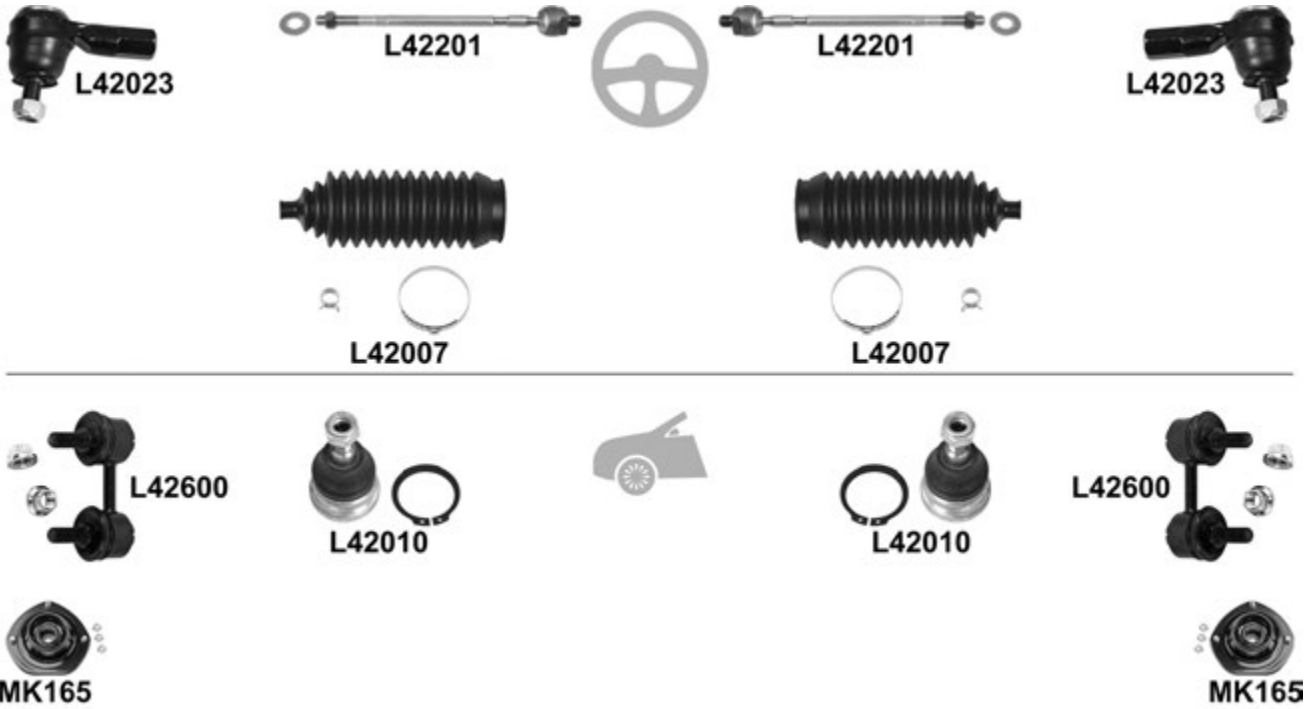

				←	→	Thread	Part Of	QPA	
⊕		↔		L42023	L42023	F 14x1,5 ♂		2	MB192430
				L42201	L42201	M 14x1,5 / M 16x1,5 ♂		2	MB532281
			⊕	L42007	L42007			2	MB501711
⊖		⊥		L42010	L42010			2	MB303375
				L42600	L42600			2	MB892982
				MK165	MK165			2	

Galant (E5#) 11.92 →

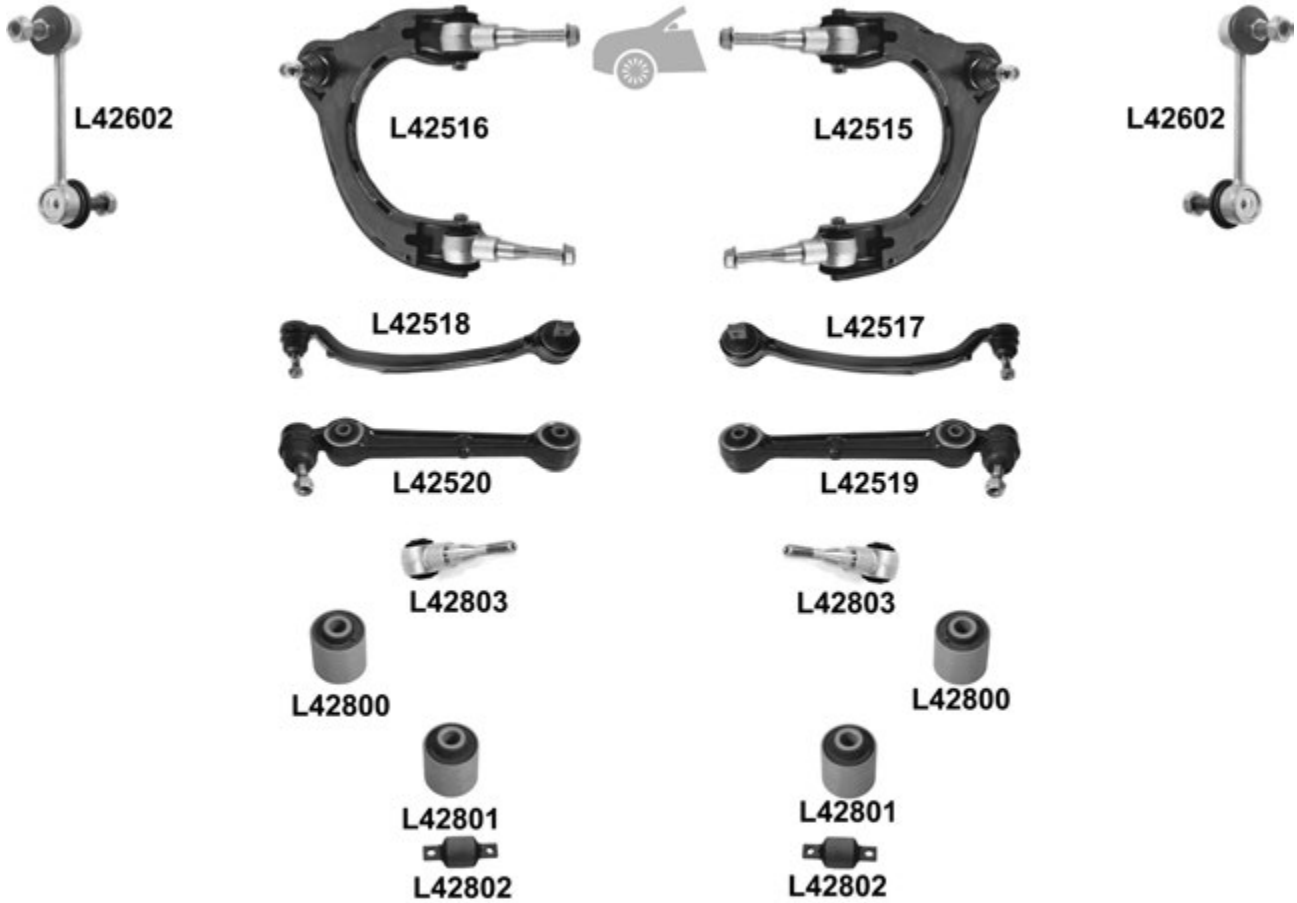

		i	←	→	Thread	Part Of	QPA	i
					L42023 L42023 F 14x1,5 U		2	MB192430
					L42208 L42208 U		2	MB949343
		↑	<input checked="" type="checkbox"/>		L42515		1	MR162804
			<input checked="" type="checkbox"/>		L42516		1	MR162803
	↓	<input checked="" type="checkbox"/>		L42517		1	MR296320	
		<input checked="" type="checkbox"/>		L42518		1	MR296319	
	↑	09.93 →	<input checked="" type="checkbox"/>		L42519		1	MR296296
		<input checked="" type="checkbox"/>		L42520		1	MR296295	
		↑		L42803 L42803		2		
		↓		L42800 L42800		2		
		↑		L42801 L42801		2		
		↓		L42802 L42802		2		
				L42602 L42602		2	MB892981	
			(-) 4WD	L42600 L42600		2	MB892982	

Galant VI (EA##) 09.96 →

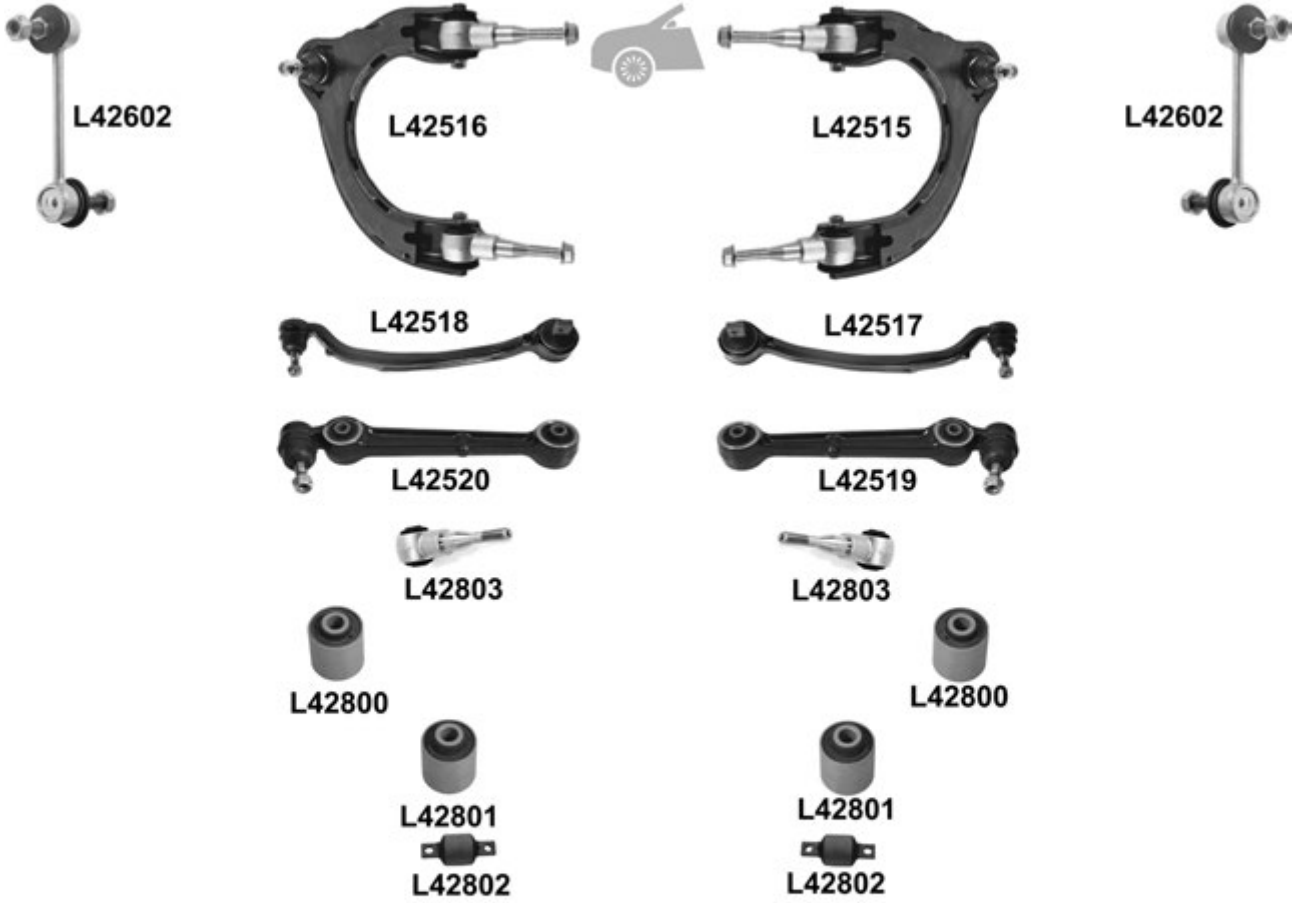

Galant VI (EA##) 09.96 →

				← → Thread		Part Of	QPA		
		↔		L42023	L42023	F 14x1,5 U	2	MB192430	
				L42208	L42208	U	2	MB949343	
		↑	<input checked="" type="checkbox"/>		L42515		1	MR162804	
				L42516			1	MR162803	
		↓	<input checked="" type="checkbox"/>		L42517		1	MR296320	
				L42518			1	MR296319	
		↓	<input checked="" type="checkbox"/>		L42519		1	MR296296	
			L42520			1	MR296295		
		↑			L42803	L42803		2	
		↓			L42800	L42800		2	
		↓			L42801	L42801		2	
		↓			L42802	L42802		2	
				L42602	L42602		2	MB892981	
				L42604	L42604		2	MB809354	

Grandis 04.04 →



				← → Thread		Part Of	QPA	
		↔		L43101	L43101	F 12x1,25 U	2	4422A002

Lancer (C11A - C37W) 11.83 → 04.88

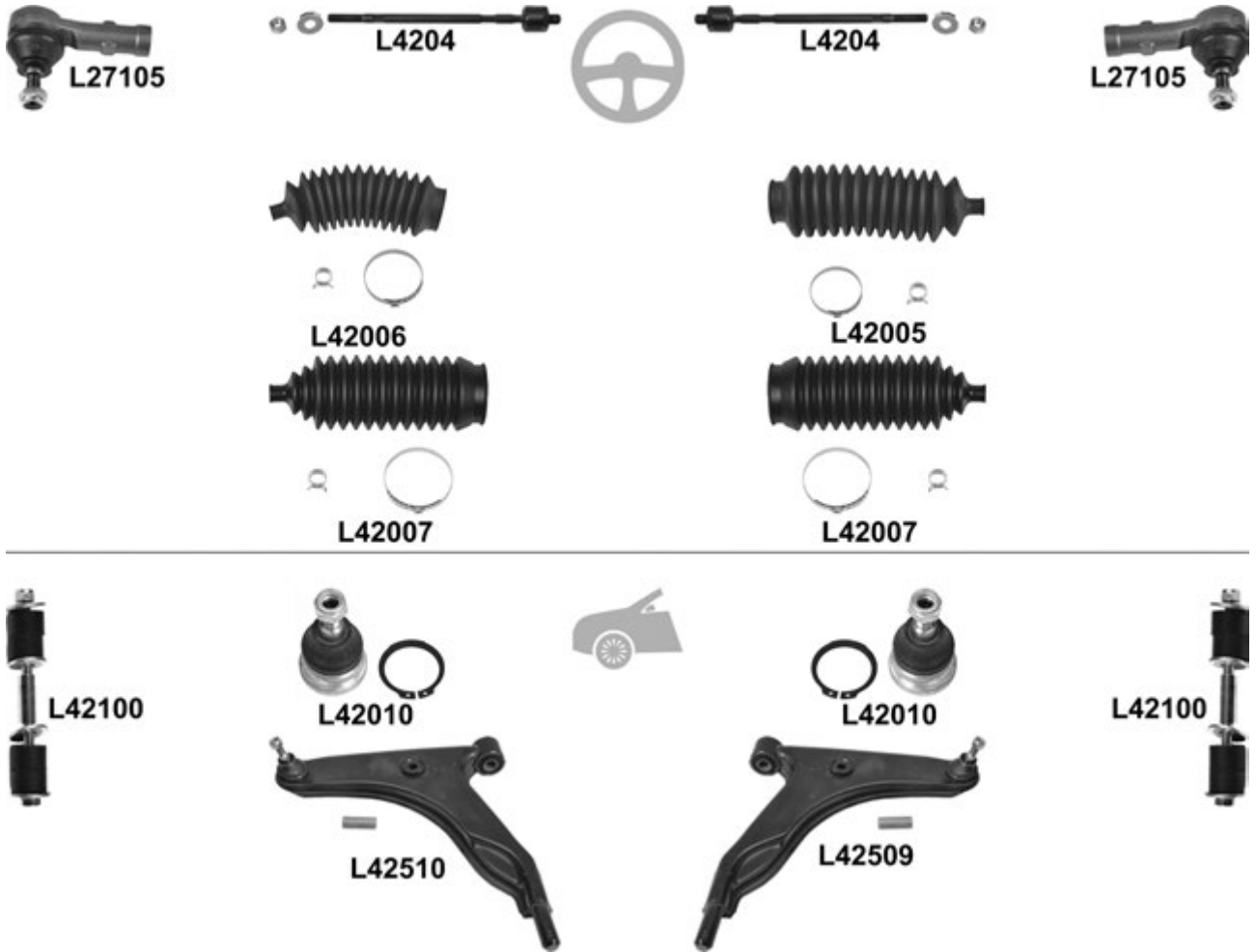

				← → Thread		Part Of	QPA			
⊕		↔		L27105	L27105	F 12x1,25 U	2	MB912076		
			(-) ⊕	L4204	L4204	M 12x1,25 / M 14x1,5 U	2	MB532046		
			⊕			L42005		1	MB347365	
			⊕		L42006			1	MB347364	
			⊕		L42007	L42007		2	MB501711	
⊖		⊥		L42010	L42010		2	MB430351		
		⊥		<input checked="" type="checkbox"/>	L42509		1	MB349446		
					L42510			1	MB349445	
		→ 01.86		L42100	L42100		2	MR954888		

Lancer (C60 serie) 04.88 → 05.94

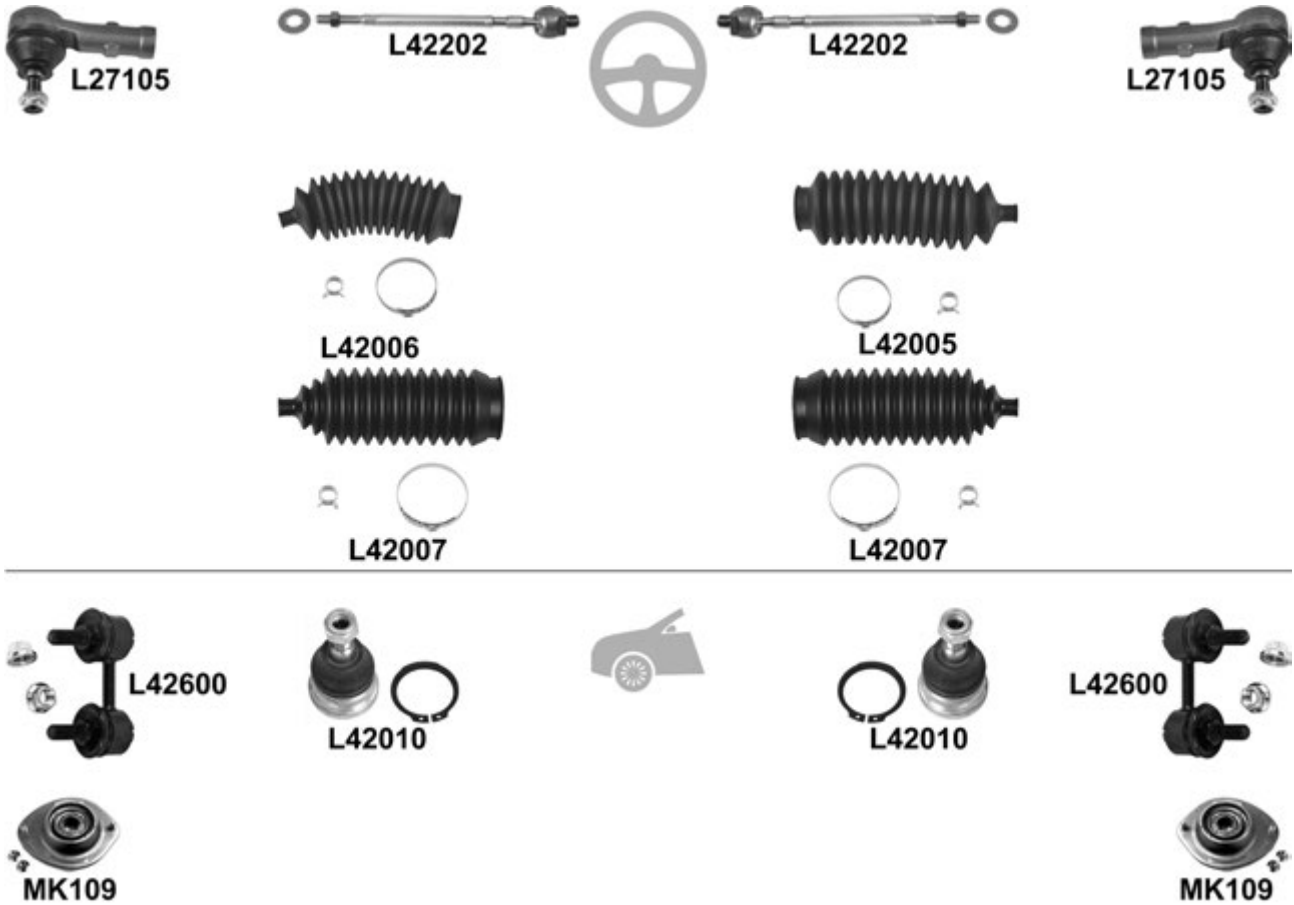

				← → Thread		Part Of	QPA		
⊕		↔		L27105	L27105	F 12x1,25 ∪	2	MB912076	
				L42202	L42202	M 12x1,25 / M 16x1,5 ∪	2	MB553249	
			⊖		L42005			1	MB347365
			⊕	L42006				1	MB347364
⊖		⊥		L42007	L42007		2	MB501711	
				L42010	L42010		2	MB430351	
				L42600	L42600		2	MB892982	
			KIT	MK109	MK109		2		

Lancer V (CB/D#A serie) 06.92 → 11.95

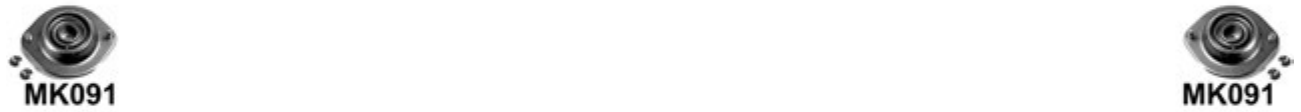

Lancer V (CB/D#A serie) 06.92 → 11.95

		i		←	→	Thread	Part Of	QPA	i
		↔		L27105	L27105	F 12x1,25 U		2	MB912076
				L42205	L42205	M 12x1,25 / M 16x1,5		2	MB910961
		↓		L42010	L42010			2	MB430351
		↓	<input checked="" type="checkbox"/>		L42513			1	MB907164
				L42514				1	MB912077
				L42100	L42100			2	MR954888
				L42601	L42601			2	MB518780
			KIT	MK091	MK091			2	MB808306
		↔↔↔	transverse	L27825	L27825			4	
		▲	longitudinal	L27827	L27827			2	MR102063
		↑	Pull		L27613			1	MB809220
		↓	Push	L27614				1	MB809221
		↓	Push	L27618	L27618			2	MR491348
				L42603	L42603			2	MB809354

Lancer V Station Wagon (CB#W, CD#W serie) 12.92 →

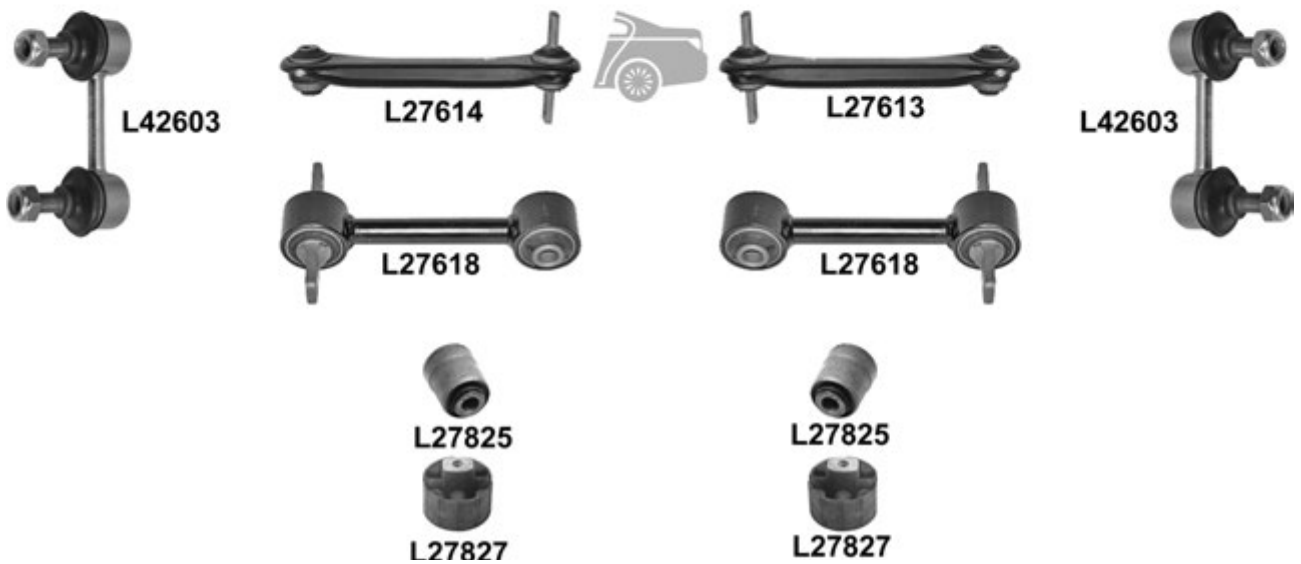

Lancer V Station Wagon (CB#W, CD#W serie) 12.92 →

				←	→	Thread	Part Of	QPA	
		↔		L27105	L27105	F 12x1,25 U		2	MB598023
				L42205	L42205	M 12x1,25 / M 16x1,5		2	MB910961
		↓		L42010	L42010			2	MB430351
		↓	<input checked="" type="checkbox"/>		L42513			1	MB907164
				L42514				1	MB912077
				L42100	L42100			2	MR954888
				L42601	L42601			2	MB518780
			KIT	MK091	MK091			2	MB808306
		↔↔↔	transverse	L27825	L27825			4	
		▲	longitudinal	L27827	L27827			2	MR102063
		↑	Pull		L27613			1	MB809220
				L27614				1	MB809221
		↓	Push	L27618	L27618			2	MR491348
				L42603	L42603			2	MB809354

Lancer VI (CK/P#A serie) 12.95 →

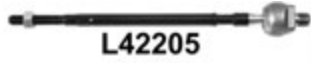

Lancer VI (CK/P#A serie) 12.95 →

				←	→	Thread	Part Of	QPA	
		↔		L27105	L27105	F 12x1,25 ∪		2	MB912076
				L42205	L42205	M 12x1,25 / M 16x1,5		2	MB910961
		↓		L42010	L42010			2	MB430351
		↓	<input checked="" type="checkbox"/>		L42523			1	MR241342
				L42524				1	MR241341
		↓ ▾			L10807			1	MB102654
				L10808				1	MB102653
		06.96 →	KIT	MK245	MK245			2	MR316457
		↔ ↔ ↔	transverse	L27825	L27825			4	
		▲	longitudinal	L27827	L27827			2	MR102063
		↑	Pull		L27613			1	MB809220
				L27614				1	MB809221
		↓	Push	L27618	L27618			2	MR491348

Lancer (CS_A) 08.03 →

				←	→	Thread	Part Of	QPA	
		↔	→ 05.08	L27105	L27105	∪		2	4422A028
				L42213	L42213	M 12x1,25 / M 16x1,5		2	4422A056
		↓		L42548 ^o	L42548 ^o			2	L42539/L42540
		↓	<input checked="" type="checkbox"/>		L42539			1	4013A274
				L42540				1	4013A273
		↓ ▾		L42804	L42804			2	MR403441
		↓ ▲		L42805	L42805			2	

Lancer Evolution (CT9A) 12.00 →



Thread

Part Of

QPA



				L43101	L43101	F 12x1,25 U		2	4422A002
					L43605			1	4056A016
				L43606				1	4056A015

Lancer Sedan (CX_A) 01.08 →
Lancer Sportsback 06.08 →

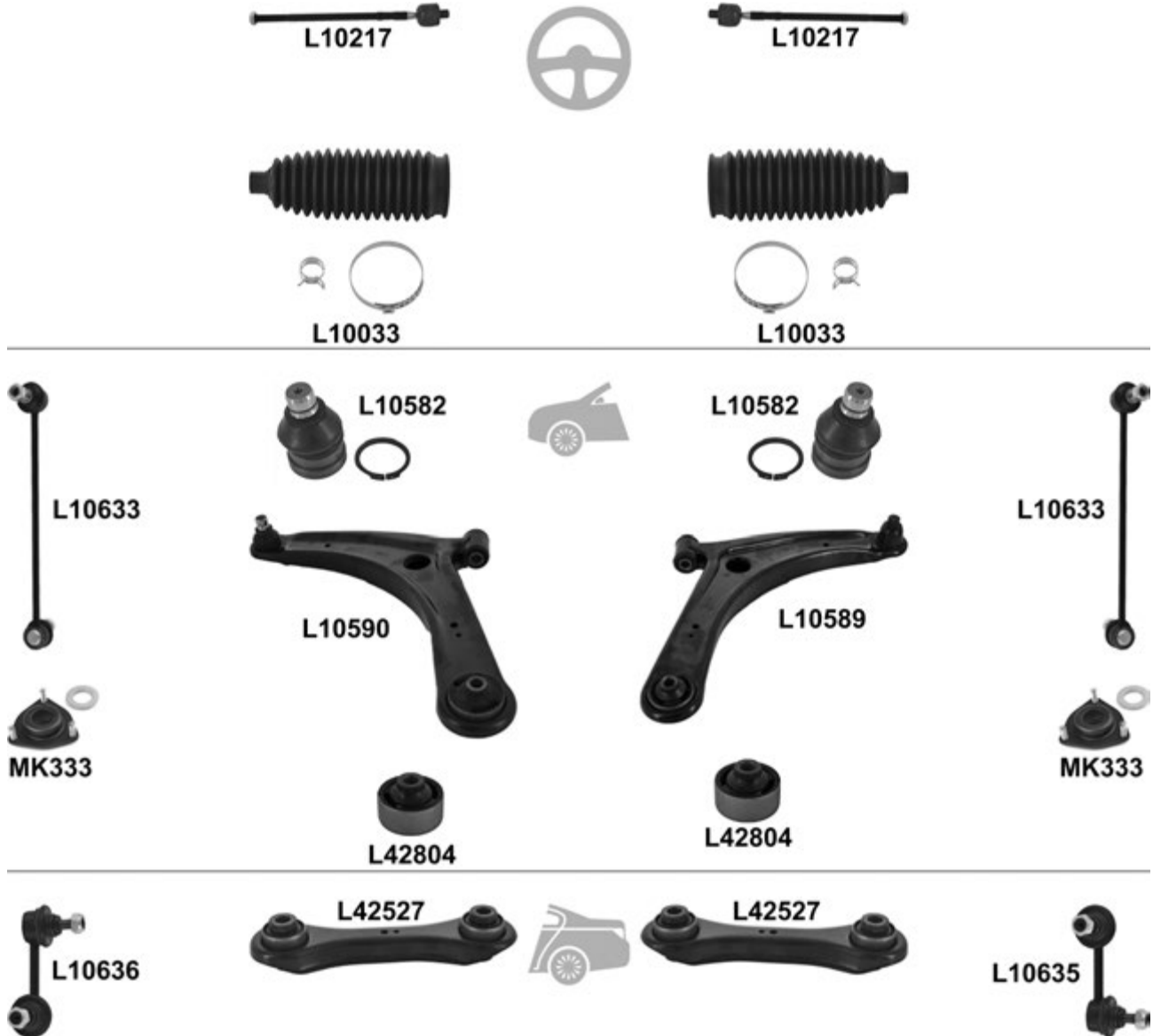

		i		←	→	Thread	Part Of	QPA	i
			Hydraulic	L10217 ^o	L10217 ^o			2	4422A012
			→ 09.09	L10033 ^o	L10033 ^o			2	4410A125
		↓		L10582	L10582			2	
		↓	→ 06.10	<input checked="" type="checkbox"/>	L10589			1	4013A010
				L10590				1	4013A009
		↓		L42804	L42804			2	MN184133
				L10633	L10633			2	MN101368
				KIT	MK333	MK333		2	MR101372
		↑	→ 06.10	L42527	L42527			2	MB910842
					L10635			1	MN184194
				L10636				1	4156A014

L 200 PICK-UP 2WD K01T, K02T, K04T 11.86 →
L 200 PICK-UP 2WD K11T, K12T, K14T 11.86 →

L42020



L42020



L42022



L42021



L4220



L4220



L42030



L42030



Thread

Part Of

QPA



				←	→	Thread	Part Of	QPA	
		↔		L42020	L42020	∪		2	MB378704
		→←			L42021	M 14x1,5 ∪		1	MB122012
				L42022		F 14x1,5 ∪		1	MB378701
		↑		L4220	L4220			2	MB349475-1
		↓		L42030	L42030			2	MB241818

L 200 PICK-UP 2WD (KA4T) 04.10 →

L42531



L42531



L42541



L42541



Thread

Part Of

QPA



				←	→	Thread	Part Of	QPA	
		↑		L42531	L42531			2	4010A029
		↓		L42541	L42541			2	4013A090

L 200 PICK-UP 4WD K22T, K24T 11.86 →

L 200 PICK-UP 4WD K32T, K34T 11.86 →



L43106



L43106



L43107



L43107



L4220



L4220



L42503



L42503

		i		←	→	Thread	Part Of	QPA	i
		↔		L43106	L43106	M 16x1,5 ♂		2	MB166765
		→←		L43107	L43107	M 16x1,5 ♂		2	MB315776
		↑		L4220	L4220			2	MB349475-1
		↓		L42503	L42503			2	MB527352

L 200 PICK-UP 4WD (K74T, K24T) 06.96 →

L42103

L42103

L43107

L43107

L42505

L42505

L42508

L42507

L42526

L42525

Thread

Part Of

QPA



		↔		L42103	L42103	M 16x1,5 ∪		2	MR296275
		→←		L43107	L43107	M 16x1,5 ∪		2	MR296274
		↑		L42505	L42505			2	MB860830
		↓			L42507			1	MB831038
				L42508				1	MB831037
		↑	<input checked="" type="checkbox"/>		L42525			1	MB831036
				L42526			1	MB831035	

L 200 PICK-UP 4WD (KB4T) 11.05 →

L42531

L42531

L42541

L42541

Thread

Part Of

QPA



		↑		L42531	L42531			2	4010A029
		↓		L42541	L42541			2	4013A090

L 300 BUS / VAN LO31P, LO31PV, LO32PV, LO33PW 06.79 → 1982
 L 300 BUS / VAN LO34P, LO35PW 06.79 → 1982



Thread

Part Of

QPA



				L4203	L4203	F 14x1,5 U		2	MB315629
				L42150	L42150			2	

L 300 BUS / VAN LO33PV, LO33PW, LO35PW 10.83 →
 L 300 BUS / VAN LO36P, LO36PV, LO38P, LO38PW 10.83 →
 L 300 BUS / VAN LO63P, LO63PV, LO63PW 10.83 →
 L 300 BUS / VAN LO68P, LO68PV, LO68PW 10.83 →



Thread

Part Of

QPA



				L42023	L42023	F 14x1,5 U		2	MB616286
				L4220	L4220			2	MB349475-1
				L42030	L42030			2	MB241818
				L42150	L42150			2	

L 300 VAN PO1V, PO2V, PO3W, PO5V 06.86 →
L 300 VAN PO5W, P12V, P15V, P12W 06.86 →

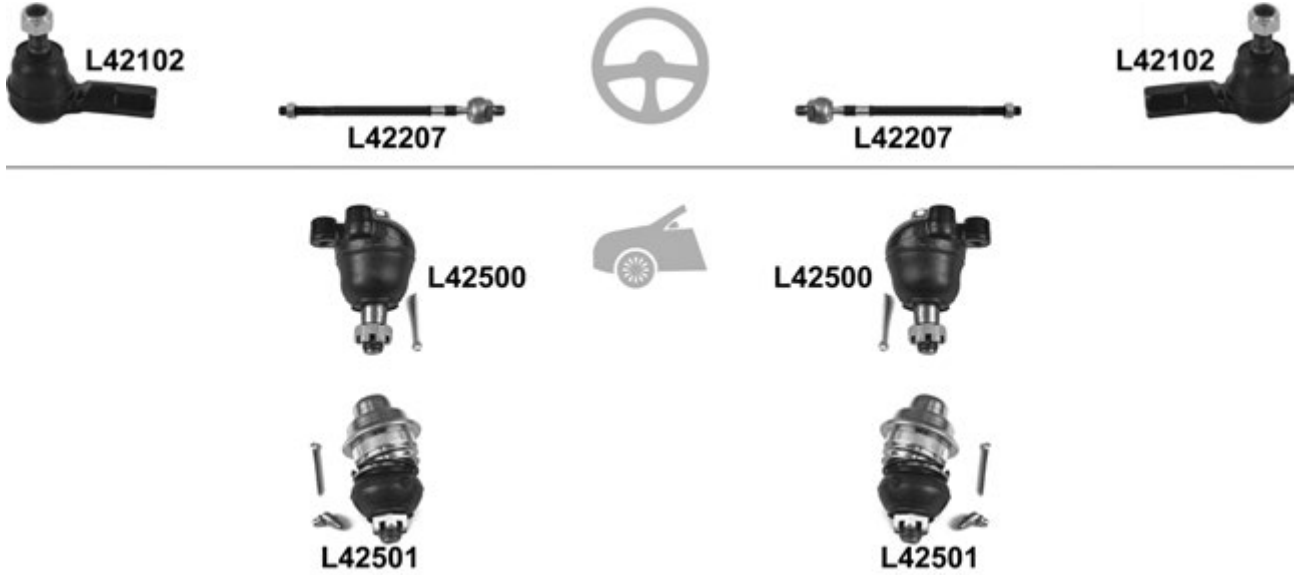

				←	→	Thread	Part Of	QPA		
		↔				F 14x1,5 ∪		2	MB527650	
						M 14x1,5 / M 16x1,5 ∪		2	MB350577	
		↑						2	MB537350	
		↓						2	MB527384-01	

L 300 VAN 4WD P23V, P23W, P25V, P25W 06.86 →

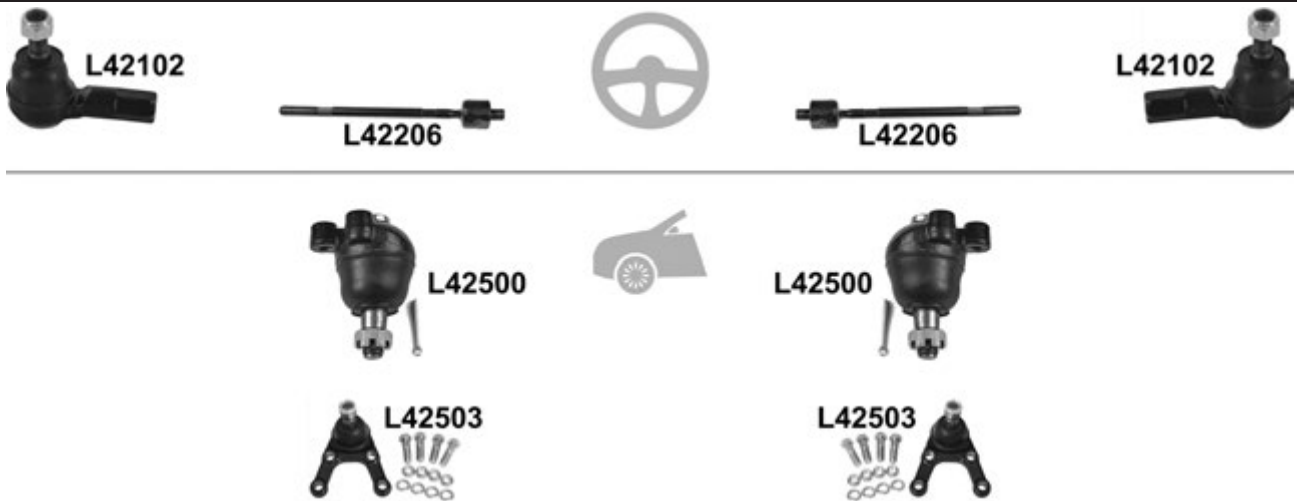

				←	→	Thread	Part Of	QPA		
		↔				F 14x1,5 ∪		2	MB527650	
								2	MB501017	
		↑						2	MB537350	
		↓						2	MB527352	

L 400 2WD (PAOV) 09.96 →



				←	→	Thread	Part Of	QPA		
		↑						2	MR241623	

L 400 4WD (PAOV) 09.96 →

Thread

Part Of

QPA



				L42500	L42500			2	MR241623
--	--	--	--	--------	--------	--	--	---	----------

Outlander I / Airtrek 02.03 →

L42805



L42805



Thread

Part Of

QPA



			→ 08.07	L43101	L43101	F 12x1,25 ♂		2	4422A002
				L42804	L42804			2	MR403441
				L42805	L42805			2	
				L43606	L43606			2	4056A015

Outlander II 11.06 →

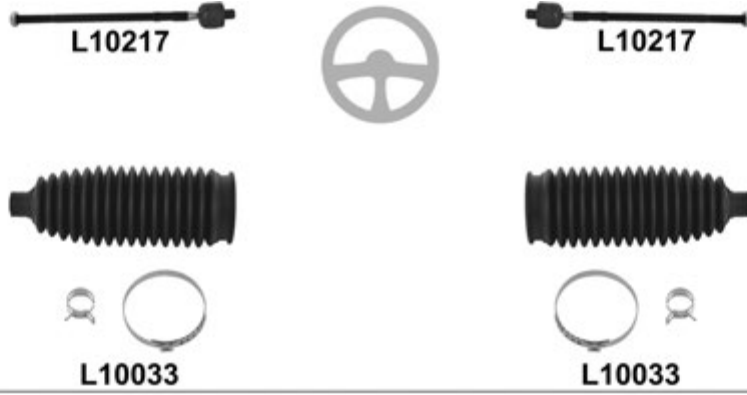

				←	→	Thread	Part Of	QPA	i
⊕				L10217 ^o	L10217 ^o	☺		2	4422A012
		→ 09.09		L10033 ^o	L10033 ^o			2	4410A125
⊖		⊥		L10582	L10582			2	
		⊥		<input checked="" type="checkbox"/>	L10589			1	4013A010
				L10590				1	4013A009
		⊥↘		L42804	L42804			2	MR403441
				L10633	L10633			2	MN101368
				KIT	MK333	MK333		2	MR101372
⊖		⊥↗		L42527	L42527			2	MB910842
			3 Seating row		L10635			1	MN184194
				L10636				1	4156A014
			(-) 3 Seating row	L10635	L10635			2	MN184194

Pajero LO41G, LO43G, LO44G 12.82 → 12.91
 Pajero LO46G, LO48G, LO49G 12.82 → 12.91



				← → Thread		Part Of	QPA		
		↔		L43106	L43106	M 16x1,5 U		2	MB166765
		↔		L43107	L43107	M 16x1,5 U		2	MB315776
		↑		L4220	L4220			2	MB527352
		↓		L42503	L42503			2	MB176308
			small	L42121	L42121			2	
				L42130	L42130			2	

Pajero / Shogun V2#W, V4#w serie 12.90 → 04.00



L42103



L42103



L42104



L42104



L42700



L42505



L42505



L42508



L42507



L42526



L42525

				←	→	Thread	Part Of	QPA	i
⊕	↔			L42103	L42103	M 16x1,5 ∪		2	MB831043
				L42104	L42104	M 16x1,5 ∪		2	MB831044
	IDLER				L42700			1	MB831042
⊖	⌈			L42505	L42505			2	MB860830
					L42507			1	MB831038
	⌋			L42508				1	MB831037
⊖	⌈		☑		L42525			1	MB831036
				L42526				1	MB831035

Pajero Pinin/I.O, Montero I.O (H6_W, H7_W) 10.99 →



L42023



L42023

				←	→	Thread	Part Of	QPA	i
⊕	↔			L42023	L42023	F 14x1,5 ∪		2	MB192430

Pajero / Montero / Shogun (V6_W, V7_W) 04.00 →

Thread

Part Of

QPA



		↑		L42531	L42531			2	4010A029
--	--	---	--	--------	--------	--	--	---	----------

Pajero IV / Montero / Shogun (V80, V88W, V90) 02.07 →

Thread

Part Of

QPA



		↑	→ 05.09	L42531	L42531			2	4010A015
--	--	---	---------	--------	--------	--	--	---	----------

Pajero Sport / Montero Sport / Challenger Shogun Sport (K9_) 11.98 →

Thread

Part Of

QPA



		↔↔		L42103	L42103	M 16x1,5 ∪		2	MR296275
		↔↔		L43107	L43107	M 16x1,5 ∪		2	MR296274
		↑		L42505	L42505			2	MB860830
		↓			L42507			1	MB831038
				L42508				1	MB831037
					<input checked="" type="checkbox"/>	L42525			1
				L42526				1	MB831035

Pajero Sport (KH_W) 07.08 →



				←	→	Thread	Part Of	QPA	i
		↑	→ 08.12	L42531	L42531			2	4010A029
		↓		L42541	L42541			2	4013A090

Space Gear (PA, PB, PD, PV, PW) 05.95 → 05.00



				←	→	Thread	Part Of	QPA	i
		↑		L42500	L42500			2	MR241623

Space Runner N1#W, N2#W 01.91 → 08.99



				←	→	Thread	Part Of	QPA	i
		↔		L42023	L42023	F 14x1,5 U		2	MB616286

Space Runner (N6_W) 06.99 →

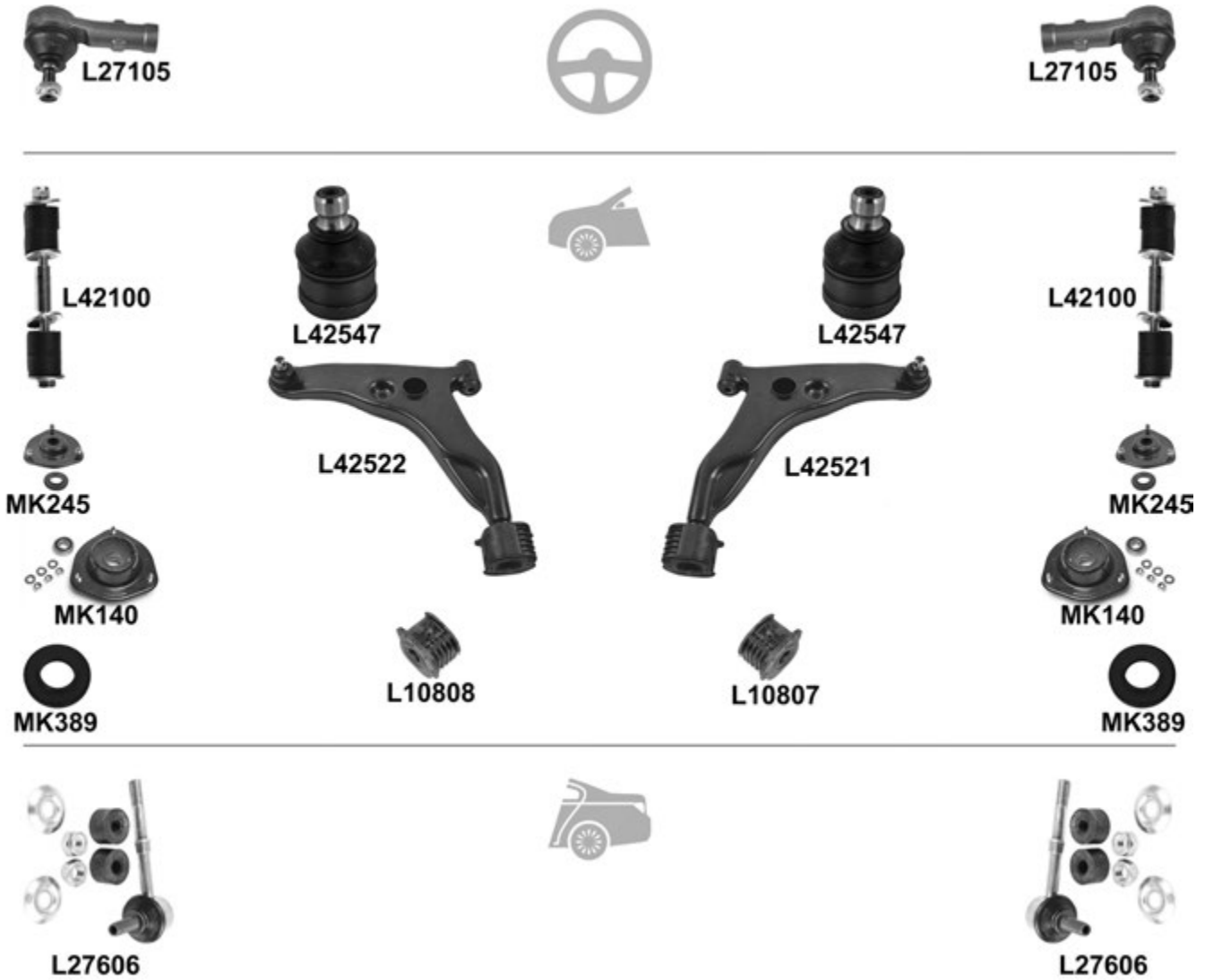

				←	→	Thread	Part Of	QPA	i
		↔		L42023	L42023	F 14x1,5 U		2	MB192430

Space Star DG0 06.98 →

		← →		Thread	Part Of	QPA	
		↔		L27105 L27105	F 12x1,25 U	2	MR485872
		↓	03.99 →, 18mm	L42547° L42547°		2	
		↓		<input checked="" type="checkbox"/> L42521		1	MR916134
				L42522		1	MR916133
		↓		L10807		1	MB808910
			03.99 →	L10808		1	MB808909
				L42100 L42100		2	MR392730
			(-)	KIT MK245 MK245		2	MR316528
		→ 05.00,	KIT MK245 MK245		2	MR316528	
		06.00 →,	MK140 MK140		2	MR130519	
			MK389° MK389°		2	MR316535	
			L27606 L27606		2	MR272118	

Space Wagon 2WD D02W, DO3W, D05W 01.84 → 04.91

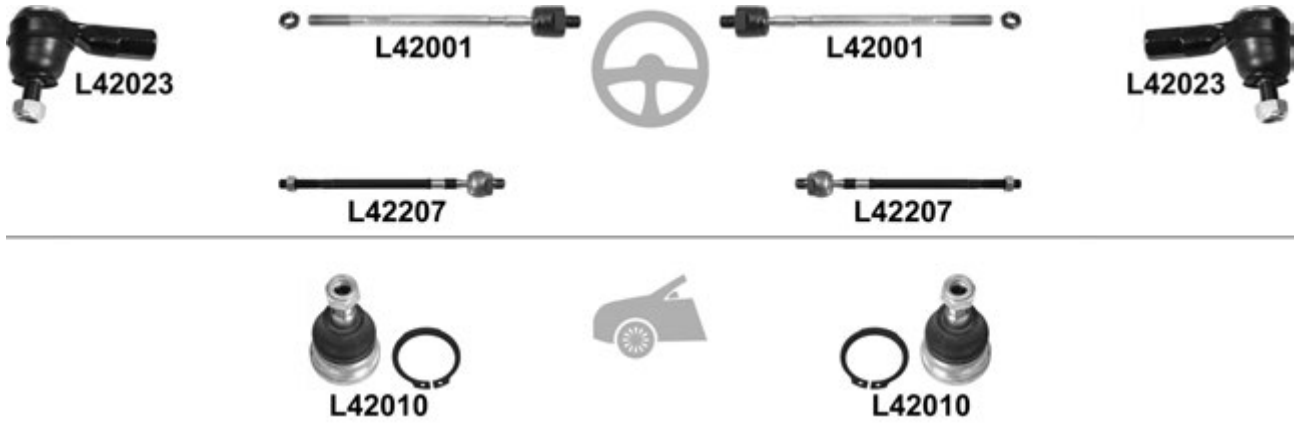

				←	→	Thread	Part Of	QPA	
⊕		↔		L42023	L42023	F 14x1,5 ∪		2	MB192430
				L42001	L42001	M 14x1,5 / M 16x1,5 ∪		2	MB315160
				L42207	L42207	∪		2	MB243329
		⊥	(-) N33W	L42010	L42010			2	MB303375

Space Wagon 4WD D08W, W09W 03.85 → 04.91



				←	→	Thread	Part Of	QPA	
⊕		↔		L42023	L42023	F 14x1,5 ∪		2	MB192430
				L42001	L42001	M 14x1,5 / M 16x1,5 ∪		2	MB315160
				L42207	L42207	∪		2	MB243329
			(-) D09W / N43W D09W → 12.87	L42010	L42010			2	MB303375

Space Wagon 2WD N3#W 10.91 → 10.98

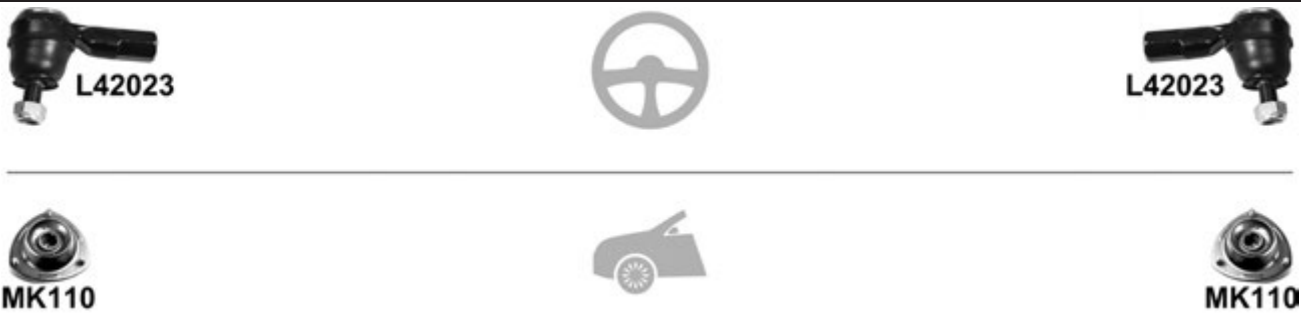

				←	→	Thread	Part Of	QPA	
⊕		↔		L42023	L42023	F 14x1,5 ∪		2	MB192430
						MK110	MK110		2

Space Wagon 4WD N4#W 10.91 → 10.98



				←	→	Thread	Part Of	QPA	
⊕		↔		L42023	L42023	F 14x1,5 ∪		2	MB192430

Space Wagon 4WD (N94W) 10.98 →



Thread

Part Of

QPA



				L42023	L42023	F 14x1,5 ♂		2	MB192430
--	--	--	--	--------	--------	------------	--	---	----------

NISSAN

Almera I (N15) 09.95 → 07.00

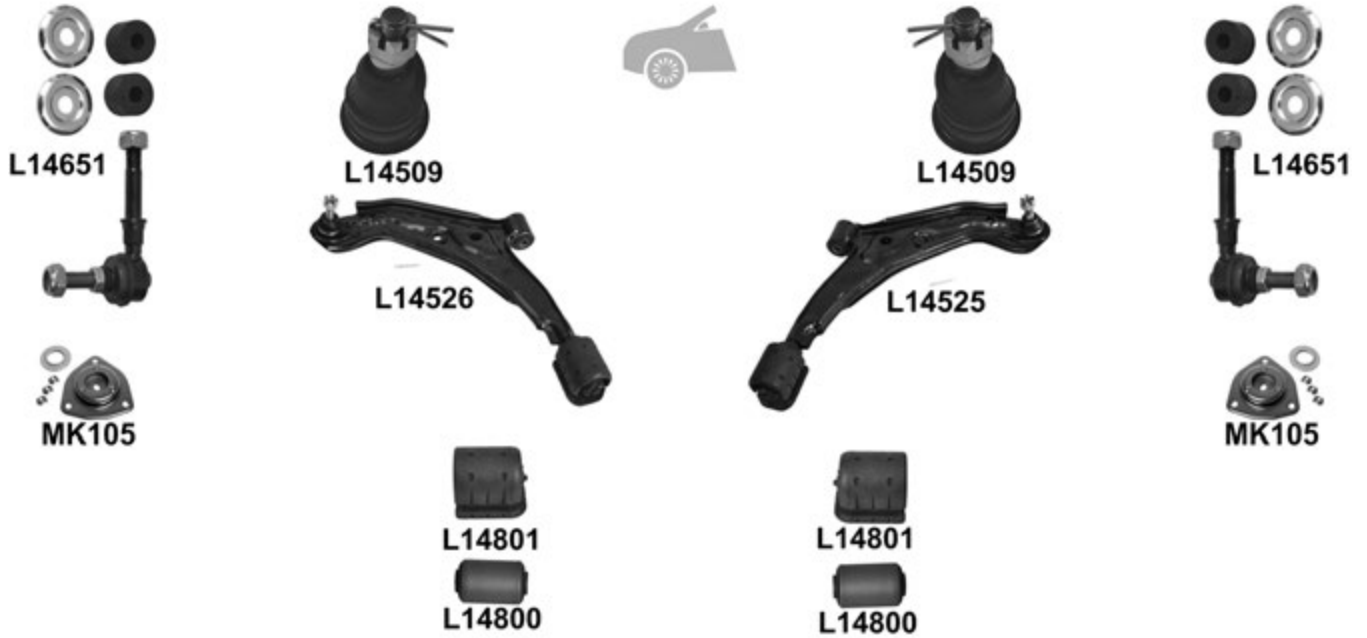

Almera I (N15) 09.95 → 07.00

				←	→	Thread	Part Of	QPA	
		↔		L14113	L14113	F 12x1,25 U		2	48520-73J25
				L14204	L14204	M 12x1,25 / M 16x1 U		2	48521-50Y00
				L14202	L14202	M 12x1,25 / M 16x1 U		2	48521-1M226
		⊥		L14509	L14509		OE no. 54500-2F500 / 54501-2F500	2	
		⊥	<input checked="" type="checkbox"/>		L14525			1	54500-0M060
				L14526				1	54501-0M060
		⊥▼		L14801	L14801			2	
		⊥▲		L14800	L14800			2	
				L14651	L14651			2	54618-50Y00
			(-) 2.0 Gti-R	KIT	MK105	MK105		2	54320-50Y12 S1
				L14663	L14663			2	54618-2F010
				MK131	MK131			2	56218-61L10 S1

Almera II (N16) 03.00 →



		i		←	→	Thread	Part Of	QPA	i
⊕	↔	ORIG (GB)	L14129	L14129	F 12x1,25 U		2	48520-BM425	
		ORIG (J)	L14127	L14127	F 14x1,5 U		2	48520-15U26	
⊖	⊥		L14017 ⁰	L14017 ⁰			2	48203-BM400	
			L14509	L14509		L14519/L14520	2		
		<input checked="" type="checkbox"/>		L14519			1	54500-4M410	
			L14520				1	54501-4M410	
			L14654	L14654			2	54618-4M400	
⊖	⊥	KIT	MK307	MK307			2	54320-BM40A	
			MK298	MK298			2		

Almera Tino (V10) 08.00 →

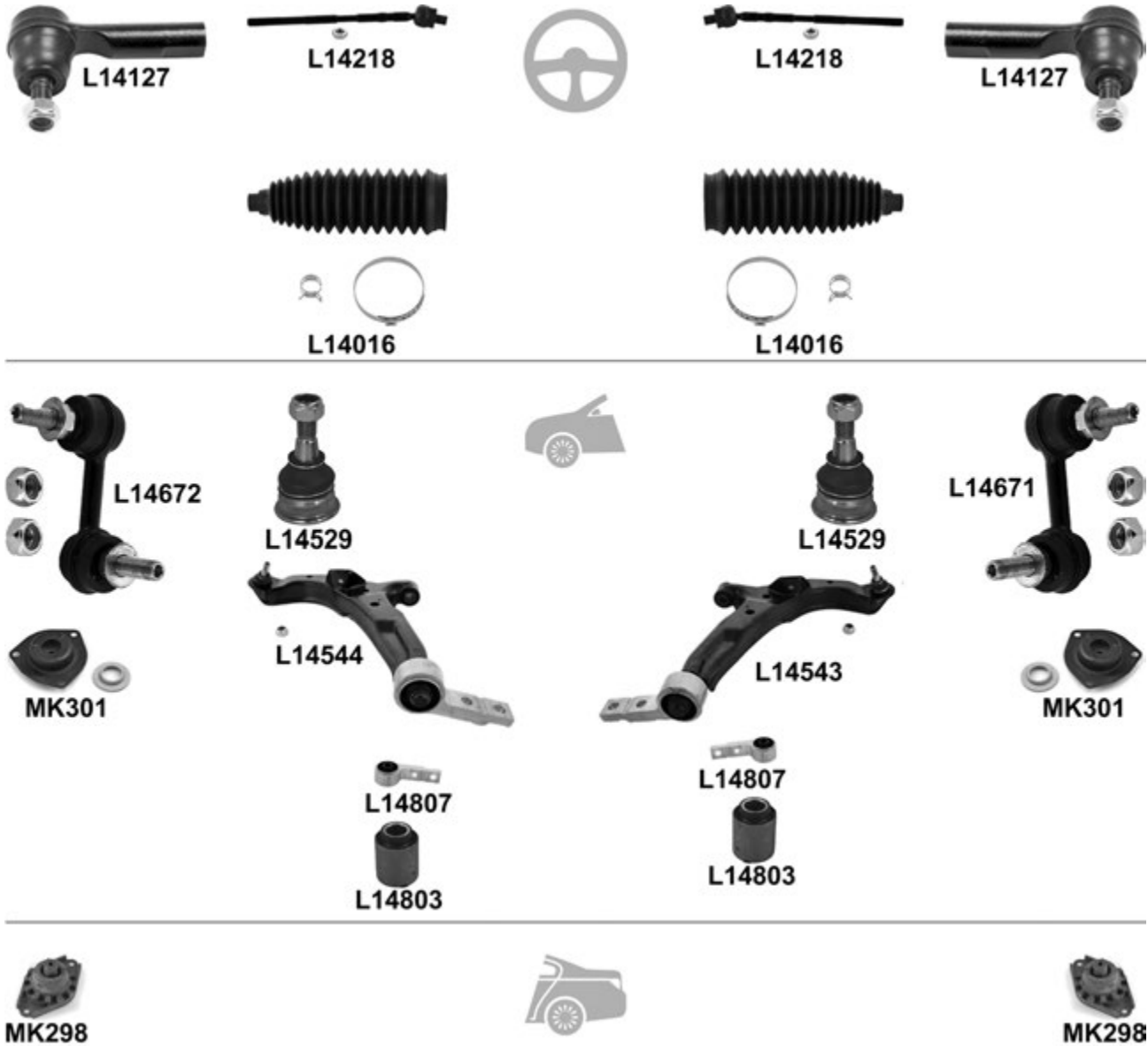

				← → Thread		Part Of	QPA		
⊕		↔		L14127	L14127	F 14x1,5 U		2	48520-15U26
			1.8 16V, L= 305mm	L14218 ^o	L14218 ^o	M 14x1,25 / M 16x1 U		2	48521-4U186
				L14016 ^o	L14016 ^o			2	48203-8H325
🚗		⊥		L14529	L14529		L14543/L14544	2	
		⊥	<input checked="" type="checkbox"/>	L14544	L14543			1	54500-BU000
				L14544				1	54501-BU000
		⊥↙		L14807 ^o	L14807 ^o		L14543/L14544	2	
		⊥↗		L14803	L14803		L14543/L14544	2	
					L14671			1	54618-BU000
					L14672			1	54668-BU000
🚗			KIT	MK301	MK301			2	
				MK298	MK298			2	

Bluebird U11 serie 04.84 → 12.90

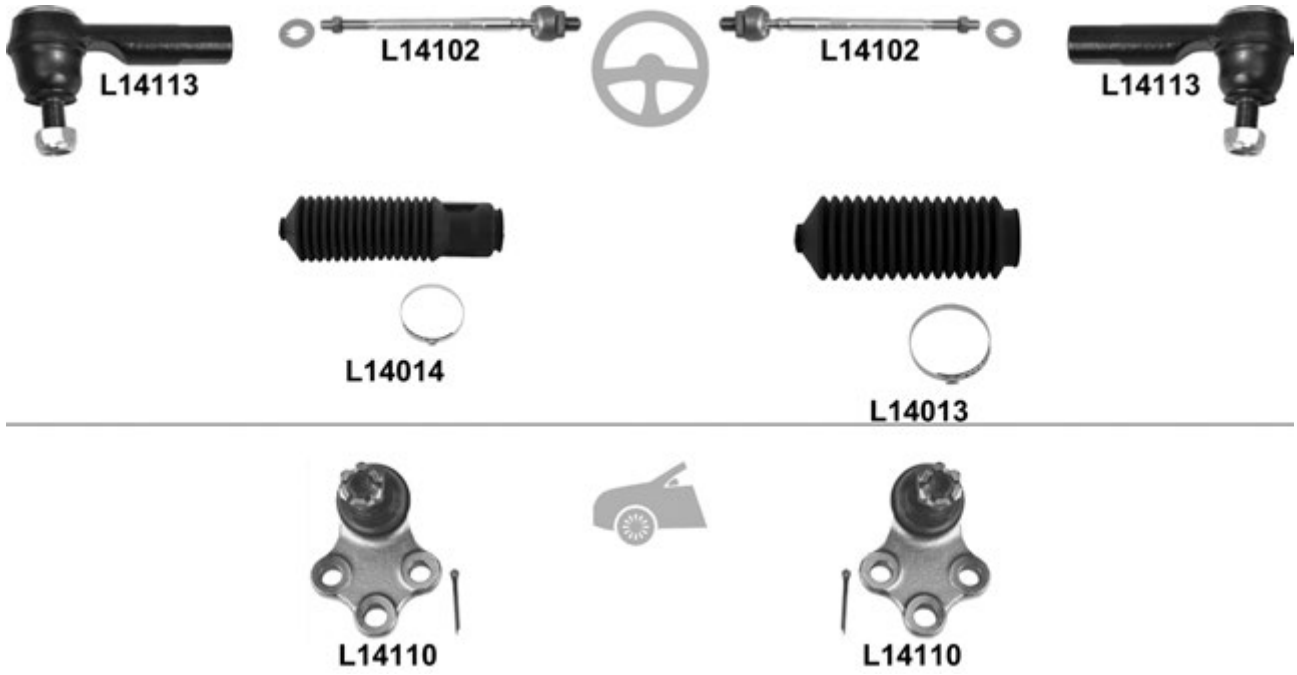

				←	→	Thread	Part Of	QPA	
				L14113	L14113	∩		2	48520-73J25
				L14102	L14102	M 12x1,25 / M 16x1 ∩		2	48521-70A06
						L14013		1	48203-01F00
				L14014				1	48204-01F00
				L14110	L14110			2	40160-85E00

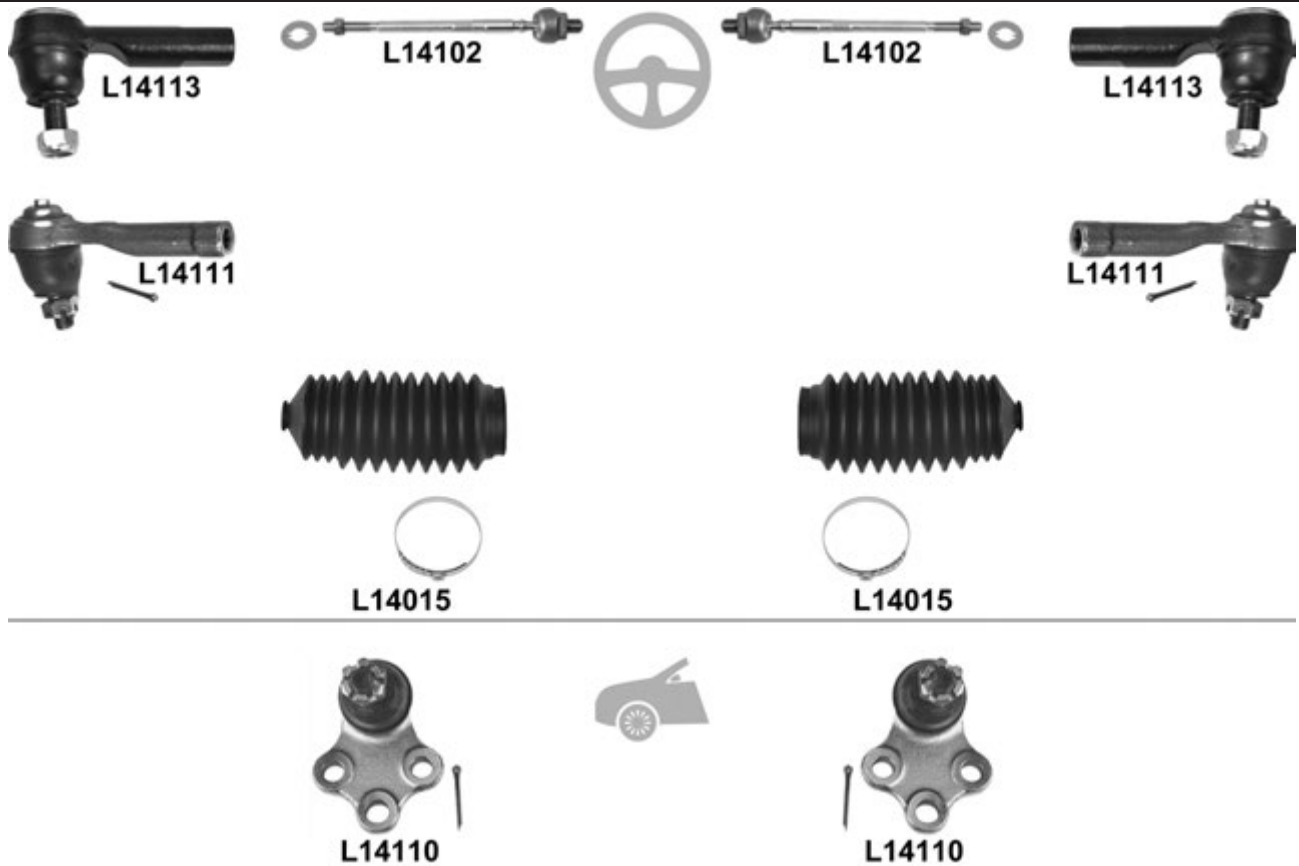
Bluebird T12 / T72 serie 12.85 → 12.90

				←	→	Thread	Part Of	QPA		
		↔	→ 09.87	L14113	L14113	∪		2	48520-73J25	
			09.87 →	L14111	L14111	F 12x1,25 ∪		2	48520-53E25	
					L14102	L14102	M 12x1,25 / M 16x1 ∪		2	48521-70A06
				09.87 →,	L14015	L14015			2	48203-10V25
		⊥		L14110	L14110			2	40160-85E00	

Cherry N10 serie 10.78 → 12.83

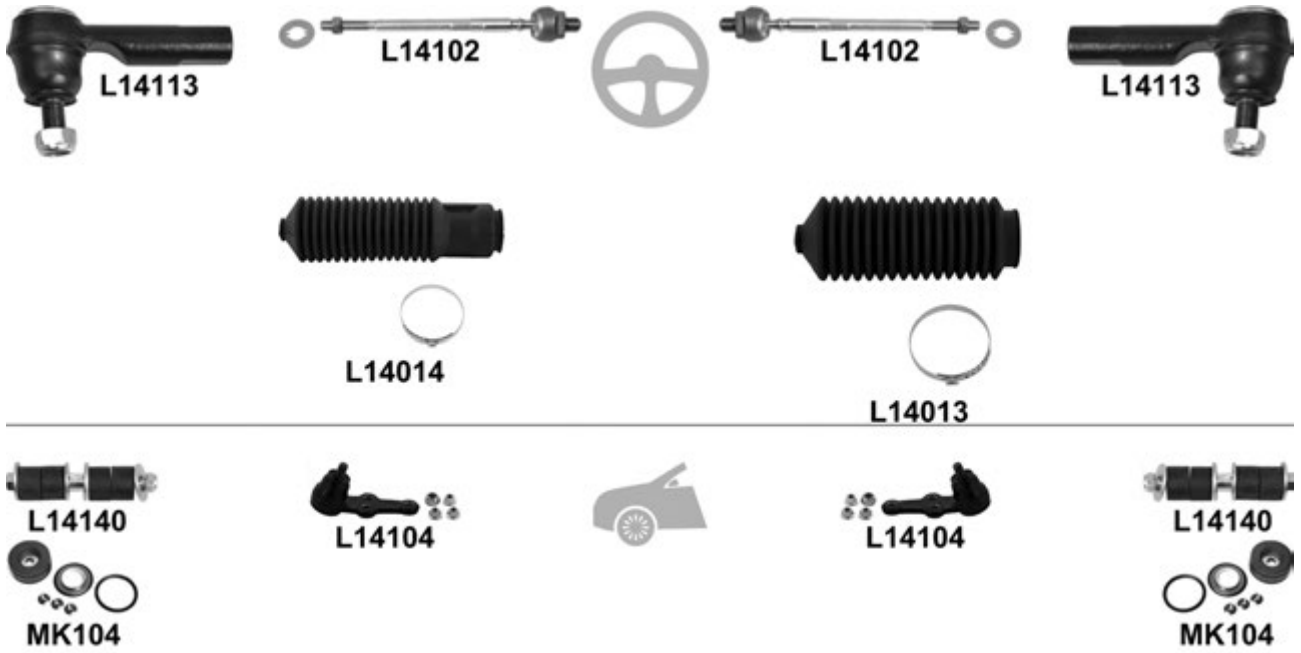

				←	→	Thread	Part Of	QPA	
				L14140	L14140			2	54618-01A00

Cherry N12 serie 05.82 → 10.86

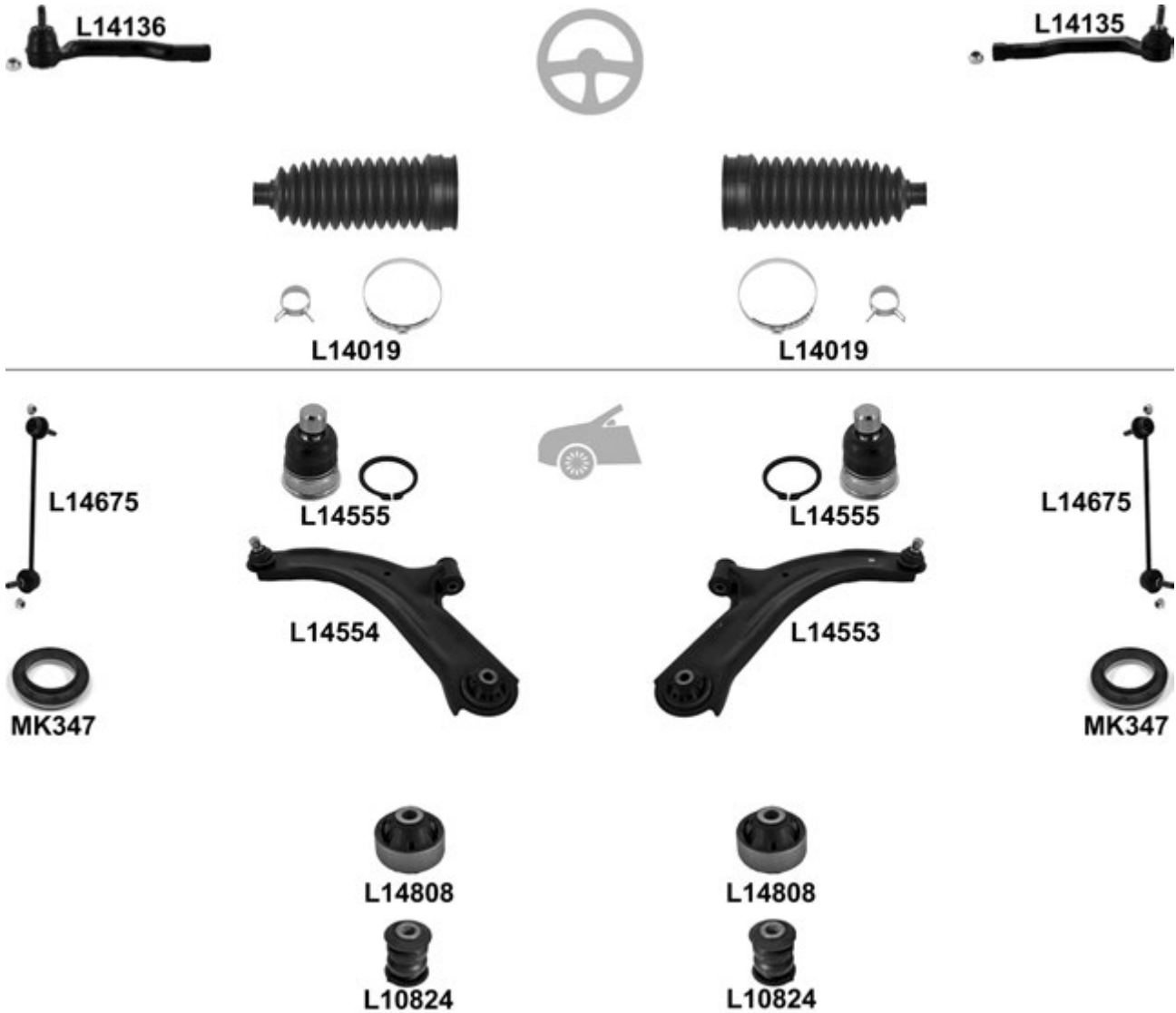

				← → Thread		Part Of	QPA		
⊕		↔		L14113	L14113	F 12x1,25 ∪	2	48520-73J25	
				L14102	L14102	M 12x1,25 / M 16x1 ∪	2	48521-70A06	
					L14013		1	48203-01F00	
				L14014			1	48204-01F00	
⊖		↓		L14104	L14104		2	40160-01A25	
				L14140	L14140		2	54618-01A00	
				KIT	MK104	MK104	2		

Cube (Z12) 03.10 →



		i	←	→	Thread	Part Of	QPA	i		
		↔		L14135	F 12x1,25 ∪		1	D8520-EW00A		
				L14136	F 12x1,25 ∪		1	D8640-EW00A		
		⊥		L14019 ^o	L14019 ^o		2	48203-3U025		
				L14555 ^o	L14555 ^o		L14553/L14554	2		
				<input checked="" type="checkbox"/>	L14553 ^o				1	54500-EL000
				L14554 ^o					1	54501-EL000
				⊥▼	L14808 ^o	L14808 ^o		L14553/L14554	2	
				⊥▲	L10824	L10824		L14553/L14554	2	
				↔	L14675 ^o	L14675 ^o			2	54618-JX00A
		MK347	MK347			2	54325-AX600			

Evalia 08.09 →

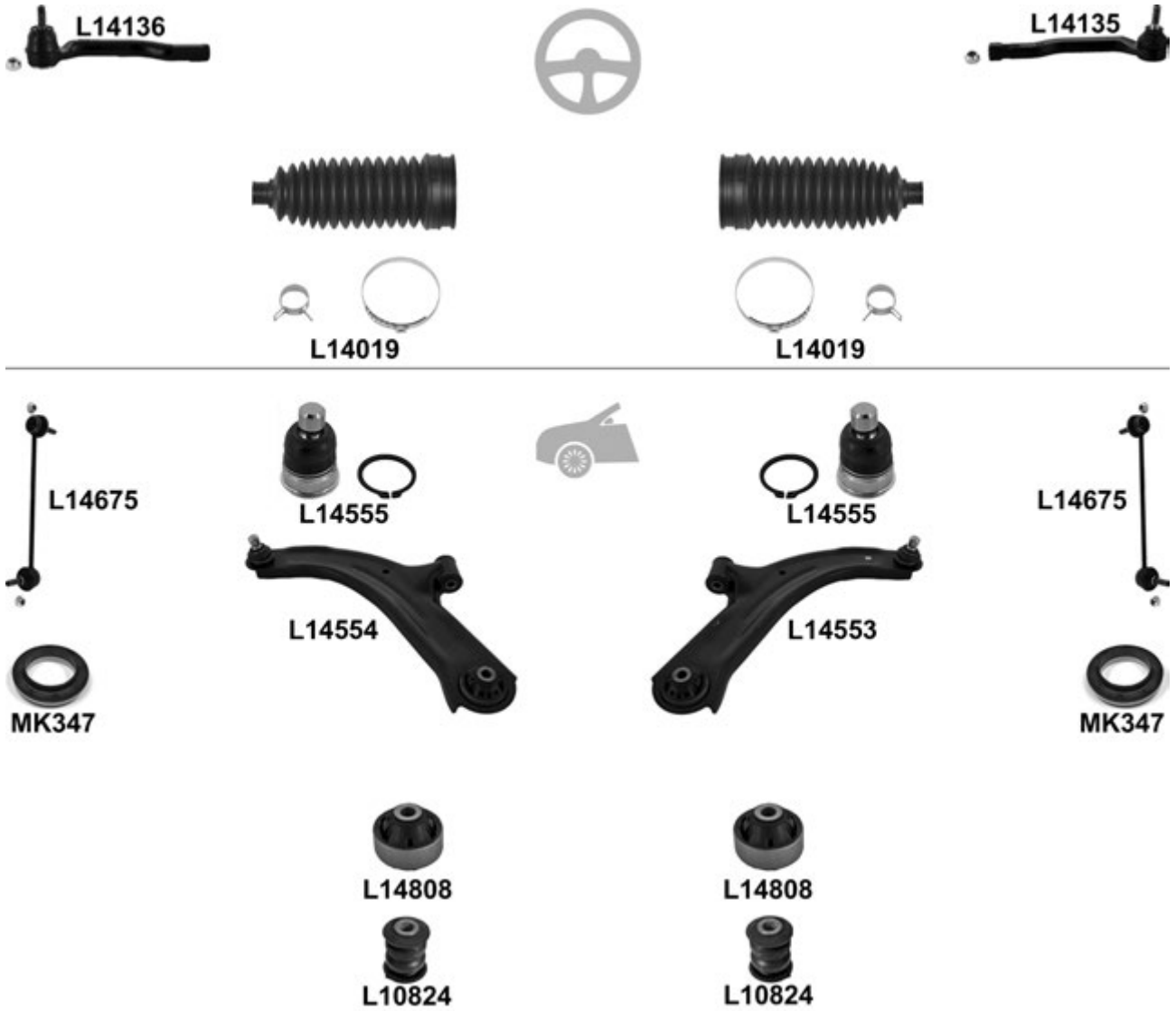

				← → Thread		Part Of	QPA	i	
⊕		↔		L14135	F 12x1,25 ∪		1	D8520-EW00A	
				L14136	F 12x1,25 ∪		1	D8640-EW00A	
⊖		⊥		L14019 ⁰	L14019 ⁰		2	48203-3U025	
				L14555 ⁰	L14555 ⁰		2	L14553/L14554	
				L14553 ⁰			1	54500-EL000	
				L14554 ⁰			1	54501-EL000	
				L14808 ⁰	L14808 ⁰		2	L14553/L14554	
				L10824	L10824		2	L14553/L14554	
				L14675 ⁰	L14675 ⁰		2	54618-JX00A	
	MK347	MK347		2		54325-AX600			

Interstar 07.02 →

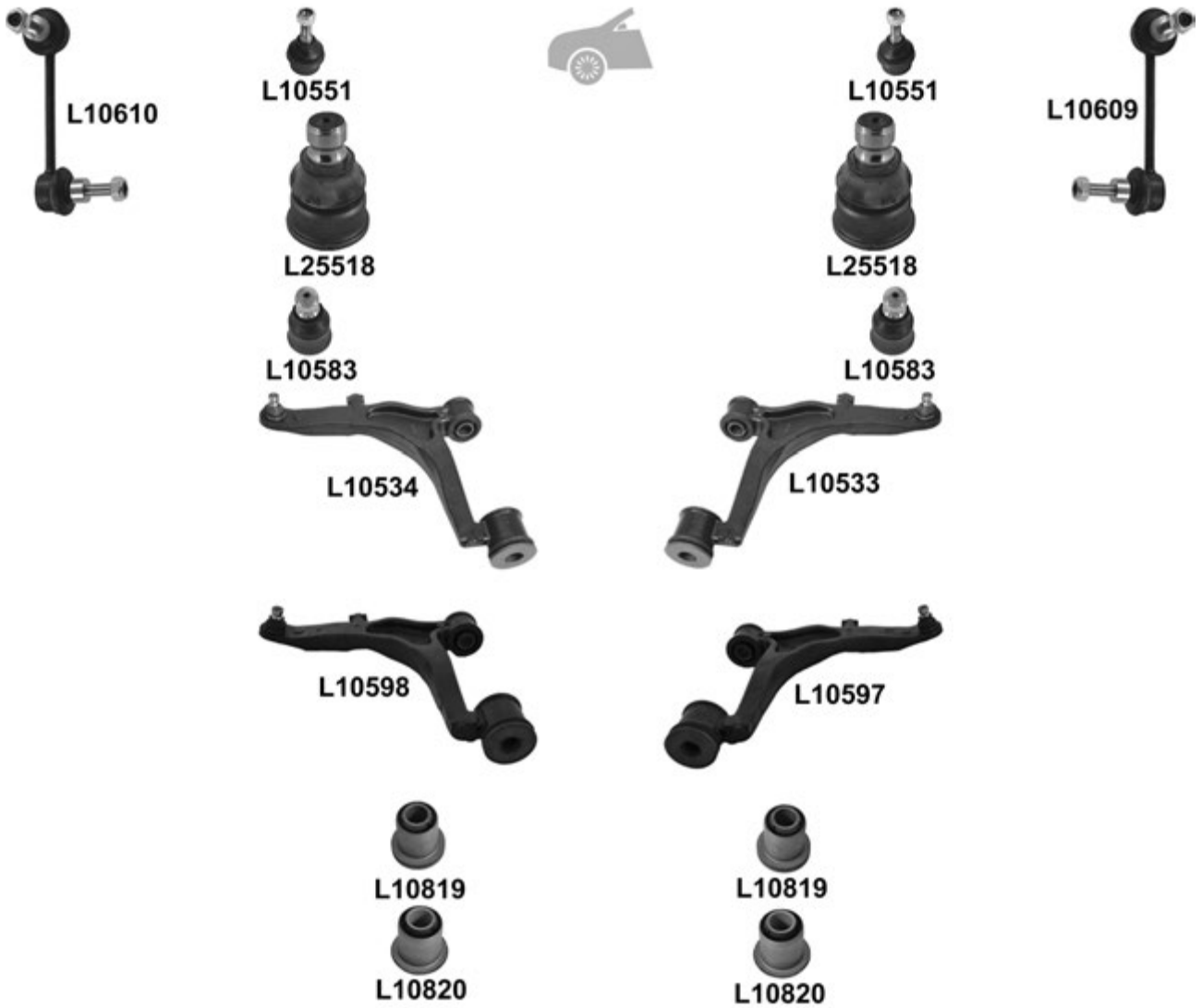
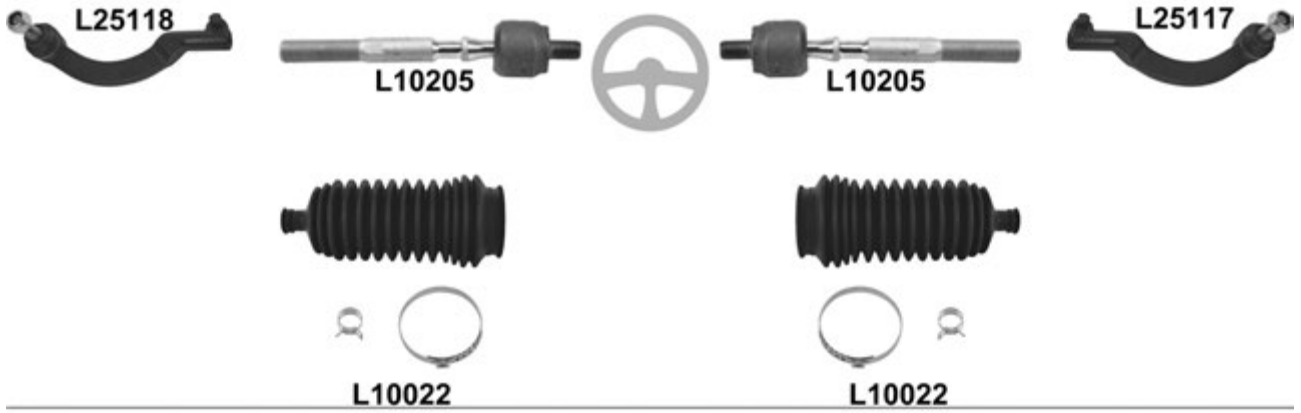

Interstar 07.02 →

		i		←	→	Thread	Part Of	QPA	i	
		↔			L25117	F 16x1,5 ∪		1	48520-00QAJ	
					L25118	F 16x1,5 ∪		1	48520-00QAH	
				L10205	L10205	M 16x1,5 / M 14x1,5 ∪		2	48521-00QAF	
				L10022 ⁰	L10022 ⁰			2	48203-00QAD	
		↑			L10551	L10551		2	40160-00QAB	
		↓	→ 08.07, 22mm	L25518	L25518			2		
		09.07 →, 24mm	L10583	L10583			2	40160-00QOB		
		↓	→ 08.07, 22mm	<input checked="" type="checkbox"/>		L10533			1	54500-00QAE
					L10534			1	54501-00QAE	
			09.07 →, 24mm	<input checked="" type="checkbox"/>		L10597		1	54500-00QOE	
					L10598			1	54501-00QOE	
		↓			L10819	L10819			2	54423-00QAA
		↑			L10820	L10820			2	54570-00QAA
						L10609			1	54618-00QAA
					L10610			1	54618-00QAB	
					L10609			1	54618-00QAA	
					L10610			1	54618-00QAB	

Juke 06.10 →

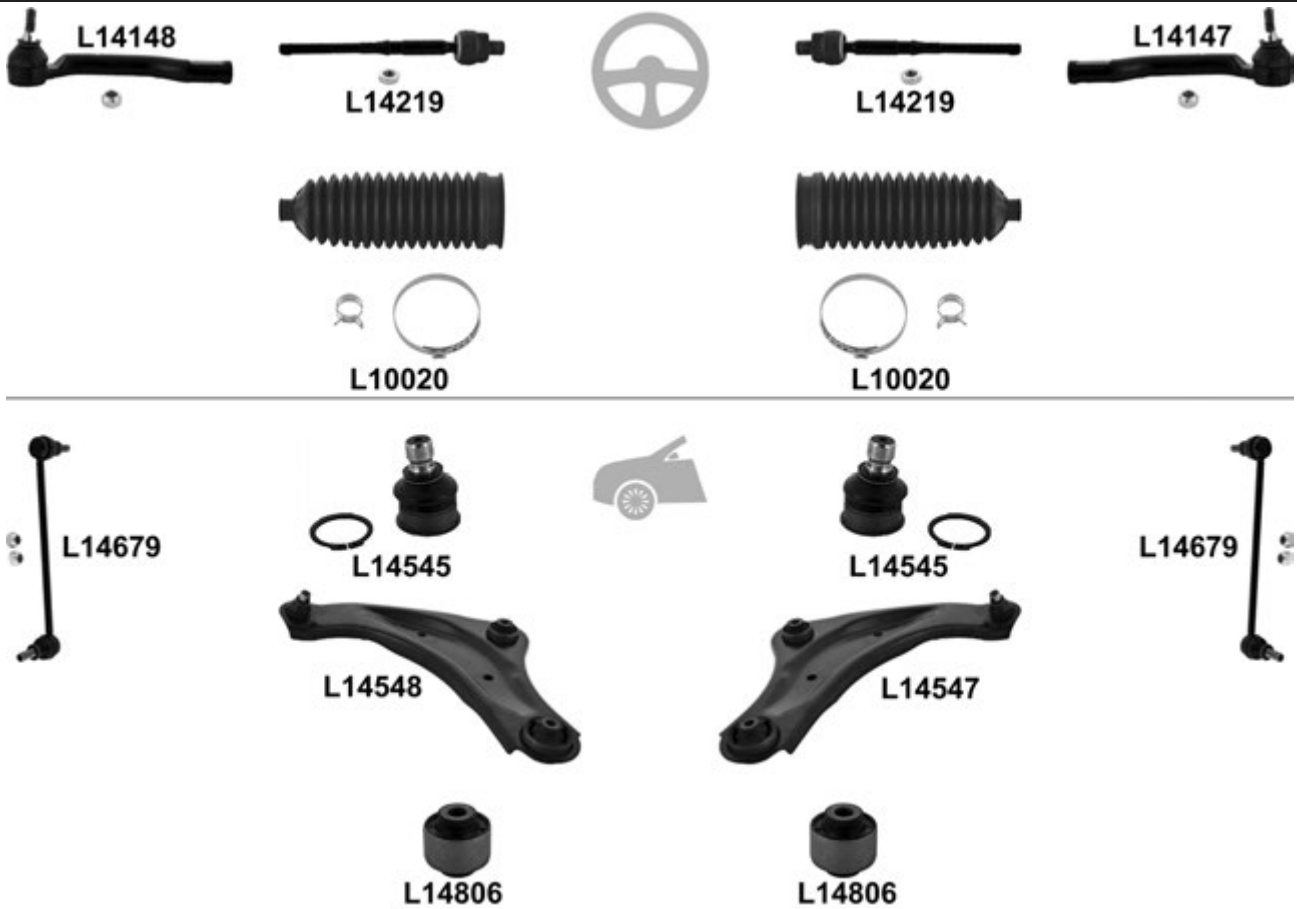

				← → Thread		Part Of	QPA		
				L14147	F 12x1,25 ♂		1	D8520-1KA0A	
			L14148		F 12x1,25 ♂		1	D8640-1KA0A	
			L14219 ^o	L14219 ^o	M 12x1,25 / M 16x1 ♂		2		
			L10020 ^o	L10020 ^o			2	D8203-1KA0A	
				L14545	L14545		2		
				L14547			1	54500-1KA0B	
			<input checked="" type="checkbox"/>	L14548			1	54501-1KA0B	
				L14806	L14806		L14547/L14548	2	
				L14679	L14679			2	54618-CY00A

King Cab 720 serie 2WD 09.79 → 04.85

Pick-Up 720 serie 2WD 09.79 → 04.85



			i	←	→	Thread	Part Of	QPA	i
		↔		L14630	L14630	M 18x1,5 U		2	48520-41W00
		↑		L14620	L14620			2	40110-01G26
		↓			L14622			1	40160-48W25

King Cab D21 serie 2WD 08.85 →

Pick-Up D21 serie 2WD 08.85 →



			i	←	→	Thread	Part Of	QPA	i
		↔		L14630	L14630	M 18x1,5 U		2	48520-01G25
		↔		L14631	L14631	M 18x1,5 U		2	48521-01G25
		↑		L14620	L14620			2	40110-01G26
		↓		L14640	L14640			2	40160-01N25
				L14200	L14200			2	

King Cab 720 serie 4WD 4.80 → 04.83

Pick-Up 720 serie 4WD 4.80 → 04.83



			i	←	→	Thread	Part Of	QPA	i
		↔		L14630	L14630	M 18x1,5 U		2	48520-41W00
		↑		L14620	L14620			2	40110-01G26
		↓			L14622			1	40160-48W25

King Cab 720 serie 4WD 05.83 → 04.85

Pick-Up 720 serie 4WD 05.83 → 04.85



			i	←	→	Thread	Part Of	QPA	i
		↑		L14620	L14620			2	40110-01G26
		↓		L14624	L14624			2	40160-93G25

King Cab / Pick-Up 4WD (D21) 08.85 → 07.92



L14625



L14625

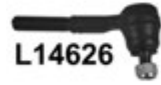

L14626

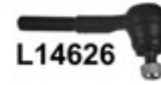

L14626



L14210



L14620



L14620



L14210



L14624



L14624



Thread

Part Of

QPA



⊕		↔↔↔↔		L14625	L14625	M 16x1,5 U		2	48520-31G25
		↔↔↔↔		L14626	L14626	M 16x1,5 U		2	48570-31G25
🚗		↑		L14620	L14620			2	40110-01G25
		↓		L14624	L14624			2	40160-93G25
				L14210	L14210			2	54630-02E0A

King Cab / Pick-Up 4WD (D21) 08.92 → 02.98



L14126



L14125



L14125



L14126



L14210



L14620



L14620



L14210



L14624



L14624



Thread

Part Of

QPA



				L14125	M 16x1,5 ♂		1	48520-61G25
			L14126		M 16x1,5 ♂		1	48570-61G25
				L14126	M 16x1,5 ♂		1	48570-61G25
			L14125		M 16x1,5 ♂		1	48520-61G25
				L14620	L14620		2	40110-01G25
				L14624	L14624		2	40160-93G25
					L14210	L14210		2

King-van / Urvan (E24) 09.86 →

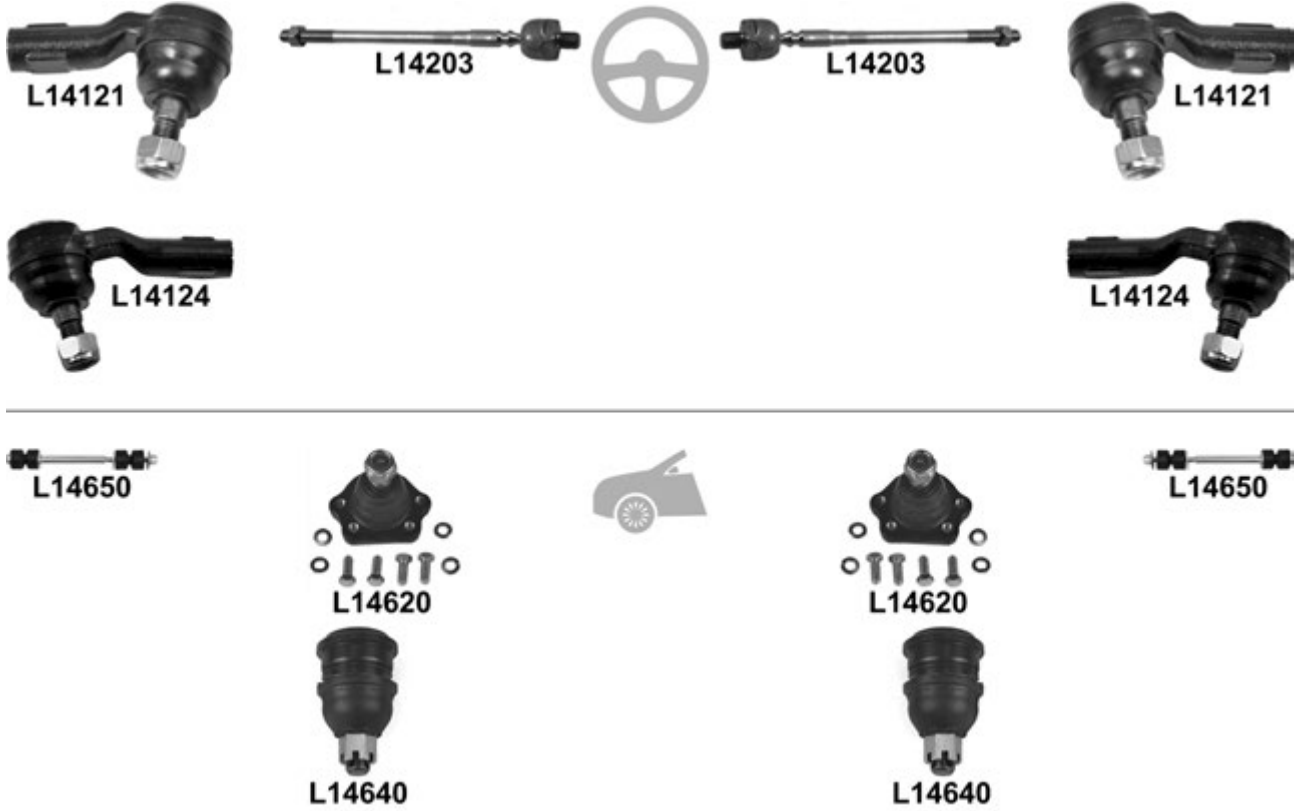

				← → Thread		Part Of	QPA		
⊕		↔	→ 09.88	L14121			1	48641-01N25	
		→←	→ 09.88	L14121			1	48641-01N25	
		↔	10.88 →	L14124	L14124		2	48520-27N25	
			10.88 →	L14203	L14203		2	48521-27N00	
		↑	→ 09.88	L14620	L14620		2	40110-01G26	
		↓		L14640	L14640		2	40160-01N25	
				L14650	L14650		2		

Kubistar 08.03 →

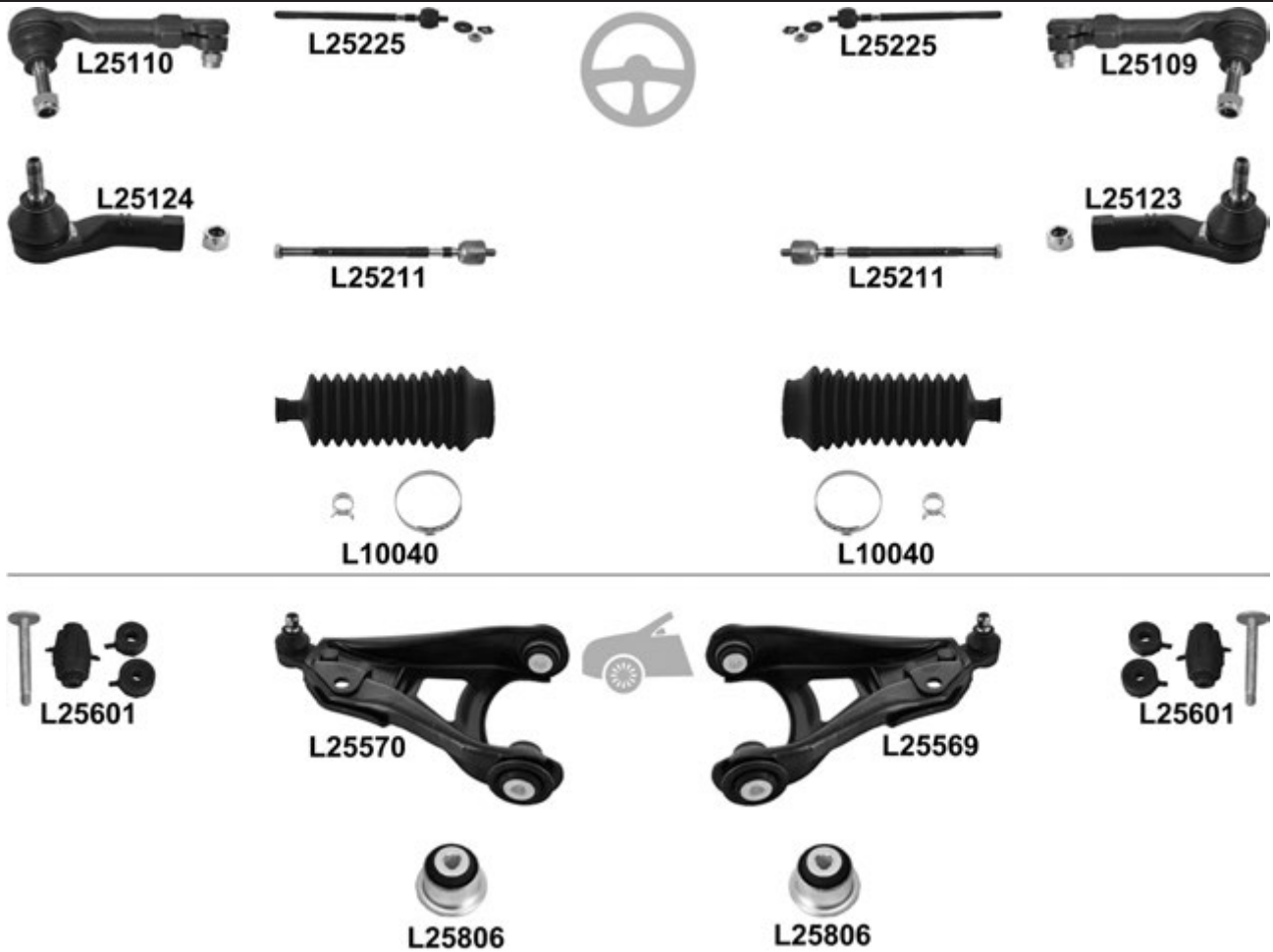

				← → Thread		Part Of	QPA	i		
⊕	↔	Height adjustment	L25109	F 14x1,5	⊖		1	48520-00QAP		
			L25110	F 14x1,5	⊖		1	48520-00QAN		
		(-) Height adjustment	L25123	F 14x1,5	⊖		1	48520-00QAF		
			L25124	F 14x1,5	⊖		1	48520-00QAE		
	⊖	⊕	L25225	L25225	M 14x1,5 / M 12x1	⊖		2	48521-00QAA	
			L25211	L25211	M 14x1,5 / M 12x1	⊖		2	48521-00QAG	
			L10040 ⁰	L10040 ⁰			2	48203-00QAA		
🚗	⊥	1.5 Dci		L25569 ⁰			1	54500-00QOM	<input checked="" type="checkbox"/>	
				L25570 ⁰			1	54501-00QOG		
	⊕	⊥	1.5 Dci	L25806	L25806		4	54560-00QAB		
			→ 01.09	L25601	L25601		2	54616-00QAA		

Leaf 11.10 →

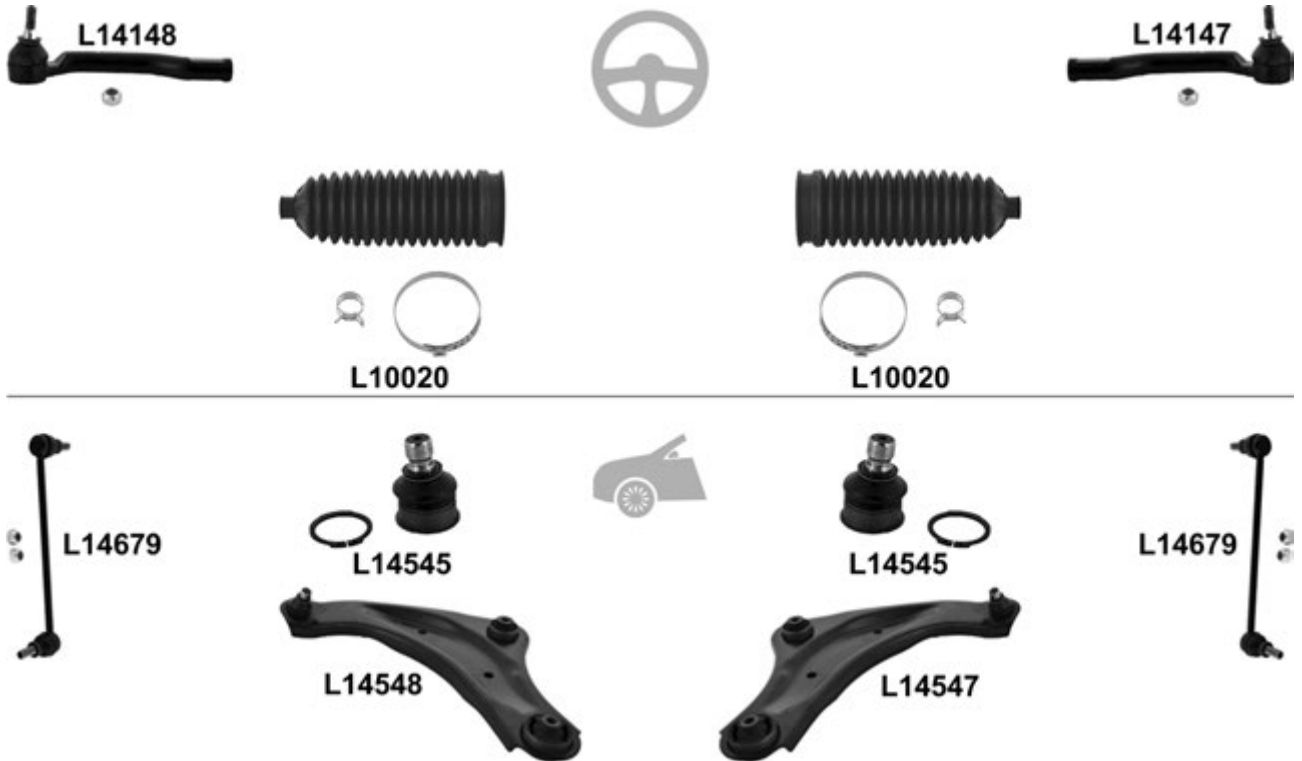

			i	←	→	Thread	Part Of	QPA	i		
						L14147	F 12x1,25 ⤴	1	D8520-1KA0A		
						L14148	F 12x1,25 ⤴	1	D8640-1KA0A		
						L10020 ^o	L10020 ^o	2	D8203-1KA0A		
						L14545	L14545	2			
				<input checked="" type="checkbox"/>				L14547		1	54500-1KA0B
								L14548		1	54501-1KA0B
					L14679	L14679	2	54618-CY00A			

Maxima J30 10.88 → 06.94

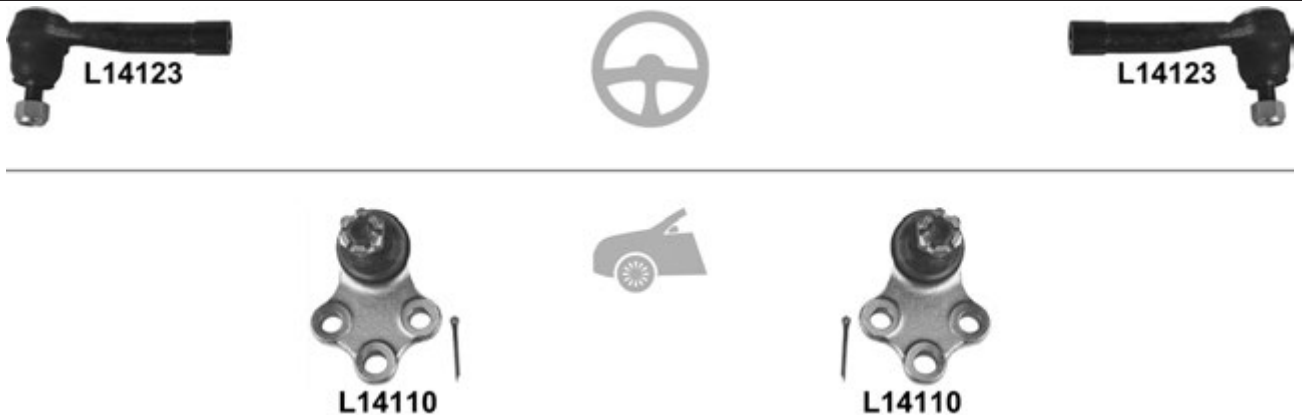

			i	←	→	Thread	Part Of	QPA	i
						L14123	L14123	2	48520-88E25
						L14110	L14110	2	40160-85E00

Maxima QX (A32) 01.95 → 08.00

Thread

Part Of

QPA



				←	→	Thread	Part Of	QPA	
		↔		L14127	L14127	F 14x1,5 ♂		2	48520-15U26
				MK137	MK137			2	
				MK131	MK131			2	56218-61L10 S1

Maxima QX (A33) 04.99 → 11.03

Thread

Part Of

QPA



				←	→	Thread	Part Of	QPA	
		↔		L14127	L14127	F 14x1,5 ♂		2	48520-15U26
			KIT	MK301	MK301			2	

Micra (K10) 12.82 → 07.92

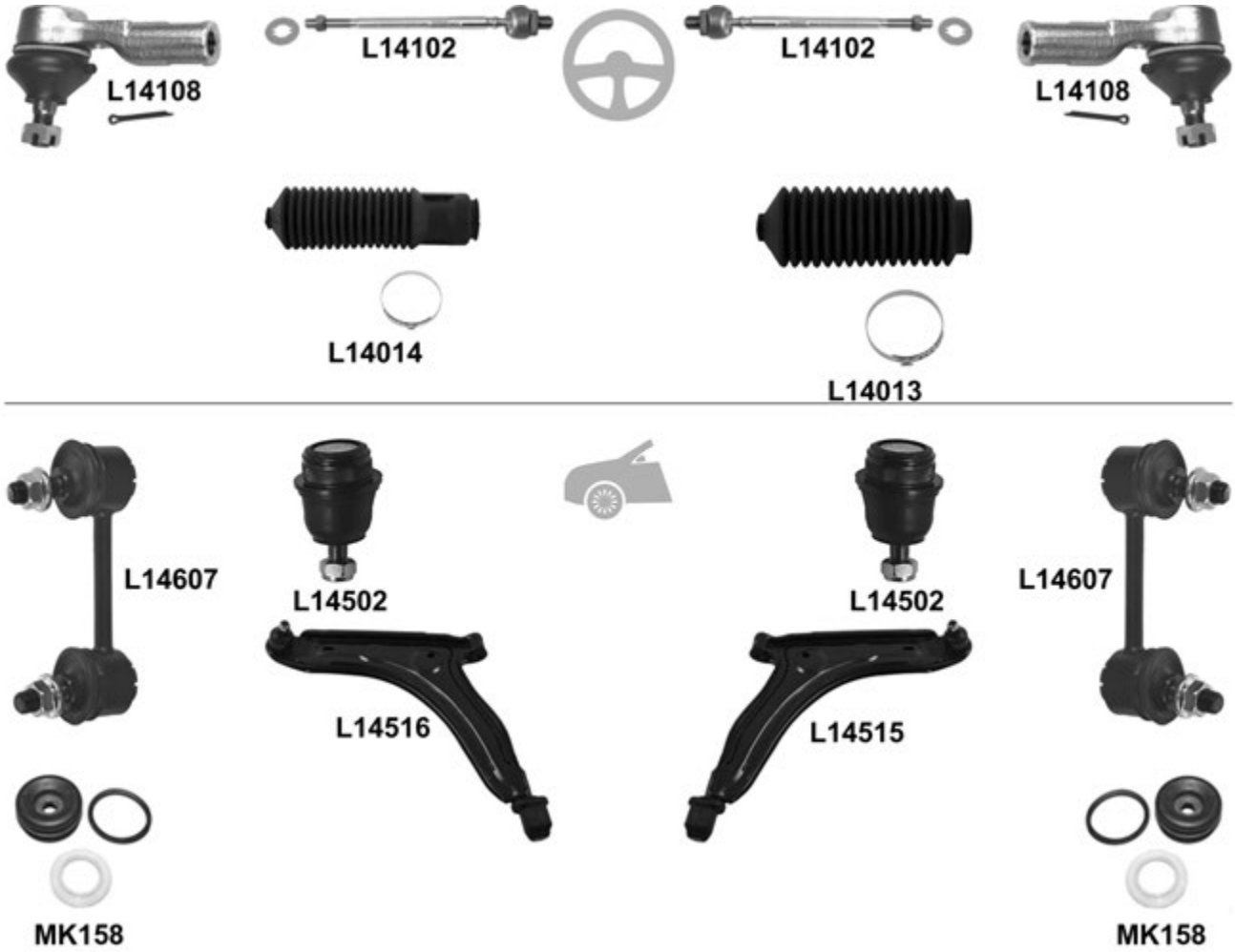

				←	→	Thread	Part Of	QPA	
⊕		↔		L14108	L14108	F 12x1,25 ∪		2	48520-17B25
			02.85 →	L14102	L14102	M 12x1,25 / M 16x1		2	48521-70A06
					L14013			1	48203-01F00
					L14014			1	48204-01F00
⊖		⊥		L14502	L14502			2	40160-01B25
		⊥			L14515			1	54500-21B00
				<input checked="" type="checkbox"/>	L14516			1	54501-21B00
				L14607	L14607			2	56261-AV611
				KIT	MK158	MK158		2	

Micra K11 08.92 → 02.03



Thread

Part Of

QPA



		↔		L14112	L14112	F 12x1,25 U		2	48520-4F125
		↓	→ 02.98, ↗ 12.4mm	L14500	L14500			2	40160-4F100
			03.98 →, ↗ 13.1mm	L14537	L14537			2	
		↓	→ 02.98, ↗ 12.4mm	<input checked="" type="checkbox"/>	L14517			1	54500-4F105
				<input type="checkbox"/>	L14518			1	54501-4F105
			03.98 →, ↗ 13.1mm	<input checked="" type="checkbox"/>	L14535			1	54500-6F600
					L14536			1	54501-6F600
				L14659	L14659			2	56261-17B01
				KIT	MK265	MK265		2	54320-4F102
				L14607	L14607			2	56261-4F725

Micra K12 01.03 →
 Micra C+C K12 08.05 →

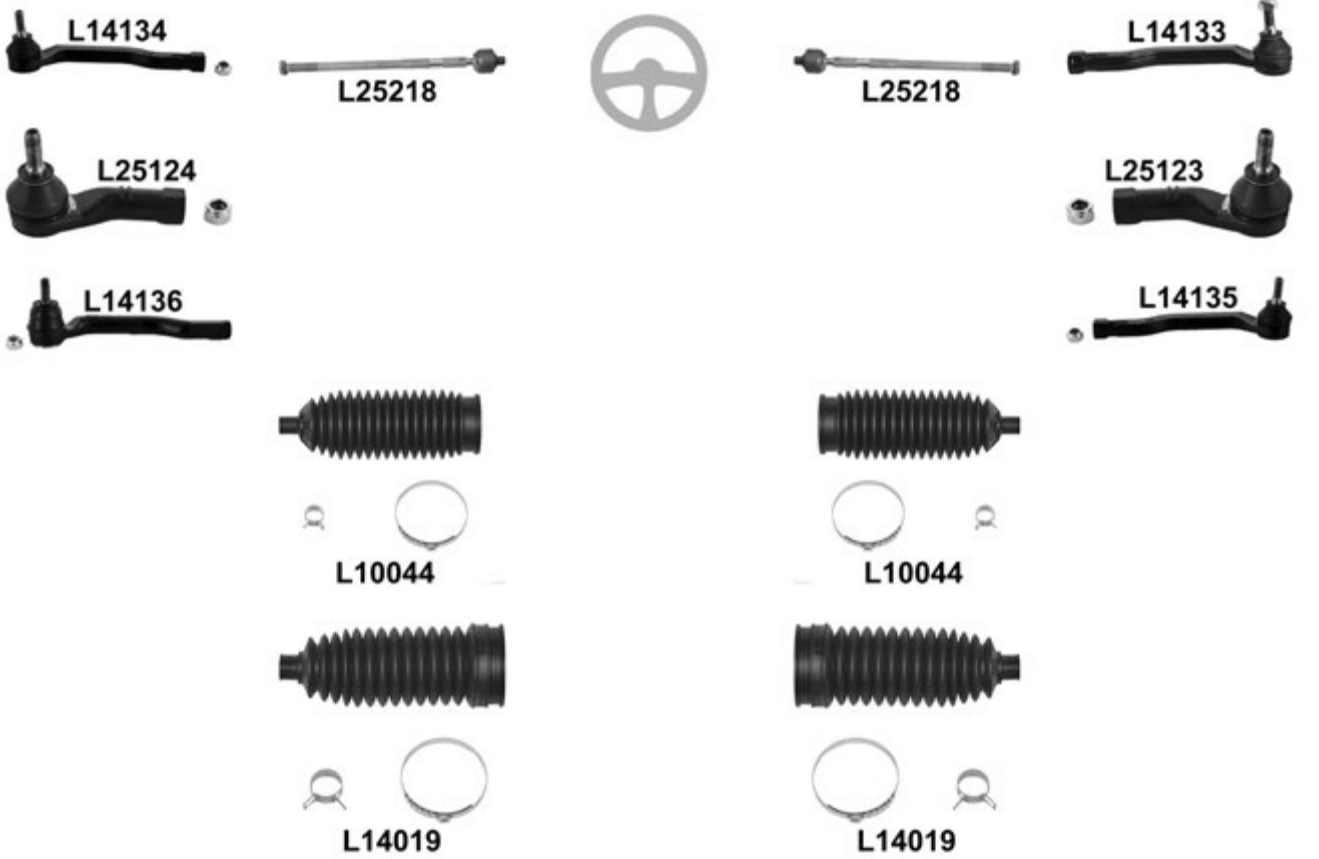

Micra K12 01.03 →
 Micra C+C K12 08.05 →

		i	←	→	Thread	Part Of	QPA	i	
⊕	↔	→ 04.04		L14133	F 14x1,5 ♂		1	48520-AX600	
			L14134	F 14x1,5 ♂		1	48640-AX600		
		05.04 → 09.07		L25123	F 14x1,5 ♂		1	48520-AX602	
			L25124	F 14x1,5 ♂		1	48640-AX602		
		10.07 →		L14135	F 12x1,25 ♂		1	48527-1U61A	
			L14136	F 12x1,25 ♂		1	48647-1U61A		
	←	04.04 →	L25218	L25218	M 14x1,5 / M 14x1,5 ♂		2		
	⌀		1.2 16V/1.2 LPG, → 08.07	L10044 ⁰	L10044 ⁰			2	48203-AX600
			1.5 Dci/1.6 16V, → 09.07	L10044 ⁰	L10044 ⁰			2	48203-AX600
			1.2 16V/1.2 LPG, 09.07 →	L14019 ⁰	L14019 ⁰			2	48203-1U61A
		1.5 Dci/1.6 16V, 10.07 →	L14019 ⁰	L14019 ⁰			2	48203-1U61A	
🚗	⊥	↔ 16mm	L14530	L14530			2	40160-AX000	
		↔ 16mm		L14533			1	54500-AX000	
	⊥		L14534				1	54501-AX000	
			L10823	L10823		🔧	2	54570-AX600	
	⊥		L10824	L10824		🔧	2	54560-AX600	
			L14657	L14657			2	54618-AX600	
	👁		KIT		MK263R		1	54320-AX600	
					MK264L		1	54321-AX600	
			MK347	MK347		2	54325-AX600		

Micra IV K13 05.10 →

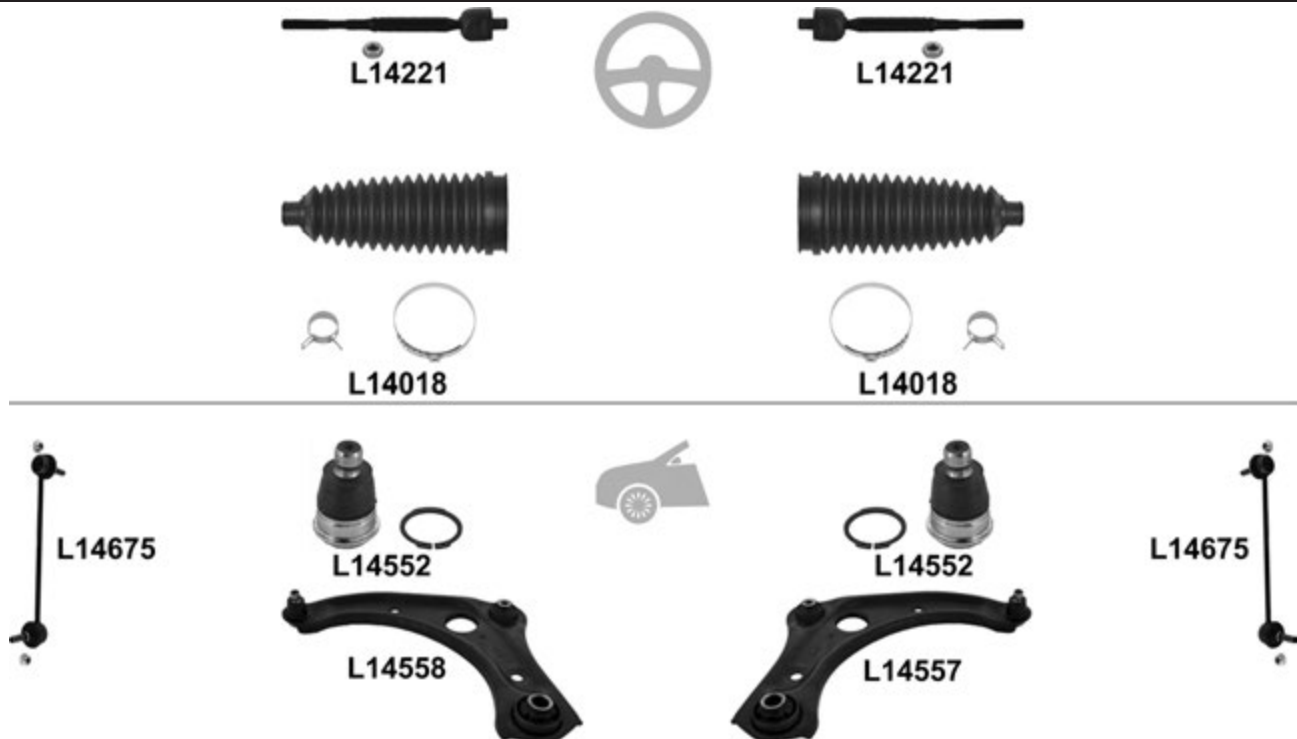

		i	←	→	Thread	Part Of	QPA	i
⊕	←		L14221 ⁰	L14221 ⁰	M 12x1,25 / M 14x1,5		2	D8521-1HA0A
	⌀		L14018 ⁰	L14018 ⁰			2	D8203-1HA0A
🚗	⊥		L14552 ⁰	L14552 ⁰			2	
				L14557 ⁰		1	54500-1HA6A	
	⊥		L14558 ⁰			1	54501-1HA6A	
		→ 05.13	L14675 ⁰	L14675 ⁰		2	54618-JX00A	

Murano (Z50) 11.04 → 06.08



Thread

Part Of

QPA



				KIT	MK310	MK310				2	54320-CN100
--	--	--	--	-----	-------	-------	--	--	--	---	-------------

Murano (Z51) 11.07 →

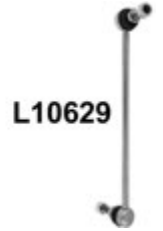
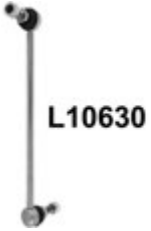

Thread

Part Of

QPA

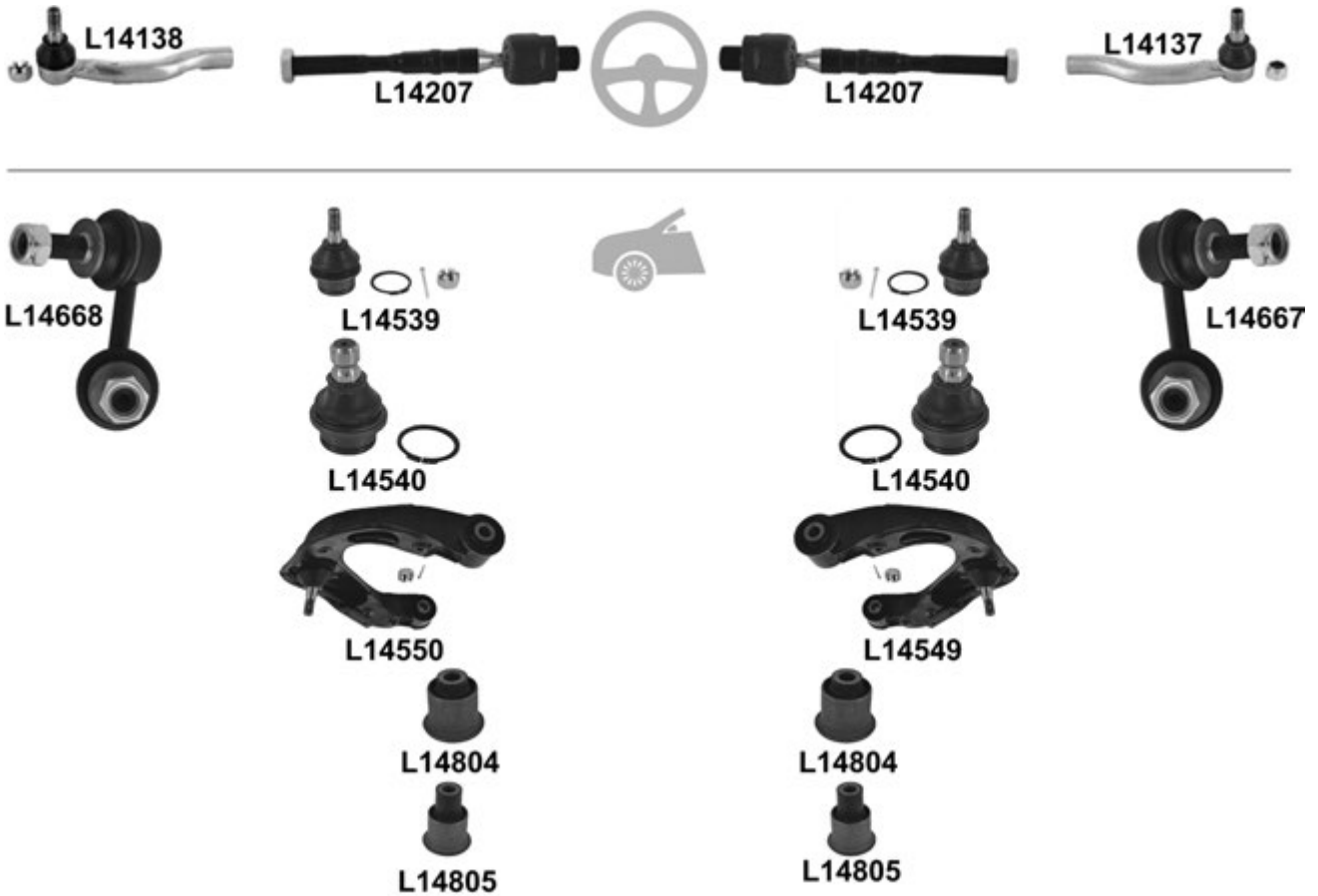

					L10629					1	54618-1AA0A
					L10630					1	54668-1AA0A

Navara (D40) 10.04 →

				←	→	Thread	Part Of	QPA		
		↔	→ 09.06		L14137	F 16x1,5 ∩		1	48640-EA01J	
				L14138		F 16x1,5 ∩		1	48520-EA01J	
		↑		L14539	L14539		L14549/L14550	2		
				L14540	L14540		OE no. 54500-EB31A / 54501-EB31A	2		
		↑			L14549			1	54524-EB30A	
				L14550			1	54525-EB30A		
		↑▲			L14804	L14804		L14549/L14550	4	
				L14805	L14805		OE no. 54500-EB31A / 54501-EB31A	4		
						L14667			1	54618-EA010
				L14668			1	54668-EA010		

Note (E11) 03.06 →

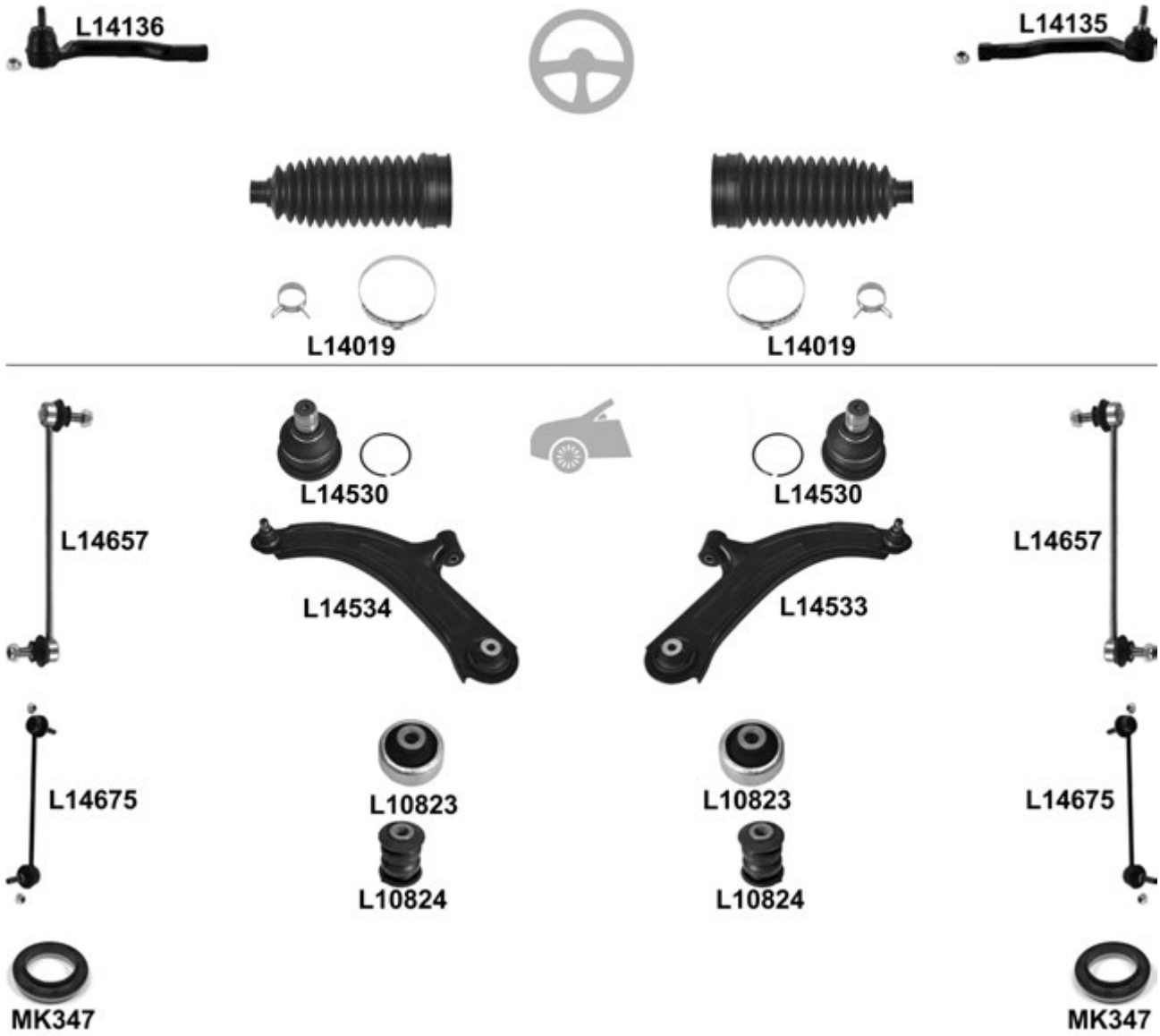

				←	→	Thread	Part Of	QPA			
		↔			L14135	F 12x1,25 ∪		1	D8520-EW00A		
				L14136		F 12x1,25 ∪		1	D8640-EW00A		
				L14019 ⁰	L14019 ⁰			2	48203-1U61A		
		↓	16mm	L14530	L14530			2	40160-AX000		
		↓	16mm	<input checked="" type="checkbox"/>	L14533			1	54500-AX000		
				L14534				1	54501-AX000		
		↓			L10823	L10823			2	54570-AX600	
		↓			L10824	L10824			2	54560-AX600	
			→ 12.08	L14657	L14657			2	54618-AX600		
			01.09 →	L14675 ⁰	L14675 ⁰			2	54618-JX00A		
				MK347	MK347			2	54325-AX600		

NP300 04.08 →

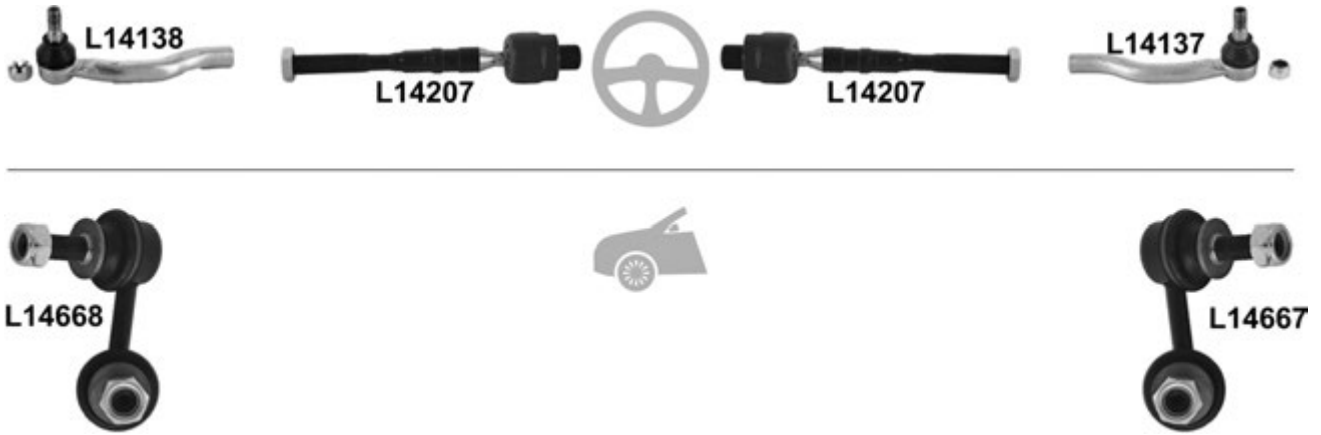

				← → Thread		Part Of	QPA	i	
				L14137	F 16x1,5 ∪		1	48520-EA01J	
			L14138		F 16x1,5 ∪		1	48640-EA01J	
			L14207	L14207	M 16x1,5 / M 20x1 ∪		2	48521-EA000	
			L14667				1	54618-EA010	
			L14668				1	54668-EA010	

NV200 02.10 →

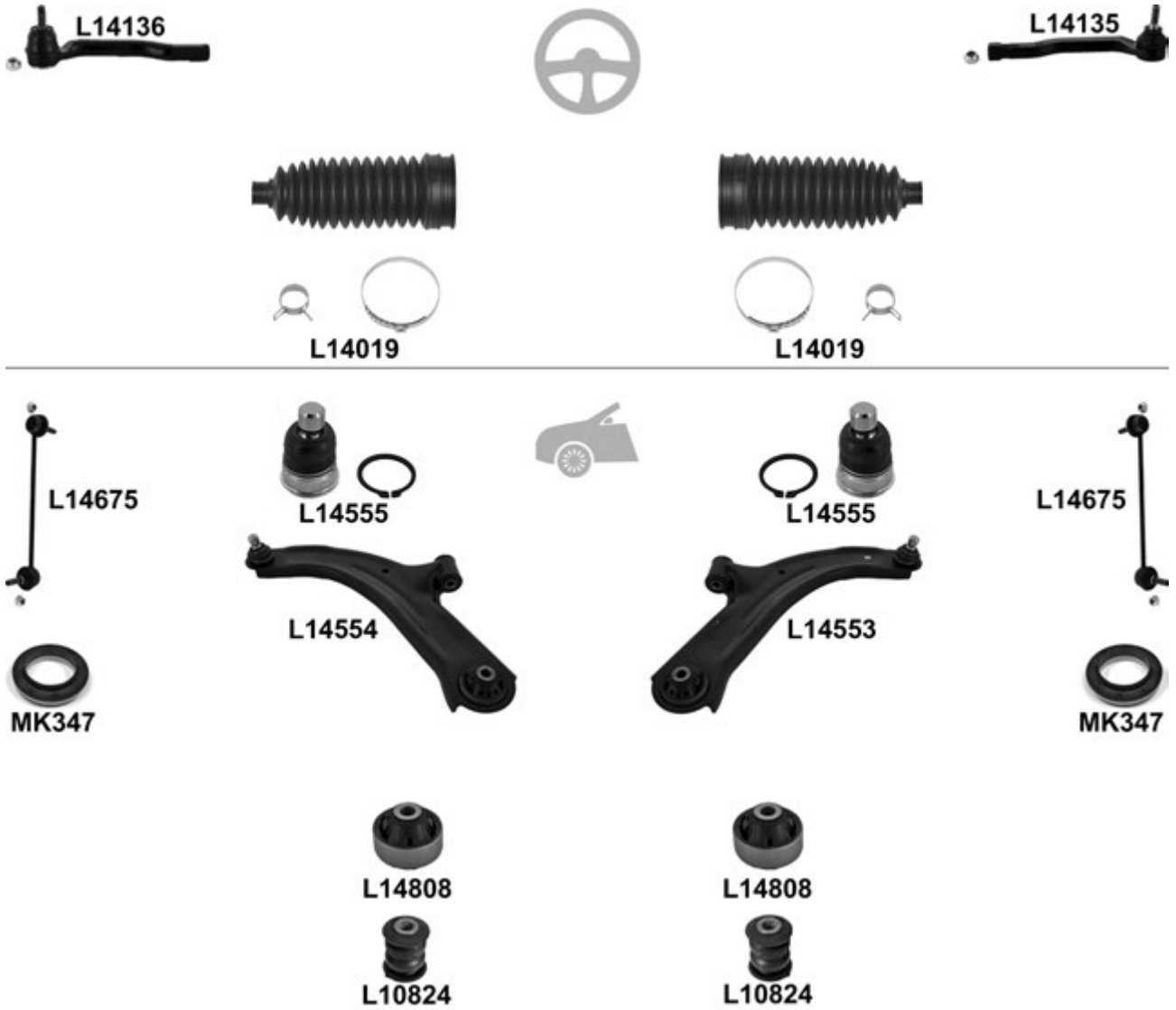

				← → Thread		Part Of	QPA	i			
⊕		↔		L14135	F 12x1,25 ∪		1	D8520-EW00A			
				L14136	F 12x1,25 ∪		1	D8640-EW00A			
⊖		⊥		L14019 ⁰	L14019 ⁰			2	48203-1U61A		
				L14555 ⁰	L14555 ⁰			L14553/L14554	2		
				L14553 ⁰					1	54500-EL000	
				L14554 ⁰					1	54501-EL000	
				L14808 ⁰	L14808 ⁰			L14553/L14554	2		
				L10824	L10824			L14553/L14554	2		
				L14675 ⁰	L14675 ⁰				2	54618-JX00A	
	MK347	MK347				2	54325-AX600				

Pathfinder R50 09.97 →



		i		←	→	Thread	Part Of	QPA	i
		↔		L14128	L14128	↺		2	48520-0W025
				L14205	L14205	↺		2	48521-0W025
		↓		L14523	L14523			2	40160-0W025
				L14658	L14658			2	54618-3W400
				L14662	L14662			2	56260-41G11

Pathfinder R51 01.05 →

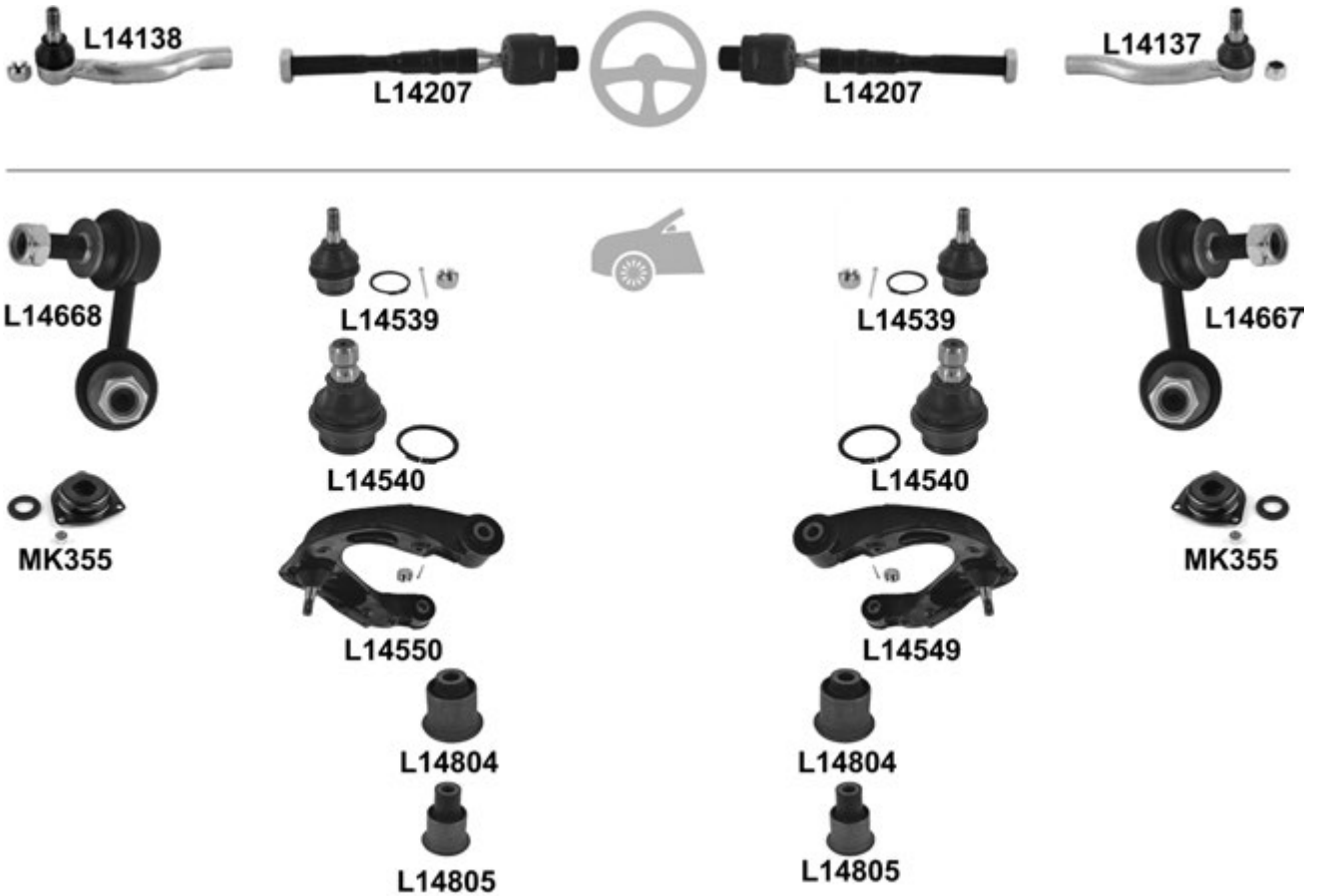

				←	→	Thread	Part Of	QPA				
		↔				L14137	F 16x1,5 ∪	1	48520-EA01J			
							L14138	F 16x1,5 ∪	1	48640-EA01J		
		↑				L14539	L14539		L14549/L14550	2		
							L14540	L14540		OE no. 54500-EB31A / 54501-EB31A	2	
		↑					L14549			1	54524-EB30A	
							L14550				1	54525-EB30A
		↑▲▼					L14804	L14804		L14549/L14550	4	
							L14805	L14805		OE no. 54500-EB31A / 54501-EB31A	4	
								L14667			1	54618-EA010
								L14668				1
					KIT	MK355	MK355			2		

Patrol Y60 serie 09.88 → 06.97



				← → Thread		Part Of	QPA	i	
				L14652	L14652		2	54618-50J11	
				L14652	L14652		2	54618-50J11	

Patrol Y61 serie 06.97 →



				← → Thread		Part Of	QPA	i	
				L14652	L14652		2	54618-50J11	

Pick-Up 4WD (D22) 02.98 →



				← → Thread		Part Of	QPA	i	
		↔		L14128	L14128	F 14x1,5 ∅	2	48520-3S525	

Pixo (UA0) 03.09 →



L24116



L24116



Thread

Part Of

QPA



				L24116	L24116	F 12x1,25 ↺		2	48520-4A00B
--	--	--	--	--------	--------	-------------	--	---	-------------

Primastar 03.01 →

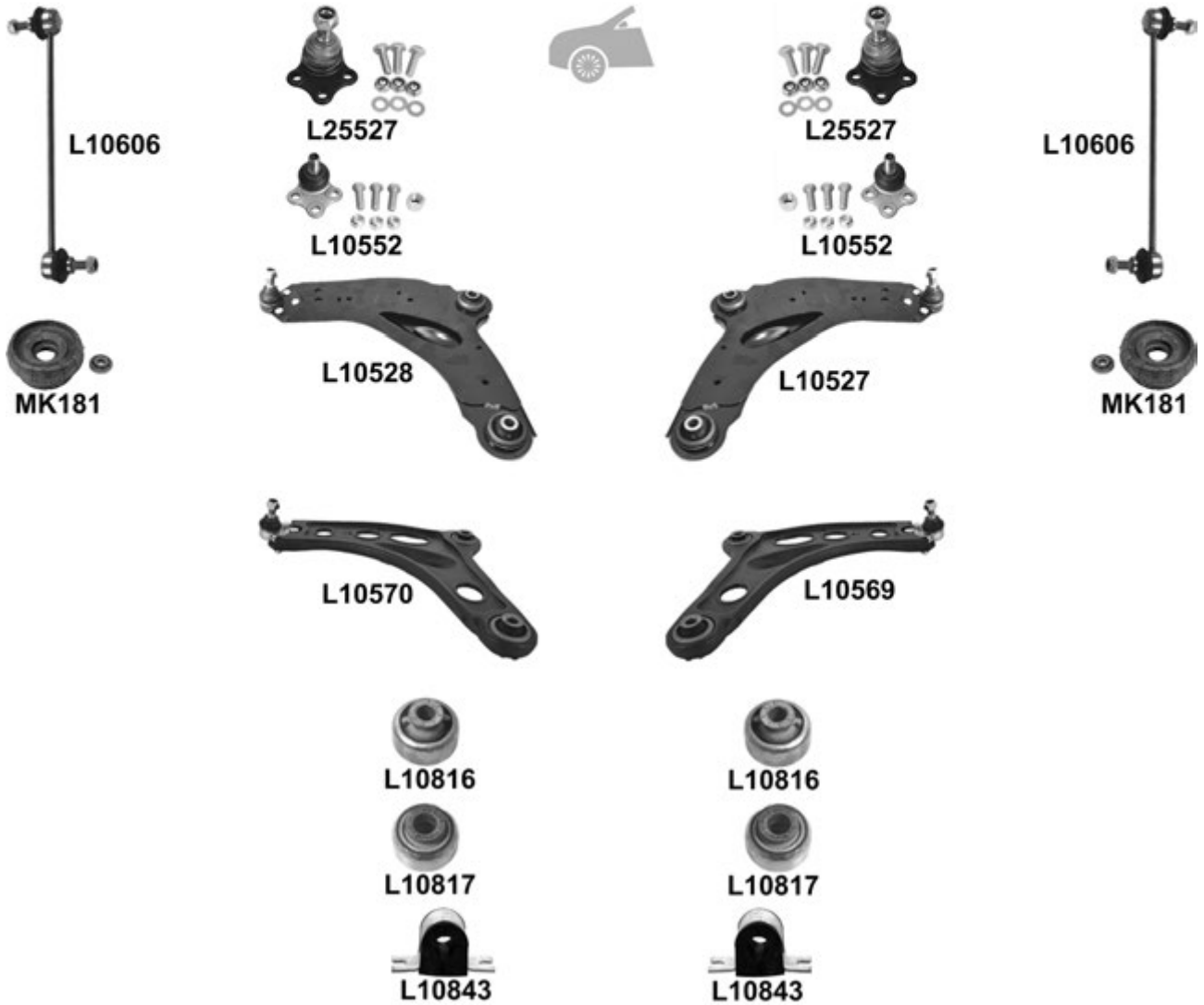
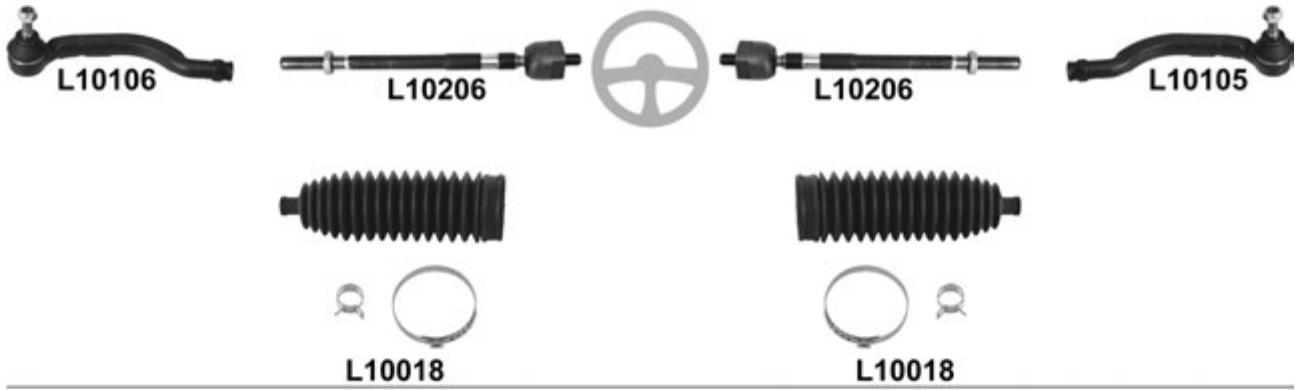

Primastar 03.01 →

		i		← →		Thread	Part Of	QPA	i	
		↔				L10105 F 14x1,5 ∪		1	48520-000AL	
						L10106 F 14x1,5 ∪		1	48520-000AK	
						L10206 L10206 M 14x1,5 / M 12x1 ∪		2	48520-000AM	
						L10018 L10018		2	48203-000AE	
		⊥	→ 08.06, 10mm ↔			L25527 L25527		2	40160-000QA	
			09.06 →, 12mm ↔			L10552 L10552		2	54503-000A S	
		⊥	→ 08.06, 10mm ↔	<input checked="" type="checkbox"/>			L10527		1	54502-000AB
							L10528		1	54503-000AB
			09.06 →, 12mm ↔	<input checked="" type="checkbox"/>			L10569		1	82 00 626 961
						L10570		1	82 00 626 959	
		⊥▼					L10816 L10816		2	
		⊥▲					L10817 L10817		2	
						L10606 L10606		2	4408904	
			22mm			L10843 L10843	Anti-roll bar	2		
			KIT			MK181 MK181		2	54320-000AA	

Primera (P10, W10) 06.90 → 03.98

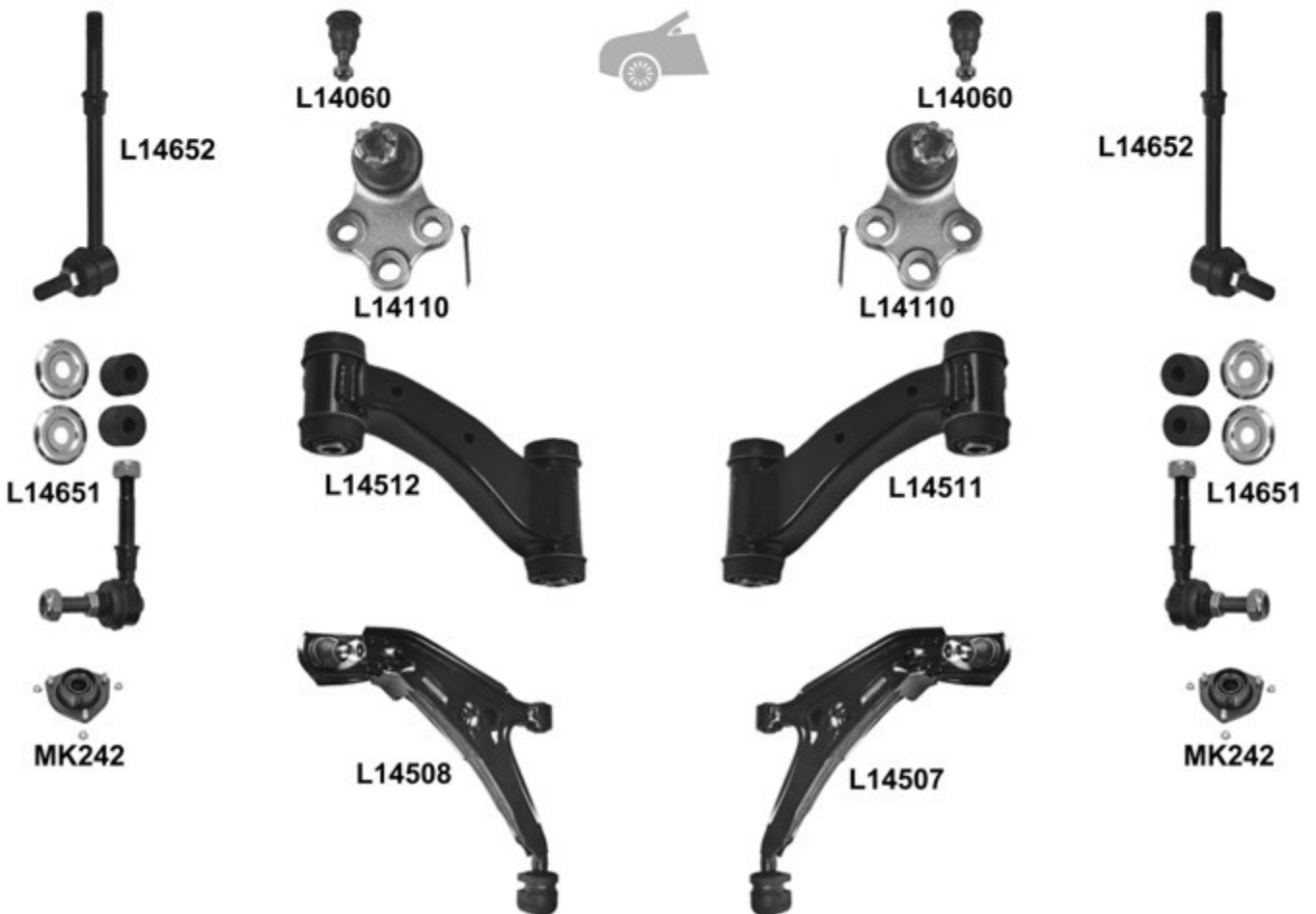
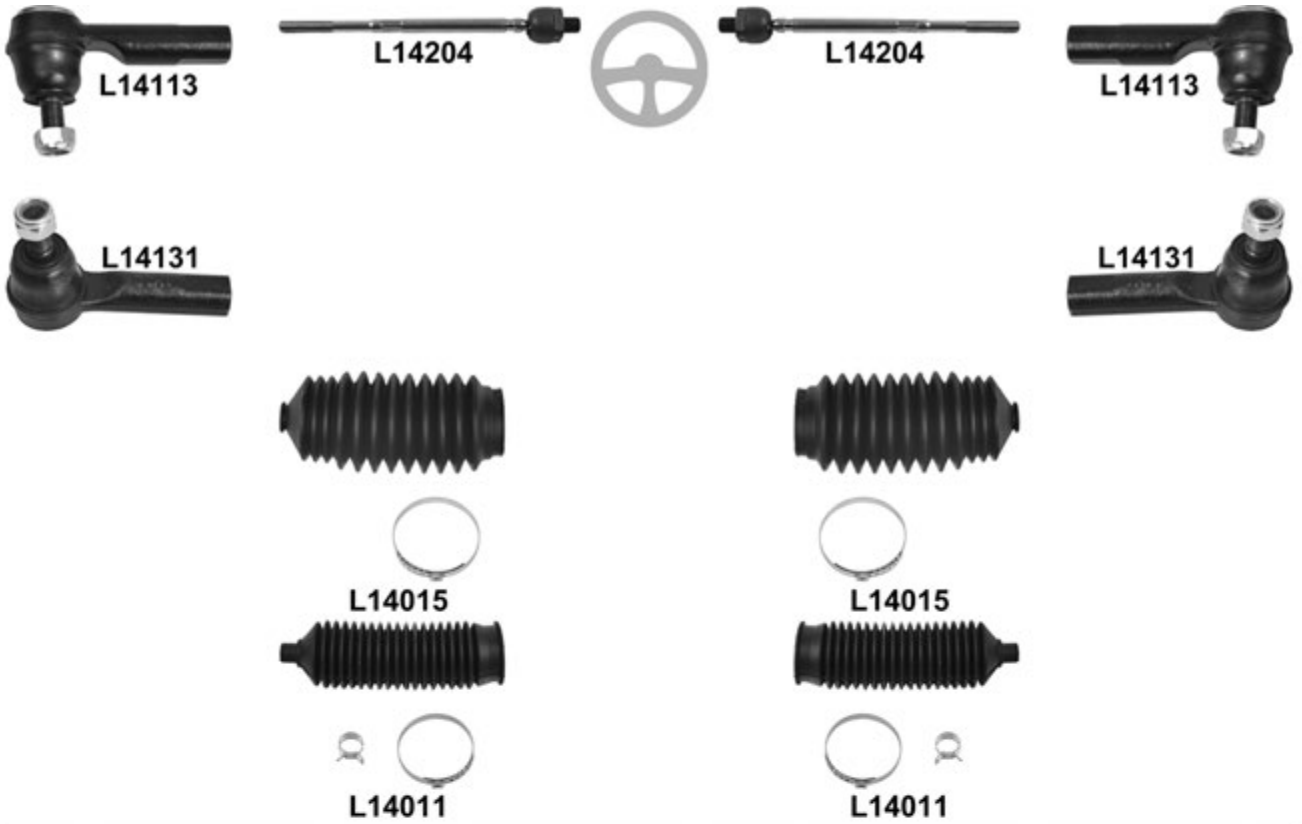

Primera (P10, W10) 06.90 → 03.98

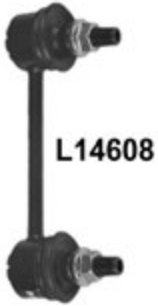

						←	→	Thread	Part Of	QPA	
		↔		L14113	L14113	F 12x1,25 ∪			2	48520-73J25	
				L14131	L14131	F 14x1,5 ∪			2	48520-50J25	
			→ 12.91	L14204	L14204	M 12x1,5 / M 16x1 ∪			2	48521-72E00	
			01.92 →	L14015	L14015				2	48203-10V25	
				L14011	L14011				2	48203-09025	
		↓	/	L14060	L14060				2	40160-70J00	
			/ Van	L14110	L14110				2	40160-85E00	
		↑	/		L14511				1	54524-86J10	
				L14512				1	54525-86J10		
		↓	/ <input checked="" type="checkbox"/>		L14507				1	54500-86J010	
				L14508				1	54501-86J010		
			1.6 /	L14651	L14651				2	54618-50Y00	
			2.0/2.0 D, /	L14652	L14652				2	54618-50J11	
			/ Van	L14651	L14651				2	54618-50Y00	
			/ Van	KIT	MK242	MK242				2	
			L14608	L14608				2	56261-90J01		

Primera (P11, WP11) 09.96 →



				←	→	Thread	Part Of	QPA			
		↔		L14113	L14113	⌚		2	48520-73J25		
		⌊		L14060	L14060			2	40160-70J00		
		⌈			L14511			1	54524-86J10		
					L14512				1	54525-86J10	
		⌋		<input checked="" type="checkbox"/>		L14513			1	54501-2F500	
					L14514				1	54501-2F500	
				L14663	L14663			2	54618-2F010		

Primera (P12, WP12) 03.02 →

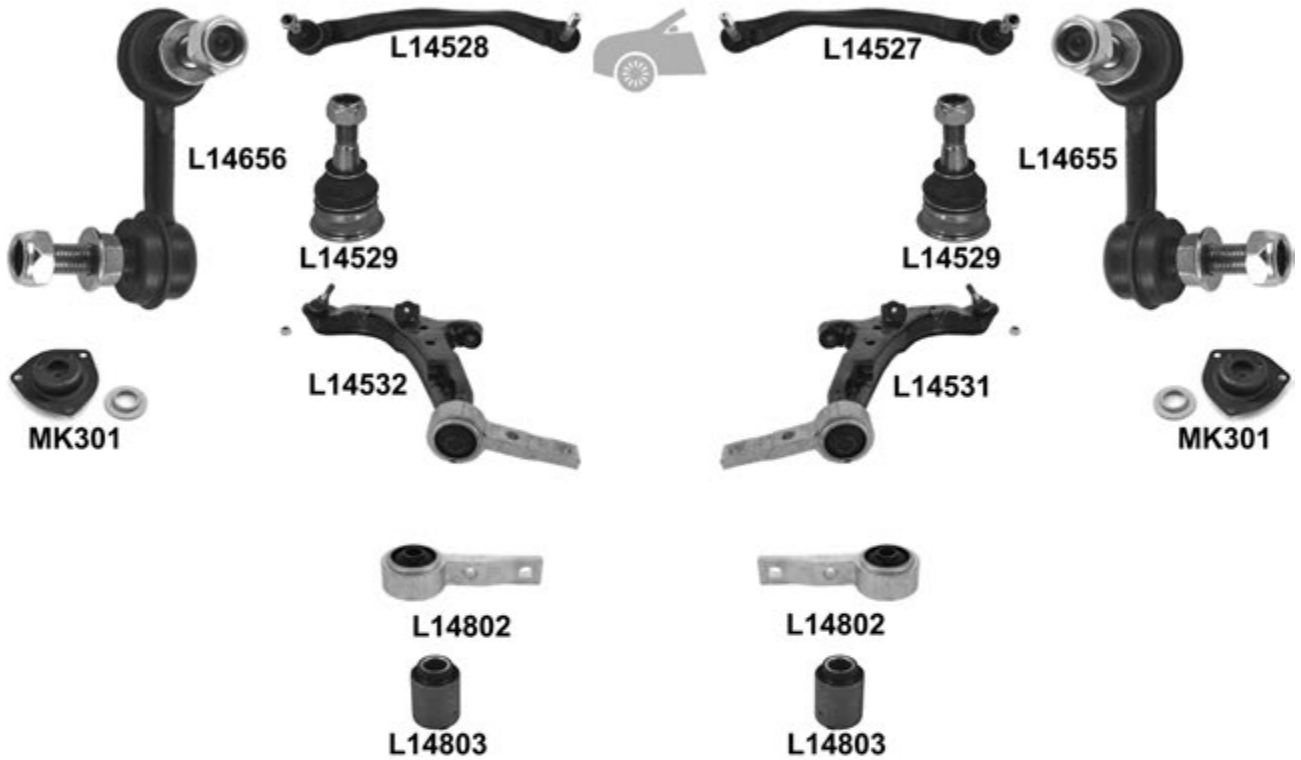
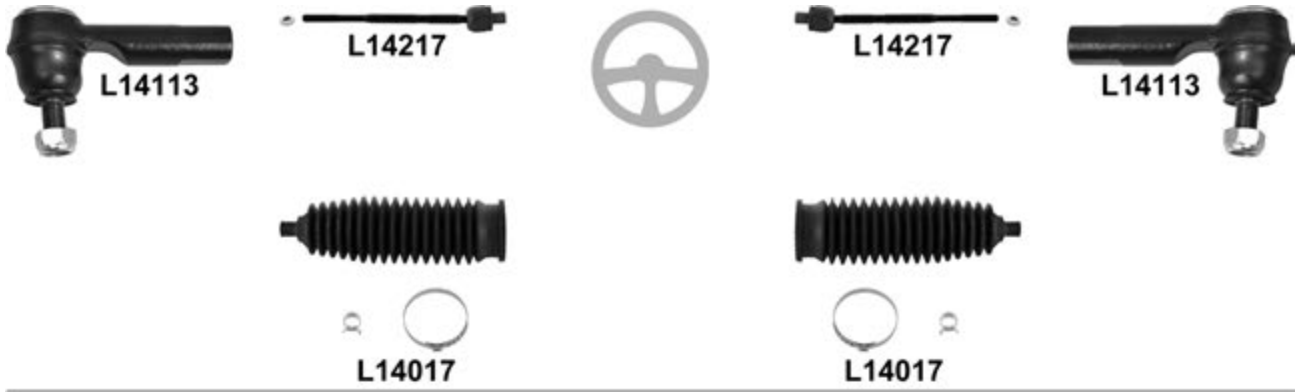

Primera (P12, WP12) 03.02 →

			←	→	Thread	Part Of	QPA	
		↔	L14113	L14113	F 12x1,25 ♂		2	48520-73J25
			L14217	L14217	M 12x1,5 / M 18x1,5 ♂	OE no. 49001-BA21A	2	
			L14017°	L14017°			2	48203-AV600
		ī		L14527			1	54524-AV601
			L14528				1	54525-AV601
		⊥	L14529	L14529			2	
		⊥	<input checked="" type="checkbox"/>	L14531			1	54500-AV606
			L14532				1	54501-AV606
		⊥▼	L14802	L14802			2	
		⊥▲	L14803	L14803			2	
				L14655			1	54618-AU000
			L14656				1	54668-AU000
			KIT	MK301	MK301		2	
		→ 10.02	L14607	L14607			2	56261-0E000
		11.02 →	L14678	L14678			2	56261-AV611
			MK298	MK298			2	

Qashqai (J10) 02.07 →
Qashqai+2 (JJ10) 02.07 →

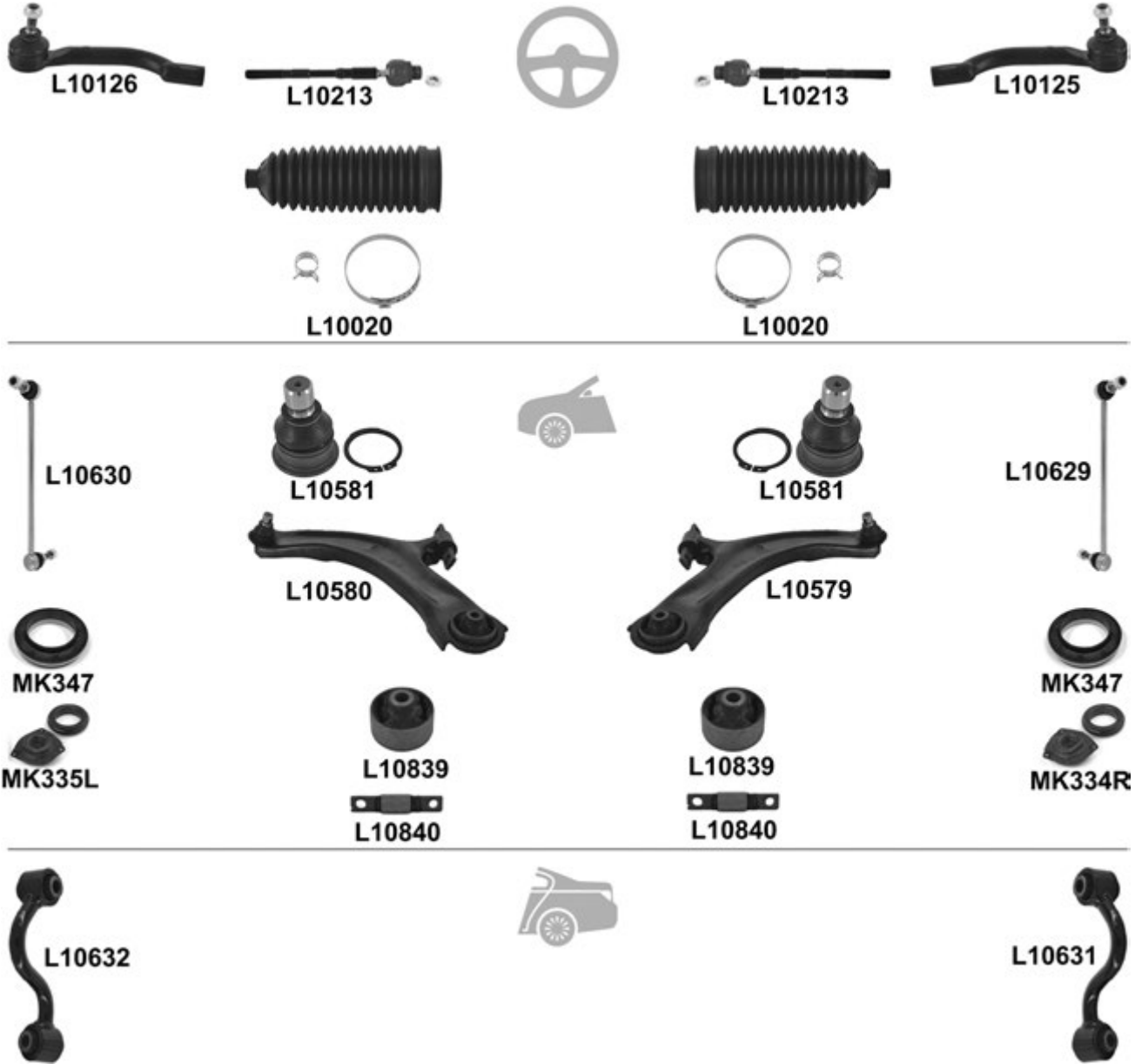

		i	←	→	Thread	Part Of	QPA	i	
⊕		↔		L10125	F 14x1,5 ∪		1	48527-JD01A	
				L10126	F 14x1,5 ∪		1	48647-JD01A	
				L10213	L10213	M 14x1,5 / M 22x1,5 ∪		2	48001-JD90B
				L10020°	L10020°			2	48203-JD01A
		↓		L10581	L10581		2		
				L10579			1	54500-JD000	
				L10580			1	54501-JD001	
				L10839	L10839		2	54570-BB00A	
				L10840	L10840		2		
				L10629			1	54618-1AA0A	
				L10630			1	54668-1AA0A	
				MK347	MK347		2	54325-AX600	
		↻		MK334R		1			
				MK335L		1			
				L10631		1	55618-JD00A		
		→ 11.13		L10632		1	55619-JD00A		

Qashqai (J11E) 02.14 →



Thread

Part Of

QPA



				L14679	L14679			2	54618-CY00A
--	--	--	--	--------	--------	--	--	---	-------------

Serena (C23) 11.92 →



L10039

L10039



Thread

Part Of

QPA

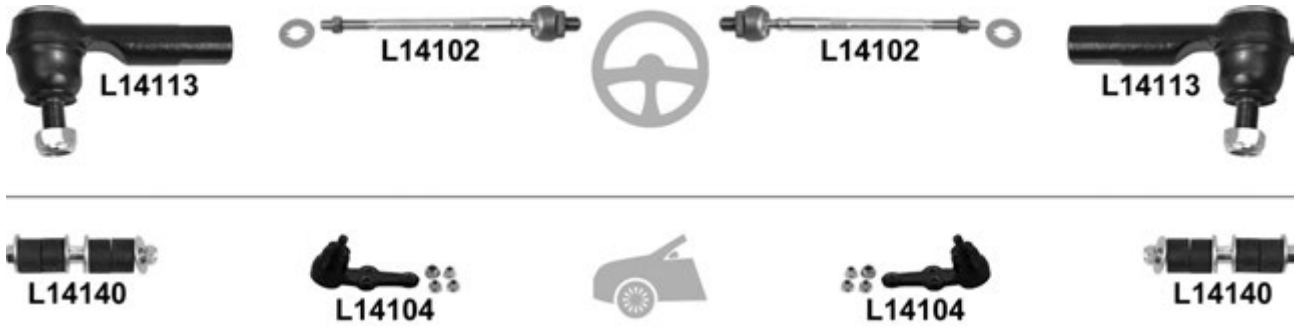

		↔		L14113	L14113	↺		2	48520-9C025
				L10039 ^o	L10039 ^o			2	48203-9C000
		⊥		<input checked="" type="checkbox"/>	L14521			1	54500-7C350
				L14522				1	54501-7C350
					L14611			1	54618-9C000
				L14612				1	54618-9C002

Sunny B11 serie 03.82 → 09.87

				←	→	Thread	Part Of	QPA	
⊕		↔		L14113	L14113	F 12x1,25 ∪		2	48520-73J25
				L14102	L14102	M 12x1,25 / M 16x1 ∪		2	48521-70A06
⊖		⊥		L14104	L14104			2	40160-01A25
				L14140	L14140			2	54618-01A00

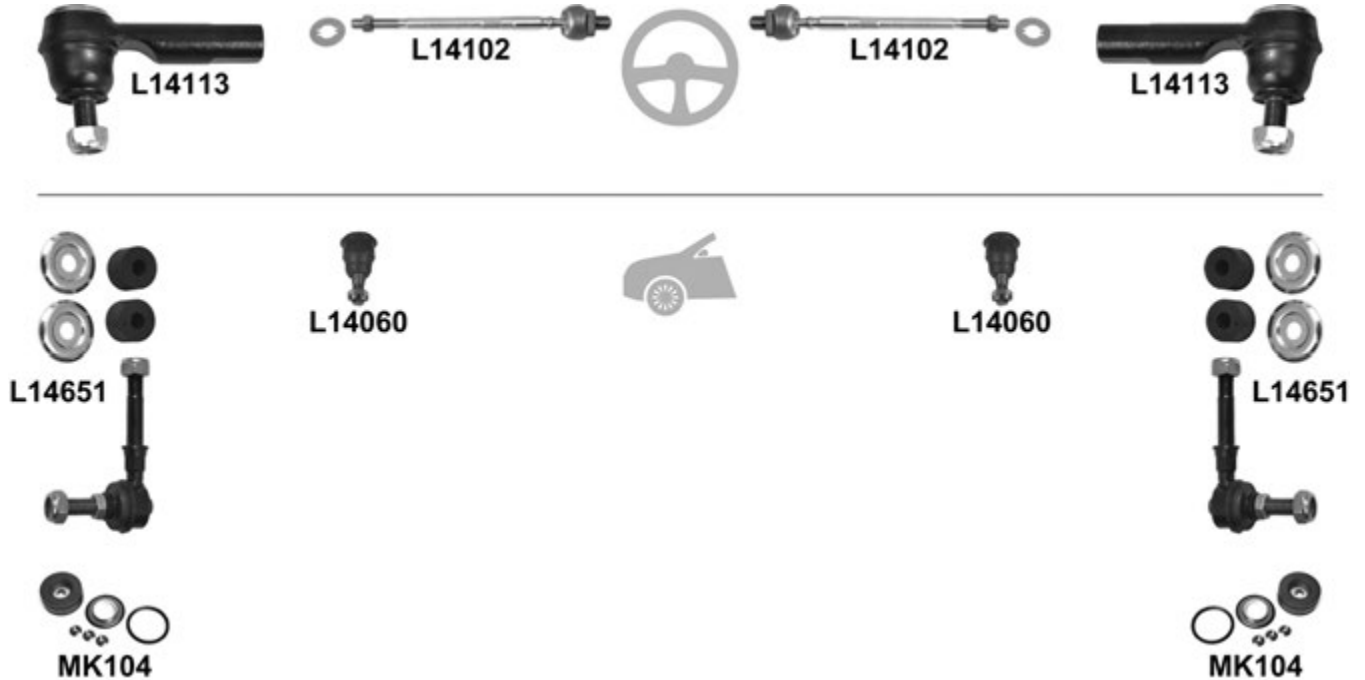
Sunny B12 serie 06.86 → 06.91

				←	→	Thread	Part Of	QPA	
⊕		↔		L14113	L14113	F 12x1,25 ∪		2	48520-50A26
				L14102	L14102	M 12x1,25 / M 16x1 ∪		2	48521-70A06
⊖		⊥		L14060	L14060			2	40160-50A00
				L14651	L14651			2	54618-50Y00
				KIT	MK104	MK104		2	

Sunny N13 serie 06.86 → 08.91

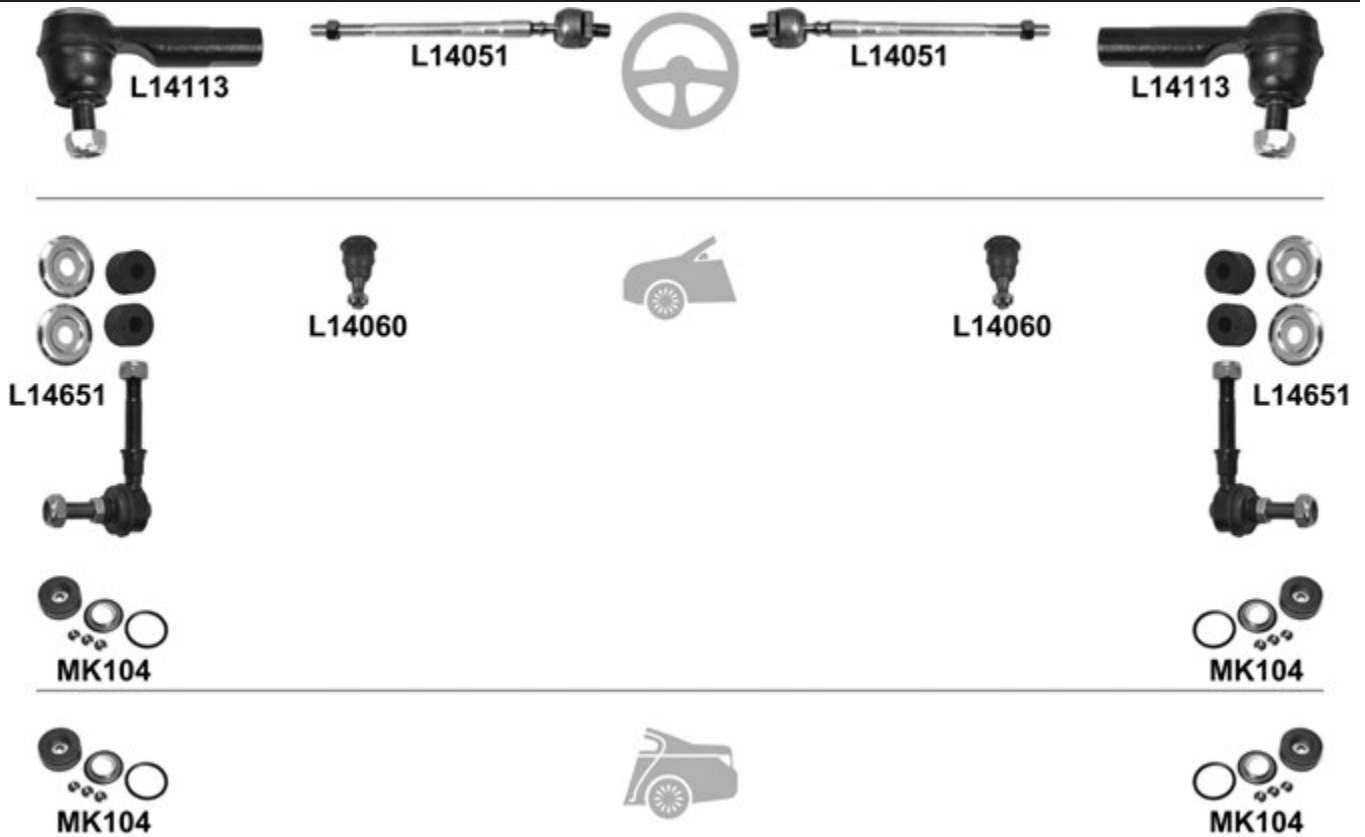

				←	→	Thread	Part Of	QPA	
				L14113	L14113	F 12x1,25 ∪		2	48520-50A26
				L14051	L14051	M 12x1,25 / M 14x1,5 ∪		2	48521-35A06
				L14060	L14060			2	40160-50A00
				L14651	L14651			2	54618-50Y00
				KIT	MK104	MK104			2
				KIT	MK104	MK104		2	

Sunny N14 serie 10.90 → 12.95



		i	←	→	Thread	Part Of	QPA	i
		↔	L14113	L14113	F 12x1,25 ☺		2	48520-73J25
		↓	L14509	L14509			2	40160-50Y20
			L14651	L14651			2	54618-50Y00
		(-) 2.0 Gti-R	KIT	MK105	MK105		2	54320-50Y12 S1
			KIT	MK130	MK130		2	55320-50Y12

Sunny Y10 serie 06.91 →



				←	→	Thread	Part Of	QPA	
		↔		L14113	L14113	U		2	48520-73J25
		↓		L14509	L14509			2	40160-50Y20
				L14651	L14651			2	54618-50Y00
			KIT	MK105	MK105			2	54320-50Y12 S1

Terrano 4WD (D21) 08.85 → 12.92



				←	→	Thread	Part Of	QPA	
		↔↔↔↔		L14625	L14625	M 16x1,5 U		2	48520-31G25
		↔↔↔↔		L14626	L14626	M 16x1,5 U		2	48570-31G25
		↑		L14620	L14620			2	40110-01G25
		↓		L14624	L14624			2	40160-93G25
				L14210	L14210			2	54630-02E0A

Terrano 4WD (D21) 01.93 → 12.95



L14126



L14125



L14125



L14126



L14210



L14620



L14620



L14210



L14624



L14624



Thread

Part Of

QPA



				←	→	Thread	Part Of	QPA		
		↔↔			L14125	M 16x1,5 ♂		1	48520-61G25	
				L14126	M 16x1,5 ♂		1	48570-61G25		
		↔↔		L14126	M 16x1,5 ♂		1	48570-61G25		
				L14125	M 16x1,5 ♂		1	48520-61G25		
		↑		L14620	L14620			2	40110-01G25	
		↓		L14624	L14624			2	40160-93G25	
				L14210	L14210			2	54630-02E0A	

Terrano 4WD (R20) 02.93 →

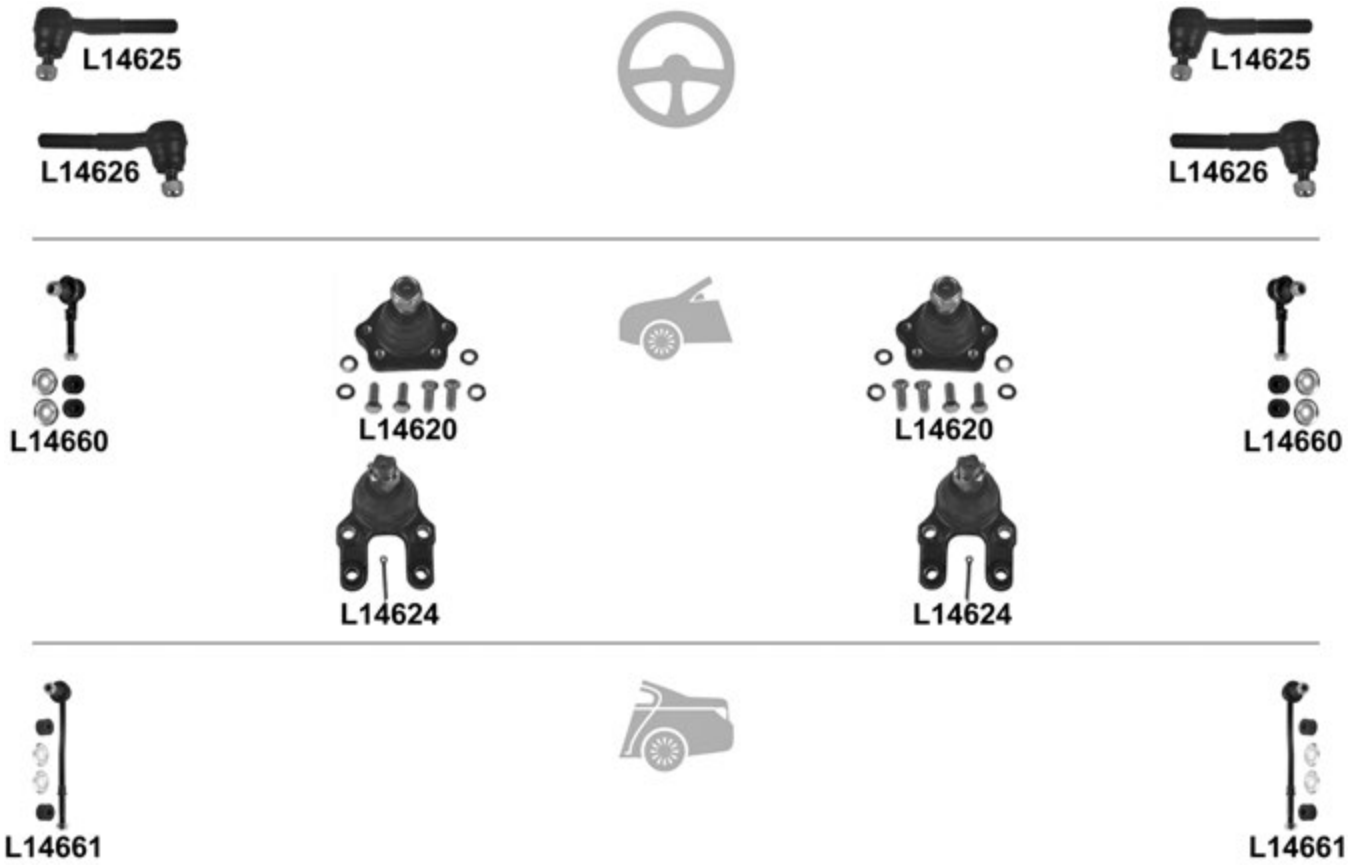

				←	→	Thread	Part Of	QPA		
		↔↔↔↔		L14625	L14625	M 16x1,5 ☺		2	48520-7F000	
		↔↔↔↔		L14626	L14626	M 16x1,5 ☺		2	48570-7F001	
		↕		L14620	L14620			2	40110-0F000	
		⊥		L14624	L14624			2	40160-0F000	
				L14660	L14660			2	54618-0F000	
				L14661	L14661			2	56260-0F001	

Tiida (C11X, SC11X) 09.07 →

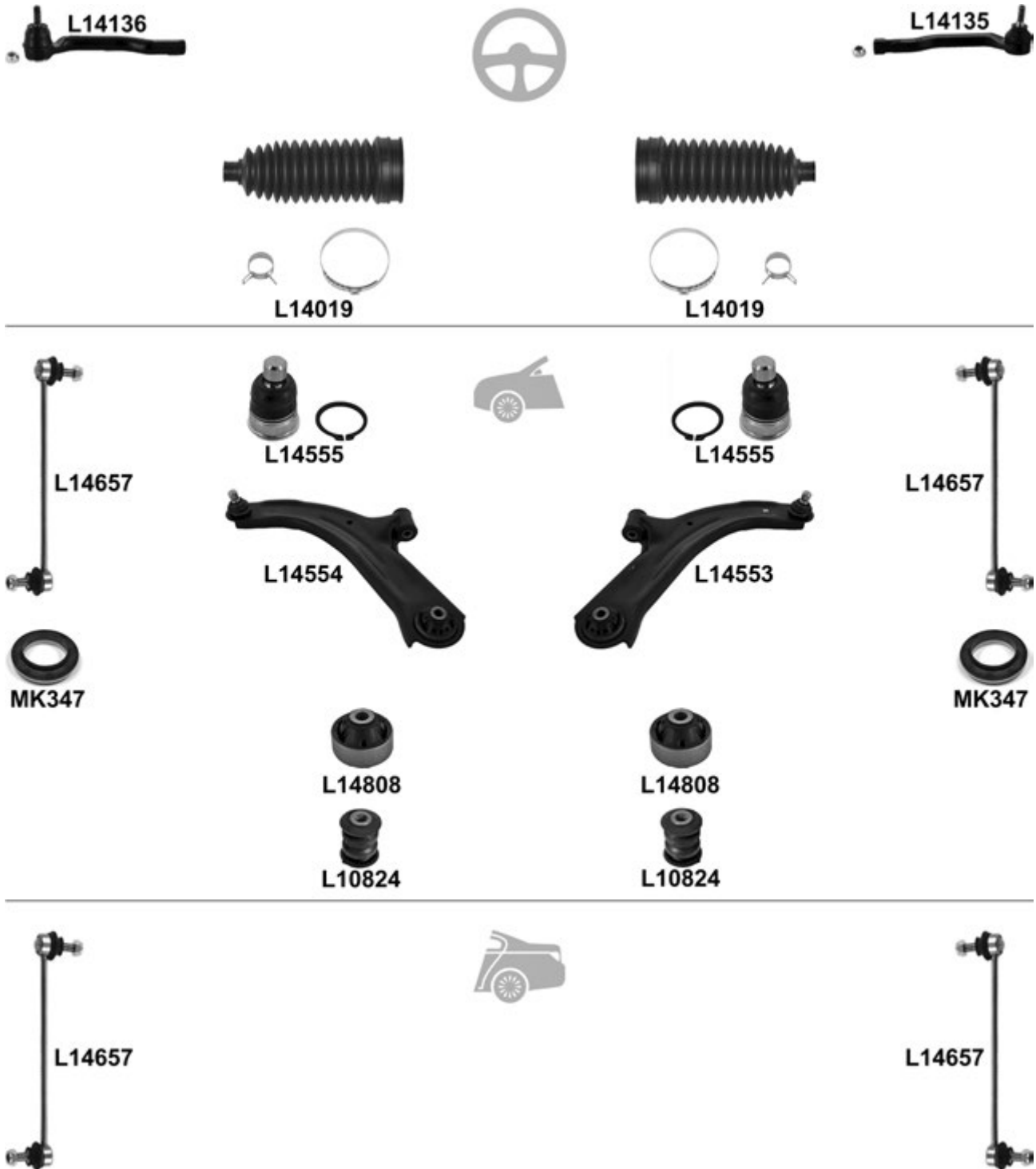

			←	→	Thread	Part Of	QPA			
				L14135	F 12x1,25 ∩		1	D8520-EW00A		
				L14136	F 12x1,25 ∩		1	D8640-EW00A		
				L14019 ⁰	L14019 ⁰		2	48203-3U025		
				L14555 ⁰	L14555 ⁰			L14553/L14554	2	
				<input checked="" type="checkbox"/>	L14553 ⁰				1	54500-EL000
				L14554 ⁰					1	54501-EL000
				L14808 ⁰	L14808 ⁰		L14553/L14554		2	
				L10824	L10824			L14553/L14554	2	
				L14657	L14657				2	54618-AX600
				MK347	MK347		2	54325-AX600		
				L14657	L14657			2	54618-AX600	

Urvan E21, E22 serie 12.78 → 1980
Urvan E23 serie 08.80 → 11.88



Thread

Part Of

QPA



		↑				Thread	Part Of	QPA	
				←	→				
		↑		L14620	L14620			2	40110-01G26
		↓			L14622			1	40160-48W25

Vanette C120 serie 06.81 → 12.87



Thread

Part Of

QPA



		↑				Thread	Part Of	QPA	
				←	→				
		↑		L14730	L14730			2	40110-G5100
		↓		L14740	L14740			2	40160-G5100

Vanette C22 serie 09.86 →



L14116



L14115



L14118



L14117



L14730



L14730



L14740



L14740

			←	→	Thread	Part Of	QPA	
		↔		L14115	∩		1	48520-G5101
				L14116	F 14x1,5 ∩		1	48640-G5101
		→←		L14117	F 14x1,5 ∩		1	48521-G5101
				L14118	F 14x1,5 ∩		1	48641-G5101
		↑	L14730	L14730	F 14x1,5		2	40110-G5100
		↓	L14740	L14740				2

Vanette HC23 serie 01.95 →



L14113



L14113



L14612



L14522



L14521



L14611

			←	→	Thread	Part Of	QPA	
		↔	L14113	L14113	∩		2	48520-9C025
		↓	<input checked="" type="checkbox"/>	L14521			1	54500-7C350
				L14522			1	54501-7C350
					L14611			1
			L14612				1	54618-9C002

X-Trail T30 07.01 →



			←	→	Thread	Part Of	QPA	
		↔	L14128	L14128	F 14x1,5 ♂		2	48520-0P725
			L14216	L14216	M 14x1,5 / M 16x1 ♂		2	48521-8H300
		↓	<input checked="" type="checkbox"/>	L14541			1	54500-8H31A
				L14542			1	54501-8H31A
					L14673		1	54618-8H300
					L14674		1	54668-8H300
			KIT		MK310	MK310	2	54320-8H310
		→ 09.03	L14608	L14608			2	56261-90J01
		10.03 →	L14677	L14677			2	56261-EQ000

X-Trail (T31) 06.07 →

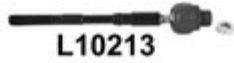

L10213

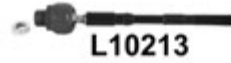

L10213



L10020



L10020

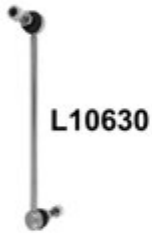

L10630



L10581



L10581

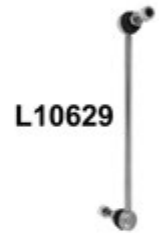

L10629



L10580



L10579



MK335L



MK334R



MK347



L10839



L10840



L10839



L10840



MK347



L10632



L10631



Thread

Part Of

QPA



⊕				L10213	L10213	M 14x1,5 / M 22x1,5 ⊕		2	D8521-JG00A
				L10020°	L10020°			2	48203-JD01A
⊖		⊥		L10581	L10581			2	
		⊥		<input checked="" type="checkbox"/>	L10579			1	54500-JG000
				L10580				1	54501-JG001
		⊥↘		L10839	L10839			2	54570-BB00A
		⊥↗		L10840	L10840			2	
					L10629			1	54618-1AA0A
				L10630				1	54668-1AA0A
⊕			→ 01.12	KIT	MK334R			1	54320-JG02B
				MK335L				1	54321-JG02B
				MK347	MK347			2	54325-AX600
⊖					L10631			1	55618-JD00A
				L10632				1	55619-JD00A

X-Trail (T32) 10.14 →

		i	←	→	Thread	Part Of	QPA	i
					L10629		1	54618-1AA0A
		(-) Grade EA3/S2			L10630		1	54668-1AA0A
					L10631		1	55618-JD00A
					L10632		1	55619-JD00A

100 NX B13 serie 03.90 → 10.94

		i	←	→	Thread	Part Of	QPA	i	
		↔			L14113	L14113	F 12x1,25 ∪	2	48520-73J25
					L14204	L14204	M 12x1,25 / M 16x1 ∪	2	48521-50Y00
		⊥			L14509	L14509		2	40160-50Y20
					L14651	L14651		2	54618-50Y00
					KIT	MK105	MK105	2	54320-50Y12
					KIT	MK130	MK130	2	55320-57C10

200 SX S13 serie 07.88 → 11.93



		← →		Thread	Part Of	QPA	
⊕	↔	↔	↔	L14113 L14113 F 12x1,25 ∪		2	48520-50A26
	↔	↔	↔	L14102 L14102 M 12x1,25 / M 16x1 ∪		2	48521-70A06

OPEL / VAUXHALL

Adam (P08) 10.12 →

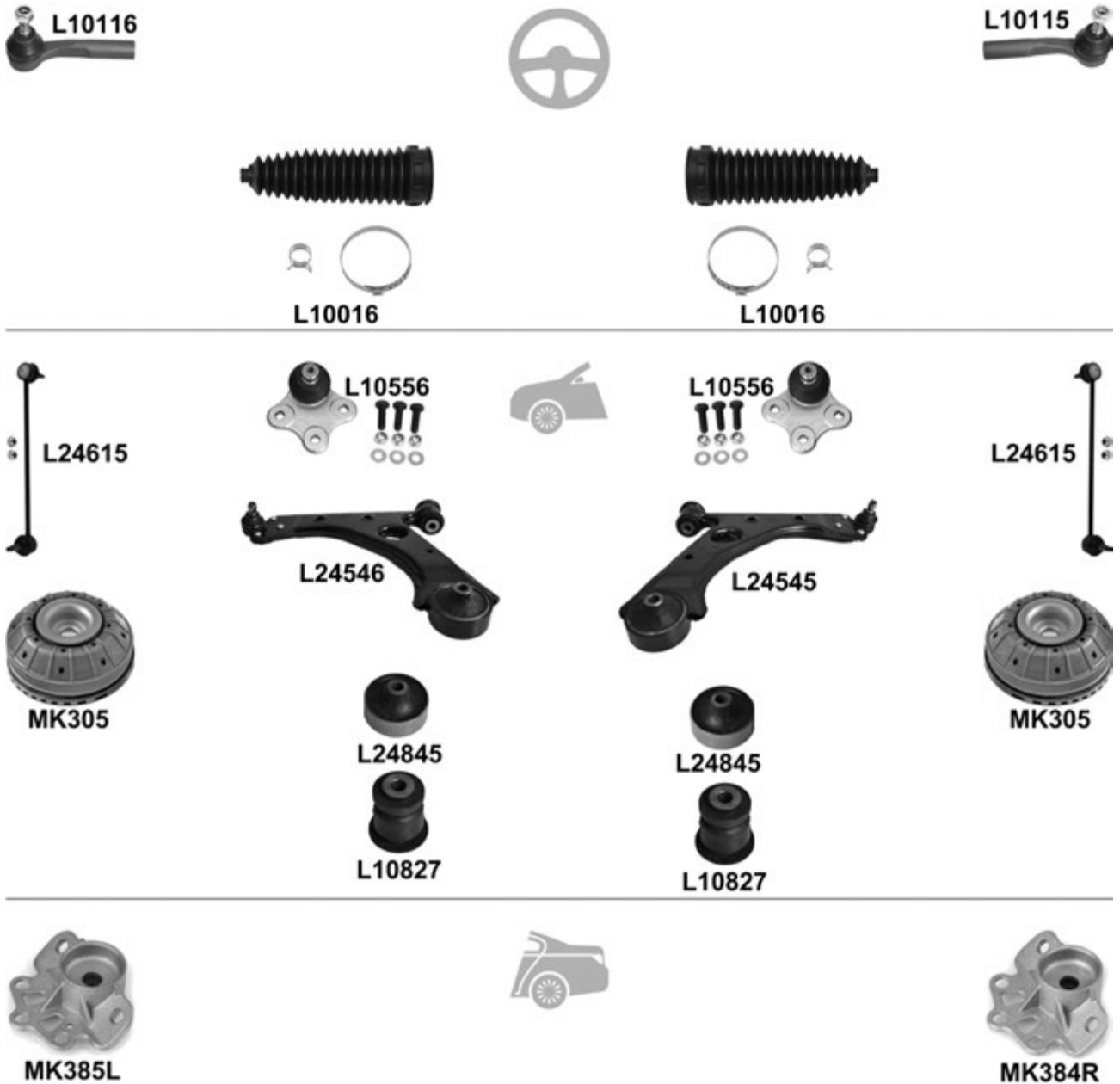

		i	←	→	Thread	Part Of	QPA	i	
		↔		L10115	F 14x1,5 U		1	1603545	
				L10116	F 14x1,5 U		1	1603544	
				L10016	L10016			2	1609347
		↓		L10556	L10556		2	352087	
			<input checked="" type="checkbox"/>		L24545			1	5352038
				L24546				1	5352039
				L24845	L24845			2	352947
				L10827	L10827			2	352864
				L24615 ⁰	L24615 ⁰			2	350233
				KIT	MK305	MK305		2	344653
						MK384R		1	55703318
					MK385L		1	55703317	

Agila (H00) 09.00 →

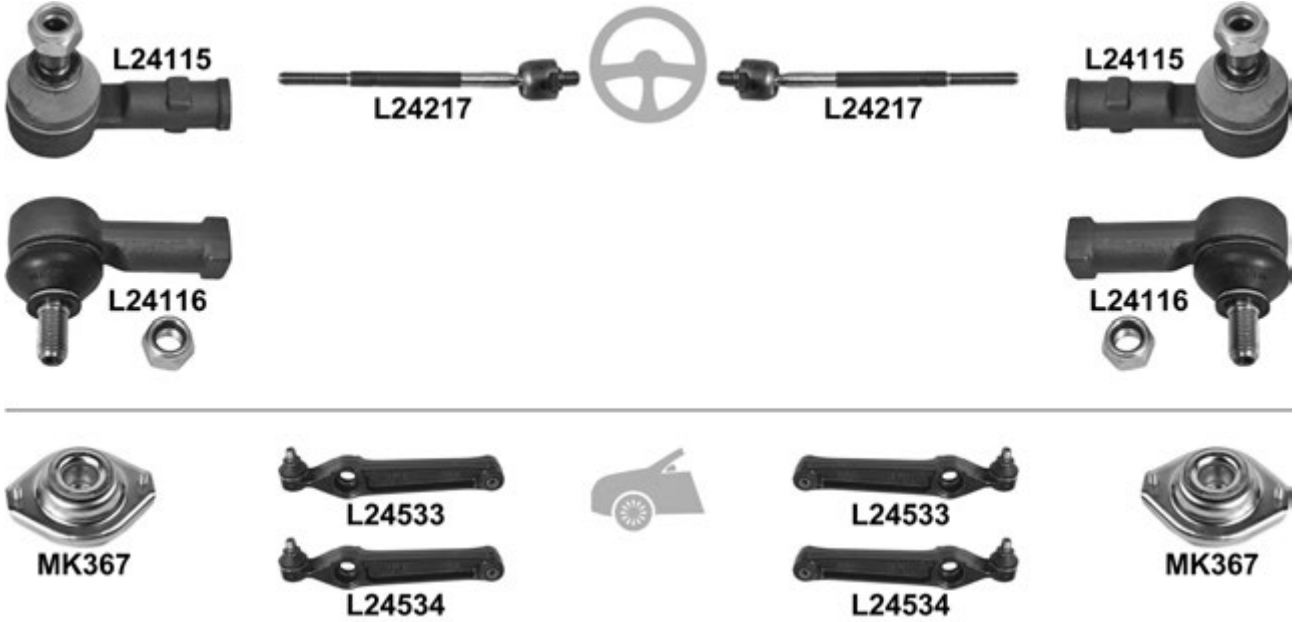

						←	→	Thread	Part Of	QPA	
			→ ch. 1G075421	L24115	L24115			F 12x1,25 ∪		2	4705655
			ch. 1G075422 →	L24116	L24116			F 12x1,25 ∪		2	4705716
				L24217	L24217			M 12x1,25 / M 14x1,5 ∪		2	4701745
			ch. → 1G075421	L24533	L24533					2	4705172
			ch. 1G075422 →	L24534	L24534					2	4707280
				MK367	MK367					2	

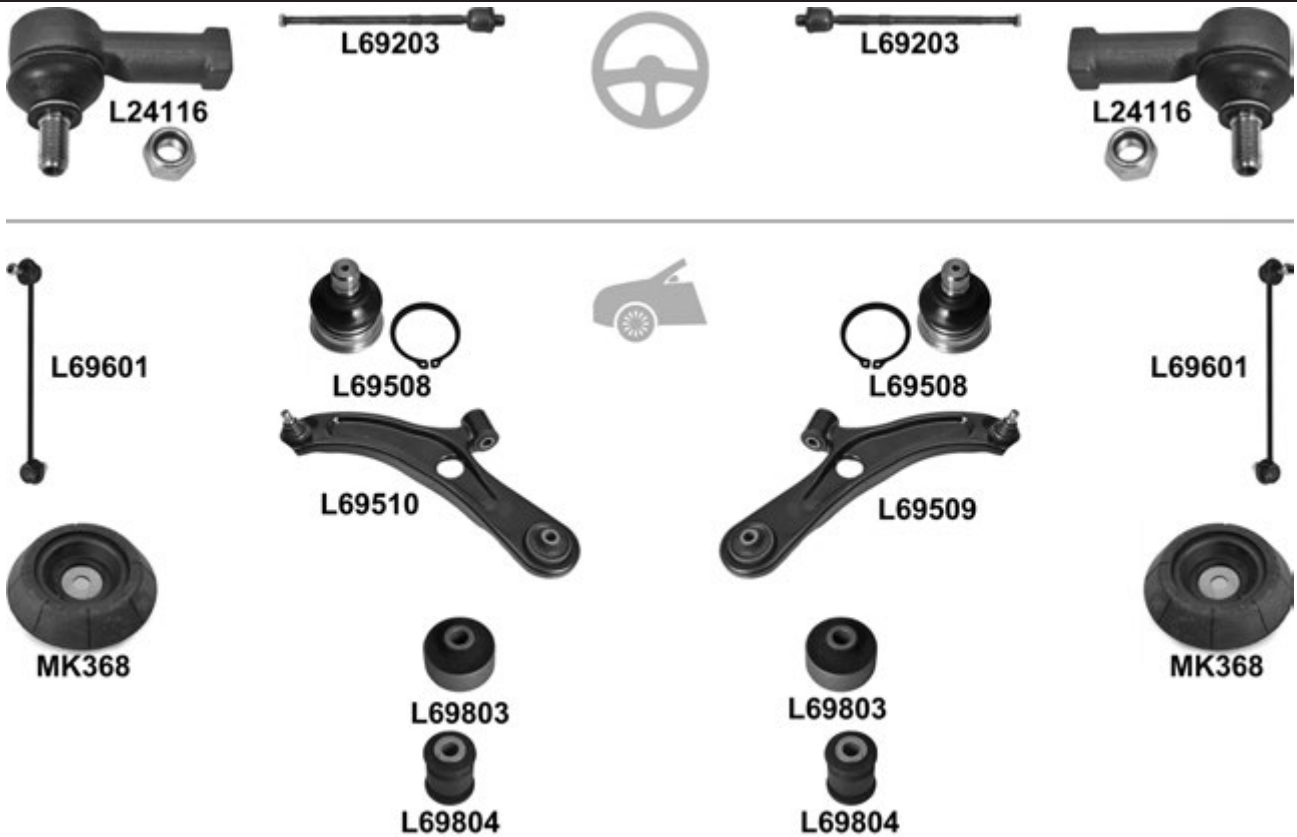
Agila 09.07 →

				←	→	Thread	Part Of	QPA	
		↔		L24116	L24116	∪		2	4709195
				L69203	L69203	M 12x1,25 / M 18x1,5 ∪		2	4709161
		↓		L69508	L69508			2	4708304
		↓	<input checked="" type="checkbox"/>		L69509			1	4708299
				L69510				1	4708300
		↓ ▾		L69803	L69803			2	
		↓ ▲		L69804	L69804			2	4708302
				L69601	L69601			2	4709702
				MK368	MK368			2	

Ampera 11.11 →



				← → Thread		Part Of	QPA		
⊕		↔		L24155	L24155	F 16x1,5 ∪		2	1609026
				L24236	L24236	M 16x1,5 / M 16x1,5 ∪		2	1609027
⊖		⊥			L21515			1	352493
				L21516				1	352492
		⊥ ▲		L24848 ⁰	L24848 ⁰			2	352866
				L10648	L10648			2	350617
				KIT	MK381	MK381		2	344573

Antara 05.06 →

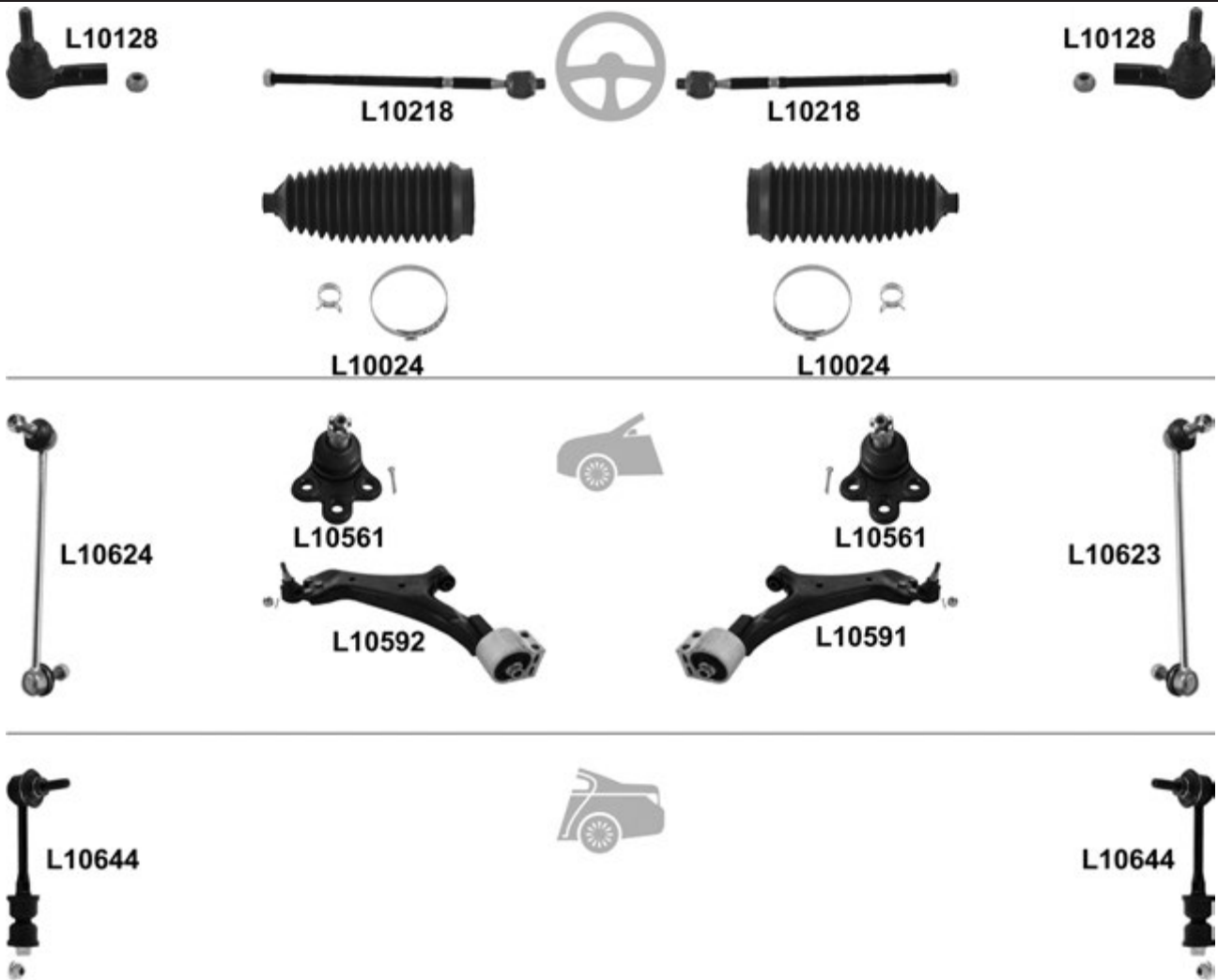

		i		← → Thread		Part Of	QPA	i
⊕		↔	→ 07.10 ch. → AB999999 ch. → A3999999	L10128	L10128	F 14x1,5 ∪	2	4803429
				L10218	L10218	M 14x1,5 / M 16x1,5 ∪	2	
			→ 07.10 ch. → AB999999 ch. → A3999999	L10024 ⁰	L10024 ⁰		2	4803246
🚗		⊥		L10561	L10561		2	96852964
		⊥	→ 07.10 ch. → AB999999 ch. → A3999999	<input checked="" type="checkbox"/>	L10591		1	4812870
				L10592			1	4810931
					L10623		1	96996451
				L10624			1	96996450
🚗			→ 07.10 ch. → AB999999 ch. → A3999999	L10644	L10644		2	4804642

Arena (TBH, TB, TF) 03.98 → 08.01



				←	→	Thread	Part Of	QPA	i
				L2572	L2572	M 14x1,5 U		2	4403661
				L2574	L2574			2	4403641

Ascona A 10.70 → 08.75

Manta A 10.70 → 08.75



				←	→	Thread	Part Of	QPA	i
				L0027	L0027			2	322506

Ascona B 09.75 → 08.81
Manta B 09.75 → 08.88

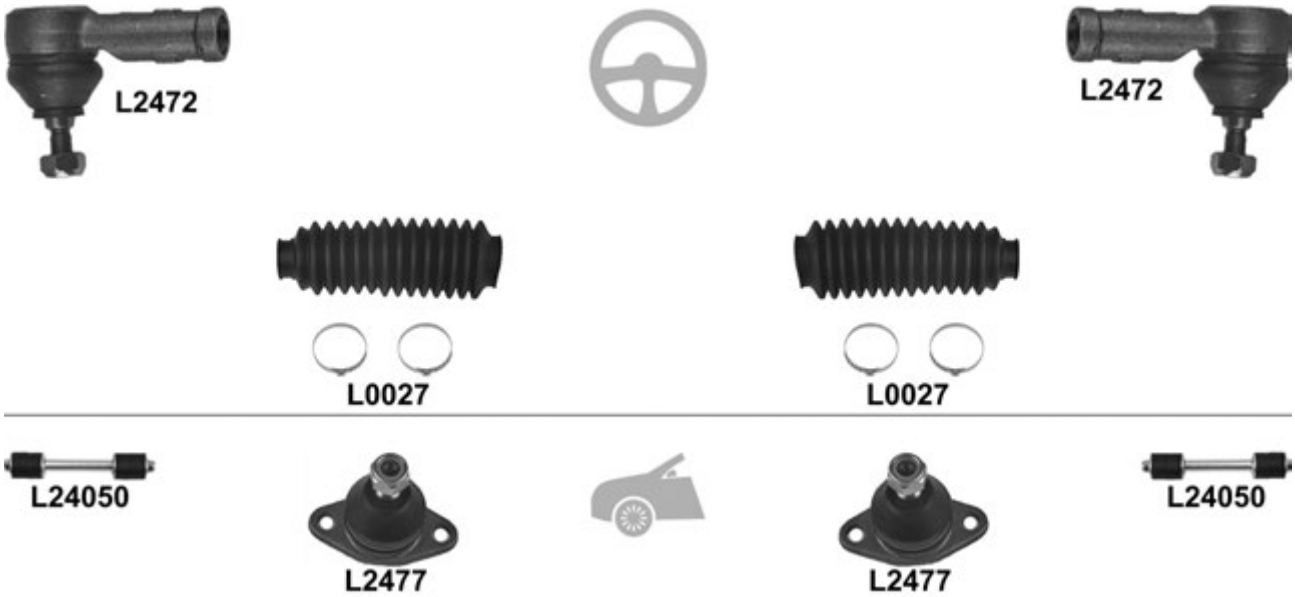

		i		←	→	Thread	Part Of	QPA	i
		↔		L2472	L2472	F 14x1,5 U		2	324120
				L0027	L0027			2	322506
		↑		L2477	L2477			2	310815
				L24050	L24050			2	1603150

Ascona C 09.81 → 10.88

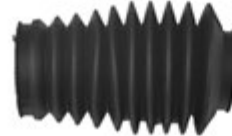
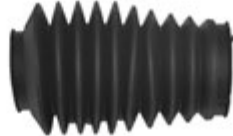
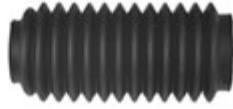

Ascona C 09.81 → 10.88

				←	→	Thread	Part Of	QPA	
		↔			L24151	F 16x1,5 ♂		1	324038
					L24150	F 16x1,5 ♂		1	324039
					L24019	L24019		2	322575
						L24153		1	
					L24152			1	
					L0028	L0028		2	902828
				L24026	L24026		2	1609073	
		⊥			L24505	L24505		2	1603167
		⊥		<input checked="" type="checkbox"/>		L24509		1	352040
					L24510			1	352039
		⊥ ▲ ▼			L24834	L24834		4	352323
				L24040	L24040		2	1603149	
			ch. → J 1189306		L24820	L24820	Hub carrier	2	402642
			ch. J 1189307 →		L24821	L24821	Hub carrier	2	402645

Astra F 09.91 → 09.98

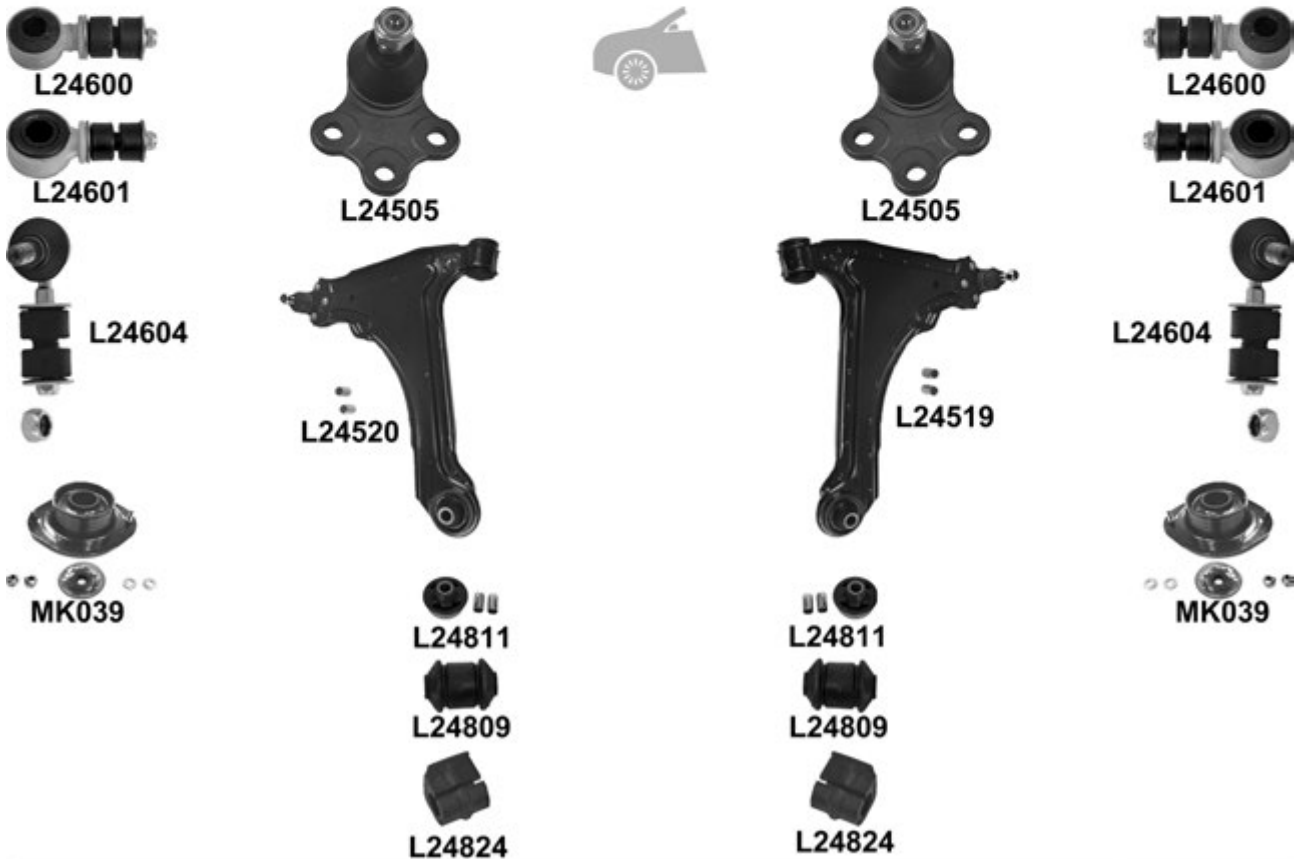
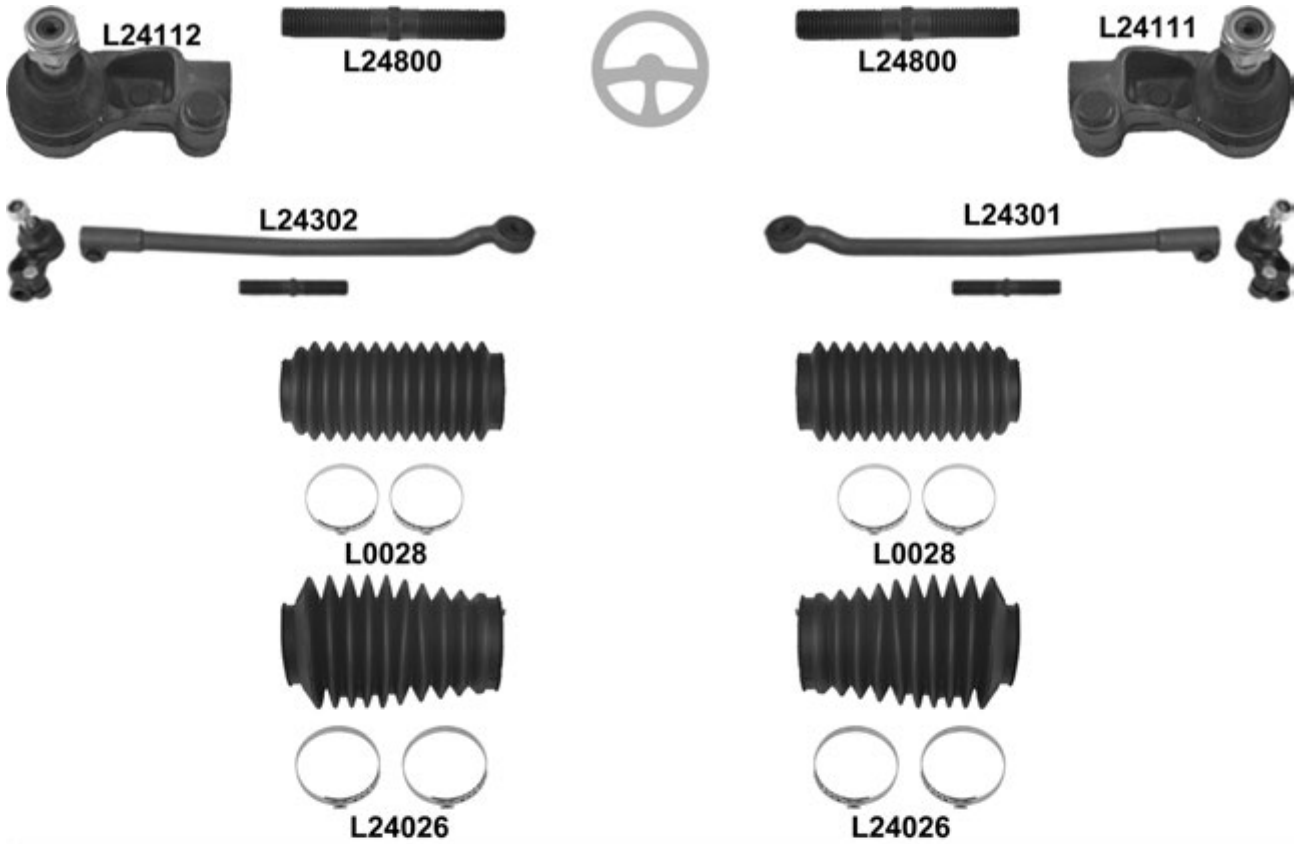

Astra F 09.91 → 09.98

		i		←	→	Thread	Part Of	QPA	i	
					L24111	F 16x2 U		1	324056	
					L24112	F 16x2 U		1	324055	
					L24800	L24800			2	322577
						L24301		OE no. 324056 / 322577 / 322146	1	
				L24302			OE no. 324055 / 322577 / 322147	1		
					L0028	L0028			2	902828
			ZF	L24026	L24026			2	1609073	
					L24505	L24505		2	1603167	
				<input checked="" type="checkbox"/>		L24519		1	5352000	
					L24520		1	5352001		
					L24811	L24811		2	352356	
			ø 12mm		L24809	L24809		2	352300	
			ø 18mm		L24600	L24600		2	350261S	
			22mm		L24601	L24601		2	350260S	
					L24604	L24604		2	350263	
			22mm		L24824	L24824		Anti-roll bar	2	350078
				KIT	MK039	MK039			2	344517S
				L24821	L24821		Hub carrier	2	402645	

Astra G All Models 02.98 →

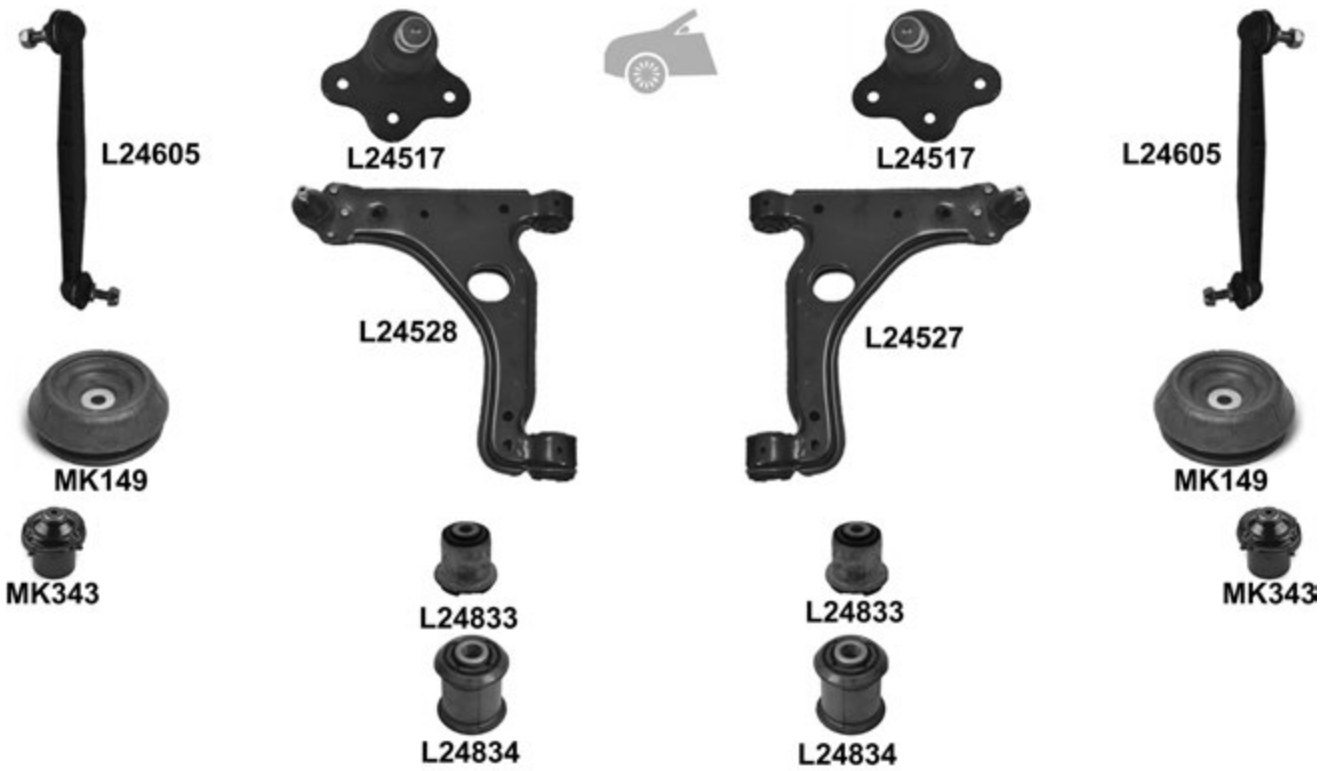
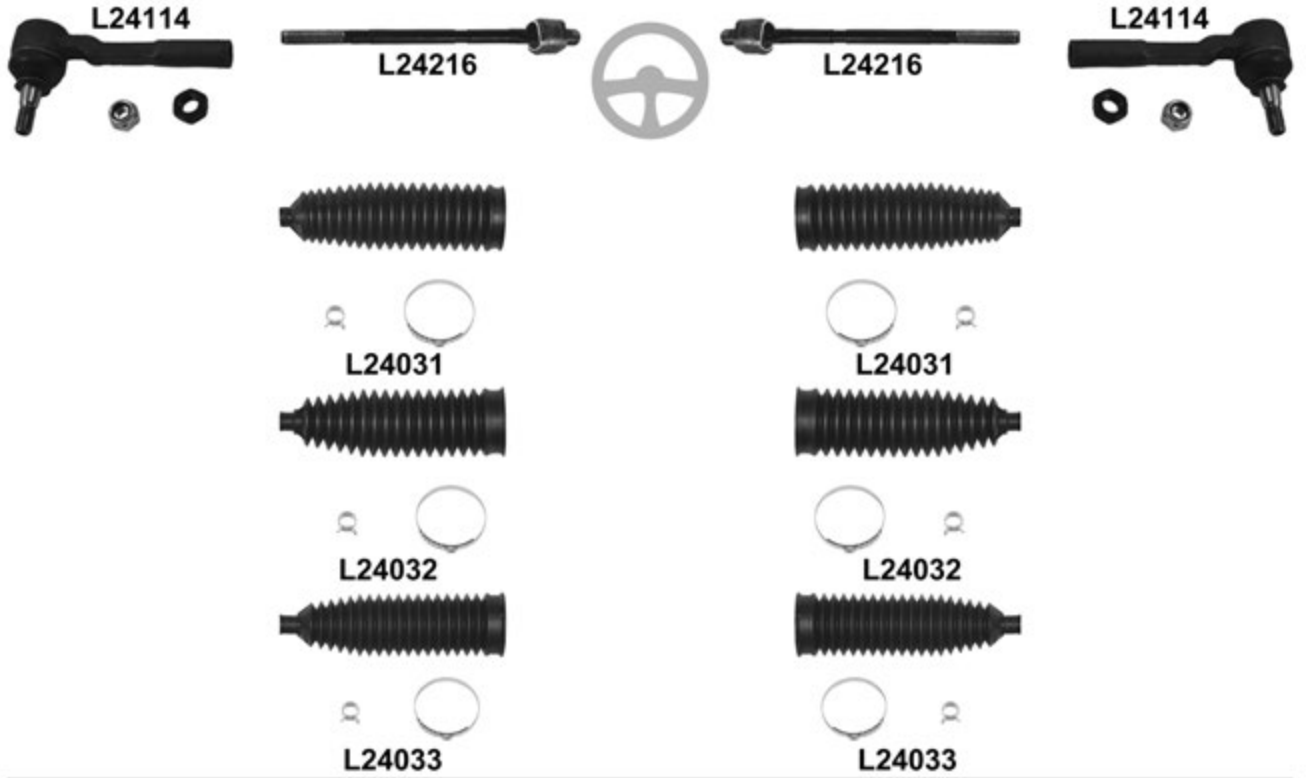

Astra G All Models 02.98 →

			←	→	Thread	Part Of	QPA		
		↔			F 14x1,5 U		2	1603215	
							2	1603216	
							2	1609109	
							2	1609113	
							2	1609356	
		↓					2	352829	
		↓	(-) SP	<input checked="" type="checkbox"/>			1	5352017	
							1	5352016	
		↓	12 x 45/48 x 60mm					2	352365
		↑	12 x 36 x 60mm					2	352364
							2	350611	
			(-) MK343	KIT	MK149	MK149		2	344525
					MK343	MK343		2	312510
		▲				Hub carrier	2	5402638	

Astra (H) 03.04 →
 Astra GTC (H) 03.05 →
 Astra Caravan (H) 08.04 →

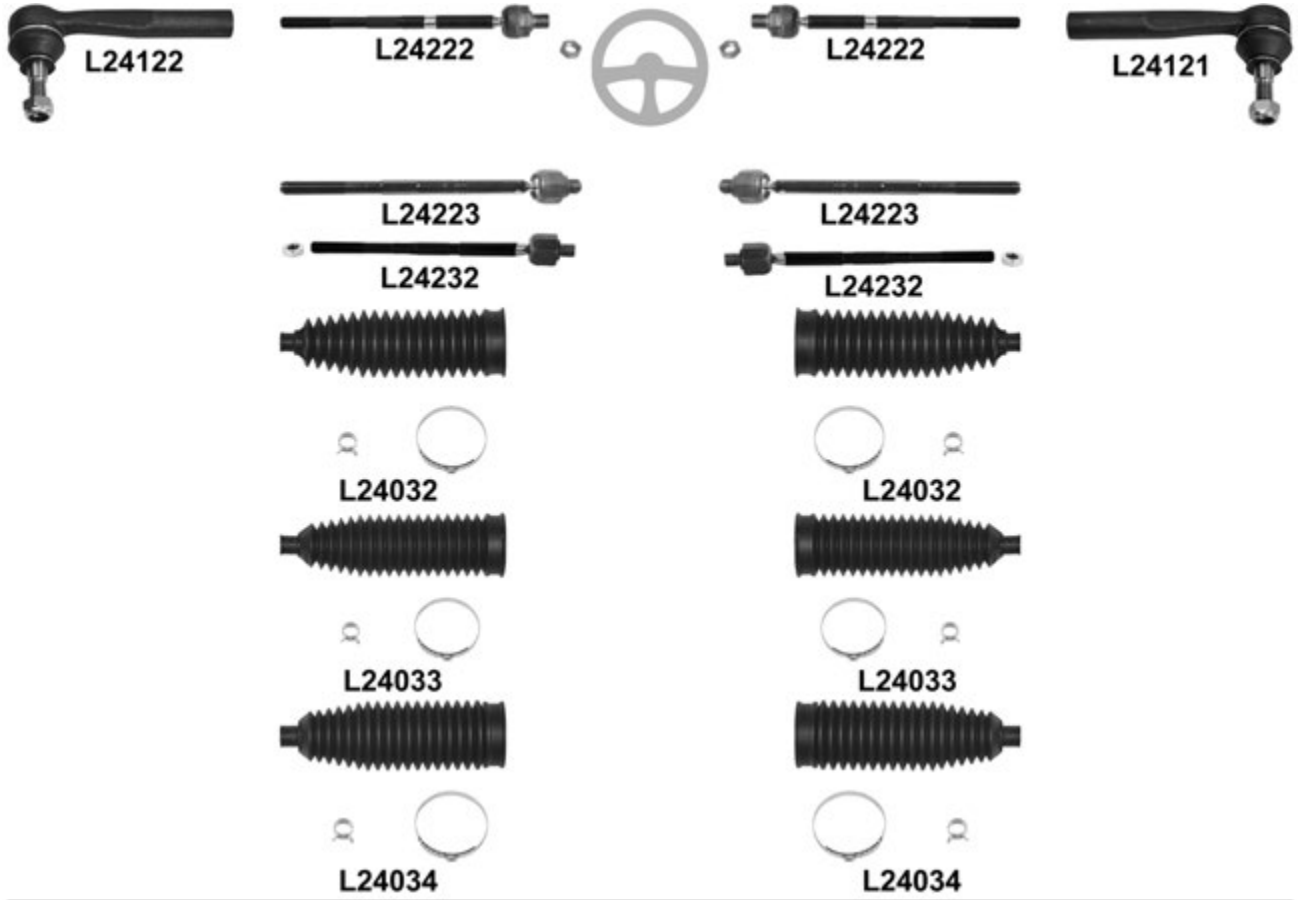

Astra (H) 03.04 →
 Astra GTC (H) 03.05 →
 Astra Caravan (H) 08.04 →

				←	→	Thread	Part Of	QPA		
		↔		L24121		F 14x1,5 ☺		1	1603257	
				L24122		F 14x1,5 ☺		1	1603258	
				(-) SP , TRW	L24222	L24222	M 14x1,5 / M 18x1,5 ☺		2	1603256
				(-) SP , ZF	L24223	L24223	M 14x1,5 / M 16x1,5 ☺		2	1603264
				SP , PR NR1, ZF	L24232	L24232	M 14x1,5 / M 16x1,5		2	1603265
				ch. → 72094719, TRW L= 200, ø 13mm, Ø 52mm	L24032 ⁰	L24032 ⁰			2	1609113
				ch. 72094720 →, TRW	L24033 ⁰	L24033 ⁰			2	1609356
				ZF, L= 190mm, ø 13mm, Ø 49mm	L24034 ⁰	L24034 ⁰			2	1609153
			↓		L24517	L24517			2	352829
				<input checked="" type="checkbox"/>	L24547				1	5352030
		↓			L24548				1	5352029
				12 x 46 x 60mm	L24840	L24840			2	352324
		↓	▲	12 x 36 x 60mm	L24834	L24834			2	352364
				(-) IDS chassis	L24605	L24605			2	350614
				IDS chassis	L24609	L24609			2	350613
					MK342	MK342			2	344665

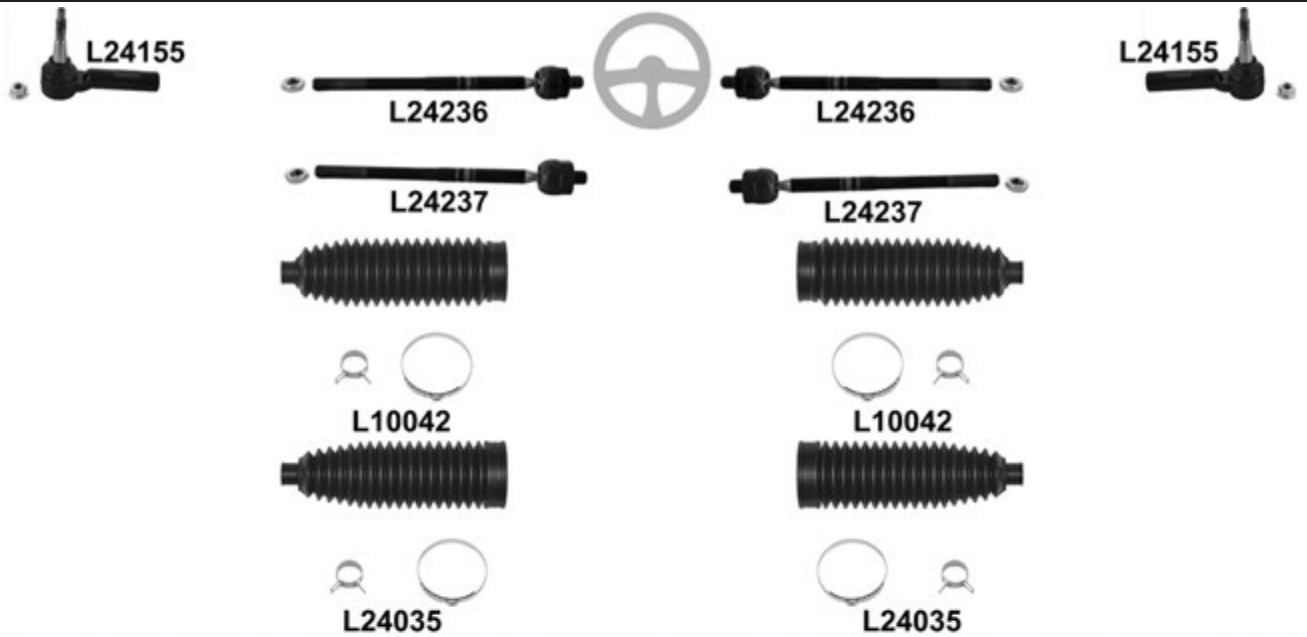

				← → Thread		Part Of	QPA	i	
⊕		↔		L24155	L24155	F 16x1,5 U		2	1609026
			Electric , PR NJ1, (-) Active	L24236	L24236	M 16x1,5 / M 16x1,5 U		2	1609027
			Electric , PR NJ0, Active	L24237	L24237	M 16x1,5 / M 16x1,5 U		2	1609029
			Hydraulic , ø 16mm, Ø 49mm, L= 190mm	L10042 ⁰	L10042 ⁰			2	13278357
			Electric , ø 16mm, Ø 53,5mm, L= 194mm	L24035 ⁰	L24035 ⁰			2	13354440
		⊥			L21515			1	352493
				L21516				1	352492
				L24848 ⁰	L24848 ⁰			2	352866
			(-) IDS chassis	L10648	L10648			2	350617
			IDS chassis	L24610	L24610			2	350618
				KIT	MK381	MK381			2

Calibra 06.90 →

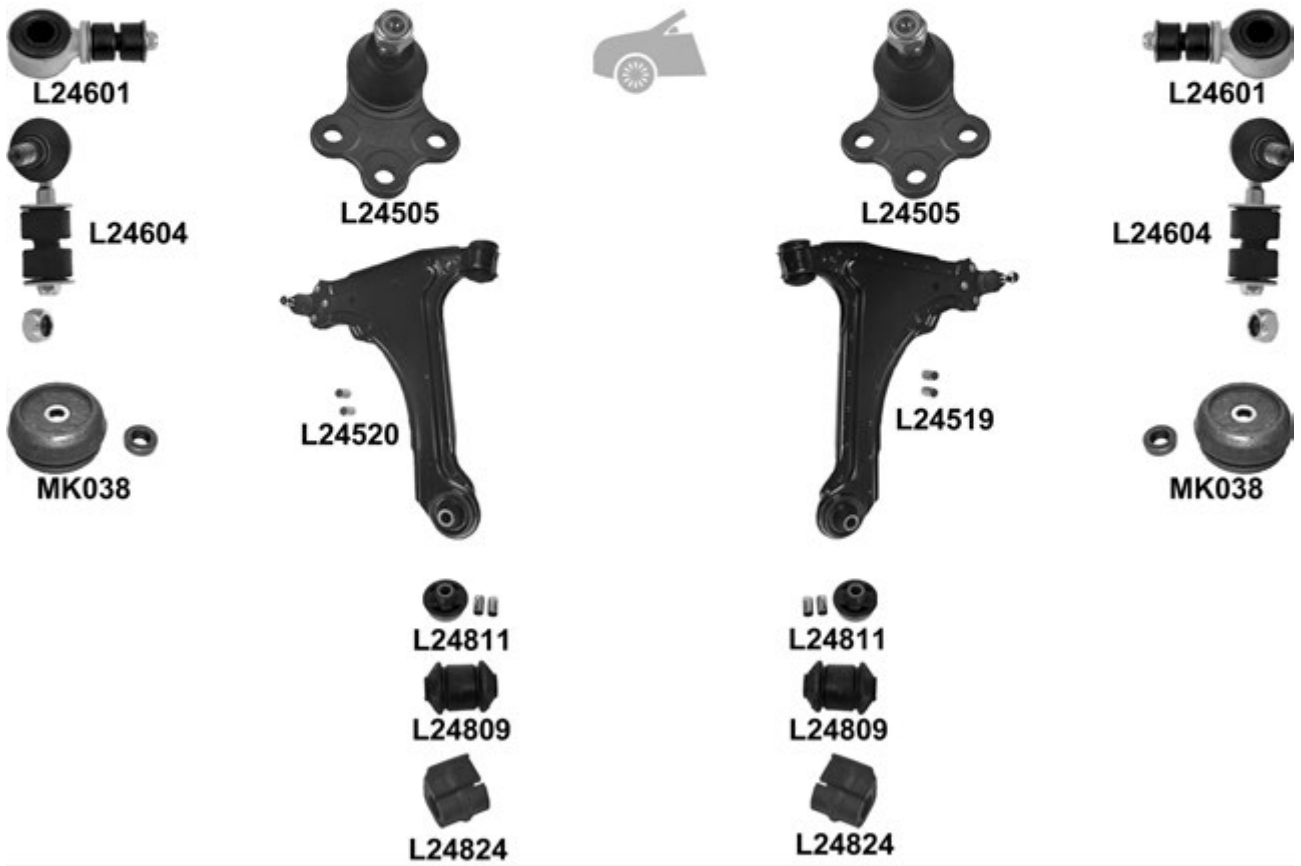
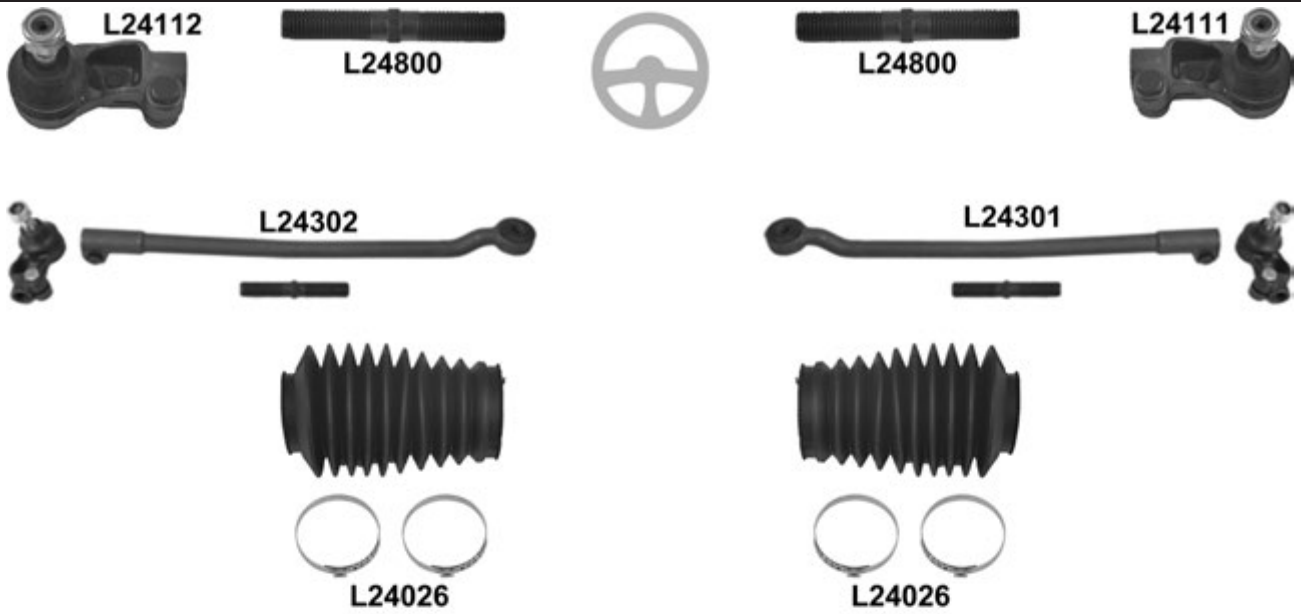

		← →		Thread	Part Of	QPA			
		↔		L24111	F 16x2 U	1	324056		
				L24112	F 16x2 U	1	324055		
		↕		L24800	L24800		2	322577	
				L24301		OE no. 324056 / 322577 / 322146	1		
		↕		L24302		OE no. 324055 / 322577 / 322147	1		
				L24026	L24026		2	1609073	
		↕	ZF	L24505	L24505		2	1603167	
			(-) 4X4 <input checked="" type="checkbox"/>	L24519		1	5352000		
				L24520		1	5352001		
		↕		L24811	L24811		2	352356	
		↕	ø 12mm	L24809	L24809		2	352300	
			C20NE ch. → R1049313 ch. → R9003126	L24601	L24601		2	350260S	
			C20XE ch. → R1049313 ch. → R9003108						
			C20LET ch. → R1049313 ch. → R9003174						
			X20XE/C25XE ch. → R104913 ø22mm						
C20NE ch. R1049314 → ch. R9003127 →			L24604	L24604		2	350263		
C20XE ch. R1049314 → ch. R9003109 →									
C20LET ch. R1049314 → ch. R9003175 →									
X20XE/C25XE ch. R104914 → ø20mm									
			22mm	L24824	L24824	Anti-roll bar	2	350078	
			C 2.0 LET/C 2.0 NE/C 2.0 EX/X 2.0 XEV ch. → R 9999999 ch. → S 1000234	KIT	MK038	MK038		2	344513S
	X 2.0 XEV ch. S 9000001 → ch. S 1000235 →	KIT	MK038	MK038		2	344514S		
			L24823	L24823		4	423313		
		ø 14mm	L24830	L24830	Anti-roll bar	2	444153		

Cascada (W13) 03.13 →



MK381



MK381



Thread

Part Of

QPA



			KIT	MK381	MK381			2	344573
--	--	--	-----	-------	-------	--	--	---	--------

Combo (Corsa B) 07.94 → 10.01



L24020



L24212

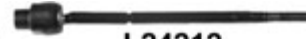

L24212



L24020



L24113



L24213



L24213



L24113



L24025



L24025



L24027



L24027

Combo (Corsa B) 07.94 → 10.01



		← →		Thread	Part Of	QPA			
⊕	↔	ch. → V 3023597	L24020	L24020	F 12x1,5 ♂	2	324050	i	
		ch. → V 4166925							
		ch. → V 6066279							
	ch. V 3023598 →	L24113	L24113	F 12x1,5 ♂	2	324066			
	ch. V 4166926 →								
		ch. V 6066280 →							
⊖	⊕		L24212	L24212	M 12x1,5 / M 14x1,5 ♂	2	322155		
			L24213	L24213	M 12x1,5 / M 14x1,5 ♂	2	322158		
	⊖		L24025	L24025		2	902827		
			L24027 ^o	L24027 ^o		2			
🚗	⊖	ch. → V 3023597	L24022	L24022		2	1603187		
		ch. → V 4166925							
		ch. → V 6066279							
		ch. V 3023598 →	L24521	L24521		2	1603222		
		ch. V 4166926 →							
		ch. V 6066280 →							
	⊖	⊖	ch. → V 3023597		L24513		1	352002	
			ch. → V 4166925	L24514			1	352003	
			ch. → V 6066279						
			ch. V 3023598 →		L24523		1	5352012	
		ch. V 4166926 →	L24524			1	5352011		
		ch. V 6066280 →							
⊖	⊖↔←		L24803	L24803		2	352301	L24513/L24514/ L24523/L24524	
	⊖↔↔	ch. → V 3023597	L24804	L24804		2	353561		
		ch. → V 4166925							
		ch. → V 6066279							
			KIT	MK017	MK017	2	355419		

Combo Karsten / Kombi (Corsa C) 10.01 →
 Combo Tour (Corsa C) 10.01 →

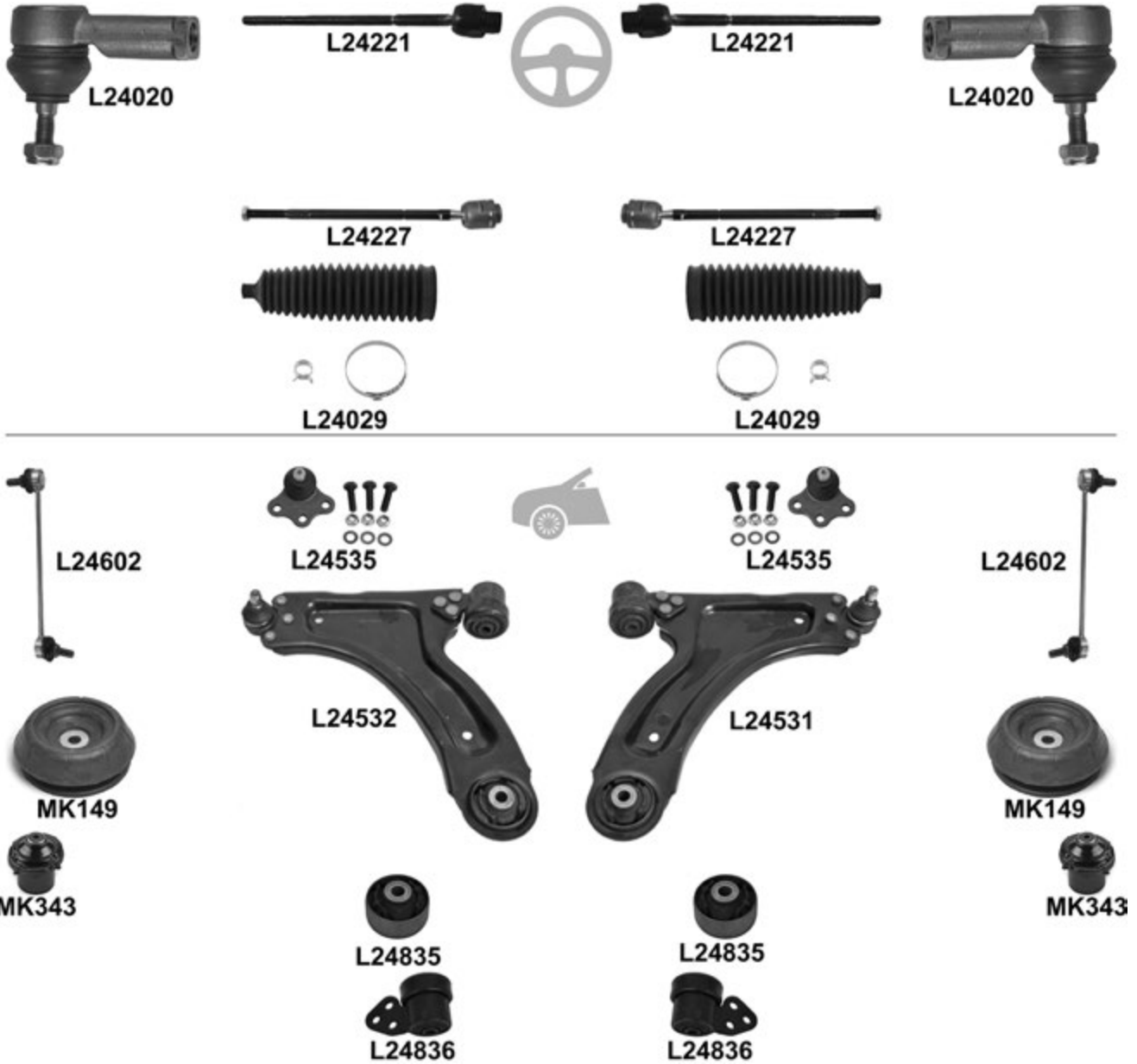

Combo Karsten / Kombi (Corsa C) 10.01 →

Combo Tour (Corsa C) 10.01 →

		i		←	→	Thread	Part Of	QPA	i
⊕		↔		L24020	L24020	F 12x1,5 ⌀		2	1603009
			→ 08.03 ch. → 33999999 ch. → 34999999 ch. → 36999999 (-) 1.3 CDTi, Mot/Eng Z13DTJ	L24221	L24221	M 12x1,5 / F 14x1,5 ⌀		2	1603008
			09.03 → ch. 43000001 → ch. 44000001 → ch. 46000001 → (-) 1.3 CDTi, Mot/Eng Z13DTJ	L24227	L24227	M 12x1,5 / F 14x1,5 ⌀		2	1603843
				L24029 ⁰	L24029 ⁰			2	1609121
⊖		⊥		L24535	L24535			2	352803
		⊥	<input checked="" type="checkbox"/>	L24531				1	352042
				L24532				1	352041
		⊥▼		L24835	L24835			2	352310
		⊥▲		L24836	L24836			2	352309
				L24602	L24602			2	350610
			(-) MK343	KIT	MK149	MK149		2	344525
			MK343	MK343			2	312510	

Corsa A 09.82 → 03.93

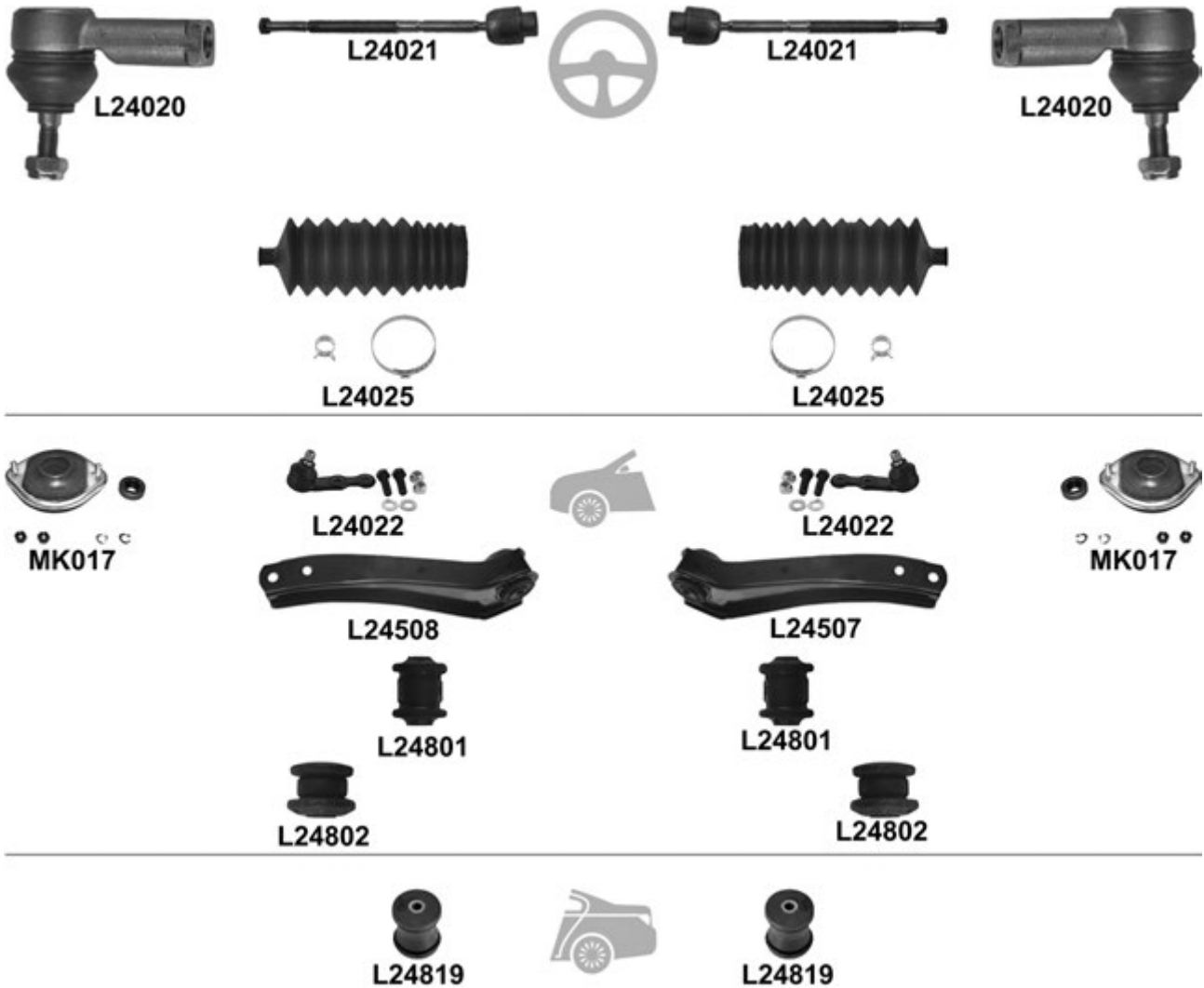

				←	→	Thread	Part Of	QPA	
⊕		↔		L24020	L24020	F 12x1,5 ♂		2	324050
				L24021	L24021	M 12x1,5 / F 14x1,5 ♂		2	322149
				L24025	L24025			2	902827
⊖		↓		L24022	L24022			2	1603187
		↓		L24508	L24507			1	352044
				L24508				1	352043
		↓↔←		L24801	L24801			2	352327
		↓↔→		L24802	L24802			2	353560
				KIT	MK017	MK017		2	344522
			L24819	L24819		Hub carrier	2	402643	

Corsa B 03.93 →

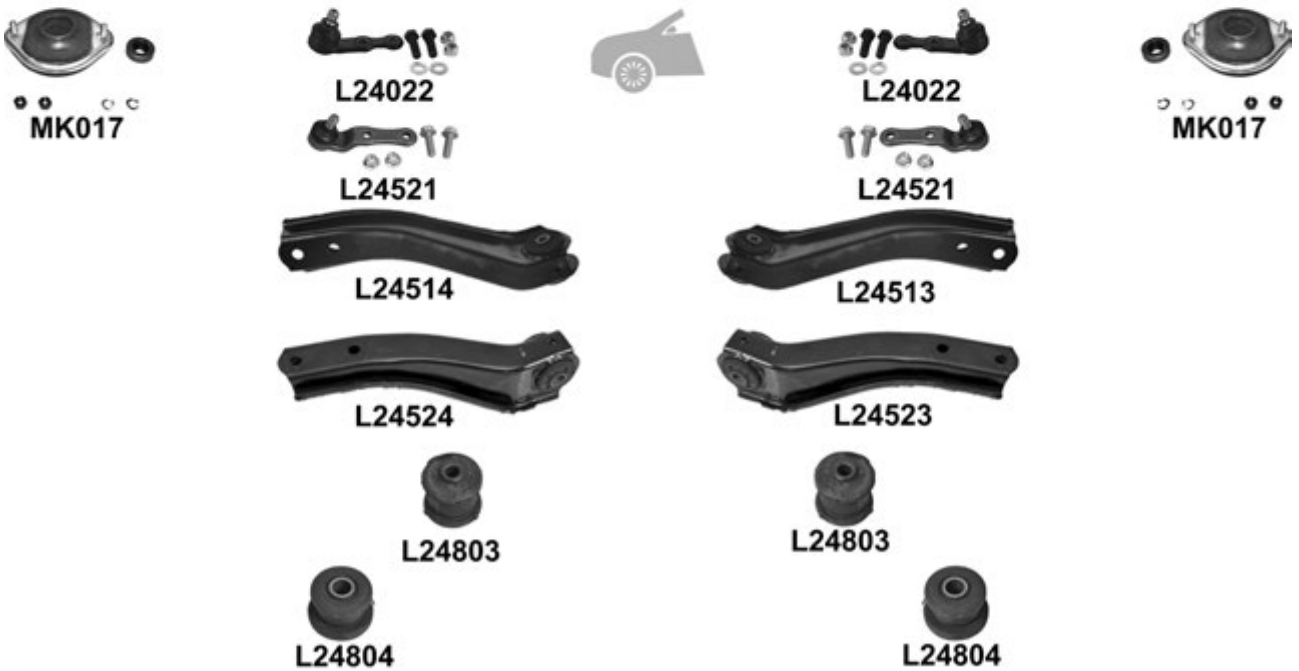
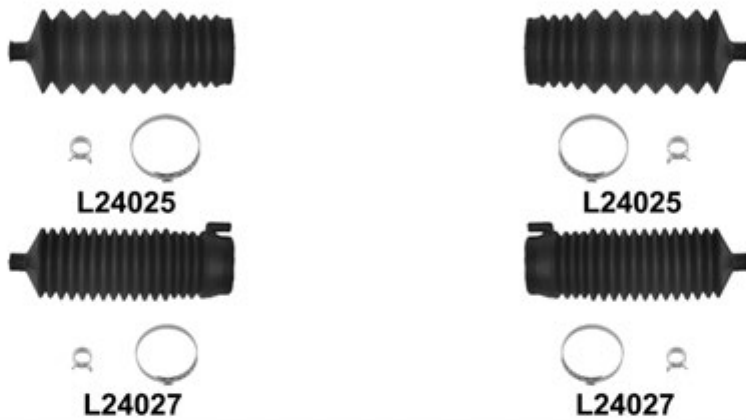
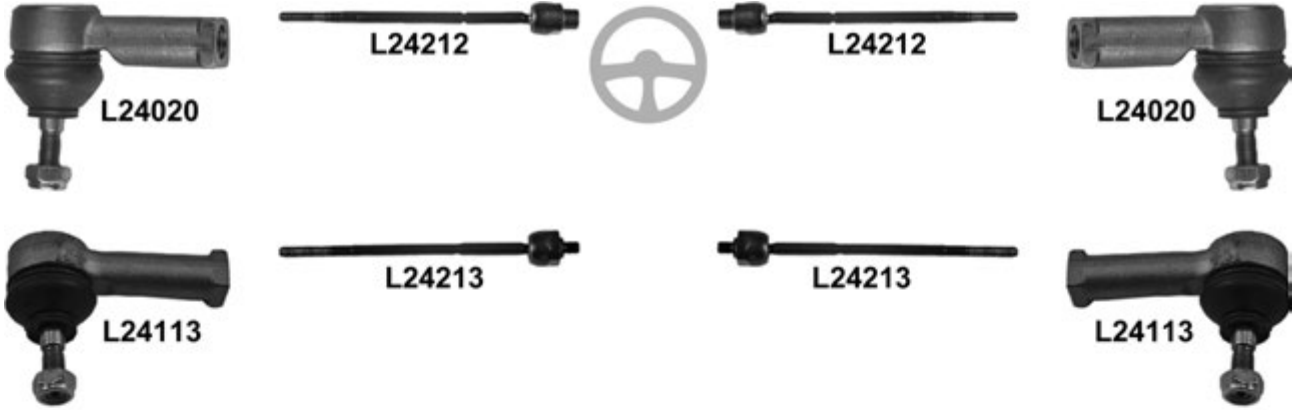

Corsa B 03.93 →

				←	→	Thread	Part Of	QPA		
		↔	ch. → V 3023597	L24020	L24020	F 12x1,5 ♂		2	324050	
			ch. → V 4166925							
			ch. → V 6066279							
				ch. V 3023598 →	L24113	L24113	F 12x1,5 ♂		2	324066
				ch. V 4166926 →						
				ch. V 6066280 →						
		⊥	ch. → V 3023597	L24022	L24022			2	1603187	
			ch. → V 4166925							
			ch. → V 6066279							
			ch. V 3023598 →	L24521	L24521			2	1603222	
			ch. V 4166926 →							
		⊥		ch. → V 3023597		L24513			1	352002
				ch. → V 4166925	L24514				1	352003
				ch. → V 6066279						
				ch. V 3023598 →		L24523			1	5352012
				ch. V 4166926 →	L24524				1	5352011
	⊥ ↔			L24803	L24803		L24513/L24514/ L24523/L24524	2	352301	
			ch. → V 3023597	L24804	L24804			2	353561	
				KIT	MK017	MK017		2	355419	
				L24819	L24819		Hub carrier	2	402643	

Corsa C (F08, F68) 09.00 →

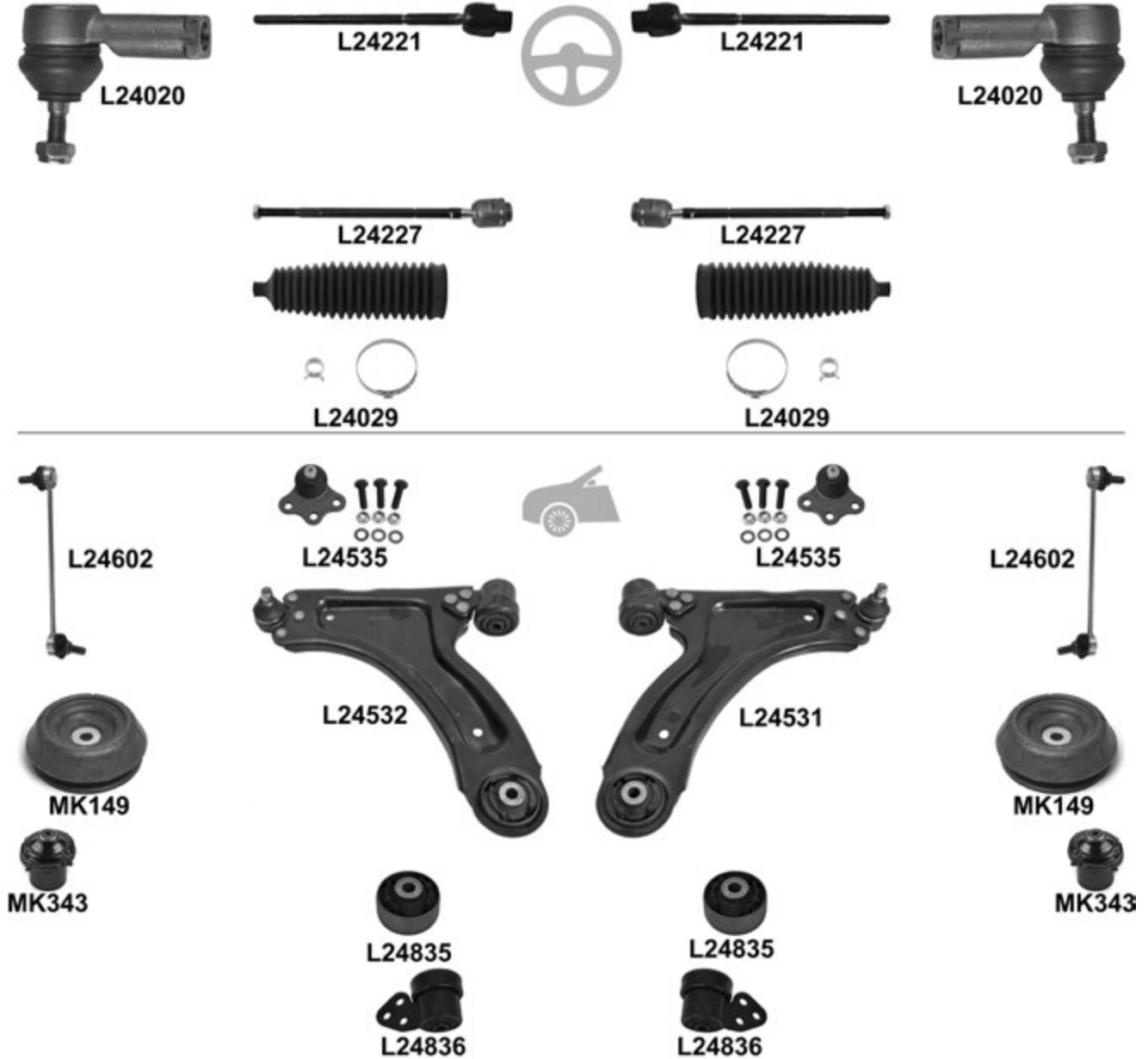

		← → Thread		Part Of	QPA			
⊕		↔	L24020	L24020	F 12x1,5 ∪	2	1603009	
			L24221	L24221	M 12x1,5 / F 14x1,5 ∪	2	1603008	
			→ 08.03					
			ch. → 33999999 ch. → 34999999 ch. → 36999999 (-) 1.7 CDTH, Mot/Eng Z17DTH 1.7 CDTi, Mot/Eng Z17DTH					
⊖		⊥	L24227	L24227	M 12x1,5 / F 14x1,5 ∪	2	1603843	
			L24029 ⁰	L24029 ⁰		2	1609121	
		⊥		L24535		2	352803	
			☑	L24531		1	352042	
		⊥	L24532			1	352041	
			L24835	L24835		2	352310	
		⊥	L24836	L24836		2	352309	
			L24602	L24602		2	350610	
			(-) MK343	KIT	MK149	MK149	2	344525
					MK343	MK343		2

Corsa C Van (F08, W5L) 09.00 →

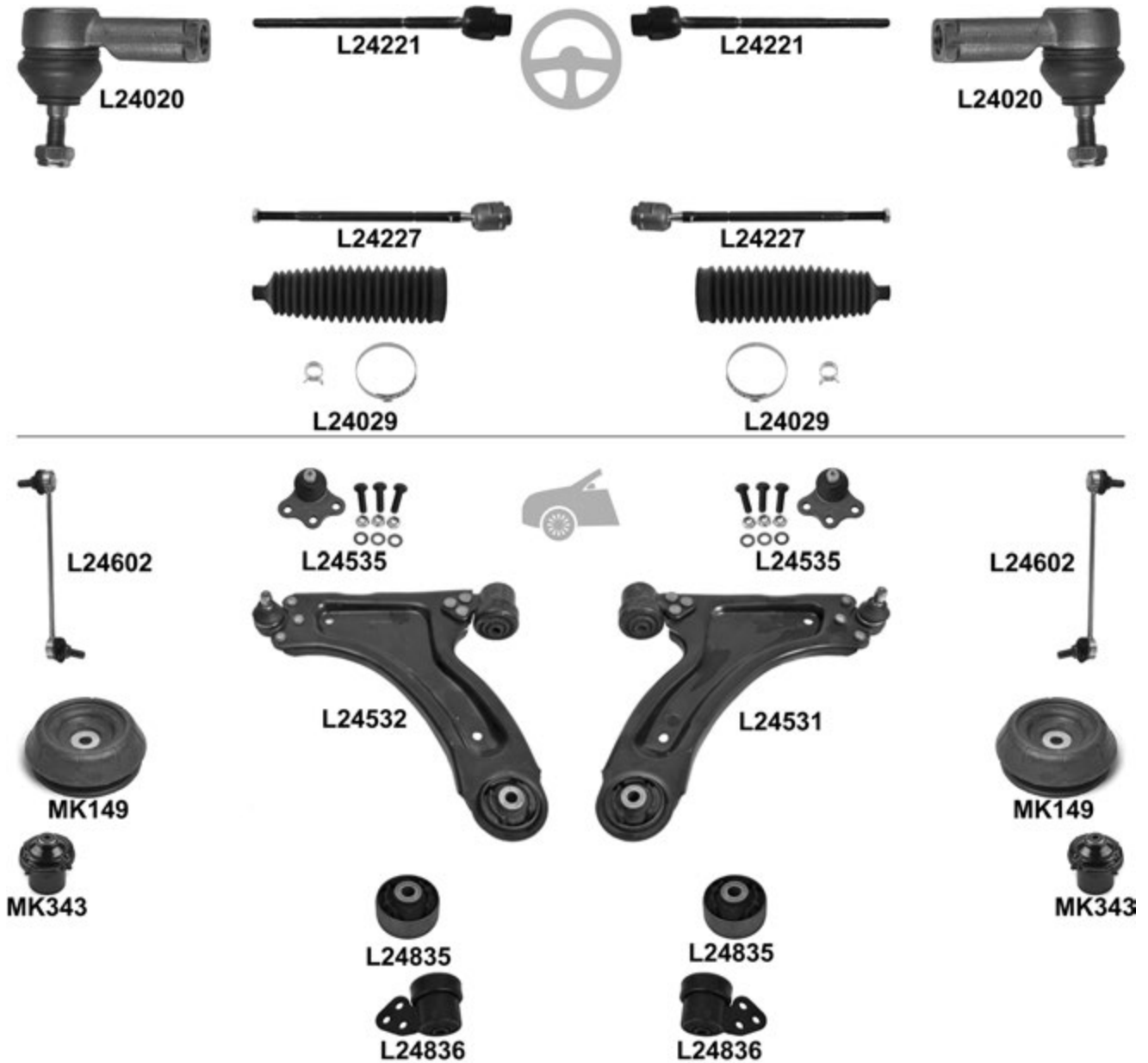

				←	→	Thread	Part Of	QPA		
⊕		↔		L24020	L24020	F 12x1,5 ∪		2	1603009	
			→ 08.03	L24221	L24221	M 12x1,5 / F 14x1,5 ∪		2	1603008	
			ch. → 33999999							
			ch. → 34999999							
			ch. → 36999999							
			(-) 1.7 CDTH, Mot/Eng Z17DTH							
			1.7 CDTi, Mot/Eng Z17DTH	L24227	L24227	M 12x1,5 / F 14x1,5 ∪		2	1603843	
				L24029 ⁰	L24029 ⁰			2	1609121	
🚗		↓		L24535	L24535			2	352803	
			<input checked="" type="checkbox"/>		L24531			1	352042	
		↓		L24532				1	352041	
				L24835	L24835			2	352310	
		↓	↙	L24836	L24836			2	352309	
			↘	L24602	L24602			2	350610	
				(-) MK343	KIT	MK149	MK149		2	344525
						MK343	MK343		2	312510

Corsa D 07.06 →

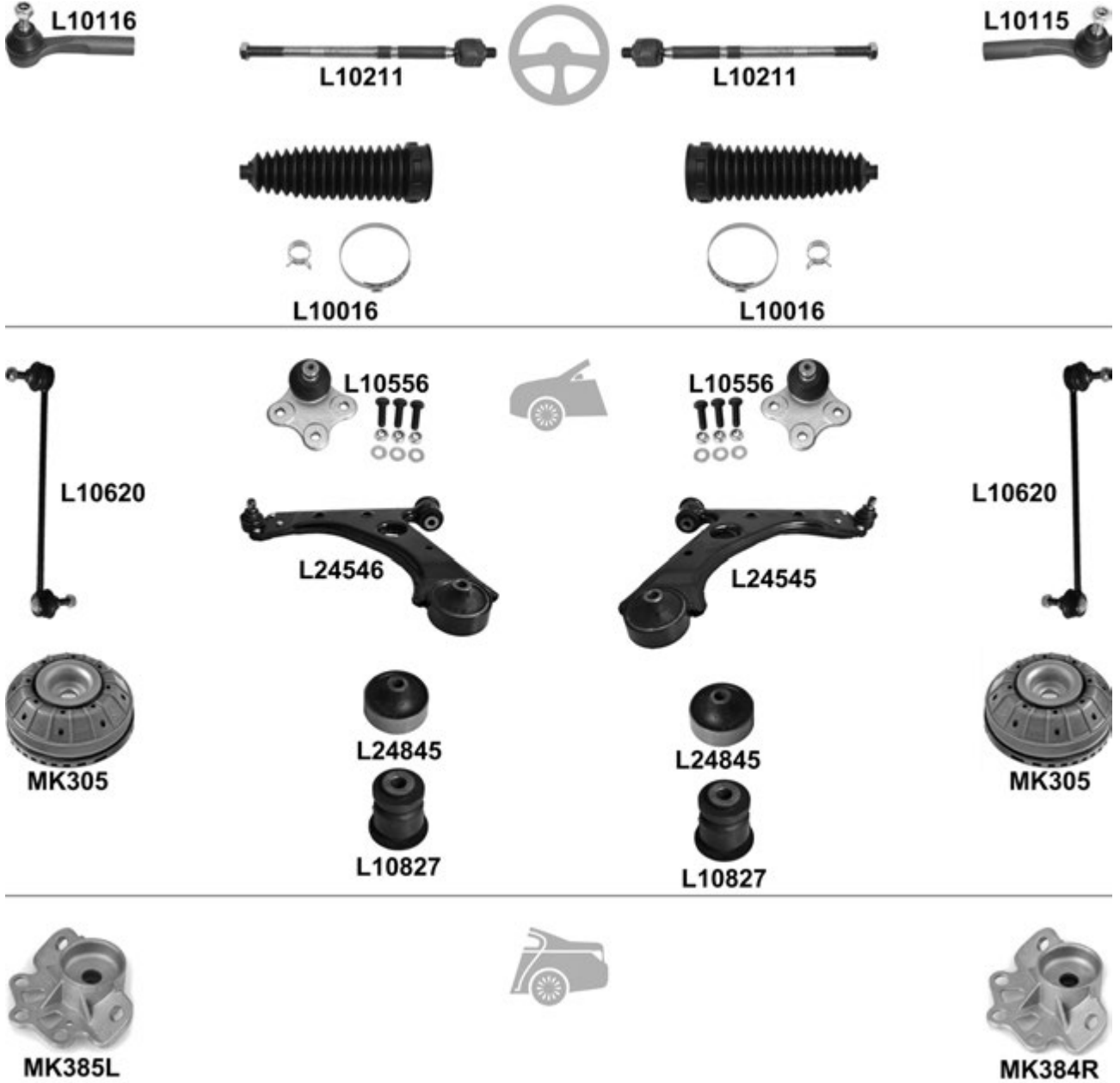

			←	→	Thread	Part Of	QPA	
		↔		L10115	F 14x1,5 ∪		1	1603545
				L10116	F 14x1,5 ∪		1	1603544
				L10211	L10211	M 14x1,5 / M 14x1,5 ∪	2	1603543
				L10016	L10016		2	1609347
		↓		L10556	L10556		2	352087
		↓	<input checked="" type="checkbox"/>		L24545		1	5352038
				L24546			1	5352039
		↓ ▾		L24845	L24845		2	352947
		↓ ▲		L10827	L10827		2	352864
				L10620	L10620		2	350616
			KIT	MK305	MK305		2	344653
					MK384R		1	55703318
				MK385L			1	55703317

Frontera A 03.92 → 10.98

				←	→	Thread	Part Of	QPA		
					L20103	↻		1	324057	
					L20104	↻		1	324058	
		↑		L20501	L20501			2	310821	
				L20503	L20503			2	352828	
		↓			L24607				1	350608
				L24608					1	350607

Frontera B 10.98 →

				←	→	Thread	Part Of	QPA		
		↑		L24541	L24541			2	310823	
				L20503	L20503			2	352828	
		↓			L24607				1	350608
				L24608					1	350607

Insignia 07.08 →

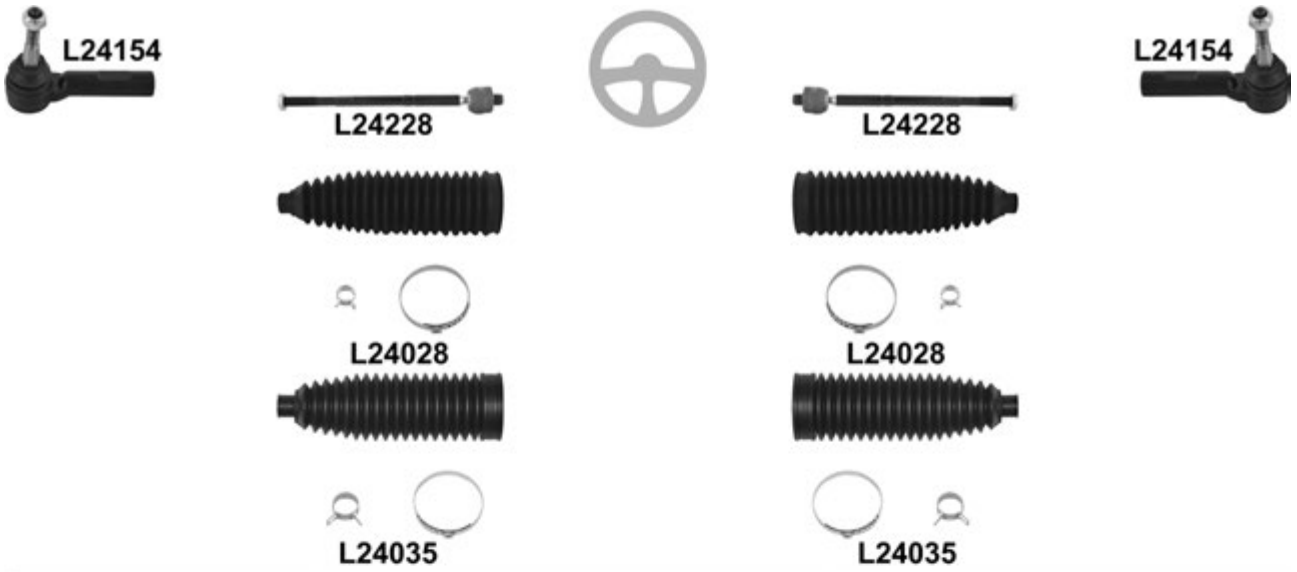

Insignia 07.08 →

		i		←	→	Thread	Part Of	QPA	i
		↔		L24154	L24154	F 16x1,5 ∪		2	13272000
				L24228	L24228	M 16x1,5 / M 18x1,5 ∪		2	13271996
			Hydraulic ∅ 15,5mm, ∅ 52mm, L= 212mm	L24028	L24028			2	1609357
		Electric ∅ 16mm, ∅ 53,5mm, L= 194mm	L24035 ⁰	L24035 ⁰				2	13286689
		↓	(-) HD <input checked="" type="checkbox"/>	L24550	L24549			1	352870
		↓ ▲		L24848 ⁰	L24848 ⁰			2	352866
			(-) IDS chassis	L10648	L10648			2	350617
		IDS chassis	L24610	L24610				2	350618
			MK328	MK328				2	
			(-) 4X4	L24611	L24611			2	444081
	4x4	L24612	L24612				2	444087	

Kadett C 08.73 → 07.79
 Kadett City 08.73 → 07.79



L2472



L2472



L0027



L0027



L24050



L2473



L2473

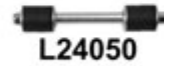

L24050



L2474



L2474



L24013



L24014



L24015



L24016



Thread

Part Of

QPA



				←	→	Thread	Part Of	QPA		
		↔		L2472	L2472	F 14x1,5 ♂		2	324120	
				L0027	L0027			2	322506	
		↑		L2473	L2473			2	310816	
		↓	(-) 1.6, 1.9, 2.0E	L2474	L2474			2	352817	
		↑				L24014		1	310127	
					L24013		1	310126		
		↓	(-) 1.6, 1.9, 2.0E				L24016		1	352096
						L24015		1	352000	
			L24050	L24050			2	1603150		

Kadett D 08.79 → 10.81
 ch. → C 500 0090 / → C 250 0000



L0028



L0028



Thread

Part Of

QPA



				L24019	L24019			2	322575
				L0028	L0028			2	902828
		↓	L 24104 is used with TCA L 24074		L24074			1	352124
			L 24104 is used with TCA L 24075	L24075				1	352123
			Change in pairs	L24060	L24060			2	1603148
				L24820	L24820		Hub carrier	2	402642

Kadett D 10.81 → 08.84
 ch. C 500 0091 → / C 250 0001 →

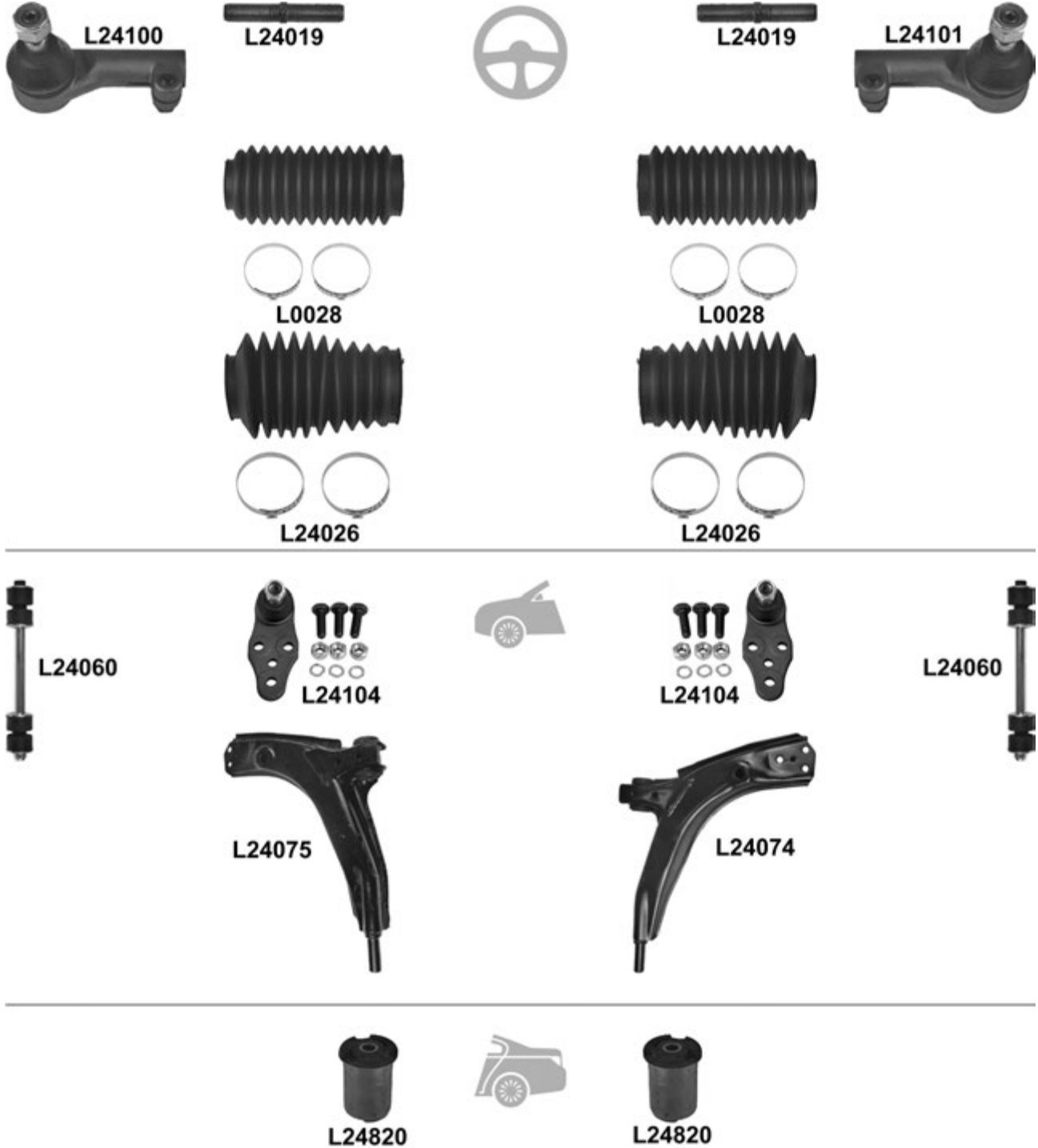

		← → Thread		Part Of	QPA		
		↔	L24101	F 16x1,5 ∪	1	324041	
			L24100	F 16x1,5 ∪	1	324040	
			L24019	L24019		2	322575
			L0028	L0028		2	902828
		⊥	L24104	L24104		2	1603164
		⊥		L24074		1	352172
			L24075			1	352169
		Change in pairs	L24060	L24060		2	1603148
			L24820	L24820	Hub carrier	2	402642

Kadett E 09.84 → 08.91
 Kadett E Cabriolet 10.86 → 02.93

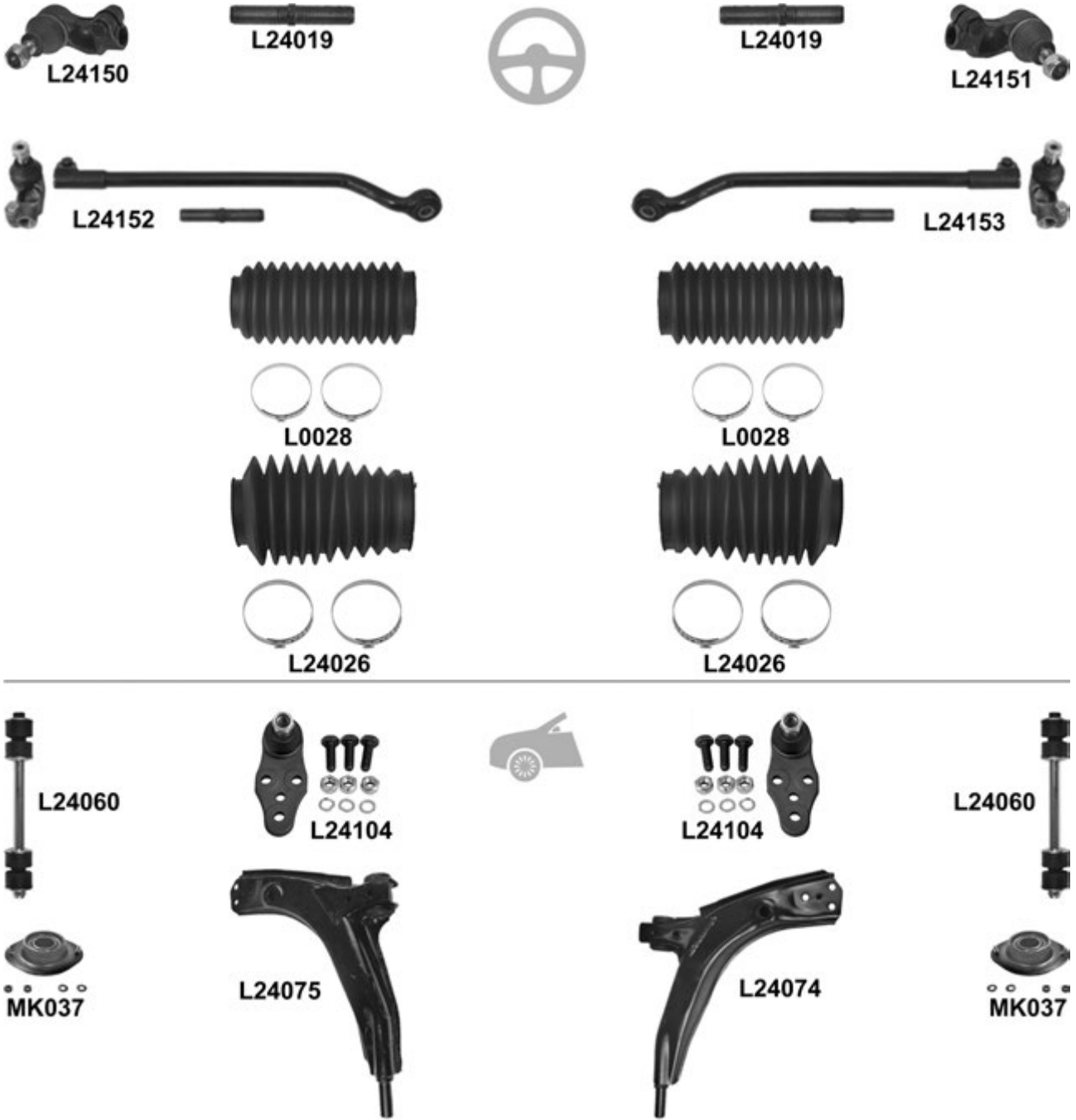

Kadett E 09.84 → 08.91
 Kadett E Cabriolet 10.86 → 02.93



Kadett E 09.84 → 08.91
Kadett E Cabriolet 10.86 → 02.93

		i		←	→	Thread	Part Of	QPA	i						
		↔			L24151	F 16x1,5 U		1	324038						
					L24150	F 16x1,5 U		1	324039						
					L24019	L24019			2	322575					
					L24153			OE no. 324038 + 322126 + 322575	1						
						L24152			OE no. 324039 + 322125 + 322575	1					
						L0028	L0028			2	902828				
					L24026	L24026			2	1609073					
		↓			L24104	L24104			2	1603164					
		↓	(-) 1.8/GSi			L24074			1	352172					
						L24075			1	352169					
		↓▼	(-) , 2.0 NE/SEH/SER/C 2.0 NE/Gti/GTE (-) , 2.0 NE/C 2.0 NE (-) , 1.8 E/SE, Diesel, 1.6 DA/1.7 D/1.7 DR			L24805	L24805			2	352335				
				↓▲	(-) , 2.0 NE/SEH/SER/C 2.0 NE/Gti/GTE (-) , 2.0 NE/C 2.0 NE (-) , 1.8 E/SE, Diesel, 1.6 DA/1.7 D/1.7 DR			L24806	L24806			2	352349		
						↓▼	, 2.0 NE/SEH/SER/C 2.0 NE/Gti/GTE, , 2.0 NE/C 2.0 NE , 1.8 E/SE, Diesel, 1.6 DA/1.7 D/1.7 DR			L24807	L24807			2	352338
								↓▲	, 2.0 NE/SEH/SER/C 2.0 NE/Gti/GTE, , 2.0 NE/C 2.0 NE , 1.8 E/SE, Diesel, 1.6 DA/1.7 D/1.7 DR			L24808	L24808		
						L24060	L24060			2	1603148				
			ø 17,5mm			L24827	L24827		Anti-roll bar	2	350112				
				20mm			L24828	L24828		Anti-roll bar	2	350113			
						KIT	MK037	MK037			2	344509			
				(-) 1.2 S OHV/1.7 D /			L24820	L24820		Hub carrier	2	402642			
1.2 S OHV, 1.7 D ch. → N 2500000 ch. → NB 547665							L24820	L24820		Hub carrier	2	402642			
					1.2 S OHV, 1.7 D ch. N 2500001 → ch. NB 547666 →			L24821	L24821		Hub carrier	2	402645		

Meriva 05.03 →

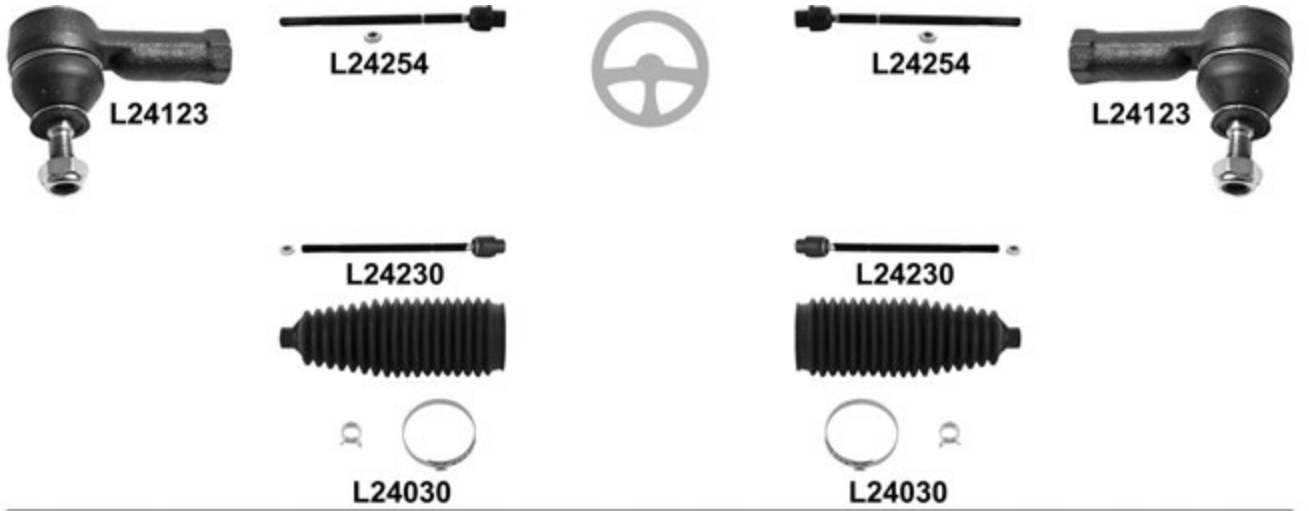

Meriva 05.03 →

				←	→	Thread	Part Of	QPA	
		↔		L24123	L24123	F 14x1,5 U		2	1603240
				L24254	L24254	M 14x1,5 / F 14x1,5 U		2	1603428
				L24230	L24230	M 14x1,5 / F 14x1,5 U		2	1603429
				L24030 ⁰	L24030 ⁰			2	1609165
		⊥			L24543			1	5352026
		⊥		L24544				1	5352025
		⊥	<input checked="" type="checkbox"/>		L24539			1	5352028
		⊥		L24540				1	5352027
		⊥▼		L24835	L24835			2	352310
		⊥▲		L24836	L24836			2	352309
				L24602	L24602			2	350610
			(-) MK343	KIT	MK149	MK149		2	344525
			MK343	MK343			2	312510	
		▲		L24843	L24843		Hub carrier	2	5402638

Meriva B 06.10 →

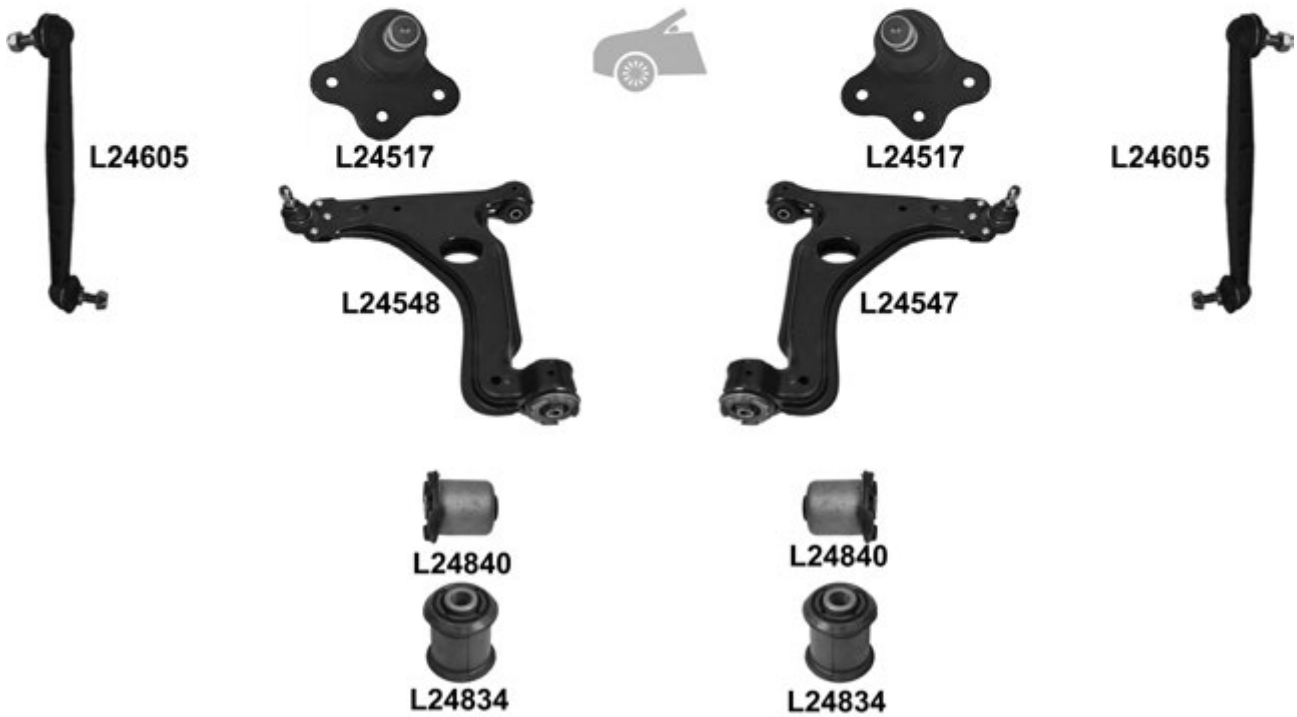
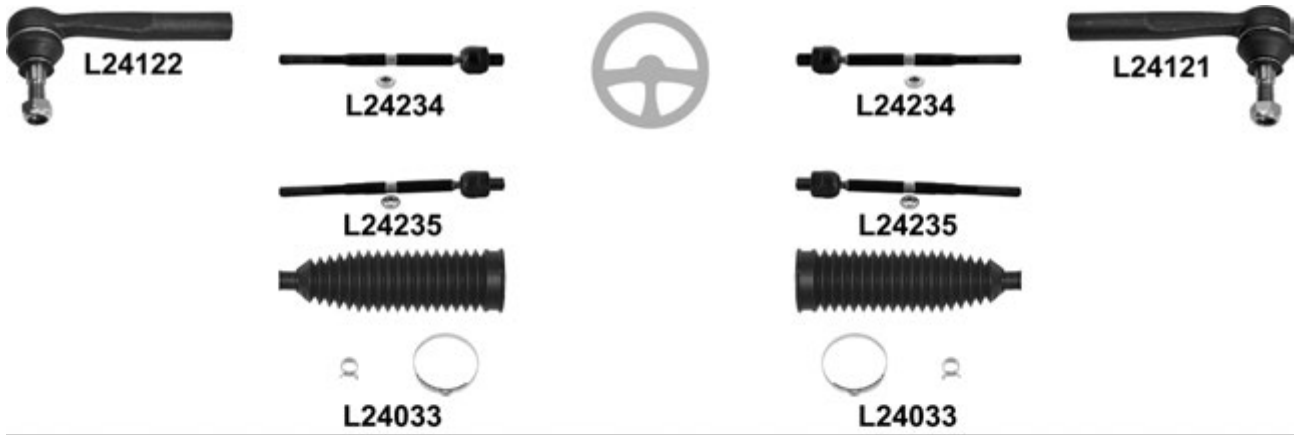

				←	→	Thread	Part Of	QPA	i
⊕		↔		L24121		F 14x1,5 U		1	1609012
				L24122		F 14x1,5 U		1	1609013
			L24234	L24234	M 14x1,5 / M 18x1,5 U		2	1609000	
			L24235	L24235	M 14x1,5 / M 18x1,5 U		2	1609011	
			⊖, ch. 72094720 →, TRW L= 211, ø 14,5mm, Ø 53mm	L24033 ⁰	L24033 ⁰			2	1609356
		↓		L24517	L24517			2	352800
		↓		<input checked="" type="checkbox"/>	L24547			1	5352030
		↓	12 x 46 x 60mm	L24840	L24840			2	352324
		↑	12 x 36 x 60mm	L24834	L24834			2	352364
				L24605	L24605			2	350176

Movano 07.98 →

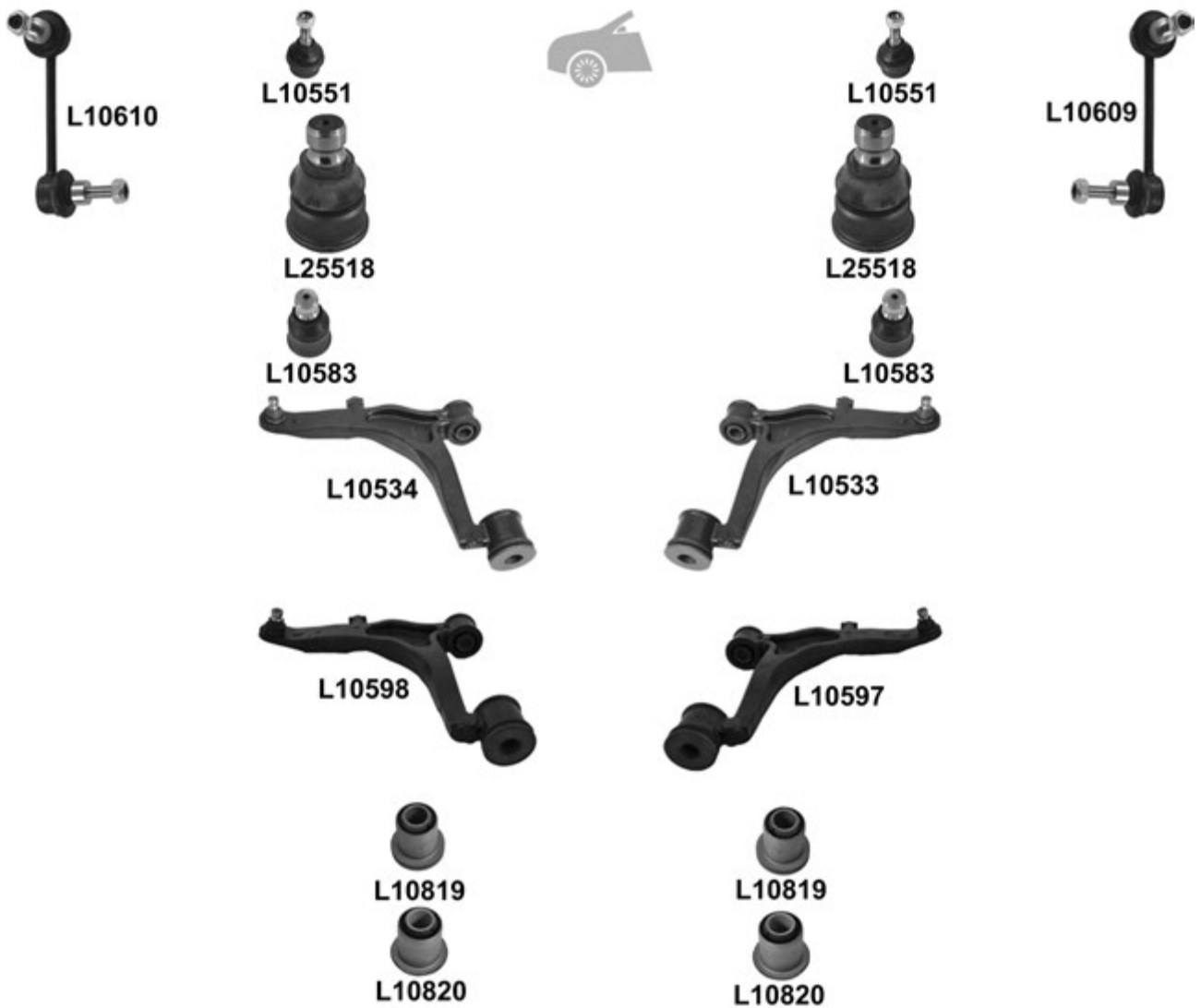
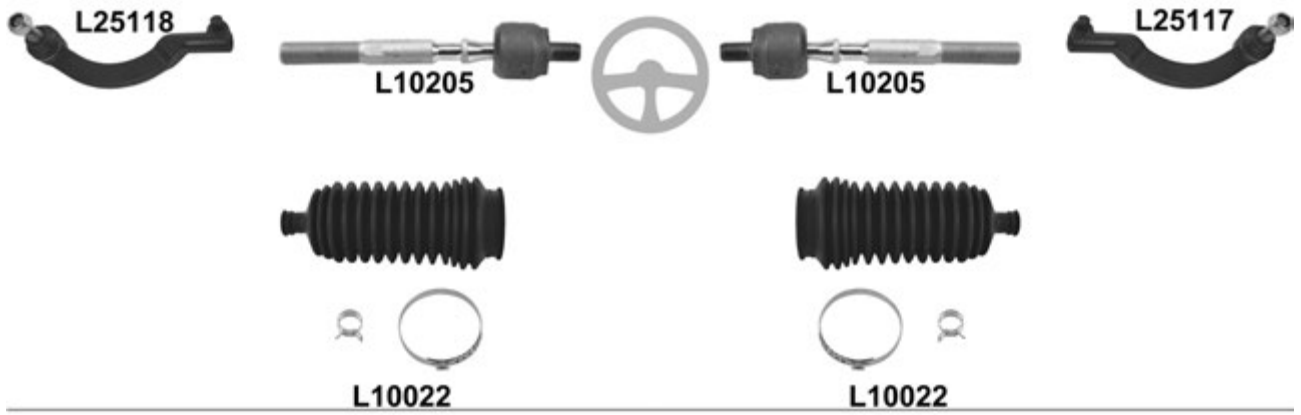

Movano 07.98 →

		← →		← →		Thread	Part Of	QPA		
		↔		L25117		F 16x1,5 ∪		1	4501263	
				L25118		F 16x1,5 ∪		1	4501262	
				L10205	L10205	M 16x1,5 / M 14x1,5 ∪		2	4501261	
					L10022 ⁰	L10022 ⁰			2	4501260
		↑		L10551	L10551			2	4500254	
		↓	→ 09.07, 22mm	L25518	L25518			2	4401909	
		09.07 →, 24mm	L10583	L10583			2	4418631		
		↓	→ 09.07, 22mm	<input checked="" type="checkbox"/>	L10533			1	4404048	
				<input checked="" type="checkbox"/>	L10534			1	4404047	
			09.07 →, 24mm	<input checked="" type="checkbox"/>	L10597			1	4418630	
				<input checked="" type="checkbox"/>	L10598			1	4418629	
		↓			L10819	L10819			2	4500095
		↑				L10820	L10820			2
						L10609			1	4500199
					L10610			1	4500198	

Movano B 05.10 →

				←	→	Thread	Part Of	QPA			
⊕		↔				L10133	F 18x1,5 ∪	1	4420098		
						L10134	F 18x1,5 ∪	1	4420097		
						L10221	L10221	M 18x1,5 / M 16x1,5 ∪	2	4420096	
⊖		⊥				L25566 ⁰	∪	1	4408252		
						L10596	∪	1	4419219		
		⊥	(-) (+)				L25573 ⁰		1	4419216	
							L25574 ⁰		1	4419215	
		⊥	16 x 70 x 77mm				L25832 ⁰	L25832 ⁰		2	
							L10844	L10844		2	
		16 x 49,2 x 64mm				L10844	L10844		2		
						L10650	L10650		2	4419291	
⊖						L25618 ⁰	L25618 ⁰		2	4419304	
						L25618 ⁰	L25618 ⁰		2	4419304	

Omega A
Senator B 09.87 → 09.93

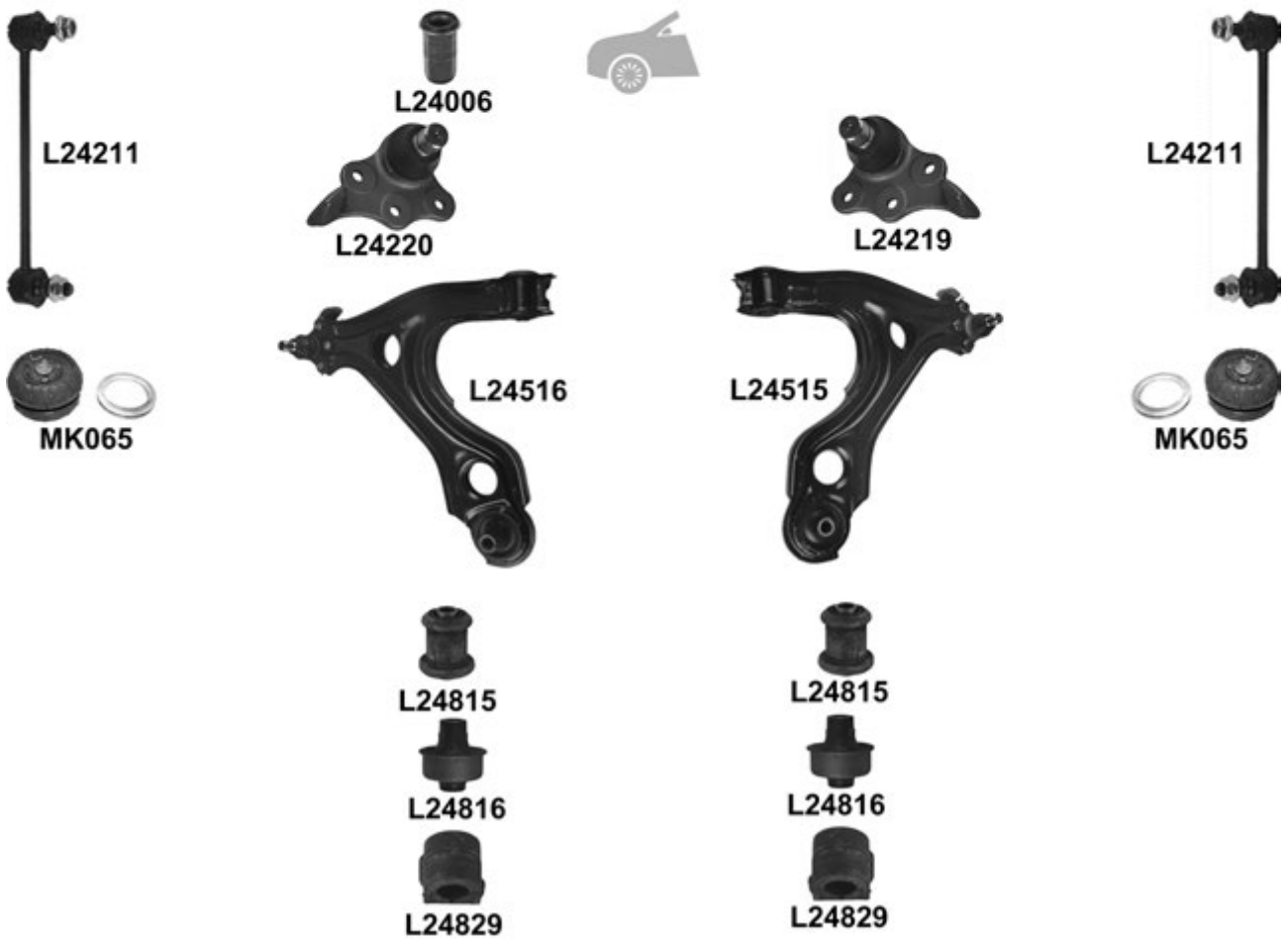

Omega A Senator B 09.87 → 09.93



				← → Thread		Part Of	QPA	
		↔↔		L24252	M 14x1,5 U		1	322176
				L24250	M 14x1,5 U		1	322175
		→←		L24107	M 14x1,5 U		1	322172
				L24108	M 14x1,5 U		1	322171
				L24253	L24253		2	322133
					L24203		1	322174
					L24204		1	322173
		→ ←	Senator 18 SEH/NVE 18 NVR/18 SV/S 18 NV C 20 NE/20 SE/C 26 NE/30 NE/C 30 LE/C 30 NE/C 30 SE C 24 NE/23 YD/23 YDT/23 DTR	L24201			1	322148
				L24303			1	322145
					L24006		IDLER	1
		↓			L24219		1	352827
					L24220		1	352826
		↓	(-) /extended body <input checked="" type="checkbox"/>		L24515		1	352136
					L24516		1	352135
		↓▼	12 x 41 / 47 x 60mm	L24815	L24815		2	352341
		↓▲	16 x 60 x 26 / 69,5mm	L24816	L24816		2	352355
				L24211	L24211		2	350605
			22mm	L24829	L24829	Anti-roll bar	2	350116
			Omega A KIT (-) /extended/2.6 Sport/3.0 24V/C 2.6 NE Sport/C 3.0 SE	MK065	MK065		2	344511S
			Senator, (-) C 3.0 SE, ch. → L 1019854 Senator, (-) 3.0 SE, ch. → L 5155054	L24823	L24823		4	423313
			Senator, C 3.0 SE, ch. L 1019855 → Senator, 3.0 SE, ch. L 5155055 →	L24825	L24825		4	423315
				L24822	L24822	Hub carrier	2	402935
				L24830	L24830	Anti-roll bar	2	444153

Omega B 03.94 →

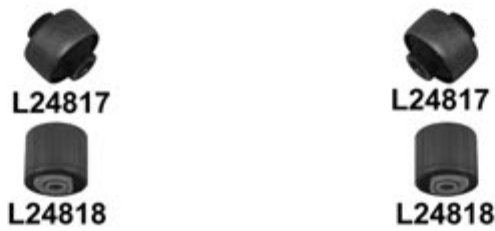
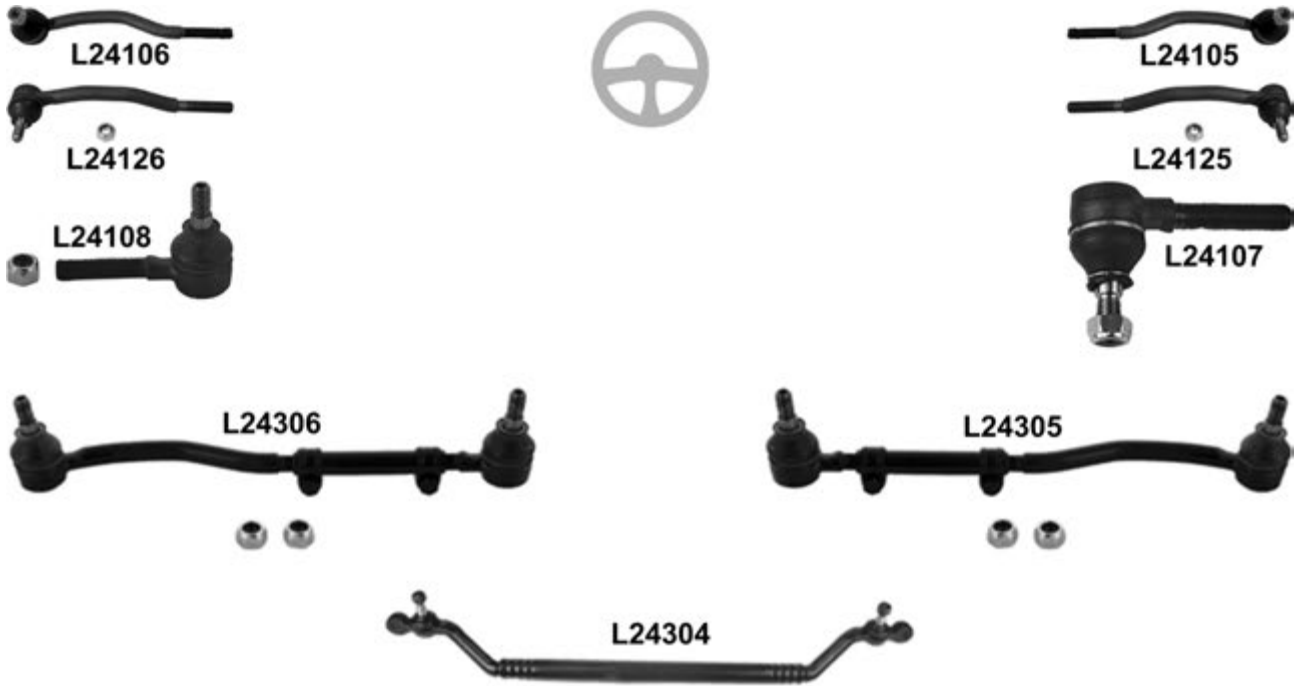

Omega B 03.94 →

				←	→	Thread	Part Of	QPA			
		↔	ch. → X1999999		L24105	M 14x1,5 ∪		1	322180		
					L24106	M 14x1,5 ∪		1	322179		
		→←	ch. Y1000001 →		L24125	M 14x1,5 ∪		1	322005		
					L24126	M 14x1,5 ∪		1	322004		
					L24107	M 14x1,5 ∪		1	322178		
		→←	ch. → X1999999		L24305			1	322168		
					L24306			1	322169		
					L24304			1	322166		
					L24517	L24517		2	352829		
					L24529		<input checked="" type="checkbox"/>	1	5352008		
	↓				L24530			1	5352007		
					L24817	L24817		2	352457		
	↓	14 x 49 x 45,5mm				L24818	L24818		2	352458	
						L24603	L24603		2	350609	
	↕	14 x 58,5 x 56mm				MK065	MK065		2	344511S	
						L24823	L24823		4	423313	
	↕	14 x 58,5 x 56mm			L24825	L24825		4	423315		
				↔	L24841	L24841		Hub carrier	2	402942	
	→←	(-)				L24842	L24842		Hub carrier	2	402649
						L24830	L24830		Anti-roll bar	2	444153

Rekord A / B 1963 → 1967



				←	→	Thread	Part Of	QPA	
			(-) Rekord A		L24006		IDLER	1	920361

Rekord C 08.66 → 12.71

Commodore A 08.66 → 12.71



				←	→	Thread	Part Of	QPA	
					L24300	L24300		2	
					L24006		IDLER	1	920361

Rekord D 01.72 → 08.77
Commodore B 01.72 → 07.78

L2465



L2465



L24070



L24006



L24070



Thread

Part Of

QPA



				L2465	L2465			2 322113
				L24070	L24070			2 1603147
				L24006			IDLER	1 920361

Rekord E 08.77 → 08.86
Commodore C 08.78 → 12.82



L24079



L2465

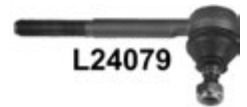

L2465



L24079



L24080



L24080



L24070



L24082



L24082



L24070



L24018



L24814



L24814



L24018



Thread

Part Of

QPA



		↔↔		L24079	L24079	M 14x1,5 ♂		2 324117
		↔↔		L24080	L24080	M 14x1,5 ♂		2 324118
				L2465	L2465			2 322113
				L24082	L24082			2 352823
			ch. → D100 0028	L24070	L24070			2 1603147
			ch. D100 0029 →	L24018	L24018			2 350602
				L24814	L24814		Hub carrier	2 353413
				L24006			IDLER	1 920361

Senator A 02.78 → 08.87
 Monza A 04.78 → 08.86



				←	→	Thread	Part Of	QPA		
⊕		↔		L24079	L24079	M 14x1,5 U		2	324117	
		→←		L24080	L24080	M 14x1,5 U		2	324118	
⊖		⊥		L2465	L2465			2	322113	
				L24082	L24082			2	352823	
				L24070	L24070			2	1603147	
				L24018	L24018			2	350602	
				L24814	L24814			2	353413	
	L24006				1	920361				

Signum 05.03 →

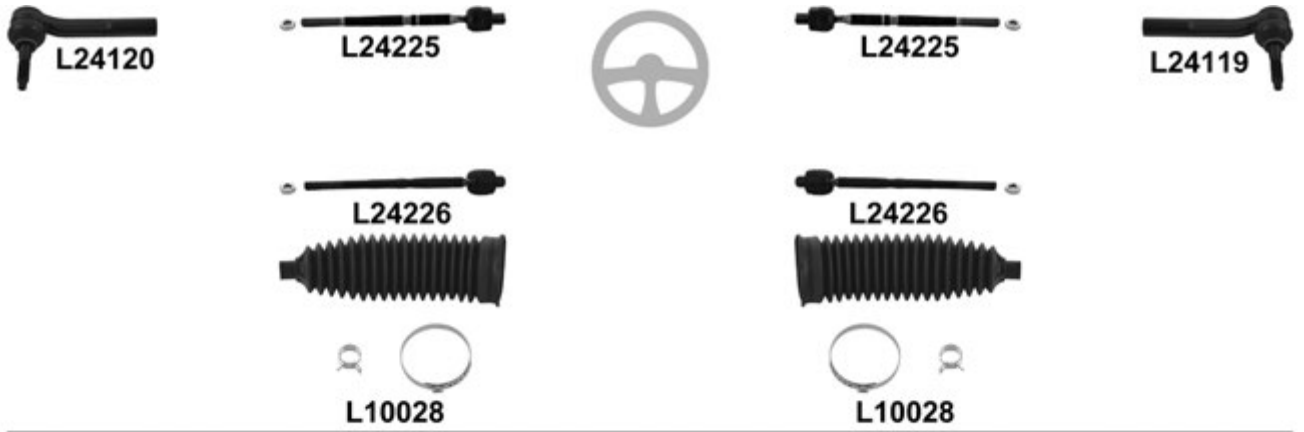

Signum 05.03 →

		i		← → Thread		Part Of	QPA	i	
		↔		L24119			1	1603228	
				L24120			1	1603227	
			(16°), (17°)	L24225	L24225		2	1603244	
			(18°), (19°)	L24226	L24226		2	1603229	
				L10028 ⁰	L10028 ⁰		2	1609558	
		⊥	ch. → 51999999	<input checked="" type="checkbox"/>	L24537		1	352052	
					L24538		1	352051	
		⊥↘		L10838	L10838		2	352319	
		⊥↗	12 x 36 x 60mm	L24834	L24834		2	352364	
			(-) IDS chassis	L24606	L24606		2	350603	
			IDS chassis	L24613	L24613		2	350612	
			(-) HD / MK342	KIT	MK208	MK208	2	344537	
				MK342	MK342		2	344665	
		↑		<input checked="" type="checkbox"/>	L10545	L10545	2	423008	
					L10637 ⁰	L10637 ⁰	2	444275	

Sintra 11.96 →

		i		← → Thread		Part Of	QPA	i	
		↔		L0016	L0016		2	324065	
				L0014	L0014		2	322189	

Tigra 07.94 → 12.00

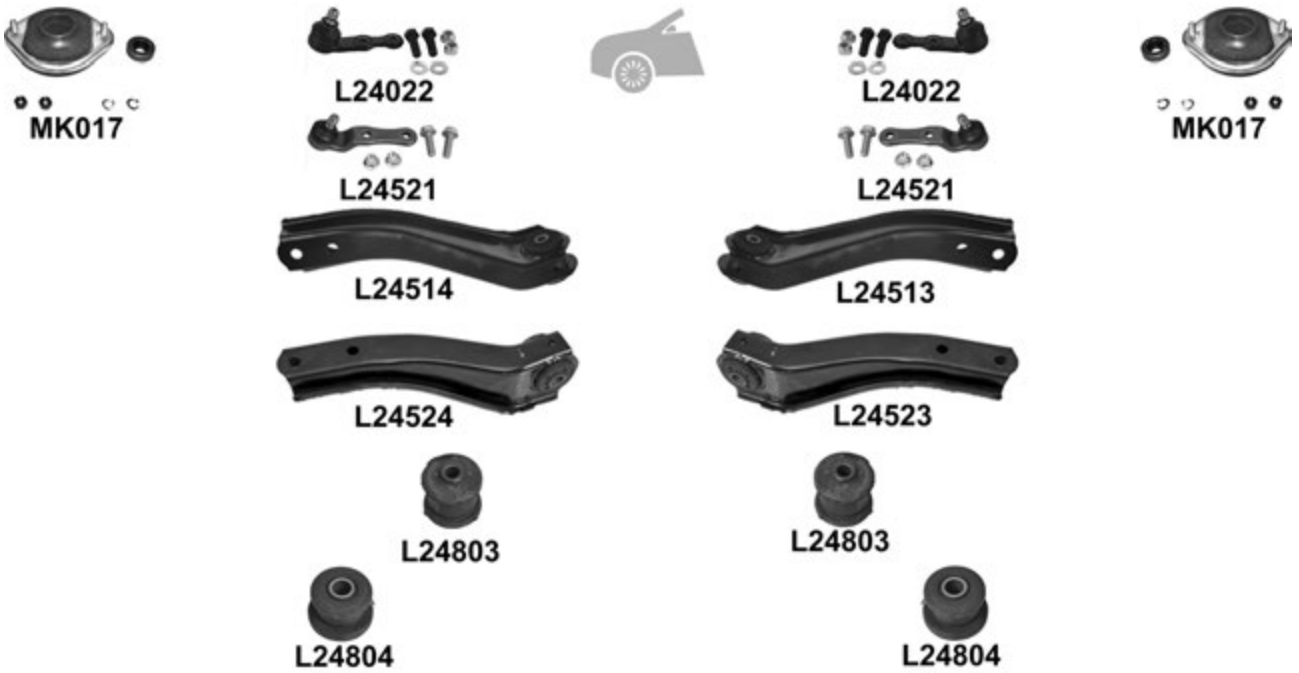

Tigra 07.94 → 12.00

		i		←	→	Thread	Part Of	QPA	i		
		↔	ch. → V 3023597	L24020	L24020	F 12x1,5 ∪		2	324050		
			ch. → V 4166925								
			ch. → V 6066279								
			ch. V 3023598 →	L24113	L24113	F 12x1,5 ∪		2	324066		
			ch. V 4166926 →								
			ch. V 6066280 →								
			/Electronic	L24212	L24212	M 12x1,5 / M 14x1,5 ∪		2	322155		
			Hydraulic	L24213	L24213	M 12x1,5 / M 14x1,5 ∪		2	322158		
				L24029°	L24029°			2	1609121		
		⊥	ch. → V 3023597	L24022	L24022			2	1603187		
			ch. → V 4166925								
			ch. → V 6066279								
			ch. V 3023598 →	L24521	L24521			2	1603222		
			ch. V 4166926 →								
		ch. V 6066280 →									
			⊥	ch. → V 3023597		L24513			1	352002	
				ch. → V 4166925	L24514				1	352003	
				ch. → V 6066279							
				ch. V 3023598 →		L24523			1	5352012	
			ch. V 4166926 →	L24524				1	5352011		
	ch. V 6066280 →										
		⊥↔←		L24803	L24803		L24513/L24514/ L24523/L24524	2	352301		
		⊥↔→	ch. → V 3023597	L24804	L24804			2	353561		
			ch. → V 4166925								
			ch. → V 6066279								
			KIT	MK017	MK017			2	355419		
				L24819	L24819		Hub carrier	2	402643		

Tigra 06.04 →

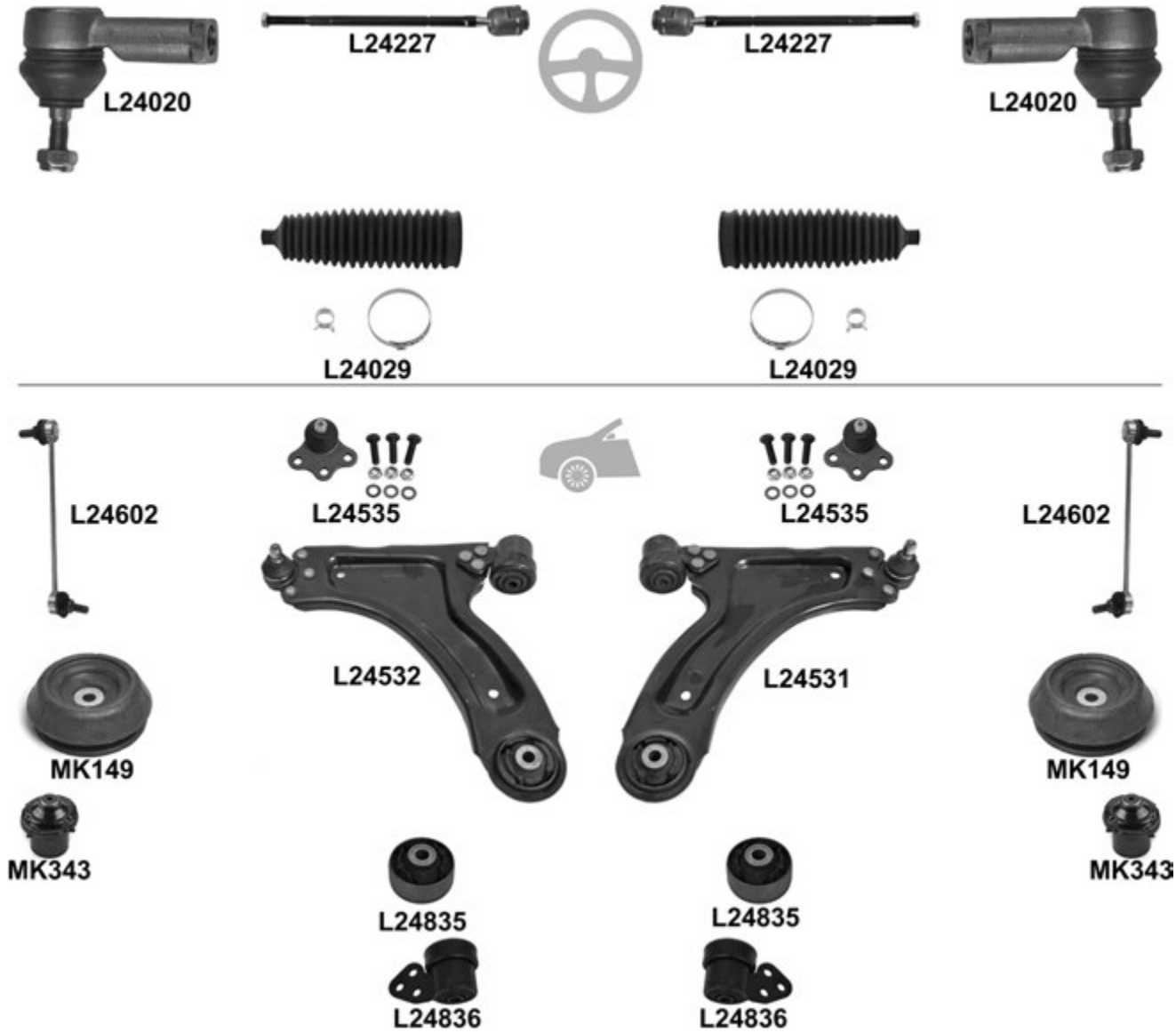

				← → Thread		Part Of	QPA	
⊕		↔	ch. → V 3023597 ch. → V 4166925 ch. → V 6066279	L24020	L24020	F 12x1,5 U		2 324050
				L24227	L24227	M 12x1,5 / F 14x1,5 U		2 1603018
				L24029°	L24029°			2 1609121
⊖		⊥		L24535	L24535			2 352803
		⊥	<input checked="" type="checkbox"/>	L24532	L24531			1 352042
		⊥↘		L24835	L24835			2 352310
		⊥↗		L24836	L24836			2 352309
				L24602	L24602			2 350610
			(-) MK343	KIT	MK149	MK149		2 344525
				MK343	MK343			2 312510

Vectra A 04.88 → 11.95

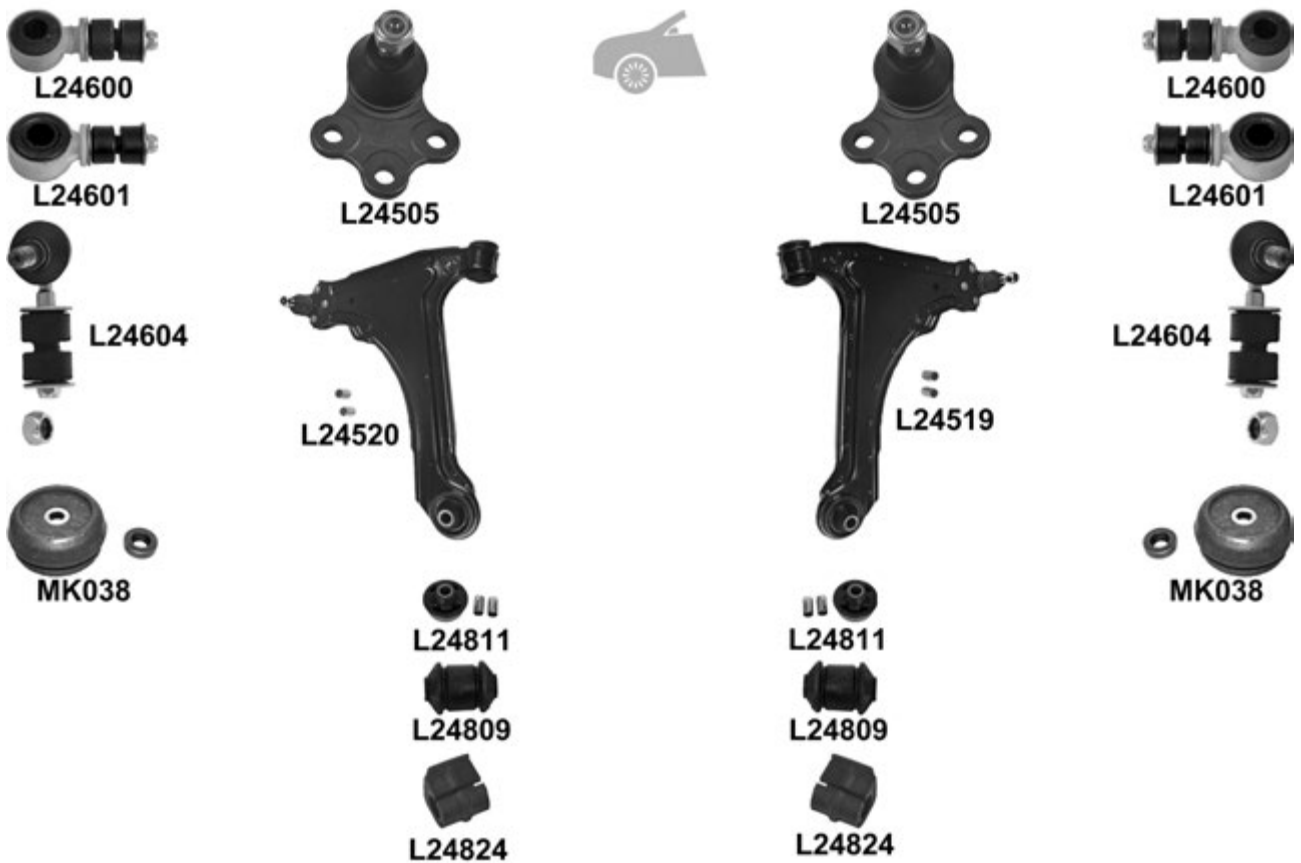
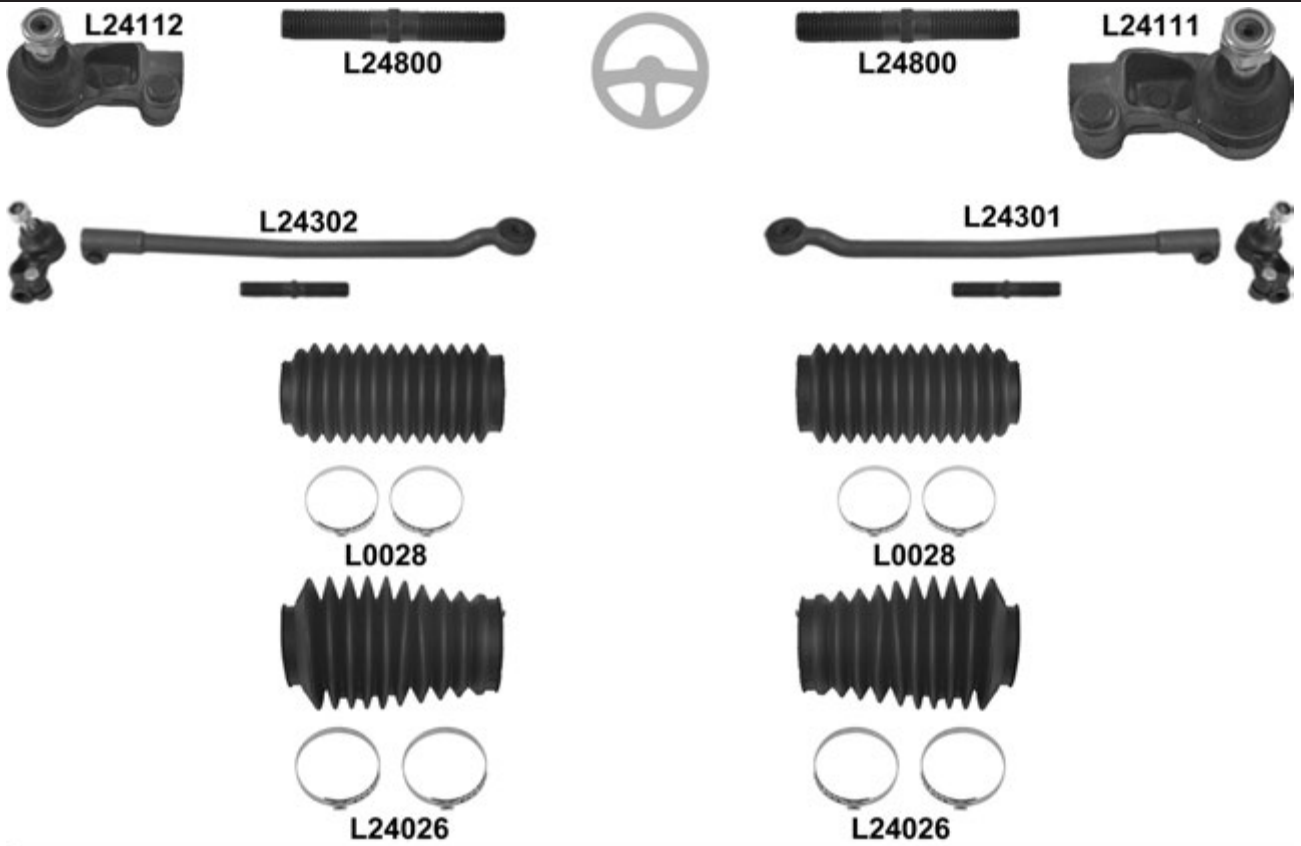

Vectra A 04.88 → 11.95



						←	→	Thread	Part Of	QPA	
⊕		↔			L24111		F 16x2 U		1	324056	
					L24112		F 16x2 U		1	324055	
				L24800	L24800				2	322577	
						L24301			OE no. 324056 / 322577 / 322146	1	
					L24302			OE no. 324055 / 322577 / 322147	1		
🚗		⊖			L0028	L0028				2	902828
					L24026	L24026				2	1609073
		⊖			L24505	L24505				2	1603167
			<input checked="" type="checkbox"/>			L24519				1	5352000
		⊖			L24520					1	5352001
					L24811	L24811			2	352356	
		⊖	⬆		L24809	L24809			2	352300	
			⬆	ø 12mm	L24600	L24600			2	350261S	
		⊖	⬆	ø 18mm	L24601	L24601			2	350260S	
			⬆	22mm	L24604	L24604			2	350263	
	⊖	⬆	20mm	L24824	L24824			2	350078		
		⬆	22mm				Anti-roll bar	2	350078		
	⊖		1.4/1.6/1.7D/TD/1.8/2.0 NE/C 20 NE, (-) GT	KIT	MK038	MK038			2	344514S	
			1.8/2.0 NE/C 20 NE GT/2.0 SEH/2.0 XE/C 2.0 XE, (+) GT	KIT	MK038	MK038			2	344513S	
🚗		⊖		4x4/2,0 XE/C 2.0 XE ch. K 1000001 → N 1999999 K 5000001 → N 5999999 KV 1000001 → NV 999999	L24823	L24823			4	423313	
				ch. → NV 299999 ch. → N 1999999 ch. → N 5999999 (-) 4x4/2,0 XE/C 2.0 XE/X 2.0 XEV	L24820	L24820		Hub carrier	2	402642	
				ch. P 1000001 → ch. P 5000001 → ch. P 7000001 → (-) 4x4/2,0 XE/C 2.0 XE/X 2.0 XEV	L24821	L24821		Hub carrier	2	402645	
				4x4/2,0 XE/C 2.0 XE/ X 2.0 XEV, ch. K 1000001 → L 1095238	L24822	L24822		Hub carrier	2	402935	

Vectra (B) 10.95 →

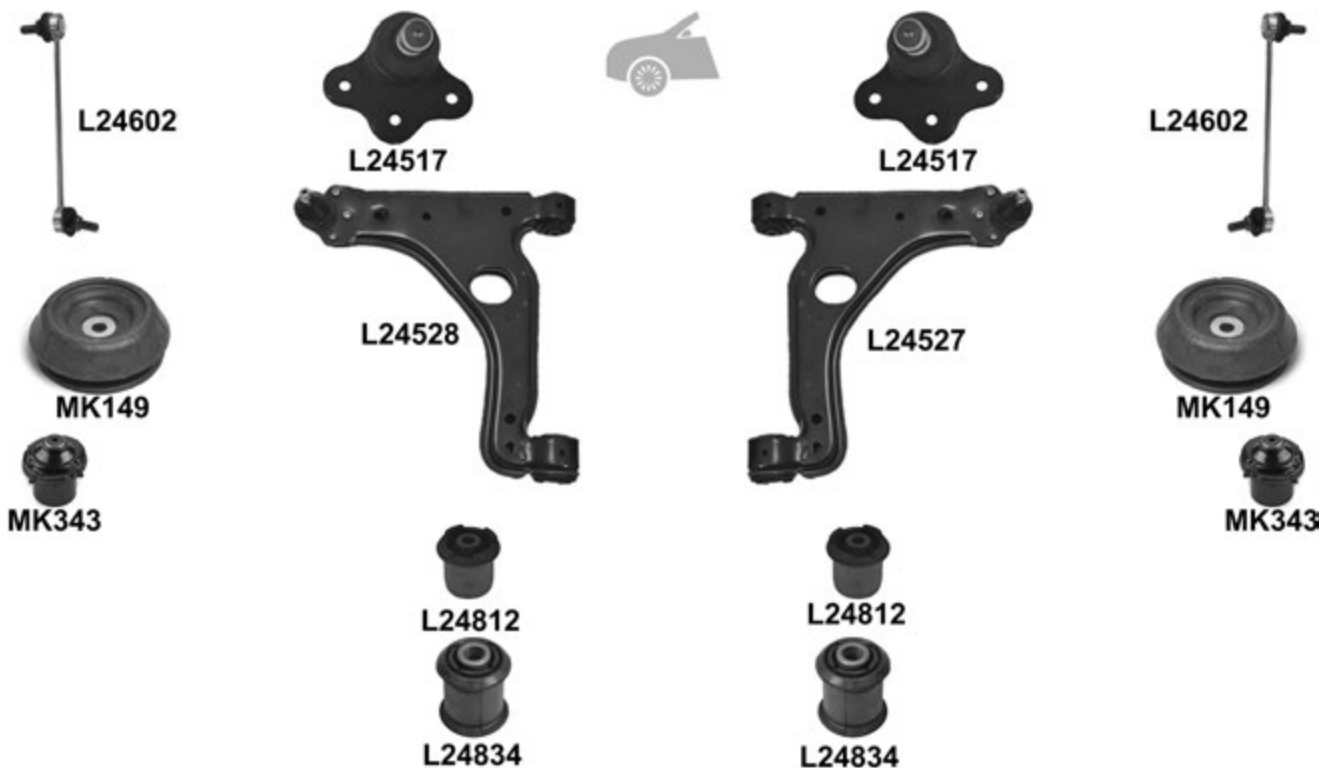
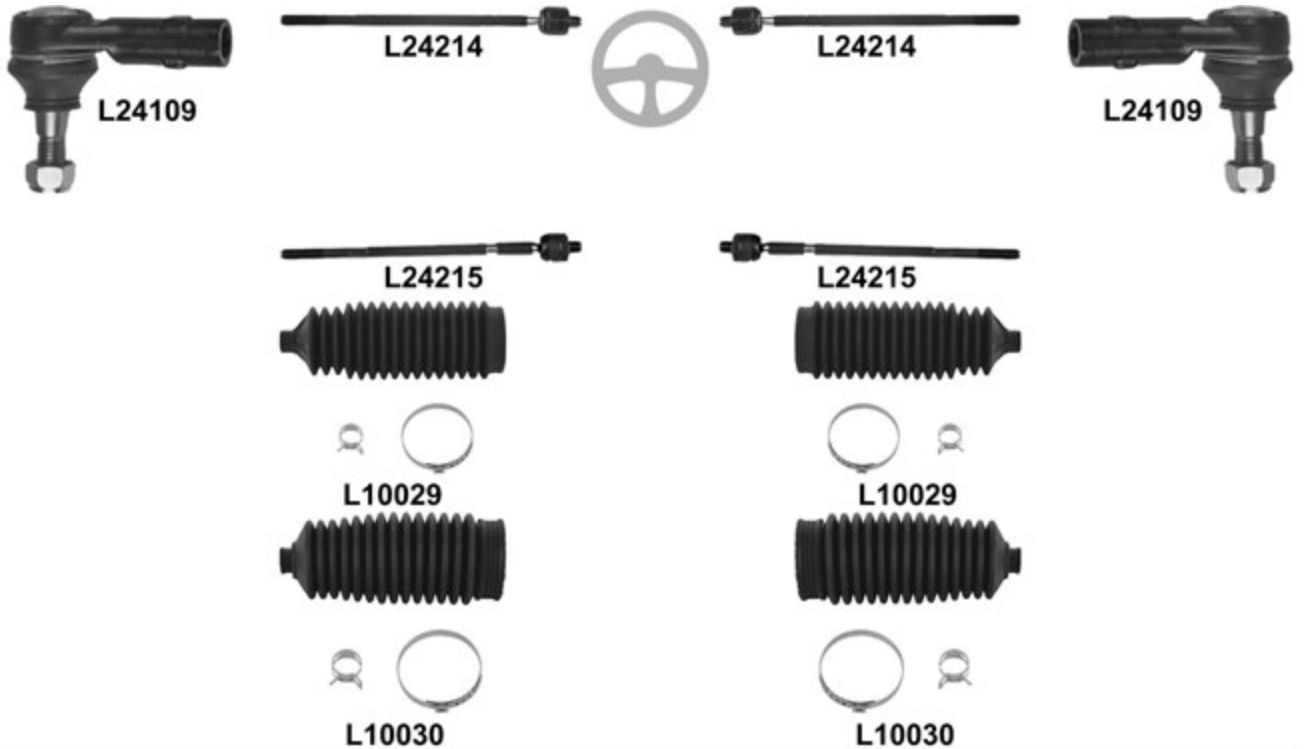

Vectra (B) 10.95 →

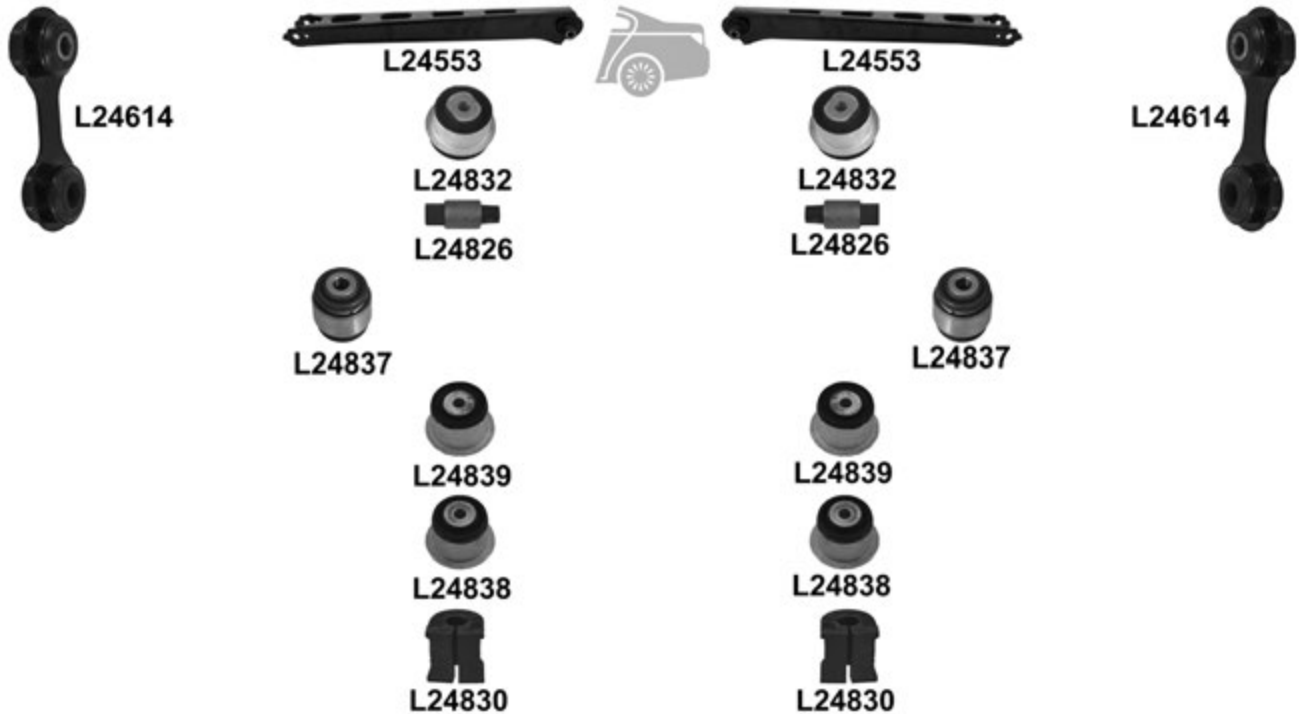

				← → Thread		Part Of	QPA			
				L24109	L24109	F 14x1,5 U	2	324063		
				L24214	L24214	M 14x1,5 / M 16x1,5 U	2	324186		
				L24215	L24215	M 14x1,5 / M 16x1,5 U	2	1603199		
		Saginaw		L10029 ^o	L10029 ^o		2	1609096		
		ZF		L10030 ^o	L10030 ^o		2	1609095		
				L24517	L24517		2	352829		
				<input checked="" type="checkbox"/>		L24527		1	5352004	
			L24528			1	5352005			
			12 x 47,5 x 60mm	L24812	L24812		2	352358		
			12 x 36 x 60mm	L24834	L24834		2	352364		
				L24602	L24602		2	350610		
			(-) MK343	KIT	MK149	MK149		2	344525	
					MK343	MK343		2	312510	
				L24832	L24832		2	423318		
				L24826	L24826		4	423316		
				L24837	L24837		4	423121		
			transverse	L24553	L24553		2	464023		
					L24839	L24839		2	5402630	
					L24838	L24838		2	5402631	
			ch. X000001 →	L24614	L24614		2	444291		
			ch. → W1999999 ch. → W5999999 ch. → W 7999999	L24830	L24830		2	444153		

Vectra (C) 04.02 →

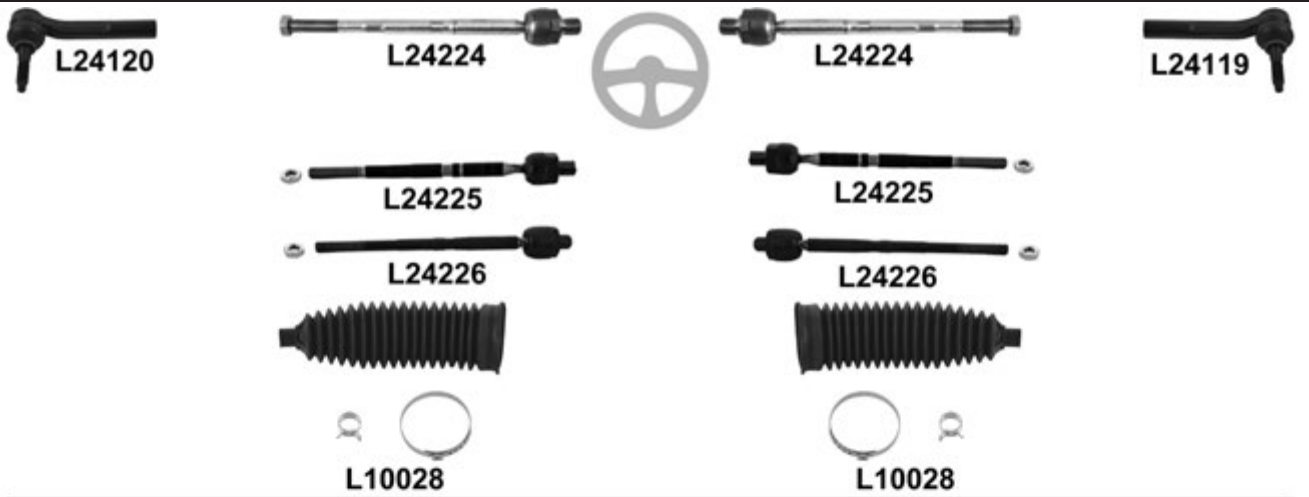

Vectra (C) 04.02 →

				←	→	Thread	Part Of	QPA	
		↔↔				L24119		1	1603228
						L24120		1	1603227
			(-) Sport			L24224	L24224	2	1603229
			Sport ch. → 31 032140 ch. → 38 040655			L24224	L24224	2	1603229
			Sport ch. 31 032141 → ch. 38 040656 → 			L24225	L24225	2	1603244
						L24226	L24226	2	1603229
		↓		<input checked="" type="checkbox"/>		L24537		1	352052
						L24538		1	352051
		↓				L10838	L10838	2	352319
		↑	12 x 36 x 60mm			L24834	L24834	2	352364
			(-) IDS chassis			L24606	L24606	2	350603
			IDS chassis			L24613	L24613	2	350612
			(-) /MK342	KIT		MK208	MK208	2	344537
						MK342	MK342	2	344665
		↑		<input checked="" type="checkbox"/>		L10545	L10545	2	423008
						L10637 ^o	L10637 ^o	2	444275

Vivaro 08.01 →

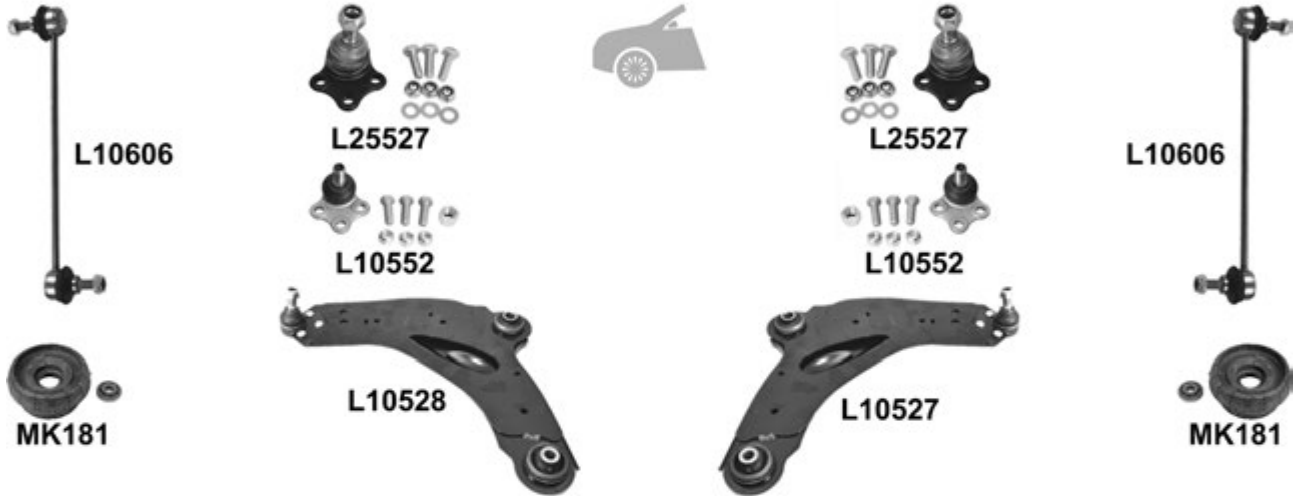

Vivaro 08.01 →

				←	→	Thread	Part Of	QPA		
		↔			L10105	F 14x1,5 ∪		1	4408511	
				L10106		F 14x1,5 ∪		1	4408510	
					L10206	L10206	M 14x1,5 / M 12x1 ∪	2	4408474	
					L10018	L10018		2	91160038	
		⊥	→ 06.06, 10mm	L25527	L25527			2	4419075	
			07.06 →, 12mm	L10552	L10552			2	4431869	
		⊥	→ 06.06, 10mm	<input checked="" type="checkbox"/>		L10527			1	4412936
					L10528			1	4412934	
				<input checked="" type="checkbox"/>		L10569		1	4417178	
			07.06 →, 12mm	<input checked="" type="checkbox"/>		L10570		1	4417177	
		⊥▼			L10816	L10816			2	
		⊥▲			L10817	L10817			2	
					L10606	L10606			2	4408904
			22mm		L10843	L10843		Anti-roll bar	2	
			KIT	MK181	MK181			2	4408054	

Zafira F75 04.99 → 06.05

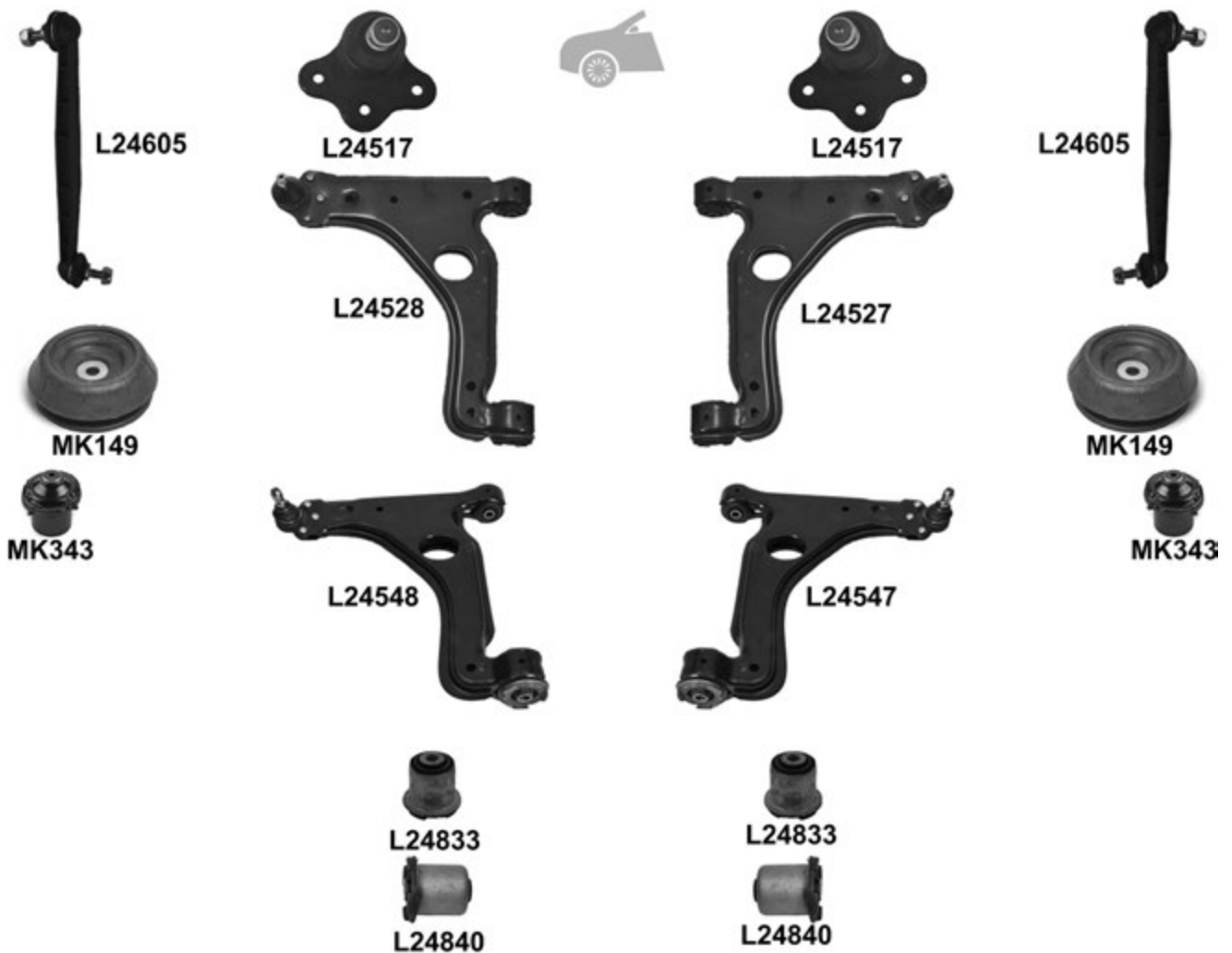
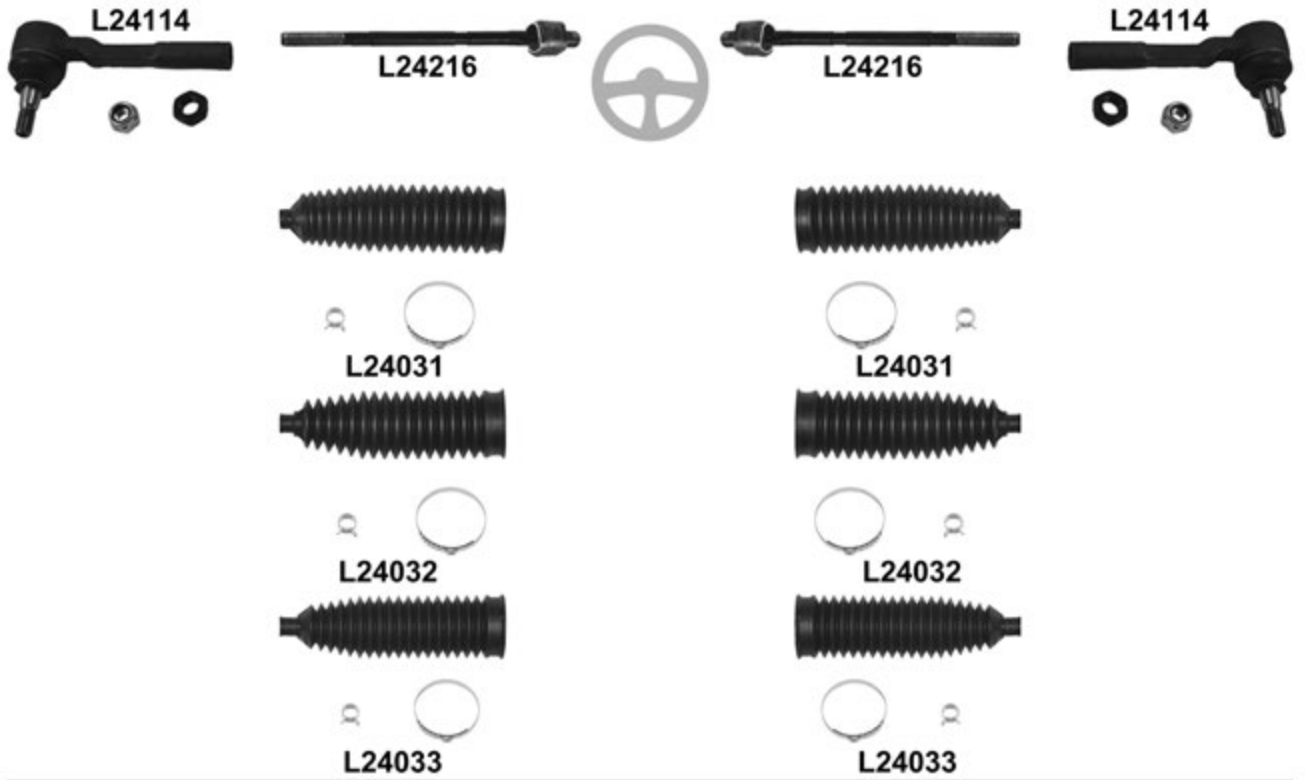

Zafira F75 04.99 → 06.05



Thread

Part Of

QPA



⊕		↔		L24114	L24114	F 14x1,5 ♂		2	1603215
				L24216	L24216			2	1603216
			, Delphi, L= 190mm, ø 13,5mm, Ø 49,5mm	L24031 ⁰	L24031 ⁰			2	1609109
			, TRW, L= 200, ø 13mm, Ø 52mm	L24032 ⁰	L24032 ⁰			2	1609113
		, TRW, L= 211, ø 14,5mm, Ø 53mm	L24033 ⁰	L24033 ⁰			2	1609356	
		↓		L24517	L24517			2	352829
			ch. → 42125089 <input checked="" type="checkbox"/>		L24527			1	5352017
		↓	ch. 42125090 → <input checked="" type="checkbox"/>		L24547			1	5352030
				L24548			1	5352029	
		↓	12 x 45/48 x 60mm, ch. → 42125089	L24833	L24833			2	352365
			12 x 46 x 60mm, ch. 42125090 →	L24840	L24840			2	352324
		↑	12 x 36 x 60mm	L24834	L24834			2	352364
				L24605	L24605			2	350611
			(-) MK343	KIT	MK149	MK149		2	344525
				MK343	MK343			2	312510
		▲		L24843	L24843		Hub carrier	2	5402638

Zafira M75 07.05 →

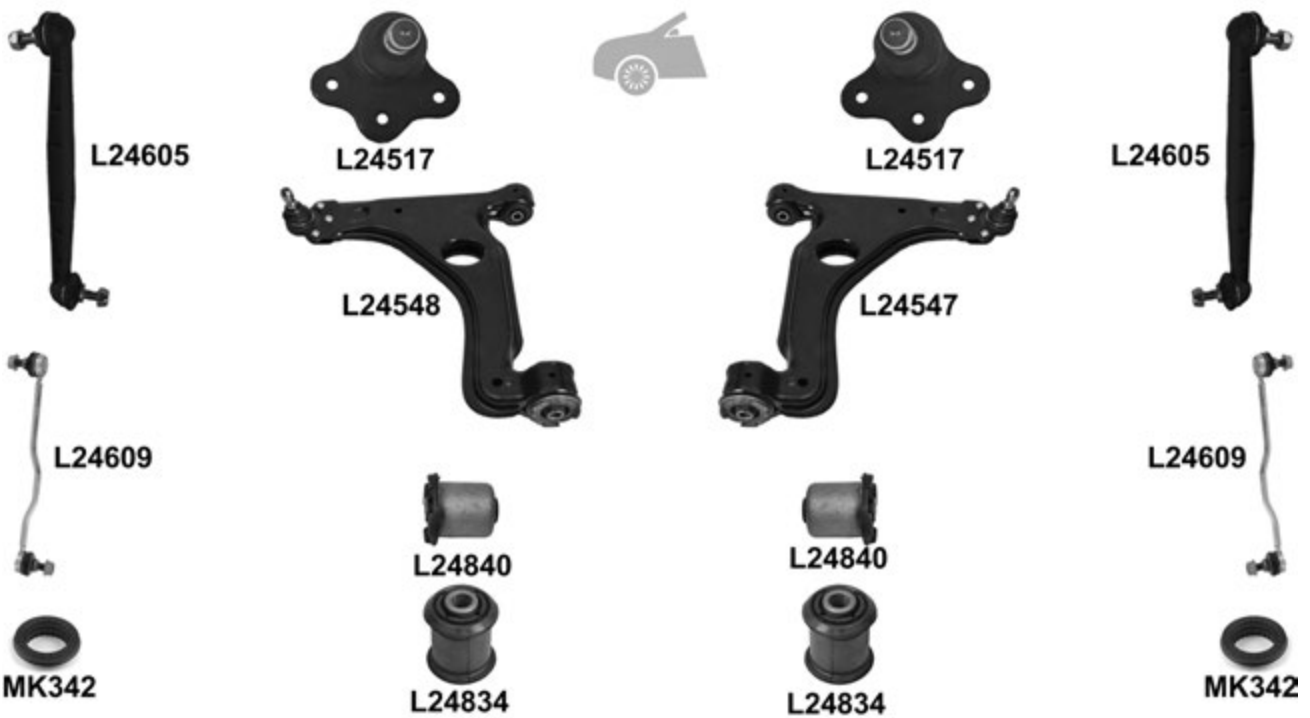
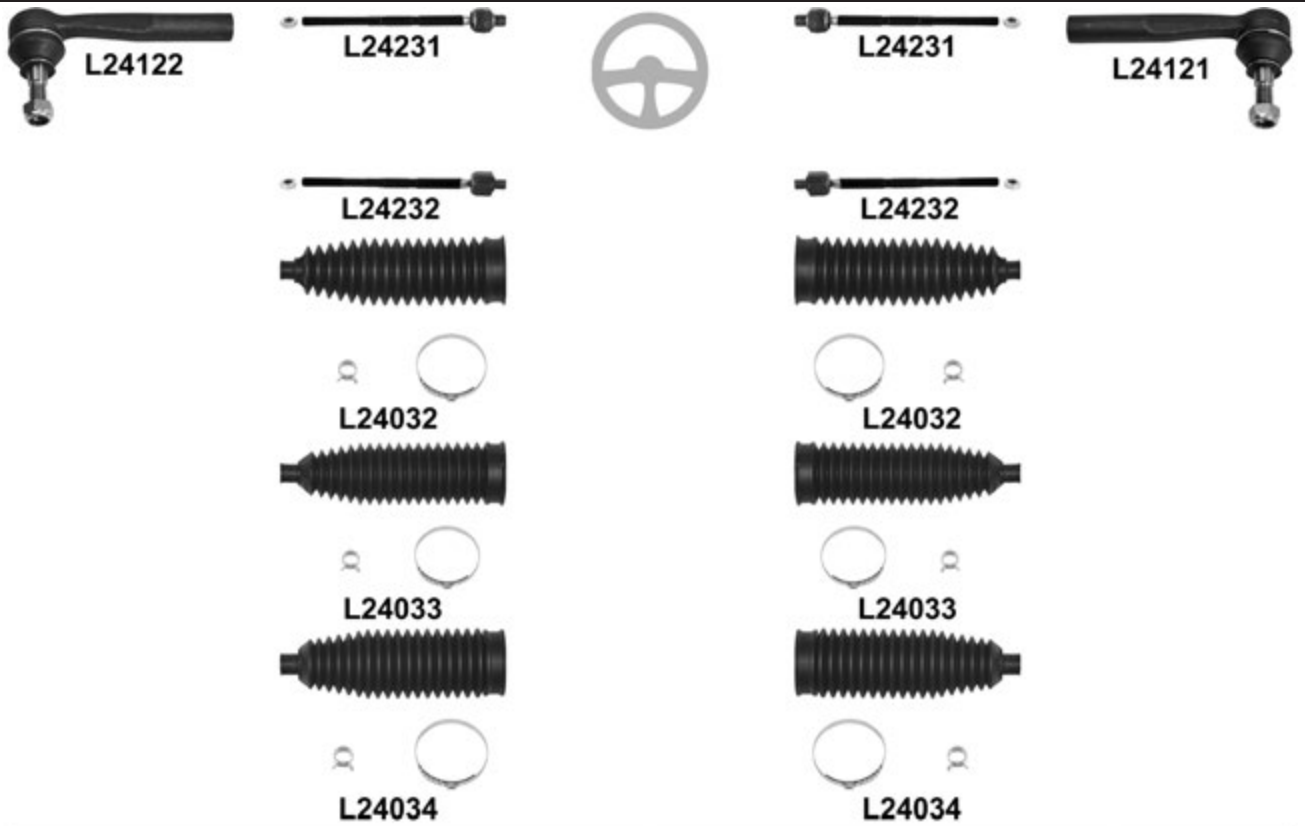

Zafira M75 07.05 →

		← →		Thread	Part Of	QPA			
		↔		L24121		1	1603257		
				L24122		1	1603258		
			TRW	L24231	L24231	M 14x1,5 / M 18x1,5	2	1603287	
			(-) , ZF	L24232	L24232	M 14x1,5 / M 16x1,5	2	1603265	
			ch. → 72095156, TRW L= 200, ø 13mm, ø 52mm	L24032 ⁰	L24032 ⁰		2	1609113	
			ch. 72095157 →, TRW L= 211, ø 14,5mm, ø 53mm	L24033 ⁰	L24033 ⁰		2	1609356	
		ZF, L= 190mm, ø 13mm, ø 49mm	L24034 ⁰	L24034 ⁰		2	1609153		
		↓		L24517	L24517		2	352829	
		↓		<input checked="" type="checkbox"/>	L24547		1	5352030	
				L24548		1	5352029		
		↓	12 x 46 x 60mm	L24840	L24840			2	352324
		↓	12 x 36 x 60mm	L24834	L24834			2	352364
			(-) IDS chassis	L24605	L24605			2	350614
			IDS chassis	L24609	L24609			2	350613
			MK342	MK342		, L24915	2	344665	

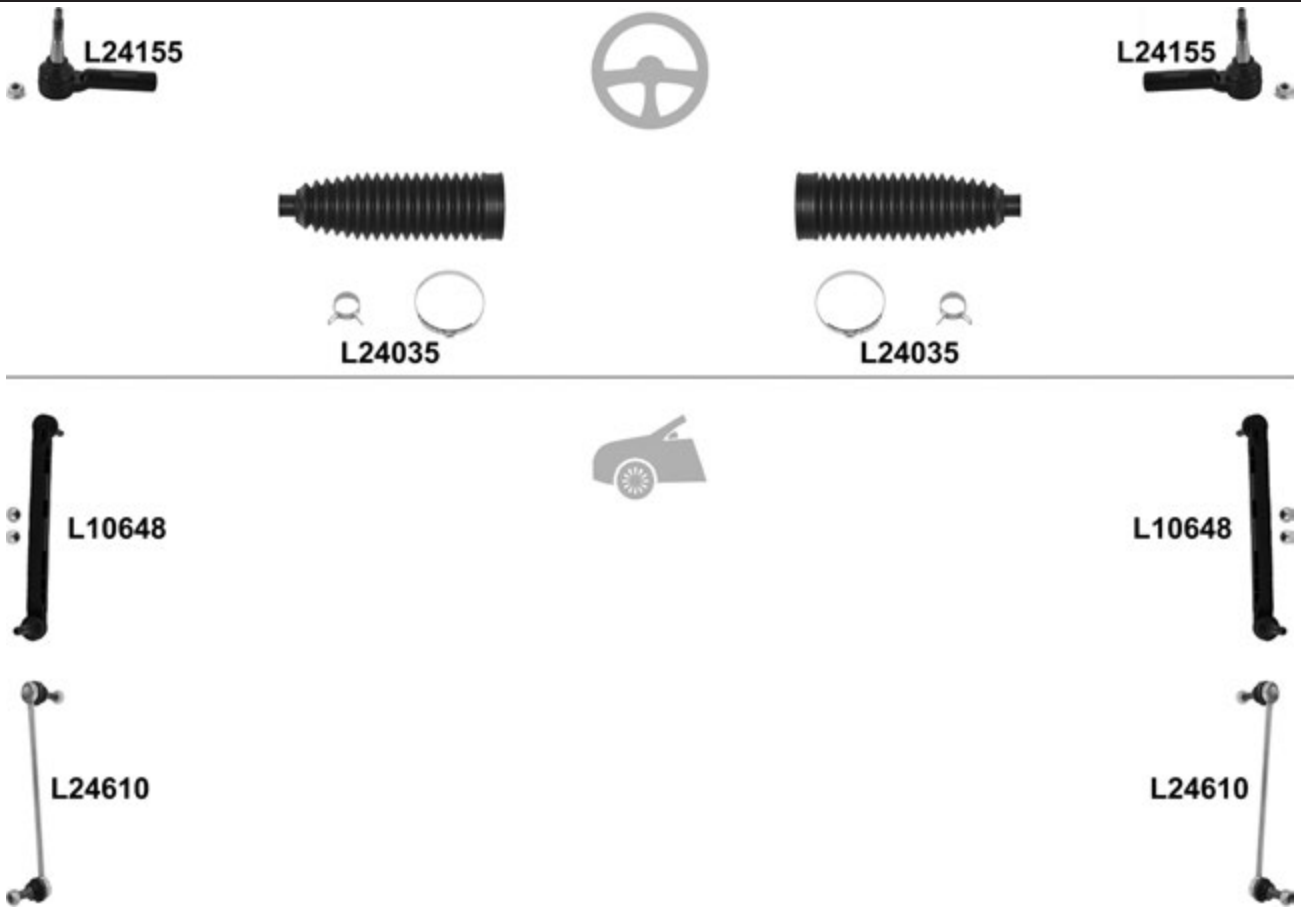
Zafira 75 09.11 →

			←	→	Thread	Part Of	QPA	
		↔	L24155	L24155	F 16x1,5 ♂		2	13286686
			Electric , ø 16mm, Ø 53,5mm, L= 194mm	L24035 ^o	L24035 ^o		2	13354440
			(-) IDS chassis	L10648	L10648		2	13219141
			IDS chassis	L24610	L24610		2	13258052

PEUGEOT

Bipper (AA_) 02.08 →

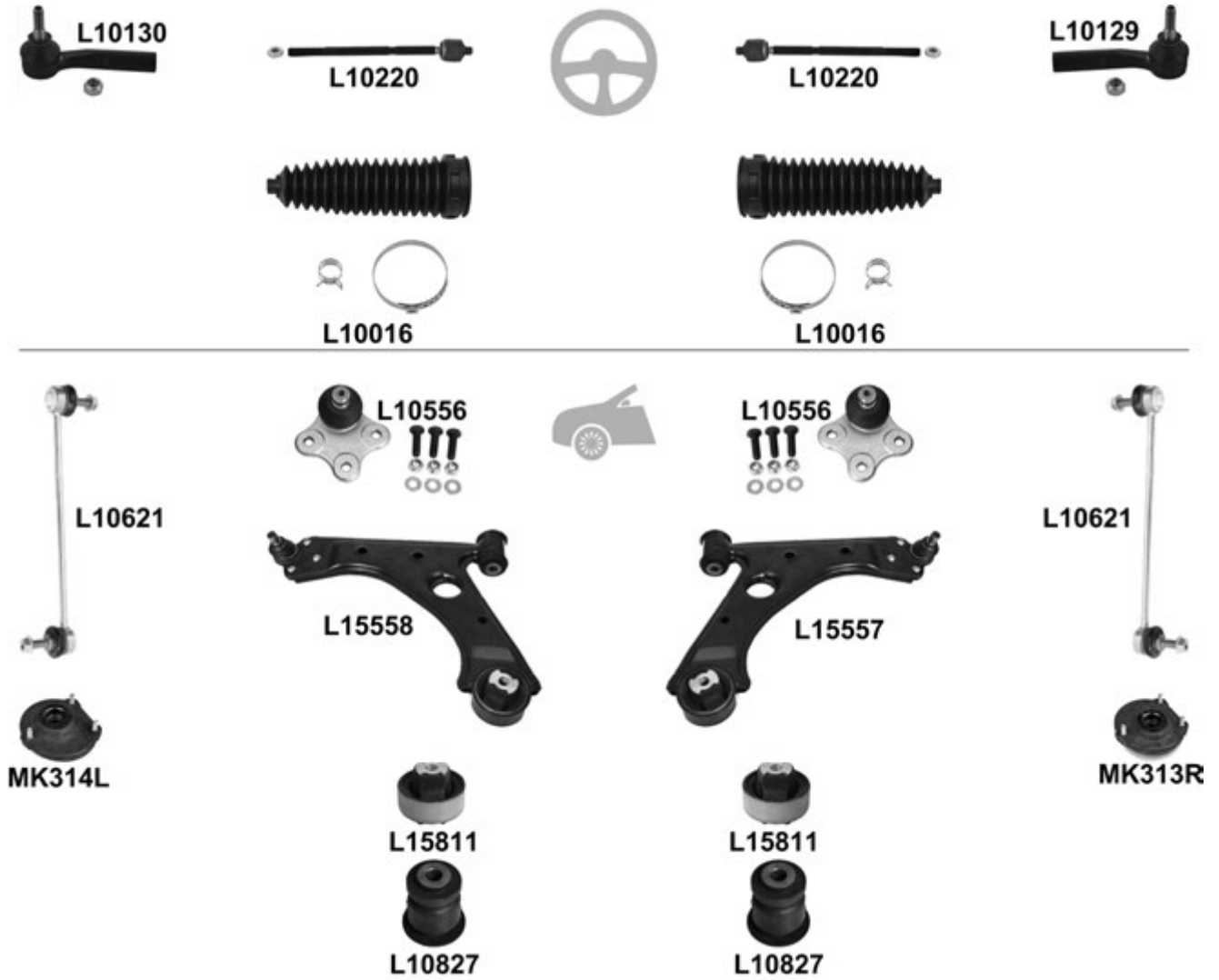

		i	←	→	Thread	Part Of	QPA	i
⊕		↔		L10129	F 14x1,5 ∪		1	3817.87
				L10130	F 14x1,5 ∪		1	3817.86
			L10220	L10220	M 14x1,5 / M 14x1,5 ∪		2	
			L10016	L10016			2	4066.95
⊖		⊥		L10556	L10556		2	3520.W3
			<input checked="" type="checkbox"/>		L15557		1	3521.S6
		L15558			1	3520.W3		
		⊥▼	L15811	L15811			2	
		⊥▲	L10827	L10827			2	
			L10621	L10621			2	5087.70
			KIT		MK313R		1	5038.J8
				MK314L		1	5038.J7	

Boxer (230P / 230L) 03.94 → 04.02

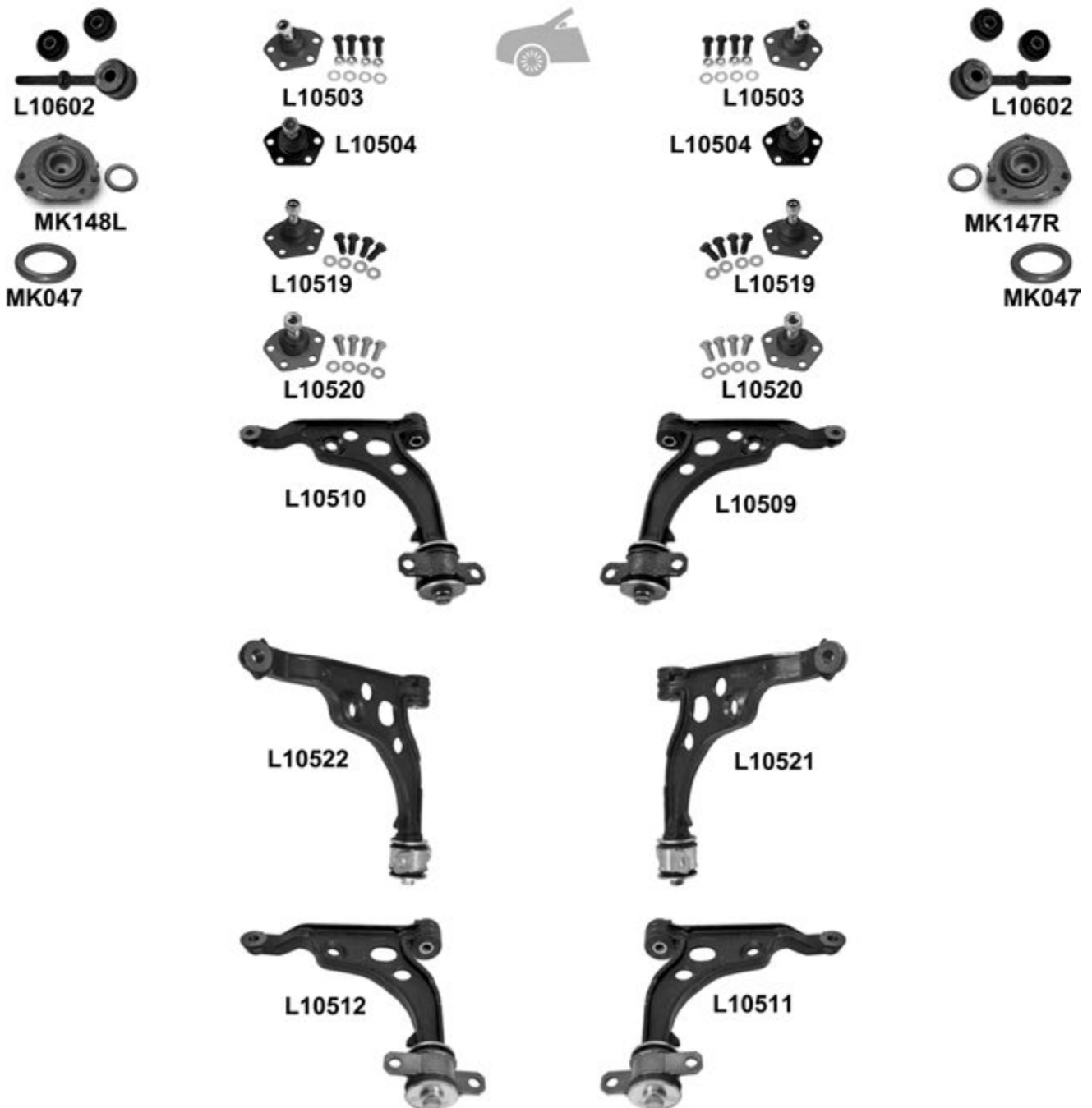
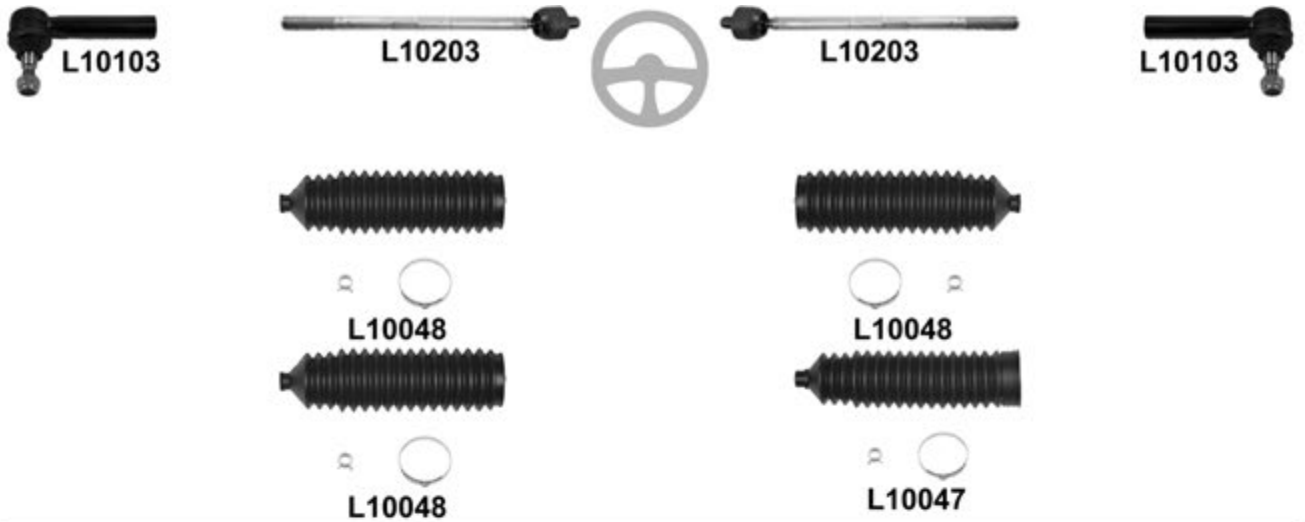

Boxer (230P / 230L) 03.94 → 04.02

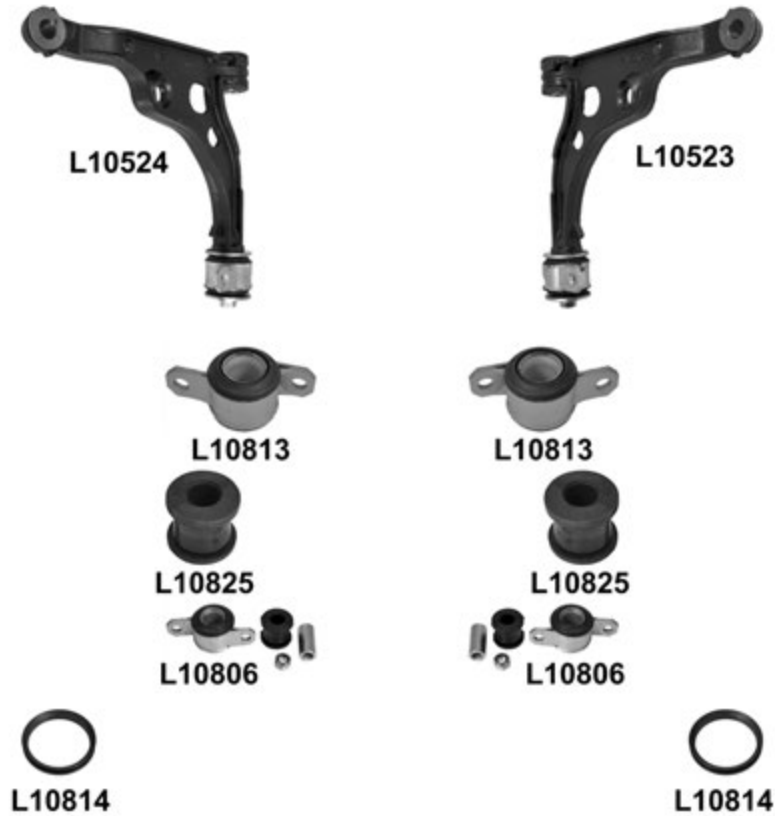

			←	→	Thread	Part Of	QPA		
			14.4mm	L10103	L10103	F 16x1,5 U	2	4018.A3	
				L10203	L10203	M 16x1,5 / M 16x1,5 U	2	4018.A4	
					L10048 ^o	L10048 ^o		2	4066.31
				, OE no. 4006.22=set of 2		L10047 ^o		1	4006.22
					L10048 ^o			1	4006.22*
			→ 01.01, 10 - 14 Q, 16,2mm	L10503	L10503		2	3640.32	
			→ 01.01, 18 Q, 19,2mm, (16°)	L10504	L10504		2	3640.33	
			02.01 →, 10 - 14 Q, 20mm	L10519	L10519		2	3640.55	
			02.01 →, 18 Q, 24mm	L10520	L10520		2	3640.54	
			→ 01.01, 10 - 14 Q, 16,2mm		L10509		1	3521.65	
				L10510		1	3520.95		
			02.01 →, 10 - 15 Q, 20mm		L10521		1	3521.J3	
				L10522		1	3520.N3		
			→ 01.01, 18 Q, 19,2mm, (16°)		L10511		1	3521.66	
				L10512		1	3520.96		
			02.01 →, 18 Q, 24mm		L10523		1	3521.J4	
		L10524		1	3520.N4				
				L10813	L10813		2	3523.94	
(+) metal sleeve			L10825	L10825		2	3523.93		
			KIT	L10806	L10806		2		
				L10602	L10602		2	13007 16080 S	
		→ 12.01, (+) MK047 / L10814	KIT		MK147R		1	5038.19 S	
					MK148L		1	5038.18 S	
				MK047	MK047		2	5035.39	
RUBBER				L10814	L10814		2	5035.50	

Boxer (244) 04.02 →

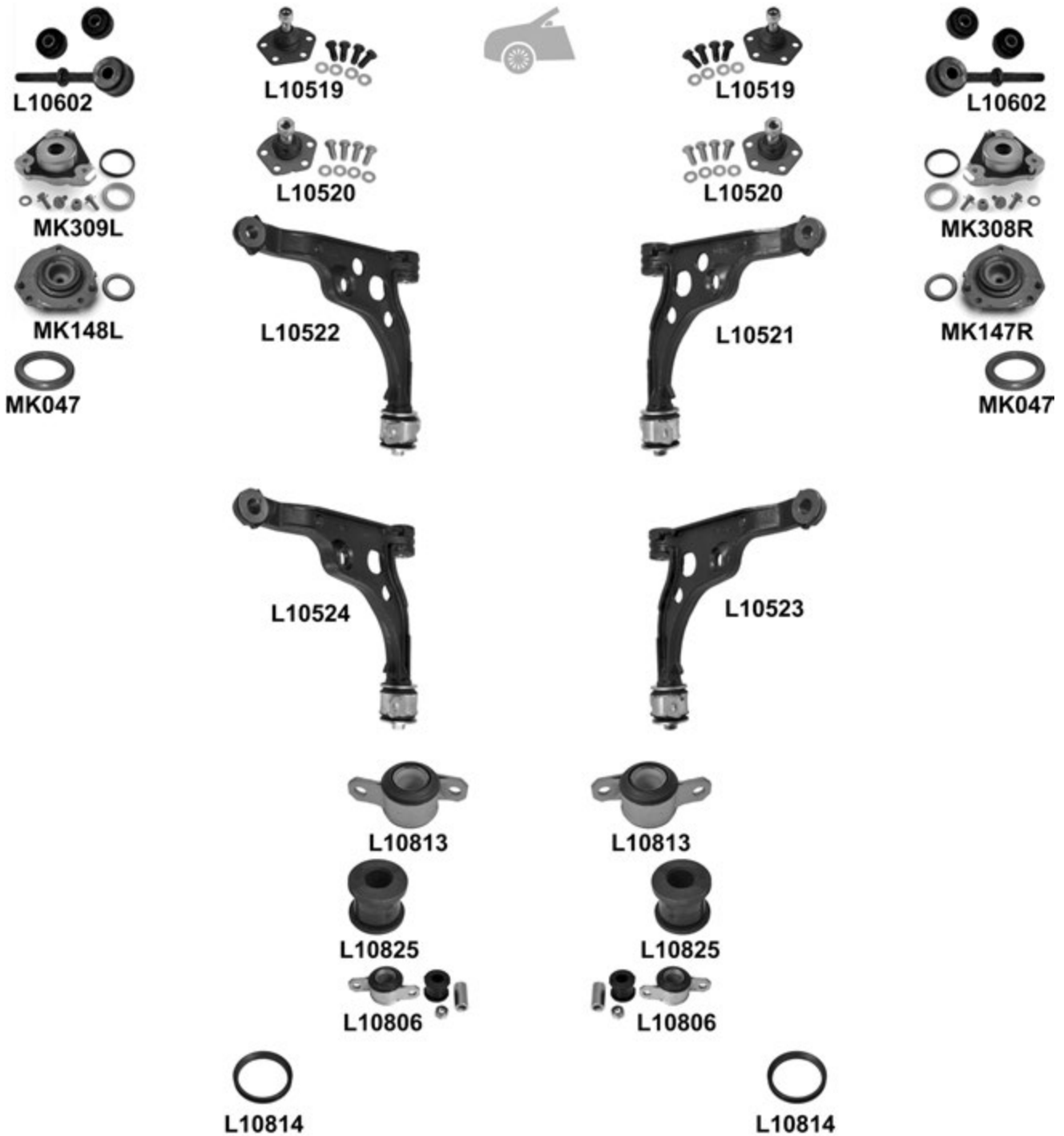

Boxer (244) 04.02 →

				←	→	Thread	Part Of	QPA		
		↔	→ 12.02, ch. → 17175290, 14.4mm	L10103	L10103	F 16x1,5 U		2	4018.H4	
			12.02 →, ch. 17175291 →, 16.7mm	L10107	L10107	F 16x1,5 U		2	4018.E0	
				L10203	L10203	M 16x1,5 / M 16x1,5 U		2	4018.A4	
		↓	10 - 15 Q, 20mm	L10519	L10519			2	3640.55	
			18 Q, 24mm	L10520	L10520			2	3640.54	
		↓	02.01 →, 10 - 15 Q, 20mm		L10521				1	3521.J3
				L10522				1	3520.N3	
			02.01 →, 18 Q, 24mm		L10523				1	3521.J4
				L10524				1	3520.N4	
		↓		L10813	L10813			2	3523.94	
		↓	(+) metal sleeve	L10825	L10825			2	3523.93	
				KIT	L10806	L10806			2	
					L10602	L10602			2	5087.37
			(-) Off-Road, (+) MK047 / L 10814	KIT		MK308R		1	5038.C9	
					MK309L			1	5038.E3	
			Off-Road, (+) MK047 / L 10814	KIT		MK147R		1	5038.29	
					MK148L			1	5038.28	
				MK047	MK047			2	5035.39	
RUBBER				L10814	L10814			2	5035.50	

Boxer 04.06 →

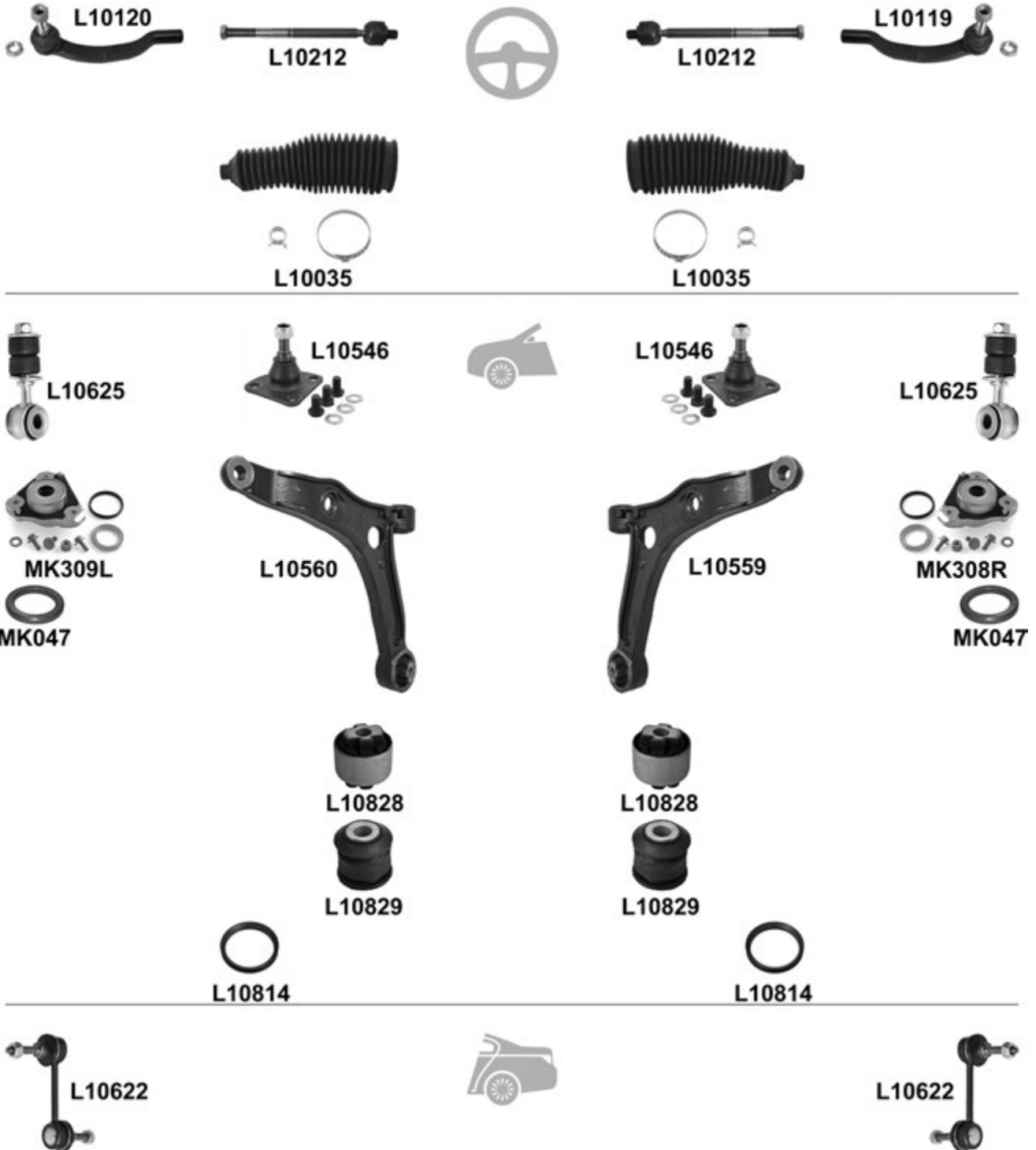

Boxer 04.06 →

		← →		Thread		Part Of		QPA	
		↔		L10119	F 16x1,5 U			1	3817.70
				L10120	F 16x1,5 U			1	3817.77
				L10212	L10212	M 16x1,5 / M 16x1,5 U		2	
				L10035 ⁰	L10035 ⁰			2	77364254
		⊥		L10546	L10546			2	3640.67
		⊥	(-)		L10559			1	3521.P2
				L10560				1	3520.S1
		⊥▼		L10828	L10828		L10559/L10560	2	51705198
		⊥▲		L10829	L10829		L10559/L10560	2	51705197
				L10625	L10625			2	
			(+) MK047 / L10814	KIT	MK308R			1	5038.C9
				MK309L				1	5038.87
				MK047	MK047			2	5035.47
RUBBER			L10814	L10814			2	5035.50	
			L10622	L10622			2	5170.F6	

Expert (222 / 223 / 224) 02.96 →

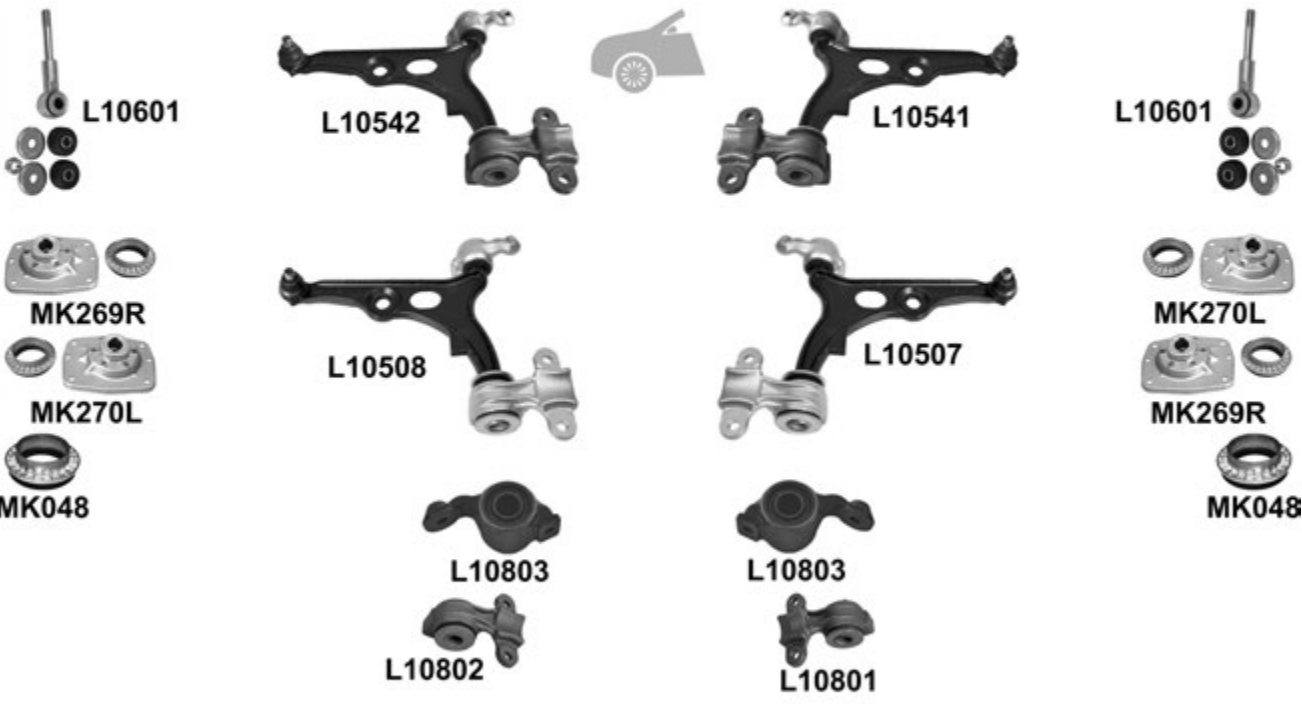

Expert (222 / 223 / 224) 02.96 →

				←	→	Thread	Part Of	QPA	
		↔	(-) 1.9 D/2.0/2.0 Hdi	L10101	L10101	F 14x1,5 U		2	4059.09
			1.9 D/2.0/2.0 Hdi, PR → 9792, → 09.03	L10101	L10101	F 14x1,5 U		2	4059.09
			1.9 D/2.0/2.0 Hdi, PR 9793 →, 10.03 →	L10108	L10108	F 14x1,5 U		2	4059.12
				L10201	L10201	M 14x1,5 / M 14x1,5 U		2	3812.A4
		⊥	Petrol, PR → 10829, → 06.06 <input checked="" type="checkbox"/>		L10541			1	3521.L0
				L10542			1	3520.P8	
			Diesel, PR → 10829, → 06.06 <input checked="" type="checkbox"/>		L10507		1	3521.K4	
		L10508			1	3520.P4			
		⊥▼		L10803	L10803		L10507/L10508/ L10541/L10542	2	
			⊥▲		L10801		L10507/L10541	1	
			L10802		L10508/L10542	1			
			L10601	L10601			2	5038.35 S	
		⊙	KIT		MK270L			1	5038.16 S
					MK269R			1	5038.17 S
		⊙	KIT		MK269R			1	5038.17 S
					MK270L			1	5038.16 S
			MK048	MK048			2	5035.38	
				L10810	L10810		Hub carrier	2	5152.61

Expert (VF3A_, VF3U_, VF3X_, 01.07 →
Expert Tepee (VF3V_) 01.07 →

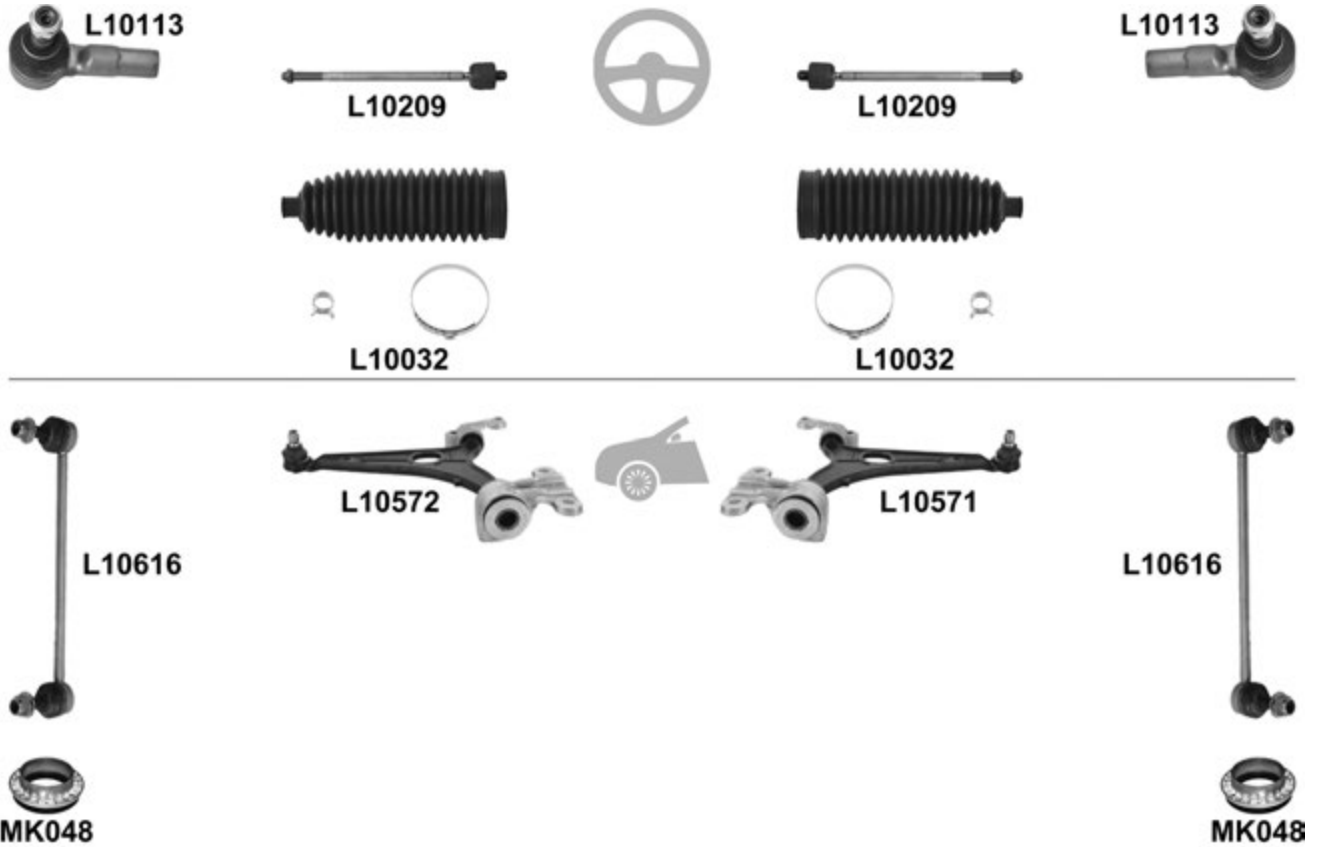

				← → Thread		Part Of	QPA		
⊕		↔		L10113	L10113	↺		2	3817.73
				L10209	L10209	↺		2	3812.F0
				L10032°	L10032°			2	4066.83
🚗		⊥	↗ 19mm		L10571			1	3521.N9
				L10572				1	3520.R8
				L10616	L10616			2	5087.56
				MK048	MK048			2	5035.55

J5 (280P / 280L / 290P / 290L 09.81 →)

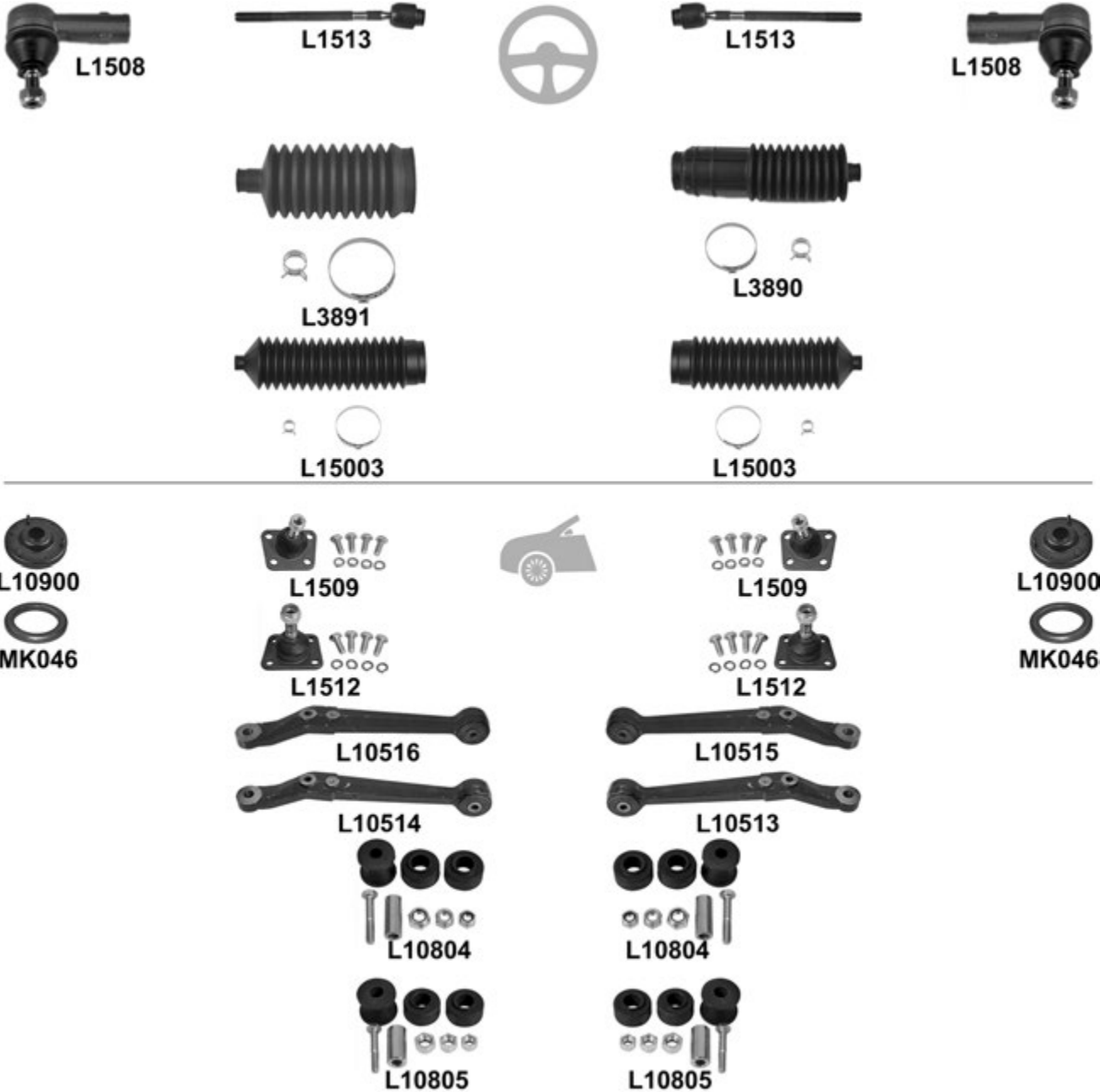

				← → Thread		Part Of	QPA			
⊕		↔		L1508	L1508	F 16x1,5 ∪		2	3817.11	
				L1513	L1513	M 16x1,5 / F 16x1,5 ∪		2	9750 001 180	
						L3890		1	4066.19	
						L3891		1	4066.18	
				L15003	L15003			2		
🚗		⊥	→ 09.85, ch. → 0224300	L1509	L1509			2	3640.18	
			10.85 →, ch. 0224301 →	L1512	L1512			2	3640.26	
		⊥	10.85 →, (-) 1800		L10515			1	3521.52	
				L10516			1	3520.76		
			10.85 →, 1800		L10513 ¹		1	3521.53		
				L10514 ¹		1	3520.77			
			(-) 1800	KIT	L10804	L10804			2	
			1800		L10805	L10805			2	
				KIT	L10900	L10900			2	5210.20 S
					MK046	MK046			2	5035.17

Partner / Ranch (5F / 5) 06.96 →

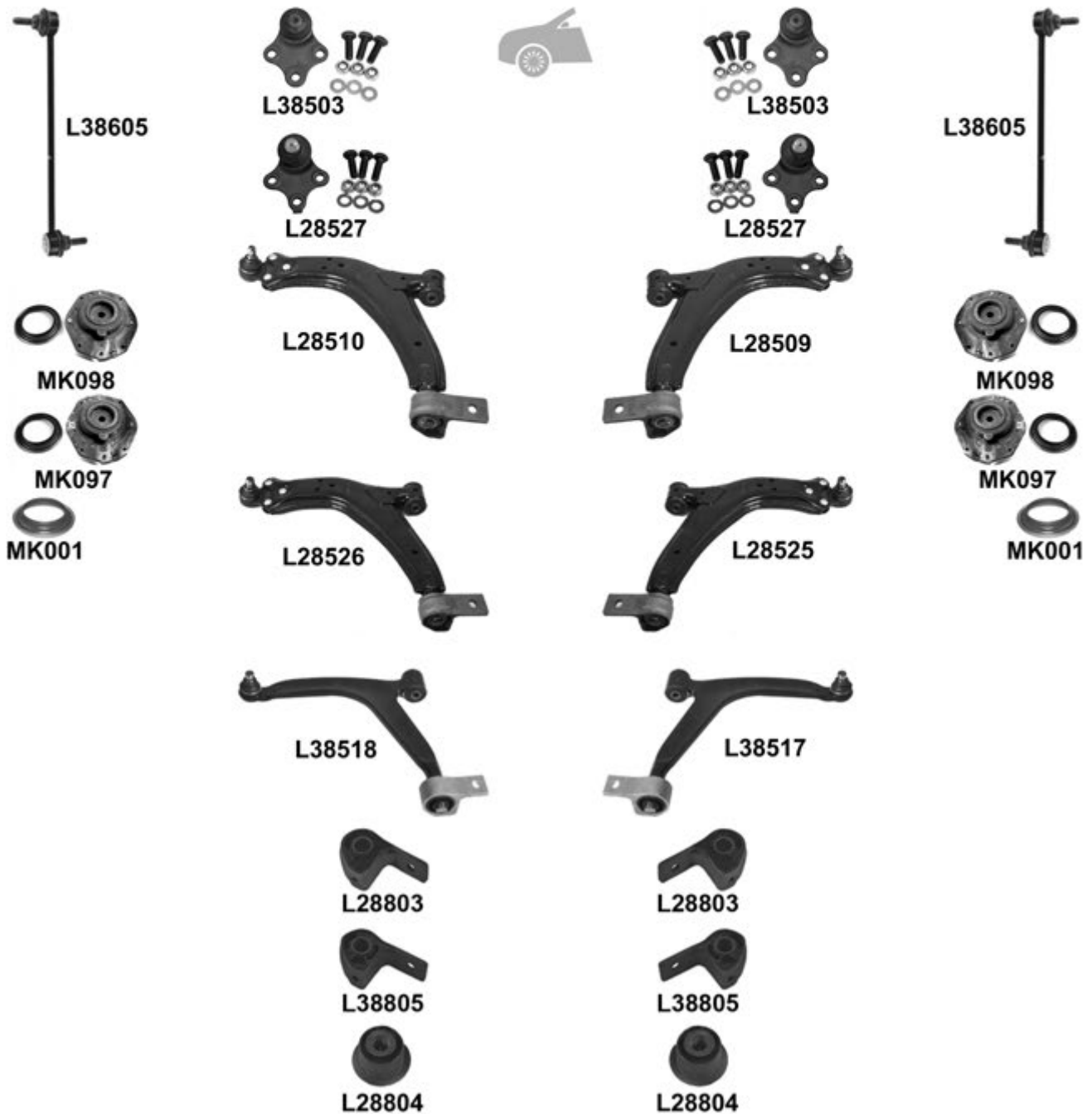
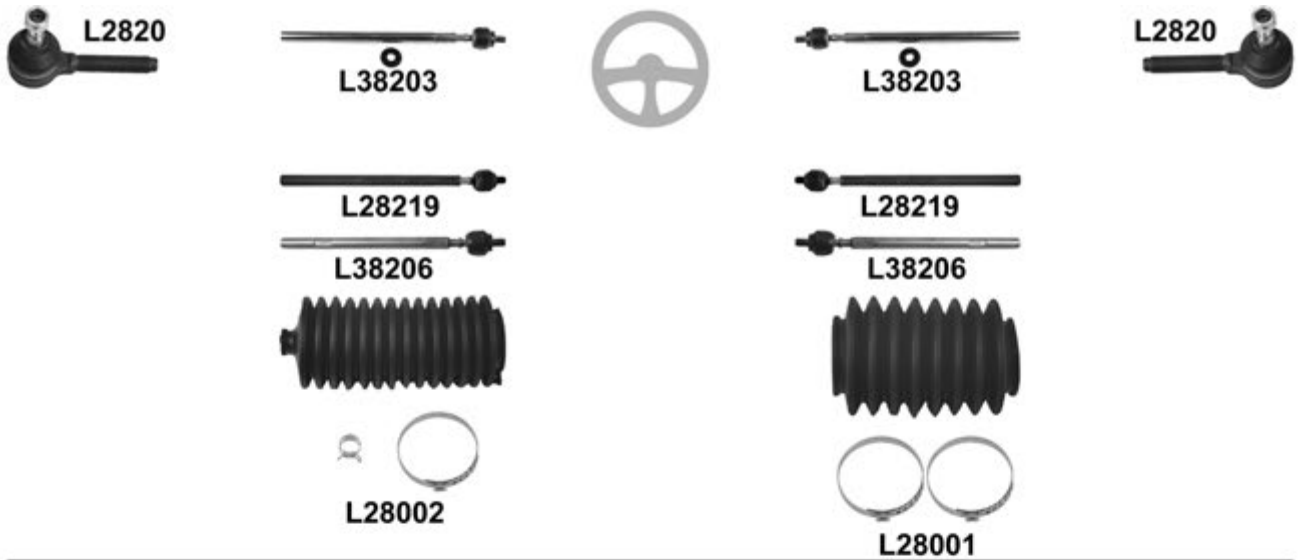

Partner / Ranch (5F / 5) 06.96 →

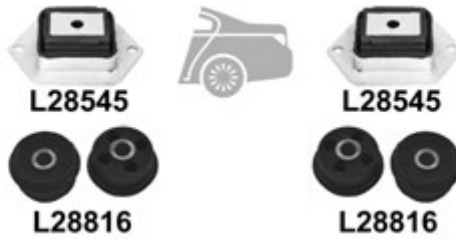

i ← → Thread Part Of QPA **i**

					←	→	Thread	Part Of	QPA	i	
					L2820	L2820	M 14x1,5 U		2	3817.18	
					L38203	L38203	F 14x1,5 / M 12x1 U		2	3812.C0	
					L28219	L28219	F 14x1,5 / M 12x1 U		2	3812.E4	
					L38206	L38206	F 14x1,5 / M 12x1 U		2	3812.C6	
				11.02 →,			L28001			1	4066.22
					L28002				1	4066.20	
		↓	PR → 7972, 16mm, (-) Hdi		L38503	L38503			2	3640.38	
			PR 7973 →, 18mm, (-) Hdi		L28527	L28527			2	3640.51	
		↓	PR → 7972, 16mm, (-) Hdi	<input checked="" type="checkbox"/>		L28509				1	3521.E5
					L28510				1	3520.H5	
			PR 7973 →, 18mm	<input checked="" type="checkbox"/>		L28525				1	3521.E6
			(-) Hdi/	<input checked="" type="checkbox"/>		L28526				1	3520.H6
			1.4, → 10.05, 18mm	<input checked="" type="checkbox"/>		L28525				1	3521.E6
					L28526				1	3520.H6	
			1.6/2.0 Hdi, → 10.02, 18mm	<input checked="" type="checkbox"/>		L28525				1	3521.E6
					L28526				1	3520.H6	
			1.4, 11.05 →	<input checked="" type="checkbox"/>		L38517				1	3521.F3
			L38518				1	3520.J3			
	1.6/2.0 Hdi 11.02 →	<input checked="" type="checkbox"/>		L38517				1	3521.F3		
			L38518				1	3520.J3			
	Hdi/	<input checked="" type="checkbox"/>		L38517				1	3521.F3		
			L38518				1	3520.J3			
		↓	(-) Hdi		L28803	L28803		L28509/L28510/ L28525/L28526	2	3523.75	
(-) Hdi				L28804	L28804		L28509/L28510/ L28525/L28526	4			
Hdi				L38805	L38805		L38517/L38518	2	3523.83		
Hdi				L28804	L28804		L38517/L38518	4			
				L38605	L38605			2	5087.46		
		→ 10.03, (-) , (-) 2.0 Hdi	KIT	MK098	MK098			2	5038.76		
		11.03 →, (-) , (-) 2.0 Hdi	KIT	MK097	MK097			2	5038.21 S		
		/Off Road Suspension, (-) 2.0 Hdi	KIT	MK097	MK097			2	5038.21 S		
		2.0 Hdi, → 08.02, (-)	KIT	MK097	MK097			2	5038.21 S		
		2.0 Hdi, 11.02 →, (-)	KIT	MK097	MK097			2	5038.21 S		
		2.0 Hdi, → 08.02, , 600 1800	KIT	MK097	MK097			2	5038.21 S		
		2.0 Hdi, 11.03 →, , 600		MK097	MK097			2	5038.21 S		
				MK001	MK001			2	5035.27		
		↓		L28545	L28545		Hub carrier	2	5152.62		
		↑	KIT	L28816	L28816		Hub carrier	2	5131.47		

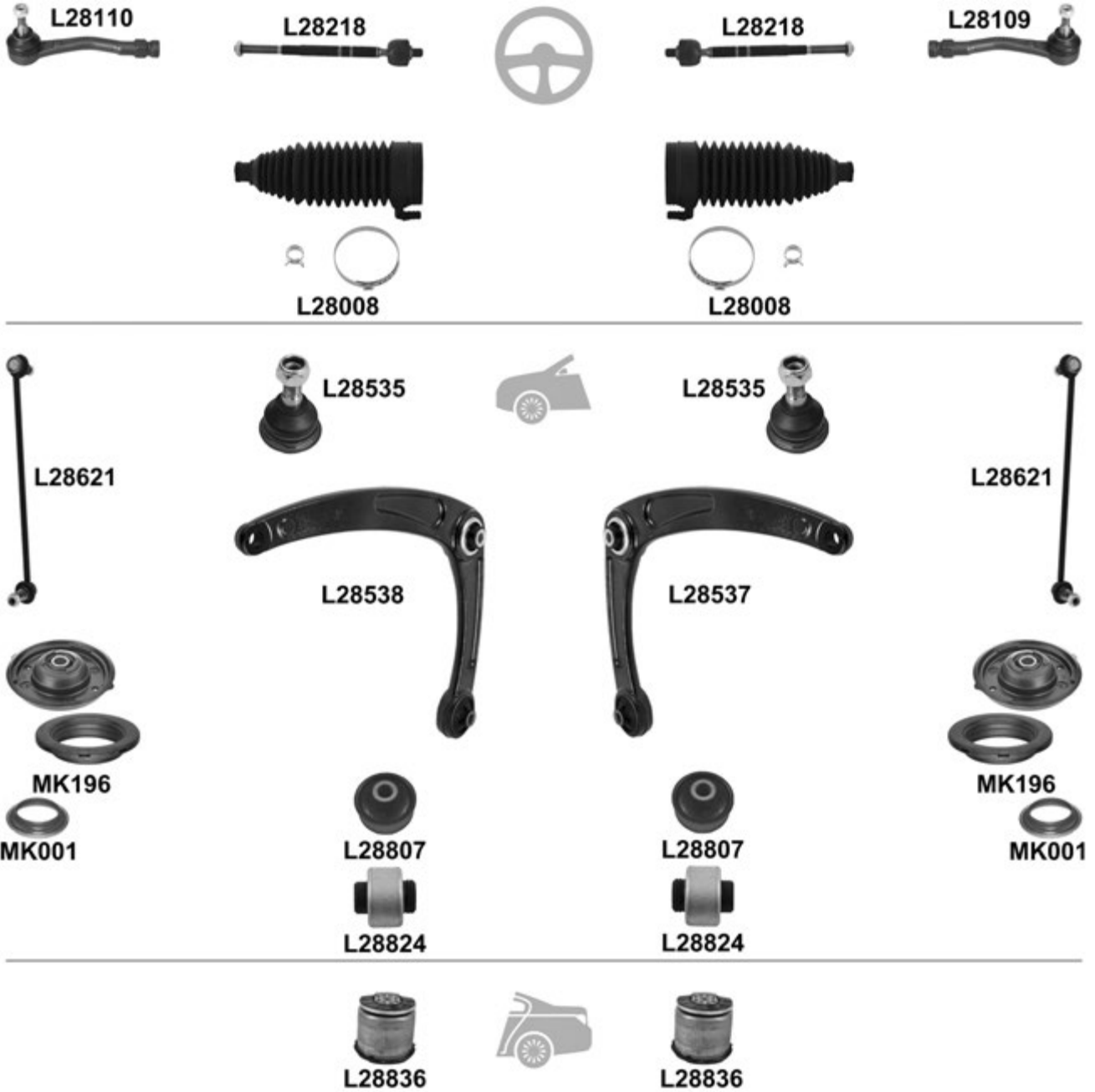
Partner / Ranch 04.08 →
 Partner Tepee / Ranch Tepee 04.08 →

			←	→	Thread	Part Of	QPA			
				L28109	F 14x1,5 ∪		1	3817.88		
			L28110	F 14x1,5 ∪		1	3817.89			
			L28218	L28218	M 14x1,5 / M 14x1,5 ∪		2	3812.F4		
			L28008 ⁰	L28008 ⁰			2	4066.85		
				L28535	L28535		2	3640.68		
			<input checked="" type="checkbox"/>	L28537			1	3521.P3		
			L28538			1	3520.S2			
				∟▼	L28807	L28807			2	3523.92
				∟▲	L28824	L28824			2	3523.91
					L28621	L28621			2	5087.57
				(+) MK001	KIT	MK196	MK196		2	5038.G0
					MK001	MK001			2	5035.58
			L28836	L28836		Hub carrier	2	5131.F2		

RCZ 03.10 →



L10113



L10113



L28008



L28008

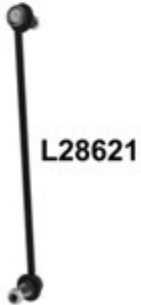

L28621

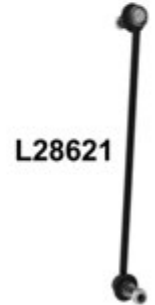

L28621



MK001



MK001



Thread

Part Of

QPA



		↔	2.2 Hdi	L10113	L10113	↻		2	3817.73
				L28008 ^o	L28008 ^o			2	4066.85
				L28621	L28621			2	5087.57
				MK001	MK001			2	5035.58

104 10.72 → 02.79

ch. → 5675804



L2566



L2566



L2837



Thread

Part Of

QPA



		⊥	05.75 →	L2566	L2566			2	91504248
				L2837				1	4040.14

104 03.79 → 06.88
ch. 5675805 →

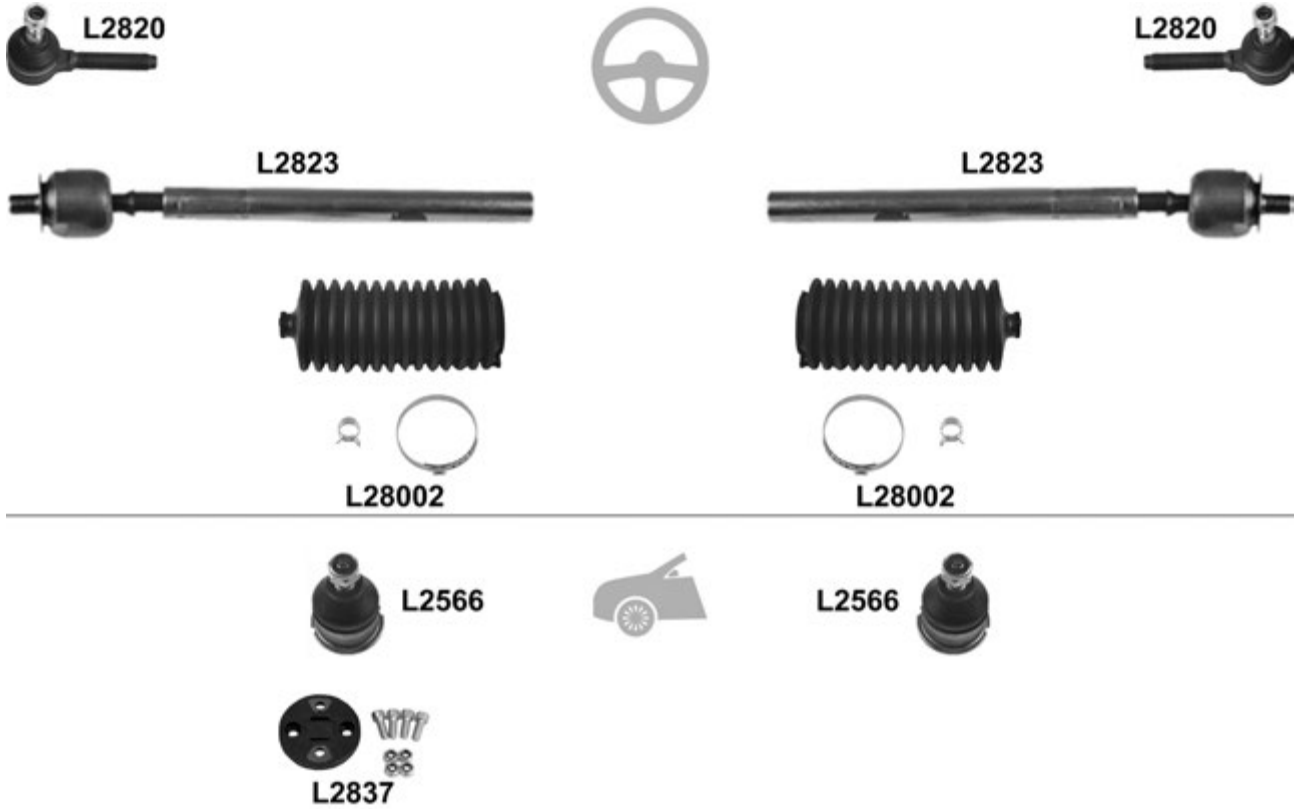

				← → Thread		Part Of	QPA	
⊕		↔		L2820	L2820	M 14x1,5 U	2	3817.18
				L2823	L2823		2	3812.19
				L28002	L28002		2	4066.15
⊖		⊥		L2566	L2566		2	91504248
				L2837			1	4040.14

106 09.91 →

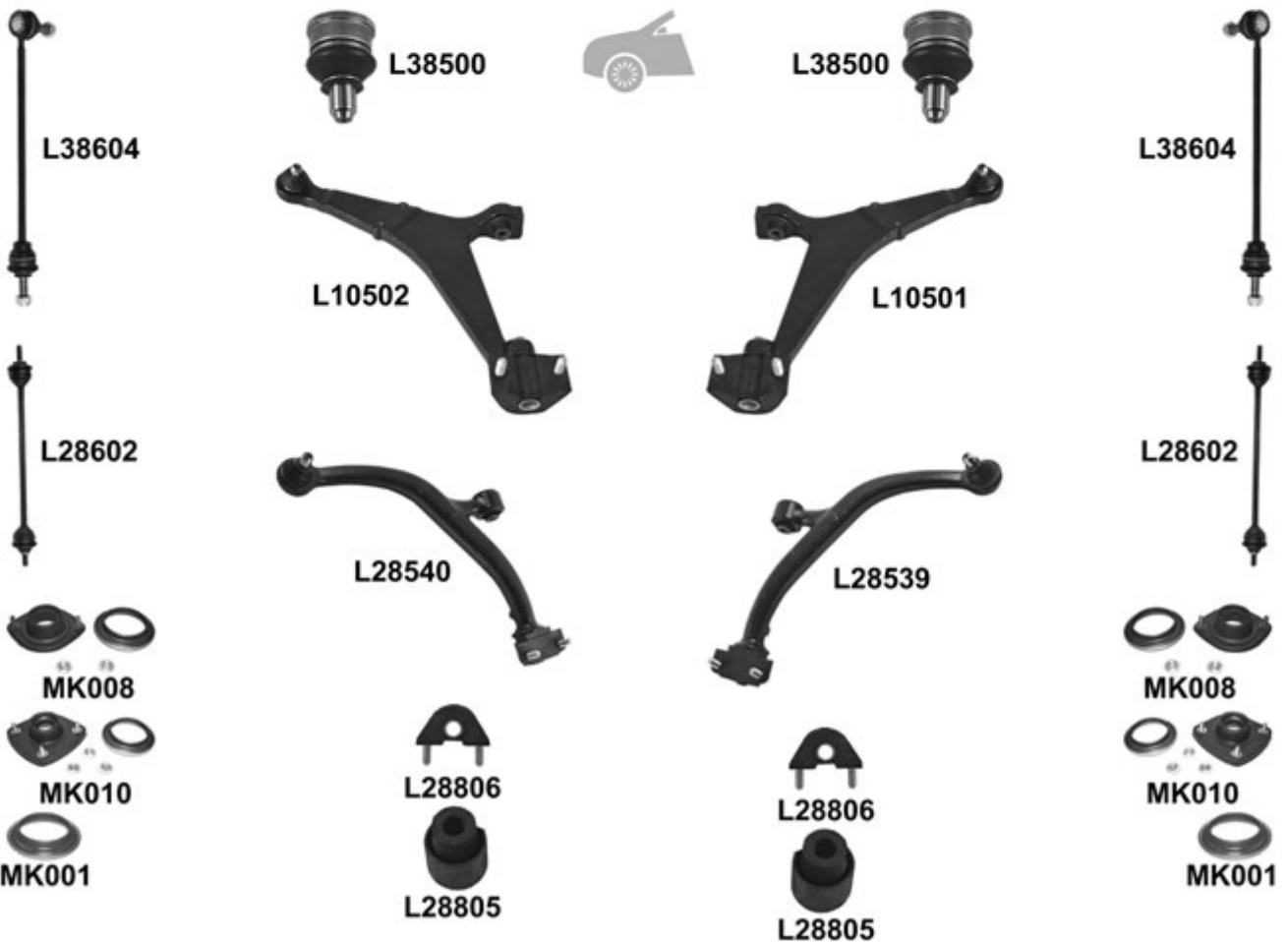
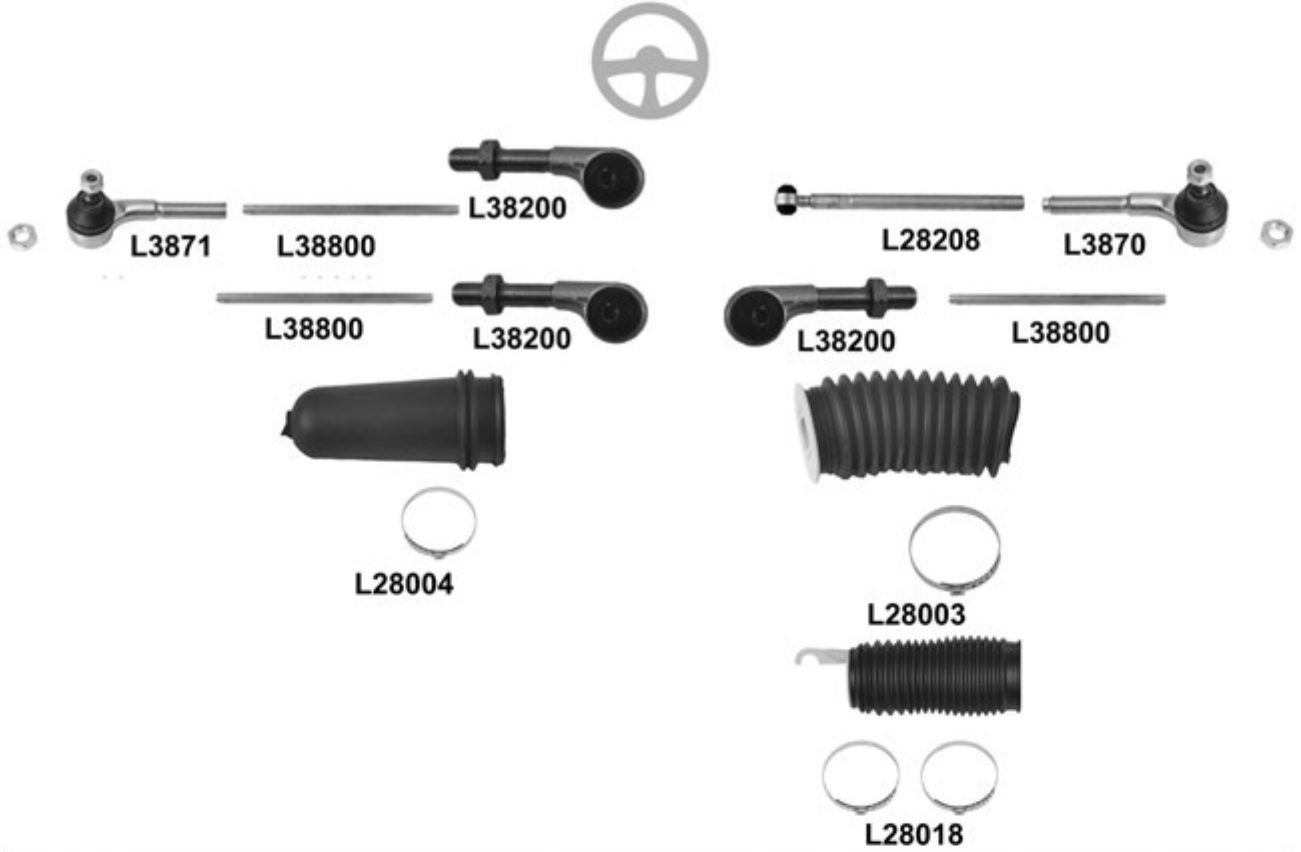



				← → Thread		Part Of	QPA			
		↔		L3870	F 14x1,5 U		1	3817.41		
				L3871	F 14x1,5 U		1	3817.42		
		→ ←			L28208			1	3817.36	
					L38200			1	3817.33	
					L38200	L38200		2	3817.33	
					L38800			1	3812.A0	
					L38800	L38800		2	3812.A0	
					L28003			1	4066.34	
					L28004			1	4066.32	
				PR 07112 →,		L28018 ^o			1	4066.50
					L28004			1	4066.32	
		↓		16mm	L38500	L38500		2	3640.36	
					L10501			1	3520.79	
		↓		106 I, (-) Mot/Eng TU2J2/TU3J/TU5J2/TU5JP <input checked="" type="checkbox"/>	L10502			1	3520.78	
				106 II, (-) Mot/Eng TU1M Sport/TU3JP Sport/TU5JP/TU5J2/TU5J4 <input checked="" type="checkbox"/>	L10501			1	3520.79	
					L10502			1	3520.78	
				106 I, Mot/Eng TU2J2/TU3J/TU5J2/TU5JP <input checked="" type="checkbox"/>	L28539			1	3520.93	
		↓			L28540			1	3520.92	
				106 II, Mot/Eng TU1M Sport/TU3JP Sport/TU5JP/TU5J2/TU5J4 <input checked="" type="checkbox"/>	L28539			1	3520.93	
		↓		(-) 1.3/1.6/1.6 i/1.6 S16	L28806	L28806		2	3523.51	
				(-) 1.3/1.6/1.6 i/1.6 S16	L28805	L28805		2	3523.50	
				106 II 03.96 →, 1.4 i - 1.6 S16	L38604	L38604		2	5087.40	
				XSi	L28602	L28602		2	5087.33	
			→ 06.94 , ch. → 50265608	KIT MK008	MK008		2	5038.08 S		
			06.94 →, ch. 50265609 →	MK010	MK010		2	5038.15 S		
				MK001	MK001		2	5035.27		
			cars with stabilizer link on rear axle	L28809	L28809	Hub carrier	2	5131.63		
			(-) cars with stabilizer link on rear axle	L28810	L28810	Hub carrier	2	5131.65		

107 06.05 →

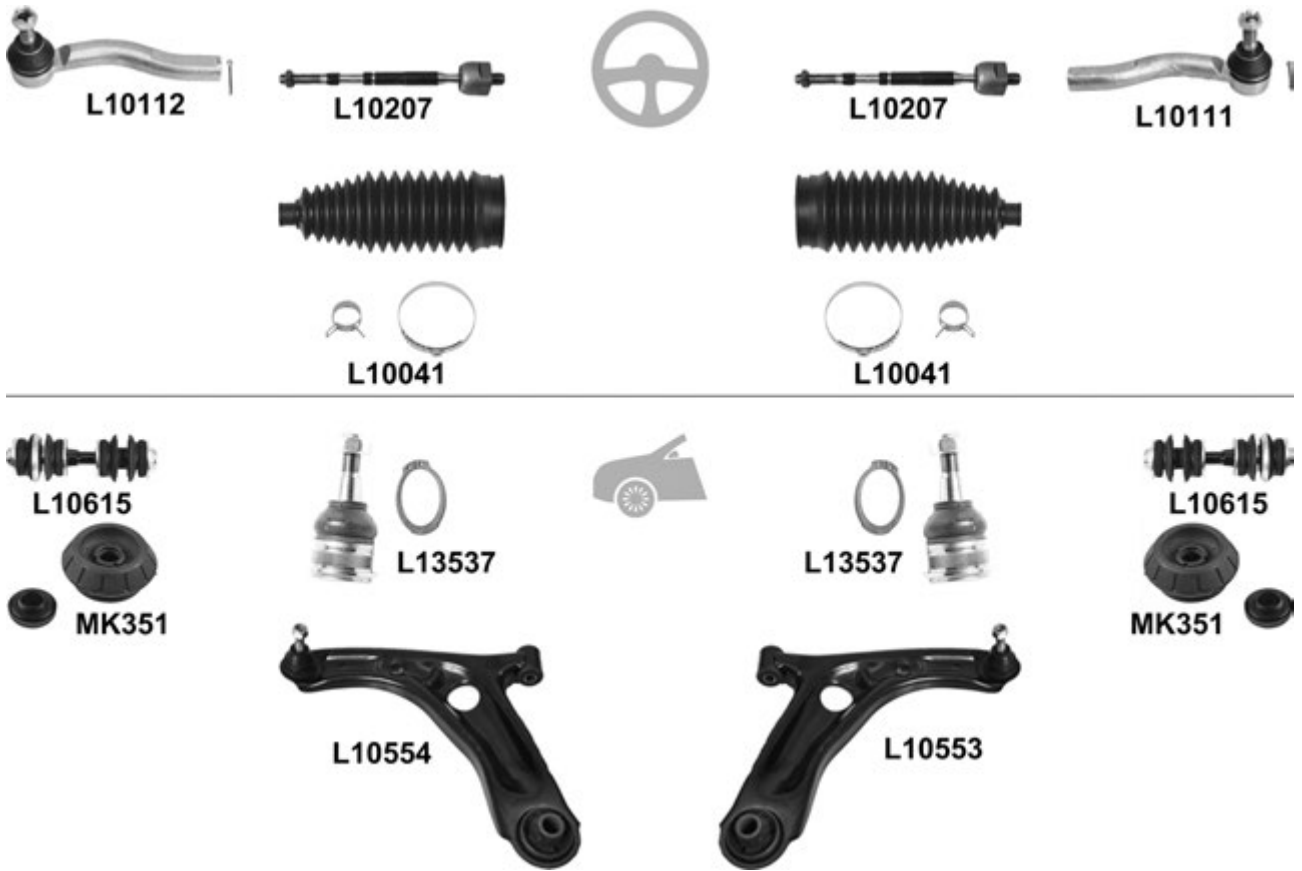

				←	→	Thread	Part Of	QPA		
⊕		↔			L10111	F 12x1,25 ∪		1	3817.64	
					L10112	F 12x1,25 ∪		1	3817.63	
					L10207	L10207	M 12x1,25 / M 14x1,5 ∪		2	
					L10041 ⁰	L10041 ⁰			2	4066.A3
⊖		⊥			L13537	L13537		2		
						L10553		1	3521.L3	
						L10554		1	3520.Q2	
					L10615	L10615		2	5091.10	
			KIT	MK351	MK351		2	5035.57		

108 05.14 →

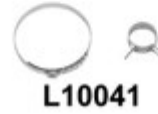
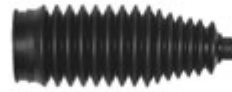
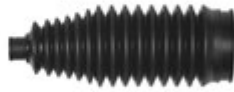

				←	→	Thread	Part Of	QPA	i
⊕		↔			L10111	F 12x1,25 ∪		1	3817.64
					L10112	F 12x1,25 ∪		1	3817.63
				L10041 ⁰	L10041 ⁰			2	4066.A3

204 1969 → 07.77



				←	→	Thread	Part Of	QPA	i
			74 →		L2837			1	4040.14

205 02.83 →

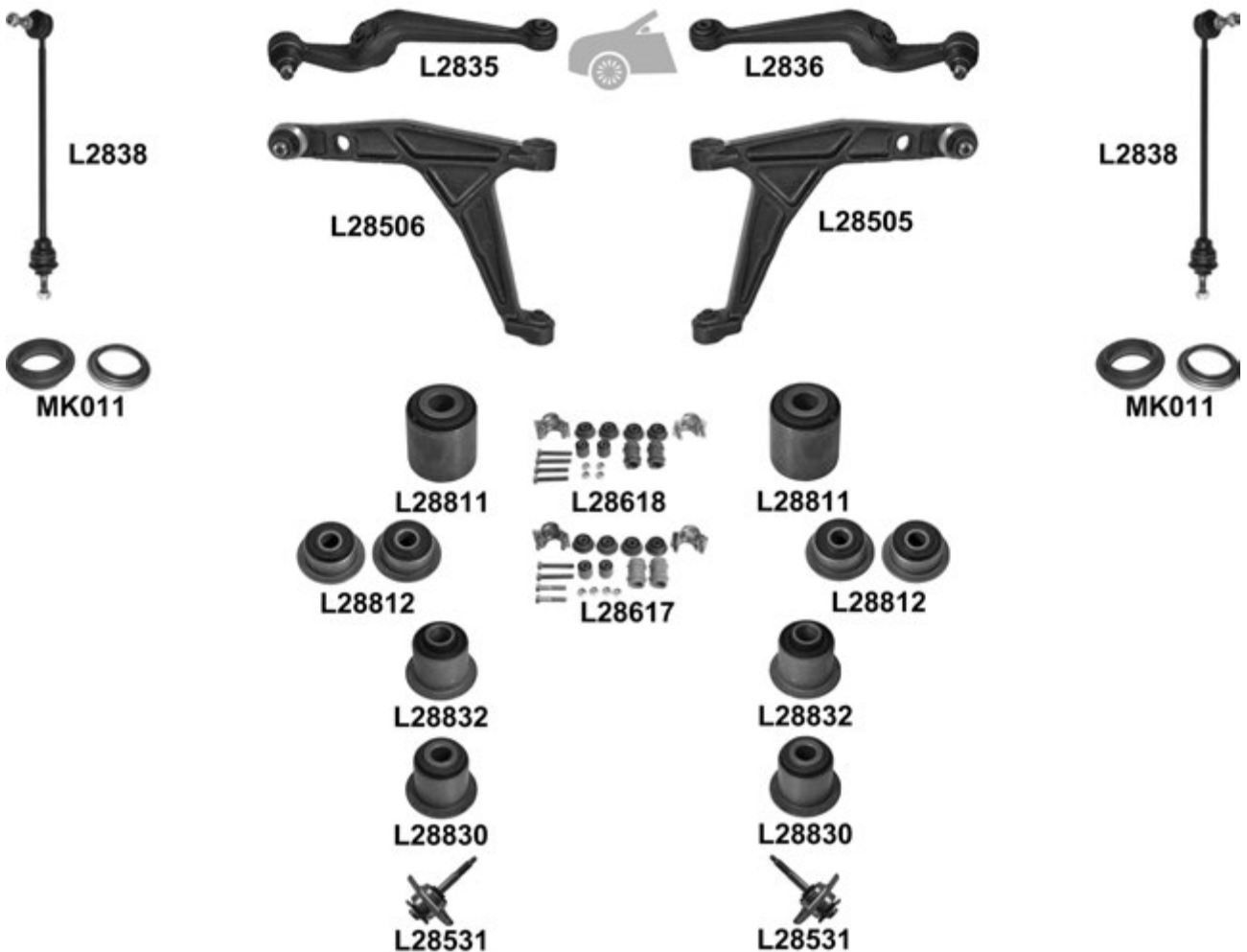
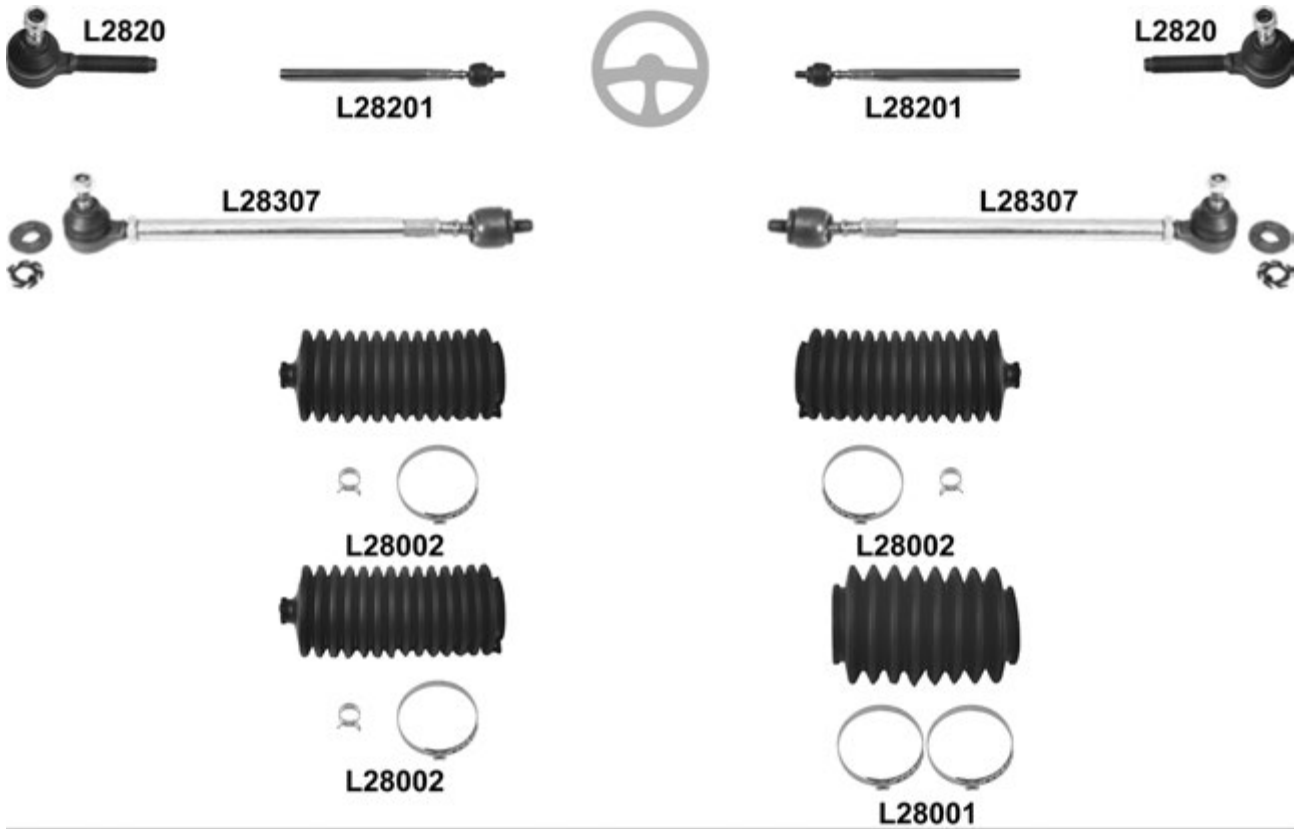



				← → Thread		Part Of	QPA			
		↔		L2820	L2820	M 14x1,5 U		2	3817.18	
				L28201	L28201	F 14x1,5 / M 12x1 U		2	3812.95	
				L28307	L28307			2	3812.38	
					L28002	L28002			2	4066.15
					L28002	L28001			1	4066.22
			L28002			1	4066.20			
		⊥	(-) Gti/Rallye/Turbo Diesel	<input checked="" type="checkbox"/>	L2836			1	3521.34	
					L2835			1	3520.51	
				<input checked="" type="checkbox"/>	L28505			1	3521.37	
					L28506			1	3520.54	
		↔	↔	(-) Gti/Rallye/Turbo Diesel	L28811	L28811			2	3523.20
					L28812	L28812			4	3523.49
					L28832	L28832			2	3523.23
					L28830	L28830			2	3523.31
					L28531	L28531		Hub carrier	2	3523.33
					L2838	L2838			2	5087.32
				(-) Gti/Rallye/TD, Ø 22mm, Green	L28831	L28831		Anti-roll bar	2	5094.37
					L28828	L28828		Anti-roll bar	2	5094.40
				ø 22mm, Green, (-) Gti/Rallye/Turbo Diesel	KIT	L28618		Anti-roll bar	1	
					KIT	L28617		Anti-roll bar	1	
				ø 23mm, Blue, (-) Gti/Rallye/Turbo Diesel	KIT	MK011	MK011		2	5035.18
					L28813	L28813		Hub carrier	2	5131.43

206 2A/C 09.98 →
 206 SW 07.02 →
 206 CC 09.00 →
 206+ (T3E) 01.09 →

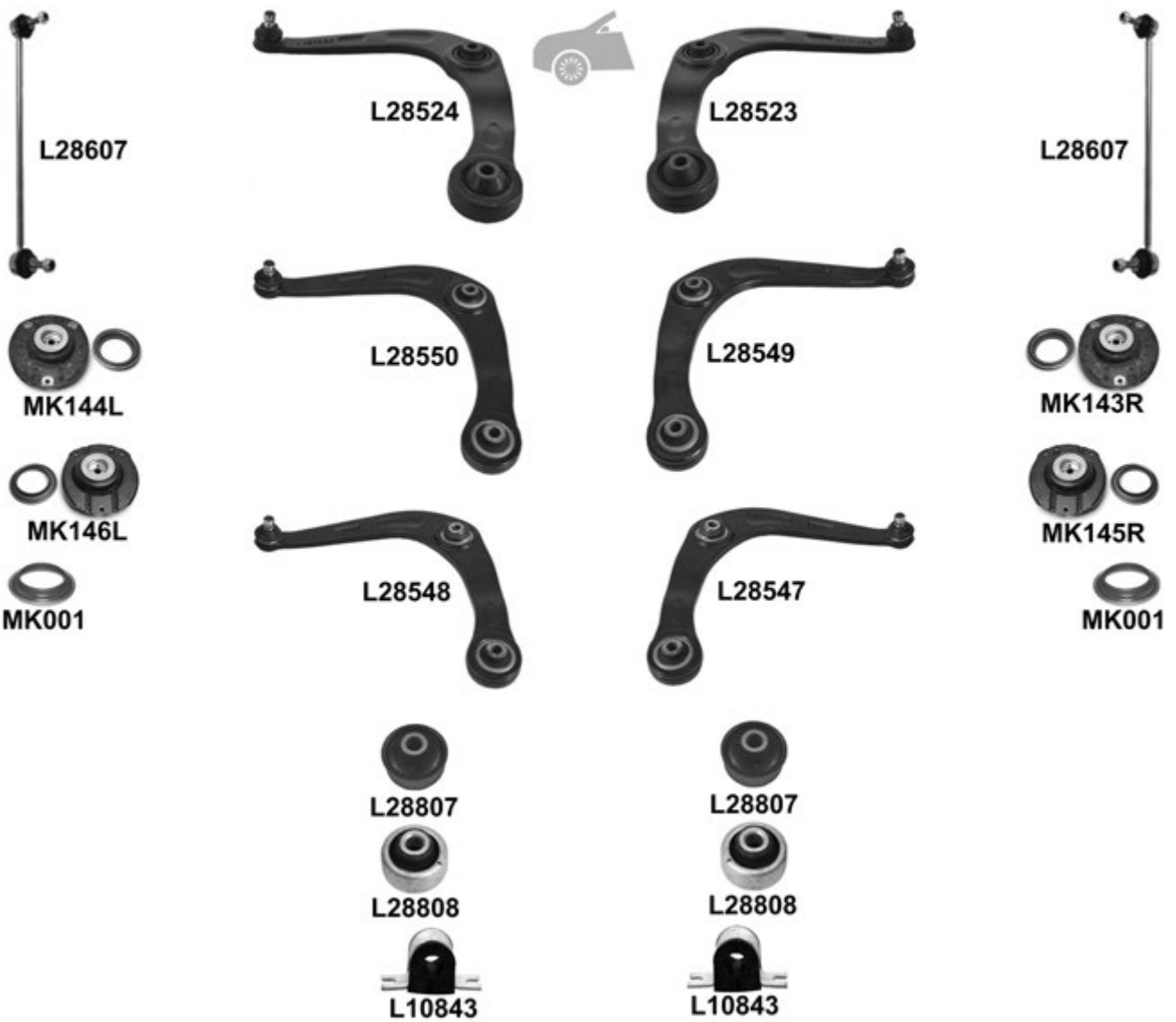
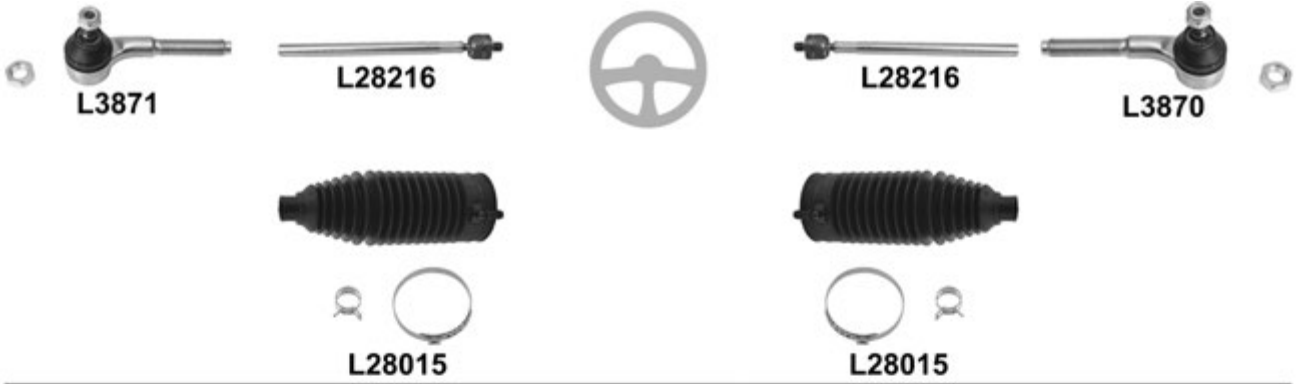

206 2A/C 09.98 →
 206 SW 07.02 →
 206 CC 09.00 →
 206+ (T3E) 01.09 →

						←	→	Thread	Part Of	QPA			
					L3870			M 14x1,5 U		1	3817.41		
					L3871			M 14x1,5 U		1	3817.42		
					L28216	L28216			F 14x1,5 / M 14x1,5 U		2	3812.C5	
					(-)	L28015 ⁰	L28015 ⁰				2	4066.73	
		1.1/1,4/1.4 Hdi/1.6 8V/1.9 D → 09.02, PR → 09440		<input checked="" type="checkbox"/>		L28523				1	3521.C8		
					L28524					1	3520.G8		
		1.1/1,4/1.4 G/1.4 Hdi/1.9 D 10.02 →, PR 09441 →		<input checked="" type="checkbox"/>		L28549					1	3521.R7	
					L28550						1	3520.V6	
		1.4, Mot/Eng KFX/KFW/TU3A/TU3JP, 1.4 Hdi, Mot/Eng 8HX/8HZ/DV4TD		<input checked="" type="checkbox"/>		L28549					1	3521.R7	
					L28550						1	3520.V6	
		HB , 1.6 16 V/1.6 L 16V, → 11.02, PR → 09506		<input checked="" type="checkbox"/>		L28547					1	3521.K2	
					L28548						1	3520.P2	
		HB , 1.6 16 V/1.6 L 16V 12.02 → 12.06 PR 09507 → 10989		<input checked="" type="checkbox"/>		L28549					1	3521.K2	
					L28550						1	3520.P2	
		SW , 1.6 16V → 09.02 PR → 09451		<input checked="" type="checkbox"/>		L28547					1	3521.K2	
					L28548						1	3520.P2	
		SW , 1.6 16V 10.02 →, PR 09452 →		<input checked="" type="checkbox"/>		L28549					1	3521.K2	
					L28550						1	3520.P2	
		CC , 1.6 16V → 09.02, PR → 09439		<input checked="" type="checkbox"/>		L28547					1	3521.K2	
					L28548						1	3520.P2	
		HB , 1.6 Hdi		<input checked="" type="checkbox"/>		L28549					1	3521.R7	
					L28550						1	3520.V6	
		SW , 1.6 Hdi		<input checked="" type="checkbox"/>		L28547					1	3521.K2	
					L28548						1	3520.P2	
		CC , 2.0 16V, → 08.02, PR → 09439		<input checked="" type="checkbox"/>		L28547					1	3521.K2	
					L28548						1	3520.P2	
		CC , 2.0 16V, 09.02 →, PR 09440 →		<input checked="" type="checkbox"/>		L28549					1	3521.R7	
					L28550						1	3520.V6	
2.0 16V/2.0 RC		<input checked="" type="checkbox"/>		L28547					1	3521.K2			
			L28548						1	3520.P2			
2.0 Hdi, → 09.02, PR → 09440		<input checked="" type="checkbox"/>		L28523					1	3521.C8			
			L28524						1	3520.G8			
2.0 Hdi, 10.02 → 11.06, PR 09441 → 10989		<input checked="" type="checkbox"/>		L28549					1	3521.R7			
			L28550						1	3520.V6			
SW , 2.0 Hdi, → 09.02, PR → 09440		<input checked="" type="checkbox"/>		L28523					1	3521.C8			
			L28524						1	3520.G8			
SW , 2.0 Hdi, 10.02 →, PR 09441 →		<input checked="" type="checkbox"/>		L28549					1	3521.R7			
			L28550						1	3520.V6			
206 +, 1.1/1.4/1.4 Hdi		<input checked="" type="checkbox"/>		L28549					1	3521.R7			
			L28550						1	3520.V6			
		(-) 1.4 16V/1.6 16V/2.0 16V/2.0 RC/2.0 S16			L28807	L28807				2	3523.77		
		(-) 1.4 16V/1.6 16V/2.0 16V/2.0 RC/2.0 S16			L28808	L28808					2	3523.76	
					L28607	L28607					2	5087.45	

206 2A/C 09.98 →
 206 SW 07.02 →
 206 CC 09.00 →
 206+ (T3E) 01.09 →

		← → Thread		Part Of	QPA		
		1.1, 04.02 →, PR 09276 → 1.4/1.4/1.6, 11.01 →, PR 09123 → 1.6 D/1.9 D, 04.02 →, PR 09276 → 2.0/2.0 D, 10.01 →, PR 09086 → 206 CC, 2.0, → 09.05 , PR → 10555, 206+ ø22mm	L10843	L10843	Anti-roll bar	2	5094.82
		: 1.1 TU1JP (+) stabilizer bar	KIT	MK143R		1	5038.40
		: 1.4 TU3JP	MK144L			1	5038.54
		: 1.6/2.0/1.9 D/2.0 D/HDI 5					
		ENTREPRISE: 2.0 D					
		: 1.1 TU1JP (-) stabilizer bar	KIT	MK145R		1	
		: 1.1 TU1JP (+)	MK146L			1	
		: HDi 3					
		ENTREPRISE: 1.9 D/HDI					
			MK001	MK001		2	5035.27
			L28815	L28815	Hub carrier	2	5131.94
			L28814	L28814	Hub carrier	2	5131.93

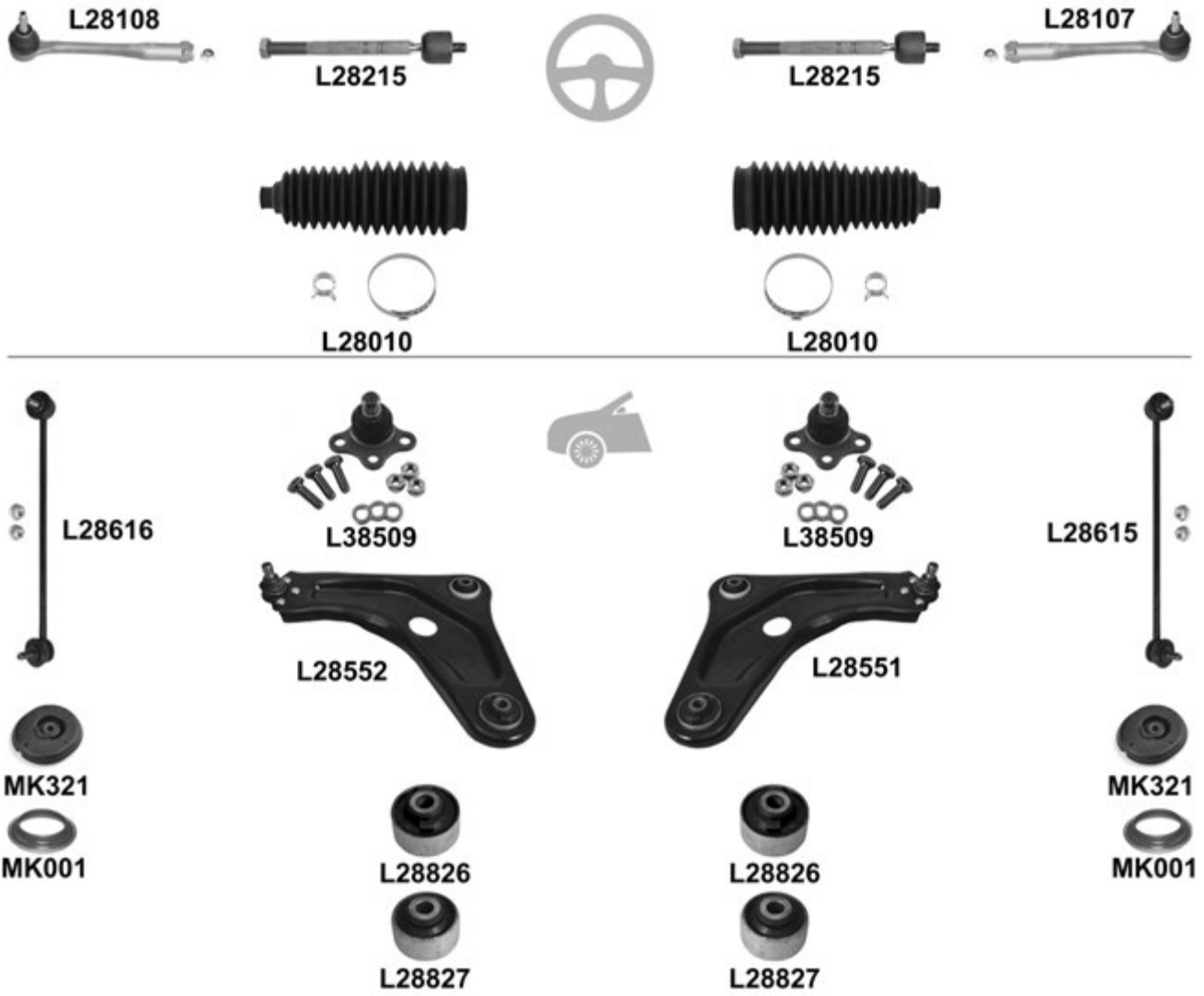
207 02.06 →
 207 CC 02.07 →
 207 SW 06.07 →

		i	←	→	Thread	Part Of	QPA	i	
		↔		L28107	F 16x1,5 ∪		1	3817.68	
				L28108	F 16x1,5 ∪		1	3817.67	
				L28215	L28215	M 16x1,5 / M 12x1 ∪		2	3812.E8
				L28010°	L28010°			2	4066.80
		⊥		L38509	L38509		2	3640.62	
				L28551			1	3521.N8	
				L28552			1	3520.R7	
				L28826	L28826			2	3523.CC
				L28827	L28827			2	3523.CE
				L28615				1	5087.55
				L28616				1	5087.54
				KIT	MK321	MK321			2
		MK001	MK001			2	5035.27		

208 03.12 →

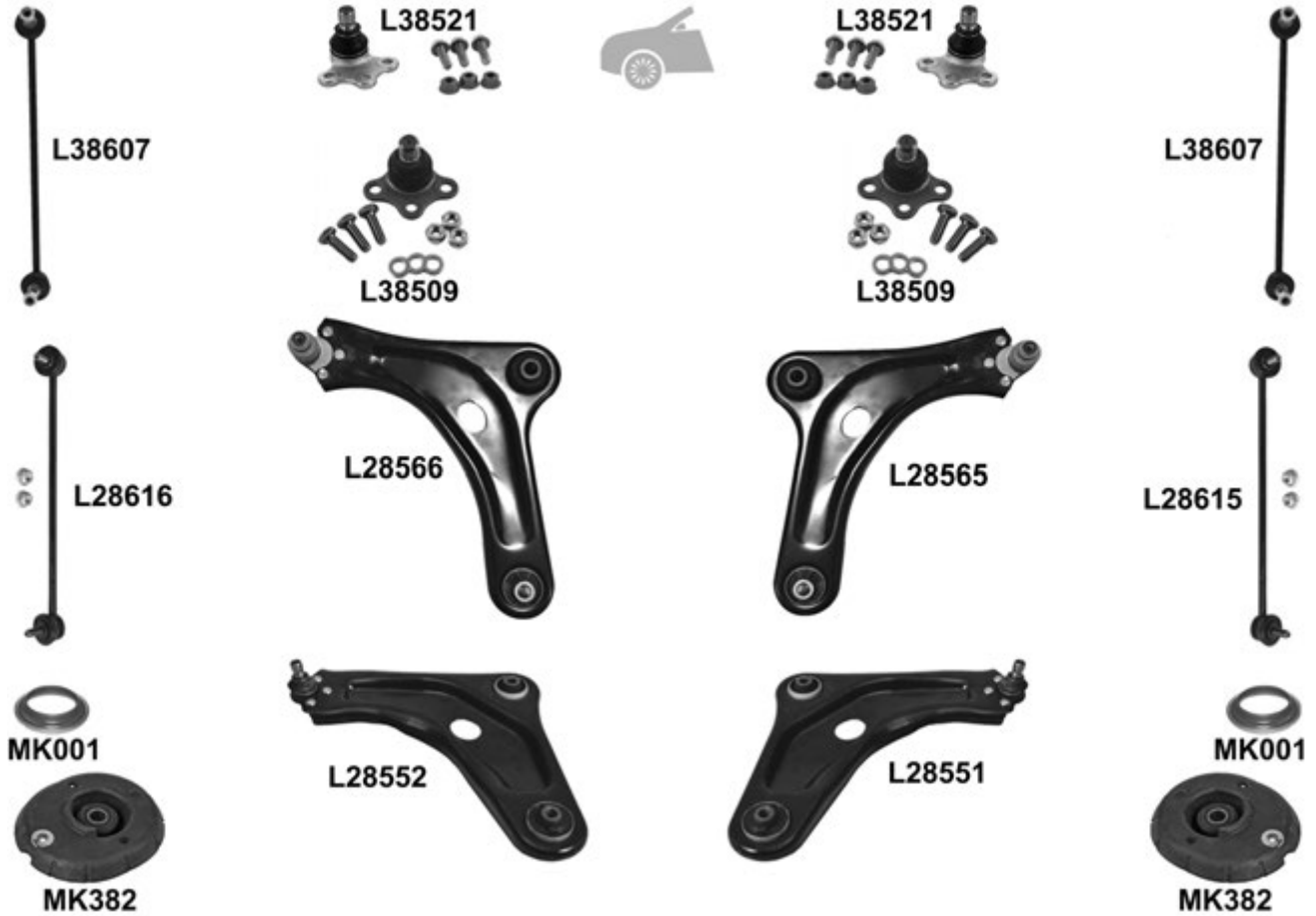

		i	←	→	Thread	Part Of	QPA	i
		⊥	1.0 Vti, Mot/Eng EB0, 1.2 VTi, Mot/Eng EB2	L38521	L38521		2	3640.77
			1.4 Hdi/e-HDi, Mot/Eng DV4C	L38509	L38509		2	3640.62
			1.4 Hdi, Mot/Eng DV4C, 1.6 Gti, Mot/Eng EP6CDTXM 72/82mm Wheel Carrier, (-) HD	L38509	L38509		2	3640.62
			1.4 Hdi, Mot/Eng DV4C, 1.6 Gti, Mot/Eng EP6CDTXM 72mm Wheel Carrier, HD	L38521	L38521		2	3640.77
			1.4 Vti, Mot/Eng EP3C, 1.6 e-HDi, Mot/Eng ED6C, 1.6 Vti, Mot/Eng EP6C	L38521	L38521		2	3640.77
			1.6 16V, Mot/Eng EP6CDT, 1.6 e-Hdi, Mot/Eng DV6DTEd/DV6DTEdM	L38509	L38509		2	3640.62
				⊥	72mm Wheel Carrier <input checked="" type="checkbox"/>		L28565 ⁰	
(-) HD / (-) \updownarrow	L28566 ⁰					1	9670772080	
82mm Wheel Carrier <input checked="" type="checkbox"/>		L28551				1	3521.N8	
		(-) HD / (-) \updownarrow	L28552			1	3520.R7	
		Disc Ø 266mm, Thickness 22mm	L38607	L38607		2	5087.71	
		Disc Ø 302mm, Thickness 26mm		L28615		1	5087.55	
			L28616			1	5087.54	
			MK001	MK001		2	5035.27	
			MK382 ⁰	MK382 ⁰		2		

301 10.12 →



				← → Thread		Part Of	QPA	i	
⊕		↔		L28107	F 16x1,5 ♂		1	1608652380	
				L28108	F 16x1,5 ♂		1	1608652280	
🚗		⊥		L38521	L38521		2	3640.77	
			<input checked="" type="checkbox"/>	L28563 ⁰			1	9675028880	
		⊥		L28564 ⁰			1	9675031880	
				L28615			1	5087.68	
		L28616			1	5087.69			
				MK001	MK001		2	5035.27	
			MK382 ⁰	MK382 ⁰		2			

304

ch. → 4156760



				← → Thread		Part Of	QPA	i	
🚗			L2837				1	4040.14	

304 04.77 →
 ch. 4156761 →



				← → Thread		Part Of	QPA		
		↔		L2820	L2820	M 14x1,5 U		2	3817.18
				L28204	L28204	F 14x1,5 / M 12x1 U		2	3812.97
		⊥	ch. 4205804 →		L3861 ¹			1	3521.26
				L3860				1	3520.37

 305 11.77 → 03.78
 ch. → 8139332

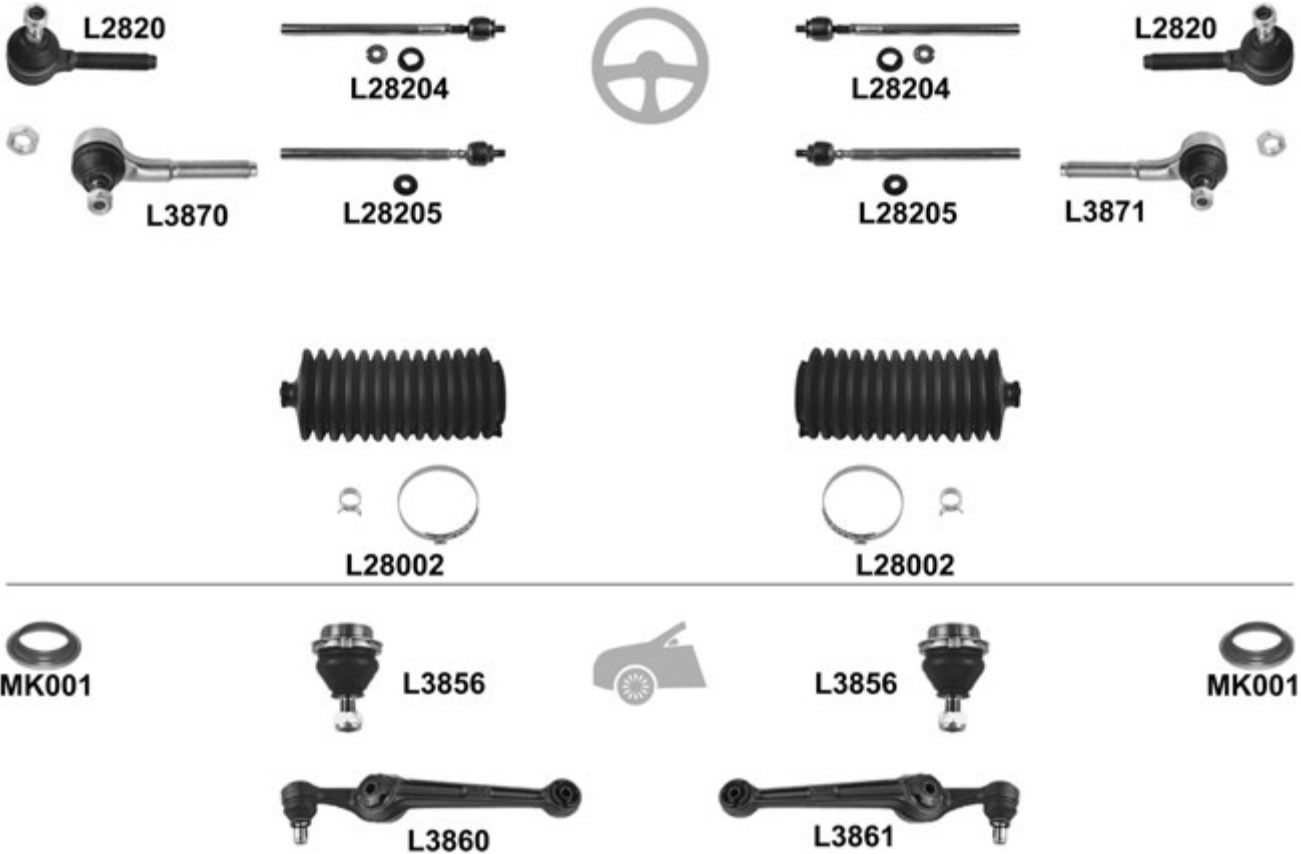
				← → Thread		Part Of	QPA		
		⊥			L3861 ¹			1	3521.26
				L3860				1	3520.37

305 04.78 →
 ch. 8139333 →

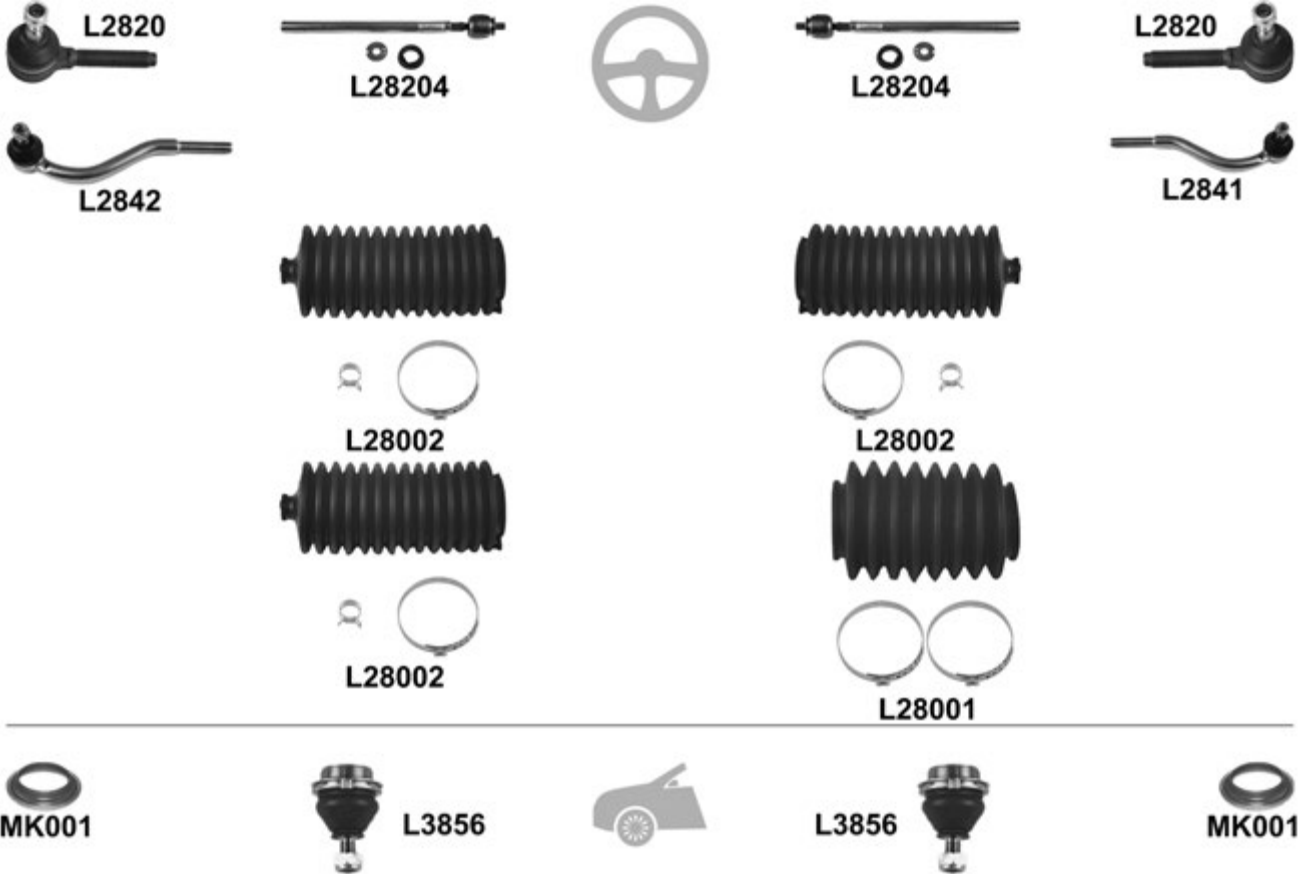
				← → Thread		Part Of	QPA		
		↔	→ 07.82	L2820	L2820	M 14x1,5 ∪		2	3817.18
			08.82 →		L3871	M 14x1,5 ∪		1	3817.42
				L3870		M 14x1,5 ∪		1	3817.41
			→ 07.82	L28204	L28204	F 14x1,5 / M 12x1 ∪		2	3812.97
			08.82 →	L28205 †	L28205 †	F 14x1,5 / M 12x1 ∪		2	3812.93
		⊥	07.82 →	L3856	L3856			2	3640.21
			→ 08.82		L3861 †			1	3521.26
				L3860				1	3520.37
			08.82 →	MK001	MK001			2	5035.27

305 10.82 → 07.84
 305 XU 08.84 → 07.90

						←	→	Thread	Part Of	QPA	
			→ 07.84	L2820	L2820			M 14x1,5 U		2	3817.18
			08.84 →		L2841			M 14x1,5 U		1	3817.27
				L2842			M 14x1,5 U		1	3817.26	
			→ 07.84	L28204	L28204			F 14x1,5 / M 12x1 U		2	3812.97
					L28002	L28002					2
					L28001					1	4066.22
				L28002						1	4066.20
				L3856	L3856					2	3640.21
				MK001	MK001					2	5035.27

306 7A / 7B / 7C / N3 / N5 05.93 →
 306 Break 7E / N3 / N5 02.97 →
 306 Cabriolet 7D / N3 / N5 03.94 →

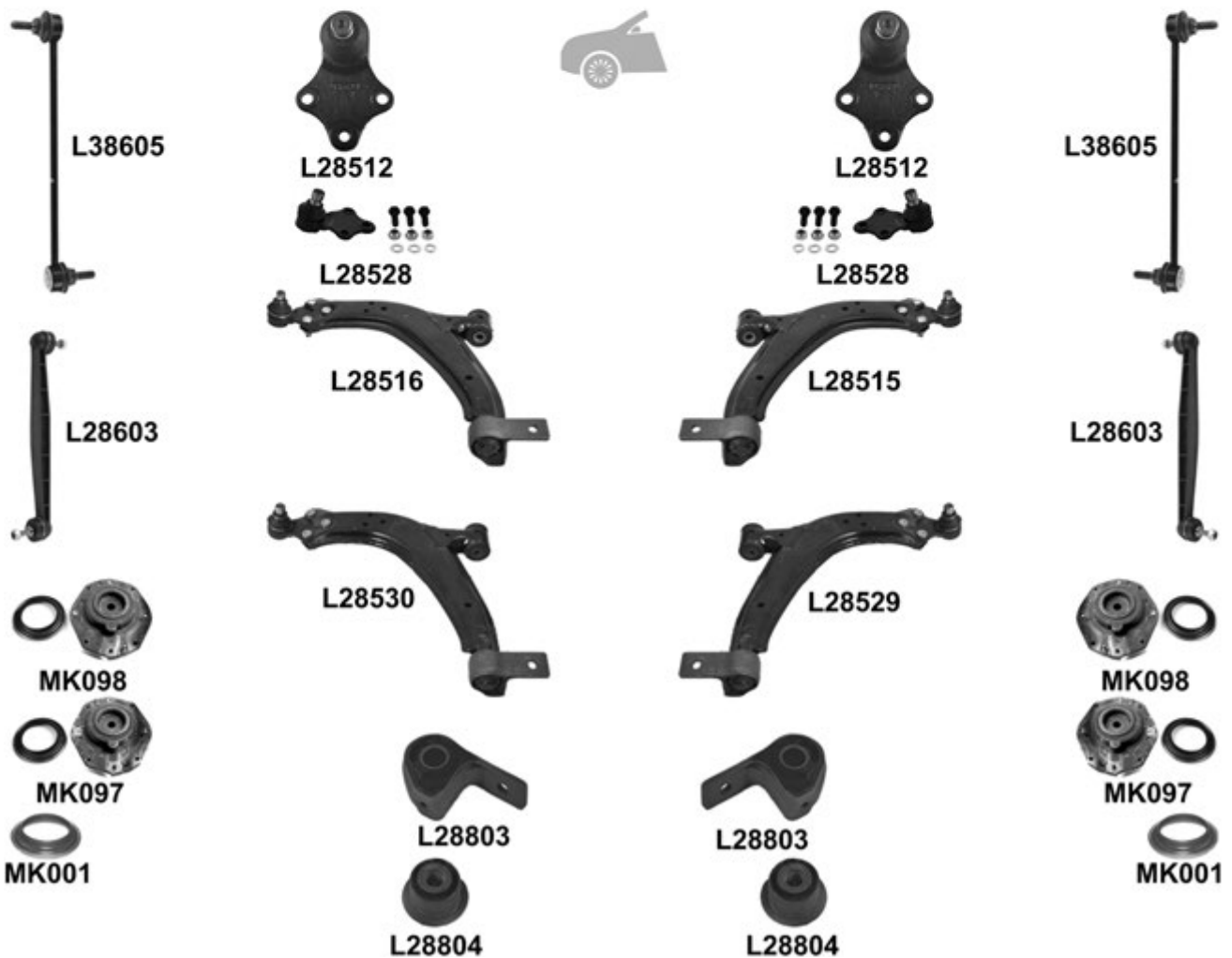
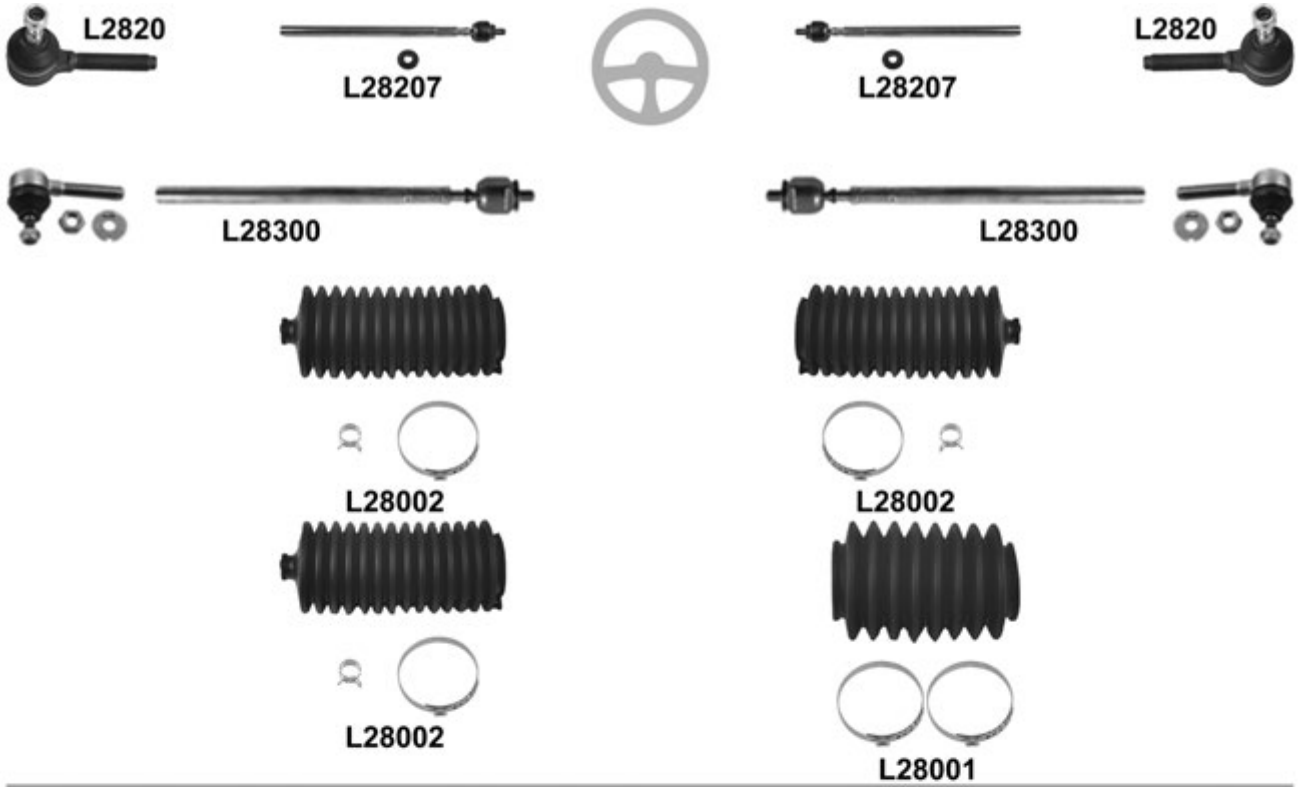

306 7A / 7B / 7C / N3 / N5 05.93 →
 306 Break 7E / N3 / N5 02.97 →
 306 Cabriolet 7D / N3 / N5 03.94 →

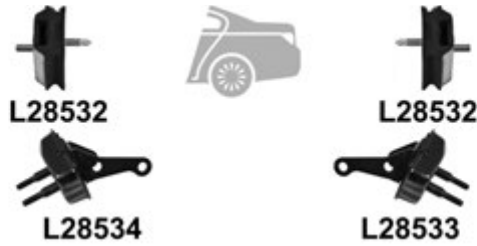

		i		←	→	Thread	Part Of	QPA	i	
		↔		L2820	L2820	M 14x1,5 U		2	3817.18	
				L28207	L28207	F 14x1,5 / M 12x1 U		2	3812.92	
			L 2820 / 28207	L28300	L28300	U		2		
				L28002	L28002			2	4066.20	
					L28001			1	4066.22	
		L28002				1	4066.20			
		↓	PR → 7969, / 16mm	L28512	L28512			2	3640.30	
			PR 7970 →, / 18mm	L28528	L28528			2	3640.49	
		↓	PR → 7969, / 16mm	<input checked="" type="checkbox"/>		L28515			1	3521.56
					L28516			1	3521.86	
				<input checked="" type="checkbox"/>		L28529			1	3521.E3
			PR 7970 →, / 18mm	<input checked="" type="checkbox"/>		L28530			1	3520.H3
			↓		L28803	L28803		L28515/L28516/ L28529/L28530	2	
			↑		L28804	L28804		L28515/L28516/ L28529/L28530	4	
				→ 09.94, Metal	L38605	L38605			2	5087.39
				09.94 →, Plastic	L28603	L28603			2	5087.42
			KIT	MK098	MK098			2	5038.76	
				MK097	MK097			2	5038.21 S	
				MK001	MK001			2	5035.27	
		▼		L28532	L28532		Hub carrier	2	5131.71	
		▲			L28533			Hub carrier	1	5131.70
				L28534				Hub carrier	1	5131.69

307 08.00 →
307 SW 03.02 →

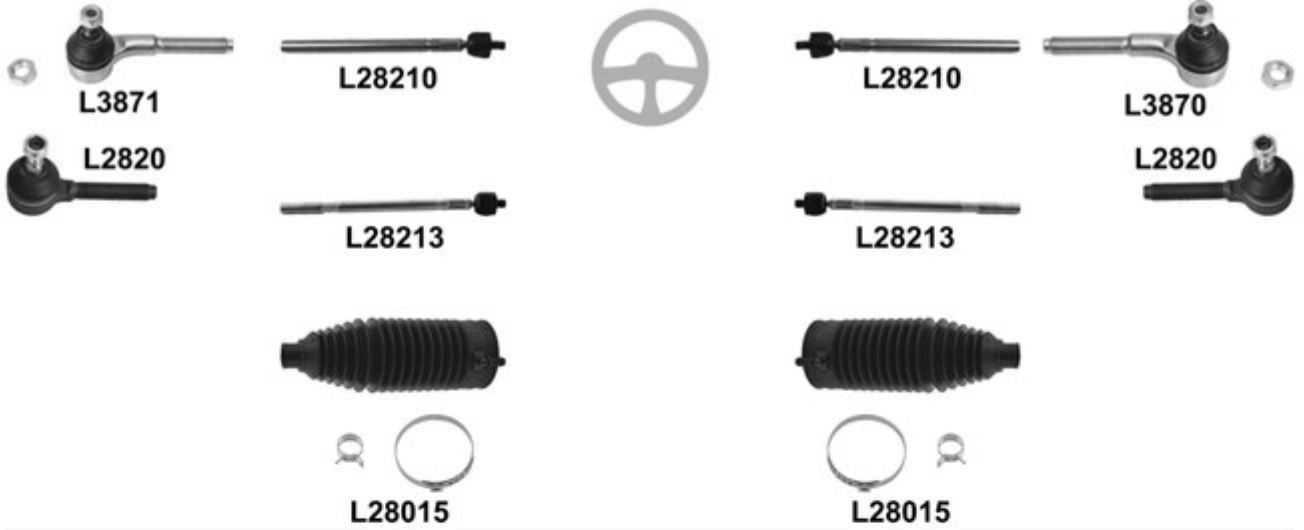

307 08.00 →
 307 SW 03.02 →

			←	→	Thread	Part Of	QPA		
		→ 01.05 , PR → 10310		L3870	M 14x1,5 ♂		1	3817.41	
			L3871		M 14x1,5 ♂		1	3817.42	
		02.05 →, PR 10311 →	L2820	L2820	M 14x1,5 ♂		2	3817.18	
			1.4 16V/1.4 Hdi, Mot/Eng ET3/8HX/8HZ/DV4TD, → 11.03 PR → 9855, L= 322mm	L28210	L28210	F 14x1,5 / M 14x1,5 ♂		2	3812.E0
			1.4 16V/1.4 Hdi, Mot/Eng ET3/8HX/8HZ/DV4TD, 12.03 → PR 9856 →, L= 340mm	L28213	L28213	F 14x1,5 / M 14x1,5 ♂		2	3812.E5
			1.6 16V, Mot/Eng NFU/TU5JP4, → 09.03 , PR → 10310 L= 322mm	L28210	L28210	F 14x1,5 / M 14x1,5 ♂		2	3812.E0
			1.6 16V, Mot/Eng NFU/TU5JP4, 10.03 →, PR 10311 → L= 340mm	L28213	L28213	F 14x1,5 / M 14x1,5 ♂		2	3812.E5
			1.6 Hdi, Mot/Eng 9HY/DV6TED4/9HZ/DV6TED4, → 08.05 PR → 1052277, L= 322mm	L28210	L28210	F 14x1,5 / M 14x1,5 ♂		2	3812.E0
			1.6 Hdi, Mot/Eng 9HY/DV6TED4/9HZ/DV6TED4, 08.05 → PR 1052377 →, L= 340mm	L28213	L28213	F 14x1,5 / M 14x1,5 ♂		2	3812.E5
			2.0 16V/2.0 Hdi Mot/Eng RFK/EW10J4S/RFN/EW10J4/RHS/ DW10ATED/RHY/DW10TD → 11.03 , PR → 9855, L= 322mm	L28210	L28210	F 14x1,5 / M 14x1,5 ♂		2	3812.E0
			2.0 16V/2.0 Hdi Mot/Eng RFK/EW10J4S/RFN/EW10J4/RHS/ DW10ATED/RHY/DW10TD 12.03 →, PR 9856 →, L= 340mm	L28213	L28213	F 14x1,5 / M 14x1,5 ♂		2	3812.E5
			2.0 HDi, Mot/Eng RHS/DW10ATED, → 01.05 , PR → 10310 L= 322mm	L28210	L28210	F 14x1,5 / M 14x1,5 ♂		2	3812.E0
			2.0 HDi, Mot/Eng RHS/DW10ATED, 02.05 →, PR 10311 → L= 340mm	L28213	L28213	F 14x1,5 / M 14x1,5 ♂		2	3812.E5
			(-)	L28015⁰	L28015⁰			2	4066.73
		⊥		L28535	L28535		2	3640.68	
		⊥	<input checked="" type="checkbox"/>		L28537		1	3521.P3	
				L28538		1	3520.S2		
		⊥▼		L28807	L28807		2	3523.92	
		⊥▲		L28824	L28824		2	3523.91	
				L28609	L28609		2	5087.50	
			(+) MK001	KIT	MK196	MK196		2	5038.85
				MK001	MK001		2	5035.27	

308 (4A_, 4C_) 09.07 →
 308 SW 09.07 →
 308 CC 04.09 →

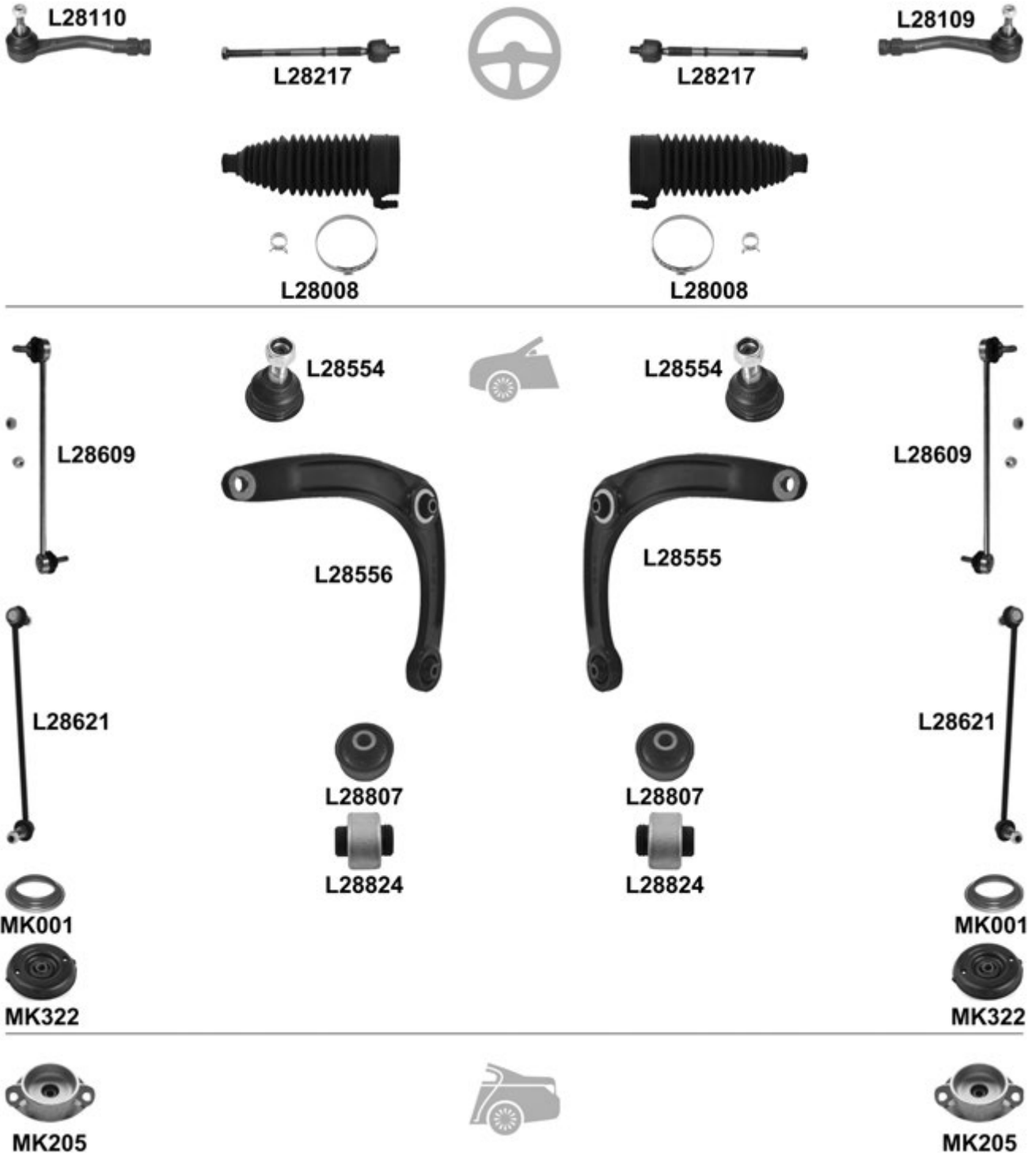

308 (4A_, 4C_) 09.07 →

308 SW 09.07 →

308 CC 04.09 →

			←	→	Thread	Part Of	QPA	
		↔			L28109 F 14x1,5 U		1	3817.88
					L28110 F 14x1,5 U		1	3817.89
					L28217 L28217 M 14x1,5 / M 14x1,5 U		2	3812.F2
					L28008 ^o L28008 ^o		2	4066.85
		⊥			L28554 L28554		2	3640.73
		⊥	(-)		L28555		1	3521.R3
					L28556		1	3520.V2
		⊥▼			L28807 L28807		2	3523.92
		⊥▲			L28824 L28824		2	3523.91
			→ 06.13		L28609 L28609		2	5087.64
			07.13 →		L28621 L28621		2	5087.87
					MK001 MK001		2	5035.27
				MK322 MK322		2		
				MK205 MK205		2	5142.34	
			308 CC					

309 10.85 → 12.93

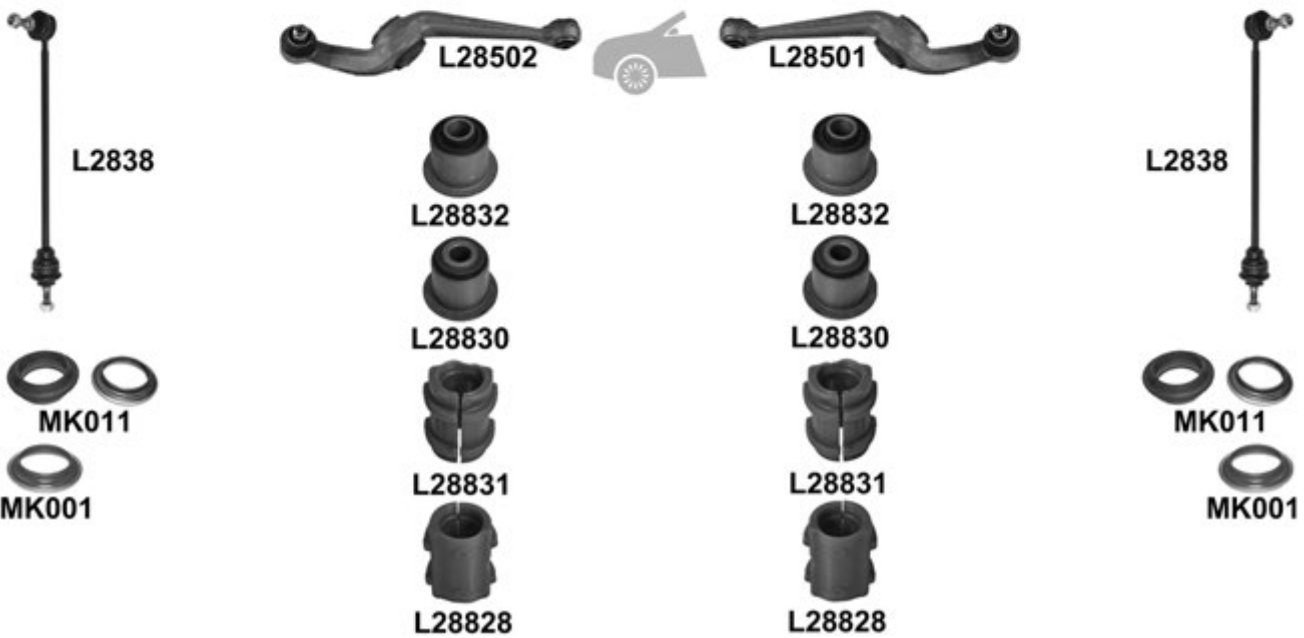
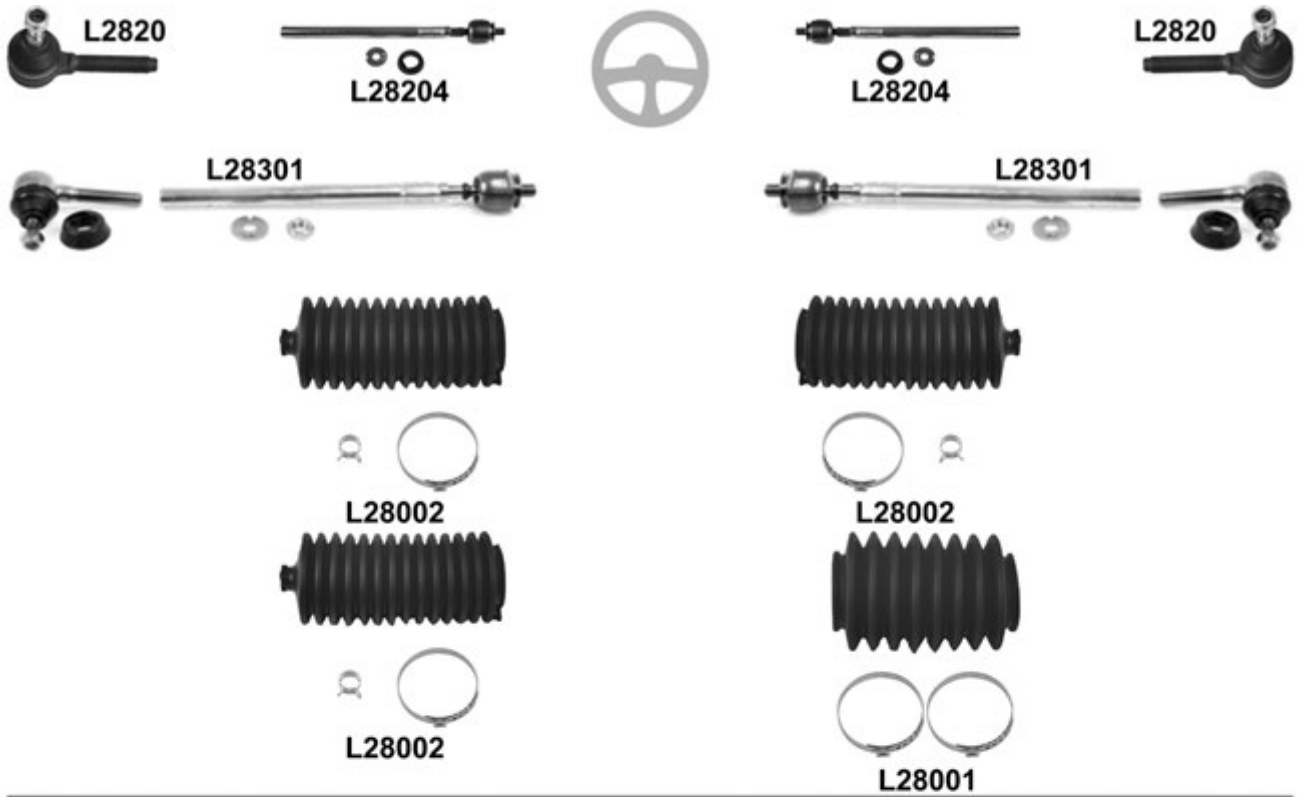

309 10.85 → 12.93

				← → Thread		Part Of	QPA	
		↔		L2820	L2820	M 14x1,5 ∪		2 3817.18
				L28204	L28204	F 14x1,5 / M 12x1 ∪		2 3812.54
				L28204	L28204	F 14x1,5 / M 12x1 ∪		2 3812.97
				L28301	L28301	∪	L2820+L28204	2
				L28002	L28002			2 4066.15
					L28001			1 4066.22
			L28002				1 4066.20	
		⊥	(-) 1.9 <input checked="" type="checkbox"/>		L28501			1 3521.41
				L28502				1 3520.60
		⊥↘		L28832	L28832			2 3523.23
		⊥↗		L28830	L28830			2 3523.31
			GTi	L2838	L2838			2 5087.32
			309 I, Model 10A/10C, → 12.89, Ø 22mm, Green	L28831	L28831		Anti-roll bar	2 5094.37
			(-) Gti/Rallye/TD, Ø 23mm, Dark blue	L28828	L28828		Anti-roll bar	2 5094.40
			KIT	MK011	MK011			2 5035.18
			MK001	MK001			2 5035.27	

404



				← → Thread		Part Of	QPA	
			74 →	L2837			1	4040.14

405 07.87 →

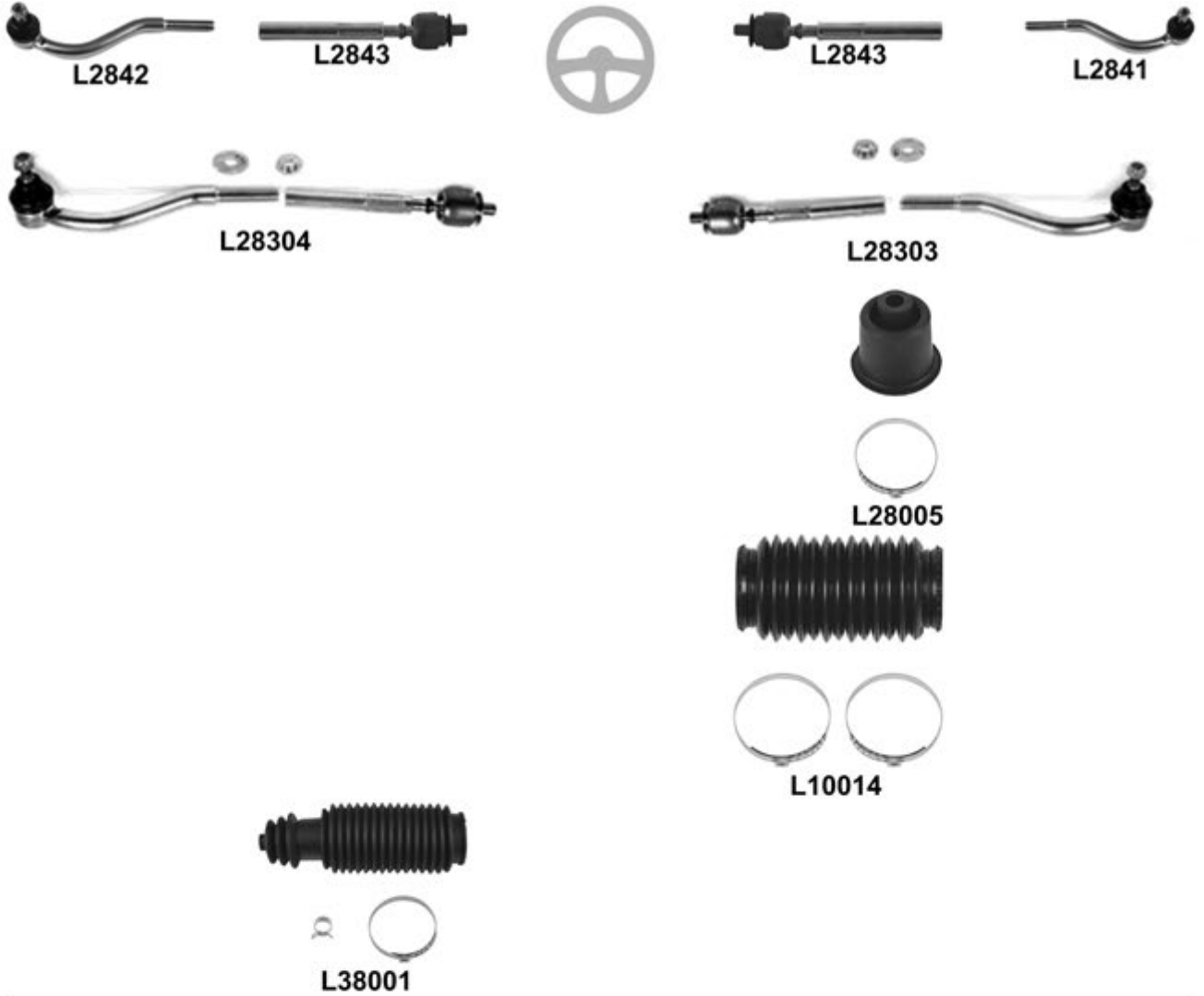

405 07.87 →

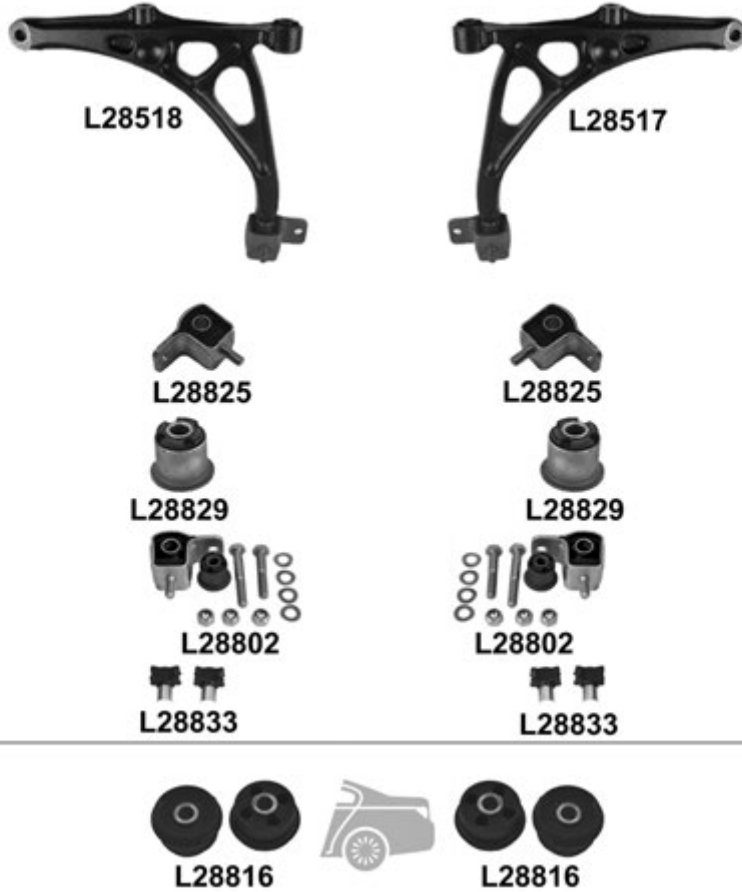

				← → Thread		Part Of	QPA					
				L2841	M 14x1,5 U		1	3817.27				
				L2842	M 14x1,5 U		1	3817.26				
				L2843	L2843	F 14x1,5 / M 12x1 U		2	3812.98			
					L28303	U	L2841+L2843	1	3812.77			
					L28304	U	L2842+L2843	1	3812.72			
				← →	405 II, Model 4B/E,	L28005 ^o		1	4066.21			
				→ ←	405 II, Model 4B/E,	L10014		1	4066.30			
					405 II, Model 4B/E,	L38001		1	4066.29			
						ch. → 71358279, 13mm	L3856	L3856		2	3640.21	
						ch. 71358280 →, 15mm	L38501	L38501		2	3640.28	
		, ch. → 71358279, 13mm, (+) , (-)			L28503			1	3521.49			
					L28504			1	3520.68			
		, ch. 71358280 →, 15mm (+) , (-)			L28517			1	3521.77			
					L28518			1	3520.A6			
					L28825	L28825		2	3523.42			
					L28829	L28829		2	3523.40			
					KIT	L28802	L28802	L28503/L28504/ L28517/L28518	2			
						L28606	L28606		2	5087.27		
			∅ 22mm	L28833	L28833	Anti-roll bar	2	5094.34				
			→ 07.92, ch. → 70613611	KIT	MK019	MK019		2	5035.21 SK			
			07.92 →, ch. 70613612 →		MK012	MK012		2	5037.26 S			
					MK001	MK001		2	5035.27			
			(-) 4WD	KIT	L28816	L28816	Hub carrier	2	5131.47			

406 (8) 11.95 →



L28102

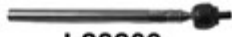

L28209



L28209



L28101



L28211

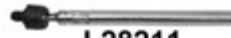

L28211



L28006

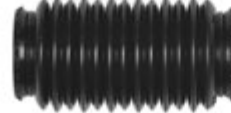

L10014



L28005



L28007



L28007

406 (8) 11.95 →

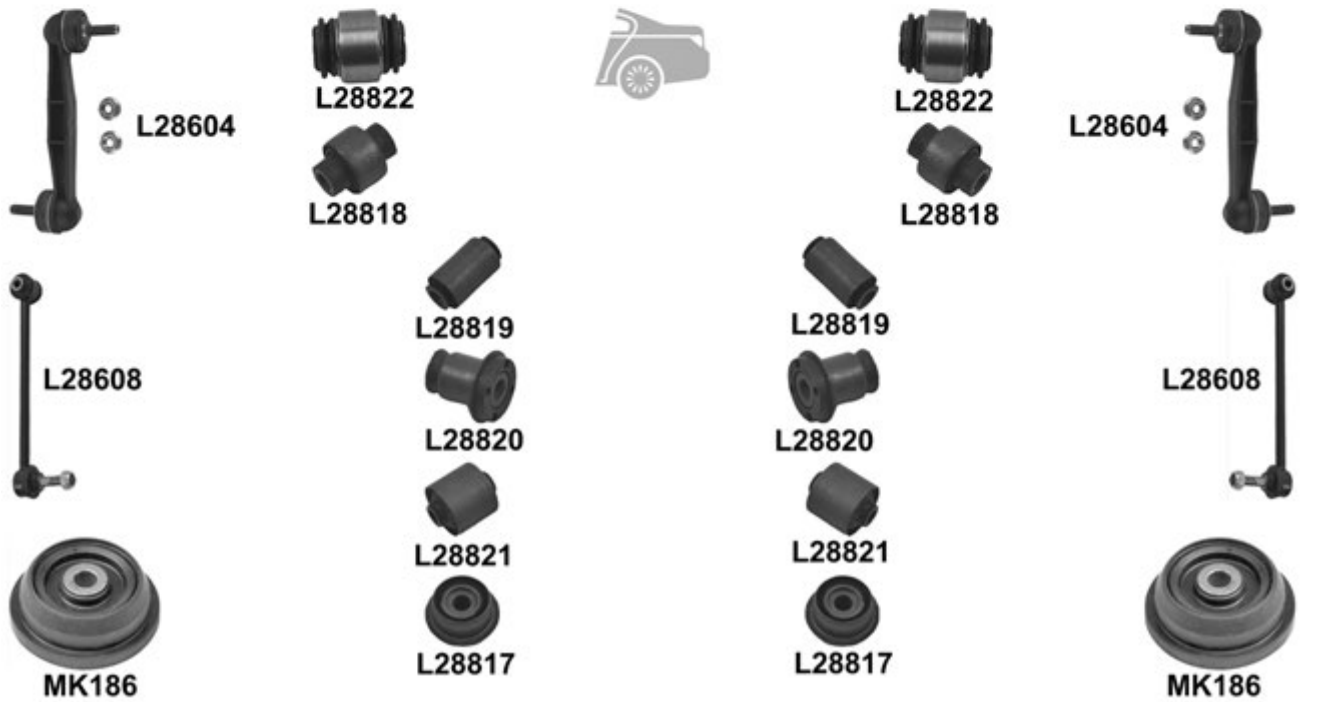
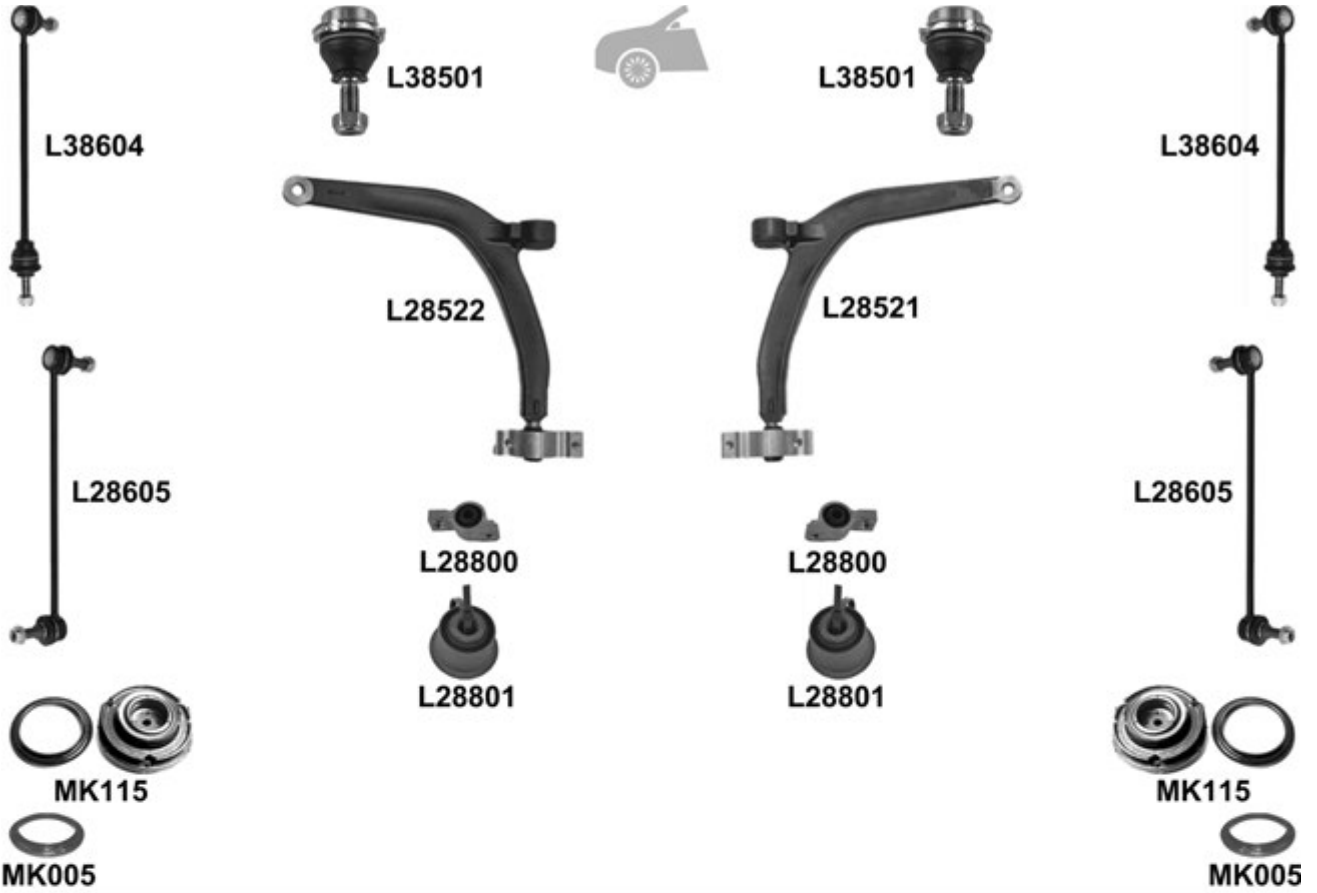

406 (8) 11.95 →

			←	→	Thread	Part Of	QPA				
		↔		L28101			1	3817.39			
				L28102			1	3817.40			
				406: 1.6/1.8/1.8 16V/1.9 D/1.9 TD, PR → 7545 406 Break: 1.8/1.8 16V/1.9 D, PR → 7608 406 Break: 1.9 TD, PR → 7545 All 2.0 16V/2.0 Turbo/2.1 TD, PR → 7664	L28209	L28209		2	3812.A9		
				406: 1.6/1.8/1.8 16V/1.9 D/1.9 TD, PR 7546 → 406 Break: 1.9 TD, PR 7546 → 406 Break: 1.8/1.8 16V/1.9 D, PR 7609 → All 2.0 16V/2.0 Turbo/2.1 TD, PR 7665 → All 2.0 Hdi/2.2/2.2 Hdi/3.0 V6/3.0 V6 24V	L28211	L28211		2	3812.C4		
				→ ← 1.6/1.8/2.0 (TRW non-variable)		L10014		1	4066.30		
				↔ 1.6/1.8/2.0 (TRW non-variable)		L28005 ⁰		1	4066.21		
				1.6/1.8/2.0 (TRW non-variable)	L28006 ⁰			1	4066.42		
				All (ZF)	L28007 ⁰	L28007 ⁰		2	4066.75		
					↓		L38501	L38501		2	3640.34
								L28521		1	3520.C0
		↓		L28522			1	3521.80			
				L28800	L28800		2	3523.61			
		↓ ▲		L28801	L28801		2	3523.60			
			→ 10.97	L38604	L38604		2	5087.40			
			11.97 →	L28605	L28605		2	5087.48			
				KIT MK115	MK115		2	5038.25 S			
				MK005	MK005		2	5035.32			
				↔	→ 11.97 transverse	L28822	L28822		2	3640.35	
	11.97 → transverse	L28818			L28818		2	3640.41			
	transverse	L28819			L28819		2	5131.80			
longitudinal	L28820	L28820				4	5131.78				
longitudinal	L28821	L28821				2	5131.79				
	L28817	L28817			Hub carrier	4	5152.59				
			L28604	L28604		2	5178.38				
		Wheel hub	L28608	L28608		2	5178.39				
			MK186	MK186		2					

407 (6D_) 05.04 →
 407 SW (6E_) 05.04 →
 407 Coupé (6C_) 10.05 →

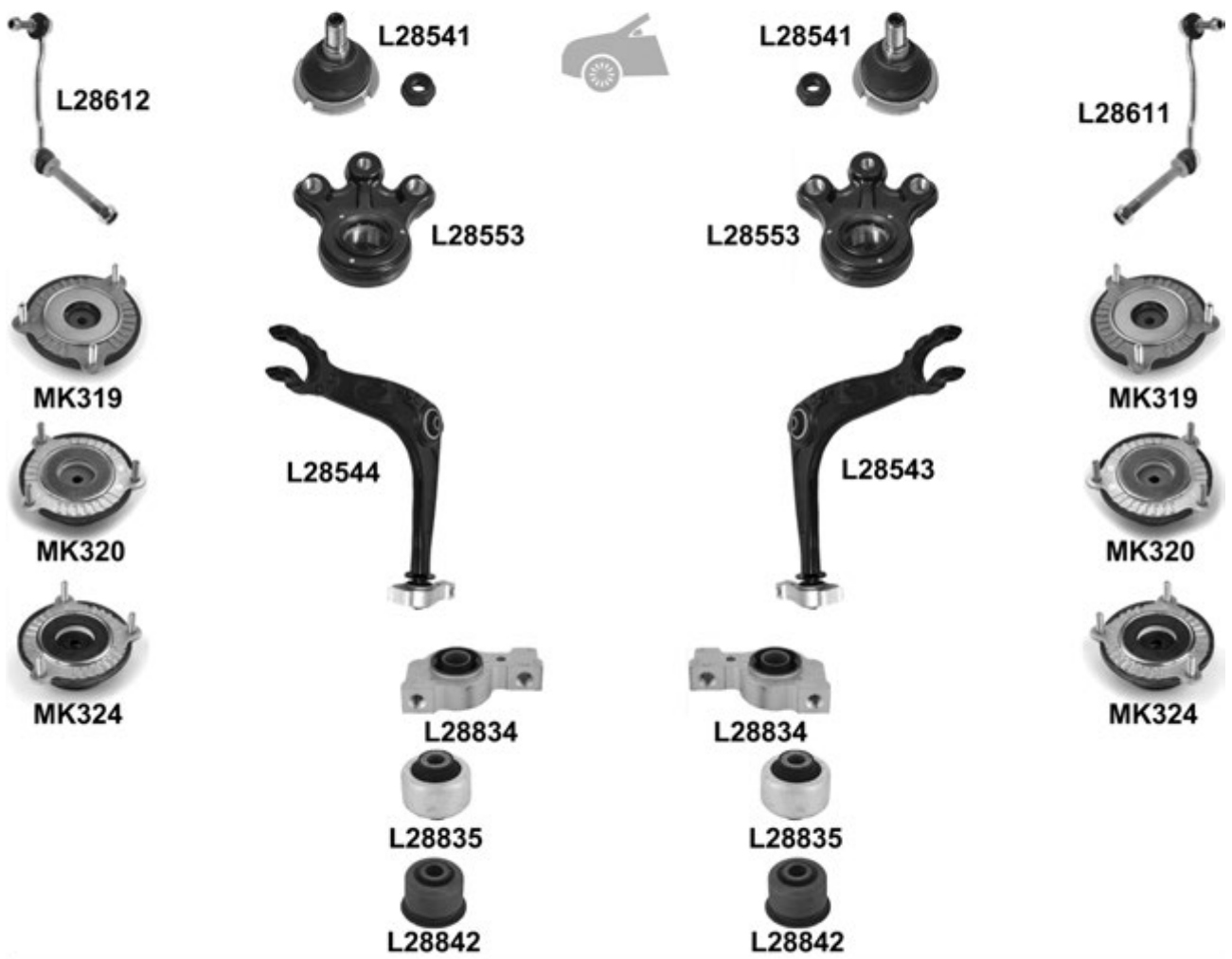
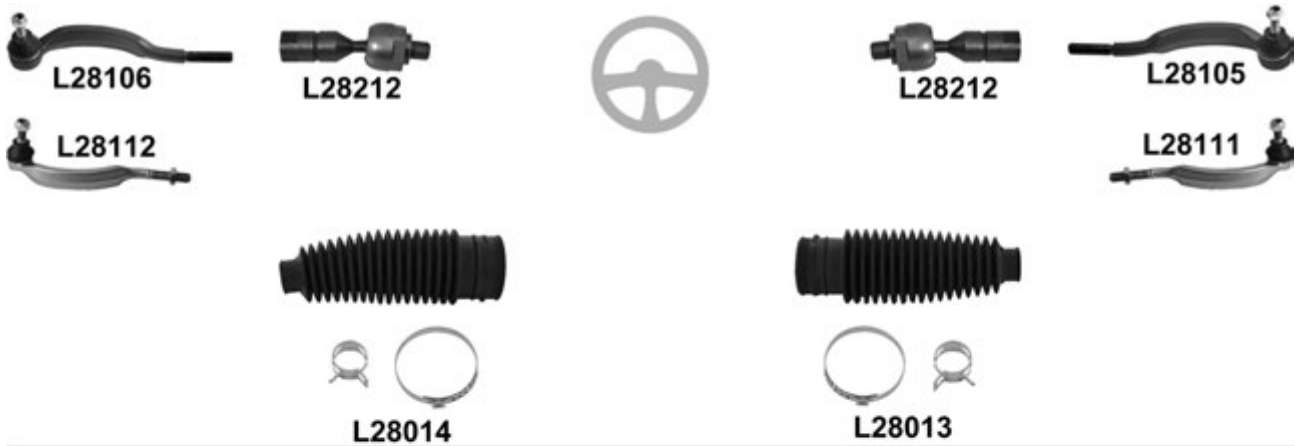

407 (6D_) 05.04 →
 407 SW (6E_) 05.04 →
 407 Coupé (6C_) 10.05 →

						←	→	Thread	Part Of	QPA		
		↔	PR → 10597, → 10.05 , ↗ 15mm		L28105			M 14x1,5 ⤴		1	3817.57	
					L28106			M 14x1,5 ⤴		1	3817.58	
			PR 10598 →, 11.05 →, ↗ 17,5mm		L28111			M 14x1,5 ⤴		1	3817.66	
					L28112			M 14x1,5 ⤴		1	3817.65	
					L28212	L28212		F 14x1,5 / M 16x1,5 ⤴		2	3812.E3	
						L28013 ⁰					1	4066.72
						L28014 ⁰					1	4066.71
			↑			L28541	L28541				2	3640.57
						L28553	L28553				2	3640.72
			↓	PR → 11801, → 02.09 , (-)			L28543					1
					L28544					1	3520.N6	
PR 11802 →, 03.09 →, with ALU Subframe, (-)						L28543					1	3521.J6
					L28544						1	3520.N6
		↓	↘		L28834	L28834				2		
			↗		L28835	L28835				2	3523.AQ	
		↓		L28842 ⁰	L28842 ⁰			Wheel bearing housing, OE no. 3646.97	2			
						L28611				1	5087.53	
					L28612				1	5087.52		
			⑮		MK319	MK319				2		
			⑰		MK320	MK320				2		
			2,7 Hdi, 3.0, 3.0 Hdi		MK324	MK324				2		
					L28613	L28613				2	5178.46	

504 → 12.79
 ch. → 3221370



						←	→	Thread	Part Of	QPA	
					L2837					1	4040.14

504 01.80 → 06.86

ch. 3221371 →



L2820



L2820



L28002



L28002



L2822



L2822



L2837



Thread

Part Of

QPA



		↔		L2820	L2820	M 14x1,5 U		2	3817.18
				L28002	L28002			2	4066.15
		⊥	ch. 3688817 →	L2822	L2822			2	3640.25
				L2837				1	4040.14

505 05.79 → 12.93
 604 01.80 → 12.93
 ch. 6607516 →

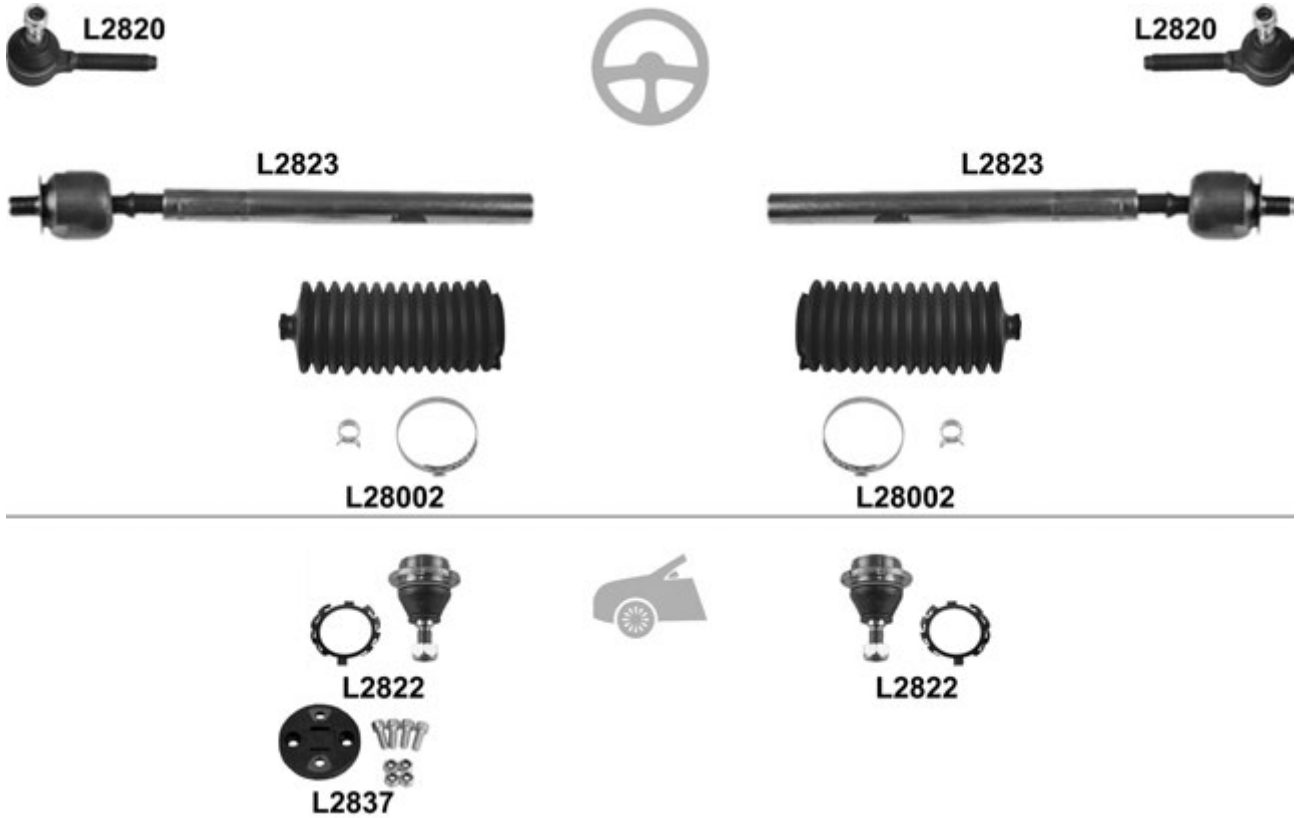

		i		←	→	Thread	Part Of	QPA	i
		↔		L2820	L2820	M 14x1,5 U		2	3817.18
				L2823	L2823			2	3812.19
				L28002	L28002			2	4066.15
		↓		L2822	L2822			2	3640.25
				L2837				1	4040.14

508 11.10 →
508 SW 11.10 →

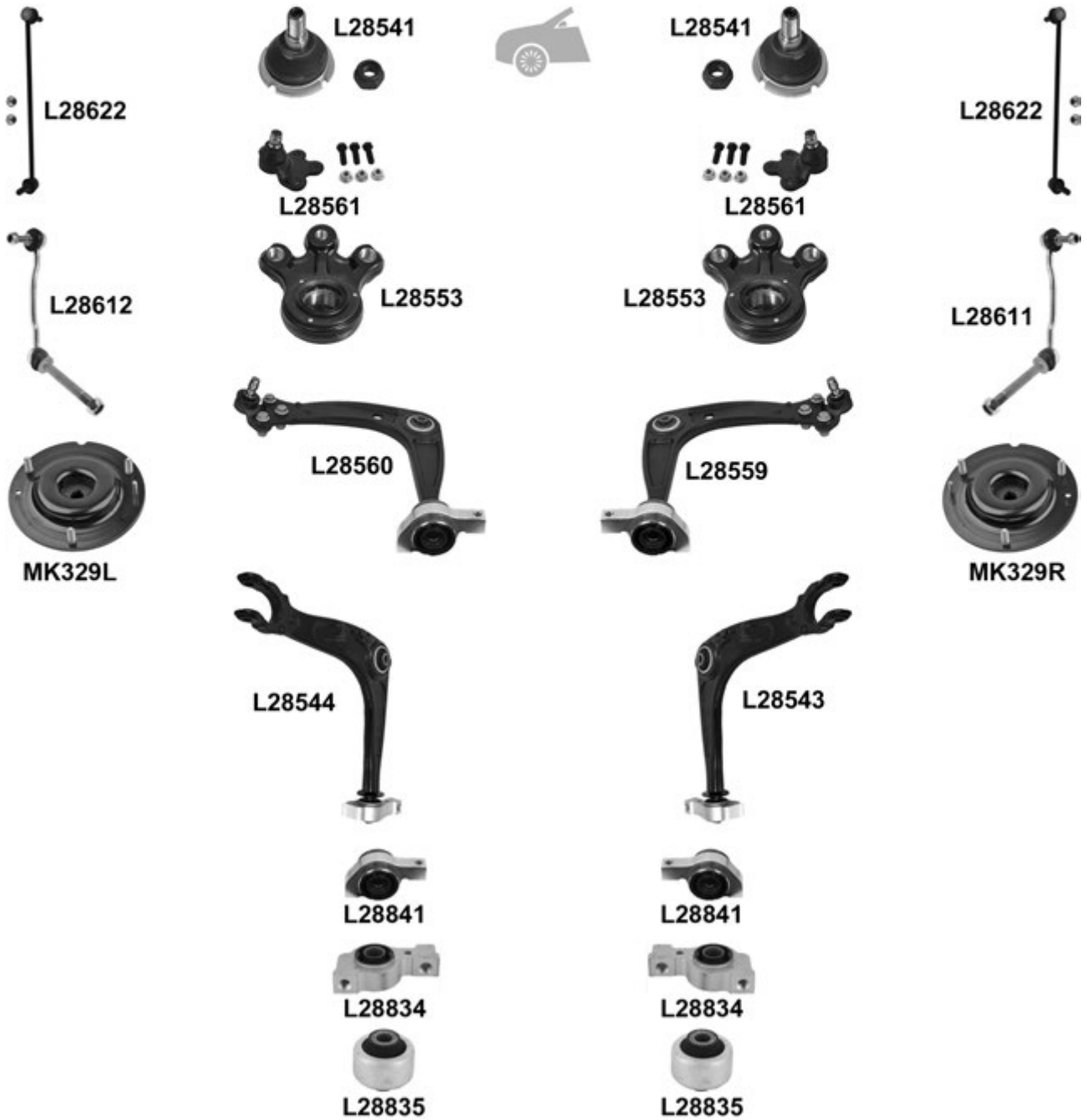
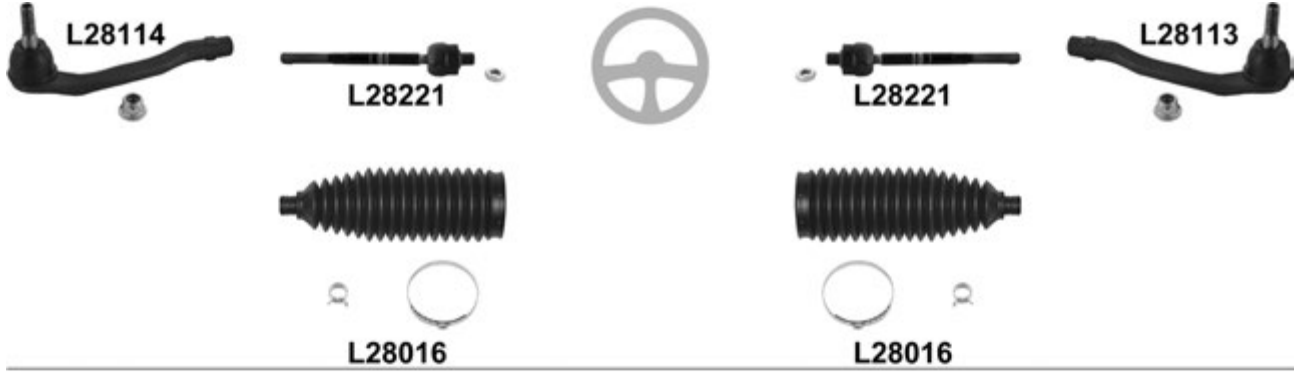

508 11.10 →
508 SW 11.10 →



			←	→	Thread	Part Of	QPA			
		↔	(-) VH10 Suspension	L28113	F 14x1,5 U		1	3817.A2		
				L28114	F 14x1,5 U		1	3817.A1		
			(-) VH10 Suspension	L28221	L28221	F 14x1,5 / M 16x1,5 U		2	3812.G3	
				L28016 ⁰	L28016 ⁰			2	4066.A0	
				L28016 ⁰	L28016 ⁰			2	4066.88	
		↑	VH10 Suspension	L28541	L28541			2	3640.57	
			↓	(-) VH10 Suspension	L28561	L28561			2	3640.83
				VH10 Suspension	L28553	L28553			2	3640.72
		↓	(-) VH10 Suspension <input checked="" type="checkbox"/>	L28559				1	3521.V1	
				L28560				1	3520.Y0	
				VH10 Suspension, (-)	L28543				1	3521.J6
				L28544				1	3520.N6	
		↓	(-) VH10 Suspension	L28841	L28841			2		
				VH10 Suspension	L28834	L28834			2	
		↑		L28835	L28835			2	3523.AQ	
			(-) VH10 Suspension	L28622	L28622			2	5087.76	
				VH10 Suspension	L28611			1	5087.53	
				L28612				1	5087.52	
					MK329R ⁰			1		
		(-) VH10 Suspension	MK330L ⁰				1			
			L28613	L28613			2	5178.46		

605 06.89 → 09.99

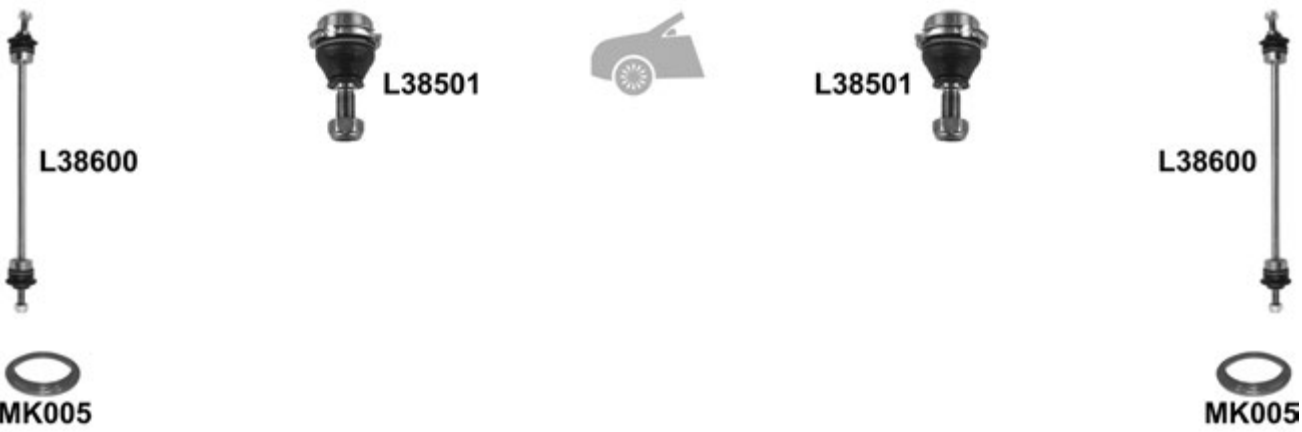
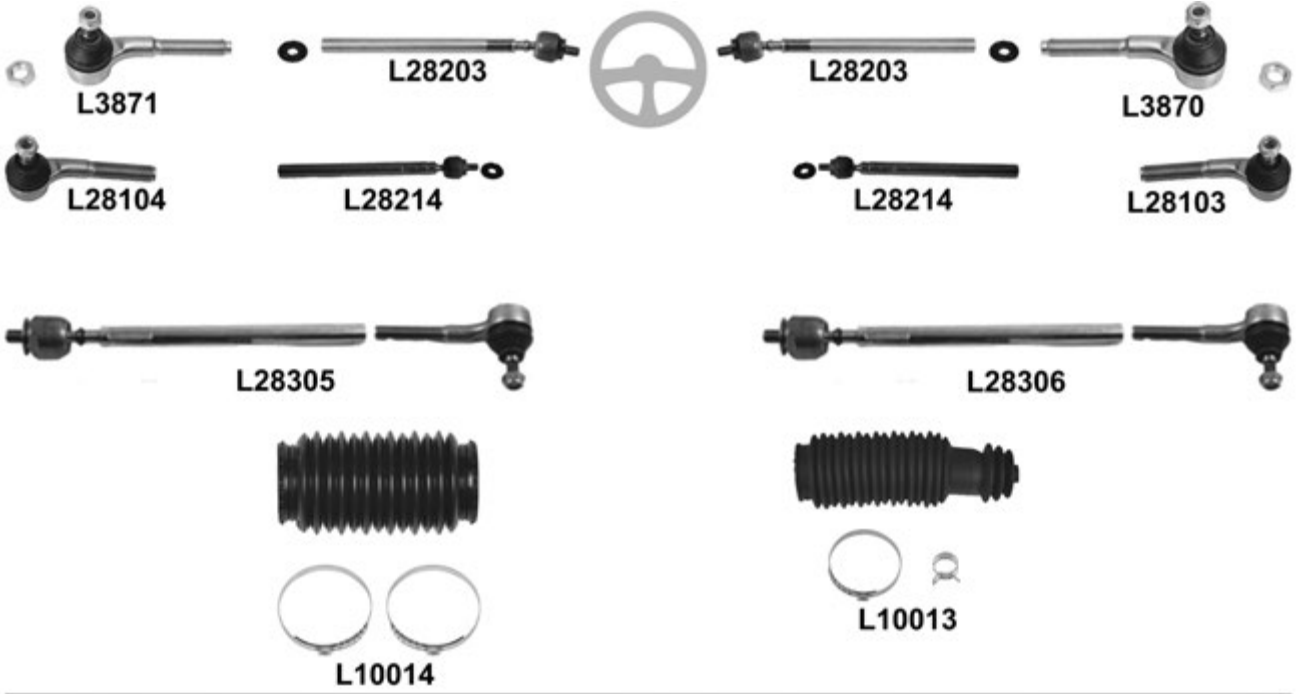

605 06.89 → 09.99

				←	→	Thread	Part Of	QPA	
		↔	→ 07.94		L3870	M 14x1,5 ☺		1	3817.41
				L3871		M 14x1,5 ☺		1	3817.42
		↔	08.94 →		L28103	M 16x1,5 ☺		1	3817.44
				L28104		M 16x1,5 ☺		1	3817.43
			→ 07.94, L= 315mm	L28203	L28203	F 14x1,5 / M 12x1		2	3812.99
			08.94 →, L= 292mm	L28214	L28214	F 14x1,5 / M 12x1		2	3812.A6
				L28306	☺	L3870/L28203	1	3812.81	
				L28305	☺	L3871/L28204	1	3812.80	
			→ 94		L10013			1	
					L10014				1
		⊥		L38501	L38501			2	3640.34
				L38600	L38600			2	5087.31
			(-) Electronic ⬆️⬆️	MK005	MK005			2	5035.32
					L28600			1	5178.31
					L28601			1	5178.30

607 (9) 02.00 →



						←	→	Thread	Part Of	QPA	
		↔			L28103			F 16x1,5 U		1	3817.44
					L28104			F 16x1,5 U		1	3817.43
		⊥			L38501	L38501				2	3640.34
					L28605	L28605				2	5087.48
					MK005	MK005				2	5035.32
					KIT		MK182	MK182			2
						L28600				1	5178.44
					L28601					1	5178.43

806 (221) 06.94 → 08.02

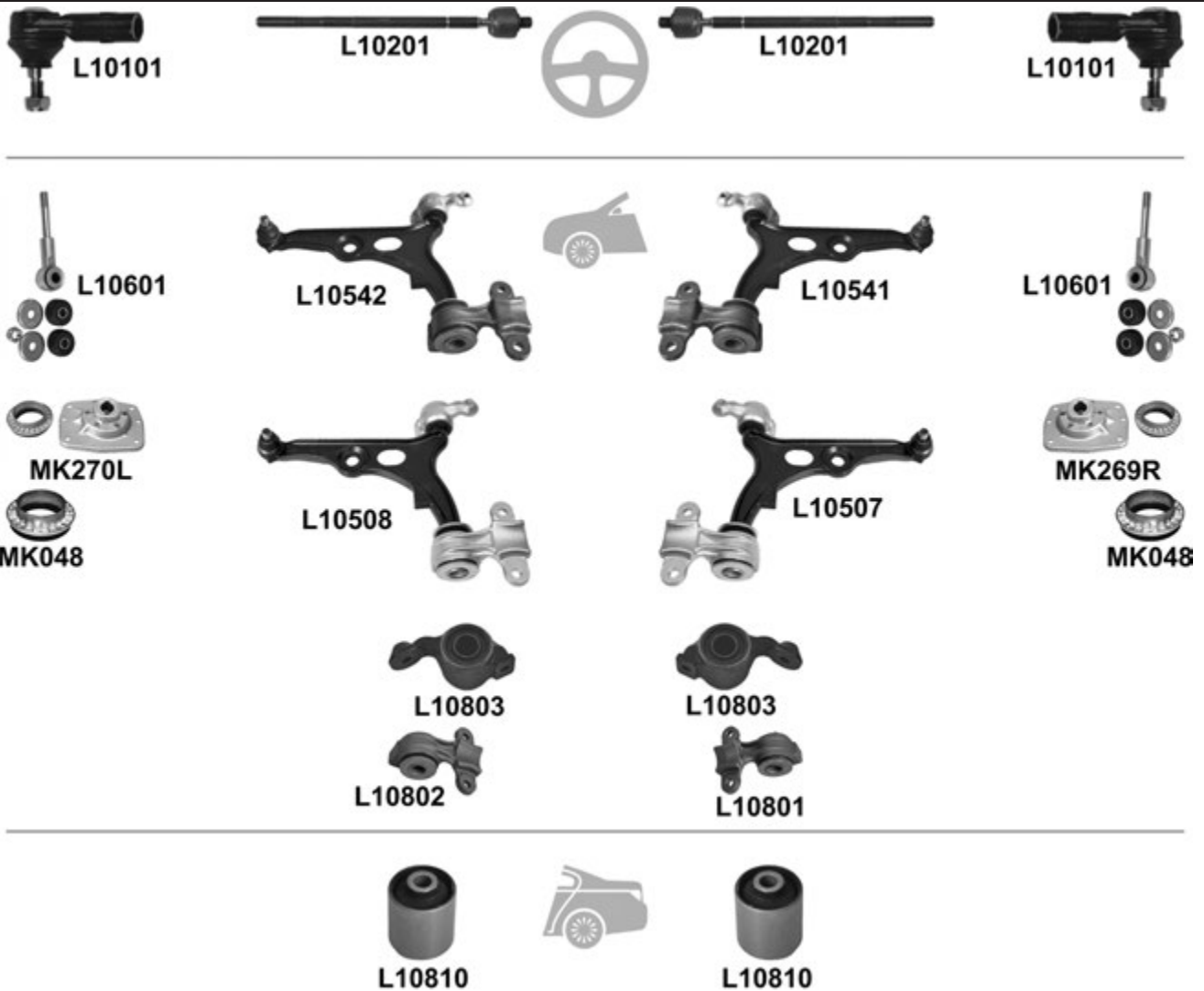

				← → Thread		Part Of	QPA		
		↔		L10101	L10101	F 14x1,5 U	2	4059.09	
				L10201	L10201	M 14x1,5 / M 14x1,5 U	2	3812.A4	
		↓	Petrol, 17mm	<input checked="" type="checkbox"/>		L10541		1	3521.L0
						L10542		1	3520.P8
		Diesel, 17mm	<input checked="" type="checkbox"/>		L10507		1	3521.K4	
					L10508		1	3520.P4	
		↓ ▼			L10803	L10803	L10507/L10508/ L10541/L10542	2	
		↓ ▲				L10801	L10507/L10541	1	
				L10802		L10508/L10542	1		
				L10601	L10601		2	5038.35 S	
			(+) MK048	KIT		MK269R	1	5038.70	
						MK270L	1	5038.68	
				MK048	MK048		2	5035.43	
				L10810	L10810	Hub carrier	2	5152.61	

807 06.02 →

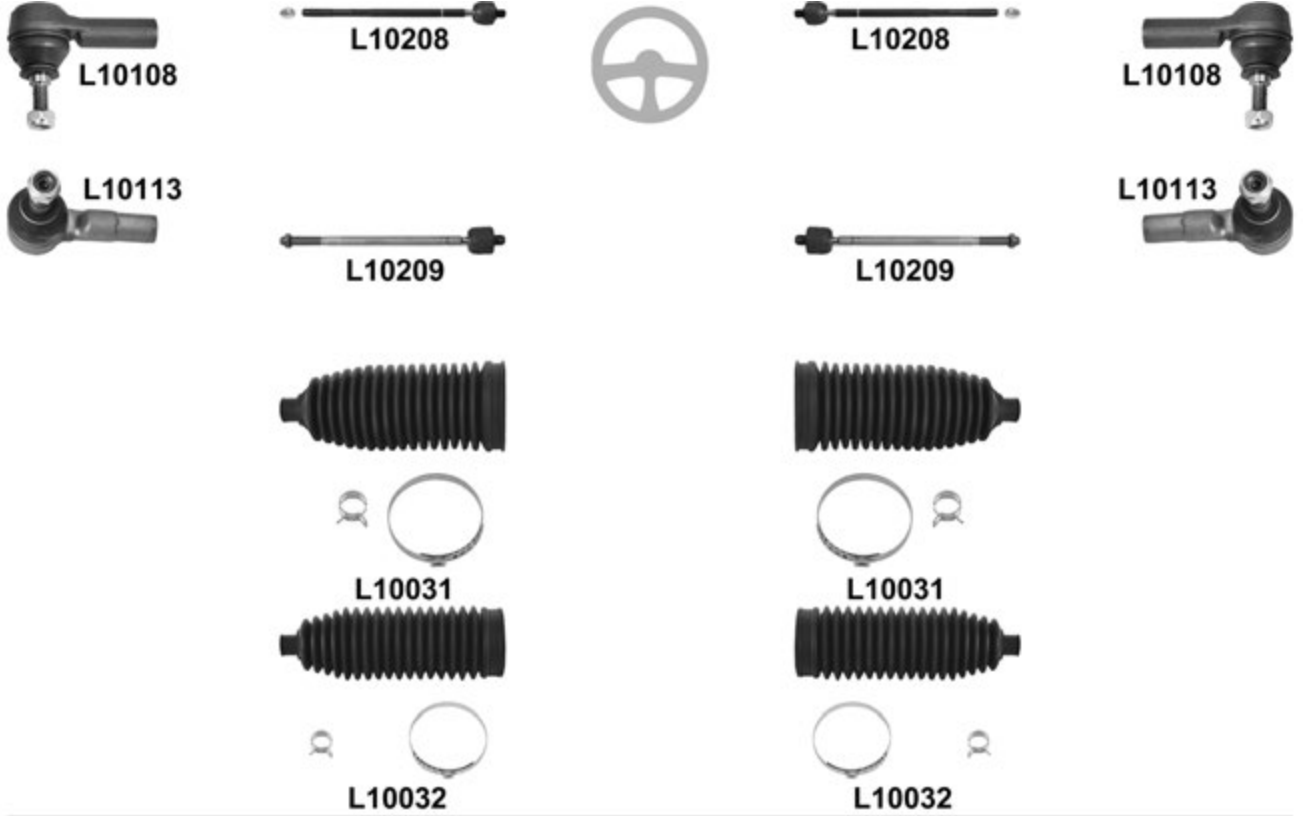

			←	→	Thread	Part Of	QPA		
		↔	(-) 2.0 Hdi, Mot/Eng DW10CTED4, 2.2 Hdi, Mot/Eng DW12BTED4	L10108	L10108	F 14x1,5 ⤴	2	4059.12	
			2.0 Hdi, Mot/Eng DW10CTED4, 2.2 Hdi, Mot/Eng DW12BTED4	L10113	L10113	F 14x1,5 ⤴	2	3817.73	
			(-) 2.0 Hdi, Mot/Eng DW10CTED4, 2.2 Hdi, Mot/Eng DW12BTED4	L10208	L10208	M 14x1,5 / M 14x1,5 ⤴	2	3812.E2	
			2.0 Hdi, Mot/Eng DW10CTED4, 2.2 Hdi, Mot/Eng DW12BTED4	L10209	L10209	⤴	2	3812.F0	
				(-) 2.0 Hdi, Mot/Eng DW10CTED4, 2.2 Hdi, Mot/Eng DW12TED4 / DW12BTED4	L10031⁰	L10031⁰		2	4066.70
				2.0 Hdi, Mot/Eng DW10CTED4	L10032⁰	L10032⁰		2	4066.83
				2.2 Hdi, Mot/Eng DW12BTED4, Hydraulic	L10031⁰	L10031⁰		2	4066.70
				2.2 Hdi, Mot/Eng DW12BTED4, Electric	L10032⁰	L10032⁰		2	4066.83
				2.2 Hdi, Mot/Eng DW12TED4	L10032⁰	L10032⁰		2	4066.83
			⊥	PR. No → 10847, 12mm <input checked="" type="checkbox"/>		L10529		1	3521.P6
				L10530		1	3520.P6		
PR 10848 →, 17mm, 14mm <input checked="" type="checkbox"/>					L10577		1	3521.T2	
				L10578		1	3520.X0		
19mm <input checked="" type="checkbox"/>					L10571		1	3521.N9	
			L10572		1	3520.R8			
				L10608	L10608		2	5087.51	
					KIT	MK269R		1	5038.70
						MK270L		1	5038.68
					MK048	MK048		2	5035.38

1007 06.05 →

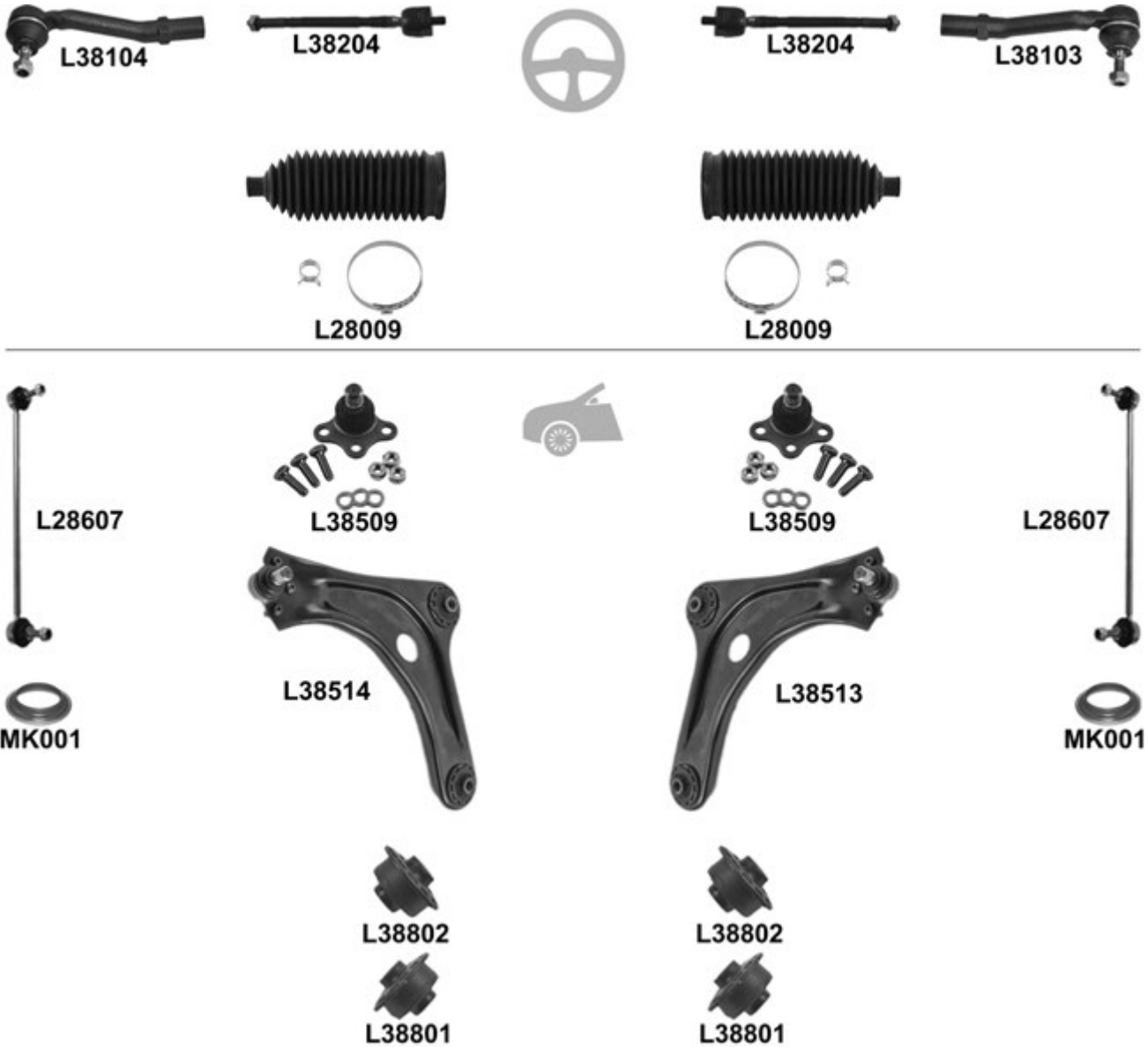

				←	→	Thread	Part Of	QPA		
⊕	🔧	↔	→ 07.06		L38103	F 14x1,5 ∪		1	3817.56	
					L38104	F 14x1,5 ∪		1	3817.55	
	🌀		→ 07.06		L38204	L38204	M 14x1,5 / M 12x1 ∪	2	3812.E1	
					L28009 ⁰	L28009 ⁰		2	4066.69	
🚗	🔧	⊥			L38509	L38509		2	3640.56	
				<input checked="" type="checkbox"/>		L38513		1	3521.H6	
	🔧	⊥			L38514			1	3520.L4	
					L38802	L38802		2	3523.AA	🔧
	🌀	⊥	↕		L38801	L38801		2	3523.98	🔧
					L28607	L28607		2	5087.45	
		🌀			MK001	MK001		2	5035.27	🌀

2008 03.13 →



				← → Thread		Part Of	QPA		
		↓		L38521	L38521		2	3640.77	
		↓	☑		L28567 ⁰		1	9803286480	
				L28568 ⁰			1		
				L28607	L28607		2	5087.59	
				MK001	MK001		2	5035.27	
			MK382 ⁰	MK382 ⁰		2			

3008 06.09 →

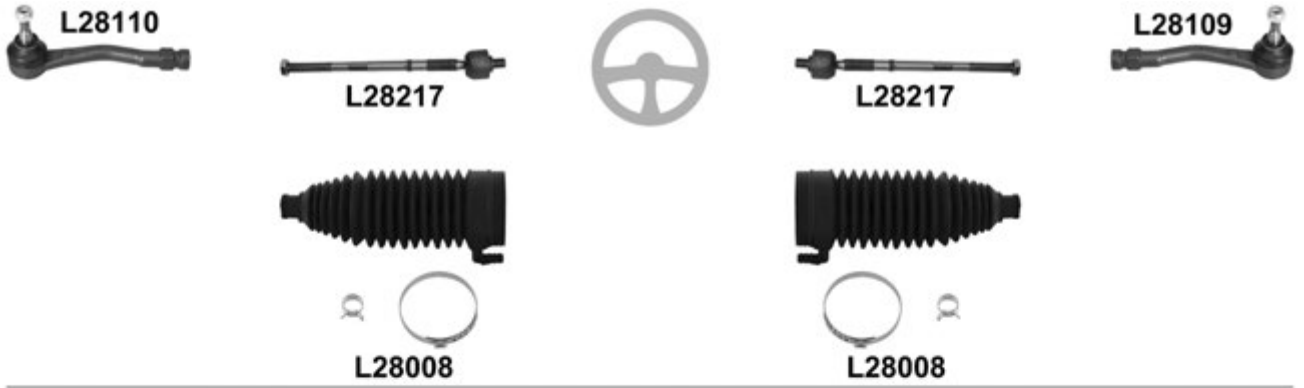

				← → Thread		Part Of	QPA			
⊕		↔		L28109	F 14x1,5 ♂		1	3817.88		
				L28110	F 14x1,5 ♂		1	3817.89		
				L28217	L28217	M 14x1,5 / M 14x1,5 ♂		2	3812.F2	
					L28008 ^o	L28008 ^o		2	4066.85	
🚗		⊥		L28554	L28554		2	3640.73		
		⊥	(-)	<input checked="" type="checkbox"/>	L28555		1	3521.R3		
		⊥		L28556			1	3520.V2		
		⊥		L28807	L28807		2	3523.92		
		⊥		L28824	L28824		2	3523.91		
		↔	→ 09.12	L28609	L28609		2	5087.64		
		↔	10.12 →	L28621	L28621		2	5087.57		
			MK001	MK001		2	5035.27			

4007 (GP_) 02.07 →

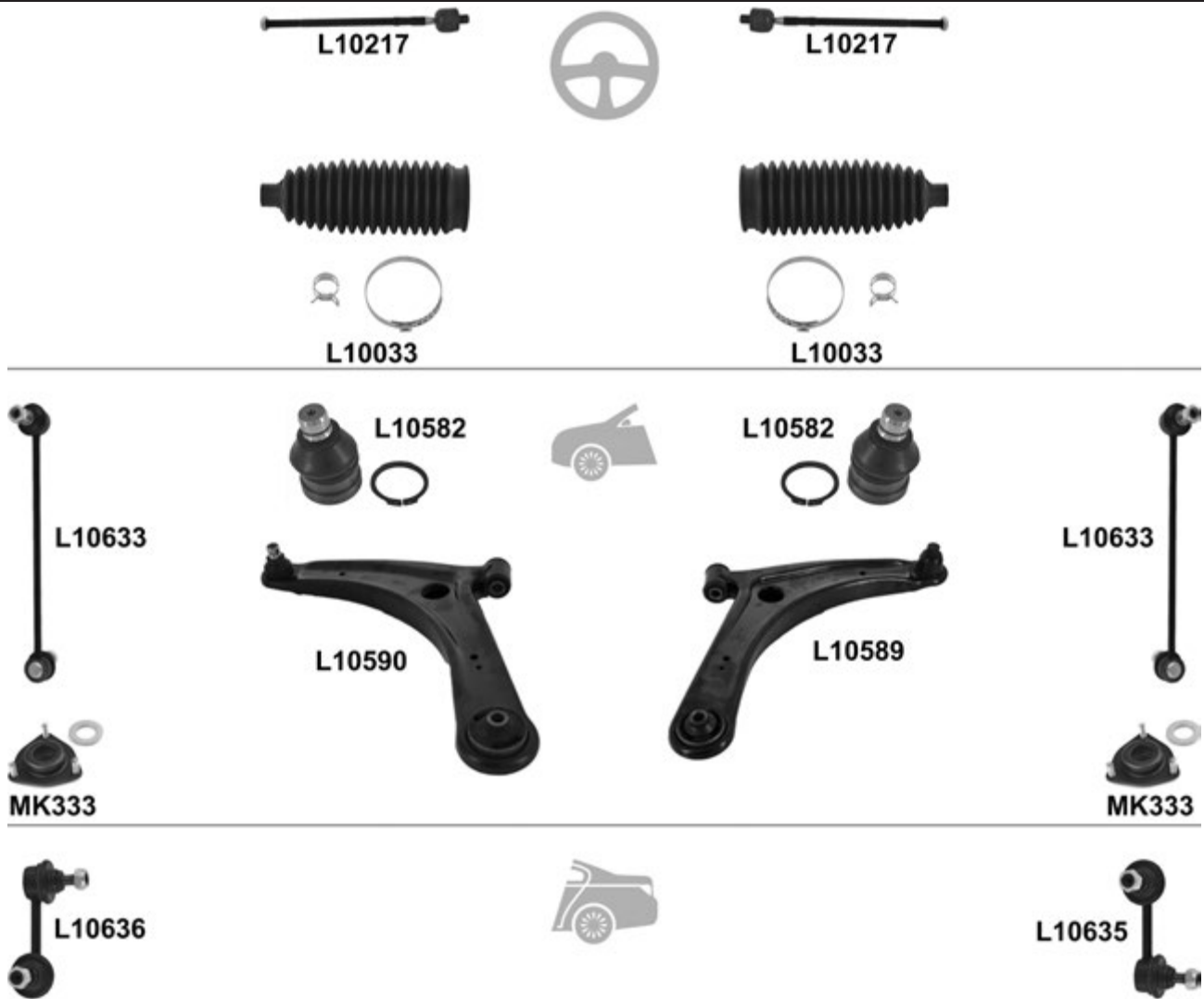

				←	→	Thread	Part Of	QPA	
⊕				L10217 ⁰	L10217 ⁰	↻		2	3812.F1
			PR → 12010, → 09.09	L10033 ⁰	L10033 ⁰			2	4066.84
⊖		⊥		L10582	L10582		L10589/L10590	2	
		⊥	<input checked="" type="checkbox"/>	L10589				1	3521.R1
				L10590				1	3520.V0
				L10633	L10633			2	5087.58
				MK333	MK333			2	
⊖					L10635			1	5178.49
				L10636				1	5178.48

5008 09.09 →

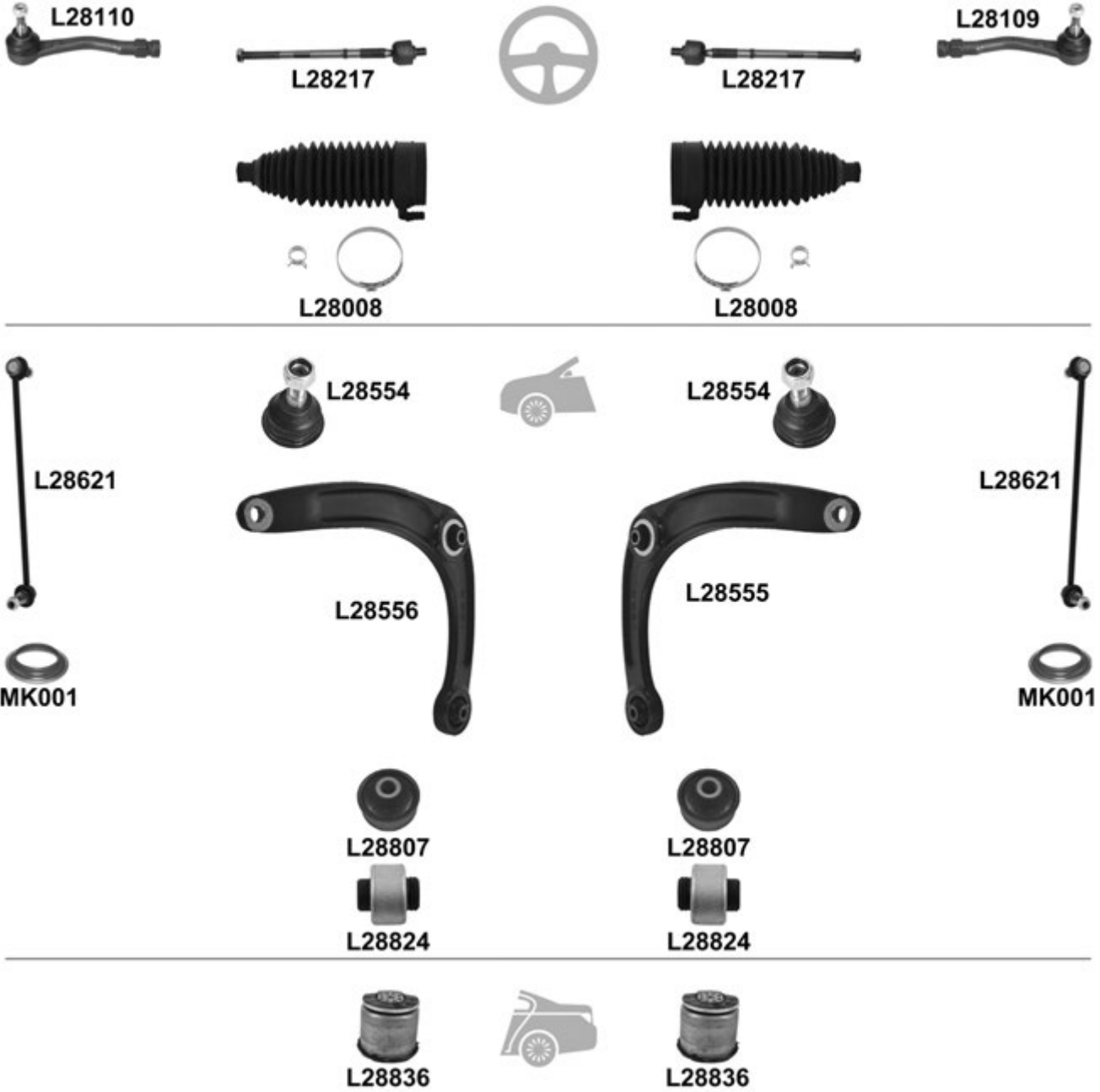

		i	←	→	Thread	Part Of	QPA	i	
⊕		↔		L28109	∪		1	3817.88	
				L28110	∪		1	3817.89	
				L28217	L28217	M 14x1,5 / M 14x1,5 ∪		2	3812.F2
			(-) 2.0 Hdi, Mot/Eng DW10CTED4		L28008 ^o	L28008 ^o			2
⊖		⊥		L28554	L28554			2	3640.73
				→ 11.12, PR → 13173, (-)		L28555			1
		⊥		L28556				1	3520.V2
				L28807	L28807			2	3523.92
		⊥		L28824	L28824			2	3523.91
				L28621	L28621			2	5087.57
				MK001	MK001			2	5035.27
			L28836	L28836		Hub carrier	2	5131.F2	

PLYMOUTH

Neon 05.94 → 08.99

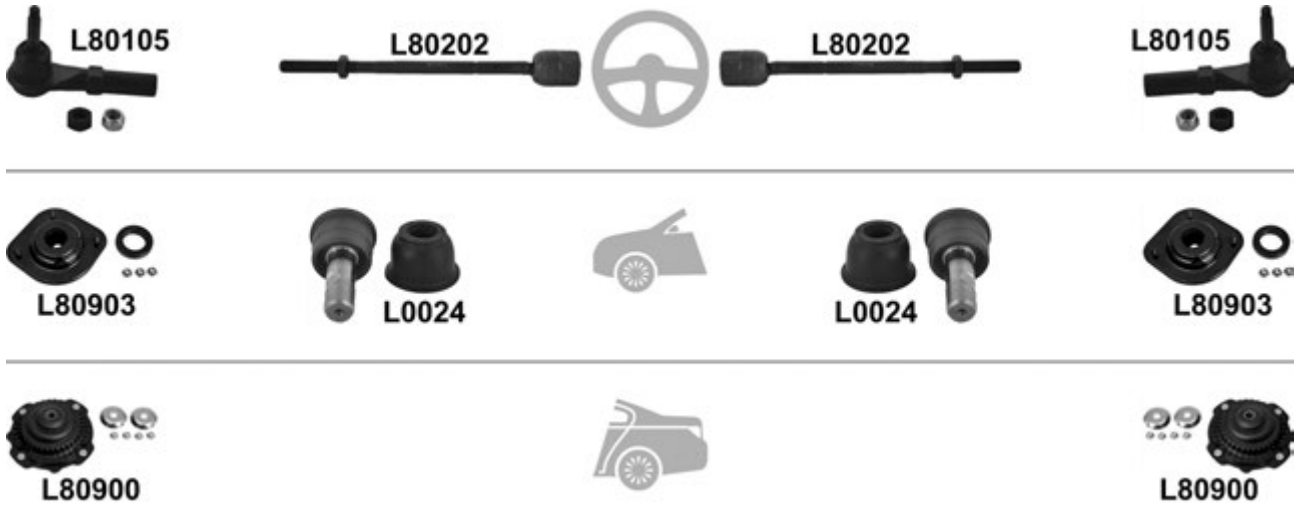

				←	→	Thread	Part Of	QPA	
⊕		↔		L80105	L80105			2	04762861AA
				L80202	L80202		OE no. 04626890AA Power Rack	2	04626890AA
🚗		⊥		L0024	L0024			2	4443405
			KIT	L80903	L80903			2	04626100AB
🚗				L80900	L80900			2	4626182

Voyager 01.95 → 03.01

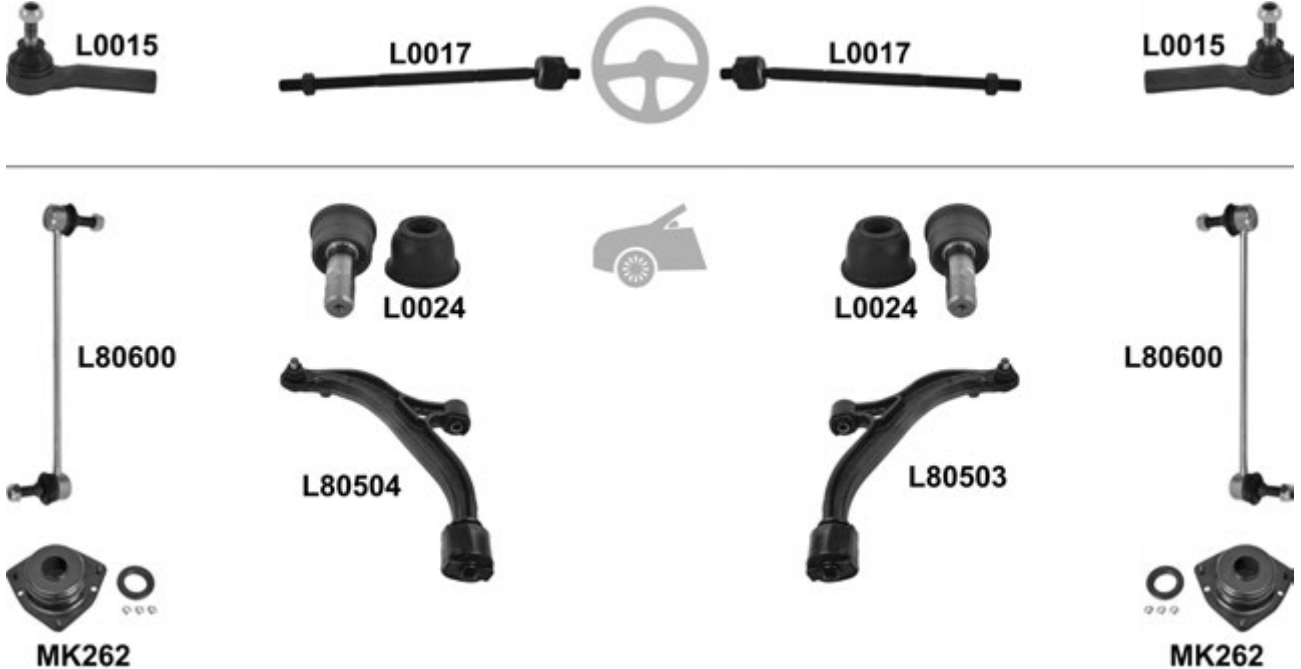

				←	→	Thread	Part Of	QPA	
⊕		↔		L0015	L0015			2	4797706
				L0017	L0017			2	
🚗		⊥		L0024	L0024			2	4449553
			<input checked="" type="checkbox"/>		L80503			1	4694760
				L80504			1	4694761	
				L80600	L80600			2	4743669AA
			KIT	MK262	MK262			2	4694870

PONTIAC

All 1971 → 1981



L80601



L80601



Thread

Part Of

QPA



			L80601	L80601			2	
--	--	--	--------	--------	--	--	---	--

Firebird, Trans AM 12.81 → 12.93



L80601



L80601



Thread

Part Of

QPA



			L80601	L80601			2	
--	--	--	--------	--------	--	--	---	--

Grand Prix 1973 → 1977



L80601



L80601



Thread

Part Of

QPA



			L80601	L80601			2	
--	--	--	--------	--------	--	--	---	--

Lemans, GTO, T-37 1964 → 1972



L80601



L80601



Thread

Part Of

QPA



			L80601	L80601			2	
--	--	--	--------	--------	--	--	---	--

Sunbird 10.75 → 1994



L80601



L80601



Thread

Part Of

QPA

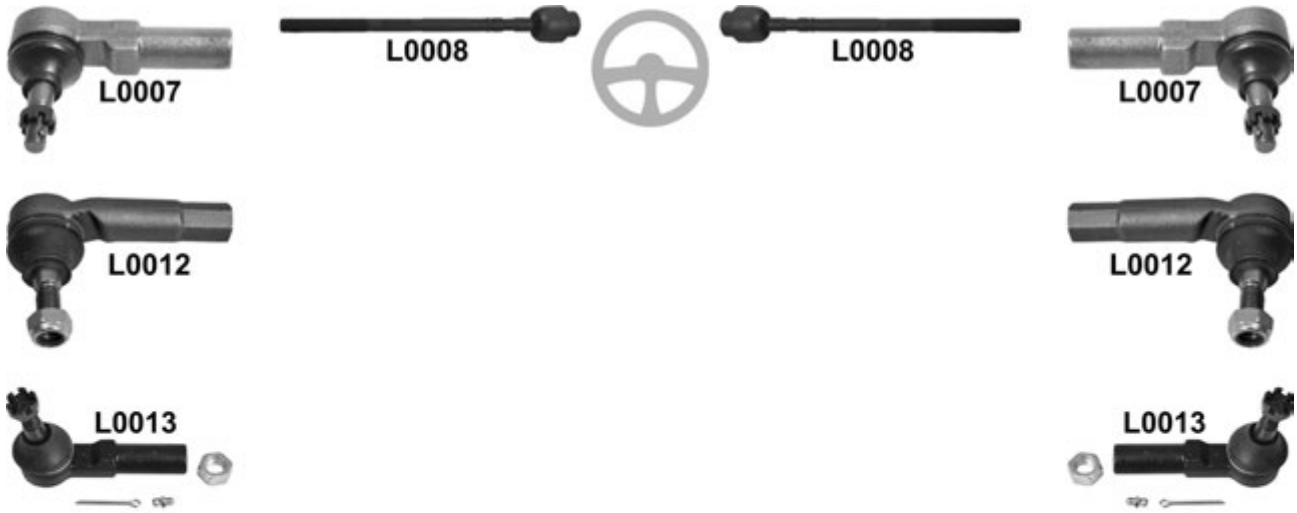

			L80601	L80601			2	
--	--	--	--------	--------	--	--	---	--

Trans Sport (89) 07.89 → 03.97

				←	→	Thread	Part Of	QPA	
⊕	↔	07.89 → 12.91	L0007	L0007				2	21011027
		01.92 → 12.92	L0012	L0012	F 14x1,5 U			2	17983075
		01.93 →	L0013	L0013				2	
⊖	↓	→ 12.92	L0021	L0021				2	
		01.93 →	L0002	L0002				2	

Trans Sport (97) 03.97 →

				←	→	Thread	Part Of	QPA	
⊕	↔		L0016	L0016				2	
		→ 10.01	L0014	L0014				2	
⊖	↓		L0025	L0025				2	

Ventura 1971 → 1979



L80601



L80601



Thread

Part Of

QPA



				L80601	L80601			2	
--	--	--	--	--------	--------	--	--	---	--

PORSCHE

Boxster (986) 09.96 →



		i		←	→	Thread	Part Of	QPA	i
		↔		L29157	L29157	☺		2	996 347 131 04
					L29653			1	996 343 070 03
				L29654				1	996 343 069 03
					L29653			1	996 343 070 03
				L29654				1	996 343 069 03

Boxster (981) 11.04 →



L29157



L29157



L29650

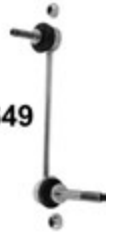

L29649

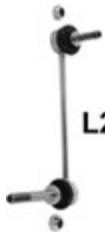

L29650

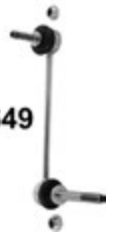

L29649

			i	←	→	Thread	Part Of	QPA	i
		↔		L29157	L29157	⌚		2	996 347 131 04
					L29649			1	997 343 070 00
				L29650				1	997 343 069 00
					L29649			1	997 343 070 00
				L29650				1	997 343 069 00

Cayenne (955) 09.02 →

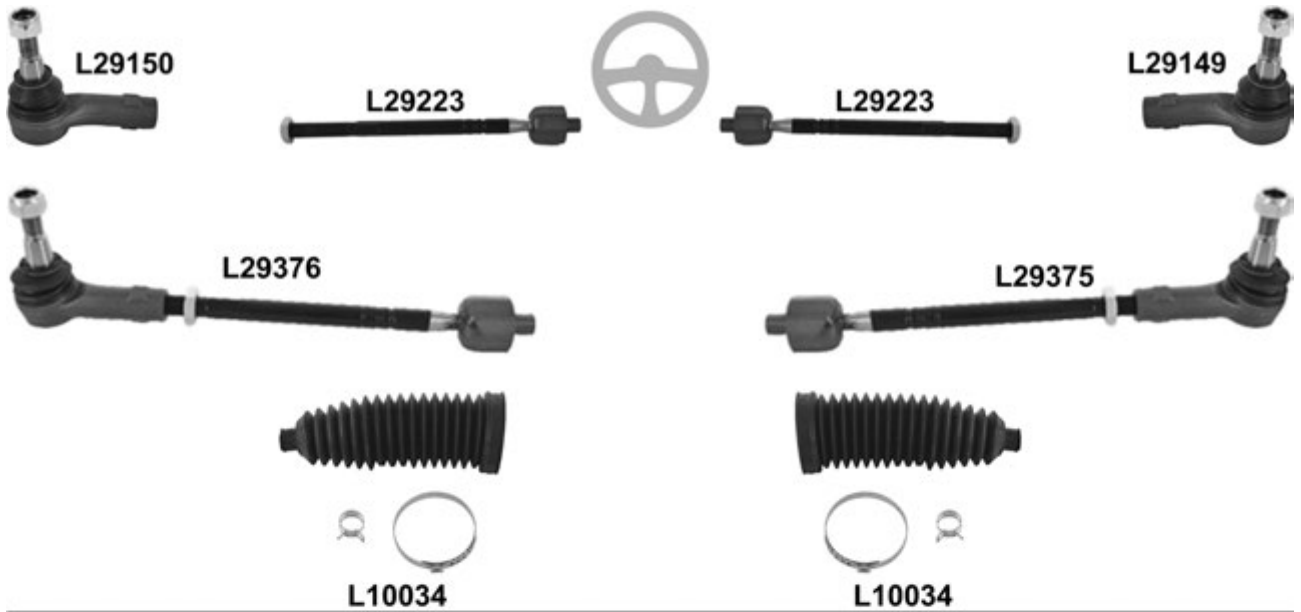

Cayenne (955) 09.02 →

				← → Thread		Part Of	QPA	i		
				L29149	F 16x1,5 ♂		1	955 347 132 22		
				L29150	F 16x1,5 ♂		1	955 347 131 22		
				L29223	L29223	M 16x1,5 / M 16x1,5 ♂		2	7L0 422 821	
				L29375				1	955 347 032 22	
				L29376				1	955 347 031 22	
				L29149						
				L29150						
				L29223	L29223					
				L29375						
				L29376						
			ch. → 9P8 LA34847	L29A12	L29A12		2	955 341 027 02		
				L29A13			1	955 341 018 33		
				L29A14			1	955 341 017 33		
				L29642	L29642		2	955 343 069 00		
				L29639			1	955 333 070 21		
				L29640			1	955 333 069 21		
				L29640			1	955 333 069 21		

Cayenne (957, 958) 06.10 →

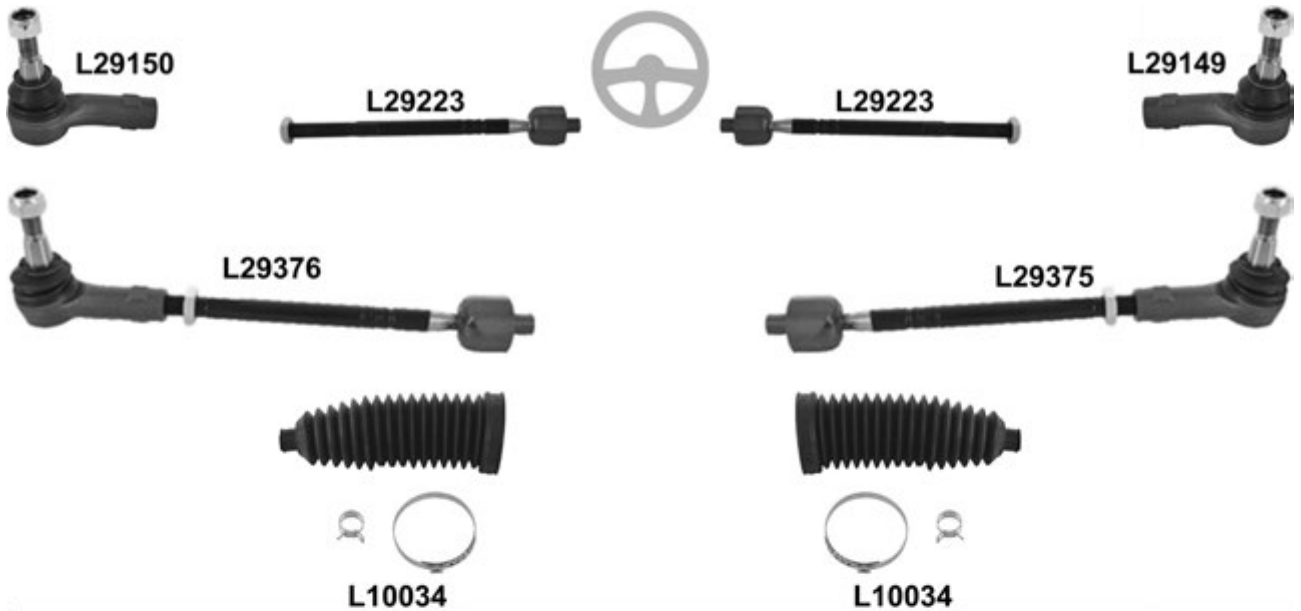

Cayenne (957, 958) 06.10 →

			i	←	→	Thread	Part Of	QPA	i
		↔			L29149	F 16x1,5 ∪		1	955 347 132 22
					L29150	F 16x1,5 ∪		1	955 347 131 22
				L29223	L29223	M 16x1,5 / M 16x1,5 ∪		2	7L0 422 821
					L29375			1	955 347 032 22
					L29376			1	955 347 031 22
			L10034 ^o	L10034 ^o			2	955 347 191 10	
			(-) Active stabilizer	L29642	L29642			2	955 343 069 00
					L29639			1	955 333 070 21
					L29640			1	955 333 069 21

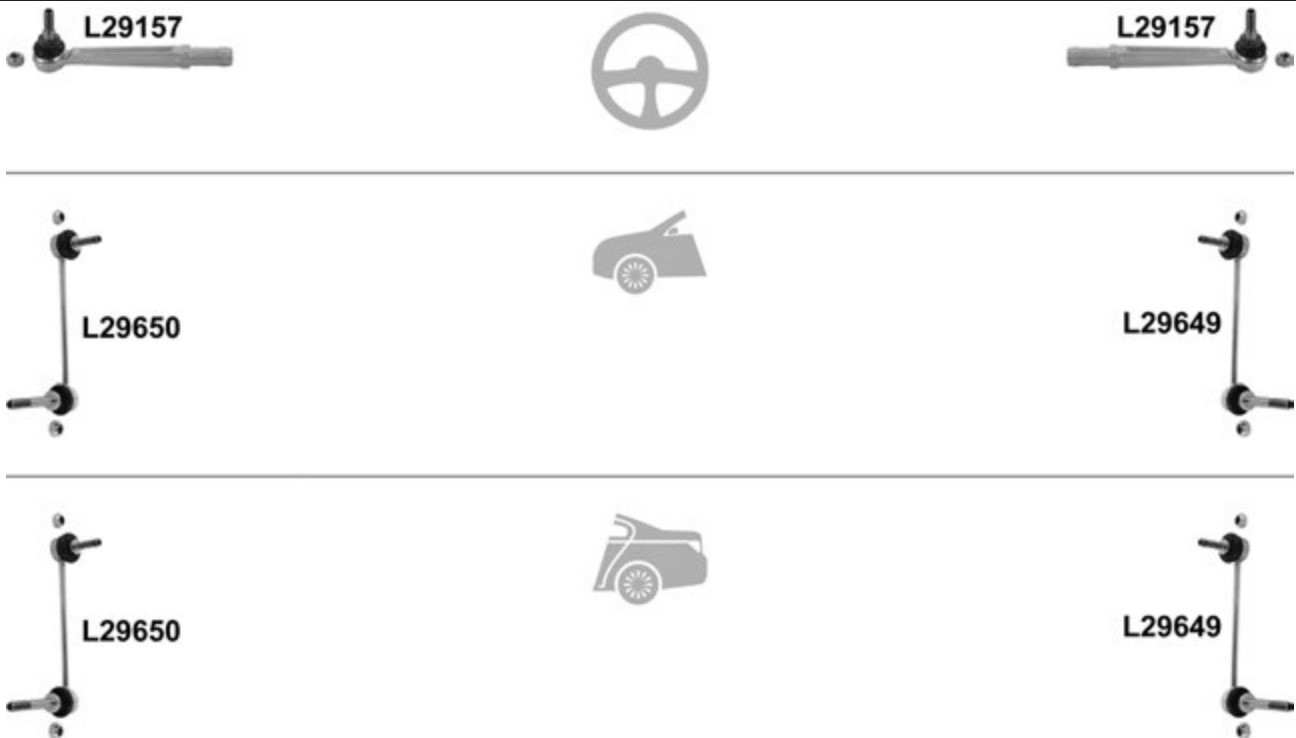
Cayman (987) 11.05 →

			i	←	→	Thread	Part Of	QPA	i
		↔		L29157	L29157	∪		2	996 347 131 04
					L29649				1
				L29650				1	997 343 069 00
					L29649			1	997 343 070 00
				L29650				1	997 343 069 00
								1	997 343 069 00

911 (996) 09.97 → 08.05



L29157



L29157



L29654

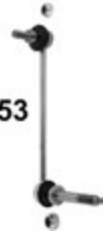

L29653

				←	→	Thread	Part Of	QPA	
		↔		L29157	L29157	↻		2	996 347 131 04
			01.00 →, (-) SP		L29653			1	996 343 070 03
				L29654				1	996 343 069 03

911 (997) 07.04 →

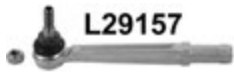

L29157

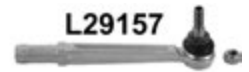

L29157



L29650

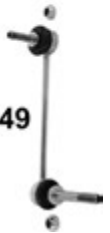

L29649

				←	→	Thread	Part Of	QPA	
		↔		L29157	L29157	↻		2	996 347 131 04
					L29649			1	997 343 070 00
				L29650				1	997 343 069 00

PROTON

Persona 300 03.96 →



			i	←	→	Thread	Part Of	QPA	i
⊕	⚙️	↔		L27105	L27105	F 12x1,25 U		2	PW510185
🚗	⚙️	⌇		L42010	L42010			2	AW311699

Persona 400 01.94 →



			i	←	→	Thread	Part Of	QPA	i
⊕	⚙️	↔		L27105	L27105	F 12x1,25 U		2	PW510185
🚗	⚙️	⌇		L42010	L42010			2	AW311699

RENAULT

Avantime (DEO) 09.01 → 05.03

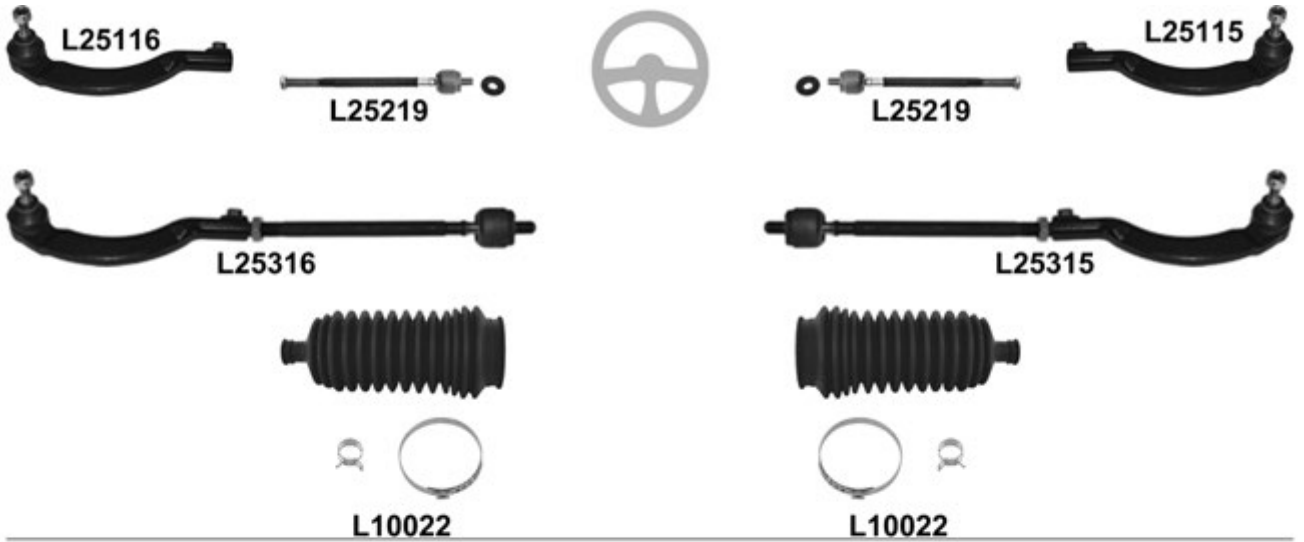

Avantime (DEO) 09.01 → 05.03

		i		←	→	Thread	Part Of	QPA	i
⊕		↔			L25115	F 14x1,5 ∪		1	6025 370 230
					L25116	F 14x1,5 ∪		1	6025 370 229
		L= 258mm		L25219	L25219	M 14x1,5 / M 12x1 ∪		2	
					L25315			1	6025 370 494
				L25316				1	6025 370 493
				L10022 ^o	L10022 ^o			2	6001 547 607
⊖		⊥		L25517	L25517			2	6025 308 155
			<input checked="" type="checkbox"/>	L25541				1	6025 307 650
		⊥		L25542				1	6025 307 649
				L25815	L25815			2	6025 311 529
		↕	▲	L25803	L25803			2	7700 822 503
			▼	L25600	L25600			2	7700 805 494
		(+ MK001)			MK152R			1	6025 305 980
				MK153L			1	6025 305 979	
			MK001	MK001			2	7700 803 635	

Captur 06.13 →

		i		←	→	Thread	Part Of	QPA	i
⊕		↔		L25139		F 14x1,5 ∪		1	48520-8355R
				L25140		F 14x1,5 ∪		1	48520-0368R
			L25232	L25232	M 14x1,5 / M 16x1,5 ∪		2	48521-1071R	

Clio I (B/C57_, 5/357_) 05.90 → 09.98

Clio I Van (S57_) 01.91 → 09.98

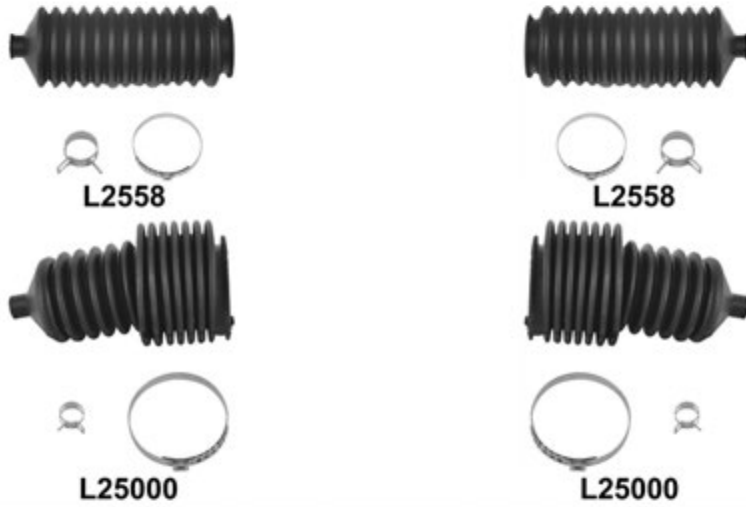

Clio I (B/C57_, 5/357_) 05.90 → 09.98

Clio I Van (S57_) 01.91 → 09.98

			←	→	Thread	Part Of	QPA		
		↔	→ 07.94	L25103	M 14x1,5 ♂		1	7701 467 274	
			L25104	M 14x1,5 ♂		1	7701 467 273		
			08.94 →, (+) Williams	L25109	F 14x1,5 ♂		1	7701 041 312	
			L25110	F 14x1,5 ♂		1	7701 041 311		
			→ 07.94	L25201	L25201	F 14x1,5 / M 12x1 ♂		2	6000 022 800
			08.94 →, (+) Williams	L25204	L25204	M 14x1,5 / M 12x1 ♂		2	6000 022 807
			→ 07.94		L25303		L25103+L25201	1	7701 467 272
				L25304			L25104+L25201	1	7701 467 271
					L2558	L2558		2	7700 781 097
					L25000	L25000		2	7700 706 007
		↓	(-) Williams	L2555	L2555		2	7701 468 883	
			(-) Williams	L25503		1	7700 794 387		
		↓	(-) Williams	L25504		1	7700 794 386		
			(-) Williams	L25804	L25804		2	7700 799 064	
		↑	(-) Williams	L25805	L25805		2	7700 799 065	
			(-) Williams	L25601	L25601		2	7700 709 404	
			1.1 / 1.2 / 1.4 / 1.8 RSi	KIT	MK018	MK018		2	7700 827 435
			1.7 / 1.8 / 1.9 D / 1.4		MK020	MK020		2	7700 827 436
		(-) Williams	L25908 ¹	L25908 ¹			2	6001 025 850	

Clio II / Symbol 09.98 →

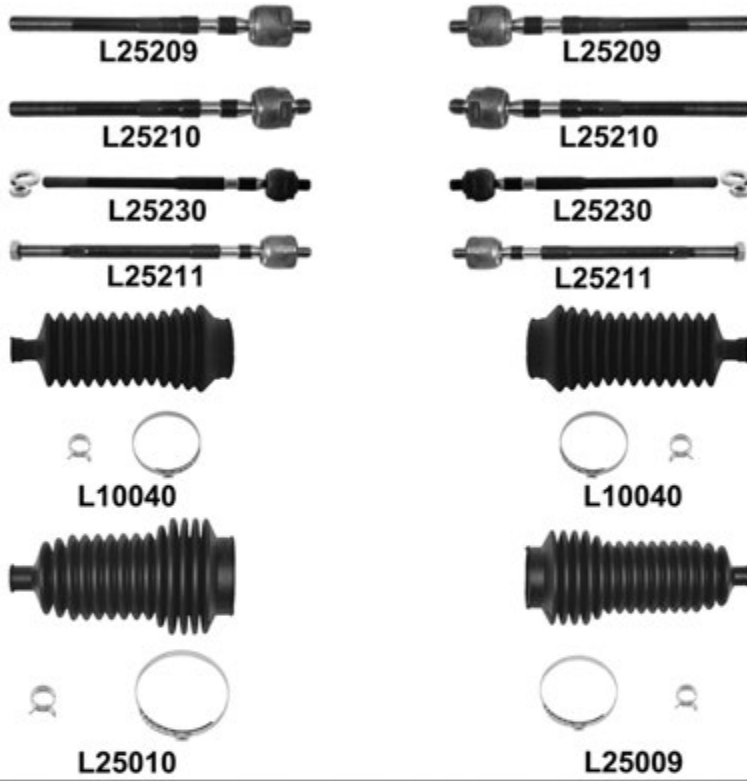

L25540

L25539

L25806

L25806

L25808

L25808

MK155L

L25803

L25803

MK154R

			←	→	Thread	Part Of	QPA		
		↔	→ 11.99	L25121	F 14x1,5 ∪		1	7701 471 146	
				L25122	F 14x1,5 ∪		1	7701 471 145	
				12.99 →	L25123	F 14x1,5 ∪		1	7701 047 416
				L25124	F 14x1,5 ∪		1	7701 047 415	
		↔	→ 11.99, L= 240mm	L25208	L25208	M 14x1,5 / M 12x1 ∪		2	7701 471 124
			12.99 →, L= 302mm	L25225	L25225	M 14x1,5 / M 12x1 ∪		2	7701 472 113
			→ 11.99, L= 240mm, Smi	L25209	L25209	M 14x1,5 / M 12x1 ∪		2	7701 471 125
			→ 11.99, L= 240mm, TRW	L25210	L25210	M 14x1,5 / M 14x1,5 ∪		2	7701 471 143
			12.99 →, L= 297mm, TRW	L25230	L25230	M 14x1,5 / M 14x1,5 ∪		2	7701 472 735
			12.99 →, (+) Model CB0M/CB1C → 05.01, L= 300mm, SMI	L25211	L25211	M 14x1,5 / M 12x1 ∪		2	7701 473 655
		↔	Smi, ø 9mm, Ø 39mm, L= 168mm	L10040 ⁰	L10040 ⁰			2	7701 469 496
			TRW, ø 12mm, Ø 40mm, L= 170mm		L25009 ⁰			1	7701 469 486
			TRW, ø 11mm, Ø 42mm, L= 143mm	L25010 ⁰				1	7701 471 141
		↓		L2555	L2555		2	7701 468 883	
			<input checked="" type="checkbox"/>	L25519			1	7700 445 228	
		↓	<input checked="" type="checkbox"/>	L25520			1	7700 445 227	
			<input checked="" type="checkbox"/>	3.0 24V, 10mm ↔	L25511		1	7700 829 842	
			<input checked="" type="checkbox"/>	L25512		1	7700 829 841		
			<input checked="" type="checkbox"/>	3.0 24V, 12mm ↔	L25539		1	7700 430 832	
		↕		L25540			1	7700 430 831	
				L25806	L25806		4	7700 424 399	
		↕	2.0 16V/3.0 24V	L25808	L25808		4	7700 789 477	
			→ 09.08	L25601	L25601		2	7700 709 404	
		↕	KIT	MK100	MK100		2	543A0-0300R	
			L25908 [!]	L25908 [!]		2	6001 025 850		
	▲	3.0 6 cyl.	L25803	L25803		2	7700 822 503		
		3.0 6 cyl.		MK154R		1	7700 832 420		
			MK155L			1	7700 832 419		

Clio III 06.05 →

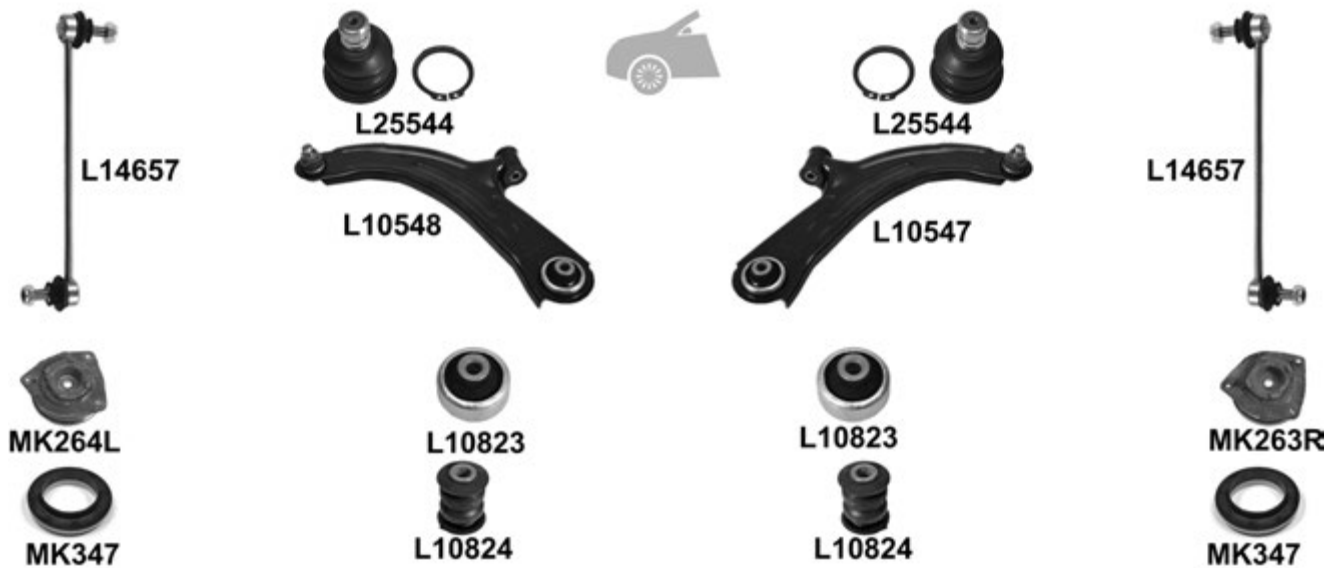
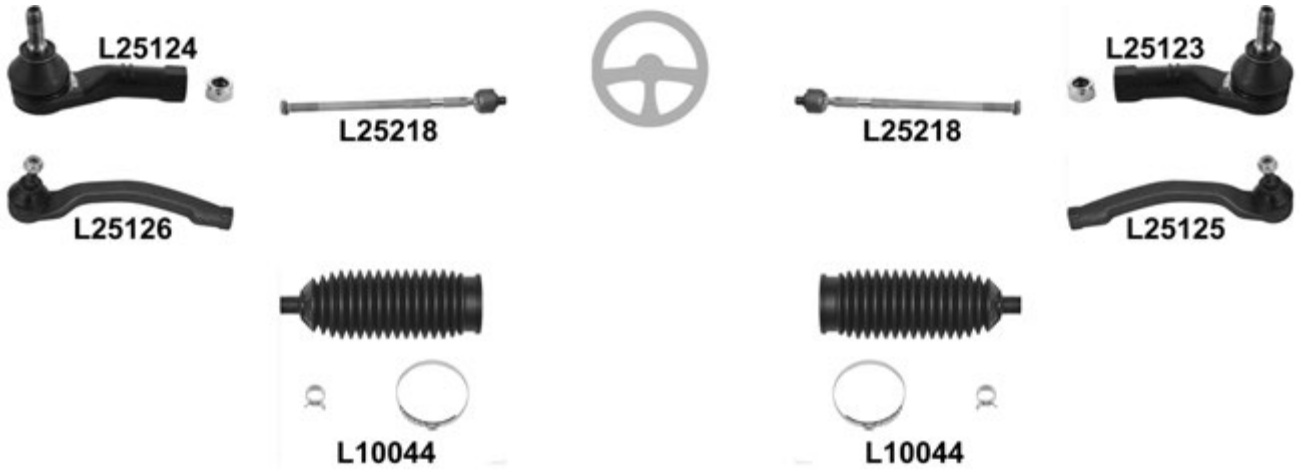

				← → Thread		Part Of	QPA				
			(-) 2.0 16V		L25123	F 14x1,5 ∪		1	7701 475 843		
					L25124	F 14x1,5 ∪		1	7701 475 842		
			2.0 16V		L25125	F 14x1,5 ∪		1	7701 474 796		
					L25126	F 14x1,5 ∪		1	7701 474 795		
					L25218	L25218	M 14x1,5 / M 14x1,5 ∪		2	7701 475 841	
			L10044 ^o	L10044 ^o			2	7701 475 840			
					L25544	L25544			2		
					L10548	L10547			1	8200 346 942	
					L10823	L10823			2	8200 696 437	
					L10824	L10824			2	8200 183 569	
					L14657	L14657			2	8200 127 308	
				→ 05.10	KIT		MK263R			1	7701 208 823
						MK264L				1	7701 208 822
			→ 05.10		MK347	MK347			2	8200 948 647	

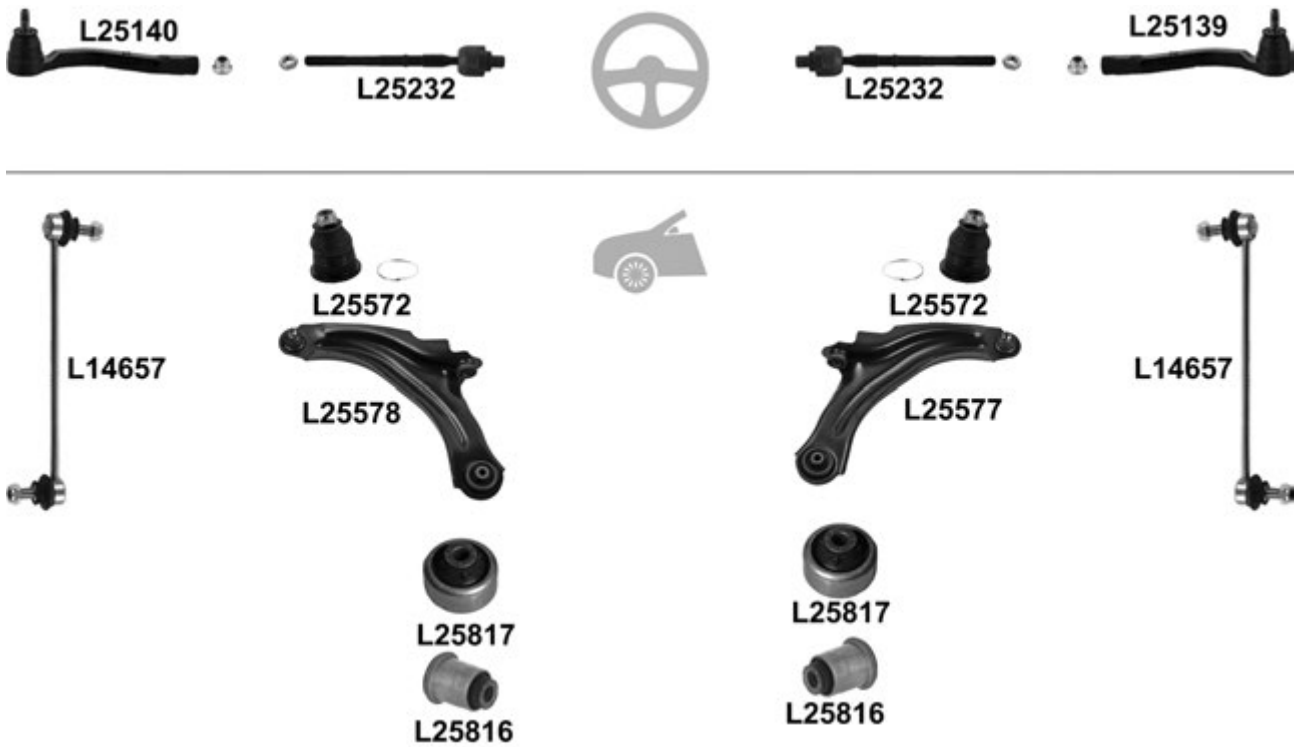
Clio IV 11.12 →

		i	←	→	Thread	Part Of	QPA	i	
		↔		L25139	F 14x1,5 ∪		1	48520-8355R	
			L25140		F 14x1,5 ∪		1	48520-0368R	
		⊥		L25232	L25232	M 14x1,5 / M 16x1,5 ∪	2	48521-1071R	
			L25572	L25572		L25577/L25578	2		
		⊥	<input checked="" type="checkbox"/>		L25577			1	54504-8506R
				L25578				1	54505-5711R
		▼		L25817	L25817		L25577/L25578	2	8200 586 564
		▲		L25816	L25816		L25577/L25578	2	8200 586 570
			L14657	L14657			2	8201 079 463	

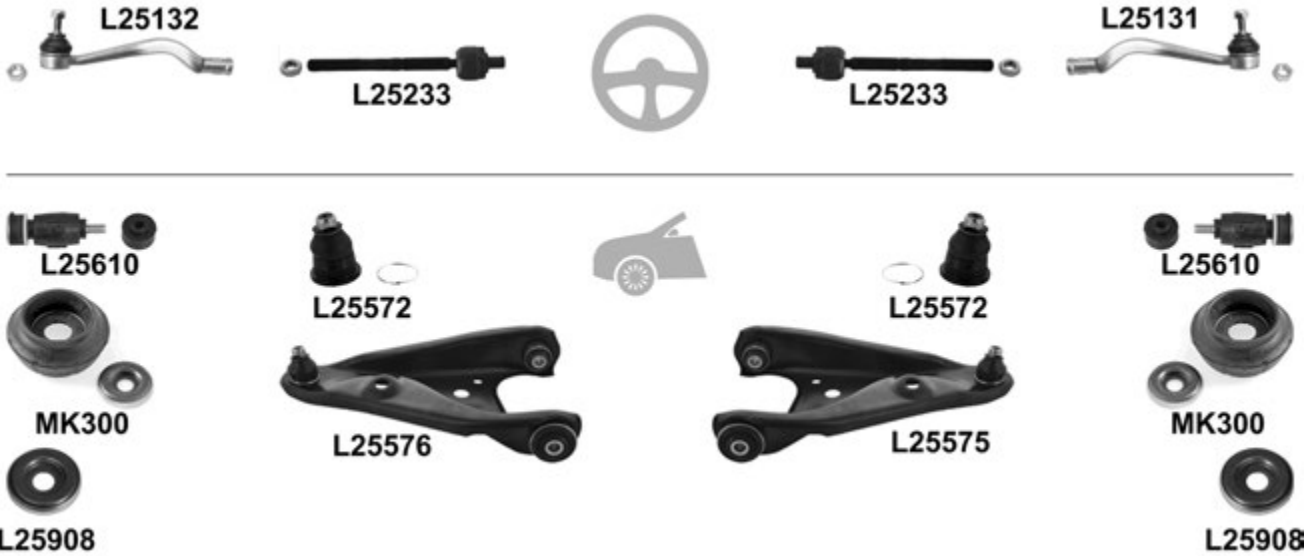
Dokker 12.13 →

						←	→	Thread	Part Of	QPA	
		↔			L25131			F 14x1,5 ∪		1	6001 550 443
					L25132			F 14x1,5 ∪		1	6001 550 442
		⊥			L25233 ⁰	L25233 ⁰		M 14x1,5 / M 14x1,5 ∪		2	48521-3172R
					L25572	L25572			L25575/L25576	2	
				<input checked="" type="checkbox"/>	L25575 ⁰					1	54500-7106R
					L25576 ⁰					1	54501-0294R
					L25610	L25610				2	6001 547 138
					KIT	MK300	MK300			2	6001 547 499
			L25908 ¹	L25908 ¹				2	6001 025 850		

Duster 06.11 →

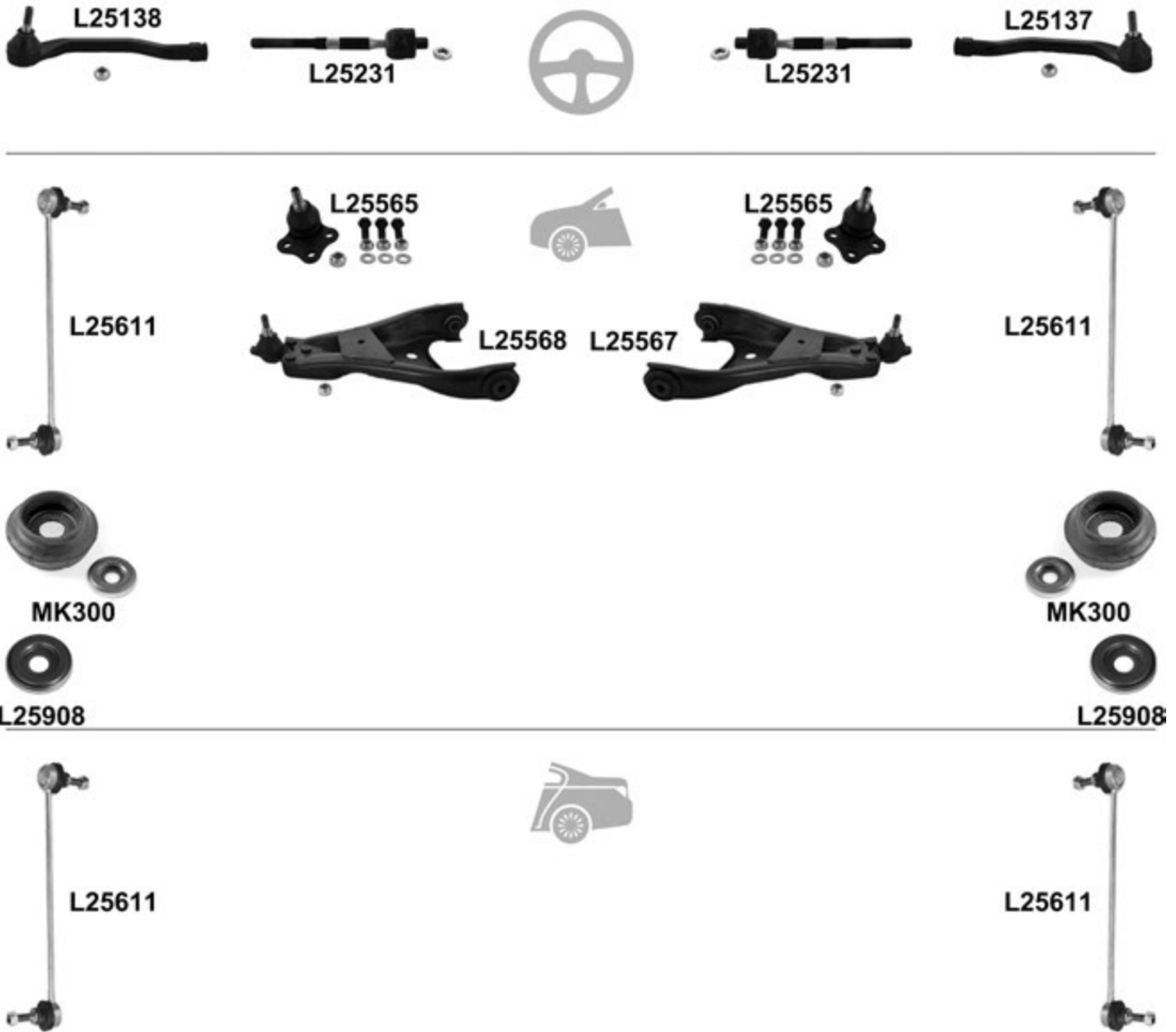

				←	→	Thread	Part Of	QPA		
					L25137	F 14x1,5 U		1	8201 108 332	
					L25138	F 14x1,5 U		1	8201 108 339	
					L25231	L25231	M 14x1,5 / M 16x1,5 U		2	8201 108 350
					L25565	L25565			2	40160-2308R
				<input checked="" type="checkbox"/>	L25567				1	54500-6542R
					L25568				1	54501-6746R
					L25611	L25611			2	8200 814 411
					KIT	MK300	MK300		2	6001 547 499
					L25908	L25908		2	6001 025 850	
					L25611	L25611		2	8200 814 411	

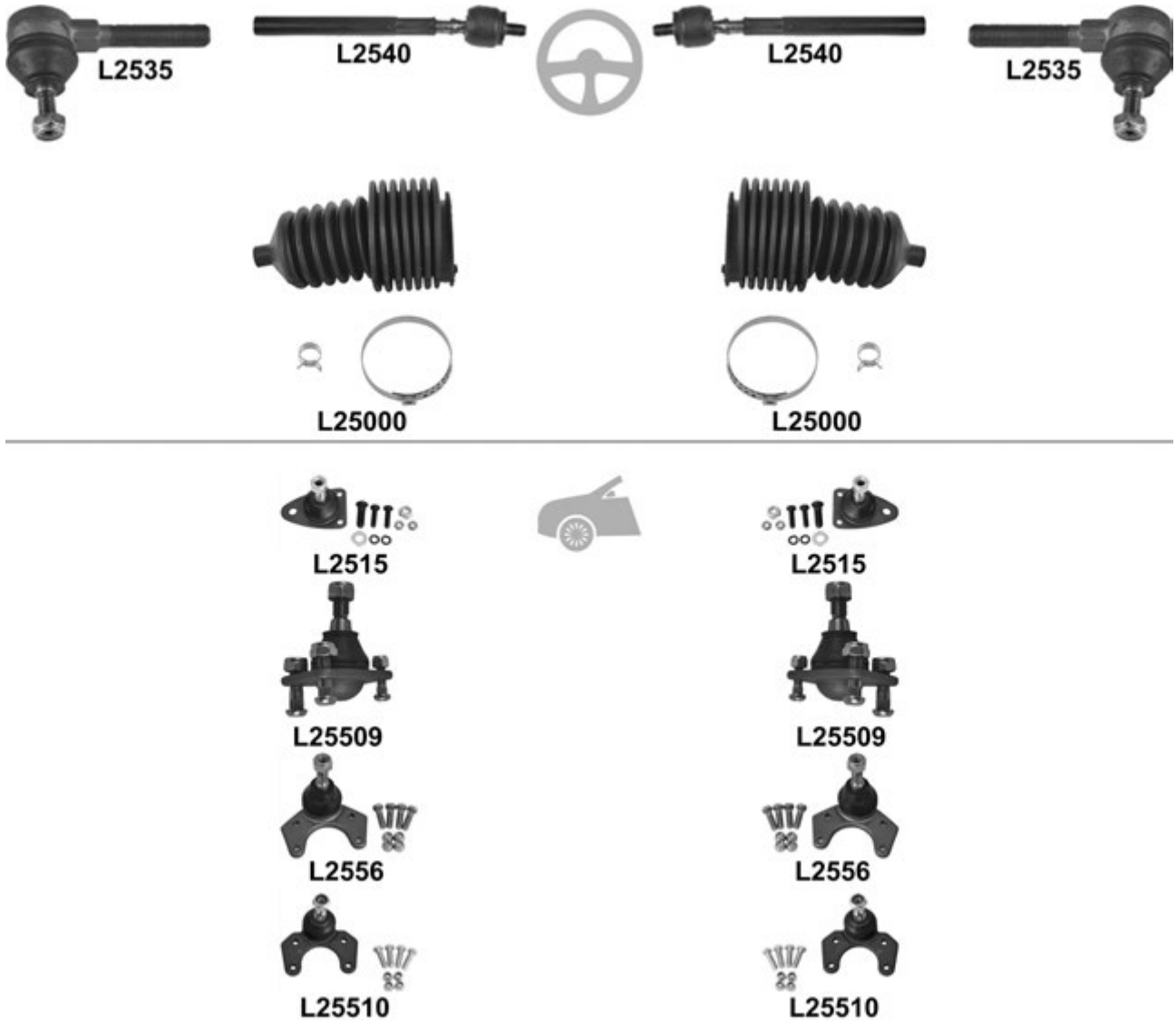
Espace I (J11/13) 07.84 → 12.92

				←	→	Thread	Part Of	QPA	
		↔		L2535	L2535	M 14x1,5 ∪		2	7701 461 141
				L2540	L2540	F 14x1,5 / M 12x1 ∪		2	
				L25000	L25000			2	7700 706 007
		↑	→ 12.87	L2515 ¹	L2515 ¹			2	7701 461 332
			01.88 →	L25509	L25509			2	7701 463 229
		↓	→ 12.87	L2556	L2556			2	7701 461 331
			01.88 →	L25510	L25510			2	7701 463 230

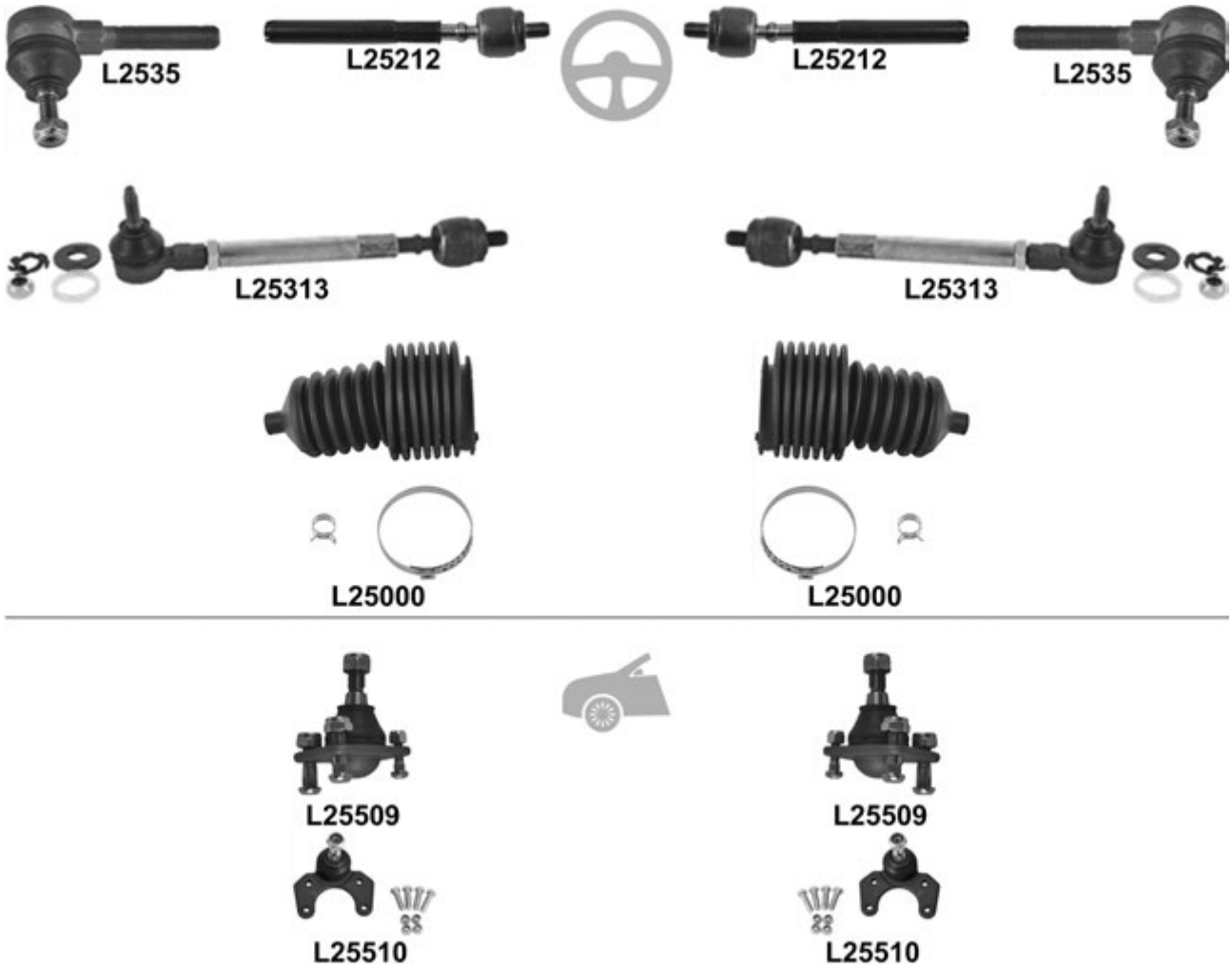
Espace II (J63#) 01.91 → 12.96

		i		←	→	Thread	Part Of	QPA	i
		↔		L2535	L2535	M 14x1,5 ∪		2	7701 461 141
				L25212	L25212	F 14x1,5 / M 12x1 ∪		2	
				L25313	L25313	∪	L2535+L25212	2	7701 469 229
				L25000	L25000			2	7700 706 007
		↑		L25509	L25509			2	7701 463 229
		↓		L25510	L25510			2	7701 463 230

Espace III (JE) 11.96 → 10.02

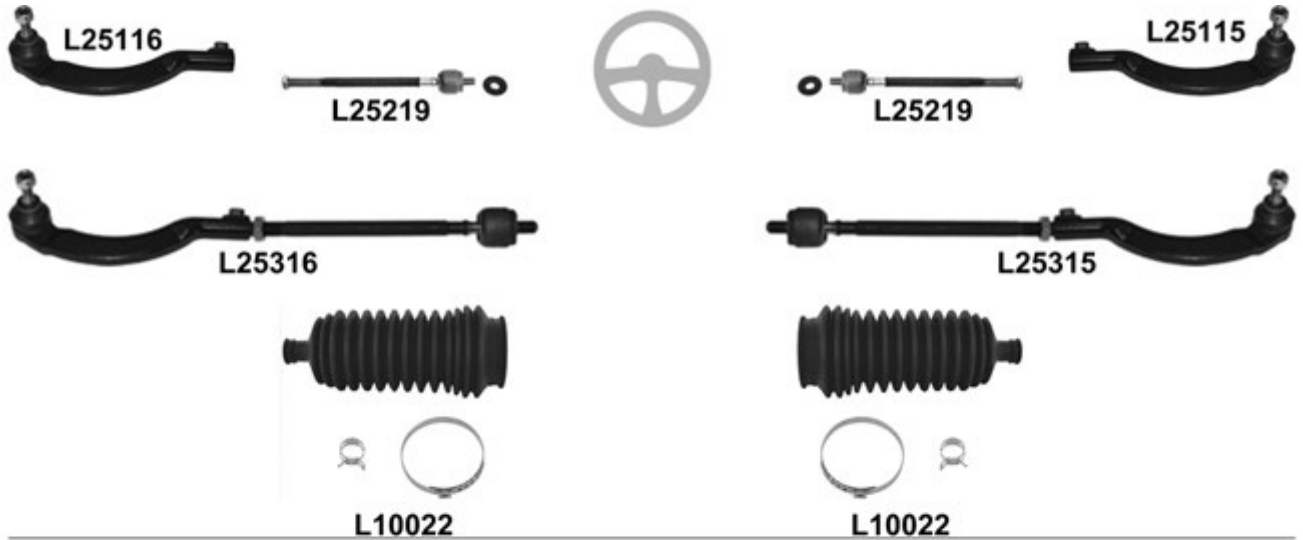

		i	←	→	Thread	Part Of	QPA	i	
⊕		↔		L25115	F 14x1,5 ∪		1	6025 370 230	
				L25116	F 14x1,5 ∪		1	6025 370 229	
				L25219	L25219	M 14x1,5 / M 12x1 ∪		2	
					L25315			1	6025 370 494
				L25316				1	6025 370 493
			L10022 ^o	L10022 ^o		2	6001 547 607		
⊖		⊥		L25517	L25517		2	6025 308 155	
			<input checked="" type="checkbox"/>		L25541		1	6025 307 650	
				L25542			1	6025 307 649	
			▼	L25815	L25815		2	6025 311 529	
			▲	L25803	L25803		2	7700 822 503	
				L25600	L25600		2	7700 805 494	
				(+) MK001		MK152R		1	6025 305 980
	MK153L				1	6025 305 979			
			MK001	MK001		2	7700 803 635		

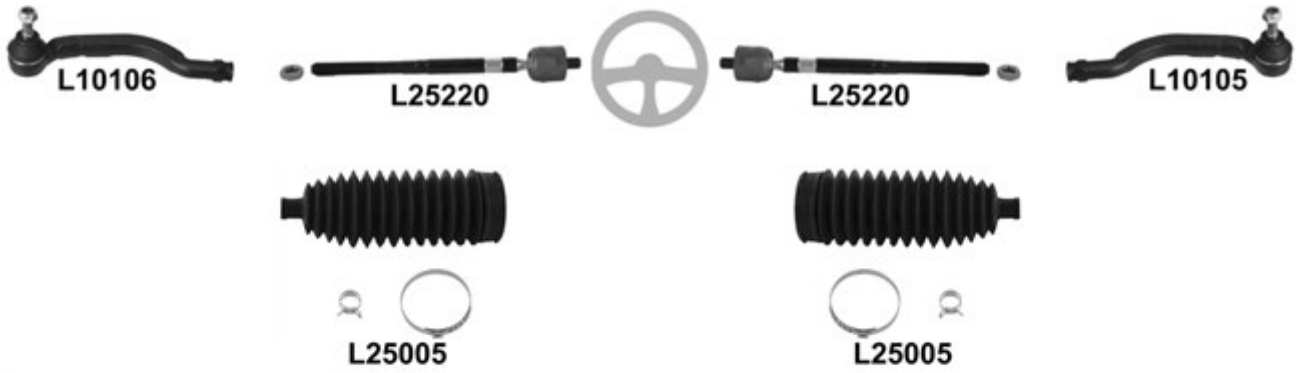
Espace IV (JK0#) 11.02 →

		i	←	→	Thread	Part Of	QPA	i	
⊕		↔		L10105	F 14x1,5 ∪		1	7701 049 283	
				L10106	F 14x1,5 ∪		1	7701 049 282	
			L= 231mm	L25220	L25220	M 14x1,5 / M 12x1 ∪		2	7701 474 076
				L25005 ^o	L25005 ^o			2	7701 474 075
⊖		⊥		L25527	L25527			2	7701 476 576
			<input checked="" type="checkbox"/>		L25551				1
		⊥		L25552				1	8200 602 617
				L10816	L10816			2	
		▲		L25818	L25818			2	
				L10606	L10606			2	8200 002 870
			(+) L 25914	KIT	MK185	MK185		2	7701 207 537 SK
				L25914	L25914		2	7700 424 481	

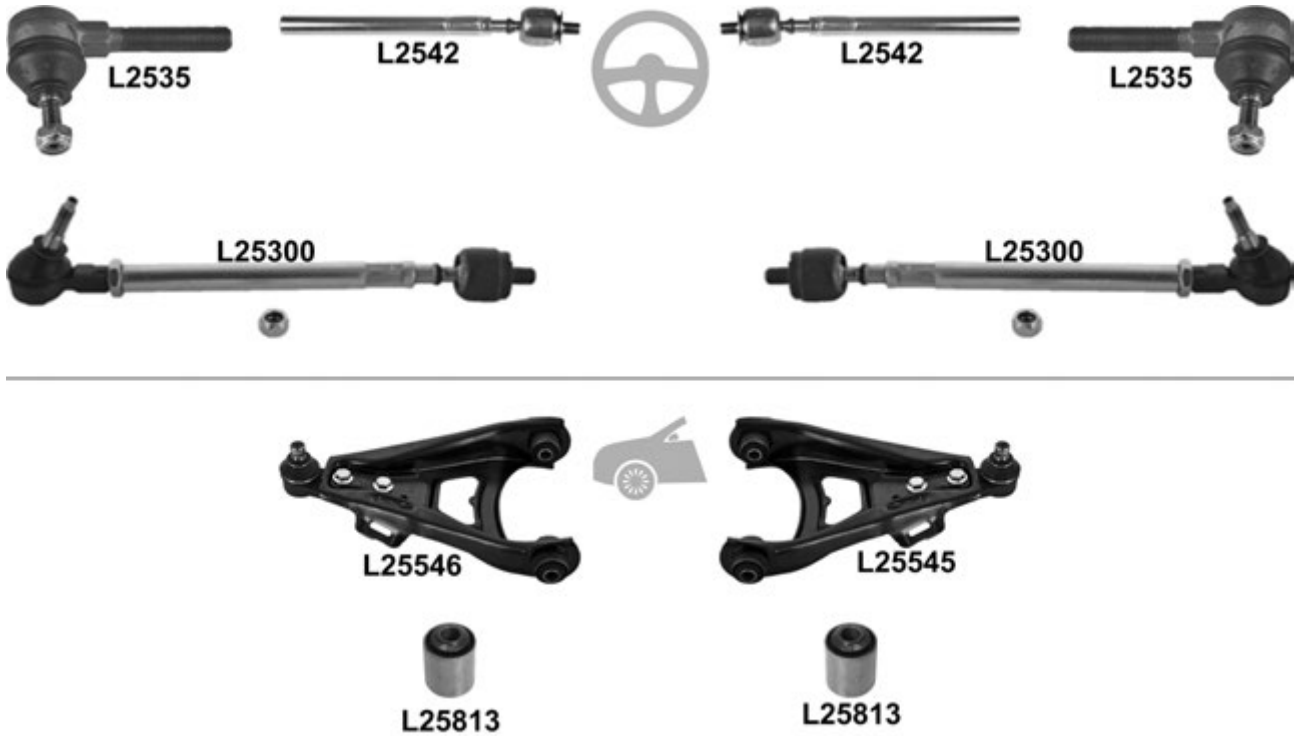
Express (F0__, G4__) 07.95 → 03.98

				←	→	Thread	Part Of	QPA		
⊕		↔		L2535	L2535	M 14x1,5 ∪		2	7701 461 141	
				L2542	L2542	F 14x1,5 / M 12x1 ∪		2	7702 145 337	
				L25300	L25300	∪	L2535+L2542	2	7701 463 346	
⊖		⊥			L25545			1	7700 783 456	
			<input checked="" type="checkbox"/>	L25546				1	7700 783 455	
		↕		L25813	L25813			4	77 04 000 681	

Fluence 02.10 →

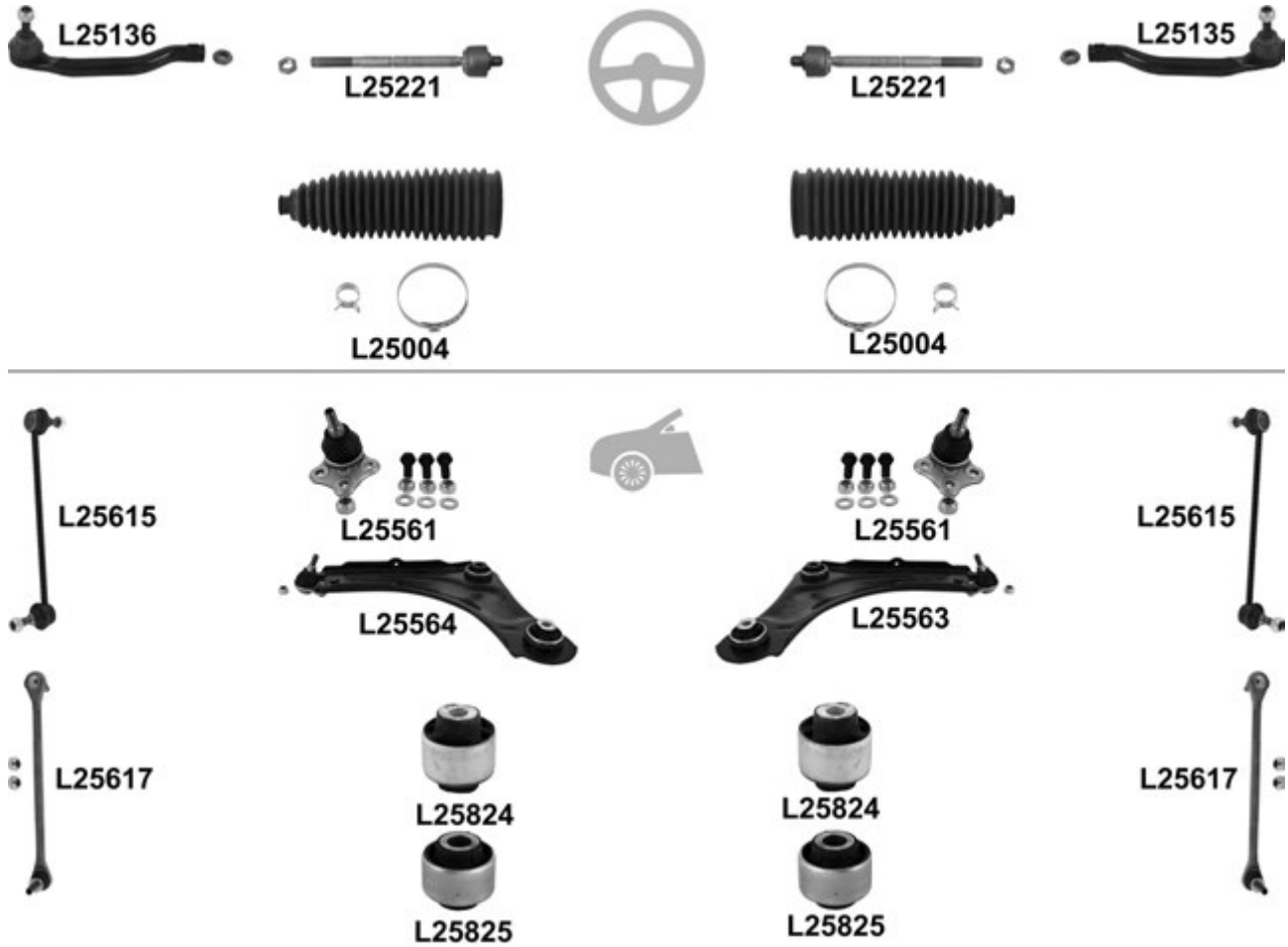

				← → Thread		Part Of	QPA	i	
⊕		↔		L25135	F 14x1,5 U		1	48520-4680R	
				L25136	F 14x1,5 U		1	48520-4710R	
			L25221	L25221	M 14x1,5 / M 14x1,5 U		2	48521-5612R	
			Thermoplast	L25004	L25004			2	48203-6715R
🚗		⊥		L25561	L25561		2	40160-9060R	
			<input checked="" type="checkbox"/>		L25563		1	54500-9207R	
		⊥		L25564			1	54501-4055R	
			<input type="checkbox"/>		L25824	L25824		2	L25563/L25564
		⊥		L25825	L25825		2	L25563/L25564	
				Metal	L25615	L25615		2	54618-0002R
	ALU	L25617	L25617		2	54618-0002R			

Grand Scénic (JM0/1_) 04.04 →



L25001

L25001

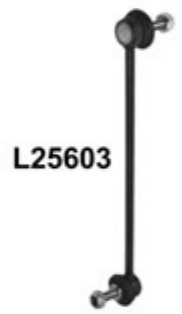
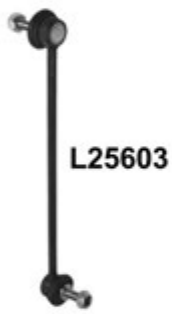

Grand Scénic (JM0/1_) 04.04 →

		i		←	→	Thread	Part Of	QPA	i
		↔				L25125 F 14x1,5 ∩		1	7701 474 796
						L25126 F 14x1,5 ∩		1	7701 474 795
						L25217 L25217 M 14x1,5 / M 14x1,5 ∩		2	7701 474 448
						L25309	L25125+L25217	1	
						L25310	L25126+L25217	1	
						L25001 L25001		2	7701 474 447
		⊥				L25544 L25544		2	
		⊥		<input checked="" type="checkbox"/>		L25533		1	8200 298 455
						L25534		1	8200 298 454
		▼				L25824 L25824	L25563/L25564	2	
		▲				L25825 L25825	L25563/L25564	2	
			(-) HD			L25603 L25603		2	8200 166 159
			HD			L25608 L25608		2	8200 669 066
			(+) L 25916	KIT		MK193 MK193		2	7701 208 891
					L25916 L25916		2	8200 222 463	

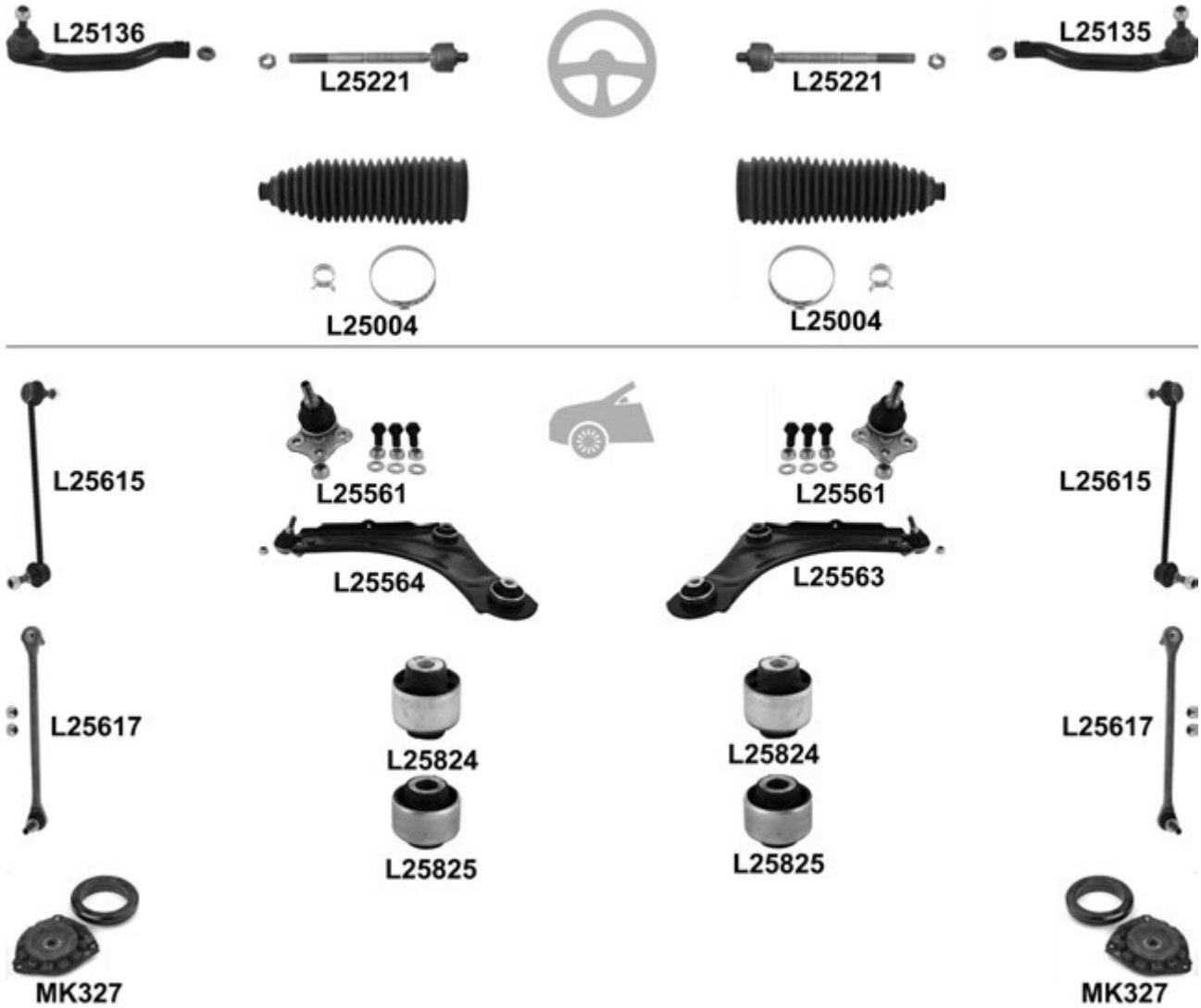
Grand Scenic III (JZ0/1_) 02.09 →

				←	→	Thread	Part Of	QPA			
⊕		↔		L25135		F 14x1,5 ∪		1	48520-4680R		
				L25136		F 14x1,5 ∪		1	48520-4710R		
			L= 200mm	L25221	L25221	M 14x1,5 / M 14x1,5 ∪		2	48521-5612R		
			Thermoplast	L25004	L25004			2	48203-6715R		
⊖		⊥		L25561	L25561			2	40160-9060R		
			<input checked="" type="checkbox"/>	L25563				1	54500-9207R		
		⊥	(-) 16°	L25564				1	54501-4055R		
				L25824	L25824			L25563/L25564	2		
		⊥		L25825	L25825			L25563/L25564	2		
				L25615	L25615				2	54618-0002R	
		ALU	L25617	L25617			2	54618-0002R			
			KIT	MK327	MK327			2			

Kangoo (KC0/1_) 03.98 →
Kangoo Van (FC0/1_) 03.98 →

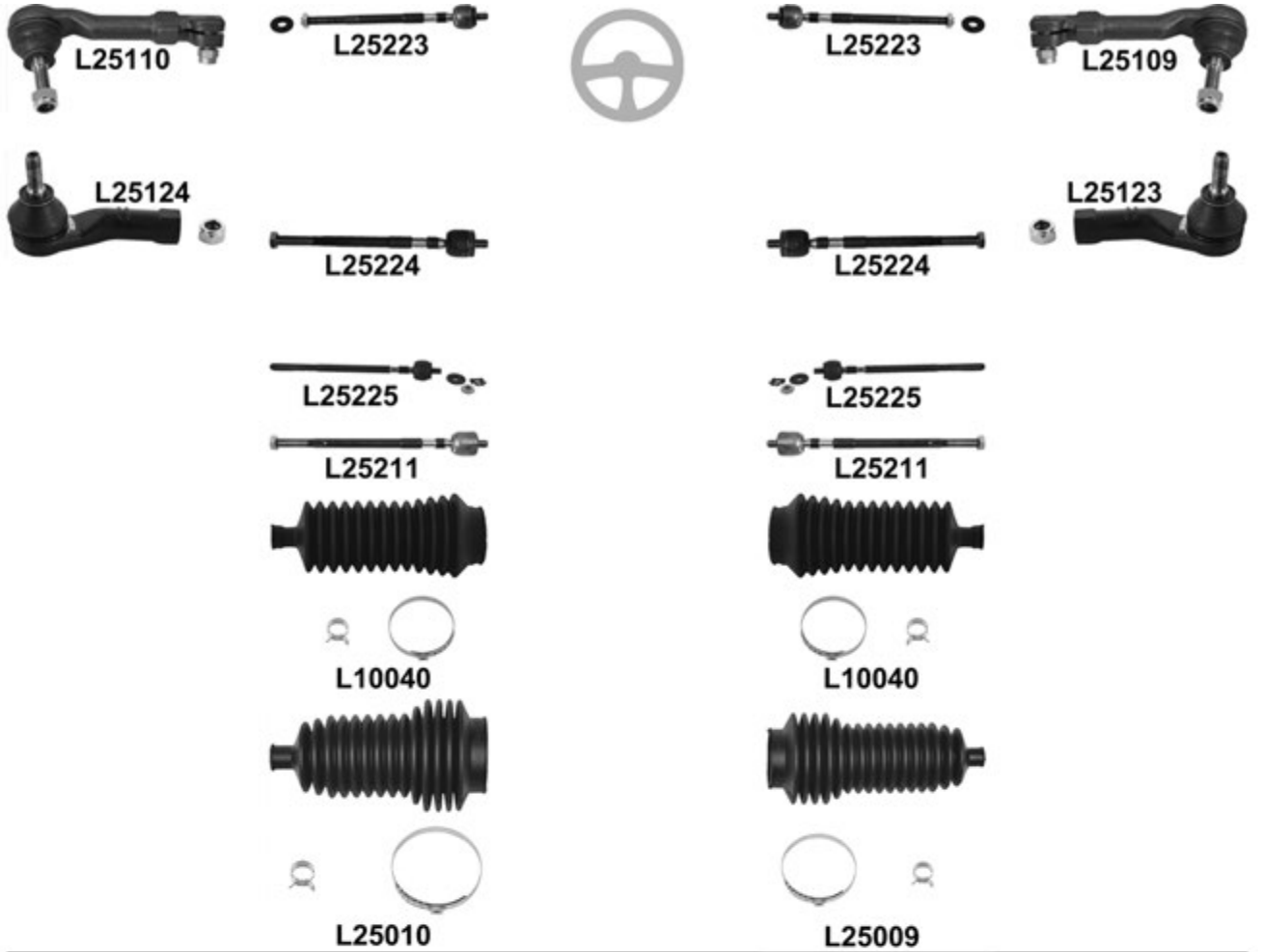

Kangoo (KC0/1_) 03.98 →
Kangoo Van (FC0/1_) 03.98 →



		i	←	→	Thread	Part Of	QPA	i
		→ 02.99		L25109	F 14x1,5 ∪		1	7701 041 312
				L25110	F 14x1,5 ∪		1	7701 041 311
		03.99 →		L25123	F 14x1,5 ∪		1	7701 047 416
				L25124	F 14x1,5 ∪		1	7701 047 415
		→ 02.99	L25223	L25223	M 14x1,5 / M 12x1 ∪		2	7701 470 763
		→ 02.99	L25224	L25224	M 14x1,5 / M 12x1 ∪		2	7701 470 764
		02.99 →	L25225	L25225	M 14x1,5 / M 12x1 ∪		2	7701 472 113
		03.99 →, L= 300mm	L25211	L25211	M 14x1,5 / M 12x1 ∪		2	7701 473 655
		Smi, ø 9mm, Ø 39mm, L= 168mm	L10040 ⁰	L10040 ⁰			2	7701 469 496
		TRW, ø 12mm, Ø 40mm, L= 170mm		L25009 ⁰			1	7701 469 486
TRW, ø 11mm, Ø 42mm, L= 143mm		L25010 ⁰				1	7701 471 141	
		⊥	10mm	L2555	L2555		2	7701 468 883
			12mm	L25535	L25535		2	
		⊥	(-) 4WD <input checked="" type="checkbox"/>		L25519		1	7700 445 228
				L25520		1	7700 445 227	
			1.5 Dci Express/Rapid 12.01 →, (-) 4WD <input checked="" type="checkbox"/>		L25569 ⁰		1	8200 942 413
					L25570 ⁰		1	8200 942 417
		▲▼	(-) 4WD	L25806	L25806		4	7700 424 399
			(-) 4WD	L25601	L25601		2	7700 709 404
			4WD	L25616	L25616		2	7700 437 136
				KIT	MK100	MK100		2
			L25908 ¹	L25908 ¹		2	60 01 025 850	

Kangoo 02.08 →
 Kangoo Express 02.08 →
 Kangoo Be Bop 02.09 →

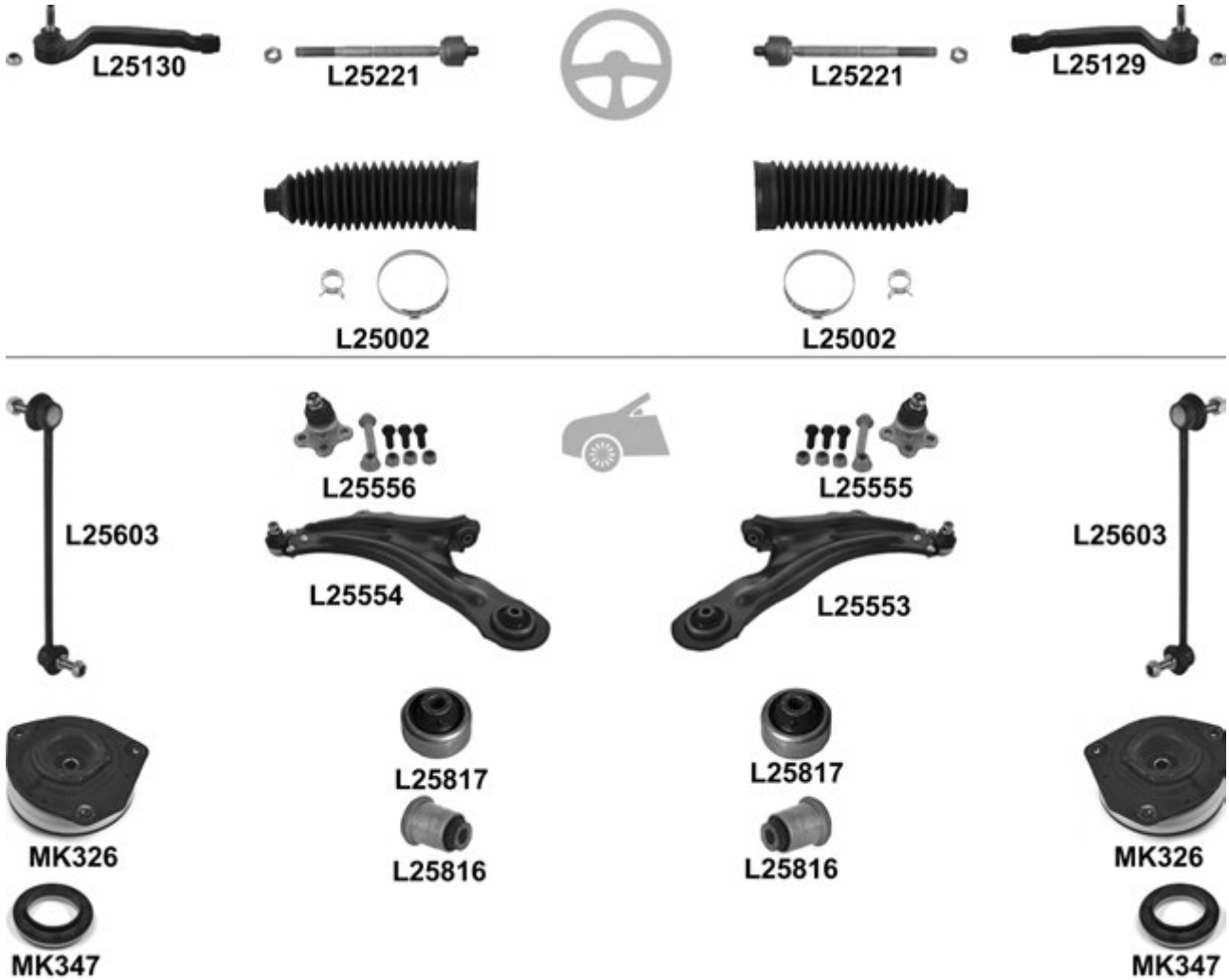

				←	→	Thread	Part Of	QPA		
⊕		↔			L25129	F 14x1,5 U		1	7701 478 408	
					L25130	F 14x1,5 U		1	7701 478 407	
		↔	L= 200mm		L25221	L25221	M 14x1,5 / M 14x1,5 U		2	7701 478 406
					L25002 ⁰	L25002 ⁰			2	7701 478 400
🚗		⊥			L25555		L25553	1		
					L25556		L25554	1		
		⊥		<input checked="" type="checkbox"/>	L25553			1	8200 586 567	
					L25554			1	8200 586 561	
		▼			L25817	L25817	L25553/L25554	2		
		▲			L25816	L25816	L25553/L25554	2	8200 586 570	
					L25603	L25603		2	8200 669 065	
				KIT	MK326	MK326		2	7701 209 840	
				MK347	MK347		2	8200 504 295		

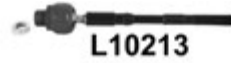
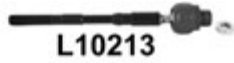
Koleos 09.08 →

L10020

L10020

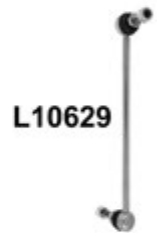
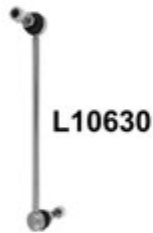

Thread

Part Of

QPA

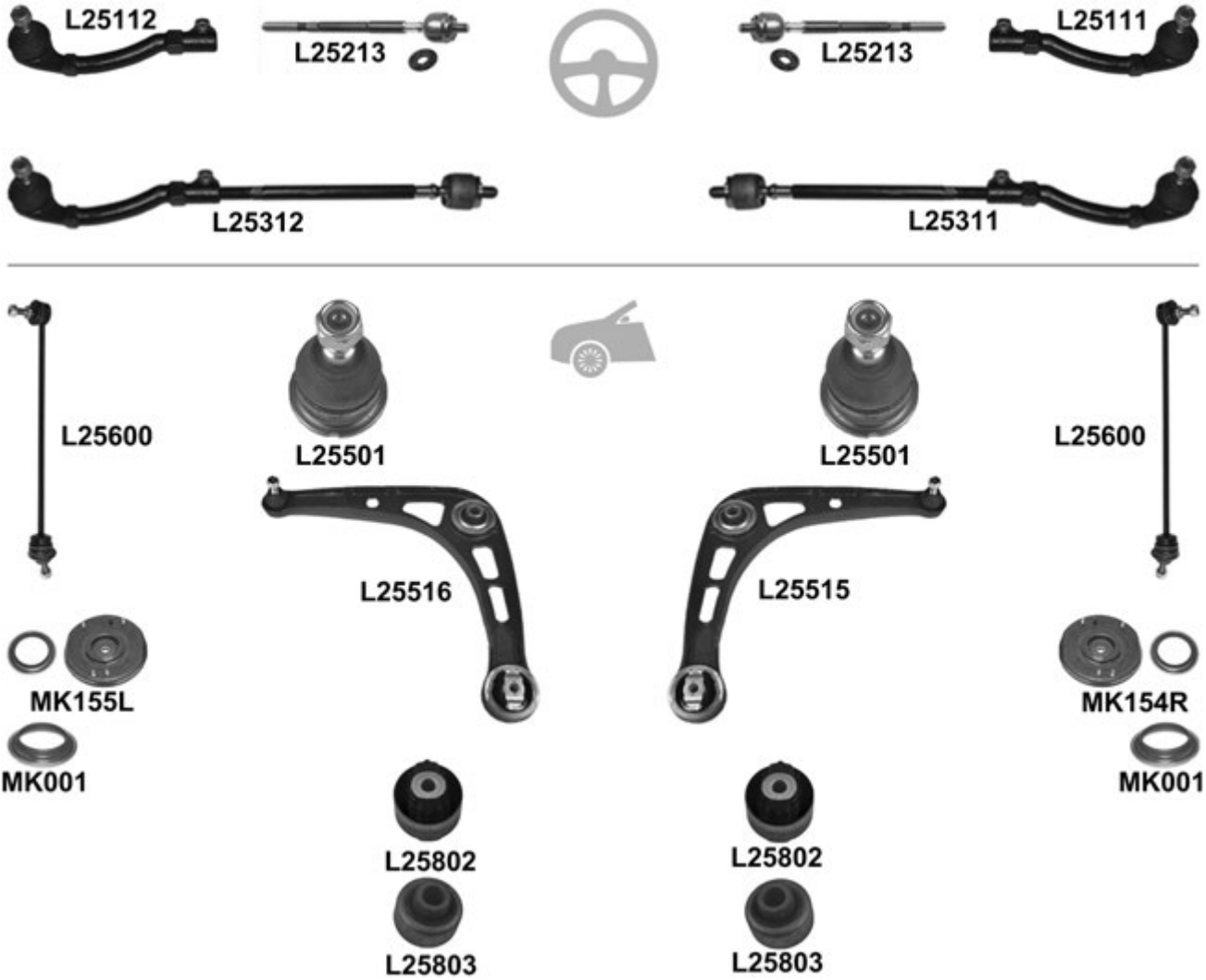

		→ 03.11		L10213	L10213	M 14x1,5 / M 22x1,5 ☺		2	D8521-JG00A
		→ 03.11		L10020 ⁰	L10020 ⁰			2	48203-JD01A
		⊥		L10581	L10581			2	
		⊥		<input checked="" type="checkbox"/>	L10579			1	54500-JY00A
				L10580				1	54505-5212R
		▼		L10839	L10839			2	
		▲		L10840	L10840			2	
					L10629			1	54618-1AA0A
				L10630				1	54668-1AA0A
					MK334R			1	
				MK335L				1	
					L10631			1	55618-JD00A
			L10632				1	55619-JD00A	

Laguna (B56_, 556_) 11.93 → 03.01
Laguna Grandtour (K56_) 11.93 → 03.01

		i		←	→	Thread	Part Of	QPA	i		
⊕		↔				L25111	F 14x1,5 ∪	1	6000 022 736		
						L25112	F 14x1,5 ∪	1	6000 022 737		
				L= 265mm		L25213	L25213	∪	2	7701 469 665	
						L25311			L25111+L25213	1	7701 467 502
						L25312			L25112+L25213	1	7701 467 501
⊖		⊥				L25501	L25501	2	7700 829 322		
					<input checked="" type="checkbox"/>	L25515			1	7700 413 494	
						L25516				1	7700 413 493
				▼		L25802	L25802			2	7700 824 042
				▲		L25803	L25803			2	7700 822 503
						L25600	L25600			2	7700 805 494
										MK154R	1
							MK155L	1	7700 832 419		
			MK001	MK001				2	7700 803 635		

Laguna II (BG0/1_) 03.01 →
 Laguna Grandtour II (KG0/1_) 03.01 →

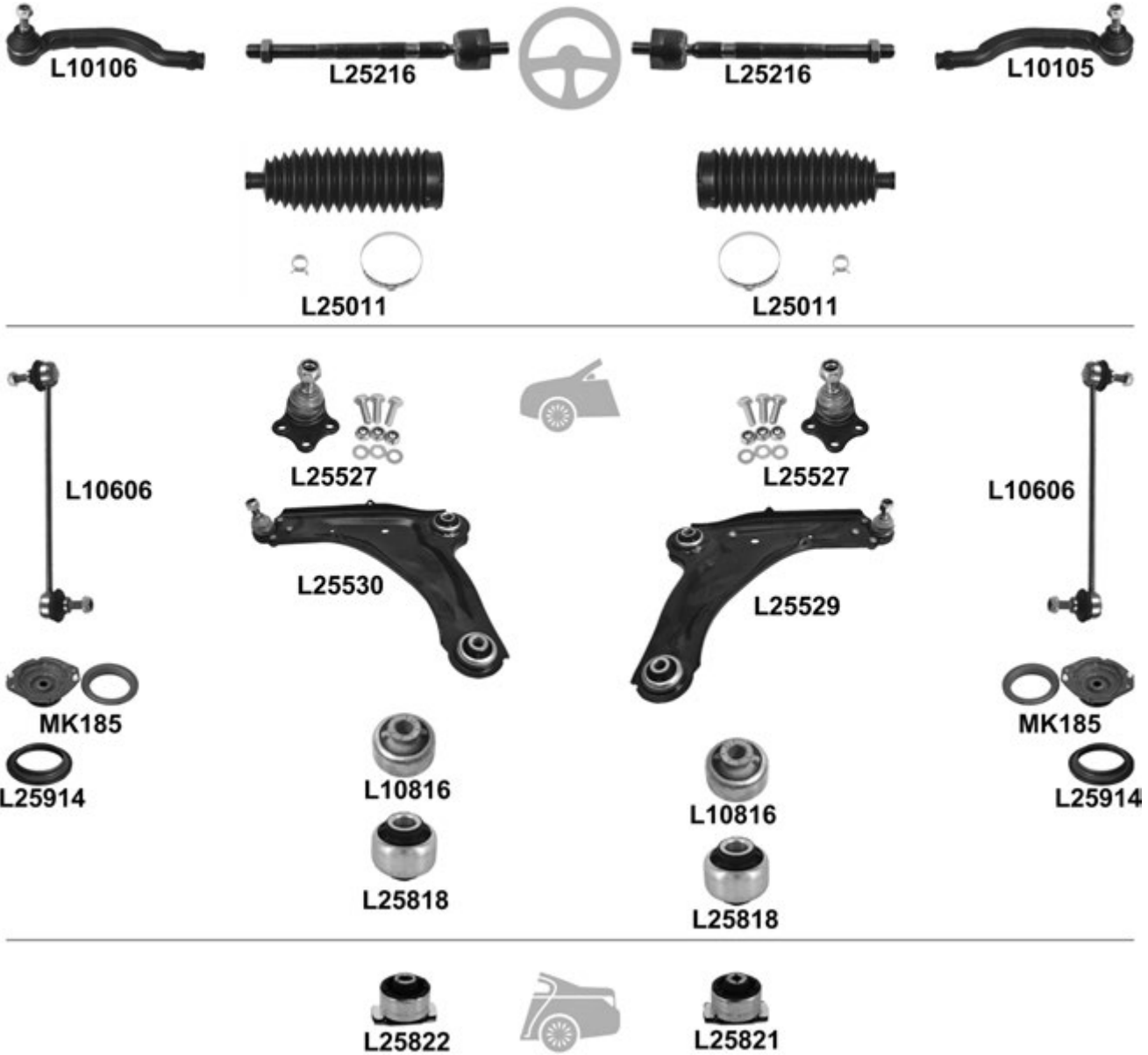

			←	→	Thread	Part Of	QPA			
				L10105	F 14x1,5 U		1	7701 049 283		
				L10106	F 14x1,5 U		1	7701 049 284		
				L25216	L25216	M 14x1,5 / M 12x1 U		2	7701 472 766	
				L25011 ⁰	L25011 ⁰			2	7701 472 765	
				L25527	L25527			2	7701 478 029	
				L25529				1	8200 266 655	
				L25530		<input checked="" type="checkbox"/>		1	8200 266 654	
				L10816	L10816			2		
				L25818	L25818			2		
				L10606	L10606			2	8200 002 870	
				(+) L 25914	KIT	MK185	MK185		2	7701 207 537 SK
				L25914	L25914			2	7700 424 481	
				L25821			Hub carrier	1	7700 415 488	
				L25822			Hub carrier	1	7700 416 271	

Laguna III (BT0/1) 10.07 →
 Laguna Grandtour III (KT0/1) 10.07 →
 Laguna Coupe 09.08 →

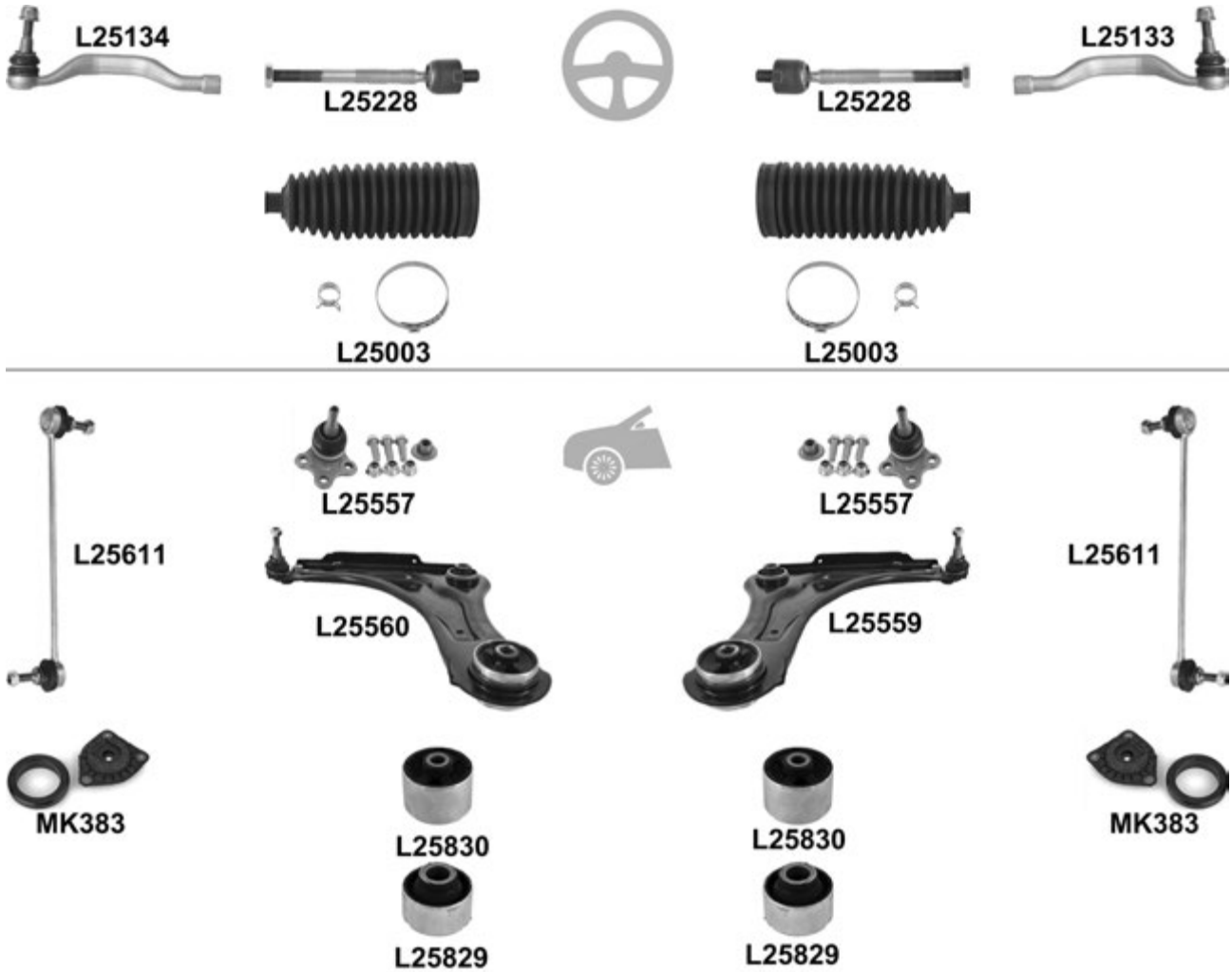

				← → Thread		Part Of	QPA		
⊕		↔		L25133	F 14x1,5 ♂		1	48520-0002R	
				L25134	F 14x1,5 ♂		1	48520-0001R	
				L25228	L25228	M 14x1,5 / M 14x1,5 ♂	2	48521-0001R	
			Thermoplast ø 14, Ø 60,5, L= 182mm	L25003 ⁰	L25003 ⁰		2	48203-0001R	
⊖		⊥		L25557	L25557		2	40160-0004R	
		⊥	<input checked="" type="checkbox"/>	L25559			1	54500-0011R	
				L25560			1	54501-0012R	
		▼		L25830	L25830		L25559/L25560	2	
		▲		L25829	L25829		L25559/L25560	2	
				L25611	L25611			2	54618-0001R
			KIT	MK383	MK383			2	

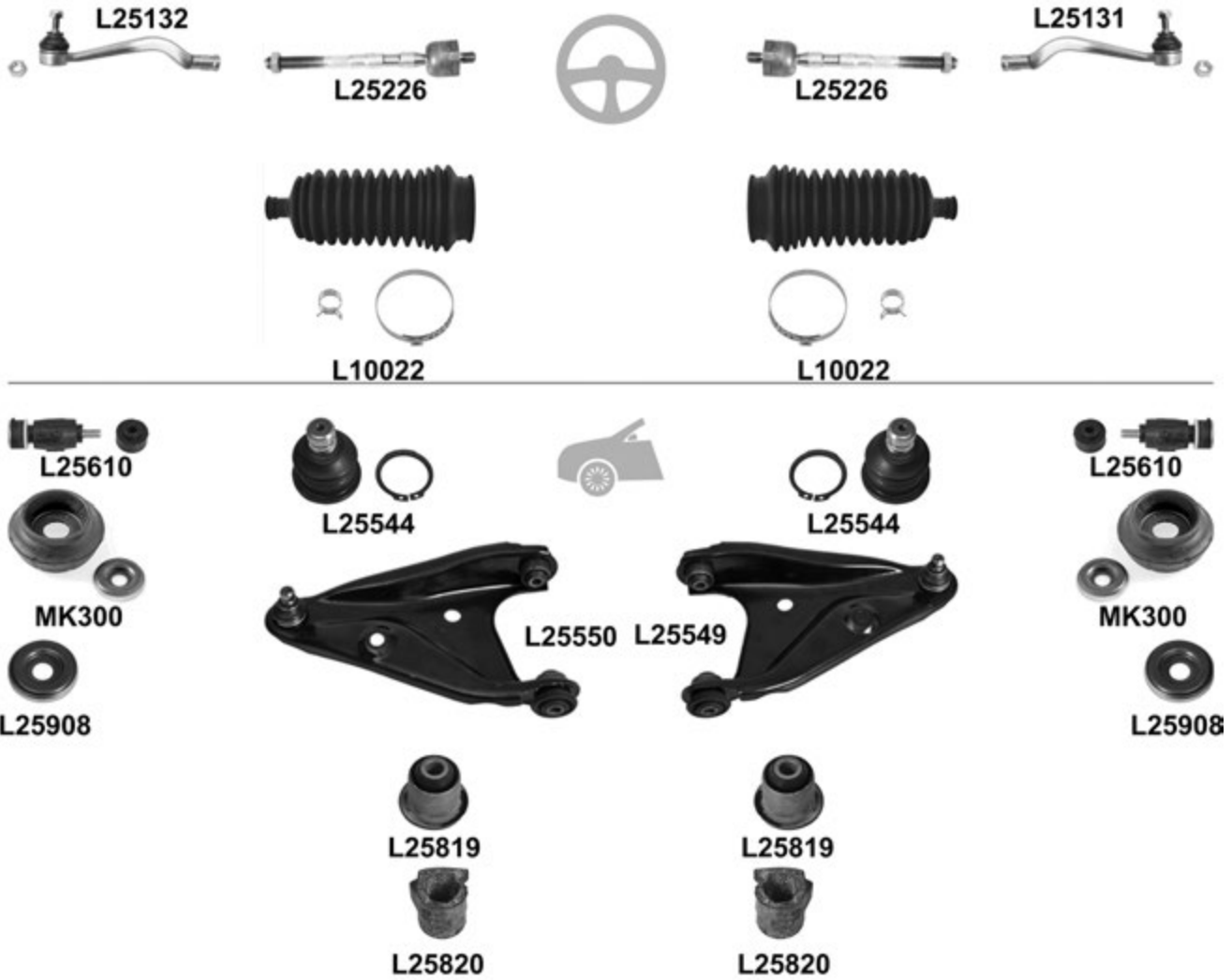
Logan (LS_) 09.04 →
 Logan Kombi (KS_) 04.07 →

				←	→	Thread	Part Of	QPA		
⊕		↔			L25131	F 14x1,5 ∪		1	6001 550 443	
					L25132	F 14x1,5 ∪		1	6001 550 442	
					L25226	L25226	M 14x1,5 / M 12x1 ∪	2	6001 550 441	
					L10022 ⁰	L10022 ⁰		2	6001 547 607	
⊖		⊥			L25544	L25544		2	40160-4793R	
		⊥		<input checked="" type="checkbox"/>	L25549			1	6001 547 520	
					L25550			1	6001 547 519	
		▲▼			L25819	L25819		4	60 40 096 299	L25549/L25550
					L25610	L25610		2	6001 547 138	
					L25820	L25820		2	6001 547 140	Anti-roll bar
					KIT	MK300	MK300	2	6001 547 499	
					L25908 ¹	L25908 ¹		2	6001 025 850	

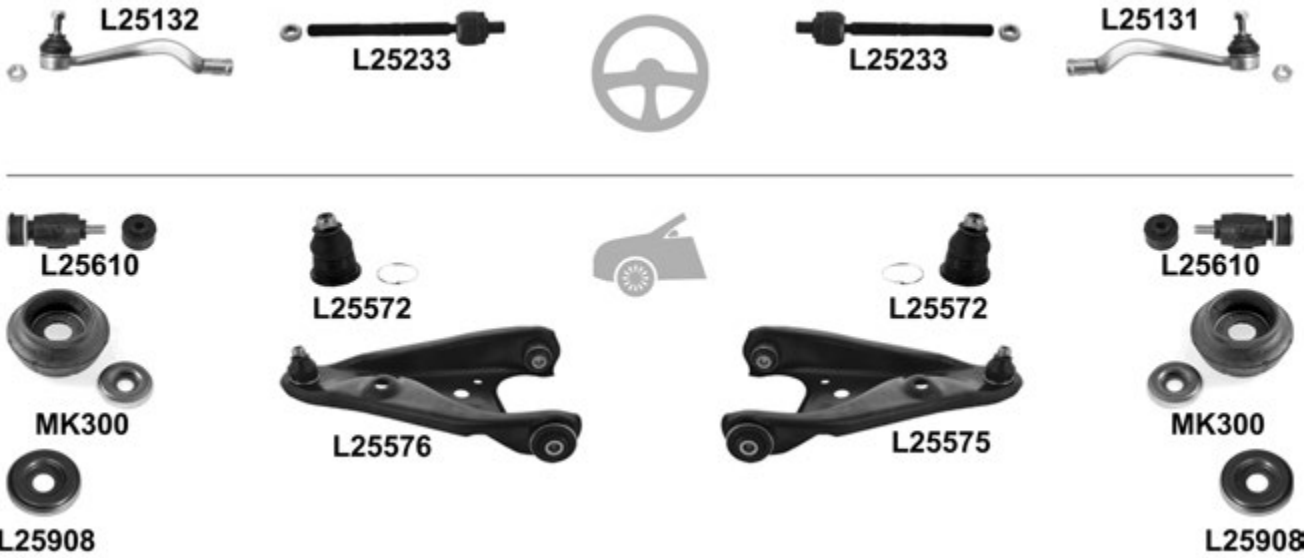
**Logan II 10.12 →
Logan MCV II 02.13 →**

				←	→	Thread	Part Of	QPA			
		↔				L25131	F 14x1,5 ♂		1	48520-2867R	
						L25132	F 14x1,5 ♂		1	48520-0410R	
						L25233 ⁰	L25233 ⁰	M 14x1,5 / M 14x1,5 ♂		2	48521-3172R
		⊥				L25572	L25572		L25575/L25576	2	
					<input checked="" type="checkbox"/>	L25575 ⁰				1	54500-4529R
						L25576 ⁰				1	54501-0529R
						L25610	L25610			2	8200 277 960
						KIT	MK300	MK300		2	8200 757 150
						L25908 ¹	L25908 ¹		2	8200 651 172	

Master I (T / P) 08.80 → 07.98

				←	→	Thread	Part Of	QPA			
		↔				L2575	L2575	F 16x1,5 ♂		2	5000 589 318
						L2576	L2576			2	5000 367 654
						L2577	L2577			2	5000 387 653

Master II / III (ED / FD / HD / JD / ND / UD) 07.98 →

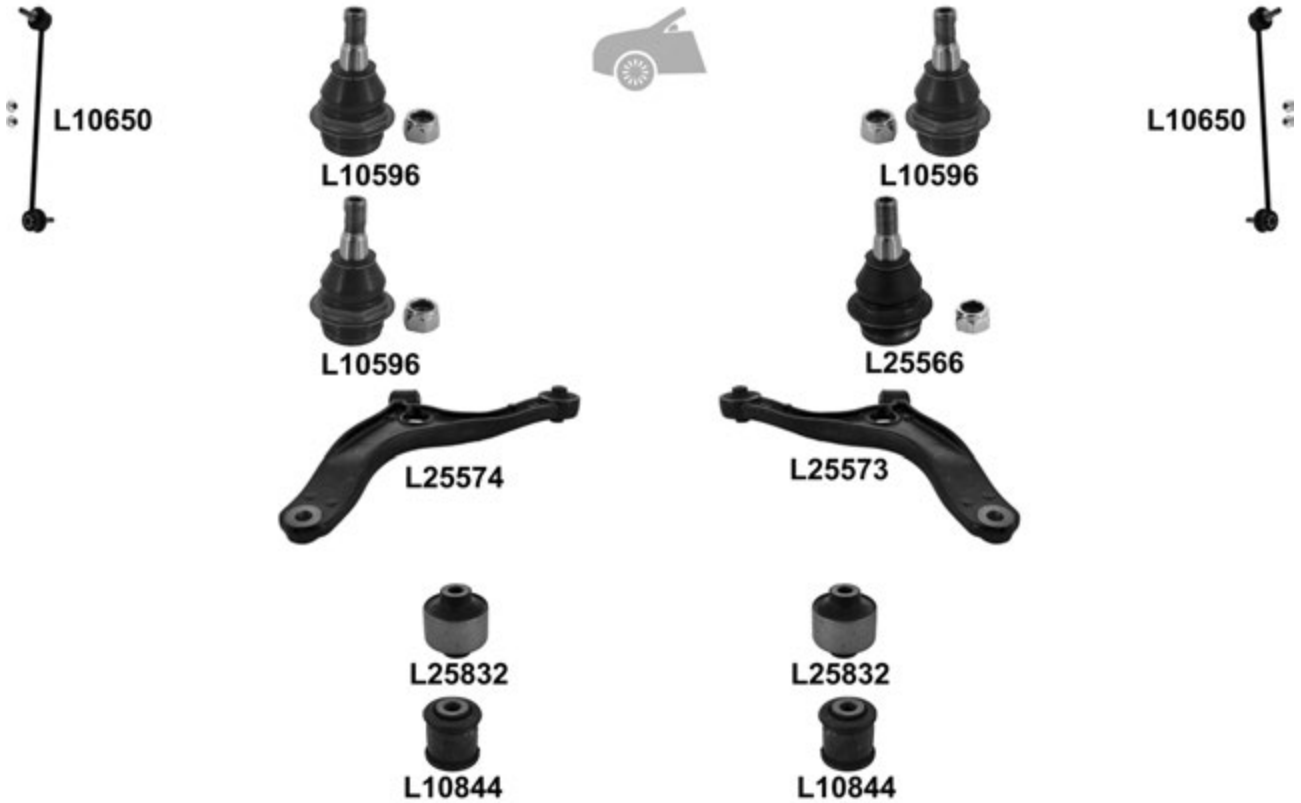

Master II / III (ED / FD / HD / JD / ND / UD) 07.98 →

		i		←	→	Thread	Part Of	QPA	i	
		↔			L25117	F 16x1,5 ∪		1	7701 470 364	
					L25118	F 16x1,5 ∪		1	7701 470 363	
				L10205	L10205	M 16x1,5 / M 14x1,5 ∪		2	7701 470 362	
				L10022 ⁰	L10022 ⁰			2	7701 470 361	
		↑		L10551	L10551	∪		2	7701 312 851	
		↓	→ 08.07, 22mm	L25518	L25518			2	7701 056 969	
		09.07 →, 24mm	L10583	L10583			2	7701 070 154		
		↓	→ 08.07, 22mm	<input checked="" type="checkbox"/>		L10533			1	8200 270 058
					L10534			1	8200 270 055	
			09.07 →, 24mm	<input checked="" type="checkbox"/>		L10597		1	8200 750 274	
					L10598			1	8200 750 273	
		▼			L10819	L10819			2	7700 302 123
		▲			L10820	L10820			2	7700 302 122
						L10609			1	7700 309 071
				L10610				1	7700 309 070	

Master (EV, FV, JV, UV) 02.10 →

				←	→	Thread	Part Of	QPA			
⊕		↔			L10133	F 18x1,5 ∪		1	48520-0780R		
					L10134	F 18x1,5 ∪		1	48520-6730R		
					L10221	L10221	M 18x1,5 / M 16x1,5 ∪	2	48521-2373R		
		⊥	→ 07.10,	L10596	L10596	∪		2	8200 688 877		
			08.10 →,		L25566 ⁰	∪		1	40160-8374R		
				L10596		∪		1	8200 688 877		
			⊥	(-) (+)		L25573 ⁰			1	8200 688 875	
						L25574 ⁰			1	8200 688 871	
			⊥	16 x 70 x 77mm	L25832 ⁰	L25832 ⁰			2		
16 x 49,2 x 64mm	L10844			L10844			2				
			L10650	L10650			2	54618-0004R			
			L25618 ⁰	L25618 ⁰			2	55110-0019R			
			L25618 ⁰	L25618 ⁰			2	55110-0019R			

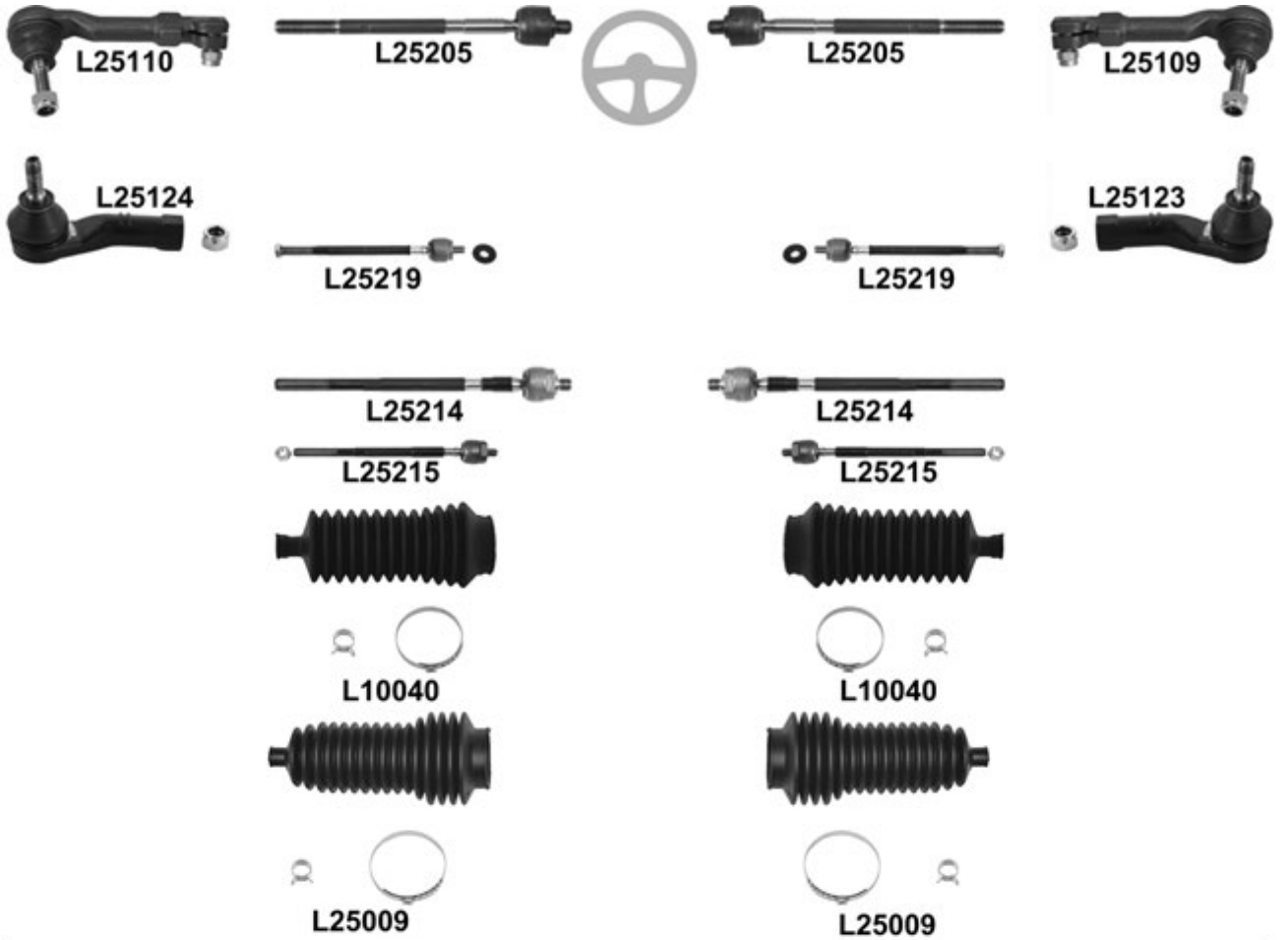
Megane I 01.96 →



Megane I 01.96 →

		i	←	→	Thread	Part Of	QPA	i	
		↔	→ 01.99	L25109	F 14x1,5 ∪		1	7701 041 312	
				L25110	F 14x1,5 ∪		1	7701 041 311	
				02.99 →	L25123	F 14x1,5 ∪		1	7701 047 416
					L25124	F 14x1,5 ∪		1	7701 047 415
			→ 01.99, TRW, L= 253mm	L25205	L25205	M 14x1,5 / M 14x1,5 ∪		2	7701 469 280
			→ 01.99, SMI, L= 258mm	L25219	L25219	M 14x1,5 / M 12x1 ∪		2	7701 469 251
			02.99 →, TRW, L= 290mm	L25214	L25214	M 14x1,5 / M 14x1,5 ∪		2	7701 472 087
			02.99 →, SMI, L= 292mm	L25215	L25215	M 14x1,5 / M 12x1 ∪		2	7701 471 844
			Smi, ø 9mm, Ø 39mm, L= 168mm	L10040 ^o	L10040 ^o			2	7701 469 496
			TRW, ø 12mm, Ø 40mm, L= 170mm	L25009 ^o	L25009 ^o			2	7701 469 486
		↓	(-) Diesel/Turbo Diesel/2.0 16V, 10mm ↔↔↔↔↔	L2555	L2555		2	7701 468 883	
			→ 10.97, Diesel/Turbo Diesel/2.0 16V, 10mm ↔↔↔↔↔	L2555	L2555		2	7701 468 883	
			10.97 →, Diesel/Turbo Diesel/2.0 16V, 12mm ↔↔↔↔↔	L25535	L25535		2		
		↓	(-) Diesel/Turbo Diesel/2.0 16V, 10mm ↔↔↔↔↔	<input checked="" type="checkbox"/>	L25505			1	7700 831 369
				<input checked="" type="checkbox"/>	L25506			1	7700 831 368
			2.0 16V, → 10.97, 10mm ↔↔↔↔↔	<input checked="" type="checkbox"/>	L25511			1	7700 829 842
				<input checked="" type="checkbox"/>	L25512			1	7700 829 841
			2.0 16V, 10.97 →, 12mm ↔↔↔↔↔	<input checked="" type="checkbox"/>	L25539			1	7700 430 832
				<input checked="" type="checkbox"/>	L25540			1	7700 430 831
			Diesel/Turbo Diesel, , 12mm ↔↔↔↔↔	<input checked="" type="checkbox"/>	L25537			1	7700 430 766
		<input checked="" type="checkbox"/>	L25538			1	7700 430 765		
	Diesel/Turbo Diesel, , 10mm ↔↔↔↔↔	<input checked="" type="checkbox"/>	L25511			1	7700 829 842		
		<input checked="" type="checkbox"/>	L25512			1	7700 829 841		
	Diesel/Turbo Diesel, , 12mm ↔↔↔↔↔	<input checked="" type="checkbox"/>	L25539			1	7700 430 832		
	<input checked="" type="checkbox"/>	L25540			1	7700 430 831			
	↕	(-) 2.0 16V	L25807	L25807			4	7700 840 741	
		2.0 16V	L25808	L25808			4	7700 789 477	
			L25602	L25602			2	7700 847 382	
		(+) L 10908	KIT	MK096	MK096		2	7700 840 234 S	
			L10908	L10908			2	7700 777 654	

Megane II Hatch Back (BM0/1_, CM0/1_) 11.02 →
 Megane II Sedan (LM0/1) 09.03 →
 Megane II Grandtour (KM0/1) 08.03 →
 Megane II Coupe-Cabriolet (EM0/1) 09.03 →

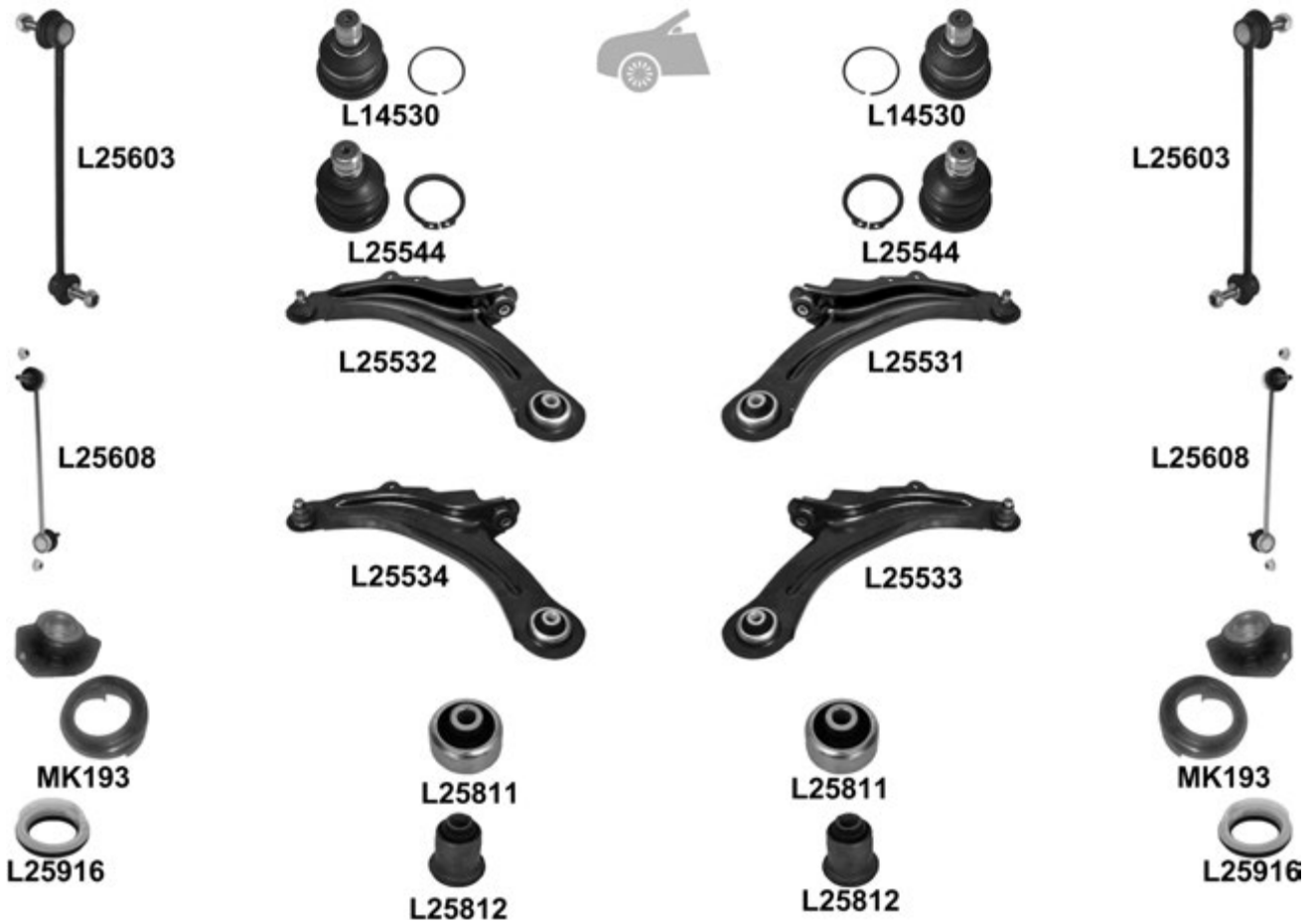
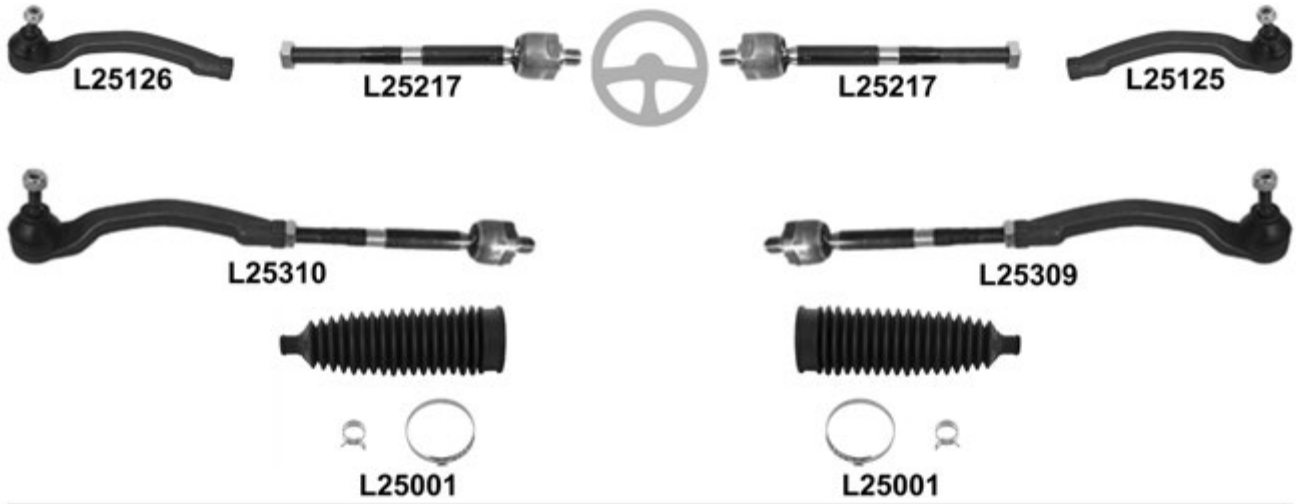

Megane II Hatch Back (BM0/1_, CM0/1_) 11.02 →
 Megane II Sedan (LM0/1) 09.03 →
 Megane II Grandtour (KM0/1) 08.03 →
 Megane II Coupe-Cabriolet (EM0/1) 09.03 →

				←	→	Thread	Part Of	QPA		
⊕		↔			L25125	F 14x1,5 ∪		1	7701 474 796	
					L25126	F 14x1,5 ∪		1	7701 474 795	
			(-) RS	L25217	L25217	M 14x1,5 / M 14x1,5 ∪		2	7701 474 448	
					L25309		L25125+L25217	1		
					L25310		L25126+L25217	1		
🚗				L25001	L25001			2	7701 474 447	
		⊥	→ 01.03, 16mm	L14530	L14530			2		
			01.03 →, 18mm	L25544	L25544			2		
		⊥	→ 01.03, 16mm	<input checked="" type="checkbox"/>	L25531			1	8200 255 761	
					L25532			1	8200 255 760	
			01.03 →, 18mm	<input checked="" type="checkbox"/>	L25533			1	8200 298 455	
					L25534			1	8200 298 454	
		▼		L25811	L25811			2		
		▲		L25812	L25812			2		
			(-) / 2.0 16V Turbo, (-) 2.0 dCi	L25603	L25603			2	8200 166 159	
			(-) HD, (-)	L25603	L25603			2	8200 166 159	
			HD,	L25608	L25608			2	8200 669 066	
		(+) L 25916	KIT	MK193	MK193		2	7701 208 891		
			L25916	L25916			2	8200 222 463		

Megane III Hatchback (BZ0/1_) 11.08 →
 Megane III Sedan 06.09 →
 Megane III Grandtour (KZ0/1) 11.08 →
 Megane III Coupe (DZ0_) 11.08 →
 Megane III CC 06.10 →

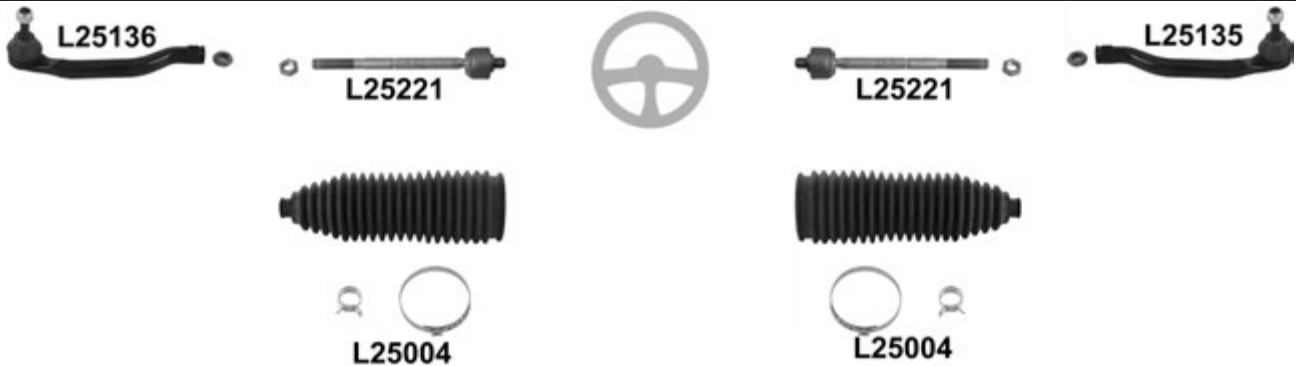

				←	→	Thread	Part Of	QPA			
⊕	⚙️	↔			L25135	F 14x1,5 U		1	48520-4680R		
					L25136	F 14x1,5 U		1	48520-4710R		
	⚙️		L=200	L25221	L25221	M 14x1,5 U		2	48521-5612R		
	🌀		Thermoplast	L25004	L25004			2	48203-6715R		
🚗	⚙️	⬇			L25561	L25561		2	40160-9060R		
					L25563			1	54500-9207R		
	🔧	⬇	(-) 1.5 D 🚐 /Van, Model KZ09	<input checked="" type="checkbox"/>	L25564			1	54501-4055R		
	🌀			L25824	L25824		🔧 L25563/L25564	2			
			▲		L25825	L25825		🔧 L25563/L25564	2		
	⚙️			Metal	L25615	L25615			2	54618-0002R	
				ALU	L25617	L25617			2	54618-0002R	
	🌀		KIT	MK327	MK327			2			

Megane Scenic (JA0) 01.97 → 09.99

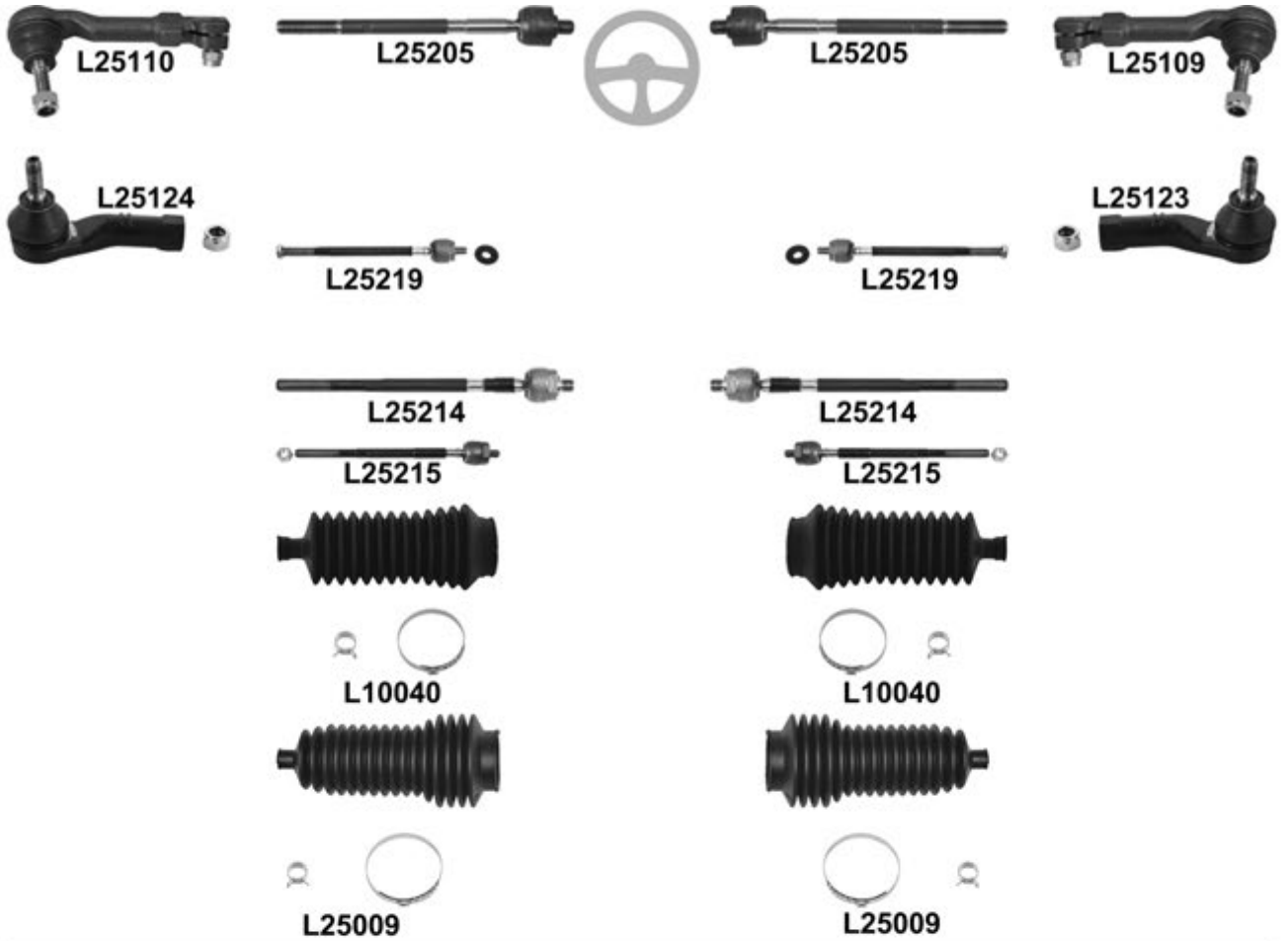

Megane Scenic (JA0) 01.97 → 09.99

			←	→	Thread	Part Of	QPA		
		↔	→ 09.98	L25109	F 14x1,5 ♂		1	7701 041 312	
			L25110	F 14x1,5 ♂		1	7701 041 311		
		10.98 →	L25123	F 14x1,5 ♂		1	7701 047 416		
			L25124	F 14x1,5 ♂		1	7701 047 415		
			→ 02.99, TRW, L= 253mm	L25205	L25205	M 14x1,5 / M 14x1,5 ♂		2	7701 469 280
			→ 02.99, SMI, L= 258mm	L25219	L25219	M 14x1,5 / M 12x1 ♂		2	7701 469 251
			03.99 →, TRW, L= 290mm	L25214	L25214	M 14x1,5 / M 14x1,5 ♂		2	7701 472 087
			03.99 →, SMI, L= 292mm	L25215	L25215	M 14x1,5 / M 12x1 ♂		2	7701 471 844
			Smi, ø 9mm, Ø 39mm, L= 168mm	L10040 ⁰	L10040 ⁰			2	7701 469 496
			TRW, ø 12mm, Ø 40mm, L= 170mm	L25009 ⁰	L25009 ⁰			2	7701 469 486
		⊥	→ 08.97	L25526	L25526		2	7701 469 464	
			09.97 →	L25535	L25535		2	7701 468 411	
		⊥	→ 08.97	<input checked="" type="checkbox"/>	L25523		1	7700 834 917	
			L25524		1	7700 834 916			
			09.97 →	<input checked="" type="checkbox"/>	L25537		1	7700 430 766	
	L25538		1	7700 430 765					
		▲▼	09.97 →	L25807	L25807		4	7700 840 741	
				L25602	L25602		2	7700 847 382	
			KIT	MK096	MK096		2	7700 840 234 S	
			L10908	L10908		2	7700 777 654		

Modus 08.04 →
Grand Modus 12.04 →

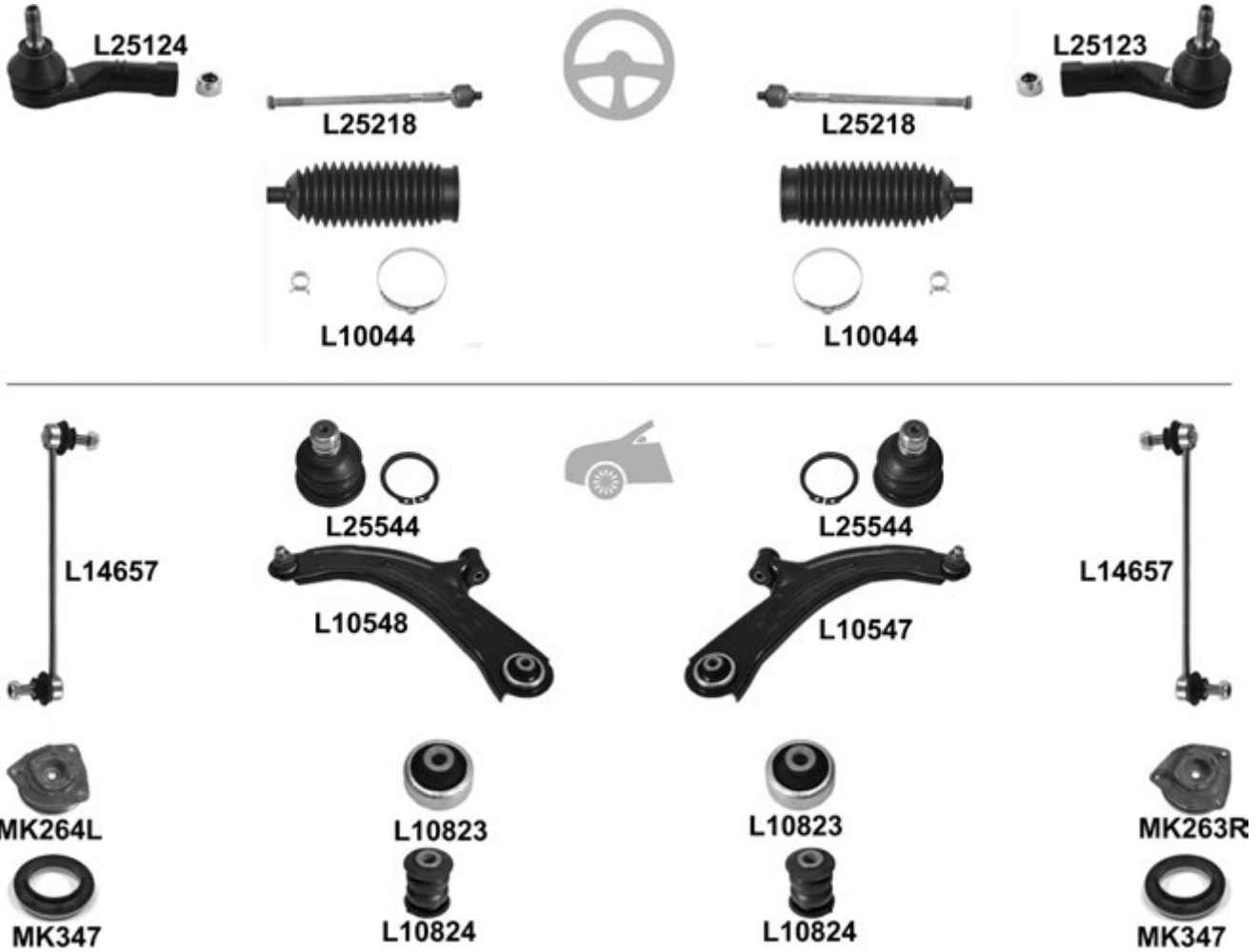

				← → Thread		Part Of	QPA			
⊕		↔		L25123	F 14x1,5 U		1	7701 475 843		
				L25124	F 14x1,5 U		1	7701 475 842		
				L25218	L25218	M 14x1,5 / M 14x1,5 U		2	7701 475 841	
				L10044	L10044			2	7701 475 840	
⊖		↓		L25544	L25544		2			
					L10547		1	8200 346 942		
		↓			L10548		1	8200 346 941		
					L10823	L10823		2	8200 696 437	
		↓			L10824	L10824		2	8200 183 569	
					L14657	L14657		2	8200 127 308	
					KIT	MK263R		1	7701 208 823	
						MK264L		1	7701 208 822	
					MK347	MK347		2	8200 504 295	

R4 R1120 468775 → 954000
 R4 R1123 212515 → 627131
 R4 R2106 → 24876



		i		←	→	Thread	Part Of	QPA	i
					L2539			1	7704 001 919

R4 → 04.78
 R1120 954001 →, R1123 627132 → 2012576, R1126 → 655996
 R1128 → 60549, R2106 24877 → 246451, R2109 → 312753
 R2370 → 98766, R2391 → 3753, R2392 → 9162, R2430
 R5 → 04.78
 R1220 → 116482, R1221 → 197823, R1222 → 1020450
 R1223 → 210
 94, R1224 → 261223, R1225 → 219268
 R1225 AUT. → 201776, R2381 → 6001, R2382 → 38121
 R6 R1180 → 598707, R1181



		i		←	→	Thread	Part Of	QPA	i
					L2539			1	7704 001 919
					L2545			1	7704 002 058
		↑			L2525	L2525		2	7701 451 904
		↓				L2524 ¹		1	7701 461 132
					L2523 ¹			1	7701 461 131

R4 05.78 → 09.81
 R1123 2012577 → 2223847, R1126 655997 →, R1128 60550 → 295566
 R2106 246452 → 294151, R2109 312754 →, 210B, R2370 98767 → 227901
 R2391 3754 → 7451, R2392 9163 →, 239B
R5 05.78 → 09.81
 R1220 116483 →, R1221 197824 → 307990, R1
 222 1020451 → 1177141
 R1223 21095 →, R1224 261224 → 399708, R1225 219269 →
 R1225 AUT. 201777 →, R1227, R1229, 122B, R1391, R1392
 R1395, R1397, R2381 6002 → 30298, R2382 38122 →, R2387
R6 05.78 → 09.81^R1180 598708 →

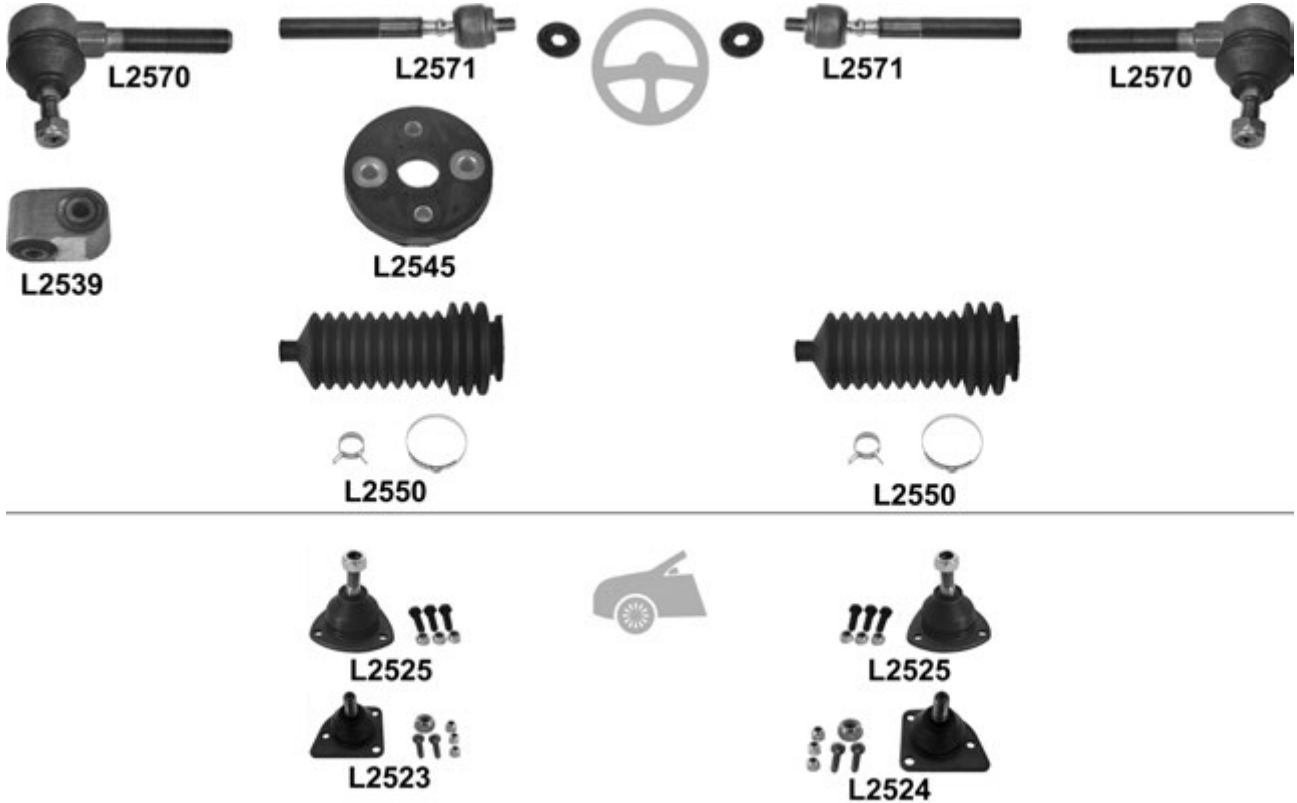

		i	←	→	Thread	Part Of	QPA	i
⊕		↔	L2570	L2570	M 14x1,5 ∪		2	7701 460 955
			L2571	L2571	F 14x1,5 / M 12x1 ∪		2	7700 656 318
			L2539				1	7704 001 919
			L2550	L2550			2	7700 656 569
			L2545				1	7704 002 058
⊖		↑	L2525	L2525			2	7701 451 904
		↓		L2524 ¹			1	7701 461 132
			L2523 ¹				1	7701 461 131

R4 10.81 → 12.93

R1123 2223848 →, R1128 295567 →, R2106 294152 →

R210B, R2370 227902 →, R2391 7452 →, 239B

R5 10.81 → 12.85

R1221 307991 →, R1222 1177142 →, R1224 399709 →, R1227

R1229, 122B, R1391, R1392, R1395, R1397, R1399^R2381 30299 →, R2387

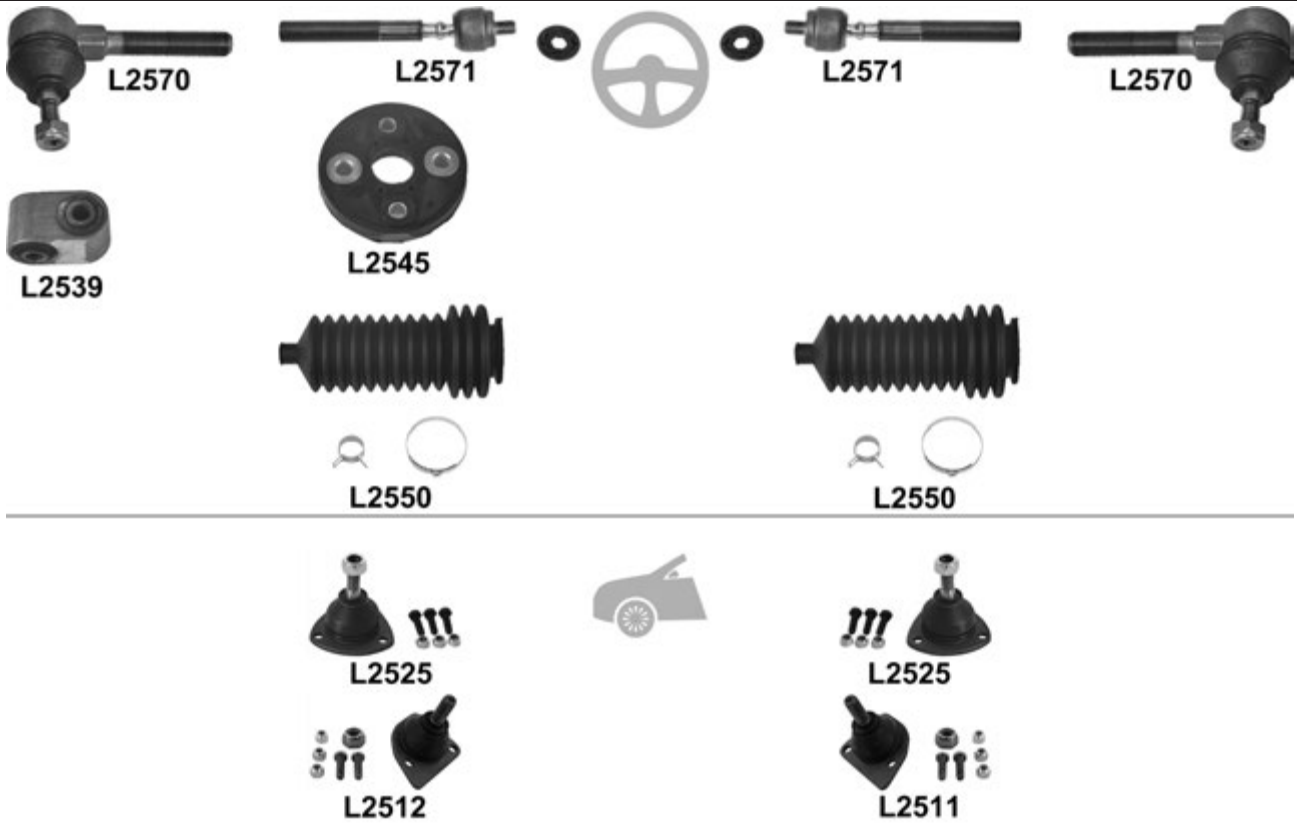

		i		←	→	Thread	Part Of	QPA	i
		↔		L2570	L2570	M 14x1,5 U		2	7701 460 955
				L2571	L2571	F 14x1,5 / M 12x1 U		2	7700 656 318
				L2539				1	7704 001 919
				L2550	L2550			2	7700 656 569
				L2545				1	7704 002 058
		↑		L2525	L2525			2	7701 451 904
		↓			L2511			1	7701 463 687
				L2512				1	7701 463 686

Super R5 (B / C40) II 10.84 → 12.96
 Super R5 Van (S40_) II 10.84 → 12.96
 Rapid Van (F40_ / G40_) 07.85 → 08.98
 Express (F40_ / G40_) 07.85 → 08.98

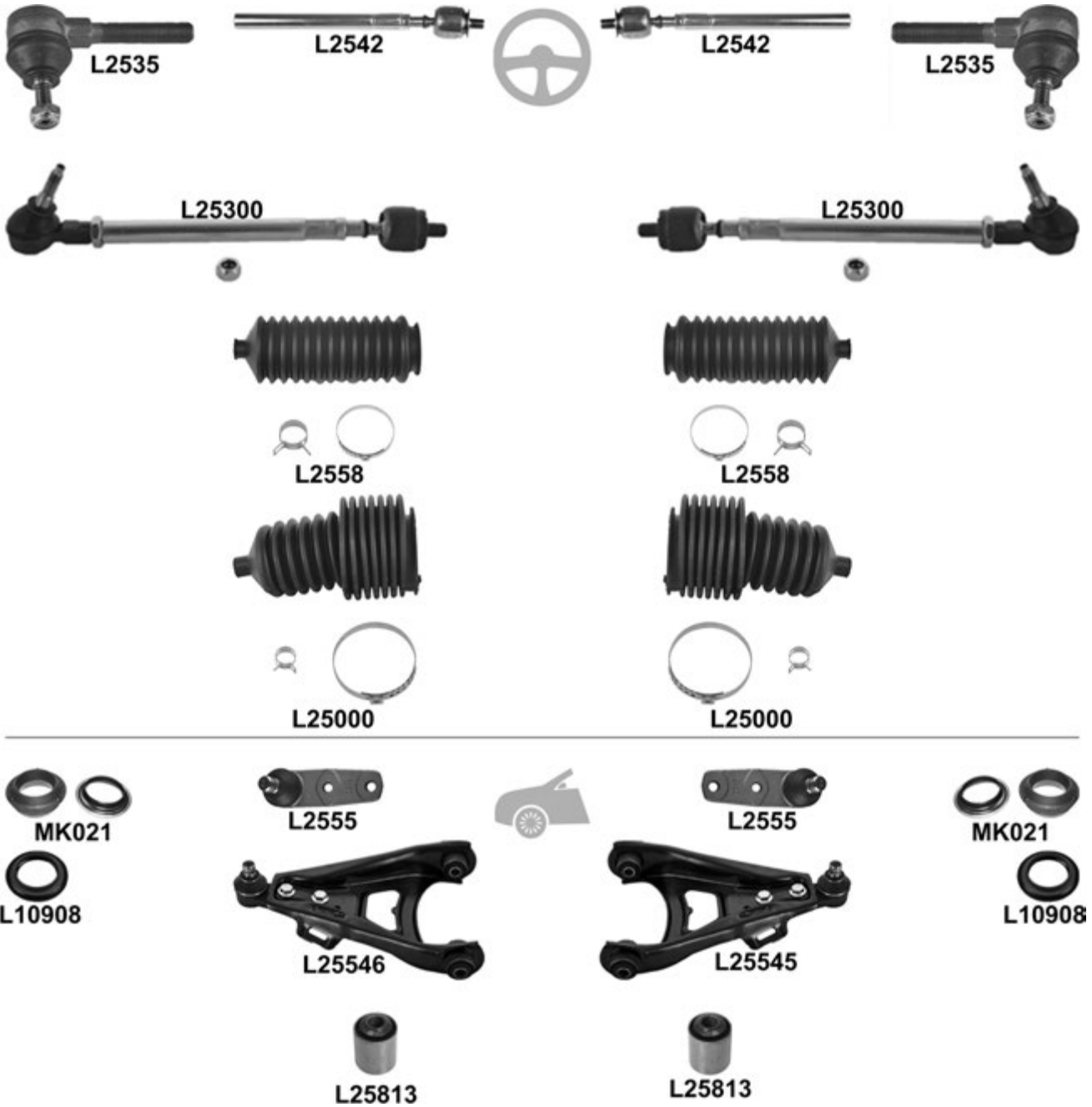

		i	←	→	Thread	Part Of	QPA	i	
⊕		↔	L2535	L2535	M 14x1,5 ∪		2	7701 461 141	
			L2542	L2542	F 14x1,5 / M 12x1 ∪		2	7702 145 337	
			L25300	L25300	∪	L2535+L2542	2	7701 463 346	
		⊕	L2558	L2558			2	7700 781 097	
		⊖	L25000	L25000			2	7700 706 007	
⊖		⊥	L2555	L2555			2	7701 468 883	
		⊥	(-) 1.4 GT Turbo, Model C405/ 1.7 i, Model C409	<input checked="" type="checkbox"/>	L25545		1	7700 783 456	
		⊥			L25546		1	7700 783 455	
		↕	(-) 1.4 GT Turbo, Model C405/ 1.7 i, Model C409		L25813	L25813		4	77 04 000 681
			KIT	MK021	MK021			2	7700 757 324 S
			L10908	L10908			2	7700 777 654	

R9 09.81 → 03.91
R11 03.83 → 07.89

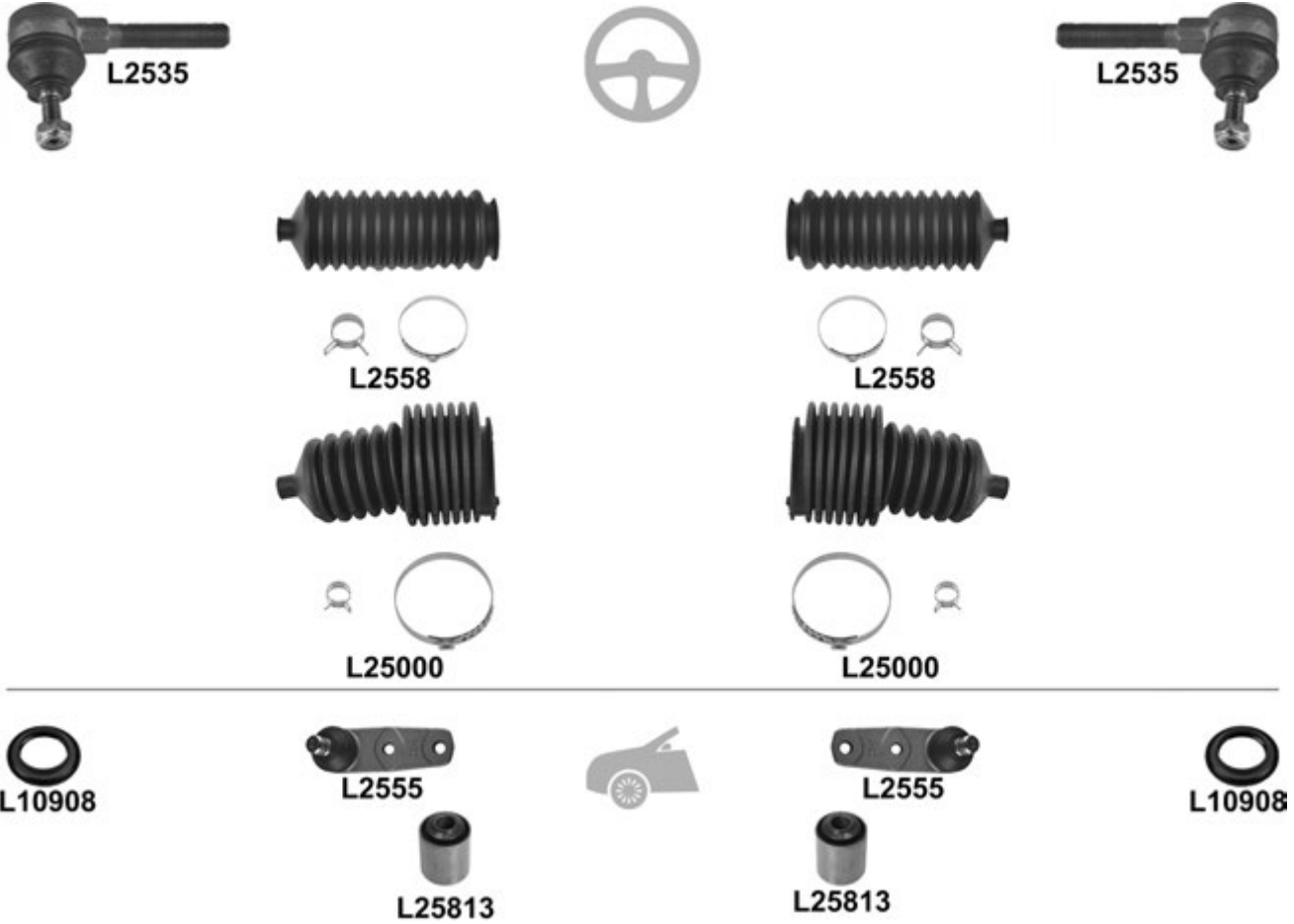

				←	→	Thread	Part Of	QPA	i
⊕		↔		L2535	L2535	M 14x1,5 U		2	7701 461 141
			⊕	L2558	L2558			2	7700 781 097
			⊕, (-) R9	L25000	L25000			2	7700 781 095
🚗		↓		L2555	L2555			2	7701 468 883
		▲▼		L25813	L25813			4	77 04 000 681
				L10908	L10908			2	7700 777 654

R12 10.69 → 08.80
R1170, R1177, R1330, R1337, R2360
R15 07.71 →
R1300, R1302
R17 07.71 →
R1312, R1313, R1318, R1322, R1323, R1328



				←	→	Thread	Part Of	QPA	i
⊕				L2539				1	7704 001 919

R14 05.76 → 1980
 R1210 ch. → 376629
 R1211 ch. → 17589



		← →		Thread	Part Of	QPA		
				L2566	L2566		2	

R14 1980 → 12.83
 R1210 ch. 376630 →
 R1211 ch. 17590 →
 R1212, R1213

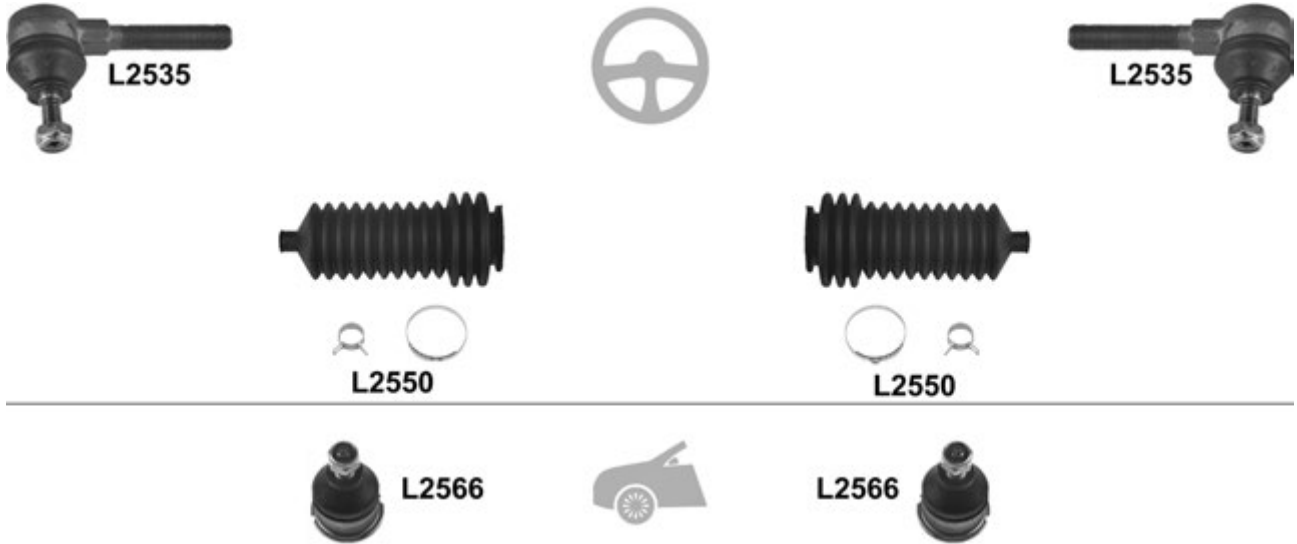

		← →		Thread	Part Of	QPA		
		↔						
							2	7701 461 141
				L2535	L2535	M 14x1,5 U		
				L2550	L2550		2	7700 656 569
							2	
				L2566	L2566			

R18 01.78 → 12.80
R1340 ch. → 534400, R1341 ch. → 504400, R1350 ch. → 114800
R1351 ch. → 107200, R2350 ch. → 1200

L2570

L2570

L2539

L2515

L2515

L2556

L2556

L2545

				← → Thread		Part Of	QPA		
		↔		L2570	L2570	M 14x1,5 U		2	7701 460 955
				L2539				1	7704 001 919
		↑	R1340	L2515 ¹	L2515 ¹			2	7701 461 332
			ch. 499801 → R1341 ch. 438551 → R1350 ch. 98601 → R1351 ch. 91001 →						
	↓	R1340	L2556	L2556			2	7701 461 331	
				L2545				1	7704 002 058

R18 01.81 → 07.86
 R1340 ch. 534401 →, R1341 ch. 504401 →, R1342, R1343
 R1344, R1345, R1346, R1350 ch. 114801 →
 R1351 ch. 107201 →, R2350 ch. 1201 →, R1352
 R1353, R1354, R1355, R1356, R2354



				←	→	Thread	Part Of	QPA		
		↔		L2535	L2535	M 14x1,5 ∪		2	7701 461 141	
				L2540	L2540	F 14x1,5 / M 12x1 ∪		2	7701 461 331 PART	
		↑		L2515 ¹	L2515 ¹			2	7701 461 332	
		↓		L2556	L2556			2	7701 461 331	

MK096 :		MK142 :	
1.4	B53A, B53G, B53H, B535, B537, C53A, C535, C537, L53A, L53G, L53H, L535, L537, S537	1.2	B53W, B530, C53W, C530, L53W, L530, S530
1.7	B53E, B53M, B533, B536, C53E, C53M, C533, L533, L536	1.4	B53P, B531, B532, C53P, C531, C532, L53P, L531, L532
1.8	B53B, B53C, B53F, B53V, B53Y, C53B, C53C, C53F, C53V, C53Y, D53C, D53V, D53Y, L53B, L53C, L53F, 353A, 353C, 353D, 353F, 453A, 453C, 453D, 453F, 453H, 553A, 553C, 553D, 553F, 553H, 853A, 853F		
1.9D	B53i, B53J, B53K, B53T, B53Z, B534, C53i, C53J, C53K, C53T, C53Z, C534, L53i, L53J, L53K, L53T, L53Z, S53i, S53J, S53K, S534		



R19 01.88 → 06.96

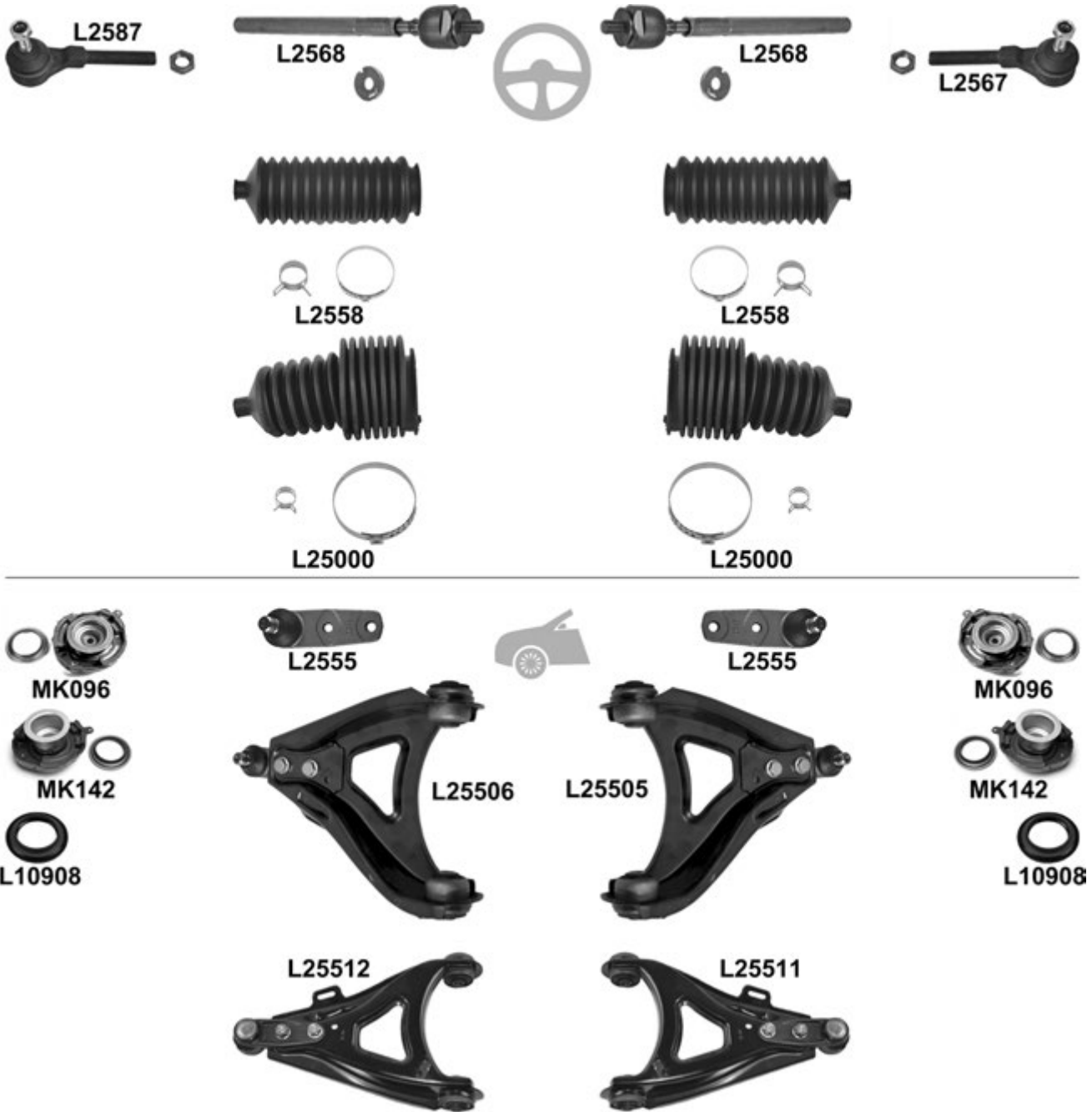

				← → Thread		Part Of	QPA			
⊕		↔		L2567	M 14x1,5 ♂		1	6000 030 048		
				L2587	M 14x1,5 ♂		1	6000 030 047		
		↔		L2568	L2568		2			
				L2558	L2558		2	7700 781 097		
				L25000	L25000		2	7700 781 095		
⊖		⊥		L2555	L2555		2	7701 468 883		
					L25505		1	7700 436 303		
					L25506		1	7700 436 302		
					L25511		1	7700 829 842		
			L25512		1	7700 829 841				
			(-) 16V		KIT	MK096	MK096	2	7700 840 234 S	
						MK142	MK142	2	7700 840 234 S	
				L10908	L10908		2	7700 777 654		

R20
R1270
R1271 ch. 187001 →
R1276, R1277
R30 TD R1270



				←	→	Thread	Part Of	QPA		
		↔		L2535	L2535	M 14x1,5 ∪		2	7701 461 141	
				L2540	L2540	F 14x1,5 / M 12x1 ∪		2	7701 461 331	
		↑ ↓		L2515 ¹	L2515 ¹			2	7701 461 332	
				L2556	L2556			2	7701 461 331	

B481/2/4
B48D/E/F/H/I/J/U
K481/2/3/4/6/8
K48E/F/H/I/J/K/M/N/U
L481/2/3/4/6/8/9/D/E
L48F/H/I/J/K/M/N/R/U/V
S481/2/H

B48C/0/R/V

K48C/0/V

L48C/K

S486/0/V

MK022

B48A/K/P/W/Y
B480/3/6/7/8
K48A/B/K/P/R/S/W
K480/3/6/7/8/9
L48K/P/Q/R/S/V/W/Y
L480/3/6/7/8/9

B48C/0/R/V

K48C/0/V

L48A/C/K/0

S486/0/V

MK023



R21 03.86 → 08.94

RENAULT

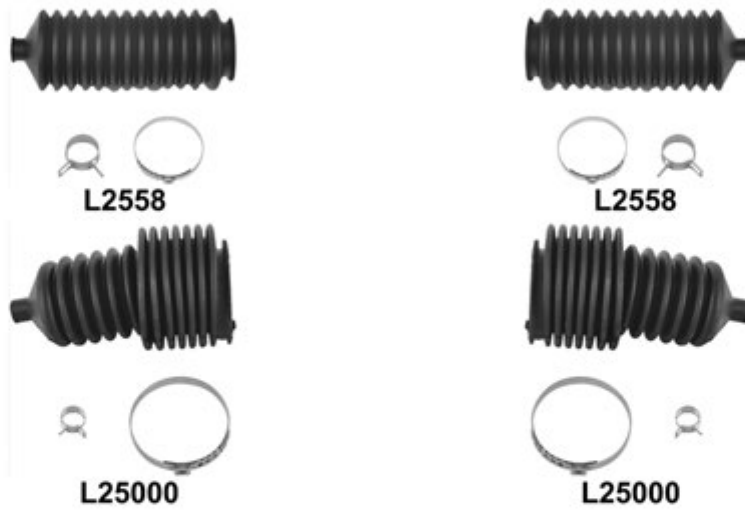

			←	→	Thread	Part Of	QPA	
		↔	Petrol models	L2535	L2535	M 14x1,5 U	2	7701 461 141
			Diesel models	L25119	L25119	M 14x1,5 U	2	7701 464 441
			Petrol models	L25207	L25207	F 14x1,5 / M 12x1 U	2	7701 465 917
				L2558	L2558		2	7700 781 097
				L25000	L25000		2	7700 706 007
		⊥	Petrol models	L2555	L2555		2	7701 468 883
			Diesel models	L25525	L25525		2	7701 464 037
		▲▼	1.7	L25813	L25813		4	77 04 000 681
			2.0/2.0 Turbo/2.1 D/2.1 Turbo-D/2.2	L25814	L25814	Anti-roll bar	2	7700 771 562
			KIT	MK022	MK022		2	?
			MK023	MK023		2	?	

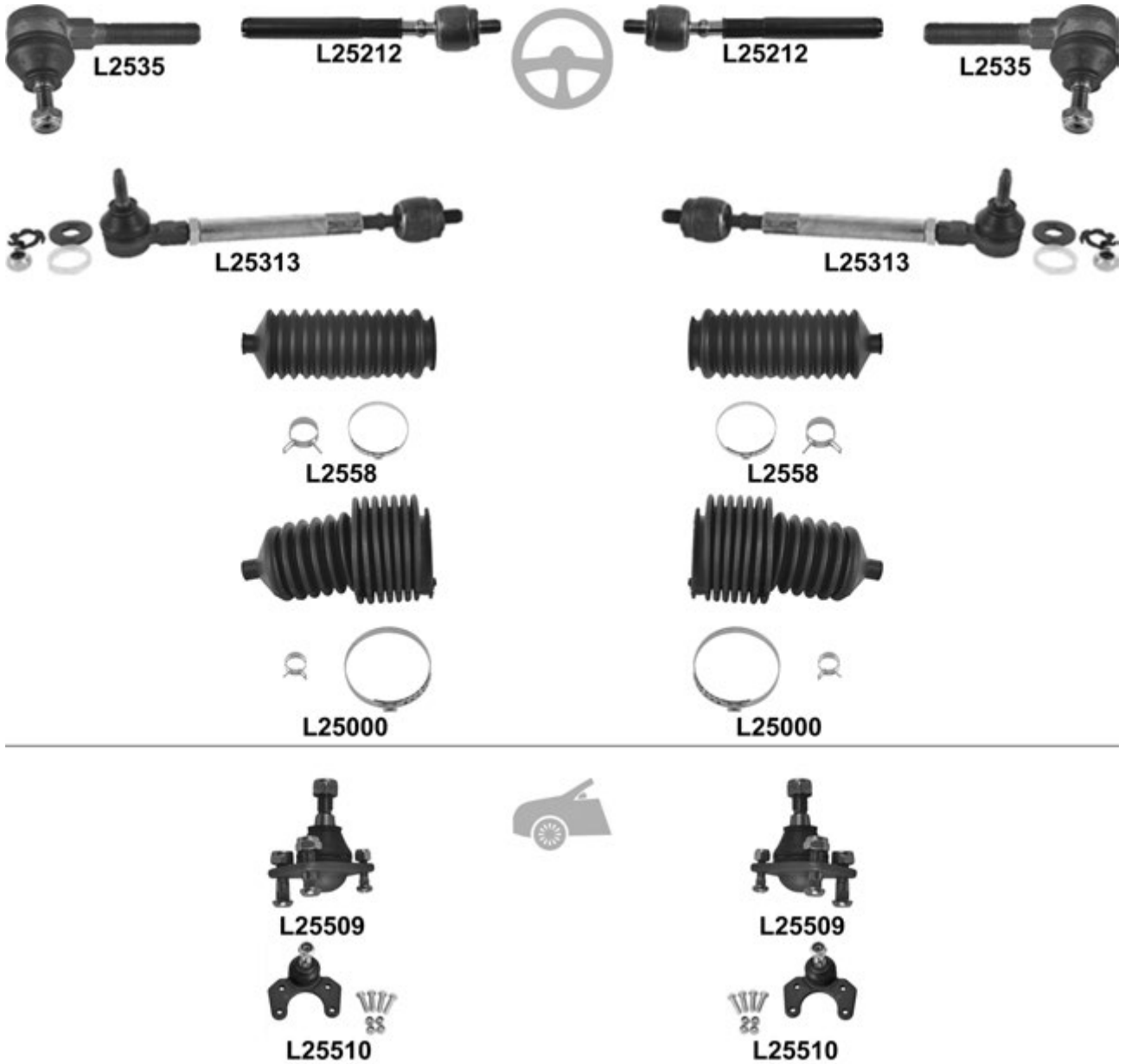
R25 (B29_) 04.84 → 12.93

				←	→	Thread	Part Of	QPA	i
⊕		↔		L2535	L2535	M 14x1,5 ∪		2	7701 461 141
				L25212	L25212	F 14x1,5 / M 12x1 ∪		2	
				L25313	L25313	∪	L2535+L25212	2	7701 469 229
			⊕	L2558	L2558			2	7700 781 097
			⊕	L25000	L25000			2	7700 706 007
🚗		↑		L25509	L25509			2	7701 463 229
		↓		L25510	L25510			2	7701 463 230

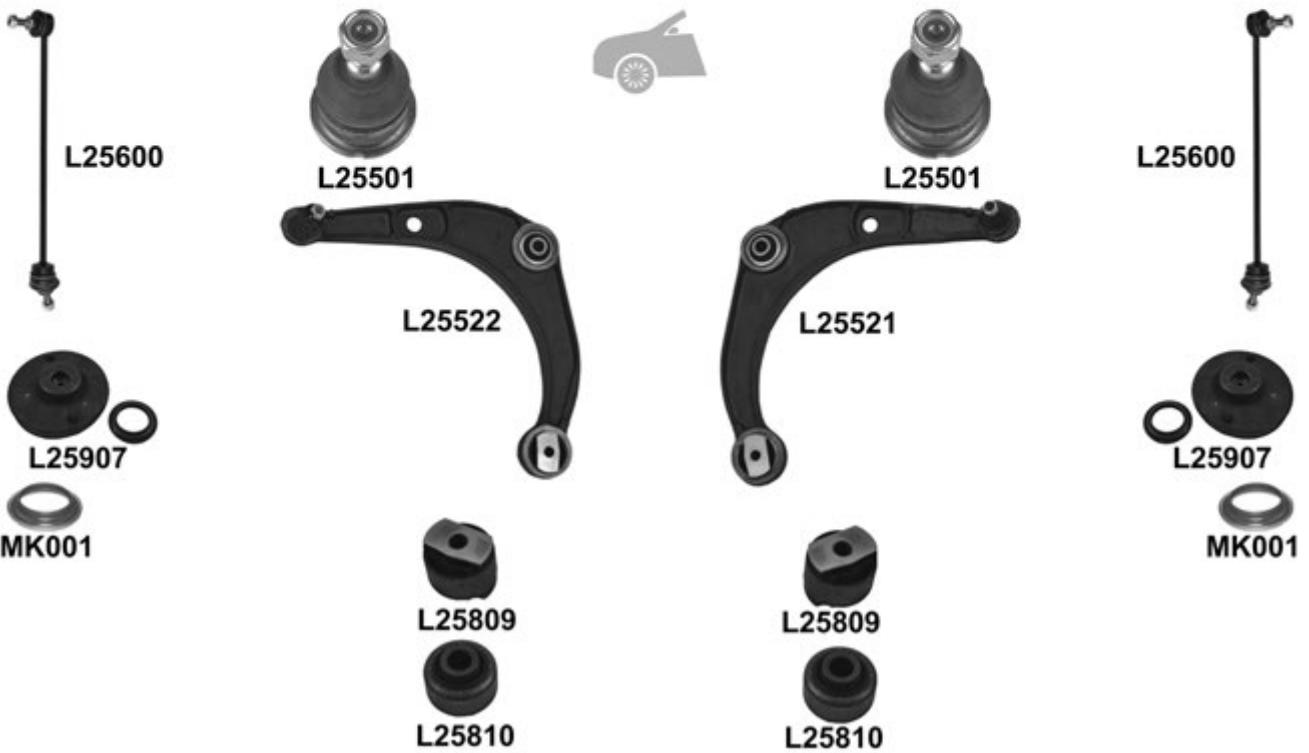
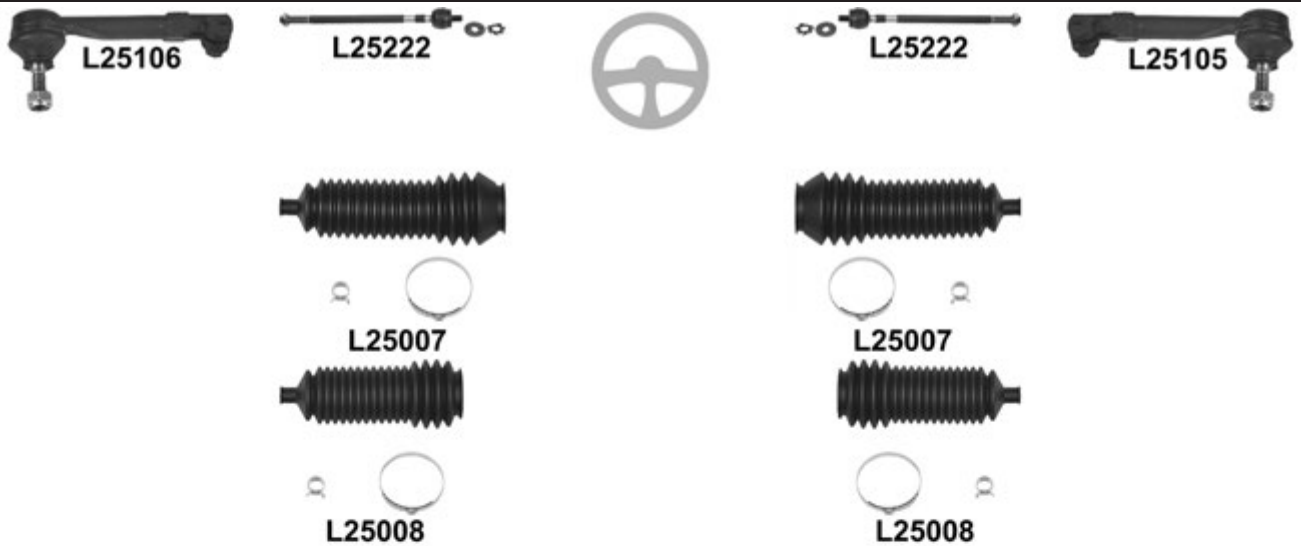
Safrane I / II (B54) 04.92 → 12.00

			←	→	Thread	Part Of	QPA	
		↔		L25105	M 14x1,5 U		1	60 00 022 715
				L25106	M 14x1,5 U		1	60 00 022 714
				L25222	F 14x1,5 / M 12x1,5 U		2	60 00 022 825
			∅ 9mm, ∅ 39mm, L= 195mm	L25007 ⁰	L25007 ⁰		2	7701 469 565
			∅ 9mm, ∅ 38mm, L= 165mm	L25008 ⁰	L25008 ⁰		2	7701 469 567
		↓		L25501	L25501		2	7700 829 322
			<input checked="" type="checkbox"/>	L25521			1	7700 807 581
		↓		L25522			1	7700 807 580
			▼	L25809	L25809		2	7700 806 238
		▲		L25810	L25810		2	7700 806 239
				L25600	L25600		2	7700 805 494
				KIT	L25907	L25907		2
				MK001	MK001		2	7700 803 635

Sandero 06.08 →

				←	→	Thread	Part Of	QPA				
						L25131	F 14x1,5 ∪	1	6001 550 443			
						L25132	F 14x1,5 ∪	1	6001 550 442			
						L25226	L25226	M 14x1,5 / M 12x1 ∪	2		6001 550 441	
						L10022 ⁰	L10022 ⁰		2		6001 547 607	
				<input checked="" type="checkbox"/>		L25549		1	6001 547 520			
						L25550		1	6001 547 519			
					KIT			MK300	MK300		2	6001 547 499
								L25908 ¹	L25908 ¹		2	6001 025 850

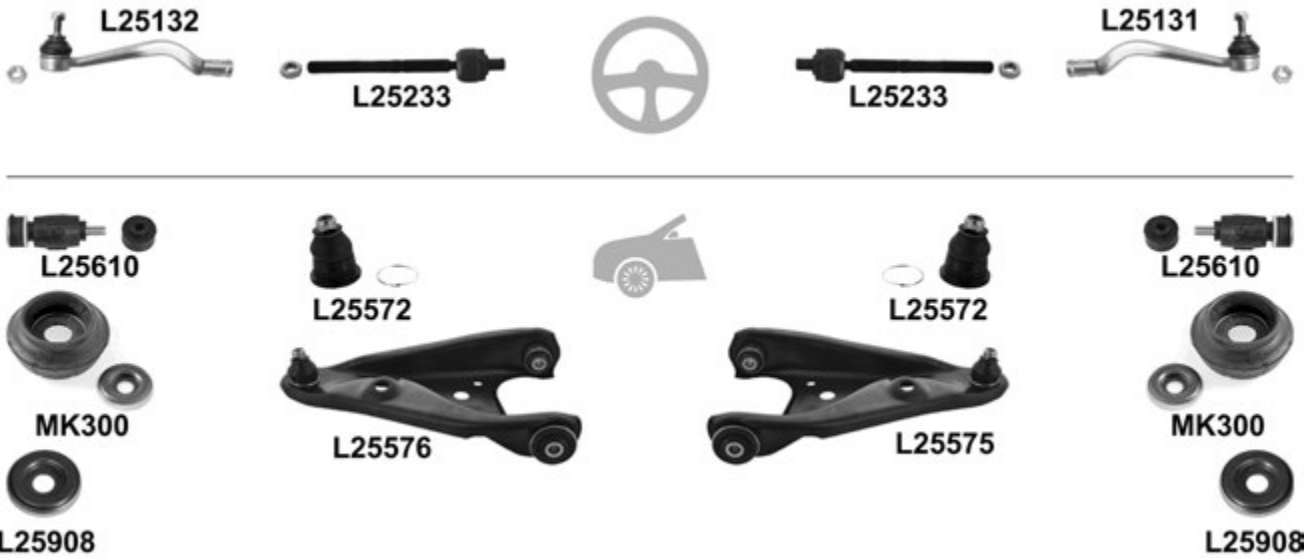
Sandero II 12.13 →

			←	→	Thread	Part Of	QPA		
		↔		L25131	F 14x1,5 ♂		1	48520-0410R	
				L25132	F 14x1,5 ♂		1	48520-2867R	
		⊥		L25233 ⁰	M 14x1,5 / M 14x1,5 ♂		2	48521-3172R	
				L25572	L25572		L25575/L25576	2	
			<input checked="" type="checkbox"/>	L25575 ⁰				1	54500-4529R
				L25576 ⁰				1	54501-0529R
				L25610	L25610			2	8200 277 960
				KIT	MK300	MK300			2
		L25908 ¹	L25908 ¹			2	8200 651 172		

Scenic (JA) 09.99 →
Scenic RX4 (JA) 03.00 → 08.03

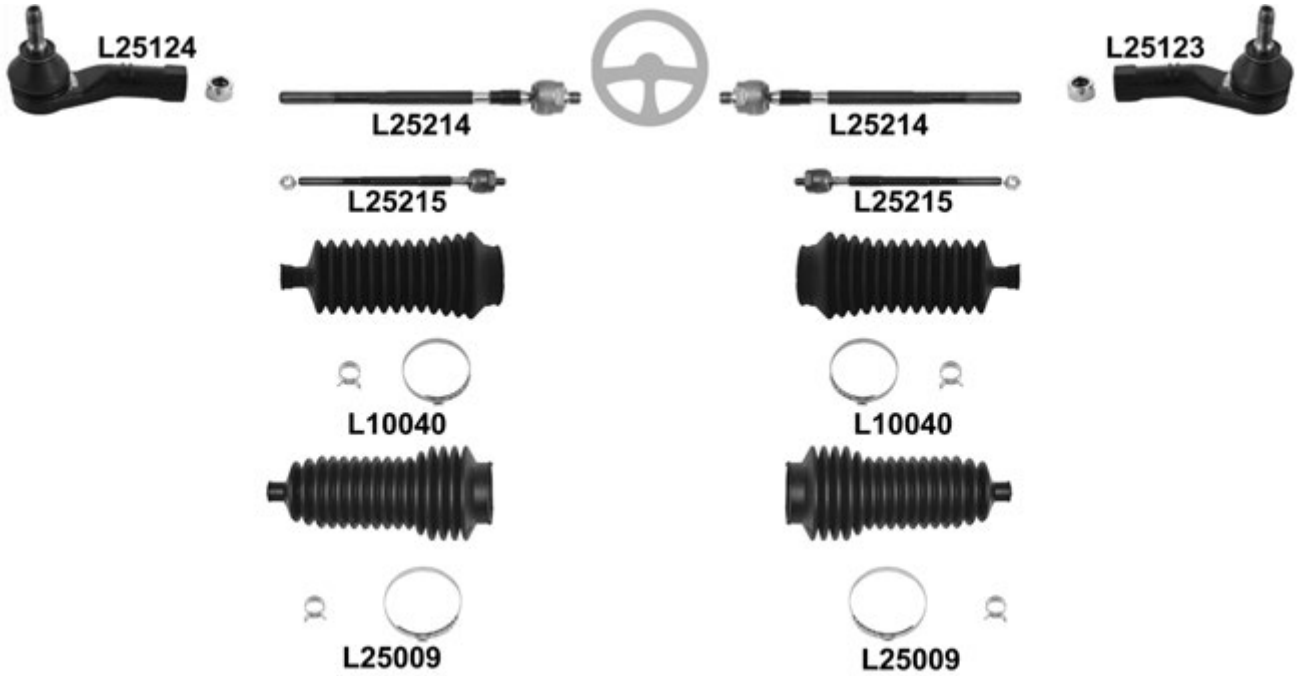

Scenic (JA) 09.99 →
Scenic RX4 (JA) 03.00 → 08.03

		i		←	→	Thread	Part Of	QPA	i	
		↔				L25123 F 14x1,5 ∪		1	7701 047 416	
						L25124 F 14x1,5 ∪		1	7701 047 415	
						L25214 L25214 M 14x1,5 / M 14x1,5 ∪		2	7701 472 087	
						L25215 L25215 M 14x1,5 / M 12x1 ∪		2	7701 471 844	
				Smi, ø 9mm, Ø 39mm, L= 168mm			L10040 ⁰ L10040 ⁰		2	7701 469 496
				TRW, ø 12mm, Ø 40mm, L= 170mm			L25009 ⁰ L25009 ⁰		2	7701 469 486
		⊥	(-) RX4			L25535 L25535		2		
		⊥	(-) RX4	<input checked="" type="checkbox"/>		L25537		1	7700 430 766	
						L25538		1	7700 430 765	
		▲▼	(-) RX4			L25807 L25807		4	7700 840 741	
			(-) RX4			L25602 L25602		2	7700 847 382	
			RX4			L25616 L25616		2	7700 437 136	
				KIT		MK096 MK096		2	7700 840 234 S	
						L10908 L10908		2	7700 777 654	

Scenic II (JM0/1_) 06.03 →

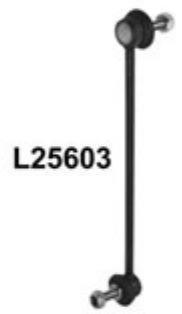
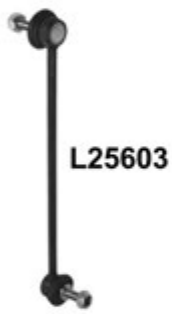

Scenic II (JM0/1_) 06.03 →

		i		←	→	Thread	Part Of	QPA	i
		↔				F 14x1,5 ∪		1	7701 474 796
						F 14x1,5 ∪		1	7701 474 795
						M 14x1,5 / M 14x1,5 ∪		2	7701 474 448
							L25125+L25217	1	
							L25126+L25217	1	
		⊥	18mm					2	7701 474 447
		⊥	18mm	<input checked="" type="checkbox"/>				1	8200 298 455
								1	8200 298 454
			(-) HD					2	8200 166 159
			HD					2	8200 669 066
			(+) L 25916	KIT	MK193	MK193		2	7701 208 891
								2	8200 222 463

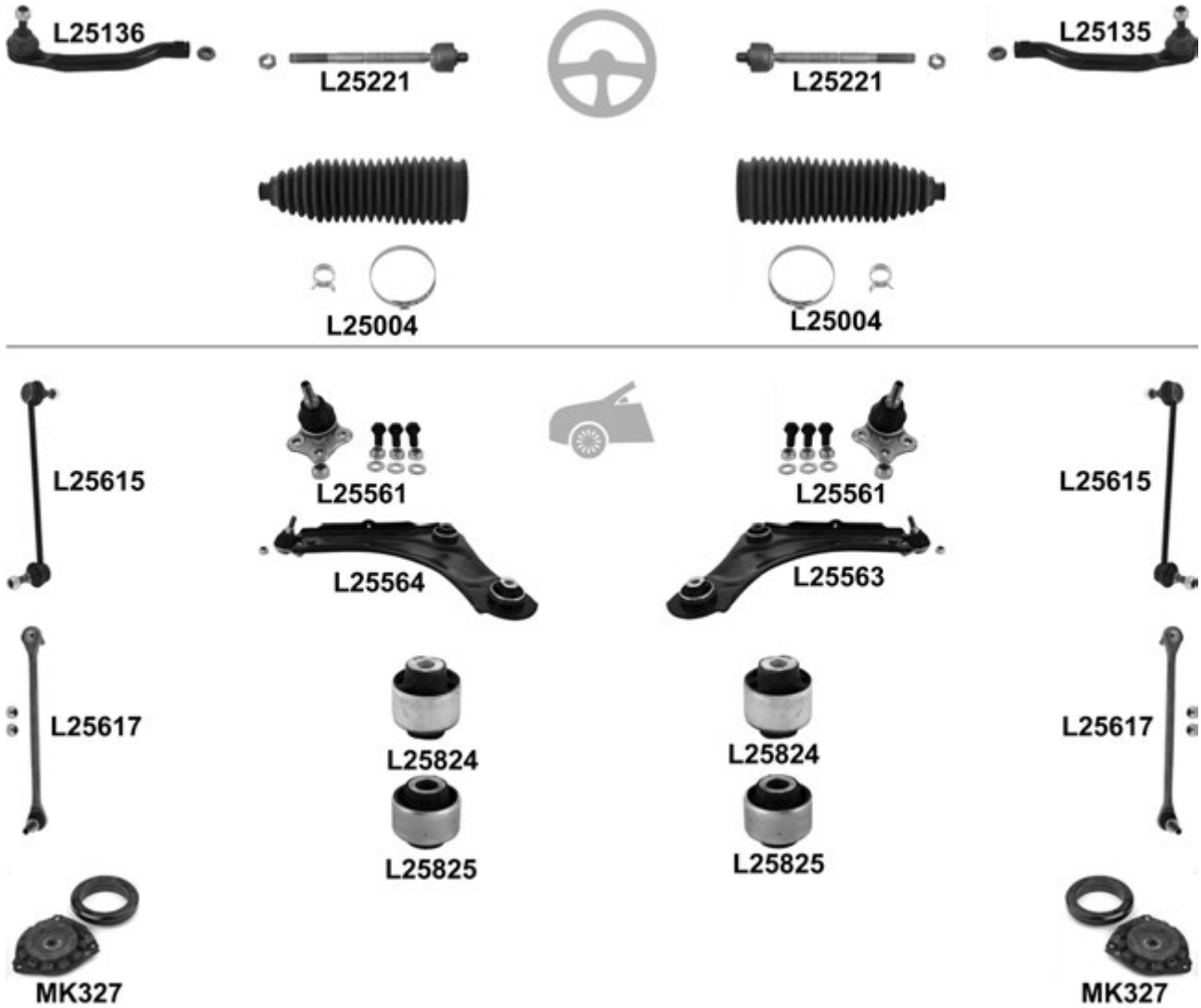
Scenic III (JZ0/1_) 02.09 →

			←	→	Thread	Part Of	QPA	
		↔		L25135	F 14x1,5 ∪		1	48520-4680R
				L25136	F 14x1,5 ∪		1	48520-4710R
			L= 200mm	L25221	L25221	M 14x1,5 / M 14x1,5 ∪	2	48521-5612R
			Thermoplast	L25004	L25004		2	48203-6715R
		⊥		L25561	L25561		2	40160-9060R
			<input checked="" type="checkbox"/>		L25563		1	54500-9207R
		⊥		L25564			1	54501-4055R
			▼	L25824	L25824		L25563/L25564	2
		▲	L25825	L25825		L25563/L25564	2	
			Metal	L25615	L25615		2	54618-0002R
			ALU	L25617	L25617		2	54618-0002R
		KIT	MK327	MK327		2		

Thalia (LB0, LB1, LB1) 02.98 → 10.03

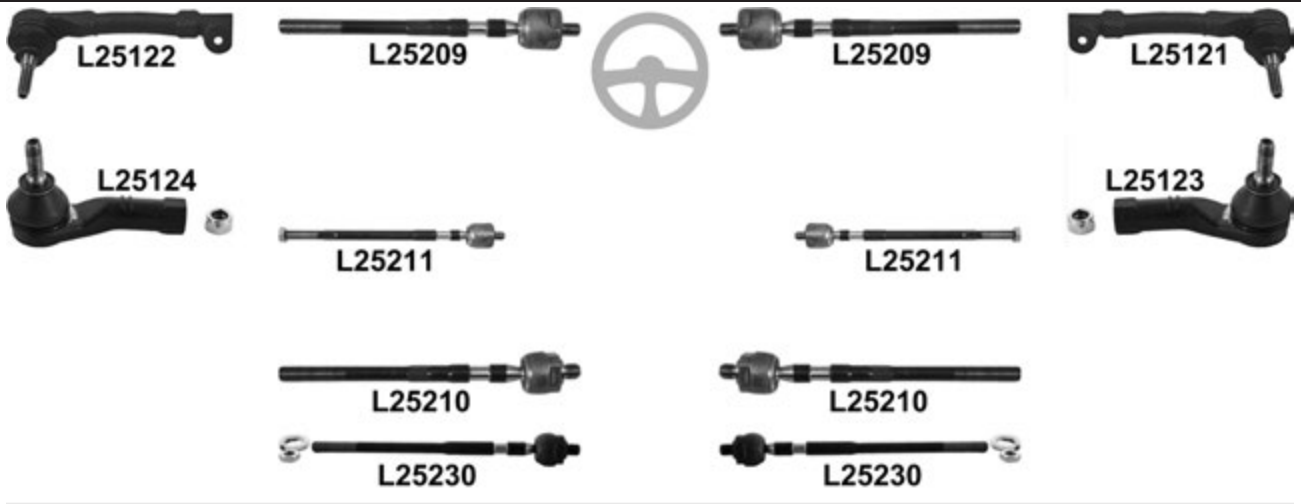

Thalia (LB0, LB1, LB1) 02.98 → 10.03

		i		←	→	Thread	Part Of	QPA	i	
		↔	→ 12.99		L25121	F 14x1,5 ∪		1	7701 471 146	
					L25122	F 14x1,5 ∪		1	7701 471 145	
			01.00 →		L25123	F 14x1,5 ∪		1	7701 047 416	
					L25124	F 14x1,5 ∪		1	7701 047 415	
				SMi, → 12.99	L25209	L25209	F 14x1,5 / M 12x1 ∪		2	7701 471 125
				SMi, 01.00 →, L= 300mm	L25211	L25211	F 14x1,5 / M 12x1 ∪		2	7701 473 655
				TRW, → 12.99, L= 240mm	L25210	L25210	M 14x1,5 / M 14x1,5 ∪		2	7701 471 143
				TRW, 01.00 →	L25230	L25230	M 14x1,5 / ∪		2	7701 472 735
		⊥	10mm	L2555	L2555			2	7701 468 883	
			12mm	L25535	L25535			2		
		⊥	1.5 Dci → 02.09	<input checked="" type="checkbox"/>	L25569 ^o			1	8200 263 166	
					L25570 ^o			1	7700 445 227	
				<input checked="" type="checkbox"/>	L25519			1	7700 445 228	
			1.5 Dci 03.09 →		L25520			1	7700 445 227	
		▲▼	(-) 4WD	L25806	L25806			4	7700 424 399	

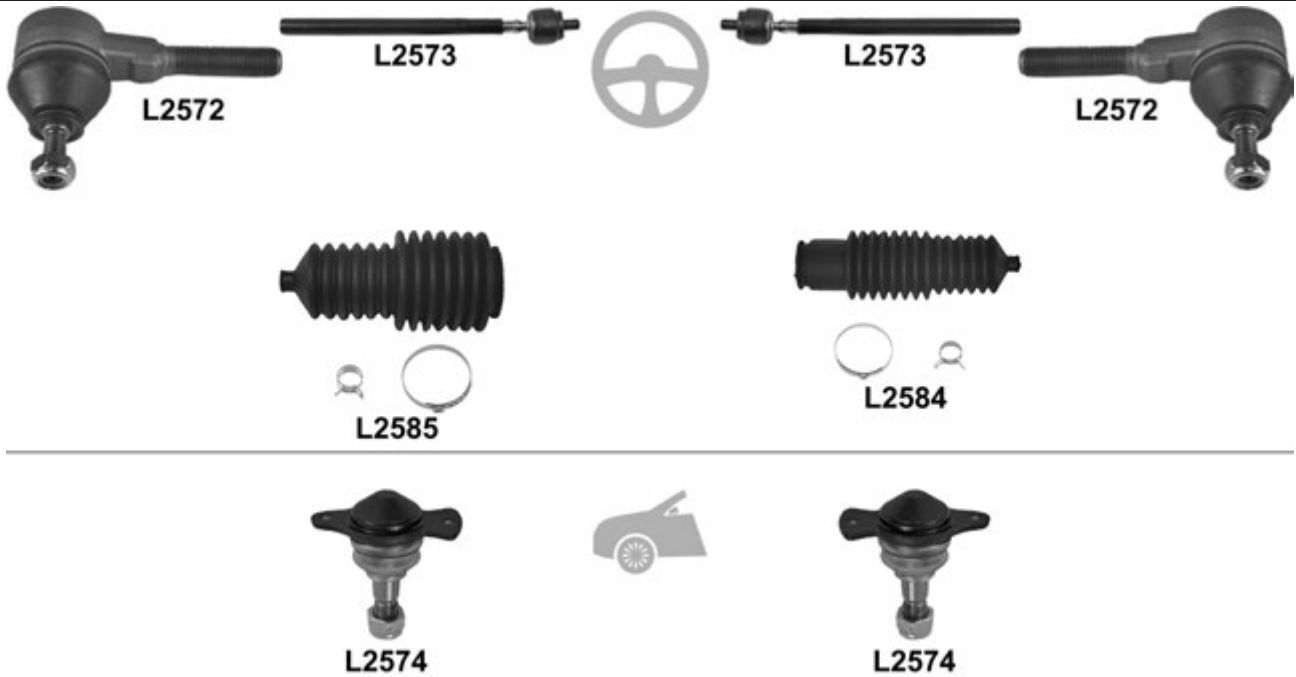
Trafic (P6 / T1/ T3 / T4 / T5 / T6 / T7 / PXX / TXX / TXW) 03.80 →

		i		←	→	Thread	Part Of	QPA	i
		↔		L2572	L2572	M 14x1,5 ∪		2	7701 461 770
				L2573	L2573	F 14x1,5 / M 12x1 ∪		2	
					L2584			1	7700 774 566
				L2585			1	7700 680 852	
		⊥		L2574	L2574			2	7701 461 667

Traffic (FL / JL) 03.01 →

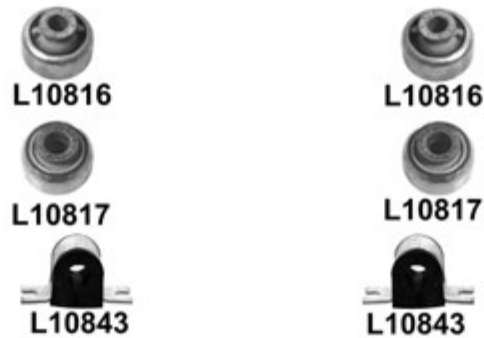

Traffic (FL / JL) 03.01 →

		i		←	→	Thread	Part Of	QPA	i
		↔				L10105 F 14x1,5 U		1	7701 049 283
						L10106 F 14x1,5 U		1	7701 049 284
						L10206 L10206 M 14x1,5 / M 12x1 U		2	7701 473 333
						L10018 L10018		2	7701 473 334
		↓	→ 08.06, 10mm ↔			L25527 L25527		2	8200 389 134 S
			08.06 →, 12mm ↔			L10552 L10552		2	7701 477 385
		↓	→ 08.06, 10mm ↔	<input checked="" type="checkbox"/>		L10527		1	54502-00QAB
						L10528		1	54503-00QAB
			08.06 →, 12mm ↔	<input checked="" type="checkbox"/>		L10569		1	8200 626 961
						L10570		1	8200 626 959
		▼				L10816 L10816		2	
		▲				L10817 L10817		2	
				KIT		MK181 MK181		2	8200 010 493
						L10606 L10606		2	4408904
		22mm			L10843 L10843	Anti-roll bar	2		

Twingo 03.93 →

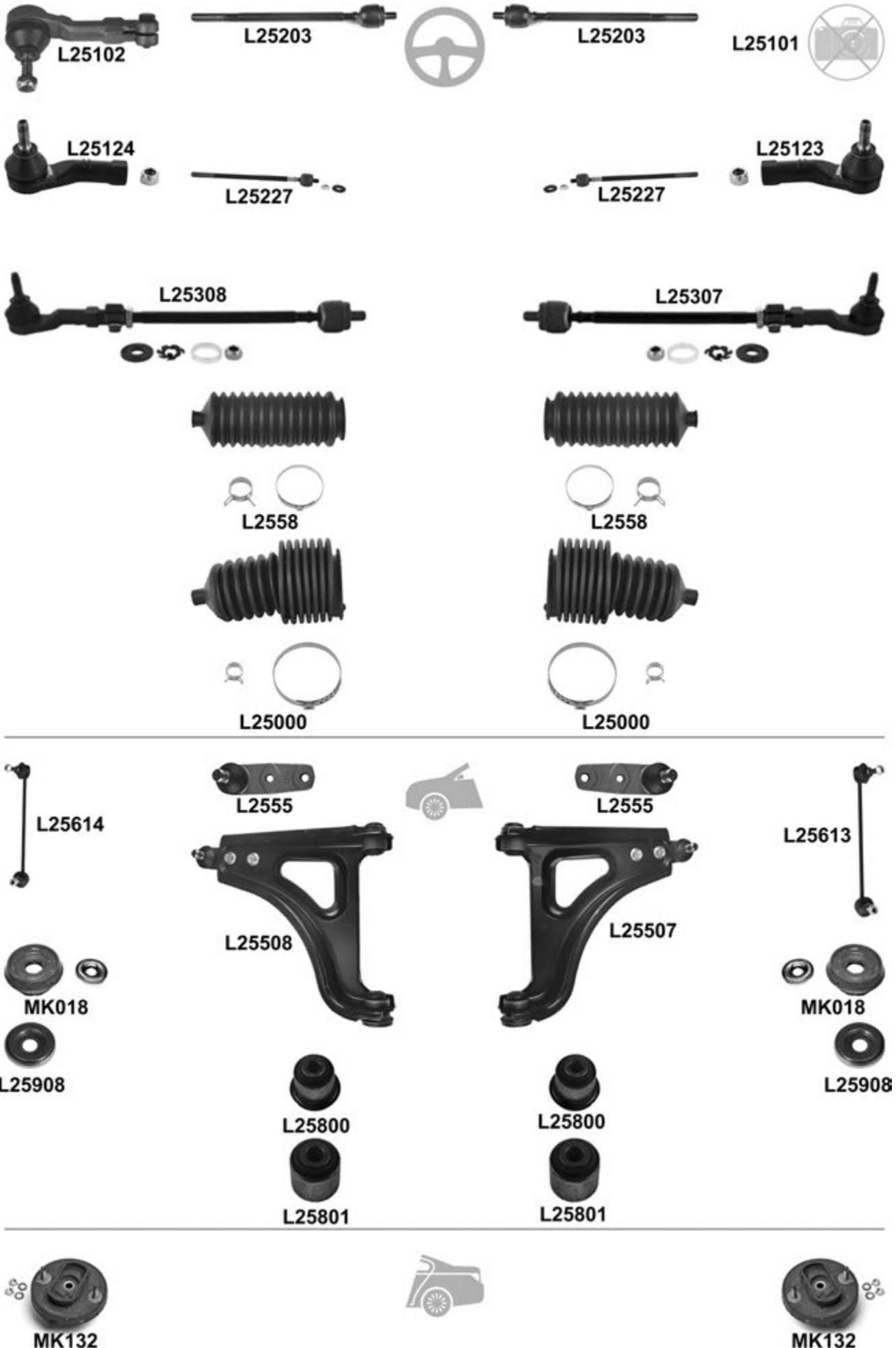

Twingo 03.93 →

				←	→	Thread	Part Of	QPA	
		↔	→ 12.99		L25101	F 14x1,5 ∪		1	60 00 022 731
					L25102	F 14x1,5 ∪		1	60 00 022 730
			12.99 →		L25123	F 14x1,5 ∪		1	7701 047 416
					L25124	F 14x1,5 ∪		1	7701 047 415
			→ 12.99, L= 300mm	L25203	L25203	M 14x1,5 / M 12x1 ∪		2	7701 469 517
			12.99 →, L= 316mm	L25227	L25227	M 14x1,5 / M 12x1 ∪		2	7701 473 498
			→ 12.99		L25307	∪	L25101+L25203	1	7701 467 219
					L25308	∪	L25102+L25203	1	7701 467 218
					L2558	L2558		2	7700 781 097
					L25000	L25000		2	7700 706 007
		⊥		L2555	L2555			2	7701 468 883
		⊥		<input checked="" type="checkbox"/>	L25507			1	7700 820 029
					L25508			1	7700 820 028
		▼		L25800	L25800			2	7700 831 364
		▲		L25801	L25801			2	7700 819 929
						L25613		1	8200 714 448
						L25614		1	8200 714 446
				KIT	MK018	MK018		2	7700 827 435
				L25908	L25908		2	60 01 025 850	
				MK132	MK132		2		

Twingo (CN0_) 03.07 →

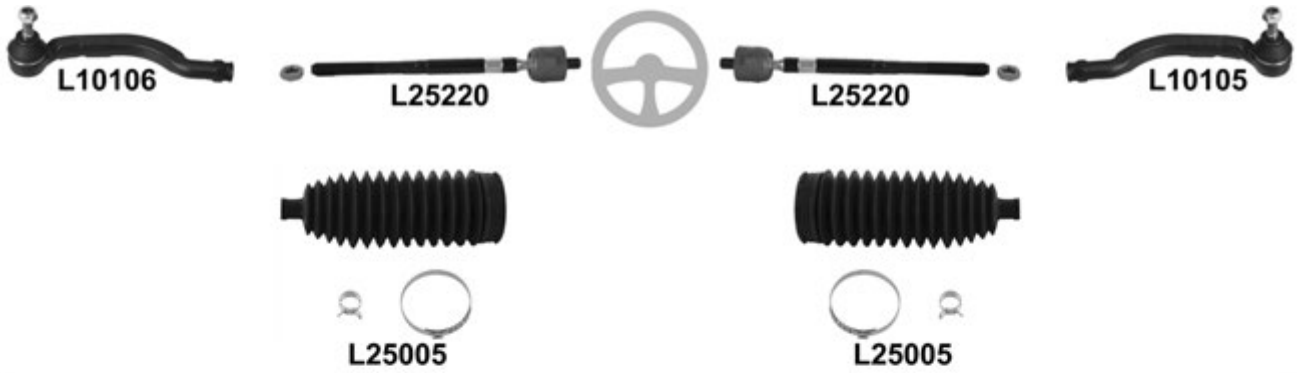

		← →		Thread	Part Of	QPA		
		↔		L25123	F 14x1,5 ∪	1	7701 047 416	
				L25124	F 14x1,5 ∪	1	7701 047 415	
				L25229	L25229	M 14x1,5 / M 12x1 ∪	2	48521-3046R
			∅ 14mm, ∅ 53,5mm, L= 165mm	L25012 ⁰	L25012 ⁰		2	7701 477 822
		⊥		L25571	L25571		2	
		⊥	(-) Stability Control System (ESP) <input checked="" type="checkbox"/>		L25569 ⁰		1	8200 942 413
					L25570 ⁰		1	8200 942 417
			(-) Stability Control System (ESP) KIT	MK100	MK100		2	543A0-0300R
				L25908 ¹	L25908 ¹		2	6001 025 850

Vel Satis (BJO) 06.02 →

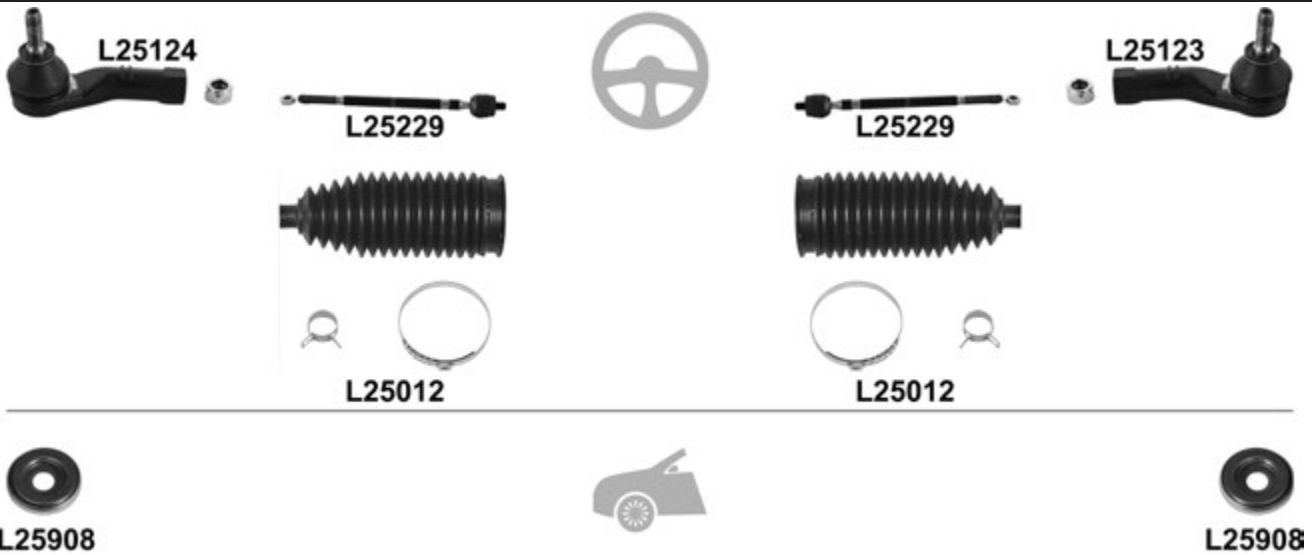
				← → Thread		Part Of	QPA			
⊕	↔			L10105	F 14x1,5 U		1	7701 049 283		
				L10106	F 14x1,5 U		1	7701 049 284		
	↔			L25220	L25220	M 14x1,5 / M 12x1 U		2	7701 474 076	
				L25005 ^o	L25005 ^o			2	7701 474 075	
⊖	⊥			L25527	L25527		2	8200 818 413/414		
		▼		L10816	L10816		2			
	▲		L25818	L25818		2				
	↔		L10606	L10606		2	8200 002 870			
	↻	12.05 →, (+) MK343	KIT	MK185	MK185		2	7701 207 537 SK		
	⊙			L25914	L25914		2	7700 424 481		

Wind 07.10 →

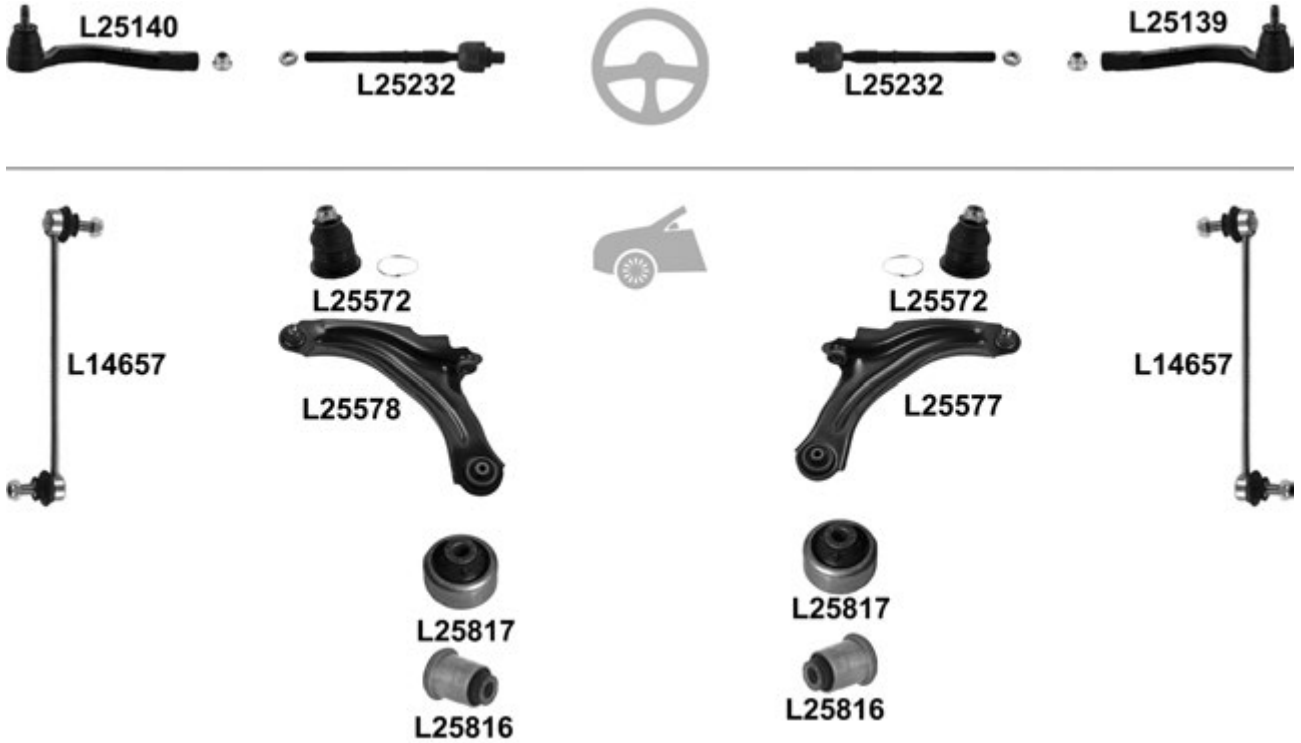
						←	→	Thread	Part Of	QPA		
				L25123	F 14x1,5 ∪					1	7701 047 416	
				L25124	F 14x1,5 ∪					1	7701 047 415	
			L25229	L25229	M 14x1,5 / M 12x1 ∪					2	48521-3046R	
			ø 14mm, Ø 53,5mm, L= 165mm	L25012 ⁰	L25012 ⁰						2	7701 477 822
			L25908 [!]	L25908 [!]						2	6001 025 850	

Zoe 06.12 →

		i	←	→	Thread	Part Of	QPA	i
				L25139	F 14x1,5 ∪		1	48520-8355R
			L25140		F 14x1,5 ∪		1	48520-0368R
				L25572	L25572		2	L25577/L25578
			<input checked="" type="checkbox"/>	L25577			1	54504-8506R
				L25578			1	54505-5711R
			<input checked="" type="checkbox"/>	L25817	L25817		2	L25577/L25578
				L25816	L25816		2	L25577/L25578
			<input checked="" type="checkbox"/>	L14657	L14657		2	8200 586 570
			L14657	L14657		2	8201 079 463	

ROVER

Allegro 1973 → 1982



		i	←	→	Thread	Part Of	QPA	i
		↔	L0003	L0003	F 1/2"x20 UNF ♂		2	GSJ100

Maxi 1500 / 1750 1969 → 1982



		i	←	→	Thread	Part Of	QPA	i
		↔	L0003	L0003	F 1/2"x20 UNF ♂		2	GSJ100

Metro 1980 → 04.90



		i	←	→	Thread	Part Of	QPA	i
		↑	L17106	L17106			2	GSJ268
	→ 10.84		L17107	L17107			2	GSJ269
	11.84 →							

Mini Clubman 1959 →
 Mini Cooper 1959 →
 Mini 850 1959 →
 Mini 1000 1959 →

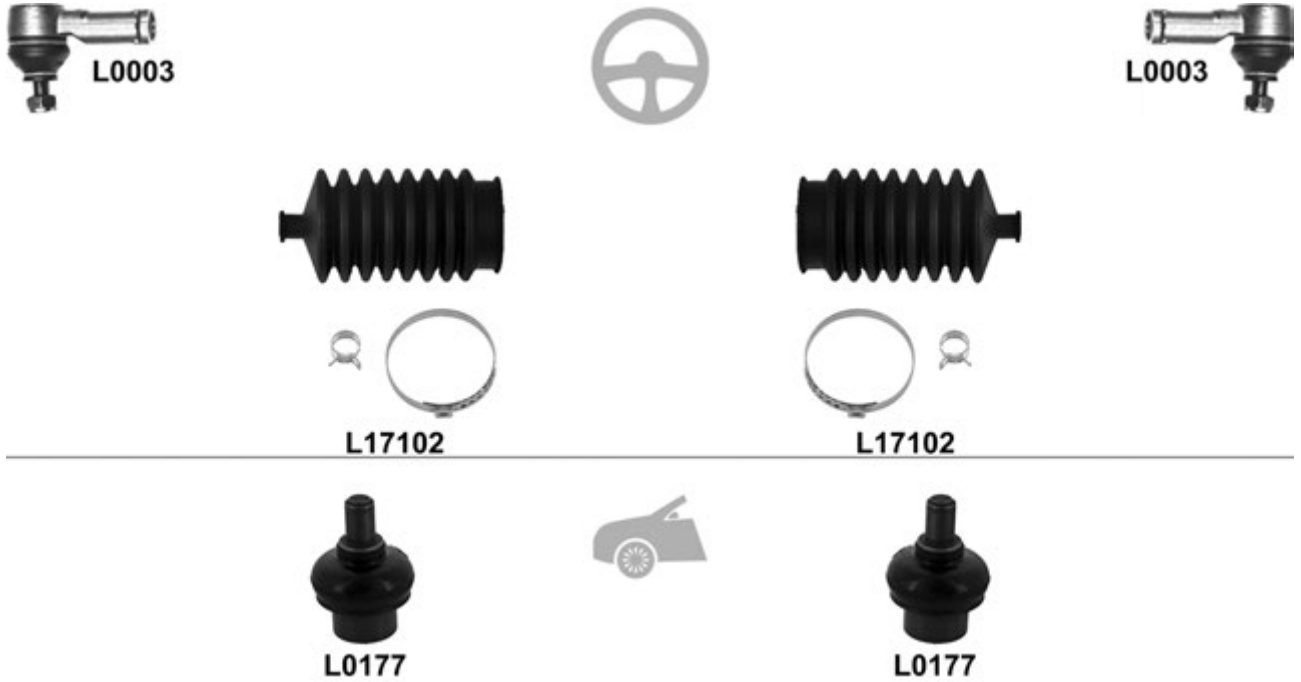

			i	←	→	Thread	Part Of	QPA	i
		↔		L0003	L0003	F 1/2"x20 UNF ♂		2	GSJ100
				L17102	L17102			2	BHM 7113
		▲▼		L0177	L0177			2	21A1163

Streetwise 08.03 →



			i	←	→	Thread	Part Of	QPA	i
		↔		L17113	L17113	F 14x1,5 ♂		2	GSJ288
		⊥	<input checked="" type="checkbox"/>		L17503			1	GSJ414
				L17504				1	GSJ413
				L10613	L10613			2	EGP1662

25 (RF) 10.99 →

				← → Thread		Part Of	QPA	
⊕		↔		L17113	L17113	F 14x1,5 ♂	2	GSJ288
				L17201	L17201	M 14x1,5 / M 14x1,5 ♂	2	GSV1170
⊖		⊥	<input checked="" type="checkbox"/>		L17503		1	GSJ414
				L17504		1	GSJ413	
				L10613	L10613	2	EGP1662	

45 (RT) 02.00 →

				← → Thread		Part Of	QPA	
⊕		↔		L40105		F 14x1,5 ♂	1	GSJ496
				L40106		F 14x1,5 ♂	1	GSJ495
⊖		↑			L10525		1	51450-ST3-E10
				L10526		1	51460-ST3-E10	
				L40160	L40160	2	90112-SE0-000	

75 (RJ) 02.99 →

L17118

L17117

L10036

L10036

L17602

L17508

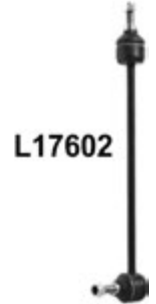
L17507

L17602

L17604

L17603

Thread
Part Of
QPA

				L17117	↺		1	QSJ878	
				L17118	↻		1	QSJ877	
				L10036 ⁰	L10036 ⁰		2	QFW000060	
					L17507			1	GSJ1000
					L17508			1	GSJ1001
				L17602	L17602		2	RBM100240	
					L17603			1	RGD100561
					L17604			1	RGD100571

213, 216, 216 Vitesse (XH) 03.85 → 09.89
 214 - 220 Turbo (XW) 10.89 →
 211 - 220 Sdi (RF) 11.95 → 03.00



				← → Thread		Part Of	QPA		
		↔		L17113	L17113	F 14x1,5 ∪		2	GSJ288
				L17201	L17201	M 14x1,5 / M 14x1,5 ∪		2	GSV1170
		⊥			L17503			1	GSJ414
					L17504			1	GSJ413
					L10613	L10613		2	EGP1662
		⊥ ▲	longitudinal	L10815	L10815			2	52385-SR3-003

414 - 420 Turbo (XW) 04.90 → 04.95
 416 - 420 Tourer (XW) 09.93 → 11.98

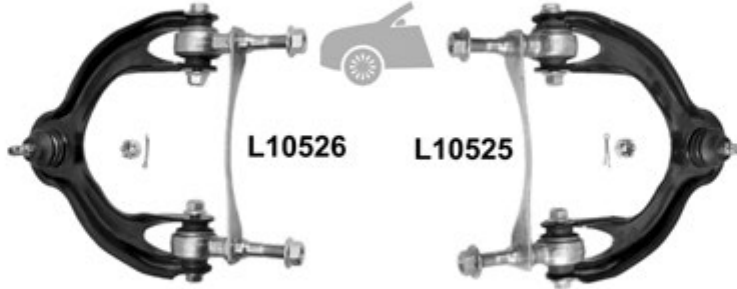

				← → Thread		Part Of	QPA		
		↔		L17113	L17113	F 14x1,5 ∪		2	GSJ288
				L17201	L17201	M 14x1,5 / M 14x1,5 ∪		2	GSV1170
		⊥			L17503			1	GSJ414
					L17504			1	GSJ413
					L10613	L10613		2	EGP1662
		⊥ ▲	longitudinal	L10815	L10815			2	52385-SR3-003

414 - 420 S8i Lux (RT) 05.95 → 03.00

Thread
Part Of
QPA

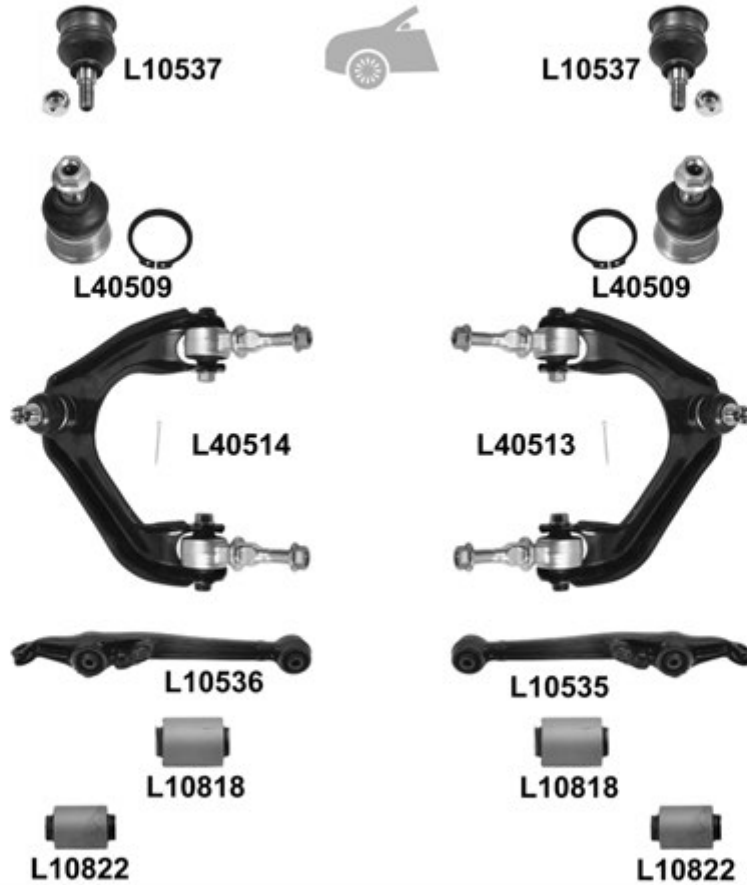
				L40105	F 14x1,5 ♂		1	GSJ496	
				L40106	F 14x1,5 ♂		1	GSJ495	
				L10525			1	RBJ102120	
				L10526			1	RBJ102130	
				L40160	L40160		2	90112-SEO-000	
			longitudinal	L10815	L10815		2	52385-SR3-003	

618 I/Si - 620 Sdi (RH) 08.93 → 02.99

			←	→	Thread	Part Of	QPA	
		↔		L40107			1	GSJ408
			L40108				1	GSJ407
		↑	L40202	L40202			2	GSV1211
			L10537	L10537		L40513/L40514	2	
		↓	L40509	L40509			2	GSJ404
				L40513			1	GSJ424
		↓	L40514				1	GSJ423
				L10535			1	RBJ100690
		↓↔	L10818	L10818			2	RBX100451
			L10822	L10822			2	
		↑	L10826	L10826			2	RGX100240

820, 825, 825 D 10.86 →
827 02.88 →



			i	←	→	Thread	Part Of	QPA	i
		↔				L17111	F 12x1,25 U	1	GSJ279
						L17112	F 12x1,25 U	1	GSJ280
		⊥				L17502	L17502	2	GSJ295

1100, 1300 1963 → 1974



			i	←	→	Thread	Part Of	QPA	i	
		↔				L0003	L0003	F 1/2"x20 UNF U	2	8G8625

SAAB

90 08.84 → 08.87



L65006



L65005



Thread

Part Of

QPA

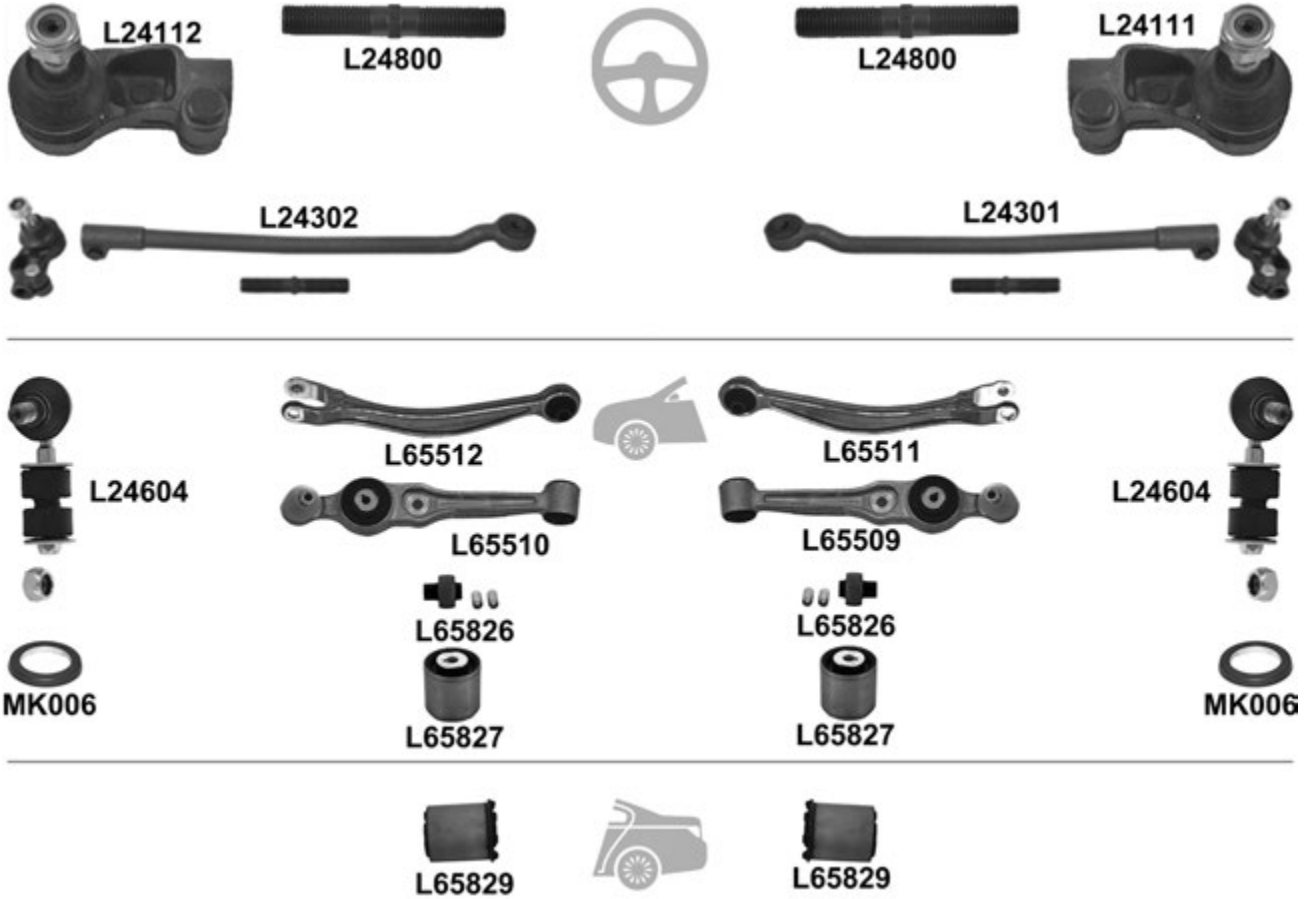

				L0006	L0006	F 14x2 U		2	8993560		
						L65005			1	8944738	
						L65006			1	8947913	
				L0658	L0658			2	8993321		
				L0658	L0658			2	8993321		
				L0658	KIT	L65800	L65800			4	
						L65804	L65804			2	7163603
			longitudinal	L65801	L65801			2	8908675		
				L65330	L65330			2			

9.3 (YS3D) 02.98 → 09.02
9.3 Cabriolet (YS3D) 02.98 → 08.03

		i	←	→	Thread	Part Of	QPA	i	
⊕		↔		L24111	F 16x2 ∩		1	4242756	
				L24112	F 16x2 ∩		1	4242749	
			L24800	L24800		Drag link	2	4242731	
			L24301				1		
🚗		⊥▼		L65511			1	4647012	
				L65512			1	4647004	
		⊥▲		L65509				1	4543468
				L65510				1	4543450
		⊥▼	L65826	L65826			2	4482402	
		⊥▲	L65827	L65827			2	4545711	
			L24604	L24604			2	4544599 S	
			MK006	MK006			2		
		L65829	L65829		Hub carrier	2	4467791		

9.3 (YS3F) 09.02 →
 9.3 Cabriolet (YS3F) 08.03 →
 9.3 Kombi 03.05 →

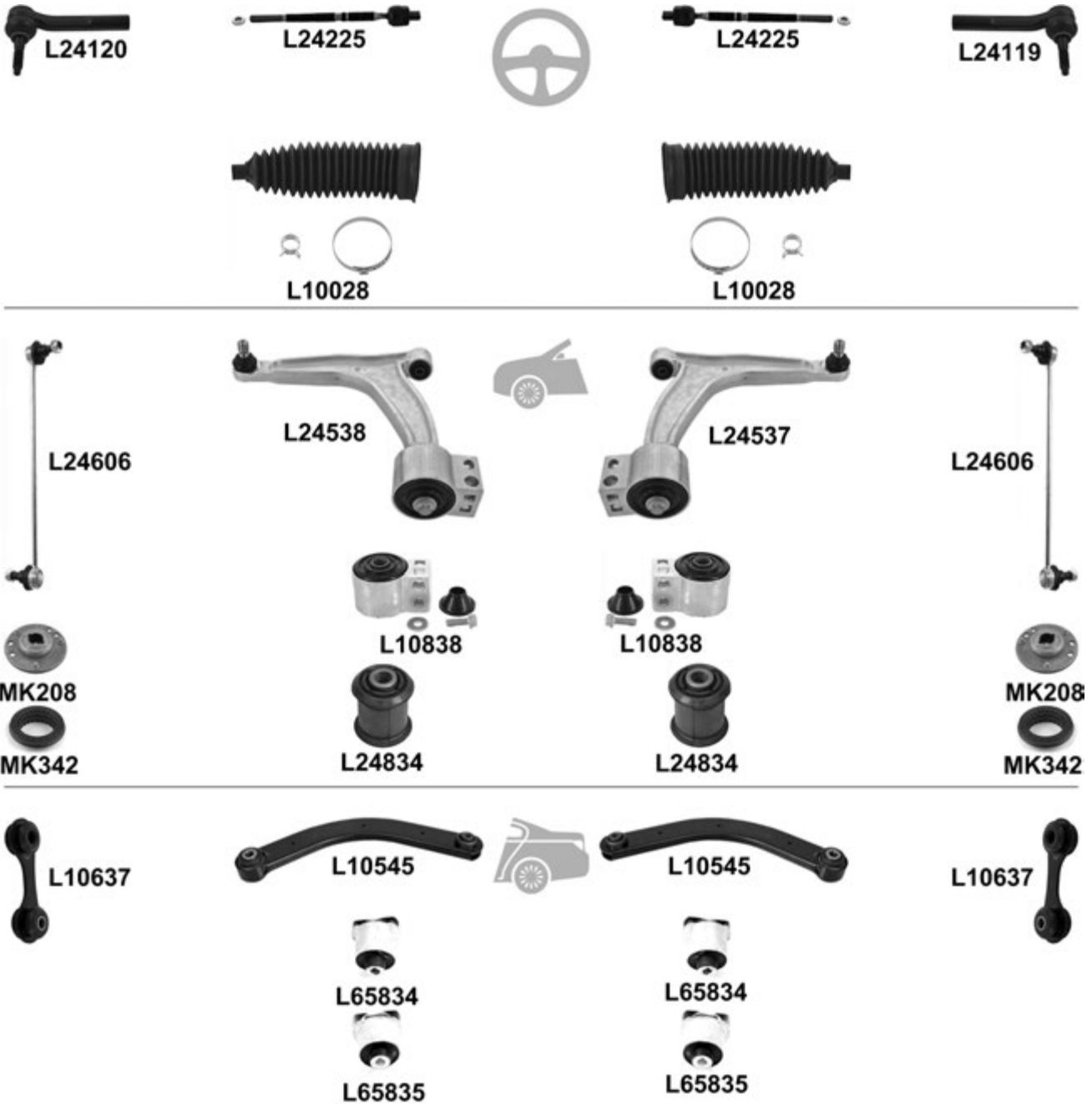

9.3 (YS3F) 09.02 →
 9.3 Cabriolet (YS3F) 08.03 →
 9.3 Kombi 03.05 →

				←	→	Thread	Part Of	QPA	
		↔	→ 12.07		L24119			1	12801423
				L24120				1	12801424
			→ 12.06, (16), (17)	L24225	L24225			2	12804238
				L10028 ⁰	L10028 ⁰			2	93191675
		⊥			L24537			1	12796014
				L24538				1	12796013
		⊥▼		L10838	L10838			2	12 786 412
		⊥▲	12 x 36 x 60mm	L24834	L24834			2	45 668 99
				L24606	L24606			2	24417251
			(+) MK342	KIT	MK208	MK208		2	13 188 763
				MK342	MK342			2	91 911 81
		⌈		L10545	L10545			2	13230274
		▼		L65834	L65834		Hub carrier	2	12786341
		▲		L65835	L65835		Hub carrier	2	12786340
				L10637 ⁰	L10637 ⁰			2	444275

9.3 Sport (D4_, E7_) 06.02 →

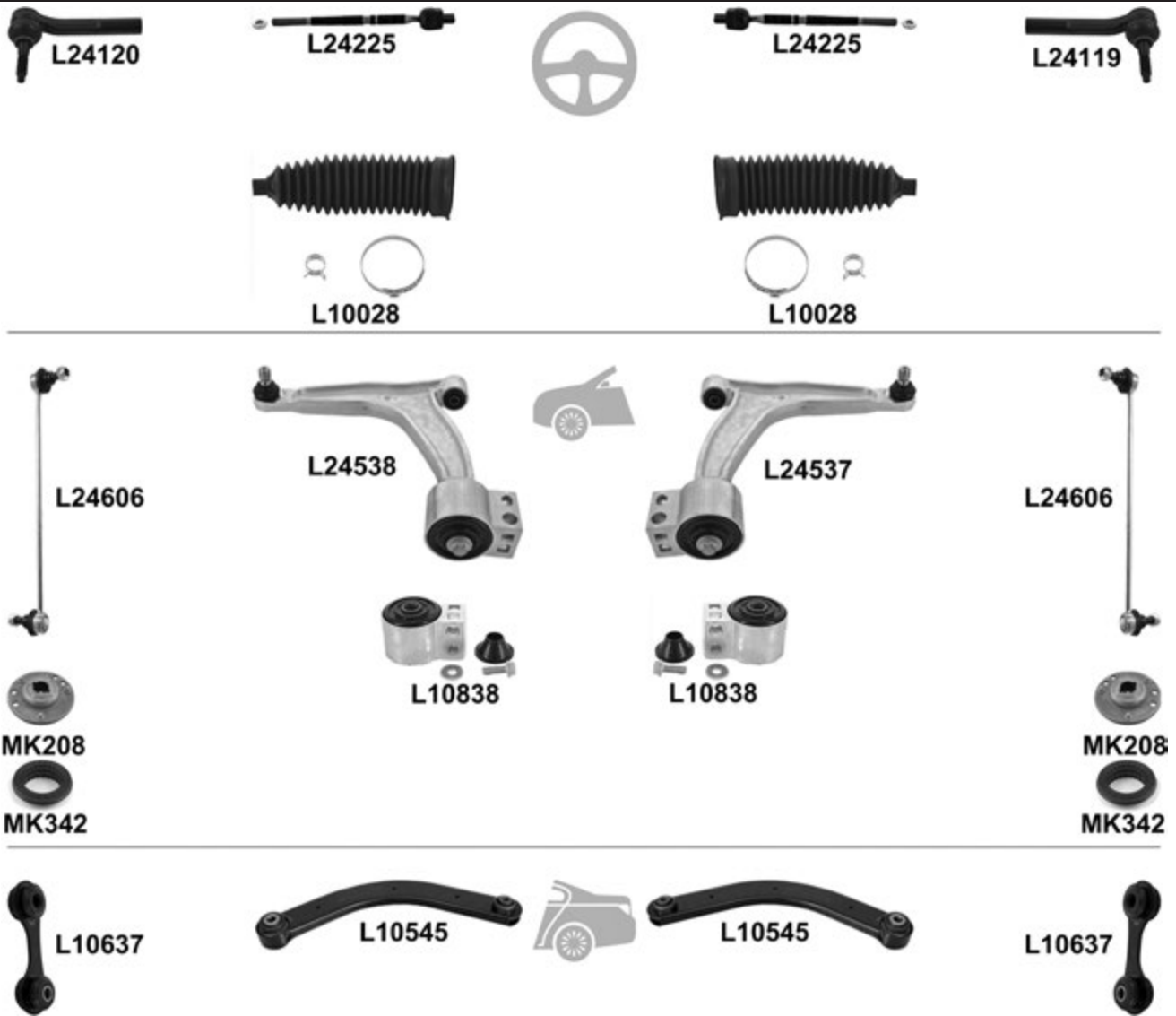

		← → Thread		Part Of		QPA		
⊕	↔	→ 12.07		L24119		1	12801423	
			L24120			1	12801424	
	→ 12.06		L24225	L24225		2	12804238	
			L10028 ⁰	L10028 ⁰		2	93191675	
🚗	⊥		<input checked="" type="checkbox"/>	L24537		1	12796014	
				L24538		1	12796013	
	⊥ ▾			L10838	L10838		2	12 786 412
				L24606	L24606		2	24417251
	→ 12.07, (+) MK342		KIT	MK208	MK208		2	13 188 763
				MK342	MK342		2	91 911 81
🚗	⊥		<input checked="" type="checkbox"/>	L10545	L10545		2	13230274
		(-) 4WD		L10637 ⁰	L10637 ⁰		2	444275

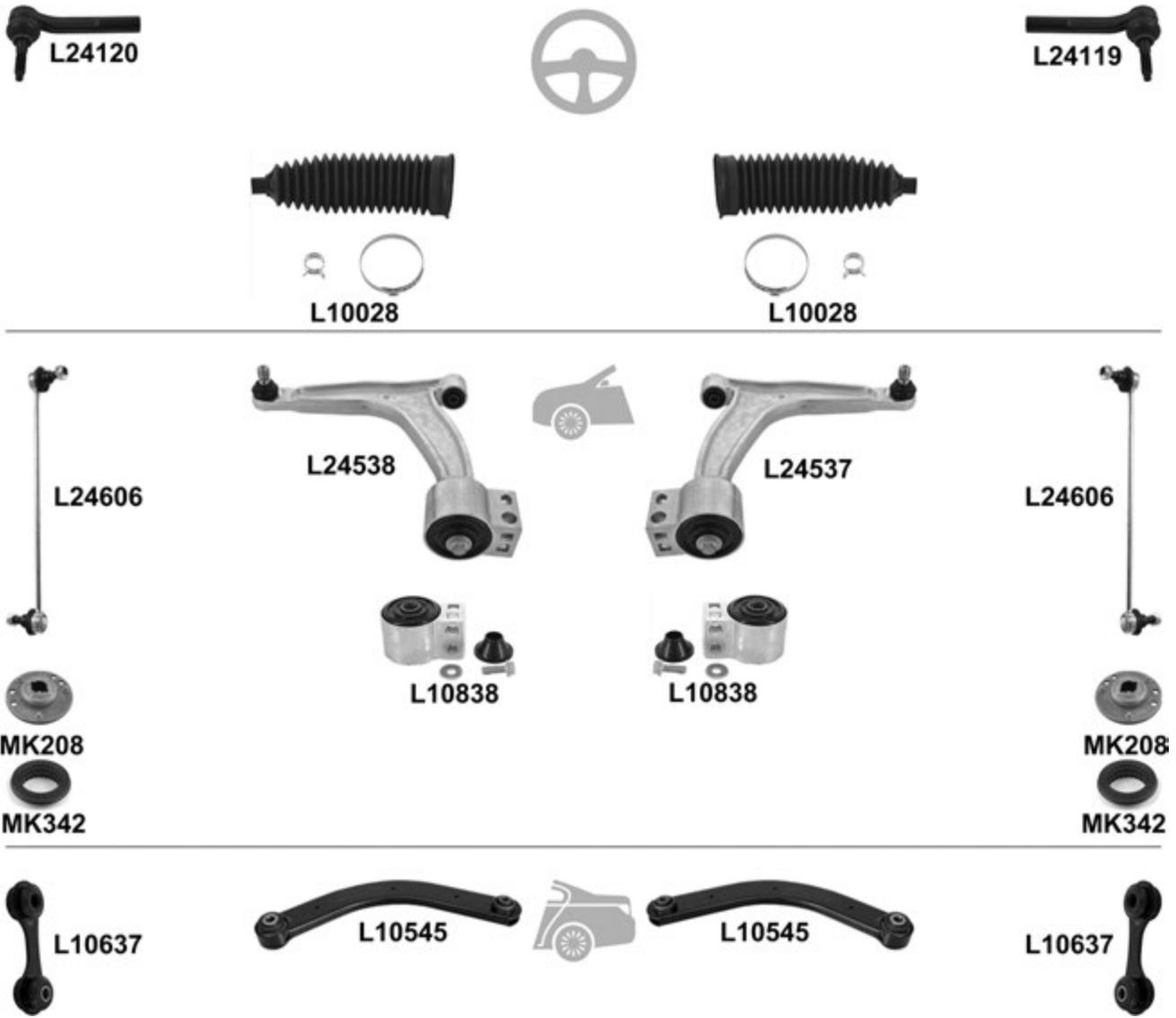
9.3 X 02.09 →

				←	→	Thread	Part Of	QPA			
		↔	1.9		L24119			1	12801423		
					L24120			1	12801424		
					L10028 ⁰	L10028 ⁰			2	93191675	
		⊥		<input checked="" type="checkbox"/>	L24537			1	12796014		
					L24538			1	12796013		
				<input checked="" type="checkbox"/>	L10838	L10838			2	12 786 412	
					L24606	L24606			2	24417251	
					→ 12.09, (+) MK342	KIT	MK208	MK208		2	13 188 763
							MK342	MK342	, MK208	2	91 911 81
		↑		<input checked="" type="checkbox"/>	L10545	L10545		2	13230274		
					L10637 ⁰	L10637 ⁰		2	444275		
			(-) 4WD								

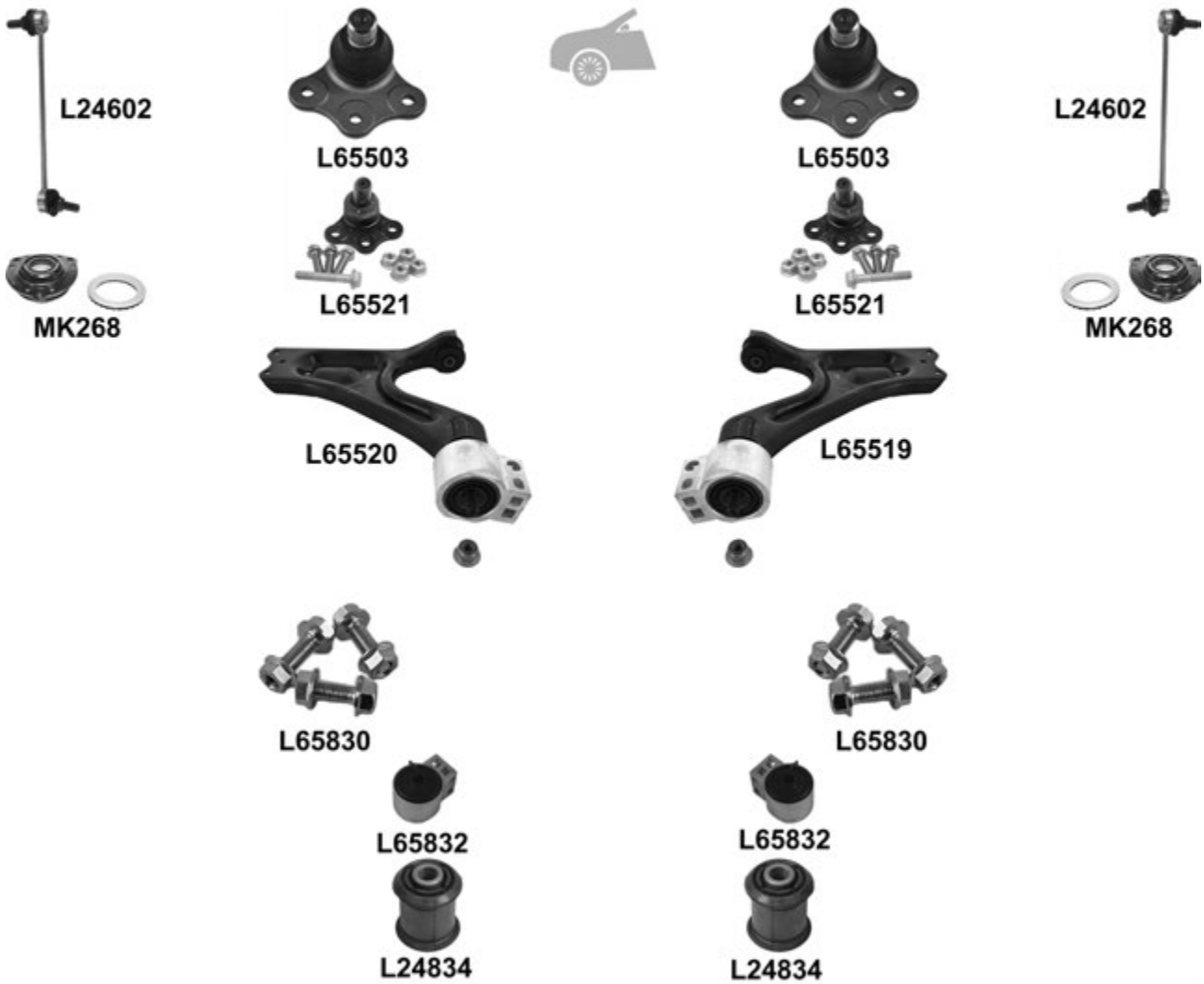
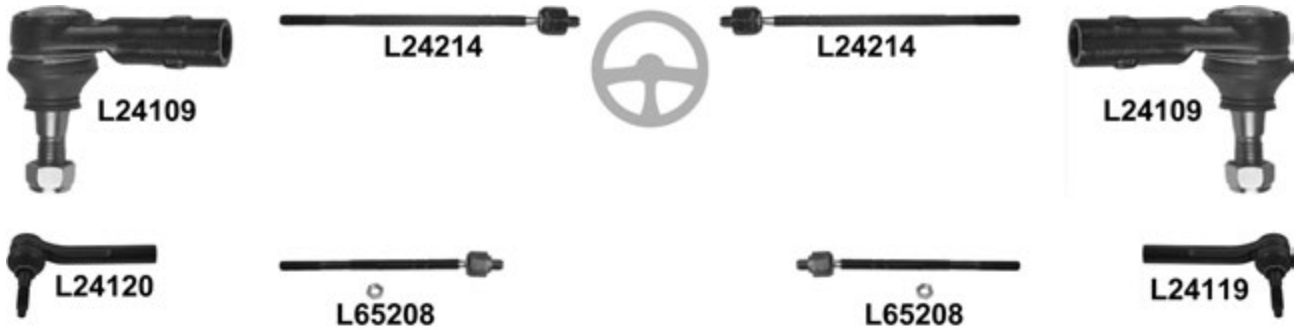
9.5 (YS3E) 09.97 →

9.5 (YS3E) 09.97 →

				←	→	Thread	Part Of	QPA	
		↔	→ 12.01 , ch. → 23039860	L24109	L24109			2	4836540
			01.02 →, ch. 23039861 →	L24120	L24119			1	5239322
			→ 12.01 , ch. → 23039860	L24214	L24214			2	48 36 557
			01.02 →, ch. 23039861 →	L65208	L65208			2	52 35 585
		⊥	→ 12.01 , 18mm	L65503	L65503			2	5231683
			01.02 →, 20mm	L65521	L65521			2	5237516
		⊥	New version Steel <input checked="" type="checkbox"/>	L65520	L65519			1	93185280
				L65520				1	93185279
			KIT	L65830	L65830			2	
		⊥		L65832	L65832			2	5063391
		⊥	12 x 36 x 60mm	L24834	L24834			2	4566899
				L24602	L24602			2	5236823
			KIT	MK268	MK268			2	
		↔		L24826	L24826			4	4566378
		↔		L24837	L24837			4	4567244
		⊥	transverse	L24553	L24553			2	9053844
				L10637 ⁰	L10637 ⁰			2	4906111

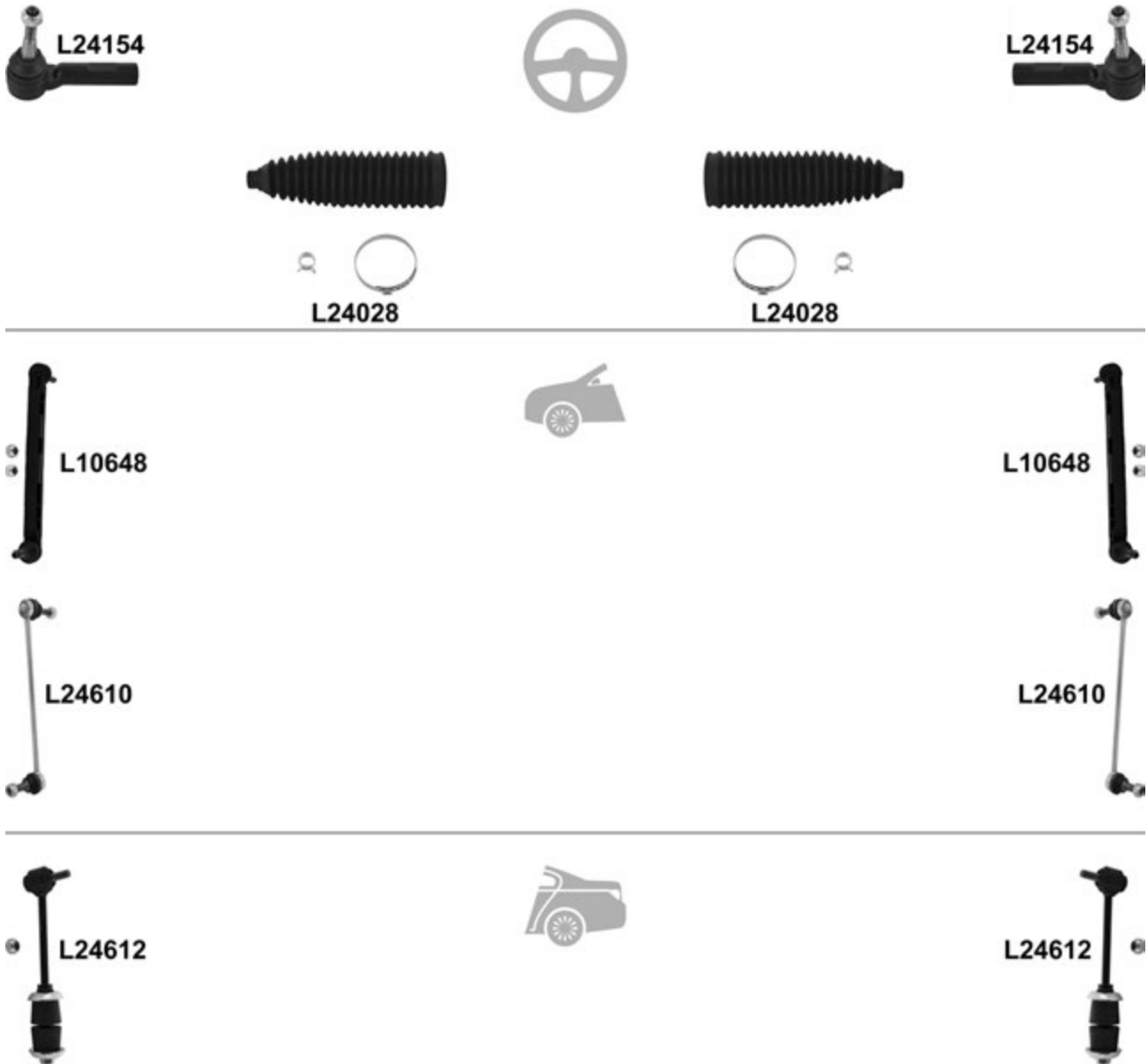
9.5 (YS3G) 05.10 →

		i		←	→	Thread	Part Of	QPA	i
		↔	(-) Sport Pack	L24154	L24154	F 16x1,5 U		2	13272000
				L24028	L24028			2	13271036
			(-) IDS chassis/Sport Pack	L10648	L10648			2	13219141
			IDS chassis, (-) Sport Pack	L24610	L24610			2	13258052
				L24612	L24612			2	13281793

93 1958 → 1976
 95 1958 → 1976
 96 1958 → 1976



Thread

Part Of

QPA



		↔		L0005	L0005	F 9/16"x18 UNF ♂		2 8993339
		↑		L0656	L0656			2 7372170
		↓		L0656	L0656			2 7372170

99 1968 → 1974



Thread

Part Of

QPA



		↑		L0658	L0658			2 8993321
		↓		L0658	L0658			2 8993321
			L0658	KIT	L65800	L65800		4
		↑		L65804	L65804			4 7163603
		▲	longitudinal	L65801	L65801			2 8908675

99 09.75 → 12.84

SAAB



L65006



L65005

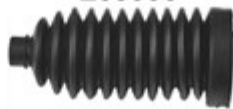

L65011

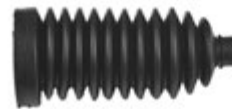

L65011



		i		←	→	Thread	Part Of	QPA	i
		↔		L0006	L0006	F 14x2 U		2	8993560
					L65005			1	8944738
				L65006				1	8947913
				L65011	L65011			2	8993099
		↑		L0658	L0658			2	8993321
		↓		L0658	L0658			2	
			L0658	KIT	L65800	L65800		4	
		↑		L65804	L65804			4	7163603
		▲	longitudinal	L65801	L65801			2	8908675
		↓	79 →	L65330	L65330			2	

900 09.78 → 06.94

SAAB

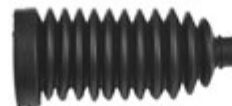
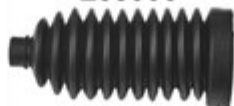
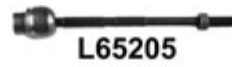
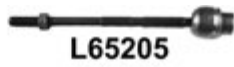

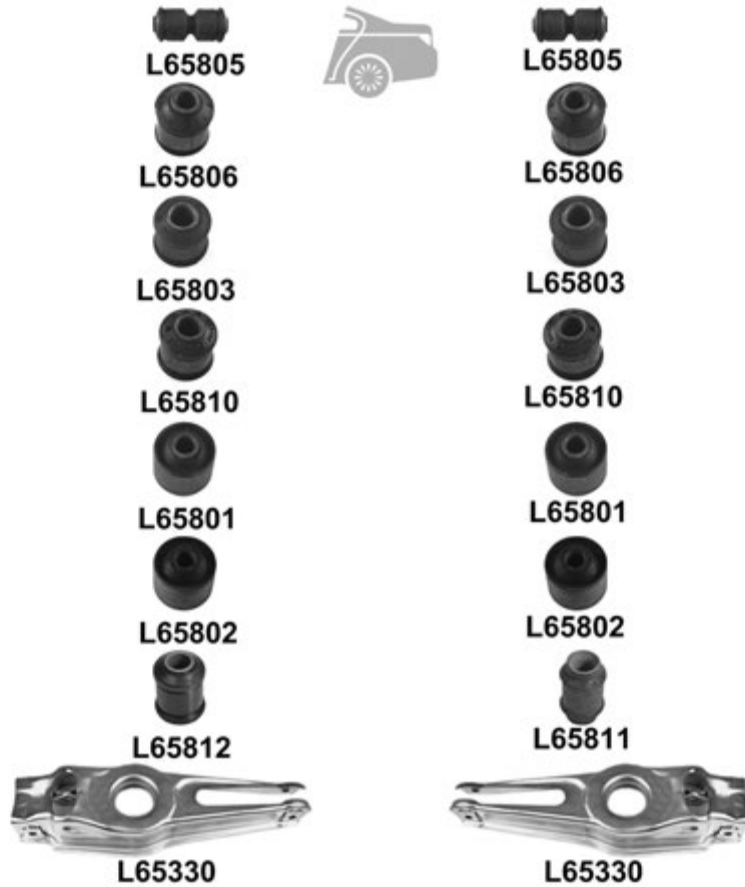

			←	→	Thread	Part Of	QPA		
		↔	L0006	L0006	F 14x2 ⌀		2	8993560	
			L65205	L65205	M 14x2 / F 14x1,5		2	8988941	
				L65005				1	8944738
				L65006				1	8947913
		↕	L0658	L0658			2	8993099	
		⊥	L0658	L0658			2	8993321	
		⊥		L65517			1	4199584	
				L65518			1	4199576	
			L0658	KIT	L65800	L65800		4	
		↕		L65804	L65804			4	7163603
		↕↕		L65809	L65809			4	7184443
				L65820	L65820		Anti-roll bar	2	8990087
		▼		L65805	L65805		2	8935306	
		▲		L65806	L65806		2	8935208	
	▼	→ 12.87 longitudinal		L65803	L65803		2	8932741	
		01.88 → longitudinal		L65810	L65810		2	8956468	
	▲	→ 12.87 longitudinal		L65801	L65801		2	8908675	
		01.88 → longitudinal		L65802	L65802		2	9103110	
		transverse			L65811		1	8930307	
			L65812			1	8932014		
			L65330	L65330			2		

900 II 07.93 →

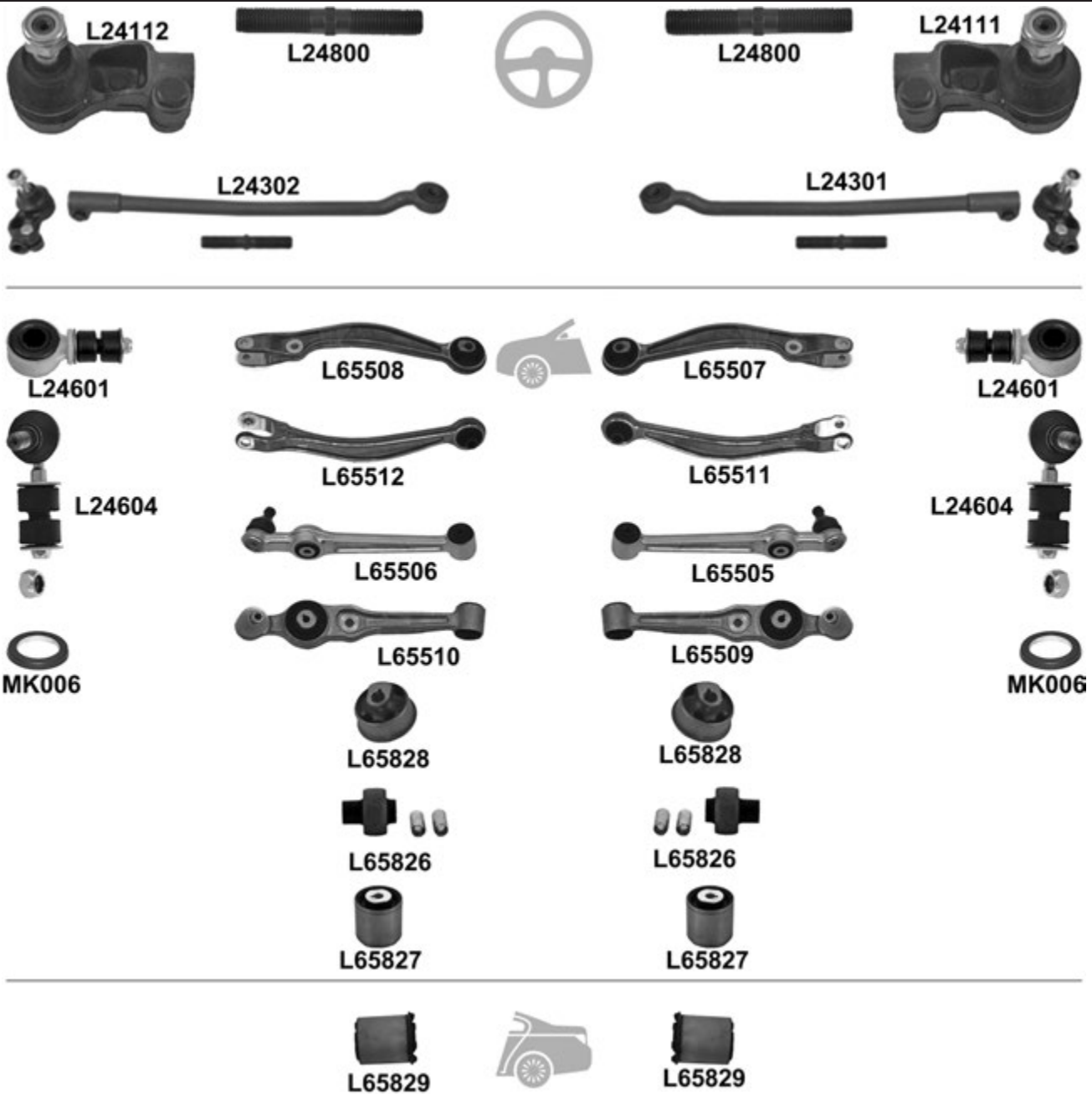

				←	→	Thread	Part Of	QPA		
		↔		L24111		F 16x2 ⌀		1	4242749	
				L24112		F 16x2 ⌀		1	4242756	
				L24800	L24800		Drag link	2	4242731	
					L24301				1	
					L24302				1	
		⊥▼	ch. → S2012271		L65507			1	4545000	
			ch. → S7014772		L65508				1	4544995
			ch. S2012272 →		L65511				1	4647012
			ch. S7014773 →		L65512				1	4647004
		⊥▲	ch. → S2012271		L65505				1	4248449
			ch. → S7014772		L65506				1	4248431
			ch. S2012272 →		L65509				1	4543468
			ch. S7014773 →		L65510				1	4543450
		⊥▼	ch. → S2012271	L65828	L65828			2	4544987	
			ch. → S7014772							
			ch. S2012272 →	L65826	L65826			2	4482402	
			ch. S7014773 →							
	⊥▲	ch. S2012272 →	L65827	L65827			2	4545711		
		ch. S7014773 →								
		ch. → S2012271	L24601	L24601			2	4400040 S		
		ch. → S7014772								
		ch. S2012272 →	L24604	L24604				2	4544599 S	
		ch. S7014773 →								
			MK006	MK006			2			
			L65829	L65829		Hub carrier	2	4467791		

9000 09.84 →

SAAB

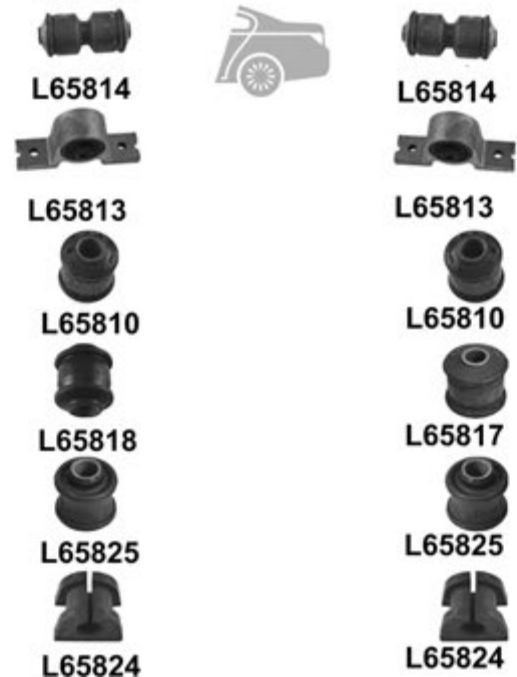
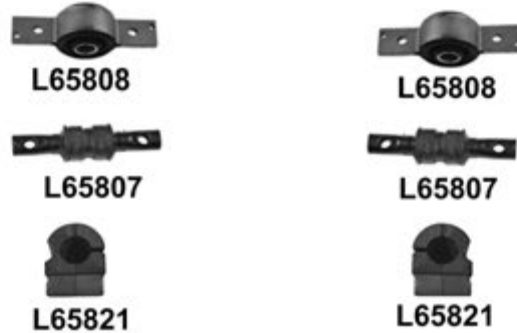

				←	→	Thread	Part Of	QPA	
		↔		L65100	L65100	F 14x1,5 U		2	8993453
				L65206	L65206			2	8962250
					L65009			1	8962516
				L65010				1	8962243
		⊥		L65101	L65101			2	8972135
		⊥	<input checked="" type="checkbox"/>		L65501			1	8958365
				L65502				1	8958373
		⊥▼		L65808	L65808			2	8965253
		⊥▲		L65807	L65807			2	8961476
		▲		L65819	L65819		L65807	2	4426003
				L65600	L65600			2	8958944
				L65821	L65821		Anti-roll bar	2	8965378
		▼		L65814	L65814			2	8951063
		▲		L65813	L65813			2	89577114
		▼	longitudinal	L65810	L65810			2	8956468
			transverse		L65817			1	8957532
				L65818				1	8952558
				L65825	L65825		Anti-roll bar	2	8962011
				L65824	L65824		Anti-roll bar	2	4425583

SEAT

Alhambra (7MS) 04.96 →
 ch. F 7M T 005 001 →

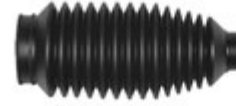
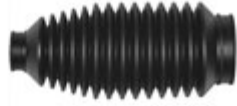

L10046

L10046

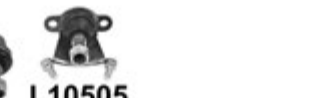
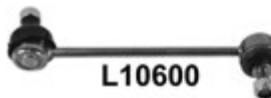

MK067

L10518

L10517

MK067



MK344

MK344



L10800

L10800



L10812

L10812



L10833

L10833



L10812

L10812



L10834

L10834

Alhambra (7MS) 04.96 →
ch. F 7M T 005 001 →

		i		←	→	Thread	Part Of	QPA	i
		↔			L29119			1	7M0 422 818 B
					L29120			1	7M0 422 817 B
					L10204	L10204	M 14x1,5 / M 14x1,5	2	7M0 422 807 G
					L29355			1	7M0 422 804 G
					L29356			1	7M0 422 803 G
			∅ 10mm, ∅ 49mm, L= 178mm	L10046 ⁰	L10046 ⁰			2	7M0 422 831 B
		↓		L10505	L10505			2	7M0 407 365 A
		↓		L10517				1	7M0 407 152 B
				L10518				1	7M0 407 151 B
		↓▼		L10800	L10800			2	7M0 407 181 A
		↓▲		L10812	L10812			2	7M0 501 541
				L10600	L10600			2	7M0 411 317 D
			∅ 17mm	L10833	L10833		Anti-roll bar	2	7M0 411 031
			(+) MK344	KIT	MK067	MK067		2	357 412 331 A
			MK344	MK344			2	357 412 349 A	
		▲	4WD	L10812	L10812			4	7M0 501 541
			HD, PR 1BB/1BJ/1BR, 20mm	L10834	L10834		Anti-roll bar	2	7M0 511 413 A

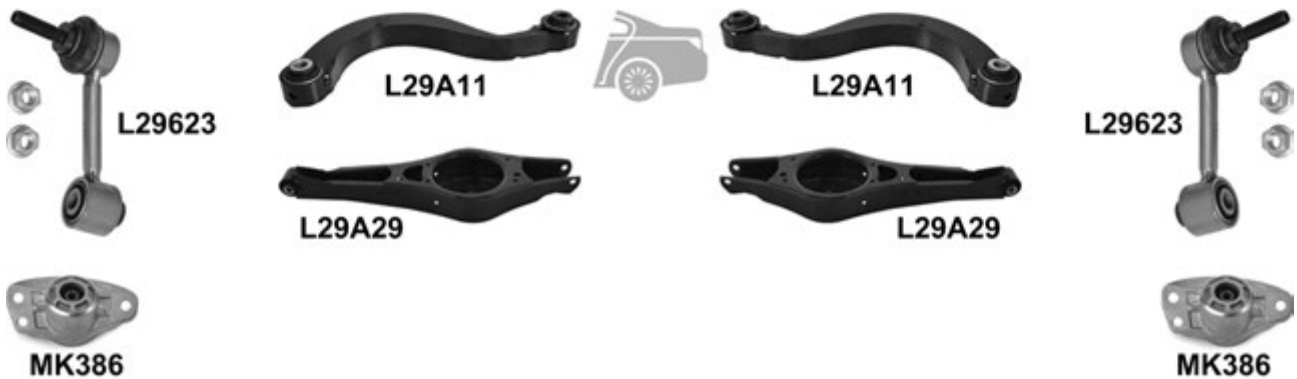
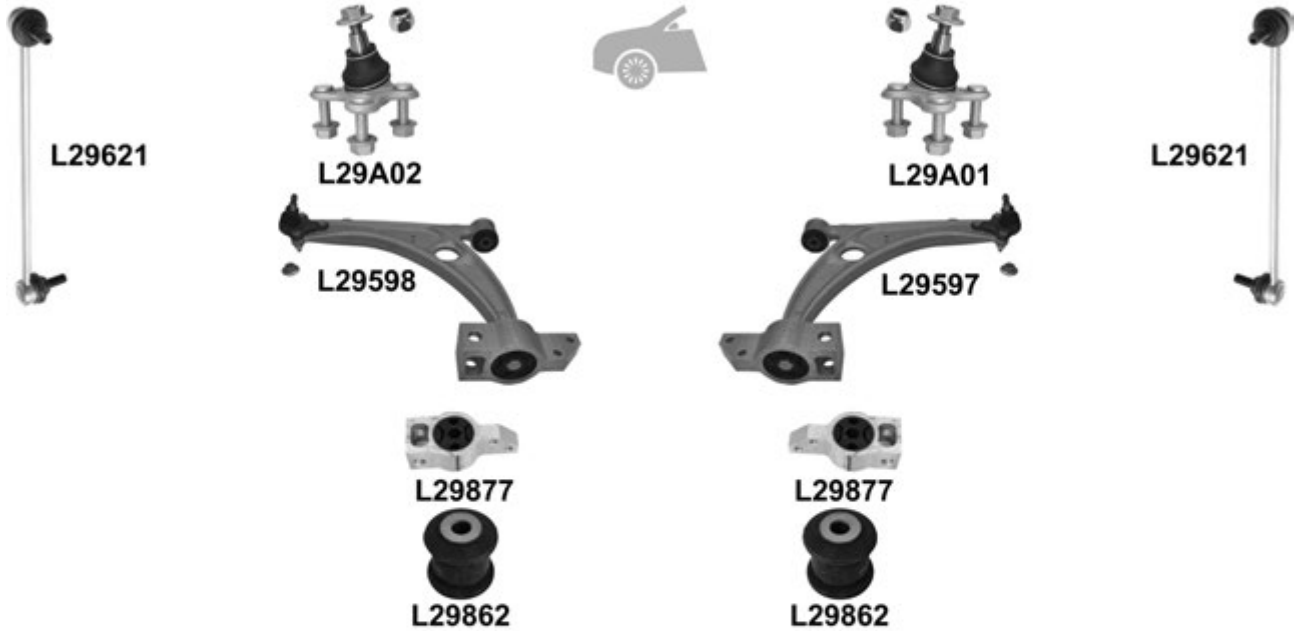
Alhambra (710) 06.10 →

				←	→	Thread	Part Of	QPA			
⊕		↔				L29135	F 16x1,5 ∪	1	1K0 423 812 G		
						L29136	F 16x1,5 ∪	1	1K0 423 811 G		
						L29215	L29215	M 16x1,5 / M 16x1,5 ∪	2	1K0 423 810 A	
⊖		↓				L29A01		1	3C0 407 366 A		
						L29A02		1	3C0 407 365 A		
				ALU	<input checked="" type="checkbox"/>		L29597		1	3C0 407 151 E	
						L29598		1	3C0 407 151 E		
					↓ ▾		L29877	L29877		2	3C0 199 231 D
					↓ ▲		L29862	L29862		2	1K0 407 182
⊖		↓ ▲				L29621	L29621	2	1K0 411 315 J		
						L29A11	L29A11	2	4K0 505 323 N		
					<input checked="" type="checkbox"/>	L29A29	L29A29	2	1K0 505 311 AB		
						L29623	L29623	2	1K0 505 465 J		
				PR FOA/1JA/1JC		MK386	MK386	2	3C0 513 353 C		

Altea (5P1) 06.04 →

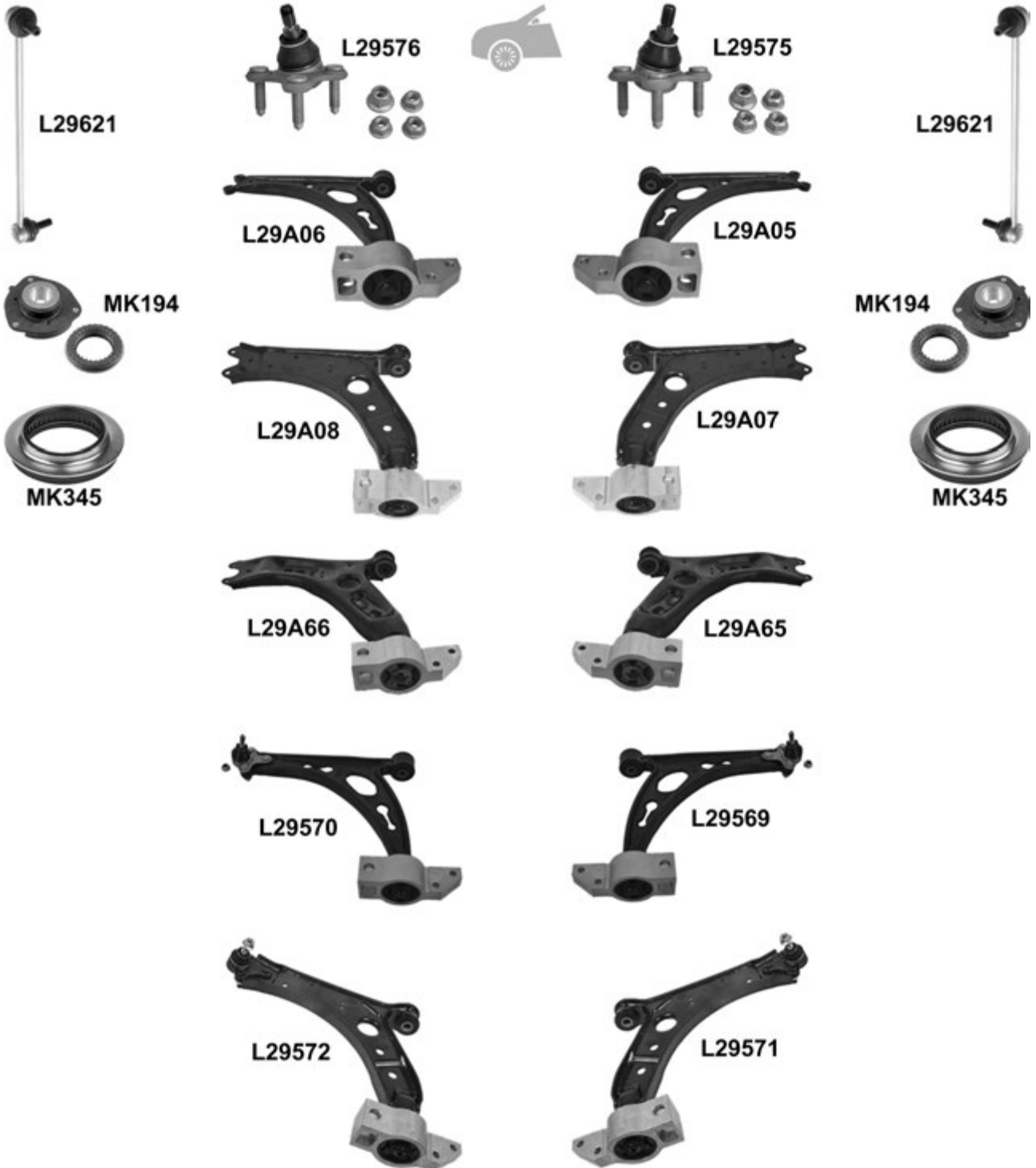
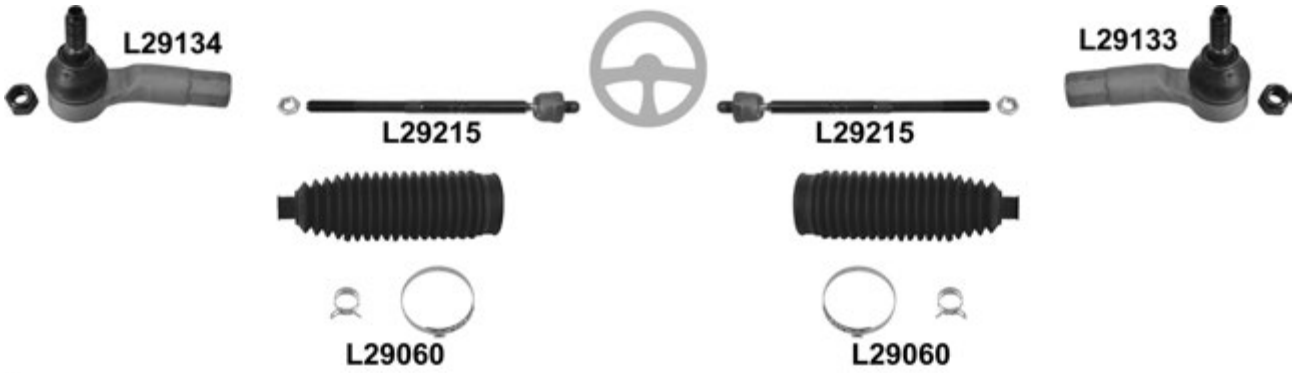



Altea (5P1) 06.04 →

			←	→	Thread	Part Of	QPA			
		↔		L29133	F 16x1,5 U		1	1K0 423 812 E		
				L29134	F 16x1,5 U		1	1K0 423 811 E		
				L29215	L29215	M 16x1,5 / M 16x1,5 U		2	1K0 423 810 A	
				Electronic	L29060	L29060			2	1K0 423 831 A
		↓		L29575				1	1K0 407 366 C	
				L29576				1	1K0 407 365 C	
		↓	(+) (-)		L29A05				1	1K0 407 152 M
					L29A06				1	1K0 407 151 M
			(+) (-)		L29A07				1	1K0 407 152 P
					L29A08				1	1K0 407 151 P
			→ 03.09. (-) (+) (-)		L29A65				1	1K0 407 152 BC
					L29A66				1	1K0 407 151 BC
				<input checked="" type="checkbox"/>	L29569				1	1K0 407 152 M
					L29570				1	1K0 407 151 M
				<input checked="" type="checkbox"/>	L29571				1	1K0 407 152 P
					L29572				1	1K0 407 151 P
	→ 03.09.	<input checked="" type="checkbox"/>	L29A67				1	1K0 407 152 BC		
			L29A68				1	1K0 407 151 BC		
	04.09 →.	<input checked="" type="checkbox"/>	L29A49 ⁰				1	1K0 407 152 BD		
			L29A50 ⁰				1	1K0 407 151 BD		
		↓	▼		L29861			1	1K0 199 232 G	
					L29876			1	1K0 199 231 G	
		↓	▲		L29862	L29862		2	1K0 407 182	
				L29621	L29621			2	1K0 411 315 D	
		(+) MK345	KIT	MK194	MK194		2	1K0 412 331 B		
			MK345	MK345			2	6N0 412 249 C		
		↑		L29A11	L29A11		2	4K0 505 323 N		
		↓		L29A29	L29A29		2	1K0 505 311 AB		
		↓	▲		L29A87 ⁰		Trailing Arm	1	1K0 505 224 K	
		▲	→ 05.09		L29637			1	1K0 501 530 C	
				L29638			1	1K0 501 529 F		
				L29623	L29623		2	1K0 505 465 J		
			PR UC0, → 07.09		MK203	MK203		2	1K0 513 353 H	
			PR UC0, 08.09 →		MK386	MK386		2	1K0 513 353 R	

Altea XL (5P5, 5P8) 10.06 →

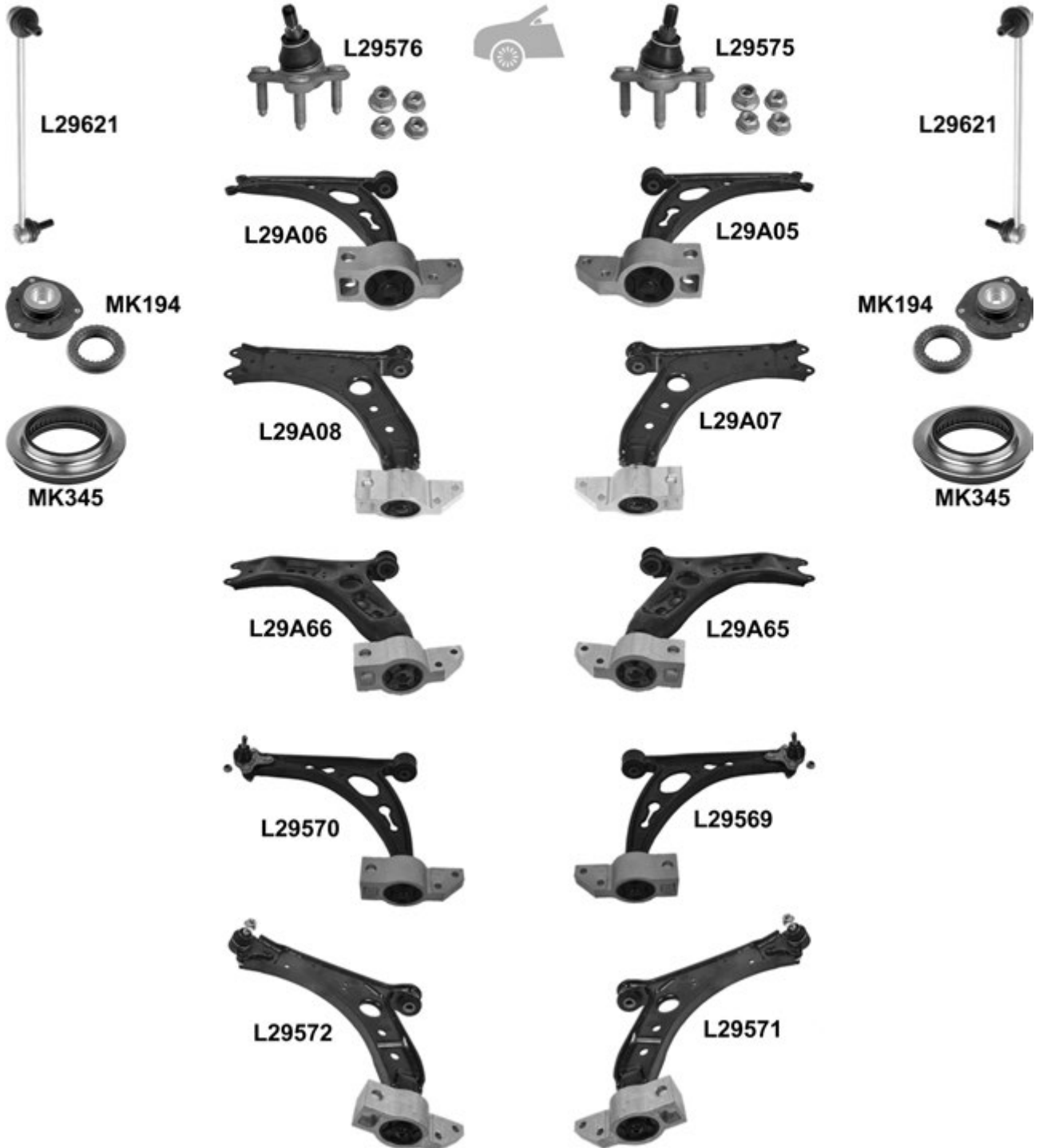
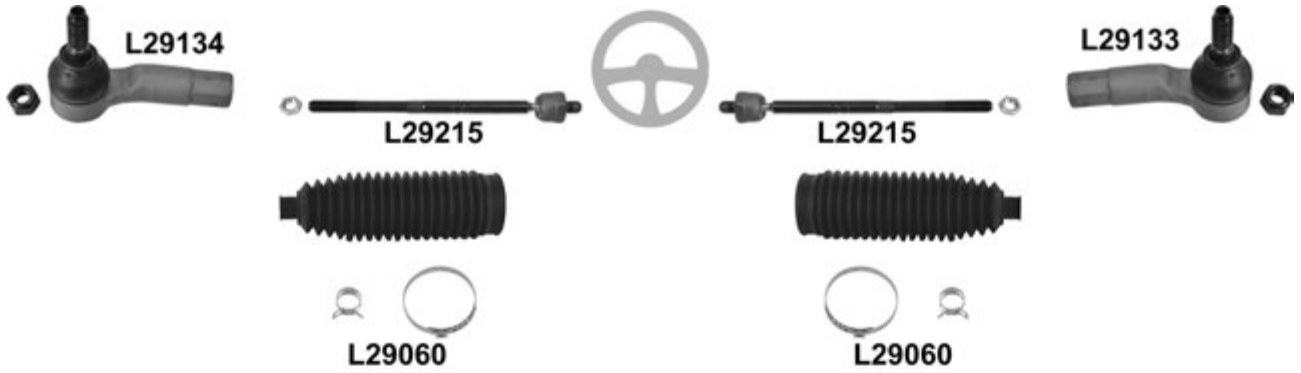

Altea XL (5P5, 5P8) 10.06 →



Altea XL (5P5, 5P8) 10.06 →

			←	→	Thread	Part Of	QPA			
		↔		L29133	F 16x1,5 ⤴		1	1K0 423 812 E		
			L29134		F 16x1,5 ⤴		1	1K0 423 811 E		
			L29215	L29215	M 16x1,5 / M 16x1,5 ⤴		2	1K0 423 810 A		
		Electronic	L29060	L29060			2	1K0 423 831 A		
		⊥		L29575			1	1K0 407 366 C		
			L29576				1	1K0 407 365 C		
		⊥	(-) (+)		L29A05			1	1K0 407 152 M	
				L29A06				1	1K0 407 151 M	
			(-) (+)		L29A07				1	1K0 407 152 P
				L29A08					1	1K0 407 151 P
			→ 03.09. (-) (+)		L29A65				1	1K0 407 152 BC
				L29A66					1	1K0 407 151 BC
				<input checked="" type="checkbox"/>	L29569				1	1K0 407 152 M
				L29570					1	1K0 407 151 M
				<input checked="" type="checkbox"/>	L29571				1	1K0 407 152 P
				L29572					1	1K0 407 151 P
	→ 03.09.	<input checked="" type="checkbox"/>	L29A67				1	1K0 407 152 BC		
		L29A68					1	1K0 407 151 BC		
	04.09 →	<input checked="" type="checkbox"/>	L29A49 ⁰				1	1K0 407 152 BD		
		L29A50 ⁰					1	1K0 407 151 BD		
		⊥ ▼		L29861				1	1K0 199 232 G	
			L29876					1	1K0 199 231 G	
		⊥ ▲	L29862	L29862				2	1K0 407 182	
			L29621	L29621				2	1K0 411 315 D	
		(+)	MK345	KIT	MK194	MK194		2	1K0 412 331 B	
										MK345
		⊥	L29A11	L29A11			2	4K0 505 323 N		
		⊥	L29A29	L29A29			2	1K0 505 311 AB		
		⊥ ▲		L29A87 ⁰			Trailing Arm	1	1K0 505 224 K	
		▲	→ 05.09		L29637			1	1K0 501 530 C	
				L29638				1	1K0 501 529 F	
				L29623	L29623			2	1K0 505 465 J	
			PR UCO → 07.09	MK203	MK203			2	1K0 513 353 H	
			PR UCO 08.09 →	MK386	MK386			2	1K0 513 353 R	

Arosa (6H) 05.97 →

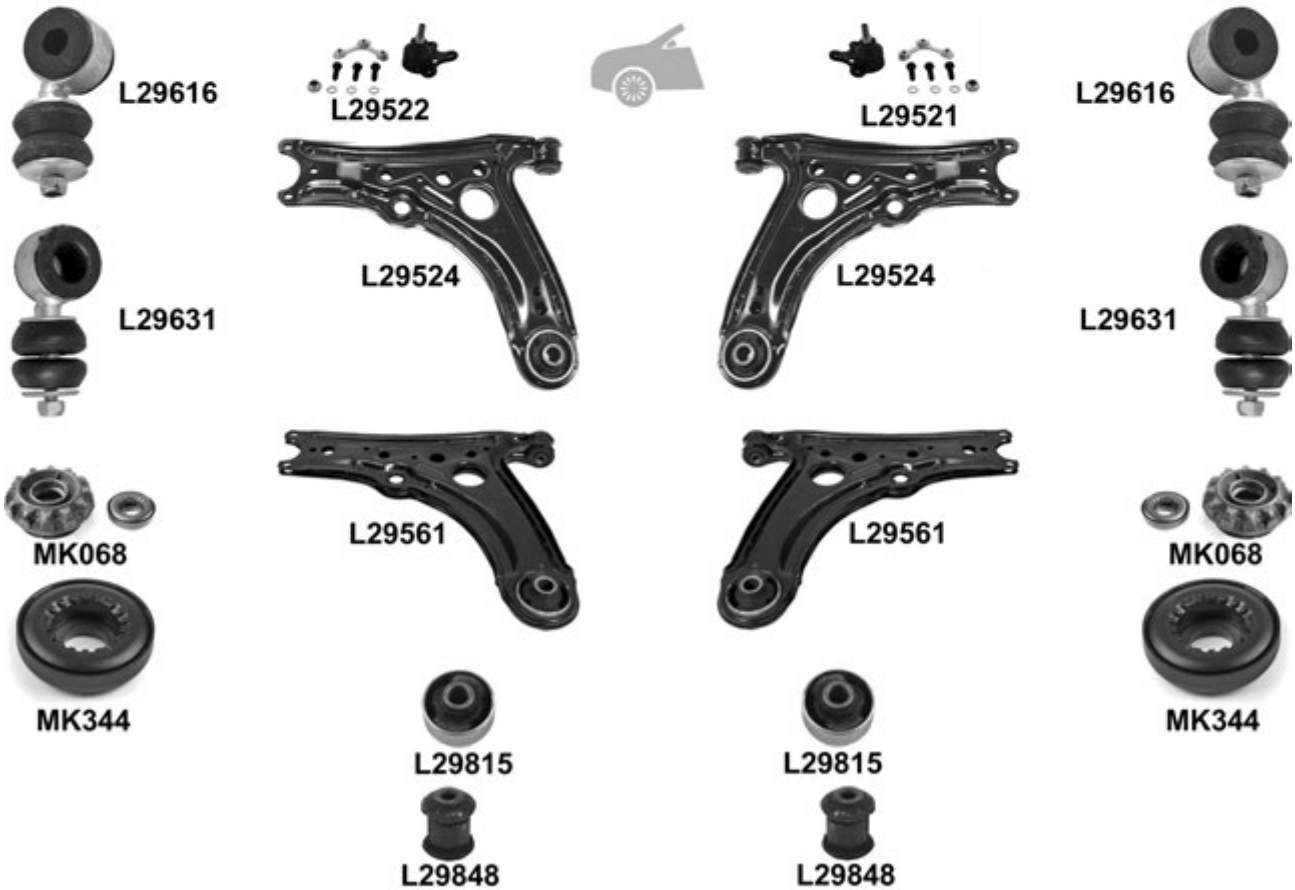
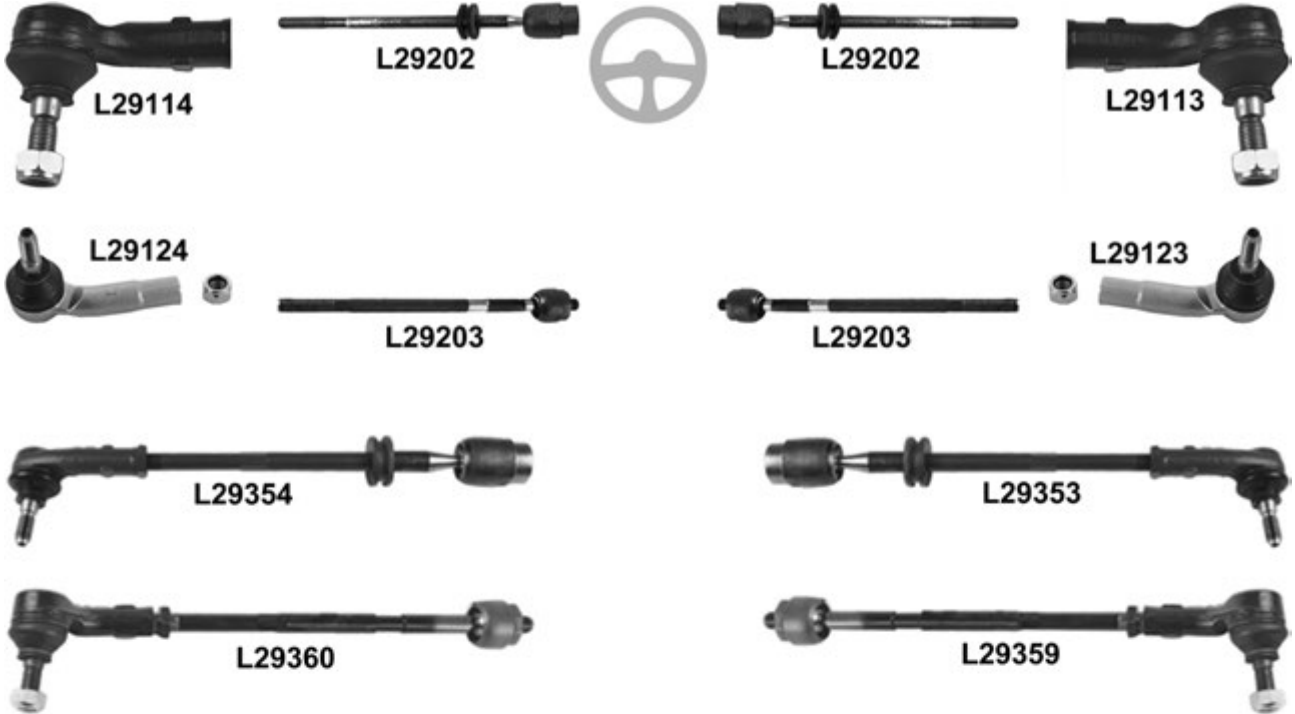

Arosa (6H) 05.97 →

				←	→	Thread	Part Of	QPA		
		↔			L29113	F 14x1,5 ∩		1	6N0 419 812	
				L29114		F 14x1,5 ∩		1	6N0 419 811	
				L29123		F 14x1,5 ∩		1	6X0 422 812	
				L29124		F 14x1,5 ∩		1	6X0 422 811	
				L29202	L29202	M 14x1,5 / F 22x1,5	L29353/L29354	2	6N0 422 821 A	
				L29203	L29203	M 14x1,5 / M 14x1,5	L29359/L29360	2	6X0 423 810 B	
					L29353			1	6N0 419 804	
					L29354			1	6N0 419 803	
					L29359			1	6X0 422 804 A	
					L29360			1	6X0 422 803 A	
		⊥			L29521			1	6N0 407 365 A	
					L29522			1	6N0 407 365	
		⊥		→ 02.98, ch. → 6H W 055 365, (+) , (-)	L29524	L29524		2	6N0 407 151	
				03.98 →, ch. 6H W 055 366 →, (+) , (-)	L29561	L29561		2	6X0 407 151 A	
		⊥▼			L29815	L29815		2	6N0 407 181	
		⊥▲			L29848	L29848		2	6N0 407 182	
				∅ 16mm, ∅ 18mm Anti-roll bar	L29616	L29616		2	6N0 411 315 C	
				∅ 18mm, ∅ 20mm/22mm Anti-roll bar	L29631	L29631		2	6N0 411 315 D	
				(+) MK344	KIT	MK068	MK068		2	6N0 412 331 AS
						MK344	MK344		2	1J0 412 249
							Hub carrier	2	6N0 501 541 D	

Cordoba (6K2/C2) 02.93 → 06.99
 Cordoba Vario (6K5) 08.96 → 06.99

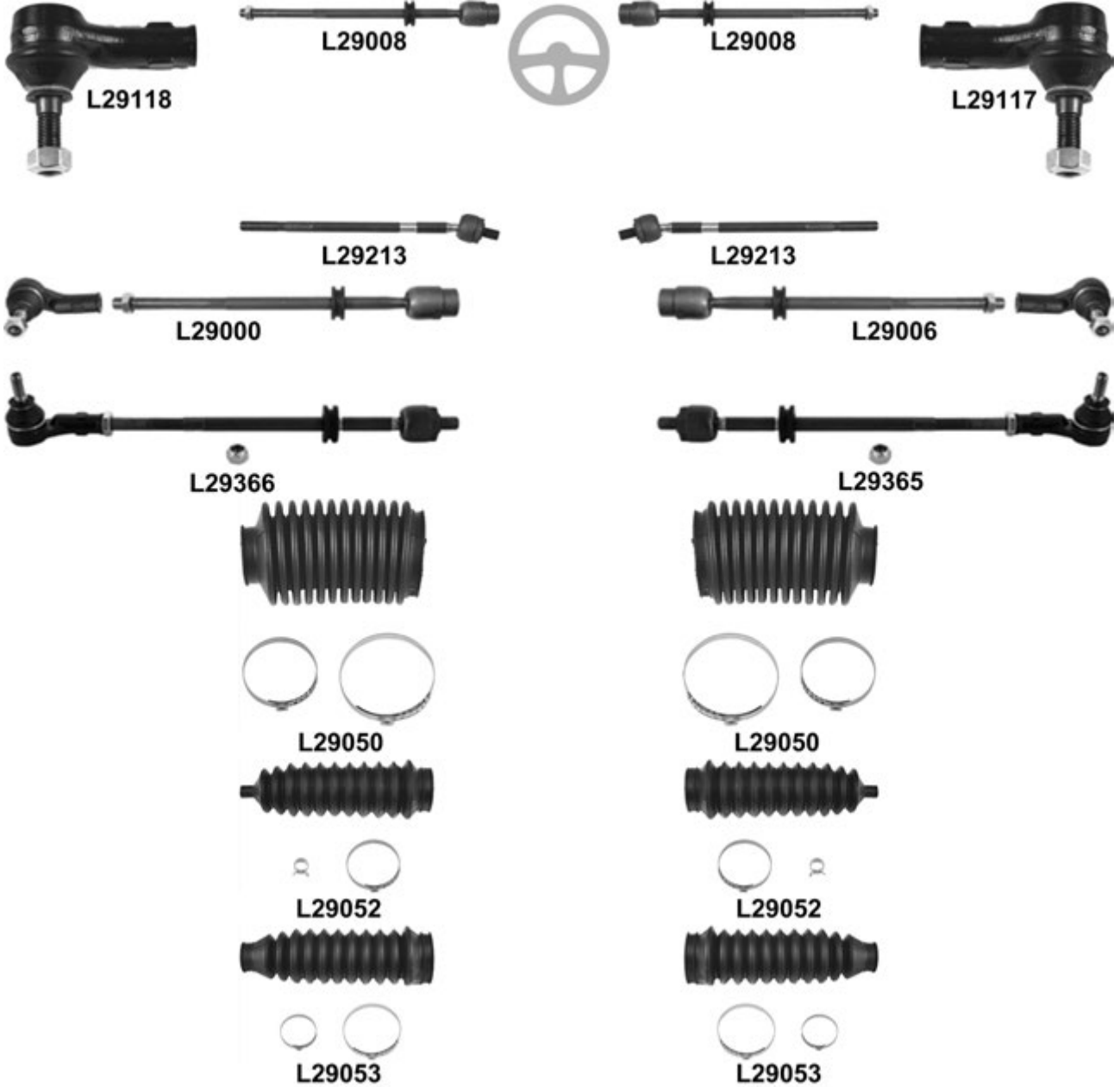

Cordoba (6K2/C2) 02.93 → 06.99
 Cordoba Vario (6K5) 08.96 → 06.99

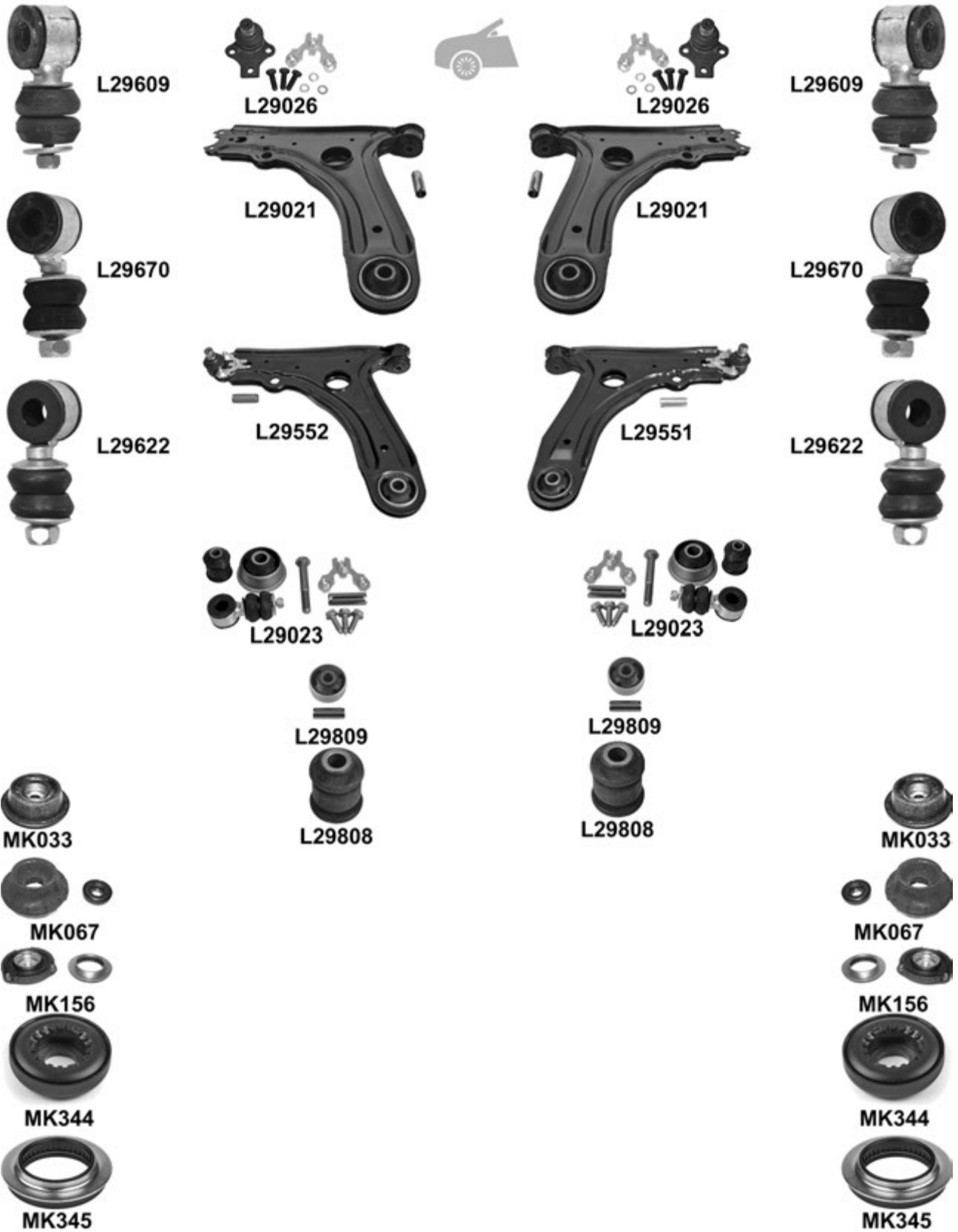

Cordoba (6K2/C2) 02.93 → 06.99
Cordoba Vario (6K5) 08.96 → 06.99



			←	→	Thread	Part Of	QPA			
		↔			L29117	F 14x1,5 ⤴	1	3A0 422 812		
					L29118	F 14x1,5 ⤴	1	3A0 422 811		
					L29008	L29008	M 14x1,5 / M 22x1,5 ⤴	2	191 419 821 A	
					L29213	L29213	M 14x1,5 / M 14x1,5 ⤴	L29365/L29366	2	
						L29006		1	191 419 804 A	
						L29000		1	191 419 803 A	
						L29365		1	6K0 422 804 A	
						L29366		1	6K0 422 803 A	
					L29050	L29050		2	191 419 831	
					L29052	L29052	(TRW)	2	1H0 422 831	
				L29053	L29053	(ZF)	2	357 422 831 B		
		↓			L29026	L29026		2	357 407 365 A	
					L29021	L29021	(-) (+)	2	191 407 153	
			<input checked="" type="checkbox"/>		L29551			1		
					L29552			1		
				KIT	L29023	L29023		2	191 407 153 S0	
						L29809	L29809		2	191 407 181 E
					L29808	L29808		2	357 407 182	
						L29609	L29609		2	191 411 315 B
					ch. → 6K ZR 040 000					
					ch. → 6K ZR 550 000					
ch. 6K ZR 040 001					L29670	L29670		2	191 411 315 A	
ch. 6K ZR 550 001 → 6K V 143 400										
Mot/Eng AFH/AFT/ACC/ADZ/1Y/AEY/AAZ/IZ/AHU/AGG/ABFAEK										
ø17mm										
				ch. → 6K V 143 401	L29622	L29622		2	6K0 411 315	
				Mot/Eng AFH/AFT/ACC/ADZ/1Y/AEY/AAZ/IZ/AHU/AGG/ABFAEK, ø19mm						
				Mot/Eng AFN, ø 19mm	L29622	L29622		2	6K0 411 315	
				Vario Mot/Eng AEX/APQ/ANX/AKV/1F/ALM, ø 17mm	L29670	L29670		2	191 411 315 A	
				Vario Mot/Eng AFT/AEY/AHU/ALE/AFN, 19mm	L29622	L29622		2	6K0 411 315	
				1.0 i, Mot/Eng AER, ch. → 6K TR 080 000, (-) Gti	KIT	MK033	MK033		2	191 412 329
				1.0 CL, Mot/Eng AAU, ch. → 6K TR 080 000	KIT	MK033	MK033		2	
				1.3 Mot/Eng AAV/2G	KIT	MK033	MK033		2	
				1.4/1.4 i/1.4 i 16V	KIT	MK033	MK033		2	
				Mot/Eng ABD/AEX/AFH/AKV/ANX/APQ, ch. → 6K TR 080 000, (-) Gti						
				1.6 i, Mot/Eng ABU/AEE/AFT/1F, ch. → 6K TR 080 000, (-) Gti	KIT	MK033	MK033		2	
				1.6 SXE, Mot/Eng 1F, ch. → 6K TR 080 000	KIT	MK033	MK033		2	
				1.8 i/1.8 i 16V, Mot/Eng ABS/ADL/ADZ, ch. → 6K TR 080 000, (-) Gti	KIT	MK033	MK033		2	
				1.9 D/1.9 Sdi/1.9 TD/1.9 Tdi, Mot/Eng AAZ/AEY/AFN/AHU/1Y/1Z	KIT	MK033	MK033		2	
ch. → 6K TR 080 000, (-) Gti										
				2.0 i/2.0 i 16V, Mot/Eng ABF/AGG/2E, ch. → 6K TR 080 000, (-) Gti	KIT	MK033	MK033		2	

Cordoba (6K2/C2) 02.93 → 06.99
Cordoba Vario (6K5) 08.96 → 06.99

		i	←	→	Thread	Part Of	QPA	i	
		1.0 i, Mot/Eng AER, ch. 6K TR 080 001 →, (-) Gti, (+) MK344	KIT	MK067	MK067			2	357 412 331 A
		1.0 i Gti, Mot/Eng AER	KIT	MK067	MK067			2	
		1.4 i/1.4 i 16V, Mot/Eng ABD/AEX/AFH, ch. 6K TR 080 001 →, (-) Gti	KIT	MK067	MK067			2	
		1.4 i Mot/Eng AKV/APQ, ch. 6K TR 080 001 → 6K X 399 999, (-) Gti	KIT	MK067	MK067			2	
		1.4 i/1.4i 16V Gti, Mot/Eng ABD/AEX/AFH/AKV/APQ	KIT	MK067	MK067			2	
		1.6 i, c AFT/1F, ch. 6K TR 080 001 →, (-) Gti	KIT	MK067	MK067			2	
		1.6 i Gti, Mot/Eng AFT/1F	KIT	MK067	MK067			2	
		1.6 i, Mot/Eng ABU, ch. 6K TR 080 001 → 6K X 399 999	KIT	MK067	MK067			2	
		1.6 i, Mot/Eng AEE, ch. 6K TR 080 001 → 6K X 289 999	KIT	MK067	MK067			2	
		1.8 i/1.8 i 16V, Mot/Eng ADL/ADZ, ch. 6K TR 080 001 → 6K X 399 999	KIT	MK067	MK067			2	
		1.8 i/1.8 i 16V Gti, Mot/Eng ABS/ADL/ADZ	KIT	MK067	MK067			2	
		1.9 D/1.9 Sdi/1.9 TD/1.9 Tdi, Mot/Eng AAZ/AEY/AFN/AHU/1Y/1Z ch. 6K TR 080 001 →, (-) Gti	KIT	MK067	MK067			2	
		1.9 Tdi, Mot/Eng AHU, ch. 6K TR 080 001 → 6K X 399 999, (-) Gti	KIT	MK067	MK067			2	
		1.9 D/1.9 Sdi/1.9 TD/1.9 TDi Gti, Mot/Eng AAZ/AEY/AFN/AUH/1Y/1Z	KIT	MK067	MK067			2	
		2.0 i/2.0 i 16V, Mot/Eng ABF/AGG/2E, ch. 6K TR 080 001 →	KIT	MK067	MK067			2	
		2.0 i/2.0 i 16V Gti, Mot/Eng ABF/AGG/2E	KIT	MK067	MK067			2	
		1.4/1.4 i, Mot/Eng AKV/ANX/APQ, ch. 6K X 400 000 →	KIT	MK156	MK156			2	6N0 412 331 E
		1.6 i, Mot/Eng ABU, ch. 6K X 400 000 →	KIT	MK156	MK156			2	
		1.6 i, Mot/Eng AEE/AFT, ch. 6K X 290 000 →	KIT	MK156	MK156			2	
		1.6 i, Mot/Eng AKL	KIT	MK156	MK156			2	
1.8 i/1.8 i 16V, Mot/Eng ADL/ADZ, ch. 6K X 400 000 →	KIT	MK156	MK156			2			
1.9 Tdi, Mot/Eng AHU, ch. 6K X 400 000 →	MK156	MK156				2			
	ch. → 6K X 290 000		MK344	MK344			2	357 412 349 A	
	ch. 6K X 290 001 →, (+) MK345	KIT	MK156	MK156			2	6N0 412 331 E	
	ch. 6K X 290 001 →		MK345	MK345			2	6N0 412 249 C	
		58mm	L29850	L29850		Hub carrier	2	6N0 501 541 D	
			MK133	MK133			2	191 512 333 S1	

Cordoba II (6K2) 06.99 → 10.02

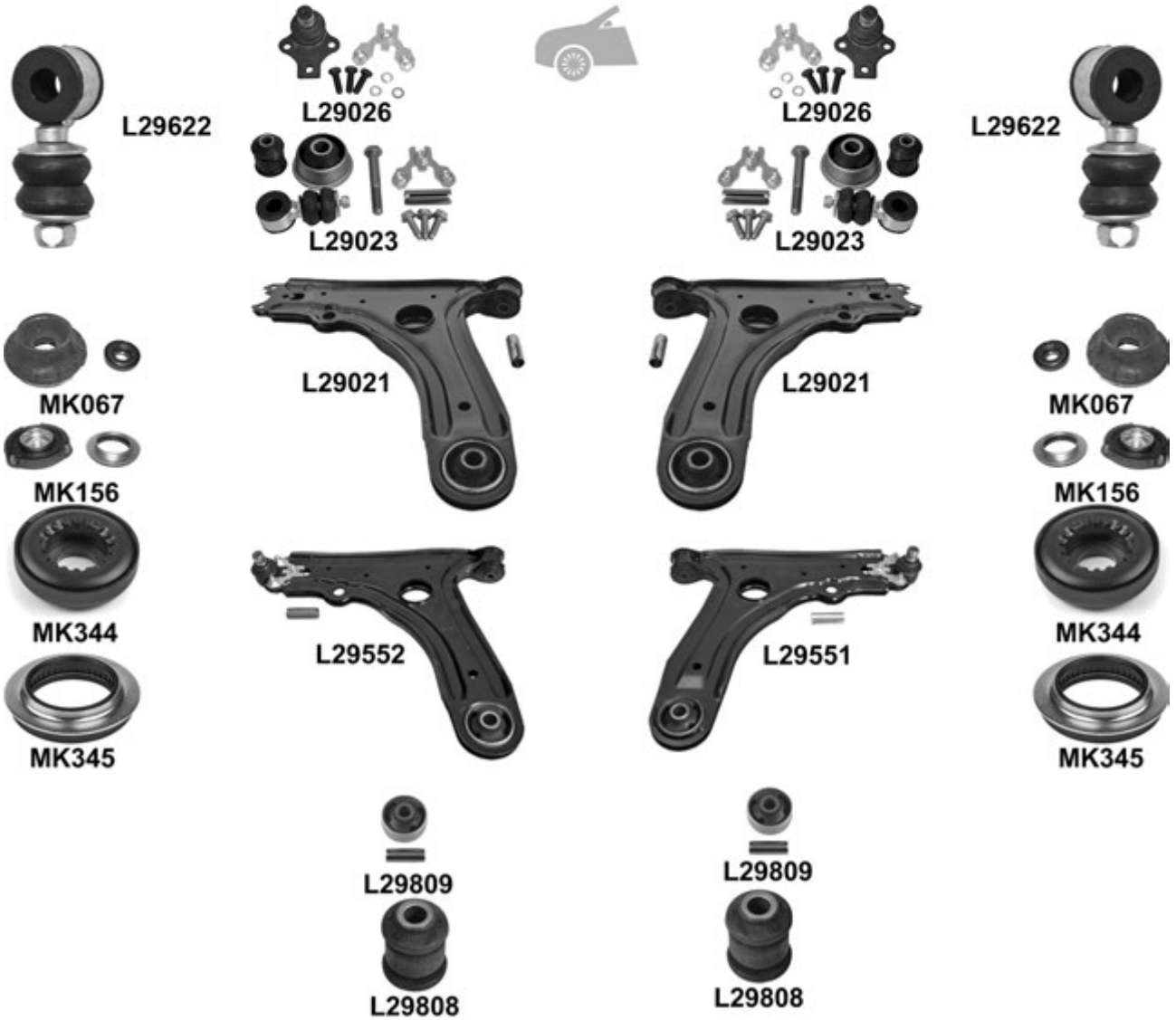
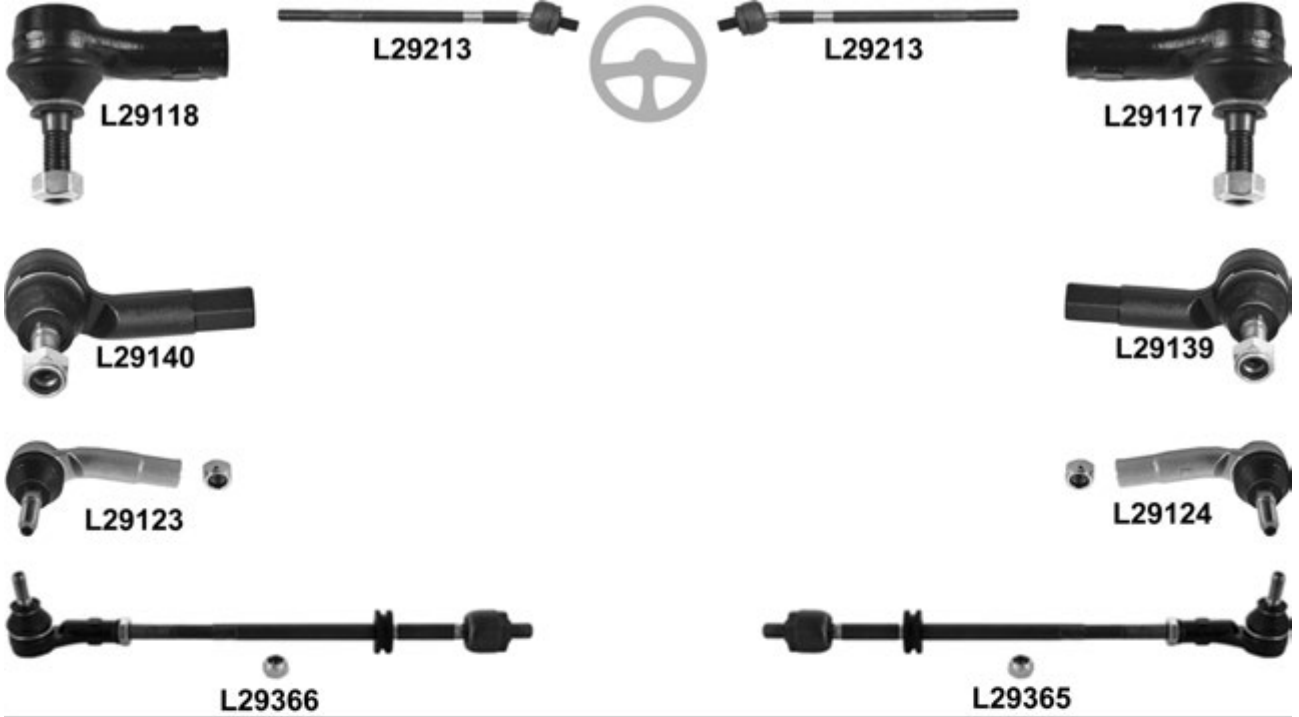
Cordoba Vario II (6K5) 06.99 →



Cordoba II (6K2) 06.99 → 10.02
Cordoba Vario II (6K5) 06.99 →

		i	←	→	Thread	Part Of	QPA	i			
					L29117	F 14x1,5 ♂		1	3A0 422 812		
				L29118	F 14x1,5 ♂		1	3A0 422 811			
				ch. → 6K 1 180 000	L29117	♂		1	3A0 422 812		
					L29118	♂		1	3A0 422 811		
				ch. 6K 1 180 001 →	L29139	♂		1	6K0 422 812		
					L29140	♂		1	6K0 422 811		
				ch. 6K 1 180 001 →, Sport chassis	L29124	F 14x1,5 ♂		1	6E0 419 812		
					L29123	F 14x1,5 ♂		1	6E0 419 811		
				ch. → 6K 1 180 000, L= 340mm	L29213	L29213	M 14x1,5 / M 14x1,5 ♂	L29365/L29366	2		
				ch. → 6K 1 180 000	L29365				1	6K0 422 804 A	
	L29366				1	6K0 422 803 A					
				L29026	L29026			2	357 407 365 A		
				KIT	L29023	L29023		2	191 407 153 S0		
					(-) (+)	L29021	L29021		2	191 407 153	
				<input checked="" type="checkbox"/>		L29551			1		
						L29552			1		
						L29809	L29809		2	191 407 181 E	
						L29808	L29808		2	357 407 182	
					∅ 19mm	L29622	L29622		2	191 411 315 AS	
					1.6, Mot/Eng ALM, (+) MK344	KIT	MK067	MK067		2	357 412 331 A
					(+) MK345	KIT	MK156	MK156		2	6N0 412 331 E
	Vario, ch. 6K X 290 000 →, (+) MK345			MK156	MK156		2	6N0 412 331 E			
		1.6, Mot/Eng ALM		MK344	MK344		2	357 412 349 A			
				MK345	MK345		2	6N0 412 249 C			
			ch. → 6K X 290 000, ∅ 58mm	L29850	L29850	Hub carrier	2	6N0 501 541 D			
				MK133	MK133		2	191 512 333 S1			

Cordoba (6L2) 09.02 →

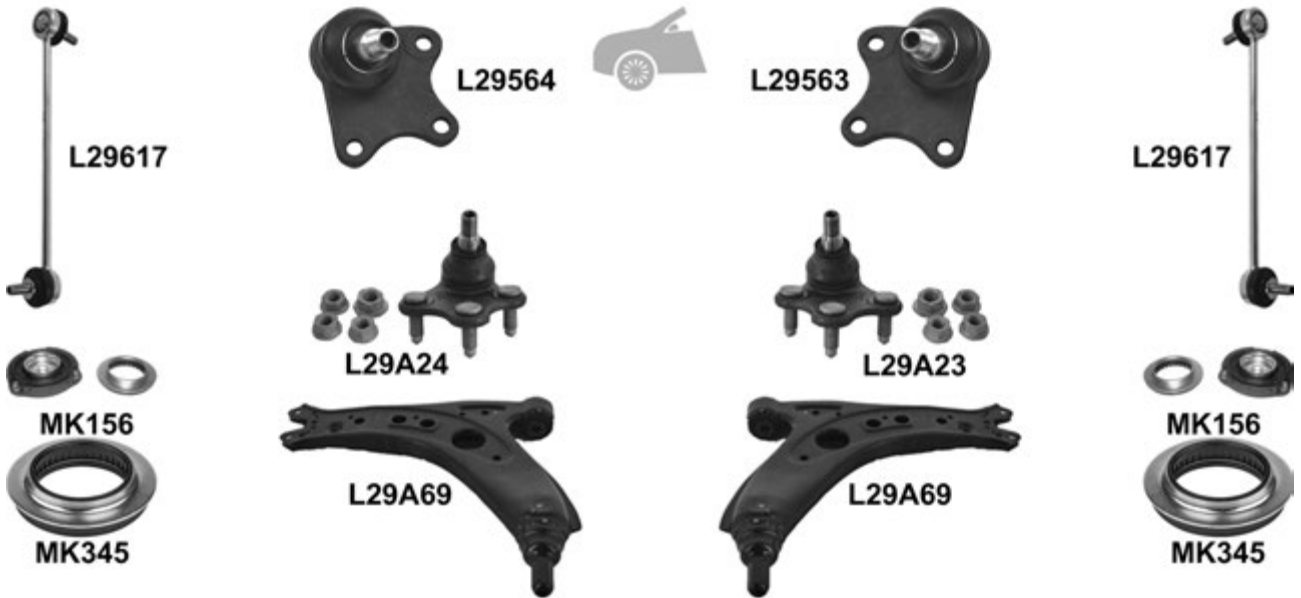
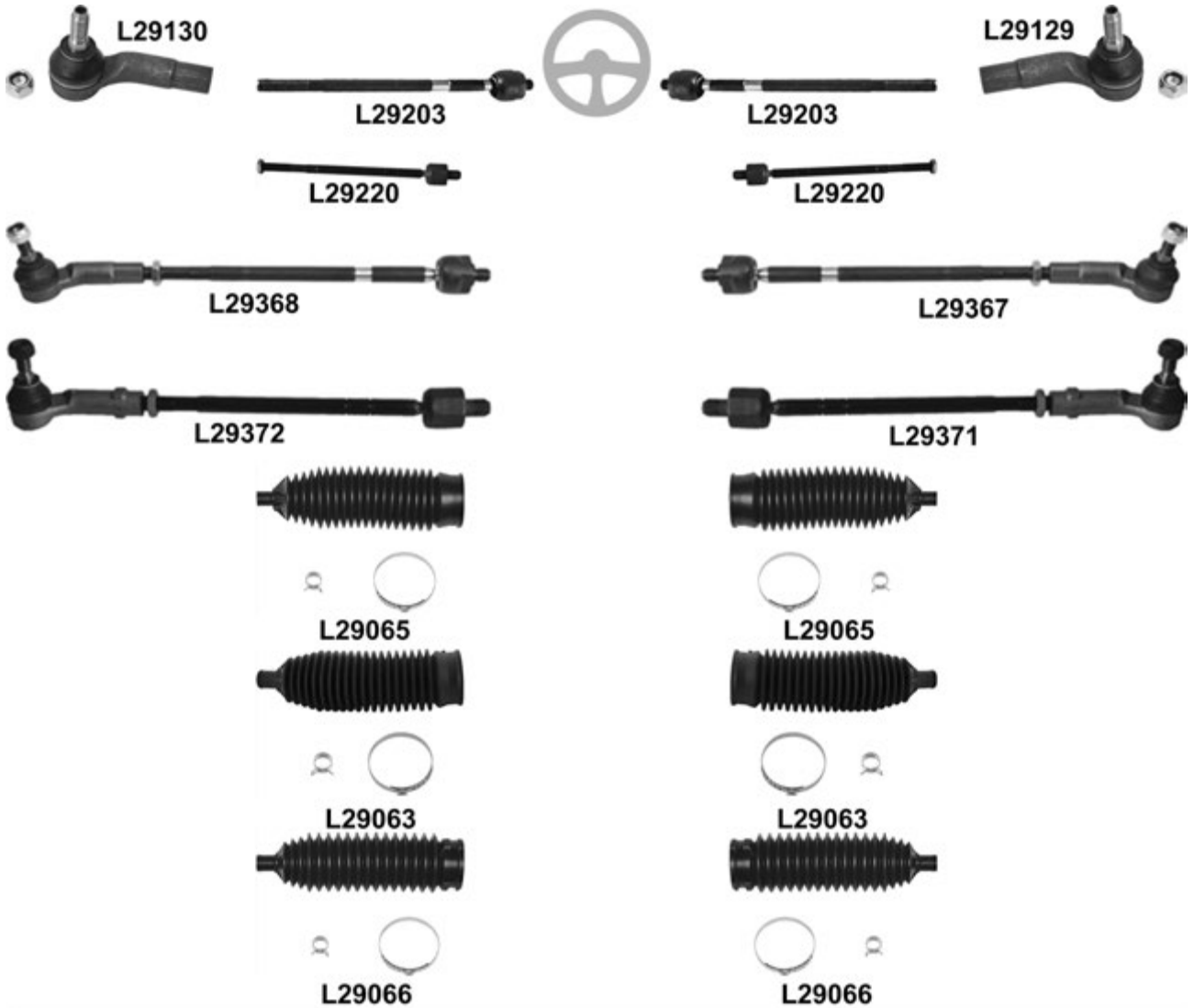

Cordoba (6L2) 09.02 →



L29566



L29565



L29A40



L29A39



L29887



L29887



L29858



L29858



L29883



L29883



MK118



MK118



L29874



L29849

Cordoba (6L2) 09.02 →

				←	→	Thread	Part Of	QPA	
		↔		L29129		F 14x1,5 ∪		1	6Q0 423 812
				L29130		F 14x1,5 ∪		1	6Q0 422 811
			TRW	L29203	L29203	M 14x1,5 / M 14x1,5 ∪		2	
			Smi / Koyo	L29220	L29220	∪		2	6Q0 423 810 G
			TRW		L29367			1	6Q0 423 804 B
				L29368			1	6Q0 423 803 B	
			Smi / Koyo		L29371		1	6Q0 423 804 G	
				L29372			1	6Q0 423 803 G	
			→ 11.02 , ch. → 6L 3 162 980 TRW, ø 12mm, Ø 48mm, L= 195mm	L29065 ⁰	L29065 ⁰		2	6E0 419 831	
			12.02 →, ch. 6L 3 162 980 → TRW, ø 14,5mm, Ø 47,5mm, L= 205mm	L29063 ⁰	L29063 ⁰		2	6Q0 423 831 D	
			Smi/Koyo, ø 13mm, Ø 45,5mm, L= 210mm	L29066 ⁰	L29066 ⁰		2	6Q0 423 831 A	
				⊥	→ 04.08 , ch. → 6L 8 185 000		L29563		1
					L29564		1	6Q0 407 365 A	
	⊥	→ 05.08 →, ch. 6L 8 185 001 →		L29A23		1	6R0 407 366		
			L29A24		1	6R0 407 365			
	⊥	→ 02.08 , ch. → 6L 8 157 034, (-) (+)	L29A69	L29A69		2	6Q0 407 151 D		
		→ 02.08 , ch. → 6L 8 157 034 <input checked="" type="checkbox"/>		L29565		1			
			L29566		1				
		03.08 →, ch. 6L 8 157 035 → <input checked="" type="checkbox"/>		L29A39		1	6R0 407 152 E		
	⊥	ch. → 6L 8 157 034	L29A40			1	6R0 407 151 E		
			L29887	L29887		2	1K0 407 183 E		
	⊥	ch. → 6L 8 157 034	L29858	L29858		2	6Q0 407 182 A		
			L29617	L29617		2	6Q0 411 315 D		
		ø 18mm	L29883	L29883	Anti-roll bar	2	6Q0 411 314 R		
		(-) SP , (+) MK345 KIT	MK156	MK156		2	6N0 412 331 E		
		SP , (+) MK345	MK156	MK156		2	6Q0 412 331 B		
			MK345	MK345		2	6N0 412 249 C		
	⊥	69mm KIT	L29874		Hub carrier	1	1J0 501 541 D		
		74mm KIT	L29849		Hub carrier	1	1J0 501 541 C		
			(-) HD	MK118	MK118		2	1J0 513 353 B	
HD			MK118	MK118		2	1J0 513 353 D		

Exeo (3R2) 03.09 →
 Exeo St (3R5) 06.09 →

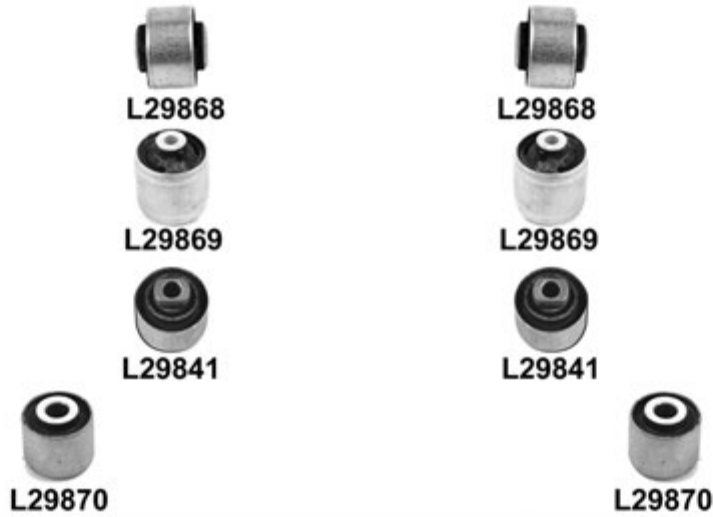
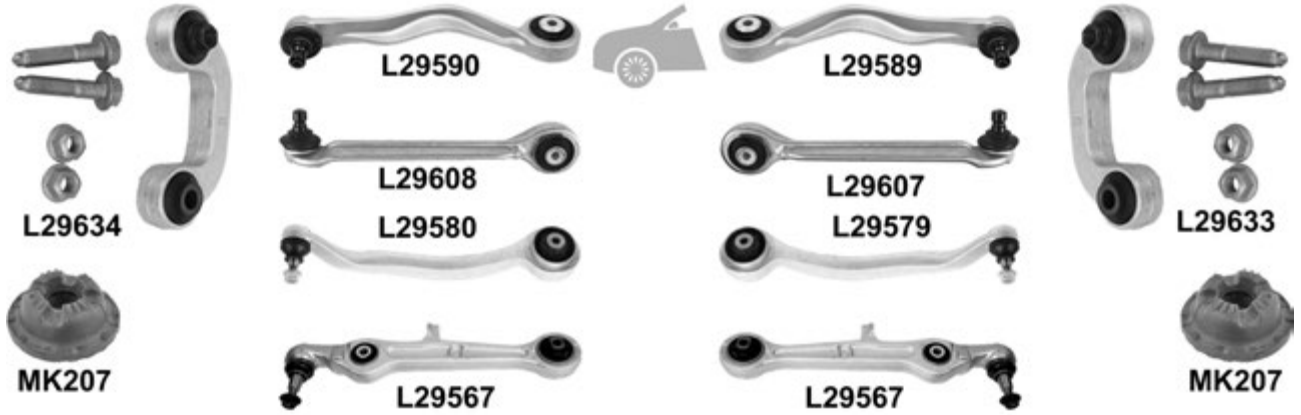

Exeo (3R2) 03.09 →
Exeo St (3R5) 06.09 →

		i		←	→	Thread	Part Of	QPA	i	
		↔		L29141	L29141	⌚		2	4FO 419 811 C	
				L29219	L29219			2	8EO 422 821	
		ī ↓			L29589			1	8EO 407 510 P	
				L29590				1	8EO 407 509 P	
		ī ▲			L29607			1	8EO 407 506 P	
				L29608				1	8EO 407 505 P	
		⊥ ↓			L29579			1	8EO 407 694 AL	
				L29580				1	8EO 407 693 AL	
		⊥ ▲		L29567	L29567			2	8EO 407 151 R	
			ī ↓ ↔		L29868	L29868		L29589/L29590	4	8DO 407 515 C
			⊥ ↓ ↔		L29869	L29869		L29579/L29580	2	4FO 407 183 C
			⊥ ▲ ↔		L29841	L29841		L29567	2	4DO 407 182 G
⊥ ▲ ↔				L29870	L29870		L29567	2	8EO 407 181 C	
		⊥			L29633			1	8EO 411 318	
					L29634			1	8EO 411 317	
			KIT	MK207	MK207			2	8EO 412 377	
				L29635	L29635			2	8EO 505 465 AC	
				MK297	MK297			2	4FO 513 353 D	

Ibiza 06.84 → 06.86
Malaga 05.85 → 09.86

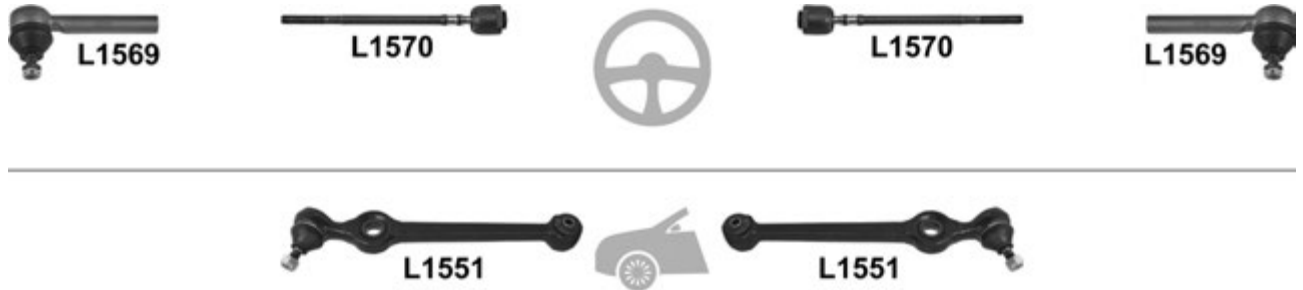

		i		←	→	Thread	Part Of	QPA	i
		↔		L1569	L1569	F 12x1,5 ⌚		2	SE 022 162 406 A
				L1570	L1570	M 12x1,5 / F 14x1,5 ⌚		2	SE 022 162 449 A
		⊥	<input checked="" type="checkbox"/>	L1551	L1551			2	SE 138 156 110 A

Ibiza 07.86 → 04.93
 Malaga 07.86 →

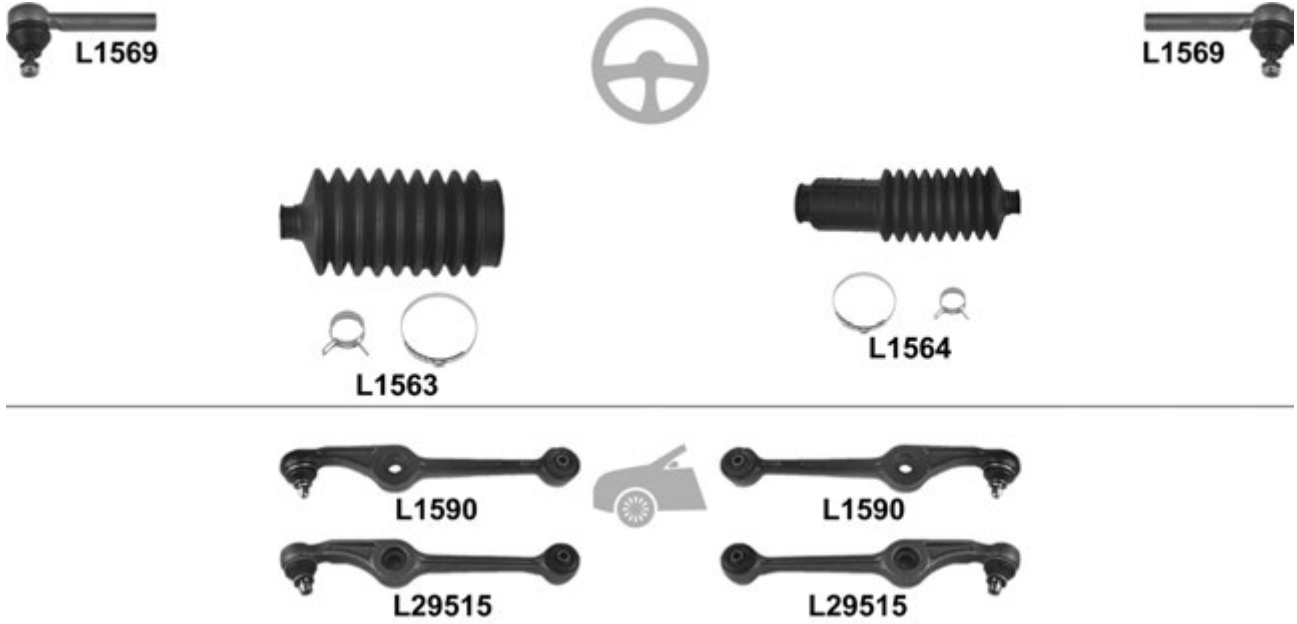

		i		←	→	Thread	Part Of	QPA	i	
		↔		L1569	L1569	F 12x1,5 ☺		2	SE 022 162 406 A	
						L1564			1	HB-16213101
						L1563			1	HB-16213200
		⊥	→ 12.88, ↗ 15mm	<input checked="" type="checkbox"/>	L1590	L1590		2	SE 021 156 110 A	
			01.89 →, ↗ 17mm		L29515	L29515		2	SE 021 156 110 B	

Ibiza (6K1) 03.93 → 08.99

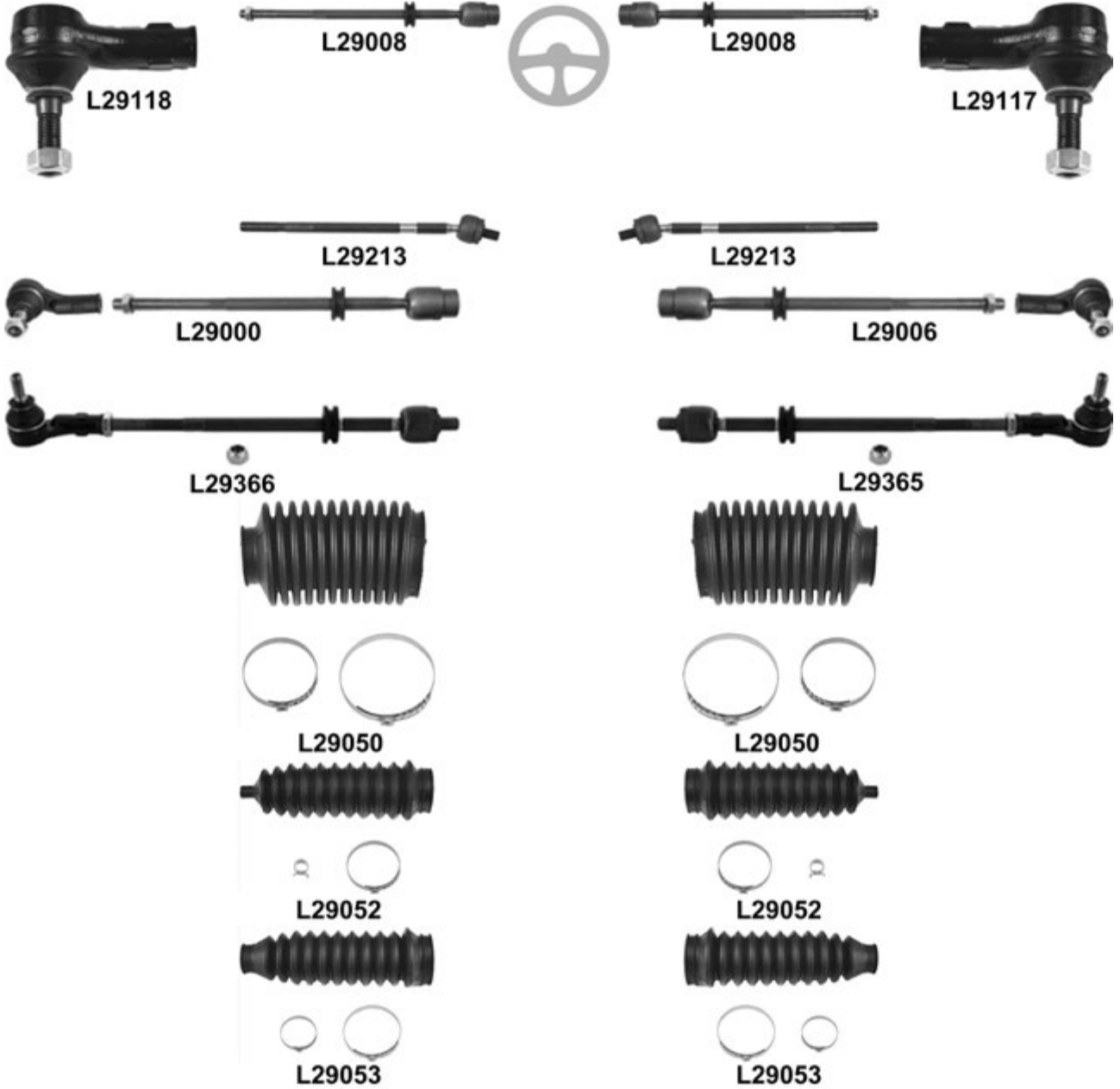

Ibiza (6K1) 03.93 → 08.99

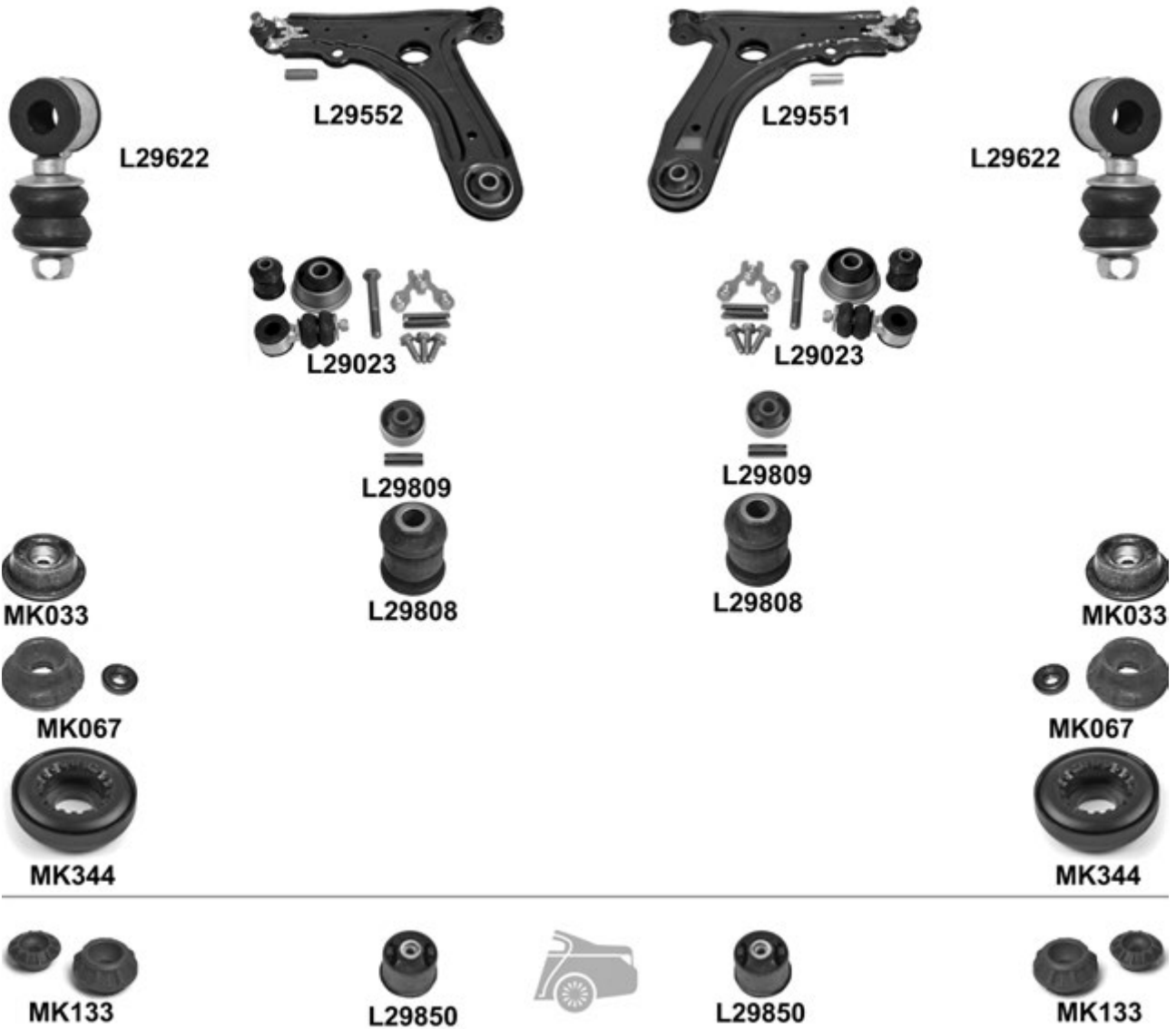

Ibiza (6K1) 03.93 → 08.99

			←	→	Thread	Part Of	QPA			
					L29117	F 14x1,5 U	1	3A0 422 812		
					L29118	F 14x1,5 U	1	3A0 422 811		
			→ 09.95 ,	L29008	L29008	M 14x1,5 / M 22x1,5 U		2		
			L= 340mm	L29213	L29213	M 14x1,5 / M 14x1,5 U	L29365/L29366	2		
						L29006		1	191 419 804 A	
						L29000		1	191 419 803 A	
							L29365		1	6K0 422 804 A
								L29366		1
						L29050	L29050	2	191 419 831	
				(TRW)	L29052	L29052		2	1H0 422 831	
(ZF)				L29053	L29053		2	357 422 831 B		
		↓			L29026	L29026	2	357 407 365 A		
					L29021	L29021	2	191 407 153		
		↓	(+)			L29551		1		
				<input checked="" type="checkbox"/>		L29552		1		
				KIT	L29023	L29023		2	191 407 153 S0	
		↓				L29809	L29809	2	191 407 181 E	
						L29808	L29808	2	357 407 182	
				ch. → 6K ZR 040 000		L29609	L29609	2	191 411 315 B	
				ch. → 6K ZR 550 000						
				ch. 6K ZR 040 001 → ch. 6K ZR 550 001 → ch. 6K V 143 400 → Mot/Eng AFH/AFT/ACC/ADZ/IY/AEY/AAZ/IZ/AHU/AGG/ABF/AEK ø17mm		L29670	L29670	2	191 411 315 A	
				ch. → 6K V 143 401 Mot/Eng AFH/AFT/ACC/ADZ/IY/AEY/AAZ/IZ/AHU/ALE/AGG/ ABF/AEK, ø19mm Mot/Eng AFN, ø 19mm		L29622	L29622	2	6K0 411 315	
				→ 12.96 , ch. → 6K TR 080 000, (-) 1.8 16V, 2.0 i	KIT	MK033	MK033	2	191 412 329	
				1.8 16V / 2.0 i, → 12.94	KIT	MK033	MK033	2	191 412 329	
				ch. → 6K ZR 082 400						
				ch. → 6K ZR 599 564						
(+) MK344				KIT	MK067	MK067	2	357 412 331 A		
1.0, 01.96 →, (+) L MK344				KIT	MK067	MK067	2			
1.0 i, 01.97 →, (+) MK344				KIT	MK067	MK067	2			
1.4 i, Mot/Eng ABD, 01.96 , Mot/Eng AKV, 01.97 →, (+) MK344				KIT	MK067	MK067	2			
1.4 i 16V, 01.97 →, (+) MK344				KIT	MK067	MK067	2			
1.6 i, 01.96 →, 1,6 i, Mot/Eng AEE, 01.96 →, (+) MK344				KIT	MK067	MK067	2			
1.8 i, Mot/Eng ADZ, 01.96 →, (+) MK344				KIT	MK067	MK067	2			
1.8 i 16V, 01.94 →, (+) MK344				KIT	MK067	MK067	2			
2.0 i 16V, (+) MK344				KIT	MK067	MK067	2			
1.9 D, 01.96 →, (+) MK344				KIT	MK067	MK067	2			
1.9 Sdi, (+) MK344				KIT	MK067	MK067	2			
1.9 TD, 01.96 →, (+) MK344	KIT	MK067	MK067	2						
1.9 Tdi, 01.97 →, (+) MK344		MK067	MK067	2						
					MK344	MK344	2	357 412 349 A		
					L29850	L29850	2	6N0 501 541 D		
					MK133	MK133	2	191 512 333 S1		

Ibiza III (6K1) 08.99 → 02.02

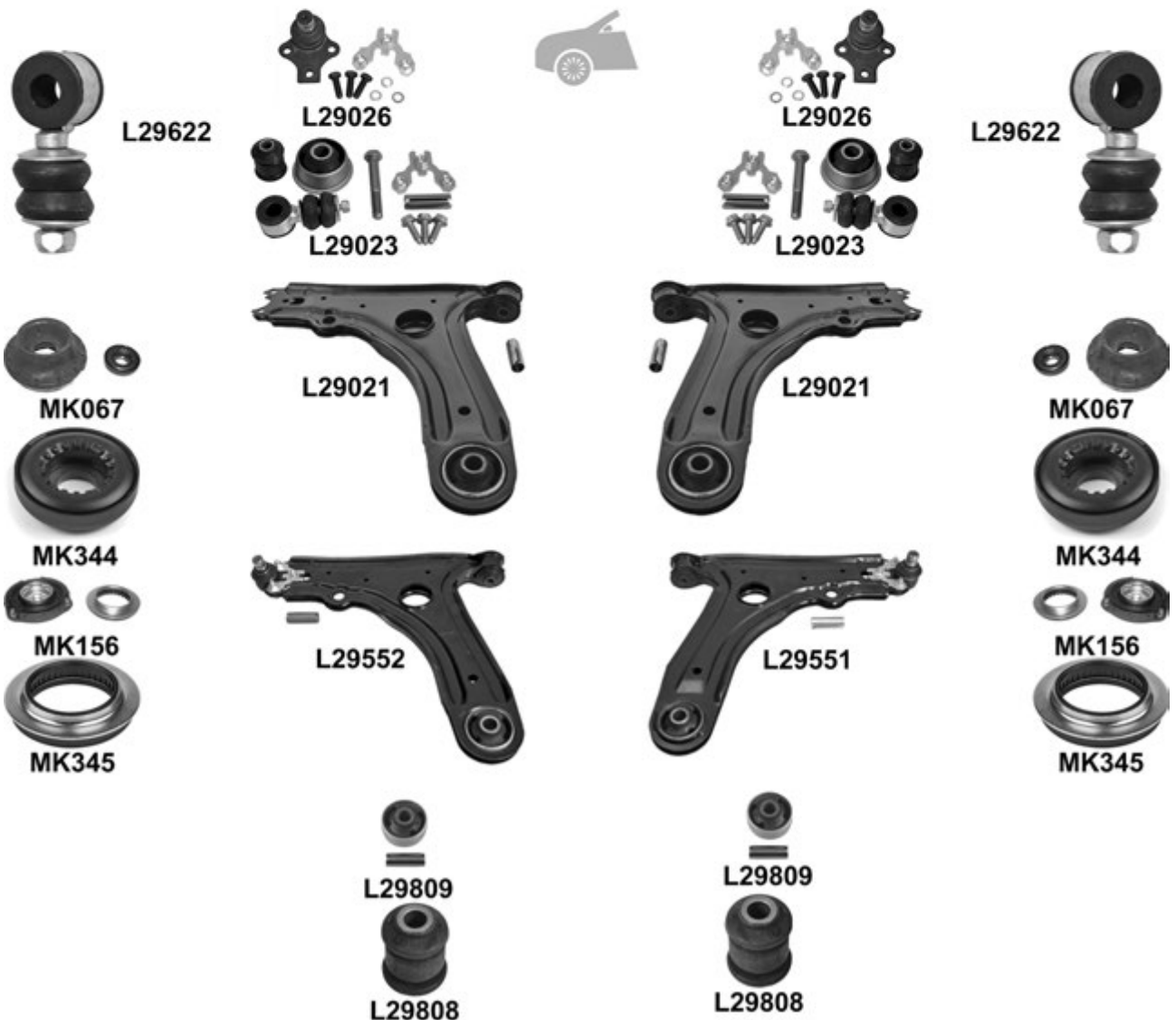
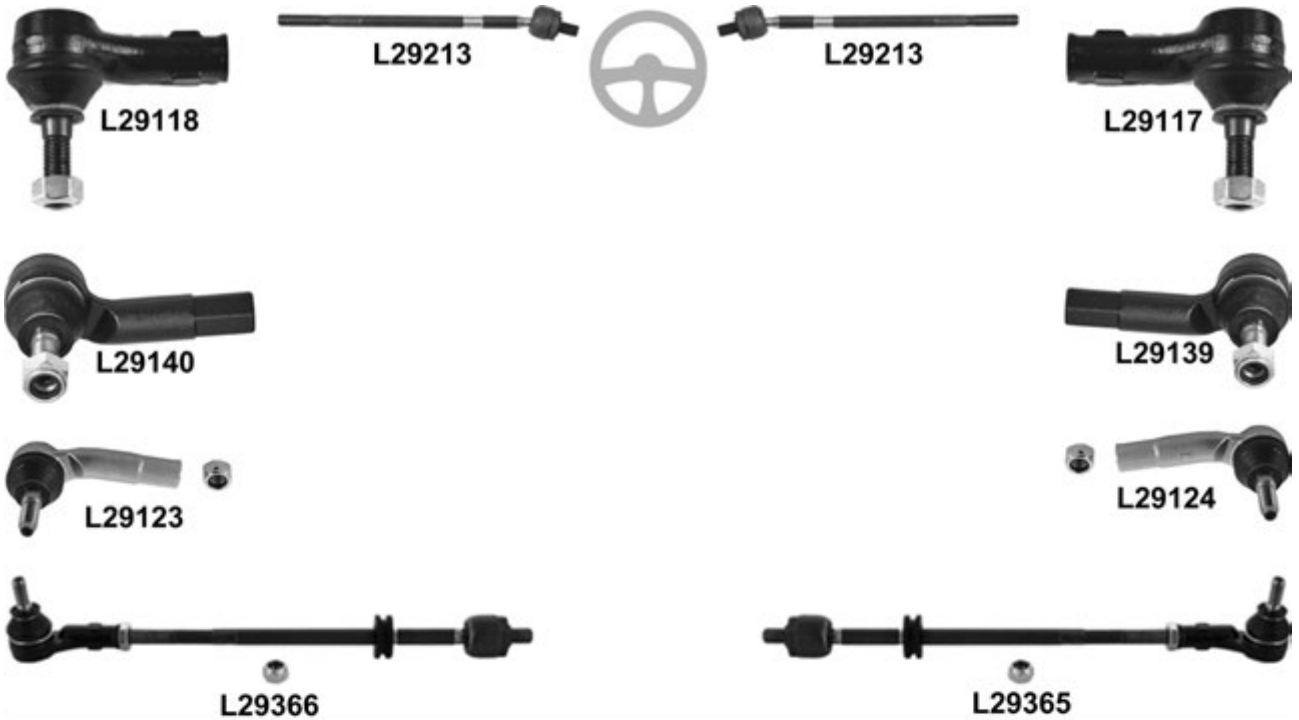

Ibiza III (6K1) 08.99 → 02.02

		← →		Thread	Part Of	QPA			
⊕		↔		L29117	F 14x1,5 ♂		1	3A0 422 812	
				L29118	F 14x1,5 ♂		1	3A0 422 811	
				L29117	♂		1	3A0 422 812	
				L29118	♂		1	3A0 422 811	
				L29139	♂		1	6K0 422 812	
				L29140	♂		1	6K0 422 811	
				L29124	F 14x1,5 ♂		1	6E0 419 812	
				L29123	F 14x1,5 ♂		1	6E0 419 811	
				L29213	L29213	M 14x1,5 / M 14x1,5 ♂	L29365/L29366	2	
				L29365				1	6K0 422 804 A
	L29366			1	6K0 422 803 A				
		⊥		L29026	L29026		2	357 407 365 A	
				L29023	L29023		2	191 407 153 S0	
				L29021	L29021		2	191 407 153	
				L29551			1		
				L29552			1		
				L29809	L29809		2	191 407 181 E	
				L29808	L29808		2	357 407 182	
				L29622	L29622		2	191 411 315 AS	
				MK067	MK067		2	357 412 331 A	
				MK344	MK344		2	357 412 349 A	
		⊥		MK156	MK156		2	6N0 412 331 E	
				MK345	MK345		2	6N0 412 249 C	
				L29850	L29850		2	6N0 501 541 D	
				MK133	MK133		2	191 512 333 S1	

Ibiza IV (6L1) 02.02 →

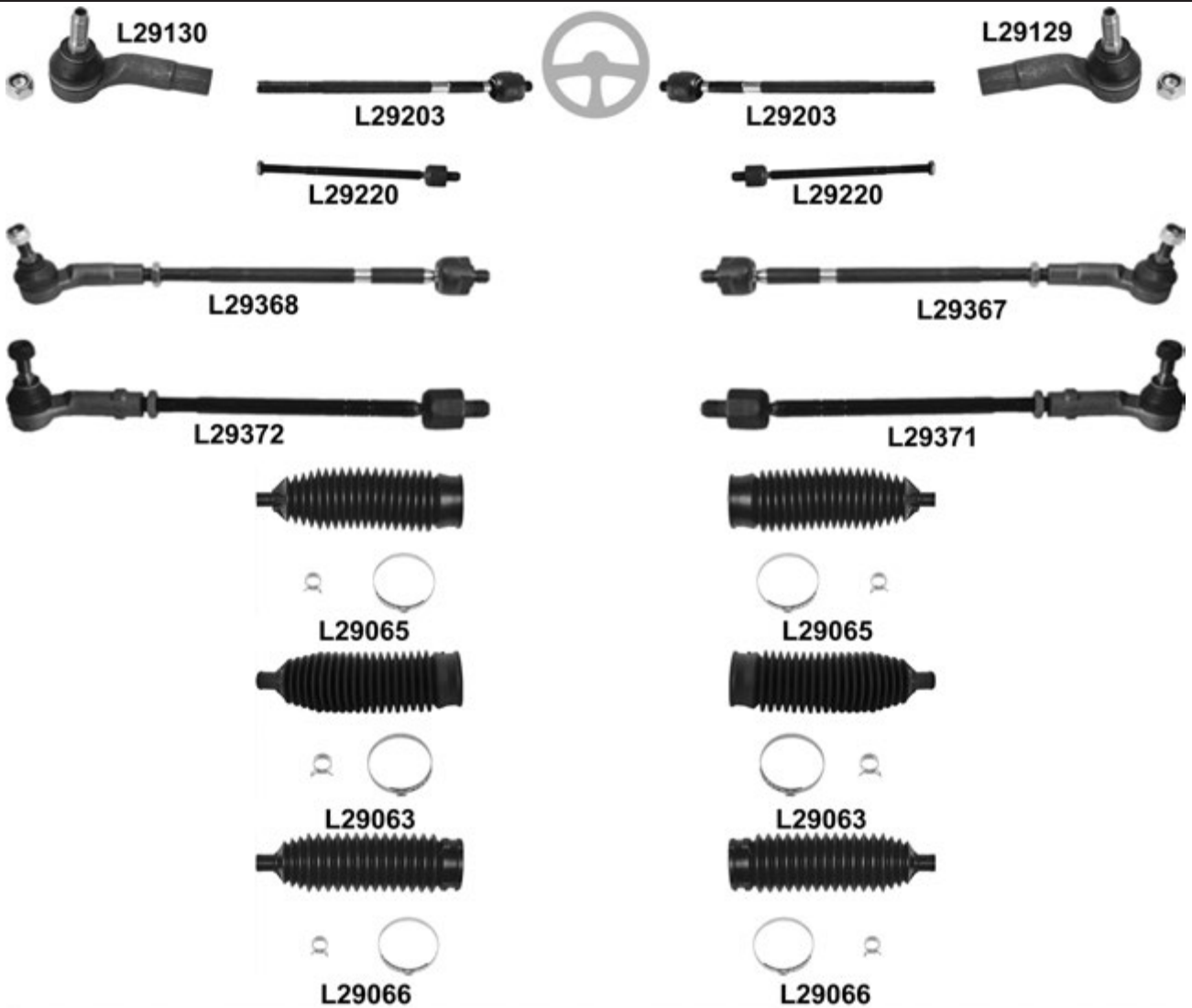

Ibiza IV (6L1) 02.02 →



				← → Thread		Part Of	QPA		
⊕		↔		L29129	F 14x1,5 ∪		1	6Q0 423 812	
				L29130	F 14x1,5 ∪		1	3A0 422 811	
			TRW	L29203	L29203	M 14x1,5 / M 14x1,5 ∪		2	
			Smi / Koyo	L29220	L29220	∪		2	6Q0 423 810 G
			TRW		L29367			1	6Q0 423 804 B
				L29368				1	6Q0 423 803 B
			Smi / Koyo		L29371			1	6Q0 423 804 G
				L29372				1	6Q0 423 803 G
			→ 12.02, TRW, ø 12mm, Ø 48mm, L= 195mm	L29065 ⁰	L29065 ⁰			2	6E0 419 831
			01.03 →, TRW, ø 14,5mm, Ø 47,5mm, L= 205mm	L29063 ⁰	L29063 ⁰			2	6Q0 423 831 D
Smi/Koyo, ø 13mm, Ø 45,5mm, L= 210mm			L29066 ⁰	L29066 ⁰			2	6Q0 423 831 A	
		⊥		L29563			1	6Q0 407 366 A	
				L29564			1	6Q0 407 365 A	
		⊥	(-) (+)	L29A69	L29A69			2	6Q0 407 151 D
			(-) 1.8 T Cupra R, 1.9 Tdi Cupra R, 2.0	<input checked="" type="checkbox"/>	L29565			1	
				L29566			1		
		⊥	(-) 1.8 T Cupra R, 1.9 Tdi Cupra R, 2.0	L29887	L29887			2	1K0 407 183 E
			(-) 1.8 T Cupra R, 1.9 Tdi Cupra R, 2.0	L29858	L29858			2	6Q0 407 182 A
				L29617	L29617			2	6Q0 411 315 D
			ø 18mm	L29883	L29883		Anti-roll bar	2	6Q0 411 314 R
			PR G17, (+) MK345	KIT	MK156	MK156		2	6N0 412 331 E
PR G03/G19/G21, (+) MK345				MK156	MK156			2	6Q0 412 331 B
			MK345	MK345			2	6N0 412 249 C	
		69mm	KIT	L29874		Hub carrier	1	1J0 501 541 D	
		74mm	KIT	L29849		Hub carrier	1	1J0 501 541 C	
		PR 1JB/1JE/1JJ/UA2/UB1		MK118	MK118			2	1J0 513 353 B
		PR 1JF/UB2		MK118	MK118			2	1J0 513 353 D

Ibiza V (6J5) 03.08 →
 Ibiza V SC (6J1) 07.08 →
 Ibiza V ST (6J8) 03.10 →

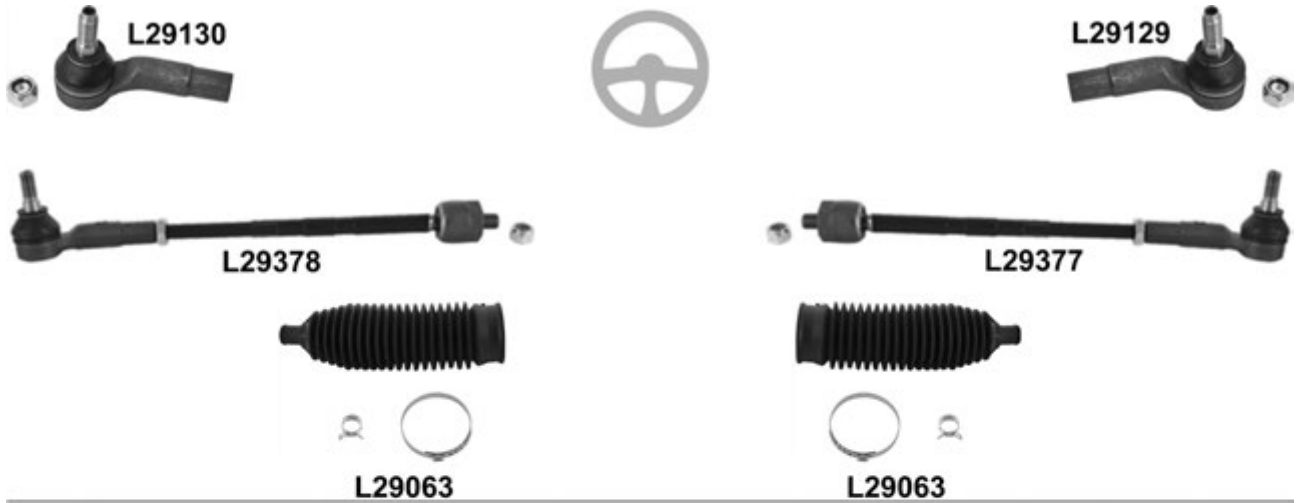

Ibiza V (6J5) 03.08 →
 Ibiza V SC (6J1) 07.08 →
 Ibiza V ST (6J8) 03.10 →

MK118

L29849

MK118

		i		←	→	Thread	Part Of	QPA	i			
⊕		↔		L29129		F 14x1,5 ♂		1	6R0 423 812			
				L29130		F 14x1,5 ♂		1	6R0 423 811			
					L29377				1	6R0 423 804 A		
					L29378				1	6R0 423 803 A		
			TRW, ø 14,5mm, Ø 47,5mm, L= 205mm	L29063 ⁰	L29063 ⁰			2	6Q0 423 831 D			
		⊥			L29A23			1	6R0 407 366			
					L29A24			1	6R0 407 365			
		⊥	PR G17/G18/G19/G20	<input checked="" type="checkbox"/>	L29A43			1	6R0 407 152 F			
					L29A44			1	6R0 407 151 F			
				<input checked="" type="checkbox"/>	PR G21/G24	L29A53		1	6R0 407 152 B			
	L29A54		1			6R0 407 151 B						
		⊥↘	PR G17/G18/G19/G20		L29847	L29847			2	1J0 407 181		
				<input checked="" type="checkbox"/>	PR G21/G24	L29881	L29881			2	8N0 407 181 B	
						L29808	L29808			2	357 407 182	
					L29617	L29617			2	6Q0 411 315 N		
			PR OAS, Ø 18mm		L29883	L29883		Anti-roll bar	2	6Q0 411 314 R		
			(+) MK344	KIT	MK077	MK077			2	1J0 412 331 BS		
					MK344	MK344			2	1J0 412 249		
			74mm	KIT	L29849		Hub carrier	1	6R0 501 541 C			
			→ 08.10		MK118	MK118			2	1J0 513 353 B		
			09.10 →		MK118	MK118			2	1J0 513 353 D		

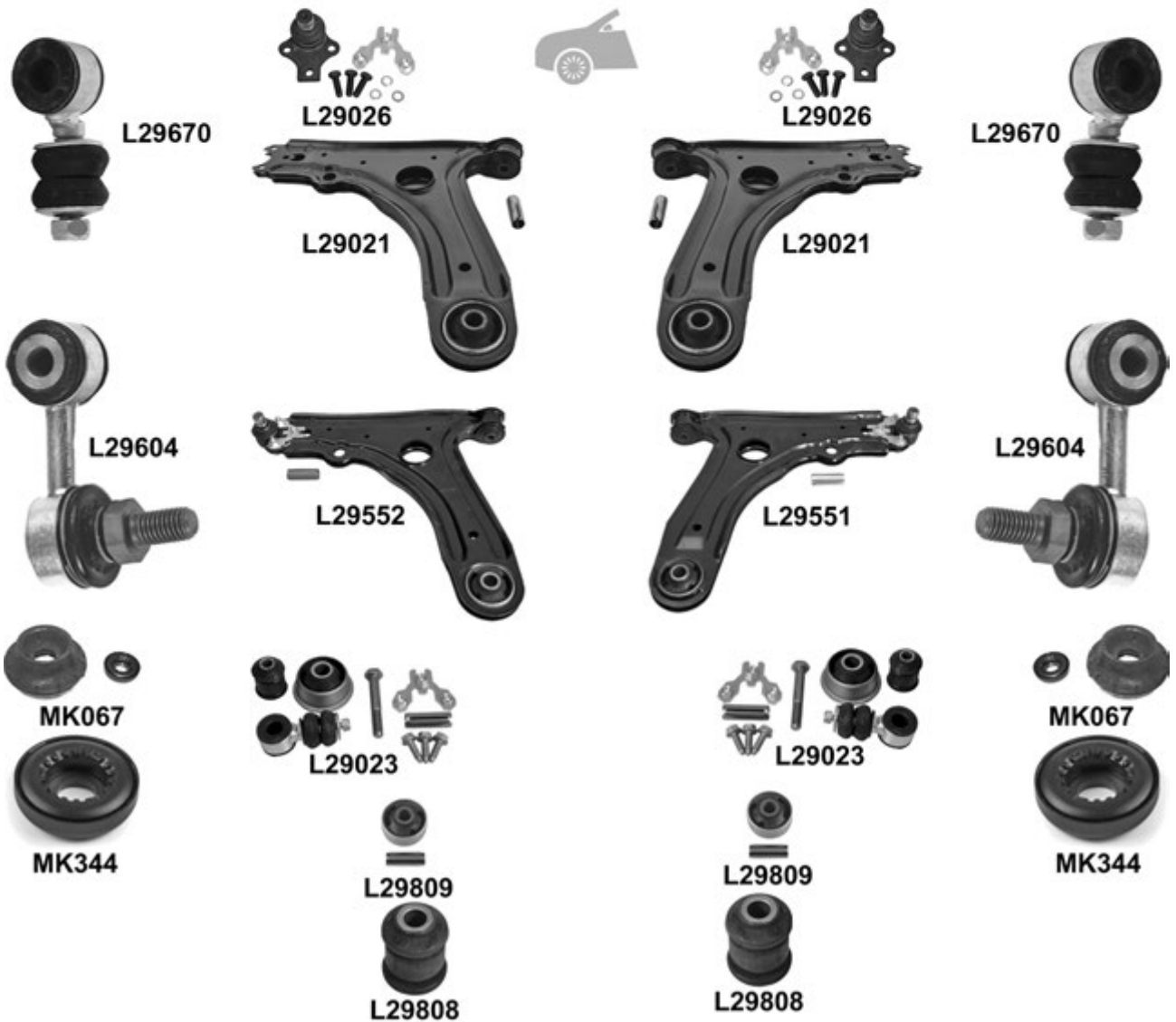
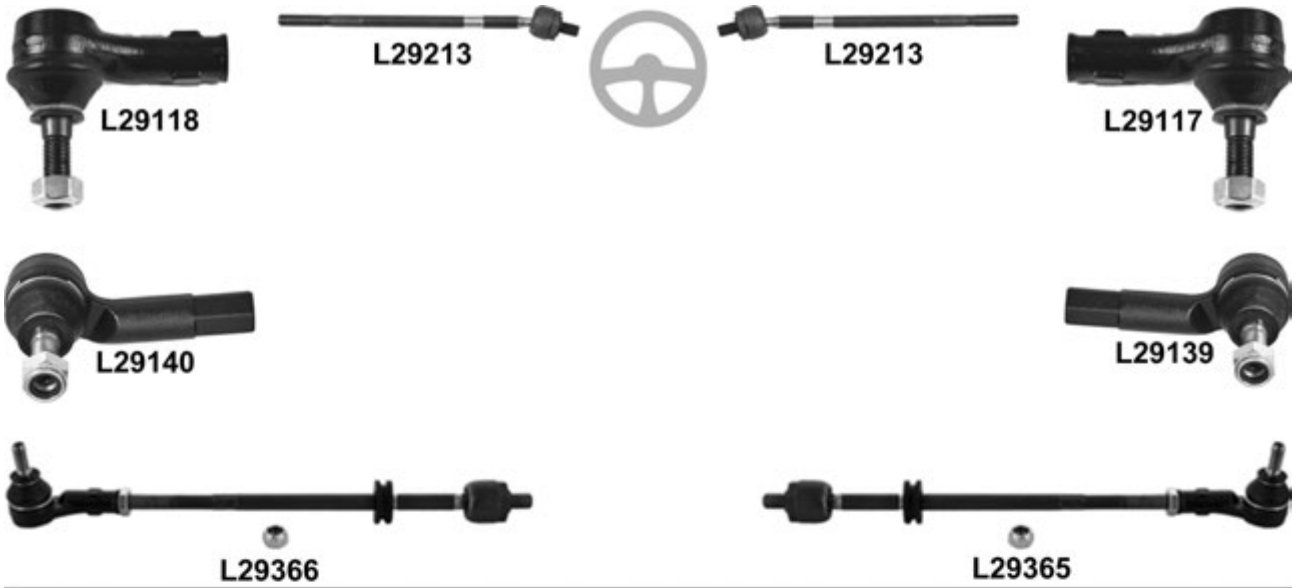
Inca (9KSF) 11.95 →

Inca (9KSF) 11.95 →

			←	→	Thread	Part Of	QPA			
		↔	ch. → 9K 1 013 000	L29117	∪		1	3A0 422 812		
			L29118	∪		1	3A0 422 811			
			ch. 9K 1 013 001 →	L29139	∪		1	6K0 422 812		
			L29140	∪		1	6K0 422 811			
			ch. → 9K 1 013 000, L= 340mm	L29213	L29213	M 14x1,5 / M 14x1,5 ∪	L29365/L29366	2		
			ch. → 9K 1 013 000	L29365				1	6K0 422 804 A	
		⊥		L29026	L29026			2	357 407 365 A	
				(-) (+)	L29021	L29021			2	191 407 153
				<input checked="" type="checkbox"/>	L29551			1		
				L29552			1			
				KIT	L29023	L29023		2	191 407 153 S0	
		⊥	↘	L29809	L29809			2	191 407 181 E	
			↙	L29808	L29808			2	357 407 182	
				→ 03.97	L29670	L29670			2	191 411 315 A
				04.97 →	L29604	L29604			2	1H0 411 315
				1.4 i Mot/Eng AEX, AKV, 1.6 i, 1.7 D, 1.9 D, 1.9 Sdi, (+) MK344 KIT	MK067	MK067			2	357 412 331 A
			1.4 i Mot/Eng AEX, AKV, 1.6 i, 1.7 D, 1.9 D, 1.9 Sdi	MK344	MK344			2	357 412 349 A	

Leon (1M1) 11.99 →

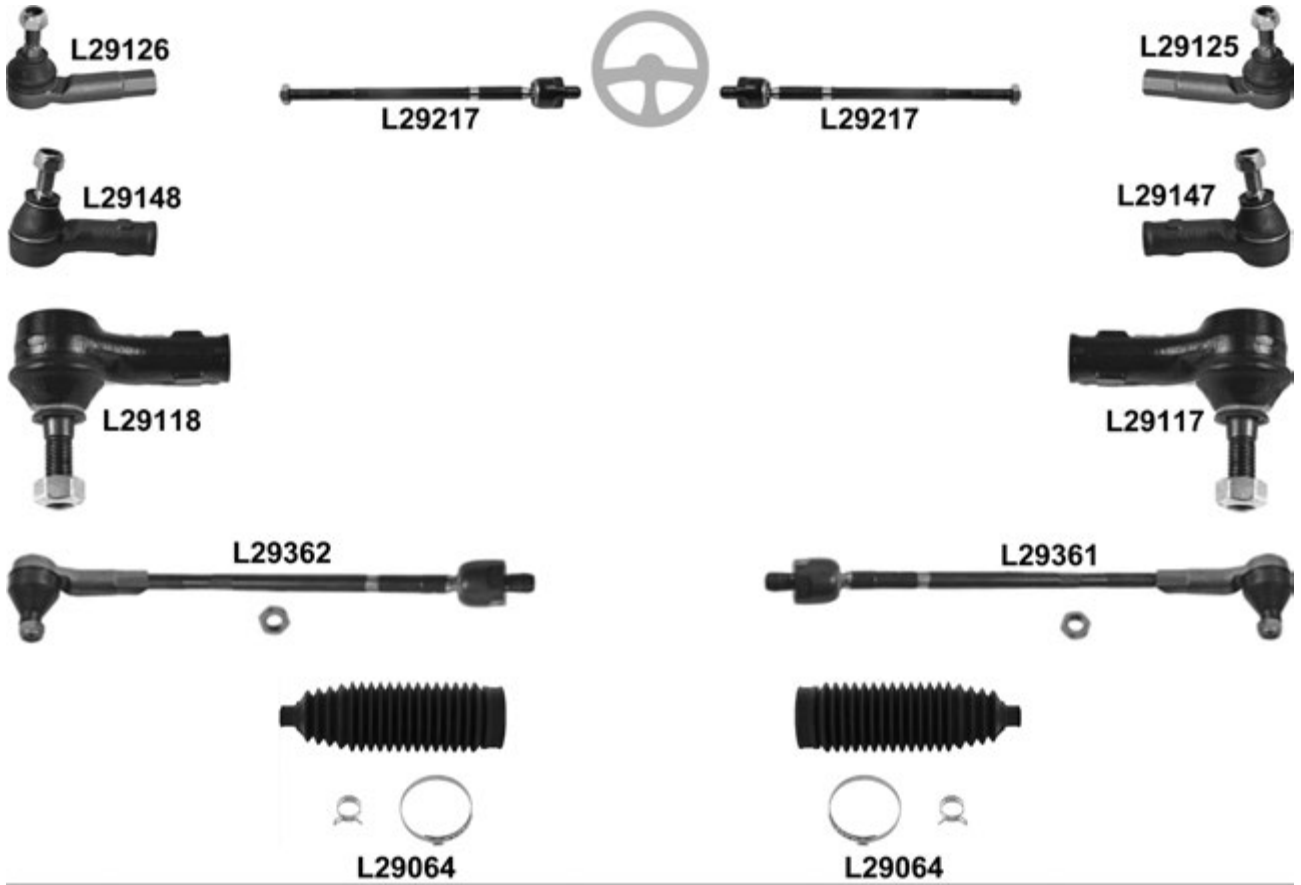

Leon (1M1) 11.99 →

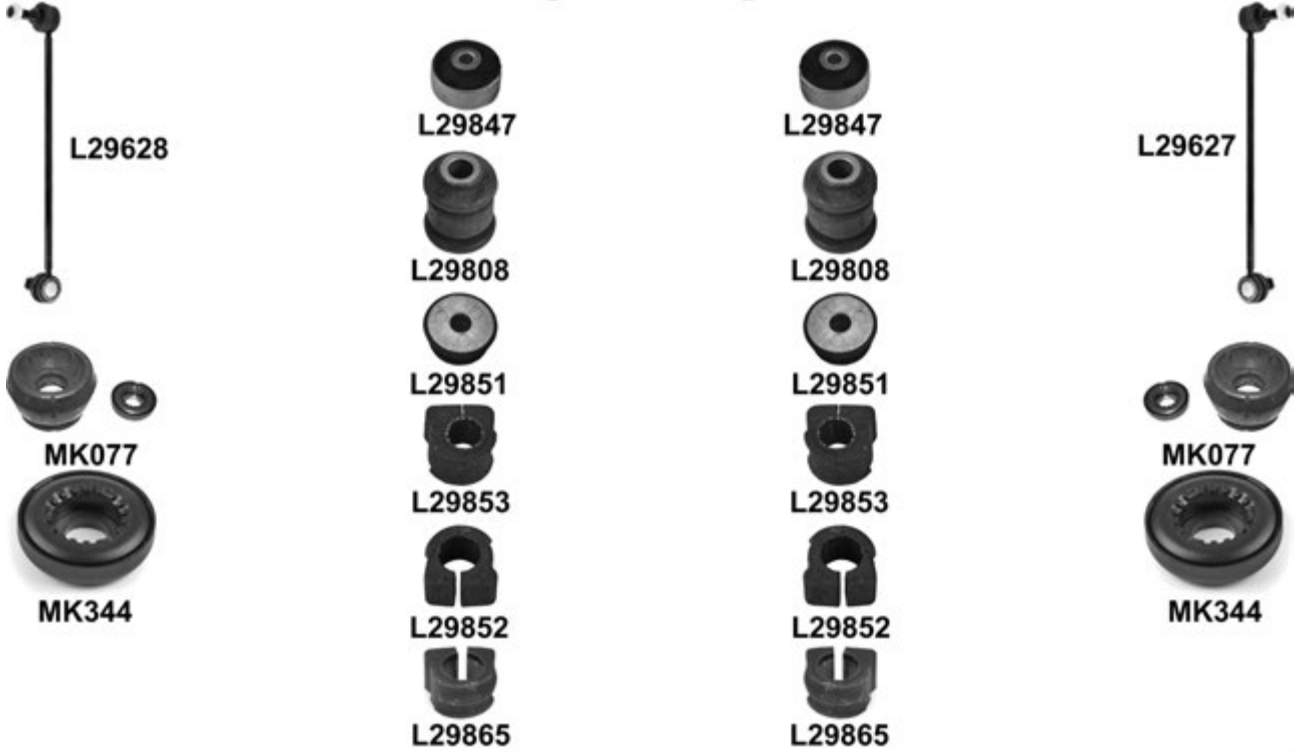

Leon (1M1) 11.99 →

			←	→	Thread	Part Of	QPA		
		↔	(-) 1.8 T Cupra R / 2.8 / 2.8 Cupra 4		L29125		1	1J0 422 812 B	
				L29126		1	1J0 422 811 B		
				1.8 T Cupra R	L29147	F 16x1,5 ∩	1	8N0 422 812 A	
					L29148	F 16x1,5 ∩	1	8N0 422 811 A	
				2.8 / 2.8 Cupra 4	L29117	∩	1	3A0 422 812	
		L29118	∩	1	3A0 422 811				
				(-) 1.8 T Cupra R / 2.8 / 2.8 Cupra 4	L29217	L29217		2	1J0 422 821 B
				(-) 1.8 T Cupra R / 2.8 / 2.8 Cupra 4	L29361			1	1J0 422 804 B
					L29362			1	1J0 422 803 B
					L29064 ⁰	L29064 ⁰		2	1J0 422 831 B
		⊥	(-) 1.8 T Cupra R		L29535		1	1J0 407 366 C	
				L29536		1	1J0 407 365 C		
		1.8 T Cupra R	L29A10	L29A10		2	8N0 407 365 C		
		⊥	(-) 1.8 T Cupra R, (-) , (+)	L29A09	L29A09		2	1J0 407 151 C	
				(-) 1.8 T Cupra R <input checked="" type="checkbox"/>	L29545		1		
		L29546		1					
		⊥	(-) 1.8 T Cupra R	L29847	L29847		2	1J0 407 181	
				L29808	L29808		2	357 407 182	
				L29851	L29851	Hub carrier	2	1J0 199 429	
			→ ch. 1M X 010 000, (-) 1.8 T Cupra R/T4, Metal	L29611	L29611		2	1J0 411 315 G	
				→ ch. 1M X 010 000, (-) 1.8 T Cupra R/T4, Plastic	L29674	L29674		2	1J0 411 315 C
				ch. 1M 1 035 001 →, (-) 1.8 T Cupra R/T4	L29673	L29673		2	1J0 411 315 H
				1.8 T Cupra R/T4 → 09.00	L29673	L29673		2	1J0 411 315 H
				1.8 T Cupra R/T4 10.00 →		L29627		1	1J0 411 316 D
					L29628		1	1J0 411 315 D	
			∅ 17mm / ∅ 19mm	L29853	L29853	Anti-roll bar	2	1J0 411 314 B	
				∅ 21mm / ∅ 23mm	L29852	L29852	Anti-roll bar	2	1J0 411 314 C
				10.00 →, ∅ 23mm	L29865	L29865	Anti-roll bar	2	1J0 411 314 G
			(+) MK344	KIT	MK077	MK077		2	1J0 412 331 BS
					MK344	MK344		2	1J0 412 249
			(-) 4WD / Syncro, ∅ 69mm	KIT	L29874	Hub carrier	1	1J0 501 541 D	
			(-) 4WD / Syncro, ∅ 74mm	KIT	L29849	Hub carrier	1	1J0 501 541 C	
				L29641	L29641		2	1J0 505 466 B	
			(-) SP	MK118	MK118		2	1J0 513 353 B	
			SP	MK118	MK118		2	1J0 513 353 D	

Leon (1P1) 09.05 →

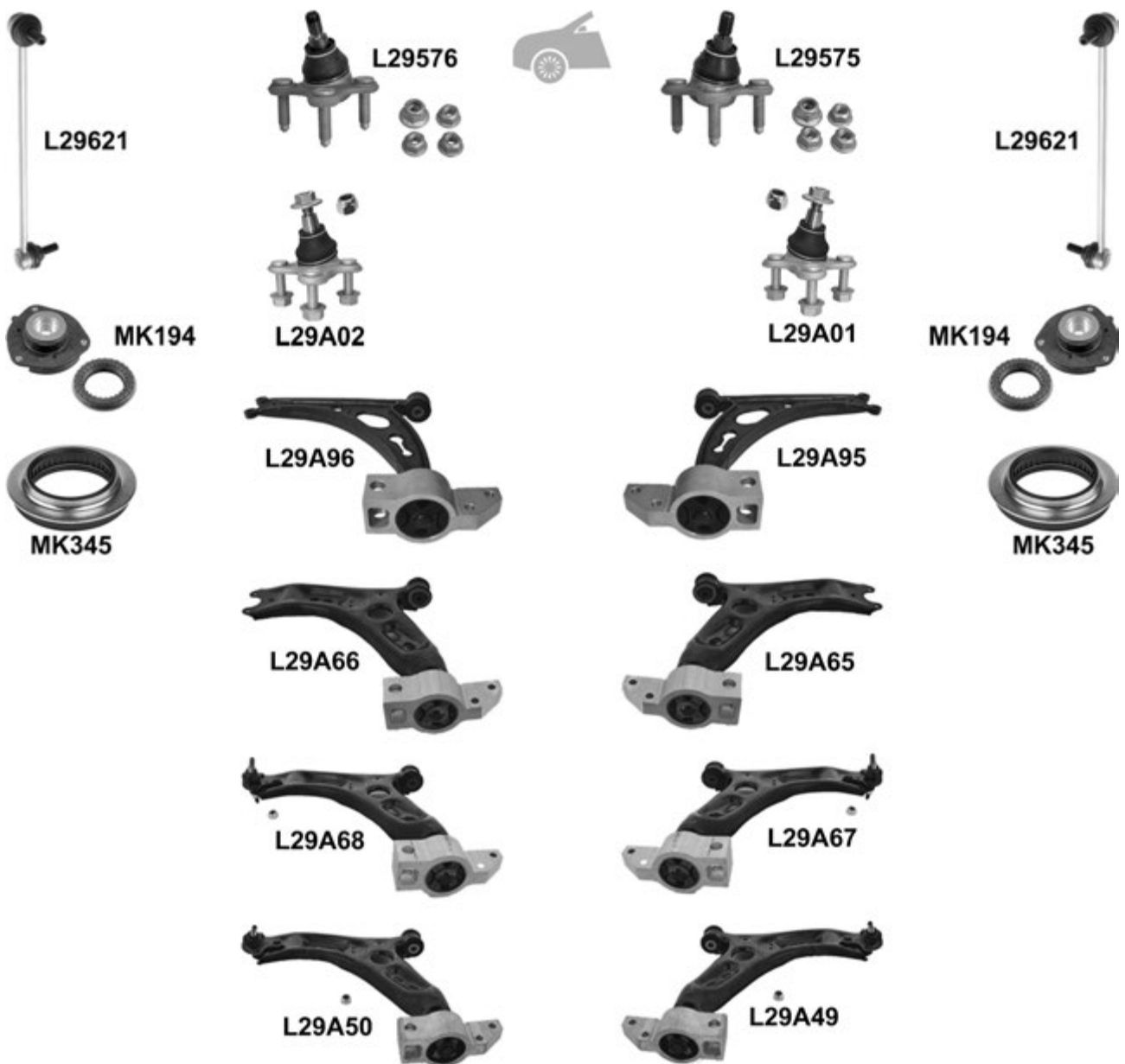
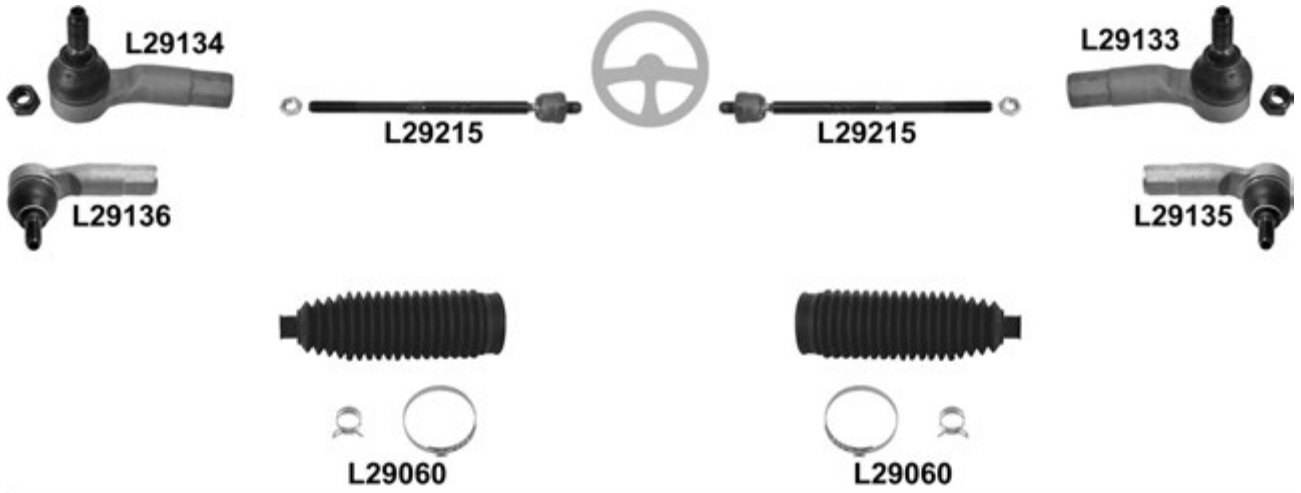



L29876



L29861



L29862



L29862



L29638



L29A11



L29A11



L29637



L29A29



L29A29



L29623



L29A88



L29A87



L29623



MK386



MK386

Leon (1P1) 09.05 →

				←	→	Thread	Part Of	QPA				
		↔	PR 1N3/1N5, (-) Servotronic		L29133	F 16x1,5 ∩		1	1K0 423 812 E			
					L29134	F 16x1,5 ∩		1	1K0 423 811 E			
				Electronic		PR 1N9, Servotronic		L29135	F 16x1,5 ∩		1	1K0 423 812 G
								L29136	F 16x1,5 ∩		1	1K0 423 811 G
							L29215	L29215	M 16x1,5 / M 16x1,5 ∩		2	1K0 423 810 A
							L29060	L29060			2	1K0 423 831 A
		↓	→ 05.10, ch. → 1PA 085 000, (-) PR 1LB / 1LU / 1LT		L29575			1	1K0 407 366 C			
					L29576			1	1K0 407 365 C			
			→ 05.10, ch. → 1PA 085 000, PR 1LB / 1LU / 1LT		L29A01		1	3C0 407 366 A				
					L29A02		1	3C0 407 365 A				
	06.10 →, ch. 1PB 000 001 →		L29A01		1	3C0 407 366 A						
			L29A02		1	3C0 407 365 A						
		↓	(-) , (+)		L29A95 ⁰		1	1K0 407 152 BF				
					L29A96 ⁰		1	1K0 407 151 BF				
			→ 05.10, (-) , (+)		L29A65		1	1K0 407 152 BC				
					L29A66		1	1K0 407 151 BC				
			→ 05.10,	<input checked="" type="checkbox"/>	L29A67		1	1K0 407 152 BC				
				<input checked="" type="checkbox"/>	L29A68		1	1K0 407 151 BC				
	06.10 →,	<input checked="" type="checkbox"/>	L29A49 ⁰		1	1K0 407 152 BD						
			L29A50 ⁰		1	1K0 407 151 BD						
			↓			L29861			1	1K0 199 232 G		
	L29876						1	1K0 199 231 G				
	↓	↑			L29862	L29862		2	1K0 407 182			
					L29621	L29621		2	1K0 411 315 D			
			PR G39/G40/G41/G51/G52, (+) MK345	KIT	MK194	MK194		2	1K0 412 331 B			
					MK345	MK345		2	6N0 412 249 C			
		↕	→ 05.12		L29A11	L29A11		2	4K0 505 323 N			
					L29A29	L29A29		2	1K0 505 311 AB			
					L29A87 ⁰		Trailing Arm	1	1K0 505 224 K			
		↑	→ 05.09		L29A88 ⁰		Trailing Arm	1	1K0 505 222 K			
					L29637			1	1K0 501 530 C			
					L29638			1	1K0 501 529 F			
					L29623	L29623		2	1K0 505 465 J			
			PR UC4		MK386	MK386		2	1K0 513 353 R			

Leon (5F1) 09.12 →
Leon SC (5F5) 09.12 →

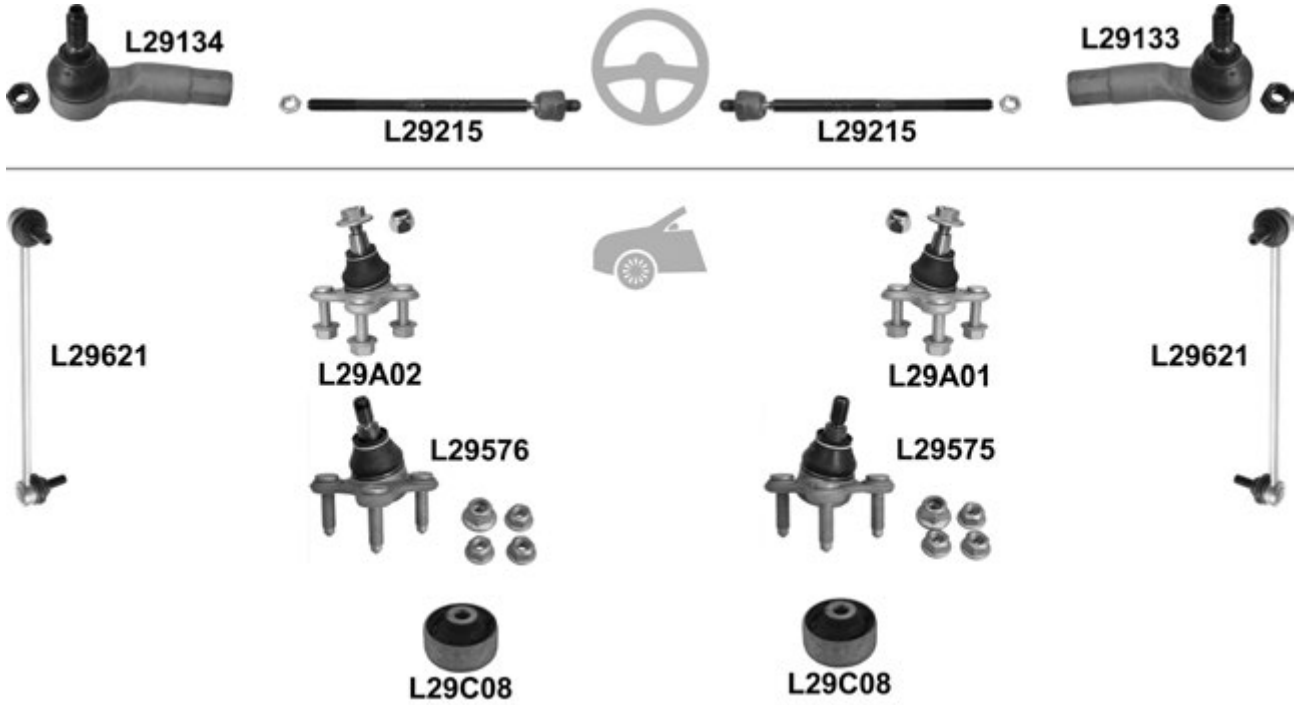

				← → Thread		Part Of	QPA			
				L29133	F 16x1,5 ∪		1	1K0 423 812 E		
				L29134	F 16x1,5 ∪		1	1K0 423 811 E		
				L29215	L29215	M 16x1,5 / M 16x1,5 ∪		2	1K0 423 810 A	
			PR 1ZA		L29A01			1	3C0 407 366 A	
					L29A02			1	3C0 407 365 A	
			PR 1ZE/1ZF		L29575			1	5Q0 407 366 A	
					L29576			1	5Q0 407 365 A	
					L29C08	L29C08			2	5Q0 407 183 E
	L29621	L29621				2	1K0 411 315 D			

Marbella 10.82 →

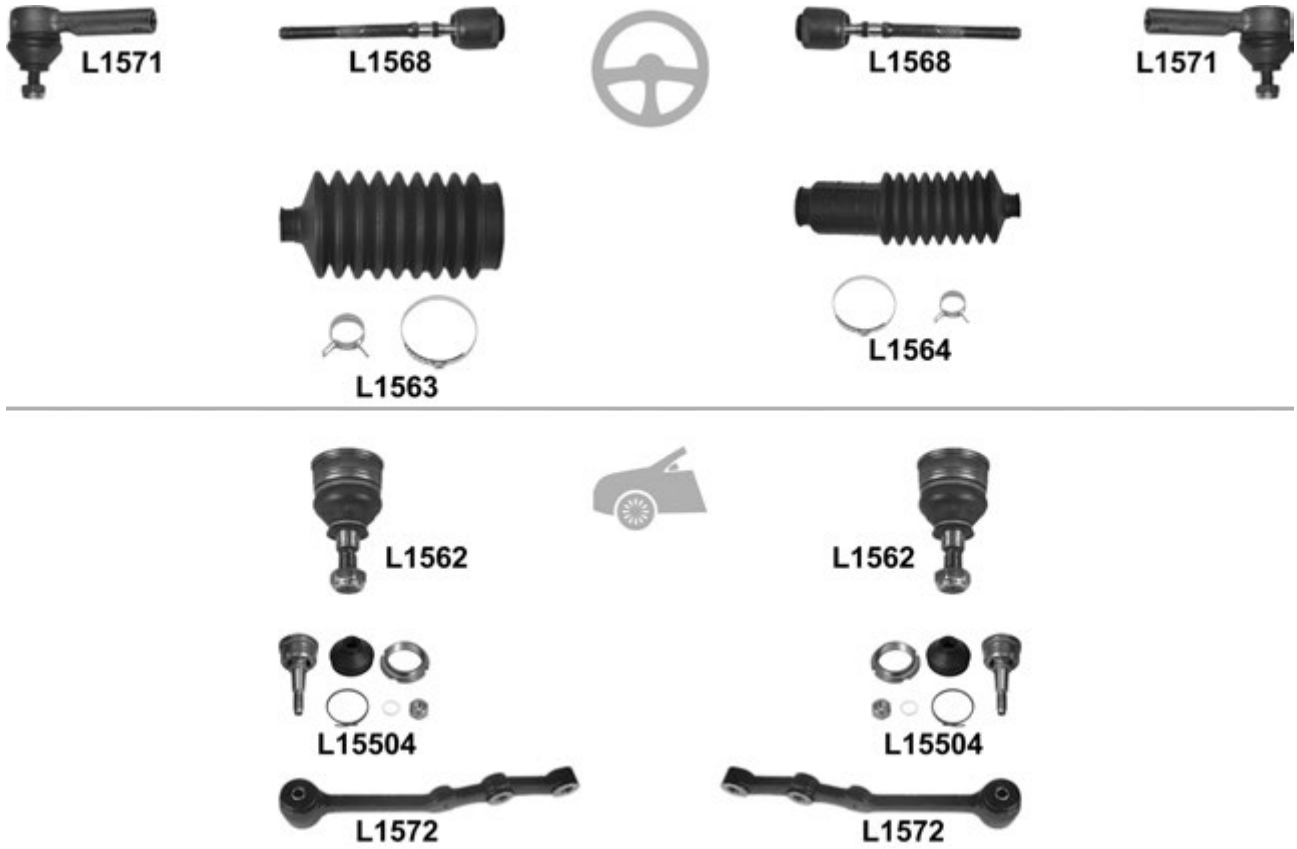

				←	→	Thread	Part Of	QPA		
⊕		↔		L1571	L1571	F 12x1,5 ∪		2	SE 141 162 410 A	
				L1568	L1568	M 12x1,5 / F 14x1,5 ∪		2	SE 141 162 449 A	
					L1564			1		
				L1563				1		
🚗		⊥		L1562	L1562		OE no. SE 141 140 104 A	2		
		⊥	KIT	L15504	L15504		, OE no.	2		
							SE 141 140 104 A			
		⊥	(-) 4WD	L1572	L1572			2	SE 141 156 110 A	

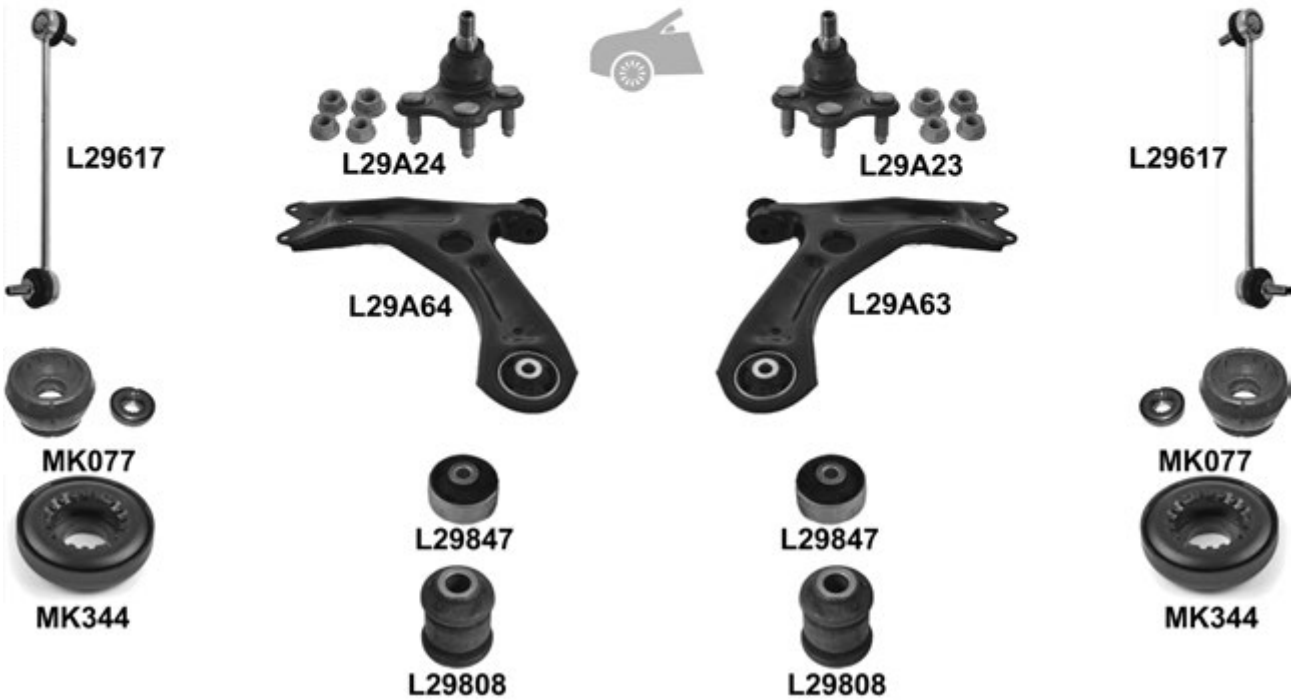
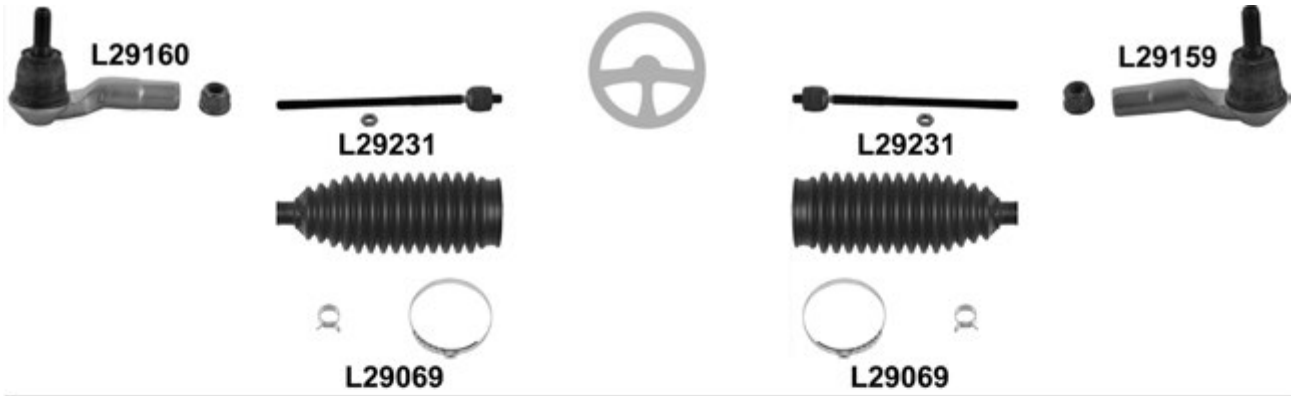
Mii 10.11 →

				←	→	Thread	Part Of	QPA		
⊕		↔			L29159	F 14x1,5 ♂		1	1S0 423 812 A	
					L29160	F 14x1,5 ♂		1	1S0 423 811 A	
				L29231	L29231	M 14x1,5 / M 14x1,5 ♂		2	1S0 423 810 A	
				∅ 14mm, ∅ 44mm, L= 167mm	L29069 ⁰	L29069 ⁰			2	1S0 423 831 A
⊖		⊥			L29A23			1	6R0 407 366	
					L29A24			1	6R0 407 365	
		⊥	(-) (+)		L29A63			1	1S0 407 152	
					L29A64			1	1S0 407 151	
		⊥		L29847	L29847			2	1J0 407 181	
				L29808	L29808			2	357 407 182	
				L29617	L29617			2	6Q0 411 315 D	
			(+) MK344	KIT	MK077	MK077		2	1J0 412 331 BS	
				MK344	MK344		2	1J0 412 249		

Toledo I (1L) 05.91 → 03.99

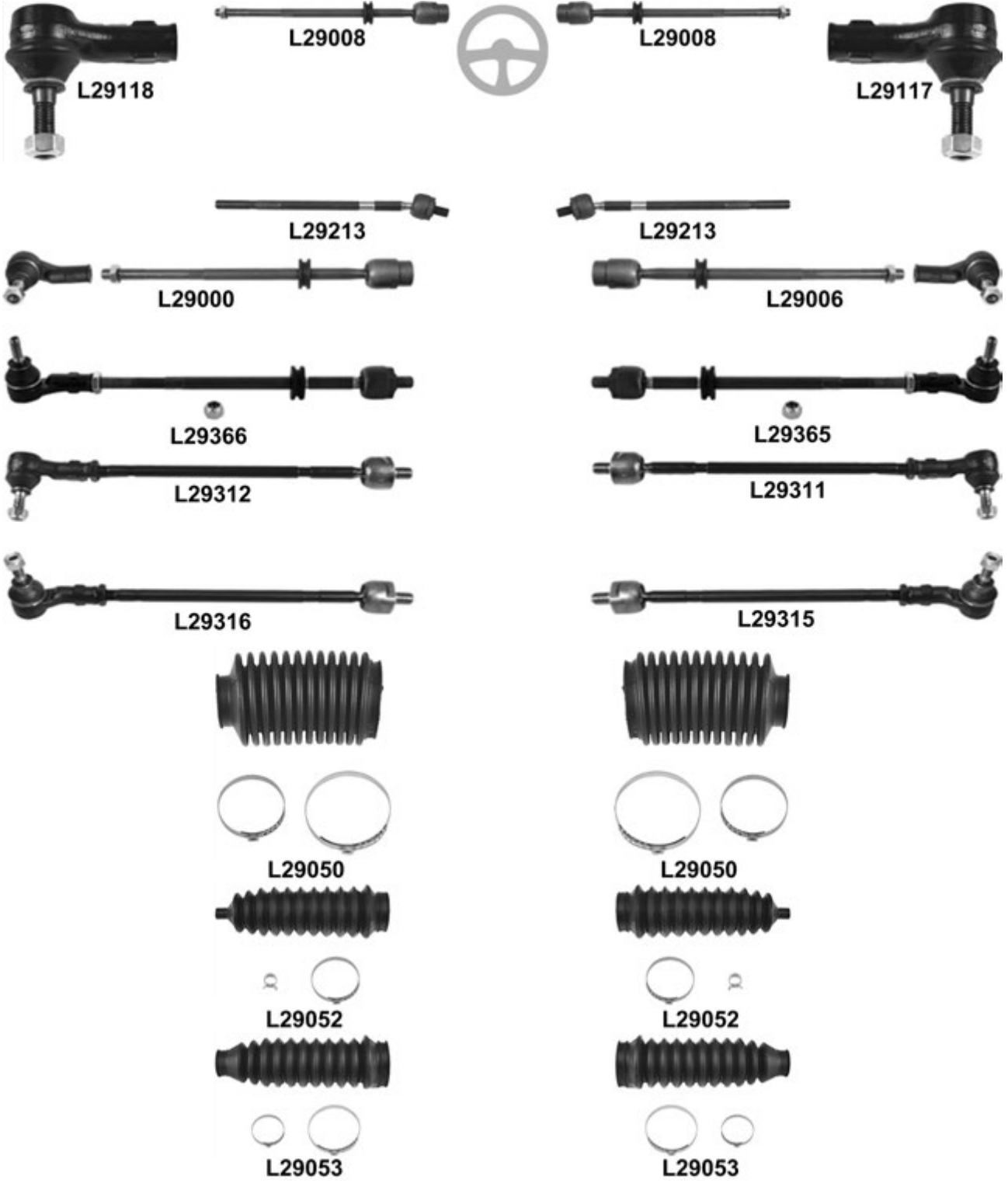

Toledo I (1L) 05.91 → 03.99

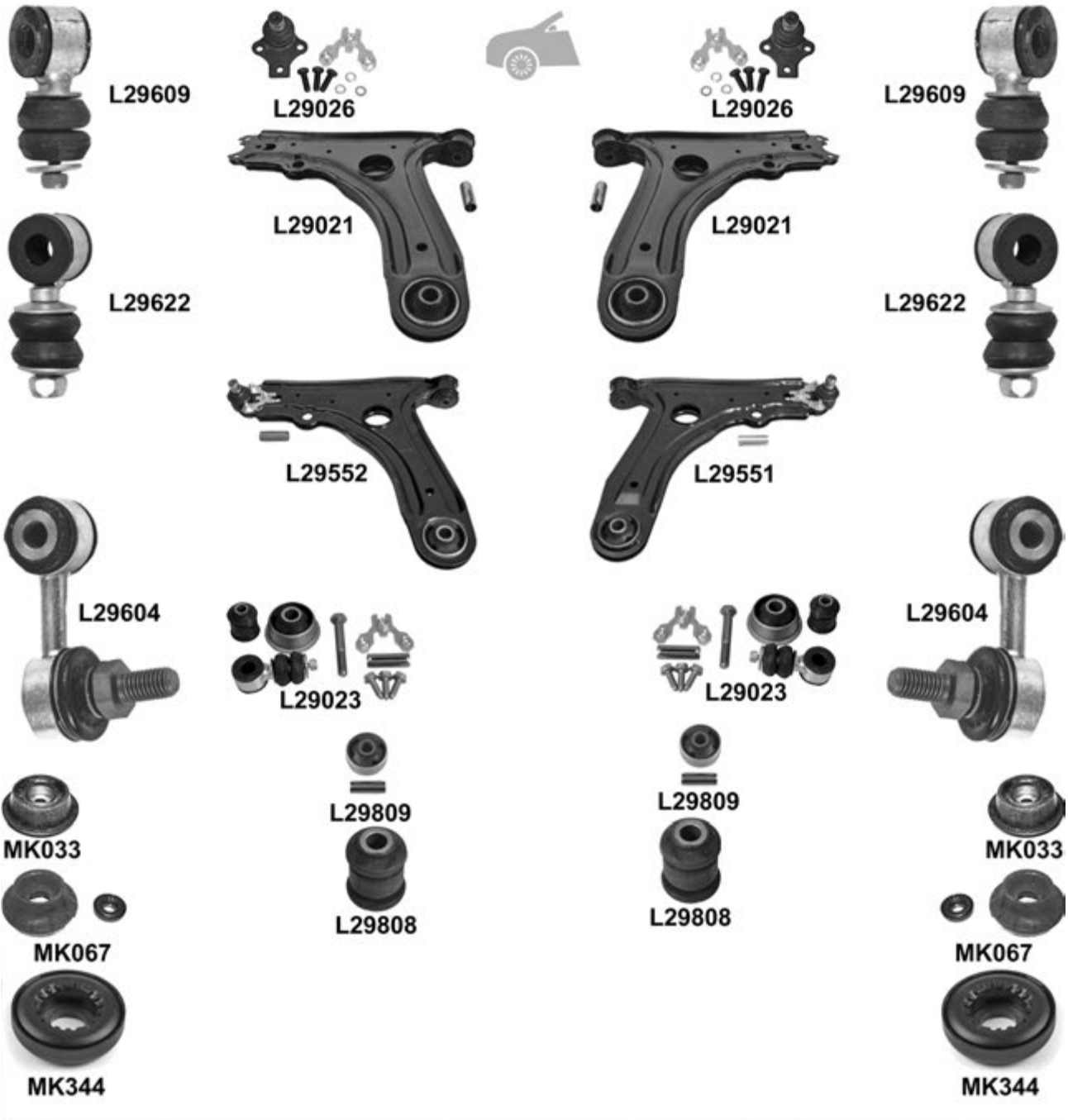

Toledo I (1L) 05.91 → 03.99

			←	→	Thread	Part Of	QPA			
					L29117	F 14x1,5 ♂		1	3A0 422 812	
				L29118		F 14x1,5 ♂		1	3A0 422 811	
					L29008	L29008	M 14x1,5 / M 22x1,5 ♂		2	191 419 821 A
					L29213	L29213	M 14x1,5 / M 14x1,5 ♂	L29365/L29366	2	6K0 422 821 A
					L29006				1	191 419 804 A
				L29000				1	191 419 803 A	
					L29365			1	6K0 422 804 A	
				L29366			1	6K0 422 803 A		
				2.0 16V,	L29311		1	1H0 422 804 A		
				L29312		1	1H0 422 803 A			
				2.0 16V,	L29315		1	1H0 422 804 B		
	L29316		1	1H0 422 803 B						
					L29050	L29050			2	191 419 831
					L29052	L29052		2	1H0 422 831	
					L29053	L29053		2	357 422 831 B	
				L29026	L29026			2	357 407 365 A	
				L29021	L29021		2	191 407 153		
				<input checked="" type="checkbox"/>	L29551			1		
				L29552			1			
				KIT	L29023	L29023		2	191 407 153 S0	
					L29809	L29809		2	191 407 181 E	
					L29808	L29808		2	357 407 182	
				ch. → 1L VR 025 500, (-) 2.0.16V	L29609	L29609		2	191 411 315 BS	
				ch. 1L VR 025 501 →, (-) 2.0 16V	L29622	L29622		2	191 411 315 AS	
				2.0 16V	L29604	L29604		2	535 411 315	
				→ 12.95 , (-) 2.0 16V, 1.9 Tdi	KIT	MK033	MK033		2	191 412 329
				01.96 →, (-) 2.0 16V, 1.9 Tdi, (+) MK344	KIT	MK067	MK067		2	357 412 331 A
2.0 16V, 1.9 Tdi, (+) MK344				MK067	MK067		2	357 412 331 A		
				MK344	MK344		2	357 412 349 A		
			(-) 2.0 16V	KIT	L29829		Hub carrier	1	191 501 541 S	
			2.0 16V	KIT	L29830		Hub carrier	1	1H0 501 541 AS	

Toledo II (1M2) 04.99 →

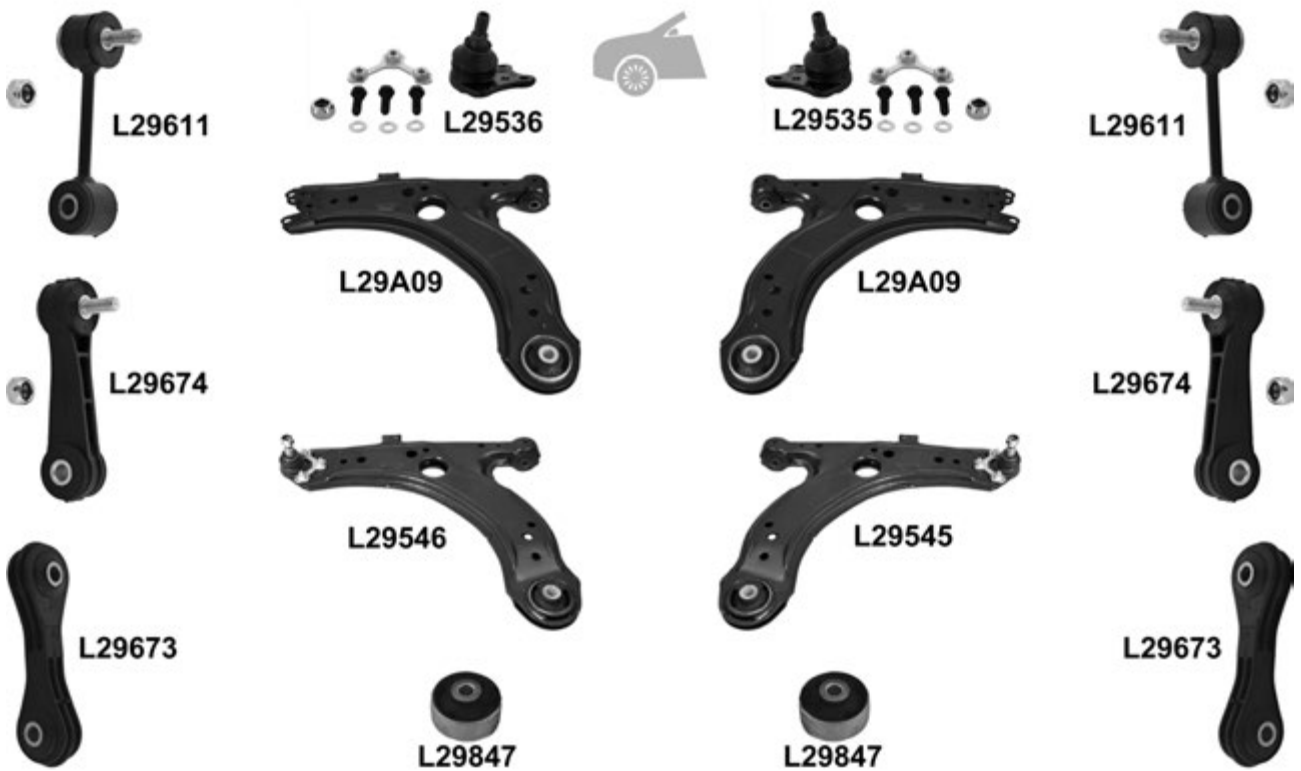
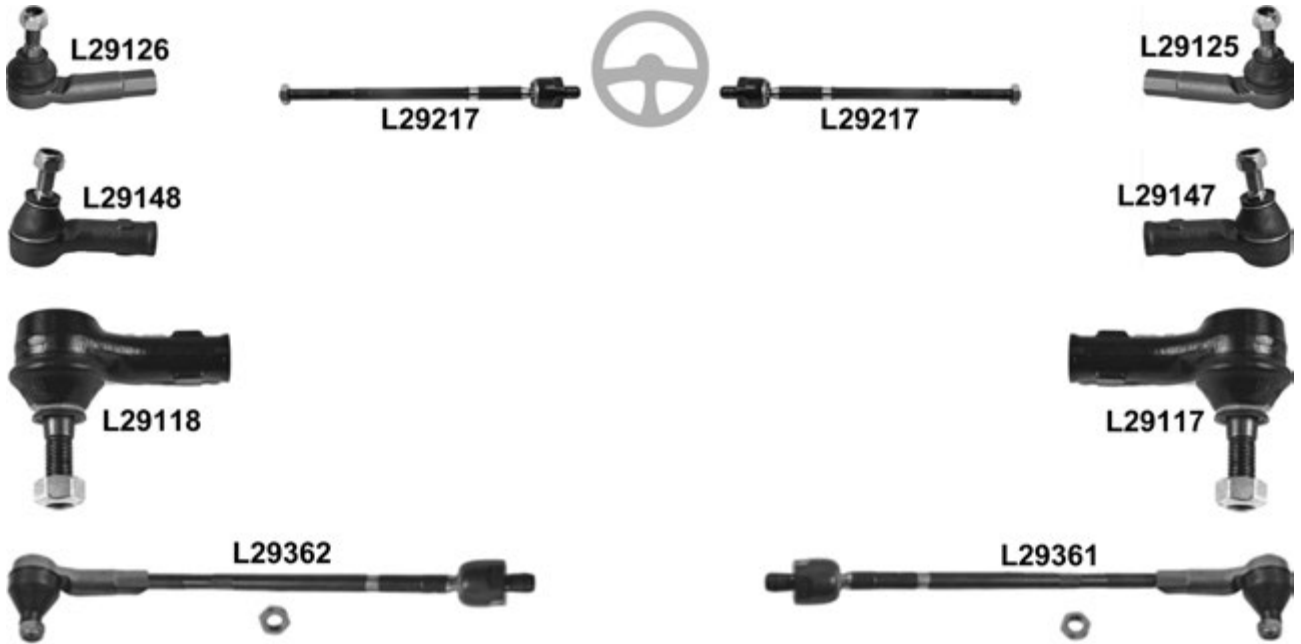

Toledo II (1M2) 04.99 →

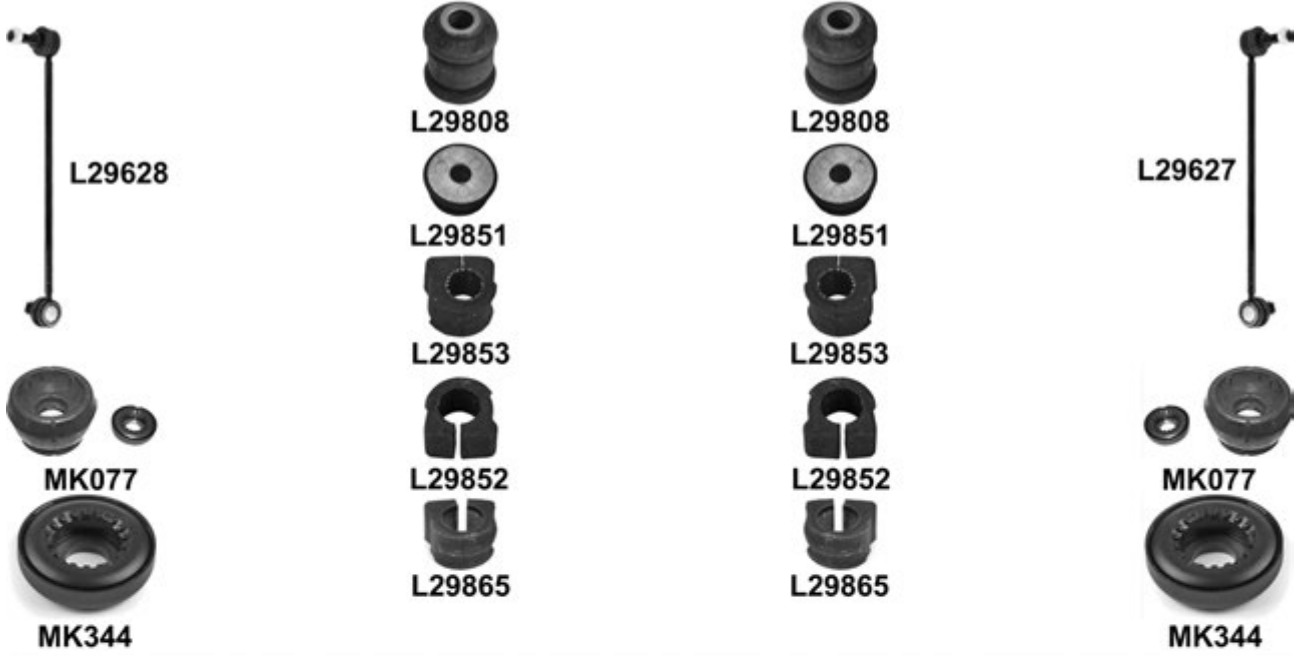

Toledo II (1M2) 04.99 →

			←	→	Thread	Part Of	QPA			
				L29125			1	1J0 422 812 B		
			L29126				1	1J0 422 811 B		
			1.8 Mot/Eng BAM, 1.8 Turbo Mot/Eng AMK, 1.9 Tdi Mot/Eng ARL	L29147	F 16x1,5 ∩		1	8N0 422 812 A		
				L29148	F 16x1,5 ∩		1	8N0 422 811 A		
			2.8 Mot/Eng, AUE/BDE PR 1N6/QZ4	L29125	F 14x1,5		1	1J0 422 812 B		
				L29126	F 14x1,5		1	1J0 422 811 B		
			2.8 Mot/Eng, AUE/BDE PR QZ5	L29117	F 14x1,5 ∩		1	3A0 422 812		
				L29118	F 14x1,5 ∩		1	3A0 422 811		
					L29217	L29217			2	1J0 422 821 B
						L29361			1	1J0 422 804 B
		L29362				1	1J0 422 803 B			
				L29535			1	1J0 407 366 C		
			L29536				1	1J0 407 365 C		
			(-) (+)	L29A09	L29A09			2	1J0 407 151 C	
			<input checked="" type="checkbox"/>	L29545				1		
				L29546				1		
				L29847	L29847			2	1J0 407 181	
				L29808	L29808			2	357 407 182	
				L29851	L29851		Hub carrier	2	1J0 199 429	
			→ 1M 1 035 000, (-) T4, Metal	L29611	L29611			2	1J0 411 315 G	
			→ 1M 1 035 000, (-) T4, Plastic	L29674	L29674			2	1J0 411 315 C	
			1M 1 035 001 →, (-) T4	L29673	L29673			2	1J0 411 315 H	
			T4 → 09.00	L29611	L29611			2	1J0 411 315 G	
			T4 10.00 →		L29627			1	1J0 411 316 D	
				L29628				1	1J0 411 315 D	
			∅ 17mm / ∅ 19mm	L29853	L29853		Anti-roll bar	2	1J0 411 314 B	
			∅ 21mm / ∅ 23mm	L29852	L29852		Anti-roll bar	2	1J0 411 314 C	
			10.00 →, ∅ 23mm	L29865	L29865		Anti-roll bar	2	1J0 411 314 G	
		(+) MK344	KIT	MK077	MK077		2	1J0 412 331 BS		
				MK344	MK344		2	1J0 412 249		
		(-) 4WD / Syncro, ∅ 69mm	KIT	L29874		Hub carrier	1	1J0 501 541 D		
		(-) 4WD / Syncro, ∅ 74mm	KIT	L29849		Hub carrier	1	1J0 501 541 C		
			L29641	L29641			2	1J0 505 466 B		
				MK118	MK118			2	1J0 513 353 B	
				MK118	MK118			2	1J0 513 353 D	

Toledo III (5P2) 10.04 →

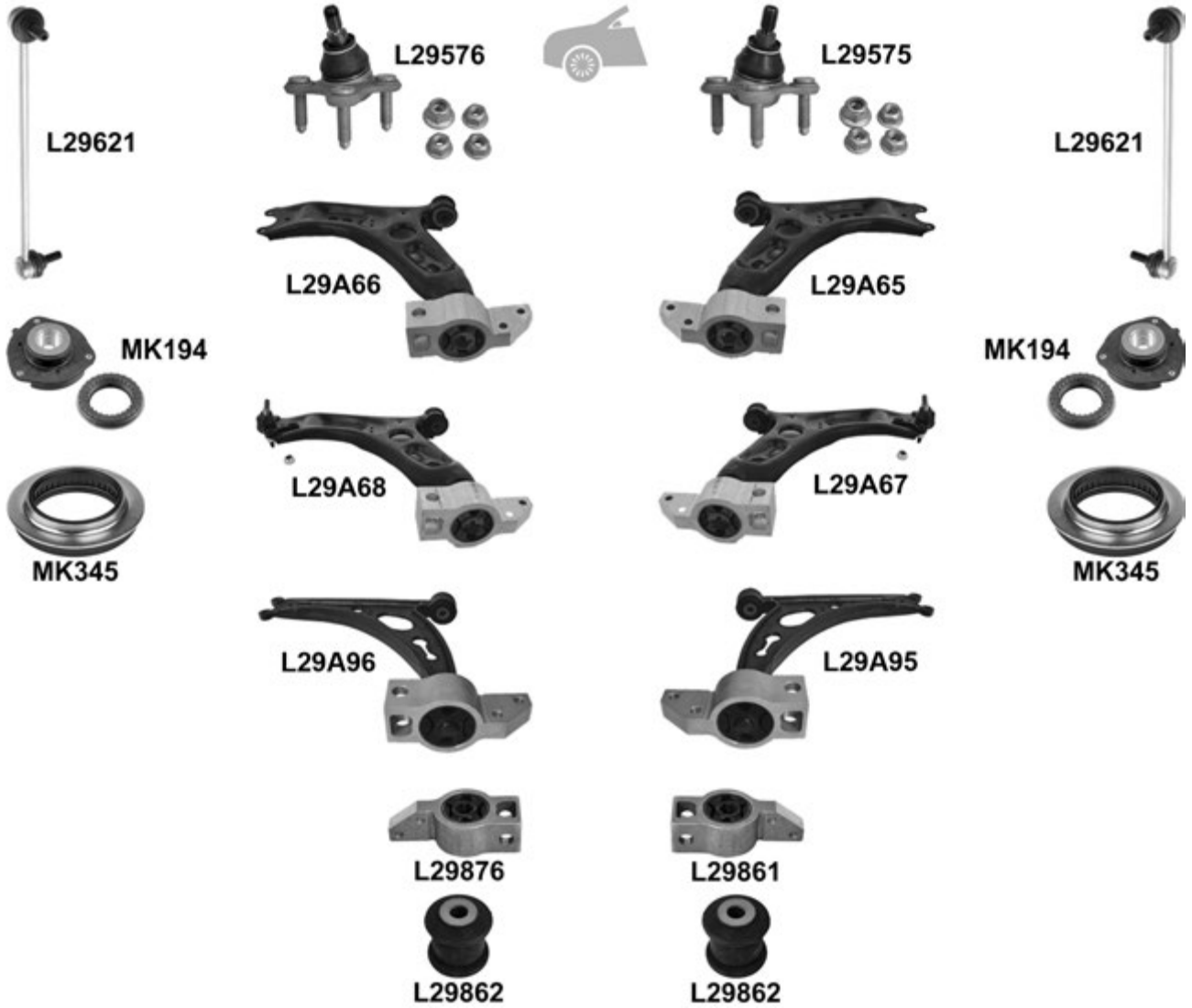
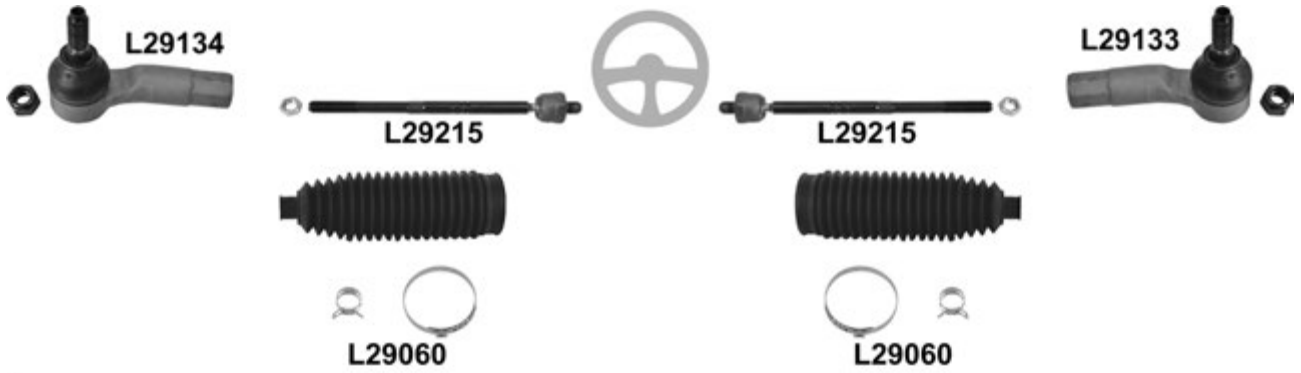

Toledo III (5P2) 10.04 →

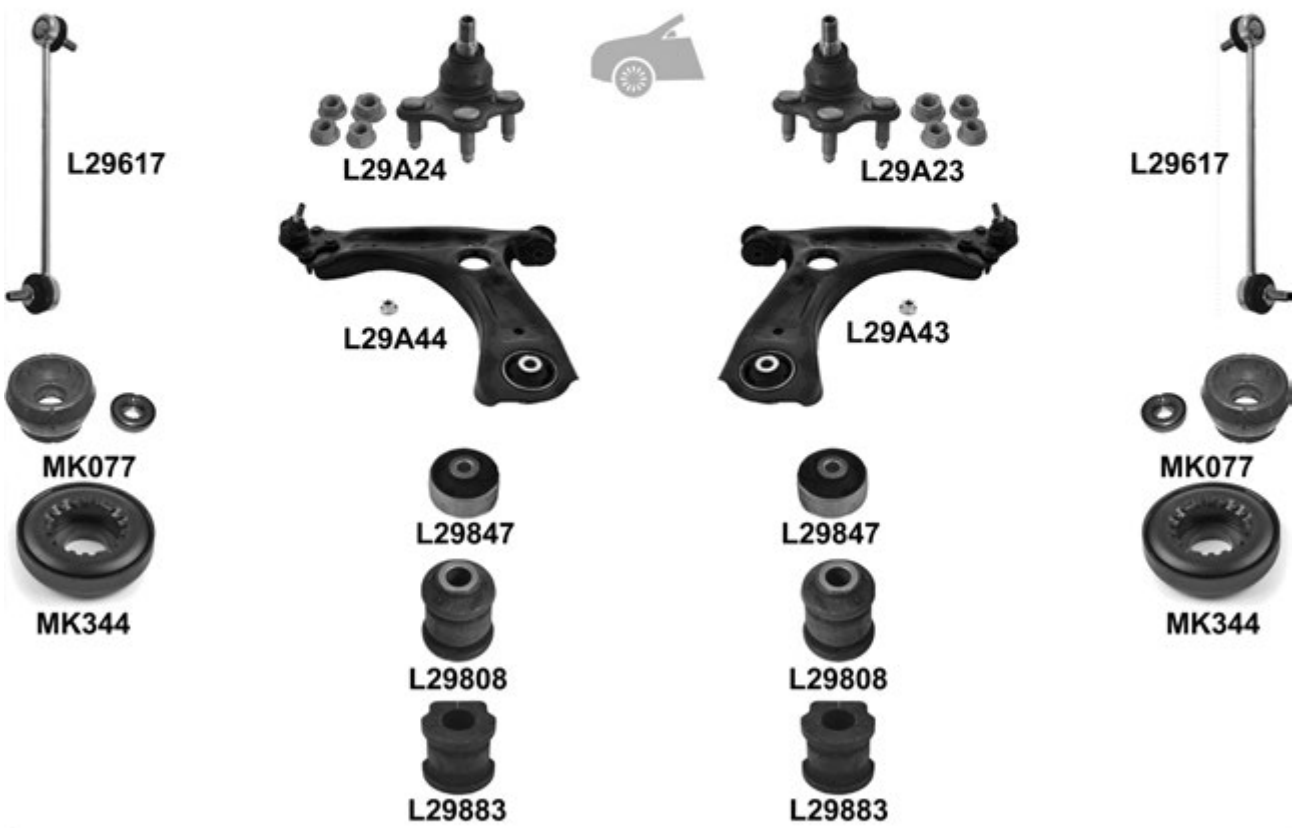
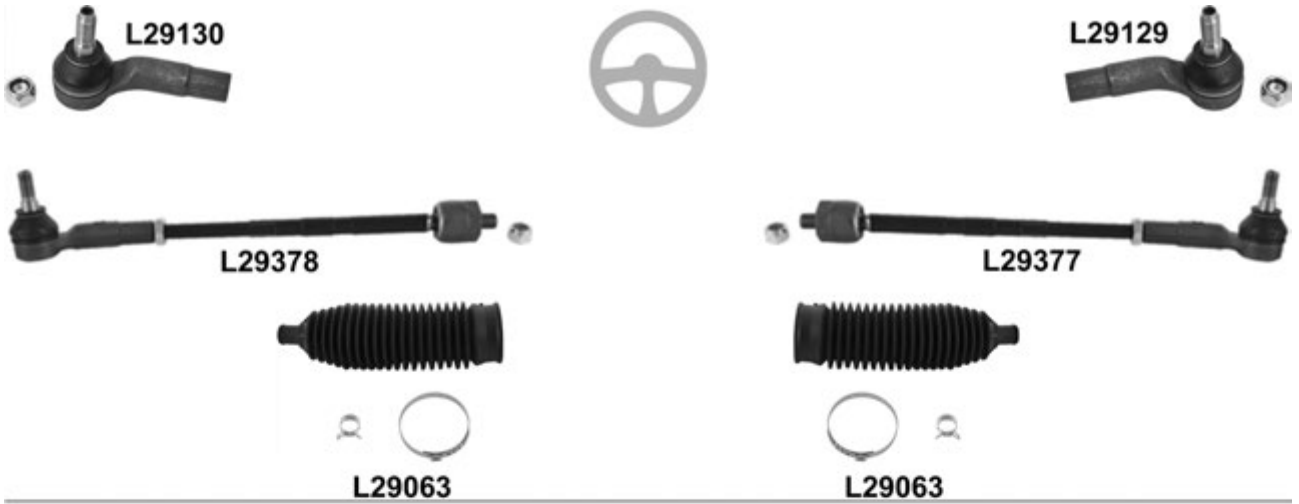

		i		←	→	Thread	Part Of	QPA	i
⊕		↔			L29133	F 16x1,5 ∪		1	1K0 423 812 E
				L29134	F 16x1,5 ∪		1	1K0 423 811 E	
				L29215	L29215	M 16x1,5 / M 16x1,5 ∪		2	1K0 423 810 A
		Electronic		L29060	L29060			2	1K0 423 831 A
		⊥			L29575			1	1K0 407 366 C
				L29576			1	1K0 407 365 C	
		⊥	(-) 1.9 Tdi/2.0 Tdi, (-) (+)		L29A65			1	1K0 407 152 BC
				L29A66		1	1K0 407 151 BC		
				(-) 1.9 Tdi/2.0 Tdi,	<input checked="" type="checkbox"/>	L29A67		1	1K0 407 152 BC
				L29A68		1	1K0 407 151 BC		
		⊥	1.9 Tdi/2.0 Tdi, (-) (+)		L29A95 ^o			1	1K0 407 152 BF
				L29A96 ^o		1	1K0 407 151 BF		
		⊥	▼		L29861			1	1K0 199 232 G
				L29876			1	1K0 199 231 G	
		⊥	▲	L29862	L29862		2	1K0 407 182	
				L29621	L29621			2	1K0 411 315 D
		(+) MK345	KIT	MK194	MK194		2	1K0 412 331 B	
			MK345	MK345			2	6N0 412 249 C	
		⊥		L29A11	L29A11			2	4K0 505 323 N
			L29A29	L29A29			2	1K0 505 311 AB	
		⊥	▲		L29A87 ^o		Trailing Arm	1	1K0 505 224 K
				L29A88 ^o		Trailing Arm	1	1K0 505 222 K	
		▲		L29637				1	1K0 501 530 C
			L29638				1	1K0 501 529 F	
			L29623	L29623			2	1K0 505 465 J	

Toledo IV (KG3) 07.12 →

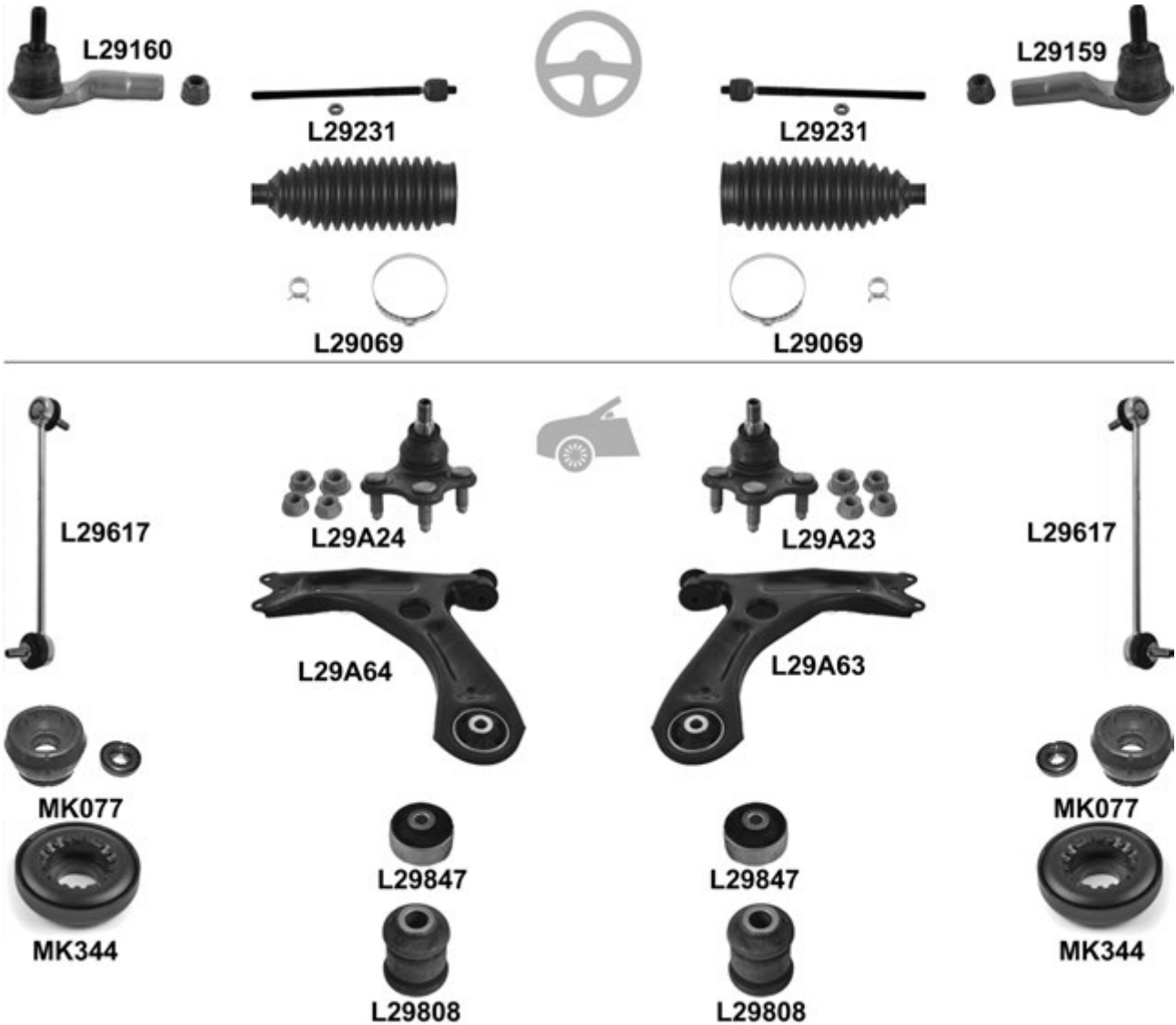

Toledo IV (KG3) 07.12 →

				←	→	Thread	Part Of	QPA	
		↔		L29129		F 14x1,5 ∩		1	6Q0 423 812
				L29130		F 14x1,5 ∩		1	6Q0 422 811
				L29377				1	6R0 423 804 A
				L29378				1	6R0 423 803 A
			PR 1N2, TRW, ø 14,5mm, Ø 47,5mm, L= 205mm	L29063 ⁰	L29063 ⁰			2	6Q0 423 831 D
		⊥		L29A23				1	6R0 407 366
				L29A24				1	6R0 407 365
		⊥	<input checked="" type="checkbox"/>	L29A43				1	6R0 407 152 F
				L29A44				1	6R0 407 151 F
		⊥▼		L29847	L29847			2	1J0 407 181
		⊥▲		L29808	L29808			2	357 407 182
				L29617	L29617			2	6Q0 411 315 D
			PR OAS, Ø 18mm	L29883	L29883		Anti-roll bar	2	6Q0 411 314 R
			(+) MK344	KIT	MK077	MK077		2	1J0 412 331 BS
				MK344	MK344			2	1J0 412 249
			MK118	MK118			2	1J0 513 353 D	

SKODA
Citigo (NF1) 10.11 →

			←	→	Thread	Part Of	QPA		
				L29159	F 14x1,5 ∪		1	1S0 423 812 A	
				L29160	F 14x1,5 ∪		1	1S0 423 811 A	
				L29231	L29231	M 14x1,5 / M 14x1,5 ∪		2	1S0 423 810 A
				L29069 ⁰	L29069 ⁰			2	1S0 423 831 A
				L29A23			1	6R0 407 366	
				L29A24			1	6R0 407 365	
					L29A63			1	1S0 407 152
					L29A64			1	1S0 407 151
					L29847	L29847		2	1J0 407 181
					L29808	L29808		2	357 407 182
				L29617	L29617			2	6Q0 411 315 D
					KIT	MK077	MK077		2
					MK344	MK344		2	1J0 412 249

Fabia (6Y2 / 6Y3) 12.99 →
 Fabia Combi (6Y5) 11.00 →
 Fabia Praktik 04.02 →

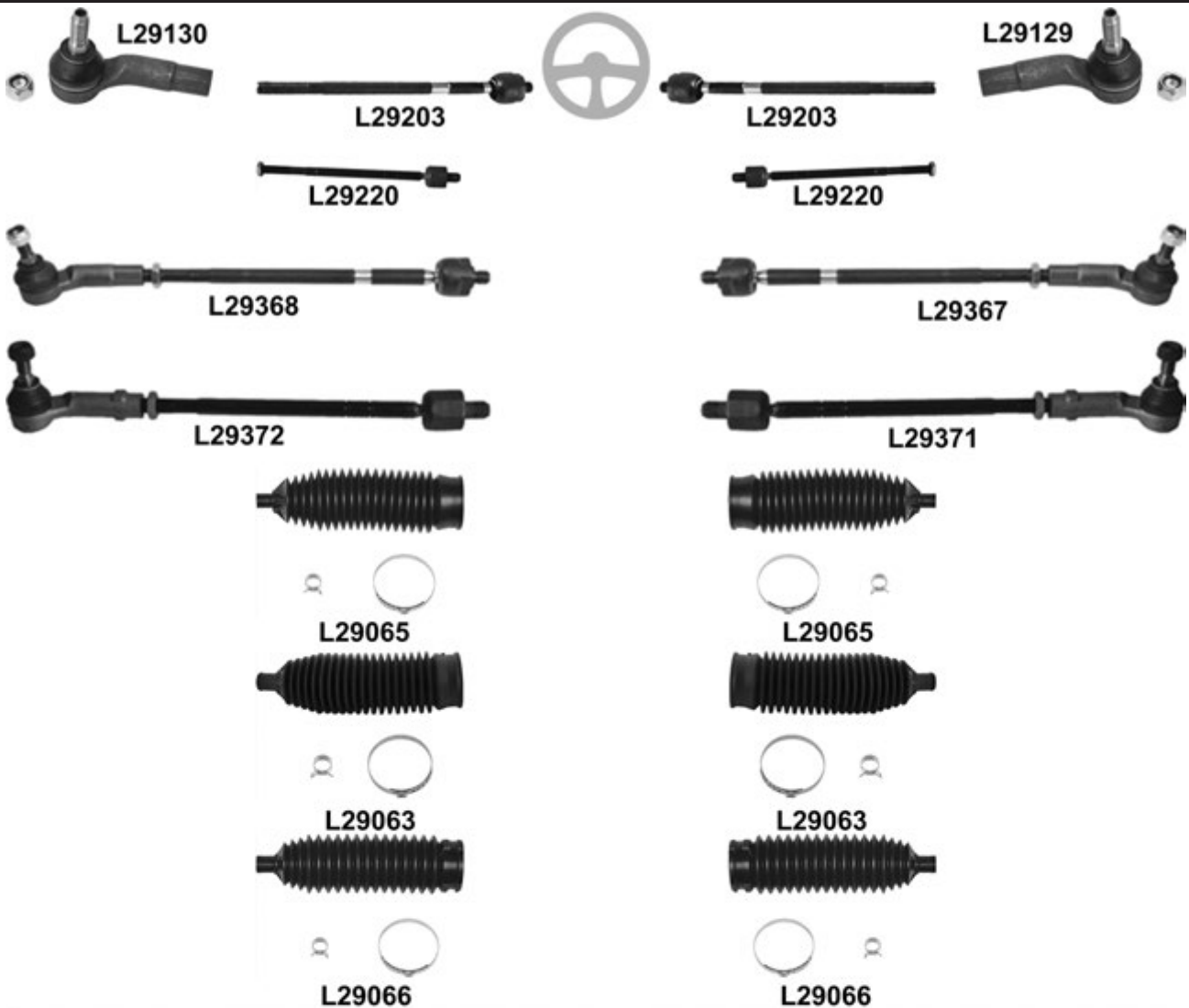

Fabia (6Y2 / 6Y3) 12.99 →
 Fabia Combi (6Y5) 11.00 →
 Fabia Praktik 04.02 →



		i	←	→	Thread	Part Of	QPA	i	
		↔		L29129	F 14x1,5 ∪		1	6Q0 423 812	
				L29130	F 14x1,5 ∪		1	3A0 422 811	
			TRW	L29203	L29203	M 14x1,5 / M 14x1,5 ∪		2	
			Smi / Koyo	L29220	L29220	∪		2	6Q0 423 810 G
			TRW		L29367			1	6Q0 423 804 B
					L29368			1	6Q0 423 803 B
			Smi / Koyo		L29371			1	6Q0 423 804 G
					L29372			1	6Q0 423 803 G
			→ 11.02, TRW, ø 12mm, Ø 48mm, L= 195mm	L29065 ^o	L29065 ^o			2	6E0 419 831
			12.02 →, TRW, ø 14,5mm, Ø 47,5mm, L= 205mm	L29063 ^o	L29063 ^o			2	6Q0 423 831 D
Smi/Koyo, ø 13mm, Ø 45,5mm, L= 210mm			L29066 ^o	L29066 ^o			2	6Q0 423 831 A	
		⊥		L29563			1	6Q0 407 366 A	
				L29564			1	6Q0 407 365 A	
		⊥	(-) (+)	L29A69	L29A69			2	6Q0 407 151 D
			<input checked="" type="checkbox"/>	L29565			1		
				L29566			1		
		⊥	↘	L29887	L29887			2	1K0 407 183 E
			↗	L29858	L29858			2	6Q0 407 182 A
				L29617	L29617			2	6Q0 411 315 D
			PR OAS, 10.02 →, ch. 6Y3 651 671 →, Ø 18mm	L29883	L29883		Anti-roll bar	2	6Q0 411 314 R
			G01/G02/G5, (+) MK345	KIT	MK156	MK156		2	6N0 412 331 E
G03/G04/G6, (+) MK345				MK156	MK156		2	6Q0 412 331 B	
				MK345	MK345		2	6N0 412 249 C	
		69mm	KIT	L29874		Hub carrier	1	1J0 501 541 D	
		74mm	KIT	L29849		Hub carrier	1	1J0 501 541 C	
				MK118	MK118		2	1J0 513 353 B	

Fabia 12.06 →
 Fabia Scout 10.07 →
 Fabia Praktik 03.07 →

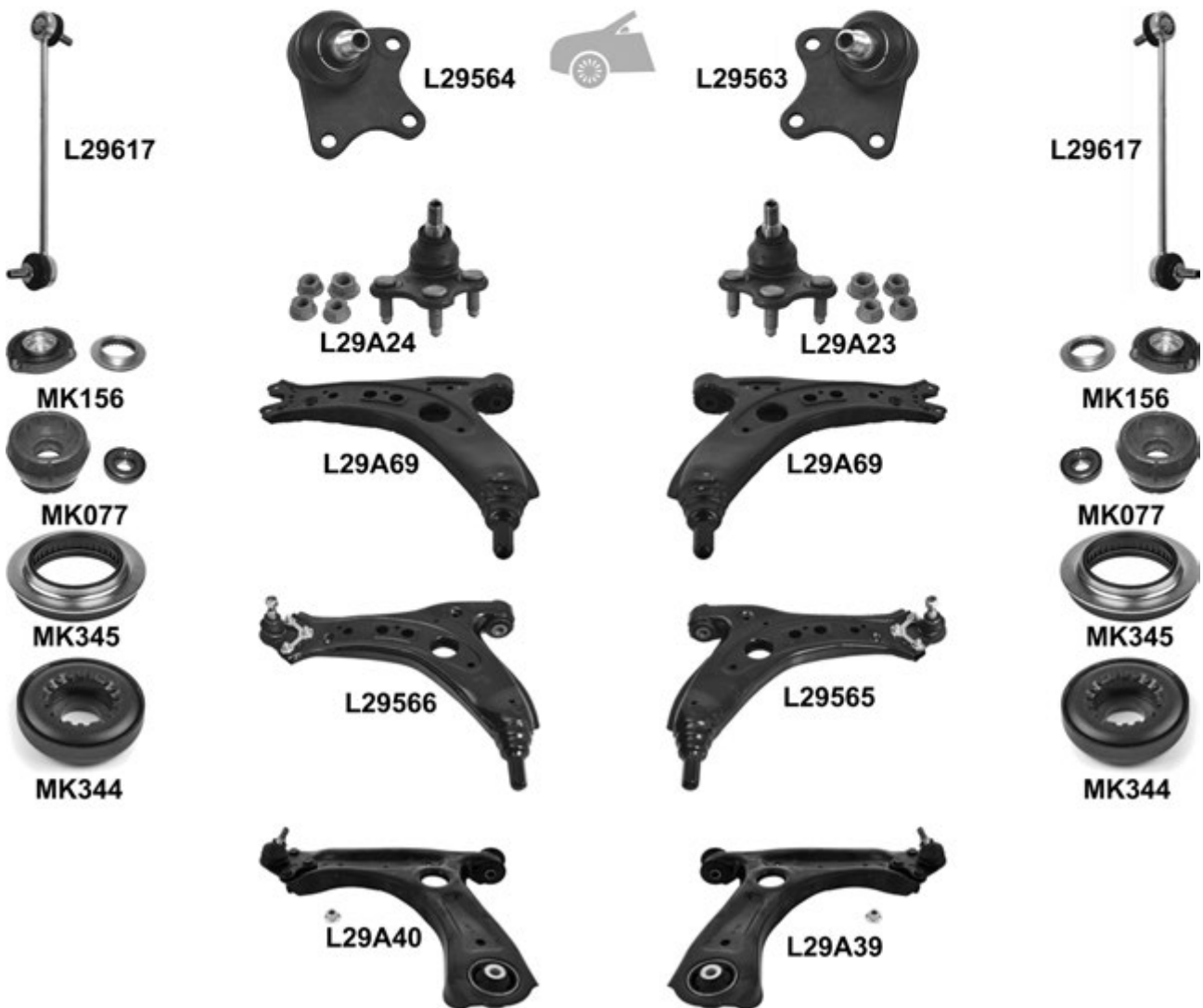
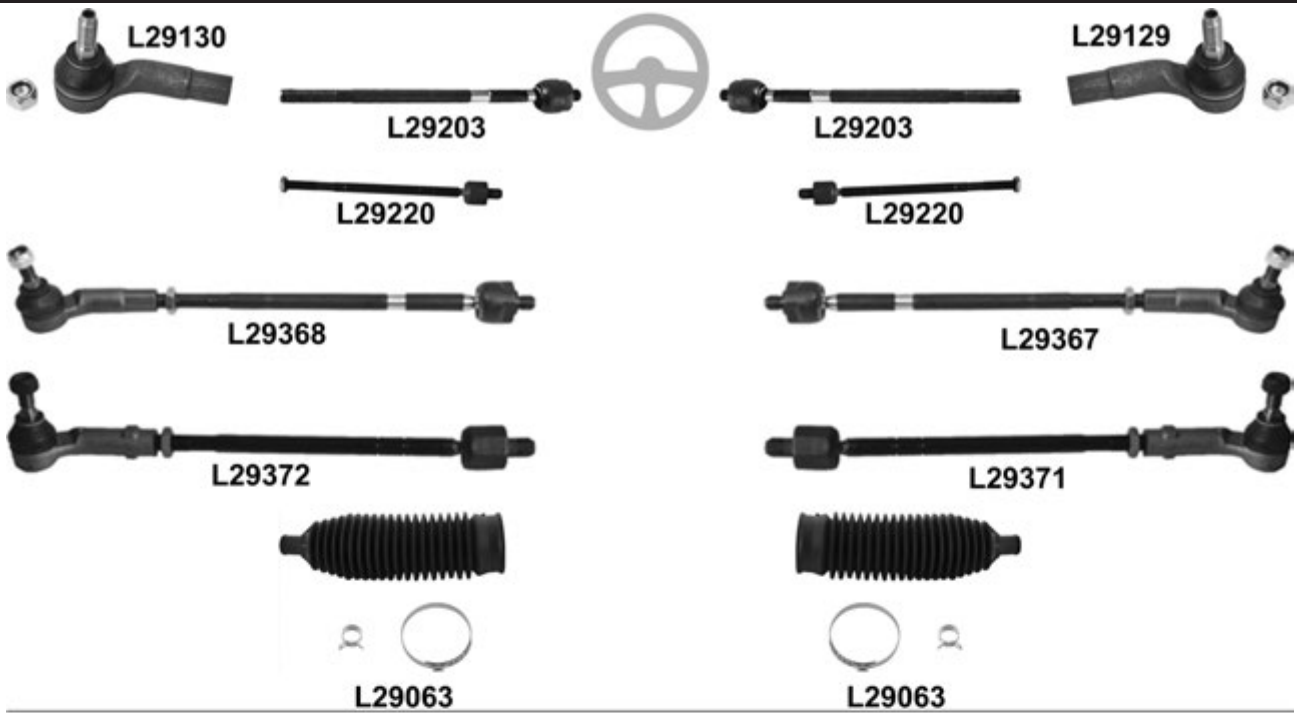

Fabia 12.06 →
 Fabia Scout 10.07 →
 Fabia Praktik 03.07 →



Fabia 12.06 →
 Fabia Scout 10.07 →
 Fabia Praktik 03.07 →

			←	→	Thread	Part Of	QPA		
		↔		L29129	F 14x1,5 ♂		1	6Q0 423 812	
				L29130	F 14x1,5 ♂		1	3A0 422 811	
			TRW	L29203	L29203	M 14x1,5 / M 14x1,5 ♂		2	
			Smi / Koyo	L29220	L29220	♂		2	6Q0 423 810 G
			TRW		L29367			1	6Q0 423 804 B
					L29368			1	6Q0 423 803 B
			Smi / Koyo		L29371			1	6Q0 423 804 G
					L29372			1	6Q0 423 803 G
			TRW, ø 14,5mm, Ø 47,5mm, L= 205mm	L29063 °	L29063 °		2	6Q0 423 831 D	
			↓	→ 02.08		L29563		1	6Q0 407 366 A
ch. → 5J 8A 502 656				L29564			1	6Q0 407 365 A	
ch. → 5J 8B 503 031									
ch. → 5J 8K 450 960									
ch. → 5J 83 172 973									
03.08 →					L29A23		1	6R0 407 366	
		↓	ch. 5J 8A 502 656 →	L29A24			1	6R0 407 365	
			ch. 5J 8B 503 031 →						
			ch. 5J 8K 450 960 →						
			ch. 5J 83 172 973 →						
	↓	→ 02.08	L29A69	L29A69		2	6Q0 407 151 D		
		ch. → 5J 8A 502 656							
		ch. → 5J 8B 503 031							
		ch. → 5J 8K 450 960							
		ch. → 5J 83 172 973							
		ch. → 5J 83 172 973							
	↓	→ 02.08 <input checked="" type="checkbox"/>		L29565		1			
		ch. → 5J 8A 502 656	L29566			1			
		ch. → 5J 8B 503 031							
		ch. → 5J 8K 450 960							
		ch. → 5J 83 172 973							
		03.08 → 03.10 , (-) PR G01/G07 <input checked="" type="checkbox"/>		L29A39		1	6R0 407 152 E		
ch. 5J 8A 502 657 →	L29A40			1	6R0 407 151 E				
	ch. 5J 8B 503 031 →								
ch. 5J 8K 450 961 →									
ch. 5J 83 172 974 →									
04.10 →, PR G02/G03/G04/G38/GG39/G40/G41 <input checked="" type="checkbox"/>		L29A39		1	6R0 407 152 E				
		L29A40		1	6R0 407 151 E				

Fabia 12.06 →
 Fabia Scout 10.07 →
 Fabia Praktik 03.07 →

			←	→	Thread	Part Of	QPA	
		ch. → 5J 8A 502 656	L29887	L29887			2	1K0 407 183 E
		ch. → 5J 8B 503 031						
		ch. → 5J 8K 450 960						
		ch. → 5J 83 172 973						
		ch. → 5J 8A 502 656	L29858	L29858			2	6Q0 407 182 A
		ch. → 5J 8B 503 031						
		ch. → 5J 8K 450 960						
		ch. → 5J 83 172 973						
		(-) PR G01/G07	L29847	L29847			2	1J0 407 181
		ch. 5J 8A 502 657 → ch. 5J 8B 503 031 → ch. 5J 8K 450 961 → ch. 5J 83 172 974 →						
	PR G01/G07	L29881	L29881			2	8N0 407 181 B	
	(-) PR G01/G07	L29808	L29808			2	357 407 182	
		L29617	L29617			2	6Q0 411 315 D	
	PR OAS, Ø 18mm	L29883	L29883		Anti-roll bar	2	6Q0 411 314 R	
	→ 12.08, G02/G05/G41, (+) MK345	KIT	MK156	MK156			2	6N0 412 331 E
	→ 12.08, G03/G04, (+) MK345	KIT	MK156	MK156			2	6Q0 412 331 B
	01.09 →, (+) MK344		MK077	MK077			2	1J0 412 331 BS
	→ 12.08		MK345	MK345			2	6N0 412 249 C
	01.09 →		MK344	MK344			2	1J0 412 249
	69mm	KIT	L29874			Hub carrier	1	1J0 501 541 D
	74mm	KIT	L29849			Hub carrier	1	1J0 501 541 C
			MK118	MK118			2	1J0 513 353 B

Favorit (781 / 785 / 787) 05.89 → 06.97

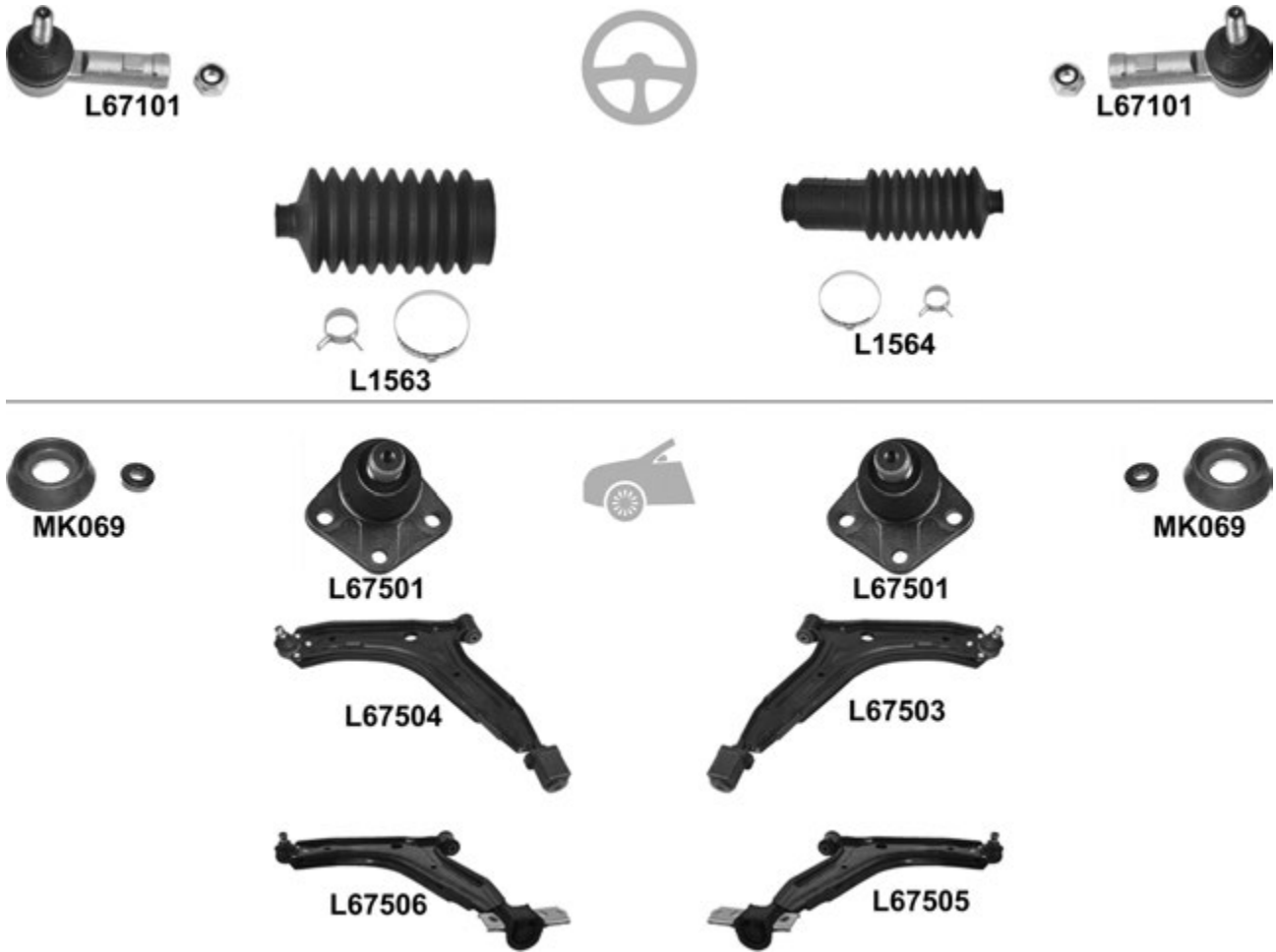

				←	→	Thread	Part Of	QPA	
		↔		L67101	L67101	F 12x1 ⌀		2	115 500 440
				L1563	L1564			1	
				L67501	L67501			2	115 420 240
		↓	→ 11.93	<input checked="" type="checkbox"/>	L67503			1	115 420 021
				<input checked="" type="checkbox"/>	L67504			1	115 420 020
		12.93 →	<input checked="" type="checkbox"/>	L67505			1	115 420 024	
				<input checked="" type="checkbox"/>	L67506			1	115 420 023
				KIT	MK069	MK069		2	

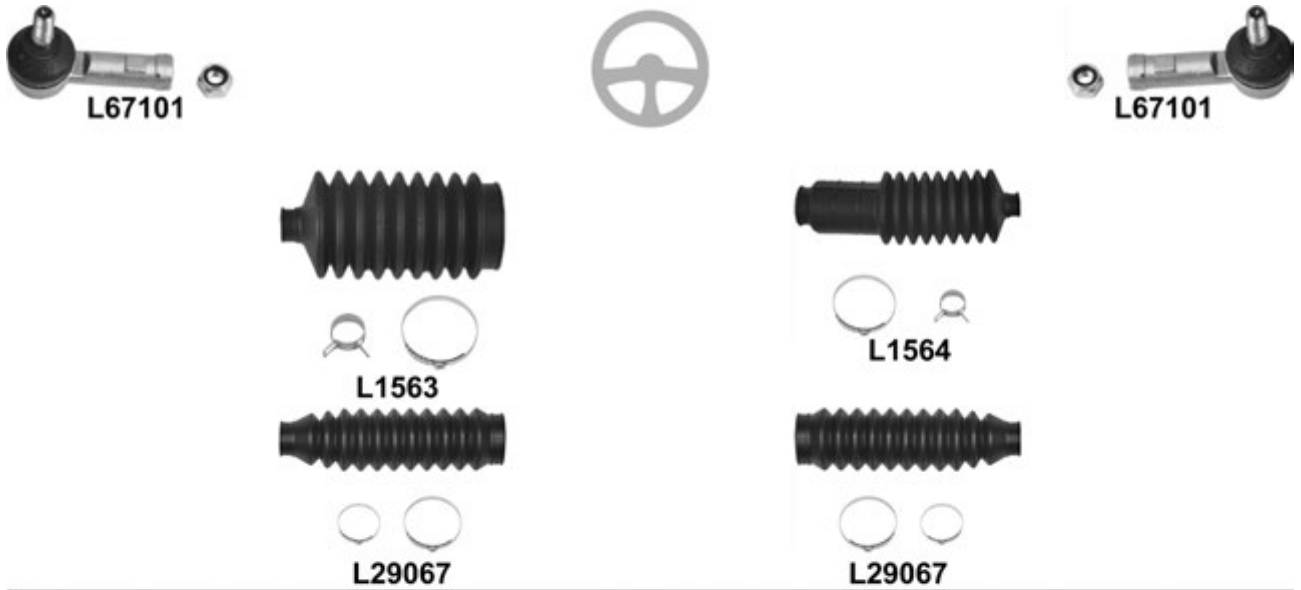
Felicia I / II 10.94 → 06.01

				←	→	Thread	Part Of	QPA	
⊕		↔		L67101	L67101	F 12x1 ⊕		2	6U0 422 811
					L1564			1	
				L1563			1		
				∅ 11mm, ∅ 42mm, L= 208mm	L29067 ⁰	L29067 ⁰		2	6U0 422 831
⊖		↓		L67501	L67501		2	6U0 407 365	
				(-) HD	<input checked="" type="checkbox"/>	L67507		1	007 304 448
				L67508			1	007 304 447	
				HD	<input checked="" type="checkbox"/>	L67509		1	6U0 407 152
				L67510			1	6U0 407 151	
				∅ 16mm Bend	L29616	L29616		2	6U0 411 315
			KIT	MK069	MK069		2		

Octavia, Octavia Combi (1U2 / 1U5) 09.96 →

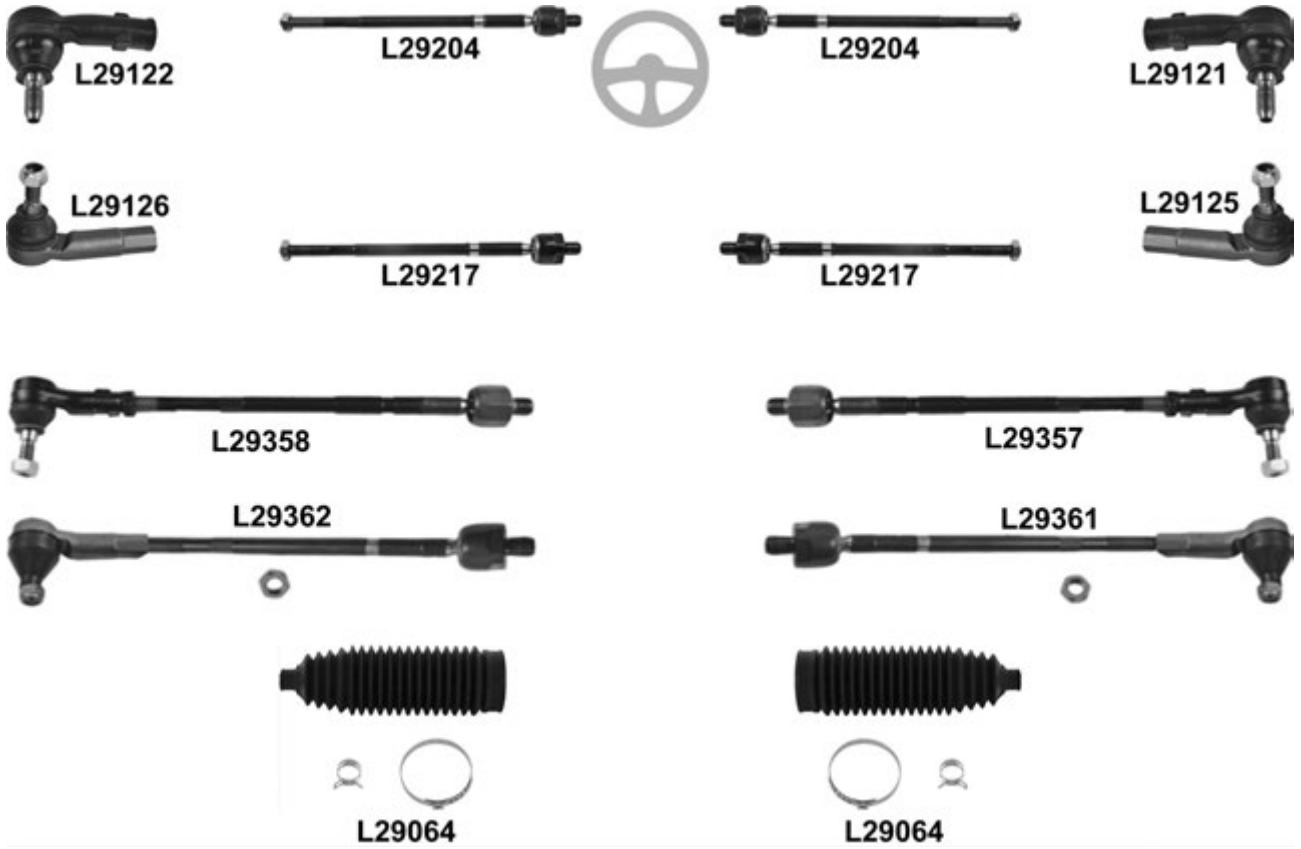

Octavia, Octavia Combi (1U2 / 1U5) 09.96 →

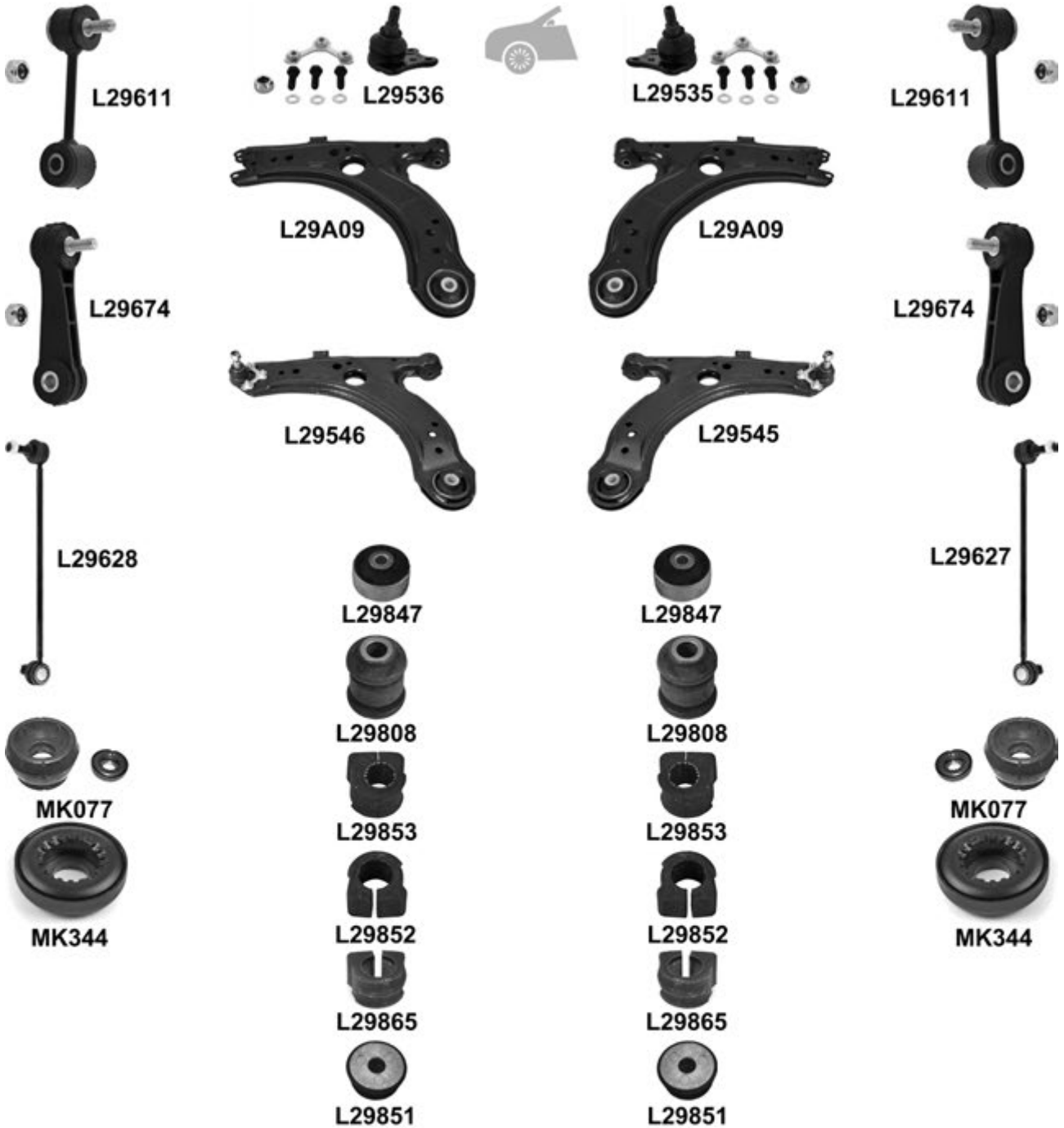

Octavia, Octavia Combi (1U2 / 1U5) 09.96 →

			←	→	Thread	Part Of	QPA		
		↔	→ 11.97, ch. → 1U W 061 000		L29121		1	1J0 422 812 A	
				L29122			1	1J0 422 811 A	
		↔	12.97 →, ch. 1U W 061 001 →		L29125			1	1J0 422 812 B
				L29126			1	1J0 422 811 B	
			→ 1U W 061 000	L29204	L29204		2	1J0 422 821 A	
			1U W 061 001 →	L29217	L29217		2	1J0 422 821 B	
			→ 11.97, ch. → 1U W 061 000		L29357		1	1J0 422 804 A	
					L29358		1	1J0 422 803 A	
		↔	12.97 →, ch. 1U W 061 001 →		L29361		1	1J0 422 804 B	
					L29362		1	1J0 422 803 B	
			L29064	L29064 ^o		2	1J0 422 831 B		
		↓			L29535		1	1J0 407 366 C	
				L29536		1	1J0 407 365 C		
		↓	(-) , (+)		L29A09	L29A09		2	1J0 407 151 C
				<input checked="" type="checkbox"/>	L29545		1		
		L29546		1					
		↓		L29847	L29847		2	1J0 407 181	
		↓		L29808	L29808		2	357 407 182	
			(-) PR 0AR / 4x4, Metal		L29611	L29611		2	1J0 411 315 G
					L29674	L29674		2	1J0 411 315 C
					L29627		1	1J0 411 316 D	
					L29628		1	1J0 411 315 D	
			06.04 →, ø 17mm / Ø 19mm	L29853	L29853	Anti-roll bar	2	1J0 411 314 B	
			ø 21mm / Ø 23mm	L29852	L29852	Anti-roll bar	2	1J0 411 314 C	
			ø 23mm	L29865	L29865	Anti-roll bar	2	1J0 411 314 G	
			L29851	L29851	Hub carrier	2	1J0 199 429		
		(+) MK344	KIT	MK077	MK077		2	1J0 412 331 BS	
			MK344	MK344		2	1J0 412 249		
		4WD		L29661	L29661		2	1J0 505 466 C	
				L29874		1	1J0 501 541 D		
		(-) 4WD, Ø 69mm	KIT	L29874		Hub carrier	1	1J0 501 541 D	
			KIT	L29849		Hub carrier	1	1J0 501 541 C	
		(-) Combi		MK118	MK118		2	1J0 513 353 B	
			Combi ch. → 1U 2 599 800	MK118	MK118		2	1J0 513 353 B	
			(+) , ch. → 1U 28541 900	MK118	MK118		2	1J0 513 353 D	
	Combi ch. 1U 2 599 801 →	MK118	MK118		2	1J0 513 353 D			
	(-) HD suspension, ch. 1U 28541 901 →								

Octavia (1Z3) 06.04 →

Octavia Combi (1Z5) 06.04 →

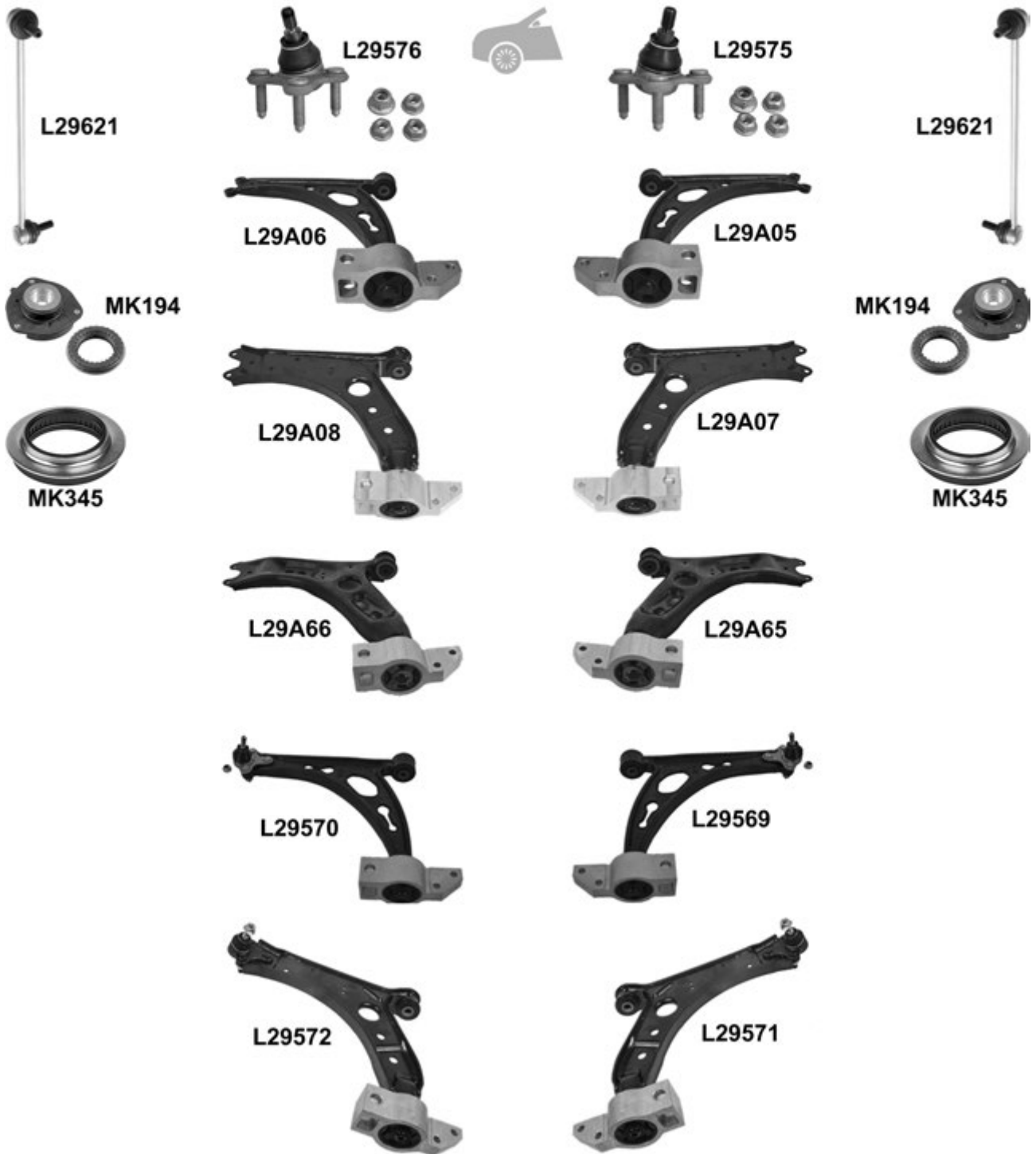
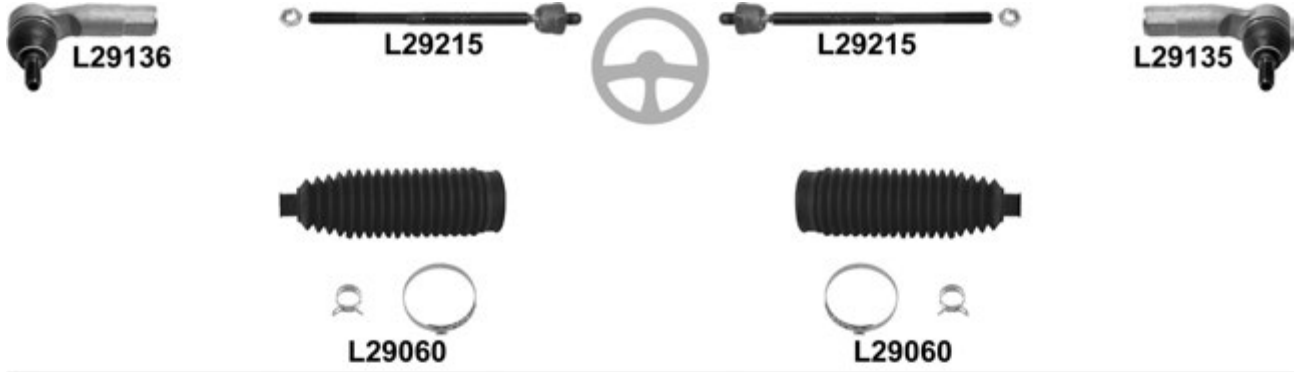

Octavia (1Z3) 06.04 →
 Octavia Combi (1Z5) 06.04 →



L29A68



L29A67



L29876



L29861



L29862



L29862



L29638



L29A11



L29A11



L29A29



L29A29



L29A88



L29A87



L29637



L29623



L29623



MK386



MK386

Octavia (1Z3) 06.04 →
Octavia Combi (1Z5) 06.04 →

		i	←	→	Thread	Part Of	QPA	i	
		↔		L29135	F 16x1,5 ♂		1	1K0 423 812 G	
				L29136	F 16x1,5 ♂		1	1K0 423 811 G	
			L29215	L29215	M 16x1,5 / M 16x1,5 ♂		2	1K0 423 810 A	
			Electronic	L29060	L29060		2	1K0 423 831 A	
		⊥		L29575			1	1K0 407 366 C	
				L29576			1	1K0 407 365 C	
		⊥	(-) (+)		L29A05			1	1K0 407 152 M
					L29A06			1	1K0 407 151 M
					L29A07			1	1K0 407 152 P
					L29A08			1	1K0 407 151 P
					L29A65			1	1K0 407 152 BC
					L29A66			1	1K0 407 151 BC
					L29569	<input checked="" type="checkbox"/>		1	1K0 407 152 M
					L29570	<input checked="" type="checkbox"/>		1	1K0 407 151 M
		L29571	<input checked="" type="checkbox"/>		1	1K0 407 152 P			
		L29572	<input checked="" type="checkbox"/>		1	1K0 407 151 P			
		L29A67	<input checked="" type="checkbox"/>		1	1K0 407 152 BC			
		L29A68	<input checked="" type="checkbox"/>		1	1K0 407 151 BC			
		⊥	▼		L29861			1	1K0 199 232 G
					L29876			1	1K0 199 231 G
		⊥	▲		L29862	L29862		2	1K0 407 182
				L29621	L29621		2	1K0 411 315 D	
			(+) MK345	KIT	MK194	MK194	2	1K0 412 331 B	
				MK345	MK345		2	6N0 412 249 C	
		⊥		L29A11	L29A11		2	4K0 505 323 N	
				L29A29	L29A29		2	1K0 505 311 AB	
				L29A87 ⁰		Trailing Arm	1	1K0 505 224 K	
		L29A88 ⁰		Trailing Arm	1	1K0 505 222 K			
		▲		L29637			1	1K0 501 530 C	
				L29638			1	1K0 501 529 F	
			L29623	L29623		2	1K0 505 465 J		
			MK386	MK386		2	1K0 513 353 J		

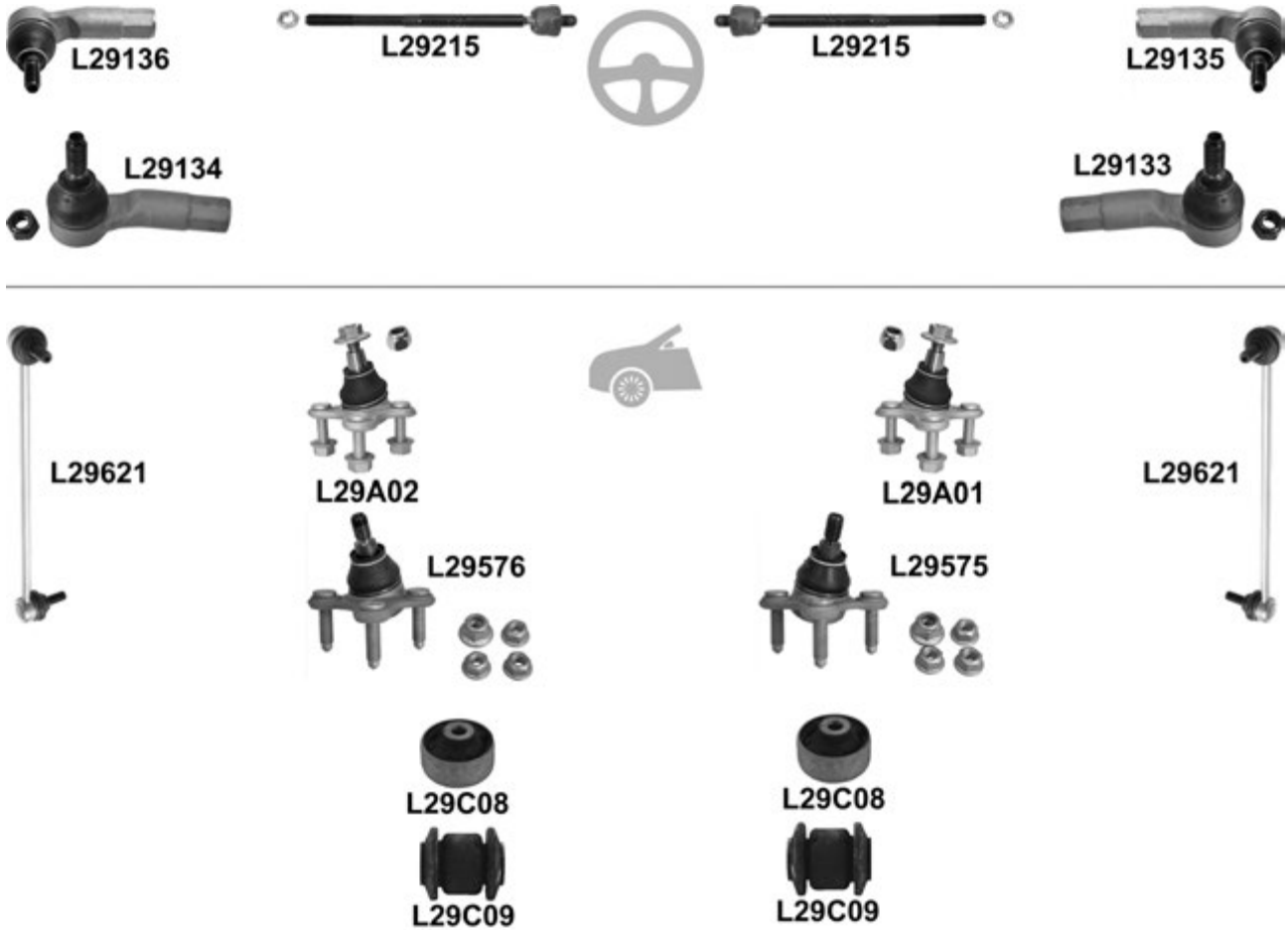
Octavia (5E3) 11.12 →
Octavia Combi (5E5) 11.12 →

			←	→	Thread	Part Of	QPA			
		↔	Servotronic Steering, PR LOL/1N3/1N5	L29135	F 16x1,5 ∪		1	1K0 423 812 G		
				L29136	F 16x1,5 ∪		1	1K0 423 811 G		
				Active Steering, PR 1N7		L29133	F 16x1,5 ∪		1	1K0 423 812 E
				L29134	F 16x1,5 ∪		1	1K0 423 811 E		
				L29215	L29215	M 16x1,5 / M 16x1,5 ∪		2	1K0 423 810 A	
		⊥	PR 1LG/1ZA	L29A01			1	3C0 407 366 A		
				L29A02			1	3C0 407 365 A		
				PR 1ZE/1ZF		L29575			1	5Q0 407 366 A
				L29576			1	5Q0 407 365 A		
			↕	→ 06.14	L29C08	L29C08		2	5Q0 407 183 E	
				↕	PR 1LG/1ZA	L29C09	L29C09		2	5Q0 407 182
					L29621	L29621		2	5Q0 411 315 A	

Rapid (NH3) 07.12 →
 Rapid Spaceback (NH1) 07.12 →

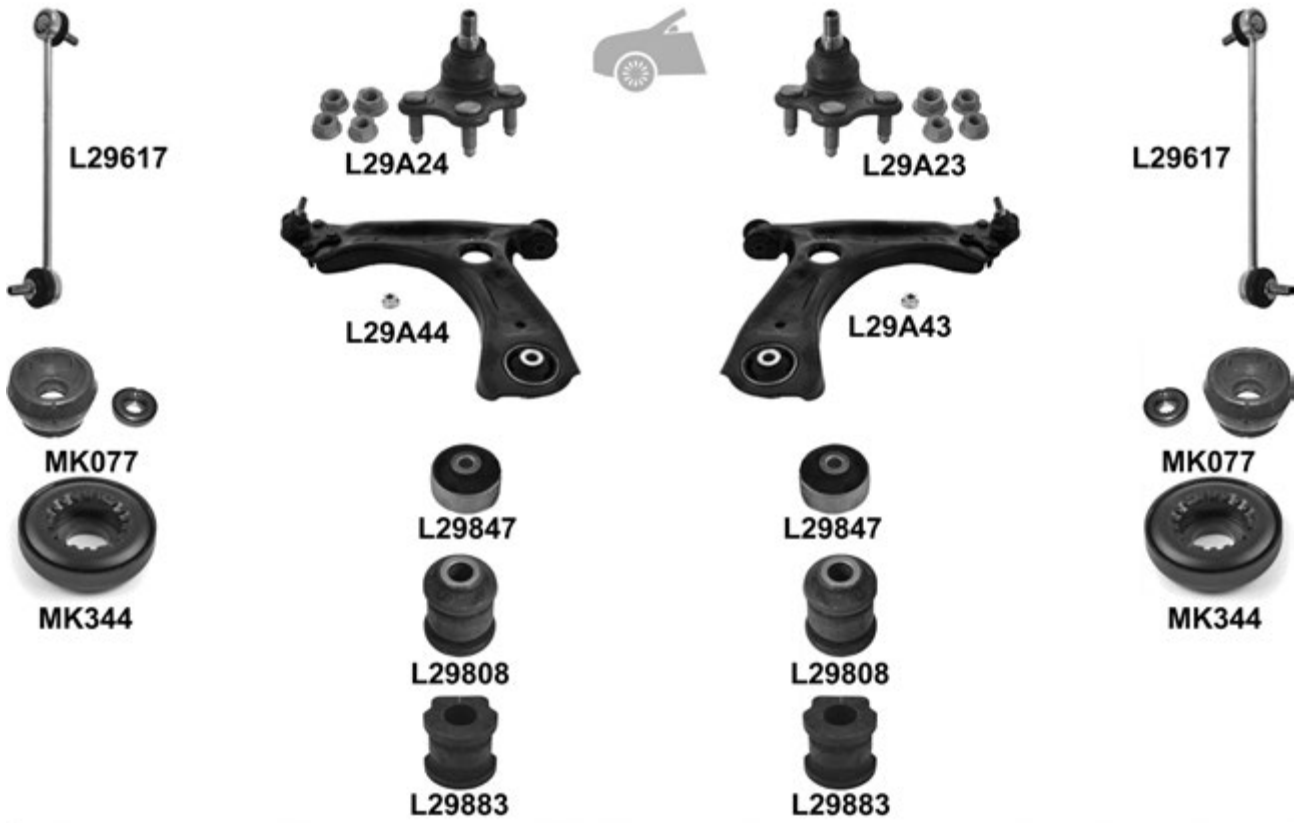
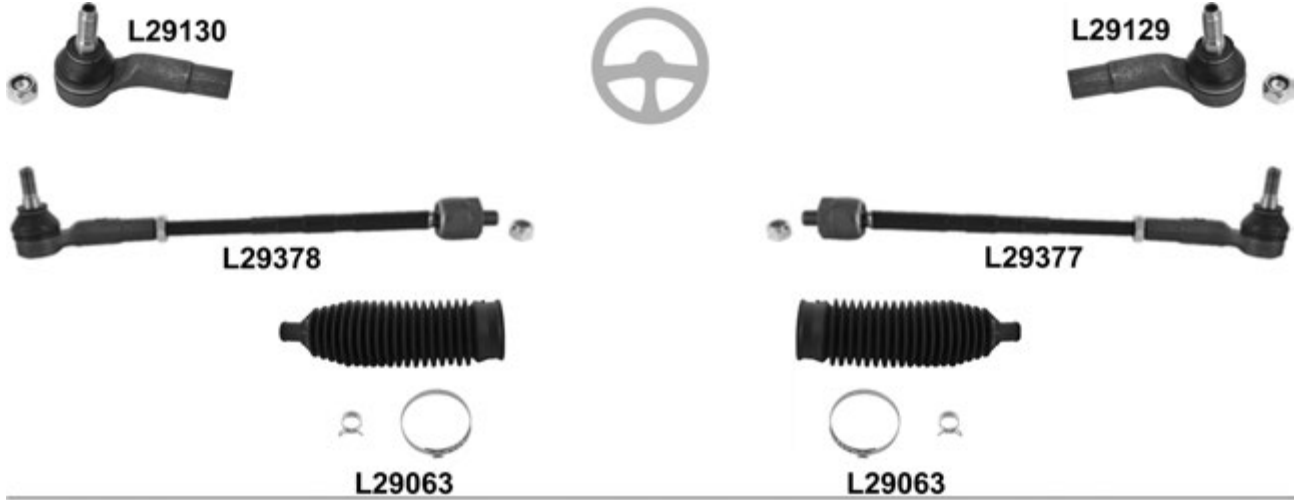

Rapid (NH3) 07.12 →
Rapid Spaceback (NH1) 07.12 →

		i		←	→	Thread	Part Of	QPA	i
		↔				L29129 F 14x1,5 U		1	6R0 423 812
						L29130 F 14x1,5 U		1	6R0 423 811
						L29377		1	6R0 423 804 A
						L29378		1	6R0 423 803 A
			Hydraulic , PR 1N2, 12.02 → TRW, ø 14,5mm, Ø 47,5mm, L= 205mm			L29063 ^o L29063 ^o		2	6Q0 423 831 D
		⊥				L29A23		1	6R0 407 366
						L29A24		1	6R0 407 365
		⊥		<input checked="" type="checkbox"/>		L29A43		1	6R0 407 151 F
						L29A44		1	6R0 407 152 F
		⊥▼				L29847 L29847		2	1J0 407 181
		⊥▲				L29808 L29808		2	357 407 182
						L29617 L29617		2	6Q0 411 315 N
			PR 0AS, Ø 18mm			L29883 L29883	Anti-roll bar	2	6Q0 411 314 R
			(+) MK344	KIT		MK077 MK077		2	1J0 412 331 BS
						MK344 MK344		2	1J0 412 249
			74mm			L29849	Hub carrier	1	6R0 501 541 A
						MK118 MK118		2	1J0 513 353 D

Roomster (5J) 03.06 →
 Roomster Praktik (5J) 03.07 →
 Roomster Scout (5J) 10.2006

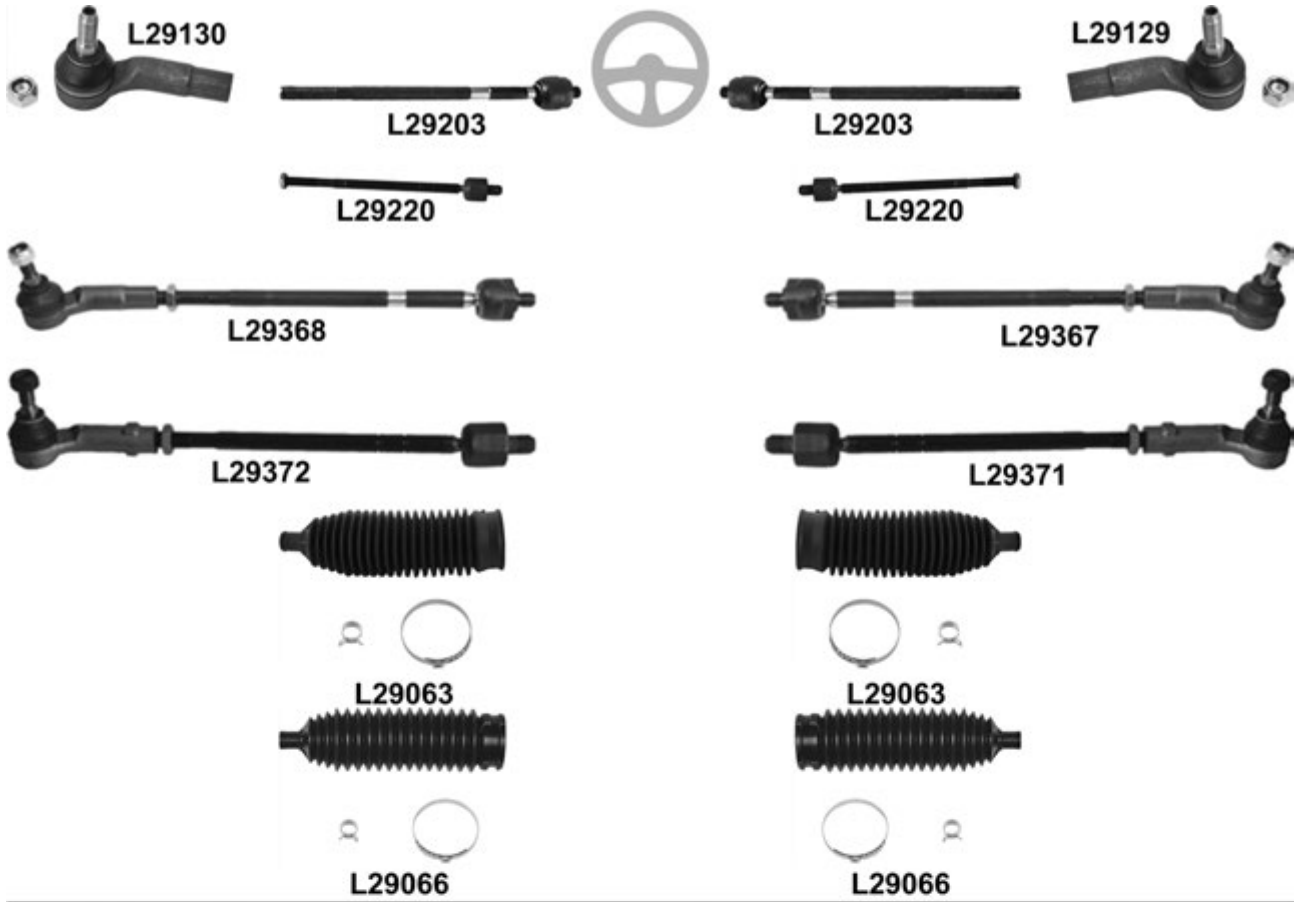

Roomster (5J) 03.06 →
 Roomster Praktik (5J) 03.07 →
 Roomster Scout (5J) 10.2006



**Roomster (5J) 03.06 →
Roomster Praktik (5J) 03.07 →
Roomster Scout (5J) 10.2006**

			←	→	Thread	Part Of	QPA		
		↔		L29129	F 14x1,5 ∪		1	6Q0 423 812	
				L29130	F 14x1,5 ∪		1	3A0 422 811	
				L29203	L29203	M 14x1,5 / M 14x1,5 ∪		2	
				L29220	L29220	∪		2	6Q0 423 810 G
		TRW			L29367			1	6Q0 423 804 B
				L29368			1	6Q0 423 803 B	
		Smi / Koyo			L29371			1	6Q0 423 804 G
				L29372			1	6Q0 423 803 G	
			TRW, ø 14,5mm, Ø 47,5mm, L= 205mm	L29063 ^o	L29063 ^o			2	6Q0 423 831 D
			Smi/Koyo, ø 13mm, Ø 45,5mm, L= 210mm	L29066 ^o	L29066 ^o			2	5Z0 422 831
		↓	→ 02.08		L29563			1	6Q0 407 366 A
			ch. → 5J 8B 600 704	L29564			1	6Q0 407 365 A	
			ch. → 5J 85 069 020						
			03.08 →		L29A23			1	6R0 407 366
	ch. 5J 8B 600 705 →	L29A24			1	6R0 407 365			
	ch. 5J 85 069 021 →								
		↓	→ 02.08	L29A69	L29A69			2	6Q0 407 151 D
			ch. → 5J 8B 600 704						
			ch. → 5J 85 069 020						
			(-) (+)						
→ 02.08 , ch. → 5J 8B 600 704	<input checked="" type="checkbox"/>	L29565			1				
	L29566			1					
03.08 →	<input checked="" type="checkbox"/>	L29A39			1	6R0 407 152 E			
ch. 5J 8B 600 705 →	L29A40			1	6R0 407 151 E				
ch. 5J BB 600 052 →									
(-) PR G01/G07									
	↓	ch. → 5J 8B 600 704	L29887	L29887			2	1K0 407 183 E	
		ch. → 5J 8B 600 704	L29858	L29858			2	6Q0 407 182 A	
		03.08 →, ch. 5J 8B 600 705 →, (-) PR G01/G07	L29847	L29847			2	1J0 407 181	
		03.08 →, ch. 5J 8B 600 705 →, (+) PR G01/G07	L29808	L29808			2	357 407 182	
			L29617	L29617			2	6Q0 411 315 D	
		ø 18mm	L29883	L29883		Anti-roll bar	2	6Q0 411 314 R	
		(-) Roomster Praktik / Scout, (+) MK345	KIT	MK156	MK156			2	6N0 412 331 E
		Roomster Praktik / Scout G40/G41, → 10.08 , ch. → 5J 9B 601 131	KIT	MK156	MK156			2	6N0 412 331 E
		(+) MK345							
		Roomster Praktik / Scout G38/G39, → 10.08 , ch. → 5J 9B 601 131	KIT	MK156	MK156			2	6Q0 412 331 B
		(+) MK345							
Roomster Praktik / Scout, 11.08 →, ch. 5J 9B 601 132 →	MK077	MK077			2	1J0 412 331 BS			
		(-) Roomster Praktik / Scout	MK345	MK345			2	6N0 412 249 C	
		Roomster Praktik / Scout G38/G39/G40/G41, → 10.08 ch. → 5J 9B 601 131	MK345	MK345			2	6N0 412 249 C	
		Roomster Praktik / Scout, 11.08 →, ch. 5J 9B 601 132 →	MK344	MK344			2	1J0 412 249	
		69mm	KIT	L29874		Hub carrier	1	1J0 501 541 D	
		74mm	KIT	L29849		Hub carrier	1	1J0 501 541 C	
				MK118	MK118			2	1J0 513 353 D

Superb (3U4) 02.02 →

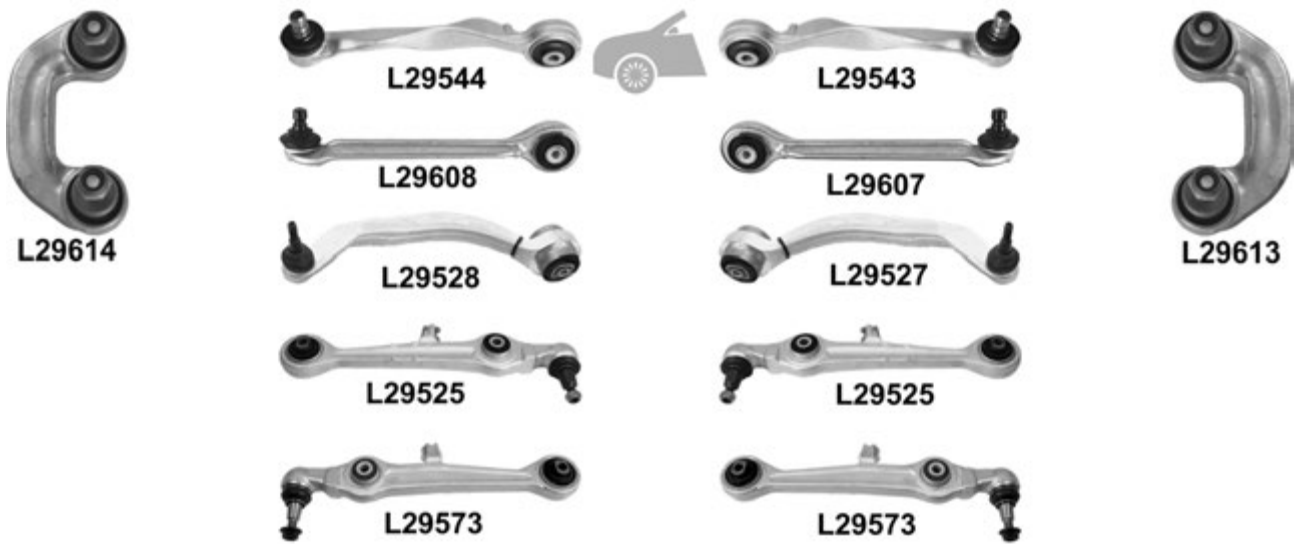
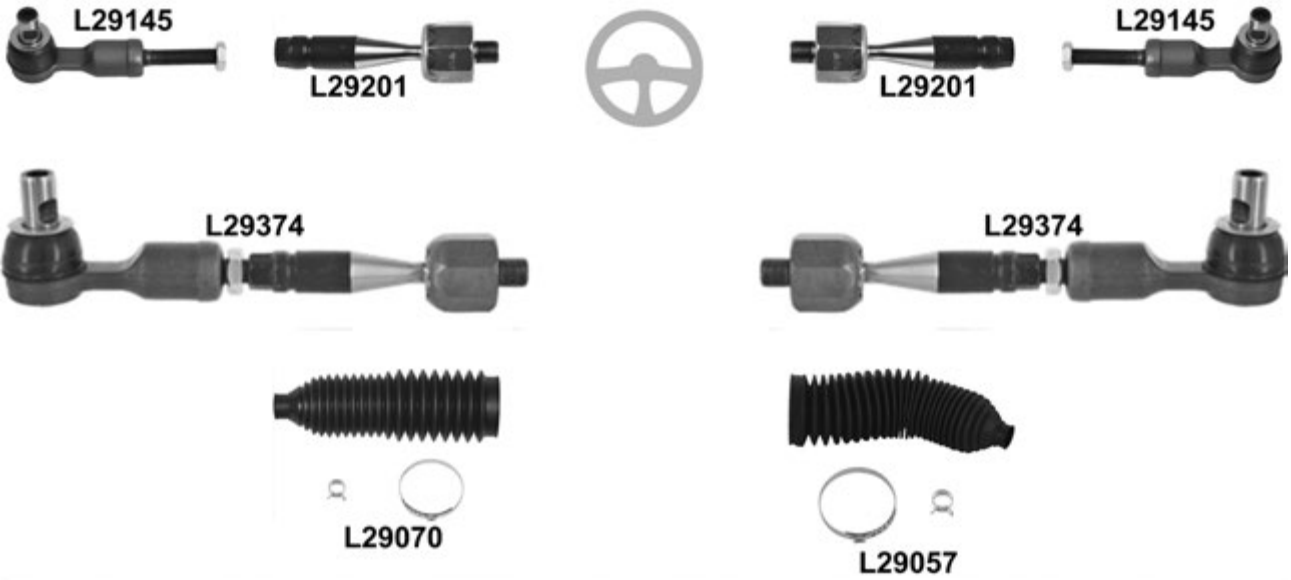

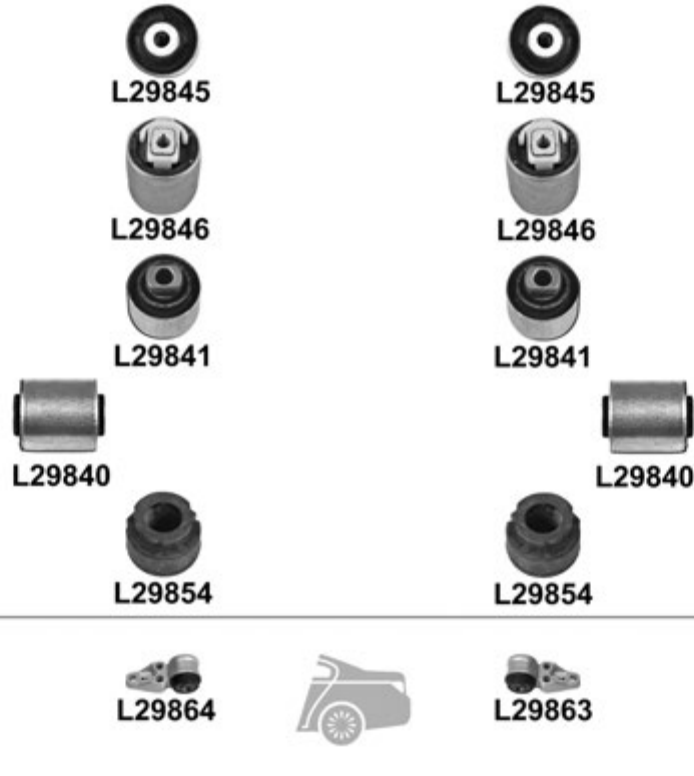
Superb (3U4) 02.02 →

					←	→	Thread	Part Of	QPA	
⊕		↔		L29145	L29145		M 14x1,5 U		2	4B0 419 811 E
				L29201	L29201		F 14x1,5 / M 16x1,5 U		2	4B0 422 821
				L29374	L29374				2	4B0 419 801 E
					L29057				1	8D0 419 831 K
					L29070 ^o				1	4D0 419 831 DE
🚗		↕			L29543				1	8D0 407 510 C
				L29544				1	8D0 407 509 C	
		↕			L29607			1	8E0 407 506 A	
				L29608			1	8E0 407 505 A		
		↕			L29527			1	8E0 407 694 K	
				L29528			1	8E0 407 693 K		
		↕	→ 06.02, → ch. 3U 3 021 397	L29525	L29525			2	4D0 407 151 K	
			07.02 →, ch. 3U 3 021 398 →	L29573	L29573			2	4B0 407 151	
			→ 06.02, → ch. 3U 3 021 397	KIT	L0018			1	8D0 498 998	
			2 x L 29145 / 2 x L 29525 / 29527 / 29528 / 29543 / 29544 / 29607 / 29608 / 29613 / 29614 / 29860							
			07.02 →, ch. 3U 3 021 398 →	KIT	L0020			1	8D0 498 998	
			2 x L 29145 / 2 x L 29573 / 29527 / 29528 / 29543 / 29544 / 29607 / 29608 / 29613 / 29614 / 29860							
			↕		L29845	L29845			4	4D0 407 515 C
			↕		L29846	L29846			2	4D0 407 183 P
			↕		L29841	L29841			2	L29525/L29567 4D0 407 182 E
	↕		L29840	L29840			2	L29567 4D0 407 181 H		
	↕			L29613			1	8D0 411 318 D		
			L29614				1	8D0 411 317 D		
		(-) 2.5 Tdi, Ø 24.8mm	L29854	L29854			Anti-roll bar	2	4D0 411 327 G	
🚗				L29863			Hub carrier	1	4B0 501 522 E	
			L29864			Hub carrier	1	4B0 501 521 E		
		KIT	MK187	MK187			2	4D0 412 377 F		

Superb (3T5) 07.08 →

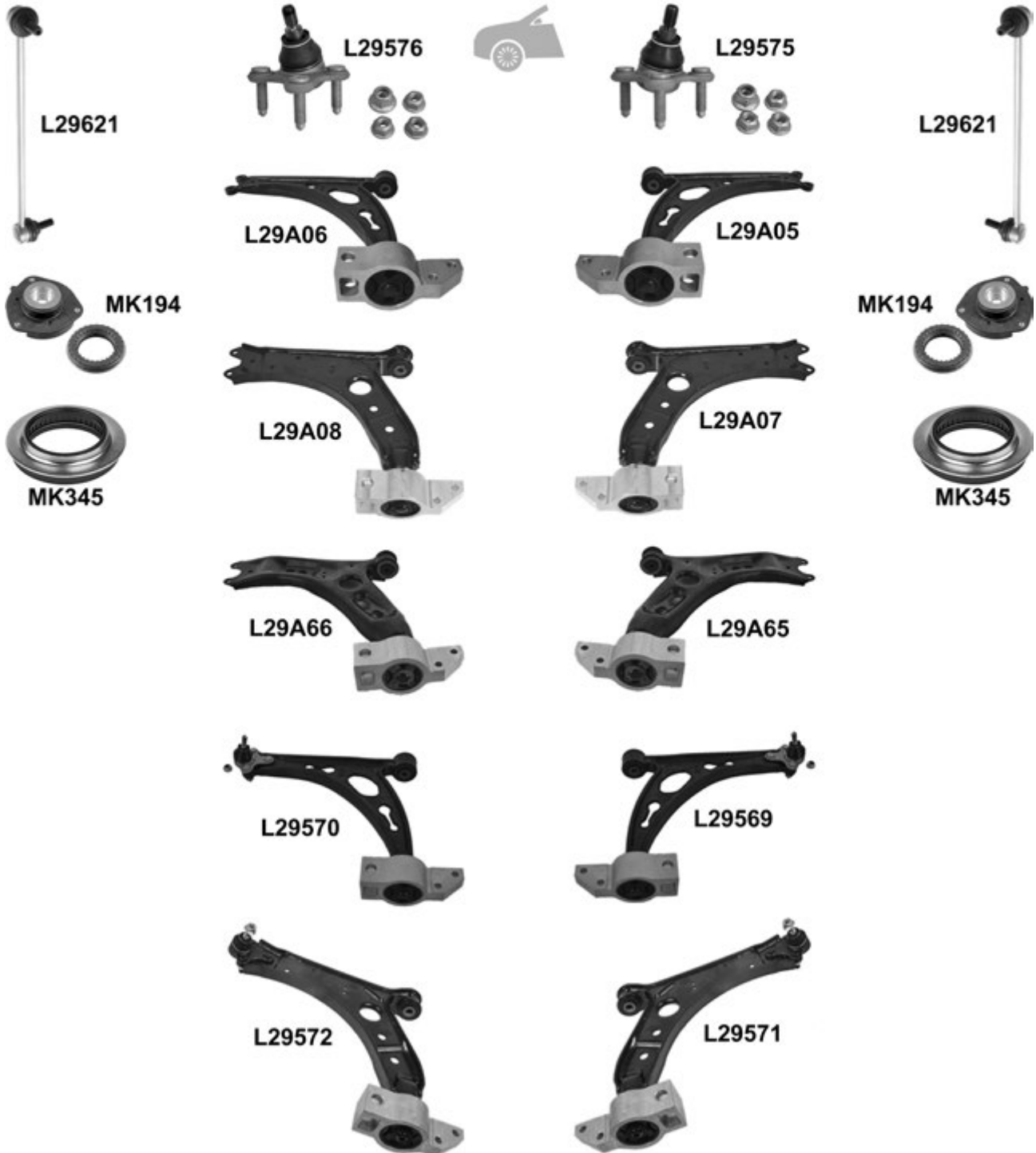
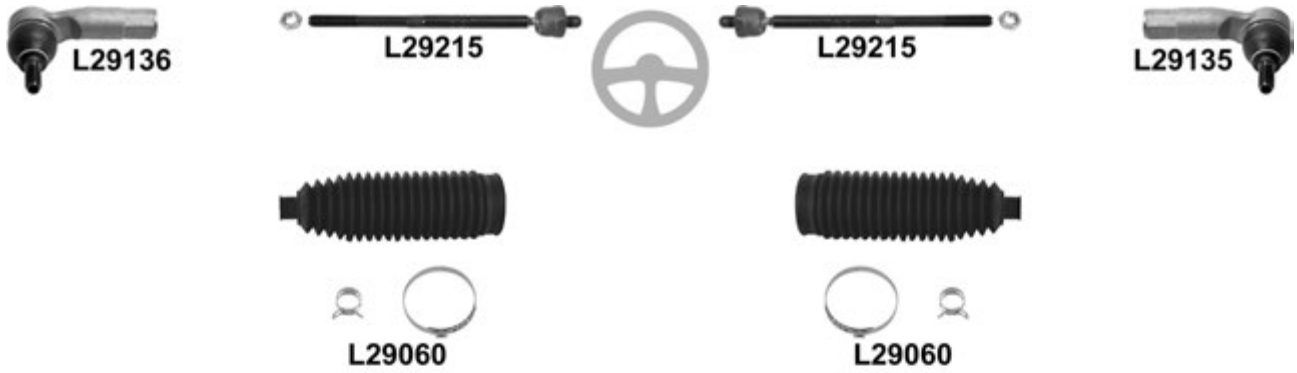



L29572



L29571



L29A68



L29A67



L29876



L29861



L29862



L29862



L29638



L29A11



L29A11



L29637



L29A29



L29A29



L29623



L29A88



L29A87



L29623



MK386



MK386

Superb (3T5) 07.08 →

			←	→	Thread	Part Of	QPA		
		↔		L29135	F 16x1,5 ∪		1	1K0 423 812 G	
			L29136		F 16x1,5 ∪		1	1K0 423 811 G	
				L29215	L29215	M 16x1,5 / M 16x1,5 ∪		2	1K0 423 810 A
		Electronic		L29060	L29060			2	1K0 423 831 A
		↓		L29575			1	1K0 407 366 C	
			L29576				1	1K0 407 365 C	
		↓	→ 04.09.		L29A05			1	1K0 407 152 M
			L29A06				1	1K0 407 151 M	
			05.09 →, (-)		L29A07			1	1K0 407 152 P
			L29A08				1	1K0 407 151 P	
			05.09 →, (-)		L29A65			1	1K0 407 152 BC
			L29A66				1	1K0 407 151 BC	
			→ 04.09.	<input checked="" type="checkbox"/>	L29569			1	1K0 407 152 M
			L29570				1	1K0 407 151 M	
	05.09 →,	<input checked="" type="checkbox"/>	L29571			1	1K0 407 152 P		
	L29572				1	1K0 407 151 P			
	05.09 →,	<input checked="" type="checkbox"/>	L29A67			1	1K0 407 152 BC		
	L29A68				1	1K0 407 151 BC			
		↓	∇		L29861			1	1K0 199 232 G
			L29876				1	1K0 199 231 G	
↑			L29862	L29862			2	1K0 407 182	
			L29621	L29621			2	1K0 411 315 D	
		(+) MK345	KIT	MK194	MK194		2	1K0 412 331 B	
				MK345	MK345		2	6N0 412 249 C	
		↑		L29A11	L29A11		2	4K0 505 323 N	
		↓		L29A29	L29A29		2	1K0 505 311 AB	
	↓	∇		L29A87 ⁰		Trailing Arm	1	1K0 505 224 K	
		L29A88 ⁰			Trailing Arm	1	1K0 505 222 K		
		∇	→ 05.09		L29637			1	1K0 501 530 C
			L29638				1	1K0 501 529 F	
				L29623	L29623			2	1K0 505 465 J
			MK386	MK386			2	1K0 513 353 J	

Yeti (5L6,5L7) 05.09 →

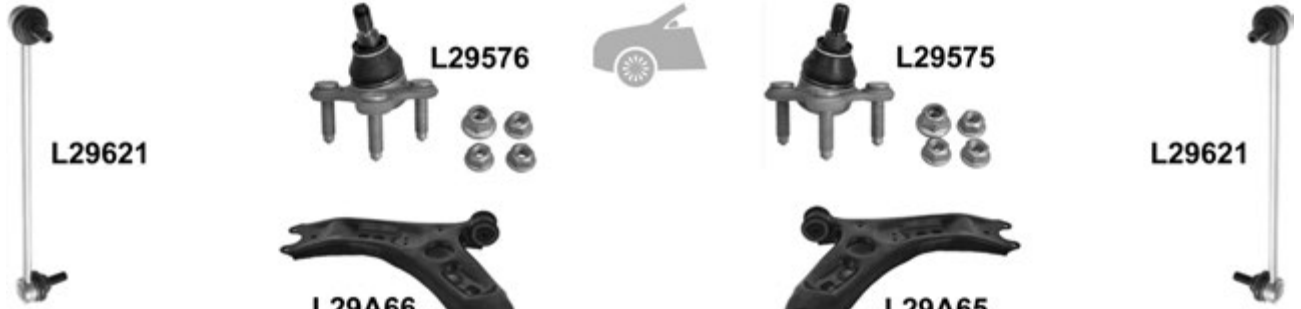

Yeti (5L6,5L7) 05.09 →

				←	→	Thread	Part Of	QPA			
		↔		L29135		F 16x1,5 ☺		1	1K0 423 812 G		
				L29136		F 16x1,5 ☺		1	1K0 423 811 G		
				L29215	L29215	M 16x1,5 / M 16x1,5 ☺		2	1K0 423 810 A		
		⊥		L29575				1	1K0 407 366 C		
				L29576				1	1K0 407 365 C		
		⊥	→ 08.10, (-) , (+) ,		L29A65				1	1K0 407 152 BC	
					L29A66				1	1K0 407 151 BC	
					L29A83				1	1K0 407 152 BB	
					L29A84				1	1K0 407 151 BB	
		⊥	→ 08.10,	<input checked="" type="checkbox"/>	L29A67				1	1K0 407 152 BC	
				L29A68				1	1K0 407 151 BC		
		⊥	↕	→ 08.10	L29861				L29A65/L29A67	1	1K0 199 232 G
					L29876				L29A66/L29A68	1	1K0 199 231 G
				→ 09.10	L29C03	L29C03			L29A83/L29A84	2	1K0 407 183 P
					L29862	L29862			L29A65/L29A66/ L29A83/L29A84	2	1K0 407 182
				L29621	L29621			2	1K0 411 315 D		
			(+)	MK345	KIT	MK194	MK194		2	1K0 412 331 B	
				MK345	MK345				2	6N0 412 249 C	
		↕	→ 05.12	L29A11	L29A11			2	4K0 505 323 N		
				L29A29	L29A29			2	1K0 505 311 AB		
				L29A87 ⁰	L29A87 ⁰		Trailing Arm	1	1K0 505 224 K		
					L29A88 ⁰	L29A88 ⁰		Trailing Arm	1	1K0 505 222 K	
					L29623	L29623			2	1K0 505 465 J	
					MK386	MK386			2	1K0 513 353 J	

SMART

Cabrio (450###) 03.00 → 12.06
 City Coupe (450###) 07.98 → 02.07
 Roadster 07.03 → 04.06
 Roadster Coupe 01.03 → 04.06

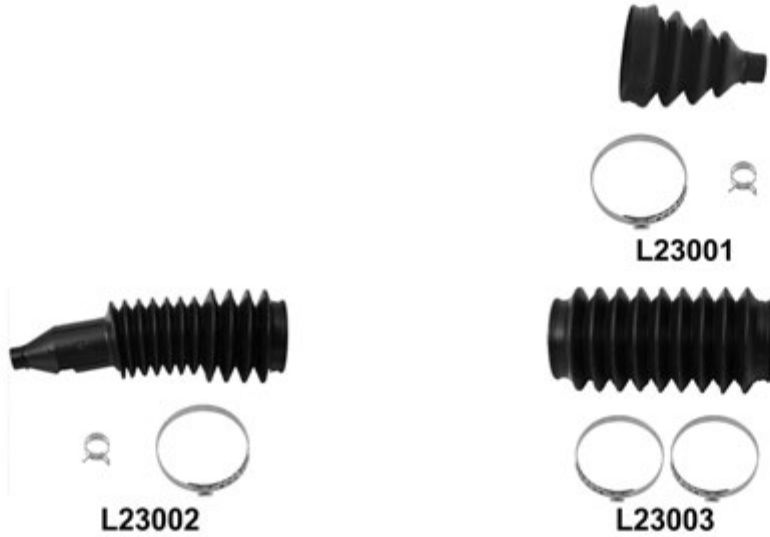

Cabrio (450###) 03.00 → 12.06
City Coupe (450###) 07.98 → 02.07
Roadster 07.03 → 04.06
Roadster Coupe 01.03 → 04.06



			←	→	Thread	Part Of	QPA	
		↔	L23127	L23127	F 14x1,5 ♂		2	4887V002000000
		↔		L23001 ⁰			1	000 5374 V001 000 000
		↔		L23003 ⁰			1	000 4914 V002 000 000
				L23002 ⁰			1	000 5376 V 001 000 000
		⊥	L23524	L23524			2	2271V0070000005
		⊥	L23544	L23544			2	14141V0020000000
			L23618	L23618			2	0005102V0050000000
			MK344	MK344			2	450 330 00 51
			L23672 ⁰	L23672 ⁰			2	0001765V005
			L23619	L23619			2	0001802V0040000000

Crossblade 09.02 → 12.03



			i	←	→	Thread	Part Of	QPA	i
		↔		L23127	L23127	F 14x1,5 ♂		2	4887V002000000
		⊥		L23544	L23544			2	14141V002000000
				L23619	L23619			2	0001802V004000000

Fortwo Cabrio (451###) 01.07 →
 Fortwo Coupe (451###) 01.07 →

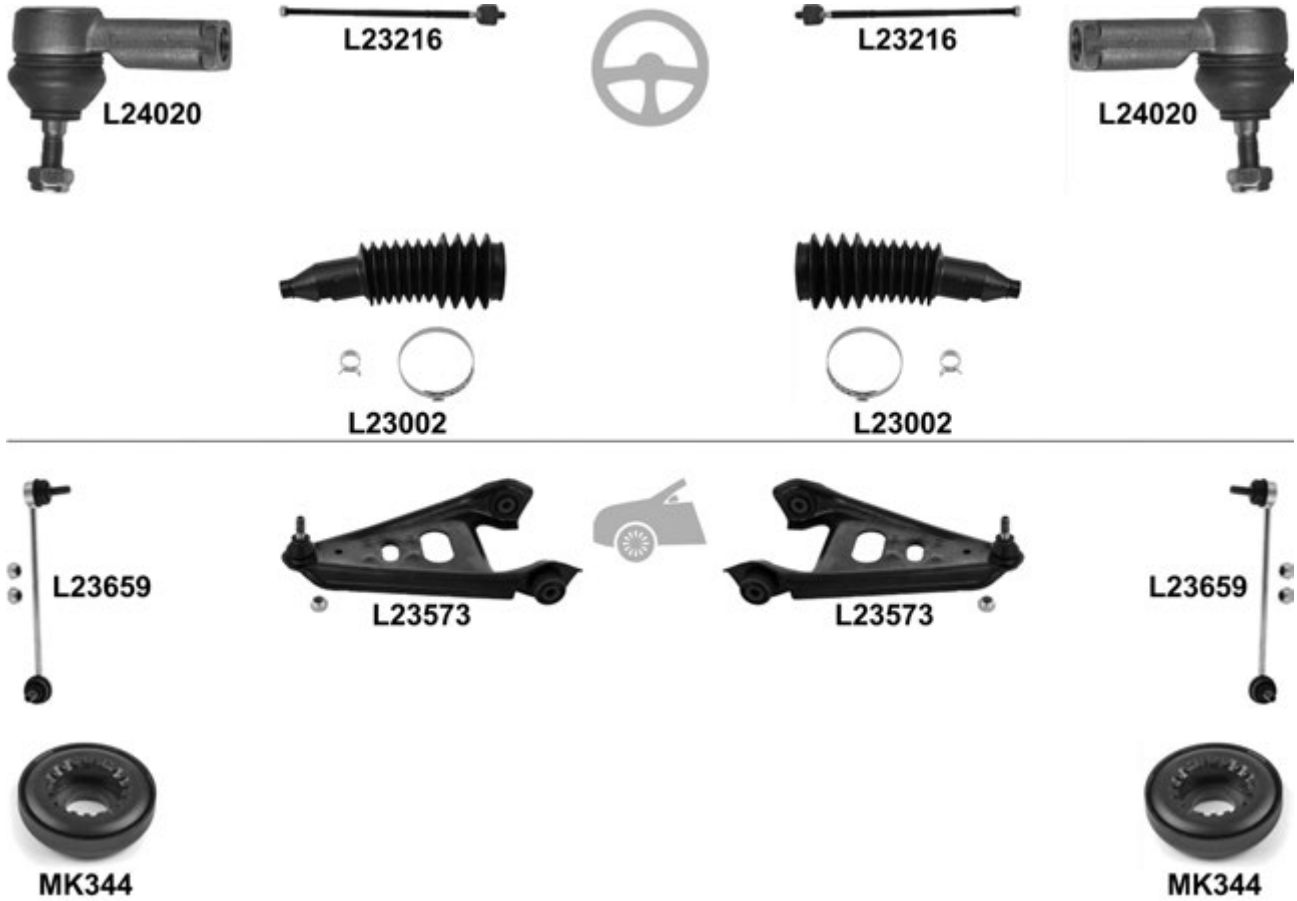

		i	←	→	Thread	Part Of	QPA	i
⊕		↔	L24020	L24020	F 12x1,5 ∪		2	451 338 00 37
			L23216	L23216	M 12x1,5 / M 14x1,5 ∪		2	
		(-) Electric	L23002 ^o	L23002 ^o			2	000 5376 V 001 000 000
🚗		⊥	<input checked="" type="checkbox"/>	L23573	L23573		2	451 330 00 10
				L23659	L23659		2	451 320 01 89
				MK344	MK344		2	450 330 00 51

Forfour 08.03 → 10.06

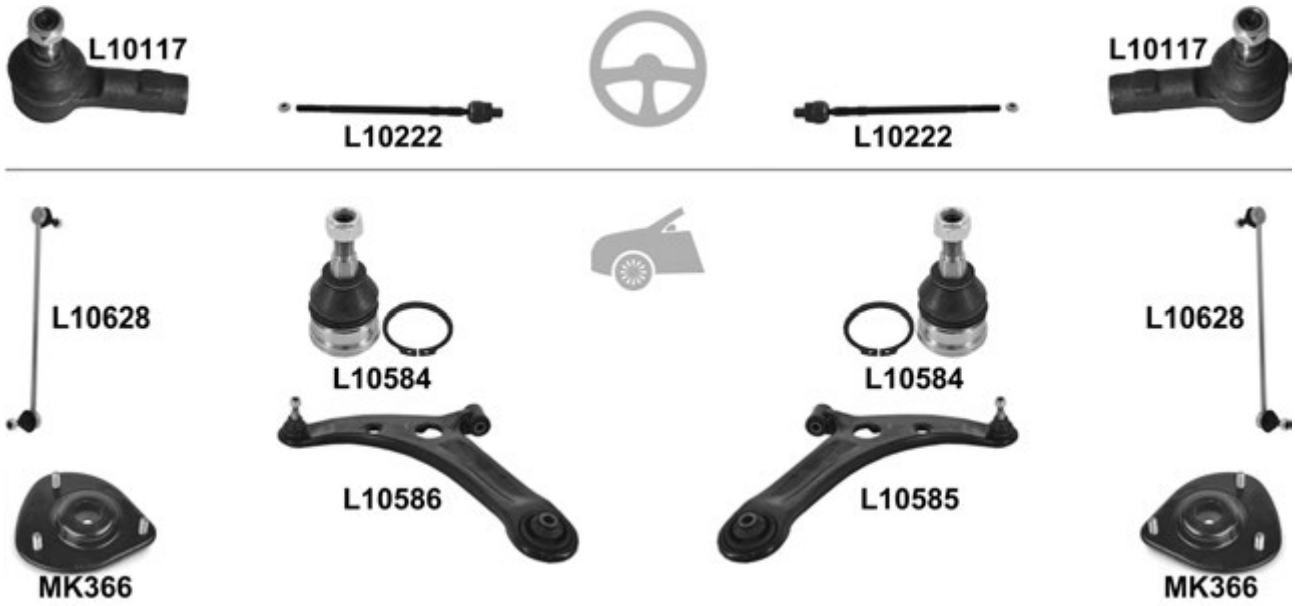

		← →		Thread	Part Of	QPA			
		↔		L10117	L10117	F 12x1,25 ∪		2	454 460 02 05
				L10222 ⁰	L10222 ⁰	M 12x1,25 / M 16x1 ∪	OE no. 4544600000 / 00400 / 00700	2	
		↓		L10584	L10584			2	
		↓	<input checked="" type="checkbox"/>	L10586	L10585			1	454 330 20 07
				L10586				1	454 330 19 07
				L10628	L10628			2	454 320 00 10
				MK366	MK366			2	

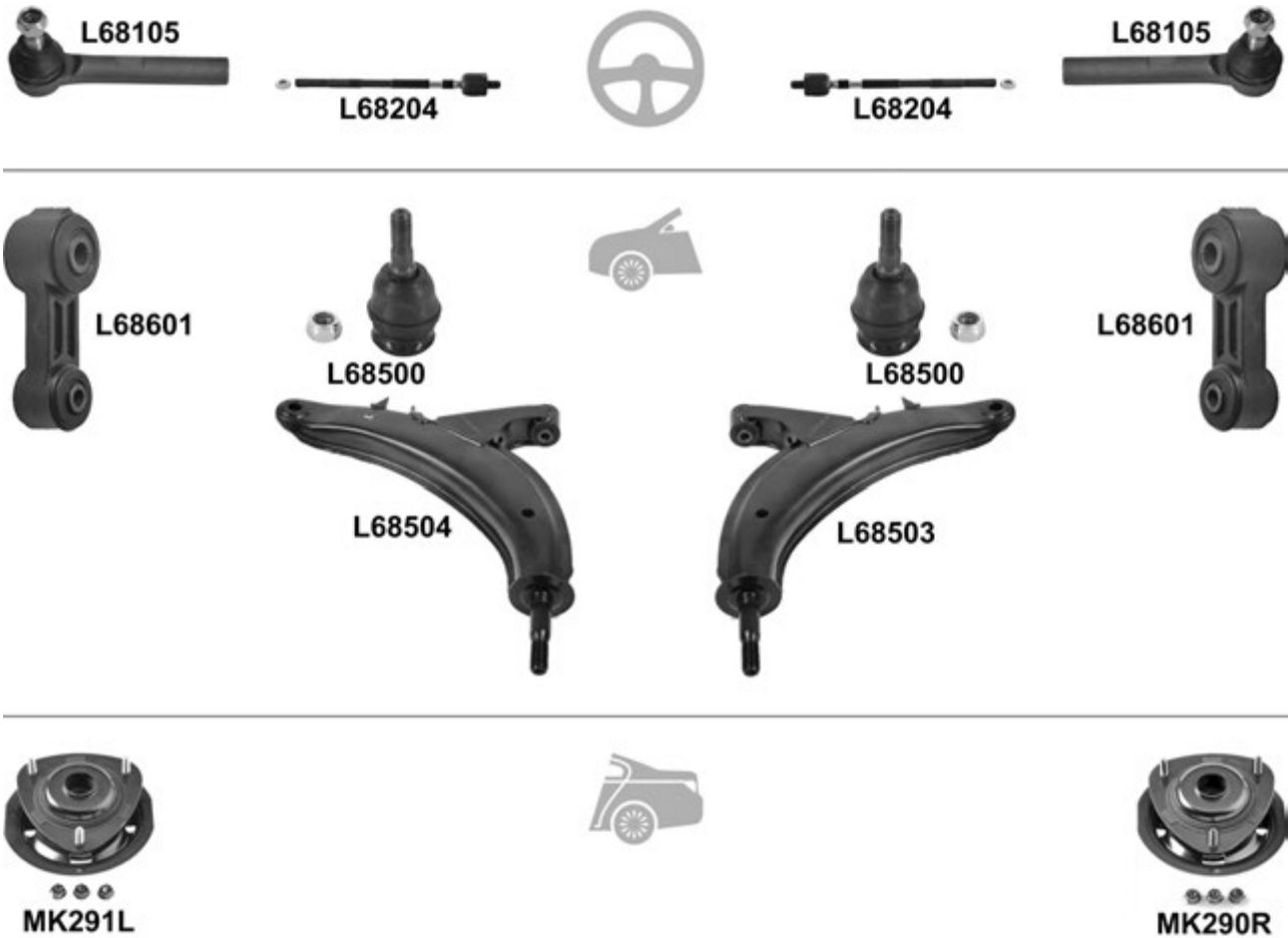
SUBARU
Forester (SF) 08.97 → 09.02

		i		←	→	Thread	Part Of	QPA	i
		↔		L68105	L68105	F 14x1,5 U		2	34141-AA041
			LHD	L68204	L68204	M 14x1,5 / M 14x1,5 U		2	34140-FC000
		↓		L68500	L68500			2	21067-GA050
		↓	→ 12.99	L68504	L68503			1	20200-AA200
				L68504				1	20200-AA210
			05.98 →	L68601	L68601			2	20420-AA003
			KIT	MK290R				1	
				MK291L				1	

Forester (SG) 07.02 → 05.08

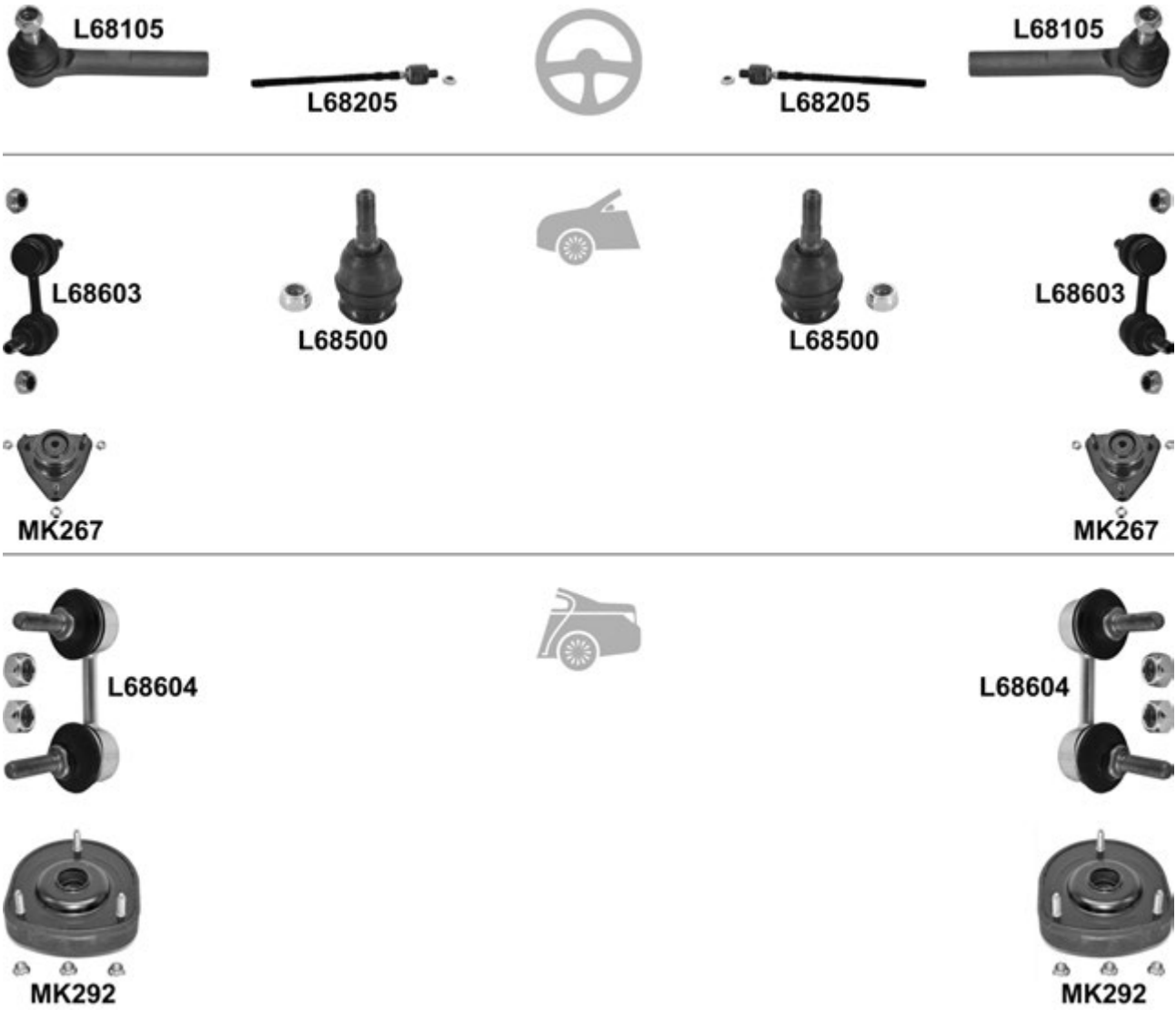

			←	→	Thread	Part Of	QPA	
		↔	L68105	L68105	F 14x1,5 ∪		2	34141-AA041
			L68205	L68205	M 14x1,5 / M 16x1,5 ∪		2	34140-AE001
		⊥	L68500	L68500			2	21067-GA050
			L68603	L68603			2	20470-SA000
			KIT	MK267	MK267		1	
			L68604	L68604			2	20470-SA011
			KIT	MK292	MK292		2	20390-FE000

Forester (SH) 01.08 →

L68105

L68105

L68603

L68500

L68500

L68603

Thread
Part Of
QPA

		↔		L68105	L68105	F 14x1,5 U		2	34141-AA041
		⊥		L68500	L68500			2	21067-GA050
				L68603	L68603			2	20470-SA000

Impreza (GC, GF, GFC) 08.92 → 12.00



L68104



L68103



L68105



L68105



L68601



L68500



L68500



L68601



L68504



L68503



L68600



L68600



MK260



MK260

		i		←	→	Thread	Part Of	QPA	i
					L68103	F 14x1,5 ∪		1	31320-GA190
					L68104	F 14x1,5 ∪		1	31320-GA200
				L68105	L68105	F 14x1,5 ∪		2	34141-AA041
				L68500	L68500			2	21067-GA050
					L68503			1	20200-AA200
				L68504			1	20200-AA210	
				L68601	L68601			2	20420-AA003
				L68600	L68600			2	20481-AA001
				MK260	MK260			2	20370-FA200

Impreza (GD, GG) 12.00 →
 Impreza WRX (GD, GG) 12.00 →

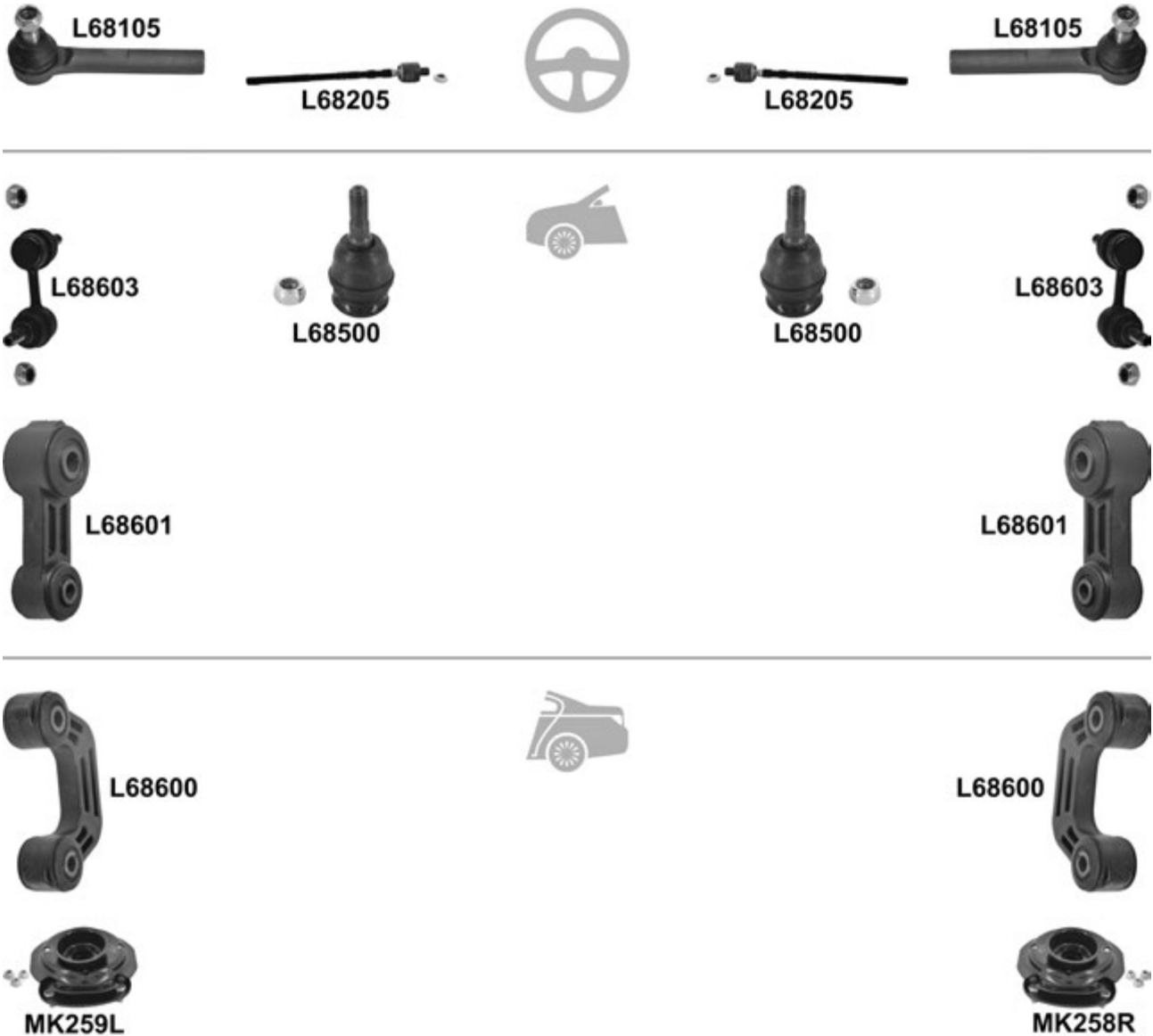

			←	→	Thread	Part Of	QPA	
		↔	L68105	L68105	F 14x1,5 ∪		2	34141-AA041
			L68205	L68205	M 14x1,5 / M 16x1,5 ∪		2	34140-AE001
		⊥	L68500	L68500			2	21067-GA050
			L68603	L68603			2	20470-SA000
			L68601	L68601			2	20420-AA003
			L68600	L68600			2	20481-AA001
		4WD		MK258R			1	20370-AC201
			MK259L				1	20370-AC211

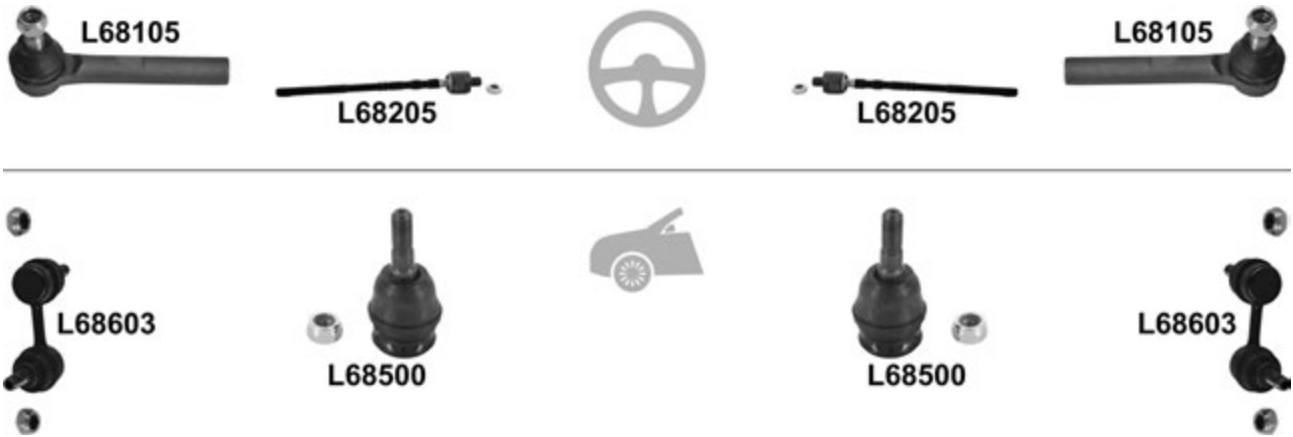
Impreza 01.08 →

				←	→	Thread	Part Of	QPA	
⊕		↔		L68105	L68105	F 14x1,5 ∪		2	34141-AA041
				L68205	L68205	M 14x1,5 / M 16x1,5 ∪		2	34140-AE001
⊖		⊥		L68500	L68500			2	21067-GA050
				L68603	L68603			2	20470-SA000

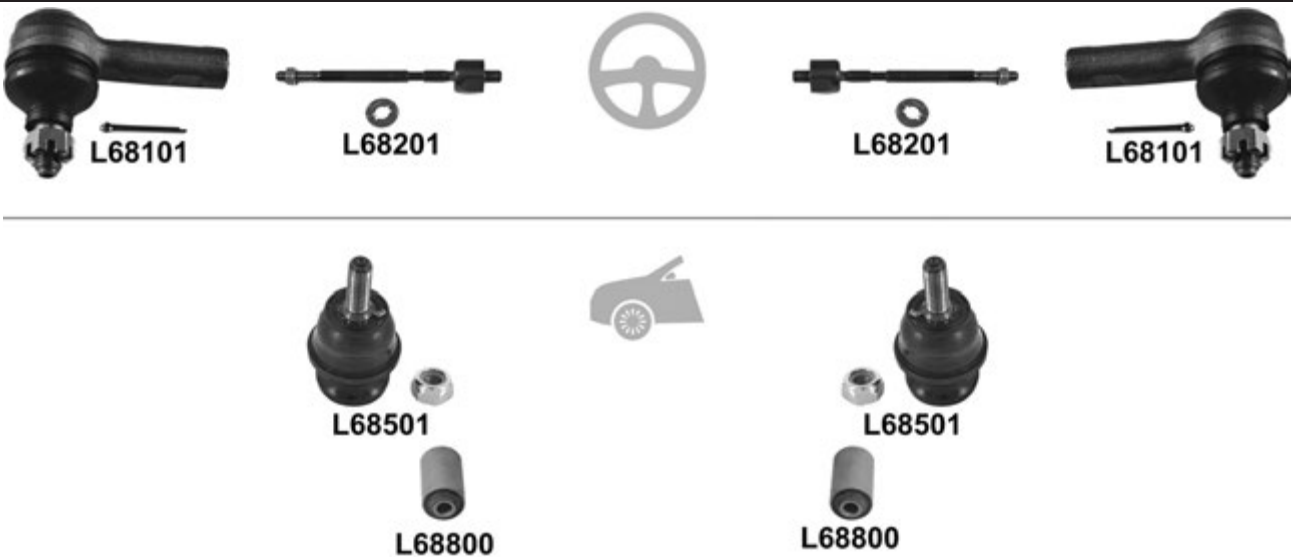
Justy (KAD) 11.84 →

				←	→	Thread	Part Of	QPA	
⊕		↔		L68101	L68101			2	7313-20020
				L68201	L68201			2	7313-10140
⊖		⊥		L68501	L68501			2	7210-67021
		⊥↔		L68800	L68800			2	

Justy II (JMA, MS) 10.95 → 11.03

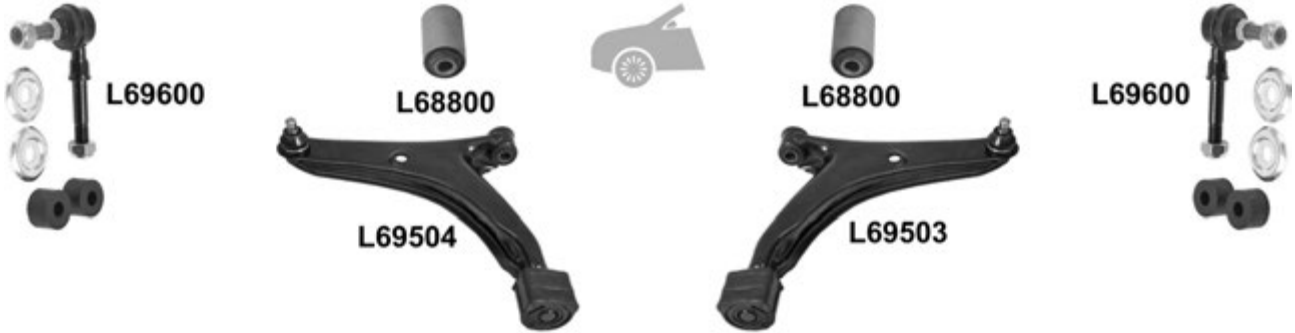

		i		← →		Thread	Part Of	QPA	i
		↔		L69101	L69101	F 12x1,25 U		2	48810-60B00
		↕↔		L68800	L68800			2	45540-60E00
		↕	1.3 SF413		L69503			1	45201-60E01
					L69504			1	45202-60E01
				L69600	L69600			2	46630-60B01
				L69600	L69600			2	46630-60B01

Justy III (G3X) 09.03 →

Thread
Part Of
QPA

		↔		L24116	L24116	F 12x1,25 ∪		2	48810-83E01
				L24217	L24217	M 12x1,25 / M 14x1,5 ∪		2	48830-86G00
				L69600	L69600			2	46630-60B01
				L69600	L69600			2	46630-60B01

Legacy I (BC, BJB) 01.89 → 07.94

				←	→	Thread	Part Of	QPA	
		↔		L68103		F 14x1,5 ♂		1	31320-GA190
				L68104		F 14x1,5 ♂		1	31320-GA200
		⊥		L68500	L68500			2	21067-GA050
					L68503			1	20200-AA200
				L68504			1	20200-AA210	
				L68601	L68601		2	20420-AA003	
				L68600	L68600			2	20481-AA001

Legacy II (BD, BG) 09.94 → 03.99

			i	←	→	Thread	Part Of	QPA	i
		↔		L68105	L68105	F 14x1,5 ♂		2	34141-AA041
		↓		L68500	L68500			2	21067-GA050
		↓			L68503			1	20200-AA200
				L68504				1	20200-AA210
				L68600	L68600			2	20481-AA001
			→ 09.98 2WD: 2.0/2.2 → 05.96 4WD: 2.0/2.2		MK258R			1	20370-AC201
				MK259L				1	20370-AC211

Legacy III (BE, BH) 10.98 → 08.03



				←	→	Thread	Part Of	QPA	
		↔		L68105	L68105	F 14x1,5 ♂		2	34141-AA041
					L68205	M 14x1,5 / M 16x1,5 ♂		1	34140-AE001
				L68204		M 14x1,5 / M 14x1,5 ♂		1	34140-FC000
		⊥		L68500	L68500			2	21067-GA050
		⊥			L68503			1	20200-AA200
				L68504				1	20200-AA210
				L68601	L68601			2	20420-AA003

Legacy IV 09.03 →

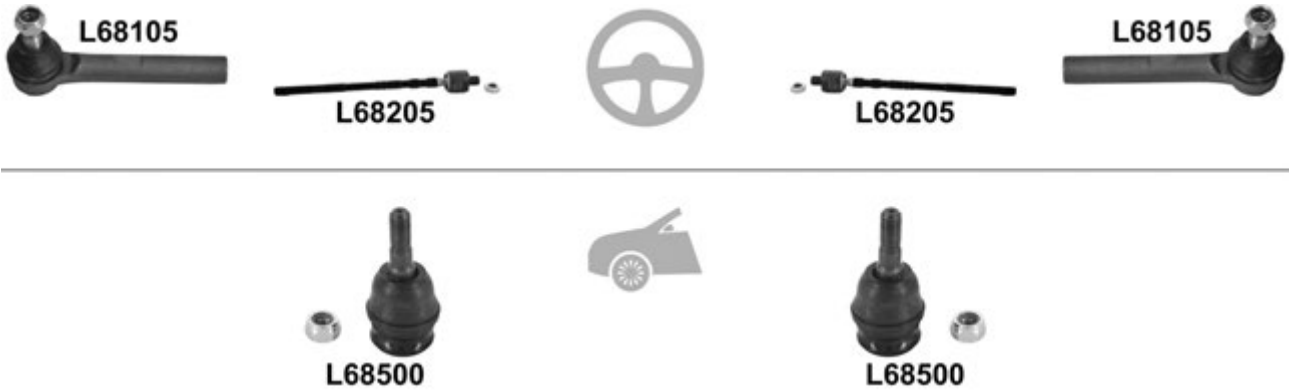

				←	→	Thread	Part Of	QPA	
		↔		L68105	L68105	F 14x1,5 ∪		2	34141-AA041
				L68205	L68205	M 14x1,5 / M 16x1,5 ∪		2	34140-AE001
		⊥		L68500	L68500			2	21067-GA050
		⊥	→ 07.04		L68503			1	20200-AA200
				L68504				1	20200-AA210
				L68603	L68603			2	20470-SA000

Legacy V 09.09 →

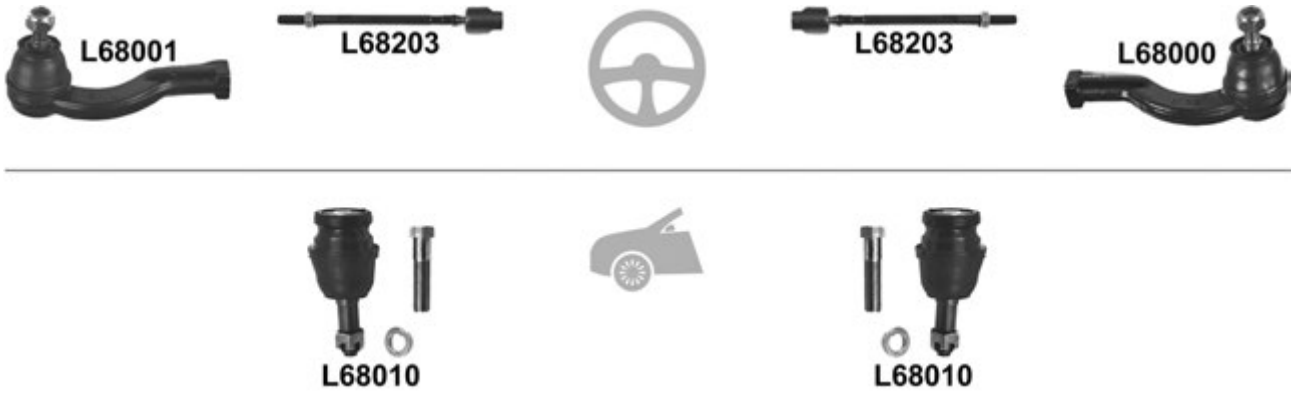

				←	→	Thread	Part Of	QPA	
		↔		L68105	L68105	F 14x1,5 ∪		2	34141-AA041
				L68205	L68205	M 14x1,5 / M 16x1,5 ∪		2	34140-AE001
		⊥		L68500	L68500			2	21067-GA050

Leone 2WD, 4WD 11.84 →

			i	←	→	Thread	Part Of	QPA	i
		↔			L68000	F 14x1,5 ♂		1	31320-GA101
					L68001	F 14x1,5 ♂		1	31320-GA111
		⊥	5B, 7B, 8D (Turbo), 3M, 4M, 4S, Coupè, (-)		L68203	L68203		2	31310-GA120
					L68010	L68010		2	7210-67003

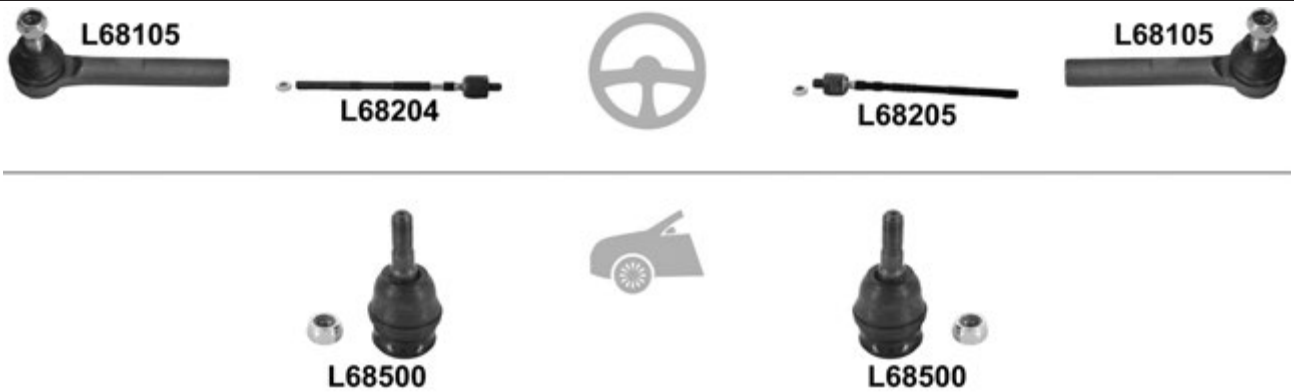
Outback (BE, BH) 01.00 → 08.03

			i	←	→	Thread	Part Of	QPA	i
		↔			L68105	L68105	F 14x1,5 ♂	2	34141-AA041
					L68205	M 14x1,5 / M 16x1,5 ♂	1	34140-AE001	
		⊥			L68204		M 14x1,5 / M 14x1,5 ♂	1	34140-FC000
					L68500	L68500		2	21067-GA050

Outback (BL, BF) 09.03 →

				←	→	Thread	Part Of	QPA	
		↔		L68105	L68105	F 14x1,5 ∪		2	34141-AA041
				L68205	L68205	M 14x1,5 / M 16x1,5 ∪		2	34140-AE001
		⊥		L68500	L68500			2	21067-GA050
					L68503			1	20200-AA200
				L68504			1	20200-AA210	
				L68603	L68603		2	20470-SA000	
			→ 07.04						

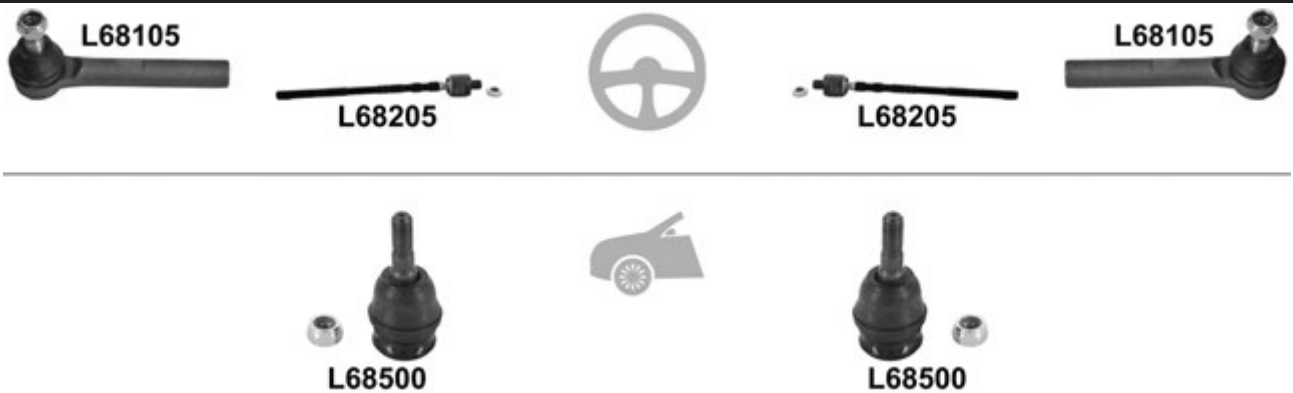
Outback (BM, BR) 09.09 →

				←	→	Thread	Part Of	QPA	
		↔		L68105	L68105	F 14x1,5 ∪		2	34141-AA041
				L68205	L68205	M 14x1,5 / M 16x1,5 ∪		2	34140-AE001
		⊥		L68500	L68500			2	21067-GA050

Tribeca (B9) 01.05 →



L68105



L68105



Thread

Part Of

QPA



				L68105	L68105	F 14x1,5 ♂		2	34141-AA041
--	--	--	--	--------	--------	------------	--	---	-------------

XV 03.12 →



L68105



L68105



L68500



L68500



Thread

Part Of

QPA

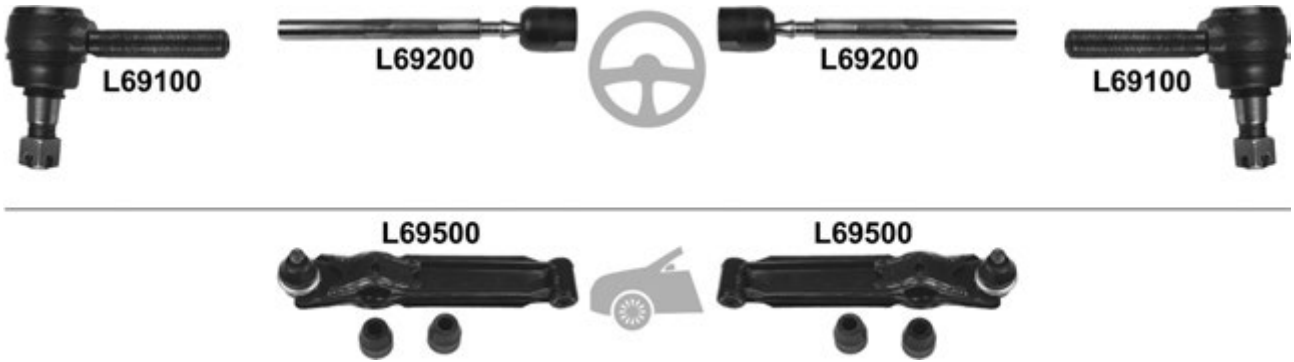

				L68105	L68105	F 14x1,5 ♂		2	34141-AA041
				L68500	L68500			2	21067-GA050

SUZUKI
Alto II (CA) 01.86 → 11.93

			i	←	→	Thread	Part Of	QPA	i
		↔		L69100	L69100	M 12x1,25 ♂		2	48810-84000-000
				L69200	L69200			2	48830-84000-000
		⊥	<input checked="" type="checkbox"/>	L69500	L69500			2	45200-84000-000

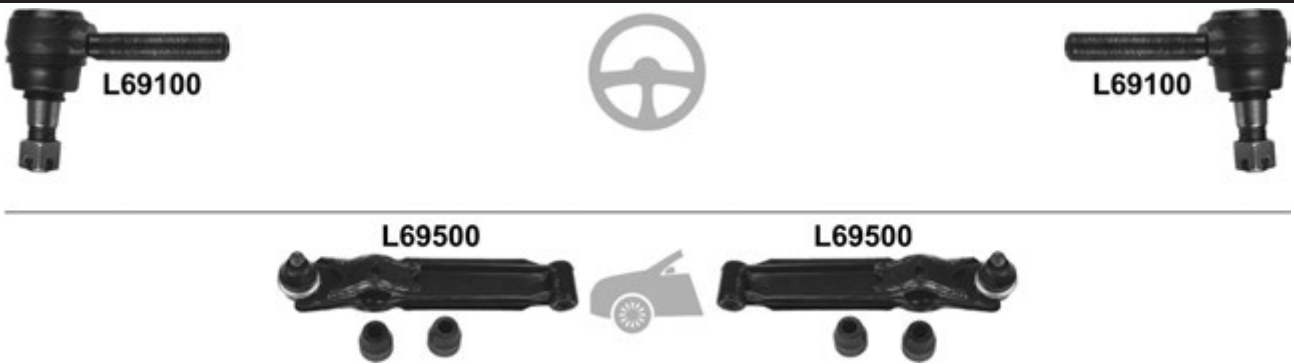
Alto III (EF) 09.94 → 06.02

			i	←	→	Thread	Part Of	QPA	i
		↔		L69100	L69100	M 12x1,25 ♂		2	48810-84000-000
		⊥	<input checked="" type="checkbox"/>	L69500	L69500			2	45200-84000-000

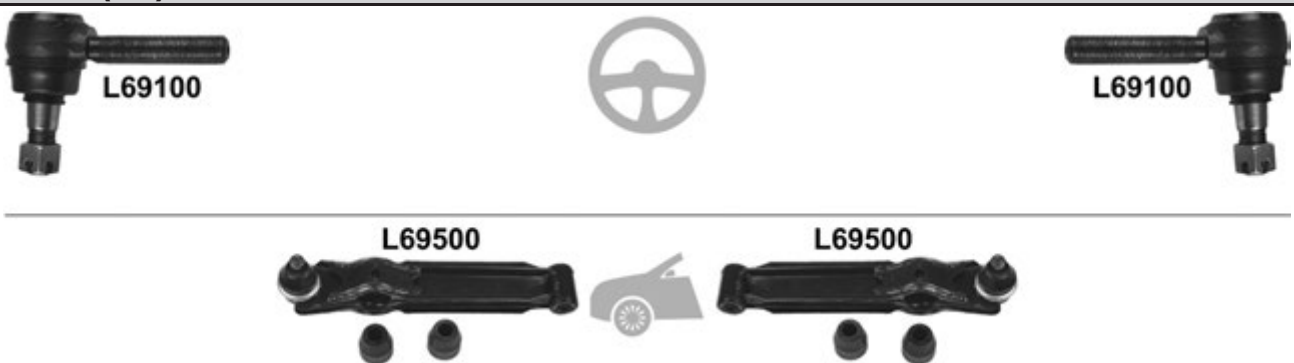
Alto IV (RF) 06.02 →

			i	←	→	Thread	Part Of	QPA	i
		↔		L69100	L69100	M 12x1,25 ♂		2	48810-84001
		⊥	<input checked="" type="checkbox"/>	L69500	L69500			2	45200-84000-000

Alto V (GF) 01.09 →



L24116



L24116



Thread

Part Of

QPA



				L24116	L24116	F 12x1,25 ⌀		2	48810-83E01
--	--	--	--	--------	--------	-------------	--	---	-------------

Baleno (EG) 07.95 →



L69101



L69101



L69600



L69506



L69505



L69600



L69800



L69802



L69800



L69802



Thread

Part Of

QPA



				L69101	L69101	F 12x1,25 ⌀		2	48810-82000-000
			<input checked="" type="checkbox"/>	L69506	L69505			1	45201-63G01-000
				L69800	L69800			2	45202-63G01-000
				L69802	L69802			2	45540-60E00-000
				L69802	L69802			2	45530-70C00-000
				L69600	L69600			2	45530-70C00-000
				L69600	L69600			2	46630-60B00-000

Grand Vitara / Grand Escudo (FT, GT) 03.98 →



				←	→	Thread	Part Of	QPA		
⊕		↔				L69103		1	48810-67D00-000	
						L69104		1	48820-67D00-000	
⊖		↓		<input checked="" type="checkbox"/>		L69511		1	45201-67D01-000	
						L69512		1	45202-67D01-000	
						L42601	L42601		2	42420-65D00-000
						KIT	MK356	MK356		2

Grand Vitara / Grand Escudo 04.05 →

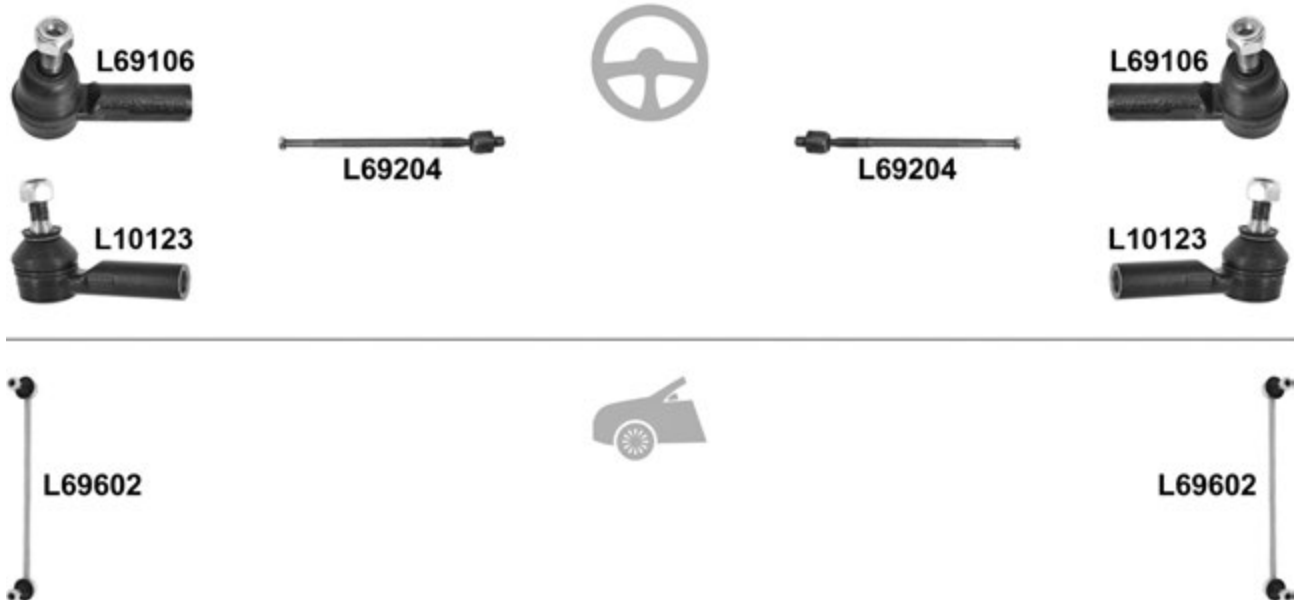

				←	→	Thread	Part Of	QPA				
⊕		↔	ch. → JSATD54V00240000			L69106	L69106	∩		2	48810-65J00-000	
			ch. → JSAJTD94V00202877									
			ch. JSATD54V00240001 →			L10123	L10123	∩		2	48810-79J00-000	
			ch. JSAJTD94V00202878 →									
						L69204	L69204	M 14x1,5 / M 18x1,5 ∩		2	48830-65J00-000	
⊖						L69602	L69602			2	42420-65J00-000	

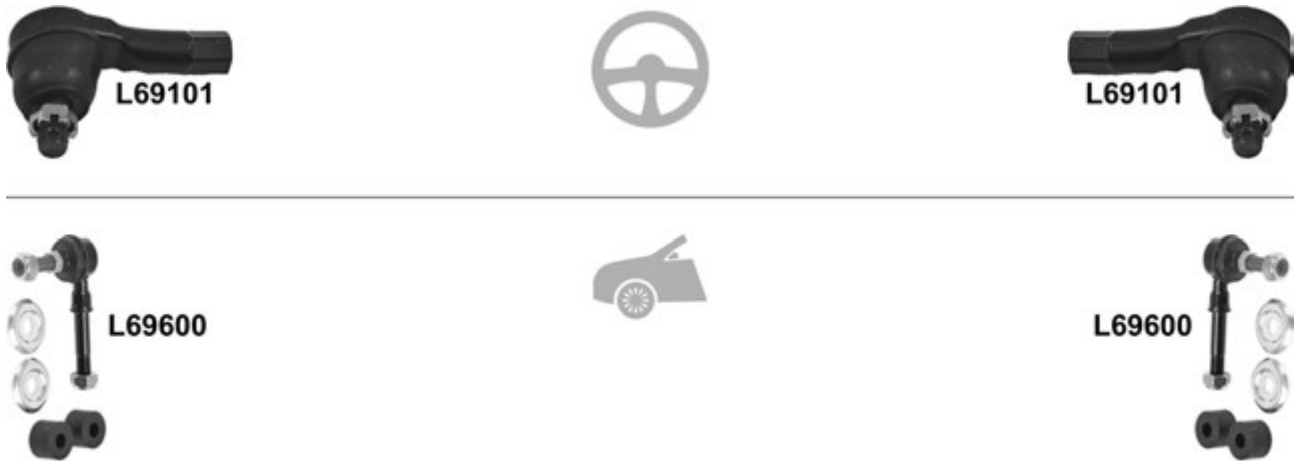
Ignis (FH) 10.00 → 09.03

			i	←	→	Thread	Part Of	QPA	i
		↔		L69101	L69101	F 12x1,25 ∪		2	48810-76G00-000
				L69600	L69600			2	46630-60B00-000

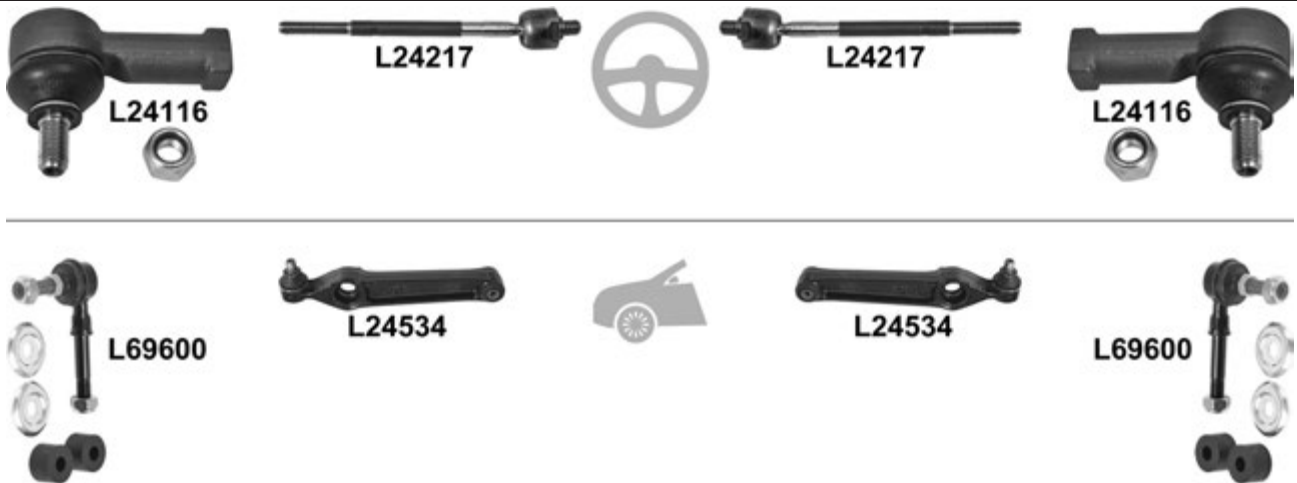
Ignis II 09.03 →

			i	←	→	Thread	Part Of	QPA	i
		↔		L24116	L24116	F 12x1,25 ∪		2	48810-83E01
				L24217	L24217	M 12x1,25 / M 14x1,5 ∪		2	48830-86G00
		⊥	ch. 140197 →	L24534	L24534			2	45200-85E00
				L69600	L69600			2	46630-60B00-000

Jimny (FJ) 09.98 →

			i	←	→	Thread	Part Of	QPA	i
		↔			L69107 ^o	M 16x1,5 ∪		1	48810-81A00
					L69108 ^o	M 16x1,5 ∪		1	48820-81A00

Kizashi (FR) 10.10 →



Thread

Part Of

QPA



			L10627	L10627			2	42420-80J00
--	--	--	--------	--------	--	--	---	-------------

Liana (ER) 07.01 →



Thread

Part Of

QPA



		↔		L69101	L69101	F 12x1,25 ♂		2	48810-76G00-000
			→ 11.03, (+) 1.6 Mot/Eng RH416F	L69600	L69600			2	46630-60B01
			12.03 →	L10627	L10627			2	42420-80J00
				KIT	MK340	MK340		2	

Samurai (SJ) 11.88 →



Thread

Part Of

QPA



				L69102	L69102	M 16x1,5 U		2	48810-85C00
--	--	--	--	--------	--------	------------	--	---	-------------

SJ410, SJ413 09.81 → 08.90



Thread

Part Of

QPA



				L69102	L69102	M 16x1,5		2	48810-60A00-000
--	--	--	--	--------	--------	----------	--	---	-----------------

Splash 01.08 →

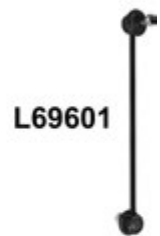
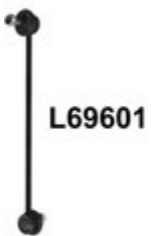
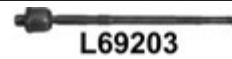
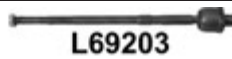

Thread

Part Of

QPA



				L24116	L24116	F 12x1,25 U		2	48810-60J10-000
				L69203	L69203	M 12x1,25 / M 18x1,5 U		2	48830-63J00-000
				L69508	L69508			2	45700-63J00-000
			<input checked="" type="checkbox"/>		L69509			1	45201-72K00-000
				L69510				1	45202-72K00-000
				L69803	L69803			2	
				L69804	L69804			2	45530-63J00-000
				L69601	L69601			2	42420-62J00-000

Swift I (AA) 10.83 → 12.89

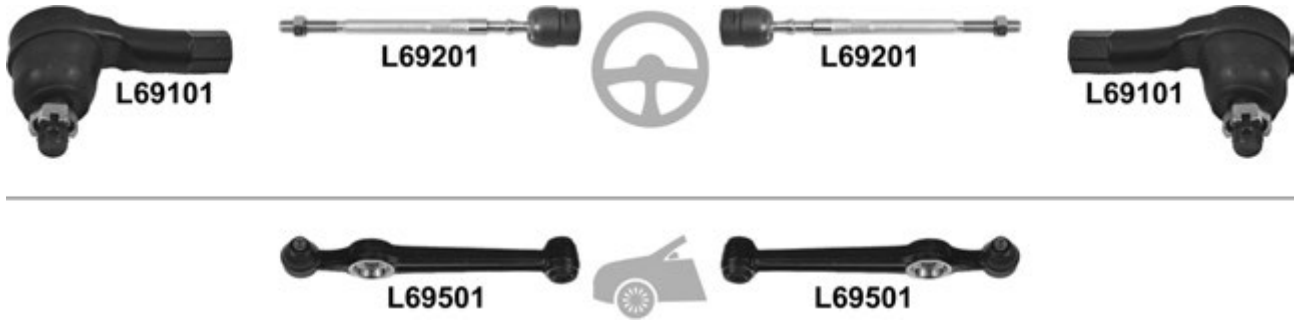

			i	←	→	Thread	Part Of	QPA	i
⊕		↔		L69101	L69101	F 12x1,25 U		2	48810-82000-000
				L69201	L69201			2	48830-82000-000
⊖		⊥		L69501	L69501			2	45200-82000-000

Swift II (EA, AH, AJ) 03.89 → 05.01



			i	←	→	Thread	Part Of	QPA	i
⊕		↔		L69101	L69101	F 12x1,25 U		2	48810-82000-000
					L69503				1
⊖		⊥		L69504				1	45202-60E01-000
				L69800	L69800			2	45540-60E00-000
⊖		⊥		L69801	L69801			2	45530-70C00-000
				L69600	L69600			2	46630-60B00-000
			KIT	MK138	MK138			2	41710-60B00-000

Swift III (SG) 02.05 →

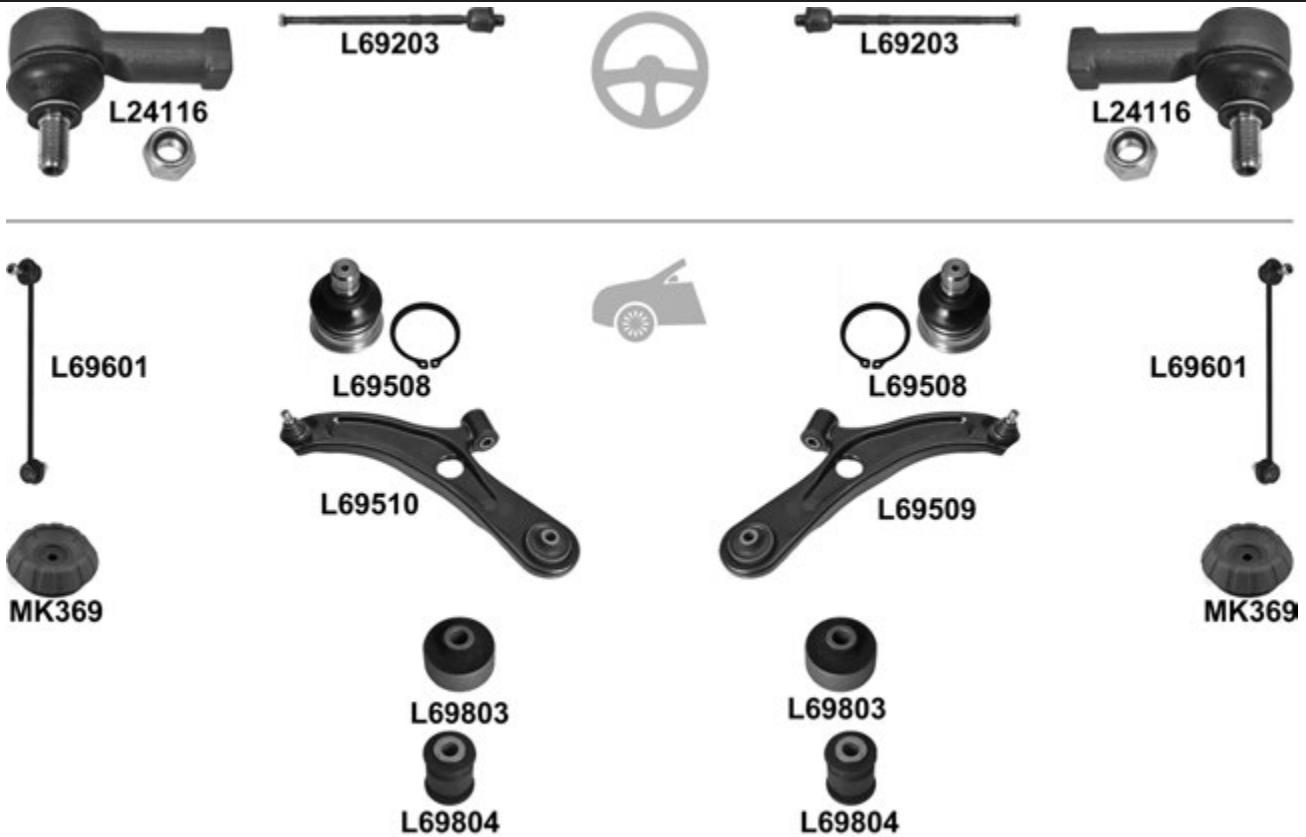

				←	→	Thread	Part Of	QPA	
		↔		L24116	L24116	F 12x1,25 ∪		2	48810-60810-000
				L69203	L69203	M 12x1,25 / M 18x1,5 ∪		2	48830-63J00-000
		↓		L69508	L69508			2	45700-63J00-000
		↓	<input checked="" type="checkbox"/>		L69509			1	45201-62J00-000
				L69510				1	45202-62J00-000
		↓▼		L69803	L69803			2	45530-62J00
		↓▲		L69804	L69804			2	45530-63J00-000
				L69601	L69601			2	42420-62J00-000
			KIT	MK369	MK369			2	

Swift IV 10.10 →



				←	→	Thread	Part Of	QPA	
				L10627	L10627			2	42420-80J00

SX4 06.06 →



				← → Thread		Part Of	QPA	i		
⊕		↔		L10123	L10123	F 14x1,5 ∪		2	48810-79J00-000	
					L10215 ^o	M 14x1,5 / M 16x1 ∪		1	48830-79J00-000	
					L10216 ^o	M 14x1,5 / M 16x1 ∪		1	48830-79J10-000	
🚗		⊥		<input checked="" type="checkbox"/>	L10593 ^o			1	45201-79J00	
					L10594 ^o			1	45202-79J00	
					L10842 ^o	L10842 ^o			2	
					L10841 ^o	L10841 ^o			2	
					L10627	L10627			2	42420-80J00-000

Wagon R+ (EM) 02.98 → 05.00

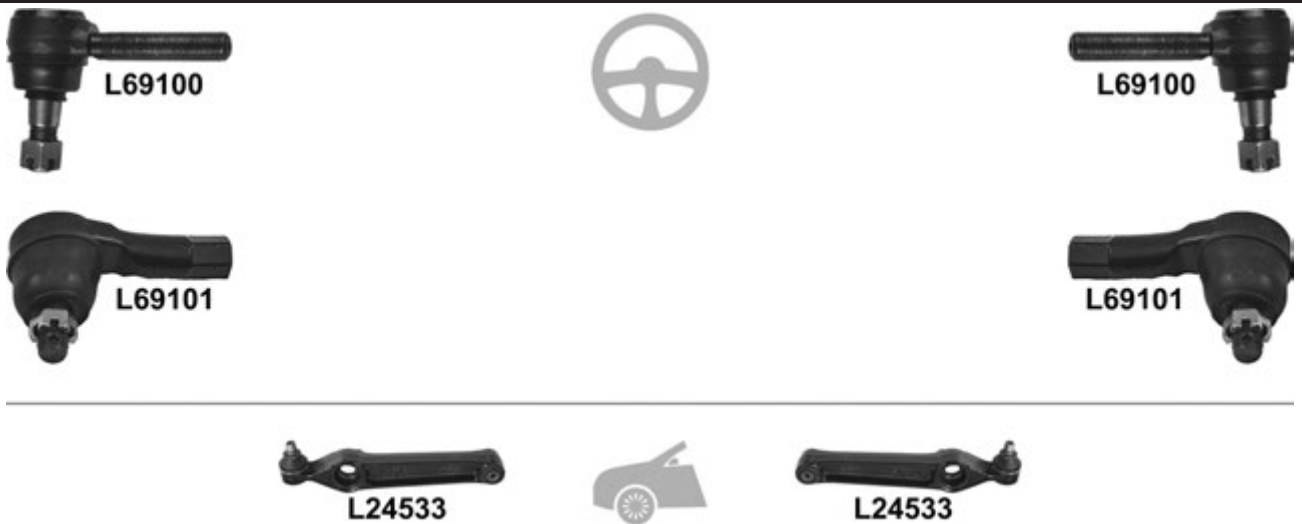

				← → Thread		Part Of	QPA	i	
⊕		↔		L69100	L69100	M 12x1,25 ∪		2	48810-84000-000
					L69101	L69101	F 12x1,25 ∪		2
🚗		⊥		<input checked="" type="checkbox"/>	L24533	L24533		2	45200-75F20-000

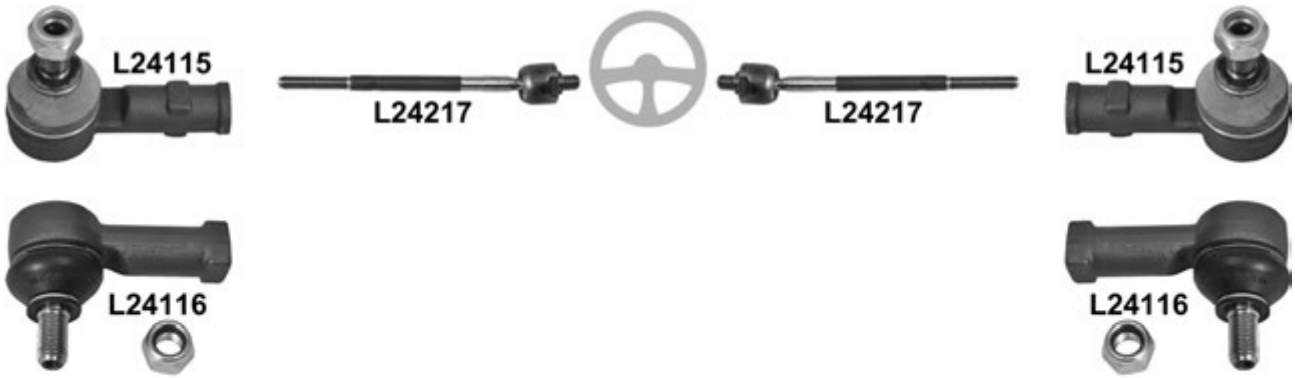
Wagon R+ (MM) 05.00 →

					←	→	Thread	Part Of	QPA	
⊕		↔	→ ch. 140196	L24115	L24115	∪			2	48810-76G00-000
			ch. 140197 →	L24116	L24116	∪			2	48810-83E01-000
				L24217	L24217	M 12x1,25 / M 14x1,5 ∪			2	48830-86G00-000
⊖		⊥	→ ch. 140196	L24533	L24533				2	45200-75F20-000
			ch. 140197 →	L24534	L24534				2	45200-84E00-000
				KIT	MK367	MK367			2	

Vitara (ET, TA) 07.88 → 03.99

					←	→	Thread	Part Of	QPA	
⊕		↔		L69102	L69102				2	48810-60A00-000
⊖		⊥		L69507	L69507				2	45700-60A01-000
				L42601	L42601				2	42420-65D00-000
				KIT	MK139	MK139			2	

X90 (EL) 09.95 →



Thread

Part Of

QPA



				←	→	Thread	Part Of	QPA	
		↔		L69102	L69102	M 16x1,5 U		2	48810-77E00
			KIT	MK139	MK139			2	

TALBOT

Samba 01.81 → 06.86

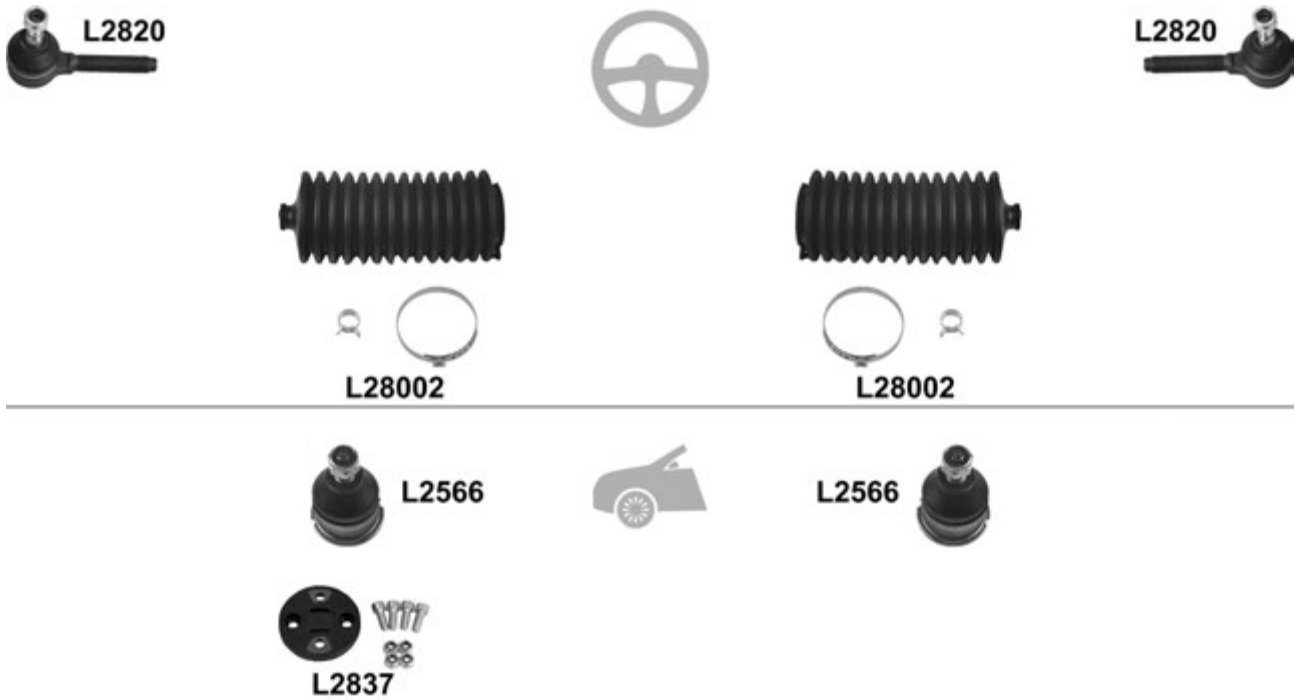

			←	→	Thread	Part Of	QPA	
		↔	L2820	L2820	M 14x1,5 U		2	9403717389
			L28002	L28002			2	7910030073
		↓	L2566	L2566			2	91504248
			L2837				1	

Sunbeam 1250, 1300, 1500, 1600 1970 → 08.77 Sunbeam Avenger 1970 → 08.77



			←	→	Thread	Part Of	QPA	
		↔	L0003	L0003	F 1/2"x20 UNF U		2	75061288

Tagora 06.80 → 12.83



			←	→	Thread	Part Of	QPA	
		↔	L2820	L2820	M 14x1,5 U		2	9403817389
		↓	L2822	L2822			2	9403640150

TOYOTA

Auris 10.06 →

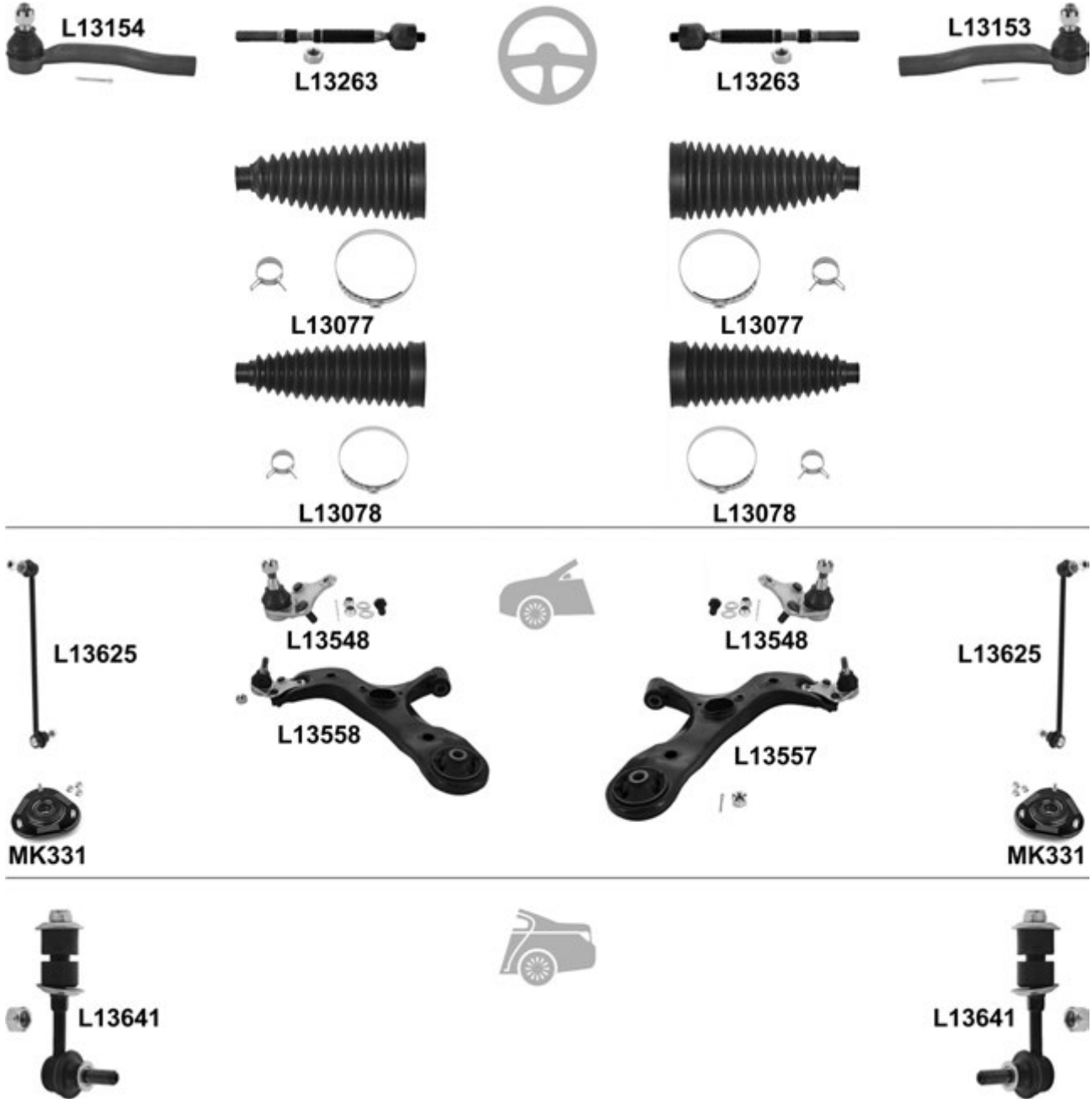

				←	→	Thread	Part Of	QPA			
						L13153	F 15x1,5 U	1	45046-19415		
						L13154	F 15x1,5 U	1	45047-19215		
						L13263 ⁰	L13263 ⁰	M 15x1,5 / M 14x1,5	2		
					ORIG (GB), ø 16mm, Ø 60mm, L= 157mm	L13077 ⁰	L13077 ⁰		2	45535-09120	
					ORIG (J), ø 15,5mm, Ø 59,5mm, L= 178mm	L13078 ⁰	L13078 ⁰		2	45535-49015	
						L13548	L13548	2	43330-09630		
						(-) 2.2D	<input checked="" type="checkbox"/>	L13557		1	48068-12300
								L13558		1	48069-12300
								L13625	L13625	2	48820-02070
						(-) 2.2D	KIT	MK331	MK331	2	
								L13641	L13641	2	48830-05030

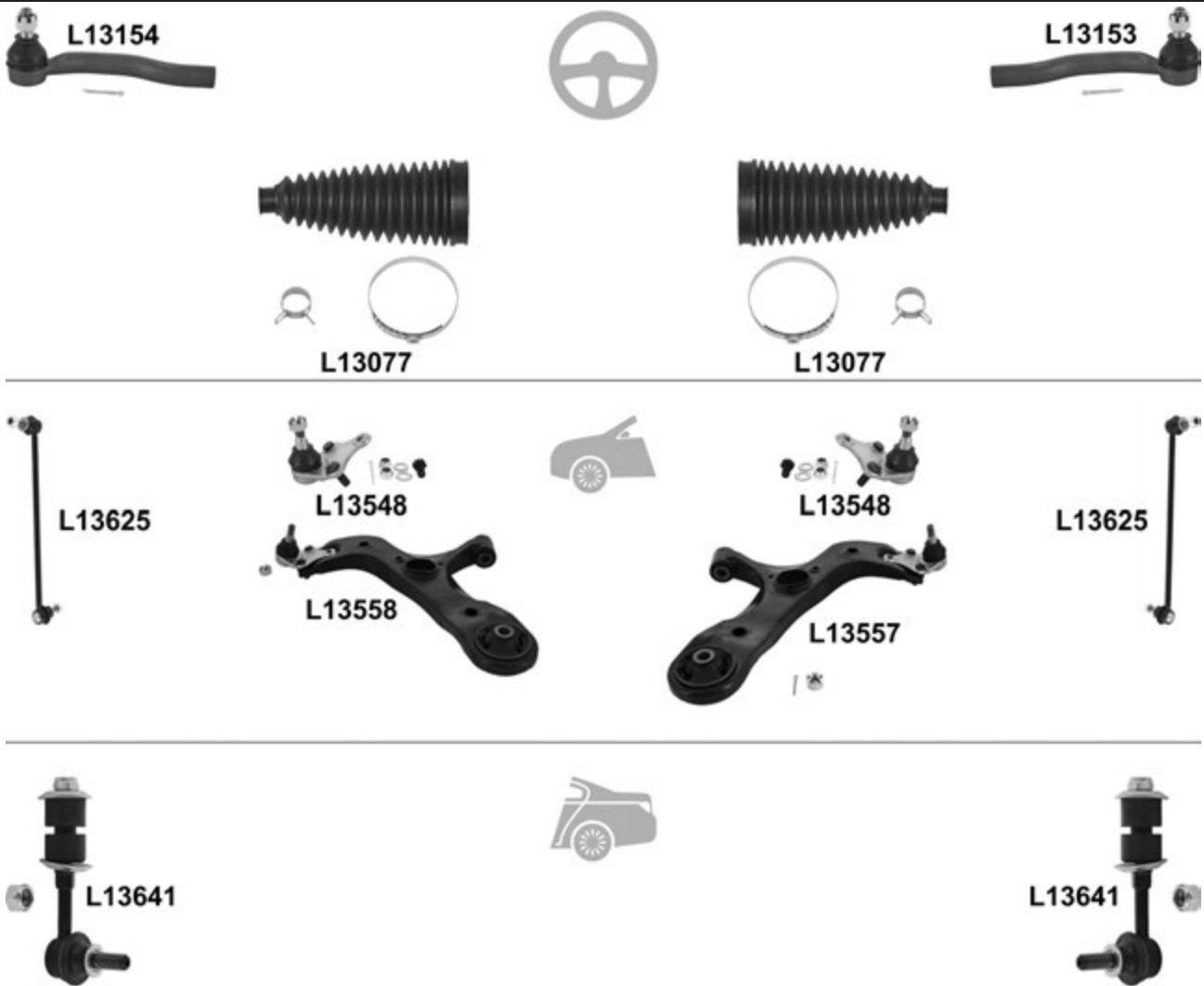
Auris (NZE18_, ZRE18_) 10.12 →

			←	→	Thread	Part Of	QPA	
				L13153	F 15x1,5 U		1	45046-19415
				L13154	F 15x1,5 U		1	45047-19215
				L13077 ^o	L13077 ^o		2	45535-09120
				L13548	L13548		2	43330-09630
				L13557		<input checked="" type="checkbox"/>	1	48068-12300
				L13558			1	48069-12300
				L13625	L13625		2	48820-02070
				L13641	L13641		2	48830-05030

Avensis (T22) 09.97 →

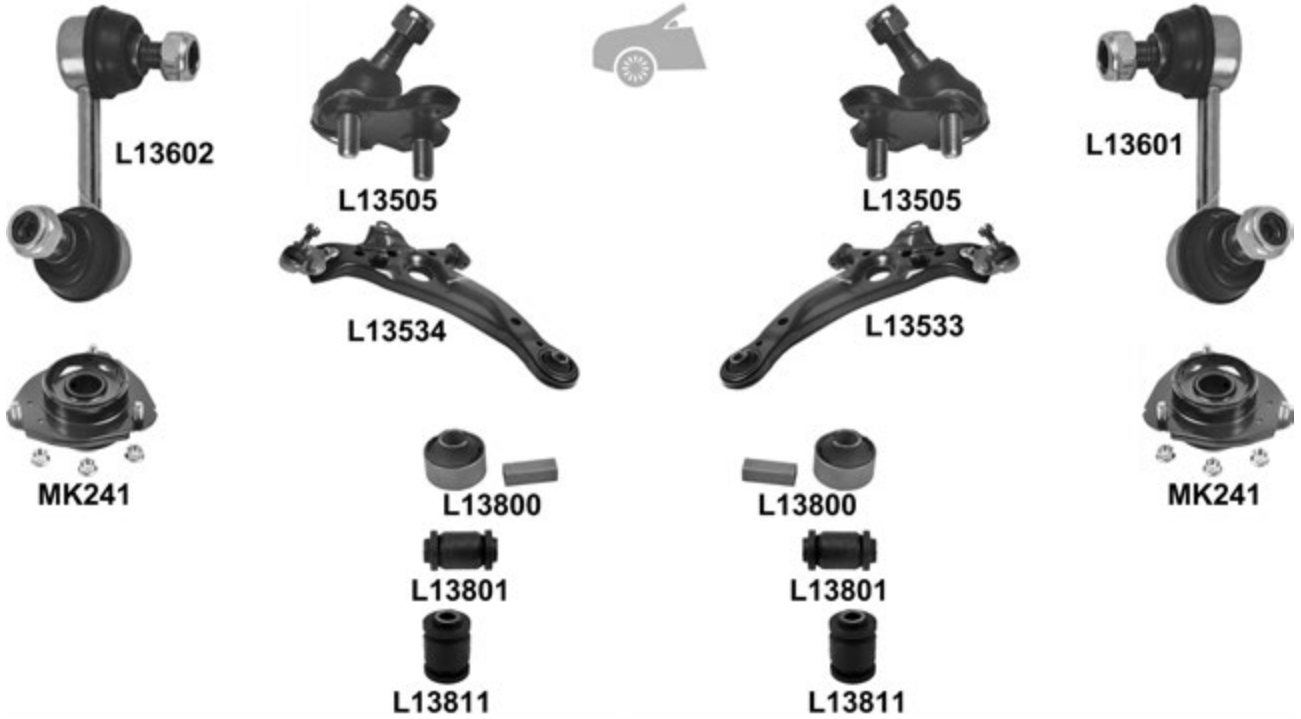

				← → Thread		Part Of	QPA	i		
⊕		↔		L13131	F 14x1,5		1	45046-29365		
				L13132	F 14x1,5		1	45047-29125		
🚗		↓		L13234	L13234	M 14x1,5 / M 16x1,5	2	45503-05020		
				L13505	L13505		2	43330-29375		
		↓	(-) AUT <input checked="" type="checkbox"/>		L13533			1	48068-05050	
					L13534			1	48069-05050	
		↓	↑		L13800	L13800		2	48655-20220	
					L13801	L13801		2		
					L13811	L13811		2		
		↔			L13601			1	48820-20040	
			L13602			1	48810-20020			
🚗			KIT	MK241	MK241		2	48609-05010		
			L13618	L13618		2	48830-05020			

Avensis (T25) 04.03 →



Avensis (T25) 04.03 →

		i	←	→	Thread	Part Of	QPA	i	
		↔	1.6 / 1.8	L13125	L13125	F 15x1,5 ∪		2	45046-29255
			(-) 1.6 / 1.8, ZF	L13151	L13151	F 16x1,5 ∪		2	45046-29425
			1.6 / 1.8	L13242	L13242	M 15x1,5 / M 14x1,5 ∪	OE no. 45500-05030	2	
			(-) 1.6 / 1.8, ZF	L13239	L13239	M 16x1,5 / M 16x1,5 ∪		2	45503-0F010
		↓	(-) 2.2D Mot/Eng 2AD-FHV / 2AD-FTV	L13542	L13542			2	43330-09210
			(-) 2.2D Mot/Eng 2AD-FHV / 2AD-FTV <input checked="" type="checkbox"/>		L13543			1	48068-05070
		↓		L13544				1	48069-05070
			↕	L13806	L13806			2	
				L13807	L13807			2	
				L13613	L13613			2	48820-47010
					L13623			1	48830-21020
				L13624				1	48840-21010

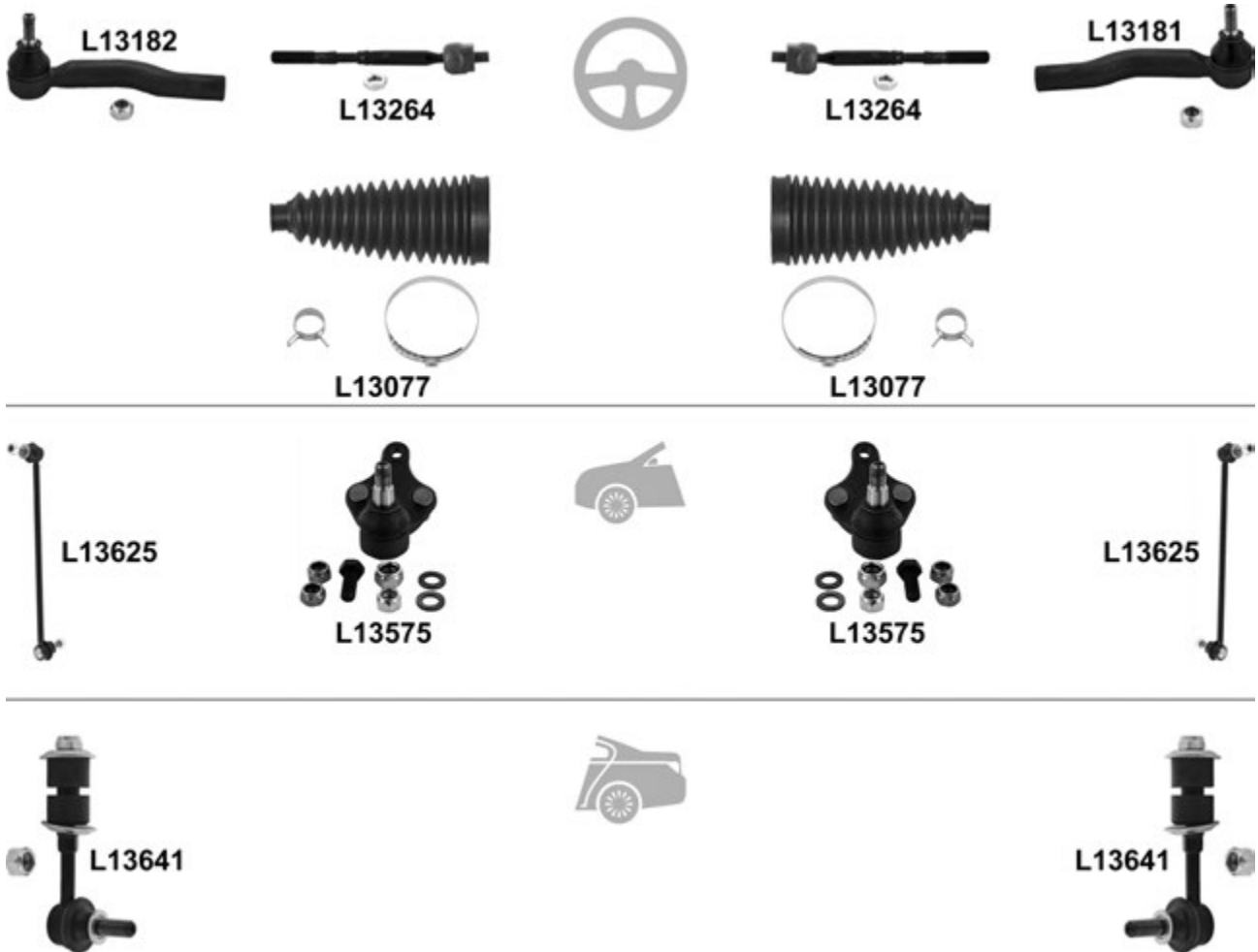
Avensis (T27) 02.09 →

		i	←	→	Thread	Part Of	QPA	i	
		↔		L13181	M 16x1,5 ∪		1	45046-09660	
				L13182	M 16x1,5 ∪		1	45047-09320	
				L13264 ^o	L13264 ^o	M 16x1,5 / M 14x1,5 ∪		2	
				L13077 ^o	L13077 ^o			2	45535-09120
		↓		L13575	L13575			2	43330-09070
				L13625	L13625			2	48820-42030
				L13641	L13641			2	48830-05030

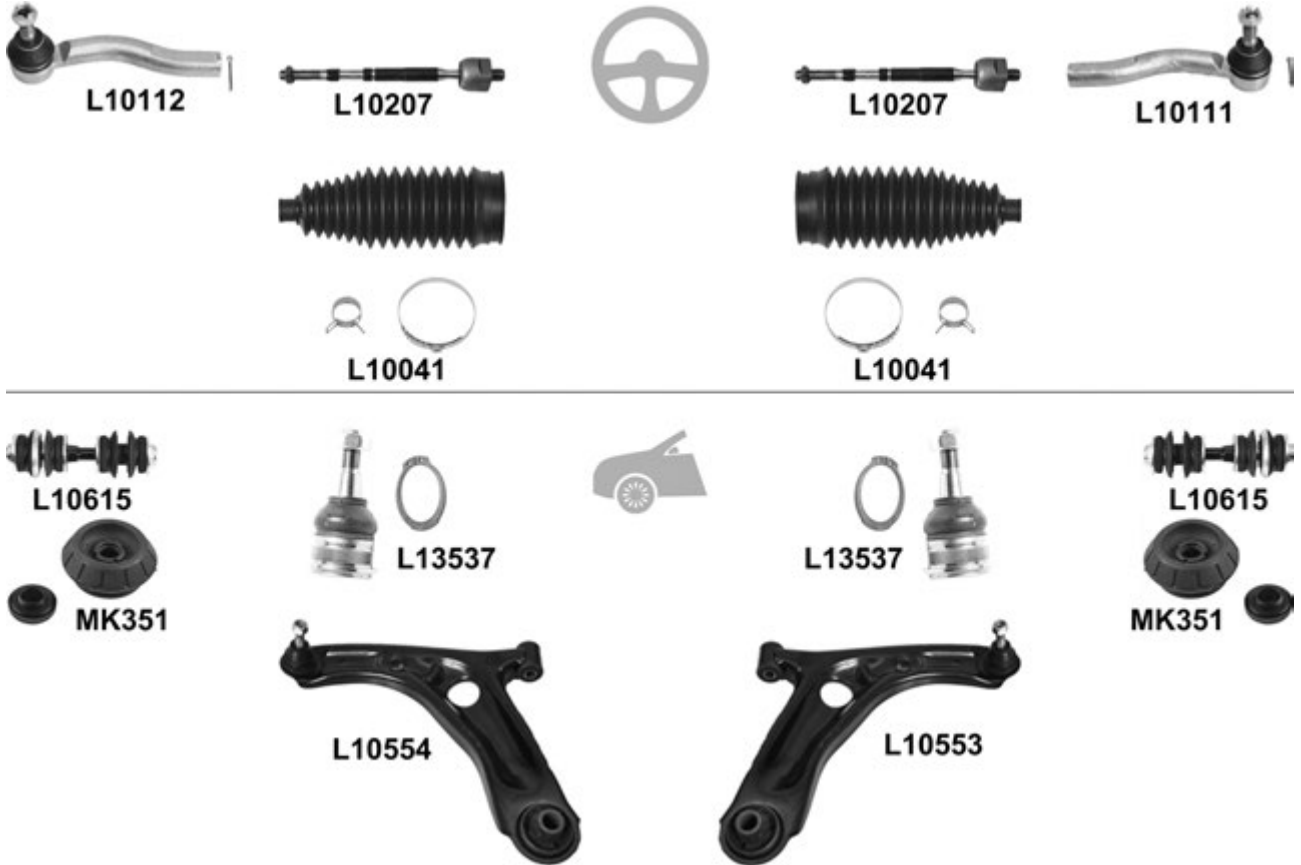
Aygo 07.05 →

				←	→	Thread	Part Of	QPA	
		↔			L10111	F 12x1,25 ∪		1	45046-09295
					L10112	F 12x1,25 ∪		1	45047-09125
					L10207	L10207	M 12x1,25 / M 14x1,5 ∪	2	
						L10041 ⁰	L10041 ⁰	OE no. 45500-0H010	2
		⊥			L13537	L13537		2	
		⊥		<input checked="" type="checkbox"/>	L10553			1	48068-0H010
					L10554			1	48069-0H010
					L10615	L10615		2	48819-70010
				KIT	MK351	MK351		2	48609-0H010

Camry SV10, SV11, CV10 02.83 → 10.86

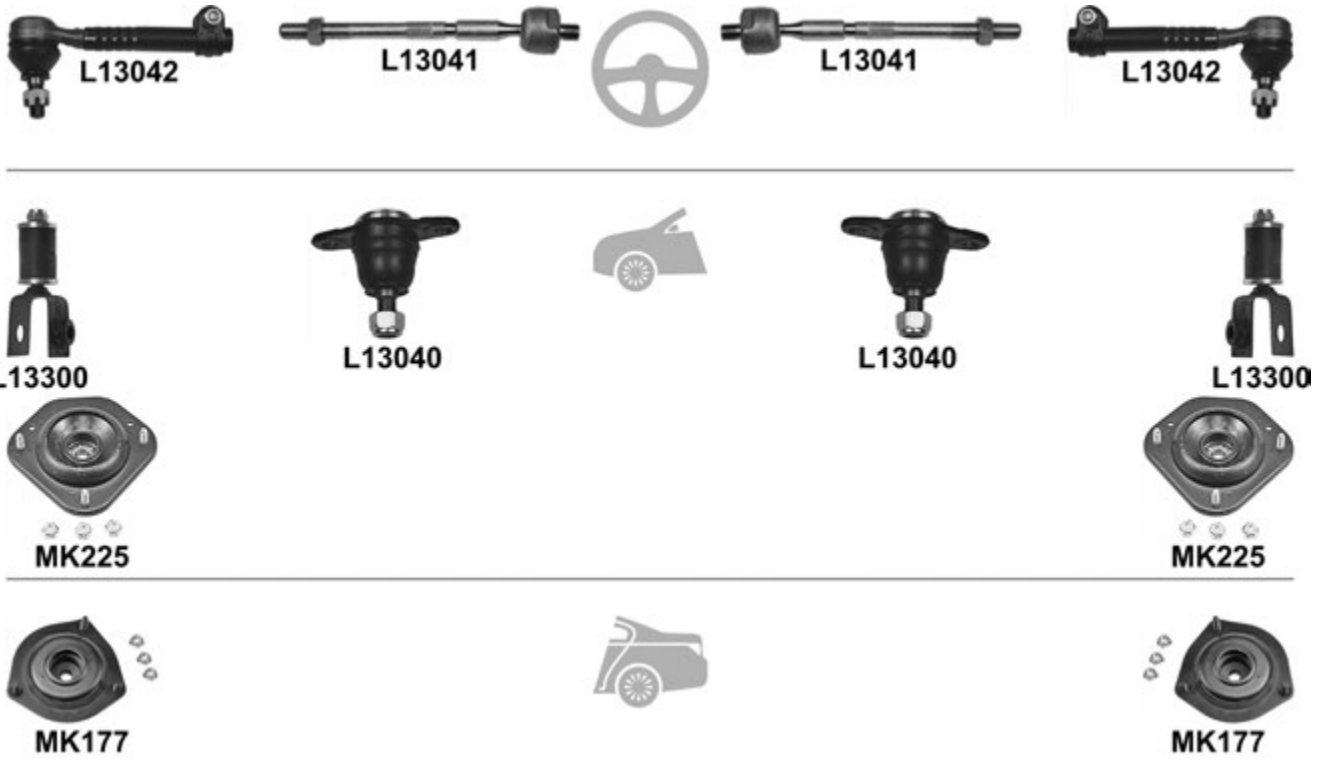

				←	→	Thread	Part Of	QPA	
		↔		L13042	L13042	F 14x1,5 ♂		2	45460-39165
				L13041	L13041	M 14x1,5 / M 14x1,5 ♂		2	45503-39015
		⊥		L13040	L13040			2	43330-39275
				L13300	L13300			2	
			KIT	MK225	MK225			2	
				MK177	MK177			2	48750-12020

Camry SV20, SV21, CV20 11.86 → 05.91



			←	→	Thread	Part Of	QPA	
		↔	L13100	L13100	F 14x1,5 ♂		2	45046-19175
			L13101	L13101	M 14x1,5 / M 14x1,5 ♂		2	45503-39025
		⊥	L13040	L13040			2	43330-39275
			KIT		MK088	MK088	2	
		SV21	L13608	L13608			2	48830-32010
		(-) 4WD	MK240	MK240			2	

Camry SXV, VCV10 06.91 → 06.97



		i		←	→	Thread	Part Of	QPA	i
		↔		←	→	F 15x1,5		2	45046-29255
								2	45503-29355
			KIT	←	→			2	48609-33011
			KIT	←	→			2	

Camry (_V20) 08.96 → 11.01

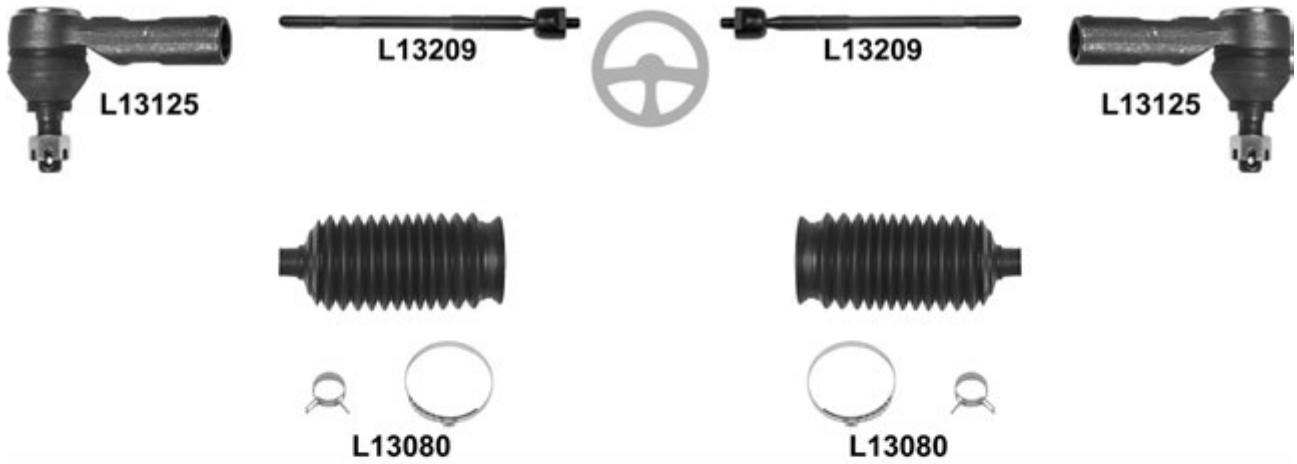

				← → Thread		Part Of	QPA	i	
⊕		↔		L13125	L13125	F 15x1,5	2	45046-29255	
				L13209	L13209		2	45503-29355	
			∅ 14mm, ∅ 47,5mm, L= 148mm	L13080 ^o	L13080 ^o		2	45535-12070	
				L13604	L13604		2	48820-33010	
			KIT		MK168R		1		
				MK169L			1		

Camry (_V30) 08.01 →



				← → Thread		Part Of	QPA	i	
		↔	→ 07.03	KIT	MK224	MK224		1	
		↔	→ 07.03	KIT	MK223	MK223		1	

Carina 1600 TA12, TA14 12.70 → 12.75

Thread
Part Of
QPA



				L13004	L13004	Thread	Part Of	QPA	
				L13004	L13004	M 14x1,5 ⌀		2	45046-29075
				L0138	L0138			2	43308-12030

Carina 1600 TA12, TA14, TA40 01.76 → 02.82

Thread
Part Of
QPA

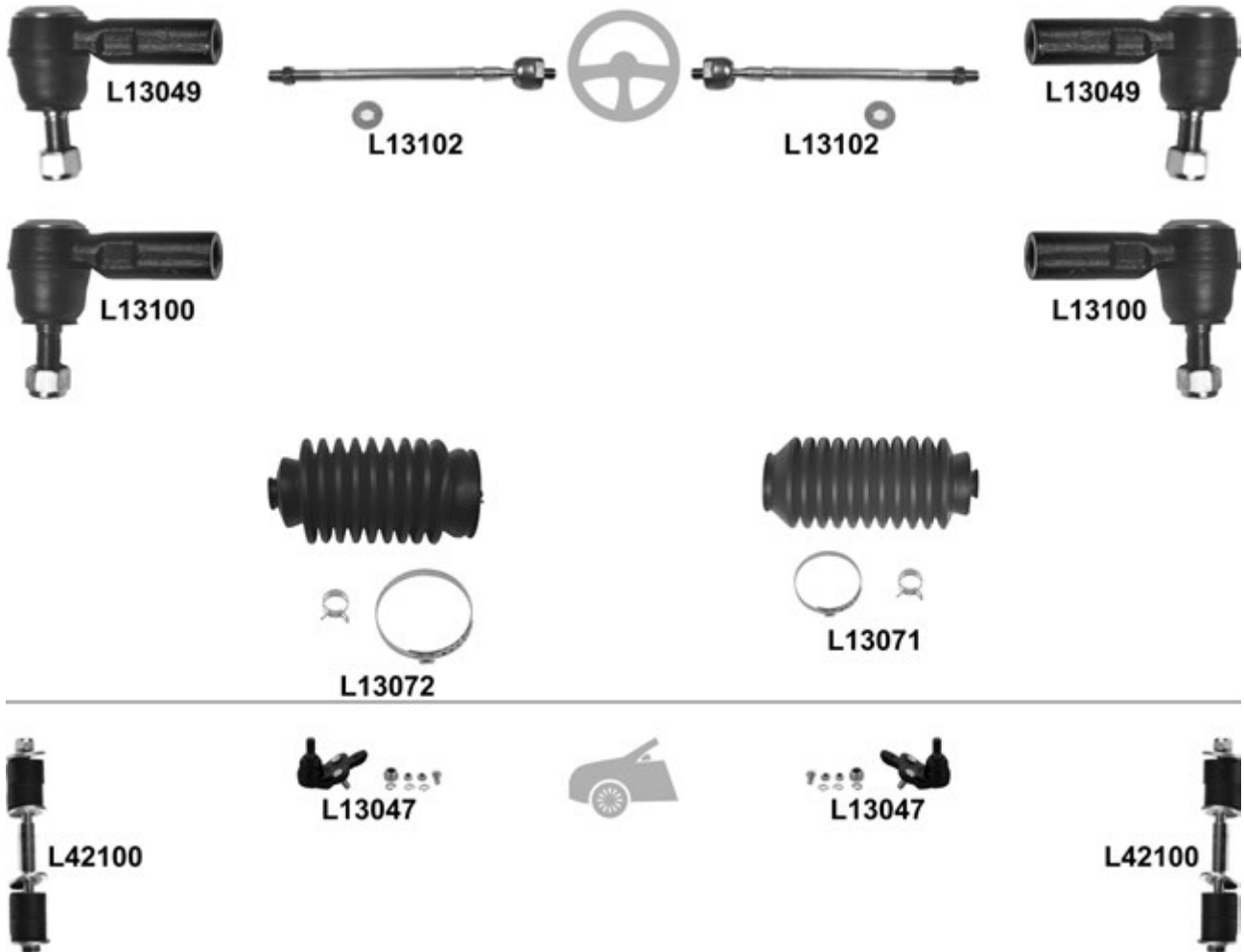

				L13004	L13004	Thread	Part Of	QPA	
				L13004	L13004	M 14x1,5 ⌀		2	45046-29075
				L0138	L0138			2	43308-12030
				L50602	L50602			2	

Carina II AT / ST / CT15_ 10.83 → 05.88

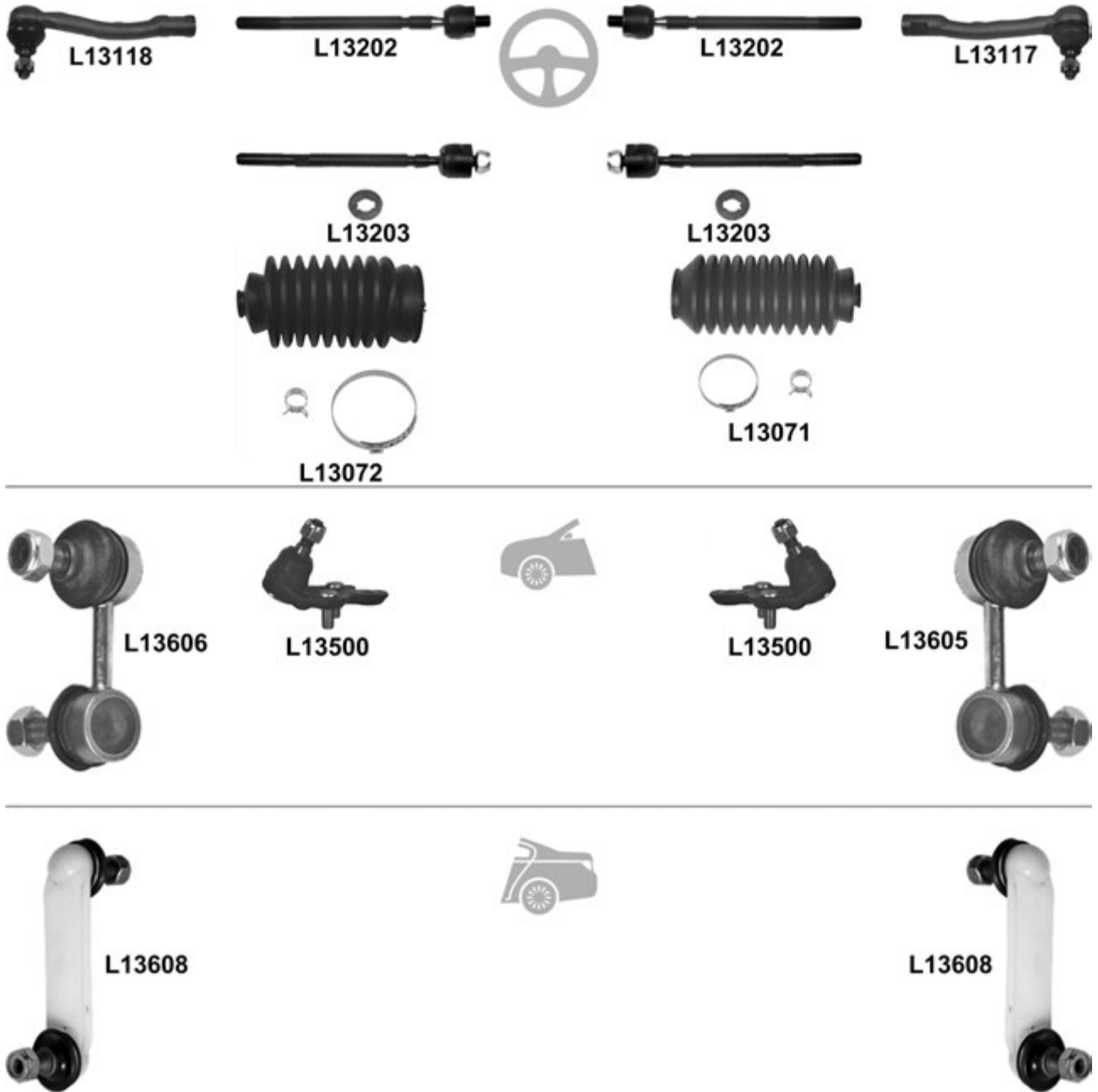

				←	→	Thread	Part Of	QPA		
		↔	→ 08.84	L13049	L13049	F 12x1,25 ∪		2	45046-29135	
			09.84 →	L13100	L13100	F 14x1,5 ∪		2	45046-19175	
				09.84 →	L13102	L13102	M 14x1,5 / M 14x1,5 ∪		2	45503-19036
						L13071				1
				L13072				1	45536-12030	
		⊥		L13047	L13047			2	43330-29139	
				L42100	L42100			2	48819-20030	

Carina II AT17_, ST17_, CT17_ 12.87 → 06.93



		i		←	→	Thread	Part Of	QPA	i	
		↔			L13117	F 15x1,5 ∪		1	45046-29165	
					L13118	F 15x1,5 ∪		1	45047-29045	
					L13202	L13202	M 15x1,5 / M 14x1,5 ∪		2	45503-29155
					L13203	L13203	M 15x1,5 / M 14x1,5 ∪		2	45503-29165
						L13071			1	45535-12011
			L13072			1	45536-12030			
				L13500	L13500			2	43330-29185	
					L13605			1	48820-20030	
					L13606			1	48810-20010	
				L13608	L13608			2	48830-32010	

Carina E (AT19_, ST19_, CT19_) 04.92 → 09.97

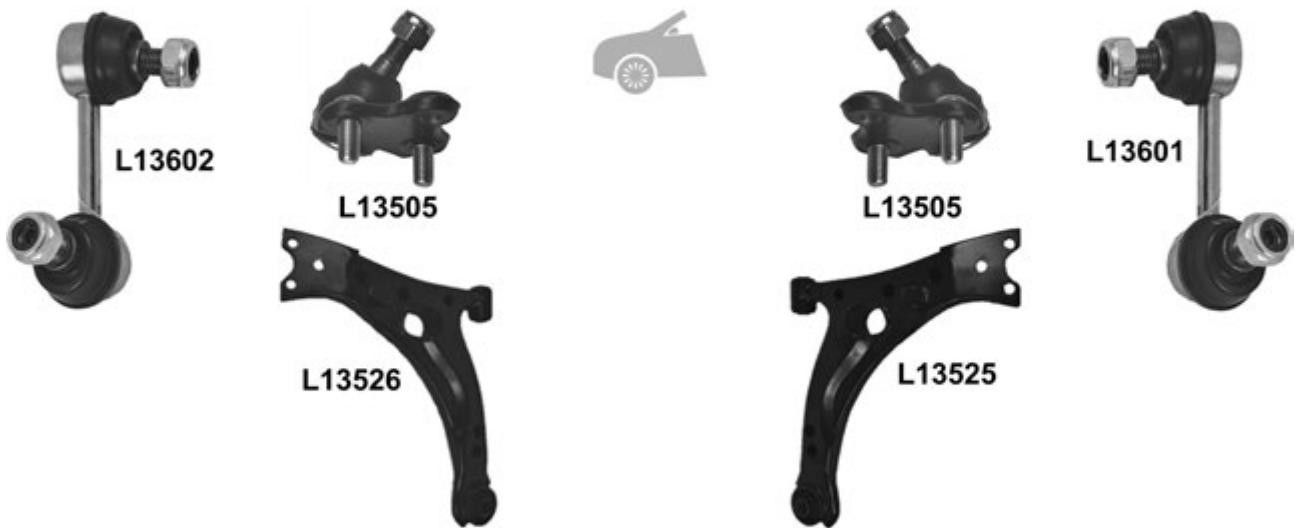
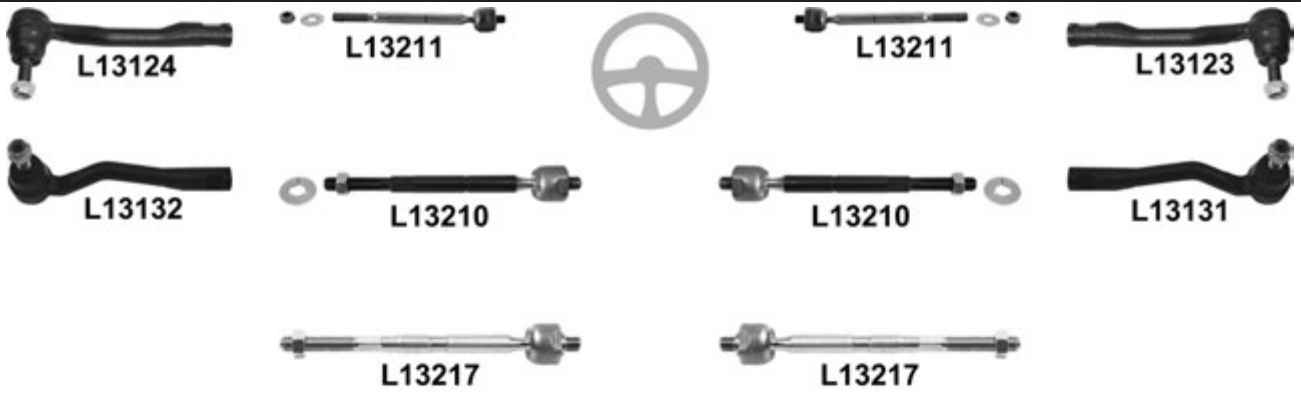

			←	→	Thread	Part Of	QPA		
		↔	ch. JT.	L13123	F 15x1,5		1	45046-29335	
				L13124	F 15x1,5		1	45047-29105	
			ch. SB.	L13131	F 14x1,5		1	45046-29365	
				L13132	F 14x1,5		1	45047-29125	
			ch. JT., L= 247mm, TOYODA	L13211	L13211	M 15x1,5 / M 14x1,5		2	45503-29475
			ch. JT., L= 237mm, TOYODA	L13210	L13210	M 15x1,5 / M 14x1,5		2	45503-29615
ch. SB., ZF			L13217	L13217	M 14x1,5 / M 14x1,5		2	45503-05010	
		↓		L13505	L13505		2	43330-29375	
			(-)		L13525		1	48068-20260	
		↓		L13526			1	48069-20260	
					L13601		1	48820-20040	
				L13602		1	48810-20020		
			L13607	L13607		2	48830-20010		

Celica 1600 TA22, TA23, TA28 12.70 → 1975
Celica 2000 RA23, RA28 12.70 → 1975



					←	→	Thread	Part Of	QPA	
		↔		L13004	L13004		M 14x1,5 U		2	45046-29075
		⊥		L0138	L0138				2	43308-12030

Celica 1600 TA22, TA23, TA28 10.75 → 1981
Celica 2000 RA23, RA28, RA40 10.75 → 1981



					←	→	Thread	Part Of	QPA	
		↔		L13004	L13004		M 14x1,5 U		2	45046-29075
		⊥		L0138	L0138				2	43308-12030
				L50602	L50602				2	

Celica AT / ST16_ 08.85 → 08.90



				←	→	Thread	Part Of	QPA	
		↔		L13100	L13100	F 14x1,5 ∪		2	45046-19175
				L13101	L13101	M 14x1,5 / M 14x1,5 ∪		2	45503-39025
		↓		L13500	L13500			2	43330-29185
					L13605			1	48820-20030
				L13606				1	48810-20010
			KIT	MK170	MK170			2	
				L13608	L13608			2	48830-32010

Celica AT / ST18_ 10.89 → 1994



				←	→	Thread	Part Of	QPA	
		↔		L13100	L13100	F 14x1,5 ∪		2	45046-19175
				L13213	L13213	M 14x1,5 / M 14x1,5 ∪		2	45503-29245
		⊥		L13504	L13504			2	43330-29326
				L13603	L13603			2	48820-20010
			(-) 4WD	KIT	MK170	MK170		2	
			(-) 4WD	L13607	L13607			2	48830-20010
			(-) 4WD	KIT	MK178	MK178		2	

Celica AT / ST20_ 11.93 →



				←	→	Thread	Part Of	QPA	
		↔		L13100	L13100	F 14x1,5 ♂		2	45046-19175
		⊥		L13505	L13505			2	43330-29265
				L13604	L13604			2	48820-33010
			(-) 1.8 16V 4WD (AE103)	L13607	L13607			2	48830-20010

Celica Supra MA61 05.82 → 10.86

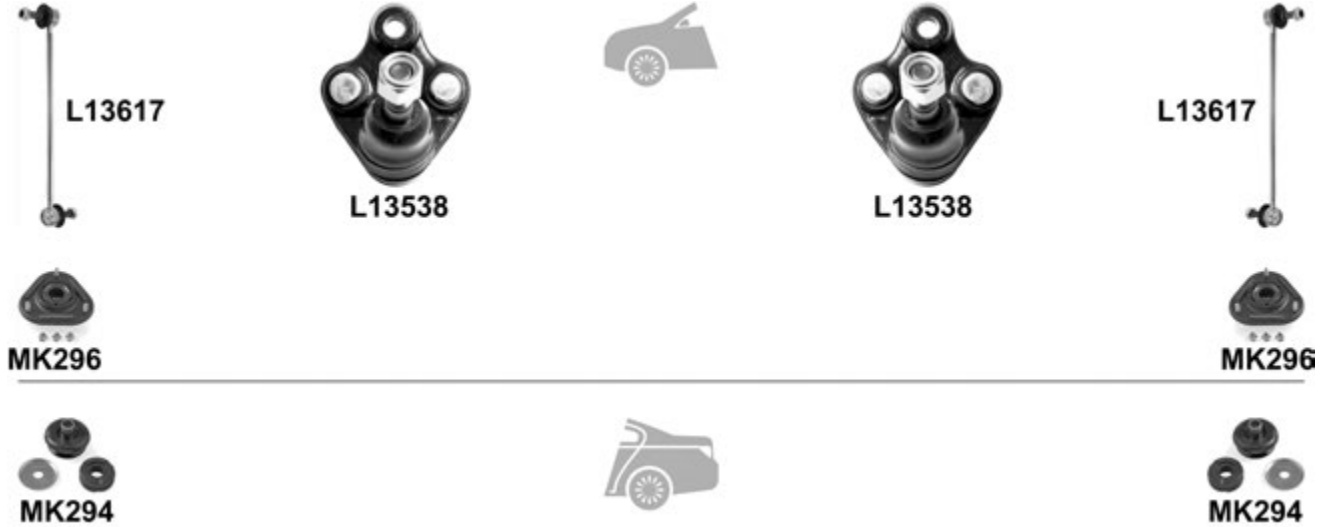

				←	→	Thread	Part Of	QPA	
		⊥		L13031	L13031			2	43308-29115

Celica (ZZT23_) 11.99 →

				← → Thread		Part Of	QPA	i	
		↓		L13538	L13538		2	43330-19115	
				L13617	L13617		2	48820-32010	
				KIT	MK296	MK296	2	48609-20471	
				KIT	MK294	MK294	2		

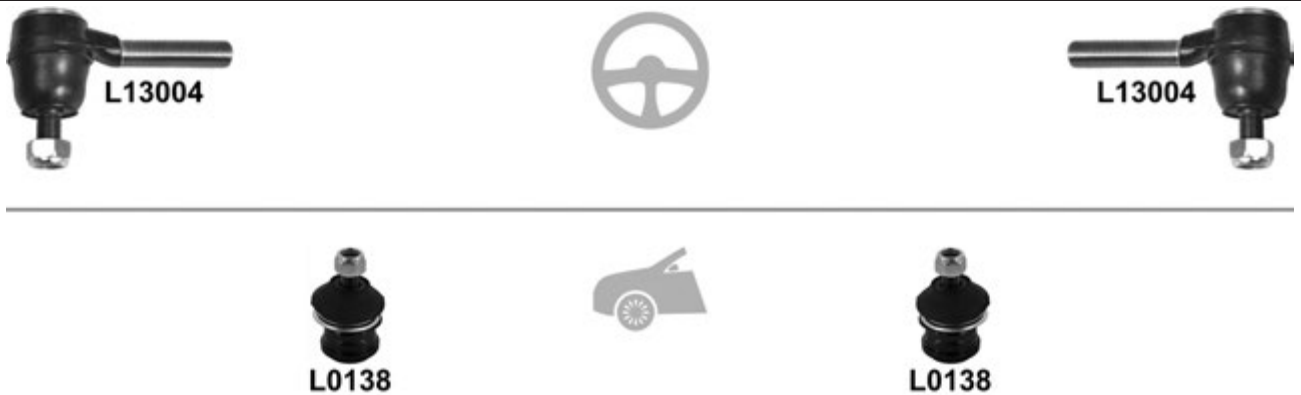
Corolla KE30, KE35, KE36, KE50 04.74 → 12.80
Corolla TE51 04.74 → 01.80

				← → Thread		Part Of	QPA	i	
		↔		L13004	L13004	M 14x1,5 U	2	45046-29075	
		↓		L0138	L0138		2	43308-12030	

Corolla KE70 09.79 → 08.87

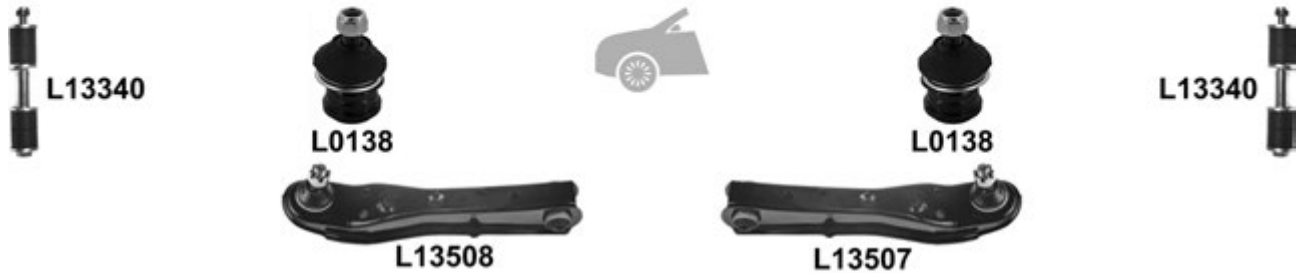

				← → Thread		Part Of	QPA	i	
				L13051	L13051	M 14x1,5 / M 14x1,5 U		2	45503-19015
		↓		L0138	L0138			2	43308-12030
		↓		<input checked="" type="checkbox"/>	L13507			1	
				L13508				1	
				L13340	L13340			2	48819-12010

 Corolla TE71 09.79 → 09.83
 Corolla CE70 02.82 → 08.87

				← → Thread		Part Of	QPA	i	
		↔		L13004	L13004	M 14x1,5 U		2	45046-29075
		↓		L0138	L0138			2	43308-12030
				L13340	L13340			2	48819-12010

Corolla AL20 05.82 → 08.84



				←	→	Thread	Part Of	QPA	
				L13044	L13044	M 14x1,5 / M 14x1,5 ♂		2	45503-19025
					L13071			1	45535-12011
		↓		L13043 [!]	L13043 [!]			2	43330-19025

Corolla AE80, AE82 06.83 → 05.88
 Corolla CE80, EE80 06.83 → 05.88



Corolla AE80, AE82 06.83 → 05.88
Corolla CE80, EE80 06.83 → 05.88

		i		←	→	Thread	Part Of	QPA	i
		↔	→ 08.84	L13049	L13049	F 12x1,25 ∪		2	45046-29135
			09.84 →	L13100	L13100	F 14x1,5 ∪		2	45046-19175
			⊙, 09.84 →	L13102	L13102	M 14x1,5 / M 14x1,5 ∪		2	45503-19036
			⊙		L13071			1	45535-12011
				L13072			1	45536-12030	
		⊥		L13047	L13047			2	43330-29205
					L13509			1	48068-20151
				L13510			1	48069-20151	
				L13340	L13340		2	48819-12010	
			L13300	L13300		2			
			(-) 4WD	MK177 ¹	MK177 ¹		2	48750-12020	

Corolla AE86 08.83 → 01.88

		i		←	→	Thread	Part Of	QPA	i
			⊙	L13051	L13051	M 14x1,5 / M 14x1,5 ∪		2	45503-19015
			⊙	L13044	L13044	M 14x1,5 / M 14x1,5 ∪		2	45503-19025
		⊥		L0138	L0138			2	43308-12030
				L13340	L13340		2	48819-12010	

Corolla AE92 / AE95 / CE90 / EE 90 08.87 → 06.93

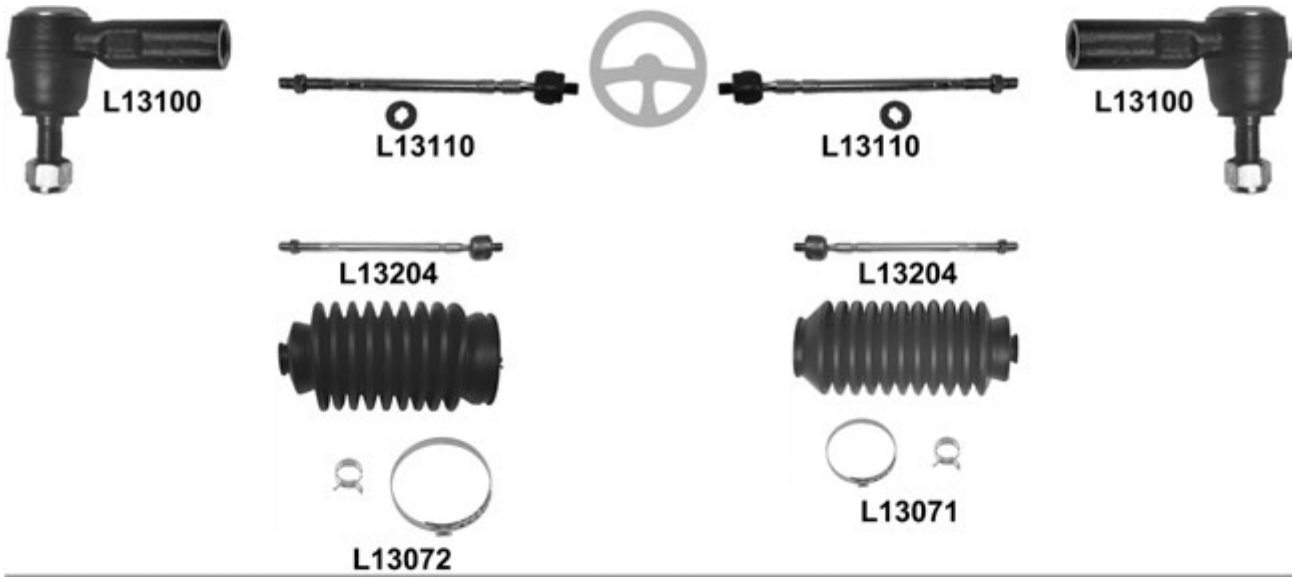

Corolla AE92 / AE95 / CE90 / EE 90 08.87 → 06.93

		i		←	→	Thread	Part Of	QPA	i
		↔		L13100	L13100	F 14x1,5 ∪		2	45046-19175
				L13110	L13110	M 14x1,5 / M 14x1,5 ∪		2	45503-19125
				L13204	L13204	M 14x1,5 / M 14x1,5 ∪		2	45503-19135
				L13072	L13071			1	45535-12011
								1	45536-12030
		↓		L13500	L13500			2	43330-29185
		↓	(-) L13500	L13516	L13515			1	48068-12110
				L13603	L13603			1	48069-12110
				L13603	L13603			2	48820-20010
			KIT	MK088	MK088			2	
				L13607	L13607			2	48830-20010
			KIT	MK180L	MK179R			1	
								1	

Corolla AE10_, CE10_, EE10_, (-) 3DS/GT 07.92 → 04.97

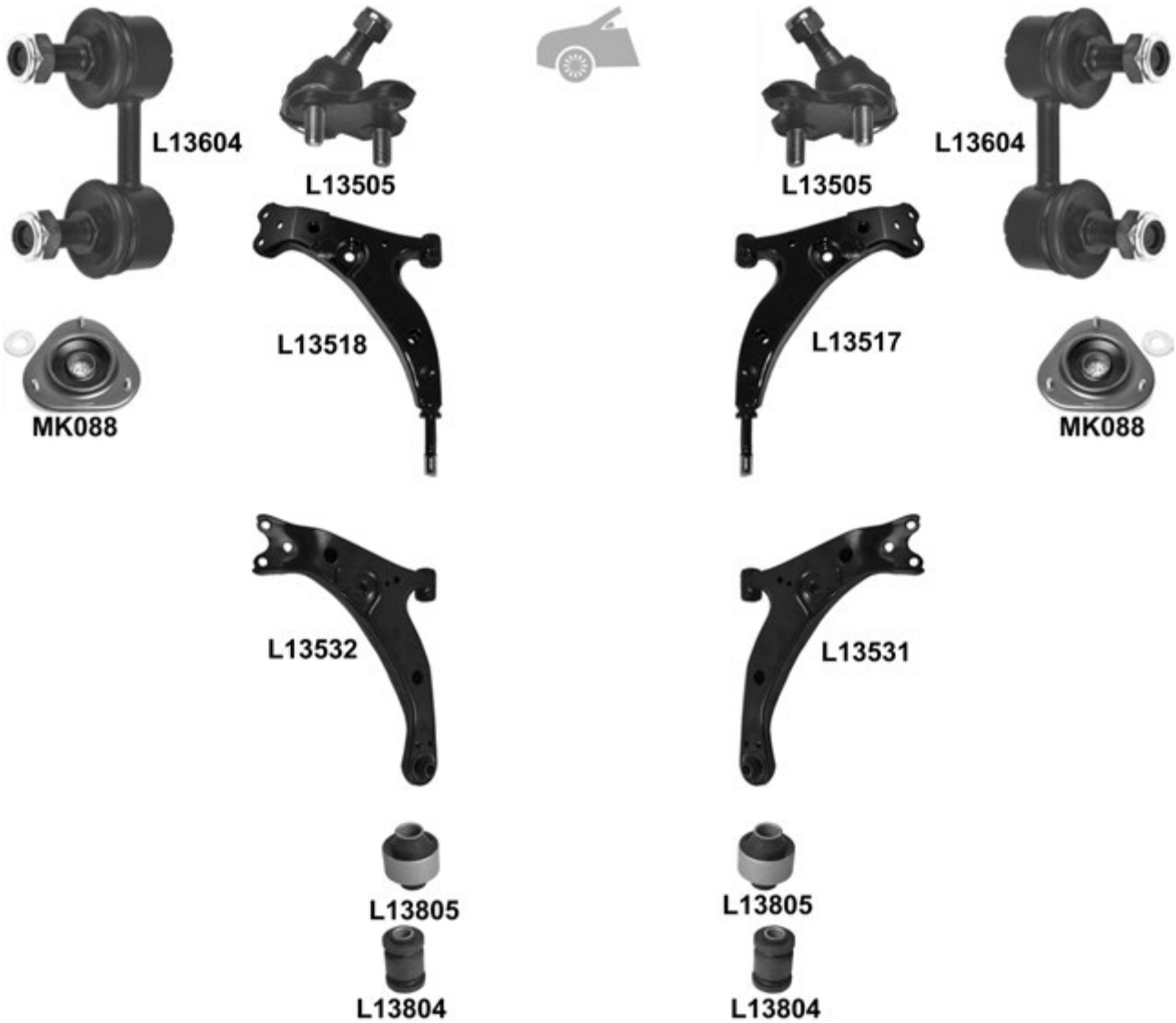
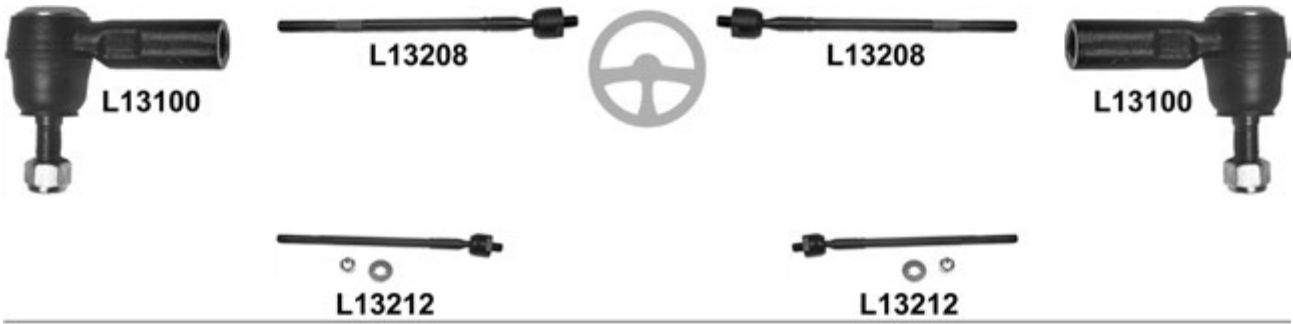

Corolla AE10_, CE10_, EE10_, (-) 3DS/GT 07.92 → 04.97



				← → Thread		Part Of	QPA			
⊕		↔		L13100	L13100	F 14x1,5 ♂		2	45046-19175	
				L13208	L13208			2	45503-29365	
				L13212	L13212			2	45503-19205	
🚗		⊥		L13505	L13505			2	43330-29265	
			→ 04.95		L13517			1	48068-12140	
				L13518			1	48069-12140		
			05.95 →		L13531			1	48068-12171	
				L13532			1	48069-12171		
			⊥ ▾	05.95 →	L13805	L13805			2	
			⊥ ▲		L13804	L13804			2	
		L13604	L13604			2	48820-33010			
		KIT	MK088	MK088			2			
🚗			(-) 1.8 16V 4WD (AE103)	L13607	L13607			2	48830-20010	
			(-) 4WD	KIT	MK179R	MK179R			2	
						MK179R			1	
					MK180L				1	

Corolla AE11_, CE10_, EE11_, 04.97 → 01.02

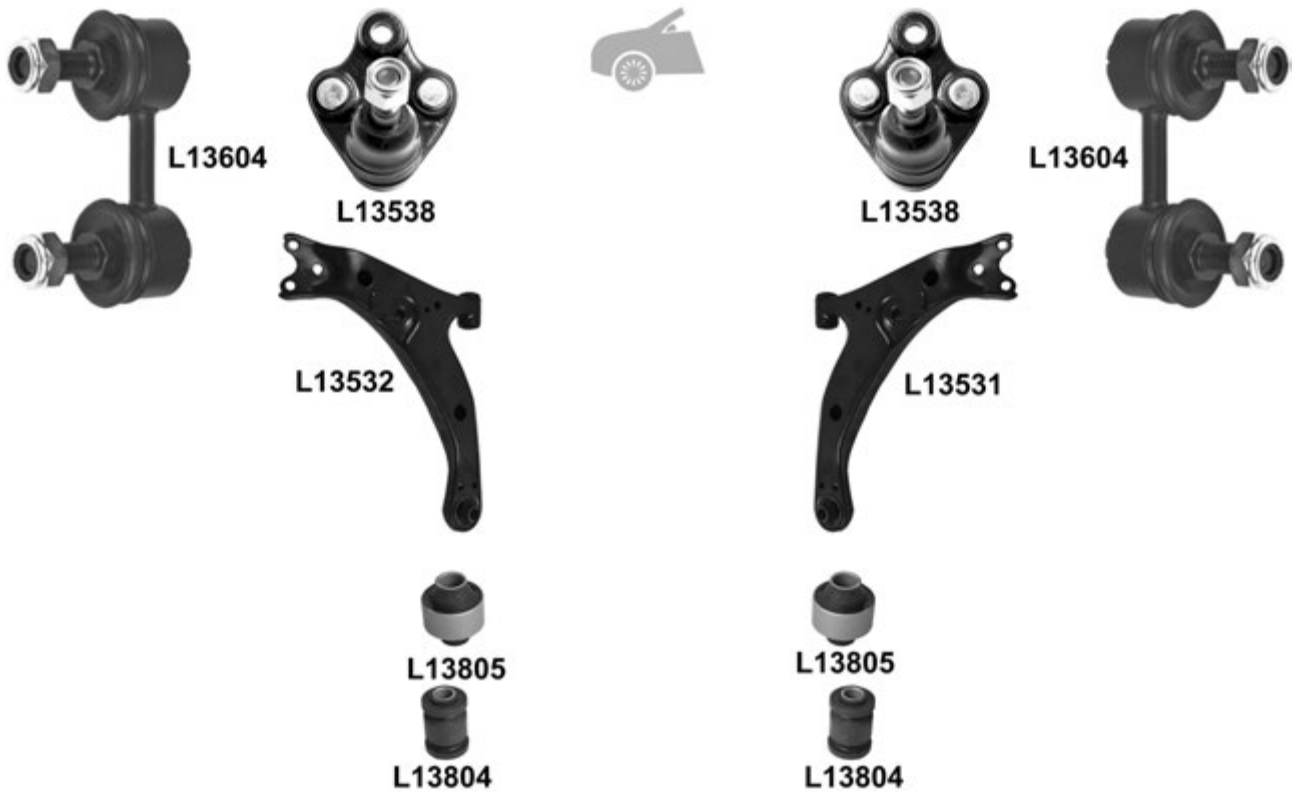
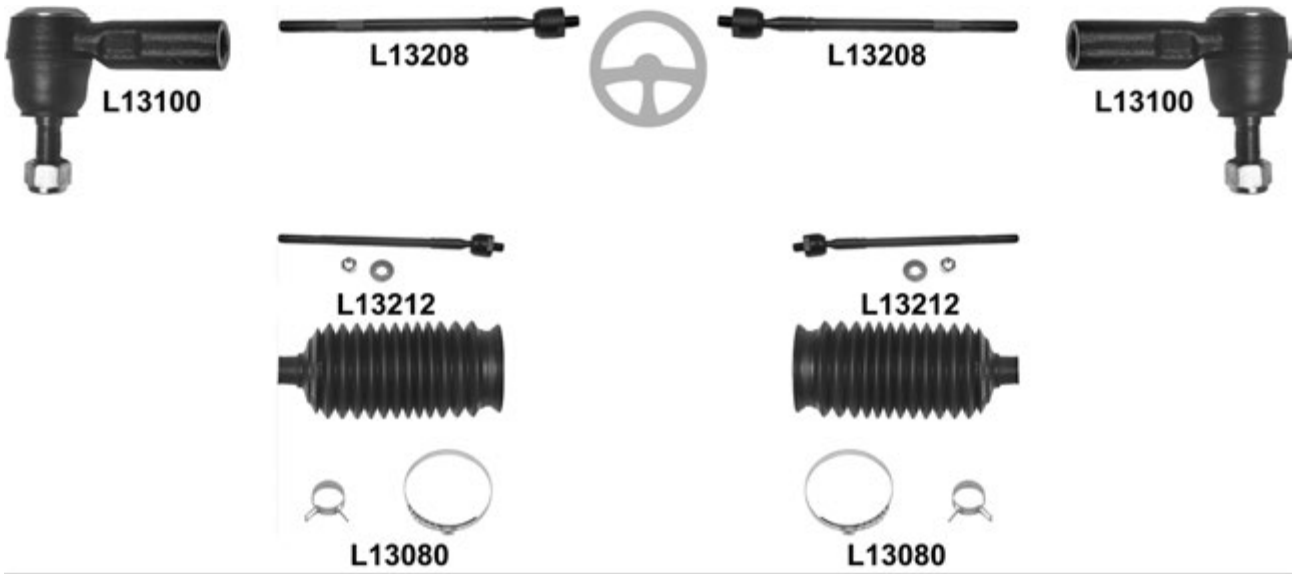

Corolla AE11_, CE10_, EE11_, 04.97 → 01.02



				← → Thread		Part Of	QPA		
		↔		L13100	L13100	F 14x1,5 U		2	45046-19175
				L13208	L13208			2	45503-29365
				L13212	L13212			2	45503-19205
			ø 14mm, Ø 47,5mm, L= 148mm	L13080 ^o	L13080 ^o			2	45535-12070
		⊥		L13538	L13538			2	43330-19115
		⊥			L13531			1	48068-12171
				L13532				1	48069-12171
		⊥▼	05.95 →	L13805	L13805			2	
		⊥▲		L13804	L13804			2	48654-12050
				L13604	L13604			2	48820-33010
			(-) 1.8 AWD (EA115), Metal	L13607	L13607			2	48830-20010
			(-) 1.8 AWD (EA115), Plastic	L13608	L13608			2	48830-32010

Corolla (_E12_) 01.02 →

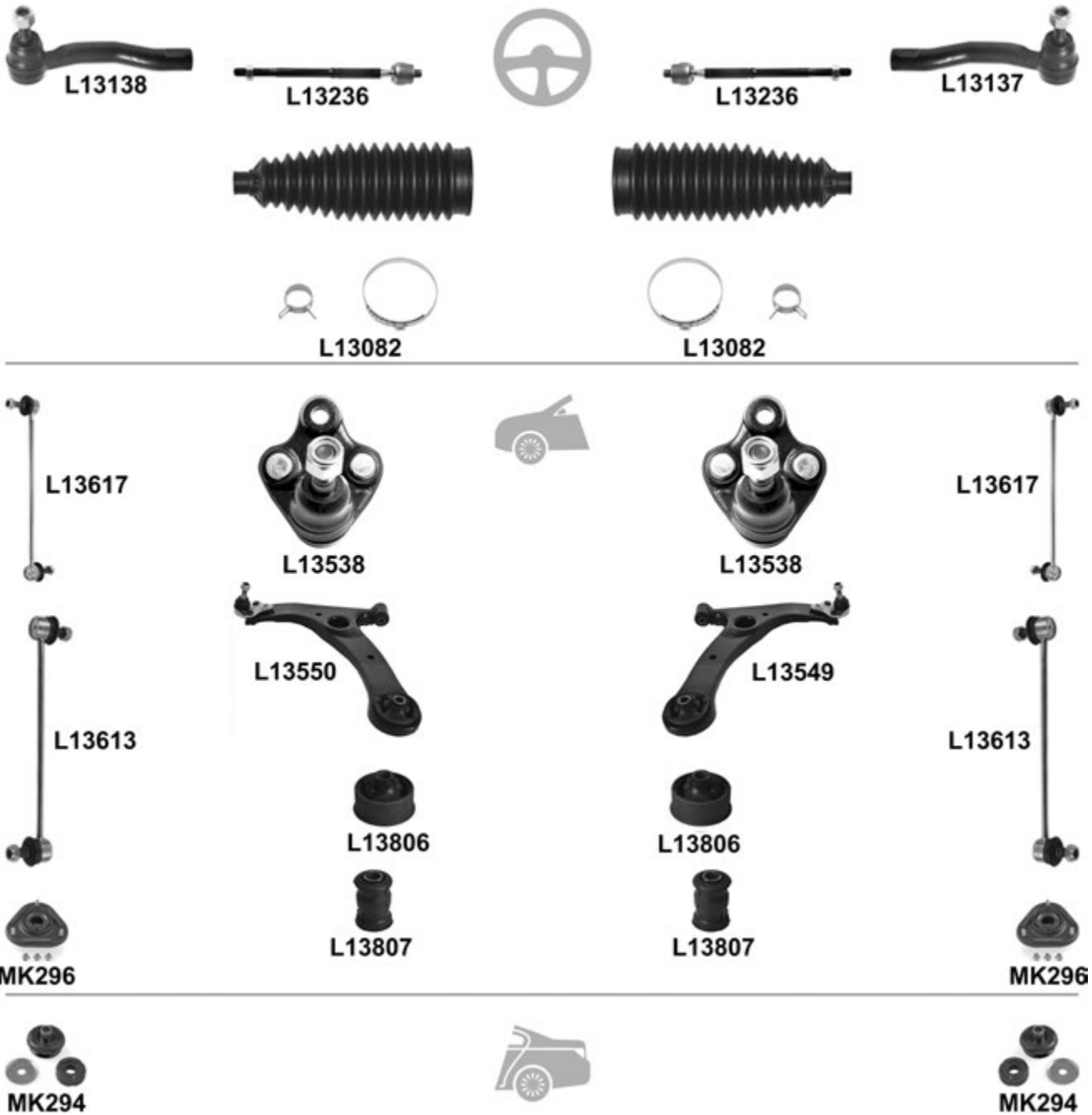

			←	→	Thread	Part Of	QPA	
		↔		L13137	F 14x1,5 ♂		1	45046-19265
				L13138	F 14x1,5 ♂		1	45047-19115
				L13236	L13236	M 14x1,5 / M 14x1,5	2	45503-12103
			ORIG	L13082 ⁰	L13082 ⁰		2	45535-09040
		↓		L13538	L13538		2	43330-19115
		↓			L13549 ⁰		1	48068-12260
		↓		L13550 ⁰			1	48069-12260
		↓ ▾		L13806	L13806		2	
		↓ ▲		L13807	L13807		2	
			ORIG	L13617	L13617		2	48820-02020
			ORIG	L13613	L13613		2	48820-47010
		→ 05.04	KIT	MK296	MK296		2	48609-20471
			KIT	MK294	MK294		2	

Corolla (_E15_) 01.07 →



				←	→	Thread	Part Of	QPA		
		↔				L13153	∩	1	45046-19415	
						L13154	∩	1	45047-19215	
		⊥	∩			L13078 ⁰	L13078 ⁰	2	45535-49015	
						L13548	L13548	2	43330-09630	
					<input checked="" type="checkbox"/>	L13557		1	48068-12300	
						L13558		1	48069-12300	
						L13625	L13625	2	48820-42030	
			KIT	MK331	MK331		2			

Corolla Verso (_E12_) 09.01 → 05.04

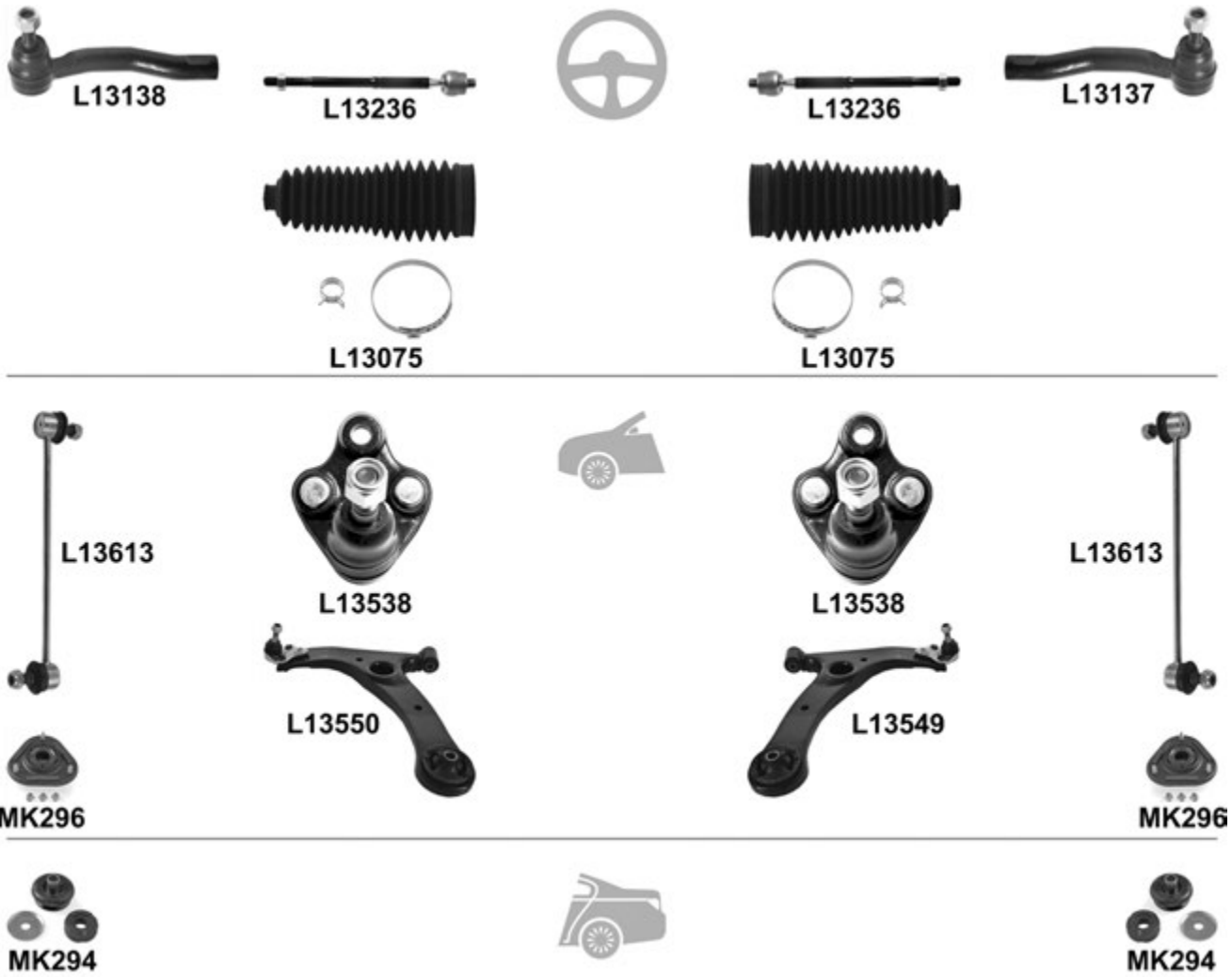

		i		←	→	Thread	Part Of	QPA	i	
						L13137	∩	1	45046-19265	
						L13138	∩	1	45047-19115	
						L13236	L13236	M 14x1,5 / M 14x1,5	2	45503-12103
						L13075 ^o	L13075 ^o		2	45535-09020
			1.8 Wti/2.0 D4d, Mot/Eng 1ZZ-FE/1CD-FTV			L13538	L13538	2	43330-19115	
				<input checked="" type="checkbox"/>			L13549 ^o		1	48068-12260
							L13550 ^o		1	48069-12260
							L13613	L13613	2	48820-47010
					KIT	MK296	MK296	2		
					KIT	MK294	MK294	2		

Corolla Verso (ZNR_, _UR_) 02.04 →

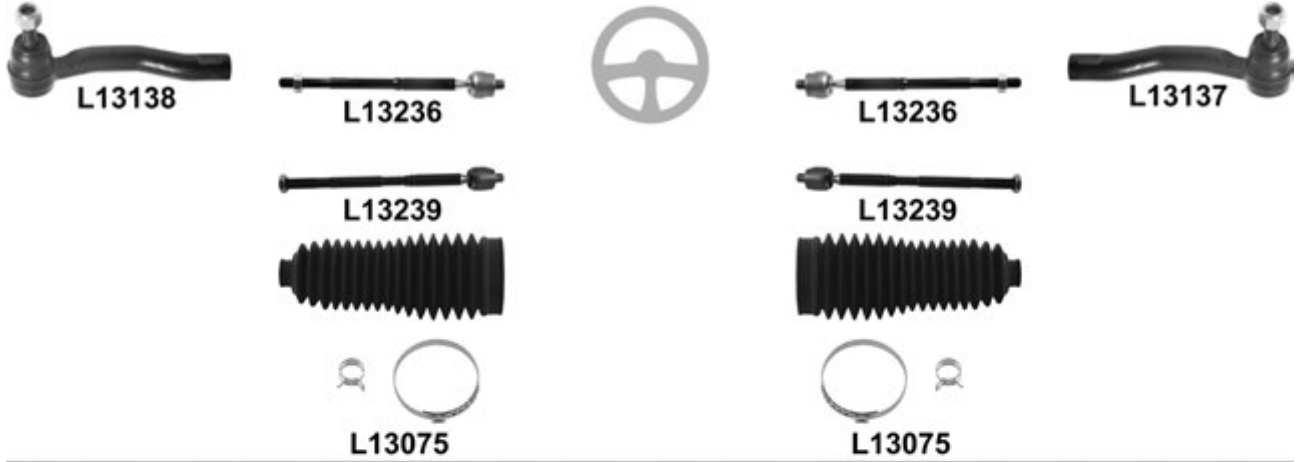

				←	→	Thread	Part Of	QPA		
⊕	🔧	↔	→ 05.04		L13137	F 14x1,5 ∪		1	45046-19265	
					L13138	F 14x1,5 ∪		1	45047-19115	
	🌀		→ 05.04	L13236	L13236	M 14x1,5 / M 14x1,5		2	45503-12103	
			06.04 →	L13239	L13239	M 16x1,5 / M 16x1,5 ∪		2	45503-0F010	
				L13075 ^o	L13075 ^o			2	45535-09020	
🚗	🔧			L13613	L13613			2	48820-47010	

Cressida RX30, RX35 07.77 → 07.81



				←	→	Thread	Part Of	QPA		
⊕	🔧	↔		L13004	L13004	M 14x1,5 ∪		2	45046-29075	
			🚗	🔧	⊥		L13031	L13031		2

Dyna 100 LH80, YH81 08.85 →



L13014



L13014



L13035



L13035



L13037

L13038



L13037

L13038

				←	→	Thread	Part Of	QPA	
		↔		L13014	L13014	M 17x1,5 U		2	45046-39235
		→←		L13035	L13035	M 17x1,5 U		2	45406-19145
		↑		L13037	L13037			2	43360-29076
		↓		L13038	L13038			2	43330-29155

Dyna 100 (LY100) 05.95 → 07.01



L13014



L13014



L13528



L13527



L13038



L13038

				←	→	Thread	Part Of	QPA	
		↔		L13014	L13014	M 17x1,5 U		2	45046-39235
		↑	09.95 →		L13527			1	48066-29075
		↓		L13528				1	48067-29075
		↓		L13038	L13038			2	43340-29105

Dyna 150/300/350 (KDY2_) 08.01 → 08.06



Thread

Part Of

QPA



		↓		L13511	L13511			2	43340-39235
--	--	---	--	--------	--------	--	--	---	-------------

Hiace LH2_, LH3_ 02.77 → 12.84

Hiace RH1_, RH2_, RH3_ 02.77 → 12.84



Thread

Part Of

QPA



		↓		L13017	L13017			2	43340-39075
				L13350	L13350			2	

Hiace LH5_, LH6_, LH7_ 03.83 → 11.89

Hiace YH5_, YH6_, YH7_ 03.83 → 11.89

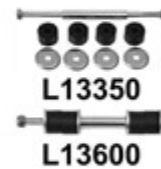

Thread

Part Of

QPA



		↔		L13014	L13014	M 17x1,5 ∩		2	45046-39235	
		→←		L13035	L13035	M 17x1,5 ∩		2	45406-19145	
		↑		L13037	L13037			2	43360-29076	
		↓		L13038	L13038			2	43340-29105	
		↓			L13521				1	48068-26H00
				L13522					1	48069-26H00
		→ 01.84		L13350	L13350			2		
		01.84 →		L13600	L13600			2		

Hiace LH10_, LH11_, LH12_ 08.89 → 08.95

Hiace RZH10_, RZH11_, RZH12_ 08.89 → 08.95

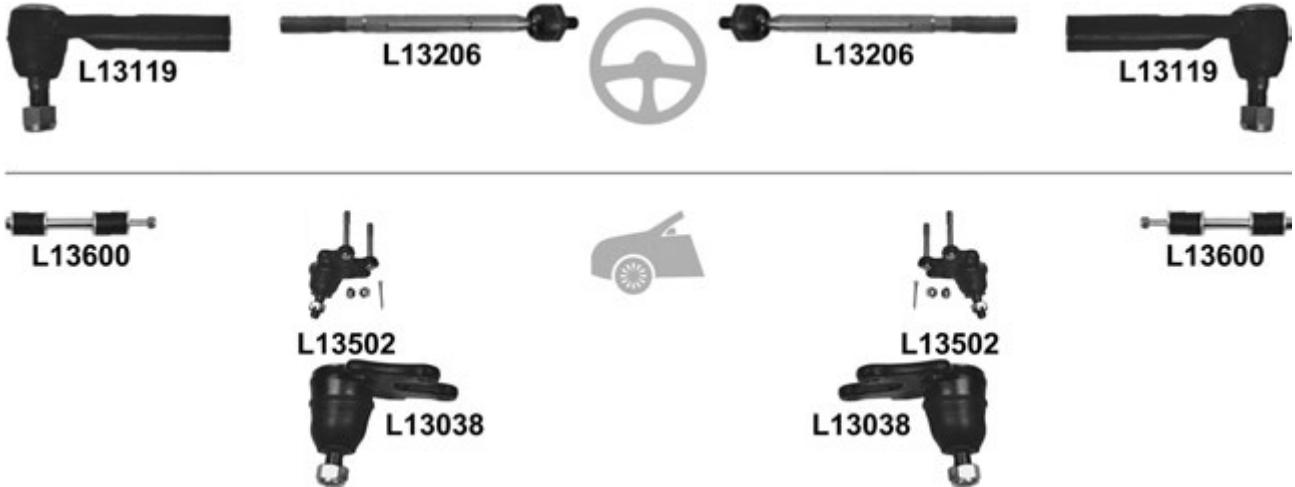

						←	→	Thread	Part Of	QPA		
		↔		L13119	L13119			M 17x1,5 ☺		2	45046-29215	
				L13206	L13206					2	45503-29255	
		↑		L13502	L13502					2	43350-29095	
			↓		L13038	L13038					2	43340-29105
				L13600	L13600					2		

Hiace (_H1_, _H2_) 08.95 →

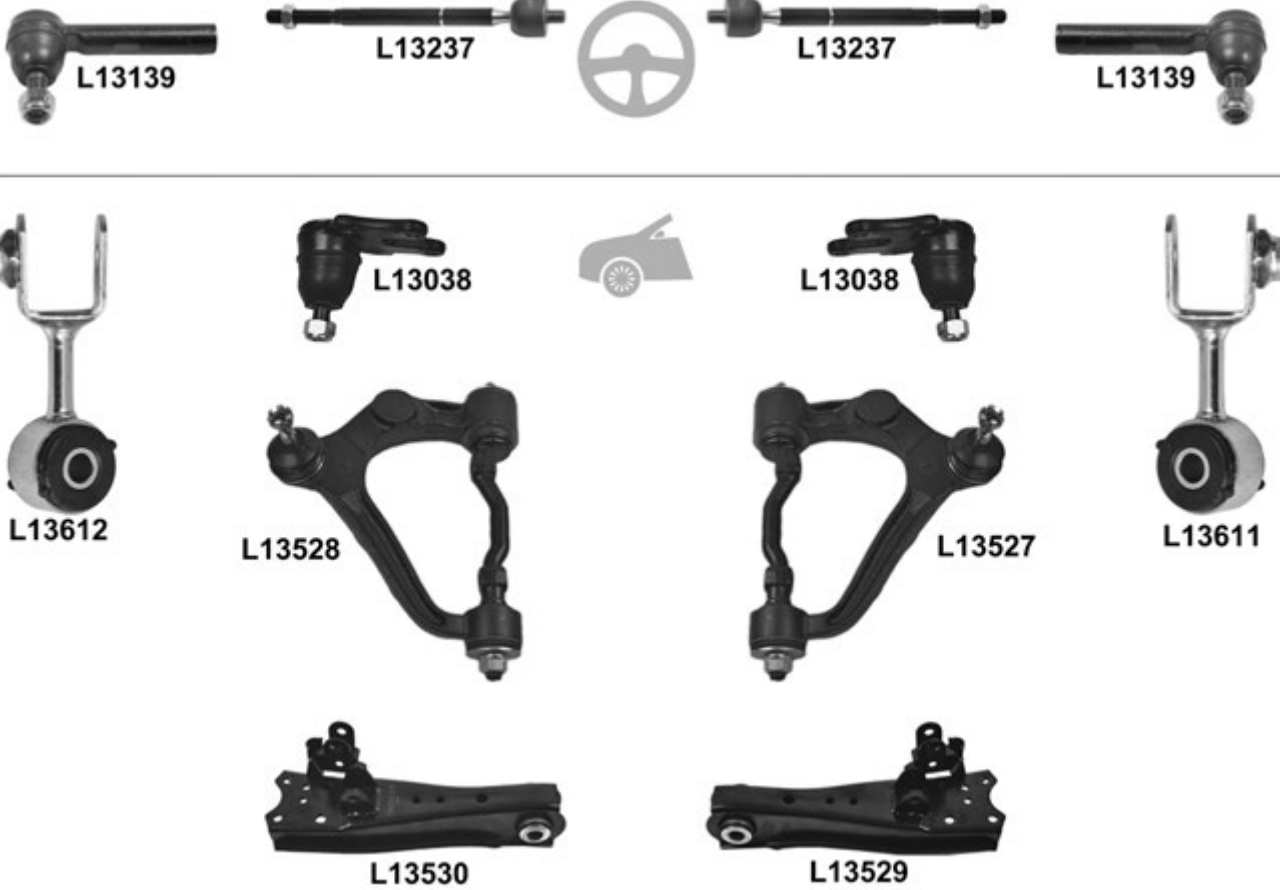

				←	→	Thread	Part Of	QPA		
		↔		L13139	L13139	F 15x1,5 ∪		2	45046-29325	
				L13237	L13237	M 15x1,5 / M 14x1,5 ∪		2	45503-29565	
		↓		L13038	L13038			2	43340-29105	
		↑			L13527			1	48066-29075	
				<input checked="" type="checkbox"/>	L13528				1	48067-29075
		↓	(-)		L13529			1	48068-26070	
				L13530				1	48069-26070	
					L13611			1	48820-26030	
				L13612				1	48810-26030	

Hiace 4WD LH56V, LH66V 08.86 → 08.89



			i	←	→	Thread	Part Of	QPA	i
		↔		L13014	L13014	M 17x1,5 U		2	45046-39235
		⊥ → 88		L13511	L13511			2	43340-39235

Hiace 4WD (_H1_, _H2_) 08.95 →



			i	←	→	Thread	Part Of	QPA	i
		↔		L13139	L13139	F 15x1,5 U		2	45046-29325
		⊥		L13511	L13511			2	43340-39235
					L13611			1	48820-26030
				L13612				1	48810-26030

Hilux LN3_, LN4_ 08.78 → 03.84
 Hilux RN3_, RN4_ 08.78 → 03.84



L13014



L13014

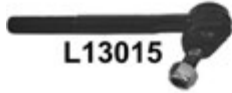

L13015

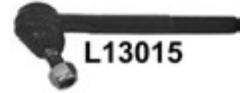

L13015



L13017



L13017

				←	→	Thread	Part Of	QPA	
		↔		L13014	L13014	M 17x1,5 ♂		2	45046-39235
		→←		L13015	L13015	M 17x1,5 ♂		2	45406-39125
		⊥		L13017	L13017			2	43340-39075

Hilux LN5_ 03.83 → 08.88
 Hilux YN5_ 03.83 → 08.88



L13014



L13014

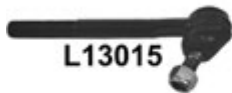

L13015

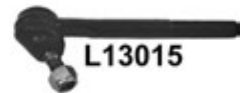

L13015



L13053



L13053



L13054



L13054

				←	→	Thread	Part Of	QPA	
		↔		L13014	L13014	M 17x1,5 ♂		2	45046-39235
		→←		L13015	L13015	M 17x1,5 ♂		2	45406-39125
		↑		L13053	L13053			2	43350-39075
		⊥		L13054	L13054			2	43340-39145

Hilux 2WD LN85 / LN90 08.88 → 02.97

Hilux 2WD YN85 / YN90 08.88 → 02.97



L13014



L13014

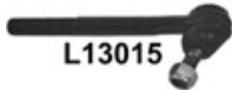

L13015

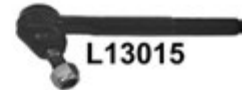

L13015



				←	→	Thread	Part Of	QPA	
		↔		L13014	L13014	M 17x1,5 U		2	45046-39235
		→←		L13015	L13015	M 17x1,5 U		2	45406-39125
		↑		L13053	L13053			2	43350-39075
		↓		L13503	L13503			2	43330-39295
		↑	(-) (-)	L13547	L13547			2	48066-35080
		↓	(-)	L13546	L13545			1	48605-35121
				<input checked="" type="checkbox"/>	L13546			1	48606-35121
	↑▲▼			L13808	L13808			4	

Hilux 2WD KZN18_ / RZN18_ / VZN18_ 08.94



				←	→	Thread	Part Of	QPA			
		↔			L13143	M 20x1,5 ♂		1	45046-39335		
				L13144			M 20x1,5 ♂		1	45047-39215	
		↑		L13238	L13238	F 20x1,5 / M 18x1,5 ♂		2	45503-39075		
						L13539			1	43330-39415	
		↓		L13540					1	43340-39325	
				L13620	L13620				2	48820-35030	
			L13621	L13621			2	48830-35020			

Hilux 2WD LN145 / LN150 02.97 →

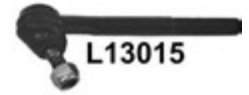
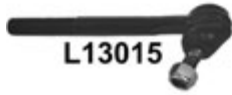

				← → Thread		Part Of	QPA	
		↔↔		L13014	L13014	M 17x1,5 U	2	45046-39235
		→←		L13015	L13015	M 17x1,5 U	2	45406-39125
		⊥		L13503	L13503		2	43330-39295
		↑	(-)	L13547	L13547		2	48066-35080
	⊥	(-)		L13545		1	48605-35121	
			L13546			1	48606-35121	
		↑↕		L13808	L13808		4	

Hilux 2WD (KUN1_) 06.06 →



				←	→	Thread	Part Of	QPA		
						M 15x1,5 / M 14x1,5 ♂		2	45503-09331	
		↑						2	43310-09015	
		↓						2	43330-09510	
			KUN26					1	48820-26030	
								1	48810-26030	

Hilux LN3_, LN4_ 4WD 10.79 → 11.82
 Hilux RN3_, RN4_ 4WD 10.79 → 11.82



				←	→	Thread	Part Of	QPA		
								2		

Hilux LN60, LN65 4WD 08.83 → 08.88
 Hilux YN60, YN65 4WD 08.83 → 08.88



				←	→	Thread	Part Of	QPA		
								2		

Hilux 4WD LN61, YN61 08.85 → 08.88



L13014



L13014



L13126

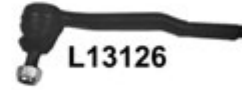

L13126



L13512



L13512



L13511



L13511

				←	→	Thread	Part Of	QPA	i
		↔		L13014	L13014	M 17x1,5 U		2	45046-39235
		↔		L13126	L13126	M 17x1,5		2	45406-39175
		↑		L13512	L13512			2	43360-39085
		↓		L13511	L13511			2	43340-39235

Hilux 4WD LN105 08.88 → 08.97

Hilux 4WD YN106 08.88 → 08.97



L13512



L13512



L13511



L13511

				←	→	Thread	Part Of	QPA	i
		↑		L13512	L13512			2	43360-39085
		↓		L13511	L13511			2	43340-39235

Hilux 4WD LN108 / LN110 08.88 → 08.97
 Hilux 4WD RN106 / RN110 08.88 → 08.97
 Hilux 4WD YN110 08.88 → 08.97

L13014

L13014

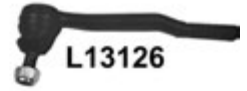
L13126

L13126

L13512

L13512

L13511

L13511

L13513

L13513

		i		←	→	Thread	Part Of	QPA	i
		↔		L13014	L13014	M 17x1,5 ∪		2	45046-39235
		→←		L13126	L13126	M 17x1,5		2	45406-39175
		↑		L13512	L13512			2	43360-39085
		↓	→ 04.89	L13511	L13511			2	43340-39235
			04.89 →	L13513	L13513			2	43340-39235

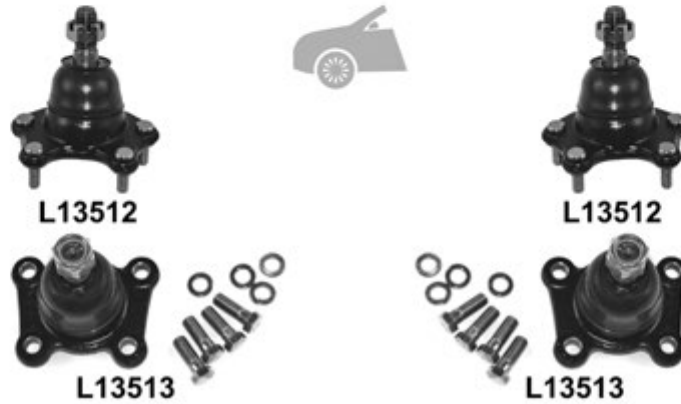
Hilux 4WD LN165 / LN170 08.97 →
 Hilux 4WD RZN168 / RZN173 08.97 →

			←	→	Thread	Part Of	QPA	
		↔	L13014	L13014	M 17x1,5 ∪		2	45046-39235
		→←	L13126	L13126	M 17x1,5		2	45406-39175
		↑	L13512	L13512			2	43360-39085
		↓	L13513	L13513			2	43340-39235

Hilux 4WD (KUN2_) 08.05 →



			←	→	Thread	Part Of	QPA		
			L13240	L13240	M 15x1,5 / M 14x1,5 ∪		2	45503-09331	
			↑	L13551	L13551			2	43310-09015
		↓	L13552	L13552			2	43330-09510	
					L13627			1	48820-26030
				L13628				1	48810-26030

Landcruiser BJ4_ 02.74 → 10.84

						←	→	Thread	Part Of	QPA	
⊕	🔧	↔	transverse		L13230			M 21x1,5 ∪		1	45046-69055
					L13231			M 21x1,5 ∪		1	45046-69035
					L13232			M 17x1,5 ∪		1	45045-69015
					L13233			M 17x1,5 ∪		1	45046-69030

Landcruiser BJ6_ , FJ6_ , HJ6_ 01.82 → 12.89

						←	→	Thread	Part Of	QPA	
⊕	🔧	↔	transverse		L13223			M 23x1,5 ∪		1	45046-69115
					L13222			M 23x1,5 ∪		1	45047-69065
					L13225			M 21x1,5 ∪		1	45045-69045
					L13229			M 21x1,5 ∪		1	45044-69055

Landcruiser BJ7_ , FJ7_ , HJ75 11.84 → 12.89

						←	→	Thread	Part Of	QPA	
⊕	🔧	↔	transverse		L13223			M 23x1,5 ∪		1	45046-69115
					L13222			M 23x1,5 ∪		1	45047-69065
					L13225			M 21x1,5 ∪		1	45045-69045
					L13220			M 21x1,5 ∪		1	45044-69085

Landcruiser LJ70, LJ71, RJ70 11.84 → 12.89



L13226



L13222



L13224



L13130



L42121



L42121

						←	→	Thread	Part Of	QPA	
			transverse		L13222			M 23x1,5 ⤴		1	45047-69065
					L13226			M 23x1,5 ⤴		1	45046-69135
					L13130			M 21x1,5 ⤴	/pitman arm	1	45045-69055
					L13224			⤴	/pitman arm	1	45044-69105
			small	L42121	L42121					2	

Landcruiser LJ7_ 01.90 →



L13128



L13223



L13220



L13225

						←	→	Thread	Part Of	QPA	
			transverse		L13223			M 23x1,5 ⤴		1	45046-69115
					L13128			M 23x1,5 ⤴		1	45047-69085
					L13225			M 21x1,5 ⤴	/pitman arm	1	45045-69045
					L13220			M 21x1,5 ⤴	/pitman arm	1	45044-69085

Landcruiser HDJ8_ , FZJ8_ 01.90 → 12.97



L13128



L13127



L13130

						←	→	Thread	Part Of	QPA	
			transverse		L13127			M 23x1,5 ⤴		1	45046-69136
					L13128			M 23x1,5 ⤴		1	45047-69085
					L13130			⤴	/pitman arm	1	45045-69065

Landcruiser HZj7_ 04.96 → 08.01



				←	→	Thread	Part Of	QPA	
⊕		↔	→ 08.99 transverse		L13223	M 23x1,5 ∪		1	45046-69115
			09.99 → transverse		L13127	M 23x1,5 ∪		1	45046-69136
			transverse	L13128		M 23x1,5 ∪		1	45047-69085

Landcruiser 90 (_J9_) 04.95 →



				←	→	Thread	Part Of	QPA		
⊕		↔			L13143	M 20x1,5 ∪		1	45046-39335	
					L13144	M 20x1,5 ∪		1	45047-39215	
					L13238	L13238	F 20x1,5 / M 18x1,5 ∪		2	45503-39075
		↑ ↓			L13541	L13541		2	43310-39016	
						L13539			1	43330-39415
					L13540				1	43340-39325
					L13620	L13620		2	48820-35030	
					L13621	L13621		2	48830-35020	

Landcruiser 100 (_J10_) 01.98 →

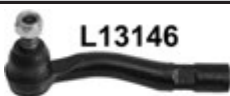

				←	→	Thread	Part Of	QPA	
⊕		↔	→ 08.02		L13145	F 20x1,25 ∪		1	45046-69195
				L13146		F 20x1,25 ∪		1	45047-69100

Landcruiser (_J12_) 01.03 →

				←	→	Thread	Part Of	QPA	i
		↔		L13147	L13147	F 15x1,5 ∪		2	45046-39505
				L13248	L13248	M 15x1,5 / M 22x1,5 ∪		2	45503-39265
					L13627			1	48820-60050
				L13628				1	48810-60040

Liteace KM20 10.79 → 1982

				←	→	Thread	Part Of	QPA	i
		↑		L13061	L13061			2	43360-29056

Liteace KM21V, YM2_, CM20 10.82 → 10.86

				←	→	Thread	Part Of	QPA	i
		↔		L13004	L13004	M 14x1,5 ∪		2	45046-29075
		↑		L13061	L13061			2	43360-29056
		↓		L13060	L13060			2	43340-29095

Liteace KM3_, CM3_, YM30 10.85 → 08.88



			i	←	→	Thread	Part Of	QPA	i
		↔		L13090	L13090	F 14x1,5 ♂		2	45470-29085
		↑		L13061	L13061			2	43360-29056
		↓		L13060	L13060			2	43340-29095

Liteace KM3_, CM3_, YM30 08.88 → 09.91



			i	←	→	Thread	Part Of	QPA	i
		↔		L13120	L13120			2	45046-29185
				L13207	L13207			2	45503-29215
		↑		L13061	L13061			2	43360-29056
		↓		L13060	L13060			2	43340-29095

Model F (Sports Wagon) YR21 08.85 → 07.88

			i	←	→	Thread	Part Of	QPA	i
		↔		L13090	L13090	F 14x1,5 ♂		2	45470-29085
		↑		L13061	L13061			2	43360-29056
		↓		L13060	L13060			2	43340-29095

Model F (Sports Wagon) YR21 08.88 → 01.90

			i	←	→	Thread	Part Of	QPA	i
		↔		L13120	L13120			2	45046-29185
				L13207	L13207			2	45503-29215
		↑		L13061	L13061			2	43360-29056
		↓		L13060	L13060			2	43340-29095

MR2 AW10, AW11 11.84 → 06.90



				←	→	Thread	Part Of	QPA	
		↔				L13049	L13049	F 12x1,25 U	
				→ 03.88			L13071		1
		↓				L13043!	L13043!		2

MR2 SW20 12.89 →



				←	→	Thread	Part Of	QPA	
		↓				L13043!	L13043!		2

MR2 (ZZW30) 10.99 → 09.05

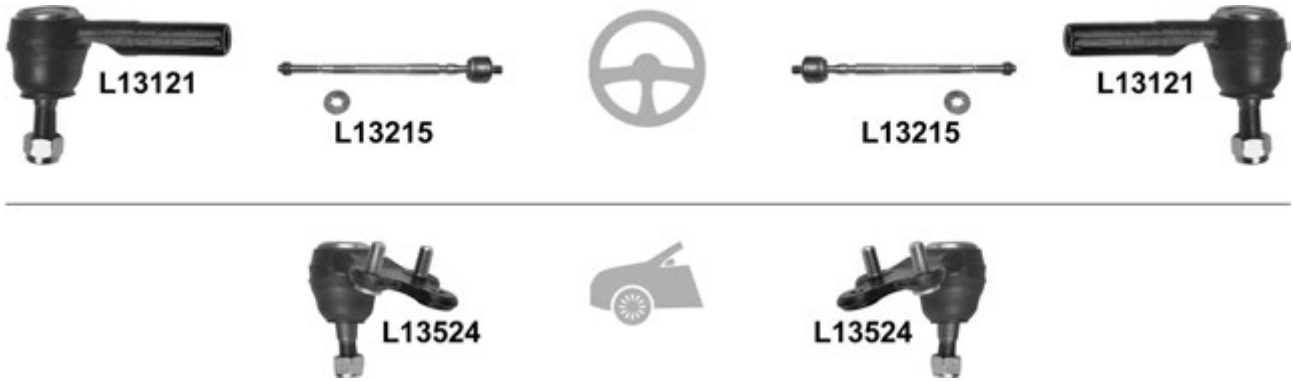

				←	→	Thread	Part Of	QPA	
		↔				L13121	L13121	F 12x1,25 U	2

Paseo EL54 08.95 → 07.99

			i	←	→	Thread	Part Of	QPA	i
		↔		L13121	L13121			2	45046-19216
				L13215	L13215			2	45503-19155
		⊥		L13524	L13524			2	43340-19025

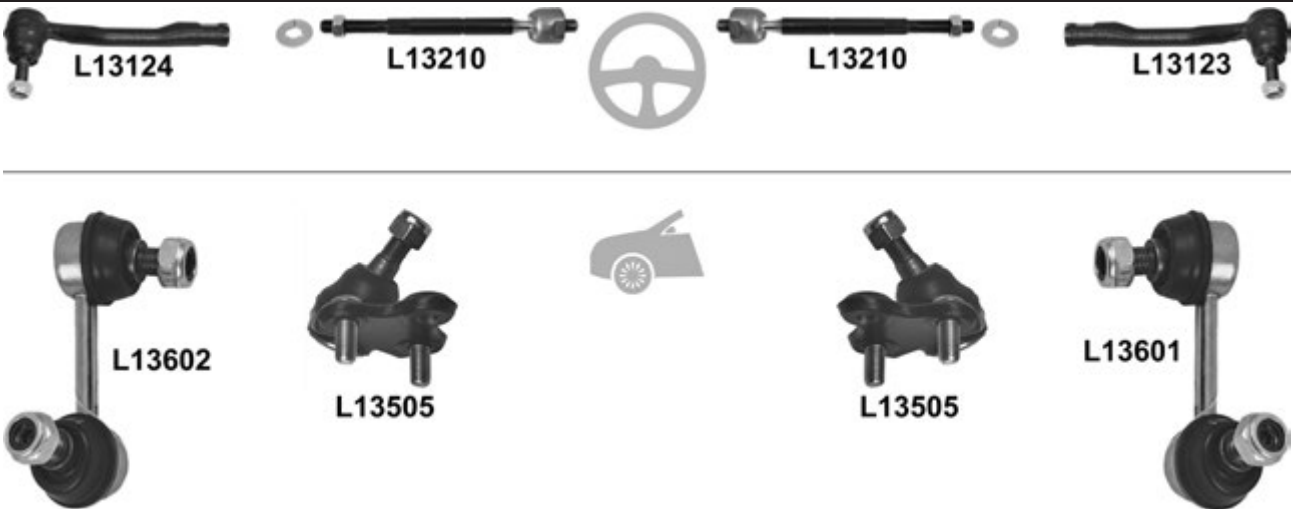
Picnic/Sports Van (_XM10) 05.96 →

			i	←	→	Thread	Part Of	QPA	i
		↔			L13123	M 15x1,5		1	45046-29335
				L13124		M 15x1,5		1	45047-29105
		⊥		L13210	L13210	M 15x1,5 / M 14x1,5		2	45503-29615
				L13505	L13505			2	43330-29375
					L13601			1	48820-44010
				L13602				1	48810-44010

Previa TCR1_, TCR2_ 08.90 → 08.00

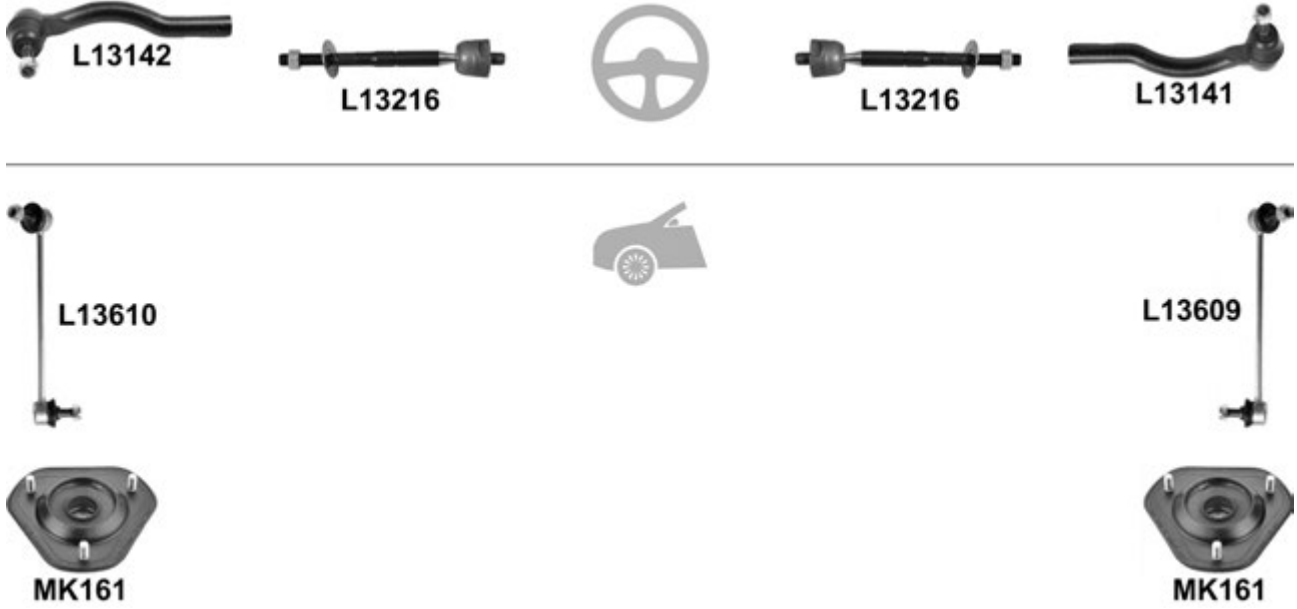

				←	→	Thread	Part Of	QPA	
⊕		↔			L13141	F 14x1,5 ♂		1	45046-29215
				L13142		F 14x1,5 ♂		1	45047-29255
⊖		↔		L13216	L13216			2	45503-29295
					L13609			1	48820-28030
				L13610				1	48810-28020
			KIT	MK161	MK161			2	

Previa (ACR5_) 10.05 →



				←	→	Thread	Part Of	QPA	
⊖		⊥		L13548	L13548			2	43330-09630
				L13625	L13625			2	48820-42030

Prius NHW11 05.00 → 01.04



				←	→	Thread	Part Of	QPA		
					L13137	F 14x1,5 U		1	45046-19115	
					L13138	F 14x1,5 U		1	45047-49045	
					L13538	L13538		2	43330-19115	
					L13613	L13613		2	48820-47010	
					KIT	MK295	MK295		2	

Prius NHW20 01.04 →

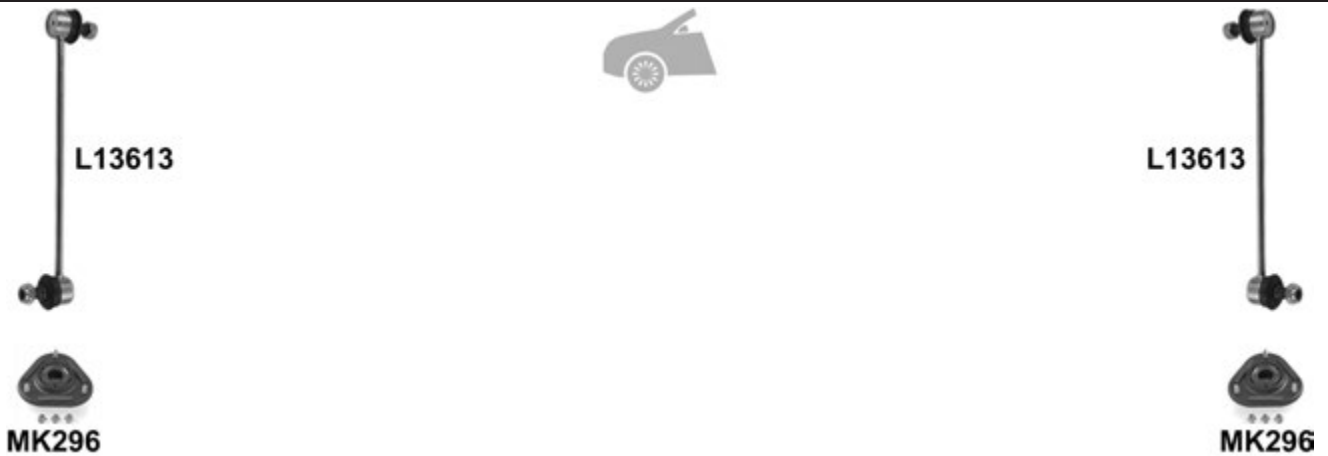

				←	→	Thread	Part Of	QPA		
					L13613	L13613		2	48820-47010	
					KIT	MK296	MK296		2	

Prius ZVW3_ 05.09 →

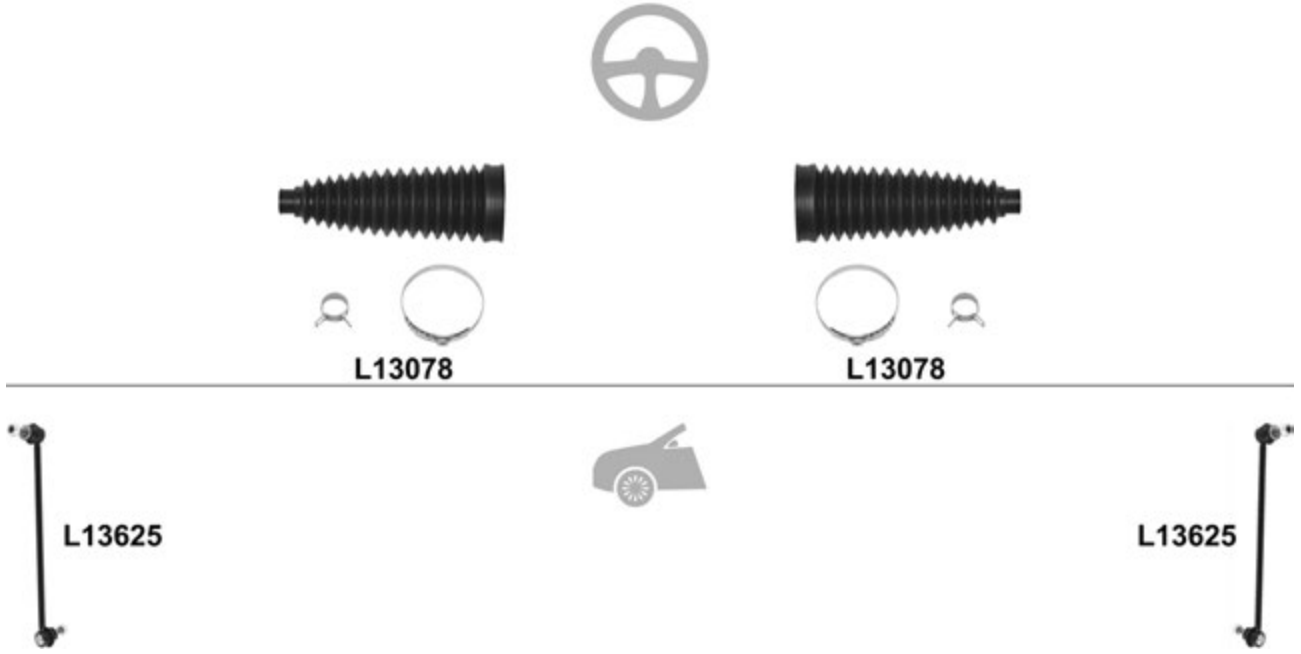

				←	→	Thread	Part Of	QPA		
			∅ 15,5mm, ∅ 59,5mm, L= 178mm			L13078 ^o	L13078 ^o		2	45535-49015
			→ 05.11			L13625	L13625		2	48820-02070

Prius ZVW40 05.11 →

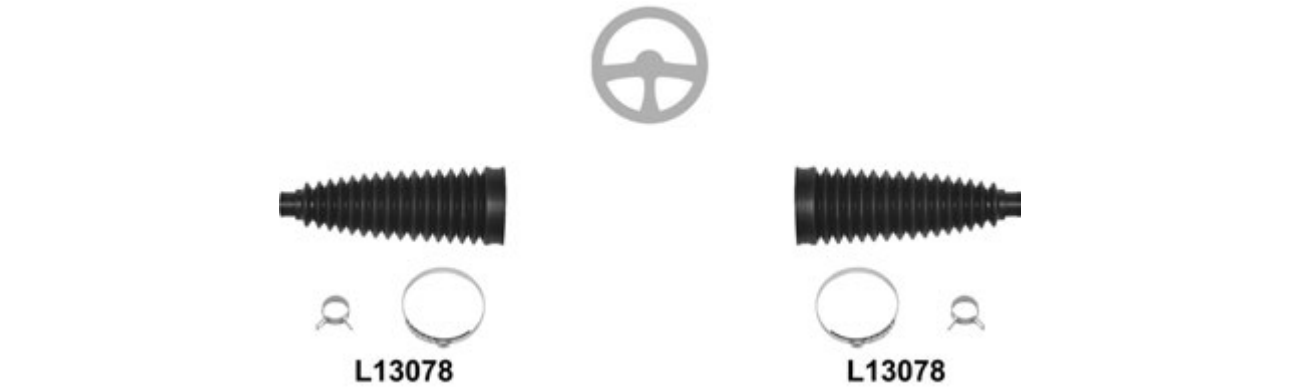

				←	→	Thread	Part Of	QPA		
			∅ 15,5mm, ∅ 59,5mm, L= 178mm			L13078 ^o	L13078 ^o		2	45535-49015

Rav 4 | SXA1 06.94 → 06.00



		i		←	→	Thread	Part Of	QPA	i
		↔		L13100	L13100	∩		2	45046-29305
				L13212	L13212	M 14x1,5 / M 14x1,5 ∩		2	45503-19205
		⊥		L13504	L13504			2	43330-49025
				L13614	L13614			2	48820-42010
				KIT	MK171	MK171		2	48609-42012

Rav 4 II XA2 06.00 →

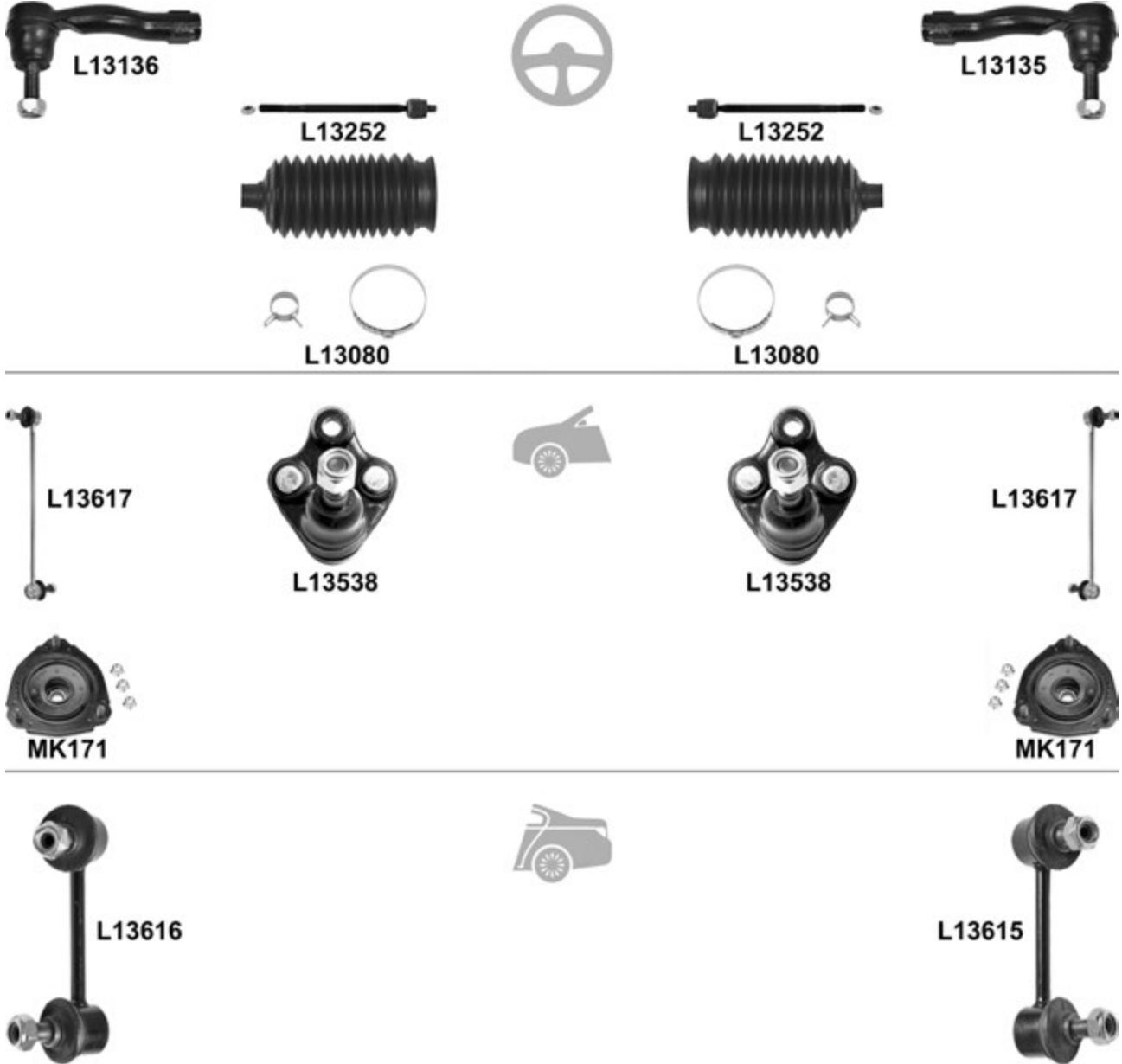

		i	←	→	Thread	Part Of	QPA	i
		↔		L13135	M 15x1,5		1	45046-49095
				L13136	M 15x1,5		1	45047-49025
		→ 06.03		L13252	L13252	M 15x1,5 / M 14x1,5 ∪	2	45503-49055
			→ 06.03, ø 14mm, Ø 47,5mm, L= 148mm	L13080 ⁰	L13080 ⁰		2	45535-12070
		⊥		L13538	L13538		2	43330-19115
				L13617	L13617		2	48820-42020
			KIT	MK171	MK171		2	48609-42012
					L13615		1	48830-42010
					L13616		1	48840-42010

Rav 4 III XA2 11.05 →

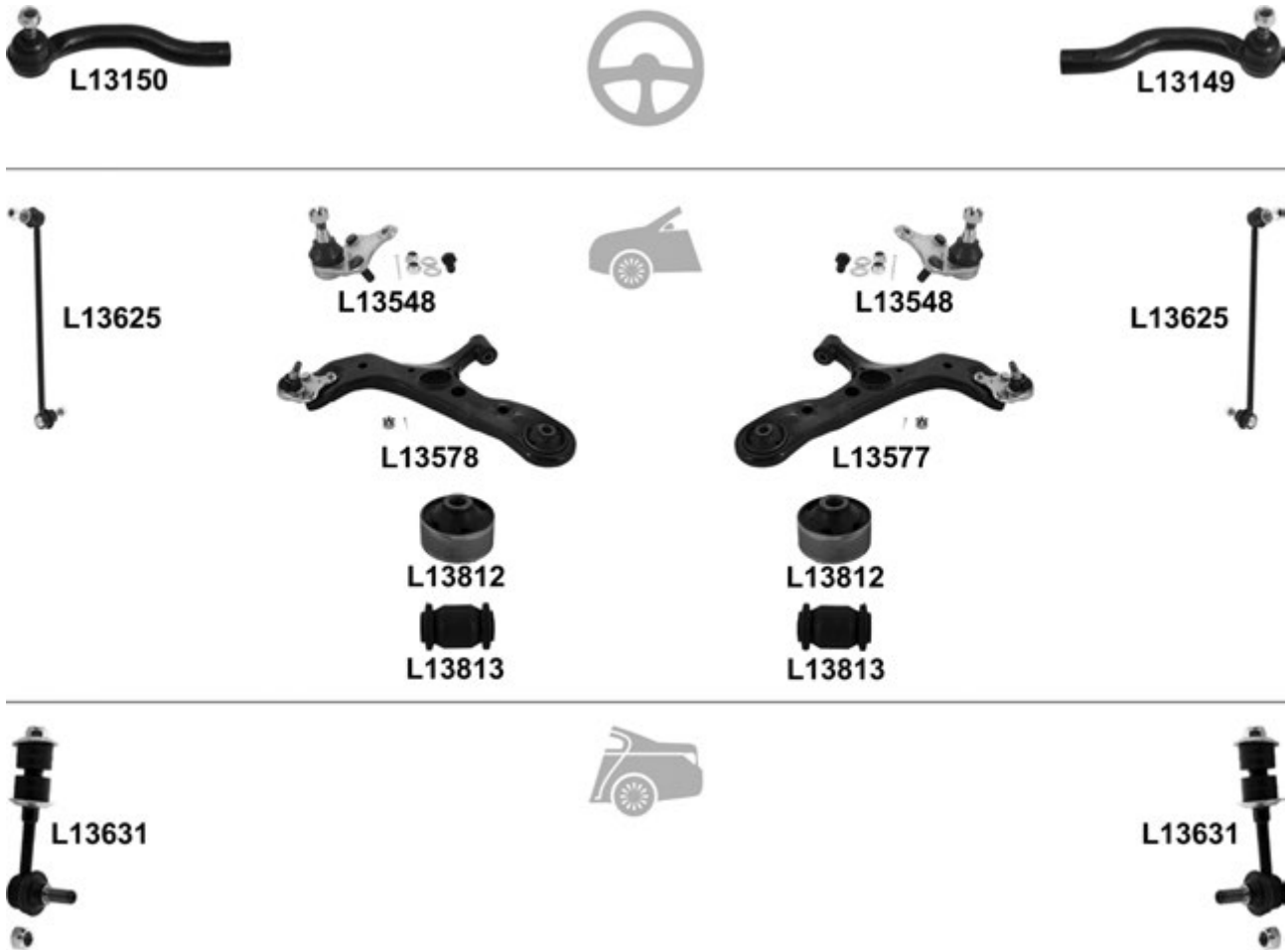

		i		←	→	Thread	Part Of	QPA	i
		↔			L13149	F 16x1,5 U		1	45046-49195
				L13150		F 16x1,5 U		1	47047-49135
		⊥		L13548	L13548			2	43330-09630
			<input checked="" type="checkbox"/>	L13577 ⁰				1	48068-42051
				L13578 ⁰				1	48069-42050
				L13812 ⁰	L13812 ⁰		2		
				L13813 ⁰	L13813 ⁰		2		
		↔		L13625	L13625			2	48820-02070
				L13631	L13631			2	48830-42020

Rav 4 IV ZSA4_/ALA4_ 12.12 →



			i	←	→	Thread	Part Of	QPA	i
					L13149	F 16x1,5 ∪		1	45046-49195
				L13150		F 16x1,5 ∪		1	47047-49135
				L13548	L13548			2	43330-09630
				L13625	L13625			2	48820-02070

Starlet KP61, KP62 02.78 → 1980



			i	←	→	Thread	Part Of	QPA	i
				L13051	L13051	M 14x1,5 / M 14x1,5 ∪		2	45503-19015

Starlet KP61, KP62 05.80 → 09.84

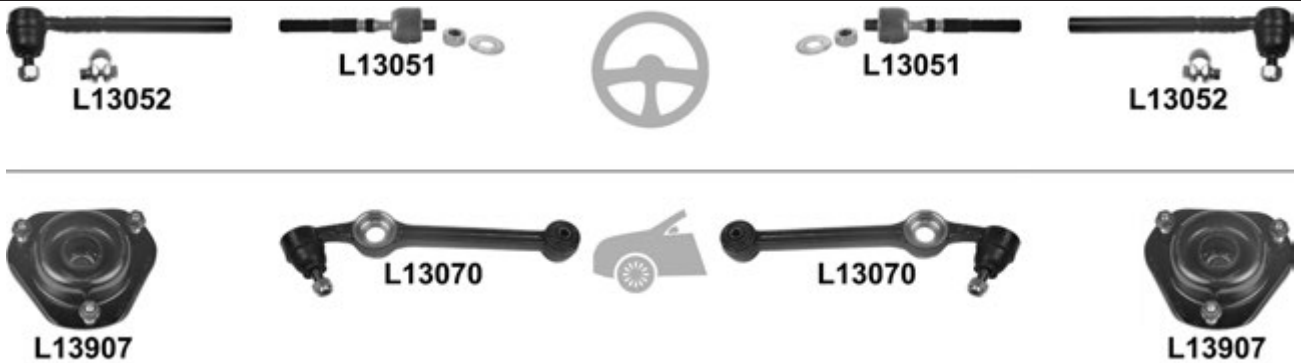

			i	←	→	Thread	Part Of	QPA	i
				L13052	L13052	F 14x1,5 ∪		2	45460-19145
				L13051	L13051	M 14x1,5 / M 14x1,5 ∪		2	45503-19015
				L13070	L13070			2	48068-19095
				KIT	L13907	L13907			2

Starlet EP70, EP71 10.84 → 12.89

Thread
Part Of
QPA

		↔		L13200	L13200	F 12x1,25 ∩		2	45046-19165
				L13201	L13201	M 12x1,25 / M 12x1,25 ∩		2	45503-19075
		⊥		L13106	L13106			2	43330-19075

Starlet (EP8_) 12.89 → 03.96

Thread
Part Of
QPA

		↔		L13121	L13121			2	45046-19216
				L13215	L13215			2	45503-19155
		⊥		L13524	L13524			2	43340-19025

Starlet (EP9_) 04.96 → 03.99

Thread
Part Of
QPA

		↔		L13121	L13121			2	45046-19216
				L13215	L13215			2	45503-19155
		⊥		L13524	L13524			2	43340-19025

Tercel AL11 03.79 → 07.82

Thread

Part Of

QPA



				L13051	L13051	M 14x1,5 / M 14x1,5 ♂		2	45503-19015
				KIT	L13907	L13907		2	

Tercel AL20 05.82 → 01.88



Thread

Part Of

QPA

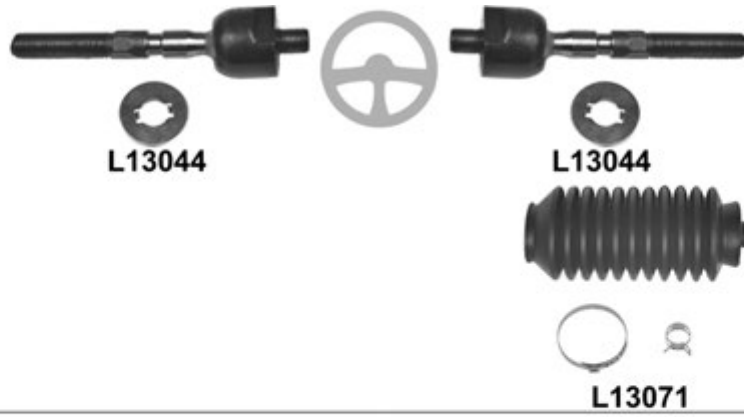

				L13044	L13044	M 14x1,5 / M 14x1,5 ♂		2	45503-19025
					L13071			1	45535-12011
		↓		L13043 ¹	L13043 ¹			2	43330-19025
				MK177 ¹	MK177 ¹			2	48750-12020

Tercel AL25 4WD 10.82 → 01.88

			←	→	Thread	Part Of	QPA	
					M 14x1,5 / M 14x1,5 ♂		2	45503-19025
							1	45535-12011
		↓					2	43330-19025

Urban Cruiser 04.09 →

			←	→	Thread	Part Of	QPA	
		↔			F 15x1,5 ♂		2	45046-59115
		↓	<input checked="" type="checkbox"/>				1	48068-09041
							1	48069-09041
							2	48820-0D010
			KIT				2	48609-52100

Verso 04.09 →

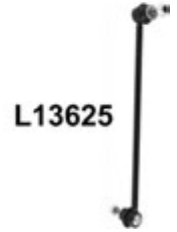
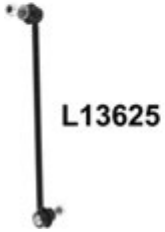

Thread

Part Of

QPA



				L13181	M 16x1,5 ♂		1	45046-09660
				L13182	M 16x1,5 ♂		1	45047-09320
				L13548	L13548		2	43330-09630
				L13625	L13625		2	48820-02070

Yaris (_CP10) 04.99 →

Yaris Verso (NC/LP2) 11.99 →

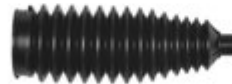
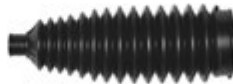
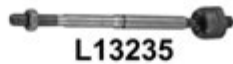

Yaris (_CP10) 04.99 →
Yaris Verso (NC/LP2) 11.99 →



L13619



MK272



L13537



L13537



L13619



MK272



L13536



L13535



L13803



L13802



L13803



L13802



Thread

Part Of

QPA

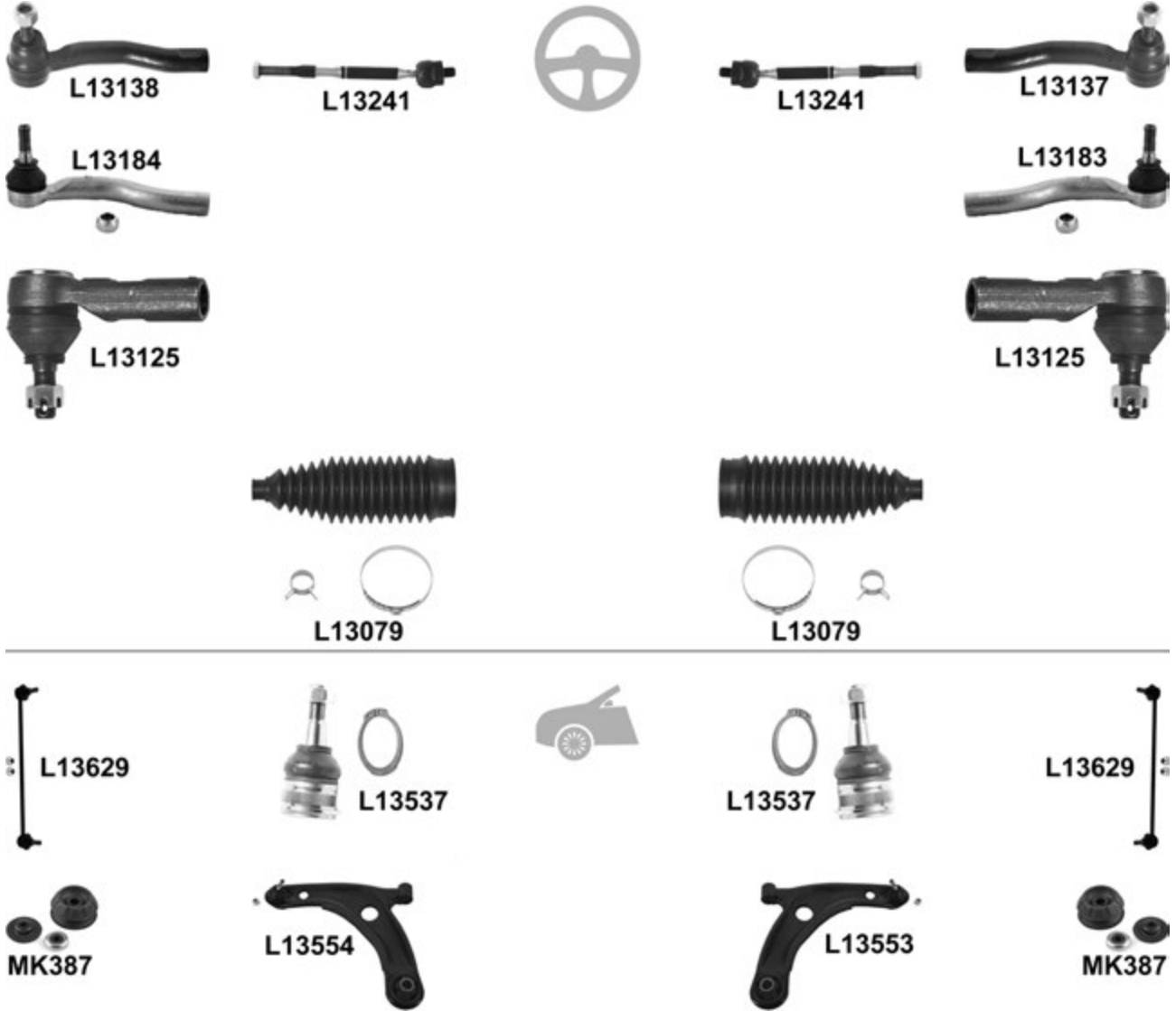

		←	→	Thread	Part Of	QPA			
			(-) NCP13	L13133	F 12x1,25 ∪		1 45046-59025		
				L13134	F 12x1,25 ∪		1 45047-59025		
			NCP13	L13100	L13100	F 14x1,5 ∪		2 45046-19175	
			1.0 16V, ORIG (J), L= 240mm	L13235	L13235	F 12x1,25 / M 14x1,5 ∪		2 45503-52010	
			1.0 16V, ORIG (FR) → 01.03, L= 240mm	L13235	L13235	F 12x1,25 / M 14x1,5 ∪		2 45503-52010	
			1.4 D, ORIG (J), L= 240mm	L13235	L13235	F 12x1,25 / M 14x1,5 ∪		2 45503-52010	
			ORIG (FR), ∅ 13mm, ∅ 52mm, L= 178mm	L13081 ⁰	L13081 ⁰			2 45535-09010	
				L13537	L13537		L13535/L13536 2 43308-59035		
				<input checked="" type="checkbox"/>		L13535		1 48068-59035	
						L13536		1 48069-59035	
						L13803	L13803		2
						L13802	L13802		2 48654-16110
						L13619	L13619		2 48819-52010
KIT	MK272	MK272				2 48609-52039			

Yaris 11.05 →

				←	→	Thread	Part Of	QPA					
⊕		↔	1.0, Model KSP90, (14°), ch. JT;;		L13137	F 14x1,5 ∪		1	45046-09490	i			
			(15°), ch. VN		L13138	F 14x1,5 ∪		1	45047-09230				
			1.0, Model KSP90, (14°), ch. VN;;		L13183	F 14x1,5 ∪		1	45046-59195				
			(15°), ch. JT		L13184	F 14x1,5 ∪		1	45047-59135				
			1.8 Wti, Model ZSP90, Mot/Eng 2ZRFE		L13125	L13125	F 15x1,5 ∪		2		45046-29255		
			(14°)		L13241	L13241	∪		2				
			∅ 15mm, ∅ 51,5mm, L= 200mm		L13079 ⁰	L13079 ⁰		2	45535-09130				
		⊥			L13537	L13537		L13553/L13554	2				
				<input checked="" type="checkbox"/>		L13553				1	48068-09041		
						L13554					1	48069-09041	
						L13629	L13629				2	48820-0D010	
						KIT	MK387 ⁰	MK387 ⁰			2	48609-52100	

Yaris (KSP130) 06.11 →

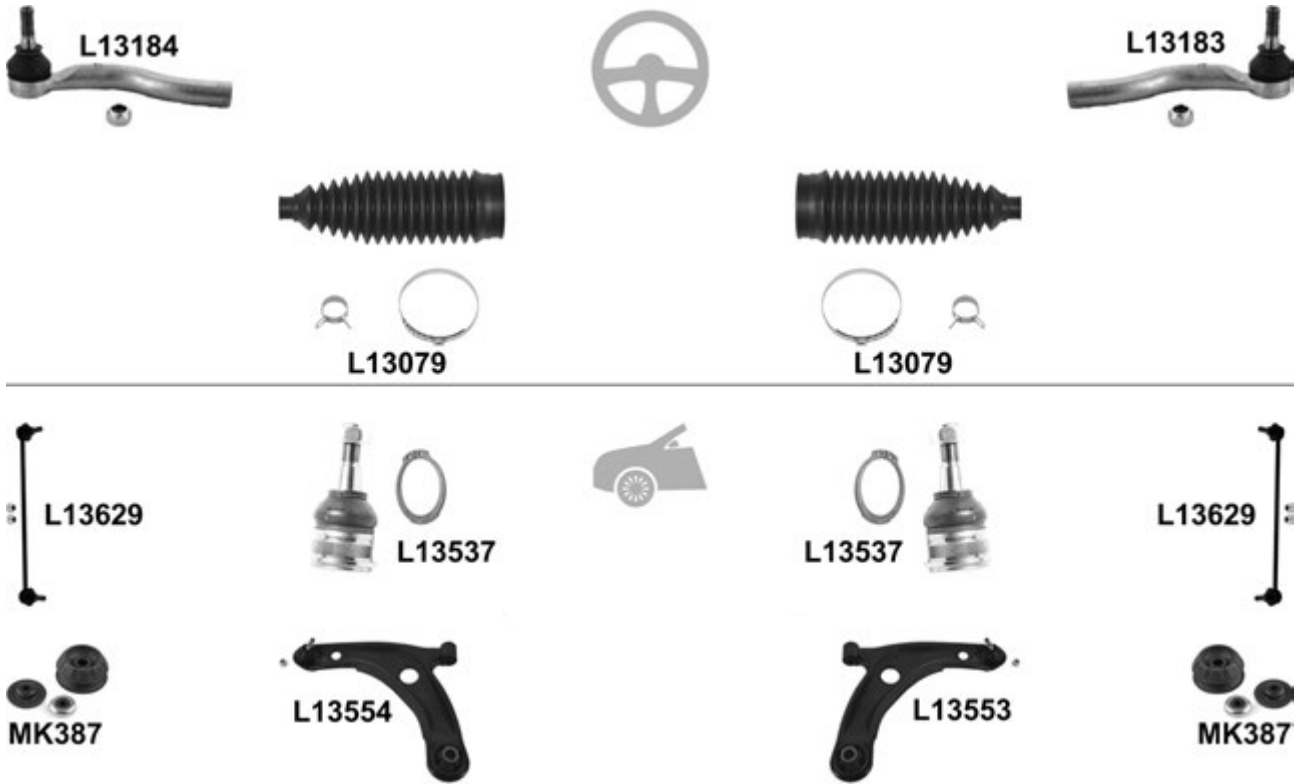

				← → Thread		Part Of	QPA			
		↔		L13183	F 14x1,5 U		1	45046-09480		
				L13184	F 14x1,5 U		1	45047-09220		
		⊥	ORIG. (FR) , ø 15mm, ø 51,5mm, L= 200mm	L13079 ⁰	L13079 ⁰		2	45535-09130		
				L13537	L13537		L13553/L13554	2		
		⊥		<input checked="" type="checkbox"/>	L13553			1		48068-09041
				<input type="checkbox"/>	L13554			1		48069-09041
		↔			L13629	L13629		2		48820-0D010
			ORIG. (J)			MK387 ⁰	MK387 ⁰			2

4 Runner 4WD KZN18_ / RZN18_ / VZN18_ 11.95 →



				←	→	Thread	Part Of	QPA		
		↔				L13143	M 20x1,5 ♂	1	45046-39335	
						L13144	M 20x1,5 ♂	1	45047-39215	
		↑				L13238	L13238	F 20x1,5 / M 18x1,5 ♂	2	45503-39075
						L13541	L13541		2	43310-39016
		↓					L13539		1	43330-39415
							L13540		1	43340-39325
						L13620	L13620	2	48820-35030	
						L13621	L13621	2	48830-35020	

VAUXHALL → OPEL / VAUXHALL
Ventora 1968 → 1972



				← →		Thread	Part Of	QPA	
				L0003	L0003	F 1/2"x20 UNF ♂		2	8819219

**Victor FD 1967 → 1972
 Viva HA / HB / HC 1963 →
 Firenze 1971 → 1973**

				← →		Thread	Part Of	QPA	
				L0003	L0003	F 1/2"x20 UNF ♂		2	8819219

VOLKSWAGEN

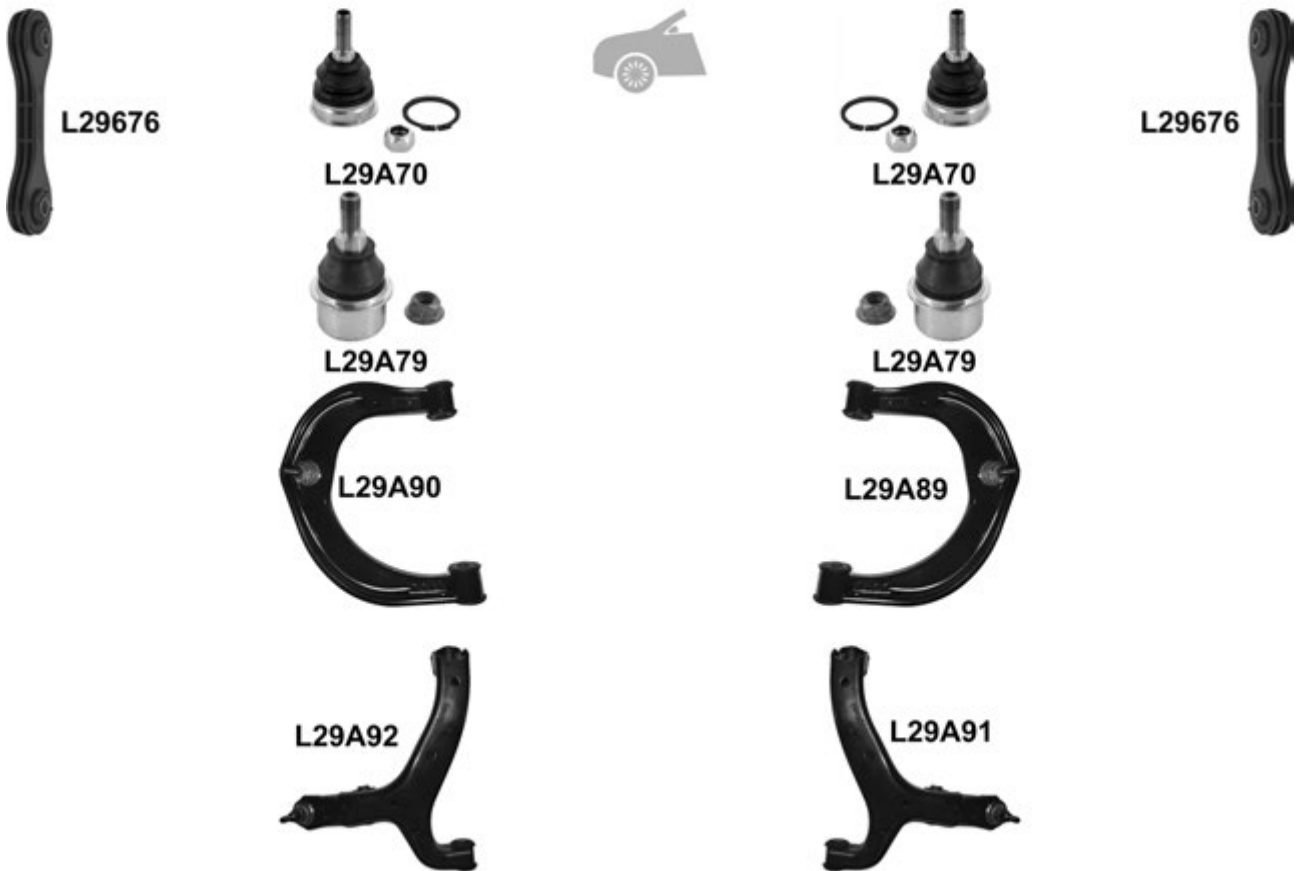
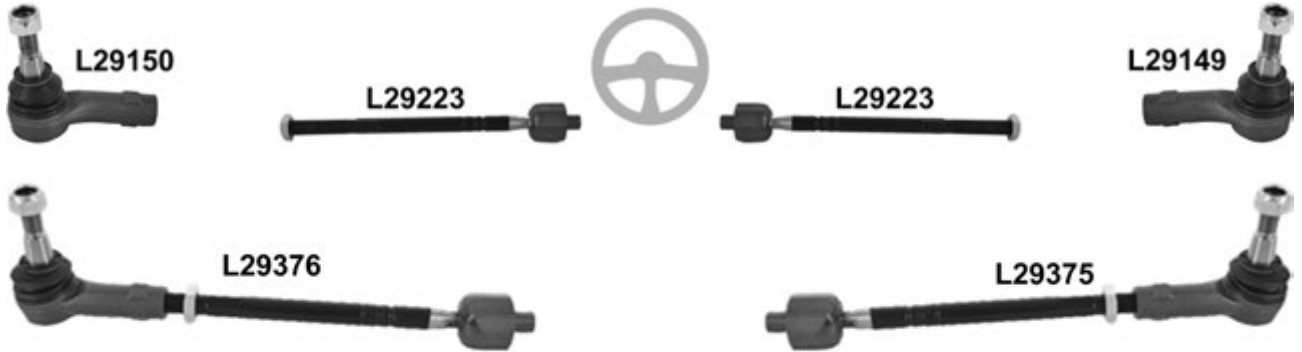
Amarok 09.10 →



			←	→	Thread	Part Of	QPA	
		↔		L29149	F 16x1,5 ∪		1	2H0 422 818
				L29150	F 16x1,5 ∪		1	2H0 422 817
			L29223	L29223	M 16x1,5 / M 16x1,5 ∪	L29375/L29376	2	
			L29375				1	7L0 422 804 D
			L29376				1	7L0 422 803 D
		↑	L29A70 ⁰	L29A70 ⁰		OE no. 2H0 407 021 B / 2H0 407 022 B	2	
		↓	L29A79	L29A79		OE no. 2H0 407 151 A / 2H0 407 152 A	2	
		↑	<input checked="" type="checkbox"/>	L29A89 ⁰			1	2H0 407 022 B
			<input type="checkbox"/>	L29A90 ⁰			1	2H0 407 021 B
		↓	<input checked="" type="checkbox"/>	L29A91 ⁰			1	2H0 407 152 A
		L29A92 ⁰				1	2H0 407 151 A	
			L29676	L29676			2	2H0 411 317 B

Beetle 10.11 →

				← → Thread		Part Of	QPA		
		↔	PR 1N3		L29135			1	1K0 423 812 G
					L29136			1	1K0 423 811 G
		↑ ↓ ↓ ▲	PR 0N4	L29A11	L29A11			2	4K0 505 323 N
			PR 0N4	L29A29	L29A29			2	1K0 505 311 AB
			PR 0N4		L29A87 ⁰		Trailing Arm	1	1K0 505 224 K
				L29A88 ⁰			Trailing Arm	1	1K0 505 222 K
			PR 0N4	L29623	L29623			2	1K0 505 465 J

Bora, Bora Variant (1J2 / 1J6) 10.98 →

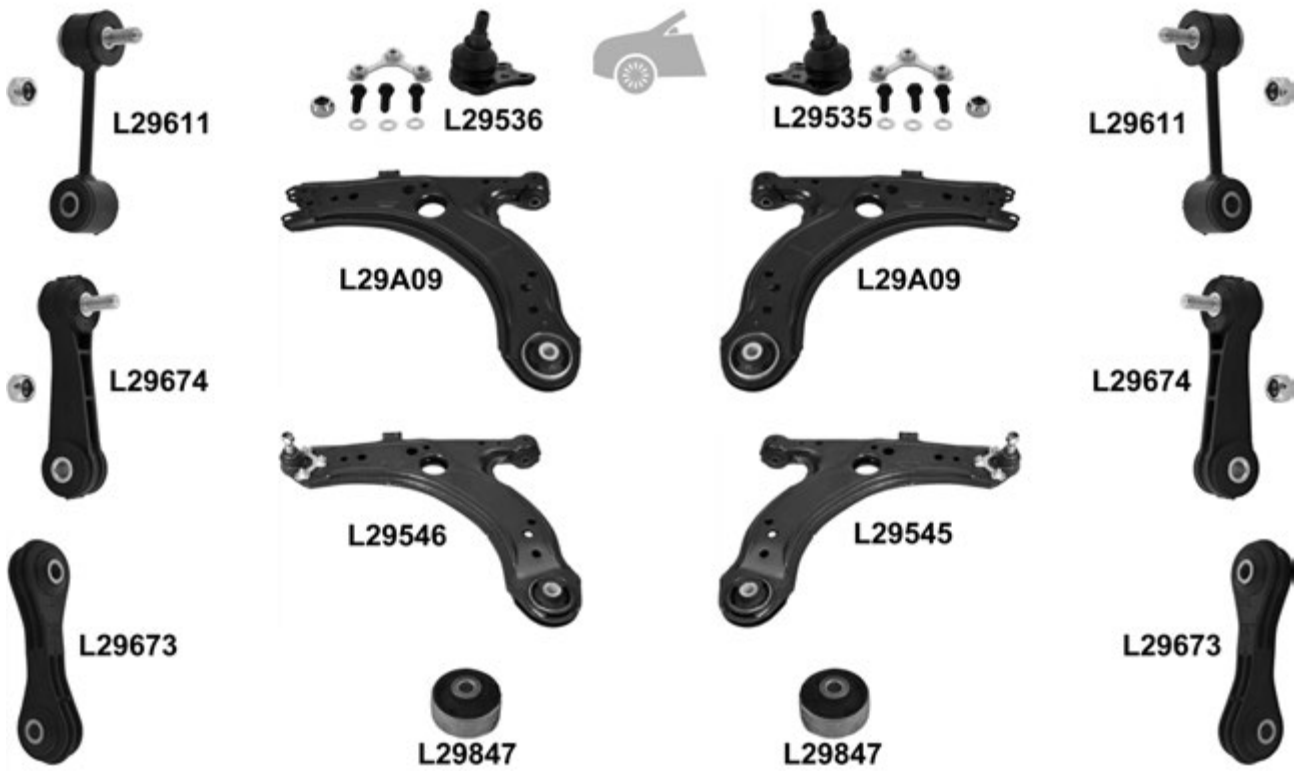
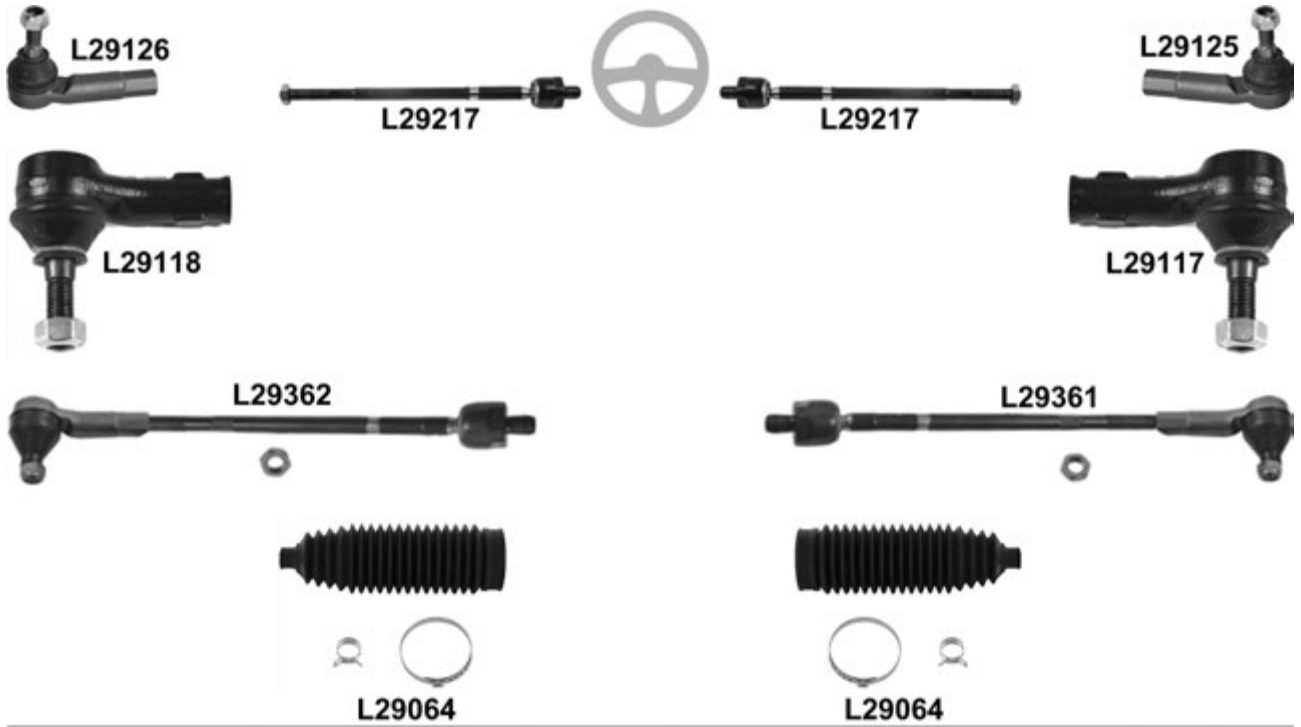

Bora, Bora Variant (1J2 / 1J6) 10.98 →

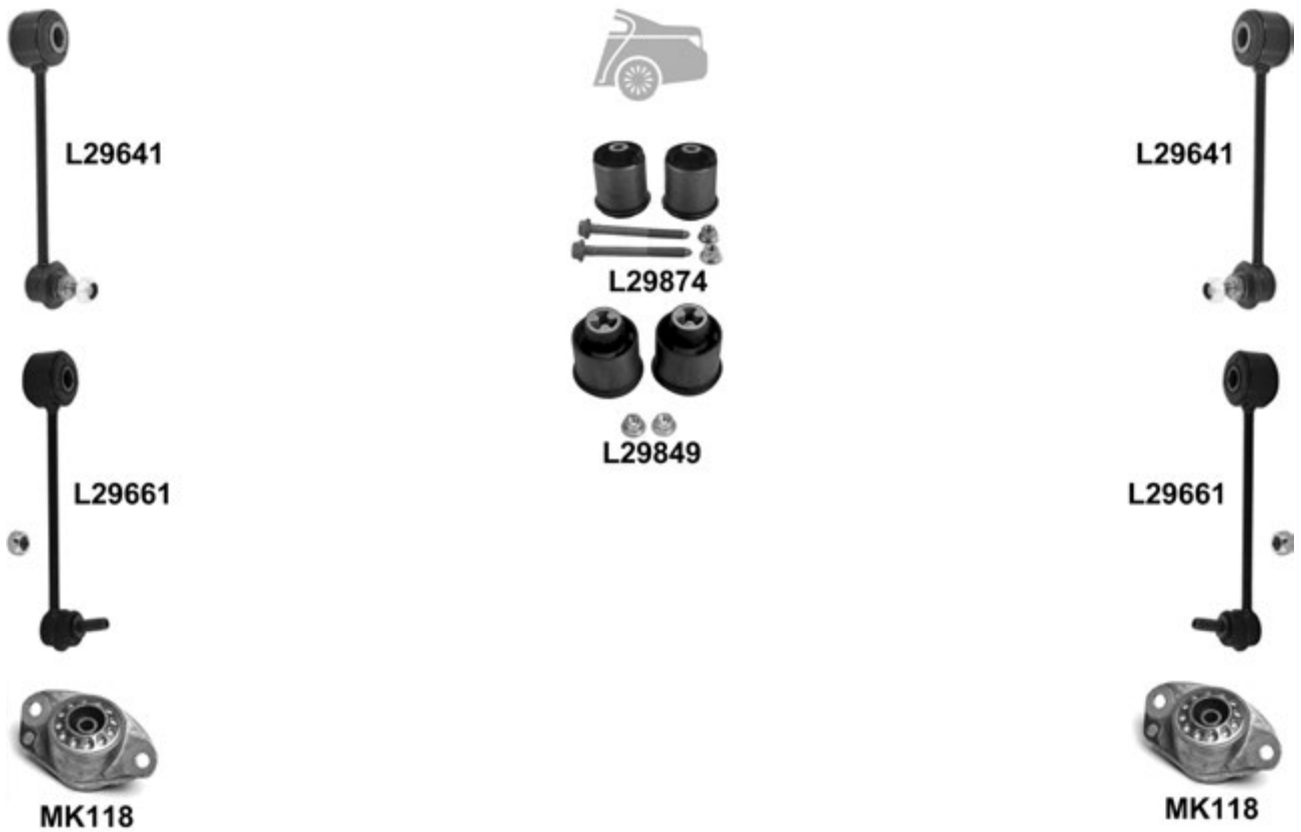
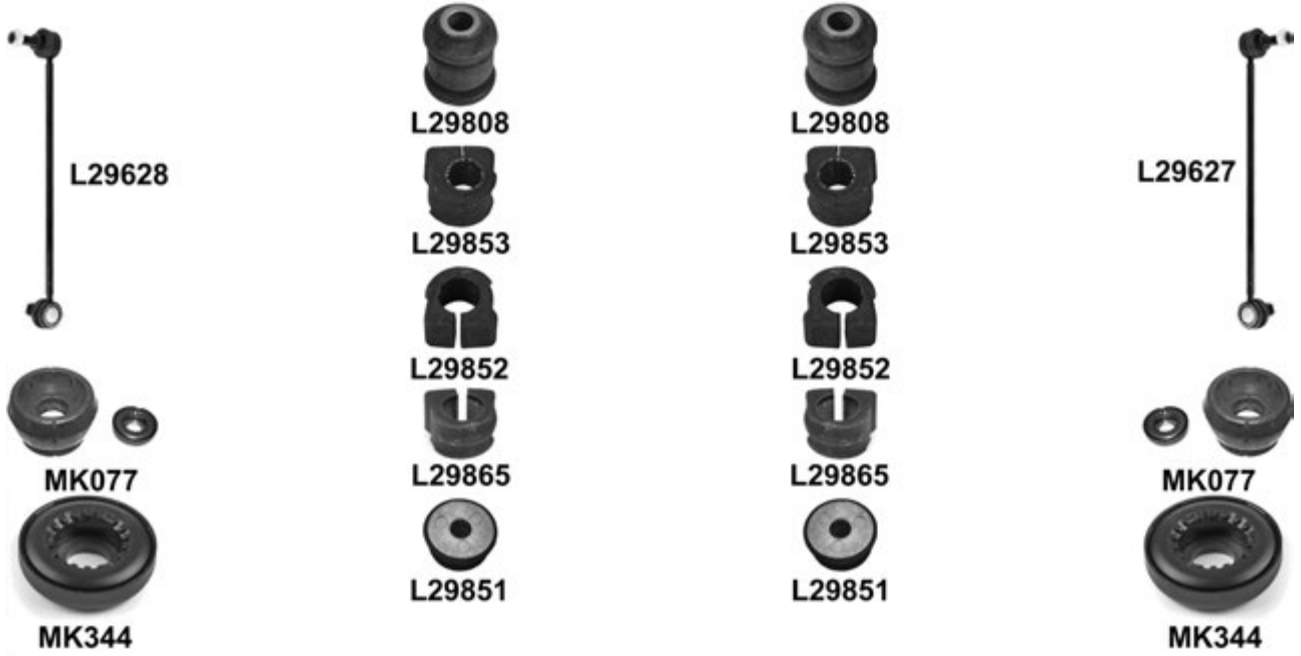

Bora, Bora Variant (1J2 / 1J6) 10.98 →

			←	→	Thread	Part Of	QPA		
		↔	(-) 2.8 V6 4-motion	L29125			1	1J0 422 812 B	
			L29126				1	1J0 422 811 B	
		2.8 V6		L29117	F 14x1,5 ∩			1	3A0 422 812
				L29118	F 14x1,5 ∩			1	3A0 422 811
			L29217	L29217			2	1J0 422 821 B	
		↔	(-) 2.8 V6 4-motion, → 04.01		L29361			1	1J0 422 804 B
			L29362				1	1J0 422 803 B	
		2.8 V6 4-motion		L29361			1	1J0 422 804 B	
				L29362			1	1J0 422 803 B	
				L29064 ⁰	L29064 ⁰			2	1J0 422 831 B
		⊥	(-) 4-motion		L29535			1	1J0 407 366 C
			L29536				1	1J0 407 365 C	
		⊥	(-) , (+)	L29A09	L29A09			2	1J0 407 151 C
			(-) 4-motion <input checked="" type="checkbox"/>		L29545			1	
				L29546			1		
		⊥	(-) 4-motion	L29847	L29847			2	1J0 407 181
			(-) 4-motion	L29808	L29808			2	357 407 182
		↔	→ 10.00 , (-) 4-motion, Metal	L29611	L29611			2	1J0 411 315 G
			→ 10.00 , (-) 4-motion, Plastic	L29674	L29674			2	1J0 411 315 C
			11.00 →, (-) 4-motion	L29673	L29673			2	1J0 411 315 H
			4-motion		L29627			1	1J0 411 316 D
				L29628			1	1J0 411 315 D	
		↔	∅ 17mm / ∅ 19mm	L29853	L29853		Anti-roll bar	2	1J0 411 314 B
			∅ 21mm / ∅ 23mm	L29852	L29852		Anti-roll bar	2	1J0 411 314 C
			05.99 →, ∅ 23mm	L29865	L29865		Anti-roll bar	2	1J0 411 314 G
				L29851	L29851		Hub carrier	2	1J0 199 429
			(+) MK344	KIT	MK077	MK077		2	1J0 412 331 BS
			MK344	MK344			2	1J0 412 249	
		↔	4-motion (-) HD	L29641	L29641			2	1J0 505 466 B
			4-motion HD	L29661	L29661			2	1J0 505 466 C
		↔	(-) 4-motion, ∅ 69mm	L29874			Hub carrier	1	1J0 501 541 D
			(-) 4-motion, ∅ 74mm	L29849			Hub carrier	1	1J0 501 541 C
			(-) 4-motion	MK118	MK118			2	1J0 513 353 B

Caddy I (Golf) 08.82 → 07.92 ch. 14 D 000 001 →

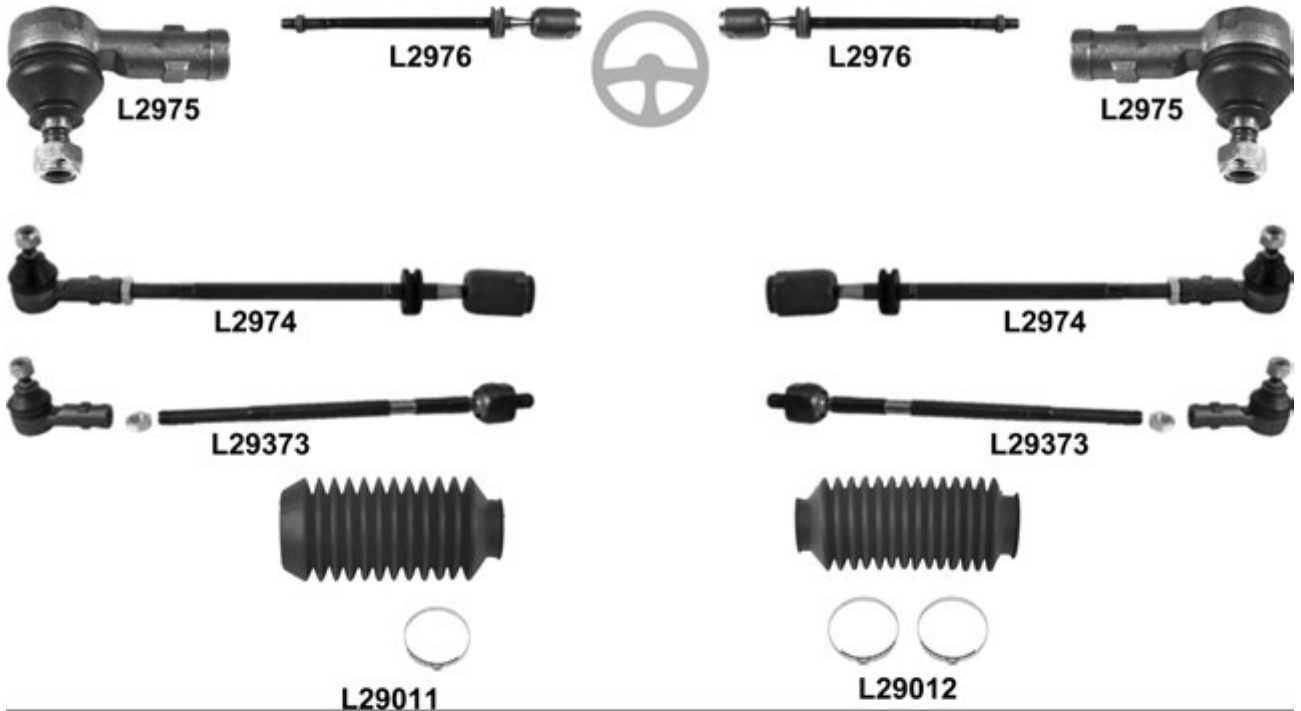

Caddy I (Golf) 08.82 → 07.92 ch. 14 D 000 001 →

		i	←	→	Thread	Part Of	QPA	i
⊕		↔			F 14x1,5 ☺		2	171 419 812
		(-) ⊕					2	171 419 821 A
		(-) ⊕					2	171 419 804 A
		⊕					2	175 422 803 A
							1	171 419 831 A
							1	171 419 831 B
⊖		⊥					2	171 407 365 G
		⊥	(-) ⊕	(-) ⊕			2	171 407 153 D
							2	171 498 153 X0
		⊥ ▾					2	171 407 181 A
		⊥ ▲					2	171 407 182 D
							2	171 412 329 A

Caddy II Pick-Up (9U7) 06.96 → 12.00

		i	←	→	Thread	Part Of	QPA	i
⊕		↔			F 12x1 ☺		2	6U0 422 811
		∅ 11mm, ∅ 42mm, L= 208mm					2	6U0 422 831
⊖		⊥					2	6U0 407 365
		⊥				<input checked="" type="checkbox"/>	1	6U0 407 152
							1	6U0 407 151

Caddy II (9K9 / 9U7) 11.95 → 01.04

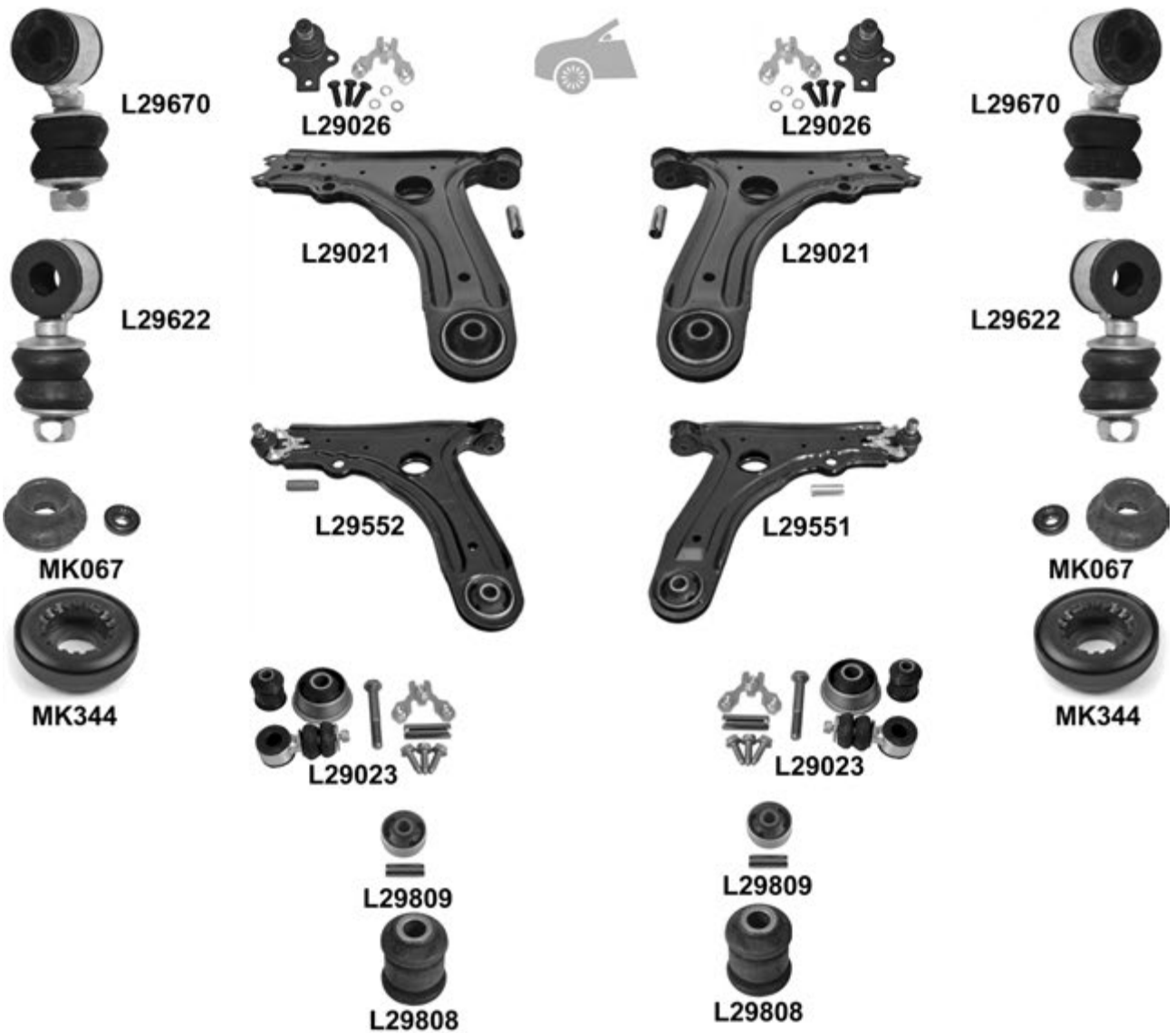
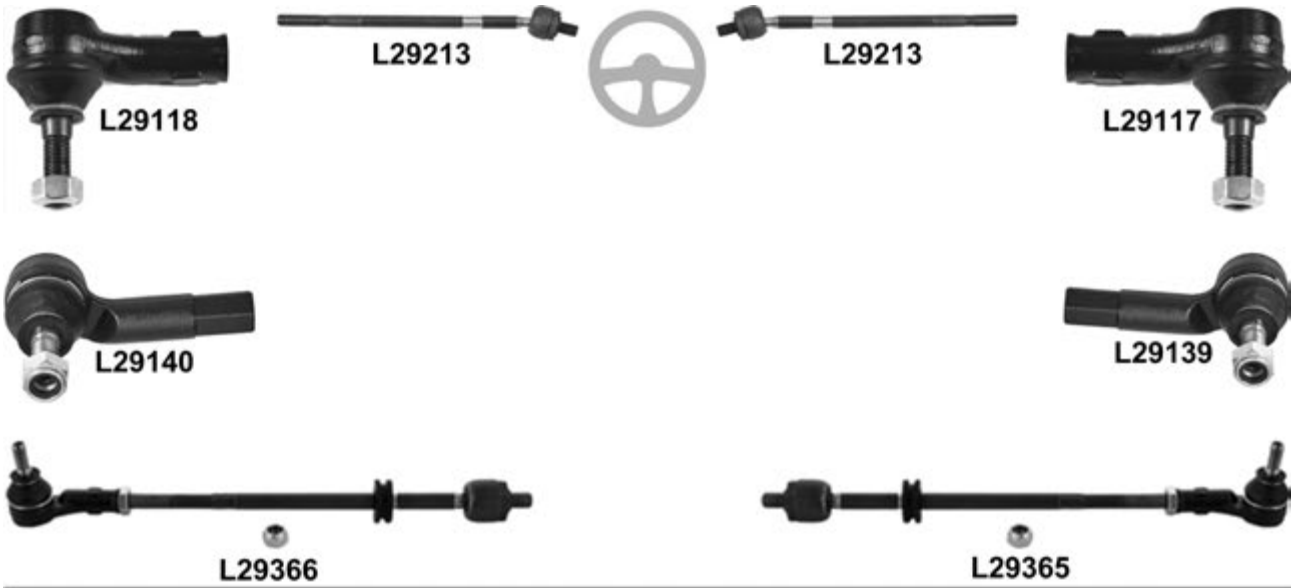

Caddy II (9K9 / 9U7) 11.95 → 01.04

			←	→	Thread	Part Of	QPA		
		↔	→ 11.00 , ch. → 9K 1 523 000	L29117	∩		1	3A0 422 812	
			L29118	∩		1	3A0 422 811		
			→ 12.00 →, ch. 9K 1 523 001 →	L29139	∩		1	6K0 422 812	
			L29140	∩		1	6K0 422 811		
			→ 11.00 , ch. → 9K 1 523 000, L= 340mm	L29213	L29213	M 14x1,5 / M 14x1,5 ∩	L29365/L29366	2	
			ch. → 9K 1 523 000, (13°)	L29365				1	6K0 422 804 A
			L29366				1	6K0 422 803 A	
		⊥		L29026	L29026			2	357 407 365 A
		⊥	(-) (+)	L29021	L29021			2	191 407 153
			<input checked="" type="checkbox"/>	L29551				1	
				L29552				1	
				L29023	L29023			2	191 407 153 S0
		⊥	↘	L29809	L29809			2	191 407 181 E
			↗	L29808	L29808			2	357 407 182
			→ 03.97 , ch. → 9K V 525 700, ø 17mm	L29670	L29670			2	191 411 315 A
			04.97 →, ch. 9K V 525 701 →, 19mm	L29622	L29622			2	6K0 411 315
				KIT	MK067	MK067		2	357 412 331 A
			MK344	MK344			2	357 412 349 A	
			L29850	L29850		Hub carrier	2	6N0 501 541 D	
			MK133	MK133			2	191 512 333 S1	

Caddy III 03.04 →
Caddy Maxi 03.04 →

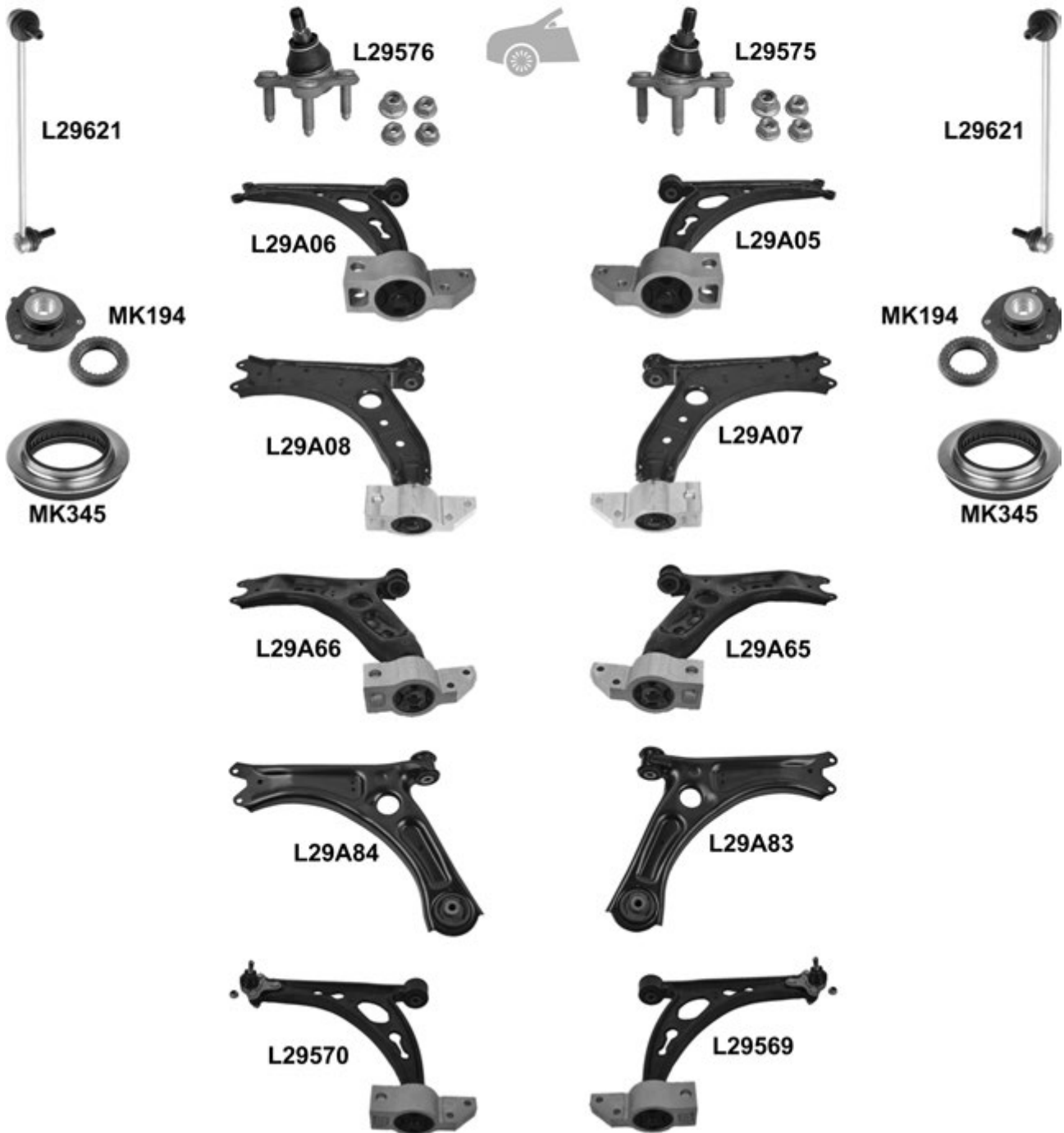
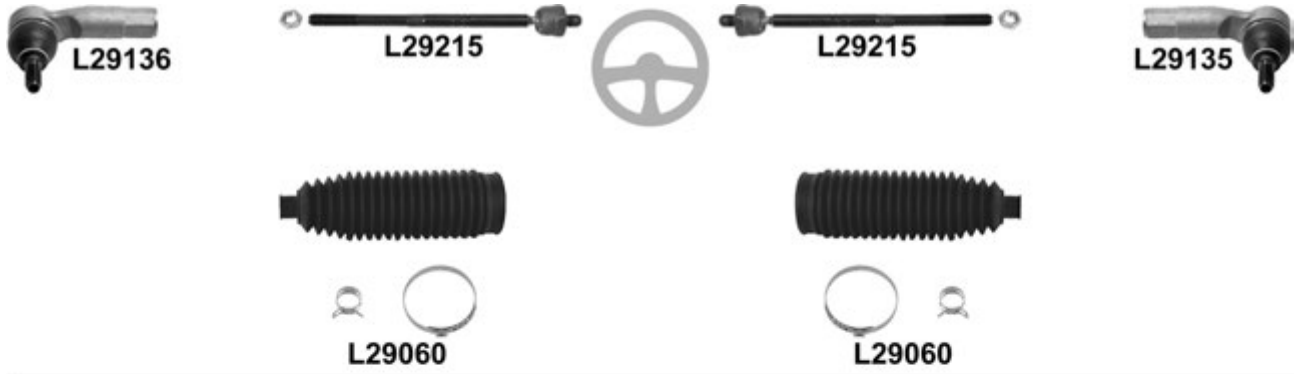

Caddy III 03.04 →
Caddy Maxi 03.04 →



Caddy III 03.04 →
Caddy Maxi 03.04 →

		i		←	→	Thread	Part Of	QPA	i			
		↔			L29135			1	1K0 423 812 G			
				L29136			1	1K0 423 811 G				
				L29215	L29215			2	1K0 423 810 A			
			Electronic	L29060	L29060			2	1K0 423 831 A			
		⊥			L29575			1	1K0 407 366 C			
				L29576			1	1K0 407 365 C				
		⊥	(-) (+)			L29A05			1	1K0 407 152 M		
					L29A06			1	1K0 407 151 M			
			→ 05.08, (-) (+)			L29A07			1	1K0 407 152 P		
					L29A08			1	1K0 407 151 P			
			06.08 → 06.10, (-) (+)			L29A65			1	1K0 407 152 BC		
					L29A66			1	1K0 407 151 BC			
			07.10 →, (-) (+)			L29A83			1	1K0 407 152 BB		
					L29A84			1	1K0 407 151 BB			
					<input checked="" type="checkbox"/>			L29569			1	1K0 407 152 M
					<input checked="" type="checkbox"/>			L29570			1	1K0 407 151 M
	→ 05.08,		<input checked="" type="checkbox"/>			L29571			1	1K0 407 152 P		
			<input checked="" type="checkbox"/>			L29572			1	1K0 407 151 P		
	06.08 → 06.10,		<input checked="" type="checkbox"/>			L29A67			1	1K0 407 152 BC		
			<input checked="" type="checkbox"/>			L29A68			1	1K0 407 151 BC		
		⊥	(-) L29A83/L29A84			L29861			1	1K0 199 232 J		
				L29876				1	1K0 199 231 J			
07.10 →						L29C03	L29C03		L29A83/L29A84	2	1K0 407 183 P	
						L29862	L29862			2	1K0 407 182	
			L29621	L29621			2	1K0 411 315 D				
		(+) MK345	KIT	MK194	MK194			2	1K0 412 331 B			
			MK345	MK345			2	6N0 412 249 C				
		S, PR OE1, Ø 19mm		L29C07 ⁰	L29C07 ⁰		Anti-roll bar	2	2K0 511 413 D			
		⊥	▲			L29A11	L29A11		2	4K0 505 323 N		
						L29637			1	1K0 501 530 C		
		▲			L29638			1	1K0 501 529 F			
					L29624	L29624		2	2K0 505 465 C			

Caddy VI (2CA) 10.10 →
 Caddy VI Maxi (2CH) 10.10 →

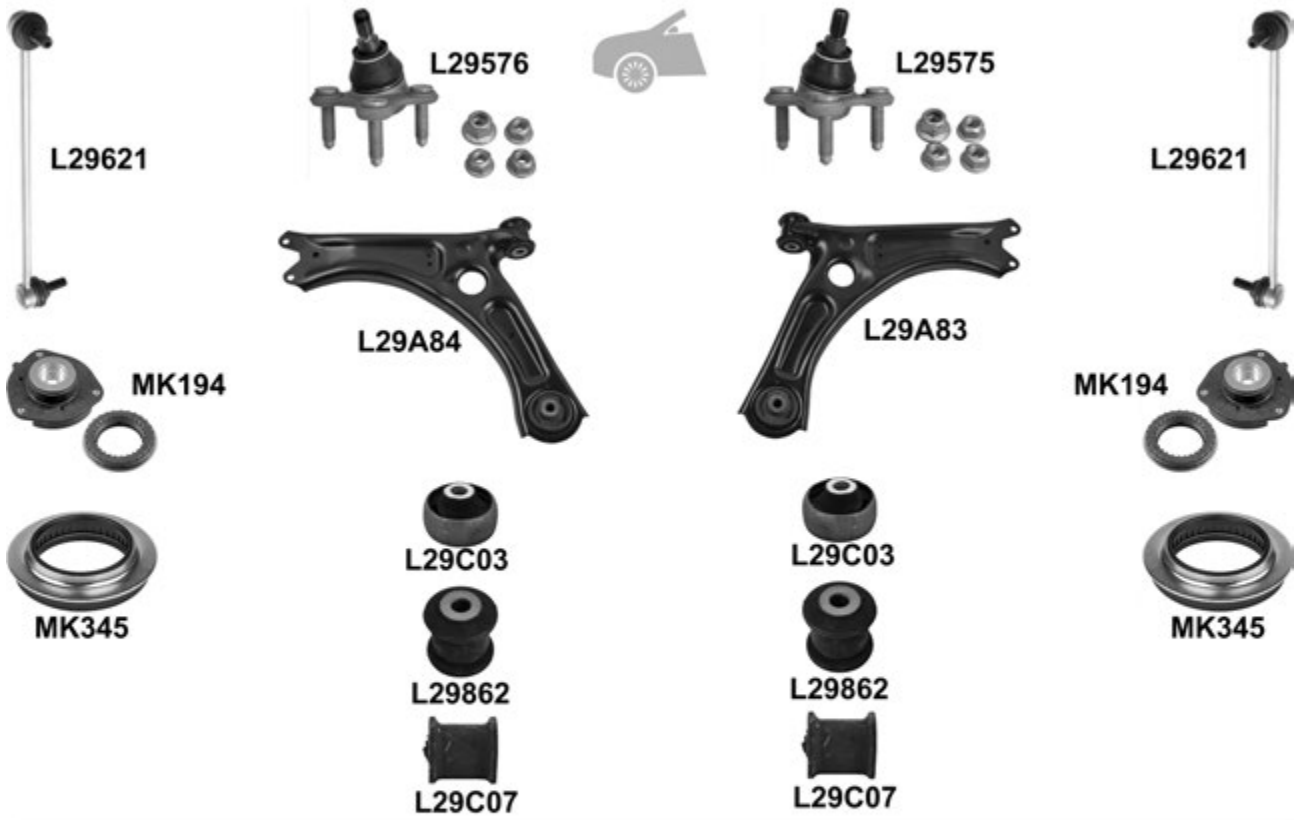

Caddy VI (2CA) 10.10 →
Caddy VI Maxi (2CH) 10.10 →

				←	→	Thread	Part Of	QPA			
		↔			L29135			1	1K0 423 812 G		
				L29136				1	1K0 423 811 G		
		⊥			L29215	L29215	M 16x1,5 / M 16x1,5 ♂	2	1K0 423 810 A		
					L29575			1	1K0 407 366 C		
		⊥	(-) (+)		L29576				1	1K0 407 365 C	
					L29A83			1	1K0 407 152 BB		
		⊥	⬇		L29A84				1	1K0 407 151 BB	
					L29C03	L29C03		L29A83/L29A84	2	1K0 407 183 P	
		⊥	⬆		L29862	L29862			2	1K0 407 182	
					L29621	L29621			2	1K0 411 315 D	
				KIT		MK194	MK194			2	1K0 412 331 B
						MK345	MK345			2	6N0 412 249 C
					L29C07 °	L29C07 °		Anti-roll bar	2	2K0 511 413 D	
					L29624	L29624			2	2K0 505 465 C	

Corrado (531) 09.88 → ch. 50 K 000 001 →

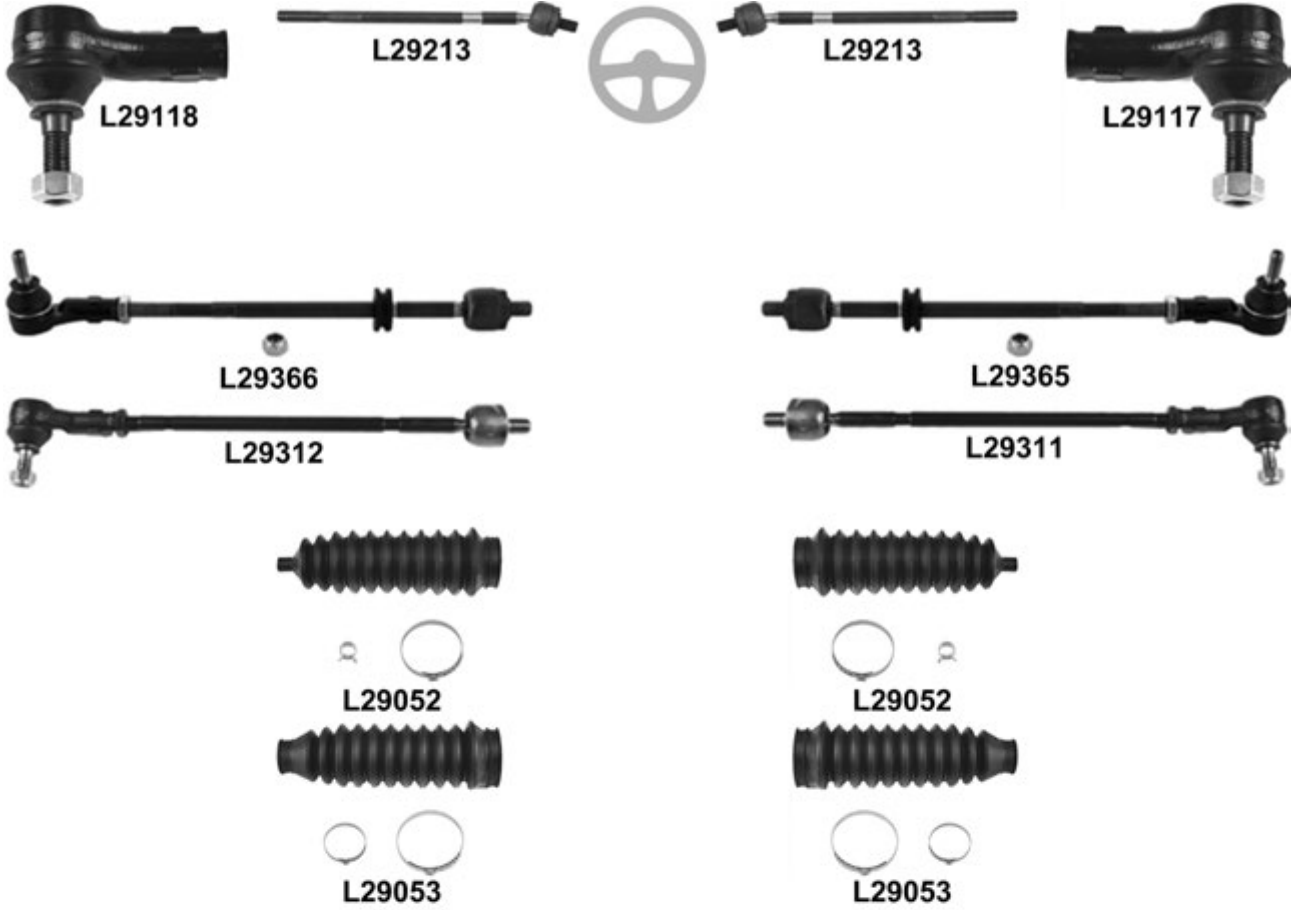

Corrado (531) 09.88 → ch. 50 K 000 001 →



L29023



L29809



L29808



L29023



L29809



L29808



MK133



L29829



L29830



MK133

			←	→	Thread	Part Of	QPA		
		↔		L29117	F 14x1,5 ∪		1	3A0 422 812	
				L29118	F 14x1,5 ∪		1	3A0 422 811	
		↔	(-) VR6, L= 340mm	L29213	L29213	M 14x1,5 / M 14x1,5 ∪	L29365/L29366	2	
			(-) VR6		L29365				1
		↔	VR6		L29366			1	191 422 803 A
					L29311			1	1H0 422 804 A
		↔			L29312			1	1H0 422 803 A
				(TRW)	L29052	L29052			2
		↔		(ZF)	L29053	L29053		2	357 422 831 B
					L29026	L29026			2
		⊥	(-) VR6, (+) VR6	L29021	L29021		2	191 407 153	
			(-) VR6 (Mot/Eng ABV), 19mm	<input checked="" type="checkbox"/>	L29551			1	
				L29552			1		
			VR6 (Mot/Eng ABV), (-) VR6, (+) VR6		L29537		1	1H0 407 152	
		L29538			1	1H0 407 151 A			
			(-) VR6	L29023	L29023			2	191 407 153 S0
		⊥		L29809	L29809			2	191 407 181 E
			(-) VR6	L29808	L29808			2	357 407 182
				L29604	L29604			2	535 411 315
			1.8/2.0 ch. → 50 S 000 051, (-) 2.9 VR6	KIT	MK033	MK033		2	357 412 329
1.8/2.0, ch. 50 S 000 052 →, (-) 2.9 VR6, (+) MK344			KIT	MK067	MK067		2	357 412 331 A	
2.8/2.9 VR6, (+) MK344				MK067	MK067		2	357 412 331 A	
			MK344	MK344			2	357 412 349 A	
		(-) VR6	KIT	L29829		Hub carrier	1	191 501 541 S	
		VR6	KIT	L29830		Hub carrier	1	1H0 501 541 AS	
				MK133	MK133			2	191 512 333 S1

Crafter (2E) 04.06 →

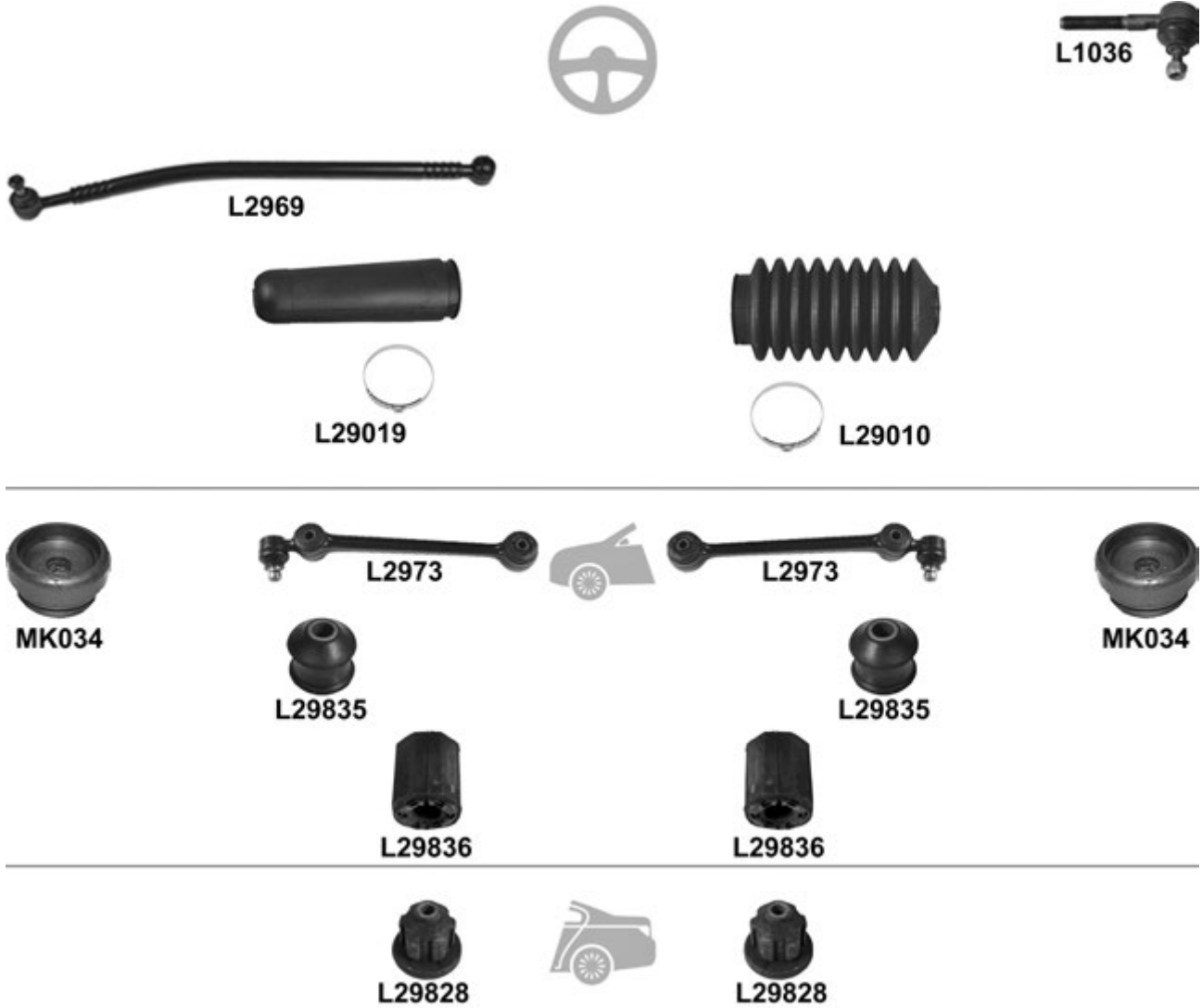

			←	→	Thread	Part Of	QPA	
		↔	L10114	L10114	F 16x1,5 U		2	2EO 713 501
			L10210	L10210	M 16x1,5 / M 18x1,5		2	2EO 713 491
			L10038°	L10038°			2	2EO 713 115
		⊥	L10555	L10555			2	
		⊥	<input checked="" type="checkbox"/>	L10587			1	2EO 407 152 M
			L10588				1	2EO 407 151 M
				L10617			1	2EO 411 318 C
				L10618			1	2EO 411 317 C
			MK287	MK287			2	2EO 407 181 C
			L10641	L10641			2	2EO 511 051 F
			(-) Crafter 46/50					

Derby (86) 02.77 → 09.81 ch. 867 2300 001 → 86/87 C 200 000

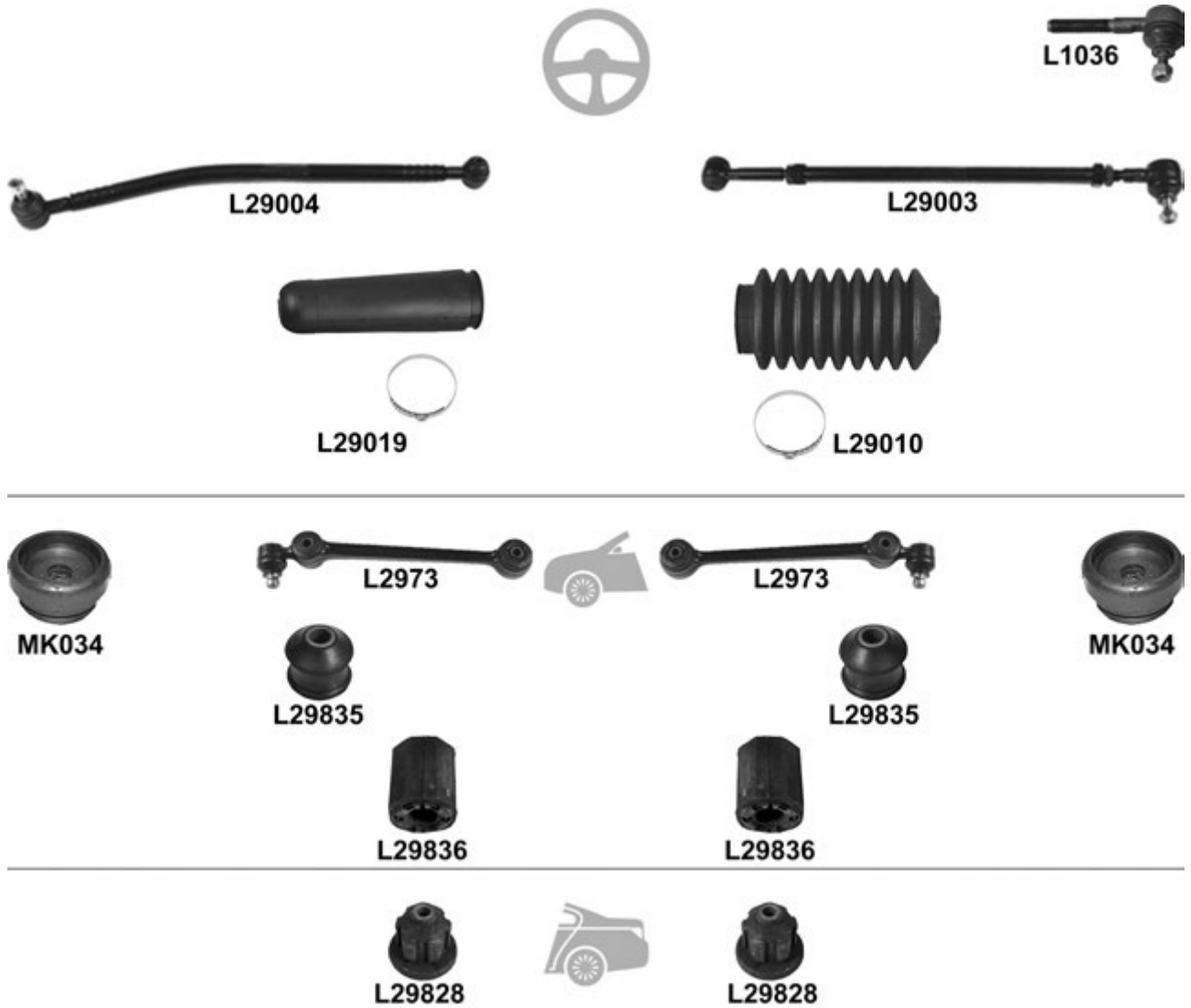

				← → Thread		Part Of	QPA		
⊕		↔		L1036	M 14x1,5		1	811 419 812	
				L2969			1	861 419 801 D	
				L29010			1	861 419 831 B	
				L29019			1	861 419 287 A	
⊖		⊥	10.78 →, ch. 869 2523 523 →	L2973	L2973		2	861 407 151 B	<input checked="" type="checkbox"/>
		⊥ → ←		L29835	L29835		2	861 407 183	
		⊥ ↔		L29836	L29836	Anti-roll bar	2	867 411 313	
				KIT MK034	MK034		2	871 412 323 A	
				L29828	L29828	Hub carrier	2	861 511 271	

Derby (86C) 08.81 → 12.84 ch. 86/87 D 000 001 → 87 G 220 000



Thread

Part Of

QPA



		↔			L1036	M 14x1,5 ☺		1	811 419 812
					L29003			1	871 419 802
					L29004			1	871 419 801 A
					L29010			1	861 419 831 B
					L29019			1	861 419 287 A
		⊥		<input checked="" type="checkbox"/>	L2973	L2973		2	861 407 151 B
		↕↔			L29835	L29835		2	861 407 183
		⊥↔			L29836	L29836	Anti-roll bar	2	867 411 313
					KIT	MK034	MK034		2
					L29828	L29828	Hub carrier	2	861 511 271

EOS (1F7, 1F8) 03.06 →

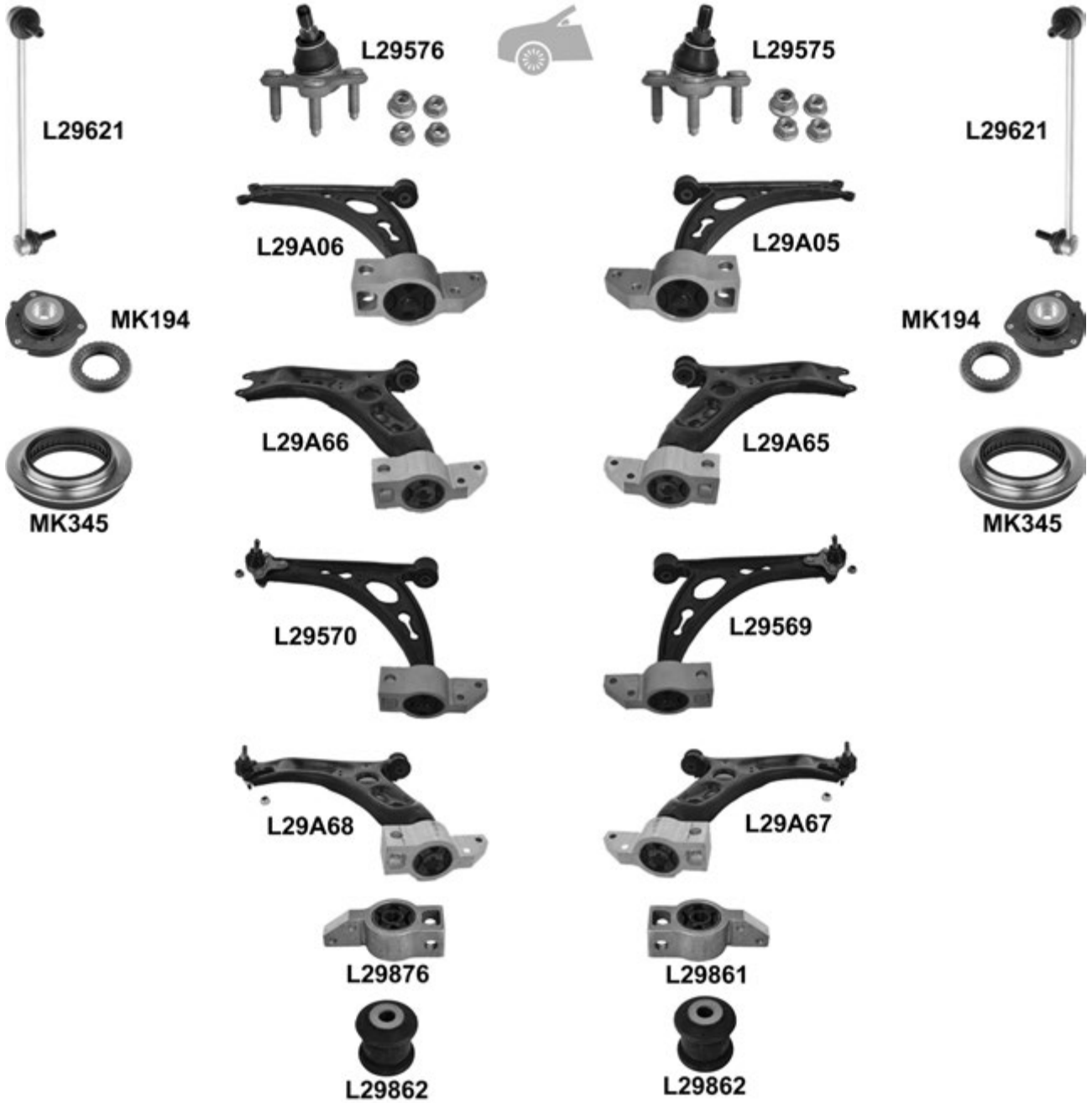
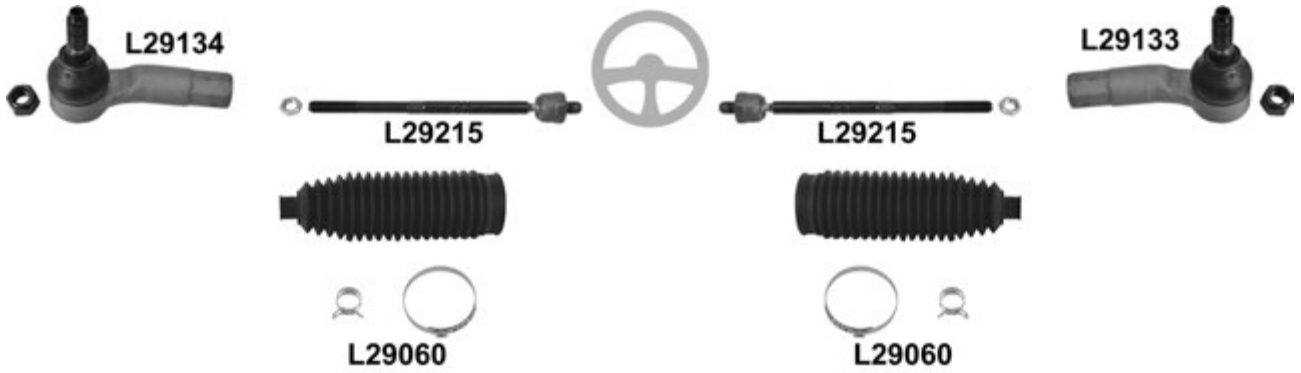

EOS (1F7, 1F8) 03.06 →



				← → Thread		Part Of	QPA		
⊕	↔			L29133	F 16x1,5 ∪		1	1K0 423 812 E	
				L29134	F 16x1,5 ∪		1	1K0 423 811 E	
	↔			L29215	L29215	M 16x1,5 / M 16x1,5 ∪	2	1K0 423 810 A	
			Electronic ⊕	L29060	L29060		2	1K0 423 831 A	
⊖	⊥				L29575		1	1K0 407 366 C	
					L29576		1	1K0 407 365 C	
	⊥	(-) ⊕, (+) ⊖, ⊕, ⊖			L29A05		1	1K0 407 152 M	
				L29A06		1	1K0 407 151 M		
		(-) ⊕, (+) ⊖, ⊕, ∞			L29A65		1	1K0 407 152 BC	
				L29A66		1	1K0 407 151 BC		
		⊕	☑		L29569		1	1K0 407 152 M	
				L29570		1	1K0 407 151 M		
		∞	☑		L29A67		1	1K0 407 152 BC	
				L29A68		1	1K0 407 151 BC		
	⊖	⊥ ∇				L29861		1	1K0 199 232 G
					L29876		1	1K0 199 231 G	
⊥ ▲				L29862	L29862		2	1K0 407 182	
↔			L29621	L29621		2	1K0 411 315 D		
⊕		(+) MK345	KIT	MK194	MK194		2	1K0 412 331 B	
⊕				MK345	MK345		2	6N0 412 249 C	
⊖	⊥	→ 05.12		L29A11	L29A11		2	4K0 505 323 N	
				L29A29	L29A29		2	1K0 505 311 AB	
	⊥ ▲				L29A87 ⁰		1	1K0 505 224 K	Trailing Arm
					L29A88 ⁰		1	1K0 505 222 K	Trailing Arm
	↔	▲	→ 11.08		L29637		1	1K0 501 530 C	
				L29638		1	1K0 501 529 F		
				L29623	L29623		2	1K0 505 465 J	

Fox (5Z1) 10.03 →

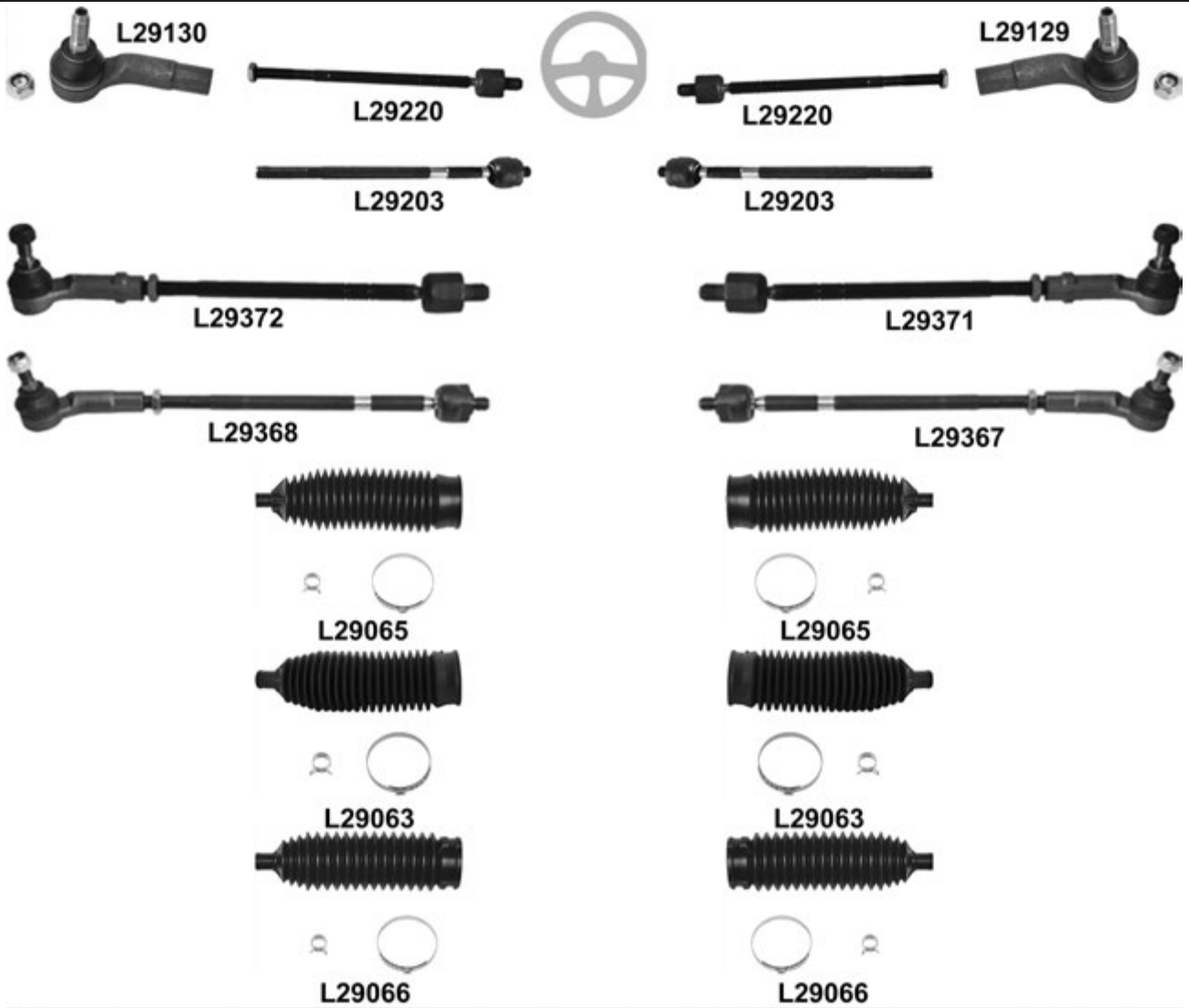

Fox (5Z1) 10.03 →



L29887



L29887



L29858



L29858



MK118



L29874



L29849



MK118

				← → Thread		Part Of	QPA			
					L29129	F 14x1,5 ♂		1	6Q0 423 812	
					L29130	F 14x1,5 ♂		1	3A0 422 811	
				Smi/Koyo	L29220	L29220	♂		2	6Q0 423 810 G
				TRW	L29203	L29203	M 14x1,5 / M 14x1,5 ♂		2	
				PR. 1N2/LOL (-) , Smi/Koyo		L29371			1	6Q0 423 804 G
					L29372				1	6Q0 423 803 G
				PR. 1N2 (-) , TRW		L29367			1	6Q0 423 804 B
					L29368				1	6Q0 423 803 B
				(-) , PR 1N0 TRW, ø 12mm, Ø 48mm, L= 195mm	L29065 ⁰	L29065 ⁰			2	6E0 419 831
				, PR 1N2 TRW, ø 14,5mm, Ø 47,5mm, L= 205mm	L29063 ⁰	L29063 ⁰			2	6Q0 423 831 D
	, PR 1N2/LOL Smi/Koyo, ø 13mm, Ø 45,5mm, L= 210mm	L29066 ⁰	L29066 ⁰			2	5Z0 422 831			
					L29563			1	6Q0 407 366 A	
					L29564				1	6Q0 407 365 A
				(-) , (+)	L29A69	L29A69			2	6Q0 407 151 D
				<input checked="" type="checkbox"/>	L29565				1	6Q0 407 151 E
					L29566				1	6Q0 407 151 E
					L29887	L29887			2	1K0 407 183 E
					L29858	L29858			2	6Q0 407 182 A
					L29617	L29617			2	6Q0 411 315 D
				PR G09/G10, (-) SP , (+) MK345	KIT	MK156	MK156		2	6N0 412 331 E
				PR G09/G10, SP , (+) MK345		MK156	MK156		2	6Q0 412 331 B
					MK345	MK345			2	6N0 412 249 C
				(-) 4-motion, Ø 69mm	L29874			Hub carrier	1	1J0 501 541 D
				(-) 4-motion, Ø 74mm	L29849			Hub carrier	1	1J0 501 541 C
					MK118	MK118			2	1J0 513 353 B

Golf I (17) 04.74 → 12.85 ch. 175 3000 001 → 17 E 140 001



Golf I (17) 04.74 → 12.85 ch. 175 3000 001 → 17 E 140 001

		i		←	→	Thread	Part Of	QPA	i
		↔		L2975	L2975	F 14x1,5 ⌀		2	171 419 812
			(-)	L2976	L2976			2	171 419 821 A
			(-)	L2974	L2974			2	171 419 804 A
				L29373	L29373			2	175 422 803 A
					L29012			1	171 419 831 A
					L29011			1	171 419 831 B
		⊥	→ 10.77 ch. → 178 3173 583 ch. → 538 2028 902 use L 2978 if Wheel hub is changed	L2972	L2972			2	171 407 365 D
			11.77 → ch. 178 3173 584 → ch. 538 2028 903 →	L2978	L2978			2	171 407 365 G
		⊥	(-)	L29013	L29013			2	171 407 153 D
				L29020	L29020			2	171 498 153 X0
		⊥ ▼		L29816	L29816			2	171 407 181 A
		⊥ ▲		L29817	L29817			2	171 407 182 D
				MK070	MK070			2	171 412 329 A

Golf II (19E) 08.83 → 12.92 ch. 19 E 300 001 → NB 030 000 / → NP / NW 300 000

VOLKSWAGEN



Golf II (19E) 08.83 → 12.92 ch. 19 E 300 001 → NB 030 000 / → NP / NW 300 000



L29609



MK033



L29009

L29026



L29021



L29550



L29552



L29023



L29809



L29808



L29009

L29026



L29021



L29549



L29551



L29023



L29809



L29808



L29609



MK033



MK133



L29829



MK133

Golf II (19E) 08.83 → 12.92 ch. 19 E 300 001 → NB 030 000 / → NP / NW 300 000

			←	→	Thread	Part Of	QPA		
		↔		L29117	F 14x1,5 ♂		1	3A0 422 812	
				L29118	F 14x1,5 ♂		1	3A0 422 811	
				L29008	L29008	M 14x1,5 / M 22x1,5		2	
			(TRW), L= 340mm	L29213	L29213	M 14x1,5 / M 14x1,5 ♂		2	1H0 422 821
					L29006			1	191 419 804 A
				L29000				1	191 419 803 A
			(TRW)		L29365			1	191 422 804 A
				L29366				1	191 422 803 A
			(ZF)		L29341			1	191 422 804 C
				L29342				1	191 422 803 C
				L29050	L29050			2	191 419 831
			(TRW)	L29052	L29052			2	1H0 422 831
			(ZF)	L29053	L29053			2	357 422 831 B
		⊥	→ 06.87 ch. → 19 HB 990 000 ch. → 16 HW 990 000 17mm	L29009	L29009			2	191 407 365 B
			07.87 → ch. 19 JW 000 001 ch. 16 JB 000 001 → 19mm	L29026	L29026			2	357 407 365 A
		⊥	(-) (+)	L29021	L29021			2	191 407 153 A
			→ 06.87 <input checked="" type="checkbox"/> ch. → 19 HB 990 000 ch. → 16 HW 990 000 17mm	L29549				1	
				L29550				1	
			07.87 → <input checked="" type="checkbox"/> ch. 19 JW 000 001 ch. 16 JB 000 001 → 19mm	L29551				1	
				L29552				1	
				L29023	L29023			2	191 407 153 S0
		⊥	▼	L29809	L29809			2	191 407 181 E
			▲	L29808	L29808			2	357 407 182
			(-) G60	L29609	L29609			2	191 411 315 BS
			(-) G60	KIT	MK033	MK033		2	191 412 329
			G60	KIT	MK033	MK033		2	357 412 329
			KIT	L29829		Hub carrier	1	191 501 541 S	
				MK133	MK133		2	191 512 333 S1	

Golf III (1HX) 10.91 → 08.97 ch. 1H NW / NB 000 001 →

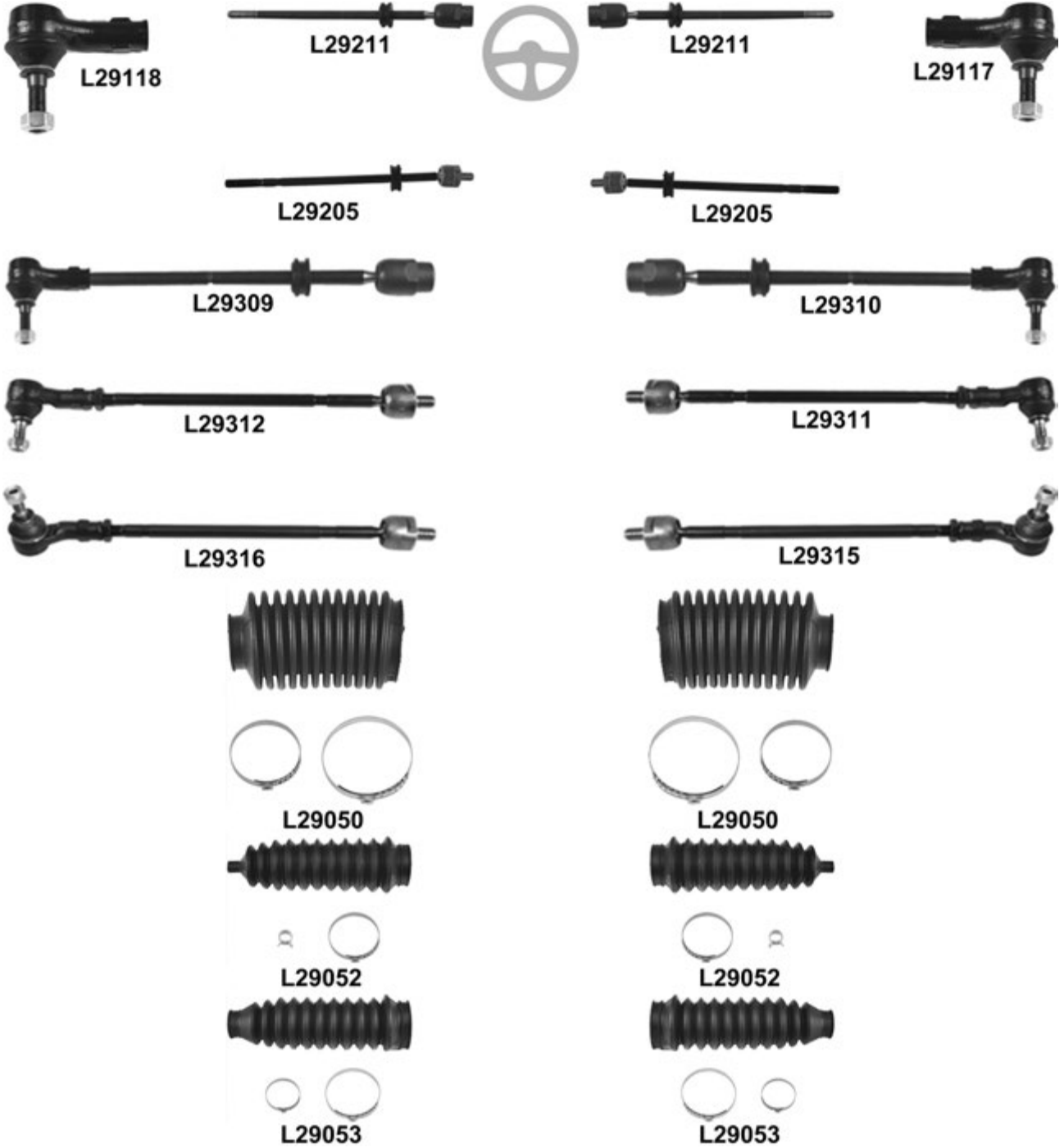

Golf III (1HX) 10.91 → 08.97 ch. 1H NW / NB 000 001 →

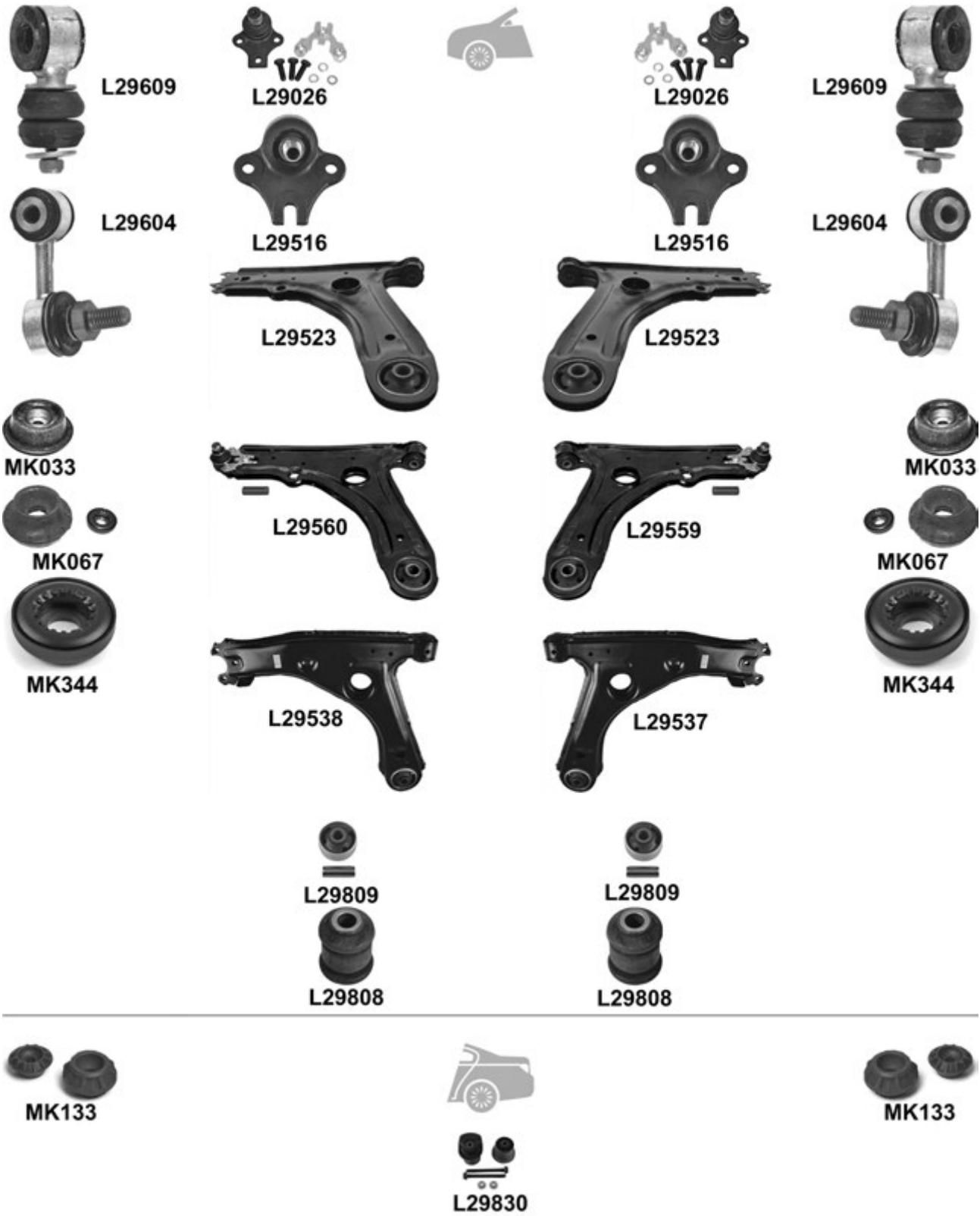

Golf III (1HX) 10.91 → 08.97 ch. 1H NW / NB 000 001 →

			←	→	Thread	Part Of	QPA		
		↔		L29117	F 14x1,5 ♂		1	3A0 422 812	
			L29118		F 14x1,5 ♂		1	3A0 422 811	
				L29211	L29211			2	
			(TRW)	L29205	L29205			2	1H0 422 821 A
					L29310			1	1H0 419 804
			L29309				1	1H0 419 803	
			(TRW)		L29311			1	1H0 422 804
			L29312				1	1H0 422 803	
			(ZF)		L29315		1	1H0 422 804 B	
				L29316			1	1H0 422 803 B	
				L29050	L29050			2	191 419 831
			(TRW)	L29052	L29052			2	1H0 422 831
			(ZF)	L29053	L29053			2	357 422 831 B
			⊥	(-) Golf 1.9 Tdi/2.0/16V/VR6	L29026	L29026		2	357 407 365 A
Golf 1.9 Tdi/2.0/16V/VR6				L29516	L29516		2	1H0 407 365	
		⊥	(-) Golf 1.9 Tdi/2.0/16V/VR6, (-) , (+)	L29523	L29523		2	1H0 407 151	
			(-) Golf 1.9 Tdi/2.0/16V/VR6 <input checked="" type="checkbox"/>		L29559		1	1H0 407 151	
			L29560			1	1H0 407 151		
			Golf 1.9 Tdi/2.0/16V/VR6, (-) , (+)		L29537		1	1H0 407 152	
		⊥		L29538			1	1H0 407 151 A	
				L29809	L29809		2	191 407 181 E	
		⊥		L29808	L29808		2	357 407 182	
			(-) Golf 1.9 Tdi/2.0/16V/VR6	L29609	L29609		2	191 411 315 BS	
			Vento 2.0 GT Mot/Eng 2E, 2.8 VR6 Mot/Eng AAA	L29604	L29604		2	535 411 315	
			ch. → 1H SW 062 538	KIT	MK033	MK033		2	357 412 329
	ch. → 1H SB 019 475								
	(-) HD/2.0/2.0 16V/VR6								
	ch. 1H SW 062 539		KIT	MK067	MK067		2	357 412 331 A	
		ch. SB 019 476 →							
		(-) HD/2.0/2.0 16V/VR6, (+) MK344							
		HD/16V/VR6, (+) MK344	MK067	MK067		2	357 412 331 A		
			MK344	MK344			2	1J0 412 249	
		(-) Syncro	KIT	L29830		Hub carrier	1	1H0 501 541 AS	
				MK133	MK133		2	191 512 333 S1	

Golf IV (1J) 08.97 →

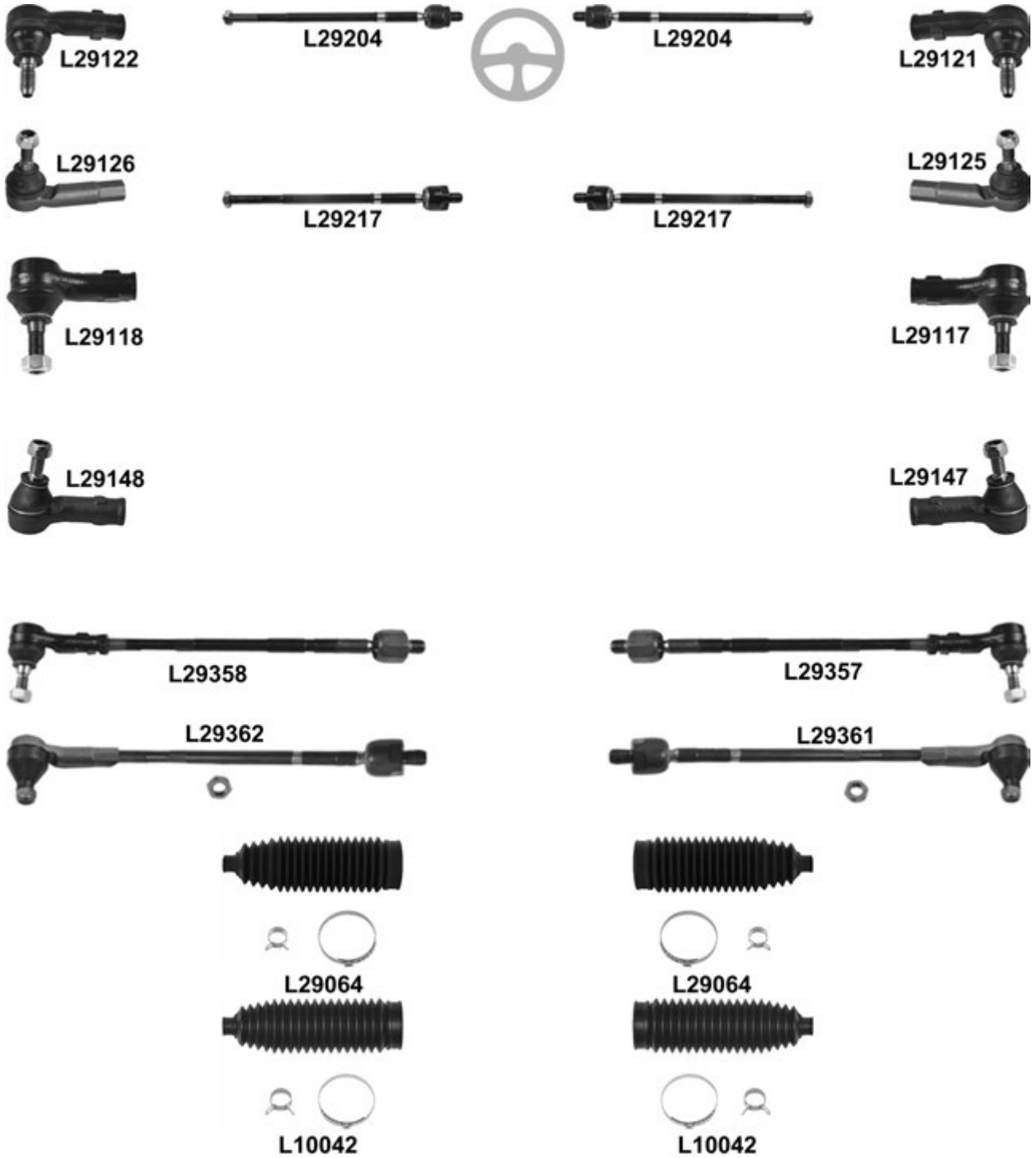

Golf IV (1J) 08.97 →

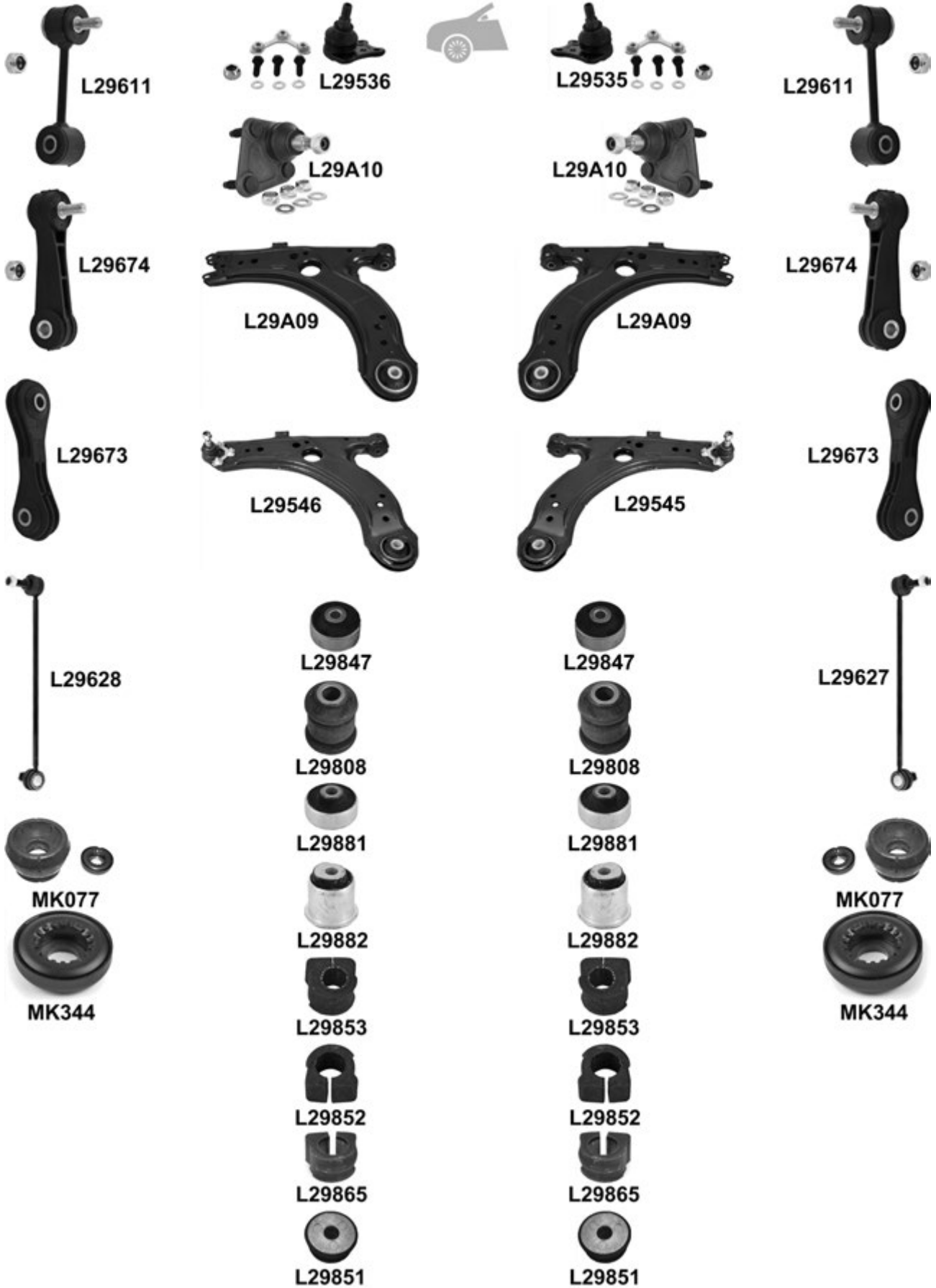

Golf IV (1J) 08.97 →

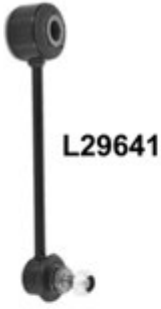

Golf IV (1J) 08.97 →

			←	→	Thread	Part Of	QPA		
		↔	→ 01.98	L29121			1	1J0 422 812 A	
			ch. → 1J WP 050 832	L29122				1	1J0 422 811 A
			ch. → 1J WD 039 150						
			ch. → 1J WB 027 484						
			ch. → 1J WW 062 359						
			(-) Syncro						
		↔	→ 02.98	L29125				1	1J0 422 812 B
			ch. 1J WP 050 833 →	L29126				1	1J0 422 811 B
			ch. 1J WD 039 151 →						
			ch. 1J WB 027 485 →						
			ch. 1J WW 062 360 →						
			(+) Syncro						
	↔	2.8 V6 4-motion	L29117		∪		1	3A0 422 812	
			L29118		∪		1	3A0 422 811	
		3.2 R32 4-motion	L29147		F 16x1,5 ∪		1	8N0 422 812 A	
			L29148		F 16x1,5 ∪		1	8N0 422 811 A	
	↔	→ 01.98	L29204	L29204			2	1J0 422 821 A	
		ch. → 1J WP 050 832							
		ch. → 1J WD 039 150							
		ch. → 1J WB 027 484							
	↔	ch. → 1J WW 062 359							
		(-) Syncro							
		→ 02.98	L29217	L29217				2	1J0 422 821 B
		ch. 1J WP 050 833 →							
	↔	ch. 1J WD 039 151 →							
		ch. 1J WB 027 485 →							
		ch. 1J WW 062 360 →							
		(+) Syncro							
	↔	→ 01.98	L29357				1	1J0 422 804 A	
		ch. → 1J WP 050 832	L29358				1	1J0 422 803 A	
		ch. → 1J WD 039 150							
		ch. → 1J WB 027 484							
		ch. → 1J WW 062 359							
		(-) Syncro/4-motion							
	↔	→ 02.98	L29361				1	1J0 422 804 B	
		ch. 1J WP 050 833 →	L29362				1	1J0 422 803 B	
		ch. 1J WD 039 151 →							
		ch. 1J WB 027 485 →							
	↔	3.2 R32	L29064 ⁰	L29064 ⁰			2	1J0 422 831 B	
		3.2 R32, ø 16mm, Ø 49mm, L= 190mm	L10042 ⁰	L10042 ⁰			2	8N0 422 831	
	⊥	(-) 3.2 R32 4-motion	L29535				1	1J0 407 366 C	
			L29536				1	1J0 407 365 C	
		3.2 R32 4-motion	L29A10	L29A10			2	8N0 407 365 C	
			⊥	(-) 3.2 R32 4-motion, (-) (+)	L29A09	L29A09			2
(-) 3.2 R32 4-motion <input checked="" type="checkbox"/>	L29545						1		
			L29546				1		

Golf IV (1J) 08.97 →

			←	→	Thread	Part Of	QPA		
		↓	(-) 3.2 R32 4-motion	L29847	L29847		2	1J0 407 181	
		↑	(-) 3.2 R32 4-motion	L29808	L29808		2	357 407 182	
		↓	3.2 R32 4-motion	L29881	L29881		2	8N0 407 181 B	
		↑	3.2 R32 4-motion	L29882	L29882		2	8N0 407 182 A	
				PR OAE → 07.00 , (-) 4-motion, Metal	L29611	L29611		2	1J0 411 315 G
				PR OAE → 07.00 , (-) 4-motion, Plastic	L29674	L29674		2	1J0 411 315 C
				PR OAE, 08.00 →, (-) 4-motion, Plastic	L29673	L29673		2	1J0 411 315 H
				PR OAL/OAM, (-) 4-motion, Metal	L29611	L29611		2	1J0 411 315 G
				PR OAL/OAM, (-) 4-motion, Plastic	L29674	L29674		2	1J0 411 315 C
				4-motion, PR OAE, ch. → 1J X 800 000	L29611	L29611		2	1J0 411 315 G
				4-motion, PR OAQ/OAR/OAS, ch. 1J Y 000 001 →		L29627		1	1J0 411 316 D
			L29628			1	1J0 411 315 D		
				PR OAR, 08.03 →, ch. 1J4 220 001 →, ø 17mm / ø 19mm	L29853	L29853	Anti-roll bar	2	1J0 411 314 B
				ø 21mm / ø 23mm	L29852	L29852	Anti-roll bar	2	1J0 411 314 C
				PR OAE, → 04.99 , ch. → 1JX 800 000, ø 23mm	L29865	L29865	Anti-roll bar	2	1J0 411 314 G
				PR OAS, 05.99 → 07.03 , ch. 1JY 000 001 → 1J4 220 000, ø 23mm	L29865	L29865	Anti-roll bar	2	1J0 411 314 G
				PR OAT, ø 23mm	L29865	L29865	Anti-roll bar	2	1J0 411 314 G
				L29851	L29851	Hub carrier	2	1J0 199 429	
			(+) MK344	KIT	MK077	MK077		2	1J0 412 331 BS
					MK344	MK344		2	1J0 412 249
			(-) 4-motion, ø 69mm	L29874		Hub carrier	1	1J0 501 541 D	
			(-) 4-motion, ø 74mm	L29849		Hub carrier	1	1J0 501 541 C	
			4-motion (-) HD	L29641	L29641		2	1J0 505 466 B	
			4-motion HD	L29661	L29661		2	1J0 505 466 C	
			PR 1JA/1JB/1JD,	MK118	MK118		2	1J0 513 353 B	
			PR 1JC/1JH, → 12.99 , ch. → 1JY 500 000	MK118	MK118		2	1J0 513 353 B	
			GTI/Turbo	MK118	MK118		2	1J0 513 353 D	
			PR 1JC/1JH, 01.00 →, ch. 1JY 500 001 →	MK118	MK118		2	1J0 513 353 D	
	PR 1JG/UA9/UB1/UB2	MK118	MK118		2	1J0 513 353 D			

Golf V (1K1) 10.03 →

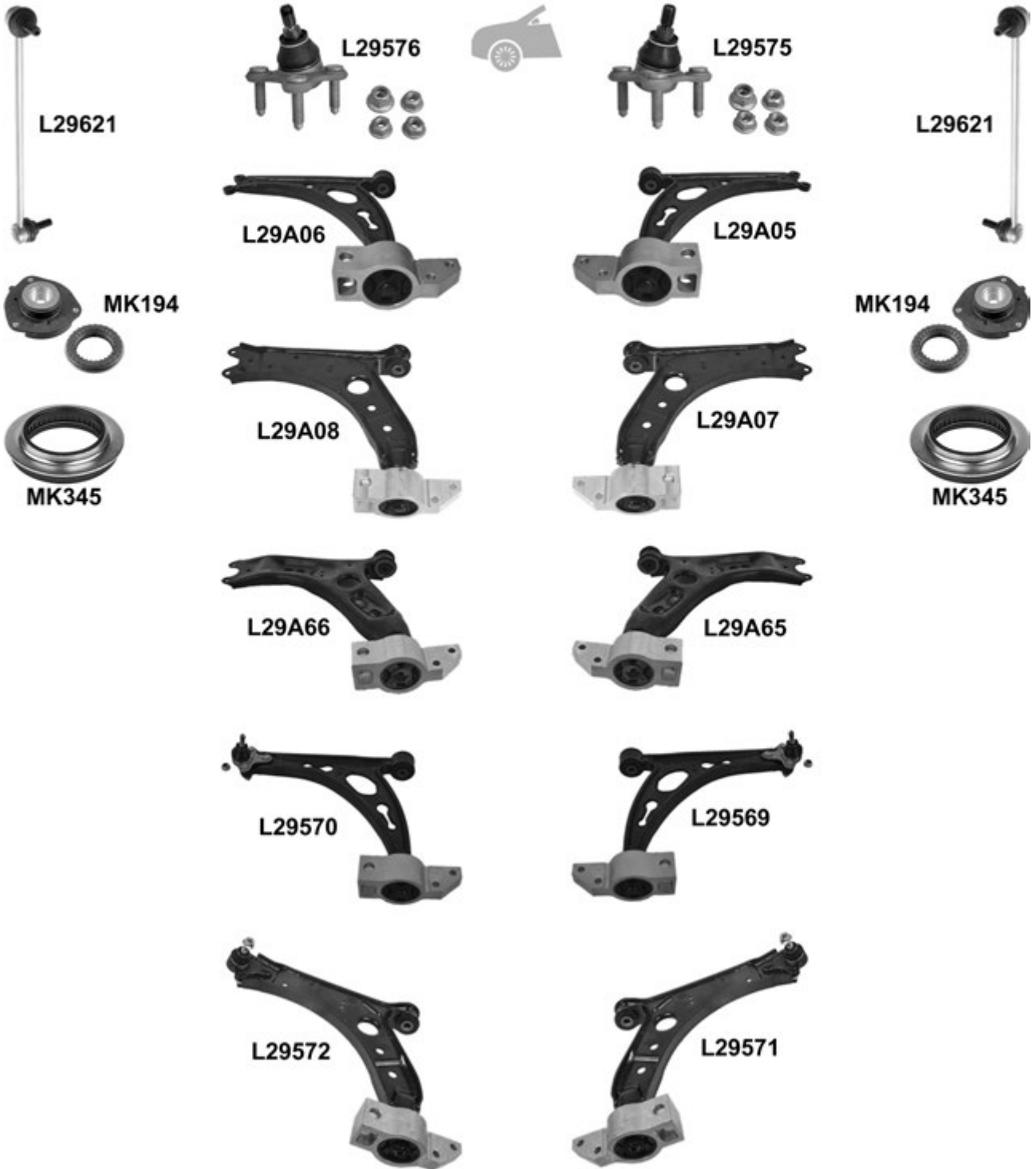
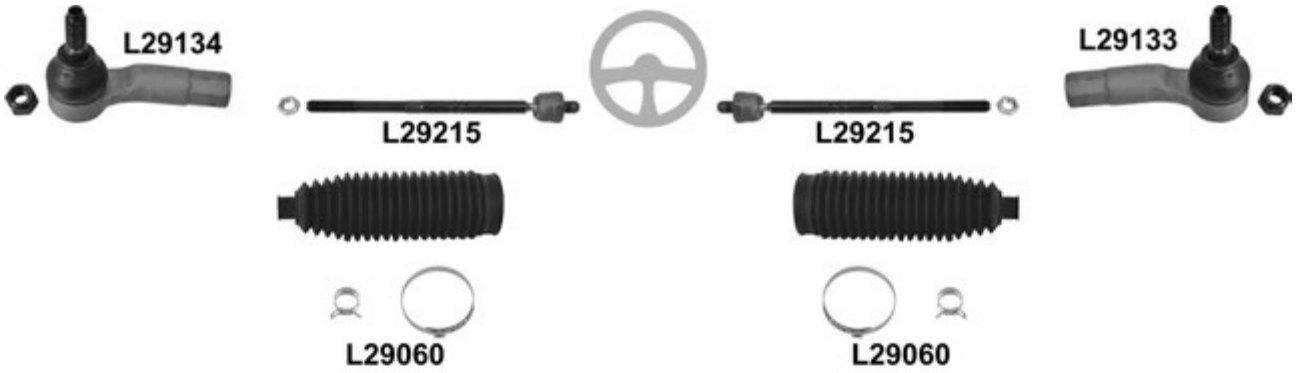

Golf V (1K1) 10.03 →



Golf V (1K1) 10.03 →

				←	→	Thread	Part Of	QPA			
		↔			L29133	F 16x1,5 ∪		1	1K0 423 812 E		
					L29134	F 16x1,5 ∪		1	1K0 423 811 E		
					L29215	L29215	M 16x1,5 / M 16x1,5 ∪		2	1K0 423 810 A	
			Electronic		L29060	L29060			2	1K0 423 831 A	
		⊥			L29575			1	1K0 407 366 C		
					L29576			1	1K0 407 365 C		
		⊥	(-) (+)			L29A05			1	1K0 407 152 M	
						L29A06			1	1K0 407 151 M	
			(-) (+)			L29A07			1	1K0 407 152 P	
						L29A08			1	1K0 407 151 P	
			(-) (+)			L29A65			1	1K0 407 152 BC	
						L29A66			1	1K0 407 151 BC	
				<input checked="" type="checkbox"/>			L29569			1	1K0 407 152 M
							L29570			1	1K0 407 151 M
		<input checked="" type="checkbox"/>			L29571			1	1K0 407 152 P		
					L29572			1	1K0 407 151 P		
		<input checked="" type="checkbox"/>			L29A67			1	1K0 407 152 BC		
					L29A68			1	1K0 407 151 BC		
		⊥▼			L29861				1	1K0 199 232 G	
					L29876				1	1K0 199 231 G	
		⊥▲			L29862	L29862			2	1K0 407 182	
				L29621	L29621			2	1K0 411 315 D		
		(+) MK345	KIT	MK194	MK194			2	1K0 412 331 B		
				MK345	MK345			2	6N0 412 249 C		
		⊥▲			L29A11	L29A11		2	4K0 505 323 N		
		⊥	<input checked="" type="checkbox"/>		L29A29	L29A29		2	1K0 505 311 AB		
		▲			L29637			1	1K0 501 530 C		
					L29638			1	1K0 501 529 F		
				L29623	L29623		2	1K0 505 465 J			

Golf V Plus (5M1) 01.05 → 01.09

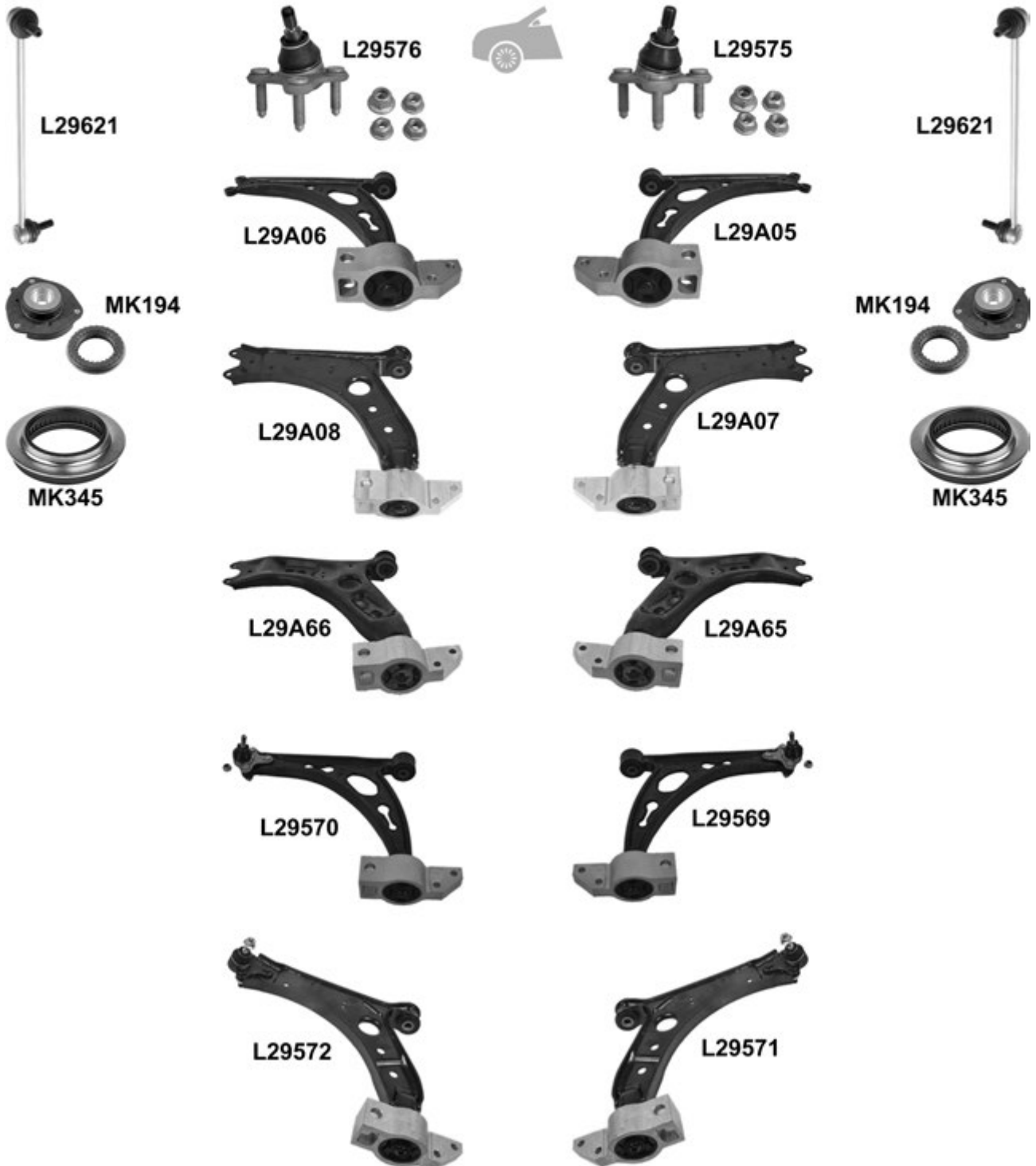
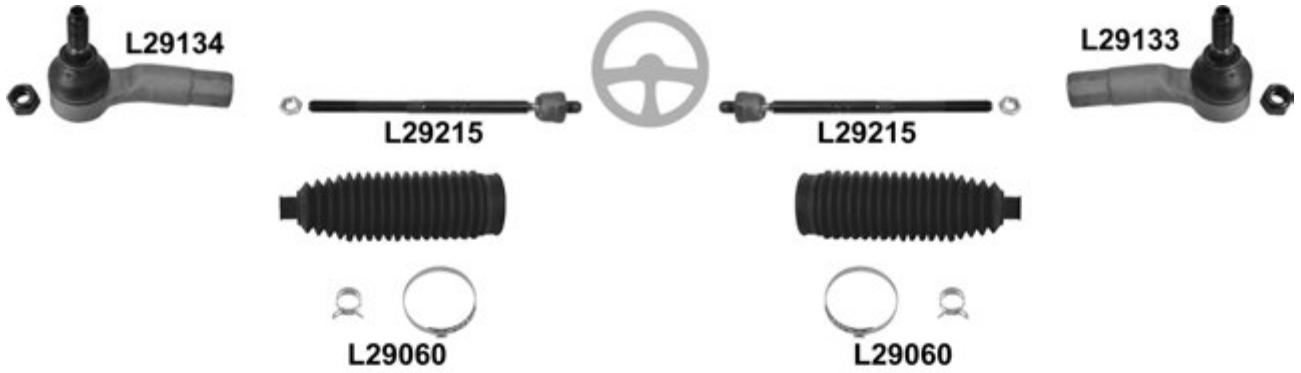

Golf V Plus (5M1) 01.05 → 01.09



Golf V Plus (5M1) 01.05 → 01.09

			←	→	Thread	Part Of	QPA			
		↔		L29133	F 16x1,5 ⤴		1	1K0 423 812 E		
				L29134	F 16x1,5 ⤴		1	1K0 423 811 E		
				L29215	L29215	M 16x1,5 / M 16x1,5 ⤴	2	1K0 423 810 A		
			Electronic	L29060	L29060		2	1K0 423 831 A		
		⊥			L29575		1	1K0 407 366 C		
					L29576		1	1K0 407 365 C		
		⊥	(-) , (+)			L29A05		1	1K0 407 152 M	
						L29A06		1	1K0 407 151 M	
			(-) , (+)			L29A07		1	1K0 407 152 P	
						L29A08		1	1K0 407 151 P	
			(-) , (+)			L29A65		1	1K0 407 152 BC	
						L29A66		1	1K0 407 151 BC	
					<input checked="" type="checkbox"/>		L29569		1	1K0 407 152 M
					<input checked="" type="checkbox"/>		L29570		1	1K0 407 151 M
					<input checked="" type="checkbox"/>		L29571		1	1K0 407 152 P
					<input checked="" type="checkbox"/>		L29572		1	1K0 407 151 P
			<input checked="" type="checkbox"/>		L29A67		1	1K0 407 152 BC		
			<input checked="" type="checkbox"/>		L29A68		1	1K0 407 151 BC		
			<input checked="" type="checkbox"/>		L29A49 ⁰		1	1K0 407 152 BD		
			<input checked="" type="checkbox"/>		L29A50 ⁰		1	1K0 407 151 BD		
		⊥	⤵			L29861		1	1K0 199 232 G	
						L29876		1	1K0 199 231 G	
		⊥	⤴			L29862	L29862	2	1K0 407 182	
						L29621	L29621	2	1K0 411 315 D	
		(+) MK345		KIT	MK194	MK194	2	1K0 412 331 B		
					MK345	MK345	2	6N0 412 249 C		
		⤴			L29A11	L29A11	2	4K0 505 323 N		
		⊥			L29A29	L29A29	2	1K0 505 311 AB		
		⊥	⤴			L29A87 ⁰		Trailing Arm	1	1K0 505 224 K
					L29A88 ⁰		Trailing Arm	1	1K0 505 222 K	
		⤴	→ 11.08, ch. → 1K9 855 000			L29637		1	1K0 501 530 C	
						L29638		1	1K0 501 529 F	
					L29623	L29623	2	1K0 505 465 J		
		PR 1JB, <input type="checkbox"/> HD			MK386	MK386	2	1K0 513 353 R		

Golf V Plus (521) 01.09 →

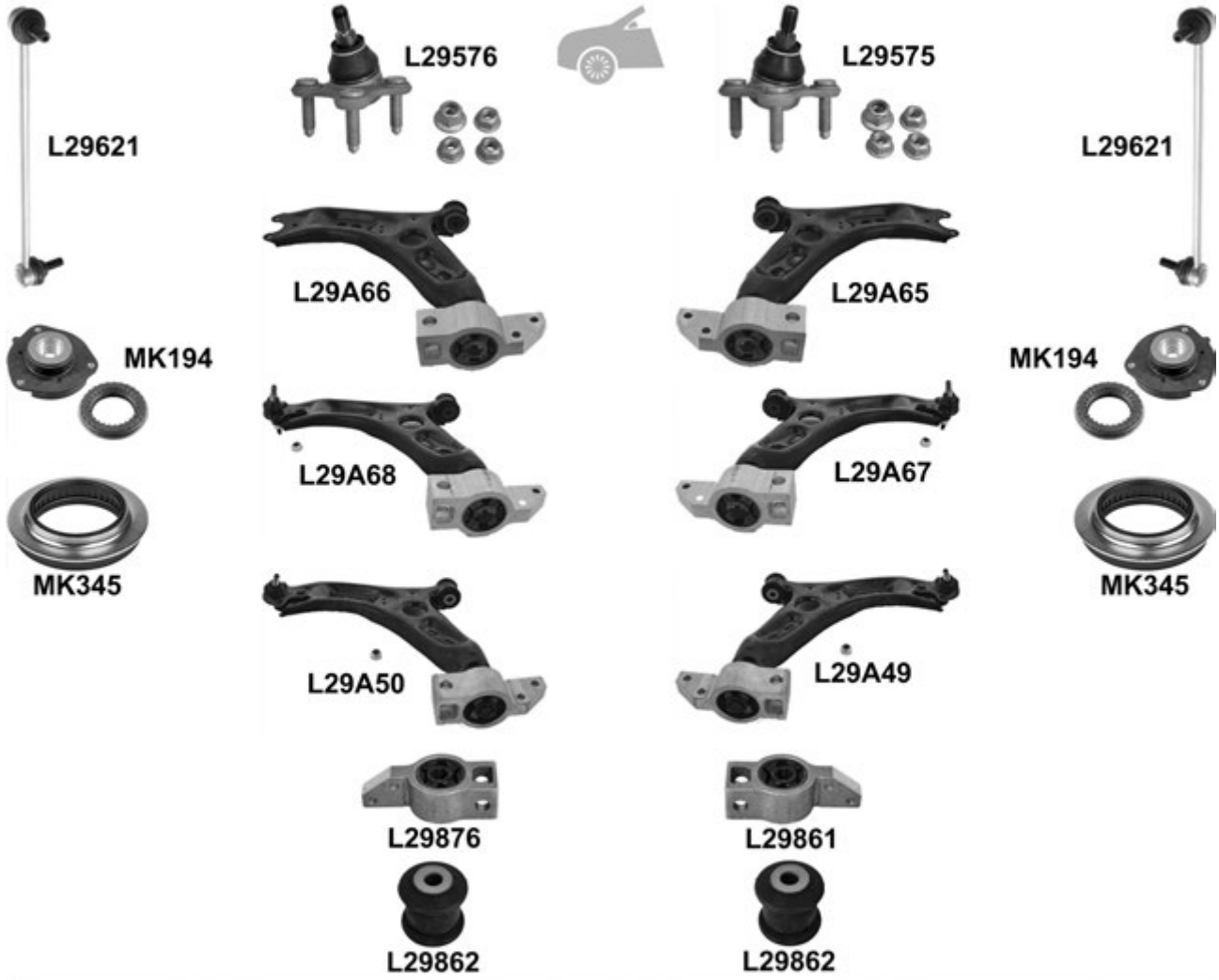
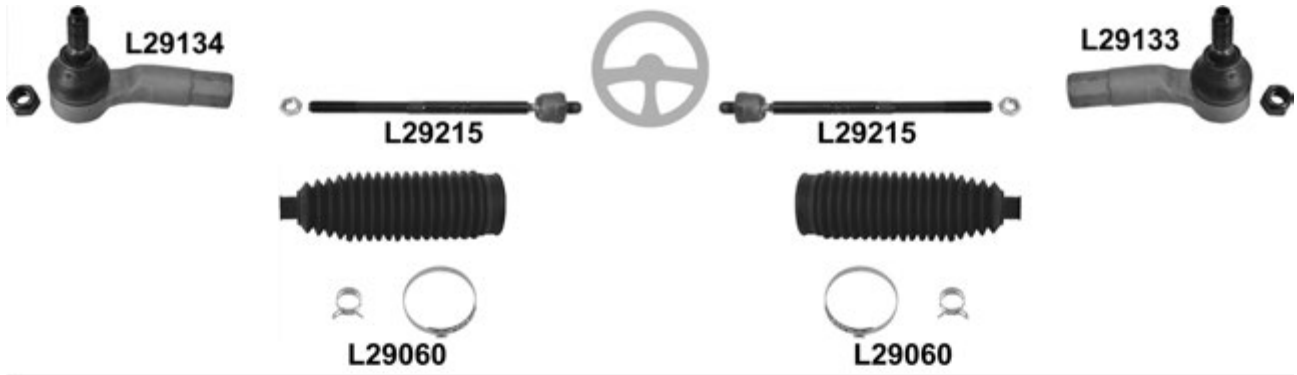

Golf V Plus (521) 01.09 →

				←	→	Thread	Part Of	QPA		
		↔		L29133		F 16x1,5 ∩		1	1K0 423 812 E	
				L29134		F 16x1,5 ∩		1	1K0 423 811 E	
				L29215	L29215	M 16x1,5 / M 16x1,5 ∩		2	1K0 423 810 A	
			Electronic	L29060	L29060			2	1K0 423 831 A	
		⊥		L29576	L29575			1	1K0 407 366 C	
		⊥		L29576				1	1K0 407 365 C	
		⊥		(-) , (+)	L29A65				1	1K0 407 152 BC
					L29A66				1	1K0 407 151 BC
					L29A67	<input checked="" type="checkbox"/>			1	1K0 407 152 BC
					L29A68				1	1K0 407 151 BC
		⊥	↙		L29A49 ⁰	<input checked="" type="checkbox"/>			1	1K0 407 152 BD
					L29A50 ⁰				1	1K0 407 151 BD
		⊥	↘		L29861				1	1K0 199 232 G
			↘		L29876				1	1K0 199 231 G
			↗		L29862	L29862			2	1K0 407 182
					L29621	L29621			2	1K0 411 315 D
				(+) MK345	KIT	MK194	MK194		2	1K0 412 331 B
					MK345	MK345			2	6N0 412 249 C
		↕	→ 05.12	L29A11	L29A11			2	4K0 505 323 N	
		⊥		L29A29	L29A29			2	1K0 505 311 AB	
		⊥ ↗			L29A87 ⁰			Trailing Arm	1	1K0 505 224 K
	⊥ ↗			L29A88 ⁰			Trailing Arm	1	1K0 505 222 K	
				L29623	L29623			2	1K0 505 465 J	
				PR 1JB, HD	MK386	MK386			2	1K0 513 353 R

Golf VI (5K1) 10.08 →

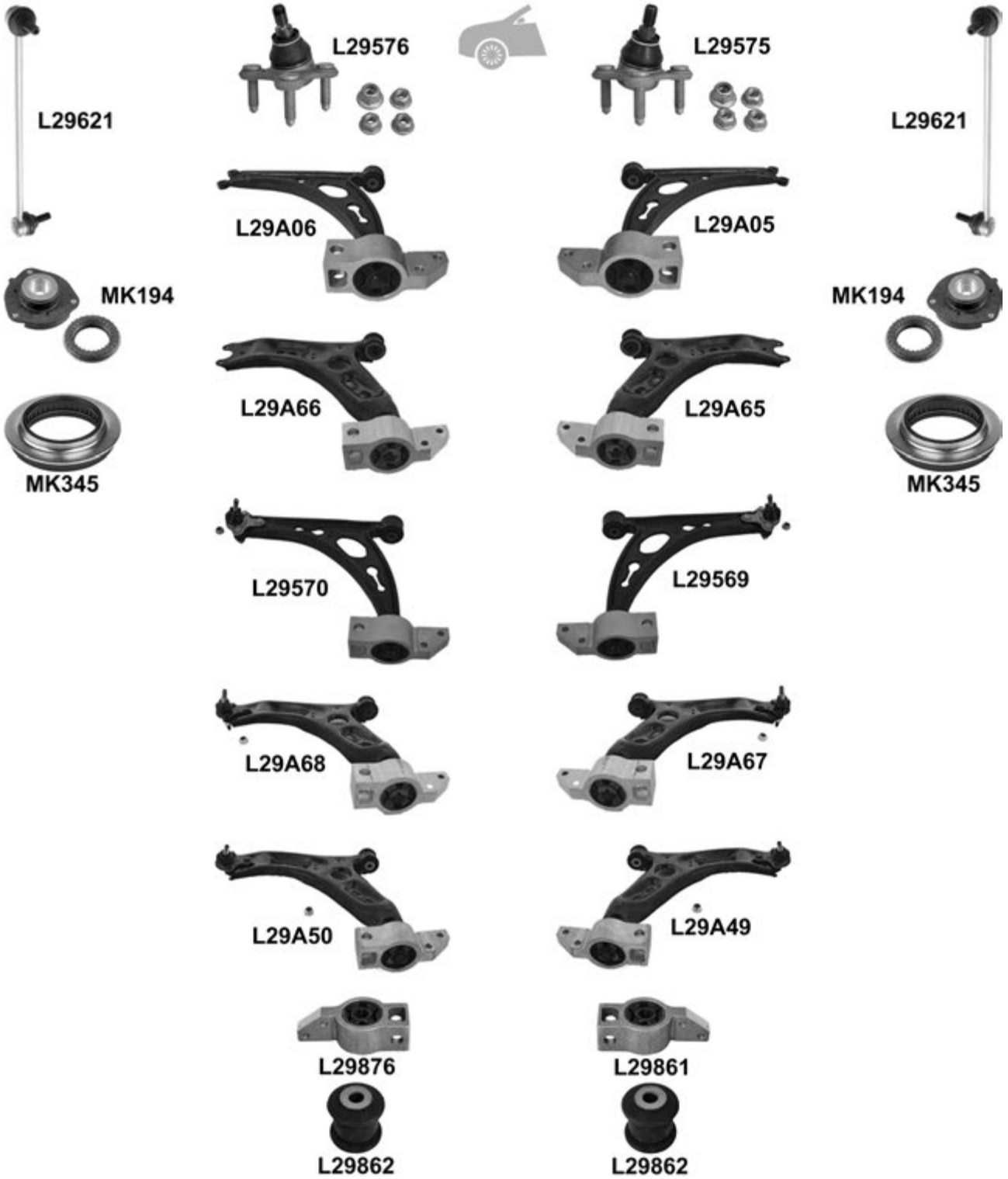
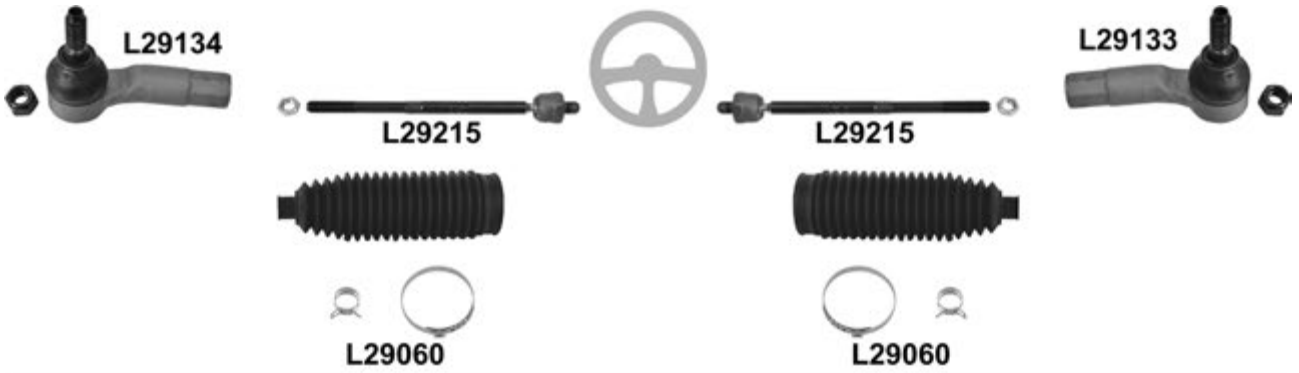

Golf VI (5K1) 10.08 →

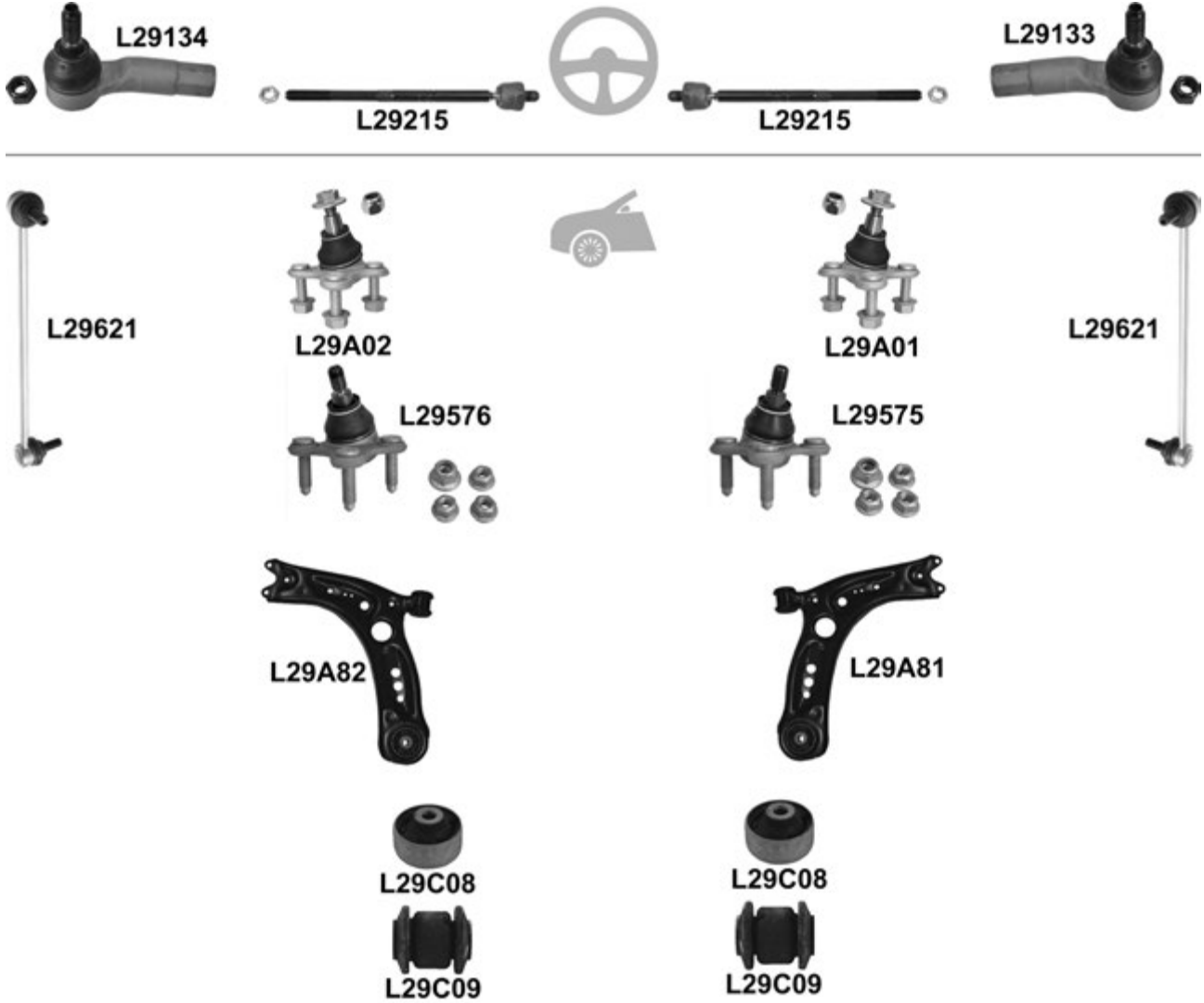

				← → Thread		Part Of	QPA				
⊕	↔			L29133	F 16x1,5 ∪		1	1K0 423 812 E			
				L29134	F 16x1,5 ∪		1	1K0 423 811 E			
	⌋			L29215	L29215	M 16x1,5 / M 16x1,5 ∪		2	1K0 423 810 A		
			Electronic	L29060	L29060			2	1K0 423 831 A		
⊖	⌋						1	1K0 407 366 C			
						L29576		1	1K0 407 365 C		
	⌋	(-) ⊕, (+) ⊖, ⊕					L29A05		1	1K0 407 152 M	
							L29A06		1	1K0 407 151 M	
		(-) ⊕, (+) ⊖, ∞					L29A65		1	1K0 407 152 BC	
							L29A66		1	1K0 407 151 BC	
		⊕	<input checked="" type="checkbox"/>			L29569		1	1K0 407 152 M		
			<input checked="" type="checkbox"/>			L29570		1	1K0 407 151 M		
		∞	<input checked="" type="checkbox"/>			L29A67		1	1K0 407 152 BC		
		<input checked="" type="checkbox"/>			L29A68		1	1K0 407 151 BC			
		<input checked="" type="checkbox"/>	03.10 →, PR F5F, ∞		L29A49 ⁰		1	1K0 407 152 BD			
					L29A50 ⁰		1	1K0 407 151 BD			
	⌋	⌋					L29861		1	1K0 199 232 G	
							L29876		1	1K0 199 231 G	
	⌋					L29862	L29862		2	1K0 407 182	
	⌋					L29621	L29621		2	1K0 411 315 D	
⊖	⌋		(+) MK345	KIT	MK194	MK194		2	1K0 412 331 B		
					MK345	MK345		2	6N0 412 249 C		
	⌋	↔	→ 05.12		L29A11	L29A11		2	4K0 505 323 N		
		⌋			L29A29	L29A29		2	1K0 505 311 AB		
		⌋				L29A87 ⁰		1	1K0 505 224 K	Trailing Arm	
	⌋	⌋				L29A88 ⁰		1	1K0 505 222 K	Trailing Arm	
↔		→ 11.08			L29637		1	1K0 501 530 C			
					L29638		1	1K0 501 529 F			
⌋	⌋				L29623	L29623		2	1K0 505 465 J		
			HD/⚡		MK386	MK386		2	3C0 513 353 C		
			PR 1JR/UC2, HD/SP		MK386	MK386		2	3C0 513 353 C		

Golf VII (5G1) 11.12 →
 E-Golf (BE1) 03.14 →

				←	→	Thread	Part Of	QPA		
		↔			L29133	F 16x1,5 ∪		1	1K0 423 812 E	
					L29134	F 16x1,5 ∪		1	1K0 423 811 E	
		⊥	PR 1LV/1ZA/1ZB/1ZD PR 1ZE/1ZF/1ZP, E-Golf		L29A01			1	3C0 407 366 A	
					L29A02			1	3C0 407 365 A	
					L29575			1	5Q0 407 366 A	
					L29576			1	5Q0 407 365 A	
		⊥	(-) 1.4 16V, PR GOK, (-) , (+)		L29A81 ⁰			1	5Q0 407 152 J	
					L29A82 ⁰			1	5Q0 407 151 J	
	⊥	(-) 1.4 16V, Mot/Eng CPTA, , PR GOK		L29C08	L29C08			2	5Q0 407 183 E	
				L29C09	L29C09			2	5Q0 407 182	
				L29621	L29621			2	5Q0 411 315 A	

Golf Cabriolet (155) 01.79 → 08.93 ch. 159 2800 001 →

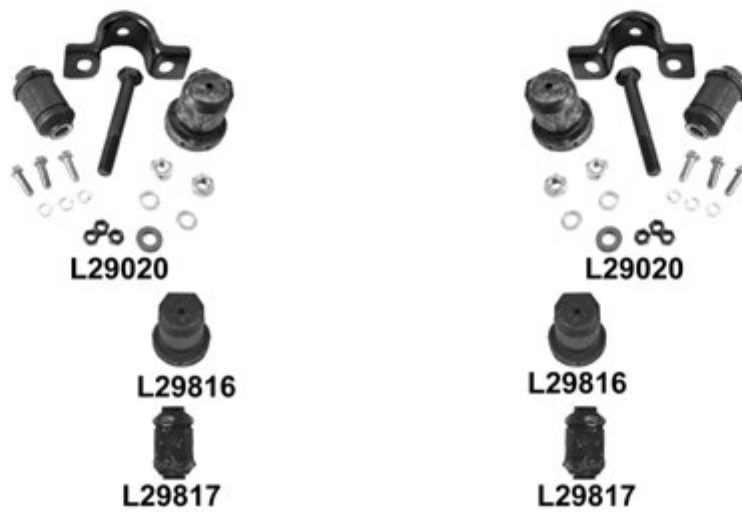
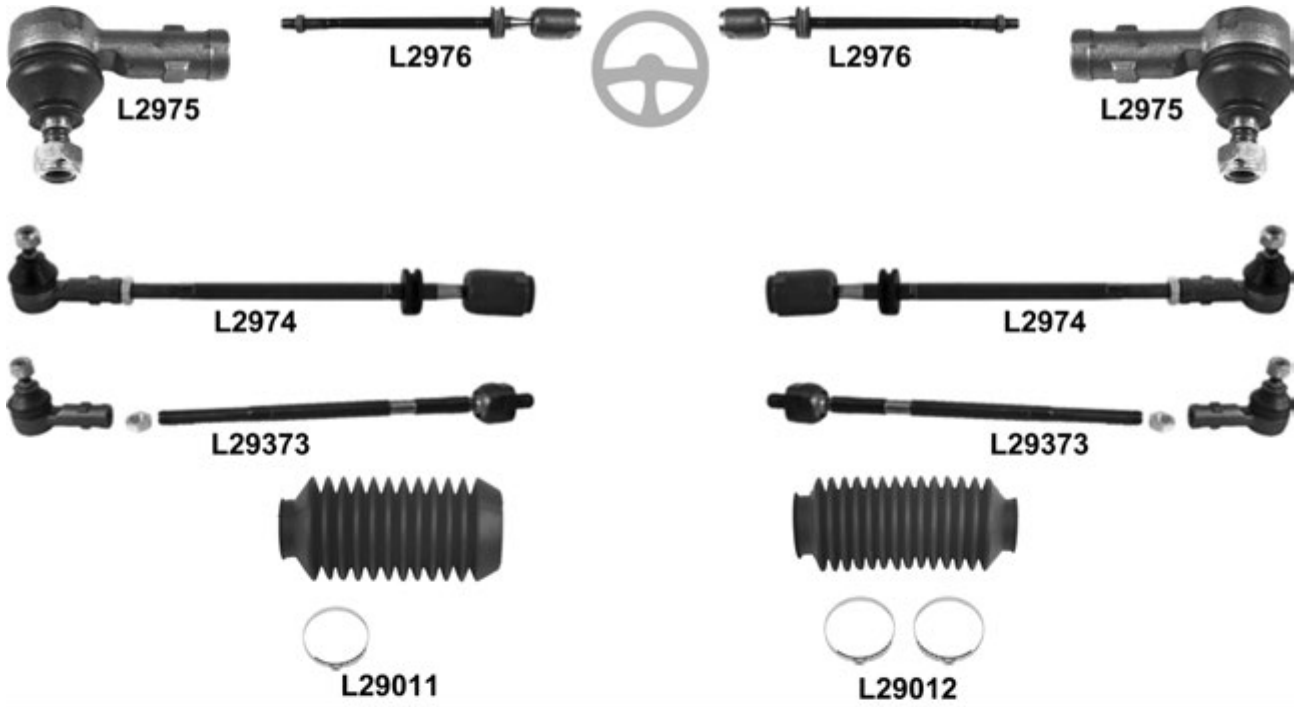

Golf Cabriolet (155) 01.79 → 08.93 ch. 159 2800 001 →

			←	→	Thread	Part Of	QPA	
		↔	L2975	L2975	F 14x1,5 ☺		2	171 419 812
		(-)	L2976	L2976			2	171 419 821 A
		(-)	L2974	L2974			2	171 419 804 A
			L29373	L29373			2	175 422 803 A
				L29012			1	171 419 831 A
			L29011			1	171 419 831 B	
		⊥	L2978	L2978			2	171 407 365 G
		⊥	L29013	L29013			2	171 407 153 D
			L29020	L29020			2	171 498 153 X0
		⊥ ▾	L29816	L29816			2	171 407 181 A
		⊥ ▲	L29817	L29817			2	171 407 182 D
			MK070	MK070			2	171 412 329 A

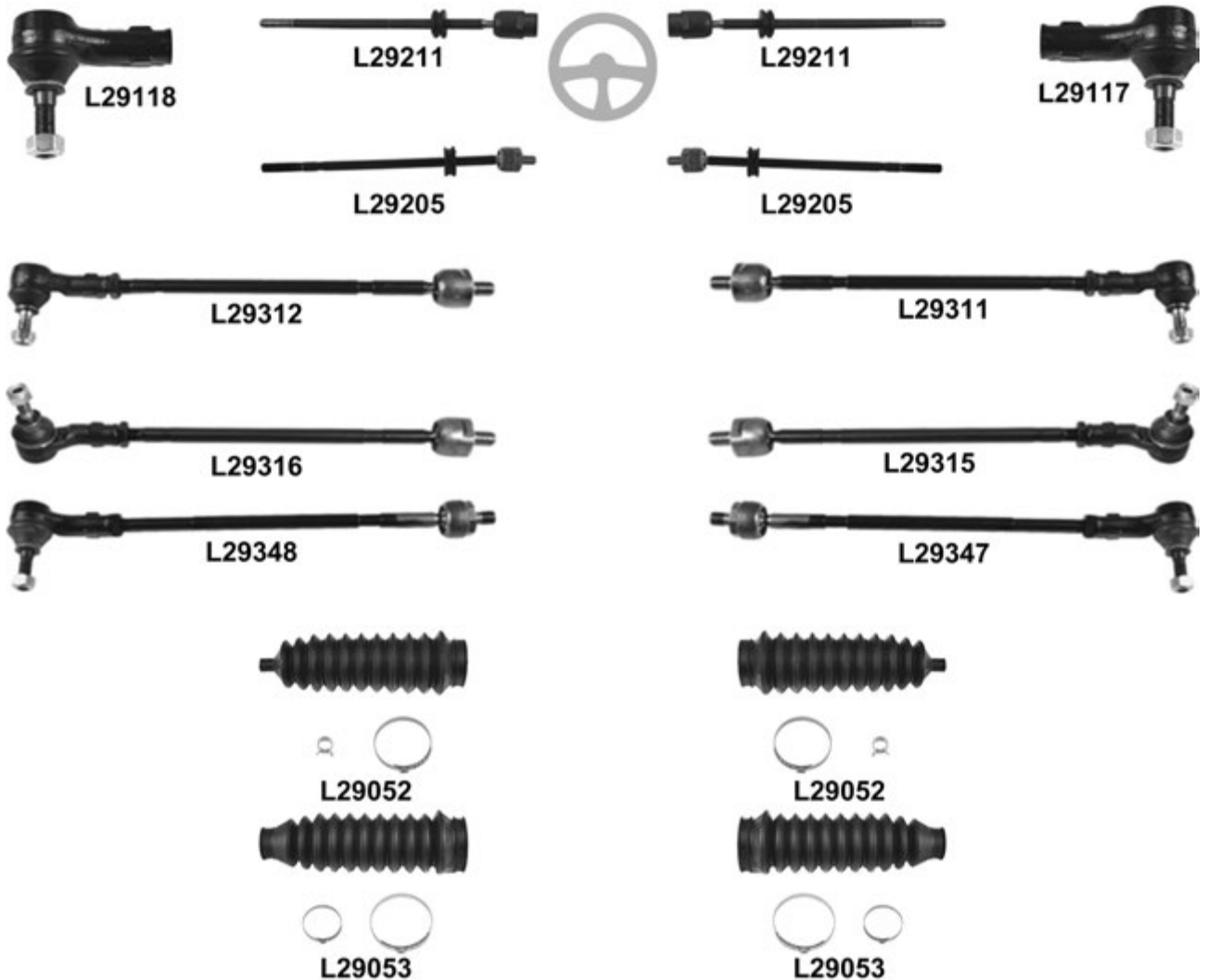
Golf Cabriolet III (1E) 07.93 → 05.98

Golf Cabriolet III (1E) 07.93 → 05.98

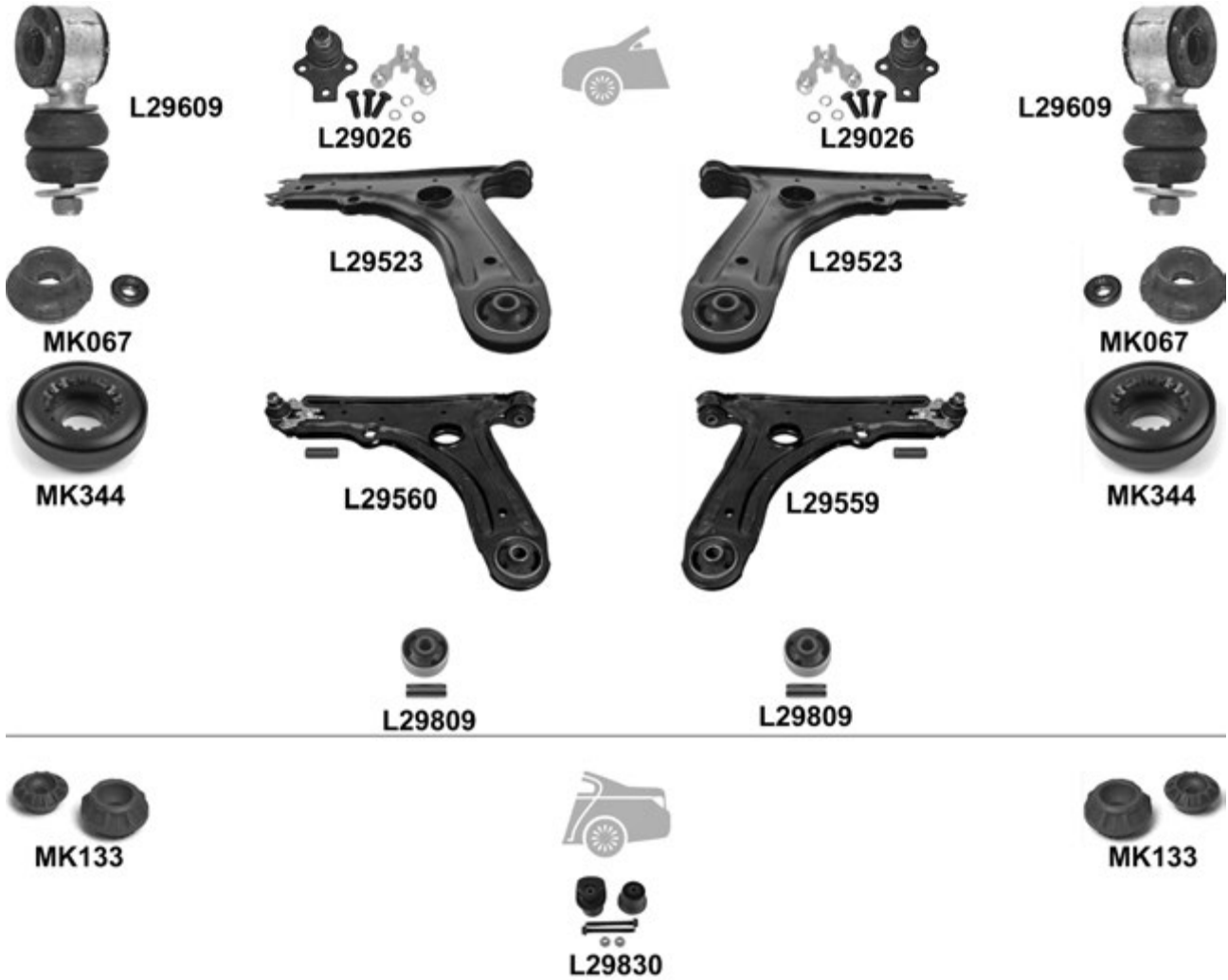

		i		←	→	Thread	Part Of	QPA	i		
		↔			L29117	↻		1	3A0 422 812		
					L29118	↻		1	3A0 422 811		
						L29211	L29211			2	
					ch. → 1E R 030 000, TRW	L29205	L29205			2	1H0 422 821 A
				↕	ch. → 1E R 030 000, TRW		L29311			1	1H0 422 804
							L29312			1	1H0 422 803
					ch. → 1E R 30 000, ZF		L29315			1	1H0 422 804 B
							L29316			1	1H0 422 803 B
					ch. 1E S 000 001 →, TRW		L29347			1	1H0 422 804 D
						L29348			1	1H0 422 803 D	
				↕	TRW, ch. → 1E S 024 000	L29052	L29052			2	191 422 831
					TRW, ch. 1E S 024 001 →	L29053	L29053			2	1H0 422 831 B
					ZF	L29053	L29053			2	357 422 831 B
		↕		L29026	L29026			2	357 407 365 A		
			(-) , (+)	L29523	L29523			2	1H0 407 151		
				(-) 2.0 <input checked="" type="checkbox"/>	L29559			1	1H0 407 151		
				L29560			1	1H0 407 151			
				↕		L29809	L29809			2	191 407 181 E
						L29609	L29609			2	191 411 315 BS
					(+) MK344	KIT	MK067	MK067		2	357 412 331 A
							MK344	MK344			2
		(-) Syncro	KIT	L29830			Hub carrier	1	1H0 501 541 AS		
					MK133	MK133		2	191 512 333 S1		

Golf Cabriolet IV (1E7) 06.98 →

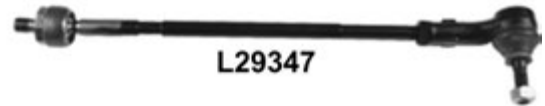
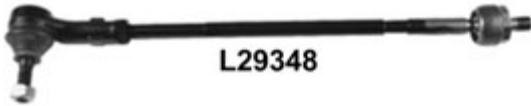
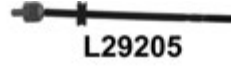
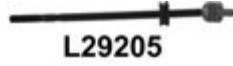

Golf Cabriolet IV (1E7) 06.98 →



				← → Thread		Part Of	QPA			
⊕		↔		L29117	↺		1	3A0 422 812		
				L29118	↺		1	3A0 422 811		
		⊕ (TRW)		L29205	L29205		2	1H0 422 807 D		
				L29347			1	1H0 422 804 D		
		⊕ (TRW)		L29348			1	1H0 422 803 D		
			⊕ (TRW)	L29052	L29052		2	1H0 422 831		
	⊕ (ZF)	L29053	L29053		2	357 422 831 B				
🚗		⊥		L29026	L29026		2	357 407 365 A		
				L29523	L29523		2	1H0 407 151		
		⊥			L29559			1	1H0 407 151	
				<input checked="" type="checkbox"/>	L29560			1	1H0 407 151	
		⊥	↘	L29809	L29809		2	191 407 181 E		
			↙	L29808	L29808		2	357 407 182		
				L29609	L29609		2	191 411 315 BS		
			∅ 17mm	L29853	L29853		2	1J0 411 314 B	Anti-roll bar	
			∅ 21mm	L29852	L29852		2	1J0 411 314 C	Anti-roll bar	
			∅ 23mm	L29865	L29865		2	1J0 411 314 G	Anti-roll bar	
			(+) MK344	KIT	MK067	MK067		2	357 412 331 A	
			MK344	MK344		2	1J0 412 249			
🚗			KIT	L29830			1	1H0 501 541 AS	Hub carrier	
				MK133	MK133		2	191 512 333 S1		

Golf Cabriolet VI (517) 03.11 →

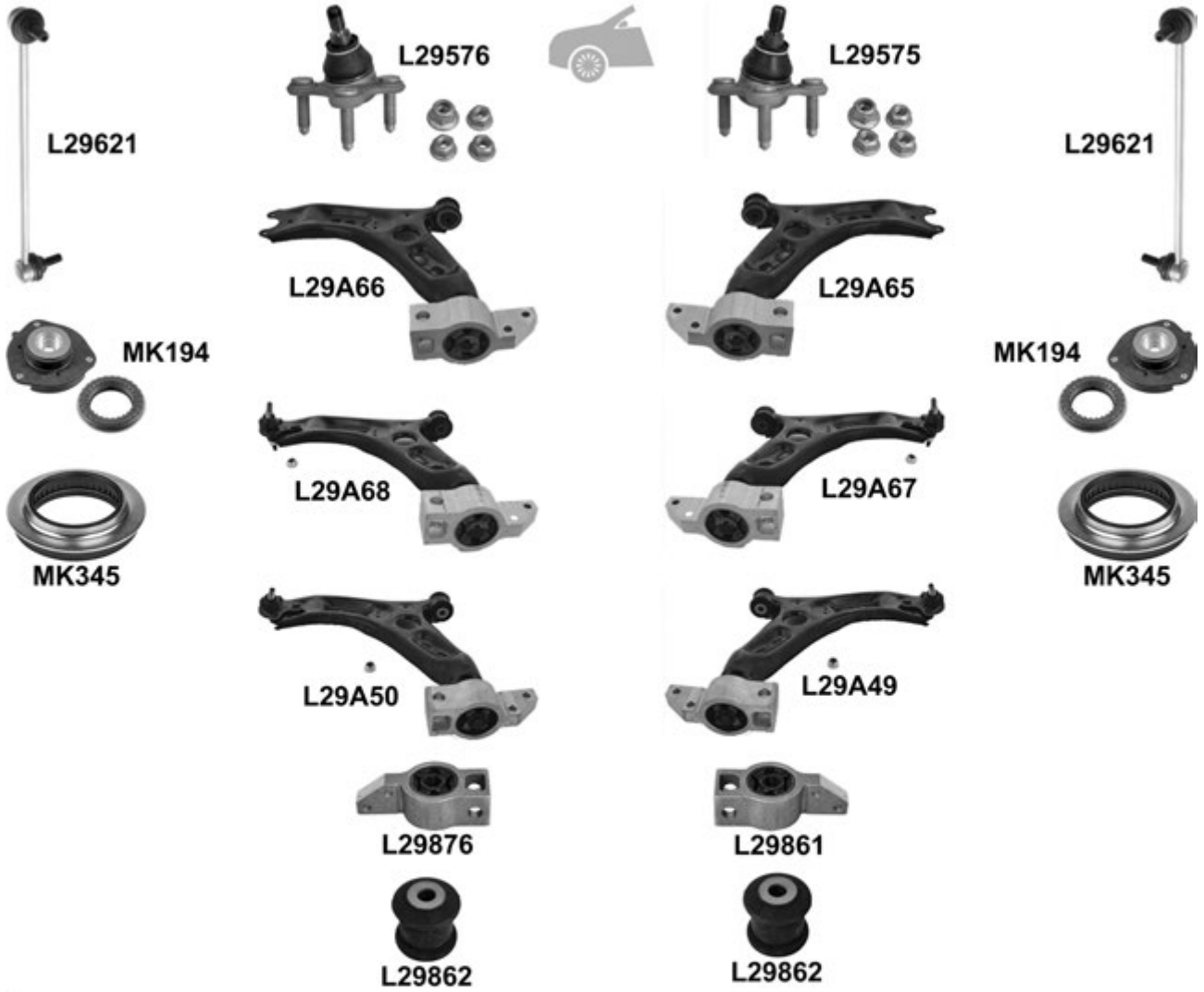

Golf Cabriolet VI (517) 03.11 →

				←	→	Thread	Part Of	QPA	
		↔		L29133		F 16x1,5 ♂		1	1K0 423 812 E
				L29134		F 16x1,5 ♂		1	1K0 423 811 E
				L29215	L29215	M 16x1,5 / M 16x1,5 ♂		2	1K0 423 810 A
		⊥		L29575				1	1K0 407 366 C
		⊥		L29576				1	1K0 407 365 C
		⊥	(-) , (+) ,	L29A65				1	1K0 407 152 BC
				L29A66				1	1K0 407 151 BC
				L29A67	<input checked="" type="checkbox"/>			1	1K0 407 152 BC
				L29A68				1	1K0 407 151 BC
			PR F5F, driving school,	L29A49 ⁰	<input checked="" type="checkbox"/>			1	1K0 407 152 BD
				L29A50 ⁰				1	1K0 407 151 BD
		⊥▼	(-) PR F5F	L29861				1	1K0 199 232 G
		⊥▲		L29876				1	1K0 199 231 G
		⊥▲		L29862	L29862			2	1K0 407 182
				L29621	L29621			2	1K0 411 315 D
		(+) MK345	MK194	MK194	KIT		2	1K0 412 331 B	
			MK345	MK345			2	6N0 412 249 C	
		⌈	→ 05.12	L29A11	L29A11			2	4K0 505 323 N
		⊥		L29A29	L29A29			2	1K0 505 311 AB
		⊥▲		L29A87 ⁰			Trailing Arm	1	1K0 505 224 K
				L29A88 ⁰			Trailing Arm	1	1K0 505 222 K
				L29623	L29623			2	1K0 505 465 J
				MK386	MK386			2	3C0 513 353 C

Golf Sportsvan (AM1) 02.14 →

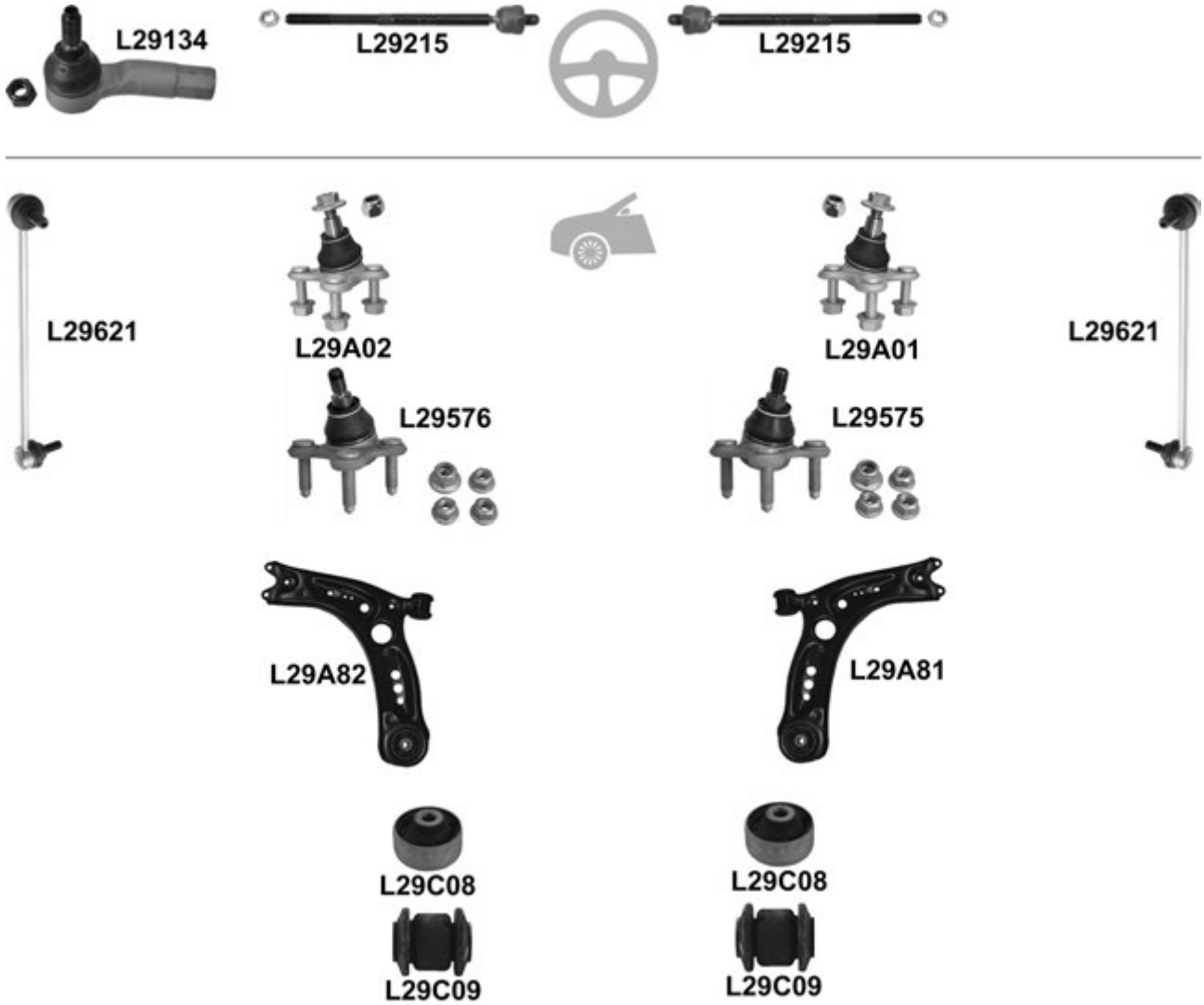

				← → Thread		Part Of	QPA		
		↔		L29134		F 16x1,5 ∪	1	1K0 423 811 E	
					L29215	L29215	M 16x1,5 / M 16x1,5 ∪	2	1K0 423 810 A
		⊥	PR 1ZA		L29A01		1	3C0 407 366 A	
					L29A02		1	3C0 407 365 A	
			PR 1ZE/1ZF/1ZP		L29575		1	5Q0 407 366 A	
					L29576		1	5Q0 407 365 A	
	⊥	(-) (+)		L29A81 ⁰		1	5Q0 407 152 J		
				L29A82 ⁰		1	5Q0 407 151 J		
	⊥	↕		L29C08	L29C08		2	5Q0 407 183 E	
				L29C09	L29C09		2	5Q0 407 182	
				L29621	L29621		2	5Q0 411 315 A	

Golf Variant III (1HXO) 07.93 → 04.99

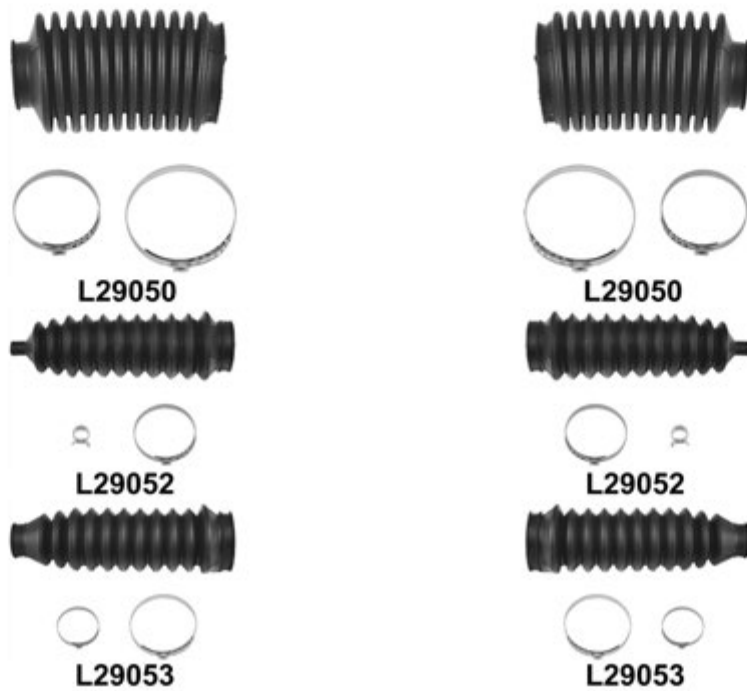
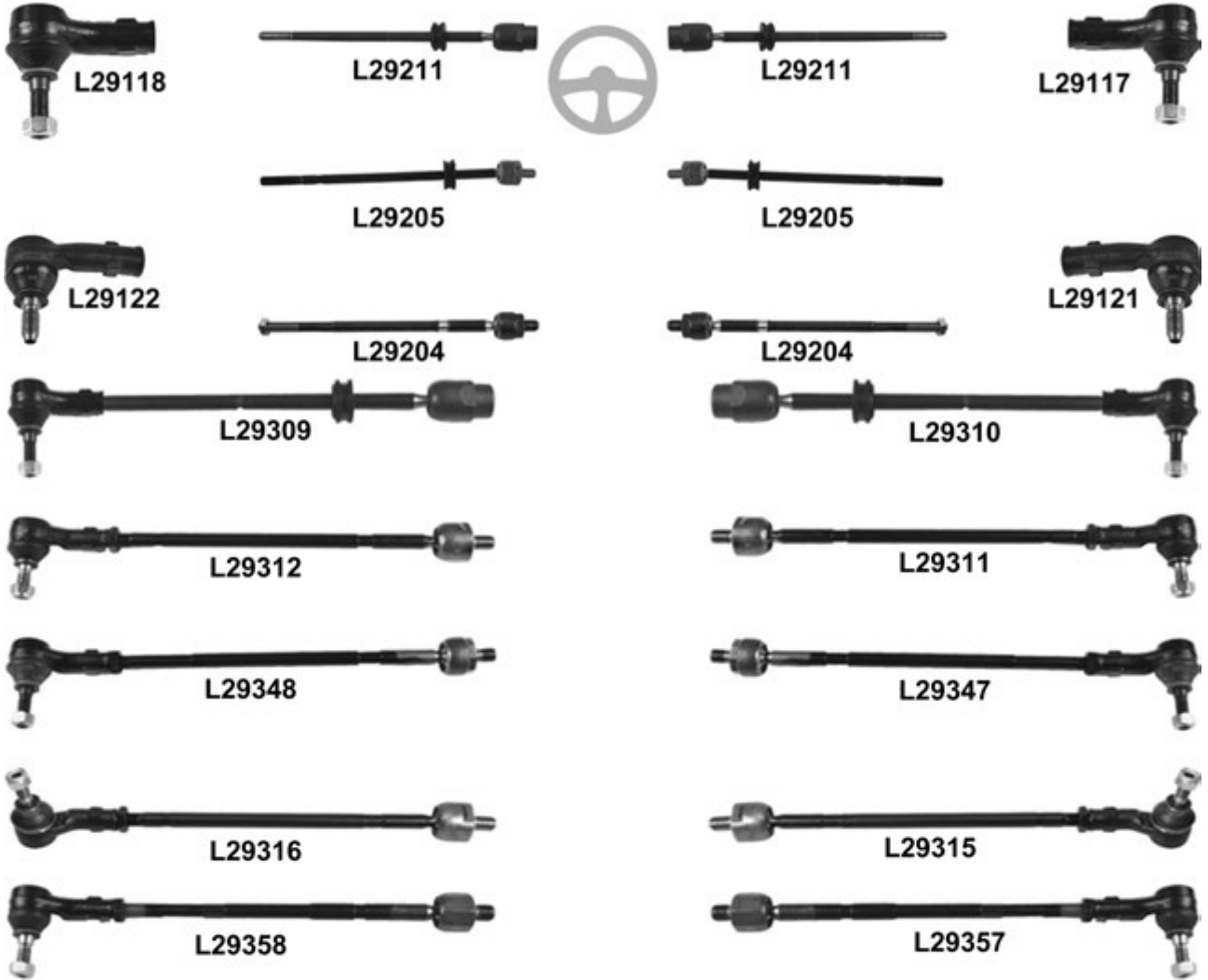

Golf Variant III (1HXO) 07.93 → 04.99

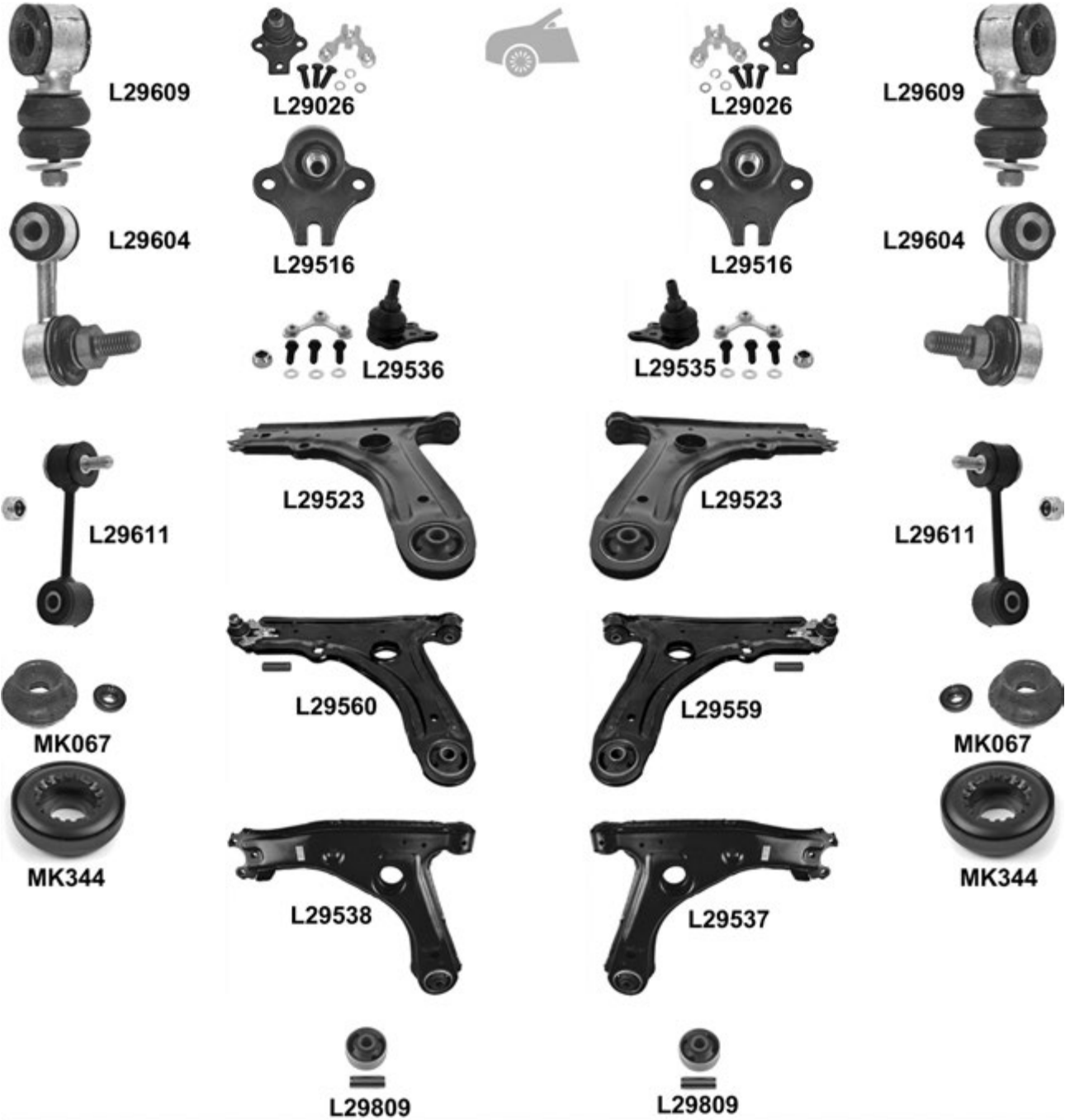

Golf Variant III (1HXO) 07.93 → 04.99

			←	→	Thread	Part Of	QPA	
				L29117	F 14x1,5 ♂		1	3A0 422 812
			L29118	F 14x1,5 ♂		1	3A0 422 811	
			(-) Sdi	L29117	F 14x1,5 ♂		1	3A0 422 812
			L29118	F 14x1,5 ♂		1	3A0 422 811	
	Sdi	L29121			1	1J0 422 812 A		
		L29122			1	1J0 422 811 A		
				L29211	L29211		2	
			ch. → 1HR 458 663, TRW, (-) VR6	L29205	L29205		2	1H0 422 821 A
			Sdi	L29204	L29204		2	1J0 422 807 A
					L29310		1	1H0 419 804
			L29309		1	1H0 419 803		
			ch. → 1HR 458 663, TRW		L29311		1	1H0 422 804
			L29312		1	1H0 422 803		
			TRW, ch. 1HR 458 664 →, (-) VR6		L29347		1	1H0 422 804 D
			L29348		1	1H0 422 803 D		
			TRW, VR6		L29311		1	1H0 422 804 A
			L29312		1	1H0 422 803 A		
			ZF, (-) Tdi 81 Kw		L29315		1	1H0 422 804 B
L29316				1	1H0 422 803 B			
Sdi	L29357		1	1J0 422 804 A				
	L29358		1	1J0 422 803 A				
			L29050	L29050		2	191 419 831	
		TRW	L29052	L29052		2	1H0 422 831	
		ZF	L29053	L29053		2	357 422 831 B	
		⊥	(-) VR6	L29026	L29026		2	357 407 365 A
			VR6	L29516	L29516		2	1H0 407 365
			Sdi		L29535		1	1J0 407 366 C
			L29536		1	1J0 407 365 C		
		⊥	(-) 2.0/16V/VR6/Sdi, (-) (+)	L29523	L29523		2	1H0 407 151
			(-) 2.0/16V/VR6 <input checked="" type="checkbox"/>		L29559		1	1H0 407 151
			L29560		1	1H0 407 151		
			VR6, (-) (+)		L29537		1	1H0 407 152
	L29538		1	1H0 407 151 A				
		⊥		L29809	L29809		2	191 407 181 E
			(-) VR6	L29609	L29609		2	191 411 315 BS
			VR6	L29604	L29604		2	535 411 315
Sdi			L29611	L29611		2	1J0 411 315 G	
		(+) MK344	KIT	MK067	MK067		2	357 412 331 A
				MK344	MK344		2	1J0 412 249
			KIT	L29833		Hub carrier	1	1H9 501 541 S
				MK133	MK133		2	191 512 333 S1

Golf Variant IV (1J5) 05.99 → 06.06

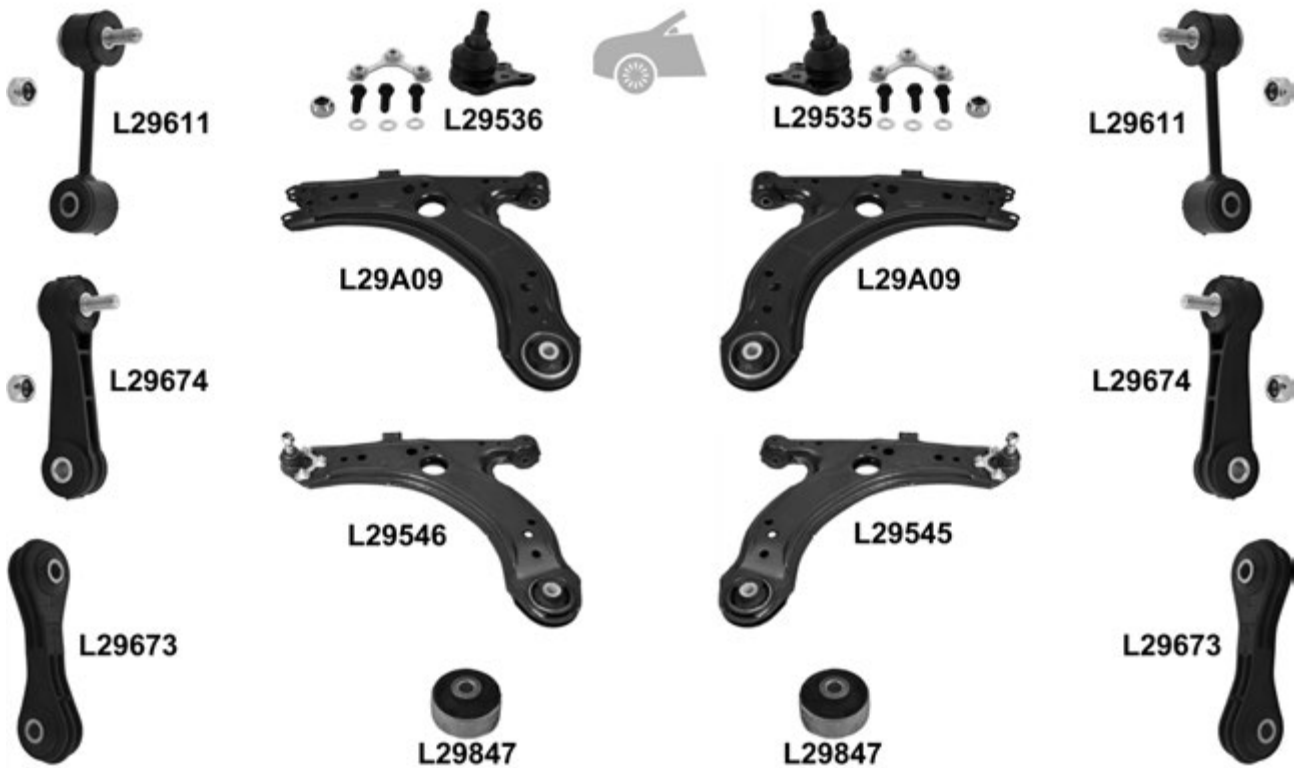
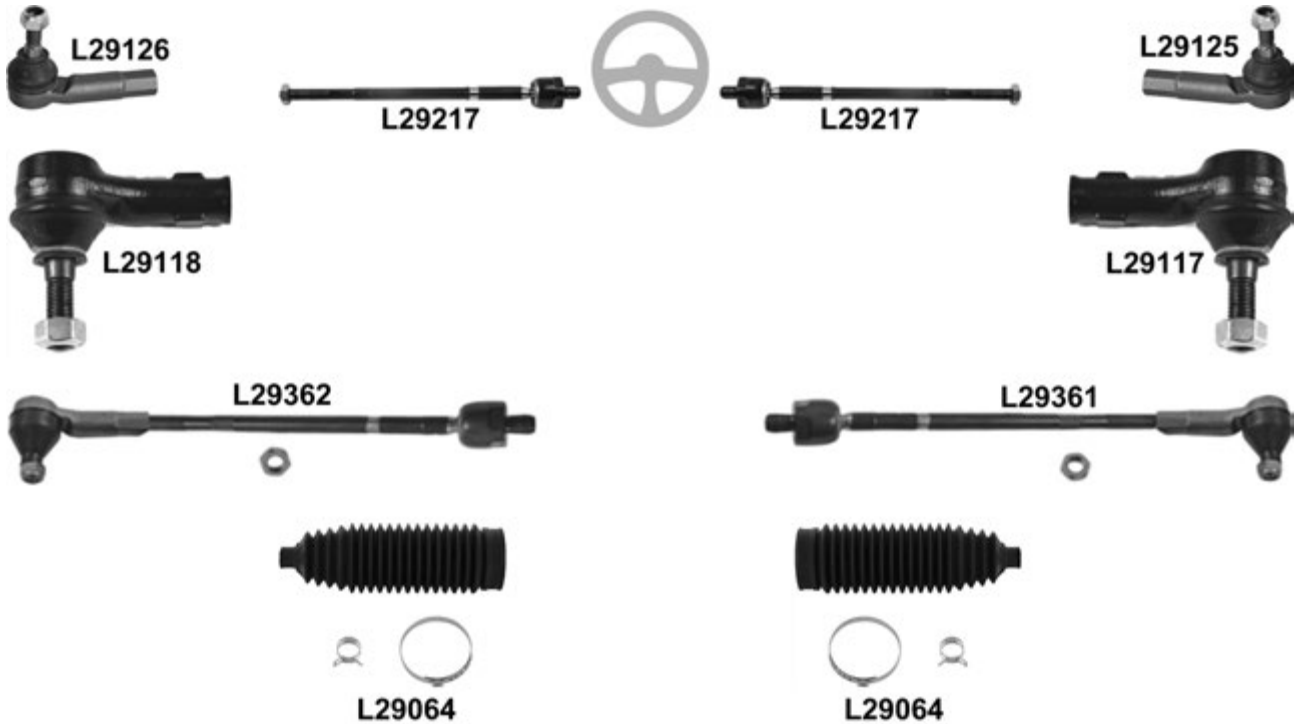

Golf Variant IV (1J5) 05.99 → 06.06



Golf Variant IV (1J5) 05.99 → 06.06

			←	→	Thread	Part Of	QPA			
		↔	(-) 4-motion		L29125			1	1J0 422 812 B	
				L29126				1	1J0 422 811 B	
					L29125			1	1J0 422 812 B	
				L29126				1	1J0 422 811 B	
					L29117		↻	1	3A0 422 812	
		L29118		↻	1	3A0 422 811				
				L29217	L29217			2	1J0 422 821 B	
					L29361			1	1J0 422 804 B	
				L29362				1	1J0 422 803 B	
				L29064 ⁰	L29064 ⁰			2	1J0 422 831 B	
		⊥			L29535			1	1J0 407 366 C	
					L29536			1	1J0 407 365 C	
		⊥	(-) , (+)		L29A09	L29A09			2	1J0 407 151 C
				<input checked="" type="checkbox"/>		L29545			1	
				L29546				1		
		⊥	↙		L29847	L29847			2	1J0 407 181
					L29808	L29808			2	357 407 182
		↔		PR OAE → 07.00 , (-) 4-motion, Metal	L29611	L29611			2	1J0 411 315 G
				PR OAE → 07.00 , (-) 4-motion, Plastic	L29674	L29674			2	1J0 411 315 C
				PR OAL/OAM, (-) 4-motion, Metal	L29611	L29611			2	1J0 411 315 G
				PR OAL/OAM, (-) 4-motion, Plastic	L29674	L29674			2	1J0 411 315 C
				PR OAE, (-) 4-motion	L29673	L29673			2	1J0 411 315 H
				4-motion		L29627			1	1J0 411 316 D
					L29628				1	1J0 411 315 D
				PR OAR, 08.03 →, ch. 1J4 220 001 →, ø 17mm/ø 19mm	L29853	L29853		Anti-roll bar	2	1J0 411 314 B
ø 21mm/ø 23mm				L29852	L29852		Anti-roll bar	2	1J0 411 314 C	
PR OAS, → 07.03 , ch. → 1J4 220 000, ø 23mm				L29865	L29865		Anti-roll bar	2	1J0 411 314 G	
PR OAE, ø 23mm				L29865	L29865		Anti-roll bar	2	1J0 411 314 G	
			L29851	L29851		Hub carrier	2	1J0 199 429		
			(+) MK344	KIT	MK077	MK077		2	1J0 412 331 BS	
					MK344	MK344			2	1J0 412 249
		↔	(-) 4-motion, ø 69mm	L29874			Hub carrier	1	1J0 501 541 D	
			(-) 4-motion, ø 74mm	L29849			Hub carrier	1	1J0 501 541 C	
				PR 1JA/1JB/1JD,	MK118	MK118			2	1J0 513 353 B
				PR 1JC/1JH, → 12.99 , ch. → 1JY 500 000	MK118	MK118			2	1J0 513 353 B
				GTi	MK118	MK118			2	1J0 513 353 D
				PR 1JC/1JH, 01.00 →, ch. 1JY 500 001 →	MK118	MK118			2	1J0 513 353 D
				PR 1JG/UA9/UB1/UB2	MK118	MK118			2	1J0 513 353 D

Golf Variant V (1K5) 06.07 →

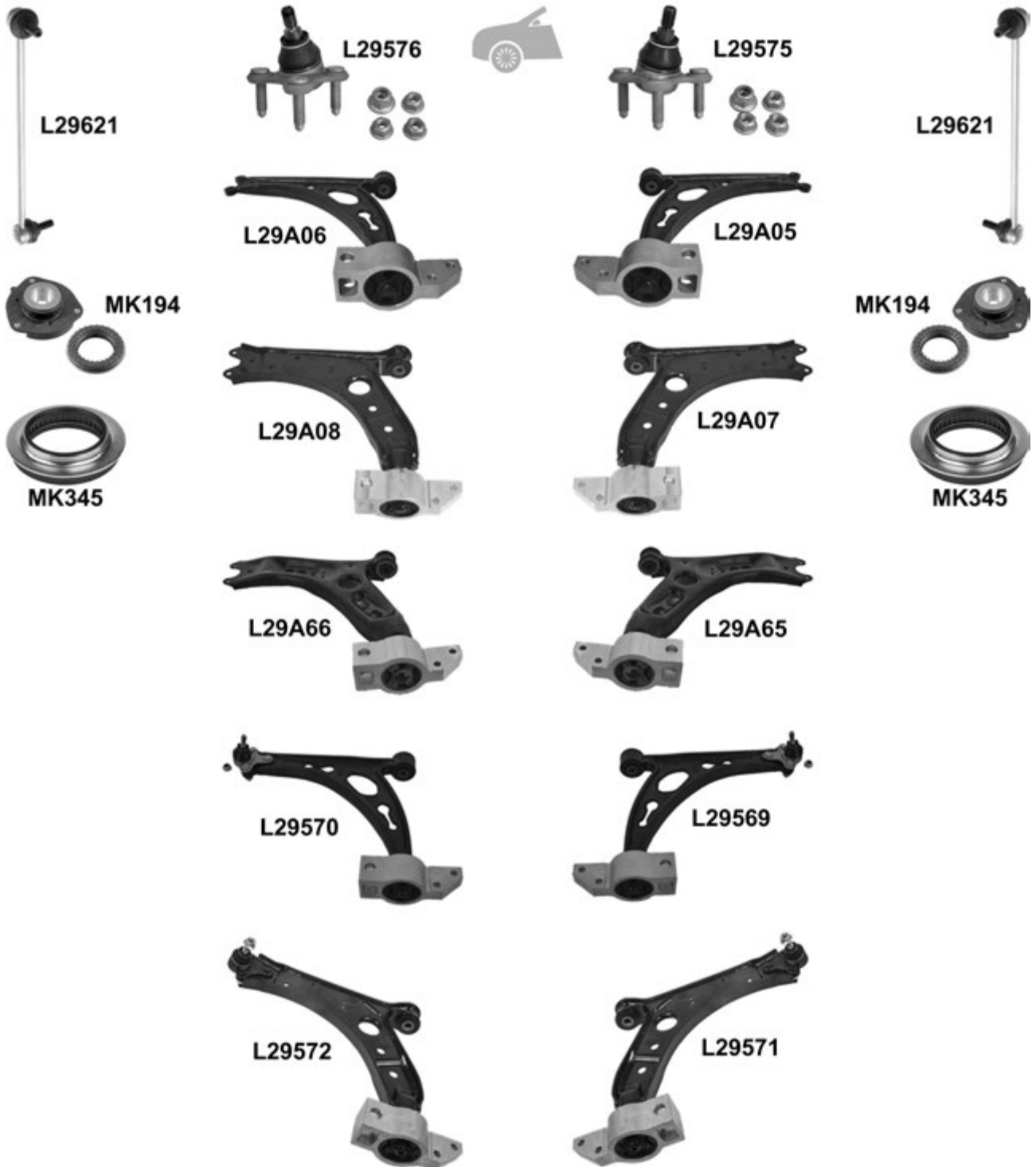
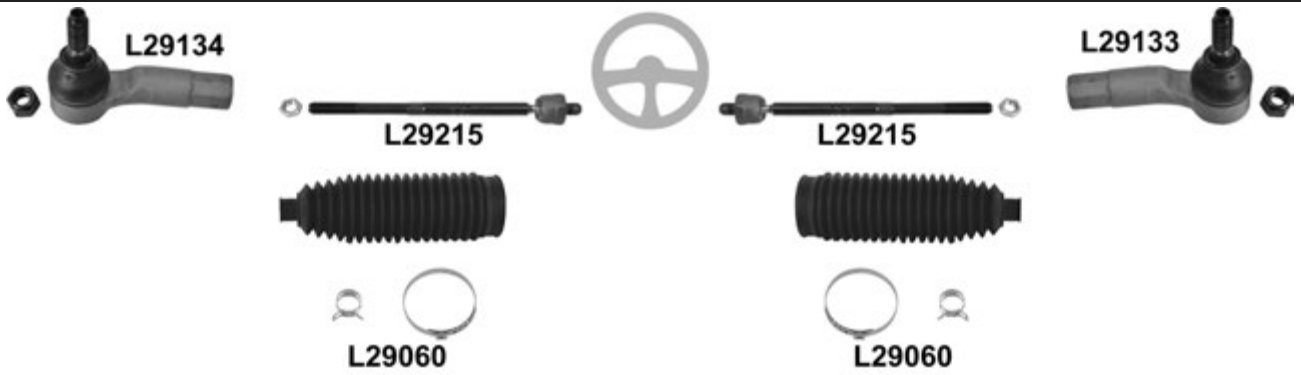

Golf Variant V (1K5) 06.07 →



Golf Variant V (1K5) 06.07 →

			←	→	Thread	Part Of	QPA		
		↔	(-) 2.8 V6 4-motion,	L29133	F 16x1,5 ∪		1	1K0 423 812 E	
			(-) 2.8 V6 4-motion	L29134	F 16x1,5 ∪		1	1K0 423 811 E	
				L29215	L29215	M 16x1,5 / M 16x1,5 ∪	2	1K0 423 810 A	
			Electronic	L29060	L29060		2	1K0 423 831 A	
		⊥		L29576	L29575		1	1K0 407 366 C	
				L29576			1	1K0 407 365 C	
		⊥	(-) , (+)		L29A05			1	1K0 407 152 M
				L29A06			1	1K0 407 151 M	
			(-) , (+)		L29A07		1	1K0 407 152 P	
				L29A08		1	1K0 407 151 P		
			(-) , (+)		L29A65		1	1K0 407 152 BC	
				L29A66		1	1K0 407 151 BC		
				<input checked="" type="checkbox"/>	L29569		1	1K0 407 152 M	
		L29570		1	1K0 407 151 M				
		<input checked="" type="checkbox"/>	L29571		1	1K0 407 152 P			
		L29572		1	1K0 407 151 P				
		<input checked="" type="checkbox"/>	L29A67		1	1K0 407 152 BC			
		L29A68		1	1K0 407 151 BC				
		⊥	⊥		L29861			1	1K0 199 232 G
				L29876			1	1K0 199 231 G	
	⊥		L29862	L29862		2	1K0 407 182		
			L29621	L29621		2	1K0 411 315 D		
		(+) MK345	KIT	MK194	MK194		2	1K0 412 331 B	
			MK345	MK345			2	6N0 412 249 C	
		⊥		L29A11	L29A11		2	4K0 505 323 N	
		⊥		<input checked="" type="checkbox"/>	L29A29	L29A29		2	1K0 505 311 AB
		⊥	→ 11.08, ch. → 1K9 295 790		L29637			1	1K0 501 530 C
				L29638			1	1K0 501 529 F	
			L29623	L29623		2	1K0 505 465 J		

Golf Variant VI (AJ5) 07.09 →

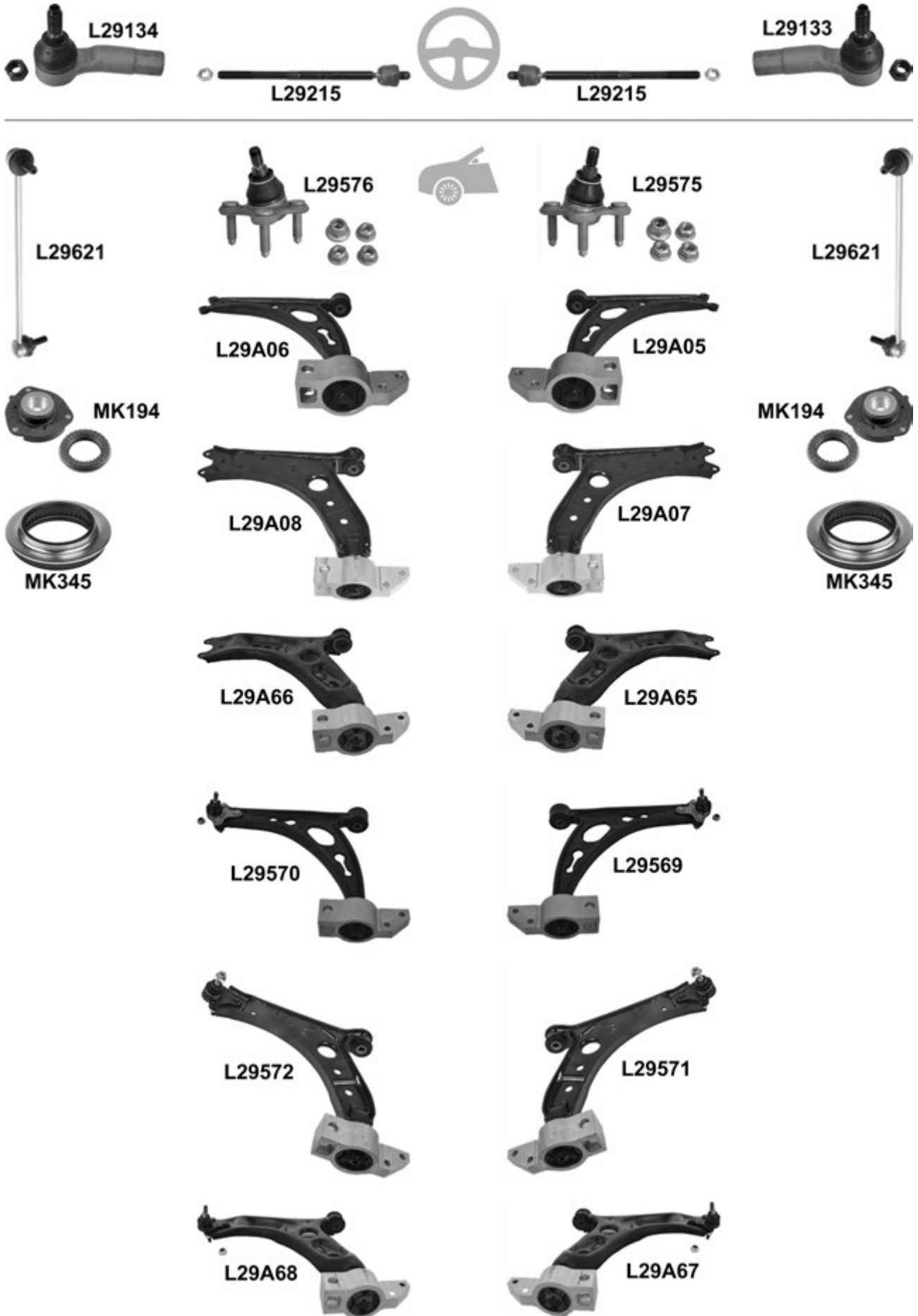

Golf Variant VI (AJ5) 07.09 →

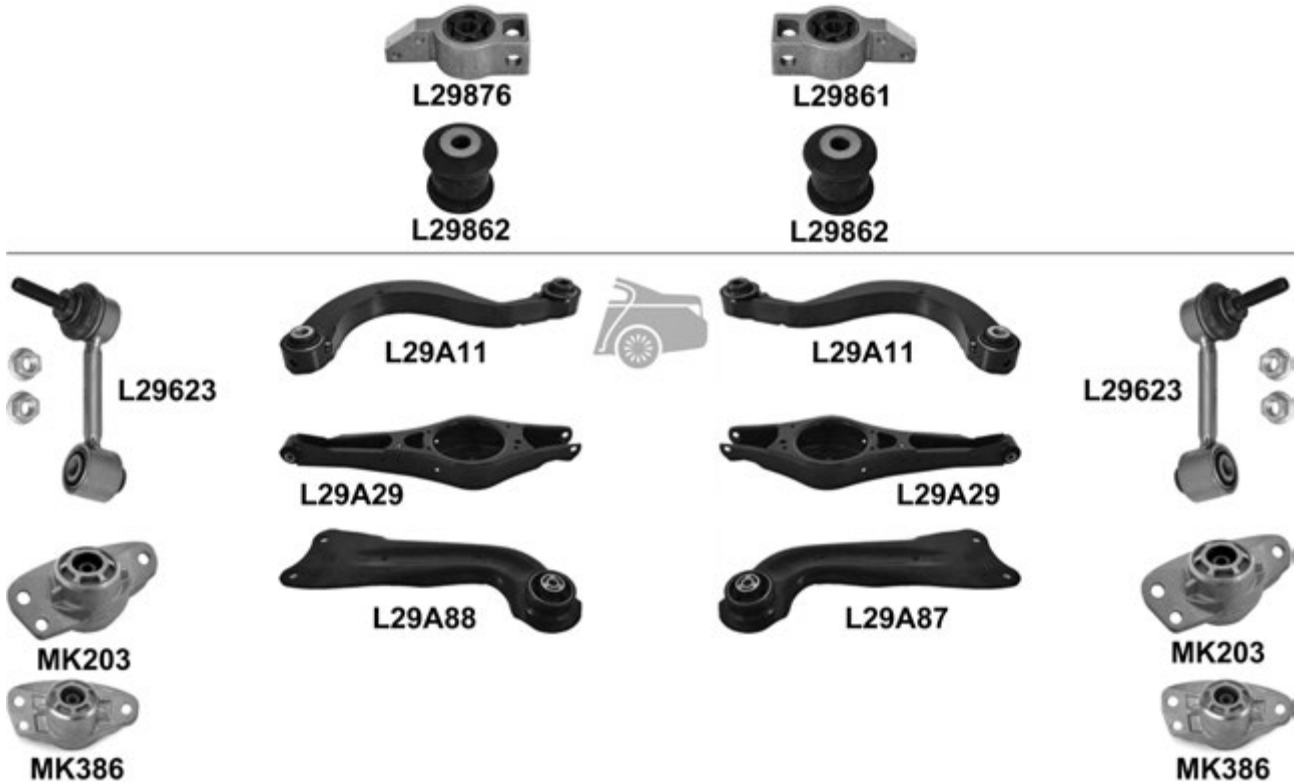

				← → Thread		Part Of	QPA			
⊕	↔			L29133	F 16x1,5 ⊕		1	1K0 423 812 E		
				L29134	F 16x1,5 ⊕		1	1K0 423 811 E		
⊖	⊥			L29215	L29215	M 16x1,5 / M 16x1,5 ⊕	2	1K0 423 810 A		
				L29575			1	1K0 407 366 C		
	⊥	(-) ⊕, (+) ⊖, ⊕, ⊖			L29A05			1	1K0 407 152 M	
					L29A06			1	1K0 407 151 M	
					L29A07			1	1K0 407 152 P	
					L29A08			1	1K0 407 151 P	
					L29A65			1	1K0 407 152 BC	
					L29A66			1	1K0 407 151 BC	
				☑	L29569			1	1K0 407 152 M	
					L29570			1	1K0 407 151 M	
				☑	L29571			1	1K0 407 152 P	
					L29572			1	1K0 407 151 P	
		☑	L29A67			1	1K0 407 152 BC			
			L29A68			1	1K0 407 151 BC			
	⊕	⊥			L29861			1	1K0 199 232 G	
				L29876			1	1K0 199 231 G		
⊕	⊥			L29862	L29862		2	1K0 407 182		
				L29621	L29621		2	1K0 411 315 D		
⊕	⊥		(+) MK345	KIT	MK194	MK194	2	1K0 412 331 B		
					MK345	MK345	2	6N0 412 249 C		
⊖	⊥			L29A11	L29A11		2	4K0 505 323 N		
				L29A29	L29A29		2	1K0 505 311 AB		
				L29A87 ⁰		Trailing Arm	1	1K0 505 224 K		
				L29A88 ⁰		Trailing Arm	1	1K0 505 222 K		
				L29623	L29623		2	1K0 505 465 J		
⊕	⊥		(-) Mot/Eng CMXA		MK203	MK203	2	1K0 513 353 H		
			Mot/Eng CMXA		MK386	MK386	2	3C0 513 353 C		

Golf Variant VII (BA5) 04.13 →

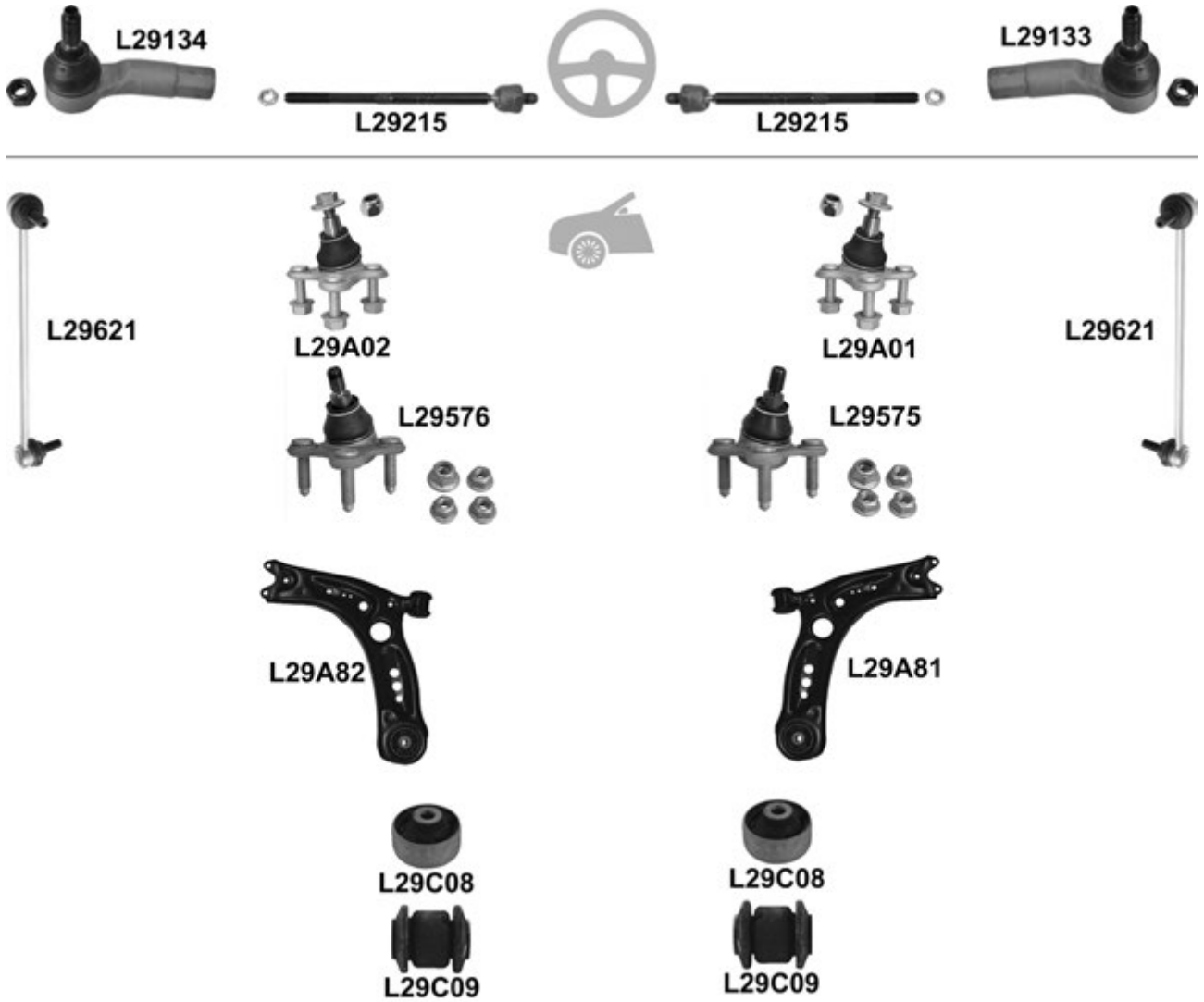

				←	→	Thread	Part Of	QPA	i
⊕		↔				L29133	F 16x1,5 ∪	1	1K0 423 812 E
						L29134	F 16x1,5 ∪	1	1K0 423 811 E
						L29215	L29215	M 16x1,5 / M 16x1,5 ∪	2
		⊥	PR 1ZA/1ZD			L29A01		1	3C0 407 366 A
						L29A02		1	3C0 407 365 A
			PR 1ZE/1ZF/1ZP			L29575		1	5Q0 407 366 A
						L29576		1	5Q0 407 365 A
	⊥	(-) (+)			L29A81 ⁰		1	5Q0 407 152 J	
					L29A82 ⁰		1	5Q0 407 151 J	
	⊥	↕			L29C08	L29C08		2	5Q0 407 183 E
					L29C09	L29C09		2	5Q0 407 182
					L29621	L29621		2	5Q0 411 315 A

Jetta I (17) 08.79 → 01.85 ch. 16A 0000 001 → 16 E 170 305

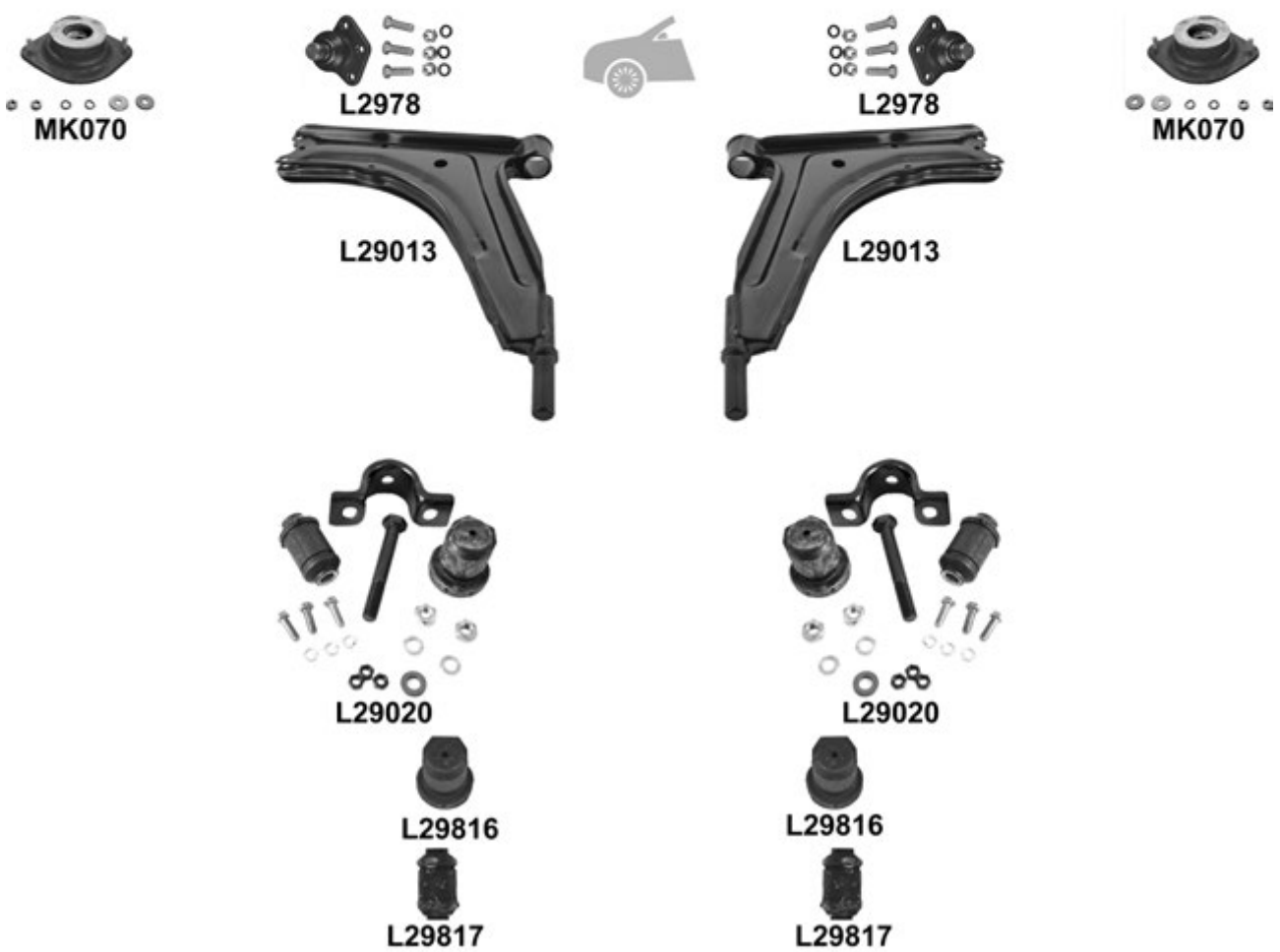
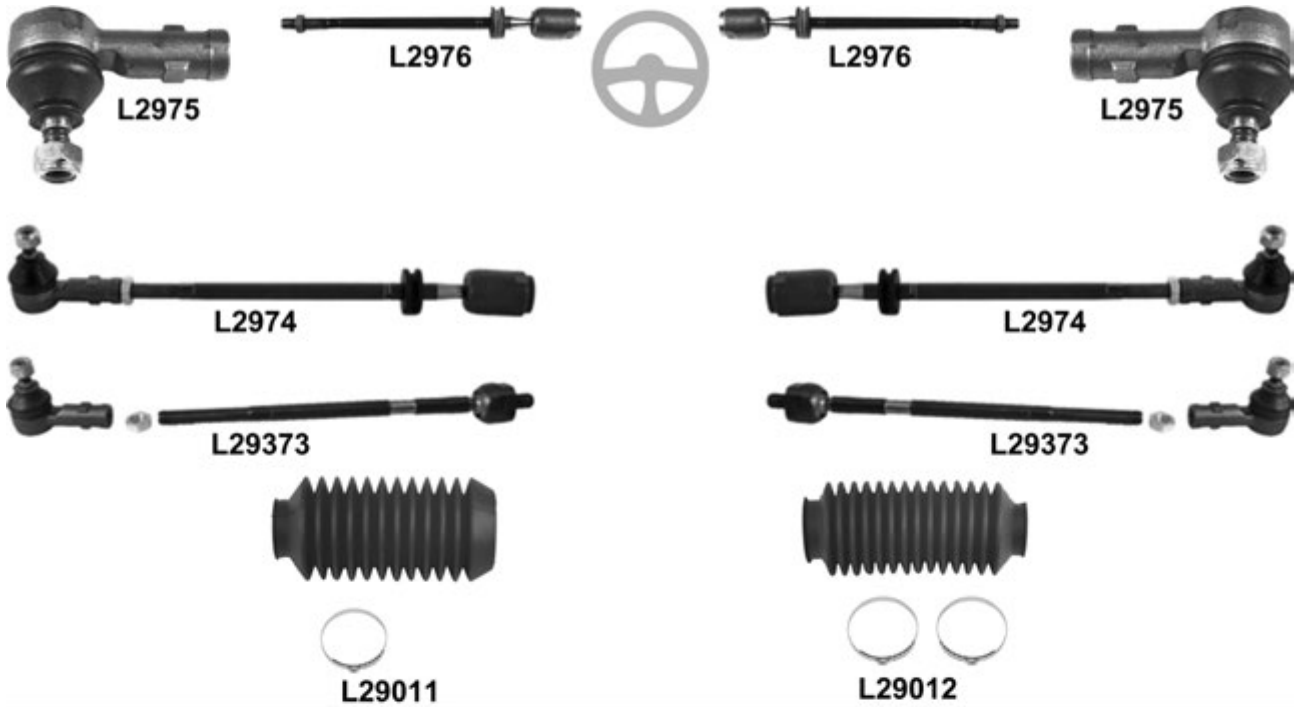

Jetta I (17) 08.79 → 01.85 ch. 16A 0000 001 → 16 E 170 305

		i		←	→	Thread	Part Of	QPA	i
		↔		L2975	L2975	F 14x1,5 ♂		2	171 419 812
			(-)	L2976	L2976			2	171 419 821 A
			(-)	L2974	L2974			2	171 419 804 A
				L29373	L29373			2	175 422 803 A
				L29011				1	171 419 831 B
				L29012				1	171 419 831 A
		⊥		L2978	L2978			2	171 407 365 G
		⊥	(-) (-)	L29013	L29013			2	171 407 153 D
				L29020	L29020			2	171 498 153 X0
		⊥ ▾		L29816	L29816			2	171 407 181 A
		⊥ ▲		L29817	L29817			2	171 407 182 D
				MK070	MK070			2	171 412 329 A

Jetta II (19E) 08.83 → 12.91 ch. 16 E 431 736 → NB 030 000 / → NP / NW 300 000



L29050



L29052



L29053



L29050



L29052



L29053

Jetta II (19E) 08.83 → 12.91 ch. 16 E 431 736 → NB 030 000 / → NP / NW 300 000



L29609

MK033



L29021



L29550



L29552



L29023



L29809

L29808



L29021



L29549



L29551



L29023



L29809

L29808



L29609

MK033



MK133



L29829



MK133

Jetta II (19E) 08.83 → 12.91 ch. 16 E 431 736 → NB 030 000 / → NP / NW 300 000

			←	→	Thread	Part Of	QPA		
		↔		L29117	F 14x1,5 ♂		1	3A0 422 812	
				L29118	F 14x1,5 ♂		1	3A0 422 811	
				L29008	L29008	M 14x1,5 / M 22x1,5		2	
			, TRW, L= 340mm	L29213	L29213	M 14x1,5 / M 14x1,5 ♂	L29365/L29366	2	1H0 422 821
					L29006			1	191 419 804 A
				L29000				1	191 419 803 A
			, TRW		L29365			1	191 422 804 A
				L29366				1	191 422 803 A
			, ZF		L29341			1	191 422 804 C
				L29342				1	191 422 803 C
				L29050	L29050			2	191 419 831
			, TRW	L29052	L29052			2	1H0 422 831
			, ZF	L29053	L29053			2	357 422 831 B
		⊥	→ 06.87 ch. → 19 HB 990 000 ch. → 16 HW 990 000 17mm	L29009	L29009			2	191 407 365 B
			07.87 → ch. 19 JW 000 001 → ch. 16 JB 000 001 → 19mm	L29026	L29026			2	357 407 365 A
		⊥	(-) , (+)	L29021	L29021			2	191 407 153 A
			→ 06.87 <input checked="" type="checkbox"/> ch. → 19 HB 990 000 ch. → 16 HW 990 000 17mm		L29549			1	
			→ 06.87 <input checked="" type="checkbox"/> ch. → 19 HB 990 000 ch. → 16 HW 990 000 17mm	L29550				1	
			07.87 → <input checked="" type="checkbox"/> ch. 19 JW 000 001 → ch. 16 JB 000 001 → 19mm		L29551			1	
				L29023	L29023			2	191 407 153 S0
		⊥	⌵	L29809	L29809			2	191 407 181 E
			⌶	L29808	L29808			2	357 407 182
			(-) G60	L29609	L29609			2	191 411 315 BS
			(-) G60	KIT	MK033	MK033		2	191 412 329
			G60	KIT	MK033	MK033		2	357 412 329
				KIT	L29829		Hub carrier	1	191 501 541 S
				MK133	MK133		2	191 512 333 S1	

Jetta III (1K2) 03.05 →

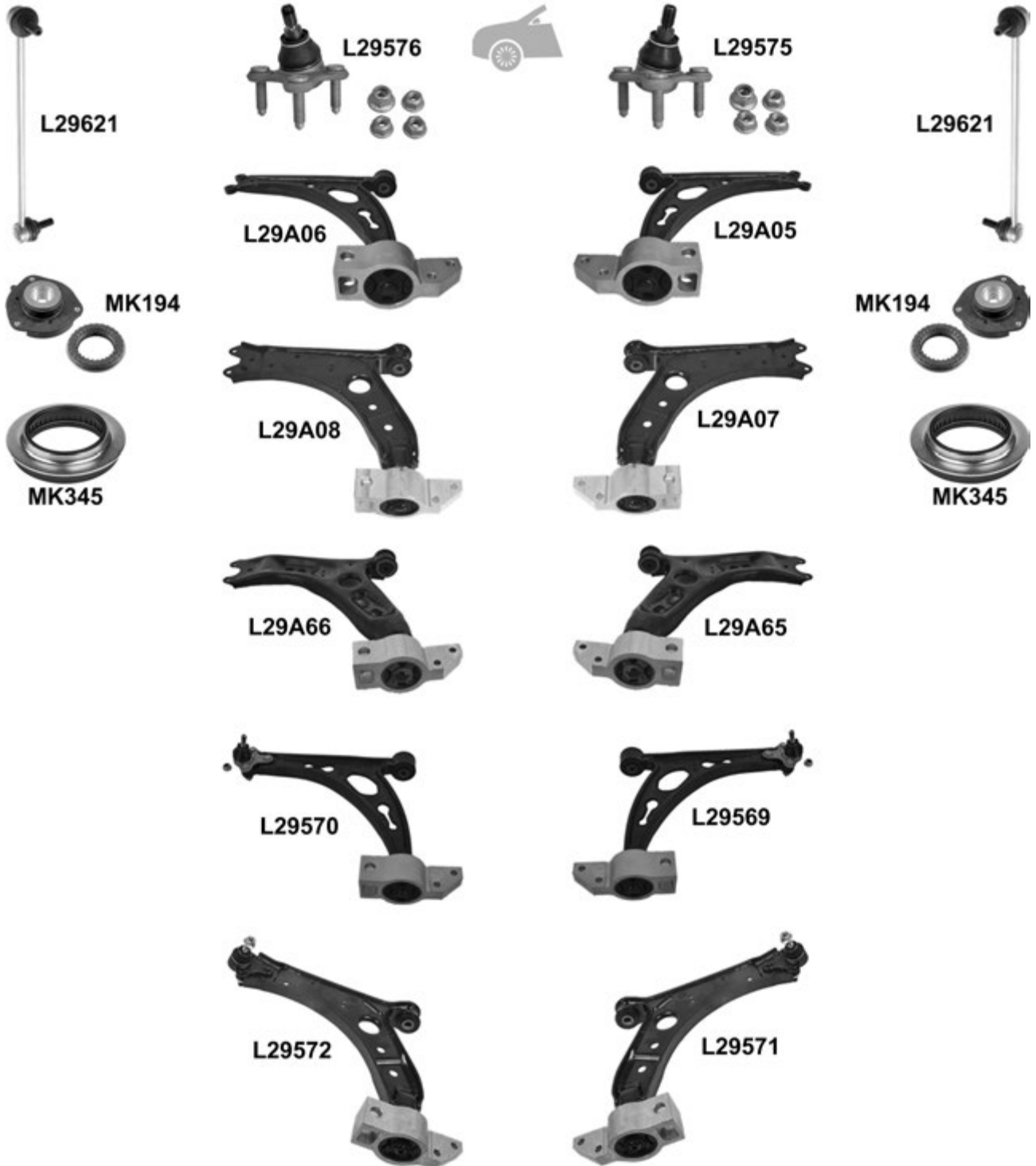
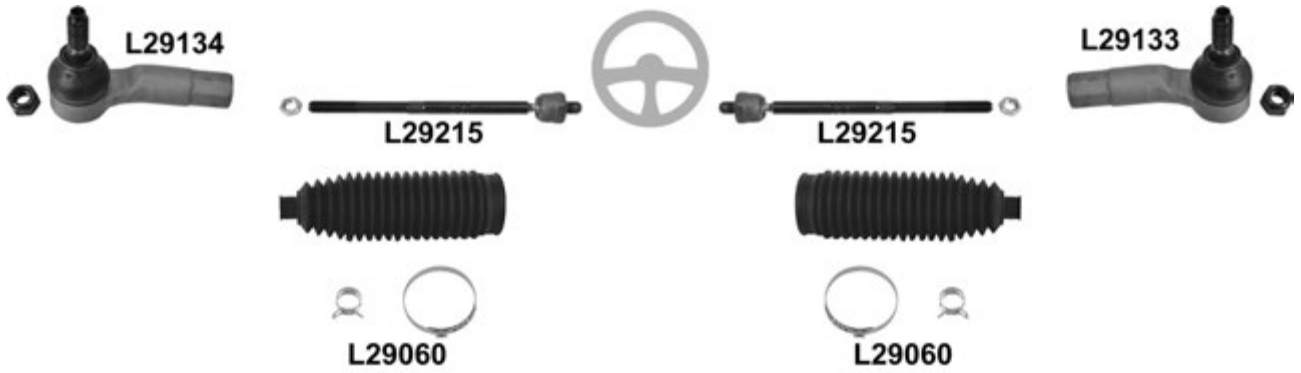

Jetta III (1K2) 03.05 →



Jetta III (1K2) 03.05 →

			←	→	Thread	Part Of	QPA		
		↔		L29133	F 16x1,5 U		1	1K0 423 812 E	
				L29134	F 16x1,5 U		1	1K0 423 811 E	
				L29215	L29215	M 16x1,5 / M 16x1,5 U		2	1K0 423 810 A
		Electronic		L29060	L29060			2	1K0 423 831 A
		↓		L29575			1	1K0 407 366 C	
				L29576			1	1K0 407 365 C	
		↓	(-) (+)		L29A05			1	1K0 407 152 M
				L29A06			1	1K0 407 151 M	
			→ 12.08, ch. → 1K 9 109 350, (-) (+)		L29A07		1	1K0 407 152 P	
					L29A08		1	1K0 407 151 P	
			01.09 →, ch. 1K 9 109 351 →, (-) (+)		L29A65		1	1K0 407 152 BC	
					L29A66		1	1K0 407 151 BC	
			<input checked="" type="checkbox"/>		L29569		1	1K0 407 152 M	
				L29570		1	1K0 407 151 M		
	→ 12.08, ch. → 1K 9 109 350,	<input checked="" type="checkbox"/>	L29571		1	1K0 407 152 P			
		L29572		1	1K0 407 151 P				
	01.09 →, ch. 1K 9 109 351 →,	<input checked="" type="checkbox"/>	L29A67		1	1K0 407 152 BC			
		L29A68		1	1K0 407 151 BC				
		↓	↘		L29861			1	1K0 199 232 G
			L29876			1	1K0 199 231 G		
↑			L29862	L29862		2	1K0 407 182		
			L29621	L29621			2	1K0 411 315 D	
		(+) MK345	KIT	MK194	MK194		2	1K0 412 331 B	
				MK345	MK345		2	6N0 412 249 C	
		↑		L29A11	L29A11		2	4K0 505 323 N	
		↓		L29A29	L29A29		2	1K0 505 311 AB	
	↕	↗		L29A87 ⁰		Trailing Arm	1	1K0 505 224 K	
		↘		L29A88 ⁰		Trailing Arm	1	1K0 505 222 K	
		▲	→ 11.08, 1K9 091 375		L29637			1	1K0 501 530 C
				L29638			1	1K0 501 529 F	
				L29623	L29623		2	1K0 505 465 J	
		→ 08.07, ch. → 1K8 020 816		MK203	MK203		2	1K0 513 353 H	
		PR 0N4/1JT, HD/Off-road Suspension		MK386	MK386		2	1K0 513 353 R	

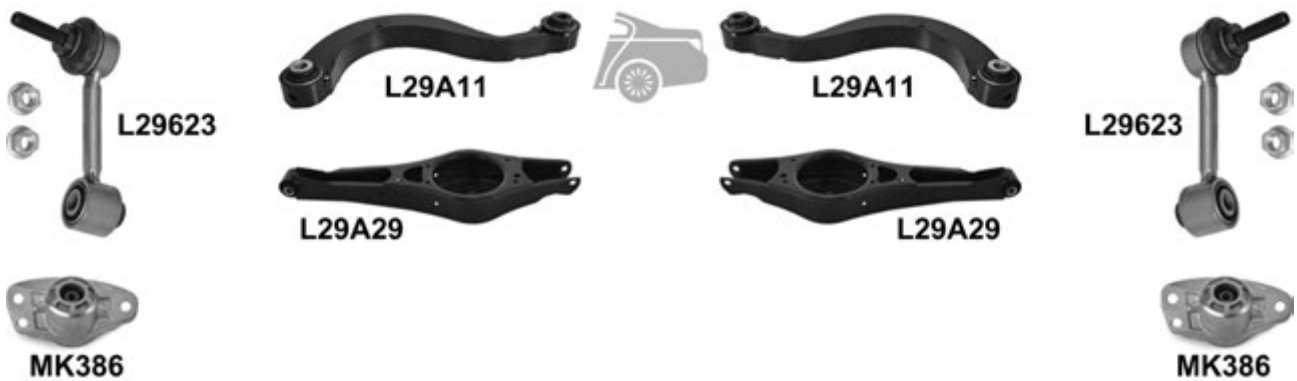
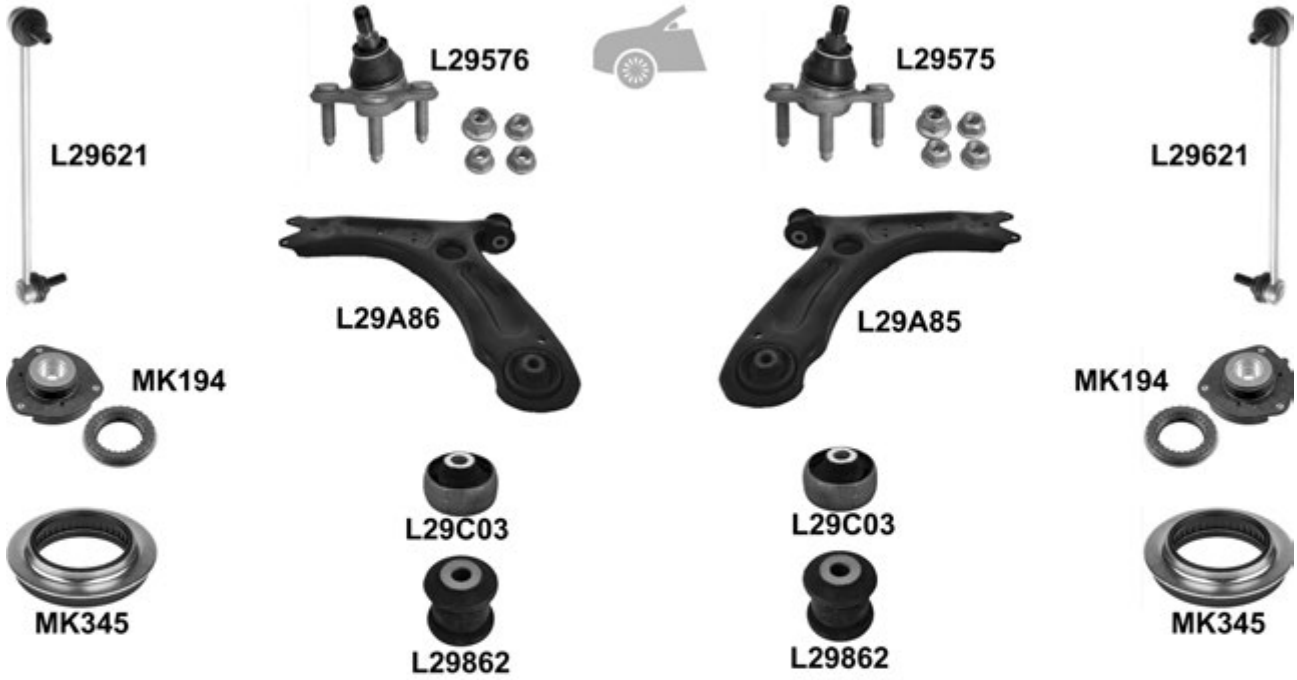
Jetta IV (162) 07.10 →

			←	→	Thread	Part Of	QPA		
		↔		L29135	F 16x1,5 ∪		1	1K0 423 812 G	
				L29136	F 16x1,5 ∪		1	1K0 423 811 G	
		⊥		L29215	M 16x1,5 / M 16x1,5 ∪		2	1K0 423 810 A	
				L29575			1	1K0 407 366 C	
		⊥		<input checked="" type="checkbox"/>	L29A85		1	5C0 407 152 B	
				<input type="checkbox"/>	L29A86		1	5C0 407 151 B	
		⊥	↘		L29C03	L29C03		2	1K0 407 183 P
			↗		L29862	L29862		2	1K0 407 182
					L29621	L29621		2	1K0 411 315 D
					KIT	MK194	MK194		2
		⊥			MK345	MK345		2	6N0 412 249 C
					MK345	MK345		2	6N0 412 249 C
		⊥	PR 0N4		L29A11	L29A11		2	4K0 505 323 N
				<input checked="" type="checkbox"/>	L29A29	L29A29		2	1K0 505 311 AB
					L29623	L29623		2	1K0 505 465 J
				MK386	MK386		2	3C0 513 353 C	

LT 28, 28 D, 31, 31 D, 35, 35 D 04.75 → 12.95 Ch. 286 2500 001 → 21 T 010 000



LT 28, 28 D, 31, 31 D, 35, 35 D 04.75 → 12.95 Ch. 286 2500 001 → 21 T 010 000

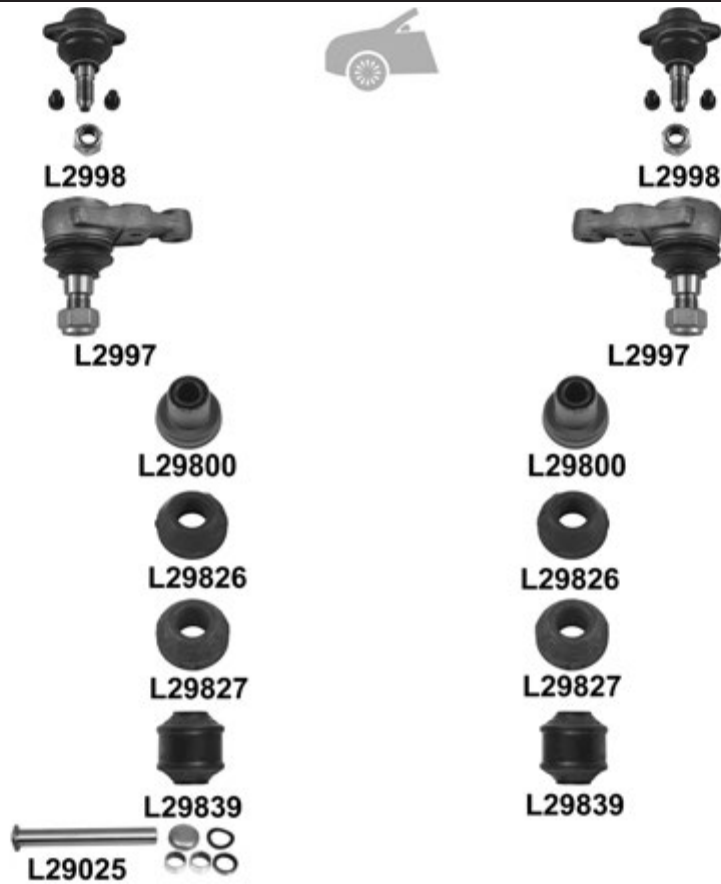

VOLKSWAGEN

						←	→	Thread	Part Of	QPA	i	
⊕		↔	ch. → 28 D 004 508	L2992				∩		1	281 415 812	
		→←	ch. → 28 D 004 508	L2993				∩		1	281 415 811	
		↔↔↔	ch. 28 D 004 509 →	L29046					∩		1	
				L29047					∩		1	
			longitudinal	L2996					M 16x1,5 ∩		1	281 415 711 A
						L2994					1	281 415 802 A
						L2991					1	281 415 801 D
							L2995				1	281 415 701 E
						L2990					1	281 415 303 B
				↑		L2998	L2998					2
↓				L2997	L2997					2	281 407 187 B	
	↑				L29800	L29800				4	281 407 077	
	▼				L29826	L29826			Trailing arm	2	281 407 180	
	▲				L29827	L29827			Trailing arm	2	281 407 179	
					L29839	L29839			Anti-roll bar	4	291 411 045	
			78 →, ch. 288 2519 374 →	KIT	L29025				IDLER	1	281 498 171 A	

LT 40, 45, 50 198.78 →



				← → Thread		Part Of		QPA			
				L29001				1	291 415 701 E		
				L29839	L29839		Anti-roll bar	4	291 411 045		
		78 →, ch. 288 2519 374 →	KIT	L29025			IDLER	1	281 498 171 A		

LT II (2DM / 2DX0→ / 2DX0FE) 05.1996 →

		i	←	→	Thread	Part Of	QPA	i
⊕		↔	L23109	L23109	F 16x1,5 ∪		2	2D0 422 811
			L23201	L23201	M 16x1,5 / M 16x1,5		2	2D0 422 803
				L10300			1	2D0 422 803
			L10017	L10017			2	2D0 498 831
⊖		⊥	L23513	L23513			2	2D0 407 361 A
		⊥		L10543		<input checked="" type="checkbox"/>	1	2D0 407 022 B
			L10544				1	2D0 407 021 B
				L10603			1	2D0 411 052
			L10604				1	2D0 411 051
		KIT	MK277	MK277			2	
⊖		(-) LT46	L10811	L10811			4	2D0 511 413
		(-) LT46	L10605	L10605			2	2D0 511 329

Lupo (6X) 04.97 →

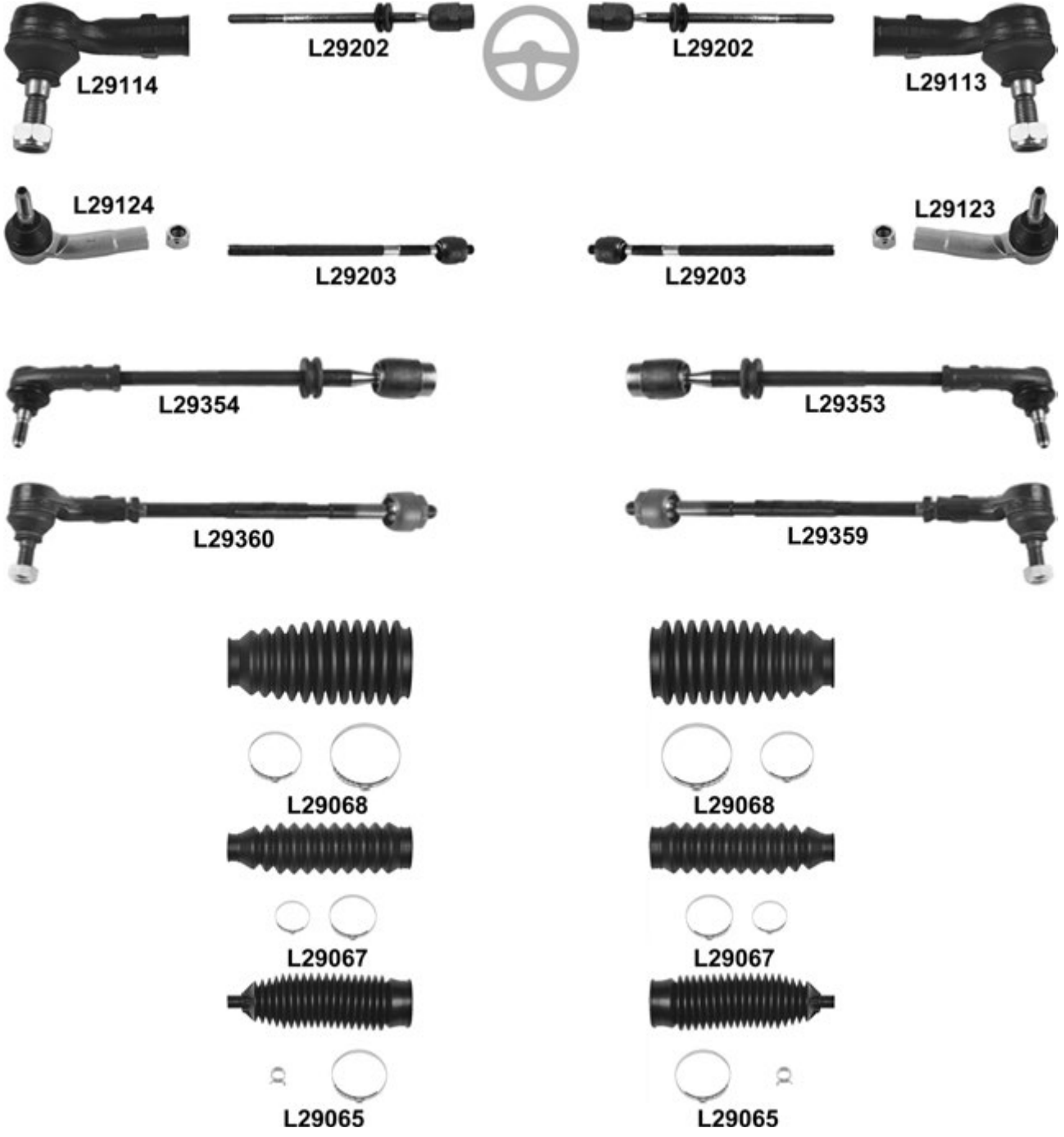

Lupo (6X) 04.97 →

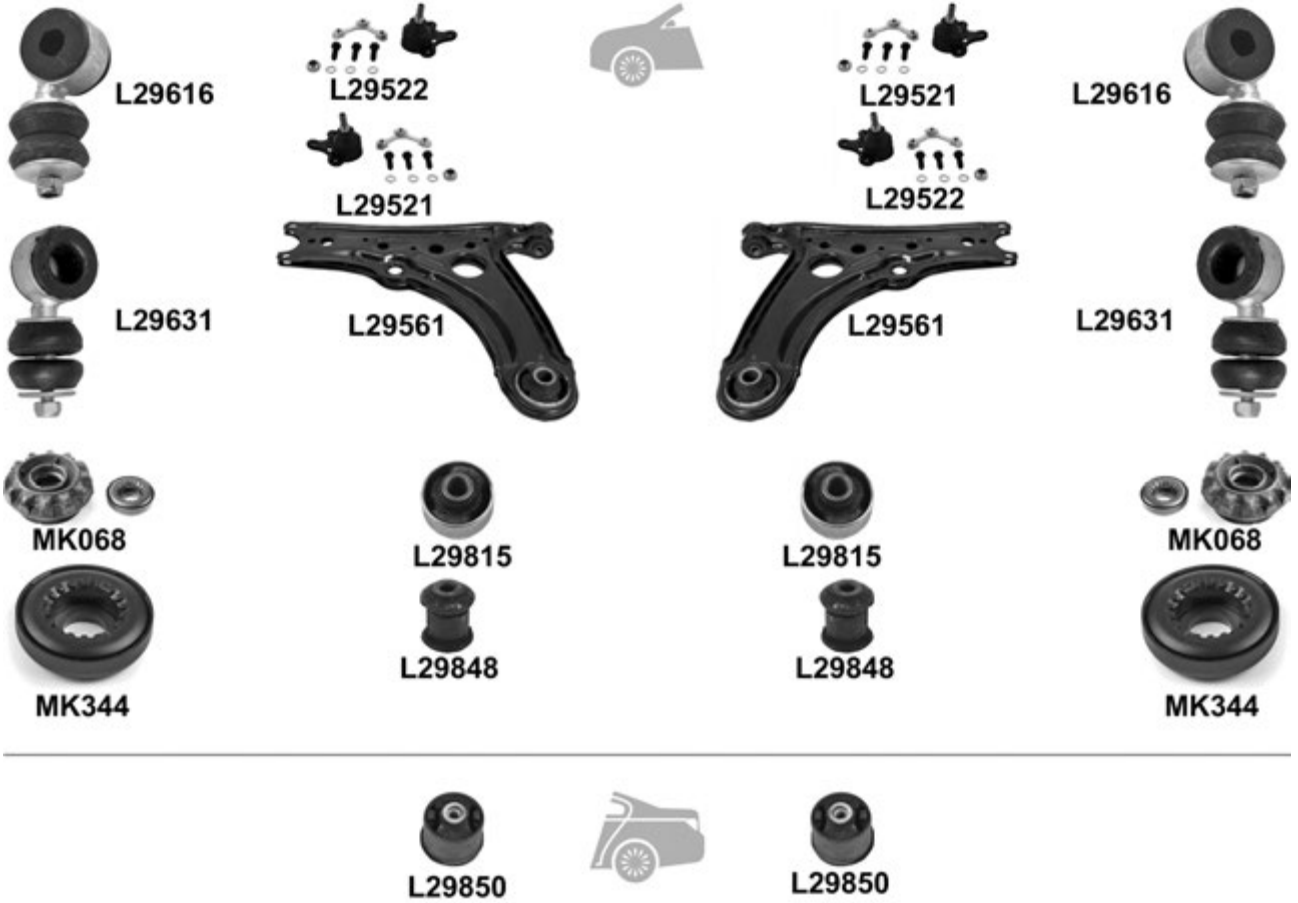

Lupo (6X) 04.97 →

				←	→	Thread	Part Of	QPA	
		↔	(-) 1.2 Tdi 3L/1.4 Fsi	L29113		F 14x1,5 U		1	6N0 419 812
				L29114		F 14x1,5 U		1	6N0 419 811
			(-) 1.2 Tdi 3L	L29123		F 14x1,5 U		1	6X0 422 812
				L29124		F 14x1,5 U		1	6X0 422 811
			1.2 Tdi 3L	L29123		F 14x1,5 U		1	6E0 419 812
				L29124		F 14x1,5 U		1	6E0 419 811
			(-) 1.2 Tdi 3L/1.4 Fsi	L29202	L29202	M 14x1,5 / F 22x1,5	L29353/L29354	2	6N0 422 821 A
			(-) 1.2 Tdi 3L/1.4 Fsi	L29203	L29203	M 14x1,5 / M 14x1,5	L29359/L29360	2	6Q0 423 810 B
			(-) 1.2 Tdi 3L/1.4 Fsi	L29353				1	6X0 419 804 A
				L29354				1	6X0 419 803 A
			(-) 1.2 Tdi 3L/1.4 Fsi	L29359					1
			(-) 1.2 Tdi 3L ø 25mm, Ø 40mm, L= 143mm	L29068 ⁰	L29068 ⁰			2	6N0 419 831
				(-) 1.2 Tdi 3L ø 11mm, Ø 42mm, L= 208mm	L29067 ⁰	L29067 ⁰			2
			1.2 Tdi 3L, TRW, ø 12mm, Ø 48mm, L= 195mm	L29065 ⁰	L29065 ⁰				2
		⊥	1.0 8V/1.4 8V/1.4 16V, PR 1LB/1LM/1ZC/1ZN	L29521				1	6N0 407 365 A
				L29522				1	6N0 407 365
			1.4 16V, PR 1ZJ	L29522				1	6N0 407 365
				L29521				1	6N0 407 365 A
			1.4 Tdi, PR 1ZE/1ZK	L29522				1	6N0 407 365
				L29521				1	6N0 407 365 A
			1.6 Gti 16V	L29521				1	6N0 407 365 A
				L29522				1	6N0 407 365
			1.7 SDi, PR 1LB/1LM/1ZC/1ZN	L29521				1	6N0 407 365 A
				L29522				1	6N0 407 365
		⊥	(-) (+) (-) 1.2 Tdi 3L/1.4 Fsi	L29561	L29561			2	6X0 407 151 A
				L29815	L29815			2	6N0 407 181
		⊥	(-) 1.2 Tdi 3L/1.4 Fsi,	L29848	L29848			2	6N0 407 182
				L29616	L29616			2	6N0 411 315 C
		PR OAB, ø 16mm, Ø 18mm Anti-roll bar, (-) 1.2 Tdi 3L/1.4 Fsi	L29631	L29631			2	6N0 411 315 D	
		PR OAD, ø 18mm, Ø 20mm/22mm Anti-roll bar, (-) 1.2 Tdi 3L/1.4 Fsi	L29631	L29631			2	6N0 411 315 D	
		(+) MK344	KIT	MK068	MK068		2	6N0 412 331 AS	
				MK344	MK344		2	1J0 412 249	
				L29850	L29850	Hub carrier	2	6N0 501 541 D	

K 70 08.70 → 10.74

				←	→	Thread	Part Of	QPA	
		↔		L2937	L2937	M 14x1,5 U		2	311 415 812 C

Multivan T5 (7HM) 04.03 →

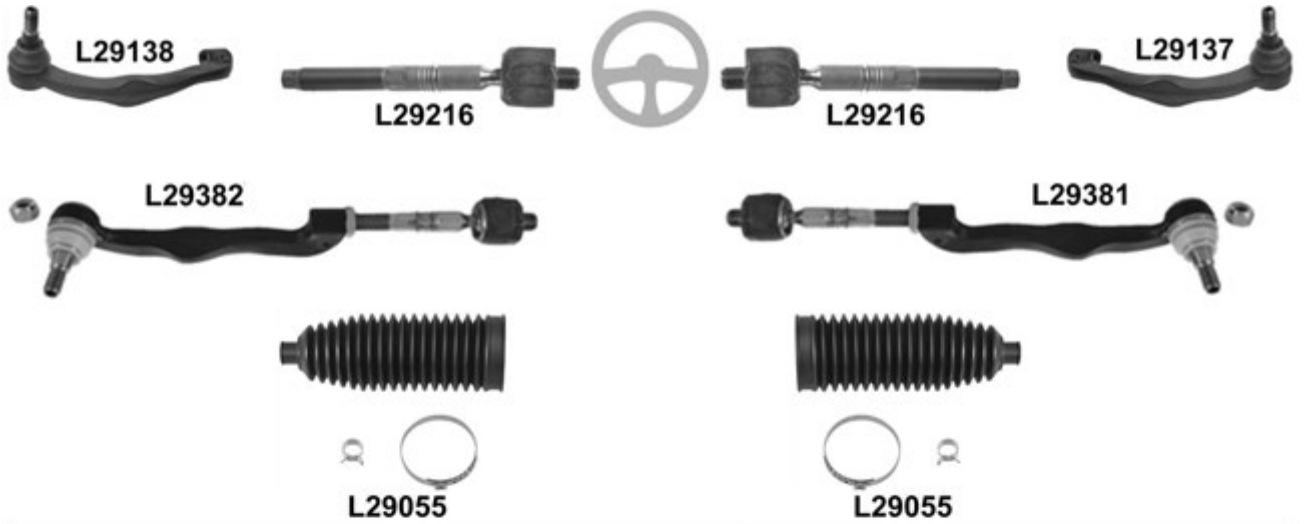

Multivan T5 (7HM) 04.03 →

			←	→	Thread	Part Of	QPA			
		↔		L29137	F 16x1,5		1	7H0 422 818 C		
				L29138	F 16x1,5		1	7H0 422 817 C		
				L29216	L29216	M 16x1,5 / M 16x1,5		2		
				L29381				1	7H0 419 804 F	
				L29382				1	7H0 419 803 F	
			L29055	L29055			2	7H0 422 831		
		↓	/ chassis total weight 3.2 T	L29577	L29577			2	7H8 407 361 A	
			/ chassis total weight 3.0 T - 3.2 T							
			PR 1BA/1BB/1BJ/1BV/2MD/2MG/2MH	L29578	L29578			2	7H0 407 361	
		↓	→ 05.11, (-)		L29A45			1	7H0 407 152 G	
					L29A46			1	7H0 407 151 G	
		↓		L29878	L29878			2	7H0 407 182 A	
		↑		L29879	L29879			2	7D0 407 183	
			∅ 9mm	L29632	L29632			2	7H5 411 317 B	
				MK346	MK346			2	7H0 412 249 A	
		↔	(-) 4-motion	L29880	L29880			4	7H0 501 132 A	

New Beetle (9C) 01.98 →

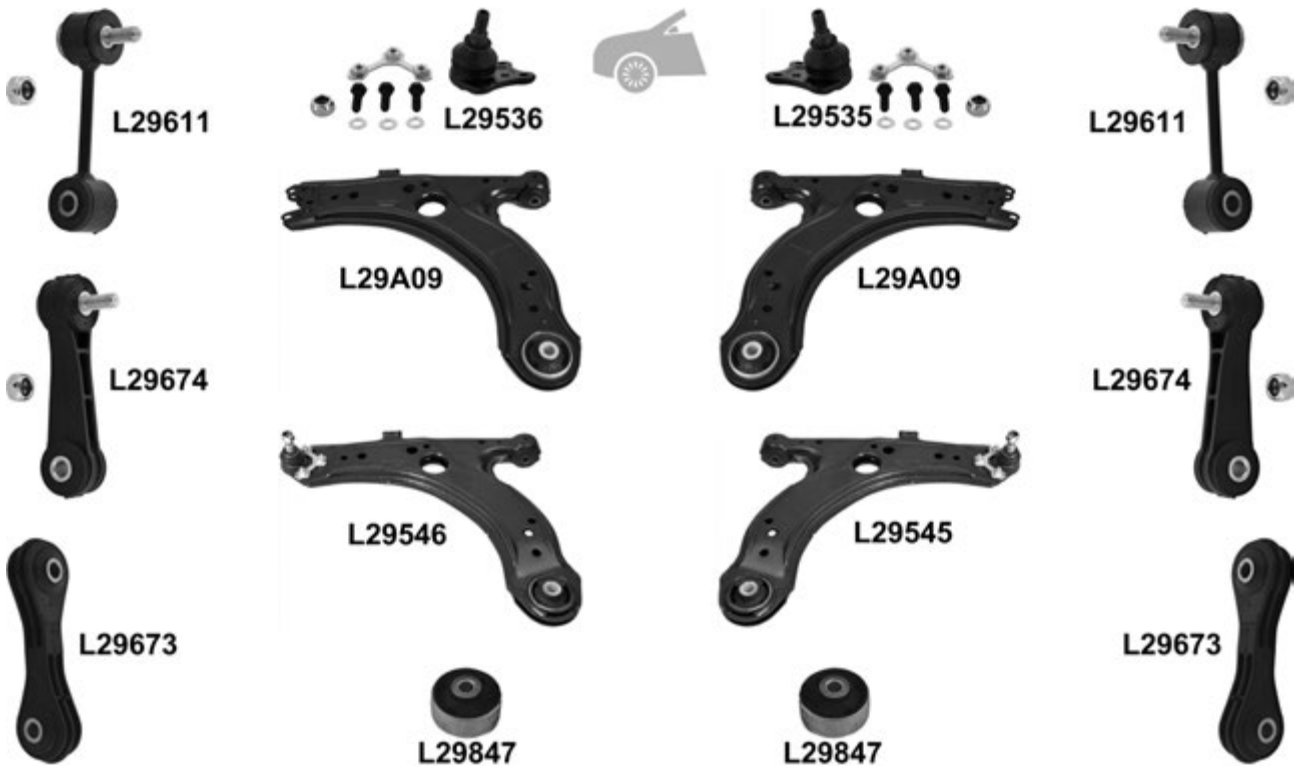
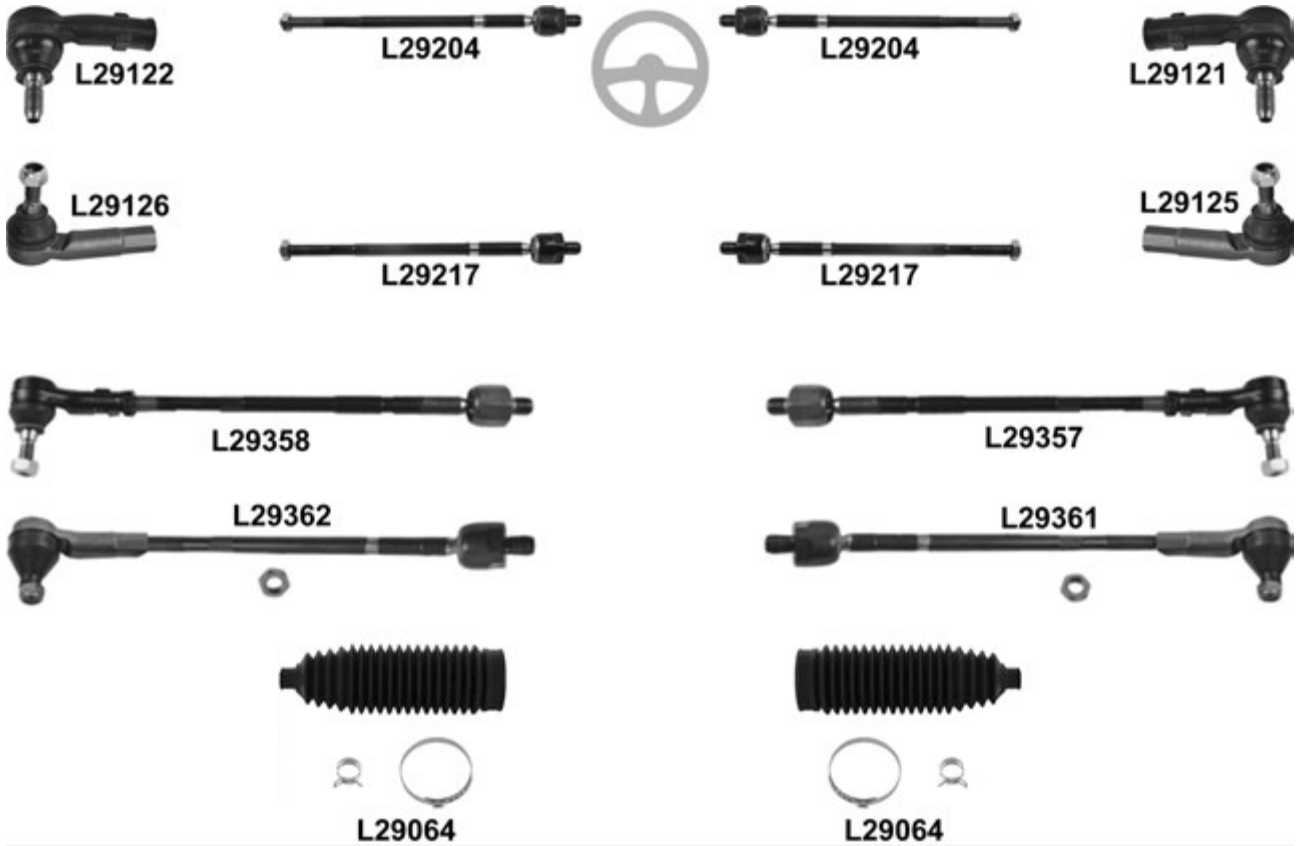

New Beetle (9C) 01.98 →



MK077

MK344



L29808

L29853

L29852

L29865

L29851



L29808

L29853

L29852

L29865

L29851



MK077

MK344



MK118



L29874



L29849



MK118

New Beetle (9C) 01.98 →

			←	→	Thread	Part Of	QPA			
		↔	ch. → 9C W 047 125	L29121			1	1J0 422 812 A		
			L29122				1	1J0 422 811 A		
		→	ch. 9C W 047 126 →	L29125				1	1J0 422 812 B	
			L29126				1	1J0 422 811 B		
			ch. → 9C W 047 125	L29204	L29204			2	1J0 422 821 A	
			ch. 9C W 047 126 →	L29217	L29217			2	1J0 422 821 B	
			ch. → 9C W 047 125	L29357				1	1J0 422 804 A	
				L29358				1	1J0 422 803 A	
		→	ch. 9C W 047 126 →	L29361				1	1J0 422 804 B	
				L29362				1	1J0 422 803 B	
			L29064 ^o	L29064 ^o			2	1J0 422 831 B		
		↓		L29535			1	1J0 407 366 C		
			L29536				1	1J0 407 365 C		
		↓	(-) (+)	L29A09	L29A09			2	1J0 407 151 C	
				<input checked="" type="checkbox"/>	L29545			1		
		↓		L29546				1		
				L29847	L29847			2	1J0 407 181	
		↓		L29808	L29808			2	357 407 182	
					→	→ 12.00, (-) Rsi, Metal	L29611	L29611		
	→ 12.00, (-) Rsi, Plastic	L29674	L29674					2	1J0 411 315 C	
	01.01 →, (-) Rsi	L29673	L29673					2	1J0 411 315 H	
			∅ 17mm	L29853	L29853		Anti-roll bar	2	1J0 411 314 B	
				∅ 21mm	L29852	L29852		Anti-roll bar	2	1J0 411 314 C
				∅ 23mm	L29865	L29865		Anti-roll bar	2	1J0 411 314 G
				L29851	L29851		Hub carrier	2	1J0 199 429	
			(+) MK344	KIT	MK077	MK077		2	1J0 412 331 BS	
			MK344	MK344			2	1J0 412 249		
			(-) 4-motion, ∅ 69mm	L29874		Hub carrier	1	1J0 501 541 D		
			(-) 4-motion, ∅ 74mm	L29849		Hub carrier	1	1J0 501 541 C		
				MK118	MK118			2	1J0 513 353 D	

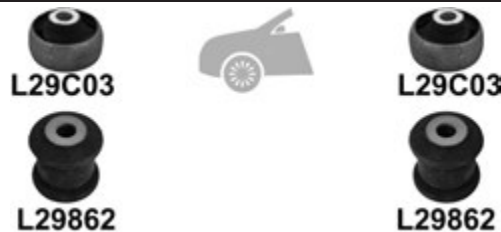
New Beetle (5C1) 10.11 →

			←	→	Thread	Part Of	QPA		
		↓		L29C03	L29C03			2	1K0 407 183 P
			↑		L29862	L29862			2

Passat (32 / 33) 07.73 → 07.80 ch. → 32 A 206 720



L29837



L29837



Thread

Part Of

QPA



		↔		L1036	L1036	M 14x1,5 ⌀		2	811 419 812
		⊥	09.77 →, ch. 328 2002 001 →, ⌀17mm	L1076	L1076			2	823 407 365 E
				L29837	L29837		Anti-roll bar	2	823 411 313 A

Passat 08.80 → 04.88 ch. 32 B 000 001 → 32 / 33 J 299 999

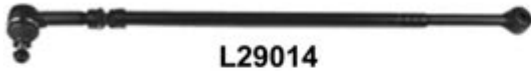
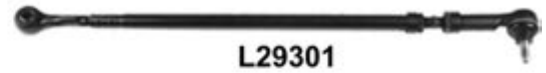
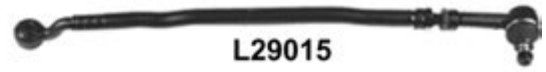

L29029



Passat 08.80 → 04.88 ch. 32 B 000 001 → 32 / 33 J 299 999

		i		←	→	Thread	Part Of	QPA	i
		↔		L29016	L29016	F 14x1,5 U		2	811 419 812 A
			ch. → 32 G 275 000		L29015			1	811 419 802 J
			ch. 32 G 275 001 →		L29301			1	811 419 802 K
			(-) 5 cyl. 2.2/2.3	L29014				1	811 419 801 E
					L29029			1	811 419 831 B
		↓		L1076	L1076			2	823 407 365 E
			, 4 cyl., ch. 32 D 099 298 →		L29501			1	855 407 366 A/B
			, 5 cyl., ch. 32 E 150 001 →	L29502				1	855 407 365 A/B
		↓		L29530	L29530			2	893 407 147 G
		↓ ▲ ▼		L29804	L29804			4	811 407 181 A
				L29806	L29806			4	857 407 181
			(-)	L29837	L29837		Anti-roll bar	2	823 411 313 A
				MK032	MK032			2	8A0 412 323 D
			KIT	L29831		Hub carrier	1	321 501 541 S	

Passat / Passat Variant (35l) 02.88 → 05.97, ch. 31 J 000 001 → 3A VE/VB/VD 300 000

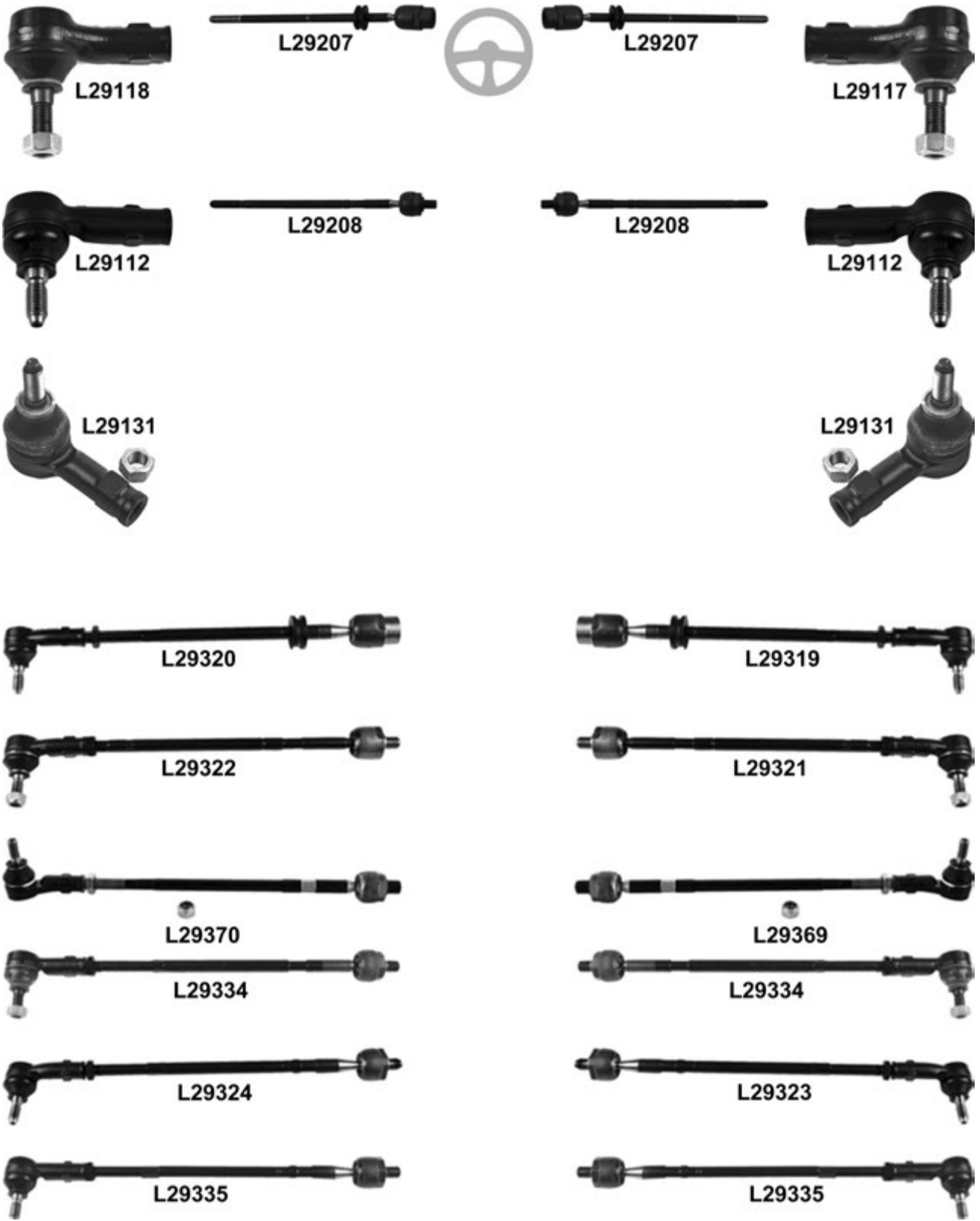

Passat / Passat Variant (35l) 02.88 → 05.97, ch. 31 J 000 001 → 3A VE/VB/VD 300 000

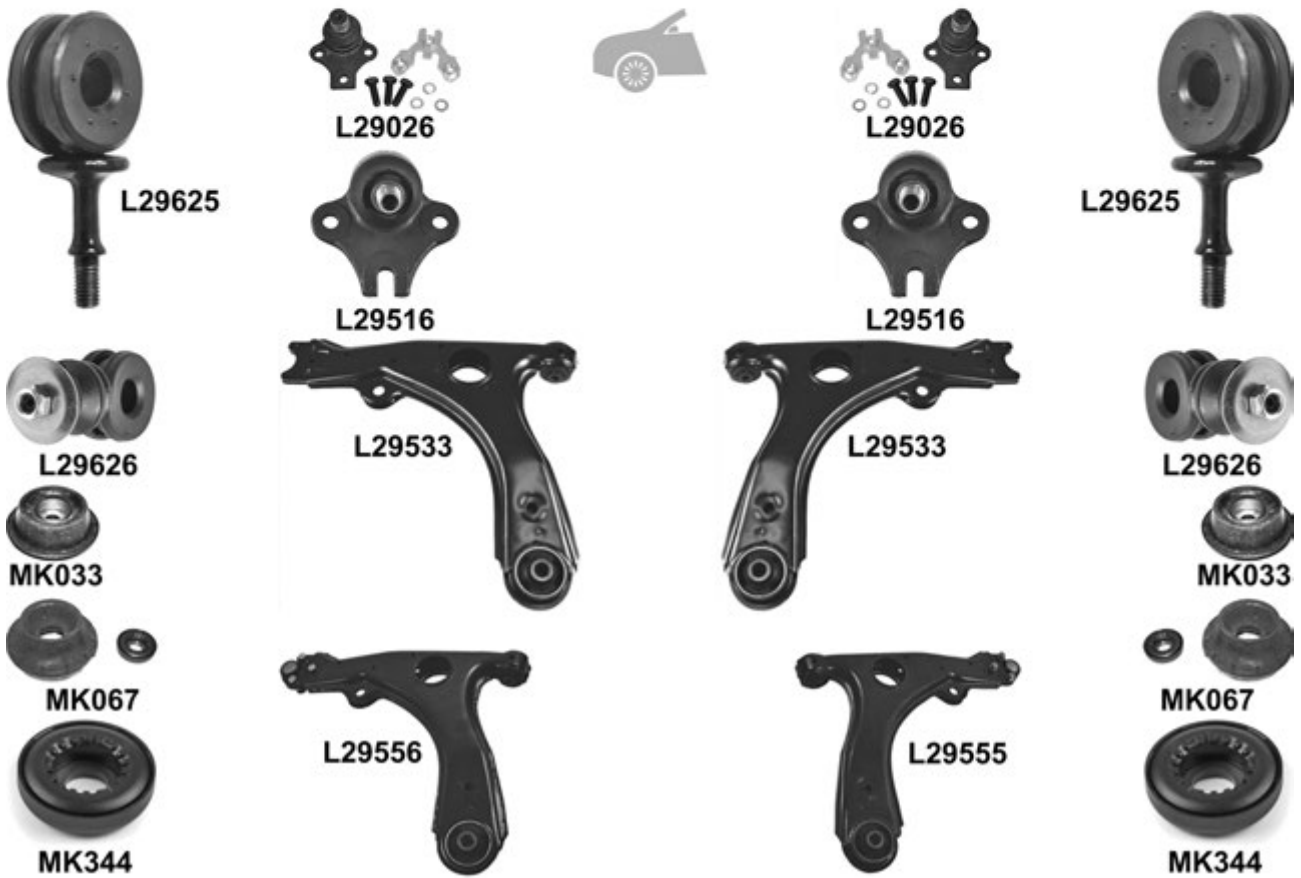
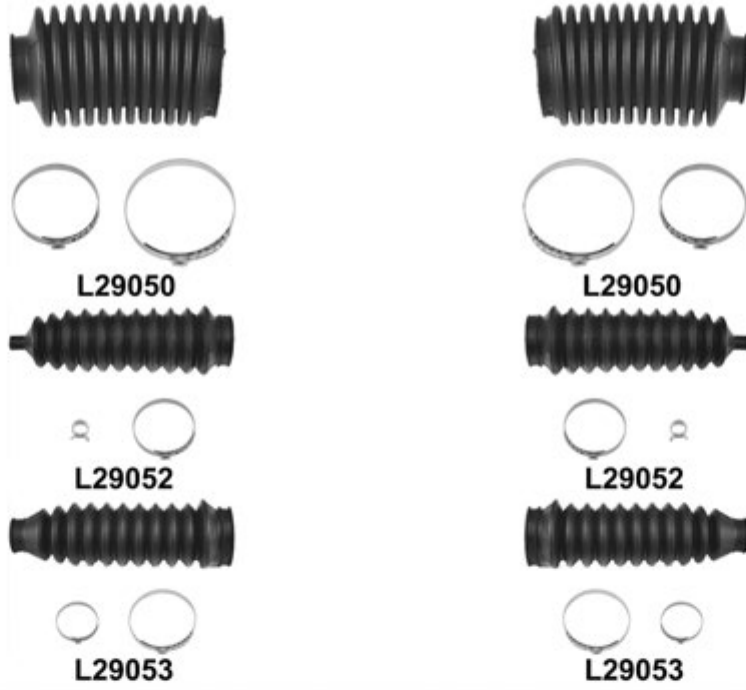

Passat / Passat Variant (35l) 02.88 → 05.97, ch. 31 J 000 001 → 3A VE/VB/VD 300 000



L29538



L29537



L29808



L29808



L29809



L29809



MK229



L29832



MK229

Passat / Passat Variant (35l) 02.88 → 05.97, ch. 31 J 000 001 → 3A VE/VB/VD 300 000

			←	→	Thread	Part Of	QPA			
		↔	(-) 2.0 16V/VR6	L29117	F 14x1,5 ∪		1	3A0 422 812		
			L29118	F 14x1,5 ∪		1	3A0 422 811			
		VR6/2.0 16V, , ZF, ch. 31 N 255 990 → 3A R 099 264	L29112	L29112	∪		2	357 422 811		
		VR6/2.0 16V, Tdi 81 KW , ZF, ch. 3A R 099 265 →	L29131	L29131	∪		2	3A0 422 811 A		
				L29207	L29207			2	357 419 821 A	
			, TRW / ZF, (-) 2.0 16V/VR6	L29208	L29208	M 14x1,5 / M 14x1,5		2	357 422 821 A	
			, → 31 N 080 000		L29319			1	357 419 804	
			L29320				1	357 419 803 A		
			ch. → 3A R 099 264, TRW, (-) 16V/VR6		L29321			1	357 422 804	
			L29322				1	357 422 803		
			ch. 3A R 099 265 →, TRW, (-) 16V/VR6/Tdi 81 KW		L29369			1	3A0 422 804 C	
			L29370				1	3A0 422 803 C		
			ch. → 3A R 099 264, 16V/VR6, TRW	L29334	L29334			2	357 422 803 B	
			ch. → 3A R 250 000, ZF, (-) VR6		L29323			1	357 422 804 A	
			L29324				1	357 422 803 A		
VR6, ch. → 31 N 255 989, , ZF				L29323			1	357 422 804 A		
L29324				1	357 422 803 A					
			L29050	L29050			2	191 419 831		
		, TRW	L29052	L29052			2	1H0 422 831		
		, ZF	L29053	L29053			2	357 422 831 B		
		⊥	(-) 1.9 Tdi 81kw/2.0 16V/2.8 VR6/2.9 VR6	L29026	L29026			2	357 407 365 A	
			2.8 VR6, ch. → 31 N 255 989	L29026	L29026			2	357 407 365 A	
			1.9 Tdi 81kw/2.0 16V/2.8 VR6, ch. 31 N 255 990 →/2.9 VR6	L29516	L29516			2	1H0 407 365	
		⊥		(+) 2.8 VR6, ch. → 31 N 255 989, (-) , (+)	L29533	L29533			2	357 407 153
				(+) 2.8 VR6, ch. → 31 N 255 989 <input checked="" type="checkbox"/>		L29555			1	
				L29556				1		
				1.9 Tdi 81kw/2.0 16V/2.8 VR6, ch. 31 N 255 990 →/2.9 VR6		L29537			1	1H0 407 152
		⊥		(-) , (+)	L29538				1	1H0 407 151 A
		⊥	↕	(+) VR6 ch. → 31 N 255 989	L29808	L29808			2	357 407 182
					L29809	L29809			2	191 407 181 E
				1.6/1.8, → 12.93 , (-) 16V/2.0/VR6/Variant/Syncro ∅ 18mm/22mm Anti-roll bar	L29625	L29625			2	357 411 315 C
				1.6/1.8, 01.94 →, (-) 16V/2.0/VR6/Variant/Syncro ∅ 20mm/24mm Anti-roll bar	L29626	L29626			2	357 411 315 D
				16V/2.0/VR6/Syncro/Variant, ∅ 20mm/24mm Anti-roll bar	L29626	L29626			2	357 411 315 D
				→ 31 P 026 435, (-) VR6	KIT	MK033	MK033		2	357 412 329
31 P 026 436 →, (-) VR6, (+) MK344				KIT	MK067	MK067		2	357 412 331 A	
VR6, (+) MK344				MK067	MK067		2	357 412 331 A		
				MK344	MK344		2	357 412 349 A		
				KIT	L29832		Hub carrier	1	3A0 501 541 S	
				KIT	MK229	MK229		2		

Passat (3B2) 08.96 → 11.00
 Passat Variant (3B5) 06.97 → 11.00

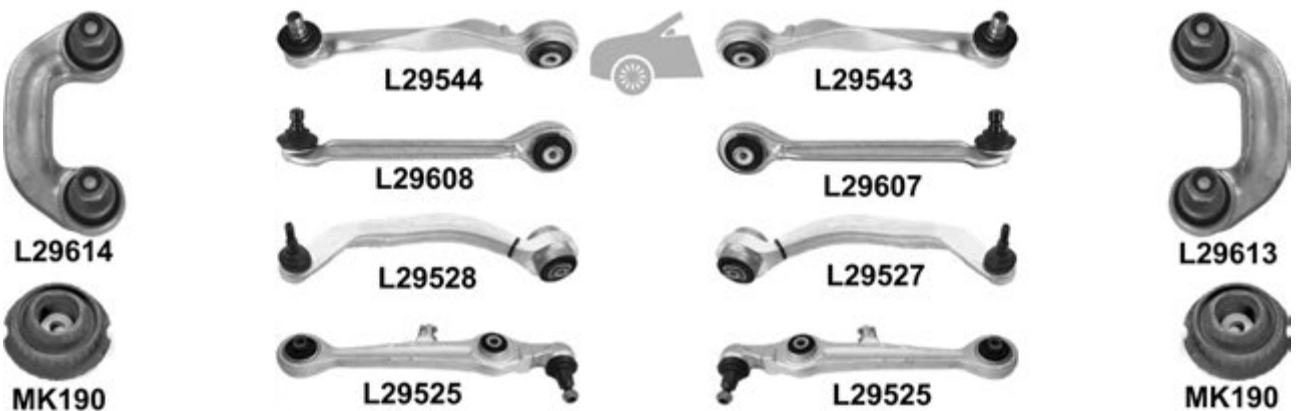
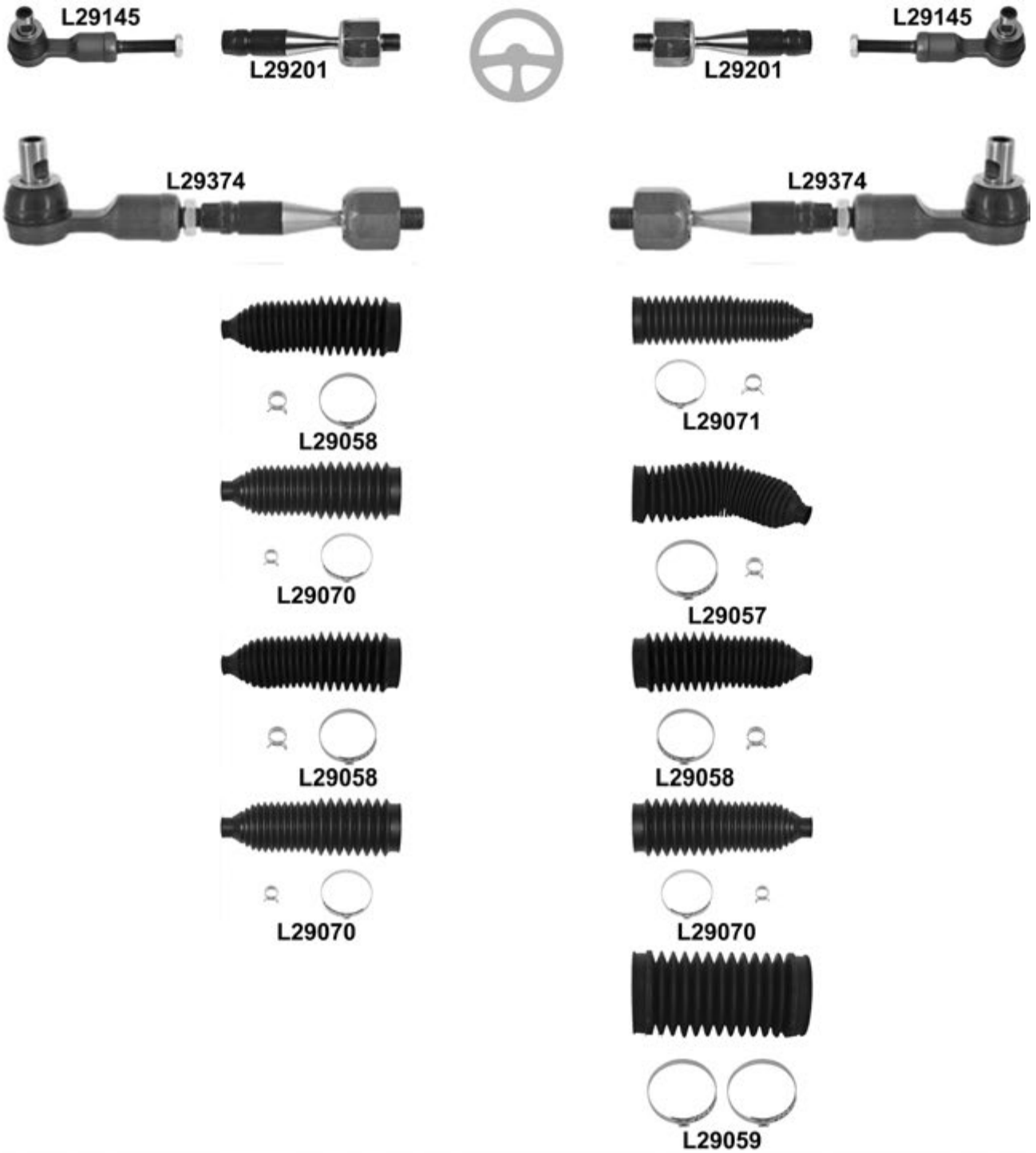

Passat (3B2) 08.96 → 11.00
 Passat Variant (3B5) 06.97 → 11.00



L0018



L29845



L29845



L29846



L29846



L29841



L29841



L29840



L29840



L29860



L29866



L29866



L29854



L29854



L29855



L29855



L29663



L29864



L29863



L29663



MK187



MK187

Passat (3B2) 08.96 → 11.00
Passat Variant (3B5) 06.97 → 11.00

		i	←	→	Thread	Part Of	QPA	i	
		↔	L29145	L29145	M 14x1,5 U		2	8E0 419 811 B	
			L29201	L29201	U		2	4D0 422 821 A	
			L29374	L29374			2	4B0 419 801 E	
		→ 01.99, 4 cyl., ø 17,5mm, Ø 63mm, L= 255mm		L29071 ⁰			1	8D0 419 831 J	
		→ 01.99, 4 cyl., ø 18mm, Ø 54mm, L= 205mm	L29058				1	4D0 419 831 D	
		02.99 →, 4 cyl., ø 19mm, Ø 63mm, L= 255mm		L29057			1	8D0 419 831 K	
		02.99 →, 4 cyl., ø 20mm, Ø 54mm, L= 205mm	L29070 ⁰				1	4D0 419 831 DE	
	↔	→ 01.99, 6 cyl., ø 18mm, Ø 54mm, L= 205mm	L29058	L29058			2	4D0 419 831 D	
		02.99 →, 6 cyl., ø 20mm, Ø 54mm, L= 205mm	L29070 ⁰	L29070 ⁰			1	4D0 419 831 DE	
	→←	6 cyl., cars with bracket for Steering damper ø 65mm, Ø 65mm, L= 141mm		L29059			1	4D0 419 831 A	
		↑▼		L29543			1	8D0 407 510 C	
			L29544				1	8D0 407 509 C	
		↑▲			L29607			1	8E0 407 506 A
				L29608				1	8E0 407 505 A
		⊥▼			L29527			1	8E0 407 694 K
				L29528				1	8E0 407 693 K
		⊥▲		L29525	L29525			2	4D0 407 151 K
		2 x L 29145/2 x L 29525/29527/29528/29543/29544/ 29607/29608/29613/29614/29860	KIT	L0018				1	8D0 498 998
		↑▲▼↔		L29845	L29845		L29543/L29544/ L29607/L29608	2	4D0 407 515 C
			⊥▼↔	L29846	L29846		L29527/L29528	2	4D0 407 183 P
			⊥▲↔	L29841	L29841		L29525	2	4D0 407 182 E
			⊥▲↔	L29840	L29840		L29525	2	4D0 407 181 H
				L 29525/29527/29528/29543/29544/ 29607/29608/29613/29614	KIT	L29860			
		↑▲	L 29607/29608	L29866	L29866			2	
				⊥		L29613			1
			L29614				1	8D0 411 317 D	
		(-) HD, PR 1BD/1BE/1BP/1BV with SP/Allroad ø 24.8mm	L29854	L29854		Anti-roll bar	2	4D0 411 327 G	
		HD, (-) Height adjustment, ø 27mm	L29855	L29855		Anti-roll bar	2	4D0 411 327 H	
			MK190	MK190			2	4D0 412 377 F	
				L29863		Hub carrier	1	4B0 501 522 E	
			L29864			Hub carrier	1	4B0 501 521 E	
			L29663	L29663			2	8E0 505 465 D	
		(-) Syncro		MK187	MK187			2	4D0 412 377 F

Passat (3B3) 11.00 → 05.05
 Passat Variant (3B6) 11.00 → 08.05

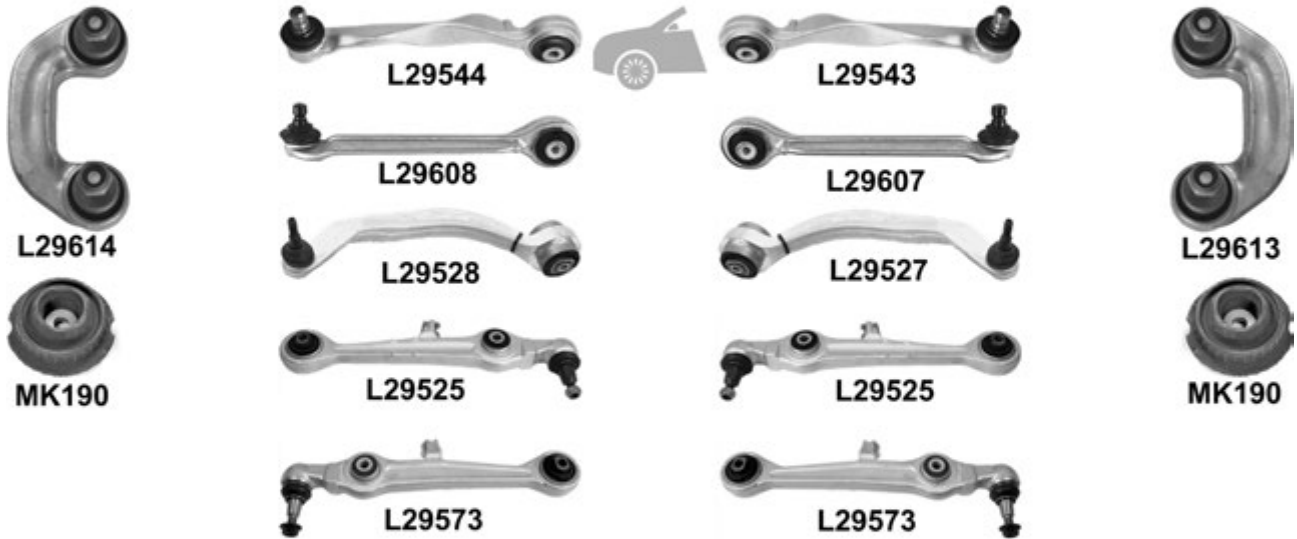
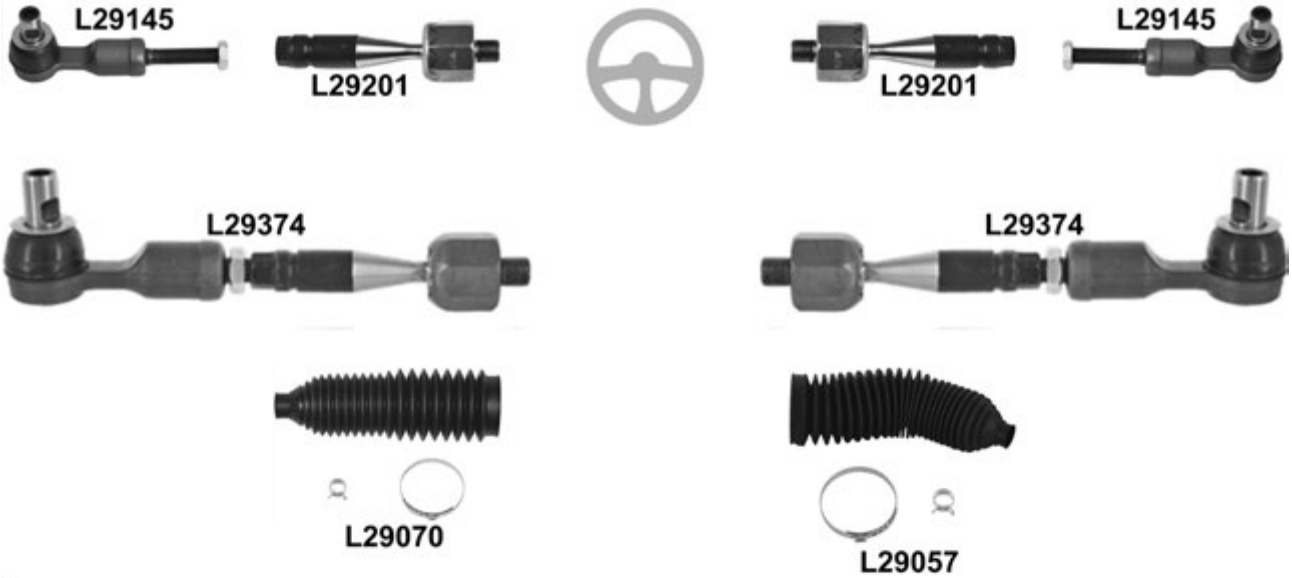

Passat (3B3) 11.00 → 05.05
 Passat Variant (3B6) 11.00 → 08.05

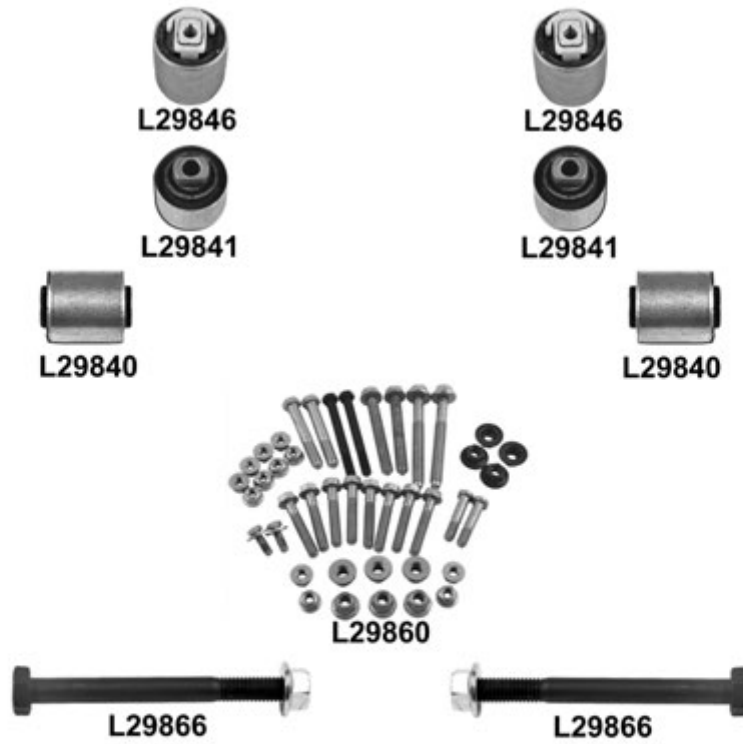

Passat (3B3) 11.00 → 05.05
Passat Variant (3B6) 11.00 → 08.05

			←	→	Thread	Part Of	QPA		
		↔	L29145	L29145	M 14x1,5 U		2	8E0 419 811 B	
			L29201	L29201	U		2	4D0 422 821 A	
			L29374	L29374			2	4B0 419 801 E	
		∅ 19mm, ∅ 63mm, L= 255mm		L29057			1	8D0 419 831 K	
		∅ 20mm, ∅ 54mm, L= 205mm		L29070 ⁰			1	4D0 419 831 E	
		↑		L29543			1	8D0 407 510 C	
			L29544				1	8D0 407 509 C	
		↑		L29607			1	8E0 407 506 A	
			L29608				1	8E0 407 505 A	
		↓		L29527			1	8E0 407 694 K	
			L29528				1	8E0 407 693 K	
		↓	→ ch. 3B 3 072 000	L29525	L29525			2	4D0 407 151 K
			ch. 3B 3 072 001 →	L29573	L29573			2	4B3 407 151 E
			→ ch. 3B 3 072 000 2 x L 29145 / 2 x L 29525 / 29527 / 29528 / 29543 / 29544 / 29607 / 29608 / 29613 / 29614 / 29860	KIT L0018				1	8D0 498 998
			ch. 3B 3 072 001 → 2 x L 29145 / 2 x L 29573 / 29527 / 29528 / 29543 / 29544 / 29607 / 29608 / 29613 / 29614 / 29860	KIT L0020				1	8D0 498 998
		↑↔↔	L29845	L29845		L29543/L29544/ L29607/L29608	4	4D0 407 515 C	
		↓↔↔	L29846	L29846		L29527/L29528	2	4D0 407 183 P	
		↑↔↔	L29841	L29841		L29525/L29573	2	4D0 407 182 E	
		↓↔↔	L29840	L29840		L29525/L29573	2	4D0 407 181 H	
			L 29525 / 29573 / 29527 / 29528 / 29543 / 29544	KIT L29860			1		
		↑	L 29607 / 29608	L29866	L29866		2		
		↓		L29613			1	8D0 411 318 D	
			L29614				1	8D0 411 317 D	
			→ 03.01 , → ch. 3B 1 300 000	MK190	MK190		2	4D0 412 377 F	
					L29863		Hub carrier	1	4B0 501 522 E
				L29864		Hub carrier	1	4B0 501 521 E	
				L29663	L29663		2	8E0 505 465 D	

Passat (3C2) 03.05 →
 Passat Variant (3C5) 08.05 →

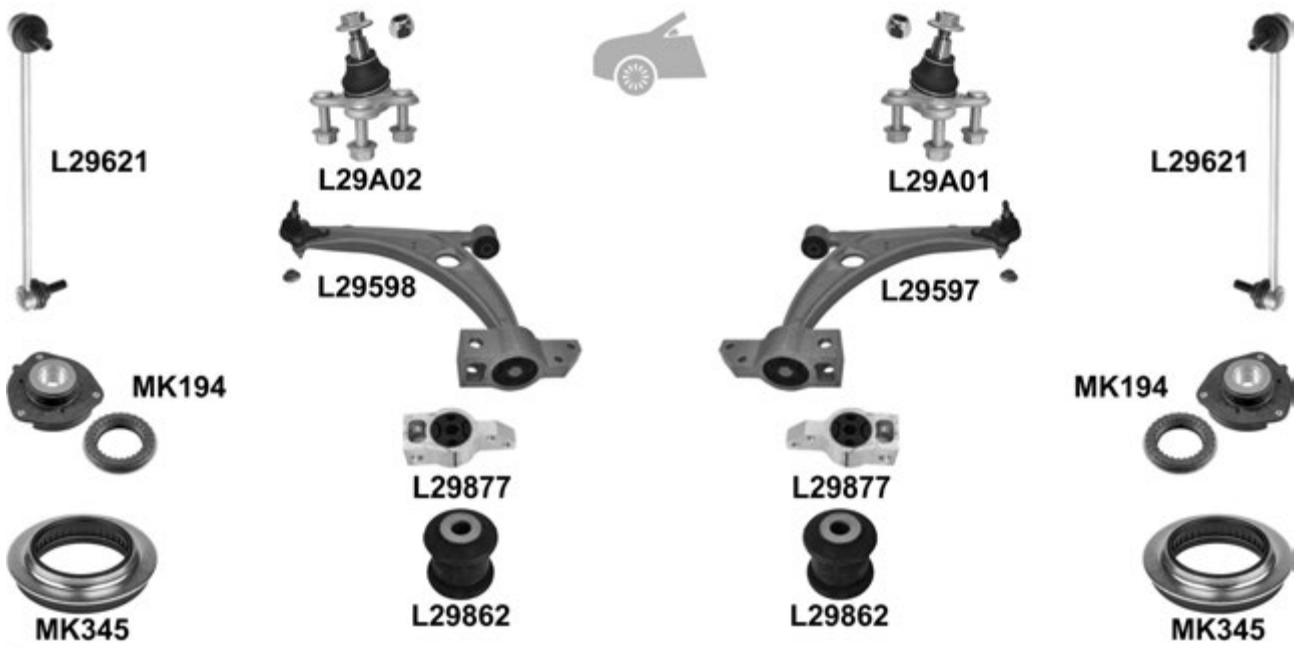
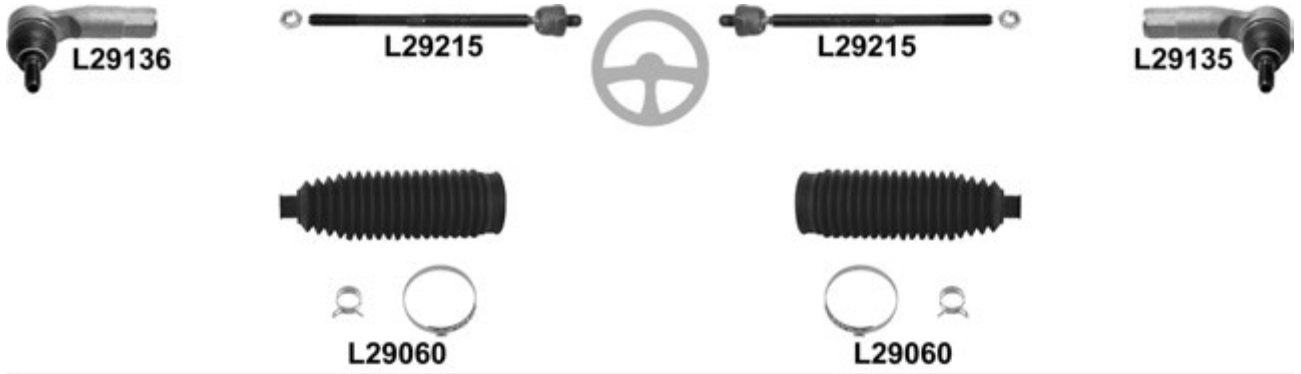

Passat (3C2) 03.05 →
Passat Variant (3C5) 08.05 →

		i		←	→	Thread	Part Of	QPA	i	
		↔			L29135	F 16x1,5 ⌀		1	1K0 423 812 G	
					L29136	F 16x1,5 ⌀		1	1K0 423 811 G	
					L29215	L29215	M 16x1,5 / M 16x1,5 ⌀	2	1K0 423 810 A	
			Electronic		L29060	L29060		2	1K0 423 831 A	
		⊥				L29A01		1	3C0 407 366 A	
						L29A02		1	3C0 407 365 A	
		⊥	ALU <input checked="" type="checkbox"/>			L29597		1	3C0 407 151 E	
						L29598		1	3C0 407 151 E	
		⊥▼				L29877	L29877		2	3C0 199 231 D
		⊥▲				L29862	L29862		2	1K0 407 182
						L29621	L29621		2	1K0 411 315 J
			(+) MK345			MK194	MK194		2	1K0 412 331 B
						MK345	MK345		2	6N0 412 249 C
			⊥▲				L29A11	L29A11		2
		⊥	<input checked="" type="checkbox"/>			L29A29	L29A29		2	1K0 505 311 AB
		▲					L29637		1	1K0 501 530 C
							L29638		1	1K0 501 529 F
							L29623	L29623	2	1K0 505 465 J
			(-) 1JH				MK386	MK386	2	3C0 513 353 C

Passat (362) 08.10 →
 Passat Variant (365) 08.10 →

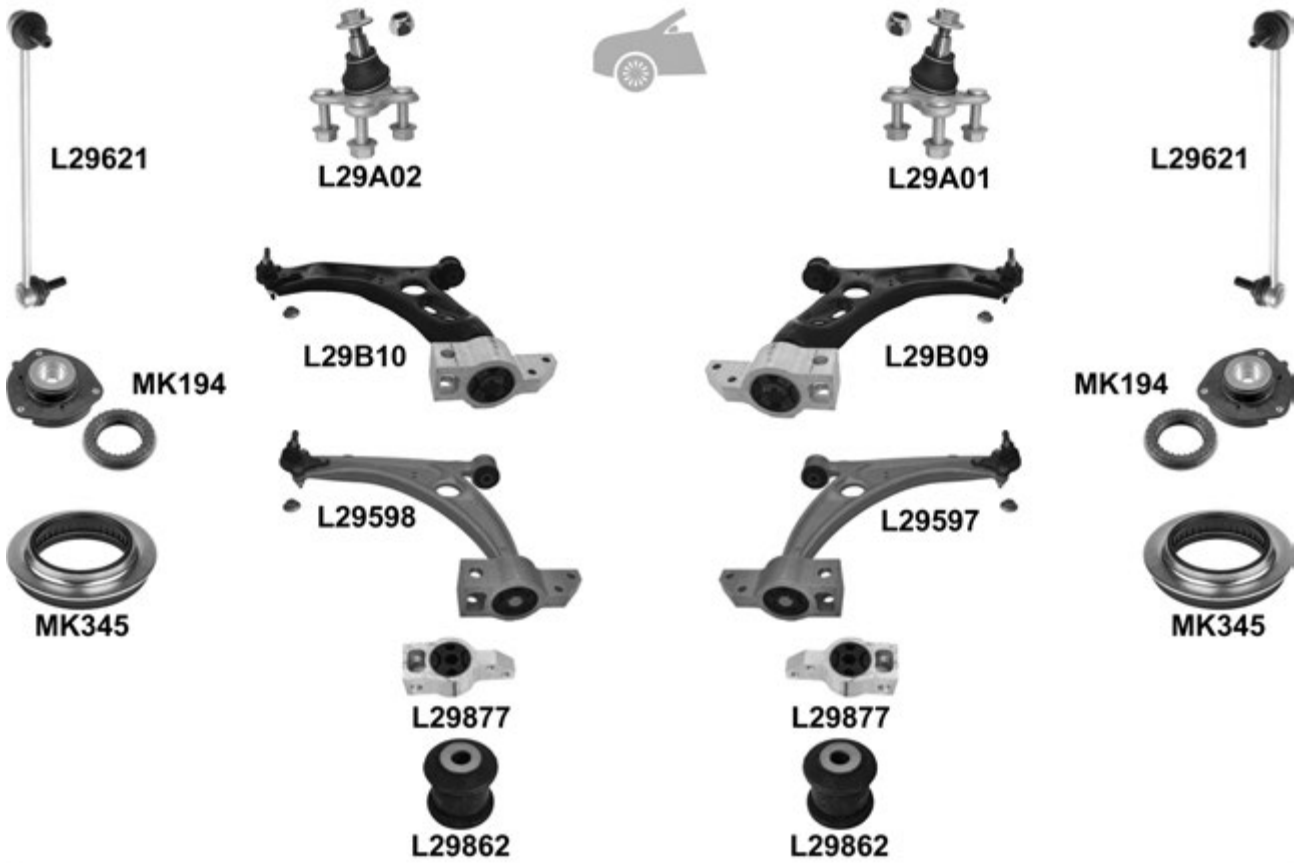

Passat (362) 08.10 →
Passat Variant (365) 08.10 →

		i		←	→	Thread	Part Of	QPA	i	
		↔				L29135 F 16x1,5 ♂		1	1K0 423 812 G	
						L29136 F 16x1,5 ♂		1	1K0 423 811 G	
						L29215 L29215 M 16x1,5 / M 16x1,5 ♂		2	1K0 423 810 A	
		⊥				L29A01		1	3C0 407 366 B	
						L29A02		1	3C0 407 365 B	
		⊥	PR 1ZG/1ZM, Sheet Metal <input checked="" type="checkbox"/>				L29B09		1	5N0 407 152
							L29B10		1	5N0 407 151
						PR 1LA/1LB, ALU <input checked="" type="checkbox"/>			L29597	
						L29598		1	3C0 407 151 E	
		⊥ ▼				L29877 L29877			2	3C0 199 231 D
						L29862 L29862			2	1K0 407 182
						L29621 L29621			2	1K0 411 315 J
						MK194 MK194			2	1K0 412 331 B
					MK345 MK345			2	6N0 412 249 C	
		⊥ ▲	→ 05.12			L29A11 L29A11			2	4K0 505 323 N
				<input checked="" type="checkbox"/>		L29A29 L29A29			2	1K0 505 311 AB
		▲				L29637			1	1K0 501 530 C
						L29638			1	1K0 501 529 F
						L29623 L29623			2	1K0 505 465 J
			(-) 1JH/017			MK386 MK386		2	3C0 513 353 C	

Passat CC 06.08 →

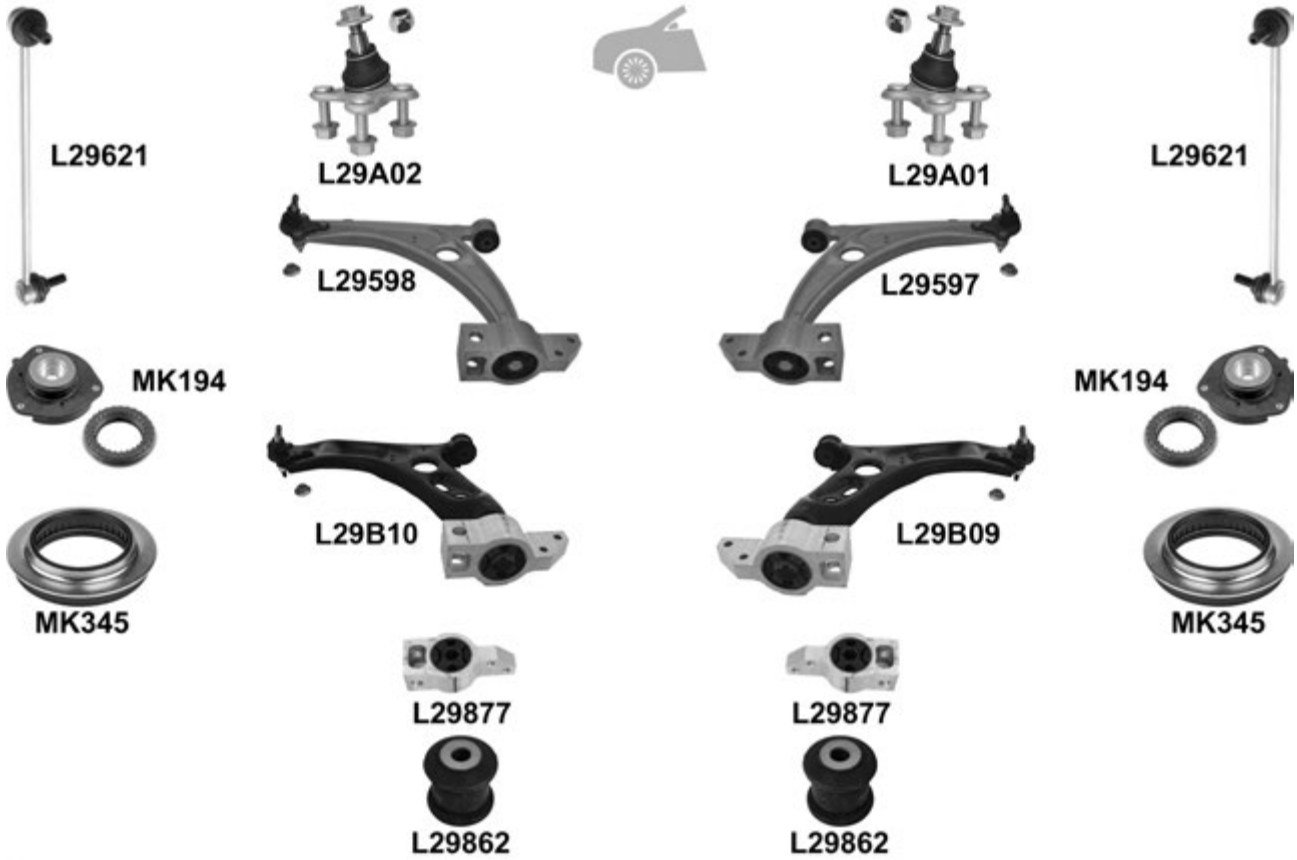

Passat CC 06.08 →

				←	→	Thread	Part Of	QPA		
		↔		L29135		F 16x1,5 ∪		1	1K0 423 812 G	
				L29136		F 16x1,5 ∪		1	1K0 423 811 G	
		↓		L29215	L29215	M 16x1,5 / M 16x1,5 ∪		2	1K0 423 810 A	
				L29A01				1	3C0 407 366 B	
		↓	→ 05.10, ALU	<input checked="" type="checkbox"/>	L29597				1	3C0 407 151 E
					L29598				1	3C0 407 151 E
				<input checked="" type="checkbox"/>	L29B09				1	5N0 407 152
					L29B10				1	5N0 407 151
				<input checked="" type="checkbox"/>	L29597				1	3C0 407 151 E
					L29598				1	3C0 407 151 E
		↓			L29877	L29877			2	3C0 199 231 D
		↑			L29862	L29862			2	1K0 407 182
					L29621	L29621			2	1K0 411 315 J
			(+) MK345		MK194	MK194			2	1K0 412 331 B
				MK345	MK345			2	6N0 412 249 C	
	↓	→ 05.12		L29A11	L29A11			2	4K0 505 323 N	
			<input checked="" type="checkbox"/>	L29A29	L29A29			2	1K0 505 311 AB	
	↑			L29637				1	1K0 501 530 C	
				L29638				1	1K0 501 529 F	
					L29623	L29623			2	1K0 505 465 J
			PR UA4/UC1		MK386	MK386			2	3C0 513 353 C
		PR 1JP, → 02.09,		MK386	MK386			2	3C0 513 353 C	

Phaeton (3D2) 04.2002 →

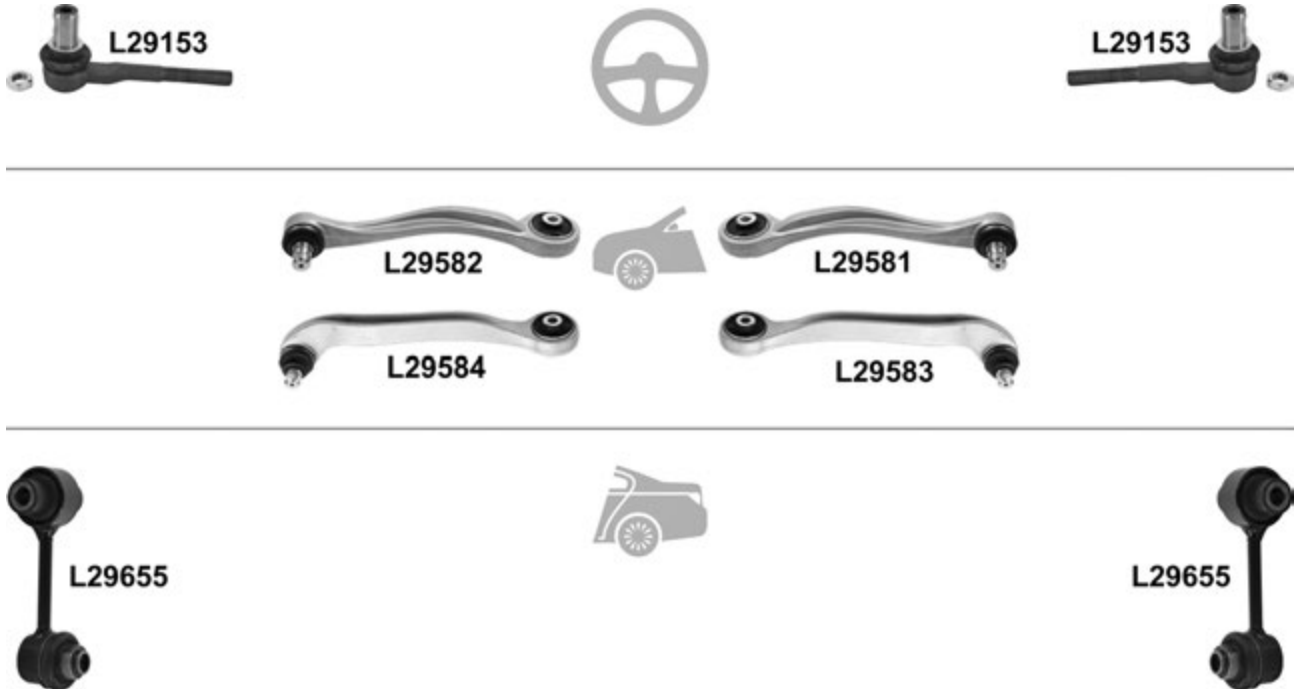

				←	→	Thread	Part Of	QPA	
		↔		L29153	L29153	∪		2	4E0 419 811 E
		↓		L29581				1	4E0 407 510 D
				L29582				1	4E0 407 509 D
				L29583				1	4E0 407 506 D
				L29584				1	4E0 407 505 D
				L29655	L29655			2	4E0 505 765 G

Polo (86) 04.75 → 09.81 ch. 866 2300 001 → 86/87 C 200 000

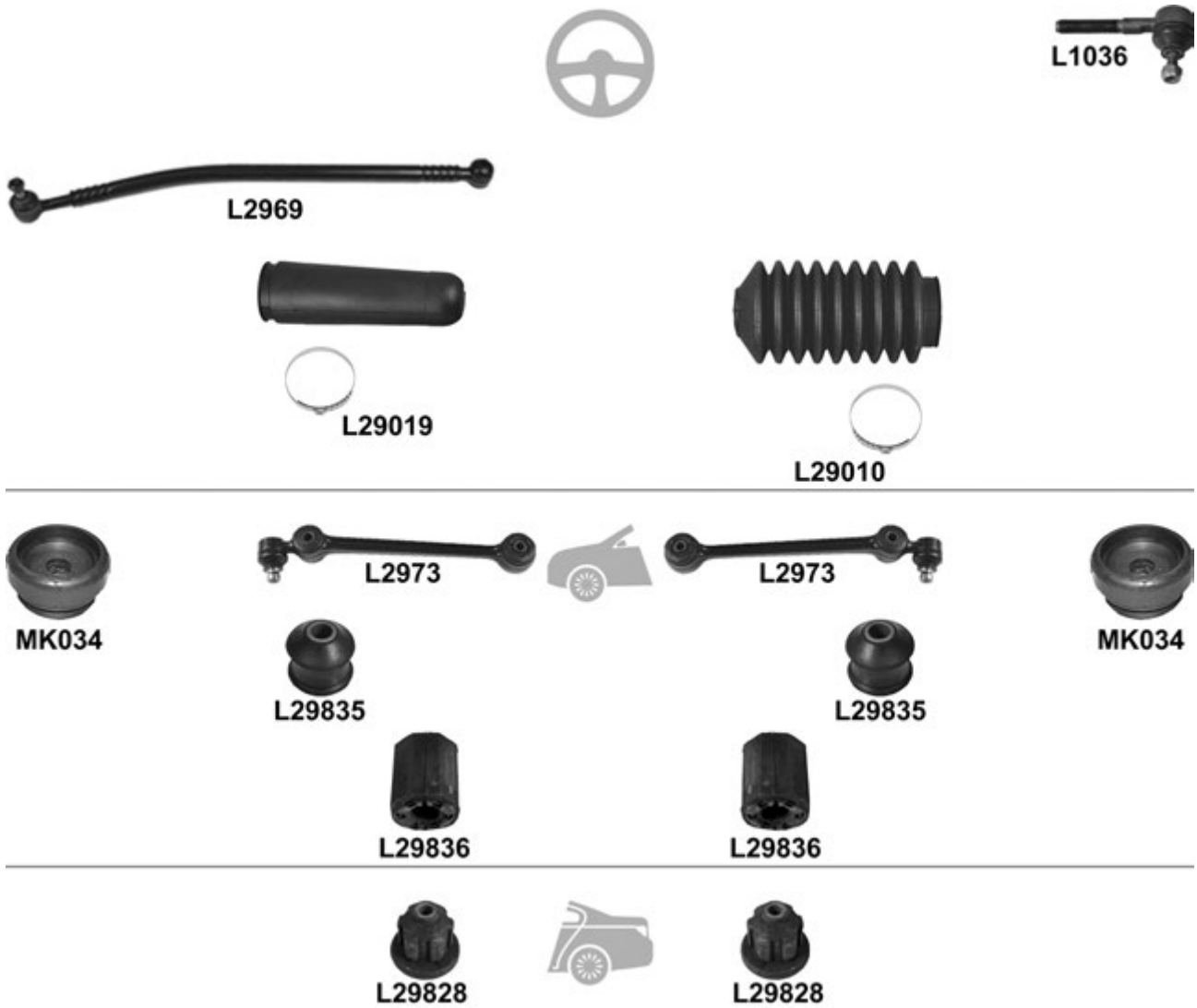

		i		←	→	Thread	Part Of	QPA	i
⊕		↔			L1036	M 14x1,5 U		1	811 419 812
					L2969			1	861 419 801 D
					L29010			1	861 419 831 B
					L29019			1	861 419 287 A
⊖		⊥	10.78 →, (-) GT 40, ch. 869 2523 523 →	<input checked="" type="checkbox"/>	L2973	L2973		2	861 407 151 B
		↕↔			L29835	L29835		2	861 407 183
		↕↔			L29836	L29836	Anti-roll bar	2	867 411 313
				KIT	MK034	MK034		2	871 412 323 A
					L29828	L29828	Hub carrier	2	861 511 271

Polo (86C) 10.81 → 09.94 ch. 86/87 D 000 001 → 80 RY 150 000

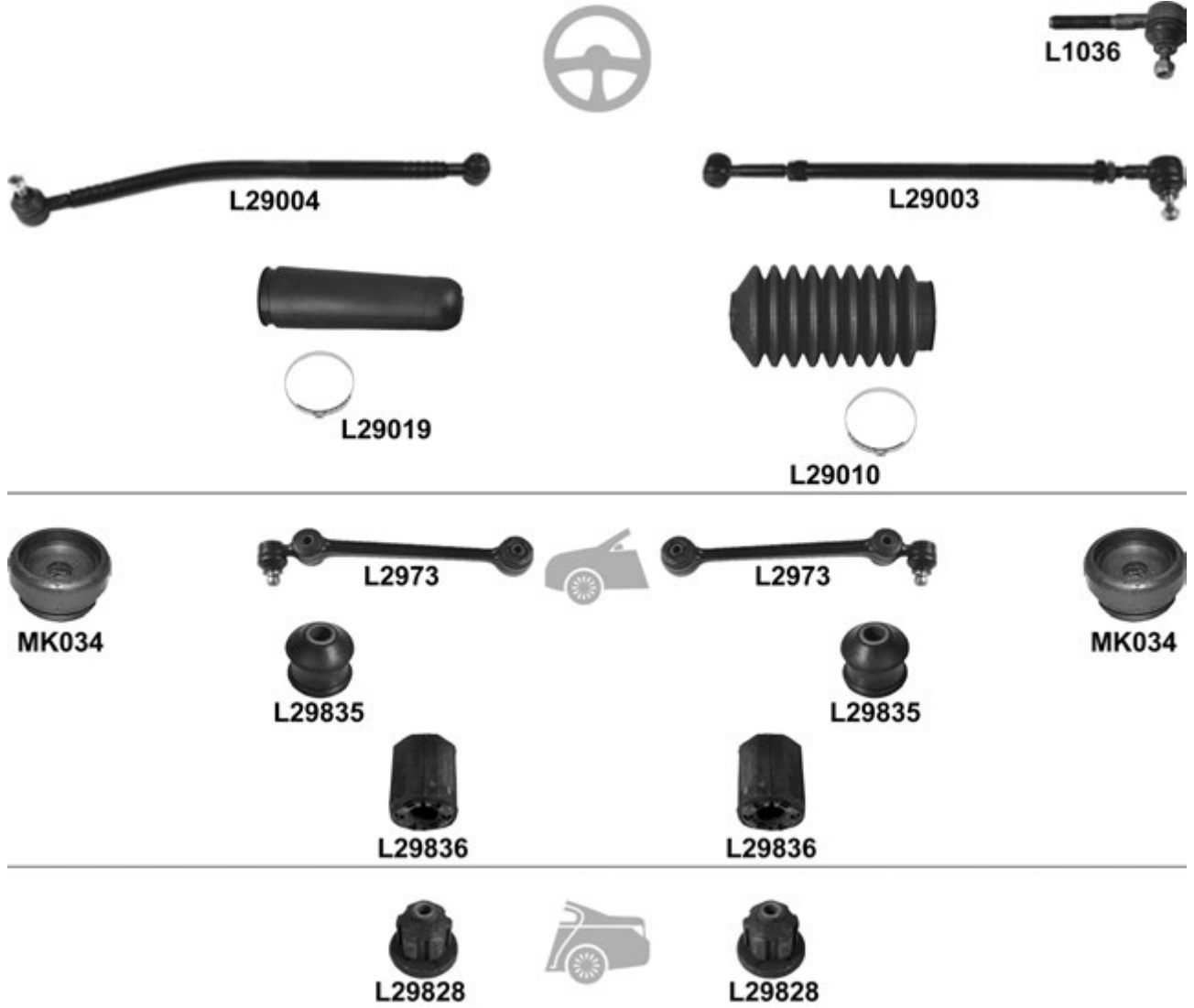

		i		←	→	Thread	Part Of	QPA	i
		↔				L1036 M 14x1,5 U		1	811 419 812
						L29003		1	871 419 802
						L29004		1	871 419 801 A
						L29010		1	861 419 831 B
						L29019		1	861 419 287 A
		⊥	(-) G40	<input checked="" type="checkbox"/>		L2973 L2973		2	861 407 151 B
		⊥↔	(-) G40			L29835 L29835		2	861 407 183
		⊥↔	(-) G40			L29836 L29836	Anti-roll bar	2	867 411 313
			(-) G40		KIT	MK034 MK034		2	871 412 323 A
						L29828 L29828	Hub carrier	2	861 511 271

Polo (6N1) 10.94 → 10.99
 Polo Van (6NF)

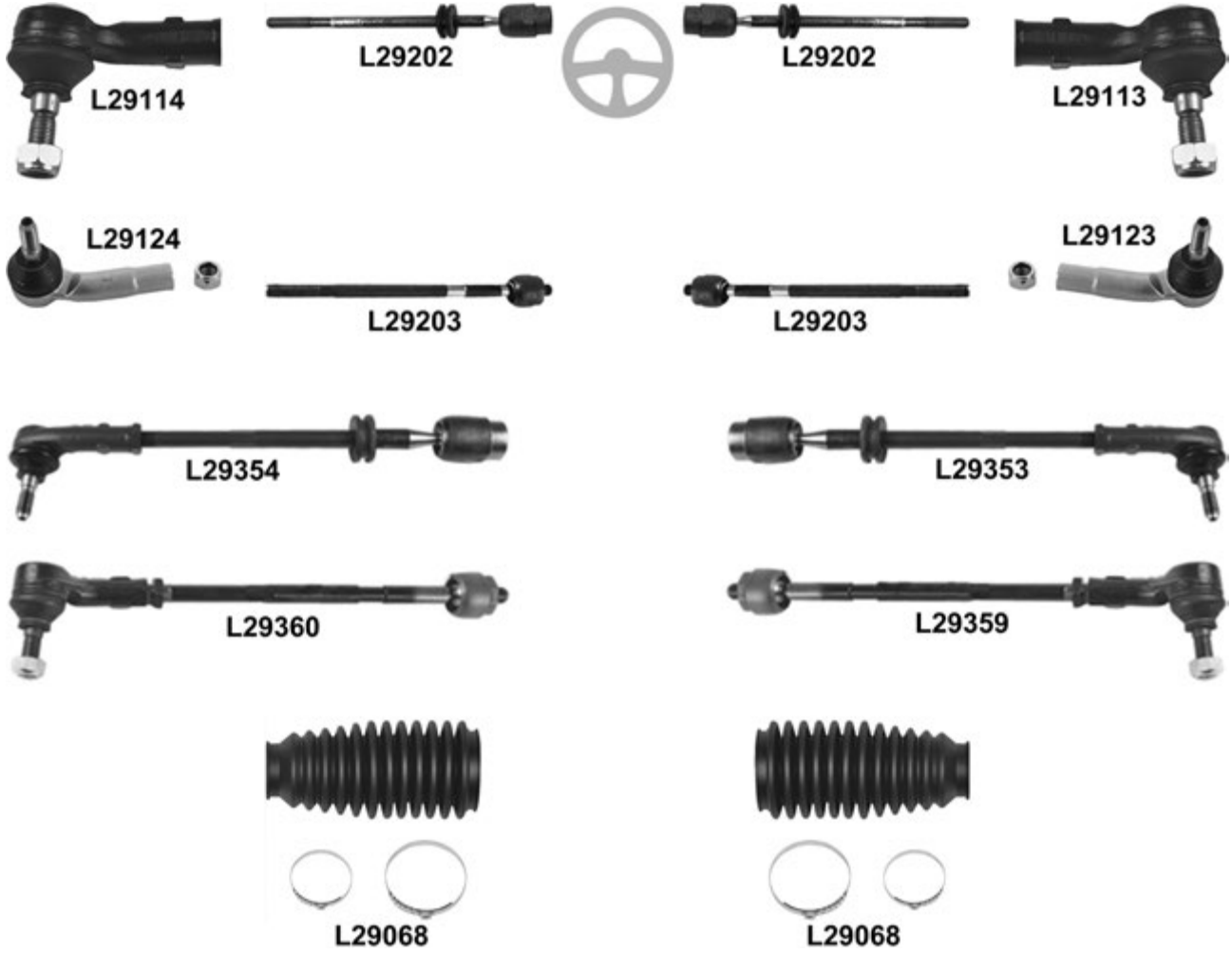

Polo (6N1) 10.94 → 10.99
 Polo Van (6NF)

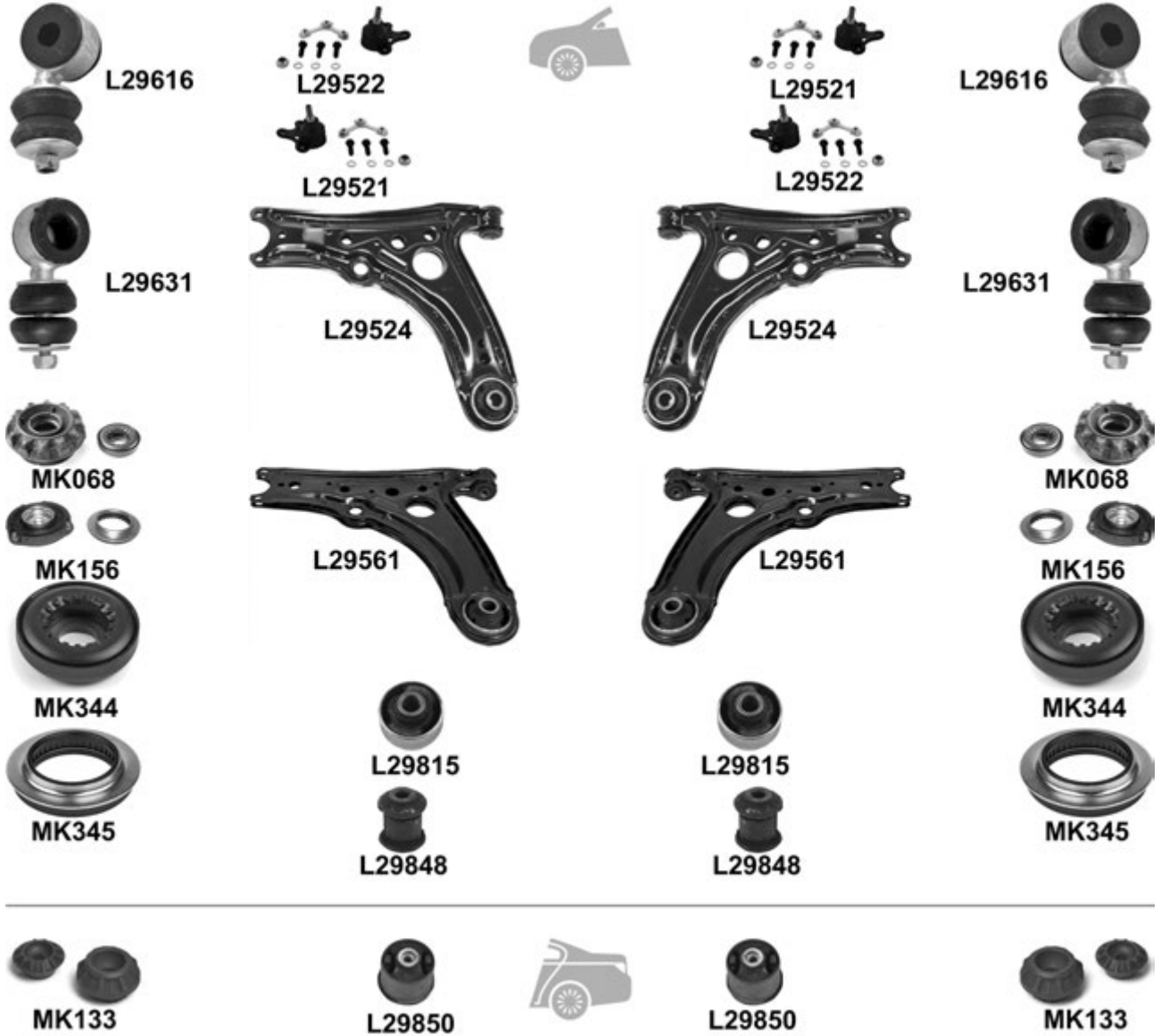

Polo (6N1) 10.94 → 10.99
Polo Van (6NF)

			←	→	Thread	Part Of	QPA		
				L29113	F 14x1,5 ♂		1	6N0 419 812	
			L29114	F 14x1,5 ♂		1	6N0 419 811		
				L29123	F 14x1,5 ♂		1	6X0 422 812	
			L29124	F 14x1,5 ♂		1	6X0 422 811		
			L29202	L29202	M 14x1,5 / F 22x1,5	L29353/L29354	2	6N0 422 821 A	
			L29203	L29203	M 14x1,5 / M 14x1,5	L29359/L29360	2	6Q0 423 810 B	
			L29353				1	6N0 419 804	
			L29354				1	6N0 419 803	
			L29359				1	6X0 422 804 A	
				L29360			1	6X0 422 803 A	
		⊖, ø 25mm, Ø 40mm, L= 143mm	L29068 ⁰	L29068 ⁰		2	6N0 419 831		
		⊥	13°	L29521			1	6N0 407 365 A	
			L29522			1	6N0 407 365		
			14°	L29522			1	6N0 407 365	
			L29521			1	6N0 407 365 A		
		⊥	→ 04.99, → ch. 6NYY 500 000, (-) , (+)	L29524	L29524		2	6N0 407 151	
			05.99 → ch. 6NYY 500 001 → /6NYD 000 001 → (-) , (+)	L29561	L29561		2	6X0 407 151 A	
		⊥		L29815	L29815		2	6N0 407 181	
				L29848	L29848		2	6N0 407 182	
			→ 04.99, ø 16mm, Ø 18mm Anti-roll bar	L29616	L29616		2	6N0 411 315 C	
			05.99 →, ø 18mm, Ø 20mm/22mm Anti-roll bar	L29631	L29631		2	6N0 411 315 D	
			(-) 60 1.7 Sdi/ 64 1.9 D/ 64 1.9 Sdi, (+) MK344	KIT	MK068	MK068		2	6N0 412 331 AS
			60 1.7 Sdi/ 64 1.9 D/ 64 1.9 Sdi, (+) MK345	MK156	MK156		2	6N0 412 331 E	
			(-) 60 1.7 Sdi/ 64 1.9 D/ 64 1.9 Sdi	MK344	MK344		2	1J0 412 249	
60 1.7 Sdi/ 64 1.9 D/ 64 1.9 Sdi			MK345	MK345		2	6N0 412 249 C		
			L29850	L29850	Hub carrier	2	6N0 501 541 D		
			MK133	MK133		2	191 512 333 S1		

Polo (6N2) 10.99 → 09.01

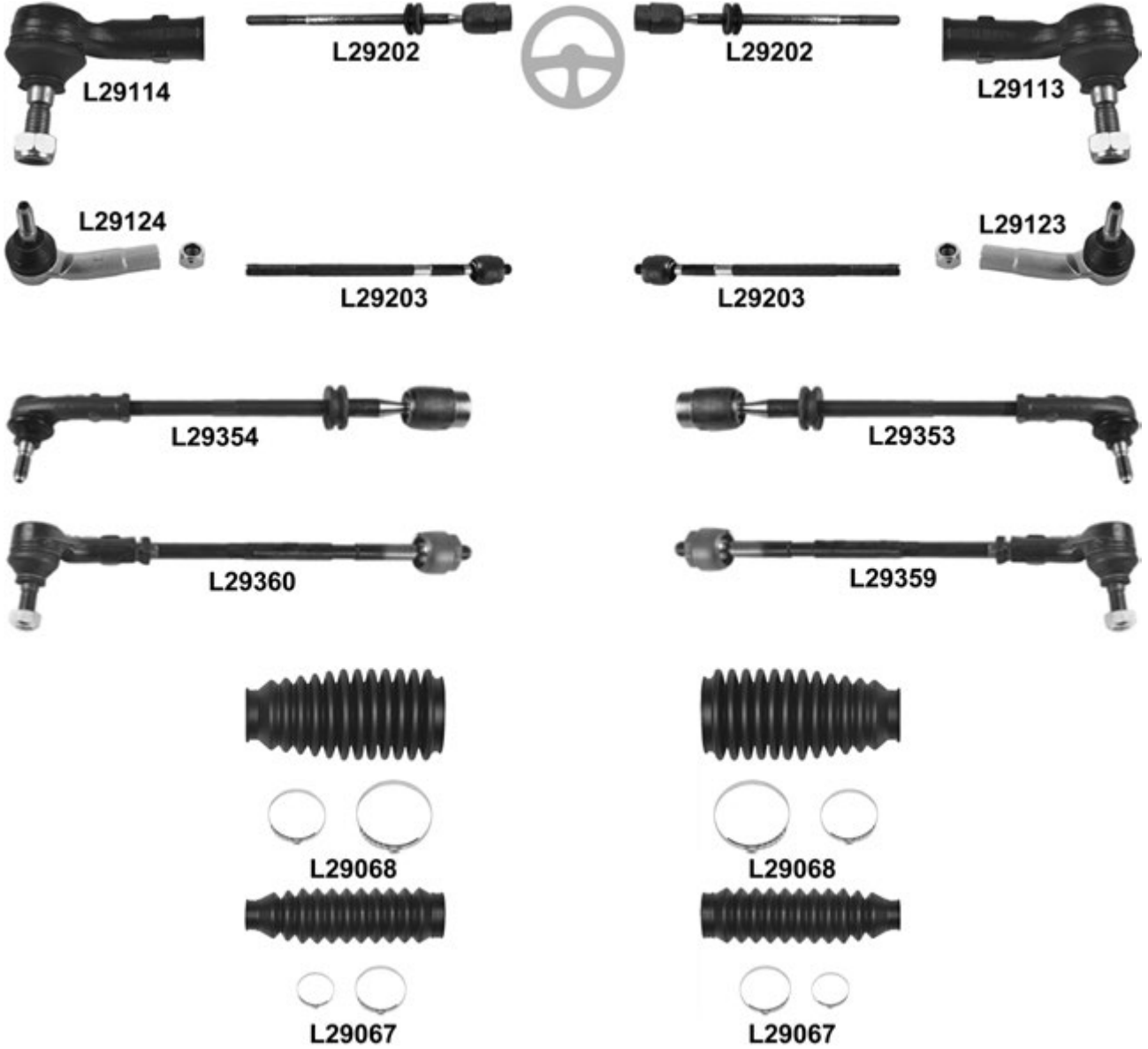

Polo (6N2) 10.99 → 09.01

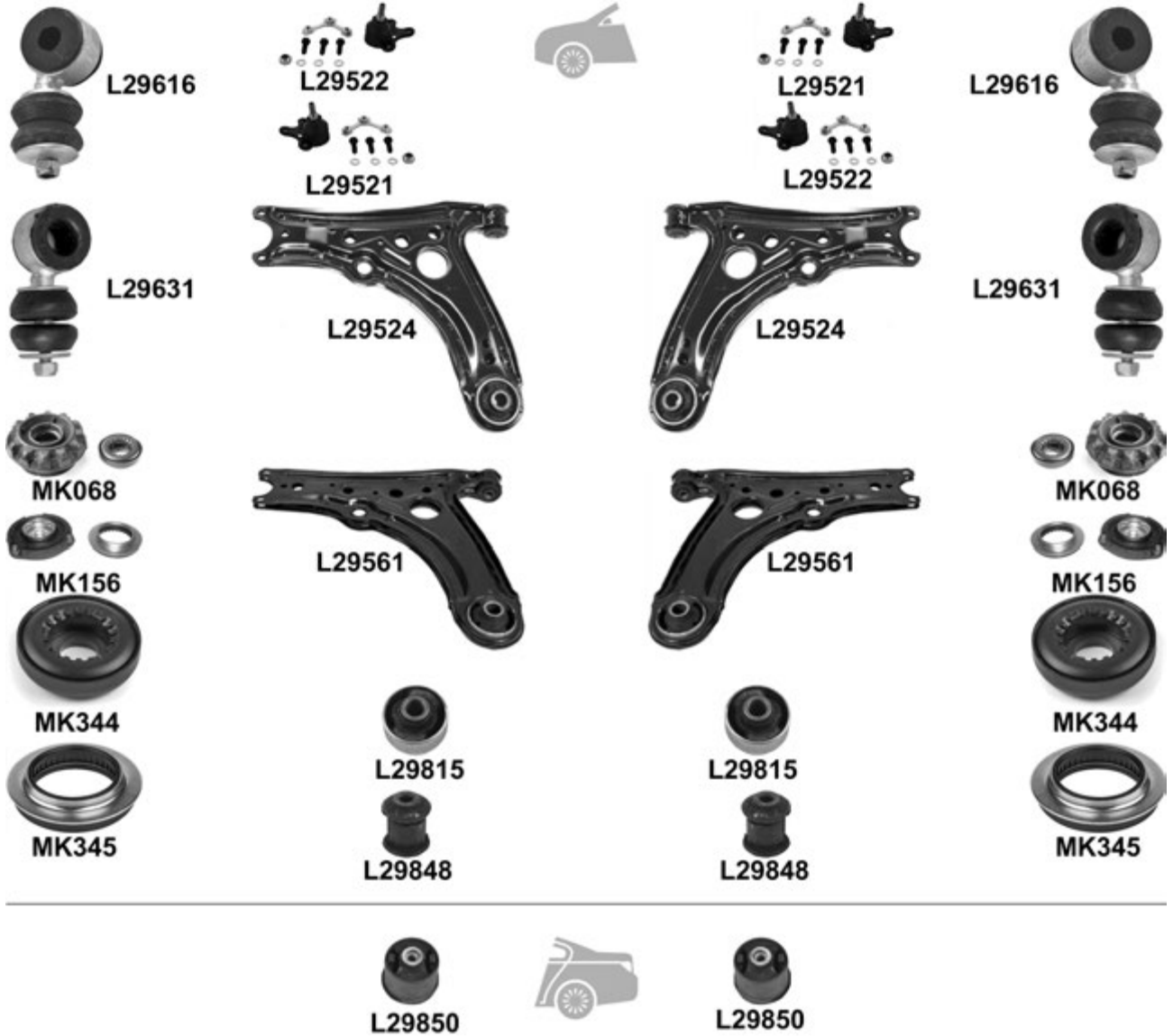

Polo (6N2) 10.99 → 09.01

			←	→	Thread	Part Of	QPA			
				L29113	F 14x1,5 ∩		1	6N0 419 812		
				L29114	F 14x1,5 ∩		1	6N0 419 811		
				L29123	F 14x1,5 ∩		1	6X0 422 812		
				L29124	F 14x1,5 ∩		1	6X0 422 811		
				L29202	L29202	M 14x1,5 / F 22x1,5	L29353/L29354	2	6N0 422 821 A	
				L29203	L29203	M 14x1,5 / M 14x1,5	L29359/L29360	2	6Q0 423 810 B	
				L29353				1	6N0 419 804 A	
				L29354				1	6N0 419 803 A	
				L29359				1	6X0 422 804 A	
				L29360				1	6X0 422 803 A	
				∅ 25mm, ∅ 40mm, L= 143mm		L29068 ^o	L29068 ^o	2	6N0 419 831	
				∅ 11mm, ∅ 42mm, L= 208mm		L29067 ^o	L29067 ^o	2	6N0 422 831	
								1	6N0 407 365 A	
				L29521				1	6N0 407 365	
				L29522				1	6N0 407 365	
				L29521				1	6N0 407 365 A	
				→ 04.99 , → ch. 6NYY 500 000, (-) , (+)		L29524	L29524	2	6N0 407 151	
				05.99 ch. 6NYY 500 001 → ch. 6NYD 000 001 → (-) , (+)		L29561	L29561	2	6X0 407 151 A	
						L29815	L29815	2	6N0 407 181	
						L29848	L29848	2	6N0 407 182	
				∅ 16mm, ∅ 18mm Anti-roll bar		L29616	L29616	2	6N0 411 315 C	
				∅ 18mm, ∅ 20mm/22mm Anti-roll bar		L29631	L29631	2	6N0 411 315 D	
				→ 12.00 , (+) MK344		KIT	MK068	MK068	2	6N0 412 331 AS
				01.01 →, (+) MK345		MK156	MK156	2	6N0 412 331 E	
			→ 12.00		MK344	MK344	2	1J0 412 249		
			01.01 →		MK345	MK345	2	6N0 412 249 C		
			ch. → 6K X 610 000, ∅ 58mm		L29850	L29850	2	6N0 501 541 D		

Polo (9N) 10.01 →

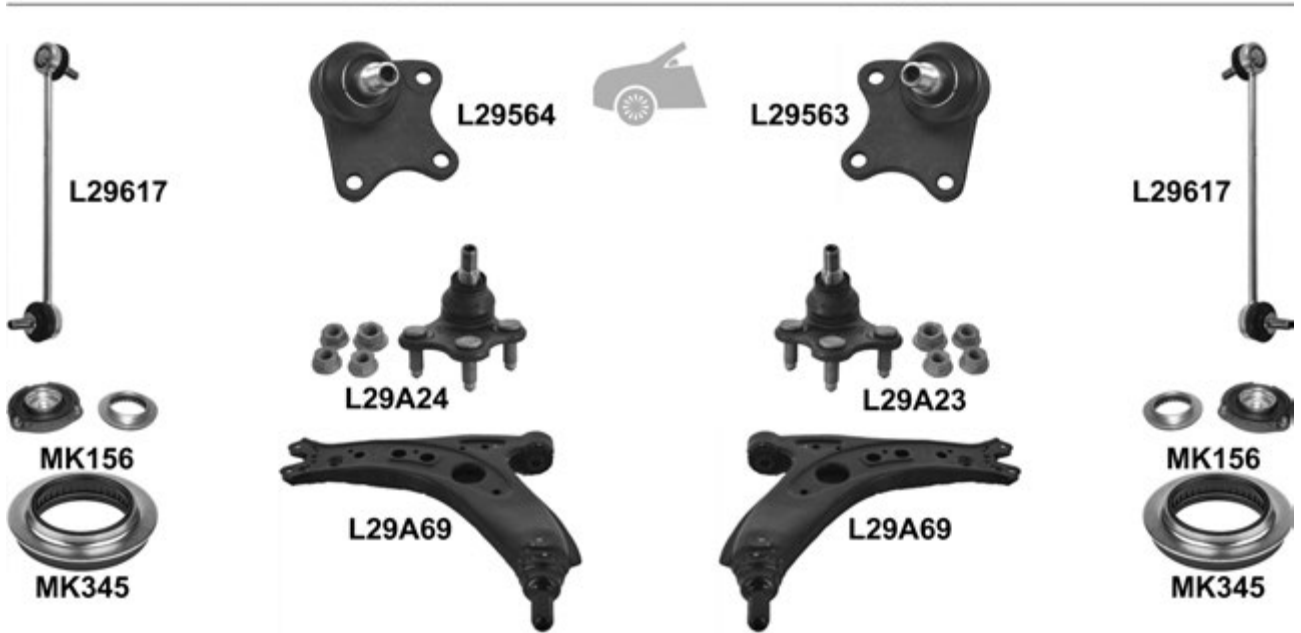
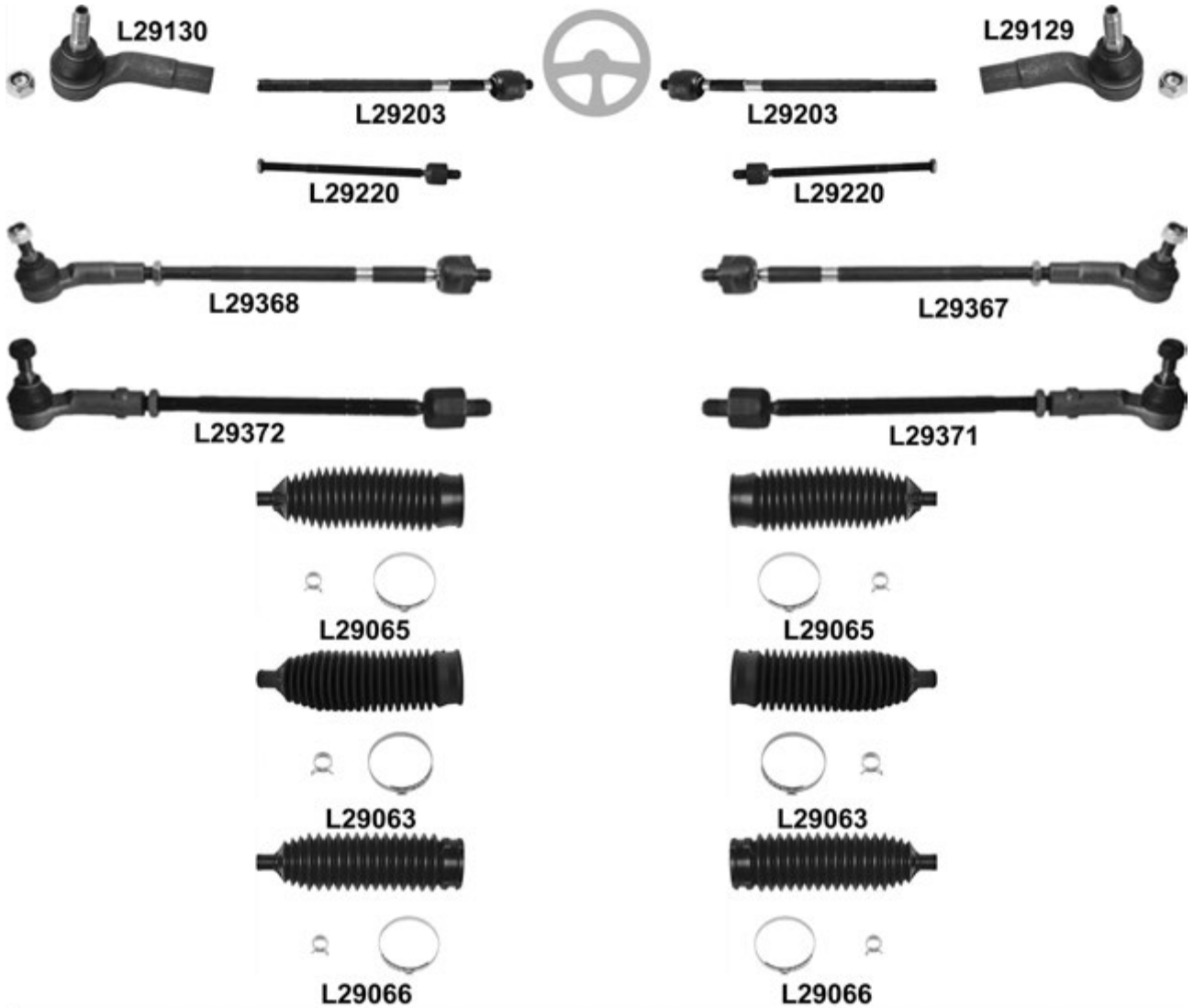

Polo (9N) 10.01 →



MK118



L29849



MK118

Polo (9N) 10.01 →

			←	→	Thread	Part Of	QPA		
		↔		L29129	F 14x1,5 ∪		1	6Q0 423 812	
			L29130		F 14x1,5 ∪		1	3A0 422 811	
			TRW	L29203	L29203	M 14x1,5 / M 14x1,5 ∪		2	
			Smi/Koyo	L29220	L29220	∪		2	6Q0 423 810 G
			TRW		L29367			1	6Q0 423 804 B
				L29368			1	6Q0 423 803 B	
			Smi/Koyo		L29371			1	6Q0 423 804 G
			→ 01.03 , TRW, ø 12mm, Ø 48mm, L= 195mm	L29065 ⁰	L29065 ⁰			2	6E0 419 831
			02.03 →, TRW, ø 14,5mm, Ø 47,5mm, L= 205mm	L29063 ⁰	L29063 ⁰			2	6Q0 423 831 D
			Smi/Koyo, ø 13mm, Ø 45,5mm, L= 210mm	L29066 ⁰	L29066 ⁰			2	6Q0 423 831 A
		↓	→ 12.08 , ch. → 9N 9 050 000		L29563			1	6Q0 407 366 A
				L29564			1	6Q0 407 365 A	
			01.09 →, ch. 9N 9 050 001 →		L29A23			1	6R0 407 366
				L29A24			1	6R0 407 365	
		↓	→ 12.08 , ch. → 9N 9 050 000, (-) (+)	L29A69	L29A69			2	6Q0 407 151 D
			→ 12.08 , ch. → 9N 9 050 000 <input checked="" type="checkbox"/>		L29565			1	6Q0 407 151 E
				L29566			1	6Q0 407 151 E	
			01.09 →, ch. 9N 9 050 001 → <input checked="" type="checkbox"/>		L29A39			1	6R0 407 151
		L29A40			1	6R0 407 152			
		↓	→ 12.08 , ch. → 9N 9 050 000	L29887	L29887			2	1K0 407 183 E
			→ 12.08 , ch. → 9N 9 050 000	L29858	L29858			2	6Q0 407 182 A
			01.09 →, ch. 9N 9 050 001 →	L29847	L29847			2	1J0 407 181
			01.09 →, ch. 9N 9 050 001 →	L29808	L29808			2	357 407 182
				L29617	L29617			2	6Q0 411 315 D
			PR OAQ, → 12.02 , ch. → 9N3 150 000, Ø 18mm	L29883	L29883		Anti-roll bar	2	6Q0 411 314 R
			PR OAS, 04.03 →, ch. 9N3 170 763 →, Ø 18mm	L29883	L29883		Anti-roll bar	2	6Q0 411 314 R
			G09/G10/G27/G28/G31, (+) MK345 KIT	MK156	MK156			2	6N0 412 331 E
			G11/G12/G16/G29/ (+) MK345	MK156	MK156			2	6Q0 412 331 B
				MK345	MK345			2	6N0 412 249 C
			(-) 4-motion, Ø 69mm		L29874		Hub carrier	1	1J0 501 541 D
(-) 4-motion, Ø 74mm				L29849		Hub carrier	1	1J0 501 541 C	
				MK118	MK118			2	1J0 513 353 B

Polo (6R_/6C1/612) 06.09 →

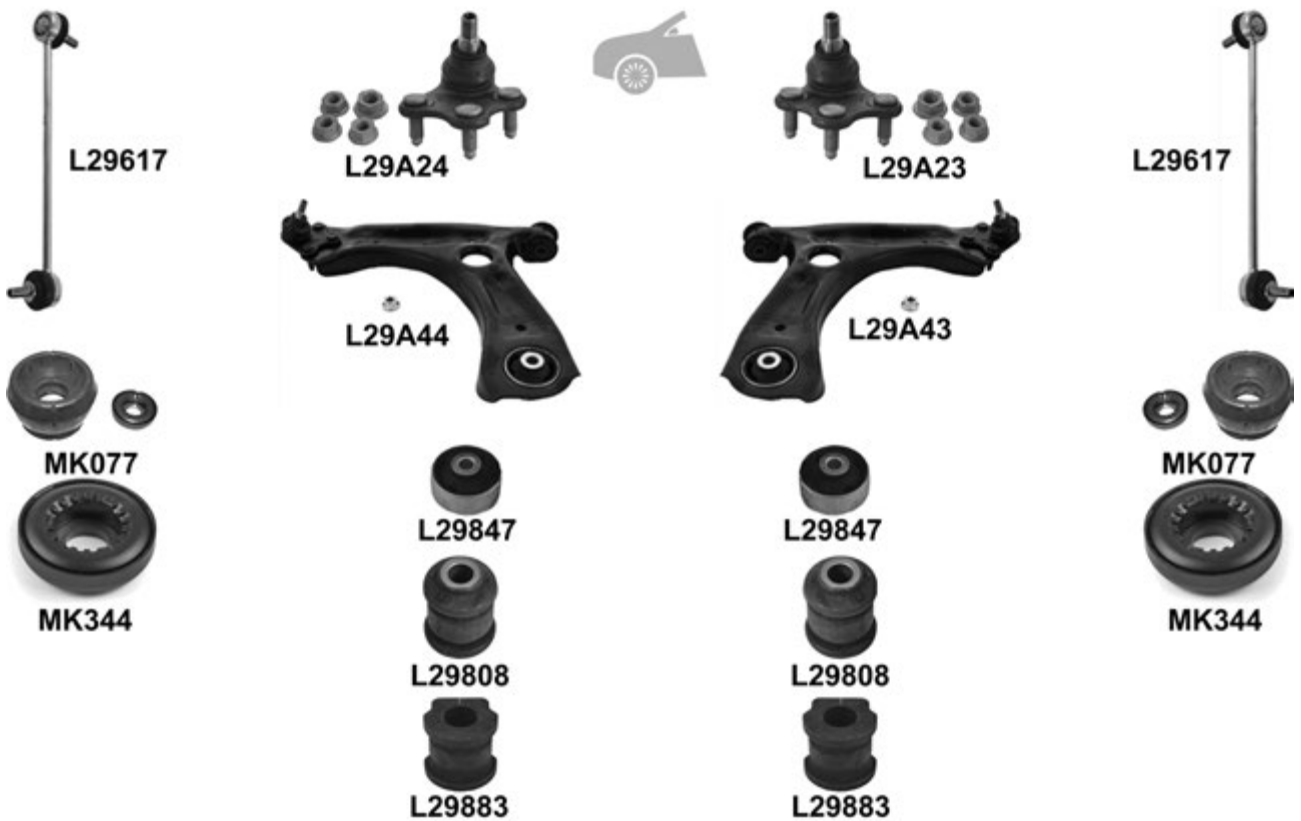
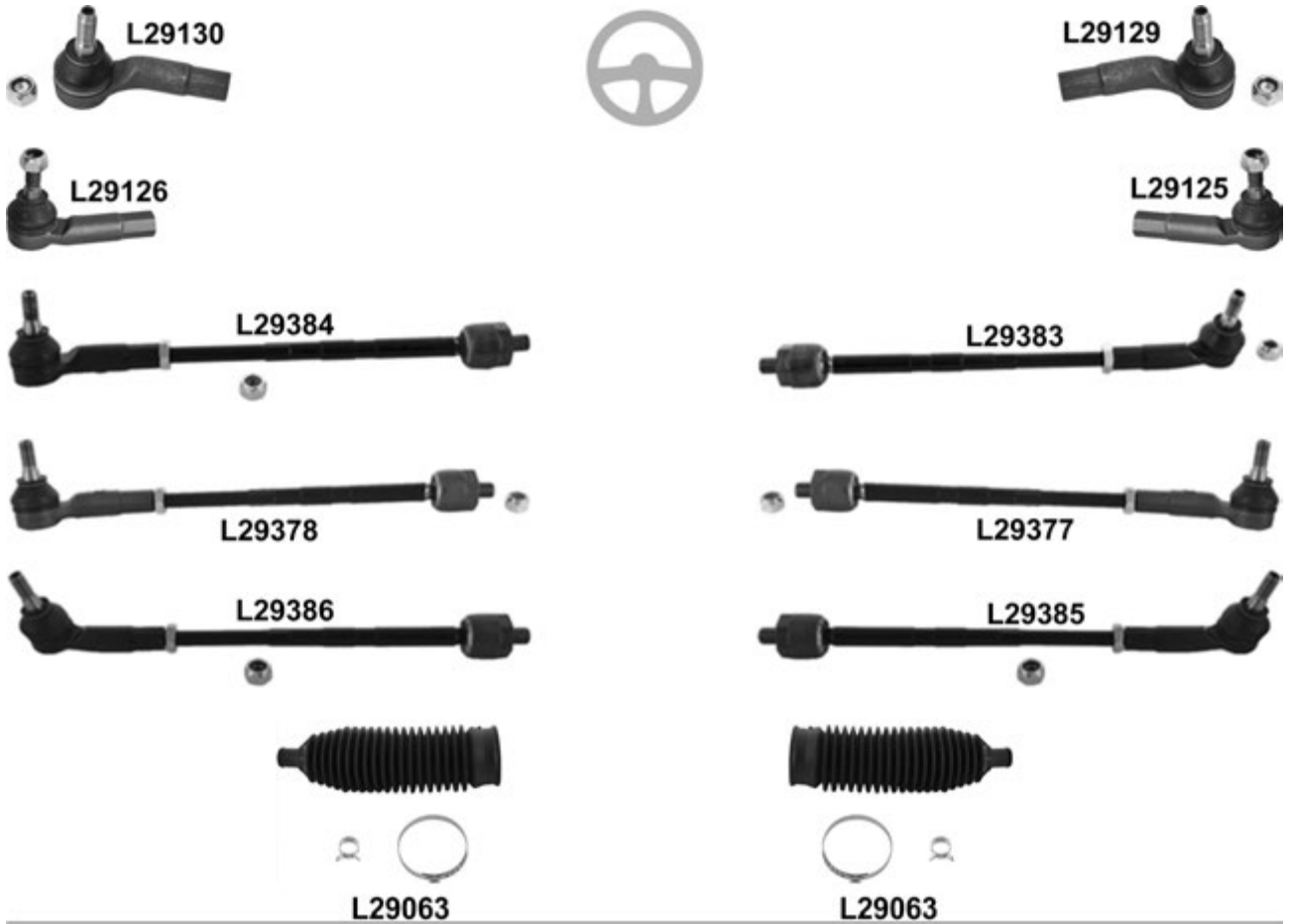

Polo (6R_/6C1/612) 06.09 →

MK118

L29849

MK118

		i		← →		Thread	Part Of	QPA	i		
		↔	PR 1N2/1N3	L29129		F 14x1,5 ♂		1	6R0 423 812		
				L29130		F 14x1,5 ♂		1	6R0 423 811		
			PR 1N4	L29125		F 14x1,5 ♂		1	6R0 423 812 A		
				L29126		F 14x1,5 ♂		1	6R0 423 811 A		
		↕	PR 1N2	L29377				1	6R0 423 804 A		
				L29378				1	6R0 423 803 A		
			PR 1N4	L29383				1	6R0 423 804 B		
				L29384				1	6R0 423 803 B		
			1.2 Tsi, PR 1N2, 05.11 →	L29377				1	6R0 423 804 A		
			1.2 Tsi, PR 1N4, 05.11 →	L29378				1	6R0 423 803 A		
			L29385 ⁰			1	6R0 423 804 D				
			L29386 ⁰			1	6R0 423 803 D				
			(-) PR 1N3, TRW, ø 14,5mm, Ø 47,5mm, L= 205mm	L29063 ⁰	L29063 ⁰			2	6Q0 423 831 D		
		↓		L29A23				1	6R0 407 366		
				L29A24				1	6R0 407 365		
		↓		L29A43				1	6R0 407 151 F		
			<input checked="" type="checkbox"/>	L29A44				1	6R0 407 152 F		
		↓ ▾		L29847	L29847				2	1J0 407 181	
		↓ ▲		L29808	L29808				2	357 407 182	
				L29617	L29617				2	6Q0 411 315 N	
			PR 0AS, Ø 18mm	L29883	L29883			Anti-roll bar	2	6Q0 411 314 R	
			(+) MK344	KIT	MK077	MK077			2	1J0 412 331 BS	
				MK344	MK344				2	1J0 412 249	
			74mm	L29849				Hub carrier	1	6R0 501 541 C	
			(-) PR 1JA/1JB/1JP/1JS	MK118	MK118				2	1J0 513 353 B	
			08.10 →, PR 1JA/1JB	MK118	MK118				2	1J0 513 353 B	
			08.10 →, PR 1JK/1JP/1JS	MK118	MK118				2	1J0 513 353 D	

Polo Classic (6KV2) 11.95 → 9.2001

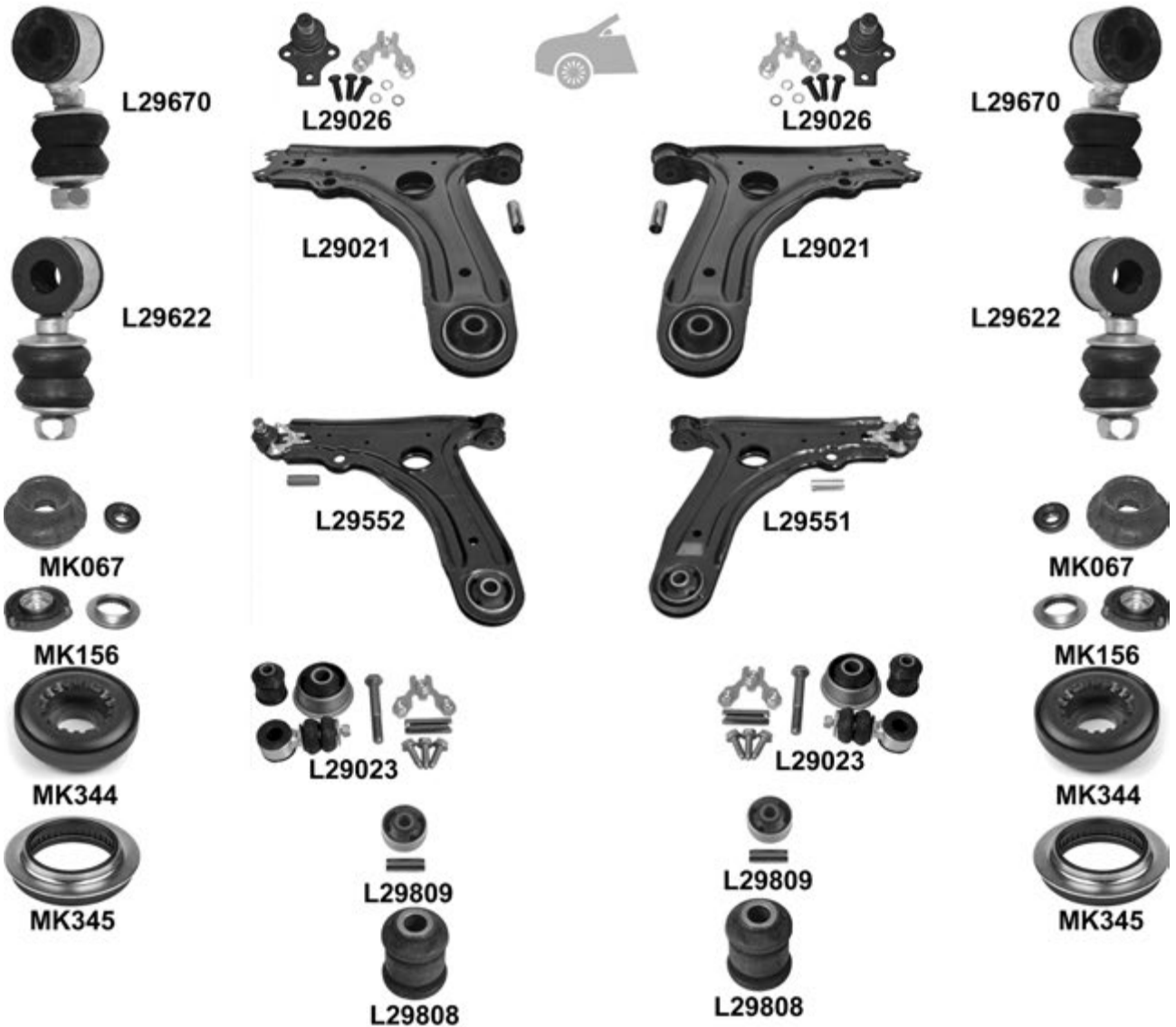
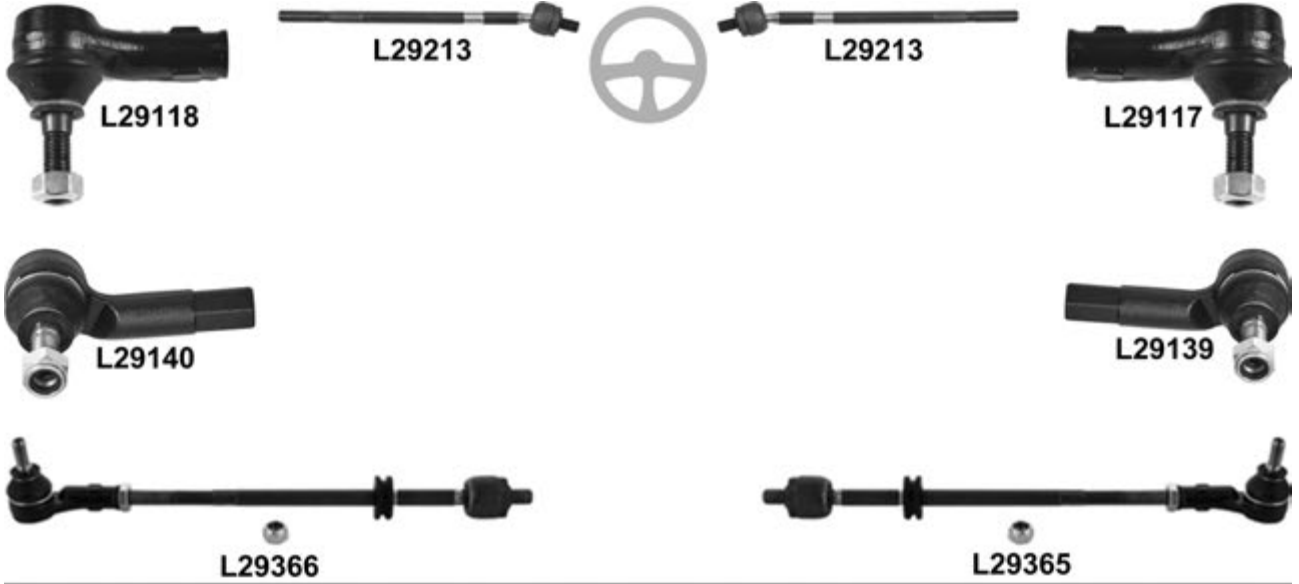

Polo Classic (6KV2) 11.95 → 9.2001

			←	→	Thread	Part Of	QPA				
		↔	→ 04.98 , ch. → 6K X 500 000	L29117	∩		1	3A0 422 812			
			L29118	∩		1	3A0 422 811				
			05.98 →, ch. 6K X 500 001 →	L29139	∩		1	6K0 422 812			
			L29140	∩		1	6K0 422 811				
			→ 04.98 , ch. → 6K X 500 000, L= 340mm	L29213	L29213	M 14x1,5 / M 14x1,5 ∩	L29365/L29366	2			
			→ 04.98 , ch. → 6K X 500 000, L= 340mm	L29365				1	6K0 422 804 A		
		↓		L29026	L29026			2	357 407 365 A		
				(-) , (+)	L29021	L29021			2	191 407 153	
		↓	<input checked="" type="checkbox"/>		L29551				1		
				L29552					1		
				L29023	L29023			2	191 407 153 S0		
		↓	↙		L29809	L29809			2	191 407 181 E	
				↘	L29808	L29808			2	357 407 182	
				Mot/Eng AEE/AEX/AKV/ALM/ANX/APQ/1F, ø 17mm	L29670	L29670			2	191 411 315 A	
				→ 03.97 , ch. → 6K V 047 500, ø 17mm	L29670	L29670			2	191 411 315 A	
				(-) Mot/Eng AEE/AEX/AKV/ALM/ANX/APQ/1F							
				04.97 →, ch. 6K V 047 501 →, ø 19mm	L29622	L29622			2	6K0 411 315	
				→ 09.99 , ch. → 6K Y 502 794, (+) MK344	KIT	MK067	MK067		2	357 412 331 A	
				10.99 →, ch. 6K Y 502 795 →, (+) MK345	MK156	MK156			2	6N0 412 331 E	
				ch. → 6K Y 502 795	MK344	MK344			2	357 412 349 A	
				ch. 6K Y 502 795 →	MK345	MK345			2	6N0 412 249 C	
			ch. → 6K X 610 000, Ø 58mm	L29850	L29850		Hub carrier	2	6N0 501 541 D		
				L29850	L29850		Hub carrier	2	6N0 501 541 D		
				MK133	MK133			2	191 512 333 S1		

Polo Sedan 09.02 →

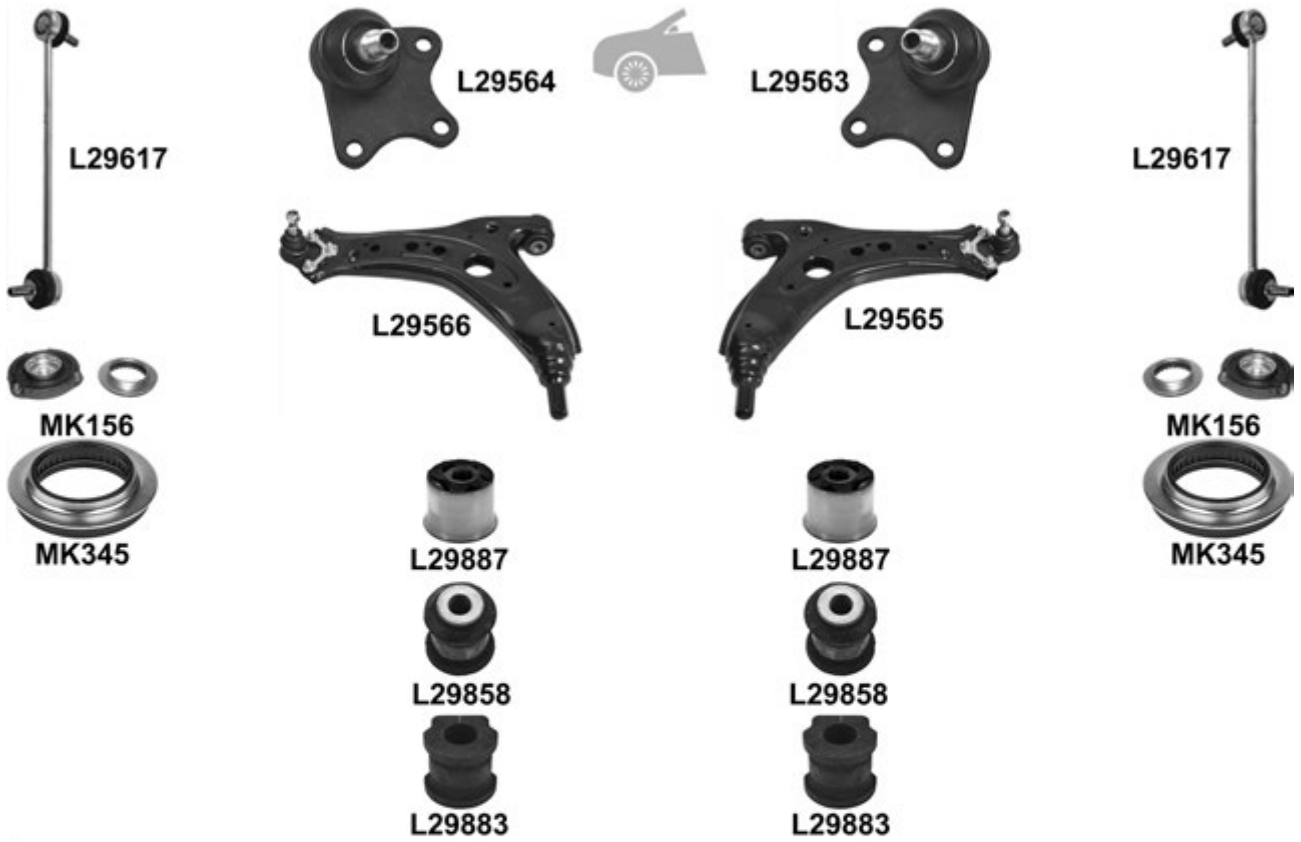

Polo Sedan 09.02 →

				←	→	Thread	Part Of	QPA		
		↔			L29129	F 14x1,5 ⤴		1	6Q0 423 812	
					L29130	F 14x1,5 ⤴		1	3A0 422 811	
			Smi/Koyo		L29220	L29220	⤴		2	6Q0 423 810 G
			Smi/Koyo			L29371			1	6Q0 423 804 G
			Smi/Koyo		L29372				1	6Q0 423 803 G
		⊥			L29563			1	6Q0 407 366 A	
					L29564			1	6Q0 407 365 A	
		⊥		<input checked="" type="checkbox"/>	L29565			1	6Q0 407 151 E	
					L29566			1	6Q0 407 151 E	
		⊥↘			L29887	L29887			2	6Q0 407 183
		⊥↗			L29858	L29858			2	6Q0 407 182 A
					L29617	L29617			2	6Q0 411 315 D
			∅ 18mm		L29883	L29883		Anti-roll bar	2	6Q0 411 314 R
			(-) SP , (+) MK345	KIT	MK156	MK156			2	6N0 412 331 E
			SP , (+) MK345		MK156	MK156			2	6Q0 412 331 B
				MK345	MK345			2	6N0 412 249 C	
			(-) 4-motion, ∅ 69mm		L29874		Hub carrier	1	1J0 501 541 D	
			(-) 4-motion, ∅ 74mm		L29849		Hub carrier	1	1J0 501 541 C	
					MK118	MK118			2	1J0 513 353 B

Polo Variant (6KV5) 05.97 → 09.01

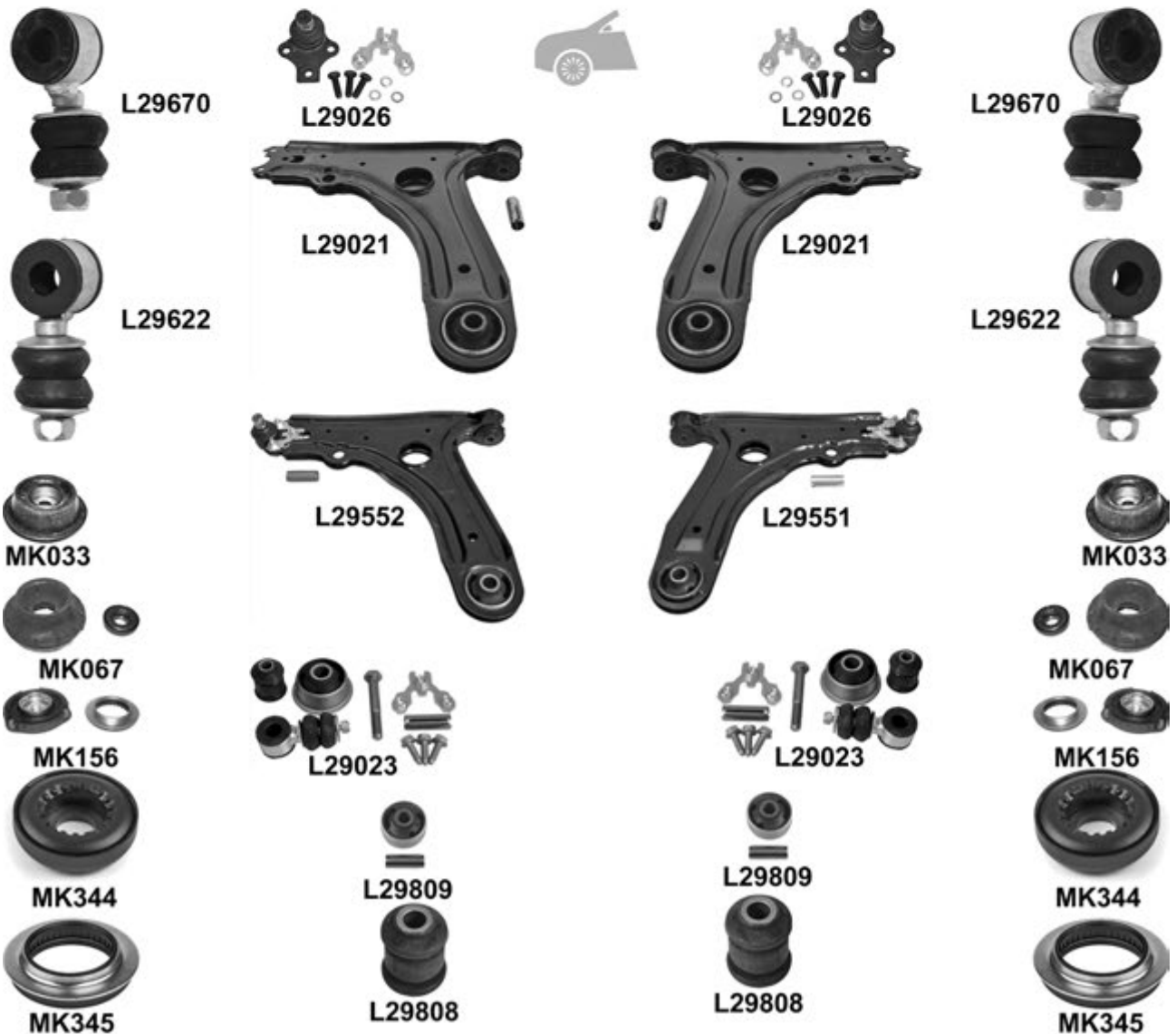
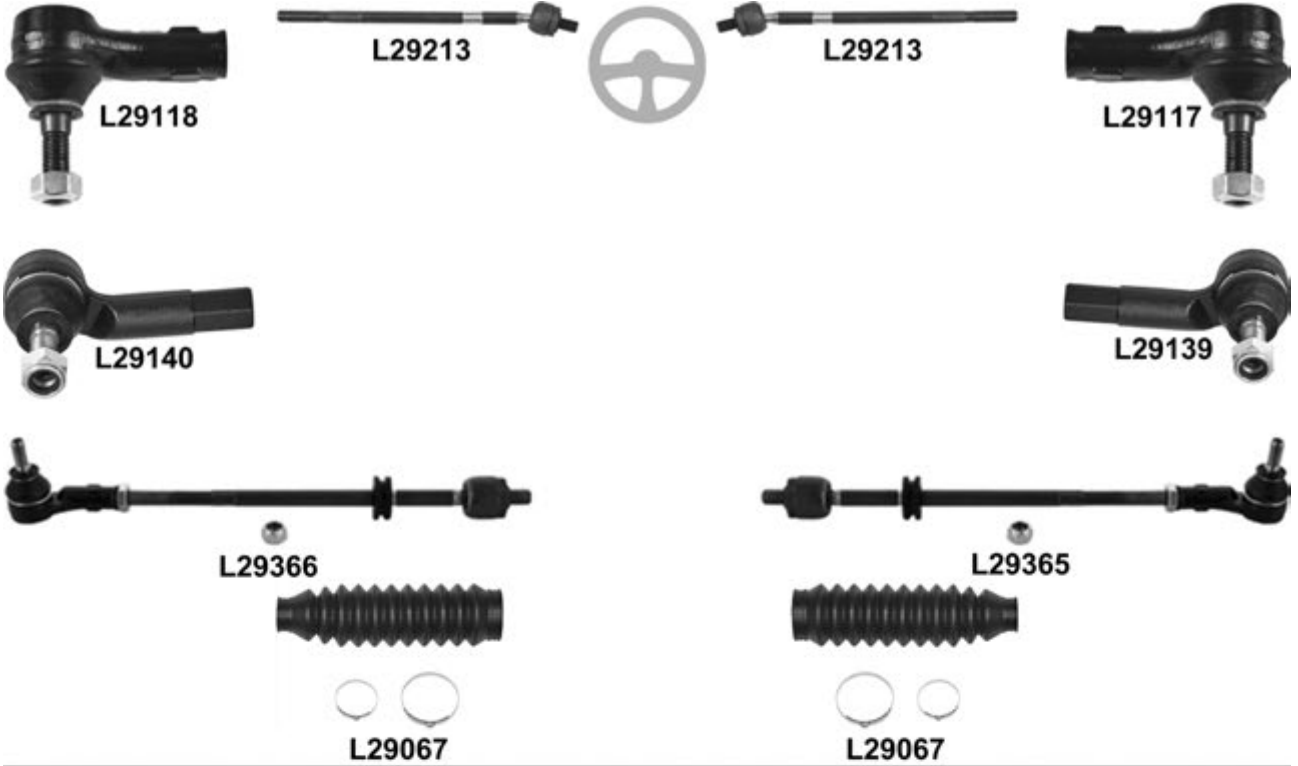

Polo Variant (6KV5) 05.97 → 09.01

MK133

L29850

L29850

MK133

		i	←	→	Thread	Part Of	QPA	i		
		↔	→ 10.00 , ch. → 6K 1 536 000	L29117	∩		1	3A0 422 812		
				L29118	∩		1	3A0 422 811		
			→ 11.00 →, ch. 6K 1 536 001 →	L29139	∩		1	6K0 422 812		
				L29140	∩		1	6K0 422 811		
			→ 10.00 , ch. → 6K 1 536 000, L= 340mm	L29213	L29213	M 14x1,5 / M 14x1,5 ∩	L29365/L29366	2		
			→ 10.00 , ch. → 6K 1 536 000		L29365			1	6K0 422 804 A	
				L29366				1	6K0 422 803 A	
			∅ 11mm, ∅ 42mm, L= 208mm	L29067 ^o	L29067 ^o			2	6N0 422 831	
			⊥		L29026	L29026			2	357 407 365 A
			⊥	(-) (+)	L29021	L29021			2	191 407 153
<input checked="" type="checkbox"/>				L29551				1		
				L29552				1		
				L29023	L29023			2	191 407 153 S0	
		⊥	▼	L29809	L29809			2	191 407 181 E	
			▲	L29808	L29808			2	357 407 182	
			→ 04.97 , 17mm	L29670	L29670			2	191 411 315 A	
			05.97 →, ∅ 19mm	L29622	L29622			2	6K0 411 315	
			→ 12.97 KIT	MK033	MK033			2	191 412 329	
			01.98 → 08.99 , → ch. 6K X 610 000, (+) MK344 KIT	MK067	MK067			2	357 412 331 A	
			09.99 →, ch. 6K X 610 001 →, (+) MK345	MK156	MK156			2	6N0 412 331 E	
			→ ch. 6K X 610 000	MK344	MK344			2	357 412 349 A	
	ch. 6K X 610 001 →		MK345	MK345			2	6N0 412 249 C		
			ch. → 6K X 610 000, ∅ 58mm	L29850	L29850		Hub carrier	2	6N0 501 541 D	
				MK133	MK133			2	191 512 333 S1	

Santana 08.81 → 12.84 ch. 32 B 000 001 → 32 / 33 J 299 999

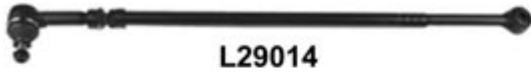
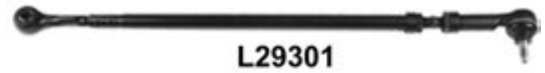
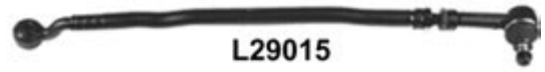

L29029



Santana 08.81 → 12.84 ch. 32 B 000 001 → 32 / 33 J 299 999

		i		←	→	Thread	Part Of	QPA	i
		↔				F 14x1,5 U		2	811 419 812 A
			ch. → 32 G 275 000			L29016		1	811 419 802 J
			ch. 32 G 275 001 →			L29015		1	811 419 802 K
			(-) 5 cyl. 2.2/2.3			L29301		1	811 419 801 E
						L29014		1	811 419 801 E
		↓				L29029		1	811 419 831 B
						L1076	L1076	2	823 407 365 E
						L29501		1	855 407 366 A/B
						L29502		1	855 407 365 A/B
		↓				L29530	L29530	2	893 407 147 G
		↓ ▲ ▼				L29804	L29804	4	811 407 181 A
						L29806	L29806	4	857 407 181
			(-)			L29837	L29837	2	823 411 313 A
						MK032	MK032	2	8A0 412 323 D
					KIT	L29831		Hub carrier	1

Scirocco (53 / 53B) 02.74 → 07.92 ch. 534 2000 001 →



Scirocco (53 / 53B) 02.74 → 07.92 ch. 534 2000 001 →

		i		←	→	Thread	Part Of	QPA	i
		↔		L2975	L2975	F 14x1,5 ⌀		2	171 419 812
			(-)	L2976	L2976			2	171 419 821 A
			(-)	L2974	L2974			2	171 419 804 A
				L29373	L29373			2	175 422 803 A
					L29012			1	171 419 831 A
					L29011			1	171 419 831 B
		↓	→ 10.77 ch. → 178 3173 583 ch. → 538 2028 902 use L 2978 if Wheel hub is changed	L2972	L2972			2	171 407 365 D
			11.77 → ch. 178 3173 584 → ch. 538 2028 903 →	L2978	L2978			2	171 407 365 G
		↓	(-) (-)	L29013	L29013			2	171 407 153 D
				L29020	L29020			2	171 498 153 X0
		↓ ▼		L29816	L29816			2	171 407 181 A
		↓ ▲		L29817	L29817			2	171 407 182 D
				MK070	MK070			2	171 412 329 A

Scirocco (137) 09.08 →

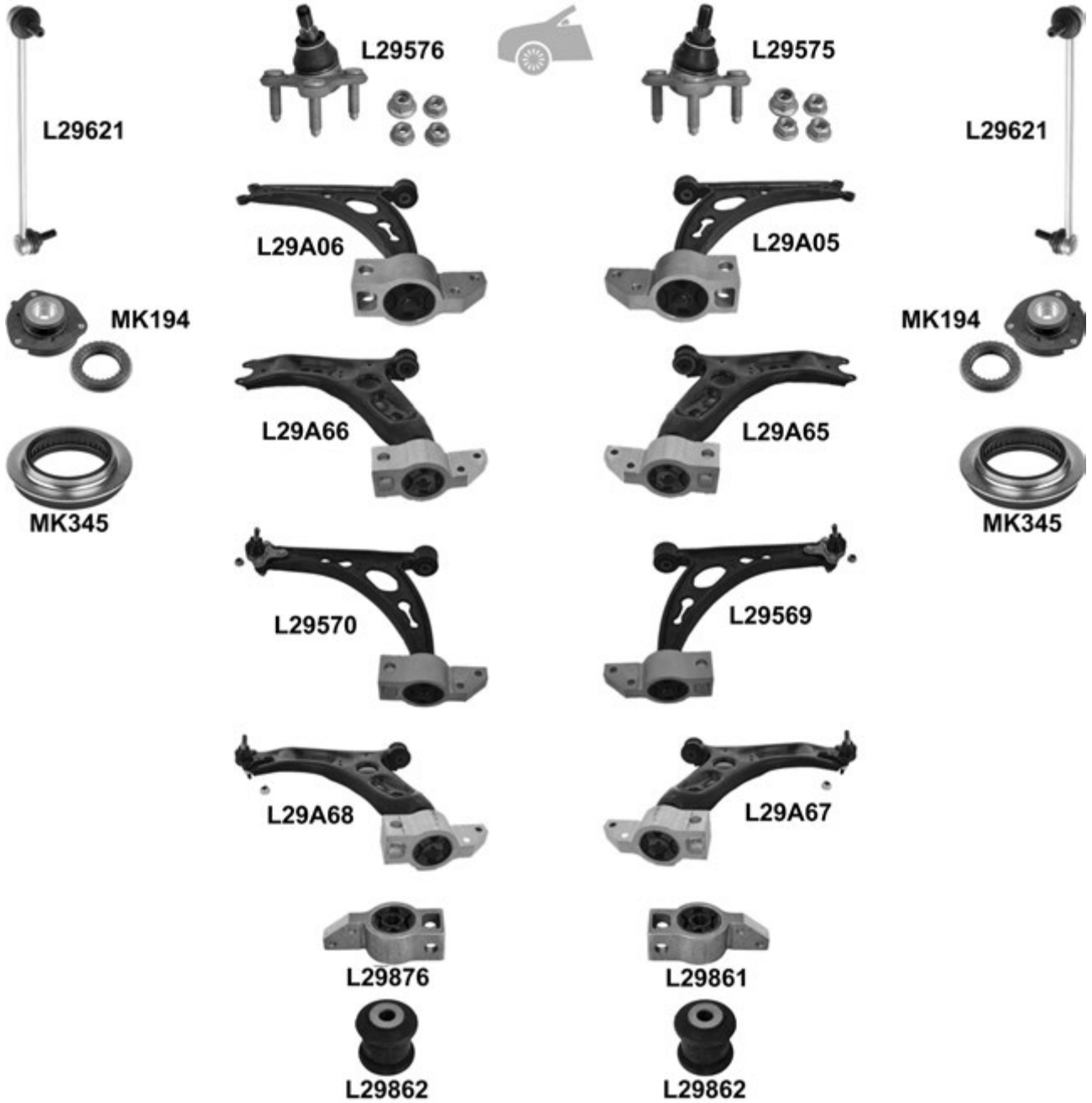
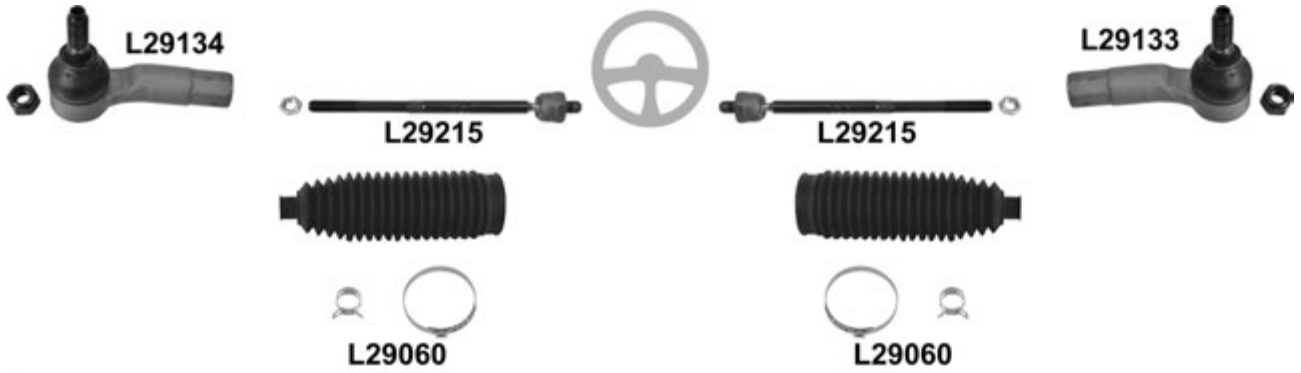

Scirocco (137) 09.08 →

		i	←	→	Thread	Part Of	QPA	i	
⊕	↔			L29133	F 16x1,5 ∪		1	1K0 423 812 E	
				L29134	F 16x1,5 ∪		1	1K0 423 811 E	
	⌋			L29215	L29215	M 16x1,5 / M 16x1,5 ∪	2	1K0 423 810 A	
		Electronic ⊕			L29060	L29060		2	1K0 423 831 A
🚗	⌋				L29575		1	1K0 407 366 C	
					L29576		1	1K0 407 365 C	
	🔧	⌋	→ 06.09, (-) ⊕, (+) ⊕, ⊕			L29A05		1	1K0 407 152 M
						L29A06		1	1K0 407 151 M
		07.09 →, (-) ⊕, (+) ⊕, ⊕				L29A65		1	1K0 407 152 BC
					L29A66		1	1K0 407 151 BC	
		→ 06.09, ⊕	☑			L29569		1	1K0 407 152 M
					L29570		1	1K0 407 151 M	
	⌋	⌆				L29A67		1	1K0 407 152 BC
						L29A68		1	1K0 407 151 BC
	⌋	⌆				L29861	🔧	1	1K0 199 232 G
						L29876	🔧	1	1K0 199 231 G
	⌋	⌆				L29862	L29862	2	1K0 407 182
						L29621	L29621	2	1K0 411 315 D
⌋	⌆				L29621	L29621	2	1K0 411 315 D	
		(+) MK345	KIT	MK194	MK194		2	1K0 412 331 B	
	⌆				MK345	MK345	2	6N0 412 249 C	
					MK345	MK345	2	6N0 412 249 C	
🚗	🔧	⌆	(-) Model 138		L29A11	L29A11	2	4K0 505 323 N	
		⌋			L29A29	L29A29	2	1K0 505 311 AB	
		⌆				L29A87 ⁰	Trailing Arm	1	1K0 505 224 K
	⌋	⌆				L29A88 ⁰	Trailing Arm	1	1K0 505 222 K
							L29637		1
	⌋	⌆	→ 11.08			L29637		1	1K0 501 530 C
						L29638		1	1K0 501 529 F
⌋	⌆				L29623	L29623	2	1K0 505 465 J	
					MK386	MK386	2	3C0 513 353 C	

Sharan (7M) 09.95 → ch. F 7M T 005 001 →



Sharan (7M) 09.95 → ch. F 7M T 005 001 →

		i		←	→	Thread	Part Of	QPA	i
		↔				L29119 F 14x1,5 U		1	7M0 422 818 B
						L29120 F 14x1,5 U		1	7M0 422 817 B
						L10204 L10204 M 14x1,5 / M 14x1,5		2	
						L29355		1	7M0 422 804 F
						L29356		1	7M0 422 803 F
			∅ 10mm, ∅ 49mm, L= 178mm				L10046 ^o L10046 ^o		2
		⊥				L10505 L10505		2	7M0 407 365 A
		⊥				L10517		1	7M0 407 152 B
						L10518		1	7M0 407 151 B
		⊥	▼			L10800 L10800		2	7M0 407 181 A
			▲			L10812 L10812		2	7M0 501 541
						L10600 L10600		2	7M0 411 317 D
			∅ 17mm			L10833 L10833	Anti-roll bar	2	7M0 411 031
			(+) MK344			MK067 MK067		2	357 412 331 A
		⊥				MK344 MK344		2	357 412 349 A
			4WD			L10812 L10812		4	7M0 501 541
			PR 1BA/1BB/1BJ/1BR, 20mm			L10834 L10834	Anti-roll bar	2	7M0 511 413 A

Sharan 07.10 →

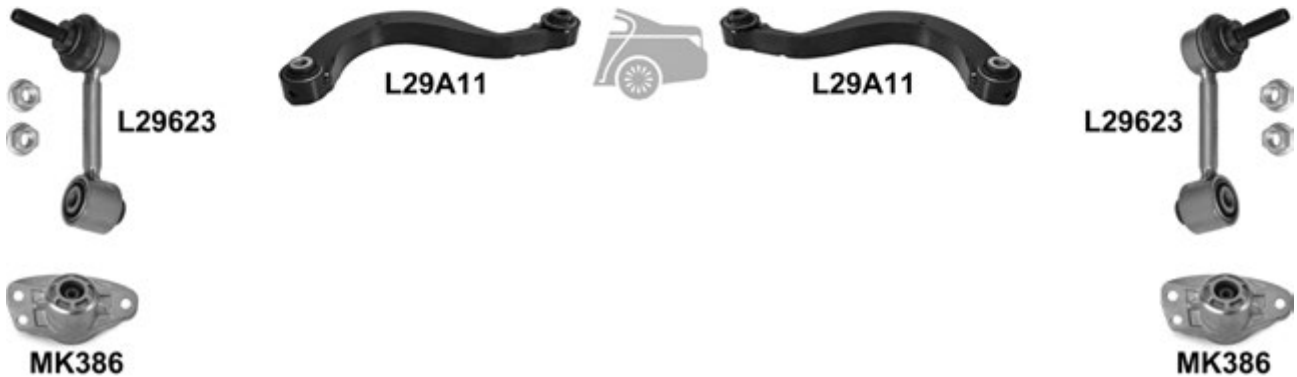
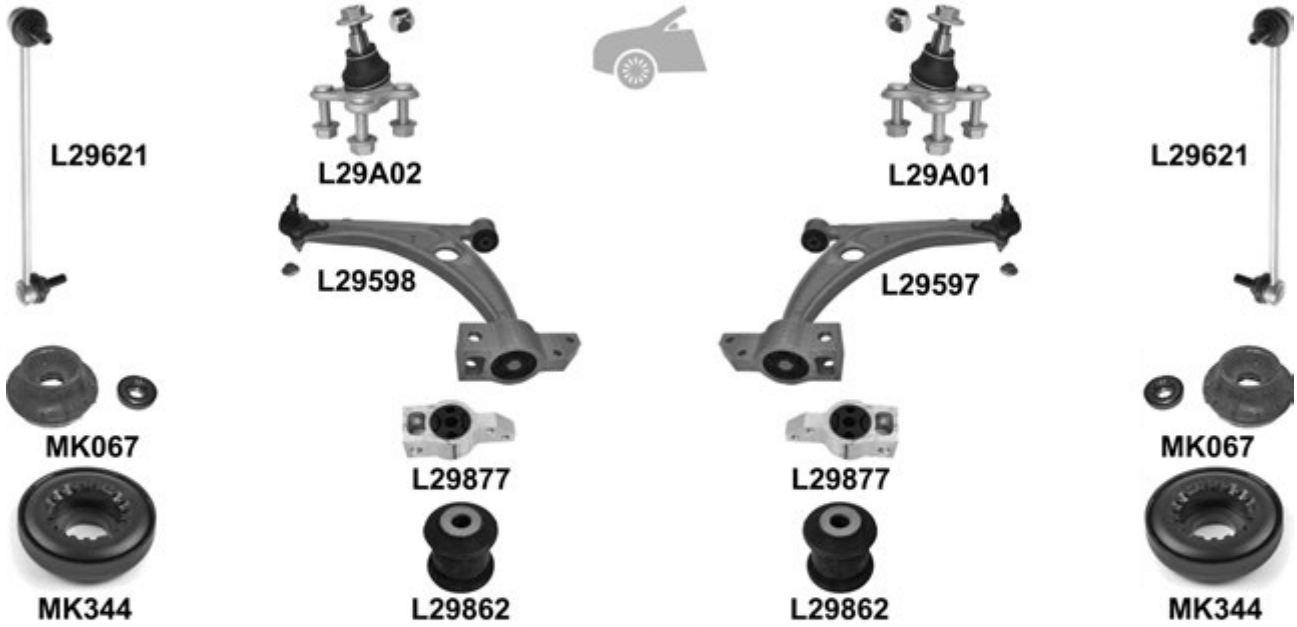

				← → Thread		Part Of	QPA					
⊕		↔		L29135	F 16x1,5 ∪		1	1K0 423 812 G				
				L29136		F 16x1,5 ∪		1	1K0 423 811 G			
⊖		⊥		L29215	L29215	M 16x1,5 / M 16x1,5 ∪		2	1K0 423 810 A			
					L29A01			1	3C0 407 366 A			
					L29A02			1	3C0 407 365 A			
					L29597			1	3C0 407 151 E			
					L29598			1	3C0 407 151 E			
				⊥↘	PR FOA/F4F	L29877	L29877			2	3C0 199 231 D	
				⊥↗	PR FOA/F4F	L29862	L29862			2	1K0 407 182	
						L29621	L29621			2	1K0 411 315 J	
					(+) MK344	MK067	MK067			2	357 412 331 A	
						MK344	MK344			2	357 412 349 A	
⊖		↑		L29A11	L29A11			2	4K0 505 323 N			
				L29623	L29623			2	1K0 505 465 K			
				PR FOA/1JA/1JC	MK386	MK386			2	3C0 513 353 C		

Taro 04.89 → 03.97

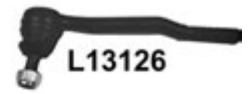
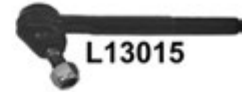
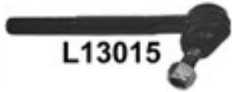

Taro 04.89 → 03.97

				←	→	Thread	Part Of	QPA	
		↔		L13014	L13014	M 17x1,5 ⤴		2	45046-39235
		→←	(-) 4WD	L13015	L13015	M 17x1,5 ⤴		2	45406-39125
			4WD	L13126	L13126	M 17x1,5		2	45406-39175
		↑	(-) 4WD	L13053	L13053			2	43350-39075
			4WD	L13512	L13512			2	43360-39085
		↓	(-) 4WD	L13503	L13503			2	43330-39295
			4WD	L13513	L13513			2	43340-39245
		↑	(-) , (+)	L13547	L13547			2	J48066-35080
		↓	(-) , (-) 4WD	L13546	L13545			1	J48605-35121
				L13546				1	J48606-35121
	↑	(-) 4WD	L13808	L13808			4	J48632-30012	

Tiguan 09.07 →

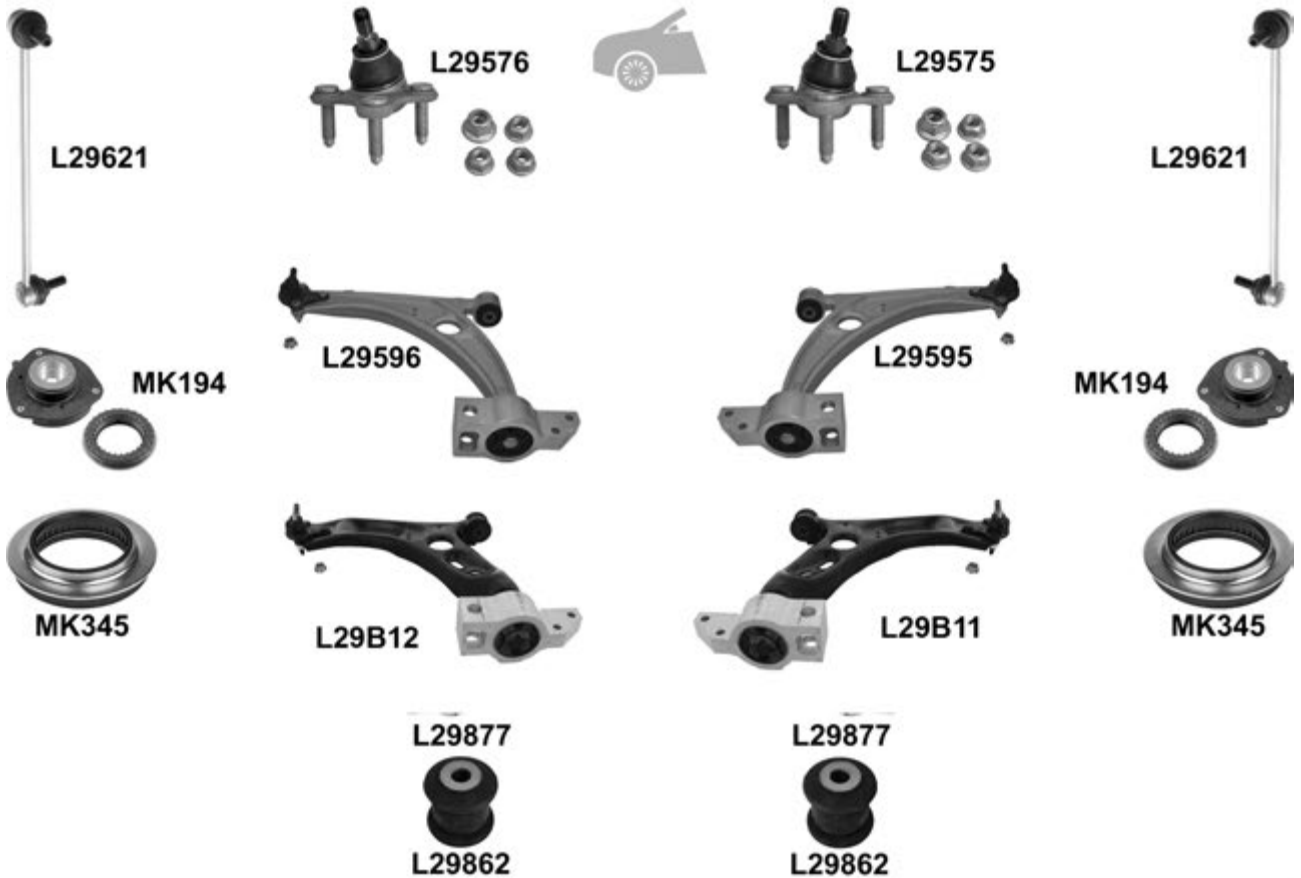
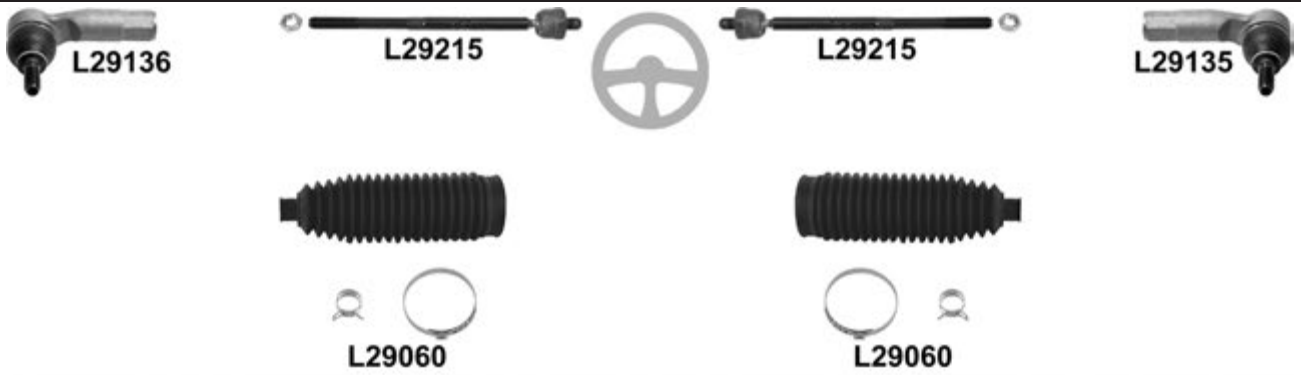

Tiguan 09.07 →

		i		←	→	Thread	Part Of	QPA	i	
		↔			L29135	F 16x1,5 ∩		1	1K0 423 812 G	
					L29136	F 16x1,5 ∩		1	1K0 423 811 G	
					L29215	L29215	M 16x1,5 / M 16x1,5 ∩	2	1K0 423 810 A	
			Electronic			L29060	L29060		2	1K0 423 831 A
		⊥				L29575		1	1K0 407 366 C	
						L29576		1	1K0 407 365 C	
		⊥	→ 10.09, ALU	<input checked="" type="checkbox"/>		L29595		1	3C0 407 151 E	
						L29596		1	3C0 407 151 E	
			11.09 →, Sheet Metal	<input checked="" type="checkbox"/>		L29B11		1	5N0 407 152	
						L29B12		1	5N0 407 151	
		⊥	⊥			L29877	L29877		2	3C0 199 231 D
			⊥			L29862	L29862		2	1K0 407 182
						L29621	L29621		2	1K0 411 315 J
				(-) , (+) MK345		MK194	MK194		2	1K0 412 331 B
						MK345	MK345		2	6N0 412 249 C
		⊥	→ 05.12		L29A11	L29A11		2	4K0 505 323 N	
				<input checked="" type="checkbox"/>	L29A29	L29A29		2	1K0 505 311 AB	
		⊥				L29637			1	1K0 501 530 C
						L29638			1	1K0 501 529 F
						L29623	L29623		2	1K0 505 465 K
			(-) Electronic Drive		MK386	MK386		2	3C0 513 353 C	

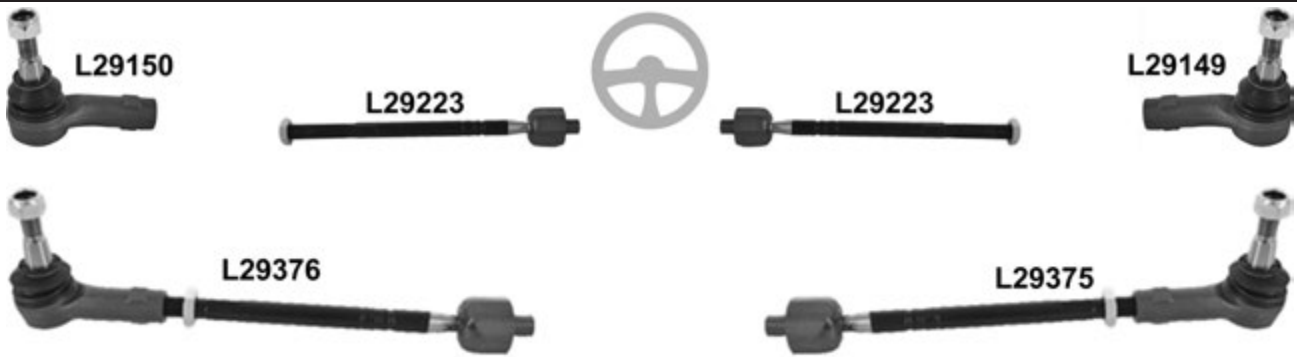
Touareg (7LA, 7L6, 7L7) 10.02 → 05.10

			←	→	Thread	Part Of	QPA	
		↔		L29149	F 16x1,5 ♂		1	7L0 422 818 D
				L29150	F 16x1,5 ♂		1	7L0 422 817 D
			L29223	L29223	M 16x1,5 / M 16x1,5 ♂		2	7L0 422 821
				L29375			1	7L0 422 804 D
			L29376				1	7L0 422 803 D
		↑	<input checked="" type="checkbox"/>	L29A12	L29A12		2	7L0 407 021 B
			<input checked="" type="checkbox"/>		L29A13		1	7L0 407 152 H
		↓	→ 05.08		L29A14		1	7L0 407 151 H
				L29642	L29642		2	7L0 411 317
					L29639		1	7L0 505 466 D
					L29640		1	7L0 505 465 D

Touareg 04.10 →

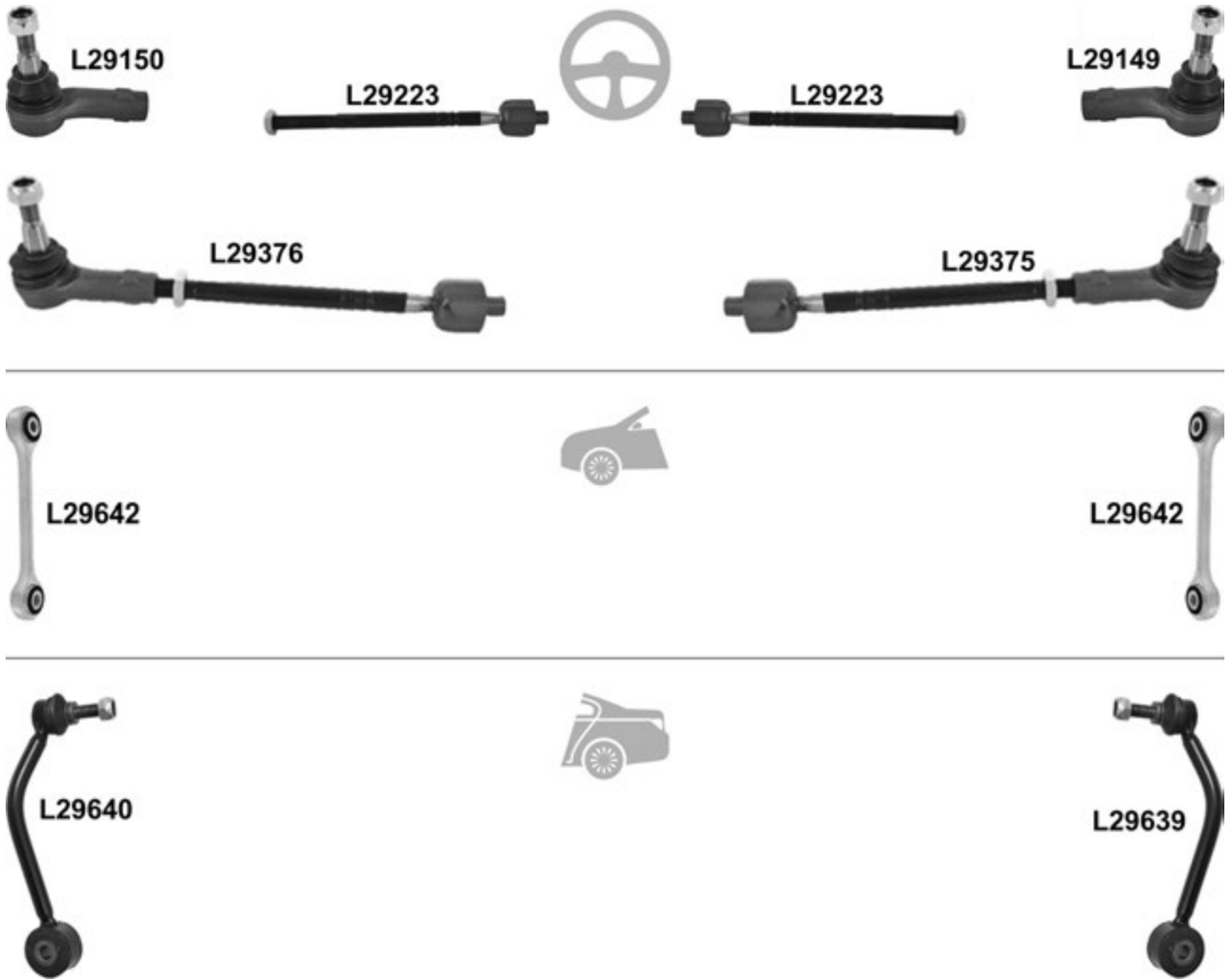

				←	→	Thread	Part Of	QPA				
⊕		↔				L29149	F 16x1,5 ♂		1	7LO 422 818 D		
						L29150	F 16x1,5 ♂		1	7LO 422 817 D		
						L29223	L29223	M 16x1,5 / M 16x1,5 ♂		2	7LO 422 821	
								L29375			1	7LO 422 804 D
								L29376			1	7LO 422 803 D
						L29642	L29642		2	7LO 411 317		
								L29639		1	7LO 505 466 D	
						L29640			1	7LO 505 465 D		

Touran (1T1, 1T2) 02.03 →

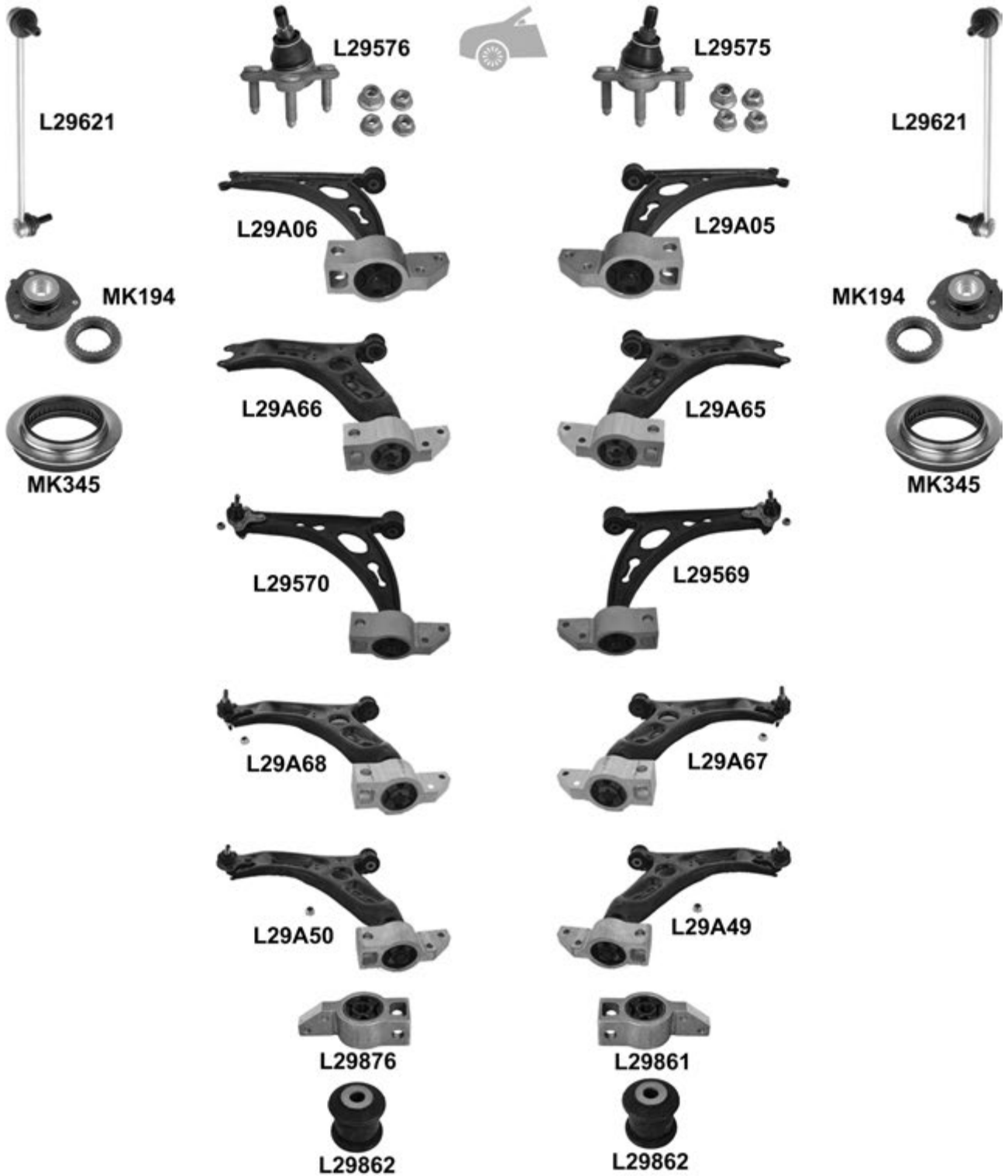
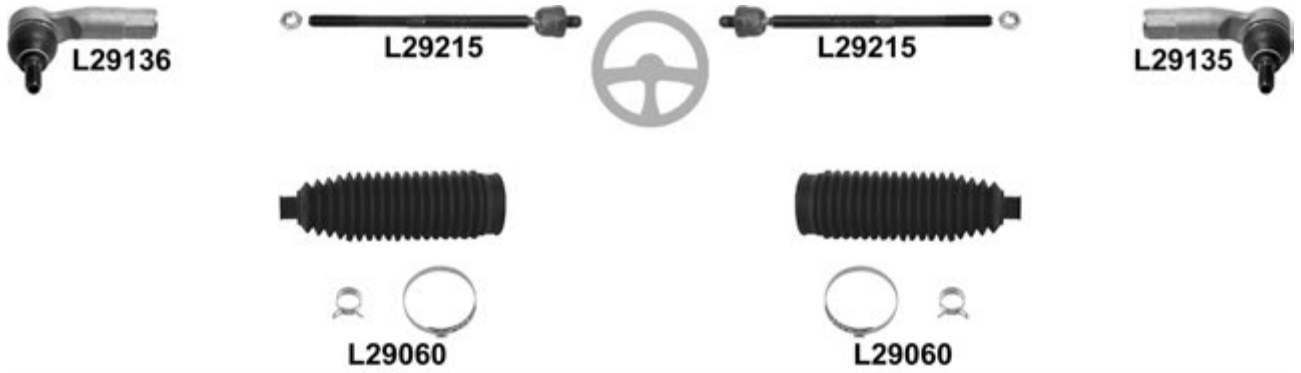

Touran (1T1, 1T2) 02.03 →



Touran (1T1, 1T2) 02.03 →

				← → Thread		Part Of	QPA			
⊕	↔			L29135	F 16x1,5 ⊕		1	1K0 423 812 G		
				L29136	F 16x1,5 ⊕		1	1K0 423 811 G		
	⊕			L29215	L29215	M 16x1,5 / M 16x1,5 ⊕	2	1K0 423 810 A		
		Electronic ⊕			L29060	L29060		2	1K0 423 831 A	
⊖	⊖				L29575		1	1K0 407 366 C		
					L29576		1	1K0 407 365 C		
	⊖	→ 05.09, ⊕, ⊕, ⊕, ⊕, ⊕				L29A05		1	1K0 407 152 M	
					L29A06		1	1K0 407 151 M		
		06.09 →, ⊕, ⊕, ⊕, ⊕, ⊕				L29A65		1	1K0 407 152 BC	
					L29A66		1	1K0 407 151 BC		
		→ 05.09, ⊕	☑		L29569		1	1K0 407 152 M		
					L29570		1	1K0 407 151 M		
	⊖	06.09 →, ⊕	☑		L29A67		1	1K0 407 152 BC		
					L29A68		1	1K0 407 151 BC		
	⊖	Cross Touran, ⊕	☑		L29A49 ⁰		1	1K0 407 152 BD		
					L29A50 ⁰		1	1K0 407 151 BD		
	⊖	⊖				L29861		1	1K0 199 232 G	
						L29876		1	1K0 199 231 G	
⊖	⊖			L29862	L29862		2	1K0 407 182		
				L29621	L29621		2	1K0 411 315 D		
⊖	⊖	(+) MK345	KIT	MK194	MK194		2	1K0 412 331 B		
				MK345	MK345		2	6N0 412 249 C		
	⊖			L29A11	L29A11		2	4K0 505 323 N		
			☑	L29A29	L29A29		2	1K0 505 311 AB		
⊖	⊖	→ 01.09, ch. → 1T9 090 000			L29637		1	1K0 501 530 C		
					L29638		1	1K0 501 529 F		
⊖	⊖			L29623	L29623		2	1K0 505 465 J		
		(-) Electronic Drive		MK386	MK386		2	3C0 513 353 C		

Touran (1T3) 05.10 →

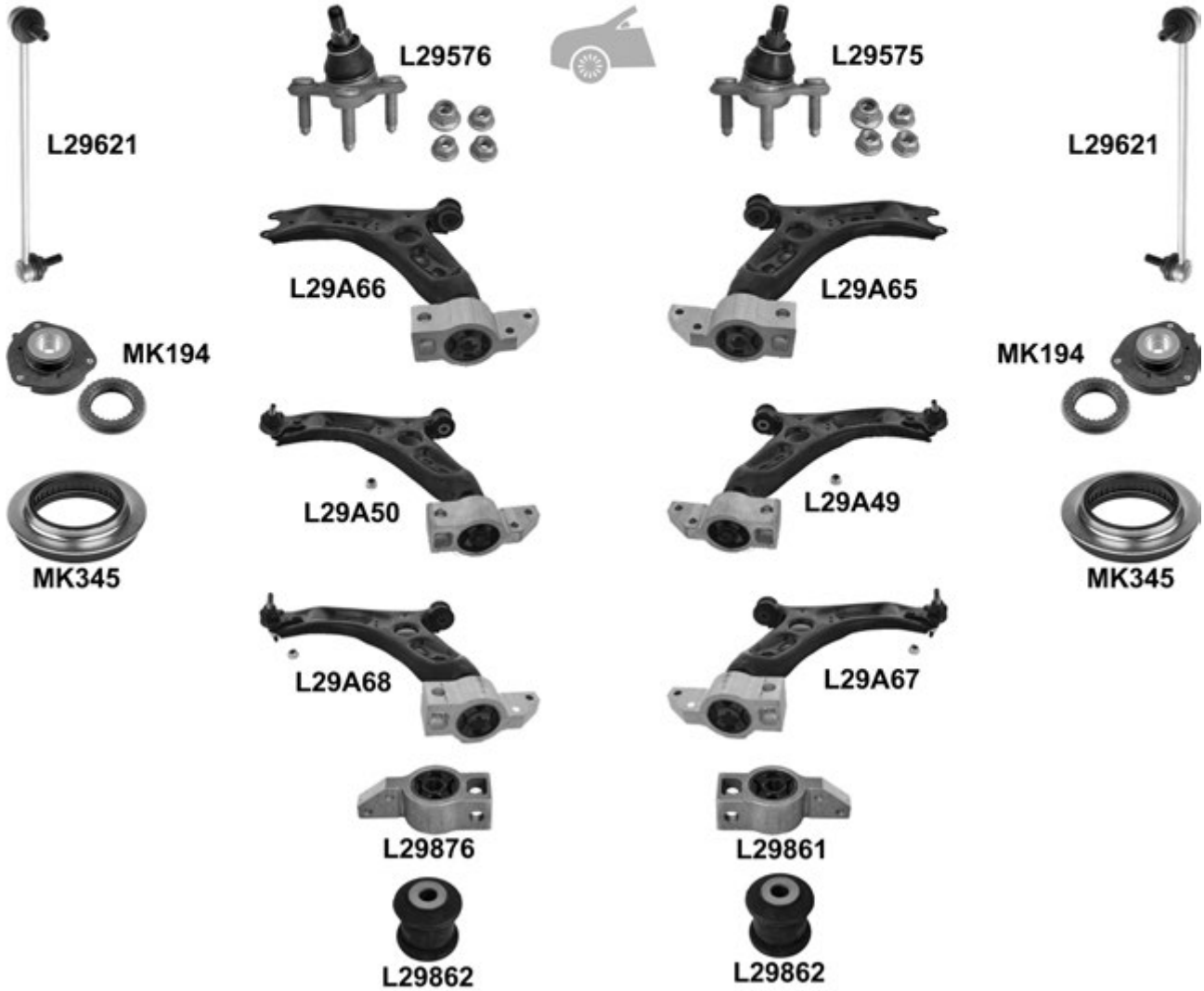
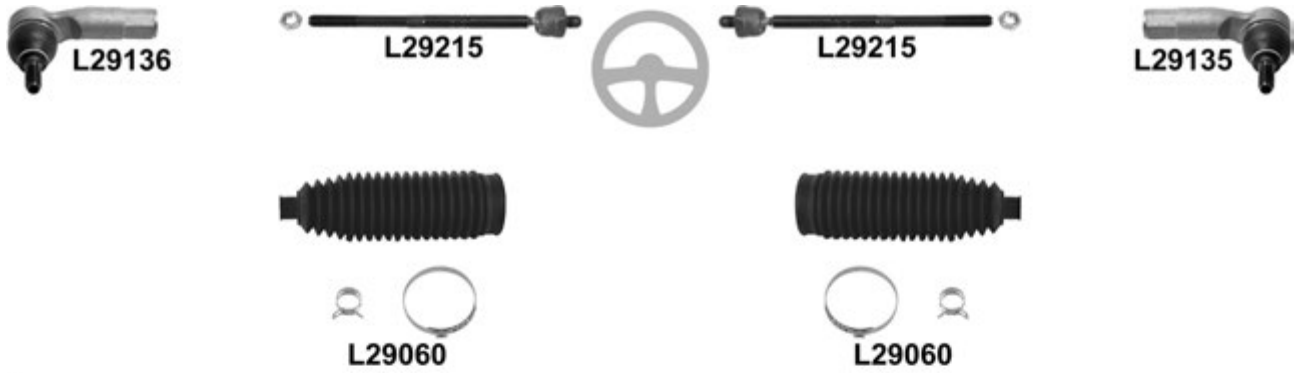

Touran (1T3) 05.10 →



				← → Thread		Part Of	QPA	i		
⊕	↔			L29135	F 16x1,5 ∪		1	1K0 423 812 G		
				L29136	F 16x1,5 ∪		1	1K0 423 811 G		
	⌋			L29215	L29215	M 16x1,5 / M 16x1,5 ∪		2	1K0 423 810 A	
			Electronic	L29060	L29060			2	1K0 423 831 A	
⊖	⌋				L29575			1	1K0 407 366 C	
					L29576			1	1K0 407 365 C	
	⌋		→ 06.10, (-) ⊕, (+) ⊕		L29A65			1	1K0 407 152 BC	
					L29A66			1	1K0 407 151 BC	
			07.10 →, ⊕	☑	L29A49 ⁰			1	1K0 407 152 BD	
					L29A50 ⁰			1	1K0 407 151 BD	
	⌋		→ 06.10, ⊕	☑	L29A67			1	1K0 407 152 BC	
					L29A68			1	1K0 407 151 BC	
	⌋				L29861		⌋	1	1K0 199 232 G	
					L29876		⌋	1	1K0 199 231 G	
⌋				L29862	L29862	⌋	2	1K0 407 182		
				L29621	L29621		2	1K0 411 315 D		
⊕		(+) MK345	KIT	MK194	MK194		2	1K0 412 331 B		
				MK345	MK345	⊕	2	6N0 412 249 C		
	⌋			L29A11	L29A11		2	4K0 505 323 N		
				☑	L29A29	L29A29		2	1K0 505 311 AB	
⌋				L29637			1	1K0 501 530 C		
				L29638			1	1K0 501 529 F		
				L29623	L29623		2	1K0 505 465 J		
⊕		(-) Electronic Drive		MK386	MK386		2	3C0 513 353 C		

Transporter I → 07.67

L2908B

L2908B

L2908A

L2908A

				←	→	Thread	Part Of	QPA	
		↔				M 14x1,5 ⤴		2	131 415 812
		↔				M 14x1,5 ⤴		2	131 415 811 D

Transporter II 08.67 → 12.78

L2937

L2933

L2931

L2931

L2931

L2931

				←	→	Thread	Part Of	QPA	
		↔				⤴		1	311 415 812 C
		↔				⤴		1	311 415 811 C
		↑	∅ 48,3mm					2	211 405 371 A
		↓	∅ 48,3mm					2	211 405 371 A

Transporter III 05.79 → 07.92 ch. 24 A 0000 001 → 24 N 015 000
 Transporter Syncro III 02.85 → 07.92 ch. 24 F 0000 001 → 24 N 015 000



L2975



L2975

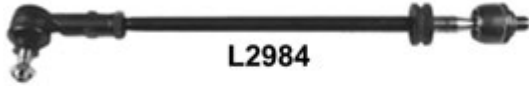

L2984

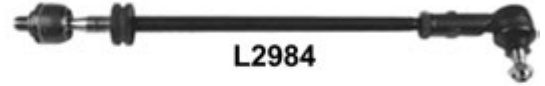

L2984

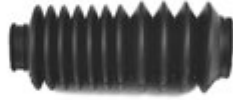

L29051



L29051



L2986



L2986



L2989



L2989



L2988



L2988



L29807



L29807



L29820



L29820



L29821



L29821



L29834



L29834

Transporter III 05.79 → 07.92 ch. 24 A 0000 001 → 24 N 015 000
 Transporter Syncro III 02.85 → 07.92 ch. 24 F 0000 001 → 24 N 015 000

		i		←	→	Thread	Part Of	QPA	i
		↔		L2975	L2975	F 14x1,5 U		2	171 419 812
				L2984	L2984			2	251 419 803 A
				L29051	L29051			2	251 419 831 A
		↑		L2986	L2986			2	251 407 361
		↓	∅ 48,3mm	L2989	L2989			2	251 407 187 A
			∅ 48,6mm	L2989	L2989			2	251 407 187 C(B)
		↑		L2988	L2988			4	251 407 077
		↓		L29807	L29807			2	251 407 183
		▼		L29820	L29820			2	251 407 175
		▲		L29821	L29821			2	251 407 179
		↓		L29834	L29834			4	251 501 131 A

Transporter T4 09.90 → 08.94 ch. 70 M 000 001 → 70 R 200 000

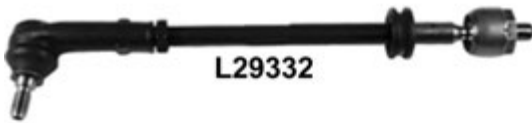
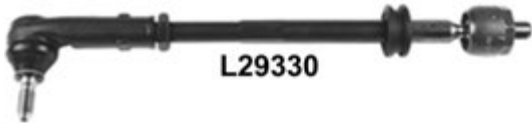
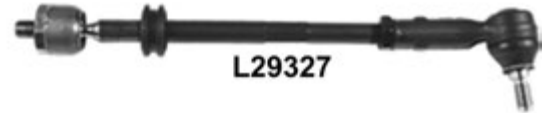
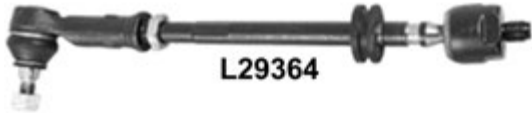
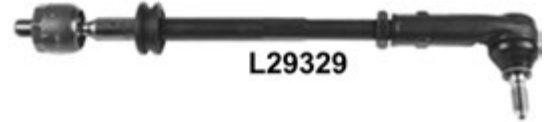
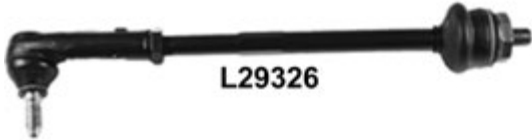
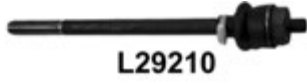

L29054



L29054



Transporter T4 09.90 → 08.94 ch. 70 M 000 001 → 70 R 200 000

Transporter T4 09.90 → 08.94 ch. 70 M 000 001 → 70 R 200 000

		i	←	→	Thread	Part Of	QPA	i		
⊕	↔	⊕ / ⊕, ch. → 70 M 096 448		L29103	⊕		1	701 419 812		
		↗ 12,7mm - 14,4mm	L29104		⊕		1	701 419 811 A		
		⊕ / ⊕, ch. 70 M 096 449 → 70 R 200 000		L29105	⊕		1	701 419 812 A		
		↗ 14,7mm - 16,3mm	L29106		⊕		1	701 419 811 B		
	⊕				L29209		L29327/L29329	1		
					L29210		L29326/L29328	1		
	⊕	↗	⊕, ch. 70 M 035 008 → 70 M 096 448, ↗ 14mm		L29329			1	701 419 804 C	
				L29326				1	701 419 803 C	
		↘	⊕, ch. 70 M 096 449 → 70 R 200 000, ↗ 16mm		L29327				1	701 419 804 D
				L29364					1	701 419 803 D
		⊕	⊕, ch. → 70 M 096 448, ↗ 14mm		L29329				1	701 419 804 C
				L29330					1	702 419 803 A
		⊕	⊕, ch. 70 M 096 449 → 70 R 200 000, ↗ 16mm		L29327				1	701 419 804 D
				L29332					1	702 419 803 B
⊕	⊕	⊕, ⊕	L29054	L29054			2	701 419 831		
			L29517	L29517			2	701 407 187 B		
	⊕		L29518	L29518			2	701 407 361 C		
		ch. 70 M 083 343 →, (-) ⊕, L= 360mm		L29A59			1	701 407 152 A		
	⊕		L29A60				1	701 407 151 A		
		↗	L29822	L29822		⊕	2	701 407 087		
	↘	↗	L29812	L29812		⊕	2	701 407 077		
		↘	L29825	L29825		⊕	2	700 407 140		
	↗	↗	L29823	L29823		⊕	2	701 407 183		
			L29618	L29618			2	701 411 049		
⊕	27mm		L29619	L29619			2	701 411 049 B		

Transporter T4 07.94 → 08.96 ch. 70 S 000 001 → 70 T 199 999

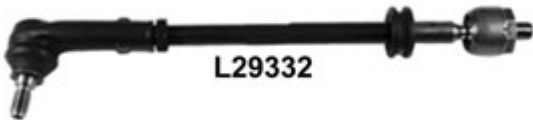
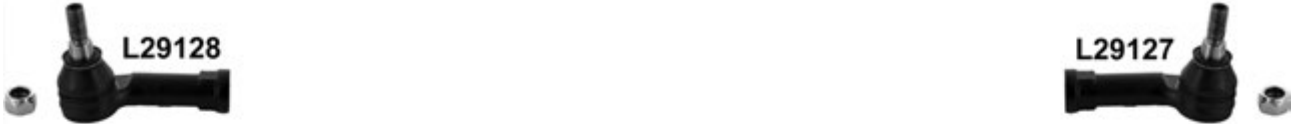

Transporter T4 07.94 → 08.96 ch. 70 S 000 001 → 70 T 199 999



			←	→	Thread	Part Of	QPA		
		/ , ch. → 70 S 002 791 14,7mm - 16,3mm		L29105	∩		1	701 419 812 A	
				L29106	∩		1	701 419 811 B	
		/ , ch. 70 S 002 792 → 14,7mm - 18,3mm		L29127	∩		1	701 419 812 D	
				L29128	∩		1	701 419 811 E	
				L29209		L29327/L29329/L29343	1		
				L29210		L29326/L29328/L29344	1		
		, ch. → 70 S 002 791, 16mm		L29327			1	701 419 804 D	
				L29364			1	701 419 803 D	
		, ch. 70 S 002 792 →, 18mm		L29343			1	701 419 804 E	
				L29344			1	701 419 803 E	
		, ch. → 70 S 002 791, 16mm		L29327			1	701 419 804 D	
				L29332			1	702 419 803 B	
		, ch. 70 S 002 792 →, 18mm		L29343			1	701 419 804 E	
				L29344			1	702 419 803 C	
			/	L29054	L29054			2	701 419 831
				L29517	L29517			2	701 407 187 B
		(-) , L= 360mm		L29518	L29518			2	701 407 361 C
				L29A59			1	701 407 152 A	
			L29A60			1	701 407 151 A		
			L29822	L29822			2	701 407 087	
			L29812	L29812			2	701 407 077	
			L29825	L29825			2	700 407 140	
			L29823	L29823			2	701 407 183	
			L29618	L29618			2	701 411 049	
	27mm	L29619	L29619			2	701 411 049 B		

Transporter T4 09.96 → ch. 70 T 200 001 →

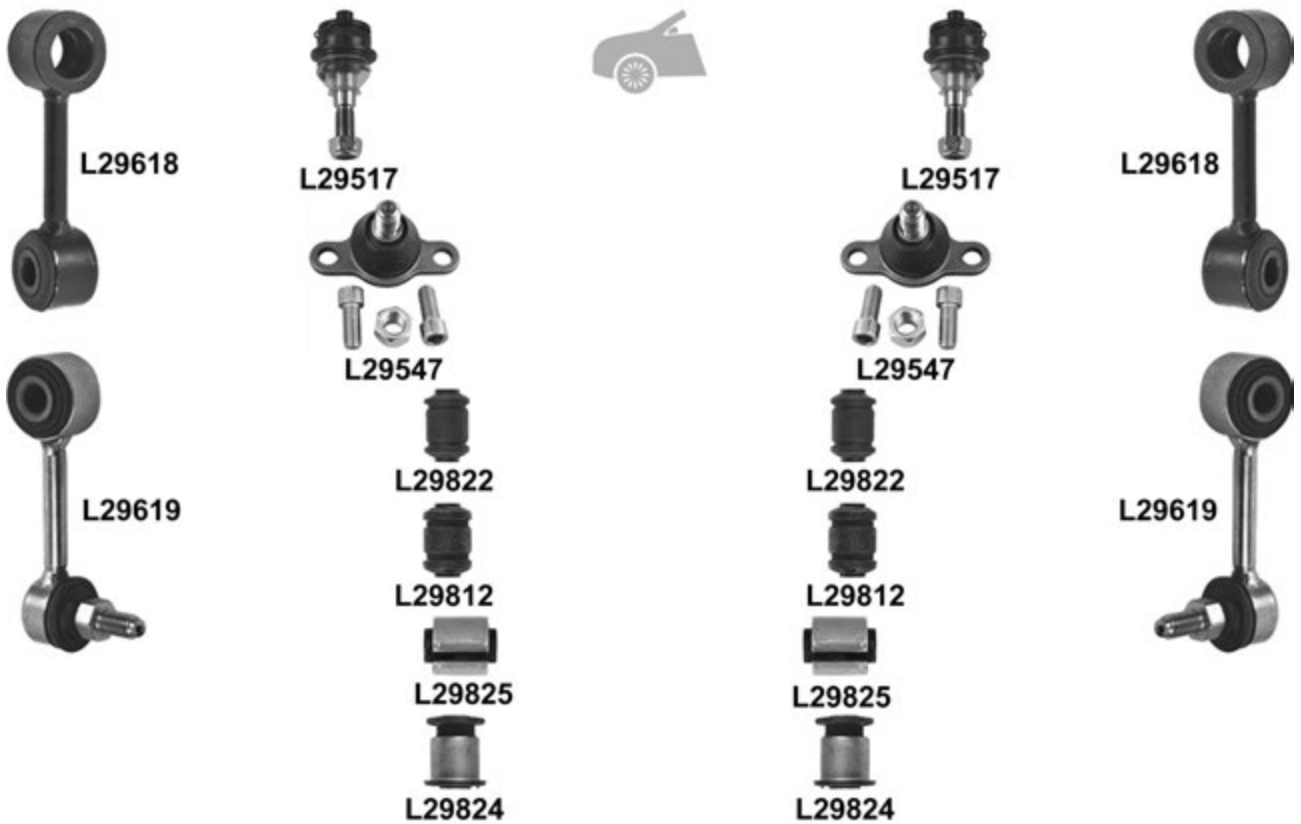
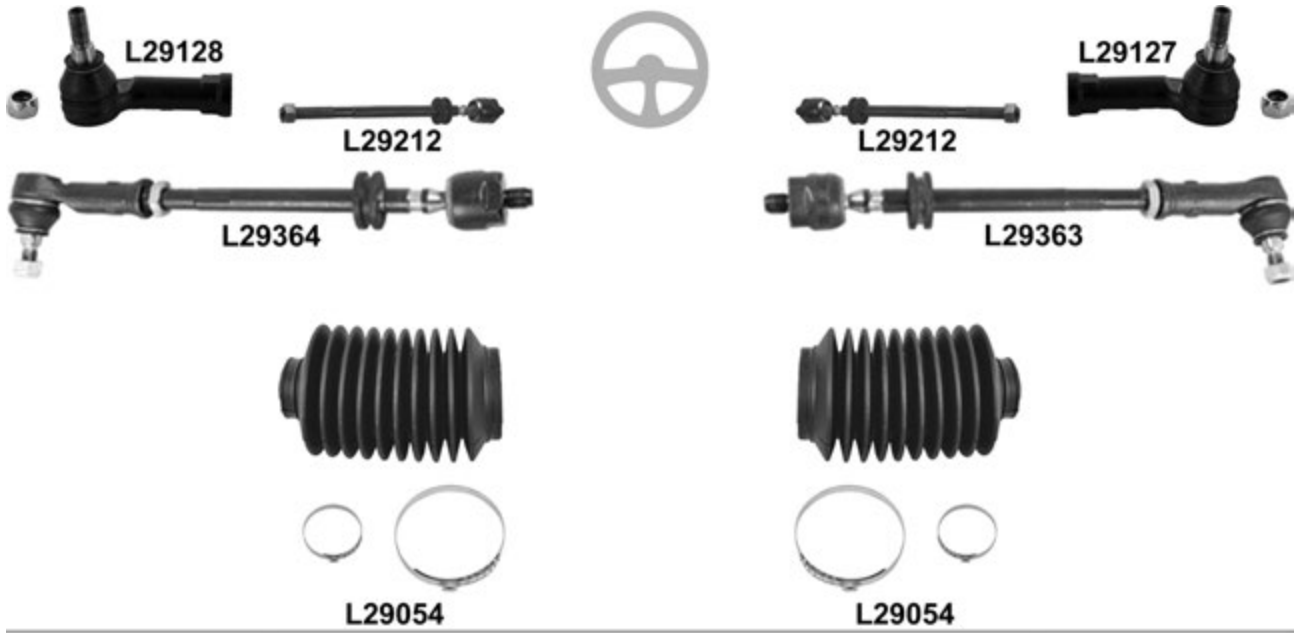

Transporter T4 09.96 → ch. 70 T 200 001 →

				←	→	Thread	Part Of	QPA		
		↔	14.7mm - 18,3mm		L29127	F 16x1,5 ♂		1	701 419 812 D	
					L29128	F 16x1,5 ♂		1	701 419 811 E	
					L29212	L29212		2		
						L29363		1	701 419 804 F	
						L29364		1	702 419 803 D	
						L29054	L29054		2	701 419 831
		↑			L29517	L29517		2	701 407 187 B	
		↓			L29547	L29547		2	700 407 361	
		↑▼			L29822	L29822		2	701 407 087	
		↑▲			L29812	L29812		2	701 407 077	
		↓▼			L29825	L29825		2	700 407 140	
		↓▲			L29824	L29824		2	700 407 183	
						L29618	L29618		2	701 411 049
		27mm				L29619	L29619		2	701 411 049 B

Transporter T4 Syncro 11.92 → 08.95 ch. 70 P 009 246 → 70 S 200 000

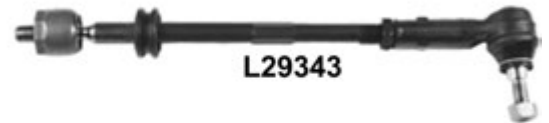
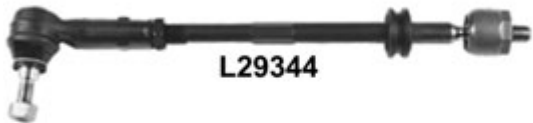
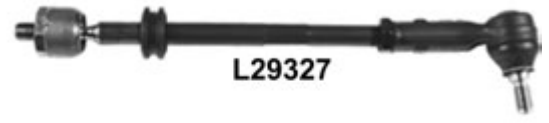
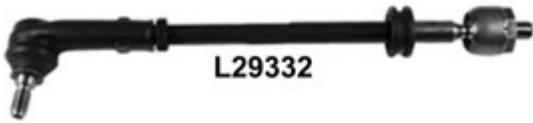

L29054

L29054



Transporter T4 Syncro 11.92 → 08.95 ch. 70 P 009 246 → 70 S 200 000



			←	→	Thread	Part Of	QPA	
		↔	ch. → 70 S 002 791, 16mm, 12,7mm - 14,4mm	L29105	∩		1	701 419 812 A
				L29106	∩		1	701 419 811 B
				L29127	∩		1	701 419 812 D
				L29128	∩		1	701 419 811 E
				L29209		L29327/L29343	1	
				L29210		L29326/L29328/L29344	1	
			ch. → 70 S 002 791, 16mm	L29327			1	701 419 804 D
				L29332			1	702 419 803 B
		ch. 70 S 002 792 →, 14,7mm - 18,3mm	L29343			1	701 419 804 E	
			L29344			1	702 419 803 C	
			L29054	L29054		2	701 419 831	
		↑	L29517	L29517		2	701 407 187 B	
		↓	L29518	L29518		2	701 407 361 C	
		↓	ch. 70 M 083 343 →, (-) , L= 360mm	L29A59			1	701 407 152 A
				L29A60			1	701 407 151 A
		↑↓		L29822	L29822		2	701 407 087
		↑↑		L29812	L29812		2	701 407 077
		↓↓		L29825	L29825		2	700 407 140
		↓↑		L29823	L29823		2	701 407 183
			27mm	L29618	L29618		2	701 411 049
				L29619	L29619		2	701 411 049 B

Transporter T4 Syncro 08.95 → 08.96 ch. 70 T 000 001 → 70 T 199 999

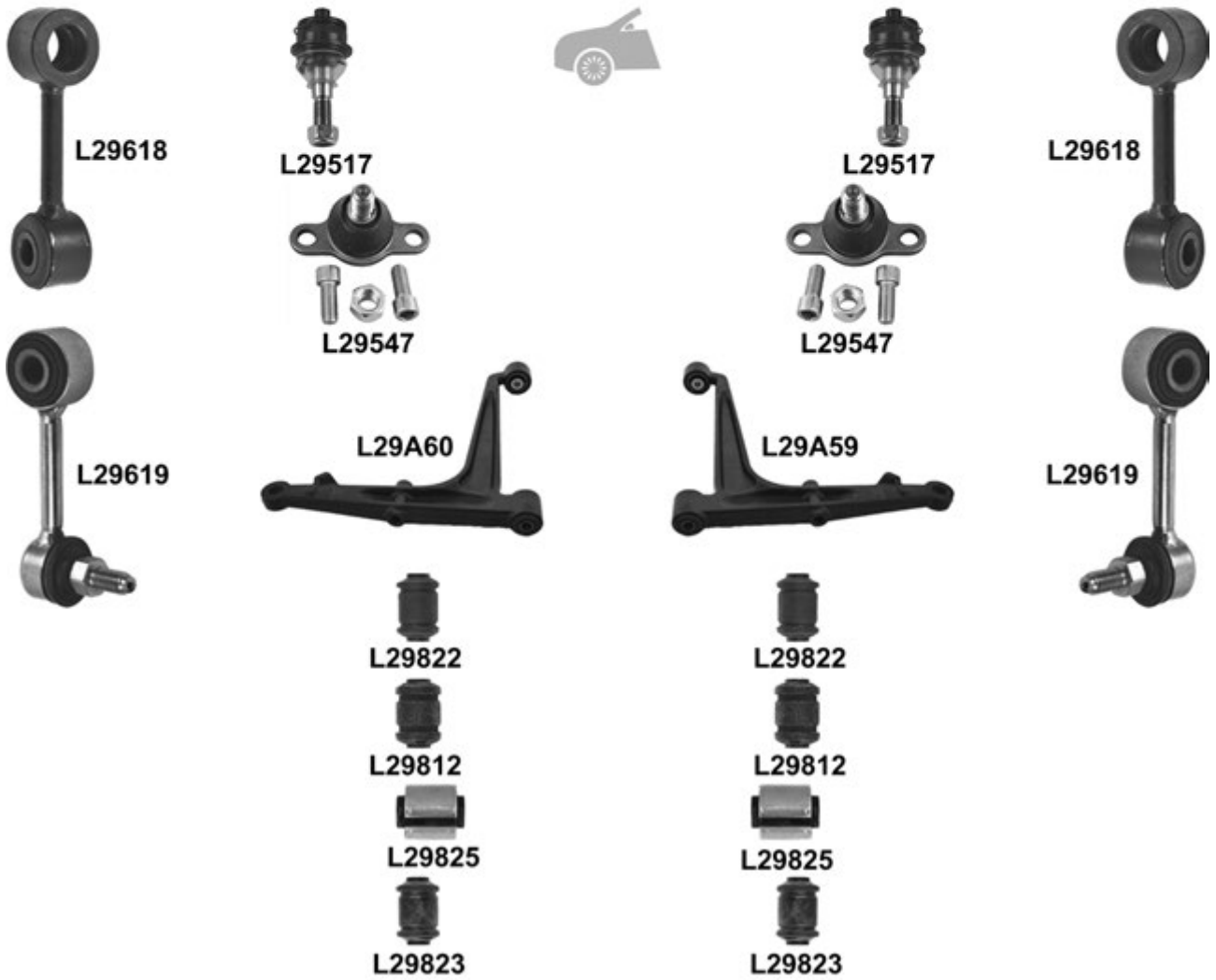
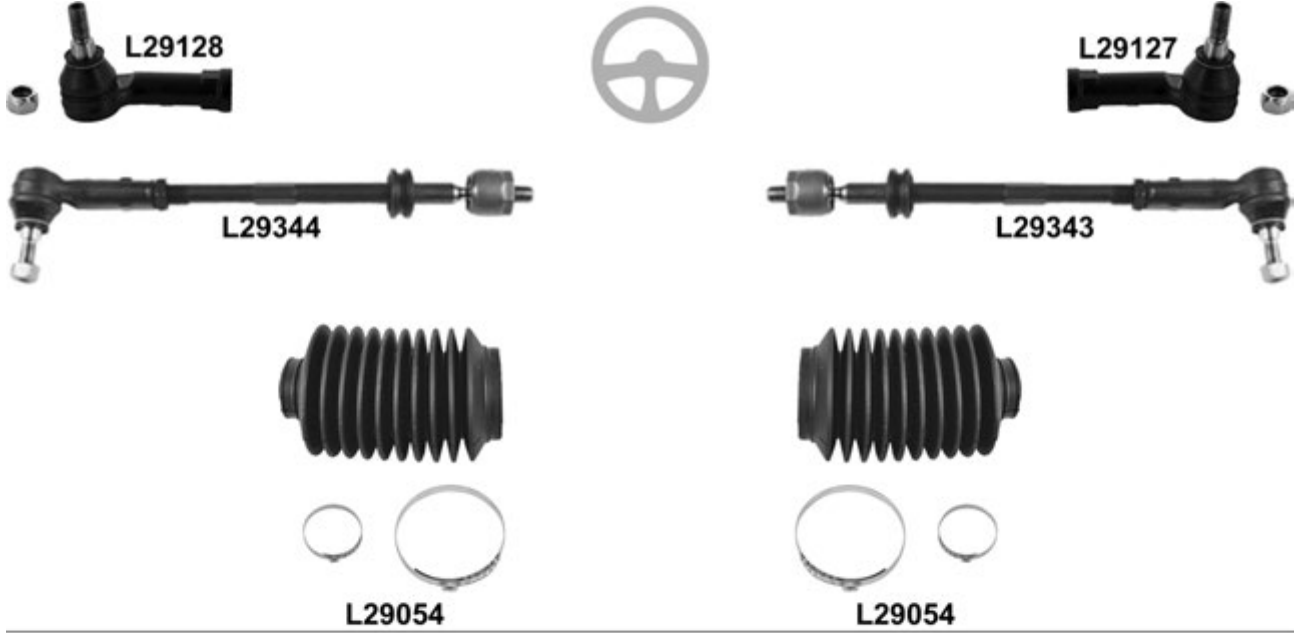

Transporter T4 Syncro 08.95 → 08.96 ch. 70 T 000 001 → 70 T 199 999

		i		←	→	Thread	Part Of	QPA	i
		↔	14,7mm - 18,3mm		L29127	↻		1	701 419 812 D
				L29128		↻		1	701 419 811 E
			14,7mm - 18,3mm		L29343			1	701 419 804 E
				L29344				1	702 419 803 C
				L29054	L29054			2	701 419 831
		↑		L29517	L29517			2	701 407 187 B
		↓		L29547	L29547			2	700 407 361
		↓	(-) L= 360mm		L29A59			1	701 407 151 A
				L29A60		1	701 407 152 A		
		↑ ↓		L29822	L29822			2	701 407 087
		↑ ▲		L29812	L29812			2	701 407 077
		↓ ▼		L29825	L29825			2	700 407 140
		↓ ▲		L29823	L29823			2	701 407 183
				L29618	L29618			2	701 411 049
			27mm	L29619	L29619			2	701 411 049 B

Transporter T4 Syncro 09.96 → ch. 70 T 200 001 →

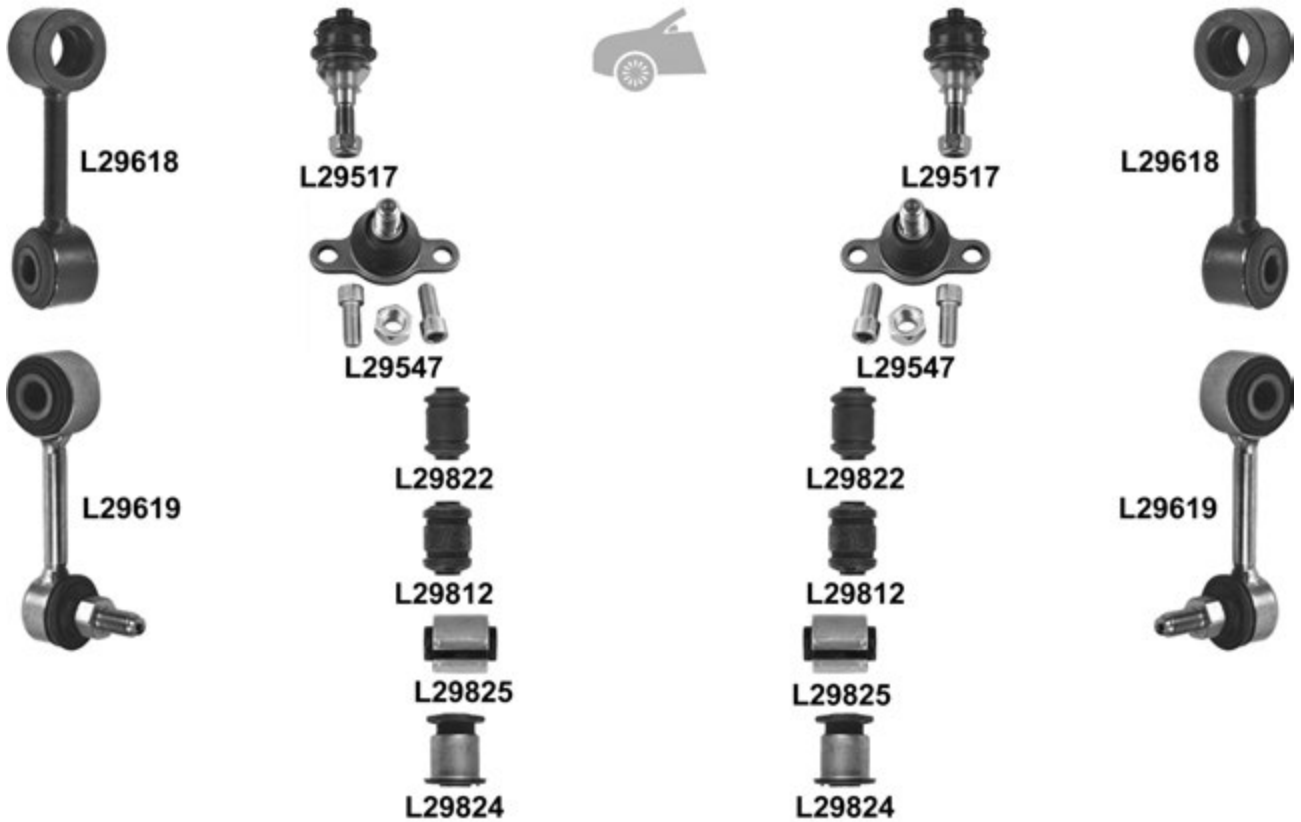
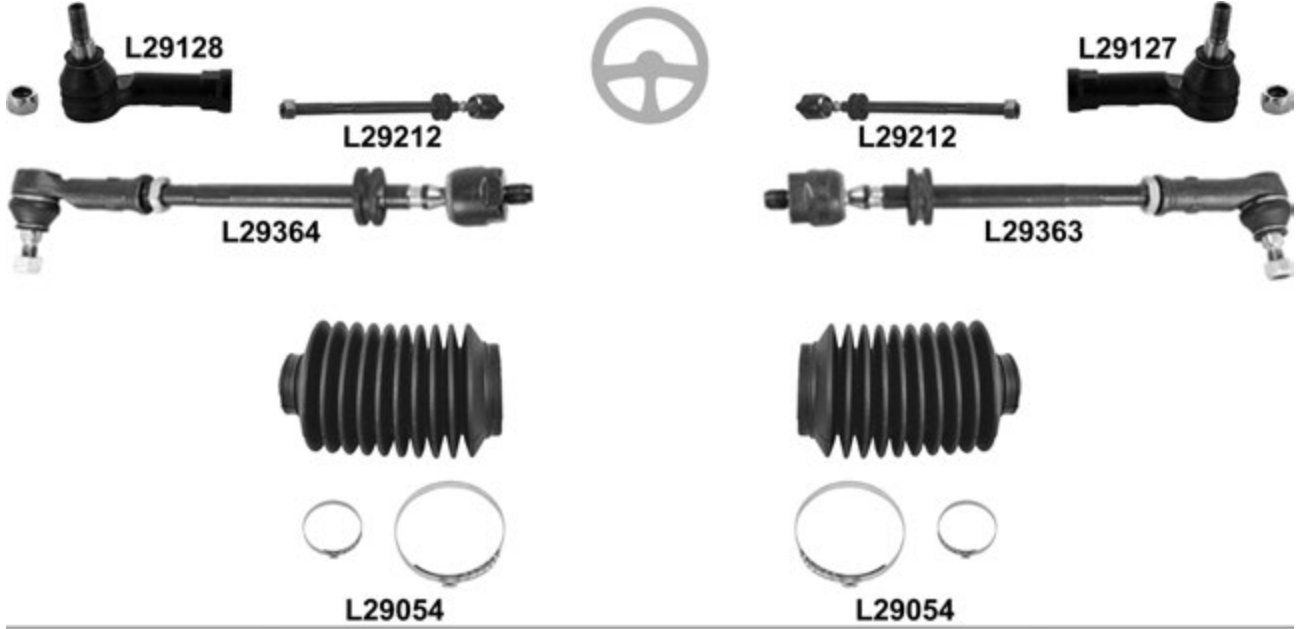

Transporter T4 Syncro 09.96 → ch. 70 T 200 001 →

		i		←	→	Thread	Part Of	QPA	i	
		↔	14.7mm - 18,3mm		L29127	F 16x1,5 ♂		1	701 419 812 D	
					L29128	F 16x1,5 ♂		1	701 419 811 E	
					L29212	L29212		2		
						L29363			1	701 419 804 F
						L29364			1	702 419 803 D
						L29054	L29054		2	701 419 831
		↑			L29517	L29517		2	701 407 187 B	
		↓			L29547	L29547		2	700 407 361	
		↑▼				L29822	L29822		2	701 407 087
		↑▲				L29812	L29812		2	701 407 077
		↓▼				L29825	L29825		2	700 407 140
		↓▲				L29824	L29824		2	700 407 183
						L29618	L29618		2	701 411 049
				27mm		L29619	L29619		2	701 411 049 B

Transporter T5 (7H#, 7J#) 04.03 →

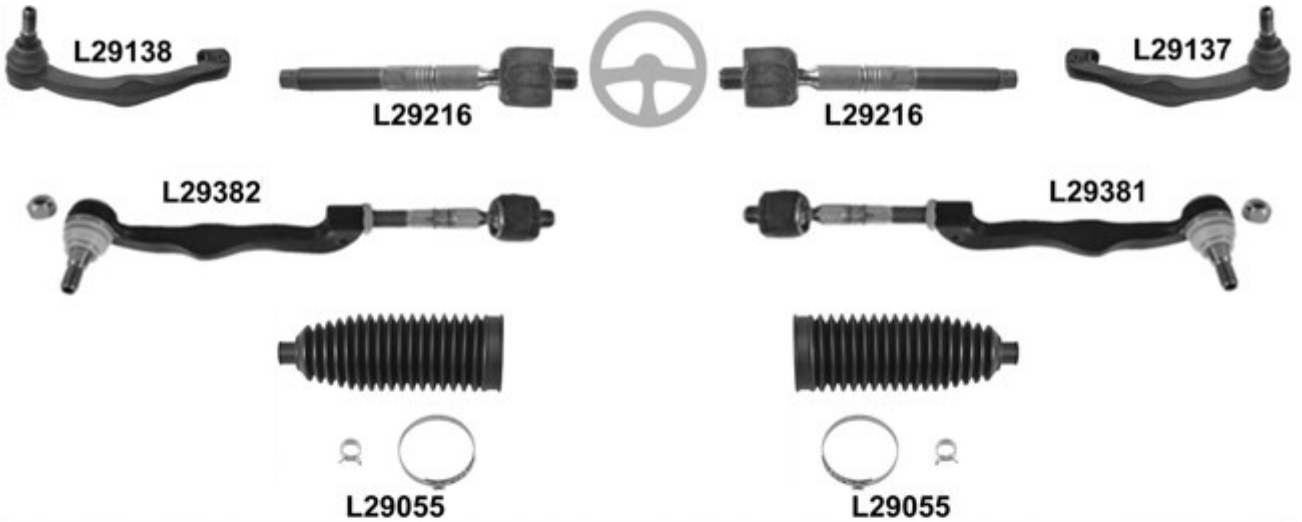

Transporter T5 (7H#, 7J#) 04.03 →

		i		←	→	Thread	Part Of	QPA	i	
		↔				L29137 F 16x1,5		1	7H0 422 818 C	
						L29138 F 16x1,5		1	7H0 422 817 C	
						L29216 L29216 M 16x1,5 / M 16x1,5		2		
						L29381		1	7H0 419 804 F	
						L29382		1	7H0 419 803 F	
						L29055 L29055		2	7H0 422 831	
		↓	chassis total weight 3.2 T chassis total weight 3.0 T - 3.2 T			L29577 L29577		2	7H8 407 361 A	
			chassis total weight 2.6 T - 3.0 T chassis total weight 2.6 T - 2.85 T			L29578 L29578		2	7H0 407 361	
		↓	(-) PR OWR/1BH/1BX/2MQ/2MR/2MT/2MU, (-) HD			L29A45		1	7H0 407 152 G	
			(-)			L29A46		1	7H0 407 151 G	
		↓				L29878 L29878		2	7H0 407 182 A	
		↓				L29879 L29879		2	7D0 407 183	
			∅ 9mm			L29632 L29632		2	7H5 411 317 B	
						MK346 MK346		2	7H0 12 249 A	
			↓ ↔ ← ↔	(-) PR OWR			L29880 L29880		4	7H0 501 132 A

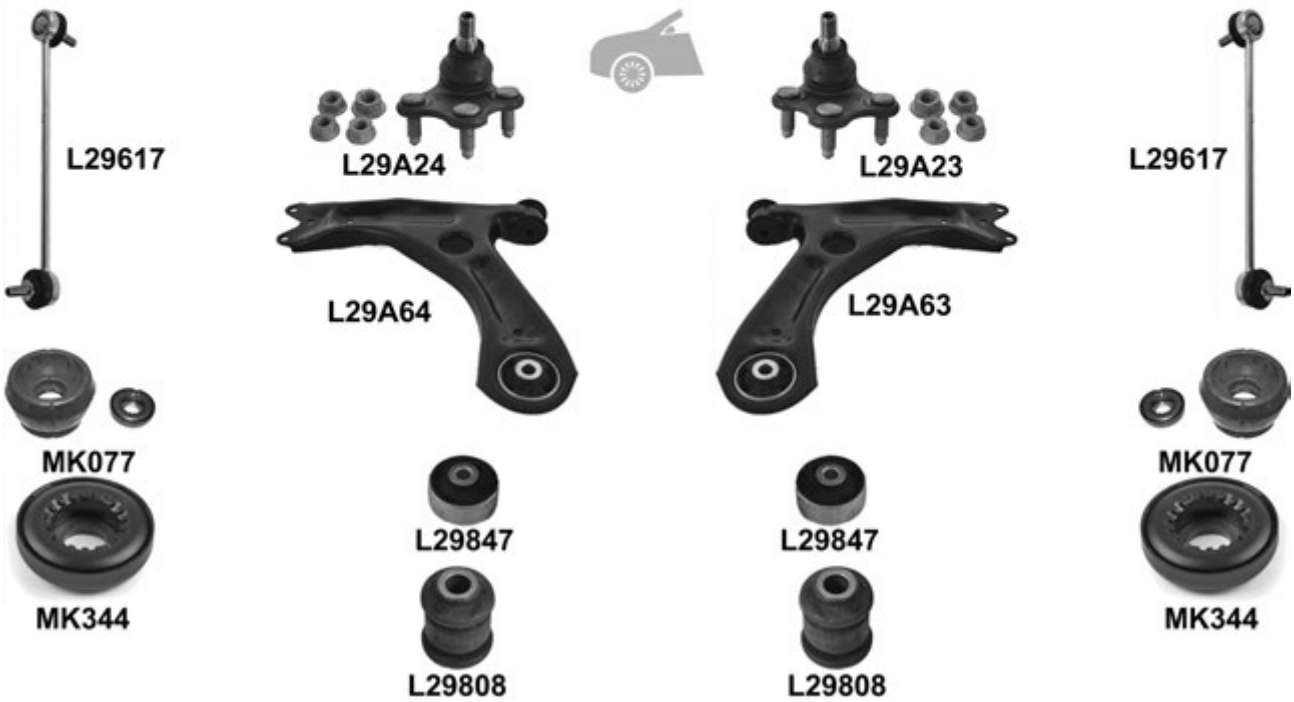
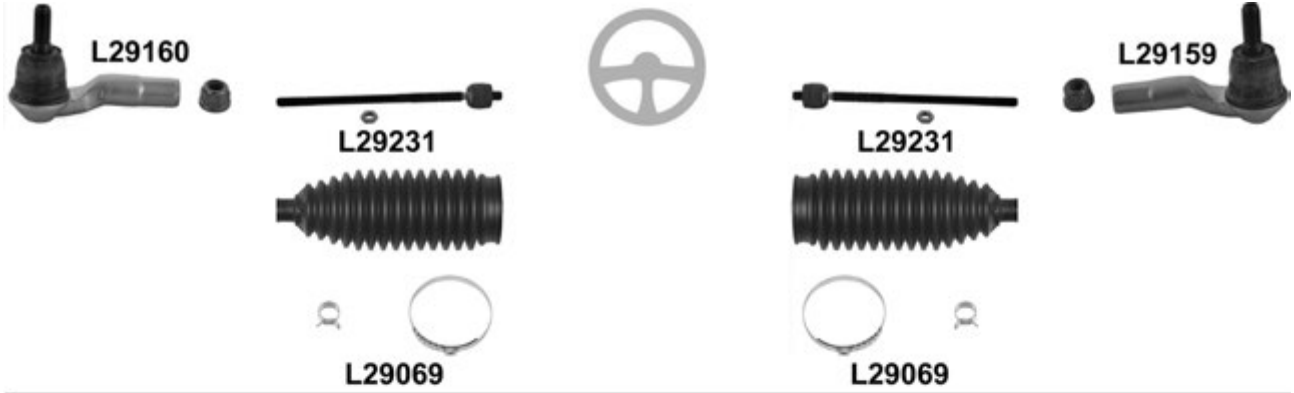
UP 12.2011
 E-Up 07.13 →

Thread

Part Of

QPA



				←	→	Thread	Part Of	QPA		
⊕		↔			L29159	F 14x1,5 ∪		1	1S0 423 812 A	
				L29160	F 14x1,5 ∪		1	1S0 423 811 A		
			L29231	L29231	M 14x1,5 / M 14x1,5 ∪		2	1S0 423 810 A		
			∅ 14mm, ∅ 44mm, L= 167mm	L29069 ^o	L29069 ^o		2	1S0 423 831 A		
⊖		⊥			L29A23			1	6R0 407 366	
				L29A24			1	6R0 407 365		
		(-) (+)			L29A63		1	1S0 407 152		
				L29A64			1	1S0 407 151		
		⊥▼			L29847	L29847		2	1J0 407 181	
			⊥▲		L29808	L29808		2	357 407 182	
				L29617	L29617			2	6Q0 411 315 D	
			(+) MK344	KIT	MK077	MK077		2	1J0 412 331 BS	
MK344					MK344		2	1J0 412 249		

Vento (1HXO) 11.91 → 09.98 ch. 1H NW / NB 000 001 →

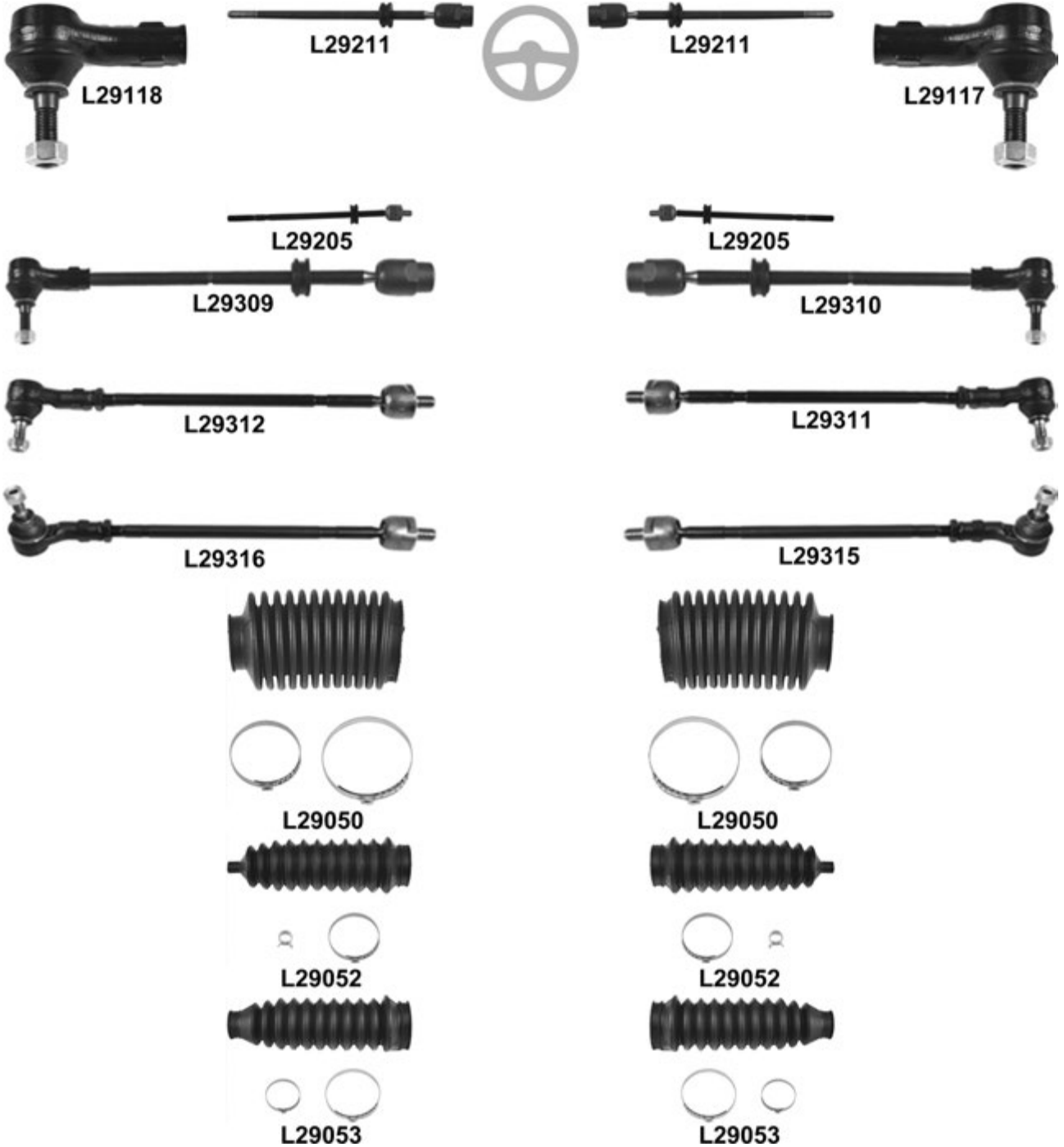

Vento (1HXO) 11.91 → 09.98 ch. 1H NW / NB 000 001 →

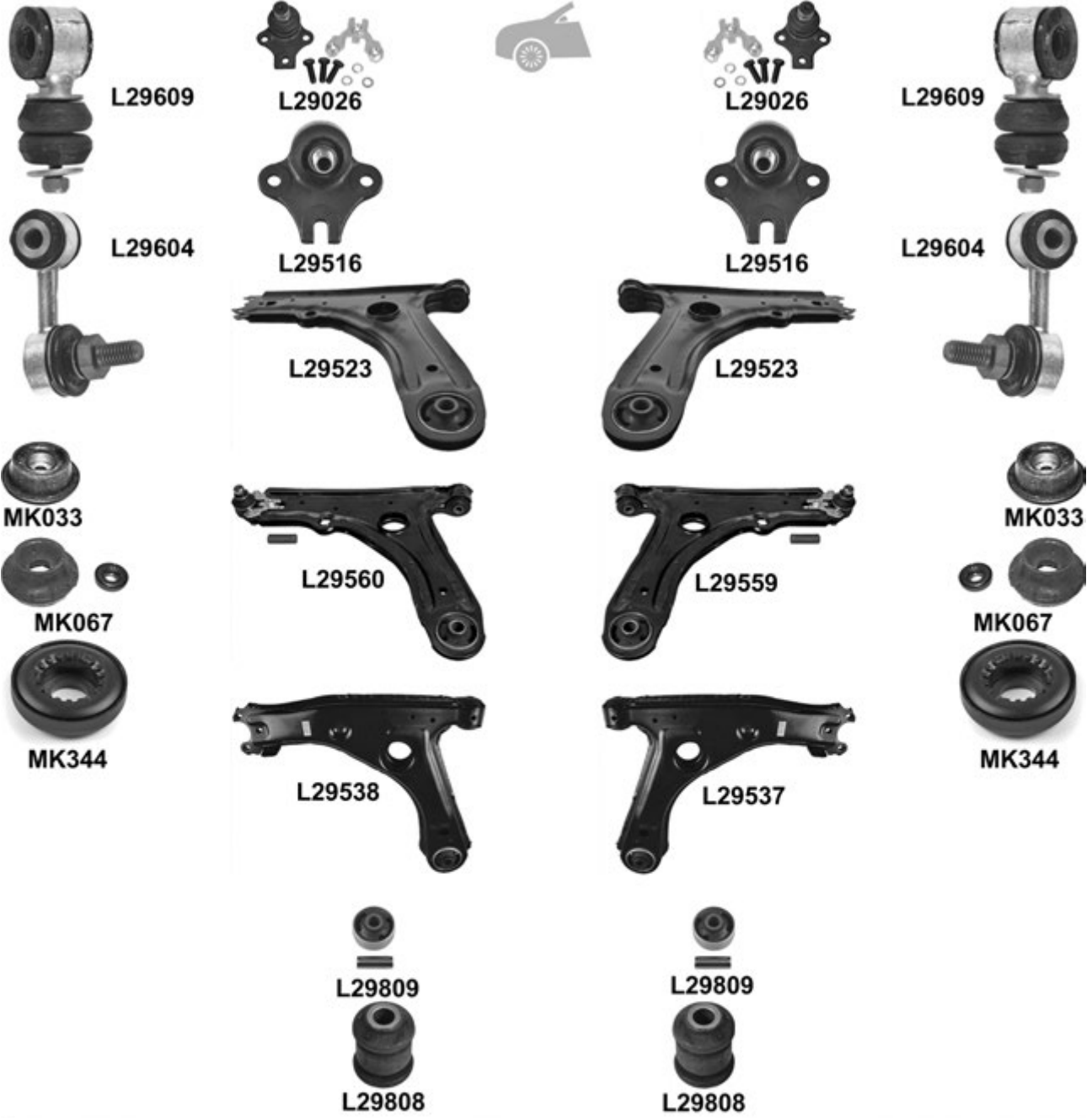

Vento (1HXO) 11.91 → 09.98 ch. 1H NW / NB 000 001 →

			←	→	Thread	Part Of	QPA			
		↔		L29117	F 14x1,5 ♂		1	3A0 422 812		
				L29118	F 14x1,5 ♂		1	3A0 422 811		
		⊙		L29211	L29211			2		
			⊙, TRW	L29205	L29205			2	1H0 422 821 A	
					L29310			1	1H0 419 804	
		⊙		L29309				1	1H0 419 803	
			⊙, TRW		L29311			1	1H0 422 804	
				L29312				1	1H0 422 803	
			⊙, ZF		L29315			1	1H0 422 804 B	
		⊙		L29316				1	1H0 422 803 B	
				L29050	L29050			2	191 419 831	
			⊙, TRW	L29052	L29052			2	1H0 422 831	
			⊥	(-) Vento 2.0/Sdi/Tdi/VR6	L29026	L29026			2	357 407 365 A
				2.0/Sdi/Tdi/VR6	L29516	L29516			2	1H0 407 365
				2.0/Sdi/Tdi/VR6, (-) (+)	L29523	L29523			2	1H0 407 151
		⊥	(-) 2.0/Sdi/Tdi/VR6 <input checked="" type="checkbox"/>	L29559				1	1H0 407 151	
				L29560				1	1H0 407 151	
			2.0/Sdi/Tdi/VR6, (-) (+)		L29537			1	1H0 407 152	
		⊥		L29538				1	1H0 407 151 A	
				L29809	L29809			2	191 407 181 E	
		⊥		L29808	L29808			2	357 407 182	
				L29609	L29609			2	191 411 315 BS	
			(-) 2.0 GT, Mot/Eng 2E, 2.8 VR6, Mot/Eng AAA	L29604	L29604			2	535 411 315	
			2.0 GT, Mot/Eng 2E, 2.8 VR6, Mot/Eng AAA							
			ch. → 1H SW 062 538	KIT	MK033	MK033			2	357 412 329
			ch. → 1H SB 019 475							
			(-) HD/2.0/2.0 16V/VR6							
	ch. 1H SW 062 539 →		KIT	MK067	MK067			2	357 412 331 A	
		ch. 1H SB 019 476 →								
		(-) HD/2.0/2.0 16V/VR6, (+) MK344								
		HD/16V/VR6, (+) MK344		MK067	MK067			2	357 412 331 A	
				MK344	MK344			2	1J0 412 249	
		(-) Syncro	KIT	L29830		Hub carrier	1	1H0 501 541 AS		
				MK133	MK133			2	191 512 333 S1	

1200 Typ 111, 115 1947 → 1961



			i	←	→	Thread	Part Of	QPA	i
⊕		↔			L2908B	M 14x1,5 ∪		1	131 415 812
		→←			L2908A	M 14x1,5 ∪		1	131 415 811

 1200 Typ 113, 117 04.60 → 08.65
 1200 Ghia 04.60 → 08.65

			i	←	→	Thread	Part Of	QPA	i
⊕		↔			L2908B	M 14x1,5 ∪		1	131 415 812
					L2908A	M 14x1,5 ∪		1	131 415 811

 1200 A, 1300 A, 1300, 1500 04.60 → 08.65 ch. 116 000 001 → 118 857 239
 1300, 1500 Karmann Ghia 08.65 → 04.68 ch. 146 000 001 → 148 857 239

			i	←	→	Thread	Part Of	QPA	i
⊕		↔			L2908B	M 14x1,5 ∪		1	131 415 812
					L2908A	M 14x1,5 ∪		1	131 415 811
		↑		L2922	L2922			2	131 405 361 F
		↓		L2923	L2923			2	131 405 371 G

1200 A, 1300 A 05.68 → ch. 118 857 240 → 118 2050 000
 1200 (1.2ltr.) 01.78 → ch. 18 2100 001 → 11 G 003 213
 1300, 1500 Karmann Ghia 05.68 → ch. 148 857 240 → 144 2999 000



			i	←	→	Thread	Part Of	QPA	i
		↔			L2937	M 14x1,5 ∪		1	311 415 812 C
				L2933		M 14x1,5 ∪		1	311 415 811 C
		↑		L2922	L2922			2	131 405 361 F
		↓		L2923	L2923			2	131 405 371 G

1302, 1302 S 08.70 → 07.72 ch. 111 2000 001 → 112 3200 000
 1303 A, 1303 S 08.72 → 07.74 ch. 133 2000 001 → 134 2999 000



			i	←	→	Thread	Part Of	QPA	i
		↔		L2933	L2933	M 14x1,5 ∪		2	311 415 811 C
		↔		L2937	L2937	M 14x1,5 ∪		2	311 415 812 C
		↓	1302, 1303 ch. → 133 3200 000	L2949	L2949			2	113 407 361 E/F

1303 01.74 → 01.80 ch. 135 2000 001 → 159 2050 000



L2937



L2937

				← → Thread		Part Of	QPA	i	
		↔		L2937	L2937	M 14x1,5 ∪		2	311 415 812 C

1500, 1500 Variant, 1600, 1600 Variant 1961 → 1967 ch. → 317 500 000



L2908A



L2908A



L2908B

				← → Thread		Part Of	QPA	i	
		↔		L2908A		M 14x1,5 ∪		1	131 415 811
		↔		L2908B		M 14x1,5 ∪		1	131 415 812
		↔		L2908A		M 14x1,5 ∪		1	131 415 811

1600, 1600 Variant 08.67 → 1973 ch. 318 000 001 →



L2933



L2937



L2933

				← → Thread		Part Of	QPA	i	
		↔		L2933		M 14x1,5 ∪		1	311 415 811 C
		↔			L2937	M 14x1,5 ∪		1	311 415 812 C
		↔		L2933		M 14x1,5 ∪		1	311 415 811 C

 411, 411 Variant 08.70 →
 412 08.72 →

L2933



L2933

				← → Thread		Part Of	QPA	i	
		↔		L2933	L2933	M 14x1,5 ∪		2	311 415 811 C

VOLVO

Amazon 1957 → 1970

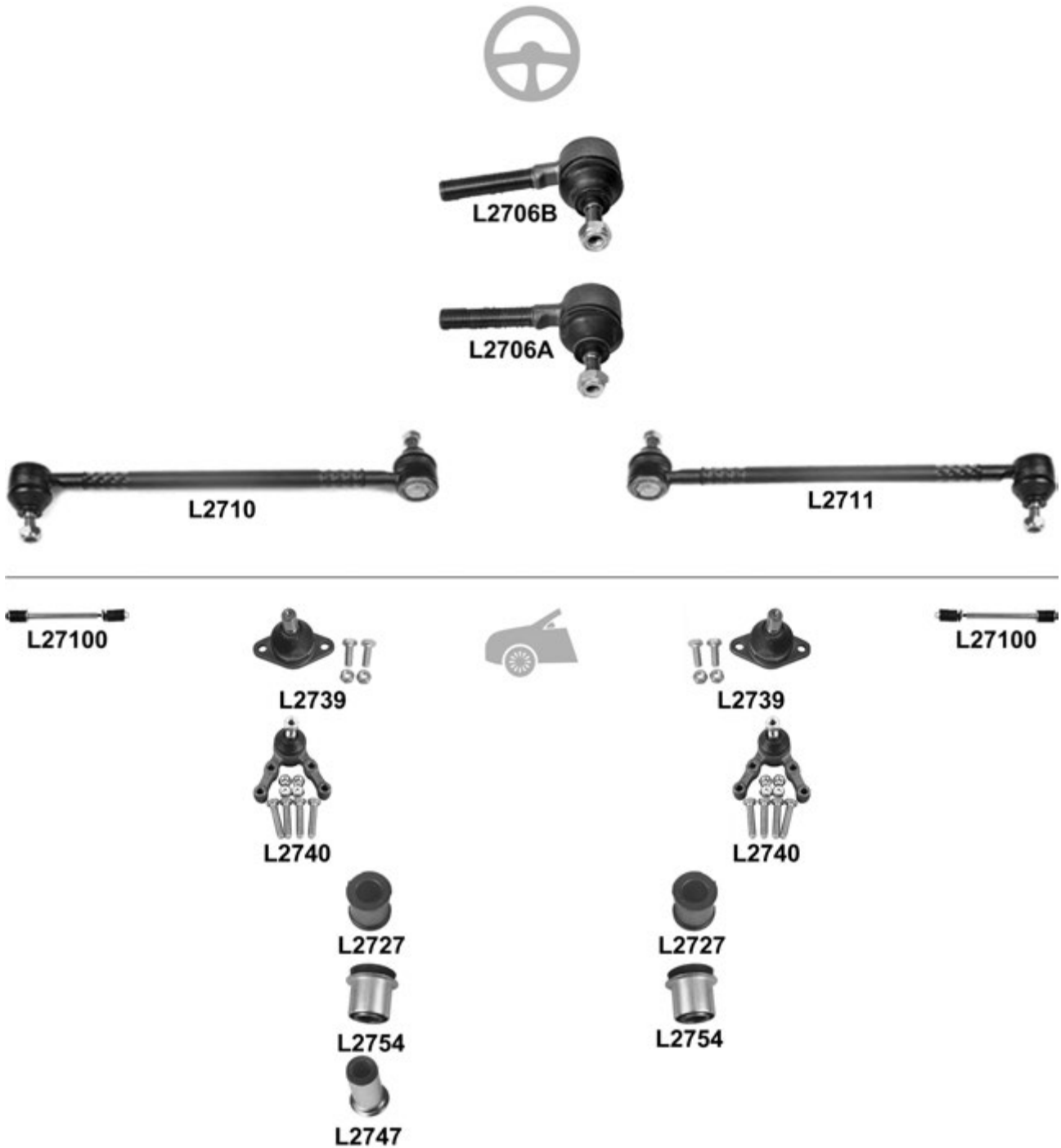

				←	→	Thread	Part Of	QPA	
				L2706B		M 14x1,5 U		1	677112
				L2706A		M 14x1,5 U		1	677111
				L2711				1	658597
				L2710				1	658596
			08.65 →	L2739	L2739			2	672803
				L2740	L2740			2	273038
				L2727	L2727			4	87033
				L2754	L2754			4	663675
				L2710	L2710			2	
					L2747			IDLER	1

Amazon → 1970

L2728

L2728

L2727

L2727

Thread
Part Of
QPA

						Thread	Part Of	QPA	
				L2728	L2728			2	672226
			transverse	L2727	L2727			2	87033

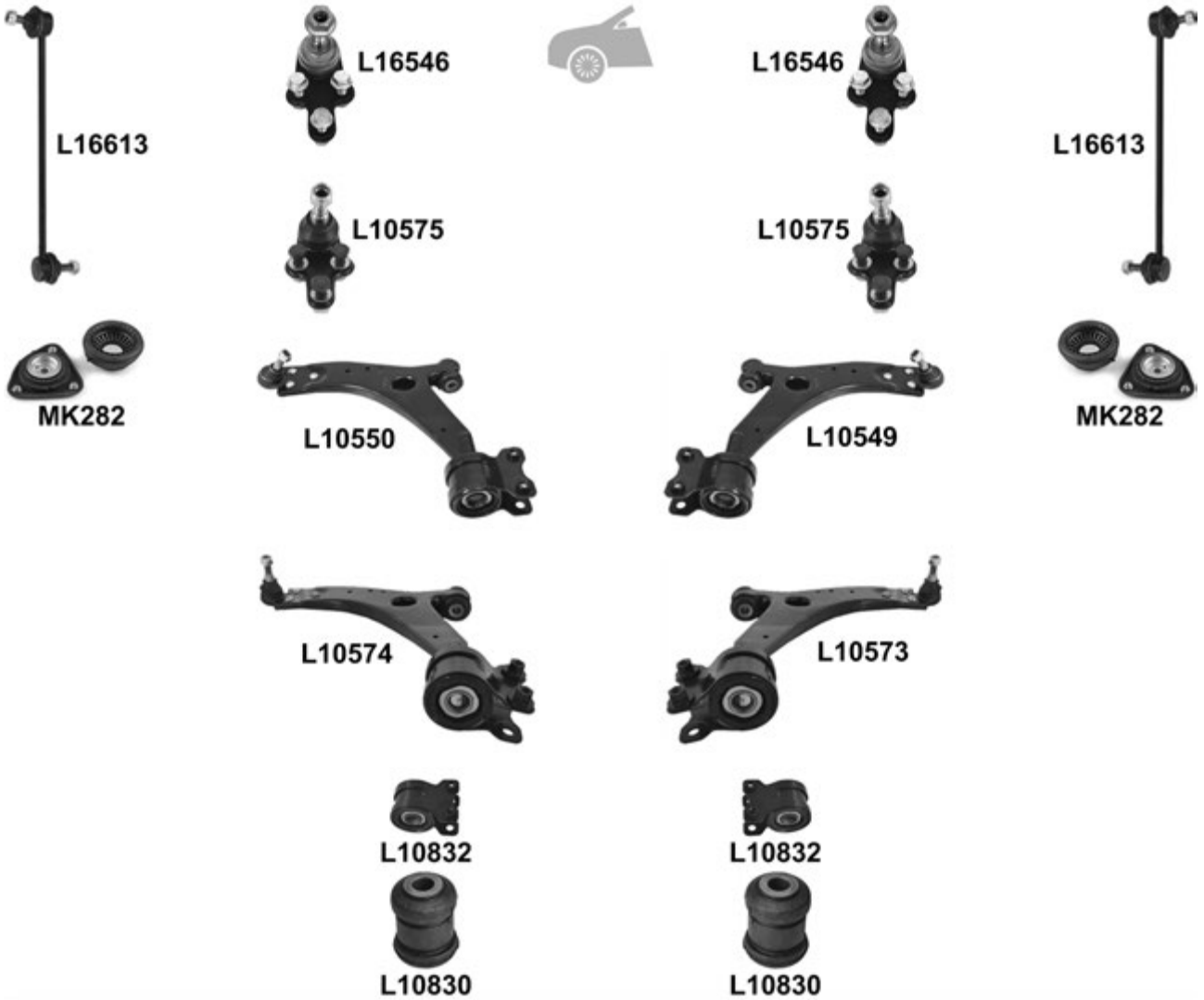
C30 10.06 →

C30 10.06 →

		i		←	→	Thread	Part Of	QPA	i	
		↔				L10109 F 16x1,5 ∪		1	274501	
						L10110 F 16x1,5 ∪		1	274500	
						L16216 L16216 M 16x1,5 / M 14x1,5 ∪		2	274502	
						L10023 L10023		2	30723085	
		↓				L16546 L16546		2	31212980	
						L10575 L10575		2	31262037	
		↓	ch. → 260, (-) SP ;	<input checked="" type="checkbox"/>			L10549		1	31277465
							L10550		1	31277464
		↓	ch. 261 →, (-) SP ;	<input checked="" type="checkbox"/>			L10573		1	31277462
							L10574		1	31277463
		↓	▼				L10832 L10832		2	
		↓	▲				L10830 L10830		2	
							L16613 L16613		2	8623576
						KIT	MK282 MK282		2	30681546
		↑				L10538 L10538		2	8671921	
		↓	▲			L10539 L10539		2	30683067	
			(-) SP	KIT		L10651		1	32760236	
			SP			L10611 L10611		2	32329966	

C70 II Cabriolet 03.06 →

VOLVO

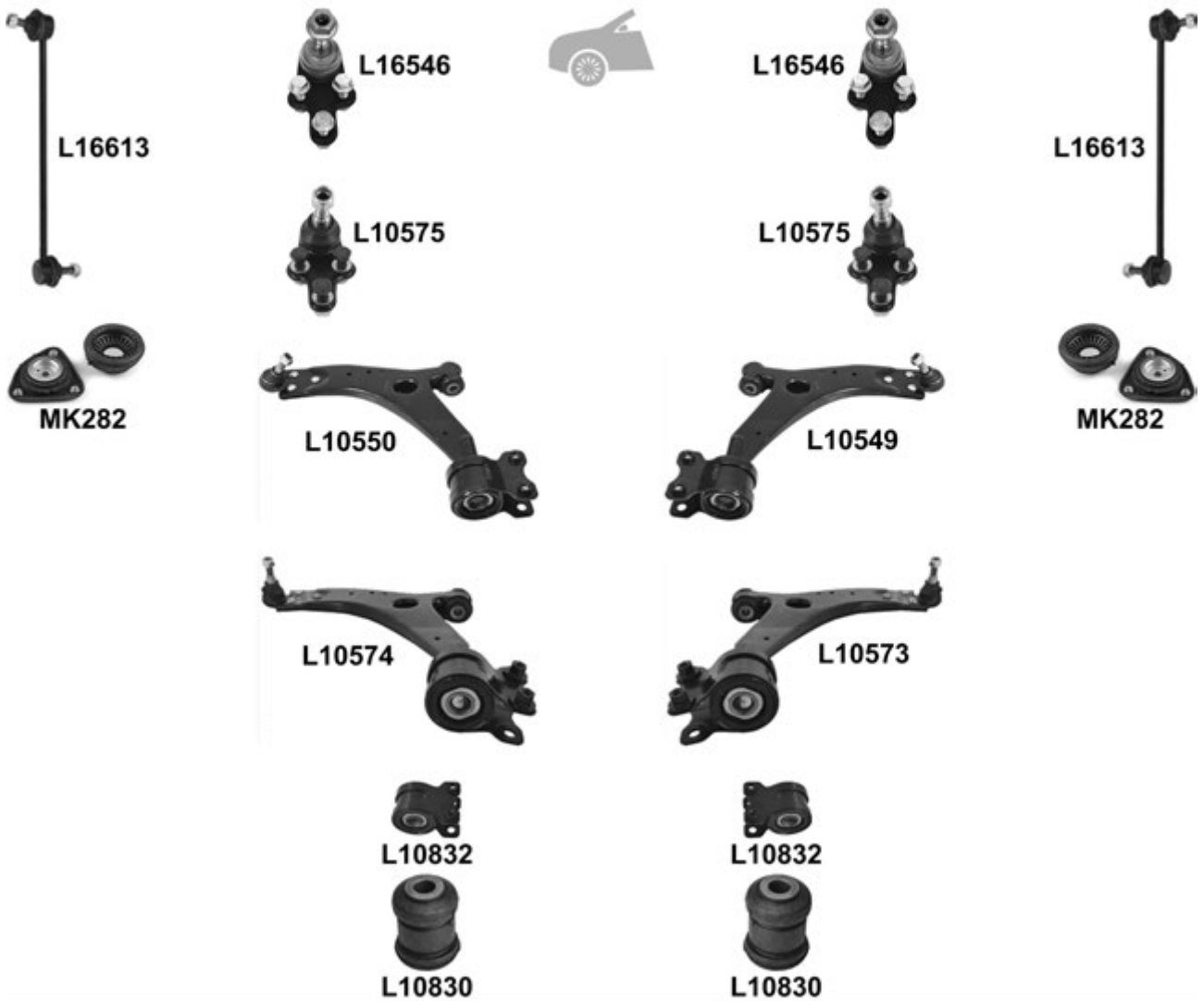
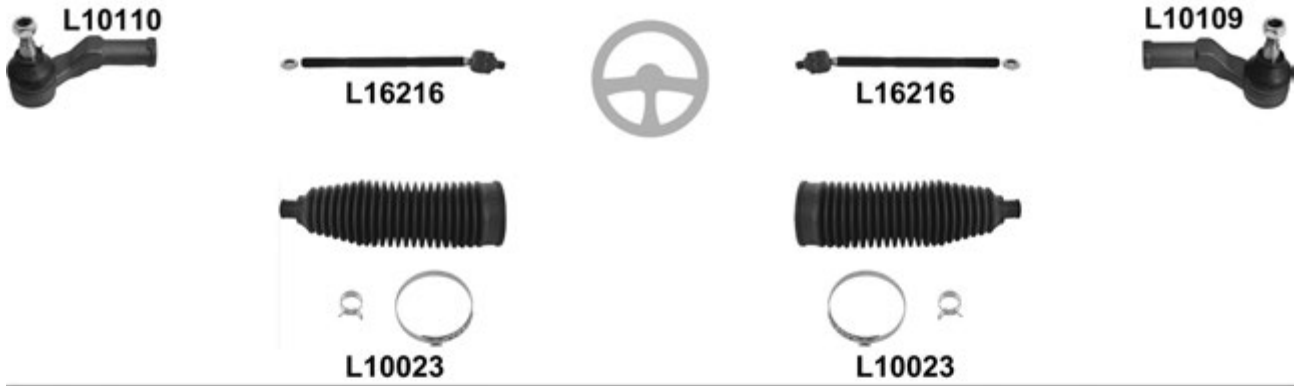

C70 II Cabriolet 03.06 →

		i		← →		Thread	Part Of	QPA	i
		↔		L10109		F 16x1,5 ∪		1	274501
			L10110		F 16x1,5 ∪		1	274500	
			L16216	L16216	M 16x1,5 / M 14x1,5 ∪		2	274502	
				L10023	L10023		2	30723085	
		⊥	ch. → 2026, 18mm	L16546	L16546			2	31212980
			ch. 2027 →, 21mm	L10575	L10575			2	31262037
		⊥	ch. → 2026, 18mm	<input checked="" type="checkbox"/>	L10549			1	31277465
			L10550				1	31277464	
			ch. 2027 →, 21mm	<input checked="" type="checkbox"/>	L10573			1	31277462
	L10574				1	31277463			
		⊥ ∇		L10832	L10832			2	
		⊥ ▲		L10830	L10830			2	
				L16613	L16613			2	8623576
				KIT	MK282	MK282		2	30681546
		⌈		L10538	L10538			2	8671921
		⊥ ▲		L10539	L10539			2	30683067
				L10611	L10611			2	30714466

S40 I (VS) 07.95 → 12.00
 V40 I (VW) 07.95 → 7.2000

VOLVO

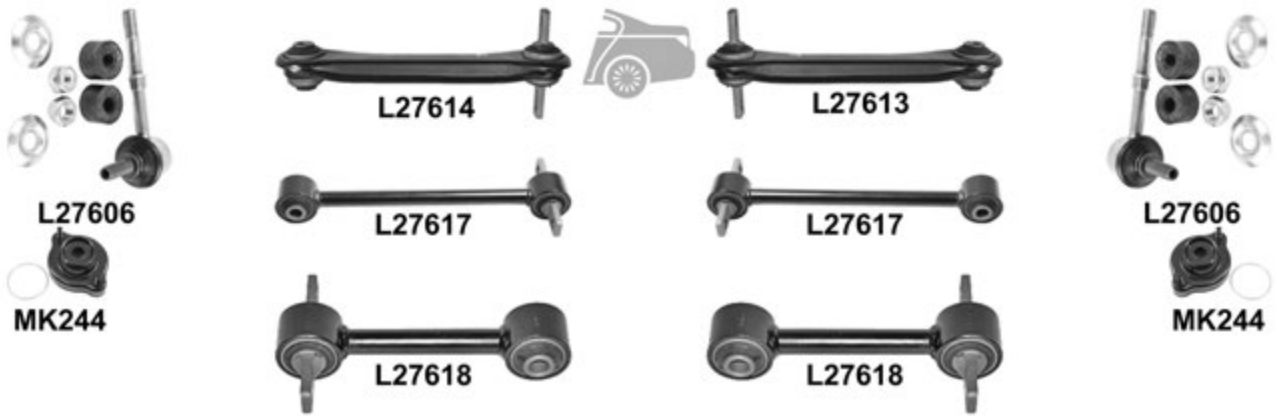
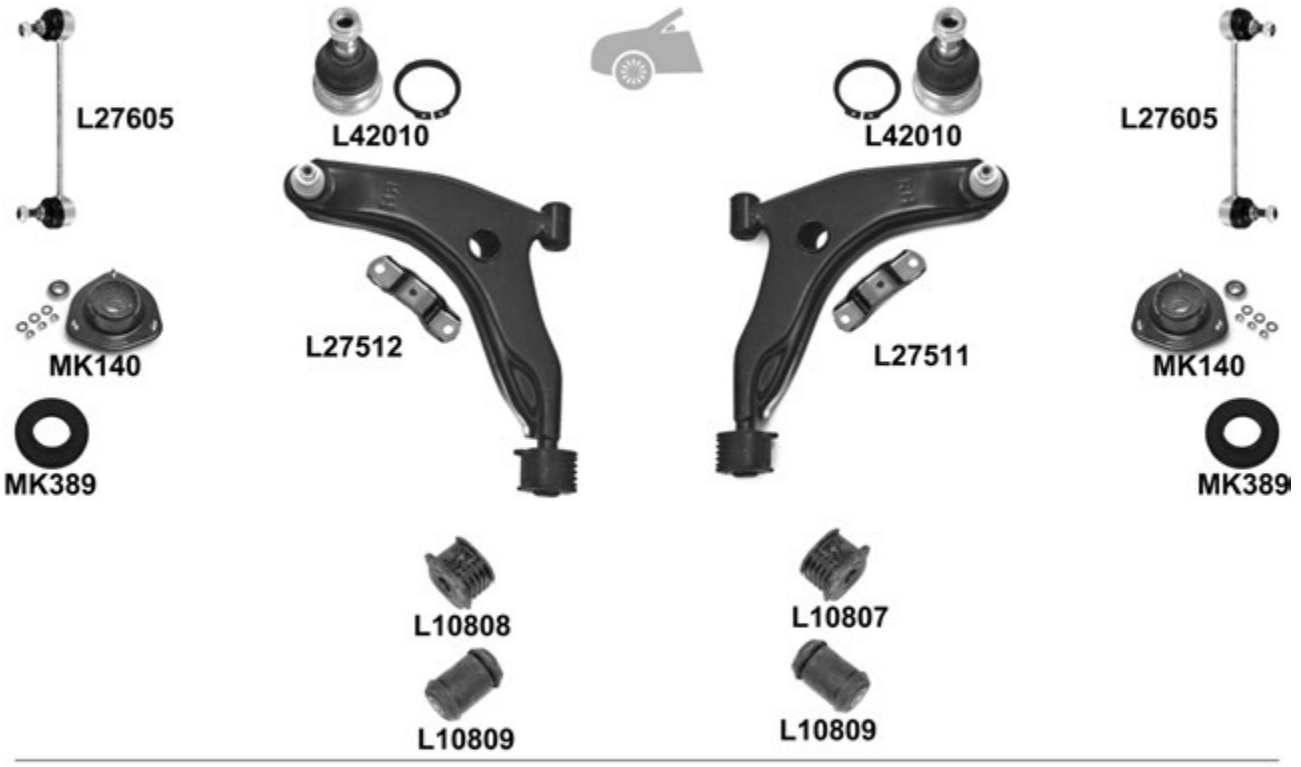

⚭ = Upper ⚮ = Lower ⬆ = Front ⬇ = Rear ⚡ = Inner ⚡ = Outer ⚡ = Center

S40 I (VS) 07.95 → 12.00
V40 I (VW) 07.95 → 7.2000



			←	→	Thread	Part Of	QPA	
		↔			L27105 L27105 F 12x1,25		2	30870695
			L= 305mm		L27204 L27204 M 16x1,5 / M 16x1,5		2	3345797
					L10015 L10015		2	3345796
		⊥			L42010 L42010		2	
		⊥		<input checked="" type="checkbox"/>	L27511		1	30887033
					L27512		1	30887025
		⊥↘			L10807		1	30872511
					L10808		1	30872510
		⊥↗			L10809 L10809		2	30818467
					L27605 L27605		2	30884358
			→ 12.99	KIT	MK140 MK140		2	30818465
		01.00 → 12.00		MK389 ⁰ MK389 ⁰		2	30875399	
		↔↔↔	transverse		L27825 L27825		4	30620972
		▲	→ 12.99, Old type, 12 x 70 x 75mm longitudinal		L27827 L27827		2	30871221
			01.00 →, New type, 12 x 77 x 75mm longitudinal		L27827 L27827		2	30851257
		↕	→ 12.97 Pull		L27613		1	30818097
					L27614		1	30818096
			01.98 → Pull		L27617 L27617		2	30620786
		⊥	Push		L27618 L27618		2	30620785
				L27606 L27606		2	30852103	
		(-) ⊥		MK244 MK244		2	30818111	

S40 I (VS) 07.00 → 12.03
 V40 I (VW) 07.00 → 06.04

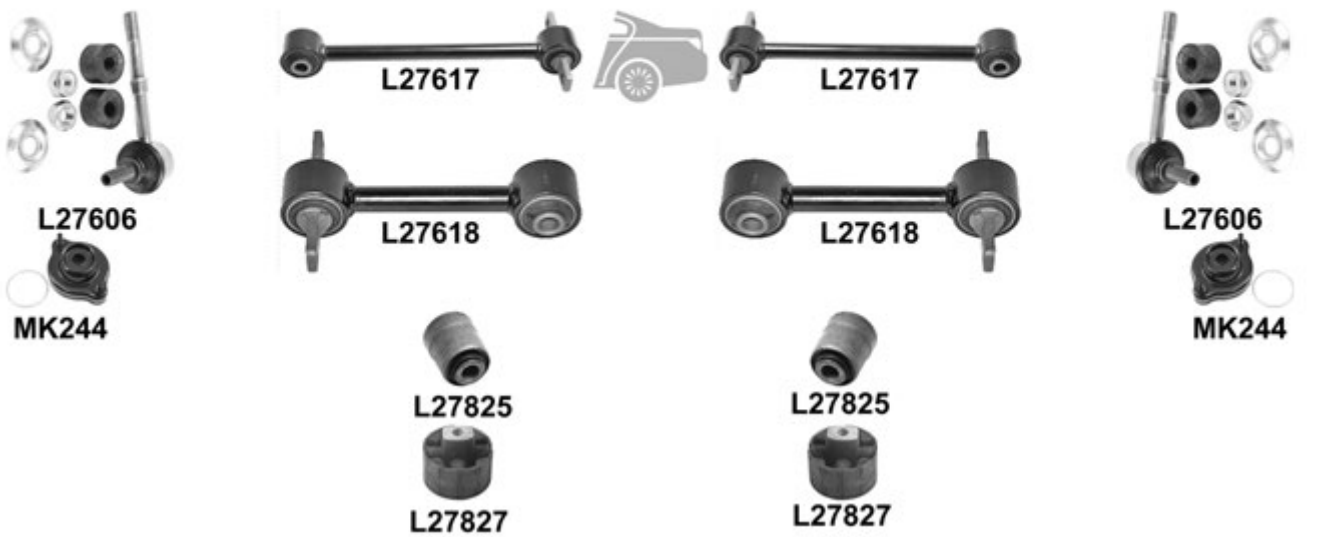
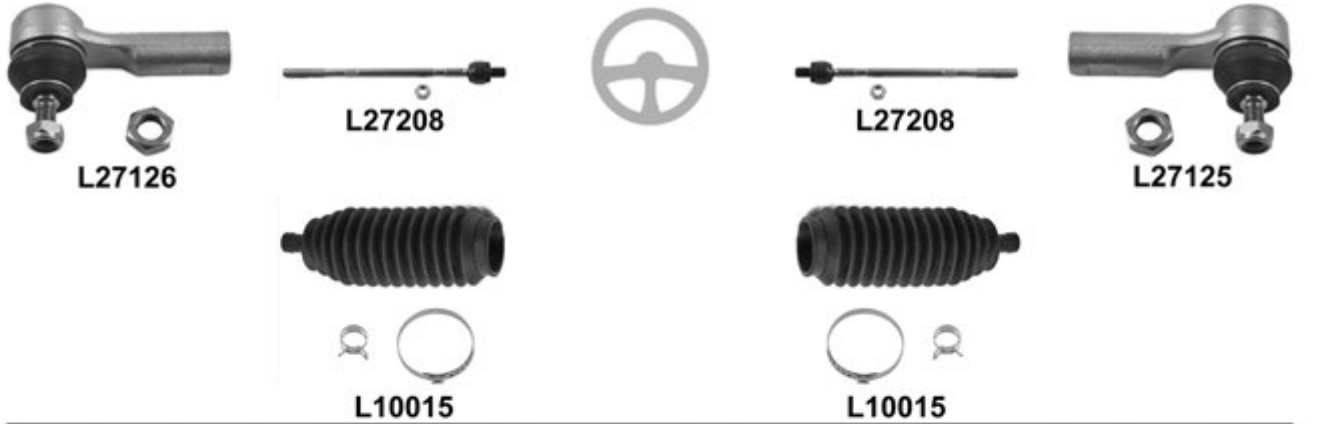

S40 I (VS) 07.00 → 12.03
 V40 I (VW) 07.00 → 06.04

		i		←	→	Thread	Part Of	QPA	i
		↔			L27125	F 14x1,5		1	274226
					L27126	F 14x1,5		1	274225
					L27208	L27208	M 14x1,5 / M 16x1,5	2	274224
					L10015	L10015		2	3345796
		⊥		<input checked="" type="checkbox"/>	L27521			1	30887654
					L27522			1	30887653
					L27612	L27612		2	30884179
			01.00 → 12.00		MK389 ^o	MK389 ^o		2	30875399
			01.01 →		L16916	L16916		2	30616825
		↔ ↔ ↔	transverse		L27825	L27825		4	30620972
		▲	longitudinal		L27827	L27827		2	30851257
		↕	Pull		L27617	L27617		2	30620786
		⊥	Push		L27618	L27618		2	30620785
					L27606	L27606		2	30852103
			(-) ⊕		MK244	MK244		2	30818111

S40 II 01.04 →

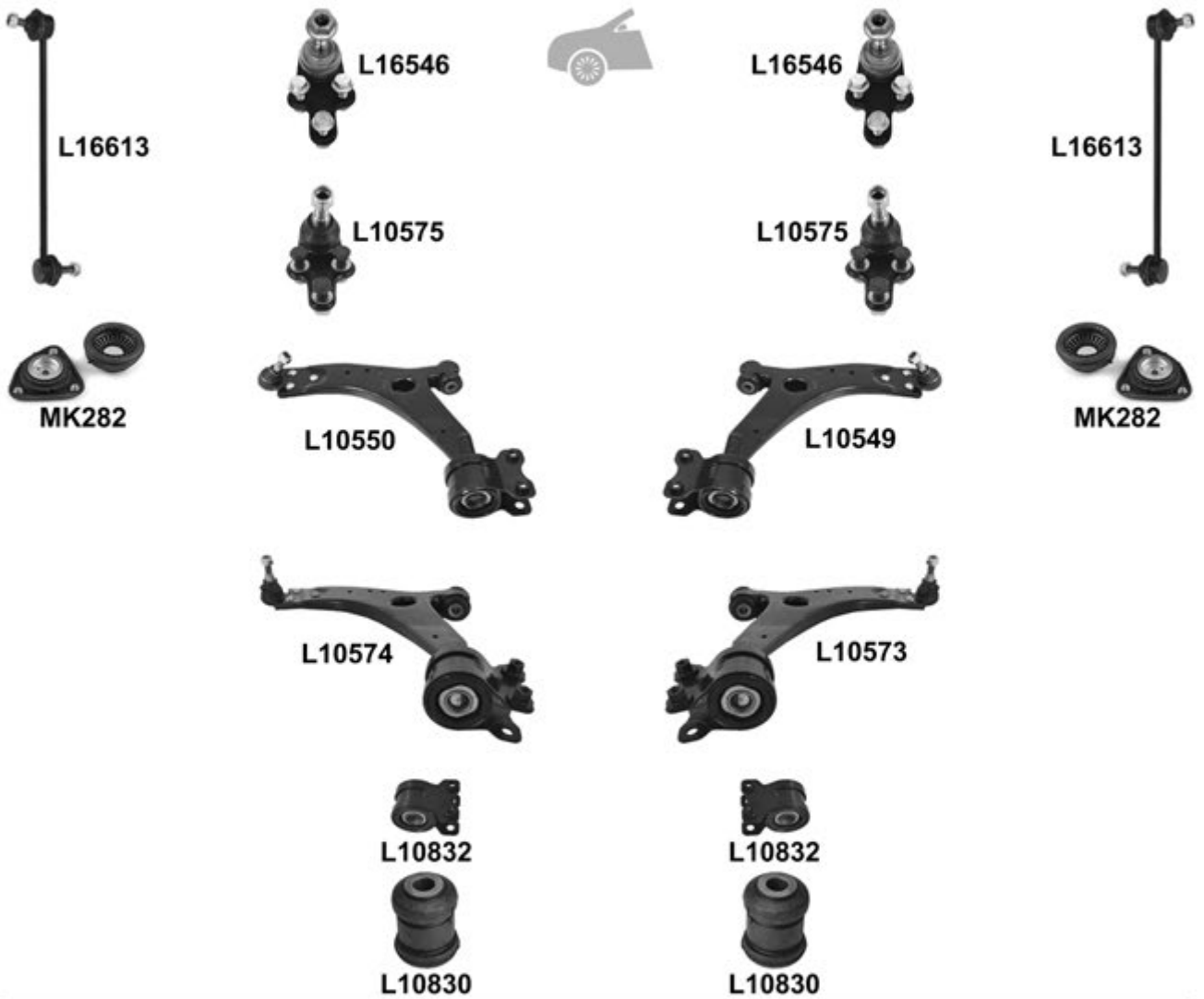

		i		← →		Thread	Part Of	QPA	i
		↔		L10109		F 16x1,5 ∩		1	274501
			L10110		F 16x1,5 ∩		1	274500	
			L16216	L16216	M 16x1,5 / M 14x1,5 ∩		2	274502	
			L10023	L10023			2	30723085	
		⊥	ch. → 209290, 18mm	L16546	L16546			2	31212980
			ch. 209291 →, 21mm	L10575	L10575			2	31262037
		⊥	ch. → 209290, 18mm	<input checked="" type="checkbox"/>	L10549			1	31277465
				L10550			1	31277464	
			ch. 209291 →, 21mm	<input checked="" type="checkbox"/>	L10573		1	31277462	
		L10574			1	31277463			
		⊥ ▼		L10832	L10832			2	
		⊥ ▲		L10830	L10830			2	
				L16613	L16613			2	8623576
				KIT	MK282	MK282		2	30681546
		⊥		L10538	L10538			2	8671921
		⊥ ▲		L10539	L10539			2	30683067
		⊥	(-) Height adjustment	L16571	L16571			2	1150353
				L10611	L10611			2	30714466
				KIT	L16612			1	
				MK376	MK376			2	30714395

S60 | 11.00 →

VOLVO

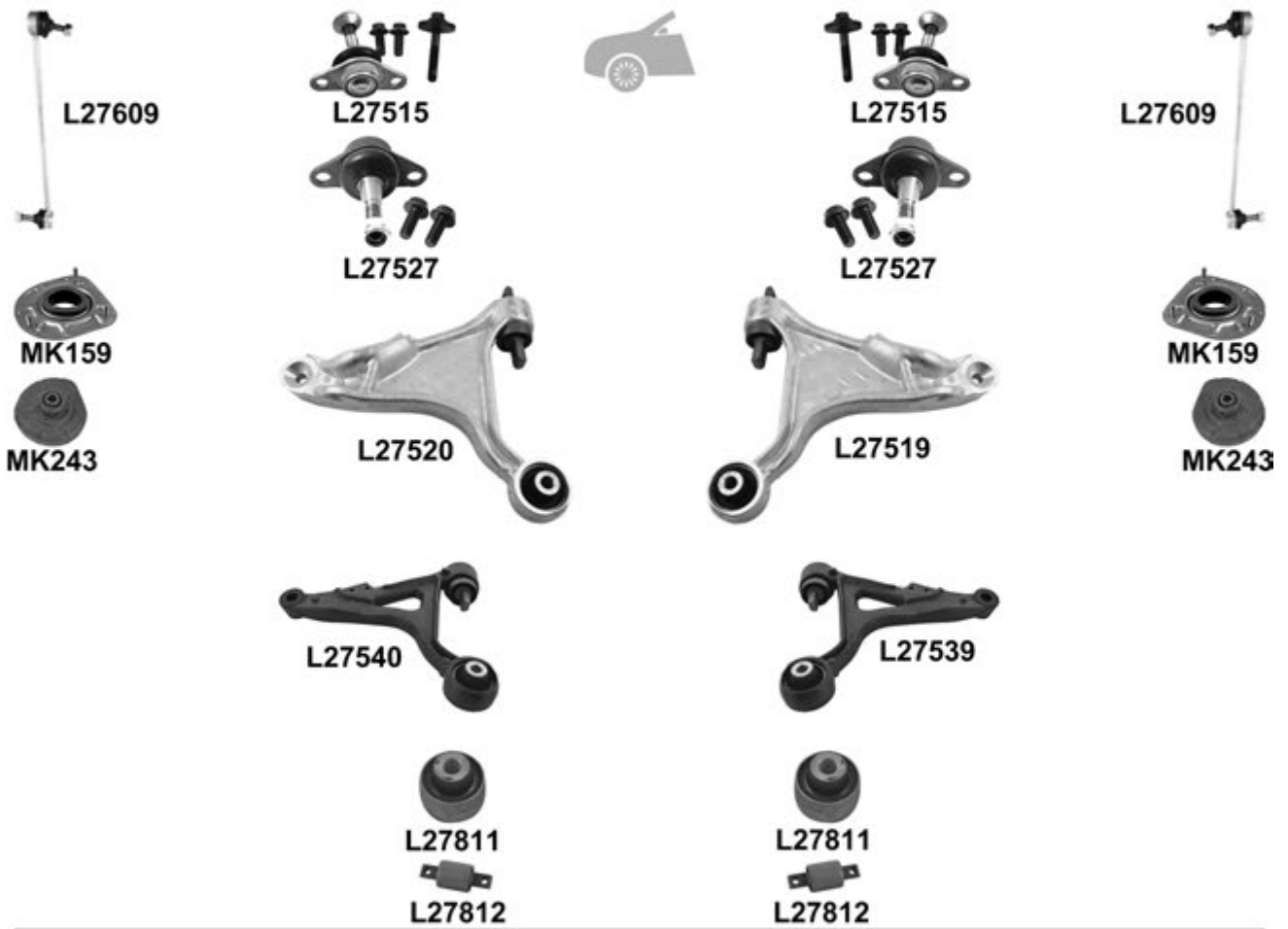
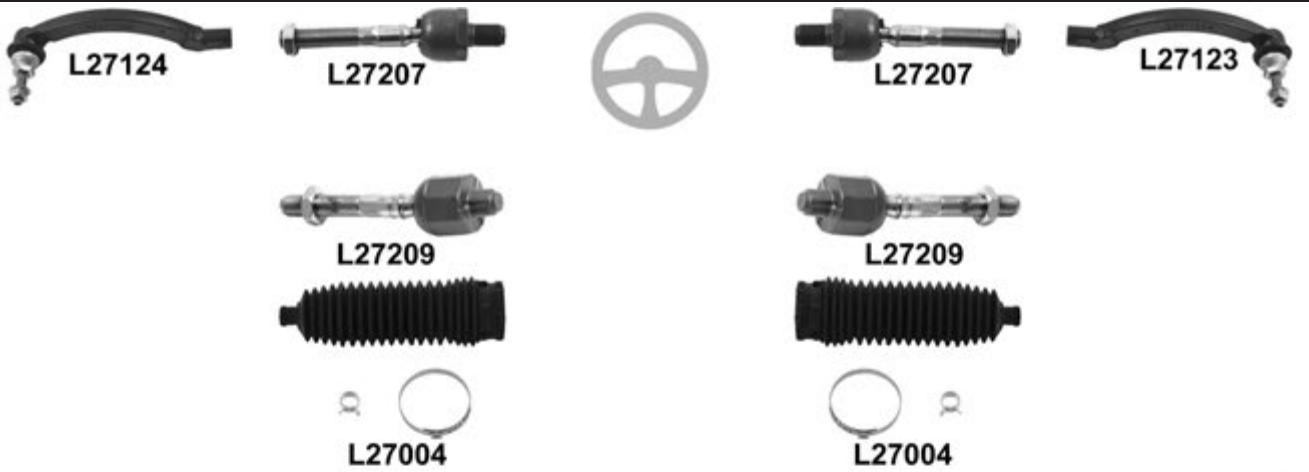

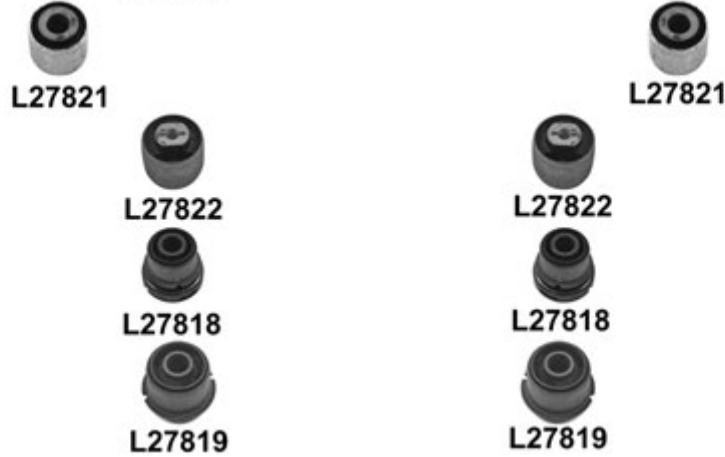
S60 | 11.00 →

			←	→	Thread	Part Of	QPA			
		↔		L27123	↺		1	274176		
				L27124	↻		1	274175		
				→ 08.03, Smi	L27207	L27207			2	274179
				09.03 →, ZF	L27209	L27209			2	274353
					L27004 ^o	L27004 ^o			2	272418
		⊥	ch. → 626501	L27515	L27515		2	274193		
			ch. 626502 →	L27527	L27527		2	274523		
		⊥	ch. → 626501		L27519		1	30635230		
			ch. 626502 →		L27520		1	30635229		
					L27539		1	30760587		
				L27540			1	30760586		
		⊥	ch. → 626501	L27811	L27811		2	8630604		
				L27812	L27812		2	9443882		
				L27609	L27609		2	274456		
			KIT	MK159	MK159		2	8634457		
		↑	MK243	MK243		2	8646713			
		↕↔↔		L27815	L27815		2	8672220		
				L27816	L27816		2	9157572		
		↕↔↔	L27815	L27815		2	8672220			
		⊥↔↔	L27817	L27817		2	9492181			
		↔↔↔	transverse	L27820	L27820		2	9157579		
		↔↔		L27821	L27821	Pull rod	2	9127363		
		↔↔		L27822	L27822	Pull rod	2	9169204		
		▲		L27818	L27818	Hub carrier	2	9157952		
		▼		L27819	L27819	Hub carrier	2	9157576		
			(-) AWD	L27610	L27610		2	8672446		
		KIT	MK195	MK195		2				

S60 II 04.10 →

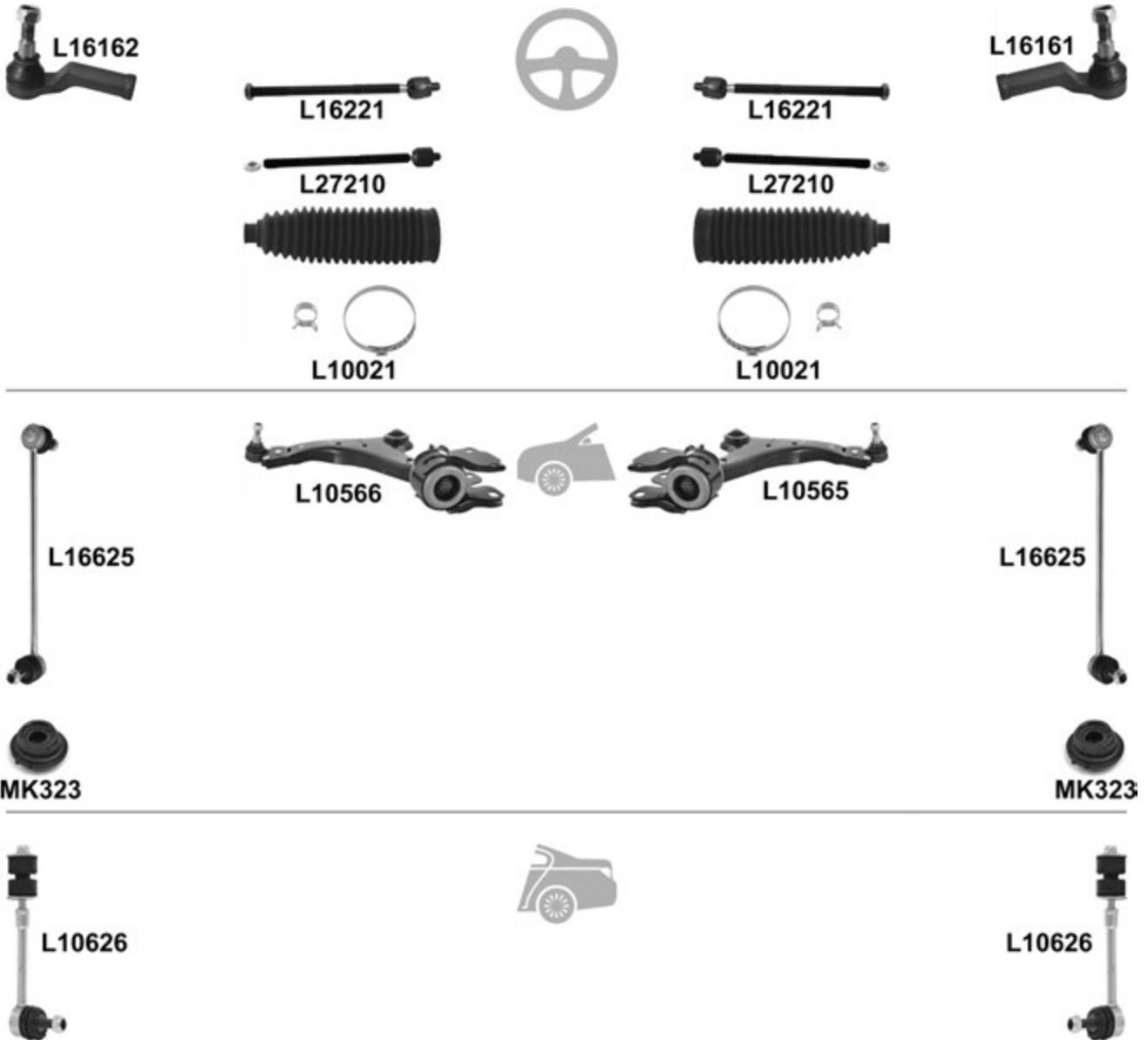

				←	→	Thread	Part Of	QPA		
		↔			L16161	F 18x1,5 ∪		1	31302344	
					L16162	F 18x1,5 ∪		1	31302345	
			Hydraulic , L= 315mm	L16221	L16221	M 18x1,5 / M 18x1,5 ∪		2	31280658	
			Electric , L= 305mm	L27210	L27210	M 18x1,5 / M 16x1,5 ∪		2	30776425	
			Hydraulic , (-) Servotronic, L= 195mm, ø15,5mm, Ø 52mm	L10021 °	L10021 °			2	30776251	
		⊥	07.10 →, ch. 75999 →	☑		L10565			1	31277344
						L10566			1	31277343
						L16625	L16625		2	30648161
						MK323	MK323		2	31277826
					L10626	L10626		2	30760678	

S70 01.97 → 11.00
 C70 Coupe 03.97 → 09.02
 C70 Cabriolet 03.98 →
 V70 I (875) 01.97 → 03.00

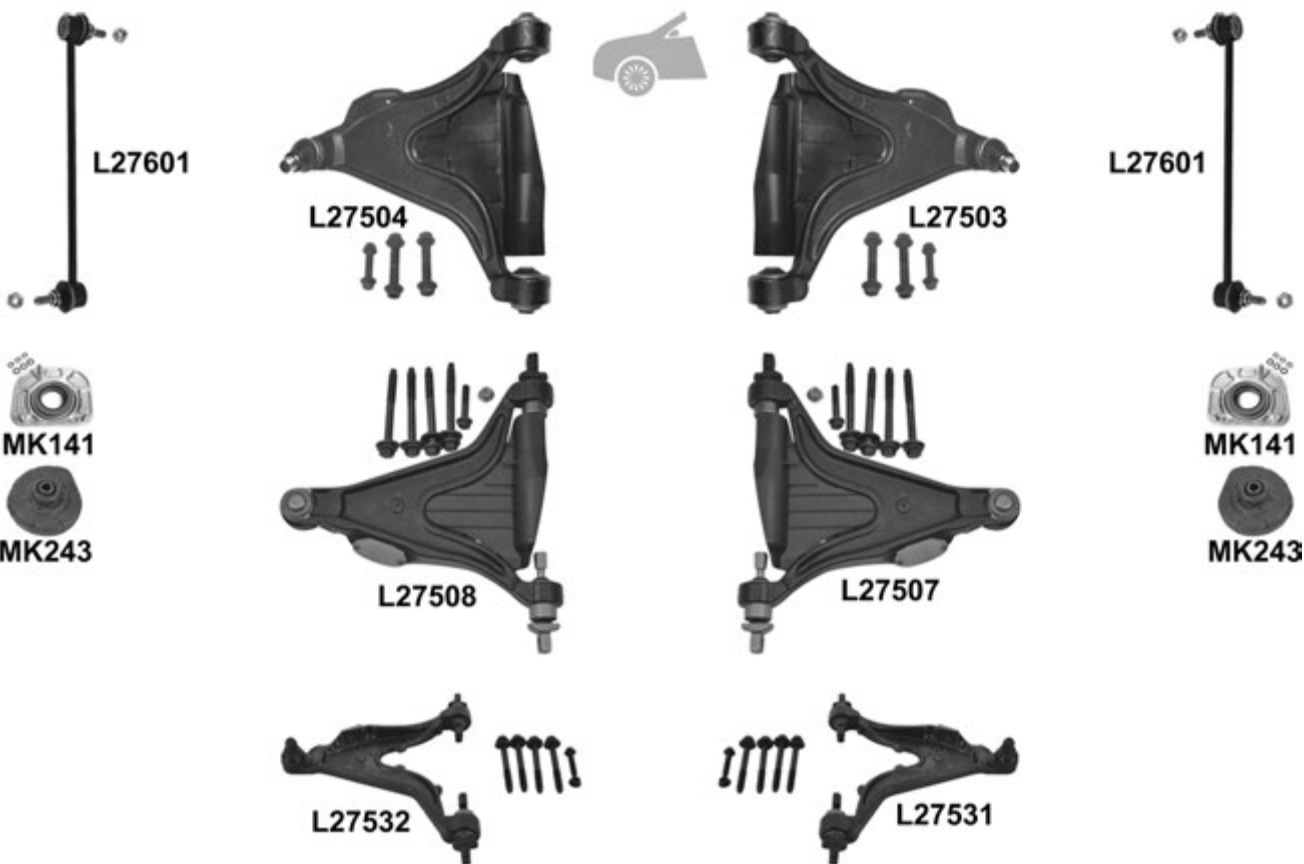
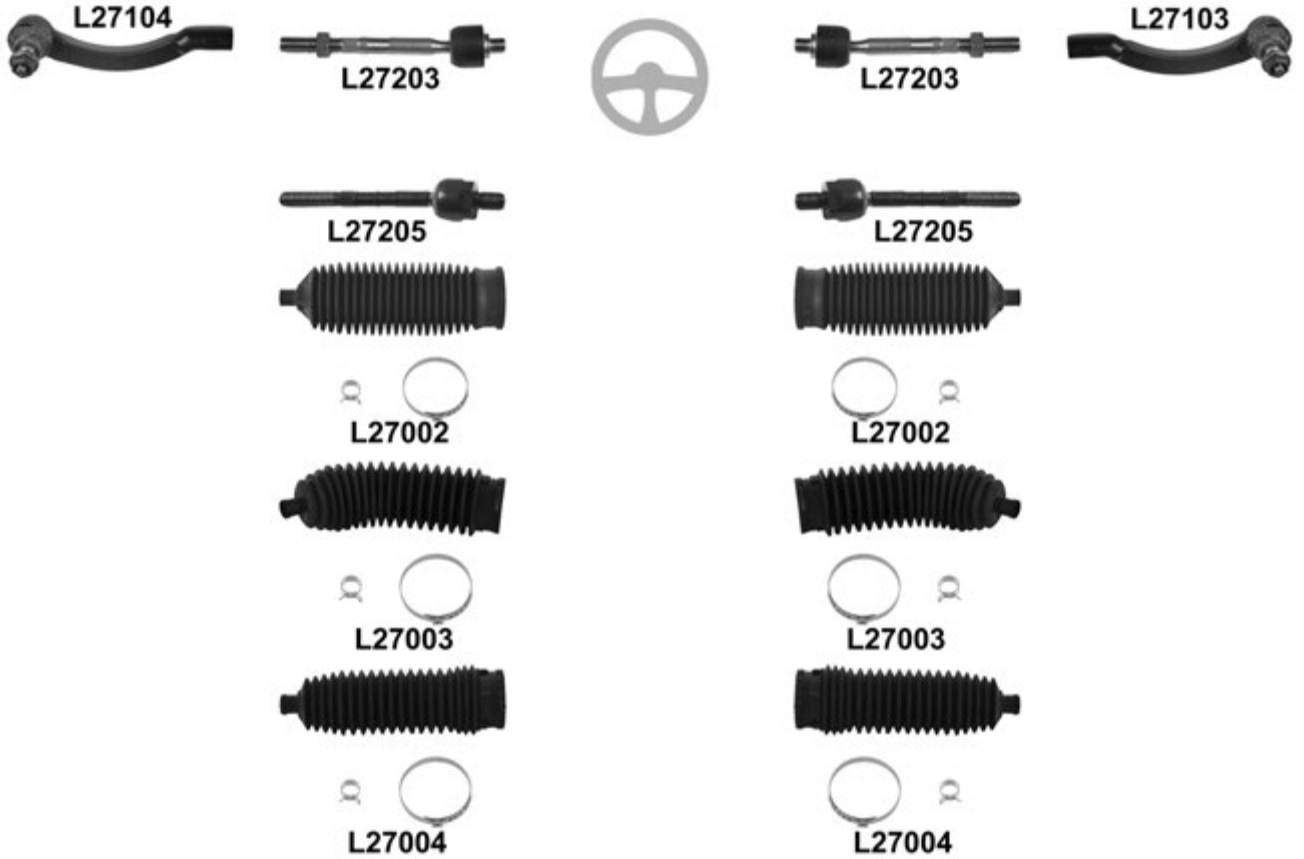

S70 01.97 → 11.00
 C70 Coupe 03.97 → 09.02
 C70 Cabriolet 03.98 →
 V70 I (875) 01.97 → 03.00



						← → Thread	Part Of	QPA		
⊕		↔			L27103	F 14x2 ∩		1	3546268	
					L27104	F 14x2 ∩		1	3546267	
				TRW, (code 4)	L27203	L27203	M 14x2 / M 14x1,5		2	3546266
				Smi, (code 5)	L27205	L27205	M 14x2 / M 16x1,5		2	9191410
				TRW/CAM.gear	L27002	L27002			2	271601
		⊥	(-) C70 / / Diesel/AWD	<input checked="" type="checkbox"/>		L27503		1	8628495	
					L27504		1	8628496		
			Diesel/AWD	<input checked="" type="checkbox"/>		L27507		1	8628497	
					L27508		1	8628498		
			C70 /	<input checked="" type="checkbox"/>		L27531		1	8628500	
					L27532		1	8628499		
				⊥ ▲ ▼		L27809	L27809	L27503/L27504	4	271631
						L27601	L27601		2	1387860
						L27808	L27808	Anti-roll bar	2	3546730
					KIT	MK141	MK141		2	3546189
		↔			MK243	MK243		2	8646713	
					L27814	L27814	Hub carrier	2	3516122	
						L27813	Hub carrier	1	3516496	
					L27824	Hub carrier	1	3530202		
				(-) Nivomat	MK134	MK134		2	3516151	

S80 06.98 → 07.06

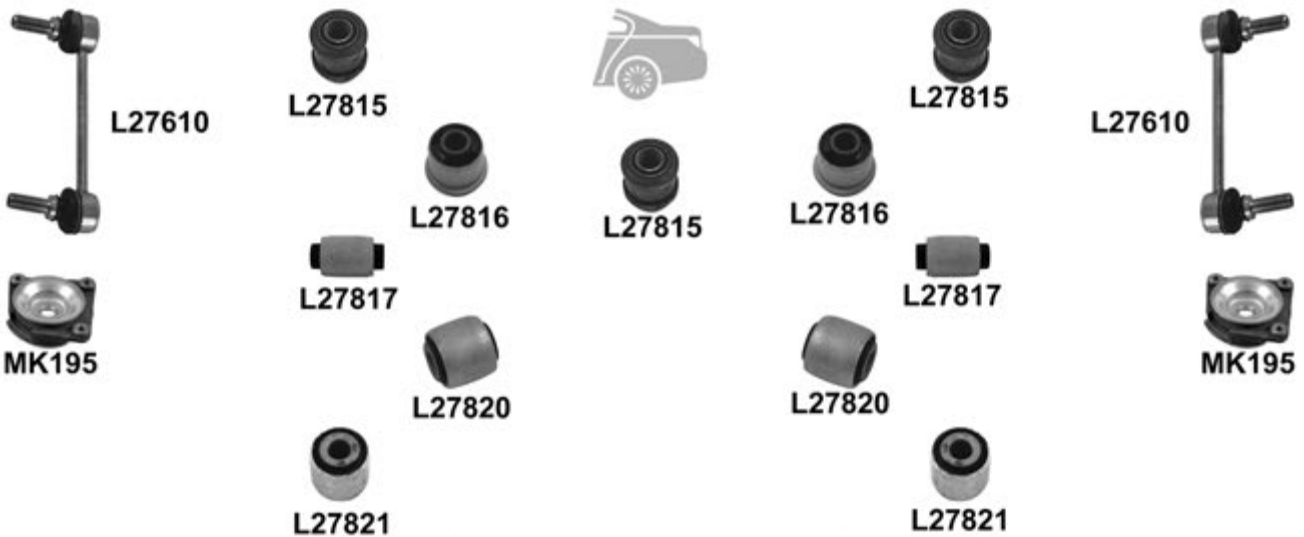
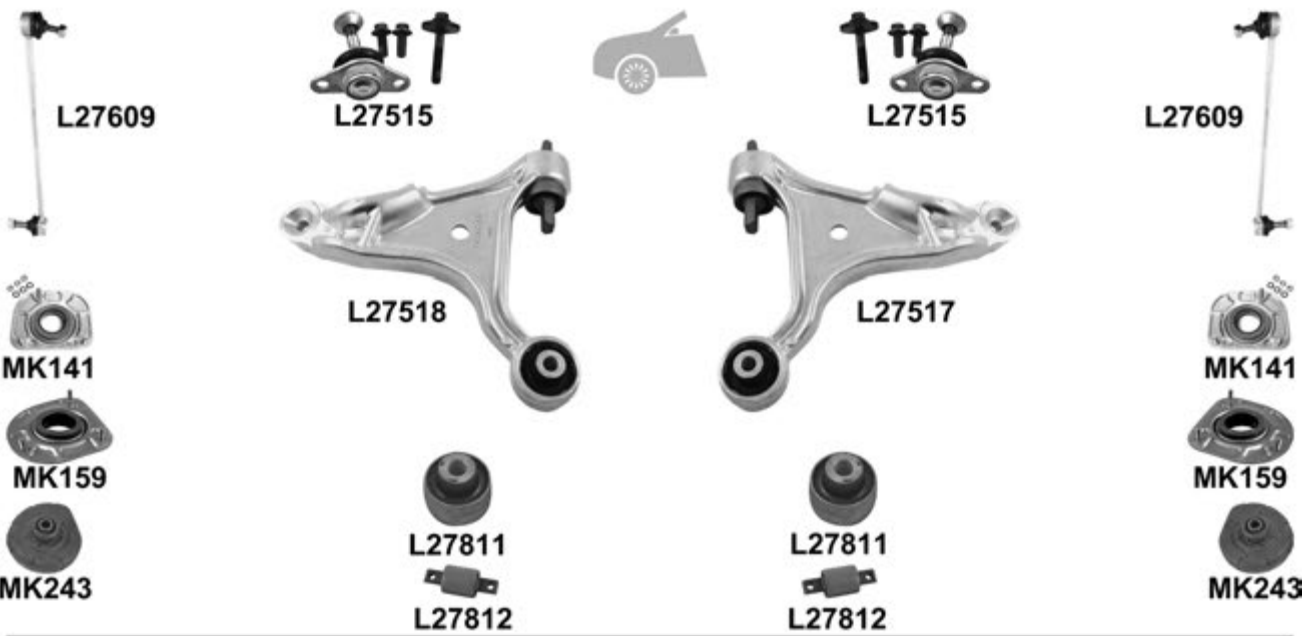

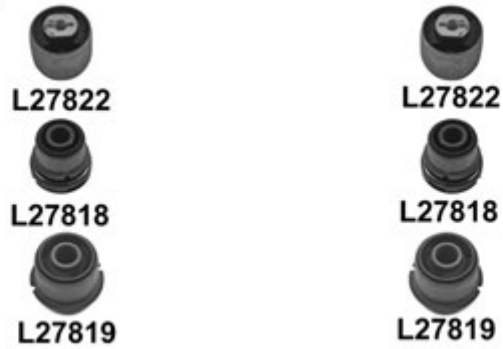

			←	→	Thread	Part Of	QPA	
		↔	→ 12.99	L27121	∪		1	272417
				L27122	∪		1	272416
		01.00 →		L27123	∪		1	274176
				L27124	∪		1	274175
		→ 12.99	L27206	L27206			2	272428
		01.00 → 12.03	L27207	L27207	M 14x1,5 / M 16x1,5		2	274179
01.04 →, ZF		L27209	L27209	M 14x1,5 / M 16x1,5		2	274353	
		L27004°	L27004°			2	272418	
		⊥	L27515	L27515			2	274456
		⊥		L27517			1	30635228
		⊥↙	L27518				1	30635227
		⊥↘	L27811	L27811			2	8630604
		⊥↗	L27812	L27812			2	9443882
			L27609	L27609			2	274303
		ch. → 153439	KIT	MK141	MK141		2	3546189
		ch. 153440 →		MK159	MK159		2	30714968
		⊥	MK243	MK243			2	8646713
			⊥↙↔	L27815	L27815			2
⊥↗↔			L27816	L27816			2	9157572
⊥↔			L27815	L27815			2	8672220
⊥↔			L27817	L27817			2	9492181
↔↔↔ transverse			L27820	L27820			2	9157579
↔↔			L27821	L27821		Pull rod	2	9127363
↔↔			L27822	L27822		Pull rod	2	9169204
▲			L27818	L27818		Hub carrier	2	9157952
▼		L27819	L27819		Hub carrier	2	9157576	
			L27610	L27610			2	8672446
		KIT	MK195	MK195		2		

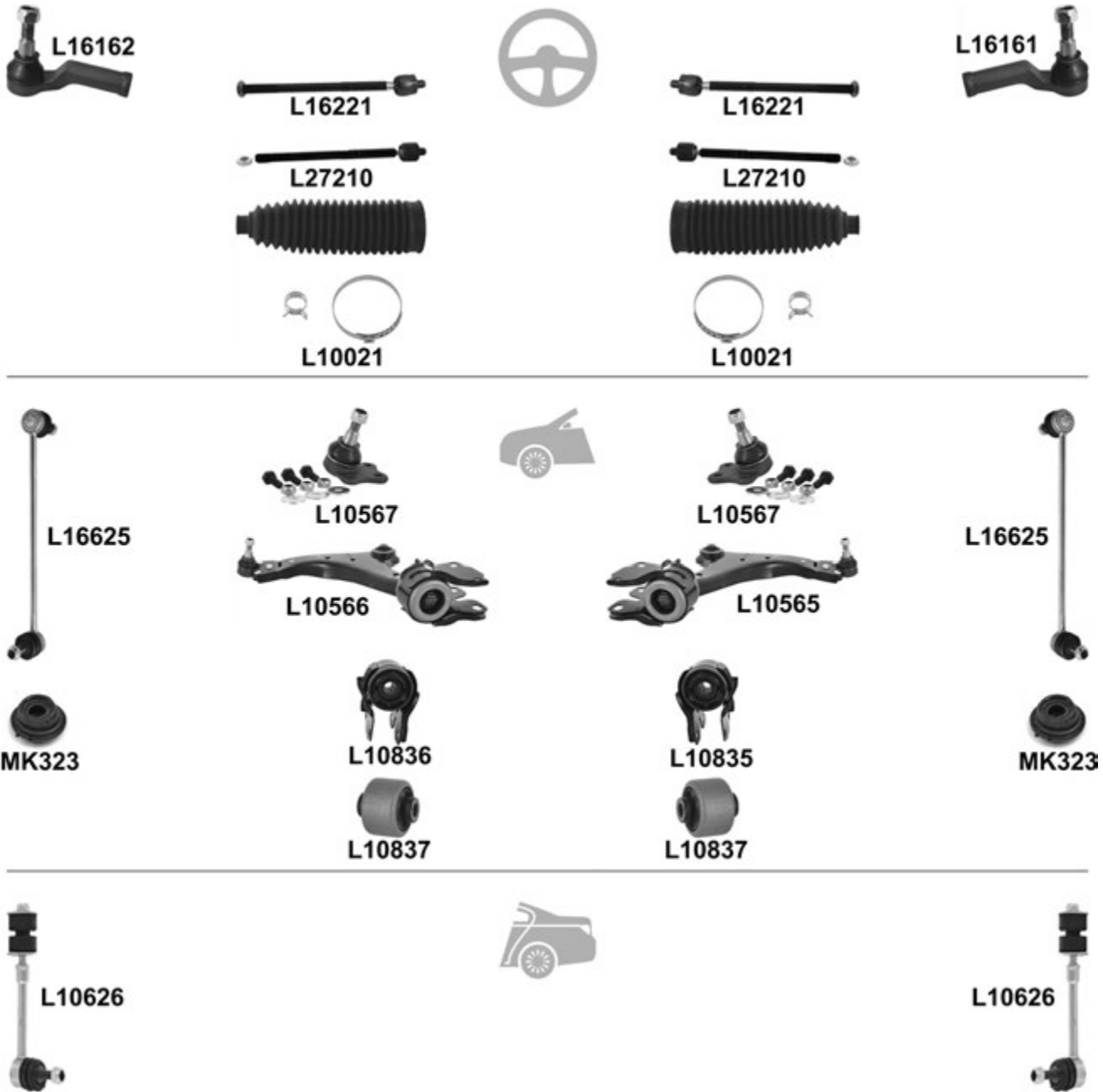
S80 II 03.06 →

		i		←	→	Thread	Part Of	QPA	i	
⊕		↔			L16161	F 18x1,5 U		1	31280001	
					L16162	F 18x1,5 U		1	31280000	
			Hydraulic , L= 315mm	L16221	L16221	M 18x1,5 / M 18x1,5 U		2	31280658	
			Electric , L= 305mm	L27210	L27210	M 18x1,5 / M 16x1,5 U		2	30776425	
			Hydraulic , (-) Servotronic, L= 195mm, ø15,5mm, ø 52mm	L10021 ^o	L10021 ^o			2	30776251	
		↓			L10567	L10567		2		
				<input checked="" type="checkbox"/>		L10565			1	31277344
		↓			L10566			1	31277343	
						L10835			1	
		↓	▼			L10836			1	
			▲			L10837	L10837			2
					L16625	L16625		2	30648461	
					MK323	MK323		2	31277826	
					L10626	L10626		2	1425853	

S90 01.97 → 05.98
V90 01.97 → 12.98

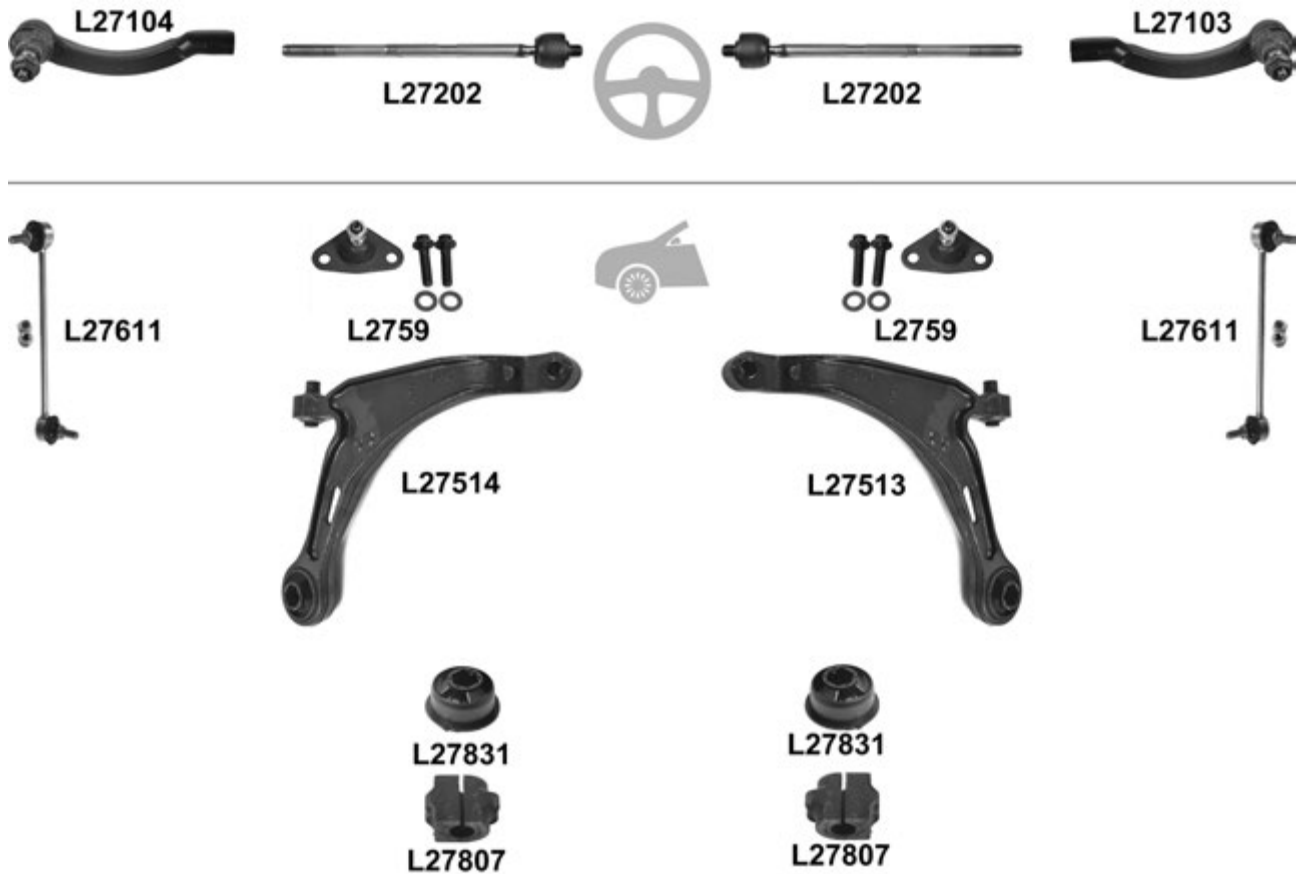

				← → Thread		Part Of	QPA	i		
⊕		↔		L27103	F 14x2 U		1	3546268		
				L27104	F 14x2 U		1	3546267		
🚗		⊥	TRW	L27202	L27202	M 14x2 / M 14x1,5		2	9140504	
				L2759	L2759			2	271758	
				L27513				1	272341	
				L27514				1	272340	
				L27831	L27831			2	9191537	
				L27611	L27611			2	9492837	
			22mm	L27807	L27807		Anti-roll bar	2	1273184	

V40 03.12 →



				← → Thread		Part Of	QPA	i	
🚗				L16613	L16613		2	8623576	

V40 Cross Country 10.12 →

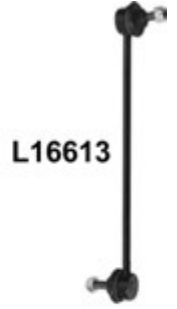
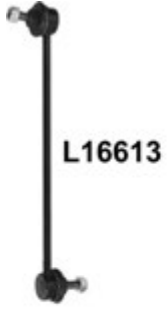

Thread

Part Of

QPA



				L16613	L16613			2 8623576
				MK376	MK376			2 30714395

V50 04.04 →

VOLVO

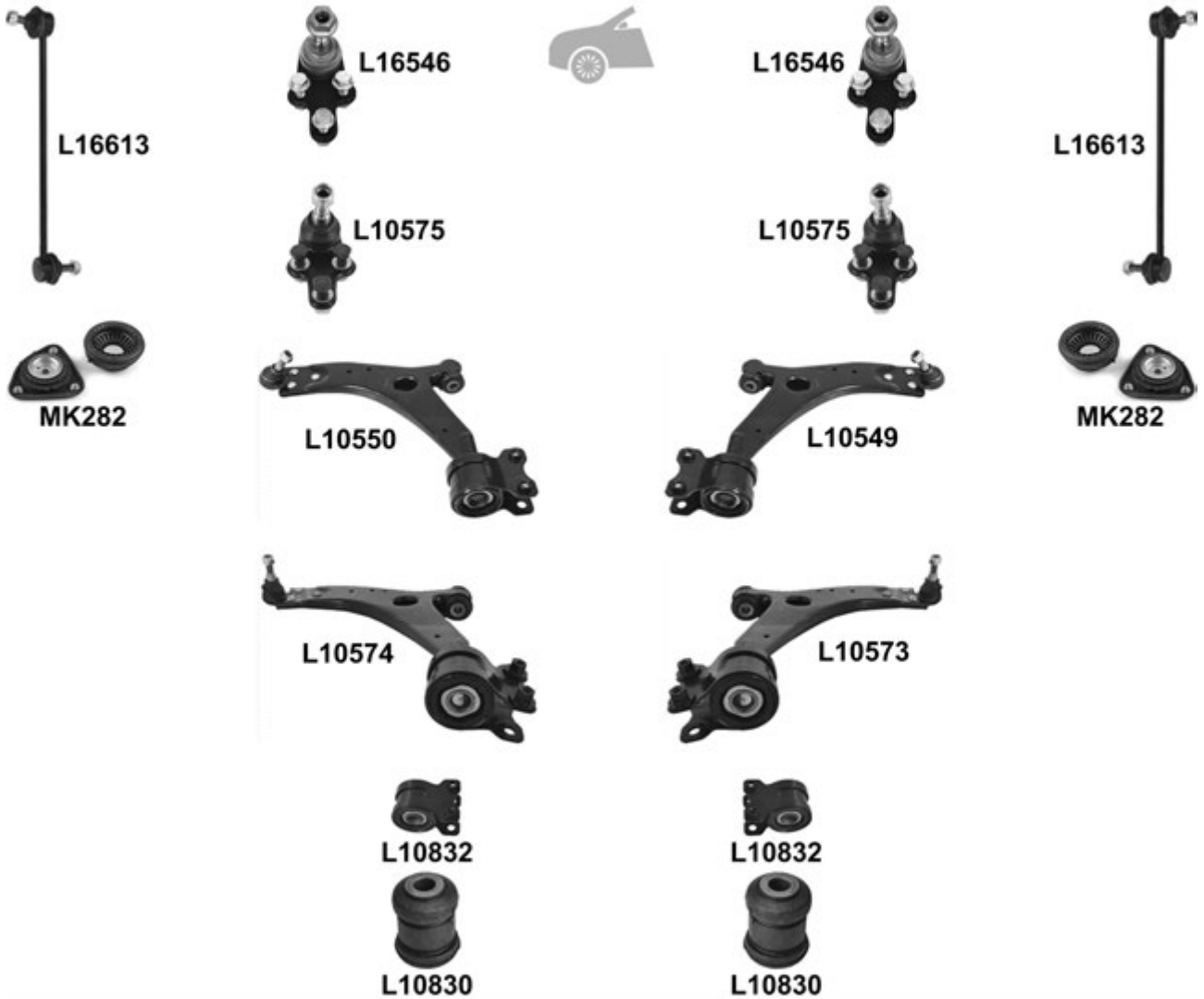

		i		← →		Thread	Part Of	QPA	i
		↔		L10109		F 16x1,5 ∩		1	274501
				L10110		F 16x1,5 ∩		1	274500
				L16216	L16216	M 16x1,5 / M 14x1,5 ∩		2	274502
				L10023	L10023			2	30723085
		⊥	ch. → 241682, 18mm	L16546	L16546			2	31212980
			ch. 241683 →, 21mm	L10575	L10575			2	31262037
		⊥	ch. → 241682, 18mm	<input checked="" type="checkbox"/>	L10549			1	31277465
				L10550				1	31277464
			ch. 241683 →, 21mm	<input checked="" type="checkbox"/>	L10573			1	31277462
				L10574				1	31277463
		⊥ ▾		L10832	L10832			2	
		⊥ ▲		L10830	L10830			2	
				L16613	L16613			2	8623576
				KIT	MK282	MK282		2	30681546
		⊥		L10538	L10538			2	8671921
		⊥ ▲		L10539	L10539			2	30683067
		⊥		L16571	L16571			2	1150353
				L10611	L10611			2	30714466
			(-) Height adjustment	MK376	MK376			2	30714395

V60 09.10 →

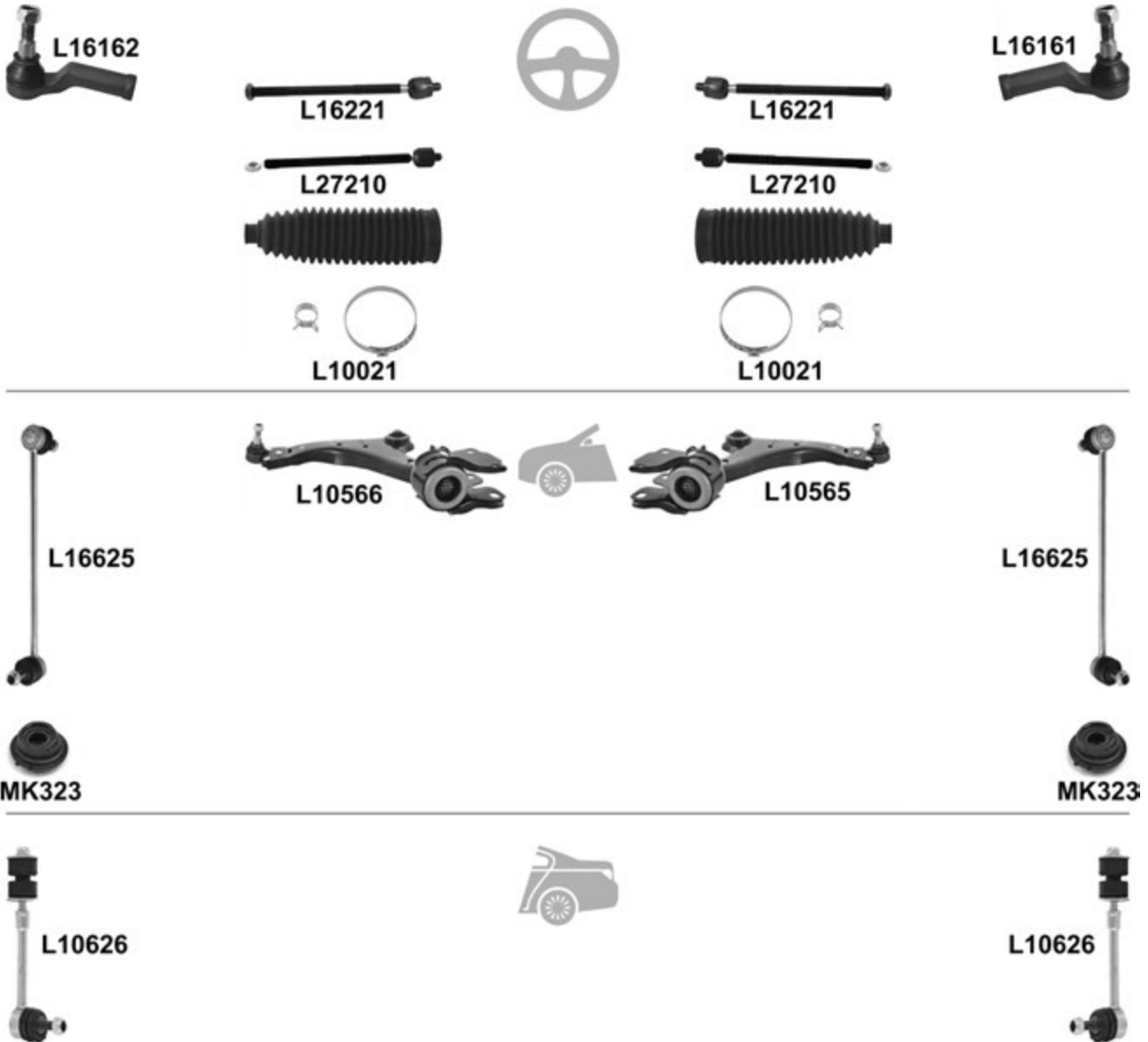

		← →		Thread	Part Of	QPA			
⊕	↔			L16161	F 18x1,5 ♂	1	31302344		
				L16162	F 18x1,5 ♂	1	31302345		
			Hydraulic, L= 315mm	L16221	L16221	M 18x1,5 / M 18x1,5 ♂	2	31280658	
			Electric, L= 305mm	L27210	L27210	M 18x1,5 / M 16x1,5 ♂	2	30776425	
⊖	⊥		Hydraulic , (-) Servotronic, L= 195mm, ø15,5mm, Ø 52mm	L10021 °	L10021 °		2	30776251	
			ch. → 35000	<input checked="" type="checkbox"/>	L10565		1	31277344	
				L10566			1	31277343	
				L16625	L16625		2	30648161	
				MK323	MK323			2	31277826
		L10626	L10626			2	30760678		

V70 II (285) 03.00 →

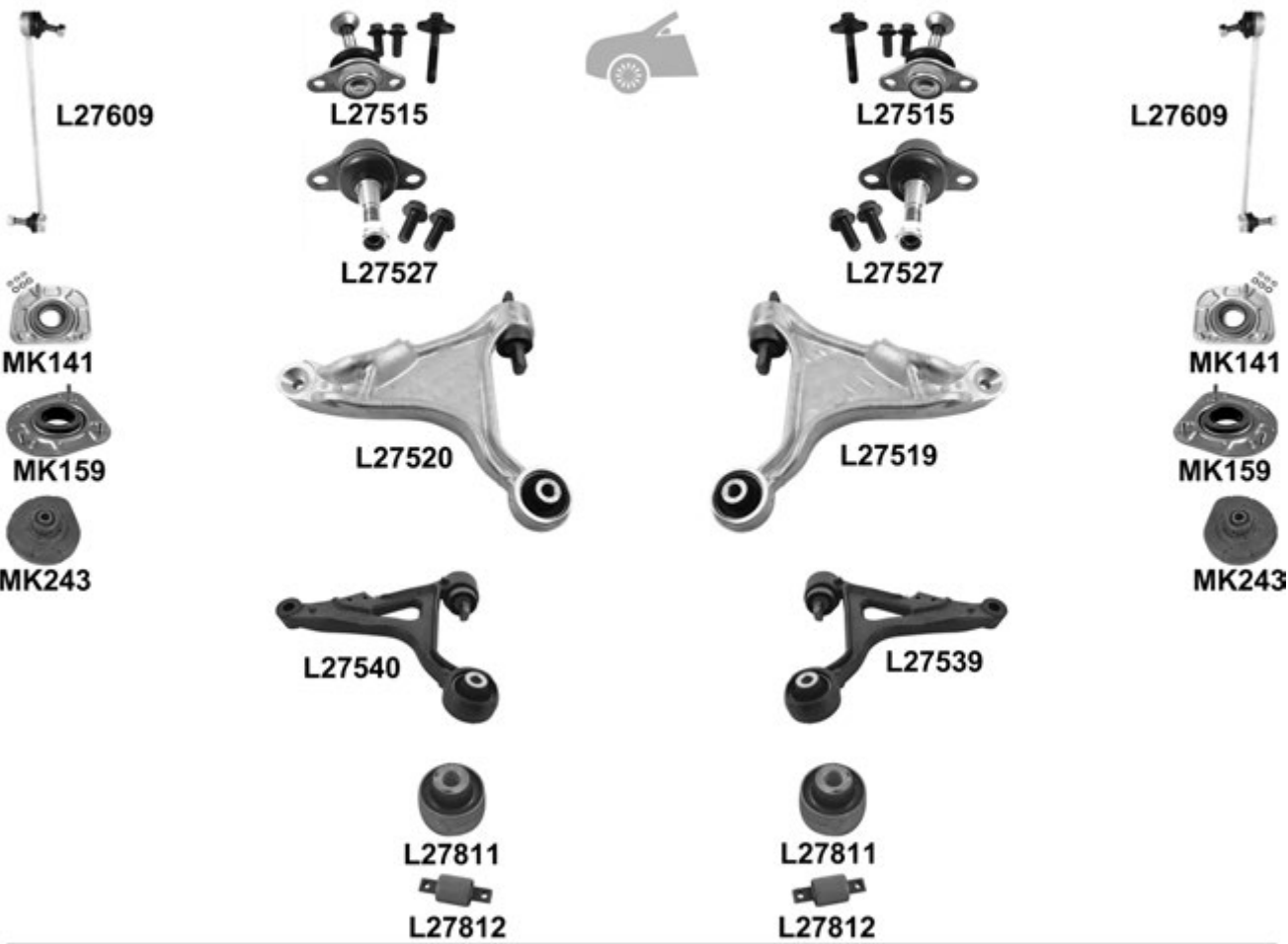
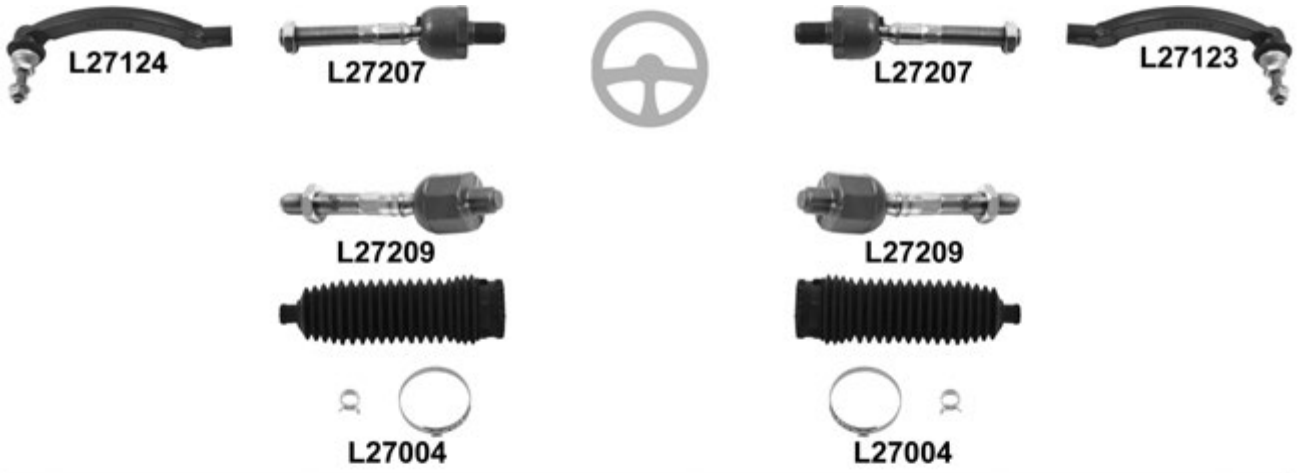

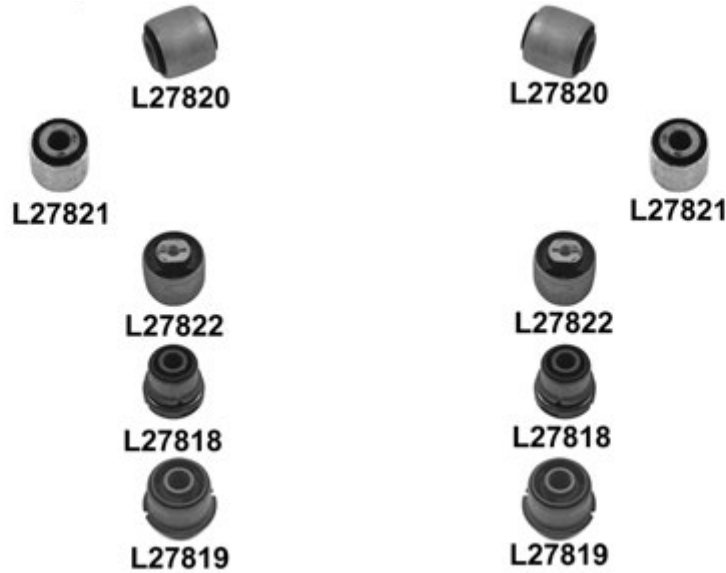

				←	→	Thread	Part Of	QPA	
					L27123	↺		1	274176
					L27124	↺		1	274175
				→ 12.03, Smi	L27207	L27207		2	274179
				01.04 →, ZF	L27209	L27209		2	274353
					L27004 °	L27004 °		2	272418
			ch. FC1 → 647148	L27515	L27515			2	274193
			ch. FC2 → 645617						
			ch. FC1 647149 →	L27527	L27527			2	274523
			ch. FC2 645618 →						
			Taxi	L27515	L27515			2	274193
			ch. FC1 404684 →						
			ch. FC2 381841 →						
			Police	L27515	L27515			2	274193
			ch. FC1 → 647195						
			ch. FC2 → 645611						
			Police	L27527	L27527			2	274523
			ch. FC1 647196 →						
ch. FC2 645612 →									
			ch. FC1 → 647148		L27519			1	30635230
			ch. FC2 → 645617	L27520				1	30635229
			ch. FC1 647149 →		L27539			1	30760587
			ch. FC2 645618 →	L27540				1	30760586
			Taxi		L27519			1	30635230
			ch. FC1 404684 →	L27520				1	30635229
			ch. FC2 381841 →						
			Police		L27519			1	30635230
			ch. FC1 → 647195	L27520				1	30635229
			ch. FC2 → 645611						
			Police		L27539			1	30760587
			ch. FC1 647196 →	L27540				1	30760586
ch. FC2 645612 →									

V70 II (285) 03.00 →

			←	→	Thread	Part Of	QPA		
		⊥▼	L27811	L27811			2	8630604	
		⊥▲	L27812	L27812			2	9443882	
			L27609	L27609			2	274456	
		ch. → 285999	KIT	MK141	MK141			2	3546189
		ch. 286000 →		MK159	MK159			2	30714968
		ī		MK243	MK243			2	8646713
		ī▼→←	L27815	L27815			2	8672220	
		ī▲→←	L27816	L27816			2	9157572	
		ī←→	L27815	L27815			2	8672220	
		⊥←→	L27817	L27817			2	9492181	
		→←←→	transverse	L27820	L27820			2	9157579
		←→		L27821	L27821		Pull rod	2	9127363
		→←		L27822	L27822		Pull rod	2	9169204
		▲		L27818	L27818		Hub carrier	2	9157952
		▼		L27819	L27819		Hub carrier	2	9157576
				L27610	L27610			2	8672446

V70 III 08.07 →

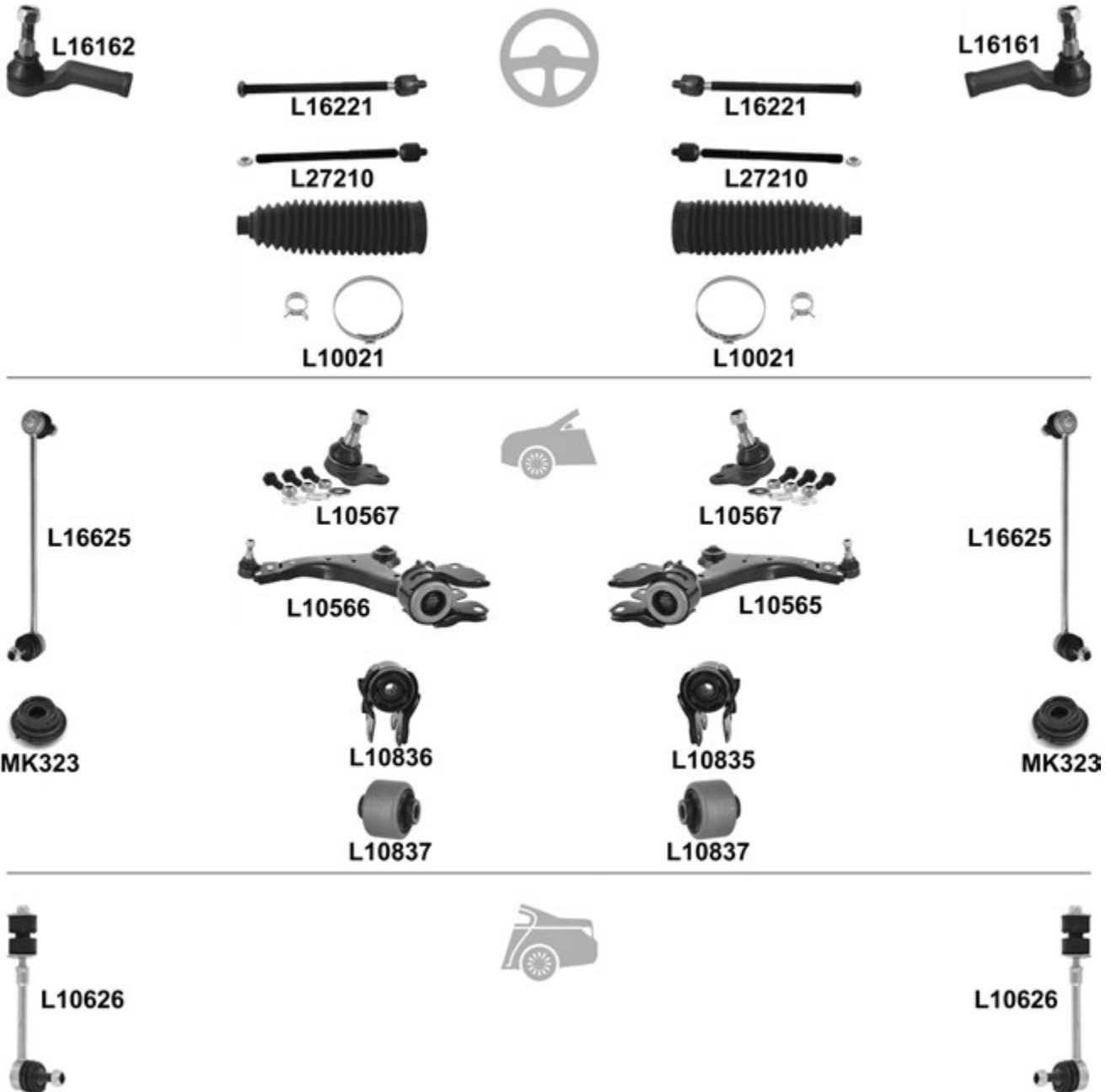

		i		←	→	Thread	Part Of	QPA	i	
		↔			L16161	F 18x1,5 ∪		1	31280001	
					L16162	F 18x1,5 ∪		1	31280000	
			(-) Servotronic, L= 315mm	L16221	L16221	M 18x1,5 / M 18x1,5 ∪		2	31280658	
			Servotronic, L= 305mm	L27210	L27210	M 18x1,5 / M 16x1,5 ∪		2	30776425	
			Hydraulic , (-) Servotronic, L= 195mm, ø15,5mm, ø 52mm	L10021 ^o	L10021 ^o			2	30776251	
		↓			L10567	L10567		2		
				<input checked="" type="checkbox"/>		L10565			1	31277344
		↓			L10566			1	31277343	
						L10835			1	
		↓	↙		L10836				1	
			↘		L10837	L10837			2	
					L16625	L16625		2	30648461	
				MK323	MK323			2	31277826	
				L10626	L10626			2	30760678	

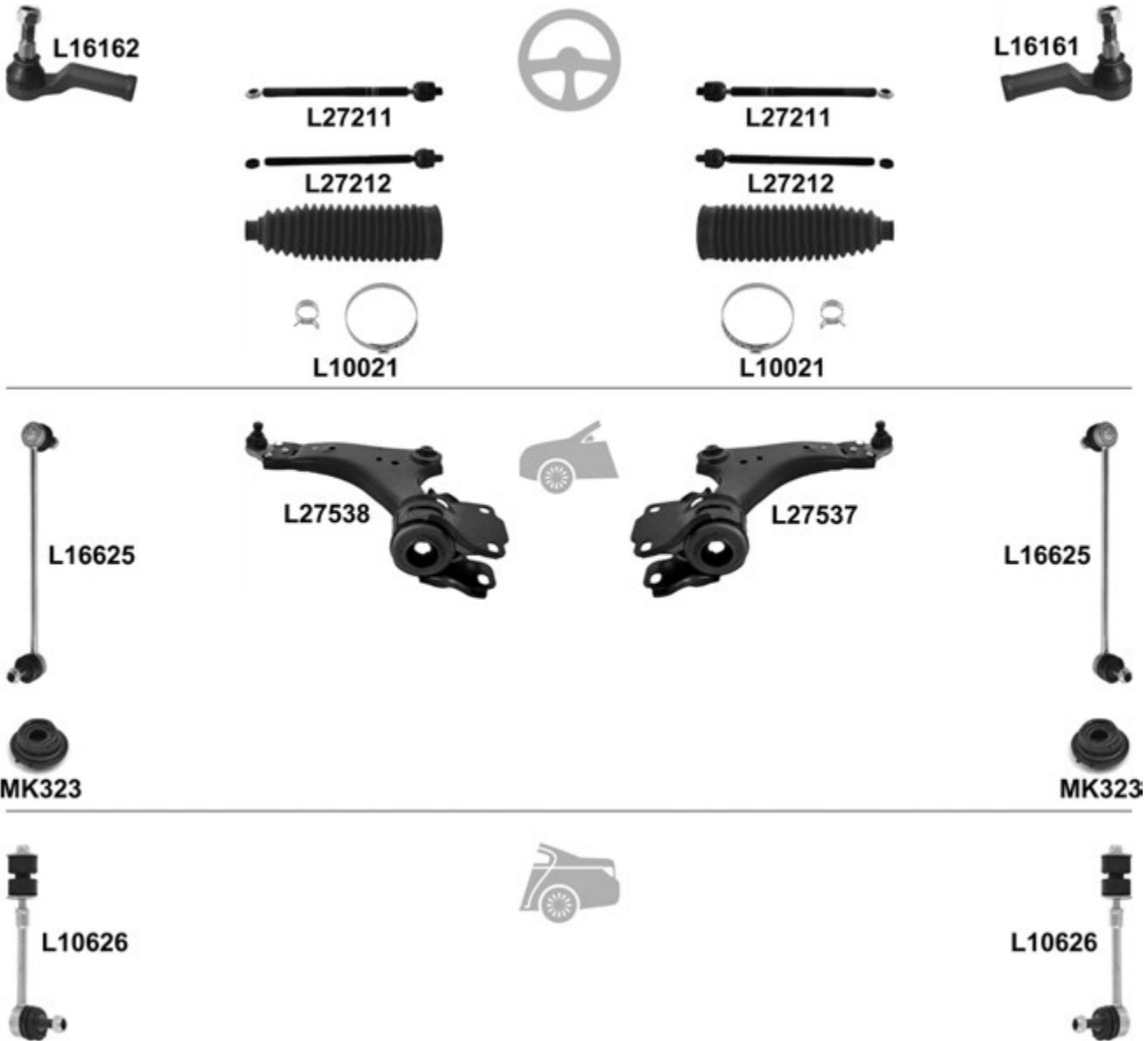
XC60 05.08 →

				←	→	Thread	Part Of	QPA		
		↔			L16161	F 18x1,5 ∪		1	31280001	
					L16162	F 18x1,5 ∪		1	31280000	
				Servotronic	L27211	L27211	M 18x1,5 / M 16x1,5 ∪		2	31280408
				(-) Servotronic	L27212	L27212	M 18x1,5 / M 16x1,5 ∪		2	31280409
				Hydraulic , (-) Servotronic, L= 195mm, ø15,5mm, Ø 52mm	L10021 ^o	L10021 ^o			2	30776251
		⊥		<input checked="" type="checkbox"/>	L27537			1	31317666	
					L27538				1	31317665
					L16625	L16625			2	30648461
					MK323	MK323			2	31277826
					L10626	L10626		2	30760678	

XC70 Cross Country 10.97 → 03.99

VOLVO

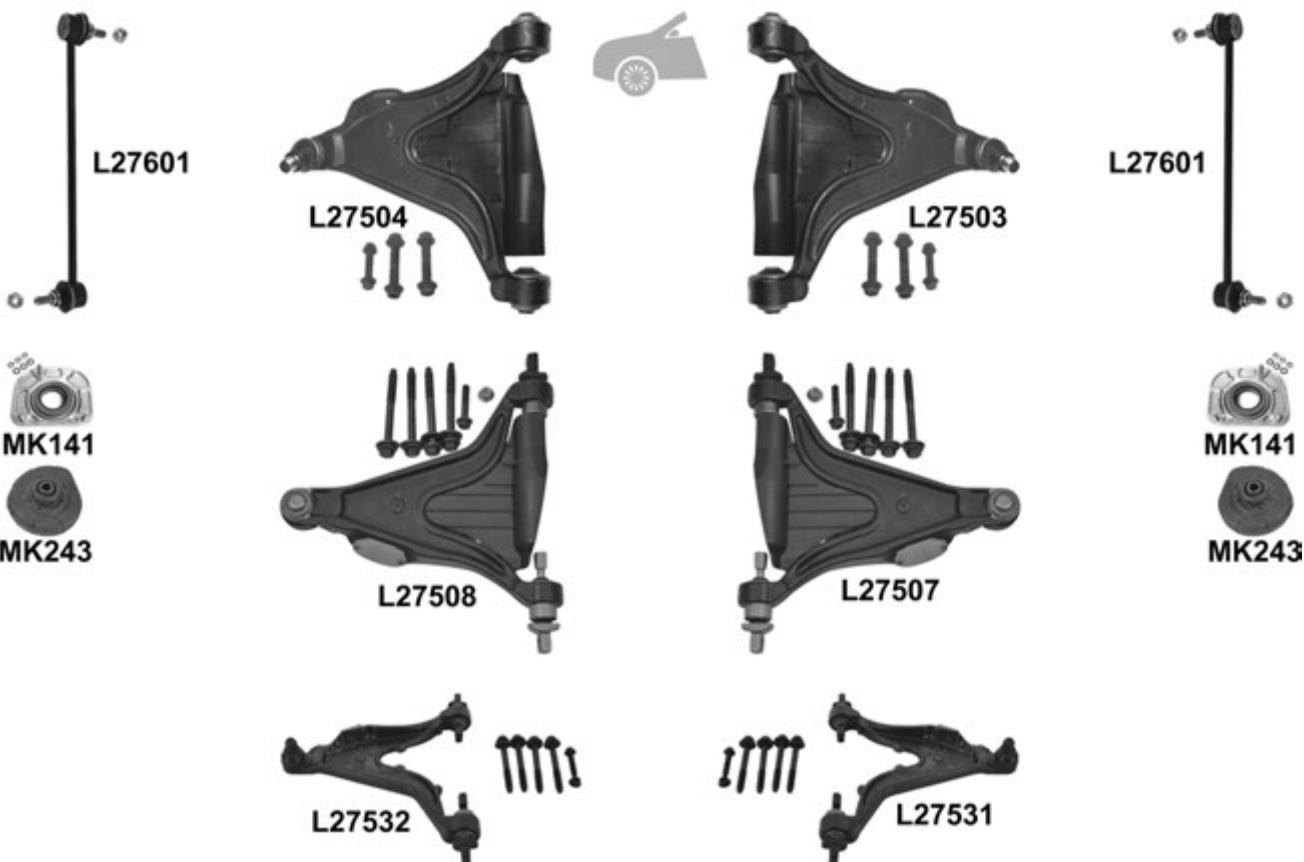
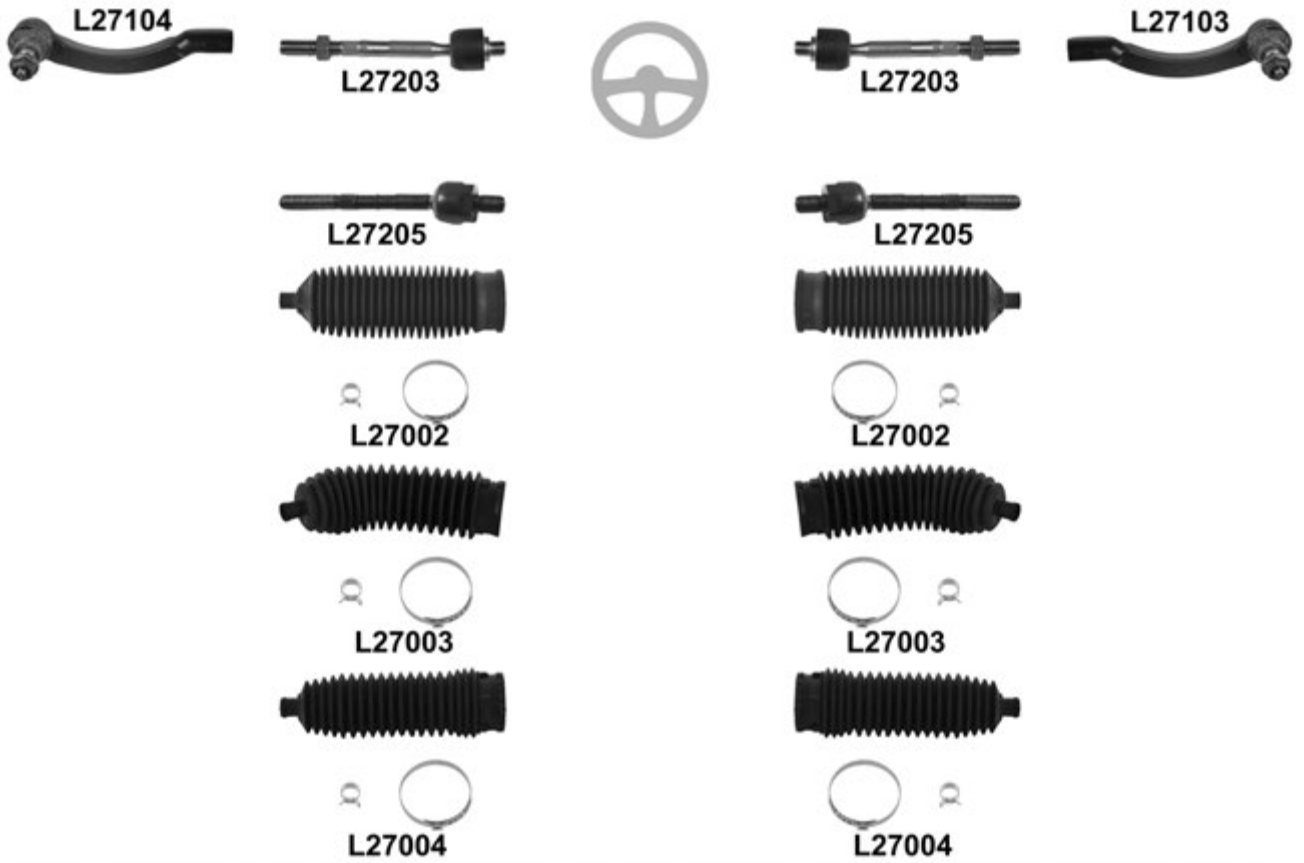

XC70 Cross Country 10.97 → 03.99

Thread
Part Of
QPA

⊕	↔			L27103	F 14x2 ♂		1	3546268	
				L27104	F 14x2 ♂		1	3546267	
	↔			L27203	L27203	M 14x2 / M 14x1,5		2	3546266
				L27205	L27205	M 14x2 / M 16x1,5		2	9191410
⌀	↔	TRW/CAM.gear		L27002	L27002			2	271601
		Smi/Koyo		L27003 ^o	L27003 ^o			2	9191409
				L27004 ^o	L27004 ^o			2	272418
🔧	⊥		☑		L27503			1	8628495
				L27504				1	8628496
		Diesel/AWD	☑		L27507			1	8628497
				L27508				1	8628498
			☑		L27531			1	8628500
			L27532				1	8628499	
	🌀	⊥ ▲ ▼			L27809	L27809	🔧 L27503/L27504	4	271631
	🌀				L27601	L27601		2	1387860
	🌀				L27808	L27808	Anti-roll bar	2	3546730
	🌀		KIT		MK141	MK141		2	3546189
🔧	↔				L27814	L27814	Hub carrier	2	3516122
					L27813		Hub carrier	1	3516496
	↔				L27824		Hub carrier	1	3530202
	🌀		(-) Nivomat		MK134	MK134		2	3516151

XC70 Cross Country 03.00 →

VOLVO

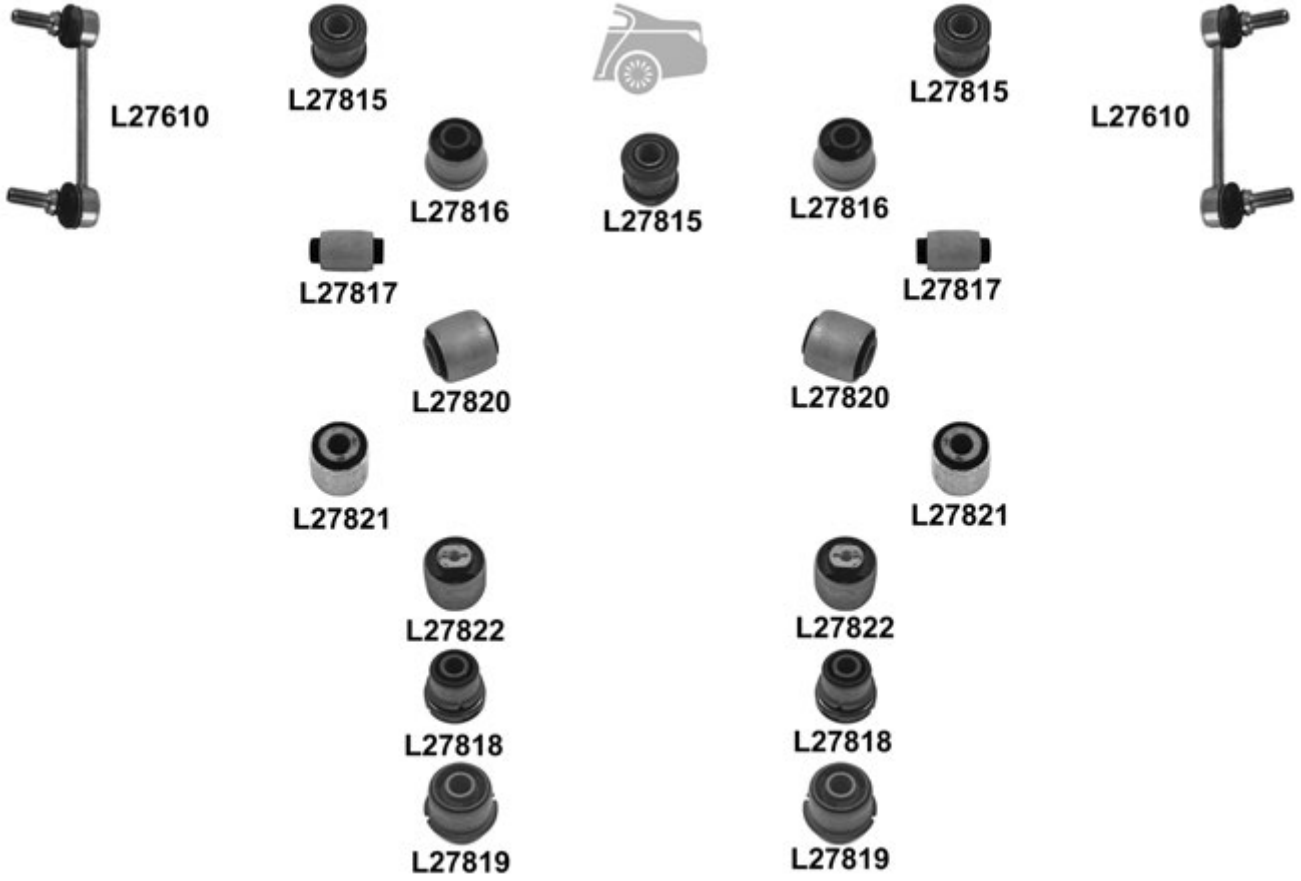

XC70 Cross Country 03.00 →

XC70 Cross Country 03.00 →

			←	→	Thread	Part Of	QPA	
		↔		L27103	F 14x2 ⤷		1	3546268
			L27104		F 14x2 ⤷		1	3546267
				L27127	F 14x1,5 ⤷		1	274499
			L27128		F 14x1,5 ⤷		1	274498
		Smi, (code 5) → 12.03, Smi/Koyo 01.04 →, ZF	L27205	L27205	M 14x2 / M 16x1,5		2	9191410
			L27207	L27207	M 14x1,5 / M 16x1,5		2	274179
			L27209	L27209	M 14x1,5 / M 16x1,5		2	274353
		TRW/CAM.gear, code 4	L27002	L27002			2	271601
			L27004 ^o	L27004 ^o			2	272418
			⊥	ch. → 269745	L27515	L27515		2
ch. 269746 →				L27527	L27527		2	274523
		⊥			L27529		1	30635232
					L27530		1	30635231
		⊥↘		L27811	L27811		2	8630604
				L27812	L27812		2	9443882
				L27601	L27601		2	1387860
				L27609	L27609		2	274456
		KIT	ch. → 28004	MK141	MK141		2	3546189
			ch. → 33857					
			ch. 28005 → ch. 33858 →	MK159	MK159		2	30714968
		⊥		MK243	MK243		2	8646713
			⊥↘↔	L27815	L27815		2	8672220
	⊥↗↔		L27816	L27816		2	9157572	
	⊥↔		L27815	L27815		2	8672220	
	⊥↔		L27817	L27817		2	9492181	
	↔↔↔		transverse	L27820	L27820		2	9157579
	↔↔			L27821	L27821	Pull rod	2	9127363
	↔↔			L27822	L27822	Pull rod	2	9169204
	↗			L27818	L27818	Hub carrier	2	9157952
	↘			L27819	L27819	Hub carrier	2	9157576
			(-) AWD	L27610	L27610		2	8672446

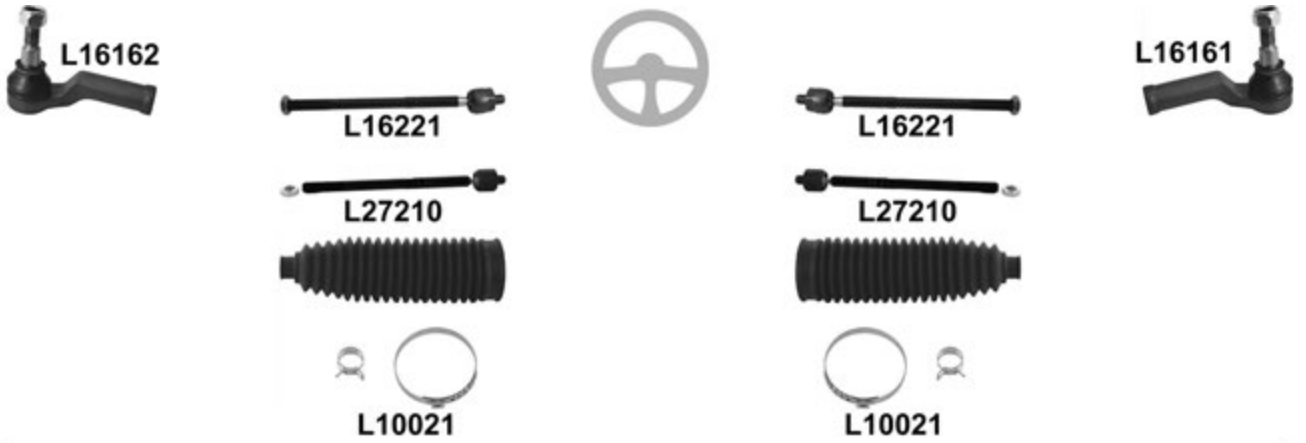
XC70 II Cross Country 08.07 →

				←	→	Thread	Part Of	QPA		
⊕		↔			L16161	F 18x1,5 ♂		1	31280001	
					L16162	F 18x1,5 ♂		1	31280000	
			Hydraulic , L= 315mm	L16221	L16221	M 18x1,5 / M 18x1,5 ♂		2	31280658	
			Electric , L= 305mm	L27210	L27210	M 18x1,5 / M 16x1,5 ♂		2	30776425	
⊖			Hydraulic , (-) Servotronic, L= 195mm, ø15,5mm, Ø 52mm	L10021 °	L10021 °			2	30776251	
				L27528	L27528			2	30683249	
		⊥		<input checked="" type="checkbox"/>	L27535			1	31277346	
		⊥			L27536			1	31277345	
⊖				L16625	L16625			2	30648461	
				MK323	MK323			2	31277826	
				L10626	L10626			2	30760678	

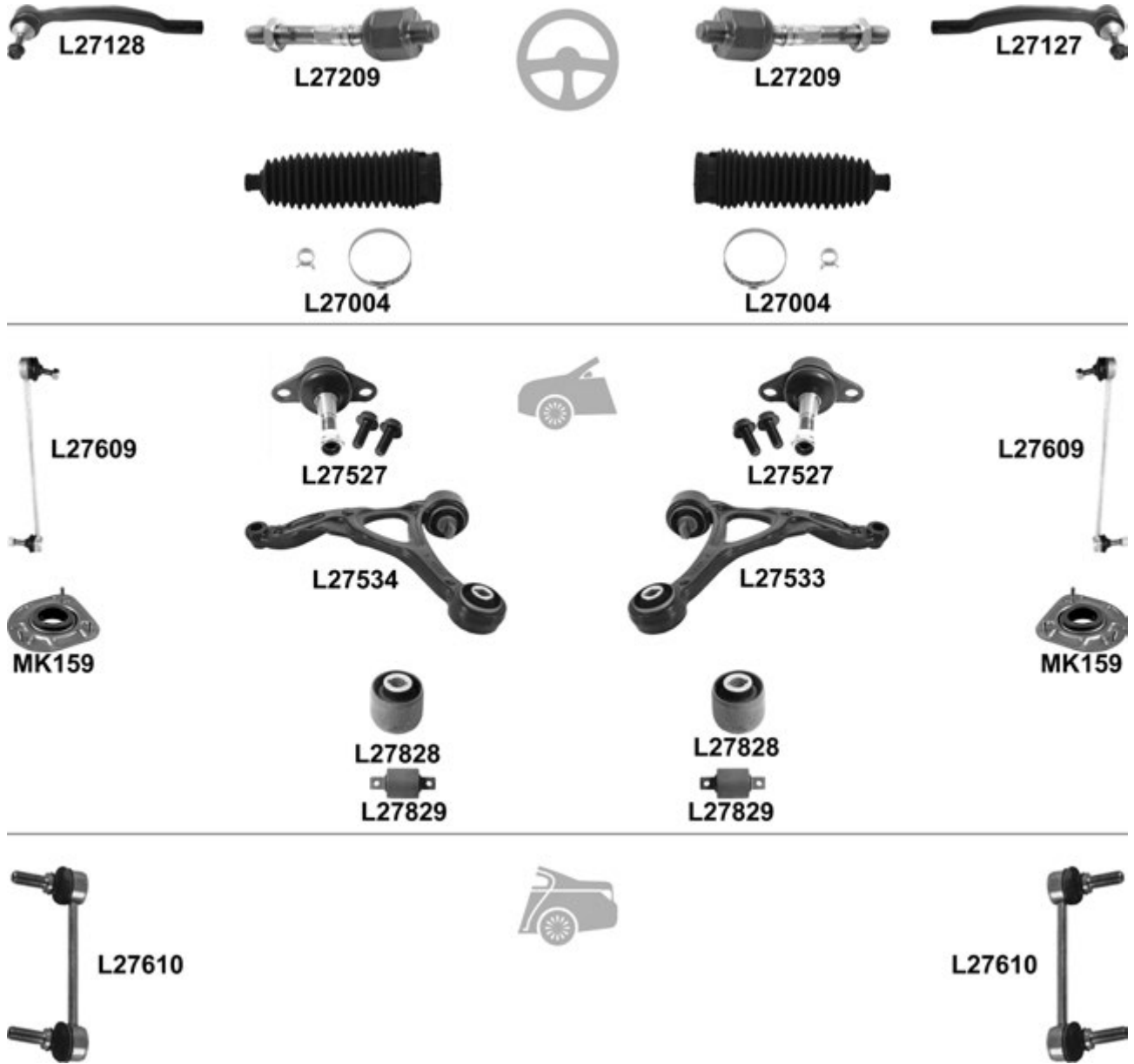
XC90 10.02 →

			←	→	Thread	Part Of	QPA	
		↔		L27127	F 14x1,5 ♂		1	274499
			L27128	F 14x1,5 ♂		1	274498	
			L27209	L27209	M 14x1,5 / M 16x1,5		2	274353
			L27004 ⁰	L27004 ⁰			2	272418
		⊥		L27527	L27527		2	274523
			(-) (+)		L27533		1	31304046
		⊥		L27534			1	31304045
				L27828	L27828		2	30645847
		⊥	↙	L27829	L27829		2	30639368
			↘	L27609	L27609		2	274456
				KIT	MK159	MK159		2
				L27610	L27610		2	30714678

142 1966 → 1968 ch. → 52 899

144 1966 → 1968 ch. → 89 799

145 1966 → 1968 ch. → 9 199

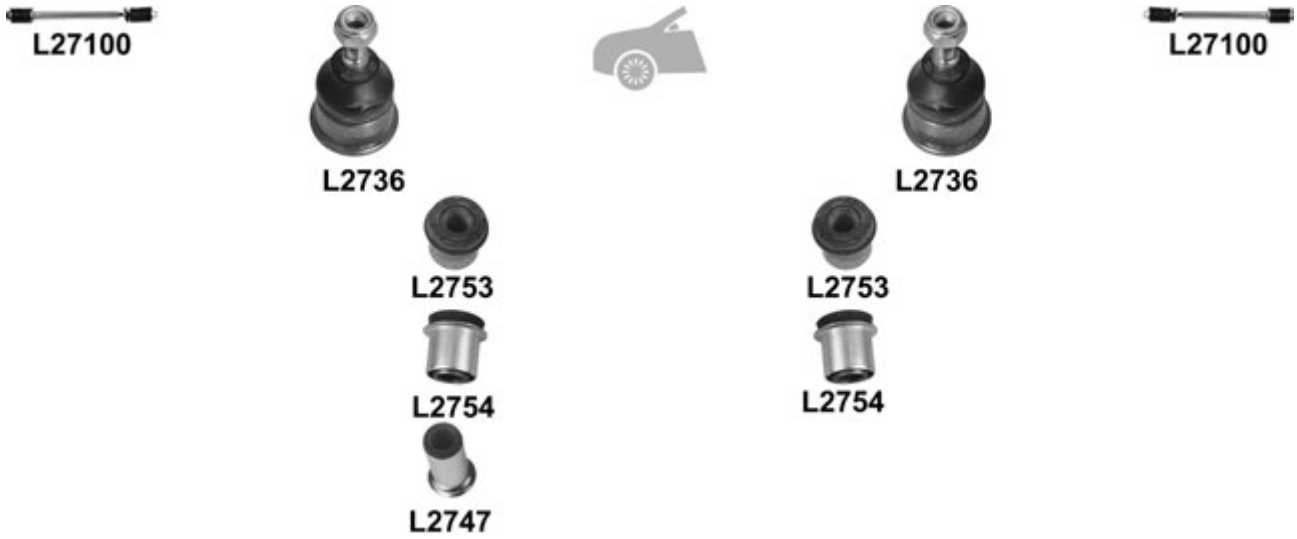

				← → Thread		Part Of	QPA		
		↓		L2736	L2736		2	686303	
		↑▲▼		L2753	L2753		2	675432	
		↓▲▼		L2754	L2754		2	663675	
				L27100	L27100		2		
				L2747		IDLER	1	671444	

142 1968 → 07.74 ch. 52 900 →
 144 1968 → 07.74 ch. 89 800 →
 145 1968 → 07.74 ch. 9 200 →
 164 1969 → 1974

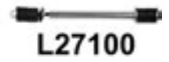
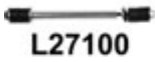
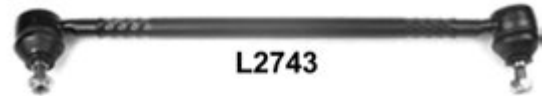

142 1968 → 07.74 ch. 52 900 →
 144 1968 → 07.74 ch. 89 800 →
 145 1968 → 07.74 ch. 9 200 →
 164 1969 → 1974

		← → Thread		Part Of	QPA			
			L2743		1	1206232		
			L2742		1	1206231		
		↑	L2746	L2746		2	686398	
		↓	L2736	L2736		2	683303	
		↑^	(-) 164	L2753	L2753		2	675432
		↓^	142, ch. → 112399 144, ch. → 138699 145, ch. → 30899	L2754	L2754		2	663675
		↓^	142, ch. 112400 → 144, ch. 138700 → 145, ch. 30900 →	L2761	L2761		2	683267
		L27100	L27100		2			
		L2747		IDLER	1	671444		
		transverse		L2719		1	1330827	
		67 → 73 transverse	L2728			1	672226	
		74 → transverse	L2725			1	1330973	

240, 260 serie 08.74 → 1978

VOLVO

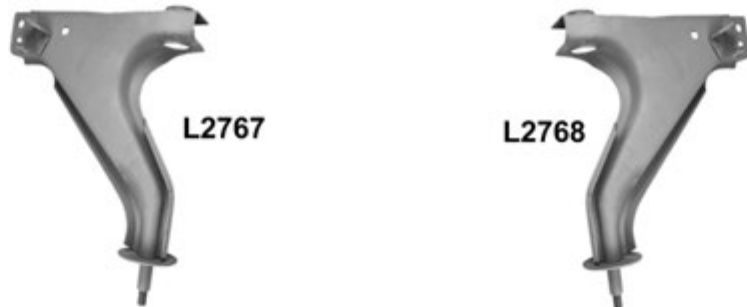

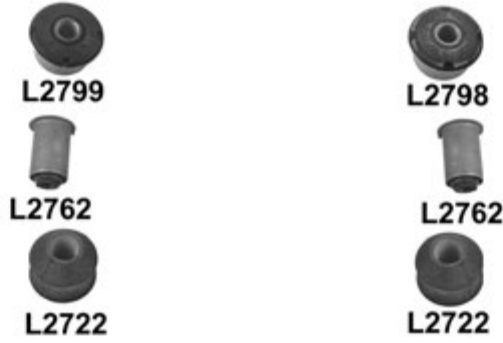
240, 260 serie 08.74 → 1978

			←	→	Thread	Part Of	QPA		
				L2751	L2751	F 14x2	2	3516944	
				L2752	L2752	M 14x2 / F 14x1,5	2	1205659	
				L2716	L2716	M 14x2 / M 14x1,5	2	3530167	
				L2717	L2717	M 14x2 / F 14x1,5	2	1272947	
					L2786		1	271543	
				L2785			1	271541	
				L2791	L2791		2	1228425	
				L2791	L2791		2	1228425	
			244, ch.335667 → 245, ch. 193463 →						
				L2794	L2794		2	271545	
				L2748	L2748		2	274117	
					L2757		1	274119	
				L2756			1	274118	
					L2768		1	1205686	
				L2767			1	1205680	
					L2798		1	1273778	
				L2799			1	1359812	
				L2762	L2762		2	1205825	
			(+)	L27110	L27110		2		
				L2722	L2722		2	1205926	
			KIT	MK082	MK082		2	1272455	

240, 260 serie 1979 → 08.93

VOLVO

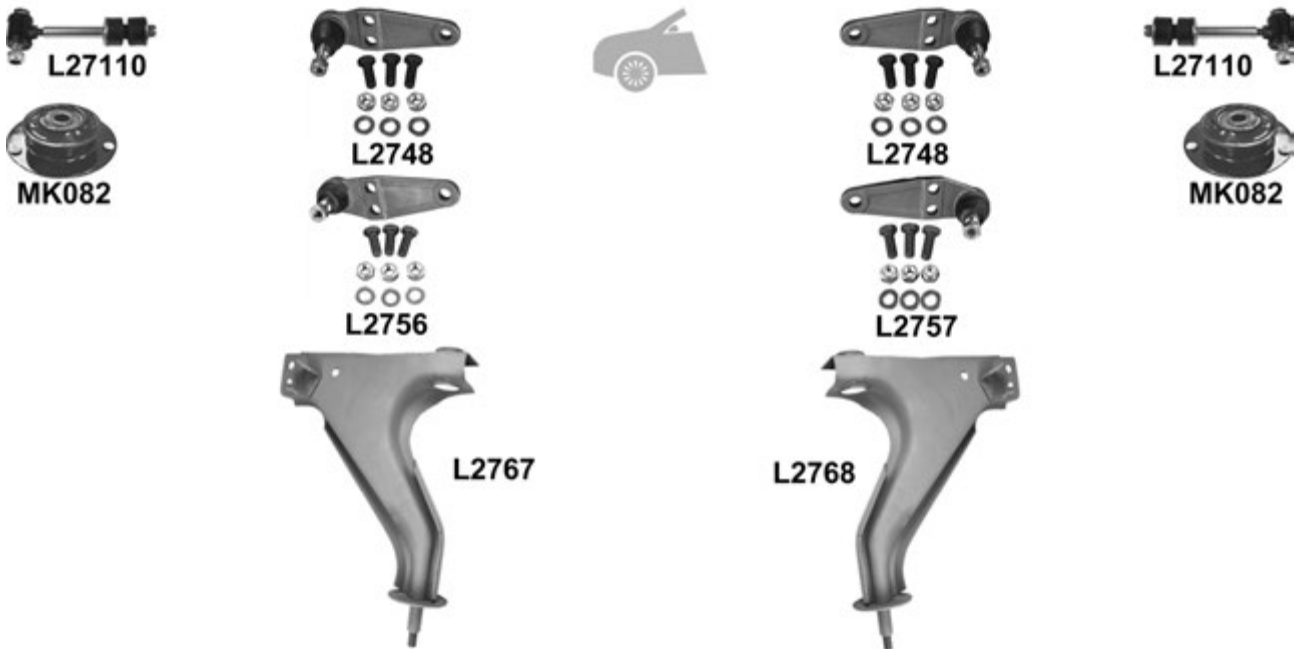
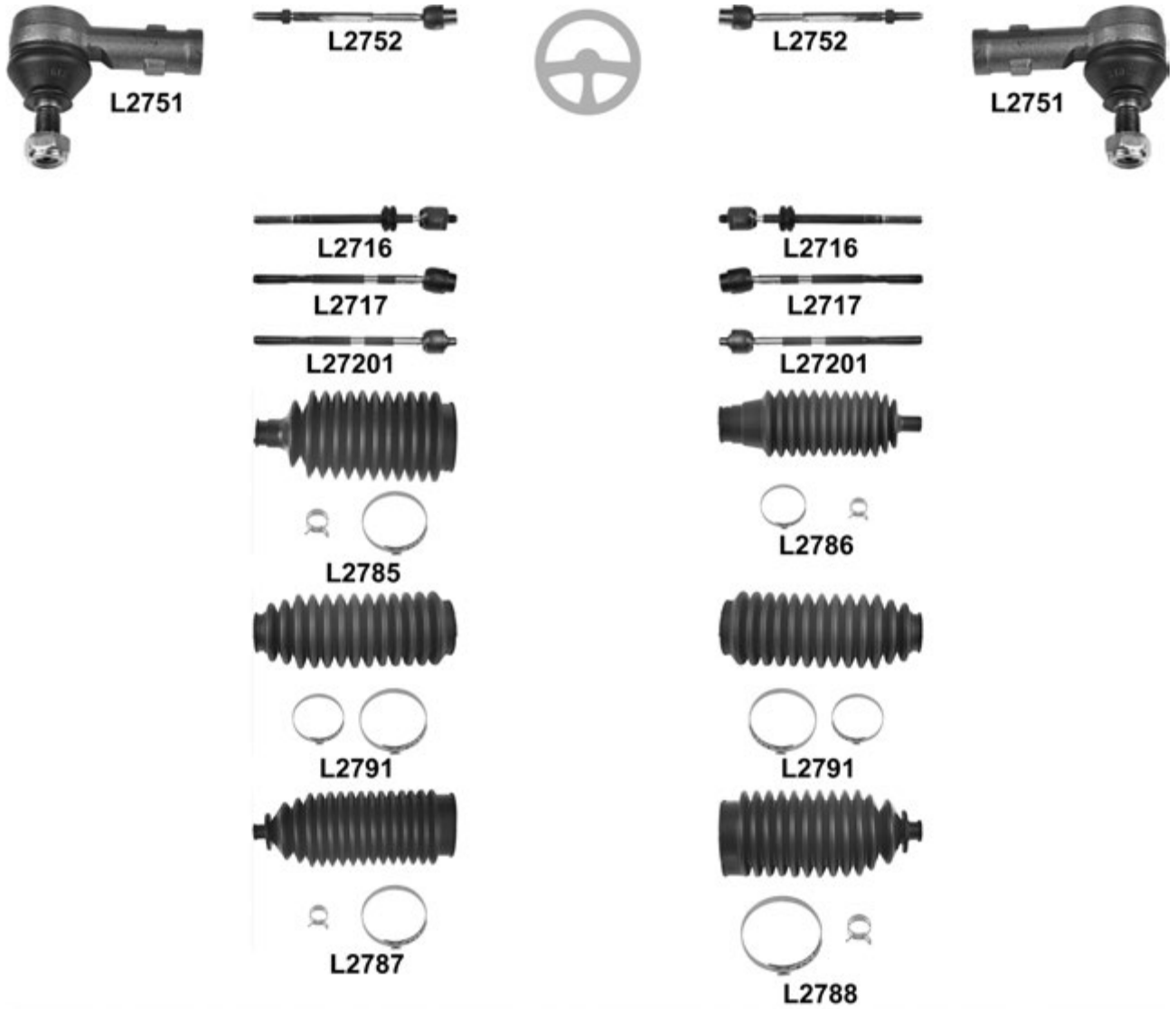

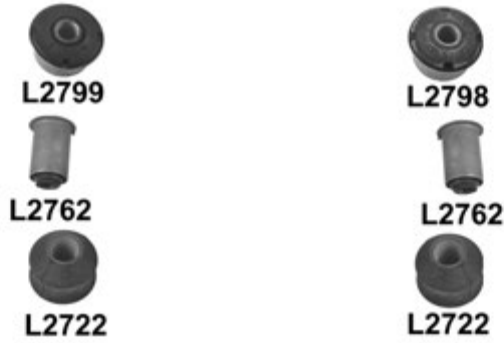
240, 260 serie 1979 → 08.93

		i	←	→	Thread	Part Of	QPA	i		
			↔	L2751	L2751	F 14x2 U		2	3516944	
				L2752	L2752	M 14x2 / F 14x1,5		2	1205659	
				L2716	L2716	M 14x2 / M 14x1,5		2	3530167	
				L2717	L2717	M 14x2 / F 20x1,5		2	1272947	
			L27201	L27201	M 14x2 / M 14x1,5		2	9140505		
					L2786			1	271543	
					L2785			1	271541	
				L2791	L2791			2	1228425	
				L2791	L2791			2	1228425	
					L2788			1	270882	
					L2787			1	270881	
				⊥	L2748	L2748			2	274117
						L2757			1	274119
						L2756			1	274118
			⊥			L2768			1	1205686
						L2767			1	1205680
			⊥↘			L2798			1	1273778
						L2799			1	1359812
						L2762	L2762			2
			(+)	L27110	L27110			2		
				L2722	L2722			2	1205926	
			KIT	MK082	MK082		2	1272455		

240, 260 serie 1975 →

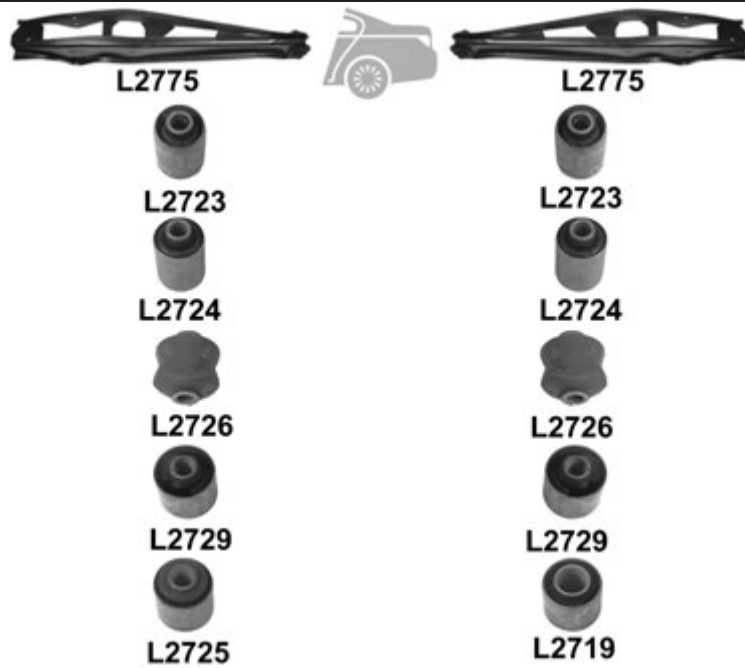

		i	←	→	Thread	Part Of	QPA	i
		↓	L2723	L2723			2	1229165
		↑	L2724	L2724			2	1229714
		242, ch. → 205100 244, ch. → 675000 245, ch. → 362900 264, ch. → 122297 265, ch. → 30464 longitudinal	L2726	L2726			2	1272603
		81 →, metal longitudinal	L2729	L2729			2	1273622
		transverse		L2719			1	1330427
			L2725				1	1330973
		⊥	(+) L 27824	L2775	L2775			2

343, 345 02.76 →
340, 360 1980 → 07.91

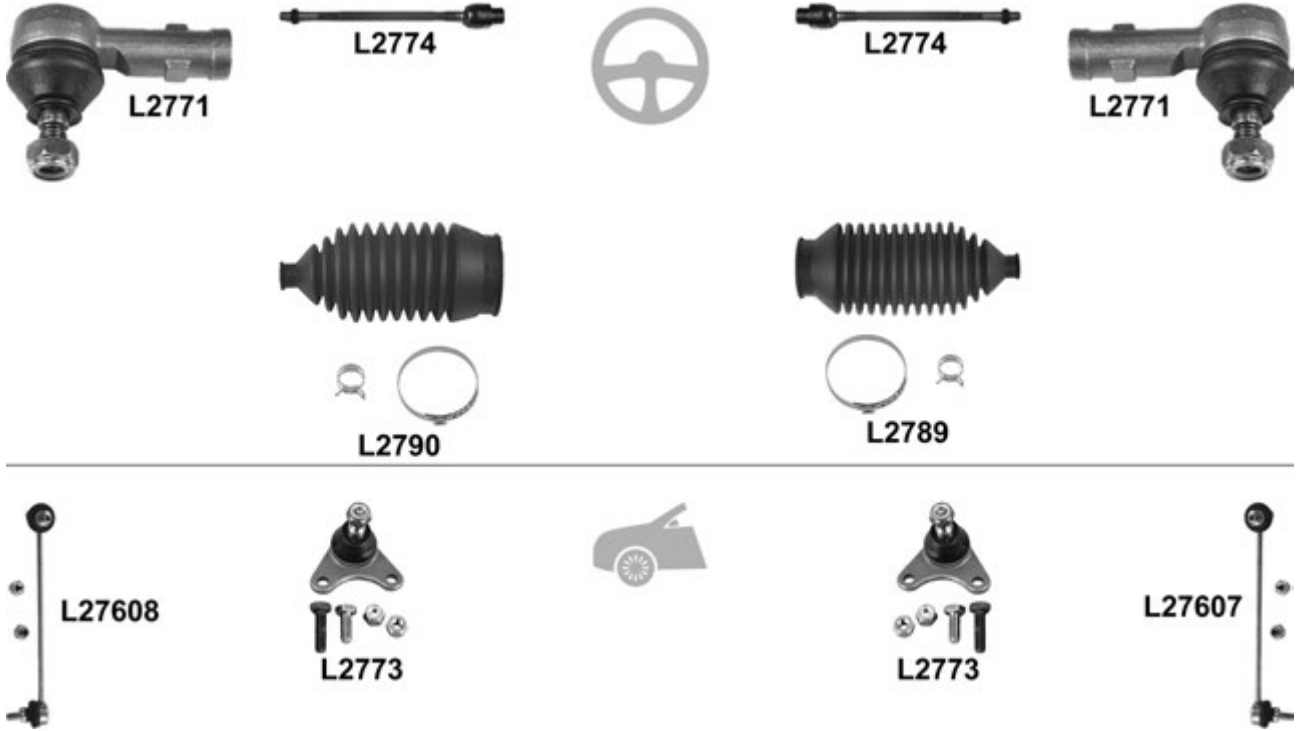

			←	→	Thread	Part Of	QPA	
		↔	L2771	L2771	F 14x2		2	3211955
			L2774	L2774	M 14x1,5 / F 14x1,5		2	3293736
				L2789			1	3343641
			L2790				1	3343642
		⊥	L2773	L2773			2	3211956
		ch. 121000 →		L27607			1	3209408
			L27608				1	3209407

440, 460 09.88 →

VOLVO

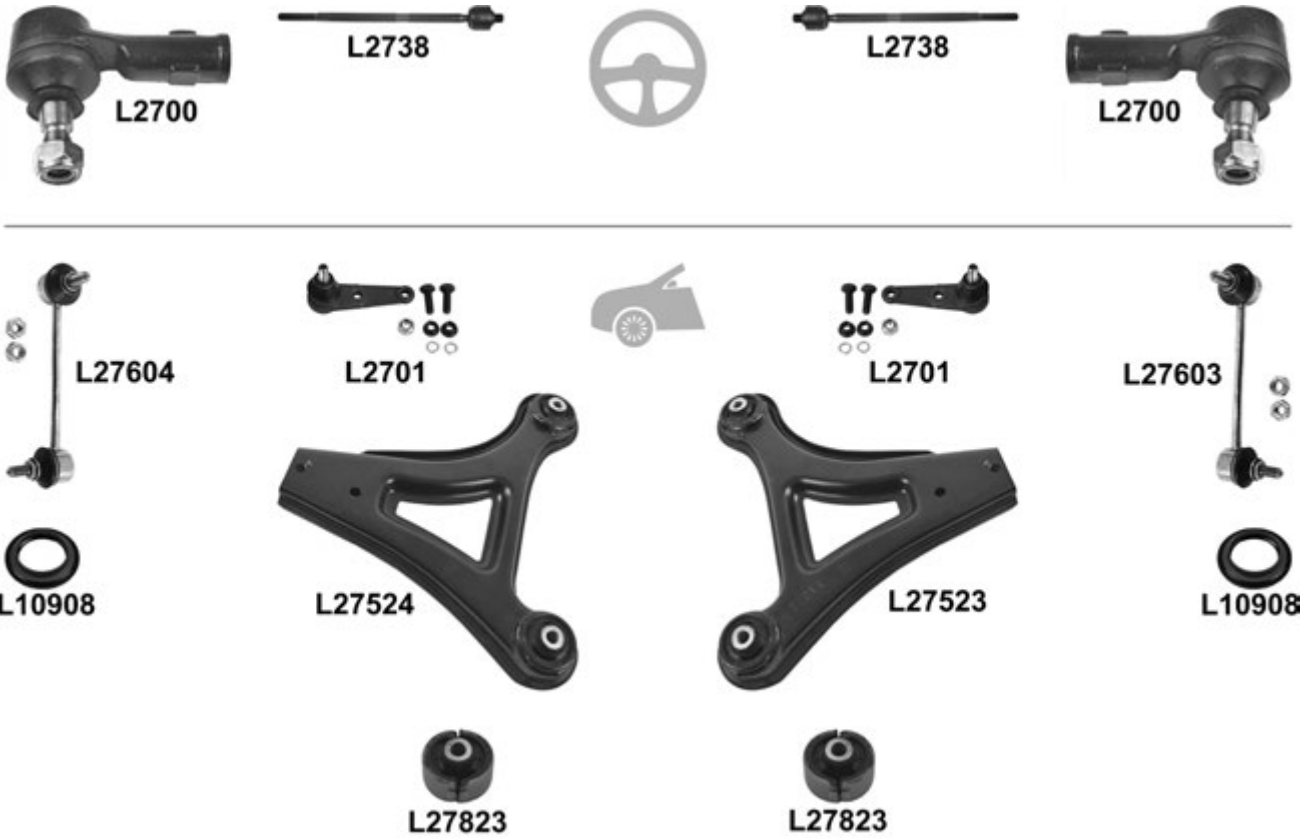

		← →		Thread	Part Of	QPA		
		↔		L2700 L2700 F 12x1,5 U		2	3480012	
				L2738 L2738 M 12x1,5 / M 14x1,5		2	3342824	
		↓		L2701 L2701		2	3465482	
		↓	MAN / AUT		L27523		1	3443999
			(-) AUT, 1.9 TD	L27524			1	3443998
			AUT, 1.9 TD	L27526			1	3421396
		↑ ↓		L27823 L27823		4	3411810	
					L27603		1	3416130
				L27604		1	3416129	
				L10908 L10908		2	3411070	

480 04.86 →

				←	→	Thread	Part Of	QPA	
		↔		L2700	L2700	F 12x1,5 ♂		2	3480012
				L2738	L2738	M 12x1,5 / M 14x1,5		2	3342824
		↓		L2701	L2701			2	3465482
		↓			L27523			1	3443999
				L27524				1	3443998
		↕		L27823	L27823			4	3411810
					L27603			1	3416130
				L27604				1	3416129
			L10908	L10908			2	770077654	

444, 544 1954 → 1968 ch. 84391 →
 210 Duett 1957 → 1968



Thread

Part Of

QPA



		→ ←		L2706B	↺		1	658432
				L2706A	↺		1	658431

740 serie 04.84 → 07.92

760 serie 08.82 → 07.92

780 serie 1985 →

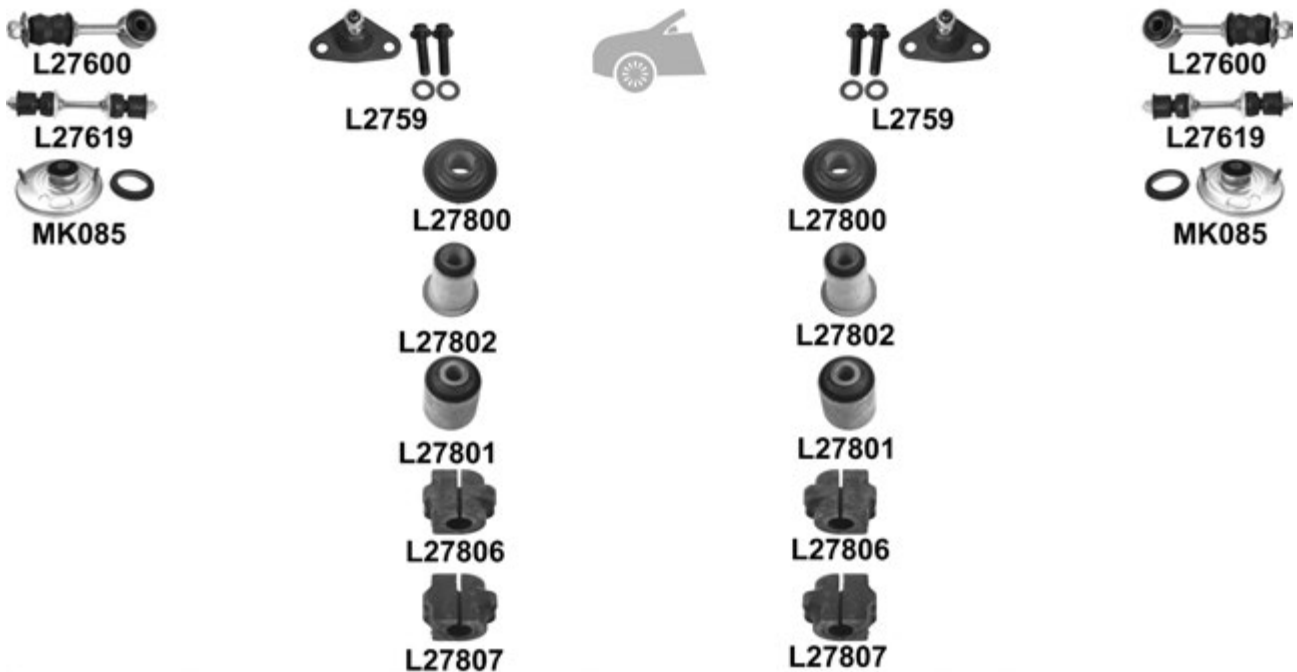
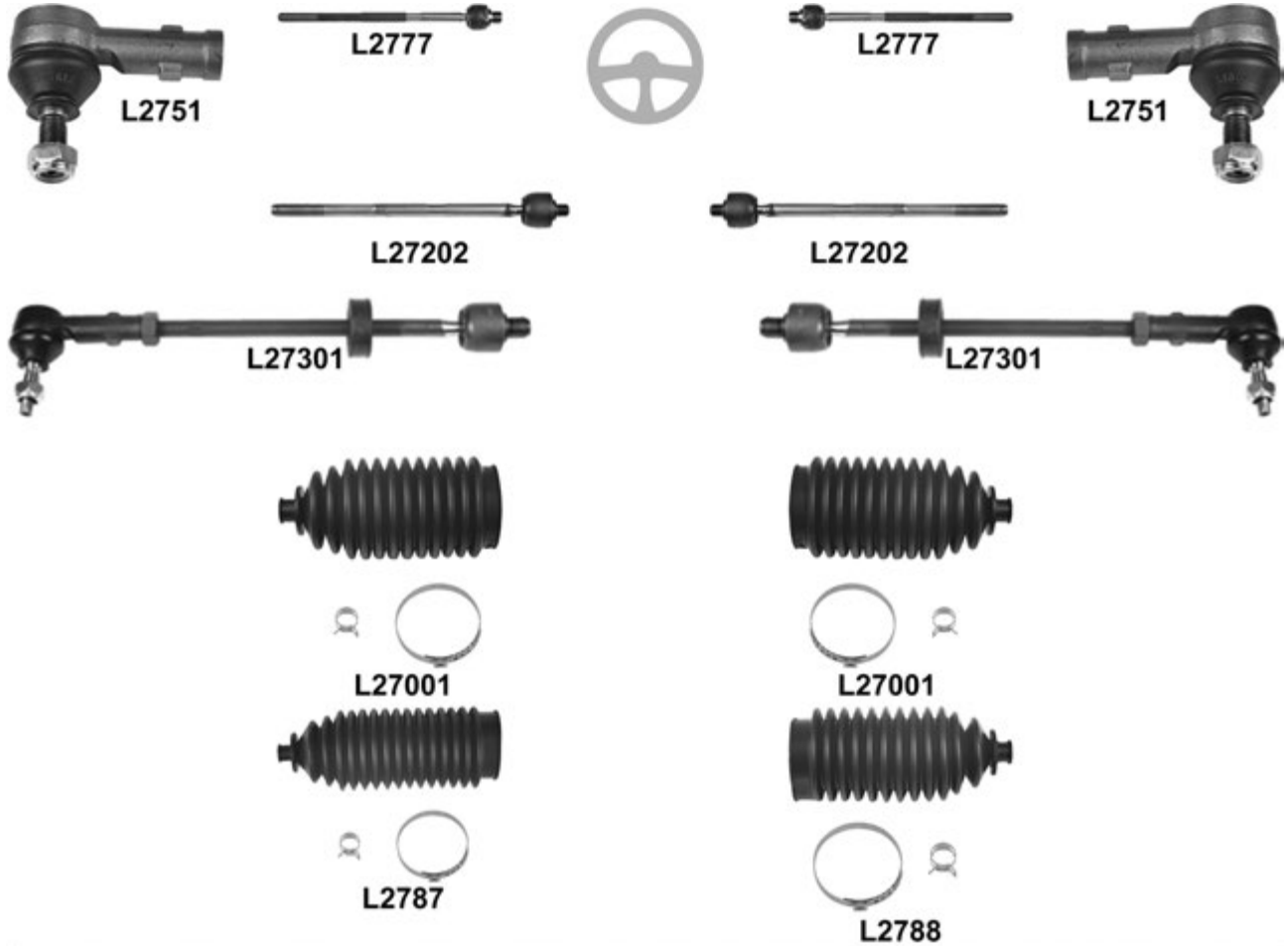

740 serie 04.84 → 07.92
 760 serie 08.82 → 07.92
 780 serie 1985 →



			←	→	Thread	Part Of	QPA		
		↔	L2751	L2751	F 14x2 U		2	3516944	
		→ 12.88	L2777	L2777	M 14x2 / M 18x1,5		2	1359347	
		01.89 →	L27202	L27202	M 14x2 / M 14x1,5		2	9140504	
		ZF, 01.88 →	L27301	L27301	M 14x2 / M 16x1,5		2	271389	
			L27001	L27001			2	271555	
			L2788				1	270882	
		⊥	L2759	L2759			2	271758	
		⊥▲	L27800	L27800			4	1359599	
		⊥▼	(-) ⊥	L27802	L27802			2	1273235
			Steel Track control arm	L27600	L27600		2	9157725	
			ALU Track control arm	L27619	L27619		2	1329395	
				L27801	L27801	Trailing arm	2	1329655	
			∅ 19mm	L27806	L27806	Anti-roll bar	2	1229389	
			21mm	L27807	L27807	Anti-roll bar	2	1273184	
			KIT	MK085	MK085		2	1387188	
			(-) ⊥	L27803	L27803			2	1330454
				L2719			1	1330427	
			L2725				1	1330973	
		▼ (-) ⊥ longitudinal	L27805	L27805			2	1272306	
		▲ (-) ⊥ longitudinal	L27804	L27804			2	1229608	

850 serie 04.92 → 12.96

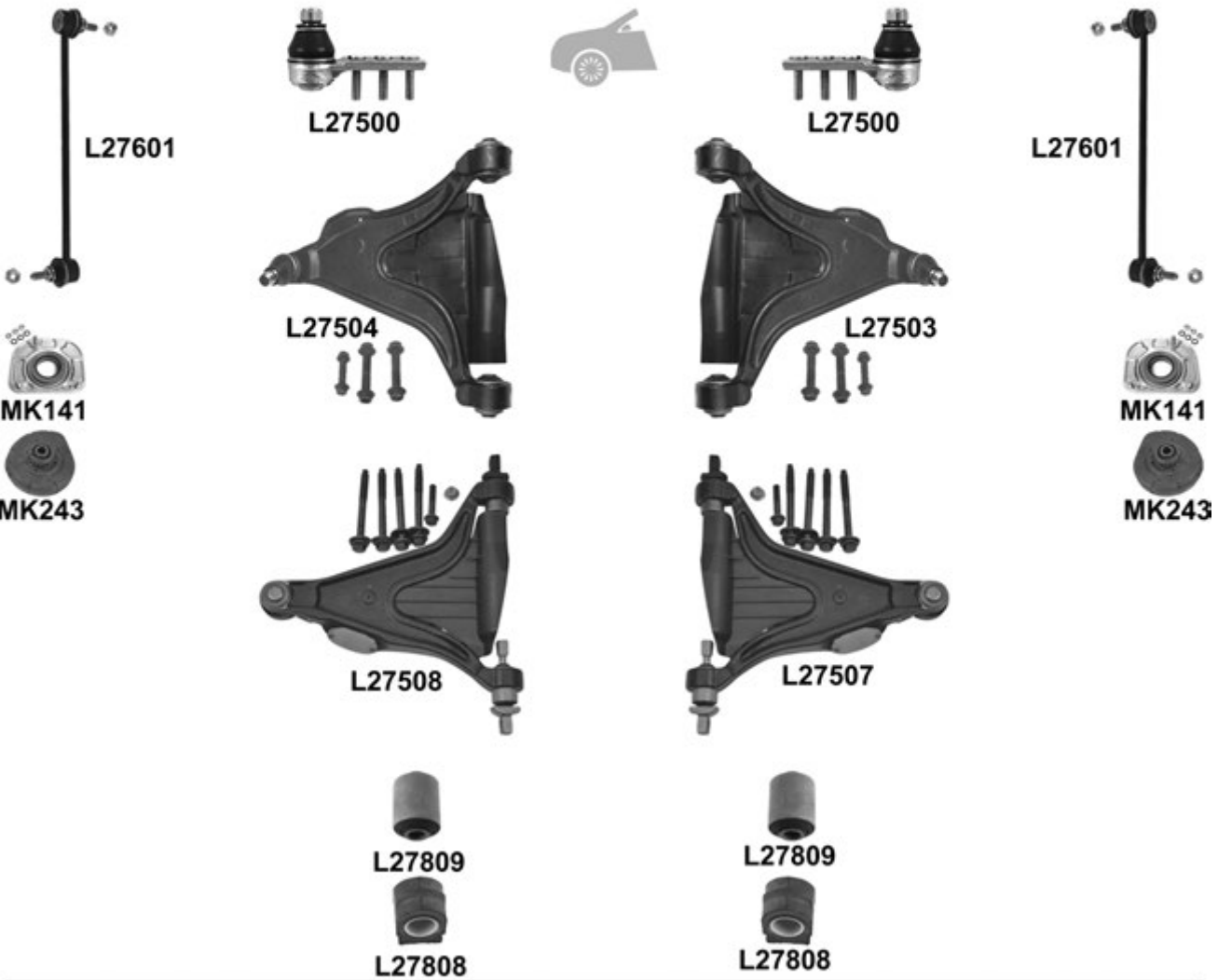
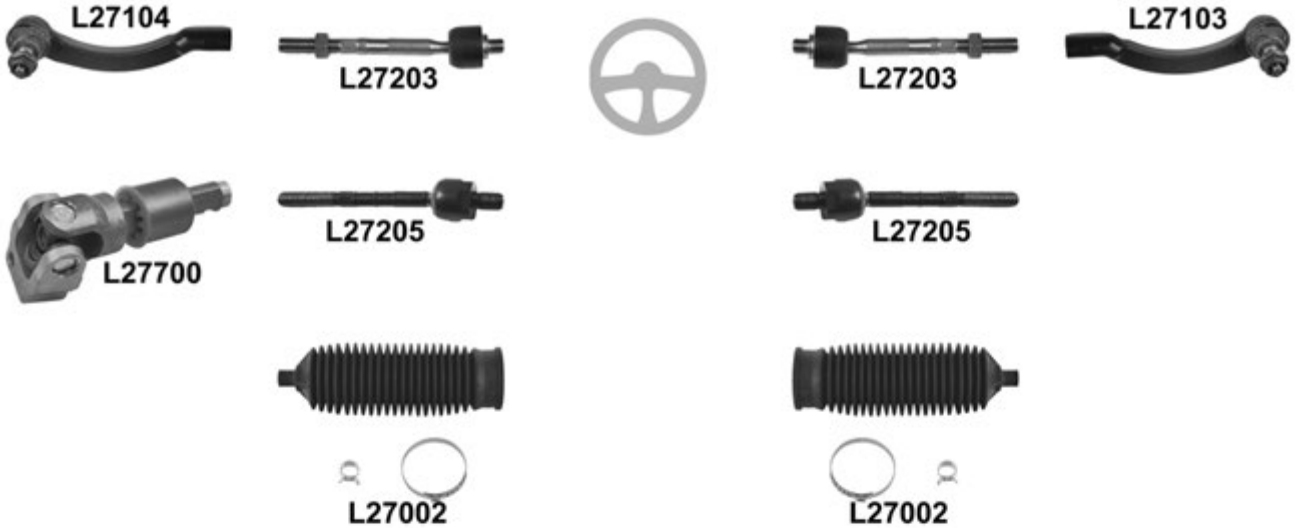

850 serie 04.92 → 12.96

		i		←	→	Thread	Part Of	QPA	i
		↔		L27103		F 14x2 ⌀		1	3546268
				L27104		F 14x2 ⌀		1	3546267
				L27203	L27203	M 14x2 / M 14x1,5		2	3546266
				L27205	L27205	M 14x2 / M 16x1,5		2	9191410
			850 , ch. → 220743 850 , ch. → 120548 TRW, (code 4)	L27700				1	9140998
			TRW/CAM-gear	L27002	L27002			2	271601
		↓	850 , ch. → 131536 850 , ch. → 37527 (-) L 27503 / 27504	L27500	L27500			2	3546524
		↓	850 , ch. 131537 → <input checked="" type="checkbox"/> 850 , ch. 37528 → (-)Diesel/AWD Diesel/AWD	L27503				1	8628496
				L27504				1	8628495
				L27507				1	8628498
				L27508				1	8628497
		↓ ▲ ▼		L27809	L27809		L27503/L27504	4	271631
				L27601	L27601			2	1387860
				L27808	L27808		Anti-roll bar	2	3546730
			KIT	MK141	MK141			2	3546189
		↑		MK243	MK243			2	8646713
		↔	(-) AWD	L27814	L27814		Hub carrier	2	
		→ ←	(-) AWD		L27813		Hub carrier	1	3516496
				L27824			Hub carrier	1	3530202
			(-) Nivomat	MK134	MK134			2	3516151

940 I / II serie 08.90 → 10.98

960 I serie 08.90 → 07.94

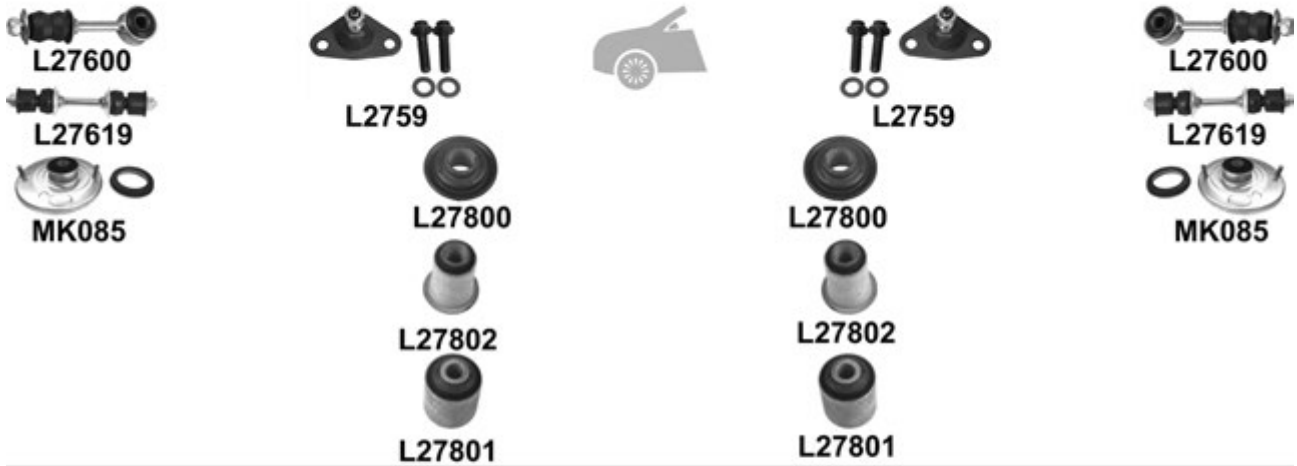

		i		←	→	Thread	Part Of	QPA	i
		↔		L2751	L2751	F 14x2 ∪		2	3516944
				L27202	L27202	M 14x2 / M 14x1,5		2	9140504
		↓		L2759	L2759			2	271758
		↓ ▲	HD	L27800	L27800			4	1359599
		↓ ▼		L27802	L27802			2	1273235
			Steel Track control arm	L27600	L27600			2	9157725
			ALU Track control arm	L27619	L27619			2	1329395
				L27801	L27801		Trailing arm	2	1329655
			KIT	MK085	MK085			2	1387188
			(-) ∪	L27803	L27803			2	1330454
					L2719			1	1330427
				L2725				1	1330973
		▲	(-) ∪ longitudinal	L27804	L27804			2	1229608
		▼	(-) ∪ longitudinal	L27805	L27805			2	1272306

960 II serie 08.94 → 12.96

VOLVO



				←	→	Thread	Part Of	QPA		
		↔			L27103	F 14x2 ♂		1	3546268	
				L27104		F 14x2 ♂		1	3546267	
		⊥		L2759	L2759			2	271758	
				L27513				1	272341	
				L27514				1	272340	
				L27831	L27831			2	9191537	
			L27611	L27611			2	9492837		

ZASTAVA

101 1969 →

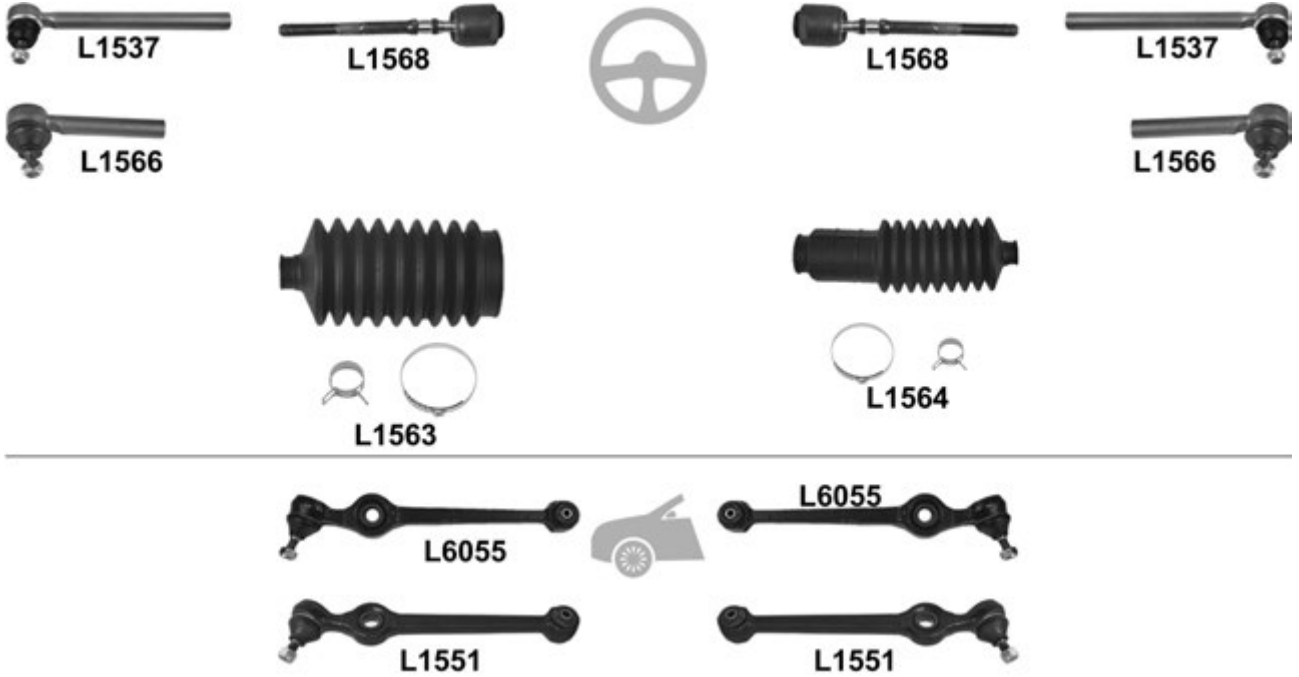

						←	→	Thread	Part Of	QPA	
		↔	→ 03.78		L1537	L1537	F 14x1 U		2	4254278	
			04.78 →		L1566	L1566	F 12x1,5 U		2	5983406	
			04.78 →		L1568	L1568	M 12x1,5 / F 14x1,5 U		2	5960321	
							L1564			1	
					L1563				1		
		⊥	→ 03.78	<input checked="" type="checkbox"/>	L6055	L6055			2	5882282	
			04.78 →		L1551	L1551			2	4402361	

Warranty Terms

(valid in Europe only)

**MONROE® Europe warrants the listed
MONROE® products to the original retail purchaser
against functional and/or material defects:**



MONROE® Quick-Strut
MONROE® Reflex
MONROE® Springs
MONROE® CVSA
Continuously Variable Semi-Active Suspension



MONROE® Adventure
MONROE® Gas-Magnum
MONROE® Level-Light
MONROE® Load-Leveler
MONROE® Magic Camber
MONROE® Magnum
MONROE® Max Lift
MONROE® Mounting Kit

MONROE® Original
MONROE® Protection Kit
MONROE® Ride-Leveler
MONROE® Sensa-Trac
MONROE® Spheres
MONROE® Suspension parts
MONROE® Van-Magnum

MONROE® Europe provides a 2 year warranty without mileage limitation.
(3 year warranty for MONROE® Reflex, MONROE® Quick-Strut, MONROE® Springs)
The Warranty of MONROE® Europe is limited to the delivery of a new MONROE® product.
All claims are first handled by the MONROE® distributor and then honoured by MONROE®.

The reseller/installer will provide the MONROE® distributor with all relevant information such as:

- consumer's name and address
- fitting or sales dates
- MONROE® product part number
- vehicle identification data
- proof of purchase documents
- description of the defect.

Excluded from warranty are:

1. Regular wear-out.
2. MONROE® products fitted contrary to application information in the MONROE® catalogue or its subsequent amendments.
3. MONROE® products which have been modified or damaged by incorrect mounting or incorrect use of the vehicle, contrary to the car manufacturers' specifications or MONROE®'s.
4. MONROE® products damaged by mounting on another car than indicated in the MONROE® catalogue or its subsequent amendments.
5. Shock absorbers with damaged piston rod or damaged oil seal due to holding the piston rod with a wrench or pliers instead of the correct tool.
6. Premature wear-out caused by re-use of damaged mounting parts such as: rubber dirt shields, damaged bump stops, etc.
7. Damages caused by an accident.
8. MONROE® products damaged while used in rally or racing sports.
9. Ride-Levelers with air sleeve abrasion caused by incorrect mounting.
10. Reconditioned or recycled MONROE® products.
11. Defects caused by lack of maintenance or maintenance wrongly executed on the vehicle.

In addition: All MONROE® products are developed and manufactured according to original suspension specifications from car manufacturers. MONROE® indicates in its catalogue the originally lowered models on which its products fit.

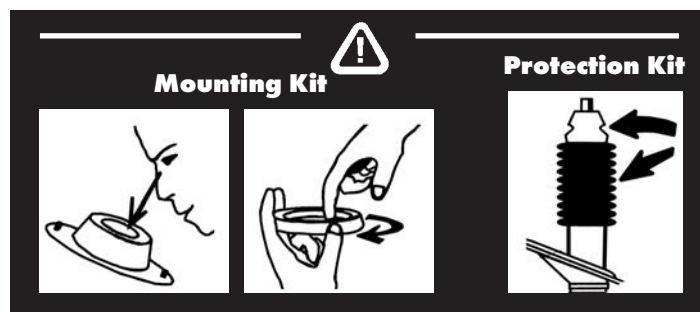
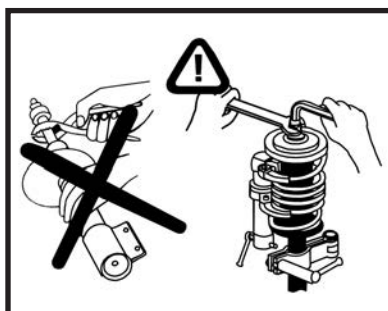

MONROE

SUSPENSION



SHOCK ABSORBERS - SPRINGS - SPHERES - GAS SPRINGS

FULL SUSPENSION OFFER

MOUNTING KITS - PROTECTION KITS - SUSPENSION PARTS

