

ORACLE[®]

LIGHTING CATALOG

2016



ORACLE
LIGHTING

ABOUT US...

Since 1999 ORACLE Lighting has been developing custom lighting solutions using the latest in CCFL, Xenon, LED, SMD, and COB Lighting Technology. Our staff is not only trained on basic product knowledge, but also to understand the processes in which our products are built, the principals of how they operate, and the proper technique of installation.

Since we specialize in lighting (and only lighting) we are always happy to spend that extra bit of time explaining the principals of lighting and helping our customers understand what separates our products from some of the others out there.

For the past SIX years consecutively INC Magazine has listed ORACLE Lighting as one of the fastest growing privately held companies in the entire United States on the Inc.500-5000 List.

In 2012 ORACLE Lighting received a bronze American Business Award for "Consumer Products Company" of the year. In 2013 we were named "Small Business of the Year" by JEDCO, named "Exporter of the Year" by the U.S. Small Business Administration, and named a "Small Business Champion" by the U.S. Senate Committee for Small Business and Entrepreneurship awarded by the Committee Chair; Senator Mary Landrieu.

The resolute principals and solid foundation on which this company was founded has allowed organic growth at a rapid pace, yet we have always stressed that we can only be successful by delivering quality products at fair prices and respecting our customer base. We have recently elevated our own standards when, in 2012, we made a commitment to use only USA made LED chips in our Solid-State products. LEDs Made in the USA have higher lumen efficiency, are more dependable, and have a longer overall lifespan. We are committed to exceeding our customers' expectations & staying on the cutting edge of lighting technology.



© 2015, Oracle Lighting. All rights reserved.



ACCOLADES...



THE AMERICAN
BUSINESS AWARDS

2012 BRONZE AWARD RECIPIENT
CONSUMER PRODUCTS COMPANY OF THE YEAR

U.S. Small Business Administration

SBA

EXPORTER OF THE YEAR
2013 AWARD WINNER - LA

Inc.500
2010

Inc.5000
2011

Inc.5000
2012

Inc.5000
2013

Inc.5000
2014

Inc.5000
2015



2013



2014



2015



ON THE COVER...

As seen in our Booth at the 2014 SEMA Show, this year's cover car is the ORACLE Lighting Ultima GTR. This British Supercar is in rare Race-Spec trim with a notably sparse interior and aggressive aero which creates excellent downforce but is not ideal for street driving. The Ultima is powered by a Porsche Twin-Turbo Flat 6 which puts the power to the ground through a Porsche 930 gearbox. This air-cooled setup puts down approximately 600HP to the 335 wide rear Hoosier racing slicks mounted on custom 3-piece Kinesis wheels.

Obviously this vehicle had to show off plenty of ORACLE Lighting accessories so we outfitted it with Quad-SMD-Halo Headlights, Interior Illumination, LED Engine Bay Illumination, Custom LED Tail Lights, and much more. The car looks amazing sitting still but even more impressive racing around the track at night!!

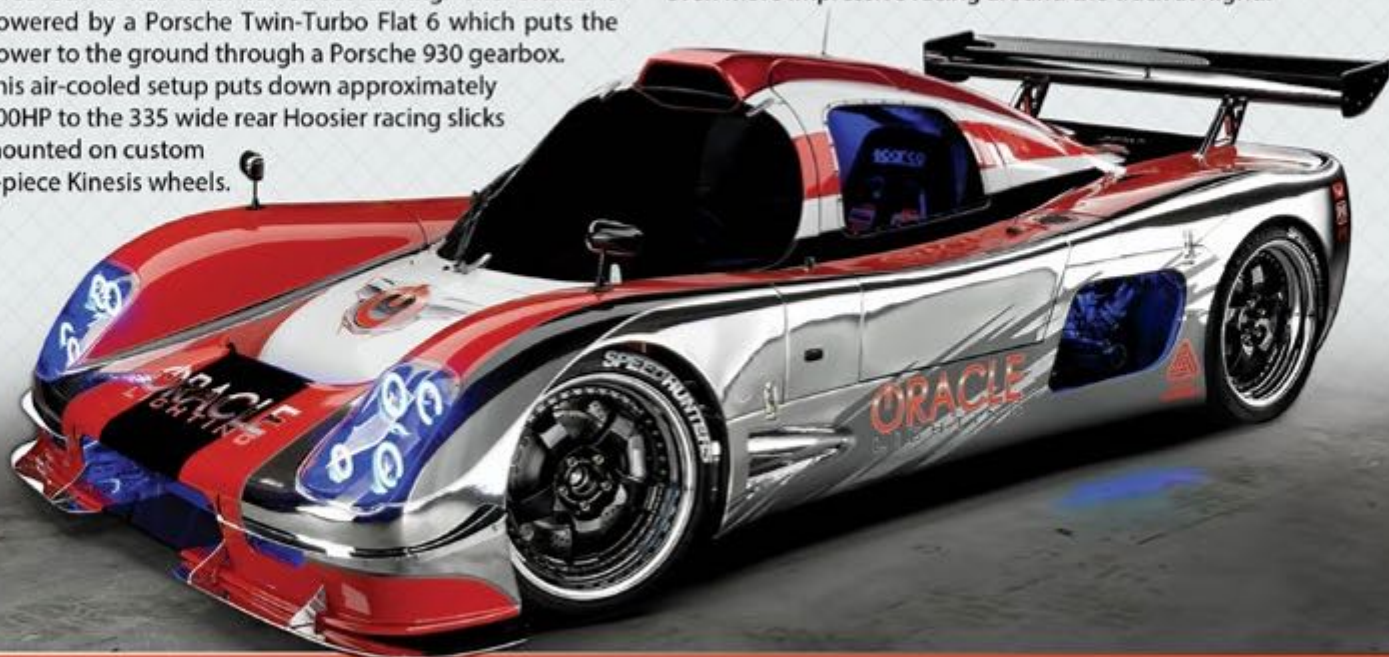

HIGH POWERED FLASHLIGHTS

24X-9 TRUE XENON FLASHLIGHT

Compact 9 inch 24 Watt Xenon Flashlight from ORACLE Lighting Technologies! The same HID lighting that ORACLE is famous for is now available in a compact, hand held flashlight. The ORACLE 24X-9 compact design incorporates all the necessary components of the High Intensity Discharge system such as the Xenon Bulb, Digital Ballast, Lithium Power Pack, and HID Igniter into a 9 inch all aluminum body. This rugged flashlight carries an IPX3 Waterproof Rating and an Unconditional 1 Year Warranty.

- Ballast Current: AC
- Kelvin: 6000K
- Brightness 2200 Lumens
- Output 24W Xenon
- Operating Time: 60 min
- Bulb Lifetime: 50,000 hrs
- Battery Life: 500+ Cycles
- Waterproof Rating: 1PX3
- 1 Year Warranty

- Accessories:
- Professional Hard Case
 - Lithium ION Battery Pack
 - AC (Home) Charger
 - Built in LED Flashlight
 - DC (Car) Charger
 - Green Halo Locator Ring



Part# 8004



Part# 8001

HANDHELD LED WORK LIGHT

The ORACLE 97 LED Handheld Work Light is designed to provide flexible lighting for either work or recreation. It has a rechargeable battery and can be used as a handheld light or as a stand-alone light source. Adjustable magnets, allow the light to be placed in versatile areas. Rechargeable LITHIUM Battery Lasts several hours on a single charge. Heavy duty rubberized construction is extremely durable.

- Part# 1006
- Operating Voltage: 12V DC
 - Brightness: 1,785 Lumens
 - Size: 13.5" x 7" x 1.75"
 - Color Temperature: 6000K
 - Lifetime: 50,000 hrs
 - Water Resistant
 - Wall Charger Included
 - Car Charger Included
 - 500 Cycle Rechargeable
 - 2 Year Warranty



DESCRIPTION	PART#	LUMENS	BATTERY LIFE	LIFETIME	WARRANTY
24X-9 HID FLASHLIGHT - SILVER	8001	2,200LM	500+ CYCLE RECHARGES	50,000 HRS	1 YEAR
24X-9 HID FLASHLIGHT - BLACK	8004	2,200LM	500+ CYCLE RECHARGES	50,000 HRS	1 YEAR
HANDHELD LED WORK LIGHT	1006	1,785LM	500+ CYCLE RECHARGES	50,000 HRS	2 YEAR

Z TACTICAL LED FLASHLIGHT

The ORACLE Lighting Technology Z flashlights provide a bright, focused beam with a wide and long lighting range. Intense brightness, long lighting time, waterproof and reliability are the characteristics of all ORACLE Lighting brand flashlights. With such high-intensity and solid design, the ORACLE Lighting Technology Z flashlight is perfect for outdoor rescue and exploration, and meets the demands of lighting in any harsh condition or climate.

Part# 1003

- Cree XRE 3W LED (Made in the U.S.A.)
- 225 Lumen Output
- IP67 Waterproof Rating
- Specialized Optics
- Momentary On/Off Switch
- 860 Minute Runtime on Low Setting
- Throws Light More than 250 Meters
- 5 Light Modes: High/Low/Dim/SOS/Strobe
- Digitally Regulated Output
- Type III Anodized Aviation Aluminum
- Rechargeable Lithium Battery and Charger
- 1 Year Warranty



T6 TACTICAL LED FLASHLIGHT

The ORACLE Lighting Technology T6 flashlights provide a bright, focused beam with a wide and long lighting range. Intense brightness, long lighting time, waterproof and reliability are the characteristics of all ORACLE Lighting brand flashlights. With such high-intensity and solid design, the ORACLE Lighting Technology T6 flashlight is perfect for outdoor rescue and exploration, and meets the demands of lighting in any harsh condition or climate.

Part# 1004

- Cree XML-T6 10W LED (Made in the U.S.A.)
- 900 Lumen Output
- IP67 Waterproof Rating
- Specialized Optics
- Momentary On/Off Switch
- 1200 Minute Runtime on Low Setting
- Throws Light More than 300 Meters
- 5 Light Modes: High/Low/Dim/SOS/Strobe
- Digitally Regulated Output
- Type III Anodized Aviation Aluminum
- Rechargeable Lithium Battery and Charger
- 1 Year Warranty



Q5 TACTICAL LED FLASHLIGHT

The ORACLE Lighting Technology Q5 flashlights provide a bright, focused beam with a wide and long lighting range. Intense brightness, long lighting time, waterproof and reliability are the characteristics of all ORACLE Lighting brand flashlights. With such high-intensity and solid design, the ORACLE Lighting Technology Q5 flashlight is perfect for outdoor rescue and exploration, and meets the demands of lighting in any harsh condition or climate.

Part# 1005

- Cree XRE 3W LED (Made in the U.S.A.)
- 350 Lumen Output
- IP67 Waterproof Rating
- Dual Battery for Extended Runtime
- Momentary On/Off Switch
- 2000 Minute Runtime on Low Setting
- Throws Light More than 500 Meters
- 5 light modes: High/Low/Dim/SOS/Strobe
- Digitally Regulated Output
- Type III Anodized Aviation Aluminum
- Rechargeable Lithium Battery and Charger
- 1 Year Warranty



DESCRIPTION	PART#	LUMENS	WATTS	BEAM DISTANCE	WARRANTY
Z TACTICAL LED FLASHLIGHT	1003	225	3W	250 METERS	1 YEAR
T6 TACTICAL LED FLASHLIGHT	1004	900	10W	300 METERS	1 YEAR
Q5 TACTICAL LED FLASHLIGHT	1005	350	3W	500 METERS	1 YEAR

LED FLOOD LIGHTS

These new Slim-Design LED Floodlights are rugged enough for use Indoors or Outdoors. This is the perfect solution for energy efficient and economical Security Lighting, Warehouse Lighting, Up-Lighting, Landscape Lighting, or Task Lighting. Each size is available in Warm White (2700K-3000K) or Pure White (4000K-4300K)



ORACLE Indoor / Outdoor, energy efficient LED Floodlights contain an internal LED Driver and delivers an immense amount of light for a such small fixture. These floodlights are highly versatile with minimized power consumption and heat output compared to halogen or sodium lights. These floodlights can be upgraded with a motion sensor or garden stake for foliage lighting. Aluminum housing is designed to be weatherproof and fire resistant.

Designed for use indoors and outdoors these highly efficient floodlights are an excellent replacement for security lighting, halogen floodlights, sodium floodlights, or for landscape lighting. LED lamps do not put out heat while halogen can become extremely hot allowing for possible injury. Rated for wet conditions and shockproof.



Photometric (.IES) files can be provided upon request.

Ground stakes and motion sensors are also available.





10W FLOOD
Part# 9045

20W FLOOD
Part# 9046

30W FLOOD
Part# 9047

50W FLOOD
Part# 9048

100W FLOOD
Part# 9050

Color Suffix
 -000 : 2700K-3000K
 -001 : 4000K-4300K

LED SHOP LIGHTS

LED Shop lights have many advantages over traditional halogen work lights. The LED versions are 10x as efficient as halogen, this means a 30W LED light would be equivalent to a 300W Halogen, that is some serious energy savings! LED shop lights also put out no heat which makes for a much more comfortable working environment.



10W SHOP LIGHT
Part# 2049

30W SHOP LIGHT
Part# 2049

50W SHOP LIGHT
Part# 2049



TELESCOPIC STANDS
 Available in single and dual setups.
 Compatible with the following:
 • 10W Flood Lights
 • 20W Flood Lights
 • 30W Flood Lights
 • 50W Flood Lights

DESCRIPTION	PART#	MAX LUMEN OUTPUT	WATERPROOF RATING	WARRANTY
10W LED FLOODLIGHT	9045-000	850 LM	IP67	3 YEAR
10W LED FLOODLIGHT	9045-001	850 LM	IP67	3 YEAR
20W LED FLOODLIGHT	9046-000	1,700 LM	IP67	3 YEAR
20W LED FLOODLIGHT	9046-001	1,700 LM	IP67	3 YEAR
30W LED FLOODLIGHT	9047-000	2,550 LM	IP67	3 YEAR
30W LED FLOODLIGHT	9047-001	2,550 LM	IP67	3 YEAR
50W LED FLOODLIGHT	9048-000	4,250 LM	IP67	3 YEAR
50W LED FLOODLIGHT	9048-001	4,250 LM	IP67	3 YEAR
100W LED FLOODLIGHT	9050-000	8,500 LM	IP67	3 YEAR
100W LED FLOODLIGHT	9050-001	8,500 LM	IP67	3 YEAR
10W LED SHOP LIGHT W/ PORTABLE HANDLE	9010-001	850 LM	IP67	3 YEAR
30W LED SHOP LIGHT W/ PORTABLE HANDLE	9011-001	2,550 LM	IP67	3 YEAR
50W LED SHOP LIGHT W/ PORTABLE HANDLE	9012-001	4,250 LM	IP67	3 YEAR
10W LED SHOP LIGHT W/ TELESCOPIC STAND	9013-001	850 LM	IP67	3 YEAR
20W LED SHOP LIGHT W/ TELESCOPIC STAND	9014-001	1,700 LM	IP67	3 YEAR
30W LED SHOP LIGHT W/ TELESCOPIC STAND	9015-001	2,550 LM	IP67	3 YEAR
50W LED SHOP LIGHT W/ TELESCOPIC STAND	9073-001	4,250 LM	IP67	3 YEAR
10W LED SHOP LIGHTS W/ DUAL CROSS BAR STAND	9016-001	1,700 LM	IP67	3 YEAR
20W LED SHOP LIGHTS W/ DUAL CROSS BAR STAND	9017-001	3,400 LM	IP67	3 YEAR
30W LED SHOP LIGHTS W/ DUAL CROSS BAR STAND	9078-001	5,100 LM	IP67	3 YEAR
50W LED SHOP LIGHTS W/ DUAL CROSS BAR STAND	9079-001	8,500 LM	IP67	3 YEAR

PRODUCT INSTALLATION AIDS

ORACLE Lighting now offers quality wiring specifically for LED lighting projects. The conductor material in this wire is made from high-purity oxygen free copper (OFC), which is recognized as one of Earth's finest conductive metals. This is to insure the best connections for your lighting projects that will last for years without corrosion or eventual degradation of the copper conductor. This is the same type of cable we use in manufacturing ORACLE Halo Rings.

20AWG 2-CONDUCTOR INSTALLATION WIRE



Part# 2005

- High Performing Cable
- Oxygen-Free Copper (OFC)
- Ideal for Single Color LEDs
- Sold by the Ft. or by the Spool
- 20AWG

This 20AWG 2-Conductor wire is the same cable used in the manufacturing of ORACLE SMD Halo Rings.



22AWG 4-CONDUCTOR INSTALLATION WIRE



Part# 2006

- High Performing Cable
- Oxygen-Free Copper (OFC)
- Ideal for ColorSHIFT LEDs
- Sold by the Ft. or by the Spool
- 4 Conductor
- 22 AWG

This 22AWG 4-Conductor wire is the same cable used in the manufacturing of ORACLE ColorSHIFT Halo Rings.



ORACLE's new Premium Headlight Sealant, the first commercially available adhesive specifically formulated for automotive headlight sealing applications. The ORACLE Adhesive line features products designed to help with the ease of installation for technicians installing ORACLE lighting products. The Premium Headlight Sealant is a formulated RTV (Room-Temperature-Vulcanizing) Waterproof Silicone Sealant with Low Out-Gassing designed for use in reassembling automotive lamp housings. The sealant has a tack time of 30 minutes and soft-cures in 3 hours, note 8 hours is recommended to insure a full cure.

HEADLIGHT SEALANT - SINGLE BOTTLE

Part# 1999

- Single 10fl OZ Tube
- Premium Black Silicone
- Becomes Tack Free in 30 Minutes
- Specifically Formulated for Sealing Headlights
- Re-usable Applicator
- Room Temperature Vulcanizing
- Use Proper Safety Protection with this Product



ISO 9001:2008

Quality Management System Certificate

ISO 14001

International Environmental Management System Certificate

HEADLIGHT SEALANT - CASE OF 24

Part# 2001

- Case of 24 Tubes
- Premium Black Silicone
- Becomes Tack Free in 30 Minutes
- Specifically Formulated for Sealing Headlights
- Re-usable Applicators
- Room Temperature Vulcanizing
- Use Proper Safety Protection with this Product



ISO 9001:2008

Quality Management System Certificate

ISO 14001

International Environmental Management System Certificate

DESCRIPTION	PART#	QUANTITY
20AWG 2-CONDUCTOR INSTALLATION WIRE - FT	2005-001	1 FT
20AWG 2-CONDUCTOR INSTALLATION WIRE - SPOOL	2005-504	328 FT
22AWG 4-CONDUCTOR INSTALLATION WIRE - FT	2006-001	1 FT
22AWG 4-CONDUCTOR INSTALLATION WIRE - SPOOL	2006-504	328 FT
PREMIUM HEADLIGHT SEALANT - SINGLE BOTTLE	1999-504	1 TUBE
PREMIUM HEADLIGHT SEALANT - CASE OF 24	2001-504	24 TUBES

REGULATED POWER SUPPLIES

ORACLE Lighting provides Premium LED Drivers and Power Supplies in many different amperages and wattages. From indoor to exterior water-proof drivers, each driver meets or exceeds federal regulations for power supply adapters and are RoHS compliant, FCC, CE Certified, and some cULus Classified.



12V 1A 12W POWER SUPPLY

- Part# 1604**
- Input: 100-240 VAC
 - Output: 12A / 12V DC Power
 - Frequency Range: 50-60 Hz
 - Size: 2.5" x 2.75" x 1"
 - Weight: 3oz
 - CE, RoHS, UL Certified
 - 2 Year Warranty



12V 5A 60W POWER SUPPLY

- Part# 1610**
- Input: 100-240 VAC
 - Output: 5A / 12V DC Power
 - Standard DC Power Plug
 - Size: 1.1" x 4.5" x 1.75"
 - Weight: 5.6 oz
 - CE, RoHS, UL Certified
 - 2 Year Warranty



12V 15A 80W POWER SUPPLY

- Part# 1606**
- Input: 110 VAC
 - Output: 15A / 12V DC Power
 - Waterproof: IP67 Rating
 - Frequency Range: 50-60 Hz
 - Size: 7.75" x 3.8" x 1.8"
 - Weight: 2 lb 3 oz
 - CE, RoHS, UL Certified
 - 2 Year Warranty



12V 17A 204W POWER SUPPLY

- Part# 1616**
- Input: 110 VAC
 - Output: 17A / 12V DC Power
 - Waterproof: IP67 Rating
 - Frequency Range: 50-60 Hz
 - Size: 8.5" x 4.75" x 2"
 - Weight: 5 lb 1.6 oz
 - CE, RoHS Certified
 - 2 Year Warranty



12V 12A 144W POWER SUPPLY

- Part# 1602**
- Input: 110 VAC
 - Output: 12A / 12V DC Power
 - Frequency Range: 47-63 Hz
 - Size: 6.25" x 4" x 1.5"
 - Weight: 1 lb 3 oz
 - CE, RoHS Certified
 - 2 Year Warranty



12V 20A 240W POWER SUPPLY

- Part# 1607**
- Input: 100-220 VAC
 - Output: 20A / 12V DC Power
 - Frequency Range: 47-63 Hz
 - Size: 8.5" x 4.5" x 2.5"
 - Weight: 1 lb 14.8 oz
 - CE, RoHS Certified
 - 2 Year Warranty



12V 30A 360W POWER SUPPLY

- Part# 1603**
- Input: 110 VAC
 - Output: 30A / 12V DC Power
 - Frequency Range: 47-63 Hz
 - Size: 8.5" x 4.5" x 2"
 - Weight: 1 lb 4 oz
 - CE, RoHS, UL Certified
 - 2 Year Warranty



36V 10A 350W POWER SUPPLY

- Part# 1626**
- Input: 110 VAC
 - Output: 10A / 36V DC Power
 - Frequency Range: 47-63 Hz
 - Size: 9" x 4.5" x 2"
 - Weight: 1 lb 4 oz
 - CE, RoHS, UL Certified
 - 2 Year Warranty



DESCRIPTION	PART#	INPUT VOLTAGE	OUTPUT VOLTAGE	CERTIFICATIONS	WARRANTY
12V 1A 12W POWER SUPPLY	1604	100-240 VAC	12A/12V DC	ROHS, FCC, CE, CULUS CLASSIFIED	2 YEAR
12V 5A 60W POWER SUPPLY	1610	100-240 VAC	5A/12V DC	ROHS, FCC, CE, CULUS CLASSIFIED	2 YEAR
12V 15A 80W POWER SUPPLY	1606	110 VAC	15A/12V DC	ROHS, FCC, CE, CULUS CLASSIFIED	2 YEAR
12V 17A 204W POWER SUPPLY	1616	110 VAC	17A/12V DC	ROHS, FCC, CE, CLASSIFIED	2 YEAR
12V 12A 144W POWER SUPPLY	1602	110 VAC	12A/12V DC	ROHS, FCC, CE, CLASSIFIED	2 YEAR
12V 20A 240W POWER SUPPLY	1607	100-240 VAC	20A/12V DC	ROHS, FCC, CE, CLASSIFIED	2 YEAR
12V 30A 360W POWER SUPPLY	1603	110 VAC	30A/12V DC	ROHS, FCC, CE, CULUS CLASSIFIED	2 YEAR
36V 10A 350W POWER SUPPLY	1626	110 VAC	10A/36V DC	ROHS, FCC, CE, CULUS CLASSIFIED	2 YEAR

FLUSH MOUNT LED SWITCHES

PREWIRED ON/OFF FLUSH MOUNT LED SWITCHES

These great looking flush latching On/Off switches allows you to add a switch to your vehicle interior without compromising your automotive style. Mechanical Lifetime is tested at over 200,000 fail free duty cycles. Each switch features heavy-duty brass assemblies and durable nickel-plated finishes and the metal housings have a definitive click you can feel when engaged.

- Pre-wired Adapter
- 12 Volt Powered
- Rating: 3A
- Requires 16MM Mounting Hole
- CE Compliant
- Glowing Ring when activated
- Mounts flush
- Heavy Duty Brass Assembly
- Durable Nickel Plated Finish



PREWIRED MOMENTARY FLUSH MOUNT LED SWITCHES

These great looking flush button momentary switches (momentary contact ie: a horn, trunk release, or nitrous purge button) allows you to add a switch to your vehicle interior without compromising your automotive style. Mechanical Lifetime is tested at over 200,000 fail free duty cycles.

- Pre-wired Adapter
- 12 Volt Powered
- Rating: 3A
- Requires 16MM Mounting Hole
- CE Compliant
- Glowing Ring when activated
- Mounts flush
- Heavy Duty Brass Assembly
- Durable Nickel Plated Finish



PREWIRED POWER SYMBOL ON/OFF FLUSH MOUNT LED SWITCHES

Take your interior to the next level with ORACLE Illuminated Flush Switches! The NEW flush mount LED switches now incorporate the power (ORACLE) symbol on each switch to give you a sophisticated style. Each switch features heavy-duty brass assemblies and durable nickel-plated finishes and the metal housings have a definitive "click" you can feel when engaged.

- Pre-wired Adapter
- 12 Volt Powered
- Rating: 3A
- Requires 16MM Mounting Hole
- CE Compliant
- Glowing Power Symbol when on
- Mounts flush
- Heavy Duty Brass Assembly
- Durable Nickel Plated Finish



PREWIRED POWER SYMBOL MOMENTARY FLUSH MOUNT LED SWITCHES

Take your interior to the next level with ORACLE Illuminated Flush Switches! The NEW flush mount LED switches now incorporate the power (ORACLE) symbol on each switch to give you a sophisticated style. Each switch features heavy-duty brass assemblies and durable nickel-plated finishes and the metal housings have a definitive "click" you can feel when engaged.

- Pre-wired Adapter
- 12 Volt Powered
- Rating: 3A
- Requires 16MM Mounting Hole
- CE Compliant
- Glowing Power Symbol when on
- Mounts flush
- Heavy Duty Brass Assembly
- Durable Nickel Plated Finish



DESCRIPTION	OUTPUT RATING	VOLTAGE	TERMINAL	ASSEMBLY	WARRANTY
ON/OFF FLUSH MOUNT SWITCH	3 AMPS	12 VOLTS	5 PIN	HEAVY DUTY BRASS	LIFETIME
MOMENTARY FLUSH MOUNT SWITCH	3 AMPS	12 VOLTS	5 PIN	HEAVY DUTY BRASS	LIFETIME
POWER SYMBOL ON/OFF FLUSH MOUNT SWITCH	3 AMPS	12 VOLTS	5 PIN	HEAVY DUTY BRASS	LIFETIME
POWER SYMBOL MOMENTARY FLUSH MOUNT SWITCH	3 AMPS	12 VOLTS	5 PIN	HEAVY DUTY BRASS	LIFETIME

WIRED LED CONTROLLERS

ORACLE LED Controllers allow you to take your LED lighting to the next level with a variety of functions and features. We offer a wide range of different types of controllers to fit just about any project or application. These controllers also make installation easier by simplifying the wiring process and creating a common junction.

IN-LINE LED CONTROLLER

Part# 1710

- Input: 8-16V DC
- Max load current: 12 Amps
- Output: 1 channel
- Output Power: 144 Watts
- Dynamic Modes: 5
- Levels of Control: 256
- Levels of Speed: 6
- Levels of Brightness: 8



IN-LINE RGB CONTROLLER

Part# 1614

- Input: 8-16V DC
- Max load current: 12 Amps
- Output: 3 channels
- Output Power: 144 Watts
- Dynamic Modes: 5
- Levels of Control: 256
- Levels of Speed: 6
- Levels of Brightness: 8



IN-LINE AMPLIFIER

Part# 1615

- Input: 8-16V DC
- Max load current: 12 Amps
- Output: 3 channels
- Output Power: 144 Watts
- Function: Amplifier allows user to surpass a LED Controller's Output Rating.



SIMPLE RGB LED CONTROLLER

Part# 1612

- Input: 9-16V DC
- 4 Amps/channel
- Output: 3 channels
- Output Power: 144 Watts
- Wireless IR Remote Control
- Auto Save Function



LED DIMMER SWITCH

Part# 1708

- Input: 12-24V DC
- Max load current: 8 Amps
- Output: 1 channel
- Output Power: 100 Watts
- Function: Dim LEDs from 01%-100% brightness.



LED PIR MOTION SENSOR

Part# 1618

- Input: 12-24V DC
- Max load current: 8 Amps
- Output: 1 channel
- Output Power: 100 Watts
- "Passive Infrared" Sensor
- Temperature Sensitive
- Activates LEDs when IR Motion is detected.



WALL PANEL SWITCH

Part# 1707

- Input: 9-16V DC
- 4 Amps/channel
- Output: 3 channels
- Output Power: 144 Watts
- Function: Control RGB LEDs with Wall Mounted Touch Panel.



RGB LED AMPLIFIER

Part# 1605

- Input: 8-16V DC
- 4 Amps/channel
- Output: 3 channels
- Output Power: 144 Watts
- Function: Amplifier allows user to surpass a LED Controller's maximum output rating.



DESCRIPTION	PART#	INPUT	OUTPUT RATING	OUTPUT CH.	WATTAGE	WARRANTY
IN-LINE LED CONTROLLER	1710	8-16V DC	12 AMPS	1 CHANNEL	144W	2 YEAR
IN-LINE RGB CONTROLLER	1614	8-16V DC	12 AMPS	3 CHANNELS	144W	2 YEAR
IN-LINE AMPLIFIER	1615	8-16V DC	12 AMPS	3 CHANNELS	144W	2 YEAR
SIMPLE RGB LED CONTROLLER	1612	9-16V DC	12 AMPS	3 CHANNELS	144W	2 YEAR
LED DIMMER SWITCH	1708	12-24V DC	8 AMPS	1 CHANNEL	100W	2 YEAR
LED PIR MOTION SENSOR	1618	12-24V DC	8 AMPS	1 CHANNEL	100W	2 YEAR
WALL PANEL SWITCH	1707	9-16V DC	12 AMPS	3 CHANNELS	144W	2 YEAR
RGB LED AMPLIFIER	1605	8-16V DC	12 AMPS	3 CHANNELS	144W	2 YEAR

WIRELESS LED CONTROLLERS

ORACLE Wireless LED Controllers allow you to take your LED lighting to the next level with a variety of functions and features. We offer a wide range of different types of controllers to fit just about any project or application. These controllers also make installation easier by simplifying the wiring process and creating a common junction.



SINGLE CHANNEL MULTIFUNCTION REMOTE

The ORACLE Multifunction Controller allows user to control several functions of one device. There is a 7-level Dimmer Function, Strobe Function, Breathing Function, and acts as a wireless On/Off switch.

Part# 1701

- Allows User to Control Several Functions of One Device Including: Dimmer, Strobe, Breathing, On/Off
- Metal Key FOB with Keypad Guard
- Can Be Programmed to Homelink
- Max Amp Rating: 8A
- Wireless Range: 100FT
- Anode Switched Device
- 1 Year Warranty



DUAL CHANNEL MULTIFUNCTION REMOTE

Featuring the same functions of the Single Channel Multifunction Controller (Strobe, Dim, Breathe) this controller features 2 separate output channels. This remote is great for Dual-Color Accessories.

Part# 1704

- Ideal for Dual Color LED accessories
- Allows User to Control Several Functions of Two Devices Including: Dimmer, Strobe, Breathing, On/Off
- Metal Key FOB with Keypad Guard
- Dual Output Channels "Zones"
- Can Be Programmed to Homelink
- Max Amp Rating: 8A (4A x 2CH)
- Wireless Range: 100FT
- 1 Year Warranty



COLORSHIFT MULTIFUNCTION REMOTE

The ORACLE ColorSHIFT® RGB LED Controller allows the user to select 10 different colors and a dozen different pre-programmed custom functions. Easy to install and use; budget friendly RGB controller.

Part# 1713

- Allows User to Control Several Functions of an RGB Device Including: Dimmer, Strobe, Breathing, On/Off, and Color Select
- Metal Key FOB with Keypad Guard
- Can Be Programmed to Homelink
- Max Amp Rating: 8A
- Wireless Range: 100FT
- Anode Switched Device
- 1 Year Warranty



MUSIC ACTIVATED LED CONTROLLER

The ORACLE Music/Sound Activated ColorSHIFT LED Controller has a new feature: to color-change to the sound and beat of music! This Controller still maintains the standard color-changing features with the option to respond to sounds.

Part# 1705

- Sounds Change Colors
- Adjustable Sensitivity
- 120W / 6A Output
- Works with all RGB LEDs
- Includes Wireless Remote
- Pre-Programmed Features
- 1 Year Warranty



COLORSHIFT V2.0 LED CONTROLLER

Integrated on board LED indicator displays what color the LEDs are set on at that time. The Powerful 18A output can control dozens of LED accessories. This controller can be programmed by the operator for an almost endless number of colors and functions and save to the units internal memory. Infrared wireless control pad included.

Part# 1706

- Over a Dozen Unique Pre-Programmed Color Patterns
- Precisely "Dial-in" the exact color LED the user desires.
- LED Preview Window Integrated into the Control Box
- 8 Memory Preset Slots to Save your Favorite Colors
- Powerful 18A Output (6A x 3CH) @12VDC
- Works with all RGB LEDs
- Includes Wireless Remote
- Includes Infrared Repeater
- Pre-Programmed Features
- 1 Year Warranty



SMART WIFI LED CONTROLLER

The new ORACLE Smart WiFi LED Controller offers plenty of versatility and RGB functionality. User can control various types of LED lighting products wirelessly with your smartphone or tablet. With a new smaller size, the controller module can now be installed in areas where space is limited. Now with over double the amount of functions as previous versions, the new ORACLE Smart WiFi LED Controller boasts a wider and more reliable WiFi signal.

Part# 9956

Controller Features:

- Supports both Apple products [iPad, iPhone] Android mobile devices [Smartphone, Tablet]
- 32 Pre-Programmed Color Changing Functions
- 8 DIY Programmable Modes- User can create and save
- Dial in any color you wish with the Color wheel/ Color Mixing option
- Design and save your own "Scenes." - Program multiple colors/ functions to a scene. Simply click the scene you've created and it will play through your designed steps.
- Operating System: Android 2.1 or above, IOS4.3 or above,
- App Memory Required: IOS[4.5MB], Android[4.2MB]
- RGB Color Change Mode: 32 Fixed Modes, 8 DIY Modes, 9 Scene Modes
- Communication Standard: 2.4GHz Wi-Fi, 802.11b/g/n Protocol
- Input Voltage: DC12V-DC24V
- Max Current Load: 4A×3CH : Max 12A
- Max Output Power: 144W/288W[12V/24V]
- Control Distance: Approx 328 ft.
- This App is Free to Download
- Dimension: 5.03" × 2.87" × 1.77"
- Package Size: 5.31" × 3.14 × 1.96"
- Weight: 11.11 oz



WiFi Expandable RF Remote Controller

Part# 9959

- Control your WiFi device with an easy to use RF remote.
- Has ability to switch between multiple zones.
- Control distance : 100 Feet
- Sync/zones (10 zones)control



WiFi Expandable RF Receiver

Part# 9958

- Supports up to 12 zones, increasing the signal distance to control multiple LED accessories from one controller.
- DC5V-DC24V
- Max 6A×3CH 18A @12VDC

DESCRIPTION	PART#	SIGNAL INTERFACE	LED DEVICES	WARRANTY
SINGLE CHANNEL MULTIFUNCTION REMOTE	1701	RF	SINGLE COLOR	1 YEAR
DUAL CHANNEL MULTIFUNCTION REMOTE	1704	RF	SINGLE COLOR	1 YEAR
COLORSHIFT MULTIFUNCTION REMOTE	1713	RF	RGB COLOR	1 YEAR
MUSIC ACTIVATED LED CONTROLLER	1705	IR	SINGLE COLOR/RGB COLOR	1 YEAR
COLORSHIFT V2.0 LED CONTROLLER	1706	IR	SINGLE COLOR/RGB COLOR	1 YEAR
SMART WIFI LED CONTROLLER	9956	WIFI	SINGLE COLOR/RGB COLOR	1 YEAR
MULTI-ZONE RF REMOTE CONTROLLER	9959	RF	SINGLE COLOR/RGB COLOR	1 YEAR
MULTI-ZONE RECEIVER	9958	RF	SINGLE COLOR/RGB COLOR	1 YEAR

REPLACEMENT DRL CIRCUIT BOARDS

Direct-Replacement DRL Circuit Boards from ORACLE Lighting allow you to easily change your factory Daytime Running Light (DRL) to ORACLE ColorSHIFT® Lighting. These Circuit Boards are controlled by one of our remote systems to produce any color the user wishes. Depending on the controller option selected; the lights can make hundreds of different colors, dozens of patterns, control the brightness, and even the speed of the functions as well! Installation is relatively simple, unscrew the factory LED Circuit Boards and install the ORACLE ColorSHIFT® Circuit Boards in place. More vehicle options will be available soon!



2014-15 CHEVY CAMARO RS
Part# 2622



2014-15 CHEVY CORVETTE C7
Part# 2624



2014-15 DODGE CHARGER
Part# 2394



2015 FORD F-150
Part# 2395



2014-15 GMC SIERRA
Part# 2450

ORACLE LIGHTING HALO KITS

Halo Technology Comparison:



ORACLE CCFL Halo Kits use Cold Cathode Fluorescent Lighting "XE" Technology which delivers a smooth and even halo illumination. Our new "XE" rings are thicker and more sturdy than traditional CCFL tubes making them brighter and more durable. The new "XE" CCFL Inverters also feature a newer updated design.

CCFL is a Phosphor-coated glass tube which illuminates when a current is passed through it. The current is input on both ends of the ring and has no polarity. CCFL Halos have an expected lifetime of 50,000 hours of continuous use and come with a LIFETIME WARRANTY.

CCFL Halos require an external power supply. ORACLE "XE" Power Inverters are included standard in every CCFL Halo Kit system we sell.

- Material: Phosphor-Coated Glass Tube
- Life: 50,000 Hours of Continuous Use.
- Light: Ambient Light Glow
- Warranty: LIFETIME
- Output: Smooth Output



ORACLE SMD Halos use a special type of LED: "Surface Mount Diode". SMD is an advanced type of LED chip that can produce bright/brilliant light output while only consuming a very small amount of power. The SMD chips are installed onto a CAD designed 6 Layer PCB (Printed Circuit Board) which is very sturdy and will not break if pressured.

The PCB design can easily be mounted to a headlight housing using the 3M self adhesive tape backing.

ORACLE SMD Halos are available in the "ColorSHIFT" option which uses 5050 RGB tri-node SMD LEDs that allow you to easily change the SMD Halo to any color the user wishes via the included wireless controller.

- Material: Multi-Layer Printed Circuit Board
- Life: 60,000 Hours of Continuous Use.
- Light: Intense Light Glow
- Warranty: LIFETIME
- Output: Bright Output



Plasma Halo™ Rings are the latest advancement in solid-state LED Lighting Technology. These new Plasma Halos™ features Chip-On-Board (COB) design where hundreds of semiconductors make direct contact to the circuit board essentially turning the entire circuit board into the luminaire.

Due to the small size of the LED chip, COB technology allows for a much higher packing density than SMD. This results in higher intensity & greater uniformity for the user.

This design makes for optimal thermal management, high packing density (no spaces), and overall high-performance light output. This new Plasma LED™ technology is not only brighter than previous LED Halo rings, but it also features very consistent light output and appears as one solid ring rather than individual LEDs.

- Material: Chip-On-Board Circuit Board
- Life: 90,000 Hours of Continuous Use.
- Light: Intense Light Glow
- Warranty: LIFETIME
- Output: Smooth & Bright



ALL ORACLE HALO KITS ARE MANUFACTURED TO EXACTING STANDARDS AND FEATURE A LIFETIME WARRANTY.

HIGH OUTPUT LED HEADLIGHTS & FOGLIGHTS



7" HIGH POWERED LED HEADLIGHTS - BLACK BEZEL

Part# 5769

- Low Beam Wattage: 30W Normal/36W Max
- Low Beam Lumens: 2200 Lumens/3600 Raw Lumens
- High Beam Wattage: 40W Normal/48W Max
- High Beam Lumens: 3600 Lumens/4800 Raw Lumens
- Input Voltage of Light: 12-24V DC
- Input Voltage of Halo (If Included): 12V DC
- Current Draw: 2.50 Amps @ 12V DC / 1.30 Amps @ 24V DC

- Optional ORACLE Halo Rings Pre-Installed
- Die-Cast Housing with Corrosion Resistant Coating
- Heavy Duty Solid State Electronics
- Hard-coated Polycarbonate Lens
- Wide Beam Pattern with Sharp Cut-Off Line
- Easy Plug & Play Installation



Uses H4 or H13 Adapters - Included



Available Halo Color Options



CANbus Rectifiers for use in Late Model Vehicles ie: Wrangler JK - Included



7" HIGH POWERED LED HEADLIGHTS - CHROME BEZEL

Part# 5770

- Low Beam Wattage: 30W Normal/36W Max
- Low Beam Lumens: 2200 Lumens/3600 Raw Lumens
- High Beam Wattage: 40W Normal/48W Max
- High Beam Lumens: 3600 Lumens/4800 Raw Lumens
- Input Voltage of Light: 12-24V DC
- Input Voltage of Halo (If Included): 12V DC
- Current Draw: 2.50 Amps @ 12V DC / 1.30 Amps @ 24V DC

- Optional ORACLE Halo Rings Pre-Installed
- Die-Cast Housing with Corrosion Resistant Coating
- Heavy Duty Solid State Electronics
- Hard-coated Polycarbonate Lens
- Wide Beam Pattern with Sharp Cut-Off Line
- Easy Plug & Play Installation



Uses H4 or H13 Adapters - Included



Available Halo Color Options



CANbus Rectifiers for use in Late Model Vehicles ie: Wrangler JK - Included



7" 75W CREE LED REPLACEMENT HEADLIGHTS

Part# 5774

- Technology: 15 x 5W CREE LEDs
- Input Voltage: 9-32V DC
- Low Beam: 1800 Lumen @ 35 Watt
- High Beam: 3800 Lumen @ 75 Watt
- Color Temperature: 6000K
- Housing: Diecast Aluminum
- Lens: PC
- Lifetime: 50,000 Hours
- Full functioning Turn Signal and DRL

- No Warm Up - Instant On / Off
- Over / Under Voltage Protection
- Weight: 2 lb 1.8 oz
- Length: 7"
- Width: 7"
- Height: 3"
- Warranty: 2 Year
- Works with H13 or H4 Connections

Uses H4 or H13 Adapters - Included



CANbus Rectifiers for use in Late Model Vehicles ie: Wrangler JK - Included



HIGH POWERED LED FOG LIGHTS

Part# 5775

- Input Voltage (of light): 9-36V DC
- Input Voltage (of halo): 12V DC
- Wattage: 30W
- Raw Lumens: 3,000 lm
- Width: 120.65 mm
- Height: 120.65 mm
- Max Depth: 88.9 mm
- Current Draw: 2.0 Amps @ 12V DC

Fits: 2007-15 Jeep Wrangler, 2011-12 Jeep Grand Cherokee, 2011-14 Dodge Charger, 2011-14 Dodge Challenger

- Optional Premium ORACLE Halo Pre-installed
- Die-Cast Housing with Corrosion-Resistant Coating
- Heavy Duty Solid State Electronics
- Hard-coated PMMA Lens
- Industry's Leading Beam Pattern
- Easy Plug & Play Installation
- Superior Energy Efficiency



Uses H10, 9145, or 5202 Adapters - Included



Available Halo Color Options



PRE-ASSEMBLED SEALED BEAMS

5.75" PRE-ASSEMBLED SEALED BEAM - ROUND

Part# 6904

- Includes Pre-Installed ORACLE SMD Halo
- Quality Glass Lens Sealed Beam
- Composite Reflector Housing
- Accepts H4 Bulb (Sold Separately)
- 1 Year Full Replacement Warranty
- Fits Classic Cars, Trucks and Motorcycles
- Amber Halos can be used as Turn Signals
- Blue, Green and Red Intended for Show Only
- Easy Installation, Wire Directly to 12V Source



Available Halo Color Options



7" PRE-ASSEMBLED SEALED BEAM - ROUND

Part# 6905

- Includes Pre-Installed ORACLE SMD Halo
- Quality Glass Lens Sealed Beam
- Composite Reflector Housing
- Accepts H4 Bulb (Sold Separately)
- 1 Year Full Replacement Warranty
- Fits Classic Cars, Trucks and Motorcycles
- Amber Halos can be used as Turn Signals
- Blue, Green and Red Intended for Show Only
- Easy Installation, Wire Directly to 12V Source



Available Halo Color Options



4"X6" PRE-ASSEMBLED SEALED BEAM - SQUARE

Part# 6909

- Includes Pre-Installed ORACLE SMD Halo
- Quality Glass Lens Sealed Beam
- Composite Reflector Housing
- Accepts H4 Bulb (Sold Separately)
- 1 Year Full Replacement Warranty
- Fits Classic Cars, Trucks and Motorcycles
- Amber Halos can be used as Turn Signals
- Blue, Green and Red Intended for Show Only
- Easy Installation, Wire Directly to 12V Source



Available Halo Color Options



7"X6" PRE-ASSEMBLED SEALED BEAM - SQUARE

Part# 6908

- Includes Pre-Installed ORACLE SMD Halo
- Quality Glass Lens Sealed Beam
- Composite Reflector Housing
- Accepts H4 Bulb (Sold Separately)
- 1 Year Full Replacement Warranty
- Fits Classic Cars, Trucks and Motorcycles
- Amber Halos can be used as Turn Signals
- Blue, Green and Red Intended for Show Only
- Easy Installation, Wire Directly to 12V Source



Available Halo Color Options



DESCRIPTION

PART#

LENS TYPE

LIFETIME

WARRANTY

7" HIGH POWERED LED HEADLIGHTS - BLACK BEZEL	5769	POLYCARBONATE	50,000 HRS	2 YEAR
7" HIGH POWERED LED HEADLIGHTS - CHROME BEZEL	5770	POLYCARBONATE	50,000 HRS	2 YEAR
7" 75W CREE LED REPLACEMENT HEADLIGHTS	5774	POLYCARBONATE	50,000 HRS	2 YEAR
HIGH POWERED LED FOG LIGHTS	5775	PMMA	50,000 HRS	2 YEAR
5.75" PRE-ASSEMBLED SEALED BEAM - ROUND	6904	GLASS	50,000 HRS	1 YEAR
7" PRE-ASSEMBLED SEALED BEAM - ROUND	6905	GLASS	50,000 HRS	1 YEAR
4"X6" PRE-ASSEMBLED SEALED BEAM - SQUARE	6909	GLASS	50,000 HRS	1 YEAR
7"X6" PRE-ASSEMBLED SEALED BEAM - SQUARE	6908	GLASS	50,000 HRS	1 YEAR

LED SEALED BEAM HEADLIGHT REPLACEMENTS



These Full LED light housings are ideal for classic vehicles with Quad Head Lamps (5.75" or 4"x6") Producing a brilliant and reliable LED output while still maintaining the "Classic" look is the main advantage of these Easy-to-Install Lights.

- Advanced Optics for increased night visibility.
- Each light produces over 3,000 lumens.
- These lights have both High and Low Beam functions and only have a 3A power draw.

5.75" LED HEADLIGHT REPLACEMENTS

The ORACLE 5.75" Sealed Beam Headlamp is an LED Replacement Headlamp for any vehicle application requiring a 5.75" Headlamp. It features 12 high output, high intensity 3 Watt CREE LEDs (Made in the U.S.A.) totaling 36W per headlamp. Waterproof, and extremely durable, these headlamps are perfect for replacing simple halogens with more effective LEDs. This product has a 2 Year Manufacturer's Warranty as well as a plug and play design Factory H4 Plug and a high beam/low beam function.



Part# 6907

- Depth: 3.4"
- Each Light is 36W
- Over 3,000 lm Each
- CREE 3W LEDs
- 2 Year Warranty
- Plug and Play Install
- Replaces Classic 5.75" Sealed Beam Headlight
- 3 Amp Power Draw

Powered by



4" X 6" LED HEADLIGHT REPLACEMENTS

The 4" x 6" Sealed Beam Headlamp is an LED Replacement Headlamp for any vehicle application requiring a 4" x 6" Headlamp. It features 15 high output, high intensity 3 Watt, made in USA, CREE LEDs, totaling 45 Watts per headlamp. Waterproof, and extremely durable, these headlamps are perfect for replacing simple halogens with more effective LEDs. This product has a 2 Year Manufacturer's Warranty as well as a plug and play design Factory H4 Plug and a high beam/low beam function.



Part# 6906

- Depth: 4.2"
- Each Light is 45W
- Over 3,000 lm Each
- CREE 3W LEDs
- 2 Year Warranty
- Plug and Play Install
- Replaces Classic 4" x 6" Sealed Beam Headlight
- 3 Amp Power Draw

Powered by



DESCRIPTION	PART#	AMP DRAW	MAX WATTAGE	MAX LUMEN OUTPUT	WARRANTY
5.75" LED HEADLIGHT REPLACEMENTS	6907	3A	72W	6,000LM	2 YEAR
4" X 6" LED HEADLIGHT REPLACEMENTS	6906	3A	90W	6,000LM	2 YEAR

DODGE ILLUMINATED CROSSHAIRS

The ORACLE Lighting Illuminated Crosshairs are designed specifically for the 2011-'14 Dodge Charger, the 2013-'15 Dodge Dart, and the 2011-'13 Dodge Durango. This Electroluminescent (EL) Panels will fit into your factory grill and illuminate with a soft glow when powered on. Each insert includes a 3M adhesive backing for ease of installation and the EL Panel just needs a 12V power source to illuminate.

2011-'14 DODGE CHARGER ILLUMINATED GRILL CROSSHAIRS



- Part# 2042**
- Durable, Waterproof
 - Smooth Light Output
 - Appears as Matte Vinyl when deactivated.
 - 3M Adhesive Backing
 - Easy Connectivity
 - 12V DC Operation
 - Depth : .25mm
 - 1 Year Warranty

This product is not intended for on road use. It is intended for car show use.



2013-'15 DODGE DART ILLUMINATED GRILL CROSSHAIRS

- Part# 2042**
- Durable, Waterproof
 - Smooth Light Output
 - Appears as Matte Vinyl when deactivated.
 - 3M Adhesive Backing
 - Easy Connectivity
 - 12V DC Operation
 - Depth : .25mm
 - 1 Year Warranty

This product is not intended for on road use. It is intended for car show use.



2011-'13 DODGE DURANGO ILLUMINATED GRILL CROSSHAIRS

- Part# 2042**
- Durable, Waterproof
 - Smooth Light Output
 - Appears as Matte Vinyl when deactivated.
 - 3M Adhesive Backing
 - Easy Connectivity
 - 12V DC Operation
 - Depth : .25mm
 - 1 Year Warranty

This product is not intended for on road use. It is intended for car show use.



DESCRIPTION

DESCRIPTION	PART#	VOLTAGE	DEPTH	WARRANTY
2011+ DODGE CHARGER ILLUMINATED GRILL CROSSHAIRS - WHITE	5300-001	12V	.25MM	1 YEAR
2011+ DODGE CHARGER ILLUMINATED GRILL CROSSHAIRS - BLUE	5300-002	12V	.25MM	1 YEAR
2011+ DODGE CHARGER ILLUMINATED GRILL CROSSHAIRS - RED	5300-003	12V	.25MM	1 YEAR
2011+ DODGE CHARGER ILLUMINATED GRILL CROSSHAIRS - GREEN	5300-004	12V	.25MM	1 YEAR
2011+ DODGE CHARGER ILLUMINATED GRILL CROSSHAIRS - AMBER	5300-005	12V	.25MM	1 YEAR
2011+ DODGE CHARGER ILLUMINATED GRILL CROSSHAIRS - YELLOW	5300-006	12V	.25MM	1 YEAR
2011+ DODGE CHARGER ILLUMINATED GRILL CROSSHAIRS - UV/PURPLE	5300-007	12V	.25MM	1 YEAR
2013+ DODGE DART ILLUMINATED GRILL CROSSHAIRS - WHITE	5315-001	12V	.25MM	1 YEAR
2013+ DODGE DART ILLUMINATED GRILL CROSSHAIRS - BLUE	5315-002	12V	.25MM	1 YEAR
2013+ DODGE DART ILLUMINATED GRILL CROSSHAIRS - RED	5315-003	12V	.25MM	1 YEAR
2013+ DODGE DART ILLUMINATED GRILL CROSSHAIRS - GREEN	5315-004	12V	.25MM	1 YEAR
2013+ DODGE DART ILLUMINATED GRILL CROSSHAIRS - AMBER	5315-005	12V	.25MM	1 YEAR
2013+ DODGE DART ILLUMINATED GRILL CROSSHAIRS - YELLOW	5315-006	12V	.25MM	1 YEAR
2013+ DODGE DART ILLUMINATED GRILL CROSSHAIRS - UV/PURPLE	5315-007	12V	.25MM	1 YEAR
2011+ DODGE DURANGO ILLUMINATED GRILL CROSSHAIRS - WHITE	5300-001	12V	.25MM	1 YEAR
2011+ DODGE DURANGO ILLUMINATED GRILL CROSSHAIRS - BLUE	5316-002	12V	.25MM	1 YEAR
2011+ DODGE DURANGO ILLUMINATED GRILL CROSSHAIRS - RED	5316-003	12V	.25MM	1 YEAR
2011+ DODGE DURANGO ILLUMINATED GRILL CROSSHAIRS - GREEN	5316-004	12V	.25MM	1 YEAR
2011+ DODGE DURANGO ILLUMINATED GRILL CROSSHAIRS - AMBER	5316-005	12V	.25MM	1 YEAR
2011+ DODGE DURANGO ILLUMINATED GRILL CROSSHAIRS - YELLOW	5316-006	12V	.25MM	1 YEAR
2011+ DODGE DURANGO ILLUMINATED GRILL CROSSHAIRS - UV/PURPLE	5316-007	12V	.25MM	1 YEAR

LED FLOOD & SPOT PODS

LED FLOOD LIGHT PODS

The New ORACLE LED Flood Light Pods are an excellent light source for illuminating any detail of your custom project. You can use these as Trunk Lights, Amp Lighting, Under Hood Accent Lighting, or even Underbody Lighting! The solid aluminum housing contains a Super-Bright 1 Watt LED bulb with a wide 120 degree output.



Part# 1701

- 120° Wide Light Output
- Easy Install
- 12V Powered
- Powerful Light Output
- Lifetime Warranty
- 1.57" X 1.57" X .78"

LED POD is ideal for:

- Trunk Lighting
- Amp Lighting
- Foot Well Lighting
- Wheel Well Lighting
- Under Hood Accent Lighting
- Underbody Lighting
- Snow Mobile Placement



LED SPOT LIGHT PODS

The New ORACLE LED Spot Light Pods are an excellent light source for illuminating any detail of your custom project. You can use these as Trunk Lights, Amp Lighting, Under Hood Accent Lighting, or even Underbody Lighting! The solid aluminum housing contains a Super-Bright 1 Watt LED bulb with a condensed 30° output.



Part# 1701

- 30° Wide Light Output
- Easy Install
- 12V Powered
- Powerful Light Output
- Lifetime Warranty
- 1.57" X 1.57" X .78"

LED POD is ideal for:

- Trunk Lighting
- Amp Lighting
- Foot Well Lighting
- Wheel Well Lighting
- Under Hood Accent Lighting
- Underbody Lighting
- Snow Mobile Placement

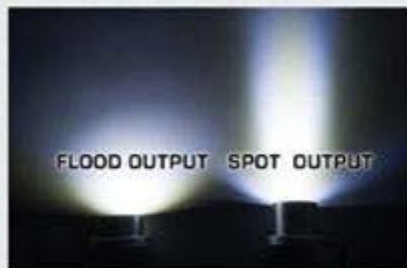

DESCRIPTION	PART#	WATTAGE	OPERATING VOLTAGE	BEAM OUTPUT	WARRANTY
LED FLOOD LIGHT POD - WHITE	3206-001	1W	12-24V DC	120°	LIFETIME
LED FLOOD LIGHT POD - BLUE	3206-002	1W	12-24V DC	120°	LIFETIME
LED FLOOD LIGHT POD - RED	3206-003	1W	12-24V DC	120°	LIFETIME
LED FLOOD LIGHT POD - GREEN	3206-004	1W	12-24V DC	120°	LIFETIME
LED FLOOD LIGHT POD - AMBER	3206-005	1W	12-24V DC	120°	LIFETIME
LED FLOOD LIGHT POD - UV/PURPLE	3206-007	1W	12-24V DC	120°	LIFETIME
LED FLOOD LIGHT POD - PINK	3206-009	1W	12-24V DC	120°	LIFETIME
LED FLOOD LIGHT POD - COLORSHIFT	3206-333	1W	12-24V DC	120°	LIFETIME
LED SPOT LIGHT POD - WHITE	3207-001	1W	12-24V DC	30°	LIFETIME
LED SPOT LIGHT POD - BLUE	3207-002	1W	12-24V DC	30°	LIFETIME
LED SPOT LIGHT POD - RED	3207-003	1W	12-24V DC	30°	LIFETIME
LED SPOT LIGHT POD - GREEN	3207-004	1W	12-24V DC	30°	LIFETIME
LED SPOT LIGHT POD - AMBER	3207-005	1W	12-24V DC	30°	LIFETIME
LED SPOT LIGHT POD - COLORSHIFT	3207-333	1W	12-24V DC	30°	LIFETIME

GOBO DOOR LED PROJECTORS

GOBO DOOR LED PROJECTORS

ORACLE G.O.B.O. Door LED Projectors is an acronym for "GO Between Optics". It is an image that can be projected when a light source is introduced. In this case the light source is a high powered LED so the image is crisp, the housing is small, and it puts out very little heat.



Part# Varies based on logo

- Solid Aluminum Construction
- High Powered 3W Cree LED
- Low Heat Output
- Powerful Image Projection
- Easy Install to 12V Source
- Drill Tool Included
- 1 Year Warranty
- 3.2" X 1.3" X 1.3"
- Custom Logos Available



EASILY PROMOTE YOUR SHOP, CAR CLUB OR BUSINESS WITH CUSTOMIZED GOBO PROJECTORS. Custom logos are available, ask your ORACLE sales rep for more information.

DESCRIPTION	WATTAGE	OPERATING VOLTAGE	HOUSING	WARRANTY
GOBO DOOR LED PROJECTORS	3W	12-24V DC	ALUMINUM	1 YEAR

UNDERCOVER LED STROBE LIGHTS

Perfect for emergency vehicles and first responders, our strobe lights come in a variety of sizes all using the latest in LED technology. The "undercover" style strobe lights come in 3 LED, 4 LED, and 6 LED sizes and have a flush-mount installation. Each type of strobe light we offer has an internal processor with 19 different strobing patterns.



3 LED UNDERCOVER

Part# 3401

- 3rd Gen 1 Watt Leds
- 19 Pattern Internal Control
- Sync Multiple Units
- 100,000 Hour Lifetime
- Flush Mount Design
- 4.3" X 1.7" X 1.7"



4 LED UNDERCOVER

Part# 3402

- 3rd Gen 1 Watt Leds
- 19 Pattern Internal Control
- Sync Multiple Units
- 100,000 Hour Lifetime
- Flush Mount Design
- 4.9" X 1.7" X 1.7"



4 LED DUAL COLOR

Part# 3403

- 3rd Gen 1 Watt Leds
- 19 Pattern Internal Control
- Sync Multiple Units
- 100,000 Hour Lifetime
- Flush Mount Design
- 4.9" X 1.7" X 1.7"



6 LED UNDERCOVER

Part# 3404

- 3rd Gen 1 Watt Leds
- 19 Pattern Internal Control
- Sync Multiple Units
- 100,000 Hour Lifetime
- Flush Mount Design
- 2.25" X 6.5" X 1.5"



OMNI DIRECTON STROBE

Part# 3507

- 3rd Gen 1 Watt Leds
- 19 Pattern Internal Control
- Sync Multiple Units
- 100,000 Hour Lifetime
- Flush Mount Design
- 1.5" X 2.75" X 1.25"



These Omni-Strobe Units can also be installed inside of your headlights.



6 LED INTERCEPTOR

Part# 3501

- 3rd Gen 1 Watt Leds
- 19 Pattern External Control
- Sync Multiple Units
- 100,000 Hour Lifetime
- 2.75" X 3.75" X 2.0"



12 LED INTERCEPTOR

Part# 3502

- 3rd Gen 1 Watt Leds
- 19 Pattern External Control
- Sync Multiple Units
- 100,000 Hour Lifetime
- 7.4" X 1.8" X 3.4"



24 LED INTERCEPTOR

Part# 3503

- 3rd Gen 1 Watt Leds
- 19 Pattern External Control
- Sync Multiple Units
- 100,000 Hour Lifetime
- 15.7" X 1.8" X 3.5"



48 LED INTERCEPTOR

Part# 3504

- 3rd Gen 1 Watt Leds
- 19 Pattern External Control
- Sync Multiple Units
- 100,000 Hour Lifetime
- 31.4" X 1.8" X 3.5"



24 LED EMERGENCY STROBE UNIT

Part# 3505

- 3rd Gen 1 Watt Leds
- 19 Pattern External Control
- Sync Multiple Units
- 100,000 Hour Lifetime
- Easily mounts to Rooftop
- 5.5" X 12" X 2.5"



42 LED EMERGENCY STROBE UNIT

Part# 3509

- 3rd Gen 1 Watt Leds
- 19 Pattern External Control
- Sync Multiple Units
- 100,000 Hour Lifetime
- Easily mounts to Rooftop
- 4.5" X 25" X 11.5"

DESCRIPTION	PART#	AVAILABLE COLORS	PATTERN CONTROL	LIFETIME	WARRANTY
3 LED UNDERCOVER STROBE	3401		INTERNAL	100,000HRS	1 YEAR
4 LED UNDERCOVER STROBE	3402		INTERNAL	100,000HRS	1 YEAR
4 LED DUAL COLOR UNDERCOVER STROBE	3403		INTERNAL	100,000HRS	1 YEAR
6 LED UNDERCOVER STROBE	3404		INTERNAL	100,000HRS	1 YEAR
4 LED OMNI DIRECTIONAL STROBE	3507		INTERNAL	100,000HRS	1 YEAR
9 LED OMNI DIRECTIONAL STROBE	3508		INTERNAL	100,000HRS	1 YEAR
24 LED EMERGENCY STROBE UNIT	3505		EXTERNAL	100,000HRS	1 YEAR
42 LED EMERGENCY STROBE UNIT	3509		EXTERNAL	100,000HRS	1 YEAR
6 LED DUAL INTERCEPTOR STROBE	3501		EXTERNAL	100,000HRS	1 YEAR
12 LED INTERCEPTOR STROBE	3502		EXTERNAL	100,000HRS	1 YEAR
24 LED INTERCEPTOR STROBE	3503		EXTERNAL	100,000HRS	1 YEAR
48 LED INTERCEPTOR STROBE	3504		EXTERNAL	100,000HRS	1 YEAR

FACTORY ILLUMINATED EMBLEMS

ORACLE LED Illuminated Factory Replacement Badges. These genuine factory badges are modified to stand out from the crowd. We take the original emblems from the vehicle manufacturer and modify them to accept an acrylic plate fitted with ORACLE LEDs for a smooth visual pop. Currently available for Chevrolet and Chrysler vehicles, more makes soon to be available. Simply remove the existing factory badge and install this in its place. Wiring is routed through existing holes in the trunk lid and ties into the parking lights. Also Includes pre-installed 3M adhesive backing. Add an ORACLE Dual-Intensity LED circuit and this illuminated badge can also be used as 3rd brake light.

2010-2013 CHEVY CAMARO ILLUMINATED BOWTIE

- Part# 3001**
- Factory Rear Deck Badges
 - Acrylic LED Plates Integrated
 - Wiring & Connectors Included
 - Can be used as 3rd Brake Light
 - 3M Adhesive Backing



We offer the option to professionally paint your emblem any factory GM paint color or flat/gloss black.

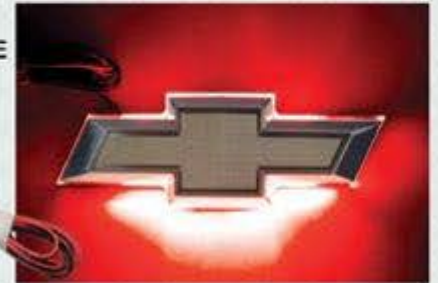

2014 CHEVY CAMARO ILLUMINATED BOWTIE

- Part# 3057**
- Factory Rear Deck Badges
 - Acrylic LED Plates Integrated
 - Wiring & Connectors Included
 - Can be used as 3rd Brake Light
 - 3M Adhesive Backing



We offer the option to professionally paint your emblem any factory GM paint color or flat/gloss black.



CHEVY CORVETTE C6 ILLUMINATED EMBLEM

- Part# 3099**
- Factory Rear Deck Badges
 - Acrylic LED Plates Integrated
 - Wiring & Connectors Included
 - Can be used as 3rd Brake Light
 - 3M Adhesive Backing



CHRYSLER ILLUMINATED SLEEK WING

- Part# 3019**
- Factory Rear Deck Badges
 - Acrylic LED Plates Integrated
 - Wiring & Connectors Included
 - Can be used as 3rd Brake Light
 - 3M Adhesive Backing



CREE HIGH POWERED LED BOLTS

3W UNIVERSAL CREE LED BOLT LIGHT

3 Watt LED Bolt Light is a High Intensity LED with a stud style screw design. It can be used on any type of vehicle or practical application. Used for interior/exterior applications including running light and flood lighting etc. The ORACLE 3-Watt CREE LED Bolt can also be used as a rock light. With a stud style screw design, the unit is resin injected making it 100% water tight and weatherproof. This makes it perfect for rugged applications such as under-cab rock lighting. This gives the driver increased visibility while crawling.

Part# 5410

- Operating Voltage: 12V DC
- Size: 1" x 1" x 1.5"
- Variety of Colors
- High Intensity 3W CREE LED
- Interior or Exterior Applicable
- 10mm Stud Style Base
- Weight: .8oz
- 2 Per Package
- 1 Year Warranty



Installed as custom Daytime Running Lights



Installed to attach fender flares.



Installed as underbody rock crawling lights.



DESCRIPTION	PART#	WATTAGE	VOLTAGE	THREAD SIZE	WARRANTY
3W UNIVERSAL CREE LED BILLET LIGHTS - WHITE	5410-001	3W	12V	10MM	1 YEAR
3W UNIVERSAL CREE LED BILLET LIGHTS - BLUE	5410-002	3W	12V	10MM	1 YEAR
3W UNIVERSAL CREE LED BILLET LIGHTS - RED	5410-003	3W	12V	10MM	1 YEAR
3W UNIVERSAL CREE LED BILLET LIGHTS - GREEN	5410-004	3W	12V	10MM	1 YEAR
3W UNIVERSAL CREE LED BILLET LIGHTS - AMBER	5410-005	3W	12V	10MM	1 YEAR

HIGH POWERED DRL MODULES

12W 6" LED DRL MODULE

12 Watt 6 LED Daytime Running Light Module uses High Intensity LEDs in a 6 inch box design. These lights are weatherproof, and suited for exterior vehicle applications, you can use them as fog lights or mount them on a vehicle that did not come with D.R.L. lights and want to mimic the look of a higher end vehicle.



Part# 5409

- Operating Voltage: 12V DC
- Aluminum for Heat Dissipation
- Size: 6" x 0.6" x 1.6"
- Weight: 5.8 oz
- 6 x 1W LEDs Per DRL
- 1,020 Total Lumens
- 1 Amp Draw
- 1 Year Warranty



30W 6" LED DRL MODULE

3 Watt LED Daytime Running Light is a High Intensity LED Module with 5 LEDs containing 3 Watts each, for a total of 15 Watts per module. These lights are weatherproof, and suited for exterior vehicle applications, you can use them as fog lights or mount them on a vehicle that did not come with D.R.L. lights and want to mimic the look of a higher end vehicle.



Part# 5411

- Operating Voltage: 12V DC
- Aluminum for Heat Dissipation
- Size: 6.2" x 1.75" x 1.1"
- Weight: 8.6 oz
- 5 x 1W LEDs Per DRL
- 2550 Lumens Total
- 2.5 Amp Draw Total
- 1 Year Warranty



12W 7" PLASMA DRL MODULE

12W 7" Daytime Running Light Module uses High Intensity Plasma LEDs in a 7" lightweight design. These lights are weatherproof, and suited for exterior vehicle applications, you can use them as fog lights or mount them on a vehicle that did not come with D.R.L. lights and want to mimic the look of a higher end vehicle.



Part# 5414

- Operating Voltage: 12V DC
- Size: 6.7" x .5" x .2"
- Weight: 5.8 oz
- Aluminum for Heat Dissipation
- Self adhesive 3M Backing
- IP 67 Waterproof Rating
- 6W Per DRL
- 1020 Lumens Total
- 1 Amp Draw Total
- 1 Year Warranty



DESCRIPTION	PART#	WATTAGE	VOLTAGE	LUMENS	AMP DRAW	WARRANTY
12W 6" LED DRL MODULE	5409	12W TOTAL	12V	1,020LM	1A	1 YEAR
30W 6" LED DRL MODULE	5411	30W TOTAL	12V	2,550LM	2.5A	1 YEAR
12W 7" PLASMA DRL MODULE	5414	12W TOTAL	12V	1,020LM	1A	1 YEAR

LED ACCENT FLEXIBLE DRLS

The ORACLE LED Accent DRL Flexible Strips allow you to add the modern luxury look of smooth LED Daytime Running Lights to any vehicle. The flexible design allows almost limitless installation applications and shapes. The weather-proof construction allows this product to be installed inside or outside of the lights.



LED ACCENT DRLS

The translucent rubber outer membrane is UV resistant and provides a smooth continuous flow of light with full flexibility.

- Available in 3 Sizes - 18", 24", and 34"
- Now Available in White, Blue, Red, Amber, & Switchback (Amber/White)
- Easily Connects to Factory Turn Signal / Parking Light
- Smoothly Diffused, Clean and Modern Look
- Waterproof, Flexible Material Composition
- Box Contents : 2x LED Accent DRL Strips
- Strips can be cut to Smaller Size
- One Year Warranty

Mounting clips included.



DESCRIPTION	PART#	COLOR	VOLTAGE	IP RATING	WARRANTY
18" LED ACCENT DRLS	5415-001	WHITE	12V	IP67	1 YEAR
18" LED ACCENT DRLS	5415-002	BLUE	12V	IP67	1 YEAR
18" LED ACCENT DRLS	5415-003	RED	12V	IP67	1 YEAR
18" LED ACCENT DRLS	5415-005	AMBER	12V	IP67	1 YEAR
18" LED ACCENT DRLS	5415-023	AMBER/WHITE	12V	IP67	1 YEAR
24" LED ACCENT DRLS	5416-001	WHITE	12V	IP67	1 YEAR
24" LED ACCENT DRLS	5416-002	BLUE	12V	IP67	1 YEAR
24" LED ACCENT DRLS	5416-003	RED	12V	IP67	1 YEAR
24" LED ACCENT DRLS	5416-005	AMBER	12V	IP67	1 YEAR
24" LED ACCENT DRLS	5416-023	AMBER/WHITE	12V	IP67	1 YEAR
33.5" LED ACCENT DRLS	5417-001	WHITE	12V	IP67	1 YEAR
33.5" LED ACCENT DRLS	5417-002	BLUE	12V	IP67	1 YEAR
33.5" LED ACCENT DRLS	5417-003	RED	12V	IP67	1 YEAR
33.5" LED ACCENT DRLS	5417-005	AMBER	12V	IP67	1 YEAR
33.5" LED ACCENT DRLS	5417-023	AMBEFR/WHITE	12V	IP67	1 YEAR

CONCEPT SMD STRIPS



White Concept SMD strips installed as Daytime Running Lights



CONCEPT SMD STRIP

Concept SMD Strips are semi-rigid high powered SMD strips used to add additional customized lighting to your headlights. Each strip contains over 140 SMDs. The SMDs on strip are in a continuous pattern with no gaps, thus giving the appearance of a laser straight illumination. The uniform intensity gives any project that "high end" look.

- Semi-Rigid High Powered SMD Strip
- Each 16" Strip Contains over 140 LEDs
- Size: 16", 12", 8" or 4" Length
- Can be cut down to smaller sizes
- Sold in Pairs
- 12V Universal Application

Amber Concept SMD strips installed as accent lighting



White Concept SMD strips installed as Daytime Running Lights

RGB 5050 CONCEPT SMD STRIP

You can now have limitless color effects added to a stylized DRL or custom headlight application. These premium, super bright 5050 SMDs are attached to a rigid but flexible straight PCB board allowing for bending and curving without the risk of fragmenting.

- Thicker PCB board makes the strips easier to bend and mold into shapes.
- Each strip uses Bridgelux 5050 RGB SMD chips (Made in the U.S.A.)
- Can produce thousands of color hues with the use of a ColorSHIFT RGB Controller
- ORACLE ColorSHIFT Technology
- Flexible & Rigid High Powered SMD Strip
- Size: 16", 8" or 4" Length
- Each strip can be cut to any size.
- Sold in Pairs
- 12 Volt Powered
- Low Heat Output



RGB 5050 Concept SMD strips installed as Daytime Running Lights behind the OEM diffusers.



bridgelux.

RGB 5050 Concept strips include "quick connects" for ease of installation.

DESCRIPTION	PART#	COLOR	VOLTAGE	AMP RATING	WARRANTY
4" CONCEPT LED STRIP (PAIR)	4508-001	WHITE	12V	≤ .75@12V	2 YEAR
4" CONCEPT LED STRIP (PAIR)	4508-002	BLUE	12V	≤ .82@12V	2 YEAR
4" CONCEPT LED STRIP (PAIR)	4508-003	RED	12V	≤ .8@12V	2 YEAR
4" CONCEPT LED STRIP (PAIR)	4508-005	AMBER	12V	≤ .77@12V	2 YEAR
8" CONCEPT LED STRIP (PAIR)	4507-001	WHITE	12V	≤ .75@12V	2 YEAR
8" CONCEPT LED STRIP (PAIR)	4507-002	BLUE	12V	≤ .82@12V	2 YEAR
8" CONCEPT LED STRIP (PAIR)	4507-003	RED	12V	≤ .8@12V	2 YEAR
8" CONCEPT LED STRIP (PAIR)	4507-005	AMBER	12V	≤ .77@12V	2 YEAR
12" CONCEPT LED STRIP (PAIR)	4506-001	WHITE	12V	≤ .75@12V	2 YEAR
12" CONCEPT LED STRIP (PAIR)	4506-002	BLUE	12V	≤ .82@12V	2 YEAR
12" CONCEPT LED STRIP (PAIR)	4506-003	RED	12V	≤ .8@12V	2 YEAR
12" CONCEPT LED STRIP (PAIR)	4506-005	AMBER	12V	≤ .77@12V	2 YEAR
16" CONCEPT LED STRIP (PAIR)	4502-001	WHITE	12V	.75@12V	2 YEAR
16" CONCEPT LED STRIP (PAIR)	4502-002	BLUE	12V	.82@12V	2 YEAR
16" CONCEPT LED STRIP (PAIR)	4502-003	RED	12V	.8@12V	2 YEAR
16" CONCEPT LED STRIP (PAIR)	4502-005	AMBER	12V	.77@12V	2 YEAR
4" CONCEPT RGB 5050 STRIP (PAIR)	4505-333	COLORSHIFT	12V	≤ .87@12V	2 YEAR
8" CONCEPT RGB 5050 STRIP (PAIR)	4504-333	COLORSHIFT	12V	≤ .87@12V	2 YEAR
16" CONCEPT RGB 5050 STRIP (PAIR)	4505-333	COLORSHIFT	12V	≤ .87@12V	2 YEAR

LED ILLUMINATED WHEEL RINGS



Looking for your next "head turning" mod guaranteed to grab attention at the local car meet? Then these are perfect for you! Designed to fit around the brake rotors of your vehicle, ORACLE Wheel Rings are aluminum strips formed in a circle, creating a ring. Mounted on the ring is high grade ORACLE LED Flex Strip. The flexible LED strip will illuminate your wheels and wheel barrels. At night these rings are intense. Each ring is built in-house by our trained technicians, and tested for durability and proper function.

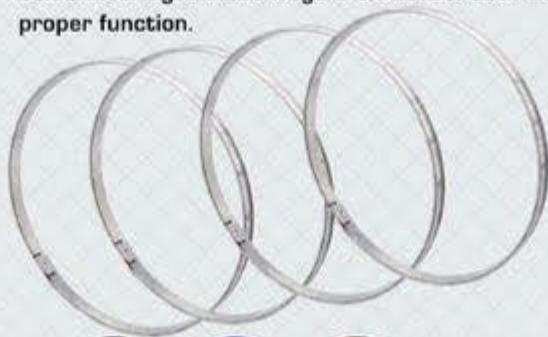

LED ILLUMINATED WHEEL RINGS

- Universal Vehicle Fitment
- LED Ring diameter: 15.5"
- Mounts to Brake Rotor Dust Shield
- Operating Voltage: 12V DC
- Vibrantly lights up Wheel Wells
- ORACLE Quality Flex LED Strip
- Fits around Brake Rotor
- Can withstand high temperatures
- Mounting Hardware included
- 1 Year Warranty



Each Illuminated Wheel Ring Kit includes a Rocker Switch for easy activation.



HAVE OVERSIZED ROTORS?

Rotors over 13.5" are considered oversized and will need to add the expanding adapter option. Be sure to check the diameter of your brake rotor to ensure proper fitment. For some vehicles with very large front rotors, expanding the front wheel rings is recommended.

DESCRIPTION	PART#	COLOR	VOLTAGE	DIAMETER	WARRANTY
LED ILLUMINATED WHEEL RINGS	4215-001	WHITE	12V	15.5"	1 YEAR
LED ILLUMINATED WHEEL RINGS	4215-002	BLUE	12V	15.5"	1 YEAR
LED ILLUMINATED WHEEL RINGS	4215-003	RED	12V	15.5"	1 YEAR
LED ILLUMINATED WHEEL RINGS	4215-004	GREEN	12V	15.5"	1 YEAR
LED ILLUMINATED WHEEL RINGS	4215-005	AMBER	12V	15.5"	1 YEAR
LED ILLUMINATED WHEEL RINGS	4215-007	UV/PURPLE	12V	15.5"	1 YEAR
LED ILLUMINATED WHEEL RINGS	4215-009	PINK	12V	15.5"	1 YEAR
LED ILLUMINATED WHEEL RINGS	4215-010	AQUA	12V	15.5"	1 YEAR
LED ILLUMINATED WHEEL RINGS	4215-330	COLORSHIFT	12V	15.5"	1 YEAR
LED ILLUMINATED WHEEL RINGS	4215-333	COLORSHIFT 2.0	12V	15.5"	1 YEAR

LED SCANNER BARS



GEN 5 CHEVY CAMARO MAIL SLOT SCANNER

The Mail Slot Scanner fits right into the hood of your Camaro and contains 40 amazingly bright 5050 Surface-Mount LEDs! The IR wireless remote gives you complete control of this Scanner. EASY installation, just connect power and ground! The rest is done for you. This V2 Model can produce over 20 lighting effects that you choose using your wireless controller.

Part# 4420

- 40 Amazingly Bright 5050 SMDs
- Fits directly into Factory Bumper Slot
- Over 20 Pre-Programmed Patterns
- 12V Powered
- Easy 2 Wire + and - Installation
- Includes Wireless Controller
- DIY Instructions Included
- 1 Year Warranty



22" V2 LED SCANNER BAR

The 22" V2 Scanner contains 40 amazingly bright 5050 Surface-Mount LEDs! The IR wireless remote gives you complete control of this Scanner. Not only can these LED scanners perform a multitude of functions but they are simple to install. Just a two wire + and - connection then you control everything else from the included wireless controller.

Part# 4401

- Scanner contains 48 LEDs
- Over 20 Pre-programmed Patterns
- Easy 2 Wire + and - Installation
- Includes Wireless Controller
- 22" Overall Length
- 1 Year Warranty



22" V2 DYNAMIC RGB LED SCANNER BAR

The 22" V2 Dynamic RGB Scanner contains 40 amazingly bright 5050 Surface-Mount LEDs, and the ability to color-mesh. The IR wireless remote gives you complete control of this Scanner. Not only can these LED scanners perform a multitude of functions but they are simple to install. Just a two wire + and - connection then you control everything else from the included wireless controller.

Part# 2042

- 48 ColorSHIFT Super Bright 5050 SMDs
- Dynamic Color Meshing Displays
- Easy 2 Wire + and - Installation
- Includes Wireless Controller
- 22" Overall Length
- 1 Year Warranty

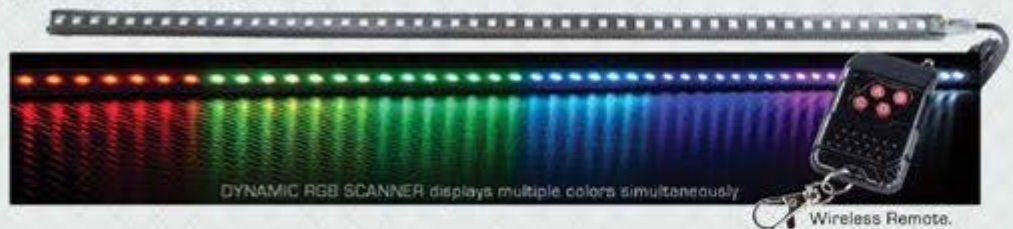

15" V2 DUAL LED SCANNER BARS

The 15" V2 Dual Scanner contains 28 amazingly bright 5050 Surface-Mount LEDs per scanner. The IR wireless remote gives you complete control of these Scanners. Not only can these LED scanners perform a multitude of functions but they are simple to install. Just a two wire + and - connection then you control everything else from the included wireless controller.

Part# 4407

- Scanners contain 28 LEDs each
- Over 20 Pre-Programmed Patterns
- Easy 2 Wire + and - Installation
- Includes Wireless Controller
- Includes two 15" scanners
- 1 Year Warranty



DESCRIPTION	PART#	AVAILABLE COLORS	LENGTH	LED COUNT	VOLTAGE	WARRANTY
GEN 5 CAMARO MAIL SLOT SCANNER	4420		20"	40 SMDs	12V	1 YEAR
22" V2 LED SCANNER	4401		22"	48 SMDs	12V	1 YEAR
22" V2 DYNAMIC RGB LED SCANNER	4400-333		22"	48 SMDs	12V	1 YEAR
15" V2 DUAL LED SCANNERS	4407		15"	28 SMDs	12V	1 YEAR

FLEXIBLE LED STRIP

SIDE FIRING FLEXIBLE LED STRIP

The light output on these strips display sideways instead of forwards. Meant to be placed in areas where you don't want the led strip to be visible, but want the light to peak through. Good for tight areas and small enclosures. The side-firing LED strip is used in applications where the light needs to shine parallel with the mounting surface rather than perpendicular with the mounting surface like normal LED strip.



- Part# 3801**
- Side Firing LEDs
 - Sold by the Foot or 200' Spools
 - 1.5W per Foot
 - Direct 12V Wiring
 - IP66 Waterproof Rating
 - Can be cut to smaller lengths
 - Lifetime Warranty

ORACLE LED strip maintains high-end double-layered P.C.B circuit boards. Double Layer circuit boards have better heat dissipation and thermal properties which results in longer LED lifetime, durability, and overall reliability.



INTERIOR FLEXIBLE LED STRIP

Our "interior" flexible strip is most commonly used on projects where the lights will not come in contact with water or moisture. The absence of the waterproofing material allows the strips to fit into tighter spaces, become slightly more flexible, and are less expensive than the waterproof version.



- Part# 3802**
- Sold by the Foot or 200' Spools
 - 3M Adhesive Backing
 - 3528 Bridgelux LEDs
 - 1.5W per Foot
 - Direct 12V Wiring
 - IP33 Weatherproof Rating
 - Can be cut to smaller lengths
 - Lifetime Warranty

ORACLE LED strip exclusively uses Bridgelux LEDs which have an excellent lumen-to-watt efficiency rating, have a very long lifetime, and are made in the USA.



DESCRIPTION	AVAILABLE COLORS	WATERPROOF RATING	LIGHT EMITTING PROFILE	WARRANTY
SIDE FIRING FLEXIBLE LED STRIP		IP66	PARALLEL TO MOUNTING SURFACE	LIFETIME
INTERIOR FLEXIBLE LED STRIP		IP33	PERPENDICULAR TO MOUNTING SURFACE	LIFETIME

FLEXIBLE LED STRIP

EXTERIOR FLEXIBLE LED STRIP - WHITE BACKING

Our waterproof LED strips have an IP66 rating and are suitable for exterior or outdoor applications and areas subjected to high heat. For the waterproofing material we use a high grade silicone rather than epoxy. The reason is that epoxy is not as flexible and tends to yellow over time. For your convenience we offer 2 different color circuit boards- white and black. This helps conceal the LED strips in different type of applications.

- Part# 3803**
- Sold by the Foot or 200' Spools
 - 3M Adhesive Backing
 - 3528 Bridgelux LEDs
 - 1.5W per Foot
 - Direct 12V Wiring
 - IP65 Weatherproof Rating
 - Can be cut to smaller lengths
 - Lifetime Warranty

Our strips also feature authentic 3M adhesive backing for ease of installation in many locations such as in the engine bay, under the vehicle, interior foot wells, and many other places.

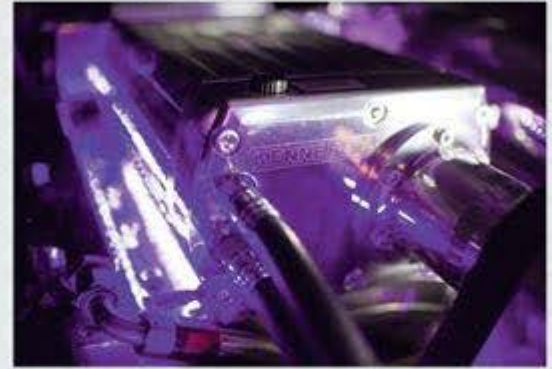

EXTERIOR FLEXIBLE LED STRIP - BLACK BACKING

Our waterproof LED strips have an IP66 rating and are suitable for exterior or outdoor applications and areas subjected to high heat. For the waterproofing material we use a high grade silicone rather than epoxy. The reason is that epoxy is not as flexible and tends to yellow over time. For your convenience we offer 2 different color circuit boards- white and black. This helps conceal the LED strips in different type of applications.

- Part# 3804**
- Black Backing
 - Sold by the Foot or 200' Spools
 - 3M Adhesive Backing
 - 3528 Bridgelux LEDs
 - 1.5W per Foot
 - Direct 12V Wiring
 - IP65 Weatherproof Rating
 - Can be cut to smaller lengths
 - Lifetime Warranty

All of our LED strips can be cut to any size and the LEDs that are cut-off can be re-used. ORACLE Flexible LED strips are backed by a LIFETIME WARRANTY.



DESCRIPTION	AVAILABLE COLORS	WATERPROOF RATING	LIGHT EMITTING PROFILE	WARRANTY
EXTERIOR FLEXIBLE LED STRIP - WHITE		IP66	PERPENDICULAR TO MOUNTING SURFACE	LIFETIME
EXTERIOR FLEXIBLE LED STRIP - BLACK		IP66	PERPENDICULAR TO MOUNTING SURFACE	LIFETIME

LED RETAIL PACKAGES

COLORSHIFT RGB LED STRIP PACKAGE

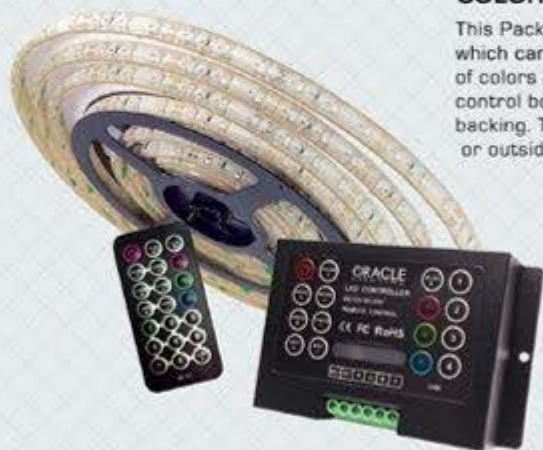

This Package Includes 200' of our high powered 5050 SMD RGB ColorSHIFT Flexible Waterproof Strip which can be controlled via the ORACLE ColorSHIFT 2.0 LED Controller. The user can select from dozens of colors as well as several pre-programmed functions. Installation is easy, simply wire the strip to the control box and then connect the box to power and ground the strip. Installs easily with its 3M adhesive backing. The ORACLE ColorSHIFT Strip can be cut down into several smaller strips and be installed inside or outside.

- Part# 4201-333**
- 5050 SMDs
 - 200' Led Strip
 - ColorSHIFT 2.0 Controller
 - Waterproof
 - 3M Adhesive Backing
 - Low Power Consumption
 - Cut down to any size
 - Point of Sale Packaging
 - Lifetime Warranty



LED STRIP 36" RETAIL PACK



The Retail set includes 3' feet (36") of waterproof LED strip. Strip can also be cut down into smaller sizes. Ideal for over the counter sales. Easy install makes this the ideal strip for enhancing your automobile's look. Strip is waterproof, and comes with a 3M adhesive for indoor or outdoor applications. Includes a Lifetime Warranty.

- Part# 4207**
- 3528 SMDs
 - 36" Led Strip
 - Less than .35A Draw
 - Waterproof
 - 3M Adhesive Backing
 - Low Power Consumption
 - Cut Down to any Size
 - Point of Sale Packaging
 - Lifetime Warranty



LED STRIP 15" PAIR - RETAIL PACK



The Retail set includes 3' feet (2 x 15") of waterproof LED strip. Strip can also be cut down into smaller sizes. Ideal for over the counter sales. Easy install makes this the ideal strip for enhancing your automobile's look. Strip is waterproof, and comes with a 3M adhesive for indoor or outdoor applications. Includes a Lifetime Warranty.

- Part# 3805**
- 3528 SMDs
 - 2 x 15" Led Strips
 - Less than .35A Draw
 - Waterproof
 - 3M Adhesive Backing
 - Low Power Consumption
 - Cut Down to any Size
 - Point of Sale Packaging
 - Lifetime Warranty



MOTORCYCLE FLEXIBLE LED KITS

MOTORCYCLE FLEXIBLE LED KITS

This Plug and Play LED kit from ORACLE Lighting features high powered 5050 SMD Flexible LED Strips that plug directly into a wireless Multifunction Controller. This kit includes everything you need and is perfect for illuminating bikes, engine bays, amp racks, interiors, or any other custom projects that you want to show off. The controller can make the LEDs Strobe, Pulse, Dim, and Breathe with the push of a button. All popular colors are available including ColorSHIFT.



- Part# 2704**
- Super Bright 3 Chip 5050 SMDs
 - Plug & Play Connectors
 - Wireless Transmitter
 - Waterproof Leds
 - 3M Self Adhesive Backing
 - Easy Installation
 - In-Line Fuse included
 - 1 Year Warranty



DESCRIPTION	PART#	WATERPROOF RATING	LIFETIME	WARRANTY
COLORSHIFT RGB STRIP PACKAGE	4201-333	IP65	50,000HRS	LIFETIME
36" LED RETAIL PACK - WHITE	4207-001	IP67	50,000HRS	LIFETIME
36" LED RETAIL PACK - BLUE	4207-002	IP67	50,000HRS	LIFETIME
36" LED RETAIL PACK - RED	4207-003	IP67	50,000HRS	LIFETIME
36" LED RETAIL PACK - GREEN	4207-004	IP67	50,000HRS	LIFETIME
36" LED RETAIL PACK - AMBER	4207-005	IP67	50,000HRS	LIFETIME
36" LED RETAIL PACK - UV/PURPLE	4207-007	IP67	50,000HRS	LIFETIME
36" LED RETAIL PACK - PINK	4207-009	IP67	50,000HRS	LIFETIME
36" LED RETAIL PACK - AQUA	4207-010	IP67	50,000HRS	LIFETIME
36" LED RETAIL PACK - COLORSHIFT	4207-333	IP67	50,000HRS	LIFETIME
PAIR 15" LED STRIPS RETAIL PACK - WHITE	3805-001	IP67	50,000HRS	LIFETIME
PAIR 15" LED STRIPS RETAIL PACK - BLUE	3805-002	IP67	50,000HRS	LIFETIME
PAIR 15" LED STRIPS RETAIL PACK - RED	3805-003	IP67	50,000HRS	LIFETIME
PAIR 15" LED STRIPS RETAIL PACK - GREEN	3805-004	IP67	50,000HRS	LIFETIME
PAIR 15" LED STRIPS RETAIL PACK - AMBER	3805-005	IP67	50,000HRS	LIFETIME
PAIR 15" LED STRIPS RETAIL PACK - UV/PURPLE	3805-007	IP67	50,000HRS	LIFETIME
PAIR 15" LED STRIPS RETAIL PACK - PINK	3805-009	IP67	50,000HRS	LIFETIME
PAIR 15" LED STRIPS RETAIL PACK - AQUA	3805-010	IP67	50,000HRS	LIFETIME
PAIR 15" LED STRIPS RETAIL PACK - COLORSHIFT	3805-333	IP67	50,000HRS	LIFETIME
MOTORCYCLE 5050 SMD KIT - WHITE	2704-001	IP67	50,000HRS	LIFETIME
MOTORCYCLE 5050 SMD KIT - BLUE	2704-002	IP67	50,000HRS	LIFETIME
MOTORCYCLE 5050 SMD KIT - RED	2704-003	IP67	50,000HRS	LIFETIME
MOTORCYCLE 5050 SMD KIT - GREEN	2704-004	IP67	50,000HRS	LIFETIME
MOTORCYCLE 5050 SMD KIT - YELLOW	2704-006	IP67	50,000HRS	LIFETIME
MOTORCYCLE 5050 SMD KIT - PURPLE	2704-007	IP67	50,000HRS	LIFETIME
MOTORCYCLE 5050 SMD KIT - PINK	2704-009	IP67	50,000HRS	LIFETIME
MOTORCYCLE 5050 SMD KIT - COLORSHIFT	2704-333	IP67	50,000HRS	LIFETIME

SMD SIDEMARKER REPLACEMENTS



2015 CORVETTE C7 SMD SIDEMARKERS



These are available with Clear or Tinted lenses and can be painted to match any of the factory paint codes.

Series Part #2392
Includes 4 (pcs)
2 Front Amber LED Sidemarkers
2 Rear Red LED Sidemarkers

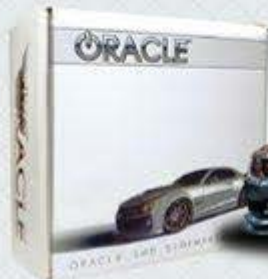

2010-14 CAMARO SMD SIDEMARKERS



These are available with Clear or Tinted lenses and can be painted to match any of the factory paint codes.

Tinted lenses shown
Series Part #3101
Includes 4 (pcs)
2 Front Amber LED Sidemarkers
2 Rear Red LED Sidemarkers



2005-13 CORVETTE C6 SMD SIDEMARKERS



These are available with Clear lenses and can be painted to match any of the factory paint codes.

Clear lenses shown
Series Part #3150
Includes 4 (pcs)
2 Front Amber LED Sidemarkers
2 Rear Red LED Sidemarkers



2008-14 CHALLENGER SMD SIDEMARKERS



These are available with Clear or Tinted lenses and can be painted to match any of the factory paint codes.

Tinted lenses shown
Series Part #9800
Includes 4 (pcs)
2 Front Amber LED Sidemarkers
2 Rear Red LED Sidemarkers



2010-14 MUSTANG SMD SIDEMARKERS



These are available with Clear or Tinted lenses and can be painted to match any of the factory paint codes.

Tinted lenses shown
Series Part #9700
Includes 4 (pcs)
2 Front Amber LED Sidemarkers
2 Rear Red LED Sidemarkers

5TH GEN CAMARO ACCESSORIES



Full functioning integrated amber LED's can be used as parking lights and turn signals. Inside components allow for full control over power mirror adjusters.

5TH GEN CAMARO CONCEPT SIDE MIRRORS

The ORACLE Camaro Concept Side Mirror takes the design from the 2009 Camaro Concept Car. The design is sleeker for a more aerodynamic look. The integrated LED's inside the mirrors can be used as both turn signals and parking lights. An aspherical mirror is added for a wider field of view, so no visibility is compromised. These are plug & play design and hook right up to the factory harness to allow for full control over the mirror adjusters. The mirrors can be custom painted by any factory GM color.



- Part# 2980**
- Modeled after the Camaro Concept Car
 - Aerodynamic Sleek Design
 - Integrated LED Marker Lights
 - Aspherical Mirror Glass
 - Fits 2010-2014 Camaro Models
 - Total 2 PCS- Driver & Passenger
 - Connects to Factory Harness



Aspherical mirrors allow for a wider field of view.



We offer the option to professionally "Ghost Paint" your side mirrors. Ghost paint hides the integrated LEDs, but allows the light to still shine through the paint.

5TH GEN CAMARO HIGH POWER REVERSE LIGHTS

These ORACLE High Power Camaro Reverse Light Assemblies are complete replacement light housings that plug into your existing wiring "Plug and Play". The lamps house 4 high-powered 3rd Gen LEDs that produce a vibrant white light with 300% more lumens than the existing factory reverse lights. Available with Tinted or Clear Lenses, these lights will fit all 5th Gen Camaro Models.

Part# 3003-020



Part# 3003-019

- Direct Replacement Parts
- Remove Existing Assembly
- Replace with New Assembly
- 4 High Power 1W LEDs per Unit
- Total 2 Pcs - Driver & Passenger
- Tinted or Clear Lens Option
- Fits 2010-2013 Camaro Models

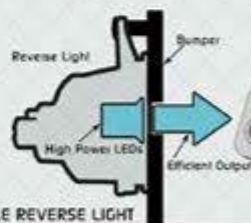
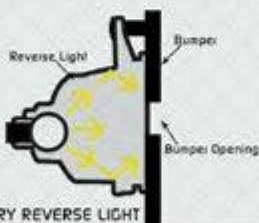

C.A.D designed for OE Factory Fitment, Plug&Play with no further modification.

LED HEADLIGHT BULB REPLACEMENTS

ORACLE LED Headlight bulbs are designed to outperform standard halogen bulbs, and match the brightness of HID bulbs. Each bulb emits 2,200 lumens rivaling the top of the line HID bulbs. The unique construction and design of each bulb allows for:

- Efficient heat dissipation
- Efficient light dispersal
- High lumen output
- Compact LED drivers
- Shock-proof
- Flicker-free
- Long lifespan
- Plug&Play



9005 LED HEADLIGHT BULBS
Part# 5217



H11 LED HEADLIGHT BULBS
Part# 5218



Stock Halogen low beam

ORACLE LED Headlight low beam



9006 LED HEADLIGHT BULBS
Part# 5221



5202 LED HEADLIGHT BULBS
Part# 5223



H4 LED HEADLIGHT BULBS
Part# 5222



H13 LED HEADLIGHT BULBS
Part# 5219



9007 LED HEADLIGHT BULBS
Part# 5224



H7 LED HEADLIGHT BULBS
Part# 5225



H16 LED HEADLIGHT BULBS
Part# 5226



H1 LED HEADLIGHT BULBS
Part# 5227

DESCRIPTION	PART #	COLOR TEMP	WATTS	LUMENS	OPERATING VOLTAGE	LIFESPAN	WARRANTY
9005 LED BULBS	5217	5500 K	56W TOTAL	2200LM PER BULB	DC9V-DC32V	30,000HRS	2 YEAR
H11 LED BULBS	5218	5500 K	56W TOTAL	2200LM PER BULB	DC9V-DC32V	30,000HRS	2 YEAR
9006 LED BULBS	5221	5500 K	56W TOTAL	2200LM PER BULB	DC9V-DC32V	30,000HRS	2 YEAR
5202 LED BULBS	5223	5500 K	56W TOTAL	2200LM PER BULB	DC9V-DC32V	30,000HRS	2 YEAR
H4 LED BULBS	5222	5500 K	56W TOTAL	2200LM PER BULB	DC9V-DC32V	30,000HRS	2 YEAR
H13 LED BULBS	5219	5500 K	56W TOTAL	2200LM PER BULB	DC9V-DC32V	30,000HRS	2 YEAR
9007 LED BULBS	5224	5500 K	56W TOTAL	2200LM PER BULB	DC9V-DC32V	30,000HRS	2 YEAR
H7 LED BULBS	5225	5500 K	56W TOTAL	2200LM PER BULB	DC9V-DC32V	30,000HRS	2 YEAR
H16 LED BULBS	5226	5500 K	56W TOTAL	2200LM PER BULB	DC9V-DC32V	30,000HRS	2 YEAR
H1 LED BULBS	5227	5500 K	56W TOTAL	2200LM PER BULB	DC9V-DC32V	30,000HRS	2 YEAR

LED FOG LIGHT & DRL BULB REPLACEMENTS

LED Lighting is a great way to update the look of your Fog lights or your Daytime Running lights. You can give your fog lights the look of expensive HID's without the higher cost, longer installation, and additional heat of an HID system. These are also great for DRL replacements due to the high-tech look of LED, which modernizes the vehicle instantly. Most applications take less than five minutes to install.



Stock Halogen Bulbs

ORACLE PLASMA Bulbs



5202 PLASMA BULBS
Part# 3606



H11 PLASMA BULBS
Part# 6909



H11 SMD BULBS
Part# 3602



P13W PLASMA BULBS
Part# 3608



9005 PLASMA BULBS
Part# 3615



9005 SMD BULBS
Part# 3603



9006 PLASMA BULBS
Part# 3624



9006 SMD BULBS
Part# 3604



H10 PLASMA BULBS
Part# 3625



H10 SMD BULBS
Part# 3601



H1 PLASMA BULBS
Part# 3623



H1 SMD BULBS
Part# 3609



H3 PLASMA BULB
Part# 3622



H3 SMD BULBS
Part# 3612

DESCRIPTION	PART #	AVAIL. COLORS	TECHNOLOGY	BRIGHTNESS	LIFESPAN	WARRANTY
5202 PLASMA BULBS	3606	○	4 x 1W PLASMA LEDS	★★★★★	100,000HRS	LIFETIME
H11 PLASMA BULBS	6909	○	4 x 1W PLASMA LEDS	★★★★★	100,000HRS	LIFETIME
H11 SMD BULBS	3602	○	18 x 5050 SMDS	★★★★	60,000HRS	LIFETIME
P13W PLASMA BULBS	3608	○	4 x 1W PLASMA LEDS	★★★★★	100,000HRS	LIFETIME
9005 PLASMA BULBS	3615	○	4 x 1W PLASMA LEDS	★★★★★	100,000HRS	LIFETIME
9005 SMD BULBS	3603	●●●●	18 x 5050 SMDS	★★★★	60,000HRS	LIFETIME
9006 PLASMA BULBS	3624	○	4 x 1W PLASMA LEDS	★★★★★	100,000HRS	LIFETIME
9006 SMD BULBS	3604	●●●●	18 x 5050 SMDS	★★★★	60,000HRS	LIFETIME
H10 PLASMA BULBS	3625	○	4 x 1W PLASMA LEDS	★★★★★	100,000HRS	LIFETIME
H10 SMD BULBS	3601	●●●●	18 x 5050 SMDS	★★★★	60,000HRS	LIFETIME
H1 PLASMA BULBS	3623	○	4 x 1W PLASMA LEDS	★★★★★	100,000HRS	LIFETIME
H1 SMD BULBS	3609	○	8 x 5050 SMDS	★★★★	60,000HRS	LIFETIME
H3 PLASMA BULB	3622	○	4 x 1W PLASMA LEDS	★★★★★	100,000HRS	LIFETIME
H3 SMD BULBS	3612	○	8 x 5050 SMDS	★★★★	60,000HRS	LIFETIME

ORACLE INTERIOR LED REPLACEMENTS

ORACLE Interior LED Replacement Bulbs are designed with quality and ease-of-use in mind. We maintain the factory bulb specifications so that we can insure that the LED bulb installs as easy as the factory bulb that you remove. Our wallet-friendly 1-Chip LEDs are great for projects with a small budget while our 3-Chip LEDs blow away any competitor in terms of quality and brightness. Our Dual-Polarity IC insures the LEDs will work regardless of the direction of installation.

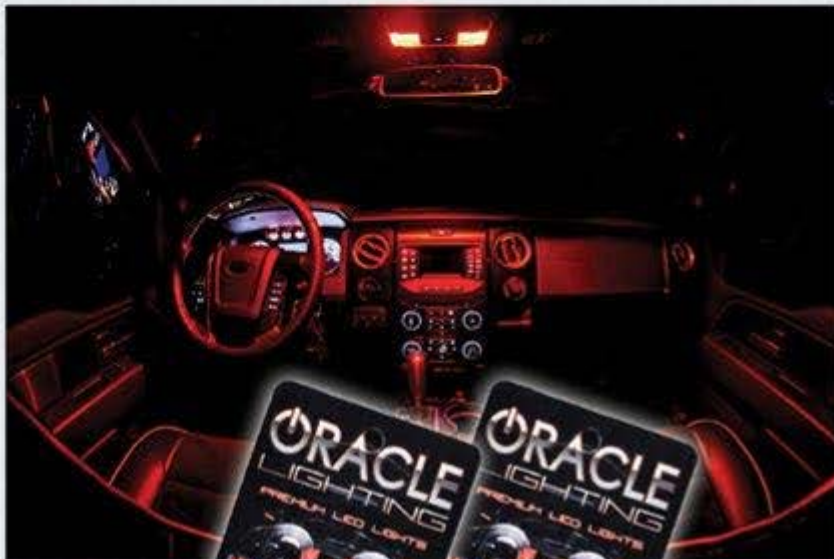

- Complete interior and exterior upgrade packages available for many vehicles.
- ORACLE Lights use high output LEDs with Surface Mount Technology.
- ORACLE LEDs have a lifespan much greater than stock lights - up to 20x longer life.
- Extensive Bulb Application covers many American, European, and Japanese cars.
- Several color choices and LED intensity levels are available.
- ORACLE Premium quality that you can depend on.
- Easy installation that anyone can do at home in just seconds.



5TH GEN CHEVY CAMARO LED DOME LIGHT

Fits Directly into the Factory Dome Light Housing
ColorSHIFT Option includes a wireless controller and allows you to change the color of the interior lights with the click of the remote



T10 3W CREE LED

Dimensions: 1.2"X.5"X.55"



T10 5 LED 1 CHIP

Dimensions: 1.05"X.45"X.45"



T10 1 LED 1 CHIP

Dimensions: 1.05"X.45"X.45"



T10 9 LED 3 CHIP

Dimensions: 1.55"X.45"X.45"



T10 4 LED FLANK

Dimensions: 1.35"X.65"X.45"



T10 1 LED 3 CHIP

Dimensions: 1.05"X.45"X.45"



UNIVERSAL 36 LED BOARD

Dimensions: 2.15"X1.2"X1.2"



T10 PLASMA
Dimensions: 1"X.45"X.45"



T10 2 LED FLANK
Dimensions: 1"X.35"X.2"



T10 9 SMD BOARD
Dimensions: 1.15"X.50"X.50"



T5 1 LED 1 CHIP
Dimensions: .75"X.25"X.25"



BA9S 5 LED 1 CHIP
Dimensions: 1"X.50"X.50"



T10 5 LED 3 CHIP
Dimensions: 1.15"X.45"X.45"



BA9S 5 LED 3 CHIP
Dimensions: 1.15"X.45"X.45"



31MM 6 LED FESTOON
Common Alternative: DE3175



33MM 4 LED FESTOON
Common Alternative: 6428



37MM 4 LED FESTOON
Common Alternative: 6411



44MM 6 LED FESTOON
Common Alternative: 562

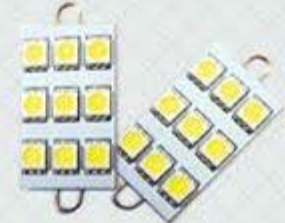

44MM 6 LED LOOP
Common Alternative: 578

DESCRIPTION	PART #	AVAIL. COLORS	VIEWING ANGLE	BRIGHTNESS	LIFESPAN	WARRANTY
CHEVY CAMARO LED DOME LIGHT	4831		180°	★★★★★	100,000 hrs.	LIFETIME
CHEVY CAMARO RGB DOME LIGHT	4831		180°	★★★★★	100,000 hrs.	LIFETIME
T10 3W CREE LED	5211		90°	★★★★★	100,000 hrs.	LIFETIME
T10 5 LED 1 CHIP	4802		180°	★★	100,000 hrs.	LIFETIME
T10 1 LED 1 CHIP	4803		90°	★★	100,000 hrs.	LIFETIME
T10 9 LED 3 CHIP	4804		270°	★★★★★	100,000 hrs.	LIFETIME
T10 4 LED FLANK	4805		180°	★★★★	100,000 hrs.	LIFETIME
T10 1 LED 3 CHIP	4806		180°	★★★★★	100,000 hrs.	LIFETIME
UNIVERSAL 36 LED BOARD	4901		180°	★★★★★	100,000 hrs.	LIFETIME
T10 PLASMA	4902		180°	★★★★	100,000 hrs.	LIFETIME
T10 2 LED FLANK	4903		90°	★★★	100,000 hrs.	LIFETIME
T10 9 SMD BOARD	5220		180°	★★★★	100,000 hrs.	LIFETIME
T5 1 LED 1 CHIP	4905		90°	★★	100,000 hrs.	LIFETIME
BA9S 5 LED 1 CHIP	4909		90°	★★	100,000 hrs.	LIFETIME
T10 5 LED 3 CHIP	4801		270°	★★★★★	100,000 hrs.	LIFETIME
BA9S 5 LED 3 CHIP	4904		270°	★★★★★	100,000 hrs.	LIFETIME
31MM 6 LED FESTOON	5202		180°	★★★★	100,000 hrs.	LIFETIME
33MM 4 LED FESTOON 1 CHIP	5203		180°	★★★	100,000 hrs.	LIFETIME
33MM 4 LED FESTOON 3 CHIP	5204		180°	★★★★★	100,000 hrs.	LIFETIME
37MM 4 LED FESTOON 1 CHIP	5205		180°	★★★	100,000 hrs.	LIFETIME
37MM 4 LED FESTOON 3 CHIP	5206		180°	★★★★★	100,000 hrs.	LIFETIME
44MM 6 LED FESTOON 1 CHIP	5207		180°	★★★	100,000 hrs.	LIFETIME
44MM 6 LED FESTOON 3 CHIP	5208		180°	★★★★★	100,000 hrs.	LIFETIME
44MM 6 LED LOOP 1 CHIP	5209		180°	★★★	100,000 hrs.	LIFETIME
44MM 6 LED LOOP 3 CHIP	5210		180°	★★★★★	100,000 hrs.	LIFETIME

LED TURN SIGNAL REPLACEMENT BULBS

ORACLE LED turn signal bulbs deliver an ultra bright output, making it safer for drivers on the road. These "Quick-Fire" response LED Bulbs are vivid and bright to keep your vehicle visible on the road. We offer a variety of bulb sizes and configurations for just about any turn signal application- car, truck, or motorcycle. LED bulbs are so efficient that the vehicle may think that no bulb installed- because of this LED turn signal bulbs often require a load equalizer or warning canceller to prevent a rapid-flash warning.



3156 13 SMD
Part# 5001



3157 13 SMD
Part# 5003



3156 18 SMD
Part# 5101



3157 18 SMD
Part# 5103



1156 13 SMD
Part# 5005



1157 13 SMD
Part# 5007



1156 18 SMD
Part# 5105



1157 18 SMD
Part# 5107



7440 13 SMD
Part# 5009



7443 13 SMD
Part# 5039



7440 18 SMD
Part# 5109



7443 18 SMD
Part# 5011



3157 SWITCHBACK
Part# 5014-005



3156 5W CREE
Part# 5212



3157 5W CREE
Part# 5213

DESCRIPTION	PART #	AVAIL. COLORS	TECHNOLOGY	BRIGHTNESS	LIFESPAN	WARRANTY
3156 13 SMD	5001	●●●●●	13 X 5050 SMDS	★★★★	60,000HRS	LIFETIME
3157 13 SMD	5003	●●●●●	13 X 5050 SMDS	★★★★	60,000HRS	LIFETIME
3156 18 SMD	5101	●●●●●	18 X 5050 SMDS	★★★★★	60,000HRS	LIFETIME
3157 18 SMD	5103	●●●●●	18 X 5050 SMDS	★★★★★	60,000HRS	LIFETIME
1156 13 SMD	5005	●●●●●	13 X 5050 SMDS	★★★★	60,000HRS	LIFETIME
1157 13 SMD	5007	●●●●●	13 X 5050 SMDS	★★★★	60,000HRS	LIFETIME
1156 18 SMD	5105	●●●●●	18 X 5050 SMDS	★★★★★	60,000HRS	LIFETIME
1157 18 SMD	5107	●●●●●	18 X 5050 SMDS	★★★★★	60,000HRS	LIFETIME
7440 13 SMD	5009	●●●●●	13 X 5050 SMDS	★★★★	60,000HRS	LIFETIME
7443 13 SMD	5039	●●●●●	13 X 5050 SMDS	★★★★	60,000HRS	LIFETIME
7440 18 SMD	5109	●●●●●	18 X 5050 SMDS	★★★★★	60,000HRS	LIFETIME
7443 18 SMD	5011	●●●●●	18 X 5050 SMDS	★★★★★	60,000HRS	LIFETIME
3157 SWITCHBACK	5014-005	●●●●●	64 X 3528 SMDS	★★★★	60,000HRS	LIFETIME
3156 5W CREE LED	5212	●	1 X 5W CREE CHIP	★★★★★★★	60,000HRS	LIFETIME
3157 5W CREE LED	5213	●	1 X 5W CREE CHIP	★★★★★★★	60,000HRS	LIFETIME



3156 SPIDER
Part# 5102



3157 SPIDER
Part# 5104



1156 SPIDER
Part# 5106



1157 SPIDER
Part# 5108



7440 SPIDER
Part# 5110



7443 SPIDER
Part# 5012



1156 WARNING CANCELLER
Part# 2034
Eliminates CANbus and Rapid Flash Errors.



1157 WARNING CANCELLER
Part# 2035
Eliminates CANbus and Rapid Flash Errors.



2 PIN FLASHER RELAY
Part# 2022
Eliminates Rapid Flash Error.



3 PIN FLASHER RELAY
Part# 2023
Eliminates Rapid Flash Error.



3156/3157 WARNING CANCELLER
Part# 2036
Eliminates CANbus and Rapid Flash Errors.



LED LOAD EQUALIZER
Part# 5013-504
Universal Unit - Eliminates Rapid Flash Errors.



7440/7443 WARNING CANCELLER
Part# 2037
Eliminates CANBUS and flickering errors

DESCRIPTION	PART #	AVAIL. COLORS	USAGE	BRIGHTNESS	LIFESPAN	WARRANTY
3156 SPIDER	5102	○	Turn signal or reverse light bulb	★★★★★	60,000HRS	LIFETIME
3157 SPIDER	5104	○	Turn signal or reverse light bulb	★★★★★	60,000HRS	LIFETIME
1156 SPIDER	5106	○	Turn signal or reverse light bulb	★★★★★	60,000HRS	LIFETIME
1157 SPIDER	5108	○	Turn signal or reverse light bulb	★★★★★	60,000HRS	LIFETIME
7440 SPIDER	5110	○	Turn signal or reverse light bulb	★★★★★	60,000HRS	LIFETIME
7443 SPIDER	5012	○	Turn signal or reverse light bulb	★★★★★	60,000HRS	LIFETIME
1156 WARNING CANCELLER	2034	N/A	Eliminates common LED issues	N/A	N/A	2 YEAR
1157 WARNING CANCELLER	2035	N/A	Eliminates common LED issues	N/A	N/A	2 YEAR
3156/3157 WARNING CANCELLER	2036	N/A	Eliminates common LED issues	N/A	N/A	2 YEAR
7440/7443 WARNING CANCELLER	2037	N/A	Eliminates common LED issues	N/A	N/A	2 YEAR
2 PIN FLASHER RELAY	2022	N/A	Eliminates common LED issues	N/A	N/A	2 YEAR
3 PIN FLASHER RELAY	2023	N/A	Eliminates common LED issues	N/A	N/A	2 YEAR
LED LOAD EQUALIZER	5013-504	N/A	Eliminates common LED issues	N/A	N/A	2 YEAR



RETROFIT PROJECTORS & BEZELS



TL 2.5" D2S RETROFIT PROJECTORS

The Acura TL Bi-Xenon Projectors are widely popular in HID retrofitting applications. These projectors are considered one of the best performing projector assemblies available on the market. The Acura TL projectors come with crystal clear ZKW-R lens. Instead of a "fuzzy" light dispersal, caused by low end lenses, these lenses create a distinct cut-off pattern (where the light output meets the top of the lens). Resulting in razor sharp and vibrant light.

Part# 8505

- Depth: 6.25 inches
- Height: 4.40 inches
- Width: 4.25 inches
- Lens Diameter: 2.5 inches
- Low & High Beam Functionality: (Bi-Xenon)
- Bulb Adapter & Holder Included
- Warranty: Three years
- Ideal for vehicles that use D2S HID Bulbs



FX 2.5" RETROFIT PROJECTORS

This projector system is an improved version of the OEM Infiniti FX35 Projector. Instead of an OEM lens, the FX Projectors come with a clear lens from the Acura TSX. This projector has a built in solenoid that changes from Xenon Low Beams to increased output Xenon High Beams. These are the best current compact Bi-Xenons out on the market. Housing has mounting tabs for an easier retrofitting process.

Part# 8501

- Depth: 5.50 inches
- Height: 3.75 inches
- Width: 4.35 inches
- Lens Diameter: 2.5 inches
- Low & High Beam Functionality: (Bi-Xenon)
- Bulb Adapter & Holder Included
- Warranty: Three years
- Ideal for vehicles that use D2S HID Bulbs



70MM 2.5" H1 6.1 RETROFIT PROJECTORS

Virtually the easiest projector to retrofit into any headlight housing, the 70mm H1 offers a low cost unit without sacrificing performance. This projector bolts right into the pre-existing hole in the back of your reflector bucket with little to no modification. The 70mm H1 offers amazing light output, the most precise sharp cutoff line, and non-existent glare.

Part# 8517

- Application: Universal
- Depth: 5.35 in.
- Width: 3.42 in.
- Height: 2.75 in.
- Mounting Shaft: 0.78 in.
- Lens Diameter: 2.5 in.
- Headlight Housing Depth Needed: 4.21 in.
- Low & High Beam Functionality: (Bi-Xenon)
- Cutoff Shields: Newly Designed Precise Cutoff
- Gating Bezels Included
- Adapter & Locking Plates Included
- Warranty: Three years



SQUARE 2.75" D2S RETROFIT PROJECTORS

The D2S Square Projector is the successor to the normal D2S Projector, but offers a new designed lens. With it's table-top light spread design, this projector is compatible with D2S and D2C bulbs, and produces a very sharp, attractive cut-off line (Vibrant band of colors across the top of light cut-off line). These projectors are very easy to install with a virtually no modification

Part# 8519

- Depth: 5.7"
- Height: 3.7"
- Width: 3.9"
- Mounting Shaft: 1.3"
- Lens Diameter: 2.75"
- Low & High Beam Functionality: (Bi-Xenon)
- Adapter & Locking Plates Included
- Warranty: Three years
- Ideal for vehicles that use D2S or D2C HID Bulbs

We also offer specialized square plasma halos for direct fitment onto your Square D2S Projectors

Part# 8519-051 White
Part# 8519-052 Blue
Part# 8519-053 Red





GTI BEZELS
Part# 8508



E46-R EXTENDED BEZELS
Part# 8512



APOLLO 1.0 BEZELS
Part# 8513



S-MAX 3.0 BEZELS
Part# 8514



MC-R BEZELS
Part# 8516



MINI 3 BEZELS
Part# 8520



RS BEZELS
Part# 8522



APOLLO 1.0 BLACK BEZELS
Part# 8523



APOLLO 2.0 BEZELS
Part# 8524



APOLLO 3.0 BEZELS
Part# 8525



OCULAR BEZELS
Part# 8526



PANAMERA BEZELS
Part# 8527



BEZEL CENTRIC RINGS
Part# 8528

Snaps directly into the inside of a 3 inch projector bezel allowing for 3 inch bezels to fit onto a 2.5 inch projector. This opens up a wider selection of bezels for 2.5" projectors to choose from, making your retrofit more diverse.

ORACLE Projector Bezel Centric Rings are compatible with the following projectors:

- ORACLE Acura TL 2.5" Projectors
- ORACLE 70mm H1 6.1 Projectors

ORACLE Projector Bezel Centric Rings are compatible with the following projector bezels:

- GTI Projector Bezels
- MINI 3 Projector Bezels
- RS Projector Bezels
- E46-R Extended Projector Bezels
- Apollo 1.0 Projector Bezels
- Apollo 1.0 Black Projector Bezels
- Apollo 2.0 Projector Bezels
- Apollo 3.0 Projector Bezels
- S-Max 3.0 Projector Bezels
- Ocular Projector Bezels
- MC-R Projector Bezels
- Panamera Projector Bezels



OFF-ROAD HIGH INTENSITY LIGHTING



High Intensity Discharge (HID) lighting is excellent for Off-Road applications. HID lights have no filament and can sustain vibration and impact better than incandescent and halogen lights. HID is also very efficient and produces six times the amount of light per watt as its incandescent counterparts. Our HID Off-Road lights are available in Spotlight and Floodlight configurations, two different styles, and three different sizes. Regardless of your Off-Road lighting needs, ORACLE has you covered!



A10 SERIES 4" HID

- Spot & Flood Available
- Ballast Type: Internal
- Technology: Xenon HID
- Operating Voltage: 12V-24V
- Lens Material: Toughened Glass
- Housing Material: ABS Plastic
- Wattage Available: 35W / 55W



A10 SERIES 7" HID

- Spot & Flood Available
- Ballast Type: Internal
- Technology: Xenon HID
- Operating Voltage: 12V-24V
- Lens Material: Toughened Glass
- Housing Material: ABS Plastic
- Wattage Available: 35W / 55W



A10 SERIES 9" HID

- Spot & Flood Available
- Ballast Type: Internal
- Technology: Xenon HID
- Operating Voltage: 12V-24V
- Lens Material: Toughened Glass
- Housing Material: ABS Plastic
- Wattage Available: 35W / 55W / 75W



B08 SERIES 4" HID

- Spot Available
- Ballast Type: Internal
- Technology: Xenon HID
- Operating Voltage: 12V-24V
- Lens Material: Toughened Glass
- Housing Material: ABS Plastic
- Wattage Available: 35W



B08 SERIES 7" HID

- Spot & Flood Available
- Ballast Type: Internal
- Technology: Xenon HID
- Operating Voltage: 12V-24V
- Lens Material: Toughened Glass
- Housing Material: ABS Plastic
- Wattage Available: 35W / 55W



B08 SERIES 9" HID

- Spot & Flood Available
- Ballast Type: Internal
- Technology: Xenon HID
- Operating Voltage: 12V-24V
- Lens Material: Toughened Glass
- Housing Material: ABS Plastic
- Wattage Available: 35W

DESCRIPTION	PART#	STYLE	WATTS	LUMENS	KELVIN TEMP	LIFESPAN	WARRANTY
4" B08 35W HID	5601-012	SPOT	35W	2,975LM	6,000K	30,000 HRS	2 YEAR
4" A10 35W HID	5604-012	SPOT	35W	2,975LM	6,000K	30,000 HRS	2 YEAR
4" A10 55W HID	5607-012	SPOT	55W	4,675LM	6,000K	30,000 HRS	2 YEAR
4" A10 35W HID	5614-012	FLOOD	35W	2,975LM	6,000K	30,000 HRS	2 YEAR
7" B08 35W HID	5602-012	SPOT	35W	2,975LM	6,000K	30,000 HRS	2 YEAR
7" A10 35W HID	5605-012	SPOT	35W	2,975LM	6,000K	30,000 HRS	2 YEAR
7" A10 55W HID	5608-012	SPOT	55W	4,675LM	6,000K	30,000 HRS	2 YEAR
7" B08 55W HID	5617-012	SPOT	55W	4,675LM	6,000K	30,000 HRS	2 YEAR
7" B08 35W HID	5612-012	FLOOD	35W	2,975LM	6,000K	30,000 HRS	2 YEAR
7" A10 35W HID	5615-012	FLOOD	35W	2,975LM	6,000K	30,000 HRS	2 YEAR
9" B08 35W HID	5603-012	SPOT	35W	2,975LM	6,000K	30,000 HRS	2 YEAR
9" A10 35W HID	5606-012	SPOT	35W	2,975LM	6,000K	30,000 HRS	2 YEAR
9" A10 55W HID	5609-012	SPOT	55W	4,675LM	6,000K	30,000 HRS	2 YEAR
9" A10 75W HID	5610-012	SPOT	75W	6,375LM	6,000K	30,000 HRS	2 YEAR
9" B08 35W HID	5613-012	FLOOD	35W	2,975LM	6,000K	30,000 HRS	2 YEAR
9" A10 35W HID	5616-012	FLOOD	35W	2,975LM	6,000K	30,000 HRS	2 YEAR

OFF-ROAD LED DOUBLE ROW LIGHT BARS



ORACLE high powered LED Off-Road Bars are designed for punishment. Our Off-road Series can withstand the toughest terrain you can put them through. Nearly indestructible rugged die-cast housing PMMA lenses and powered by high output CREE LEDs (made in the U.S.A.), these lightbars allow you to explore the roads less travelled with efficiency and style.

DOUBLE ROW LIGHT BARS INCLUDE:

- Highest Output per Watt
- Special Designed Optics
- Shockproof Design
- 50,000hr Lifespan
- 30° Spot Precision Beam
- Low Power Draw
- 6000k Color Temp
- 2 Year Warranty
- IP67 Rating
- Side-Mounting Brackets
- Installation Hardware



8" 36W LED BAR

Part # 5702
Lumen Output: 3,060 lm
Dim: 8" X 3.25" X 3.5"



12" 60W LED BAR

Part # 5703
Lumen Output: 5,100 lm
Dim: 12" X 3.25" X 3.5"



13.5" 72W LED BAR

Part # 5704
Lumen Output: 6,120 lm
Dim: 13.5" X 3.25" X 3.5"



22" 120W LED BAR

Part # 5705
Lumen Output: 10,200 lm
Dim: 22" X 3.25" X 3.5"



32" 180W LED BAR

Part # 5706
Lumen Output: 15,300 lm
Dim: 32" X 3.25" X 3.5"



42" 240W LED BAR

Part # 5707
Lumen Output: 20,400 lm
Dim: 42" X 3.25" X 3.5"



50" 288W LED BAR

Part # 5756
Lumen Output: 25,000 lm
Dim: 50" X 3.25" X 3.5"



52" 300W LED BAR

Part # 5780
Lumen Output: 25,500 lm
Dim: 52" X 3.25" X 3.5"



DESCRIPTION	OPERATING VOLTAGE	AMP DRAW	TECHNOLOGY	WEIGHT	WARRANTY
8" 36W LED BAR	12V - 24V DC	3.0A @12V / 1.5A @24V	12X 3W LEDES	2 LBS 8 OZ	2 YEAR
12" 60W LED BAR	12V - 24V DC	5.0A @12V / 2.5A @24V	20X 3W LEDES	3 LBS 8 OZ	2 YEAR
13.5" 72W LED BAR	12V - 24V DC	7.0A @12V / 3.5A @24V	24X 3W LEDES	4 LBS 8 OZ	2 YEAR
22" 120W LED BAR	12V - 24V DC	10A @12V / 5.0A @24V	40X 3W LEDES	5 LBS 7 OZ	2 YEAR
32" 180W LED BAR	12V - 24V DC	14A @12V / 6.0A @24V	60X 3W LEDES	9 LBS 0 OZ	2 YEAR
42" 240W LED BAR	12V - 24V DC	19A @12V / 9.0A @24V	80X 3W LEDES	10 LBS 12 OZ	2 YEAR
50" 288W LED BAR	12V - 24V DC	20A @12V / 10A @24V	96X 3W LEDES	12 LBS 7 OZ	2 YEAR
52" 300W LED BAR	12V - 24V DC	21A @12V / 11A @24V	100X 3W LEDES	14 LBS 2 OZ	2 YEAR

STRAIGHT LED BARS

CURVED LED LIGHT BARS

ORACLE Lighting now offers the CREE powered 50", 52", and 54" Light Bars in a Curved Housing Option. These LED light bars transform the common rectangular light bar style into a curved style, matching the curved styling of most vehicles and offering a wider light dispersion without sacrificing forward firing distance. These light bars are perfect for off-roaders needing both forward and peripheral light dispersal, while eliminating the necessity of adding multiple light bars for this desired effect. These light bars contain both flood and spot optics for optimal light dispersal.



50" 288W CURVED BAR

•PART # 5758

•LUMEN OUTPUT: 25,000 LM



52" 300W CURVED BAR

•PART # 5760

•LUMEN OUTPUT: 26,000 LM



54" 312W CURVED BAR

•PART # 5764

•LUMEN OUTPUT: 27,000 LM

CURVED LED LIGHT BARS INCLUDE:

- Spot / Flood Style
- Double Row LEDs
- PMMA Lens
- Die-Cast Aluminum Housing
- 50,000+ Hour Lifespan
- No Warm Up- Instant On/Off
- 10V-30V Wide Input Range
- Over / Under Voltage Protection
- 6000K Color Temp
- 2 Year Warranty
- IP67 Rating
- Die-Cast Side-Mounting Brackets
- Installation Hardware



IP67
WATERPROOF



FLOOD OPTICS

SPOT OPTICS

FLOOD OPTICS



DESCRIPTION	PART#	TECHNOLOGY	AMP DRAW	DIM	WEIGHT	WARRANTY
50" 288W CURVED BAR	5758	96 X 3W CREE LEDS	22A @ 12V	50" X 3.6" X 3.2"	15LB 60Z	2 YEAR
52" 300W CURVED BAR	5760	100 X 3W CREE LEDS	25A @ 12V	52" X 3.6" X 3.2"	15LB 90Z	2 YEAR
54" 312W CURVED BAR	5764	104 X 3W CREE LEDS	25A @ 12V	54" X 3.6" X 3.2"	16LB 30Z	2 YEAR

sleek LED LIGHT BARS

ORACLE Off-Road Sleek LED Light Bars boast a slim design and the latest optical lenses on the market, 4D optics. These new optics allow for precision spot illumination with the least amount of light fall-off. Utilizing a separately designed fish eye lens, instead of a reflector, the new optics system captures the maximum amount of light emitted from the LED and projects it exactly where you need it.



Adjustable Bolt Sliding Mount Brackets included



5" 20W SLEEK BAR

Part # 5741
Lumen Output: 1,900 lm



8" 40W SLEEK BAR

Part # 5742
Lumen Output: 3,800 lm



11" 60W SLEEK BAR

Part # 5743
Lumen Output: 5,700 lm



17" 100W SLEEK BAR

Part # 5744
Lumen Output: 9,500 lm



20" 120W SLEEK BAR

Part # 5745
Lumen Output: 11,400 lm



30" 180W SLEEK BAR

Part # 5746
Lumen Output: 17,100 lm



40" 240W SLEEK BAR

Part # 5747
Lumen Output: 22,800 lm



44" 260W SLEEK BAR

Part # 5748
Lumen Output: 24,700 lm



DESCRIPTION	PART#	TECHNOLOGY	OPERATING VOLTAGE	DIM	WEIGHT	WARRANTY
5" 20W SLEEK BAR	5741	2 X 10W CREE LEDS	12V - 24V	5" X 3.25" X 3.15"	1 LB 10 OZ	2 YEAR
8" 40W SLEEK BAR	5742	4 X 10W CREE LEDS	12V - 24V	8" X 3.25" X 3.15"	2 LBS 9 OZ	2 YEAR
11" 60W SLEEK BAR	5743	6 X 10W CREE LEDS	12V - 24V	11" X 3.25" X 3.15"	3 LBS 8 OZ	2 YEAR
17" 100W SLEEK BAR	5744	10 X 10W CREE LEDS	12V - 24V	17" X 3.25" X 3.15"	5 LBS 5 OZ	2 YEAR
20" 120W SLEEK BAR	5745	12 X 10W CREE LEDS	12V - 24V	20" X 3.25" X 3.15"	6 LBS 8 OZ	2 YEAR
30" 180W SLEEK BAR	5746	18 X 10W CREE LEDS	12V - 24V	30" X 3.25" X 3.15"	9 LBS 1 OZ	2 YEAR
40" 240W SLEEK BAR	5747	24 X 10W CREE LEDS	12V - 24V	40" X 3.25" X 3.15"	11 LBS 4 OZ	2 YEAR
44" 260W SLEEK BAR	5748	26 X 10W CREE LEDS	12V - 24V	44" X 3.25" X 3.15"	12 LBS 10 OZ	2 YEAR

CURVED LIGHT BAR BRACKETS

Our Curved LED Light Bar Brackets will allow you to mount a 52" Curved LED Light Bar to the roof of your vehicle. These brackets are designed to match the curvature of the ORACLE 52" 300W LED Light Bar and are made from Powder-Coated plate steel. These brackets mount inside of the door jamb or drip sill depending on your application, but fully protect your vehicle from the outside elements by using the included all-weather gaskets. All stainless steel mounting hardware, weather gaskets and DIY Installation Instructions are included. These brackets will also fit 54" Light Bar #5764 as well as the 50" Curved Light Bar #5758 (with spacers)

2007-2013 SILVERADO/SIERRA CURVED 52" LED LIGHT BAR BRACKETS



Part# 2051

- Weight: 8.8 oz.
- Width: 5.5"
- Height: .25"
- Length: 7"
- Mounts to Upper Door Jamb
- Weather Resistant Coating
- All Weather Mounting w/ Rubber Gaskets
- Welded Steel Construction
- Will Fit All 2007-13 Chevy Silverado/GMC Sierra Models



Recommended to use with
52" 300W Curved Light Bar
Part# 5760

2009-2014 FORD F-150/SVT RAPTOR CURVED 52" LED LIGHT BAR BRACKETS



Part# 2053

- Weight: 1 lb 3.8 oz.
- Width: 4"
- Height: .125"
- Length: 12.25"
- Mounts to Upper Drip Sill
- Weather Resistant Coating
- All Weather Mounting w/ Rubber Gaskets
- Welded Steel Construction
- Will Fit All 2009-14 Ford F-150/SVT Raptor Models



Recommended to use with
52" 300W Curved Light Bar
Part# 5760

2004-2014 NISSAN TITAN CURVED 52" LED LIGHT BAR BRACKETS



Part# 2054

- Weight: 11.6 oz.
- Width: 4"
- Height: .25"
- Length: 7"
- Mounts to Upper Drip Sill
- Weather Resistant Coating
- All Weather Mounting w/ Rubber Gaskets
- Welded Steel Construction
- Will Fit All 2004-2014 Nissan Titan Models



Recommended to use with
52" 300W Curved Light Bar
Part# 5760

2007-2014 TOYOTA TUNDRA CURVED 52" LED LIGHT BAR BRACKETS



Part# 2055

- Weight: 1 lb 3.2 oz.
- Width: 3.5"
- Height: .125"
- Length: 14.5"
- Mounts to Upper Drip Sill
- Weather Resistant Coating
- All Weather Mounting w/ Rubber Gaskets
- Welded Steel Construction
- Will Fit All 2007-2014 Toyota Tundra Models



Recommended to use with
52" 300W Curved Light Bar
Part# 5760



2002-2008 DODGE RAM 1500/2500/3500 LED LIGHT BAR BRACKETS

- Part# 2156**
- Weight: 1 Lb 15.4oz
 - Width: 10.6"
 - Height: 4.6"
 - Length: 4"
 - Mounts to inside door jamb
 - Weather Resistant Coating
 - Welded Steel Construction
 - Will Fit all 2002-2008 Dodge Ram 1500/2500/3500 Models



Matches perfectly with
50" 288W Curved Light Bar
Part# 5758



1999-2006 GMC SIERRA LED LIGHT BAR BRACKETS

- Part# 2157**
- Weight: 1 Lb 3.0oz
 - Width: 10"
 - Height: 4"
 - Length: 2.5"
 - Mounts to inside door jamb
 - Weather Resistant Coating
 - Welded Steel Construction
 - Will Fit all 1999-2006 GMC Sierra Models



Recommended to use with
52" 300W Curved Light Bar
Part# 5760



1999-2006 CHEVY SILVERADO/TAHOE/SUBURBAN LED LIGHT BAR BRACKETS

- Part# 2158**
- Weight: 1 Lb 3.0oz
 - Width: 10"
 - Height: 4"
 - Length: 2.5"
 - Mounts to inside door jamb
 - Weather Resistant Coating
 - Welded Steel Construction
 - Will Fit all 1999-2006 GMC Sierra Models



Recommended to use with
52" 300W Curved Light Bar
Part# 5760



1999-2014 FORD F250/F350/SUPERDUTY/EXCURSION LED LIGHT BAR BRACKETS

- Part# 2159**
- Weight: 15.2 oz
 - Width: 9.1"
 - Height: 7"
 - Length: 4"
 - Mounts to inside door jamb
 - Weather Resistant Coating
 - Welded Steel Construction
 - Will Fit all 1999-2014 Ford F250/F350/Superduty/Excursion Models



Recommended to use with
52" 300W Curved Light Bar
Part# 5760



DESCRIPTION	PART#	COMPATIBLE YEARS	COMPATIBLE BARS	WARRANTY
SILVERADO/SIERRA CURVED BRACKETS	2051	2007-2013	50" CURVED	2 YEAR
FORD F-150/SVT RAPTOR CURVED BRACKETS	2053	2009-2014	50" CURVED	2 YEAR
NISSAN TITAN CURVED BRACKETS	2054	2004-2014	50" CURVED	2 YEAR
TOYOTA TUNDRA CURVED BRACKETS	2055	2007-2014	50" CURVED	2 YEAR
DODGE RAM 1500/2500/3500 BRACKETS	2156	2002-2008	50" CURVED, 50"/52" STRAIGHT	2 YEAR
GMC SIERRA BRACKETS	2157	1999-2006	50" CURVED, 50"/52" STRAIGHT	2 YEAR
CHEVY SILVERADO/TAHOE/SUBURBAN BRACKETS	2158	1999-2006	50" CURVED, 50"/52" STRAIGHT	2 YEAR
FORD F250/F350/SUPERDUTY/EXCURSION BRACKETS	2159	1999-2014	50" CURVED, 50"/52" STRAIGHT	2 YEAR



OFF-ROAD SERIES LED LIGHTS

ORACLE Off Road LED Lights use CREE Powered Chips and High Quality LED Optics to produce unmatched brightness. All CREE LED Chips are Made in the USA and are known as a worldwide leader in Quality. These Lights are impervious to shock and vibration and the rugged chassis are IP67 rated so you never need to worry moisture damaging your lights. We offer a wide range of LED Off Road lights for a variety of applications as well as OE design services.



2" 10W LED SQUARE SPOT

Part# 5723

- Lumen Output: 850lm
- Beam Type: 30° Spot
- Technology: 1X 10W CREE LED
- Total Power: 10W
- Operating Voltage: 10V-30V DC
- Weight: 11.2 oz
- Dim: 2" X 3" X 2"
- Amp Draw: .7A @12V / .35A @24V



2" 10W LED MODULAR SPOT

Part# 5719

- Lumen Output: 850lm
- Beam Type: 30° Spot
- Technology: 1X 10W CREE LED
- Total Power: 10W
- Operating Voltage: 10V-30V DC
- Weight: 11.2 oz
- Dim: 2" X 3" X 2"
- Amp Draw: .7A @12V / .35A @24V
- Designed to link with other modular spotlights to create a light bar.



2.5" 12W LED SQUARE SPOT

Part# 5701

- Lumen Output: 1020lm
- Beam Type: 30° Spot
- Technology: 4X 3W CREE LEDs
- Total Power: 12W
- Weight: 15.6oz
- Dim: 2.5" X 5" X 2.5"
- Operating Voltage: 10V-30V DC
- Amp Draw: .9A @12V / .48A @24V



3" 20W 4D OPTIC LED SQUARE SPOT

Part# 5779

- Lumens Output: 2000lm
- Beam Type: 30° Spot
- Technology: 4 x 5W CREE XT-E LEDs
- Total Power: 20W
- Weight: 1 lb 5.6 oz
- Dim: 3" X 3" X 3.5"
- Operating Voltage: 10V-30V DC
- Amp Draw: .9A @12V / .48A @24V



3.5" 20W FLUSH LED SQUARE SPOT

Part# 5768

- Lumens Output: 2000lm
- Beam Type: 30° Spot
- Technology: 4 x 5W CREE XT-E LEDs
- Total Power: 20W
- Weight: 1 lb 5.6 oz
- Dim: 3.6" X 4.8" X 3.1"
- Operating Voltage: 10V-30V DC
- Amp Draw: .9A @12V / .48A @24V



4.5" 20W ROUND LED PLASMA SPOT

Part# 5725

- Lumens Output: 2000lm
- Beam Type: 30° Spot
- Technology: 1 x 20W CREE LED
- Total Power: 20W
- Weight: 1 Lb 11.6oz
- Dim: 6" X 4.5" X 3.8"
- Operating Voltage: 10V-30V DC
- Amp Draw: 1.8A @ 12V / 0.9A @ 24V



DESCRIPTION	PART#	WATTS	LUMENS	LENS TYPE	LIFETIME	WARRANTY
2" 10W LED SQUARE SPOT	5723	10W	850LM	PMMA	50,000 HRS	2 YEAR
2" 10W LED MODULAR SPOT	5719	10W	850LM	PMMA	50,000 HRS	2 YEAR
2.5" 12W LED SQUARE SPOT	5701	12W	1020LM	PMMA	50,000 HRS	2 YEAR
3" 20W 4D OPTIC LED SQUARE SPOT	5779	20W	2000LM	PMMA	50,000 HRS	2 YEAR
3.5" 20W FLUSH LED SQUARE SPOT	5768	20W	2000LM	PMMA	50,000 HRS	2 YEAR
4.5" 20W ROUND LED PLASMA SPOT	5725	20W	2000LM	PMMA	50,000 HRS	2 YEAR



5" 21W LED ROUND SPOT

Part# 5718

- Lumens Output: 1,785lm
- Beam Type: 60° Spot
- Technology: 7X 3W CREE LEDs
- Total Power: 21W
- Weight: 3 Lb 8oz
- Dim: 3" X 5.25" X 9"
- Operating Voltage: 12V-24V DC
- Amp Draw: 1.75A @12V / .87A @24V



8" 24W LED SPOT BAR

Part# 5721

- Lumens Output: 2,040lm
- Beam Type: 60° Spot
- Technology: 24X 1W CREE LEDs
- Total Power: 24W
- Weight: 3 Lb 1oz
- Dim: 8" X 4.5" X 1.5"
- Operating Voltage: 12V-24V DC
- Amp Draw: 1.8A @12V / .85A @24V



6" 50W LED SQUARE SPOT

Part# 5764

- Lumens Output: 4250lm
- Beam Type: 25° Spot
- Technology: 5 X 10W CREE LEDs
- Total Power: 50W
- Weight: 3lb 6oz
- Dim: 6" X 4.3" X 3.7"
- Operating Voltage: 10-60V DC
- Amp Draw: 1.75A @12V / .87A @24V



50W PORTABLE SEARCH LIGHT

Part# 5750

- Lumens Output: 4,700lm
- Beam Type: 30° Spot
- Technology: 10 X 5W CREE LEDs
- Total Power: 50W
- Weight: 7Lbs 7oz
- Dim: 6" X 4.3" X 3.7"
- Operating Voltage: 12-24V DC
- 360° Horizontal Rotation
- 180° Vertical Rotation
- 500-600 Ft Wireless Range
- 12V Auxiliary Plug
- Removable Mounting Base



6" 51W LED ROUND SPOT

Part# 5717

- Lumens Output: 3500lm
- Beam Type: 30° Spot
- Technology: 10 X 5W CREE LEDs
- Total Power: 50W
- Weight: 4Lbs 15oz
- Dim: 7" x 9.25" x 3.4"
- Operating Voltage: 10V-30V DC
- Amp Draw: 1.75A @12V / .87A @24V



6.25" 100W LED SQUARE SPOT

Part# 5765

- Lumens Output: 10,800lm
- Beam Type: 25° Spot
- Technology: 20 X 5W CREE LEDs
- Total Power: 100W
- Weight: 6lb 7oz
- Dim: 6.25" x 5.25" x 4.27"
- Operating Voltage: 10V-30V DC
- Amp Draw: 1.75A @12V / .87A @24V



DESCRIPTION	PART#	WATTS	LUMENS	LENS TYPE	LIFETIME	WARRANTY
5" 21W LED ROUND SPOT	5718	21W	1785LM	PMMA	50,000 HRS	2 YEAR
8" 24W LED SPOT BAR	5721	24W	2040LM	PMMA	50,000 HRS	2 YEAR
6" 50W LED SQUARE SPOT	5764	50W	4250LM	POLYCARBONATE	50,000 HRS	2 YEAR
50W PORTABLE SEARCH LIGHT	5750	50W	4700LM	PMMA	50,000 HRS	2 YEAR
6" 51W LED ROUND SPOT	5717	51W	3500LM	PMMA	50,000 HRS	2 YEAR
6.25" 100W LED SQUARE SPOT	5765	100W	10800LM	POLYCARBONATE	50,000 HRS	2 YEAR



JEEP WRANGLER LIGHT BRACKETS

JEEP JK LOWER WINDSHIELD UNIVERSAL POST MOUNT BRACKETS

Install any Post-Mount Auxiliary Light with this universal bracket designed for the 2007-2015 Jeep Wrangler JK. Attaches to the lower windshield pillars and retains driver visibility. These brackets are made specifically for the JEEP Wrangler JK model and will attach directly to your vehicle using the existing factory hardware.



- Part# 2042**
- Weight: 8.6 oz.
 - Width: 4"
 - Height: 3"
 - Length: 3.6"
 - Mounts to Windshield Pillar
 - Uses Factory Bolt Hardware
 - Weather Resistant Coating
 - Welded Steel Construction
 - Will Fit all 2007-15 Jeep JK Models

Suggested Light Module:
3" 20W 4D Optic LED Square
Part# 5779



JEEP JK LOWER WINDSHIELD SINGLE CUBE LIGHT MOUNT BRACKETS

Mount "Cube" style lights to the lower windshield of a 2007-2015 Jeep Wrangler. This bracket eliminates the cube light's post mount for a cleaner and more secure fitment. These brackets are made specifically for the JEEP Wrangler JK model and will attach directly to your vehicle using the existing factory hardware.



- Part# 2050**
- Weight: 3.8 oz.
 - Width: 2.2"
 - Height: 2"
 - Length: 3.4"
 - Mounts to Windshield Pillar
 - Uses Factory Bolt Hardware
 - Weather Resistant Coating
 - Welded Steel Construction
 - Will Fit all 2007-15 Jeep JK Models

Suggested Light Module:
3" 20W 4D Optic LED Square
Part# 5779



JEEP JK LOWER WINDSHIELD DUAL CUBE LIGHT MOUNT BRACKETS

Mount 2x "Cube" style lights to the lower windshield of a 2007-2015 Jeep Wrangler. This bracket eliminates the cube lights' post mount for a cleaner and more secure fitment. These brackets are made specifically for the JEEP Wrangler JK model and will attach directly to your vehicle using the existing factory hardware.



- Part# 2045**
- Weight: 8.4 oz.
 - Width: 2.3"
 - Height: 2.4"
 - Length: 7"
 - Mounts to Windshield Pillar
 - Uses Factory Bolt Hardware
 - Weather Resistant Coating
 - Welded Steel Construction
 - Will Fit all 2007-15 Jeep JK Models

Suggested Light Modules:
3" 20W 4D Optic LED Square
Part# 5779





JEEP WRANGLER JK UPPER WINDSHIELD BRACKETS

Mount the ORACLE 288W 50" Double Row LED Light Bar across the front windshield of a Jeep Wrangler JK easily with this new pillar mount bracket from ORACLE Lighting. These brackets are made specifically for the JEEP Wrangler JK models and will attach directly to your vehicle without further modification.

Part# 2046

- Weight: 3lb. 9oz.
- Width: 3.5"
- Height: 6.5"
- Length: 22.5"
- Mounts to windshield Pillar
- Uses Factory Bolt Hardware
- Weather Resistant Coating
- Welded Steel Construction
- Will Fit all Jeep JK Models

Suggested Light Module:
288W 50" Double Row LED Light Bar
Part# 5756



JEEP WRANGLER TJ UPPER WINDSHIELD BRACKETS

Mount the ORACLE 288W 50" Double Row LED Light Bar across the front windshield of a Jeep Wrangler TJ easily with this new pillar mount bracket from ORACLE Lighting. These brackets are made specifically for the JEEP Wrangler TJ models and will attach directly to your vehicle without further modification.

Part# 2160

- Weight: 3lb. 9oz.
- Width: 3.5"
- Height: 6.5"
- Length: 22.5"
- Mounts to windshield Pillar
- Uses Factory Bolt Hardware
- Weather Resistant Coating
- Welded Steel Construction
- Will Fit all Jeep TJ Models

Suggested Light Module:
288W 50" Double Row LED Light Bar
Part# 5756



JEEP JK HOOD MOUNTING BRACKETS SM

Mount the ORACLE 120W 22" Double Row LED Light Bar to the hood of a 2007-2015 Jeep Wrangler JK easily with this new hood mount bracket from ORACLE Lighting. These brackets are made specifically for the JEEP Wrangler JK model and will attach directly to your vehicle without further modification.

Part# 2043

- Weight: 15.6 oz.
- Width: 6.5"
- Height: 3.25"
- Length: 5.1"
- Mounts to Hood Hinge
- Uses Factory Bolt Hardware
- Weather Resistant Coating
- Welded Steel Construction
- Will Fit all 2007-15 Jeep JK Models

Suggested Light Module:
120W 22" Double Row LED Light Bar
Part# 5705



DESCRIPTION	PART#	INCLUDED LIGHTS	MAX LUMEN OUTPUT	WARRANTY
LOWER WINDSHIELD BRACKETS	2042	N/A	N/A	2 YEAR
SINGLE LIGHT MOUNTING PILLAR BRACKETS	2050	N/A	N/A	2 YEAR
DUAL LIGHT MOUNTING PILLAR BRACKETS	2045	N/A	N/A	2 YEAR
UPPER WINDSHIELD BRACKETS - JK	2046	N/A	N/A	2 YEAR
UPPER WINDSHIELD BRACKETS - TJ	2160	N/A	N/A	2 YEAR
HOOD MOUNTING BRACKETS	2043	N/A	N/A	2 YEAR
LOWER WINDSHIELD BRACKETS COMBO	2142	2 X 3" 20W 4D SQUARES	3,400LM	2 YEAR
SINGLE LIGHT PILLAR BRACKETS COMBO	2150	2 X 3" 20W 4D SQUARES	3,400LM	2 YEAR
DUAL LIGHT PILLAR BRACKETS COMBO	2145	4 X 3" 20W 4D SQUARES	6,800LM	2 YEAR
UPPER WINDSHIELD BRACKETS COMBO - JK	2146	1 X 50" 288W DOUBLE ROW BAR	25,000LM	2 YEAR
UPPER WINDSHIELD BRACKETS COMBO - TJ	2161	1 X 50" 288W DOUBLE ROW BAR	25,000LM	2 YEAR
HOOD MOUNTING BRACKETS COMBO	2143	1 X 22" 120W DOUBLE ROW BAR	10,000LM	2 YEAR

FOG LIGHT REPLACEMENT BRACKETS

ORACLE Fog Light Replacement Brackets are perfect for upgrading your factory halogen fog lights to superior LEDs. These brackets are manufactured to match the OEM fitment of the following vehicles. We also offer combo packages including the LED lights and brackets; everything you need to have more light output while improving styling.

FORD RAPTOR 2010-2014 FOG LIGHT REPLACEMENT BRACKETS

Mount the ORACLE 20W 3" Double Row LED Square Spots to the lower portion of a 2010-2014 Ford Raptor easily with this new fog light mount bracket from ORACLE Lighting. These brackets are made specifically for the 2010-2014 Ford Raptor models and will attach directly to your vehicle without further modification.



- Part# 2049**
- Weight: 2 Lb 11.4 oz
 - Width: 9.5"
 - Height: 9.25"
 - Length: 1"
 - Uses Factory Bolt Hardware
 - Weather Resistant Coating
 - Welded Steel Construction
 - Will Fit all 2010-2014 Ford Raptor Models

Matches perfectly with
3" 20W 4D Optic LED Square
Part# 5779



FORD F-150 1999-2014 FOG LIGHT REPLACEMENT BRACKETS

Replace your factory fog lights with two 6" 50W LED Square Spots easily with these new fog light mount brackets from ORACLE Lighting. These brackets are made specifically for the 1999-2014 Ford F-150 and Superduty models with existing fog lights. These will attach directly to your vehicle without further modification.



- Part# 2062**
- Weight: 2 Lb 11.4 oz
 - Width: 9.5"
 - Height: 9.25"
 - Length: 1"
 - Uses Factory Bolt Hardware
 - Weather Resistant Coating
 - Welded Steel Construction
 - Will Fit all 1999-2014 Ford F-150 Models with Fog Light Package

Matches perfectly with
6" 50W LED Square Spot
Part# 5764



CHEVY SILVERADO 2007-2013 FOG LIGHT REPLACEMENT BRACKETS

Replace your factory fog lights with four 2.5" 12W LED Square Spots easily with these new fog light mount brackets from ORACLE Lighting. These brackets are made specifically for the 2007-2013 Chevy Silverado models with existing fog lights. These will attach directly to your vehicle without further modification.



- Part# 2063**
- Weight: 2 Lb 11.4 oz
 - Width: 9.5"
 - Height: 9.25"
 - Length: 1"
 - Uses Factory Bolt Hardware
 - Weather Resistant Coating
 - Welded Steel Construction
 - Will Fit all 2007-2013 Chevy Silverado Models with Fog Light Package

Matches perfectly with
2.5" 12W LED Square Spot
Part# 5701



DESCRIPTION	PART#	INCLUDED LIGHTS	MAX LUMEN OUTPUT	WARRANTY
RAPTOR FOG LIGHT BRACKETS	2049	N/A	N/A	2 YEAR
FORD F-150 FOG LIGHT BRACKETS	2062	N/A	N/A	2 YEAR
CHEVY SILVERADO FOG LIGHT BRACKETS	2063	N/A	N/A	2 YEAR
RAPTOR FOG LIGHT BRACKETS COMBO	2149	4 X 3" 20W 4D SQUARES	6,800LM	2 YEAR
FORD F-150 FOG LIGHT BRACKETS COMBO	2162	2 X 6" 50W SQUARES	8,500LM	2 YEAR
CHEVY SILVERADO FOG LIGHT BRACKETS COMBO	2163	2 X 2.5" 12W SQUARES	2,040LM	2 YEAR

OFF-ROAD LIGHTING ACCESSORIES



LIGHT BAR DELUXE ROCKER SWITCH

- Part# 2070**
- Single Pole/Single Throw (SPST) on/off
 - Watertight sealed
 - Five 1/4" male contact terminals
 - Female push ON connector: CFP-164
 - Switch mounting cutout: 0.830" by 1.45"
 - Optimal panel thickness: 0.125"
 - Current rating: 20A @ 12V



40A SINGLE LIGHT HARNESS

- Part# 2073**
- 40 AMP relay with connectors
 - 30 AMP in-line fuse
 - Max wattage output : 288W
 - Simplifies off-road light installation
 - Pre-wired on/off switch
 - Soldered and heat shrunk connections



40A DOUBLE LIGHT HARNESS

- Part# 2014**
- 40 AMP relay with connectors
 - 30 AMP in-line fuse
 - Max wattage output : 80W x2
 - Simplifies off-road light installation
 - Pre-wired on/off switch
 - Soldered and heat shrunk connections



WIRELESS DOUBLE LIGHT HARNESS

- Part# 5772**
- 40 AMP relay with connectors
 - 30 AMP in-line fuse
 - Max wattage output : 80W
 - Simplifies off-road light installation
 - Wireless on/off switch
 - Soldered and heat shrunk connections



2" ALUMINUM BAR CLAMP MOUNT

- Part# 5771**
- Billet aluminum construction
 - Textured black powdercoat finish
 - Universal mount fits 1.5"-2" tube
 - Includes rubber insulators
 - 304 stainless steel hardware
 - Use with any auxiliary lights



1" ALUMINUM BAR CLAMP MOUNT

- Part# 5773**
- Billet aluminum construction
 - Textured black powdercoat finish
 - Universal mount fits 1"-1.5" tube
 - 304 stainless steel hardware
 - Use with any auxiliary lights



OFF-ROAD MAGNET MOUNT

- Part# 2015**
- Completely versatile
 - Add off-road lighting without drilling holes
 - Industrial strength magnet
 - Can be used with off-road lights & bars



WATERPROOF SQUARED²™ HALOS



The new ORACLE Waterproof 3" Squared Halos can be installed onto any 3" Square Off-Road Lights. Revolutionary Waterproof design can operate in the worst possible conditions. Each square halo utilizes a hard resin outer shell with a silicone inner seal that protects the LEDs and components. Easily installs onto the outside of the lamp housing and is visible even with the LED lamp turned on!

- Part# 5776**
- UV resistant hard resin outer shell
 - Waterproof soft silicone inner potting
 - Easy installation, takes just minutes!
 - No need to remove light lens
 - Will not void your light bar warranty
 - Six color options including ColorSHIFT



- ColorSHIFT halos include quick connects
- Multi-layer 3M adhesive backing
- Optimized high density LED spacing
- Fits all standard 3" x 3" cube LED lights
- ORACLE lifetime LED warranty

DESCRIPTION	PART #	APPLICATION	MAX WATTAGE	WARRANTY
LIGHT BAR DELUXE ROCKER SWITCH	2070	UNIVERSAL	N/A	2 YEAR
40A SINGLE LIGHT HARNESS	2073	UNIVERSAL	288W	2 YEAR
40A DOUBLE LIGHT HARNESS	2014	UNIVERSAL	80W	2 YEAR
WIRELESS DOUBLE LIGHT HARNESS	5772	UNIVERSAL	80W	2 YEAR
2" ALUMINUM BAR CLAMP MOUNT	5771	UNIVERSAL	N/A	2 YEAR
1" ALUMINUM BAR CLAMP MOUNT	5773	UNIVERSAL	N/A	2 YEAR
OFF-ROAD MAGNET MOUNT	2015	UNIVERSAL	N/A	2 YEAR
WATERPROOF SQUARED ² ™ HALOS	5776	3" X 3" SQUARE	N/A	LIFETIME

LED OFF-ROAD MIRROR REPLACEMENTS

Besides being functional these new LED Mirrors from ORACLE Lighting look great as well! The LED light bar is a custom design that features a total of 24 Cree XPE 1W LEDs. This gives the driver a total of 24W of LED power producing approximately 2200lm. Each unit has a 45° beam angle to optimize the driver's peripheral visibility weather riding on the trail or in the desert. Multiple aluminum heat sinks are used to effectively wick heat away from the LEDs and are designed to use the airflow through the mirror housing to increase cooling similar to a radiator. The housing material is made from rugged Polycarbonate and bolts onto the vehicle using the factory mounts for easy installation. A set of anodized rock guards protects the LED acrylic lenses, which also houses the DBM Reflex LED optics. These efficient optics focus the light for optimal visibility from the driver seat position.



Why is peripheral illumination important?

Factory headlights and most auxiliary lights only illuminate the area in front of the vehicle. Ideally for off-road activities, such as trail riding, the driver needs to be able to clearly see the area on the sides of the trail to spot obstructions, which would otherwise go unnoticed and could be a potential hazard.

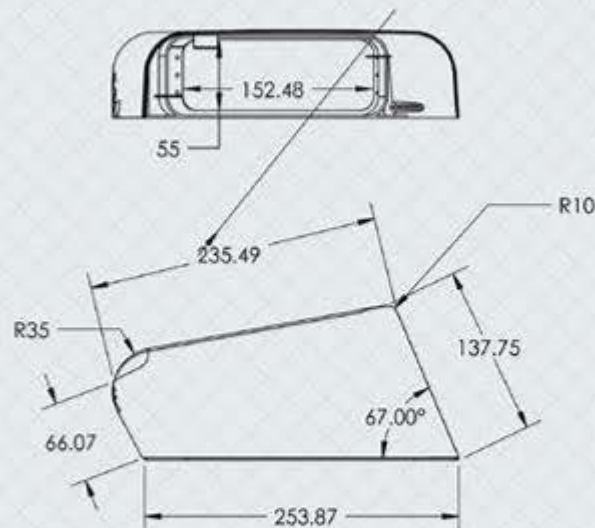
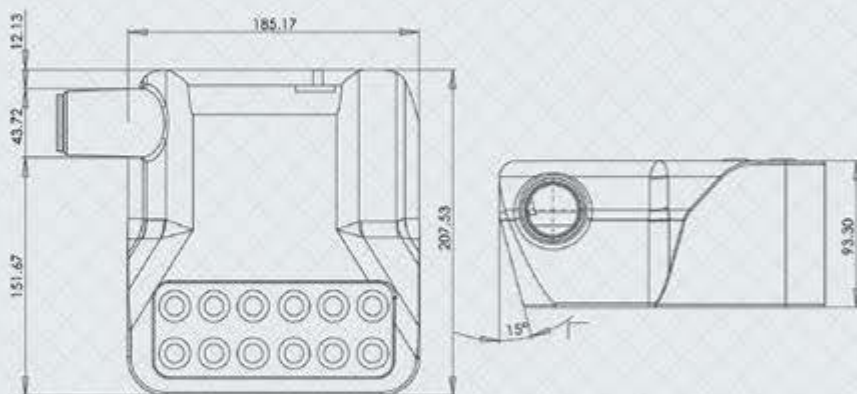
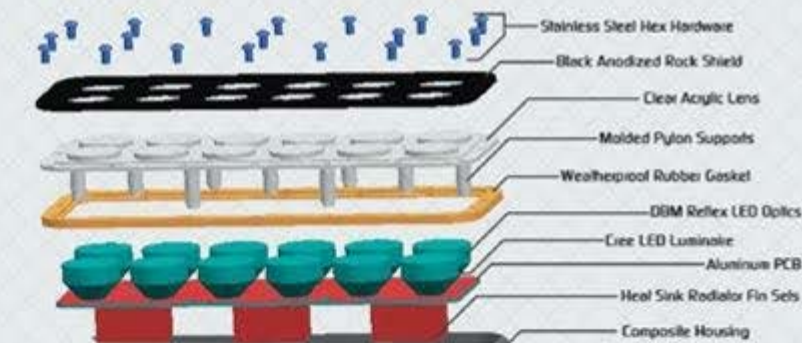



JEEP WRANGLER JK LED OFF-ROAD MIRROR ATTACHMENTS

All new Jeep JK Mirror Inserts for the Off-Road enthusiast. These mirrors attachments are plug and play and offer a more peripheral light source. Attaches directly to factory mirrors.

Part# 5751

- 24X 1W CREE LEDs
- 2,200 lm Total Output
- 45° LED Beam Angle
- Advanced LED Optics
- Uses Factory Mounts
- 2 Year Warranty
- 6000K Color Temp
- 2 Amp Power Draw
- Patented Design



FORD F150/SVT RAPTOR LED OFF-ROAD MIRROR ATTACHMENTS

All new Ford F150/Raptor Mirror Inserts for the Off-Road enthusiast. These mirrors attachments are plug and play and offer a more peripheral light source. Attaches directly to factory mirrors.

Part# 5752

- 24X 1W CREE LEDs
- 2,200 lm Total Output
- 45° LED Beam Angle
- Advanced LED Optics
- Uses Factory Mounts
- 2 Year Warranty
- 6000K Color Temp
- 2 Amp Power Draw
- Patented Design



DESCRIPTION

DESCRIPTION	PART#	LUMENS	AMP DRAW	WATTAGE	WARRANTY
JEEP WRANGLER JK LED OFF-ROAD MIRROR ATTACHMENTS	5751	2,200LM	2A	24W	2 YEAR
FORD F150/SVT RAPTOR LED OFF-ROAD MIRROR ATTACHMENTS	5752	2,200LM	2A	24W	2 YEAR

OFF-ROAD LED WHIPS

Introducing our new Off-Road LED Whips that deliver outstanding color brilliance and illumination. These whips are easy to install and can be used as safety or warning devices for ATV, UTV and Off-Road vehicles. Each Off-Road LED Whip utilizes High Quality Polycarbonate tubing for an increased resistance level and flexibility. Available in 4 ft and 6 ft sizes and in a variety of bright colors including White, Blue, Red, Green, Amber & ColorSHIFT. LED Whips have a 50,000 hour lifespan and includes a 1 Year Warranty.



OFF-ROAD 6FT LED WHIP

Part# 5782

- High Color Output
- Perfect for Safety Use
- Weather and Shock Resistant
- Easily Connects to 12V System
- ORACLE Off-Road Flag Included
- Quick Connect Plug Included
- Size: 6 ft
- Bright SMD-LED Technology
- Input Voltage: 12-24V DC
- HQ Transparent PC Tubing
- Lifetime: 50,000 Hours
- Waterproof Rating: IP68
- 1-Year Product Warranty
- Colors: White, Blue, Red, Green, Amber and ColorSHIFT



ColorSHIFT LED Whip includes Built-in Controller



OFF-ROAD 4FT LED WHIP

Part# 5781

- High Color Output
- Perfect for Safety Use
- Weather and Shock Resistant
- Easily Connects to 12V System
- ORACLE Off-Road Flag Included
- Quick Connect Plug Included
- Size: 4 ft
- Bright SMD-LED Technology
- Input Voltage: 12-24V DC
- HQ Transparent PC Tubing
- Lifetime: 50,000 Hours
- Waterproof Rating: IP68
- 1-Year Product Warranty
- Colors: White, Blue, Red, Green, Amber and ColorSHIFT



DESCRIPTION	PART#	INPUT VOLTAGE	WATERPROOF RATING	LIFETIME	WARRANTY
OFF-ROAD 4FT LED WHIP - WHITE	5781-001	12-24V DC	IP68	50,000HRS	1 YEAR
OFF-ROAD 4FT LED WHIP - BLUE	5781-002	12-24V DC	IP68	50,000HRS	1 YEAR
OFF-ROAD 4FT LED WHIP - RED	5781-003	12-24V DC	IP68	50,000HRS	1 YEAR
OFF-ROAD 4FT LED WHIP - GREEN	5781-004	12-24V DC	IP68	50,000HRS	1 YEAR
OFF-ROAD 4FT LED WHIP - AMBER	5781-005	12-24V DC	IP68	50,000HRS	1 YEAR
OFF-ROAD 4FT LED WHIP - COLORSHIFT	5781-333	12-24V DC	IP68	50,000HRS	1 YEAR
OFF-ROAD 6FT LED WHIP - WHITE	5782-001	12-24V DC	IP68	50,000HRS	1 YEAR
OFF-ROAD 6FT LED WHIP - BLUE	5782-002	12-24V DC	IP68	50,000HRS	1 YEAR
OFF-ROAD 6FT LED WHIP - RED	5782-003	12-24V DC	IP68	50,000HRS	1 YEAR
OFF-ROAD 6FT LED WHIP - GREEN	5782-004	12-24V DC	IP68	50,000HRS	1 YEAR
OFF-ROAD 6FT LED WHIP - AMBER	5782-005	12-24V DC	IP68	50,000HRS	1 YEAR
OFF-ROAD 6FT LED WHIP - COLORSHIFT	5782-333	12-24V DC	IP68	50,000HRS	1 YEAR

OFF-ROAD LED WHIP ACCESSORIES



**ORACLE Off-Road Replacement Flag
Part# 5783**

Replace your lost or damaged LED Whip Flag with a brand new ORACLE Lighting Flag.



**Off-Road LED Whip Replacement Power Plug
Part# 5789**

Replace your lost or damaged LED Whip Power Plug with this replacement.



**Off-Road Heavy Duty Spring Mount
Part# 5784**

Add flexibility and impact resistance to your LED whip with this direct screw on Heavy Duty Spring Mount.



**Off-Road LED Whip Quick Disconnect Attachment
Part# 5785**

Easily remove your LED Whip with this LED Whip Quick Disconnect Attachment. The red wire is your + power, the attachment is self grounding.



**Off-Road 1.5" Whip Bar Folding Mount Clamp
Part# 5786**

Easily mount your Off-Road LED Whip with this all aluminum 1.5" Whip Bar Folding Mount Clamp. Includes a threaded receiver.



**Off-Road 1.75" Whip Bar Folding Mount Clamp
Part# 5787**

Easily mount your Off-Road LED Whip with this all aluminum 1.75" Whip Bar Folding Mount Clamp. Includes a threaded receiver.



**Off-Road 2" Whip Bar Folding Mount Clamp
Part# 5788**

Easily mount your Off-Road LED Whip with this all aluminum 2" Whip Bar Folding Mount Clamp. Includes a threaded receiver.

DESCRIPTION	PART#	COMPATIBILITY	INSTALLATION	WARRANTY
WHIP REPLACEMENT FLAG	5783	4FT & 6FT LED WHIPS	N/A	1 YEAR
WHIP REPLACEMENT POWER PLUG	5789	4FT & 6FT LED WHIPS	N/A	1 YEAR
WHIP HEAVY DUTY SPRING MOUNT	5784	4FT & 6FT LED WHIPS	MOUNTING HARDWARE INCLUDED	1 YEAR
WHIP QUICK DISCONNECT ATTACHMENT	5785	4FT & 6FT LED WHIPS	MOUNTING HARDWARE INCLUDED	1 YEAR
1.5" WHIP BAR FOLDING MOUNT CLAMP	5786	4FT & 6FT LED WHIPS	MOUNTING HARDWARE INCLUDED	1 YEAR
1.75" WHIP BAR FOLDING MOUNT CLAMP	5787	4FT & 6FT LED WHIPS	MOUNTING HARDWARE INCLUDED	1 YEAR
2" WHIP BAR FOLDING MOUNT CLAMP	5788	4FT & 6FT LED WHIPS	MOUNTING HARDWARE INCLUDED	1 YEAR

MARINE Lighting



ORACLE Marine LED lights are designed for any boating light situation, and outperform other marine lighting options in virtually every aspect, from durability and much lower power consumption, to extreme lower temperatures and beautiful crisp 6000K light output. ORACLE Marine Lights offer Solid State Engineering, Anti Corrosive Enamel, and 316 Stainless Steel Bracket / Hardware Construction.

21W LED ROUND SPOT



- Part# 2804**
- 7X 3W Cree LEDs
 - 30° Spot Light
 - Solid State Engineering
 - Anti Corrosive Enamel
 - 1.5A Power Draw
 - 1,785 Lumen Output
 - Dim: 3" X 5.25" X 9"

IP67 WATERPROOF

24W LED SPREADER SPOT



- Part# 2805**
- 24X 1W Cree LEDs
 - 60° Spreader Light
 - Solid State Engineering
 - Anti Corrosive Enamel
 - 1.65A Power Draw
 - 2,040 Lumen Output
 - Dim: 8" X 3.3" X 1.4"
 - Weight 3Lbs 1oz

IP67 WATERPROOF

10W LED SQUARE SPOT



- Part# 2806**
- 1X 10W Cree LEDs
 - 30° Spot Light
 - Solid State Engineering
 - White Composite Housing
 - Can be "Linked" in Series
 - 850 Lumen Output
 - Dim: 2" X 2" X 2.5"
 - Weight: 11.2 oz

IP67 WATERPROOF

15W LED SPREADER SPOT



- Part# 2807**
- 5X 3W Cree LEDs
 - 30° Spot Light
 - Solid State Engineering
 - Anti Corrosive Enamel
 - 1.25A Power Draw
 - 1,275 Lumen Output
 - Dim: 5.7" X 1.8" X 3.4"
 - Weight 1Lb 2.6 oz

IP67 WATERPROOF

20W LED ROUND SPOT



- Part# 2907**
- 1X 20W Cree LEDs
 - 30° Spot Light
 - Solid State Engineering
 - Anti Corrosive Enamel
 - 1.8A Power Draw
 - 1,700 Lumen Output
 - Dim: 6" X 4.5" X 3.8"

IP67 WATERPROOF

12W LED SQUARE SPOT



- Part# 5781**
- 4X 3W Cree LEDs
 - 30° Spot Light
 - Solid State Engineering
 - Anti Corrosive Enamel
 - .9A Power Draw
 - 950 Lumen Output
 - Dim: 3.1" X 2.9" X 3.1"
 - Weight 1Lbs 5.6oz

IP67 WATERPROOF

COLORED LENS INCLUDED

50W LED SEARCH LIGHT



- Part# 2808**
- Lumens Output: 4,700lm
 - Beam Type: 30° Spot
 - Technology: 10 X 5W CREE LEDs
 - Total Power: 50W
 - Weight: 7Lbs 7oz
 - Dim: 6" X 4.3" X 3.7"
 - Operating Voltage: 12-24V DC
 - 360° Horizontal Rotation
 - 180° Vertical Rotation
 - 500-600 Ft Wireless Range
 - 12V Auxiliary Plug
 - Removable Mounting Base

IP67 WATERPROOF

12W LED FLUSH SPOT



- Part# 2908**
- 4X 3W Cree LEDs
 - 60° Spot Led Light
 - Solid State Engineering
 - Anti Corrosive Enamel
 - 1.65A Power Draw
 - 1,020 Lumen Output
 - Dim: 6" X 2.5" X 1.6"
 - Weight 9.8oz

IP68 WATERPROOF



9W LED TRANSOM LIGHT

- Part# 2801**
- 3X 3W Cree LEDs
 - 120° Viewing Angle
 - Surface Mounted
 - Requires Small Hole
 - 316 Stainless Steel
 - 3.5" Diameter
 - INTENDED FOR UNDERWATER USE

IP68 WATERPROOF

Available colors:



6W LED TRANSOM LIGHT

- Part# 2802**
- 6X 1W Cree LEDs
 - 120° Viewing Angle
 - Surface Mounted
 - Requires Small Hole
 - 316 Stainless Steel
 - 3.5" Diameter
 - INTENDED FOR UNDERWATER USE

IP68 WATERPROOF

Available colors:



18W LED TRANSOM LIGHT

- Part# 2803**
- 6X 3W Cree LEDs
 - 120° Viewing Angle
 - Surface Mounted
 - Requires Small Hole
 - 316 Stainless Steel
 - 4.5" Diameter
 - INTENDED FOR UNDERWATER USE

IP68 WATERPROOF

Available colors:



18W LED TRANSOM LIGHT

- Part# 2901**
- 6X 3W Cree LEDs
 - 90° Viewing Angle
 - Surface Mounted
 - Requires Small Hole
 - 316 Stainless Steel
 - INTENDED FOR UNDERWATER USE

IP68 WATERPROOF

Available colors:



18W LED TRIM TAB LIGHT

- Part# 2904**
- 2X 9W Cree LEDs Each
 - 30° Spot Led Light
 - Built in Circuit Protection
 - 316 Stainless Steel
 - 10V-13.5V Operating Voltage
 - 3,060 Total Lumen Output
 - Dim: 4" X 9" X 2.5"
 - Weight 2Lbs

IP68 WATERPROOF

Available colors:



9W LED TRIM TAB LIGHT

- Part# 2905**
- 1X 9W Cree LEDs Each
 - 30° Spot Light
 - Built in Circuit Protection
 - 316 Stainless Steel
 - 10V-13.5V Operating Voltage
 - 1,530 Total Lumen Output
 - Dim: 4.2" X 3.5" X 1.2"
 - Weight 1.5oz

IP68 WATERPROOF

Available colors:



9W LED DRAIN PLUG

- Part# 2906**
- 1X 9W Cree LED
 - 1/2" NPT Thread
 - 8V-28V Protection
 - 316 Stainless Steel
 - 5 Minute Install
 - 765 Lumen Output
 - Dim: 1" X 2" X 1"

IP68 WATERPROOF

Available colors:



27W LED DRAIN PLUG

- Part# 2909**
- 9 X 4W Cree LED
 - 1/2" NPT Thread
 - 8V-28V Protection
 - 316 Stainless Steel
 - 5 Minute Install
 - 1,800 Lumen Output
 - Dim: 1.93" X 1.77" X 1.3"

IP68 WATERPROOF

Available colors:

DESCRIPTION	PART#	WATTS	LUMENS	HOUSING MATERIAL	LIFETIME	WARRANTY
21W LED ROUND SPOT	2804	21W	1,785LM	ANTI-CORROSIVE ENAMEL	50,000HRS	2 YEAR
24W LED SPREADER SPOT	2805	24W	2,040LM	ANTI-CORROSIVE ENAMEL	50,000HRS	2 YEAR
10W LED SQUARE SPOT	2806	10W	850LM	ANTI-CORROSIVE ENAMEL	50,000HRS	2 YEAR
15W LED SPREADER SPOT	2807	15W	1,275LM	ANTI-CORROSIVE ENAMEL	50,000HRS	2 YEAR
20W LED ROUND SPOT	2907	20W	1,700LM	ANTI-CORROSIVE ENAMEL	50,000HRS	2 YEAR
12W LED SQUARE SPOT	5761	12W	950LM	ANTI-CORROSIVE ENAMEL	50,000HRS	2 YEAR
50W LED SEARCH LIGHT	2808	50W	4,700LM	ABS PLASTIC	50,000HRS	2 YEAR
12W LED FLUSH SPOT	2908	12W	1,020LM	ANTI-CORROSIVE ENAMEL	50,000HRS	2 YEAR
9W LED TRANSOM LIGHT	2801	9W	765LM	STAINLESS STEEL	50,000HRS	2 YEAR
6W LED TRANSOM LIGHT	2802	6W	510LM	STAINLESS STEEL	50,000HRS	2 YEAR
18W LED TRANSOM LIGHT	2803	18W	1,530LM	STAINLESS STEEL	50,000HRS	2 YEAR
18W LED TRANSOM LIGHT	2901	18W	1,530LM	STAINLESS STEEL	50,000HRS	2 YEAR
18W LED TRIM TAB LIGHT	2904	18W	3,060LM	STAINLESS STEEL	50,000HRS	2 YEAR
9W LED TRIM TAB LIGHT	2905	9W	1,530LM	STAINLESS STEEL	50,000HRS	2 YEAR
9W LED DRAIN PLUG	2906	9W	765LM	STAINLESS STEEL	50,000HRS	2 YEAR
27W LED DRAIN PLUG	2909	27W	1,800LM	STAINLESS STEEL	50,000HRS	2 YEAR



ORACLE LIGHTING

