

2012

MANUFACTURER OF
RACE-PROVEN
WORLD-CLASS PRODUCTS

PIAA

POWERSPORTS



LAMPS | BULBS | H.I.D. LAMPS AND BULBS | LED LAMPS AND BULBS
KITS | ACCESSORIES | BRACKETS | LIGHT BARS

The road to better visibility starts with **PIAA**

POWERSPORTS

Established in 1963, PIAA Corporation is a global leader in the design and manufacture of high quality auxiliary driving and fog light systems, headlamp upgrade bulbs, accessory-lighting equipment and silicone wiper blades for the automotive, light truck, off-road, motorsports, and powersports markets. PIAA's company mission is to combine market driven concepts with the latest technology to create products customers can use with pride and confidence while making night and inclement weather driving as safe as possible.

Every PIAA customer enjoys the benefits of the **PIAA Advantage...**

- Advanced technology based on cutting-edge research in laboratories around the world.
- Lamps and bulbs for virtually every vehicular application (automotive, powersports and motorsports).
- A race-proven standard of quality and durability backed by an industry leading warranty.
- Easy-to-install lamp systems and bulbs.
- Unmatched technical and product support.
- Legendary PIAA illumination engineered to perform anywhere and in any conditions, making driving in inclement weather as safe as possible.

WHY BUY PIAA

TECHNOLOGY

PIAA has been the acknowledged leader in innovative automotive products for decades. Visionary design, inspired engineering, and quality components are the hallmark of PIAA's reputation with drivers of distinction. Propelled by PIAA's Technical Design Center, our products cross the line from ordinary to extraordinary.

RACE-PROVEN QUALITY

"Dependable and reliable under the most severe racing conditions," note racing professionals. PIAA lenses are computer designed for optimum performance to withstand the rigors of off road racing and normal highway hazards. PIAA's lamps feature a specially designed housing making it possible for the lamps to operate using higher wattage bulbs without sacrificing bulb life.

EASE OF INSTALLATION

You don't have to be an automotive electrician to install PIAA light kits. First, all PIAA light kits come complete with a pre-assembled wiring harness which includes relay, fuse, and switch. Second, PIAA offers a wide range of mounting kits designed to ease installation of your PIAA lighting system. PIAA mounting kits come complete with everything you need to make your installation almost effortless. The use of PIAA mounting kits ensure a professional looking installation you can be proud of.



RS800 SHOCK LAMP page 19



LP530 LED FOG page 4



1100 LED page 5



LP530 LED DRIVING page 4



570 LED page 5



510 NIGHT-TECH 55W page 23

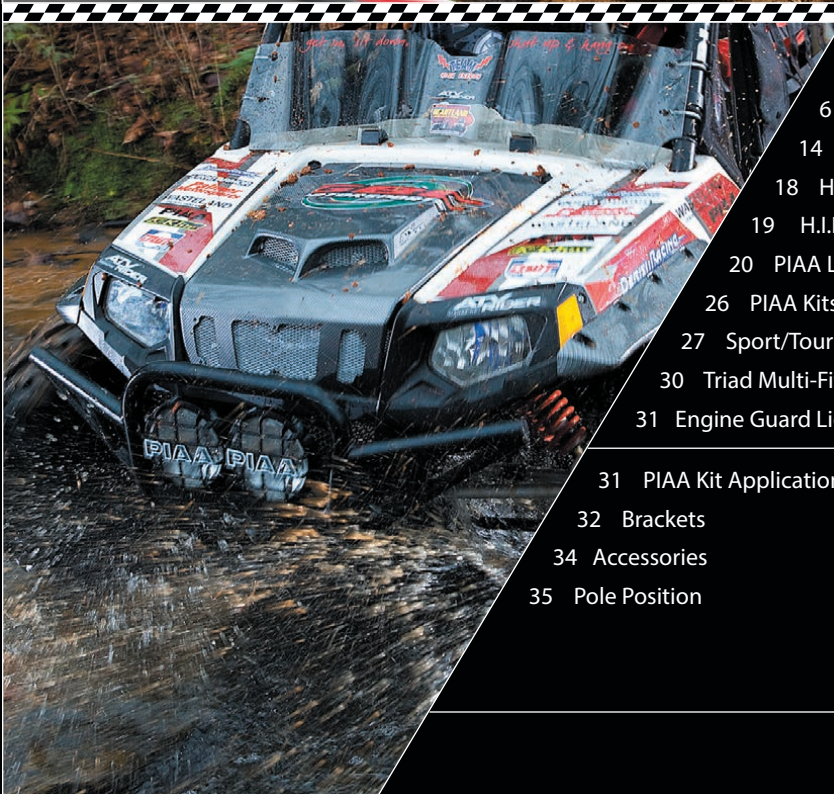

- 4 LED Lamps and Bulbs
- 6 PIAA Bulbs
- 14 Bulb Application Guide
- 18 H.I.D. Bulb Conversion Kits
- 19 H.I.D. Lamp Kits
- 20 PIAA Lamps
- 26 PIAA Kits And Accessories
- 27 Sport/Touring Lamp Systems
- 30 Triad Multi-Fit Bracket Systems
- 31 Engine Guard Light Kit
- 31 PIAA Kit Application Guide
- 32 Brackets
- 34 Accessories
- 35 Pole Position

PIAA
POWERSPORTS

LED

SEE AND BE SEEN
with PIAA's High Intensity LED lamps and bulbs.

THE PIAA LED ADVANTAGE

Be seen with PIAA's line of LED lights. Light-emitting diodes (LEDs) provide outstanding illumination while providing longer life and very low power consumption compared with halogen lighting. Plus, they're more compact and run cooler than halogen bulbs, promoting even longer life.

PIAA's newest LED lamps provide the latest innovations to assure performance and durability. The New 1100LED is digitally controlled by means of a microprocessor to monitor heat and charging system irregularities. The three 4W high performance LED's and perfectly focused lenses produce a beam pattern which continues to make the 1100 Series lamp the hallmark in the Powersports Industry. The LP530 fog and driving, and 570 driving lamps feature a unique LED orientation where the LEDs face the reflector allowing the beam to project off of a precisely computer-designed multi-surface reflector, providing better beam control and greater output than ordinary LED lamps.

PIAA's advanced LED technology, coupled with the compact size and cool operation of LEDs, allows PIAA to offer LED lamps in a wide variety of sizes, shapes and applications.

All PIAA lamps and bulbs are backed by The PIAA Advantage, which is your assurance of the best-performing, most durable and safest lighting products available anywhere.



LP530 LED FOG AND DRIVING LAMPS **NEW!**

New PIAA LP530 LED 3-1/2" fog and driving lamps feature exclusive reflector-facing LED bulbs and a geometrically-perfect reflector to provide precise beam control and increased output compared with ordinary halogen bulbs. The LED bulbs are much more durable than halogen bulbs, provide more output and consume far less power. Available in true fog and long range driving beam patterns.

2 LAMP KIT PN 73530
BULB TYPE Two 3W LED, 6000K
DESCRIPTION Cast aluminum housing with polycarbonate lens
TECHNOLOGY LED Fog
KIT INCLUDES Pre-wired harness with fuse and switch

2 LAMP KIT PN 73532
BULB TYPE Two 3W LED, 6000K
DESCRIPTION Cast aluminum housing with polycarbonate lens
TECHNOLOGY LED Long Range Driving
KIT INCLUDES Pre-wired harness with fuse and switch

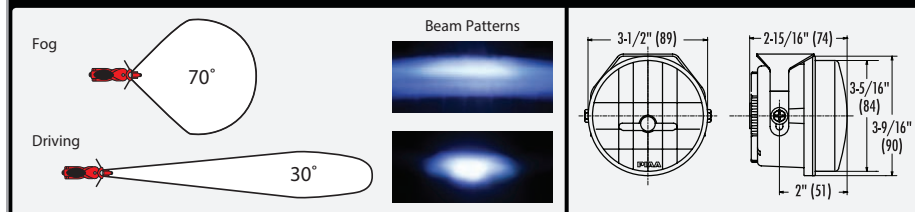

LP530 LED FOG
2 LAMP KIT PN 73530



LP530 LED LONG RANGE DRIVING
2 LAMP KIT PN 73532

FOG — SINGLE LAMP 5300 SINGLE LENS N/A REPLACEMENT BULB N/A WIRING HARNESS 78901 RELAY 74086 SWITCH 74034 LAMP COVER N/A

DRIVING — SINGLE LAMP 5302 SINGLE LENS N/A REPLACEMENT BULB N/A WIRING HARNESS 78901 RELAY 74086 SWITCH 74034 LAMP COVER N/A

NEW!**1100LED DRIVING LAMP**

The PIAA 1100LED takes its cues from its famous predecessor the 1100X. The 1100LED is designed to give supreme LED performance and still fit into the same mounting locations and on the same brackets as the 1100X. The 1100LED features computer controlled Pulse Width Modulation (PWM) providing thermal protection allowing its high performance LED's to perform to their maximum potential. Conspicuity and night time visibility is enhanced by a color temperature of 6300K. From the machined die-cast aluminum housing to the computer designed cooling fins and 4mm high-impact lens, only the highest quality workmanship and materials go into the 1100LED. Light output of the 1100LED is similar to the 1100X giving off a symmetrical pattern so a rider won't lose visibility when leaning into a turn.

2 LAMP KIT PN 73122

BULB TYPE Three 4W LEDs, 6300K
DESCRIPTION CNC machined die-cast aluminum housing and computer designed cooling fins

TECHNOLOGY LED long range driving
KIT INCLUDES Pre-wired harness with fuse and switch

Driving

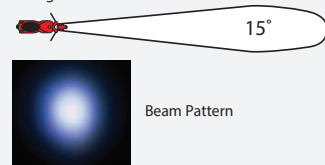

Beam Pattern

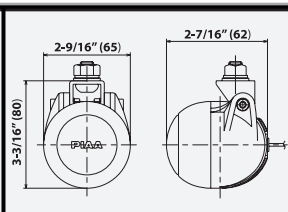

2 LAMP KIT PN 73122

SINGLE LAMP 73120 SINGLE LENS N/A REPLACEMENT BULB N/A WIRING HARNESS 78901 RELAY N/A SWITCH N/A LAMP COVER N/A

NEW!**570 LED LONG RANGE DRIVING LAMP**

Need longer range? Step up to the PIAA 570 seven inch LED long range driving lights. Reflector-facing LEDs project off of an ingenious computer-designed multi-surface reflector, offering greater illumination than halogen lamps with the durability and low power draw of LED lighting.

2 LAMP KIT PN 73572

BULB TYPE Two 5W LED, 6000K
DESCRIPTION Polycarbonate and cast aluminum housing with polycarbonate lens

TECHNOLOGY LED long range driving
KIT INCLUDES Pre-wired harness with fuse and switch

Driving

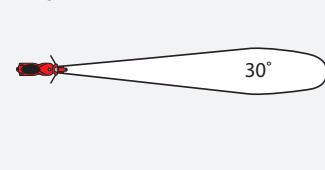

30°

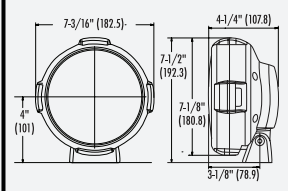

2 LAMP KIT PN 73572

SINGLE LAMP 5702 SINGLE LENS N/A REPLACEMENT BULB N/A WIRING HARNESS 78901 RELAY N/A SWITCH N/A LAMP COVER N/A

DĚNO SERIES LED LAMPS**DĚNO 2**

Nine high-intensity LEDs are aligned in a light blue honeycomb designed reflector with white beam output in a compact size.
 4-3/4" W x 1-7/8" H x 2-1/8" D

Single Lamp Kit PN 72562
 Wiring harness included

**DĚNO 3 REAR FOG LED**

Twelve LEDs are aligned horizontally in a clear reflector compartment.
 4-1/2" W x 1-3/4" H x 3-1/2" D

Single Lamp Kit PN 72553

**DĚNO 6**

Nine high-intensity LEDs are aligned horizontally in a light blue reflector with a low profile design.
 8-5/8" W x 1" H x 1-7/8" D

Single Lamp Kit PN 72566
 Wiring harness included

**HYPER-D SUPER LED BULB**

With a brilliant multi-surface lens, the new 5W Hyper-D produces a wide beam pattern and great appearance. It fits a wide range of applications from turn signals and side markers, to dash and instrumentation lights.

Hyper-D Super LED

Twin Pack 72522
Bulb Type 168 Wedge
Wattage 5W
Kelvin 6000K



Please check our application guide for your vehicle's bulb type.



THE PIAA BULB ADVANTAGE

GREATER PERFORMANCE: PIAA bulbs are engineered with XTRA Technology for greater performance per watt than any other bulb on the road. (XTRA is a term coined by PIAA to designate a high-efficiency bulb that is designed to produce greater light output than its rated power consumption, i.e. 55W = 85W of light output.) Greatly enhance your ability to see and be seen. A metal bond holds the heat-resistant glass tube securely to prevent cracks and leaks. A welded focus ring and one-piece filament support assures proper positioning.

BRILLIANT COLOR: Beam color affects visibility and eye strain over long periods. The brilliant white/blue light allows comfortable night driving over extended periods of time. PIAA bulbs are both a performance upgrade and an aesthetic enhancement. You will see the difference even in the daytime.

WARRANTY AND SUPPORT: PIAA is so confident in the durability and reliability of our products that we offer a no questions asked, replacement of any halogen bulb that fails within one year of purchase. PIAA bulbs are an investment in safety and peace of mind.



PIAA Xtreme White Plus Bulbs



Standard Bulbs

Kelvin Scale

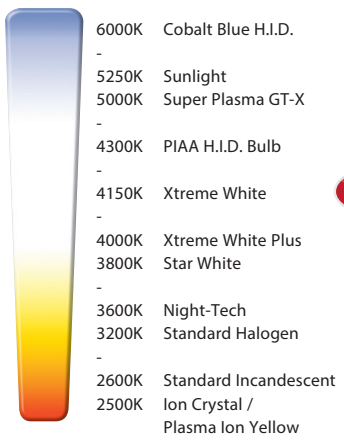

Super Plasma GT-X — The Super Plasma GT-X bulbs offer an unmatched combination of fashion and performance with a bluish-purple color very similar to H.I.D. and the closest yet to sunlight.

Xtreme White / Xtreme White Plus — The Xtreme White Series of bulbs have a cool white light output that gives the driver better color recognition on depth perception and better contrast than stock halogen lamps. The blue top coat on this series of bulbs adds a slight blue tint to a lamp with no loss of performance.

Star White — Star White bulbs are significantly whiter and brighter than stock halogen and will increase bulb performance without taxing your vehicle's electrical system.

NEW! Night-Tech — The new Night-Tech line of bulbs from PIAA features several advancements in performance, durability, and manufacturing. Through the use of a unique mix of gasses including a higher proportion of inert gasses as well as a new filament material these bulbs offer up to 90% more light than a conventional bulb with a greater life span. The gasses, filament material, and coatings on the bulbs offer a color temperature in the 3600 Kelvin range for a whiter output than standard bulbs and retain a DOT/SAE approval. The unique dual band bulb coatings not only create a whiter light but a brighter, longer range (up to 35 meters) output when compared to OE and other conventional bulbs.

Ion Crystal/Plasma Ion Yellow — Ion Crystal coating transforms white light into amber light without diminishing the strength of the beam. Ion Crystal technology allows as much as 95% of the light produced by the bulb to pass through, compared to as little as 65% through dyed glass. The long wavelength Plasma Ion beam reduces refraction for dramatically increased visibility in snow, rain and fog.

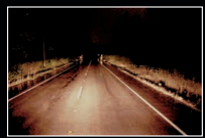

Standard Halogen



Ion Crystal / Plasma Ion Yellow



Night-Tech



Star White



Xtreme White / Xtreme White Plus



Super Plasma GT-X

NEW!

Night-Tech



up to
+90%
More Light



up to
+35m
Longer Beam



up to
+10%
White Light

Innovations in chemistry and materials allow PIAA's new line of Night-Tech bulbs to achieve new levels of halogen lighting. The result is an exciting new family of bulbs that offer up to 90% more light, whiter/brighter illumination, and up to 100 feet more range than conventional bulbs, all while offering longer life.

The magic is in the chemistry. PIAA Night-Tech bulbs use an innovative new blend of gases with a higher proportion of inert gases, coupled with a new and exclusive filament material. These new materials are incorporated into the Night-Tech bulb using proprietary manufacturing processes and quality control testing and validation. In addition, illumination is enhanced through the use of unique dual band coatings engineered to optimize the output generated by the new materials.

The result is a family of Night-Tech bulbs that offer more light, better light, greater range, and longer life than standard halogen bulbs, all with DOT and SAE compliance.

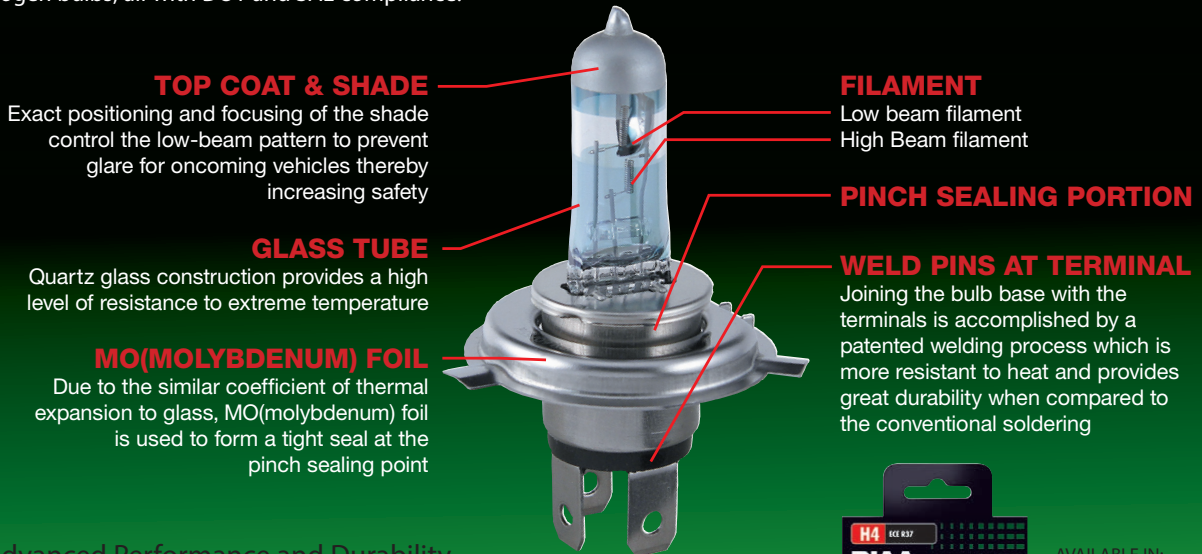

- Advanced Performance and Durability
- DOT/SAE Approved
- Up to 90% More Light than Conventional Bulbs
- Up to 50% Longer Life
- 3600 Kelvin for Whiter Light than Standard Halogen Bulbs
- Dual Band Coating for Greater Reach
- More Affordable Price



- AVAILABLE IN:
- H1 • H11
 - H3 • 9005
 - H4 • 9006
 - H7



PIAA POWERSPORTS 881 BULB

NEW!

881 Xtreme White Plus

- Twin Pack 70822
- Single Pack 70821
- Wattage 27W = 50W
- Kelvin 4000K



Please check our application guide for your vehicle's bulb type.

PIAA POWERSPORTS H1 BULBS

NEW!

H1 Night-Tech

Single Pack 70185
Wattage 55W = 100W
Kelvin 3600K

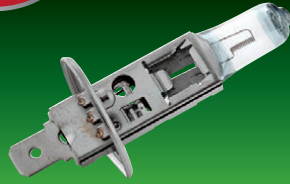

H1 Xtreme White Plus

Single Pack 70165
Wattage 55W = 110W
Kelvin 4000K

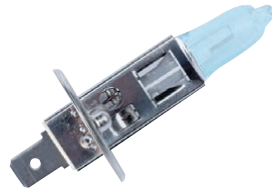

PIAA POWERSPORTS H3 BULBS

NEW!

H3 Night-Tech

Single Pack 70385
Wattage 55W = 100W
Kelvin 3600K

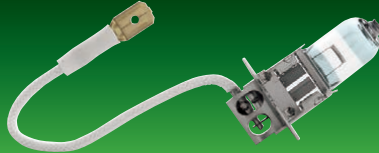

H3 Xtreme White Plus

Single Pack 70323
Wattage 35W = 70W
Kelvin 4000K



H3 Xtreme White Plus

Single Pack 70325
Wattage 55W = 110W
Kelvin 4000K



H3 Super Plasma GT-X

Single Pack 70375
Wattage 55W = 110W
Kelvin 5000K



NEW!

H4 Night-Tech

Single Pack 70485
 Wattage 60/55W = 110/100W
 Kelvin 3600K



**H4 Xtreme White Plus
 ANTI-VIBRATION**

Twin Pack 70856
 Single Pack 70456
 Wattage 60/55W = 110/100W
 Kelvin 4000K



**H4 Super Plasma GT-X
 ANTI-VIBRATION
 TWIN BEAM**

Single Pack 70476
 Wattage 60/55W = 135/125W
 Kelvin 3800/5000K



**H4 Star White
 ANTI-VIBRATION**

Single Pack 70426
 Wattage 60/55W = 110/100W
 Kelvin 3800K

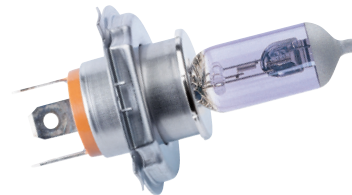

H4 Ion Crystal

Single Pack 70446
 Wattage 60/55W = 110/100W
 Kelvin 2500K



H6M Xtreme White

Single Pack 70023
 Wattage 35/35W = 60/60W
 Kelvin 4150K



PIAA POWERSPORTS H7 BULBS

NEW!

H7 Night-Tech

Single Pack 70785
Wattage 55W = 100W
Kelvin 3600K



H7 Xtreme White Plus

Single Pack 70755
Wattage 55W = 110W
Kelvin 4000K



PIAA POWERSPORTS H8 BULB

H8 Xtreme White

Single Pack 70853
Wattage 35W = 70W
Kelvin 4150K



PIAA POWERSPORTS H9 BULB

H9 Xtreme White Plus

Single Pack 70955
Wattage 65W = 120W
Kelvin 4000K

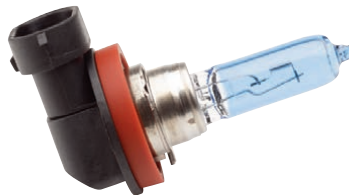

PIAA POWERSPORTS H11 BULBS

NEW!

H11 Night-Tech

Single Pack 70585

Wattage 55W = 100W

Kelvin 3600K

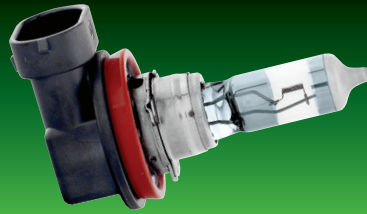

H11 Xtreme White Plus

Single Pack 70555

Wattage 55W = 110W

Kelvin 4000K

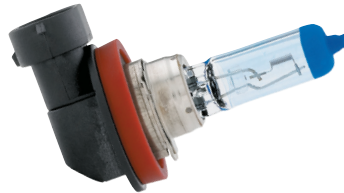

PIAA POWERSPORTS H13 BULB

H13 Xtreme White Plus DUAL FILAMENT

Single Pack 71856

Wattage 65/55W = 85/75W

Kelvin 4000K



PIAA POWERSPORTS HS1 BULB

HS1 Super Plasma GT-X

Single Pack 70473

Wattage 35/35W = 60/60W

Kelvin 5000K



PIAA POWERSPORTS 9005 BULBS

NEW!

9005 Night-Tech

Single Pack 71586
Wattage 60W = 110W
Kelvin 3600K



9005 Xtreme White Plus

Single Pack 71556
Wattage 60W = 120W
Kelvin 4000K

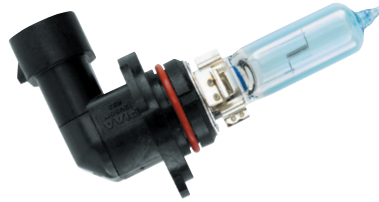

9005 Super Plasma GT-X

Single Pack 71576
Wattage 60W = 110W
Kelvin 5000K

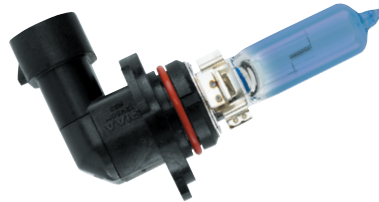

PIAA POWERSPORTS 9006 BULBS

NEW!

9006 Night-Tech

Single Pack 71685
Wattage 51W = 95W
Kelvin 3600K



9006 Super Plasma GT-X

Single Pack 71675
Wattage 51W = 100W
Kelvin 5000K

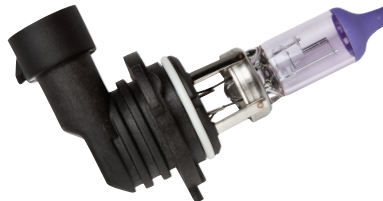

PIAA POWERSPORTS 168 BULB

168 Xtreme White

Twin Pack 72020
Wattage 5W
Kelvin 4150K



PIAA POWERSPORTS 1156 BULB

1156 Xtreme White SINGLE FILAMENT

Twin Pack 72620
Wattage 27W
Kelvin 4150K



PIAA POWERSPORTS 1157 BULB

1157 Xtreme White DUAL FILAMENT

Twin Pack 72720
Wattage 27W/8W
Kelvin 4150K



PIAA POWERSPORTS 3156 BULB

3156 Xtreme White

Twin Pack 72822
Wattage 27W
Kelvin 4150K



PIAA POWERSPORTS 3157 BULB

3157 Xtreme White

Twin Pack 72922
Wattage 27W/8W
Kelvin 4150K



Please check our application guide for your vehicle's bulb type.

PIAA POWERSPORTS BULB APPLICATION GUIDE

MODEL	TYPE	YEAR	H#1	NOTES	H#2	NOTES
APRILIA						
1099	MC	08	H9	High	H9	Low
Dorsoduro	MC	10-11	H7	High	H7	Low
Falco 100	MC	99	H7	High	H7	Low
Mana 850	MC	09-11	H7	High	H7	Low
Pegasco Cube	MC	99	H1	High	H4	Low
RSV 1000R / Factory	MC	10-11	H3	High	H3	Low
RSV Mille 1000	MC	99	H3	High	H1	Low
Shiver	MC	09-11	H7	High	H7	Low
Tuono / Factory	MC	07-11	H11	X2	H11	X2
BIMOTA						
DB7	MC	09-10	H7	High	H7	Low
V Due	MC	99	H4	High & Low		
BMW						
F650CS	MC	02-08	H3	High	H1	Low
F650GS (Single)	MC	99-10	H4	High & Low		
F650GS (Twin)	MC	09	H7	High	H7	Low
F650ST	MC	97-99	H4	High & Low		
F800GS	MC	09-12	H7	High	H7	Low
F800R	MC	11-12	H7	High	H7	Low
F800S	MC	07-10	H7	High	H7	Low
F800ST	MC	07-12	H7	High	H7	Low
G450X	MC	09-11	H4	High & Low		
G650GS (Single)	MC	10-12	H4	High & Low		
G650X	MC	07-09	H4	High & Low		
HP Megamoto	MC	10	H7	High	H7	Low
HP2 Sport	MC	10-11	H7	High	H7	Low
K1200GT	MC	01-04	H3	High	H7	Low
K1200GT	MC	05-10	H7	High	H7	Low
K1200LT	MC	98-10	H3	High	H7	Low
K1200LT w/H.I.D.	MC	07-10	H9	High	D2R	Low
K1200R	MC	05-10	H7	High	H7	Low
K1200R Sport	MC	07-09	H7	High	H7	Low
K1200RS	MC	98-04	H3	High	H7	Low
K1200S	MC	05-09	H7	High	H7	Low
K1300GT	MC	10	H7x2	High	H7	Low
K1300GT w/optional H.I.D.	MC	10	H7x2	High	D1R	Low
K1300S	MC	10-11	H7x2	High	H7	Low
K1600GT	MC	11	H7x2	High	D1S	Low
K1600GTL	MC	11	H7x2	High	D1S	Low
R1100GS	MC	95-99	H4	High & Low		
R1100R	MC	95-05	H4	High & Low		
R1100RS	MC	93-97	H4	High & Low		
R1100RT	MC	96-01	H4	High & Low		
R1100S	MC	98-08	H7	High	H1	Low
R1150GS - Adventure	MC	99-08	H1	High	H1	Low
R1150R	MC	00-10	H4	High & Low		
R1150R Rockster	MC	02-05	H1	High	H1	Low
R1150RS	MC	01-09	H4	High & Low		
R1150RT	MC	01-09	H3	High	H7	Low
R1200C	MC	97-09	H4	High & Low		
R1200C Montauk	MC	04-09	H4	High & Low		
R1200CL	MC	05-09	H1X2	High	H4X2	Low

MODEL	TYPE	YEAR	H#1	NOTES	H#2	NOTES
BMW (CONT'D)						
R1200GS	MC	05-11	H7	High	H7	Low
R1200R Touring	MC	10-11	H4			
R1200R	MC	10-11	H7	High	H7	Low
R1200R Classic	MC	10-11	H4			
R1200RT	MC	05-12	H7x2	High	H7	Low
R1200ST	MC	05-09	H4X2	High & Low		
S1000RR	MC	10-12	H7	High	H7	Low
BUELL						
1125 CR	MC	09-10	H7	High	H7	Low
1125R	MC	08-10	H7	High	H7	Low
Firebolt XB12R	MC	05-10	H3	High	H3	Low
Firebolt XB9R	MC	05-10	H3	High	H3	Low
Lightning CityX-XB9SX	MC	03-05	H3	High	H3	Low
Lightning Long XB12Ss	MC	06	H7	High	H7	Low
Lightning XB12S	MC	04-10	H7	High	H7	Low
Lightning XB12SCG	MC	06	H7	High	H7	Low
Lightning XB9S	MC	03-05	H7	High	H7	Low
Ulysses XB12X	MC	06-10	H7	High	H7	Low
DUCATI						
848	MC	09-11	H11	High	H11	Low
1198	MC	07-10	H11	High	H11	Low
Hypermotard	MC	09-10	H4	High & Low		
Monster	MC	95-11	H4	High & Low		
Multistrada 1200	MC	10-11	H11	High & Low		x4
Sport Touring	MC	98-10	H3	High	H1	Low
Superbike	MC	97-09	H3	High	H1	Low
Supersport	MC	97-09	H4	High & Low		
HARLEY-DAVIDSON						
1200 Super Low	MC	11	H4	High & Low		
Bad Boy	MC	96-97	H4	High & Low		
Dyna Convertible	MC	94-99	H4	High & Low		
Dyna Low Rider	MC	93-09	H4	High & Low		
Dyna Super Glide	MC	93-09	H4	High & Low		
Dyna Wide Glide	MC	93-09	H4	High & Low		
Electra Glide	MC	93-09	H4	High & Low		
Fat Bob	MC	10-11	H13	High	H13	Low
Fat Boy	MC	96-09	H4	High & Low		
Heritage Softail	MC	96-09	H4	High & Low		
Heritage Springer	MC	97-03	H4	High & Low		
Monster V-Rod	MC	09-10	H11	High	H9	Low
Night Rod	MC	07-10	H4	High & Low		
Nightrain	MC	99-09	H4	High & Low		
Road Glide	MC	98-09	H4	High & Low		
Road King	MC	95-09	H4	High & Low		
Screamin' Eagle	MC	00-09	H4	High & Low		
Softail Custom	MC	96-99	H4	High & Low		
Softail Deuce	MC	00-09	H4	High & Low		
Softail Standard	MC	93-09	H4	High & Low		
Sportster 1200	MC	88-09	H4	High & Low		
Sportster 883	MC	86-09	H4	High & Low		
Springer Softail	MC	93-09	H4	High & Low		
Street Bob	MC	06-09	H4	High & Low		

H#1 - HEADLIGHT NUMBER ONE // H#2 - HEADLIGHT NUMBER TWO

PIAA POWERSPORTS BULB APPLICATION GUIDE

MODEL	TYPE	YEAR	H#1	NOTES	H#2	NOTES
HARLEY-DAVIDSON (CONT'D)						
Ultra Classic	MC	89-10	H4	High & Low		
V-Rod	MC	02-10	H11	High	H9	Low
XR 1200X	MC	11	H4	High & Low		
HONDA						
599 - CB600	MC	01-09	H11	High	H11	Low
919 - CB900	MC	02-09	H4	High & Low		
CB1000R	MC	11	H4	High & Low		
CBR125R	MC	11	H4	High & Low		
CBR250R	MC	11	H4	High & Low		
CBR600	MC	91-00	H4	High & Low		
CBR600F4i	MC	01-09	H7	High	H7	Low
CBR600RR	MC	04-11	H7	High	H7	Low
CBR929	MC	00-02	H7	High	H7	Low
CBR954	MC	02-03	H7	High	H7	Low
CBR1000RR	MC	04-11	H7	High	H7	Low
CBR1100XX	MC	97-03	H7	High	H7	Low
DN-01	MC	09	H7	High	H7	Low
Fury	MC	10	H4	High & Low		
GL1500 - Valkyrie	MC	01-03	H4	High & Low		
GL1800 - Gold Wing	MC	01-09	H7	High x 2	H7	Low x 2
Interceptor - ABS	MC	02-10	H4	High	H7	Low
Nighthawk - CB250	MC	01-07	H4	High & Low		
Nighthawk - CB750	MC	91-05	H4	High & Low		
NT700V	MC	10-11	H7	High	H7	Low
PC800	MC	94-98	H4	High & Low		
RC51	MC	00-06	H7	High	H7	Low
Rebel	MC	04-10	H4	High & Low		
Shadow Aero	MC	04-10	H4	High & Low		
Shadow Line	MC	10	H4	High & Low		
Shadow Sabre	MC	04-09	H4	High & Low		
Shadow Spirit	MC	98-10	H4	High & Low		
Shadow Spirit 750	MC	98-09	H4	High & Low		
Shadow VLX	MC	04-09	H4	High & Low		
Shadow VLX Deluxe	MC	04-09	H4	High & Low		
ST1300	MC	03-09	H4	High & Low		
Stateline VT1300 CR	MC	10-11	H4	High & Low		
Super Hawk	MC	97-05	H4	High & Low		
Valkyrie Rune	MC	04-05	H7	High	H7	Low
VF750	MC	94-03	H4	High & Low		
VT600	MC	91-04	H4	High & Low		
VTX1300 (All)	MC	04-06	H4	High & Low		
VTX1800	MC	02-09	H4	High & Low		
XR250L	MC	91-96	H4	High & Low		
XR650L	MC	93-98	H4	High & Low		
XR650L	MC	01-07	H4	High & Low		
Elite 80	SCTR	01-08	H6M			
Helix	SCTR	92-08	H4	High & Low		
Metropolitan	SCTR	10	H4	High & Low		
Reflex	SCTR	01-10	H7	High	H7	Low
Rucks	SCTR	10-11	H4	High & Low		
Silver Wing	SCTR	02-06	H7	High	H7	Low
TRX700XX	ATV	08-09	H4	High	H4	Low
Sportrax 300EX	ATV	93-04	H4	High & Low		

MODEL	TYPE	YEAR	H#1	NOTES	H#2	NOTES
HONDA (CONT'D)						
Sportrax 400EX	ATV	97-04	H6M			
TRX300EX	ATV	05-10	H4	High & Low		
TRX400EX	ATV	05-11	H4	High & Low		
TRX450R	ATV	05-11	H4	High & Low		
KAWASAKI						
1700 Voyager	MC	09-10	H4	High	H4	Low
1700 Classic	MC	10	H4	High	H4	Low
1700 Classic LT	MC	10	H4	High	H4	Low
Concours	MC	86-06	H4	High & Low		
Concours 14	MC	08-11	H4	High	H4	Low
Eliminator 125	MC	00-06	H4	High & Low		
Eliminator 600	MC	96-00	H4	High & Low		
EX500	MC	87-93	H4	High & Low		
KL250 Super Sherpa	MC	00-02	H4	High & Low		
KLR250	MC	93-06	H4	High & Low		
KZ1000 Police	MC	96-03	H4	High & Low		
Ninja 250R	MC	93-07	H4	High & Low		
Ninja 250R	MC	08-11	H7	High	H7	Low
Ninja 500R	MC	94-10	H4	High & Low		
Ninja 650R	MC	06-11	H7	High	H7	Low
Ninja 1000	MC	11	H7	High	H7	Low
Ninja ZX-10R	MC	04-11	H7	High	H7	Low
Ninja ZX-1100	MC	90-01	H4	High & Low		
Ninja ZX-12R	MC	90-04	H4	High & Low		
Ninja ZX-14	MC	06-11	H9	High	H11	Low
Ninja ZX-14 Monster	MC	10	H9	High	H11	Low
Ninja ZX-6/ZX-600	MC	93-02	H4	High & Low		
Ninja ZX-6R/RR	MC	01-02	H4	High & Low		
Ninja ZX-6R/RR	MC	03-06	H7	High	H7	Low
Ninja ZX-6R	MC	10-11	H7	High	H7	Low
Ninja ZX-7R	MC	96-02	H4	High & Low		
Versys	MC	08-11	H7	High	H7	Low
Vulcan 1500 Classic	MC	96-10	H4	High & Low		
Vulcan 1500 Drifter	MC	99-04	H4	High & Low		
Vulcan 1500 Mean Streak	MC	02-03	H4	High & Low		
Vulcan 1500 Nomad	MC	00-04	H4	High & Low		
Vulcan 1600 Classic	MC	04-10	H4	High & Low		
Vulcan 1600 Mean Streak	MC	04-10	H4	High & Low		
Vulcan 1600 Nomad	MC	05-10	H4	High & Low		
Vulcan 1700 Nomad	MC	11	H4	High & Low		
Vulcan 88	MC	89-98	H4	High & Low		
Vulcan 500	MC	01-09	H4	High & Low		
Vulcan 750	MC	94-08	H4	High & Low		
Vulcan 800	MC	04	H4	High & Low		
Vulcan 800 Classic	MC	95-02	H4	High & Low		
Vulcan 800 Drifter	MC	00-06	H4	High & Low		
Vulcan 900 Classic/LT	MC	06-10	H4	High & Low		
Vulcan 900 Custom	MC	10	H4	High & Low		
Vulcan 1700 Vaquero	MC	11	H4	High & Low		
Vulcan 2000	MC	04-10	H9	High	H7	Low
W650	MC	00-02	H4	High & Low		
Z1000	MC	04-07	H7	High	H7	Low
Z750S	MC	05-07	H7	High	H7	Low

PIAA POWERSPORTS BULB APPLICATION GUIDE

MODEL	TYPE	YEAR	H#1	NOTES	H#2	NOTES
KAWASAKI (CONTD)						
ZG1200 Voyager	MC	86-02	H4	High & Low		
ZR1100	MC	92-00	H4	High & Low		
ZR550 Zephyr	MC	99	H4	High & Low		
ZR-75	MC	01-02	H4	High & Low		
ZRX1200	MC	04	H4	High & Low		
ZX7/ZX750	MC	95-00	H4	High & Low		
ZX9/R	MC	94-00	H4	High & Low		
ZX900	MC	94-96	H4	High & Low		
ZZR1200	MC	04-05	H4	High	H4	Low
ZZR600	MC	04-09	H4	High	H4	Low
Bayou 220	ATV	98-03	H6M			
Bayou 300	ATV	96-04	H6M			
KFX400	ATV	05-09	H6M			
KLX250	ATV	05-09	H4	High & Low	H4	
KLX250	ATV	94-04	H6M			
KLX300	ATV	94-04	H6M			
Lakota Sport 300	ATV	96-02	H6M			
Mojave 250	ATV	95-03	H6M			
Prairie 300	ATV	96-02	H6M			
Prairie 360	ATV	96-08	H6M			
Prairie 400	ATV	00-03	H6M			
Prairie 650	ATV	00-03	H6M			
KTM						
950R	MC	08-10	H4	High & Low		
950SM	MC	08-10	H4	High & Low		
S Duke	MC	07-10	H4	High & Low		
Duke 690	MC	06-10	H4	High & Low		
RC8	MC	08-10	H7	High	H7	Low
Duke 990	MC	09-11	H4	High & Low		
POLARIS						
Ranger	SxS	07-09	881L	X2		
Ranger	SxS	10-11	H13	X2		
Razor	SxS	07-09	881L	X2		
Razor	SxS	10-11	H13	X2		
SUZUKI						
109 Blvd	MC	07-10	H4	High & Low		
CBandit 1200	MC	01-03	H4	High & Low		
Bandit 1200S	MC	97-00	H4	High & Low		
Bandit 1200S	MC	01-04	9005	High	9006	Low
Bandit 600S	MC	00-03	9006	High	9007	Low
B King	MC	08-10	H4	High & Low		
Boulevard C50 / Black / T	MC	05-10	H4	High & Low		
Boulevard C50 T	MC	10	H4	High & Low		
Boulevard C50 Special Ed	MC	10	H4	High & Low		
Boulevard C90 / Black	MC	05-09	H4	High & Low		
Boulevard C90T	MC	05-09	H4	High & Low		
Boulevard C90T	MC	10	H4	High & Low		
Boulevard M109R	MC	05-09	H4	High & Low		
Boulevard C109RT	MC	10	H4	High & Low		
Boulevard M50 / Black	MC	05-10	H4	High & Low		
Boulevard M95	MC	05-10	H4	High & Low		

MODEL	TYPE	YEAR	H#1	NOTES	H#2	NOTES
SUZUKI (CONTD)						
Boulevard S40	MC	05-10	H4	High & Low		
Boulevard S50	MC	05-10	H4	High & Low		
Boulevard S83	MC	05-08	H4	High & Low		
C 50	MC	06-10	H4	High & Low		
CT 90	MC	07-10	H4	High & Low		
DL 1000K2	MC	02	H4	High & Low		
DL 1000 V-Strom	MC	02-11	H4	High & Low		
DR-200SE	MC	96-08	H4	High & Low		
DR-250S	MC	93-95	H4	High & Low		
DR-350S	MC	92-99	H4	High & Low		
DR-650E	MC	93-02	H4	High & Low		
DR-650SE	MC	02-10	H4	High & Low		
DR-Z250 (Off-Road)	MC	00-03	H6M	High & Low		
DR-Z400S	MC	00-10	H4	High & Low		
DR-Z400SM	MC	05-10	H4	High & Low		
Gladius	MC	09-10	H4	High & Low		
GS500	MC	01-02	H4	High & Low		
GS500F	MC	04-10	H4	High & Low		
GSX-1300R Hayabusa	MC	99-09	9005	High	H7	Low
GSX-1300R Hayabusa	MC	09-10	H7	High	H9	Low
GSX-R1000	MC	01-04	H7	High	H4	Low
GSX-R1000	MC	05-11	9005	High	H7	Low
GSX-R1100	MC	93-98	H4	High & Low		
GSX 1250FA	MC	11	H4	High & Low		
GSX-R600	MC	97-05	H7	High	H4	Low
GSX-R600	MC	06-11	H9	High	H7	Low
GSX-R750	MC	96-11	H4	High & Low		
GSX-R750	MC	00-05	H7	High	H4	Low
GSX-R750	MC	06	H9	High - N/A	H7	Low
GZ250	MC	99-06	H4	High & Low		
Intruder 800	MC	99-04	H4	High & Low		
Intruder 1400	MC	99-04	H4	High & Low		
Intruder LC 1500	MC	99-04	H4	High & Low		
Intruder Volusia	MC	99-04	H4	High & Low		
Katana 600	MC	99-06	H4	High	H4	Low
Katana 750	MC	99-06	H4	High	H4	Low
M80	MC	06-10	H4	High & Low		
Marauder 800	MC	99-04	H4	High & Low		
Marauder 1600	MC	04	H4	High & Low		
RF900R	MC	99-01	H4	High & Low		
Savage 650	MC	99-04	H4	High & Low		
SV650/S	MC	99-11	H4	High & Low		
SV1000/S	MC	99-07	H4	High & Low		
TL 1000R	MC	99-04	H4	High & Low		
TL 1000S	MC	99-02	H4	High & Low		
S 40	MC	06-10	H4	High & Low		
S 50	MC	06-10	H4	High & Low		
V-Strom 650	MC	04-11	H4	High	H4	Low
Eiger 400	ATV	02-10	H6M			
Eiger Celebration Edition	ATV	06	H6M			
King Quad 250	ATV	91-01	H6M			
King Quad 300	ATV	91-01	H6M			
LT-500F Quadrunner	ATV	98-02	H6M			
LT-F250	ATV	90-02	H6M			

H#1 - HEADLIGHT NUMBER ONE // H#2 - HEADLIGHT NUMBER TWO

PIAA POWERSPORTS BULB APPLICATION GUIDE

MODEL	TYPE	YEAR	H#1	NOTES	H#2	NOTES
SUZUKI (CONT'D)						
Ozark 250	ATV	02-10	H6M			
QuadSport Z400	ATV	03-10	H6M			
Vinson 500	ATV	02-06	H6M			
TRIUMPH						
America	MC	06-09	H4	High & Low		
Bonneville	MC	06-09	H4	High & Low		
Bonneville SE	MC	09-10	H4	High & Low		
Bonneville T100	MC	09-10	H4	High & Low		
Daytona	MC	06-09	H7	High	H7	Low
Rocket 3	MC	06-09	H4	High & Low	H4	High & Low
Rocket 3 Classic	MC	10	H4	High & Low		
Rocket 3 Touring	MC	10	H4	High & Low		
Scrambler	MC	06-10	H4	High & Low		
Speedmtr	MC	06-09	H4	High & Low		
Speedmstr	MC	11	H4	High	H4	Low
Speed Trip	MC	06-09	H4	High & Low	H4	High & Low
Speed Trip SE	MC	10	H4	High	H4	Low
Sprint	MC	06-09	H7	High	H7	Low
Street Trip	MC	06-10	H4	High	H4	Low
Street Trip 3	MC	06-10	H4	High	H4	Low
ThruXton	MC	06-10	H4	High & Low		
Thunderbird	MC	10	H4	High & Low		
Thunderbird Strom	MC	11	H4	High & Low		
Tiger 1050	MC	06-09	H7	High	H7	Low
Tiger 800	MC	11	H4	High	H4	Low
VICTORY						
Hammer	MC	05-08	H9	High	H11	Low
Hammer S	MC	10	H9	High	H11	Low
Hammer 8-Ball	MC	11	H9	High	H11	Low
Kingpin	MC	05-08	H9	High	H11	Low
Touring Cruiser	MC	05-08	H9	High	H11	Low
Vegas	MC	05-08	H9	High	H11	Low
Vision	MC	08	H9	High	H11	Low
Vision 8-Ball	MC	11	H7	High	H1	Low
Vision Cross Country	MC	11	H7	High	H1	Low
Vision Cross Roads	MC	11	H7	High	H1	Low
Vision Tour	MC	10	H7	High	H1	Low
YAMAHA						
FJR1300/A	MC	03-11	H4	High & Low		
FZ1	MC	01-11	H4	High	H4	Low
FZ6	MC	05-09	H4	High & Low		
FZ6R	MC	09-11	H4	High & Low		
FZ8	MC	11	H4	High & Low		
Raider	MC	08-09	H4	High & Low		
Raider S	MC	08-11	H4	High & Low		
Road Star	MC	99-09	H4	High & Low		
Road Star Midnight Warrior	MC	05-09	H4	High & Low		
Road Star S	MC	10	H4	High & Low		
Road Star Silverado S	MC	10-11	H4	High & Low		
Route 66	MC	97-98	H4	High & Low		
Royal Star 1300 Classic/Vent	MC	97-09	H4	High & Low		

MODEL	TYPE	YEAR	H#1	NOTES	H#2	NOTES
YAMAHA (CONT'D)						
Stratoliner Deluxe	MC	10-11	H4	High & Low		
Stratoliner S	MC	10-11	H4	High & Low		
Stryker	MC	11	H4	High & Low		
Super Tenere	MC	11	H4	High & Low		
TTR250	MC	00-05	H6M			
TW200	MC	87-09	H4	High & Low		
Virago 250	MC	99-11	H4	High & Low		
Virago 535	MC	97-99	H4	High & Low		
V-Max 1200	MC	97-11	H4	High & Low		
V-Star 650 Custom / Classic	MC	98-11	H4	High & Low		
V-Star 650 Silverado	MC	98-09	H4	High & Low		
V-Star 950	MC	09-11	H4	High & Low		
V-Star 950 Tourer	MC	09	H4	High & Low		
V-Star 1100 Classic	MC	99-11	H4	High & Low		
V-Star 1100 Custom	MC	99-11	H4	High & Low		
V-Star 1100 Silverado	MC	05-00	H4	High & Low		
V-Star 1300 Tourer	MC	10	H4	High & Low		
Warrior 1670	MC	02-03	H4	High & Low		
WR250F	MC	00-03	H4	High & Low		
WR250X	MC	08-09	H51	Low		
WR400 / 426 / 450F	MC	97-03	H4	High & Low		
XT225	MC	94-09	H4	High & Low		
YFZ-R1	MC	09-11	H7	High	H7	Low
YFZ-R1 LE	MC	10	H7	High	H7	Low
YZF-R6/S	MC	03-09	H7	High	H7	Low
YZF-R6	MC	98-11	H4	High & Low		
Banshee 350	ATV	97-08	H6M			
Bear Tracker 250	ATV	99-03	H6M			
Big Bear 350	ATV	97-99	H6M			
Big Bear 400	ATV	00-09	H6M			
Blaster 200	ATV	95-07	H6M			
Breeze 125	ATV	95-03	H6M			
Bruin 250	ATV	05	H6M			
Bruin 350	ATV	05-09	H6M			
Grizzly 125	ATV	05-09	H6M			
Grizzly 600	ATV	98-01	H6M			
Grizzly 660	ATV	02-06	H6M			
Kodiak 400	ATV	97-06	H6M			
Kodiak 450	ATV	03-05	H6M			
Raptor 350 - YFM350	ATV	03-06	H6M			
Raptor 660	ATV	05	H6M			
Rhino	ATV	01-05	H6M			
Timber Wolf 250	ATV	97-00	H6M			
Warrior 350	ATV	97-01	H6M			
Wolverine 350	ATV	97-09	H6M			
YZF450	ATV	04-09	H6M			

Every attempt has been made to make this application guide as current and accurate as possible. However, vehicles and products do change throughout the course of time. We recommend you check with your dealer or PIAA's Customer Service to confirm applications prior to installation.

H.I.D. TECHNOLOGY FROM PIAA



Stock Bulbs



PIAA H.I.D. Conversion Bulbs

Photos taken at Family Powersports in Weatherford, Texas. Shot with a Canon EOS-1Ds Mark III with a 70mm lens, ISO 400, f/9.5, 1.5 sec (stock bulbs), 1.0 sec (H.I.D. bulbs)



THE PIAA H.I.D. ADVANTAGE

With nearly 50 years of experience in designing and manufacturing exceptional quality halogen bulbs, PIAA offers a wide range of innovative, industry-specific designs for Powersports. By scientifically engineering our bulbs to exacting specifications, PIAA utilizes the latest, integrated, computer-aided technology. Only the highest-grade materials are selected for use in PIAA products, so you can use them with total confidence.

PIAA offers the most durable and well-tested H.I.D. bulbs and lamps and backs them with a 2 year unconditional warranty. PIAA H.I.D. bulbs and lamps are so dependable, and perform so well, that they are the choice of many professional racers.



H.I.D. Conversion Kits

Convert ordinary headlights into extraordinary headlights with three to four times the output of stock bulbs. PIAA H.I.D. Conversion Bulbs come with the most compact and lightest ballast of any conversion kit available making it easy to install. The additional relay harness standard with our kit provides protection for factory switch and draws power directly from the battery for maximum performance.

Complete kits include bulb(s), ultra-thin ballast, igniters, relay harness, hardware, harness ties and installation manual

*NOTE: Color temperature is a unit of measure for the color of light and is not necessarily related to the heat and brightness of the light source. A higher color temperature can be related to an appearance closer to daylight.

H6M H.I.D. CONVERSION KIT

Fits Yamaha Rhino (all years) that use the H6M bulb and all ATV applications using the standard H6M bulb. (Will not fit H6 bulb model with a black plastic base. Please check your model of bulb before ordering kit.)

Technology	High Intensity Discharge (H.I.D.)
Complete Kit	71691
Bulb Type	H6M
Wattage	35W
Color Temp	6000 Kelvin



SINGLE BULB 71690 RELAY HARNESS 78700 BALLAST/IGNITER 78702 POWER LEAD 78701



HS1 H.I.D. CONVERSION KITS

Fits all snow machines which use an HS1 or H4 headlight bulb.

Technology	High Intensity Discharge (H.I.D.)
Single Lamp Kit	71190
Two Lamp Kit	71191
Bulb Type	HS1
Wattage	35W
Color Temp	6000 Kelvin



SINGLE BULB 71199 BALLAST/IGNITER 78702



PIAA's H.I.D. Shock Lamps feature an internal ballast, unmatched durability and legendary PIAA H.I.D. Illumination. These lamps are engineered to perform anywhere, at any time and in any conditions.

RS400

SINGLE LAMP PN 73804
BULB TYPE 12V - H3 H.I.D. 35W
DESCRIPTION Black polyamide with glass fiber housing, hardened glass lens and Multi-Surface Reflector
TECHNOLOGY H.I.D.
KIT INCLUDES Single lamp with integrated ballast - wiring harness sold separately

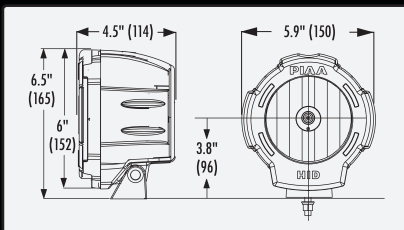

RS400 SINGLE LAMP PN 73804
 Wiring harness sold separately

RS600

SINGLE LAMP PN 73806
BULB TYPE 12V - H3 H.I.D. 35W
DESCRIPTION Black polyamide with glass fiber housing, polycarbonate with hard clear coat lens and Multi-Surface Reflector
TECHNOLOGY H.I.D.
KIT INCLUDES Single lamp with integrated ballast - wiring harness sold separately

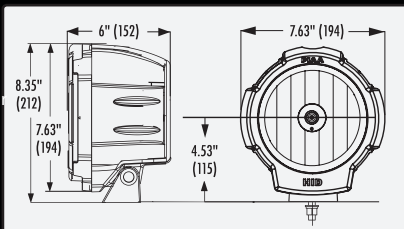

RS600 SINGLE LAMP PN 73806
 Wiring harness sold separately

RS800

SINGLE LAMP PN 73808
BULB TYPE 12V - D2S H.I.D. 35W
DESCRIPTION Black polyamide with glass fiber housing, polycarbonate with hard clear coat lens and Multi-Surface Reflector
TECHNOLOGY H.I.D.
KIT INCLUDES Single lamp with integrated ballast - wiring harness sold separately

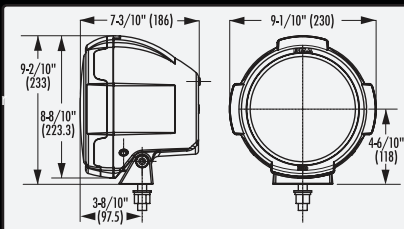

NEW!



RS800 SINGLE LAMP PN 73808
 Wiring harness sold separately

H.I.D. Long Range Driving



Internal Ballast System



RS400 — SINGLE LENS 38004 REPLACEMENT BULB 19993 WIRING HARNESS Sold Separately LAMP COVER N/A

RS600 — SINGLE LENS 38006 REPLACEMENT BULB 19993 WIRING HARNESS Sold Separately LAMP COVER N/A

RS800 — SINGLE LENS 38008 REPLACEMENT BULB 19993 WIRING HARNESS Sold Separately LAMP COVER N/A

SHOCK LAMP WIRE HARNESS



The Shock Lamp Wire Harness is designed to be used with the RS400, RS600 or RS800 Shock Lamps. Harness comes pre-terminated with switch, relay ballast and igniter. One harness connects two lamps. Shock Lamp Wire Harness is sold separately from the Shock Lamps.

WIRING HARNESS 78935 RELAY 33260 SWITCH 30036

RS SHOCK LAMP JUMPER HARNESS



Use the RS Shock Lamp Jumper Harness to hook up a Shock Lamp to the PIAA Powersports Wiring Harness PN 74040. If you are building a custom harness for multiple lamps, this is the must-have connector to make that perfect connection to the lamp. RS Shock Lamp Jumper Harness is sold separately from the Shock Lamps and Wiring Harness 74040.

WIRING HARNESS 78706



THE PIAA LAMP ADVANTAGE

PIAA Corporation was established with the commitment to manufacture world-class products that our customers could use with pride and confidence.

Then, PIAA built its reputation with winning products. PIAA'S race-proven, easy-to-install lamps, and lifetime warranty make their products stand apart.

Visionary design, inspired engineering, and quality components are the hallmark of PIAA's reputation. Propelled by PIAA's Technical Design Center, their products cross the line from ordinary to extraordinary. PIAA's lamps feature a specially designed housing making it possible for the lamps to operate using higher wattage bulbs without sacrificing bulb life. Look for PIAA's XTRA Technology in the lamp specifications to see the difference.

ATP All-Terrain Beam Pattern

PIAA engineers addressed the needs of ATV riders by creating the ATP All-Terrain Beam Pattern, that gives the ultimate combination of spread, height and distance for use on ATVs.



Driving Beam Pattern

Driving lamps are designed to increase the range and brightness of your vehicle's high beam. They are especially useful at higher cruising speeds where they help to identify hazards and signs long before they would be seen with stock lamps. All driving lamps are extremely bright and must be used with caution.



All-Weather Beam Pattern

Fog Lamps enhance your vehicle's low beams for improved visibility in rain, fog or snow. Distance of illumination is similar to your vehicle's low beam.

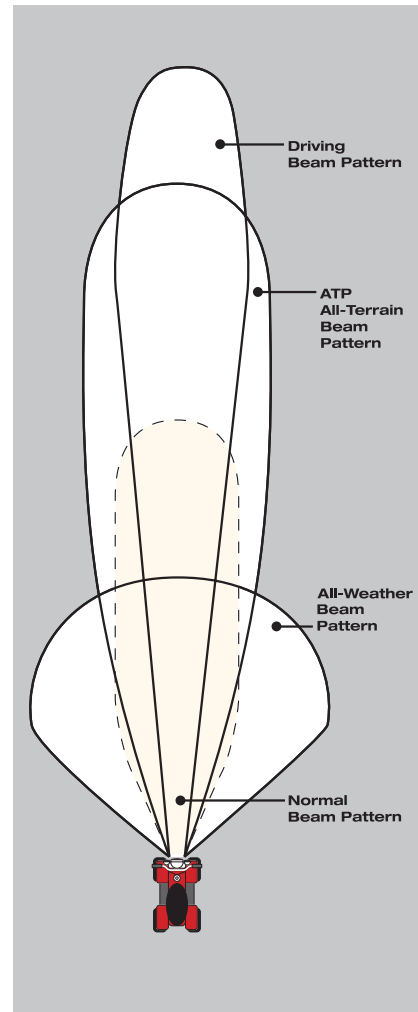

1100X PLATINUM DRIVING

The compact design of the 1100X lends to the versatility of this light without sacrificing performance – and talk about fashion – wow! The 1100X lamp is loved for its symmetrical pattern allowing for greater visibility even when leaning into turns. It's easy to see why the 1100X remains atop our best seller's list.

2 LAMP KIT PN 73112
 BULB TYPE Dichroic, 55W=85W
 DESCRIPTION Silver PPS housing, chrome-plated aluminum trim ring and glass lens
 TECHNOLOGY Platinum
 KIT INCLUDES Wiring harness, relay and switch

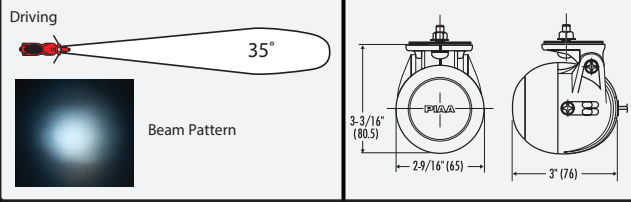

2 LAMP KIT PN 73112

SINGLE LAMP 73110 SINGLE LENS N/A REPLACEMENT BULB 70215 WIRING HARNESS 74040 RELAY 74086 (MLR-4E) SWITCH 74034 LAMP COVER N/A

005 LONG RANGE DRIVING

With its traditional good looks, brilliant chrome finish and legendary PIAA performance, the 005 has quickly become the choice for the discriminating rider. Its hollow bolt design allows for easy mounting to OE style light bars. When quality and performance are most important, run with the 005 Xtreme White Long Range Driving Lamp.

2 LAMP KIT PN 73052
 BULB TYPE H3, 35W=70W
 DESCRIPTION Chrome PPS housing, and glass lens
 TECHNOLOGY Xtreme White
 KIT INCLUDES Wiring harness, relay and switch

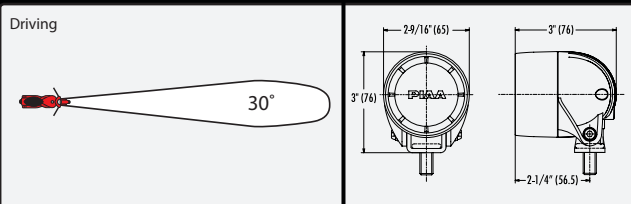

2 LAMP KIT PN 73052

SINGLE LAMP 73050 SINGLE LENS 75052 REPLACEMENT BULB 70323 WIRING HARNESS 74040 RELAY 74086 (MLR-4E) SWITCH 74034 LAMP COVER N/A



005 PIAA Lamps with L-Bracket Bar Clamps on 2010 Suzuki Boulevard M50



510 ATP — 4"

The 510 All-Terrain Pattern (ATP) provides the perfect combination of height, width and distance for ATV's, and off-road or dual-use bikes. The 510 ATP lamps are fitted with a 35W high output bulb and is ideally suited for bikes and ATV's where minimal factory charging systems are utilized. The rotatable lens and trim ring allows the lamps to mount up or down.

2 LAMP KIT PN 73516
 BULB TYPE H3, 35W=60W
 DESCRIPTION Black stamped steel housing, with grill cover
 TECHNOLOGY Star White - ATP (All-Terrain Pattern)
 KIT INCLUDES Wiring harness, relay and switch

All-Terrain (ATP)

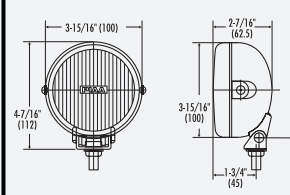
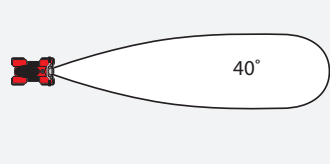

2 LAMP KIT PN 73516

SINGLE LAMP 73506 SINGLE LENS 75506 REPLACEMENT BULB 70363 WIRING HARNESS 74040 RELAY 74086 (MLR-4E) SWITCH 74034 LAMP COVER 76012

Amy McConnell Xcountry Photos



520 ATP — 6"

When PIAA came out with the off-road oriented 510 ATP the response was overwhelming. However some riders felt they could use a bigger light with more power and the same proprietary ATP (All-Terrain Pattern) Technology. It provides a pattern much better for off-road use than a standard fog or driving light. The 520 ATP can also be used as a long range driving light with the benefits of illuminating the sides of the road. This light is perfect for your UTV and is quickly becoming popular among adventure motorcycle riders as well. The rotatable lens and trim ring allows the lamps to mount up or down.

2 LAMP KIT PN 73526
 BULB TYPE H3, 55W=110W
 DESCRIPTION Black stamped steel housing and glass lens
 TECHNOLOGY Xtreme White Plus - ATP (All-Terrain Pattern)
 KIT INCLUDES Wiring harness, relay and switch

All-Terrain (ATP)

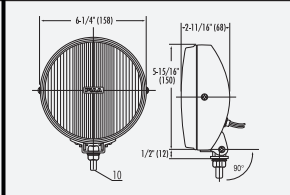
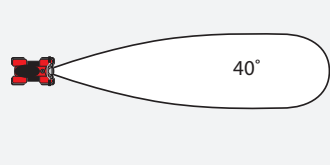

2 LAMP KIT PN 73526

SINGLE LAMP 73596 SINGLE LENS 75526 REPLACEMENT BULB 70325 WIRING HARNESS 74040 RELAY 74086 (MLR-4E) SWITCH 74034 LAMP COVER 76022

NEW!

510 LONG RANGE DRIVING 55W NIGHT-TECH — 4"

The 510 Night-Tech adds the new Night-Tech bulb technology to our popular 510 lamp for even greater performance. The 55W Night-Tech bulb throws an avalanche of light down the road and its 30 degree spread picks up objects along the sides. The compact size of this light allows for multiple applications and the rotatable lens and trim ring allow the lamps to mount up or down.

2 LAMP KIT PN 73515
BULB TYPE H3, 55W=100W
DESCRIPTION Black stamped steel housing, with grill cover
TECHNOLOGY Night-Tech
KIT INCLUDES Wiring harness, relay and switch

Driving

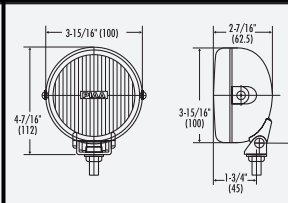
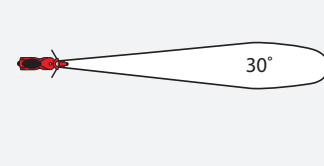

2 LAMP KIT PN 73515

SINGLE LAMP 70385 SINGLE LENS 75504 REPLACEMENT BULB 70363 WIRING HARNESS 74040 RELAY 74086 (MLR-4E) SWITCH 74034 LAMP COVER 76012



GBC Motorsports



510 LONG RANGE DRIVING — 4"

The compact size of this powerhouse allows for a multitude of applications. This long range driving light gets an amazing amount of light down the road and ahead of your high beams. The rotatable lens and trim ring allows the lamps to mount up or down.

2 LAMP KIT PN 73514
BULB TYPE H3, 35W=60W
DESCRIPTION Black stamped steel housing, with grill cover
TECHNOLOGY Star White
KIT INCLUDES Wiring harness, relay and switch

Driving

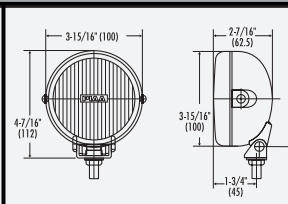
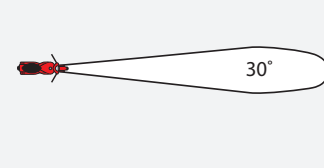

2 LAMP KIT PN 73514

SINGLE LAMP 73504 SINGLE LENS 75504 REPLACEMENT BULB 70363 WIRING HARNESS 74040 RELAY 74086 (MLR-4E) SWITCH 74034 LAMP COVER 76012



540 LONG RANGE DRIVING — 5"

The 540 adds performance in a mid-size driving lamp. More powerful than the 510 but not as big as the 520, the 540 is just the right combination for many motorcycle and ATV applications. The rotatable lens and trim ring allows the lamps to mount up or down.

2 LAMP KIT PN 73542
 BULB TYPE H3, 55W=110W
 DESCRIPTION Black stamped steel housing and glass lens
 TECHNOLOGY Xtreme White
 KIT INCLUDES Wiring harness, relay and switch

Driving

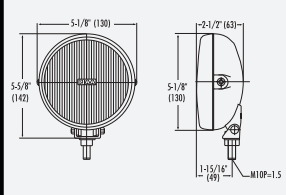

2 LAMP KIT PN 73542

SINGLE LAMP 5402 SINGLE LENS 35402 REPLACEMENT BULB 70325 WIRING HARNESS 34085 RELAY 33086 (PL5FB) SWITCH 30034 LAMP COVER 45400

520 SMR — 6"

The 520 Super Multi-Surface Reflector directs its powerful driving beam pattern without the need of lens fluting, thus enhancing the performance and appearance. Computer designed, this lamp reduces stray light and improves range with greater focus. The rotatable lens and trim ring allows the lamps to mount up or down.

2 LAMP KIT PN 73524
 BULB TYPE H3, 55W=110W
 DESCRIPTION Black stamped steel housing and glass lens and multi-surface reflector
 TECHNOLOGY Xtreme White SMR (Super Multi-Surface Reflector)
 KIT INCLUDES Wiring harness, relay and switch

Driving

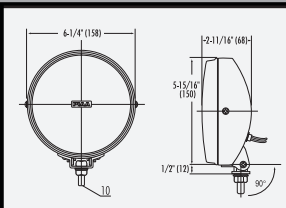

2 LAMP KIT PN 73524

SINGLE LAMP 5214 SINGLE LENS 35202 REPLACEMENT BULB 70325 WIRING HARNESS 34260 RELAY 33260 (LR-21) SWITCH 30034 LAMP COVER 45022

004 SERIES

Durability, dependability and reliability combine to make the 004 Series the best value on the market. This versatile utility lamp is compact enough to mount anywhere on motorcycles, ATVs, scooters and snowmobiles. The PIAA 004Xi Ion has an ultra high visibility amber beam color. The bluish coating on the lens changes light frequency to bright amber without losing any output as you would experience with amber lenses or bulbs.

<p>TECHNOLOGY Ion Crystal Driving 2 LAMP KIT PN 73463 BULB TYPE H3, 35W=70W DESCRIPTION Black PPS housing, ultra light weight and compact size KIT INCLUDES Wiring harness, relay and switch</p>	<p>TECHNOLOGY Xtreme White 2 LAMP KIT PN 73492 BULB TYPE H3, 35W=70W DESCRIPTION Silver PPS housing, ultra light weight and compact size KIT INCLUDES Wiring harness, relay and switch</p>
<p>Driving</p>	



004Xi ION CRYSTAL
2 LAMP KIT PN 73463



004XT XTREME WHITE
2 LAMP KIT PN 73492

IONCRYSTALDRIVING—SINGLELAMP73403 SINGLELENS75403 REPLACEMENTBULB70305 WIRINGHARNESS74040 RELAY74086 (MLR-4E) SWITCH74034 LAMPCOVERN/A

XTREMEWHITEDRIVING—SINGLELAMP73402 SINGLELENS75402 REPLACEMENTBULB70323 WIRINGHARNESS74040 RELAY74086 (MLR-4E) SWITCH74034 LAMPCOVER

910 TOURING

Touring bike owners love this lamp because of its extreme performance. The high-output bulb with a focused driving pattern sends light farther down the road for safer high speed touring. Elliptical design defines the unique character of this lamp. Made from powder coated die-cast aluminum this is truly a high-performance lamp you will be proud to own.

<p>2 LAMP KIT PN 73910 BULB TYPE H3, 85W=130W DESCRIPTION Black die-cast aluminum housing, trim ring and glass lens TECHNOLOGY High Power with XTRA Technology KIT INCLUDES Wiring harness, relay and switch</p>	<p>Driving</p>	
--	----------------	--



2 LAMP KIT PN 73910

SINGLE LAMP 73912 SINGLE LENS 75912 REPLACEMENT BULB 70308 WIRING HARNESS 74040 RELAY 74086 (MLR-4E) SWITCH 74034 LAMP COVER N/A





THE PIAA KIT AND ACCESSORY ADVANTAGE

Ease of installation has always been important and PIAA knows how hard it is to get lights onto motorcycles and keep that factory look. PIAA offers complete kits which include mounting brackets for various types of bikes.

SPORT/TOURING LAMP SYSTEMS

The PIAA Sport/Touring Lamp Systems include a custom designed and engineered application-specific mounting system. From our most popular Honda 1800GS kit to our mounting systems for the BMW F650/800GS, these kits are designed to offer great lighting with an enhanced aesthetic appeal. Everything you need to customize your specific motorcycle comes in one box. Individual Sport/Touring Brackets are available separately and will fit most PIAA Powersports Lamps.

TRIAD MULTI-FIT BRACKET SYSTEMS

Lighting is not only to enhance night-time driving but also functions to increase safety during the day. The better you are seen by other motorists the safer you are. PIAA Triad Multi-Fit Bracket Systems offer a lower mounting position to give you additional conspicuity by forming a "triangle" of light with your headlight which makes your bike much more obvious on the road.

The PIAA Triad Multi-Fit Bracket Systems are made of CNC machined solid 6061 T6 Aluminum. All the fasteners are stainless steel and use nylock style nuts for a secure installation. Everything to fit your motorcycle comes in one box including two PIAA Powersports lamps, pre-terminated relay/switch wiring harness, two bike-specific Triad Multi-Fit Brackets, mounting hardware and installation instructions.

BRACKETS

PIAA offers a variety of brackets to help with your lighting installations. Our 360 x 4 Universal Bracket will mount just about any PIAA Powersports light onto any round bar from 7/8 inches up to 1-3/4 inches. And in case you prefer to mount the 004 or 005 light kits in place of the 1100, PIAA offers each of our Sport/Touring Brackets separately.

ACCESSORIES

When you want another driver to notice you, loud is good. That is what the PIAA Sports Horns offer: a louder, lighter weight and higher pitch than most stock horns. A must for enhancing your safety on the road! Other PIAA accessories include lens protection.

1100PIAA Triad Multi-Fit Bracket System
on 2010 Suzuki SV650



Aftermarket accessories may affect
the fit of some PIAA lamp kits.



BMW K1200RS SPORT/TOURING LAMP SYSTEM



BMW R1200RT SPORT/TOURING LAMP SYSTEM

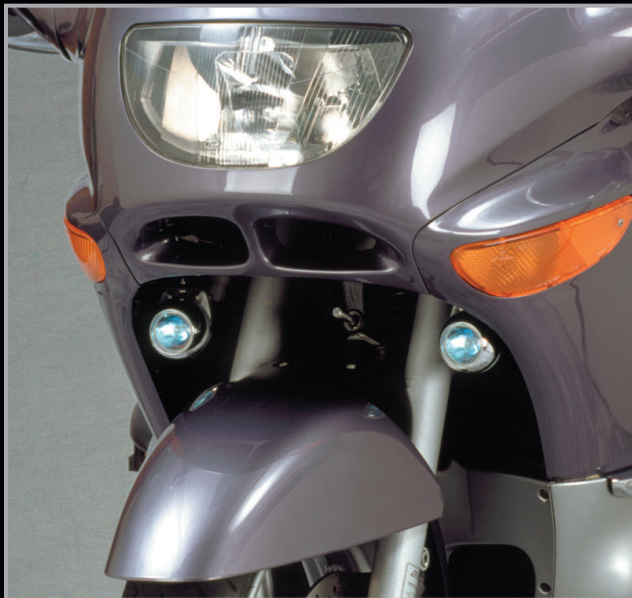

BMW K1200LT SPORT/TOURING LAMP SYSTEM



BMW 650GS SPORT/TOURING LAMP SYSTEM

BMW SPORT/TOURING LAMP SYSTEMS

Kits come complete with (2) PIAA Powersports Lamps, (2) custom mounting brackets, wiring harness, hardware and installation instructions.

BMW K1200RS (02-08) Kit With PIAA 1100X Lamps
Kit PN 74125

BMW R1200RT (05-09) Kit With PIAA 1100X Lamps
Kit PN 74124

BMW K1200LT Kit With PIAA 1100X Lamps
Kit PN 74120

BMW 650GS Kit With PIAA 510 Star White Lamps
Kit PN 74650



1100LED BMW R1200RT DOHC SPORT/TOURING LAMP SYSTEM

NEW!

The new 1100LED takes its cues from its famous predecessor the 1100X and was designed to give supreme LED performance and still fit into the same mounting locations and on the same brackets. The 1100LED features computer controlled Pulse Width Modulation (PWM) providing thermal protection allowing its three 4W high performance LED's to operate to their maximum potential. Night time visibility is enhanced by a color temperature of 6300K. From the machined die-cast aluminum housing to the computer designed cooling fins, only the highest quality workmanship and materials go into the 1100LED. Light output of the 1100LED is similar to the 1100X giving off a symmetrical pattern so a rider won't lose visibility when leaning into a turn. Comes with everything you need including two lights, wiring, and custom mounting brackets to fit all 2010 or newer R1200RT.

Kit PN 77012

LED



1100X BMW/TRIUMPH SPORT/TOURING LAMP SYSTEM

PIAA's most popular light mounts easily to your BMW F650 or F800GS or your Triumph Tiger 800. Lights bolt right to headlight using the existing hardware. The 1100X lamp kit provides a wide symmetrical beam pattern, good when leaning into turns. It also picks up more of the sides of the roads than a focused high beam. Provides twice the light. Complete kit comes with two lights, two billet aluminum mounting brackets, pre-terminated switch/relay/wiring harness, and installation instructions.

Kit PN 77110



510 BMW F650/800GS SPORT/TOURING LAMP SYSTEM

The 510 35W=60W light has a 30° spread - good for picking up items on the sides as well as far down the road. The durable brackets are 12 gauge laser-cut steel, with UV resistant black semi-gloss Powder-coat finish and a 3-piece bolt-up installation that requires no drilling. Use the cross brace to mount a PIAA Sports Horn under the beak. Complete kit comes with two PIAA 510 lights, PIAA rock guards, three piece brackets, pre-terminated switch/relay/wiring harness, hardware and installation instructions.

Kit PN 77650



BMW 1200GS LIGHT BAR

The PIAA R1200GS Light Bar is designed to install PIAA lights on all BMW R1200GS bikes including the Adventure models. (Will not fit Adventure models with OE factory projector lamps.) Made from 6061-T6 billet aluminum, it is both light weight and strong. An easy to install mounting bracket attaches the bar to the frame in a secure location under the front fender. Each end is threaded to accept a 10mm bolt which makes it the perfect location to mount a second PIAA lamp. (We recommend the PIAA 1100X.)

PN 74202





NEW! 1100LED HONDA GOLD WING SPORT/TOURING LAMP SYSTEM

The 1100LED complete kit comes with everything you need including two lights, wiring and custom mounting brackets to fit all GL1800 Gold Wings including the 2012. The new 1100LED takes its cues from its famous predecessor the 1100X and was designed to give supreme LED performance and still fit into the same mounting locations and on the same brackets. The 1100LED features computer controlled Pulse Width Modulation (PWM) providing thermal protection allowing its three 4W high performance LED's to operate to their maximum potential. Conspicuity and night time visibility are enhanced by a color temperature of 6300K. From the machined die-cast aluminum housing to the computer designed cooling fins, only the highest quality workmanship and materials go into the 1100LED. Light output of the 1100LED is similar to the 1100X giving off a symmetrical pattern so a rider won't lose visibility when leaning into a turn. The 1100LED is the next generation in lighting.

Kit PN 77008

LED



1100X HONDA GOLD WING GL1800 SPORT/TOURING LAMP SYSTEM



Kit comes complete with two PIAA Powersports 1100X Lamps, two custom mounting brackets, wiring harness, hardware and installation instructions. Fits models up to 2010. (Aftermarket accessories may affect the fit of this kit.)

Kit PN 74118



1100X TRIAD MULTI-FIT BRACKET SYSTEM

The 1100X lamp is loved for its symmetrical pattern which allows greater visibility even when leaning in turns. PIAA's most popular Powersports lamp comes in a complete kit to fit a multitude of applications.

Kit PN 74220
Kit PN 74224

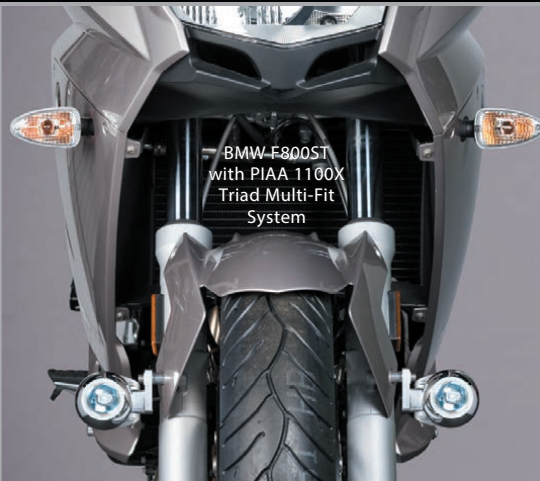

005 TRIAD MULTI-FIT BRACKET SYSTEM

The PIAA 005 Lamp features an Xtreme White H3 bulb and a brilliant chrome finish. With everything you need to customize your specific model in one box, the 005 Triad Multi-Fit Bracket System will make a handsome and functional addition to your bike.

Kit PN 74222



005 ENGINE GUARD LIGHT KIT



If your motorcycle is equipped with a 1-1/4" engine guard, then you can easily mount PIAA 005 Engine Guard Light Kit. Kits come complete with two 005 lamps, pre-terminated relay/switch wiring harness, two billet aluminum chrome 1-1/4" brackets, mounting hardware and installation instructions.

- Features a PIAA H3 35W XTRA bulb shining at 4150 Kelvin and equivalent in output to a standard 70W bulb
- Wide 30° driving pattern for great side to side visibility

Kit PN 73054



PIAA KIT APPLICATION GUIDE

MODEL	YEAR	TRIAD MULTI-FIT 1100X SYSTEM	TRIAD MULTI-FIT 005 SYSTEM	SPORT/TOURING 1100X LAMP SYSTEM	SPORT/TOURING 510 LAMP SYSTEM	SPORT/TOURING 1100LED LAMP SYSTEM	BRACKET ONLY*
BMW							
F650GS (SINGLE)	99-08	-	-	-	74650	-	74651
F650GS (TWIN)	ALL	-	-	77110	-	-	74110
		-	-	-	77650	-	74652
F800GS	ALL	-	-	77110	-	-	74110
		-	-	-	77650	-	74652
F800ST	ALL	74224	-	-	-	-	-
G650GS (SINGLE)	08-10	-	-	-	74650	-	74651
K1200LT	99+	-	-	74120	-	-	74121
K1200R	ALL	74224	-	-	-	-	-
K1200RS	02-04	-	-	74125	-	-	74126
K1200S	ALL	74224	-	-	-	-	-
K1200/1300GT	ALL	74224	-	-	-	-	-
R1150R	ALL	74224	-	-	-	-	-
R1200GS**	ALL	-	-	-	-	-	74202
R1200RT	05-09	74224	-	74124	-	-	74123
R1200RT DOHC	10+	74224	-	-	-	77012	74122
R1200ST	ALL	74224	-	-	-	-	-
DUCATI							
749	04-07	74220	74222	-	-	-	-
999	03-07	74220	74222	-	-	-	-
MULTI ST	04-07	74220	74222	-	-	-	-
ST2	98-07	74220	74222	-	-	-	-
ST3	04-07	74220	74222	-	-	-	-
ST4	00-07	74220	74222	-	-	-	-
HONDA							
CBR600RR	04-07	74220	74222	-	-	-	-
CBR1000RR	04-07	74220	74222	-	-	-	-
GOLD WING GL1800	-10	-	-	74118	-	77018	74008
GOLD WING GL1800	ALL	-	-	-	-	77018	74008
SILVER WING SCOOTER	ALL	74220	74222	-	-	-	-
NT700	ALL	74220	-	-	-	-	-
ST1300	04-07	74220	74222	-	-	-	-
VFR800	ALL	74220	74222	-	-	-	-

MODEL	YEAR	TRIAD MULTI-FIT 1100X SYSTEM	TRIAD MULTI-FIT 005 SYSTEM	SPORT/TOURING 1100X LAMP SYSTEM	SPORT/TOURING 510 LAMP SYSTEM	SPORT/TOURING 1100LED LAMP SYSTEM	BRACKET ONLY*
KAWASAKI							
CONCOURS	-08	74220	74222	-	-	-	-
Z-1000	03-07	74220	74222	-	-	-	-
ZX636R	ALL	74220	74222	-	-	-	-
ZX600RR	ALL	74220	74222	-	-	-	-
KTM							
SUPER DUKE	ALL	74220	74222	-	-	-	-
SUZUKI							
BLVD M50	ALL	74220	74222	-	-	-	-
BLVDM109R	ALL	74220	74222	-	-	-	-
BURGMAN SCOOTER	ALL	74220	74222	-	-	-	-
GSXR600	ALL	74220	74222	-	-	-	-
GSXR750	ALL	74220	74222	-	-	-	-
GSXR1000	ALL	74220	74222	-	-	-	-
TL 1000	ALL	74220	74222	-	-	-	-
V-STROM	ALL	74220	74222	-	-	-	74600
V-STROM 650	ALL	74220	74222	-	-	-	74600
TRIUMPH							
BONNEVILLE	ALL	74220	74222	-	-	-	-
ROCKET	ALL	74220	74222	-	-	-	-
SPRINT ST	ALL	74224	-	-	-	-	-
TIGER	05-09	74220	74222	-	-	-	-
TIGER 800	10-12	-	-	77110	-	-	74110
TROPHY	97-03	74220	74222	-	-	-	-
YAMAHA							
FJR1300	ALL	74220	74222	-	-	-	-
ROADLINER	ALL	74224	-	-	-	-	-
STRATOLINER	ALL	74224	-	-	-	-	-
SUPER TÉNÉRÉ	ALL	-	-	-	-	-	74300
T-MAX	ALL	74224	-	-	-	-	-

* For a list of lamps that will work with each bracket see page 33.

**Will not fit Adventure models with OE factory projector lamps.

360 X 4 UNIVERSAL BRACKET

Our single clamp system with infinite adjustability, redefines universal! The new 360 x 4 Universal Bracket is named for the fact that the light mounting base can be rotated 360° and fits 4 different bar sizes. Mount lights to any bar from 7/8 inch utility ATV bars to a 1-1/4 inch motorcycle engine guard. Can also be used for 1 inch or 1-1/8 inch handle bars. Simply slip in one of the three inserts provided and you have the size you need. With 360° adjustability you can mount lights onto just about any angle bar on whatever vehicle you own. Machined from solid billet aluminum for strength and powder-coated for rugged wear and long life.

7/8" - 1-1/4" Black Twin Pack PN: 74000



L-BRACKET BAR CLAMPS

The PIAA L-Brackets are lightweight, strong, easy-to-install and attractive. These brackets are made to mount practically any PIAA light anywhere you have a bar.

1-1/2" Black Twin Pack PN: 74116

1-3/4" Black Twin Pack PN: 74117



PIAA Cruiser L-Brackets will mount PIAA lights and other accessories to your 1-1/4 inch engine guard with style. All billet aluminum chrome brackets can be adjusted to compensate for bends and angles on your engine bar. We recommend using these brackets with the PIAA P-1000 (discontinued) or 005 model lights for a clean and modern chrome look that is both beautiful and functional.

1-1/4" Chrome Twin Pack
PN: 74115



PIAA 1100X
Lamps on a
Harley-Davidson
Ultra-Classic
with lowers



PIAA 004Xi Ion Crystal Lamps on a BMW R1200RT with PIAA Sport/Touring Brackets



Suzuki V-Strom with PIAA Sport/Touring Bracket



SPORT/TOURING BRACKETS

Sold separately, the brackets that make up our popular Sport/Touring Kits (see pages 27-29) are custom made to fit specific bikes. Easy to install and guaranteed to fit. Mount your favorite PIAA light and get riding!



PN: 74008
Honda Gold Wing (GL1800)
Fits 1100X, 1100LED, 004
and 005 lamps

PN: 74110
BMW F650GS (Twin) / F800GS
Fits 1100X and 1100LED lamps

PN: 74121
BMW K1200LT 99+
Fits 1100X, 1100LED, 004
and 005 lamps

PN: 74122
BMW R1200RT DOHC 10+
Fits 1100X, 1100LED, 004
and 005 lamps

PN: 74123
BMW R1200RT -09
Fits 1100X, 1100LED, 004
and 005 lamps

PN: 74126
BMW K1200RS 02-04
Fits 1100X, 1100LED, 004
and 005 lamps

PN: 74129
BMW K1200RS 98-01
Fits 1100X, 1100LED, 004
and 005 lamps



PN: 74300
Yamaha Super Ténéré
Fits LP530 LED lamp

PN: 74600
Suzuki V-Strom
Fits 1100X, 1100LED, 004, 005,
510, 520 and LP530 LED lamps

PN: 74651
BMW F650GS/G650GS (Single) 99-11
Fits 510, LP530 LED and 1100LED lamps

PN: 74652
BMW F650GS (Twin) / F800GS
Fits 510, LP530 LED and 1100LED lamps

UNIVERSAL MOUNTING BRACKET



Easily install PIAA auxiliary lights with our Universal Mounting Bracket. Designed for the larger ATV's and Side x Side's which use larger diameter tubing. Fits both 1-1/2" and 1-3/4" bars.

Twin Pack PN: 74102



SPORTS HORNS

A loud, attention getting horn is one of your most important safety devices. Make sure people notice you with these super-light weight and easy to install horns from PIAA.



SLIM LINE SPORTS HORN

KIT PN 76501

KIT INCLUDES

One (1) PIAA 112db 500Hz Sports Horn
No wiring harness required.

Works with all bikes, especially for space-limited applications.

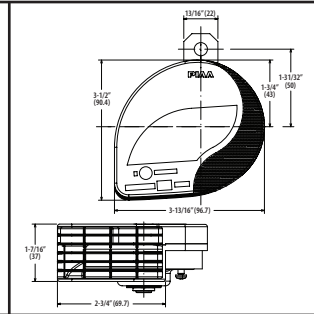

STANDARD SPORTS HORN

KIT PN 76500

KIT INCLUDES

One (1) PIAA 115db 500Hz Sports Horn
with weather resistant cover
No wiring harness required.

Works with all bikes.

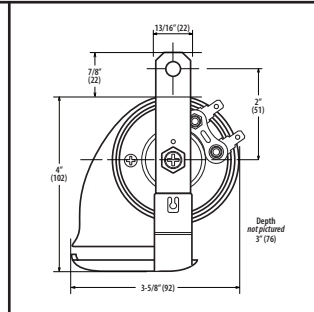

PIAA LENS PROTECTION

Extremely durable and impact-resistant, this self-adhesive, transparent lens protection is second to none. With a special formulated vinyl, the PIAA Lens Protection is over 1/16 inch thick, optically clear and race-tested to over 160mph. Each pre-cut lamp application is highly transparent and will not alter the performance of the lens. Simply peel off backing and apply to lens.

Kit PN	Fits PIAA Lamps
79510	510 and RS400 Shock Lamp
79601	540
79520	520 and RS600 Shock Lamp



POLE POSITION

START FROM THE POLE...

ACCELERATE YOUR SALES...



PIAA INTERACTIVE TRAINING



DIRECT COMMUNICATION



PIT BOARD



NEW RESEARCH DEVELOPMENT



MEDIA CENTER



SHOPATRON



DCI / DEALER LOCATOR

FINISH ON THE PODIUM.

Product and sales training online, direct communication with PIAA, participate in PIAA new product development, receive deep discounts on point-of-purchase displays, and rev up sales from an online sales service.

Winning in the marketplace is like winning in motorsports. When you start from the Pole Position, victory is that much closer.